



# CRNOGORSKI GLASNIK INTELEKTUALNE SVOJINE

INTELLECTUAL PROPERTY GAZETTE OF MONTENEGRO

Službeni glasnik Zavoda za intelektualnu svojinu Crne Gore  
Official Gazette of the Montenegrin Intellectual Property Office

# 13/2013



Zavod za intelektualnu svojinu Crne Gore  
ul. Rimski trg br. 46,  
81000 Podgorica,  
Crna Gora

# CRNOGORSKI GLASNIK INTELEKTUALNE SVOJINE

Godina IV

Datum objavljivanja: 20. 12. 2013. god.

*Izdavač:*

ZAVOD ZA INTELEKTUALNU  
SVOJINU CRNE GORE  
Rimski trg br. 46,  
81000 Podgorica, Crna Gora

*Za izdavača:*

Novak Adžić, direktor

*Glavni i odgovorni urednik:*

Novak Adžić

*Urednički odbor:*

Novak Adžić, Predrag Malbaša,  
Dušanka Perović, Milica Savić,  
Gordana Tripković

*Tehnički urednik:*

Predrag Malbaša

*Prevod:*

Gordana Tripković

*Dizajn:*

Aleksandar-Saša Samardžić

OVAJ BROJ SLUŽBENOG GLASNIKA OBJAVLJEN JE U ELEKTRONSKOJ FORMI

Crnogorski glasnik intelektualne svojine službeno je glasilo Zavoda za intelektualnu svojinu Crne Gore. U Glasniku se objavljuju sve relevantnim zakonima i pravilnicima propisane informacije iz postupka dodjele prava industrijskog vlasništva, informacije o dodijeljenim pravima te o kasnijim promjenama u vezi s tim pravima, kao i ostale službene informacije.

The Montenegrinan intellectual property gazette is the official gazette of the State Intellectual Property Office of the Montenegro. The Gazette publishes all the information, prescribed by the relevant laws and regulations, relating to the industrial property granting procedure concerning granted rights and subsequent changes made in connection with such right, as well as other official information.

## SADRŽAJ

DVOSLOVNE OZNAKE ZEMALJA, TERITORIJA I MEĐUNARODNIH ORGANIZACIJA  
TWO LETTER CODE COUNTRIES, TERRITORIES AND INTERNATIONAL ORGANIZATIONS ..... 1719

**PATENTI**

**PATENTS ..... 1721**

MEĐUNARODNI KODOVI ZA IDENTIFIKACIJU BIBLIOGRAFSKIH PODATAKA O PATENTIMA

PREMA WIPO STANDARDU ST. 9

RECOMMENDATION CONCERNING BIBLIOGRAFIC DATA ON AND RELATING TO

PATENTS- WIPO-ST. 9..... 1723

OBAVJEŠTENJE

NOTICE ..... 1725

OBJAVE PRIJAVA PATENATA

PUBLICATION OF PATENT APPLICATIONS..... 1727

INDEKS NOSILACA PATENTA

PATENT OWNER INDEX ..... 1737

INDEKS BROJEVA PRIJAVA PATENATA

APPLICANTS NUMBER INDEX ..... 1741

INDEKS OBJAVLJENIH PRIJAVA PATENATA PREMA MKP

INDEX OF PATENT APPLICANTS ACCORDINT TO IPC ..... 1743

OBJAVE ZAHTJEVA ZA PROŠIRENJE EVROPSKIH PRIJAVA PATENATA

PUBLICATION OF REQUEST FOR THE EXTENSION OF THE EFFECTS OF EUROPEAN PATENT

APPLICATIONS ..... 1745

INDEKS BROJEVA ZAHTJEVA ZA PROŠIRENJE EVROPSKIH PRIJAVA PATENTA

INDEX ON NUMBER OF REQUESTS FOR EXTENSION ON EUROPEAN PATENT APPLICATIONS . 1873

INDEKS KLASIFIKACIJSKIH OZNAKA BROJEVA ZAHTJEVA ZA PROŠIRENJE EVROPSKIH

PRIJAVA PATENTA PREMA MKP

INDEX ON CLASSIFICATION MARKS ON REQUESTS FOR EXTENSION OF EUROPEAN PATENT

APPLICATION IN ACCORDANCE WITH THE INTERNATIONAL PATENT CLASSIFICATION .. 1915

INDEKS PODNOSITELJA ZAHTJEVA ZA PROŠIRENJE EVROPSKIH PRIJAVA PATENTA

INDEX ON NUMBER OF APPLICATIONS FOR EXTENSION OF EUROPEAN PATENT

APPLICATION ..... 2013

OBJAVA POVUČENIH ZAHTJEVA ZA PROŠIRENJE EVROPSKIH PRIJAVA PATENTA

PUBLICATION OF WITHDRAWN REQUESTS FOR EXTENSION OF EUROPEAN PATENT

APPLICATION ..... 2081

OBJAVA PROŠIRENIH EUROPSKIH PATENATA

PUBLICATION OF EXTENDED EUROPEAN PATENTS..... 2083

**ŽIGOVI**

**TRADEMARKS..... 2185**

MEĐUNARODNI KODOVI ZA IDENTIFIKACIJU BIBLIOGRAFSKIH PODATAKA O ŽIGOVIMA

PREMA WIPO ST 60

RECOMMENDATION CONCERNING BIBLIOGRAFIC DATA RELATING TO

TRADEMARKS- WIPO-ST. 60 ..... 2187

OBAVJEŠTENJE	
NOTICE .....	2189
OBJAVA PRIJAVA ŽIGOVA	
PUBLICATION OF TRADEMARK APPLICATIONS .....	2191
OBJAVA ŽIGOVA	
PUBLICATION OF TRADEMARKS .....	2389
INDEKS NOSILACA ŽIGOVA	
INDEX OF THE HOLDER OF THE REGISTRATION .....	2503
INDEKS BROJEVA ŽIGOVA	
INDEX OF THE TRADEMARK NUMBERS .....	2509
INDEKS PO KLASAMA NIČANSKE KLASIFIKACIJE ROBA I USLUGA	
INDEX ACCORDING TO THE NICE CLASSIFICATION OF GOODS AND SERVICES .....	2511
OBJAVA ISPRAVKI	
CORRECTIONS.....	2515
OBJAVA UPISA U REGISTAR ŽIGOVA CRNE GORE	
PUBLICATION OF THE ENTRY TRADEMARK REGISTER MONTENEGRO .....	2519
<b>DIZAJN</b>	
<b>DESIGNS .....</b>	<b>2527</b>
MEĐUNARODNI KODOVI ZA IDENTIFIKACIJU BIBLIOGRAFSKIH PODATAKA O DIZAJNU	
PREMA WIPO CT.80	
RECOMMENDATION CONCERNING BIBLIOGRAPHIC DATA RELATING TO INDUSTRIJAL	
DESIGNS WIPO CT.80 .....	2529
OBJAVE DIZAJNA	
PUBLICATION OF DESIGNS.....	2531
INDEKS NOSILACA DIZAJNA	
INDEX OF INDUSTRIAL DESIGNS OWERS .....	2557
INDEKS BROJEVA DIZAJNA	
INDEX OF INDUSTRIAL DESIGNS NUMBERS.....	2559
INDEKS PO KLASAMA I PODKLASAMA LOKARNSKE KLASIFIKACIJE	
INDEX ACCORDING TO CLASSES SUBCLASSEN THE LOCARNO CLASSIFICATION .....	2561
<b>INFORMATOR</b>	
<b>INFORMATION.....</b>	<b>2563</b>

**DVOSLOVNE OZNAKE ZEMALJA, TERITORIJA I MEĐUNARODNIH  
ORGANIZACIJA  
(prema WIPO standardu ST. 3)**

<b>AD</b>	Andora	<b>CF</b>	Centralna Afrička Republika	<b>GB</b>	Velika Britanija
<b>AE</b>	Ujedinjeni Arapski Emirati	<b>CG</b>	Kongo	<b>GC</b>	Patentna kancelarija Savjeta za saradnju država Arapskog Zaliva (GCC)
<b>AF</b>	Afganistan	<b>CH</b>	Švajcarska	<b>GD</b>	Grenada
<b>AG</b>	Antigva i Barbuda	<b>CI</b>	Obala Bjelokosti	<b>GE</b>	Gruzija
<b>AI</b>	Angvila	<b>CK</b>	Kukova ostrva	<b>GG</b>	Guernsey
<b>AL</b>	Albanija	<b>CL</b>	Čile	<b>GH</b>	Gana
<b>AM</b>	Armenija	<b>CM</b>	Kamerun	<b>GI</b>	Gibraltar
<b>AN</b>	Holandski Antili	<b>CN</b>	Kina	<b>GL</b>	Grenland
<b>AO</b>	Angola	<b>CO</b>	Kolumbija	<b>GM</b>	Gambija
<b>AP</b>	Afrička regionalna organizacija za industrijsko vlasništvo (ARIPO)	<b>CR</b>	Kostarika	<b>GN</b>	Gvineja
<b>AR</b>	Argentina	<b>CU</b>	Kuba	<b>GQ</b>	Ekvatorska Gvineja
<b>AT</b>	Austrija	<b>CV</b>	Kabo Verde	<b>GR</b>	Grčka
<b>AU</b>	Australija	<b>CY</b>	Kipar	<b>GS</b>	Južna Džordžija i Ostrva Južni Sendvič
<b>AW</b>	Aruba	<b>CZ</b>	Češka Republika	<b>GT</b>	Gvatemala
<b>AZ</b>	Azerbejdžan	<b>DE</b>	Njemačka	<b>GW</b>	Gvineja-Bisao
<b>BA</b>	Bosna i Hercegovina	<b>DJ</b>	Džibuti	<b>GY</b>	Gvajana
<b>BB</b>	Barbados	<b>DK</b>	Danska	<b>HK</b>	Hongkong – Posebna administrativna regija
<b>BD</b>	Bangladeš	<b>DM</b>	Dominika	<b>HN</b>	NR Kine Honduras
<b>BE</b>	Belgija	<b>DO</b>	Dominikanska Republika	<b>HR</b>	Hrvatska
<b>BF</b>	Burkina Faso	<b>DZ</b>	Alžir	<b>HT</b>	Haiti
<b>BG</b>	Bugarska	<b>EA</b>	Evroazijska patentna organizacija (EAPO)	<b>HU</b>	Mađarska
<b>BH</b>	Bahrein	<b>EC</b>	Ekvador	<b>IB</b>	Međunarodna kancelarija Svjetske organizacije za intelektualno vlasništvo (WIPO)
<b>BI</b>	Burundi	<b>EE</b>	Estonija	<b>ID</b>	Indonezija
<b>BJ</b>	Benin	<b>EG</b>	Egipat	<b>IE</b>	Irska
<b>BM</b>	Bermudi	<b>EH</b>	Zapadna Sahara	<b>IL</b>	Izrael
<b>BN</b>	Brunej Darussalam	<b>EM</b>	Kancelarija za harmonizaciju Unutrašnjeg tržišta (žigovi i dizajn) (OHIM)	<b>IM</b>	Ostrvo Man
<b>BO</b>	Bolivija	<b>EP</b>	Evropska patentna kancelarija (EPO)	<b>IN</b>	Indija
<b>BR</b>	Brazil	<b>ER</b>	Eritreja	<b>IQ</b>	Irak
<b>BS</b>	Bahami	<b>ES</b>	Španija	<b>IR</b>	Iran (Islamska Republika)
<b>BT</b>	Butan	<b>ET</b>	Etiopija	<b>IS</b>	Island
<b>BV</b>	Ostrvo Buve	<b>FI</b>	Finska	<b>IT</b>	Italija
<b>BW</b>	Bocvana	<b>FJ</b>	Fidži	<b>JE</b>	Džersi
<b>BX</b>	Kancelarija za intelektualno vlasništvo Beneluksa (BOIP)	<b>FK</b>	Foklandska ostrva (Malvini)	<b>JM</b>	Jamajka
<b>BY</b>	Bjelorusija	<b>FO</b>	Farska Ostrva	<b>JO</b>	Jordan
<b>BZ</b>	Belize	<b>FR</b>	Francuska		
<b>CA</b>	Kanada	<b>GA</b>	Gabon		
<b>CD</b>	Demokratska Republika Kongo				

<b>JP</b>	Japan	<b>NA</b>	Namibija	<b>SY</b>	Sirijska Arapska Republika
<b>KE</b>	Kenija	<b>NE</b>	Niger	<b>SZ</b>	Svazi
<b>KG</b>	Kirgistan	<b>NG</b>	Nigerija	<b>TC</b>	Turska i Kajkoska Ostrva
<b>KH</b>	Kambodža	<b>NI</b>	Nikaragva	<b>TD</b>	Čad
<b>KI</b>	Kiribati	<b>NL</b>	Holandija	<b>TG</b>	Togo
<b>KM</b>	Komori	<b>NO</b>	Norveška	<b>TH</b>	Tajland
<b>KN</b>	Sveti Kristofor i Nevis	<b>NP</b>	Nepal	<b>TJ</b>	Tadžikistan
<b>KP</b>	Demokratska Narodna Republika Koreja	<b>NR</b>	Nauru	<b>TL</b>	Istočni Timor
<b>KR</b>	Republika Koreja	<b>NZ</b>	Novi Zeland	<b>TM</b>	Turkmenistan
<b>KW</b>	Kuvajt	<b>OA</b>	Afrička organizacija za intelektualno vlasništvo (OAPI)	<b>TN</b>	Tunis
<b>KY</b>	Kajmanska Ostrva	<b>OM</b>	Oman	<b>TO</b>	Tonga
<b>KZ</b>	Kazahstan	<b>PA</b>	Panama	<b>TR</b>	Turska
<b>LA</b>	Narodna Demokratska Republika Laos	<b>PE</b>	Peru	<b>TT</b>	Trinidad i Tobago
<b>LB</b>	Libanon	<b>PG</b>	Papuanska Nova Gvineja	<b>TV</b>	Tuvalu
<b>LC</b>	Sveta Lucija	<b>PH</b>	Filipini	<b>TW</b>	Tajvan, Kineska Pokrajina
<b>LI</b>	Lihtenštajn	<b>PK</b>	Pakistan	<b>TZ</b>	Ujedinjena Republika Tanzanija
<b>LK</b>	Šri Lanka	<b>PL</b>	Poljska	<b>UA</b>	Ukrajina
<b>LR</b>	Liberija	<b>PT</b>	Portugal	<b>UG</b>	Uganda
<b>LS</b>	Lesoto	<b>PW</b>	Palau	<b>US</b>	Sjedinjene Američke Države
<b>LT</b>	Litva	<b>PY</b>	Paragvaj	<b>UY</b>	Urugvaj
<b>LU</b>	Luksemburg	<b>QA</b>	Katar	<b>UZ</b>	Uzbekistan
<b>LV</b>	Latvija	<b>QZ</b>	Kancelarija Zajednice za biljne sorte (Evropska Unija) (CPVO)	<b>VA</b>	Sveta Stolica (Vatikan)
<b>LY</b>	Libijska Arapska Džamahirija	<b>RO</b>	Rumunija	<b>VC</b>	Sveti Vincent i Grenadini
<b>MA</b>	Maroko	<b>RS</b>	Srbija	<b>VE</b>	Venecuela
<b>MC</b>	Monako	<b>RU</b>	Ruska Federacija	<b>VG</b>	Britanska Djevičanska Ostrva
<b>MD</b>	Republika Moldavija	<b>RW</b>	Ruanda	<b>VN</b>	Vijetnam
<b>ME</b>	Crna Gora	<b>SA</b>	Saudijska Arabija	<b>VU</b>	Vanuatu
<b>MG</b>	Madagaskar	<b>SB</b>	Solomonska Ostrva	<b>WO</b>	Svjetska organizacije za intelektualno vlasništvo (WIPO) (Međunarodna kancelarija)
<b>MK</b>	Bivša Jugoslovenska Republika Makedonija	<b>SC</b>	Sejšeli	<b>WS</b>	Samoa
<b>ML</b>	Mali	<b>SD</b>	Sudan	<b>XN</b>	Nordijski institut za patente (NPI)
<b>MM</b>	Mianmar	<b>SE</b>	Švedska	<b>YE</b>	Jemen
<b>MN</b>	Mongolija	<b>SG</b>	Singapur	<b>ZA</b>	Južnoafrička Republika
<b>MO</b>	Makao	<b>SH</b>	Sveta Jelena	<b>ZM</b>	Zambija
<b>MP</b>	Sjeverna Marijanska Ostrva	<b>SI</b>	Slovenija	<b>ZW</b>	Zimbabve
<b>MR</b>	Mauritanija	<b>SK</b>	Slovačka		
<b>MS</b>	Montserrat	<b>SL</b>	Sijera Leone		
<b>MT</b>	Malta	<b>SM</b>	San Marino		
<b>MU</b>	Mauricijus	<b>SN</b>	Senegal		
<b>MV</b>	Maldivi	<b>SO</b>	Somalija		
<b>MW</b>	Malavi	<b>SR</b>	Surinam		
<b>MX</b>	Meksiko	<b>ST</b>	Sveti Toma i Princip		
<b>MY</b>	Malezija	<b>SV</b>	Salvador		
<b>MZ</b>	Mozambik				



# PATENTI

## PATENTS

Službeni glasnik Zavoda za intelektualnu svojinu Crne Gore  
Official Gazette of the Montenegrin Intellectual Property Office

# 13/2013



Zavod za intelektualnu svojinu Crne Gore  
ul. Rimski trg br. 46,  
81000 Podgorica,  
Crna Gora





**MEĐUNARODNI KODOVI ZA IDENTIFIKACIJU BIBLIOGRAFSKIH PODATAKA O PATENTIMA PREMA WIPO STANDARDU ST. 9**  
**RECOMMENDATION CONCERNING BIBLIOGRAFIC DATA ON AND RELATING TO PATENTS- WIPO-ST. 9**

CRNOGORSKI	MDK	ENGLJSKI
IDENTIFIKATOR DOKUMENTA	<b>10</b>	IDENTIFICATION OF THE PATENT
BROJ DOKUMENTA	<b>11</b>	NUMBER OF THE PATENT
VRST DOKUMENTA	<b>13</b>	KIND-OF-DOCUMENT CODE ACCORDING TO WIPO STANDARD
BROJ PRIJAVE	<b>21</b>	NUMBER(S) ASSIGNED TO THE APPLICATION(S)
DATUM PODNOŠENJA PRIJAVE	<b>22</b>	DATE(S) OF FILING THE APPLICATION(S)
DATUM IZLAGANJA NA MEĐUNARODNOJ IZLOŽBI	<b>23</b>	DATE OF EXHIBITING AT THE INTERNATIONAL EXHIBITION
PODACI O PRAVU PRVJENSTVA	<b>30</b>	PRIORITY DATA
DATUM OBJAVLJIVANJA PRIJAVE	<b>43</b>	PUBLICATION DATE OF THE UNEXAMINED APPLICATION
DATUM OBJAVLJIVANJA PATENTA	<b>45</b>	PUBLICATION DATE OF REGISTERED PATENT
MEĐUNARODNA KLASIFIKACIJA PATENATA	<b>51</b>	INTERNATIONAL PATENT CLASSIFICATION CODE
NAZIV PRONALASKA	<b>54</b>	TITLE OF THE INVENTION
APSTRAKT ILI PATENTNI ZAHTJEV	<b>57</b>	ABSTRACT OR CLAIM
BROJ OSNOVNE PRIJAVE (ILI PATENTA) ZA KOJI SE PODNOSI DOPUNSKA PRIJAVA	<b>61</b>	NUMBER OF THE EARLIER APPLICATION (OR PATENT) TO WHICH THE PRESENT DOCUMENT IS AN ADDITION
BROJ PRVOBITNE PRIJAVE IZ KOJE JE PRIJAVA IZDOJENA	<b>62</b>	NUMBER OF THE EARLIER APPLICATION FROM WHICH THE PRESENT DOCUMENT HAS BEEN DIVIDED UP
IME PODNOSIOCA PRIJAVE	<b>71</b>	NAME OF THE APPLICANT
IME PRONALAZAČA	<b>72</b>	NAME OF THE INVENTOR
IME NOSIOCA PATENTA	<b>73</b>	NAME OF THE OWNER OF PATENT
IME PUNOMOĆNIKA	<b>74</b>	NAME OF THE REPRESENTATIVE
BROJ I DATUM PODNOŠENJA MEĐUNARODNE PRIJAVE	<b>86</b>	NUMBER AND FILING DATE OF THE INTERNATIONAL APPLICATION
BROJ I DATUM MEĐUNARODNE OBJAVE	<b>87</b>	NUMBER AND DATE OF THE PUBLICATION OF THE INTERNATIONAL APPLICATION

VRSTA DOKUMENTA		TYPES OF DOCUMENTS
OBJAVA PRIJAVA PATENATA	<b>A</b>	PUBLICATION OF PATENT APPLICATIONS
REGISTROVANI PATENTI	<b>B</b>	REGISTERED PATENTS



**OBAVJEŠTENJE**  
NOTICE

Obavještavamo korisnike da se od 6-og broja Crnogorskog glasnika za intelektualnu svojinu koji se objavljuje na web stranici Zavoda za intelektualnu svojinu Crne Gore, u elektronskoj formi, odnosno od 10.10.2011 godine (Glasnik broj 6/2011) uvode promjene u objavi patentnih dokumenata.

Tako, objavljena prijava patenta (dokument A) sadrži i broj pod kojim je patent upisan u Registar patenata, (međunarodni kod 11 – broj dokumenta), koji je do sada bio objavljivan u svakom narednom broju Crnogorskog glasnika za intelektualnu svojinu. Kako Zavoda za intelektualnu svojinu Crne Gore, ispituje samo formalne uslove za priznavanje patenta, izmjenu uvodimo da bi svi podaci o priznatom patentu bili u istom broju Crnogorskog glasnika za intelektualnu svojinu, a ujedno i pojednostavili put do dodjele isprave, sve u skladu sa članom 40 Zakona o patenima ("Sl. list CG" broj 66/2008 i 40/2010).



(51) **C07D 209/42**  
**A61K 31/404**  
**A61P 9/00**

(11) **1367**  
 (13) **A**

(21) P-2008-672

(22) 06.07.2001.

(30) 00/08791 06.07.2000. FR

(86) PCT/FR2001/002169 06.07.2001.

(87) WO 2001/083439 08.11.2001.

(54) (ME) **NOVI ŠG(Y) KRISTALNI OBLIK TERCIJALNE BUTILAMINSKE SOLI PERINDOPRILA, POSTUPAK DOBIJANJA I FARMACEUTSKE KOMPOZIICIJE KOJE SADRŽE ISTO**

(EN) **NOVEL ŠG(Y) CRYSTALLINE FORM OF PERINDOPRIL TERT-BUTYLAMINE SALT, PREPARATION METHOD, AND PHARMACEUTICAL COMPOSITIONS CONTAINING SAME.**

(73) LES LABORATOIRES SERVIER; 35, rue de Verdun, 92284 Suresnes Cedex FR

(72) PFEIFFER, Bruno; 47, rue Ernest Renan F-95320 Saint Leu la Forêt FR

GINOT, Yves-Michel; 8, quai Saint Laurent F-45000 Orléans FR

COQUEREL, Gérard; 192, rue de l'Église F-76520 Boos FR

BEILLES, Stéphane; 35, place de la Basse Vieille Tour F-76000 Rouen FR

(74) Jusić Jasna, Crnogorskih serdara bb, Podgorica ME

(57) Pronalazak se odnosi na kristalni oblik jedinjenja sa formulom (I) koji se karakteriše dijagramom praha (rendgenske difrakcije). Pronalazak je primjenljiv za dobijanje lijekova u medicine.

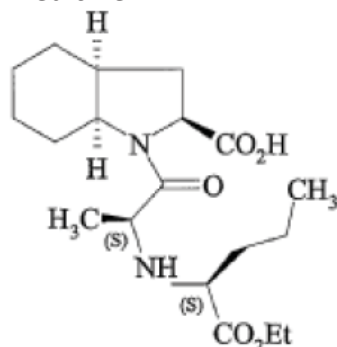

(51) **A61K 9/06**

(11) **1425**

(13) **A**

(21) P-2010-179

(22) 26.10.2010.

(54) (ME) **DUZBALT MAST**

(EN) OINTMENT DUZBALT

(73) JURLINA PAVLE, Seljanovo 12, Tivat ME

(72) JURLINA, Pavle; Seljanovo 12, Tivat ME

(57) Problem curenja rane, upale, infekcije, epitelizacije rane uspješno je riješen mješanjem izbalansirane kombinacije aktivnih supstanci u jednostavnoj podlozi. Preparat se lako nanosi, doziranje je minimalno, a djelovanje brzo i efikasno.

- (51) **C07K 16/40**  
**C12N 9/64**  
**A61K 39/395**  
**A61P 3/06**
- (11) **1327**  
(13) **A**
- (21) P-2011-111  
(22) 15.12.2009.
- (30) 61/122,482 15.12.2008. US  
61/210,566 18.03.2009. US  
61/168,753 13.04.2009. US  
61/218,136 18.06.2009. US  
61/249,135 06.10.2009. US  
61/261,776 17.11.2009. US
- (86) PCT/US2009/068013 15.12.2009.  
(87) WO 2010/077854 08.07.2010.
- (54) (ME) **HUMANA ANTITIJELA VISOKOG AFINITETA ZA PCSK9**  
(EN) HIGH AFFINITY HUMAN ANTIBODIES TO PCSK9
- (73) REGENERON PHARMACEUTICALS, INC. 777 Old Saw Mill River Road Tarrytown, NY 10591 US
- (72) SLEEMAN, Mark, W.; 118 Lake Drive Mahopac, NY 10541 US  
MARTIN, Joel, H.; 244 Church Road Putnam Valley, NY 10579 US  
HUANG, Tammy, T.; 10 Green Hill Road Goldens Bridge, NY 10526 US  
MACDONALD, Douglas; 260 West End Avenue, Apt. 10C New York, NY 10023 US
- (74) Čejović Vladimir, 13. jula 21, Podgorica ME
- (57) Humano antitijelo ili antigen-vezujući fragment humanog antitijela koje specifično vezuje i inhibira humani proprotein konvertazu subtilizin/keksin tip 9 (hPCSK9) karakteriše se sposobnošću da smanji serumski LDL holesterol za 40-80% tokom perioda od 24, 60 ili 90 dana u odnosu na nivo prije doziranja, sa neznatno ili bez smanjenja serumskog HDL holesterola i/ili sa malo ili bez mjerljivog efekta na funkciju jetre, ako se određuje mjerenjem ALT i AST.

- (51) **C07D 487/04** (11) **1329**  
**A01N 43/90** (13) **A**
- (21) 31.08.2009.  
(22) P-2012-17  
(86) PCT/US2009/055522 31.08.2009.  
(87) WO 2011/025505 03.03.2011.
- (54) (ME) **PTERIDINI I NJIHOVA UPOTREBA KAO AGROHEMIKALIJE**  
(EN) PTERIDINES AND THEIR USE AS AGROCHEMICALS
- (73) DOW AGROSCIENCES LLC; 9330 Zionsville Road Indianapolis, IN 46268-1054 US  
(72) BREWSTER, William; 1927 Pamona Drive Indianapolis, IN 46214 US  
DEMETER, David; 10657 Blackthorn Court Fishers, IN 46038 US  
ERICKSON, W.; 4608 Buckingham Court Carmel, IN 46033 US  
LOWE, Christian; 17034 Troy Lane Westfield, IN 46074 US  
KLITTICH, Carla; 1621 Village Walk Drive Zionsville, IN 46077 US  
NUGENT, Jaime; 794 King Fisher Drive Brownsburg, IN 46112 US  
RIEDER, Brent; 3756 Forest Lane Greenfield, IN 46140 US  
SIDDALL, Thomas; 1925 South 900 East Zionsville, IN 46077 US  
YAO, Chenglin; 14178 Esprit Drive Westfield, IN 46074 US  
YERKES, Carla; 4571 South State Road 47 Crawfordsville, IN 47933 US  
ZHU, Yuanming; 12514 Spring Violet Place Carmel, IN 46033 US
- (74) Radulović Božidar, Jovana Tomaševića 9/III, Podgorica ME
- (57) Prikazano otkriće se odnosi na 1- ili 2-(4-(ariloksi)-fenil) etilamino-, oksii ili sulfanil) pteridine i 1- ili 2-(4-(heteroariloksi)-fenil) etilamino-, oksii ili sulfanil) pteridine i njihovu primjenu kao agrohemi-kali-je i proizvodi za zaštitu zdravlja životinja.



- (51) **C07J 71/00**  
**A61K 31/58**  
**A61P 5/44**
- (11) **1331**  
(13) **A**
- (21) P-2012-28  
(22) 01.09.2010.  
(30) 09011665.8 11.09.2009. EP  
(86) PCT/EP2010/005366 01.09.2010.  
(87) WO 2011/029547 17.03.2011.
- (54) (ME) **DERIVATI IZOKSAZOLIDINA**  
(EN) ISOXAZOLIDINE DERIVATIVES
- (73) CHIESI FARMACEUTICI S.P.A.; Via Palermo, 26/A I-43100 Parma IT  
(72) ARMANI, Elisabetta; Chiesi Farmaceutici S.p.A. Via Palermo 26/A I-43100 Parma IT  
GHIDINI, Eleonora; c/o Chiesi Farmaceutici S.p.A. Via Palermo 26/A I-43100 Parma IT  
PERETTO, Ilaria; Chiesi Farmaceutici S.p.A. Via Palermo, 26/A I-43100 Parma IT  
VIRDIS, Andrea; Chiesi Farmaceutici S.p.A. Via Palermo, 26/A I-43100 Parma IT
- (74) Radulović Božidar, Jovana Tomaševića 9/III, Podgorica ME
- (57) Predmetni pronalazak se odnosi na nova anti-inflamatorna i antialergijska jedinjenja iz serije glukokortikosteroida, postupke za dobijanje takvih jedinjenja, farmaceutske preparate koji ih sadrže, njihove kombinacije i terapijske primene. Konkretnije, predmetni pronalazak se odnosi na glukokortikosteroide koji su derivati izoksazolidina.

- (51) **C07D 213/75** (11) **01311**  
**C07D 401/04** (13) **A**  
**C07D 401/12**

- (21) P-2008-770  
 (22) 09.07.2001.  
 (30) 00115287.5 14.07.2000. EP  
 (86) PCT/EP2001/007850 09.07.2001.  
 (87) WO/2002/006236 24.01.2002.

(54) (ME) **N-OKSIDI KAO PROLEKOVI 4-FENIL-PIRIDINSKIH DERIVATA KOJI SU ANTAGONISTI NK1 RECEPTORA**

(EN) N-OXIDES AS NK1 RECEPTOR ANTAGONIST PRODRUGS OF 4-PHENYL-PYRIDINE DERIVATIVES

- (73) F. HOFFMANN-LA ROCHE AG , Grenzacherstrasse 124 CH-4070 Basle CH  
 (72) HOFFMANN, Torsten; Kleinhueninger Strasse 15 79576 Weil am Rhein DE  
 POLI, Sonia, Maria; Baerschwilerstrasse 10 CH-4053 Basle CH  
 SCHNIDER, Patrick; Stallenrain 7 CH-4104 Oberwil CH  
 SLEIGHT, Andrew; Résidence Le Manoir 3a, rue de la Lisière F-68400 Riedisheim FR  
 (74) Čejović Vladimir, 13. jula 21, Podgorica ME

- (57) Ovaj pronalazak se odnosi na jedinjenja opšte formule I je R vodonik, niži alkil, niži akoksi, halogen ili trifluormetil; R1 je vodonik ili halogen; ili R i R1 mogu biti zajedno sa ugljenikovim atomima prstena za koji su prikazani -CH=CH-CH=CH-; R2 i R2 su nezavno jedan od drugog vodonik, halogen, trifluormetil, niži akoksi ili cijano; ili R2 i R2 mogu biti zajedno -CH=CH-CH=CH-, proizvoljno supstituisan sa jednim ili dva supstituenta izabrana od nižeg alkil ili nižeg akoksi; R3, R3 oU nezavisno jedan od drugog vodonik, niži alkil ili cikloalkil; R4, R4'su nezavisno jedan od drugog -(CH2)mOR6 ili niži alkil; ili R4 i R4 čine zajedno sa N-atomom za koji su prikazani ciklični tercijarni amin grupe II R5 je vodonik, hidroksi, niži alkil, -niži akoksi, -(CH2)mOH, -COOR3, -CON(R3)2, -N(R3)CO- niži alkil ili -C(O)R3; R6 je vodonik, niži alkil ili fenil; X je - (O)N(R6)-, -N(R6)C(O)-, -(CH2)mO- ili -O(CH2)m-; n je 0, 1, 2, 3 ili 4; i m je 1, 2 ili 3; i na njihove farmaceutski prihvatljive kisele adicione soli. Nađeno je da ova jedinjenja mogu da se koriste kao prolekovi za tretiranje ili prevenciju bolesti, povezanih sa NK1 receptorom.

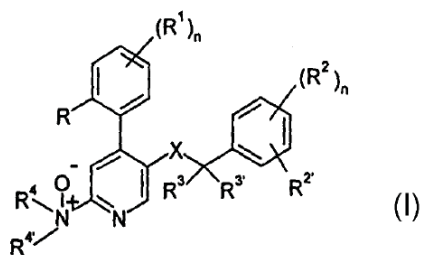

(51) **C07D 263/32**  
**C07D 413/12**  
**C07D 413/14**

(11) **01310**

(13) **A**

(21) 06.05.2002.

(22) P-2008-775

(30) 01111745.4 15.05.2001. EP

(86) PCT/EP2002/004962 06.05.2002.

(87) WO/2002/092084 21.11.2002.

(54) (ME) **DERIVATI OKSAZOLA KOJI SU SUPSTITUISANI KARBOKSILNOM KISELINOM ZA PRIMENU KAO PPAR-ALFA- I -GAMA AKTIVATORI U LEČENJU DIJABETESA**

(EN) CARBOXYLIC ACID SUBSTITUTED OXAZOLE DERIVATIVES FOR USE AS PPAR-ALPHA AND -GAMMA ACTIVATORS IN THE TREATMENT OF DIABETES

(73) F. HOFFMANN-LA ROCHE AG, 124 Grenzacherstrasse, CH-4070 Basle CH

(72) BINGGELI, Alfred; 50 Im Kugelfang CH-4102 Binningen CH

BOEHRINGER, Markus; 4 Dachsweg CH-4313 Moehlin CH

GRETHER, Uwe; Hugemattweg 10b 79541 Loerrach DE

HILPERT, Hans; Fasanenstrasse 12 CH-4153 Reinach CH

MAERKI, Hans-Peter; Seltisbergerstrasse 75 CH-4059 Basle CH

MEYER, Markus; Maurenweg 6 79395 Neuenburg DE

MOHR, Peter; Bekenstrasse 26 CH-4054 Basle CH

RICKLIN, Fabienne; 6, impasse des Cerisiers F-68490 Hombourg FR

(74) Čejović Vladimir, 13. jula 21, Podgorica ME

(57) Ovaj pronalazak se odnosi na jedinjenja formule (I) u kojoj su R1 do R7 definisani kao što je dato u opisu i zahtevima, i na njihove farmaceutski prihvatljive soli i estre. Ova jedinjenja su primenljiva za lečenje bolesti kao što je dijabetes.

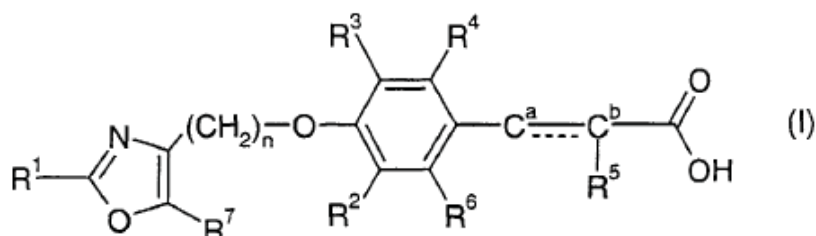

(51) **A22C 17/00**(11) **01341**(13) **A**

(21) 21.07.2009

(22) P-2010-220

(30) 01189/08 29.07.2008. CH

02008/08 22.12.2008. CH

(86) PCT/CH2009/000261 21.07.2009.

(87) WO/2010/012115 04.02.2010.

(54) (ME) **OMOTAČ, POSTOLJE ZA NJIHOVO PREUZIMANJE I POSTUPAK ZA PROIZVODNJU DONER TJELAŠCA/ĆEVAPA**

(EN) CASING, RACK FOR RECEIVING THE SAME AND METHOD FOR PRODUCING DÖNER-LIKE MOLDED BODIES

(73) GEWÜRZ BERGER AG, Industriestrasse 40 FL-9487 Gamprin-Bendern LI

(72) DUBUISSON, Nils; Dammweg 6 FL-9490 Vaduz LI

(74) Radulović Božidar, Jovana Tomaševića 9/III, Podgorica ME

(57) Omotač (1) za proizvodnju i izvođenje Donera se sastoji od jednog, u pravcu dole kupasto-suženog dela u obliku vreće ili kese, koji je na svom donjem kraju (E) zatvoren, a na gornjem kraju (O) otvoren za punjenje. Prvenstveno se sastoji omotač (1) od tekstilnog materijala i nosi na otvorenom kraju (O) spojnice (5), koje se poklapaju oko kraju (O) granične ivice<sup>®</sup> omotača (1). Postolja (6) za preuzimanje omotača (1) pokazuje stub (17), u čijem centru je predviđen ražanj (15) za sprovođenje pogonske cevi (14). Na stubu (17) je pričvršćena korpa (19) u obliku zarubljene kupe, koja odgovara u suštini željenom Doner obliku. Radi olakšavanja preuzimanja mesa iz korpe (19) pokazuje ova na obema suprotnim stranama po jedan osovinski zapušač (29), čiji osovinski zapušači (29) se mogu uključiti u po svako ležište (28; 28) na jednoj za drugom suprotnim stranama postolja (6). Na taj način je korpa (19) sposobna za kipovanje za preuzeti napunjeni omotač (1).

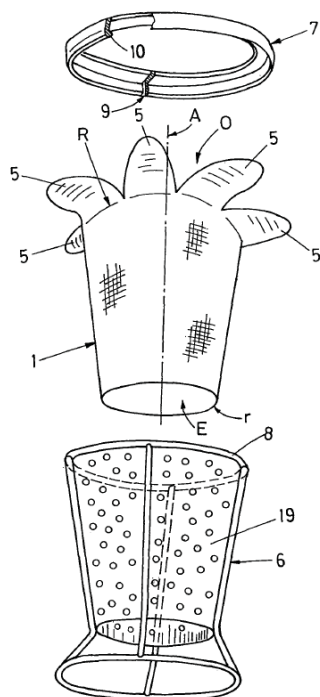

Fig.1a

(51) **B60K 1/04**

(11) **01427**

(13) **A**

(21) P-2013-60

(22) 20130617

(54) (ME) **AUTOMOBIL NA ELEKTRIČNI POGON**

(EN) ELECTRIC VEHICLE

(73) Milan Bojović, Njegoševa 4, Žabljak ME

(72) Milan Bojović, Njegoševa 4, Žabljak ME

Zoran Savović, Đura Petrovića, Lovćenac RS

(57) Nov konstruktivno rešenje u oblasti automobilske industrije elektro motor koji obezbeđuje autonomnost elektroautomobila i čini ga nezavisnim od drugih izvora energije, pouzdanost u radu, jeftin u eksploataciji, jeftin za održavanje i ekološki čisto vozilo(motor). Konstrukcija se sastoji u tome: elektromotor 1, se pričvsti čeličnom pločom 2 za mjenjač vozila, elektromotor 1 se kablom poveže za bateriju 12V tačka 3, transformator tačka 4, pretvarač tačka 5, punjač tačka 6, regulator napona tačka 7, displej jednosmerne struje ampermetar i voltmetar tačka 8, displej naizmjenične struje ampermetar i voltmetar tačka 9.

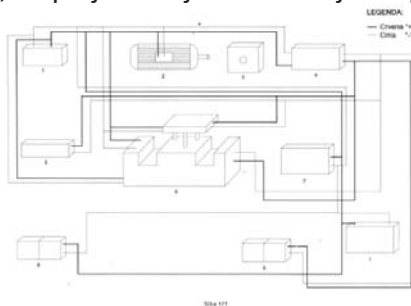

(51) E04B 2/02

(11) 01434

(13) A

(21) P-2013-94

(22) 21.08.2013.

(54) (ME) **VIŠESLOJNI TERMOIZOLACIONI BLOK ZA ZIDANJE GRAĐEVINA**  
(EN) MULTI LAYER TERMO-ISOLATION BLOCK FOR CONSTRUCTION OF BUILDINGS

(73) Zoran Ilinčić, M. Bulatovića 15, Kolašin ME

(72) Zoran Ilinčić, M. Bulatovića 15, Kolašin ME

(57) Suština pronalaska je u tome da se za izradu Višeslojnog termoizolacionog bloka za zidanje građevina koriste dva ili više slojeva materijala i sistem za njihovo povezivanje, pri čemu su jedni materijali sa dobrim termo i zvučnim izolacionim svojstvima, a drugi sa dobrim mehaničkim karakteristikama. U ovom slučaju, izrada Višeslojnog termoizolacionog bloka za zidanje građevina je predviđena od više slojeva betona, koji formiraju Nosače (1) i stiropora, koji su Izolatori (2), dok se njihovo povezivanje u jednu nerazdjeljivu cjelinu ostvaruje pomoću pogodno pripremljenih Spojnica (3) od plastike. Pri tom se između slojeva ostavlja prostor koji formira Vazдушnu komoru (4).

Takođe, kroz tu Vazдушnu komoru (4) se po potrebi mogu provući kablovi za električnu struju, vodovodna instalacija i si. Ovaj pronalazak se može vrlo funkcionalno primijeniti za zidanje građevina. Poseban njegov kvalitet je u tome što su mu izolaciona svojstva za istu debljinu zida, značajno bolja nego kod drugih sličnih i poznatih konstrukcija. Konstrukcija je trajna, ekstremno jeftina i lako primjenjiva.

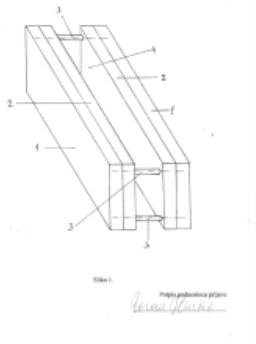

**INDEKS NOSILACA PATENTA**  
**PATENT OWNER INDEX**

(73)	(51)	(21)
ARDEA BIOSCIENCES INC.	C07D 249/12 C07D 235/28	P-2010-100
BELRON HUNGARY KFT - ZUG BRANCH	B25B 11/00 B62D 65/06 B65G 7/12 B65G 49/06 B66C 1/02	P-2011-174
CHIESI FARMACEUTICI S.P.A.	C07D 213/61 C07D 213/89 A61K 31/44 A61P 11/00	P-2011-150
CHIESI FARMACEUTICI S.P.A.	C07D 453/02 A61K 31/439 A61P 11/00	P-2011-24
CHIESI FARMACEUTICI S.P.A.	C07K 14/785 A61K 38/00	P-2011-197
CORNELL UNIVERSITY	A61K 39/04	P-2010-62
CRYSTAL LAGOONS CORPORATION LLC	C02F 1/68	P-2012-5
DJERASSEM	F03B 17/00	P-2011-152
EGIS GYÓGYSZERGYÁR NYILVÁNOSAN MŰKÖDŐ RÉSZVÉNYTÁRSASÁG	A61K 9/0 A61K 47/24 A61K 47/34 A61K 9/50	P-2011-159
EMPRESAS PÚBLICAS DE MEDELLIN E.S.P. UNIVERSIDAD DE ANTIOQUIA	C12P 7/64 C12N 5/04 C12N 5/02	P-2011-154
GRANITIFIANDRE S.p.A.	C04B 41/50 C04B 41/52 C04B 41/87 C04B 41/89	P-2011-202

HARI	H04L 12/28 H04L 12/46	P-2011-52
IFCO SYSTEMS GMBH	B65D 6/18	P-2011-170
Milan Bojović	F03B13/00	P-2013-19
NOVARTIS AG	C07D 401/12 A61K 31/501 A61K 31/506 A61P 35/00 C07D 401/14 C07D 403/12 C07D 413/14 C07D 471/04	P-2011-6
NOVARTIS AG	C07D 417/14 A61K 31/4439 A61P 35/00	P-2011-21
NOVARTIS AG	C07D 487/04 A61K 31/519 A61P 35/00	P-2011-25
NOVARTIS AG	C07D 401/12 A61K 31/444 A61P 35/00 C07D 401/14	P-2011-37
NOVARTIS AG	C07D 413/04 A61K 35/00 A61K 31/5377	P-2011-50
ONYX THERAPEUTICS, INC.	C07D 277/56 A61K 38/55 C07K 5/08	P-2011-164
PFIZER INC.	C07D 493/10 A61K 31/357 A61P 3/10 C07H 15/18	P-2011-45
PFIZER INC.	C07D 213/75 A61K 31/44 A61P 29/00	P-2010-221



PFIZER INC.	C07D 231/40 A61K 31/4155 A61K 31/4178 A61K 31/4427 A61K 31/497 A61K 31/506 A61P 3/00 C07D 401/12 C07D 403/12 C07D 513/	P-2011-44
PFIZER INC. AMGEN FREMONT INC.	C07K 16/28	P-2010-215
SANOFI-AVENTIS	A61K 31/343 A61K 9/28 A61P 9/10	P-2011-19
SANOFI-AVENTIS	C07D 493/18 C07H 19/01	P-2011-51
Vujković Dejan	A47B 97/08 A47C 17/54	P-2010-186
Zoetis LLC	C07D 487/04 A61K 31/519 A61P 37/00	P-2011-22
Zoetis W LLC	C12N 7/08 A61K 39/215	P-2011-23
Zoetis W LLC	A61K 39/39	P-2011-33



**INDEKS BROJEVA PRIJAVA PATENATA**  
**APPLICANTS NUMBER INDEX**

(21)	(51)	(21)	(51)
P-2010-62	A61K 39/04	P-2011-44	C07D 231/40
P-2010-100	C07D 249/12		A61K 31/4155
	C07D 235/28		A61K 31/4178
P-2010-186	A47B 97/08		A61K 31/4427
	A47C 17/54		A61K 31/497
P-2010-215	C07K 16/28		A61K 31/506
P-2010-221	C07D 213/75		A61P 3/00
	A61K 31/44		C07D 401/12
	A61P 29/00		C07D 403/12
P-2011-6	C07D 401/12	P-2011-45	C07D 513/
	A61K 31/501		C07D 493/10
	A61K 31/506		A61K 31/357
	A61P 35/00		A61P 3/10
	C07D 401/14		C07H 15/18
	C07D 403/12	P-2011-50	C07D 413/04
	C07D 413/14		A61K 35/00
	C07D 471/04		A61K 31/5377
P-2011-19	A61K 31/343	P-2011-51	C07D 493/18
	A61K 9/28		C07H 19/01
	A61P 9/10	P-2011-52	H04L 12/28
P-2011-21	C07D 417/14		H04L 12/46
	A61K 31/4439	P-2011-150	C07D 213/61
	A61P 35/00		C07D 213/89
P-2011-22	C07D 487/04		A61K 31/44
	A61K 31/519		A61P 11/00
	A61P 37/00	P-2011-152	F03B 17/00
P-2011-23	C12N 7/08	P-2011-154	C12P 7/64
	A61K 39/215		C12N 5/04
P-2011-24	C07D 453/02		C12N 5/02
	A61K 31/439	P-2011-159	A61K 9/0
	A61P 11/00		A61K 47/24
P-2011-25	C07D 487/04		A61K 47/34
	A61K 31/519		A61K 9/50
	A61P 35/00	P-2011-164	C07D 277/56
P-2011-33	A61K 39/39		A61K 38/55
P-2011-37	C07D 401/12		C07K 5/08
	A61K 31/444	P-2011-170	B65D 6/18
	A61P 35/00		
	C07D 401/14		

(21)	(51)
------	------

P-2011-174	B25B 11/00 B62D 65/06 B65G 7/12 B65G 49/06 B66C 1/02
P-2011-197	C07K 14/785 A61K 38/00
P-2011-202	C04B 41/50 C04B 41/52 C04B 41/87 C04B 41/89
P-2012-5	C02F 1/68
P-2013-19	F03B13/00

**INDEKS OBJAVLJENIH PRIJAVA PATENATA PREMA MKP**  
**INDEX OF PATENT APPLICANTS ACCORDINT TO IPC**

(51)	(21)	(51)	(21)
A47B 97/08	P-2010-186	A61K 9/28	P-2011-19
A47C 17/54	P-2010-186	A61K 9/50	P-2011-159
A61K 31/343	P-2011-19	A61P 11/00	P-2011-150
A61K 31/357	P-2011-45	A61P 11/00	P-2011-24
A61K 31/4155	P-2011-44	A61P 29/00	P-2010-221
A61K 31/4178	P-2011-44	A61P 3/00	P-2011-44
A61K 31/439	P-2011-24	A61P 3/10	P-2011-45
A61K 31/44	P-2010-221	A61P 35/00	P-2011-21
A61K 31/44	P-2011-150	A61P 35/00	P-2011-25
A61K 31/4427	P-2011-44	A61P 35/00	P-2011-37
A61K 31/4439	P-2011-21	A61P 35/00	P-2011-6
A61K 31/444	P-2011-37	A61P 37/00	P-2011-22
A61K 31/497	P-2011-44	A61P 9/10	P-2011-19
A61K 31/501	P-2011-6	B25B 11/00	P-2011-174
A61K 31/506	P-2011-44	B62D 65/06	P-2011-174
A61K 31/506	P-2011-6	B65D 6/18	P-2011-170
A61K 31/519	P-2011-22	B65G 49/06	P-2011-174
A61K 31/519	P-2011-25	B65G 7/12	P-2011-174
A61K 31/5377	P-2011-50	B66C 1/02	P-2011-174
A61K 35/00	P-2011-50	C02F 1/68	P-2012-5
A61K 38/00	P-2011-197	C04B 41/50	P-2011-202
A61K 38/55	P-2011-164	C04B 41/52	P-2011-202
A61K 39/04	P-2010-62	C04B 41/87	P-2011-202
A61K 39/215	P-2011-23	C04B 41/89	P-2011-202
A61K 39/39	P-2011-33	C07D 213/61	P-2011-150
A61K 47/24	P-2011-159	C07D 213/75	P-2010-221
A61K 47/34	P-2011-159	C07D 213/89	P-2011-150
A61K 9/0	P-2011-159	C07D 231/40	P-2011-44

(51)	(21)	(51)	(21)
C07D 235/28	P-2010-100	F03B 13/00	P-2013-19
C07D 249/12	P-2010-100	H04L 12/28	P-2011-52
C07D 277/56	P-2011-164	H04L 12/46	P-2011-52
C07D 401/12	P-2011-37		
C07D 401/12	P-2011-44		
C07D 401/12	P-2011-6		
C07D 401/14	P-2011-37		
C07D 401/14	P-2011-6		
C07D 403/12	P-2011-44		
C07D 403/12	P-2011-6		
C07D 413/04	P-2011-50		
C07D 413/14	P-2011-6		
C07D 417/14	P-2011-21		
C07D 453/02	P-2011-24		
C07D 471/04	P-2011-6		
C07D 487/04	P-2011-22		
C07D 487/04	P-2011-25		
C07D 493/10	P-2011-45		
C07D 493/18	P-2011-51		
C07D 513/	P-2011-44		
C07H 15/18	P-2011-45		
C07H 19/01	P-2011-51		
C07K 14/785	P-2011-197		
C07K 16/28	P-2010-215		
C07K 5/08	P-2011-164		
C12N 5/02	P-2011-154		
C12N 5/04	P-2011-154		
C12N 7/08	P-2011-23		
C12P 7/64	P-2011-154		
F03B 17/00	P-2011-152		

**OBJAVE ZAHTJEVA ZA PROŠIRENJE EVROPSKIH PRIJAVA PATENATA**  
**PUBLICATION OF REQUEST FOR THE EXTENSION OF THE EFFECTS OF**  
**EUROPEAN PATENT APPLICATIONS**

(51) MKP  
**A61B 5/145 (2006.01)** (97) **2455876**  
**G06F 19/00 (2011.01)**  
(86) 12155074.3 23.05.2012  
(97) 2455876, 23.05.2012 en  
(54) System and method for diabetes management  
(71) Lifescan Scotland Limited, Beechwood Park North, Inverness IV2 3ED, GB  
(72) Jerdonek, Ronald, 407 N. Alfred, Alexandria VA 22314, US  
Longmuir, Alistair, Alexandra Terrace, Forres Morayshire IV36 1DL, GB  
Raj, Siv, 12 Grove Court, Beaconsfield HP9 1QW, GB  
Macrae, Allan, 20a Culcabock Avenue, Inverness IV2 3RG, GB  
Weseley, Lisa, 10 Torino Lane, San Carlos CA 94070, US  
Stephens, Chris, 1034 Ringwood Avenue, Menlo Park CA 94025, US

(51) MKP  
**C01B 33/12 (2006.01)** (97) **2609033 \***  
**C01B 33/16 (2006.01)**  
(86) US2011046680 05.08.2011  
(96) 11815354.3 03.07.2013  
(87) WO2012019064, 05.08.2011  
(97) 2609033, 03.07.2013 en  
(54) SILICA HYDROGEL IMPREGNATED WITH TiO<sub>2</sub> AND METHOD OF MAKING SAME  
(71) PQ Corporation, 300 Lindenwood Drive Valleybrooke Corporate Center, Malvern, PA 19355-1740, US  
(72) RIBEIRO, Flavio Ernesto, 11661 Rushmore Dr., Plainfield Illinois 60585, US  
FLOR, Ronaldo dos Santos, Rua Cidade de São Sebastião 209 bairro nova Petrópolis São Bernardo do Campo, 09770-550 SP, BR

(51) MKP  
**C08G 77/50 (2006.01)** (97) **2601245 \***  
**C08L 83/14 (2006.01)**  
(86) US2011001393 04.08.2011  
(96) 11749018.5 12.06.2013  
(87) WO2012018403, 04.08.2011  
(97) 2601245, 12.06.2013 en  
(54) CYCLOSILOXANE-SUBSTITUTED POLYSILOXANE COMPOUNDS, COMPOSITIONS CONTAINING THE COMPOUNDS AND METHODS OF USE THEREOF  
(71) Biofilm IP, LLC, 990 Ironwood Drive, Minden, NV 89423, US  
(72) WRAY, Daniel, X., P.O. Box 2649, Minden, NV 89423, US  
HALSDORFF, Michael, B., 530 Whitesage Road, San Marcos, CA 92078, US  
DE ARMOND, Robert, L., 42790 Calle Montecillo, Temecula, CA 92590, US

(51) MKP  
**C08G 77/42 (2006.01)** (97) **2625217 \***  
**C08G 77/46 (2006.01)**  
**C08G 77/442 (2006.01)**  
**G02B 1/04 (2006.01)**  
**C08L 83/10 (2006.01)**  
**C08G 77/20 (2006.01)**  
(86) US2011054870 05.10.2011  
(96) 11770628.3 14.08.2013  
(87) WO2012047964, 05.10.2011  
(97) 2625217, 14.08.2013 en  
(54) CHAIN-EXTENDED POLYSILOXANE CROSSLINKERS WITH DANGLING HYDROPHILIC POLYMER CHAINS  
(71) Novartis AG, Lichtstrasse 35, 4056 Basel, CH  
(72) KUYU, Selma, 825 Chatburn Lane, Duluth Georgia 30097, US  
SMITH, Dawn, Alison, 230A Ranolf Street, Rotorua 3010, NZ  
HUANG, Jinyu, 917 Summer Forest Drive, Suwanee Georgia 30024, US  
CHANG, Frank, 8489 Spring Breeze Terrace, Suwanee Georgia 30024, US  
SCOTT, Robert, 1220 Longpointe Pass, Alpharetta Georgia 30005, US  
MEDINA, Arturo Norberto, 4021 McGinnis Ferry Road 2222, Suwanee Georgia 30024, US  
SHANKERNARAYANAN, Manivakkam J., 4730 Hastings Terrace, Alpharetta Georgia 30005, US

(51) MKP  
**A61M 21/02 (2006.01)** (97) **2629825 \***  
(86) NZ2011000223 21.10.2011  
(96) 11834694.9 28.08.2013  
(87) WO2012053913, 21.10.2011  
(97) 2629825, 28.08.2013 en  
(54) INFANT CALMING AID  
(71) Magic Mitten Limited, Level 9 C/- James&Wells Intellectual Property James&Wells Tower 56 Cawley Street, Ellerslie, Auckland 1051, NZ  
(72) HUBBLE, Mark Vincent, Level 9 C/- James&Wells Intellectual Property James&Wells Tower 56 Cawley Street, Auckland 1051, NZ  
ROGERS, Jason Paul, Level 9 C/- James&Wells Intellectual Property James&Wells Tower 56 Cawley Street, Auckland 1051, NZ  
SMITH, Dean Maxwell, Level 9 C/- James&Wells Intellectual Property James&Wells Tower 56 Cawley Street, Auckland 1051, NZ

(51) MKP  
**C12N 5/04 (2006.01)** (97) **2603578 \***  
(86) US2011047811 15.08.2011  
(96) 11818629.5 19.06.2013  
(87) WO2012024244, 15.08.2011  
(97) 2603578, 19.06.2013 en  
(54) COMPOSITIONS AND METHODS FOR INHIBITING POTATO PATHOGENS  
(71) University Of Idaho, 414 Morrill Hall P.O. Box 443003, Moscow, ID 83844-3003, US  
(72) WHARTON, Phillip, 1693 S. 2700 W., Aberdeen, ID 83210, US

- (51) MKP  
**C07D 213/82 (2006.01)** (97) **2598483 \***  
**C07D 295/04 (2006.01)**  
**C07D 401/12 (2006.01)**  
**C07D 401/14 (2006.01)**  
**C07D 405/12 (2006.01)**  
**C07D 409/12 (2006.01)**  
**C07D 413/12 (2006.01)**  
**C07D 471/10 (2006.01)**  
**A61K 31/4427 (2006.01)**  
**A61K 31/501 (2006.01)**  
**A61K 31/5377 (2006.01)**  
**A61P 3/10 (2006.01)**  
**A61P 9/10 (2006.01)**  
(86) US2011046019 29.07.2011  
(96) 11746709.2 05.06.2013  
(87) WO2012016217, 29.07.2011  
(97) 2598483, 05.06.2013 en  
(54) AMPK-ACTIVATING HETEROCYCLIC COMPOUNDS AND METHODS FOR USING THE SAME  
(71) Rigel Pharmaceuticals, Inc., 1180 Veterans Boulevard, South San Francisco, CA 94080, US  
(72) GOFF, Dane, 77 Markham Avenue, Redwood City CA 94063, US  
PAYAN, Donald, 24 Windsor Drive, Hillsborough CA 94010, US  
SINGH, Rajinder, 1832 Hillman Avenue, Belmont CA 94002, US  
SHAW, Simon, 1232 19th Street Unit 10 Oakland, CA 94607, US  
CARROLL, David, 87 Dolores Street Apt. 105, San Francisco CA 94103, US  
HITOSHI, Yasumichi, 331 Callippe Court, Brisbane CA 94005, US

- (51) MKP  
**B01D 11/02 (2006.01)** (97) **2632559 \***  
**A23L 1/30 (2006.01)**  
**A61K 36/00 (2006.01)**  
(86) US2011001808 25.10.2011  
(96) 11782261.9 04.09.2013  
(87) WO2012060861, 25.10.2011  
(97) 2632559, 04.09.2013 en  
(54) SIMPLE PROCESS TO PRODUCE AND SEPARATE WATER SOLUBLE AND OIL SOLUBLE ANTIOXIDATIVE FLAVORING COMPOSITIONS FROM LABIATAE HERBS USING GREEN SOLVENTS  
(71) Kalamazoo Holdings, Inc., 3713 West Main Street, Kalamazoo, MI 49006, US  
(72) NAHAS, Roger, 4710 Roland Cir., Portage, MI 49024, US  
BARREN, Elizabeth, 4105 Stoney Hill Drive, Kalamazoo, MI 49009, US  
REYNHOUT, Gregory, S., 8807 North 17th Street, Kalamazoo, MI 49009, US

- (51) MKP  
**A61K 39/395 (2006.01)** (97) **2606069 \***  
**A61P 37/06 (2006.01)**  
**C07K 16/28 (2006.01)**  
**A61P 35/02 (2006.01)**  
(86) AU2011001056 17.08.2011  
(96) 11817577.7 26.06.2013  
(87) WO2012021934, 17.08.2011  
(97) 2606069, 26.06.2013 en  
(54) HUMANIZED ANTI-INTERLEUKIN 3 RECEPTOR ALPHA CHAIN ANTIBODIES  
(71) CSL Limited, 45 Poplar Road, Parkville, Victoria 3052, AU  
(72) PANOUSIS, Con, 88 Linacre Drive, Bundoora Victoria 3083, AU

- (51) MKP  
**C07D 413/14 (2006.01)** (97) **2625170 \***  
**C07D 417/06 (2006.01)**  
**C07D 417/14 (2006.01)**  
**C07D 267/10 (2006.01)**  
**C07D 413/04 (2006.01)**  
**C07D 413/06 (2006.01)**  
**C07D 413/10 (2006.01)**  
**C07D 413/12 (2006.01)**  
(86) JP2011073745 05.10.2011  
(96) 11778987.5 14.08.2013  
(87) WO2012046882, 05.10.2011  
(97) 2625170, 14.08.2013 en  
(54) 1,4-OXAZEPANE DERIVATIVES  
(71) Takeda Pharmaceutical Company Limited, 1-1 Doshomachi 4-chome Chuo-ku, Osaka-shi, Osaka 541-0045, JP  
(72) ISHICHI, Yuji, c/o TAKEDA PHARMACEUTICAL COMPANY LIMITED 26-1 Muraoka-Higashi 2-chome, Fujisawa-shi Kanagawa 251-0012, JP  
YAMADA, Masami, c/o Takeda Pharmaceutical Company Limited 26-1, Muraoka-Higashi 2-chome Fujisawa, Kanagawa 251-0012, JP  
KAMEI, Taku, c/o TAKEDA PHARMACEUTICAL COMPANY LIMITED 26-1 Muraoka-Higashi 2-chome, Fujisawa-shi Kanagawa 251-0012, JP  
FUJIMORI, Ikuo, c/o Takeda Pharmaceutical Company Limited 26-1, Muraoka-Higashi 2-chome Fujisawa, Kanagawa 251-0012, JP  
NAKADA, Yoshihisa, c/o TAKEDA PHARMACEUTICAL COMPANY LIMITED 26-1 Muraoka-Higashi 2-chome, Fujisawa-shi Kanagawa 251-0012, JP  
YUKAWA, Tomoya, c/o TAKEDA PHARMACEUTICAL COMPANY LIMITED 26-1 Muraoka-Higashi 2-chome, Fujisawa-shi Kanagawa 251-0012, JP  
SAKAUCHI, Nobuki, c/o TAKEDA PHARMACEUTICAL COMPANY LIMITED 26-1 Muraoka-Higashi 2-chome, Fujisawa-shi Kanagawa 251-0012, JP  
OHBA, Yusuke, c/o TAKEDA PHARMACEUTICAL COMPANY LIMITED 26-1 Muraoka-Higashi 2-chome, Fujisawa-shi Kanagawa 251-0012, JP  
TSUKAMOTO, Tetsuya, c/o TAKEDA PHARMACEUTICAL COMPANY LIMITED 26-1 Muraoka-Higashi 2-chome, Fujisawa-shi Kanagawa 251-0012, JP

- (51) MKP  
**C12N 15/85 (2006.01)** (97) **2578688**  
**C12N 9/64 (2006.01)**  
**C07K 16/46 (2006.01)**  
**C07K 16/28 (2006.01)**  
**C07K 16/40 (2006.01)**  
**A01K 67/027 (2006.01)**  
(86) 12192727.1 10.04.2013  
(97) 2578688, 10.04.2013 en  
(54) ADAM6 mice  
(71) Regeneron Pharmaceuticals, Inc., 777 Old Saw Mill River Road, Tarrytown, NY 10591, US  
(72) MacDonald, Lynn, 16 Gedney Way, White Plains, NY 10605, US  
Stevens, Sean, 355 Berry Street, No. 413, San Francisco, CA 94158, US  
Murphy, Andrew J., 10 Newton Court, Croton-on-Hudson, NY 10520, US

- (51) MKP  
**A61K 51/04 (2006.01)** (97) **2637704 \***  
**G01N 33/60 (2006.01)**  
**A61K 101/02 (2006.01)**  
**C07B 59/00 (2006.01)**  
**C07D 471/04 (2006.01)**  
(86) DK2011000132 10.11.2011  
(96) 11791424.2 18.09.2013  
(87) WO2012062319, 10.11.2011  
(97) 2637704, 18.09.2013 en  
(54) RADIOLABELLED PHENYLIMIDAZOLE-BASED LIGANDS  
(71) H. Lundbeck A/S, Ottiliavej 9, 2500 Valby, DK  
(72) KEHLER, Jan, Nymøllevej 28, DK-2800 Lyngby, DK  
BANG-ANDERSEN, Benny, Lillegrund 23, DK-2300 København S, DK



(51) MKP  
**A61M 5/24 (2006.01)** (97) **2621562 \***  
 (86) EP2011066930 28.09.2011  
 (96) 11761638.3 07.08.2013  
 (87) WO2012041932, 28.09.2011  
 (97) 2621562, 07.08.2013 en  
 (54) NON-DETACHABLE RESERVOIR HOLDER FOR A DRUG DELIVERY DEVICE  
 (71) Sanofi-Aventis Deutschland GmbH, Brüningstraße 50, 65929 Frankfurt, DE  
 (72) TEUCHER, Axel, c/o Sanofi-Aventis Deutschland GmbH, 65926 Frankfurt am Main, DE  
 JUGL, Michael, c/o Sanofi-Aventis Deutschland GmbH, 65926 Frankfurt am Main, DE  
 OSMAN, Thomas Frederick, 30 Willes Road Leamington Spa, Warwickshire CV31 1, GB  
 SANDERS, David, Kettlewell Close Woodloes Park, Warwick Warwickshire CV34 5XE, GB  
 AVERY, Richard James Vincent, 28 Nursery Close, Mickleton Gloucestershire GL55 6TX, GB  
 BUTLER, Joseph, 6 Hadfield Close Clifton, Rugby Warwickshire CV23 0DL, GB

(51) MKP  
**A61K 31/765 (2006.01)** (97) **2635289 \***  
**A61P 35/00 (2006.01)**  
 (86) GB2011001561 04.11.2011  
 (96) 11785050.3 11.09.2013  
 (87) WO2012059725, 04.11.2011  
 (97) 2635289, 11.09.2013 en  
 (54) PEG OR PEG BLOCK COPOLYMERS FOR TREATING COLORECTAL CANCER  
 (71) Norgine B.V., Hogehilweg 7, 1101 CA Amsterdam ZO, NL  
 (72) STEIN, Peter, c/o Norgine Ltd Norgine House Widewater Place Harefield, Uxbridge, Middlesex UB9 6NS, GB  
 COX, Ian, c/o Norgine Ltd New Road Tir-y-Berth, Hengoed, Mid-Glamorgan CF828SJ, GB  
 SMITH, Samuel, c/o Norgine Ltd New Road Tir-y-Berth, Hengoed, Mid-Glamorgan CF82 8SJ, GB  
 JONES, Leighton, c/o Norgine Ltd New Road Tir-y-Berth, Hengoed, Mid-Glamorgan CF82 8SJ, GB  
 PLESSL, Jörg, c/o Norgine Ltd New Road Tir-y-Berth, Hengoed, Mid-Glamorgan CF82 8SJ, GB  
 DE VRIES, Corinne, c/o Norgine Ltd New Road Tir-y-Berth, Hengoed, Mid-Glamorgan CF82 8SJ, GB  
 CHARLTON, Rachel, c/o Norgine Ltd. New Road Tir-y-Berth, Hengoed, Mid-Glamorgan CF82 8SJ, GB

(51) MKP  
**H04W 64/00 (2009.01)** (97) **2601801 \***  
**H04W 4/02 (2009.01)**  
**H04L 29/08 (2006.01)**  
**G01S 19/49 (2010.01)**  
 (86) US2011046666 04.08.2011  
 (96) 11751701.1 12.06.2013  
 (87) WO2012019055, 04.08.2011  
 (97) 2601801, 12.06.2013 en  
 (54) DETERMINING LOCATION OF A TARGET DEVICE BASED ON RELATIVE CHANGE IN LOCATION INFORMATION  
 (71) Qualcomm Incorporated, 5775 Morehouse Drive, San Diego, CA 92121-1714, US  
 (72) EDGE, Stephen William, 5775 Morehouse Drive, San Diego California 92121, US

(51) MKP  
**H04B 3/02 (2006.01)** (97) **2601746 \***  
**H04L 12/10 (2006.01)**  
**H04L 25/02 (2006.01)**  
 (86) IB2012050974 01.03.2012  
 (96) 12713321.3 12.06.2013  
 (87) WO2012117371, 01.03.2012  
 (97) 2601746, 12.06.2013 en  
 (54) METHOD AND DEVICE FOR COUPLING A DC SUPPLY LINE TO A TELEPHONE LINE OR COAXIAL CABLE  
 (71) A TLC S.r.l., Via G.B. Martini 2, 00198 Roma RM, IT  
 (72) MARCHETTI, Stefano, Via Manin 10 Osimo Stazione, I-60027 Osimo AN, IT

(51) MKP  
**A61K 39/395 (2006.01)** (97) **2632490 \***  
 (86) US2011058378 28.10.2011  
 (96) 11837192.1 04.09.2013  
 (87) WO2012058588, 28.10.2011  
 (97) 2632490, 04.09.2013 en  
 (54) NOVEL EGFR-BINDING MOLECULES AND IMMUNOCONJUGATES THEREOF  
 (71) Immunogen, Inc., 830 Winter Street, Waltham, MA 02451, US  
 (72) SETIADY, Julianto, 132 Clocktower Drive Unit 4110, Waltham, MA 02452, US  
 PARK, Peter, U., 25 Webster Avenue 301, Somerville, MA 02143, US  
 RUI, Lingyun, 11 Arrowhead Road, Weston, MA 02493, US  
 CHITTENDEN, Thomas, 24 Walker Farm Road, Sudbury, MA 01776, US  
 PAYNE, Gillian, 21 Oakvale Road, Waban, MA 02468, US

(51) MKP  
**G07F 17/32 (2006.01)** (97) **2636030 \***  
**G06F 3/048 (2013.01)**  
 (86) EP2011069266 02.11.2011  
 (96) 11776471.2 11.09.2013  
 (87) WO2012059519, 02.11.2011  
 (97) 2636030, 11.09.2013 en  
 (54) METHOD AND SYSTEM FOR SECRETLY REVEALING ITEMS ON A MULTI-TOUCH INTERFACE  
 (71) Novomatic AG, Wiener Strasse 158, 2352 Gumpoldskirchen, AT  
 (72) HOMER, Alois, Hufgasse 9, A-1210 Vienna, AT

(51) MKP  
**A61K 31/505 (2006.01)** (97) **2636409 \***  
**A61K 31/506 (2006.01)**  
**A61K 31/4174 (2006.01)**  
**A61K 45/00 (2006.01)**  
**A61K 31/7048 (2006.01)**  
**A61K 31/444 (2006.01)**  
**A61K 38/00 (2006.01)**  
**A61K 31/4196 (2006.01)**  
**A61P 31/10 (2006.01)**  
**A61K 31/427 (2006.01)**  
**A61P 43/00 (2006.01)**  
**A61K 31/496 (2006.01)**  
 (86) JP2011075481 04.11.2011  
 (96) 11838098.9 11.09.2013  
 (87) WO2012060448, 04.11.2011  
 (97) 2636409, 11.09.2013 en  
 (54) COMBINED PHARMACEUTICAL COMPOSITION AS ANTIFUNGAL AGENT  
 (71) Eisai R&D Management Co., Ltd., 6-10, Koishikawa 4-chome Bunkyo-ku, Tokyo 112-8088, JP  
 (72) WATANABE, Naoaki, c/o Tsukuba Research Laboratories EISAI CO. LTD. 1-3 Tokodai 5-chome, Tsukuba-shi Ibaraki 300-2635, JP  
 HATA, Katsura, c/o Tsukuba Research Laboratories EISAI CO. LTD. 1-3 Tokodai 5-chome, Tsukuba-shi Ibaraki 300-2635, JP  
 MIYAZAKI, Mamiko, c/o Tsukuba Research Laboratories EISAI CO. LTD. 1-3 Tokodai 5-chome, Tsukuba-shi Ibaraki 300-2635, JP  
 HORII, Takaaki, c/o Tsukuba Research Laboratories EISAI CO. LTD. 1-3 Tokodai 5-chome, Tsukuba-shi Ibaraki 300-2635, JP

- (51) MKP  
**H04N 21/475 (2011.01)** (97) **2619993 \***  
**H04N 21/41 (2011.01)**  
**H04L 12/28 (2006.01)**  
(86) US2011001635 22.09.2011  
(96) 11768187.4 31.07.2013  
(87) WO2012039769, 22.09.2011  
(97) 2619993, 31.07.2013 en  
(54) PROGRAMMABLE MULTIMEDIA CONTROLLER WITH FLEXIBLE USER ACCESS AND SHARED DEVICE CONFIGURATIONS  
(71) Savant Systems LLC., 886 Main Street, Osterville, MA 02655, US  
(72) LOCASCIO, Timothy, R., 424 Old Mill Road, Osterville MA 02655, US  
MADONNA, Robert, P., 32 Wianno Avenue, Osterville MA 02655, US  
McKINLEY, David, 499 Horseneck Drive, Dartmouth MA 02748, US  
SILVA, Michael, C., 6 Fairfield Drive, East Sandwich MA 02537, US

- (51) MKP  
**A61K 31/417 (2006.01)** (97) **2599775 \***  
**A61P 25/04 (2006.01)**  
**C07D 231/14 (2006.01)**  
**A61K 31/4245 (2006.01)**  
**A61P 25/20 (2006.01)**  
**A61K 31/42 (2006.01)**  
**A61P 25/18 (2006.01)**  
**A61K 31/415 (2006.01)**  
**A61K 31/496 (2006.01)**  
**A61P 25/30 (2006.01)**  
**A61K 31/4174 (2006.01)**  
**A61P 25/08 (2006.01)**  
**C07D 231/12 (2006.01)**  
**A61K 31/4709 (2006.01)**  
**A61P 25/28 (2006.01)**  
**A61K 31/4439 (2006.01)**  
**A61P 25/22 (2006.01)**  
**A61K 31/4155 (2006.01)**  
**A61K 31/506 (2006.01)**  
**A61P 43/00 (2006.01)**  
(86) JP2011067394 29.07.2011  
(96) 11812613.5 05.06.2013  
(87) WO2012015024, 29.07.2011  
(97) 2599775, 05.06.2013 en  
(54) ETHINYL-PYRAZOLE DERIVATIVE  
(71) Taisho Pharmaceutical Co., Ltd., 24-1, Takada 3-chome Toshima-ku, Tokyo 170-8633, JP  
(72) NAKAMURA Toshio, c/o TAISHO PHARMACEUTICAL CO. LTD. 24-1, Takada 3-chome Toshima-ku, Tokyo 170-8633, JP  
SAKAGAMI Kazunari, c/o TAISHO PHARMACEUTICAL CO. LTD. 24-1, Takada 3-chome Toshima-ku, Tokyo 170-8633, JP  
KONISHI Kazuhide, c/o TAISHO PHARMACEUTICAL CO. LTD. 24-1, Takada 3-chome Toshima-ku, Tokyo 170-8633, JP  
YAMAMOTO Kanako, c/o TAISHO PHARMACEUTICAL CO. LTD. 24-1, Takada 3-chome Toshima-ku, Tokyo 170-8633, JP  
MASUDA Seiji, c/o TAISHO PHARMACEUTICAL CO. LTD. 24-1, Takada 3-chome Toshima-ku, Tokyo 170-8633, JP  
OKADA Kumiko, c/o TAISHO PHARMACEUTICAL CO. LTD. 24-1, Takada 3-chome Toshima-ku, Tokyo 170-8633, JP  
SHIBATA Tsuyoshi, c/o TAISHO PHARMACEUTICAL CO. LTD. 24-1, Takada 3-chome Toshima-ku, Tokyo 170-8633, JP  
OHTA Hiroshi, c/o TAISHO PHARMACEUTICAL CO. LTD. 24-1, Takada 3-chome Toshima-ku, Tokyo 170-8633, JP  
YASUHARA Akito, c/o TAISHO PHARMACEUTICAL CO. LTD. 24-1, Takada 3-chome Toshima-ku, Tokyo 170-8633, JP  
KAWAMOTO Hiroshi, c/o TAISHO PHARMACEUTICAL CO. LTD. 24-1, Takada 3-chome Toshima-ku, Tokyo 170-8633, JP

- (51) MKP  
**C07D 213/50 (2006.01)** (97) **2639221**  
(96) 13158458.3 18.09.2013  
(97) 2639221, 18.09.2013 en  
(54) Process for preparing a ketosulfone derivative  
(71) ZaCh System S.p.A., Via Lillo del Duca, 10, 20091 Bresso (Milano), IT  
(72) Melotto, Elisa, Via Ponovo 5, 36045 Lonigo (Vicenza), IT  
Michieletto, Ivan, Via S. Polo 2452, 30125 VENEZIA, IT  
Frega, Vincenzo, Via Federico Saudino, 5, 36100 Vicenza, IT  
Cotarca, Livius, Via Mercato, 18, 33052 Cervignano del Friuli (Udine), IT  
Verzini, Massimo, Via Terme, 10, 37042 Caldiero (Verona), IT  
Massaccesi, Franco, Piazza del Donatore, 13, 36040 Grancona (VI), IT  
Munari, Ilaria, Strada Postumia, 139, 36100 Vicenza, IT

- (51) MKP  
**A61K 31/5377 (2006.01)** (97) **2640395 \***  
**A61P 25/30 (2006.01)**  
**A61K 31/55 (2006.01)**  
**A61K 31/454 (2006.01)**  
**A61P 25/18 (2006.01)**  
**A61K 31/485 (2006.01)**  
**A61P 25/24 (2006.01)**  
**A61K 31/4178 (2006.01)**  
**A61P 25/00 (2006.01)**  
**A61K 31/551 (2006.01)**  
**A61P 25/36 (2006.01)**  
**A61K 31/4162 (2006.01)**  
**A61P 25/34 (2006.01)**  
**A61K 31/4439 (2006.01)**  
**A61P 25/32 (2006.01)**  
**A61K 31/519 (2006.01)**  
**A61K 31/44 (2006.01)**  
**A61P 25/08 (2006.01)**  
(86) US2011059626 07.11.2011  
(96) 11840549.7 25.09.2013  
(87) WO2012064667, 07.11.2011  
(97) 2640395, 25.09.2013 en  
(54) TREATMENT OF ADDICTION AND IMPULSE-CONTROL DISORDERS USING PDE7 INHIBITORS  
(71) Omeros Corporation, 201 Elliott Avenue West, Seattle, WA 98119, US  
(72) DEMOPULOS, Gregory, A., 4548 Forest Avenue SE, Mercer Island WA 98040, US  
GAITANARIS, George, A., 740 Bellevue Avenue East 704, Seattle WA 98102, US

- (51) MKP  
**A61K 9/16 (2006.01)** (97) **2632438 \***  
**A61K 9/20 (2006.01)**  
**A61K 9/48 (2006.01)**  
**A61K 9/50 (2006.01)**  
**A61K 31/4184 (2006.01)**  
**A61K 31/4422 (2006.01)**  
(86) EP2011068806 26.10.2011  
(96) 11779142.6 04.09.2013  
(87) WO2012055941, 26.10.2011  
(97) 2632438, 04.09.2013 en  
(54) MULTILAYER PHARMACEUTICAL COMPOSITION COMPRISING TELMISARTAN AND AMLODIPINE  
(71) KRKA, tovarna zdravil, d.d., Novo mesto, Smarjeska cesta 6, 8501 Novo mesto, SI  
(72) SEDMAK, Gregor, Ogrinova 26, 1291 Lavrica, SI  
ZUPANCIC, Silvo, Zupnca 4b, 8000 Novo mesto, SI

- (51) MKP  
**A61K 31/495 (2006.01)** (97) **2608789 \***  
**A61P 25/00 (2006.01)**  
(86) DK2011050317 22.08.2011  
(96) 11749331.2 03.07.2013  
(87) WO2012025123, 22.08.2011  
(97) 2608789, 03.07.2013 en  
(54) THERAPEUTIC USES OF 1-[2-(2,4-DIMETHYL-PHENYLSULFANYL)PHENYL]PIPERAZINE  
(71) H. Lundbeck A/S, Ottiliavej 9, 2500 Valby-Copenhagen, DK  
(72) DRAGHEIM, Marianne, Troidager 2, DK-2950 Vedbæk, DK  
FLOREA, Ioana, Engløkken 16, DK-2791 Dragør, DK

- (51) MKP  
**A61K 31/137 (2006.01)** (97) **2642987 \***  
**A61K 31/341 (2006.01)**  
**A61K 31/381 (2006.01)**  
**A61K 31/4184 (2006.01)**  
**A61K 31/4402 (2006.01)**  
**A61K 31/519 (2006.01)**  
**A61K 31/52 (2006.01)**  
**C07C 211/27 (2006.01)**  
**C07C 211/29 (2006.01)**  
**C07C 217/58 (2006.01)**  
**C07C 255/58 (2006.01)**  
**C07D 233/58 (2006.01)**  
**C07D 235/08 (2006.01)**  
**C07D 473/16 (2006.01)**  
**C07D 473/34 (2006.01)**  
(86) EP2011070620 22.11.2011  
(96) 11784710.3 02.10.2013  
(87) WO2012069442, 22.11.2011  
(97) 2642987, 02.10.2013 en  
(54) DIPHENYL-AMINE DERIVATIVES: USES, PROCESS OF SYNTHESIS AND PHARMACEUTICAL COMPOSITIONS  
(71) Faes Farma, S.A., Máximo Aguirre 14, 48940 Lamiako (Lejona) - Vizcaya, ES  
(72) RODES SOLANES, Rosa, Faes Farma S.A. Máximo Aguirre 14, E-48940 Lamiako (Lejona) - Vizcaya, ES  
**GARCÍA DOMÍNGUEZ, Neftalí, Faes Farma S.A. Máximo Aguirre 14, E-48940 Lamiako (Lejona) - Vizcaya, ES**  
**LÓPEZ ORTEGA, Beatriz, Faes Farma S.A. Máximo Aguirre 14, E-48940 Lamiako (Lejona) - Vizcaya, ES**  
**ÁLVAREZ DE MON SOTO, Melchor, Faes Farma S.A. Máximo Aguirre 14, E-48940 Lamiako (Lejona) - Vizcaya, ES**  
**DE LA HERA MARTÍNEZ, Antonio, Faes Farma S.A. Máximo Aguirre 14, E-48940 Lamiako (Lejona) - Vizcaya, ES**  
**MUÑOZ MUÑOZ, Ana, Faes Farma S.A. Máximo Aguirre 14, E-48940 Lamiako (Lejona) - Vizcaya, ES**  
**LEDO GÓMEZ, Francisco, Faes Farma S.A. Máximo Aguirre 14, E-48940 Lamiako (Lejona) - Vizcaya, ES**
- 
- (51) MKP  
**C07D 213/74 (2006.01)** (97) **2603491 \***  
**C07D 239/42 (2006.01)**  
(86) EP2011063504 05.08.2011  
(96) 11743050.4 19.06.2013  
(87) WO2012019967, 05.08.2011  
(97) 2603491, 19.06.2013 en  
(54) PROCESS FOR THE PREPARATION OF ENANTIOMERIC FORMS OF 2,3-DIAMINOPROPIONIC ACID DERIVATIVES  
(71) SANOFI, 54, rue de la Boétie, 75008 Paris, FR  
(72) GRAF, Claus-Dieter, Sanofi-Aventis Deutschland GmbH Industriepark Höchst, 65926 Frankfurt am Main, DE  
**RIEKE-ZAPP, Joerg, Sanofi-Aventis Deutschland GmbH Industriepark Höchst, 65926 Frankfurt am Main, DE**
- 
- (51) MKP  
**C07K 16/18 (2006.01)** (97) **2603523 \***  
**G01N 33/577 (2006.01)**  
**A61K 39/395 (2006.01)**  
**A61P 25/28 (2006.01)**  
(86) US2011046994 09.08.2011  
(96) 11745672.3 19.06.2013  
(87) WO2012021469, 09.08.2011  
(97) 2603523, 19.06.2013 en  
(54) ANTI-N3pGlu AMYLOID BETA PEPTIDE ANTIBODIES AND USES THEREOF  
(71) Eli Lilly and Company, Lilly Corporate Center, Indianapolis, IN 46285, US  
(72) LU, Jirong, c/o Eli Lilly and Company P.O. Box 6288, Indianapolis Indiana 46206-6288, US  
**TANG, Ying, c/o Eli Lilly and Company P.O. Box 6288, Indianapolis Indiana 46206-6288, US**  
**DEMATTOS, Ronald Bradley, c/o Eli Lilly and Company P.O. Box 6288, Indianapolis Indiana 46206-6288, US**
- 
- (51) MKP  
**A61K 9/48 (2006.01)** (97) **2603208 \***  
**A61K 9/50 (2006.01)**  
**A23L 1/30 (2006.01)**  
(86) US2011046901 08.08.2011  
(96) 11746732.4 19.06.2013  
(87) WO2012021432, 08.08.2011  
(97) 2603208, 19.06.2013 en  
(54) PROCESS OF MANUFACTURING A STABLE SOFTGEL CAPSULE CONTAINING MICROENCAPSULATED PROBIOTIC BACTERIA  
(71) R.P. Scherer Technologies, LLC, C/o CSC Services of Nevada, Inc. 502 East John Street, Carson City, NV 89706, US  
(72) VALLA, Claudia, Via Martiri Della Resistenza 31, I-29100 Piacenza, IT  
**BERTOLAMI, Rosa, Piazza Tuscolo 5, I-00183 Roma, IT**  
**ROSINA, Giovanni, Via Po N 6, I-28069 Trecate, IT**  
**HELSON, Karen, 60 Appleton Road, Cumnor Oxford OX2 9QH, GB**
- 
- (51) MKP  
**B29C 49/56 (2006.01)** (97) **2591905**  
(96) 12191388.3 15.05.2013  
(97) 2591905, 15.05.2013 en  
(54) Machine for the blowing or stretch blow moulding of bottles in polymeric material  
(71) SMI S.p.A., Via Monte Grappa, 7, 24121 Bergamo, IT  
(72) Zacche, Vanni, c/o SMI S.p.A. Via Monte Grappa, 7, I-24121 BERGAMO, IT
- 
- (51) MKP  
**B66F 9/075 (2006.01)** (97) **2535308**  
**B62D 11/08 (2006.01)**  
(96) 12171381.2 19.12.2012  
(97) 2535308, 19.12.2012 en  
(54) A traction axle for work machines.  
(71) OTO S.p.A., Via D. Marchesi 4 Zona Industriale Rondello, 42022 Boretto, Reggio Emilia, IT  
(72) Chezzi, Aleardo, VIA FIRENZE 9, 42022 BORETTO, REGGIO EMILIA, IT
- 
- (51) MKP  
**E05F 15/04 (2006.01)** (97) **2543807**  
**F15B 15/06 (2006.01)**  
(96) 11425180.4 09.01.2013  
(97) 2543807, 09.01.2013 en  
(54) Rotary actuator for moving a swivel swing door, particularly in vehicles  
(71) Isaf Bus Components S.r.l., Via Stazione, 43, 21020 Mornago (VA), IT  
(72) Sessa, Massimo, Alzaia Naviglio Pavese, 66, 20143 Milano, IT  
**Turcatti, Gianni, Alzaia Naviglio Pavese, 66, 20143 Milano, IT**
- 
- (51) MKP  
**C07K 16/22 (2006.01)** (97) **2606066 \***  
**A61P 19/08 (2006.01)**  
**A61P 21/00 (2006.01)**  
(86) US2011047806 15.08.2011  
(96) 11745910.7 26.06.2013  
(87) WO2012024242, 15.08.2011  
(97) 2606066, 26.06.2013 en  
(54) ANTIBODIES THAT BIND MYOSTATIN, COMPOSITIONS AND METHODS  
(71) Amgen Inc., One Amgen Center Drive, Thousand Oaks, CA 91320, US  
(72) HAN, Hq, 3353 Crossland Street, Thousand Oaks California 91362, US  
**ARORA, Taruna, 5380 Via Pisa, Thousand Oaks California 91320, US**  
**CHEN, Qing, 4595 El Capitan Place, Camarillo California 93012, US**  
**LU, Hsieng Sen, 2758 Rainfield Avenue, Westlake Village California 91362, US**  
**ZHOU, Xiaolan, 3876 Rodene Street, Newbury Park California 91320, US**

- (51) MKP  
**C07D 239/28 (2006.01)** (97) **2621908 \***  
**C07D 239/30 (2006.01)**  
**C07D 401/04 (2006.01)**
- (86) US2011053808 29.09.2011  
(96) 11767362.4 07.08.2013  
(87) WO2012044727, 29.09.2011  
(97) 2621908, 07.08.2013 en
- (54) MANUFACTURING PROCESS FOR PYRIMIDINE DERIVATIVES
- (71) Novartis AG, Lichtstrasse 35, 4056 Basel, CH  
(72) CALIENNI, John Vincent, Novartis Pharmaceuticals Corporation One Health Plaza, East Hanover, New Jersey 07936, US  
DE LA CRUZ, Marilyn, Novartis Pharmaceuticals Corporation One Health Plaza, East Hanover, New Jersey 07936, US  
FLUBACHER, Dietmar, Novartis Pharma AG Postfach, CH-4002 Basel, CH  
GONG, Baoqing, Novartis Pharmaceuticals Corporation One Health Plaza, East Hanover, New Jersey 07936, US  
KAPA, Prasad Koteswara, Novartis Pharmaceuticals Corporation One Health Plaza, East Hanover, NJ 07936, US  
KARPINSKI, Piotr H., Novartis Pharmaceuticals Corporation One Health Plaza, East Hanover, New Jersey 07936, US  
LIU, Hui, 2 Blue Ridge Avenue, Green Brook, New Jersey 08812, US  
MICHEL, Pascal, Novartis Pharma AG Postfach, CH-4002 Basel, CH  
MOSE, Rasmus, Novartis Pharma AG Postfach, CH-4002 Basel, CH  
TESTA, Maria Caterina, Novartis Pharma AG Postfach, CH-4002 Basel, CH  
WAYKOLE, Liladhar Murlidhar, Novartis Pharmaceuticals Corporation One Health Plaza, East Hanover, New Jersey 07936, US

- (51) MKP  
**A61K 31/07 (2006.01)** (97) **2640368 \***  
**A61K 47/00 (2006.01)**
- (86) US2011060838 15.11.2011  
(96) 11842396.1 25.09.2013  
(87) WO2012068147, 15.11.2011  
(97) 2640368, 25.09.2013 en
- (54) CONTROLLED RELEASE MUCOADHESIVE SYSTEMS
- (71) The Ohio State University Research Foundation, 1524 North High Street, Columbus, OH 43201, US  
The Regents of The University of Michigan, 1600 Huron Parkway 2nd Floor, Ann Arbor, Michigan 48109, US  
(72) MALLERY, Susan, R., 133 Garden Road, Columbus OH 43214, US  
LARSEN, Peter, E., 4919 Rosalind Lane, Powell OH 43065, US  
STONER, Gary, D., 6445 Strathaven Court, Worthington OH 43085, US  
SCHWENDEMAN, Steven, P., 5310 Betheny Cir, Superior Twp. MI 48198, US  
DESAI, Kashappa-Goud, 2016 Medford Road Apt. 18 Ann Arbor, MI 48104, US

- (51) MKP  
**F25D 3/11 (2006.01)** (97) **2522935**  
**B01J 2/06 (2006.01)**
- (96) 12166747.1 14.11.2012  
(97) 2522935, 14.11.2012 de
- (54) Device for pelletising or granulating a fluid or paste material
- (71) Messer Group GmbH, Messer-Platz 1, 65812 Bad Soden, DE  
Messer Industriegase GmbH, Messer-Platz 1, 65812 Bad Soden, DE  
(72) Moser, Friedrich, Gerlingstraße 12, 47167 Duisburg, DE  
Kosock, Stefan, Am Riddershof 9, 47805 Krefeld, DE

- (51) MKP  
**G01N 33/49 (2006.01)** (97) **2619575 \***  
**G01N 33/86 (2006.01)**
- (86) EP2011066200 19.09.2011  
(96) 11761327.3 31.07.2013  
(87) WO2012038370, 19.09.2011  
(97) 2619575, 31.07.2013 en
- (54) METHOD FOR THE DETECTION AND/OR QUANTIFICATION OF THE INTERACTION OF PLATELETS WITH INTERACTION PARTNERS
- (71) SANOFI, 54, rue de la Boétie, 75008 Paris, FR  
(72) DE HOOP, Meltsje, Sanofi-Aventis Deutschland GmbH, 65926 Frankfurt am Main, DE  
LINDAUER, Klaus, Sanofi-Aventis Deutschland GmbH, 65926 Frankfurt am Main, DE  
LUKASCZYK, Ulrike, Sanofi-Aventis Deutschland GmbH, 65926 Frankfurt am Main, DE  
BLUM, Horst, Sanofi-Aventis Deutschland GmbH, 65926 Frankfurt am Main, DE  
LANGER, Thomas, Sanofi-Aventis Deutschland GmbH, 65926 Frankfurt am Main, DE  
ZERLIN, Marion, Sanofi-Aventis Deutschland GmbH, 65926 Frankfurt am Main, DE

- (51) MKP  
**C07D 487/04 (2006.01)** (97) **2598506 \***
- (86) US2011045807 29.07.2011  
(96) 11745862.0 05.06.2013  
(87) WO2012016095, 29.07.2011  
(97) 2598506, 05.06.2013 en
- (54) PROCESS FOR THE PREPARATION OF THE COMPOUND OSI - 906
- (71) OSI Pharmaceuticals, LLC, 1 Bioscience Park Drive, Farmingdale, NY 11735, US  
(72) CASTELHANO, Arlindo, L., OSI Pharmaceuticals LLC 140 East Hanover Avenue, Cedar Knolls, NY 07927, US  
CUTTING, Gary, A., SAFC Pharma The Old Brickyard New Rd., Gillingham Dorset SP8 4XT, GB  
LOCKE, Andrew, J., AMRI Global Pilot Plant Operations 33 Riverside Ave., Rensselaer, NY 12144, US  
MAO, Yunyu, OSI Pharmaceuticals LLC 1 Bioscience Park Drive, Farmingdale, NY 11735, US  
MULVIHILL, Kristen, Michelle, OSI Pharmaceuticals LLC 1 Bioscience Park Drive, Farmingdale, NY 11735, US  
NORRIE, Robert, AMRI 21 Corporate Circle, Albany, NY 12212-5098, US  
O'BRIEN, Andrew, J., API Productions Washington Armory 195 Washington Ave., Albany, NY 12210, US  
PARK, Stuart, R., SAFC Pharma The Old Brickyard New Rd., Gillingham Dorset SP8 4 XT, GB  
RECHKA, Josef, A., OSI Pharmaceuticals LLC 1 Bioscience Park Drive, Farmingdale, NY 11735, US  
STEVENS, Andrew, Michael, null, Delmar, NY 12054, US  
THOMAS, Christopher, I., SAFC Pharma The Old Brickyard New Rd., Gillingham Dorset SP8 4XT, GB

- (51) MKP  
**C07D 471/08 (2006.01)** (97) **2625169 \***  
**A61P 9/06 (2006.01)**  
**A61K 31/517 (2006.01)**  
**A61P 25/02 (2006.01)**  
**C07D 239/74 (2006.01)**  
**A61P 25/28 (2006.01)**  
**C07D 239/84 (2006.01)**  
**A61P 25/06 (2006.01)**  
**C07D 401/12 (2006.01)**  
**A61P 25/24 (2006.01)**  
**C07D 401/04 (2006.01)**  
**A61P 25/08 (2006.01)**  
**C07D 403/12 (2006.01)**  
**A61P 25/14 (2006.01)**  
(86) IB2011002362 05.10.2011  
(96) 11784766.5 14.08.2013  
(87) WO2012046132, 05.10.2011  
(97) 2625169, 14.08.2013 en  
(54) QUINAZOLINE COMPOUNDS AS SODIUM CHANNEL BLOCKERS  
(71) Purdue Pharma L.P., One Stamford Forum 201 Tresser Boulevard, Stamford, CT 06901-3431, US  
(72) GOEHRING, R., Richard, 252 Aspen Woods Drive, Yardley PA 19067, US  
TAFESSE, Laykea, 8 Windward Way, Robbinsville NJ 08690, US  
YAO, Jiangchao, 10 Bellflower Court, Princeton NJ 08540, US

- (51) MKP  
**C07D 401/12 (2006.01)** (97) **2627630 \***  
**C07D 207/08 (2006.01)**  
**A61P 11/00 (2006.01)**  
**A61K 31/40 (2006.01)**  
(86) US2011055580 10.10.2011  
(96) 11773367.5 21.08.2013  
(87) WO2012051103, 10.10.2011  
(97) 2627630, 21.08.2013 en  
(54) SEROTONIN REUPTAKE INHIBITORS  
(71) Theravance, Inc., 901 Gateway Boulevard, South San Francisco, CA 94080, US  
(72) STANGELAND, Eric L., 896 Corona Drive, Pacifica California 94044, US  
PATTERSON, Lori Jean, 3 Whitney Street, San Francisco California 94131, US  
SAITO, Daisuke Roland, 1600 E. 3rd Avenue 2803, San Mateo California 94401, US

- (51) MKP  
**H02J 7/34 (2006.01)** (97) **2523305**  
**H02J 9/00 (2006.01)**  
(96) 11165799.5 14.11.2012  
(97) 2523305, 14.11.2012 de  
(54) Emergency energy supply device and method for supplying emergency energy  
(71) Moog Unna GmbH, Max-Born-Strasse 1, 59423 Unna, DE  
(72) Rösman, Tobias, Elbinger Straße 10, 44263 Dortmund, DE

- (51) MKP  
**C07D 473/04 (2006.01)** (97) **2616469 \***  
**A61K 31/52 (2006.01)**  
**C07D 471/10 (2006.01)**  
(86) US2011051563 14.09.2011  
(96) 11776614.7 24.07.2013  
(87) WO2012037226, 14.09.2011  
(97) 2616469, 24.07.2013 en  
(54) INHIBITORS OF PI3K-DELTA AND METHODS OF THEIR USE AND MANUFACTURE  
(71) Exelixis, Inc., 210 East Grand Avenue, South San Francisco, CA 94080, US  
(72) PATRICK, Kearney, 195 Bocana Street, San Francisco CA 94110, US

- (51) MKP  
**F03B 13/18 (2006.01)** (97) **2596235 \***  
(86) EP2011062155 15.07.2011  
(96) 11732468.1 29.05.2013  
(87) WO2012010518, 15.07.2011  
(97) 2596235, 29.05.2013 en  
(54) OCEAN WAVE POWER PLANT  
(71) Dragic, Mile, Bogdana Gavrilovica 35, 21204 Sremska Kamenica, RS  
(72) Dragic, Mile, Bogdana Gavrilovica 35, 21204 Sremska Kamenica, RS

- (51) MKP  
**A47B 85/04 (2006.01)** (97) **2625986**  
**A47D 11/00 (2006.01)**  
**A47D 9/00 (2006.01)**  
**A47C 13/00 (2006.01)**  
**A47C 4/03 (2006.01)**  
(96) 13154540.2 14.08.2013  
(97) 2625986, 14.08.2013 en  
(54) Modular piece of furniture  
(71) Pintore, Isa, Via dei Pepi 37, 50122 Firenze (FI), IT  
Condorelli, Alessandro, Via Bonifacio Lupi 11, 50129 Firenze (FI), IT  
(72) Pintore, Isa, Via dei Pepi 37, 50122 Firenze (FI), IT  
Condorelli, Alessandro, Via Bonifacio Lupi 11, 50129 Firenze (FI), IT

- (51) MKP  
**A23C 3/037 (2006.01)** (97) **2595492 \***  
**A23C 9/12 (2006.01)**  
**A23C 9/142 (2006.01)**  
(86) EP2011062663 22.07.2011  
(96) 11745512.1 29.05.2013  
(87) WO2012010699, 22.07.2011  
(97) 2595492, 29.05.2013 en  
(54) LACTOSE-REDUCED MILK-RELATED PRODUCT, AND A PROCESS AND MILK PROCESSING PLANT FOR ITS MANUFACTURE  
(71) Arla Foods Amba, Sønderhøj 14, 8260 Viby J, DK  
(72) HOLST, Hans Henrik, Rosenallé 86, DK-6920 Videbæk, DK  
SUNDGREN, Anja, Mårdvägen 32d, S-14 140 Huddinge, SE  
RAUH, Valentin, Pemmeringerstrasse 36, 85656 Buch am Buchrain, DE

- (51) MKP  
**A61P 1/04 (2006.01)** (97) **2604601 \***  
**A61P 37/08 (2006.01)**  
**A61P 19/02 (2006.01)**  
**C07D 401/14 (2006.01)**  
**A61P 29/00 (2006.01)**  
**A61K 31/5377 (2006.01)**  
**A61P 35/02 (2006.01)**  
**A61P 11/06 (2006.01)**  
**A61P 43/00 (2006.01)**  
**A61P 17/06 (2006.01)**  
**A61K 31/541 (2006.01)**  
**A61P 37/02 (2006.01)**  
**A61K 31/55 (2006.01)**  
**A61P 37/06 (2006.01)**  
(86) JP2011068169 09.08.2011  
(96) 11816426.8 19.06.2013  
(87) WO2012020762, 09.08.2011  
(97) 2604601, 19.06.2013 en  
(54) HETERO RING COMPOUND  
(71) Astellas Pharma Inc., 3-11, Nihonbashi-Honcho 2-chome Chuo-ku, Tokyo 103-8411, JP  
(72) TAKAHASHI, Fumie, c/o Astellas Pharma Inc. 3-11 Nihonbashi-Honcho 2-chome Chuo-ku, Tokyo 103-8411, JP  
IMADA, Sunao, c/o Astellas Pharma Inc. 3-11 Nihonbashi-Honcho 2-chome Chuo-ku, Tokyo 103-8411, JP  
ASANO, Toru, c/o Astellas Pharma Inc. 3-11 Nihonbashi-Honcho 2-chome Chuo-ku, Tokyo 103-8411, JP  
KOZUKI, Yoshihiro, c/o Astellas Pharma Inc. 3-11 Nihonbashi-Honcho 2-chome Chuo-ku, Tokyo 103-8411, JP  
MAEDA, Junko, c/o Astellas Pharma Inc. 3-11 Nihonbashi-Honcho 2-chome Chuo-ku, Tokyo 103-8411, JP  
KATO, Koji, c/o Astellas Pharma Inc. 3-11 Nihonbashi-Honcho 2-chome Chuo-ku, Tokyo 103-8411, JP  
FUKAHORI, Hidehiko, c/o Astellas Pharma Inc. 3-11 Nihonbashi-Honcho 2-chome Chuo-ku, Tokyo 103-8411, JP

- (51) MKP  
**A61K 39/12 (2006.01)** (97) **2632485 \***  
(86) US2011058026 27.10.2011  
(96) 11865332.8 04.09.2013  
(87) WO2012154202, 27.10.2011  
(97) 2632485, 04.09.2013 en  
(54) RECOMBINANT SUBUNIT DENGUE VIRUS VACCINE  
(71) Merck Sharp & Dohme Corp., 126 East Lincoln Avenue, Rahway NJ 07065-0907, US  
(72) COLLER, Beth-Ann Griswold, 770 Sumneytown Pike, West Point Pennsylvania 19486, US  
PAI, Vidya B., 4704 Red Fox Road, Rockville Maryland 20852, US  
PARKS, D. Elliot, 4568 Vista de la Tierra, Del Mar California 92014, US  
YELMENE, Michele, 4568 Vista de la Tierra, Del Mar California 92014, US  
BETT, Andrew J., 770 Sumneytown Pike, West Point Pennsylvania 19486, US  
MARTYAK, Timothy, 99-193 Aiea Heights Drive Suite 200, Aiea Hawaii 96701, US
- 
- (51) MKP  
**A61P 35/04 (2006.01)** (97) **2595618 \***  
**A61K 31/282 (2006.01)**  
**A61K 31/7068 (2006.01)**  
**A61K 31/166 (2006.01)**  
**A61K 31/337 (2006.01)**  
**A61P 35/00 (2006.01)**  
(86) US2011044560 19.07.2011  
(96) 11810294.6 29.05.2013  
(87) WO2012012448, 19.07.2011  
(97) 2595618, 29.05.2013 en  
(54) METHODS OF TREATING BREAST CANCER USING 4-iodo-3-nitrobenzamide in combination with anti-tumor agents  
(71) BiPar Sciences, Inc., 55 Corporate Drive, Bridgewater NJ 08807, US  
(72) BRADLEY, Charles, 66 Spyglass Court, Half Moon Bay CA 94019, US
- 
- (51) MKP  
**A61K 31/44 (2006.01)** (97) **2608667 \***  
**A01N 43/16 (2006.01)**  
**A61K 31/35 (2006.01)**  
**C07D 315/00 (2006.01)**  
**A01N 43/40 (2006.01)**  
(86) US2011049037 25.08.2011  
(96) 11820626.7 03.07.2013  
(87) WO2012027521, 25.08.2011  
(97) 2608667, 03.07.2013 en  
(54) PESTICIDAL COMPOSITIONS  
(71) Dow AgroSciences LLC, 9330 Zionsville Road, Indianapolis, IN 46268, US  
(72) CREEMER, Lawrence, C., 1763 N. James Blvd, Greenfield, IN 46140, US  
CROUSE, Gary, D., 5069 East 146th Street, Noblesville, IN 46062, US  
SPARKS, Thomas, C., 1322 Greenhills Road, Greenfield, IN 46140, US  
MCLEOD, CaSandra Lee, 1121 Walnut St, Apt 2R, Philadelphia, PA 19107, US
- 
- (51) MKP  
**E04F 21/18 (2006.01)** (97) **2573297**  
**B62B 1/00 (2006.01)**  
(96) 12306002.2 27.03.2013  
(97) 2573297, 27.03.2013 fr  
(54) Movable structure for handling and installing panels or plates onto walls or ceilings  
(71) M.B.H. Developpement, Le Temple, 42640 Saint Romain la Motte, FR  
(72) Bottazzi, Marc, Chemin des Ormes, 42120 SAINT VINCENT DE BOISSET, FR
- 
- (51) MKP  
**B62B 7/06 (2006.01)** (97) **2611670 \***  
**B62B 9/08 (2006.01)**  
(86) AU2011001133 01.09.2011  
(96) 11820927.9 10.07.2013  
(87) WO2012027795, 01.09.2011  
(97) 2611670, 10.07.2013 en  
(54) FOLDING STROLLER IMPROVEMENTS  
(71) Britax Childcare Pty Ltd., 99 Derby Road, Sunshine, VIC 3020, AU  
(72) TANG, Weng, Onn, 99 Derby Road, Sunshine Victoria 3020, AU  
LIU, Xiuping, No. 11 Yongan Road Lianguang Industrial Zone Zhuhai Road Jinwan District. Zhuhai Guangdong, CN
- 
- (51) MKP  
**A61K 31/4196 (2006.01)** (97) **2640384 \***  
**A61P 35/00 (2006.01)**  
**A61K 31/436 (2006.01)**  
**A61K 31/506 (2006.01)**  
**A61K 31/502 (2006.01)**  
**A61K 31/517 (2006.01)**  
**A61K 31/4439 (2006.01)**  
**A61K 31/437 (2006.01)**  
**A61K 31/395 (2006.01)**  
(86) US2011061446 18.11.2011  
(96) 11791158.6 25.09.2013  
(87) WO2012068487, 18.11.2011  
(97) 2640384, 25.09.2013 en  
(54) PRESELECTION OF SUBJECTS FOR THERAPEUTIC TREATMENT WITH OXYGEN SENSITIVE AGENTS BASED ON HYPOXIC STATUS  
(71) Synta Pharmaceuticals Corp., 45 Hartwell Avenue, Lexington, MA 02421, US  
(72) BLACKMAN, Ronald, K., 140 Sewall Avenue, 2, Brookline MA 02446, US  
VUKOVIC, Vojo, 51 Wildwood Street, Winchester MA 01890, US
- 
- (51) MKP  
**F16L 58/00 (2006.01)** (97) **2601431 \***  
(86) GB2011051483 04.08.2011  
(96) 11755102.8 12.06.2013  
(87) WO2012017250, 04.08.2011  
(97) 2601431, 12.06.2013 en  
(54) CORROSION PROTECTION OF PIPES SUSPENDED IN SEAWATER  
(71) Flexlife Limited, Excel Centre Exploration Drive, Bridge of Don AB23 8GX, GB  
(72) KEYWORTH, Craig Scott, Rasebrook Farm North Street Middle Rasen, Lincolnshire LN8 3TS, GB
- 
- (51) MKP  
**B65G 1/137 (2006.01)** (97) **2514690**  
**B66F 9/075 (2006.01)**  
**G05D 1/02 (2006.01)**  
(96) 11163027.3 24.10.2012  
(97) 2514690, 24.10.2012 en  
(54) Warehouse guiding system for industrial trucks  
(71) Deutsche Post AG, Charles-de-Gaulle-Strasse 20, 53113 Bonn, DE  
(72) Cavalheiro Lopes, José Manuel, Urbanizacao da Malvarosa Rua Engenheiro Moniz Maia n. 17R/C D, 2615-044 Alverca do Ribatejo, PT
-

(51) MKP  
**C07D 491/20 (2006.01)** (97) **2643325 \***  
**A61K 31/527 (2006.01)**  
**A61P 25/28 (2006.01)**  
(86) US2011061473 18.11.2011  
(96) 11791392.1 02.10.2013  
(87) WO2012071279, 18.11.2011  
(97) 2643325, 02.10.2013 en  
(54) SPIRO-AMINO-IMIDAZOLONE AND SPIRO-AMINO-DIHYDRO-PYRIMIDINONE COMPOUNDS AS BETA-SECRETASE MODULATORS AND METHODS OF USE  
(71) Amgen Inc., One Amgen Center Drive, Thousand Oaks, CA 91320, US  
(72) MINATTI, Ana Elena, 6301 De Soto Avenue 325, Woodland Hills California 91367, US  
EPSTEIN, Oleg, 44 Trowbridge Street, Belmont Massachusetts 02478, US  
WHITE, Ryan, 34 Willow Avenue Unit 1, Somerville Massachusetts 02144, US  
WEISS, Matthew, 99 Revere Street, Boston Massachusetts 02114, US  
ZHONG, Wenge, 2921 Venezia Lane, Thousand Oaks California 91362, US  
LOW, Jonathan, 18644 Clark Street 5, Tarzana California 91356, US

(51) MKP  
**G06K 7/08 (2006.01)** (97) **2628127 \***  
(86) US2011055375 07.10.2011  
(96) 11833169.3 21.08.2013  
(87) WO2012051067, 07.10.2011  
(97) 2628127, 21.08.2013 en  
(54) READ HEAD DEVICE WITH SLOT CONFIGURED TO REDUCE TORQUE  
(71) Square, Inc., 110 Fifth Street, San Francisco, CA 94103, US  
(72) MCKELVEY, James, M., 7501 Scenic Highway, Pensacola FL 32504, US  
WEN, Xuancong, 901 Mission Street Suite 104, San Francisco CA 94103, US  
DORSEY, Jack, 901 Mission Street Suite 104, San Francisco CA 94103, US  
BABU, Amish, Rajesh, 355 N. Wolfe Road Apt. 336, Sunnyvale CA 94085, US

(51) MKP  
**C08F 8/00 (2006.01)** (97) **2635610 \***  
(86) US2011059320 04.11.2011  
(96) 11838872.7 11.09.2013  
(87) WO2012061702, 04.11.2011  
(97) 2635610, 11.09.2013 en  
(54) DUAL-CURE POLYMER SYSTEMS  
(71) The Regents of the University of Colorado, A Body Corporate, 1800 Grant Street, 8th Floor, Denver, CO 80203, US  
(72) BOWMAN, Christopher, 5205 Waterstone Drive, Boulder CO 80301, US  
NAIR, Devatha, 1843 Trevor Circle, Longmont, CO 80501, US  
CRAMER, Neil, 4180 Evans Dr., Boulder CO 80303, US  
SHANDAS, Robin, 1408 Kingwood Place, Boulder CO 80304, US

(51) MKP  
**F24D 13/02 (2006.01)** (97) **2596293 \***  
(86) IB2010053349 22.07.2010  
(96) 10752397.9 29.05.2013  
(87) WO2012010931, 22.07.2010  
(97) 2596293, 29.05.2013 en  
(54) HEATING DEVICE  
(71) Thermo Engineering S.r.l., Via Poloni 4, 37100 Verona, IT  
(72) STABILE, Aldo, c/o Thermo Engineering S.r.l. Via Poloni 4, I-37100 Verona, IT

(51) MKP  
**A61K 31/4709 (2006.01)** (97) **2583677**  
**A61K 31/4025 (2006.01)**  
**A61K 31/4725 (2006.01)**  
**A61P 31/14 (2006.01)**  
**A61K 31/5377 (2006.01)**  
**A61K 31/513 (2006.01)**  
**A61K 31/4178 (2006.01)**  
**A61K 31/497 (2006.01)**  
(96) 12189198.0 24.04.2013  
(97) 2583677, 24.04.2013 en  
(54) Methods for treating HCV comprising at least two direct acting antiviral agent, ribavirin but not interferon.  
(71) Abbvie Inc., 1 North Waukegan Road, North Chicago, IL 60064, US  
(72) Bernstein, Barry M., 10829 Wyngate Trace, Mequon, WI Wisconsin 53092, US  
Menon, Rajeev M., 81 Pinyon Pine Court, Buffalo Grove, IL Illinois 60089, US  
Khatri, Amit, 1360 S. White Oak Drive, Apt. 225, Waukegan, IL Illinois 60085, US  
Mensing, Sven, Langer Schlag 95a, 68305 Mannheim, DE  
Dutta, Sandeep, 9303 Clem Drive, Gurnee, IL Illinois 60031, US  
Cohen, Daniel E., 930 Oakwood Avenue, Wilmette, IL Illinois 60091, US  
Podsadecki, Thomas, 708 B. North Orleans, Chicago, IL Illinois 60654, US  
Brun, Scott C., 31048 Prairie Ridge Road, Green Oaks, IL Illinois 60048, US  
Awni, Walid M., 14105 Edgewater Court, Green Oaks, IL Illinois 60048, US  
Dumas, Emily O., 232 E. Winchester, Libertyville, IL Illinois 60048, US  
Klein, Cheri E., 1933 Barberry Road, Northbrook, IL Illinois 60062, US

(51) MKP  
**C07J 41/00 (2006.01)** (97) **2611821 \***  
**C07J 31/00 (2006.01)**  
(86) IN2011000600 02.09.2011  
(96) 11805619.1 10.07.2013  
(87) WO2012029077, 02.09.2011  
(97) 2611821, 10.07.2013 en  
(54) PROCESS FOR PREPARING FLUTICASONE PROPIONATE/FUROATE  
(71) Cadila Healthcare Limited, Zydus Tower Satellite Cross Roads, Ahmedabad 380 015, Gujarat, IN  
(72) SOLANKI, Kirtipalsinh, Cadila Healthcare Limited Zydus Tower Satellite Cross Road Ahmedabad 380 015, Gujarat, IN  
BAVADIA, Ruchir Z, Cadila Healthcare Limited Zydus Tower Satellite Cross Road Ahmedabad 380 015, Gujarat, IN  
PATEL, Dhaval P, Cadila Healthcare Limited Zydus Tower Satellite Cross Road Ahmedabad 380 015, Gujarat, IN  
PATEL, Dhaval J, Cadila Healthcare Limited Zydus Tower Satellite Cross Road Ahmedabad 380 015, Gujarat, IN  
SHAH, Tejash C, Cadila Healthcare Limited Zydus Tower Satellite Cross Road Ahmedabad 380 015, Gujarat, IN  
SINGH, Manoj Kumar, Cadila Healthcare Limited Zydus Tower Satellite Cross Road Ahmedabad 380 015, Gujarat, IN

(51) MKP  
**A61B 17/115 (2006.01)** (97) **2524655**  
(96) 12168704.0 21.11.2012  
(97) 2524655, 21.11.2012 en  
(54) Circular stapling instrument having a breakaway washer attachment member  
(71) Ethicon Endo-Surgery, Inc., 4545 Creek Road, Cincinnati, OH 45242, US  
(72) Nalagatla, Anil K., 6581 Gove Court, Mason, Ohio 45040, US  
Kruszynski, Michael L., 1410 Cheltenham Drive, Loveland, Ohio 45140, US  
Adams, Thomas E., 4098 Crestview Drive, Loveland, Ohio 45140, US

- (51) MKP  
**E04F 21/18 (2006.01)** (97) **2573298**  
(96) 12306007.1 27.03.2013  
(97) 2573298, 27.03.2013 fr  
(54) Plate support for an apparatus for mounting plates onto walls or ceilings  
(71) M.B.H. Developpement, Le Temple, 42640 Saint Romain la Motte, FR  
(72) Bottazi, Marc, Chemin des Ormes, 42120 SAINT VINCENT DE BOISSET, FR
- 
- (51) MKP  
**B07B 1/14 (2006.01)** (97) **2511014**  
**B07B 1/15 (2006.01)**  
(96) 11003153.1 17.10.2012  
(97) 2511014, 17.10.2012 de  
(54) Roller screen filter device  
(71) August Müller GmbH & Co. KG, Hochmauernstrasse 9, 78628 Rottweil, DE  
(72) Seifried, Richard, Am Schwarzen Felsen 1, 78628 Rottweil, DE  
Wagner, Gerd, Neckarstrasse 74, 78628 Rottweil, DE
- 
- (51) MKP  
**C07D 401/14 (2006.01)** (97) **2625175 \***  
**A61K 31/4439 (2006.01)**  
**A61P 35/00 (2006.01)**  
(86) US2011053798 29.09.2011  
(96) 11771312.3 14.08.2013  
(87) WO2012047699, 29.09.2011  
(97) 2625175, 14.08.2013 en  
(54) CRYSTALLINE (R) - (E) -2- (4- (2- (5- (1- (3, 5 -DICHLOROPYRIDIN-4 -YL) ETHOXY) - 1H - INDAZOL - 3 - YL) VINYL) -1 H- PYRAZOL- 1 -YL) ETHANOL AND ITS USE AS FGFR INHIBITOR  
(71) Eli Lilly and Company, Lilly Corporate Center, Indianapolis, IN 46285, US  
(72) DISEROAD, Benjamin Alan, c/o Eli Lilly and Company P.O.Box 6288, Indianapolis, Indiana 46206-6288, US
- 
- (51) MKP  
**C07D 221/06 (2006.01)** (97) **2640705 \***  
**C07D 221/08 (2006.01)**  
**C07D 221/10 (2006.01)**  
**C07D 401/04 (2006.01)**  
**C07D 417/04 (2006.01)**  
**C07D 471/04 (2006.01)**  
**C07D 471/14 (2006.01)**  
**C07D 487/04 (2006.01)**  
**C07D 491/048 (2006.01)**  
**C07D 491/06 (2006.01)**  
**C07D 495/04 (2006.01)**  
**C07D 495/14 (2006.01)**  
**C07D 519/00 (2006.01)**  
**A61P 31/00 (2006.01)**  
**A61K 31/435 (2006.01)**  
**A61K 31/4355 (2006.01)**  
**A61K 31/437 (2006.01)**  
**A61K 31/519 (2006.01)**  
(86) EP2011070089 15.11.2011  
(96) 11781819.5 25.09.2013  
(87) WO2012065963, 15.11.2011  
(97) 2640705, 25.09.2013 en  
(54) NOVEL ANTIVIRAL COMPOUNDS  
(71) Katholieke Universiteit Leuven, Minderbroedersstraat 8A - bus 5105, 3000 Leuven, BE  
(72) CHALTIN, Patrick, Chaussée de Tirlemont 467, B-1370 Zetrud-Lumay, BE  
CHRIST, Frauke, Idalaan 8, B-3001 Heverlee, BE  
DEBYSER, Zeger, Korbeek-Losestraat 108, B-3001 Heverlee, BE  
DE MAEYER, Marc, Onze-Lieve-Vrouwstraat 24, B-3054 Vaalbeek, BE  
MARCHAND, Arnaud, Nieuwstraat 17, B-3360 Korbeek-Lo, BE  
MARCHAND, Damien, Guido Gezellelaan 14/4, B-3010 Kessel-Lo, BE  
VOET, Arnout, 2-2 Hirotagawa, Wako-shi Saitama, JP
- 
- (51) MKP  
**C11D 3/386 (2006.01)** (97) **2627747 \***  
**C11D 3/00 (2006.01)**  
**C11D 11/00 (2006.01)**  
**A61L 2/18 (2006.01)**  
(86) EP2010065567 15.10.2010  
(96) 10765797.5 21.08.2013  
(87) WO2012048758, 15.10.2010  
(97) 2627747, 21.08.2013 fr  
(54) PRODUCT AND METHOD FOR THE REMOVAL OF BIOFILMS  
(71) Realco SA, Avenue Albert Einstein 15, 1348 Louvain La Neuve, BE  
Institut National De La Recherche Agronomique (INRA), 147 Rue de l'Université, 75338 Paris Cedex 07, FR  
(72) BOELS, Gauthier, Rue des Pères Blancs 11, B-1040 Bruxelles, BE  
BLACKMAN, Gordon, Rue Bois Eloi 23, B-1380 Lasnes, BE  
FAILLE, Christine, Rue de Loos 21, F-59000 Lille, FR  
LEQUETTE, Yannick, Rue de Carency 7, F-62144 Mont saint Eloi, FR  
CLARISSE, Martine, Rue des Ecoles 32, F-59390 Lys-lez-Lannoy, FR
- 
- (51) MKP  
**C07H 21/02 (2006.01)** (97) **2638056 \***  
**A61K 31/7125 (2006.01)**  
**A61P 31/14 (2006.01)**  
(86) EP2011069824 10.11.2011  
(96) 11788786.9 18.09.2013  
(87) WO2012062847, 10.11.2011  
(97) 2638056, 18.09.2013 en  
(54) USE OF 2',5'-OLIGOADENYLATE DERIVATIVE COMPOUNDS  
(71) Protea Biopharma N.V., De Tyraslaan 111, 1120 Neder-Over-Heembeek, BE  
(72) ROELANT, Christiaan, 's Hertogenlaan 115, B-3000 Leuven, BE  
DE MEIRLEIR, Kenny, Stuivenbergbaan 89, B-2800 Mechelen, BE
- 
- (51) MKP  
**A61K 31/4196 (2006.01)** (97) **2616070 \***  
**C07D 401/14 (2006.01)**  
**C07D 403/06 (2006.01)**  
**C07D 413/14 (2006.01)**  
**A61P 5/06 (2006.01)**  
(86) EP2011066057 16.09.2011  
(96) 11757614.0 24.07.2013  
(87) WO2012035124, 16.09.2011  
(97) 2616070, 24.07.2013 en  
(54) NOVEL TRIAZOLE DERIVATIVES WITH IMPROVED RECEPTOR ACTIVITY AND BIOAVAILABILITY PROPERTIES AS GHRELIN ANTAGONISTS OF GROWTH HORMONE SECRETAGOGUE RECEPTORS  
(71) Æterna Zentaris GmbH, Weismüllerstraße 50, 60314 Frankfurt am Main, DE  
Centre National de la Recherche Scientifique, 3, rue Michel-Ange, 75794 Paris Cedex 16, FR  
University of Montpellier I, 5, boulevard Henri IV, 34967 Montpellier Cedex 2, FR  
University of Montpellier II, Place Eugène Bataillon Case Courrier 406, 34095 Montpellier Cedex 5, FR  
(72) AICHER, Babette, Scheffelstraße 13, 60318 Frankfurt am Main, DE  
MÜLLER, Gilbert, Bischofsweg 1 A, 60598 Frankfurt am Main, DE  
PAULINI, Klaus, Bahnhofstraße 136c, 63477 Maintal, DE  
BLUMENSTEIN, Lars, Erich-Kästner-Straße 11, 60388 Frankfurt am Main, DE  
SCHMIDT, Peter, Dittersdorfer Strasse 42, 61137 Schöneck, DE  
GERLACH, Matthias, Pfarrgasse 1, 63636 Brachtal, DE  
TEIFEL, Michael, Franz-Seliger-Str. 15, 64331 Weiterstadt, DE  
MARTINEZ, Jean, Le Jardin des Muses 9 rue Jean Moulin, F-34720 Caux, FR  
FEHRENTZ, Jean-Alain, 217 avenue de l'Abriado, F-34400 St. Nazaire de Pezan, FR  
BLAYO, Anne-Laure, Kergohan, F-56580 Credin, FR



- (51) MKP  
**A61K 38/16 (2006.01)** (97) **2621478 \***  
**A61J 3/07 (2006.01)**  
**A61K 9/48 (2006.01)**  
**A61K 38/01 (2006.01)**  
**A61J 3/02 (2006.01)**  
**A61K 9/16 (2006.01)**  
**A61P 35/00 (2006.01)**
- (86) US2011054238 30.09.2011  
(96) 11829971.8 07.08.2013  
(87) WO2012044939, 30.09.2011  
(97) 2621478, 07.08.2013 en  
(54) METHOD OF PREPARING A DRY POWDER FROM A WATER BACTERIA EXTRACT-CONCENTRATE  
(71) Golub, Emil, 2000 Atlantic Shores Blvd. Apt 416, Hallendale, FL 33009, US  
(72) Golub, Emil, 2000 Atlantic Shores Blvd. Apt 416, Hallendale, FL 33009, US
- 
- (51) MKP  
**A01N 59/00 (2006.01)** (97) **2624701 \***  
**C02F 1/467 (2006.01)**  
**E03C 1/046 (2006.01)**  
**A01P 1/00 (2006.01)**  
**A61K 33/20 (2006.01)**
- (86) CH2011000233 03.10.2011  
(96) 11770996.4 14.08.2013  
(87) WO2012051728, 03.10.2011  
(97) 2624701, 14.08.2013 de  
(54) METHOD FOR PRODUCING ELECTRO ACTIVATED WATER BY ELECTROLYSIS OF AN AQUEOUS SODIUM CHLORIDE SOLUTION  
(71) Meier, René, Hörndlirain 20, 6318 Walchwil, CH  
(72) Meier, René, Hörndlirain 20, 6318 Walchwil, CH
- 
- (51) MKP  
**A61K 41/00 (2006.01)** (97) **2598169 \***  
**A61K 49/22 (2006.01)**
- (86) IB2011053341 27.07.2011  
(96) 11767068.7 05.06.2013  
(87) WO2012014163, 27.07.2011  
(97) 2598169, 05.06.2013 en  
(54) AN ANTIGEN SPECIFIC ULTRASOUND CONTRAST MEDIUM, A PROCESS FOR THE PREPARATION THEREOF AND ITS USES  
(71) Sabino, Giuseppe, Via Roma 7, 81050 Pastorano (CE), IT  
(72) Sabino, Giuseppe, Via Roma 7, 81050 Pastorano (CE), IT
- 
- (51) MKP  
**G06F 19/00 (2011.01)** (97) **2455877**  
**A61B 5/145 (2006.01)**
- (96) 12155076.8 23.05.2012  
(97) 2455877, 23.05.2012 en  
(54) Method for diabetes management  
(71) Lifescan Scotland Limited, Beechwood Park North, Inverness IV2 3ED, GB  
(72) Jerdonek, Ronald, 407 N. Alfred, Alexandria VA 22314, US  
Longmuir, Alistair, Alexandra Terrace, Forres Morayshire IV36 1DL, GB  
Raj, Siv, 12 Grove Court, Beaconsfield HP9 1QW, GB  
Macrae, Allan, 20a Culcabock Avenue, Inverness IV2 3RG, GB  
Weseley, Lisa, 10 Torino Lane, San Carlos CA 94070, US  
Stephens, Chris, 1034 Ringwood Avenue, Menlo Park CA 94025, US
- 
- (51) MKP  
**A61K 31/55 (2006.01)** (97) **2640396 \***
- (86) US2011060840 15.11.2011  
(96) 11842041.3 25.09.2013  
(87) WO2012068149, 15.11.2011  
(97) 2640396, 25.09.2013 en  
(54) BENZODIAZEPINE DERIVATIVES, COMPOSITIONS AND METHODS FOR TREATING COGNITIVE IMPAIRMENT  
(71) Agenebio, Inc., 351 West 10th Street, Indianapolis, IN 46202, US  
(72) LOWE, John, A., III, 28 Coveside Lane, Stonington CT 06378, US
- 

- (51) MKP  
**C07D 205/04 (2006.01)** (97) **2611774 \***  
**C07D 403/14 (2006.01)**  
**C07D 409/14 (2006.01)**  
**C07D 413/14 (2006.01)**  
**C07D 417/12 (2006.01)**  
**C07D 417/14 (2006.01)**  
**C07D 513/04 (2006.01)**  
**A61K 31/427 (2006.01)**  
**A61K 31/429 (2006.01)**  
**A61P 29/00 (2006.01)**
- (86) US2011049885 31.08.2011  
(96) 11755498.0 10.07.2013  
(87) WO2012030907, 31.08.2011  
(97) 2611774, 10.07.2013 en  
(54) DI-AZETIDINYL DIAMIDE AS MONOACYLGLYCEROL LIPASE INHIBITORS  
(71) Janssen Pharmaceutica, N.V., Turnhoutseweg 30, 2340 Beerse, BE  
(72) CONNOLLY, Peter, J., Welsh and McKean Roads P.O. Box 776, Spring House, PA 19477, US  
MACIELAG, Mark, J., Welsh and McKean Roads P.O. Box 776, Spring House, PA 19477, US  
ZHU, Bin, Welsh and McKean Roads P.O. Box 776, Spring House, PA 19477, US
- 
- (51) MKP  
**C07D 401/12 (2006.01)** (97) **2640467 \***  
**A61P 35/00 (2006.01)**  
**A61K 31/495 (2006.01)**
- (86) EP2011070385 17.11.2011  
(96) 11790916.8 25.09.2013  
(87) WO2012066095, 17.11.2011  
(97) 2640467, 25.09.2013 en  
(54) CRYSTALLINE FORM OF AN INHIBITOR OF MDM2/4 AND P53 INTERACTION  
(71) Novartis AG, Lichtstrasse 35, 4056 Basel, CH  
(72) BERGHAUSEN, Joerg, Novartis Pharma AG Postfach, CH-4002 Basel, CH  
REN, Haixia, China Novartis Institutes for BioMedical Research No. 8 Building Lane 898 Halei Road, Shanghai 201203, CN
- 
- (51) MKP  
**A61K 35/00 (2006.01)** (97) **2643317 \***  
**C07D 413/14 (2006.01)**  
**C07D 471/04 (2006.01)**  
**C07D 513/14 (2006.01)**  
**C07D 413/04 (2006.01)**  
**A61K 31/553 (2006.01)**  
**C07D 417/14 (2006.01)**
- (86) US2011062052 23.11.2011  
(96) 11805679.5 02.10.2013  
(87) WO2012071519, 23.11.2011  
(97) 2643317, 02.10.2013 en  
(54) BENZOXAZEPINES AS INHIBITORS OF P13K/MTOR AND METHODS OF THEIR USE AND MANUFACTURE  
(71) Exelixis, Inc., 210 East Grand Avenue, South San Francisco, CA 94080, US  
(72) RICE, Kenneth, 44 Montecillos Road, San Rafael, CA 94903, US  
FOSTER, Paul, 51 Portsmouth Dr., Novato, CA 94949, US
- 
- (51) MKP  
**A61K 39/00 (2006.01)** (97) **2608803 \***  
**C07K 16/00 (2006.01)**
- (86) US2011049147 25.08.2011  
(96) 11820654.9 03.07.2013  
(87) WO2012027570, 25.08.2011  
(97) 2608803, 03.07.2013 en  
(54) DUAL VARIABLE DOMAIN IMMUNOGLOBULINS AND USES THEREOF  
(71) Abbvie Inc., 1 North Waukegan Road, North Chicago, IL 60064, US  
(72) GHAYUR, Tariq, 1014 Washington Street, Holliston, Massachusetts 01746, US  
SALFELD, Jochen, G., 177 Old Westboro Road, North Grafton, Massachusetts 01536, US  
MCPHERSON, Michael, J., 287 Pillsbury Road, Ashby, Massachusetts 01431, US
-

- (51) MKP  
**B22D 19/00 (2006.01)** (97) **2621649 \***  
**F27D 1/12 (2006.01)**  
**F28D 1/047 (2006.01)**  
**F28F 3/12 (2006.01)**  
(86) EP2011059470 08.06.2011  
(96) 11725906.9 07.08.2013  
(87) WO2012041542, 08.06.2011  
(97) 2621649, 07.08.2013 en  
(54) HEAT EXCHANGER WITH DIE-CAST ELEMENTS AND METHOD FOR MANUFACTURING THE SAME  
(71) Unical AG S.p.A., Via Roma 123, 46033 Castel D'ario, IT  
(72) MORINI, Mario, Via San Saluto 19, I-27043 Broni, IT
- 
- (51) MKP  
**C07D 487/04 (2006.01)** (97) **2638045 \***  
(86) EP2011069637 08.11.2011  
(96) 11784978.6 18.09.2013  
(87) WO2012062748, 08.11.2011  
(97) 2638045, 18.09.2013 en  
(54) AMINOALCOHOL SUBSTITUTED  
2,3-DIHYDROIMIDAZO[1,2-C]QUINAZOLINE DERIVATIVES USEFUL FOR TREATING HYPER-PROLIFERATIVE DISORDERS AND DISEASES ASSOCIATED WITH ANGIOGENESIS  
(71) Bayer Intellectual Property GmbH, Alfred-Nobel-Str. 10, 40789 Monheim am Rhein, DE  
(72) SCOTT, William Johnston, 210 Saddle Hill Drive, Guilford, CT 06437, US  
LIU, Ningshu, Ringstr. 89a, 12203 Berlin, DE  
MÖWES, Manfred, Maßmannstr. 9, 12163 Berlin, DE  
HÄGEBARTH, Andrea, An den Eldenaer Höfen 13, 10247 Berlin, DE  
BÖMER, Ulf, Leipziger Str. 49, 16548 Glienicke, DE  
MÖNNING, Ursula, Eichendamm 5, 15569 Woltersdorf, DE
- 
- (51) MKP  
**C07C 255/43 (2006.01)** (97) **2644597**  
**C07C 215/08 (2006.01)**  
**C07C 229/34 (2006.01)**  
**C07D 223/16 (2006.01)**  
(86) 13161193.1 02.10.2013  
(97) 2644597, 02.10.2013 fr  
(54) Novel method for synthesising ivabradine and its pharmaceutically acceptable acid addition salts  
(71) Les Laboratoires Servier, 35, rue de Verdun, 92284 Suresnes Cedex, FR  
(72) Le Flohic, Alexandre, 25 rue des jardins, 76640 Fauville en Caux, FR  
Grandjean, Mathieu, 7 chemin du bois du roi, 76170 La Frenaye, FR
- 
- (51) MKP  
**C07D 401/12 (2006.01)** (97) **2638030 \***  
**A61K 31/519 (2006.01)**  
**A61P 35/00 (2006.01)**  
(86) US2011059890 09.11.2011  
(96) 11791110.7 18.09.2013  
(87) WO2012064805, 09.11.2011  
(97) 2638030, 18.09.2013 en  
(54) SALT(S) OF 7-CYCLOPENTYL-2-(5-PIPERAZIN-1-YL-PYRIDIN-2-YLAMINO)-7H-PYRROLO[2,3-D]PYRIMIDINE-6-CARBOXYLIC ACID DIMETHYLAMIDE AND PROCESSES OF MAKING THEREOF  
(71) Novartis AG, Lichtstrasse 35, 4056 Basel, CH  
Astex Therapeutics Limited, 436 Cambridge Science Park Milton Park Cambridge, Cambridgeshire CB4 0QA, GB  
(72) CALIENNI, John Vincent, Novartis Pharmaceuticals Corporation One Health Plaza East Hanover, New Jersey 07936, US  
CHEN, Guang-Pei, 33 Preston Drive, Livingston New Jersey 07039, US  
GONG, Baoqing, Novartis Pharmaceuticals Corporation One Health Plaza East Hanover, New Jersey 07936, US  
KAPA, Prasad Koteswara, Novartis Pharmaceuticals Corporation One Health Plaza East Hanover, NJ 07936, US  
SAXENA, Vishal, 2001 Falls Boulevard Apt. 124 Quincy, Massachusetts 02169, US
- 
- (51) MKP  
**F02B 75/26 (2006.01)** (97) **2633207 \***  
**F16H 23/08 (2006.01)**  
**F01B 3/00 (2006.01)**  
**F01B 3/02 (2006.01)**  
**F04B 1/22 (2006.01)**  
**F04B 27/08 (2006.01)**  
(86) IB2011054745 25.10.2011  
(96) 11835719.3 04.09.2013  
(87) WO2012056392, 25.10.2011  
(97) 2633207, 04.09.2013 en  
(54) AXIAL PISTON MACHINES  
(71) Duke Engines Limited, Level 9 Waterloo Towers 20 Waterloo Quadrant, Auckland 1010, NZ  
(72) DUKE, Noel Stephen, 95C Ostrich Road RD4 Pukekohe, Auckland, NZ
- 
- (51) MKP  
**E03D 11/02 (2006.01)** (97) **2562314**  
**E03D 11/08 (2006.01)**  
(86) 12179751.8 27.02.2013  
(97) 2562314, 27.02.2013 en  
(54) Flush toilet  
(71) TOTO LTD., 1-1, Nakashima 2-chome Kokurakita-ku, Kitakyushu-shi Fukuoka 802-8601, JP  
(72) Yamasaki, Yu, c/o TOTO LTD. 1-1 Nakashima 2-chome, Kokurakita-ku,, Kitakyushu-shi, Fukuoka 802-8601, JP  
Inoue, Masaaki, c/o TOTO LTD. 1-1 Nakashima 2-chome, Kokurakita-ku,, Kitakyushu-shi, Fukuoka 802-8601, JP  
Nakamura, Masahiro, c/o TOTO LTD. 1-1 Nakashima 2-chome, Kokurakita-ku,, Kitakyushu-shi, Fukuoka 802-8601, JP  
Watanabe, Kenji, c/o TOTO LTD. 1-1 Nakashima 2-chome, Kokurakita-ku,, Kitakyushu-shi, Fukuoka 802-8601, JP
- 
- (51) MKP  
**A61M 16/06 (2006.01)** (97) **2603268 \***  
**A61M 16/14 (2006.01)**  
(86) EP2011063645 08.08.2011  
(96) 11741221.3 19.06.2013  
(87) WO2012020004, 08.08.2011  
(97) 2603268, 19.06.2013 en  
(54) DEVICE AND SYSTEM FOR DELIVERY OF AN AEROSOL TO A PATIENT ON VENTILATORY SUPPORT  
(71) Takeda GmbH, Byk-Gulden-Strasse 2, 78467 Konstanz, DE  
IWATSCHENKO, Peter, MediTech Franken GmbH Forther Hauptstr. 65, 90542 Eckenthal, DE  
POHLMANN, Gerhard, Am Gallweg 14, 31715 Meerbeck, DE  
RAHMEL, Daniela, Sonnenweg 33, 22045 Hamburg, DE  
TAUT, Friedemann, Renkenweg 1, 78464 Konstanz, DE  
DE MUYNCK, Christian, Haydnstr. 21, 78464 Konstanz, DE  
KOCH, Wolfgang, Wendenborsteler Str. 35, 31634 Steimbke, DE  
WINDT, Horst, Celler Weg 9a, 30938 Burgwedel, DE
- 
- (51) MKP  
**G01N 33/558 (2006.01)** (97) **2618153**  
13151778.1 24.07.2013  
(97) 2618153, 24.07.2013 en  
(54) Controlling fluid flow through an assay device  
(71) ORTHO-CLINICAL DIAGNOSTICS, INC., 1001 U.S. Route 202, Raritan, NJ 08869, US  
(72) Kanaley, James D., 23 East Street, Honeoye Falls, New York, NY 14472, US  
Ding, Zhong, 35 Delancey Court, Pittsford, New York, NY 14534, US  
Hosimer, Philip C., 11 Beach Terrace, Rochester, New York, NY 14617, US  
Scalice, Edward R., 30 Cobblestone Crossing, Penfield, New York, NY 14526, US  
Danielson, Susan, 47 Partridge Hill, Honeoye Falls, New York, NY 14472, US  
Tomasso, David A., 174 Old Well Road, Rochester, New York, NY 14626, US  
Warren, Timothy C., 59 Sannita Drive, Rochester, New York, NY 14626, US
-

- (51) MKP  
**A61K 31/4184 (2006.01)** (97) **2603215 \***  
 (86) US2011047263 10.08.2011  
 (96) 11816990.3 19.06.2013  
 (87) WO2012021629, 10.08.2011  
 (97) 2603215, 19.06.2013 en  
 (54) NOVEL D3 DOPAMINE RECEPTOR AGONISTS TO TREAT DYSKINESIA IN PARKINSON'S DISEASE  
 (71) Philadelphia Health and Education Corporation, d/b/a Drexel University College of Medicine 245 N. 15th Street, Philadelphia, PA 19102, US  
 University of Medicine and Dentistry New Jersey Medica School, P.O. Box 2688, New Brunswick, NJ 08903-2688, US  
 (72) KORTAGERE, Sandhya, 43 Northrup Court, Newtown PA 18940, US  
 KUZHIKANDAHIL, Eldo, V., 14 Fairway Drive, West Orange NJ 07103, US
- 
- (51) MKP  
**C07K 16/28 (2006.01)** (97) **2609118 \***  
**C12N 15/13 (2006.01)**  
**A61K 39/395 (2006.01)**  
**A61P 35/00 (2006.01)**  
 (86) US2011048752 23.08.2011  
 (96) 11820495.7 03.07.2013  
 (87) WO2012027328, 23.08.2011  
 (97) 2609118, 03.07.2013 en  
 (54) ANTI-OX40 ANTIBODIES AND METHODS OF USING THE SAME  
 (71) Board of Regents, The University of Texas System, 201 West 7th Street, Austin, TX 78701, US  
 (72) LIU, Yong-Jun, 2623 West Bainbridge Circle, Pearland, TX 77584, US  
 VOO, Kui Shin, 2207 Drake Falls, Pearland, TX 77584, US  
 BOVER, Laura, 4522 Brookren Court, Pearland, TX 77584, US  
 TSURUSHITA, Naoya, 3719 Redwood Circle, Palo Alto, CA 94306, US  
 TSO, J. Yun, 445 Oak Grove Avenue 16, Menlo Park, CA 94025, US  
 KUMAR, Shankar, 3930 Kral Place, Pleasanton, CA 94588, US
- 
- (51) MKP  
**G06F 3/02 (2006.01)** (97) **2610713 \***  
**H04M 1/02 (2006.01)**  
 (86) KR2011006332 26.08.2011  
 (96) 11820215.9 03.07.2013  
 (87) WO2012026788, 26.08.2011  
 (97) 2610713, 03.07.2013 en  
 (54) INPUT METHOD USING ALL OF THE FINGERS OF ONE HAND  
 (71) Kang, Dong-Koo, Jamwonhanshin APT 3-701 Jamwon-Dong 56-3 Seocho-gu Seoul 137-796, Seoul 137-796, KR  
 (72) Kang, Dong-Koo, Jamwonhanshin APT 3-701 Jamwon-Dong 56-3 Seocho-gu Seoul 137-796, Seoul 137-796, KR
- 
- (51) MKP  
**A61K 9/16 (2006.01)** (97) **2608775 \***  
**A61K 31/47 (2006.01)**  
 (86) US2011049467 26.08.2011  
 (96) 11755179.6 03.07.2013  
 (87) WO2012027731, 26.08.2011  
 (97) 2608775, 03.07.2013 en  
 (54) PHARMACEUTICAL COMPOSITION AND ADMINISTRATIONS THEREOF  
 (71) Vertex Pharmaceuticals Incorporated, 130 Waverly Street, Cambridge, MA 02139, US  
 (72) DOKOU, Eleni, 60 Fairfield Street Unit 1, Cambridge, MA 02140, US  
 JAMZAD, Shahla, 4 Lorimer Road, Belmont, MA 02478, US  
 ISRANI, Meghna Jai, 331 Huntington Avenue, 13, Boston, MA 02115, US  
 DAS, Laura, 42 Eighth Street, Unit 2324, Charlestown, MA 02129, US  
 KNEZIC, Dragutin, 28 Franklin Street, Watertown, MA 02472, US  
 KUZMISSION, Andrew, G., 9 Crimson Drive, Shrewsbury, MA 01545, US

- (51) MKP  
**E04C 2/04 (2006.01)** (97) **2643931 \***  
**H03K 17/96 (2006.01)**  
**H05B 37/02 (2006.01)**  
 (86) GB2011052288 22.11.2011  
 (96) 11799802.1 02.10.2013  
 (87) WO2012069818, 22.11.2011  
 (97) 2643931, 02.10.2013 en  
 (54) ACTUATOR AND METHOD OF MANUFACTURE THEREOF  
 (71) Saint-Gobain Placo SAS, 34 Avenue Franklin Roosevelt, 92150 Suresnes, FR  
 (72) EHRENSPERGER, Marie-Virginie, 39 Quai Lucien Lefranc BP 135, F-93303 Aubervilliers Cedex, FR  
 GUERING, Paul-Henri, 39 Quai Lucien Lefranc BP 135, F-93303 Aubervilliers, FR  
 LAVAL, Philippe, 39 Quai Lucien Lefranc BP 135, F-93303 Aubervilliers, FR  
 MORLAT, Richard, 306-348 route de Meaux, F-93410 Vaujours, FR  
 MONGROLLE, Jean-Louis, 456 rue Emile Romanet, F-73000 Chambéry, FR  
 BENKEMOUN, Yves, 34 Avenue Franklin Roosevelt, F-92282 Suresnes Cedex, FR  
 POUSSÉ, Christelle, 348 route de Meaux, F-93410 Vaujours, FR
- 
- (51) MKP  
**C07D 498/02 (2006.01)** (97) **2595994 \***  
 (86) US2011044489 19.07.2011  
 (96) 11810260.7 29.05.2013  
 (87) WO2012012391, 19.07.2011  
 (97) 2595994, 29.05.2013 en  
 (54) PROCESS FOR PREPARING PYRANO - [2,3-C]PYRIDINE DERIVATIVES  
 (71) Glaxo Group Limited, 980 Great West Road, Brentford, Middlesex TW8 9GS, GB  
 (72) SISKO, Joseph, GlaxoSmithKline c/o Global Patents 709 Swedeland Road King of Prussia, PA 19406, US  
 MANS, Douglas, GlaxoSmithKline c/o Global Patents 709 Swedeland Road King of Prussia, PA 19406, US  
 YIN, Hao, GlaxoSmithKline c/o Global Patents 709 Swedeland Road King of Prussia, PA 19406, US
- 
- (51) MKP  
**A61K 31/407 (2006.01)** (97) **2638046 \***  
**C07D 487/10 (2006.01)**  
**A61P 35/00 (2006.01)**  
 (86) US2011060300 11.11.2011  
 (96) 11840490.4 18.09.2013  
 (87) WO2012065022, 11.11.2011  
 (97) 2638046, 18.09.2013 en  
 (54) SPIRO-OXINDOLE MDM2 ANTAGONISTS  
 (71) The Regents of The University of Michigan, 1600 Huron Parkway 2nd Floor, Ann Arbor, Michigan 48109, US  
 Ascenta Licensing Corporation, 1105 N. Market Street, Suite 1300, Wilmington, DE 19801, US  
 SANOFI, 54 rue La Boétie, 75008 Paris, FR  
 (72) WANG, Shaomeng, 9343 Yorkshire Drive, Saline, Michigan 48176, US  
 ZHAO, Yujun, 3535 GreenBrier Blvd. Apartment 58B, Ann Arbor, Michigan 48105, US  
 SUN, Wei, 2825 Arrowwood Trail, Ann Arbor, Michigan 48105, US  
 KUMAR, Sanjeev, 3310 Alpine Drive, Ann Arbor, Michigan 48108, US  
 LEOPOLD, Lance, 1441 Catlin Way, Dresher, Pennsylvania 19025, US  
 DEBUSSCHE, Laurent, c/o Sanofi 174 avenue de France, F-75013 Paris, FR  
 BARRIERE, Cedric, c/o Sanofi 174 avenue de France, F-75013 Paris, FR  
 CARRY, Jean-Christophe, c/o Sanofi 174 avenue de France, F-75013 Paris, FR  
 AMANING, Kwame, c/o Sanofi 174 avenue de France, F-75013 Paris, FR  
 GUO, Ming, 5810 Aster Meadows Place, San Diego, CA 92130, US

- (51) MKP  
**C12N 15/13 (2006.01)** (97) **2621949 \***  
**C07K 16/18 (2006.01)**  
**A61K 39/00 (2006.01)**  
**C07K 16/46 (2006.01)**  
(86) US2011054143 30.09.2011  
(96) 11829947.8 07.08.2013  
(87) WO2012044893, 30.09.2011  
(97) 2621949, 07.08.2013 en  
(54) POLYPEPTIDES THAT BIND TO HUMAN COMPLEMENT COMPONENT C5  
(71) Alexion Pharmaceuticals, Inc., 352 Knotter Drive, Cheshire, CT 06410, US  
(72) GIES, David, 172 Sleepy Hill Road, Southbury, CT 06488, US  
HUNTER, Jeffrey, W., 125 Carlton Street, New Britain, CT 06053, US  
SPRINGHORN, Jeremy, P., 150 Ironwood Road, Guilford, CT 06437, US
- 
- (51) MKP  
**C09K 8/16 (2006.01)** (97) **2609169 \***  
**E21B 21/00 (2006.01)**  
(86) CA2011000973 26.08.2011  
(96) 11819240.0 03.07.2013  
(87) WO2012024786, 26.08.2011  
(97) 2609169, 03.07.2013 en  
(54) DRILLING FLUID AND METHOD FOR DRILLING IN COAL-CONTAINING FORMATIONS  
(71) TECH-STAR FLUID SYSTEMS INC., 625, 404 - 6 Avenue SW, Calgary, Alberta T2P 0R9, CA  
(72) SMITH, Carl, Keith, 59 Springbank Crescent SW, Calgary Alberta T3H 3S6, CA
- 
- (51) MKP  
**B60J 7/06 (2006.01)** (97) **2619023 \***  
**B60J 5/10 (2006.01)**  
(86) EP2011066347 20.09.2011  
(96) 11757666.0 31.07.2013  
(87) WO2012038440, 20.09.2011  
(97) 2619023, 31.07.2013 en  
(54) CONSTRUCTION FOR A SLIDING ROOF, SLIDING ROOF SYSTEM, TRUCK WITH SLIDING ROOF SYSTEM, SLIDING CANVAS TRAILER WITH A SLIDING ROOF SYSTEM, TOP COVER CONSTRUCTION.  
(71) VBG Group Truck Equipment N.v., Lochtemanweg 50, 3580 Beringen, BE  
(72) RAYEN, Luc, Theodorus, Julien, C/o Vbg Group Truck Equipment N.v. Lochtemanweg 50, B-3580 Beringen, BE  
LEURS, Joris, C/o Vbg Group Truck Equipment N.v. Lochtemanweg 50, B-3580 Beringen, BE
- 
- (51) MKP  
**D21H 17/00 (2006.01)** (97) **2641941**  
**C09C 1/02 (2006.01)**  
(96) 12161144.6 25.09.2013  
(97) 2641941, 25.09.2013 en  
(54) Preparation of pigments  
(71) Omya Development AG, Baslerstrasse 42, 4665 Oftringen, CH  
(72) Rentsch, Samuel, Burgpark 2, 4663 Aarburg, CH  
Gerard, Daniel E., Rheinfelderstrasse 12, 4058 Basel, CH  
Buri, Matthias, Mätteliweg 20, 4852 Rothrist, CH  
Gane, Patrick A. C., Studenweg 8, 4852 Rothrist, CH  
Kukkamo, Vesa, Am Wettingertobel 1 A, 8049 Zürich, CH
- 
- (51) MKP  
**C12N 15/82 (2006.01)** (97) **2633044 \***  
**C12N 15/09 (2006.01)**  
(86) PL2011000111 27.10.2011  
(96) 11794260.7 04.09.2013  
(87) WO2012057640, 27.10.2011  
(97) 2633044, 04.09.2013 en  
(54) A PLANT HOMOLOG TO AUTOPHAGY PROTEIN P62  
(71) Instytut Biochemii i Biofizyki PAN, Ul. Pawinskiego 5A, 02-106 Warszawa, PL  
(72) ZIENTARA-RYTTER, Katarzyna, Osiedle Parkowe 4, PL-05-462 Wi zowna, PL  
MONIUSZKO, Grzegorz, ul. Balladyny 24, PL-15-169 Bia ystok, PL  
WAWRZY SKA, Anna, ul. Emancypatek 1 m. 67, PL-08-504 Pruszków, PL  
LUKOMSKA, Jolanta, ul. Piaski 13, PL-87-500 Rypin, PL  
LISZEWSKA, Frantz, 131 rue Delpuch, F-80000 Amiens, FR  
SIRKO, Agieszka, ul. Szymczaka 5 m. 29, PL-01-227 Warszawa, PL
- 
- (51) MKP  
**A61B 1/04 (2006.01)** (97) **2600759 \***  
(86) US2011046621 04.08.2011  
(96) 11815331.1 12.06.2013  
(87) WO2012019023, 04.08.2011  
(97) 2600759, 12.06.2013 en  
(54) SYSTEMS AND METHODS FOR OPTIMIZING AND MAINTAINING VISUALIZATION OF A SURGICAL FIELD DURING THE USE OF SURGICAL SCOPES  
(71) Minimally Invasive Devices, LLC, 1275 Kinnear Road, Columbus, OH 43212, US  
(72) DRACH, Gregory, 7170 Ashview Road, Liberty Township, OH 45011, US  
POLL, Wayne, L., 3968 Redford Court, New Albany, OH 43054, US
- 
- (51) MKP  
**G02C 7/04 (2006.01)** (97) **2598935 \***  
(86) EP2011062397 20.07.2011  
(96) 11743477.9 05.06.2013  
(87) WO2012013549, 20.07.2011  
(97) 2598935, 05.06.2013 en  
(54) COLORED CONTACT LENSES AND METHOD OF MAKING THE SAME  
(71) Novartis AG, Lichtstrasse 35, 4056 Basel, CH  
(72) TUCKER, Robert Carey, 615 Stonestile Trace, Suwanee, GA 30024, US  
DAY, Ellen, A., 11101 Parkview Lane, Alpharetta, GA 30005, US  
CORTI, Sandra, 3420 Ashton Drive, Suwanee, GA 30024, US  
SCHMIEDER, Roland, Merianweg 6, 61381 Friedrichsdorf, DE  
CREECH, Laura, A., 2479 Peachtree Road NE Apt. 1702, Atlanta, GA 30305, US
- 
- (51) MKP  
**G01N 23/02 (2006.01)** (97) **2616798 \***  
(86) IB2011002752 16.09.2011  
(96) 11799182.8 24.07.2013  
(87) WO2012035440, 16.09.2011  
(97) 2616798, 24.07.2013 en  
(54) SYSTEM AND METHOD FOR X-RAY INSPECTION  
(71) Smiths Heimann GmbH, Im Herzen 4, 65205 Wiesbaden, DE  
(72) SCHOLLING, Axel, Ueber den Wiesen 15, 65388 Schlagenbad, DE
-

(51) MKP  
**C07D 471/04 (2006.01)** (97) **2640723 \***  
**C07D 487/04 (2006.01)**  
**A61K 31/519 (2006.01)**  
(86) US2011061374 18.11.2011  
(96) 11791155.2 25.09.2013  
(87) WO2012068450, 18.11.2011  
(97) 2640723, 25.09.2013 en  
(54) CYCLOBUTYL SUBSTITUTED PYRROLOPYRIDINE AND PYRROLOPYRIMIDINE DERIVATIVES AS JAK INHIBITORS  
(71) Incyte Corporation, Experimental Station Route 141 & Henry Clay Road Building 336, Wilmington, DE 19880, US  
(72) RODGERS, James D., 2 Hillside Lane, Landenberg Pennsylvania 19350, US  
ZHU, Wenyu, 21 Abel Place, Media Pennsylvania 19063, US  
SHAO, Lixin, 22 Golf View Drive Apt. A5, Newark Delaware 19702, US  
GLENN, Joseph, 103 Deer Horn Drive, Mount Royal New Jersey 08061, US  
SHEPARD, Stacey, 2200 C Inglewood Road, Wilmington, Delaware 19803, US

(51) MKP  
**C07D 487/04 (2006.01)** (97) **2614063 \***  
**A61K 31/5025 (2006.01)**  
**A61P 35/00 (2006.01)**  
(86) EP2011065368 06.09.2011  
(96) 11751910.8 17.07.2013  
(87) WO2012032031, 06.09.2011  
(97) 2614063, 17.07.2013 en  
(54) SUBSTITUTED IMIDAZOPYRIDAZINES  
(71) Bayer Intellectual Property GmbH, Alfred-Nobel-Strasse 10, 40789 Monheim, DE  
(72) KLAR, Ulrich, Isegrimsteig 8a, 13503 Berlin, DE  
KOPPITZ, Marcus, Scharnhorststr. 28, 10115 Berlin, DE  
JAUTELAT, Rolf, Zur Pumpstation 35, 42781 Haan, DE  
KOSEMUND, Dirk, Klutstr. 14, 12587 Berlin, DE  
BOHLMANN, Rolf, Kuehler Weg 6a, 14055 Berlin, DE  
LIENAU, Philip, Jahnstrasse 13, 10967 Berlin, DE  
SIEMEISTER, Gerhard, Reimerswalder Steig 26, 13503 Berlin, DE  
WENIGNER, Antje, Margret, Borkumstrasse 12 e, 13189 Berlin, DE

(51) MKP  
**A61K 31/4985 (2006.01)** (97) **2616076 \***  
(86) US2011051713 15.09.2011  
(96) 11825920.9 24.07.2013  
(87) WO2012037320, 15.09.2011  
(97) 2616076, 24.07.2013 en  
(54) PHARMACEUTICAL COMPOSITIONS  
(71) VIIV Healthcare Company, Five Moore Drive, Research Triangle Park, NC 27709, US  
(72) MUNDHRA, Deepak B., c/o GlaxoSmithKline Global Patents Department 1250 South Collegeville Road P. O. Box 5089, Collegeville, Pennsylvania 19426, US  
PAN, Rennan, c/o GlaxoSmithKline Global Patents Department 709 Swedeland Road P. O. Box 1539, King of Prussia, Pennsylvania 19406, US

(51) MKP  
**A61K 9/70 (2006.01)** (97) **2613772 \***  
**A61K 31/565 (2006.01)**  
**A61K 31/57 (2006.01)**  
(86) EP2011065261 05.09.2011  
(96) 11757811.2 17.07.2013  
(87) WO2012031999, 05.09.2011  
(97) 2613772, 17.07.2013 en  
(54) LOW-DOSE TRANSDERMAL PATCHES WITH HIGH DRUG RELEASE  
(71) Bayer Intellectual Property GmbH, Alfred-Nobel-Strasse 10, 40789 Monheim, DE  
(72) TERESESI, Ildiko, Reichensteiner Weg 5, 14195 Berlin, DE  
ZURTH, Christian, Herrnholzweg 21 a, 13469 Berlin, DE  
ULBRICH, Hannes-Friedrich, Fischerhüttenstr. 55, 14163 Berlin, DE

(51) MKP  
**A61B 5/0408 (2006.01)** (97) **2642915 \***  
**A61H 35/00 (2006.01)**  
**A47K 3/022 (2006.01)**  
(86) AT2011000476 23.11.2011  
(96) 11813752.0 02.10.2013  
(87) WO2012068608, 23.11.2011  
(97) 2642915, 02.10.2013 de  
(54) MEASURING APPARATUS FOR THE REPETITIVE CONTACTLESS ASCERTAINMENT OF CHARACTERISTIC INTERVALS BETWEEN ELECTRICAL PULSES OF A BEATING HEART  
(71) Human Research Institut für Gesundheitstechnologie und Präventionsforschung GmbH, Franz-Pichler-Strasse 30, 8160 Weiz, AT  
Puff, Henry, Eixendorf 46, 9064 Pischeldorf, AT  
Software + Systeme Erfurt GmbH, Fichtenweg 8, 99198 Erfurt-Kerspleben, DE  
Breithuber, Raimund, Palmengasse 16, 9020 Klagenfurt, AT  
(72) PUFF, Henry, Eixendorf 46, A-9064 Pischeldorf, AT  
BREITHUBER, Raimund, Palmengasse 16, A-9020 Klagenfurt, AT  
MOSER, Maximilian, Schillerstrasse 25, A-8010 Graz, AT  
MANDLER, Dietrich, Hinter dem Dorfe 9, 99102 Erfurt-Rohda, DE  
SCHLÜTER, Christiane, Adolf-Sexauer-Str. 18, 79312 Emmendingen, DE

(51) MKP  
**C07D 413/14 (2006.01)** (97) **2632921 \***  
**A61K 31/422 (2006.01)**  
**A61P 35/00 (2006.01)**  
**A61P 37/00 (2006.01)**  
**A61P 11/00 (2006.01)**  
**A61P 31/12 (2006.01)**  
(86) EP2011068604 25.10.2011  
(96) 11776738.4 04.09.2013  
(87) WO2012055846, 25.10.2011  
(97) 2632921, 04.09.2013 en  
(54) POLYMORPHS AND SALTS OF 6-(1H-INDOL-4-YL)-4-(5-{ [4-(1-METHYLETHYL)-1-PI PERAZINYLMETHYL]-1,3-OXAZOL-2-YL}-1H-INDAZOLE AS PI3K INHIBITORS FOR USE IN THE TREATMENT OF E.G. RESPIRATORY DISORDERS  
(71) Glaxo Group Limited, 980 Great West Road, Brentford, Middlesex TW8 9GS, GB  
(72) HAMBLIN, Julie Nicole, GlaxoSmithKline Gunnels Wood Road, Stevenage Hertfordshire SG1 2NY, GB  
JONES, Paul Spencer, c/o GlaxoSmithKline Gunnels Wood Road, Stevenage Hertfordshire SG1 2NY, GB  
KEELING, Suzanne Elaine, c/o GlaxoSmithKline Gunnels Wood Road, Stevenage Hertfordshire SG1 2NY, GB  
LE, Joelle, GlaxoSmithKline Gunnels Wood Road, Stevenage Hertfordshire SG1 2NY, GB  
PARR, Nigel James, GlaxoSmithKline Gunnels Wood Road, Stevenage Hertfordshire SG1 2NY, GB  
WILLACY, Robert David, GlaxoSmithKline Gunnels Wood Road, Stevenage Hertfordshire SG1 2NY, GB

(51) MKP  
**A61P 35/00 (2006.01)** (97) **2640406 \***  
**A61K 38/17 (2006.01)**  
(86) US2011060661 14.11.2011  
(96) 11790705.5 25.09.2013  
(87) WO2012068030, 14.11.2011  
(97) 2640406, 25.09.2013 en  
(54) TREATMENT OF CANCER WITH ELEVATED DOSAGES OF SOLUBLE FGFR1 FUSION PROTEINS  
(71) Five Prime Therapeutics, Inc., Two Corporate Drive, South San Francisco, CA 94080, US  
(72) KEER, Harold, 230 Ferndale Way, Emerald Hills, California 94062, US

- (51) MKP  
**A61K 31/4196 (2006.01)** (97) **2614824 \***  
**A61K 31/4245 (2006.01)**  
**A61P 21/00 (2006.01)**  
**A61P 25/04 (2006.01)**  
**C07D 249/08 (2006.01)**  
**C07D 413/12 (2006.01)**  
(86) JP2011070205 06.09.2011  
(96) 11823545.6 17.07.2013  
(87) WO2012033070, 06.09.2011  
(97) 2614824, 17.07.2013 en  
(54) THERAPEUTIC AGENT FOR PAIN  
(71) Astellas Pharma Inc., 3-11, Nihonbashi-Honcho 2-chome Chuo-ku, Tokyo 103-8411, JP  
(72) KISO, Tetsuo, c/o Astellas Pharma Inc. 3-11 Nihonbashi-Honcho 2-chome Chuo-ku, Tokyo 103-8411, JP  
TSUKAMOTO, Mina, c/o Astellas Pharma Inc. 3-11 Nihonbashi-Honcho 2-chome Chuo-ku, Tokyo 103-8411, JP

- (51) MKP  
**C10J 3/62 (2006.01)** (97) **2479244**  
**C10J 3/66 (2006.01)**  
**C10J 3/48 (2006.01)**  
**C10B 57/10 (2006.01)**  
(96) 11450155.4 25.07.2012  
(97) 2479244, 25.07.2012 de  
(54) Method for operating an assembly for energy generation  
(71) GEHA Stiftung, Herrengasse 21, 9490 Vaduz, LI  
(72) Hirr, Günther, Thomas-Koschat-Gase 7, 9360 Friesach, AT

- (51) MKP  
**C12R 1/645 (2006.01)** (97) **2633085 \***  
**C12N 9/02 (2006.01)**  
**C12P 7/56 (2006.01)**  
(86) EP2011068968 28.10.2011  
(96) 11784963.8 04.09.2013  
(87) WO2012055996, 28.10.2011  
(97) 2633085, 04.09.2013 en  
(54) USE OF MONASCUS IN ORGANIC ACID PRODUCTION  
(71) Total Raffinage Marketing, 24 CRS Michelet, 92800 Puteaux, FR  
(72) WEUSTHUIS, Ruud Alexander, Magnoliaaan 18, NL-6866 GD Heesum, NL  
WOLBERT, Emil Johan Harald, Leeuweriksweide 208, NL-6708 LP Wageningen, NL  
SPRINGER, Jan, Bennekomseweg 180, NL-6704 AL Wageningen, NL  
VAN DER OOST, John, Bram Streefandweg 116, NL-6871 HZ Renkum, NL  
EGGINK, Gerrit, Erasmusstate 59, NL-6716 SC Ede, NL

- (51) MKP  
**B64D 10/00 (2006.01)** (97) **2637927 \***  
(86) US2011055783 11.10.2011  
(96) 11834865.5 18.09.2013  
(87) WO2012054262, 11.10.2011  
(97) 2637927, 18.09.2013 en  
(54) METHODS AND DEVICE TO REDUCE SLOSH ENERGY ABSORPTION EFFECTS BY REDUCING BLOOD FLOW FROM THE CRANIUM  
(71) WEST VIRGINIA UNIVERSITY, 886 Chestnut Ridge Road, Morgantown, WV 26506-6845, US  
(72) SMITH, David, 4572 Greenmount Pike, Richmond IN 47374, US  
FISHER, Joseph, Arnold, 603 Clark Avenue West, Thornhill Ontario L4J8P9, CA

- (51) MKP  
**A61K 31/497 (2006.01)** (97) **2635282 \***  
**A61K 9/48 (2006.01)**  
**A61P 7/00 (2006.01)**  
(86) US2011059643 07.11.2011  
(96) 11838957.6 11.09.2013  
(87) WO2012061833, 07.11.2011  
(97) 2635282, 11.09.2013 en  
(54) COMPOSITIONS AND METHODS FOR TREATING MYELOFIBROSIS  
(71) TargeGen, Inc., 55 Corporate Drive Bridgewater, New Jersey 08807, US  
(72) JAYAN, Arvind, 7509 Draper Avenue Apt. 303, La Jolla CA 92037, US  
CACACE, Janice, 527 NE 57th Street, Miami FL 33137, US  
TEFFERI, Ayalew, Hematology Mayo Clinic 200 First Street S.w., Rochester, MN 55905, US

- (51) MKP  
**A61K 39/00 (2006.01)** (97) **2629791 \***  
(86) US2011056122 13.10.2011  
(96) 11770986.5 28.08.2013  
(87) WO2012054294, 13.10.2011  
(97) 2629791, 28.08.2013 en  
(54) HER2 DNA VACCINE AS ADJUNCT TREATMENT FOR CANCERS IN COMPANION ANIMALS  
(71) Merial Limited, 3239 Satellite Blvd., Duluth, GA 30096, US  
(72) FISCHER, Laurent, Bernard, 17 Chemin Vert, F-69110 Sainte Foy Les Lyon, FR

- (51) MKP  
**A61K 38/08 (2006.01)** (97) **2599494**  
**A61K 38/18 (2006.01)**  
**A61K 38/00 (2006.01)**  
(96) 12008309.2 05.06.2013  
(97) 2599494, 05.06.2013 en  
(54) PKC inhibitors for the treatment of inflammatory disease or disorder  
(71) Healer Ltd., P.O. Box 4115, 74140 Ness-Ziona, IL  
(72) Tennenbaum, Tamar, 12 Herzel Boulevard, IL96105 Jerusalem, IL  
Braiman-Wiksman, Liora, 24 Stephan Wies Street, IL75400 Rishon Le-Zion, IL  
Sagiv, Yuval, 12 Smadar Street, IL70700 Gedera, IL  
Gartsbein, Marina, 77 Pinsker Street, IL49221 Petach Tikva, IL  
Brenner, Ephraim, 4 Mania Shochat Street, IL75241 Rishon Le-Zion, IL  
Ben-Hamo, Moshe, 11 Zvi Herling Street, IL51223 Bene Braq, IL  
Hammer, Liat, 21/2 Itzhak Rabbim, IL71700 Modiin, IL

- (51) MKP  
**B65D 5/00 (2006.01)** (97) **2619098 \***  
**B65D 85/60 (2006.01)**  
(86) EP2010006044 04.10.2010  
(96) 10768403.7 31.07.2013  
(87) WO2012037956, 04.10.2010  
(97) 2619098, 31.07.2013 en  
(54) FOLDING WALLET PACKAGING FOR CONFECTIONERY PRODUCTS, MORE PARTICULARLY BARS OR SLABS OF CHEWING GUM  
(71) Perfetti Van Melle S.p.A., Via XXV Aprile, 7, 20020 Lainate, IT  
(72) TRALDI, Ubaldo, c/o Perfetti Van Melle S.p.A. Via XXV Aprile 7, I-20020 Lainate (MI), IT

- (51) MKP  
**F23H 17/08 (2006.01)** (97) **2598801 \***  
**F23H 7/08 (2006.01)**  
**F23H 3/02 (2006.01)**  
(86) CH2011000169 21.07.2011  
(96) 11745476.9 05.06.2013  
(87) WO2012012909, 21.07.2011  
(97) 2598801, 05.06.2013 de  
(54) WATER-COOLED SLIDING COMBUSTION GRATE HAVING A PARALLEL DRIVE  
(71) Doikos Investments, Ltd., 27 Pier Road, St. Helier, Channel Islands Jersey JE4 8TZ, GB  
(72) STIEFFEL, Martin, Gfellerstrasse 1, CH-8626 Ottikon, CH

- (51) MKP  
**H04M 3/42 (2006.01)** (97) **2609726 \***  
**H04M 3/487 (2006.01)**
- (86) MD2012000001 17.01.2012  
(96) 12706121.6 03.07.2013  
(87) WO2012125012, 17.01.2012  
(97) 2609726, 03.07.2013 en  
(54) METHOD FOR NOTIFICATION OF A CALLED SUBSCRIBER IN THE ABSENCE OF SUFFICIENT CREDIT OF THE CALLING PARTY  
(71) Nicolaescu, Gheorghe, Str. Biruinta 4 Com. Lozova, Straseni 3721, MD  
(72) Nicolaescu, Gheorghe, Str. Biruinta 4 Com. Lozova, Straseni 3721, MD
- 
- (51) MKP  
**A61K 39/395 (2006.01)** (97) **2635303 \***  
**C07K 16/24 (2006.01)**  
**A61K 31/519 (2006.01)**
- (86) EP2011069476 04.11.2011  
(96) 11778903.2 11.09.2013  
(87) WO2012059598, 04.11.2011  
(97) 2635303, 11.09.2013 en  
(54) METHODS OF TREATING RHEUMATOID ARTHRITIS USING IL-17 ANTAGONISTS  
(71) Novartis AG, Lichtstrasse 35, 4056 Basel, CH  
(72) MPOFU, Shephard, Novartis Pharma AG Postfach, CH-4002 Basel, CH  
RICHARDS, Hanno, Novartis Pharma AG Postfach, CH-4002 Basel, CH  
THANGAVELU, Karthinathan, Novartis Pharma AG Postfach, CH-4002 Basel, CH  
MACHACEK, Matthias, Novartis Pharma AG Postfach, CH-4002 Basel, CH
- 
- (51) MKP  
**A61B 6/00 (2006.01)** (97) **2599438 \***
- (86) JP2011066900 26.07.2011  
(96) 11812451.0 05.06.2013  
(87) WO2012014862, 26.07.2011  
(97) 2599438, 05.06.2013 en  
(54) EVALUATION AID  
(71) National University Corporation, Tohoku University, 1-1, Katahira 2-chome Aoba-ku, Sendai-shi, Miyagi 980-8577, JP  
Mitaya Manufacturing Co., Ltd., 8-12, Yoshinodai 2-chome Kawagoe-shi, Saitama 350-0833, JP  
(72) CHIDA, Koichi, 7-11, Ichomachi Miyagino-ku, Sendai-shi Miyagi 983-0047, JP  
KAGA, Yuji, 6-34, Sakuradahigashi 2-chome, Yamagata-shi Yamagata 990-2323, JP  
YOKOUCHI, Goro, 9-5, Sakuradai 3-chome Nerima-ku, Tokyo 176-0002, JP
- 
- (51) MKP  
**B01F 7/00 (2006.01)** (97) **2363200**  
**B01F 7/18 (2006.01)**  
**B01F 7/22 (2006.01)**  
**B01F 13/10 (2006.01)**
- (86) 10015727.0 07.09.2011  
(97) 2363200, 07.09.2011 de  
(54) Colloidal mixer and method, in particular for preparing building materials  
(71) MAT Mischanlagentechnik GmbH, Illerstrasse 6, 87509 Immenstadt-Seifen, DE  
(72) Felber, Christian, Hans-Böckler-Str. 3, 87527 Sonthofen, DE  
Kleimeier, Manfred, Metzlerstr. 29, 87527 Sonthofen, DE  
Machaczek, Alexander, Jörgstr. 7, 87437 Kempten, DE
- 
- (51) MKP  
**C07D 223/16 (2006.01)** (97) **2611782 \***  
**A61K 31/55 (2006.01)**  
**A61P 3/04 (2006.01)**
- (86) US2011049935 31.08.2011  
(96) 11758011.8 10.07.2013  
(87) WO2012030938, 31.08.2011  
(97) 2611782, 10.07.2013 en  
(54) SALTS OF LORCASERIN WITH OPTICALLY ACTIVE ACIDS  
(71) Arena Pharmaceuticals, Inc., 6154 Nancy Ridge Drive, San Diego, CA 92121, US  
(72) BLACKBURN, Anthony C., 12633 Caminito Rosita, San Diego California 92128, US  
BETTS, William Lucas III, 4518 Patria Drive, San Diego California 92115, US  
RUETER, Jaimie Karyn, 9022 Westvale Road, San Diego California 92129, US  
SHAN, Yun, 11429 Honey Ridge, San Diego California 92130, US  
SHIFRINA, Anna, 11957 Miro Circle, San Diego California 92131, US  
STIRN, Scott, 14710 Carmel Ridge Road, San Diego California 92128, US
- 
- (51) MKP  
**A01N 45/00 (2006.01)** (97) **2533643 \***  
**A61K 31/50 (2006.01)**  
**A61K 31/56 (2006.01)**
- (86) US2011024174 09.02.2011  
(96) 11742730.2 19.12.2012  
(87) WO2011100308, 09.02.2011  
(97) 2533643, 19.12.2012 en  
(54) DERIVATIVES OF BETULIN  
(71) GlaxoSmithKline LLC, One Franklin Plaza 200 North 16th Street, Philadelphia, PA 19102, US  
(72) GAO, Daxin, c/o ChemPartner, 720 Cailun Rd Zhangjiang Hi-tech Park Pudong, Shanghai 201203, CN  
HAN, Nianhe, c/o ChemPartner, 720 Cailun Rd Zhangjiang Hi-tech Park Pudong, Shanghai 201203, CN  
JIN, Zhimin, c/o ChemPartner, 720 Cailun Rd Zhangjiang Hi-tech Park Pudong, Shanghai 201203, CN  
NING, Fangxian, c/o ChemPartner, 720 Cailun Rd Zhangjiang Hi-tech Park Pudong, Shanghai 201203, CN  
TANG, Jun, c/o GlaxoSmithKline Global Patents Five Moore Drive P. O. Box 13398, Research Triangle Park, North Carolina 27709, US  
WU, Yongyong, c/o ChemPartner, 720 Cailun Rd Zhangjiang Hi-tech Park Pudong, Shanghai 201203, CN  
YANG, Heping, c/o ChemPartner, 720 Cailun Rd Zhangjiang Hi-tech Park Pudong, Shanghai 201203, CN
- 
- (51) MKP  
**A61K 9/20 (2006.01)** (97) **2601936 \***  
**A61P 1/04 (2006.01)**  
**A61K 47/38 (2006.01)**  
**A61K 47/26 (2006.01)**  
**A61K 31/4439 (2006.01)**
- (86) JP2011067806 03.08.2011  
(96) 11814681.0 12.06.2013  
(87) WO2012018056, 03.08.2011  
(97) 2601936, 12.06.2013 en  
(54) COMPRESSED COMPOSITION  
(71) Eisai R&D Management Co., Ltd., 6-10, Koishikawa 4-chome Bunkyo-ku, Tokyo 112-8088, JP  
(72) SAKAMOTO, Hirokazu, c/o EISAI CO. LTD. Formulation Research 1 Kawashimatakehaya-machi, Kakamigahara-shi Gifu 501-6195, JP  
NAGANE, Kentaro, c/o EISAI CO. LTD. Formulation Research 1 Kawashimatakehaya-machi, Kakamigahara-shi Gifu 501-6195, JP  
NOHARA, Masami, c/o EISAI CO. LTD. Formulation Research 1 Kawashimatakehaya-machi, Kakamigahara-shi Gifu 501-6195, JP

- (51) MKP  
**C12M 1/107 (2006.01)** (97) **2565259**  
(96) 11179779.1 06.03.2013  
(97) 2565259, 06.03.2013 de  
(54) Method and device for biogas production  
(71) Conviotec GmbH, Lise-Meitner-Straße 2, 24941 Flensburg, DE  
(72) Schneider, Dr., Holger, Conviotec GmbH, Geschäftsführung  
Lise-Meitner-Straße 2, 24941 Flensburg, DE
- 
- (51) MKP  
**A23L 3/3463 (2006.01)** (97) **2603099 \***  
**A23L 3/3526 (2006.01)**  
**A23L 3/3472 (2006.01)**  
(86) US2011001402 09.08.2011  
(96) 11749275.1 19.06.2013  
(87) WO2012021163, 09.08.2011  
(97) 2603099, 19.06.2013 en  
(54) METHODS FOR ENHANCING THE STABILITY OF FOODS,  
BEVERAGES, AND COSMETICS USING NATURAL  
PRODUCTS DERIVED FROM NON-ALLERGENIC  
PROTEINACEOUS SOURCES  
(71) Kalamazoo Holdings, Inc., 3713 West Main Street, Kalamazoo,  
MI 49006, US  
(72) NAHAS, Roger, 4710 Roland Cir, Portage MI 49024, US  
VANALSTYNE, Peter, Collins, 47119 County Road 653, Paw  
Paw MI 49079, US  
UHLIR, Anita, E., 445507 M40, Paw Paw MI 49079, US  
BERDAHL, Donald, 77267 Cr 652, Lawton MI 49065, US
- 
- (51) MKP  
**C12N 15/09 (2006.01)** (97) **2612911 \***  
**C12N 7/00 (2006.01)**  
**C12N 5/10 (2006.01)**  
(86) JP2011069588 30.08.2011  
(96) 11821786.8 10.07.2013  
(87) WO2012029770, 30.08.2011  
(97) 2612911, 10.07.2013 en  
(54) COMPOSITION FOR INDUCING PLURIPOTENT STEM  
CELL, AND USE THEREOF  
(71) Dnavec Corporation, 6 Ohkubo Tsukuba-shi, Ibaraki 300-2611,  
JP  
(72) BAN, Hiroshi, c/o Dnavec Corporation 6 Ohkubo, Tsukuba-shi  
Ibaraki 300-2611, JP  
UEDA, Yasuji, c/o Dnavec Corporation 6 Ohkubo, Tsukuba-shi  
Ibaraki 300-2611, JP  
FUSAKI, Noemi, c/o Dnavec Corporation 6 Ohkubo, Tsukuba-  
shi Ibaraki 300-2611, JP  
SAEKI, Koichi, c/o Dnavec Corporation 6 Ohkubo, Tsukuba-shi  
Ibaraki 300-2611, JP  
HASEGAWA, Mamoru, c/o Dnavec Corporation 6 Ohkubo,  
Tsukuba-shi Ibaraki 300-2611, JP
- 
- (51) MKP  
**C08G 77/42 (2006.01)** (97) **2625216 \***  
**C08G 77/442 (2006.01)**  
**C08L 83/10 (2006.01)**  
**G02B 1/04 (2006.01)**  
**C08G 77/28 (2006.01)**  
**C08G 77/48 (2006.01)**  
**C08F 283/12 (2006.01)**  
**C08F 290/06 (2006.01)**  
**C08G 77/20 (2006.01)**  
(86) US2011054865 05.10.2011  
(96) 11770626.7 14.08.2013  
(87) WO2012047961, 05.10.2011  
(97) 2625216, 14.08.2013 en  
(54) POLYMERIZABLE CHAIN-EXTENDED POLYSILOXANES  
WITH PENDANT HYDROPHILIC GROUPS  
(71) Novartis AG, Lichtstrasse 35, 4056 Basel, CH  
(72) CHANG, Frank, 8489 Spring Breeze Terrace, Suwanee  
Georgia 30024, US  
HUANG, Jinyu, 917 Summer Forest Drive, Suwanee Georgia  
30024, US  
SANDERS, Laura, Ann, 1359 Sanden Ferry Drive, Decatur  
Georgia 30033, US
- 
- (51) MKP  
**A61P 31/04 (2006.01)** (97) **2627320 \***  
**A61K 38/10 (2006.01)**  
**A61K 9/48 (2006.01)**  
(86) GB2011001046 12.07.2011  
(96) 11738462.8 21.08.2013  
(87) WO2012007711, 12.07.2011  
(97) 2627320, 21.08.2013 en  
(54) FORMULATION COMPRISING A TYPE B LANTIBIOTIC  
(71) Novacta Biosystems Limited, BioPark Hertfordshire  
Broadwater Road, Welwyn Garden City Hertfordshire AL7 3AX,  
GB  
(72) APPLEBYARD, Antony, Nicholas, Novacta Biosystems Limited  
BioPark Hertfordshire Broadwater Road Welwyn Garden City,  
Herts AL7 3AX, GB  
WADMAN, Sjoerd, Nicolaas, Novacta Biosystems Limited  
BioPark Hertfordshire Broadwater Road Welwyn Garden City,  
Herts AL7 3AX, GB
- 
- (51) MKP  
**F03B 11/00 (2006.01)** (97) **2469257**  
**E02B 17/02 (2006.01)**  
**F03B 17/06 (2006.01)**  
**F03B 13/26 (2006.01)**  
**E02D 15/08 (2006.01)**  
**G01M 10/00 (2006.01)**  
(96) 10196786.7 27.06.2012  
(97) 2469257, 27.06.2012 en  
(54) A hydroelectric turbine testing method  
(71) Openhydro IP Limited, South Dock House Hanover Quay,  
Dublin 2, IE  
(72) Dunne, Paul, 12 Homefarm Park Drumcondra, 9, Dublin, IE  
Ives, James, South Dock House Hanover Quay, 2, Dublin, IE
- 
- (51) MKP  
**F04B 1/04 (2006.01)** (97) **2530315**  
**F02M 59/10 (2006.01)**  
**F02M 59/44 (2006.01)**  
**F02M 63/00 (2006.01)**  
(96) 11168571.5 05.12.2012  
(97) 2530315, 05.12.2012 en  
(54) Fuel pump lubrication  
(71) Delphi Technologies Holding S.à.r.l., Avenue de Luxembourg,  
4940 Bascharage, LU  
(72) Rosu, Cristian, 59 Chaucer Road, Gillingham, Kent ME7 5LX,  
GB  
Jorach, Rainer, Hegelstr 9, 71686 Remseck, DE
- 
- (51) MKP  
**A61M 15/00 (2006.01)** (97) **2613828 \***  
(86) EP2011065301 05.09.2011  
(96) 11749866.7 17.07.2013  
(87) WO2012032008, 05.09.2011  
(97) 2613828, 17.07.2013 en  
(54) METERED-DOSE INHALER ACTUATOR, METERED-DOSE  
INHALER  
(71) CHIESI FARMACEUTICI S.p.A., Via Palermo, 26/A, 43122  
Parma, IT  
(72) BRAMBILLA, Gaetano, c/o Chiesi Farmaceutici S.p.A., Via  
Palermo 26/A, I-43122 Parma, IT  
LEWIS, David Andrew, c/o Chiesi Farmaceutici S.p.A., Via  
Palermo 26/A, I-43122 Parma, IT  
JOHNSON, Robert, c/o Chiesi Farmaceutici S.p.A., Via  
Palermo 26/A, I-43122 Parma, IT
-



- (51) MKP  
**C07D 487/04 (2006.01)** (97) **2603511 \***  
**A61K 31/519 (2006.01)**  
**A61P 25/28 (2006.01)**
- (86) EP2011063705 09.08.2011  
(96) 11740949.0 19.06.2013  
(87) WO2012020022, 09.08.2011  
(97) 2603511, 19.06.2013 en
- (54) 6-CYCLOALKYL-1, 5-DIHYDRO-PYRAZOLO [3, 4-D] PYRIMIDIN-4-ONE DERIVATIVES AND THEIR USE AS PDE9A INHIBITORS
- (71) Boehringer Ingelheim International GmbH, Binger Strasse 173, 55216 Ingelheim am Rhein, DE
- (72) HEINE, Niklas, Boehringer Ingelheim GmbH Corporate Patents Binger Strasse 173, 55216 Ingelheim Am Rhein, DE  
EICKMEIER, Christian, Boehringer Ingelheim GmbH Corporate Patents Binger Strasse 173, 55216 Ingelheim Am Rhein, DE  
FERRARA, Marco, Boehringer Ingelheim GmbH Corporate Patents Binger Strasse 173, 55216 Ingelheim Am Rhein, DE  
GIOVANNINI, Riccardo, Boehringer Ingelheim GmbH Corporate Patents Binger Strasse 173, 55216 Ingelheim Am Rhein, DE  
ROSENBROCK, Holger, Boehringer Ingelheim GmbH Corporate Patents Binger Strasse 173, 55216 Ingelheim Am Rhein, DE  
SCHAENZLE, Gerhard, Boehringer Ingelheim GmbH Corporate Patents Binger Strasse 173, 55216 Ingelheim Am Rhein, DE
- 
- (51) MKP  
**A01N 43/42 (2006.01)** (97) **2608670 \***  
**A61K 31/44 (2006.01)**
- (86) US2011048794 23.08.2011  
(96) 11820517.8 03.07.2013  
(87) WO2012027359, 23.08.2011  
(97) 2608670, 03.07.2013 en
- (54) METHODS FOR TREATING ANTIPSYCHOTIC-INDUCED WEIGHT GAIN
- (71) Alkermes Pharma Ireland Limited, Connaught House 1 Burlington Road, Dublin 4, IE
- (72) DEEVER, Daniel, 4 Maple Brook Lane, Franklin MA 02038, US  
TODTENKOPF, Mark, 4 Stephen Way, Franklin MA 02038, US
- 
- (51) MKP  
**C12P 21/08 (2006.01)** (97) **2608809 \***  
**A61K 39/395 (2006.01)**
- (86) US2011049448 26.08.2011  
(96) 11820759.6 03.07.2013  
(87) WO2012027721, 26.08.2011  
(97) 2608809, 03.07.2013 en
- (54) ANTIBODIES TO MATRIX METALLOPROTEINASE 9
- (71) Gilead Biologics, Inc., 333 Lakeside Drive, Foster City, CA 94404, US
- (72) MCCAULEY, Scott Alan, 333 Lakeside Drive, Foster City California 94404, US  
VAYSBERG, Maria, 33 Lakeside Drive, Foster City, CA 94404, US
- 
- (51) MKP  
**B65D 17/00 (2006.01)** (97) **2607471**  
**B67C 3/02 (2006.01)**  
**C12G 1/00 (2006.01)**
- (96) 12161345.9 26.06.2013  
(97) 2607471, 26.06.2013 en
- (54) Wine packaged in aluminium containers
- (71) Barokes PTY Ltd., Suite 602, 101 Cecil Street, South Melbourne, Victoria 3205, AU
- (72) Stokes, Gregory John Charles, 7 Belford Court, Keilor, Victoria 3036, AU  
Barics, Steven John Anthony, 51 Waratah Avenue, Tullamarine, Victoria 3043, AU

- (51) MKP  
**A61B 3/00 (2006.01)** (97) **2605694 \***  
**A61B 3/10 (2006.01)**  
**A61B 3/117 (2006.01)**  
**A61B 5/00 (2006.01)**
- (86) US2011047628 12.08.2011  
(96) 11745903.2 26.06.2013  
(87) WO2012024188, 12.08.2011  
(97) 2605694, 26.06.2013 en
- (54) SYSTEM AND METHOD FOR DETECTING AMYLOID PROTEINS
- (71) Cognoptix, Inc., 20 Main Street, Acton, MA 01720, US
- (72) HARTUNG, Paul, D., 32 Jackson Drive, Acton, MA 01720, US  
VALVO, Vincent, 7 Latisquama Road, Southborough, MA 01772, US  
KERBAGE, Charles, 4 Longfellow Pl. Apt. 2207, Boston, Massachusetts 02114, US  
CAGLE, Gerald, D., 6309 Greenway Road, Fort Worth, TX 76116, US  
NILAN, Dennis, J., 2 Geneseo Circle, Milford, MA 01757, US
- 
- (51) MKP  
**B01D 35/05 (2006.01)** (97) **2621602 \***
- (86) US2011053543 27.09.2011  
(96) 11831321.2 07.08.2013  
(87) WO2012047680, 27.09.2011  
(97) 2621602, 07.08.2013 en
- (54) FLOATED SOLIDS SEPARATION
- (71) World Water Works, Inc., 4061 Nw 3rd St., Oklahoma City, OK 73107, US
- (72) BOOTH, Kyle, 6405 Blue Stem West, Oklahoma City, OK 73162, US  
COSBY, Mike, 1009 Sweetgum Street, Moore, OK 73160, US  
FOSSHAGE, Mark, 92 Elmwood Avenue, Hohokus, NJ 07423, US  
POE, Scott, 2600 Tealwood Drive, Oklahoma City, OK 73120, US  
SCHLEGEL, Dave, 1401 NW 16th Street, Oklahoma City, OK 73106, US
- 
- (51) MKP  
**A61K 31/404 (2006.01)** (97) **2605770 \***  
**A61P 31/10 (2006.01)**  
**A61K 31/16 (2006.01)**  
**A61K 31/351 (2006.01)**
- (86) CA2011000945 19.08.2011  
(96) 11817615.5 26.06.2013  
(87) WO2012021982, 19.08.2011  
(97) 2605770, 26.06.2013 en
- (54) ANTIFUNGAL AGENTS AND USES THEREOF
- (71) MethylGene Inc., 7220 Frederick Banting, Suite 200, Montreal, Québec H4S 2A1, CA
- (72) BESTERMAN, Jeffrey M., 51 rue Gray, Baie d'Urfe, Québec H9X 3V3, CA
- 
- (51) MKP  
**A61M 5/24 (2006.01)** (97) **2603262 \***
- (86) EP2011063844 11.08.2011  
(96) 11743534.7 19.06.2013  
(87) WO2012020086, 11.08.2011  
(97) 2603262, 19.06.2013 en
- (54) CODING SYSTEM FOR A DRUG DELIVERY DEVICE AND DRUG DELIVERY SYSTEM
- (71) Sanofi-Aventis Deutschland GmbH, Brüningstraße 50, 65929 Frankfurt, DE
- (72) CERMAN, Zdenek, Sanofi-Aventis Deutschland GmbH, 65926 Frankfurt am Main, DE  
SHARPE, Timothy Lewis, The Old School Banbury Road, Ettington Warwickshire CV37 7TB, GB  
LANGLEY, Christopher Nigel, 120 Leicester Lane, Leamington Spa Warwickshire CV32 7HH, GB  
AVERY, Richard James Vincent, 28 Nursery Close, Mickleton Chipping Campden Gloucestershire GL55 6TX, GB  
BUTLER, Joseph, 6 Hadfield Close, Clifton Rugby Warwickshire CV23 0DL, GB  
HEALD, Michael, 22 Wells Avenue UK Cheshire, Crewe Cheshire CW1 5RZ, GB

- (51) MKP  
**E04F 15/12 (2006.01)** (97) **2374768**  
**E04F 15/18 (2006.01)**  
**C04B 28/02 (2006.01)**  
**C04B 28/06 (2006.01)**  
**F24D 13/02 (2006.01)**  
**F24D 3/14 (2006.01)**  
(96) 11160002.9 12.10.2011  
(97) 2374768, 12.10.2011 de  
(54) Base layer for floor coverings  
(71) Uzin Utz AG, Dieselstrasse 3, 89079 Ulm, DE  
(72) Säle, Michael, Herzogring 22a, 97241 Bergtheim-Opferbaum, DE  
Dr. Arnold, Norbert, Schluckenauer Str. 20, 89264 Weifsenhorn, DE

- (51) MKP  
**A61K 31/495 (2006.01)** (97) **2640386 \***  
**A61K 31/551 (2006.01)**  
**A61K 45/06 (2006.01)**  
**A61P 35/00 (2006.01)**  
**A61K 31/437 (2006.01)**  
(86) US2011060998 16.11.2011  
(96) 11793585.8 25.09.2013  
(87) WO2012074754, 16.11.2011  
(97) 2640386, 25.09.2013 en  
(54) COMBINATION OF CHECKPOINT KINASE 1 INHIBITORS AND WEE 1 KINASE INHIBITORS  
(71) Array Biopharma, Inc., 3200 Walnut Street, Boulder, CO 80301, US  
(72) DAVIES, Kurtis, D., 3200 Walnut Street, Boulder, Colorado 80301, US  
GROSS, Stefan, 3200 Walnut Street, Boulder, Colorado 80301, US

- (51) MKP  
**C12N 15/11 (2006.01)** (97) **2638160 \***  
**C07H 21/00 (2006.01)**  
**C12N 15/10 (2006.01)**  
**C12Q 1/68 (2006.01)**  
(86) US2011059656 07.11.2011  
(96) 11840569.5 18.09.2013  
(87) WO2012064675, 07.11.2011  
(97) 2638160, 18.09.2013 en  
(54) NUCLIONS AND RIBOCAPSIDS  
(71) Webb, Nigel L., 1101 Green Valley Road, Bryn Mawr, PA 19010, US  
(72) GAMPER, Howard, B., Thomas Jefferson University Department of Biochemistry and Molecular Biology 233 South 10th Street, Philadelphia, PA 19107, US

- (51) MKP  
**A43B 7/12 (2006.01)** (97) **2640209 \***  
**A43B 13/16 (2006.01)**  
**A43B 13/12 (2006.01)**  
(86) EP2011067975 14.10.2011  
(96) 11770755.4 25.09.2013  
(87) WO2012065792, 14.10.2011  
(97) 2640209, 25.09.2013 en  
(54) VAPOR-PERMEABLE SHOE WITH WATERPROOF AND VAPOR-PERMEABLE SOLE  
(71) Geox S.p.A., Via Feltrina Centro, 16, 31044 Montebelluna Località Biadene (Treviso), IT  
(72) POLEGATO MORETTI, Mario, Via Fantin 96, I-31035 Crocetta Del Montello, IT

- (51) MKP  
**C01G 49/08 (2006.01)** (97) **2598443 \***  
(86) IB2011051952 03.05.2011  
(96) 11811901.5 05.06.2013  
(87) WO2012014094, 03.05.2011  
(97) 2598443, 05.06.2013 en  
(54) PROCESS FOR OBTAINING FUNCTIONALIZED NANOPARTICULATE MAGNETIC FERRITES FOR EASY DISPERSION AND MAGNETIC FERRITES OBTAINED THROUGH THE SAME  
(71) Nanum Nanotecnologia S/A, Avenida Jose Candido Da Silveira 2100 Salas 25 E 26, Horto, 31170-000 Belo Horizonte, Minas Gerais, BR  
(72) CONTADINI, Jose Fernando, Avenida Olegario Maciel 1727 Apto 701, 30180-111 Belo Horizonte Minas Gerais, BR  
MOHALLEM, Tarik Della Santina, Rua Nivaldo Correia 35 Jaraguá, 313261-5454 Belo Horizonte Minas Gerais, BR  
DE SOUZA, Taiane Guedes Fonseca, Rua João Alexandre Pires 419 Milionarios, 313251-5454 Belo Horizonte Minas Gerais, BR

- (51) MKP  
**A01N 35/00 (2006.01)** (97) **2611294 \***  
**A01N 35/02 (2006.01)**  
**A01P 21/00 (2006.01)**  
(86) US2011050286 02.09.2011  
(96) 11822697.6 10.07.2013  
(87) WO2012031174, 02.09.2011  
(97) 2611294, 10.07.2013 en  
(54) ENHANCEMENT OF POTATO TUBER SPROUTING INHIBITORS USING VARIOUS COMBINATIONS OF AGENTS  
(71) Washington State University Researchfoundation, 1610 NE Eastgate Boulevard Suite 650, Pullman, WA 99163, US  
(72) KNOWLES, Lisa, 985 SW Meyer Drive, Pullman, WA 99163, US  
KNOWLES, Norman, R., 985 Sw Meyer Drive, Pullman, WA 99163, US

- (51) MKP  
**E02F 9/06 (2006.01)** (97) **2520726**  
**E02F 5/28 (2006.01)**  
**E02B 3/02 (2006.01)**  
**E02F 3/47 (2006.01)**  
**E02F 7/06 (2006.01)**  
(96) 12405041.0 07.11.2012  
(97) 2520726, 07.11.2012 de  
(54) Device and method for removing material deposits from the reservoir of a hydrotechnical structure  
(71) BRA turbo Ing AG, Industriestrasse 11, 6343 Rotkreuz, CH  
(72) Bachmann, Hanspeter, Schlossberg 18, 6343 Risch, CH

- (51) MKP  
**C07K 16/18 (2006.01)** (97) **2632951 \***  
**C07K 16/22 (2006.01)**  
(86) US2011058025 27.10.2011  
(96) 11779531.0 04.09.2013  
(87) WO2012058393, 27.10.2011  
(97) 2632951, 04.09.2013 en  
(54) DKK1 ANTIBODIES AND METHODS OF USE  
(71) Amgen Inc., One Amgen Center Drive, Thousand Oaks, California 91320-1799, US  
(72) RICHARDS, William Gleason, 3079 Espana Lane, Thousand Oaks California 91362, US  
LU, Hsieng Sen, 2758 Rainfield Avenue, Westlake Village California 91362, US  
KE, Hua Zhu, 5258 Via Dolores, Newbury Park California 91320, US  
LI, Chaoyang, 97 Via Aldea, Newbury Park California 91320, US  
JACOBSEN, Frederick W., 1168 Homestake Place, Newbury Park California 91320, US

- (51) MKP  
**B65D 90/12 (2006.01)** (97) **2595903 \***  
**E04H 12/12 (2006.01)**  
**F03D 11/04 (2006.01)**
- (86) EP2011062703 25.07.2011  
(96) 11736095.8 29.05.2013  
(87) WO2012010710, 25.07.2011  
(97) 2595903, 29.05.2013 de  
(54) PROTECTIVE FOOT FOR A UNIT LOAD, IN PARTICULAR CONCRETE TOWER SEGMENTS  
(71) Wobben Properties GmbH, Dreekamp 5, 26605 Aurich, DE  
(72) ALBRECHTS, Harald, Dwarsweg 44, 26624 Moorhusen, DE
- 
- (51) MKP  
**C02F 1/04 (2006.01)** (97) **2609038 \***  
**B01D 1/30 (2006.01)**  
**E21B 43/24 (2006.01)**  
**C09K 8/592 (2006.01)**
- (86) CA2011000325 29.03.2011  
(96) 11819218.6 03.07.2013  
(87) WO2012024764, 29.03.2011  
(97) 2609038, 03.07.2013 en  
(54) A CONTAMINANT CONTROL SYSTEM IN AN EVAPORATIVE WATER TREATING SYSTEM  
(71) Kemex Ltd., 1000, 734 -7th Avenue S.W., Calgary, AB T2P 3P8, CA  
(72) JAMES, Kenneth, 243137 Range Road 31, Calgary Alberta T3Z 3L7, CA
- 
- (51) MKP  
**E21B 43/12 (2006.01)** (97) **2625381 \***  
**E21B 34/14 (2006.01)**  
**E21B 23/08 (2006.01)**  
**E21B 33/12 (2006.01)**
- (86) CA2011001133 06.10.2011  
(96) 11830162.1 14.08.2013  
(87) WO2012045165, 06.10.2011  
(97) 2625381, 14.08.2013 en  
(54) ACTUATION DART FOR WELLBORE OPERATIONS, WELLBORE TREATMENT APPARATUS AND METHOD  
(71) Packers Plus Energy Services Inc., Bow Valley Square 2 Suite 2200, 205 - 5 Avenue SW, Calgary, Alberta T2P 2V7, CA  
(72) COON, Robert, Joe, 8606 Hall Retreat CT, Missouri City Texas 77459, US
- 
- (51) MKP  
**C07D 233/64 (2006.01)** (97) **2638016 \***  
**C07D 233/84 (2006.01)**
- (86) EP2011069603 08.11.2011  
(96) 11779661.5 18.09.2013  
(87) WO2012062730, 08.11.2011  
(97) 2638016, 18.09.2013 en  
(54) Process for the preparation of 3-(6-amino-pyridin-3yl)-2-acrylic acid derivatives  
(71) SANOFI, 54, rue de la Boétie, 75008 Paris, FR  
(72) BOEHM, Claudius, c/o Sanofi-Aventis Deutschland GmbH, 65926 Frankfurt am Main, DE  
KLEIN, Susanne, c/o Sanofi-Aventis Deutschland GmbH, 65926 Frankfurt am Main, DE  
NAPIERSKI, Bernd, c/o Sanofi-Aventis Deutschland GmbH, 65926 Frankfurt am Main, DE  
SOMMER, Christian, c/o Sanofi-Aventis Deutschland GmbH, 65926 Frankfurt am Main, DE

- (51) MKP  
**C07D 309/10 (2006.01)** (97) **2595980 \***  
**C07H 19/00 (2006.01)**
- (86) US2011045102 22.07.2011  
(96) 11743709.5 29.05.2013  
(87) WO2012012776, 22.07.2011  
(97) 2595980, 29.05.2013 en  
(54) METHODS AND COMPOUNDS FOR TREATING PARAMYXOVIRIDAE VIRUS INFECTIONS  
(71) Gilead Sciences, Inc., 333 Lakeside Drive, Foster City, CA 94404, US  
(72) MACKMAN, Richard, L., 360 Ashton Avenue, Millbrae, CA 94030, US  
PARRISH, Jay, P., 720 Bair Island Rd. 106, Redwood City, CA 94063, US  
RAY, Adrian, S., 19 Pilot Circle, Redwood City, CA 94065, US  
THEODORE, Dorothy, Agnes, 19487 Vaughn Avenue, Castro Valley, CA 94546, US
- 
- (51) MKP  
**A23G 3/42 (2006.01)** (97) **2628397**  
**A23L 1/236 (2006.01)**  
**A23G 3/44 (2006.01)**  
**A23L 2/60 (2006.01)**
- (96) 13167730.4 21.08.2013  
(97) 2628397, 21.08.2013 de  
(54) Sucralose-containing sweetener compositions  
(71) Krüger GmbH & Co. KG, Senefelderstrasse 44, 51469 Bergisch-Gladbach, DE  
(72) Krüger, Willibert, Zaunkönigweg 5, 51467 Bergisch Gladbach, DE
- 
- (51) MKP  
**F02B 21/00 (2006.01)** (97) **2625400 \***  
**F02M 31/04 (2006.01)**  
**F02M 31/16 (2006.01)**  
**F01B 17/02 (2006.01)**  
**F01D 13/02 (2006.01)**
- (86) EP2011067212 03.10.2011  
(96) 11764537.4 14.08.2013  
(87) WO2012045694, 03.10.2011  
(97) 2625400, 14.08.2013 fr  
(54) SELF-PRESSURE-REGULATING COMPRESSED AIR ENGINE COMPRISING AN INTEGRATED ACTIVE CHAMBER  
(71) Motor Development International S.A., 17 Rue des Bains, 1212 Luxembourg, LU  
(72) NEGRE, Guy, 3 rue Abbé Jos Keip, L-1260 Luxembourg, LU  
NEGRE, Cyril, 1 rue St Aignan, F-06300 Nice, FR
- 
- (51) MKP  
**B66C 1/12 (2006.01)** (97) **2550225 \***
- (86) EP2011054432 23.03.2011  
(96) 11710759.9 30.01.2013  
(87) WO2011117290, 23.03.2011  
(97) 2550225, 30.01.2013 de  
(54) LIFTING UNIT FOR LIFTING A ROTOR OF A WIND ENERGY INSTALLATION  
(71) Wobben Properties GmbH, Dreekamp 5, 26605 Aurich, DE  
(72) LÜLKER, Frank, Wallster Weg 29, 26603 Aurich, DE

- (51) MKP  
**C07D 237/32 (2006.01)** (97) **2619185 \***  
**C07D 253/08 (2006.01)**  
**C07D 265/26 (2006.01)**  
**C07D 401/12 (2006.01)**  
**C07D 403/12 (2006.01)**  
**C07D 409/12 (2006.01)**  
**A61K 31/502 (2006.01)**  
**A61K 31/53 (2006.01)**  
**A61K 31/536 (2006.01)**  
**A61P 29/00 (2006.01)**
- (86) IB2011054227 26.09.2011  
(96) 11776883.8 31.07.2013  
(87) WO2012038942, 26.09.2011  
(97) 2619185, 31.07.2013 en  
(54) MATRIX METALLOPROTEINASE INHIBITORS  
(71) Ranbaxy Laboratories Limited, Head Office: 12th Floor Devika Tower 06 Nehru Place New Delhi, Delhi 110019, IN  
(72) KHERA, Manoj Kumar, R-511 Jalvayo Tower Sector-56, Gurgaon Haryana 122001, IN  
SONI, Ajay, B-6 Om Vihar Uttam Nagar, New Delhi Delhi 110059, IN  
SATTIGERI, Jitendra, N-323 Vijay Rattan Vihar Sector 15-II, Gurgaon Haryana 122001, IN  
SATTIGERI, Viswajanani, N-323 Vijay Rattan Vihar Sector 15-II, Gurgaon Haryana 122001, IN  
DAS, Biswajit, 2nd Floor J7/13 DLF-II, Gurgaon Haryana 122001, IN  
CLIFFE, Ian A., E-704 Ambience Island NH-8, Gurgaon Haryana 122001, IN  
BHATNAGAR, Pradip Kumar, 300 South Balderston Drive, Exton Pennsylvania 19341, US  
RAUF, Abdul Rehman Abdul, Islampura Chandur Biswa Nandura, Buldana Maharashtra 443401, IN  
MUSIB, Arpita, d/o Mr. P. L. Musib Rabindra Sarani Post-Khatra Bankura, West Bengal 722140, IN  
SAHA, Subham, New Delhi, Delhi 122001, IN  
YADAV, Neeraj Kumar, Village - Rohila Post - Rohila Lohia Nagar, Farrukhabad Uttar Pradesh 206451, IN  
AHAMMED, Sabir, New Delhi, Delhi 110019, IN  
REDDY, Ranadheer R., P.O. Thimmapuram (Mandal) Chievemula Nalgonda, Suryapet Andhra Pradesh 501213, IN  
RAY, Abhijit, Sector C-1 Flat No. 1408 Vasant Kunj, New Delhi Delhi 110070, IN  
SRIVASTAVA, Punit, 1263A Sector-15 Part -II, Gurgaon Haryana 122015, IN  
DASTIDAR, Sunanda Ghosh, B-138 Sarita Vihar, New Delhi Delhi 110076, IN
- 
- (51) MKP  
**E04F 13/08 (2006.01)** (97) **2619377 \***  
**E04B 1/76 (2006.01)**  
**E04B 2/92 (2006.01)**
- (86) IB2011054224 26.09.2011  
(96) 11797347.9 31.07.2013  
(87) WO2012038941, 26.09.2011  
(97) 2619377, 31.07.2013 en  
(54) SELF-SUPPORTING MODULE FOR THE FACADE OF A BUILDING  
(71) Pro Energy Systems S.r.l., Lungo Castellano Sisto V, 36, Ascoli Piceno, IT  
(72) FICCADENTI, Marco, c/o PRO ENERGY SYSTEMS S.r.l. Lungo Castellano Sisto V, 36, Ascoli Piceno, IT  
LEUZZI, Angela Giovanna, c/o PRO ENERGY SYSTEMS S.r.l. Lungo Castellano Sisto V, 36, Ascoli Piceno, IT  
MARCHETTI, Alessandra, c/o PRO ENERGY SYSTEMS S.r.l. Lungo Castellano Sisto V, 36, Ascoli Piceno, IT  
MORRESI, Lorenzo, c/o PRO ENERGY SYSTEMS S.r.l. Lungo Castellano Sisto V, 36, Ascoli Piceno, IT  
MURRI, Roberto, c/o PRO ENERGY SYSTEMS S.r.l. Lungo Castellano Sisto V, 36, Ascoli Piceno, IT  
OTTONE, Maria Federica, c/o PRO ENERGY SYSTEMS S.r.l. Lungo Castellano Sisto V, 36, Ascoli Piceno, IT  
PINTO, Nicola, c/o PRO ENERGY SYSTEMS S.r.l. Lungo Castellano Sisto V, 36, Ascoli Piceno, IT  
TASCINI, Simone, c/o PRO ENERGY SYSTEMS S.r.l. Lungo Castellano Sisto V, 36, Ascoli Piceno, IT
- 
- (51) MKP  
**A61B 18/12 (2006.01)** (97) **2540243**  
(96) 11171770.8 02.01.2013  
(97) 2540243, 02.01.2013 en  
(54) An electrosurgical instrument  
(71) Lina Medical ApS, Formervangen 5, 2600 Glostrup, DK  
(72) Poulsen, Henrik Bisgaard, Bakkesvinget 15, 3550 Slangerup, DK
- 
- (51) MKP  
**C07D 487/04 (2006.01)** (97) **2601193 \***  
**A61K 31/53 (2006.01)**  
**A61P 31/04 (2006.01)**
- (86) EP2011063434 04.08.2011  
(96) 11740921.9 12.06.2013  
(87) WO2012017030, 04.08.2011  
(97) 2601193, 12.06.2013 en  
(54) COMPOUNDS WITH ANTIBACTERIAL ACTIVITY AGAINST CLOSTRIDIUM  
(71) Elanco Animal Health Ireland Limited, 70 Sir John Rogerson's Quay, Dublin, IE  
(72) GUILLEMONT, Jérôme, Emile, Georges, Johnson&Johnson Pharmaceutical Research and Development A division of Janssen-Cilag Campus de Maignemont BP615, F-27106 Val de Reuil Cedex, FR  
RABOISSON, Pierre Jean-Marie Bernard, Tibotec BVBA Turnhoutseweg 30, B-2340 Beerse, BE  
LOUNIS, Nacer, Tibotec Bvba Turnhoutseweg 30, B-2340 Beerse, BE
- 
- (51) MKP  
**G02B 1/12 (2006.01)** (97) **2598937 \***  
**C07F 7/10 (2006.01)**  
**B29D 11/00 (2006.01)**  
**G02C 7/04 (2006.01)**
- (86) US2011045809 29.07.2011  
(96) 11813221.6 05.06.2013  
(87) WO2012016097, 29.07.2011  
(97) 2598937, 05.06.2013 en  
(54) AMPHIPHILIC POLYSILOXANE PREPOLYMERS AND USES THEREOF  
(71) Novartis AG, Lichtstrasse 35, 4056 Basel, CH  
(72) CHANG, Frank, 8489 Spring Breeze Terrace, Suwanee Georgia 30024, US  
SCOTT, Robert, 1220 Longpointe Pass, Alpharetta Georgia 30005, US  
HUANG, Jinyu, 917 Summer Forest Drive, Suwanee Georgia 30024, US  
MEDINA, Arturo, N., 4021 McGinnis Ferry Road 2222, Suwanee Georgia 30024, US  
SMITH, Dawn, A., 616 Avenue C SE, Cullman Alabama 35055, US  
SANDERS, Laura, Ann, 1359 Sanden Ferry Drive, Decatur Georgia 30033, US  
PRUITT, John, Dallas, 5060 Winding Rose Drive, Suwanee Georgia 30024, US
- 
- (51) MKP  
**F02M 51/00 (2006.01)** (97) **2538066**  
**F02M 59/46 (2006.01)**  
**F02M 61/16 (2006.01)**  
**F02M 63/02 (2006.01)**  
**F02M 63/00 (2006.01)**  
**F16K 31/06 (2006.01)**  
**F16L 37/088 (2006.01)**
- (96) 11170541.4 26.12.2012  
(97) 2538066, 26.12.2012 en  
(54) Assembly for an electrically operated valve  
(71) Delphi Technologies Holding S.à.r.l., Avenue de Luxembourg, 4940 Bascharage, LU  
(72) Dupont, Richard, 20 Avenue Leonard de Vinci, 37400 Amboise, FR  
Marechal, Michel, 48 route d'onzain, 41150 Chouzy Sur Cisse, FR  
Cardon, Christophe, 1 bis chemin de pissevin, 41000 Saint Denis Sur Loire, FR

(51) MKP  
**E04F 13/12 (2006.01)** (97) **2630315 \***  
**E04F 13/08 (2006.01)**  
(86) FR2010000701 22.10.2010  
(96) 10784329.4 28.08.2013  
(87) WO2012052625, 22.10.2010  
(97) 2630315, 28.08.2013 fr  
(54) METAL SIDING HAVING A SECURE COVER  
(71) Arcelormittal Investigación y Desarrollo SL, CL/Chavarri, 6, 48910 Sestao, Bizkaia, ES  
(72) MASURE, David, 34 rue Yves Kermen, F-92100 Boulogne Billancourt, FR  
**CHABAS, Eric, 25 rue Massenet, F-77270 Villeparisis, FR**

(51) MKP  
**A63F 9/24 (2006.01)** (97) **2598218 \***  
(86) US2011045991 29.07.2011  
(96) 11813282.8 05.06.2013  
(87) WO2012016199, 29.07.2011  
(97) 2598218, 05.06.2013 en  
(54) PAYMENT CARDS, DEVICES, SYSTEMS, AND METHODS FOR PROVIDING GAME ACTIONS WITH PAYMENT DATA, SOCIAL NETWORKING MECHANISMS AND INFORMATION EXCHANGE MECHANISMS  
(71) Dynamics Inc., 493 Nixon Road, Cheswick, PA 15024, US  
(72) MULLEN, Jeffrey, D., 731 South Negley Avenue Apartment 2, Pittsburgh PA 15232, US  
YEN, Philip, W., 21821 McClellan Road, Cupertino CA 95014, US  
RIGATTI, Christopher, J., 321 Jacksonia Street, Pittsburgh PA 15212, US

(51) MKP  
**C07K 16/28 (2006.01)** (97) **2643354 \***  
**A61K 39/395 (2006.01)**  
**A61P 35/00 (2006.01)**  
(86) EP2011070846 23.11.2011  
(96) 11787692.0 02.10.2013  
(87) WO2012069550, 23.11.2011  
(97) 2643354, 02.10.2013 en  
(54) NOVEL HOMOGENEOUS HUMANIZED ANTIPROLIFERATION ANTIBODIES  
(71) Pierre Fabre Medicament, 45, Place Abel Gance, 92100 Boulogne-Billancourt, FR  
(72) GOETSCH, Liliane, 15 route de Cluses, F-74130 Ayzé, FR  
CORVAIA, Nathalie, Résidence arc en ciel Le coin 20 route de Vovray, F-74160 Collonges Sous Saleve, FR  
HAEUW, Jean-François, Domaine du Salève Route du Salève, F-74160 Beaumont, FR  
BES, Cédric, 32B rue du Calvaire de Grillaud, F-44100 Nantes, FR  
**BECK, Alain, 71 allée de Beauregard, F-74160 Feigères, FR**

(51) MKP  
**B05B 11/00 (2006.01)** (97) **2618940 \***  
(86) FR2011051725 19.07.2011  
(96) 11754443.7 31.07.2013  
(87) WO2012010793, 19.07.2011  
(97) 2618940, 31.07.2013 fr  
(54) DEVICE FOR DISPENSING A LIQUID AND METHOD OF MANUFACTURING SUCH A DEVICE  
(71) GB Developpement, 59 rue Voltaire, 92800 Puteaux, FR  
(72) BOULAIS, Guillaume, 44 rue Voltaire, F-92300 Levallois Perret, FR

(51) MKP  
**C12N 15/62 (2006.01)** (97) **2633060 \***  
**C12N 9/24 (2006.01)**  
**C12N 9/42 (2006.01)**  
**C12N 15/56 (2006.01)**  
**C12P 7/10 (2006.01)**  
**C07K 14/33 (2006.01)**  
(86) EP2011068645 25.10.2011  
(96) 11785617.9 04.09.2013  
(87) WO2012055863, 25.10.2011  
(97) 2633060, 04.09.2013 en  
(54) COVALENT CELLULOSOMES AND USES THEREOF  
(71) Total Raffinage Marketing, 24 Cours Michelet, 92800 Puteaux, FR  
Le Centre National de la Recherche Scientifique (CNRS), 3, rue Michel Ange, 75794 Paris Cedex 16, FR  
L'Université de la Méditerranée, Jardin du Pharo 58 Boulevard Charles-Livon, 13284 Marseille Cedex 7, FR  
L'Université de Provence, 3 Place Victor Hugo, 13331 Marseille Cedex 3, FR  
L'Institut National des Sciences Appliquées (INSA), 135 Avenue de Ranguel, 31077 Toulouse Cedex 4, FR  
(72) FIEROBE, Henri-Pierre, 31 Chemin Joseph Aiguier, F-13009 Marseille, FR  
CHANAL-VIAL, Angélique, 3 place Eugène Bertrand, F-Marseille 13012, FR  
RECEVEUR-BRÉCHOT, Véronique, La Miolane Bât. B2 Allée des Bartavelles, F-83270 Saint-Cyr-sur-Mer, FR  
NOUAILLER, Matthieu, Ch 151 Colline Saint Joseph Le Manoir Bât. C, F-13009 Marseille, FR

(51) MKP  
**C09D 5/00 (2006.01)** (97) **2643415 \***  
(86) EP2011071072 25.11.2011  
(96) 11807874.0 02.10.2013  
(87) WO2012069651, 25.11.2011  
(97) 2643415, 02.10.2013 de  
(54) COATING COMPOSITION WITH SPARKLE EFFECT  
(71) Brillux GmbH & Co. KG, Weseler Strasse 401, 48163 Münster, DE  
(72) KRECHTING, Andreas, Münsterstraße 24, 48163 Schöppingen, DE

(51) MKP  
**A61L 27/38 (2006.01)** (97) **2637711 \***  
**A61L 27/50 (2006.01)**  
**A61L 27/52 (2006.01)**  
**A61L 27/22 (2006.01)**  
(86) US2011001887 10.11.2011  
(96) 11793523.9 18.09.2013  
(87) WO2012064369, 10.11.2011  
(97) 2637711, 18.09.2013 en  
(54) INJECTABLE FORMULATIONS FOR ORGAN AUGMENTATION  
(71) Tengion, Inc., 2900 Potshop Lane, Suite 100, East Norriton, PA 19403, US  
(72) BASU, Joydeep, 435 Mica Court, Winston-Salem NC 27103, US  
PAYNE, Richard, 934 Franklin St., Winston-Salem NC 27101, US  
ROBBINS, Neil, F., Jr., 1111-5 Barbara Ann Circle, Winston-Salem NC 27103, US  
KNIGHT, Oluwatoyin, A., 3919 Heatherview Lane, Winston-Salem NC 27127, US  
JAIN, Deepak, 559 Sun Creek Drive, Winston-Salem NC 27104, US  
HALBERSTADT, Craig, R., Winston-Salem, NC, US  
SERBAN, Monica, A., 188 Cameron Way Circle, Winston-Salem NC 27103, US

- (51) MKP  
**G01N 33/543 (2006.01)** (97) **2618149**  
**G01N 33/558 (2006.01)**
- (96) 13151780.7 24.07.2013  
(97) 2618149, 24.07.2013 en  
(54) Assay device having uniform flow around corners  
(71) ORTHO-CLINICAL DIAGNOSTICS, INC., 1001 U.S. Route 202, Raritan, NJ 08869, US  
(72) Kanaley, James D., 23 East Street, Honeoye Falls, New York, NY 14472, US  
Ding, Zhong, 35 Delancey Court, Pittsford, New York, NY 14534, US  
Hosimer, Philip C., 11 Beach Terrace, Rochester, New York, NY 14617, US  
Scalice, Edward R., 30 Cobblestone Crossing, Penfield, New York, NY 14526, US  
Danielson, Susan, 47 Partridge Hill, Honeoye Falls, New York, NY 14472, US  
Tomasso, David A., 174 Old Well Road, Rochester, New York, NY 14626, US  
Warren, Timothy C., 59 Sannita Drive, Rochester, New York, NY 14626, US

- (51) MKP  
**G01N 33/543 (2006.01)** (97) **2618150**  
**G01N 33/558 (2006.01)**
- (96) 13151781.5 24.07.2013  
(97) 2618150, 24.07.2013 en  
(54) Assay device having multiple reagent cells  
(71) ORTHO-CLINICAL DIAGNOSTICS, INC., 1001 U.S. Route 202, Raritan, NJ 08869, US  
(72) Ding, Zhong, 35 Delancey Court, Pittsford, New York, NY 14534, US

- (51) MKP  
**H01R 13/62 (2006.01)** (97) **2617105 \***  
**H01R 13/71 (2006.01)**  
**H01R 13/24 (2006.01)**
- (86) IT2010000409 27.09.2010  
(96) 10776190.0 24.07.2013  
(87) WO2012035567, 27.09.2010  
(97) 2617105, 24.07.2013 en  
(54) MAGNETICALLY ENSLAVED UNIPOLAR ELECTRICAL CONTACT ARRANGED FOR EMBEDDING IN THE SIDES OF GENERIC FRAMES AND IN PARTICULAR OF GLASS-CHAMBER FRAMES  
(71) Pellini S.p.A., Via Fusari 19, 26845 Codogno (Lodi), IT  
(72) NICOLOSI, Giovanni, Via G. di Vittorio 4, I-20070 Dresano (Milano), IT

- (51) MKP  
**A61M 5/32 (2006.01)** (97) **2627383 \***
- (86) EP2011067685 11.10.2011  
(96) 11767703.9 21.08.2013  
(87) WO2012049147, 11.10.2011  
(97) 2627383, 21.08.2013 en  
(54) CAP ASSEMBLY FOR A DRUG DELIVERY DEVICE  
(71) Sanofi-Aventis Deutschland GmbH, Brüningstraße 50, 65929 Frankfurt am Main, DE  
(72) HELMER, Michael, c/o Sanofi-Aventis Deutschland GmbH, 65926 Frankfurt am Main, DE

- (51) MKP  
**A24F 47/00 (2006.01)** (97) **2614731**
- (96) 12151002.8 17.07.2013  
(97) 2614731, 17.07.2013 en  
(54) An atomizer for electronic cigarette  
(71) Shenzhen First Union Technology Co., Ltd., 1-3 F, Building C Gaoxin Industry Zone Tangwei Village Fuyong Town Baoan District, Shenzhen Guangdong, CN  
(72) Li, Yonghai, 1-3F, Building C, Gaoxin Industry Zone, Tangwei Village, Fuyong Town, Baoan District, Shenzhen Guangdong, CN  
Xu, Zhongli, 1-3F, Building C, Gaoxin Industry Zone, Tangwei Village, Fuyong Town, Baoan District, Shenzhen Guangdong, CN

- (51) MKP  
**G09B 29/10 (2006.01)** (97) **2613272 \***  
**G06F 17/30 (2006.01)**  
**G06Q 10/00 (2012.01)**
- (86) JP2011001752 25.03.2011  
(96) 11821229.9 10.07.2013  
(87) WO2012029204, 25.03.2011  
(97) 2613272, 10.07.2013 en  
(54) ELECTRONIC MAP DATA PROCESSING SYSTEM  
(71) Kabushiki Kaisha Toshiba, 1-1 Shibaura 1-chome, Minato-ku Tokyo 105-8001, JP  
Toshiba Solutions Corporation, 1-1 Shibaura 1-chome Minato-ku, Tokyo 105-8001, JP  
(72) OMURA, Tsuyoshi, c/o TOSHIBA SOLUTIONS CORPORATION 1-1, Shibaura 1-chome Minato-ku, Tokyo 105-8001, JP  
UEMATSU, Takeshi, c/o TOSHIBA SOLUTIONS CORPORATION 1-1, Shibaura 1-chome Minato-ku, Tokyo 105-8001, JP  
TAKAHASHI, Koji, c/o TOSHIBA SOLUTIONS CORPORATION 1-1, Shibaura 1-chome Minato-ku, Tokyo 105-8001, JP  
SOMAKI, Kazuo, c/o TOSHIBA SOLUTIONS CORPORATION 1-1, Shibaura 1-chome Minato-ku, Tokyo 105-8001, JP

- (51) MKP  
**E04F 13/14 (2006.01)** (97) **2605893 \***  
**B28D 1/00 (2006.01)**  
**B44C 5/04 (2006.01)**
- (86) HU2011000085 12.08.2011  
(96) 11817823.5 26.06.2013  
(87) WO2012022993, 12.08.2011  
(97) 2605893, 26.06.2013 en  
(54) METHOD FOR PREPARING FLEXIBLE STONE CLADDINGS HAVING NATURAL SURFACE  
(71) Sasvári, Gábor, Csabakirályfi u. 2., 2612 Kosd, HU  
(72) Sasvári, Gábor, Csabakirályfi u. 2., 2612 Kosd, HU

- (51) MKP  
**G06F 19/10 (2011.01)** (97) **2611941 \***  
**C12Q 1/68 (2006.01)**  
**C12N 15/11 (2006.01)**
- (86) US2011049760 30.08.2011  
(96) 11822498.9 10.07.2013  
(87) WO2012030840, 30.08.2011  
(97) 2611941, 10.07.2013 en  
(54) GENE SIGNATURES FOR CANCER DIAGNOSIS AND PROGNOSIS  
(71) Myriad Genetics, Inc., 320 Wakara Way, Salt Lake City, UT 84108, US  
Stone, Steve, 320 Wakara Way, Salt Lake City, UT 84108, US  
Gutin, Alexander, 320 Wakara Way, Salt Lake City, Utah 84108, US  
Wagner, Susanne, 320 Wakara Way, Salt Lake City, UT 84108, US  
Reid, Julia E., 320 Wakara Way, Salt Lake City, UT 84108, US  
(72) STONE, Steven, 320 Wakara Way, Salt Lake City Utah 84108, US  
GUTIN, Alexander, 320 Wakara Way, Salt Lake City Utah 84108, US  
WAGNER, Susanne, 320 Wakara Way, Salt Lake City Utah 84108, US  
REID, Julia, 320 Wakara Way, Salt Lake City Utah 84108, US

- (51) MKP  
**C02F 1/74 (2006.01)** (97) **2609040 \***  
**C02F 3/20 (2006.01)**  
**B01F 5/12 (2006.01)**  
**B01F 7/22 (2006.01)**  
**F04D 13/08 (2006.01)**
- (86) US2011048936 24.08.2011  
(96) 11820579.8 03.07.2013  
(87) WO2012027451, 24.08.2011  
(97) 2609040, 03.07.2013 en  
(54) WATER TREATMENT AND REVITALIZATION SYSTEM AND METHOD  
(71) Qwtip LLC, 223 North Guadalupe Street 462, Santa Fe, NM 87501, US  
(72) IRVIN, Whitaker Ben, Sr., 223 North Guadalupe Street 462, Santa Fe New Mexico 87501, US  
HIRSCHFELD, Luis Octavio Perez, Baudelio Pelayo 8302-17, Ciudad Jaurez 32460, MX

- (51) MKP  
**A61K 9/20 (2006.01)** (97) **2603205 \***  
**A61K 31/485 (2006.01)**
- (86) EP2011063864 11.08.2011  
(96) 11743537.0 19.06.2013  
(87) WO2012020097, 11.08.2011  
(97) 2603205, 19.06.2013 en  
(54) USE OF BINDERS FOR MANUFACTURING STORAGE STABLE FORMULATIONS
- (71) Euro-Celtique S.A., 2, avenue Charles de Gaulle, 1653 Luxembourg, LU  
(72) PRATER, Derek Allan, 28 Pearson Close, Milton Cambridge CB24 6YS, GB  
SPITZLEY, Christof, Am Linsengraben 2, 65627 Elbtal, DE  
HEUN, Gerhard Josef, Limburgerstraße 80, 65611 Brechen, DE  
SCHÜTZ, Alexander, Oranienstraße 6A, 65597 Hünfelden Nauheim, DE  
HAHN, Udo, Nordstraße 1, 56412 Nentershausen, DE  
LEUNER, Christian, Blauwiesenweg 65, 60439 Frankfurt, DE
- 
- (51) MKP  
**A61K 31/4188 (2006.01)** (97) **2635588 \***  
**C07D 491/052 (2006.01)**
- (86) US2012065681 16.11.2012  
(96) 12798525.7 11.09.2013  
(87) WO2013075029, 16.11.2012  
(97) 2635588, 11.09.2013 en  
(54) CONDENSED IMIDAZOLYLIMIDAZOLES AS ANTIVIRAL COMPOUNDS
- (71) Gilead Sciences, Inc., 333 Lakeside Drive, Foster City, CA 94404, US  
(72) BACON, Elizabeth, M., 1218 Floribunda Avenue Apt. 8, Burlingame, California 94010, US  
COTTELL, Jeremy, J., 701 Baltic Circle 719, Redwood City, California 94065, US  
KATANA, Ashley, Anne, 2201 Bridgepoint Parkway 205, San Mateo, California 94404, US  
KATO, Darryl, 223 Connecticut Street, San Francisco, California 94107, US  
KRYGOWSKI, Evan, S., 2231 California Street NW 507, Washington, District of Columbia 20008, US  
LINK, John, O., 74 Prospect Avenue, San Francisco, California 94110, US  
TAYLOR, James, 100 State Street, San Mateo, California 94401, US  
TRAN, Chinh Viet, 10322 Baron Drive, San Diego, California 92126, US  
TREJO MARTIN, Teresa, Alejandra, 32772 S. Artistry Loop, Union City, California 94587, US  
YANG, Zheng-Yu, 338 El Carmelo Avenue, Palo Alto, California 94306, US  
ZIPFEL, Sheila, 22 N. San Mateo Drive Apt. 205, San Mateo, California 94401, US
- 
- (51) MKP  
**A61K 8/84 (2006.01)** (97) **2637639 \***  
**A61Q 19/00 (2006.01)**  
**A61K 8/92 (2006.01)**  
**A61Q 1/00 (2006.01)**  
**A61K 8/72 (2006.01)**  
**A61K 8/97 (2006.01)**
- (86) US2011059744 08.11.2011  
(96) 11839960.9 18.09.2013  
(87) WO2012064716, 08.11.2011  
(97) 2637639, 18.09.2013 en  
(54) TRANSFER RESISTANT COSMETICS AND METHOD OF MAKING
- (71) Coty Inc., 2 Park Avenue, New York, NY 10016, US  
(72) BARONE, Salvatore, J., 63 Peacock Loop, Staten Island New York 10309, US  
NGUYEN, Lethu, 400 Middlesex Avenue, Colonia New Jersey 07067, US  
VANCE MAILLARD, Frederic, 7 Cite Martignac, F-75007 Paris, FR
- 
- (51) MKP  
**A61K 9/00 (2006.01)** (97) **2613765 \***  
**A61K 35/14 (2006.01)**  
**A61L 15/32 (2006.01)**  
**A61P 17/02 (2006.01)**
- (86) IB2011002756 08.09.2011  
(96) 11805177.0 17.07.2013  
(87) WO2012032418, 08.09.2011  
(97) 2613765, 17.07.2013 en  
(54) ACTIVATED LEUKOCYTE CONDITIONED SUPERNATANT AND USES FOR WOUND HEALING
- (71) Macrocare, Ltd., 9 Bareket Street P.O. Box 7988 Ryat Matalon, 49250 Petach Tikva, IL  
(72) SHIRVAN, Mitchell, Tel Hay 47 St., 46432 Herzliyya, IL  
BAIN, Eilat, Dereh Yavne 74 St., 76303 Rehovot, IL  
BUBIS, Marina, Hanasie Harishon 35 St., 76303 Rehovot, IL  
GINIS, Irene, 16 Hahadas St., 99557 Beit Shemesh, IL
- 
- (51) MKP  
**A61K 31/4375 (2006.01)** (97) **2621491 \***  
**A61P 31/04 (2006.01)**
- (86) US2011052003 16.09.2011  
(96) 11771292.7 07.08.2013  
(87) WO2012047487, 16.09.2011  
(97) 2621491, 07.08.2013 en  
(54) 2-PYRIDONE ANTIMICROBIAL COMPOSITIONS
- (71) Evolva SA, Duggingerstrasse 23, 4153 Reinach, CH  
(72) ROUSSEL, Patrick, 3 Sentier au Bois, F-68100 Mulhouse, FR  
HEIM, Jutta, Zelgling 17, CH-4433 Ramllinsburg, CH  
SCHNEIDER, Peter, Baumliackerstrasse 8, CH-4103 Bottminger/BL, CH  
BARTELS, Christian, Baslerstrasse 128, CH-4123 Allschwil/BL, CH  
LIU, Yaoquan, 4415 James Avenue, Castro Valley CA 94546, US  
DALE, Glenn, C. F. Meyerstrasse 10, CH-4059 Basel, CH  
MILLIGAN, Daniel, 3650 18th Street Apt. 4, San Francisco, California, US
- 
- (51) MKP  
**C12N 5/0735 (2010.01)** (97) **2611909 \***  
**C12N 5/02 (2006.01)**  
**C12N 5/071 (2010.01)**
- (86) US2011048127 17.08.2011  
(96) 11822349.4 10.07.2013  
(87) WO2012030538, 17.08.2011  
(97) 2611909, 10.07.2013 en  
(54) DIFFERENTIATION OF HUMAN EMBRYONIC STEM CELLS
- (71) Janssen Biotech, Inc., 800/850 Ridgeview Drive, Horsham, PA 19044, US  
(72) FRYER, Benjamin, 199 Grandview Road, Skillman, NJ 08558, US
-

- (51) MKP  
**A01N 43/80 (2006.01)** (97) **2601190 \***  
**C07D 413/12 (2006.01)**  
**C07D 413/14 (2006.01)**
- (86) IB2011053355 27.07.2011  
(96) 11757416.0 12.06.2013  
(87) WO2012017359, 27.07.2011  
(97) 2601190, 12.06.2013 en
- (54) ISOXAZOLINE DERIVATIVES AS ANTIPARASITIC AGENTS  
(71) AH USA 42 LLC, 235 East 42nd Street, New York, NY 10017, US
- (72) CHUBB, Nathan, A., L., Pfizer Global Research and Development 7000 Portage Road, Kalamazoo, Michigan 49001, US  
CURTIS, Michael, Paul, Pfizer Global Research and Development 7000 Portage Road, Kalamazoo, Michigan 49001, US  
HOWSON, William, Pfizer Global Research and Development 7000 Portage Road, Kalamazoo, Michigan 49001, US  
KYNE, Graham, M., Pfizer Global Research and Development 7000 Portage Road, Kalamazoo, Michigan 49001, US  
MENON, Sanjay Rajagopal, Pfizer Global Research and Development 7000 Portage Road, Kalamazoo, Michigan 49001, US  
SHEEHAN, Susan, Mary, Kult, Pfizer Global Research and Development 7000 Portage Road, Kalamazoo, Michigan 49001, US  
SKALITZKY, Donald, James, Pfizer Global Research and Development 7000 Portage Road, Kalamazoo, Michigan 49001, US  
VAILLANCOURT, Valerie, Ann, Pfizer Global Research and Development 7000 Portage Road, Kalamazoo, Michigan 49001, US  
WENDT, John, A., Pfizer Global Research and Development 7000 Portage Road, Kalamazoo, Michigan 49001, US

- (51) MKP  
**A61P 37/00 (2006.01)** (97) **2640715 \***  
**A61K 31/506 (2006.01)**  
**C07D 413/14 (2006.01)**  
**A61P 35/00 (2006.01)**  
**C07D 401/14 (2006.01)**  
**A61P 29/00 (2006.01)**
- (86) US2011061141 17.11.2011  
(96) 11791704.7 25.09.2013  
(87) WO2012068343, 17.11.2011  
(97) 2640715, 25.09.2013 en
- (54) QUINOLINE DERIVATIVES AS PIK3 INHIBITORS  
(71) Amgen Inc., One Amgen Center Drive, Thousand Oaks, California 91320-1799, US
- (72) CUSHING, Timothy D., 1064 Glacier Avenue, Pacifica California 94044, US  
LOHMAN, Julia Winslow, 94A Sussex, San Francisco California 94131, US  
SHIN, Youngsook, 64 Loop 22, Emeryville California 94608, US

- (51) MKP  
**B65H 29/60 (2006.01)** (97) **2236447**
- (86) 10158095.9 06.10.2010  
(97) 2236447, 06.10.2010 en
- (54) Space Efficient Multi-Sheet Buffer Module and Modular Printing System  
(71) Xerox Corporation, Xerox Square - 20A 100 Clinton Avenue South, Rochester, NY 14644, US  
(72) Suh, Eun Suk, 220 Landing Road South, Rochester, NY 14610, US

- (51) MKP  
**A62C 35/68 (2006.01)** (97) **2599525 \***  
**A62C 31/00 (2006.01)**
- (86) RU2011000517 14.07.2011  
(96) 11815812.0 05.06.2013  
(87) WO2013009214, 14.07.2011  
(97) 2599525, 05.06.2013 en
- (54) AN AUTOMATED FIRE - FIGHTING COMPLEX INTEGRATING A TELEVISION SYSTEM  
(71) Joint-Stock Company "Engineering Centre of Fire Robots Technology "FR", Ul. Zavodskaya 4, Petrozavodsk 185031 Republic of Karelia, RU  
(72) GORBAN, Yury Ivanovich, ul. Pravdy 11a-8, Petrozavodsk 185005 Republic of Karelia, RU

- (51) MKP  
**A61K 31/404 (2006.01)** (97) **2616063 \***  
**A61K 31/4196 (2006.01)**  
**A61K 31/423 (2006.01)**  
**A61K 45/06 (2006.01)**  
**A61P 35/00 (2006.01)**
- (86) US2011051320 13.09.2011  
(96) 11760643.4 24.07.2013  
(87) WO2012037072, 13.09.2011  
(97) 2616063, 24.07.2013 en
- (54) HSP90 INHIBITORS FOR TREATING NON-SMALL CELL LUNG CANCERS IN WILD-TYPE EGFR AND/OR KRAS PATIENTS  
(71) Synta Pharmaceuticals Corp., 45 Hartwell Avenue, Lexington, MA 02421, US  
(72) VUKOVIC, Vojo, 51 Wildwood Street, Winchester MA 01890, US  
TEOFILOVICI, Florentina, 40 Mill Road, Wilmington MA 01887, US

- (51) MKP  
**D21F 1/02 (2006.01)** (97) **2492392**  
**D21H 13/26 (2006.01)**
- (96) 11275113.6 29.08.2012  
(97) 2492392, 29.08.2012 en
- (54) Method for preparing aramid paper and the aramid paper obtained therefrom  
(71) Zhong, Zhou, Room 1101-1103 Tongda Building N°. 1 Lane 600 Tianshang Road, ChangNing District Shanghai, CN  
(72) Zhong, Zhou, Room 1101-1103 Tongda Building N°. 1 Lane 600 Tianshang Road, ChangNing District Shanghai, CN

- (51) MKP  
**A61K 39/395 (2006.01)** (97) **2621531 \***  
**C07K 16/28 (2006.01)**  
**C07K 16/30 (2006.01)**  
**A61P 35/00 (2006.01)**
- (86) EP2011066648 26.09.2011  
(96) 11761360.4 07.08.2013  
(87) WO2012041800, 26.09.2011  
(97) 2621531, 07.08.2013 en
- (54) ANTI-CD38 ANTIBODY AND LENALIDOMIDE OR BORTEZOMIB FOR THE TREATMENT OF MULTIPLE MYELOMA AND NHL  
(71) MorphoSys AG, Lena-Christ-Strasse 48, 82152 Martinsried/ München, DE  
(72) ROJKJAER, Lisa, Frohmoosstrasse 38h, 8908 Hedingen, CH  
BOXHAMMER, Rainer, Egmatiner Str.5, 85653 Aying, DE  
ENDELL, Jan, Barer Str. 36, 80333 München, DE  
WINDERLICH, Mark, Implerstr. 52, 81371 München, DE  
SAMUELSSON, Christofer, Daisenbergerstr. 1, 83607 Holzkirchen, DE

- (51) MKP  
**C12N 5/071 (2010.01)** (97) **2614143 \***  
**C12N 5/0783 (2010.01)**
- (86) US2011050780 08.09.2011  
(96) 11824106.6 17.07.2013  
(87) WO2012033885, 08.09.2011  
(97) 2614143, 17.07.2013 en
- (54) IMMUNOTHERAPY OF CANCER USING GENETICALLY ENGINEERED GD2-SPECIFIC T CELLS  
(71) Baylor College Of Medicine, One Baylor Plaza, Houston, TX 77030, US  
(72) BRENNER, Malcolm, 4802 Willow Street, Bellaire, TX 77401, US  
DOTTI, Gianpietro, 4914 Jackson Street, Houston, TX 77004, US  
AHMED, Nabil, 3414 Norris Drive, Houston, TX 77025, US  
ROSSIG, Claudia, Raesfeldstrasse 40, D-48149 Münster, DE  
GOTTSCHALK, Stephen, M.g., 1908 Canterbury, Houston, TX 77030, US  
GRADA, Zakaria, 11830 Corona Lane, Houston, TX 77072, US



(51) MKP  
**A61K 31/353 (2006.01)** (97) **2543370**  
**A61P 31/22 (2006.01)**  
**A61P 31/12 (2006.01)**  
(86) 11178325.4 09.01.2013  
(97) 2543370, 09.01.2013 en  
(54) Compositions and Methods for Treating Herpes Simplex Virus  
(71) Georgia Health Sciences University Research Institute, Inc.,  
1120 15th Street CJ-3301, Augusta GA 30912, US  
(72) Hsu, Stephen, 4476 Woodberry Court, Evans, GA Georgia  
30809, US

(51) MKP  
**A61K 31/34 (2006.01)** (97) **2642992 \***  
**A61P 31/00 (2006.01)**  
**C07D 507/00 (2006.01)**  
(86) IN2011000813 25.11.2011  
(96) 11820847.9 02.10.2013  
(87) WO2012070071, 25.11.2011  
(97) 2642992, 02.10.2013 en  
(54) COMPOUNDS AND THEIR USE  
(71) Allegra Therapeutics GmbH, c/o Loeba Treuhand GmbH  
Wallbrunnstrasse 24, 79539 Lörrach, DE  
(72) UDAYAMPALAYAM PALANISAMY, Senthilkumar, Orchid  
Chemicals&Pharmaceuticals Ltd R&D Centre: Plot No:476/14  
Old Mahabalipuram Road, Sozhanganallur 600119 Chennai,  
IN  
PAUL-SATYASEELA, Maneesh, Orchid Research Laboratories  
Ltd R&D Centre Plot No. 476/17A1B Old Mahabalipuram  
Road, Sozhanganallur 600119 Chennai, IN  
NARAYANAN, Shridhar, Orchid Research Laboratories Ltd  
R&D Centre Plot No. 476/17A1B Old Mahabalipuram Road,  
Sozhanganallur 600119 Chennai, IN  
BALASUBRAMANIAN, Gopalan, Orchid Research  
Laboratories Ltd. R&D Centre Plot No. 476/17A1B Old  
Mahabalipuram Road, Sozhanganallur 600119 Chennai, IN  
APPU, Aravind, Orchid Chemicals&Pharmaceuticals Ltd  
R&D Centre Plot No. 476/14 Old Mahabalipuram Road,  
Sozhanganallur 600119 Chennai, IN  
MANICKAM, Senthilnathan, Orchid  
Chemicals&Pharmaceuticals Ltd R&D Centre Plot No. 476/14  
Old Mahabalipuram Road, Sozhanganallur 600119 Chennai,  
IN  
PERIASAMY, Hariharan, Orchid Research Laboratories Ltd  
R&D Centre Plot No. 476/17A1B Old Mahabalipuram Road,  
Sozhanganallur 600119 Chennai, IN

(51) MKP  
**C07C 51/41 (2006.01)** (97) **2630114 \***  
**C07C 51/48 (2006.01)**  
**C07C 59/08 (2006.01)**  
**C07C 51/295 (2006.01)**  
(86) GB2011001483 17.10.2011  
(96) 11776482.9 28.08.2013  
(87) WO2012052703, 17.10.2011  
(97) 2630114, 28.08.2013 en  
(54) PROCESS FOR PRODUCING A LACTIC ACID-AMINE  
COMPLEX  
(71) Plaxica Limited, Imperial College Incubator Level 1 Bessemer  
Building Imperial College, London SW7 2AZ, GB  
(72) MARSHALL, Edward, Leslie, c/o Plaxica Limited Imperial  
College Incubator Level 1 Bessemer Building Imperial College,  
London SW7 2AZ, GB

(51) MKP  
**C07K 14/00 (2006.01)** (97) **2596010 \***  
**C12P 21/08 (2006.01)**  
(86) US2011044586 19.07.2011  
(96) 11810311.8 29.05.2013  
(87) WO2012012469, 19.07.2011  
(97) 2596010, 29.05.2013 en  
(54) SIGNAL BIOMARKERS  
(71) Otago Innovation Limited, 87 St. David Street, Dunedin, NZ  
(72) PEMBERTON, Christopher, Joseph, 54 Steadman Road,  
Christchurch, NZ  
RICHARDS, Arthur, Mark, 8A Mona Vale Ave., Riccarton  
Christchurch 8011, NZ

(51) MKP  
**B26D 1/547 (2006.01)** (97) **2643130 \***  
**B26B 27/00 (2006.01)**  
**B25B 11/00 (2006.01)**  
**B60J 1/02 (2006.01)**  
**B60J 1/00 (2006.01)**  
(86) GB2011052164 08.11.2011  
(96) 11781588.6 02.10.2013  
(87) WO2012069804, 08.11.2011  
(97) 2643130, 02.10.2013 en  
(54) APPARATUS AND METHOD FOR CUTTING OUT A VEHICLE  
GLAZING PANEL  
(71) Belron Hungary Kft-Zug Branch, Gotthardstrasse 20, 6304  
Zug, CH  
(72) DAVIES, Christopher, Ty Coch Farm Pembrey Road, Kidwelly  
SA17 4TF, GB  
FINCK, William, 31 Doddinghurst Road, Brentwood Essex  
CM15 9EP, GB

(51) MKP  
**C07K 16/00 (2006.01)** (97) **2606063 \***  
**A61K 39/395 (2006.01)**  
(86) GB2011051563 19.08.2011  
(96) 11763754.6 26.06.2013  
(87) WO2012022982, 19.08.2011  
(97) 2606063, 26.06.2013 en  
(54) IMPROVED ANTIBODIES OF THE CLASS IGG4  
(71) UCB Pharma, S.A., 60, allée de la Recherche, 1170 Brussels,  
BE  
(72) HUMPHREYS, David Paul, c/o IPD UCB Celltech 208 Bath  
Road, Slough Berkshire SL1 3WE, GB  
ADAMS, Ralph, c/o IPD UCB Celltech 208 Bath Road, Slough  
Berkshire SL1 3WE, GB  
HEADS, James, c/o IPD UCB Celltech 208 Bath Road, Slough  
Berkshire SL1 3WE, GB  
PETERS, Shirley Jane, c/o IPD UCB Celltech 208 Bath Road,  
Slough Berkshire SL1 3WE, GB

(51) MKP  
**C07D 403/04 (2006.01)** (97) **2621918 \***  
**C07D 403/14 (2006.01)**  
**C07D 409/14 (2006.01)**  
**C07D 417/14 (2006.01)**  
**A61K 31/506 (2006.01)**  
**A61P 29/00 (2006.01)**  
(86) US2011053442 27.09.2011  
(96) 11771300.8 07.08.2013  
(87) WO2012044613, 27.09.2011  
(97) 2621918, 07.08.2013 en  
(54) OXOPIPERAZINE-AZETIDINE AMIDES AND  
OXODIAZEPINE-AZETIDINE AMIDES AS  
MONOACYLGLYCEROL LIPASE INHIBITORS  
(71) Janssen Pharmaceutica, N.V., Turnhoutseweg 30, 2340  
Beerse, BE  
(72) CONNOLLY, Peter, J., Welsh and McKean Roads, Spring  
House, PA 19477, US  
MACIELAG, Mark, J., Welsh and McKean Roads, Spring  
House, PA 19477, US  
MCDONNELL, Mark, E., 1280 Sumneytown Pike, Landsdale,  
PA 19446, US  
ZHU, Bin, Welsh and McKean Roads, Spring House, PA  
19477, US

(51) MKP  
**A61K 38/10 (2006.01)** (97) **2603232 \***  
(86) US2011047434 11.08.2011  
(96) 11745896.8 19.06.2013  
(87) WO2012021715, 11.08.2011  
(97) 2603232, 19.06.2013 en  
(54) STABLE FORMULATIONS OF LINACLOTIDE  
(71) Ironwood Pharmaceuticals, Inc., 301 Binney Street,  
Cambridge, MA 02142, US  
Forest Laboratories Holdings Limited, 18 Parliament Street  
Milner House, Hamilton HM12, BM  
(72) MO, Yun, 60 Fairfield Way Apt. 1, Commack NY 11725, US  
FRETZEN, Angelika, 7 Avon Street, Somerville MA 02143, US  
CALI, Brian, 100 Hillside Avenue, Arlington MA 02476, US  
DEDHIYA, Mahendra, 1 Lea Court, Pomona NY 10970, US

- (51) MKP  
**A61M 5/24 (2006.01)** (97) **2603259 \***  
**A61M 5/315 (2006.01)**
- (86) EP2011063845 11.08.2011  
(96) 11741596.8 19.06.2013  
(87) WO2012020087, 11.08.2011  
(97) 2603259, 19.06.2013 en
- (54) CODING SYSTEM FOR A DRUG DELIVERY DEVICE AND DRUG DELIVERY SYSTEM
- (71) Sanofi-Aventis Deutschland GmbH, Brüningstraße 50, 65929 Frankfurt, DE
- (72) AVERY, Richard James Vincent, 28 Nursery Close, Mickleton Chipping Campden Gloucestershire GL55 6TX, GB  
BUTLER, Joseph, 6 Hadfield Close, Clifton Rugby Warwickshire CV23 0DL, GB
- 
- (51) MKP  
**C03C 3/118 (2006.01)** (97) **2616399 \***  
**C03C 13/00 (2006.01)**  
**B32B 17/00 (2006.01)**  
**C08J 5/24 (2006.01)**  
**C08K 7/14 (2006.01)**  
**C08J 5/04 (2006.01)**
- (86) US2011051532 14.09.2011  
(96) 11760934.7 24.07.2013  
(87) WO2012037205, 14.09.2011  
(97) 2616399, 24.07.2013 en
- (54) LOW DENSITY AND HIGH STRENGTH FIBER GLASS FOR BALLISTIC APPLICATIONS
- (71) PPG Industries Ohio, Inc., 3800 West 143rd Street, Cleveland, OH 44111, US
- (72) PETERS, James, Carl, 359 Hunting Ridge Lane, Shelby North Carolina 28150, US  
SERRANO, Juan, Camilo, 2808 Scarborough Court, Gastonia North Carolina 28054, US  
LI, Hong, 1621 Norman Drive, Sewickley Pennsylvania 15143, US  
RICHARDS, Cheryl, A., 104 Trotwood Drive, Monroeville Pennsylvania 15146, US
- 
- (51) MKP  
**E21B 43/14 (2006.01)** (97) **2625380 \***  
**E21B 43/26 (2006.01)**  
**E21B 34/14 (2006.01)**  
**E21B 23/14 (2006.01)**
- (86) CA2011001121 04.10.2011  
(96) 11830153.0 14.08.2013  
(87) WO2012045156, 04.10.2011  
(97) 2625380, 14.08.2013 en
- (54) WIRELINE CONVEYED APPARATUS FOR WELLBORE FLUID TREATMENT
- (71) Packers Plus Energy Services Inc., Bow Valley Square 2 Suite 2200, 205 - 5 Avenue SW, Calgary, Alberta T2P 2V7, CA
- (72) THEMIG, Daniel Jon, 256 Woodhaven Place SW, Calgary Alberta T2W 5P9, CA  
FEHR, James, 31 Woodfield Drive, Sherwood Park, Alberta T8A 4A1, CA  
ARABSKY, Serhiy, 3204 - 62 Street, Beaumont Alberta T4X 1T6, CA
- 
- (51) MKP  
**B65G 47/14 (2006.01)** (97) **2517988**
- (96) 12165762.1 31.10.2012  
(97) 2517988, 31.10.2012 de
- (54) Device and method for singulating and/or sorting used beverage containers
- (71) Brenner, Stefan, Bergstraße 24, 57520 Rosenheim, DE
- (72) Brenner, Stefan, Bergstraße 24, 57520 Rosenheim, DE
- 
- (51) MKP  
**G01T 3/00 (2006.01)** (97) **2628022 \***
- (86) US2011052348 20.09.2011  
(96) 11832973.9 21.08.2013  
(87) WO2012050762, 20.09.2011  
(97) 2628022, 21.08.2013 en
- (54) SELF-CALIBRATING, HIGHLY ACCURATE, LONG-LIVED, DUAL RHODIUM VANADIUM EMITTER NUCLEAR IN-CORE DETECTOR
- (71) Areva NP Inc., 3315 Old Forest Road P.O.Box 10935, Lynchburg, VA 24506-0935, US
- (72) HOLADAY, Veldon, D., 1700 Langhorne Road, Lynchburg VA 24503, US  
DEVENEY, Richard, C., 203 Crestview Drive, Forest VA 24551, US  
CHENG, Alexander, Y., 3527 Ridgcroft Drive, Lynchburg VA 24503, US  
DAVIS, John, Wesley, 1046 Shadow Peak Road, Forest VA 24551, US  
STULTS, Dr. W., 101 Waterview Circle, Forest, VA 24551, US
- 
- (51) MKP  
**A61K 47/32 (2006.01)** (97) **2591781 \***  
**A61K 31/426 (2006.01)**  
**A61K 9/20 (2006.01)**  
**A61K 47/10 (2006.01)**
- (86) JP2011065721 08.07.2011  
(96) 11803699.5 15.05.2013  
(87) WO2012005365, 08.07.2011  
(97) 2591781, 15.05.2013 en
- (54) PARTICLE COATING PREPARATION
- (71) Teijin Pharma Limited, 2-1, Kasumigaseki 3-chome Chiyoda-ku, Tokyo 100-0013, JP
- (72) NAKAMURA, Kazuhiro, c/o Teijin Pharma Limited Iwakuni Research Center 2-1 Hinodecho, Iwakuni-shi, Yamaguchi 740-0014, JP  
OGAWA, Teppei, c/o Teijin Pharma Limited Iwakuni Research Center 2-1 Hinodecho, Iwakuni-shi, Yamaguchi 740-0014, JP  
AKUTAGAWA, Tomoya, c/o Teijin Pharma Limited Iwakuni Research Center 2-1 Hinodecho, Iwakuni-shi, Yamaguchi 740-0014, JP
- 
- (51) MKP  
**A61K 31/4184 (2006.01)** (97) **2595660 \***  
**A61K 47/40 (2006.01)**  
**A61P 35/00 (2006.01)**
- (86) IB2011003367 23.02.2011  
(96) 11861891.7 29.05.2013  
(87) WO2012127277, 23.02.2011  
(97) 2595660, 29.05.2013 en
- (54) BENDAMUSTINE ANIONIC-CATIOINIC CYCLOPOLYSACCHARIDE COMPOSITIONS
- (71) Supratek Pharma, Inc., 215 Bouchard Blvd. Suite 1315, Dorval, Quebec H9S 1A9, CA
- (72) ALAKHOV, Valery, 1 Terrasse Bourdon, Ile Bizard, Quebec H9E 1K6, CA  
PIETRZYNSKI, Grzegorz, 6230 Dugas, Montreal, Quebec H1N 1P2, CA  
PATEL, Kishore, 4988 de La Morandiere, Pierrefonds, Quebec H9K 1S7, CA  
POPEK, Tomasz, 151 Vanguard Avenue, Pointe-Claire, Quebec H9R 3T4, CA
- 
- (51) MKP  
**A61K 35/00 (2006.01)** (97) **2595619 \***  
**A61K 31/166 (2006.01)**  
**A61P 35/04 (2006.01)**  
**A61K 31/4745 (2006.01)**
- (86) US2011044569 19.07.2011  
(96) 11810298.7 29.05.2013  
(87) WO2012012454, 19.07.2011  
(97) 2595619, 29.05.2013 en
- (54) METHODS OF TREATING METASTATIC BREAST CANCER WITH 4-IODO-3-NITROBENZAMIDE AND IRINOTECAN
- (71) BiPar Sciences, Inc., 55 Corporate Drive, Bridgewater NJ 08807, US
- (72) BRADLEY, Charles, 66 Spyglass Court, Half Moon Bay CA 94019, US

(51) MKP  
**A61M 5/315 (2006.01)** (97) **2529775**  
 (96) 12165099.8 05.12.2012  
 (97) 2529775, 05.12.2012 en  
 (54) Resetting mechanism for a drug delivery device  
 (71) Sanofi-Aventis Deutschland GmbH, Brüningstraße 50, 65929 Frankfurt am Main, DE  
 (72) Plumpre, David Aubrey, 36 Shire Way, Droitwich Spa, Worcestershire WR9 7RQ, GB  
 Jones, Christopher John, The Old Thatch Grafton Gloucestershire GL20 7AT, Tewkesbury, Gloucestershire GL20 7AT, GB

(51) MKP  
**C07D 213/30 (2006.01)** (97) **2603490 \***  
**C07D 239/26 (2006.01)**  
**C07D 405/06 (2006.01)**  
**C07D 405/08 (2006.01)**  
**A61K 31/4402 (2006.01)**  
**A61K 31/4433 (2006.01)**  
**A61K 31/505 (2006.01)**  
**A61P 25/00 (2006.01)**  
**A61P 29/00 (2006.01)**  
 (86) CN2010001213 10.08.2010  
 (96) 10855736.4 19.06.2013  
 (87) WO2012019315, 10.08.2010  
 (97) 2603490, 19.06.2013 en  
 (54) NOVEL TRPV3 MODULATORS  
 (71) AbbVie Inc., 1 North Waukegan Road, North Chicago, IL 60064, US  
 (72) BAYBURT, Erol, K., 17462 West Chestnut, Gurnee IL 60031, US  
 CLAPHAM, Bruce, 2813 Falling Waters Drive, Lindenhurst IL 60046, US  
 COX, Phil, B., 285 N. Cambridge Court, Grayslake IL 60030, US  
 DAANEN, Jerome, F., 4137 Nantucket Place, Racine WI 53405, US  
 GOMTSYAN, Arthur, 104 Adair Court, Vernon Hills IL 60061, US  
 KORT, Michael, E., 507 Green Avenue, Lake Bluff IL 60044-1529, US  
 KYM, Philip, R., 1002 Gracewood Drive, Libertyville IL 60048, US  
 VOIGHT, Eric, A., 10615 48th Avenue, Pleasant Prairie WI 53158, US

(51) MKP  
**C12N 15/85 (2006.01)** (97) **2625277 \***  
 (86) IN2011000703 10.10.2011  
 (96) 11805635.7 14.08.2013  
 (87) WO2012046255, 10.10.2011  
 (97) 2625277, 14.08.2013 en  
 (54) EXPRESSION VECTOR FOR HIGH LEVEL EXPRESSION OF RECOMBINANT PROTEINS  
 (71) Cadila Healthcare Limited, Zydus Tower Satellite Cross Roads, Ahmedabad 380 015, Gujarat, IN  
 (72) PARIKH, Aashini, Cadila Healthcare Limited Zydus Tower Satellite Cross Road Ahmedabad 380 015, Gujarat, IN  
 SINGH, Arun, Cadila Healthcare Limited Zydus Tower Satellite Cross Road Ahmedabad 380 015, Gujarat, IN  
 GUPTA, Ajit K, Cadila Healthcare Limited Zydus Tower Satellite Cross Road Ahmedabad 380 015, Gujarat, IN  
 JAKHADE, Mansi, Cadila Healthcare Limited Zydus Tower Satellite Cross Road Ahmedabad 380 015, Gujarat, IN  
 MENDIRATTA, Sanjeev Kumar, Cadila Healthcare Limited Zydus Tower Satellite Cross Road Ahmedabad 380 015, Gujarat, IN

(51) MKP  
**C07K 16/30 (2006.01)** (97) **2614086 \***  
**G01N 33/53 (2006.01)**  
**G01N 33/574 (2006.01)**  
**G01N 33/68 (2006.01)**  
 (86) US2011050891 08.09.2011  
 (96) 11778725.9 17.07.2013  
 (87) WO2012033953, 08.09.2011  
 (97) 2614086, 17.07.2013 en  
 (54) METHODS FOR ASSESSING AND IDENTIFYING OR EVOLVING CONDITIONALLY ACTIVE THERAPEUTIC PROTEINS  
 (71) Halozyme, Inc., 11388 Sorrento Valley Road, San Diego, CA 92121, US  
 (72) KODANDAPANI, Lalitha, 6578 Dandelion Way, San Diego CA 92130, US  
 BOOKBINDER, Louis, Howard, 14823 Gable Ridge Rd., San Diego CA 92128, US  
 FROST, Gregory, Ian, 13662 Mercado Drive, Del Mar CA 92014, US  
 SHERIDAN, Philip, Lee, 13289 Deer Canyon Place, San Diego CA 92129, US  
 SHEPARD, Harold, Michael, 8124 Montrose Way, San Diego CA 92122, US  
 WEI, Ge, 11530 Miro Circle, San Diego CA 92131, US  
 HUANG, Lei, 3683 Caminito Carmel Landing, San Diego CA 92130, US

(51) MKP  
**C07C 43/00 (2006.01)** (97) **2640684 \***  
 (86) US2011060747 15.11.2011  
 (96) 11841387.1 25.09.2013  
 (87) WO2012068079, 15.11.2011  
 (97) 2640684, 25.09.2013 en  
 (54) METHODS FOR ENHANCING OXYGENATION OF JEOPARDIZED TISSUE  
 (71) Mast Therapeutics, Inc., 12390 El Camino Real, Suite 150, San Diego, CA 92130, US  
 (72) EMANUELE, Martin, 15234 Maple Grove Lane, San Diego, California 92131, US

(51) MKP  
**A61B 1/267 (2006.01)** (97) **2600760 \***  
**A61B 1/005 (2006.01)**  
 (86) AU2011000699 03.06.2011  
 (96) 11788987.3 12.06.2013  
 (87) WO2011150469, 03.06.2011  
 (97) 2600760, 12.06.2013 en  
 (54) IMPROVEMENTS IN LARYNGOSCOPY  
 (71) Hales, Paul Christopher, 20 Burnell Street, Mount Eliza, Victoria 3930, AU  
 (72) Hales, Paul Christopher, 20 Burnell Street, Mount Eliza, Victoria 3930, AU

(51) MKP  
**A01N 43/90 (2006.01)** (97) **2600719 \***  
**A61K 31/519 (2006.01)**  
**A61K 31/505 (2006.01)**  
 (86) US2011044807 21.07.2011  
 (96) 11815012.7 12.06.2013  
 (87) WO2012018540, 21.07.2011  
 (97) 2600719, 12.06.2013 en  
 (54) 2-SUBSTITUTED-8-ALKYL-7-OXO-7,8-DIHYDROPYRIDO[2,3-D]PYRIMIDINE-6-CARBONITRILES AND USES THEREOF  
 (71) Temple University - Of The Commonwealth System of Higher Education, Broad Street and Montgomery Avenue, Philadelphia, PA 19122, US  
 (72) REDDY, E., Premkumar, 547 Atterbury Road, Villanova, PA 19085, US  
 REDDY, M. V., Ramana, 921 Saint Joseph Drive, Upper Darby, PA 19082, US

(51) MKP  
**A61B 5/22 (2006.01)** (97) **2621340 \***  
**A63B 23/12 (2006.01)**  
**A61H 1/02 (2006.01)**  
(86) FR2011051998 31.08.2011  
(96) 11764823.8 07.08.2013  
(87) WO2012045934, 31.08.2011  
(97) 2621340, 07.08.2013 fr  
(54) APPARATUS FOR CLOSED KINETIC CHAIN MUSCLE STRENGTHENING AND/OR REHABILITATION OF THE SHOULDER JOINT AND OF THE UPPER LIMB  
(71) Europhyseo, 1Bis, rue de l'Eglise, 08000 Charleville-Mézières, FR  
(72) STEVENOT, Thierry, 16 Rue Jacquemart-Templeux, F-08000 Charleville-mezieres, FR  
LUBIN, Mathias, 1 Rue de la Verte Voie, F-08090 Saint Laurent, FR

(51) MKP  
**B65F 1/14 (2006.01)** (97) **2643242 \***  
(86) IT2010000469 23.11.2010  
(96) 10807676.1 02.10.2013  
(87) WO2012070074, 23.11.2010  
(97) 2643242, 02.10.2013 en  
(54) WASTE BIN HAVING A CONVERTER FOR CONVERTING MECHANICAL ENERGY INTO ELECTRICAL ENERGY  
(71) HERA S.p.A., Viale Berti Pichat, 2/4, 40127 Bologna (BO), IT  
(72) ANZALONE, Claudio, Via Francesco Nullo 14, I-47121 Forlì, IT  
GIUNCHI, Daniele, Via E. Cecere 52, I-47121 Forlì, IT  
PAOLI, Paolo, Via Della Pace 107, I-44123 Ferrara, IT

(51) MKP  
**A61K 31/137 (2006.01)** (97) **2600859 \***  
**A61K 31/216 (2006.01)**  
**A61P 13/10 (2006.01)**  
(86) US2011046208 02.08.2011  
(96) 11748801.5 12.06.2013  
(87) WO2012018773, 02.08.2011  
(97) 2600859, 12.06.2013 en  
(54) COMBINATIONS OF BETA - 3 ADRENERGIC RECEPTOR AGONISTS AND MUSCARINIC RECEPTOR ANTAGONISTS FOR TREATING OVERACTIVE BLADDER  
(71) Altherx Inc., 21 Carriage Path, Chadds Ford, PA 19317, US  
(72) CALTABIANO, Stephen, 709 Swedeland Road, King Of Prussia PA 19406, US  
OHLSTEIN, Eliot, 15 Yeaton Lane, Glenmoore PA 19343, US  
MCCALLUM, Stewart, 709 Swedeland Road, King Of Prussia PA 19406, US

(51) MKP  
**A61K 31/706 (2006.01)** (97) **2616080 \***  
**C07H 7/06 (2006.01)**  
**C07H 21/04 (2006.01)**  
**A61P 31/16 (2006.01)**  
(86) US2011051249 12.09.2011  
(96) 11761204.4 24.07.2013  
(87) WO2012037038, 12.09.2011  
(97) 2616080, 24.07.2013 en  
(54) 2'-FLUORO SUBSTITUTED CARBA-NUCLEOSIDE ANALOGS FOR ANTIVIRAL TREATMENT  
(71) Gilead Sciences, Inc., 333 Lakeside Drive, Foster City, CA 94404, US  
(72) CLARKE, Michael O' Neil Hanrahan, 545 Seastorm Drive, Redwood City CA 94065, US  
KIM, Choung, U., 1750 Elizabeth Street, San Carlos CA 94070, US  
LEW, Willard, 1437 Overland Drive, San Mateo CA 94403, US

(51) MKP  
**C07D 513/04 (2006.01)** (97) **2603513 \***  
**A61K 31/542 (2006.01)**  
**A61P 25/00 (2006.01)**  
(86) JP2011068497 09.08.2011  
(96) 11749944.2 19.06.2013  
(87) WO2012020848, 09.08.2011  
(97) 2603513, 19.06.2013 en  
(54) HETEROCYCLIC COMPOUND AND USE THEREOF  
(71) Takeda Pharmaceutical Company Limited, 1-1 Doshomachi 4-chome Chuo-ku, Osaka-shi, Osaka 541-0045, JP  
(72) KORI, Masakuni, c/o TAKEDA PHARMACEUTICAL COMPANY LIMITED 17-85 Jusohonmachi 2-chome Yodogawa-ku, Osaka-shi Osaka 532-0024, JP  
IMAEDA, Toshihiro, c/o TAKEDA PHARMACEUTICAL COMPANY LIMITED 26-1, Muraoka-Higashi 2-chome, Fujisawa Kanagawa 251-0012, JP  
NAKAMURA, Shinji, c/o TAKEDA PHARMACEUTICAL COMPANY LIMITED 26-1 Muraokahigashi 2-chome, Fujisawa-shi Kanagawa 251-0012, JP  
TOYOFUKU, Masashi, c/o TAKEDA PHARMACEUTICAL COMPANY LIMITED 26-1 Muraokahigashi 2-chome, Fujisawa-shi Kanagawa 251-0012, JP  
HONDA, Eiji, c/o TAKEDA PHARMACEUTICAL COMPANY LIMITED 26-1 Muraokahigashi 2-chome, Fujisawa-shi Kanagawa 251-0012, JP  
ASANO, Yasutomi, c/o TAKEDA PHARMACEUTICAL COMPANY LIMITED 26-1 Muraokahigashi 2-chome, Fujisawa-shi Kanagawa 251-0012, JP  
UJIKAWA, Osamu, c/o TAKEDA PHARMACEUTICAL COMPANY LIMITED 26-1, Muraoka-Higashi 2-chome Fujisawa, Kanagawa 251-0012, JP  
MOCHIZUKI, Michiyo, c/o TAKEDA PHARMACEUTICAL COMPANY LIMITED 26-1 Muraokahigashi 2-chome, Fujisawa-shi Kanagawa 251-0012, JP

(51) MKP  
**C07B 59/00 (2006.01)** (97) **2611759 \***  
**C07D 211/24 (2006.01)**  
**A61K 31/445 (2006.01)**  
**A61P 25/00 (2006.01)**  
(86) EP2011064954 31.08.2011  
(96) 11757801.3 10.07.2013  
(87) WO2012028635, 31.08.2011  
(97) 2611759, 10.07.2013 en  
(54) DEUTERATED ANALOGS OF PRIDOPIDINE USEFUL AS DOPAMINERGIC STABILIZERS  
(71) IVAX INTERNATIONAL GMBH, Alpenstrasse 2, 8640 Rapperswil, CH  
(72) SONESSON, Clas, c/o NeuroSearch Sweden AB Arvid Wallgrens Backe 20, S-41346 Göteborg, SE

(51) MKP  
**A01B 69/00 (2006.01)** (97) **2510774**  
**A01D 41/12 (2006.01)**  
**A01D 43/073 (2006.01)**  
**G03B 17/55 (2006.01)**  
**A01D 41/127 (2006.01)**  
**A01D 43/08 (2006.01)**  
**A01D 75/18 (2006.01)**  
(96) 12157412.3 17.10.2012  
(97) 2510774, 17.10.2012 de  
(54) Camera for monitoring machine functions of a vehicle and use of a camera  
(71) CLAAS Selbstfahrende Erntemaschinen GmbH, Münsterstrasse 33, 33428 Harsewinkel, DE  
(72) Ruthenberg, Dirk, Klusring 23, 49152 Bad Essen, DE

(51) MKP  
**C07D 413/14 (2006.01)** (97) **2643315 \***  
**C07D 471/04 (2006.01)**  
**A61K 31/5377 (2006.01)**  
**A61P 35/00 (2006.01)**  
**C07D 413/04 (2006.01)**  
(86) US2011062025 23.11.2011  
(96) 11791722.9 02.10.2013  
(87) WO2012071501, 23.11.2011  
(97) 2643315, 02.10.2013 en  
(54) BENZOXAZEPINES AS INHIBITORS OF P13K/mTOR AND METHODS OF THEIR USE AND MANUFACTURE  
(71) Exelixis, Inc., 210 East Grand Avenue, South San Francisco, CA 94080, US  
(72) RICE, Kenneth, 44 Montecillo Road, San Rafael, CA 94903, US

(51) MKP  
**A61K 47/22 (2006.01)** (97) **2632436 \***  
**A61P 35/00 (2006.01)**  
**A61K 9/48 (2006.01)**  
**A61K 47/26 (2006.01)**  
**A61K 9/14 (2006.01)**  
**A61K 47/38 (2006.01)**  
**A61K 47/32 (2006.01)**  
**A61K 31/437 (2006.01)**  
**A61K 47/44 (2006.01)**  
**A61K 47/12 (2006.01)**  
**A61K 47/34 (2006.01)**  
(86) US2011058024 27.10.2011  
(96) 11782300.5 04.09.2013  
(87) WO2012058392, 27.10.2011  
(97) 2632436, 04.09.2013 en  
(54) SOLID DISPERSIONS CONTAINING AN APOPTOSIS-INDUCING AGENT  
(71) Abbvie Inc., 1 North Waukegan Road, North Chicago, IL 60064, US  
(72) CATRON, Nathaniel D., 305 Lakeside Drive, Vernon Hills Illinois 60061, US  
LINDLEY, David J., 676 Needlegrass Parkway, Antioch Illinois 60002, US  
MILLER, Jonathan, 1228 Meade Drive, Lindenhurst Illinois 60046, US  
SCHMITT, Eric A., 319 Evergreen Court, Libertyville Illinois 60048, US  
TONG, Ping, 1520 Eric Lane, Libertyville Illinois 60048, US

(51) MKP  
**C07D 207/26 (2006.01)** (97) **2621901 \***  
**C07D 233/36 (2006.01)**  
**C07D 263/24 (2006.01)**  
**C07D 417/04 (2006.01)**  
**A61K 31/402 (2006.01)**  
**A61K 31/4166 (2006.01)**  
**A61K 31/421 (2006.01)**  
**A61P 19/10 (2006.01)**  
(86) US2011053375 27.09.2011  
(96) 11767355.8 07.08.2013  
(87) WO2012047617, 27.09.2011  
(97) 2621901, 07.08.2013 en  
(54) SELECTIVE ANDROGEN RECEPTOR MODULATORS  
(71) Radius Health, Inc, 201 Broadway, 6th Floor, Cambridge, MA 02139, US  
(72) MILLER, Chris, P., 201 Broadway 6th Floor, Cambridge, MA 02139, US

(51) MKP  
**A01N 25/00 (2006.01)** (97) **2635116 \***  
(86) US2011059252 04.11.2011  
(96) 11838847.9 11.09.2013  
(87) WO2012061668, 04.11.2011  
(97) 2635116, 11.09.2013 en  
(54) CONTROL OF PHENOXYALKANOIC ACID HERBICIDE-RESISTANT WEEDS WITH 4-AMINO-3-CHLORO-6-(4-CHLORO-2-FLUORO-3-METHOXYPHENYL)PYRIDINE-2-CARBOXYLIC ACID AND ITS SALTS OR ESTERS  
(71) Dow AgroSciences LLC, 9330 Zionsville Road, Indianapolis, IN 46268, US  
(72) SATCHIVI, Norbert, M., 3100 Cherub Court, Westfield IN 46074, US  
SCHMITZER, Paul, R., 7960 North Whittier Place, Indianapolis IN 46250, US

(51) MKP  
**C07D 213/82 (2006.01)** (97) **2635556 \***  
(86) US2011058826 01.11.2011  
(96) 11784869.7 11.09.2013  
(87) WO2012061418, 01.11.2011  
(97) 2635556, 11.09.2013 en  
(54) BENZAMIDES AND NICOTINAMIDES AS SYK MODULATORS  
(71) Portola Pharmaceuticals, Inc., 270 East Grand Avenue Suite 22, South San Francisco, California 94080, US  
(72) JIA, Zhaozhong, J., 3416 Leafwood Court, San Mateo California 94403, US  
SONG, Yonghong, 860 Polaris Avenue, Foster City California 94404, US  
XU, Qing, 968 Diaz Lane, Foster City California 94404, US  
KANE, Brian, 5964 Merriewood Drive, Oakland California 94611, US  
BAUER, Shawn, M., 181 Beachview Avenue, Pacifica California 94044, US  
PANDEY, Anjali, 4506 Amiens Avenue, Fremont California 94555, US

(51) MKP  
**C07C 309/14 (2006.01)** (97) **2625163 \***  
**C07C 303/02 (2006.01)**  
(86) EP2011067524 07.10.2011  
(96) 11769843.1 14.08.2013  
(87) WO2012045849, 07.10.2011  
(97) 2625163, 14.08.2013 en  
(54) METHOD FOR THE PREPARATION OF (3S,3S') 4,4'-DISULFANEDIYLBIS (3-AMINO BUTANE 1-SULFONIC ACID)  
(71) Quantum Genomics, Bâtiment L'Odyssee 2-12, chemin des Femmes, 91300 Massy, FR  
(72) BALAVOINE, Fabrice, 43 rue des Favorites, F-75015 Paris, FR  
MADEC, Jonathan, 225 rue des Landes, F-78400 Chatou, FR  
SCHNEIDER, Jean-Marie, 11 chemin des Merles, F-78200 Magnanville, FR  
COQUEREL, Gérard, 192 rue de l'Eglise, F-76520 Boos, FR  
COUVRAT, Nicolas, 1 rue des Champs Saint Gervais, F-76000 Rouen, FR  
CARTIGNY, Yohann, 97 rue du Rouvre Vert, F-76230 Bois Guillaume, FR  
PETIT, Marie-Noëlle, 14 rue Hénocque, F-76130 Mont Saint-Aignan, FR

(51) MKP  
**G06F 17/50 (2006.01)** (97) **2628102 \***  
(86) FR2011052407 14.10.2011  
(96) 11794531.1 21.08.2013  
(87) WO2012049434, 14.10.2011  
(97) 2628102, 21.08.2013 fr  
(54) RAPID PROTOTYPING METHOD AND DEVICE  
(71) Phidias Technologies, 2 rue du Fond des Prés Z.I., 91460 Marcoussis, FR  
(72) ALLANIC, André-Luc, Route de Grandcamp, F-14710 Vierville-Sur-Mer, FR

- (51) MKP  
**F03B 1/00 (2006.01)** (97) **2365209**  
**F03B 1/02 (2006.01)**  
**F01D 5/30 (2006.01)**  
(96) 11152625.7 14.09.2011  
(97) 2365209, 14.09.2011 de  
(54) Turbine wheel with strongly connected and force-fit blades  
(71) Unterlercher, Bernhard, Plon 34, 9961 Hopfgarten, AT  
(72) Unterlercher, Bernhard, Plon 34, 9961 Hopfgarten, AT
- 
- (51) MKP  
**A61P 35/02 (2006.01)** (97) **2643321 \***  
**C07D 471/04 (2006.01)**  
**C07D 487/04 (2006.01)**  
**A61K 31/5025 (2006.01)**  
**A61P 37/06 (2006.01)**  
**A61P 35/00 (2006.01)**  
(86) EP2011005929 24.11.2011  
(96) 11788775.2 02.10.2013  
(87) WO2012069202, 24.11.2011  
(97) 2643321, 02.10.2013 en  
(54) IMIDAZO [1,2-B]PYRIDAZINE AND IMIDAZO [4,5-B] PYRIDINE DERIVATIVES AS JAK INHIBITORS  
(71) Almirall S.A., Ronda del General Mitre, 151, 08022 Barcelona, ES  
(72) GONZALEZ RODRIGUEZ, Jacob, Laurea Miró 408-410, 08980 Sant Feliu de Llobregat Barcelona, ES  
VIDAL JUAN, Bernat, Laurea Miró 408-410, 08980 Sant Feliu de Llobregat Barcelona, ES  
VIDAL GISPERT, Laura, Laurea Miró 408-41, 08980 Sant Feliu de Llobregat Barcelona, ES  
BACH TANA Jordi, Laurea Miró 408-410, 08980 Sant Feliu de Llobregat Barcelona, ES
- 
- (51) MKP  
**B24B 23/00 (2006.01)** (97) **2572828**  
**B24B 55/10 (2006.01)**  
**B24B 7/18 (2006.01)**  
(96) 12306130.1 27.03.2013  
(97) 2572828, 27.03.2013 fr  
(54) Mobile structure for a tool supported on a pivoting arm  
(71) M.B.H. Développement, Le Temple, 42640 Saint Romain la Motte, FR  
(72) Bottazzi, Marc, Chemin des Ormes, 42120 SAINT VINCENT DE BOISSET, FR
- 
- (51) MKP  
**C07D 487/04 (2006.01)** (97) **2619207 \***  
**A61K 31/4985 (2006.01)**  
**A61P 25/28 (2006.01)**  
(86) EP2011066343 20.09.2011  
(96) 11757886.4 31.07.2013  
(87) WO2012038438, 20.09.2011  
(97) 2619207, 31.07.2013 en  
(54) 4,7-DIHYDRO-PYRAZOLO[1,5-a]PYRAZIN-6-YLAMINE DERIVATIVES USEFUL AS INHIBITORS OF BETA-SECRETASE (BACE)  
(71) Janssen Pharmaceutica, N.V., Turnhoutseweg 30, 2340 Beerse, BE  
(72) TRABANCO-SUÁREZ, Andrés, Avelino, c/o Janssen-Cilag S.A. Calle Jarama 75 Poligono Industrial, E-45007 Toledo, ES  
TRESADERN, Gary, John, c/o Janssen-Cilag S.A. Calle Jarama 75 Poligono Industrial, E-45007 Toledo, ES  
DELGADO-JIMÉNEZ, Francisca, c/o Janssen-Cilag S.A. Calle Jarama 75 Poligono Industrial, E-45007 Toledo, ES
- 
- (51) MKP  
**C07D 413/14 (2006.01)** (97) **2619198 \***  
**A61K 31/506 (2006.01)**  
**A61P 3/00 (2006.01)**  
(86) US2011052478 21.09.2011  
(96) 11764056.5 31.07.2013  
(87) WO2012040279, 21.09.2011  
(97) 2619198, 31.07.2013 en  
(54) MODULATORS OF THE GPR119 RECEPTOR AND THE TREATMENT OF DISORDERS RELATED THERETO  
(71) Arena Pharmaceuticals, Inc., 6154 Nancy Ridge Drive, San Diego, CA 92121, US  
(72) JONES, Robert M., 10937 Corte luz del Sol, San Diego, California 92130, US  
LEHMANN, Juerg, 9840 La Tortola Court, San Diego, California 92129, US  
CHEN, Weichao, 10617 Senda Acuario, San Diego, California 92130, US  
EDWARDS, Jeffrey, 4679 Torrey Circle Apt. D307, San Diego, California 92130, US  
MARQUEZ, Glen, 578 Breezyglen Court, San Jose, California 95133, US  
MORGAN, Michael E., 11746 Candy Rose Way, San Diego, California 92131, US  
SADEQUE, Abu J.M., 11828 Pickford Road, San Diego, California 92131, US  
KIM, Sun Hee, 8936 Fieldthorn Street, San Diego, California 92126, US
- 
- (51) MKP  
**A61K 31/337 (2006.01)** (97) **2629760 \***  
**A61K 47/30 (2006.01)**  
**A61K 9/16 (2006.01)**  
**A61K 47/48 (2006.01)**  
**A61K 47/36 (2006.01)**  
(86) US2011057498 24.10.2011  
(96) 11835279.8 28.08.2013  
(87) WO2012054923, 24.10.2011  
(97) 2629760, 28.08.2013 en  
(54) THERAPEUTIC NANOPARTICLES WITH HIGH MOLECULAR WEIGHT COPOLYMERS  
(71) Bind Therapeutics, Inc., 325 Vassar Street, Cambridge, Massachusetts 02139, US  
(72) DEWITT, David, 37 Bayard Street, Alliston MA 02134, US  
FIGUEIREDO, Maria, One Olive Square, Somerville MA 02143, US  
WANG, Hong, 27 Cottage Place, Newton MA 02465, US  
TROIANO, Greg, 38 Lily's Way, Pembroke MA 02359, US  
SONG, Young-ho, 33 Bradford Road, Natick MA 01760, US
- 
- (51) MKP  
**A61J 3/06 (2006.01)** (97) **2635247 \***  
(86) US2011059458 04.11.2011  
(96) 11785864.7 11.09.2013  
(87) WO2012061780, 04.11.2011  
(97) 2635247, 11.09.2013 en  
(54) METHOD FOR PRODUCING MONOLITHIC TABLETS  
(71) AbbVie Inc., 1 North Waukegan Road, North Chicago, IL 60064, US  
Abbvie Deutschland GmbH & Co. KG, Max-Planck-Ring 2a, 65205 Wiesbaden, DE  
(72) GHOSH, Soumojeet, 5510 Notting Hill Road, Gurnee Illinois 60031, US  
LEFEBVRE, Didier, 335 Rye Road, Mundelein Illinois 60060, US  
WIESNER, Bryan, 1551 Littlefield Court, Lake Forest Illinois 60045, US  
BREITENBACH, Joerg, Hans-Sachs-Ring 95a, 68199 Mannheim, DE  
KESSLER, Thomas, Mutterstadter Strasse 113, 67105 Schifferstadt, DE
-

(51) MKP  
**E21B 43/26 (2006.01)** (97) **2619405 \***  
**E21B 34/14 (2006.01)**  
**E21B 43/14 (2006.01)**  
(86) CA2011001066 23.09.2011  
(96) 11826257.5 31.07.2013  
(87) WO2012037661, 23.09.2011  
(97) 2619405, 31.07.2013 en  
(54) APPARATUS AND METHOD FOR FLUID TREATMENT OF A WELL  
(71) Packers Plus Energy Services Inc., Bow Valley Square 2 Suite 2200, 205 - 5 Avenue SW, Calgary, Alberta T2P 2V7, CA  
(72) THEMIG, Daniel Jon, 256 Woodhaven Place SW, Calgary Alberta T2W 5P9, CA  
COON, Robert, Joe, c/o 11221 Cutten Road 2, Houston Texas 77066, US  
EMERSON, John Lee, 21607 Sandystone Ln, Katy Texas 77449, US

(51) MKP  
**A61K 9/20 (2006.01)** (97) **2611427 \***  
**A61K 9/28 (2006.01)**  
**A61K 31/55 (2006.01)**  
(86) US2011049914 31.08.2011  
(96) 11755504.5 10.07.2013  
(87) WO2012030927, 31.08.2011  
(97) 2611427, 10.07.2013 en  
(54) MODIFIED-RELEASE DOSAGE FORMS OF 5-HT2C AGONISTS USEFUL FOR WEIGHT MANAGEMENT & xA;  
(71) Arena Pharmaceuticals, Inc., 6154 Nancy Ridge Drive, San Diego, CA 92121, US  
(72) SHAO, Zezhi Jesse, 11356 Saddle Cove Lane, San Diego California 92130, US  
BLACKBURN, Anthony C., 12633 Caminito Rosita, San Diego California 92128, US  
GROTTICK, Andrew J., 1112 Paseo Entrada, Chula Vista California 91910, US  
MORGAN, Michael, 11746 Candy Rose Way, San Diego California 92131, US  
RUETER, Jaimie Karyn, 9022 Westvale Road, San Diego California 92129, US  
SHIFRINA, Anna, 11957 Miro Circle, San Diego California 92131, US  
STIRN, Scott, 14710 Carmel Ridge Road, San Diego California 92128, US  
YANG, Libo, 3455 Lebon Drive No. 1513, San Diego California 92122, US  
YOON, Woo Hyun, 17076 Silver Pine Road, San Diego California 92127, US

(51) MKP  
**H03K 5/08 (2006.01)** (97) **2533423**  
**H03K 5/1534 (2006.01)**  
**H04B 1/7163 (2011.01)**  
(86) 11425151.5 12.12.2012  
(97) 2533423, 12.12.2012 en  
(54) Method for detecting with a high temporal accuracy a threshold crossing instant by a signal  
(71) Thales Italia S.p.A., Viale Bianca Maria, 25, 20122 Milano, IT  
(72) Casti, Maurizio, Piazza Marco Biagi, 23, 20060 Truccazzano Milano, IT

(51) MKP  
**A61K 31/545 (2006.01)** (97) **2620152 \***  
**A61K 47/04 (2006.01)**  
**A61K 9/51 (2006.01)**  
**A61P 31/04 (2006.01)**  
(86) RU2011000320 11.05.2011  
(96) 11825509.0 31.07.2013  
(87) WO2012036585, 11.05.2011  
(97) 2620152, 31.07.2013 en  
(54) PHARMACEUTICAL COMPOSITION WITH ANTIMICROBIAL ACTIVITY FOR PARENTERAL ADMINISTRATION AND PROCESS FOR PREPARING SAME  
(71) Limonov, Viktor Lvovich, ul. Raschupkina, 10-62, Moscow 121374, RU  
(72) GAIDUL, Konstantin Valentinovich, ul. Bogatkova 260-71, Novosibirsk 630089, RU  
DUSHKIN, Aleksandr Valerevich, ul. Arbusova 5-144, Novosibirsk 630117, RU

(51) MKP  
**G09B 19/00 (2006.01)** (97) **2541532**  
**G09B 19/24 (2006.01)**  
**G09B 5/06 (2006.01)**  
**G09B 23/28 (2006.01)**  
(86) 11171725.2 02.01.2013  
(97) 2541532, 02.01.2013 en  
(54) A training device for an auto-injector  
(71) Alk AG, Industriestrasse 30, 8604 Volketswil, CH  
(72) Groves, Bryce Vernon, 10A Blackett Street Putney, London SW15 1 QG, GB  
Yeates, Henry Samuel, 77 Woodcock Court Three Mile Cross, Reading, Berkshire RG7 1BZ, GB  
Coady, Gareth Michael, Ty'n Llwyn Chapel Road, Wick Vale of Glamorgan, GB

(51) MKP  
**C12N 5/0735 (2010.01)** (97) **2611910 \***  
**C12N 5/02 (2006.01)**  
**C12N 5/071 (2010.01)**  
(86) US2011048129 17.08.2011  
(96) 11822350.2 10.07.2013  
(87) WO2012030539, 17.08.2011  
(97) 2611910, 10.07.2013 en  
(54) DIFFERENTIATION OF HUMAN EMBRYONIC STEM CELLS  
(71) Janssen Biotech, Inc., 800/850 Ridgeview Drive, Horsham, PA 19044, US  
(72) REZANIA, Alireza, 199 Grandview Road, Skillman, NJ 08558, US

(51) MKP  
**A61K 39/00 (2006.01)** (97) **2629792 \***  
**A61M 5/178 (2006.01)**  
(86) EP2011068090 17.10.2011  
(96) 11772945.9 28.08.2013  
(87) WO2012052394, 17.10.2011  
(97) 2629792, 28.08.2013 en  
(54) METHOD OF STORING A VACCINE CONTAINING AN ALUMINUM ADJUVANT  
(71) Sanofi Pasteur, 2, avenue Pont Pasteur, 69367 Lyon Cedex 07, FR  
(72) CHACORNAC, Isabelle, 1645 Chemin du Crêt, F-69420 Tupinet-Semons, FR  
IKHELEF-GRIBI, Nabila, 36 A Grande Rue, F-69340 Francheville, FR  
RONZON, Frédéric, Le Vanel, F-69610 Montromant, FR  
TIREFORT, Julien, 20 rue Longue, 69001 Lyon, FR  
LENTSCH GRAF, Sandrine, 3 allée de Candolle, F-69110 Sainte-Foy les Lyon, FR

(51) MKP  
**A61P 3/00 (2006.01)** (97) **2637667 \***  
**A61K 31/554 (2006.01)**  
(86) SE2011051337 08.11.2011  
(96) 11839645.6 18.09.2013  
(87) WO2012064268, 08.11.2011  
(97) 2637667, 18.09.2013 en  
(54) IBAT INHIBITORS FOR TREATMENT OF METABOLIC DISORDERS AND RELATED CONDITIONS  
(71) Albireo AB, Arvid Wallgrens Backe 20, 413 46 Göteborg, SE  
(72) GILLBERG, Per-Göran, Södermalmsgatan 22, S-431 69 Mölndal, SE  
STARKE, Ingemar, Frigångsgatan 8C, S-413 01 Göteborg, SE  
GRAFFNER, Hans, Konsulns Väg 16, S-252 84 Helsingborg, SE  
LINDQVIST, Ann-Margret, Gjutebrunnsvägen 36C, S-436 45 Askim, SE  
ANGELIN, Bo, Baggensgatan 15, S-111 31 Stockholm, SE

- (51) MKP  
**G06F 3/041 (2006.01)** (97) **2643812 \***  
**G06F 3/01 (2006.01)**  
**G06T 7/00 (2006.01)**  
**G06F 3/042 (2006.01)**
- (86) AT2011000475 23.11.2011  
(96) 11811309.1 02.10.2013  
(87) WO2012068607, 23.11.2011  
(97) 2643812, 02.10.2013 en  
(54) METHOD FOR DISPLAYING AN ITEM ON A DISPLAY UNIT  
(71) Kienzl, Thomas, Annenstrasse 57/1, 8020 Graz, AT  
(72) Kienzl, Thomas, Annenstrasse 57/1, 8020 Graz, AT
- 
- (51) MKP  
**C07D 471/04 (2006.01)** (97) **2611803 \***
- (86) EP2011065004 31.08.2011  
(96) 11757221.4 10.07.2013  
(87) WO2012028645, 31.08.2011  
(97) 2611803, 10.07.2013 de  
(54) METHOD FOR THE PRODUCTION OF 5-FLUORO-1H-PYRAZOLO[3,4-B]PYRIDINE-3-CARBONITRILE  
(71) Bayer Pharma Aktiengesellschaft, Müllerstrasse 178, 13353 Berlin, DE  
(72) FOLLMANN, Markus, Rosmarinweg 28, 50859 Köln, DE  
ACKERSTAFF, Jens, Schliemannstrasse 15, 10437 Berlin, DE
- 
- (51) MKP  
**A24D 1/00 (2006.01)** (97) **2532258**  
**A24D 1/04 (2006.01)**  
**A24D 3/06 (2006.01)**
- (96) 11169128.3 12.12.2012  
(97) 2532258, 12.12.2012 en  
(54) A tar reducing cigar with filter section comprising expanded, cut tobacco stems  
(71) Scandinavian Tobacco Group Lummen N.V., Europark 1030, 3530 Houthalen, BE  
(72) Van Mierlo, Bob, Scandinavian Tobacco Group Houthalen N.V. Halveweg 41, 3600 Genk, BE  
Lommelen, Toon, Scandinavian Tobacco Group Houthalen N.V. Beukenbergsveld 7, 2491 Olmen, BE
- 
- (51) MKP  
**A61K 31/135 (2006.01)** (97) **2603212 \***
- (86) US2011045574 27.07.2011  
(96) 11813130.9 19.06.2013  
(87) WO2012015950, 27.07.2011  
(97) 2603212, 19.06.2013 en  
(54) USE OF RASAGILINE FOR THE TREATMENT OF OLFACTORY DYSFUNCTION  
(71) Teva Pharmaceutical Industries Ltd., 5 Basel Street P.O. Box 3190, 49131 Petah Tiqva, IL  
(72) PETIT, Geraldine, Stora Tomtegatan 46, S-22351 Lund, SE  
BRUNDIN, Patrik, Ostervangsvagen 5, S-22460 Lund, SE
- 
- (51) MKP  
**A61K 9/00 (2006.01)** (97) **2605752 \***  
**A61K 31/56 (2006.01)**  
**A61K 31/575 (2006.01)**  
**A61K 47/26 (2006.01)**  
**A61K 47/28 (2006.01)**  
**A61K 47/32 (2006.01)**  
**A61K 47/36 (2006.01)**
- (86) US2011047920 16.08.2011  
(96) 11749654.7 26.06.2013  
(87) WO2012024298, 16.08.2011  
(97) 2605752, 26.06.2013 en  
(54) OPHTHALMIC FORMULATIONS OF SQUALAMINE  
(71) OHR Pharmaceutical, Inc., 489 Fifth Avenue, 28th Floor, New York, NY 10017, US  
(72) TARAPOREWALA, Irach, B., 24 Carhart Avenue, White Plains, NY 10605, US  
BACKENROTH, Samuel, I., 489 5th Avenue 28th Floor, New York, NY 10017, US
- 
- (51) MKP  
**A61K 31/365 (2006.01)** (97) **2627181 \***  
**A01N 43/78 (2006.01)**  
**A01N 43/16 (2006.01)**  
**A61K 31/35 (2006.01)**  
**A61K 31/425 (2006.01)**
- (86) US2011056135 13.10.2011  
(96) 11833402.8 21.08.2013  
(87) WO2012051410, 13.10.2011  
(97) 2627181, 21.08.2013 en  
(54) HETEROARYLS AND USES THEREOF  
(71) Millennium Pharmaceuticals, Inc., 40 Landsdowne Street, Cambridge, MA 02139, US  
(72) FREEZE, Brian, S., 67 Gates Street Unit 1, Boston, MA 02127, US  
HIROSE, Masaaki, c/o Takeda Pharmaceutical Company Limited Oncology DDU C-1 2F 1110 26-1 Muraokahigashi 2-chome Fujisawa, Kanagawa 251-0012, JP  
LEE, Hong Myung, 118 Amory Street, Cambridge MA 02139, US  
SELLS, Todd, B., 32 Ray Avenue, Bellingham MA 02019, US  
SHI, Zhan, 18 Shagbark Road, Concord MA 01742, US  
TAKAOKA, Leo, R., 2366 Commonwealth Avenue 2-2, Newton MA 02466, US  
VYSKOCIL, Stepan, 34 Eustis Street, Arlington MA 02476, US  
XU, Tianlin, 2 Arrowhead Drive, Shrewsbury MA 01545, US
- 
- (51) MKP  
**B09B 3/00 (2006.01)** (97) **2598259 \***  
**B27B 3/00 (2006.01)**  
**B29B 17/02 (2006.01)**
- (86) FR2011051786 25.07.2011  
(96) 11752287.0 05.06.2013  
(87) WO2012022883, 25.07.2011  
(97) 2598259, 05.06.2013 fr  
(54) METHOD FOR CLEANING UP MATERIALS THAT RESULT FROM THE RECYCLING OF FURNITURE, IN PARTICULAR MATTRESSES, BED BASES AND SEATS  
(71) Ecoval Environnement, 8 Allée des Palombes, 77185 Lognes, FR  
(72) LANZA, Rémy, Chemin du Félin, F-84500 Bollene, FR  
TOUATI, Salim, 9 rue Anatole France Le Grand Monarque, F-26250 Livron Sur Drome, FR
- 
- (51) MKP  
**A01N 43/50 (2006.01)** (97) **2548437**  
**A01N 25/30 (2006.01)**  
**A01N 25/02 (2006.01)**  
**A01N 53/00 (2006.01)**  
**A01N 37/42 (2006.01)**  
**A01N 43/653 (2006.01)**  
**A01N 47/12 (2006.01)**  
**A01N 47/20 (2006.01)**  
**A01N 43/40 (2006.01)**
- (96) 11174573.3 23.01.2013  
(97) 2548437, 23.01.2013 en  
(54) Improved method for producing emulsifiable pesticide solutions  
(71) Agriphar S.A., Rue de Renoy 26/1, 4102 Ougrée, BE  
(72) Pirotte, Alan, Cour de l'Abbaye 7, 6660 Houffalize, BE
- 
- (51) MKP  
**B01D 53/52 (2006.01)** (97) **2632569 \***  
**B01D 53/78 (2006.01)**  
**B01D 53/96 (2006.01)**
- (86) US2011050898 08.09.2011  
(96) 11761195.4 04.09.2013  
(87) WO2012057925, 08.09.2011  
(97) 2632569, 04.09.2013 en  
(54) HIGH PRESSURE REDUCTION-OXIDATION DESULFURIZATION PROCESS  
(71) MERCHEM COMPANY, 5455 Old Spanish Trail, Houston, TX 77023, US  
(72) NAGL, Gary, J., 200 Hidden Pines Drive, Deer Park IL 60010, US
-



(51) MKP  
**H01R 4/06 (2006.01)** (97) **2562875**  
**H01R 43/00 (2006.01)**  
(96) 11178530.9 27.02.2013  
(97) 2562875, 27.02.2013 en  
(54) Pulling device for pulling a punch in a contact bush  
(71) CEMBRE S.p.A., Via Serenissima 9, I-25135 Brescia, IT  
(72) Barezani, Gualtiero, Viale Giovanni XXIII, 27, I-25062 Concesio, Brescia, IT  
(72) Veglianti, Samuel, c/o Cembre S.p.A. Via Serenissima, 9, I-25135 Brescia, IT

(51) MKP  
**A61M 5/24 (2006.01)** (97) **2603258 \***  
(86) EP2011063841 11.08.2011  
(96) 11741593.5 19.06.2013  
(87) WO2012020085, 11.08.2011  
(97) 2603258, 19.06.2013 en  
(54) MECHANISM FOR PREVENTING SELECTION OF A DOSE  
(71) Sanofi-Aventis Deutschland GmbH, Brüningstraße 50, 65929 Frankfurt, DE  
(72) BUTLER, Joseph, 6 Hadfield Close, Clifton Rugby Warwickshire CV23 0DL, GB  
(72) AVERY, Richard James Vincent, 28 Nursery Close, Mickleton Chipping Campden Gloucestershire GL55 6TX, GB

(51) MKP  
**A61P 25/04 (2006.01)** (97) **2621496 \***  
**A61K 33/42 (2006.01)**  
**A61K 31/194 (2006.01)**  
**A61K 31/765 (2006.01)**  
**A61K 31/485 (2006.01)**  
(86) SE2011051161 29.09.2011  
(96) 11829686.2 07.08.2013  
(87) WO2012044243, 29.09.2011  
(97) 2621496, 07.08.2013 en  
(54) CRYSTALLINE NALOXOL-PEG CONJUGATE  
(71) AstraZeneca AB, null, 151 85 Södertälje, SE  
Nektar Therapeutics, 455 Mission Bay Boulevard South, Suite 100, San Francisco, CA 94185, US  
(72) ÅSLUND, Bengt Leonard, AstraZeneca R&D Södertälje, SE-151 85 Södertälje, SE  
AURELL, Carl-Johan, AstraZeneca R&D Södertälje, SE-151 85 Södertälje, SE  
BOHLIN, Martin Hans, AstraZeneca R&D Södertälje, SE-151 85 Södertälje, SE  
SEBHATU, Tesfai, AstraZeneca R&D Södertälje, SE-151 85 Södertälje, SE  
YMÉN, Bo Ingvar, AstraZeneca R&D Södertälje, SE-151 85 Södertälje, SE  
HEALY, Eric Thomas, Nektar Therapeutics 455 Mission Bay Boulevard South, Suite 100, San Francisco, California 94158, US  
JENSEN, David Richard, Nektar Therapeutics 455 Mission Bay Boulevard South, Suite 100, San Francisco, California 94158, US  
JONAITIS, David Thomas, SSCI A Division of APTUIT 3065 Kent Avenue, West Lafayette, Indiana 47906-1076, US  
PARENT, Stephan, SSCI A Division of APTUIT 3065 Kent Avenue, West Lafayette, Indiana 47906-1076, US

(51) MKP  
**F24J 2/52 (2006.01)** (97) **2642218**  
**H01L 31/042 (2006.01)**  
(96) 12179408.5 25.09.2013  
(97) 2642218, 25.09.2013 en  
(54) A modular apparatus for architectural integration of frameless solar modules  
(71) Brandoni Solare S.p.A., Via O. Pignini, 8, 60022 Castelfidardo (AN), IT  
(72) Liciotti, Claudio, Via Pozzetto, 632, 63011 Sant'Elpidio a Mare (FM), IT  
(72) Cingolani, Andrea, Via Montoro Selva, 8, 60022 Castelfidardo (AN), IT

(51) MKP  
**C07D 413/04 (2006.01)** (97) **2643316 \***  
(86) US2011062040 23.11.2011  
(96) 11794897.6 02.10.2013  
(87) WO2012071509, 23.11.2011  
(97) 2643316, 02.10.2013 en  
(54) BENZOAZEPINES AS INHIBITORS OF P13K/MTOR AND METHODS OF THEIR USE AND MANUFACTURE  
(71) Exelixis, Inc., 210 East Grand Avenue, South San Francisco, CA 94080, US  
(72) RICE, Kenneth, 44 Montecillo Road, San Rafael, CA 94903, US

(51) MKP  
**A23J 1/14 (2006.01)** (97) **2605666 \***  
**A23J 3/16 (2006.01)**  
(86) CA2011000942 18.08.2011  
(96) 11817613.0 26.06.2013  
(87) WO2012021980, 18.08.2011  
(97) 2605666, 26.06.2013 en  
(54) IMPROVED PRODUCTION OF PROTEIN SOLUTIONS FROM SOY  
(71) Burcon Nutrascience (MB) Corp., 1388 Waller Avenue, Winnipeg, Manitoba R3T 1P9, CA  
(72) GREEN, Brent E., 24 Poplarwood Drive Box 603, Warren, Manitoba R0C 3E0, CA  
(72) SCHWEIZER, Martin, 117 Haig Avenue, Winnipeg, Manitoba R2M 0E3, CA

(51) MKP  
**C07K 16/32 (2006.01)** (97) **2606070 \***  
**A61K 39/395 (2006.01)**  
**A61P 35/00 (2006.01)**  
(86) EP2011064407 22.08.2011  
(96) 11746252.3 26.06.2013  
(87) WO2012022814, 22.08.2011  
(97) 2606070, 26.06.2013 en  
(54) ANTIBODIES FOR EPIDERMAL GROWTH FACTOR RECEPTOR 3 (HER3)  
(71) Novartis AG, Lichtstrasse 35, 4056 Basel, CH  
(72) ELIS, Winfried, MORPHOSYS AG Lena-Christ-Strasse 48, 82152 Planegg, DE  
ETTENBERG, Seth, Novartis Institutes for BioMedical Research Inc. 250 Massachusetts Avenue Cambridge, Massachusetts 02139, US  
GARNER, Andrew Paul, Novartis Institutes for BioMedical Research Inc. 250 Massachusetts Avenue Cambridge, Massachusetts 02139, US  
HAUBST, Nicole, MORPHOSYS AG Lena-Christ-Strasse 48, 82152 Planegg, DE  
KUNZ, Christian Carsten Silvester, MORPHOSYS AG Lena-Christ-Strasse 48, 82152 Planegg, DE  
REISINGER SPRAGUE, Elizabeth Anne, Novartis Institutes for BioMedical Research Inc. 250 Massachusetts Avenue Cambridge, Massachusetts 02139, US

(51) MKP  
**C07K 16/28 (2006.01)** (97) **2576621 \***  
**A61K 39/00 (2006.01)**  
(86) EP2011058779 27.05.2011  
(96) 11722423.8 10.04.2013  
(87) WO2011147986, 27.05.2011  
(97) 2576621, 10.04.2013 en  
(54) MONOCLONAL ANTIBODIES AGAINST HER2  
(71) Genmab A/S, Bredgade 34 E, 1260 Copenhagen K, DK  
(72) GOEIJ, Bart de, Yalelaan 60, NL-3584 CM Utrecht, NL  
HAIJ, Simone de, Blokland 51, NL-1383 AB Weesp, NL  
RIEDL, Thilo, Yalelaan 60, NL-3584 CM Utrecht, NL  
HOET, René, Van Speyk 126, NL-5831 LG Boxmeer, NL  
BAADSGAARD, Ole, Tuborg Sundpark 10 1. Tv., DK-2900 Hellerup, DK  
WINKEL, Jan van de, Yalelaan 60, NL-3584 CM Utrecht, NL  
SATIJN, David, Yalelaan 60, NL-3584 CM Utrecht, NL  
PARREN, Paul, Yalelaan 60, NL-3584 CM Utrecht, NL  
LABRIJN, Aran Frank, Yalelaan 60, NL-3584 CM Utrecht, NL  
MEESTERS, Joyce, Yalelaan 60, NL-3584 CM Utrecht, NL  
SCHUURMAN, Janine, Yalelaan 60, NL-3584 CM Utrecht, NL  
BRINK, Edward N. van den, Yalelaan 60, NL-3584 CM Utrecht, NL

- (51) MKP  
**C07D 209/42 (2006.01)** (97) **2612850**  
**A61K 31/403 (2006.01)**
- (96) 13150296.5 10.07.2013  
(97) 2612850, 10.07.2013 fr
- (54) Delta crystalline form of the arginine salt of perindopril, a process for its preparation, and pharmaceutical compositions containing it
- (71) Les Laboratoires Servier, 35, rue de Verdun, 92284 Suresnes Cedex, FR
- (72) Linol, Julie, 25 rue Léon Malandain, 76770 Malaunay, FR  
Laurent, Stéphane, 2588, La Vieille Route, 76190 Valliquerville, FR  
Grenier, Arnaud, 400, Hameau du Maugendre, 76110 Breaute, FR  
Mathieu, Sébastien, 15, rue des Aulnes La Payennière, 76290 Montivillers, FR
- 
- (51) MKP  
**G06F 17/30 (2006.01)** (97) **2447859**
- (96) 11171831.8 02.05.2012  
(97) 2447859, 02.05.2012 en
- (54) System and method for acceleration of malware detection using antivirus cache
- (71) Kaspersky Lab, ZAO, 10 Geroyev Panfilovtsev Street, Moscow 125363, RU
- (72) Batenin, Vyacheslav A., c/o KASPERSKY LAB ZAO 10/1, 1st Volokolamsky Proezd, 123060 Moscow, RU
- 
- (51) MKP  
**B65D 21/06 (2006.01)** (97) **2517971**  
**B65D 43/02 (2006.01)**
- (96) 11009616.1 31.10.2012  
(97) 2517971, 31.10.2012 en
- (54) Material handling device
- (71) CANADA POST CORPORATION, 2701 Riverside Drive, Suite N1110, Ottawa, Ontario K1A 0B1, CA
- (72) Ulmer, John, B432-2701 Riverside Drive, Ottawa ON K1A 0B1, CA  
Li, Hongqiao, 5750-50th Street, Edmonton Alberta T6B 2Z8, CA  
McTavish, Kevin, 5750-50th Street, Edmonton Alberta T6B 2Z8, CA
- 
- (51) MKP  
**A61M 5/315 (2006.01)** (97) **2632512 \***
- (86) EP2011068603 25.10.2011  
(96) 11781469.9 04.09.2013  
(87) WO2012055845, 25.10.2011  
(97) 2632512, 04.09.2013 en
- (54) DRUG DELIVERY DEVICE AND METHOD FOR ASSEMBLING A DRUG DELIVERY DEVICE
- (71) Sanofi-Aventis Deutschland GmbH, Brüningstraße 50, 65929 Frankfurt, DE
- (72) NODERER, Michael, c/o Sanofi-Aventis Deutschland GmbH, 65926 Frankfurt am Main, DE  
CLAUGHTON, Timothy Giles, 18 High Low Avenue, Congleton Cheshire CW12 2EP, GB  
TERRY, Warren, 11 Corner House Windsor Place Leamington Spa, Warwickshire CV32 5EN, GB  
VEASEY, Robert, 31 Lonsdale Road Leamington Spa, Warwickshire CV32 7EP, GB
- 
- (51) MKP  
**G01B 9/04 (2006.01)** (97) **2607889 \***  
**G01N 21/64 (2006.01)**
- (86) KR2011006084 18.08.2011  
(96) 11818416.7 26.06.2013  
(87) WO2012023816, 18.08.2011  
(97) 2607889, 26.06.2013 en
- (54) FLUORESCENCE MICROSCOPE FOR MULTI-FLUORESCENCE IMAGE OBSERVATION, FLUORESCENCE IMAGE OBSERVATION METHOD USING THE SAME, AND MULTI-FLUORESCENCE IMAGE OBSERVATION SYSTEM
- (71) Nanoentek Inc., 12 Floor Ace High-End Tower 235-2 Guro-dong Guro-Gu, 152-711 Seoul, KR
- (72) PARK, Hwa Joon, 302-403 Daechong Apt. Gaepo-dong Gangnam-gu, Seoul 135-940, KR  
HWANG, Jeoung Ku, 106-2204 Doosan Apt. Guro 4(sa)-dong Guro-gu, Seoul 152-764, KR  
KIM, Jee Young, 202, 692-1 Bokjeong-dong Sujeong-gu, Seongnam-si Gyeonggi-do 461-831, KR  
CHUNG, Chan Il, 6-907 Hongsil Apt. Samseong 1(il)-dong Gangnam-gu, Seoul 435-866, KR
- 
- (51) MKP  
**D04H 5/02 (2012.01)** (97) **2540892**  
**D04H 5/06 (2006.01)**  
**D04H 13/00 (2006.01)**  
**A47L 13/17 (2006.01)**  
**A61K 8/02 (2006.01)**
- (96) 11172330.0 02.01.2013  
(97) 2540892, 02.01.2013 en
- (54) Water dispersible nonwoven fabric material
- (71) Suominen Corporation, Vestonkatu 24, 33580 Tampere, FI
- (72) Pedoja, Roberto, c/o AHLSTROM COPORATION Salmisaarenaukio 1, FI-00180 HELSINKI, FI
- 
- (51) MKP  
**A61K 31/33 (2006.01)** (97) **2603214 \***  
**A61K 31/425 (2006.01)**
- (86) US2011047407 11.08.2011  
(96) 11817031.5 19.06.2013  
(87) WO2012021696, 11.08.2011  
(97) 2603214, 19.06.2013 en
- (54) HETEROARYLS AND USES THEREOF
- (71) Millennium Pharmaceuticals, Inc., 40 Landsdowne Street, Cambridge, MA 02139, US
- (72) FREEZE, Brian S., 67 Gates Street Unit 1, Boston MA 02127, US  
HIROSE, Masaaki, C/o Takeda Pharmaceutical Company Limited Oncology DDU C-1 2F 1110 26-1 Muraokahigashi 2-chome, Fujisawa Kanagawa 251-0012, JP  
HU, Yongbo, 24 Shepard Court, Winchester MA 01890, US  
HU, Zhigen, 42 Truman Road, Newton Center MA 02459, US  
LEE, Hong Myung, 321 Harvard Street 309, Cambridge MA 02139, US  
SELLS, Todd B., 32 Ray Avenue, Bellingham MA 02019, US  
SHI, Zhan, 18 Shagbark Road, Concord MA 01742, US  
VYSKOCIL, Stepan, 34 Eustis Street, Arlington MA 02476, US  
XU, Tianlin, 2 Arrowwood Drive, Shrewsbury MA 01545, US
- 
- (51) MKP  
**B66D 1/50 (2006.01)** (97) **2554507**
- (96) 12175124.2 06.02.2013  
(97) 2554507, 06.02.2013 en
- (54) Cable tension measuring device
- (71) Pizzamiglio, Cristian, Via Stazione, 33, 37014 Castelnuovo del Garda (VR), IT
- (72) Pizzamiglio, Cristian, Via Stazione, 33, 37014 Castelnuovo del Garda (VR), IT

(51) MKP  
**B30B 5/06 (2006.01)** (97) **2625030 \***  
**B30B 9/32 (2006.01)**  
(86) IT2010000417 08.10.2010  
(96) 10803520.5 14.08.2013  
(87) WO2012046258, 08.10.2010  
(97) 2625030, 14.08.2013 en  
(54) COMPACTING CONVEYOR BELT PARTICULARLY FOR THE FEED OF PYROLYSIS, GASIFICATION AND COMBUSTION PLANTS  
(71) NSE Industry S.p.A., Via Raffaello Sanzio n. 199, 50053 Empoli (FI), IT  
(72) MORANDI Enzo, Via della Corsina n. 44, I-53031 Casole d'Elsa (SI), IT

(51) MKP  
**C07D 233/70 (2006.01)** (97) **2638017 \***  
**A61K 31/4174 (2006.01)**  
**A61P 9/00 (2006.01)**  
(86) US2011059895 09.11.2011  
(96) 11785872.0 18.09.2013  
(87) WO2012064807, 09.11.2011  
(97) 2638017, 18.09.2013 en  
(54) CRYSTALLINE FORMS OF AN ALKOXYIMIDAZOL-1-YLMETHYL BIPHENYL CARBOXYLIC ACID  
(71) Theravance, Inc., 901 Gateway Boulevard, South San Francisco, CA 94080, US  
(72) FATHEREE, Paul R., 921 Minnesota Street, San Francisco California 94107, US  
THALLADI, Venkat R., 888 Foster City Boulevard Apt. E3, Foster City California 94404, US

(51) MKP  
**A61K 9/113 (2006.01)** (97) **2616047 \***  
**A61K 9/107 (2006.01)**  
**A61K 31/728 (2006.01)**  
(86) KR2011006707 09.09.2011  
(96) 11825390.5 24.07.2013  
(87) WO2012036430, 09.09.2011  
(97) 2616047, 24.07.2013 en  
(54) NON-AQUEOUS OILY INJECTABLE FORMULATION EXHIBITING PRESERVATIVE EFFICACY  
(71) LG Life Sciences Ltd, LG Gwanghwamun Bldg. 92 Sinmunno 2-ga, Jongno-gu, Seoul 110-062, KR  
(72) SO, Jin Eon, Research Centers LG Life Sciences Ltd. 104-1, Munji-dong Yuseong-gu, Daejeon 305-380, KR  
YEO, Dong Jun, Research Centers LG Life Sciences Ltd. 104-1, Munji-dong Yuseong-gu, Daejeon 305-380, KR  
JANG, Yoon-Seon, Research Centers LG Life Sciences Ltd. 104-1, Munji-dong Yuseong-gu, Daejeon 305-380, KR

(51) MKP  
**H01L 29/18 (2006.01)** (97) **2603930 \***  
(86) US2011043539 11.07.2011  
(96) 11816752.7 19.06.2013  
(87) WO2012021238, 11.07.2011  
(97) 2603930, 19.06.2013 en  
(54) LED PACKAGE WITH EFFICIENT, ISOLATED THERMAL PATH  
(71) Cree, Inc., 4600 Silicon Drive, Durham, NC 27703-8475, US  
(72) HUSSELL, Christopher, P., 101 Glenmore Road, Cary NC 27519, US

(51) MKP  
**A61K 35/76 (2006.01)** (97) **2605783 \***  
**C12N 15/45 (2006.01)**  
**A61P 35/00 (2006.01)**  
**C12N 9/10 (2006.01)**  
**C12N 9/78 (2006.01)**  
**C07K 19/00 (2006.01)**  
(86) EP2011004200 19.08.2011  
(96) 11748282.8 26.06.2013  
(87) WO2012022495, 19.08.2011  
(97) 2605783, 26.06.2013 en  
(54) ONCOLYTIC MEASLES VIRUS  
(71) Lauer, Ulrich M., Rammertstraße 43, 72072 Tübingen, DE  
Bitzer, Michael, Weilerstraße 4, 72108 Rottenburg, DE  
Lampe, Johanna, Vöchtingstrasse 17, 72076 Tübingen, DE  
Zimmermann, Martina, Lilli-Zapf-Straße 17, 72072 Tübingen, DE  
Berchtold, Susanne, Raichbergstraße 40B, 72072 Tübingen, DE  
Lange, Sebastian, Viktor-Renner-Straße 51, 72074 Tübingen, DE  
Neubert, Wolfgang J., Bahnhofstr. 7b, 86926 Greifenberg, DE  
Bossow, Sascha, Bahnhofstraße 9, 69115 Heidelberg, DE  
(72) Lauer, Ulrich M., Rammertstraße 43, 72072 Tübingen, DE  
Bitzer, Michael, Weilerstraße 4, 72108 Rottenburg, DE  
Lampe, Johanna, Vöchtingstrasse 17, 72076 Tübingen, DE  
Zimmermann, Martina, Lilli-Zapf-Straße 17, 72072 Tübingen, DE  
Berchtold, Susanne, Raichbergstraße 40B, 72072 Tübingen, DE  
Lange, Sebastian, Viktor-Renner-Straße 51, 72074 Tübingen, DE  
Neubert, Wolfgang J., Bahnhofstr. 7b, 86926 Greifenberg, DE  
Bossow, Sascha, Bahnhofstraße 9, 69115 Heidelberg, DE

(51) MKP  
**A61K 36/25 (2006.01)** (97) **2605831 \***  
**A61K 36/11 (2006.01)**  
**A61K 36/53 (2006.01)**  
**A61P 11/00 (2006.01)**  
**A61K 36/57 (2006.01)**  
**A61K 36/185 (2006.01)**  
**A61P 11/10 (2006.01)**  
**A61K 36/28 (2006.01)**  
**A61P 11/12 (2006.01)**  
**A61K 36/235 (2006.01)**  
**A61K 36/35 (2006.01)**  
(86) EP2011005076 11.10.2011  
(96) 11773679.3 26.06.2013  
(87) WO2012076069, 11.10.2011  
(97) 2605831, 26.06.2013 de  
(54) METHOD FOR PRODUCING NON-ALCOHOLIC PLANT-BASED COMPOSITIONS, COMPOSITIONS PRODUCED IN SAID MANNER AND USE THEREOF  
(71) Maria Clementine Martin Klosterfrau Vertriebsgesellschaft mbH, Gereonsmühlengasse 1-11, 50670 Köln, DE  
(72) NAUERT, Christian, Waldstrasse 26A, 41542 Dormagen, DE  
GREVE, Harald, Schorlemerstraße 3a, 40545 Düsseldorf, DE

(51) MKP  
**A61K 31/55 (2006.01)** (97) **2611449 \***  
**A61P 3/04 (2006.01)**  
(86) US2011049936 31.08.2011  
(96) 11758012.6 10.07.2013  
(87) WO2012030939, 31.08.2011  
(97) 2611449, 10.07.2013 en  
(54) ADMINISTRATION OF LORCASERIN TO INDIVIDUALS WITH RENAL IMPAIRMENT  
(71) Arena Pharmaceuticals, Inc., 6154 Nancy Ridge Drive, San Diego, CA 92121, US  
(72) ANDERSON, Christen M., 756 Poinsettia Park South, Encinitas California 92024, US  
SHANAHAN, William R., 4948 Rancho Viejo Drive, Del Mar California 92014, US

- (51) MKP  
**A61M 5/28 (2006.01)** (97) **2595677 \***  
**A61J 1/06 (2006.01)**
- (86) EP2011062277 18.07.2011  
(96) 11734077.8 29.05.2013  
(87) WO2012010563, 18.07.2011  
(97) 2595677, 29.05.2013 en  
(54) MEDICAMENT CARTRIDGES WITH NON-STANDARD DIMENSIONS  
(71) Sanofi-Aventis Deutschland GmbH, Brüningstraße 50, 65929 Frankfurt, DE  
(72) HEMMANN, Kerstine, c/o Sanofi-Aventis Deutschland GmbH, 65926 Frankfurt am Main, DE
- 
- (51) MKP  
**B60K 28/06 (2006.01)** (97) **2596975 \***  
**G01N 33/497 (2006.01)**  
**B60R 25/04 (2013.01)**  
**G06K 9/00 (2006.01)**
- (86) ES2011070533 19.07.2011  
(96) 11811876.9 29.05.2013  
(87) WO2012013849, 19.07.2011  
(97) 2596975, 29.05.2013 en  
(54) IDENTIFICATION AND SECURITY DEVICE USING SHORT-DISTANCE OCULAR BIOMETRY  
(71) Valls Chaparro, Isaac, Plz.Mossen Cinto Verdaguer 12, 2º 2ª, 08221 Terrassa (Barcelona), ES  
López Roca, Sergio, Plz.Mossen Cinto Verdaguer 12, 2º 2ª, 08221 Terrassa (Barcelona), ES  
(72) CALDERÓN OLIVERAS, Alberto, Plz.Mossen Cinto Verdaguer 12, 2º 2ª, E-08221 Terrassa (Barcelona), ES
- 
- (51) MKP  
**C07K 1/18 (2006.01)** (97) **2598514 \***  
**C07K 1/36 (2006.01)**
- (86) EP2011062837 26.07.2011  
(96) 11736364.8 05.06.2013  
(87) WO2012013682, 26.07.2011  
(97) 2598514, 05.06.2013 en  
(54) PROTEIN PURIFICATION  
(71) UCB Pharma, S.A., 60, allée de la Recherche, 1170 Brussels, BE  
(72) SPITALI, Mariangela, c/o UCB Celltech 208 Bath Road Slough, Berkshire SL1 3WE, GB  
SYMMONS, Jonathan, c/o UCB Celltech 208 Bath Road Slough, Berkshire SL1 3WE, GB  
WHITCOMBE, Richard, c/o UCB Celltech 208 Bath Road Slough, Berkshire SL1 3WE, GB  
PEARCE-HIGGINS, Mark Robert, c/o UCB Celltech 208 Bath Road Slough, Berkshire SL1 3WE, GB
- 
- (51) MKP  
**A62B 17/00 (2006.01)** (97) **2407208**  
**A62B 9/00 (2006.01)**  
**A62B 9/02 (2006.01)**
- (96) 11002827.1 18.01.2012  
(97) 2407208, 18.01.2012 de  
(54) Protective suit with breathing air supply device  
(71) Tesimax - Altinger GmbH, Leimenstrasse 2, 75242 Neuhausen-Steinegg, DE  
(72) Altinger, Sven, Bunsenstr.30, 75173 Pforzheim, DE
- 
- (51) MKP  
**C21C 5/48 (2006.01)** (97) **2635715 \***  
**F27D 3/16 (2006.01)**  
**B22D 1/00 (2006.01)**
- (86) UA2010000089 25.11.2010  
(96) 10812964.4 11.09.2013  
(87) WO2012060796, 25.11.2010  
(97) 2635715, 11.09.2013 en  
(54) SECTION FOR PROCESSING LIQUID METAL WITH GASES  
(71) SHEMIGON, Mikhail Vladimirovich, Marshal Zhukov Av., 52, appt. 89 Mariupol' Donetsk Region, 87503, UA  
Zhivchenko, Vladimir Semyonovich, Uspenskogo str.1-2, Makeevka 86102, Donetsk Region, UA  
(72) SHEMIGON, Mikhail Vladimirovich, Marshal Zhukov Av., 52, appt. 89 Mariupol' Donetsk Region, 87503, UA  
Zhivchenko, Vladimir Semyonovich, Uspenskogo str.1-2, Makeevka 86102, Donetsk Region, UA
- 
- (51) MKP  
**E03C 1/22 (2006.01)** (97) **2554755**  
**E03F 5/04 (2006.01)**  
**A47K 3/40 (2006.01)**
- (96) 11176440.3 06.02.2013  
(97) 2554755, 06.02.2013 de  
(54) Floor drainage system  
(71) Geberit International AG, Schachenstrasse 77, 8645 Jona, CH  
(72) Kiffmeyer, Thomas, Hauptstrasse 2, 8716 Schmerikon, CH  
Schnyder, Patrick, Haldenstrasse 19, 6313 Menzingen, CH
- 
- (51) MKP  
**C07D 401/12 (2006.01)** (97) **2635565 \***  
**C07D 401/14 (2006.01)**  
**C07D 473/34 (2006.01)**  
**C07D 239/48 (2006.01)**  
**C07D 403/12 (2006.01)**  
**A61K 31/506 (2006.01)**  
**A61K 31/52 (2006.01)**  
**A61K 31/505 (2006.01)**  
**A61P 29/00 (2006.01)**  
**A61P 19/02 (2006.01)**  
**A61P 35/00 (2006.01)**  
**A61P 37/00 (2006.01)**
- (86) US2011059309 04.11.2011  
(96) 11785857.1 11.09.2013  
(87) WO2012061696, 04.11.2011  
(97) 2635565, 11.09.2013 en  
(54) 5 -CYANO-4, 6 -DIAMINOPYRIMIDINE OR 6 -AMINOPURINE DERIVATIVES AS PI3K- DELTA INHIBITORS  
(71) Amgen Inc., One Amgen Center Drive, Thousand Oaks, California 91320-1799, US  
(72) FISHER, Benjamin, 411-23rd Avenue, San Mateo California 94403, US  
JOHNSON, Michael G., 409 Clipper Street, San Francisco California 94114, US  
LUCAS, Brian, 133 10th Avenue, San Francisco California 94118, US  
SHIN, Youngsook, 64 Loop 22, Emeryville California 94608, US  
KAIZERMAN, Jacob, deceased, US
- 
- (51) MKP  
**C08F 2/00 (2006.01)** (97) **2625206 \***
- (86) US2011055037 06.10.2011  
(96) 11831570.4 14.08.2013  
(87) WO2012048075, 06.10.2011  
(97) 2625206, 14.08.2013 en  
(54) ACCELERATOR COMPOSITION FOR ELASTOMERS  
(71) Vanderbilt Chemicals, LLC, 30 Winfield Street, Norwalk CT 06855, US  
(72) FORGUE, Jennifer, A., 169 Brushy Hill Rd., Danbury CT 06810, US  
NOLA, Chris, M., 813 Wonderland Ct., Franklin TN 3709, US  
BURTRAW II, Roger, L., W 5511 Evergreen Street, Elkhorn WI 53121, US
- 
- (51) MKP  
**A61K 38/17 (2006.01)** (97) **2632952 \***  
**C07K 16/18 (2006.01)**  
**A61K 39/395 (2006.01)**  
**C07K 14/435 (2006.01)**  
**C12N 15/13 (2006.01)**  
**A61P 21/00 (2006.01)**
- (86) US2011057699 25.10.2011  
(96) 11836951.1 04.09.2013  
(87) WO2012058220, 25.10.2011  
(97) 2632952, 04.09.2013 en  
(54) ANTI-SOD1 ANTIBODIES AND USES THEREOF  
(71) The University of Massachusetts, 225 Franklin Street, 12th Floor, Boston, MA 02210, US  
(72) AMBROSINO, Donna, 241 Perkins Street, H101, Jamaica Plain, MA 02130, US  
BABCOCK, Gregory, 38 Muir Way, Marlborough, MA 01752, US  
BROERING, Teresa, 74 Parkman Street, 3, Brookline, MA 02446, US  
XU, Zuoshang, 70 Manor Avenue, Wellesley, MA 02482, US

(51) MKP  
**C07D 209/42 (2006.01)** (97) **2627632 \***  
**A61K 31/404 (2006.01)**  
**A61P 3/04 (2006.01)**  
**C07D 333/68 (2006.01)**  
**C07D 409/04 (2006.01)**  
**C07D 495/04 (2006.01)**  
**A61K 31/381 (2006.01)**  
**C07D 333/26 (2006.01)**  
(86) US2011055987 12.10.2011  
(96) 11773159.6 21.08.2013  
(87) WO2012051318, 12.10.2011  
(97) 2627632, 21.08.2013 en  
(54) SULPHONAMIDE COMPOUNDS AND METHODS OF MAKING AND USING SAME  
(71) Zafgen, Inc., One Broadway, 8th Floor, Cambridge, MA 02142, US  
(72) ZAHLER, Robert, 1 Cambridge Center Suite 702, Cambridge, MA 02142, US  
DYKE, Hazel, Joan, 8/9 Spire Green Centre Flex Meadow, Harlow Essex CM19 5TR, GB  
PALLIN, Thomas, David, 8/9 Spire Green Center Flex Meadow, Harlow Essex CM19 5TR, GB  
CRAMP, Susan, Mary, 8/9 Spire Green Centre Flex Meadow, Harlow Essex CM19 5TR, GB

(51) MKP  
**C07C 5/08 (2006.01)** (97) **2607300 \***  
**C07C 29/17 (2006.01)**  
**C01B 3/08 (2006.01)**  
**C07C 15/18 (2006.01)**  
**C07C 41/20 (2006.01)**  
**C07B 31/00 (2006.01)**  
**C07C 15/52 (2006.01)**  
**C07C 43/205 (2006.01)**  
**C01B 3/04 (2006.01)**  
**C07C 9/15 (2006.01)**  
**C07C 41/18 (2006.01)**  
**C07C 5/10 (2006.01)**  
**C07C 33/22 (2006.01)**  
**C01B 4/00 (2006.01)**  
**C07C 15/24 (2006.01)**  
**C07C 41/24 (2006.01)**  
**C07C 5/09 (2006.01)**  
**C07C 33/20 (2006.01)**  
**C07C 1/26 (2006.01)**  
**C07C 29/143 (2006.01)**  
(86) JP2011068535 16.08.2011  
(96) 11818187.4 26.06.2013  
(87) WO2012023546, 16.08.2011  
(97) 2607300, 26.06.2013 en  
(54) PROCESS FOR PRODUCING HYDROGEN OR HEAVY HYDROGENS, AND HYDROGENATION (PROTIATION, DEUTERATION OR TRITIATION) OF ORGANIC COMPOUNDS USING SAME  
(71) Shiono Chemical Co., Ltd., 2-10-8 Yaesu Chuo-ku, Tokyo 104-0028, JP  
(72) SAJIKI, Hironao, c/o Gifu Pharmaceutical University 1-25-4 Daigaku-nishi, Gifu-shi Gifu 501-1196, JP  
MONGUCHI, Yasunari, c/o Gifu Pharmaceutical University 1-25-4 Daigaku-nishi, Gifu-shi Gifu 501-1196, JP  
SAWAMA, Yoshinari, c/o Gifu Pharmaceutical University 1-25-4 Daigaku-nishi, Gifu-shi Gifu 501-1196, JP  
KONDO, Shinichi, c/o Gifu Pharmaceutical University 1-25-4 Daigaku-nishi, Gifu-shi Gifu 501-1196, JP

(51) MKP  
**C07D 277/20 (2006.01)** (97) **2610248 \***  
**C07D 277/56 (2006.01)**  
**A61K 31/426 (2006.01)**  
**A61P 19/06 (2006.01)**  
**A61P 43/00 (2006.01)**  
(86) JP2011069250 26.08.2011  
(96) 11820025.2 03.07.2013  
(87) WO2012026565, 26.08.2011  
(97) 2610248, 03.07.2013 en  
(54) METHOD FOR PRODUCING PHENYL-SUBSTITUTED HETEROCYCLIC DERIVATIVE BY MEANS OF COUPLING METHOD USING A PALLADIUM COMPOUND  
(71) Teijin Pharma Limited, 2-1, Kasumigaseki 3-chome Chiyoda-ku, Tokyo 100-0013, JP  
(72) KOMIYAMA, Masato, c/o Teijin Pharma Limited Tokyo ResearchCenter 3-2 Asahigaoka 4-chome, Hino-shi Tokyo 191-0065, JP

(51) MKP  
**H01L 31/048 (2006.01)** (97) **2521188**  
(96) 12166057.5 07.11.2012  
(97) 2521188, 07.11.2012 en  
(54) Photovoltaic module in the shape of an architectural element and process for the realization thereof  
(71) Quagliato, Giovanni Battista, Via Camisana, 62, 36040 Grumolo Delle Abbadesse (VI), IT  
(72) Quagliato, Giovanni Battista, Via Camisana, 62, 36040 Grumolo Delle Abbadesse (VI), IT

(51) MKP  
**A61K 9/28 (2006.01)** (97) **2605760 \***  
**A61K 9/20 (2006.01)**  
(86) US2011048024 17.08.2011  
(96) 11751736.7 26.06.2013  
(87) WO2012024360, 17.08.2011  
(97) 2605760, 26.06.2013 en  
(54) TABLET SLEEVE FOR IMPROVED PERFORMANCE  
(71) McNeil-PPC, Inc., 199 Grandview Avenue, Skillman, NJ 08558, US  
(72) WALDMAN, Joel, 124 Statesman Road, Chalfont, PA 18914, US

(51) MKP  
**A61K 9/00 (2006.01)** (97) **2611415 \***  
**A61K 31/4427 (2006.01)**  
**A61K 31/4439 (2006.01)**  
**A61P 27/06 (2006.01)**  
(86) EP2011064829 29.08.2011  
(96) 11752517.0 10.07.2013  
(87) WO2012028585, 29.08.2011  
(97) 2611415, 10.07.2013 en  
(54) ADENOSINE A1 AGONISTS FOR THE TREATMENT OF GLAUCOMA AND OCULAR HYPERTENSION  
(71) Bayer Intellectual Property GmbH, Alfred-Nobel-Strasse 10, 40789 Monheim, DE  
(72) KLAR, Jürgen, Mozartstr. 48, 42115 Wuppertal, DE  
VON DEGENFELD, Georges, Friedrich-Weskott-Str. 10, 51373 Leverkusen, DE  
LERCHEN, Hans-Georg, Sürderstr. 3, 51375 Leverkusen, DE  
ALBRECHT-KÜPPER, Barbara, Heidestr. 9, 42489 Wülfrath, DE  
KNORR, Andreas, Trillser Graben 10, 40699 Erkrath, DE  
SANDNER, Peter, Julius-Lucas-Weg 59, 42113 Wuppertal, DE  
MEIBOM, Daniel, In den Birken 62b, 42113 Wuppertal, DE

(51) MKP  
**F21S 8/00 (2006.01)** (97) **2402645**  
**F21S 8/08 (2006.01)**  
**F21V 21/116 (2006.01)**  
**F21Y 101/02 (2006.01)**  
**F21W 131/103 (2006.01)**  
(96) 11002094.8 04.01.2012  
(97) 2402645, 04.01.2012 de  
(54) Illumination device  
(71) Hempel, Armin, Lessingstrasse 36, 58809 Neuenrade, DE  
(72) Hempel, Armin, Lessingstrasse 36, 58809 Neuenrade, DE

(51) MKP  
**G06F 21/44 (2013.01)** (97) **2634724**  
**G06F 21/85 (2013.01)**  
**G06F 13/38 (2006.01)**  
(96) 12194586.9 04.09.2013  
(97) 2634724, 04.09.2013 en  
(54) Adapter for electronic devices  
(71) APPLE INC., 1 Infinite Loop, Cupertino, CA 95014, US  
(72) Terlizzi, Jeffrey J., c/o Apple Inc. 1 Infinite Loop, Cupertino, CA 95014, US  
Fritchman, Daniel J., c/o Apple Inc. 1 Infinite Loop, Cupertino, CA 95014, US  
Krueger, Scott, c/o Apple Inc. 1 Infinite Loop, Cupertino, CA 95014, US  
Tikalsky, Terry, c/o Apple Inc. 1 Infinite Loop, Cupertino, CA 95014, US  
Sillman, Debra A., c/o Apple Inc. 1 Infinite Loop, Cupertino, CA 95014, US  
Ng, Tony Chi Wang, c/o Apple Inc. 1 Infinite Loop, Cupertino, CA 95014, US  
Golko, Albert J., c/o Apple Inc. 1 Infinite Loop, Cupertino, CA 95014, US  
Jol, Eric S., c/o Apple Inc. 1 Infinite Loop, Cupertino, CA 95014, US  
Schmidt, Mathias W., c/o Apple Inc. 1 Infinite Loop, Cupertino, CA 95014, US

(51) MKP  
**C07D 513/04 (2006.01)** (97) **2643327 \***  
**A61K 31/437 (2006.01)**  
(86) US2011062042 23.11.2011  
(96) 11790718.8 02.10.2013  
(87) WO2012071511, 23.11.2011  
(97) 2643327, 02.10.2013 en  
(54) BENZOXAZEPINES AS INHIBITORS OF MTOR AND METHODS OF THEIR USE AND MANUFACTURE  
(71) Exelixis, Inc., 210 East Grand Avenue, South San Francisco, CA 94080, US  
(72) RICE, Kenneth, 44 Montecillo Road, San Rafael, CA 94903, US

(51) MKP  
**A61P 31/14 (2006.01)** (97) **2583680**  
**A61K 31/4725 (2006.01)**  
**A61K 31/501 (2006.01)**  
**A61P 31/12 (2006.01)**  
**A61K 45/06 (2006.01)**  
**A61K 31/7072 (2006.01)**  
**A61K 31/4178 (2006.01)**  
**A61K 31/513 (2006.01)**  
**A61K 31/5377 (2006.01)**  
**A61K 31/4709 (2006.01)**  
(96) 12189195.6 24.04.2013  
(97) 2583680, 24.04.2013 en  
(54) Mono (PSI-7977) or combination treatment of DAAs for use in treating HCV  
(71) Abbvie Inc., 1 North Waukegan Road, North Chicago, IL 60064, US  
(72) Bernstein, Barry M., 10829 Wyngate Trace, Mequon, WI Wisconsin 53092, US  
Menon, Rajeev M., 81 Pinyon Pine Court, Buffalo Grove, IL Illinois 60089, US  
Khatri, Amit, 1360 S. White Oak Drive, Apt. 225, Waukegan, IL Illinois 60085, US  
Mensing, Sven, Langer Schlag 95a, 68305 Mannheim, DE  
Dutta, Sandeep, 9303 Clem Drive, Gurnee, IL Illinois 60031, US  
Cohen, Daniel E., 930 Oakwood Avenue, Wilmette, IL Illinois 60091, US  
Podsadecki, Thomas, 708 B. North Orleans, Chicago, IL Illinois 60654, US  
Brun, Scott C., 31048 Prairie Ridge Road, Green Oaks, IL Illinois 60048, US  
Awni, Walid M., 14105 Edgewater Court, Green Oaks, IL Illinois 60048, US  
Dumas, Emily O., 232 E. Winchester, Libertyville, IL Illinois 60048, US  
Klein, Cheri E., 1933 Barberry Road, Northbrook, IL Illinois 60062, US

(51) MKP  
**C07D 417/00 (2006.01)** (97) **2640387 \***  
**A61K 31/44 (2006.01)**  
**C07D 417/14 (2006.01)**  
**G01N 33/53 (2006.01)**  
**C07D 401/00 (2006.01)**  
**C12Q 1/68 (2006.01)**  
(86) US2011061408 18.11.2011  
(96) 11842177.5 25.09.2013  
(87) WO2012068468, 18.11.2011  
(97) 2640387, 25.09.2013 en  
(54) METHOD OF TREATMENT WITH BRAF INHIBITOR  
(71) Glaxosmithkline Intellectual Property (No. 2) Limited, 980 Great West Road, Brentford, Middlesex TW8 9SG, GB  
(72) BLEAM, Maureen, 1250 South Collegeville Road, Collegeville, PA 19426, US  
GILMER, Tona, M., Five Moore Drive, Research Triangle Park, NC 27709, US  
GREGER, James, G., Jr., 1250 South Collegeville Road, Collegeville, PA 19426, US  
LAQUERRE, Sylvie, G., 709 Swedeland Road, King of Prussia, PA 19406, US  
LIU, Li, 1250 South Collegeville Road, Collegeville, PA 19426, US

(51) MKP  
**A61K 31/4045 (2006.01)** (97) **2632429 \***  
**A61K 47/02 (2006.01)**  
**A61K 47/26 (2006.01)**  
**A61K 31/519 (2006.01)**  
**A61K 47/44 (2006.01)**  
**A61K 31/495 (2006.01)**  
**A61K 9/00 (2006.01)**  
**A61K 9/70 (2006.01)**  
(86) EP2011068813 27.10.2011  
(96) 11784961.2 04.09.2013  
(87) WO2012055944, 27.10.2011  
(97) 2632429, 04.09.2013 de  
(54) ORAL PHARMACEUTICAL FILM FORMULATION FOR BITTER-TASTING DRUGS  
(71) Hexal AG, Industriestrasse 25, 83607 Holzkirchen, DE  
(72) KOHR, Thomas, Hexal AG Industriestr. 25, 83607 Holzkirchen, DE  
OBERMEIER, Petra, Hexal AG Industriestr. 25, 83607 Holzkirchen, DE

(51) MKP  
**A61K 31/554 (2006.01)** (97) **2637668 \***  
**A61P 1/16 (2006.01)**  
(86) SE2011051335 08.11.2011  
(96) 11840392.2 18.09.2013  
(87) WO2012064266, 08.11.2011  
(97) 2637668, 18.09.2013 en  
(54) IBAT INHIBITORS FOR THE TREATMENT OF LIVER DISEASES  
(71) Albireo AB, Arvid Wallgrens Backe 20, 413 46 Göteborg, SE  
(72) GILLBERG, Per-Göran, Södermalmsgatan 22, S-431 69 Mölndal, SE  
GRAFFNER, Hans, Konsulns väg 16, S-252 84 Helsingborg, SE  
STARKE, Ingemar, Frigångsgatan 8C, S-413 01 Göteborg, SE

(51) MKP  
**C08K 9/00 (2006.01)** (97) **2612881**  
**C08J 9/04 (2006.01)**  
**C08J 9/00 (2006.01)**  
**C08K 3/26 (2006.01)**  
**C08K 9/04 (2006.01)**  
(96) 12150304.9 10.07.2013  
(97) 2612881, 10.07.2013 en  
(54) Fillers for foamed rigid polymer products  
(71) Omya Development AG, Baslerstrasse 42, 4665 Oftringen, CH  
(72) Raymond, Edward, 2318 Lottery Road, Shrewsbury, VT Vermont 05738, US  
Lewis, Rabun Walker, 1025 Saint Charles Ave NE D, Atlanta, GA Georgia 30306, US

(51) MKP  
**B27M 1/08 (2006.01)** (97) **2598297 \***  
**B27M 3/18 (2006.01)**  
**B27G 11/00 (2006.01)**  
(86) US2011045758 28.07.2011  
(96) 11743725.1 05.06.2013  
(87) WO2012016066, 28.07.2011  
(97) 2598297, 05.06.2013 en  
(54) AUTOMATED DOOR ASSEMBLY, PRESS, AND ADHESIVE THEREFOR  
(71) Masonite Corporation, One Tampa City Center 201 N. Franklin Street, Suite 300, Tampa, Florida 33602, US  
(72) LIANG, Bei-Hong, 2528 Spartina Lane, Naperville Illinois 60564, US  
MACDONALD, Michael, 1028 Chillem Drive, Batavia Illinois 60510, US  
HARDWICK, Geoffrey, 1908 Fairview Drive, St. Charles Illinois 60174, US  
RITCHIE, Robert, 604 Brintons Bridge Road, West Chester Pennsylvania 19382, US  
CUCCHI, George, 17603 Crawley Road, Odessa Florida 33556, US  
FEDIO, Bruce, 12 Waverly Circle, Hattiesburg Mississippi 39402, US

(51) MKP  
**G07B 15/02 (2011.01)** (97) **2279919**  
**G08G 1/14 (2006.01)**  
**G07F 17/24 (2006.01)**  
**B60R 25/10 (2006.01)**  
(96) 10169317.4 02.02.2011  
(97) 2279919, 02.02.2011 de  
(54) Device and method for preventing a parked car from being stolen and monitoring a parked car  
(71) E.B.M.-Elektro-Bau-Montage GmbH & Co. KG, Karmannstrasse 13, 49084 Osnabrück, DE  
(72) Zachmann, Reinhard, Regensburger Straße 8, 93093, Donaustauf, DE

(51) MKP  
**A61K 9/00 (2006.01)** (97) **2600829 \***  
**A61K 31/44 (2006.01)**  
**A61P 11/06 (2006.01)**  
(86) EP2011062527 21.07.2011  
(96) 11740611.6 12.06.2013  
(87) WO2012016845, 21.07.2011  
(97) 2600829, 12.06.2013 en  
(54) PHARMACEUTICAL FORMULATION COMPRISING A PHOSPHODIESTERASE INHIBITOR  
(71) Chiesi Farmaceutici S.p.A., Via Palermo, 26/A, 43100 Parma, IT  
(72) BONELLI, Sauro, c/o CHIESI FARMACEUTICI S.P.A. Via Palermo 26/A, I-43100 Parma, IT  
LOSI, Elena, c/o CHIESI FARMACEUTICI S.p.A. Via Palermo 26/A, I-43100 Parma, IT  
ZAMBELLI, Enrico, c/o CHIESI FARMACEUTICI S.P.A. Via Palermo 26/A, I-43100 Parma, IT

(51) MKP  
**A61P 9/12 (2006.01)** (97) **2601180 \***  
**A61K 31/41 (2006.01)**  
**C07D 257/04 (2006.01)**  
(86) EP2011063254 01.08.2011  
(96) 11752132.8 12.06.2013  
(87) WO2012016969, 01.08.2011  
(97) 2601180, 12.06.2013 en  
(54) HIGHLY CRYSTALLINE VALSARTAN  
(71) Novartis AG, Lichtstrasse 35, 4056 Basel, CH  
(72) BURGBACHER, Jens, Novartis Pharma AG Postfach, CH-4002 Basel, CH  
HAHN, Björn Thomas, Horstmarer Landweg 80a, 48149 Münster, DE  
RAMPF, Florian Andreas, Novartis Pharma AG Postfach, CH-4002 Basel, CH  
SCHNEEBERGER, Ricardo, Novartis Pharma AG Postfach, CH-4002 Basel, CH

(51) MKP  
**A41D 1/06 (2006.01)** (97) **2630507 \***  
**G01H 5/00 (2006.01)**  
**G01R 27/28 (2006.01)**  
(86) US2011056888 19.10.2011  
(96) 11835068.5 28.08.2013  
(87) WO2012054605, 19.10.2011  
(97) 2630507, 28.08.2013 en  
(54) ELECTRICAL SYSTEM, METHOD, AND APPARATUS OF FINGERPRINT SENSOR USING ACOUSTIC IMPEDIOMETRY  
(71) Sonavation, Inc., 357 Hiatt Drive, Palm Beach Gardens, FL 33418, US  
(72) LIAUTAUD, Christian, 1501 Southwest 7th Street, Boca Raton, FL 33486, US  
SCHMITT, Rainer, M., 86 Ironwood Way, Palm Beach Gardens, FL 33418, US

(51) MKP  
**G08G 1/14 (2006.01)** (97) **2309472**  
(96) 10186766.1 13.04.2011  
(97) 2309472, 13.04.2011 de  
(54) Parking guidance system and method for operating a parking guidance system  
(71) E.B.M.-Elektro-Bau-Montage GmbH & Co. KG, Karmannstrasse 13, 49084 Osnabrück, DE  
(72) Zachmann, Reinhard, Regensburger Strasse 8, 93093 Donaustauf, DE

(51) MKP  
**G02C 7/04 (2006.01)** (97) **2598938 \***  
**B29D 11/00 (2006.01)**  
**B05D 5/06 (2006.01)**  
(86) US2011045810 29.07.2011  
(96) 11813222.4 05.06.2013  
(87) WO2012016098, 29.07.2011  
(97) 2598938, 05.06.2013 en  
(54) A SILICONE HYDROGEL LENS WITH A CROSSLINKED HYDROPHILIC COATING  
(71) Novartis AG, Lichtstrasse 35, 4056 Basel, CH  
(72) QIU, Yongxing, 540 Stedford Lane, Duluth Georgia 30097, US  
SAMUEL, Newton, T., 315 Friars Head Drive, Suwanee Georgia 30024, US  
PRUITT, John, Dallas, 5060 Winding Rose Drive, Suwanee Georgia 30024, US  
KOLLURU, Chandana, 1105 Goldenrod Lane, Suwanee Georgia 30024, US  
MEDINA, Arturo, N., 4021 McGinnis Ferry Road 2222, Suwanee Georgia 30024, US  
WINTERTON, Lynn, Cook, 840 Lucust Grove Court, Alpharetta Georgia 30004, US  
WU, Daqing, 920 Rockbass Road, Suwanee Georgia 30024, US  
QIAN, Xinming, 11720 Bentham Court, Johns Creek Georgia 30005, US  
NELSON, Jared, 1012 Holly Meadow Drive, Buford Georgia 30518, US

(51) MKP  
**C07D 211/60 (2006.01)** (97) **2632898 \***  
(86) US2011058472 28.10.2011  
(96) 11837232.5 04.09.2013  
(87) WO2012058645, 28.10.2011  
(97) 2632898, 04.09.2013 en  
(54) HETEROCYCLIC TYROSINE KINASE INHIBITORS  
(71) Biogen Idec MA Inc., 133 Boston Post Road, Weston, MA 02493, US  
Sunesis Pharmaceuticals, Inc., 395 Oyster Point Blvd., Suite 400, South San Francisco, CA 94080, US  
(72) HOPKINS, Brian, T., 169 Washington Street Apt. 13, Newton, MA 02458, US  
SCOTT, Daniel, 42 Bradyll Road, Weston, MA 02493, US  
CONLON, Patrick, 20 Eaton Street, Wakefield, MA 01880, US  
JENKINS, Tracy, J., 44 Vincent Avenue, Belmont, MA 02478, US  
POWELL, Noel, 28 Carlisle Road, Westford, MA 01886, US  
GUAN, Bing, 66 Douglas Road, Needham, MA 02492, US  
CUERVO, Julio, H., 40 Columbia Road, Arlington, MA 02474, US  
WANG, Deping, 52 Cannon Ball Road, Sharon, MA 02067, US  
TAVERAS, Art. 6 Joslin Lane, Southborough, MA 01772, US

- (51) MKP  
**A61K 31/40 (2006.01)** (97) **2640189 \***  
**A01N 43/38 (2006.01)**  
 (86) US2011061485 18.11.2011  
 (96) 11841603.1 25.09.2013  
 (87) WO2012068512, 18.11.2011  
 (97) 2640189, 25.09.2013 en  
 (54) 3-DEUTERO-POMALIDOMIDE  
 (71) Deuteria Pharmaceuticals, Inc., 86 Morris Avenue, Summit, New Jersey 07901, US  
 (72) DEWITT, Sheila, 346 Bunker Hill Rd, Auburn New Hampshire 03032, US

- (51) MKP  
**C07D 413/10 (2006.01)** (97) **2606045 \***  
**C07D 413/14 (2006.01)**  
**C07D 417/12 (2006.01)**  
**C07D 417/14 (2006.01)**  
**C07D 471/04 (2006.01)**  
**C07D 487/04 (2006.01)**  
**C07D 498/04 (2006.01)**  
**A61K 31/437 (2006.01)**  
**A61K 31/4439 (2006.01)**  
**A61K 31/444 (2006.01)**  
**A61K 31/497 (2006.01)**  
**A61K 31/4985 (2006.01)**  
**A61K 31/506 (2006.01)**  
**A61K 31/5365 (2006.01)**  
**A61K 31/5377 (2006.01)**  
**A61K 31/541 (2006.01)**  
**A61P 9/00 (2006.01)**  
**A61P 9/10 (2006.01)**  
**A61P 29/00 (2006.01)**  
**A61P 37/08 (2006.01)**  
**A61P 11/00 (2006.01)**  
 (86) US2011047356 11.08.2011  
 (96) 11748842.9 26.06.2013  
 (87) WO2012024150, 11.08.2011  
 (97) 2606045, 26.06.2013 en  
 (54) OXADIAZOLE INHIBITORS OF LEUKOTRIENE PRODUCTION  
 (71) Boehringer Ingelheim International GmbH, Binger Strasse 173, 55216 Ingelheim am Rhein, DE  
 (72) BARTOLOZZI, Alessandra, Boehringer Ingelheim Pharmaceuticals Inc. 900 Ridgebury Road P.O. Box 368, Ridgefield, Connecticut 06877-0368, US  
 BOSANAC, Todd, Boehringer Ingelheim Pharmaceuticals Inc. 900 Ridgebury Road P.O. 368, Ridgefield, Connecticut 06877-0368, US  
 CHEN, Zhidong, Boehringer Ingelheim Pharmaceuticals Inc. 900 Ridgebury Road P.O. Box 368, Ridgefield, Connecticut 06877-0368, US  
 DE LOMBAERT, Stephane, 22 Prospect Hill Road, Branford, Connecticut 06405, US  
 HUBER, John, D., c/o VP, IP, Legal Boehringer Ingelheim USA Corp. 900 Ridgebury Road P.O. Box 368, Ridgefield, Connecticut 06877-0368, US  
 LO, Ho Yin, Boehringer Ingelheim Pharmaceuticals Inc. 900 Ridgebury Road P.O. Box 368, Ridgefield, Connecticut 06877-0368, US  
 LOKE, Pui Leng, 114 Milton Park, Abingdon Oxfordshire OX14 4SA, GB  
 LIU, Weimin, c/o VP, IP, Legal Boehringer Ingelheim USA Corp. 900 Ridgebury Road P.O. Box 368, Ridgefield, Connecticut 06877-0368, US  
 MORWICK, Tina Marie, 5317 Ripplingbrook Way, Carmel Indiana 46033, US  
 OLAGUE, Alan, Boehringer Ingelheim Pharmaceuticals Inc. 900 Ridgebury Road P.O. Box 368, Ridgefield, Connecticut 06877-0368, US  
 RIETHER, Doris, Boehringer Ingelheim GmbH Corporate Patents Binger Strasse 173, 55216 Ingelheim am Rhein, DE  
 TYE, Heather, 114 Milton Park, Abingdon Oxfordshire OX14 4SA, GB  
 WU, Lifen, Boehringer Ingelheim Pharmaceuticals Inc. 900 Ridgebury Road P.O. Box 368, Ridgefield, Connecticut 06877-0368, US  
 ZINDELL, Renee, Boehringer Ingelheim Pharmaceuticals Inc. 900 Ridgebury Road P.O. Box 368, Ridgefield, Connecticut 06877-0368, US

- (51) MKP  
**A01N 43/42 (2006.01)** (97) **2597954 \***  
 (86) US2011043383 08.07.2011  
 (96) 11804411.4 05.06.2013  
 (87) WO2012006538, 08.07.2011  
 (97) 2597954, 05.06.2013 en  
 (54) DEUTERATED N-ETHYL-N-PHENYL-1,2-DIHYDRO-4-HYDROXY-5-CHLORO-1-METHYL-2-OXOQUINOLINE-3-CARBOXAMIDE, SALTS AND USES THEREOF  
 (71) Teva Pharmaceutical Industries Ltd., 5 Basel Street P.O. Box 3190, 49131 Petah Tiqva, IL  
 (72) PIRYATINSKY, Victor, Oley Hagardom 10b/13, 42398 Netanya, IL  
 LAXER, Avital, 92 Levi Eshkol St., 69361 Tel-aviv, IL

- (51) MKP  
**H02G 3/22 (2006.01)** (97) **2333924**  
**H02G 15/013 (2006.01)**  
 (96) 10188969.9 15.06.2011  
 (97) 2333924, 15.06.2011 de  
 (54) Wall bushing for feeding through cables, cable protection tubes or other conduits  
 (71) gabo Systemtechnik GmbH, Am Schaidweg 7, 94559 Niederwinkling, DE  
 (72) Geiger, Alexander, Birkenweg 3, 94559, Niederwinkling, DE  
 Lederer, Roland, Tassilostr. 5, 94374, Schwarzach, DE  
 Karl, Markus, Degernbach 62, 94327, Bogen, DE

- (51) MKP  
**A61B 17/064 (2006.01)** (97) **2517635**  
**A61B 17/072 (2006.01)**  
 (96) 12166165.6 31.10.2012  
 (97) 2517635, 31.10.2012 en  
 (54) Staple cartridge with implantable compressible portion and insertion cap  
 (71) Ethicon Endo-Surgery, Inc., 4545 Creek Road, Cincinnati, OH 45242, US  
 (72) Shelton, IV, Frederick E., 245 East Main Street, Hillsboro, OH Ohio 45133, US  
 Baxter, III, Chester O., 6375 Pawnee Ridge, Loveland, OH Ohio 45140, US  
 Aronhalt, Taylor W., 306 Beech Road, Loveland, OH Ohio 45140, US  
 Vasudevan, Venkataramanan Mandakolathur, 11321 Village Brook Drive, Apt. 2228, 45249 Cincinnati, IN  
 Nur, Israel, House No. 277 Moshai, 79860 Timmorim, IL  
 Hunt, John V., 3654 Moorhill Drive, Cincinnati, OH Ohio 45241, US  
 Hueil, Geoffrey C., 7693 Misty Springs Court, Mason, OH Ohio 45040, US  
 Fanuele, Gregory J., 5085 Oak Creek Trail, Liberty Township, OH Ohio 45011, US

- (51) MKP  
**C07D 487/04 (2006.01)** (97) **2598507 \***  
**A61P 35/00 (2006.01)**  
 (86) IB2011053310 25.07.2011  
 (96) 11749535.8 05.06.2013  
 (87) WO2012014147, 25.07.2011  
 (97) 2598507, 05.06.2013 en  
 (54) ANTICANCER DERIVATIVES, PREPARATION THEREOF AND THERAPEUTIC USE THEREOF  
 (71) SANOFI, 174, Avenue de France, 75013 Paris, FR  
 COMMERCON, Alain, c/o Sanofi Patent Department 174 avenue de France, F-75013 Paris, FR  
 GAUZY-LAZO, Laurence, c/o Sanofi Patent Department 174 avenue de France, F-75013 Paris, FR  
 HUBERT, Philippe, c/o Sanofi Patent Department 174 avenue de France, F-75013 Paris, FR



(51) MKP  
**C07D 223/16 (2006.01)** (97) **2611781 \***  
**A61K 31/55 (2006.01)**  
**A61P 3/04 (2006.01)**  
(86) US2011049953 31.08.2011  
(96) 11755511.0 10.07.2013  
(87) WO2012030951, 31.08.2011  
(97) 2611781, 10.07.2013 en  
(54) FAST-DISSOLVE DOSAGE FORMS OF 5-HT<sub>2C</sub> AGONISTS  
(71) Arena Pharmaceuticals, Inc., 6154 Nancy Ridge Drive, San Diego, CA 92121, US  
(72) BLACKBURN, Anthony, C., 12633 Caminito Rosita, San Diego, CA 92128, US  
STIRN, Scott, 14710 Carmel Ridge Road, San Diego, CA 92128, US  
SHAN, Yun, 11429 Honey Ridge, San Diego, CA 92130, US  
SHIFRINA, Anna, 11957 Miro Circle, San Diego, CA 92131, US

(51) MKP  
**C07K 14/71 (2006.01)** (97) **2601214 \***  
(86) US2011046802 05.08.2011  
(96) 11745870.3 12.06.2013  
(87) WO2012019128, 05.08.2011  
(97) 2601214, 12.06.2013 en  
(54) VEGF ANTAGONIST COMPOSITIONS AND USES THEREOF  
(71) Genzyme Corporation, 49 New York Avenue, Framingham, MA 01701, US  
(72) STEFANO, James, 49 New York Avenue, Framingham, MA 01701, US  
PAN, Clark, 49 New York Avenue, Framingham, MA 01701, US  
QIU, Huawei, 49 New York Avenue, Framingham, MA 01701, US  
O'CALLAGHAN, Michael, 49 New York Avenue, Framingham, MA 01701, US  
MATTHEWS, Gloria, 49 New York Avenue, Framingham, MA 01701, US

(51) MKP  
**B32B 27/18 (2006.01)** (97) **2619007 \***  
**B65D 81/26 (2006.01)**  
**A23L 1/30 (2006.01)**  
(86) EP2011066302 20.09.2011  
(96) 11764135.7 31.07.2013  
(87) WO2012038414, 20.09.2011  
(97) 2619007, 31.07.2013 en  
(54) PRODUCT INCLUDING LACTIC ACID BACTERIA AND A DESICCANT  
(71) Biogaia AB, P.O. Box 3242, 103 64 Stockholm, SE  
(72) SÖBERG, Elisabeth, Kyrkoled 8, S-227 31 Lund, SE

(51) MKP  
**C07D 409/06 (2006.01)** (97) **2616445 \***  
**C07D 401/06 (2006.01)**  
**A61K 31/416 (2006.01)**  
**A61K 31/4192 (2006.01)**  
**A61P 35/00 (2006.01)**  
**C07D 231/56 (2006.01)**  
**C07D 249/18 (2006.01)**  
(86) US2011051845 15.09.2011  
(96) 11825982.9 24.07.2013  
(87) WO2012037411, 15.09.2011  
(97) 2616445, 24.07.2013 en  
(54) ESTROGEN RECEPTOR MODULATORS AND USES THEREOF  
(71) Aragon Pharmaceuticals, Inc., 12780 El Camino Real Suite 301, San Diego, CA 92130, US  
(72) SMITH, Nicholas, D., 1204 Beryl Street, San Diego, CA 92109, US  
KAHRAMAN, Mehmet, 8617 Via Mallorca Unit E, La Jolla, CA 92037, US  
GOVEK, Steven, P., 13216 Via Santillana, San Diego, CA 92129, US  
NAGASAWA, Johnny, Y., 8525 Park Run Road, San Diego, CA 92129, US  
LAI, Andilly, G., 7360 Calle Cristobal Unit 112, San Diego, CA 92126, US  
JULIEN, Jackaline, D., 517 ½ Stratford Ct., Del Mar, CA 92014, US  
HERBERT, Mark R., 4180 Amoroso St., San Diego, CA 92111, US  
BONNEFOUS, Celine, 4425 Via Sepulveda Unit 3, San Diego, CA 92122, US  
DOUGLAS, Karen L., 4050 Rosenda Court Unit 244, San Diego, CA 92122, US

(51) MKP  
**C12Q 1/68 (2006.01)** (97) **2611931 \***  
(86) EP2011064951 31.08.2011  
(96) 11749199.3 10.07.2013  
(87) WO2012028633, 31.08.2011  
(97) 2611931, 10.07.2013 en  
(54) GENOMIC MARKERS FOR PREDICTION OF LONG-TERM RESPONSE TO GROWTH HORMONE (GH) THERAPY  
(71) Merck Serono S.A., Centre Industriel, 1267 Coinsins, CH  
(72) CROTEAU, Pascal, 1029 rue Bessières, Laval Québec H7X 3B4, CA  
RAELSON, John, 85 Elm Street, Hudson Heights Québec J0P 1J0, CA  
WOJCIK, Jérôme, 218 Rue Combe de l'Eau, 01220 Divonne Les Bains, FR  
DESTENAVES, Benoit, 555 rue de Paruthiol, 01630 Peron, FR  
OLIVIER, Clément, Rue Gautier 8, 1201 Genève, CH  
SCHNIEPER-SAMEC, Sonia, 15 Chemin des Roches, 1208 Genève, CH

(51) MKP  
**C08K 3/08 (2006.01)** (97) **2603617 \***  
**C10L 5/14 (2006.01)**  
**C08K 3/22 (2006.01)**  
**C22B 1/244 (2006.01)**  
(86) AU2011000960 01.08.2011  
(96) 11815892.2 19.06.2013  
(87) WO2012019216, 01.08.2011  
(97) 2603617, 19.06.2013 en  
(54) COMPOSITE PRODUCTS AND MANUFACTURING METHOD  
(71) Onesteel NSW Pty Limited, 22 Kellogg Road, Rooty Hill, New South Wales 2766, AU  
(72) O'KANE, Paul James, 22 Kellogg Road, Rooty Hills, NSW 2766, AU  
SKIDMORE, Catherine, Louise, 22 Kellogg Road, Rooty Hills, NSW 2766, AU

- (51) MKP  
**B21D 47/04 (2006.01)** (97) **2616199 \***  
**E04C 3/08 (2006.01)**
- (86) EP2011004685 20.09.2011  
(96) 11761011.3 24.07.2013  
(87) WO2012041453, 20.09.2011  
(97) 2616199, 24.07.2013 de  
(54) DEVICE AND METHOD FOR EXPANDING METAL ELEMENTS  
(71) Protektorwerk Florenz Maisch GmbH & Co. KG, Viktoriastrasse 58, 76571 Gaggenau, DE  
(72) MAISCH, Christof, Baden-Badener-Str. 15, 76571 Gaggenau, DE
- 
- (51) MKP  
**H04N 7/26 (2006.01)** (97) **2625856 \***  
**H04N 7/68 (2006.01)**
- (86) US2011054709 04.10.2011  
(96) 11768260.9 14.08.2013  
(87) WO2012047849, 04.10.2011  
(97) 2625856, 14.08.2013 en  
(54) SYSTEMS AND METHODS FOR ERROR RESILIENT SCHEME FOR LOW LATENCY H.264 VIDEO CODING  
(71) Blue Jeans Network, Inc., 3000 Lakeside Drive, Santa Clara, CA 95054, US  
(72) WEBER, Emmanuel, 4512 Carnaby Court, San Jose CA 95136, US
- 
- (51) MKP  
**H04L 12/46 (2006.01)** (97) **2617166 \***  
**H04L 12/18 (2006.01)**
- (86) NO2011000258 16.09.2011  
(96) 11825503.3 24.07.2013  
(87) WO2012036566, 16.09.2011  
(97) 2617166, 24.07.2013 en  
(54) METHOD AND APPARATUS FOR REDUCING RECEIVER IDENTIFICATION OVERHEAD IN IP BROADCAST NETWORKS  
(71) Marlink AS, Lysaker Torg 45, 1366 Lysaker, NO  
(72) KLABACKA, Jan, Langgaten 21, N-3081 Holmestrand, NO  
BARZDINS, Guntis, Lacplesa Str. 29 Apt. 63, Riga LV-1011, LV
- 
- (51) MKP  
**F16B 37/12 (2006.01)** (97) **2557322**
- (96) 11176849.5 13.02.2013  
(97) 2557322, 13.02.2013 en  
(54) Fixing arrangement  
(71) Delphi Technologies Holding S.à.r.l., Avenue de Luxembourg, 4940 Bascharage, LU  
(72) Navas Sanchez, Borja, Flat 4, 95-97 High Street, Chatham, Kent ME4 4DL, GB
- 
- (51) MKP  
**A61K 39/00 (2006.01)** (97) **2618835 \***  
**C07K 14/705 (2006.01)**  
**C07K 14/47 (2006.01)**  
**C07K 14/045 (2006.01)**
- (86) EP2011004674 19.09.2011  
(96) 11761508.8 31.07.2013  
(87) WO2012038055, 19.09.2011  
(97) 2618835, 31.07.2013 en  
(54) ANTIGEN-SPECIFIC T CELL RECEPTORS AND T CELL EPITOPES  
(71) Biontech AG, Hölderlinstrasse 8, 55131 Mainz, DE  
Universitätsmedizin der Johannes Gutenberg-Universität Mainz, Langenbeckstraße 1, 55131 Mainz, DE  
TRON - Translationale Onkologie an der Universitätsmedizin der Johannes Gutenberg- Universität Mainz gemeinnützige GmbH, Langenbeckstrasse 1, 55131 Mainz, DE  
(72) SAHIN, Ugur, Philipp-von-Zabern-Platz 1, 55116 Mainz, DE  
TÜRECI, Özlem, Philipp-von-Zabern-Platz 1, 55116 Mainz, DE  
SIMON, Petra, Silvanerstrasse 33 a, 55129 Mainz, DE  
OMOKOKO, Tana, Klarastrasse 1, 55116 Mainz, DE
- 
- (51) MKP  
**F01B 17/02 (2006.01)** (97) **2625385 \***  
**F02G 1/02 (2006.01)**  
**F24J 2/42 (2006.01)**
- (86) EP2011067211 03.10.2011  
(96) 11764179.5 14.08.2013  
(87) WO2012045693, 03.10.2011  
(97) 2625385, 14.08.2013 fr  
(54) MONO-ENERGY AND/OR DUAL-ENERGY ENGINE WITH COMPRESSED AIR AND/OR ADDITIONAL ENERGY, COMPRISING AN ACTIVE CHAMBER INCLUDED IN THE CYLINDER  
(71) Motor Development International S.A., 17 Rue des Bains, 1212 Luxembourg, LU  
(72) NEGRE, Guy, 3 rue Abbé Jos Keip, L-1260 Luxembourg, LU  
NEGRE, Cyril, 1 rue St Aignan, F-06300 Nice, FR
- 
- (51) MKP  
**A61K 9/00 (2006.01)** (97) **2629757 \***  
**A61K 9/06 (2006.01)**  
**A61K 47/32 (2006.01)**  
**A61K 31/498 (2006.01)**
- (86) EP2011068263 19.10.2011  
(96) 11805792.6 28.08.2013  
(87) WO2012052479, 19.10.2011  
(97) 2629757, 28.08.2013 en  
(54) BRIMONIDINE GEL COMPOSITIONS AND METHODS OF USE  
(71) Galderma S.A., Zugerstrasse 8, 6330 Cham, CH  
(72) BUGE, Jean-Christophe, 60 Chemin Vallon Barla Le Val D'azur Bat A, F-06200 Nice, FR  
NADAU FOURCADE, Karine, Les Restanques de Vaugrenier 1214 Avenue de Vaugrenier, F-06270 Villeneuve Loubet, FR  
MEUNIER, Cyril, 1 rue Saint Jacques, F-06250 Mougins, FR
- 
- (51) MKP  
**G01N 33/574 (2006.01)** (97) **2638395 \***
- (86) US2011060407 11.11.2011  
(96) 11839397.4 18.09.2013  
(87) WO2012065085, 11.11.2011  
(97) 2638395, 18.09.2013 en  
(54) METHODS OF TREATING CANCER  
(71) Endocyte, Inc., 3000 Kent Avenue, West Lafayette, IN 47906, US  
(72) REDDY, Joseph Anand, 3323 Cinnabar Street, West Lafayette, IN 47906, US  
LEAMON, Christopher Paul, 5830 Farm Ridge Road, West Lafayette, IN 47906, US
- 
- (51) MKP  
**G01N 33/574 (2006.01)** (97) **2612151 \***  
**A61K 39/00 (2006.01)**
- (86) US2011050069 31.08.2011  
(96) 11754597.0 10.07.2013  
(87) WO2012031027, 31.08.2011  
(97) 2612151, 10.07.2013 en  
(54) BIOMARKERS AND METHODS OF TREATMENT  
(71) Genentech, Inc., 1 DNA Way, South San Francisco, CA 94080, US  
(72) PATEL, Premal, c/o Genentech Inc. 1 DNA Way, South San Francisco, California 94080, US  
PETERSON, Amy C., 952 Capp Street, San Francisco, California 94110, US  
YAUCH, Robert L., c/o Genentech Inc. 1 DNA Way, South San Francisco, California 94080, US  
ZHA, Jiping, 6 Beijing West Road, Taicang Economic Development Area Jiangsu Province 215400, CN

(51) MKP  
**C07D 303/16 (2006.01)** (97) **2638023 \***  
**A61K 31/336 (2006.01)**  
**A61P 3/00 (2006.01)**  
(86) US2011059966 09.11.2011  
(96) 11788684.6 18.09.2013  
(87) WO2012064838, 09.11.2011  
(97) 2638023, 18.09.2013 en  
(54) CRYSTALLINE SOLIDS OF A METAP-2 INHIBITOR AND METHODS OF MAKING AND USING SAME  
(71) Zafgen, Inc., One Broadway, 8th Floor, Cambridge, MA 02142, US  
(72) CRAWFORD, Thomas, 13 Clark Lane, Essex CT 06426, US  
REECE, Hayley, A., Flat 10 Fishermans Court 25 New Street  
Musselburgh, Midlothian Scotland EH21 6JH, GB

(51) MKP  
**G01N 33/66 (2006.01)** (97) **2630501 \***  
**G01N 33/68 (2006.01)**  
**G01N 33/72 (2006.01)**  
(86) US2011056811 19.10.2011  
(96) 11835034.7 28.08.2013  
(87) WO2012054555, 19.10.2011  
(97) 2630501, 28.08.2013 en  
(54) IMPROVED IDENTIFICATION OF PRE-DIABETES USING A COMBINATION OF MEAN GLUCOSE AND 1,5-ANHYDROGLUCITOL MARKERS  
(71) Glycomark, Inc., 101 North Chestnut Street Piedmont Triad Research Park, Winston-Salem, NC 27101, US  
(72) BUTTON, Eric, 192 Tifton Street, Bermuda Run, NC 27006, US  
FOSTER, Robert, 120 Wellesley Place Court, Lewisville, NC 27023, US

(51) MKP  
**A61P 1/00 (2006.01)** (97) **2598165 \***  
**G01N 33/48 (2006.01)**  
**A61P 29/00 (2006.01)**  
**A61P 35/00 (2006.01)**  
**A61K 39/00 (2006.01)**  
**A61K 39/02 (2006.01)**  
**A61K 39/12 (2006.01)**  
(86) CA2011000851 26.07.2011  
(96) 11811677.1 05.06.2013  
(87) WO2012012874, 26.07.2011  
(97) 2598165, 05.06.2013 en  
(54) IMMUNOGENIC ANTI-INFLAMMATORY COMPOSITIONS  
(71) Qu Biologics Inc, 887 Great Northern Way, Suite 138, Vancouver, BC V5T 4T5, CA  
(72) GUNN, Harold David, 1116 Ironwork Passage, Vancouver British Columbia V6H 3P1, CA  
DHANJI, Salim, 1425 Sutherland Avenue, North Vancouver British Columbia V7L 4B4, CA

(51) MKP  
**C07K 16/24 (2006.01)** (97) **2635601 \***  
(86) US2011058869 02.11.2011  
(96) 11781949.0 11.09.2013  
(87) WO2012061448, 02.11.2011  
(97) 2635601, 11.09.2013 en  
(54) ANTI-IL-23 ANTIBODIES  
(71) Boehringer Ingelheim International GmbH, Binger Strasse 173, 55216 Ingelheim am Rhein, DE  
(72) BARRETT, Rachel Rebecca, Boehringer Ingelheim Pharmaceuticals Inc. 900 Ridgebury Road P.O. Box 368, Ridgefield, Connecticut 06877-0368, US  
CANADA, Keith, Boehringer Ingelheim Pharmaceuticals Inc. 900 Ridgebury Road P.O. Box 368, Ridgefield, Connecticut 06877-0368, US  
CATRON, Katrina Mary, Boehringer Ingelheim Pharmaceuticals Inc. 900 Ridgebury Road P.O. Box 368, Ridgefield, CT 06877-0368, US  
COPENHAVER, Robert, Boehringer Ingelheim Pharmaceuticals Inc. 900 Ridgebury Road P.O. Box 368, Ridgefield, CT 06877-0368, US  
FREGO, Lee Edward, Boehringer Ingelheim Pharmaceuticals Inc. 900 Ridgebury Road P.O. Box 368, Ridgefield, Connecticut 06877-0368, US  
RAYMOND, Ernest Lee, Boehringer Ingelheim Pharmaceuticals Inc. 900 Ridgebury Road P.O. Box 368, Ridgefield, Connecticut 06877-0368, US  
SINGH, Sanjaya, Boehringer Ingelheim Pharmaceuticals Inc. 900 Ridgebury Road P.O. Box 368, Ridgefield, Connecticut 06877-0368, US  
ZHU, Xiangyang, Boehringer Ingelheim Pharmaceuticals Inc. 900 Ridgebury Road P.O. Box 368, Ridgefield, Connecticut 06877-0368, US

(51) MKP  
**A61K 8/19 (2006.01)** (97) **2637640 \***  
**A61Q 1/00 (2006.01)**  
**A61K 8/97 (2006.01)**  
**A61K 8/72 (2006.01)**  
**A61K 8/92 (2006.01)**  
**A61Q 1/04 (2006.01)**  
(86) US2011059740 08.11.2011  
(96) 11840071.2 18.09.2013  
(87) WO2012064714, 08.11.2011  
(97) 2637640, 18.09.2013 en  
(54) SHINY, TRANSFER RESISTANT LIPSTICK AND METHOD OF MAKING  
(71) Coty Inc., 2 Park Avenue, New York, NY 10016, US  
(72) BARONE, Salvatore J., 63 Peacock Loop, Staten Island New York 10309, US  
NGUYEN, Lethu, 400 Middlesex Avenue, Colonia New Jersey 07067, US  
VANCE MAILLARD, Fredericke, 7 Cite Martignac, F-75007 Paris, FR

- (51) MKP  
**C07D 239/42 (2006.01)** (97) **2640710 \***  
 (86) HU2011000107 16.11.2011  
 (96) 11827789.6 25.09.2013  
 (87) WO2012066365, 16.11.2011  
 (97) 2640710, 25.09.2013 en  
 (54) CRYSTALLINE PHARMACEUTICALLY ACTIVE INGREDIENTS  
 (71) Egis Gyógyszergyár Nyilvánosan Működő Részvénytársaság, Keresztúri út 30-38, 1106 Budapest, HU  
 (72) MARKOVITS, Imre, Hercegprímás utca 17., H-1051 Budapest, HU  
 JURÁK, Ferenc, Hantmadár utca 20/1, H-1173 Budapest, HU  
 KOVÁNYINÉ LAX, Györgyi, Mogyoródi út 110., H-1141 Budapest, HU  
 HÁMORI, Csaba, Fehérvári út 187. 6/70, H-1116 Budapest, HU  
 HAVASI, Balázs, Felvidék u. 59, H-1202 Budapest, HU  
 SIPOS, Éva, Magyarhida utca 47, H-1172 Budapest, HU  
 VOLK, Balázs, Piliási u. 54, H-1106 Budapest, HU  
 RUNGE, Zsolt, Szatmári utca 4, H-1161 Budapest, HU  
 FODORNÉ KOCSMÁR, Krisztina, 538. utca 10/A, H-1173 Budapest, HU  
 LUKÁCS, Gyula, Bronz utca 5, H-1163 Budapest, HU  
 KÁTAINÉ FADGYAS, Katalin, Szegf utca 5., H-2040 budaörs, HU  
 MEZÖVÁRI, Mónika, Komp. utca. 2, H-2310 Szigetszentmiklós, HU

- (51) MKP  
**C07D 403/12 (2006.01)** (97) **2630139 \***  
**A61P 29/00 (2006.01)**  
**C07D 417/14 (2006.01)**  
**C07D 405/14 (2006.01)**  
**A61K 31/427 (2006.01)**  
**A61K 31/381 (2006.01)**  
**A61K 31/4025 (2006.01)**  
**C07D 409/14 (2006.01)**  
**A61P 25/00 (2006.01)**  
 (86) US2011057090 20.10.2011  
 (96) 11778748.1 28.08.2013  
 (87) WO2012054721, 20.10.2011  
 (97) 2630139, 28.08.2013 en  
 (54) AMINO-PYRROLIDINE-AZETIDINE DIAMIDES AS MONOACYLGLYCEROL LIPASE INHIBITORS  
 (71) Janssen Pharmaceutica, N.V., Turnhoutseweg 30, 2340 Beerse, BE  
 (72) ZHANG, Yue-mei, Welsh&McKean Roads, Spring House PA 19477, US  
 CONNOLLY, Peter, J., Welsh&McKean Roads, Spring House PA 19477, US  
 LIN, Shu-chen, 4895 Redfield Road, Doylestown PA 18902, US  
 MACIELAG, Mark, J., Welsh&McKean Roads, Spring House PA 19477, US

- (51) MKP  
**A61P 35/00 (2006.01)** (97) **2631233 \***  
**A61K 31/506 (2006.01)**  
**A61K 31/496 (2006.01)**  
**A61P 5/26 (2006.01)**  
**C07D 401/12 (2006.01)**  
**C07D 403/12 (2006.01)**  
 (86) JP2011074261 21.10.2011  
 (96) 11834469.6 28.08.2013  
 (87) WO2012053630, 21.10.2011  
 (97) 2631233, 28.08.2013 en  
 (54) ANTAGONIST FOR MUTATED ANDROGEN RECEPTOR  
 (71) Astellas Pharma Inc., 3-11, Nihonbashi-Honcho 2-chome Chuo-ku, Tokyo 103-8411, JP  
 (72) IDEYAMA, Yukitaka, c/o Astellas Pharma Inc. 3-11 Nihonbashi-Honcho 2-chome Chuo-ku, Tokyo 103-8411, JP  
 KUROMITSU, Sadao, c/o Astellas Pharma Inc. 3-11 Nihonbashi-Honcho 2-chome Chuo-ku, Tokyo 103-8411, JP  
 FURUTANI, Takashi, c/o Astellas Pharma Inc. 3-11 Nihonbashi-Honcho 2-chome Chuo-ku, Tokyo 103-8411, JP  
 TAKEDA, Masayoshi, c/o Astellas Pharma Inc. 3-11 Nihonbashi-Honcho 2-chome Chuo-ku, Tokyo 103-8411, JP  
 KONAGAI, Satoshi, c/o Astellas Pharma Inc. 3-11 Nihonbashi-Honcho 2-chome Chuo-ku, Tokyo 103-8411, JP  
 YAMADA, Tomohiro, c/o Astellas Pharma Inc. 3-11 Nihonbashi-Honcho 2-chome Chuo-ku, Tokyo 103-8411, JP  
 TANIGUCHI, Nobuaki, c/o Astellas Pharma Inc. 3-11 Nihonbashi-Honcho 2-chome Chuo-ku, Tokyo 103-8411, JP  
 KONDOH, Yutaka, c/o Astellas Pharma Inc. 3-11 Nihonbashi-Honcho 2-chome Chuo-ku, Tokyo 103-8411, JP  
 HIRANO, Masaaki, c/o Astellas Pharma Inc. 3-11 Nihonbashi-Honcho 2-chome Chuo-ku, Tokyo 103-8411, JP  
 WATANABE, Kazushi, c/o Astellas Pharma Inc. 3-11 Nihonbashi-Honcho 2-chome Chuo-ku, Tokyo 103-8411, JP  
 SUGANE, Takashi, c/o Astellas Pharma Inc. 3-11 Nihonbashi-Honcho 2-chome Chuo-ku, Tokyo 103-8411, JP  
 KAKEFUJIDA, Akio, c/o Astellas Pharma Inc. 3-11 Nihonbashi-Honcho 2-chome Chuo-ku, Tokyo 103-8411, JP

- (51) MKP  
**A61P 7/04 (2006.01)** (97) **2632479 \***  
**A61K 38/37 (2006.01)**  
**C07K 14/755 (2006.01)**  
 (86) US2011058165 27.10.2011  
 (96) 11796846.1 04.09.2013  
 (87) WO2012058480, 27.10.2011  
 (97) 2632479, 04.09.2013 en  
 (54) FVIII PEPTIDES FOR IMMUNE TOLERANCE INDUCTION AND IMMUNODIAGNOSTICS  
 (71) Baxter International Inc, One Baxter Parkway, Deerfield, IL 60015, US  
 Baxter Healthcare SA, Thurgauerstrasse 130, 8152 Glattpark (Opfikon), CH  
 (72) STEINITZ, Katharina, Nora, Querweg 14, A-2500 Siegenfeld, AT  
 WILHELMINA VAN HELDEN, Paula, Maria, Eimeren 54, NL-5235 DV Den Bosch, NL  
 REIPERT, Birgit, Maria, Heinegasse 2, A-2232 Deutsch-Wagram, AT  
 SCHWARZ, Hans-Peter, Weimarer Strasse 76, A-1180 Vienna, AT  
 EHRLICH, Hartmut, Bienenweg 1, A-1170 Vienna, AT

- (51) MKP  
**A23J 1/14 (2006.01)** (97) **2642873 \***  
**A23J 3/16 (2006.01)**  
 (86) CA2011001296 24.11.2011  
 (96) 11851902.4 02.10.2013  
 (87) WO2012083418, 24.11.2011  
 (97) 2642873, 02.10.2013 en  
 (54) ASTRINGENCY IN SOY PROTEIN SOLUTIONS  
 (71) Burcon Nutrascience (MB) Corp., 1388 Waller Avenue, Winnipeg, Manitoba R3T 1P9, CA  
 (72) MEDINA, Sarah, 315 Wildwood Park, Winnipeg, Manitoba R3T 0E5, CA  
 SEGALL, Kevin I., 31 Dunbar Crescent, Winnipeg, Manitoba R3P 0W6, CA

- (51) MKP  
**B29C 53/08 (2006.01)** (97) **2608946 \***  
**G05B 19/19 (2006.01)**
- (86) RS2010000016 14.12.2010  
(96) 10819691.6 03.07.2013  
(87) WO2012026836, 14.12.2010  
(97) 2608946, 03.07.2013 en  
(54) BENDING PVC PROFILES USING LASER AND PLC CONTROLLING SYSTEM  
(71) Turanjanin, Uros, Vladimira Rolovica 12, 34000 Kragujevac, YU  
(72) Turanjanin, Uros, Vladimira Rolovica 12, 34000 Kragujevac, YU
- 
- (51) MKP  
**C07D 409/04 (2006.01)** (97) **2595983 \***  
**C07D 409/14 (2006.01)**  
**C07D 413/04 (2006.01)**  
**C07D 413/14 (2006.01)**  
**C07D 417/14 (2006.01)**  
**C07D 487/04 (2006.01)**  
**C07D 498/04 (2006.01)**  
**A61K 31/381 (2006.01)**  
**A61P 31/12 (2006.01)**
- (86) EP2011062545 21.07.2011  
(96) 11743481.1 29.05.2013  
(87) WO2012010663, 21.07.2011  
(97) 2595983, 29.05.2013 en  
(54) 2,3,5-TRISUBSTITUTED THIOPHENE COMPOUNDS AND USES THEREOF  
(71) Novartis AG, Lichtstrasse 35, 4056 Basel, CH  
(72) BARNES, David, Novartis Institutes for BioMedical Research Inc. 100 Technology Square Cambridge, Massachusetts 02139, US  
COHEN, Scott Louis, Novartis Institutes for BioMedical Research Inc. 100 Technology Square Cambridge, Massachusetts 02139, US  
FU, Jiping, Novartis Institutes for BioMedical Research Inc. 250 Massachusetts Avenue Cambridge, Massachusetts 02139, US  
SHU, Lei, Novartis Institutes for BioMedical Research Inc. 250 Massachusetts Avenue Cambridge, Massachusetts 02139, US  
ZHENG, Rui, Novartis Institutes for BioMedical Research Inc. 250 Massachusetts Avenue Cambridge, Massachusetts 02139, US
- 
- (51) MKP  
**B02C 13/14 (2006.01)** (97) **2635379 \***  
**B02C 13/20 (2006.01)**
- (86) IB2012050591 09.02.2012  
(96) 12707922.6 11.09.2013  
(87) WO2012117307, 09.02.2012  
(97) 2635379, 11.09.2013 en  
(54) MILL FOR GRINDING RUBBISH  
(71) Chrysopoeia S.r.l., Via Aldo Moro 10, 25124 Brescia, IT  
(72) TREBUCCHI, Piervittorio, Via G. Cesare, sn, I-25010 Rivoltella del Garda (BS), IT  
EICH, Norbert, Via G. di Vittorio 25/C 10, I-20060 Mediglia (MI), IT  
ZUBANI, Lorenzo, Via G. Cesare, sn, I-25010 Rivoltella del Garda (BS), IT
- 
- (51) MKP  
**B60K 28/02 (2006.01)** (97) **2633376 \***  
**B60W 50/08 (2012.01)**  
**B60W 40/08 (2012.01)**  
**G05G 9/02 (2006.01)**
- (86) US2011057702 25.10.2011  
(96) 11838536.8 04.09.2013  
(87) WO2012061141, 25.10.2011  
(97) 2633376, 04.09.2013 en  
(54) CONTROL SYSTEM WITH SOLID STATE TOUCH SENSOR FOR COMPLEX SURFACE GEOMETRY  
(71) Uico, Inc., 612 Lamont Road, Elmhurst, IL 60126, US  
(72) WADIA, Bahar, N., 612 Lamont Road, Elmhurst IL 60126, US

- (51) MKP  
**B65D 47/32 (2006.01)** (97) **2601105 \***  
**B65B 31/02 (2006.01)**
- (86) AU2011001013 05.08.2011  
(96) 11813965.8 12.06.2013  
(87) WO2012016301, 05.08.2011  
(97) 2601105, 12.06.2013 en  
(54) VIAL PREPARATION METHOD AND SYSTEM  
(71) Hospira Australia Pty Ltd, Level 3, 500 Collins Street, Melbourne, Victoria 3000, AU  
(72) WANSLEY, Emma J, Apartment 834 1300 South White Oak Drive, Waukegan, Illinois 60085, US  
KNILL, Andrew Malcolm, 58 Davies Road, Bittern Victoria 3918, AU  
SUENDERMANN, John Fredric, 2/77 Paxton Street, Malvern East Victoria 3145, AU
- 
- (51) MKP  
**E05D 7/08 (2006.01)** (97) **2611980 \***  
**E05D 7/02 (2006.01)**  
**E05D 15/26 (2006.01)**
- (86) AU2011000982 03.08.2011  
(96) 11822921.0 10.07.2013  
(87) WO2012031313, 03.08.2011  
(97) 2611980, 10.07.2013 en  
(54) GUIDE ASSEMBLY  
(71) RMD Industries Pty Ltd, 6-10 Market Road, Sunshine, Victoria 3020, AU  
(72) PELEKANOS, Stylianos, 6-10 Market Road, Sunshine, Victoria 3020, AU  
PAGE, Louise, Helen, 6-10 Market Road, Sunshine, Victoria 3020, AU
- 
- (51) MKP  
**B31F 5/06 (2006.01)** (97) **2627504 \***  
**C09J 7/02 (2006.01)**
- (86) US2011022314 25.01.2011  
(96) 11872169.5 21.08.2013  
(87) WO2013058723, 25.01.2011  
(97) 2627504, 21.08.2013 en  
(54) COMPONENT CARRIER REEL SPLICING TAPE  
(71) Rome, Patrick, 3001 Silver, El Paso, TX 79930, US  
(72) Rome, Patrick, 3001 Silver, El Paso, TX 79930, US
- 
- (51) MKP  
**H04B 1/38 (2006.01)** (97) **2302815**
- (96) 10172239.5 30.03.2011  
(97) 2302815, 30.03.2011 en  
(54) Helmet-attachable communication device  
(71) Chia Soon Electronics Co., Ltd., N°. 1 145-1, An Kan Road Nei Hu, Taipei 11484, TW  
(72) Kou, Mei-Ling, 7 F., No. 147, Sec. 5, Minsheng E. Rd., Songshan Dist., Taipei City 10573, TW
- 
- (51) MKP  
**C07H 21/00 (2006.01)** (97) **2625188 \***  
**G01N 33/48 (2006.01)**
- (86) US2011054906 05.10.2011  
(96) 11831508.4 14.08.2013  
(87) WO2012047985, 05.10.2011  
(97) 2625188, 14.08.2013 en  
(54) MOLECULAR DETERMINANT-BASED TYPING OF KIR ALLELES AND KIR-LIGANDS  
(71) St. Jude Children's Research Hospital, 262 Danny Thomas Place, Memphis, TN 38105-2794, US  
(72) LEUNG, Wing, 379 Fairfield Circle, Memphis TN 38117, US  
BARI, Rafijul, 1183 Natchez Point Apt. 2, Memphis TN 38103, US

- (51) MKP  
**F16L 39/00 (2006.01)** (97) **2638317 \***  
**F16L 19/00 (2006.01)**  
(86) FR2011052612 09.11.2011  
(96) 11794540.2 18.09.2013  
(87) WO2012063000, 09.11.2011  
(97) 2638317, 18.09.2013 fr  
(54) DEVICE FOR THE SECURED CONNECTION OF TWO END FITTINGS, PARTICULARLY OF A PIPE  
(71) JPB Systeme, Allée des Pleus ZAC du Tuboeuf, 77170 Briecomte-Robert, FR  
(72) MARC, Damien, 27 Rue du Bel Air, F-77370 Nangis, FR

- (51) MKP  
**A61K 9/70 (2006.01)** (97) **2632443 \***  
(86) EP2011068825 27.10.2011  
(96) 11782080.3 04.09.2013  
(87) WO2012055947, 27.10.2011  
(97) 2632443, 04.09.2013 de  
(54) PREPARATION OF ORODISPERSIBLE FILMS  
(71) Hexal AG, Industriestrasse 25, 83607 Holzkirchen, DE  
(72) KREKELER, Andreas, Hexal AG Industriestrasse 25, 83607 Holzkirchen, DE  
NEUMANN, Dimitri, Hexal AG Industriestrasse 25, 83607 Holzkirchen, DE

- (51) MKP  
**C08G 14/06 (2006.01)** (97) **2609129 \***  
**C09J 161/34 (2006.01)**  
**C03C 25/34 (2006.01)**  
**C08K 5/053 (2006.01)**  
**C08K 5/21 (2006.01)**  
**F16L 59/00 (2006.01)**  
(86) FR2011051969 26.08.2011  
(96) 11761672.2 03.07.2013  
(87) WO2012025699, 26.08.2011  
(97) 2609129, 03.07.2013 fr  
(54) PHENOLIC RESIN, METHOD FOR PREPARING SAME, SIZING COMPOSITION FOR MINERAL FIBERS AND RESULTING PRODUCT  
(71) Saint-Gobain Isover, 18 Avenue d'Alsace, 92400 Courbevoie, FR  
Mallier, Jean-Louis, 462 rue de la République, 60290 Laigneville, FR  
(72) RONCUZZI, Claudio, 29 rue des Recollets, F-75010 Paris, FR  
DOUCE, Jérôme, 135 Boulevard Magenta, F-75010 Paris, FR  
ROUSSELET, Guillaume, 30 Le Courtil Côme, 60600 Etouy, FR  
MALLIER, Jean\_Louis, 462 rue de la République, 60290 Laigneville, FR

- (51) MKP  
**C07D 401/12 (2006.01)** (97) **2595981 \***  
**C07D 401/14 (2006.01)**  
**C07D 403/12 (2006.01)**  
**C07D 403/14 (2006.01)**  
**C07D 407/14 (2006.01)**  
**C07D 413/12 (2006.01)**  
**C07D 417/12 (2006.01)**  
**C07D 417/14 (2006.01)**  
**A01N 43/60 (2006.01)**  
**A01N 43/80 (2006.01)**  
(86) EP2011062198 18.07.2011  
(96) 11737922.2 29.05.2013  
(87) WO2012010534, 18.07.2011  
(97) 2595981, 29.05.2013 en  
(54) NOVEL HETARYL (THIO)CARBOXAMIDE COMPOUNDS FOR CONTROLLING INVERTEBRATE PESTS  
(71) BASF SE, null, 67056 Ludwigshafen, DE  
(72) SÖRGEL, Sebastian, Marienstr. 19, 67063 Ludwigshafen, DE  
DEFIEBER, Christian, Tullastraße 13, 68165 Mannheim, DE  
LE VEZOUET, Ronan, Neckarpromenade 20, 68167 Mannheim, DE  
CULBERTSON, Deborah L., 6400 Vintage Ridge Lane, Fuquay Varina NC 27526, US  
ANSPAUGH, Douglas D., 4007 Winecott Drive, Apex NC 27502, US

- (51) MKP  
**F16M 13/02 (2006.01)** (97) **2601432 \***  
**G06F 1/16 (2006.01)**  
**F16M 11/10 (2006.01)**  
(86) US2011001322 27.07.2011  
(96) 11743674.1 12.06.2013  
(87) WO2012018373, 27.07.2011  
(97) 2601432, 12.06.2013 en  
(54) IN-WALL DOCK FOR A TABLET COMPUTER  
(71) Savant Systems LLC., 886 Main Street, Osterville, MA 02655, US  
(72) MADONNA, Robert, P., 32 Wianno Avenue, Osterville, MA 02655, US  
LACEY, Kathleen, M., 343 Buckskin Path, Centerville, MA 02632, US  
CORSINI, Peter, H., 7 Marshview Circle, East Sandwich, MA 02537, US  
NOONAN, Michael, E., 7 Rolling Ridge Lane, Sandwich, MA 02563, US

- (51) MKP  
**F16K 17/04 (2006.01)** (97) **2559926**  
(96) 11178080.5 20.02.2013  
(97) 2559926, 20.02.2013 de  
(54) Safety valve  
(71) Goetze KG Armaturen, Robert Mayer-Str. 21, 71636 Ludwigsburg, DE  
(72) Wolpert, Gerhard, Griesinger Str. 30, 72770 Reutlingen, DE

- (51) MKP  
**C07D 277/68 (2006.01)** (97) **2643307 \***  
**A61P 31/00 (2006.01)**  
**A61K 31/428 (2006.01)**  
**C07D 417/12 (2006.01)**  
(86) FR2011052699 18.11.2011  
(96) 11796759.6 02.10.2013  
(87) WO2012069743, 18.11.2011  
(97) 2643307, 02.10.2013 fr  
(54) NITROBENZOTHAZOLE DERIVATIVES AND USE THEREOF FOR TREATING TUBERCULOSIS  
(71) SANOFI, 174, Avenue de France, 75013 Paris, FR  
(72) PELLET, Alain, c/o Sanofi Département Brevets 174 Avenue de France, F-75013 Paris, FR

- (51) MKP  
**C07D 489/12 (2006.01)** (97) **2619212 \***  
**A61K 31/485 (2006.01)**  
**A61P 25/04 (2006.01)**  
(86) IB2011002208 20.09.2011  
(96) 11776855.6 31.07.2013  
(87) WO2012038813, 20.09.2011  
(97) 2619212, 31.07.2013 en  
(54) BUPRENORPHINE ANALOGS  
(71) Purdue Pharma L.P., One Stamford Forum 201 Tresser Boulevard, Stamford, CT 06901-3431, US  
(72) KYLE, Donald, J., 173 N. Main Street, Yardley, PA 19067, US  
TAFESSE, Laykea, 8 Windward Way, Robbinsville, NJ 08690, US

- (51) MKP  
**B24D 3/14 (2006.01)** (97) **2567784**  
(96) 11180639.4 13.03.2013  
(97) 2567784, 13.03.2013 en  
(54) Bonded abrasive article  
(71) 3M Innovative Properties Co., P.O. Box 33427, St. Paul, MN 55133-3427, US

(51) MKP  
**A61K 31/46 (2006.01)** (97) **2623499 \***  
**A61P 25/00 (2006.01)**  
**A61P 29/00 (2006.01)**  
**A61K 31/5377 (2006.01)**  
**A61P 25/08 (2006.01)**  
**A61K 31/5386 (2006.01)**  
**A61P 25/14 (2006.01)**  
**C07D 249/12 (2006.01)**  
**A61P 7/10 (2006.01)**  
**A61P 25/18 (2006.01)**  
**A61K 31/4196 (2006.01)**  
**A61P 9/12 (2006.01)**  
**A61P 25/22 (2006.01)**  
**A61K 31/454 (2006.01)**  
**A61P 17/02 (2006.01)**  
**A61P 25/28 (2006.01)**  
**A61K 31/4545 (2006.01)**  
**A61P 17/14 (2006.01)**  
**A61P 25/36 (2006.01)**  
**A61K 31/553 (2006.01)**  
**A61P 25/16 (2006.01)**  
(86) JP2011072556 30.09.2011  
(96) 11829344.8 07.08.2013  
(87) WO2012043791, 30.09.2011  
(97) 2623499, 07.08.2013 en  
(54) 1,2,4-TRIAZOLONE DERIVATIVE  
(71) TAISHO PHARMACEUTICAL CO., LTD, 24-1 Takada 3-chome  
Toshima-ku, Tokyo 170-8633, JP  
(72) KUWADA, Takeshi, c/o Taisho Pharmaceutical Co. Ltd. 24-1  
Takada 3-chome Toshima-ku, Tokyo 170-8633, JP  
YOSHINAGA, Mitsukane, c/o Taisho Pharmaceutical Co. Ltd.  
24-1 Takada 3-chome Toshima-ku, Tokyo 170-8633, JP  
ISHIZAKA, Tomoko, c/o Taisho Pharmaceutical Co. Ltd. 24-1  
Takada 3-chome Toshima-ku, Tokyo 170-8633, JP  
WAKASUGI, Daisuke, c/o Taisho Pharmaceutical Co. Ltd. 24-1  
Takada 3-chome Toshima-ku, Tokyo 170-8633, JP  
SHIROKAWA, Shin-ichi, c/o Taisho Pharmaceutical Co. Ltd.  
24-1 Takada 3-chome Toshima-ku, Tokyo 170-8633, JP  
HATTORI, Nobutaka, c/o Taisho Pharmaceutical Co. Ltd. 24-1  
Takada 3-chome Toshima-ku, Tokyo 170-8633, JP  
SHIMAZAKI, Youichi, c/o Taisho Pharmaceutical Co. Ltd. 24-1  
Takada 3-chome Toshima-ku, Tokyo 170-8633, JP  
MIYAKOSHI, Naoki, c/o Taisho Pharmaceutical Co. Ltd. 24-1  
Takada 3-chome Toshima-ku, Tokyo 170-8633, JP

(51) MKP  
**B65B 65/00 (2006.01)** (97) **2578502**  
**B23D 36/00 (2006.01)**  
**B65B 27/10 (2006.01)**  
**B21B 15/00 (2006.01)**  
(96) 12164147.6 10.04.2013  
(97) 2578502, 10.04.2013 en  
(54) Method and apparatus for producing cut to length bars in a  
steel mill  
(71) Pong, David Teng, Apt 6A Tower One, No. 1 Po Shan Road  
Hong Kong SAR, CN  
(72) Pong, David Teng, Apt 6A Tower One, No. 1 Po Shan Road  
Hong Kong SAR, CN

(51) MKP  
**A61N 5/01 (2006.01)** (97) **2605828 \***  
(86) US2011048151 17.08.2011  
(96) 11818754.1 26.06.2013  
(87) WO2012024448, 17.08.2011  
(97) 2605828, 26.06.2013 en  
(54) AUTOMATED TREATMENT PLANNING FOR RADIATION  
THERAPY  
(71) BOARD OF REGENTS, THE UNIVERSITY OF TEXAS  
SYSTEM, 201 West Seventh Street, Austin, TX 78701, US  
(72) ZHANG, Xiaodong, 2518 Gramercy St., Houston TX 77030,  
US  
PAN, Xiaoning, 5606 Bissonnet St. Apt. 25, Houston TX 77081,  
US  
LI, Yupeng, 8906 Bevlyn Dr., Houston TX 77025, US  
LI, Xiaoqiang, 6220 Alder Dr. Apt. 3725, Houston TX 77081,  
US  
MOHAN. Radhe. 3118 Murworth Dr., Houston TX 77025. US

(51) MKP  
**G01S 13/02 (2006.01)** (97) **2606379 \***  
**G01V 3/10 (2006.01)**  
(86) US2011047316 11.08.2011  
(96) 11818575.0 26.06.2013  
(87) WO2012024133, 11.08.2011  
(97) 2606379, 26.06.2013 en  
(54) METAL DETECTOR AND GROUND-PENETRATING RADAR  
HYBRID HEAD AND MANUFACTURING METHOD THEREOF  
(71) Niitek, Inc., 23031 Ladbroke Drive, Dulles, VA 20166, US  
(72) ETEBARI, Ali, 44140 Shady Glen Ter, Ashburn, VA 20147, US  
WOLFSON, Jason, 15200 General Stevens Court, Chantilly,  
VA 20151, US  
WHALEY, Brian, A., 503 Park St. NE, Vienna, VA 22180, US  
HIBBARD, Mark. 4109F Lee Hwy. Arlington, VA 22207, US

(51) MKP  
**C12N 9/64 (2006.01)** (97) **2635677 \***  
(86) US2011059233 03.11.2011  
(96) 11781973.0 11.09.2013  
(87) WO2012061654, 03.11.2011  
(97) 2635677, 11.09.2013 en  
(54) MODIFIED FACTOR IX POLYPEPTIDES AND USES  
THEREOF  
(71) Catalyst Biosciences, Inc., 260 Littlefield Avenue, South San  
Francisco, CA 94080, US  
(72) MADISON, Edwin, L., 558 48th Avenue, San Francisco CA  
94121, US  
THANOS, Christopher, 3579 Sacramento St., San Francisco  
CA 94118, US  
BLOUSE, Grant, Ellsworth, 201 11th Avenue Unit 12, San  
Francisco CA 94118, US

(51) MKP  
**A61K 9/00 (2006.01)** (97) **2608769 \***  
(86) EP2011064399 22.08.2011  
(96) 11748639.9 03.07.2013  
(87) WO2012025496, 22.08.2011  
(97) 2608769, 03.07.2013 en  
(54) HUMIDIFIED PARTICLES COMPRISING A  
THERAPEUTICALLY ACTIVE SUBSTANCE  
(71) Takeda GmbH, Byk-Gulden-Strasse 2, 78467 Konstanz, DE  
(72) RAHMEL, Daniela, Sonnenweg 33, 22045 Hamburg, DE  
TAUT, Friedemann, Renkenweg 1, 78464 Konstanz, DE  
DE MUYNCK, Christian, Haydnstr. 21, 78464 Konstanz, DE  
RAST, Markus, Espelweg 6, 78315 Radolfzell, DE  
IWATSCHENKO, Peter, Forther Hauptstr. 65 MediTech  
Franken GmbH, 90542 Eckenthal, DE  
POHLMANN, Gerhard, Am Gallweg 14, 31715 Meerbeck, DE  
KOCH, Wolfgang, Wendenborsteler Str. 35, 31634 Steimbke,  
DE  
WINDT, Horst, Celler Weg 9a, 30938 Burgwedel, DE

(51) MKP  
**D04H 1/56 (2006.01)** (97) **2603626 \***  
**D01D 4/02 (2006.01)**  
**D01D 5/098 (2006.01)**  
(86) EP2011063770 10.08.2011  
(96) 11743819.2 19.06.2013  
(87) WO2012020053, 10.08.2011  
(97) 2603626, 19.06.2013 en  
(54) PROCESS AND APPARATUS FOR SPINNING FIBRES  
AND IN PARTICULAR FOR PRODUCING A FIBROUS-  
CONTAINING NONWOVEN  
(71) BOMA ENGINEERING SRL, Via Giacomo Leopardi 8, 20123  
Milano (MI), IT  
(72) Boscolo, Galliano, viale Chiapei 18, 13856 Vigiiano Biellese, IT

(51) MKP  
**H02M 5/16 (2006.01)** (97) **2549638**  
(96) 11174546.9 23.01.2013  
(97) 2549638, 23.01.2013 de  
(54) Power supply assembly for a reactor for polysilicon production  
with a frequency converter  
(71) AEG Power Solutions B.V., Weerenweg 29, 1161 AH  
Zwanenburg, NL  
(72) Wallmeier, Peter, Tilsiter Strasse 59, 59556 Lippstadt, DE

- (51) MKP  
**C11D 1/37 (2006.01)** (97) **2638137 \***  
**C11D 3/50 (2006.01)**  
**C11D 17/00 (2006.01)**  
**E03D 9/02 (2006.01)**  
**C11D 3/48 (2006.01)**  
(86) EP2011069965 11.11.2011  
(96) 11787809.0 18.09.2013  
(87) WO2012062914, 11.11.2011  
(97) 2638137, 18.09.2013 de  
(54) BALL-SHAPED TOILET BLOCKS BASED ON ANIONIC SURFACTANTS  
(71) Henkel AG & Co. KGaA, Henkelstrasse 67, 40589 Düsseldorf, DE  
(72) SCHIEDEL, Marc-Steffen, Rotdornstr. 61, 40789 Monheim, DE  
GIESEN, Brigitte, Torfbruchstr. 83 a, 40625 Düsseldorf, DE  
ERNST, Anke, Alte Holzerstr. 13, 42799 Leichlingen, DE  
REICHERT, Christian, Tannenstr. 40a, 40476 Düsseldorf, DE  
CAPPLEMAN, Robert Stephen, Krausstr. 11, 47119 Duisburg, DE  
HORN, Michael, Scheffelstr. 13 B, 40470 Düsseldorf, DE
- 
- (51) MKP  
**G06Q 20/00 (2012.01)** (97) **2638512 \***  
(86) US2011055394 07.10.2011  
(96) 11833174.3 18.09.2013  
(87) WO2012051072, 07.10.2011  
(97) 2638512, 18.09.2013 en  
(54) METHOD OF CONDUCTING FINANCIAL TRANSACTIONS WHERE A PAYER'S FINANCIAL ACCOUNT INFORMATION IS ENTERED ONLY ONCE WITH A PAYMENT SYSTEM  
(71) Square, Inc., 110 Fifth Street, San Francisco, CA 94103, US  
(72) DORSEY, Jack, 901 Mission Street Suite 104, San Francisco CA 94103, US  
HENDERSON, William, 1657 Hayes Street Unit 2, San Francisco CA 94117, US  
GRASSADONIA, Brian, 2038 Scott Street, San Francisco CA 94117, US  
MCKELVEY, James, M., 7501 Scenic Highway, Pensacola FL 32504, US
- 
- (51) MKP  
**F16L 19/06 (2006.01)** (97) **2609354 \***  
(86) DK2011000064 17.06.2011  
(96) 11819448.9 03.07.2013  
(87) WO2012025114, 17.06.2011  
(97) 2609354, 03.07.2013 en  
(54) TUBE CONNECTION  
(71) Whirlux APS, Holbergsgade 4, 4200 Slagelse, DK  
(72) JØRGENSEN, Ole, Holbergsgade 4, DK-4200 Slagelse, DK
- 
- (51) MKP  
**A61K 31/785 (2006.01)** (97) **2632435 \***  
**A61P 35/00 (2006.01)**  
**A61K 47/24 (2006.01)**  
**A61K 9/127 (2006.01)**  
**A61K 9/00 (2006.01)**  
**A61K 31/155 (2006.01)**  
(86) EP2011005453 28.10.2011  
(96) 11784939.8 04.09.2013  
(87) WO2012055568, 28.10.2011  
(97) 2632435, 04.09.2013 en  
(54) LIPOSOMAL DRUG COMPOSITION CONTAINING A POLYMERIC GUANIDINE DERIVATIVE  
(71) Mindinvest Holdings Ltd., 60/2 Melita Street, 1122 Valleta VLT, MT  
(72) SCHMIDT, Oskar, Dannebergplatz 16/9, A-1030 Wien, AT  
WAGNER, Andreas, Hietzinger Kai 199/23, A-1130 Wien, AT  
RUPP-STANSCHITZ, Barbara, Klein-Jetzelsdorf 19, A-3730 Klein Jetzelsdorf, AT
- 
- (51) MKP  
**B29B 17/02 (2006.01)** (97) **2635418 \***  
**F26B 23/02 (2006.01)**  
**C10J 3/66 (2006.01)**  
**B04B 15/02 (2006.01)**  
**H01B 15/00 (2006.01)**  
(86) GB2011001310 07.09.2011  
(96) 11760810.9 11.09.2013  
(87) WO2012059706, 07.09.2011  
(97) 2635418, 11.09.2013 en  
(54) IMPROVEMENTS IN WASTE PROCESSING  
(71) Chinook End-Stage Recycling Limited, No. 1 Nottingham Science Park Jesse Boot Avenue University Boulevard, Nottingham, Nottinghamshire NG7 2RU, GB  
(72) PERRY, Ophneil Henry, Chinook End-Stage Recycling Limited No 1 Nottingham Science Park Jesse Boot Avenue, Nottingham, Nottinghamshire NG7 2RU, GB  
CHALABI, Rifat Al., No. 1, Nottingham Science Park Jesse Boot Avenue University Boulevard, Nottingham NG7 2 RU, GB
- 
- (51) MKP  
**C07D 235/30 (2006.01)** (97) **2606036 \***  
**A61K 31/4184 (2006.01)**  
**A61P 11/00 (2006.01)**  
**A61P 29/00 (2006.01)**  
(86) EP2011064258 19.08.2011  
(96) 11746237.4 26.06.2013  
(87) WO2012022793, 19.08.2011  
(97) 2606036, 26.06.2013 en  
(54) NEW COMPOUNDS  
(71) Boehringer Ingelheim International GmbH, Binger Strasse 173, 55216 Ingelheim am Rhein, DE  
(72) PRIEPKE, Henning, Boehringer Ingelheim GmbH Corporate Patents Binger Strasse 173, 55216 Ingelheim Am Rhein, DE  
DOODS, Henri, Boehringer Ingelheim GmbH Corporate Patents Binger Strasse 173, 55216 Ingelheim Am Rhein, DE  
KUELZER, Raimund, Boehringer Ingelheim GmbH Corporate Patents Binger Strasse 173, 55216 Ingelheim Am Rhein, DE  
PFAU, Roland, Boehringer Ingelheim GmbH Corporate Patents Binger Strasse 173, 55216 Ingelheim Am Rhein, DE  
STENKAMP, Dirk, Boehringer Ingelheim GmbH Corporate Patents Binger Strasse 173, 55216 Ingelheim Am Rhein, DE  
PELCMAN, Benjamin, Orexo AB Box 303, S-751 05 Uppsala, SE  
ROENN, Robert, Orexo AB Box 303, S-751 05 Uppsala, SE
- 
- (51) MKP  
**A61P 11/00 (2006.01)** (97) **2630149 \***  
**C07D 487/04 (2006.01)**  
**A61P 19/02 (2006.01)**  
**A61P 11/06 (2006.01)**  
**A61P 17/00 (2006.01)**  
**A61K 31/519 (2006.01)**  
**A61P 35/00 (2006.01)**  
(86) GB2011052015 18.10.2011  
(96) 11787742.3 28.08.2013  
(87) WO2012052753, 18.10.2011  
(97) 2630149, 28.08.2013 en  
(54) QUINAZOLIN-4 (3H) -ONE DERIVATIVES USED AS PI3 KINASE INHIBITORS  
(71) Respivert Limited, 50-100 Holmers Farm Way, High Wycombe, Buckinghamshire HP12 4EG, GB  
(72) KING-UNDERWOOD, John, Moorend Cottage School Lane Pendock, Worcestershire GL19 3PW, GB  
ITO, Kazuhiro, c/o Respivert Limited Imperial College Biolncubator Level1 Bessemer Building, Imperial College London SW7 2AZ, GB  
MURRAY, Peter John, c/o Respivert Limited Imperial College Biolncubator Level 1 Bessemer Building, Imperial College London SW7 2AZ, GB  
HARDY, George, Sunny Bank Brightling Road Robertsbridge, East Sussex TN32 5EJ, GB  
BROOKFIELD, Frederick Arthur, c/o Evotec (UK) Limited 114 Milton Park Abingdon, Oxfordshire OX14 4SA, GB  
BROWN, Christopher John, c/o Evotec (UK) Limited 114 Milton Park Abingdon, Oxfordshire OX14 4SA, GB
-



- (51) MKP  
**F02M 61/12 (2006.01)** (97) **2535554**  
**F02M 63/02 (2006.01)**  
**F02M 63/00 (2006.01)**  
**F16K 31/06 (2006.01)**  
(86) 11169945.0 19.12.2012  
(97) 2535554, 19.12.2012 en  
(54) Electro-valve for discharging common rail  
(71) Delphi Technologies Holding S.à.r.l., Avenue de Luxembourg, 4940 Bascharage, LU  
(72) Marechal, Michel, 48 route d'onzain, 41150 Chouzy Sur Cisse, FR  
Sauvage, Frederic, 43 rue du pont, 45190 Beaugency, FR  
Cardon, Christophe, 1 bis chemin de pissevins, 41000 Saint Denis Sur Loire, FR
- 
- (51) MKP  
**A61K 39/21 (2006.01)** (97) **2621528 \***  
(86) EP2011066754 27.09.2011  
(96) 11763641.5 07.08.2013  
(87) WO2012041842, 27.09.2011  
(97) 2621528, 07.08.2013 en  
(54) VACCINE  
(71) GlaxoSmithKline Biologicals S.A., rue de l'Institut, 89, 1330 Rixensart, BE  
(72) BOURGUIGNON, Patricia, GlaxoSmithKline Biologicals S.A. rue de l'Institut 89, B-1330 Rixensart, BE  
KOUTSOUKOS, Marguerite Christine, GlaxoSmithKline Biologicals S.A. rue de l'Institut 89, B-1330 Rixensart, BE  
VOSS, Gerald Hermann, GlaxoSmithKline Biologicals S.A. rue de l'Institut 89, B-1330 Rixensart, BE
- 
- (51) MKP  
**F03D 11/04 (2006.01)** (97) **2640912 \***  
**E04G 21/32 (2006.01)**  
(86) DK2011000125 31.10.2011  
(96) 11841036.4 25.09.2013  
(87) WO2012065611, 31.10.2011  
(97) 2640912, 25.09.2013 en  
(54) A SAFETY NET FOR MOUNTING IN A WIND TURBINE TOWER  
(71) Catonets Licens ApS, Læsøvej 5A, 9800 Hjørring, DK  
(72) CHRISTENSEN, Cato Castro, Corasvej 38, DK-9990 Skagen, DK
- 
- (51) MKP  
**A61K 31/4188 (2006.01)** (97) **2640383 \***  
(86) US2011061333 18.11.2011  
(96) 11841947.2 25.09.2013  
(87) WO2012068435, 18.11.2011  
(97) 2640383, 25.09.2013 en  
(54) METHOD FOR TREATING BREAST CANCER AND OVARIAN CANCER  
(71) Takeda Pharmaceutical Company Limited, 1-1 Doshomachi 4-chome Chuo-ku, Osaka-shi, Osaka 541-0045, JP  
(72) DARNOWSKI, James, W., 20 Devonshire Drive, Barrington RI 02806, US
- 
- (51) MKP  
**C07D 413/14 (2006.01)** (97) **2643319 \***  
**A61K 31/423 (2006.01)**  
(86) US2011062029 23.11.2011  
(96) 11793623.7 02.10.2013  
(87) WO2012074869, 23.11.2011  
(97) 2643319, 02.10.2013 en  
(54) BENZOXAZEPINES AS INHIBITORS OF PI3K/MTOR AND METHODS OF THEIR USE AND MANUFACTURE  
(71) Exelixis, Inc., 210 East Grand Avenue, South San Francisco, CA 94080, US  
(72) RICE, Kenneth, 44 Montecillo Road, San Rafael, CA 94903, US
- 
- (51) MKP  
**A61P 1/12 (2006.01)** (97) **2637646 \***  
**A61K 9/52 (2006.01)**  
**A61K 31/785 (2006.01)**  
**A61K 31/554 (2006.01)**  
**A61P 1/16 (2006.01)**  
**A61P 3/00 (2006.01)**  
(86) SE2011051336 08.11.2011  
(96) 11840481.3 18.09.2013  
(87) WO2012064267, 08.11.2011  
(97) 2637646, 18.09.2013 en  
(54) A PHARMACEUTICAL COMBINATION COMPRISING AN IBAT INHIBITOR AND A BILE ACID BINDER  
(71) Albireo AB, Arvid Wallgrens Backe 20, 413 46 Göteborg, SE  
(72) GILLBERG, Per-Göran, Södermalmsgatan 22, S-431 69 Mölndal, SE  
GRAFFNER, Hans, Konsulns väg 16, S-252 84 Helsingborg, SE  
STARKE, Ingemar, Frigångsgatan 8C, S-413 01 Göteborg, SE
- 
- (51) MKP  
**C07C 323/52 (2006.01)** (97) **2614049 \***  
**A61K 31/215 (2006.01)**  
**A61P 31/00 (2006.01)**  
(86) AT2011000342 11.08.2011  
(96) 11751528.8 17.07.2013  
(87) WO2012031307, 11.08.2011  
(97) 2614049, 17.07.2013 en  
(54) PLEUROMUTILIN DERIVATIVES FOR USE IN THE TREATMENT OF DISEASES MEDIATED BY MICROBES  
(71) Nabriva Therapeutics AG, Leberstrasse 20, 1110 Wien, AT  
(72) RIEDL, Rosemarie, Reglergasse 3/204, A-1220 Wien, AT  
THIRRING, Klaus, Anton Baumgartner Strasse 44/A2/016, A-1230 Wien, AT  
HEILMAYER, Werner, Obere Weideacker 19, A-7034 Zillingtal, AT
- 
- (51) MKP  
**C07D 413/12 (2006.01)** (97) **2640698 \***  
**C07D 471/04 (2006.01)**  
**C07D 403/12 (2006.01)**  
**A61P 9/10 (2006.01)**  
**C07D 209/44 (2006.01)**  
**A61P 35/00 (2006.01)**  
**C07D 407/12 (2006.01)**  
**A61K 31/407 (2006.01)**  
**A61K 31/4035 (2006.01)**  
**C07D 407/14 (2006.01)**  
(86) US2011060425 11.11.2011  
(96) 11787996.5 25.09.2013  
(87) WO2012067965, 11.11.2011  
(97) 2640698, 25.09.2013 en  
(54) NAMPT AND ROCK INHIBITORS  
(71) AbbVie Inc., 1 North Waukegan Road, North Chicago, IL 60064, US  
(72) CURTIN, Michael L., 8625 113th Avenue, Pleasant Prairie, Wisconsin 53158, US  
SORENSEN, Bryan K., 524 First Street, Antioch, Illinois 60002, US  
HEYMAN, Howard R., 827 Woodward Avenue, Deerfield, Illinois 60015, US  
CLARK, Richard F., 2142 Spruce Pointe Court, Gurnee, Illinois 60031, US  
WOLLER, Kevin R., 1072 Joy Court, Antioch, Illinois 60002, US  
SHAH, Omar J., 25306 SE 133rd Street, Issaquah, Washington 98027, US  
MICHAELIDES, Michael, 4452 West Gavin Lane, Libertyville, Illinois 60048, US  
TSE, Chris, 1321 St. William Drive, Libertyville, Illinois 60048, US  
VASUDEVAN, Anil, 105 13th Avenue, Union Grove, Wisconsin 53182, US  
MACK, Helmut, Neustadter Ring 80, 67067 Ludwigshafen, DE  
HANSEN, Todd M., 191 Seymour Avenue, Grayslake, Illinois 60030, US  
SWEIS, Ramzi, 1012 Plaister Avenue, Lake Bluff, Illinois 60044, US  
PLIUSHCHEV, Marina A., 337 Albert Drive, Vernon Hills, Illinois 60061, US
-

- (51) MKP  
**A61N 1/05 (2006.01)** (97) **2629839 \***  
 (86) US2011056716 18.10.2011  
 (96) 11834992.7 28.08.2013  
 (87) WO2012054484, 18.10.2011  
 (97) 2629839, 28.08.2013 en  
 (54) OPTICAL CONTROL OF CARDIAC FUNCTION  
 (71) The Research Foundation of State University of New York, 35 State Street, Albany, NY 12207, US  
 (72) ENTACHEVA, Emilia, 43 Hawkins Road, Stony Brook, NY 11790, US  
 JIA, Zhiheng, 218 Main Street, East Setauket, NY 11733, US  
 LU, Zhongju, 9 Beaver Lane, East Setauket, NY 11733, US  
 BIEN, Harold, 1423 Stony Brook Road, Stony Brook, NY 11790, US  
 COHEN, Ira, S., 23 Hawks Nest Road, Stony Brook, NY 11790, US
- 
- (51) MKP  
**A01P 7/04 (2006.01)** (97) **2635278 \***  
**A01P 17/00 (2006.01)**  
**A01P 5/00 (2006.01)**  
**A01P 23/00 (2006.01)**  
**C07D 401/14 (2006.01)**  
**A01P 3/00 (2006.01)**  
**A01P 15/00 (2006.01)**  
**A61K 31/4439 (2006.01)**  
**A01P 7/02 (2006.01)**  
**A01P 19/00 (2006.01)**  
**C07D 401/04 (2006.01)**  
**A01P 1/00 (2006.01)**  
**A01P 21/00 (2006.01)**  
**C07D 417/14 (2006.01)**  
**A01P 13/00 (2006.01)**  
**A01H 5/10 (2006.01)**  
**A61K 31/444 (2006.01)**  
**A01P 9/00 (2006.01)**  
**A01N 25/34 (2006.01)**  
**A01P 11/00 (2006.01)**  
 (86) US2011058578 31.10.2011  
 (96) 11838618.4 11.09.2013  
 (87) WO2012061290, 31.10.2011  
 (97) 2635278, 11.09.2013 en  
 (54) PESTICIDAL COMPOSITIONS AND PROCESSES RELATED THERETO  
 (71) Dow AgroSciences LLC, 9330 Zionsville Road, Indianapolis, IN 46268, US  
 (72) YAP, Maurice C. H., 22 Chestnut Court, Zionsville IN 46077, US  
 BUYASSE, Ann M., 743 Alwyne Road, Carmel IN 46032, US  
 KNUEPPEL, Daniel, 8836 Weather Stone Crossing, Zionsville IN 46077, US  
 ZHANG, Yu, 13481 Lablanca Bend, Carmel IN 46074, US  
 GARIZI, Negar, 1298 Liberty Drive, Indianapolis IN 46074, US  
 NIYAZ, Noormohamed M., 1034 Saratoga Circle, Indianapolis IN 46280, US  
 LOWE, Christian T., 466 Elnora Lane, Westfield IN 46074, US  
 HUNTER, Ricky, 342 West Tansey Crossing, Westfield IN 46074, US  
 TRULLINGER, Tony K., 644 Zephyr Way, Westfield IN 46074, US  
 DEMETER, David A., 10657 Blackthorn Court, Fishers IN 46038, US  
 PERNICH, Dan, 211 W. 47th Street, Indianapolis IN 46208-3509, US  
 DEAMICIS, Carl, 11321 Echo Ridge Lane, Indianapolis IN 46236, US  
 ROSS, Ronald, 445 West Hawthorne Street, Zionsville IN 46077, US  
 JOHNSON, Timothy C., 2010 Brewster Road, Indianapolis IN 46260, US
- 
- (51) MKP  
**C07D 211/58 (2006.01)** (97) **2619180 \***  
**A61P 11/00 (2006.01)**  
**A61K 31/4468 (2006.01)**  
 (86) EP2011064906 30.08.2011  
 (96) 11748693.6 31.07.2013  
 (87) WO2012028614, 30.08.2011  
 (97) 2619180, 31.07.2013 en  
 (54) 5-HT2B RECEPTOR ANTAGONISTS  
 (71) Janssen Pharmaceutica, N.V., Turnhoutseweg 30, 2340 Beerse, BE  
 (72) THURING, Johannes, Wilhelmus, John F., Janssen Pharmaceutica NV Turnhoutseweg 30, B-2340 Beerse, BE  
 VER DONCK, Luc, August, Laurentius, Janssen Pharmaceutica NV Turnhoutseweg 30, B-2340 Beerse, BE
- 
- (51) MKP  
**C04B 35/581 (2006.01)** (97) **2595940 \***  
**H01L 21/683 (2006.01)**  
**H01L 23/15 (2006.01)**  
 (86) US2011044475 19.07.2011  
 (96) 11741722.0 29.05.2013  
 (87) WO2012012384, 19.07.2011  
 (97) 2595940, 29.05.2013 en  
 (54) POLYCRYSTALLINE ALUMINUM NITRIDE MATERIAL AND METHOD OF PRODUCTION THEREOF  
 (71) Hexatech Inc., 991 Aviation Parkway, Morrisville, North Carolina 27560, US  
 (72) MOODY, Baxter, 2112 Ramsgate Street, Raleigh North Carolina 27603, US  
 DALMAU, Rafael, 2028 Summer Shire Way, Raleigh North Carolina 27604, US  
 HENSHALL, David, 7533 Silver View Lane, Raleigh North Carolina 27613, US  
 SCHLESSER, Raoul, 3329 Oaklyn Springs Drive, Raleigh North Carolina 27606, US
- 
- (51) MKP  
**B65D 41/14 (2006.01)** (97) **2639178 \***  
**B65D 47/36 (2006.01)**  
**B65D 41/20 (2006.01)**  
**B65D 53/04 (2006.01)**  
 (86) KR2011008577 10.11.2011  
 (96) 11840141.3 18.09.2013  
 (87) WO2012064132, 10.11.2011  
 (97) 2639178, 18.09.2013 en  
 (54) SEALING MEMBER FOR CONTAINER  
 (71) Rho, Hee Kwon, 2-402 Solhyanggi town 544-1 Ilsan-ri Mohyeon-myeon Cheoin-gu Yongin, 449-855 Gyeonggi-do, KR  
 (72) Rho, Hee Kwon, 2-402 Solhyanggi town 544-1 Ilsan-ri Mohyeon-myeon Cheoin-gu Yongin, 449-855 Gyeonggi-do, KR
- 
- (51) MKP  
**A61M 5/145 (2006.01)** (97) **2600922 \***  
**A61M 5/315 (2006.01)**  
 (86) EP2011063444 04.08.2011  
 (96) 11741207.2 12.06.2013  
 (87) WO2012017035, 04.08.2011  
 (97) 2600922, 12.06.2013 en  
 (54) CARTRIDGE HOLDER AND METHOD FOR ASSEMBLING A CARTRIDGE UNIT FOR A DRUG DELIVERY DEVICE  
 (71) Sanofi-Aventis Deutschland GmbH, Brüningstraße 50, 65929 Frankfurt, DE  
 (72) NZIKE, Philippe, c/o Sanofi-Aventis Deutschland GmbH, 65926 Frankfurt am Main, DE  
 RAAB, Steffen, c/o Sanofi-Aventis Deutschland GmbH, 65926 Frankfurt am Main, DE  
 DASBACH, Uwe, c/o Sanofi-Aventis Deutschland GmbH, 65926 Frankfurt am Main, DE
-

(51) MKP  
**C07D 471/04 (2006.01)** (97) **2624698 \***  
**C07D 239/42 (2006.01)**  
**A01N 43/54 (2006.01)**  
(86) US2011055366 07.10.2011  
(96) 11831679.3 14.08.2013  
(87) WO2012048222, 07.10.2011  
(97) 2624698, 14.08.2013 en  
(54) FURO[3,2-d]PYRIMIDINE COMPOUNDS  
(71) AbbVie Inc., 1 North Waukegan Road, North Chicago, IL 60064, US  
(72) CALDERWOOD, David, J., 4 McCarthy Circle, Framingham MA 01702, US  
WILSON, Noel, S., 6934 97th Avenue, Kenosha Wisconsin 53142, US  
COX, Philip, 285 N Cambridge Ct, Grayslake Illinois 60030, US  
HOEMANN, Michael, Z., 41 Lilac Circle, Marlborough MA 01752, US  
CLAPHAM, Bruce, 2813 Fallingwaters Drive, Lindenhurst Illinois 60046, US  
MULLEN, Kelly, D., 64 Cranberry Meadow Road, Charlton MA 01507, US  
VASUDEVAN, Anil, 105 13th Avenue, Union Grove Wisconsin 53182, US  
VILLAMIL, Clara I, 813 Long Road, Glenview Illinois 60025, US  
LI, Bin, 11 Hunters Lane, Ashland Massachusetts 01721, US  
SOMAL, Gagandeep, 57 Auburn Street Ext. Apt. 5, Framingham Massachusetts 01701, US

(51) MKP  
**A61B 17/128 (2006.01)** (97) **2627260 \***  
**A61B 17/00 (2006.01)**  
**A61B 17/122 (2006.01)**  
(86) AU2011001319 17.10.2011  
(96) 11831861.7 21.08.2013  
(87) WO2012048387, 17.10.2011  
(97) 2627260, 21.08.2013 en  
(54) SURGICAL CLAMPING DEVICES AND TOOLS FOR USE THEREWITH  
(71) Surgiclamp Pty Ltd, Level 1 346 Belmore Road, Balwyn East, Victoria 3103, AU  
(72) WHELAN, Geoffrey Paul, 120 Windsor Crescent, Surrey Hills, Victoria 3127, AU  
KOUZANI, Abbas, 1-2 Sloane Court, Highton, Victoria 3216, AU

(51) MKP  
**A61K 39/00 (2006.01)** (97) **2632482 \***  
(86) US2011058135 27.10.2011  
(96) 11837112.9 04.09.2013  
(87) WO2012058460, 27.10.2011  
(97) 2632482, 04.09.2013 en  
(54) CHIMERIC CD27 RECEPTORS FOR REDIRECTING T CELLS TO CD70-POSITIVE MALIGNANCIES  
(71) Baylor College Of Medicine, One Baylor Plaza, Houston, TX 77030-3411, US  
(72) GOTTSCHALK, Stephen, M., G, 1908 Canterbury, Houston, TX 77030, US  
SHAFFER, Donald, R., 2120 El Paseo Street No. 2205, Houston, TX 77054, US  
SPENCER, David, M., 2811 Prescott Street, Houston, TX 77025, US

(51) MKP  
**F16D 1/116 (2006.01)** (97) **2606250 \***  
**F16D 3/38 (2006.01)**  
**F16D 3/84 (2006.01)**  
(86) SI2011000045 19.08.2011  
(96) 11769953.8 26.06.2013  
(87) WO2012023905, 19.08.2011  
(97) 2606250, 26.06.2013 en  
(54) PROTECTIVE CASING WITH A MOVABLE LEVER FOR A COUPLING SPLINED YOKE WITH A SAFETY PIN  
(71) Cerjak D.o.o., Zadovinek 38, 8273 Leskovec pri Krskem, SI  
(72) KONECNIK, Stanislav, Podsreda 39, 3257 Podsreda, SI  
CERJAK, Matjaz, Racja vas 26, 8263 Cerklje ob Krki, SI  
VOGRINC, Vilko, Bukovsek 44, 8250 Brezice, SI

(51) MKP  
**C10L 5/38 (2006.01)** (97) **2614130 \***  
**C10L 7/02 (2006.01)**  
**C10L 8/00 (2006.01)**  
**C01B 3/08 (2006.01)**  
(86) HR2010000031 08.09.2010  
(96) 10779034.7 17.07.2013  
(87) WO2012032363, 08.09.2010  
(97) 2614130, 17.07.2013 en  
(54) FUEL AND COMBUSTIBLE MIXTURE USED AS A SUBSTITUTE FOR FOSSIL FUELS IN THERMOELECTRIC POWER PLANTS, INDUSTRIAL AND CENTRAL HEATING FURNACES  
(71) Cor Brevis D.o.o., Bednjanska 12, 10000 Zagreb, HR  
(72) OSI, Drago, Slavenskog 19, HR-10000 Zagreb, HR

(51) MKP  
**C07K 16/18 (2006.01)** (97) **2606065 \***  
**C12N 15/13 (2006.01)**  
(86) EP2011064000 12.08.2011  
(96) 11745761.4 26.06.2013  
(87) WO2012022703, 12.08.2011  
(97) 2606065, 26.06.2013 en  
(54) IMPROVED ANTI-SERUM ALBUMIN BINDING VARIANTS  
GlaxoSmithKline Intellectual Property Development Limited, 980 Great West Road, Brentford Middlesex TW8 9GS, GB  
DE ANGELIS, Elena, Domantis Limited 315 Cambridge Science Park, Cambridge Cambridgeshire CB4 0WG, GB  
ENEVER, Carolyn, Domantis Limited 315 Cambridge Science Park, Cambridge Cambridgeshire CB4 0WG, GB  
LIU, Haiqun, Domantis Limited 315 Cambridge Science Park, Cambridge Cambridgeshire CB4 0WG, GB  
PUPECKA-SWIDER, Malgorzata, Domantis Limited 315 Cambridge Science Park, Cambridge Cambridgeshire CB4 0WG, GB  
SCHON, Oliver, Domantis Limited 315 Cambridge Science Park, Cambridge Cambridgeshire CB4 0WG, GB

(51) MKP  
**C07D 401/14 (2006.01)** (97) **2638033 \***  
**A61K 31/4995 (2006.01)**  
**A61P 35/00 (2006.01)**  
(86) US2011058692 01.11.2011  
(96) 11788263.9 18.09.2013  
(87) WO2012064548, 01.11.2011  
(97) 2638033, 18.09.2013 en  
(54) COMPOUNDS USEFUL FOR INHIBITING CHK1  
(71) Eli Lilly and Company, Lilly Corporate Center, Indianapolis, IN 46285, US  
(72) JOSEPH, Sajjan, c/o Eli Lilly and Company P.O. Box 6288, Indianapolis Indiana 46206-6288, US  
SAMAJDAR, Susanta, c/o Eli Lilly and Company P.O. Box 6288, Indianapolis Indiana 46206-6288, US

(51) MKP  
**E01C 5/00 (2006.01)** (97) **2619369 \***  
(86) GB2011051338 15.07.2011  
(96) 11738268.9 31.07.2013  
(87) WO2012007768, 15.07.2011  
(97) 2619369, 31.07.2013 en  
(54) IMPROVEMENTS RELATING TO TILES OR PAVING PIECES  
(71) Little, Keith, 228A Garstang Road Fulwood, Preston, Lancashire PR2 9QB, GB  
(72) Little, Keith, 228A Garstang Road Fulwood, Preston, Lancashire PR2 9QB, GB

- (51) MKP  
**C12P 7/64 (2006.01)** (97) **2636747 \***  
 (86) CN2011081784 04.11.2011  
 (96) 11837591.4 11.09.2013  
 (97) WO2012059065, 04.11.2011  
 (97) 2636747, 11.09.2013 en  
 (54) PROCESS FOR PREPARING BIODIESEL FROM RENEWABLE GREASE WITH LIPASE AS CATALYST AND ONLINE DEHYDRATION  
 (71) Tsinghua University, Qinghuayuan Tsinghua University Haidian District, Beijing 100084, CN  
 (72) LIU, Dehua, Qinghuayuan Haidian District, Beijing 100084, CN  
 DU, Wei, Qinghuayuan Haidian District, Beijing 100084, CN  
 ZHAO, Xuebing, Qinghuayuan Haidian District, Beijing 100084, CN  
 ZHU, Luole, Qinghuayuan Haidian District, Beijing 100084, CN

- (51) MKP  
**A61B 17/24 (2006.01)** (97) **2611369 \***  
**A61B 17/34 (2006.01)**  
**A61F 2/18 (2006.01)**  
**A61M 29/00 (2006.01)**  
 (86) US2011049452 26.08.2011  
 (96) 11752063.5 10.07.2013  
 (87) WO2012030673, 26.08.2011  
 (97) 2611369, 10.07.2013 en  
 (54) DEVICES FOR DILATING A PARANASAL SINUS OPENING AND FOR TREATING SINUSITIS  
 (71) Sinusys Corporation, 4030 Fabian Way, Palo Alto, California 94303, US  
 (72) SCHRECK, Thomas, A., 4030 Fabian Way, Palo Alto CA 94303, US  
 HESTER, Jerome, E., 4030 Fabian Way, Palo Alto CA 94303, US  
 EDGREN, David, E., 4030 Fabian Way, Palo Alto CA 94303, US  
 POUTIATINE, Andrew, I., 4030 Fabian Way, Palo Alto CA 94303, US  
 RIESER, Curtis, L., 4030 Fabian Way, Palo Alto CA 94303, US

- (51) MKP  
**C09K 5/18 (2006.01)** (97) **2619279 \***  
**B65D 77/04 (2006.01)**  
**B65D 75/58 (2006.01)**  
**F25D 5/02 (2006.01)**  
**B65D 81/32 (2006.01)**  
**B65D 81/34 (2006.01)**  
 (86) IB2011002223 26.09.2011  
 (96) 11782207.2 31.07.2013  
 (87) WO2012038819, 26.09.2011  
 (97) 2619279, 31.07.2013 en  
 (54) FLEXIBLE CONTAINER HAVING A BUILT-IN AUTO -HEATING OR AUTO - REFRIGERATING ELEMENT.  
 (71) Sarcinella, Giuseppe, Residenza alla Cascata 5, 6595 Riazzino, CH  
 (72) Sarcinella, Giuseppe, Residenza alla Cascata 5, 6595 Riazzino, CH

- (51) MKP  
**C07C 231/02 (2006.01)** (97) **2621893 \***  
**C07C 231/12 (2006.01)**  
**C07C 231/18 (2006.01)**  
**C07C 237/22 (2006.01)**  
 (86) EP2011067038 29.09.2011  
 (96) 11763692.8 07.08.2013  
 (87) WO2012041986, 29.09.2011  
 (97) 2621893, 07.08.2013 en  
 (54) PROCESS FOR THE PREPARATION OF AMINO ACID DERIVATIVES  
 (71) UCB Pharma GmbH, Alfred-Nobel-Strasse 10, 40789 Monheim, DE  
 (72) MERSCHAERT, Alain, c/o UCB PHARMA S.A. IP Department 60 Allée de la Recherche, B-1070 Brussels, BE  
 BOUVY, Didier, c/o UCB PHARMA S.A. IP Department 60 Allée de la Recherche, B-1070 Brussels, BE  
 VASSELIN, David, c/o UCB PHARMA S.A. IP Department 60 Allée de la Recherche, B-1070 Brussels, BE  
 CARLY, Nicolas, c/o UCB PHARMA S.A. IP Department 60 Allée de la Recherche, B-1070 Brussels, BE

- (51) MKP  
**C07D 489/12 (2006.01)** (97) **2635586 \***  
**C07D 489/08 (2006.01)**  
 (86) DK2011000128 04.11.2011  
 (96) 11785301.0 11.09.2013  
 (87) WO2012059103, 04.11.2011  
 (97) 2635586, 11.09.2013 en  
 (54) METHOD FOR THE MANUFACTURING OF NALTREXONE  
 (71) H. Lundbeck A/S, Ottiliavej 9, 2500 Valby, DK  
 (72) DE FAVERI, Carla, Via dei Colli 28, I-31010 Farra di Soligo, IT  
 HUBER, Florian, Anton, Martin, Via G.B. Velutti 34, I-30031 Dolo, IT  
 STIVANELLO, Mariano, Via Marostica 20, I-36015 Schio, IT

- (51) MKP  
**E21B 29/00 (2006.01)** (97) **2640930 \***  
**E21B 17/00 (2006.01)**  
**E21B 34/14 (2006.01)**  
**E21B 43/12 (2006.01)**  
**E21B 23/00 (2006.01)**  
 (86) CA2011001290 21.11.2011  
 (96) 11840838.4 25.09.2013  
 (87) WO2012065259, 21.11.2011  
 (97) 2640930, 25.09.2013 en  
 (54) KOBE SUB, WELLBORE TUBING STRING APPARATUS AND METHOD  
 (71) Packers Plus Energy Services Inc., Bow Valley Square 2 Suite 2200, 205 - 5 Avenue SW, Calgary, Alberta T2P 2V7, CA  
 (72) THEMIG, Daniel Jon, 256 Woodhaven Place SW, Calgary Alberta T2W 5P9, CA  
 DESRANLEAU, Christopher Denis, 307 Ridgeland Crescent, Sherwood Park Alberta T8A 3A5, CA  
 COON, Robert Joe, 8606 Hall Retreat CT, Missouri City Texas 77459, US

- (51) MKP  
**A61M 11/00 (2006.01)** (97) **2635336 \***  
 (86) US2011059461 04.11.2011  
 (96) 11838919.6 11.09.2013  
 (87) WO2012061783, 04.11.2011  
 (97) 2635336, 11.09.2013 en  
 (54) BREATHING APPARATUS  
 (71) Insleep Technologies, LLC, 3040 Universal Boulevard Suite 150, Weston, Florida 33331, US  
 (72) GUSKY, Michael, H., 2696 Boot Lane, Weston FL 33331, US  
 KARTEN, Stuart, Allan, 223 Linnie Canal, Venice CA 90291, US  
 BENTZLER, Jeffrey, Walter, 11810 Mayfield Ave. 206, Los Angeles CA 90049, US  
 SCHROEDER, Dennis, Lynn, 4025 Albright Avenue, Los Angeles CA 90066, US

- (51) MKP  
**A61K 47/34 (2006.01)** (97) **2595608 \***  
**A61K 31/444 (2006.01)**  
**A61K 9/16 (2006.01)**  
**A61P 19/02 (2006.01)**  
 (86) GB2011051357 19.07.2011  
 (96) 11746291.1 29.05.2013  
 (87) WO2012010883, 19.07.2011  
 (97) 2595608, 29.05.2013 en  
 (54) PHARMACEUTICAL DEPOT FOR 5-FLUORO-2 [[ (1S) -1-(5-FLUORO-2-PYRIDYL)ETHYL]AMINO]-6-[(5-ISOPROPOXY-1H-PYRAZOL-3-YL)AMINO]PYRIDINE-3-CARBONITRILE  
 (71) AstraZeneca AB, null, 151 85 Södertälje, SE  
 (72) FULLER, Emily, Alderley Park Macclesfield, Cheshire SK10 4TG, GB  
 JANIN, Armelle, Alderley Park Macclesfield, Cheshire SK10 4TG, GB  
 MACFAUL, Philip, Alderley Park Macclesfield, Cheshire SK10 4TG, GB  
 PUGH, Rachel, Alderley Park Macclesfield, Cheshire SK10 4TG, GB  
 NASH, Ian, Alderley Park Macclesfield, Cheshire SK10 4TG, GB

- (51) MKP  
**A61K 8/02 (2006.01)** (97) **2613755 \***  
**A61K 8/37 (2006.01)**  
**A61K 8/67 (2006.01)**  
**A61K 8/81 (2006.01)**  
**A61Q 19/02 (2006.01)**  
**A61Q 19/08 (2006.01)**
- (86) IB2011053947 09.09.2011  
(96) 11773857.5 17.07.2013  
(87) WO2012032493, 09.09.2011  
(97) 2613755, 17.07.2013 en  
(54) PEEL -OFF POLYVINYL FACIAL MASK FOR TREATMENT OF SKIN CONDITIONS COMPRISING A HIGH CONCENTRATION OF RETINOIC ACID
- (71) Laboratori Farmaceutici Krymi S.p.A., Piazza Bologna 22, 00162 Roma, IT  
(72) CRIMI, Rocco, c/o Laboratori Farmaceutici Krymi S.p.A. Via Galvani 34, I-00015 Monterotondo RM, IT  
COZZI, Raniero, c/o Laboratori Farmaceutici Krymi S.p.A. Via Galvani 34, I-00015 Monterotondo RM, IT
- 
- (51) MKP  
**B65H 29/24 (2006.01)** (97) **2394940**  
**B65H 29/46 (2006.01)**  
**B65H 31/24 (2006.01)**
- (96) 11004825.3 14.12.2011  
(97) 2394940, 14.12.2011 de  
(54) Stacking device for stacking flat workpieces
- (71) Bäumer, Josef, Meisenweg 10, 48496 Hopsten, DE  
(72) Bäumer, Josef, Meisenweg 10, 48496 Hopsten, DE
- 
- (51) MKP  
**A61K 9/16 (2006.01)** (97) **2608777 \***  
**A61K 9/08 (2006.01)**  
**A61K 47/38 (2006.01)**  
**A61K 31/498 (2006.01)**  
**A61K 38/43 (2006.01)**  
**A61K 35/12 (2006.01)**  
**A61P 9/00 (2006.01)**
- (86) US2011049026 24.08.2011  
(96) 11820625.9 03.07.2013  
(87) WO2012027514, 24.08.2011  
(97) 2608777, 03.07.2013 en  
(54) COMPOSITIONS AND METHODS FOR CARDIAC THERAPY
- (71) The Regents of The University of California, 1111 Franklin Street, 8th floor, Oakland, CA 94607, US  
Ventrix, Inc., 3030 Bunker Hill Street Suite 117D, San Diego, CA 92109, US  
(72) CHRISTMAN, Karen, 3231 Hill Street, San Diego, CA 92106, US  
SINGELYN, Jennifer, 7316 Conventry Ct., Riverdale, NJ 07457, US  
DEQUACH, Jessica, 1 Miramar Street 929288, San Diego, CA 92037, US  
KINSEY, Adam, 3972 Jackdaw Street 213, San Diego, CA 92103, US
- 
- (51) MKP  
**A61K 31/00 (2006.01)** (97) **2621481 \***  
**A61K 31/47 (2006.01)**  
**A61P 35/00 (2006.01)**  
**A61P 35/04 (2006.01)**
- (86) US2011053233 26.09.2011  
(96) 11764655.4 07.08.2013  
(87) WO2012044572, 26.09.2011  
(97) 2621481, 07.08.2013 en  
(54) DUAL INHIBITORS OF MET AND VEGF FOR THE TREATMENT OF CASTRATION- RESISTANT PROSTATE CANCER AND OSTEOBLASTIC BONE METASTASES
- (71) Exelixis, Inc., 210 East Grand Avenue P.O. Box 511, South San Francisco, CA 94080-0511, US  
(72) SMITH, David, 1245 Morehead Ct., Ann Arbor MI 48103, US  
HUSSAIN, Maha, 3690 Creekside Dr., Ann Arbor MI 48105, US

- (51) MKP  
**G06F 3/12 (2006.01)** (97) **2549375**
- (96) 12176878.2 23.01.2013  
(97) 2549375, 23.01.2013 de  
(54) Method for producing at least one printing ink carrier and method for producing one or more printed products
- (71) CeWe Color AG & Co. OHG, Meerweg 30-32, 26133 Oldenburg, DE  
(72) Meißner, Stefan, Dipl.-Ing., Nordstraße 20a, 01099 Dresden, DE
- 
- (51) MKP  
**B60J 7/06 (2006.01)** (97) **2595825 \***
- (86) EP2011062399 20.07.2011  
(96) 11736067.7 29.05.2013  
(87) WO2012010618, 20.07.2011  
(97) 2595825, 29.05.2013 en  
(54) STRUCTURE FOR A SLIDING ROOF, SLIDING ROOF SYSTEM, TRUCK WITH SLIDING ROOF SYSTEM, CURTAINSIDER TRAILER WITH A SLIDING ROOF SYSTEM
- (71) VBG Group Truck Equipment N.V., Lochtemanweg 50, 3580 Beringen, BE  
(72) RAYEN, Luc, Theodorus, Julien, VBG Group Truck Equipment N.V. Lochtemanweg 50, B-3580 Beringen, BE  
LEURS, Joris, VBG Group Truck Equipment N.V. Lochtemanweg 50, B-3580 Beringen, BE
- 
- (51) MKP  
**C07D 471/04 (2006.01)** (97) **2643322 \***  
**A61K 31/437 (2006.01)**  
**A61P 35/00 (2006.01)**  
**A61P 37/00 (2006.01)**
- (86) US2011061678 21.11.2011  
(96) 11791401.0 02.10.2013  
(87) WO2012071336, 21.11.2011  
(97) 2643322, 02.10.2013 en  
(54) SALTS AND CRYSTALLINE FORMS OF AN APOPTOSIS-INDUCING AGENT
- (71) Abbvie Inc., 1 North Waukegan Road, North Chicago, IL 60064, US  
(72) CATRON, Nathaniel D., 305 Lakeside Drive, Vernon Hills, Illinois 60061, US  
CHEN, Shuang, 17781 W. Elsbury Street, Gurnee, Illinois 60031, US  
GONG, Yuchuan, 947 S. Darla Court, Waukegan, Illinois 60079, US  
ZHANG, Geoff G., 1372 N. Maidstone Drive, Vernon Hills, Illinois 60061, US
- 
- (51) MKP  
**F16F 6/00 (2006.01)** (97) **2598773 \***  
**F16F 15/03 (2006.01)**
- (86) US2011024699 14.02.2011  
(96) 11812875.0 05.06.2013  
(87) WO2012015488, 14.02.2011  
(97) 2598773, 05.06.2013 en  
(54) ELECTRICITY GENERATING SHOCK ABSORBERS
- (71) The Research Foundation Of State University Of New York, Post Office Box 9, Albany, NJ 12201-0009, US  
(72) ZUO, Lei, 835 Nesconset Highway Apt. C9, Nesconset, New York 11767, US  
ZHANG, Pei Sheng, 16-15 200th St., Bayside, New York 11360, US  
TANG, Xiudong, 700 Health Sciences Drive, A2007A, Stony Brook, New York 11790, US

- (51) MKP  
**A61K 39/175 (2006.01)** (97) **2595652 \***  
**C12N 15/863 (2006.01)**
- (86) IB2011053198 18.07.2011  
(96) 11746637.5 29.05.2013  
(87) WO2012011045, 18.07.2011  
(97) 2595652, 29.05.2013 en  
(54) PARAPOXVIRUS VECTORS  
(71) AH USA 42 LLC, 235 East 42nd Street, New York, NY 10017, US  
(72) MARTINON, Olivier Michel, Pfizer Global Research and Development 7000 Portage Road, Kalamazoo, Michigan 49001, US  
REDDY, Nanda Kumar Damavarapu, Pfizer Pharmaceutical India Pvt. Ltd Plot No. 16, TTC MIDC Indl Area, Thane Belapur Road K.U. Bazar Post Turbhe Navi, Mumbai 400 705, IN
- 
- (51) MKP  
**A61K 9/08 (2006.01)** (97) **2616046 \***  
**A61K 9/16 (2006.01)**  
**A61K 31/167 (2006.01)**  
**A61K 31/192 (2006.01)**  
**A61K 31/616 (2006.01)**  
**A23L 2/00 (2006.01)**
- (86) US2011051386 13.09.2011  
(96) 11760656.6 24.07.2013  
(87) WO2012037117, 13.09.2011  
(97) 2616046, 24.07.2013 en  
(54) AQUEOUS DRUG DELIVERY SYSTEM COMPRISING OFF - FLAVOR MASKING AGENT  
(71) Bev-RX, Inc., 91 Front St 103, Scituate, MA 02066, US  
(72) REED, Kyle, A., 1 Lake Hollinsworth Dr., 6, Lakeland FL 33803, US
- 
- (51) MKP  
**F24J 2/46 (2006.01)** (97) **2625472 \***  
**E04H 5/02 (2006.01)**  
**E04H 14/00 (2006.01)**
- (86) IB2011052311 26.05.2011  
(96) 11861321.5 14.08.2013  
(87) WO2012160420, 26.05.2011  
(97) 2625472, 14.08.2013 en  
(54) METHOD AND APPARATUS FOR MAKING STATIONERY PARABOLIC SOLAR COLLECTOR  
(71) Ozkul, Tarik, Yali Mah. Fevzi Cakmak Cad. Saygin Sok. 8A/11, Maltepe, 34844 Istanbul, TR  
(72) The designation of the inventor has not yet been filed , null, null
- 
- (51) MKP  
**A61K 39/00 (2006.01)** (97) **2640415 \***  
**C07K 14/725 (2006.01)**  
**A61P 31/10 (2006.01)**  
**G01N 33/569 (2006.01)**
- (86) GB2011052239 16.11.2011  
(96) 11805135.8 25.09.2013  
(87) WO2012066331, 16.11.2011  
(97) 2640415, 25.09.2013 en  
(54) CROSS PROTECTIVE EPITOPES OF ASPERGILLUS FUMIGATUS AND CANDIDA ALBICANS  
(71) Cell Medica Ltd, 27 Fitzroy Square, London W1T 6ES, GB  
(72) TOPP, Max, S, Medical Clinic and Polyclinic II Immuno- and Genetherapy University of Wuerzburg Versbacher Strasse 5, 97078 Wuerzburg, DE  
STUEHLER, Claudia, Medical Clinic and Polyclinic II Immuno- and Genetherapy University of Wuerzburg Versbacher Strasse 5, 97078 Wuerzburg, DE  
KHANNA, Nina, Department of Biomedicine University Hospital Basel Hebelstrasse 20, 4031 Basel, CH
- 
- (51) MKP  
**A41B 9/02 (2006.01)** (97) **2597978 \***
- (86) HR2010000025 27.07.2010  
(96) 10759707.2 05.06.2013  
(87) WO2012013991, 27.07.2010  
(97) 2597978, 05.06.2013 en  
(54) MEN'S BRIEFS WITH SEPARATE SPACE FOR PENIS  
(71) Delija, Frane, Doverska 33, 21000 Split, HR  
(72) Delija, Frane, Doverska 33, 21000 Split, HR
- 
- (51) MKP  
**B27N 3/00 (2006.01)** (97) **2598261 \***  
**B09B 3/00 (2006.01)**
- (86) FR2011051796 26.07.2011  
(96) 11752295.3 05.06.2013  
(87) WO2012022892, 26.07.2011  
(97) 2598261, 05.06.2013 fr  
(54) METHOD FOR RECYCLING FURNITURE, IN PARTICULAR BED BASES, WEB OF MATERIAL OBTAINED BY SUCH A METHOD, AND ASSOCIATED RECYCLING INSTALLATION  
(71) Ecoval Environnement, 8 Allée des Palombes, 77185 Lognes, FR  
(72) LANZA, Rémy, Chemin du Félin, F-84500 Bollene, FR  
TOUATI, Salim, 9 rue Anatole France Le Grand Monarque, F-26250 Livron Sur Drome, FR
- 
- (51) MKP  
**C07K 14/365 (2006.01)** (97) **2601209 \***  
**C12N 15/11 (2006.01)**  
**C12P 19/26 (2006.01)**
- (86) EP2011063243 01.08.2011  
(96) 11741187.6 12.06.2013  
(87) WO2012016960, 01.08.2011  
(97) 2601209, 12.06.2013 en  
(54) GENOMICS OF ACTINOPLANES UTAHENSIS  
(71) Bayer Intellectual Property GmbH, Alfred-Nobel-Strasse 10, 40789 Monheim, DE  
(72) SELBER, Klaus, Bachstrasse 32, 42781 Haan, DE  
WEINGÄRTNER, Bernhard, Birkenweg 4, 42489 Wülfrath, DE  
WEHLMANN, Hermann, Mastweg 3A, 42349 Wuppertal, DE  
ROSEN, Winfried, Kremenholz 27a, 42857 Remscheid, DE  
PÜHLER, Alfred, Am Waldschlosschen 2, 33615 Bielefeld, DE  
SCHWIENTEK, Patrick, Karulleriestrasse 14, 33602 Bielefeld, DE  
KALINOWSKI, Jörn, Leubachstrasse 19, 33615 Bielefeld, DE  
WEHMEIER, Udo, Hospitalstrasse 16, 42119 Wuppertal, DE
- 
- (51) MKP  
**G06Q 20/00 (2012.01)** (97) **2628139 \***
- (86) US2011055382 07.10.2011  
(96) 11833171.9 21.08.2013  
(87) WO2012051069, 07.10.2011  
(97) 2628139, 21.08.2013 en  
(54) METHODS FOR TRANSFERRING FUNDS USING A PAYMENT SERVICE WHERE FINANCIAL ACCOUNT INFORMATION IS ONLY ENTERED ONCE WITH A PAYMENT SERVICE AND NEED NOT BE RE-ENTERED FOR FUTURE TRANSFERS  
(71) Square, Inc., 110 Fifth Street, San Francisco, CA 94103, US  
(72) DORSEY, Jack, 901 Mission Street Suite 104, San Francisco CA 94103, US  
HENDERSON, William, 1657 Hayes Street Unit 2, San Francisco CA 94117, US  
GRASSADONIA, Brian, 2038 Scott Street, San Francisco CA 94117, US  
MCKELVEY, James, M., 7501 Scenic Highway, Pensacola FL 32504, US
- 
- (51) MKP  
**A61P 1/00 (2006.01)** (97) **2629790 \***  
**A61K 38/43 (2006.01)**
- (86) EP2010065916 21.10.2010  
(96) 10773032.7 28.08.2013  
(87) WO2012052060, 21.10.2010  
(97) 2629790, 28.08.2013 en  
(54) Method to increase the growth velocity of human infants  
(71) Swedish Orphan Biovitrum AB (Publ), null, 112 76 Stockholm, SE  
(72) Hernel, Olle, Skolgatan 28, S-903 22 Umeå, SE  
Strömberg, Patrik, Kanalvägen 28B, S-191 34 Sollentuna, SE  
Svensson, Lennart, Gustav III:s boulevard 99, S-169 74 Solna, SE  
Timdahl, Kristina, Bokvägen 59A, S-146 50 Tullinge, SE  
Vägerö, Märten, Branddammsvägen 3B, S-132 44 Saltsjö-boo, SE  
Öhman, Maria, P.O.Box 142, SE-941 23 Piteå, SE  
Olsson, Birgitta, Ekeberga, S-179 62 Stenhamra, SE
-

- (51) MKP  
**A61K 31/23 (2006.01)** (97) **2526936**  
 (96) 11167114.5 28.11.2012  
 (97) 2526936, 28.11.2012 en  
 (54) Particle size distribution of cetyl myristate and/or cetyl palmitate  
 (71) Deva Holding Anonim Sirketi, Halkali Merkez Mah. Basin Ekpres Caddesi, No. 1, Kat: 5 Kucukcekmece, 34303 Istanbul, TR  
 (72) Haas, Philipp Daniel, DEVA HOLDING ANONIM SIRKETI Halkali Merkez Mah., Ba Basin Ekpres Caddesi, No:1, Patent Law Dpt., Kat:5, KUCUKCEKMECE, 34303, ISTANBUL, TR  
 Firat, Omer Faruk, R&D DEVA HOLDING ANONIM SIRKETI R&D Halkali Merkez Mah, Basin Ekpres Caddesi No: 1, Patent Law Dpt, Kat:5, KUCUKCEKMECE, 34303, ISTANBUL, TR  
 Kandemir, Levent, R&D DEVA HOLDING ANONIM SIRKETI R&D Halkali Merkez Mah, Basin Ekpres Caddesi No: 1, Patent Law Dpt, Kat:5, KUCUKCEKMECE, 34303, ISTANBUL, TR  
 Koc, Fikret, R&D DEVA HOLDING ANONIM SIRKETI Halkali Merkez Mah, Basin Ekpres Caddesi No:1, Patent Law Dpt, Kat: 5, KUCUKCEKMECE, 34303, ISTANBUL, TR  
 Sivasligil, Ramazan, R&D DEVA HOLDING ANONIM SIRKETI Halkali Merkez Mah, Basin Ekpres Caddesi No:1, Patent Law Dpt, Kat:5, KUCUKCEKMECE, 34303, ISTANBUL, TR

- (51) MKP  
**C08G 64/20 (2006.01)** (97) **2634202 \***  
 (86) JP2011073658 14.10.2011  
 (96) 11836042.9 04.09.2013  
 (87) WO2012056903, 14.10.2011  
 (97) 2634202, 04.09.2013 en  
 (54) PROCESS FOR PRODUCING POLYCONDENSATION POLYMER, AND POLYMERIZER  
 (71) Asahi Kasei Chemicals Corporation, 1-105, Kanda Jinbocho Chiyoda-ku, Tokyo 101-8101, JP  
 (72) AMINAKA Muneaki, c/o Asahi Kasei Chemicals Corporation 1-105, Kanda Jinbocho Chiyoda-ku, Tokyo 101-8101, JP  
 YASUDA Kazuharu, c/o Asahi Kasei Chemicals Corporation 1-105, Kanda Jinbocho Chiyoda-ku, Tokyo 101-8101, JP

- (51) MKP  
**A61K 31/573 (2006.01)** (97) **2637670 \***  
**A61K 39/395 (2006.01)**  
**C07K 16/28 (2006.01)**  
 (86) EP2011068862 27.10.2011  
 (96) 11788077.3 18.09.2013  
 (87) WO2012062596, 27.10.2011  
 (97) 2637670, 18.09.2013 en  
 (54) PREVENTION OF ADVERSE EFFECTS CAUSED BY CD3 SPECIFIC BINDING DOMAINS  
 (71) Amgen Research (Munich) GmbH, Staffelseestrasse 2, 81477 München, DE  
 (72) ZUGMAIER, Gerhard, c/o Amgen Research (Munich) GmbH Staffelseestr. 2, 81477 Muenchen, DE  
 NAGORSEN, Dirk, c/o Amgen Research (Munich) GmbH Staffelseestr. 2, 81477 Muenchen, DE  
 SCHEELE, Juergen, c/o Amgen Research (Munich) GmbH Staffelseestr. 2, 81477 Muenchen, DE

- (51) MKP  
**A61M 5/315 (2006.01)** (97) **2529774**  
 (96) 12165097.2 05.12.2012  
 (97) 2529774, 05.12.2012 en  
 (54) Resetting mechanism for a drug delivery device  
 (71) Sanofi-Aventis Deutschland GmbH, Brüningstraße 50, 65929 Frankfurt am Main, DE  
 (72) Plumptre, David Aubrey, 36 Shire Way, Droitwich Spa, Worcestershire WR9 7RQ, GB  
 Jones, Christopher John, The Old Thatch Grafton Gloucestershire GL20 7AT, Tewkesbury, Gloucestershire GL20 7AT, GB

- (51) MKP  
**A61B 17/115 (2006.01)** (97) **2524658**  
**A61B 17/29 (2006.01)**  
 (96) 12168717.2 21.11.2012  
 (97) 2524658, 21.11.2012 en  
 (54) Improved anvil and cartridge alignment configuration for a circular stapler  
 (71) Ethicon Endo-Surgery, Inc., 4545 Creek Road, Cincinnati, OH 45242, US  
 (72) Nalagatla, Anil K., 6581 Gove Court, Mason, Ohio 45040, US  
 Adams, Thomas E., 4098 Crestview Drive, Loveland, Ohio 45140, US

- (51) MKP  
**A61K 31/50 (2006.01)** (97) **2640391 \***  
 (86) US2011060854 15.11.2011  
 (96) 11841746.8 25.09.2013  
 (87) WO2012068161, 15.11.2011  
 (97) 2640391, 25.09.2013 en  
 (54) PYRIDAZINE DERIVATIVES, COMPOSITIONS AND METHODS FOR TREATING COGNITIVE IMPAIRMENT  
 (71) Agenebio, Inc., 351 West 10th Street, Indianapolis, IN 46202, US  
 (72) LOWE, John, A., III, 28 Coveside Lane, Stonington CT 06378, US

- (51) MKP  
**A61K 47/48 (2006.01)** (97) **2643022 \***  
**A61K 9/00 (2006.01)**  
**A61K 31/35 (2006.01)**  
 (86) EP2011070951 24.11.2011  
 (96) 11790937.4 02.10.2013  
 (87) WO2012069591, 24.11.2011  
 (97) 2643022, 02.10.2013 en  
 (54) FAST DISINTEGRATING COMPOSITIONS COMPRISING NABILONE AND RANDOMLY METHYLATED BETA CYCLODEXTRIN  
 (71) AOP Orphan Pharmaceuticals AG, Wilhelminenstrasse 91/II f, 1160 Wien, AT  
 (72) VIERNSTEIN, Helmut, Gymnasiumstr. 26/18, A-1180 Wien, AT  
 TOEGEL, Stefan, Kressg. 27/1, A-3013 Tullnerbach, AT  
 SCHUELLER, Regina, Piaristeng. 25/5, A-1080 Wien, AT

- (51) MKP  
**C12N 5/00 (2006.01)** (97) **2601287 \***  
**C12N 5/10 (2006.01)**  
**C07K 5/06 (2006.01)**  
 (86) US2011046850 05.08.2011  
 (96) 11748824.7 12.06.2013  
 (87) WO2012019160, 05.08.2011  
 (97) 2601287, 12.06.2013 en  
 (54) DIPEPTIDES TO ENHANCE YIELD AND VIABILITY FROM CELL CULTURES  
 (71) Amgen Inc., One Amgen Center Drive, Thousand Oaks, California 91320-1799, US  
 (72) KANG, Sohye, 2124 Los Feliz Dr., Thousand Oaks California 91362, US  
 DESHPANDE, Rohini, 251 Bellafonte Court, Camarillo California 93012, US  
 MCCOY, Rebecca E., 5647 37th Ave SW, Seattle Washington 98126, US  
 MIRANDA, Leslie P., 3586 Mapleknoll PL., Thousand Oaks California 91362, US  
 MORRIS, Arvia E., 4535 Thackeray Place NE, Seattle Washington 98105, US

- (51) MKP  
**C07K 14/045 (2006.01)** (97) **2627352 \***  
**A61K 39/245 (2006.01)**  
 (86) EP2011068040 14.10.2011  
 (96) 11768058.7 21.08.2013  
 (87) WO2012049317, 14.10.2011  
 (97) 2627352, 21.08.2013 en  
 (54) NOVEL ANTIGEN  
 (71) GlaxoSmithKline Biologicals S.A., rue de l'Institut, 89, 1330 Rixensart, BE  
 (72) BAUDOUX, Guy, Jean, Marie, Fernand, Pierre, GlaxoSmithKline Biologicals S.A. rue de l'Institut 89, B-1330 Rixensart, BE  
 BLAIS, Normand, ID Biomedical Corporation of Quebec 525 Cartier Boulevard West, Laval, Québec H7V 3S8, CA  
 MARCHAND, Martine, GlaxoSmithKline Biologicals S.A. rue de l'Institut 89, B-1330 Rixensart, BE

- (51) MKP  
**A61K 48/00 (2006.01)** (97) **2621512 \***  
**A61P 25/02 (2006.01)**  
**A61P 25/04 (2006.01)**  
**A61K 38/17 (2006.01)**  
**A61K 9/00 (2006.01)**  
 (86) DK2011050369 30.09.2011  
 (96) 11773666.0 07.08.2013  
 (87) WO2012041328, 30.09.2011  
 (97) 2621512, 07.08.2013 en  
 (54) USE OF METEORIN FOR THE TREATMENT OF ALLODYNIA, HYPERALGESIA, SPONTANEOUS PAIN AND PHANTOM PAIN  
 (71) NsGene A/S, Baltorpevej 154, 2750 Ballerup, DK  
 (72) JOHANSEN, Teit E., Stampeengen 26, DK-2970 Hørsholm, DK  
 WAHLBERG, Lars Ulrik, 259 Riverside Dr., Tiverton Rhode Island 02878, US  
 JØRGENSEN, Jesper Roland, Mariendalsvej 73 2.tv., DK-2000 Frederiksberg, DK

- (51) MKP  
**E03D 11/02 (2006.01)** (97) **2562315**  
 (96) 12179753.4 27.02.2013  
 (97) 2562315, 27.02.2013 en  
 (54) Flush toilet  
 (71) TOTO LTD., 1-1, Nakashima 2-chome Kokurakita-ku, Kitakyushu-shi Fukuoka 802-8601, JP  
 (72) Yamasaki, Yu, c/o TOTO LTD. 1-1 Nakashima 2-chome, Kokurakita-ku., Kitakyushu-shi, Fukuoka 802-8601, JP  
 Inoue, Masaaki, c/o TOTO LTD. 1-1 Nakashima 2-chome, Kokurakita-ku., Kitakyushu-shi, Fukuoka 802-8601, JP  
 Nakamura, Masahiro, c/o TOTO LTD. 1-1 Nakashima 2-chome, Kokurakita-ku., Kitakyushu-shi, Fukuoka 802-8601, JP

- (51) MKP  
**C11B 1/10 (2006.01)** (97) **2616531 \***  
**C11B 3/00 (2006.01)**  
**C11B 3/06 (2006.01)**  
**C11B 3/08 (2006.01)**  
 (86) EP2011065864 13.09.2011  
 (96) 11755341.2 24.07.2013  
 (87) WO2012035020, 13.09.2011  
 (97) 2616531, 24.07.2013 en  
 (54) REFINED VEGETABLE OIL AND A METHOD OF PRODUCING IT  
 (71) Palsgaard A/S, Palsgaardvej 10, 7130 Juelsminde, DK  
 (72) NORN, Viggo Creemers, Grundvej 5, DK-7140 Stouby, DK  
 NIELSEN, Lars Preuss, Bygaden 42, DK-7130 Juelsminde, DK

- (51) MKP  
**G01N 33/543 (2006.01)** (97) **2616810 \***  
 (86) EP2011065671 09.09.2011  
 (96) 11757267.7 24.07.2013  
 (87) WO2012034946, 09.09.2011  
 (97) 2616810, 24.07.2013 en  
 (54) PREPARATION OF A MOLECULAR RECOGNITION ELEMENT  
 (71) Fachhochschule Nordwestschweiz Hochschule Für Life Sciences, Gründenstrasse 40, 4132 Muttenz, CH  
 (72) SHAHGALDIAN, Patrick, 30 Pasteur St, F-68300 Saint Louis, FR  
 CUMBO, Alessandro, Maulbeerstrasse 69, CH-4058 Basel, CH  
 CORVINI, Philippe, 13 rue de la Fontaine, F-68220 Leymen, FR

- (51) MKP  
**C07D 487/04 (2006.01)** (97) **2619206 \***  
**A61K 31/41 (2006.01)**  
 (86) US2011029441 22.03.2011  
 (96) 11715792.5 31.07.2013  
 (87) WO2012039791, 22.03.2011  
 (97) 2619206, 31.07.2013 en  
 (54) 2'-FLUORO SUBSTITUTED CARBA-NUCLEOSIDE ANALOGS FOR ANTIVIRAL TREATMENT  
 (71) Gilead Sciences, Inc., 333 Lakeside Drive, Foster City, CA 94404, US  
 (72) CHO, Aesop, 1656 Notre Dame Drive, Mountain View CA 94040, US  
 KIM, Choung, 1750 Elizabeth Street, San Carlos CA 94070, US  
 RAY, Adrian, 19 Pilot Circle, Redwood City CA 94065, US

- (51) MKP  
**C07D 211/16 (2006.01)** (97) **2629851 \***  
**C07D 417/12 (2006.01)**  
**A61K 31/4523 (2006.01)**  
**A61P 29/00 (2006.01)**  
**C07D 417/14 (2006.01)**  
**C07D 205/04 (2006.01)**  
 (86) US2011057085 20.10.2011  
 (96) 11784828.3 28.08.2013  
 (87) WO2012054716, 20.10.2011  
 (97) 2629851, 28.08.2013 en  
 (54) PIPERIDIN-4-YL-AZETIDINE DIAMIDES AS MONOACYLGLYCEROL LIPASE INHIBITORS  
 (71) Janssen Pharmaceutica N.V., Turnhoutseweg 30, 2340 Beerse, BE  
 (72) CONNOLLY, Peter, J., Walsh&Mckean Roads, Spring House PA 19477, US  
 BIAN, Haiyan, 109 York Drive, Princeton NJ 08540, US  
 LI, Xun, Welsh&Mckean Roads, Spring House PA 19477, US  
 LIU, Li, 12914 Summit Ridge Terrace, Germantown MD 20874, US  
 MACIELAG, Mark, J., Welsh&Mckean Roads, Spring House PA 19477, US  
 MCDONNELL, Mark, E., 1280 Sumneytown Pike, Lansdale PA 19446, US

- (51) MKP  
**C07K 14/47 (2006.01)** (97) **2643349 \***  
 (86) EP2011071083 25.11.2011  
 (96) 11788815.6 02.10.2013  
 (87) WO2012069654, 25.11.2011  
 (97) 2643349, 02.10.2013 en  
 (54) DESIGNED REPEAT PROTEINS BINDING TO SERUM ALBUMIN  
 (71) Molecular Partners AG, Wagistrasse 14, 8952 Schlieren, CH  
 (72) STEINER, Daniel, Langmauerstrasse 28, CH-8006 Zürich, CH  
 BINZ, Hans Kaspar, Bachstrasse 27, CH-8903 Birmensdorf, CH  
 GULOTTI-GEORGIEVA, Maya, Niederweg 36, CH-8907 Wettswil a.A., CH  
 MERZ, Frieder W., Im Geerig 79, CH-5507 Mellingen, CH  
 PHILLIPS, Douglas, Eulenweg 37, CH-5400 Baden, CH  
 SONDEREGGER, Ivo, Im Baurenacker 9, CH-8902 Urdorf, CH



- (51) MKP  
**B65D 51/26 (2006.01)** (97) **2494941**  
**A61C 19/02 (2006.01)**  
(86) 12157948.6 05.09.2012  
(97) 2494941, 05.09.2012 de  
(54) Container for transporting dental objects  
(71) Speiko - Dr. Speier GmbH, Haferlandweg 12, 48155 Münster, DE  
(72) Kreuzer, Stefan, Burgwall 6, 48165 Münster, DE
- 
- (51) MKP  
**A61K 38/07 (2006.01)** (97) **2627669 \***  
**C07K 14/47 (2006.01)**  
**A61P 19/08 (2006.01)**  
**A61K 38/06 (2006.01)**  
**A61K 38/00 (2006.01)**  
(86) US2011055588 10.10.2011  
(96) 11833199.0 21.08.2013  
(87) WO2012051106, 10.10.2011  
(97) 2627669, 21.08.2013 en  
(54) CYTOKINE BIOMARKERS AS PREDICTIVE BIOMARKERS OF CLINICAL RESPONSE FOR GLATIRAMER ACETATE  
(71) Teva Pharmaceutical Industries Ltd., 5 Basel Street P.O. Box 3190, 49131 Petah Tiqva, IL  
(72) KASPER, Lloyd, H., 128 Upper Pasture Road, Norwich VT 05005, US  
SMITH, Jacqueline, Y., 37 Wellington Cirle, Lebanon NH 03766, US
- 
- (51) MKP  
**A61P 5/50 (2006.01)** (97) **2601949**  
**A61P 9/10 (2006.01)**  
**A61K 31/155 (2006.01)**  
**A61P 13/12 (2006.01)**  
**A61K 31/382 (2006.01)**  
**A61P 9/14 (2006.01)**  
**A61K 31/64 (2006.01)**  
**A61P 27/02 (2006.01)**  
**A61K 45/00 (2006.01)**  
**A61P 43/00 (2006.01)**  
**A61P 3/10 (2006.01)**  
**C07D 335/02 (2006.01)**  
**A61K 31/4439 (2006.01)**  
**A61P 25/00 (2006.01)**  
(86) 13157571.4 12.06.2013  
(97) 2601949, 12.06.2013 en  
(54) Pharmaceutical compositions  
(71) Taisho Pharmaceutical Co., Ltd., 24-1 Takata 3-chome Toshima-ku, Tokyo 170-8633, JP  
(72) Takahashi, Teisuke, c/o TAISHO PHARMACEUTICAL CO., LTD. 24-1, Takada 3-chome Toshima-ku, Tokyo, 170-8633, JP  
Uchida, Saeko, c/o TAISHO PHARMACEUTICAL CO., LTD. 24-1, Takada 3-chome Toshima-ku, Tokyo, 170-8633, JP
- 
- (51) MKP  
**A47J 43/07 (2006.01)** (97) **2615954 \***  
**B26D 1/00 (2006.01)**  
(86) SE2011051081 07.09.2011  
(96) 11825528.0 24.07.2013  
(87) WO2012036614, 07.09.2011  
(97) 2615954, 24.07.2013 en  
(54) KNIFE FOR A CUTTING DISC FOR A CUTTING MACHINE  
(71) AB Hällde Maskiner, Box 1165, 164 26 Kista, SE  
(72) EKSTRÖM, Ulf, Majvägen 31, S-187 51 Täby, SE
- 
- (51) MKP  
**G02C 5/22 (2006.01)** (97) **2616875 \***  
(86) IB2011000020 04.01.2011  
(96) 11709180.1 24.07.2013  
(87) WO2012035382, 04.01.2011  
(97) 2616875, 24.07.2013 en  
(54) MINIATURISED ELASTIC HINGE, IN PARTICULAR FOR EYEGLASSES  
(71) Ideal S.R.L., Via Andrea Redusio 6/8/10, 32030 Quero (BL), IT  
(72) GASPARETTO, Michela, Via Mercatelli Sant'Anna 32, Susegana, IT

- (51) MKP  
**A61P 25/00 (2006.01)** (97) **2643056 \***  
(86) US2011062135 23.11.2011  
(96) 11845518.7 02.10.2013  
(87) WO2012074882, 23.11.2011  
(97) 2643056, 02.10.2013 en  
(54) PHAGOCYTIC ACTIVITY AS A MARKER OF SYNUCLEINOPATHIC DISEASE  
(71) Elan Pharmaceuticals, Inc., 300 Technology Square, Cambridge, MA 02139, US  
(72) GARDAL, Shyra, 2856 Chronical Avenue, Hayward California 94542, US  
JOHNSTON, Jennifer A., 889 Marin Drive, Mill Valley California 94941, US
- 
- (51) MKP  
**C07D 231/22 (2006.01)** (97) **2603495 \***  
**A61P 25/16 (2006.01)**  
**A61P 25/00 (2006.01)**  
**A61K 31/4152 (2006.01)**  
(86) EP2011063583 08.08.2011  
(96) 11740675.1 19.06.2013  
(87) WO2012019984, 08.08.2011  
(97) 2603495, 19.06.2013 en  
(54) 4-[-2-[[5-METHYL-1-(2-NAPHTALENYL)-1H-PYRAZOL-3-YL]OXY]ETHYL]MORPHOLINE HYDROCHLORIDE AMORPHOUS SOLID FORMS  
(71) Laboratorios del. Dr. Esteve, S.A., Avda Mare de Deu de Montserrat 221, 08041 Barcelona, ES  
(72) BENET BUCHHOLZ, Jordi, Plaza Romaní 3 Casa A, E-43893 Altafulla-Tarragona, ES  
PUIG FERNANDEZ, Laura, C/ El maquinista de la General 37 2A, E-50019 Zaragoza, ES
- 
- (51) MKP  
**G01N 33/48 (2006.01)** (97) **2619574 \***  
(86) US2011051803 15.09.2011  
(96) 11825959.7 31.07.2013  
(87) WO2012037378, 15.09.2011  
(97) 2619574, 31.07.2013 en  
(54) MOLECULAR DIAGNOSTIC TEST FOR CANCER  
(71) Almac Diagnostics Limited, Almac House 20 Seagoe Industrial Estate, Craigavon BT63 5QD, GB  
Davison, Timothy, 4445 Honeysuckle Lane, Doylestown, PA 18902, US  
(72) DAVISON, Timothy, 4445 Honeysuckle Lane, Doylestown, PA 18902, US  
O'DONNELL, Jude, 8 Camaghy Road South, Galbally Dungannon BT70 2NL, GB  
BYLESJO, Max, 1/1 22 Westminster Terrace, Glasgow G3 7RU, GB  
MCDYER, Fionnuala, Apt. 50 South Studios Tates Avenue, Belfast BT9 7BS, GB  
DEHARO, Steve, Apartment 2 3 The Manor Blacks Road, Belfast BT10 0TJ, GB  
HILL, Laura A., 24 Brustin Lee, Ballygally Larne BT40 2QA, GB  
KEATING, Katherine E., 44 Waterfoot Road, Magherafelt BT45 6LQ, GB  
PROUTSKI, Vitali, 6 Kilwarlin Crescent, Hillsborough BT26 6QF, GB  
HARKIN, Denis Paul, 195 Ballygowan Road, Dromore Co. Down BT25 IRQ, GB  
KENNEDY, Richard, 15 Edgumbe Gardens, Belfast BT4 2EG, GB  
GOFFARD, Nicolas, 16a Lisburn Street, Hillsborough BT26 6AB, GB

- (51) MKP  
**C12N 9/88 (2006.01)** (97) **2633042 \***  
**C12P 1/00 (2006.01)**  
**C12N 15/82 (2006.01)**  
(86) US2011058456 28.10.2011  
(96) 11779944.5 04.09.2013  
(87) WO2012058636, 28.10.2011  
(97) 2633042, 04.09.2013 en  
(54) MODIFIED VALENCENE SYNTHASE POLYPEPTIDES,  
ENCODING NUCLEIC ACID MOLECULES AND USES  
THEREOF  
(71) Allylix, Inc., 7220 Trade Street, Suite 209, San Diego, CA  
92121, US  
(72) AMICK, Jean, Davin, 1825 Yorktown Road, Lexington KY  
40504, US  
PARK, Grace Eunyoung, 716 Sprucewood Drive, Lexington,  
KY 40514, US  
JULIEN, Bryan, N., 3016 Blackmoor Park Circle, Lexington KY  
40509, US  
BURLINGAME, Richard, P., 181 Water Works Road,  
Nicholasville KY 40356, US

- (51) MKP  
**F42B 12/66 (2006.01)** (97) **2635870 \***  
(86) US2010055150 02.11.2010  
(96) 10859360.9 11.09.2013  
(87) WO2012060822, 02.11.2010  
(97) 2635870, 11.09.2013 en  
(54) PROJECTILE FOR USE WITH A RIFLED BARREL  
(71) Advanced Ballistic Concepts LLC, 2606 15th Avenue Ct.,  
Greeley, CO 80631, US  
(72) KUCHMAN, Todd, 2606 15th Avenue Ct., Greeley, CO 80631,  
US

- (51) MKP  
**A61K 31/502 (2006.01)** (97) **2640385 \***  
**A61K 31/506 (2006.01)**  
**A61K 31/436 (2006.01)**  
**A61K 31/395 (2006.01)**  
**A61K 31/4196 (2006.01)**  
**A61P 35/00 (2006.01)**  
**A61K 31/437 (2006.01)**  
**A61K 39/395 (2006.01)**  
**A61K 31/517 (2006.01)**  
**A61K 31/4439 (2006.01)**  
(86) US2011061440 18.11.2011  
(96) 11793607.0 25.09.2013  
(87) WO2012068483, 18.11.2011  
(97) 2640385, 25.09.2013 en  
(54) PRESELECTION OF SUBJECTS FOR THERAPEUTIC  
TREATMENT BASED ON HYPOXIC STATUS  
(71) Synta Pharmaceuticals Corp., 45 Hartwell Avenue, Lexington,  
MA 02421, US  
(72) BLACKMAN, Ronald, K., 140 Sewall Avenue 2 Brookline, MA  
02446, US  
VUKOVIC, Vojko, 51 Wildwood Street, Winchester MA 01890,  
US

- (51) MKP  
**A61P 43/00 (2006.01)** (97) **2636671 \***  
**C07D 333/32 (2006.01)**  
**A61K 31/381 (2006.01)**  
**A61P 7/04 (2006.01)**  
(86) JP2011075218 01.11.2011  
(96) 11838038.5 11.09.2013  
(87) WO2012060388, 01.11.2011  
(97) 2636671, 11.09.2013 en  
(54) ORGANIC AMINE SALT OF AMINOBENZOIC ACID  
DERIVATIVE, AND METHOD FOR PRODUCING SAME  
(71) Nissan Chemical Industries, Ltd., 7-1 Kanda-Nishiki-cho  
3-chome, Chiyoda-ku Tokyo 101-0054, JP  
(72) IWAMOTO, Shunsuke, c/o Nissan Chemical Industries Ltd.  
Chemical Research Laboratories 10-1 Tsuboi-Nishi 2-chome,  
Funabashi-shi Chiba 274-8507, JP  
NAKANO, Satoshi, c/o Nissan Chemical Industries Ltd.  
Chemical Research Laboratories 10-1 Tsuboi-Nishi 2-chome,  
Funabashi-shi Chiba 274-8507, JP  
ISHIDA, Mariko, c/o Nissan Chemical Industries Ltd. Chemical  
Research Laboratories 10-1 Tsuboi-Nishi 2-chome, Funabashi-  
shi Chiba 274-8507, JP  
YAMAMOTO, Masao, c/o Environmental Technical Laboratory,  
Ltd., 11-17, Kohoku 2-chome, Adachi-ku, Tokyo 1230872, JP  
TAKEUCHI, Kazuya, c/o Nissan Chemical Industries Ltd.  
Biological Research Laboratories 1470, Shiraoka, Shiraoka-shi  
Saitama 3490294, JP

- (51) MKP  
**B03B 5/32 (2006.01)** (97) **2598250 \***  
**B04B 1/20 (2006.01)**  
(86) IB2011001653 14.07.2011  
(96) 11751937.1 05.06.2013  
(87) WO2012014031, 14.07.2011  
(97) 2598250, 05.06.2013 en  
(54) DEVICE FOR SEPARATING PARTICLES OF DIFFERENT  
SYNTHETIC MATERIALS  
(71) Cassani, Stefano, 51 Via Casola Canina, 40026 Imola,  
Bologna, IT  
(72) Cassani, Stefano, 51 Via Casola Canina, 40026 Imola,  
Bologna, IT

- (51) MKP  
**E05D 7/00 (2006.01)** (97) **2557258**  
(86) 12179517.3 13.02.2013  
(97) 2557258, 13.02.2013 en  
(54) Adjustable hinge for window or door frames  
(71) MasterLAB S.r.l. - Unipersonale, SP 37 Conversano-  
Castiglione Km 0, 700, 70014 Conversano, IT  
(72) Loperfido, Michele, Via della Resistenza 29, 70013 Castellana  
Grotte (BA), IT

- (51) MKP  
**C07D 473/04 (2006.01)** (97) **2611807 \***  
(86) US2011050229 01.09.2011  
(96) 11757476.4 10.07.2013  
(87) WO2012031138, 01.09.2011  
(97) 2611807, 10.07.2013 en  
(54) POLYMORPHS OF (S)-1-(4,4,6,6,6-PENTADEUTERO-5-  
HYDROXYHEXYL)-3-7-DIMETHYL-1H-PURINE-2,6(3H,7H)  
DIONE  
(71) Concert Pharmaceuticals Inc., 99 Hayden Avenue, Lexington,  
MA 02421, US  
(72) BIS, Joanna, A., 606 Baucom Grove Ct., Cary, NC 27519, US  
IGO, David, H., 9421 Brimstone Lane, Raleigh, NC 27613, US  
TURNQUIST, David, J., 26 Charles Road, Winchester, MA  
01890, US

- (51) MKP  
**B01D 15/08 (2006.01)** (97) **2627425 \***  
(86) US2011055691 11.10.2011  
(96) 11833232.9 21.08.2013  
(87) WO2012051147, 11.10.2011  
(97) 2627425, 21.08.2013 en  
(54) PROCESSES FOR PURIFICATION OF PROTEINS  
(71) AbbVie Inc., 1 North Waukegan Road, North Chicago, IL  
60064, US  
(72) WANG, Chen, 11 Flamingo Circle, Shrewsbury, MA 01545, US  
HICKMAN, Robert, K., 6 Hibiscus Drive, Worcester, MA 01605,  
US

- (51) MKP  
**C07K 16/26 (2006.01)** (97) **2598531 \***  
 (86) EP2011062686 22.07.2011  
 (96) 11738200.2 05.06.2013  
 (87) WO2012013609, 22.07.2011  
 (97) 2598531, 05.06.2013 en  
 (54) METHODS AND COMPOSITIONS FOR LIVER CANCER THERAPY  
 (71) Les Laboratoires Servier, 35, rue de Verdun, 92284 Suresnes Cedex, FR  
 INSERM (Institut National de la Santé et de la Recherche Médicale), 101, rue de Tolbiac, 75654 Paris Cedex 13, FR  
 Centre National de la Recherche Scientifique (CNRS), Campus Gérard-Mégie 3, rue Michel-Ange, 75794 Paris Cedex 16, FR  
 (72) HOUHOU, Leila, 2 rue Renaud de Villeneuve, F-34090 Montpellier, FR  
 DUMÉ, Anne-Sophie, 76 Rue de St. Priest, F-34090 Montpellier, FR  
 JOUBERT, Dominique, 10 rue Gabriel Peri, F-34200 Sete, FR  
 HOLLANDE, Frederic, 26 Moresby Street, Mitcham, VIC 3132, AU
- 
- (51) MKP  
**H01L 31/052 (2006.01)** (97) **2571063**  
 (96) 11184658.0 20.03.2013  
 (97) 2571063, 20.03.2013 en  
 (54) Solar generator apparatus with elastically cable-controlled tracking  
 (71) TOPPER SUN ENERGY TECHNOLOGY CO., LTD., 458-9, Sinsing Road Hukou Township, Hsinchu County 303, TW  
 Luo, Chia Ching, 458-9, Sinsing Road Hukou Township, Hsinchu County 303, TW  
 (72) Luo, Chia Ching, Topper Sun Energy Technology Co., Ltd. No. 458-9, Sinsing Rd., 303 Hukou Township, Hsinchu County, TW
- 
- (51) MKP  
**C07D 279/08 (2006.01)** (97) **2640712 \***  
**A61K 31/5415 (2006.01)**  
**A61P 31/06 (2006.01)**  
 (86) IB2011055209 21.11.2011  
 (96) 11796822.2 25.09.2013  
 (87) WO2012066518, 21.11.2011  
 (97) 2640712, 25.09.2013 en  
 (54) 2-PIPERAZIN-1-YL-4H-1,3-BENZOTHIAZIN-4-ONE DERIVATIVES AND THEIR USE FOR THE TREATMENT OF MAMMALIAN INFECTIONS  
 (71) Ecole Polytechnique Fédérale de Lausanne (EPFL), EPFL-TTO Quartier de l'Innovation J, 1015 Lausanne, CH  
 (72) MAKAROV, Vadim, Sadovnicheskaya str. 41-1-65, Moscow 115035, RU  
 COLE, Stewart, Chemin de la Cocarde 17bis, CH-1014 Ecublens, CH
- 
- (51) MKP  
**A61M 5/315 (2006.01)** (97) **2600924 \***  
 (86) EP2011063445 04.08.2011  
 (96) 11740652.0 12.06.2013  
 (87) WO2012017036, 04.08.2011  
 (97) 2600924, 12.06.2013 en  
 (54) ASSEMBLY FOR A DRUG DELIVERY DEVICE, PISTON ROD AND DRUG DELIVERY DEVICE  
 (71) Sanofi-Aventis Deutschland GmbH, Brüningstraße 50, 65929 Frankfurt, DE  
 (72) NZIKE, Philippe, c/o Sanofi-Aventis Deutschland GmbH, 65926 Frankfurt am Main, DE  
 RAAB, Steffen, c/o Sanofi-Aventis Deutschland GmbH, 65926 Frankfurt am Main, DE  
 DASBACH, Uwe, c/o Sanofi-Aventis Deutschland GmbH, 65926 Frankfurt am Main, DE  
 BOESER, Uwe, c/o Sanofi-Aventis Deutschland GmbH, 65926 Frankfurt am Main, DE  
 BRÜGGEMANN, Ulrich, c/o Sanofi-Aventis Deutschland GmbH, 65926 Frankfurt am Main, DE  
 SOARES, Francisco, c/o Sanofi-Aventis Deutschland GmbH, 65926 Frankfurt am Main, DE

- (51) MKP  
**E05D 3/00 (2006.01)** (97) **2603656 \***  
**E05D 7/04 (2006.01)**  
**E05D 7/06 (2006.01)**  
**E05D 11/10 (2006.01)**  
 (86) IB2011053495 05.08.2011  
 (96) 11816164.5 19.06.2013  
 (87) WO2012020362, 05.08.2011  
 (97) 2603656, 19.06.2013 en  
 (54) A HINGE  
 (71) Manfred Frank Patent Holdings Limited, 222 Moumoukai Hill Road RD 5 Clevedon Papakura, Auckland, NZ  
 (72) FRANK, Manfred Johannes, 222 Moumoukai Hill Road RD 5 Clevedon Papakura, Auckland, NZ  
 GRAHAM, Michael Gordon, 387 Paparata Road Rd 1, Bombay, NZ  
 SCHEIB, Michael Kevin, 118 Ngapuhi Road Remuera, Auckland, NZ
- 
- (51) MKP  
**C07K 14/605 (2006.01)** (97) **2611825 \***  
**C07K 1/04 (2006.01)**  
 (86) EP2011064877 30.08.2011  
 (96) 11749833.7 10.07.2013  
 (87) WO2012028602, 30.08.2011  
 (97) 2611825, 10.07.2013 en  
 (54) SOLID PHASE SYNTHESIS OF H(GLY2)GLP-2  
 (71) Takeda GmbH, Byk-Gulden-Strasse 2, 78467 Konstanz, DE  
 (72) WELLINGS, Don, 3 Blue Cap Cottages Chester Road Sandiway, Northwich Cheshire CW9 2AU, GB
- 
- (51) MKP  
**A61B 10/02 (2006.01)** (97) **2621344 \***  
 (86) US2011053537 27.09.2011  
 (96) 11831319.6 07.08.2013  
 (87) WO2012047678, 27.09.2011  
 (97) 2621344, 07.08.2013 en  
 (54) APPARATUS, METHOD, AND SYSTEM FOR THE AUTOMATED IMAGING AND EVALUATION OF EMBRYOS, OOCYTES, AND STEM CELLS  
 (71) Auxogyn, Inc., 1490 O'Brien Drive Suite A, Menlo Park, California 94025, US  
 (72) LOEWKE, Kevin, 542 Fremont Street, Menlo Park, California 94025, US  
 YOUNG, Lisa, 168 Villa Nueva Court, Mountain View, California 94040, US  
 MENARD, Edward, 10 Clover Lane, San Carlos, California 94070, US  
 SHEN, Shehua, 18026 Harvest Lane, Saratoga, California 95070, US  
 GOLDENSTEIN, Lissa, 1075 Lassen Drive, Menlo Park, California 94025, US  
 MOUSSAVI, Farshid, 155 Buckeye Avenue, Oakland, California 94618, US  
 TUCKER, Eugene, 924 La Barbera Drive, San Jose, California 95126, US
- 
- (51) MKP  
**C07D 487/04 (2006.01)** (97) **2640725 \***  
 (86) US2011061351 18.11.2011  
 (96) 11793604.7 25.09.2013  
 (87) WO2012068440, 18.11.2011  
 (97) 2640725, 25.09.2013 en  
 (54) HETEROCYCLIC-SUBSTITUTED PYRROLOPYRIDINES AND PYRROLOPYRIMIDINES AS JAK INHIBITORS  
 (71) Incyte Corporation, Experimental Station Route 141 & Henry Clay Road Building 336, Wilmington, DE 19880, US  
 (72) RODGERS, James, D., 2 Hillside Lane, Landenberg PA 19350, US  
 ZHU, Wenyu, 21 Abel Place, Media PA 19063, US  
 GLENN, Joseph, 103 Deer Horn Drive, Mount Royal NJ 08061, US

- (51) MKP  
**A61K 9/20 (2006.01)** (97) **2598124 \***  
**A61K 31/4045 (2006.01)**  
**A61P 25/00 (2006.01)**
- (86) EP2011062634 22.07.2011  
(96) 11748604.3 05.06.2013  
(87) WO2012013595, 22.07.2011  
(97) 2598124, 05.06.2013 en  
(54) THREE-PHASE CONTROLLED-RELEASE TABLET COMPRISING MELATONIN AND PROCESS OF PREPARATION  
(71) Ambros Pharma S.r.l., Via Larga 2, 20122 Milano, IT  
(72) STANKOV, Bojidar Mihaylov, Largo Cavalieri di Malta 12, I-20146 Milan, IT
- 
- (51) MKP  
**A61M 15/00 (2006.01)** (97) **2643039 \***
- (86) GB2011052338 25.11.2011  
(96) 11791039.8 02.10.2013  
(87) WO2012069854, 25.11.2011  
(97) 2643039, 02.10.2013 en  
(54) INHALER  
(71) Vectura Delivery Devices Limited, 1 Prospect West, Chippenham, Wiltshire SN14 6FH, GB  
(72) MELINIOTIS, Andreas, 21 Cambridge Science Park Milton Road, Cambridgeshire CB4 0FJ, GB  
EASON, Stephen, 21 Cambridge Science Park Milton Road, Cambridgeshire CB4 0FJ, GB  
CLARKE, Roger, 21 Cambridge Science Park Milton Road, Cambridgeshire CB4 0FJ, GB  
McGUINNESS, Liam, 24 Hailes Wood Elsenham, Herts CM22 6DQ, GB
- 
- (51) MKP  
**C07D 307/82 (2006.01)** (97) **2595978 \***
- (86) HU2011000067 13.07.2011  
(96) 11746608.6 29.05.2013  
(87) WO2012010913, 13.07.2011  
(97) 2595978, 29.05.2013 en  
(54) NOVEL PROCESS FOR THE PREPARATION OF DRONEDARONE  
(71) SANOFI, 54 rue La Boétie, 75008 Paris, FR  
(72) FRIESZ, Antal, Chinoin Gyógyszer és Vegyészeti Termékek Gyára Zrt. Iparjog Tó u. 1 -5., H-1045 Budapest, HU  
HUSZÁR, Csaba, Chinoin Gyógyszer és Vegyészeti Termékek Gyára Zrt. Iparjog Tó u. 1 -5., H-1045 Budapest, HU
- 
- (51) MKP  
**A61K 9/06 (2006.01)** (97) **2605753 \***  
**A61K 47/32 (2006.01)**  
**A61K 9/00 (2006.01)**  
**A61K 31/498 (2006.01)**  
**A61K 47/10 (2006.01)**
- (86) EP2011068261 19.10.2011  
(96) 11771146.5 26.06.2013  
(87) WO2012052478, 19.10.2011  
(97) 2605753, 26.06.2013 en  
(54) TOPICAL GEL COMPOSITION  
(71) Galderma S.A., Zugerstrasse 8, 6330 Cham, CH  
(72) BUGE, Jean-Christophe, 60 Chemin Vallon Barla Le Val D'Azur Bat A, F-06200 Nice, FR  
NADAU FOURCADE, Karine, « Les Restanques de Vaugrenier » 1214 Avenue de Vaugrenier, F-06270 Villeneuve Loubet, FR  
MEUNIER, Cyril, 1 rue Saint Jacques, F-06250 Mougins, FR
- 
- (51) MKP  
**B64C 5/02 (2006.01)** (97) **2605961 \***  
**F02K 99/00 (2009.01)**
- (86) DK2011000047 18.05.2011  
(96) 11783103.2 26.06.2013  
(87) WO2011144210, 18.05.2011  
(97) 2605961, 26.06.2013 en  
(54) DEVICE FOR SANDBLASTING USES EXHAUST GAS FROM A JET ENGINE FOR BLASTING  
(71) Winterskov, Bo, Elmevej 3, 5800 Nyborg, DK  
(72) Winterskov, Bo, Elmevej 3, 5800 Nyborg, DK
- 
- (51) MKP  
**A61K 39/395 (2006.01)** (97) **2637690 \***
- (86) US2011060388 11.11.2011  
(96) 11839071.5 18.09.2013  
(87) WO2012065072, 11.11.2011  
(97) 2637690, 18.09.2013 en  
(54) IMPROVED HIGH CONCENTRATION ANTI-TNFalpha ANTIBODY LIQUID FORMULATIONS  
(71) AbbVie Biotechnology Ltd, Clarendon House 2, Church Street, HM 11 Hamilton, BM  
(72) NEU, Michael, Hinter Der Post 6, 68535 Edingen-Neckarhausen, DE  
TSCHOEPE, Markus, Wiesenstrasse 9, 67229 Laumersheim, DE  
WEBER, Carsten, Rietburgstrasse 29, 67133 Maxdorf, DE  
REDDEN, Laura, 1342 Pleasant Lane, Glenview, IL 60025, US  
FRAUNHOFER, Wolfgang, 6290 Murfield Drive, Gurnee, IL 60031, US
- 
- (51) MKP  
**H04L 12/24 (2006.01)** (97) **2617164 \***  
**G06F 17/30 (2006.01)**  
**H04L 29/06 (2006.01)**
- (86) NO2011000247 13.09.2011  
(96) 11825501.7 24.07.2013  
(87) WO2012036557, 13.09.2011  
(97) 2617164, 24.07.2013 en  
(54) SYSTEM AND METHOD FOR TRAFFIC ANALYSIS  
(71) Online Userfacts AS, P.O. Box 1545 Vika, 0117 Oslo, NO  
(72) VØIEN, Thomas, c/o Online Userfacts AS P.O. box 1545 Vika, N-0117 Oslo, NO
- 
- (51) MKP  
**C07D 403/04 (2006.01)** (97) **2635567 \***  
**C07D 403/14 (2006.01)**  
**C07D 413/12 (2006.01)**  
**A61K 31/404 (2006.01)**  
**A61P 29/00 (2006.01)**
- (86) HU2011000104 04.11.2011  
(96) 11788570.7 11.09.2013  
(87) WO2012059776, 04.11.2011  
(97) 2635567, 11.09.2013 en  
(54) INDOLE DERIVATIVES  
(71) Richter Gedeon Nyrt., Gyömrői út 19-21., 1103 Budapest, HU  
BEKE, Gyula, Kert u. 7-9., H-2092 Budakeszi, HU  
BÉNYEI, Gyula Attila, Szepes u. 28., H-1185 Budapest, HU  
BORZA, István, Margó Tivadar u. 218., H-1186 Budapest, HU  
BOZÓ, Éva, Liget u. 40., H-1102 Budapest, HU  
FARKAS, Sándor, Olajliget u. 42., H-1103 Budapest, HU  
HORNOK, Katalin, Paskál u. 12., H-1141 Budapest, HU  
PAPP, Andrea, Tölgyfa u. 14., H-1027 Budapest, HU  
VÁGÓ, István, Denevér u. 64., H-1121 Budapest, HU  
VASTAG, Mónika, Gyömrői út 19-21., H-1103 Budapest, HU
- 
- (51) MKP  
**C07D 217/26 (2006.01)** (97) **2595960 \***
- (86) GB2011001096 21.07.2011  
(96) 11740973.0 29.05.2013  
(87) WO2012010843, 21.07.2011  
(97) 2595960, 29.05.2013 en  
(54) SALT AND SOLVATES OF A TETRAHYDROISOQUINOLINE DERIVATIVE  
(71) Spinifex Pharmaceuticals Pty Ltd, South Yarra Corporate Centre Suite T18, Level 1 122 Toorak Road, South Yarra, VIC 3141, AU  
(72) MCCARTHY, Thomas, David, 40 Tooronga Road, Malvern East, Victoria 3145, AU  
KELLY, Peter, Michael, 36 Rimu Road, Kelburn, Wellington, NZ  
BOYLE, Craig, James, Stewart, 18 Whitton Close, Swavesey Cambridgeshire CB24 4RT, GB  
EBERLIN, Alexander, Redvers, 6 Scholars Walk, Cambridge CB4 1EJ, GB

(51) MKP  
**G01N 33/487 (2006.01)** (97) **2520932**  
 (96) 11164942.2 07.11.2012  
 (97) 2520932, 07.11.2012 en  
 (54) Test strip for a medical meter  
 (71) Sanofi-Aventis Deutschland GmbH, Brüningsstraße 50, 65929 Frankfurt, DE  
 (72) Teucher, Axel, c/o Sanofi-Aventis Deutschland GmbH, 65928 Frankfurt am Main, DE  
 Jugl, Michael, c/o Sanofi-Aventis Deutschland GmbH, 65926 Frankfurt am Main, DE

(51) MKP  
**B32B 7/06 (2006.01)** (97) **2637861 \***  
**B32B 7/12 (2006.01)**  
**B32B 27/32 (2006.01)**  
**B32B 27/36 (2006.01)**  
**B65D 77/20 (2006.01)**  
**C09J 7/02 (2006.01)**  
**C08J 7/04 (2006.01)**  
 (86) DK2011000130 08.11.2011  
 (96) 11785572.6 18.09.2013  
 (87) WO2012062317, 08.11.2011  
 (97) 2637861, 18.09.2013 en  
 (54) A LAMINATE FOR USE IN PACKAGES, A METHOD OF MAKING A RECLOSABLE LAMINATE AND USE THEREOF  
 (71) Danapak Flexibles A/S, Strudsbergsvej 3, 4200 Slagelse, DK  
 (72) SCHMIDT, Palle, c/o Danapak Flexibles A/S Strudsbergsvej 3, 4200 Slagelse, DK  
 JOHANSEN, Peter, c/o Danapak Flexibles A/S Strudsbergsvej 3, DK-4200 Slagelse, DK  
 DYDENSBORG, Else, c/o Danapak Flexibles A/S Strudsbergsvej 3, DK-4200 Slagelse, DK  
 BRØDSGAARD, Ole, c/o Danapak Flexibles A/S Strudsbergsvej 3, DK-4200 Slagelse, DK  
 WÆDELED, Benjamin, c/o Danapak Flexibles A/S Strudsbergsvej 3, DK-4200 Slagelse, DK  
 CHRISTENSEN, Lars, c/o Danapak Flexibles A/S Strudsbergsvej 3, DK-4200 Slagelse, DK

(51) MKP  
**E01B 7/24 (2006.01)** (97) **2557229**  
 (96) 12179937.3 13.02.2013  
 (97) 2557229, 13.02.2013 en  
 (54) Heating device for rails  
 (71) Accomandita Tecnologie Speciali Energia SPA in Breve Accomandita T.S.E. SPA, Strada San Giuseppe, 19, 43039 Salsomaggiore Terme (PR), IT  
 (72) Cenci, Enzo, c/o ACCOMANDITA TECNOLOGIE SPECIALI ENERGIA SPA IN BREVE ACCOMANDITA T.S.E. SPA Strada San Giuseppe, 19, 43039 Salsomaggiore Terme (PR), IT

(51) MKP  
**B32B 37/12 (2006.01)** (97) **2607076 \***  
**B32B 38/14 (2006.01)**  
**B41M 1/00 (2006.01)**  
**B32B 27/00 (2006.01)**  
**B32B 27/10 (2006.01)**  
 (86) CN2011072052 22.03.2011  
 (96) 11817677.5 26.06.2013  
 (87) WO2012022149, 22.03.2011  
 (97) 2607076, 26.06.2013 en  
 (54) PERSPECTIVE FILM AND PREPARING METHOD THEREOF  
 (71) Wen, Minghua, Room 1-402 Huafeng Building Zhongling North Road Zhongcun Town Panyu, Guangzhou, Guangdong 511495, CN  
 (72) Wen, Minghua, Room 1-402 Huafeng Building Zhongling North Road Zhongcun Town Panyu, Guangzhou, Guangdong 511495, CN

(51) MKP  
**A61K 39/00 (2006.01)** (97) **2621524 \***  
**A61K 39/12 (2006.01)**  
**A61K 39/145 (2006.01)**  
**A61K 39/39 (2006.01)**  
 (86) EP2011067080 30.09.2011  
 (96) 11770724.0 07.08.2013  
 (87) WO2012042003, 30.09.2011  
 (97) 2621524, 07.08.2013 en  
 (54) IMPROVED VACCINE COMPOSITIONS  
 (71) Eurocine Vaccines AB, Karolinska Science Park Fogdevreten 2, 171 77 Stockholm, SE  
 (72) SCHRÖDER, Ulf, Spelmanshöjden 14, S-174 50 Sundbyberg, SE  
 ARWIDSSON, Hans, Tornstigen 4, S-64542 Strängnäs, SE

(51) MKP  
**C12N 5/074 (2010.01)** (97) **2598633 \***  
 (86) IB2011002167 29.07.2011  
 (96) 11764293.4 05.06.2013  
 (87) WO2012014076, 29.07.2011  
 (97) 2598633, 05.06.2013 en  
 (54) LIVER ORGANOID, USES THEREOF AND CULTURE METHOD FOR OBTAINING THEM  
 (71) Koninklijke Nederlandse Akademie van Wetenschappen, Hubrecht Institute Uppsalalaan 8, 3584 CT Utrecht, NL  
 (72) HUCH ORTEGA, Meritxell, Willem Barentszstraat 25-11, 3572 PB Utrecht, NL  
 CLEVERS, Johannes, Carolus, Ruysdaellaan 7, 3712 AP Huis ter Heide, NL

(51) MKP  
**A61P 5/18 (2006.01)** (97) **2642980 \***  
**A61K 9/14 (2006.01)**  
**A61K 9/00 (2006.01)**  
 (86) US2011062085 23.11.2011  
 (96) 11794307.6 02.10.2013  
 (87) WO2012071535, 23.11.2011  
 (97) 2642980, 02.10.2013 en  
 (54) PEDIATRIC FORMULATION  
 (71) Amgen Inc., 1120 Veterans Boulevard, South San Francisco, CA 94080, US  
 (72) BI, Mingda, 3853 Santa Lucia Street, Simi Valley, California 93063, US  
 ALVAREZ-NUNEZ, Fernando, 3866 Briar Ridge Court, Newbury Park, California 91320, US  
 ALVAREZ, Francisco Javier, 817 Paseo De Leon, Newbury Park, California 91320, US

(51) MKP  
**A61B 17/072 (2006.01)** (97) **2517641**  
 (96) 12166167.2 31.10.2012  
 (97) 2517641, 31.10.2012 en  
 (54) Staple cartridge comprising a variable thickness compressible portion  
 (71) Ethicon Endo-Surgery, Inc., 4545 Creek Road, Cincinnati, OH 45242, US  
 (72) Shelton, IV, Frederick E., 245 East Main Street, Hillsboro, OH Ohio 45133, US  
 Baxter, III, Chester O., 6375 Pawnee Ridge, Loveland, OH Ohio 45140, US  
 Swayze, Jeffrey S., 7047 Birchley Drive, Hamilton, OH Ohio 45011, US  
 Morgan, Jerome R., 3275 S. Whitetree Circle, Cincinnati, OH Ohio 45236, US  
 Rhee, Sora, 353 West 4th Street, Cincinnati, OH Ohio 45202, US  
 Aronhalt, Taylor W., 306 Beech Road, Loveland, OH Ohio 45140, US

- (51) MKP  
**C07D 401/14 (2006.01)** (97) **2598498 \***  
**A61K 31/47 (2006.01)**  
**A61K 31/4704 (2006.01)**  
**A61P 31/12 (2006.01)**  
**C07D 403/14 (2006.01)**  
**C07D 417/14 (2006.01)**  
**C07D 471/04 (2006.01)**  
**C07D 491/10 (2006.01)**  
(86) EP2011062774 26.07.2011  
(96) 11740622.3 05.06.2013  
(87) WO2012013643, 26.07.2011  
(97) 2598498, 05.06.2013 en  
(54) HETERO-BICYCLIC DERIVATIVES AS HCV INHIBITORS  
(71) Janssen R&D Ireland, Eastgate Village, Eastgate, Little Island, County Cork, IE  
(72) VANDYCK, Koen, Deurnestraat 74, B-3583 Paal-Beringen, BE  
VERSCHUEREN, Wim Gaston, De Wittestraat 5, B-2600 Berchem, BE  
RABOISSON, Pierre Jean-Marie Bernard, Rue Jolie 3, B-1331 Rosières, BE
- 
- (51) MKP  
**G06K 7/08 (2006.01)** (97) **2628128 \***  
(86) US2011055386 07.10.2011  
(96) 11833172.7 21.08.2013  
(87) WO2012051070, 07.10.2011  
(97) 2628128, 21.08.2013 en  
(54) SYSTEMS AND METHODS FOR FINANCIAL TRANSACTION THROUGH MINIATURIZED CARD READER WITH DECODING ON A SELLER'S MOBILE DEVICE  
(71) Square, Inc., 110 Fifth Street, San Francisco, CA 94103, US  
(72) MCKELVEY, James, M., 7501 Scenic Highway, Pensacola FL 32504, US  
WEN, Xuancong, 901 Mission Street Suite 104, San Francisco CA 94103, US  
DORSEY, Jack, 901 Mission Street Suite 104, San Francisco CA 94103, US
- 
- (51) MKP  
**A01G 9/12 (2006.01)** (97) **2608655 \***  
**A01G 13/10 (2006.01)**  
**A01M 29/00 (2011.01)**  
**A01G 13/02 (2006.01)**  
(86) DK2011000091 10.08.2011  
(96) 11751799.5 03.07.2013  
(87) WO2012025116, 10.08.2011  
(97) 2608655, 03.07.2013 en  
(54) DEVICE FOR PROCESSING LEADERS OF CONIFERS, GROWTH INHIBITOR DEVICE, AND BIRD PERCH DEVICE  
(71) Thøstesen, Svend Erik, Kasthøjvej 2, 6862 Tistrup, DK  
(72) Thøstesen, Svend Erik, Kasthøjvej 2, 6862 Tistrup, DK
- 
- (51) MKP  
**B60J 1/00 (2006.01)** (97) **2635452 \***  
**B62D 65/06 (2006.01)**  
**B25B 11/00 (2006.01)**  
(86) GB2011052130 02.11.2011  
(96) 11781584.5 11.09.2013  
(87) WO2012059755, 02.11.2011  
(97) 2635452, 11.09.2013 en  
(54) WINDSCREEN INSTALLATION APPARATUS AND METHOD  
(71) Belron Hungary Kft - Zug Branch, Gotthardstrasse 20, 6304 Zug, CH  
(72) FINCK, William, 31 Doddinghurst Road Brentwood, Essex CM15 9EP, GB  
DAVIES, Christopher, Ty Coch Farm Pembrey Road, Kidwelly SA17 4TF, GB
- 
- (51) MKP  
**C12N 7/00 (2006.01)** (97) **2640831 \***  
**A61K 39/395 (2006.01)**  
(86) US2011001917 17.11.2011  
(96) 11817443.2 25.09.2013  
(87) WO2012099566, 17.11.2011  
(97) 2640831, 25.09.2013 en  
(54) INFLUENZA VIRUS NEUTRALIZING AGENTS THAT MIMIC THE BINDING SITE OF AN INFLUENZA NEUTRALIZING ANTIBODY  
(71) Sea Lane Biotechnologies, Inc., 356 Selby Lane, Atherton, CA 94027, US  
(72) HOROWITZ, Lawrence, 362 Selby Lane, Atherton, CA 94027, US  
BHATT, Ramesh, 2729 Waltham Cross, Belmont, CA 94002, US  
KASHYAP, Arun, K., 35288 Sevem Drive, Newark, CA 94539, US
- 
- (51) MKP  
**H01L 31/052 (2006.01)** (97) **2620987**  
**H01L 31/058 (2006.01)**  
(96) 12000537.6 31.07.2013  
(97) 2620987, 31.07.2013 fr  
(54) Devices and systems for concentration / collection of solar energy and industrial and household applications  
(71) Arfak Energie, Route de Demigny, 71100 Chalon sur Saône, FR  
(72) Roussac, Arnaud, 16 Avenue du 8 septembre 1944, 21200 Beaune, FR
- 
- (51) MKP  
**C07F 7/18 (2006.01)** (97) **2634171 \***  
**A61P 19/10 (2006.01)**  
**C07C 401/00 (2006.01)**  
**A61K 31/593 (2006.01)**  
(86) JP2011074414 24.10.2011  
(96) 11836202.9 04.09.2013  
(87) WO2012057068, 24.10.2011  
(97) 2634171, 04.09.2013 en  
(54) 23-YNE-VITAMIN D3 DERIVATIVE  
(71) Teijin Pharma Limited, 2-1, Kasumigaseki 3-chome Chiyodaku, Tokyo 100-0013, JP  
(72) SAITO, Hiroshi, c/o Teijin Pharma Limited Tokyo Research Center 3-2 Asahigaoka 4-chome, Hino-shi Tokyo 191-0065, JP  
KOMIYAMA, Masato, c/o Teijin Pharma Limited Tokyo Research Center 3-2 Asahigaoka 4-chome, Hino-shi Tokyo 191-0065, JP  
OCHIAI, Eiji, c/o Teijin Pharma Limited Tokyo Research Center 3-2 Asahigaoka 4-chome, Hino-shi Tokyo 191-0065, JP  
TAKAGI, Kenichiro, c/o Teijin Pharma Limited Tokyo Research Center 3-2 Asahigaoka 4-chome, Hino-shi Tokyo 191-0065, JP  
CHIDA, Takayuki, c/o Teijin Pharma Limited Tokyo Research Center 3-2 Asahigaoka 4-chome, Hino-shi Tokyo 191-0065, JP  
FUJITA, Mariko, c/o Teijin Pharma Limited Tokyo Research Center 3-2 Asahigaoka 4-chome, Hino-shi Tokyo 191-0065, JP  
IMAZUMI, Keiichiro, c/o Teijin Pharma Limited Tokyo Research Center 3-2 Asahigaoka 4-chome, Hino-shi Tokyo 191-0065, JP  
KANeko, Toshiyuki, c/o Teijin Pharma Limited Tokyo Research Center 3-2 Asahigaoka 4-chome, Hino-shi Tokyo 191-0065, JP
- 
- (51) MKP  
**F21S 9/03 (2006.01)** (97) **2638319 \***  
**F21V 14/00 (2006.01)**  
**F21V 17/00 (2006.01)**  
**F21V 21/30 (2006.01)**  
(86) US2011060503 13.11.2011  
(96) 11840653.7 18.09.2013  
(87) WO2012065150, 13.11.2011  
(97) 2638319, 18.09.2013 en  
(54) ADJUSTABLE SOLAR CHARGED LAMP  
(71) Katsaros, Stephen, 650 Grant Street, Denver, CO 80203, US  
(72) Katsaros, Stephen, 650 Grant Street, Denver, CO 80203, US

- (51) MKP  
**C07D 223/16 (2006.01)** (97) **2607354**  
(96) 12197929.8 26.06.2013  
(97) 2607354, 26.06.2013 fr
- (54) Process for the synthesis of ivabradine and addition salts thereof and its pharmaceutically acceptable acid
- (71) Les Laboratoires Servier, 35, rue de Verdun, 92284 Suresnes Cedex, FR
- (72) Renaud, Jean-Luc, 5 rue des Alouettes, 14112 Bieville-Beuville, FR  
Pannetier, Nicolas, 8 rue des Carmes, 14000 Caen, FR  
Gaillard, Sylvain, 25 rue de la Haie Vigne, 14000 Caen, FR  
Lecouve, Jean-Pierre, 93, rue du Docteur Vigné, 76600 Le Havre, FR  
Vaysse-Ludot, Lucile, 150, route de Rançon, 76490 Saint-Wandrille-Rançon, FR
- 
- (51) MKP  
**H01R 25/14 (2006.01)** (97) **2330694**  
**H01R 29/00 (2006.01)**  
(96) 10193249.9 08.06.2011  
(97) 2330694, 08.06.2011 en
- (54) Power take-off adapter for conductor track
- (71) Nordic Aluminium Oyj, Kaapelitie 68, 02490 Pikkala, FI
- (72) Nieminen, Fero, Jaäskeläntie 33, 02660 Espoo, FI
- 
- (51) MKP  
**A61K 39/395 (2006.01)** (97) **2632492 \***  
(86) US2011057519 24.10.2011  
(96) 11838481.7 04.09.2013  
(87) WO2012061074, 24.10.2011  
(97) 2632492, 04.09.2013 en
- (54) METHODS FOR DETERMINING DIFFERENCES IN ALPHA-4 INTEGRIN ACTIVITY BY CORRELATING DIFFERENCES IN sVCAM AND/OR sMAdCAM LEVELS
- (71) Elan Pharmaceuticals, Inc., 300 Technology Square, Cambridge, MA 02139, US
- (72) CHACKERIAN, Alisha, A., 895 Hazelnut Court, Sunnyvale California 94087, US
- 
- (51) MKP  
**B02C 13/04 (2006.01)** (97) **2603322 \***  
**B68G 1/00 (2006.01)**  
**B02C 13/284 (2006.01)**  
**B02C 18/18 (2006.01)**  
(86) DK2011000085 19.07.2011  
(96) 11737887.7 19.06.2013  
(87) WO2012019605, 19.07.2011  
(97) 2603322, 19.06.2013 en
- (54) A METHOD AND A SYSTEM FOR THE MANUFACTURE OF A PLASTICS FILLING MATERIAL
- (71) Fossfill ApS, Egebjerg Alle 14, 2900 Hellerup, DK
- (72) FOSS, Adam, Fossfill ApS Egebjerg Alle 14, DK-2900 Hellerup, DK
- 
- (51) MKP  
**A61K 31/69 (2006.01)** (97) **2613788 \***  
**C07F 5/02 (2006.01)**  
**A61P 31/04 (2006.01)**  
(86) US2011050728 07.09.2011  
(96) 11758050.6 17.07.2013  
(87) WO2012033858, 07.09.2011  
(97) 2613788, 17.07.2013 en
- (54) BORON-CONTAINING SMALL MOLECULES
- (71) Anacor Pharmaceuticals, Inc., 1020 East Meadow Circle, Palo Alto, CA 94303, US
- (72) HERNANDEZ, Vincent, S., 287 Gilchrist Lane, Watsonville CA 95076, US  
DING, Charles, 23 Treetop Lane, San Mateo CA 94402, US  
PLATTNER, Jacob, J., 119 Via Floreado, Orinda CA 94563, US  
ALLEY, Michael Richard, Kevin, 3751 Lillick Drive, Santa Clara CA 95051, US  
ROCK, Fernando, 1183 Lisa Lane, Los Altos CA 94024, US  
ZHANG, Suoming, 3702 Redwood Circle, Palo Alto CA 94306, US  
EASOM, Eric, 1558 Mercy Street, Mountain View CA 94041, US  
LI, Xianfeng, 10059 Craft Drive, Cupertino CA 95014, US  
ZHOU, Ding, 2nd Floor Bldg. 1B 528 Rui Qing Road Shanghai, Pudong 201201, CN
- 
- (51) MKP  
**B27K 5/04 (2006.01)** (97) **2524780**  
**B05B 15/12 (2006.01)**  
**B07B 9/02 (2006.01)**  
**B07B 15/00 (2006.01)**  
**B27L 11/00 (2006.01)**  
**F26B 17/00 (2006.01)**  
**B05B 13/02 (2006.01)**  
**E04B 1/76 (2006.01)**  
(96) 11166268.0 21.11.2012  
(97) 2524780, 21.11.2012 de
- (54) Tensioning assembly and method for its production
- (71) Glesser, Erika, Unteres Schwengifeld 7, 4438 Langenbruck, CH
- (72) Glesser, Erika, Unteres Schwengifeld 7, 4438 Langenbruck, CH
- 
- (51) MKP  
**A43C 7/04 (2006.01)** (97) **2601852**  
**A43C 7/00 (2006.01)**  
**A43C 7/08 (2006.01)**  
(96) 11192046.8 12.06.2013  
(97) 2601852, 12.06.2013 en
- (54) Binding assembly
- (71) Jin Jiang City, Shoes-Lock Co., Ltd., No. 9, Dragon Spring Route Fu Pu Development Zone, JinJiang City, Fujian, CN  
Chen, Yi-Liang, 3F.-6, No.112, Zhongming S. Rd., West Dist., Taichung City, TW
- 
- (51) MKP  
**A61K 31/403 (2006.01)** (97) **2601942**  
**A61P 25/28 (2006.01)**  
**A61K 31/13 (2006.01)**  
(96) 12195997.7 12.06.2013  
(97) 2601942, 12.06.2013 fr
- (54) Novel combination of 4-{3-[cis-hexahydrocyclopenta[c]pyrrol-2(1h)-yl]propoxy}benzamide and an acetylcholinesterase inhibitor, and pharmaceutical compositions containing same
- (71) Les Laboratoires Servier, 35, rue de Verdun, 92284 Suresnes Cedex, FR
- (72) Sors, Aurore, 131, rue de Javel, 75015 Paris, FR  
Trocme-Thibierge, Caryn, 74, rue Adolphe Guyot, 92270 Bois Colombes, FR  
Merdes, Annette, Wessobrunner Strasse 24, 81377 Munich, DE
- 
- (51) MKP  
**A61K 36/03 (2006.01)** (97) **2548564**  
**A61K 36/81 (2006.01)**  
**A61K 36/71 (2006.01)**  
**A61K 36/185 (2006.01)**  
**A61P 3/04 (2006.01)**  
**A61K 36/72 (2006.01)**  
(96) 12176150.6 23.01.2013  
(97) 2548564, 23.01.2013 de
- (54) Pharmaceutical agent, nutrition for a patient and weight reduction method
- (71) Schnappinger, Uta, Hinter der Lieth 54, 27632 Midlum, DE
- (72) Schnappinger, Uta, Hinter der Lieth 54, 27632 Midlum, DE
- 
- (51) MKP  
**H04L 29/08 (2006.01)** (97) **2638684 \***  
**G01D 4/00 (2006.01)**  
**G08B 25/00 (2006.01)**  
(86) US2011056866 19.10.2011  
(96) 11776671.7 18.09.2013  
(87) WO2012064474, 19.10.2011  
(97) 2638684, 18.09.2013 en
- (54) SYSTEMS FOR DETECTING, COLLECTING, COMMUNICATING, AND USING INFORMATION ABOUT ENVIRONMENTAL CONDITIONS AND OCCURRENCES
- (71) Landis + Gyr Innovations, Inc., 30000 Mill Creek Avenue, Alpharetta, GA 30022, US
- (72) CHASKO, Stephen, J., 8101 Deer Creek Place, Alpharetta Georgia 30004, US

- (51) MKP  
**A41F 15/00 (2006.01)** (97) **2597983 \***  
**A41C 3/00 (2006.01)**
- (86) IB2011001633 13.07.2011  
(96) 11755433.7 05.06.2013  
(87) WO2012014030, 13.07.2011  
(97) 2597983, 05.06.2013 en  
(54) SELF-ADJUSTING BRA STRAP  
(71) Stretchline Intellectual Properties Limited, Offshore Incorporation Centre, Road Town, Tortola, VG  
(72) WEERAWANSA, Krishan, Stretchline (Pvt) Limited Lot 9 Biyagama Export Processing Zone Walgama, Malwana, LK DE ALWIS, Nalantha, 100/3 Wattalpola, Panadura, LK
- 
- (51) MKP  
**A47J 19/02 (2006.01)** (97) **2600926 \***  
**A61G 10/02 (2006.01)**  
**A61M 15/02 (2006.01)**  
**A47J 42/32 (2006.01)**  
**A61M 16/00 (2006.01)**  
**A61M 15/00 (2006.01)**
- (86) IB2011053381 29.07.2011  
(96) 11754739.8 12.06.2013  
(87) WO2012017365, 29.07.2011  
(97) 2600926, 12.06.2013 en  
(54) DEVICE FOR SUPPLYING MICRONIZED MEDICAL SALT  
(71) Tecno Sun S.r.l., Via Gavardina 5, 25081 Bedizzole (BS), IT  
(72) MONTERENZI, Roberto, c/o Tecno Sun S.r.l. Via Gavardina 5, I-25081 Bedizzole (BS), IT
- 
- (51) MKP  
**A01N 43/54 (2006.01)** (97) **2603081 \***  
**C07D 471/22 (2006.01)**  
**C07D 471/04 (2006.01)**
- (86) US2011046926 08.08.2011  
(96) 11816874.9 19.06.2013  
(87) WO2012021444, 08.08.2011  
(97) 2603081, 19.06.2013 en  
(54) BESYLATE SALT OF A BTK INHIBITOR  
(71) Celgene Avilomics Research, Inc., 45 Wiggins Avenue, Bedford, MA 01730, US  
(72) WITOWSKI, Steven, Richard, 171 Laurel Street, Melrose, MA 02176, US  
WESTLIN III, William, Frederick, 130 Barteau Lane, Boxborough, MA 01719, US  
TESTER, Richland, Wayne, 23 Gregoire Drive, Marlborough, MA 01752, US
- 
- (51) MKP  
**E04B 9/18 (2006.01)** (97) **2470729 \***  
**F16B 5/07 (2006.01)**  
**F16B 5/10 (2006.01)**
- (86) EP2010005833 23.09.2010  
(96) 10760927.3 04.07.2012  
(87) WO2011038859, 23.09.2010  
(97) 2470729, 04.07.2012 de  
(54) Assembled component and method for producing an assembled component  
(71) Protektorwerk Florenz Maisch GmbH & Co. KG, Viktoriastrasse 58, 76571 Gaggenau, DE  
(72) STUDNIORZ, Thilo, Am Rosenkranz 43, 09306 Rochlitz, DE
- 
- (51) MKP  
**C07D 401/06 (2006.01)** (97) **2635563 \***  
**A61K 31/435 (2006.01)**  
**A61P 3/00 (2006.01)**
- (86) US2011059331 04.11.2011  
(96) 11785232.7 11.09.2013  
(87) WO2012061708, 04.11.2011  
(97) 2635563, 11.09.2013 en  
(54) CRYSTALLINE FORMS OF HYDROCHLORIDE SALT OF (4A-R,9A-S) -1- (1H - BENZOIMIDAZOLE- 5 -CARBONYL) -2, 3, 4, 4A, 9, 9A - HEXAHYDRO -1H- INDENO [2, 1 -B] PYRIDINE- 6 -CARBONITRILE AND THEIR USE AS HSD 1 INHIBITORS  
(71) Boehringer Ingelheim International GmbH, Binger Strasse 173, 55216 Ingelheim am Rhein, DE  
(72) ECKHARDT, Matthias, Boehringer Ingelheim GmbH Corporate Patents Binger Strasse 173, 55216 Ingelheim am Rhein, DE  
MARTIN, Hans-Juergen, Boehringer Ingelheim GmbH Corporate Patents Binger Strasse 173, 55216 Ingelheim am Rhein, DE  
SCHUEHLE, Martin, Boehringer Ingelheim GmbH Corporate Patents Binger Strasse 173, 55216 Ingelheim am Rhein, DE  
SICK, Sandra, Boehringer Ingelheim GmbH Corporate Patents Binger Strasse 173, 55216 Ingelheim am Rhein, DE  
YANG, Bing-Shiou, Boehringer Ingelheim Pharmaceuticals Inc. 900 Ridgebury Road Ridgefield, CT 06877, US
- 
- (51) MKP  
**A61K 31/4468 (2006.01)** (97) **2616074 \***  
**A61K 31/454 (2006.01)**  
**A61P 3/04 (2006.01)**  
**C07D 413/14 (2006.01)**
- (86) US2011051821 15.09.2011  
(96) 11764392.4 24.07.2013  
(87) WO2012037393, 15.09.2011  
(97) 2616074, 24.07.2013 en  
(54) PIPERIDINYL-SUBSTITUTED LACTAMS AS GPR119 MODULATORS  
(71) Array Biopharma, Inc., 3200 Walnut Street, Boulder, CO 80301, US  
(72) AICHER, Thomas Daniel, 3070 N. Torreys Peak Drive, Superior, Colorado 80027, US  
BENCSEK, Josef R., 1529 Prairie Hawk Drive, Longmont, Colorado 80501, US  
BOYD, Steven Armen, 5665 St. Vrain Road, Longmont, Colorado 80021, US  
CONDROSKI, Kevin Ronald, 13892 Fox Ridge Drive, Broomfield, Colorado 80020, US  
FELL, Jay Bradford, c/o Array BioPharma Inc. 3200 Walnut Street, Boulder, Colorado 80301, US  
FISCHER, John P., c/o Array BioPharma Inc. 3200 Walnut Street, Boulder, Colorado 80301, US  
HINKLIN, Ronald Jay, c/o Array BioPharma Inc. 3200 Walnut Street, Boulder, Colorado 80301, US  
PRATT, Scott Alan, 11713 Victor Drive, Longmont, Colorado 80504, US  
SINGH, Ajay, 3800 Pike Road Unit 3-202, Longmont, Colorado 80503, US  
TURNER, Timothy M., 1028 Morning Dove Drive, Longmont, Colorado 80501, US
- 
- (51) MKP  
**A61B 17/072 (2006.01)** (97) **2517647**
- (96) 12166184.7 31.10.2012  
(97) 2517647, 31.10.2012 en  
(54) Tissue thickness compensator comprising portions having different properties  
(71) Ethicon Endo-Surgery, Inc., 4545 Creek Road, Cincinnati, OH 45242, US  
(72) Shelton, IV, Frederick E., 245 East Main Street, Hillsboro, OH Ohio 45133, US  
Rhee, Sora, 353 West 4th Street, Cincinnati, OH Ohio 45202, US  
Baxter, III, Chester O., 6375 Pawnee Ridge, Loveland, OH Ohio 45140, US  
Aronhalt, Taylor W., 306 Beech Road, Loveland, OH Ohio 45140, US



(51) MKP  
**A61K 9/20 (2006.01)** (97) **2635264 \***  
**A61P 1/10 (2006.01)**  
**A61K 31/765 (2006.01)**  
(86) GB2011001560 04.11.2011  
(96) 11785049.5 11.09.2013  
(87) WO2012059724, 04.11.2011  
(97) 2635264, 11.09.2013 en  
(54) FORMULATIONS COMPRISING POLYETHYLENE GLYCOL  
(71) Norgine B.V., Hogeihlweg 7, 1101 CA Amsterdam ZO, NL  
(72) STEIN, Peter, Norgine Ltd Norgine House Widewater Place  
Harefield, Uxbridge Middlesex UB9 6NS, GB  
COX, Ian, Norgine Ltd New Road Tir-y-Berth, Hengoed Mid-  
Glamorgan CF82 8SJ, GB  
SMITH, Samuel, Norgine Ltd New Road Tir-y-Berth, Hengoed  
Mid-Glamorgan CF82 8SJ, GB  
JONES, Leighton, Norgine Ltd New Road Tir-y-Berth, Hengoed  
Mid-Glamorgan CF82 8SJ, GB  
PLESSL, Jörg, Norgine Ltd New Road Tir-y-Berth, Hengoed  
Mid-Glamorgan CF82 8SJ, GB

(51) MKP  
**A61K 31/365 (2006.01)** (97) **2624827 \***  
**A61P 3/10 (2006.01)**  
**A61P 25/28 (2006.01)**  
**A61P 35/00 (2006.01)**  
(86) SE2011051207 07.10.2011  
(96) 11831013.5 14.08.2013  
(87) WO2012047171, 07.10.2011  
(97) 2624827, 14.08.2013 en  
(54) PICROPODOPHYLLIN POLYMORPHS B OR C FOR USE IN  
CANCER THERAPY  
(71) Axelar AB, Nobels väg 3, 171 65 Solna, SE  
(72) BISLAT, Mikael, Utsiktsvägen 34, Strängnäs 645 42, SE  
BRISANDER, Magnus, Rapsvägen 15, Ekerö 178 35, SE

(51) MKP  
**A47G 19/16 (2006.01)** (97) **2596725 \***  
(86) RU2011000689 08.09.2011  
(96) 11818457.1 29.05.2013  
(87) WO2012023883, 08.09.2011  
(97) 2596725, 29.05.2013 fr  
(54) DISPOSABLE STRAINER FOR INFUSING TEA WITH A  
SQUEEZING SYSTEM  
(71) Merinova, Elena Arkadyevna, Ul. Lenina 41-b/n, Kirov 610000,  
RU  
(72) Merinova, Elena Arkadyevna, Ul. Lenina 41-b/n, Kirov 610000,  
RU

(51) MKP  
**A61K 47/26 (2006.01)** (97) **2627319 \***  
**A61K 47/38 (2006.01)**  
**A61K 47/20 (2006.01)**  
**A61K 9/20 (2006.01)**  
**A61K 31/444 (2006.01)**  
(86) US2011056275 14.10.2011  
(96) 11779278.8 21.08.2013  
(87) WO2012051488, 14.10.2011  
(97) 2627319, 21.08.2013 en  
(54) PHARMACEUTICAL COMPOSITIONS CONTAINING A  
DGAT1 INHIBITOR  
(71) Novartis AG, Lichtstrasse 35, 4056 Basel, CH  
(72) WEN, Hong, 11505 Alcinda Lane, North Potomac Maryland  
20878, US  
KUMARAPERUMAL, Natrajan, 40-B, Byrne Court, Wayne New  
Jersey 07470, US  
NAUSE, Richard, Novartis Pharmaceuticals Corporation One  
Health Plaza East Hanover, New Jersey 07936-1080, US

(51) MKP  
**E06B 3/92 (2006.01)** (97) **2639391**  
**E05D 15/06 (2006.01)**  
**E05D 15/58 (2006.01)**  
(96) 12159701.7 18.09.2013  
(97) 2639391, 18.09.2013 de  
(54) Sliding and pivoting leaf system  
(71) Sunflex Aluminiumsysteme GmbH, Im Ruttenberge 12, 57482  
Wenden-Gerlingen, DE  
(72) Schneider, Dennis Nicolas, Theodor-Heuss-Ring 32, 50668  
Köln, DE

(51) MKP  
**A61K 31/775 (2006.01)** (97) **2635290 \***  
**C08G 65/38 (2006.01)**  
**A61K 35/00 (2006.01)**  
(86) IB2011054903 03.11.2011  
(96) 11797363.6 11.09.2013  
(87) WO2012059884, 03.11.2011  
(97) 2635290, 11.09.2013 en  
(54) NOVEL SELF-ASSEMBLING POLYPHENOL-QUINONOID  
POLYMER DERIVATIVES AND USES THEREOF  
(71) ABRA Pharmaceuticals sàrl, Avenue de Rumine 20, 1003  
Lausanne, CH  
(72) BRUCCOLERI, Aldo, 6908 Deer Street Lacombe, Alberta T4L  
1Z1, CA

(51) MKP  
**C07D 487/04 (2006.01)** (97) **2643324 \***  
**A61K 31/5517 (2006.01)**  
**A61P 31/10 (2006.01)**  
(86) EP2011070458 18.11.2011  
(96) 11784506.5 02.10.2013  
(87) WO2012069380, 18.11.2011  
(97) 2643324, 02.10.2013 en  
(54) ANTIFUNGAL 5,6-DIHYDRO-4H-PYRROLO[1,2-A]  
[1,4]-BENZODIAZEPINES AND 6H-PYRROLO[1,2-A]  
[1,4]BENZODIAZEPINES SUBSTITUTED WITH PHENYL  
DERIVATIVES  
(71) Janssen Pharmaceutica, N.V., Turnhoutseweg 30, 2340  
Beerse, BE  
(72) MEERPOEL, Lieven, c/o Janssen Pharmaceutica NV  
Turnhoutseweg 30, B-2340 Beerse, BE  
MAES, Louis, Jules, Roger, Marie, c/o University of Antwerp  
Prinsstraat 13, B-2000 Antwerp, BE  
DE WIT, Kelly, Hendrik van Boutersemstraat 15, B-2170  
Merksem, BE

(51) MKP  
**F02M 59/46 (2006.01)** (97) **2557307**  
**F02M 63/02 (2006.01)**  
(96) 11176834.7 13.02.2013  
(97) 2557307, 13.02.2013 en  
(54) Pump head for a fuel pump  
(71) Delphi Technologies Holding S.à.r.l., Avenue de Luxembourg,  
4940 Bascharage, LU  
(72) Whitehead, Leon, 38 Wyles Road, Chatham, Kent ME4 6LD,  
GB  
Jury, Thomas, 67 Beanshaw, London, SE9 3HL, GB  
Hennig, Christian, 14 Ashcroft Road, Wainscott, Kent ME3  
8GS, GB  
Jorach, Rainer, Hegelstr 9, 71686 Remseck, DE

(51) MKP  
**A61K 39/00 (2006.01)** (97) **2598164 \***  
(86) US2011039060 03.06.2011  
(96) 11790462.3 05.06.2013  
(87) WO2011153431, 03.06.2011  
(97) 2598164, 05.06.2013 en  
(54) PERIPHERAL BLOOD SPARC ANTIBODIES AND USES  
THEREOF  
(71) Abraxis BioScience, LLC, 11755 Wilshire Boulevard Suite  
2100, Los Angeles, CA 90025, US  
(72) TRIEU, Vuong, 4003 Jim Bowie Boulevard, Agoura Hills,  
California 91301, US  
LIU, Xiping, 6035 Camellia Ave., Temple City, California 91780,  
US  
DESAI, Beil, 11755 Wilshire Boulevard Suite 2000, Los  
Angeles, California 90025, US

- (51) MKP  
**A61B 17/15 (2006.01)** (97) **2613718 \***  
 (86) US2011050670 07.09.2011  
 (96) 11757511.8 17.07.2013  
 (87) WO2012033821, 07.09.2011  
 (97) 2613718, 17.07.2013 en  
 (54) POSITIONING APPARATUS AND METHOD FOR A PROSTHETIC IMPLANT  
 (71) The Cleveland Clinic Foundation, 9500 Euclid Avenue, Cleveland, OH 44195, US  
 (72) IANNOTTI, Joseph, P., 17504 Willow Wood Drive, Strongsville, OH 44136, US  
 BARSOUM, Wael, K., 27158 Lake Road, Bay Village, OH 44140, US  
 BRYAN, Jason, A., 31669 Winners Circle, Avon Lake, OH 44012, US

- (51) MKP  
**H04L 12/28 (2006.01)** (97) **2636188 \***  
 (86) MY2012000203 16.07.2012  
 (96) 12751143.4 11.09.2013  
 (87) WO2013015673, 16.07.2012  
 (97) 2636188, 11.09.2013 en  
 (54) APPARATUS AND METHODS FOR MULTIMODE INTERNETWORKING CONNECTIVITY  
 (71) Lee, Chooi Tian, A-20-03A Rhythm Avenue Persiaran Kewajipan USJ 19, Uep Subang Jaya, Selangor 47620, MY  
 (72) Lee, Chooi Tian, A-20-03A Rhythm Avenue Persiaran Kewajipan USJ 19, Uep Subang Jaya, Selangor 47620, MY

- (51) MKP  
**C07C 279/24 (2006.01)** (97) **2616434 \***  
**C07D 233/64 (2006.01)**  
**A61K 31/155 (2006.01)**  
 (86) GB2011051730 14.09.2011  
 (96) 11760822.4 24.07.2013  
 (87) WO2012035346, 14.09.2011  
 (97) 2616434, 24.07.2013 en  
 (54) PRODRUGS OF GUANFACINE  
 (71) Shire LLC, 9200 Brookfield Court, Florence, KY 41042, US  
 (72) WHOMSLEY, Rhys, c/o Shire LLC 9200 Brookfield Court, Florence, Kentucky 41042, US  
 GOLDING, Bernard, c/o Shire LLC 9200 Brookfield Court, Florence, Kentucky 41042, US  
 TYSON, Bob, c/o Shire LLC 9200 Brookfield Court, Florence, Kentucky 41042, US

- (51) MKP  
**G01N 33/574 (2006.01)** (97) **2638397 \***  
 (86) US2011060395 11.11.2011  
 (96) 11840607.3 18.09.2013  
 (87) WO2012065079, 11.11.2011  
 (97) 2638397, 18.09.2013 en  
 (54) METHODS OF TREATING CANCER  
 (71) Endocyte, Inc., 3000 Kent Avenue, West Lafayette, IN 47906, US  
 (72) NGUYEN, Binh, 11022 Tenacious Drive, Indianapolis, IN 46236, US  
 REDDY, Joseph, Anand, 3323 Cinnabar Street, West Lafayette, IN 47906, US  
 LEAMON, Christopher, Paul, 5830 Farm Ridge Road, West Lafayette, IN 47906, US

- (51) MKP  
**B01J 27/10 (2006.01)** (97) **2639234 \***  
**C07D 271/06 (2006.01)**  
**A61K 31/485 (2006.01)**  
**A61P 1/08 (2006.01)**  
**A61P 1/10 (2006.01)**  
**C07D 489/08 (2006.01)**  
 (86) JP2011076034 11.11.2011  
 (96) 11839554.0 18.09.2013  
 (87) WO2012063933, 11.11.2011  
 (97) 2639234, 18.09.2013 en  
 (54) CRYSTALLINE 6,7-UNSATURATED-7-CARBAMOYL MORPHINANE DERIVATIVE, AND METHOD FOR PRODUCING SAME  
 (71) Shionogi & Co., Ltd., 1-8, Doshomachi 3-chome Chuo-ku Osaka-shi, Osaka 541-0045, JP  
 (72) TAMURA, Yoshinori, c/o Shionogi & Co. Ltd. Futaba-cho 3-chome., Toyonaka-shi, Osaka 553-0002, JP  
 NOGUCHI, Kouichi, c/o Shionogi & Co. Ltd. 1-3 Kuise Terajima 2-chome, Amagasaki-shi Hyogo 660-0813, JP  
 INAGAKI, Masanao, c/o Shionogi & Co. Ltd. Futaba-cho 3-chome., Toyonaka-shi, Osaka 553-0002, JP  
 MORIMOTO, Kenji, c/o Shionogi & Co. Ltd. Futaba-cho 3-chome., Toyonaka-shi, Osaka 553-0002, JP  
 HAGA, Nobuhiro, c/o Shionogi & Co. Ltd. Futaba-cho 3-chome., Toyonaka-shi, Osaka 553-0002, JP  
 ODA, Shinichi, c/o Shionogi & Co. Ltd., 7, Moriyama, Nishine, Kanegasaki-cho., Isawa-gun, Iwate 029-4503, JP  
 OMURA, Sohei, c/o Shionogi & Co. Ltd., 1-3 Kuise Terajima 2-chome., Amagasaki-shi, Hyogo 660-0813, JP

- (51) MKP  
**A61K 9/16 (2006.01)** (97) **2629755 \***  
**A61K 9/20 (2006.01)**  
**A61K 9/00 (2006.01)**  
 (86) IB2011054689 20.10.2011  
 (96) 11785108.9 28.08.2013  
 (87) WO2012052955, 20.10.2011  
 (97) 2629755, 28.08.2013 en  
 (54) PROCESS FOR MAKING MULTIPARTICULATE GASTRORETENTIVE DOSAGE FORMS  
 (71) Meliatys, 56, Avenue de la Victoire, 13790 Rousset, FR  
 (72) KIRKORIAN, Joël, Sylvain, Michel, Rue du Tennis, F-84400 Apt, FR

- (51) MKP  
**A43B 7/08 (2006.01)** (97) **2621301 \***  
**A43B 7/12 (2006.01)**  
**A43B 13/12 (2006.01)**  
**A43B 9/12 (2006.01)**  
**A43B 13/42 (2006.01)**  
 (86) EP2011065170 02.09.2011  
 (96) 11752537.8 07.08.2013  
 (87) WO2012041637, 02.09.2011  
 (97) 2621301, 07.08.2013 en  
 (54) VAPOR-PERMEABLE SHOE WITH WATERPROOF AND VAPOR-PERMEABLE SOLE  
 (71) Geox S.p.A., Via Feltrina Centro, 16, 31044 Montebelluna Località Biadene (Treviso), IT  
 (72) POLEGATO MORETTI, Mario, Via Fantin 96, I-31035 Crocetta Del Montello, IT

(51) MKP  
**A61K 31/27 (2006.01)** (97) **2619179 \***  
**A61K 31/4035 (2006.01)**  
**A61K 31/53 (2006.01)**  
**C07D 401/12 (2006.01)**  
**C07C 271/28 (2006.01)**  
**A61P 11/00 (2006.01)**  
**C07D 209/48 (2006.01)**  
**A61P 19/02 (2006.01)**  
**C07D 253/04 (2006.01)**  
**A61P 35/00 (2006.01)**  
(86) IB2011054229 26.09.2011  
(96) 11776885.3 31.07.2013  
(87) WO2012038944, 26.09.2011  
(97) 2619179, 31.07.2013 en  
(54) MATRIX METALLOPROTEINASE INHIBITORS  
(71) Ranbaxy Laboratories Limited, Head Office: 12th Floor Devika Tower 06 Nehru Place New Delhi, Delhi 110019, IN  
(72) KHERA, Manoj Kumar, C-660/10 Krishna Colony, Gurgaon Haryana 122001, IN  
PALLE, Venkata P., G901 Sylvan Heights Sanewadi Aundh, Pune Maharashtra 411007, IN  
SATTIGERI, Viswajanani, N-323 Vijay Rattan Vihar Sector 15-II, Gurgaon Haryana 122001, IN  
SATTIGERI, Jitendra, N-323 Vijay Rattan Vihar Sector 15-II, Gurgaon Haryana 122001, IN  
SONI, Ajay, B-6 Om Vihar Uttam Nagar, New Delhi Delhi 110059, IN  
RAUF, Abdul Rehman Abdul, Islampura Chandur Biswa Nandura, Buldana Maharashtra 443401, IN  
SIVAKUMAR, R., Old No. 10 New No. 90 Southwest Boag Road Nagar Chennai, Tamil Nadu 600017, IN  
REDDY, Ranadheer R., P.O. Thimmapuram (Mandal) Chievemula Nalgonda, Suryapet Andhra Pradesh 501213, IN  
MUSIB, Arpita, d/o Mr. P. L. Musib Rabindra Sarani Post-Khatra Bankura, West Bengal 722140, IN  
CLIFFE, Ian A., E-704 Ambience Island NH-8, Gurgaon Haryana 122001, IN  
BHATNAGAR, Pradip Kumar, 300 South Balderston Drive, Exton Pennsylvania 19341, US  
RAY, Abhijit, Sector C-1 Flat No. 1408 Vasant Kunj, New Delhi Delhi 110070, IN  
SRIVASTAVA, Punit, 1263A Sector-15 Part -II, Gurgaon Haryana 122015, IN  
DASTIDAR, Sunanda Ghosh, B-138 Sarita Vihar, New Delhi Delhi 110076, IN

(51) MKP  
**E21B 43/26 (2006.01)** (97) **2643547 \***  
**E21B 23/06 (2006.01)**  
**E21B 23/04 (2006.01)**  
**E21B 33/124 (2006.01)**  
(86) CA2011001286 23.11.2011  
(96) 11842815.0 02.10.2013  
(87) WO2012068672, 23.11.2011  
(97) 2643547, 02.10.2013 en  
(54) METHOD AND APPARATUS FOR SETTING A WELLBORE PACKER  
(71) Packers Plus Energy Services Inc., Bow Valley Square 2 Suite 2200, 205 - 5 Avenue SW, Calgary, Alberta T2P 2V7, CA  
(72) THEMIG, Daniel Jon, 256 Woodhaven Place SW, Calgary, Alberta T2W 5P9, CA  
COON, Robert Joe, 8606 Hall Retreat CT, Missouri City, TX 77459, US

(51) MKP  
**G01N 33/543 (2006.01)** (97) **2618152**  
**G01N 33/558 (2006.01)**  
(96) 13151797.1 24.07.2013  
(97) 2618152, 24.07.2013 en  
(54) Assay device having controllable sample size  
(71) ORTHO-CLINICAL DIAGNOSTICS, INC., 1001 U.S. Route 202, Raritan, NJ 08869, US  
(72) Scalice, Edward R., 30 Cobblestone Crossing, Penfield, New York, NY 14526, US  
Hosimer, Philip C., 11 Beach Terrace, Rochester, New York, NY 14617, US  
Ding, Zhong, 35 Delancey Court, Pittsford, New York, NY 14534, US  
Kanaley, James D., 23 East Street, Honeoye Falls, New York, NY 14472, US  
Tomasso, David A., 174 Old Well Road, Rochester, New York, NY 14626, US  
Salotto, Daniel P., 55 W. Bend Drive, Rochester, New York, NY 14612, US  
Warren, Timothy C., 59 Sannita Drive, Rochester, New York, NY 14626, US

(51) MKP  
**G01R 21/00 (2006.01)** (97) **2622357 \***  
(86) US2011050845 08.09.2011  
(96) 11831150.5 07.08.2013  
(87) WO2012047441, 08.09.2011  
(97) 2622357, 07.08.2013 en  
(54) UTILITY DEVICE MANAGEMENT  
(71) Landis + Gyr Innovations, Inc., 30000 Mill Creek Avenue, Alpharetta, GA 30022, US  
(72) SALAZAR, Ruben, 120 Saint Ignaius Close, Johns Creek, Georgia 30022, US  
SHUDARK, Jeffrey, B., 8215 Stonebrook Ct, Cumming, Georgia 30040, US  
MONNERIE, Emmanuel, 3720 Homestead Ridge Drive, Cumming, Georgia 30041, US  
CHASKO, Stephen, J., 8101 Deer Creek Place, Alpharetta, Georgia 30004, US

(51) MKP  
**H03M 13/37 (2006.01)** (97) **2567461 \***  
**H04L 27/00 (2006.01)**  
**H04L 27/233 (2006.01)**  
**H04L 1/00 (2006.01)**  
(86) CN2011073878 10.05.2011  
(96) 11844010.6 13.03.2013  
(87) WO2012151742, 10.05.2011  
(97) 2567461, 13.03.2013 en  
(54) METHOD AND APPARATUS FOR DETECTING A PARITY ERROR IN A SEQUENCE OF DQPSK SYMBOLS OF A DIGITAL TRANSMISSION SYSTEM  
(71) Huawei Technologies Co., Ltd., Huawei Administration Building Bantian, Longgang Shenzhen Guangdong 518129, CN  
(72) HAUSKE, Fabian Nikolaus, Riesstrasse 25, 80992 München, DE  
BAUCH, Gerhard, Werner-Heisenberg-Weg 39, 85577 Neubiberg, DE  
PFLUEGER, Doris, Werner-Heisenberg-Weg 39, 85577 Neubiberg, DE

(51) MKP  
**E21F 1/00 (2006.01)** (97) **2598718 \***  
**E21F 1/08 (2006.01)**  
(86) HR2010000026 27.07.2010  
(96) 10759708.0 05.06.2013  
(87) WO2012013992, 27.07.2010  
(97) 2598718, 05.06.2013 en  
(54) METHOD AND SYSTEM FOR TUNNEL VENTILATION IN NORMAL CONDITIONS AND IN CONDITIONS OF FIRE  
(71) Pavetic, Josip, Brezovacka 24, 10415 Novo Cice, HR  
(72) PAVETIC, Josip, Brezovacka 24, HR-10415 Novo Cice, HR  
PAVETIC, Ivor, Brezovacka 24, HR-10415 Novo Cice, HR  
PAVETIC, Svibor, Brezovacka 24, HR-10415 Novo Cice, HR

- (51) MKP  
**C12P 7/46 (2006.01)** (97) **2619314 \***  
(86) EP2011066267 20.09.2011  
(96) 11760468.6 31.07.2013  
(87) WO2012038390, 20.09.2011  
(97) 2619314, 31.07.2013 en  
(54) DICARBOXYLIC ACID PRODUCTION PROCESS  
(71) DSM IP Assets B.V., Het Overloon 1, 6411 TE Heerlen, NL  
Roquette Frères SA, Rue Adam Grunewald, 62136 Lestrem, FR  
(72) JANSEN, Mickel Leonardus August, Noorderbeekdwarsstraat 53, NL-2562 XN Den Haag, NL  
SEGUEILHA, Laurent, Appartement 111 46 A Rue du Général Leclerc, F-59350 Saint André-lez-lille, FR  
VERWAAL, René, Marsdiep 7, NL-2631 NL Nootdorp, NL  
LOUCHART, Mélanie, Boulevard Fochr Résidence Les Nenuphars Bâtiment Nymphaea - Appartement 12B, F-59660 Merville, FR
- 
- (51) MKP  
**A61K 31/16 (2006.01)** (97) **2635285 \***  
**A61K 31/506 (2006.01)**  
(86) US2011058616 31.10.2011  
(96) 11838628.3 11.09.2013  
(87) WO2012061303, 31.10.2011  
(97) 2635285, 11.09.2013 en  
(54) HETEROARYL COMPOUNDS AND USES THEREOF  
(71) Celgene Avilomics Research, Inc., 45 Wiggins Avenue, Bedford, MA 01730, US  
(72) LEE, Kwangho, 22 Middlesex Circle, 7, Waltham MA 02452, US  
NIU, Deqiang, 30 Grapevine Avenue, Lexington MA 02421, US  
PETTER, Russell, C., 22 Robinwood Lane, Stow MA 01775, US  
SINGH, Juswinder, 94 Heritage Avenue, Ashland MA 01721, US
- 
- (51) MKP  
**C04B 28/14 (2006.01)** (97) **2643276 \***  
(86) GB2011052298 23.11.2011  
(96) 11791327.7 02.10.2013  
(87) WO2012069826, 23.11.2011  
(97) 2643276, 02.10.2013 en  
(54) CALCIUM SULPHATE-BASED PRODUCTS AND METHODS FOR THE MANUFACTURE THEREOF  
(71) Saint-Gobain Placo SAS, 34 Avenue Franklin Roosevelt, 92150 Suresnes, FR  
(72) FISHER, Robin Daniel, 2 Lawrence Way Loughborough, Leicestershire LE11 5XZ, GB  
RIDEOUT, Jan, 9 Oldfield Lane Rothley, Leicester LE7 7QD, GB
- 
- (51) MKP  
**A61K 38/22 (2006.01)** (97) **2611458 \***  
**C07K 14/575 (2006.01)**  
**A61P 3/10 (2006.01)**  
**A61P 3/08 (2006.01)**  
**A61P 3/04 (2006.01)**  
(86) EP2010062638 30.08.2010  
(96) 10747854.7 10.07.2013  
(87) WO2012028172, 30.08.2010  
(97) 2611458, 10.07.2013 en  
(54) USE OF AVE0010 FOR THE MANUFACTURE OF A MEDICAMENT FOR THE TREATMENT OF DIABETES MELLITUS TYPE 2  
(71) Sanofi-Aventis Deutschland GmbH, Brüningstraße 50, 65929 Frankfurt, DE  
(72) BOKA, Gabor, c/o Sanofi-Aventis Département Brevets 174 Avenue de France, F-75013 Paris, FR  
MIOSSEC, Patrick, c/o Sanofi-Aventis Département Brevets 174 Avenue de France, F-75013 Paris, FR  
SILVESTRE, Louise, c/o sanofi-aventis Patent Department 174 avenue de France, F-75013 Paris, FR
- 
- (51) MKP  
**C07D 471/04 (2006.01)** (97) **2611802 \***  
**C07D 487/04 (2006.01)**  
**A61K 31/437 (2006.01)**  
**A61K 31/519 (2006.01)**  
**A61P 9/00 (2006.01)**  
**A61P 9/04 (2006.01)**  
**A61P 9/12 (2006.01)**  
**A61P 9/14 (2006.01)**  
**A61P 9/10 (2006.01)**  
**A61P 7/02 (2006.01)**  
**A61P 13/12 (2006.01)**  
(86) EP2011065006 31.08.2011  
(96) 11752194.8 10.07.2013  
(87) WO2012028647, 31.08.2011  
(97) 2611802, 10.07.2013 de  
(54) BICYCLIC AZA HETEROCYCLES, AND USE THEREOF  
(71) Bayer Intellectual Property GmbH, Alfred-Nobel-Strasse 10, 40789 Monheim, DE  
(72) FOLLMANN, Markus, Rosmarinweg 28, 50859 Köln, DE  
STASCH, Johannes-Peter, Alfred-Nobel-Str. 109, 42651 Solingen, DE  
REDLICH, Gorden, Schadowstraße, 44799 Bochum, DE  
ACKERSTAFF, Jens, Schliemannstrasse 15, 10437 Berlin, DE  
GRIEBENOW, Nils, Kurfürstenstr. 39, 41541 Dormagen, DE  
KNORR, Andreas, Trillser Graben 10, 40699 Erkrath, DE  
WUNDER, Frank, Schwarzer Weg 251, 42117 Wuppertal, DE  
LI, Volkhart Min-Jian, Im Wiesengrund 40, 42553 Velbert, DE  
BÄRFACKER, Lars, Walter-Flex-Str. 29, 46047 Oberhausen, DE  
WEIGAND, Stefan, Wölfi 29, 82377 Penzberg, DE
- 
- (51) MKP  
**A61K 38/48 (2006.01)** (97) **2616091 \***  
**A61K 39/395 (2006.01)**  
**A61K 47/02 (2006.01)**  
**A61K 47/18 (2006.01)**  
**A61K 9/00 (2006.01)**  
**A61K 38/00 (2006.01)**  
(86) US2011052048 16.09.2011  
(96) 11764394.0 24.07.2013  
(87) WO2012037530, 16.09.2011  
(97) 2616091, 24.07.2013 en  
(54) STABILIZATION OF IMMUNOGLOBULINS AND OTHER PROTEINS THROUGH AQUEOUS FORMULATIONS WITH SODIUM CHLORIDE AT WEAK ACIDIC TO NEUTRAL PH  
(71) Baxter International Inc, One Baxter Parkway, Deerfield, IL 60015, US  
Baxter Healthcare SA, Thurgauerstrasse 130, 8152 Glattpark (Opfikon), CH  
(72) BUTTERWECK, Harald, Arno, Naufahrtweg 5, A-1220 Vienna, AT  
BAUER, Theresa, Friederike, Marchettigasse 8/3, A-1060 Vienna, AT  
HOFBAUER, Lucia, Grafenberg 9, A-3730 Eggenburg, AT  
TESCHNER, Wolfgang, Gestettengasse 19/14, A-1030 Vienna, AT  
ZOCHLING, Oliver, Panikengasse 12/1/4, A-1160 Vienna, AT  
SCHWARZ, Hans-Peter, Weimarer Strasse 76, A-1180 Vienna, AT  
MAYER, Christa, Bahnhofstrasse 2, A-2412 Wolfsthal, AT  
HASSLACHER, Meinhard, Vorgartenstrasse 221/1/7, A-1020 Vienna, AT
-

(51) MKP  
**C07D 403/14 (2006.01)** (97) **2627651 \***  
 (86) US2011056045 12.10.2011  
 (96) 11773371.7 21.08.2013  
 (87) WO2012051361, 12.10.2011  
 (97) 2627651, 21.08.2013 en  
 (54) ANTI-VIRAL COMPOUNDS  
 (71) Abbvie Inc., 1 North Waukegan Road, North Chicago, IL 60064, US  
 (72) DEGOEY, David A., 8649 226th Avenue, Salem, Wisconsin 53168, US  
 KATI, Warren M., 152 Knob Hill Lane, Gurnee, Illinois 60031, US  
 HUTCHINS, Charles W., 31005 Prairie Ridge Road, Green Oaks, Illinois 60048, US  
 DONNER, Pamela L., 1901 McRae Lane, Mundelien, Illinois 60060, US  
 KRUEGER, Allan C., 7260 Presidential Drive, Gurnee, Illinois 60031, US  
 RANDOLPH, John T., 304 Broadway Avenue, Libertyville, Illinois 60048, US  
 MOTTER, Christopher E., 10135 South Warwick Drive, Oak Creek, Wisconsin 53154, US  
 NELSON, Lissa T., 640 Broadview Avenue, Highland Park, Illinois 60035, US  
 PATEL, Sachel V., 1259 S. Meadow Road, Round Lake, Illinois 60073, US  
 MATULENKO, Mark A., 1875 Countryside Drive, Libertyville, Illinois 60048, US  
 KEDDY, Ryan G., 10046 West Hendee Road, Beach Park, Illinois 60087, US  
 JINKERSON, Tammie K., 11129 10th Avenue, Pleasant Prairie, Wisconsin 53158, US  
 GAO, Yi, 210 East Baltusrol Drive, Vernon Hills, Illinois 60061, US  
 LIU, Dachun, 1276 Georgetown Way, Vernon Hills, Illinois 60061, US  
 PRATT, John K., 8210 61st Avenue, Kenosha, Wisconsin 53142, US  
 ROCKWAY, Todd W., 34136 N. Lavender Circle, Grayslake, Illinois 60030, US  
 MARING, Clarence J., 1228 W. Borders Drive, Palatine, Illinois 60067, US  
 HUTCHINSON, Douglas K., 160 Depot Street, Antioch, Illinois 60002, US  
 FLENTGE, Charles A., 8628 225th Avenue, Salem, Wisconsin 53168, US  
 WAGNER, Rolf, 42530 Sheridan Oaks Drive, Antioch, Illinois 60002, US  
 TUFANO, Michael D., 6539 North Washtenaw, Chicago, Illinois 60645, US  
 BETEBENNER, David A., 32329 N. Forest Drive, Grayslake, Illinois 60030, US  
 SARRIS, Kathy, 1309 Andover Drive, Mundelein, Illinois 60060, US  
 WOLLER, Kevin R., 1072 Joy Court, Antioch, Illinois 60002, US  
 WAGAW, Sebel H., 2311 Ridgeway, Evanston, Illinois 60201, US  
 CALIFANO, Jean C., 6167 N. Bay Ridge, Whitefish Bay, Wisconsin 53217, US  
 LI, Wenke, 7203 Buchanan Drive, Gurnee, Illinois 60031, US  
 CASPI, Daniel D., 807 Davis Street 912, Evanston, Illinois 60201, US  
 BELLIZZI, Mary E., 771 N. McKinley Road, Lake Forest, Illinois 60045, US  
 CARROLL, William A., 2325 Ridgeway Avenue, Evanston, Illinois 60201, US

(51) MKP  
**A61K 47/48 (2006.01)** (97) **2628489**  
 (96) 13167519.1 21.08.2013  
 (97) 2628489, 21.08.2013 en  
 (54) PEG oligomer-fentanyl conjugates  
 (71) Nektar Therapeutics, 455 Mission Bay Boulevard South, San Francisco, CA 94158, US  
 (72) Riggs-Sauthier, Jennifer, 7917 Smoke Rise Road, Huntsville, AL Alabama 35802, US  
 Deng, Bo-Liang, 209 Meadow Wood Drive, Madison, AL Alabama 35756, US  
 Riley, Timothy A, 211 Morningwalk Lane, Huntsville, AL Alabama 35824, US

(51) MKP  
**A61P 25/28 (2006.01)** (97) **2632254 \***  
**A61K 31/135 (2006.01)**  
**C07C 309/29 (2006.01)**  
**C07C 211/42 (2006.01)**  
**C07C 309/04 (2006.01)**  
**A01N 33/02 (2006.01)**  
 (86) US2011057698 25.10.2011  
 (96) 11836950.3 04.09.2013  
 (87) WO2012058219, 25.10.2011  
 (97) 2632254, 04.09.2013 en  
 (54) DEUTERIUM ENRICHED RASAGILINE  
 (71) Teva Pharmaceutical Industries Ltd., 5 Basel Street P.O. Box 3190, 49131 Petah Tiqva, IL  
 (72) BAHAR, Eliezer, 95 Haim Levanon Str., 69345 Tel-aviv, IL  
 FRENKEL, Anton, 15 Amnon Ve Tamar Str. Apt. 10, 42202 Netanya, IL  
PIRYATINSKY, Victor, Ole Hagardom 10b/13, Netanya, IL

(51) MKP  
**A61B 19/00 (2006.01)** (97) **2598074 \***  
**A61B 17/56 (2006.01)**  
**A61B 5/11 (2006.01)**  
**G01C 19/02 (2006.01)**  
 (86) CA2010001206 30.07.2010  
 (96) 10855135.9 05.06.2013  
 (87) WO2012012863, 30.07.2010  
 (97) 2598074, 05.06.2013 en  
 (54) BONE TRACKING WITH A GYROSCOPE SENSOR IN COMPUTER-ASSISTED SURGERY  
 (71) Orthosoft, Inc., 75 Queen Street Suite 3300, Montreal, Québec H3C 2N6, CA  
 (72) AMIOT, Louis-Philippe, 49 rue Thurlow, Hampstead Québec H3X 3G8, CA  
 ZUHARS, Joel, 2759 E. Lake Tahoe Trail, Warsaw Indiana 46582, US  
 PROULX, Catherine, 3964 Bannantyne 301, Verdun Québec H4G 1C1, CA  
 VALIN, Myriam, 284 avenue Brien, Laval Québec H7N 3M7, CA  
 NGUYEN, Tin, 1289 Avila-Desrochers, Laval Québec H7L 0C2, CA  
 PELLETIER, Benoît, 96, 7e rue, Laval Québec H7N 2C7, CA  
 DUVAL, Karine, 775 St-Joseph Est, apt. 1, Montréal Québec H2J 1K3, CA  
 RICHARD, Alain, 890 46e avenue, Lachine Québec H8T 2N6, CA  
 KIBLAWI, Rula, 346 Amsterdam, Dollard-des-Ormeaux Québec H9G 1P5, CA  
 BOUTIN, Yannick, 6274 St-André, apt. 8, Montréal Québec H2S 2K5, CA

(51) MKP  
**A61P 25/00 (2006.01)** (97) **2620433 \***  
**C07D 277/20 (2006.01)**  
**A61P 35/00 (2006.01)**  
**A61P 9/00 (2006.01)**  
**C07D 417/12 (2006.01)**  
**A61K 31/426 (2006.01)**  
**C07D 277/56 (2006.01)**  
**A61K 31/341 (2006.01)**  
**A61P 43/00 (2006.01)**  
**A61K 31/427 (2006.01)**  
**C07D 307/68 (2006.01)**  
**A61P 29/00 (2006.01)**  
**A61P 13/00 (2006.01)**  
 (86) JP2011071635 22.09.2011  
 (96) 11826905.9 31.07.2013  
 (87) WO2012039460, 22.09.2011  
 (97) 2620433, 31.07.2013 en  
 (54) SUBSTITUTED AMIDE COMPOUND  
 (71) Astellas Pharma Inc., 3-11, Nihonbashi-Honcho 2-chome Chuo-ku, Tokyo 103-8411, JP  
 (72) KAWAMINAMI Eiji, c/o Astellas Pharma Inc. 3-11, Nihonbashi-Honcho 2-chome Chuo-ku, Tokyo 103-8411, JP  
 TAKAHASHI Tatsuhisa, c/o Astellas Pharma Inc. 3-11, Nihonbashi-Honcho 2-chome Chuo-ku, Tokyo 103-8411, JP  
 KANAYAMA Takatoshi, c/o Astellas Pharma Inc. 3-11, Nihonbashi-Honcho 2-chome Chuo-ku, Tokyo 103-8411, JP  
 SAKAMOTO Kazuyuki, c/o Astellas Pharma Inc. 3-11, Nihonbashi-Honcho 2-chome Chuo-ku, Tokyo 103-8411, JP

- (51) MKP  
**C07D 209/42 (2006.01)** (97) **2612851**  
 (96) 13150305.4 10.07.2013  
 (97) 2612851, 10.07.2013 fr  
 (54) Process for the preparation of the L-arginine salt of perindopril  
 (71) Les Laboratoires Servier, 35, rue de Verdun, 92284 Suresnes Cedex, FR  
 (72) Linol, Julie, 25 rue Léon Malandin, 76770 MALAUNAY, FR  
 Laurent, Stéphane, 2588, La Vieille Route, 76190 VALLIQUERVILLE, FR  
 Grenier, Arnaud, 400, Hameau du Maugeudre, 76110 BREAUITE, FR  
 Mathieu, Sébastien, 15, rue des Aulnes La Payennière, 76290 MONTVILLERS, FR

- (51) MKP  
**C07D 217/06 (2006.01)** (97) **2640704 \***  
**C07D 401/12 (2006.01)**  
**C07D 405/12 (2006.01)**  
**C07D 409/12 (2006.01)**  
**C07D 409/14 (2006.01)**  
**C07D 413/12 (2006.01)**  
**C07D 471/04 (2006.01)**  
**A61K 31/4375 (2006.01)**  
**A61K 31/496 (2006.01)**  
**A61K 31/472 (2006.01)**  
**A61K 31/4725 (2006.01)**  
**A61P 29/00 (2006.01)**  
**A61P 37/00 (2006.01)**  
**A61P 9/00 (2006.01)**  
**A61P 35/00 (2006.01)**  
 (86) US2011060411 11.11.2011  
 (96) 11785266.5 25.09.2013  
 (87) WO2012067963, 11.11.2011  
 (97) 2640704, 25.09.2013 en  
 (54) NAMPT INHIBITORS  
 (71) Abbvie Inc., 1 North Waukegan Road, North Chicago, IL 60064, US  
 (72) CURTIN, Michael L., 8625 113th Avenue, Pleasant Prairie, Wisconsin 53158, US  
 SORENSEN, Bryan K., 524 First Street, Antioch, Illinois 60002, US  
 HEYMAN, Howard R., 827 Woodward Avenue, Deerfield, Illinois 60015, US  
 CLARK, Richard F., 2142 Spruce Pointe Court, Gurnee, Illinois 60031, US  
 MICHAELIDES, Michael, 4452 West Gavin Lane, Libertyville, Illinois 60048, US  
 TSE, Chris, 1321 St. William Drive, Libertyville, Illinois 60048, US

- (51) MKP  
**C03C 3/118 (2006.01)** (97) **2616400 \***  
**C03C 13/00 (2006.01)**  
**B32B 17/00 (2006.01)**  
**C08J 5/24 (2006.01)**  
**C08K 7/14 (2006.01)**  
**C08J 5/04 (2006.01)**  
 (86) US2011051555 14.09.2011  
 (96) 11760937.0 24.07.2013  
 (87) WO2012037219, 14.09.2011  
 (97) 2616400, 24.07.2013 en  
 (54) LOW DENSITY AND HIGH STRENGTH FIBER GLASS FOR REINFORCEMENT APPLICATIONS  
 (71) PPG Industries Ohio, Inc., 3800 West 143rd Street, Cleveland, OH 44111, US  
 (72) PETERS, James, Carl, 359 Hunting Ridge Lane, Shelby North Carolina 28150, US  
 SERRANO, Juan, Camilo, 2808 Scarborough Court, Gastonia North Carolina 28054, US  
 LI, Hong, 1621 Norman Drive, Sewickley Pennsylvania 15143, US  
 PARKS, Steven, Joel, 208 Comanche Trail, Lexington North Carolina 27295, US  
 RICHARDS, Cheryl, A., 104 Trotwood Drive, Monroeville Pennsylvania 15146, US

- (51) MKP  
**C07C 323/58 (2006.01)** (97) **2640697 \***  
**A61K 31/10 (2006.01)**  
 (86) US2011060730 15.11.2011  
 (96) 11791692.4 25.09.2013  
 (87) WO2012068067, 15.11.2011  
 (97) 2640697, 25.09.2013 en  
 (54) 4-SUBSTITUTED-3-PHENYLSULFANYLMETHYL-BICYCLO[3.1.0]HEXANE COMPOUNDS AS MGLUR 2/3 ANTAGONISTS  
 (71) Eli Lilly and Company, Lilly Corporate Center, Indianapolis, IN 46285, US  
 (72) SMITH, Stephon Cornell, c/o Eli Lilly and Company P. O. Box 6288, Indianapolis, Indiana 46206-6288, US  
 LI, Renhua, c/o Eli Lilly and Company P.O. Box 6288, Indianapolis, Indiana 46206-6288, US  
 MITCH, Charles Howard, c/o Eli Lilly and Company P.O. Box 6288, Indianapolis, Indiana 46206-6288, US  
 VETMAN, Tatiana Natali, c/o Eli Lilly and Company P.O. Box 6288, Indianapolis, Indiana 46206-6288, US

- (51) MKP  
**C07D 417/00 (2006.01)** (97) **2609093 \***  
 (86) US2011048966 24.08.2011  
 (96) 11820594.7 03.07.2013  
 (87) WO2012027471, 24.08.2011  
 (97) 2609093, 03.07.2013 en  
 (54) SALT COMPOUND  
 (71) SGC Pharma Inc., 207 Grandview Road, Ottawa, ON K2H 8B9, CA  
 (72) BENDER, Robert, 207 Grandview Rd., Ottawa K2H 8B9, CA  
 CHAU, Ho-Lun, Joseph, 7203 Fitzsimmons Road, Whistler BC V0N1B7, CA  
 COWART, Doug, 16100 Riffle Ford Road, North Potomac MD 20878, US

- (51) MKP  
**A01N 25/00 (2006.01)** (97) **2613629 \***  
**A61K 9/00 (2006.01)**  
**A61K 39/205 (2006.01)**  
**B65D 75/42 (2006.01)**  
 (86) EP2011065698 10.09.2011  
 (96) 11761319.0 17.07.2013  
 (87) WO2012032182, 10.09.2011  
 (97) 2613629, 17.07.2013 en  
 (54) ORAL VETERINARY PREPARATIONS  
 (71) IDT Biologika GmbH, Am Pharmapark, 06861 Dessau-Rosslau, DE  
 (72) VOS, Adrian, 100 chemin de la bastide candeliers, F-83510 Lorgues, FR  
 SCHUSTER, Peter, Rheinstr. 33, 06846 Dessau-Rosslau, DE  
 BOROWSKI, Klaus, Poetschstr. 8A, 06862 Dessau-Rosslau, DE

- (51) MKP  
**A23L 1/30 (2006.01)** (97) **2526785**  
**C02F 1/04 (2006.01)**  
**C02F 1/44 (2006.01)**  
**C02F 3/34 (2006.01)**  
**A61K 36/63 (2006.01)**  
**A23L 1/212 (2006.01)**  
 (96) 12169465.7 28.11.2012  
 (97) 2526785, 28.11.2012 en  
 (54) Process for producing a phytoextract from vegetation waters and olive oil pomaces  
 (71) Phenofarm S.r.l., Via Giovanni Nicotera, 29, 00195 Roma, IT  
 (72) Germani, Stefano, c/o PHENOFARM S.r.l. Via Giovanni Nicotera, 29, 00195 Roma, IT  
 Vitagliano, Massimo, c/o PHENOFARM S.r.l. Via Giovanni Nicotera, 29, 00195 Roma, IT  
 Pizzichini, Daniele, c/o PHENOFARM S.r.l. Via Giovanni Nicotera, 29, 00195 Roma, IT  
 Pizzichini, Massimo, c/o PHENOFARM S.r.l. Via Giovanni Nicotera, 29, 00195 Roma, IT

- (51) MKP  
**C12P 7/56 (2006.01)** (97) **2633027 \***  
**C12R 1/645 (2006.01)**  
**C12N 1/14 (2006.01)**  
(86) EP2011068969 28.10.2011  
(96) 11782575.2 04.09.2013  
(87) WO2012055997, 28.10.2011  
(97) 2633027, 04.09.2013 en  
(54) PROCESS FOR POLYLACTIC ACID PRODUCTION USING MONASCUS  
(71) Total Research & Technology Feluy SA, Zone Industrielle C, 7181 Seneffe (Feluy), BE  
(72) WEUSTHUIS, Ruud Alexander, Magnoliaaan 18, NL-6866 GD Heelsum, NL  
WOLBERT, Emil Johan Harald, Leeuweriksweide 208, NL-6708 LP Wageningen, NL  
SPRINGER, Jan, Bennekomseweg 180, NL-6704 AL Wageningen, NL  
VAN DER OOST, John, Bram Streeflandweg 116, NL-6871 HZ Renkum, NL  
EGGINK, Gerrit, Erasmusstate 59, NL-6716 SC Ede, NL

- (51) MKP  
**A61K 31/42 (2006.01)** (97) **2611298 \***  
**A01N 43/76 (2006.01)**  
(86) US2011050066 31.08.2011  
(96) 11822606.7 10.07.2013  
(87) WO2012031024, 31.08.2011  
(97) 2611298, 10.07.2013 en  
(54) BICYCLIC OXAZOLE AND THIAZOLE COMPOUNDS AND THEIR USE AS ALLOSTERIC MODULATORS OF MGLUR5 RECEPTORS  
(71) Vanderbilt University, Center for Technology Transfer and Commercialization 305 Kirkland Hall 2201 West End Avenue, Nashville, TN 37240, US  
(72) CONN, P., Jeffrey, 9012 Grey Point Ct., Brentwood, TN 37027, US  
LINDSLEY, Craig, W., 401 Briery Court, Brentwood, TN 37027, US  
STAUFFER, Shaun, R., 9500 Wexcroft Drive, Brentwood, TN 37027, US  
JONES, Carrie, K., 7221 Highway 70 South Apt. 636, Nashville, TN 37221, US  
BARTOLOME-NEBREDA, Jose, Manuel, c/o Janssen-Cilag S.A. Calle Jarama, 75, 45007 Poligono Industrial, Toledo, ES  
CONDE-CEIDE, Susana, c/o Janssen-Cilag S.A. Calle Jarama, 75, 45007 Poligono Industrial, Toledo, ES  
MACDONALD, Gregor, James, c/o Janssen Pharmaceutica NV Turnhoutseweg 30, B-2340 Beerse, BE  
ALCAZAR VACA, Manuel, Jesus, c/o Janssen-Cilag S.A. Calle Jarama, 75, 45007 Poligono Industrial, Toledo, ES

- (51) MKP  
**A61K 31/505 (2006.01)** (97) **2616077 \***  
(86) IB2011002248 08.09.2011  
(96) 11769929.8 24.07.2013  
(87) WO2012035423, 08.09.2011  
(97) 2616077, 24.07.2013 en  
(54) ANTI-CANCER ACTIVITY OF NOVEL BICYCLIC HETEROCYCLES  
(71) Katholieke Universiteit Leuven, K.U. Leuven R&D, Minderbroedersstraat 8a Bus 5105, 3000 Leuven, BE  
(72) HERMAN, Jean, Honiersdreef 100, B-3001 Heverlee, BE  
LOUAT, Thierry, Verbindingslaan 48 Bus 0303, B-3001 heverlee, BE

- (51) MKP  
**C22B 21/04 (2006.01)** (97) **2639320 \***  
(86) RU2011000676 06.09.2011  
(96) 11839007.9 18.09.2013  
(87) WO2012064220, 06.09.2011  
(97) 2639320, 18.09.2013 en  
(54) METHOD FOR PRODUCING ALUMINIUM BY METALLOTHERMIC REDUCTION OF TRICHLORIDE WITH MAGNESIUM AND APPARATUS FOR CARRYING OUT SAID METHOD  
(71) Begunov, Albert Ivanovich, Ul. Lermontova 297B-88, Irkutsk 664033, RU  
(72) Begunov, Albert Ivanovich, Ul. Lermontova 297B-88, Irkutsk 664033, RU

- (51) MKP  
**G01N 33/574 (2006.01)** (97) **2643698 \***  
**A61K 39/00 (2006.01)**  
(86) EP2011070661 22.11.2011  
(96) 11788121.9 02.10.2013  
(87) WO2012069462, 22.11.2011  
(97) 2643698, 02.10.2013 en  
(54) BIOMARKERS FOR PREDICTING THE EFFICACY OF AN IMMUNOTHERAPY AGAINST CANCER  
(71) Immatics Biotechnologies GmbH, Paul-Ehrlich-Strasse 15, 72076 Tübingen, DE  
(72) WEINSCHENK, Toni, Im Morgenrain 15, 73773 Aichwald, DE  
SINGH, Harpreet, Bei den Pferdestaellen 9, 72072 Tuebingen, DE  
FRITSCHKE, Jens, Im Schoenblick 48, 72076 Tuebingen, DE  
MAHR, Andrea, Kirschenweg 22, 72076 Tuebingen, DE

- (51) MKP  
**H04W 52/14 (2009.01)** (97) **2645786 \***  
(86) CN2011081041 20.10.2011  
(96) 11842593.3 02.10.2013  
(87) WO2012068934, 20.10.2011  
(97) 2645786, 02.10.2013 en  
(54) METHOD AND BASE STATION FOR ADJUSTING UPLINK GRANT PHYSICAL DOWNLINK CONTROL CHANNEL OF UE  
(71) China Mobile Communications Corporation, 29, Jinrong Ave. Xicheng District, Beijing 100032, CN  
(72) JIANG, Dajie, 29 Jinrong Ave. Xicheng District, Beijing 100032, CN

- (51) MKP  
**C07D 211/22 (2006.01)** (97) **2601177 \***  
**A61K 31/445 (2006.01)**  
**A61P 35/00 (2006.01)**  
**A61P 35/02 (2006.01)**  
(86) GB2011051484 05.08.2011  
(96) 11746295.2 12.06.2013  
(87) WO2012017251, 05.08.2011  
(97) 2601177, 12.06.2013 en  
(54) N-ACYLSULFONAMIDE APOPTOSIS PROMOTERS  
(71) AstraZeneca AB, null, 151 85 Södertälje, SE  
DIEBOLD, Robert Bruce, AstraZeneca R&D Boston 35 Gatehouse Drive, Waltham, Massachusetts 02451, US  
GERO, Thomas, AstraZeneca R&D Boston 35 Gatehouse Drive, Waltham, Massachusetts 02451, US  
GROVER, Paul, AstraZeneca R&D Boston 35 Gatehouse Drive, Waltham, Massachusetts 02451, US  
HUANG, Shan, AstraZeneca R&D Boston 35 Gatehouse Drive, Waltham, Massachusetts 02451, US  
IOANNIDIS, Stephanos, AstraZeneca R&D Boston 35 Gatehouse Drive, Waltham, Massachusetts 02451, US  
OGOE, Claude Afona, AstraZeneca R&D Boston 35 Gatehouse Drive, Waltham, Massachusetts 02451, US  
SAEH, Jamal Carlos, AstraZeneca R&D Boston 35 Gatehouse Drive, Waltham, Massachusetts 02451, US  
VARNES, Jeffrey Gilbert, AstraZeneca R&D Boston 35 Gatehouse Drive, Waltham, Massachusetts 02451, US

- (51) MKP  
**C10G 19/02 (2006.01)** (97) **2611887 \***  
**C10G 67/10 (2006.01)**  
**C07C 7/10 (2006.01)**  
(86) US2011049821 31.08.2011  
(96) 11776610.5 10.07.2013  
(87) WO2012030880, 31.08.2011  
(97) 2611887, 10.07.2013 en  
(54) SULFONE REMOVAL FROM AN OXIDIZED HYDROCARBON FUEL  
(71) MERICHEM COMPANY, 5455 Old Spanish Trail, Houston, TX 77023, US  
(72) ZHANG, Tiejun, 4320 Jonathan Street, Bellaire TX 77401, US  
ANAND, Nachiketa, 27923 Norfolk Trail, Katy TX 77494, US  
HOOVER, Theodore, Sidney, 2713 Elmhurst Avenue, Oklahoma City OK 73120, US

- (51) MKP  
**B29C 65/18 (2006.01)** (97) **2643144 \***  
**B42C 15/00 (2006.01)**  
**B65B 51/14 (2006.01)**
- (86) EP2011070678 22.11.2011  
(96) 11785431.5 02.10.2013  
(87) WO2012069470, 22.11.2011  
(97) 2643144, 02.10.2013 en  
(54) ELECTRICALLY OPERATED MACHINE FOR COVERING BOOK COVERS AND SEALING ENVELOPES AND ARTICLES OF VARIOUS KIND  
(71) Colibri' System S.p.A., Via E. Cernuschi, 4, 20129 Milano, IT  
(72) FARNETI, Aldo, Via Claudio Achillini, 14, I-20162 Milano, IT
- 
- (51) MKP  
**A61K 36/185 (2006.01)** (97) **2605785 \***  
**A61K 36/53 (2006.01)**
- (86) EP2011005075 11.10.2011  
(96) 11773998.7 26.06.2013  
(87) WO2012076068, 11.10.2011  
(97) 2605785, 26.06.2013 de  
(54) METHOD FOR PRODUCING NON-ALCOHOLIC COMPOSITIONS, COMPOSITIONS PRODUCED IN SAID MANNER AND USE THEREOF  
(71) Maria Clementine Martin Klosterfrau Vertriebsgesellschaft mbH, Gereonsmühlengasse 1-11, 50670 Köln, DE  
(72) NAUERT, Christian, Waldstrasse 26A, 41542 Dormagen, DE  
GREVE, Harald, Schorlemerstraße 3a, 40545 Düsseldorf, DE
- 
- (51) MKP  
**B22D 11/06 (2006.01)** (97) **2629907 \***
- (86) AU2011001323 18.10.2011  
(96) 11833618.9 28.08.2013  
(87) WO2012051646, 18.10.2011  
(97) 2629907, 28.08.2013 en  
(54) TWIN ROLL CONTINUOUS CASTER  
(71) Castrip LLC, 1915 Rexford Road, Charlotte, NC 28211, US  
(72) OTSUKA, Hiroyuki, 2-44-20 Mitsuura-Minami Kanazawa-ku Yokohama-city, Tokyo 135-8710, JP
- 
- (51) MKP  
**A61K 31/52 (2006.01)** (97) **2635287 \***  
**A61P 35/00 (2006.01)**
- (86) US2011059060 03.11.2011  
(96) 11838783.6 11.09.2013  
(87) WO2012061551, 03.11.2011  
(97) 2635287, 11.09.2013 en  
(54) ADMINISTRATION OF NEDD8-ACTIVATING ENZYME INHIBITOR  
(71) Millennium Pharmaceuticals, Inc., 40 Landsdowne Street, Cambridge, MA 02139, US  
(72) DEZUBE, Bruce, J., Millennium Pharmaceuticals Inc. 40 Landsdowne Street, Cambridge, MA 02139, US  
PETRUZZELLI, Lilli, M., Novartis Institute For Biomedical Research 220 Massachusetts Avenue, Cambridge, MA 02139, US
- 
- (51) MKP  
**B23B 27/22 (2006.01)** (97) **2636472 \***  
**B23B 27/04 (2006.01)**  
**B23B 27/14 (2006.01)**
- (86) JP2011072532 30.09.2011  
(96) 11837826.4 11.09.2013  
(87) WO2012060173, 30.09.2011  
(97) 2636472, 11.09.2013 en  
(54) CUTTING INSERT, CUTTING TOOL, AND METHOD FOR MANUFACTURING CUT PRODUCT USING SAME  
(71) Kyocera Corporation, 6, Takeda Tobadono-cho, Fushimi-ku, Kyoto-shi, Kyoto-fu 612-8501, JP  
(72) SAKAI, kouhei, c/o KYOCERA CORPORATION HEAD OFFICE 6 Takeda Tobadono-cho, Fushimi-ku, Kyoto-shi, Kyoto 612-8501, JP
- 
- (51) MKP  
**E21B 43/10 (2006.01)** (97) **2598714 \***
- (86) CA2011000869 28.07.2011  
(96) 11811687.0 05.06.2013  
(87) WO2012012884, 28.07.2011  
(97) 2598714, 05.06.2013 en  
(54) WELLBORE LATERAL LINER PLACEMENT SYSTEM  
(71) Packers Plus Energy Services Inc., Bow Valley Square 2 Suite 2200, 205 - 5 Avenue SW, Calgary, Alberta T2P 2V7, CA  
(72) THEMIG, Daniel, Jon, 256 Woodhaven Place SW, Calgary Alberta T2W 5P9, CA
- 
- (51) MKP  
**C07D 417/14 (2006.01)** (97) **2643311 \***  
**A61P 19/00 (2006.01)**  
**A61K 31/444 (2006.01)**  
**C07D 471/04 (2006.01)**  
**C07D 401/12 (2006.01)**  
**A61P 3/04 (2006.01)**  
**C07D 401/14 (2006.01)**  
**A61P 3/10 (2006.01)**  
**C07D 491/08 (2006.01)**  
**C07D 413/14 (2006.01)**  
**A61P 9/00 (2006.01)**  
**A61K 31/506 (2006.01)**
- (86) IB2011002814 24.11.2011  
(96) 11808320.3 02.10.2013  
(87) WO2012069917, 24.11.2011  
(97) 2643311, 02.10.2013 en  
(54) BICYCLIC GPR119 MODULATORS  
(71) Lupin Limited, 159 CST Road Kalina Santacruz (East), State of Maharashtra, Mumbai 400 098, IN  
(72) THOTAPALLY, Rajesh, Lupin Limited (Research Park) 46A/47A Village Nande Taluka Mulshi, Maharashtra 411 042 Pune, IN  
KACHI, Onkar, Gangaram, Lupin Limited (Research Park) 46A/47A Village Nande Taluka Mulshi, Maharashtra 411 042 Pune, IN  
RODGE, Atish, Harishchandra, Lupin Limited (Research Park) 46A/47A Village Nande Taluka Mulshi, Maharashtra 411 042 Pune, IN  
PATHAK, Ashok, Bhau, Lupin Limited (Research Park) 46A/47A Village Nande Taluka Mulshi, Maharashtra 411 042 Pune, IN  
KARDILE, Bhavana, Shrirang, Lupin Limited (Research Park) 46A/47A Village Nande Taluka Mulshi, Maharashtra 411 042 Pune, IN  
SINDKHEDKAR, Milind, Dattatraya, Lupin Limited (Research Park) 46A/47A Village Nande Taluka Mulshi, Maharashtra 411 042 Pune, IN  
PALLE, Venkata, P., Lupin Limited (Research Park) 46A/47A Village Nande Taluka Mulshi, Maharashtra 411 042 Pune, IN  
KAMBOJ, Rajender, Kumar, Lupin Limited (Research Park) 46A/47A Village Nande Taluka Mulshi, Maharashtra 411 042 Pune, IN
- 
- (51) MKP  
**F02M 59/46 (2006.01)** (97) **2538067**  
**F02M 63/00 (2006.01)**  
**F02M 63/02 (2006.01)**  
**F02M 51/00 (2006.01)**  
**F16K 31/06 (2006.01)**  
**F16L 37/098 (2006.01)**  
**F02M 61/16 (2006.01)**
- (96) 11170542.2 26.12.2012  
(97) 2538067, 26.12.2012 en  
(54) Assembly for an electrically operated valve  
(71) Delphi Technologies Holding S.à.r.l., Avenue de Luxembourg, 4940 Bascharage, LU  
(72) Dupont, Richard, 20 Avenue Leonard de Vinci, 37400 Amboise, FR  
Marechal, Michel, 48 route d'onzain, 41150 Chouzy Sur Cisse, FR
-



(51) MKP  
**A61M 11/00 (2006.01)** (97) **2537548**  
**A61M 11/06 (2006.01)**  
**A61M 15/00 (2006.01)**  
(96) 12172518.8 26.12.2012  
(97) 2537548, 26.12.2012 en  
(54) A method and apparatus for controlling and monitoring of an apparatus for generating an aerosol during administration of a dose of a substance by way of inhalation  
(71) Secura-Nova Spolka z Ograniczona Odpowiedzialnoscia, Aleja 3-go Maja 2 lok. 4, 00391 Warszawa, PL  
(72) Florkiewicz, Emil, Ul. Braterstwa Broni 10 m. 16, 98-200 Sieradz, PL  
Florkiewicz, Maciej, Ul. Taczanowskiego 2/7, 98-200 Sieradz, PL  
Pirozynski, Michal, Ul. Ordynacka 14 m 10, 00-358 Warszawa, PL

(51) MKP  
**C07K 16/46 (2006.01)** (97) **2627672 \***  
**C07K 16/18 (2006.01)**  
(86) IB2011002786 11.10.2011  
(96) 11797115.0 21.08.2013  
(87) WO2012049570, 11.10.2011  
(97) 2627672, 21.08.2013 en  
(54) HUMAN ANTI-TAU ANTIBODIES  
(71) Biogen IDEC International Neuroscience GmbH, Wagistrasse 13, 8952 Schlieren, CH  
University of Zurich, Rämistr. 71, 8006 Zurich, CH  
(72) CHEN, Feng, Breiteinsteinstrasse 84, CH-8037 Zurich, CH  
GRIMM, Jan, Burglistrasse 16, CH-8600 Duebendorf, CH  
BAERISWYL, Jean-Luc, Chemin du Gerbey 20, CH-1742 Villars-sur-Glâne, CH  
NITSCH, Roger, Langwisstrasse 27, CH-8126 Zumikon, CH  
HOCK, Christoph, Riestr. 43, CH-8703 Erlenbach, CH

(51) MKP  
**B01D 53/02 (2006.01)** (97) **2608866 \***  
**B01D 17/038 (2006.01)**  
(86) US2011048901 24.08.2011  
(96) 11820570.7 03.07.2013  
(87) WO2012027435, 24.08.2011  
(97) 2608866, 03.07.2013 en  
(54) SYSTEM AND METHOD FOR SEPARATING FLUIDS AND CREATING MAGNETIC FIELDS  
(71) Qwtip LLC, 223 North Guadalupe Street 462, Santa Fe, NM 87501, US  
(72) IRVIN, SR., Whitaker, Ben, 223 North Guadalupe Street 462, Santa Fe NM 87501, US

(51) MKP  
**A61L 101/32 (2006.01)** (97) **2629807 \***  
**A61L 9/01 (2006.01)**  
**A61L 9/12 (2006.01)**  
(86) US2011057554 24.10.2011  
(96) 11835295.4 28.08.2013  
(87) WO2012054939, 24.10.2011  
(97) 2629807, 28.08.2013 en  
(54) WATER-BASED AIR FRESHENER COMPOSITIONS, SYSTEMS, AND METHODS OF USE THEREOF  
(71) Agilex Flavor&Fragrances, 140 Centennial Avenue, Suite 100, Piscataway, NJ 08854, US  
(72) VLAD, Florin-Joseph, 9 Sunnyfield Drive, Annandale NJ 08801, US  
ZLOTNIK, Stuart, A., 4 Cloud Drive, Montville NJ 07045, US  
HINDEN-KUHLES, Natalie, 9 Homestead Road, Somerville NJ 08876, US

(51) MKP  
**B65G 67/20 (2006.01)** (97) **2627592 \***  
**B65G 67/08 (2006.01)**  
**B65G 57/112 (2006.01)**  
(86) US2011035889 10.05.2011  
(96) 11720271.3 21.08.2013  
(87) WO2012050640, 10.05.2011  
(97) 2627592, 21.08.2013 en  
(54) APPARATUS AND METHOD FOR LOADING AND UNLOADING CONTAINERS  
(71) Sanofi-Aventis U.S. LLC, 55 Corporate Drive, Bridgewater, NJ 08807, US  
(72) BYRNE, Brian, Paul, 5 Water Mill Court, Valley Cottage New York 10989, US  
MCLEESTER, Douglas, Edward, 1 Daniel Robbins Lane, Flemington New Jersey 08822, US

(51) MKP  
**B01D 63/04 (2006.01)** (97) **2614880**  
**B01D 65/00 (2006.01)**  
(96) 13001864.1 17.07.2013  
(97) 2614880, 17.07.2013 de  
(54) Membrane device for filtering and separating fluids  
(71) TIG Automation GmbH, Bötelpkamp 38, 22529 Hamburg, DE  
(72) Die Erfindernennung liegt noch nicht vor, null, null, null

(51) MKP  
**H01L 21/02 (2006.01)** (97) **2410556**  
**H01L 21/36 (2006.01)**  
(96) 11174885.1 25.01.2012  
(97) 2410556, 25.01.2012 en  
(54) Sodium sputtering doping method for large scale CIGS based thin film photovoltaic materials  
(71) Stion Corporation, 6321 San Ignacio Avenue, San Jose, CA 95119, US  
(72) Shao, May, 1009 Swenson Farm BLVD, Pflugerville, TX 78660, US

(51) MKP  
**B27N 3/00 (2006.01)** (97) **2598260 \***  
**B29B 17/02 (2006.01)**  
**B09B 3/00 (2006.01)**  
(86) FR2011051791 26.07.2011  
(96) 11752290.4 05.06.2013  
(87) WO2012022888, 26.07.2011  
(97) 2598260, 05.06.2013 fr  
(54) METHOD FOR RECYCLING FURNITURE MATERIALS, IN PARTICULAR MATTRESS, BOX-SPRING, AND SEAT MATERIALS, SHEET OF MATERIAL OBTAINED BY SUCH A METHOD, AND RELATED RECYCLING FACILITY  
(71) Ecoval Environnement, 8 Allée des Palombes, 77185 Lognes, FR  
(72) LANZA, Rémy, Chemin du Félin, Bollene 84500, FR  
TOUATI, Salim, 9 rue Anatole France Le Grand Monarque, F-26250 Livron Sur Drome, FR

(51) MKP  
**G01N 33/53 (2006.01)** (97) **2603794 \***  
**G01N 33/68 (2006.01)**  
**G01N 33/564 (2006.01)**  
(86) US2011047289 10.08.2011  
(96) 11745890.1 19.06.2013  
(87) WO2012021648, 10.08.2011  
(97) 2603794, 19.06.2013 en  
(54) DUAL FUNCTION IN VITRO TARGET BINDING ASSAY FOR THE DETECTION OF NEUTRALIZING ANTIBODIES AGAINST TARGET ANTIBODIES  
(71) Amgen Inc., Patent Operations M/S 28-2-C One Amgen Center Drive, Thousand Oaks, California 91320-1799, US  
(72) CHEN, Xinyi Cynthia, 3789 Camino Cordorniz, Calabasas California 91302, US  
CIVOLI, Francesca, 844 Cayo Grande Court, Newbury Park California 91320, US  
GUPTA, Shalini, 3486 W. Farrell Circle, Newbury Park California 91320, US

- (51) MKP  
**C07C 333/08 (2006.01)** (97) **2619177 \***  
**A61K 31/192 (2006.01)**  
**A61K 31/325 (2006.01)**  
**C07C 309/60 (2006.01)**  
**C07C 321/28 (2006.01)**  
**A61P 11/00 (2006.01)**  
**A61P 19/02 (2006.01)**  
**A61P 35/00 (2006.01)**
- (86) IB2011054228 26.09.2011  
(96) 11776884.6 31.07.2013  
(87) WO2012038943, 26.09.2011  
(97) 2619177, 31.07.2013 en
- (54) MATRIX METALLOPROTEINASE INHIBITORS  
(71) Ranbaxy Laboratories Limited, Head Office: 12th Floor Devika Tower 06 Nehru Place New Delhi, Delhi 110019, IN  
(72) KHERA, Manoj Kumar, R-511 Jalvayo Tower Sector-56, Gurgaon Haryana 122001, IN  
SATTIGERI, Jitendra, N-323 Vijay Rattan Vihar Sector 15-II, Gurgaon Haryana 122001, IN  
YADAV, Neeraj Kumar, Village - Rohila Post - Rohila Lohia Nagar, Farrukhabad Uttar Pradesh 206451, IN  
RAUF, Abdul Rehman Abdul, Islampura Chandur Biswa Nandura, Buldana Maharashtra 443401, IN  
CLIFFE, Ian A., E-704 Ambience Island NH-8, Gurgaon Haryana 122001, IN  
BHATNAGAR, Pradip Kumar, 300 South Balderston Drive, Exton Pennsylvania 19341, US  
RAY, Abhijit, Sector C-1 Flat No. 1408 Vasant Kunj, New Delhi Delhi 110070, IN  
SRIVASTAVA, Punit, 1263A Sector-15 Part -II, Gurgaon Haryana 122015, IN  
DASTIDAR, Sunanda Ghosh, B-138 Sarita Vihar, New Delhi Delhi 110076, IN

- (51) MKP  
**B41K 1/26 (2006.01)** (97) **2522524**  
**B41K 1/28 (2006.01)**  
**B41K 1/50 (2006.01)**  
**B41K 1/52 (2006.01)**
- (96) 11166084.1 14.11.2012  
(97) 2522524, 14.11.2012 de
- (54) Marking device for marking balls, use of such a marking device and method for producing such a marking device  
(71) Lehmann, Annette, Langensandhöhe 9, 6005 St. Niklausen, CH  
(72) Vaucher, Vincent, Sous la Rive 2, 2743 Eschert, CH  
Mast, Markus, Florastrasse 20, 3005 Bern, CH  
Lehmann, Annette, Langensandhöhe 9, 6005 St. Niklausen, CH  
Amgwerd, Luc, Chemin de la Neigette 1, 2533 Evilard, CH

- (51) MKP  
**G02B 6/36 (2006.01)** (97) **2625557 \***  
**G02B 7/00 (2006.01)**
- (86) FR2011052317 04.10.2011  
(96) 11779795.1 14.08.2013  
(87) WO2012045976, 04.10.2011  
(97) 2625557, 14.08.2013 fr
- (54) OPTICAL HEAD FOR PERFORMING AN ATMOSPHERIC MEASUREMENT, AND RELATED SYSTEM AND MANUFACTURING METHOD  
(71) Leosphere, 76 rue Monceau, 75008 Paris, FR  
(72) LALEU, Nicolas, 25 Résidence les Gros Chênes, F-91370 Verrieres-le-buisson, FR  
PARMENTIER, Rémy, 80 rue de Paris, F-92100 Boulogne-billancourt, FR

- (51) MKP  
**A61K 31/133 (2006.01)** (97) **2611433 \***
- (86) US2011049960 31.08.2011  
(96) 11755512.8 10.07.2013  
(87) WO2012030957, 31.08.2011  
(97) 2611433, 10.07.2013 en
- (54) NON-HYGROSCOPIC SALTS OF 5-HT<sub>2C</sub> AGONISTS  
(71) Arena Pharmaceuticals, Inc., 6154 Nancy Ridge Drive, San Diego, CA 92121, US  
(72) BLACKBURN, Anthony C., 12633 Caminito Rosita, San Diego, California 92128, US  
SHAN, Yun, 11429 Honey Ridge, San Diego, California 92130, US  
SHIFRINA, Anna, 11957 Miro Circle, San Diego, California 92131, US  
STIRN, Scott, 14710 Carmel Ridge Road, San Diego, California 92128, US

- (51) MKP  
**A61K 38/10 (2006.01)** (97) **2613794 \***  
**A61P 1/00 (2006.01)**  
**A61P 43/00 (2006.01)**
- (86) US2011051080 09.09.2011  
(96) 11758343.5 17.07.2013  
(87) WO2012034068, 09.09.2011  
(97) 2613794, 17.07.2013 en
- (54) TREATMENT OF CONSTIPATION-PREDOMINANT IRRITABLE BOWEL SYNDROME  
(71) Ironwood Pharmaceuticals, Inc., 301 Binney Street, Cambridge, MA 02142, US  
Forest Laboratories Holdings Limited, 18 Parliament Street Milner House, Hamilton HM12, BM  
(72) JOHNSTON, Jeffrey, 26 Hanson Street Unit 2, Boston MA 02118, US  
LAVINS, Bernard, Joseph, 21 Ellison Road, Lexington MA 02421, US  
SCHNEIER, Harvey, 25 Harrison Street, New York NY 10013, US

- (51) MKP  
**A61K 39/395 (2006.01)** (97) **2611463 \***
- (86) US2011050451 02.09.2011  
(96) 11788622.6 10.07.2013  
(87) WO2012031280, 02.09.2011  
(97) 2611463, 10.07.2013 en
- (54) IDENTIFICATION AND ENRICHMENT OF CELL SUBPOPULATIONS  
(71) Stem Centrx, Inc., 450 East Jamie Court, South San Francisco, CA 94080, US  
(72) DYLLA, Scott, J., 743 Wake Forest Drive, Mountain View, CA 94043, US  
SANTAGUIDA, Marianne, 780 Upton Street, Redwood City, CA 94061, US  
ANDERSON, Wade C., 5177 Pond Side Way, Fairfield, CA 94534, US

- (51) MKP  
**A01N 43/52 (2006.01)** (97) **2624696 \***  
**A61K 31/4164 (2006.01)**
- (86) US2011052857 23.09.2011  
(96) 11831214.9 14.08.2013  
(87) WO2012047538, 23.09.2011  
(97) 2624696, 14.08.2013 en
- (54) BENZIMIDAZOLE DERIVATIVES AS PI3 KINASE INHIBITORS  
(71) GlaxoSmithKline LLC, One Franklin Plaza 200 North 16th Street, Philadelphia, PA 19102, US  
QU, Junya, c/o GlaxoSmithKline Global Patents Department 1250 South Collegeville Road P. O. Box 5089, Collegeville, Pennsylvania 19426, US  
RIVERO, Ralph, c/o GlaxoSmithKline Global Patents Department 1250 South Collegeville Road P. O. Box 5089, Collegeville, Pennsylvania 19426, US  
SANCHEZ, Robert, c/o GlaxoSmithKline Global Patents Department 1250 South Collegeville Road P. O. Box 5089, Collegeville, Pennsylvania 19426, US  
TEDESCO, Rosanna, c/o GlaxoSmithKline Global Patents Department 1250 South Collegeville Road P. O. Box 5089, Collegeville, Pennsylvania 19426, US

(51) MKP  
**G02B 27/12 (2006.01)** (97) **2596400 \***  
 (86) US2011044805 21.07.2011  
 (96) 11810390.2 29.05.2013  
 (87) WO2012012608, 21.07.2011  
 (97) 2596400, 29.05.2013 en  
 (54) NANO-OPTIC REFRACTIVE OPTICS  
 (71) University of Pittsburgh - Of The Commonwealth System of Higher Education, 200 Gardner Steel Conference Center Thackeray & O'Hara Streets, Pittsburgh, PA 15260, US  
 (72) KIM, Hong, Koo, 1816 Willow Oak Drive, Pittsburgh, PA 15090, US  
 JUNG, Yun-Suk, 6617 Woodwell Street, Pittsburgh, PA 15217, US  
 XI, Yonggang, 5854 Forbes Avenue Apt. 11, Pittsburgh, PA 15217, US

(51) MKP  
**A01N 37/34 (2006.01)** (97) **2595481 \***  
**A01N 43/653 (2006.01)**  
**A01N 43/54 (2006.01)**  
**A01N 37/50 (2006.01)**  
**A01N 47/34 (2006.01)**  
**A01N 37/32 (2006.01)**  
**A01N 43/56 (2006.01)**  
**A01N 41/06 (2006.01)**  
**A01N 47/38 (2006.01)**  
**A01N 43/36 (2006.01)**  
**A01N 47/44 (2006.01)**  
**A01N 43/40 (2006.01)**  
**A01N 53/00 (2006.01)**  
**A01N 43/50 (2006.01)**  
**A01P 3/00 (2006.01)**  
 (86) JP2011004124 21.07.2011  
 (96) 11745584.0 29.05.2013  
 (87) WO2012011287, 21.07.2011  
 (97) 2595481, 29.05.2013 en  
 (54) CONTROL AGENT FOR SOFT ROT AND CONTROL METHOD FOR THE SAME  
 (71) Ishihara Sangyo Kaisha, Ltd., 3-15 Edobori 1-chome Nishi-ku, Osaka-shi, Osaka 550-0002, JP  
 (72) SUGIMOTO, Koji, c/o Ishihara Sangyo Kaisha Ltd. Chuo Kenkyusho 3-1 Nishi-shibukawa 2-chome, Kusatsu-shi Shiga 525-0025, JP  
 HAYASHI, Hiroyuki, c/o Ishihara Sangyo Kaisha Ltd. Chuo Kenkyusho 3-1 Nishi-shibukawa 2-chome, Kusatsu-shi Shiga 525-0025, JP

(51) MKP  
**A61P 1/00 (2006.01)** (97) **2629789 \***  
**A61K 38/43 (2006.01)**  
 (86) EP2010065915 21.10.2010  
 (96) 10768239.5 28.08.2013  
 (87) WO2012052059, 21.10.2010  
 (97) 2629789, 28.08.2013 en  
 (54) METHOD TO INCREASE THE ABSORPTION OF UNSATURATED FATTY ACIDS BY HUMAN INFANTS  
 (71) Swedish Orphan Biovitrum AB (Publ), null, 112 76 Stockholm, SE  
 (72) HERNELL, Olle, Skolgatan 28, S-903 22 Umeå, SE  
 OLSSON, Birgitta, Ekeberga, S-179 62 Stenhamra, SE  
 STRÖMBERG, Patrik, Kanalvägen 28B, S-191 34 Sollentuna, SE  
 SVENSSON, Lennart, Gustav III:s boulevard 99, S-169 74 Solna, SE  
 TIMDAHL, Kristina, Bokvägen 59A, S-146 50 Tullinge, SE  
 VAGERÖ, Märten, Branddammsvägen 3B, S-132 44 Saltsjö-Boo, SE  
 ÖHMAN, Maria, P.O.Box 142, SE- 941 23 Piteå, SE

(51) MKP  
**F24J 2/20 (2006.01)** (97) **2625470 \***  
 (86) AT2012000093 05.04.2012  
 (96) 12721159.7 14.08.2013  
 (87) WO2012142632, 05.04.2012  
 (97) 2625470, 14.08.2013 de  
 (54) SOLAR COLLECTOR  
 (71) Inova Lisec Technologiezentrum GmbH, Peter-Lisec-Straße 1, 3353 Seitenstetten, AT  
 (72) MADER, Leopold, Gaistechen 39, A-3364 Neuhofen/Ybbs, AT

(51) MKP  
**C12N 1/14 (2006.01)** (97) **2633028 \***  
**C12R 1/645 (2006.01)**  
 (86) EP2011068971 28.10.2011  
 (96) 11784446.4 04.09.2013  
 (87) WO2012055998, 28.10.2011  
 (97) 2633028, 04.09.2013 en  
 (54) USE OF MONASCUS IN ORGANIC ACID PRODUCTION  
 (71) Total Raffinage Marketing, 24 CRS Michelet, 92800 Puteaux, FR  
 (72) WEUSTHUIS, Ruud Alexander, Magnoliaaan 18, NL-6866 GD Heesum, NL  
 WOLBERT, Emil Johan Harald, Leeuweriksweide 208, NL-6708 LP Wageningen, NL  
 SPRINGER, Jan, Bennekomseweg 180, NL-6704 AL Wageningen, NL  
 VAN DER OOST, John, Bram Streeflandweg 116, NL-6871 HZ Renkum, NL  
 EGGINK, Gerrit, Erasmusstate 59, NL-6716 SC Ede, NL

(51) MKP  
**A61B 17/04 (2006.01)** (97) **2566402 \***  
**A61B 17/08 (2006.01)**  
**D02J 3/10 (2006.01)**  
**D02J 3/02 (2006.01)**  
 (86) US2011035271 04.05.2011  
 (96) 11778311.8 13.03.2013  
 (87) WO2011140283, 04.05.2011  
 (97) 2566402, 13.03.2013 en  
 (54) SELF-RETAINING SYSTEMS HAVING LASER-CUT RETAINERS  
 (71) Ethicon, LLC, Road 183 KM 8.3 Hato Industrial Area, San Lorenzo, PR 00754, US  
 (72) GROSS, Jeffrey, M., 1100 Garden View Road, 200, Encinitas, CA 92024, US  
 D'AGOSTINO, William, L., 19 Douglas Drive, Hamden Connecticut 06518, US  
 DRUBETSKY, Lev, 2948 Waterford Place, Coquitlam British Columbia V3E 2S9, CA  
 NAIMAGON, Alexander, 11-8711 General Currie Road, Richmond British Columbia V6Y 1M3, CA

(51) MKP  
**C12N 5/02 (2006.01)** (97) **2611907 \***  
**C12N 5/0735 (2010.01)**  
**C12N 5/071 (2010.01)**  
 (86) US2011048131 17.08.2011  
 (96) 11822351.0 10.07.2013  
 (87) WO2012030540, 17.08.2011  
 (97) 2611907, 10.07.2013 en  
 (54) DIFFERENTIATION OF PLURIPOTENT STEM CELLS  
 (71) Janssen Biotech, Inc., 800/850 Ridgeview Drive, Horsham, PA 19044, US  
 (72) REZANIA, Alireza, 199 Grandview Road, Skillman, NJ 08558, US

(51) MKP  
**B65D 17/34 (2006.01)** (97) **2621820 \***  
 (86) DK2011000108 30.09.2011  
 (96) 11779332.3 07.08.2013  
 (87) WO2012041319, 30.09.2011  
 (97) 2621820, 07.08.2013 en  
 (54) LID FOR BEVERAGE CAN  
 (71) Clean Canned ApS, Røngård Alle 23, 2610 Rødovre, DK  
 (72) RAUFER, Sune, Røn Alle 23, DK-2610 Rødovre, DK

- (51) MKP  
**B65D 47/18 (2006.01)** (97) **2616352 \***  
**B65D 49/04 (2006.01)**  
**B65D 81/26 (2006.01)**  
**B65D 47/32 (2006.01)**  
**B65D 51/16 (2006.01)**  
(86) IB2011001741 28.07.2011  
(96) 11755118.4 24.07.2013  
(87) WO2012014050, 28.07.2011  
(97) 2616352, 24.07.2013 fr  
(54) HEAD FOR DISPENSING A LIQUID AS A DRIP  
(71) Laboratoires Thèa, 12, rue Louis Bléroit Zone Industrielle du Brezet, 63100 Clermont-Ferrand, FR  
(72) DEFEMME, Alain, 7 rue des Galoubies, F-63400 Chamalieres, FR  
MERCIER, Fabrice, 34 avenue Léon Blum, F-63000 Clermont-Ferrand, FR
- 
- (51) MKP  
**A61K 31/496 (2006.01)** (97) **2642999 \***  
**A61P 37/00 (2006.01)**  
(86) US2011061769 22.11.2011  
(96) 11793928.0 02.10.2013  
(87) WO2012071374, 22.11.2011  
(97) 2642999, 02.10.2013 en  
(54) METHODS OF TREATMENT USING SELECTIVE BCL-2 INHIBITORS  
(71) AbbVie Inc., 1 North Waukegan Road, North Chicago, IL 60064, US  
(72) ELMORE, Steven, 2139 Ash Lane, Northbrook, Illinois 60062, US  
SOUERS, Andrew, 901 Hinman Apt. 3a, Evanston, Illinois 60202, US  
WANG, Li Chun, 177 Old Westboro Road, North Grafton, Massachusetts 01581, US  
GHAYUR, Tariq, 1014 Washington Street, Holliston, Massachusetts 01746, US  
PERPER, Stuart J., 10 Partridge Trail, Bellingham, Massachusetts 02019, US
- 
- (51) MKP  
**A61K 31/37 (2006.01)** (97) **2595624 \***  
**A61K 31/42 (2006.01)**  
**A61K 31/573 (2006.01)**  
**A61K 38/47 (2006.01)**  
**A61P 43/00 (2006.01)**  
**A61P 29/00 (2006.01)**  
**A61P 7/10 (2006.01)**  
**A61P 21/00 (2006.01)**  
**A61P 35/00 (2006.01)**  
(86) US2011044281 15.07.2011  
(96) 11735755.8 29.05.2013  
(87) WO2012012300, 15.07.2011  
(97) 2595624, 29.05.2013 en  
(54) ADVERSE SIDE-EFFECTS ASSOCIATED WITH ADMINISTRATION OF AN ANTI-HYALURONAN AGENT AND METHODS FOR AMELIORATING OR PREVENTING THE SIDE-EFFECTS  
(71) Halozyme, Inc., 11388 Sorrento Valley Road, San Diego, CA 92121, US  
(72) SHEPARD, Harold, Michael, 8124 Montrose Way, San Diego CA 92122, US  
THOMPSON, Curtis, 10355 Veracruz Ct., San Diego CA 92124, US  
LI, Xiaoming, 8886 Adobe Bluffs Dr., San Diego CA 92129, US  
FROST, Gregory, Ian, 13662 Mercado Drive, Del Mar CA 92014, US
- 
- (51) MKP  
**H02G 3/08 (2006.01)** (97) **2643911 \***  
**H02G 3/22 (2006.01)**  
**H02G 15/013 (2006.01)**  
(86) EP2011005468 28.10.2011  
(96) 11778531.1 02.10.2013  
(87) WO2012069128, 28.10.2011  
(97) 2643911, 02.10.2013 de  
(54) SINGLE-LINE SEAL  
(71) Rehau AG & Co, Rheniumhaus, 95111 Rehau, DE  
(72) VOHLER, Tobias, Am Stocken 23a, 92318 Neumarkt, DE
- 
- (51) MKP  
**A61K 31/502 (2006.01)** (97) **2598491 \***  
**C07D 237/32 (2006.01)**  
**C07D 403/12 (2006.01)**  
**A61P 35/00 (2006.01)**  
(86) IN2011000455 07.07.2011  
(96) 11767077.8 05.06.2013  
(87) WO2012014221, 07.07.2011  
(97) 2598491, 05.06.2013 en  
(54) SUBSTITUTED 4-(4-FLUORO-3-(PIPERAZINE-1-CARBONYL)BENZYL)PHTHALAZIN-1(2H)-ONE DERIVATIVES AS POLY (ADP-RIBOSE) POLYMERASE- 1 INHIBITORS  
(71) Cadila Healthcare Limited, Zydus Tower Satellite Cross Roads, Ahmedabad 380 015, Gujarat, IN  
(72) SHRIVASTAVA, Brijesh Kumar, Cadila Healthcare Limited Zydus Tower Satellite Cross Road Ahmedabad 380 015, Gujarat, IN
- 
- (51) MKP  
**A61K 38/46 (2006.01)** (97) **2613798 \***  
**A61K 31/366 (2006.01)**  
**A61K 31/397 (2006.01)**  
**A61K 31/135 (2006.01)**  
**A61P 3/06 (2006.01)**  
(86) US2011051096 09.09.2011  
(96) 11758644.6 17.07.2013  
(87) WO2012050695, 09.09.2011  
(97) 2613798, 17.07.2013 en  
(54) USE OF LYSOSOMAL ACID LIPASE FOR TREATING LYSOSOMAL ACID LIPASE DEFICIENCY IN PATIENTS  
(71) Synageva BioPharma Corp., 128 Spring Street, Suite 520, Lexington, MA 02421, US  
(72) QUINN, Anthony, 107 Manet Road, Chestnut Hill Massachusetts 02467, US
- 
- (51) MKP  
**A61K 39/395 (2006.01)** (97) **2632954 \***  
**C07K 16/28 (2006.01)**  
**C07K 16/46 (2006.01)**  
**A61P 35/00 (2006.01)**  
(86) EP2011068851 27.10.2011  
(96) 11787633.4 04.09.2013  
(87) WO2012055961, 27.10.2011  
(97) 2632954, 04.09.2013 en  
(54) MEANS AND METHODS FOR TREATING DLBCL  
(71) Amgen Research (Munich) GmbH, Staffelseestrasse 2, 81477 München, DE  
(72) ZUGMAIER, Gerhard, c/o Amgen Research (Munich) GmbH Staffelseestr. 2, 81477 Muenchen, DE  
NAGORSEN, Dirk, c/o Amgen Research (Munich) GmbH Staffelseestr. 2, 81477 Muenchen, DE  
SCHEELE, Juergen, c/o Amgen Research (Munich) GmbH Staffelseestr. 2, 81477 Muenchen, DE
- 
- (51) MKP  
**C12N 15/09 (2006.01)** (97) **2644693**  
**C12N 1/20 (2006.01)**  
**C12N 9/18 (2006.01)**  
**C12N 5/10 (2006.01)**  
**C12N 15/70 (2006.01)**  
(96) 12002306.4 02.10.2013  
(97) 2644693, 02.10.2013 en  
(54) Biologically active polypeptide expressed on the surface of a cell  
(71) IP Bewertungs AG (IPB), Stephansplatz 10, 20354 Hamburg, DE  
(72) Coksezen, Atilla, Dr., Bornstr. 33, 20146 Hamburg, DE  
Rehn, Ulrike, Dr., Quellenweg 15, 20535 Hamburg, DE  
Richter, Carsten, Dr., Frauenstr. 39, 48143 Münster, DE  
Kähler, Markus, Dr., Haakesstr. 25, 21075 Hamburg, DE  
Stachelhaus, Torsten, Dr., im Torfmoos 6, 22417 Hamburg, DE
-

- (51) MKP  
**C12Q 1/04 (2006.01)** (97) **2596119 \***  
**C12N 5/071 (2010.01)**  
**C12N 5/0735 (2010.01)**  
**G01N 33/533 (2006.01)**  
(86) US2011045232 25.07.2011  
(96) 11810518.8 29.05.2013  
(87) WO2012012803, 25.07.2011  
(97) 2596119, 29.05.2013 en  
(54) METHODS FOR DETECTION OF RARE SUBPOPULATIONS OF CELLS AND HIGHLY PURIFIED COMPOSITIONS OF CELLS  
(71) Advanced Cell Technology, Inc., 33 Locke Drive, Marlborough, MA 01752, US  
(72) KLIMANSKAYA, Irina, 75 Mechanic Street, Upton, Massachusetts 01568, US  
GAY, Roger, J., 18 Wiley Road, Belmont, Massachusetts 02478, US
- 
- (51) MKP  
**E06B 9/00 (2006.01)** (97) **2601371 \***  
**E06B 9/02 (2006.01)**  
(86) AT2011000333 03.08.2011  
(96) 11757527.4 12.06.2013  
(87) WO2012016265, 03.08.2011  
(97) 2601371, 12.06.2013 de  
(54) CLAMPING DEVICE  
(71) Schröcker, Siegfried, null, 4581 Rosenau am Hengstpass Nr. 58, AT  
(72) Schröcker, Siegfried, null, 4581 Rosenau am Hengstpass Nr. 58, AT
- 
- (51) MKP  
**A47B 67/04 (2006.01)** (97) **2621307 \***  
**A47B 88/20 (2006.01)**  
(86) AT2011000380 16.09.2011  
(96) 11764075.5 07.08.2013  
(87) WO2012040751, 16.09.2011  
(97) 2621307, 07.08.2013 de  
(54) FEEDING STATION FOR PETS AND CABINET HAVING SUCH A FEEDING STATION  
(71) Probst, Franz, Burg-Neudegg-Gasse 10, 2630 Ternitz, AT  
(72) Probst, Franz, Burg-Neudegg-Gasse 10, 2630 Ternitz, AT
- 
- (51) MKP  
**G05D 11/13 (2006.01)** (97) **2616385 \***  
**B67D 3/00 (2006.01)**  
(86) IL2012050047 15.02.2012  
(96) 12709704.6 24.07.2013  
(87) WO2012117399, 15.02.2012  
(97) 2616385, 24.07.2013 en  
(54) BEVERAGE DISPENSING SYSTEM  
(71) Strauss Water Ltd, 49 Hasivim Street, Petach Tikva 49517, IL  
(72) WILDER, Haim, 7 Yehuda Halevi Street, 43555 Raanana, IL  
KRYSTAL, Eyal, 19/17 Hachia Street, 44250 Kfar Saba, IL  
BAR-ON, Omri, Hachalutz St. 24 Beit Hakerem, 96222 Jerusalem, IL
- 
- (51) MKP  
**B60K 15/03 (2006.01)** (97) **2625053 \***  
**F17C 1/00 (2006.01)**  
(86) PL2010050051 06.10.2010  
(96) 10798645.7 14.08.2013  
(87) WO2012047123, 06.10.2010  
(97) 2625053, 14.08.2013 en  
(54) PRESSURE TANK  
(71) Elpigaz Sp. z o.o., ul. Perseusza 9, 80-299 Gdansk, PL  
(72) JARZYNSKI, Grzegorz, Szumilowo 9, PL 87-220 Radzyn Chelminski, PL
- 
- (51) MKP  
**C08L 25/08 (2006.01)** (97) **2639183 \***  
**B65D 65/02 (2006.01)**  
**B65D 83/04 (2006.01)**  
**C08K 3/00 (2006.01)**  
**C08J 5/18 (2006.01)**  
**B65D 75/34 (2006.01)**  
(86) JP2011075857 09.11.2011  
(96) 11840693.3 18.09.2013  
(87) WO2012063876, 09.11.2011  
(97) 2639183, 18.09.2013 en  
(54) PUSH-THROUGH PACK PACKAGING  
(71) Asahi Kasei Chemicals Corporation, 1-105, Kanda Jinbocho Chiyoda-ku, Tokyo 101-8101, JP  
(72) MATSUKI Yutaka, 1-105 Kanda Jinbocho Chiyoda-ku, Tokyo 101-8101, JP  
HAYASHI Hideki, 1-105 Kanda Jinbocho Chiyoda-ku, Tokyo 101-8101, JP  
KIMURA Hiroaki, 1-105 Kanda Jinbocho Chiyoda-ku, Tokyo 101-8101, JP
- 
- (51) MKP  
**F02G 5/02 (2006.01)** (97) **2495422**  
(96) 12157982.5 05.09.2012  
(97) 2495422, 05.09.2012 de  
(54) Combustion engine  
(71) Behr GmbH & Co. KG, Mauserstr. 3, 70469 Stuttgart, DE  
(72) Geskes, Peter, Theodor-Rothschild-Str. 72, 73760 Ostfildern, DE  
Pantow, Eberhard, Lavendelweg 8, 71364 Winnenden, DE
- 
- (51) MKP  
**A47F 7/024 (2006.01)** (97) **2586340**  
(96) 11186905.3 01.05.2013  
(97) 2586340, 01.05.2013 de  
(54) Ring holder, system comprising ring holder and ring display and method for connecting a ring with a ring holder  
(71) beeline GmbH, Grünstraße 1, 51063 Köln, DE  
(72) Steber, Harald, Max-Keith-Straße 11, 45136 Essen, DE  
Noster, Meike, Max-Keith-Straße 11, 45136 Essen, DE  
Frankowski, Marcus, Max-Keith-Straße 11, 45136 Essen, DE
- 
- (51) MKP  
**E03D 13/00 (2006.01)** (97) **2627836 \***  
**E03D 9/00 (2006.01)**  
(86) EP2012063211 06.07.2012  
(96) 12731491.2 21.08.2013  
(87) WO2013017373, 06.07.2012  
(97) 2627836, 21.08.2013 de  
(54) INSERT FOR THE DRAINAGE OPENING OF A URINAL  
(71) Urimat Holding AG, Bellevueweg 1, 8832 Wollerau, CH  
(72) SCHMED, Arthur, Bellevueweg, CH-8832 Wollerau, CH  
BALKAU, Werner, Lassigen 277, CH-8762 Schwändi bei Schwanden, CH
- 
- (51) MKP  
**C07K 16/28 (2006.01)** (97) **2640749 \***  
(86) EP2011070058 14.11.2011  
(96) 11781571.2 25.09.2013  
(87) WO2012065950, 14.11.2011  
(97) 2640749, 25.09.2013 en  
(54) SILENT FC VARIANTS OF ANTI-CD40 ANTIBODIES  
(71) Novartis AG, Lichtstrasse 35, 4056 Basel, CH  
(72) HEUSSER, Christoph, Novartis Pharma AG Lichtstrasse 35, CH-4056 Basel, CH  
RUSH, James, Novartis Pharma AG Lichtstrasse 35, CH-4056 Basel, CH  
VINCENT, Karen, Novartis Pharma AG Lichtstrasse 35, CH-4056 Basel, CH

- (51) MKP  
**B67B 5/00 (2006.01)** (97) **2600870 \***  
**A61K 31/4745 (2006.01)**
- (86) US2011046847 05.08.2011  
(96) 11815401.2 12.06.2013  
(87) WO2012019158, 05.08.2011  
(97) 2600870, 12.06.2013 en
- (54) PUMP SYSTEMS AND METHODS FOR STORING AND DISPENSING A PLURALITY OF PRECISELY MEASURED UNIT-DOSES OF IMIQUIMOD CREAM
- (71) Medicis Pharmaceutical Corporation, 7720 North Dobson Road, Scottsdale, AZ 85256, US
- (72) NORDSIEK, Michael, T., 208 Grouse Lane, Wayne, PA 19087, US  
BALAJI, Kodumudi, S., 1521 Ide Drive, Lansdale, PA 19446, US
- 
- (51) MKP  
**A61P 35/00 (2006.01)** (97) **2640367 \***  
**G01N 33/00 (2006.01)**  
**A61K 31/00 (2006.01)**
- (86) US2011060786 15.11.2011  
(96) 11788001.3 25.09.2013  
(87) WO2012068106, 15.11.2011  
(97) 2640367, 25.09.2013 en
- (54) BENZOXAZEPINES AS INHIBITORS OF PI3K/MTOR AND METHODS OF THEIR USE AND MANUFACTURE
- (71) Exelixis, Inc., 210 East Grand Avenue, South San Francisco, CA 94080, US
- (72) RICE, Kenneth, 44 Montecillo Road, San Rafael CA 94903, US  
MARKBY, David, 3309 Folsom Street, San Francisco CA 94110, US
- 
- (51) MKP  
**F21S 6/00 (2006.01)** (97) **2530371**
- (96) 11176746.3 05.12.2012  
(97) 2530371, 05.12.2012 en
- (54) An electronic candle
- (71) Nantong Ya Tai Candle Arts & Crafts Co., Ltd., No. 1 East of Yubei Bridge, Tongzhou Area Nantong City Jiangsu, CN  
Shanghai Q Mall & Co. Ltd., Room 2503B, No. 500, Zhabei District Xinjiang Road, Shanghai City, CN
- (72) Ding, Yingqi, No. 1 East of Yubei Bridge Tongzhou Area,, Nantong City, Jiangsu Province,, CN
- 
- (51) MKP  
**A61P 31/16 (2006.01)** (97) **2620436 \***  
**C07D 471/04 (2006.01)**  
**A61K 31/53 (2006.01)**  
**A61P 43/00 (2006.01)**
- (86) JP2011071446 21.09.2011  
(96) 11826859.8 31.07.2013  
(87) WO2012039414, 21.09.2011  
(97) 2620436, 31.07.2013 en
- (54) SUBSTITUTED POLYCYCLIC CARBAMOYL PYRIDONE DERIVATIVE PRODRUG
- (71) Shionogi & Co., Ltd., 1-8, Doshomachi 3-chome Chuo-ku Osaka-shi, Osaka-shi, Osaka 5410045, JP
- (72) TAKAHASHI, Chika, c/o Shionogi & Co., Ltd. 1-1, Futabacho 3-chome, Toyonaka-shi Osaka 561-0825, JP  
MIKAMIYAMA, Hidenori, c/o Shionogi & Co., Ltd. 1-1, Futabacho 3-chome, Toyonaka-shi Osaka 561-0825, JP  
AKIYAMA, Toshiyuki, c/o Shionogi & Co., Ltd. 1-1, Futabacho 3-chome, Toyonaka-shi Osaka 561-0825, JP  
TOMITA, Kenji, c/o Shionogi & Co., Ltd. 1-1, Futabacho 3-chome, Toyonaka-shi Osaka 561-0825, JP  
TAODA, Yoshiyuki, c/o Shionogi & Co., Ltd. 1-1, Futabacho 3-chome, Toyonaka-shi Osaka 561-0825, JP  
KAWAI, Makoto, c/o Shionogi & Co., Ltd. 1-1, Futabacho 3-chome, Toyonaka-shi Osaka 561-0825, JP  
ANAN, Kosuke, c/o Shionogi & Co., Ltd. 1-1, Futabacho 3-chome, Toyonaka-shi Osaka 561-0825, JP  
MIYAGAWA, Masayoshi, c/o Shionogi & Co., Ltd. 1-1, Futabacho 3-chome, Toyonaka-shi Osaka 561-0825, JP  
SUZUKI, Naoyuki, c/o Shionogi & Co., Ltd. 1-1, Futabacho 3-chome, Toyonaka-shi Osaka 561-0825, JP
- 
- (51) MKP  
**C07D 401/12 (2006.01)** (97) **2621917 \***  
**A61K 31/444 (2006.01)**  
**A61P 11/08 (2006.01)**
- (86) US2011053997 29.09.2011  
(96) 11771325.5 07.08.2013  
(87) WO2012044825, 29.09.2011  
(97) 2621917, 07.08.2013 en
- (54) CRYSTALLINE OXALATE SALTS OF A DIAMIDE COMPOUND
- (71) Theravance, Inc., 901 Gateway Boulevard, South San Francisco, CA 94080, US
- (72) RAPTA, Miroslav, 411 E. Duane Avenue, Sunnyvale California 94085, US  
THALLADI, Venkat, 888 Foster City Boulevard Apt. E3, Foster City California 94404, US  
CHAO, Robert, 1121 Doyle Circle, Santa Clara California 95054, US
- 
- (51) MKP  
**H04B 5/00 (2006.01)** (97) **2633702 \***  
**H04R 25/00 (2006.01)**
- (86) IB2011002545 26.10.2011  
(96) 11835702.9 04.09.2013  
(87) WO2012056298, 26.10.2011  
(97) 2633702, 04.09.2013 en
- (54) PAIRING OR ASSOCIATING ELECTRONIC DEVICES
- (71) Cochlear Ltd., 1 University Avenue, Macquarie Centre NSW 2109, AU
- (72) BANNA, Rami, c/o Macquarie University IP Department 1 University Avenue, NSW 2109, AU  
GILMOUR, Justin, c/o Macquarie University IP Department 1 University Avenue, NSW 2109, AU  
MESKENS, Werner, c/o Macquarie University IP Department 1 University Avenue, NSW 2109, AU  
GORDON, Brian, c/o Macquarie University IP Department 1 University Avenue, NSW 2109, AU
- 
- (51) MKP  
**C25C 3/08 (2006.01)** (97) **2619518 \***  
**F27D 1/12 (2006.01)**
- (86) NO2011000263 20.09.2011  
(96) 11827027.1 31.07.2013  
(87) WO2012039624, 20.09.2011  
(97) 2619518, 31.07.2013 en
- (54) SYSTEM AND METHOD FOR CONTROL OF SIDE LAYER FORMATION IN AN ALUMINIUM ELECTROLYSIS CELL
- (71) Goodtech Recovery Technology AS, Per Kroghs vei 4, 1065 Oslo, NO
- (72) SALVADOR, John, Paul, c/o Goodtech Recovery Technology AS Per Kroghs vei 4, N-1065 Oslo, NO  
SEDLAK, Veroslav, c/o Goodtech Recovery Technology AS Per Kroghs vei 4, N-1065 Oslo, NO
- 
- (51) MKP  
**A61M 5/315 (2006.01)** (97) **2624893 \***  
**A61M 5/00 (2006.01)**
- (86) EP2011067417 05.10.2011  
(96) 11764229.8 14.08.2013  
(87) WO2012045793, 05.10.2011  
(97) 2624893, 14.08.2013 en
- (54) DRIVE MECHANISM FOR A DRUG DELIVERY DEVICE AND DRUG DELIVERY DEVICE
- (71) Sanofi-Aventis Deutschland GmbH, Brüningstraße 50, 65929 Frankfurt, DE
- (72) PLUMPTRE, David Aubrey, 36 Shire Way Droitwich Spa, Worcestershire WR9 7RQ, GB

- (51) MKP  
**A61P 3/00 (2006.01)** (97) **2595970 \***  
**C07D 237/20 (2006.01)**  
**A61K 31/425 (2006.01)**  
**C07D 271/06 (2006.01)**
- (86) IB2011053278 22.07.2011  
(96) 11746655.7 29.05.2013  
(87) WO2012011081, 22.07.2011  
(97) 2595970, 29.05.2013 en  
(54) DERIVATIVES OF OXADIAZOLE AND PYRIDAZINE, THEIR PREPARATION AND THEIR APPLICATION IN THERAPEUTICS
- (71) SANOFI, 174, Avenue de France, 75013 Paris, FR  
(72) FETT, Eykmar, c/o Sanofi Département Brevets 174 Avenue de France, F-75013 Paris, FR  
MOUGENOT, Patrick, c/o Sanofi Département Brevets 174 Avenue de France, F-75013 Paris, FR  
NAMANE, Claudie, c/o Sanofi Département Brevets 174 Avenue de France, F-75013 Paris, FR  
NICOLAI, Eric, c/o Sanofi Département Brevets 174 Avenue de France, F-75013 Paris, FR  
PHILIPPO, Christophe, c/o Sanofi Département Brevets 174 Avenue de France, F-75013 Paris, FR
- 
- (51) MKP  
**A61K 31/00 (2006.01)** (97) **2637648 \***  
**A61K 31/341 (2006.01)**  
**A61K 38/28 (2006.01)**  
**A61P 3/10 (2006.01)**
- (86) EP2011069532 07.11.2011  
(96) 11778916.4 18.09.2013  
(87) WO2012062698, 07.11.2011  
(97) 2637648, 18.09.2013 en  
(54) PHARMACEUTICAL COMPOSITION, METHODS FOR TREATING AND USES THEREOF
- (71) Boehringer Ingelheim International GmbH, Binger Strasse 173, 55216 Ingelheim am Rhein, DE  
(72) GREMPLE, Rolf, Boehringer Ingelheim GmbH Corporate Patents Binger Strasse 173, 55216 Ingelheim Am Rhein, DE  
JOHANSEN, Odd-Erik, Boehringer Ingelheim GmbH Corporate Patents Binger Strasse 173, 55216 Ingelheim Am Rhein, DE  
KLEIN, Thomas, Boehringer Ingelheim GmbH Corporate Patents Binger Strasse 173, 55216 Ingelheim Am Rhein, DE  
LUIPPOLD, Gerd, Boehringer Ingelheim GmbH Corporate Patents Binger Strasse 173, 55216 Ingelheim Am Rhein, DE  
MARK, Michael, Boehringer Ingelheim GmbH Corporate Patents Binger Strasse 173, 55216 Ingelheim Am Rhein, DE
- 
- (51) MKP  
**A61K 9/70 (2006.01)** (97) **2613771 \***
- (86) EP2011065204 02.09.2011  
(96) 11757808.8 17.07.2013  
(87) WO2012031985, 02.09.2011  
(97) 2613771, 17.07.2013 de  
(54) TRANSDERMAL THERAPEUTIC SYSTEMS WITH CRYSTALLIZATION-INHIBITING PROTECTIVE FILM (RELEASE LINER)
- (71) Bayer Intellectual Property GmbH, Alfred-Nobel-Strasse 10, 40789 Monheim, DE  
(72) BRACHT, Stefan, Staerkstr. 29, 16548 Glienicke Nordbahn, DE  
TEREBESI, Ildiko, Reichensteiner Weg 5, 14195 Berlin, DE  
LANGGUTH, Thomas, Am Goethepark 2B, 07751 Jena, DE
- 
- (51) MKP  
**C07D 239/47 (2006.01)** (97) **2619186 \***
- (86) EP2011066295 20.09.2011  
(96) 11761054.3 31.07.2013  
(87) WO2012038411, 20.09.2011  
(97) 2619186, 31.07.2013 de  
(54) PROCESS FOR PREPARING PAN-CDK INHIBITORS OF THE FORMULA (I), AND INTERMEDIATES IN THE PREPARATION
- (71) Bayer Pharma Aktiengesellschaft, Müllerstrasse 178, 13353 Berlin, DE  
(72) KRÜGER, Joachim, Zeppenheimer Weg 71, 40489 Düsseldorf, DE  
GRIES, Jörg, August-Macke-Weg 34, 42781 Haan, DE  
LOVIS, Kai, Bismarckstr. 87, 42115 Wuppertal, DE  
HASSFELD, Jorma, Auf dem Rheindamm 14, 40221 Düsseldorf, DE
- 
- (51) MKP  
**G01N 33/68 (2006.01)** (97) **2630495 \***  
**G01N 33/558 (2006.01)**
- (86) US2011056777 18.10.2011  
(96) 11788248.0 28.08.2013  
(87) WO2012054532, 18.10.2011  
(97) 2630495, 28.08.2013 en  
(54) METHODS FOR DETERMINING ANTI-DRUG ANTIBODY ISOTYPES
- (71) Nestec S.A. CT-IAM, Avenue Nestlé 55, 1800 Vevey, CH  
(72) WANG, Shui Long, 4555 Saddle Mountain Court, San Diego, California 92130, US  
OHRMUND, Linda, 3519 Tennyson Street, San Diego, California 92106, US  
HAUENSTEIN, Scott, 3565 Caminito El Rincon 211, San Diego, California 92130, US  
SINGH, Sharat, 8171 Top of the Morning Way, Rancho Santa Fe, California 92127, US
- 
- (51) MKP  
**C12P 21/08 (2006.01)** (97) **2596114 \***  
**C07K 16/00 (2006.01)**  
**A61K 39/00 (2006.01)**  
**C12N 5/00 (2006.01)**  
**C12P 21/06 (2006.01)**  
**C07H 21/04 (2006.01)**
- (86) US2011044020 14.07.2011  
(96) 11807516.7 29.05.2013  
(87) WO2012009544, 14.07.2011  
(97) 2596114, 29.05.2013 en  
(54) DOMAIN INSERTION IMMUNOGLOBULIN
- (71) Amgen, Inc, One Amgen Center Drive, Thousand Oaks, CA 91320-1799, US  
(72) ZHOU, Hongxing, c/o Amgen Inc. One Amgen Center Drive, Thousand Oaks California 91320-1799, US
- 
- (51) MKP  
**A61K 47/02 (2006.01)** (97) **2627606 \***  
**C01B 33/12 (2006.01)**  
**C04B 33/02 (2006.01)**
- (86) HU2011000098 12.10.2011  
(96) 11827788.8 21.08.2013  
(87) WO2012049527, 12.10.2011  
(97) 2627606, 21.08.2013 en  
(54) METHOD FOR PURIFYING DIATOMACEOUS EARTH SUITABLE FOR PHARMACEUTICAL USE
- (71) EGIS GYÓGYSZERGYÁR Nyilvánosan Működő Részvénytársaság, Keresztúri út 30-38, 1106 Budapest, HU  
Onp Holding SE, 20B Stasicratous Str. Krambis Building, 2nd floor, 1065 Nicosia, CY  
(72) MIKULÁSIK, Endre, Kossuth Lajos u. 47., H-9783 Egyházasközpont, HU  
SPAITS, Tamás, Bátya utca 19., Körmend, HU  
NAGY, Kálmán, Túrta út 2/A, H-1025 Budapest, HU  
LUKÁCS, Gyula, Bronz utca 5., H-1163 Budapest, HU  
MARKOVITS, Imre, Hercegprímás utca 17., H-1051 Budapest, HU  
FODORNÉ KOCSMÁR, Krisztina, 538. utca 10/A, H-1173 Budapest, HU  
GREGORNÉ BOROS, Livia, Vágóhid utca 7., H-2141 Csömör, HU  
MÓRÁSZ, Tamás, Magyarvár utca 18., H-1163 Budapest, HU  
SZLÁVIK, László, Jász utca 57. 2.em.9., H-1135 Budapest, HU  
HUDÁK, Máté, Szóvetseg utca 41. 1.em.8., H-1074 Budapest, HU  
HERÉB, Gyöngyi, Gépmadár utca 14. VII.em.27., H-1106 Budapest, HU  
PUSKÁS, Réka, Eszter, Hadnagy utca 19., I.em.5., H-3300 Eger, HU  
VARGA, Zoltán, Tanár utca 188., H-1171 Budapest, HU  
KAPUI, Imre, Bihari utca 37., H-2030 Érd, HU  
CLEMENTIS, György, Szent L. utca 89/A, H-8600 Siófok, HU  
BACHER, Gábor Attila, Lajtha László utca 18-20. IV/65., H-1203 Budapest, HU  
BÁNKÖVI, Beatrix, Béke utca 5., H-1039 Budapest, HU  
KISS, Gitta, Bronz utca 5., H-1163 Budapest, HU  
ALBRECHT, Ottó, Kaffka M. u. 48., H-1148 Budapest, HU
-

(51) MKP  
**C07D 453/02 (2006.01)** (97) **2630145 \***  
**A61K 31/439 (2006.01)**  
**A61P 11/14 (2006.01)**  
(86) EP2011067431 06.10.2011  
(96) 11776386.2 28.08.2013  
(87) WO2012052297, 06.10.2011  
(97) 2630145, 28.08.2013 en  
(54) CARBONATE DERIVATIVES FOR THE TREATMENT OF COUGH  
(71) Chiesi Farmaceutici S.p.A., Via Palermo, 26/A, 43100 Parma, IT  
(72) PATACCHINI, Riccardo, c/o CHIESI FARMACEUTICI S.p.A. Via Palermo 26/A, I-43100 Parma, IT  
GEPPETTI, Pierangelo, c/o CHIESI FARMACEUTICI S.p.A. Via Palermo 26/A, I-43100 Parma, IT

(51) MKP  
**B01D 11/04 (2006.01)** (97) **2600955 \***  
**B01D 17/04 (2006.01)**  
**C10G 27/04 (2006.01)**  
**C10G 33/06 (2006.01)**  
(86) US2011045544 27.07.2011  
(96) 11743908.3 12.06.2013  
(87) WO2012018657, 27.07.2011  
(97) 2600955, 12.06.2013 en  
(54) SEPARATION PROCESS  
(71) MERICHEM COMPANY, 5455 Old Spanish Trail, Houston, TX 77023, US  
(72) ZHANG, Tiejun, 4320 Jonathan Street, Bellaire TX 77401, US  
TURNER, V. Keith, 9907 Green Meadow Drive, La Porte TX 77571, US

(51) MKP  
**A61K 31/437 (2006.01)** (97) **2611444 \***  
**A61K 31/496 (2006.01)**  
**A61K 31/55 (2006.01)**  
**A61K 31/5517 (2006.01)**  
**C07D 413/12 (2006.01)**  
**C07D 417/12 (2006.01)**  
**C07D 471/04 (2006.01)**  
**C07D 498/04 (2006.01)**  
**A61P 23/00 (2006.01)**  
**A61P 25/00 (2006.01)**  
(86) IN2010000740 15.11.2010  
(96) 10803396.0 10.07.2013  
(87) WO2012029070, 15.11.2010  
(97) 2611444, 10.07.2013 en  
(54) HETEROCYCLYL COMPOUNDS AS HISTAMINE H3 RECEPTOR LIGANDS  
(71) Suven Life Sciences Limited, Serene Chambers Road No. 5, Avenue 7, Banjara Hills, Hyderabad 500 034, Andhra Pradesh, IN  
(72) NIROGI, Ramakrishna, Suven Life Sciences Limited Serene Chambers Road - 5 Avenue - 7 Banjara Hills, Hyderabad 500 034 Andhra Pradesh, IN  
SHINDE, Anil, Karbhari, Suven Life Sciences Limited Serene Chambers Road - 5 Avenue - 7 Banjara Hills, Hyderabad 500 034 Andhra Pradesh, IN  
KAMBHAMPATI, Ramasastry, Suven Life Sciences Limited Serene Chambers Road - 5 Avenue - 7 Banjara Hills, Hyderabad 500 034 Andhra Pradesh, IN  
NAMALA, Rambabu, Suven Life Sciences Limited Serene Chambers Road - 5 Avenue - 7 Banjara Hills, Hyderabad 500 034 Andhra Pradesh, IN  
DWARAMPUDI, Adi, Reddy, Suven Life Sciences Limited Serene Chambers Road - 5 Avenue - 7 Banjara Hills, Hyderabad 500 034 Andhra Pradesh, IN  
KOTA, Laxman, Suven Life Sciences Limited Serene Chambers Road - 5 Avenue - 7 Banjara Hills, Hyderabad 500 034 Andhra Pradesh, IN  
GAMPA, Murlimohan, Suven Life Sciences Limited Serene Chambers Road - 5 Avenue - 7 Banjara Hills, Hyderabad 500 034 Andhra Pradesh, IN  
KODRU, Padmavathi, Suven Life Sciences Limited Serene Chambers Road - 5 Avenue - 7 Banjara Hills, Hyderabad 500 034 Andhra Pradesh, IN  
TIRIVEEDHI, Taraka, Naga, Vinaykumar, Suven Life Sciences Limited Serene Chambers Road - 5 Avenue - 7 Banjara Hills, Hyderabad 500 034 Andhra Pradesh, IN  
KANDIKERE, Vishwottam, Nagaraj, Suven Life Sciences Limited Serene Chambers Road - 5 Avenue - 7 Banjara Hills, Hyderabad 500 034 Andhra Pradesh, IN  
MUDDANA, Nageshwara, Rao, Suven Life Sciences Limited Serene Chambers Road - 5 Avenue - 7 Banjara Hills, Hyderabad 500 034 Andhra Pradesh, IN  
SARALAYA, Ramanatha, Shrikantha, Suven Life Sciences Limited Serene Chambers Road - 5 Avenue - 7 Banjara Hills, Hyderabad 500 034 Andhra Pradesh, IN  
JAYARAJAN, Pradeep, Suven Life Sciences Limited Serene Chambers Road - 5 Avenue - 7 Banjara Hills, Hyderabad 500 034 Andhra Pradesh, IN  
SHANMUGANATHAN, Dhanalakshmi, Suven Life Sciences Limited Serene Chambers Road - 5 Avenue - 7 Banjara Hills, Hyderabad 500 034 Andhra Pradesh, IN  
AHMAD, Ishtiyaque, Suven Life Sciences Limited Serene Chambers Road - 5 Avenue - 7 Banjara Hills, Hyderabad 500 034 Andhra Pradesh, IN  
JASTI, Venkateswarlu, Suven Life Sciences Limited Serene Chambers Road - 5 Avenue - 7 Banjara Hills, Hyderabad 500 034 Andhra Pradesh, IN



(51) MKP  
**G06Q 20/00 (2012.01)** (97) **2628140 \***  
 (86) US2011055387 07.10.2011  
 (96) 11833173.5 21.08.2013  
 (87) WO2012051071, 07.10.2011  
 (97) 2628140, 21.08.2013 en  
 (54) PAYMENT METHODS WITH A PAYMENT SERVICE AND TABS SELECTED BY A FIRST PARTY AND OPENED BY A SECOND PARTY AT ANY GEOGRAPHIC LOCATION OF THE FIRST PARTY'S MOBILE DEVICE  
 (71) Square, Inc., 110 Fifth Street, San Francisco, CA 94103, US  
 (72) DORSEY, Jack, 901 Mission Street Suite 104, San Francisco CA 94103, US  
 HENDERSON, William, 1657 Hayes Street Unit 2, San Francisco CA 94117, US  
 GRASSADONIA, Brian, 2038 Scott Street, San Francisco CA 94117, US  
 MCKELVEY, James, M., 7501 Scenic Highway, Pensacola FL 32504, US

(51) MKP  
**E03D 9/08 (2006.01)** (97) **2354337**  
**B05B 1/34 (2006.01)**  
**B05B 7/04 (2006.01)**  
 (96) 10196703.2 10.08.2011  
 (97) 2354337, 10.08.2011 en  
 (54) Sanitary washing apparatus  
 (71) TOTO LTD., 1-1, Nakashima 2-chome Kokurakita-ku, Kitakyushu-shi Fukuoka 802-8601, JP  
 (72) Fukuzato, Shintaro, c/o TOTO LTD 1-1 Nakashima 2-chome, Kokurakita-ku., Kitakyushu-shi Fukuoka 802-8601, JP  
 Kozono, Yukihiro, c/o TOTO LTD. 1-1 Nakashima 2-chome, Kokurakita-ku, Kitakyushu-shi Fukuoka 802-8601, JP  
 Koso, Shinichi, c/o TOTO LTD. 1-1 Nakashima 2-chome, Kokurakita-ku, Kitakyushu-shi Fukuoka 802-8601, JP

(51) MKP  
**F23H 7/08 (2006.01)** (97) **2598800 \***  
 (86) EP2011062893 27.07.2011  
 (96) 11736103.0 05.06.2013  
 (87) WO2012013700, 27.07.2011  
 (97) 2598800, 05.06.2013 de  
 (54) HYDRAULIC DRIVE FOR A SLIDING COMBUSTION GRATE  
 (71) Doikos Investments, Ltd., 27 Pier Road, St. Helier Jersey JE4 8TZ, GB  
 (72) STIEFEL, Martin, Gfellerstrasse 1, CH-8626 Ottikon, CH

(51) MKP  
**C07K 1/16 (2006.01)** (97) **2601207 \***  
**C07K 1/18 (2006.01)**  
**C07K 1/22 (2006.01)**  
**C07K 14/46 (2006.01)**  
**C07K 14/47 (2006.01)**  
 (86) EP2011063291 02.08.2011  
 (96) 11738247.3 12.06.2013  
 (87) WO2012016984, 02.08.2011  
 (97) 2601207, 12.06.2013 en  
 (54) METHOD OF PRODUCING AND PURIFYING AN ACTIVE SOLUBLE SIALYLTRANSFERASE  
 (71) Biogenerix GmbH, Graf-Arco-Strasse 3, 89079 Ulm, DE  
 (72) ANGERMANN, Axel, An der Tränk 23, 63266 Dreieich, DE  
 SCHECKERMANN, Christian, Sägegasse 1c, 79238 Ehrenkirchen, DE  
 SCHMIDT, Karsten, Kösliner Str. 60, 76139 Karlsruhe, DE

(51) MKP  
**A61M 5/315 (2006.01)** (97) **2529773**  
 (96) 12165094.9 05.12.2012  
 (97) 2529773, 05.12.2012 en  
 (54) Resetting mechanism for a drug delivery device  
 (71) Sanofi-Aventis Deutschland GmbH, Brüningstraße 50, 65929 Frankfurt am Main, DE  
 (72) Plumptre, David Aubrey, 36 Shire Way, Droitwich Spa, Worcestershire WR9 7RQ, GB  
 Jones, Christopher John, The Old Thatch Grafton Gloucestershire GL20 7AT, Tewkesbury, Gloucestershire GL20 7AT, GB

(51) MKP  
**A01N 43/52 (2006.01)** (97) **2549874 \***  
**A61K 31/415 (2006.01)**  
 (86) US2011029147 21.03.2011  
 (96) 11759968.8 30.01.2013  
 (87) WO2011119465, 21.03.2011  
 (97) 2549874, 30.01.2013 en  
 (54) SUBSTITUTED IMIDAZO[1,2-B]PYRIDAZINE DERIVATIVES, PHARMACEUTICAL COMPOSITIONS, AND METHODS OF USE AS BETA-SECRETASE INHIBITORS  
 (71) High Point Pharmaceuticals, LLC, 4170 Mendenhall Oaks Parkway, High Point, North Carolina 27265, US  
 (72) MJALLI, Adnan, M.M., 6421 Ashton Park Drive, Oak Ridge, North Carolina 27310, US  
 HARI, Anitha, 3712 Pemberton Way, High Point, North Carolina 27265, US  
 GADDAM, Babu, 3749 Single Leaf Circle, High Point, North Carolina 27265, US  
 GOHIMUKKULA, Devi, Reddy, 4061 Cobbler Court, Jamestown, North Carolina 27282, US  
 POLISETTI, Dharma, Rao, 3741 Deerfield Street, High Point, North Carolina 27265, US  
 RAO, Mohan, 4914 Riding Ridge Drive, Greensboro, North Carolina 27410, US  
 GOWDA, Raju, Bore, 601 Stafford Pointe Court, Oak Ridge, North Carolina 27310, US  
 ANDREWS, Robert, Carl, 3312 Morris Farm Drive, Jamestown, North Carolina 27282, US  
 XIE, Rongyuan, 6407 Estes Court, Greensboro, North Carolina 27410, US  
 SAHOO, Soumya, P., 1131-R Knox Place, Greensboro, North Carolina 27407, US  
 REN, Tan, 8422 Pheasant Ridge Drive, Colfax, North Carolina 27235, US  
 BANNER, William, Kenneth, 10 Country Walk Lane, Greensboro, North Carolina 27407, US

(51) MKP  
**A61K 31/4995 (2006.01)** (97) **2637663 \***  
**A61K 31/69 (2006.01)**  
**A61K 45/06 (2006.01)**  
**A61K 38/15 (2006.01)**  
**A61P 35/00 (2006.01)**  
**A61P 35/02 (2006.01)**  
**A61K 31/513 (2006.01)**  
**A61K 31/519 (2006.01)**  
**A61K 31/7068 (2006.01)**  
 (86) EP2011069976 11.11.2011  
 (96) 11781807.0 18.09.2013  
 (87) WO2012062920, 11.11.2011  
 (97) 2637663, 18.09.2013 en  
 (54) COMBINATION THERAPY WITH AN ANTITUMOR ALKALOID  
 (71) Pharma Mar S.A., Avda. de los Reyes, 1 Polígono Industrial La Mina-Norte, 28770 Colmenar Viejo Madrid, ES  
 (72) MONEO OCAÑA, Victoria, Pharma Mar S.A. Avda. de los Reyes 1 Polígono Industrial La Mina-Norte, E-28770 Colmenar Viejo-Madrid, ES  
 SANTAMARÍA NÚÑEZ, Gema, Pharma Mar S.A. Avda. de los Reyes 1 Polígono Industrial La Mina-Norte, E-28770 Colmenar Viejo-Madrid, ES  
 GARCÍA FERNÁNDEZ, Luis Francisco, Pharma Mar S.A. Avda. de los Reyes 1 Polígono Industrial La Mina, E-28770 Colmenar Viejo - Madrid, ES  
 GALMARINI, Carlos María, Pharma Mar S.A. Avda. de los Reyes 1 Polígono Industrial La Mina-Norte, E-28770 Colmenar Viejo-Madrid, ES  
 GUILLÉN NAVARRO, María José, Pharma Mar S.A. Avda. de los Reyes 1 P.I. La Mina Norte, E-28770 Colmenar Viejo - Madrid, ES  
 AVILÉS MARÍN, Pablo Manuel, Pharma Mar S.A. Avda. de los Reyes 1 Polígono Industrial La Mina-Norte, E-28770 Colmenar Viejo - Madrid, ES

- (51) MKP  
**A61K 39/395 (2006.01)** (97) **2608808 \***  
**A61K 38/17 (2006.01)**  
**A61K 38/20 (2006.01)**  
**A61P 35/00 (2006.01)**  
(86) US2011048747 23.08.2011  
(96) 11820492.4 03.07.2013  
(87) WO2012027324, 23.08.2011  
(97) 2608808, 03.07.2013 en  
(54) TREATMENT FOR NEOPLASTIC DISEASES  
(71) XBiotech, Inc, 1055 West Hastings Street, Suite 300,  
Vancouver, BC V6E 2E9, CA  
(72) SIMARD, John, 8201 East Riverside Drive Bldg. 4, Suite 100,  
Austin, TX 78744, US

- (51) MKP  
**C07D 213/73 (2006.01)** (97) **2598482 \***  
**C07D 237/20 (2006.01)**  
**C07D 239/42 (2006.01)**  
**C07D 241/20 (2006.01)**  
**C07D 261/14 (2006.01)**  
**C07D 263/48 (2006.01)**  
**C07D 277/40 (2006.01)**  
**C07D 285/12 (2006.01)**  
**C07D 401/12 (2006.01)**  
**C07D 413/12 (2006.01)**  
**C07D 417/12 (2006.01)**  
**C07D 271/07 (2006.01)**  
**C07D 271/113 (2006.01)**  
**C07D 253/07 (2006.01)**  
**A61K 31/44 (2006.01)**  
(86) EP2011062949 27.07.2011  
(96) 11749119.1 05.06.2013  
(87) WO2012013728, 27.07.2011  
(97) 2598482, 05.06.2013 en  
(54) ARYL CYCLOPROPYLAMINE BASED DEMETHYLASE  
INHIBITORS OF LSD1 AND THEIR MEDICAL USE  
(71) Oryzon Genomics, S.A., Calle Sant Ferran, 74, 08940 Cornellà  
de Llobregat - Barcelona, ES  
(72) ORTEGA MUÑOZ, Alberto, Oryzon Genomics S.A. C/Sant  
Ferran 74, E-08940 Cornellà de Llobregat Barcelona, ES  
FYFE, Matthew, Colin, Thor, Oryzon Genomics S.A. C/Sant  
Ferran 74, E-08940 Cornellà de Llobregat Barcelona, ES  
MARTINELL PEDEMONTE, Marc, Oryzon Genomics S.A. C/  
Sant Ferran 74, E-08940 Cornellà de Llobregat Barcelona, ES  
TIRAPU FERNANDEZ DE LA CUESTA, Iñigo, Oryzon  
Genomics S.A. C/Sant Ferran 74, E-08940 Cornellà de  
Llobregat Barcelona, ES  
ESTIARTE-MARTÍNEZ, María de los Ángeles, Oryzon  
Genomics S.A. C/Sant Ferran 74, E-08940 Cornellà de  
Llobregat Barcelona, ES

- (51) MKP  
**A61K 47/34 (2006.01)** (97) **2605795 \***  
(86) US2011048183 18.08.2011  
(96) 11818760.8 26.06.2013  
(87) WO2012024461, 18.08.2011  
(97) 2605795, 26.06.2013 en  
(54) INTRAVAGINAL DEVICES, METHODS OF MAKING, AND  
USES THEREOF  
(71) Tsao, Jiexiang, 4 Morgan Court, Nanuet, NY 10954, US  
Teva Women's Health, Inc., 400 Chestnut Ridge Road,  
Woodcliff Lake, NJ 07677, US  
(72) TSAO, Jiexiang, 4 Morgan Court, Nanuet NY 10954, US

- (51) MKP  
**C07D 223/16 (2006.01)** (97) **2607353**  
(96) 12191902.1 26.06.2013  
(97) 2607353, 26.06.2013 fr  
(54) New method for synthesising ivabradine and its added salts  
with a pharmaceutically acceptable acid.  
(71) Les Laboratoires Servier, 35, rue de Verdun, 92284 Suresnes  
Cedex, FR  
(72) Renaud, Jean-Luc, 5 rue des Alouettes, 14112 Bievilleville-  
Beuville, FR  
Pannetier, Nicolas, 8 rue des Carmes, 14000 Caen, FR  
Lecouve, Jean-Pierre, 93, rue du Docteur Vigné, 76600 Le  
Havre, FR  
Vaysse-Ludot, Lucile, 150, route de Rançon, 76490 Saint-  
Wandrille-Rançon, FR  
Moulin, Solenne, 3, Place d'Alsodorf, 22000 Saint-Brieuc, FR

- (51) MKP  
**A61K 31/426 (2006.01)** (97) **2586442 \***  
**A61P 9/12 (2006.01)**  
**A61P 13/12 (2006.01)**  
**A61P 19/06 (2006.01)**  
(86) JP2011064569 24.06.2011  
(96) 11798271.0 01.05.2013  
(87) WO2011162390, 24.06.2011  
(97) 2586442, 01.05.2013 en  
(54) SUSTAINED-RELEASE THERAPEUTIC AGENT FOR  
HYPERTENSION AND RENAL DYSFUNCTION  
(71) Teijin Pharma Limited, 2-1, Kasumigaseki 3-chome Chiyoda-  
ku, Tokyo 100-0013, JP  
(72) SHIRAKURA, Takashi, c/o Teijin Pharma Limited Tokyo  
Research Center 3-2, Asahigaoka 4-chome, Hino-shi Tokyo  
191-0065, JP  
TAMURA, Mizuho, c/o Teijin Pharma Limited Tokyo Research  
Center 3-2, Asahigaoka 4-chome, Hino-shi Tokyo 191-0065, JP  
TAKAHASHI, Yoshimasa, c/o Teijin Pharma Limited Tokyo  
Research Center 3-2, Asahigaoka 4-chome, Hino-shi Tokyo  
191-0065, JP  
KUWAHARA, Ippei, 1-5-2-405, Nishihashimoto Midori-ku,  
Sagamihara-shi Kanagawa 252-0131, JP

- (51) MKP  
**A61K 31/506 (2006.01)** (97) **2643310 \***  
**A61P 3/10 (2006.01)**  
**C07D 401/14 (2006.01)**  
**C07D 403/14 (2006.01)**  
**A61K 31/454 (2006.01)**  
**C07D 401/04 (2006.01)**  
(86) IB2011054996 09.11.2011  
(96) 11802149.2 02.10.2013  
(87) WO2012069948, 09.11.2011  
(97) 2643310, 02.10.2013 en  
(54) 4- (5-CYANO-PYRAZOL-1-YL) -PIPERIDINE DERIVATIVES  
AS GPR 119 MODULATORS  
(71) Pfizer Inc, 235 East 42nd Street, New York, NY 10017, US  
(72) MASCITTI, Vincent, Pfizer Global Research and Development  
Eastern Point Road, Groton, Connecticut 06340, US  
MCCLURE, Kim Francis, Pfizer Global Research and  
Development 87 Cambridge Park Drive, Cambridge,  
Massachusetts 02140, US  
MUNCHHOF, Michael John, 266 West Road, Salem,  
Connecticut 06420, US  
ROBINSON, Ralph Pelton, Jr., Pfizer Global Research and  
Development Eastern Point Road, Groton, Connecticut 06340,  
US

- (51) MKP  
**A61K 35/12 (2006.01)** (97) **2603226 \***  
**A61K 38/18 (2006.01)**  
**A61K 38/22 (2006.01)**  
**A61P 3/10 (2006.01)**  
(86) US2011047410 11.08.2011  
(96) 11817033.1 19.06.2013  
(87) WO2012021698, 11.08.2011  
(97) 2603226, 19.06.2013 en  
(54) TREATMENT OF DIABETES WITH PANCREATIC  
ENDOCRINE PRECURSOR CELLS  
(71) Janssen Biotech, Inc., 800/850 Ridgeview Drive, Horsham, PA  
19044, US  
(72) XU, Jean, 199 Grandview Road, Skillman NJ 08558, US

(51) MKP  
**A61K 39/395 (2006.01)** (97) **2608807 \***  
**C07K 16/22 (2006.01)**  
**C07K 16/40 (2006.01)**  
(86) US2011049458 26.08.2011  
(96) 11752429.8 03.07.2013  
(87) WO2012027723, 26.08.2011  
(97) 2608807, 03.07.2013 en  
(54) NOTUM PROTEIN MODULATORS AND METHODS OF USE  
(71) Stem Centrx, Inc., 450 East Jamie Court, South San Francisco, CA 94080, US  
(72) STULL, Robert, A., 1519 Fifth Street, Alameda, California 94501, US  
DYLIA, Scott, J., 743 Wake Forest Drive, Mountain View, California 94043, US  
FOORD, Orit, 712 Cayman Lane, Foster City, California 94404, US  
AUJAY, Monette, 840 Potrero Avenue, San Francisco, California 94110, US

(51) MKP  
**C12Q 1/68 (2006.01)** (97) **2625293 \***  
(86) US2011055391 07.10.2011  
(96) 11831689.2 14.08.2013  
(87) WO2012048236, 07.10.2011  
(97) 2625293, 14.08.2013 en  
(54) MICRORNAS (MIRNA) AS BIOMAKERS FOR THE IDENTIFICATION OF FAMILIAL AND NON-FAMILIAL COLORECTAL CANCER  
(71) Baylor Research Institute, 3310 Live Oak Street, Suite 501, Dallas, TX 75204, US  
Hospital Clinic de Barcelona, C/ Villarroel, 170, 08036 Barcelona, ES  
Centro de Investigacion en Red de Enfermedades Hepaticas y Digestivas, (CIBEREHD) Villarroel 170, 08036 Barcelona, ES  
(72) GOEL, Ajay, 6149 Marquita Avenue, Dallas TX 75214, US  
BOLAND, Richard, C., 2214B Allen Street, Dallas, TX 75204, US  
BALAGUER, Francesc, Lluís Domenech i Muntaner 6 Esc.7 5B-C Esplugues De Llobregat, E-08095 Barcelona, ES  
GIRONELLA I COS, Meritxell, Muntanya 84 First Floor, E-08026 Barcelona, ES  
CASTELLS I GARANGOU, Antoni, Domenec Oristrell 77 Second Floor Second Door Sant Cugat Del Valles, E-08190 Barcelona, ES  
MOREIRA RUIZ, Leticia, Onyar 6 Bajos 2, E-08038 Barcelona, ES  
LOZANO SALVATELLA, Juan, Jose, Berna 1-3 First Floor Second Door, E-08023 Barcelona, ES

(51) MKP  
**A61P 1/12 (2006.01)** (97) **2632550 \***  
(86) US2011058549 31.10.2011  
(96) 11837249.9 04.09.2013  
(87) WO2012058664, 31.10.2011  
(97) 2632550, 04.09.2013 en  
(54) METHODS AND COMPOSITIONS FOR TREATING HIV-ASSOCIATED DIARRHEA  
(71) Salix Pharmaceuticals, Ltd., 8510 Colonnade Center Drive, Raleigh, NC 27615, US  
Napo Pharmaceuticals Inc, 185 Berry Street Suite 1300, San Francisco, CA 94107, US  
(72) FORBES, William, 1008 Heydon Court, Raleigh NC 27614, US  
BORTEY, Enoch, 225 Ocoee Falls Drive, Chapel Hill NC 27517, US  
KING, Steven, 191 Arbor Lane, Moss Beach CA 94038, US  
CHATURVEDI, Pravin, 27 Jenkins Road, Andover MA 01810, US

(51) MKP  
**B01J 19/00 (2006.01)** (97) **2621626 \***  
**C01B 33/107 (2006.01)**  
(86) US2011053479 27.09.2011  
(96) 11773584.5 07.08.2013  
(87) WO2012047658, 27.09.2011  
(97) 2621626, 07.08.2013 en  
(54) HEATER AND RELATED METHODS THEREFOR  
(71) GTAT Corporation, 243 Daniel Webster Highway, Merrimack, NH 03054, US  
(72) FAHRENBRUCK, Scott, 4905 Mallard Way, Missoula, MT 59808, US  
HAZELTINE, Bruce, 4975 Evergreen, Missoula, MT 59804, US

(51) MKP  
**C07D 477/20 (2006.01)** (97) **2630147 \***  
(86) IB2011054727 21.10.2011  
(96) 11787942.9 28.08.2013  
(87) WO2012052978, 21.10.2011  
(97) 2630147, 28.08.2013 en  
(54) A PROCESS FOR THE PREPARATION OF PURE MEROPENEM TRIHYDRATE  
(71) Ranbaxy Laboratories Limited, Head Office: 12th Floor Devika Tower 06 Nehru Place New Delhi, Delhi 110019, IN  
(72) SHARMA, Prashant, Kumar, House No. 536 Gali No. 9 Ward No. 4 Shakti Nagar Derabassi Mohali, Punjab 140507, IN  
VASHISHTA, Bhupendra, Flat No. Y-145 Regency Park - 2 DLF Phase - 4 Gurgaon, Haryana 122002, IN  
SINGH, Shailendra, K., U-18/9 FF Phase - 3 DLF City, Gurgaon Haryana 122002, IN  
TIWARI, Neera, K-10/19 First Floor Phase - II DLF Qutab Enclave Gurgaon, Haryana 122001, IN  
DHAR, Subhash, 41 Type - IV Quarters NCERT Campus Sri Aurobindo Marg New Delhi, Delhi 110016, IN

(51) MKP  
**E01F 8/00 (2006.01)** (97) **2601352 \***  
**E04H 17/20 (2006.01)**  
(86) IT2010000359 06.08.2010  
(96) 10763870.2 12.06.2013  
(87) WO2012017460, 06.08.2010  
(97) 2601352, 12.06.2013 en  
(54) AN IMPROVEMENT OF A SUPPORTING STRUCTURE FOR AN ANTI-NOISE BARRIER WHEREIN FOUNDATIONS AND LIFTING POST ARE REALIZED IN A SINGLE ELEMENT AND RELATIVE ASSEMBLY METHOD  
(71) Urbantech S.R.L., Via Lombardia 26 Zona Industriale Gello, 56025 Pontedera (PI), IT  
(72) TIZZONI, Giampaolo, Via De Gasperi n. 33, I-56025 Pontedera (PI), IT

(51) MKP  
**A61K 39/395 (2006.01)** (97) **2635304 \***  
**G01N 33/574 (2006.01)**  
**G01N 33/82 (2006.01)**  
(86) US2011059411 04.11.2011  
(96) 11785862.1 11.09.2013  
(87) WO2012061759, 04.11.2011  
(97) 2635304, 11.09.2013 en  
(54) FOLATE RECEPTOR ALPHA AS A DIAGNOSTIC AND PROGNOSTIC MARKER FOR FOLATE RECEPTOR ALPHA-EXPRESSING CANCERS  
(71) Morphotek, Inc., 210 Welsh Pool Road, Exton, PA 19341, US  
(72) O'SHANNESY, Daniel, J., 515 Gerloff Road, Schwenksville PA 19473, US  
GRASSO, Luigi, 403 Barbara Lane, Bryn Mawr PA 19010, US  
WAN, Shanhong, 11 Devon Circle, Paoli PA 19301, US  
CHAO, Qimin, 10 E Langhorne Ave, Havertown PA 19083, US  
SOMERS, Elizabeth, Brooke, P.O.Box 158, Unionville PA 19375, US

- (51) MKP  
**A61K 31/437 (2006.01)** (97) **2613784 \***  
**A61K 31/445 (2006.01)**  
**A61K 9/00 (2006.01)**  
**A61K 9/70 (2006.01)**  
(86) GB2011051658 05.09.2011  
(96) 11767034.9 17.07.2013  
(87) WO2012032337, 05.09.2011  
(97) 2613784, 17.07.2013 en  
(54) A TRANSDERMAL DRUG ADMINISTRATION DEVICE  
(71) Orexo AB, Box 303, 751 05 Uppsala, SE  
(72) ENGQVIST, Håkan, Källörsgatan 6, SE-74236 Östhammar, SE  
BREDENBERG, Susanne, Orexo AB P O Box 303, SE-751 05 Uppsala, SE  
PETTERSSON, Anders, Orexo AB P O Box 303, SE-751 05 Uppsala, SE  
LUNDQVIST, Thomas, Orexo AB P O Box 303, SE-751 05 Uppsala, SE  
DAHLGREN, Anna, Orexo AB P O Box 303, SE-751 05 Uppsala, SE  
SÄGSTRÖM, Anders, Orexo AB P O Box 303, SE-751 05 Uppsala, SE

- (51) MKP  
**A01N 43/54 (2006.01)** (97) **2615912 \***  
**A01N 43/40 (2006.01)**  
**A01N 31/00 (2006.01)**  
**A01N 37/10 (2006.01)**  
**A01P 13/00 (2006.01)**  
**A01N 25/32 (2006.01)**  
**A01N 43/66 (2006.01)**  
**A01N 43/90 (2006.01)**  
(86) US2011051862 16.09.2011  
(96) 11825995.1 24.07.2013  
(87) WO2012037425, 16.09.2011  
(97) 2615912, 24.07.2013 en  
(54) LIQUID AGRICULTURAL FORMULATIONS OF IMPROVED STABILITY  
(71) Dow AgroSciences LLC, 9330 Zionsville Road, Indianapolis, IN 46268, US  
(72) ATKINSON, John M., 2044 Williams Glen Boulevard, Zionsville, IN 46077, US  
LIU, Lei, 1501 Brookmill Court, Carmel, IN 46032, US  
OLDS, Melissa Gail, 2132 Williams Glen Boulevard, Zionsville, IN 46077, US  
KEENEY, Franklin N., 12304 Windsor Drive, Carmel, IN 46033, US

- (51) MKP  
**A61K 38/19 (2006.01)** (97) **2618830 \***  
**C07K 14/535 (2006.01)**  
**A61P 29/00 (2006.01)**  
(86) US2011052692 22.09.2011  
(96) 11764063.1 31.07.2013  
(87) WO2012040421, 22.09.2011  
(97) 2618830, 31.07.2013 en  
(54) FORMULATIONS FOR BOVINE GRANULOCYTE COLONY STIMULATING FACTOR AND VARIANTS THEREOF  
(71) Eli Lilly and Company, Lilly Corporate Center, Indianapolis, IN 46285, US  
(72) DAVAGNINO, Juan, c/o Eli Lilly and Company P. O. Box 6288 Indianapolis, IN 46206-6288, US  
KHA, Catherine, Ngan, c/o Eli Lilly and Company P. O. Box 6288 Indianapolis, IN 46206-6288, US  
KLOTZ, Alan Voskamp, c/o Eli Lilly and Company P. O. Box 6288 Indianapolis, IN 46206-6288, US

- (51) MKP  
**G10L 21/02 (2013.01)** (97) **2608197 \***  
**H04R 3/02 (2006.01)**  
(86) CN2012073712 10.04.2012  
(96) 12830760.0 26.06.2013  
(87) WO2013033991, 10.04.2012  
(97) 2608197, 26.06.2013 en  
(54) METHOD, DEVICE, AND SYSTEM FOR NOISE REDUCTION IN MULTI-MICROPHONE ARRAY  
(71) Goertek Inc., No.268, Dongfang Road High-Tech Industrial Development Zone Weifang, Shandong 261031, CN  
(72) LIU, Song, No. 268 Dongfang Road Hi-Tech Industry District, Weifang Shandong 261031, CN  
LI, Bo, No. 268 Dongfang Road Hi-Tech Industry District, Weifang Shandong 261031, CN

- (51) MKP  
**A61C 17/34 (2006.01)** (97) **2618776 \***  
**A61C 17/22 (2006.01)**  
(86) EP2011066493 22.09.2011  
(96) 11761064.2 31.07.2013  
(87) WO2012038501, 22.09.2011  
(97) 2618776, 31.07.2013 en  
(54) REPLACEABLE HEAD PART FOR AN ELECTRIC TOOTHBRUSH  
(71) GlaxoSmithKline Consumer Healthcare GmbH & Co.KG., Bussmatten 1, 77815 Buehl (Baden), DE  
(72) REINBOLD, Klaus, GlaxoSmithKline Consumer Healthcare GmbH&Co KG Bussmatten 1, 77815 Buehl (Baden), DE

- (51) MKP  
**A61K 31/44 (2006.01)** (97) **2595628 \***  
**A61K 31/505 (2006.01)**  
**A61K 31/519 (2006.01)**  
**A61P 35/00 (2006.01)**  
(86) US2011044506 19.07.2011  
(96) 11740767.6 29.05.2013  
(87) WO2012012404, 19.07.2011  
(97) 2595628, 29.05.2013 en  
(54) DRUG COMBINATIONS WITH FLUORO-SUBSTITUTED OMEGA-CARBOXYARYL DIPHENYL UREA FOR THE TREATMENT AND PREVENTION OF DISEASES AND CONDITIONS  
(71) Bayer HealthCare LLC, 555 White Plains Road, Tarrytown, NY 10591, US  
(72) CHRISTENSEN, Olaf, 555 White Plains Road, Tarrytown New York 10591, US  
KUSS,Iris, 555 White Plains Road, Tarrytown New York 10591, US

- (51) MKP  
**C07D 487/04 (2006.01)** (97) **2598505 \***  
**A61K 31/5025 (2006.01)**  
(86) EP2011062927 27.07.2011  
(96) 11737952.9 05.06.2013  
(87) WO2012013713, 27.07.2011  
(97) 2598505, 05.06.2013 en  
(54) SUBSTITUTED IMIDAZO[1,2-B]PYRIDAZINES  
(71) Bayer Intellectual Property GmbH, Alfred-Nobel-Strasse 10, 40789 Monheim, DE  
(72) REHWINKEL, Hartmut, Blücherstr. 13, 10961 Berlin, DE  
HAEGEBARTH, Andrea, An den Eldenaer Höfen 13, 10247 Berlin, DE  
POLITZ, Oliver, Steenerbuschstr. 73, 16341 Panketal OT Zepernick, DE  
NEUHAUS, Roland, Lauenburger Str. 28, 12157 Berlin, DE  
BÖMER, Ulf, Leipziger Str. 49, 16548 Glienicke, DE

(51) MKP  
**A61K 31/427 (2006.01)** (97) **2617715 \***  
**A61K 31/5377 (2006.01)**  
**A61K 31/437 (2006.01)**  
**A61P 25/04 (2006.01)**  
**A61K 31/4439 (2006.01)**  
**A61P 25/08 (2006.01)**  
**C07D 233/90 (2006.01)**  
**A61K 31/444 (2006.01)**  
**A61P 25/14 (2006.01)**  
**A61K 31/4178 (2006.01)**  
**A61K 31/4709 (2006.01)**  
**A61P 25/18 (2006.01)**  
**A61K 31/4196 (2006.01)**  
**A61K 31/4725 (2006.01)**  
**A61K 31/422 (2006.01)**  
**A61K 31/497 (2006.01)**  
**A61K 31/4245 (2006.01)**  
**A61K 31/506 (2006.01)**  
(86) JP2011071241 16.09.2011  
(96) 11825276.6 24.07.2013  
(87) WO2012036278, 16.09.2011  
(97) 2617715, 24.07.2013 en  
(54) GLYCINE TRANSPORTER INHIBITOR  
(71) TAISHO PHARMACEUTICAL CO., LTD, 24-1 Takada 3-chome  
Toshima-ku, Tokyo 170-8633, JP  
(72) MORIYA, Minoru, c/o Taisho Pharmaceutical Co. Ltd. 24-1  
Takada 3-chome Toshima-ku, Tokyo 170-8633, JP  
YASUHARA, Akitō, c/o Taisho Pharmaceutical Co. Ltd. 24-1  
Takada 3-chome Toshima-ku, Tokyo 170-8633, JP  
SAKAGAMI, Kazunari, c/o Taisho Pharmaceutical Co. Ltd.  
24-1 Takada 3-chome Toshima-ku, Tokyo 170-8633, JP  
OHTA, Hiroshi, c/o Taisho Pharmaceutical Co. Ltd. 24-1  
Takada 3-chome Toshima-ku, Tokyo 170-8633, JP  
ABE, Kumi, c/o Taisho Pharmaceutical Co. Ltd. 24-1 Takada  
3-chome Toshima-ku, Tokyo 170-8633, JP  
YAMAMOTO, Shuji, c/o Taisho Pharmaceutical Co. Ltd. 24-1  
Takada 3-chome Toshima-ku, Tokyo 170-8633, JP  
ARAKI, Yuko, c/o Taisho Pharmaceutical Co. Ltd. 24-1 Takada  
3-chome Toshima-ku, Tokyo 170-8633, JP  
URABE, Hiroki, c/o Taisho Pharmaceutical Co. Ltd. 24-1  
Takada 3-chome Toshima-ku, Tokyo 170-8633, JP  
SUN, Xiang-Min, c/o Taisho Pharmaceutical Co. Ltd. 24-1  
Takada 3-chome Toshima-ku, Tokyo 170-8633, JP

(51) MKP  
**C01F 11/18 (2006.01)** (97) **2623467**  
**C02F 1/66 (2006.01)**  
**C01F 5/24 (2006.01)**  
**C02F 1/68 (2006.01)**  
**C02F 1/52 (2006.01)**  
(96) 12153905.0 07.08.2013  
(97) 2623467, 07.08.2013 en  
(54) Process for the preparation of an aqueous solution comprising  
at least one earth alkali hydrogen carbonate and its use  
(71) Omya Development AG, Baslerstrasse 42, 4665 Oftringen, CH  
(72) Buri, Matthias, Mättelweg 20, 4852 Rothrist, CH  
Rentsch, Samuel, Burgpark 2, 4663 Aarburg, CH  
Gane, Patrick A. C., Studenweg 8, 4852 Rothrist, CH  
Blum, René Vinzenz, Sagiacher 3, 4915 St. Urban, CH

(51) MKP  
**A61N 1/30 (2006.01)** (97) **2643048 \***  
**A61N 1/32 (2006.01)**  
(86) US2011059981 09.11.2011  
(96) 11788281.1 02.10.2013  
(87) WO2012071175, 09.11.2011  
(97) 2643048, 02.10.2013 en  
(54) USER-ACTIVATED SELF-CONTAINED CO-PACKAGED  
IONTOPHORETIC DRUG DELIVERY SYSTEM  
(71) Nupathe Inc., 227 Washington Street Suite 200,  
Conshohocken, PA 19428, US  
(72) SEBREE, Terri, B., 922 Merion Square Road, Gladwyne PA  
19035, US  
STATHOPULOS, Robert, P., 434 Liberty Street, Boonton NJ  
07005-1542, US  
VINATORU, Mihai, A., 286 Brook Valley Road, Kinnelon NJ  
07405, US

(51) MKP  
**C12P 21/08 (2006.01)** (97) **2611829 \***  
**C07K 16/18 (2006.01)**  
**C07H 21/00 (2006.01)**  
(86) US2011050322 02.09.2011  
(96) 11822713.1 10.07.2013  
(87) WO2012031198, 02.09.2011  
(97) 2611829, 10.07.2013 en  
(54) NOVEL ANTIGEN BINDING PROTEINS  
(71) GlaxoSmithKline Intellectual Property Development Limited,  
980 Great West Road, Brentford Middlesex TW8 9GS, GB  
(72) CLARKE, Neil, James, Gunnels Wood Road, Stevenage  
Hertfordshire SG1 2NY, GB  
JOHANSON, Kyung, Oh, 25 Haymarket Lane, Byrn Mawr, PA  
19010, US  
JONAK, Zdenka, Ludmila, 709 Swedeland Road, King of  
Prussia, PA 19406, US  
TAYLOR, Alexander, H., 709 Swedeland Road, King of  
Prussia, PA 19406, US  
HOPSON, Christopher, B., 1250 South Collegeville Road,  
Collegeville, PA 19426, US  
TRULLI, Stephen, H., 709 Swedeland Road, King of Prussia,  
PA 19406, US  
HASKOVA, Zdenka, 709 Swedeland Road, King of Prussia, PA  
19406, US  
LEE, Judithann, M., 709 Swedeland Road, King of Prussia, PA  
19406, US  
WHITE, John, R., 709 Swedeland Road, King of Prussia, PA  
19406, US  
XUE, Yu, 709 Swedeland Road, King of Prussia, PA 19406, US

(51) MKP  
**F03D 1/00 (2006.01)** (97) **2607685**  
**F03D 11/04 (2006.01)**  
(96) 11194856.8 26.06.2013  
(97) 2607685, 26.06.2013 en  
(54) Bolt mounting and tightening robot for wind turbines  
(71) Johst, Kenneth, Rosenoms alle 32 2 tv, 1970 Frederiksberg C,  
DK  
Jagd, Lars, Lilla Varvsgatan 14, 511, 211 15 Malmö, SE  
Bovin, Jonas, Kollemosevej 48, 2830 Virum, DK  
Marinitsch, Gerald, Buchengasse 5, 8401 Kalsdorf, AT  
(72) Johst, Kenneth, Rosenoms alle 32 2 tv, 1970 Frederiksberg C,  
DK  
Jagd, Lars, Lilla Varvsgatan 14, 511, 211 15 Malmö, SE  
Bovin, Jonas, Kollemosevej 48, 2830 Virum, DK  
Marinitsch, Gerald, Buchengasse 5, 8401 Kalsdorf, AT

(51) MKP  
**C07D 487/04 (2006.01)** (97) **2604610 \***  
**A61K 31/5025 (2006.01)**  
**A61K 31/502 (2006.01)**  
**C07D 403/12 (2006.01)**  
**A61P 43/00 (2006.01)**  
**A61P 35/00 (2006.01)**  
(86) CN2011001223 26.07.2011  
(96) 11815986.2 19.06.2013  
(87) WO2012019427, 26.07.2011  
(97) 2604610, 19.06.2013 en  
(54) PHTHALAZINONE KETONE DERIVATIVE, PREPARATION  
METHOD THEREOF, AND PHARMACEUTICAL USE  
THEREOF  
(71) Jiangsu Hansoh Pharmaceutical Co., Ltd., Economic &  
Technical Development Zone, Lianyungang, Jiangsu 222047,  
CN  
(72) TANG, Pengcho, No.279 Wenjing Road Minhang District,  
Shanghai 200245, CN  
LI, Xin, No.279 Wenjing Road Minhang District, Shanghai  
200245, CN  
LI, Xiangqin, No.279 Wenjing Road Minhang District, Shanghai  
200245, CN  
CHEN, Yang, No.279 Wenjing Road Minhang District,  
Shanghai 200245, CN  
WANG, Bin, No.279 Wenjing Road Minhang District, Shanghai  
200245, CN  
ZHU, Zhe, No. 279 Wenjing Road Minhang District, Shanghai  
200245, CN

- (51) MKP  
**A01N 43/54 (2006.01)** (97) **2632265 \***  
**A01P 13/00 (2006.01)**
- (86) US2011057972 27.10.2011  
(96) 11837050.1 04.09.2013  
(87) WO2012058361, 27.10.2011  
(97) 2632265, 04.09.2013 en  
(54) SYNERGISTIC HERBICIDAL COMPOSITION CONTAINING PENOXSULAM AND ORYZALIN  
(71) Dow AgroSciences LLC, 9330 Zionsville Road, Indianapolis, IN 46268, US  
(72) MANN, Richard K., 1828 South 550 East, Franklin IN 46131, US
- 
- (51) MKP  
**E21B 34/06 (2006.01)** (97) **2619403 \***
- (86) CA2011001028 12.09.2011  
(96) 11826242.7 31.07.2013  
(87) WO2012037646, 12.09.2011  
(97) 2619403, 31.07.2013 en  
(54) DELAYED OPENING WELLBORE TUBULAR PORT CLOSURE  
(71) Packers Plus Energy Services Inc., Bow Valley Square 2 Suite 2200, 205 - 5 Avenue SW, Calgary, Alberta T2P 2V7, CA  
(72) DESRANLEAU, Christopher, Denis, 307 Ridgeland Crescent, Sherwood Park Alberta T8A 3A5, CA  
THEMIG, Daniel Jon, 256 Woodhaven Place SW, Calgary Alberta T2W 5P9, CA  
RADTKE, Cameron, Building 995 Apt. 45 Road 3320 Block 333, Mahooz, BH  
ADDY, Ryan Fredrick, 51 Walters Place, Leduc Alberta T9E 0G2, CA
- 
- (51) MKP  
**H04Q 1/14 (2006.01)** (97) **2625868 \***
- (86) IT2011000344 10.10.2011  
(96) 11782687.5 14.08.2013  
(87) WO2012046263, 10.10.2011  
(97) 2625868, 14.08.2013 en  
(54) DYNAMIC-JUNCTION APPARATUS FOR MULTIPAIRS TELEPHONE CABLES  
(71) Cirulli, Gabriele Maria, Via Tolmino 12, 00198 Roma (RM), IT  
(72) Cirulli, Gabriele Maria, Via Tolmino 12, 00198 Roma (RM), IT
- 
- (51) MKP  
**C07K 14/705 (2006.01)** (97) **2598528 \***
- (86) GB2010001433 28.07.2010  
(96) 10793010.9 05.06.2013  
(87) WO2012013913, 28.07.2010  
(97) 2598528, 05.06.2013 en  
(54) T CELL RECEPTORS  
(71) Immunocore Ltd., 57c Milton Park Abingdon, Oxfordshire OX14 4RX, GB  
(72) JAKOBSEN, Bent, Karsten, Immunocore Ltd 57c Milton Park, Abingdon, Oxfordshire OX14 4RX, GB  
LIDDY, Nathaniel, Ross, Immunocore Ltd 57c Milton Park, Abingdon, Oxfordshire OX14 4RX, GB
- 
- (51) MKP  
**F24J 2/08 (2006.01)** (97) **2598810 \***  
**F24J 2/14 (2006.01)**  
**F24J 2/24 (2006.01)**  
**G02F 1/00 (2006.01)**
- (86) EP2011003577 18.07.2011  
(96) 11738966.8 05.06.2013  
(87) WO2012013307, 18.07.2011  
(97) 2598810, 05.06.2013 en  
(54) DEVICE FOR THE CAPTURE OF SOLAR ENERGY WITH HIGH ANGULAR EFFICIENCY.  
(71) Ohikia S.R.L., Via F.lli Gabba, 1/A, 20121 Milano, IT  
(72) NEGRISOLO, Francesco, Via Roma 7, Sesto San Giovanni, Milano 20099, IT  
ROSSO, Maria Cristina, C. so Orbassano 90, Torino 10136, IT
- 
- (51) MKP  
**A47J 36/38 (2006.01)** (97) **2603125 \***  
**A47J 37/12 (2006.01)**
- (86) IT2011000293 09.08.2011  
(96) 11767787.2 19.06.2013  
(87) WO2012020442, 09.08.2011  
(97) 2603125, 19.06.2013 en  
(54) FRYER WITH PERFORATED COVER  
(71) BY ME S.R.L., Via Congiunte Sinistre, No. 18, 04100 Latina, IT  
(72) FERRARI, Luciano, BY ME S.R.L. Via Congiunte Sinistre No. 18, I-04100 Latina (LT), IT
- 
- (51) MKP  
**B01D 53/14 (2006.01)** (97) **2637765 \***  
**B01D 53/80 (2006.01)**
- (86) IN2011000244 08.04.2011  
(96) 11741284.1 18.09.2013  
(87) WO2012063253, 08.04.2011  
(97) 2637765, 18.09.2013 en  
(54) A NOVEL SYSTEM FOR ADSORBING AND SEPARATING SUSPENDED GASEOUS IMPURITIES FROM EFFLUENT GASES AND THEREBY RECOVERY OF VALUE ADDED PRODUCTS  
(71) Dhananjay, Digambar Pande, 203 "B" Wing Bhanukant Complex Jn Of Western Express Highway Goregaon East, Mumbai 400 063, IN  
(72) Dhananjay, Digambar Pande, 203 "B" Wing Bhanukant Complex Jn Of Western Express Highway Goregaon East, Mumbai 400 063, IN
- 
- (51) MKP  
**A61M 5/158 (2006.01)** (97) **2640444 \***  
**A61M 5/32 (2006.01)**  
**A61M 5/20 (2006.01)**  
**A61M 5/00 (2006.01)**  
**A61M 5/34 (2006.01)**  
**A61M 5/142 (2006.01)**
- (86) US2011061098 17.11.2011  
(96) 11788308.2 25.09.2013  
(87) WO2012068321, 17.11.2011  
(97) 2640444, 25.09.2013 en  
(54) NEEDLE MAGAZINE FOR MEDICATION INJECTION DEVICE  
(71) Eli Lilly and Company, Lilly Corporate Center, Indianapolis, IN 46285, US  
(72) BYERLY, Roy Howard, c/o Eli Lilly and Company P.O. Box 6288, Indianapolis, Indiana 46206-6288, US  
MELZI, Ilario, c/o Eli Lilly and Company P.O. Box 6288, Indianapolis, Indiana 46206-6288, US
- 
- (51) MKP  
**B60D 1/00 (2006.01)** (97) **2643175 \***  
**B60D 1/02 (2006.01)**  
**B60D 1/54 (2006.01)**
- (86) IB2012056403 14.11.2012  
(96) 12799642.9 02.10.2013  
(87) WO2013072854, 14.11.2012  
(97) 2643175, 02.10.2013 en  
(54) ATTACHMENT DEVICE FOR TRAILER TOW BAR  
(71) Appoloni, Omar, Via Decima 182/c Dorsino, 38070 Trento, IT  
(72) Appoloni, Omar, Via Decima 182/c Dorsino, 38070 Trento, IT

(51) MKP  
**C07C 211/31 (2006.01)** (97) **2632892 \***  
**C07C 251/34 (2006.01)**  
**C07C 251/54 (2006.01)**  
**A61K 31/15 (2006.01)**  
**C07D 211/46 (2006.01)**  
(86) EP2011068702 26.10.2011  
(96) 11776414.2 04.09.2013  
(87) WO2012055894, 26.10.2011  
(97) 2632892, 04.09.2013 en  
(54) DITERPENOID DERIVATIVES ENDOWED OF BIOLOGICAL PROPERTIES  
(71) SIGMA-TAU Industrie Farmaceutiche Riunite S.p.A., Viale Shakespeare, 47, 00144 Rome, IT  
(72) CERRI, Alberto, Via Barnaba Oriani 55, I-20156 Milan, IT  
GOBBINI, Mauro, Via Clerici 165/12, I-21020 Mercallo (VA), IT  
TORRI, Marco, Via Monte Grappa 20, I-2017 Rho (MI), IT  
FERRARI, Patrizia, Via Gasparotto 57/A, I-21100 Varese, IT  
FERRANDI, Mara, Via Cenisio 34, I-20154 Milano, IT  
BIANCHI, Giuseppe, Piazza Adigrat 4, I-20133 Milan, IT

(51) MKP  
**A61K 31/496 (2006.01)** (97) **2632463 \***  
(86) US2011057080 20.10.2011  
(96) 11836886.9 04.09.2013  
(87) WO2012058091, 20.10.2011  
(97) 2632463, 04.09.2013 en  
(54) ARIPIPIRAZOLE COMPOSITIONS AND METHODS FOR ITS TRANSDERMAL DELIVERY  
(71) Transdermal Research Pharm Laboratories, LLC, 157-14 Cryders Lane, Whitestone, NY 11357, US  
(72) PLAKOGIANNIS, Fotios, M., 157-14 Cryders Lane, Whitestone New York 11357, US  
HOSSAIN, Muhammed, Anwar, 17 Quaspeak Road, Congers New York 10920, US

(51) MKP  
**A63H 3/02 (2006.01)** (97) **2598220 \***  
**A63H 3/00 (2006.01)**  
(86) US2011045400 26.07.2011  
(96) 11813058.2 05.06.2013  
(87) WO2012015832, 26.07.2011  
(97) 2598220, 05.06.2013 en  
(54) STUFFED TOYS HAVING INTERCHANGEABLE SCENT PACKETS AND METHODS AND SYSTEMS INCLUDING SUCH STUFFED TOYS  
(71) Scentsy, Inc., 3698 E. Lanark, Meridian, ID 83642, US  
(72) THOMPSON, Heidi, 3045 W. Sugar Crest, Eagle, Idaho 83616, US  
THOMPSON, R. Orville, 3045 W. Sugar Crest, Eagle, Idaho 83616, US

(51) MKP  
**A61K 9/50 (2006.01)** (97) **2623096**  
**A61K 31/495 (2006.01)**  
(96) 13153638.5 07.08.2013  
(97) 2623096, 07.08.2013 fr  
(54) Pharmaceutical composition with slow release of trimetazidine  
(71) Les Laboratoires Servier, 35, rue de Verdun, 92284 Suresnes Cedex, FR  
(72) Genty, Patrick, 2, rue des fleurs, 45100 ORLEANS, FR  
Hermelin, Christophe, 62 rue de la Groupe, 45380 CHAINGY, FR  
Pean, Jean-Manuel, 2 bis rue Adolphe Crespin, 45000 ORLEANS, FR

(51) MKP  
**A61M 5/24 (2006.01)** (97) **2603261 \***  
**B65D 41/54 (2006.01)**  
**G09F 3/03 (2006.01)**  
**A61M 39/10 (2006.01)**  
(86) EP2011063840 11.08.2011  
(96) 11743066.0 19.06.2013  
(87) WO2012020084, 11.08.2011  
(97) 2603261, 19.06.2013 en  
(54) CONNECTOR FOR A DRUG DELIVERY DEVICE RESERVOIR  
(71) Sanofi-Aventis Deutschland GmbH, Brüningstraße 50, 65929 Frankfurt, DE  
(72) AVERY, Richard James Vincent, 28 Nursery Close, Mickleton Chipping Campden Gloucestershire GL55 6TX, GB  
BUTLER, Joseph, 6 Hadfield Close, Clifton Rugby Warwickshire CV23 0DL, GB

(51) MKP  
**A61P 7/06 (2006.01)** (97) **2640394 \***  
**A61K 31/506 (2006.01)**  
**A61P 7/00 (2006.01)**  
**A61K 31/519 (2006.01)**  
**A61K 31/505 (2006.01)**  
(86) US2011061202 17.11.2011  
(96) 11842009.0 25.09.2013  
(87) WO2012068381, 17.11.2011  
(97) 2640394, 25.09.2013 en  
(54) PROTECTION OF RENAL TISSUES FROM ISCHEMIA THROUGH INHIBITION OF THE PROLIFERATIVE KINASES CDK4 AND CDK6  
(71) The University of North Carolina At Chapel Hill, 308 Bynum Hall Campus Box 4105, Chapel Hill, NC 27599-4105, US  
The Brigham and Women's Hospital, 75 Francis Street, Boston, MA 02115, US  
G-Zero Therapeutics, 450 West Drive Room 21-232, Chapel Hill, NC 27599-7295, US  
(72) DIROCCO, Derek, Paul, 1677 Beacon Street Apt 1, Brookline MA 02445, US  
SHARPLESS, Norman, E., 8323 Loch Laven Lane, Chapel Hill NC 27516, US  
STRUM, Jay, Copeland, 616 Deerhaven Court, Hillsborough NC 27278, US  
BISI, John, Emerson, 103 Timberlea Ct., Apex NC 27502, US  
ROBERTS, Patrick, Joseph, 2508 West Club Blvd., Durham North Carolina 27705, US  
HUMPHREYS, Benjamin, Duane, 319 Dean Rd., Brookline MA 02445, US  
WONG, Kwok-Kin, 49 Columbia Road, Arlington MA 02474, US

(51) MKP  
**C08G 61/10 (2006.01)** (97) **2596043 \***  
(86) EP2011003525 15.07.2011  
(96) 11738619.3 29.05.2013  
(87) WO2012016634, 15.07.2011  
(97) 2596043, 29.05.2013 de  
(54) UNIT COMPRISING POROUS ORGANIC POLYMERS AND USE THEREOF I  
(71) Blücher GmbH, Mettmanner Strasse 25, 40699 Erkrath, DE  
(72) BÖHRINGER, Bertram, Bussardweg 33, 42115 Wuppertal, DE  
FICHTNER, Sven., Bunsenstrasse 5, 14727 Premnitz, DE  
KASKEL, Stefan, Technische Universität Dresden Institut für Anorganische Chemie Mommsenstrasse 6, 01069 Dresden, DE  
ROSE, Marcus, Technische Universität Dresden Institut für Anorganische Chemie Mommsenstrasse 6, 01069 Dresden, DE

- (51) MKP  
**C02F 1/52 (2006.01)** (97) **2623466**  
**C02F 1/66 (2006.01)**  
**C02F 1/68 (2006.01)**  
**C01F 11/18 (2006.01)**  
**C01F 5/24 (2006.01)**  
(96) 12153898.7 07.08.2013  
(97) 2623466, 07.08.2013 en  
(54) Process for the preparation of an aqueous solution comprising at least one earth alkali hydrogen carbonate and its use  
(71) Omya Development AG, Baslerstrasse 42, 4665 Oftringen, CH  
(72) Buri, Matthias, Mätteliweg 20, 4852 Rothrist, CH  
Rentsch, Samuel, Burgpark 2, 4663 Aarburg, CH  
Gane, Patrick A. C., Studenweg 8, 4852 Rothrist, CH  
Blum, René Vinzenz, Sagiacher 3, 4915 St. Urban, CH
- 
- (51) MKP  
**A61P 17/00 (2006.01)** (97) **2611413 \***  
**A61K 31/795 (2006.01)**  
**A61K 8/89 (2006.01)**  
**A61K 31/74 (2006.01)**  
**A61Q 19/00 (2006.01)**  
(86) US2011050003 31.08.2011  
(96) 11822576.2 10.07.2013  
(87) WO2012030984, 31.08.2011  
(97) 2611413, 10.07.2013 en  
(54) SKIN COMPOSITIONS AND METHODS OF USE THEREOF  
(71) Living Proof, Inc., 301 Binney Street, First Floor, Cambridge, MA 02142, US  
(72) YU, Betty, 57 Reservoir Street Unit 2, Cambridge, MA 02138, US  
LOMAKIN, Joseph, 140 Huron Avenue Unit 8, Cambridge, MA 02138, US  
KANG, Soo-Young, 65 Spiers Road, Newton, MA 02459, US  
ADAMS, Benjamin, W., 22 Lowden Ave. 1, Somerville, MA 02144, US
- 
- (51) MKP  
**A61K 39/395 (2006.01)** (97) **2624857 \***  
**A61P 3/00 (2006.01)**  
**A61K 38/08 (2006.01)**  
**A61P 9/00 (2006.01)**  
**A61P 29/00 (2006.01)**  
**A61K 38/16 (2006.01)**  
**A61K 38/10 (2006.01)**  
(86) US2011055130 06.10.2011  
(96) 11831608.2 14.08.2013  
(87) WO2012048125, 06.10.2011  
(97) 2624857, 14.08.2013 en  
(54) INNOVATIVE DISCOVERY OF THERAPEUTIC, DIAGNOSTIC, AND ANTIBODY COMPOSITIONS RELATED PROTEIN FRAGMENTS OF TRYPTOPHANYL TRNA SYNTHETASES  
(71) aTyr Pharma, Inc., 3545 John Hopkins Court, Suite 250, San Diego, CA 92121, US  
Pangu Biopharma Limited, Edinburgh Tower, 18/F The Landmark 15 Queen's Road Central, Hong Kong, CN  
(72) GREENE, Leslie Ann, 13941 Davenport Avenue, San Diego California 92129, US  
CHIANG, Kyle P., 1615 Debann Road, Cardiff California 92007, US  
HONG, Fei, 12646 Spindletop Road, San Diego California 92129, US  
VASSEROT, Alain P., 6421 La Paloma Street, Carlsbad California 92009, US  
LO, Wing-Sze, RM 815 Sui Ming House Siu Sai Wan Estate, Hong Kong, CN  
WATKINS, Jeffrey D., 3442 Fortuna Ranch Road, Encinitas California 92024, US  
QUINN, Cheryl L., 408 North 1st Street No. 706, Minneapolis MN 55401, US  
MENDLEIN, John D., 1550 Neptune Avenue, Encinitas California 92024, US
- 
- (51) MKP  
**C07D 471/04 (2006.01)** (97) **2614061 \***  
**A61K 31/519 (2006.01)**  
**A61P 9/00 (2006.01)**  
**A61P 25/28 (2006.01)**  
**A61P 29/00 (2006.01)**  
(86) GB2011051647 02.09.2011  
(96) 11755423.8 17.07.2013  
(87) WO2012032334, 02.09.2011  
(97) 2614061, 17.07.2013 en  
(54) QUINOLINE AND QUINOXALINE DERIVATIVES AS KINASE INHIBITORS  
(71) UCB Pharma, S.A., 60, allée de la Recherche, 1070 Brussels, BE  
(72) PARTON, Andrew Harry, UCB Celltech 208 Bath Road, Slough Berkshire SL1 3WE, GB  
ALI, Mezher Hussein, UCB Celltech 208 Bath Road, Slough Berkshire SL1 3WE, GB  
BROOKINGS, Daniel Christopher, UCB Celltech 208 Bath Road, Slough Berkshire SL1 3WE, GB  
BROWN, Julien Alistair, UCB Celltech 208 Bath Road, Slough Berkshire SL1 3WE, GB  
FORD, Daniel James, UCB Celltech 208 Bath Road, Slough Berkshire SL1 3WE, GB  
FRANKLIN, Richard Jeremy, UCB Celltech 208 Bath Road, Slough Berkshire SL1 3WE, GB  
LANGHAM, Barry John, UCB Celltech 208 Bath Road, Slough Berkshire SL1 3WE, GB  
NEUSS, Judi Charlotte, UCB Celltech 208 Bath Road, Slough Berkshire SL1 3WE, GB  
QUINCEY, Joanna Rachel, UCB Celltech 208 Bath Road, Slough Berkshire SL1 3WE, GB
- 
- (51) MKP  
**A61B 18/12 (2006.01)** (97) **2540242**  
**A61B 18/14 (2006.01)**  
(96) 11171767.4 02.01.2013  
(97) 2540242, 02.01.2013 en  
(54) An electrosurgical instrument and apparatus for use with the instrument  
(71) Lina Medical ApS, Formervangen 5, 2600 Glostrup, DK  
(72) Poulsen, Henrik Bisgaard, Bakkesvinget 15, 3550 Slangerup, DK
- 
- (51) MKP  
**A61P 37/00 (2006.01)** (97) **2598477 \***  
**A61P 29/00 (2006.01)**  
**C07C 271/56 (2006.01)**  
**A61K 31/27 (2006.01)**  
(86) US2011045114 22.07.2011  
(96) 11812991.5 05.06.2013  
(87) WO2012015704, 22.07.2011  
(97) 2598477, 05.06.2013 en  
(54) PERIPHERALLY RESTRICTED FAAH INHIBITORS  
(71) The Regents of the University of California, 1111 Franklin Street 12th Floor, Oakland, CA 94607-5200, US  
Università Degli Studi Di Urbino "Carlo Bo", Via Saffi, 2, 61029 Urbino, IT  
Università Degli Studi di Parma, Dipartimento Farmaceutico, 43100 Parma, IT  
(72) PIOMELLI, Daniele, 3 Valley View, Irvine California 92612, US  
CLAPPER, Jason, R., 1613 Verano Place, Irvine California 92617, US  
MORENO-SANZ, Guillermo, 203 Berkeley Avenue, Irvine California 92612, US  
DURANTI, Andrea, Stretto del Tasso 1, I-61029 Urbino, IT  
TONTINI, Andrea, Via A. Toscanini 41, I-61100 Pesaro, IT  
MOR, Marco, Via Fabio Filzi 70, I-25016 Ghedi, IT  
TARZIA, Giorgio, Via Giovanni XXIII 17, I-61020 Petriano, IT
-



(51) MKP  
**E05B 1/00 (2006.01)** (97) **2325419**  
**E05B 65/20 (2006.01)**  
**E05B 15/04 (2006.01)**  
(96) 10191475.2 25.05.2011  
(97) 2325419, 25.05.2011 de  
(54) Safety door handle  
(71) Huf Hülbeck & Fürst GmbH & Co. KG, Steeger Strasse 17, 42551 Velbert, DE  
(72) Müller, Dirk, Dreigarbenfeld 61, 45359, Essen, DE  
Kalesse, Michael, Johann-Peter-Melchior-Straße 53a, 40885, Ratingen, DE  
Lennhoff, Ralf, Küsterskamp 5, 58093, Hagen, DE

(51) MKP  
**C09C 3/04 (2006.01)** (97) **2623564**  
**C09C 1/02 (2006.01)**  
(96) 12153877.1 07.08.2013  
(97) 2623564, 07.08.2013 en  
(54) Installation for the purification of minerals, pigments and/or fillers and/or the preparation of precipitated earth alkali carbonate  
(71) Omya International AG, Baslerstrasse 42, 4665 Oftringen, CH  
(72) Buri, Matthias, Mätteliweg 20, 4852 Rothrist, CH  
Rentsch, Samuel, Höheweg 1, 4663 Aarburg, CH  
Gane, Patrick A. C., Studenweg 8, 4852 Rothrist, CH  
Blum, René Vinzenz, Saggiacher 3, 4915 St. Urban, CH

(51) MKP  
**H04B 3/54 (2006.01)** (97) **2625794 \***  
(86) EP2010065008 07.10.2010  
(96) 10762682.2 14.08.2013  
(87) WO2012045357, 07.10.2010  
(97) 2625794, 14.08.2013 en  
(54) METHOD AND APPARATUS FOR REMOTE METERING THE CONSUMPTION OF ELECTRICITY OVER POWER LINE NETWORK  
(71) Enel Distribuzione S.p.A., Via Ombrone 2, 00198 Roma, IT  
(72) VERONI, Fabio, Via Aldo Motta n. 24/A, I-20059 Vimercate - Milano, IT

(51) MKP  
**A61K 48/00 (2006.01)** (97) **2608801 \***  
**A61P 29/00 (2006.01)**  
**A61P 25/00 (2006.01)**  
**A61K 38/16 (2006.01)**  
**A61K 39/395 (2006.01)**  
**A61K 38/10 (2006.01)**  
**A61K 38/08 (2006.01)**  
(86) US2011049223 25.08.2011  
(96) 11820682.0 03.07.2013  
(87) WO2012027611, 25.08.2011  
(97) 2608801, 03.07.2013 en  
(54) INNOVATIVE DISCOVERY OF THERAPEUTIC, DIAGNOSTIC, AND ANTIBODY COMPOSITIONS RELATED TO PROTEIN FRAGMENTS OF TYROSYL-tRNA SYNTHETASES  
(71) aTyr Pharma, Inc., 3545 John Hopkins Court, Suite 250, San Diego, CA 92121, US  
Pangu Biopharma Limited, Edinburgh Tower, 18/F The Landmark 15 Queen's Road Central, Hong Kong, CN  
(72) GREENE, Leslie Ann, 13941 Davenport Avenue, San Diego, California 92129, US  
CHIANG, Kyle P., 1615 Debann Road, Cardiff, California 92007, US  
HONG, Fei, 12646 Spindletop Road, San Diego, California 92129, US  
VASSEROT, Alain P., 6421 La Paloma Street, Carlsbad, California 92009, US  
LO, Wing-Sze, RM 815 Sui Ming House Siu Sai Wan Estate, Hong Kong, CN  
WATKINS, Jeffrey D., 3442 Fortuna Ranch Road, Encinitas, California 92024, US  
QUINN, Cheryl L., 408 North 1st Street No.706, Minneapolis, Minnesota 55401, US  
MENDLEIN, John D., 1550 Neptune Avenue, Encinitas, California 92024, US

(51) MKP  
**A01N 43/54 (2006.01)** (97) **2611301 \***  
**A01N 43/88 (2006.01)**  
**A01P 13/02 (2006.01)**  
**A01N 43/90 (2006.01)**  
(86) US2011049480 29.08.2011  
(96) 11822417.9 10.07.2013  
(87) WO2012030684, 29.08.2011  
(97) 2611301, 10.07.2013 en  
(54) SYNERGISTIC HERBICIDAL COMPOSITION CONTAINING PENOXSULAM AND BENTAZON  
(71) Dow AgroSciences LLC, 9330 Zionsville Road, Indianapolis, IN 46268, US  
(72) MANN, Richard, K., 1828 South 550 East, Franklin IN 46131, US  
HUANG, Yi-hsiou, No. 100 Shui-Yuan Road Fang-Hua Tsun Chang-Chih Hsiang Pingtung Hsieng, 90841 Taiwan, TW

(51) MKP  
**A61K 9/00 (2006.01)** (97) **2600830 \***  
**A61K 31/44 (2006.01)**  
**A61P 11/06 (2006.01)**  
(86) EP2011062872 27.07.2011  
(96) 11741172.8 12.06.2013  
(87) WO2012016889, 27.07.2011  
(97) 2600830, 12.06.2013 en  
(54) DRY POWDER FORMULATION COMPRISING A PHOSPHODIESTERASE INHIBITOR  
(71) Chiesi Farmaceutici S.p.A., Via Palermo, 26/A, 43100 Parma, IT  
(72) COCCONI, Daniela, Via Palermo 26/A, I-43100 Parma, IT  
SCHIARETTI, Francesca, Via Palermo 26/A, I-43100 Parma, IT  
BILZI, Roberto, c/o Chiesi Farmaceutici S.p.a. Via Palermo 26/A, I-43100 Parma, IT

(51) MKP  
**C25B 9/00 (2006.01)** (97) **2596155 \***  
**C25B 13/04 (2006.01)**  
**C01B 3/58 (2006.01)**  
(86) RO2011000015 20.04.2011  
(96) 11729189.8 29.05.2013  
(87) WO2012011829, 20.04.2011  
(97) 2596155, 29.05.2013 en  
(54) MEMBRANE ELECTRO - CATALYTIC SYSTEM AND PROCESS FOR OBTAINING FUEL GAS FROM WATER  
(71) S.C. Centrul De Cercetare Pentru Materiale Macrom, Splaiul Independen ei nr. 202B, 060023 Bucuresti 6, RO  
(72) RADU, Marin, Calea Rahovei 217-12 Sc. 1 Ap. 1, R-050896 Bucuresti 5, RO  
RADU, Florica, Calea Rahovei 217-12 Sc. 1 Ap. 1, R-050896 Bucuresti 5, RO  
RADU, Valentin, Calea Rahovei 217-12 Sc. 1 Ap. 1, R-050896 Bucuresti 5, RO  
RADU, Daniela, Calea Rahovei 217-12 Sc. 1 Ap. 1, R-050896 Bucuresti 5, RO  
CIOROIANU, Florian, G-ral dr. Ion Cernatescu 22BI. -F1 Sc. 2 Ap. 25 Et. 6 Judetul Dolj, R-00092 Craiova, RO  
CIOROIANU, Mariana, G-ral dr. Ion Cernatescu 22BI. -F1 Sc. 2 Ap. 25 Et. 6 Judetul Dolj, R-00092 Craiova, RO

(51) MKP  
**C07D 471/08 (2006.01)** (97) **2619205 \***  
**A61K 31/439 (2006.01)**  
**A61P 25/00 (2006.01)**  
**A61P 25/28 (2006.01)**  
(86) US2011052668 21.09.2011  
(96) 11764428.6 31.07.2013  
(87) WO2012040404, 21.09.2011  
(97) 2619205, 31.07.2013 en  
(54) MONOHYDRATE OF AN AZAADAMANTANE DERIVATIVE  
(71) AbbVie Inc., 1 North Waukegan Road, North Chicago, IL 60064, US  
(72) CHEN, Shuang, 17781 W. Elsbury Street, Gurnee Illinois 60031, US  
NAPIER, James J., 1058 White Pine Drive, Antioch Illinois 60002, US  
ZHANG, Geoff G. Z., 1372 N. Maidstone Drive, Vernon Hills Illinois 60061, US  
BRACKEMEYER, Paul J., 1717 W. Catalpa Lane, Mount Prospect Illinois 60056, US

- (51) MKP  
**H04W 4/02 (2009.01)** (97) **2601800 \***  
**G01S 5/00 (2006.01)**
- (86) US2011046668 04.08.2011  
(96) 11745655.8 12.06.2013  
(87) WO2012019057, 04.08.2011  
(97) 2601800, 12.06.2013 en  
(54) TRANSFER AND MODIFICATION OF LOCATION RELATED DATA DURING AN ONGOING LOCATION SESSION  
(71) Qualcomm Incorporated, 5775 Morehouse Drive, San Diego, CA 92121-1714, US  
(72) EDGE, Stephen William, 5775 Morehouse Drive, San Diego California 92121, US
- 
- (51) MKP  
**A61B 17/04 (2006.01)** (97) **2629679 \***  
**A61B 17/00 (2006.01)**  
**A61F 2/08 (2006.01)**
- (86) IB2011054536 13.10.2011  
(96) 11776901.8 28.08.2013  
(87) WO2012052891, 13.10.2011  
(97) 2629679, 28.08.2013 en  
(54) A FIXING DEVICE FOR SUTURE THREADS TO BE INSERTED INTO A BONE TISSUE  
(71) NCS Lab S.r.l., Via Pola Esterna 4/12 Carpi, 41012 Modena, IT  
(72) MANTOVANI, Matteo, Via Fossanuova Carpi, I-41012 Modena, IT  
RASIA DANI, Enrico, Via Europa 5, I-36040 Torri Di Quartesolo (Vicenza), IT
- 
- (51) MKP  
**A61K 31/4725 (2006.01)** (97) **2599774 \***  
**C07D 401/12 (2006.01)**  
**A61K 31/553 (2006.01)**  
**C07D 495/04 (2006.01)**  
**A61K 31/541 (2006.01)**  
**C07D 413/12 (2006.01)**  
**A61P 43/00 (2006.01)**  
**A61K 31/5377 (2006.01)**  
**C07D 405/12 (2006.01)**  
**A61P 29/00 (2006.01)**  
**A61P 25/04 (2006.01)**  
**C07D 217/26 (2006.01)**  
**C07D 237/34 (2006.01)**
- (86) JP2011067222 28.07.2011  
(96) 11812552.5 05.06.2013  
(87) WO2012014963, 28.07.2011  
(97) 2599774, 05.06.2013 en  
(54) CONDENSED RING PYRIDINE COMPOUND  
(71) Astellas Pharma Inc., 3-11, Nihonbashi-Honcho 2-chome Chuo-ku, Tokyo 103-8411, JP  
(72) MATSUSHIMA, Yuji, c/o Astellas Pharma Inc. 3-11, Nihonbashi-Honcho 2-chome Chuo-ku, Tokyo 103-8411, JP  
KAMEDA, Minoru, c/o Astellas Pharma Inc. 3-11, Nihonbashi-Honcho 2-chome Chuo-ku, Tokyo 103-8411, JP  
HONDA, Shugo, c/o Astellas Pharma Inc. 3-11, Nihonbashi-Honcho 2-chome Chuo-ku, Tokyo 103-8411, JP  
SUGANO, Yukihito, c/o Astellas Pharma Inc. 3-11, Nihonbashi-Honcho 2-chome Chuo-ku, Tokyo 103-8411, JP  
USUDA, Hiroyuki, c/o Astellas Pharma Inc. 3-11, Nihonbashi-Honcho 2-chome Chuo-ku, Tokyo 103-8411, JP  
TERASAKA, Tadashi, c/o Astellas Pharma Inc. 3-11, Nihonbashi-Honcho 2-chome Chuo-ku, Tokyo 103-8411, JP  
TERASAWA, Takeshi, c/o Astellas Pharma Inc. 3-11, Nihonbashi-Honcho 2-chome Chuo-ku, Tokyo 103-8411, JP  
NISHIGAKI, Fusako, c/o Astellas Pharma Inc. 3-11, Nihonbashi-Honcho 2-chome Chuo-ku, Tokyo 103-8411, JP
- 
- (51) MKP  
**H02K 3/28 (2006.01)** (97) **2638620 \***  
**H02K 19/36 (2006.01)**
- (86) FR2011052615 10.11.2011  
(96) 11794542.8 18.09.2013  
(87) WO2012063002, 10.11.2011  
(97) 2638620, 18.09.2013 fr  
(54) ELECTRIC MACHINE COMPRISING A SINGLE-TOOTH WINDING WITH GROUPED PHASES  
(71) Erneo, Avenue de l'Europe, 34830 Clapiers, FR  
(72) JAC, Julien, Résidence Le Clos Margot 32 rue Robert DESNOS, F-34070 Montpellier, FR  
ZIEGLER, Nicolas, Philippe, Résidence Le Benjamin - Bâtiment A - Appartement 208 690 rue de la Vieille Poste, F-34070 Montpellier, FR
- 
- (51) MKP  
**A61K 31/496 (2006.01)** (97) **2616440 \***  
**A61P 25/00 (2006.01)**  
**C07D 209/40 (2006.01)**  
**C07D 235/30 (2006.01)**  
**C07D 275/04 (2006.01)**  
**C07D 319/20 (2006.01)**  
**C07D 413/12 (2006.01)**
- (86) EP2011066054 16.09.2011  
(96) 11767950.6 24.07.2013  
(87) WO2012035123, 16.09.2011  
(97) 2616440, 24.07.2013 en  
(54) ARYLOSULFONAMIDES FOR THE TREATMENT OF CNS DISEASES  
(71) Adamed sp. z o.o., Pienków 149, 05-152 Czosnów k/ Warszawy, PL  
(72) KOLACZKOWSKI, Marcin, ul. Lany 2, PL-32-020 Wieliczka, PL  
KOWALSKI, Piotr, ul. J. Lea 9B/5, PL-30-046 Kraków, PL  
JASKOWSKA, Jolanta, ul. Radzikowskiego 100D/7, PL-31-315 Kraków, PL  
MARCINKOWSKA, Monika, ul. Na Mostkach 3, PL-31-267 Kraków, PL  
MITKA, Katarzyna, Al. Pokoju 12/5, PL-31-548 Kraków, PL  
BUCKI, Adam, ul. 3 Maja 159, PL-32-100 Proszowice, PL  
WESOLOWSKA, Anna, Os. Kombatantów 8/32, PL-31-630 Kraków, PL  
PAWLOWSKI, Maciej, ul. Reformacka 87, PL-32-020 Wieliczka, PL
- 
- (51) MKP  
**A61K 38/47 (2006.01)** (97) **2537528**  
**C12N 9/38 (2006.01)**  
**C12N 9/40 (2006.01)**  
**A61P 1/04 (2006.01)**
- (96) 12172907.3 26.12.2012  
(97) 2537528, 26.12.2012 en  
(54) Pharmaceutical or nutritional compositions containing galactosidase, and their use  
(71) Promefarm S.r.l., Corso Indipendenza, 6, 20129 Milano, IT  
(72) Zanarotti, Alessandro, c/o PROMEFARM SRL C. so Indipendenza, 6, 20129 MILANO, IT  
Brunetti, Gabriele, Viale dei Mille, 27, 20129 MILANO, IT  
Cecchetti, Sergio, Via Gendarini, 3, 20060 POZZUOLO MARTESANA (MI), IT
- 
- (51) MKP  
**C12Q 1/68 (2006.01)** (97) **2619325 \***
- (86) IB2011002584 22.09.2011  
(96) 11802132.8 31.07.2013  
(87) WO2012038831, 22.09.2011  
(97) 2619325, 31.07.2013 en  
(54) A METHOD FOR DETECTING, QUANTIFYING AND MAPPING DAMAGE AND/OR REPAIR OF DNA STRANDS  
(71) Genomic Vision, 80-84 rue des Meuniers, 92220 Bagneux, FR  
(72) CINQUE, Lucia, 12 rue Clouet, 75015 Paris, FR  
BENSIMON, Aaron, 5 rue Clos de l'Abbaye, 92160 Antony, FR

- (51) MKP  
**C07D 519/00 (2006.01)** (97) **2615096 \***  
**A61K 31/4985 (2006.01)**  
**A61P 13/02 (2006.01)**  
**A61P 43/00 (2006.01)**  
**C07D 487/04 (2006.01)**  
(86) JP2011070287 06.09.2011  
(96) 11823576.1 17.07.2013  
(87) WO2012033101, 06.09.2011  
(97) 2615096, 17.07.2013 en  
(54) QUINOXALINE COMPOUND  
(71) Astellas Pharma Inc., 3-11, Nihonbashi-Honcho 2-chome Chuo-ku, Tokyo 103-8411, JP  
(72) KAIZAWA, Hiroyuki, c/o Astellas Pharma Inc. 3-11 Nihonbashi-Honcho 2-chome Chuo-ku, Tokyo 103-8411, JP  
SUGITA, Mari, c/o Astellas Pharma Inc. 3-11 Nihonbashi-Honcho 2-chome Chuo-ku, Tokyo 103-8411, JP  
YAMAMOTO, Hirofumi, c/o Astellas Pharma Inc. 3-11 Nihonbashi-Honcho 2-chome Chuo-ku, Tokyo 103-8411, JP  
KAMIJO, Kazunori, -, deceased, JP  
TSUCHIYA, Kazuyuki, c/o Astellas Pharma Inc. 3-11 Nihonbashi-Honcho 2-chome Chuo-ku, Tokyo 103-8411, JP  
SEO, Ryushi, c/o Astellas Pharma Inc. 3-11 Nihonbashi-Honcho 2-chome Chuo-ku, Tokyo 103-8411, JP  
YAMAMOTO, Satoshi, c/o Astellas Pharma Inc. 3-11 Nihonbashi-Honcho 2-chome Chuo-ku, Tokyo 103-8411, JP

- (51) MKP  
**C07D 491/00 (2006.01)** (97) **2595988 \***  
**C07D 493/00 (2006.01)**  
**C07D 513/00 (2006.01)**  
**A61K 31/353 (2006.01)**  
**A61K 31/425 (2006.01)**  
**A61K 31/4738 (2006.01)**  
**A61P 3/04 (2006.01)**  
(86) US2011044864 21.07.2011  
(96) 11741370.8 29.05.2013  
(87) WO2012012642, 21.07.2011  
(97) 2595988, 29.05.2013 en  
(54) TRICYCLIC COMPOUNDS AND METHODS OF MAKING AND USING SAME  
(71) Zafgen, Inc., One Broadway, 8th Floor, Cambridge, MA 02142, US  
(72) CLARK, David, 8/9 Spire Green Centre Flex Meadow, Harlow Essex CM19 5TR, GB  
CRAMP, Susan, Mary, 8/9 Spire Green Centre Flex Meadow, Harlow Essex CM19 5TR, GB  
DYKE, Hazel, Joan, 8/9 Spire Green Centre Flex Meadow, Harlow Essex CM19 5TR, GB  
PALLIN, Thomas, David, 8/9 Spire Green Centre Flex Meadow, Harlow Essex CM19 5TR, GB  
ZÄHLER, Robert, 1 Cambridge Center Suite 702, Cambridge, MA 02142, US

- (51) MKP  
**G01N 33/574 (2006.01)** (97) **2627671 \***  
**C07K 14/72 (2006.01)**  
**C12N 5/00 (2006.01)**  
**C07K 16/28 (2006.01)**  
(86) EP2011067848 13.10.2011  
(96) 11782568.7 21.08.2013  
(87) WO2012049229, 13.10.2011  
(97) 2627671, 21.08.2013 en  
(54) ESTROGEN RECEPTOR ALPHA POLYPEPTIDE SEQUENCE, DIAGNOSTIC AND THERAPEUTIC APPLICATIONS THEREOF  
(71) Université Libre de Bruxelles, Avenue F. D. Roosevelt 50 CP 161, 1050 Bruxelles, BE  
University of Crete - School of Medicine, P.O. Box 2208, 71003 Heraklion, GR  
CNRS, 3 Rue Michel Ange, 75794 Paris Cedex 16, FR  
Université Pierre et Marie Curie, 4 Place Jussieu, 75252 Paris Cedex 05, FR  
(72) GALLO, Dominique, 1 rue Héger-Bordet, B-1000 Bruxelles, BE  
LECLERCQ, Guy, 1 rue Héger-Bordet, B-1000 Bruxelles, BE  
HADDAD, Iman, 10 rue Vauquelin, F-75231 Paris Cedex 05, FR  
VINH, Joëlle, 10 rue Vauquelin, F-75231 Paris Cedex 05, FR  
CASTANAS, Elias, P.O. Box 2208, GR-71003 Heraklion, GR  
KAMPA, Marilena, P.O. Box 2208, GR-71003 Heraklion, GR  
PELEKANOU, Vasiliki, P.O. Box 2208, GR-71003 Heraklion, GR  
JACQUOT, Yves, 24 rue Lhomond, F-75231 Paris Cedex 05, FR

- (51) MKP  
**C09B 23/00 (2006.01)** (97) **2630196 \***  
**G01N 33/58 (2006.01)**  
**C09B 23/08 (2006.01)**  
**C09B 69/00 (2006.01)**  
(86) US2011057134 20.10.2011  
(96) 11777011.5 28.08.2013  
(87) WO2012054749, 20.10.2011  
(97) 2630196, 28.08.2013 en  
(54) CYANINE DYES AND THEIR CONJUGATES  
(71) LI-COR, INC., 4647 Superior Street, Lincoln, NE 68504, US  
(72) XU, Xinshe, 9220 Benziger Drive, Lincoln Nebraska 68526, US  
DRANEY, Daniel R., 1800 Buckingham Drive, Lincoln Nebraska 68506, US  
CHEUNG, Lael, 4647 Superior Street, Lincoln Nebraska 68504, US

- (51) MKP  
**B63B 25/22 (2006.01)** (97) **2581301**  
(96) 11008176.7 17.04.2013  
(97) 2581301, 17.04.2013 de  
(54) Containers stowage device  
(71) IPP Ingenieur Partner Pool GmbH, Kajen 6-8, Detjen Haus., 20459 Hamburg, DE  
(72) Radebold, Helmut, Deichweg 5, 25379 Herzhorn, DE  
Pruin, Berend, Binnenfeld 17, 21423 Winsen, DE

- (51) MKP  
**C07D 403/14 (2006.01)** (97) **2640719 \***  
**A61K 31/4178 (2006.01)**  
**C07D 405/14 (2006.01)**  
**A61K 31/4184 (2006.01)**  
**C07D 493/04 (2006.01)**  
**C07D 491/10 (2006.01)**  
**C07D 495/04 (2006.01)**  
**C07D 471/08 (2006.01)**  
**A61P 31/12 (2006.01)**  
**C07D 417/14 (2006.01)**  
**A61K 31/4188 (2006.01)**  
**C07D 513/04 (2006.01)**  
(86) US2011060966 16.11.2011  
(96) 11791700.5 25.09.2013  
(87) WO2012068234, 16.11.2011  
(97) 2640719, 25.09.2013 en  
(54) ANTIVIRAL COMPOUNDS  
(71) Gilead Sciences, Inc., 333 Lakeside Drive, Foster City, CA 94404, US  
(72) BACON, Elizabeth, M., c/o Gilead Sciences, Inc. 333 Lakeside Drive, Foster City, CA 94404, US  
COTTELL, Jeromy, J., c/o Gilead Sciences, Inc. 333 Lakeside Drive, Foster City, CA 94404, US  
KATANA, Ashley, Anne, c/o Gilead Sciences, Inc. 333 Lakeside Drive, Foster City, CA 94404, US  
KATO, Darryl, c/o Gilead Sciences, Inc. 333 Lakeside Drive, Foster City, CA 94404, US  
KRYGOWSKI, Evan, S., c/o Gilead Sciences, Inc. 333 Lakeside Drive, Foster City, CA 94404, US  
LINK, John, O., c/o Gilead Sciences, Inc. 333 Lakeside Drive, Foster City, CA 94404, US  
TAYLOR, James, c/o Gilead Sciences, Inc. 333 Lakeside Drive, Foster City, CA 94404, US  
TRAN, Chinh, Viet, c/o Gilead Sciences, Inc. 333 Lakeside Drive, Foster City, CA 94404, US  
TREJO MARTIN, Teresa, Alejandra, c/o Gilead Sciences, Inc. 333 Lakeside Drive, Foster City, CA 94404, US  
YANG, Zheng-Yu, c/o Gilead Sciences, Inc. 333 Lakeside Drive, Foster City, CA 94404, US  
ZIPFEL, Sheila, c/o Gilead Sciences, Inc. 333 Lakeside Drive, Foster City, CA 94404, US

- (51) MKP  
**A61K 47/20 (2006.01)** (97) **2623100 \***  
**A61K 47/36 (2006.01)**  
**A61K 47/38 (2006.01)**  
**A61K 9/20 (2006.01)**  
**A61K 9/48 (2006.01)**  
**A61K 31/405 (2006.01)**  
**A61K 47/02 (2006.01)**  
**A61K 31/426 (2006.01)**  
(86) JP2011072355 29.09.2011  
(96) 11829262.2 07.08.2013  
(87) WO2012043709, 29.09.2011  
(97) 2623100, 07.08.2013 en  
(54) PREPARATION FOR IMPROVING SOLUBILITY OF POORLY SOLUBLE DRUG  
(71) Shionogi & Co., Ltd., 1-8, Doshomachi 3-chome Chuo-ku, Osaka-shi, Osaka 541-0045, JP  
(72) SAKUMA, Satoshi, c/o Shionogi&Co. Ltd. 1-3 Kuise Terajima 2-chome, Amagasaki-shi Hyogo 660-0813, JP  
UEDA, Hiroshi, c/o Shionogi & Co. Ltd., 1-1, Futabacho 3-chome,, Toyonaka-shi Osaka 561-0825, JP  
MASHIMO, Akira, c/o Shionogi&Co. Ltd. 1-3 Kuise Terajima 2-chome, Amagasaki-shi Hyogo 660-0813, JP  
MURAZATO, Hiroshi, c/o Shionogi&Co. Ltd. 1-8 Doshomachi 3-chome Chuo-ku, Osaka-shi Osaka 541-0045, JP

- (51) MKP  
**C07K 16/22 (2006.01)** (97) **2643351 \***  
(86) EP2011070868 23.11.2011  
(96) 11785457.0 02.10.2013  
(87) WO2012069557, 23.11.2011  
(97) 2643351, 02.10.2013 en  
(54) MULTISPECIFIC ANTIGEN BINDING PROTEINS TARGETING HGF  
(71) Glaxo Group Limited, 980 Great West Road, Brentford, Middlesex TW8 9GS, GB  
(72) GRIGGS, Jeremy, GlaxoSmithKline Gunnels Wood Road, Stevenage Hertfordshire SG1 2NY, GB  
PARMAR, Radha, Shah, GlaxoSmithKline Gunnels Wood Road, Stevenage Hertfordshire SG1 2NY, GB  
STEWART, Michael, GlaxoSmithKline Gunnels Wood Road, Stevenage Hertfordshire SG1 2NY, GB

- (51) MKP  
**A61M 5/24 (2006.01)** (97) **2603263 \***  
**A61M 5/315 (2006.01)**  
(86) EP2011063847 11.08.2011  
(96) 11743535.4 19.06.2013  
(87) WO2012020089, 11.08.2011  
(97) 2603263, 19.06.2013 en  
(54) DIFFERENTIATION FOR A DRUG DELIVERY DEVICE  
(71) Sanofi-Aventis Deutschland GmbH, Brüningstraße 50, 65929 Frankfurt, DE  
(72) PLUMPTRE, David, 36 Shire Way Droitwich Spa, Worcestershire WR9 7RQ, GB  
AVERY, Richard James Vincent, 28 Nursery Close Mickleton Chipping Campden, Gloucestershire GL55 6TX, GB

- (51) MKP  
**A61F 13/15 (2006.01)** (97) **2628472**  
(86) 13156051.8 21.08.2013  
(97) 2628472, 21.08.2013 en  
(54) Method of forming bonds between discrete components of disposable articles  
(71) Curt G. Joa, Inc., 100 Crocker Avenue, Sheboygan Falls, Wisconsin 53085, US  
(72) Fritz, Jeff W, N4989 Country Aire Road, Plymouth, WI Wisconsin 53073, US

- (51) MKP  
**F16L 37/24 (2006.01)** (97) **2369215**  
(86) 10195369.3 28.09.2011  
(97) 2369215, 28.09.2011 de  
(54) Connector  
(71) VAG-Armaturen GmbH, Carl-Reuther-Strasse 1, 68305 Mannheim, DE  
(72) Hauner, Ivo, Mokre Radky 265, 69602 Ratiskovice, CZ

- (51) MKP  
**A61K 9/14 (2006.01)** (97) **2635258 \***  
**A61K 9/26 (2006.01)**  
(86) US2011059456 04.11.2011  
(96) 11784893.7 11.09.2013  
(87) WO2012061779, 04.11.2011  
(97) 2635258, 11.09.2013 en  
(54) DRUG FORMULATIONS  
(71) AbbVie Inc., 1 North Waukegan Road, North Chicago, IL 60064, US  
Abbvie Deutschland GmbH & Co. KG, Max-Planck-Ring 2a, 65205 Wiesbaden, DE  
(72) GHOSH, Soumojeet, 5510 Notting Hill Road, Gurnee Illinois 60031, US  
LEFEBVRE, Didier, 335 Rye Road, Mundelein Illinois 60060, US  
WIESNER, Bryan, 1551 Littlefield Court, Lake Forest Illinois 60045, US  
BREITENBACH, Joerg, Hans-Sachs-Ring 95a, 68199 Mannheim, DE  
KESSLER, Thomas, Mutterstadter Strasse 113, 67105 Schifferstadt, DE

- (51) MKP  
**C07D 403/04 (2006.01)** (97) **2603502 \***  
**C07D 403/14 (2006.01)**  
**C07D 413/14 (2006.01)**  
**C07D 417/14 (2006.01)**  
**C07D 405/14 (2006.01)**  
**A61K 31/517 (2006.01)**  
**A61K 31/55 (2006.01)**  
**A61P 9/00 (2006.01)**  
**A61P 3/10 (2006.01)**
- (86) US2011047626 12.08.2011  
(96) 11749643.0 19.06.2013  
(87) WO2012021830, 12.08.2011  
(97) 2603502, 19.06.2013 en  
(54) 4 - AMINOQUINAZOLIN- 2 - YL - 1 - PYRRAZOLE -  
4 - CARBOXYLIC ACID COMPOUNDS AS PROLYL  
HYDROXYLASE INHIBITORS
- (71) Janssen Pharmaceutica, N.V., Turnhoutseweg 30, 2340  
Beerse, BE
- (72) RABINOWITZ, Michael, H., 8525 Celtic Court, San Diego CA  
92129, US  
ROSEN, Mark, D., 5052 Via Cinta, San Diego CA 92122, US  
TARANTINO, Kyle, T., 3950 Ingraham Street 206, San Diego,  
CA 92109, US  
VENKATESAN, Hariharan, 17065 Bernardo Oaks Drive, San  
Diego CA 92128, US

- (51) MKP  
**B01D 46/00 (2006.01)** (97) **2532407**  
**B01D 53/00 (2006.01)**  
**B03C 3/00 (2006.01)**  
**F24F 3/00 (2006.01)**
- (86) 12171069.3 12.12.2012  
(97) 2532407, 12.12.2012 en  
(54) Air purification device and method
- (71) Chan, Yiu Ming, Unit 542, Enterprise Place No. 5 Science  
Park West Avenue Hong Kong Science Park, Shatin, N.T.,  
Hong Kong, CN
- (72) Chan, Yiu Ming, Unit 542, Enterprise Place, No. 5 Science  
Park West Avenue, Hong Kong Science Park, Shatin, N.T., CN  
Chan, Yiu Wai, Unit 542, Enterprise Place, No. 5 Science Park  
West Avenue, Hong Kong Science Park, Shatin, N.T., CN  
Law, Sui Chun, Unit 542, Enterprise Place, No. 5 Science Park  
West Avenue, Hong Kong Science Park, Shatin, N.T., CN

- (51) MKP  
**A61K 31/4188 (2006.01)** (97) **2624831 \***  
**A61K 31/4745 (2006.01)**  
**A61P 35/00 (2006.01)**
- (86) US2011054536 03.10.2011  
(96) 11770611.9 14.08.2013  
(87) WO2012047775, 03.10.2011  
(97) 2624831, 14.08.2013 en  
(54) PHARMACEUTICAL COMBINATIONS
- (71) Novartis AG, Lichtstrasse 35, 4056 Basel, CH  
CHEN, Yan, Novartis Institutes for BioMedical Research Inc.  
250 Massachusetts Avenue, Cambridge, Massachusetts  
02139, US  
HUANG, Xizhong, Novartis Institutes for BioMedical Research  
Inc. 250 Massachusetts Avenue, Cambridge, Massachusetts  
02139, US  
MURPHY, Leon, Novartis Institutes for BioMedical Research  
Inc. 250 Massachusetts Avenue, Cambridge, Massachusetts  
02139, US  
NYFELER, Beat, Novartis Institutes for BioMedical Research  
Inc. 250 Massachusetts Avenue, Cambridge, Massachusetts  
02139, US

- (51) MKP  
**A61K 31/337 (2006.01)** (97) **2640377 \***  
**A61K 31/475 (2006.01)**  
**A61K 31/519 (2006.01)**  
**A61K 38/18 (2006.01)**  
**A61K 45/06 (2006.01)**  
**A61P 35/00 (2006.01)**  
**A61K 39/395 (2006.01)**  
**A61K 31/4745 (2006.01)**  
**A61K 31/513 (2006.01)**  
**A61K 31/555 (2006.01)**  
**A61K 31/704 (2006.01)**  
**A61K 31/7048 (2006.01)**  
**A61K 33/24 (2006.01)**  
**A61K 38/17 (2006.01)**  
**C07K 19/00 (2006.01)**
- (86) US2011060666 14.11.2011  
(96) 11784918.2 25.09.2013  
(87) WO2012068032, 14.11.2011  
(97) 2640377, 25.09.2013 en  
(54) FGFR1 EXTRACELLULAR DOMAIN COMBINATION  
THERAPIES
- (71) Five Prime Therapeutics, Inc., Two Corporate Drive, South San  
Francisco, CA 94080, US
- (72) LONG, Li, 3209 Greenhills Drive, Lafayette, California 94549,  
US  
BRENNAN, Thomas, 5294 Amelia Drive, San Jose, California  
95118, US

- (51) MKP  
**A61K 31/4412 (2006.01)** (97) **2611805 \***  
**A61K 31/437 (2006.01)**  
**A61P 25/28 (2006.01)**  
**C07D 471/04 (2006.01)**
- (86) JP2011070419 01.09.2011  
(96) 11791058.8 10.07.2013  
(87) WO2012029991, 01.09.2011  
(97) 2611805, 10.07.2013 en  
(54) FUSED TRIAZOLES FOR THE TREATMENT OR  
PROPHYLAXIS OF MILD COGNITIVE IMPAIRMENT
- (71) Takeda Pharmaceutical Company Limited, 1-1 Doshomachi  
4-chome Chuo-ku, Osaka-shi, Osaka 541-0045, JP
- (72) KOIKE, Tatsuki, c/o TAKEDA PHARMACEUTICAL COMPANY  
LIMITED 26-1 Muraoka-Higashi 2-chome, Fujisawa-shi  
Kanagawa 251-0012, JP  
NAKAMURA, Minoru, c/o TAKEDA PHARMACEUTICAL  
COMPANY LIMITED 26-1 Muraoka-Higashi 2-chome,  
Fujisawa-shi Kanagawa 251-0012, JP  
TOMATA, Yoshihide, c/o TAKEDA PHARMACEUTICAL  
COMPANY LIMITED 26-1 Muraoka-Higashi 2-chome,  
Fujisawa-shi Kanagawa 251-0012, JP  
TAKAI, Takafumi, c/o TAKEDA PHARMACEUTICAL  
COMPANY LIMITED 26-1 Muraoka-Higashi 2-chome,  
Fujisawa-shi Kanagawa 251-0012, JP  
HOASHI, Yasutaka, c/o TAKEDA PHARMACEUTICAL  
COMPANY LIMITED 26-1, Muraoka-Higashi 2-chome,  
Kanagawa 251-0012, JP  
KAJITA, Yuichi, c/o TAKEDA PHARMACEUTICAL COMPANY  
LIMITED 26-1 Muraoka-Higashi 2-chome, Fujisawa-shi  
Kanagawa 251-0012, JP  
TSUKAMOTO, Tetsuya, c/o TAKEDA PHARMACEUTICAL  
COMPANY LIMITED 17-85 Jusohonmachi 2-chome  
Yodogawa-ku, Osaka-shi Osaka 532-0024, JP  
KAMATA, Makoto, c/o TAKEDA PHARMACEUTICAL  
COMPANY LIMITED 26-1 Muraoka-Higashi 2-chome,  
Fujisawa-shi Kanagawa 251-0012, JP

- (51) MKP  
**C07D 401/12 (2006.01)** (97) **2625172 \***  
**A61K 31/415 (2006.01)**  
**A61P 3/04 (2006.01)**
- (86) US2011054841 05.10.2011  
(96) 11770622.6 14.08.2013  
(87) WO2012047948, 05.10.2011  
(97) 2625172, 14.08.2013 en
- (54) NEW CRYSTALLINE FORMS OF THE SODIUM SALT OF (4-{4-[5-(6-TRIFLUOROMETHYL-PYRIDIN-3-YLAMINO)-PYRIDIN-2-YL]-PHENYL}-CYCLOHEXYL)-ACETIC ACID
- (71) Novartis AG, Lichtstrasse 35, 4056 Basel, CH
- (72) SUTTON, Paul, Allen, Novartis Pharmaceuticals Corporation One Health Plaza East Hanover, New Jersey 07936-1080, US  
GIRGIS, Michael, J., Novartis Pharmaceuticals Corporation One Health Plaza East Hanover, New Jersey 07936-1080, US  
LIANG, Jessica, Novartis Pharmaceuticals Corporation One Health Plaza East Hanover, New Jersey 07936-1080, US  
PRASHAD, Mahavir, Novartis Pharmaceuticals Corporation One Health Plaza East Hanover, New Jersey 07936-1080, US  
VILLHAUER, Edwin, Bernard, Novartis Pharmaceuticals Corporation One Health Plaza East Hanover, New Jersey 07936-1080, US
- 
- (51) MKP  
**G01N 33/50 (2006.01)** (97) **2631646 \***  
**G01N 33/92 (2006.01)**  
**G01N 33/15 (2006.01)**  
**G01N 33/68 (2006.01)**
- (86) JP2011064487 23.06.2011  
(96) 11834097.5 28.08.2013  
(87) WO2012053255, 23.06.2011  
(97) 2631646, 28.08.2013 en
- (54) BIOMARKER FOR ALZHEIMER'S DISEASE OR MILD COGNITIVE IMPAIRMENT
- (71) Eisai R&D Management Co., Ltd., 6-10, Koishikawa 4-chome Bunkyo-ku, Tokyo 112-8088, JP
- (72) SATO, Yoshiaki, c/o EISAI CO. LTD. Tsukuba Research Laboratories 1-3 Tokodai 5-chome, Tsukuba-shi Ibaraki 300-2635, JP  
AOSHIMA, Ken, c/o EISAI CO. LTD. Tsukuba Research Laboratories 1-3 Tokodai 5-chome, Tsukuba-shi Ibaraki 300-2635, JP  
BERNIE, Francois, c/o EISAI CO. LTD. Tsukuba Research Laboratories 1-3 Tokodai 5-chome, Tsukuba-shi Ibaraki 300-2635, JP
- 
- (51) MKP  
**A61K 31/00 (2006.01)** (97) **2637649 \***  
**A61K 31/4164 (2006.01)**  
**A61K 31/675 (2006.01)**  
**A61K 38/00 (2006.01)**  
**A61P 29/00 (2006.01)**  
**A61P 29/02 (2006.01)**  
**A61P 25/04 (2006.01)**
- (86) EP2011069986 11.11.2011  
(96) 11781808.8 18.09.2013  
(87) WO2012062925, 11.11.2011  
(97) 2637649, 18.09.2013 en
- (54) COMPOUNDS AND METHODS FOR TREATING PAIN
- (71) Akron Molecules GmbH, Helmut-Quaitinger-Gasse 2, 1030 Vienna, AT
- (72) PENNINGER, Josef, Himmelhofgasse 62, A-1130 Vienna, AT  
NEELY, Graham Gregory, 4/186-190 Lawrence St Alexandria Sydney, 2015, AU  
MCMANUS, Shane, Klimschgasse 5/5, A-1030 Vienna, AT  
Nilsson, Henrik, Reisnerstrasse 11/6, 1030 Vienna, AT
- 
- (51) MKP  
**F02M 59/02 (2006.01)** (97) **2557306**  
**F02M 59/44 (2006.01)**  
**F04B 1/04 (2006.01)**
- (96) 11176843.8 13.02.2013  
(97) 2557306, 13.02.2013 en
- (54) Fuel pump
- (71) Delphi Technologies Holding S.à.r.l., Avenue de Luxembourg, 4940 Bascharage, LU
- (72) Navas Sanchez, Borja, Flat 4, 95-97 High Street, Chatham, Kent ME4 4DL, GB
- 
- (51) MKP  
**G06K 9/00 (2006.01)** (97) **2638507 \***  
**G06T 7/00 (2006.01)**  
**B01L 3/00 (2006.01)**  
**C12M 1/34 (2006.01)**  
**G01N 15/06 (2006.01)**  
**G01N 15/14 (2006.01)**  
**G01N 35/00 (2006.01)**
- (86) US2011060459 11.11.2011  
(96) 11791124.8 18.09.2013  
(87) WO2012065122, 11.11.2011  
(97) 2638507, 18.09.2013 en
- (54) HIGH THROUGHPUT, OPTICAL METHOD AND SYSTEM FOR DETERMINING THE EFFECT OF A TEST SUBSTANCE ON LIVING CELLS
- (71) AbbVie Inc., 1 North Waukegan Road, North Chicago, IL 60064, US
- (72) TRUMBULL, Jonathan D., 5551 North Glenwood Avenue, Chicago, Illinois 60640, US  
GINTANT, Gary A., 1205 Brian Circle, Libertyville, Illinois 60048, US  
KANTOR, Stanislaw, 485 Satinwood Terrace, Buffalo Grove, Illinois 60089, US  
PAN, Jeffrey Yen, 27190 N. Bradley Road, Lake Forest, Illinois 60045, US  
DIAZ, Gilbert J., 949 North Quince Lane, Mount Prospect, Illinois 60056, US  
GREEN, Jonathon, 3124 Valley Falls Street, Elgin, Illinois 60124, US  
SU, Zhi, 22 LindonLane, Vernon Hills, Illinois 60061, US  
OLSON, Jeffrey A., 619 Mullady Pkwy., Libertyville, Illinois 60048, US
- 
- (51) MKP  
**A47C 7/38 (2006.01)** (97) **2635159 \***  
**B60N 2/48 (2006.01)**
- (86) NO2011000309 02.11.2011  
(96) 11782486.2 11.09.2013  
(87) WO2012060716, 02.11.2011  
(97) 2635159, 11.09.2013 en
- (54) NECK REST
- (71) Ekornes ASA, Postboks 23, 6222 Ikornnes, NO
- (72) KLOKK, Jan, Kato, Nakkegata 50, N-6230 Sykkylven, NO
- 
- (51) MKP  
**B63B 3/06 (2006.01)** (97) **2433858**  
**B63B 35/38 (2006.01)**  
**E02B 3/06 (2006.01)**  
**E01D 15/14 (2006.01)**  
**E04B 1/343 (2006.01)**
- (96) 11182208.6 28.03.2012  
(97) 2433858, 28.03.2012 en
- (54) A modular system for realising chambers joined to one another
- (71) Stem S.r.l., 12/D, Strada Ghiaie, 43014 Medesano (Parma), IT
- (72) Menna, Ezio, STEM S.R.L. 12/D, Strada Ghiaie, 43014 MEDESANO (PARMA), IT
- 
- (51) MKP  
**B65B 55/20 (2006.01)** (97) **2616345 \***  
**B65D 81/09 (2006.01)**  
**B65B 1/22 (2006.01)**
- (86) EP2011066127 16.09.2011  
(96) 11757632.2 24.07.2013  
(87) WO2012035146, 16.09.2011  
(97) 2616345, 24.07.2013 de
- (54) METHOD AND DEVICE FOR FILLING PACKETS WITH PADDING IN THE FORM OF BULK MATERIAL
- (71) B&W Solutions GmbH, Adolf-Heim-Str. 11, 74321 Bietigheim-Bissingen, DE  
Koteam Maschinenbau GmbH, Oberer Wasen 23, 73630 Remshalden, DE
- (72) KONNERTH, Hans, Eichengrund 7, 71397 Leutenbach, DE
-

- (51) MKP  
**B82Y 5/00 (2011.01)** (97) **2627360 \***  
**A61K 49/00 (2006.01)**
- (86) IB2011054546 13.10.2011  
(96) 11776904.2 21.08.2013  
(87) WO2012049657, 13.10.2011  
(97) 2627360, 21.08.2013 en
- (54) SILICA NANOPARTICLES DOPED WITH MULTIPLE DYES FEATURING HIGHLY EFFICIENT ENERGY TRANSFER AND TUNABLE STOKES-SHIFT
- (71) Alma Mater Studiorum -Universita' di Bologna, Via Zamboni, 33, 40126 Bologna, IT
- (72) BONACCHI, Sara, c/o Alma Mater Studiorum Università di Bologna Via Zamboni 33, I-40126 Bologna, IT  
MONTALTI, Marco, c/o Alma Mater Studiorum Università di Bologna Via Zamboni 33, I-40126 Bologna, IT  
PRODI, Luca, c/o Alma Mater Studiorum Università di Bologna Via Zamboni 33, I-40126 Bologna, IT  
ZACCHERONI, Nelsi, c/o Alma Mater Studiorum Università di Bologna Via Zamboni 33, I-40126 Bologna, IT  
JURIS, Riccardo, c/o Alma Mater Studiorum Università di Bologna Via Zamboni 33, I-40126 Bologna, IT  
GENOVESE, Damiano, c/o Alma Mater Studiorum Università di Bologna Via Zamboni 33, I-40126 Bologna, IT  
RAMPAZZO, Enrico, c/o Alma Mater Studiorum Università di Bologna Via Zamboni 33, I-40126 Bologna, IT
- 
- (51) MKP  
**A61K 39/00 (2006.01)** (97) **2640727 \***  
**A61K 31/535 (2006.01)**  
**C07D 491/12 (2006.01)**
- (86) US2011061031 16.11.2011  
(96) 11793586.6 25.09.2013  
(87) WO2012074757, 16.11.2011  
(97) 2640727, 25.09.2013 en
- (54) ALANINYL MAYTANSINOL ANTIBODY CONJUGATES
- (71) Genentech, Inc., 1 DNA Way, South San Francisco, CA 94080, US
- (72) FLYGARE, John, C/O Genentech Inc. 1 DNA Way, South San Francisco, California 94080, US  
JUNUTULA, Jagath Reddy, C/O Genentech Inc. 1 DNA Way, South San Francisco, California 94080, US  
PILLOW, Thomas, C/O Genentech Inc. 1 DNA Way, South San Francisco, California 94080, US
- 
- (51) MKP  
**F01M 13/04 (2006.01)** (97) **2614228 \***  
**F02D 41/22 (2006.01)**  
**F02D 41/00 (2006.01)**  
**F01M 13/02 (2006.01)**
- (86) NL2011050616 08.09.2011  
(96) 11770547.5 17.07.2013  
(87) WO2012036547, 08.09.2011  
(97) 2614228, 17.07.2013 en
- (54) SYSTEM AND METHOD FOR MONITORING BLOW-BY IN A COMBUSTION ENGINE
- (71) Daf Trucks N.V., Hugo van der Goeslaan 1, 5643 TW Eindhoven, NL
- (72) DOPPER, Den, Jasper, Zoutendijk 12, NL-4927 AT Hooge Zwaluwe, NL
- 
- (51) MKP  
**B01D 61/10 (2006.01)** (97) **2598231 \***  
**B01D 61/20 (2006.01)**  
**B01D 65/00 (2006.01)**  
**C12H 1/06 (2006.01)**  
**B01D 65/02 (2006.01)**
- (86) NL2011050511 14.07.2011  
(96) 11736193.1 05.06.2013  
(87) WO2012015298, 14.07.2011  
(97) 2598231, 05.06.2013 en
- (54) A FILTRATION METHOD FOR OPERATING A FILTRATION MODULE WITH GAS FEED AT ITS PERMEATE SIDE TO PREVENT BACKFLOW OF PERMEATE
- (71) X-Flow B.V., Marssteden 50, 7547 TC Enschede, NL
- (72) MEPSCHEN, André, 2 Verlengde Hoogeveensevaart, NL-7861 TB Oosterhesselen, NL

- (51) MKP  
**A61M 5/145 (2006.01)** (97) **2600921 \***
- (86) EP2011063502 05.08.2011  
(96) 11740657.9 12.06.2013  
(87) WO2012017063, 05.08.2011  
(97) 2600921, 12.06.2013 en
- (54) METHOD AND SYSTEM FOR RETAINING A CARTRIDGE IN A HOLDER
- (71) Sanofi-Aventis Deutschland GmbH, Brüningstraße 50, 65929 Frankfurt, DE
- (72) AVERY, Richard James Vincent, 28 Nursery Close, Mickleton Chipping Campden Gloucestershire GL55 6TX, GB  
BUTLER, Joseph, 6 Hadfield Close, Clifton Rugby Warwickshire CV23 0DL, GB
- 
- (51) MKP  
**F16K 11/074 (2006.01)** (97) **2616724 \***
- (86) US2011001530 31.08.2011  
(96) 11825552.0 24.07.2013  
(87) WO2012036723, 31.08.2011  
(97) 2616724, 24.07.2013 en
- (54) FLUID-DIRECTING MULTIPOINT ROTARY VALVE
- (71) Gulf Sea Ventures LLC, 6432 Lake Sunrise Drive, Apollo Beach, FL 33572, US
- (72) AHLGREN, Brad, K., 6432 Lake Sunrise Drive, Apollo Beach FL 33572, US  
PEDERSON, Brian, K., 22076 Timber Lane, Morton IL 61550, US
- 
- (51) MKP  
**F23D 1/00 (2006.01)** (97) **2369230**  
**F23C 7/00 (2006.01)**
- (96) 11153325.3 28.09.2011  
(97) 2369230, 28.09.2011 de
- (54) Burner with tangential spiral intake elbow
- (71) Hitachi Power Europe GmbH, Schifferstrasse 80, 47059 Duisburg, DE
- (72) Leisse, Alfons, Otmarstraße 26, 45131 Essen, DE  
Lasthaus, Dieter, Chemnitzstr. 19, 47906 Kempen, DE  
Niesbach, Jürgen, In den Böcken 20, 44805 Bochum, DE  
Weirich, Tanja, Repelener Str. 97, 47441 Moers, DE
- 
- (51) MKP  
**H02K 9/197 (2006.01)** (97) **2636131 \***  
**H02K 7/18 (2006.01)**  
**F03D 9/00 (2006.01)**
- (86) EP2011069117 31.10.2011  
(96) 11776206.2 11.09.2013  
(87) WO2012059463, 31.10.2011  
(97) 2636131, 11.09.2013 de
- (54) WIND ENERGY INSTALLATION HAVING A SYNCHRONOUS GENERATOR, AND SLOWLY ROTATING SYNCHRONOUS GENERATOR
- (71) Wobben Properties GmbH, Dreekamp 5, 26605 Aurich, DE
- (72) HILDEBRAND, Arno, Driestweg 2, 26409 Wittmund, DE  
BAUMGÄRTEL, Christian, Wallster Weg 39, 26603 Aurich, DE
- 
- (51) MKP  
**C07K 16/24 (2006.01)** (97) **2643352 \***
- (86) EP2011070604 21.11.2011  
(96) 11785424.0 02.10.2013  
(87) WO2012069433, 21.11.2011  
(97) 2643352, 02.10.2013 en
- (54) ANTIGEN BINDING PROTEINS TO ONCOSTATIN M (OSM)
- (71) Glaxo Group Limited, Glaxo Wellcome House Berkeley Avenue Greenford, Middlesex UB6 0NN, GB
- (72) BEMBRIDGE, Gary Peter, GlaxoSmithKline Gunnels Wood Road, Stevenage Hertfordshire SG1 2NY, GB  
CHUNG, Chun-wa, GlaxoSmithKline Gunnels Wood Road, Stevenage Hertfordshire SG1 2NY, GB  
FEENEY, Maria, GlaxoSmithKline Gunnels Wood Road, Stevenage Hertfordshire SG1 2NY, GB  
FORD, Susannah Karen, GlaxoSmithKline Gunnels Wood Road, Stevenage Hertfordshire SG1 2NY, GB  
KIRBY, Ian, GlaxoSmithKline Gunnels Wood Road, Stevenage Hertfordshire SG1 2NY, GB  
MCADAM, Ruth, GlaxoSmithKline Gunnels Wood Road, Stevenage Hertfordshire SG1 2NY, GB

- (51) MKP  
**A47B 73/00 (2006.01)** (97) **2595503 \***  
(86) EP2011062476 20.07.2011  
(96) 11740609.0 29.05.2013  
(87) WO2012010643, 20.07.2011  
(97) 2595503, 29.05.2013 de  
(54) BOTTLE RACK  
(71) Lange, Frank, Gravenbruchstrasse 53, 63303 Dreieich, DE  
(72) Lange, Frank, Gravenbruchstrasse 53, 63303 Dreieich, DE
- 
- (51) MKP  
**A61L 2/025 (2006.01)** (97) **2601982 \***  
**A61L 27/36 (2006.01)**  
**A61F 2/28 (2006.01)**  
**C12N 5/071 (2010.01)**  
(86) KR2011005748 05.08.2011  
(96) 11814841.0 12.06.2013  
(87) WO2012018241, 05.08.2011  
(97) 2601982, 12.06.2013 en  
(54) METHOD FOR PROCESSING BONE GRAFT MATERIAL USING TEETH, AND BONE GRAFT MATERIAL PROCESSED THEREBY  
(71) Um, In Woong, 104-904 Kolon Apt. 4-ga 73 Samseon-dong Seongbuk-gu, Seoul 136-044, KR  
(72) Um, In Woong, 104-904 Kolon Apt. 4-ga 73 Samseon-dong Seongbuk-gu, Seoul 136-044, KR
- 
- (51) MKP  
**A61K 39/395 (2006.01)** (97) **2624865 \***  
**C07K 16/28 (2006.01)**  
(86) US2011054856 05.10.2011  
(96) 11770625.9 14.08.2013  
(87) WO2012047954, 05.10.2011  
(97) 2624865, 14.08.2013 en  
(54) STABILIZED FORMULATIONS CONTAINING ANTI-INTERLEUKIN-4 RECEPTOR (IL-4R) ANTIBODIES  
(71) Regeneron Pharmaceuticals, Inc., 777 Old Saw Mill River Road, Tarrytown, NY 10591, US  
(72) DIX, Daniel, B., 55 Memory Trail, Lagrangeville, NY 12540, US  
TANG, Xiaolin, 5 Eckerson Court, Old Tappan, NJ07675, US
- 
- (51) MKP  
**C12N 15/82 (2006.01)** (97) **2627771 \***  
**C12N 5/10 (2006.01)**  
**A01H 5/00 (2006.01)**  
**A01H 5/10 (2006.01)**  
**C12N 15/54 (2006.01)**  
**C12N 15/62 (2006.01)**  
(86) EP2011004929 30.09.2011  
(96) 11764685.1 21.08.2013  
(87) WO2012048807, 30.09.2011  
(97) 2627771, 21.08.2013 en  
(54) METHODS FOR ALTERING THE REACTIVITY OF PLANT CELL WALLS  
(71) Bayer CropScience NV, J.E. Mommaertsiaan 14, 1831 Diegem, BE  
(72) MEULEWAETER, Frank, Sparrenstraat 51, 9820 Merelbeke, BE  
VANHOLME, Bartel, Waterstraat 288, 9041 Oostakker, BE
- 
- (51) MKP  
**H04M 9/08 (2006.01)** (97) **2627065 \***  
(86) CN2012073641 09.04.2012  
(96) 12830880.6 14.08.2013  
(87) WO2013097372, 09.04.2012  
(97) 2627065, 14.08.2013 en  
(54) MULTI-RECEIVER END ECHO CANCELLATION METHOD AND SYSTEM  
(71) Goertek Inc., No. 268 Dongfang Road, Hi-Tech Industry District Weifang, Shandong 261031, CN  
(72) LOU, Shasha, No. 268 Dongfang Road Hi-Tech Industry Development District Weifang,, Shandong 261031, CN  
LIU, Song, No. 268 Dongfang Road Hi-Tech Industry Development District Weifang,, Shandong 261031, CN
- 
- (51) MKP  
**A61K 31/40 (2006.01)** (97) **2640689 \***  
**C07C 235/36 (2006.01)**  
**C07D 235/00 (2006.01)**  
**A61K 31/437 (2006.01)**  
**C07D 257/04 (2006.01)**  
**A61K 31/192 (2006.01)**  
**C07D 213/55 (2006.01)**  
**C07C 235/40 (2006.01)**  
**A61K 31/341 (2006.01)**  
**C07D 207/16 (2006.01)**  
**A61P 9/08 (2006.01)**  
**A61K 31/4402 (2006.01)**  
**C07D 307/52 (2006.01)**  
**A61K 31/216 (2006.01)**  
(86) EP2011070066 14.11.2011  
(96) 11785381.2 25.09.2013  
(87) WO2012065953, 14.11.2011  
(97) 2640689, 25.09.2013 en  
(54) SUBSTITUTED CARBAMOYL-CYCLOALKYL ACETIC ACID DERIVATIVES AS NEP INHIBITORS  
(71) Novartis AG, Lichtstrasse 35, 4056 Basel, CH  
(72) KARKI, Rajeshri Ganesh, Novartis Institutes for BioMedical Research Inc. 100 Technology Square Cambridge, Massachusetts 02139, US  
KAWANAMI, Toshio, Novartis Institutes for BioMedical Research Inc. 100 Technology Square Cambridge MA 02139, Massachusetts 02139, US  
KSANDER, Gary Michael, 37 The Flume, Amherst New Hampshire 03031, US  
LIU, Qian, Novartis Institutes for BioMedical Research Inc. 100 Technology Square Cambridge, Massachusetts 02139, US  
MOGI, Muneto, Novartis Institutes for BioMedical Research Inc. 100 Technology Square Cambridge, Massachusetts 02139, US  
SCHIERING, Nikolaus, Novartis Pharma AG Postfach, CH-4002 Basel, CH  
SUN, Robert, Novartis Institutes for BioMedical Research Inc. 100 Technology Square Cambridge, Massachusetts 02139, US
- 
- (51) MKP  
**F03D 7/02 (2006.01)** (97) **2556246 \***  
**F03D 11/00 (2006.01)**  
(86) EP2012059769 24.05.2012  
(96) 12723681.8 13.02.2013  
(87) WO2012168089, 24.05.2012  
(97) 2556246, 13.02.2013 de  
(54) METHOD FOR OPERATING A WIND ENERGY PLANT IN ICING CONDITIONS  
(71) Wobben Properties GmbH, Dreekamp 5, 26605 Aurich, DE  
(72) JEPSEN, Torsten, Abraham-Wolffs-Strasse 8, 26603 Aurich, DE
- 
- (51) MKP  
**B65H 75/14 (2006.01)** (97) **2522611**  
**B65H 75/50 (2006.01)**  
**B29C 45/44 (2006.01)**  
(96) 11003813.0 14.11.2012  
(97) 2522611, 14.11.2012 en  
(54) Reels with corrugated flanges and undercuts  
(71) Carris Reels, Inc., 49 Main Street, Proctor VT 05765, US  
(72) McDonough, James, 222 Interstate Parkway, Bradford, PA 16707, US
-



- (51) MKP  
**A43B 3/26 (2006.01)** (97) **2635145 \***  
**A43B 13/18 (2006.01)**  
**A43B 13/16 (2006.01)**  
**B29D 35/00 (2010.01)**  
**B29D 35/12 (2010.01)**  
(86) EP2011002285 09.05.2011  
(96) 11718952.2 11.09.2013  
(87) WO2012059142, 09.05.2011  
(97) 2635145, 11.09.2013 en  
(54) SOLE FOR SHOES HAVING ONE OR MORE VERTICAL ELEMENTS FOLDED OVER EACH OTHER, EXTENSIBLE AND ADAPTABLE TO THE DIFFERENT WIDTH OF THE ASSEMBLY LAST OF THE UPPER AND TO THE VARIATION OF THE CONFORMATION OF THE FOOT, EVEN PERMANENTLY  
(71) AL.PI. S.R.L., Via Enzo Ferrari snc, 62012 Civitanova Marche (MC), IT  
(72) BIANCUCCI, Demetrio, Via Cristoforo Colombo 504, I-62012 Civitanova Marche (MC), IT  
BRASCA, Alfredo, Via Civitanova 79, I-62012 Civitanova Marche (MC), IT
- 
- (51) MKP  
**C07D 519/00 (2006.01)** (97) **2640731 \***  
**A61K 31/519 (2006.01)**  
**A61P 25/24 (2006.01)**  
**A61P 25/18 (2006.01)**  
**A61P 25/00 (2006.01)**  
(86) DK2011000136 18.11.2011  
(96) 11793325.9 25.09.2013  
(87) WO2012065612, 18.11.2011  
(97) 2640731, 25.09.2013 en  
(54) IMIDAZOLE DERIVATIVES AS PDE10A ENZYME INHIBITORS  
(71) H. Lundbeck A/S, Ottiliavej 9, 2500 Valby-Copenhagen, DK  
(72) KEHLER, Jan, Nymøllevvej 28, DK-2800 Lyngby, DK  
NIELSEN, Jacob, Bodilsgade 2 4.th., DK-1732 København V, DK  
MARIGO, Mauro, Jyttevej 23, DK-2740 Skovlunde, DK  
KILBURN, John, Paul, Kærsgårdvej 7, DK-4690 Haslev, DK  
LANGGÅRD, Morten, Rågevej 20, DK-2600 Glostrup, DK
- 
- (51) MKP  
**A61K 9/00 (2006.01)** (97) **2624815 \***  
**A61K 39/145 (2006.01)**  
**A61K 47/36 (2006.01)**  
(86) US2011055689 11.10.2011  
(96) 11779263.0 14.08.2013  
(87) WO2012048333, 11.10.2011  
(97) 2624815, 14.08.2013 en  
(54) ORAL VACCINE FAST-DISSOLVING DOSAGE FORM USING STARCH  
(71) R.P. Scherer Technologies, LLC, CSC Services of Nevada, Inc. 502 East John Street, Carson City, NV 89706, US  
(72) TIAN, Wei, 6 Sawyers Close Minety, Wiltshire SN16 9QS, GB  
MCLAUGHLIN, Rosie, 34 Sprats Barn Crescent Wootton Bassett Swindon, Wiltshire SN4 7JR, GB
- 
- (51) MKP  
**A61K 31/31 (2006.01)** (97) **2598136 \***  
**C07C 211/00 (2006.01)**  
(86) US2011045569 27.07.2011  
(96) 11813128.3 05.06.2013  
(87) WO2012015946, 27.07.2011  
(97) 2598136, 05.06.2013 en  
(54) DISPERSIONS OF RASAGILINE CITRATE  
(71) Teva Pharmaceutical Industries Ltd., 5 Basel Street P.O. Box 3190, 49131 Petah Tiqva, IL  
(72) LORIMER, Keith, 11 The Gate Lodge, Linengreen, Lisburn BT28 3NZ, IE  
ENGERS, David, 818 Pike Street, West Lafayette, IN 47906, US
- 
- (51) MKP  
**A61K 49/04 (2006.01)** (97) **2626085 \***  
(86) JP2011073236 07.10.2011  
(96) 11830778.4 14.08.2013  
(87) WO2012046847, 07.10.2011  
(97) 2626085, 14.08.2013 en  
(54) LIQUID PREPARATION FOR ORAL ADMINISTRATION WHICH CAN BE USED IN CT COLONOGRAPHY, AND COMPOSITION FOR IMAGING DIGESTIVE TRACT  
(71) Ajinomoto Co., Inc., 15-1, Kyobashi 1-chome Chuo-ku, Tokyo 104-8315, JP  
(72) MOTOYAMA Takehiko, c/o Ajinomoto Pharmaceuticals Co. Ltd. 1-1 Irifune 2-chome Chuo-ku, Tokyo 104-0042, JP  
NAGATA Koichi, 3400-10 Asaba, Fukuroi-shi Shizuoka 437-1101, JP  
HONDA Tetsuro, 1549-11 Aokata-go Shinkamigoto-cho, Minamimatsuura-gun Nagasaki 857-4404, JP
- 
- (51) MKP  
**C07K 16/00 (2006.01)** (97) **2601218 \***  
(86) US2011046233 02.08.2011  
(96) 11815172.9 12.06.2013  
(87) WO2012018790, 02.08.2011  
(97) 2601218, 12.06.2013 en  
(54) DUAL VARIABLE DOMAIN IMMUNOGLOBULINS AND USES THEREOF  
(71) AbbVie Inc., 1 North Waukegan Road, North Chicago, IL 60064, US  
(72) GHAYUR, Tariq, 1014 Washington Street, Holliston, MA 01746, US  
LIU, Junjian, 14 Crimson Drive, Shewsbury, MA 01545, US  
ISAKSON, Peter, C., 14 Hillside Avenue, Southborough, MA 01610, US
- 
- (51) MKP  
**E04H 6/42 (2006.01)** (97) **2603651 \***  
**E01F 9/08 (2006.01)**  
(86) EP2011062324 19.07.2011  
(96) 11736060.2 19.06.2013  
(87) WO2012019884, 19.07.2011  
(97) 2603651, 19.06.2013 de  
(54) ARRANGEMENT FOR ORIENTING MULTI-TRACK VEHICLES IN THE DIRECTION OF TRAVEL IN CAR PARKS  
(71) Karisch, Franz, Martin-Hosp-Str. 51, 9100 Völkermarkt, AT  
(72) Karisch, Franz, Martin-Hosp-Str. 51, 9100 Völkermarkt, AT
- 
- (51) MKP  
**F01N 3/20 (2006.01)** (97) **2541010**  
(96) 11171730.2 02.01.2013  
(97) 2541010, 02.01.2013 en  
(54) Pump assembly  
(71) Delphi Technologies Holding S.à.r.l., Avenue de Luxembourg, 4940 Bascharage, LU  
(72) Wright, Keith, 6 Kinross Close Walderslade, Chatham, Kent ME5 7RS, GB
- 
- (51) MKP  
**C08F 6/00 (2006.01)** (97) **2635609 \***  
**B01J 8/00 (2006.01)**  
**C08F 10/00 (2006.01)**  
(86) US2010055287 03.11.2010  
(96) 10776894.7 11.09.2013  
(87) WO2012060828, 03.11.2010  
(97) 2635609, 11.09.2013 en  
(54) POSTTREATMENT AND SYSTEM FOR POSTTREATMENT OF PELLETIZED POLYOLEFIN RESINS  
(71) Rahim, Waseem, 2600 South Shore Boulevard Suite 500, League City, TX 77573, US  
Sander, Robert, 2600 South Shore Boulevard Suite 500, League City, TX 77573, US  
Yanosik, John, 2600 South Shore Boulevard Suite 500, League City, TX 77573, US  
(72) Rahim, Waseem, 2600 South Shore Boulevard Suite 500, League City, TX 77573, US  
Sander, Robert, 2600 South Shore Boulevard Suite 500, League City, TX 77573, US  
Yanosik, John, 2600 South Shore Boulevard Suite 500, League City, TX 77573, US
-

- (51) MKP  
**A01H 1/04 (2006.01)** (97) **2621261 \***  
**C12N 15/82 (2006.01)**
- (86) EP2011004858 26.09.2011  
(96) 11767378.0 07.08.2013  
(87) WO2012041496, 26.09.2011  
(97) 2621261, 07.08.2013 en  
(54) A GENE EXPRESSION SIGNATURE FOR THE SELECTION OF HIGH ENERGY USE EFFICIENT PLANTS  
(71) Bayer CropScience NV, J.E. Mommaertsiaan 14, 1831 Diegem, BE  
Universiteit Gent, Sint-Pietersnieuwstraat 25, 9000 Gent, BE  
VIB VZM, Rijvisschestraat 120, 9052 Gent, BE  
(72) DE BLOCK, Marc, Abrikozenstraat 26, B-9820 Merelbeke, BE  
HANNAH, Matthew, Hoogpoort 3B Bus 301, BE-9000 Gent, BE  
VAN DER KELEN, Katrien, Zebrastraat 8, B-9000 Gent, BE  
VAN BREUSEGEM, Frank, Zebrastraat 8, B-9000 Gent, BE
- 
- (51) MKP  
**C07D 495/04 (2006.01)** (97) **2640729 \***  
**A61K 31/4365 (2006.01)**  
**A61P 31/18 (2006.01)**
- (86) IB2011054852 01.11.2011  
(96) 11785122.0 25.09.2013  
(87) WO2012066442, 01.11.2011  
(97) 2640729, 25.09.2013 en  
(54) INHIBITORS OF HIV REPLICATION  
(71) VIIV Healthcare UK Limited, 980 Great West Road, Brentford, Middlesex TW8 9GS, GB  
(72) BELL, Andrew Simon, Petal Cottage The Avenue Kingsdown Deal, Kent CT14 8DU, GB  
GARDNER, Iain Brian, Apt. 23 240 Abbeydale Road South, Sheffield S17 3LJ, GB  
PRYDE, David Cameron, Neusentis Portway Building Granta Park, Cambridge CB21 6GS, GB  
WAKENHUT, Florian Michel, 322 rue de Bretigny 21- le vert village, F-01210 Ornex, FR  
GIBSON, Karl Richard, Pfizer Global Research&Development Ramsgate Road Sandwich, Kent CT13 9NJ, GB
- 
- (51) MKP  
**B32B 15/06 (2006.01)** (97) **2625034 \***  
**B32B 15/08 (2006.01)**  
**B32B 15/10 (2006.01)**  
**B66F 9/12 (2006.01)**
- (86) IT2011000222 30.06.2011  
(96) 11754528.5 14.08.2013  
(87) WO2012046259, 30.06.2011  
(97) 2625034, 14.08.2013 en  
(54) AN ANTI-SCRATCH AND ANTI-SLIP DEVICE FOR LIFTING LOADS, PREFERABLY THROUGH THE USE OF A LIFT FORK  
(71) Giannetti, Mirco, Via Grotta n. 11/C, 47843 Misano Adriatico (RN), IT  
(72) Giannetti, Mirco, Via Grotta n. 11/C, 47843 Misano Adriatico (RN), IT
- 
- (51) MKP  
**A61L 27/04 (2006.01)** (97) **2637603 \***  
**A61F 2/06 (2013.01)**
- (86) US2011060053 09.11.2011  
(96) 11839684.5 18.09.2013  
(87) WO2012064888, 09.11.2011  
(97) 2637603, 18.09.2013 en  
(54) SPECIALLY DESIGNED MAGNESIUM-ALUMINUM ALLOYS AND MEDICAL USES THEREOF IN A HEMODYNAMIC ENVIRONMENT  
(71) Transluminal Technologies, LLC, 930 Erie Boulevard East, Syracuse, NY 13224, US  
(72) GREEN, Stephen, 1 Drumlins Terrace, Syracuse NY 13224, US  
BUCHHEIT, Rudolph, 244 Canterbury Road, Columbus OH 43221, US
- 
- (51) MKP  
**G01N 33/543 (2006.01)** (97) **2618151**  
**G01N 33/558 (2006.01)**
- (86) 13151783.1 24.07.2013  
(97) 2618151, 24.07.2013 en  
(54) Low volume assay device having increased sensitivity  
(71) ORTHO-CLINICAL DIAGNOSTICS, INC., 1001 U.S. Route 202, Raritan, NJ 08869, US  
(72) Hosimer, Philip C., 11 Beach Terrace, Rochester, New York, NY 14617, US  
Ding, Zhong, 35 Delancey Court, Pittsford, New York, NY 14534, US  
Heavner, David A., 119 East Pointe, Fairport, New York, NY 14450, US  
Scalice, Edward R., 30 Cobblestone Crossing, Penfield, New York, NY 14526, US  
Danielson, Susan, 47 Partridge Hill, Honeoye Falls, New York, NY 14472, US  
Kanaley, James D., 23 East Street, Honeoye Falls, New York, NY 14472, US  
Tomasso, David A., 174 Old Well Road, Rochester, New York, NY 14626, US  
Warren, Timothy C., 59 Sannita Drive, Rochester, New York, NY 14626, US
- 
- (51) MKP  
**A23L 1/318 (2006.01)** (97) **2624707 \***  
**A23L 1/00 (2006.01)**
- (86) US2011001569 12.09.2011  
(96) 11831018.4 14.08.2013  
(87) WO2012047252, 12.09.2011  
(97) 2624707, 14.08.2013 en  
(54) PROCESS FOR REDUCING OIL AND FAT CONTENT IN COOKED FOOD WITH PEA PROTEIN  
(71) Proteus Industries, Inc., 15 Great Republic Drive, Gloucester MA 01930, US  
(72) KELLEHER, Stephen, D., 86 Little Neck Road, Ipswich MA 01938, US  
FIELDING, William, R., 68 Crosswinds Drive, Hilton Head SC 29926, US  
SAUNDERS, Wayne, S., 133 Thatcher Road, Gloucester MA 01930, US  
WILLIAMSON, Peter, G., 122 R Thatcher Road, Gloucester MA 01930, US
- 
- (51) MKP  
**A61K 9/14 (2006.01)** (97) **2613769 \***  
**A61K 9/20 (2006.01)**  
**A61K 31/437 (2006.01)**  
**A61K 47/02 (2006.01)**  
**A61K 47/22 (2006.01)**  
**A61K 47/26 (2006.01)**  
**A61K 47/32 (2006.01)**
- (86) US2011054959 05.10.2011  
(96) 11770975.8 17.07.2013  
(87) WO2012121758, 05.10.2011  
(97) 2613769, 17.07.2013 en  
(54) MELT-EXTRUDED SOLID DISPERSIONS CONTAINING AN APOPTOSIS-INDUCING AGENT  
(71) Abbvie Inc., 1 North Waukegan Road, North Chicago, IL 60064, US  
Abbott GmbH & Co. KG, Max-Planck-Ring 2, 65205 Wiesbaden-Delkenheim, DE  
(72) RÖSCH, Esther, Hardstrabe 15 Eingang Lameystrabe, 76185 Karlsruhe, DE  
HOELIG, Peter, Hopfengarten 11, 63607 Waechtersbach, DE  
LINDLEY, David J., 676 Needlegress Parkway, Antioch, Illinois 60002, US  
SANZGIRI, Yeshwant D., 1323 Deer Run Road, Gurnee, Illinois 60031, US  
TONG, Ping, 1520 Eric Lane, Libertyville, Illinois 60048, US
-

- (51) MKP  
**E21B 4/14 (2006.01)** (97) **2593628 \***  
(86) GB2011051318 14.07.2011  
(96) 11743581.8 22.05.2013  
(87) WO2012007756, 14.07.2011  
(97) 2593628, 22.05.2013 en  
(54) TWO-PORT PERCUSSION MOLE  
(71) Geo-Mole Limited, Nether Court Abbey Farm Faversham, Kent ME13 7BL, GB  
(72) BRICE, Mark, Nether Court Abbey Farm Faversham, Kent ME13 7BL, GB
- 
- (51) MKP  
**A61K 31/522 (2006.01)** (97) **2595630 \***  
**A61P 9/12 (2006.01)**  
**A61P 11/00 (2006.01)**  
**A61K 31/00 (2006.01)**  
(86) US2011042379 29.06.2011  
(96) 11730524.3 29.05.2013  
(87) WO2012003220, 29.06.2011  
(97) 2595630, 29.05.2013 en  
(54) USE OF A2B ADENOSINE RECEPTOR ANTAGONISTS FOR TREATING PULMONARY HYPERTENSION  
(71) Gilead Sciences, Inc., 333 Lakeside Drive, Foster City, CA 94404, US  
(72) BELARDINELLI, Luiz, 205 Manzanita Ave., Palo Alto California 94304, US  
ZENG, Dewan, 871 Sycamore Drive, Palo Alto California 94303, US  
ZHONG, Hongyan, 156 Montelena Court, Mountain View California 94040, US
- 
- (51) MKP  
**B65D 75/54 (2006.01)** (97) **2502848**  
**B65B 61/20 (2006.01)**  
**B65D 25/20 (2006.01)**  
(96) 12159495.6 26.09.2012  
(97) 2502848, 26.09.2012 de  
(54) Container, in particular bag or bucket and device for producing this container  
(71) Knauf Gips KG, Am Bahnhof 7, 97346 Iphofen, DE  
(72) Schäfer, Matthias, Simmingerstrasse 4, 97244 Bütthard, DE  
Pabstmann, Marco, Neue Flurstrasse 52, 97320 Albertshofen, DE  
Gräf, Thorsten, Hüttenheim 8, 97348 Willanzheim, DE
- 
- (51) MKP  
**A01N 43/72 (2006.01)** (97) **2627180 \***  
(86) US2011055662 11.10.2011  
(96) 11833218.8 21.08.2013  
(87) WO2012051128, 11.10.2011  
(97) 2627180, 21.08.2013 en  
(54) GROWTH INHIBITION OF PERENNIAL FORAGE GRASSES WITH PYROXSULAM  
(71) Dow AgroSciences LLC, 9330 Zionsville Road, Indianapolis, IN 46268, US  
(72) HARE, Donald Douglas, 32 Cactus Way, Sherwood Park, AB T8H 1T2, CA
- 
- (51) MKP  
**A61K 9/19 (2006.01)** (97) **2603204 \***  
**A61K 38/10 (2006.01)**  
**A61K 47/26 (2006.01)**  
**A61K 9/00 (2006.01)**  
(86) GB2011001191 09.08.2011  
(96) 11749878.2 19.06.2013  
(87) WO2012020219, 09.08.2011  
(97) 2603204, 19.06.2013 en  
(54) FORMULATIONS FOR INFUSION OF TYPE B LANTIBIOTICS  
(71) Novacta Biosystems Limited, BioPark Hertfordshire Broadwater Road, Welwyn Garden City, Hertfordshire AL7 3AX, GB  
(72) APPLEBYARD, Antony Nicholas, Novacta Biosystems Limited BioPark Hertfordshire Broadwater Road, Welwyn Garden City Hertfordshire AL7 3AX, GB  
WADMAN, Sjoerd Nicolaas, Novacta Biosystems Limited BioPark Hertfordshire Broadwater Road, Welwyn Garden City Hertfordshire AL7 3AX, GB
- 
- (51) MKP  
**C07K 1/16 (2006.01)** (97) **2415779**  
**C07K 1/18 (2006.01)**  
**C07K 1/22 (2006.01)**  
**C07K 14/46 (2006.01)**  
**C07K 14/47 (2006.01)**  
(96) 10171626.4 08.02.2012  
(97) 2415779, 08.02.2012 en  
(54) Method of producing and purifying an active soluble sialyltransferase  
(71) BioGeneriX AG, High-Tech-Park Mannheim Janderstrasse 3, 68199 Mannheim, DE  
(72) Angermann, Axel, Dr., An der Tränk 23, 63266 Dreieich, DE  
Scheckermann, Christian, Dr., Sägegasse 1c, 79238 Ehrenkirchen, DE  
Schmidt, Karsten, Kösliner Str. 60, 76139 Karlsruhe, DE
- 
- (51) MKP  
**C07D 403/12 (2006.01)** (97) **2518067**  
**C07D 403/14 (2006.01)**  
**C07D 405/14 (2006.01)**  
**C07D 409/14 (2006.01)**  
**C07D 413/14 (2006.01)**  
**C07D 471/04 (2006.01)**  
**C07D 471/08 (2006.01)**  
**C07D 487/04 (2006.01)**  
**C07D 487/08 (2006.01)**  
**A61K 31/455 (2006.01)**  
**A61K 31/439 (2006.01)**  
**A61K 31/497 (2006.01)**  
**A61K 31/501 (2006.01)**  
**A61K 31/506 (2006.01)**  
**A61P 9/00 (2006.01)**  
**C07D 401/14 (2006.01)**  
(96) 11306144.4 31.10.2012  
(97) 2518067, 31.10.2012 fr  
(54) Derivatives of N-[(1H-pyrazol-1-yl)aryl]-1H-indole or 1H-indazole-3-carboxamide and their therapeutic uses as P2Y12 antagonists  
(71) SANOFI, 54 rue La Boétie, 75008 Paris, FR  
(72) Badorc, Alain, c/o Sanofi Patent Department 174 avenue de France, 75013 Paris, FR  
Boldron, Christophe, c/o Sanofi Patent Department 174 avenue de France, 75013 Paris, FR  
Delesque, Nathalie, c/o Sanofi Patent Department 174 avenue de France, 75013 Paris, FR  
Fossey, Valérie, c/o Sanofi Patent Department 174 avenue de France, 75013 Paris, FR  
Lassalle, Gilbert, c/o Sanofi Patent Department 174 avenue de France, 75013 Paris, FR  
Yvon, Xavier, c/o Sanofi Patent Department 174 avenue de France, 75013 Paris, FR
- 
- (51) MKP  
**A61K 31/428 (2006.01)** (97) **2621490 \***  
(86) US2011053979 29.09.2011  
(96) 11833111.5 07.08.2013  
(87) WO2012050971, 29.09.2011  
(97) 2621490, 07.08.2013 en  
(54) PROPARGYL-TRIFLUOROMETHOXY-AMINO BENZOTHAZOLE DERIVATIVES, THEIR PREPARATION AND USE  
(71) Teva Pharmaceutical Industries Ltd., 5 Basel Street P.O. Box 3190, 49131 Petah Tiqva, IL  
(72) FALB, Eliezer, 58 Hahagana St., Givatayim, IL  
STERLING, Jeffrey, 28 Hatzabar St., Tel Mond, IL  
HERZIG, Yaacov, 7 Hashirion St., 43266 Raanana, IL  
NUDELMAN, Raphael, 15 Miller St., 76284 Rehovot, IL  
ULANENKO, Konstantin, 11/16 Leon Reich St., 42446 Netanya, IL
-

- (51) MKP  
**C07K 14/47 (2006.01)** (97) **2640739 \***  
(86) EP2011070404 17.11.2011  
(96) 11785011.5 25.09.2013  
(87) WO2012066103, 17.11.2011  
(97) 2640739, 25.09.2013 en  
(54) INHIBITORS OF APOPTOSIS AND USES THEREOF  
(71) Centre National de la Recherche Scientifique CNRS, 3 rue Michel Ange, 75794 Paris Cedex 16, FR  
Université de Montpellier 2, Sciences et Techniques Place Eugène Bataillon, 34090 Montpellier, FR  
Universite de Montpellier 1, 5, boulevard Henri IV CS 19044, 34967 Montpellier Cedex 2, FR  
(72) BARRERE, Stéphanie, 13 rue des Enclos, F-34680 Saint Georges D'Orques, FR  
NARGEOT, Joël, 9 rue de Nazareth Bat. G1, F-34090 Montpellier, FR  
LEBLEU, Bernard, 140 rue Pioch de Boutonnet Bat. A1, F-34090 Montpellier, FR  
BOISGUERIN, Prisca, 8 rue la Preneuse, F-30240 Le Graud-du-Roi, FR  
PIOT, Christophe, 172 avenue de Peyre Grosse, F-34980 Saint Clément de Rivière, FR
- 
- (51) MKP  
**H01L 31/052 (2006.01)** (97) **2609629 \***  
**H01L 31/042 (2006.01)**  
**H01L 31/05 (2006.01)**  
**H01L 31/068 (2012.01)**  
**H01L 25/04 (2006.01)**  
**H01L 27/142 (2006.01)**  
**H01L 31/0216 (2006.01)**  
**H01L 31/0224 (2006.01)**  
(86) NO2011000227 19.08.2011  
(96) 11820229.0 03.07.2013  
(87) WO2012026822, 19.08.2011  
(97) 2609629, 03.07.2013 en  
(54) PHOTOVOLTAIC MODULE AND METHOD FOR IMPROVED REVERSE BIAS, REVERSE CURRENT AND HOTSPOT PROTECTION  
(71) Innotech Solar ASA, null, 8512 Narvik, NO  
(72) LOMMASSON, Timothy Charles, Svanedamsveien 37, N-4621 Kristiansand, NO  
HOFMÜLLER, Eckehard, Humboldtstr. 26, 06114 Halle, DE
- 
- (51) MKP  
**C07D 213/30 (2006.01)** (97) **2616441 \***  
**C07D 403/12 (2006.01)**  
**C07D 213/46 (2006.01)**  
**C07D 403/14 (2006.01)**  
**C07D 213/74 (2006.01)**  
**A61K 31/4418 (2006.01)**  
**C07D 213/79 (2006.01)**  
**A61K 31/4439 (2006.01)**  
**C07D 213/81 (2006.01)**  
**A61K 31/444 (2006.01)**  
**C07D 213/84 (2006.01)**  
**A61P 23/00 (2006.01)**  
**C07D 401/04 (2006.01)**  
**C07D 401/12 (2006.01)**  
(86) IB2011002172 16.09.2011  
(96) 11776851.5 24.07.2013  
(87) WO2012035421, 16.09.2011  
(97) 2616441, 24.07.2013 en  
(54) PYRIDINE COMPOUNDS AND THE USES THEREOF  
(71) Purdue Pharma LP, One Stamford Forum 201 Tresser Boulevard, Stamford, CT 06901-3431, US  
(72) NI, Chiyou, 5 Ford Court, Belle Mead NJ 08502, US  
SHAO, Bin, 23 Shelbourne Road, Richboro PA 18954, US  
TAFESSE, Laykea, 11 Abbingtton Lane, Robbinsville NJ 08691, US  
YAO, Jiangchao, 10 Bellflower Court, Princeton NJ 08540, US  
YU, Jianming, 100 Marion Drive, Plainsboro NJ 08536, US  
ZHOU, Xiaoming, 22 Dogwood Drive, Plainsboro NJ 08523, US
- 
- (51) MKP  
**C08F 10/00 (2006.01)** (97) **2625208 \***  
**C08F 2/44 (2006.01)**  
**C08K 3/00 (2006.01)**  
**C08K 5/00 (2006.01)**  
(86) CZ2010000134 27.12.2010  
(96) 10816363.5 14.08.2013  
(87) WO2012045288, 27.12.2010  
(97) 2625208, 14.08.2013 en  
(54) : METHOD OF PREPARATION OF NUCLEATED SEMI-CRYSTALLINE POLYMER  
(71) Polymer Institute Brno, Spol. S R.O., Tkalcovská 2, 656 49 Brno, CZ  
(72) SKOUMAL, Miroslav, Opálkova 12, 635 00 Brno, CZ  
POSPISIL, Ladislav, Obilni trh 6, 602 00 Brno, CZ  
ZBORILOVÁ, Petra, Trída kapitana Jarose 23, 602 00 Brno, CZ
- 
- (51) MKP  
**B65D 17/00 (2006.01)** (97) **2607470**  
**C12G 1/00 (2006.01)**  
**B67C 3/02 (2006.01)**  
(96) 12161341.8 26.06.2013  
(97) 2607470, 26.06.2013 en  
(54) Packaging wine in aluminium containers  
(71) Barokes PTY Ltd., Suite 602, 101 Cecil Street, South Melbourne, Victoria 3205, AU  
(72) Stokes, Gregory John Charles, 7 Belford Court, Keilor, Victoria 3036, AU  
Barics, Steven John Anthony, 51 Waratah Avenue, Tullamarine, Victoria 3043, AU
- 
- (51) MKP  
**A61K 31/216 (2006.01)** (97) **2628724 \***  
**A61K 31/421 (2006.01)**  
**A61K 31/17 (2006.01)**  
**A61K 31/4196 (2006.01)**  
**A61K 31/4409 (2006.01)**  
**A61K 31/341 (2006.01)**  
**A61K 31/426 (2006.01)**  
**A61K 31/197 (2006.01)**  
**A61K 31/42 (2006.01)**  
**A01N 47/34 (2006.01)**  
**A61K 31/41 (2006.01)**  
**A61K 31/4402 (2006.01)**  
**A01P 7/02 (2006.01)**  
**A61K 31/415 (2006.01)**  
**A61K 31/4406 (2006.01)**  
**C07C 275/64 (2006.01)**  
**A61K 31/381 (2006.01)**  
**A61K 31/44 (2006.01)**  
**A61K 31/277 (2006.01)**  
**A61K 31/4245 (2006.01)**  
(86) JP2011073082 06.10.2011  
(96) 11832476.3 21.08.2013  
(87) WO2012050041, 06.10.2011  
(97) 2628724, 21.08.2013 en  
(54) ARYLOXYUREA COMPOUND AND PEST CONTROL AGENT  
(71) Nippon Soda Co., Ltd., 2-1, Ohtemachi 2-chome Chiyoda-ku, Tokyo 100-8165, JP  
(72) FURUKAWA Hironori, c/o Odawara Research Center Nippon Soda Co. Ltd. 345 Takada, Odawara-shi Kanagawa 250-0280, JP  
NAKAMURA Takehiko, c/o Odawara Research Center Nippon Soda Co. Ltd. 345 Takada, Odawara-shi Kanagawa 250-0280, JP  
TAMAI Tetsuo, c/o Odawara Research Center Nippon Soda Co. Ltd. 345 Takada, Odawara-shi Kanagawa 250-0280, JP  
HANAI Daisuke, c/o Odawara Research Center Nippon Soda Co. Ltd. 345 Takada, Odawara-shi Kanagawa 250-0280, JP
-

- (51) MKP  
**A61K 47/48 (2006.01)** (97) **2616103 \***  
 (86) US2011051775 15.09.2011  
 (96) 11760950.3 24.07.2013  
 (87) WO2012037358, 15.09.2011  
 (97) 2616103, 24.07.2013 en  
 (54) ASYMMETRIC BIFUNCTIONAL SILYL MONOMERS AND PARTICLES THEREOF AS PRODRUGS AND DELIVERY VEHICLES FOR PHARMACEUTICAL, CHEMICAL AND BIOLOGICAL AGENTS  
 (71) The University of North Carolina At Chapel Hill, 308 Bynum Hall Campus Box 4105, Chapel Hill, NC 27599-4105, US  
 (72) DESIMONE, Joseph, M., 304 Nottingham Drive, Chapel Hill, NC 27517, US  
 FINNISS, Mathew, P.O. Box 4563 191 Marshall Hill Road, Sussex, NB E4E 5L7, CA  
 NAPIER, Mary, 104 Breckenridge Place, Chapel Hill NC 27514, US  
 PANDYA, Ashish, 104 Drakeshire Court, Morrisville, NC 27560, US  
 PARROTT, Matthew, 222 Old Fayetteville Road Apartment F301, Carrboro, NC 27510, US

- (51) MKP  
**A61K 9/00 (2006.01)** (97) **2596783**  
**A61K 9/08 (2006.01)**  
 (86) 12186239.5 29.05.2013  
 (97) 2596783, 29.05.2013 en  
 (54) Pharmaceutical composition for the preparation of infusion solutions of antimicrobial preparations, its production process  
 (71) Limonov, Viktor Lvovich, ul. Raschupkina, 10-62, Moscow 121374, RU  
 (72) Limonov, Viktor Lvovich, ul. Rashchupkina, 10, kv. 62, Moscow 121374, RU  
 Gaidul, Konstantin Valentinovich, ul. Bogatkova, 260, kv. 71, Novosibirsk, RU  
 Dushkin, Aleksandr Valerevich, ul. Arbutova, 5, kv. 144, Novosibirsk, RU

- (51) MKP  
**A61F 2/00 (2006.01)** (97) **2611876 \***  
**A61B 17/08 (2006.01)**  
**A61L 31/04 (2006.01)**  
**A61L 31/06 (2006.01)**  
**B29C 33/52 (2006.01)**  
**C09J 7/00 (2006.01)**  
 (86) US2011048584 22.08.2011  
 (96) 11773331.1 10.07.2013  
 (87) WO2012030570, 22.08.2011  
 (97) 2611876, 10.07.2013 en  
 (54) ADHESIVE STRUCTURE WITH STIFF PROTRUSIONS ON ADHESIVE SURFACE  
 (71) ETHICON ENDO-SURGERY, INC., 4545 Creek Road, Cincinnati, Ohio 45242, US  
 Agency for Science, Technology and Research, 1 Fusionopolis Way 20-10 Connexis, Singapore 138632, SG  
 (72) NATARAJAN, Sriram, 3216 Winder Drive, Bridgewater NJ 08807, US  
 COOPER, Kevin, 2 Newell Road, Flemington NJ 08822, US  
 ELMOUELHI, Noha, 53 Quail Run, Randolph NJ 07869, US  
 VYAKARNAM, Murty, N., 2805 Johnson Circle, Bridgewater NJ 08807, US  
 YEE, Low, Hong, 242J Pasir Panjang Road 02-14, Pasir Panjang 117490, SG  
 RODRIGUEZ, Isabel, 111 Loyang Rise, Loyang 507490, SG  
 TIONG, Lim, Chee, 297 Ocean Drive 04-21, Sentosa Cove 098535, SG  
 YEE, Audrey, Ho Yoke, Block 656 19-27, Choa Chu Kang Cresant, Choa Chu Kang 680656, SG

- (51) MKP  
**A61K 47/48 (2006.01)** (97) **2537532**  
**A61K 49/00 (2006.01)**  
**A61K 49/18 (2006.01)**  
**A61P 35/00 (2006.01)**  
**A61P 29/00 (2006.01)**  
**A61K 9/127 (2006.01)**  
**C07D 405/12 (2006.01)**  
**C07K 7/02 (2006.01)**  
 (96) 11005110.9 26.12.2012  
 (97) 2537532, 26.12.2012 en  
 (54) Cathepsin-binding compounds bound to a nanodevice and their diagnostic and therapeutic use  
 (71) J. Stefan Institute, Jamova 39, 1000 Ljubljana, SI  
 Schaschke, Norbert, Hugelstrasse 1, 33613 Bielefeld, DE  
 (72) Vasiljeva, Olga, Preloska cesta 16 Prelog, 1230 Domzale, SI  
 Mikhaylov, Georgy, ul Aleksandra Nevskogo 11a, 050040 Almaty, KZ  
 Turk, Boris, Gradisce IV 069, 1291 Skofljica, SI  
 Schaschke, Norbert, Hugelstrasse 1, 33613 Bielefeld, DE

- (51) MKP  
**A61K 9/16 (2006.01)** (97) **2618819 \***  
**A61K 9/20 (2006.01)**  
**A61K 31/44 (2006.01)**  
 (86) IB2011054133 21.09.2011  
 (96) 11776879.6 31.07.2013  
 (87) WO2012038898, 21.09.2011  
 (97) 2618819, 31.07.2013 en  
 (54) PHARMACEUTICAL FORMULATIONS CONTAINING RIFAXIMIN, PROCESSES FOR THEIR OBTAINMENT AND METHOD OF TREATING INTESTINAL DISEASE  
 (71) ALFA WASSERMANN S.p.A., Via Enrico Fermi, 1, 65020 Alanno (PE), IT  
 (72) GIUSEPPE CLAUDIO, Viscomi, 5 Via Ragazzi Del '99, I-40133 Bologna, IT  
 PAOLA, Maffei, 5 Via Ragazzi Del '99, I-40133 Bologna, IT  
 GIUSEPPE, Bottoni, 5 Via Ragazzi Del '99, I-40133 Bologna, IT  
 MARIA, Grimaldi, 5 Via Ragazzi Del '99, I-40133 Bologna, IT

- (51) MKP  
**A61K 9/48 (2006.01)** (97) **2600849 \***  
 (86) US2010044419 04.08.2010  
 (96) 10855698.6 12.06.2013  
 (87) WO2012018329, 04.08.2010  
 (97) 2600849, 12.06.2013 en  
 (54) FILM-FORMING COMPOSITION FOR SOFT CAPSULES  
 (71) R.P. Scherer Technologies, LLC, CSC Services of Nevada, Inc. 502 East John Street, Carson City, NV 89706, US  
 (72) FUJII, Takuma, Soreado-203 19-10 Kamenokou 1-chome, Kakegawa City Shizuoka Prefecture 436-0028, JP  
 NAGURA, Masanori, 1095 Takao, Fukuroi City Shizuoka Prefecture 437-0023, JP  
 AMEMIYA, Tohru, 1030-1 Agehari, Kakegawa City Shizuoka Prefecture 436-0022, JP

- (51) MKP  
**A61K 31/506 (2006.01)** (97) **2635284 \***  
**A61K 31/16 (2006.01)**  
 (86) US2011058610 31.10.2011  
 (96) 11838624.2 11.09.2013  
 (87) WO2012061299, 31.10.2011  
 (97) 2635284, 11.09.2013 en  
 (54) HETEROCYCLIC COMPOUNDS AND USES THEREOF  
 (71) Celgene Avilomics Research, Inc., 45 Wiggins Avenue, Bedford, MA 01730, US  
 (72) LEE, Kwangho, 22 Middlesex Circle 7, Waltham MA 02452, US  
 NIU, Deqiang, 30 Grapevine Avenue, Lexington MA 02421, US  
 PETTER, Russell, C., 22 Robinwood Lane, Stow MA 01775, US  
 BAEVSKY, Matthew, Frank, 65 West Street, Northborough MA 01532, US  
 SINGH, Juswinder, 94 Heritage Avenue, Ashland MA 01721, US

- (51) MKP  
**H04W 72/12 (2009.01)** (97) **2606701 \***  
 (86) US2011048193 18.08.2011  
 (96) 11752392.8 26.06.2013  
 (87) WO2012024466, 18.08.2011  
 (97) 2606701, 26.06.2013 en  
 (54) ARBITRATION BETWEEN MULTIPLE WIRELESS PROTOCOLS IN A WIRELESS DEVICE  
 (71) Qualcomm Incorporated, International IP Administration 5775 Morehouse Drive, San Diego, CA 92121-1714, US  
 (72) GAO, Qinghai, 1700 Technology Drive, San Jose California 95110, US  
 SANKARAN, Sundar, G., 1700 Technology Drive, San Jose California 95110, US  
 YUCEK, Tevfik, 1700 Technology Drive, San Jose California 95110, US  
 GULASEKARAN, Susinder, R., 1700 Technology Drive, San Jose California 95110, US

- (51) MKP  
**C07K 16/28 (2006.01)** (97) **2614081 \***  
 (86) US2011050131 01.09.2011  
 (96) 11754805.7 17.07.2013  
 (87) WO2012033696, 01.09.2011  
 (97) 2614081, 17.07.2013 en  
 (54) ANTI-VEGFR-3 ANTIBODY COMPOSITIONS  
 (71) ImClone LLC, 440 Route 22 East, Bridgewater, NJ 08807, US  
 (72) PYTOWSKI, Bronislaw, c/o ELI LILLY AND COMPANY P.O. Box 6288, Indianapolis Indiana 46206-6288, US  
 PERSAUD, Krishnadatt, c/o ELI LILLY AND COMPANY P.O. Box 6288, Indianapolis Indiana 46206-6288, US  
 ZAYEK, Nathalie, c/o ELI LILLY AND COMPANY P.O. Box 6288, Indianapolis Indiana 46206-6288, US

- (51) MKP  
**B65D 17/32 (2006.01)** (97) **2611705 \***  
 (86) EP2011065143 01.09.2011  
 (96) 11764694.3 10.07.2013  
 (87) WO2012028694, 01.09.2011  
 (97) 2611705, 10.07.2013 en  
 (54) RECLOSING CAN FOR FOOD PRODUCT  
 (71) E.V.D.S. BVBA, Oude Brusselseweg 83, 9050 Gentbrugge, BE  
 (72) VANDERSTRAETEN, Erwin, Oude Brusselseweg 83, B-9050 Gentbrugge, BE

- (51) MKP  
**A01N 43/90 (2006.01)** (97) **2597956 \***  
**A01N 47/36 (2006.01)**  
**A01N 25/00 (2006.01)**  
**A01P 13/00 (2006.01)**  
 (86) US2011045439 27.07.2011  
 (96) 11746356.2 05.06.2013  
 (87) WO2012015854, 27.07.2011  
 (97) 2597956, 05.06.2013 en  
 (54) SYNERGISTIC HERBICIDAL COMPOSITIONS CONTAINING PYROXSULAM AND SULFOSULFURON  
 (71) Dow AgroSciences LLC, 9330 Zionsville Road, Indianapolis, IN 46268, US  
 (72) YADAV, Mayank, 489 Kapashera Gurgaon Road, New Delhi 110037, IN  
 RAMACHANDRAN, Suresh, Building 41A 21 Brindavan Society, Thane 400601, IN  
 GAST, Roger, 1725 Continental Drive, Zionsville, IN 46077, US

- (51) MKP  
**E04B 1/76 (2006.01)** (97) **2543791**  
**E04F 13/08 (2006.01)**  
 (96) 12175042.6 09.01.2013  
 (97) 2543791, 09.01.2013 en  
 (54) Method for making façades of buildings  
 (71) Tecnodima S.r.l., Via G.B. Zappella 15, 24050 Cividate Al Piano (Bergamo), IT  
 (72) Di Scola, Orlando, c/o TECNODIMA S.R.L. Via G.B. Zappella 15, 24050 Cividate Al Piano (Bergamo), IT

- (51) MKP  
**G01N 33/52 (2006.01)** (97) **2628013 \***  
**G01N 33/68 (2006.01)**  
**G01N 33/53 (2006.01)**  
 (86) US2011056338 14.10.2011  
 (96) 11833480.4 21.08.2013  
 (87) WO2012051519, 14.10.2011  
 (97) 2628013, 21.08.2013 en  
 (54) BIOMARKERS OF BRAIN INJURY  
 (71) The Johns Hopkins University, 3400 North Charles Street, Baltimore, MD 21218, US  
 (72) EVERETT, Allan Dale, 3563 Cattail Creek Drive, Glenwood Maryland 21738, US  
 CASELLA, James Francis, 5109 Falls Road Terrace, Baltimore Maryland 21210, US  
 VAN EYK, Jennifer, 6604 Loch Raven Blvd., Baltimore Maryland 21239, US

- (51) MKP  
**C07D 487/22 (2006.01)** (97) **2635585 \***  
**A61K 39/00 (2006.01)**  
**A61K 47/48 (2006.01)**  
 (86) EP2011069425 04.11.2011  
 (96) 11788783.6 11.09.2013  
 (87) WO2012059584, 04.11.2011  
 (97) 2635585, 11.09.2013 en  
 (54) HIGH-EFFICIENCY CATALYSTS, PREPARATION AND USE THEREOF  
 (71) Inkidia S.R.L., Via Camaldolilli 59, 80128 Napoli, IT  
 (72) PAVONE, Vincenzo, Via Crispi, 31, 80121 Napoli, IT  
 NASTRI, Flavia, Via Camillo De Nardis, 7, 80127 Napoli, IT  
 MAGLIO, Ornella, Via Emanuele Gianturco, 36, 80055 Portici, IT  
 LOMBARDI, Angelina, Via Camaldolilli, 59/E, 80128 Napoli, IT

- (51) MKP  
**A61K 39/00 (2006.01)** (97) **2640414 \***  
 (86) US2010057396 19.11.2010  
 (96) 10859722.0 25.09.2013  
 (87) WO2012067624, 19.11.2010  
 (97) 2640414, 25.09.2013 en  
 (54) IMMUNOGLOBULIN CLEAVAGE FRAGMENTS VACCINE COMPOSITIONS  
 (71) Janssen Biotech, Inc., 800/850 Ridgeview Drive, Horsham, PA 19044, US  
 (72) JORDAN, Robert, 15 Memel Drive, Thorton, PA 19373, US  
 KNIGHT, David, 2430 Whitehorse Road, Berwyn, PA 19312, US  
 BREZSKI, Randall, 1400 McKean Road, Spring House, PA 19477, US

- (51) MKP  
**F24J 2/52 (2006.01)** (97) **2562487**  
**E04D 1/12 (2006.01)**  
**E04D 1/34 (2006.01)**  
**H01L 31/048 (2006.01)**  
 (96) 11178674.5 27.02.2013  
 (97) 2562487, 27.02.2013 de  
 (54) Assembly of multiple frames for holding board-shaped elements on a surface and side profile for a frame for use in such an assembly  
 (71) Milboro Aktiengesellschaft, Industriestrasse 26, 9491 Ruggell, LI  
 (72) Lechthaler, Andreas, Beschlingerstrasse 9, 6710 Nenzing, AT

- (51) MKP  
**A61K 31/422 (2006.01)** (97) **2603216 \***  
 (86) US2011047245 10.08.2011  
 (96) 11816983.8 19.06.2013  
 (87) WO2012021615, 10.08.2011  
 (97) 2603216, 19.06.2013 en  
 (54) HETEROARYLS AND USES THEREOF  
 (71) Millennium Pharmaceuticals, Inc., 40 Landsdowne Street, Cambridge, MA 02139, US  
 (72) CULLIS, Courtney, A., 122 Springs Road, Bedford MA 01730, US  
 GRANGER, Krista, E., 42 Marion Street, Medford MA 02155, US  
 GUO, Jianping, 29 Vine Street Unit 5, Winchester MA 01890, US  
 HIROSE, Masaaki, C/o Takeda Pharmaceutical Company Limited Oncology Ddu C-1 2f 1110 26-1 Muraokahigashi 2-chome Fujisawa Kanagawa, 251-0012, JP  
 LI, Gang, 3 Hundreds Road, Westborough MA 01581, US  
 MIZUTANI, Miho, 31 Rice Street 2, Cambridge MA 02140, US  
 VOS, Tricia, J., 4 Albamon Road 2, Winchester MA 01890, US

- (51) MKP  
**C03B 37/08 (2006.01)** (97) **2522637**  
 (96) 11165372.1 14.11.2012  
 (97) 2522637, 14.11.2012 de  
 (54) Bushing Assembly for Producing Fibers from Molten Mineral Material  
 (71) Umicore AG & Co. KG, Rodenbacher Chaussee 4, 63457 Hanau-Wolfgang, DE  
 (72) Singer, Rudolf, Am Sportfeld 1, 55270, Engelstadt, DE

- (51) MKP  
**D06F 57/08 (2006.01)** (97) **2527516**  
**D06F 57/10 (2006.01)**  
**D06F 57/06 (2006.01)**  
 (96) 12163585.8 28.11.2012  
 (97) 2527516, 28.11.2012 en  
 (54) Stabilizing base for a clothes horse  
 (71) Borgato SRL, Via Bolzani, 116/A, 35020 Masera di Padova (PD), IT  
 (72) Borgato, Roberto, Vicolo San Mauro, 2 i.6, 35036 Montegrotto Terme (PD), IT

- (51) MKP  
**A47J 31/44 (2006.01)** (97) **2613678 \***  
 (86) DK2011000100 07.09.2011  
 (96) 11770038.5 17.07.2013  
 (87) WO2012031593, 07.09.2011  
 (97) 2613678, 17.07.2013 en  
 (54) A BREWING DEVICE  
 (71) Scanomat A/S, Vibe Allé 3, 2980 Kokkedal, DK  
 (72) PETERSEN, Kim Vibe, Scanomat A/S Vibe Allé 3, DK-2980 Kokkedal, DK

- (51) MKP  
**A62C 31/00 (2006.01)** (97) **2599524 \***  
**A62C 5/00 (2006.01)**  
**A62C 35/68 (2006.01)**  
 (86) RU2011000519 14.07.2011  
 (96) 11815737.9 05.06.2013  
 (87) WO2013009216, 14.07.2011  
 (97) 2599524, 05.06.2013 en  
 (54) AUTOMATED NITROGEN- WATER FIRE - FIGHTING COMPLEX  
 (71) Joint-Stock Company "Engineering Centre of Fire Robots Technology "FR", Ul. Zavodskaya 4, Petrozavodsk 185031 Republic of Karelia, RU  
 (72) GORBAN, Yury Ivanovich, ul. Pravdy 11a-8, Petrozavodsk 185005 Republic of Karelia, RU

- (51) MKP  
**G02C 7/10 (2006.01)** (97) **2506064**  
**B29D 11/00 (2006.01)**  
 (96) 12161700.5 03.10.2012  
 (97) 2506064, 03.10.2012 en  
 (54) Method of making and prescribing tinted lenses  
 (71) ChromaGen Vision LLC, null, Romansville, PA, US  
 Chromagen Limited, c/o Cantor & Nissel Limited Market Place, Brackley, Northamptonshire NN13 7NN, GB  
 (72) Harris, David Andrew, 19 Capel Street Capel-le-Ferne Folkestone, Kent CT18 7LZ, GB

- (51) MKP  
**A61M 25/04 (2006.01)** (97) **2640453 \***  
 (86) EP2010067499 15.11.2010  
 (96) 10776371.6 25.09.2013  
 (87) WO2012065625, 15.11.2010  
 (97) 2640453, 25.09.2013 en  
 (54) AN ASSEMBLY WITH A GUIDE WIRE AND A FIXATOR FOR ATTACHING TO A BLOOD VESSEL  
 (71) Endovascular Development AB, Vasagatan 5B, 753-13 Uppsala, SE  
 (72) LIUNGMAN, Krister, Vasagatan 5B, S-753-13 Uppsala, SE

- (51) MKP  
**E04H 15/56 (2006.01)** (97) **2407614**  
**E04F 15/024 (2006.01)**  
**E04B 5/02 (2006.01)**  
 (96) 11173612.0 18.01.2012  
 (97) 2407614, 18.01.2012 de  
 (54) Base structure for a tent and tent with such a base structure  
 (71) Haltec Hallensysteme GmbH, Hauptstrasse 285, 58675 Hemer, DE

- (51) MKP  
**C07D 307/87 (2006.01)** (97) **2595979 \***  
 (86) DK2011050276 12.07.2011  
 (96) 11738154.1 29.05.2013  
 (87) WO2012010174, 12.07.2011  
 (97) 2595979, 29.05.2013 en  
 (54) PROCESS FOR THE PURIFICATION OF PHARMACEUTICALLY ACCEPTABLE SALTS  
 (71) H. Lundbeck A/S, Ottiliavej 9, 2500 Valby, DK  
 (72) PETERSEN, Hans, Guldagervej 11, DK-2720 Vanløse, DK  
 KNUDSEN, Martin, Markvard, Kongebakken 15 3.th., DK-4000 Roskilde, DK

- (51) MKP  
**C40B 30/04 (2006.01)** (97) **2640876 \***  
 (86) US2011061184 17.11.2011  
 (96) 11840749.3 25.09.2013  
 (87) WO2012068372, 17.11.2011  
 (97) 2640876, 25.09.2013 en  
 (54) METHOD OF AND SYSTEM FOR PRINTING IN-WELL CALIBRATION FEATURES  
 (71) Aushon Biosystems, 43 Manning Road, 1st Floor, Billerica, MA 01821, US  
 (72) HONKANEN, Peter, 1437-5 Monument Street, Concord, MA 01742, US  
 BURNS, Christine, A., 9 Salem Road, Wellesley, MA 02481, US

- (51) MKP  
**E06B 3/667 (2006.01)** (97) **2594722**  
 (96) 12192886.5 22.05.2013  
 (97) 2594722, 22.05.2013 de  
 (54) Plug connector  
 (71) CERA Handelsgesellschaft mbH, Gewerbepark - Fürgen 14., 87674 Ruderatshofen-Immenhofen, DE  
 (72) Rafeld-Cech, Karin, Frohnschwenden 77, D-87499 Wildpoldsried, DE

- (51) MKP  
**G01D 5/14 (2006.01)** (97) **2630449 \***  
 (86) SI2011000060 19.10.2011  
 (96) 11810704.4 28.08.2013  
 (97) WO2012053991, 19.10.2011  
 (97) 2630449, 28.08.2013 en  
 (54) TESTER FOR DETERMINATION OF MACHINE ROTATION DIRECTION AND ACCURACY OF STATOR WINDING CONNECTION  
 (71) University of Maribor, Smetanova 17, 2000 Maribor, SI  
 (72) KLOP I., Beno, orgova ulica 78, 1231 rmu e, SI  
 DOLINAR, Drago, Bor tnikova ulica 82, 2000 Maribor, SI  
 POPOVI, Jelena, Betnavska cesta 54, 2000 Maribor, SI

- (51) MKP  
**C07D 249/12 (2006.01)** (97) **2619188 \***  
**A61K 31/4196 (2006.01)**  
**A61P 9/00 (2006.01)**  
 (86) EP2011065000 31.08.2011  
 (96) 11757802.1 31.07.2013  
 (87) WO2012028644, 31.08.2011  
 (97) 2619188, 31.07.2013 de  
 (54) SUBSTITUTED N-PHENETHYLTRIAZOLONEACETAMIDES AND USE THEREOF  
 (71) Bayer Intellectual Property GmbH, Alfred-Nobel-Strasse 10, 40789 Monheim, DE  
 (72) FÜRSTNER, Chantal, Arnoldstraße 33, 45478 Mülheim/Ruhr, DE  
 KELDENICH, Jörg, Damaschkeweg 49, 42113 Wuppertal, DE  
 DELBECK, Martina, Müllerweg 10, 42579 Heiligenhaus, DE  
 KOLKHOF, Peter, Falkenberg 121, 42113 Wuppertal, DE  
 KRETSCHMER, Axel, Am Acker 23, 42113 Wuppertal, DE  
 POOK, Elisabeth, Im Lehbruch 24, 42109 Wuppertal, DE  
 SCHMECK, Carsten, Carl-Friedrich-Goerdeler-Str. 24, 45472 Mülheim/Ruhr, DE  
 TRÜBEL, Hubert, Lante 23, 42281 Wuppertal, DE

- (51) MKP  
**A61K 36/48 (2006.01)** (97) **2617412**  
**A61K 36/68 (2006.01)**  
**A61P 29/00 (2006.01)**  
**A61K 9/12 (2006.01)**  
**A61K 36/185 (2006.01)**  
**A61K 36/09 (2006.01)**  
**A61K 36/73 (2006.01)**  
 (96) 12006743.4 24.07.2013  
 (97) 2617412, 24.07.2013 de  
 (54) Composition for topical treatment  
 (71) Maria Clementine Martin Klosterfrau Vertriebsgesellschaft mbH, Gereonsmühlengasse 1-11, 50670 Köln, DE  
 (72) Greve, Harald, Dr., Schorlemerstrasse 3A, 40545 Düsseldorf, DE  
 Vestweber, Anna-Maria, Dr., Maxhan 34, 51399 Burscheid, DE

- (51) MKP  
**C07K 14/47 (2006.01)** (97) **2643348 \***  
 (86) EP2011071084 25.11.2011  
 (96) 11788152.4 02.10.2013  
 (87) WO2012069655, 25.11.2011  
 (97) 2643348, 02.10.2013 en  
 (54) IMPROVED CAPPING MODULES FOR DESIGNED ANKYRIN REPEAT PROTEINS  
 (71) Molecular Partners AG, Wagistrasse 14, 8952 Schlieren, CH  
 (72) BINZ, Hans Kaspar, Bachstrasse 27, CH-8903 Birmensdorf, CH

- (51) MKP  
**G06K 19/06 (2006.01)** (97) **2619714 \***  
 (86) EP2010064187 24.09.2010  
 (96) 10763166.5 31.07.2013  
 (87) WO2012037985, 24.09.2010  
 (97) 2619714, 31.07.2013 fr  
 (54) TWO-DIMENSIONAL IDENTIFICATION PATTERN, ARTICLE INCLUDING SUCH A PATTERN, AND METHODS FOR MARKING AND IDENTIFYING SUCH A PATTERN  
 (71) SICPA HOLDING SA, Avenue de Florissant 41, 1008 Prilly, CH  
 (72) DECOUX, Eric, Rue du Jura 8, CH-1800 Vevey, CH  
 VUISTINER, Dave, Chemin des Libellules 8, CH-1010 Lausanne, CH

- (51) MKP  
**G06F 19/00 (2011.01)** (97) **2455875**  
**G01N 27/327 (2006.01)**  
**A61B 5/145 (2006.01)**  
 (96) 12155072.7 23.05.2012  
 (97) 2455875, 23.05.2012 en  
 (54) System and method for diabetes management  
 (71) Lifescan Scotland Limited, Beechwood Park North, Inverness IV2 3ED, GB  
 (72) Jerdonek, Ronald, 407 N. Alfred, Alexandria VA 22314, US  
 Longmuir, Alistair, Alexandra Terrace, Forres Morayshire IV36 1DL, GB  
 Raj, Siv, 12 Grove Court, Beaconsfield HP9 1QW, GB  
 Macrae, Allan, 20a Culcabock Avenue, Inverness IV2 3RG, GB  
 Weseley, Lisa, 10 Torino Lane, San Carlos CA 94070, US  
 Stephens, Chris, 1034 Ringwood Avenue, Menlo Park CA 94025, US

- (51) MKP  
**A61M 16/06 (2006.01)** (97) **2632525 \***  
 (86) EP2011068685 25.10.2011  
 (96) 11774064.7 04.09.2013  
 (87) WO2012055886, 25.10.2011  
 (97) 2632525, 04.09.2013 en  
 (54) BUTTERFLY NASAL MASK  
 (71) Insleep Technologies, LLC, 3040 Universal Boulevard Suite 150, Weston, Florida 33331, US  
 Baecke, Martin, null, Dessau-Roßlau, DE  
 Borgward, Marcel, null, Oedheim, DE  
 (72) BAECKE, Martin, Lindenstrasse 7, 06847 Dessau-Roßlau, DE  
 BORGWARD, Marcel, Klinge 2, 74229 Oedheim, DE



(51) MKP  
**C10G 3/00 (2006.01)** (97) **2639286**  
**C10L 1/02 (2006.01)**  
**C10G 67/04 (2006.01)**  
**C10G 47/04 (2006.01)**  
**C10G 47/06 (2006.01)**  
**C10G 47/10 (2006.01)**  
**C10L 1/04 (2006.01)**  
**C10L 1/14 (2006.01)**  
**C10L 1/16 (2006.01)**  
**C10L 1/183 (2006.01)**  
**C10L 1/188 (2006.01)**  
**C10L 1/19 (2006.01)**  
**C10L 1/223 (2006.01)**  
**C10L 10/08 (2006.01)**  
(96) 13171966.8 18.09.2013  
(97) 2639286, 18.09.2013 en  
(54) Process for the production of fuel and fuel additives capable for use for internal combustion engines and the fuels and fuel additives obtained  
(71) MOL Magyar Olaj- és Gázipari Nyrt., Október huszonharmadika utca 18., 1117 Budapest, HU  
OLAJTERV Fővállalkozó és Tervező Zrt., Lajos utca 103., 1036 Budapest, HU  
Pannon Egyetem, Egyetem utca. 10, 8200 Veszprém, HU  
Magyar Tudományos Akadémia Kémiai Kutatóközpont, Pusztaszeri út 59-67, 1025 Budapest, HU  
(72) THERNESZ, Artur, MOL Nyrt. Egres utca 27., 2000 Szentendre, HU  
BODA, László, MOL Nyrt. Körtefa utca 13/3., 2440 Százhalombatta, HU  
PETRÓ, József, MOL Nyrt. Rákóczi utca 40., 2440 Százhalombatta, HU  
LEVELES, László, MOL Nyrt. Ponty utca 6., 2440 Százhalombatta, HU  
WÁHLNÉ HORVÁTH, Ilona, MOL Nyrt. Kodály Zoltán sétány 12. 1/5., 2440 Százhalombatta, HU  
SZALMÁSZNÉ PÉCSVÁRI, Gabriella, MOL Nyrt. Sas utca 10., 2440 Százhalombatta, HU  
KELEMEN, Béla, MOL Nyrt. Zentai utca 25., 1222 Budapest, HU  
VUK, Tibor, MOL Nyrt. Gagarin utca 7., 2837 Vértesszőlős, HU  
RÁCZ, László, MOL Nyrt. Újvilág utca 15., 1145 Budapest, HU  
HOLLÓ, András, MOL Nyrt. Meggyfa utca 4., 2440 Százhalombatta, HU  
SZERENCSE, Zoltán, MOL Nyrt. Honfoglalás utca 13., 2045 Törökbálint, HU  
KOVÁCS, Ferenc, MOL Nyrt. Budai Nagy Antal út 5/D, 2500 Esztergom, HU  
KOVÁCS, Imre, MOL Nyrt. Széchenyi utca 48., 2462 Martonvásár, HU  
TOLVAJNÉ NÉMETH, Krisztina, MOL Nyrt. Mátyás király utca 46., 2030 Érd, HU  
ARÁNYI, László, OLAJTERV Zrt. Gömb utca 4/B 5/5, 1139 Budapest, HU  
STÉGER, Csaba, OLAJTERV Zrt. Egressy út 31-33. D212, 1149 Budapest, HU  
VALYON, József, MTA Kémiai Kutatóközpont Lepke utca 8. fsz. 2., 1026 Budapest, HU  
ONYESTYÁK, György, MTA Kémiai Kutatóközpont Szabadság utca 11., 1165 Budapest, HU  
HANCSÓK, Jen, Pannon Egyetem Zrínyi Miklós út 5/6, 8200 Veszprém, HU  
KRÁR, Márton, Pannon Egyetem Futó utca 4. II/9, 8400 Ajka, HU  
NAGY, Gábor, Pannon Egyetem Moroló utca 29., 7694 Hosszúhetény, HU  
VARGA, Zoltán, Pannon Egyetem Március 15. utca 3/C, 8200 Veszprém, HU

(51) MKP  
**G06F 17/30 (2006.01)** (97) **2606442 \***  
**G06Q 30/00 (2012.01)**  
(86) GB2011001186 08.08.2011  
(96) 11754453.6 26.06.2013  
(87) WO2012022929, 08.08.2011  
(97) 2606442, 26.06.2013 en  
(54) CONTENT SERVER  
(71) Dancing Sun Limited, 1st Floor, 37 Commercial Road, Poole, Dorset BH14 0HU, GB  
(72) BARNETT, Tom, 2 Fir Road, Ashurst SO40 7AZ, GB

(51) MKP  
**C07D 403/14 (2006.01)** (97) **2635571 \***  
**A61K 31/4025 (2006.01)**  
**A61K 31/12 (2006.01)**  
(86) US2011059061 03.11.2011  
(96) 11784875.4 11.09.2013  
(87) WO2012061552, 03.11.2011  
(97) 2635571, 11.09.2013 en  
(54) NOVEL INHIBITORS OF HEPATITIS C VIRUS  
(71) Theravance, Inc., 901 Gateway Boulevard, South San Francisco, CA 94080, US  
(72) MCKINNELL, Robert Murray, 321 Poplar Avenue, Millbrae California 94030, US  
LONG, Daniel D., 10 Sunview Drive, San Francisco California 94131, US  
VAN ORDEN, Lori Jean, 3 Whitney Street, San Francisco California 94131, US  
JIANG, Lan, 788 Santa Maria Lane, Foster City California 94404, US  
LOO, Mandy, 2119 Imwalle Court, San Jose California 95131, US  
SAITO, Daisuke Roland, 1600 E. 3rd Avenue 2803, San Mateo California 94030, US  
ZIPFEL, Sheila, 22 N. San Mateo Drive Apt. 205, San Mateo California 94401, US  
STANGELAND, Eric L., 896 Corona Drive, Pacifica California 94044, US  
LEPACK, Kassandra, 3014 Los Prados Street Apt. 300, San Mateo California 94403, US  
OGAWA, Gavin, 541 Hugo Street, San Francisco California 94122, US  
HUANG, Xiaojun, 125 Connemara Way 35, Sunnyvale California 94087, US  
ZHANG, Weijiang, 1282 North Montecito Drive, Concord CA 94521, US

(51) MKP  
**C07D 471/04 (2006.01)** (97) **2637502 \***  
**C07D 239/42 (2006.01)**  
**A01N 43/54 (2006.01)**  
(86) US2011059726 08.11.2011  
(96) 11839800.7 18.09.2013  
(87) WO2012064706, 08.11.2011  
(97) 2637502, 18.09.2013 en  
(54) MUTANT-SELECTIVE EGFR INHIBITORS AND USES THEREOF  
(71) Celgene Avilomics Research, Inc., 45 Wiggins Avenue, Bedford, MA 01730, US  
(72) LEE, Kwangho, 22 Middlesex Circle 7, Waltham, MA 02452, US  
NIU, Deqiang, 30 Grapevine Avenue, Lexington, MA 02421, US  
BAEVSKY, Matthew, Frank, 65 West Street, Northborough, MA 01532, US

(51) MKP  
**A61P 35/00 (2006.01)** (97) **2624828 \***  
**A61P 25/28 (2006.01)**  
**A61K 31/365 (2006.01)**  
**A61P 3/10 (2006.01)**  
(86) SE2011051208 07.10.2011  
(96) 11831014.3 14.08.2013  
(87) WO2012047172, 07.10.2011  
(97) 2624828, 14.08.2013 en  
(54) PICROPODOPHYLLIN MONOHYDRATE OR POLYMORPH A IN CANCER THERAPY  
(71) Axelar AB, Nobels väg 3, 171 65 Solna, SE  
(72) BISLAT, Mikael, Utsiktsvägen 34, S-645 42 Strängnäs, SE  
BRISANDER, Magnus, Rapsvägen 15, S-178 35 Ekerö, SE

(51) MKP  
**F02D 41/20 (2006.01)** (97) **2546499**  
(86) 11174004.9 16.01.2013  
(97) 2546499, 16.01.2013 en  
(54) Electrical drive arrangement for a fuel injection system  
(71) Delphi Technologies Holding S.à.r.l., Avenue de Luxembourg, 4940 Bascharage, LU  
(72) Engel, Joseph, 100, av. du Parc des Sports, 4671 Differdange, LU

- (51) MKP  
**C07H 19/02 (2006.01)** (97) **2596004 \***  
**C07H 19/10 (2006.01)**  
**C07H 19/20 (2006.01)**  
**C07H 1/00 (2006.01)**  
**C07H 1/06 (2006.01)**  
**C07D 309/10 (2006.01)**  
(86) US2011044581 19.07.2011  
(96) 11743400.1 29.05.2013  
(87) WO2012012465, 19.07.2011  
(97) 2596004, 29.05.2013 en  
(54) METHODS FOR THE PREPARATION OF  
DIASTEROMERICALLY PURE PHOSPHORAMIDATE  
PRODRUGS  
(71) Gilead Sciences, Inc., 333 Lakeside Drive, Foster City, CA  
94404, US  
(72) CHO, Aesop, 1656 Notre Dame Drive, Mountain View CA  
94040, US  
WOLCKENHAUER, Scott, Alan, 644 Topaz Street, Redwood  
City CA 94061, US  
CLARKE, Michael, O'Neil Hanrahan, 545 Seastorm Drive,  
Redwood City, CA 94065, US

- (51) MKP  
**C12N 15/82 (2006.01)** (97) **2603591 \***  
**C12Q 1/68 (2006.01)**  
**G01N 33/573 (2006.01)**  
**A01H 5/00 (2006.01)**  
**A01H 5/10 (2006.01)**  
**C12N 9/02 (2006.01)**  
(86) US2011047553 12.08.2011  
(96) 11745899.2 19.06.2013  
(87) WO2012021785, 12.08.2011  
(97) 2603591, 19.06.2013 en  
(54) COMPOSITIONS AND METHODS COMPRISING  
SEQUENCES HAVING HYDROXYPHENYLPYRUVATE  
DIOXYGENASE (HPPD) ACTIVITY  
(71) Pioneer Hi-Bred International Inc., 7100 N.W. 62nd Avenue,  
Johnston, IA 50131, US  
(72) ALBERT, Henrik, 2525 Webb Avenue, Alameda CA 94501, US  
BERMUDEZ, Ericka R., 734 Clubhouse Drive, Aptos CA  
95003, US  
CASTLE, Linda A., 784 Hans Avenue, Mountain View CA  
94040, US  
DONG, Yuxia, 3796 Vindara Lane, San Ramon CA 94582, US  
HECKERT, Matthew J., 30693 Tidewater Drive, Union City CA  
94587, US  
HOU, Jingtong, 3973 Selmi Grove, San Pablo CA 94806, US  
HOU, Zhenglin, 703 N.W. Rockerest Circle, Ankeny IA 50023,  
US  
LU, Jian, 34722 Iris Way, Union City CA 94587, US  
SIEHL, Daniel L., 310 Durham Street, Menlo Park CA 94025,  
US  
TAO, Yumin, 4605 Ashwood Drive, Urbandale IA 50322, US

- (51) MKP  
**F04B 1/04 (2006.01)** (97) **2530316**  
**F02M 59/10 (2006.01)**  
**F02M 59/44 (2006.01)**  
**F02M 63/00 (2006.01)**  
(96) 11168572.3 05.12.2012  
(97) 2530316, 05.12.2012 en  
(54) Fuel pump lubrication  
(71) Delphi Technologies Holding S.à.r.l., Avenue de Luxembourg,  
4940 Bascharage, LU  
(72) Rosu, Cristian, 59 Chaucer Road, Gillingham, Kent ME7 5LX,  
GB  
Garland, Paul, 39 Holmside, Gillingham, Kent ME7 4BQ, GB

- (51) MKP  
**C07D 487/04 (2006.01)** (97) **2625179 \***  
**C12N 9/02 (2006.01)**  
**C12P 17/18 (2006.01)**  
(86) IN2011000702 10.10.2011  
(96) 11805634.0 14.08.2013  
(87) WO2012046254, 10.10.2011  
2625179, 14.08.2013 en  
(54) PROCESS FOR PREPARING AN INTERMEDIATE OF  
SITAGLIPTIN VIA ENZYMATIC CONVERSION  
(71) Cadila Healthcare Limited, Zydus Tower Satellite Cross  
Roads, Ahmedabad 380 015, Gujarat, IN  
(72) MENDIRATTA, Sanjeev Kumar, Cadila Healthcare Limited  
Zydus Tower Satellite Cross Road Ahmedabad 380015,  
Gujarat, IN  
PANDEY, Bipin, Cadila Healthcare Limited Zydus Tower  
Satellite Cross Road Ahmedabad 380015, Gujarat, IN  
JOSHI, Rupal, Cadila Healthcare Limited Zydus Tower Satellite  
Cross Road Ahmedabad 380015, Gujarat, IN  
TRIVEDI, Umang, Cadila Healthcare Limited Zydus Tower  
Satellite Cross Road Ahmedabad 380015, Gujarat, IN  
DAVE, Mayank, G., Cadila Healthcare Limited Zydus Tower  
Satellite Cross Road Ahmedabad 380015, Gujarat, IN  
KOTHARI, Himanshu, M., Cadila Healthcare Limited Zydus  
Tower Satellite Cross Road Ahmedabad 380015, Gujarat, IN  
SHUKLA, Bhavin, Cadila Healthcare Limited Zydus Tower  
Satellite Cross Road Ahmedabad 380015, Gujarat, IN

- (51) MKP  
**H01P 1/06 (2006.01)** (97) **2601706 \***  
**H01P 1/16 (2006.01)**  
(86) EP2011003800 28.07.2011  
(96) 11738972.6 12.06.2013  
(87) WO2012016665, 28.07.2011  
(97) 2601706, 12.06.2013 en  
(54) POWER DUAL-BAND ROTARY JOINT OPERATING ON TWO  
DIFFERENT BANDS  
(71) G.E.M. Elettronica S.r.l., Via Vespucci 9, 63074 San  
Benedetto del Tronto, IT  
(72) MORINI, Antonio, Via Carlo Maratta 12, I-60121 Ancona, IT  
MALASPINA, Vincenzo, Contrada San Michele 25, I-63846  
Monte Gilberto, IT  
PANICHI, Paolo, Via Leonardo Da Vinci 10, I-63066  
Grottammare, IT

- (51) MKP  
**C12N 15/82 (2006.01)** (97) **2643464 \***  
(86) US2010058011 24.11.2010  
(96) 10784933.3 02.10.2013  
(87) WO2012071040, 24.11.2010  
(97) 2643464, 02.10.2013 en  
(54) BRASSICA GAT EVENT DP-073496-4 AND COMPOSITIONS  
AND METHODS FOR THE IDENTIFICATION AND/OR  
DETECTION THEREOF  
(71) Pioneer Hi-Bred International Inc., 7100 N.W. 62nd Avenue  
Box 1014, Johnston, IA 50131-1014, US  
E.I. DUPONT DE NEMOURS AND COMPANY, 1007 Market  
Street, Wilmington DE 19898, US  
(72) CHARNE, David, George, 138 Dimson Avenue, Guelph, ON  
N1G 4P2, CA  
CHEN, Wenpin, 50 Hillcrest Avenue Unit 7, Brampton, ON  
L6W 0B1, CA  
KOSCIELNY, Chadwick, Bruce, R.R 2, Miami, Manitoba R0G  
1H0, CA  
PATEL, Jayantilal, Devabhai, 21 Bayhampton Cr., Thornhill,  
ON L4J 7H1, CA  
THOONEN, Ferdinand, Gerard, 155 Ontario Street, Guelph,  
ON N1E 3B3, CA  
TULSIERAM, Lomas, 2795 Gulfstream Way, Mississauga, ON  
L5N 6K2, CA  
ZHANG, Yongping, 14 Prada Court, Brampton, ON L6P 2K1,  
CA  
LI, Zhongsen, 24 Forest Creek Drive, Hockessin, DE 19707,  
US

- (51) MKP  
**G01N 33/68 (2006.01)** (97) **2598888 \***  
 (86) GB2011001135 28.07.2011  
 (96) 11744051.1 05.06.2013  
 (87) WO2012013933, 28.07.2011  
 (97) 2598888, 05.06.2013 en  
 (54) ANALYTICAL METHOD FOR FAB AND FAB' MOLECULES  
 (71) UCB Pharma, S.A., 60, allée de la Recherche, 1070 Brussels, BE  
 (72) SMITH, Bryan, John, IPD, UCB Celltech 208 Bath Road, Slough Berkshire SL1 3WE, GB  
 KIRKE, Helen, Marie, IPD, UCB Celltech 208 Bath Road, Slough Berkshire SL1 3WE, GB

- (51) MKP  
**C07D 257/04 (2006.01)** (97) **2616450 \***  
**C07D 307/82 (2006.01)**  
**C07D 333/34 (2006.01)**  
**C07D 333/62 (2006.01)**  
**C07D 405/12 (2006.01)**  
**C07D 417/12 (2006.01)**  
**C07D 409/04 (2006.01)**  
**C07D 417/14 (2006.01)**  
**C07D 409/12 (2006.01)**  
**C07C 311/21 (2006.01)**  
**C07D 409/14 (2006.01)**  
**C07C 311/29 (2006.01)**  
**C07D 413/12 (2006.01)**  
**A61K 31/41 (2006.01)**  
**C07D 413/04 (2006.01)**  
**A61K 31/422 (2006.01)**  
**C07D 413/14 (2006.01)**  
**A61K 31/381 (2006.01)**  
**C07D 417/04 (2006.01)**  
**A61K 31/4436 (2006.01)**  
 (86) EP2011066250 19.09.2011  
 (96) 11761329.9 24.07.2013  
 (87) WO2012035171, 19.09.2011  
 (97) 2616450, 24.07.2013 en  
 (54) SULFONAMIDE COMPOUNDS  
 (71) Cancera AB, Karolinska Institutet Science Park Banvaktsvägen 22, 17148 Solna, SE  
 (72) BYSTRÖM, Styrbjörn, Hedåsvägen 1, S-187 36 Täby, SE  
 HEDGECOCK, Charles, Duvhöksvägen 7, S-757 56 Uppsala, SE  
 HOMAN, Evert, Kantorsgränd 11, S-192 72 Sollentuna, SE  
 LUNDBÄCK, Thomas, Kungsvägen 17, S-142 66 Trångsund, SE  
 MARTINSSON, Jessica, Hästhagsvägen 23C, S-191 63 Sollentuna, SE  
 SARI, Meral, Veckovägen 33, S-177 62 Järfälla, SE  
 FÄRNEGÅRDH, Katarina, Borstvetevägen 6, S-178 35 Ekerö, SE  
 JÖNSSON, Mattias, Fomgravsvägen 4A, S-741 42 Knivsta, SE

- (51) MKP  
**A61K 31/517 (2006.01)** (97) **2608793 \***  
**A61P 13/12 (2006.01)**  
 (86) US2011049077 25.08.2011  
 (96) 11752707.7 03.07.2013  
 (87) WO2012027537, 25.08.2011  
 (97) 2608793, 03.07.2013 en  
 (54) USE OF A RECEPTOR-TYPE KINASE MODULATOR FOR TREATING POLYCYSTIC KIDNEY DISEASE  
 (71) Symphony Evolution, Inc., 7361 Calhoun Place, Suite 325, Rockville, MD 20850, US  
 (72) FROST, Philip, c/o Symphony Evolution Inc. 7361 Calhoun Place Suite 325, Rockville, MD 20850, US  
 LIAO, William, W., N., c/o Symphony Evolution Inc. 7361 Calhoun Place Suite 325, Rockville, MD 20850, US  
 ROWINSKY, Eric, K., c/o Symphony Evolution Inc. 7361 Calhoun Place Suite 325, Rockville, MD 20850, US

- (51) MKP  
**A01N 43/40 (2006.01)** (97) **2632262 \***  
**A01P 13/00 (2006.01)**  
 (86) US2010054232 27.10.2010  
 (96) 10773803.1 04.09.2013  
 (87) WO2012057743, 27.10.2010  
 (97) 2632262, 04.09.2013 en  
 (54) SYNERGISTIC HERBICIDAL COMPOSITION CONTAINING FLUROXYPYR AND QUINCLORAC  
 (71) Dow AgroSciences LLC, 9330 Zionsville Road, Indianapolis, IN 46268, US  
 (72) MANN, Richard, 1828 South 550 East, Franklin, IN 46131, US  
 MCVEIGH-NELSON, Andrea, 1333 Alimingo Drive, Indianapolis, IN 46260, US

- (51) MKP  
**C07D 307/80 (2006.01)** (97) **2595976 \***  
 (86) FR2011051710 18.07.2011  
 (96) 11754698.6 29.05.2013  
 (87) WO2012010788, 18.07.2011  
 (97) 2595976, 29.05.2013 fr  
 (54) PROCESS FOR PREPARING AMINO BENZOYL BENZOFURAN DERIVATIVES  
 (71) SANOFI, 54 rue La Boétie, 75008 Paris, FR  
 (72) BON, Xavier, c/o Sanofi Département Brevets 174 avenue de France, F-75013 Paris, FR  
 BIENCOURT, Christine, c/o Sanofi Département Brevets 174 avenue de France, F-75013 Paris, FR  
 LEROY, Corinne, c/o Sanofi Département Brevets 174 avenue de France, F-75013 Paris, FR  
 MATEOS-CARO, Julia, c/o Sanofi Département Brevets 174 avenue de France, F-75013 Paris, FR  
 VAYRON, Philippe, c/o Sanofi Département Brevets 174 avenue de France, F-75013 Paris, FR

- (51) MKP  
**F03B 17/00 (2006.01)** (97) **2535558**  
 (86) 11004923.6 19.12.2012  
 (97) 2535558, 19.12.2012 de  
 (54) Method and device for generating drive power by causing pressure differentials in a closed gas/fluid system  
 (71) Akbayir, Zeki, Erbacher Str. 25, 64743 Beerfelden, DE  
 (72) Akbayir, Zeki, Erbacher Str. 25, 64743 Beerfelden, DE

- (51) MKP  
**C07D 487/04 (2006.01)** (97) **2630148 \***  
 (86) GB2011052053 21.10.2011  
 (96) 11776833.3 28.08.2013  
 (87) WO2012052781, 21.10.2011  
 (97) 2630148, 28.08.2013 en  
 (54) PROCESS FOR THE PREPARATION OF ANAGRELIDE AND ANALOGUES THEREOF  
 (71) Shire LLC, 9200 Brookfield Court, Florence, KY 41042, US  
 (72) McGEE, Paul, c/o Shire Pharmaceutical Development Hampshire International Business Park Chineham, Basingstoke RG24 8EP, GB

- (51) MKP  
**A01K 67/027 (2006.01)** (97) **2618656 \***  
 (86) US2011052363 20.09.2011  
 (96) 11827353.1 31.07.2013  
 (87) WO2012040207, 20.09.2011  
 (97) 2618656, 31.07.2013 en  
 (54) HUMAM SIRPAalpha TRANSGENIC ANIMALS AND THEIR METHODS OF USE  
 (71) Yale University, Inc., 2 Whitney Avenue, New Haven, CT 06511, US  
 (72) FLAVELL, Richard, A., 283 Moose Hill Road, Guilford, CT 06437, US  
 STROWIG, Till, 20 Tilton Street, New Haven, CT 06511, US  
 EYNON, Elizabeth, 275 Concord Street, New Haven, CT 06512, US  
 PHILBRICK, William, 496 B Woodward Avenue, New Haven, CT 06512, US  
 MANZ, Markus, Toberstrasse 35, CH-8044 Zurich, CH

- (51) MKP  
**A61K 39/395 (2006.01)** (97) **2624867 \***  
 (86) US2011055140 06.10.2011  
 (96) 11831616.5 14.08.2013  
 (87) WO2012048134, 06.10.2011  
 (97) 2624867, 14.08.2013 en  
 (54) METHODS FOR TREATING PSORIASIS  
 (71) AbbVie Inc., 100 Abbott Park Road, Abbott Park, IL 60064, US  
 (72) VALDES, Joaquin Mario, 1290 Kasting Lane, Mundelein Illinois 60060, US  
 PAULSON, Susan K., 1490 Wood Avenue, Downers Grove Illinois 60515, US  
 CHARTASH, Elliot K., 4789 Crest Park Lane, Marietta Georgia 30068, US  
 BAO, Yanjun, 2995 Roslyn Lane, Buffalo Grove Illinois 60089, US  
 MULANI, Parvez, M., 298 Jennifer Court, Gurnee Illinois 60031, US  
 SUNDARAM, Murali, 226 Woodstone Circle, Buffalo Grove Illinois 60089, US  
 GU, Yihua, 230 S. Thorne Grove Drive, Vernon Hills Illinois 60061, US  
 HECKAMAN, Michele Olds, 34104 White Oak Lane, Gurnee Illinois 60031, US  
 HARRIS, Tom C., 1132 Oakmeadow Court, Gurnee Illinois 60031, US  
 KAUL, Martin, Otto-Dill-Strasse 13, 67433 Neustadt, DE  
 WILLIAMS, David Allen, 520 Stablewood Lane, Lake Forest Illinois 60045, US  
 LANGLEY, Richard G.B., 6037 Oakland Road, Halifax Nova Scotia B3H 1N9, CA  
 GORDON, Kenneth, 925 Sutton Drive, Northbrook Illinois 60062, US
- 
- (51) MKP  
**A61P 1/04 (2006.01)** (97) **2600852 \***  
**A61K 31/573 (2006.01)**  
**A61K 9/50 (2006.01)**  
**A61P 1/12 (2006.01)**  
 (86) IB2011053430 02.08.2011  
 (96) 11754741.4 12.06.2013  
 (87) WO2012017385, 02.08.2011  
 (97) 2600852, 12.06.2013 en  
 (54) BECLOMETHASONE DIPROPIONATE COMPOSITIONS IN MODIFIED-RELEASE GASTRO-RESISTANT MICROSPHERES AND PROCESS FOR OBTAINING THEM  
 (71) Sofar SPA, Via Firenze 40, 20060 Trezzano Rosa (MI), IT  
 (72) LABRUZZO, Carla, Via Melzi d'Eril 16, I-20154 Milano, IT
- 
- (51) MKP  
**F16J 15/34 (2006.01)** (97) **2606261 \***  
 (86) US2011048080 17.08.2011  
 (96) 11818723.6 26.06.2013  
 (87) WO2012024398, 17.08.2011  
 (97) 2606261, 26.06.2013 en  
 (54) PUMP SEAL  
 (71) Lobepro, Inc., 2610 Sidney Lanier Drive, Brunswick, Georgia 31525, US  
 (72) RAMOS, Rolando Nico, M., 5400 N. Ocean Drive, Singer Island, FL 33404, US
- 
- (51) MKP  
**A61P 35/00 (2006.01)** (97) **2640366 \***  
**G01N 33/00 (2006.01)**  
**A61K 31/00 (2006.01)**  
 (86) US2011060771 15.11.2011  
 (96) 11787999.9 25.09.2013  
 (87) WO2012068096, 15.11.2011  
 (97) 2640366, 25.09.2013 en  
 (54) BENZOAZEPINES AS INHIBITORS OF PI3K/MTOR AND METHODS OF THEIR USE AND MANUFACTURE  
 (71) Exelixis, Inc., 210 East Grand Avenue, South San Francisco, CA 94080, US  
 (72) RICE, Kenneth, 44 Montecillo Road, San Rafael CA 94903, US  
 MARKBY, David, 3309 Folsom Street, San Francisco CA 94110, US
- 
- (51) MKP  
**B07B 13/10 (2006.01)** (97) **2598256 \***  
**B07B 13/11 (2006.01)**  
**B07B 13/16 (2006.01)**  
 (86) NL2011050515 15.07.2011  
 (96) 11736196.4 05.06.2013  
 (87) WO2012015299, 15.07.2011  
 (97) 2598256, 05.06.2013 en  
 (54) SEPARATION APPARATUS  
 (71) Inashco R&D B.V., Stevinweg 1, 2628 CN Delft, NL  
 (72) BERKHOUT, Simon Peter Maria, Molensingel 117, NL-2614 LC Delft, NL  
 REM, Peter Carlo, Jaagpad 5B, NL-2288 AB Rijswijk, NL
- 
- (51) MKP  
**E04C 3/09 (2006.01)** (97) **2573291**  
**E04C 3/08 (2006.01)**  
 (96) 12197573.4 27.03.2013  
 (97) 2573291, 27.03.2013 de  
 (54) Thin-walled cold-formed lightweight structural profile element and method for producing such a profile element  
 (71) Protektorwerk Florenz Maisch GmbH & Co. KG, Viktoriastrasse 58, 76571 Gaggenau, DE  
 (72) Maisch, Christof, Baden-Badener-Straße 15, 76571 Gaggenau, DE
- 
- (51) MKP  
**G06F 17/50 (2006.01)** (97) **2378444**  
 (96) 10159805.0 19.10.2011  
 (97) 2378444, 19.10.2011 de  
 (54) Method, device and computer program product for determining an electromagnetic near field of a field excitation source for an electrical system  
 (71) CST-Computer Simulation Technology AG, Bad Nauheimer Straße 19, 64289 Darmstadt, DE  
 (72) Schöberl, Joachim, Haus-Heyden Straße 228, 52134 Herzogenrath, DE  
 Koutschan, Christoph, Eichenweg 1, 96271 Grub am Forst, DE  
 Paule, Peter, Buchenweg 11, 4203 Altenberg bei Linz, AT
- 
- (51) MKP  
**A61F 13/15 (2006.01)** (97) **2596778**  
 (96) 12194051.4 29.05.2013  
 (97) 2596778, 29.05.2013 en  
 (54) Apparatus and method for applying short machine direction adhesive patches to a carrier layer  
 (71) Curt G. Joa, Inc., 100 Crocker Avenue, Sheboygan Falls, Wisconsin 53085, US  
 (72) Shin, Sang Hyub, 2217 Terrace View Drive, 3D, Sheboygan, WI Wisconsin 53081, US  
 Pelland, Jon Allen, 2043 White Pine Lane, Sheboygan, WI Wisconsin 53083, US  
 Gutowski, Jesse, 1178 Shetland Place, De Pere, WI Wisconsin 54115, US  
 Veldman, Cory, 34 Hein Avenue, Plymouth, WI Wisconsin 53073, US  
 Jenquin, Peter J, W6085 Whispering Lane, Plymouth, WI Wisconsin 53073, US  
 Kiela II, Gene F, N5481 Country Aire Road, Plymouth, WI Wisconsin 53073, US  
 Nelson, Chris, 75 Log Cabin Drive, Apt. 921, Dallas, GA Georgia 30157, US
-

(51) MKP  
**G01N 33/68 (2006.01)** (97) **2611462 \***  
**A61P 3/10 (2006.01)**  
**A61K 39/395 (2006.01)**  
**A61P 17/06 (2006.01)**  
**C07K 16/28 (2006.01)**  
**A61P 9/10 (2006.01)**  
**A61P 35/00 (2006.01)**  
**A61P 29/00 (2006.01)**  
**A61P 37/02 (2006.01)**  
(86) EP2011064926 30.08.2011  
(96) 11757216.4 10.07.2013  
(87) WO2012028622, 30.08.2011  
(97) 2611462, 10.07.2013 en  
(54) PEPTIDE OR PEPTIDE COMPLEX BINDING TO 2 INTEGRIN AND METHODS AND USES INVOLVING THE SAME  
(71) SANOFI, 54, rue de la Boétie, 75008 Paris, FR  
(72) CORVEY, Carsten, c/o Sanofi-Aventis Deutschland GmbH, 65926 Frankfurt am Main, DE  
BLUM, Horst, c/o Sanofi-Aventis Deutschland GmbH, 65926 Frankfurt am Main, DE  
CAMERON, Béatrice, c/o sanofi-aventis Département Brevets 174 Avenue de France, F-75013 Paris, FR  
DABDOUBI, Tarik, c/o sanofi-aventis Département Brevets 174 Avenue de France, F-75013 Paris, FR  
DECARY, Stephanie, c/o sanofi-aventis Département Brevets 174 Avenue de France, F-75013 Paris, FR  
BAURIN, Nicolas, c/o sanofi-aventis Département Brevets 174 Avenue de France, F-75013 Paris, FR  
PAPIN, David, c/o sanofi-aventis Département Brevets 174 Avenue de France, F-75013 Paris, FR  
LANGE, Christian, c/o Sanofi-Aventis Deutschland GmbH, 65926 Frankfurt am Main, DE

(51) MKP  
**A61B 17/02 (2006.01)** (97) **2632344 \***  
**A61B 17/04 (2006.01)**  
**A61B 17/00 (2006.01)**  
(86) IB2010002759 29.10.2010  
(96) 10796468.6 04.09.2013  
(87) WO2012042290, 29.10.2010  
(97) 2632344, 04.09.2013 en  
(54) SINGLE USE, DISPOSABLE, TISSUE SUSPENDER DEVICE  
(71) Vectec S.A., Bioparc, 03270 Hauterive, FR  
(72) D'ARPIANY, Francis, 40 rue Capitaine Selvez, F-03110 Vendat, FR  
WATTIEZ, Arnaud, 13 rue des Roseraies, F-67300 Schiltigheim, FR

(51) MKP  
**A61K 36/886 (2006.01)** (97) **2595643 \***  
**A61P 31/18 (2006.01)**  
**A61K 31/715 (2006.01)**  
(86) US2011044652 20.07.2011  
(96) 11810330.8 29.05.2013  
(87) WO2012012513, 20.07.2011  
(97) 2595643, 29.05.2013 en  
(54) ANTI-VIRAL PROPERTIES OF ALOE VERA AND ACQUIRED IMMUNE DEFICIENCY SYNDROME (AIDS) TREATMENT  
(71) North Texas Medical Associates, 222 Sw 2nd Street Suite 201, Grand Prairie, TX 75051, US  
(72) DANHOF, Ivan, E., 2322 Ingleside Drive, Grand Prairie, Texas 75050, US

(51) MKP  
**G01N 33/574 (2006.01)** (97) **2619585 \***  
(86) EP2011066397 21.09.2011  
(96) 11758209.8 31.07.2013  
(87) WO2012038463, 21.09.2011  
(97) 2619585, 31.07.2013 en  
(54) USE OF MYELOID CELL BIOMARKERS FOR THE DIAGNOSIS OF CANCER  
(71) Immatics Biotechnologies GmbH, Paul-Ehrlich-Strasse 15, 72076 Tübingen, DE  
(72) SINGH, Harpreet, Bei den Pferdeställen 9, 72072 Tübingen, DE  
WALTER, Steffen, Steinenbergstrasse 2, 72764 Reutlingen, DE  
MENDRZYK, Regina, Engelbergstrasse 43d, 79106 Freiburg im Breisgau, DE  
BRONTE, Vincenzo, Department of Pathology Immunology Section Verona University P.le.L.A. Scuro 10, 37134 Verona, IT  
MANDRUZZATO, Susanna, Istituto Oncologico Veneto Università degli studi di Padova Via Gattamelata 64, 35128 Padova, IT

(51) MKP  
**C02F 1/42 (2006.01)** (97) **2616395 \***  
(86) BR2011000328 13.09.2011  
(96) 11824379.9 24.07.2013  
(87) WO2012034202, 13.09.2011  
(97) 2616395, 24.07.2013 en  
(54) A METHOD FOR THE REMOVAL OF ORGANIC CHEMICALS AND ORGANOMETALLIC COMPLEXES FROM PROCESS WATER OR OTHER STREAMS OF A MINERAL PROCESSING PLANT USING ZEOLITE  
(71) Vale S.A., Avenida Graça Aranha 26 - Centro, Cep: 20030-000 Rio de Janeiro - RJ, BR  
Dong, Jie, 3143 Cottage Clay Road, Mississauga, Ontario L5B 4J2, CA  
Xu, Manqui, 32 Hiawatha Parkway, Mississauga, Ontario L5G 3S2, CA  
(72) XU, Manqui, 32 Hiawatha Parkway, Mississauga, Ontario L5G 3S2, CA  
SCHOLEY, Kenneth Erwin, 359 Cairns Valley Court, Oakville, Ontario L6J 6L3, CA

(51) MKP  
**A01N 43/54 (2006.01)** (97) **2627179 \***  
**A61K 31/505 (2006.01)**  
(86) US2011056457 14.10.2011  
(96) 11833524.9 21.08.2013  
(87) WO2012051587, 14.10.2011  
(97) 2627179, 21.08.2013 en  
(54) METHODS FOR INHIBITING CELL PROLIFERATION IN EGFR-DRIVEN CANCERS  
(71) ARIAD Pharmaceuticals, Inc, 26 Landsdowne Street, Cambridge, MA 02139, US  
(72) DALGARNO, David, C., 50 Crowninshield Road, Brookline MA 02446, US  
SHAKEPEARE, William, C., 2 Hublely Lane, Southborough MA 01772, US  
ZHU, Xiaotian, 137 Temple Street, Newton MA 02465, US  
RIVERA, Victor, M., 15 Lakeview Street, Arlington MA 02476, US  
MIRET, Juan, J., 9 Old Farm Circle, Shrewsbury MA 01545, US

(51) MKP  
**E06B 9/28 (2006.01)** (97) **2643539 \***  
**E06B 7/082 (2006.01)**  
(86) IT2010000510 22.12.2010  
(96) 10812955.2 02.10.2013  
(87) WO2012070077, 22.12.2010  
(97) 2643539, 02.10.2013 en  
(54) VENETIAN BLIND FOR INTERNAL USE WITH SLATS FIXED TO UPRIGHT CARRIER SLATS, DESIGNED FOR INCLUSION IN A GLASS-ENCLOSED CHAMBER  
(71) Pellini S.p.A., Via Fusari 19, 26845 Codogno (Lodi), IT  
(72) NICOLOSI, Giovanni, Via G. Di Vittorio 4, I-20070 Dresano (Milano), IT

- (51) MKP  
**A61K 31/405 (2006.01)** (97) **2614051 \***  
**A61P 35/00 (2006.01)**  
**C07D 209/42 (2006.01)**  
**C07D 209/30 (2006.01)**  
**C07D 209/14 (2006.01)**  
**C07D 209/26 (2006.01)**  
**A61K 31/404 (2006.01)**
- (86) US2011001553 08.09.2011  
(96) 11823879.9 17.07.2013  
(87) WO2012033525, 08.09.2011  
(97) 2614051, 17.07.2013 en  
(54) P53-MDM2 ANTAGONISTS  
(71) University of Pittsburgh - Of The Commonwealth System of Higher Education, 200 Gardner Steel Conference Center Thackeray & O'Hara Streets, Pittsburgh, PA 15260, US  
(72) DOEMLING, Alexander, 1200 Macon Ave., Pittsburgh, PA 15218, US
- 
- (51) MKP  
**B29C 44/44 (2006.01)** (97) **2599606**  
**B29C 37/00 (2006.01)**  
**B05D 1/02 (2006.01)**
- (96) 12195058.8 05.06.2013  
(97) 2599606, 05.06.2013 en  
(54) Method for the realization of objects of polystyrene covered with a hardened layer of polymeric material, preferably objects of decor and furniture  
(71) Caponi, Annarita, Via Molino dei Fichi 15, 56034 Casciana Terme (PI), IT  
(72) Salvadori, Fabio, Via Molino dei Fichi 15, 56034 Casciana Terme (PI), IT
- 
- (51) MKP  
**A61P 25/08 (2006.01)** (97) **2604602 \***  
**C07D 403/04 (2006.01)**  
**A61P 25/28 (2006.01)**  
**A61K 31/4155 (2006.01)**  
**A61P 25/36 (2006.01)**  
**A61K 31/4245 (2006.01)**  
**C07D 403/14 (2006.01)**  
**A61P 25/20 (2006.01)**  
**A61P 25/22 (2006.01)**  
**A61K 31/4439 (2006.01)**  
**C07D 413/04 (2006.01)**  
**A61P 25/04 (2006.01)**  
**C07D 413/14 (2006.01)**
- (86) JP2011068343 11.08.2011  
(96) 11816483.9 19.06.2013  
(87) WO2012020820, 11.08.2011  
(97) 2604602, 19.06.2013 en  
(54) HETEROARYL-PYRAZOLE DERIVATIVE  
(71) Taisho Pharmaceutical Co., Ltd., 24-1, Takada 3-chome Toshima-ku, Tokyo 170-8633, JP  
(72) NAKAMURA Toshio, c/o TAISHO PHARMACEUTICAL CO. LTD. 24-1 Takada 3-chome Toshima-ku, Tokyo 170-8633, JP SAKAGAMI Kazunari, c/o TAISHO PHARMACEUTICAL CO. LTD. 24-1 Takada 3-chome Toshima-ku, Tokyo 170-8633, JP KONISHI Kazuhide, c/o TAISHO PHARMACEUTICAL CO. LTD. 24-1 Takada 3-chome Toshima-ku, Tokyo 170-8633, JP YAMAMOTO Kanako, c/o TAISHO PHARMACEUTICAL CO. LTD. 24-1 Takada 3-chome Toshima-ku, Tokyo 170-8633, JP MASUDA Seiji, c/o TAISHO PHARMACEUTICAL CO. LTD. 24-1 Takada 3-chome Toshima-ku, Tokyo 170-8633, JP MATSUDA Yohei, c/o TAISHO PHARMACEUTICAL CO. LTD. 24-1 Takada 3-chome Toshima-ku, Tokyo 170-8633, JP OKADA Kumiko, c/o TAISHO PHARMACEUTICAL CO. LTD. 24-1 Takada 3-chome Toshima-ku, Tokyo 170-8633, JP SHIBATA Tsuyoshi, c/o TAISHO PHARMACEUTICAL CO. LTD. 24-1 Takada 3-chome Toshima-ku, Tokyo 170-8633, JP OHTA Hiroshi, c/o TAISHO PHARMACEUTICAL CO. LTD. 24-1 Takada 3-chome Toshima-ku, Tokyo 170-8633, JP YASUHARA Akito, c/o TAISHO PHARMACEUTICAL CO. LTD. 24-1 Takada 3-chome Toshima-ku, Tokyo 170-8633, JP KAWAMOTO Hiroshi, c/o TAISHO PHARMACEUTICAL CO. LTD. 24-1 Takada 3-chome Toshima-ku, Tokyo 170-8633, JP AMADA Hideaki, c/o TAISHO PHARMACEUTICAL CO. LTD. 24-1 Takada 3-chome Toshima-ku, Tokyo 170-8633, JP URABE Hiroki, c/o TAISHO PHARMACEUTICAL CO. LTD. 24-1 Takada 3-chome Toshima-ku, Tokyo 170-8633, JP NISHIKAWA Rie, c/o TAISHO PHARMACEUTICAL CO. LTD. 24-1 Takada 3-chome Toshima-ku, Tokyo 170-8633, JP KASHIWA Shuhei, c/o TAISHO PHARMACEUTICAL CO. LTD. 24-1 Takada 3-chome Toshima-ku, Tokyo 170-8633, JP
- 
- (51) MKP  
**F16K 3/26 (2006.01)** (97) **2535622**
- (96) 11169949.2 19.12.2012  
(97) 2535622, 19.12.2012 en  
(54) Valve assembly  
(71) Delphi Technologies Holding S.à.r.l., Avenue de Luxembourg, 4940 Bascharage, LU  
(72) Marechal, Michel, 48 route d'onzain, 41150 Chouzy Sur Cisse, FR  
Sauvage, Frederic, 43 rue du pont, 45190 Beaugency, FR  
Bellamy, Pascal, 5 rue Prateaux, 41120 Chailles, FR  
Breant, Christophe, 3 bis rue des Tilleuls, 41000 Saint Sulpice, FR
-

(51) MKP  
**C01B 17/02 (2006.01)** (97) **2643266 \***  
**C01B 17/00 (2006.01)**  
**B01J 2/12 (2006.01)**  
(86) US2011052012 16.09.2011  
(96) 11843884.5 02.10.2013  
(87) WO2012071104, 16.09.2011  
(97) 2643266, 02.10.2013 en  
(54) METHOD AND SYSTEM FOR GENERATING SULFUR SEEDS AND GRANULES  
(71) Brimrock International Inc., P.O. Box 191, Kilgore, TX 75663, US  
(72) LANG, Leslie L., 40 Sunpark Plaza Se Suite 308, Calgary AB T2Z 3X7, CA  
LARSON, Paul R., 40 Sunpark Plaza SE Suite 308, Calgary AB T2Z 3X7, CA  
IRANI, Jamsheed P., 40 Sunpark Plaza SE Suite 308, Calgary AB T2Z 3X7, CA  
DE PAOLI, Sergio A., 40 Sunpark Plaza SE Suite 308, Calgary AB T2Z 3X7, CA

(51) MKP  
**A61M 5/315 (2006.01)** (97) **2574358**  
**A61M 5/24 (2006.01)**  
(86) 12198968.5 03.04.2013  
(97) 2574358, 03.04.2013 en  
(54) Use of a spring in a drug delivery device  
(71) Sanofi-Aventis Deutschland GmbH, Brüningstraße 50, 65929 Frankfurt am Main, DE  
(72) Veasey, Robert F., 31 Lonsdale Road Lillington, Leamington Spa, Warwickshire CV32 7EP, GB  
Bilton, Simon Lewis, 47 Wathen Road, Leamington Spa, Warwickshire CV32 5UY, GB  
Jones, Christopher John, The Old Thatch Grafton, Tewkesbury, Gloucestershire GL20 7AT, GB  
Kouyoumjian, Garen, 2A Plymouth Place, Leamington Spa, Warwickshire CV31 1HN, GB  
MacDonald, Catherine Anne, 58 Highfields Close, Ashby-de-la-Zouch, Leicestershire LE65 2FN, GB

(51) MKP  
**A61K 39/395 (2006.01)** (97) **2624866 \***  
**C07K 16/00 (2006.01)**  
(86) US2011037972 25.05.2011  
(96) 11831066.3 14.08.2013  
(87) WO2012047317, 25.05.2011  
(97) 2624866, 14.08.2013 en  
(54) TUMOR SPECIFIC ANTIBODIES AND USES THEREFOR  
(71) The University Of North Carolina At Charlotte Office Of Technology Transfer, 305 Cameron Building 9201 University City Blvd., Charlotte, NC 28223-0001, US  
(72) MUKHERJEE, Pinku, 804 Wandering Way Drive, Waxhaw, NC 28173, US

(51) MKP  
**C12N 9/72 (2006.01)** (97) **2640834 \***  
**C12N 9/48 (2006.01)**  
(86) IN2011000790 15.11.2011  
(96) 11817539.7 25.09.2013  
(87) WO2012066569, 15.11.2011  
(97) 2640834, 25.09.2013 en  
(54) A NOVEL PROCESS FOR THE PURIFICATION OF TISSUE PLASMINOGEN ACTIVATOR  
(71) Cadila Healthcare Limited, Zydus Tower Satellite Cross Roads, Ahmedabad 380 015, Gujarat, IN  
(72) BANDYOPADHYAY, Sanjay, Cadila Healthcare Limited Zydus Tower Satellite Cross Roads Ahmedabad-380 015, Gujarat, IN  
MENDIRATTA, Sanjeev Kumar, Cadila Healthcare Limited Zydus Tower Satellite Cross Roads Ahmedabad-380 015, Gujarat, IN  
BANDYOPADHYAY, Sushobhan, Cadila Healthcare Limited Zydus Tower Satellite Cross Roads Ahmadabad-380 015, Guarat, IN

(51) MKP  
**H01M 4/36 (2006.01)** (97) **2638597 \***  
**H01M 10/0525 (2010.01)**  
**H01M 4/66 (2006.01)**  
**H01M 4/62 (2006.01)**  
**H01M 10/0566 (2010.01)**  
(86) US2011057028 20.10.2011  
(96) 11839945.0 18.09.2013  
(87) WO2012064481, 20.10.2011  
(97) 2638597, 18.09.2013 en  
(54) HIGH PERFORMANCE LITHIUM OR LITHIUM ION CELL  
(71) Leyden Energy, Inc., 46840 Lakeview Boulevard, Fremont, CA 94538, US  
(72) TIKHONOV, Konstantin, 4677 Carson Ct., Pleasanton CA 94588, US  
JOHNSON, Tobias, 35395 Monterra Circle, Union City CA 94587, US  
CHAU, Jesse, 6233 Zulmida Ave., Newark CA 94560, US  
YIP, Ka Ki, 1863 Washington Ave., San Leandro CA 94577, US  
JUZKOW, Marc, 782 Vinci Way, Livermore CA 94550, US

(51) MKP  
**C07D 471/04 (2006.01)** (97) **2638040 \***  
(86) EP2011069643 08.11.2011  
(96) 11779664.9 18.09.2013  
(87) WO2012062752, 08.11.2011  
(97) 2638040, 18.09.2013 en  
(54) RADIOLABELLED mGLuR2 PET LIGANDS  
(71) Janssen Pharmaceuticals, Inc., 1125 Trenton-Harbourton Road, Titusville, NJ 08560, US  
(72) ANDRÉS-GIL, José, Ignacio, c/o Janssen-Cilag S.A. Calle Jarama 75 Poligono Industrial, E-45007 Toledo, ES  
ALCÁZAR-VACA, Manuel, Jesús, c/o Janssen-Cilag S.A. Calle Jarama 75 Poligono Industrial, E-45007 Toledo, ES  
CID-NÚÑEZ, José, Maria, c/o Janssen-Cilag S.A. Calle Jarama 75 Poligono Industrial, E-45007 Toledo, ES  
TRABANCO-SUÁREZ, Andrés, Avelino, c/o Janssen-Cilag S.A. Calle Jarama 75 Poligono Industrial, E-45007 Toledo, ES  
BORMANS, Guy, Maurits R., c/o Katholieke Universiteit Leuven KU Leuven Research & Development Waaistraat 6, bus 5105,, B-3000 Leuven, BE  
CELEN, Sofie, Jeanne, Leopoldine, c/o Katholieke Universiteit Leuven KU Leuven Research & Development Waaistraat 6, bus 5105, B-3000 Leuven, BE  
KOOLE, Michel, c/o Katholieke Universiteit Leuven K.U.Leuven R&D Waisstraat 6 bus 5105, B-3000 Leuven, BE

(51) MKP  
**C07K 16/22 (2006.01)** (97) **2611831 \***  
**C07K 16/28 (2006.01)**  
**A61K 39/395 (2006.01)**  
**A61P 9/10 (2006.01)**  
(86) US2011001536 01.09.2011  
(96) 11758276.7 10.07.2013  
(87) WO2012030394, 01.09.2011  
(97) 2611831, 10.07.2013 en  
(54) TREATMENT OF MYOCARDIAL INFARCTION USING TGF - BETA ANTAGONISTS  
(71) Genzyme Corporation, 500 Kendall Street, Cambridge, MA 02142, US  
(72) AKITA, Geoffrey Y., 209 West St., Northborough Massachusetts 01532, US  
LONNING, Scott, 337 Olivia Dr., Northbridge Massachusetts 01534, US  
GREGORY, Richard C., Jr., 369 Old Connecticut Path, Framingham Massachusetts 01701, US  
KUDEJ, Amelia B., 9 Charles St., Westborough Massachusetts 01589, US

- (51) MKP  
**B65D 5/42 (2006.01)** (97) **2635499 \***  
**B65D 65/00 (2006.01)**  
(86) NZ2011000231 01.11.2011  
(96) 11838297.7 11.09.2013  
(87) WO2012060721, 01.11.2011  
(97) 2635499, 11.09.2013 en  
(54) IMPROVEMENTS IN AND RELATING TO PACKAGING  
(71) Corcel IP Limited, Level 12, James&Wells Intellectual Property KPMG Centre 85 Alexandra Street, Hamilton 3240, NZ  
(72) VAN BERLO, Patrick Petrus Antonius Maria, Level 12 C/- James&Wells Intellectual Property KPMG Centre 85 Alexandra Street, Hamilton 3240, NZ  
ROGERS, Jason Paul, Level 12 C/- James&Wells Intellectual Property KPMG Centre 85 Alexandra Street, Hamilton 3240, NZ

- (51) MKP  
**B65G 49/06 (2006.01)** (97) **2595906 \***  
(86) IB2011051355 30.03.2011  
(96) 11720866.0 29.05.2013  
(87) WO2012010985, 30.03.2011  
(97) 2595906, 29.05.2013 en  
(54) APPARATUS FOR THE APPLICATION OF SPACER ELEMENTS ONTO PLATES  
(71) Nort S.r.L., Via San Gaetano 223, 31044 Montebelluna (Treviso), IT  
(72) MAZZOCATO, Luca, c/o NORT S.r.l. Via San Gaetano 223, I-31044 Montebelluna (Treviso), IT

- (51) MKP  
**C10B 27/06 (2006.01)** (97) **2625248 \***  
**C10B 41/08 (2006.01)**  
(86) FR2011000541 05.10.2011  
(96) 11779734.0 14.08.2013  
(87) WO2012045926, 05.10.2011  
(97) 2625248, 14.08.2013 fr  
(54) COKING PLANT AND METHOD FOR CONTROLLING SAID PLANT  
(71) Arcelormittal Maizières Research S.A., Immeuble Le Cézanne 6, rue André Campra, 93200 Saint-Denis, FR  
(72) GAILLET, Jean-Paul, 1 impasse des Lys, F-57730 Petit-Ebersviller, FR  
PETIT, Etienne, 8 rue du Terreau, F-57420 Fey, FR  
ISLER, Daniel, 8 rue de Catalogne, F-57730 Folschvillers, FR  
DELINCHANT, Juliette, 7 rue de Mory, F-57690 Elvanche, FR

- (51) MKP  
**C12Q 1/00 (2006.01)** (97) **2625280 \***  
(86) US2011055473 07.10.2011  
(96) 11831724.7 14.08.2013  
(87) WO2012048292, 07.10.2011  
(97) 2625280, 14.08.2013 en  
(54) IGF-1 DEPENDENT MODULATION OF VSELS  
(71) University Of Louisville Research Foundation, Inc., Jouett Hall, Suite L102 2301 South Third Street, Louisville KY 40208, US  
(72) RATAJCZAK, Mariusz, 15311 Champion Lakes Place, Louisville KY 40245, US  
MAGDALENA, Kucia, 644 South 3rd Street Apt. 134, Louisville KY 40202, US  
RATAJCZAK, Janina, 15311 Champion Lakes Place, Louisville KY 40245, US

- (51) MKP  
**G01N 33/53 (2006.01)** (97) **2601525 \***  
(86) IT2011000276 01.08.2011  
(96) 11754539.2 12.06.2013  
(87) WO2012017466, 01.08.2011  
(97) 2601525, 12.06.2013 en  
(54) USE OF HMGB1 AS A BIOLOGICAL MARKER OF BOWEL INFLAMMATORY CONDITIONS, NON-INVASIVE METHOD FOR ITS DETECTION IN FECAL SAMPLES AND KIT THEREOF  
(71) D.M.G. Italia Srl, Via Laurentina Km 26,700, 00040 Pomezia (RM), IT  
(72) CUCCHIARA, Salvatore, Via Claudio Achillini 15, I-00141 Roma, IT  
STRONATI, Laura, Via Claudio Achillini 15, I-00141 Roma, IT  
VITALI, Roberta, Vicolo del Fosso di Tor Pagnotta 41, I-00134 Roma, IT

- (51) MKP  
**A44B 11/00 (2006.01)** (97) **2615937 \***  
(86) AT2011000373 13.09.2011  
(96) 11801952.0 24.07.2013  
(87) WO2012034151, 13.09.2011  
(97) 2615937, 24.07.2013 de  
(54) BELT BUCKLE THAT CAN BE DETACHED WITHOUT TOOLS AND THAT HAS AN INTEGRATED CONTAINER FOR CHECK CARDS, IDENTITY CARDS, A DRIVER'S LICENSE, AND THE LIKE  
(71) Ölzant, Eveline, Heidenreichsteiner Strasse 77/Top 3, 3872 Aalfang/Amaliendorf, AT  
(72) Ölzant, Eveline, Heidenreichsteiner Strasse 77/Top 3, 3872 Aalfang/Amaliendorf, AT

- (51) MKP  
**A61M 5/24 (2006.01)** (97) **2637719 \***  
**A61M 5/315 (2006.01)**  
(86) EP2011069582 08.11.2011  
(96) 11784621.2 18.09.2013  
(87) WO2012062717, 08.11.2011  
(97) 2637719, 18.09.2013 en  
(54) DOSE SETTING MECHANISM AND DRUG DELIVERY DEVICE  
(71) Sanofi-Aventis Deutschland GmbH, Brüningstrasse 50, 65926 Frankfurt am Main, DE  
(72) AVERY, Richard James Vincent, 28 Nursery Close Chipping Campden, Mickleton Gloucestershire GL55 6TX, GB  
DRAPER, Paul Richard, 2 Clyde Avenue, Evesham Worcestershire WR11 3SE, GB  
JAMES, Aled Meredydd, 1 Ettington Close, Dorridge West Midlands B93 8RR, GB

- (51) MKP  
**C11C 5/00 (2006.01)** (97) **2611895 \***  
(86) US2011049906 31.08.2011  
(96) 11822538.2 10.07.2013  
(87) WO2012030920, 31.08.2011  
(97) 2611895, 10.07.2013 en  
(54) DECORATIVE CANDLE AND METHOD  
(71) RAREEARTH, LLC, 1264 Park Road, Chanhassen MN 55317, US  
(72) JOBELIUS, Sherri, L., 156 Lake Street, Excelsior Minnesota 55331, US  
PAULSEN, Brian, T., 156 Lake Street, Excelsior Minnesota 55331, US

- (51) MKP  
**B61H 13/20 (2006.01)** (97) **2627548 \***  
**B61H 1/00 (2006.01)**  
(86) US2011053435 27.09.2011  
(96) 11833008.3 21.08.2013  
(87) WO2012050825, 27.09.2011  
(97) 2627548, 21.08.2013 en  
(54) RAILWAY TRUCK MOUNTED BRAKE RIGGING HAVING RAISED CONNECTION OF FORCE-TRANSMITTING MEMBER WITH TRANSFER LEVER  
(71) Wabtec Holding Corp., 1001 Air Brake Avenue, Wilmerding, PA 15148, US  
(72) MARLOW, Jonathon, 1430 Swift Street, Hobart Indiana 46342, US  
GREGAR, Peter, 1033 N 350 E, Chesterton Indiana 46304, US



(51) MKP  
**C04B 26/02 (2006.01)** (97) **2601151 \***  
**C04B 30/02 (2006.01)**  
**C04B 26/16 (2006.01)**  
**C04B 18/30 (2006.01)**  
**C04B 26/12 (2006.01)**  
(86) US2011046798 05.08.2011  
(96) 11758284.1 12.06.2013  
(87) WO2012019124, 05.08.2011  
(97) 2601151, 12.06.2013 en  
(54) COMPOSITE BUILDING MATERIALS AND METHODS OF MANUFACTURE  
(71) Material Innovations, LLC, 30 Kennedy Plaza, Suite 400, Providence, RI 02903, US  
(72) MANCOSH, Douglas, 30 Angell Court, Warwick RI 02889, US  
MURDOCH, David, E., 5775 Sells Mills Drive, Dublin OH 43017, US  
PRZYBILINSKI, James, 1554 Voorhees Circle, St. Helena CA 94574, US

(51) MKP  
**B65D 83/14 (2006.01)** (97) **2627454 \***  
**B65D 83/28 (2006.01)**  
**B65D 83/30 (2006.01)**  
**B05C 17/005 (2006.01)**  
(86) AT2011000423 11.10.2011  
(96) 11779081.6 21.08.2013  
(87) WO2012048358, 11.10.2011  
(97) 2627454, 21.08.2013 de  
(54) DEVICE FOR DISTRIBUTING ADHESIVE  
(71) Rathor AG, Rütistrasse 14, 9050 Appenzell, CH  
(72) VUJANIC, Aleksandar, Boppartshofweg 12, CH-9014 St. Gallen, CH  
BÜRKLE, Jochen, Ziegelackerstrasse 16, 71711 Steinheim, DE

(51) MKP  
**C07D 207/12 (2006.01)** (97) **2643295 \***  
**C07D 451/10 (2006.01)**  
**C07D 453/02 (2006.01)**  
**A61K 31/40 (2006.01)**  
**A61K 31/46 (2006.01)**  
**A61K 31/439 (2006.01)**  
**A61P 11/08 (2006.01)**  
**A61P 29/02 (2006.01)**  
(86) EP2011068894 27.10.2011  
(96) 11785359.8 02.10.2013  
(87) WO2012069275, 27.10.2011  
(97) 2643295, 02.10.2013 en  
(54) GLYCINE DERIVATIVES AND THEIR USE AS MUSCARINIC RECEPTOR ANTAGONISTS  
(71) Chiesi Farmaceutici S.p.A., Via Palermo, 26/A, 43100 Parma, IT  
(72) AMARI, Gabriele, c/o CHIESI FARMACEUTICI S.P.A. Via Palermo 26/A, I-43100 Parma, IT  
RICCABONI, Mauro, c/o CHIESI FARMACEUTICI S.P.A. Via Palermo 26/A, I-43100 Parma, IT  
FARINA, Marco, c/o CHIESI FARMACEUTICI S.P.A. Via Palermo 26/A, I-43100 Parma, IT

(51) MKP  
**C07K 16/00 (2006.01)** (97) **2640742 \***  
**C12N 15/10 (2006.01)**  
(86) EP2011070473 18.11.2011  
(96) 11785411.7 25.09.2013  
(87) WO2012066129, 18.11.2011  
(97) 2640742, 25.09.2013 en  
(54) A COLLECTION AND METHODS FOR ITS USE  
(71) MorphoSys AG, Lena-Christ-Strasse 48, 82152 Planegg-Martinsried, DE  
(72) URLINGER, Stefanie, Astenstraße 12, 80689 Munich, DE  
TILLER, Thomas, Sauerbruchstraße 60, 81377 Munich, DE  
SCHUSTER, Ingrid, Walchenseeplatz 1, 81539 Munich, DE  
STARK, Yvonne, Kreillerstrasse 7, 81673 Munich, DE

(51) MKP  
**C07C 69/753 (2006.01)** (97) **2626428**  
**C07C 213/08 (2006.01)**  
**C07C 62/34 (2006.01)**  
**C07C 217/58 (2006.01)**  
**C07D 223/16 (2006.01)**  
**C12P 7/40 (2006.01)**  
**C12P 7/62 (2006.01)**  
**C12P 41/00 (2006.01)**  
(96) 13154505.5 14.08.2013  
(97) 2626428, 14.08.2013 fr  
(54) Method for enzymatic synthesis of (7S)-3,4-dimethoxybicyclo[4.2.0]octa-1,3,5-triene-7-carboxylic acid or the esters thereof, and use for the synthesis of ivabradine and the salts thereof  
(71) Les Laboratoires Servier, 35, rue de Verdun, 92284 Suresnes Cedex, FR  
(72) Pedragosa Moreau, Sandrine, 79 bis rue Vieille Levée, 45100 ORLEANS, FR  
Lefoulon, François, 33, rue Jules Lemaître, 45000 ORLEANS, FR

(51) MKP  
**G06F 13/38 (2006.01)** (97) **2523117**  
(96) 11165722.7 14.11.2012  
(97) 2523117, 14.11.2012 en  
(54) Interface module for HW block  
(71) Telefonaktiebolaget L M Ericsson (publ), null, 164 83 Stockholm, SE  
(72) Breschel, Michael, Möllevångsvägen 16, SE-222 40, Lund, SE  
Brkic, Toni, Sköldgatan 2a, SE-212 29, Malmö, SE  
Malmberg, Magnus, Klockarevägen 151, SE-247 34, Södra Sandby, SE  
Bergh, Christel, Bokvägen 11, SE-247 36, Södra Sandby, SE  
Singh Ram, Satbinder, Koebelevvej 10 B, DK-2730, Herlev, DK

(51) MKP  
**F42B 12/40 (2006.01)** (97) **2630436 \***  
(86) US2011057485 24.10.2011  
(96) 11779053.5 28.08.2013  
(87) WO2012061065, 24.10.2011  
(97) 2630436, 28.08.2013 en  
(54) MULTI-MARKER MARKING SYSTEM  
(71) Cyalume Technologies, Inc, 96 Windsor Street, West Springfield MA 01089, US  
(72) CRANOR, Earl, 24 Lincoln Park, Longmeadow MA 01106, US

(51) MKP  
**A61F 2/00 (2006.01)** (97) **2635197 \***  
**A61B 17/03 (2006.01)**  
**A61B 17/08 (2006.01)**  
**A61L 31/02 (2006.01)**  
(86) US2011058936 02.11.2011  
(96) 11838738.0 11.09.2013  
(87) WO2012061486, 02.11.2011  
(97) 2635197, 11.09.2013 en  
(54) CLOSURE DEVICE, DEPLOYMENT APPARATUS, AND METHOD OF DEPLOYING A CLOSURE DEVICE  
(71) Transluminal Technologies, Inc., 2930 East Genesee Street, Syracuse, NY 13224-1614, US  
(72) GREEN, Stephen, M., 1 Drumlins Terrace, Syracuse, NY 13224, US  
FAIRMAN, Brian, 123 N. Hoopes Avenue, Auburn, NY 13021, US  
BRODT, Herbert, F., 2713 Webb Road, Lafayette, NY 13084, US  
BOGER, David, K., 1098 Lake Colny Lane, Vestavia Hills, AL 35242, US

- (51) MKP  
**C07C 237/22 (2006.01)** (97) **2640691 \***  
**C07C 229/22 (2006.01)**  
**C07C 233/47 (2006.01)**
- (86) EP2011069721 09.11.2011  
(96) 11779451.1 25.09.2013  
(87) WO2012065891, 09.11.2011  
(97) 2640691, 25.09.2013 en  
(54) PROCESS FOR PREPARING LACOSAMIDE  
(71) UCB Pharma GmbH, Alfred-Nobel-Strasse 10, 40789 Monheim, DE  
(72) MERSCHAERT, Alain, UCB PHARMA S.A. 60 Allée de la Recherche, B-1070 Brussels, BE  
SZCZEPANIAK, Christophe Joseph, UCB PHARMA S.A. 60 Allée de la Recherche, B-1070 Brussels, BE  
HAMANN, Joerg, Auguststrasse 45, 50733 Köln, DE  
KANZLER, Ralf, Duerer Strasse 23, 51371 Leverkusen, DE
- 
- (51) MKP  
**A61P 31/18 (2006.01)** (97) **2640720 \***  
**A61K 31/496 (2006.01)**  
**C07D 405/14 (2006.01)**
- (86) US2011061174 17.11.2011  
(96) 11842404.3 25.09.2013  
(87) WO2012068366, 17.11.2011  
(97) 2640720, 25.09.2013 en  
(54) BIFUNCTIONAL MOLECULES WITH ANTIBODY-RECRUITING AND ENTRY INHIBITORY ACTIVITY AGAINST THE HUMAN IMMUNODEFICIENCY VIRUS  
(71) Yale University, Inc., 2 Whitney Avenue, New Haven, CT 06511, US  
(72) SPIEGEL, David, 33 North Water Street Unit 407, Norwalk CT 06854, US  
PARKER, Christopher, 545 Whitney Avenue Apt. No. 3, New Haven CT 06515, US
- 
- (51) MKP  
**A23L 1/0524 (2006.01)** (97) **2600734 \***  
**A23G 3/54 (2006.01)**
- (86) EP2011063486 04.08.2011  
(96) 11741209.8 12.06.2013  
(87) WO2012017054, 04.08.2011  
(97) 2600734, 12.06.2013 en  
(54) "GUMDROPS WITH FLUID FILLING AND METHOD OF OBTAINING THEM"  
(71) Perfetti Van Melle S.p.A., Via XXV Aprile, 7, 20020 Lainate (Milano), IT  
(72) ZANNI, Massimiliano, c/o PERFETTI VAN MELLE S.P.A. Via XXV Aprile 7, I-20020 Lainate (MI), IT  
BRUIN, Pieter Jacob, c/o PERFETTI VAN MELLE S.P.A. Via XXV Aprile 7, I-20020 Lainate (MI), IT  
COLLE, Roberto, c/o PERFETTI VAN MELLE S.P.A. Via XXV Aprile 7, I-20020 Lainate (MI), IT  
HENDRIKX, Henri, c/o PERFETTI VAN MELLE S.P.A. Via XXV Aprile 7, I-20020 Lainate (MI), IT  
RUGGERI, Alessandro, c/o PERFETTI VAN MELLE S.P.A. Via XXV Aprile 7, I-20020 Lainate (MI), IT
- 
- (51) MKP  
**H01H 36/00 (2006.01)** (97) **2590197**
- (96) 12186428.4 08.05.2013  
(97) 2590197, 08.05.2013 en  
(54) Magnetic sensor designed to operate with a corresponding magnet and magnetic contact comprising said magnetic sensor and corresponding magnet  
(71) Tsec S.r.l., Via Gavardina Trav. I, 74, 25081 Bedizzole (BS), IT  
(72) Salgarelli, Luca, Via Manara 20, 20045 Besana in Brianza MI, IT
- 
- (51) MKP  
**B65D 51/28 (2006.01)** (97) **2616354 \***
- (86) IB2011002151 15.09.2011  
(96) 11776848.1 24.07.2013  
(87) WO2012035417, 15.09.2011  
(97) 2616354, 24.07.2013 en  
(54) CLOSING DEVICE FOR A CONTAINER AND CONTAINER COMPRISING SAID CLOSING DEVICE  
(71) Biofarma SPA, Via Castelliere 2, 33036 Mereto Di Tomba, IT  
(72) SCARPA, Germano, Via Gorizia 9, I-33100 Udine, IT  
COGOLLO, Luigi, Via Giusto Muratti 66, I-33100 Udine, IT
- 
- (51) MKP  
**A61L 2/12 (2006.01)** (97) **2598176 \***
- (86) FR2011051821 28.07.2011  
(96) 11757364.2 05.06.2013  
(87) WO2012013903, 28.07.2011  
(97) 2598176, 05.06.2013 fr  
(54) METHOD FOR DISINFECTING BEDDING ITEMS BY MICROWAVES, IN PARTICULAR MATTRESSES, AND RELATED FACILITY  
(71) Ecoval Environnement, 8 Allée des Palombes, 77185 Lognes, FR  
(72) LANZA, Rémy, Chemin du Félin, F-84500 Bollene, FR  
TOUATI, Salim, 9 rue Anatole France Le Grand Monarque, F-26250 Livron Sur Drome, FR
- 
- (51) MKP  
**H04N 21/41 (2011.01)** (97) **2619991 \***  
**H04N 21/436 (2011.01)**  
**H04N 5/44 (2011.01)**  
**H04M 1/725 (2006.01)**  
**G06F 1/16 (2006.01)**
- (86) US2011001636 22.09.2011  
(96) 11764007.8 31.07.2013  
(87) WO2012039770, 22.09.2011  
(97) 2619991, 31.07.2013 en  
(54) PROGRAMMABLE MULTIMEDIA CONTROL SYSTEM HAVING A TACTILE REMOTE CONTROL  
(71) Savant Systems LLC., 886 Main Street, Osterville, MA 02655, US  
(72) CORSINI, Peter, H., 7 Marshview Circle, East Sandwich MA 02537, US  
LOCASCIO, Timothy, R., 424 Old Mill Road, Osterville MA 02655, US  
NOONAN, Michael, E., 7 Rolling Ridge Lane, Sandwich MA 02563, US  
SILVA, Michael, C., 6 Fairchild Drive, East Sandwich MA 02537, US
- 
- (51) MKP  
**C12Q 1/68 (2006.01)** (97) **2643470 \***  
**G01N 33/53 (2006.01)**  
**C12Q 1/00 (2006.01)**
- (86) US2011062062 23.11.2011  
(96) 11842505.7 02.10.2013  
(87) WO2012071525, 23.11.2011  
(97) 2643470, 02.10.2013 en  
(54) COMPOSITIONS AND METHODS FOR DIAGNOSING AND TREATING DISEASES AND DISORDERS ASSOCIATED WITH D-DT  
(71) Yale University, Two Whitney Avenue, New Haven, CT 06511, US  
(72) BUCALA, Richard, J., 22 Benenson Drive, Cos Cob, CT 06807-1406, US  
YOUNG, Lawrence, H., 14 October Hill Road, Woodbridge, CT 06525, US
- 
- (51) MKP  
**A61K 39/395 (2006.01)** (97) **2611464 \***
- (86) US2011050439 02.09.2011  
(96) 11820900.6 10.07.2013  
(87) WO2012031273, 02.09.2011  
(97) 2611464, 10.07.2013 en  
(54) NOVEL MODULATORS AND METHODS OF USE  
(71) Stem Centrx, Inc., 450 East Jamie Court, South San Francisco, CA 94080, US  
(72) DYLLA, Scott, J., 743 Wake Forest Drive, Mountain View, California 94043, US  
FOORD, Orit, 712 Cayman Lane, Foster City, California 94404, US  
STULL, Robert, A., 1519 Fifth Street, Alameda, California 94501, US  
ANDERSON, Wade, C., 5177 Pond Side Way, Fairfield, California 94534, US  
OHSHIMA, Saiyou, 10100 Torre Avenue Apt. 214, Cupertino, California 95014, US

(51) MKP  
**C07D 413/14 (2006.01)** (97) **2625177 \***  
**C07D 417/14 (2006.01)**  
**A61K 31/506 (2006.01)**  
**A61P 3/10 (2006.01)**  
(86) IN2011000694 05.10.2011  
(96) 11805633.2 14.08.2013  
(87) WO2012046249, 05.10.2011  
(97) 2625177, 14.08.2013 en  
(54) NOVEL GPR 119 AGONISTS  
(71) Cadila Healthcare Limited, Zydus Tower Satellite Cross Roads, Ahmedabad 380 015, Gujarat, IN  
(72) PINGALI, Harikishore, Cadila Healthcare Limited Zydus Tower Satellite Cross Road, Ahmedabad 380015 Gujarat, IN  
ZAWARE, Pandurang, Cadila Healthcare Limited Zydus Tower Satellite Cross Road, Ahmedabad 380015 Gujarat, IN

(51) MKP  
**F42B 12/40 (2006.01)** (97) **2630215 \***  
**C09K 11/07 (2006.01)**  
**F42B 12/36 (2006.01)**  
(86) US2011057437 24.10.2011  
(96) 11779050.1 28.08.2013  
(87) WO2012058139, 24.10.2011  
(97) 2630215, 28.08.2013 en  
(54) COMBINED THERMAL AND CHEMILUMINESCENT REACTION SYSTEM  
(71) Cyalume Technologies, Inc, 96 Windsor Street, West Springfield, MA 01089, US  
(72) CRANOR, Earl, 24 Lincoln Park, Longmeadow MA 01106, US  
JACOB, Linda, 98 Maple Vale Drive, Woodbridge CT 06525, US

(51) MKP  
**C07D 471/04 (2006.01)** (97) **2635578 \***  
**C07D 487/04 (2006.01)**  
**A61K 31/5025 (2006.01)**  
**A61P 35/00 (2006.01)**  
(86) US2011066837 22.12.2011  
(96) 11808541.4 11.09.2013  
(87) WO2012088411, 22.12.2011  
(97) 2635578, 11.09.2013 en  
(54) 2-ARYLIMIDAZO[1,2-B]PYRIDAZINE, 2-PHENYLIMIDAZO[1,2-A]PYRIDINE, AND 2-PHENYLIMIDAZO[1,2-A]PYRAZINE DERIVATIVES  
(71) Hengrui (USA) Ltd., 2005 Eastpark Boulevard, Cranbury, New Jersey 08512, US  
(72) ATKINSON, Robert N., 11908 Radner Way, Raleigh, NC 27613, US  
OMMEN, Andy J., 804 South Colorado Ave, Laramie, WY 82070, US  
VEAL, James M., 8916 Weaver Crossing Road, Apex, NC 27502, US  
HUANG, Kenneth H., 214 Glenmore Road, Chapel Hill, NC 27516, US  
SMITH, Emilie, D., 709 Straywhite Avenue, Apex, NC 27539, US

(51) MKP  
**A61K 47/48 (2006.01)** (97) **2640422 \***  
**A61P 35/00 (2006.01)**  
(86) EP2011070441 18.11.2011  
(96) 11784668.3 25.09.2013  
(87) WO2012066117, 18.11.2011  
(97) 2640422, 25.09.2013 en  
(54) POLYMERIC CONJUGATES OF ACTIVE PRINCIPLES, THEIR PROCESS OF PREPARATION AND THEIR POLYMERIC INTERMEDIATES  
(71) SANOFI, 54, rue de la Boétie, 75008 Paris, FR  
Centre National de la Recherche Scientifique (C.N.R.S.), 3, rue Michel Ange, 75016 Paris, FR  
Universite Paul Sabatier Toulouse III, 118 route de Narbonne, 31062 Toulouse Cedex 9, FR  
(72) AMGOUNE, Abderrahmane, 16 avenue Maurice Bourges-Manoury, F-31200 Toulouse, FR  
BAZILE, Didier, c/o Sanofi Patent Department 174 avenue de France, F-75013 Paris, FR  
BENSAID, Fethi, 8 rue Hubert Monloup, F-31200 Toulouse, FR  
BOURISSOU, Didier, 7 bis rue de Charlas, F-31830 Plaisance Du Touch, FR  
DIDIER, Eric, c/o Sanofi Patent Department 174 avenue de France, F-75013 Paris, FR  
GRECO, Stéphanie, c/o Sanofi Patent Department 174 avenue de France, F-75013 Paris, FR  
LAKKIREDDY, Harivardhan Reddy, c/o Sanofi Patent Department 174 avenue de France, F-75013 Paris, FR  
SABLE, Serge, c/o Sanofi Patent Department 174 avenue de France, F-75013 Paris, FR  
VEILLARD, Michel, c/o Sanofi Patent Department 174 avenue de France, F-75013 Paris, FR

(51) MKP  
**C12N 15/82 (2006.01)** (97) **2622082 \***  
**A61K 39/145 (2006.01)**  
(86) EP2011004874 29.09.2011  
(96) 11769781.3 07.08.2013  
(87) WO2012041503, 29.09.2011  
(97) 2622082, 07.08.2013 en  
(54) GENERATION OF VIROSOME PARTICLES  
(71) Franvax S.r.l., Stradale Agnelli Angolo Stradale Lancia Blocco Palma 1, Zona Industriale, 95121 Catania, IT  
(72) DI NARO, Maria, c/o FRANVAX S.R.L. Stradale Agnelli Angolo Stradale Lancia Blocco Palma 1 Zona Industriale, I-95121 Catania, IT

(51) MKP  
**C07D 487/04 (2006.01)** (97) **2595987 \***  
**C07D 493/14 (2006.01)**  
**C07D 495/14 (2006.01)**  
**C07D 498/14 (2006.01)**  
**A61K 31/517 (2006.01)**  
**A61P 35/00 (2006.01)**  
(86) EP2011062683 22.07.2011  
(96) 11734158.6 29.05.2013  
(87) WO2012010704, 22.07.2011  
(97) 2595987, 29.05.2013 en  
(54) NEW AMINOPYRAZOLOQUINAZOLINES  
(71) Boehringer Ingelheim International GmbH, Binger Strasse 173, 55216 Ingelheim am Rhein, DE  
(72) TREU, Matthias, Boehringer Ingelheim GmbH Corporate Patents Binger Strasse 173, 55216 Ingelheim am Rhein, DE

(51) MKP  
**E21B 19/24 (2006.01)** (97) **2643542 \***  
**E21B 33/06 (2006.01)**  
(86) GB2011052293 22.11.2011  
(96) 11804745.5 02.10.2013  
(87) WO2012069822, 22.11.2011  
(97) 2643542, 02.10.2013 en  
(54) VALVE APPARATUS AND IMPROVED RAM  
(71) Hunting Energy Services (Well Intervention) Ltd, Silverburn Place Bridge of Don, Aberdeen AB23 8EG, GB  
(72) BROWN, Gareth Edward George, 88 Kalamunda Road, Kalamunda Western Australia 6076, AU  
RITCHIE, Colin, 21 Betteral Road Kingseat Meadows Kingseat Aberdeen, Aberdeenshire AB21 0AT, GB

- (51) MKP  
**A01N 25/02 (2006.01)** (97) **2611292 \***  
**A01N 25/30 (2006.01)**  
**A01N 51/00 (2006.01)**
- (86) DK2011050327 30.08.2011  
(96) 11751531.2 10.07.2013  
(87) WO2012028151, 30.08.2011  
(97) 2611292, 10.07.2013 en  
(54) NEONICOTINYL FORMULATIONS  
(71) Cheminova A/S, P.O. Box 9, 7620 Lemvig, DK  
(72) BATTAL, Turgut, Æblebakken 6, DK-7600 Struer, DK
- 
- (51) MKP  
**A61K 9/00 (2006.01)** (97) **2522342**  
**A61P 31/10 (2006.01)**  
**A61K 31/19 (2006.01)**  
**A61P 17/12 (2006.01)**  
**A61K 45/06 (2006.01)**  
**A61K 31/17 (2006.01)**
- (96) 12167943.5 14.11.2012  
(97) 2522342, 14.11.2012 en  
(54) A topical formulation for treatment of hyperkeratotic skin  
(71) Auxilium Cura Innovatio, 21 Priory Hall Stillorgan, Co. Dublin, IE  
(72) Sundbom Nilsson, Johan, Kungsvägen 6, SE-182 79 Stocksund, SE  
Lodén, Marie, Bergshamra Allé 9, SE-170 77 Solna, SE
- 
- (51) MKP  
**A61K 9/16 (2006.01)** (97) **2605756 \***  
**A61K 9/50 (2006.01)**
- (86) IL2011000676 18.08.2011  
(96) 11817865.6 26.06.2013  
(87) WO2012023142, 18.08.2011  
(97) 2605756, 26.06.2013 en  
(54) FUNCTIONAL FOOD COMPOSITIONS AND METHODS  
(71) Clearfarma Industries Ltd., 25 Lehi St., 51200 Bnei Brak, IL  
(72) FRIEDMAN, Doron, 33 Alon St., 99797 Carme-Yosef, IL  
STRASSMANN, Gideon, 5600 SW 74th Ct., Miami Florida 33143, US  
SHMULEWITZ, Ascher, 20 Yoav St., 69081 Tel Aviv, IL
- 
- (51) MKP  
**G06F 19/00 (2011.01)** (97) **2603622 \***  
**C40B 30/04 (2006.01)**
- (86) US2011047570 12.08.2011  
(96) 11817097.6 19.06.2013  
(87) WO2012021795, 12.08.2011  
(97) 2603622, 19.06.2013 en  
(54) PANCREATIC CANCER BIOMARKERS AND USES THEREOF  
(71) Somalogic, Inc., 2945 Wilderness Place, Boulder, CO 80301, US  
(72) WILLIAMS, Stephen, Alaric, 3111 4th Street, Boulder Colorado 80304, US  
RIEL-MEHAN, Michael, 845 W. Linden St., Louisville Colorado 80027, US  
OSTROFF, Rachel, M., 10203 King Court, Westminster Colorado 80031, US
- 
- (51) MKP  
**E21B 43/12 (2006.01)** (97) **2619404 \***  
**E21B 43/25 (2006.01)**  
**E21B 34/14 (2006.01)**
- (86) CA2011001027 12.09.2011  
(96) 11826241.9 31.07.2013  
(87) WO2012037645, 12.09.2011  
(97) 2619404, 31.07.2013 en  
(54) WELLBORE FRAC TOOL WITH INFLOW CONTROL  
(71) Packers Plus Energy Services Inc., Bow Valley Square 2 Suite 2200, 205 - 5 Avenue SW, Calgary, Alberta T2P 2V7, CA  
(72) THEMIG, Daniel Jon, 256 Woodhaven Place SW, Calgary Alberta T2W 5P9, CA
- 
- (51) MKP  
**D05C 17/02 (2006.01)** (97) **2635734 \***
- (86) NL2011050742 01.11.2011  
(96) 11779885.0 11.09.2013  
(87) WO2012060698, 01.11.2011  
(97) 2635734, 11.09.2013 en  
(54) METHOD OF MANUFACTURING A CARPET OR CARPET TILE, CARPET OR CARPET TILE OBTAINED BY PERFORMING THE MANUFACTURING METHOD, AND SUPPORT MATERIAL FOR USE IN THE METHOD  
(71) Interface European Manufacturing B.V., 15 Industrielaan, 3925 BD Scherpenzeel, NL  
(72) VOGEL, Petrus Govardus Johannes, 50, Planterslaan, 3956 VX Leersum, NL  
VAN DE BOVENKAMP, Hendrik Jacobus, Castorweg, 7557 KH Hengelo, NL
- 
- (51) MKP  
**G07F 17/32 (2006.01)** (97) **2636031 \***  
**G06F 3/048 (2013.01)**
- (86) IB2011003047 02.11.2011  
(96) 11815701.5 11.09.2013  
(87) WO2012059822, 02.11.2011  
(97) 2636031, 11.09.2013 en  
(54) APPARATUS AND SYSTEM FOR REVEALING GRAPHICAL ITEMS ON A MULTI-TOUCH INTERFACE  
(71) Novomatic AG, Wiener Strasse 158, 2352 Gumpoldskirchen, AT  
(72) HOMER, Alois, Hufgasse 9, A-1210 Vienna, AT
- 
- (51) MKP  
**F01L 7/12 (2006.01)** (97) **2598728 \***  
**F02B 33/04 (2006.01)**  
**F01L 7/02 (2006.01)**
- (86) EP2011062931 27.07.2011  
(96) 11736371.3 05.06.2013  
(87) WO2012013715, 27.07.2011  
(97) 2598728, 05.06.2013 en  
(54) DISCHARGE VALVE ASSEMBLY FOR TWO-STROKE ENGINE, PROVIDED WITH COOLING, NON-CONTACTING SEAL AND SELF-CLEANING  
(71) E2F di Esposti Federici Ettore, 2 Via Amendola, 06039 Trevi (PG), IT  
(72) ESPOSTI FEDERICI, Ettore, 2 Via Amendola, I-06039 Trevi (PG), IT
- 
- (51) MKP  
**A61K 39/395 (2006.01)** (97) **2629796 \***
- (86) US2011001787 19.10.2011  
(96) 11834758.2 28.08.2013  
(87) WO2012054084, 19.10.2011  
(97) 2629796, 28.08.2013 en  
(54) ANTIBODIES  
(71) Oxford Biotherapeutics Ltd., 94A Milton Park, Abingdon, Oxon OX14 4RY, GB  
(72) TERRETT, Jonathan, Alexander, Oxford Bio Therapeutics Inc. San Jose Biocenter 5941 Optical Court, San Jose, CA 95138, US
- 
- (51) MKP  
**G06Q 30/00 (2012.01)** (97) **2601628 \***  
**G07C 9/00 (2006.01)**
- (86) IB2011052160 17.05.2011  
(96) 11727778.0 12.06.2013  
(87) WO2011145054, 17.05.2011  
(97) 2601628, 12.06.2013 en  
(54) METHODS FOR USING A SHOPPING BAG OF REUSABLE TYPE WITH IDENTIFICATION OF DIGITAL TYPE  
(71) Carnevale, Vittoria, Via Pollella 30, 87038 San Lucido (CS), IT  
(72) Carnevale, Vittoria, Via Pollella 30, 87038 San Lucido (CS), IT

(51) MKP  
**C01B 31/02 (2006.01)** (97) **2616391 \***  
**B01J 35/00 (2006.01)**  
**B01J 37/16 (2006.01)**  
(86) NL2011050628 16.09.2011  
(96) 11760877.8 24.07.2013  
(87) WO2012036555, 16.09.2011  
(97) 2616391, 24.07.2013 en  
(54) CARBON NANOSTRUCTURES AND NETWORKS PRODUCED BY CHEMICAL VAPOR DEPOSITION  
(71) Delft Enterprises B.V., Mekelweg 2, 2628 CD Delft, NL  
(72) KOWLGI, Krishna Narayan Kumar, c/a Technische Universiteit Delft Valorisation Centre Postbus 5, NL-2600 AA Delft, NL  
KOPER, Gerardus Joseph Maria, c/a Technische Universiteit Delft Valorisation Centre Postbus 5, NL-2600 AA Delft, NL  
VAN RAALTEN, Rutger Alexander David, c/a Technische Universiteit Delft Valorisation Centre Postbus 5, NL-2600 AA Delft, NL

(51) MKP  
**A61B 3/113 (2006.01)** (97) **2632322 \***  
**G06F 3/01 (2006.01)**  
**G06T 7/00 (2006.01)**  
(86) EP2010066495 29.10.2010  
(96) 10784460.7 04.09.2013  
(87) WO2012055444, 29.10.2010  
(97) 2632322, 04.09.2013 en  
(54) METHOD OF DETERMINING REFLECTIONS OF LIGHT  
(71) IT-universitetet I København, Rued Langgaards Vej 7, 2300 Copenhagen S, DK  
(72) HANSEN, Dan Witzner, Vandmanden 70, DK-3650 Ølstykke, DK

(51) MKP  
**A61K 31/351 (2006.01)** (97) **2629756 \***  
**A61K 9/06 (2006.01)**  
**A61K 9/00 (2006.01)**  
**A61K 47/46 (2006.01)**  
(86) EP2011068242 19.10.2011  
(96) 11770791.9 28.08.2013  
(87) WO2012052472, 19.10.2011  
(97) 2629756, 28.08.2013 en  
(54) PHARMACEUTICAL TOPICAL COMPOSITION OF MUPIROCIN  
(71) Laboratorios Ojer Pharma S.L., C/ Sancho El Mayor 2, 1º Iz, 31002 Pamplona, ES  
(72) GONZÁLEZ OJER, Carlos, Av. Baja Navarra 17, 2º izq., E-31002 Pamplona, ES  
GOÑI ALLO, Beatriz, C. Santa Alodia 8, 1º izq., E-31014 Pamplona, ES  
PASTOR FERNÁNDEZ, Fiona, Av. Los Chopos 37-A, 1B, E-48990 Getxo, ES  
YÁRNOZ DE MIGUEL, Cayetana, C. Monasterio de Cilveti 2, 2º C, E-31011 Pamplona, ES

(51) MKP  
**B29D 11/00 (2006.01)** (97) **2637847 \***  
(86) US2011059718 08.11.2011  
(96) 11785245.9 18.09.2013  
(87) WO2012064699, 08.11.2011  
(97) 2637847, 18.09.2013 en  
(54) METHOD FOR MAKING CONTACT LENSES  
(71) Novartis AG, Lichtstrasse 35, 4056 Basel, CH  
(72) HOLLAND, Troy, Vernon, 357 Breezewood Court, Suwanee Georgia 30024, US  
SMITH, Dawn Alison, 230A Ranolf Street, Rotorua 3010, NZ

(51) MKP  
**H04L 29/06 (2006.01)** (97) **2636203 \***  
**H04W 4/02 (2009.01)**  
(86) US2011059455 04.11.2011  
(96) 11788658.0 11.09.2013  
(87) WO2012087435, 04.11.2011  
(97) 2636203, 11.09.2013 en  
(54) AUTHENTICATION IN SECURE USER PLANE LOCATION (SUPL) SYSTEMS  
(71) Qualcomm Incorporated, 5775 Morehouse Drive, San Diego CA 92121-1714, US  
(72) HAWKES, Philip Michael, 5775 Morehouse Drive, San Diego California 92121, US  
WACHTER, Andreas Klaus, 5775 Morehouse Drive, San Diego California 92121, US  
ESCOTT, Adrian Edward, 5775 Morehouse Drive, San Diego California 92121, US  
EDGE, Stephen William, 5775 Morehouse Drive, San Diego California 92121, US

(51) MKP  
**C07C 1/04 (2006.01)** (97) **2598464 \***  
**C10L 3/08 (2006.01)**  
(86) EP2011061893 12.07.2011  
(96) 11738676.3 05.06.2013  
(87) WO2012013493, 12.07.2011  
(97) 2598464, 05.06.2013 de  
(54) PROCESS FOR PRODUCING A METHANE-CONTAINING GAS FROM SYNTHESIS GAS AND METHANE PRODUCTION PLANT FOR CARRYING OUT THE PROCESS  
(71) ThyssenKrupp Uhde GmbH, Friedrich-Uhde-Strasse 15, 44141 Dortmund, DE  
(72) MENZEL, Johannes, Krummer Weg 8, 45731 Waltrop, DE  
THIELERT, Holger, Westerwikstrasse 38, 44379 Dortmund, DE

(51) MKP  
**A61F 6/18 (2006.01)** (97) **2632398 \***  
(86) FI2011050933 26.10.2011  
(96) 11785459.6 04.09.2013  
(87) WO2012056105, 26.10.2011  
(97) 2632398, 04.09.2013 en  
(54) AN INSERTER FOR AN INTRAUTERINE SYSTEM  
(71) Bayer Oy, P.O. Box 415, 20101 Turku, FI  
(72) JUTILA, Ilkka, Osmalahdenmutka 1, FI-21570 Sauvo, FI  
LYYTIKÄINEN, Heikki, Onkitie 2, FI-21100 Naantali, FI

(51) MKP  
**C07K 1/36 (2006.01)** (97) **2598516 \***  
**C07K 16/24 (2006.01)**  
**C07K 14/245 (2006.01)**  
(86) GB2011001129 27.07.2011  
(96) 11745810.9 05.06.2013  
(87) WO2012013930, 27.07.2011  
(97) 2598516, 05.06.2013 en  
(54) PROCESS FOR PURIFYING PROTEINS  
(71) UCB Pharma, S.A., 60, allée de la Recherche, 1170 Brussels, BE  
(72) WILD, Gavin, Barry, IPD, UCB Celltech 208 Bath Road, Slough, Berkshire SL1 3WE, GB

- (51) MKP  
**C07D 401/12 (2006.01)** (97) **2606042 \***  
**C07D 401/14 (2006.01)**  
**C07D 403/12 (2006.01)**  
**A61K 31/455 (2006.01)**  
**A61K 31/506 (2006.01)**  
**A61K 31/501 (2006.01)**  
**A61P 29/00 (2006.01)**  
**A61P 11/00 (2006.01)**  
**A61P 19/02 (2006.01)**  
**A61P 17/00 (2006.01)**
- (86) EP2011064260 19.08.2011  
(96) 11748634.0 26.06.2013  
(87) WO2012022795, 19.08.2011  
(97) 2606042, 26.06.2013 de  
(54) DISUBSTITUTED TETRAHYDOFURANYL COMPOUNDS AS ANTAGONISTS OF THE BRADYKININ B1 RECEPTOR  
(71) Boehringer Ingelheim International GmbH, Binger Strasse 173, 55216 Ingelheim am Rhein, DE  
(72) HAUDEL, Norbert, Boehringer Ingelheim GmbH Corporate Patents Binger Strasse 173, 55216 Ingelheim Am Rhein, DE  
CECI, Angelo, Boehringer Ingelheim GmbH Corporate Patents Binger Strasse 173, 55216 Ingelheim Am Rhein, DE  
DOODS, Henri, Boehringer Ingelheim GmbH Corporate Patents Binger Strasse 173, 55216 Ingelheim Am Rhein, DE  
JUNG, Birgit, Boehringer Ingelheim GmbH Corporate Patents Binger Strasse 173, 55216 Ingelheim Am Rhein, DE  
KUELZER, Raimund, Boehringer Ingelheim GmbH Corporate Patents Binger Strasse 173, 55216 Ingelheim Am Rhein, DE
- 
- (51) MKP  
**A61P 9/08 (2006.01)** (97) **2638042 \***  
**C07D 471/10 (2006.01)**  
**A61K 31/519 (2006.01)**  
**A61K 31/437 (2006.01)**
- (86) US2011060081 10.11.2011  
(96) 11787987.4 18.09.2013  
(87) WO2012064910, 10.11.2011  
(97) 2638042, 18.09.2013 en  
(54) PIPERIDINONE CARBOXAMIDE AZAINDANE CGRP RECEPTOR ANTAGONISTS  
(71) Merck Sharp & Dohme Corp., 126 East Lincoln Avenue, Rahway, NJ 07065-0907, US  
(72) BELL, Ian, M., 770 Sumneytown Pike, West Point Pennsylvania 19486, US  
FRALEY, Mark, E., 770 Sumneytown Pike, West Point Pennsylvania 19486, US  
GALLICCHIO, Steven, N., 770 Sumneytown Pike, West Point Pennsylvania 19486, US  
GINNETTI, Anthony, 770 Sumneytown Pike, West Point Pennsylvania 19486, US  
MITCHELL, Helen, J., 770 Sumneytown Pike, West Point Pennsylvania 19486, US  
PAONE, Daniel, V., 770 Sumneytown Pike, West Point Pennsylvania 19486, US  
STAAS, Donnette, D., 770 Sumneytown Pike, West Point Pennsylvania 19486, US  
WANG, Cheng, 770 Sumneytown Pike, West Point Pennsylvania 19486, US  
ZARTMAN, C. Blair, 770 Sumneytown Pike, West Point Pennsylvania 19486, US  
STEVENSON, Heather, E., 330 W. 6th Avenue, Conshohocken Pennsylvania 19428, US
- 
- (51) MKP  
**A61K 38/17 (2006.01)** (97) **2630963**  
**A61P 35/00 (2006.01)**
- (96) 13166837.8 28.08.2013  
(97) 2630963, 28.08.2013 en  
(54) SPARC angiogenic domain and methods of use  
(71) Abraxis BioScience, LLC, 11755 Wilshire Boulevard Suite 2000, Los Angeles, CA 90025, US  
(72) Trieu, Vuong, 4003 Jim Bowie Boulevard, Agoura Hills, CA 91301, US  
Knauer, Daniel, 1109 El Camino Drive, Costa Mesa, CA 92626, US  
Desai, Neil P., 11755 Wilshire Boulevard, Suite 2310, Los Angeles, CA 90025, US
- 
- (51) MKP  
**B63B 25/00 (2006.01)** (97) **2607224**  
**B63B 25/12 (2006.01)**  
**F02M 21/02 (2006.01)**
- (96) 11010174.8 26.06.2013  
(97) 2607224, 26.06.2013 de  
(54) Buoyant body, in particular container ship  
(71) Technolog GmbH Handels- und Beteiligungsgesellschaft Für Technologie, Kajen 6-8, Detjen Haus, 20459 Hamburg, DE  
(72) Radebold, Helmut, Deichweg 5, 25379 Herzhorn, DE  
Pruin, Berend, Binnenfeld 17, 21423 Winsen, DE
- 
- (51) MKP  
**A61K 31/17 (2006.01)** (97) **2621486 \***  
**A61K 31/18 (2006.01)**  
**A61K 31/44 (2006.01)**  
**A61P 35/00 (2006.01)**
- (86) EP2011067041 29.09.2011  
(96) 11763694.4 07.08.2013  
(87) WO2012041987, 29.09.2011  
(97) 2621486, 07.08.2013 en  
(54) SUBSTITUTED N-(2-ARYLAMINO)ARYL SULFONAMIDE-CONTAINING COMBINATIONS  
(71) Bayer Intellectual Property GmbH, Alfred-Nobel-Strasse 10, 40789 Monheim, DE  
(72) PÜHLER, Florian, Jules-Verne-Str. 50, 14089 Berlin, DE  
HITCHCOCK, Marion, Pfeddersheimer Weg 51A, 14129 Berlin, DE
- 
- (51) MKP  
**A61M 5/315 (2006.01)** (97) **2624894 \***
- (86) EP2011067418 05.10.2011  
(96) 11764230.6 14.08.2013  
(87) WO2012045794, 05.10.2011  
(97) 2624894, 14.08.2013 en  
(54) DRIVE MECHANISM FOR A DRUG DELIVERY DEVICE AND DRUG DELIVERY DEVICE  
(71) Sanofi-Aventis Deutschland GmbH, Brüningstraße 50, 65929 Frankfurt, DE  
(72) PLUMPTRE, David Aubrey, 36 Shire Way Droitwich Spa, Worcestershire WR9 7RQ, GB
- 
- (51) MKP  
**F24F 13/14 (2006.01)** (97) **2592359**  
**F24F 13/02 (2006.01)**
- (96) 11188324.5 15.05.2013  
(97) 2592359, 15.05.2013 de  
(54) Fire protection flap with a housing and a pivotable shut-off valve which can be pivoted around a pivoting axle, in particular a central pivoting axle  
(71) TROX GmbH, Heinrich-Trox Platz 1, 47506 Neukirchen-Vluyn, DE  
(72) Mosters, Martin, Xantener Straße 53 a, 46519 Alpen, DE  
Grabner, Dieter, Vom-Bruck-Platz 26, 47805 Krefeld, DE  
Gurny, Rüdiger, Steinofenweg 7 a, 46459 Rees, DE  
Walter, Siegfried, Birmesstraße 18, 47807 Krefeld, DE
- 
- (51) MKP  
**G01N 33/50 (2006.01)** (97) **2619577 \***  
**G01N 33/68 (2006.01)**
- (86) US2011052082 19.09.2011  
(96) 11827278.0 31.07.2013  
(87) WO2012040073, 19.09.2011  
(97) 2619577, 31.07.2013 en  
(54) BIOMARKERS OF RENAL INJURY  
(71) University of Pittsburgh of the Commonwealth System of Higher Education, 200 Gardner Steel Conference Center Thackeray & O'Hara Streets, Pittsburgh, PA 15260, US  
(72) SINGBARTL, Kai, 413 S. Highland Avenue Apt. 2, Pittsburgh, PA 15206, US  
KELLUM, John, A., 5541 Hampton Street, Pittsburgh, PA 15206, US
-

(51) MKP  
**A61K 31/00 (2006.01)** (97) **2632445 \***  
**C12Q 1/70 (2006.01)**  
**G01N 33/50 (2006.01)**  
**C40B 30/02 (2006.01)**  
(86) EP2011068924 27.10.2011  
(96) 11776776.4 04.09.2013  
(87) WO2012055987, 27.10.2011  
(97) 2632445, 04.09.2013 en  
(54) NOVEL DRUG TARGET SITE WITHIN GP120 OF HIV  
(71) KFLP Biotech, LLC A Delaware Limited Liability Company, 621 Seventeenth Street, Suite 801, Denver, CO 80293, US  
(72) VINNIK, Andrey, Nelidovskaya Street House 23 Building 2 Flat 1, Moscow 125363, RU  
FEDICHEV, Peter, Likhachevskoye Shosse House 20 Building 2 Flat 35, Dolgoprudny 141707, RU  
KHOLIN, Maxim, Tukhachevskogo Street House 25 Building 2 Flat 70, Moscow 123154, RU  
MOLLOY, Christopher, 8 Barley Brow High Elms Lane, Watford Hertfordshire WD25 0JW, GB  
KATZ, Aron, 301 Garfield Street, Denver, CO 80206, US

(51) MKP  
**C10L 5/00 (2006.01)** (97) **2638131 \***  
(86) US2010056045 09.11.2010  
(96) 10859558.8 18.09.2013  
(87) WO2012064324, 09.11.2010  
(97) 2638131, 18.09.2013 en  
(54) METHODS AND COMPOSITIONS FOR DRYING COAL  
(71) Ross Technology Corporation, 104 N. Maple Avenue, Leola, PA 17540-0646, US  
(72) HARSH, Philip, 538 Bentley Ridge Boulevard, Lancaster, PA 17602, US  
HURLEY, Michael, 1317 Newton Road, Lancaster, PA 17603, US  
JONES, Andrew K., 124 Roundtop Drive, Lancaster, PA 17601, US  
SIKKA, Vinod K., 115 Danworth Lane, Oak Ridge, Tennessee, US  
RICIGLIANO, Joseph W., 8256 Private Lane, Annandale, VA 22003, US

(51) MKP  
**B05C 5/00 (2006.01)** (97) **2464466 \***  
**B08B 3/08 (2006.01)**  
(86) US2010045139 11.08.2010  
(96) 10808682.8 20.06.2012  
(87) WO2011019802, 11.08.2010  
(97) 2464466, 20.06.2012 en  
(54) VAPOR SHEATH FOR LIQUID DISPENSING NOZZLE  
(71) GlaxoSmithKline LLC, One Franklin Plaza 200 North 16th Street, Philadelphia, PA 19102, US  
(72) CLARKE, Allan, J., 1250 South Collegeville Road, Collegville PA 19426, US  
FIESSER, Frederick, H., 1250 South Collegeville Road, Collegville PA 19426, US  
MCHUGH, James, A., 1250 South Collegeville Road, Collegville PA 19426, US

(51) MKP  
**A61K 31/165 (2006.01)** (97) **2640372 \***  
**A61P 35/00 (2006.01)**  
(86) US2011061453 18.11.2011  
(96) 11793609.6 25.09.2013  
(87) WO2012068491, 18.11.2011  
(97) 2640372, 25.09.2013 en  
(54) PRESELECTION OF SUBJECTS FOR THERAPEUTIC TREATMENT WITH ELESCLMOL BASED ON HYPOXIC STATUS  
(71) Synta Pharmaceuticals Corp., 45 Hartwell Avenue, Lexington, MA 02421, US  
(72) BLACKMAN, Ronald, K., 140 Sewall Avenue 2 Brookline, MA 02446, US  
VUKOVIC, Vojo, 51 Wildwood Street, Winchester MA 01890, US

(51) MKP  
**A61K 31/439 (2006.01)** (97) **2621494 \***  
**A61K 9/00 (2006.01)**  
(86) EP2011066062 16.09.2011  
(96) 11767661.9 07.08.2013  
(87) WO2012041717, 16.09.2011  
(97) 2621494, 07.08.2013 en  
(54) USE OF MAGNESIUM STEARATE IN DRY POWDER FORMULATIONS FOR INHALATION  
(71) Chiesi Farmaceutici S.p.A., Via Palermo, 26/A, 43100 Parma, IT  
(72) COCCONI, Daniela, c/o Chiesi Farmaceutici S.P.A. Via Palermo 26/A, I-43100 Parma, IT  
DAGLI ALBERI, Massimiliano, c/o Chiesi Farmaceutici S.P.A. Via Palermo 26/A, I-43100 Parma, IT  
BUSCA, Andrea, c/o Chiesi Farmaceutici S.P.A. Via Palermo 26/A, I-43100 Parma, IT  
SCHIARETTI, Francesca, c/o Chiesi Farmaceutici S.P.A. Via Palermo 26/A, I-43100 Parma, IT

(51) MKP  
**A61K 31/192 (2006.01)** (97) **2637654 \***  
**A61K 31/19 (2006.01)**  
**A61P 31/10 (2006.01)**  
**A61P 31/22 (2006.01)**  
(86) CA2010001812 12.11.2010  
(96) 10859588.5 18.09.2013  
(87) WO2012061920, 12.11.2010  
(97) 2637654, 18.09.2013 en  
(54) TOPICAL ORGANIC ACID SALT COMPOSITIONS SUITABLE FOR TREATING INFECTIONS  
(71) Biocepta Corporation, 120 Eglinton Avenue East, Suite 1100, Toronto, ON M4P 1E2, CA  
(72) MLADENOVICH, Peter, 1280 Greeniaus Road, Oakville, Ontario L6J 6Y5, CA  
LOUGHEED, William D., 28 Crestview Road, Toronto, Ontario M5N 1H6, CA

(51) MKP  
**C07D 491/20 (2006.01)** (97) **2601197 \***  
**C07D 491/22 (2006.01)**  
**C07D 498/20 (2006.01)**  
**C07D 498/22 (2006.01)**  
**A61K 31/436 (2006.01)**  
**A61K 31/437 (2006.01)**  
**A61K 31/537 (2006.01)**  
(86) US2011046667 04.08.2011  
(96) 11748808.0 12.06.2013  
(87) WO2012019056, 04.08.2011  
(97) 2601197, 12.06.2013 en  
(54) AMINO-ISO-INDOLE, AMINO-AZA-ISO-INDOLE, AMINO-DIHYDROISOQUINOLINE AND AMINO-BENZOXAZINE COMPOUNDS AS BETA-SECRETASE MODULATORS AND METHODS OF USE  
(71) Amgen Inc., One Amgen Center Drive Thousand Oaks, California 91320, US  
(72) MINATTI, Ana, Elena, 6301 De Soto Avenue 325, Woodland Hills CA 91367, US  
CHENG, Yuan, 5329 Via Jacinto, Newbury Park CA 91320, US  
ZHONG, Wenge, 2921 Venezia Lane, Thousand Oaks CA 91362, US

(51) MKP  
**E21B 33/129 (2006.01)** (97) **2625376 \***  
**E21B 23/06 (2006.01)**  
(86) CA2011001152 06.10.2011  
(96) 11830165.4 14.08.2013  
(87) WO2012045168, 06.10.2011  
(97) 2625376, 14.08.2013 en  
(54) WELLBORE PACKER BACK-UP RING ASSEMBLY, PACKER AND METHOD  
(71) Packers Plus Energy Services Inc., Bow Valley Square 2 Suite 2200, 205 - 5 Avenue SW, Calgary, Alberta T2P 2V7, CA  
(72) THEMIG, Daniel Jon, 256 Woodhaven Place SW, Calgary Alberta T2W 5P9, CA

- (51) MKP  
**G02C 11/08 (2006.01)** (97) **2598940 \***  
**A61F 9/02 (2006.01)**  
**G02C 5/12 (2006.01)**  
**G02C 5/14 (2006.01)**
- (86) EP2011061434 06.07.2011  
(96) 11733628.9 05.06.2013  
(87) WO2012013465, 06.07.2011  
(97) 2598940, 05.06.2013 en  
(54) FRAME FOR GLASSES, MASKS FOR PROFESSIONAL OR SPORTS USE, AND THE LIKE
- (71) Geox S.p.A., Via Feltrina Centro, 16, 31044 Montebelluna Località Biadene (Treviso), IT  
(72) POLEGATO MORETTI, Mario, Via Fantin 96, I-31035 Crocetta Del Montello, IT
- 
- (51) MKP  
**A61K 31/221 (2006.01)** (97) **2608784 \***  
**A61K 31/41 (2006.01)**  
**A61P 9/00 (2006.01)**  
**A61P 9/04 (2006.01)**  
**A61P 9/12 (2006.01)**
- (86) US2011048542 22.08.2011  
(96) 11751752.4 03.07.2013  
(87) WO2012027237, 22.08.2011  
(97) 2608784, 03.07.2013 en  
(54) TREATMENT OF HYPERTENSION AND/OR PREVENTION OR TREATMENT OF HEART FAILURE IN A MAMMAL RECEIVING ANTI-COAGULANT THERAPY
- (71) Novartis AG, Lichtstrasse 35, 4056 Basel, CH  
(72) ALBRECHT, Diego, Novartis Pharma AG Postfach, CH-4002 Basel, CH  
CHANDRA, Priyamvada, Novartis Pharmaceuticals Corporation One Health Plaza, East Hanover New Jersey 07936-1080, US  
GODTFREDSSEN, Sven, Novartis Pharmaceuticals Corporation One Health Plaza, East Hanover New Jersey 07936-1080, US  
JORDAAN, Pierre, Novartis Pharma AG Postfach, CH-Basel 4002, CH  
LEFKOWITZ, Martin, Novartis Pharmaceuticals Corporation One Health Plaza, East Hanover New Jersey 07936-1080, US
- 
- (51) MKP  
**C09K 11/02 (2006.01)** (97) **2616522 \***  
**C09K 11/56 (2006.01)**  
**C09K 11/70 (2006.01)**  
**C09K 11/74 (2006.01)**  
**C09K 11/88 (2006.01)**
- (86) IL2011000734 15.09.2011  
(96) 11776912.5 24.07.2013  
(87) WO2012035535, 15.09.2011  
(97) 2616522, 24.07.2013 en  
(54) ANISTROPIC SEMICONDUCTOR NANOPARTICLES
- (71) Yissum Research Development Company of the Hebrew University of Jerusalem Ltd., Hi-Tech Park Edmond J. Safra Campus Givat Ram, 91390 Jerusalem, IL  
(72) BANIN, Uri, 37 Yasmin Street, 90805 Mevasseret Zion, IL  
ZIMRAN, Adiel, 27 Pitum Haktoret Street, 90435 Efrat, IL  
LIEBERMAN, Itai, 43 C/4 Dam Hamacabim Street, 67893 Tel Aviv, IL  
SITT, Amit, 47 Merkaz Baalei Melacha Street, 63824 Tel Aviv, IL
- 
- (51) MKP  
**A61K 8/86 (2006.01)** (97) **2637638 \***  
**A61Q 1/04 (2006.01)**  
**A61Q 1/00 (2006.01)**  
**A61K 8/97 (2006.01)**  
**A61K 8/19 (2006.01)**  
**A61K 8/72 (2006.01)**  
**A61K 8/92 (2006.01)**
- (86) US2011059749 08.11.2011  
(96) 11839440.2 18.09.2013  
(87) WO2012064720, 08.11.2011  
(97) 2637638, 18.09.2013 en  
(54) LIPSTICK AND OTHER COSMETICS AND METHOD OF MAKING
- (71) Coty Inc., 2 Park Avenue, New York, NY 10016, US  
(72) BARONE, Salvatore, J., 63 Peacock Loop, Staten Island, New York, 10309, US  
NGUYEN, Lethu, 400 Middlesex Avenue, Colonia, New Jersey 07067, US  
LIN, Samuel, Q., 76 Brown Circle, Paramus, New Jersey 07652, US
- 
- (51) MKP  
**A61K 9/14 (2006.01)** (97) **2605755 \***  
**A61K 38/00 (2006.01)**  
**A61K 47/02 (2006.01)**  
**C01B 33/18 (2006.01)**  
**A61K 48/00 (2006.01)**  
**A61K 31/70 (2006.01)**
- (86) AU2011001040 15.08.2011  
(96) 11817565.2 26.06.2013  
(87) WO2012021922, 15.08.2011  
(97) 2605755, 26.06.2013 en  
(54) PARTICULATE SUBSTANCES COMPRISING CERAMIC PARTICLES FOR DELIVERY OF BIOMOLECULES
- (71) AUSTRALIAN NUCLEAR SCIENCE & TECHNOLOGY ORGANISATION, New Illawarra Road, Lucas Heights New South Wales 2234, AU  
(72) BARBÉ, Christophe, Jean, Alexandre, 35/104 William Street, Five Dock NSW 2046, AU  
FINNIE, Kim, Suzanne, 34 Greville Street, Chatswood West NSW 2067, AU  
KNIGHT, Samuel, PO Box 489, Mundaring W.A. 6073, AU  
PASSIOURA, Toby, Johnston, 409/82-92 Cooper St, Surry Hills NSW 2010, AU
- 
- (51) MKP  
**A61M 15/00 (2006.01)** (97) **2613829 \***  
**A61J 1/20 (2006.01)**  
**B05B 11/00 (2006.01)**  
**B65D 83/14 (2006.01)**
- (86) EP2011065303 05.09.2011  
(96) 11757244.6 17.07.2013  
(87) WO2012032010, 05.09.2011  
(97) 2613829, 17.07.2013 en  
(54) METERED-DOSE INHALER AND METHOD OF USING THE SAME
- (71) CHIESI FARMACEUTICI S.p.A., Via Palermo, 26/A, 43122 Parma, IT  
(72) BRAMBILLA, Gaetano, c/o Chiesi Farmaceutici S.p.A., Via Palermo 26/A, I-43122 Parma, IT  
LEWIS, David Andrew, c/o Chiesi Farmaceutici S.p.A., Via Palermo 26/A, I-43122 Parma, IT  
JOHNSON, Robert, c/o Chiesi Farmaceutici S.p.A., Via Palermo 26/A, I-43122 Parma, IT  
HOWLETT, David, c/o Chiesi Farmaceutici S.p.A., Via Palermo 26/A, I-43122 Parma, IT



(51) MKP  
**C07D 249/12 (2006.01)** (97) **2616448 \***  
**C07D 409/04 (2006.01)**  
**A61K 31/4196 (2006.01)**  
**A61P 9/00 (2006.01)**  
(86) EP2011065961 14.09.2011  
(96) 11758447.4 24.07.2013  
(87) WO2012035075, 14.09.2011  
(97) 2616448, 24.07.2013 de  
(54) SUBSTITUTED PHENYLACETATE AND PHENYLPROPANE AMIDES AND USE THEREOF  
(71) Bayer Intellectual Property GmbH, Alfred-Nobel-Strasse 10, 40789 Monheim, DE  
(72) FÜRSTNER, Chantal, Arnoldstr. 33, 45478 Mülheim, DE  
KELDENICH, Jörg, Damaschkeweg 49, 42113 Wuppertal, DE  
DELBECK, Martina, Müllerweg 10, 42579 Heiligenhaus, DE  
KOLKHOF, Peter, Falkenberg 121, 42113 Wuppertal, DE  
KRETSCHMER, Axel, Am Acker 23, 42113 Wuppertal, DE  
POOK, Elisabeth, Im Lehmbruch 24, 42109 Wuppertal, DE  
SCHMECK, Carsten, Carl-Friedrich-Goerdeler-Straße, 45472 Mülheim, DE  
TRÜBEL, Hubert, Lante 23, 42281 Wuppertal, DE

(51) MKP  
**C07D 403/14 (2006.01)** (97) **2621921 \***  
(86) US2011052869 23.09.2011  
(96) 11764925.1 07.08.2013  
(87) WO2012044520, 23.09.2011  
(97) 2621921, 07.08.2013 en  
(54) SOLID STATE FORMS OF A POTENT HCV INHIBITOR  
(71) Boehringer Ingelheim International GmbH, Binger Strasse 173, 55216 Ingelheim am Rhein, DE  
(72) BRICKL, Rolf-Stefan, Boehringer Ingelheim GmbH Corporate Patents Binger Strasse 173, 55216 Ingelheim am Rhein, DE  
CHEN, Shirlynn, Boehringer Ingelheim Pharmaceuticals INC. 900 Ridgebury Road P.O. Box 368, Ridgefield, Connecticut 06877-0368, US  
CHUNG, Jihchin, Boehringer Ingelheim Pharmaceuticals INC. 900 Ridgebury Road P.O. Box 368, Ridgefield, Connecticut 06877-0368, US  
DUDHEDIA, Mayur Suryakant, Boehringer Ingelheim Pharmaceuticals INC. 900 Ridgebury road P.O. Box 368, Ridgefield, Connecticut 06877-0368, US  
LI, Danping, 4 Colonial Court, Middlebury, Connecticut 06762, US  
LU, Zhi-Hui, Boehringer Ingelheim Pharmaceuticals Inc. 900 Ridgebury Road P.O. Box 368, Ridgefield, Connecticut 06877-0368, US  
MUJUMDAR, Siddhartha, Boehringer Ingelheim Pharmaceuticals INC. 900 Ridgebury Road P.O. Box 368, Ridgefield, Connecticut 06877-0368, US  
TELANG, Chitra, Boehringer Ingelheim Pharmaceuticals INC. 900 Ridgebury Road P.O. Box 368, Ridgefield, Connecticut 06877-0368, US  
VARSOLONA, Richard, 1973 Inverness Drive, Scotch Plains, New Jersey 07076, US  
WANG, Zeren, 88 Elk Drive, Southbury, Connecticut 06488, US

(51) MKP  
**A01C 15/00 (2006.01)** (97) **2567606**  
**A01C 3/06 (2006.01)**  
(96) 12182939.4 13.03.2013  
(97) 2567606, 13.03.2013 fr  
(54) Shutter for spreading device  
(71) Ets. Joskin S.A., Rue de Wergifosse, 39, 4000 Liege, BE  
(72) Joskin, Victor, Rue Large Voie, 8A, B-4633 Melen, BE

(51) MKP  
**A61K 36/235 (2006.01)** (97) **2621505 \***  
**A61K 36/35 (2006.01)**  
**A61K 36/57 (2006.01)**  
**A61K 36/28 (2006.01)**  
**A61P 11/10 (2006.01)**  
**A61K 36/25 (2006.01)**  
**A61P 11/12 (2006.01)**  
**A61K 36/11 (2006.01)**  
**A61K 36/53 (2006.01)**  
**A61K 36/185 (2006.01)**  
**A61P 11/00 (2006.01)**  
(86) EP2011005077 11.10.2011  
(96) 11773680.1 07.08.2013  
(87) WO2012084075, 11.10.2011  
(97) 2621505, 07.08.2013 de  
(54) METHOD FOR PRODUCING PLANT-BASED ALCOHOL-FREE COMPOSITIONS, COMPOSITIONS PRODUCED IN THIS WAY, AND USE OF SAID COMPOSITIONS  
(71) Maria Clementine Martin Klosterfrau Vertriebsgesellschaft mbH, Gereonsmühlengasse 1-11, 50670 Köln, DE  
(72) NAUERT, Christian, Waldstrasse 26A, 41542 Dormagen, DE  
GREVE, Harald, Schorlemerstraße 3a, 40545 Düsseldorf, DE

(51) MKP  
**C07K 16/24 (2006.01)** (97) **2625199 \***  
**A61K 39/395 (2006.01)**  
(86) EP2011067522 07.10.2011  
(96) 11764764.4 14.08.2013  
(87) WO2012045848, 07.10.2011  
(97) 2625199, 14.08.2013 en  
(54) METHODS OF TREATING PSORIASIS USING IL-17 ANTAGONISTS  
(71) Novartis AG, Lichtstrasse 35, 4056 Basel, CH  
(72) GUETTNER, Achim, Novartis Pharma AG Postfach, CH-4002 Basel, CH  
MACHACEK, Matthias, Novartis Pharma AG Postfach, CH-4002 Basel, CH  
PAPAVASSILIS, Charis, Novartis Pharma AG Postfach, CH-4002 Basel, CH  
SANDER, Oliver, Novartis Pharma AG Postfach, CH-4002 Basel, CH

(51) MKP  
**C12P 19/02 (2006.01)** (97) **2596113 \***  
**C12P 19/12 (2006.01)**  
**C12P 19/14 (2006.01)**  
**C12P 19/18 (2006.01)**  
**A23L 1/09 (2006.01)**  
**C07H 3/04 (2006.01)**  
**C07H 3/06 (2006.01)**  
(86) EP2011062355 19.07.2011  
(96) 11734090.1 29.05.2013  
(87) WO2012010597, 19.07.2011  
(97) 2596113, 29.05.2013 en  
(54) GALACTO-OLIGOSACCHARIDE-CONTAINING COMPOSITION AND A METHOD OF PRODUCING IT  
(71) Arla Foods Amba, Sønderhøj 14, 8260 Viby J, DK  
(72) BERTELSEN, Hans, Chr. Aagaardsvej 8, DK-6920 Videbæk, DK  
LANGBORG WEJSE, Peter, Fridtjof Nansens Vej 25, DK-8200 Aarhus N, DK

- (51) MKP  
**A61K 31/427 (2006.01)** (97) **2637659 \***  
**A61K 31/4439 (2006.01)**  
**A61K 31/444 (2006.01)**  
**A61K 31/497 (2006.01)**  
**A61K 31/506 (2006.01)**  
**C07D 401/04 (2006.01)**  
**C07D 401/14 (2006.01)**  
**C07D 403/04 (2006.01)**  
**C07D 407/14 (2006.01)**  
**C07D 413/14 (2006.01)**  
**C07D 417/04 (2006.01)**  
**C07D 417/14 (2006.01)**  
**A61P 7/02 (2006.01)**  
**A61P 9/08 (2006.01)**  
(86) US2011058902 02.11.2011  
(96) 11784873.9 18.09.2013  
(87) WO2012064559, 02.11.2011  
(97) 2637659, 18.09.2013 en  
(54) SGC STIMULATORS  
(71) Ironwood Pharmaceuticals, Inc., 301 Binney Street, 2nd Floor, Cambridge, MA 02142, US  
(72) KIM, Charles, 348 Franklin St. Apt. 4D, Cambridge MA 02139, US  
NAKAI, Takashi, 7 Gardner Street, Newton MA 02458, US  
LEE, Thomas, Wai-ho, 665 Lowell Street Unit 60, Lexington MA 02420, US  
MOORE, Joel, 4 Cherry Street, Lexington MA 02421, US  
PERL, Nicholas, Robert, 1569 Beacon Street Apt. 44, Brookline MA 02446, US  
ROHDE, Jason, 151 Temescal Circle, Emeryville CA 94608, US

- (51) MKP  
**E04D 13/12 (2006.01)** (97) **2633135 \***  
**E04G 21/32 (2006.01)**  
(86) EP2011069038 28.10.2011  
(96) 11776004.1 04.09.2013  
(87) WO2012056020, 28.10.2011  
(97) 2633135, 04.09.2013 en  
(54) ROOF PROVIDED WITH A SAFETY SYSTEM  
(71) Flesst B.V., Koekoeksweg 6, 8084 GM't Harde, NL  
(72) Borra, Hans Antonius, Kritzingerlaan 61, NL-3707 TB Zeist, NL

- (51) MKP  
**A61K 31/675 (2006.01)** (97) **2640362 \***  
**A61K 31/513 (2006.01)**  
**A61P 31/18 (2006.01)**  
**A61K 31/505 (2006.01)**  
**A61K 9/20 (2006.01)**  
(86) US2011061515 18.11.2011  
(96) 11791161.0 25.09.2013  
(87) WO2012068535, 18.11.2011  
(97) 2640362, 25.09.2013 en  
(54) THERAPEUTIC COMPOSITIONS COMPRISING RILPIVIRINE HCL AND TENOFOVIR DISOPROXIL FUMARATE  
(71) Gilead Sciences, Inc., 333 Lakeside Drive, Foster City, CA 94404, US  
Janssen R&D Ireland, Eastgate Village Eastgate, Little Island, County Cork 999937, IE  
(72) OLIYAI, Reza, 1504 Alturas Drive, Burlingame California 94010, US  
WISER, Lauren, 10093 Senate Way, Cupertino California 95014, US  
MENNING, Mark, 9 Hugo Street, San Francisco California 94122, US

- (51) MKP  
**G10L 21/02 (2006.01)** (97) **2437260**  
(86) 11179183.6 04.04.2012  
(97) 2437260, 04.04.2012 en  
(54) Sound signal processing device  
(71) Roland Corporation, 2036-1 Nakagawa, Hosoe-cho Kita-ku, 431-1304 Shizuoka, Hamamatsu, JP  
(72) Sato, Kenji, 2036-1 Nakagawa, Hosoe-cho Kita-ku, Hamamatsu, Shizuoka 431-1304, JP

- (51) MKP  
**C07F 5/02 (2006.01)** (97) **2632927 \***  
**C07F 5/04 (2006.01)**  
**A61K 31/69 (2006.01)**  
(86) US2011056844 19.10.2011  
(96) 11779904.9 04.09.2013  
(87) WO2012058065, 19.10.2011  
(97) 2632927, 04.09.2013 en  
(54) BORONATES AS ARGINASE INHIBITORS  
(71) Mars, Incorporated, 6885 Elm Street, McLean, VA 22101, US  
(72) VAN ZANDT, Michael, c/o Mars Incorporated 6885 Elm Street, McLean, Virginia 22101, US  
JAGDMANN, JR., Gunnar Erik, c/o Mars Incorporated 6885 Elm Street, McLean, Virginia 22101, US

- (51) MKP  
**C12N 15/62 (2006.01)** (97) **2622078 \***  
**C07K 14/245 (2006.01)**  
**A61K 35/74 (2006.01)**  
**A61K 39/04 (2006.01)**  
(86) EP2011066854 28.09.2011  
(96) 11763647.2 07.08.2013  
(87) WO2012041899, 28.09.2011  
(97) 2622078, 07.08.2013 en  
(54) FUSION PROTEIN FOR SECRETORY PROTEIN EXPRESSION  
(71) Abera Bioscience AB, Stureplan 15, 2 tr, 111 45 Stockholm, SE  
(72) LUIRINK, Joen, Dept. Molecular Microbiology Fac. Earth&Life Sc. Vrije Universiteit De Boelelaan 1085, NL-1081 HV Amsterdam, NL  
JONG, Wouter S.P., Kwintheulstraat 36, NL-1062 ED Amsterdam, NL

- (51) MKP  
**H01Q 1/12 (2006.01)** (97) **2599160 \***  
**H01Q 1/32 (2006.01)**  
(86) EP2011062935 27.07.2011  
(96) 11748324.8 05.06.2013  
(87) WO2012013718, 27.07.2011  
(97) 2599160, 05.06.2013 en  
(54) ANTENNA FIXING UNIT.  
(71) Calearo Antenne S.p.A., Corso G. Matteotti 1, 20121 Milano, IT  
(72) SPAGNOLO, Gioele, Via Liston San Gaetano 6/2, I-36034 Malo (VI), IT  
KARCHER, Torsten, Kelterstrasse 12, 74211 Leingarten, DE  
SALIN, Natalino, Via G. Segantini 18, I-36031 Dueville (VI), IT  
ZAMBERLAN, Daniel, Via Molini 50/C, I-36051 Creazzo (VI), IT  
CALEARO, CIMAN, Massimo, Via N. Sauro 24, I-36030 Costabissara (VI), IT  
ROTONDI, Vito, Via Sebastiano Schiavon 15, I-35020 Ponte San Nicola' (PD), IT

- (51) MKP  
*C07D 213/30 (2006.01)* (97) **2609081 \***  
*C07D 213/71 (2006.01)*  
*C07D 213/74 (2006.01)*  
*C07D 231/18 (2006.01)*  
*C07D 239/42 (2006.01)*  
*C07D 241/04 (2006.01)*  
*C07D 277/36 (2006.01)*  
*C07D 333/34 (2006.01)*  
*C07D 405/12 (2006.01)*  
*C07D 409/12 (2006.01)*  
*C07D 409/14 (2006.01)*  
*C07D 413/14 (2006.01)*  
*C07D 417/12 (2006.01)*  
*C07D 491/08 (2006.01)*  
*C07D 498/08 (2006.01)*  
(86) US2011048596 22.08.2011  
(96) 11752398.5 03.07.2013  
(87) WO2012027261, 22.08.2011  
(97) 2609081, 03.07.2013 en  
(54) SULFONYLPYPERAZINE DERIVATIVES THAT INTERACT WITH GLUCOKINASE REGULATORY PROTEIN FOR THE TREATMENT OF DIABETES  
(71) Amgen Inc., One Amgen Center Drive, Thousand Oaks, California 91320-1799, US  
(72) ASHTON, Kate, 30948 Minute Man Way, Westlake Village California 91361, US  
BARTBERGER, Michael David, 4471 Ventura Canyon Avenue D-105, Sherman Oaks California 91423, US  
BO, Yunxin, 419 Calle Veracruz, Thousand Oaks California 91320, US  
BRYAN, Marian C., 24001 Victory Boulevard, West Hills California 91307, US  
CROGHAN, Michael, 233 McAfee Court, Thousand Oaks California 91360, US  
FOTSCH, Christopher Harold, 533 Timberwood Avenue, Thousand Oaks California 91360, US  
HALE, Clarence Henderson, 4787 Aqua Verde Court, Camarillo California 93012, US  
KUNZ, Roxanne Kay, 1112 Montana Avenue 259, Santa Monica California 90403, US  
LIU, Longbin, 753 Rushing Creek Place, Thousand Oaks California 91360, US  
NISHIMURA, Nobuko, 24050 Arminta Street, West Hills California 91304, US  
NORMAN, Mark H., 130 Venus Street, Thousand Oaks California 91360, US  
PENNINGTON, Lewis Dale, 5477 Ralston Street Unit 114, Ventura California 93003, US  
POON, Steve Fong, 5147 Comercio Avenue, Woodland Hills California 91364, US  
STEC, Markian Myroslaw, One Amgen Center Drive, Thousand Oaks California 91320, US  
ST. JEAN, David, Joseph, Jr., 4690 Marris Way, Camarillo California 93012, US  
TAMAYO, Nuria A., 4394 Camino de la Rosa, Newbury Park California 91320, US  
TEGLEY, Christopher Michael, 478 Thunderhead Street, Thousand Oaks California 91360, US  
YANG, Kevin Chao, 8871 Camino Real Avenue, San Gabriel California 91775, US

- (51) MKP  
*A61K 9/16 (2006.01)* (97) **2526931**  
*A61K 31/22 (2006.01)*  
(96) 11167115.2 28.11.2012  
(97) 2526931, 28.11.2012 en  
(54) Wet granulation methods of cetyl myristate and/or cetyl palmitate  
(71) Deva Holding Anonim Sirketi, Halkali Merkez Mah. Basin Ekpres Caddesi, No. 1, Kat: 5 Kucukcekmece, 34303 Istanbul, TR  
(72) Haas, Philipp Daniel, Deva Holding Anonim Sirketi Halkali Merkez Mah. Basin Ekpres Caddesi No:1, Patent Law Department, Kat: 5 Kucukcekmece, 34303 Istanbul, TR  
Firat, Omer Faruk, Deva Holding Anonim Sirketi R&D Halkali Merkez Mah. Basin Ekpres Caddesi No: 1, Patent Law Department, Kat: 5 Kucukcekmece, 34303 Istanbul, TR  
Sivasligil, Ramazan, Deva Holding Anonim Sirketi R&D Halkali Merkez Mah. Basin Ekpres Caddesi No: 1, Patent Law Department, Kat: 5 Kucukcekmece, 34303 Istanbul, TR  
Koc, Fikret, Deva Holding Anonim Sirketi R&D Halkali Merkez Mah. Basin Ekpres Caddesi No: 1, Patent Law Department, Kat: 5 Kucukcekmece, 34303 Istanbul, TR  
Kandemir, Levent, Deva Holding Anonim Sirketi R&D Halkali Merkez Mah. Basin Ekpres Caddesi No: 1, Patent Law Department, Kat: 5 Kucukcekmece, 34303 Istanbul, TR

- (51) MKP  
*A61P 35/00 (2006.01)* (97) **2616442 \***  
*C07D 215/06 (2006.01)*  
*A61K 31/52 (2006.01)*  
*C07D 241/44 (2006.01)*  
*A61K 31/4709 (2006.01)*  
*C07D 401/14 (2006.01)*  
*A61K 31/47 (2006.01)*  
*C07D 405/12 (2006.01)*  
*A61K 31/497 (2006.01)*  
*C07D 413/14 (2006.01)*  
*A61K 31/551 (2006.01)*  
*C07D 473/34 (2006.01)*  
*A61K 31/5377 (2006.01)*  
*C07D 495/04 (2006.01)*  
(86) US2011051531 14.09.2011  
(96) 11779004.8 24.07.2013  
(87) WO2012037204, 14.09.2011  
(97) 2616442, 24.07.2013 en  
(54) INHIBITORS OF PI3K-DELTA AND METHODS OF THEIR USE AND MANUFACTURE  
(71) Exelixis, Inc., 210 East Grand Avenue, South San Francisco, CA 94080, US  
(72) LEAHY, James, William, 1185 Camellia Court, San Leandro CA 94577, US

- (51) MKP  
**C07D 413/14 (2006.01)** (97) **2619197 \***  
**A61K 31/497 (2006.01)**  
**A61P 11/00 (2006.01)**
- (86) US2011052254 20.09.2011  
(96) 11761775.3 31.07.2013  
(87) WO2012040139, 20.09.2011  
(97) 2619197, 31.07.2013 en
- (54) OXADIAZOLE INHIBITORS OF LEUKOTRIENE PRODUCTION  
(71) Boehringer Ingelheim International GmbH, Binger Strasse 173, 55216 Ingelheim, DE
- (72) BARTOLOZZI, Alessandra, Boehringer Ingelheim Pharmaceuticals Inc. 900 Ridgebury Road P.O. Box 368, Ridgefield, CT 06877-0368, US  
BOSANAC, Todd, Boehringer Ingelheim Pharmaceuticals Inc. 900 Ridgebury Road P.O. Box 368, Ridgefield, CT 06877-0368, US  
CHEN, Zhidong, Boehringer Ingelheim Pharmaceuticals Inc. 900 Ridgebury Road P.O. Box 368, Ridgefield, CT 06877-0368, US  
DE LOMBAERT, Stéphane, 22 Prospect Hill Road, Branford, CT 06405, US  
DINES, Jonathon, Alan, 114 Milton Park, Abingdon Oxfordshire OX14 4SA, GB  
HUBER, John, D., 37 Summer Street, Floor 2, New Canaan, CT 06840, US  
LIU, Weimin, c/o Boehringer Ingelheim Pharmaceuticals, Inc. 900 Ridgebury Road P.O. Box 368, Ridgefield, CT 06877, US  
LOKE, Pui Leng, 114 Milton Park, Abingdon Oxfordshire OX14 4SA, GB  
MORWICK, Tina, Marie, 5317 Ripplingbrook Way, Carmel, IN 46033, US  
OLAGUE, Alan, Boehringer Ingelheim Pharmaceuticals Inc. 900 Ridgebury Road P.O. Box 368, Ridgefield, CT 06877-0368, US  
RIETHER, Doris, Boehringer Ingelheim GmbH Corporate Patents Binger Strasse 173, 55216 Ingelheim am Rhein, DE  
TYE, Heather, 114 Milton Park, Abingdon Oxfordshire OX14 4SA, GB  
WU, Lifen, Boehringer Ingelheim Pharmaceuticals Inc. 900 Ridgebury Road P.O.Box368, Ridgefield, CT 06877-0368, US  
ZINDELL, Renee, M., Boehringer Ingelheim Pharmaceuticals Inc. 900 Ridgebury Road P.O. Box 368, Ridgefield, CT 06877-0368, US

- (51) MKP  
**F28F 1/40 (2006.01)** (97) **2635868 \***  
**F28F 13/06 (2006.01)**  
**F28F 13/12 (2006.01)**
- (86) EP2011062874 27.07.2011  
(96) 11740624.9 11.09.2013  
(87) WO2012059250, 27.07.2011  
(97) 2635868, 11.09.2013 en
- (54) DEVICE FOR OPTIMIZING THE TRANSMISSION OF HEAT IN A PIPE FOR CONVEYING EXHAUST GASES IN A HEAT EXCHANGE APPARATUS  
(71) Unical AG S.p.A., Via Roma 123, 46033 Castel D'ario, IT  
(72) IORI, Valentino, Viale Fiume 16, I-46100 Mantova, IT  
DE SANTI, Giuseppe, Via Fianchetti 12, I-46032 Castelbelforte, IT

- (51) MKP  
**C07D 231/20 (2006.01)** (97) **2619182 \***  
**A61K 31/415 (2006.01)**  
**A61P 29/00 (2006.01)**
- (86) US2011051163 12.09.2011  
(96) 11760631.9 31.07.2013  
(87) WO2012039972, 12.09.2011  
(97) 2619182, 31.07.2013 en
- (54) PHARMACEUTICAL COMPOSITION  
(71) Eisai R&D Management Co., Ltd., 6-10, Koishikawa 4-chome Bunkyo-ku, Tokyo 112-8088, JP  
(72) SPYVEE, Mark, 75 Laura Lane, Hampstead New Hampshire 03841, US  
SATO, Takashi, 21 Paulornette Circle, Andover Massachusetts 01810, US  
CARLSON, Jonathan Eric, 14 Blair Road, Merrimack New Hampshire 03054, US

- (51) MKP  
**A61K 38/48 (2006.01)** (97) **2621520 \***  
**A61K 47/36 (2006.01)**
- (86) EP2011004890 30.09.2011  
(96) 11773677.7 07.08.2013  
(87) WO2012041512, 30.09.2011  
(97) 2621520, 07.08.2013 en
- (54) COLLAGENASE G AND COLLAGENASE H COMPOSITIONS FOR THE TREATMENT OF DISEASES INVOLVING ALTERATIONS OF COLLAGEN  
(71) Proteos Biotech S.L.U., C/ Almansa 14, 02006 Albacete, ES  
(72) MUNOZ MONTANO, Juan Ramon, C/ Gran Via 62 4° Izda., E-28013 Madrid, ES

- (51) MKP  
**G09F 21/02 (2006.01)** (97) **2637154**  
**G09F 7/06 (2006.01)**
- (96) 13157537.5 11.09.2013  
(97) 2637154, 11.09.2013 en
- (54) Method for producing a label, particularly for items of clothing.  
(71) Ribbontex s.r.l., Via A. Palladio, 34, 35010 Paviola di San Giorgio in Bosco (PD), IT  
(72) Rosa, Ilario, c/o RIBBONTEX s.r.l. via A. Palladio, 34, 35010 Paviola di San Giorgio in Bosco (PD), IT

- (51) MKP  
**B01F 5/12 (2006.01)** (97) **2640501 \***
- (86) US2011061235 17.11.2011  
(96) 11840793.1 25.09.2013  
(87) WO2012068398, 17.11.2011  
(97) 2640501, 25.09.2013 en
- (54) TWO COMPARTMENT CONTAINER  
(71) La Prairie, Inc., 680 Fifth Avenue, New York, New York 10019, US  
(72) KALYANPUR, Anil, 14 Ellison Avenue, Edison New Jersey 08817, US  
SUHR, Richard, 21 Blaine Avenue Unit 6, Seaside Heights New Jersey 08751, US

- (51) MKP  
**C07D 307/80 (2006.01)** (97) **2595977 \***  
**C07C 251/16 (2006.01)**  
**C07C 39/04 (2006.01)**  
**A61K 31/343 (2006.01)**  
**A61P 9/00 (2006.01)**
- (86) FR2011051751 20.07.2011  
(96) 11754896.6 29.05.2013  
(87) WO2012010802, 20.07.2011  
(97) 2595977, 29.05.2013 fr
- (54) PROCESS FOR PREPARING BENZOFURAN DERIVATIVES SUBSTITUTED AT POSITION 5  
(71) SANOFI, 54, rue de la Boétie, 75008 Paris, FR  
(72) BAILLY, Frédéric, c/o Sanofi Département Brevets 174 avenue de France, F-75013 Paris, FR  
BON, Xavier, c/o Sanofi Département Brevets 174 avenue de France, F-75013 Paris, FR  
VAYRON, Philippe, c/o Sanofi Département Brevets 174 avenue de France, F-75013 Paris, FR

- (51) MKP  
**A61B 19/00 (2006.01)** (97) **2611378 \***  
**A61B 17/56 (2006.01)**
- (86) CA2010001311 31.08.2010  
(96) 10856541.7 10.07.2013  
(87) WO2012027815, 31.08.2010  
(97) 2611378, 10.07.2013 en
- (54) PROXIMITY-TRIGGERED COMPUTER-ASSISTED SURGERY SYSTEM AND METHOD  
(71) Orthosoft, Inc., 75 Queen Street Suite 3300, Montreal, Québec H3C 2N6, CA  
(72) BOUTIN, Yannick, 6274 St-André Apt. 8, Montréal Québec H2S 2K5, CA  
ABIVEN, Jean-Guillaume, 352 Ste-Madeleine, Montréal Québec H3K 2K7, CA  
CHEVRIER, Mathieu, 7 - 14th Street, Roxboro Québec H8Y 1M1, CA

- (51) MKP  
**C08G 63/78 (2006.01)** (97) **2598553 \***  
**C08L 67/04 (2006.01)**  
**A61K 9/00 (2006.01)**  
**C08G 63/08 (2006.01)**
- (86) IB2010053383 26.07.2010  
(96) 10752926.5 05.06.2013  
(87) WO2012014011, 26.07.2010  
(97) 2598553, 05.06.2013 en  
(54) COMPOSITIONS COMPRISING POLYMERS PREPARED FROM 2-HYDROXYALKYL ACIDS  
(71) Université de Genève, 24 rue du Général-Dufour, 1211 Genève 4, CH  
(72) MOELLER, Michael, La Chèvrerie, CH-1273 Arzier, CH  
ASMUS, Lutz, Rue Guillaume-Farel 8, CH-1204 Geneva, CH  
GURNY, Robert, 7 rue Calvin, CH-1204 Geneva, CH
- 
- (51) MKP  
**G02B 27/01 (2006.01)** (97) **2605056**  
(96) 12163175.8 19.06.2013  
(97) 2605056, 19.06.2013 de  
(54) System for observing an eye-related display  
(71) Grunert, Joachim Rainer, Russenweg 3, 8008 Zürich, CH  
(72) Grunert, Joachim Rainer, Russenweg 3, 8008 Zürich, CH
- 
- (51) MKP  
**F02M 59/36 (2006.01)** (97) **2535553**  
**F04B 49/22 (2006.01)**  
**F04B 53/10 (2006.01)**
- (96) 11169958.3 19.12.2012  
(97) 2535553, 19.12.2012 en  
(54) Inlet Valve Arrangement for a Fuel Pump  
(71) Delphi Technologies Holding S.à.r.l., Avenue de Luxembourg, 4940 Bascharage, LU  
(72) Schanz, Robert, c/o Eisbein Alte Silberstrasse 28, OT Scharfenberg, 01665 Klipphausen, DE  
Buckley, Paul, 7 Callams Close, Gillingham, Kent ME8 9ES, GB  
Jorach, Rainer, Hegelstr 9, 71686 Remseck, DE
- 
- (51) MKP  
**B01L 7/00 (2006.01)** (97) **2637789 \***  
(86) GB2011001565 08.11.2011  
(96) 11796763.8 18.09.2013  
(87) WO2012063011, 08.11.2011  
(97) 2637789, 18.09.2013 en  
(54) HEATING AND COOLING LOW VOLUME BIOLOGICAL REACTION VESSELS  
(71) BG Research Ltd, 6 The Business Centre Harvard Way Kimbolton, Cambridgeshire PE28 0NJ, GB  
(72) NAZARETH, Nelson, 1 Clockwinders High Street, Upper Dean Cambridgeshire PE28 0ND, GB  
DRISCOLL, Antony, 82 Station Road, Langford Bedfordshire SG18 9PQ, GB  
EDGE, David, 41 Verdayne Gardens Warlingham, Surrey CR6 9RP, GB
- 
- (51) MKP  
**C07D 401/14 (2006.01)** (97) **2625174 \***  
**C07D 211/58 (2006.01)**  
**C07D 213/81 (2006.01)**  
**C07D 401/04 (2006.01)**  
**A61K 31/454 (2006.01)**  
**A61P 31/00 (2006.01)**
- (86) EP2011067437 06.10.2011  
(96) 11764572.1 14.08.2013  
(87) WO2012045803, 06.10.2011  
(97) 2625174, 14.08.2013 en  
(54) CO-CRYSTALS AND SALTS OF CCR3-INHIBITORS  
(71) Boehringer Ingelheim International GmbH, Binger Strasse 173, 55216 Ingelheim am Rhein, DE  
(72) FRANK, Markus, Boehringer Ingelheim GmbH Corporate Patents Binger Strasse 173, 55216 Ingelheim am Rhein, DE  
HAEBERLE, Hans, Boehringer Ingelheim GmbH Corporate Patents Binger Strasse 173, 55216 Ingelheim am Rhein, DE  
HENRY, Manuel, Boehringer Ingelheim GmbH Corporate Patents Binger Strasse 173, 55216 Ingelheim am Rhein, DE  
PACHUR, Thorsten, Boehringer Ingelheim GmbH Corporate Patents Binger Strasse 173, 55216 Ingelheim am Rhein, DE  
SANTAGOSTINO, Marco, Boehringer Ingelheim GmbH Corporate Patents Binger Strasse 173, 55216 Ingelheim am Rhein, DE  
STERTZ, Uwe, Boehringer Ingelheim GmbH Corporate Patents Binger Strasse 173, 55216 Ingelheim am Rhein, DE  
TREBING, Thomas, Boehringer Ingelheim GmbH Corporate Patents Binger Strasse 173, 55216 Ingelheim am Rhein, DE  
WERTHMANN, Ulrike, Boehringer Ingelheim GmbH Corporate Patents Binger Strasse 173, 55216 Ingelheim am Rhein, DE
- 
- (51) MKP  
**C12N 7/08 (2006.01)** (97) **2637688 \***  
**C07K 14/08 (2006.01)**  
**A61K 39/12 (2006.01)**
- (86) IB2011055003 09.11.2011  
(96) 11799833.6 18.09.2013  
(87) WO2012063212, 09.11.2011  
(97) 2637688, 18.09.2013 en  
(54) NORTH AMERICAN PORCINE REPRODUCTIVE AND RESPIRATORY SYNDROME (PRRS) VIRUS AND USES THEREOF  
(71) Zoetis LLC, 100 Campus Drive, Florham Park NJ 07932, US  
(72) WELCH, Siao-Kun Wan, Pfizer Global Research and Development 7000 Portage Road, Kalamazoo, MI 49001, US  
CALVERT, Jay Gregory, Pfizer Global Research and Development 7000 Portage Road, Kalamazoo, MI 49001, US
- 
- (51) MKP  
**A61K 31/427 (2006.01)** (97) **2600883 \***  
**A61K 38/44 (2006.01)**  
**A61K 38/06 (2006.01)**  
**A61P 31/12 (2006.01)**  
**A61P 39/06 (2006.01)**
- (86) IB2011053390 29.07.2011  
(96) 11754493.2 12.06.2013  
(87) WO2012017367, 29.07.2011  
(97) 2600883, 12.06.2013 en  
(54) COMPOSITION COMPRISING GLUTATHIONE REDUCTASE AND OXIDIZED GLUTATHIONE, AND THERAPEUTIC USES THEREOF  
(71) Cattarini Mastelli, Giulia, Via Goffredo Mameli 7/5, 16100 Genova, IT  
Cattarini Mastelli, Laura, Piazza Farini 1, 18018 Taggia Imperia, IT  
Ansovini, Raffaele, Strada Canneto Colognola 8/F, 06100 Perugia, IT  
(72) ANSOVINI, Raffaele, Strada Canneto Colognola 8/F, I-06100 Perugia, IT
-

- (51) MKP  
**A01N 47/06 (2006.01)** (97) **2629619 \***  
**A01N 47/38 (2006.01)**  
**A01N 43/80 (2006.01)**  
**A01P 13/02 (2006.01)**  
**A01N 41/10 (2006.01)**  
(86) JP2011074373 18.10.2011  
(96) 11778997.4 28.08.2013  
(87) WO2012053652, 18.10.2011  
(97) 2629619, 28.08.2013 en  
(54) HERBICIDAL COMPOSITION  
(71) Ishihara Sangyo Kaisha, Ltd., 3-15 Edobori 1-chome Nishi-ku, Osaka-shi, Osaka 550-0002, JP  
(72) KIKUGAWA, Hiroshi, c/o Ishihara Sangyo Kaisha Ltd. 3-15 Edobori 1-chome, Nishi-ku, Osaka-shi Osaka 5500002, JP  
SATAKE, Yoshikazu, c/o Ishihara Sangyo Kaisha Ltd. Chuo Kenkyusho 3-1 Nishi-shibukawa 2-chome, Kusatsu-shi Shiga 525-0025, JP

- (51) MKP  
**B21J 13/03 (2006.01)** (97) **2529855**  
**B23P 19/02 (2006.01)**  
**B30B 15/02 (2006.01)**  
**B21J 13/08 (2006.01)**  
**B21J 17/02 (2006.01)**  
**B21D 37/16 (2006.01)**  
(96) 12170312.8 05.12.2012  
(97) 2529855, 05.12.2012 de  
(54) Device for heating die holders  
(71) G & P GmbH, Steffensweg 7, 59581 Warstein, DE  
(72) Gauseweg, Hubert, Steffensweg 7, 59581 Warstein, DE

- (51) MKP  
**A61G 15/10 (2006.01)** (97) **2616032 \***  
(86) IT2011000314 13.09.2011  
(96) 11782482.1 24.07.2013  
(87) WO2013038431, 13.09.2011  
(97) 2616032, 24.07.2013 en  
(54) ADAPTER MATTRESS FOR DENTAL CHAIRS  
(71) Bacchiocchi, Danilo, 20 Via Dominici, 60022 Castelfidardo (AN), IT  
(72) Bacchiocchi, Danilo, 20 Via Dominici, 60022 Castelfidardo (AN), IT

- (51) MKP  
**A61K 31/7105 (2006.01)** (97) **2623119 \***  
**A61K 38/00 (2006.01)**  
**A61K 39/395 (2006.01)**  
**A61K 45/00 (2006.01)**  
**A61P 35/00 (2006.01)**  
(86) JP2011072428 29.09.2011  
(96) 11829300.0 07.08.2013  
(87) WO2012043747, 29.09.2011  
(97) 2623119, 07.08.2013 en  
(54) GLIOMA TREATMENT METHOD, GLIOMA EXAMINATION METHOD, METHOD OF DELIVERING A DESIRED MATERIAL TO A GLIOMA, AND DRUG USED IN SAID METHODS  
(71) Riken, 2-1, Hirosawa, Wako-shi., Saitama 351-0198, JP  
(72) KONDO Toru, c/o RIKEN Kobe Institute, 2-2-3, Minatojima-minamimachi, Chuo-ku., Kobe-shi, Hyogo 650-0047, JP

- (51) MKP  
**G01N 33/53 (2006.01)** (97) **2625525 \***  
(86) US2011055367 07.10.2011  
(96) 11831680.1 14.08.2013  
(87) WO2012048223, 07.10.2011  
(97) 2625525, 14.08.2013 en  
(54) SPARC MICROENVIRONMENT SIGNATURE, PLASMA SPARC, AND LDH AS PROGNOSTIC BIOMARKERS IN THE TREATMENT OF CANCER  
(71) Abraxis BioScience, LLC, 11755 Wilshire Boulevard Suite 2000, Los Angeles, CA 90025, US  
(72) TRIEU, Vuong, 4003 Jim Bowie Boulevard, Agoura Hills California 91301, US  
HWANG, Larn, 131 South 2nd Avenue A, Arcadia California 91006, US  
MOTAMED, Kouros, 25 Palatine 433, Irvine California 92616, US  
LIU, Xiping, 6035 Camellia Avenue, Temple City California 91780, US  
DESAI, Neil, 11755 Wilshire Boulevard Suite 2100, Los Angeles California 90025, US

**INDEKS BROJEVA ZAHTJEVA ZA PROŠIRENJE EVROPSKIH PRIJAVA  
PATENTA  
INDEX ON NUMBER OF REQUESTS FOR EXTENSION ON EUROPEAN PATENT  
APPLICATIONS**

Broj objave evropske prijave patenta (97)	MKP (51)	Broj objave evropske prijave patenta (97)	MKP (51)	Broj objave evropske prijave patenta (97)	MKP (51)
2455876	<b>A61B 5/145</b> (2006.01) <b>G06F 19/00</b> (2011.01)	2598483 *	<b>C07D 213/82</b> (2006.01) <b>C07D 295/04</b> (2006.01) <b>C07D 401/12</b> (2006.01) <b>C07D 401/14</b> (2006.01) <b>C07D 405/12</b> (2006.01) <b>C07D 409/12</b> (2006.01) <b>C07D 413/12</b> (2006.01) <b>C07D 471/10</b> (2006.01) <b>A61K 31/4427</b> (2006.01) <b>A61K 31/501</b> (2006.01) <b>A61K 31/5377</b> (2006.01) <b>A61P 3/10</b> (2006.01) <b>A61P 9/10</b> (2006.01)	2578688	<b>C12N 15/85</b> (2006.01) <b>C12N 9/64</b> (2006.01) <b>C07K 16/46</b> (2006.01) <b>C07K 16/28</b> (2006.01) <b>C07K 16/40</b> (2006.01) <b>A01K 67/027</b> (2006.01)
2601245 *	<b>C08G 77/50</b> (2006.01) <b>C08L 83/14</b> (2006.01)			2637704 *	<b>A61K 51/04</b> (2006.01) <b>G01N 33/60</b> (2006.01) <b>A61K 101/02</b> (2006.01) <b>C07B 59/00</b> (2006.01) <b>C07D 471/04</b> (2006.01)
2629825 *	<b>A61M 21/02</b> (2006.01)				
2603578 *	<b>C12N 5/04</b> (2006.01)			2621562 *	<b>A61M 5/24</b> (2006.01)
2609033 *	<b>C01B 33/12</b> (2006.01) <b>C01B 33/16</b> (2006.01)			2635289 *	<b>A61K 31/765</b> (2006.01) <b>A61P 35/00</b> (2006.01)
2625217 *	<b>C08G 77/42</b> (2006.01) <b>C08G 77/46</b> (2006.01) <b>C08G 77/442</b> (2006.01) <b>G02B 1/04</b> (2006.01) <b>C08L 83/10</b> (2006.01) <b>C08G 77/20</b> (2006.01)	2632559 *	<b>B01D 11/02</b> (2006.01) <b>A23L 1/30</b> (2006.01) <b>A61K 36/00</b> (2006.01)	2601801 *	<b>H04W 64/00</b> (2009.01) <b>H04W 4/02</b> (2009.01) <b>H04L 29/08</b> (2006.01) <b>G01S 19/49</b> (2010.01)
		2606069 *	<b>A61K 39/395</b> (2006.01) <b>A61P 37/06</b> (2006.01) <b>C07K 16/28</b> (2006.01) <b>A61P 35/02</b> (2006.01)	2601746 *	<b>H04B 3/02</b> (2006.01) <b>H04L 12/10</b> (2006.01) <b>H04L 25/02</b> (2006.01)
		2625170 *	<b>C07D 413/14</b> (2006.01) <b>C07D 417/06</b> (2006.01) <b>C07D 417/14</b> (2006.01) <b>C07D 267/10</b> (2006.01) <b>C07D 413/04</b> (2006.01) <b>C07D 413/06</b> (2006.01) <b>C07D 413/10</b> (2006.01) <b>C07D 413/12</b> (2006.01)	2632490 *	<b>A61K 39/395</b> (2006.01)
				2636030 *	<b>G07F 17/32</b> (2006.01) <b>G06F 3/048</b> (2013.01)

Broj objave evropske prijava patenta (97)	MKP (51)	Broj objave evropske prijava patenta (97)	MKP (51)	Broj objave evropske prijava patenta (97)	MKP (51)
2636409 *	<b>A61K 31/505</b> (2006.01) <b>A61K 31/506</b> (2006.01) <b>A61K 31/4174</b> (2006.01) <b>A61K 45/00</b> (2006.01) <b>A61K 31/7048</b> (2006.01) <b>A61K 31/444</b> (2006.01) <b>A61K 38/00</b> (2006.01) <b>A61K 31/4196</b> (2006.01) <b>A61P 31/10</b> (2006.01) <b>A61K 31/427</b> (2006.01) <b>A61P 43/00</b> (2006.01) <b>A61K 31/496</b> (2006.01)	2599775 *	<b>A61K 31/417</b> (2006.01) <b>A61P 25/04</b> (2006.01) <b>C07D 231/14</b> (2006.01) <b>A61K 31/4245</b> (2006.01) <b>A61P 25/20</b> (2006.01) <b>A61K 31/42</b> (2006.01) <b>A61P 25/18</b> (2006.01) <b>A61K 31/415</b> (2006.01) <b>A61K 31/496</b> (2006.01) <b>A61P 25/30</b> (2006.01) <b>A61K 31/4174</b> (2006.01) <b>A61P 25/08</b> (2006.01) <b>C07D 231/12</b> (2006.01) <b>A61K 31/4709</b> (2006.01) <b>A61P 25/28</b> (2006.01) <b>A61K 31/4439</b> (2006.01) <b>A61P 25/22</b> (2006.01) <b>A61K 31/4155</b> (2006.01) <b>A61K 31/506</b> (2006.01) <b>A61P 43/00</b> (2006.01)	2640395 *	<b>A61K 31/5377</b> (2006.01) <b>A61P 25/30</b> (2006.01) <b>A61K 31/55</b> (2006.01) <b>A61K 31/454</b> (2006.01) <b>A61P 25/18</b> (2006.01) <b>A61K 31/485</b> (2006.01) <b>A61P 25/24</b> (2006.01) <b>A61K 31/4178</b> (2006.01) <b>A61P 25/00</b> (2006.01) <b>A61K 31/551</b> (2006.01) <b>A61P 25/36</b> (2006.01) <b>A61K 31/4162</b> (2006.01) <b>A61P 25/34</b> (2006.01) <b>A61K 31/4439</b> (2006.01) <b>A61P 25/32</b> (2006.01) <b>A61K 31/519</b> (2006.01) <b>A61K 31/44</b> (2006.01) <b>A61P 25/08</b> (2006.01)
2619993 *	<b>H04N 21/475</b> (2011.01) <b>H04N 21/41</b> (2011.01) <b>H04L 12/28</b> (2006.01)	2639221	<b>C07D 213/50</b> (2006.01)	2632438 *	<b>A61K 9/16</b> (2006.01) <b>A61K 9/20</b> (2006.01) <b>A61K 9/48</b> (2006.01) <b>A61K 9/50</b> (2006.01) <b>A61K 31/4184</b> (2006.01) <b>A61K 31/4422</b> (2006.01)
				2608789 *	<b>A61K 31/495</b> (2006.01) <b>A61P 25/00</b> (2006.01)



Broj objave evropske prijava patenta (97)	MKP (51)	Broj objave evropske prijava patenta (97)	MKP (51)	Broj objave evropske prijava patenta (97)	MKP (51)
2642987 *	<b>A61K 31/137</b> (2006.01) <b>A61K 31/341</b> (2006.01) <b>A61K 31/381</b> (2006.01) <b>A61K 31/4184</b> (2006.01) <b>A61K 31/4402</b> (2006.01) <b>A61K 31/519</b> (2006.01) <b>A61K 31/52</b> (2006.01) <b>C07C 211/27</b> (2006.01) <b>C07C 211/29</b> (2006.01) <b>C07C 217/58</b> (2006.01) <b>C07C 255/58</b> (2006.01) <b>C07D 233/58</b> (2006.01) <b>C07D 235/08</b> (2006.01) <b>C07D 473/16</b> (2006.01) <b>C07D 473/34</b> (2006.01)	2606066 *	<b>C07K 16/22</b> (2006.01) <b>A61P 19/08</b> (2006.01) <b>A61P 21/00</b> (2006.01)	2627630 *	<b>C07D 401/12</b> (2006.01) <b>C07D 207/08</b> (2006.01) <b>A61P 11/00</b> (2006.01) <b>A61K 31/40</b> (2006.01)
		2621908 *	<b>C07D 239/28</b> (2006.01) <b>C07D 239/30</b> (2006.01) <b>C07D 401/04</b> (2006.01)	2523305	<b>H02J 7/34</b> (2006.01) <b>H02J 9/00</b> (2006.01)
		2640368 *	<b>A61K 31/07</b> (2006.01) <b>A61K 47/00</b> (2006.01)	2616469 *	<b>C07D 473/04</b> (2006.01) <b>A61K 31/52</b> (2006.01) <b>C07D 471/10</b> (2006.01)
		2522935	<b>F25D 3/11</b> (2006.01) <b>B01J 2/06</b> (2006.01)	2596235 *	<b>F03B 13/18</b> (2006.01)
		2619575 *	<b>G01N 33/49</b> (2006.01) <b>G01N 33/86</b> (2006.01)	2625986	<b>A47B 85/04</b> (2006.01) <b>A47D 11/00</b> (2006.01) <b>A47D 9/00</b> (2006.01) <b>A47C 13/00</b> (2006.01) <b>A47C 4/03</b> (2006.01)
2603491 *	<b>C07D 213/74</b> (2006.01) <b>C07D 239/42</b> (2006.01)	2598506 *	<b>C07D 487/04</b> (2006.01)		
		2625169 *	<b>C07D 471/08</b> (2006.01) <b>A61P 9/06</b> (2006.01) <b>A61K 31/517</b> (2006.01) <b>A61P 25/02</b> (2006.01) <b>C07D 239/74</b> (2006.01) <b>A61P 25/28</b> (2006.01) <b>C07D 239/84</b> (2006.01) <b>A61P 25/06</b> (2006.01) <b>C07D 401/12</b> (2006.01) <b>A61P 25/24</b> (2006.01) <b>C07D 401/04</b> (2006.01) <b>A61P 25/08</b> (2006.01) <b>C07D 403/12</b> (2006.01) <b>A61P 25/14</b> (2006.01)	2595492 *	<b>A23C 3/037</b> (2006.01) <b>A23C 9/12</b> (2006.01) <b>A23C 9/142</b> (2006.01)
2603523 *	<b>C07K 16/18</b> (2006.01) <b>G01N 33/577</b> (2006.01) <b>A61K 39/395</b> (2006.01) <b>A61P 25/28</b> (2006.01)				
2603208 *	<b>A61K 9/48</b> (2006.01) <b>A61K 9/50</b> (2006.01) <b>A23L 1/30</b> (2006.01)				
2591905	<b>B29C 49/56</b> (2006.01)				
2535308	<b>B66F 9/075</b> (2006.01) <b>B62D 11/08</b> (2006.01)				
2543807	<b>E05F 15/04</b> (2006.01) <b>F15B 15/06</b> (2006.01)				

Broj objave evropske prijava patenta (97)	MKP (51)	Broj objave evropske prijava patenta (97)	MKP (51)	Broj objave evropske prijava patenta (97)	MKP (51)
2604601 *	<b>A61P 1/04</b> (2006.01) <b>A61P 37/08</b> (2006.01) <b>A61P 19/02</b> (2006.01) <b>C07D 401/14</b> (2006.01) <b>A61P 29/00</b> (2006.01) <b>A61K 31/5377</b> (2006.01) <b>A61P 35/02</b> (2006.01) <b>A61P 11/06</b> (2006.01) <b>A61P 43/00</b> (2006.01) <b>A61P 17/06</b> (2006.01) <b>A61K 31/541</b> (2006.01) <b>A61P 37/02</b> (2006.01) <b>A61K 31/55</b> (2006.01) <b>A61P 37/06</b> (2006.01)	2640384 *	<b>A61K 31/4196</b> (2006.01) <b>A61P 35/00</b> (2006.01) <b>A61K 31/436</b> (2006.01) <b>A61K 31/506</b> (2006.01) <b>A61K 31/502</b> (2006.01) <b>A61K 31/517</b> (2006.01) <b>A61K 31/4439</b> (2006.01) <b>A61K 31/437</b> (2006.01) <b>A61K 31/395</b> (2006.01)	2524655	<b>A61B 17/115</b> (2006.01)
		2601431 *	<b>F16L 58/00</b> (2006.01)	2573298	<b>E04F 21/18</b> (2006.01)
		2514690	<b>B65G 1/137</b> (2006.01) <b>B66F 9/075</b> (2006.01) <b>G05D 1/02</b> (2006.01)	2511014	<b>B07B 1/14</b> (2006.01) <b>B07B 1/15</b> (2006.01)
2632485 *	<b>A61K 39/12</b> (2006.01)	2643325 *	<b>C07D 491/20</b> (2006.01) <b>A61K 31/527</b> (2006.01) <b>A61P 25/28</b> (2006.01)	2625175 *	<b>C07D 401/14</b> (2006.01) <b>A61K 31/4439</b> (2006.01) <b>A61P 35/00</b> (2006.01)
2595618 *	<b>A61P 35/04</b> (2006.01) <b>A61K 31/282</b> (2006.01) <b>A61K 31/7068</b> (2006.01) <b>A61K 31/166</b> (2006.01) <b>A61K 31/337</b> (2006.01) <b>A61P 35/00</b> (2006.01)	2628127 *	<b>G06K 7/08</b> (2006.01)	2640705 *	<b>C07D 221/06</b> (2006.01) <b>C07D 221/08</b> (2006.01) <b>C07D 221/10</b> (2006.01) <b>C07D 401/04</b> (2006.01) <b>C07D 417/04</b> (2006.01) <b>C07D 471/04</b> (2006.01) <b>C07D 471/14</b> (2006.01) <b>C07D 487/04</b> (2006.01) <b>C07D 491/048</b> (2006.01) <b>C07D 491/06</b> (2006.01) <b>C07D 495/04</b> (2006.01) <b>C07D 495/14</b> (2006.01) <b>C07D 519/00</b> (2006.01) <b>A61P 31/00</b> (2006.01) <b>A61K 31/435</b> (2006.01) <b>A61K 31/4355</b> (2006.01) <b>A61K 31/437</b> (2006.01) <b>A61K 31/519</b> (2006.01)
2608667 *	<b>A61K 31/44</b> (2006.01) <b>A01N 43/16</b> (2006.01) <b>A61K 31/35</b> (2006.01) <b>C07D 315/00</b> (2006.01) <b>A01N 43/40</b> (2006.01)	2635610 *	<b>C08F 8/00</b> (2006.01)	2596293 *	<b>F24D 13/02</b> (2006.01)
		2596293 *	<b>F24D 13/02</b> (2006.01)		
		2583677	<b>A61K 31/4709</b> (2006.01) <b>A61K 31/4025</b> (2006.01) <b>A61K 31/4725</b> (2006.01) <b>A61P 31/14</b> (2006.01) <b>A61K 31/5377</b> (2006.01) <b>A61K 31/513</b> (2006.01) <b>A61K 31/4178</b> (2006.01) <b>A61K 31/497</b> (2006.01)	2627747 *	<b>C11D 3/386</b> (2006.01) <b>C11D 3/00</b> (2006.01) <b>C11D 11/00</b> (2006.01) <b>A61L 2/18</b> (2006.01)
2573297	<b>E04F 21/18</b> (2006.01) <b>B62B 1/00</b> (2006.01)				
2611670 *	<b>B62B 7/06</b> (2006.01) <b>B62B 9/08</b> (2006.01)	2611821 *	<b>C07J 41/00</b> (2006.01) <b>C07J 31/00</b> (2006.01)		

Broj objave evropske prijava patenta (97)	MKP (51)	Broj objave evropske prijava patenta (97)	MKP (51)	Broj objave evropske prijava patenta (97)	MKP (51)
2638056 *	<b>C07H 21/02</b> (2006.01) <b>A61K 31/7125</b> (2006.01) <b>A61P 31/14</b> (2006.01)	2611774 *	<b>C07D 205/04</b> (2006.01) <b>C07D 403/14</b> (2006.01) <b>C07D 409/14</b> (2006.01) <b>C07D 413/14</b> (2006.01) <b>C07D 417/12</b> (2006.01) <b>C07D 417/14</b> (2006.01) <b>C07D 513/04</b> (2006.01) <b>A61K 31/427</b> (2006.01) <b>A61K 31/429</b> (2006.01) <b>A61P 29/00</b> (2006.01)	2644597	<b>C07C 255/43</b> (2006.01) <b>C07C 215/08</b> (2006.01) <b>C07C 229/34</b> (2006.01) <b>C07D 223/16</b> (2006.01)
2616070 *	<b>A61K 31/4196</b> (2006.01) <b>C07D 401/14</b> (2006.01) <b>C07D 403/06</b> (2006.01) <b>C07D 413/14</b> (2006.01) <b>A61P 5/06</b> (2006.01)	2640467 *	<b>C07D 401/12</b> (2006.01) <b>A61P 35/00</b> (2006.01) <b>A61K 31/495</b> (2006.01)	2638030 *	<b>C07D 401/12</b> (2006.01) <b>A61K 31/519</b> (2006.01) <b>A61P 35/00</b> (2006.01)
2621478 *	<b>A61K 38/16</b> (2006.01) <b>A61J 3/07</b> (2006.01) <b>A61K 9/48</b> (2006.01) <b>A61K 38/01</b> (2006.01) <b>A61J 3/02</b> (2006.01) <b>A61K 9/16</b> (2006.01) <b>A61P 35/00</b> (2006.01)	2643317 *	<b>A61K 35/00</b> (2006.01) <b>C07D 413/14</b> (2006.01) <b>C07D 471/04</b> (2006.01) <b>C07D 513/14</b> (2006.01) <b>C07D 413/04</b> (2006.01) <b>A61K 31/553</b> (2006.01) <b>C07D 417/14</b> (2006.01)	2633207 *	<b>F02B 75/26</b> (2006.01) <b>F16H 23/08</b> (2006.01) <b>F01B 3/00</b> (2006.01) <b>F01B 3/02</b> (2006.01) <b>F04B 1/22</b> (2006.01) <b>F04B 27/08</b> (2006.01)
2624701 *	<b>A01N 59/00</b> (2006.01) <b>C02F 1/467</b> (2006.01) <b>E03C 1/046</b> (2006.01) <b>A01P 1/00</b> (2006.01) <b>A61K 33/20</b> (2006.01)	2608803 *	<b>A61K 39/00</b> (2006.01) <b>C07K 16/00</b> (2006.01)	2562314	<b>E03D 11/02</b> (2006.01) <b>E03D 11/08</b> (2006.01)
2598169 *	<b>A61K 41/00</b> (2006.01) <b>A61K 49/22</b> (2006.01)	2621649 *	<b>B22D 19/00</b> (2006.01) <b>F27D 1/12</b> (2006.01) <b>F28D 1/047</b> (2006.01) <b>F28F 3/12</b> (2006.01)	2603268 *	<b>A61M 16/06</b> (2006.01) <b>A61M 16/14</b> (2006.01)
2455877	<b>G06F 19/00</b> (2011.01) <b>A61B 5/145</b> (2006.01)	2640396 *	<b>A61K 31/55</b> (2006.01)	2618153	<b>G01N 33/558</b> (2006.01)
2640396 *	<b>A61K 31/55</b> (2006.01)	2638045 *	<b>C07D 487/04</b> (2006.01)	2603215 *	<b>A61K 31/4184</b> (2006.01)
				2609118 *	<b>C07K 16/28</b> (2006.01) <b>C12N 15/13</b> (2006.01) <b>A61K 39/395</b> (2006.01) <b>A61P 35/00</b> (2006.01)
				2610713 *	<b>G06F 3/02</b> (2006.01) <b>H04M 1/02</b> (2006.01)
				2608775 *	<b>A61K 9/16</b> (2006.01) <b>A61K 31/47</b> (2006.01)

Broj objave evropske prijava patenta (97)	MKP (51)	Broj objave evropske prijava patenta (97)	MKP (51)	Broj objave evropske prijava patenta (97)	MKP (51)
2643931 *	<b>E04C 2/04</b> (2006.01) <b>H03K 17/96</b> (2006.01) <b>H05B 37/02</b> (2006.01)	2614063 *	<b>C07D 487/04</b> (2006.01) <b>A61K 31/5025</b> (2006.01) <b>A61P 35/00</b> (2006.01)	2633085 *	<b>C12R 1/645</b> (2006.01) <b>C12N 9/02</b> (2006.01) <b>C12P 7/56</b> (2006.01)
2595994 *	<b>C07D 498/02</b> (2006.01)	2616076 *	<b>A61K 31/4985</b> (2006.01)	2637927 *	<b>B64D 10/00</b> (2006.01)
2638046 *	<b>A61K 31/407</b> (2006.01) <b>C07D 487/10</b> (2006.01) <b>A61P 35/00</b> (2006.01)	2613772 *	<b>A61K 9/70</b> (2006.01) <b>A61K 31/565</b> (2006.01) <b>A61K 31/57</b> (2006.01)	2635282 *	<b>A61K 31/497</b> (2006.01) <b>A61K 9/48</b> (2006.01) <b>A61P 7/00</b> (2006.01)
2621949 *	<b>C12N 15/13</b> (2006.01) <b>C07K 16/18</b> (2006.01) <b>A61K 39/00</b> (2006.01) <b>C07K 16/46</b> (2006.01)	2642915 *	<b>A61B 5/0408</b> (2006.01) <b>A61H 35/00</b> (2006.01) <b>A47K 3/022</b> (2006.01)	2629791 *	<b>A61K 39/00</b> (2006.01)
2609169 *	<b>C09K 8/16</b> (2006.01) <b>E21B 21/00</b> (2006.01)	2632921 *	<b>C07D 413/14</b> (2006.01) <b>A61K 31/422</b> (2006.01) <b>A61P 35/00</b> (2006.01) <b>A61P 37/00</b> (2006.01) <b>A61P 11/00</b> (2006.01) <b>A61P 31/12</b> (2006.01)	2599494	<b>A61K 38/08</b> (2006.01) <b>A61K 38/18</b> (2006.01) <b>A61K 38/00</b> (2006.01)
2619023 *	<b>B60J 7/06</b> (2006.01) <b>B60J 5/10</b> (2006.01)	2640406 *	<b>A61P 35/00</b> (2006.01) <b>A61K 38/17</b> (2006.01)	2619098 *	<b>B65D 5/00</b> (2006.01) <b>B65D 85/60</b> (2006.01)
2641941	<b>D21H 17/00</b> (2006.01) <b>C09C 1/02</b> (2006.01)	2614824 *	<b>A61K 31/4196</b> (2006.01) <b>A61K 31/4245</b> (2006.01) <b>A61P 21/00</b> (2006.01) <b>A61P 25/04</b> (2006.01) <b>C07D 249/08</b> (2006.01) <b>C07D 413/12</b> (2006.01)	2598801 *	<b>F23H 17/08</b> (2006.01) <b>F23H 7/08</b> (2006.01) <b>F23H 3/02</b> (2006.01)
2633044 *	<b>C12N 15/82</b> (2006.01) <b>C12N 15/09</b> (2006.01)	2609726 *		2609726 *	<b>H04M 3/42</b> (2006.01) <b>H04M 3/487</b> (2006.01)
2600759 *	<b>A61B 1/04</b> (2006.01)	2635303 *		2635303 *	<b>A61K 39/395</b> (2006.01) <b>C07K 16/24</b> (2006.01) <b>A61K 31/519</b> (2006.01)
2598935 *	<b>G02C 7/04</b> (2006.01)	2599438 *		2599438 *	<b>A61B 6/00</b> (2006.01)
2616798 *	<b>G01N 23/02</b> (2006.01)	2479244	<b>C10J 3/62</b> (2006.01) <b>C10J 3/66</b> (2006.01) <b>C10J 3/48</b> (2006.01) <b>C10B 57/10</b> (2006.01)	2363200	<b>B01F 7/00</b> (2006.01) <b>B01F 7/18</b> (2006.01) <b>B01F 7/22</b> (2006.01) <b>B01F 13/10</b> (2006.01)
2640723 *	<b>C07D 471/04</b> (2006.01) <b>C07D 487/04</b> (2006.01) <b>A61K 31/519</b> (2006.01)				

Broj objave evropske prijave patenta (97)	MKP (51)	Broj objave evropske prijave patenta (97)	MKP (51)	Broj objave evropske prijave patenta (97)	MKP (51)
2611782 *	<b>C07D 223/16</b> (2006.01) <b>A61K 31/55</b> (2006.01) <b>A61P 3/04</b> (2006.01)	2627320 *	<b>A61P 31/04</b> (2006.01) <b>A61K 38/10</b> (2006.01) <b>A61K 9/48</b> (2006.01)	2621602 *	<b>B01D 35/05</b> (2006.01)
2533643 *	<b>A01N 45/00</b> (2006.01) <b>A61K 31/50</b> (2006.01) <b>A61K 31/56</b> (2006.01)	2469257	<b>F03B 11/00</b> (2006.01) <b>E02B 17/02</b> (2006.01) <b>F03B 17/06</b> (2006.01) <b>F03B 13/26</b> (2006.01) <b>E02D 15/08</b> (2006.01) <b>G01M 10/00</b> (2006.01)	2605770 *	<b>A61K 31/404</b> (2006.01) <b>A61P 31/10</b> (2006.01) <b>A61K 31/16</b> (2006.01) <b>A61K 31/351</b> (2006.01)
2601936 *	<b>A61K 9/20</b> (2006.01) <b>A61P 1/04</b> (2006.01) <b>A61K 47/38</b> (2006.01) <b>A61K 47/26</b> (2006.01) <b>A61K 31/4439</b> (2006.01)	2530315	<b>F04B 1/04</b> (2006.01) <b>F02M 59/10</b> (2006.01) <b>F02M 59/44</b> (2006.01) <b>F02M 63/00</b> (2006.01)	2603262 *	<b>A61M 5/24</b> (2006.01)
2565259	<b>C12M 1/107</b> (2006.01)			2374768	<b>E04F 15/12</b> (2006.01) <b>E04F 15/18</b> (2006.01) <b>C04B 28/02</b> (2006.01) <b>C04B 28/06</b> (2006.01) <b>F24D 13/02</b> (2006.01) <b>F24D 3/14</b> (2006.01)
2603099 *	<b>A23L 3/3463</b> (2006.01) <b>A23L 3/3526</b> (2006.01) <b>A23L 3/3472</b> (2006.01)	2613828 *	<b>A61M 15/00</b> (2006.01)	2640386 *	<b>A61K 31/495</b> (2006.01) <b>A61K 31/551</b> (2006.01) <b>A61K 45/06</b> (2006.01) <b>A61P 35/00</b> (2006.01) <b>A61K 31/437</b> (2006.01)
2612911 *	<b>C12N 15/09</b> (2006.01) <b>C12N 7/00</b> (2006.01) <b>C12N 5/10</b> (2006.01)	2603511 *	<b>C07D 487/04</b> (2006.01) <b>A61K 31/519</b> (2006.01) <b>A61P 25/28</b> (2006.01)		
		2608670 *	<b>A01N 43/42</b> (2006.01) <b>A61K 31/44</b> (2006.01)	2638160 *	<b>C12N 15/11</b> (2006.01) <b>C07H 21/00</b> (2006.01) <b>C12N 15/10</b> (2006.01) <b>C12Q 1/68</b> (2006.01)
2625216 *	<b>C08G 77/42</b> (2006.01) <b>C08G 77/442</b> (2006.01) <b>C08L 83/10</b> (2006.01) <b>G02B 1/04</b> (2006.01) <b>C08G 77/28</b> (2006.01) <b>C08G 77/48</b> (2006.01) <b>C08F 283/12</b> (2006.01) <b>C08F 290/06</b> (2006.01) <b>C08G 77/20</b> (2006.01)	2608809 *	<b>C12P 21/08</b> (2006.01) <b>A61K 39/395</b> (2006.01)	2640209 *	<b>A43B 7/12</b> (2006.01) <b>A43B 13/16</b> (2006.01) <b>A43B 13/12</b> (2006.01)
		2607471	<b>B65D 17/00</b> (2006.01) <b>B67C 3/02</b> (2006.01) <b>C12G 1/00</b> (2006.01)	2598443 *	<b>C01G 49/08</b> (2006.01)
		2605694 *	<b>A61B 3/00</b> (2006.01) <b>A61B 3/10</b> (2006.01) <b>A61B 3/117</b> (2006.01) <b>A61B 5/00</b> (2006.01)	2611294 *	<b>A01N 35/00</b> (2006.01) <b>A01N 35/02</b> (2006.01) <b>A01P 21/00</b> (2006.01)

Broj objave evropske prijava patenta (97)	MKP (51)	Broj objave evropske prijava patenta (97)	MKP (51)	Broj objave evropske prijava patenta (97)	MKP (51)
2520726	<b>E02F 9/06</b> (2006.01) <b>E02F 5/28</b> (2006.01) <b>E02B 3/02</b> (2006.01) <b>E02F 3/47</b> (2006.01) <b>E02F 7/06</b> (2006.01)	2625400 *	<b>F02B 21/00</b> (2006.01) <b>F02M 31/04</b> (2006.01) <b>F02M 31/16</b> (2006.01) <b>F01B 17/02</b> (2006.01) <b>F01D 13/02</b> (2006.01)	2538066	<b>F02M 51/00</b> (2006.01) <b>F02M 59/46</b> (2006.01) <b>F02M 61/16</b> (2006.01) <b>F02M 63/02</b> (2006.01) <b>F02M 63/00</b> (2006.01) <b>F16K 31/06</b> (2006.01) <b>F16L 37/088</b> (2006.01)
2632951 *	<b>C07K 16/18</b> (2006.01) <b>C07K 16/22</b> (2006.01)	2550225 *	<b>B66C 1/12</b> (2006.01)	2630315 *	<b>E04F 13/12</b> (2006.01) <b>E04F 13/08</b> (2006.01)
2595903 *	<b>B65D 90/12</b> (2006.01) <b>E04H 12/12</b> (2006.01) <b>F03D 11/04</b> (2006.01)	2619185 *	<b>C07D 237/32</b> (2006.01) <b>C07D 253/08</b> (2006.01) <b>C07D 265/26</b> (2006.01) <b>C07D 401/12</b> (2006.01) <b>C07D 403/12</b> (2006.01) <b>C07D 409/12</b> (2006.01) <b>A61K 31/502</b> (2006.01) <b>A61K 31/53</b> (2006.01) <b>A61K 31/536</b> (2006.01) <b>A61P 29/00</b> (2006.01)	2598218 *	<b>A63F 9/24</b> (2006.01)
2609038 *	<b>C02F 1/04</b> (2006.01) <b>B01D 1/30</b> (2006.01) <b>E21B 43/24</b> (2006.01) <b>C09K 8/592</b> (2006.01)	2609038 *	<b>C02F 1/04</b> (2006.01) <b>B01D 1/30</b> (2006.01) <b>E21B 43/24</b> (2006.01) <b>C09K 8/592</b> (2006.01)	2643354 *	<b>C07K 16/28</b> (2006.01) <b>A61K 39/395</b> (2006.01) <b>A61P 35/00</b> (2006.01)
2625381 *	<b>E21B 43/12</b> (2006.01) <b>E21B 34/14</b> (2006.01) <b>E21B 23/08</b> (2006.01) <b>E21B 33/12</b> (2006.01)	2619377 *	<b>E04F 13/08</b> (2006.01) <b>E04B 1/76</b> (2006.01) <b>E04B 2/92</b> (2006.01)	2618940 *	<b>B05B 11/00</b> (2006.01)
2638016 *	<b>C07D 233/64</b> (2006.01) <b>C07D 233/84</b> (2006.01)	2540243	<b>A61B 18/12</b> (2006.01)	2633060 *	<b>C12N 15/62</b> (2006.01) <b>C12N 9/24</b> (2006.01) <b>C12N 9/42</b> (2006.01) <b>C12N 15/56</b> (2006.01) <b>C12P 7/10</b> (2006.01) <b>C07K 14/33</b> (2006.01)
2595980 *	<b>C07D 309/10</b> (2006.01) <b>C07H 19/00</b> (2006.01)	2601193 *	<b>C07D 487/04</b> (2006.01) <b>A61K 31/53</b> (2006.01) <b>A61P 31/04</b> (2006.01)	2643415 *	<b>C09D 5/00</b> (2006.01)
2628397	<b>A23G 3/42</b> (2006.01) <b>A23L 1/236</b> (2006.01) <b>A23G 3/44</b> (2006.01) <b>A23L 2/60</b> (2006.01)	2598937 *	<b>G02B 1/12</b> (2006.01) <b>C07F 7/10</b> (2006.01) <b>B29D 11/00</b> (2006.01) <b>G02C 7/04</b> (2006.01)	2637711 *	<b>A61L 27/38</b> (2006.01) <b>A61L 27/50</b> (2006.01) <b>A61L 27/52</b> (2006.01) <b>A61L 27/22</b> (2006.01)
				2618149	<b>G01N 33/543</b> (2006.01) <b>G01N 33/558</b> (2006.01)

Broj objave evropske prijave patenta (97)	MKP (51)	Broj objave evropske prijave patenta (97)	MKP (51)	Broj objave evropske prijave patenta (97)	MKP (51)
2618150	<b>G01N 33/543</b> (2006.01) <b>G01N 33/558</b> (2006.01)	2637639 *	<b>A61K 8/84</b> (2006.01) <b>A61Q 19/00</b> (2006.01) <b>A61K 8/92</b> (2006.01) <b>A61Q 1/00</b> (2006.01) <b>A61K 8/72</b> (2006.01) <b>A61K 8/97</b> (2006.01)	2616063 *	<b>A61K 31/404</b> (2006.01) <b>A61K 31/4196</b> (2006.01) <b>A61K 31/423</b> (2006.01) <b>A61K 45/06</b> (2006.01) <b>A61P 35/00</b> (2006.01)
2617105 *	<b>H01R 13/62</b> (2006.01) <b>H01R 13/71</b> (2006.01) <b>H01R 13/24</b> (2006.01)			2492392	<b>D21F 1/02</b> (2006.01) <b>D21H 13/26</b> (2006.01)
2627383 *	<b>A61M 5/32</b> (2006.01)	2613765 *	<b>A61K 9/00</b> (2006.01) <b>A61K 35/14</b> (2006.01) <b>A61L 15/32</b> (2006.01) <b>A61P 17/02</b> (2006.01)	2621531 *	<b>A61K 39/395</b> (2006.01) <b>C07K 16/28</b> (2006.01) <b>C07K 16/30</b> (2006.01) <b>A61P 35/00</b> (2006.01)
2614731	<b>A24F 47/00</b> (2006.01)				
2613272 *	<b>G09B 29/10</b> (2006.01) <b>G06F 17/30</b> (2006.01) <b>G06Q 10/00</b> (2012.01)	2621491 *	<b>A61K 31/4375</b> (2006.01) <b>A61P 31/04</b> (2006.01)	2614143 *	<b>C12N 5/071</b> (2010.01) <b>C12N 5/0783</b> (2010.01)
2605893 *	<b>E04F 13/14</b> (2006.01) <b>B28D 1/00</b> (2006.01) <b>B44C 5/04</b> (2006.01)	2611909 *	<b>C12N 5/0735</b> (2010.01) <b>C12N 5/02</b> (2006.01) <b>C12N 5/071</b> (2010.01)	2543370	<b>A61K 31/353</b> (2006.01) <b>A61P 31/22</b> (2006.01) <b>A61P 31/12</b> (2006.01)
2611941 *	<b>G06F 19/10</b> (2011.01) <b>C12Q 1/68</b> (2006.01) <b>C12N 15/11</b> (2006.01)	2601190 *	<b>A01N 43/80</b> (2006.01) <b>C07D 413/12</b> (2006.01) <b>C07D 413/14</b> (2006.01)	2642992 *	<b>A61K 31/34</b> (2006.01) <b>A61P 31/00</b> (2006.01) <b>C07D 507/00</b> (2006.01)
2609040 *	<b>C02F 1/74</b> (2006.01) <b>C02F 3/20</b> (2006.01) <b>B01F 5/12</b> (2006.01) <b>B01F 7/22</b> (2006.01) <b>F04D 13/08</b> (2006.01)	2640715 *	<b>A61P 37/00</b> (2006.01) <b>A61K 31/506</b> (2006.01) <b>C07D 413/14</b> (2006.01) <b>A61P 35/00</b> (2006.01) <b>C07D 401/14</b> (2006.01) <b>A61P 29/00</b> (2006.01)	2630114 *	<b>C07C 51/41</b> (2006.01) <b>C07C 51/48</b> (2006.01) <b>C07C 59/08</b> (2006.01) <b>C07C 51/295</b> (2006.01)
2603205 *	<b>A61K 9/20</b> (2006.01) <b>A61K 31/485</b> (2006.01)	2236447	<b>B65H 29/60</b> (2006.01)	2596010 *	<b>C07K 14/00</b> (2006.01) <b>C12P 21/08</b> (2006.01)
2635588 *	<b>A61K 31/4188</b> (2006.01) <b>C07D 491/052</b> (2006.01)	2599525 *	<b>A62C 35/68</b> (2006.01) <b>A62C 31/00</b> (2006.01)		

Broj objave evropske prijave patenta (97)	MKP (51)	Broj objave evropske prijave patenta (97)	MKP (51)	Broj objave evropske prijave patenta (97)	MKP (51)
2643130 *	<b>B26D 1/547</b> (2006.01) <b>B26B 27/00</b> (2006.01) <b>B25B 11/00</b> (2006.01) <b>B60J 1/02</b> (2006.01) <b>B60J 1/00</b> (2006.01)	2591781 *	<b>A61K 47/32</b> (2006.01) <b>A61K 31/426</b> (2006.01) <b>A61K 9/20</b> (2006.01) <b>A61K 47/10</b> (2006.01)	2600719 *	<b>A01N 43/90</b> (2006.01) <b>A61K 31/519</b> (2006.01) <b>A61K 31/505</b> (2006.01)
2606063 *	<b>C07K 16/00</b> (2006.01) <b>A61K 39/395</b> (2006.01)	2595660 *	<b>A61K 31/4184</b> (2006.01) <b>A61K 47/40</b> (2006.01) <b>A61P 35/00</b> (2006.01)	2621340 *	<b>A61B 5/22</b> (2006.01) <b>A63B 23/12</b> (2006.01) <b>A61H 1/02</b> (2006.01)
2621918 *	<b>C07D 403/04</b> (2006.01) <b>C07D 403/14</b> (2006.01) <b>C07D 409/14</b> (2006.01) <b>C07D 417/14</b> (2006.01) <b>A61K 31/506</b> (2006.01) <b>A61P 29/00</b> (2006.01)	2595619 *	<b>A61K 35/00</b> (2006.01) <b>A61K 31/166</b> (2006.01) <b>A61P 35/04</b> (2006.01) <b>A61K 31/4745</b> (2006.01)	2643242 *	<b>B65F 1/14</b> (2006.01)
2603232 *	<b>A61K 38/10</b> (2006.01)	2529775	<b>A61M 5/315</b> (2006.01)	2600859 *	<b>A61K 31/137</b> (2006.01) <b>A61K 31/216</b> (2006.01) <b>A61P 13/10</b> (2006.01)
2603259 *	<b>A61M 5/24</b> (2006.01) <b>A61M 5/315</b> (2006.01)	2603490 *	<b>C07D 213/30</b> (2006.01) <b>C07D 239/26</b> (2006.01) <b>C07D 405/06</b> (2006.01) <b>C07D 405/08</b> (2006.01) <b>A61K 31/4402</b> (2006.01) <b>A61K 31/4433</b> (2006.01) <b>A61K 31/505</b> (2006.01) <b>A61P 25/00</b> (2006.01) <b>A61P 29/00</b> (2006.01)	2616080 *	<b>A61K 31/706</b> (2006.01) <b>C07H 7/06</b> (2006.01) <b>C07H 21/04</b> (2006.01) <b>A61P 31/16</b> (2006.01)
2616399 *	<b>C03C 3/118</b> (2006.01) <b>C03C 13/00</b> (2006.01) <b>B32B 17/00</b> (2006.01) <b>C08J 5/24</b> (2006.01) <b>C08K 7/14</b> (2006.01) <b>C08J 5/04</b> (2006.01)	2625277 *	<b>C12N 15/85</b> (2006.01)	2603513 *	<b>C07D 513/04</b> (2006.01) <b>A61K 31/542</b> (2006.01) <b>A61P 25/00</b> (2006.01)
2625380 *	<b>E21B 43/14</b> (2006.01) <b>E21B 43/26</b> (2006.01) <b>E21B 34/14</b> (2006.01) <b>E21B 23/14</b> (2006.01)	2614086 *	<b>C07K 16/30</b> (2006.01) <b>G01N 33/53</b> (2006.01) <b>G01N 33/574</b> (2006.01) <b>G01N 33/68</b> (2006.01)	2611759 *	<b>C07B 59/00</b> (2006.01) <b>C07D 211/24</b> (2006.01) <b>A61K 31/445</b> (2006.01) <b>A61P 25/00</b> (2006.01)
2517988	<b>B65G 47/14</b> (2006.01)	2640684 *	<b>C07C 43/00</b> (2006.01)	2510774	<b>A01B 69/00</b> (2006.01) <b>A01D 41/12</b> (2006.01) <b>A01D 43/073</b> (2006.01) <b>G03B 17/55</b> (2006.01) <b>A01D 41/127</b> (2006.01) <b>A01D 43/08</b> (2006.01) <b>A01D 75/18</b> (2006.01)
2628022 *	<b>G01T 3/00</b> (2006.01)	2600760 *	<b>A61B 1/267</b> (2006.01) <b>A61B 1/005</b> (2006.01)		



Broj objave evropske prijave patenta (97)	MKP (51)	Broj objave evropske prijave patenta (97)	MKP (51)	Broj objave evropske prijave patenta (97)	MKP (51)
2643315 *	<b>C07D 413/14</b> (2006.01) <b>C07D 471/04</b> (2006.01) <b>A61K 31/5377</b> (2006.01) <b>A61P 35/00</b> (2006.01) <b>C07D 413/04</b> (2006.01)	2365209	<b>F03B 1/00</b> (2006.01) <b>F03B 1/02</b> (2006.01) <b>F01D 5/30</b> (2006.01)	2611427 *	<b>A61K 9/20</b> (2006.01) <b>A61K 9/28</b> (2006.01) <b>A61K 31/55</b> (2006.01)
2632436 *	<b>A61K 47/22</b> (2006.01) <b>A61P 35/00</b> (2006.01) <b>A61K 9/48</b> (2006.01) <b>A61K 47/26</b> (2006.01) <b>A61K 9/14</b> (2006.01) <b>A61K 47/38</b> (2006.01) <b>A61K 47/32</b> (2006.01) <b>A61K 31/437</b> (2006.01) <b>A61K 47/44</b> (2006.01) <b>A61K 47/12</b> (2006.01) <b>A61K 47/34</b> (2006.01)	2643321 *	<b>A61P 35/02</b> (2006.01) <b>C07D 471/04</b> (2006.01) <b>C07D 487/04</b> (2006.01) <b>A61K 31/5025</b> (2006.01) <b>A61P 37/06</b> (2006.01) <b>A61P 35/00</b> (2006.01)	2533423	<b>H03K 5/08</b> (2006.01) <b>H03K 5/1534</b> (2006.01) <b>H04B 1/7163</b> (2011.01)
2621901 *	<b>C07D 207/26</b> (2006.01) <b>C07D 233/36</b> (2006.01) <b>C07D 263/24</b> (2006.01) <b>C07D 417/04</b> (2006.01) <b>A61K 31/402</b> (2006.01) <b>A61K 31/4166</b> (2006.01) <b>A61K 31/421</b> (2006.01) <b>A61P 19/10</b> (2006.01)	2572828	<b>B24B 23/00</b> (2006.01) <b>B24B 55/10</b> (2006.01) <b>B24B 7/18</b> (2006.01)	2620152 *	<b>A61K 31/545</b> (2006.01) <b>A61K 47/04</b> (2006.01) <b>A61K 9/51</b> (2006.01) <b>A61P 31/04</b> (2006.01)
2635116 *	<b>A01N 25/00</b> (2006.01)	2619207 *	<b>C07D 487/04</b> (2006.01) <b>A61K 31/4985</b> (2006.01) <b>A61P 25/28</b> (2006.01)	2541532	<b>G09B 19/00</b> (2006.01) <b>G09B 19/24</b> (2006.01) <b>G09B 5/06</b> (2006.01) <b>G09B 23/28</b> (2006.01)
2635556 *	<b>C07D 213/82</b> (2006.01)	2619198 *	<b>C07D 413/14</b> (2006.01) <b>A61K 31/506</b> (2006.01) <b>A61P 3/00</b> (2006.01)	2611910 *	<b>C12N 5/0735</b> (2010.01) <b>C12N 5/02</b> (2006.01) <b>C12N 5/071</b> (2010.01)
2625163 *	<b>C07C 309/14</b> (2006.01) <b>C07C 303/02</b> (2006.01)	2629760 *	<b>A61K 31/337</b> (2006.01) <b>A61K 47/30</b> (2006.01) <b>A61K 9/16</b> (2006.01) <b>A61K 47/48</b> (2006.01) <b>A61K 47/36</b> (2006.01)	2629792 *	<b>A61K 39/00</b> (2006.01) <b>A61M 5/178</b> (2006.01)
2628102 *	<b>G06F 17/50</b> (2006.01)	2635247 *	<b>A61J 3/06</b> (2006.01)	2637667 *	<b>A61P 3/00</b> (2006.01) <b>A61K 31/554</b> (2006.01)
		2619405 *	<b>E21B 43/26</b> (2006.01) <b>E21B 34/14</b> (2006.01) <b>E21B 43/14</b> (2006.01)	2643812 *	<b>G06F 3/041</b> (2006.01) <b>G06F 3/01</b> (2006.01) <b>G06T 7/00</b> (2006.01) <b>G06F 3/042</b> (2006.01)
				2611803 *	<b>C07D 471/04</b> (2006.01)

Broj objave evropske prijava patenta (97)	MKP (51)	Broj objave evropske prijava patenta (97)	MKP (51)	Broj objave evropske prijava patenta (97)	MKP (51)
2532258	<b>A24D 1/00</b> (2006.01) <b>A24D 1/04</b> (2006.01) <b>A24D 3/06</b> (2006.01)	2632569 *	<b>B01D 53/52</b> (2006.01) <b>B01D 53/78</b> (2006.01) <b>B01D 53/96</b> (2006.01)	2632512 *	<b>A61M 5/315</b> (2006.01)
2603212 *	<b>A61K 31/135</b> (2006.01)	2562875	<b>H01R 4/06</b> (2006.01) <b>H01R 43/00</b> (2006.01)	2607889 *	<b>G01B 9/04</b> (2006.01) <b>G01N 21/64</b> (2006.01)
2605752 *	<b>A61K 9/00</b> (2006.01) <b>A61K 31/56</b> (2006.01) <b>A61K 31/575</b> (2006.01) <b>A61K 47/26</b> (2006.01) <b>A61K 47/28</b> (2006.01) <b>A61K 47/32</b> (2006.01) <b>A61K 47/36</b> (2006.01)	2603258 *	<b>A61M 5/24</b> (2006.01)	2540892	<b>D04H 5/02</b> (2012.01) <b>D04H 5/06</b> (2006.01) <b>D04H 13/00</b> (2006.01) <b>A47L 13/17</b> (2006.01) <b>A61K 8/02</b> (2006.01)
2627181 *	<b>A61K 31/365</b> (2006.01) <b>A01N 43/78</b> (2006.01) <b>A01N 43/16</b> (2006.01) <b>A61K 31/35</b> (2006.01) <b>A61K 31/425</b> (2006.01)	2621496 *	<b>A61P 25/04</b> (2006.01) <b>A61K 33/42</b> (2006.01) <b>A61K 31/194</b> (2006.01) <b>A61K 31/765</b> (2006.01) <b>A61K 31/485</b> (2006.01)	2603214 *	<b>A61K 31/33</b> (2006.01) <b>A61K 31/425</b> (2006.01)
2598259 *	<b>B09B 3/00</b> (2006.01) <b>B27B 3/00</b> (2006.01) <b>B29B 17/02</b> (2006.01)	2642218	<b>F24J 2/52</b> (2006.01) <b>H01L 31/042</b> (2006.01)	2554507	<b>B66D 1/50</b> (2006.01)
2548437	<b>A01N 43/50</b> (2006.01) <b>A01N 25/30</b> (2006.01) <b>A01N 25/02</b> (2006.01) <b>A01N 53/00</b> (2006.01) <b>A01N 37/42</b> (2006.01) <b>A01N 43/653</b> (2006.01) <b>A01N 47/12</b> (2006.01) <b>A01N 47/20</b> (2006.01) <b>A01N 43/40</b> (2006.01)	2643316 *	<b>C07D 413/04</b> (2006.01)	2625030 *	<b>B30B 5/06</b> (2006.01) <b>B30B 9/32</b> (2006.01)
		2605666 *	<b>A23J 1/14</b> (2006.01) <b>A23J 3/16</b> (2006.01)	2638017 *	<b>C07D 233/70</b> (2006.01) <b>A61K 31/4174</b> (2006.01) <b>A61P 9/00</b> (2006.01)
		2606070 *	<b>C07K 16/32</b> (2006.01) <b>A61K 39/395</b> (2006.01) <b>A61P 35/00</b> (2006.01)	2616047 *	<b>A61K 9/113</b> (2006.01) <b>A61K 9/107</b> (2006.01) <b>A61K 31/728</b> (2006.01)
		2576621 *	<b>C07K 16/28</b> (2006.01) <b>A61K 39/00</b> (2006.01)	2603930 *	<b>H01L 29/18</b> (2006.01)
		2612850	<b>C07D 209/42</b> (2006.01) <b>A61K 31/403</b> (2006.01)	2605783 *	<b>A61K 35/76</b> (2006.01) <b>C12N 15/45</b> (2006.01) <b>A61P 35/00</b> (2006.01) <b>C12N 9/10</b> (2006.01) <b>C12N 9/78</b> (2006.01) <b>C07K 19/00</b> (2006.01)
		2447859	<b>G06F 17/30</b> (2006.01)		
		2517971	<b>B65D 21/06</b> (2006.01) <b>B65D 43/02</b> (2006.01)		

Broj objave evropske prijave patenta (97)	MKP (51)	Broj objave evropske prijave patenta (97)	MKP (51)	Broj objave evropske prijave patenta (97)	MKP (51)
2605831 *	<b>A61K 36/25</b> (2006.01) <b>A61K 36/11</b> (2006.01) <b>A61K 36/53</b> (2006.01) <b>A61P 11/00</b> (2006.01) <b>A61K 36/57</b> (2006.01) <b>A61K 36/185</b> (2006.01) <b>A61P 11/10</b> (2006.01) <b>A61K 36/28</b> (2006.01) <b>A61P 11/12</b> (2006.01) <b>A61K 36/235</b> (2006.01) <b>A61K 36/35</b> (2006.01)	2554755	<b>E03C 1/22</b> (2006.01) <b>E03F 5/04</b> (2006.01) <b>A47K 3/40</b> (2006.01)	2607300 *	<b>C07C 5/08</b> (2006.01) <b>C07C 29/17</b> (2006.01) <b>C01B 3/08</b> (2006.01) <b>C07C 15/18</b> (2006.01) <b>C07C 41/20</b> (2006.01) <b>C07B 31/00</b> (2006.01) <b>C07C 15/52</b> (2006.01) <b>C07C 43/205</b> (2006.01) <b>C01B 3/04</b> (2006.01) <b>C07C 9/15</b> (2006.01) <b>C07C 41/18</b> (2006.01) <b>C07C 5/10</b> (2006.01) <b>C07C 33/22</b> (2006.01) <b>C01B 4/00</b> (2006.01) <b>C07C 15/24</b> (2006.01) <b>C07C 41/24</b> (2006.01) <b>C07C 5/09</b> (2006.01) <b>C07C 33/20</b> (2006.01) <b>C07C 1/26</b> (2006.01) <b>C07C 29/143</b> (2006.01)
2611449 *	<b>A61K 31/55</b> (2006.01) <b>A61P 3/04</b> (2006.01)	2635565 *	<b>C07D 401/12</b> (2006.01) <b>C07D 401/14</b> (2006.01) <b>C07D 473/34</b> (2006.01) <b>C07D 239/48</b> (2006.01) <b>C07D 403/12</b> (2006.01) <b>A61K 31/506</b> (2006.01) <b>A61K 31/52</b> (2006.01) <b>A61K 31/505</b> (2006.01) <b>A61P 29/00</b> (2006.01) <b>A61P 19/02</b> (2006.01) <b>A61P 35/00</b> (2006.01) <b>A61P 37/00</b> (2006.01)	2610248 *	<b>C07D 277/20</b> (2006.01) <b>C07D 277/56</b> (2006.01) <b>A61K 31/426</b> (2006.01) <b>A61P 19/06</b> (2006.01) <b>A61P 43/00</b> (2006.01)
2595677 *	<b>A61M 5/28</b> (2006.01) <b>A61J 1/06</b> (2006.01)	2625206 *	<b>C08F 2/00</b> (2006.01)	2521188	<b>H01L 31/048</b> (2006.01)
2596975 *	<b>B60K 28/06</b> (2006.01) <b>G01N 33/497</b> (2006.01) <b>B60R 25/04</b> (2013.01) <b>G06K 9/00</b> (2006.01)	2632952 *	<b>A61K 38/17</b> (2006.01) <b>C07K 16/18</b> (2006.01) <b>A61K 39/395</b> (2006.01) <b>C07K 14/435</b> (2006.01) <b>C12N 15/13</b> (2006.01) <b>A61P 21/00</b> (2006.01)	2605760 *	<b>A61K 9/28</b> (2006.01) <b>A61K 9/20</b> (2006.01)
2598514 *	<b>C07K 1/18</b> (2006.01) <b>C07K 1/36</b> (2006.01)	2627632 *	<b>C07D 209/42</b> (2006.01) <b>A61K 31/404</b> (2006.01) <b>A61P 3/04</b> (2006.01) <b>C07D 333/68</b> (2006.01) <b>C07D 409/04</b> (2006.01) <b>C07D 495/04</b> (2006.01) <b>A61K 31/381</b> (2006.01) <b>C07D 333/26</b> (2006.01)	2611415 *	<b>A61K 9/00</b> (2006.01) <b>A61K 31/4427</b> (2006.01) <b>A61K 31/4439</b> (2006.01) <b>A61P 27/06</b> (2006.01)
2407208	<b>A62B 17/00</b> (2006.01) <b>A62B 9/00</b> (2006.01) <b>A62B 9/02</b> (2006.01)				
2635715 *	<b>C21C 5/48</b> (2006.01) <b>F27D 3/16</b> (2006.01) <b>B22D 1/00</b> (2006.01)				

Broj objave evropske prijava patenta (97)	MKP (51)	Broj objave evropske prijava patenta (97)	MKP (51)	Broj objave evropske prijava patenta (97)	MKP (51)
2402645	<b>F21S 8/00</b> (2006.01) <b>F21S 8/08</b> (2006.01) <b>F21V 21/116</b> (2006.01) <b>F21Y 101/02</b> (2006.01) <b>F21W 131/103</b> (2006.01)	2632429 *	<b>A61K 31/4045</b> (2006.01) <b>A61K 47/02</b> (2006.01) <b>A61K 47/26</b> (2006.01) <b>A61K 31/519</b> (2006.01) <b>A61K 47/44</b> (2006.01) <b>A61K 31/495</b> (2006.01) <b>A61K 9/00</b> (2006.01) <b>A61K 9/70</b> (2006.01)	2630507 *	<b>A41D 1/06</b> (2006.01) <b>G01H 5/00</b> (2006.01) <b>G01R 27/28</b> (2006.01)
2634724	<b>G06F 21/44</b> (2013.01) <b>G06F 21/85</b> (2013.01) <b>G06F 13/38</b> (2006.01)	2637668 *	<b>A61K 31/554</b> (2006.01) <b>A61P 1/16</b> (2006.01)	2309472	<b>G08G 1/14</b> (2006.01)
2643327 *	<b>C07D 513/04</b> (2006.01) <b>A61K 31/437</b> (2006.01)	2612881	<b>C08K 9/00</b> (2006.01) <b>C08J 9/04</b> (2006.01) <b>C08J 9/00</b> (2006.01) <b>C08K 3/26</b> (2006.01) <b>C08K 9/04</b> (2006.01)	2598938 *	<b>G02C 7/04</b> (2006.01) <b>B29D 11/00</b> (2006.01) <b>B05D 5/06</b> (2006.01)
2583680	<b>A61P 31/14</b> (2006.01) <b>A61K 31/4725</b> (2006.01) <b>A61K 31/501</b> (2006.01) <b>A61P 31/12</b> (2006.01) <b>A61K 45/06</b> (2006.01) <b>A61K 31/7072</b> (2006.01) <b>A61K 31/4178</b> (2006.01) <b>A61K 31/513</b> (2006.01) <b>A61K 31/5377</b> (2006.01) <b>A61K 31/4709</b> (2006.01)	2598297 *	<b>B27M 1/08</b> (2006.01) <b>B27M 3/18</b> (2006.01) <b>B27G 11/00</b> (2006.01)	2632898 *	<b>C07D 211/60</b> (2006.01)
2640387 *	<b>C07D 417/00</b> (2006.01) <b>A61K 31/44</b> (2006.01) <b>C07D 417/14</b> (2006.01) <b>G01N 33/53</b> (2006.01) <b>C07D 401/00</b> (2006.01) <b>C12Q 1/68</b> (2006.01)	2279919	<b>G07B 15/02</b> (2011.01) <b>G08G 1/14</b> (2006.01) <b>G07F 17/24</b> (2006.01) <b>B60R 25/10</b> (2006.01)	2640189 *	<b>A61K 31/40</b> (2006.01) <b>A01N 43/38</b> (2006.01)
		2600829 *	<b>A61K 9/00</b> (2006.01) <b>A61K 31/44</b> (2006.01) <b>A61P 11/06</b> (2006.01)	2606045 *	<b>C07D 413/10</b> (2006.01) <b>C07D 413/14</b> (2006.01) <b>C07D 417/12</b> (2006.01) <b>C07D 417/14</b> (2006.01) <b>C07D 471/04</b> (2006.01) <b>C07D 487/04</b> (2006.01) <b>C07D 498/04</b> (2006.01) <b>A61K 31/437</b> (2006.01) <b>A61K 31/4439</b> (2006.01) <b>A61K 31/444</b> (2006.01) <b>A61K 31/497</b> (2006.01) <b>A61K 31/4985</b> (2006.01) <b>A61K 31/506</b> (2006.01) <b>A61K 31/5365</b> (2006.01) <b>A61K 31/5377</b> (2006.01) <b>A61K 31/541</b> (2006.01) <b>A61P 9/00</b> (2006.01) <b>A61P 9/10</b> (2006.01) <b>A61P 29/00</b> (2006.01) <b>A61P 37/08</b> (2006.01) <b>A61P 11/00</b> (2006.01)
		2601180 *	<b>A61P 9/12</b> (2006.01) <b>A61K 31/41</b> (2006.01) <b>C07D 257/04</b> (2006.01)		

Broj objave evropske prijava patenta (97)	MKP (51)	Broj objave evropske prijava patenta (97)	MKP (51)	Broj objave evropske prijava patenta (97)	MKP (51)
2597954 *	<b>A01N 43/42</b> (2006.01)	2616199 *	<b>B21D 47/04</b> (2006.01) <b>E04C 3/08</b> (2006.01)	2598165 *	<b>A61P 1/00</b> (2006.01) <b>G01N 33/48</b> (2006.01) <b>A61P 29/00</b> (2006.01) <b>A61P 35/00</b> (2006.01) <b>A61K 39/00</b> (2006.01) <b>A61K 39/02</b> (2006.01) <b>A61K 39/12</b> (2006.01)
2333924	<b>H02G 3/22</b> (2006.01) <b>H02G 15/013</b> (2006.01)	2625856 *	<b>H04N 7/26</b> (2006.01) <b>H04N 7/68</b> (2006.01)		
2517635	<b>A61B 17/064</b> (2006.01) <b>A61B 17/072</b> (2006.01)	2617166 *	<b>H04L 12/46</b> (2006.01) <b>H04L 12/18</b> (2006.01)		
2598507 *	<b>C07D 487/04</b> (2006.01) <b>A61P 35/00</b> (2006.01)	2557322	<b>F16B 37/12</b> (2006.01)	2635601 *	<b>C07K 16/24</b> (2006.01)
2611781 *	<b>C07D 223/16</b> (2006.01) <b>A61K 31/55</b> (2006.01) <b>A61P 3/04</b> (2006.01)	2618835 *	<b>A61K 39/00</b> (2006.01) <b>C07K 14/705</b> (2006.01) <b>C07K 14/47</b> (2006.01) <b>C07K 14/045</b> (2006.01)	2637640 *	<b>A61K 8/19</b> (2006.01) <b>A61Q 1/00</b> (2006.01) <b>A61K 8/97</b> (2006.01) <b>A61K 8/72</b> (2006.01) <b>A61K 8/92</b> (2006.01) <b>A61Q 1/04</b> (2006.01)
2601214 *	<b>C07K 14/71</b> (2006.01)	2625385 *	<b>F01B 17/02</b> (2006.01) <b>F02G 1/02</b> (2006.01) <b>F24J 2/42</b> (2006.01)	2640710 *	<b>C07D 239/42</b> (2006.01)
2619007 *	<b>B32B 27/18</b> (2006.01) <b>B65D 81/26</b> (2006.01) <b>A23L 1/30</b> (2006.01)	2629757 *	<b>A61K 9/00</b> (2006.01) <b>A61K 9/06</b> (2006.01) <b>A61K 47/32</b> (2006.01) <b>A61K 31/498</b> (2006.01)	2630139 *	<b>C07D 403/12</b> (2006.01) <b>A61P 29/00</b> (2006.01) <b>C07D 417/14</b> (2006.01) <b>C07D 405/14</b> (2006.01) <b>A61K 31/427</b> (2006.01) <b>A61K 31/381</b> (2006.01) <b>A61K 31/4025</b> (2006.01) <b>C07D 409/14</b> (2006.01) <b>A61P 25/00</b> (2006.01)
2616445 *	<b>C07D 409/06</b> (2006.01) <b>C07D 401/06</b> (2006.01) <b>A61K 31/416</b> (2006.01) <b>A61K 31/4192</b> (2006.01) <b>A61P 35/00</b> (2006.01) <b>C07D 231/56</b> (2006.01) <b>C07D 249/18</b> (2006.01)	2638395 *	<b>G01N 33/574</b> (2006.01)		
2611931 *	<b>C12Q 1/68</b> (2006.01)	2612151 *	<b>G01N 33/574</b> (2006.01) <b>A61K 39/00</b> (2006.01)		
2603617 *	<b>C08K 3/08</b> (2006.01) <b>C10L 5/14</b> (2006.01) <b>C08K 3/22</b> (2006.01) <b>C22B 1/244</b> (2006.01)	2638023 *	<b>C07D 303/16</b> (2006.01) <b>A61K 31/336</b> (2006.01) <b>A61P 3/00</b> (2006.01)	2631233 *	<b>A61P 35/00</b> (2006.01) <b>A61K 31/506</b> (2006.01) <b>A61K 31/496</b> (2006.01) <b>A61P 5/26</b> (2006.01) <b>C07D 401/12</b> (2006.01) <b>C07D 403/12</b> (2006.01)
		2630501 *	<b>G01N 33/66</b> (2006.01) <b>G01N 33/68</b> (2006.01) <b>G01N 33/72</b> (2006.01)		

Broj objave evropske prijave patenta (97)	MKP (51)	Broj objave evropske prijave patenta (97)	MKP (51)	Broj objave evropske prijave patenta (97)	MKP (51)
2632479 *	<b>A61P 7/04</b> (2006.01) <b>A61K 38/37</b> (2006.01) <b>C07K 14/755</b> (2006.01)	2302815	<b>H04B 1/38</b> (2006.01)	2643307 *	<b>C07D 277/68</b> (2006.01) <b>A61P 31/00</b> (2006.01) <b>A61K 31/428</b> (2006.01) <b>C07D 417/12</b> (2006.01)
2642873 *	<b>A23J 1/14</b> (2006.01) <b>A23J 3/16</b> (2006.01)	2625188 *	<b>C07H 21/00</b> (2006.01) <b>G01N 33/48</b> (2006.01)	2619212 *	<b>C07D 489/12</b> (2006.01) <b>A61K 31/485</b> (2006.01) <b>A61P 25/04</b> (2006.01)
2608946 *	<b>B29C 53/08</b> (2006.01) <b>G05B 19/19</b> (2006.01)	2632443 *	<b>A61K 9/70</b> (2006.01)	2567784	<b>B24D 3/14</b> (2006.01)
2595983 *	<b>C07D 409/04</b> (2006.01) <b>C07D 409/14</b> (2006.01) <b>C07D 413/04</b> (2006.01) <b>C07D 413/14</b> (2006.01) <b>C07D 417/14</b> (2006.01) <b>C07D 487/04</b> (2006.01) <b>C07D 498/04</b> (2006.01) <b>A61K 31/381</b> (2006.01) <b>A61P 31/12</b> (2006.01)	2609129 *	<b>C08G 14/06</b> (2006.01) <b>C09J 161/34</b> (2006.01) <b>C03C 25/34</b> (2006.01) <b>C08K 5/053</b> (2006.01) <b>C08K 5/21</b> (2006.01) <b>F16L 59/00</b> (2006.01)	2623499 *	<b>A61K 31/46</b> (2006.01) <b>A61P 25/00</b> (2006.01) <b>A61P 29/00</b> (2006.01) <b>A61K 31/5377</b> (2006.01) <b>A61P 25/08</b> (2006.01) <b>A61K 31/5386</b> (2006.01) <b>A61P 25/14</b> (2006.01) <b>C07D 249/12</b> (2006.01) <b>A61P 7/10</b> (2006.01) <b>A61P 25/18</b> (2006.01) <b>A61K 31/4196</b> (2006.01) <b>A61P 9/12</b> (2006.01) <b>A61P 25/22</b> (2006.01) <b>A61K 31/454</b> (2006.01) <b>A61P 17/02</b> (2006.01) <b>A61P 25/28</b> (2006.01) <b>A61K 31/4545</b> (2006.01)
2635379 *	<b>B02C 13/14</b> (2006.01) <b>B02C 13/20</b> (2006.01)	2595981 *	<b>C07D 401/12</b> (2006.01) <b>C07D 401/14</b> (2006.01) <b>C07D 403/12</b> (2006.01) <b>C07D 403/14</b> (2006.01) <b>C07D 407/14</b> (2006.01) <b>C07D 413/12</b> (2006.01) <b>C07D 417/12</b> (2006.01) <b>C07D 417/14</b> (2006.01) <b>A01N 43/60</b> (2006.01) <b>A01N 43/80</b> (2006.01)	261432 *	<b>F16M 13/02</b> (2006.01) <b>G06F 1/16</b> (2006.01) <b>F16M 11/10</b> (2006.01)
2633376 *	<b>B60K 28/02</b> (2006.01) <b>B60W 50/08</b> (2012.01) <b>B60W 40/08</b> (2012.01) <b>G05G 9/02</b> (2006.01)	2601432 *	<b>F16M 13/02</b> (2006.01) <b>G06F 1/16</b> (2006.01) <b>F16M 11/10</b> (2006.01)	2611980 *	<b>A61P 25/28</b> (2006.01) <b>A61K 31/4545</b> (2006.01) <b>A61P 17/14</b> (2006.01) <b>A61P 25/36</b> (2006.01) <b>A61K 31/553</b> (2006.01) <b>A61P 25/16</b> (2006.01)
2601105 *	<b>B65D 47/32</b> (2006.01) <b>B65B 31/02</b> (2006.01)	2559926	<b>F16K 17/04</b> (2006.01)	2627504 *	<b>B31F 5/06</b> (2006.01) <b>C09J 7/02</b> (2006.01)
2611980 *	<b>E05D 7/08</b> (2006.01) <b>E05D 7/02</b> (2006.01) <b>E05D 15/26</b> (2006.01)				

Broj objave evropske prijava patenta (97)	MKP (51)	Broj objave evropske prijava patenta (97)	MKP (51)	Broj objave evropske prijava patenta (97)	MKP (51)
2578502	<b>B65B 65/00</b> (2006.01) <b>B23D 36/00</b> (2006.01) <b>B65B 27/10</b> (2006.01) <b>B21B 15/00</b> (2006.01)	2635418 *	<b>B29B 17/02</b> (2006.01) <b>F26B 23/02</b> (2006.01) <b>C10J 3/66</b> (2006.01) <b>B04B 15/02</b> (2006.01) <b>H01B 15/00</b> (2006.01)	2637646 *	<b>A61P 1/12</b> (2006.01) <b>A61K 9/52</b> (2006.01) <b>A61K 31/785</b> (2006.01) <b>A61K 31/554</b> (2006.01) <b>A61P 1/16</b> (2006.01) <b>A61P 3/00</b> (2006.01)
2605828 *	<b>A61N 5/01</b> (2006.01)	2606036 *	<b>C07D 235/30</b> (2006.01) <b>A61K 31/4184</b> (2006.01) <b>A61P 11/00</b> (2006.01) <b>A61P 29/00</b> (2006.01)	2614049 *	<b>C07C 323/52</b> (2006.01) <b>A61K 31/215</b> (2006.01) <b>A61P 31/00</b> (2006.01)
2606379 *	<b>G01S 13/02</b> (2006.01) <b>G01V 3/10</b> (2006.01)	2630149 *	<b>A61P 11/00</b> (2006.01) <b>C07D 487/04</b> (2006.01) <b>A61P 19/02</b> (2006.01) <b>A61P 11/06</b> (2006.01) <b>A61P 17/00</b> (2006.01) <b>A61K 31/519</b> (2006.01) <b>A61P 35/00</b> (2006.01)	2640698 *	<b>C07D 413/12</b> (2006.01) <b>C07D 471/04</b> (2006.01) <b>C07D 403/12</b> (2006.01) <b>A61P 9/10</b> (2006.01) <b>C07D 209/44</b> (2006.01) <b>A61P 35/00</b> (2006.01) <b>C07D 407/12</b> (2006.01) <b>A61K 31/407</b> (2006.01) <b>A61K 31/4035</b> (2006.01) <b>C07D 407/14</b> (2006.01)
2635677 *	<b>C12N 9/64</b> (2006.01)	2535554	<b>F02M 61/12</b> (2006.01) <b>F02M 63/02</b> (2006.01) <b>F02M 63/00</b> (2006.01) <b>F16K 31/06</b> (2006.01)	2629839 *	<b>A61N 1/05</b> (2006.01)
2608769 *	<b>A61K 9/00</b> (2006.01)	2621528 *	<b>A61K 39/21</b> (2006.01)		
2603626 *	<b>D04H 1/56</b> (2006.01) <b>D01D 4/02</b> (2006.01) <b>D01D 5/098</b> (2006.01)	2640912 *	<b>F03D 11/04</b> (2006.01) <b>E04G 21/32</b> (2006.01)		
2549638	<b>H02M 5/16</b> (2006.01)	2640383 *	<b>A61K 31/4188</b> (2006.01)		
2638137 *	<b>C11D 1/37</b> (2006.01) <b>C11D 3/50</b> (2006.01) <b>C11D 17/00</b> (2006.01) <b>E03D 9/02</b> (2006.01) <b>C11D 3/48</b> (2006.01)	2643319 *	<b>C07D 413/14</b> (2006.01) <b>A61K 31/423</b> (2006.01)		
2638512 *	<b>G06Q 20/00</b> (2012.01)				
2609354 *	<b>F16L 19/06</b> (2006.01)				
2632435 *	<b>A61K 31/785</b> (2006.01) <b>A61P 35/00</b> (2006.01) <b>A61K 47/24</b> (2006.01) <b>A61K 9/127</b> (2006.01) <b>A61K 9/00</b> (2006.01) <b>A61K 31/155</b> (2006.01)				

Broj objave evropske prijave patenta (97)	MKP (51)	Broj objave evropske prijave patenta (97)	MKP (51)	Broj objave evropske prijave patenta (97)	MKP (51)
2635278 *	<b>A01P 7/04</b> (2006.01) <b>A01P 17/00</b> (2006.01) <b>A01P 5/00</b> (2006.01) <b>A01P 23/00</b> (2006.01) <b>C07D 401/14</b> (2006.01) <b>A01P 3/00</b> (2006.01) <b>A01P 15/00</b> (2006.01) <b>A61K 31/4439</b> (2006.01) <b>A01P 7/02</b> (2006.01) <b>A01P 19/00</b> (2006.01) <b>C07D 401/04</b> (2006.01) <b>A01P 1/00</b> (2006.01) <b>A01P 21/00</b> (2006.01) <b>C07D 417/14</b> (2006.01) <b>A01P 13/00</b> (2006.01) <b>A01H 5/10</b> (2006.01) <b>A61K 31/444</b> (2006.01) <b>A01P 9/00</b> (2006.01) <b>A01N 25/34</b> (2006.01) <b>A01P 11/00</b> (2006.01)	2624698 *	<b>C07D 471/04</b> (2006.01) <b>C07D 239/42</b> (2006.01) <b>A01N 43/54</b> (2006.01)	2619279 *	<b>C09K 5/18</b> (2006.01) <b>B65D 77/04</b> (2006.01) <b>B65D 75/58</b> (2006.01) <b>F25D 5/02</b> (2006.01) <b>B65D 81/32</b> (2006.01) <b>B65D 81/34</b> (2006.01)
		2627260 *	<b>A61B 17/128</b> (2006.01) <b>A61B 17/00</b> (2006.01) <b>A61B 17/122</b> (2006.01)	2621893 *	<b>C07C 231/02</b> (2006.01) <b>C07C 231/12</b> (2006.01) <b>C07C 231/18</b> (2006.01) <b>C07C 237/22</b> (2006.01)
		2632482 *	<b>A61K 39/00</b> (2006.01)	2635586 *	<b>C07D 489/12</b> (2006.01) <b>C07D 489/08</b> (2006.01)
		2606250 *	<b>F16D 1/116</b> (2006.01) <b>F16D 3/38</b> (2006.01) <b>F16D 3/84</b> (2006.01)	2640930 *	<b>E21B 29/00</b> (2006.01) <b>E21B 17/00</b> (2006.01) <b>E21B 34/14</b> (2006.01) <b>E21B 43/12</b> (2006.01) <b>E21B 23/00</b> (2006.01)
		2614130 *	<b>C10L 5/38</b> (2006.01) <b>C10L 7/02</b> (2006.01) <b>C10L 8/00</b> (2006.01) <b>C01B 3/08</b> (2006.01)	2635336 *	<b>A61M 11/00</b> (2006.01)
		2606065 *	<b>C07K 16/18</b> (2006.01) <b>C12N 15/13</b> (2006.01)	2595608 *	<b>A61K 47/34</b> (2006.01) <b>A61K 31/444</b> (2006.01) <b>A61K 9/16</b> (2006.01) <b>A61P 19/02</b> (2006.01)
		2638033 *	<b>C07D 401/14</b> (2006.01) <b>A61K 31/4995</b> (2006.01) <b>A61P 35/00</b> (2006.01)	2613755 *	<b>A61K 8/02</b> (2006.01) <b>A61K 8/37</b> (2006.01) <b>A61K 8/67</b> (2006.01) <b>A61K 8/81</b> (2006.01) <b>A61Q 19/02</b> (2006.01) <b>A61Q 19/08</b> (2006.01)
2619180 *	<b>C07D 211/58</b> (2006.01) <b>A61P 11/00</b> (2006.01) <b>A61K 31/4468</b> (2006.01)	2619369 *	<b>E01C 5/00</b> (2006.01)		
2595940 *	<b>C04B 35/581</b> (2006.01) <b>H01L 21/683</b> (2006.01) <b>H01L 23/15</b> (2006.01)	2636747 *	<b>C12P 7/64</b> (2006.01)		
2639178 *	<b>B65D 41/14</b> (2006.01) <b>B65D 47/36</b> (2006.01) <b>B65D 41/20</b> (2006.01) <b>B65D 53/04</b> (2006.01)	2611369 *	<b>A61B 17/24</b> (2006.01) <b>A61B 17/34</b> (2006.01) <b>A61F 2/18</b> (2006.01) <b>A61M 29/00</b> (2006.01)		
2600922 *	<b>A61M 5/145</b> (2006.01) <b>A61M 5/315</b> (2006.01)				



Broj objave evropske prijave patenta (97)	MKP (51)	Broj objave evropske prijave patenta (97)	MKP (51)	Broj objave evropske prijave patenta (97)	MKP (51)
2394940	<b>B65H 29/24</b> (2006.01) <b>B65H 29/46</b> (2006.01) <b>B65H 31/24</b> (2006.01)	2616046 *	<b>A61K 9/08</b> (2006.01) <b>A61K 9/16</b> (2006.01) <b>A61K 31/167</b> (2006.01) <b>A61K 31/192</b> (2006.01) <b>A61K 31/616</b> (2006.01) <b>A23L 2/00</b> (2006.01)	2529774	<b>A61M 5/315</b> (2006.01)
2608777 *	<b>A61K 9/16</b> (2006.01) <b>A61K 9/08</b> (2006.01) <b>A61K 47/38</b> (2006.01) <b>A61K 31/498</b> (2006.01) <b>A61K 38/43</b> (2006.01) <b>A61K 35/12</b> (2006.01) <b>A61P 9/00</b> (2006.01)	2625472 *	<b>F24J 2/46</b> (2006.01) <b>E04H 5/02</b> (2006.01) <b>E04H 14/00</b> (2006.01)	2524658	<b>A61B 17/115</b> (2006.01) <b>A61B 17/29</b> (2006.01)
2621481 *	<b>A61K 31/00</b> (2006.01) <b>A61K 31/47</b> (2006.01) <b>A61P 35/00</b> (2006.01) <b>A61P 35/04</b> (2006.01)	2640415 *	<b>A61K 39/00</b> (2006.01) <b>C07K 14/725</b> (2006.01) <b>A61P 31/10</b> (2006.01) <b>G01N 33/569</b> (2006.01)	2640391 *	<b>A61K 31/50</b> (2006.01)
2549375	<b>G06F 3/12</b> (2006.01)	2597978 *	<b>A41B 9/02</b> (2006.01)	2643022 *	<b>A61K 47/48</b> (2006.01) <b>A61K 9/00</b> (2006.01) <b>A61K 31/35</b> (2006.01)
2595825 *	<b>B60J 7/06</b> (2006.01)	2598261 *	<b>B27N 3/00</b> (2006.01) <b>B09B 3/00</b> (2006.01)	2601287 *	<b>C12N 5/00</b> (2006.01) <b>C12N 5/10</b> (2006.01) <b>C07K 5/06</b> (2006.01)
2643322 *	<b>C07D 471/04</b> (2006.01) <b>A61K 31/437</b> (2006.01) <b>A61P 35/00</b> (2006.01) <b>A61P 37/00</b> (2006.01)	2601209 *	<b>C07K 14/365</b> (2006.01) <b>C12N 15/11</b> (2006.01) <b>C12P 19/26</b> (2006.01)	2627352 *	<b>C07K 14/045</b> (2006.01) <b>A61K 39/245</b> (2006.01)
2598773 *	<b>F16F 6/00</b> (2006.01) <b>F16F 15/03</b> (2006.01)	2628139 *	<b>G06Q 20/00</b> (2012.01)	2621512 *	<b>A61K 48/00</b> (2006.01) <b>A61P 25/02</b> (2006.01) <b>A61P 25/04</b> (2006.01) <b>A61K 38/17</b> (2006.01) <b>A61K 9/00</b> (2006.01)
2595652 *	<b>A61K 39/175</b> (2006.01) <b>C12N 15/863</b> (2006.01)	2629790 *	<b>A61P 1/00</b> (2006.01) <b>A61K 38/43</b> (2006.01)	2562315	<b>E03D 11/02</b> (2006.01)
		2526936	<b>A61K 31/23</b> (2006.01)	2616531 *	<b>C11B 1/10</b> (2006.01) <b>C11B 3/00</b> (2006.01) <b>C11B 3/06</b> (2006.01) <b>C11B 3/08</b> (2006.01)
		2634202 *	<b>C08G 64/20</b> (2006.01)	2616810 *	<b>G01N 33/543</b> (2006.01)
		2637670 *	<b>A61K 31/573</b> (2006.01) <b>A61K 39/395</b> (2006.01) <b>C07K 16/28</b> (2006.01)	2619206 *	<b>C07D 487/04</b> (2006.01) <b>A61K 31/41</b> (2006.01)

Broj objave evropske prijava patenta (97)	MKP (51)	Broj objave evropske prijava patenta (97)	MKP (51)	Broj objave evropske prijava patenta (97)	MKP (51)
2629851 *	<b>C07D 211/16</b> (2006.01) <b>C07D 417/12</b> (2006.01) <b>A61K 31/4523</b> (2006.01) <b>A61P 29/00</b> (2006.01) <b>C07D 417/14</b> (2006.01) <b>C07D 205/04</b> (2006.01)	2616875 *	<b>G02C 5/22</b> (2006.01)	2611807 *	<b>C07D 473/04</b> (2006.01)
2643349 *	<b>C07K 14/47</b> (2006.01)	2643056 *	<b>A61P 25/00</b> (2006.01)	2627425 *	<b>B01D 15/08</b> (2006.01)
2494941	<b>B65D 51/26</b> (2006.01) <b>A61C 19/02</b> (2006.01)	2603495 *	<b>C07D 231/22</b> (2006.01) <b>A61P 25/16</b> (2006.01) <b>A61P 25/00</b> (2006.01) <b>A61K 31/4152</b> (2006.01)	2598531 *	<b>C07K 16/26</b> (2006.01)
2627669 *	<b>A61K 38/07</b> (2006.01) <b>C07K 14/47</b> (2006.01) <b>A61P 19/08</b> (2006.01) <b>A61K 38/06</b> (2006.01) <b>A61K 38/00</b> (2006.01)	2619574 *	<b>G01N 33/48</b> (2006.01)	2571063	<b>H01L 31/052</b> (2006.01)
2601949	<b>A61P 5/50</b> (2006.01) <b>A61P 9/10</b> (2006.01) <b>A61K 31/155</b> (2006.01) <b>A61P 13/12</b> (2006.01) <b>A61K 31/382</b> (2006.01) <b>A61P 9/14</b> (2006.01) <b>A61K 31/64</b> (2006.01) <b>A61P 27/02</b> (2006.01) <b>A61K 45/00</b> (2006.01) <b>A61P 43/00</b> (2006.01) <b>A61P 3/10</b> (2006.01) <b>C07D 335/02</b> (2006.01) <b>A61K 31/4439</b> (2006.01) <b>A61P 25/00</b> (2006.01)	2633042 *	<b>C12N 9/88</b> (2006.01) <b>C12P 1/00</b> (2006.01) <b>C12N 15/82</b> (2006.01)	2640712 *	<b>C07D 279/08</b> (2006.01) <b>A61K 31/5415</b> (2006.01) <b>A61P 31/06</b> (2006.01)
2615954 *	<b>A47J 43/07</b> (2006.01) <b>B26D 1/00</b> (2006.01)	2635870 *	<b>F42B 12/66</b> (2006.01)	2600924 *	<b>A61M 5/315</b> (2006.01)
		2640385 *	<b>A61K 31/502</b> (2006.01) <b>A61K 31/506</b> (2006.01) <b>A61K 31/436</b> (2006.01) <b>A61K 31/395</b> (2006.01) <b>A61K 31/4196</b> (2006.01) <b>A61P 35/00</b> (2006.01) <b>A61K 31/437</b> (2006.01) <b>A61K 39/395</b> (2006.01) <b>A61K 31/517</b> (2006.01) <b>A61K 31/4439</b> (2006.01)	2603656 *	<b>E05D 3/00</b> (2006.01) <b>E05D 7/04</b> (2006.01) <b>E05D 7/06</b> (2006.01) <b>E05D 11/10</b> (2006.01)
		2636671 *	<b>A61P 43/00</b> (2006.01) <b>C07D 333/32</b> (2006.01) <b>A61K 31/381</b> (2006.01) <b>A61P 7/04</b> (2006.01)	2611825 *	<b>C07K 14/605</b> (2006.01) <b>C07K 1/04</b> (2006.01)
		2598250 *	<b>B03B 5/32</b> (2006.01) <b>B04B 1/20</b> (2006.01)	2621344 *	<b>A61B 10/02</b> (2006.01)
		2557258	<b>E05D 7/00</b> (2006.01)	2640725 *	<b>C07D 487/04</b> (2006.01)
				2598124 *	<b>A61K 9/20</b> (2006.01) <b>A61K 31/4045</b> (2006.01) <b>A61P 25/00</b> (2006.01)
				2643039 *	<b>A61M 15/00</b> (2006.01)
				2595978 *	<b>C07D 307/82</b> (2006.01)

Broj objave evropske prijava patenta (97)	MKP (51)	Broj objave evropske prijava patenta (97)	MKP (51)	Broj objave evropske prijava patenta (97)	MKP (51)
2605753 *	<b>A61K 9/06</b> (2006.01) <b>A61K 47/32</b> (2006.01) <b>A61K 9/00</b> (2006.01) <b>A61K 31/498</b> (2006.01) <b>A61K 47/10</b> (2006.01)	2607076 *	<b>B32B 37/12</b> (2006.01) <b>B32B 38/14</b> (2006.01) <b>B41M 1/00</b> (2006.01) <b>B32B 27/00</b> (2006.01) <b>B32B 27/10</b> (2006.01)	2635452 *	<b>B60J 1/00</b> (2006.01) <b>B62D 65/06</b> (2006.01) <b>B25B 11/00</b> (2006.01)
2605961 *	<b>B64C 5/02</b> (2006.01) <b>F02K 99/00</b> (2009.01)	2621524 *	<b>A61K 39/00</b> (2006.01) <b>A61K 39/12</b> (2006.01) <b>A61K 39/145</b> (2006.01) <b>A61K 39/39</b> (2006.01)	2640831 *	<b>C12N 7/00</b> (2006.01) <b>A61K 39/395</b> (2006.01)
2637690 *	<b>A61K 39/395</b> (2006.01)			2620987	<b>H01L 31/052</b> (2006.01) <b>H01L 31/058</b> (2006.01)
2617164 *	<b>H04L 12/24</b> (2006.01) <b>G06F 17/30</b> (2006.01) <b>H04L 29/06</b> (2006.01)	2598633 *	<b>C12N 5/074</b> (2010.01)	2634171 *	<b>C07F 7/18</b> (2006.01) <b>A61P 19/10</b> (2006.01) <b>C07C 401/00</b> (2006.01) <b>A61K 31/593</b> (2006.01)
2635567 *	<b>C07D 403/04</b> (2006.01) <b>C07D 403/14</b> (2006.01) <b>C07D 413/12</b> (2006.01) <b>A61K 31/404</b> (2006.01) <b>A61P 29/00</b> (2006.01)	2642980 *	<b>A61P 5/18</b> (2006.01) <b>A61K 9/14</b> (2006.01) <b>A61K 9/00</b> (2006.01)	2638319 *	<b>F21S 9/03</b> (2006.01) <b>F21V 14/00</b> (2006.01) <b>F21V 17/00</b> (2006.01) <b>F21V 21/30</b> (2006.01)
2595960 *	<b>C07D 217/26</b> (2006.01)	2517641	<b>A61B 17/072</b> (2006.01)	2607354	<b>C07D 223/16</b> (2006.01)
2520932	<b>G01N 33/487</b> (2006.01)	2598498 *	<b>C07D 401/14</b> (2006.01) <b>A61K 31/47</b> (2006.01) <b>A61K 31/4704</b> (2006.01) <b>A61P 31/12</b> (2006.01) <b>C07D 403/14</b> (2006.01) <b>C07D 417/14</b> (2006.01) <b>C07D 471/04</b> (2006.01) <b>C07D 491/10</b> (2006.01)	2330694	<b>H01R 25/14</b> (2006.01) <b>H01R 29/00</b> (2006.01)
2637861 *	<b>B32B 7/06</b> (2006.01) <b>B32B 7/12</b> (2006.01) <b>B32B 27/32</b> (2006.01) <b>B32B 27/36</b> (2006.01) <b>B65D 77/20</b> (2006.01) <b>C09J 7/02</b> (2006.01) <b>C08J 7/04</b> (2006.01)	2628128 *	<b>G06K 7/08</b> (2006.01)	2632492 *	<b>A61K 39/395</b> (2006.01)
2557229	<b>E01B 7/24</b> (2006.01)	2608655 *	<b>A01G 9/12</b> (2006.01) <b>A01G 13/10</b> (2006.01) <b>A01M 29/00</b> (2011.01) <b>A01G 13/02</b> (2006.01)	2603322 *	<b>B02C 13/04</b> (2006.01) <b>B68G 1/00</b> (2006.01) <b>B02C 13/284</b> (2006.01) <b>B02C 18/18</b> (2006.01)
				2613788 *	<b>A61K 31/69</b> (2006.01) <b>C07F 5/02</b> (2006.01) <b>A61P 31/04</b> (2006.01)

Broj objave evropske prijave patenta (97)	MKP (51)	Broj objave evropske prijave patenta (97)	MKP (51)	Broj objave evropske prijave patenta (97)	MKP (51)
2524780	<b>B27K 5/04</b> (2006.01) <b>B05B 15/12</b> (2006.01) <b>B07B 9/02</b> (2006.01) <b>B07B 15/00</b> (2006.01) <b>B27L 11/00</b> (2006.01) <b>F26B 17/00</b> (2006.01) <b>B05B 13/02</b> (2006.01) <b>E04B 1/76</b> (2006.01)	2600926 *	<b>A47J 19/02</b> (2006.01) <b>A61G 10/02</b> (2006.01) <b>A61M 15/02</b> (2006.01) <b>A47J 42/32</b> (2006.01) <b>A61M 16/00</b> (2006.01) <b>A61M 15/00</b> (2006.01)	2627319 *	<b>A61K 47/26</b> (2006.01) <b>A61K 47/38</b> (2006.01) <b>A61K 47/20</b> (2006.01) <b>A61K 9/20</b> (2006.01) <b>A61K 31/444</b> (2006.01)
		2603081 *	<b>A01N 43/54</b> (2006.01) <b>C07D 471/22</b> (2006.01) <b>C07D 471/04</b> (2006.01)	2639391	<b>E06B 3/92</b> (2006.01) <b>E05D 15/06</b> (2006.01) <b>E05D 15/58</b> (2006.01)
2601852	<b>A43C 7/04</b> (2006.01) <b>A43C 7/00</b> (2006.01) <b>A43C 7/08</b> (2006.01)	2470729 *	<b>E04B 9/18</b> (2006.01) <b>F16B 5/07</b> (2006.01) <b>F16B 5/10</b> (2006.01)	2635290 *	<b>A61K 31/775</b> (2006.01) <b>C08G 65/38</b> (2006.01) <b>A61K 35/00</b> (2006.01)
2601942	<b>A61K 31/403</b> (2006.01) <b>A61P 25/28</b> (2006.01) <b>A61K 31/13</b> (2006.01)	2635563 *	<b>C07D 401/06</b> (2006.01) <b>A61K 31/435</b> (2006.01) <b>A61P 3/00</b> (2006.01)	2643324 *	<b>C07D 487/04</b> (2006.01) <b>A61K 31/5517</b> (2006.01) <b>A61P 31/10</b> (2006.01)
2548564	<b>A61K 36/03</b> (2006.01) <b>A61K 36/81</b> (2006.01) <b>A61K 36/71</b> (2006.01) <b>A61K 36/185</b> (2006.01) <b>A61P 3/04</b> (2006.01) <b>A61K 36/72</b> (2006.01)	2616074 *	<b>A61K 31/4468</b> (2006.01) <b>A61K 31/454</b> (2006.01) <b>A61P 3/04</b> (2006.01) <b>C07D 413/14</b> (2006.01)	2557307	<b>F02M 59/46</b> (2006.01) <b>F02M 63/02</b> (2006.01)
		2517647	<b>A61B 17/072</b> (2006.01)	2598164 *	<b>A61K 39/00</b> (2006.01)
2638684 *	<b>H04L 29/08</b> (2006.01) <b>G01D 4/00</b> (2006.01) <b>G08B 25/00</b> (2006.01)	2635264 *	<b>A61K 9/20</b> (2006.01) <b>A61P 1/10</b> (2006.01) <b>A61K 31/765</b> (2006.01)	2613718 *	<b>A61B 17/15</b> (2006.01)
				2636188 *	<b>H04L 12/28</b> (2006.01)
2597983 *	<b>A41F 15/00</b> (2006.01) <b>A41C 3/00</b> (2006.01)	2624827 *	<b>A61K 31/365</b> (2006.01) <b>A61P 3/10</b> (2006.01) <b>A61P 25/28</b> (2006.01) <b>A61P 35/00</b> (2006.01)	2616434 *	<b>C07C 279/24</b> (2006.01) <b>C07D 233/64</b> (2006.01) <b>A61K 31/155</b> (2006.01)
		2596725 *	<b>A47G 19/16</b> (2006.01)	2638397 *	<b>G01N 33/574</b> (2006.01)

Broj objave evropske prijava patenta (97)	MKP (51)	Broj objave evropske prijava patenta (97)	MKP (51)	Broj objave evropske prijava patenta (97)	MKP (51)
2639234 *	<b>B01J 27/10</b> (2006.01) <b>C07D 271/06</b> (2006.01) <b>A61K 31/485</b> (2006.01) <b>A61P 1/08</b> (2006.01) <b>A61P 1/10</b> (2006.01) <b>C07D 489/08</b> (2006.01)	2622357 *	<b>G01R 21/00</b> (2006.01)	2616091 *	<b>A61K 38/48</b> (2006.01) <b>A61K 39/395</b> (2006.01) <b>A61K 47/02</b> (2006.01) <b>A61K 47/18</b> (2006.01) <b>A61K 9/00</b> (2006.01) <b>A61K 38/00</b> (2006.01)
2629755 *	<b>A61K 9/16</b> (2006.01) <b>A61K 9/20</b> (2006.01) <b>A61K 9/00</b> (2006.01)	2598718 *	<b>E21F 1/00</b> (2006.01) <b>E21F 1/08</b> (2006.01)	2627651 *	<b>C07D 403/14</b> (2006.01)
2621301 *	<b>A43B 7/08</b> (2006.01) <b>A43B 7/12</b> (2006.01) <b>A43B 13/12</b> (2006.01) <b>A43B 9/12</b> (2006.01) <b>A43B 13/42</b> (2006.01)	2619314 *	<b>C12P 7/46</b> (2006.01)	2628489	<b>A61K 47/48</b> (2006.01)
2619179 *	<b>A61K 31/27</b> (2006.01) <b>A61K 31/4035</b> (2006.01) <b>A61K 31/53</b> (2006.01) <b>C07D 401/12</b> (2006.01) <b>C07C 271/28</b> (2006.01) <b>A61P 11/00</b> (2006.01) <b>C07D 209/48</b> (2006.01) <b>A61P 19/02</b> (2006.01) <b>C07D 253/04</b> (2006.01) <b>A61P 35/00</b> (2006.01)	2635285 *	<b>A61K 31/16</b> (2006.01) <b>A61K 31/506</b> (2006.01)	2632254 *	<b>A61P 25/28</b> (2006.01) <b>A61K 31/135</b> (2006.01) <b>C07C 309/29</b> (2006.01) <b>C07C 211/42</b> (2006.01) <b>C07C 309/04</b> (2006.01) <b>A01N 33/02</b> (2006.01)
2643547 *	<b>E21B 43/26</b> (2006.01) <b>E21B 23/06</b> (2006.01) <b>E21B 23/04</b> (2006.01) <b>E21B 33/124</b> (2006.01)	2643276 *	<b>C04B 28/14</b> (2006.01)	2598074 *	<b>A61B 19/00</b> (2006.01) <b>A61B 17/56</b> (2006.01) <b>A61B 5/11</b> (2006.01) <b>G01C 19/02</b> (2006.01)
2618152	<b>G01N 33/543</b> (2006.01) <b>G01N 33/558</b> (2006.01)	2611458 *	<b>A61K 38/22</b> (2006.01) <b>C07K 14/575</b> (2006.01) <b>A61P 3/10</b> (2006.01) <b>A61P 3/08</b> (2006.01) <b>A61P 3/04</b> (2006.01)	2620433 *	<b>A61P 25/00</b> (2006.01) <b>C07D 277/20</b> (2006.01) <b>A61P 35/00</b> (2006.01) <b>A61P 9/00</b> (2006.01) <b>C07D 417/12</b> (2006.01) <b>A61K 31/426</b> (2006.01) <b>C07D 277/56</b> (2006.01) <b>A61K 31/341</b> (2006.01) <b>A61P 43/00</b> (2006.01) <b>A61K 31/427</b> (2006.01) <b>C07D 307/68</b> (2006.01) <b>A61P 29/00</b> (2006.01) <b>A61P 13/00</b> (2006.01)
		2611802 *	<b>C07D 471/04</b> (2006.01) <b>C07D 487/04</b> (2006.01) <b>A61K 31/437</b> (2006.01) <b>A61K 31/519</b> (2006.01) <b>A61P 9/00</b> (2006.01) <b>A61P 9/04</b> (2006.01) <b>A61P 9/12</b> (2006.01) <b>A61P 9/14</b> (2006.01) <b>A61P 9/10</b> (2006.01) <b>A61P 7/02</b> (2006.01) <b>A61P 13/12</b> (2006.01)		

Broj objave evropske prijave patenta (97)	MKP (51)	Broj objave evropske prijave patenta (97)	MKP (51)	Broj objave evropske prijave patenta (97)	MKP (51)
2612851	<b>C07D 209/42</b> (2006.01)	2526785	<b>A23L 1/30</b> (2006.01) <b>C02F 1/04</b> (2006.01) <b>C02F 1/44</b> (2006.01) <b>C02F 3/34</b> (2006.01) <b>A61K 36/63</b> (2006.01) <b>A23L 1/212</b> (2006.01)	2605785 *	<b>A61K 36/185</b> (2006.01) <b>A61K 36/53</b> (2006.01)
2640704 *	<b>C07D 217/06</b> (2006.01) <b>C07D 401/12</b> (2006.01) <b>C07D 405/12</b> (2006.01) <b>C07D 409/12</b> (2006.01) <b>C07D 409/14</b> (2006.01) <b>C07D 413/12</b> (2006.01) <b>C07D 471/04</b> (2006.01) <b>A61K 31/4375</b> (2006.01) <b>A61K 31/496</b> (2006.01) <b>A61K 31/472</b> (2006.01) <b>A61K 31/4725</b> (2006.01) <b>A61P 29/00</b> (2006.01) <b>A61P 37/00</b> (2006.01) <b>A61P 9/00</b> (2006.01) <b>A61P 35/00</b> (2006.01)	2633027 *	<b>C12P 7/56</b> (2006.01) <b>C12R 1/645</b> (2006.01) <b>C12N 1/14</b> (2006.01)	2629907 *	<b>B22D 11/06</b> (2006.01)
		2611298 *	<b>A61K 31/42</b> (2006.01) <b>A01N 43/76</b> (2006.01)	2635287 *	<b>A61K 31/52</b> (2006.01) <b>A61P 35/00</b> (2006.01)
		2616077 *	<b>A61K 31/505</b> (2006.01)	2636472 *	<b>B23B 27/22</b> (2006.01) <b>B23B 27/04</b> (2006.01) <b>B23B 27/14</b> (2006.01)
		2639320 *	<b>C22B 21/04</b> (2006.01)	2598714 *	<b>E21B 43/10</b> (2006.01)
		2643698 *	<b>G01N 33/574</b> (2006.01) <b>A61K 39/00</b> (2006.01)	2643311 *	<b>C07D 417/14</b> (2006.01) <b>A61P 19/00</b> (2006.01) <b>A61K 31/444</b> (2006.01) <b>C07D 471/04</b> (2006.01) <b>C07D 401/12</b> (2006.01) <b>A61P 3/04</b> (2006.01) <b>C07D 401/14</b> (2006.01) <b>C07D 401/12</b> (2006.01) <b>A61P 3/10</b> (2006.01) <b>C07D 491/08</b> (2006.01) <b>C07D 413/14</b> (2006.01) <b>A61P 9/00</b> (2006.01) <b>A61K 31/506</b> (2006.01)
2616400 *	<b>C03C 3/118</b> (2006.01) <b>C03C 13/00</b> (2006.01) <b>B32B 17/00</b> (2006.01) <b>C08J 5/24</b> (2006.01) <b>C08K 7/14</b> (2006.01) <b>C08J 5/04</b> (2006.01)	2645786 *	<b>H04W 52/14</b> (2009.01)		
		2601177 *	<b>C07D 211/22</b> (2006.01) <b>A61K 31/445</b> (2006.01) <b>A61P 35/00</b> (2006.01) <b>A61P 35/02</b> (2006.01)	2538067	<b>F02M 59/46</b> (2006.01) <b>F02M 63/00</b> (2006.01) <b>F02M 63/02</b> (2006.01) <b>F02M 51/00</b> (2006.01) <b>F16K 31/06</b> (2006.01) <b>F16L 37/098</b> (2006.01) <b>F02M 61/16</b> (2006.01)
2640697 *	<b>C07C 323/58</b> (2006.01) <b>A61K 31/10</b> (2006.01)	2611887 *	<b>C10G 19/02</b> (2006.01) <b>C10G 67/10</b> (2006.01) <b>C07C 7/10</b> (2006.01)		
2609093 *	<b>C07D 417/00</b> (2006.01)				
2613629 *	<b>A01N 25/00</b> (2006.01) <b>A61K 9/00</b> (2006.01) <b>A61K 39/205</b> (2006.01) <b>B65D 75/42</b> (2006.01)	2643144 *	<b>B29C 65/18</b> (2006.01) <b>B42C 15/00</b> (2006.01) <b>B65B 51/14</b> (2006.01)		

Broj objave evropske prijave patenta (97)	MKP (51)	Broj objave evropske prijave patenta (97)	MKP (51)	Broj objave evropske prijave patenta (97)	MKP (51)
2537548	<b>A61M 11/00</b> (2006.01) <b>A61M 11/06</b> (2006.01) <b>A61M 15/00</b> (2006.01)	2619177 *	<b>C07C 333/08</b> (2006.01) <b>A61K 31/192</b> (2006.01) <b>A61K 31/325</b> (2006.01) <b>C07C 309/60</b> (2006.01) <b>C07C 321/28</b> (2006.01) <b>A61P 11/00</b> (2006.01) <b>A61P 19/02</b> (2006.01) <b>A61P 35/00</b> (2006.01)	2595481 *	<b>A01N 37/34</b> (2006.01) <b>A01N 43/653</b> (2006.01) <b>A01N 43/54</b> (2006.01) <b>A01N 37/50</b> (2006.01) <b>A01N 47/34</b> (2006.01) <b>A01N 37/32</b> (2006.01) <b>A01N 43/56</b> (2006.01) <b>A01N 41/06</b> (2006.01) <b>A01N 47/38</b> (2006.01) <b>A01N 43/36</b> (2006.01) <b>A01N 47/44</b> (2006.01) <b>A01N 43/40</b> (2006.01) <b>A01N 53/00</b> (2006.01) <b>A01N 43/50</b> (2006.01) <b>A01P 3/00</b> (2006.01)
2627672 *	<b>C07K 16/46</b> (2006.01) <b>C07K 16/18</b> (2006.01)	2522524	<b>B41K 1/26</b> (2006.01) <b>B41K 1/28</b> (2006.01) <b>B41K 1/50</b> (2006.01) <b>B41K 1/52</b> (2006.01)	2629789 *	<b>A61P 1/00</b> (2006.01) <b>A61K 38/43</b> (2006.01)
2608866 *	<b>B01D 53/02</b> (2006.01) <b>B01D 17/038</b> (2006.01)	2625557 *	<b>G02B 6/36</b> (2006.01) <b>G02B 7/00</b> (2006.01)	2625470 *	<b>F24J 2/20</b> (2006.01)
2629807 *	<b>A61L 101/32</b> (2006.01) <b>A61L 9/01</b> (2006.01) <b>A61L 9/12</b> (2006.01)	2611433 *	<b>A61K 31/133</b> (2006.01)	2633028 *	<b>C12N 1/14</b> (2006.01) <b>C12R 1/645</b> (2006.01)
2627592 *	<b>B65G 67/20</b> (2006.01) <b>B65G 67/08</b> (2006.01) <b>B65G 57/112</b> (2006.01)	2613794 *	<b>A61K 38/10</b> (2006.01) <b>A61P 1/00</b> (2006.01) <b>A61P 43/00</b> (2006.01)	2611463 *	<b>A61K 39/395</b> (2006.01)
2614880	<b>B01D 63/04</b> (2006.01) <b>B01D 65/00</b> (2006.01)	2611463 *	<b>A61K 39/395</b> (2006.01)	2624696 *	<b>A01N 43/52</b> (2006.01) <b>A61K 31/4164</b> (2006.01)
2410556	<b>H01L 21/02</b> (2006.01) <b>H01L 21/36</b> (2006.01)	2611463 *	<b>A61K 39/395</b> (2006.01)	2596400 *	<b>G02B 27/12</b> (2006.01)
2598260 *	<b>B27N 3/00</b> (2006.01) <b>B29B 17/02</b> (2006.01) <b>B09B 3/00</b> (2006.01)	2611463 *	<b>A61K 39/395</b> (2006.01)	2611907 *	<b>C12N 5/02</b> (2006.01) <b>C12N 5/0735</b> (2010.01) <b>C12N 5/071</b> (2010.01)
2603794 *	<b>G01N 33/53</b> (2006.01) <b>G01N 33/68</b> (2006.01) <b>G01N 33/564</b> (2006.01)	2611463 *	<b>A61K 39/395</b> (2006.01)	2621820 *	<b>B65D 17/34</b> (2006.01)

Broj objave evropske prijava patenta (97)	MKP (51)	Broj objave evropske prijava patenta (97)	MKP (51)	Broj objave evropske prijava patenta (97)	MKP (51)
2616352 *	<b>B65D 47/18</b> (2006.01) <b>B65D 49/04</b> (2006.01) <b>B65D 81/26</b> (2006.01) <b>B65D 47/32</b> (2006.01) <b>B65D 51/16</b> (2006.01)	2632954 *	<b>A61K 39/395</b> (2006.01) <b>C07K 16/28</b> (2006.01) <b>C07K 16/46</b> (2006.01) <b>A61P 35/00</b> (2006.01)	2586340	<b>A47F 7/024</b> (2006.01)
		2644693	<b>C12N 15/09</b> (2006.01) <b>C12N 1/20</b> (2006.01) <b>C12N 9/18</b> (2006.01) <b>C12N 5/10</b> (2006.01) <b>C12N 15/70</b> (2006.01)	2627836 *	<b>E03D 13/00</b> (2006.01) <b>E03D 9/00</b> (2006.01)
2642999 *	<b>A61K 31/496</b> (2006.01) <b>A61P 37/00</b> (2006.01)			2640749 *	<b>C07K 16/28</b> (2006.01)
				2600870 *	<b>B67B 5/00</b> (2006.01) <b>A61K 31/4745</b> (2006.01)
2595624 *	<b>A61K 31/37</b> (2006.01) <b>A61K 31/42</b> (2006.01) <b>A61K 31/573</b> (2006.01) <b>A61K 38/47</b> (2006.01) <b>A61P 43/00</b> (2006.01) <b>A61P 29/00</b> (2006.01) <b>A61P 7/10</b> (2006.01) <b>A61P 21/00</b> (2006.01) <b>A61P 35/00</b> (2006.01)	2596119 *	<b>C12Q 1/04</b> (2006.01) <b>C12N 5/071</b> (2010.01) <b>C12N 5/0735</b> (2010.01) <b>G01N 33/533</b> (2006.01)	2640367 *	<b>A61P 35/00</b> (2006.01) <b>G01N 33/00</b> (2006.01) <b>A61K 31/00</b> (2006.01)
		2601371 *	<b>E06B 9/00</b> (2006.01) <b>E06B 9/02</b> (2006.01)	2530371	<b>F21S 6/00</b> (2006.01)
		2621307 *	<b>A47B 67/04</b> (2006.01) <b>A47B 88/20</b> (2006.01)	2620436 *	<b>A61P 31/16</b> (2006.01) <b>C07D 471/04</b> (2006.01) <b>A61K 31/53</b> (2006.01) <b>A61P 43/00</b> (2006.01)
2643911 *	<b>H02G 3/08</b> (2006.01) <b>H02G 3/22</b> (2006.01) <b>H02G 15/013</b> (2006.01)	2616385 *	<b>G05D 11/13</b> (2006.01) <b>B67D 3/00</b> (2006.01)	2621917 *	<b>C07D 401/12</b> (2006.01) <b>A61K 31/444</b> (2006.01) <b>A61P 11/08</b> (2006.01)
		2625053 *	<b>B60K 15/03</b> (2006.01) <b>F17C 1/00</b> (2006.01)	2633702 *	<b>H04B 5/00</b> (2006.01) <b>H04R 25/00</b> (2006.01)
2598491 *	<b>A61K 31/502</b> (2006.01) <b>C07D 237/32</b> (2006.01) <b>C07D 403/12</b> (2006.01) <b>A61P 35/00</b> (2006.01)	2639183 *	<b>C08L 25/08</b> (2006.01) <b>B65D 65/02</b> (2006.01) <b>B65D 83/04</b> (2006.01) <b>C08K 3/00</b> (2006.01) <b>C08J 5/18</b> (2006.01) <b>B65D 75/34</b> (2006.01)	2619518 *	<b>C25C 3/08</b> (2006.01) <b>F27D 1/12</b> (2006.01)
				2624893 *	<b>A61M 5/315</b> (2006.01) <b>A61M 5/00</b> (2006.01)
2613798 *	<b>A61K 38/46</b> (2006.01) <b>A61K 31/366</b> (2006.01) <b>A61K 31/397</b> (2006.01) <b>A61K 31/135</b> (2006.01) <b>A61P 3/06</b> (2006.01)	2495422	<b>F02G 5/02</b> (2006.01)		



Broj objave evropske prijava patenta (97)	MKP (51)	Broj objave evropske prijava patenta (97)	MKP (51)	Broj objave evropske prijava patenta (97)	MKP (51)
2595970 *	<b>A61P 3/00</b> (2006.01) <b>C07D 237/20</b> (2006.01) <b>A61K 31/425</b> (2006.01) <b>C07D 271/06</b> (2006.01)	2611444 *	<b>A61K 31/437</b> (2006.01) <b>A61K 31/496</b> (2006.01) <b>A61K 31/55</b> (2006.01) <b>A61K 31/5517</b> (2006.01) <b>C07D 413/12</b> (2006.01) <b>C07D 417/12</b> (2006.01) <b>C07D 471/04</b> (2006.01) <b>C07D 498/04</b> (2006.01) <b>A61P 23/00</b> (2006.01) <b>A61P 25/00</b> (2006.01)	2637663 *	<b>A61K 31/4995</b> (2006.01) <b>A61K 31/69</b> (2006.01) <b>A61K 45/06</b> (2006.01) <b>A61K 38/15</b> (2006.01) <b>A61P 35/00</b> (2006.01) <b>A61P 35/02</b> (2006.01) <b>A61K 31/513</b> (2006.01) <b>A61K 31/519</b> (2006.01) <b>A61K 31/7068</b> (2006.01)
2637648 *	<b>A61K 31/00</b> (2006.01) <b>A61K 31/341</b> (2006.01) <b>A61K 38/28</b> (2006.01) <b>A61P 3/10</b> (2006.01)	2628140 *	<b>G06Q 20/00</b> (2012.01)	2608808 *	<b>A61K 39/395</b> (2006.01) <b>A61K 38/17</b> (2006.01) <b>A61K 38/20</b> (2006.01) <b>A61P 35/00</b> (2006.01)
2613771 *	<b>A61K 9/70</b> (2006.01)	2354337	<b>E03D 9/08</b> (2006.01) <b>B05B 1/34</b> (2006.01) <b>B05B 7/04</b> (2006.01)	2598482 *	<b>C07D 213/73</b> (2006.01) <b>C07D 237/20</b> (2006.01) <b>C07D 239/42</b> (2006.01) <b>C07D 241/20</b> (2006.01) <b>C07D 261/14</b> (2006.01) <b>C07D 263/48</b> (2006.01) <b>C07D 277/40</b> (2006.01) <b>C07D 285/12</b> (2006.01) <b>C07D 401/12</b> (2006.01) <b>C07D 413/12</b> (2006.01) <b>C07D 417/12</b> (2006.01) <b>C07D 271/07</b> (2006.01) <b>C07D 271/113</b> (2006.01) <b>C07D 253/07</b> (2006.01) <b>A61K 31/44</b> (2006.01)
2619186 *	<b>C07D 239/47</b> (2006.01)	2598800 *	<b>F23H 7/08</b> (2006.01)	2627606 *	<b>A61K 47/02</b> (2006.01) <b>C01B 33/12</b> (2006.01) <b>C04B 33/02</b> (2006.01)
2630495 *	<b>G01N 33/68</b> (2006.01) <b>G01N 33/558</b> (2006.01)	2601207 *	<b>C07K 1/16</b> (2006.01) <b>C07K 1/18</b> (2006.01) <b>C07K 1/22</b> (2006.01) <b>C07K 14/46</b> (2006.01) <b>C07K 14/47</b> (2006.01)	2630145 *	<b>C07D 453/02</b> (2006.01) <b>A61K 31/439</b> (2006.01) <b>A61P 11/14</b> (2006.01)
2596114 *	<b>C12P 21/08</b> (2006.01) <b>C07K 16/00</b> (2006.01) <b>A61K 39/00</b> (2006.01) <b>C12N 5/00</b> (2006.01) <b>C12P 21/06</b> (2006.01) <b>C07H 21/04</b> (2006.01)	2529773	<b>A61M 5/315</b> (2006.01)	2600955 *	<b>B01D 11/04</b> (2006.01) <b>B01D 17/04</b> (2006.01) <b>C10G 27/04</b> (2006.01) <b>C10G 33/06</b> (2006.01)
2627606 *	<b>A61K 47/02</b> (2006.01) <b>C01B 33/12</b> (2006.01) <b>C04B 33/02</b> (2006.01)	2549874 *	<b>A01N 43/52</b> (2006.01) <b>A61K 31/415</b> (2006.01)	2605795 *	<b>A61K 47/34</b> (2006.01)
2630145 *	<b>C07D 453/02</b> (2006.01) <b>A61K 31/439</b> (2006.01) <b>A61P 11/14</b> (2006.01)			2607353	<b>C07D 223/16</b> (2006.01)

Broj objave evropske prijava patenta (97)	MKP (51)	Broj objave evropske prijava patenta (97)	MKP (51)	Broj objave evropske prijava patenta (97)	MKP (51)
2586442 *	<b>A61K 31/426</b> (2006.01) <b>A61P 9/12</b> (2006.01) <b>A61P 13/12</b> (2006.01) <b>A61P 19/06</b> (2006.01)	2613784 *	<b>A61K 31/437</b> (2006.01) <b>A61K 31/445</b> (2006.01) <b>A61K 9/00</b> (2006.01) <b>A61K 9/70</b> (2006.01)	2617715 *	<b>A61K 31/427</b> (2006.01) <b>A61K 31/5377</b> (2006.01) <b>A61K 31/437</b> (2006.01) <b>A61P 25/04</b> (2006.01) <b>A61K 31/4439</b> (2006.01) <b>A61P 25/08</b> (2006.01) <b>C07D 233/90</b> (2006.01) <b>A61K 31/444</b> (2006.01) <b>A61P 25/14</b> (2006.01) <b>A61K 31/4178</b> (2006.01) <b>A61K 31/4709</b> (2006.01) <b>A61P 25/18</b> (2006.01) <b>A61K 31/4196</b> (2006.01) <b>A61K 31/4725</b> (2006.01) <b>A61K 31/422</b> (2006.01) <b>A61K 31/497</b> (2006.01) <b>A61K 31/4245</b> (2006.01) <b>A61K 31/506</b> (2006.01)
2643310 *	<b>A61K 31/506</b> (2006.01) <b>A61P 3/10</b> (2006.01) <b>C07D 401/14</b> (2006.01) <b>C07D 403/14</b> (2006.01) <b>A61K 31/454</b> (2006.01) <b>C07D 401/04</b> (2006.01)	2615912 *	<b>A01N 43/54</b> (2006.01) <b>A01N 43/40</b> (2006.01) <b>A01N 31/00</b> (2006.01) <b>A01N 37/10</b> (2006.01) <b>A01P 13/00</b> (2006.01) <b>A01N 25/32</b> (2006.01) <b>A01N 43/66</b> (2006.01) <b>A01N 43/90</b> (2006.01)	2603226 *	<b>A61K 35/12</b> (2006.01) <b>A61K 38/18</b> (2006.01) <b>A61K 38/22</b> (2006.01) <b>A61P 3/10</b> (2006.01)
2608807 *	<b>A61K 39/395</b> (2006.01) <b>C07K 16/22</b> (2006.01) <b>C07K 16/40</b> (2006.01)	2618830 *	<b>A61K 38/19</b> (2006.01) <b>C07K 14/535</b> (2006.01) <b>A61P 29/00</b> (2006.01)	2608197 *	<b>A61K 39/395</b> (2006.01) <b>C07K 16/22</b> (2006.01) <b>C07K 16/40</b> (2006.01)
2625293 *	<b>C12Q 1/68</b> (2006.01)	2618776 *	<b>A61C 17/34</b> (2006.01) <b>A61C 17/22</b> (2006.01)	2623467	<b>C01F 11/18</b> (2006.01) <b>C02F 1/66</b> (2006.01) <b>C01F 5/24</b> (2006.01) <b>C02F 1/68</b> (2006.01) <b>C02F 1/52</b> (2006.01)
2632550 *	<b>A61P 1/12</b> (2006.01)	2595628 *	<b>A61K 31/44</b> (2006.01) <b>A61K 31/505</b> (2006.01) <b>A61K 31/519</b> (2006.01) <b>A61P 35/00</b> (2006.01)	2643048 *	<b>A61N 1/30</b> (2006.01) <b>A61N 1/32</b> (2006.01)
2630147 *	<b>C07D 477/20</b> (2006.01)	2598505 *	<b>C07D 487/04</b> (2006.01) <b>A61K 31/5025</b> (2006.01)	2611829 *	<b>C12P 21/08</b> (2006.01) <b>C07K 16/18</b> (2006.01) <b>C07H 21/00</b> (2006.01)
2601352 *	<b>E01F 8/00</b> (2006.01) <b>E04H 17/20</b> (2006.01)	2607685			<b>F03D 1/00</b> (2006.01) <b>F03D 11/04</b> (2006.01)
2635304 *	<b>A61K 39/395</b> (2006.01) <b>G01N 33/574</b> (2006.01) <b>G01N 33/82</b> (2006.01)				

Broj objave evropske prijava patenta (97)	MKP (51)	Broj objave evropske prijava patenta (97)	MKP (51)	Broj objave evropske prijava patenta (97)	MKP (51)
2604610 *	<b>C07D 487/04</b> (2006.01) <b>A61K 31/5025</b> (2006.01) <b>A61K 31/502</b> (2006.01) <b>C07D 403/12</b> (2006.01) <b>A61P 43/00</b> (2006.01) <b>A61P 35/00</b> (2006.01)	2632892 *	<b>C07C 211/31</b> (2006.01) <b>C07C 251/34</b> (2006.01) <b>C07C 251/54</b> (2006.01) <b>A61K 31/15</b> (2006.01) <b>C07D 211/46</b> (2006.01)	2611413 *	<b>A61P 17/00</b> (2006.01) <b>A61K 31/795</b> (2006.01) <b>A61K 8/89</b> (2006.01) <b>A61K 31/74</b> (2006.01) <b>A61Q 19/00</b> (2006.01)
2632265 *	<b>A01N 43/54</b> (2006.01) <b>A01P 13/00</b> (2006.01)	2632463 *	<b>A61K 31/496</b> (2006.01)	2624857 *	<b>A61K 39/395</b> (2006.01) <b>A61P 3/00</b> (2006.01) <b>A61K 38/08</b> (2006.01) <b>A61P 9/00</b> (2006.01) <b>A61P 29/00</b> (2006.01) <b>A61K 38/16</b> (2006.01) <b>A61K 38/10</b> (2006.01)
2619403 *	<b>E21B 34/06</b> (2006.01)	2623096	<b>A61K 9/50</b> (2006.01) <b>A61K 31/495</b> (2006.01)		
2625868 *	<b>H04Q 1/14</b> (2006.01)				
2598528 *	<b>C07K 14/705</b> (2006.01)	2603261 *	<b>A61M 5/24</b> (2006.01) <b>B65D 41/54</b> (2006.01) <b>G09F 3/03</b> (2006.01) <b>A61M 39/10</b> (2006.01)	2614061 *	<b>C07D 471/04</b> (2006.01) <b>A61K 31/519</b> (2006.01) <b>A61P 9/00</b> (2006.01) <b>A61P 25/28</b> (2006.01) <b>A61P 29/00</b> (2006.01)
2598810 *	<b>F24J 2/08</b> (2006.01) <b>F24J 2/14</b> (2006.01) <b>F24J 2/24</b> (2006.01) <b>G02F 1/00</b> (2006.01)	2640394 *	<b>A61P 7/06</b> (2006.01) <b>A61K 31/506</b> (2006.01) <b>A61P 7/00</b> (2006.01) <b>A61K 31/519</b> (2006.01) <b>A61K 31/505</b> (2006.01)		
2603125 *	<b>A47J 36/38</b> (2006.01) <b>A47J 37/12</b> (2006.01)			2540242	<b>A61B 18/12</b> (2006.01) <b>A61B 18/14</b> (2006.01)
2637765 *	<b>B01D 53/14</b> (2006.01) <b>B01D 53/80</b> (2006.01)	2596043 *	<b>C08G 61/10</b> (2006.01)	2598477 *	<b>A61P 37/00</b> (2006.01) <b>A61P 29/00</b> (2006.01) <b>C07C 271/56</b> (2006.01) <b>A61K 31/27</b> (2006.01)
2640444 *	<b>A61M 5/158</b> (2006.01) <b>A61M 5/32</b> (2006.01) <b>A61M 5/20</b> (2006.01) <b>A61M 5/00</b> (2006.01) <b>A61M 5/34</b> (2006.01) <b>A61M 5/142</b> (2006.01)	2623466	<b>C02F 1/52</b> (2006.01) <b>C02F 1/66</b> (2006.01) <b>C02F 1/68</b> (2006.01) <b>C01F 11/18</b> (2006.01) <b>C01F 5/24</b> (2006.01)	2325419	<b>E05B 1/00</b> (2006.01) <b>E05B 65/20</b> (2006.01) <b>E05B 15/04</b> (2006.01)
2643175 *	<b>B60D 1/00</b> (2006.01) <b>B60D 1/02</b> (2006.01) <b>B60D 1/54</b> (2006.01)			2623564	<b>C09C 3/04</b> (2006.01) <b>C09C 1/02</b> (2006.01)
				2625794 *	<b>H04B 3/54</b> (2006.01)

Broj objave evropske prijave patenta (97)	MKP (51)	Broj objave evropske prijave patenta (97)	MKP (51)	Broj objave evropske prijave patenta (97)	MKP (51)
2608801 *	<b>A61K 48/00</b> (2006.01) <b>A61P 29/00</b> (2006.01) <b>A61P 25/00</b> (2006.01) <b>A61K 38/16</b> (2006.01) <b>A61K 39/395</b> (2006.01) <b>A61K 38/10</b> (2006.01) <b>A61K 38/08</b> (2006.01)	2599774 *	<b>A61K 31/4725</b> (2006.01) <b>C07D 401/12</b> (2006.01) <b>A61K 31/553</b> (2006.01) <b>C07D 495/04</b> (2006.01) <b>A61K 31/541</b> (2006.01) <b>C07D 413/12</b> (2006.01) <b>A61P 43/00</b> (2006.01) <b>A61K 31/5377</b> (2006.01) <b>C07D 405/12</b> (2006.01) <b>A61P 29/00</b> (2006.01) <b>A61P 25/04</b> (2006.01) <b>C07D 217/26</b> (2006.01) <b>C07D 237/34</b> (2006.01)	2615096 *	<b>C07D 519/00</b> (2006.01) <b>A61K 31/4985</b> (2006.01) <b>A61P 13/02</b> (2006.01) <b>A61P 43/00</b> (2006.01) <b>C07D 487/04</b> (2006.01)
2611301 *	<b>A01N 43/54</b> (2006.01) <b>A01N 43/88</b> (2006.01) <b>A01P 13/02</b> (2006.01) <b>A01N 43/90</b> (2006.01)	2638620 *	<b>H02K 3/28</b> (2006.01) <b>H02K 19/36</b> (2006.01)	2627671 *	<b>G01N 33/574</b> (2006.01) <b>C07K 14/72</b> (2006.01) <b>C12N 5/00</b> (2006.01) <b>C07K 16/28</b> (2006.01)
2600830 *	<b>A61K 9/00</b> (2006.01) <b>A61K 31/44</b> (2006.01) <b>A61P 11/06</b> (2006.01)	2616440 *	<b>A61K 31/496</b> (2006.01) <b>A61P 25/00</b> (2006.01) <b>C07D 209/40</b> (2006.01) <b>C07D 235/30</b> (2006.01) <b>C07D 275/04</b> (2006.01) <b>C07D 319/20</b> (2006.01) <b>C07D 413/12</b> (2006.01)	2581301	<b>B63B 25/22</b> (2006.01)
2596155 *	<b>C25B 9/00</b> (2006.01) <b>C25B 13/04</b> (2006.01) <b>C01B 3/58</b> (2006.01)	2637528	<b>A61K 38/47</b> (2006.01) <b>C12N 9/38</b> (2006.01) <b>C12N 9/40</b> (2006.01) <b>A61P 1/04</b> (2006.01)	2595988 *	<b>C07D 491/00</b> (2006.01) <b>C07D 493/00</b> (2006.01) <b>C07D 513/00</b> (2006.01) <b>A61K 31/353</b> (2006.01) <b>A61K 31/425</b> (2006.01) <b>A61K 31/4738</b> (2006.01) <b>A61P 3/04</b> (2006.01)
2619205 *	<b>C07D 471/08</b> (2006.01) <b>A61K 31/439</b> (2006.01) <b>A61P 25/00</b> (2006.01) <b>A61P 25/28</b> (2006.01)	2619325 *	<b>C12Q 1/68</b> (2006.01)	2630196 *	<b>C09B 23/00</b> (2006.01) <b>G01N 33/58</b> (2006.01) <b>C09B 23/08</b> (2006.01) <b>C09B 69/00</b> (2006.01)
2601800 *	<b>H04W 4/02</b> (2009.01) <b>G01S 5/00</b> (2006.01)				
2629679 *	<b>A61B 17/04</b> (2006.01) <b>A61B 17/00</b> (2006.01) <b>A61F 2/08</b> (2006.01)				

Broj objave evropske prijava patenta (97)	MKP (51)	Broj objave evropske prijava patenta (97)	MKP (51)	Broj objave evropske prijava patenta (97)	MKP (51)
2640719 *	<b>C07D 403/14</b> (2006.01) <b>A61K 31/4178</b> (2006.01) <b>C07D 405/14</b> (2006.01) <b>A61K 31/4184</b> (2006.01) <b>C07D 493/04</b> (2006.01) <b>C07D 491/10</b> (2006.01) <b>C07D 495/04</b> (2006.01) <b>C07D 471/08</b> (2006.01) <b>A61P 31/12</b> (2006.01) <b>C07D 417/14</b> (2006.01) <b>A61K 31/4188</b> (2006.01) <b>C07D 513/04</b> (2006.01)	2603502 *	<b>C07D 403/04</b> (2006.01) <b>C07D 403/14</b> (2006.01) <b>C07D 413/14</b> (2006.01) <b>C07D 417/14</b> (2006.01) <b>C07D 405/14</b> (2006.01) <b>A61K 31/517</b> (2006.01) <b>A61K 31/55</b> (2006.01) <b>A61P 9/00</b> (2006.01) <b>A61P 3/10</b> (2006.01)	2611805 *	<b>A61K 31/4412</b> (2006.01) <b>A61K 31/437</b> (2006.01) <b>A61P 25/28</b> (2006.01) <b>C07D 471/04</b> (2006.01)
		2532407	<b>B01D 46/00</b> (2006.01) <b>B01D 53/00</b> (2006.01) <b>B03C 3/00</b> (2006.01) <b>F24F 3/00</b> (2006.01)	2625172 *	<b>C07D 401/12</b> (2006.01) <b>A61K 31/415</b> (2006.01) <b>A61P 3/04</b> (2006.01)
2623100 *	<b>A61K 47/20</b> (2006.01) <b>A61K 47/36</b> (2006.01) <b>A61K 47/38</b> (2006.01) <b>A61K 9/20</b> (2006.01) <b>A61K 9/48</b> (2006.01) <b>A61K 31/405</b> (2006.01) <b>A61K 47/02</b> (2006.01) <b>A61K 31/426</b> (2006.01)	2624831 *	<b>A61K 31/4188</b> (2006.01) <b>A61K 31/4745</b> (2006.01) <b>A61P 35/00</b> (2006.01)	2631646 *	<b>G01N 33/50</b> (2006.01) <b>G01N 33/92</b> (2006.01) <b>G01N 33/15</b> (2006.01) <b>G01N 33/68</b> (2006.01)
		2640377 *	<b>A61K 31/337</b> (2006.01) <b>A61K 31/475</b> (2006.01) <b>A61K 31/519</b> (2006.01) <b>A61K 38/18</b> (2006.01) <b>A61K 45/06</b> (2006.01) <b>A61P 35/00</b> (2006.01) <b>A61K 39/395</b> (2006.01) <b>A61K 31/4745</b> (2006.01) <b>A61K 31/513</b> (2006.01) <b>A61K 31/555</b> (2006.01) <b>A61K 31/704</b> (2006.01) <b>A61K 31/7048</b> (2006.01) <b>A61K 33/24</b> (2006.01) <b>A61K 38/17</b> (2006.01) <b>C07K 19/00</b> (2006.01)	2637649 *	<b>A61K 31/00</b> (2006.01) <b>A61K 31/4164</b> (2006.01) <b>A61K 31/675</b> (2006.01) <b>A61K 38/00</b> (2006.01) <b>A61P 29/00</b> (2006.01) <b>A61P 29/02</b> (2006.01) <b>A61P 25/04</b> (2006.01)
2643351 *	<b>C07K 16/22</b> (2006.01)			2557306	<b>F02M 59/02</b> (2006.01) <b>F02M 59/44</b> (2006.01) <b>F04B 1/04</b> (2006.01)
2603263 *	<b>A61M 5/24</b> (2006.01) <b>A61M 5/315</b> (2006.01)			2638507 *	<b>G06K 9/00</b> (2006.01) <b>G06T 7/00</b> (2006.01) <b>B01L 3/00</b> (2006.01) <b>C12M 1/34</b> (2006.01) <b>G01N 15/06</b> (2006.01) <b>G01N 15/14</b> (2006.01) <b>G01N 35/00</b> (2006.01)
2628472	<b>A61F 13/15</b> (2006.01)				
2369215	<b>F16L 37/24</b> (2006.01)				
2635258 *	<b>A61K 9/14</b> (2006.01) <b>A61K 9/26</b> (2006.01)			2635159 *	<b>A47C 7/38</b> (2006.01) <b>B60N 2/48</b> (2006.01)

Broj objave evropske prijava patenta (97)	MKP (51)	Broj objave evropske prijava patenta (97)	MKP (51)	Broj objave evropske prijava patenta (97)	MKP (51)
2433858	<b>B63B 3/06</b> (2006.01) <b>B63B 35/38</b> (2006.01) <b>E02B 3/06</b> (2006.01) <b>E01D 15/14</b> (2006.01) <b>E04B 1/343</b> (2006.01)	2636131 *	<b>H02K 9/197</b> (2006.01) <b>H02K 7/18</b> (2006.01) <b>F03D 9/00</b> (2006.01)	2640689 *	<b>A61K 31/40</b> (2006.01) <b>C07C 235/36</b> (2006.01) <b>C07D 235/00</b> (2006.01) <b>A61K 31/437</b> (2006.01) <b>C07D 257/04</b> (2006.01) <b>A61K 31/192</b> (2006.01) <b>C07D 213/55</b> (2006.01) <b>C07C 235/40</b> (2006.01) <b>A61K 31/341</b> (2006.01) <b>C07D 207/16</b> (2006.01) <b>A61P 9/08</b> (2006.01) <b>A61K 31/4402</b> (2006.01) <b>C07D 307/52</b> (2006.01) <b>A61K 31/216</b> (2006.01)
2616345 *	<b>B65B 55/20</b> (2006.01) <b>B65D 81/09</b> (2006.01) <b>B65B 1/22</b> (2006.01)	2595503 *	<b>A47B 73/00</b> (2006.01)		
2627360 *	<b>B82Y 5/00</b> (2011.01) <b>A61K 49/00</b> (2006.01)	2601982 *	<b>A61L 2/025</b> (2006.01) <b>A61L 27/36</b> (2006.01) <b>A61F 2/28</b> (2006.01) <b>C12N 5/071</b> (2010.01)		
2640727 *	<b>A61K 39/00</b> (2006.01) <b>A61K 31/535</b> (2006.01) <b>C07D 491/12</b> (2006.01)	2624865 *	<b>A61K 39/395</b> (2006.01) <b>C07K 16/28</b> (2006.01)		
2614228 *	<b>F01M 13/04</b> (2006.01) <b>F02D 41/22</b> (2006.01) <b>F02D 41/00</b> (2006.01) <b>F01M 13/02</b> (2006.01)	2627771 *	<b>C12N 15/82</b> (2006.01) <b>C12N 5/10</b> (2006.01) <b>A01H 5/00</b> (2006.01) <b>A01H 5/10</b> (2006.01) <b>C12N 15/54</b> (2006.01) <b>C12N 15/62</b> (2006.01)	2556246 *	<b>F03D 7/02</b> (2006.01) <b>F03D 11/00</b> (2006.01)
2598231 *	<b>B01D 61/10</b> (2006.01) <b>B01D 61/20</b> (2006.01) <b>B01D 65/00</b> (2006.01) <b>C12H 1/06</b> (2006.01) <b>B01D 65/02</b> (2006.01)	2627065 *	<b>H04M 9/08</b> (2006.01)	2522611	<b>B65H 75/14</b> (2006.01) <b>B65H 75/50</b> (2006.01) <b>B29C 45/44</b> (2006.01)
2600921 *	<b>A61M 5/145</b> (2006.01)			2635145 *	<b>A43B 3/26</b> (2006.01) <b>A43B 13/18</b> (2006.01) <b>A43B 13/16</b> (2006.01) <b>B29D 35/00</b> (2010.01) <b>B29D 35/12</b> (2010.01)
2616724 *	<b>F16K 11/074</b> (2006.01)			2640731 *	<b>C07D 519/00</b> (2006.01) <b>A61K 31/519</b> (2006.01) <b>A61P 25/24</b> (2006.01) <b>A61P 25/18</b> (2006.01) <b>A61P 25/00</b> (2006.01)
2369230	<b>F23D 1/00</b> (2006.01) <b>F23C 7/00</b> (2006.01)				

Broj objave evropske prijava patenta (97)	MKP (51)	Broj objave evropske prijava patenta (97)	MKP (51)	Broj objave evropske prijava patenta (97)	MKP (51)
2624815 *	<b>A61K 9/00</b> (2006.01) <b>A61K 39/145</b> (2006.01) <b>A61K 47/36</b> (2006.01)	2624707 *	<b>A23L 1/318</b> (2006.01) <b>A23L 1/00</b> (2006.01)	2518067	<b>C07D 403/12</b> (2006.01) <b>C07D 403/14</b> (2006.01) <b>C07D 405/14</b> (2006.01) <b>C07D 409/14</b> (2006.01) <b>C07D 413/14</b> (2006.01) <b>C07D 471/04</b> (2006.01) <b>C07D 471/08</b> (2006.01) <b>C07D 487/04</b> (2006.01) <b>C07D 487/08</b> (2006.01) <b>A61K 31/455</b> (2006.01) <b>A61K 31/439</b> (2006.01) <b>A61K 31/497</b> (2006.01) <b>A61K 31/501</b> (2006.01) <b>A61K 31/506</b> (2006.01) <b>A61P 9/00</b> (2006.01) <b>C07D 401/14</b> (2006.01)
2598136 *	<b>A61K 31/31</b> (2006.01) <b>C07C 211/00</b> (2006.01)	2613769 *	<b>A61K 9/14</b> (2006.01) <b>A61K 9/20</b> (2006.01) <b>A61K 31/437</b> (2006.01) <b>A61K 47/02</b> (2006.01) <b>A61K 47/22</b> (2006.01) <b>A61K 47/26</b> (2006.01) <b>A61K 47/32</b> (2006.01)		
2626085 *	<b>A61K 49/04</b> (2006.01)				
2601218 *	<b>C07K 16/00</b> (2006.01)				
2603651 *	<b>E04H 6/42</b> (2006.01) <b>E01F 9/08</b> (2006.01)	2593628 *	<b>E21B 4/14</b> (2006.01)		
2541010	<b>F01N 3/20</b> (2006.01)	2595630 *	<b>A61K 31/522</b> (2006.01) <b>A61P 9/12</b> (2006.01) <b>A61P 11/00</b> (2006.01) <b>A61K 31/00</b> (2006.01)		
2635609 *	<b>C08F 6/00</b> (2006.01) <b>B01J 8/00</b> (2006.01) <b>C08F 10/00</b> (2006.01)				
		2502848	<b>B65D 75/54</b> (2006.01) <b>B65B 61/20</b> (2006.01) <b>B65D 25/20</b> (2006.01)	2621490 *	<b>A61K 31/428</b> (2006.01)
2621261 *	<b>A01H 1/04</b> (2006.01) <b>C12N 15/82</b> (2006.01)			2640739 *	<b>C07K 14/47</b> (2006.01)
2640729 *	<b>C07D 495/04</b> (2006.01) <b>A61K 31/4365</b> (2006.01) <b>A61P 31/18</b> (2006.01)	2627180 *	<b>A01N 43/72</b> (2006.01)	2609629 *	<b>H01L 31/052</b> (2006.01) <b>H01L 31/042</b> (2006.01) <b>H01L 31/05</b> (2006.01) <b>H01L 31/068</b> (2012.01) <b>H01L 25/04</b> (2006.01) <b>H01L 27/142</b> (2006.01) <b>H01L 31/0216</b> (2006.01) <b>H01L 31/0224</b> (2006.01)
2625034 *	<b>B32B 15/06</b> (2006.01) <b>B32B 15/08</b> (2006.01) <b>B32B 15/10</b> (2006.01) <b>B66F 9/12</b> (2006.01)	2603204 *	<b>A61K 9/19</b> (2006.01) <b>A61K 38/10</b> (2006.01) <b>A61K 47/26</b> (2006.01) <b>A61K 9/00</b> (2006.01)		
		2415779	<b>C07K 1/16</b> (2006.01) <b>C07K 1/18</b> (2006.01) <b>C07K 1/22</b> (2006.01) <b>C07K 14/46</b> (2006.01) <b>C07K 14/47</b> (2006.01)		
2637603 *	<b>A61L 27/04</b> (2006.01) <b>A61F 2/06</b> (2013.01)				
2618151	<b>G01N 33/543</b> (2006.01) <b>G01N 33/558</b> (2006.01)				

Broj objave evropske prijava patenta (97)	MKP (51)	Broj objave evropske prijava patenta (97)	MKP (51)	Broj objave evropske prijava patenta (97)	MKP (51)
2616441 *	<b>C07D 213/30</b> (2006.01) <b>C07D 403/12</b> (2006.01) <b>C07D 213/46</b> (2006.01) <b>C07D 403/14</b> (2006.01) <b>C07D 213/74</b> (2006.01) <b>A61K 31/4418</b> (2006.01) <b>C07D 213/79</b> (2006.01) <b>A61K 31/4439</b> (2006.01) <b>C07D 213/81</b> (2006.01) <b>A61K 31/444</b> (2006.01) <b>C07D 213/84</b> (2006.01) <b>A61P 23/00</b> (2006.01) <b>C07D 401/04</b> (2006.01) <b>C07D 401/12</b> (2006.01)	2628724 *	<b>A61K 31/216</b> (2006.01) <b>A61K 31/421</b> (2006.01) <b>A61K 31/17</b> (2006.01) <b>A61K 31/4196</b> (2006.01) <b>A61K 31/4409</b> (2006.01) <b>A61K 31/341</b> (2006.01) <b>A61K 31/426</b> (2006.01) <b>A61K 31/197</b> (2006.01) <b>A61K 31/42</b> (2006.01) <b>A01N 47/34</b> (2006.01) <b>A61K 31/41</b> (2006.01) <b>A61K 31/4402</b> (2006.01) <b>A01P 7/02</b> (2006.01) <b>A61K 31/415</b> (2006.01) <b>A61K 31/4406</b> (2006.01) <b>C07C 275/64</b> (2006.01) <b>A61K 31/381</b> (2006.01) <b>A61K 31/44</b> (2006.01) <b>A61K 31/277</b> (2006.01) <b>A61K 31/4245</b> (2006.01)	2537532	<b>A61K 47/48</b> (2006.01) <b>A61K 49/00</b> (2006.01) <b>A61K 49/18</b> (2006.01) <b>A61P 35/00</b> (2006.01) <b>A61P 29/00</b> (2006.01) <b>A61K 9/127</b> (2006.01) <b>C07D 405/12</b> (2006.01) <b>C07K 7/02</b> (2006.01)
				2618819 *	<b>A61K 9/16</b> (2006.01) <b>A61K 9/20</b> (2006.01) <b>A61K 31/44</b> (2006.01)
				2600849 *	<b>A61K 9/48</b> (2006.01)
				2635284 *	<b>A61K 31/506</b> (2006.01) <b>A61K 31/16</b> (2006.01)
2625208 *	<b>C08F 10/00</b> (2006.01) <b>C08F 2/44</b> (2006.01) <b>C08K 3/00</b> (2006.01) <b>C08K 5/00</b> (2006.01)			2606701 *	<b>H04W 72/12</b> (2009.01)
				2614081 *	<b>C07K 16/28</b> (2006.01)
2607470	<b>B65D 17/00</b> (2006.01) <b>C12G 1/00</b> (2006.01) <b>B67C 3/02</b> (2006.01)	2616103 *	<b>A61K 47/48</b> (2006.01)	2611705 *	<b>B65D 17/32</b> (2006.01)
		2596783	<b>A61K 9/00</b> (2006.01) <b>A61K 9/08</b> (2006.01)	2597956 *	<b>A01N 43/90</b> (2006.01) <b>A01N 47/36</b> (2006.01) <b>A01N 25/00</b> (2006.01) <b>A01P 13/00</b> (2006.01)
		2611876 *	<b>A61F 2/00</b> (2006.01) <b>A61B 17/08</b> (2006.01) <b>A61L 31/04</b> (2006.01) <b>A61L 31/06</b> (2006.01) <b>B29C 33/52</b> (2006.01) <b>C09J 7/00</b> (2006.01)	2543791	<b>E04B 1/76</b> (2006.01) <b>E04F 13/08</b> (2006.01)
				2628013 *	<b>G01N 33/52</b> (2006.01) <b>G01N 33/68</b> (2006.01) <b>G01N 33/53</b> (2006.01)



Broj objave evropske prijave patenta (97)	MKP (51)	Broj objave evropske prijave patenta (97)	MKP (51)	Broj objave evropske prijave patenta (97)	MKP (51)
2635585 *	<b>C07D 487/22</b> (2006.01) <b>A61K 39/00</b> (2006.01) <b>A61K 47/48</b> (2006.01)	2594722	<b>E06B 3/667</b> (2006.01)	2639286	<b>C10G 3/00</b> (2006.01) <b>C10L 1/02</b> (2006.01) <b>C10G 67/04</b> (2006.01) <b>C10G 47/04</b> (2006.01)
2640414 *	<b>A61K 39/00</b> (2006.01)	2630449 *	<b>G01D 5/14</b> (2006.01)		<b>C10G 47/06</b> (2006.01) <b>C10G 47/10</b> (2006.01) <b>C10L 1/04</b> (2006.01) <b>C10L 1/14</b> (2006.01)
2562487	<b>F24J 2/52</b> (2006.01) <b>E04D 1/12</b> (2006.01) <b>E04D 1/34</b> (2006.01) <b>H01L 31/048</b> (2006.01)	2619188 *	<b>C07D 249/12</b> (2006.01) <b>A61K 31/4196</b> (2006.01) <b>A61P 9/00</b> (2006.01)		<b>C10L 1/16</b> (2006.01) <b>C10L 1/183</b> (2006.01) <b>C10L 1/188</b> (2006.01) <b>C10L 1/19</b> (2006.01) <b>C10L 1/223</b> (2006.01) <b>C10L 10/08</b> (2006.01)
2603216 *	<b>A61K 31/422</b> (2006.01)	2617412	<b>A61K 36/48</b> (2006.01) <b>A61K 36/68</b> (2006.01) <b>A61P 29/00</b> (2006.01) <b>A61K 9/12</b> (2006.01) <b>A61K 36/185</b> (2006.01) <b>A61K 36/09</b> (2006.01) <b>A61K 36/73</b> (2006.01)		
2522637	<b>C03B 37/08</b> (2006.01)	2643348 *	<b>C07K 14/47</b> (2006.01)	2606442 *	<b>G06F 17/30</b> (2006.01) <b>G06Q 30/00</b> (2012.01)
2527516	<b>D06F 57/08</b> (2006.01) <b>D06F 57/10</b> (2006.01) <b>D06F 57/06</b> (2006.01)	2619714 *	<b>G06K 19/06</b> (2006.01)	2635571 *	<b>C07D 403/14</b> (2006.01) <b>A61K 31/4025</b> (2006.01) <b>A61K 31/12</b> (2006.01)
2613678 *	<b>A47J 31/44</b> (2006.01)	2455875	<b>G06F 19/00</b> (2011.01) <b>G01N 27/327</b> (2006.01) <b>A61B 5/145</b> (2006.01)	2637502 *	<b>C07D 471/04</b> (2006.01) <b>C07D 239/42</b> (2006.01) <b>A01N 43/54</b> (2006.01)
2599524 *	<b>A62C 31/00</b> (2006.01) <b>A62C 5/00</b> (2006.01) <b>A62C 35/68</b> (2006.01)	2632525 *	<b>A61M 16/06</b> (2006.01)		
2506064	<b>G02C 7/10</b> (2006.01) <b>B29D 11/00</b> (2006.01)			2624828 *	<b>A61P 35/00</b> (2006.01) <b>A61P 25/28</b> (2006.01) <b>A61K 31/365</b> (2006.01) <b>A61P 3/10</b> (2006.01)
2640453 *	<b>A61M 25/04</b> (2006.01)			2546499	<b>F02D 41/20</b> (2006.01)
2407614	<b>E04H 15/56</b> (2006.01) <b>E04F 15/024</b> (2006.01) <b>E04B 5/02</b> (2006.01)				
2595979 *	<b>C07D 307/87</b> (2006.01)				
2640876 *	<b>C40B 30/04</b> (2006.01)				

Broj objave evropske prijave patenta (97)	MKP (51)	Broj objave evropske prijave patenta (97)	MKP (51)	Broj objave evropske prijave patenta (97)	MKP (51)
2596004 *	<b>C07H 19/02</b> (2006.01) <b>C07H 19/10</b> (2006.01) <b>C07H 19/20</b> (2006.01) <b>C07H 1/00</b> (2006.01) <b>C07H 1/06</b> (2006.01) <b>C07D 309/10</b> (2006.01)	2616450 *	<b>C07D 257/04</b> (2006.01) <b>C07D 307/82</b> (2006.01) <b>C07D 333/34</b> (2006.01) <b>C07D 333/62</b> (2006.01) <b>C07D 405/12</b> (2006.01) <b>C07D 417/12</b> (2006.01) <b>C07D 409/04</b> (2006.01) <b>C07D 417/14</b> (2006.01) <b>C07D 409/12</b> (2006.01) <b>C07C 311/21</b> (2006.01) <b>C07D 409/14</b> (2006.01) <b>C07C 311/29</b> (2006.01) <b>C07D 413/12</b> (2006.01) <b>A61K 31/41</b> (2006.01) <b>C07D 413/04</b> (2006.01) <b>A61K 31/422</b> (2006.01) <b>C07D 413/14</b> (2006.01) <b>A61K 31/381</b> (2006.01) <b>C07D 417/04</b> (2006.01) <b>A61K 31/4436</b> (2006.01)	2600852 *	<b>A61P 1/04</b> (2006.01) <b>A61K 31/573</b> (2006.01) <b>A61K 9/50</b> (2006.01) <b>A61P 1/12</b> (2006.01)
2603591 *	<b>C12N 15/82</b> (2006.01) <b>C12Q 1/68</b> (2006.01) <b>G01N 33/573</b> (2006.01) <b>A01H 5/00</b> (2006.01) <b>A01H 5/10</b> (2006.01) <b>C12N 9/02</b> (2006.01)	2606261 *		2606261 *	<b>F16J 15/34</b> (2006.01)
2530316	<b>F04B 1/04</b> (2006.01) <b>F02M 59/10</b> (2006.01) <b>F02M 59/44</b> (2006.01) <b>F02M 63/00</b> (2006.01)	2640366 *		2640366 *	<b>A61P 35/00</b> (2006.01) <b>G01N 33/00</b> (2006.01) <b>A61K 31/00</b> (2006.01)
2625179 *	<b>C07D 487/04</b> (2006.01) <b>C12N 9/02</b> (2006.01) <b>C12P 17/18</b> (2006.01)	2598256 *		2598256 *	<b>B07B 13/10</b> (2006.01) <b>B07B 13/11</b> (2006.01) <b>B07B 13/16</b> (2006.01)
2601706 *	<b>H01P 1/06</b> (2006.01) <b>H01P 1/16</b> (2006.01)	2573291		2573291	<b>E04C 3/09</b> (2006.01) <b>E04C 3/08</b> (2006.01)
2643464 *	<b>C12N 15/82</b> (2006.01)	2378444		2378444	<b>G06F 17/50</b> (2006.01)
2598888 *	<b>G01N 33/68</b> (2006.01)	2608793 *	<b>A61K 31/517</b> (2006.01) <b>A61P 13/12</b> (2006.01)	2596778	<b>A61F 13/15</b> (2006.01)
		2632262 *	<b>A01N 43/40</b> (2006.01) <b>A01P 13/00</b> (2006.01)	2611462 *	<b>G01N 33/68</b> (2006.01) <b>A61P 3/10</b> (2006.01) <b>A61K 39/395</b> (2006.01) <b>A61P 17/06</b> (2006.01) <b>C07K 16/28</b> (2006.01) <b>A61P 9/10</b> (2006.01) <b>A61P 35/00</b> (2006.01) <b>A61P 29/00</b> (2006.01) <b>A61P 37/02</b> (2006.01)
		2595976 *	<b>C07D 307/80</b> (2006.01)		
		2535558	<b>F03B 17/00</b> (2006.01)		
		2630148 *	<b>C07D 487/04</b> (2006.01)	2632344 *	<b>A61B 17/02</b> (2006.01) <b>A61B 17/04</b> (2006.01) <b>A61B 17/00</b> (2006.01)
		2618656 *	<b>A01K 67/027</b> (2006.01)		
		2624867 *	<b>A61K 39/395</b> (2006.01)		

Broj objave evropske prijava patenta (97)	MKP (51)	Broj objave evropske prijava patenta (97)	MKP (51)	Broj objave evropske prijava patenta (97)	MKP (51)
2595643 *	<b>A61K 36/886</b> (2006.01) <b>A61P 31/18</b> (2006.01) <b>A61K 31/715</b> (2006.01)	2604602 *	<b>A61P 25/08</b> (2006.01) <b>C07D 403/04</b> (2006.01) <b>A61P 25/28</b> (2006.01) <b>A61K 31/4155</b> (2006.01) <b>A61P 25/36</b> (2006.01) <b>A61K 31/4245</b> (2006.01) <b>C07D 403/14</b> (2006.01) <b>A61P 25/20</b> (2006.01) <b>A61P 25/22</b> (2006.01) <b>A61K 31/4439</b> (2006.01) <b>C07D 413/04</b> (2006.01) <b>A61P 25/04</b> (2006.01) <b>C07D 413/14</b> (2006.01)	2611831 *	<b>C07K 16/22</b> (2006.01) <b>C07K 16/28</b> (2006.01) <b>A61K 39/395</b> (2006.01) <b>A61P 9/10</b> (2006.01)
2619585 *	<b>G01N 33/574</b> (2006.01)			2635499 *	<b>B65D 5/42</b> (2006.01) <b>B65D 65/00</b> (2006.01)
2616395 *	<b>C02F 1/42</b> (2006.01)			2595906 *	<b>B65G 49/06</b> (2006.01)
2627179 *	<b>A01N 43/54</b> (2006.01) <b>A61K 31/505</b> (2006.01)			2625248 *	<b>C10B 27/06</b> (2006.01) <b>C10B 41/08</b> (2006.01)
2643539 *	<b>E06B 9/28</b> (2006.01) <b>E06B 7/082</b> (2006.01)			2625280 *	<b>C12Q 1/00</b> (2006.01)
2614051 *	<b>A61K 31/405</b> (2006.01) <b>A61P 35/00</b> (2006.01) <b>C07D 209/42</b> (2006.01) <b>C07D 209/30</b> (2006.01) <b>C07D 209/14</b> (2006.01) <b>C07D 209/26</b> (2006.01) <b>A61K 31/404</b> (2006.01)	2535622	<b>F16K 3/26</b> (2006.01)	2601525 *	<b>G01N 33/53</b> (2006.01)
		2643266 *	<b>C01B 17/02</b> (2006.01) <b>C01B 17/00</b> (2006.01) <b>B01J 2/12</b> (2006.01)	2615937 *	<b>A44B 11/00</b> (2006.01)
		2574358	<b>A61M 5/315</b> (2006.01) <b>A61M 5/24</b> (2006.01)	2637719 *	<b>A61M 5/24</b> (2006.01) <b>A61M 5/315</b> (2006.01)
2599606	<b>B29C 44/44</b> (2006.01) <b>B29C 37/00</b> (2006.01) <b>B05D 1/02</b> (2006.01)			2611895 *	<b>C11C 5/00</b> (2006.01)
		2624866 *	<b>A61K 39/395</b> (2006.01) <b>C07K 16/00</b> (2006.01)	2627548 *	<b>B61H 13/20</b> (2006.01) <b>B61H 1/00</b> (2006.01)
		2640834 *	<b>C12N 9/72</b> (2006.01) <b>C12N 9/48</b> (2006.01)	2601151 *	<b>C04B 26/02</b> (2006.01) <b>C04B 30/02</b> (2006.01) <b>C04B 26/16</b> (2006.01) <b>C04B 18/30</b> (2006.01) <b>C04B 26/12</b> (2006.01)
		2638597 *	<b>H01M 4/36</b> (2006.01) <b>H01M 10/0525</b> (2010.01) <b>H01M 4/66</b> (2006.01) <b>H01M 4/62</b> (2006.01) <b>H01M 10/0566</b> (2010.01)	2627454 *	<b>B65D 83/14</b> (2006.01) <b>B65D 83/28</b> (2006.01) <b>B65D 83/30</b> (2006.01) <b>B05C 17/005</b> (2006.01)
		2638040 *	<b>C07D 471/04</b> (2006.01)		

Broj objave evropske prijave patenta (97)	MKP (51)	Broj objave evropske prijave patenta (97)	MKP (51)	Broj objave evropske prijave patenta (97)	MKP (51)
2643295 *	<b>C07D 207/12</b> (2006.01) <b>C07D 451/10</b> (2006.01) <b>C07D 453/02</b> (2006.01) <b>A61K 31/40</b> (2006.01) <b>A61K 31/46</b> (2006.01) <b>A61K 31/439</b> (2006.01) <b>A61P 11/08</b> (2006.01) <b>A61P 29/02</b> (2006.01)	2640720 *	<b>A61P 31/18</b> (2006.01) <b>A61K 31/496</b> (2006.01) <b>C07D 405/14</b> (2006.01)	2635578 *	<b>C07D 471/04</b> (2006.01) <b>C07D 487/04</b> (2006.01) <b>A61K 31/5025</b> (2006.01) <b>A61P 35/00</b> (2006.01)
		2600734 *	<b>A23L 1/0524</b> (2006.01) <b>A23G 3/54</b> (2006.01)	2640422 *	<b>A61K 47/48</b> (2006.01) <b>A61P 35/00</b> (2006.01)
		2590197	<b>H01H 36/00</b> (2006.01)		
		2616354 *	<b>B65D 51/28</b> (2006.01)	2622082 *	<b>C12N 15/82</b> (2006.01) <b>A61K 39/145</b> (2006.01)
2640742 *	<b>C07K 16/00</b> (2006.01) <b>C12N 15/10</b> (2006.01)	2598176 *	<b>A61L 2/12</b> (2006.01)	2595987 *	<b>C07D 487/04</b> (2006.01) <b>C07D 493/14</b> (2006.01) <b>C07D 495/14</b> (2006.01) <b>C07D 498/14</b> (2006.01) <b>A61K 31/517</b> (2006.01) <b>A61P 35/00</b> (2006.01)
2626428	<b>C07C 69/753</b> (2006.01) <b>C07C 213/08</b> (2006.01) <b>C07C 62/34</b> (2006.01) <b>C07C 217/58</b> (2006.01) <b>C07D 223/16</b> (2006.01) <b>C12P 7/40</b> (2006.01) <b>C12P 7/62</b> (2006.01) <b>C12P 41/00</b> (2006.01)	2619991 *	<b>H04N 21/41</b> (2011.01) <b>H04N 21/436</b> (2011.01) <b>H04N 5/44</b> (2011.01) <b>H04M 1/725</b> (2006.01) <b>G06F 1/16</b> (2006.01)	2643542 *	<b>E21B 19/24</b> (2006.01) <b>E21B 33/06</b> (2006.01)
		2643470 *	<b>C12Q 1/68</b> (2006.01) <b>G01N 33/53</b> (2006.01) <b>C12Q 1/00</b> (2006.01)	2611292 *	<b>A01N 25/02</b> (2006.01) <b>A01N 25/30</b> (2006.01) <b>A01N 51/00</b> (2006.01)
2523117	<b>G06F 13/38</b> (2006.01)	2611464 *	<b>A61K 39/395</b> (2006.01)		
2630436 *	<b>F42B 12/40</b> (2006.01)	2625177 *	<b>C07D 413/14</b> (2006.01) <b>C07D 417/14</b> (2006.01) <b>A61K 31/506</b> (2006.01) <b>A61P 3/10</b> (2006.01)	2522342	<b>A61K 9/00</b> (2006.01) <b>A61P 31/10</b> (2006.01) <b>A61K 31/19</b> (2006.01) <b>A61P 17/12</b> (2006.01) <b>A61K 45/06</b> (2006.01) <b>A61K 31/17</b> (2006.01)
2635197 *	<b>A61F 2/00</b> (2006.01) <b>A61B 17/03</b> (2006.01) <b>A61B 17/08</b> (2006.01) <b>A61L 31/02</b> (2006.01)	2630215 *	<b>F42B 12/40</b> (2006.01) <b>C09K 11/07</b> (2006.01) <b>F42B 12/36</b> (2006.01)	2605756 *	<b>A61K 9/16</b> (2006.01) <b>A61K 9/50</b> (2006.01)
2640691 *	<b>C07C 237/22</b> (2006.01) <b>C07C 229/22</b> (2006.01) <b>C07C 233/47</b> (2006.01)			2603622 *	<b>G06F 19/00</b> (2011.01) <b>C40B 30/04</b> (2006.01)

Broj objave evropske prijave patenta (97)	MKP (51)	Broj objave evropske prijave patenta (97)	MKP (51)	Broj objave evropske prijave patenta (97)	MKP (51)
2619404 *	<b>E21B 43/12</b> (2006.01) <b>E21B 43/25</b> (2006.01) <b>E21B 34/14</b> (2006.01)	2598464 *	<b>C07C 1/04</b> (2006.01) <b>C10L 3/08</b> (2006.01)	2624894 *	<b>A61M 5/315</b> (2006.01)
2635734 *	<b>D05C 17/02</b> (2006.01)	2632398 *	<b>A61F 6/18</b> (2006.01)	2592359	<b>F24F 13/14</b> (2006.01) <b>F24F 13/02</b> (2006.01)
2636031 *	<b>G07F 17/32</b> (2006.01) <b>G06F 3/048</b> (2013.01)	2598516 *	<b>C07K 1/36</b> (2006.01) <b>C07K 16/24</b> (2006.01) <b>C07K 14/245</b> (2006.01)	2619577 *	<b>G01N 33/50</b> (2006.01) <b>G01N 33/68</b> (2006.01)
2598728 *	<b>F01L 7/12</b> (2006.01) <b>F02B 33/04</b> (2006.01) <b>F01L 7/02</b> (2006.01)	2606042 *	<b>C07D 401/12</b> (2006.01) <b>C07D 401/14</b> (2006.01) <b>C07D 403/12</b> (2006.01) <b>A61K 31/455</b> (2006.01) <b>A61K 31/506</b> (2006.01) <b>A61K 31/501</b> (2006.01) <b>A61P 29/00</b> (2006.01) <b>A61P 11/00</b> (2006.01) <b>A61P 19/02</b> (2006.01) <b>A61P 17/00</b> (2006.01)	2632445 *	<b>A61K 31/00</b> (2006.01) <b>C12Q 1/70</b> (2006.01) <b>G01N 33/50</b> (2006.01) <b>C40B 30/02</b> (2006.01)
2629796 *	<b>A61K 39/395</b> (2006.01)	2629796 *	<b>A61K 31/506</b> (2006.01) <b>A61K 31/501</b> (2006.01) <b>A61P 29/00</b> (2006.01) <b>A61P 11/00</b> (2006.01) <b>A61P 19/02</b> (2006.01) <b>A61P 17/00</b> (2006.01)	2638131 *	<b>C10L 5/00</b> (2006.01)
2601628 *	<b>G06Q 30/00</b> (2012.01) <b>G07C 9/00</b> (2006.01)	2601628 *	<b>A61P 11/00</b> (2006.01) <b>A61P 19/02</b> (2006.01) <b>A61P 17/00</b> (2006.01)	2464466 *	<b>B05C 5/00</b> (2006.01) <b>B08B 3/08</b> (2006.01)
2616391 *	<b>C01B 31/02</b> (2006.01) <b>B01J 35/00</b> (2006.01) <b>B01J 37/16</b> (2006.01)	2616391 *	<b>A61P 19/02</b> (2006.01) <b>A61P 17/00</b> (2006.01)	2640372 *	<b>A61K 31/165</b> (2006.01) <b>A61P 35/00</b> (2006.01)
2632322 *	<b>A61B 3/113</b> (2006.01) <b>G06F 3/01</b> (2006.01) <b>G06T 7/00</b> (2006.01)	2638042 *	<b>A61P 9/08</b> (2006.01) <b>C07D 471/10</b> (2006.01) <b>A61K 31/519</b> (2006.01) <b>A61K 31/437</b> (2006.01)	2621494 *	<b>A61K 31/439</b> (2006.01) <b>A61K 9/00</b> (2006.01)
2629756 *	<b>A61K 31/351</b> (2006.01) <b>A61K 9/06</b> (2006.01) <b>A61K 9/00</b> (2006.01) <b>A61K 47/46</b> (2006.01)	2630963	<b>A61K 38/17</b> (2006.01) <b>A61P 35/00</b> (2006.01)	2637654 *	<b>A61K 31/192</b> (2006.01) <b>A61K 31/19</b> (2006.01) <b>A61P 31/10</b> (2006.01) <b>A61P 31/22</b> (2006.01)
2637847 *	<b>B29D 11/00</b> (2006.01)	2607224	<b>B63B 25/00</b> (2006.01) <b>B63B 25/12</b> (2006.01) <b>F02M 21/02</b> (2006.01)	2601197 *	<b>C07D 491/20</b> (2006.01) <b>C07D 491/22</b> (2006.01) <b>C07D 498/20</b> (2006.01) <b>C07D 498/22</b> (2006.01) <b>A61K 31/436</b> (2006.01) <b>A61K 31/437</b> (2006.01) <b>A61K 31/537</b> (2006.01)
2636203 *	<b>H04L 29/06</b> (2006.01) <b>H04W 4/02</b> (2009.01)	2621486 *	<b>A61K 31/17</b> (2006.01) <b>A61K 31/18</b> (2006.01) <b>A61K 31/44</b> (2006.01) <b>A61P 35/00</b> (2006.01)		

Broj objave evropske prijava patenta (97)	MKP (51)	Broj objave evropske prijava patenta (97)	MKP (51)	Broj objave evropske prijava patenta (97)	MKP (51)
2625376 *	<b>E21B 33/129</b> (2006.01) <b>E21B 23/06</b> (2006.01)	2613829 *	<b>A61M 15/00</b> (2006.01) <b>A61J 1/20</b> (2006.01) <b>B05B 11/00</b> (2006.01) <b>B65D 83/14</b> (2006.01)	2596113 *	<b>C12P 19/02</b> (2006.01) <b>C12P 19/12</b> (2006.01) <b>C12P 19/14</b> (2006.01) <b>C12P 19/18</b> (2006.01) <b>A23L 1/09</b> (2006.01) <b>C07H 3/04</b> (2006.01) <b>C07H 3/06</b> (2006.01)
2598940 *	<b>G02C 11/08</b> (2006.01) <b>A61F 9/02</b> (2006.01) <b>G02C 5/12</b> (2006.01) <b>G02C 5/14</b> (2006.01)	2616448 *	<b>C07D 249/12</b> (2006.01) <b>C07D 409/04</b> (2006.01) <b>A61K 31/4196</b> (2006.01) <b>A61P 9/00</b> (2006.01)	2637659 *	<b>A61K 31/427</b> (2006.01) <b>A61K 31/4439</b> (2006.01) <b>A61K 31/444</b> (2006.01) <b>A61K 31/497</b> (2006.01) <b>A61K 31/506</b> (2006.01) <b>C07D 401/04</b> (2006.01) <b>C07D 401/14</b> (2006.01) <b>C07D 403/04</b> (2006.01) <b>C07D 407/14</b> (2006.01) <b>C07D 413/14</b> (2006.01) <b>C07D 417/04</b> (2006.01) <b>C07D 417/14</b> (2006.01) <b>A61P 7/02</b> (2006.01) <b>A61P 9/08</b> (2006.01)
2608784 *	<b>A61K 31/221</b> (2006.01) <b>A61K 31/41</b> (2006.01) <b>A61P 9/00</b> (2006.01) <b>A61P 9/04</b> (2006.01) <b>A61P 9/12</b> (2006.01)	2621921 *	<b>C07D 403/14</b> (2006.01)		
		2567606	<b>A01C 15/00</b> (2006.01) <b>A01C 3/06</b> (2006.01)		
2616522 *	<b>C09K 11/02</b> (2006.01) <b>C09K 11/56</b> (2006.01) <b>C09K 11/70</b> (2006.01) <b>C09K 11/74</b> (2006.01) <b>C09K 11/88</b> (2006.01)	2621505 *	<b>A61K 36/235</b> (2006.01) <b>A61K 36/35</b> (2006.01) <b>A61K 36/57</b> (2006.01) <b>A61K 36/28</b> (2006.01) <b>A61P 11/10</b> (2006.01) <b>A61K 36/25</b> (2006.01) <b>A61P 11/12</b> (2006.01) <b>A61K 36/11</b> (2006.01) <b>A61K 36/53</b> (2006.01) <b>A61K 36/185</b> (2006.01) <b>A61P 11/00</b> (2006.01)	2633135 *	<b>E04D 13/12</b> (2006.01) <b>E04G 21/32</b> (2006.01)
2637638 *	<b>A61K 8/86</b> (2006.01) <b>A61Q 1/04</b> (2006.01) <b>A61Q 1/00</b> (2006.01) <b>A61K 8/97</b> (2006.01) <b>A61K 8/19</b> (2006.01) <b>A61K 8/72</b> (2006.01) <b>A61K 8/92</b> (2006.01)	2625199 *	<b>C07K 16/24</b> (2006.01) <b>A61K 39/395</b> (2006.01)	2640362 *	<b>A61K 31/675</b> (2006.01) <b>A61K 31/513</b> (2006.01) <b>A61P 31/18</b> (2006.01) <b>A61K 31/505</b> (2006.01) <b>A61K 9/20</b> (2006.01)
2605755 *	<b>A61K 9/14</b> (2006.01) <b>A61K 38/00</b> (2006.01) <b>A61K 47/02</b> (2006.01) <b>C01B 33/18</b> (2006.01) <b>A61K 48/00</b> (2006.01) <b>A61K 31/70</b> (2006.01)			2437260	<b>G10L 21/02</b> (2006.01)

Broj objave evropske prijava patenta (97)	MKP (51)	Broj objave evropske prijava patenta (97)	MKP (51)	Broj objave evropske prijava patenta (97)	MKP (51)
2632927 *	<b>C07F 5/02</b> (2006.01) <b>C07F 5/04</b> (2006.01) <b>A61K 31/69</b> (2006.01)	2616442 *	<b>A61P 35/00</b> (2006.01) <b>C07D 215/06</b> (2006.01) <b>A61K 31/52</b> (2006.01) <b>C07D 241/44</b> (2006.01) <b>A61K 31/4709</b> (2006.01) <b>C07D 401/14</b> (2006.01) <b>A61K 31/47</b> (2006.01) <b>C07D 405/12</b> (2006.01) <b>A61K 31/497</b> (2006.01) <b>C07D 413/14</b> (2006.01) <b>A61K 31/551</b> (2006.01) <b>C07D 473/34</b> (2006.01) <b>A61K 31/5377</b> (2006.01) <b>C07D 495/04</b> (2006.01)	2595977 *	<b>C07D 307/80</b> (2006.01) <b>C07C 251/16</b> (2006.01) <b>C07C 39/04</b> (2006.01) <b>A61K 31/343</b> (2006.01) <b>A61P 9/00</b> (2006.01)
2622078 *	<b>C12N 15/62</b> (2006.01) <b>C07K 14/245</b> (2006.01) <b>A61K 35/74</b> (2006.01) <b>A61K 39/04</b> (2006.01)	2611378 *	<b>A61B 19/00</b> (2006.01) <b>A61B 17/56</b> (2006.01)	2598553 *	<b>C08G 63/78</b> (2006.01) <b>C08L 67/04</b> (2006.01) <b>A61K 9/00</b> (2006.01) <b>C08G 63/08</b> (2006.01)
2599160 *	<b>H01Q 1/12</b> (2006.01) <b>H01Q 1/32</b> (2006.01)	2605056	<b>G02B 27/01</b> (2006.01)	2635553	<b>F02M 59/36</b> (2006.01) <b>F04B 49/22</b> (2006.01) <b>F04B 53/10</b> (2006.01)
2609081 *	<b>C07D 213/30</b> (2006.01) <b>C07D 213/71</b> (2006.01) <b>C07D 213/74</b> (2006.01) <b>C07D 231/18</b> (2006.01) <b>C07D 239/42</b> (2006.01) <b>C07D 241/04</b> (2006.01) <b>C07D 277/36</b> (2006.01) <b>C07D 333/34</b> (2006.01) <b>C07D 405/12</b> (2006.01) <b>C07D 409/12</b> (2006.01) <b>C07D 409/14</b> (2006.01) <b>C07D 413/14</b> (2006.01) <b>C07D 417/12</b> (2006.01) <b>C07D 491/08</b> (2006.01) <b>C07D 498/08</b> (2006.01)	2619197 *	<b>C07D 413/14</b> (2006.01) <b>A61K 31/497</b> (2006.01) <b>A61P 11/00</b> (2006.01)	2637789 *	<b>B01L 7/00</b> (2006.01)
2526931	<b>A61K 9/16</b> (2006.01) <b>A61K 31/22</b> (2006.01)	2635868 *	<b>F28F 1/40</b> (2006.01) <b>F28F 13/06</b> (2006.01) <b>F28F 13/12</b> (2006.01)	2625174 *	<b>C07D 401/14</b> (2006.01) <b>C07D 211/58</b> (2006.01) <b>C07D 213/81</b> (2006.01) <b>C07D 401/04</b> (2006.01) <b>A61K 31/454</b> (2006.01) <b>A61P 31/00</b> (2006.01)
		2619182 *	<b>C07D 231/20</b> (2006.01) <b>A61K 31/415</b> (2006.01) <b>A61P 29/00</b> (2006.01)	2637688 *	<b>C12N 7/08</b> (2006.01) <b>C07K 14/08</b> (2006.01) <b>A61K 39/12</b> (2006.01)
		2621520 *	<b>A61K 38/48</b> (2006.01) <b>A61K 47/36</b> (2006.01)		
		2637154	<b>G09F 21/02</b> (2006.01) <b>G09F 7/06</b> (2006.01)		
		2640501 *	<b>B01F 5/12</b> (2006.01)		

Broj objave evropske prijava patenta (97)	MKP (51)
2600883 *	<b>A61K 31/427</b> (2006.01) <b>A61K 38/44</b> (2006.01) <b>A61K 38/06</b> (2006.01) <b>A61P 31/12</b> (2006.01) <b>A61P 39/06</b> (2006.01)
2629619 *	<b>A01N 47/06</b> (2006.01) <b>A01N 47/38</b> (2006.01) <b>A01N 43/80</b> (2006.01) <b>A01P 13/02</b> (2006.01) <b>A01N 41/10</b> (2006.01)
2529855	<b>B21J 13/03</b> (2006.01) <b>B23P 19/02</b> (2006.01) <b>B30B 15/02</b> (2006.01) <b>B21J 13/08</b> (2006.01) <b>B21J 17/02</b> (2006.01) <b>B21D 37/16</b> (2006.01)
2616032 *	<b>A61G 15/10</b> (2006.01)
2623119 *	<b>A61K 31/7105</b> (2006.01) <b>A61K 38/00</b> (2006.01) <b>A61K 39/395</b> (2006.01) <b>A61K 45/00</b> (2006.01) <b>A61P 35/00</b> (2006.01)
2625525 *	<b>G01N 33/53</b> (2006.01)



**INDEKS KLASIFIKACIJSKIH OZNAKA BROJEVA ZAHTJEVA ZA PROŠIRENJE  
EVROPSKIH PRIJAVA PATENTA PREMA MKP**  
INDEX ON CLASSIFICATION MARKS ON REQUESTS FOR EXTENSION  
OF EUROPEAN PATENT APPLICATION IN ACCORDANCE WITH THE  
INTERNATIONAL PATENT CLASSIFICATION

MKP (51)	Broj objave evropske prijave patenta (97)	Naziv pronalaska (54)	MKP (51)	Broj objave evropske prijave patenta (97)	Naziv pronalaska (54)
<b>A61B 5/145</b> (2006.01)	2455876	System and method for diabetes management	<b>C08L 83/10</b> (2006.01)	2625217 *	CHAIN-EXTENDED POLYSILOXANE CROSSLINKERS WITH DANGLING HYDROPHILIC POLYMER CHAINS
<b>G06F 19/00</b> (2011.01)	2455876	System and method for diabetes management	<b>C08G 77/20</b> (2006.01)	2625217 *	CHAIN-EXTENDED POLYSILOXANE CROSSLINKERS WITH DANGLING HYDROPHILIC POLYMER CHAINS
<b>C08G 77/50</b> (2006.01)	2601245 *	CYCLOSILOXANE-SUBSTITUTED POLYSILOXANE COMPOUNDS, COMPOSITIONS CONTAINING THE COMPOUNDS AND METHODS OF USE THEREOF	<b>C07D 213/82</b> (2006.01)	2598483 *	AMPK-ACTIVATING HETEROCYCLIC COMPOUNDS AND METHODS FOR USING THE SAME
<b>C08L 83/14</b> (2006.01)	2601245 *	CYCLOSILOXANE-SUBSTITUTED POLYSILOXANE COMPOUNDS, COMPOSITIONS CONTAINING THE COMPOUNDS AND METHODS OF USE THEREOF	<b>C07D 295/04</b> (2006.01)	2598483 *	AMPK-ACTIVATING HETEROCYCLIC COMPOUNDS AND METHODS FOR USING THE SAME
<b>A61M 21/02</b> (2006.01)	2629825 *	INFANT CALMING AID	<b>C07D 401/12</b> (2006.01)	2598483 *	AMPK-ACTIVATING HETEROCYCLIC COMPOUNDS AND METHODS FOR USING THE SAME
<b>C12N 5/04</b> (2006.01)	2603578 *	COMPOSITIONS AND METHODS FOR INHIBITING POTATO PATHOGENS	<b>C07D 401/14</b> (2006.01)	2598483 *	AMPK-ACTIVATING HETEROCYCLIC COMPOUNDS AND METHODS FOR USING THE SAME
<b>C01B 33/12</b> (2006.01)	2609033 *	SILICA HYDROGEL IMPREGNATED WITH TIO <sub>2</sub> AND METHOD OF MAKING SAME	<b>C07D 405/12</b> (2006.01)	2598483 *	AMPK-ACTIVATING HETEROCYCLIC COMPOUNDS AND METHODS FOR USING THE SAME
<b>C01B 33/16</b> (2006.01)	2609033 *	SILICA HYDROGEL IMPREGNATED WITH TIO <sub>2</sub> AND METHOD OF MAKING SAME	<b>C07D 409/12</b> (2006.01)	2598483 *	AMPK-ACTIVATING HETEROCYCLIC COMPOUNDS AND METHODS FOR USING THE SAME
<b>C08G 77/42</b> (2006.01)	2625217 *	CHAIN-EXTENDED POLYSILOXANE CROSSLINKERS WITH DANGLING HYDROPHILIC POLYMER CHAINS	<b>C07D 413/12</b> (2006.01)	2598483 *	AMPK-ACTIVATING HETEROCYCLIC COMPOUNDS AND METHODS FOR USING THE SAME
<b>C08G 77/46</b> (2006.01)	2625217 *	CHAIN-EXTENDED POLYSILOXANE CROSSLINKERS WITH DANGLING HYDROPHILIC POLYMER CHAINS	<b>C07D 471/10</b> (2006.01)	2598483 *	AMPK-ACTIVATING HETEROCYCLIC COMPOUNDS AND METHODS FOR USING THE SAME
<b>C08G 77/442</b> (2006.01)	2625217 *	CHAIN-EXTENDED POLYSILOXANE CROSSLINKERS WITH DANGLING HYDROPHILIC POLYMER CHAINS	<b>A61K 31/4427</b> (2006.01)	2598483 *	AMPK-ACTIVATING HETEROCYCLIC COMPOUNDS AND METHODS FOR USING THE SAME
<b>G02B 1/04</b> (2006.01)	2625217 *	CHAIN-EXTENDED POLYSILOXANE CROSSLINKERS WITH DANGLING HYDROPHILIC POLYMER CHAINS			

MKP (51)	Broj objave evropske prijava patenta (97)	Naziv pronalaska (54)	MKP (51)	Broj objave evropske prijava patenta (97)	Naziv pronalaska (54)
<b>A61K 31/501</b> (2006.01)	2598483 *	AMPK-ACTIVATING HETEROCYCLIC COMPOUNDS AND METHODS FOR USING THE SAME	<b>C07D 413/06</b> (2006.01)	2625170 *	1,4-OXAZEPANE DERIVATIVES
<b>A61K 31/5377</b> (2006.01)	2598483 *	AMPK-ACTIVATING HETEROCYCLIC COMPOUNDS AND METHODS FOR USING THE SAME	<b>C07D 413/10</b> (2006.01)	2625170 *	1,4-OXAZEPANE DERIVATIVES
<b>A61P 3/10</b> (2006.01)	2598483 *	AMPK-ACTIVATING HETEROCYCLIC COMPOUNDS AND METHODS FOR USING THE SAME	<b>C07D 413/12</b> (2006.01)	2625170 *	1,4-OXAZEPANE DERIVATIVES
<b>A61P 9/10</b> (2006.01)	2598483 *	AMPK-ACTIVATING HETEROCYCLIC COMPOUNDS AND METHODS FOR USING THE SAME	<b>C12N 15/85</b> (2006.01)	2578688	ADAM6 mice
<b>B01D 11/02</b> (2006.01)	2632559 *	SIMPLE PROCESS TO PRODUCE AND SEPARATE WATER SOLUBLE AND OIL SOLUBLE ANTIOXIDATIVE FLAVORING COMPOSITIONS FROM LABIATAE HERBS USING GREEN SOLVENTS	<b>C12N 9/64</b> (2006.01)	2578688	ADAM6 mice
<b>A23L 1/30</b> (2006.01)	2632559 *	SIMPLE PROCESS TO PRODUCE AND SEPARATE WATER SOLUBLE AND OIL SOLUBLE ANTIOXIDATIVE FLAVORING COMPOSITIONS FROM LABIATAE HERBS USING GREEN SOLVENTS	<b>C07K 16/46</b> (2006.01)	2578688	ADAM6 mice
<b>A61K 36/00</b> (2006.01)	2632559 *	SIMPLE PROCESS TO PRODUCE AND SEPARATE WATER SOLUBLE AND OIL SOLUBLE ANTIOXIDATIVE FLAVORING COMPOSITIONS FROM LABIATAE HERBS USING GREEN SOLVENTS	<b>C07K 16/28</b> (2006.01)	2578688	ADAM6 mice
<b>A61K 39/395</b> (2006.01)	2606069 *	HUMANIZED ANTI-INTERLEUKIN 3 RECEPTOR ALPHA CHAIN ANTIBODIES	<b>C07K 16/40</b> (2006.01)	2578688	ADAM6 mice
<b>A61P 37/06</b> (2006.01)	2606069 *	HUMANIZED ANTI-INTERLEUKIN 3 RECEPTOR ALPHA CHAIN ANTIBODIES	<b>A01K 67/027</b> (2006.01)	2578688	ADAM6 mice
<b>C07K 16/28</b> (2006.01)	2606069 *	HUMANIZED ANTI-INTERLEUKIN 3 RECEPTOR ALPHA CHAIN ANTIBODIES	<b>A61K 51/04</b> (2006.01)	2637704 *	RADIOLABELLED PHENYLIMIDAZOLE-BASED LIGANDS
<b>A61P 35/02</b> (2006.01)	2606069 *	HUMANIZED ANTI-INTERLEUKIN 3 RECEPTOR ALPHA CHAIN ANTIBODIES	<b>G01N 33/60</b> (2006.01)	2637704 *	RADIOLABELLED PHENYLIMIDAZOLE-BASED LIGANDS
<b>C07D 413/14</b> (2006.01)	2625170 *	1,4-OXAZEPANE DERIVATIVES	<b>A61K 101/02</b> (2006.01)	2637704 *	RADIOLABELLED PHENYLIMIDAZOLE-BASED LIGANDS
<b>C07D 417/06</b> (2006.01)	2625170 *	1,4-OXAZEPANE DERIVATIVES	<b>C07B 59/00</b> (2006.01)	2637704 *	RADIOLABELLED PHENYLIMIDAZOLE-BASED LIGANDS
<b>C07D 417/14</b> (2006.01)	2625170 *	1,4-OXAZEPANE DERIVATIVES	<b>C07D 471/04</b> (2006.01)	2637704 *	RADIOLABELLED PHENYLIMIDAZOLE-BASED LIGANDS
<b>C07D 267/10</b> (2006.01)	2625170 *	1,4-OXAZEPANE DERIVATIVES	<b>A61M 5/24</b> (2006.01)	2621562 *	NON-DETACHABLE RESERVOIR HOLDER FOR A DRUG DELIVERY DEVICE
<b>C07D 413/04</b> (2006.01)	2625170 *	1,4-OXAZEPANE DERIVATIVES	<b>A61K 31/765</b> (2006.01)	2635289 *	PEG OR PEG BLOCK COPOLYMERS FOR TREATING COLORECTAL CANCER
			<b>A61P 35/00</b> (2006.01)	2635289 *	PEG OR PEG BLOCK COPOLYMERS FOR TREATING COLORECTAL CANCER
			<b>H04W 64/00</b> (2009.01)	2601801 *	DETERMINING LOCATION OF A TARGET DEVICE BASED ON RELATIVE CHANGE IN LOCATION INFORMATION
			<b>H04W 4/02</b> (2009.01)	2601801 *	DETERMINING LOCATION OF A TARGET DEVICE BASED ON RELATIVE CHANGE IN LOCATION INFORMATION
			<b>H04L 29/08</b> (2006.01)	2601801 *	DETERMINING LOCATION OF A TARGET DEVICE BASED ON RELATIVE CHANGE IN LOCATION INFORMATION
			<b>G01S 19/49</b> (2010.01)	2601801 *	DETERMINING LOCATION OF A TARGET DEVICE BASED ON RELATIVE CHANGE IN LOCATION INFORMATION

MKP (51)	Broj objave evropske prijava patenta (97)	Naziv pronalaska (54)	MKP (51)	Broj objave evropske prijava patenta (97)	Naziv pronalaska (54)
<b>H04B 3/02</b> (2006.01)	2601746 *	METHOD AND DEVICE FOR COUPLING A DC SUPPLY LINE TO A TELEPHONE LINE OR COAXIAL CABLE	<b>A61K 31/427</b> (2006.01)	2636409 *	COMBINED PHARMACEUTICAL COMPOSITION AS ANTIFUNGAL AGENT
<b>H04L 12/10</b> (2006.01)	2601746 *	METHOD AND DEVICE FOR COUPLING A DC SUPPLY LINE TO A TELEPHONE LINE OR COAXIAL CABLE	<b>A61P 43/00</b> (2006.01)	2636409 *	COMBINED PHARMACEUTICAL COMPOSITION AS ANTIFUNGAL AGENT
<b>H04L 25/02</b> (2006.01)	2601746 *	METHOD AND DEVICE FOR COUPLING A DC SUPPLY LINE TO A TELEPHONE LINE OR COAXIAL CABLE	<b>A61K 31/496</b> (2006.01)	2636409 *	COMBINED PHARMACEUTICAL COMPOSITION AS ANTIFUNGAL AGENT
<b>A61K 39/395</b> (2006.01)	2632490 *	NOVEL EGFR-BINDING MOLECULES AND IMMUNOCONJUGATES THEREOF	<b>H04N 21/475</b> (2011.01)	2619993 *	PROGRAMMABLE MULTIMEDIA CONTROLLER WITH FLEXIBLE USER ACCESS AND SHARED DEVICE CONFIGURATIONS
<b>G07F 17/32</b> (2006.01)	2636030 *	METHOD AND SYSTEM FOR SECRETLY REVEALING ITEMS ON A MULTI-TOUCH INTERFACE	<b>H04N 21/41</b> (2011.01)	2619993 *	PROGRAMMABLE MULTIMEDIA CONTROLLER WITH FLEXIBLE USER ACCESS AND SHARED DEVICE CONFIGURATIONS
<b>G06F 3/048</b> (2013.01)	2636030 *	METHOD AND SYSTEM FOR SECRETLY REVEALING ITEMS ON A MULTI-TOUCH INTERFACE	<b>H04L 12/28</b> (2006.01)	2619993 *	PROGRAMMABLE MULTIMEDIA CONTROLLER WITH FLEXIBLE USER ACCESS AND SHARED DEVICE CONFIGURATIONS
<b>A61K 31/505</b> (2006.01)	2636409 *	COMBINED PHARMACEUTICAL COMPOSITION AS ANTIFUNGAL AGENT	<b>A61K 31/417</b> (2006.01)	2599775 *	ETHINYL-PYRAZOLE DERIVATIVE
<b>A61K 31/506</b> (2006.01)	2636409 *	COMBINED PHARMACEUTICAL COMPOSITION AS ANTIFUNGAL AGENT	<b>A61P 25/04</b> (2006.01)	2599775 *	ETHINYL-PYRAZOLE DERIVATIVE
<b>A61K 31/4174</b> (2006.01)	2636409 *	COMBINED PHARMACEUTICAL COMPOSITION AS ANTIFUNGAL AGENT	<b>C07D 231/14</b> (2006.01)	2599775 *	ETHINYL-PYRAZOLE DERIVATIVE
<b>A61K 45/00</b> (2006.01)	2636409 *	COMBINED PHARMACEUTICAL COMPOSITION AS ANTIFUNGAL AGENT	<b>A61K 31/4245</b> (2006.01)	2599775 *	ETHINYL-PYRAZOLE DERIVATIVE
<b>A61K 31/7048</b> (2006.01)	2636409 *	COMBINED PHARMACEUTICAL COMPOSITION AS ANTIFUNGAL AGENT	<b>A61P 25/20</b> (2006.01)	2599775 *	ETHINYL-PYRAZOLE DERIVATIVE
<b>A61K 31/444</b> (2006.01)	2636409 *	COMBINED PHARMACEUTICAL COMPOSITION AS ANTIFUNGAL AGENT	<b>A61K 31/42</b> (2006.01)	2599775 *	ETHINYL-PYRAZOLE DERIVATIVE
<b>A61K 38/00</b> (2006.01)	2636409 *	COMBINED PHARMACEUTICAL COMPOSITION AS ANTIFUNGAL AGENT	<b>A61P 25/18</b> (2006.01)	2599775 *	ETHINYL-PYRAZOLE DERIVATIVE
<b>A61K 31/4196</b> (2006.01)	2636409 *	COMBINED PHARMACEUTICAL COMPOSITION AS ANTIFUNGAL AGENT	<b>A61K 31/415</b> (2006.01)	2599775 *	ETHINYL-PYRAZOLE DERIVATIVE
<b>A61P 31/10</b> (2006.01)	2636409 *	COMBINED PHARMACEUTICAL COMPOSITION AS ANTIFUNGAL AGENT	<b>A61K 31/496</b> (2006.01)	2599775 *	ETHINYL-PYRAZOLE DERIVATIVE
			<b>A61P 25/30</b> (2006.01)	2599775 *	ETHINYL-PYRAZOLE DERIVATIVE
			<b>A61K 31/4174</b> (2006.01)	2599775 *	ETHINYL-PYRAZOLE DERIVATIVE
			<b>A61P 25/08</b> (2006.01)	2599775 *	ETHINYL-PYRAZOLE DERIVATIVE
			<b>C07D 231/12</b> (2006.01)	2599775 *	ETHINYL-PYRAZOLE DERIVATIVE
			<b>A61K 31/4709</b> (2006.01)	2599775 *	ETHINYL-PYRAZOLE DERIVATIVE

MKP (51)	Broj objave evropske prijava patenta (97)	Naziv pronalaska (54)	MKP (51)	Broj objave evropske prijava patenta (97)	Naziv pronalaska (54)
<b>A61P 25/28</b> (2006.01)	2599775 *	ETHINYL-PYRAZOLE DERIVATIVE	<b>A61K</b> <b>31/4162</b> (2006.01)	2640395 *	TREATMENT OF ADDICTION AND IMPULSE-CONTROL DISORDERS USING PDE7 INHIBITORS
<b>A61K</b> <b>31/4439</b> (2006.01)	2599775 *	ETHINYL-PYRAZOLE DERIVATIVE	<b>A61P 25/34</b> (2006.01)	2640395 *	TREATMENT OF ADDICTION AND IMPULSE-CONTROL DISORDERS USING PDE7 INHIBITORS
<b>A61P 25/22</b> (2006.01)	2599775 *	ETHINYL-PYRAZOLE DERIVATIVE	<b>A61K</b> <b>31/4155</b> (2006.01)	2640395 *	TREATMENT OF ADDICTION AND IMPULSE-CONTROL DISORDERS USING PDE7 INHIBITORS
<b>A61K</b> <b>31/4155</b> (2006.01)	2599775 *	ETHINYL-PYRAZOLE DERIVATIVE	<b>A61P 25/32</b> (2006.01)	2640395 *	TREATMENT OF ADDICTION AND IMPULSE-CONTROL DISORDERS USING PDE7 INHIBITORS
<b>A61K</b> <b>31/506</b> (2006.01)	2599775 *	ETHINYL-PYRAZOLE DERIVATIVE	<b>A61K</b> <b>31/519</b> (2006.01)	2640395 *	TREATMENT OF ADDICTION AND IMPULSE-CONTROL DISORDERS USING PDE7 INHIBITORS
<b>A61P 43/00</b> (2006.01)	2599775 *	ETHINYL-PYRAZOLE DERIVATIVE	<b>A61K 31/44</b> (2006.01)	2640395 *	TREATMENT OF ADDICTION AND IMPULSE-CONTROL DISORDERS USING PDE7 INHIBITORS
<b>C07D 213/50</b> (2006.01)	2639221	Process for preparing a ketosulfone derivative	<b>A61P 25/08</b> (2006.01)	2640395 *	TREATMENT OF ADDICTION AND IMPULSE-CONTROL DISORDERS USING PDE7 INHIBITORS
<b>A61K</b> <b>31/5377</b> (2006.01)	2640395 *	TREATMENT OF ADDICTION AND IMPULSE-CONTROL DISORDERS USING PDE7 INHIBITORS	<b>A61K 9/16</b> (2006.01)	2632438 *	MULTILAYER PHARMACEUTICAL COMPOSITION COMPRISING TELMISARTAN AND AMLODIPINE
<b>A61P 25/30</b> (2006.01)	2640395 *	TREATMENT OF ADDICTION AND IMPULSE-CONTROL DISORDERS USING PDE7 INHIBITORS	<b>A61K 9/20</b> (2006.01)	2632438 *	MULTILAYER PHARMACEUTICAL COMPOSITION COMPRISING TELMISARTAN AND AMLODIPINE
<b>A61K 31/55</b> (2006.01)	2640395 *	TREATMENT OF ADDICTION AND IMPULSE-CONTROL DISORDERS USING PDE7 INHIBITORS	<b>A61K 9/48</b> (2006.01)	2632438 *	MULTILAYER PHARMACEUTICAL COMPOSITION COMPRISING TELMISARTAN AND AMLODIPINE
<b>A61K</b> <b>31/454</b> (2006.01)	2640395 *	TREATMENT OF ADDICTION AND IMPULSE-CONTROL DISORDERS USING PDE7 INHIBITORS	<b>A61K 9/50</b> (2006.01)	2632438 *	MULTILAYER PHARMACEUTICAL COMPOSITION COMPRISING TELMISARTAN AND AMLODIPINE
<b>A61P 25/18</b> (2006.01)	2640395 *	TREATMENT OF ADDICTION AND IMPULSE-CONTROL DISORDERS USING PDE7 INHIBITORS	<b>A61K 31/4184</b> (2006.01)	2632438 *	MULTILAYER PHARMACEUTICAL COMPOSITION COMPRISING TELMISARTAN AND AMLODIPINE
<b>A61K</b> <b>31/485</b> (2006.01)	2640395 *	TREATMENT OF ADDICTION AND IMPULSE-CONTROL DISORDERS USING PDE7 INHIBITORS	<b>A61K</b> <b>31/4422</b> (2006.01)	2632438 *	MULTILAYER PHARMACEUTICAL COMPOSITION COMPRISING TELMISARTAN AND AMLODIPINE
<b>A61P 25/24</b> (2006.01)	2640395 *	TREATMENT OF ADDICTION AND IMPULSE-CONTROL DISORDERS USING PDE7 INHIBITORS	<b>A61K</b> <b>31/495</b> (2006.01)	2608789 *	THERAPEUTIC USES OF 1-[2-(2,4-DIMETHYL- PHENYLSULFANYL)PHENYL] PIPERAZINE
<b>A61K</b> <b>31/4178</b> (2006.01)	2640395 *	TREATMENT OF ADDICTION AND IMPULSE-CONTROL DISORDERS USING PDE7 INHIBITORS			
<b>A61P 25/00</b> (2006.01)	2640395 *	TREATMENT OF ADDICTION AND IMPULSE-CONTROL DISORDERS USING PDE7 INHIBITORS			
<b>A61K</b> <b>31/551</b> (2006.01)	2640395 *	TREATMENT OF ADDICTION AND IMPULSE-CONTROL DISORDERS USING PDE7 INHIBITORS			
<b>A61P 25/36</b> (2006.01)	2640395 *	TREATMENT OF ADDICTION AND IMPULSE-CONTROL DISORDERS USING PDE7 INHIBITORS			

MKP (51)	Broj objave evropske prijava patenta (97)	Naziv pronalaska (54)	MKP (51)	Broj objave evropske prijava patenta (97)	Naziv pronalaska (54)
<b>A61P 25/00</b> (2006.01)	2608789 *	THERAPEUTIC USES OF 1-[2-(2,4-DIMETHYL- PHENYLSULFANYL)PHENYL] PIPERAZINE	<b>C07D 235/08</b> (2006.01)	2642987 *	DIPHENYL-AMINE DERIVATIVES: USES, PROCESS OF SYNTHESIS AND PHARMACEUTICAL COMPOSITIONS
<b>A61K 31/137</b> (2006.01)	2642987 *	DIPHENYL-AMINE DERIVATIVES: USES, PROCESS OF SYNTHESIS AND PHARMACEUTICAL COMPOSITIONS	<b>C07D 473/16</b> (2006.01)	2642987 *	DIPHENYL-AMINE DERIVATIVES: USES, PROCESS OF SYNTHESIS AND PHARMACEUTICAL COMPOSITIONS
<b>A61K 31/341</b> (2006.01)	2642987 *	DIPHENYL-AMINE DERIVATIVES: USES, PROCESS OF SYNTHESIS AND PHARMACEUTICAL COMPOSITIONS	<b>C07D 473/34</b> (2006.01)	2642987 *	DIPHENYL-AMINE DERIVATIVES: USES, PROCESS OF SYNTHESIS AND PHARMACEUTICAL COMPOSITIONS
<b>A61K 31/381</b> (2006.01)	2642987 *	DIPHENYL-AMINE DERIVATIVES: USES, PROCESS OF SYNTHESIS AND PHARMACEUTICAL COMPOSITIONS	<b>C07D 213/74</b> (2006.01)	2603491 *	PROCESS FOR THE PREPARATION OF ENANTIOMERIC FORMS OF 2,3-DIAMINOPROPIONIC ACID DERIVATIVES
<b>A61K 31/4184</b> (2006.01)	2642987 *	DIPHENYL-AMINE DERIVATIVES: USES, PROCESS OF SYNTHESIS AND PHARMACEUTICAL COMPOSITIONS	<b>C07D 239/42</b> (2006.01)	2603491 *	PROCESS FOR THE PREPARATION OF ENANTIOMERIC FORMS OF 2,3-DIAMINOPROPIONIC ACID DERIVATIVES
<b>A61K 31/4402</b> (2006.01)	2642987 *	DIPHENYL-AMINE DERIVATIVES: USES, PROCESS OF SYNTHESIS AND PHARMACEUTICAL COMPOSITIONS	<b>C07K 16/18</b> (2006.01)	2603523 *	ANTI-N3pGlu AMYLOID BETA PEPTIDE ANTIBODIES AND USES THEREOF
<b>A61K 31/519</b> (2006.01)	2642987 *	DIPHENYL-AMINE DERIVATIVES: USES, PROCESS OF SYNTHESIS AND PHARMACEUTICAL COMPOSITIONS	<b>G01N 33/577</b> (2006.01)	2603523 *	ANTI-N3pGlu AMYLOID BETA PEPTIDE ANTIBODIES AND USES THEREOF
<b>A61K 31/52</b> (2006.01)	2642987 *	DIPHENYL-AMINE DERIVATIVES: USES, PROCESS OF SYNTHESIS AND PHARMACEUTICAL COMPOSITIONS	<b>A61K 39/395</b> (2006.01)	2603523 *	ANTI-N3pGlu AMYLOID BETA PEPTIDE ANTIBODIES AND USES THEREOF
<b>C07C 211/27</b> (2006.01)	2642987 *	DIPHENYL-AMINE DERIVATIVES: USES, PROCESS OF SYNTHESIS AND PHARMACEUTICAL COMPOSITIONS	<b>A61P 25/28</b> (2006.01)	2603523 *	ANTI-N3pGlu AMYLOID BETA PEPTIDE ANTIBODIES AND USES THEREOF
<b>C07C 211/29</b> (2006.01)	2642987 *	DIPHENYL-AMINE DERIVATIVES: USES, PROCESS OF SYNTHESIS AND PHARMACEUTICAL COMPOSITIONS	<b>A61K 9/48</b> (2006.01)	2603208 *	PROCESS OF MANUFACTURING A STABLE SOFTGEL CAPSULE CONTAINING MICROENCAPSULATED PROBIOTIC BACTERIA
<b>C07C 217/58</b> (2006.01)	2642987 *	DIPHENYL-AMINE DERIVATIVES: USES, PROCESS OF SYNTHESIS AND PHARMACEUTICAL COMPOSITIONS	<b>A61K 9/50</b> (2006.01)	2603208 *	PROCESS OF MANUFACTURING A STABLE SOFTGEL CAPSULE CONTAINING MICROENCAPSULATED PROBIOTIC BACTERIA
<b>C07C 255/58</b> (2006.01)	2642987 *	DIPHENYL-AMINE DERIVATIVES: USES, PROCESS OF SYNTHESIS AND PHARMACEUTICAL COMPOSITIONS	<b>A23L 1/30</b> (2006.01)	2603208 *	PROCESS OF MANUFACTURING A STABLE SOFTGEL CAPSULE CONTAINING MICROENCAPSULATED PROBIOTIC BACTERIA
<b>C07D 233/58</b> (2006.01)	2642987 *	DIPHENYL-AMINE DERIVATIVES: USES, PROCESS OF SYNTHESIS AND PHARMACEUTICAL COMPOSITIONS	<b>B29C 49/56</b> (2006.01)	2591905	Machine for the blowing or stretch blow moulding of bottles in polymeric material
			<b>B66F 9/075</b> (2006.01)	2535308	A traction axle for work machines.
			<b>B62D 11/08</b> (2006.01)	2535308	A traction axle for work machines.

MKP (51)	Broj objave evropske prijava patenta (97)	Naziv pronalaska (54)	MKP (51)	Broj objave evropske prijava patenta (97)	Naziv pronalaska (54)
<b>E05F 15/04</b> (2006.01)	2543807	Rotary actuator for moving a swivel swing door, particularly in vehicles	<b>C07D 239/74</b> (2006.01)	2625169 *	QUINAZOLINE COMPOUNDS AS SODIUM CHANNEL BLOCKERS
<b>F15B 15/06</b> (2006.01)	2543807	Rotary actuator for moving a swivel swing door, particularly in vehicles	<b>A61P 25/28</b> (2006.01)	2625169 *	QUINAZOLINE COMPOUNDS AS SODIUM CHANNEL BLOCKERS
<b>C07K 16/22</b> (2006.01)	2606066 *	ANTIBODIES THAT BIND MYOSTATIN, COMPOSITIONS AND METHODS	<b>C07D 239/84</b> (2006.01)	2625169 *	QUINAZOLINE COMPOUNDS AS SODIUM CHANNEL BLOCKERS
<b>A61P 19/08</b> (2006.01)	2606066 *	ANTIBODIES THAT BIND MYOSTATIN, COMPOSITIONS AND METHODS	<b>A61P 25/06</b> (2006.01)	2625169 *	QUINAZOLINE COMPOUNDS AS SODIUM CHANNEL BLOCKERS
<b>A61P 21/00</b> (2006.01)	2606066 *	ANTIBODIES THAT BIND MYOSTATIN, COMPOSITIONS AND METHODS	<b>C07D 401/12</b> (2006.01)	2625169 *	QUINAZOLINE COMPOUNDS AS SODIUM CHANNEL BLOCKERS
<b>C07D 239/28</b> (2006.01)	2621908 *	MANUFACTURING PROCESS FOR PYRIMIDINE DERIVATIVES	<b>A61P 25/24</b> (2006.01)	2625169 *	QUINAZOLINE COMPOUNDS AS SODIUM CHANNEL BLOCKERS
<b>C07D 239/30</b> (2006.01)	2621908 *	MANUFACTURING PROCESS FOR PYRIMIDINE DERIVATIVES	<b>C07D 401/04</b> (2006.01)	2625169 *	QUINAZOLINE COMPOUNDS AS SODIUM CHANNEL BLOCKERS
<b>C07D 401/04</b> (2006.01)	2621908 *	MANUFACTURING PROCESS FOR PYRIMIDINE DERIVATIVES	<b>A61P 25/08</b> (2006.01)	2625169 *	QUINAZOLINE COMPOUNDS AS SODIUM CHANNEL BLOCKERS
<b>A61K 31/07</b> (2006.01)	2640368 *	CONTROLLED RELEASE MUCOADHESIVE SYSTEMS	<b>C07D 403/12</b> (2006.01)	2625169 *	QUINAZOLINE COMPOUNDS AS SODIUM CHANNEL BLOCKERS
<b>A61K 47/00</b> (2006.01)	2640368 *	CONTROLLED RELEASE MUCOADHESIVE SYSTEMS	<b>A61P 25/14</b> (2006.01)	2625169 *	QUINAZOLINE COMPOUNDS AS SODIUM CHANNEL BLOCKERS
<b>F25D 3/11</b> (2006.01)	2522935	Device for pelletising or granulating a fluid or paste material	<b>C07D 401/12</b> (2006.01)	2627630 *	SEROTONIN REUPTAKE INHIBITORS
<b>B01J 2/06</b> (2006.01)	2522935	Device for pelletising or granulating a fluid or paste material	<b>C07D 207/08</b> (2006.01)	2627630 *	SEROTONIN REUPTAKE INHIBITORS
<b>G01N 33/49</b> (2006.01)	2619575 *	METHOD FOR THE DETECTION AND/OR QUANTIFICATION OF THE INTERACTION OF PLATELETS WITH INTERACTION PARTNERS	<b>A61P 11/00</b> (2006.01)	2627630 *	SEROTONIN REUPTAKE INHIBITORS
<b>G01N 33/86</b> (2006.01)	2619575 *	METHOD FOR THE DETECTION AND/OR QUANTIFICATION OF THE INTERACTION OF PLATELETS WITH INTERACTION PARTNERS	<b>A61K 31/40</b> (2006.01)	2627630 *	SEROTONIN REUPTAKE INHIBITORS
<b>C07D 487/04</b> (2006.01)	2598506 *	PROCESS FOR THE PREPARATION OF THE COMPOUND OSI - 906	<b>H02J 7/34</b> (2006.01)	2523305	Emergency energy supply device and method for supplying emergency energy
<b>C07D 471/08</b> (2006.01)	2625169 *	QUINAZOLINE COMPOUNDS AS SODIUM CHANNEL BLOCKERS	<b>H02J 9/00</b> (2006.01)	2523305	Emergency energy supply device and method for supplying emergency energy
<b>A61P 9/06</b> (2006.01)	2625169 *	QUINAZOLINE COMPOUNDS AS SODIUM CHANNEL BLOCKERS	<b>C07D 473/04</b> (2006.01)	2616469 *	INHIBITORS OF PI3K-DELTA AND METHODS OF THEIR USE AND MANUFACTURE
<b>A61K 31/517</b> (2006.01)	2625169 *	QUINAZOLINE COMPOUNDS AS SODIUM CHANNEL BLOCKERS	<b>A61K 31/52</b> (2006.01)	2616469 *	INHIBITORS OF PI3K-DELTA AND METHODS OF THEIR USE AND MANUFACTURE
<b>A61P 25/02</b> (2006.01)	2625169 *	QUINAZOLINE COMPOUNDS AS SODIUM CHANNEL BLOCKERS	<b>C07D 471/10</b> (2006.01)	2616469 *	INHIBITORS OF PI3K-DELTA AND METHODS OF THEIR USE AND MANUFACTURE
			<b>F03B 13/18</b> (2006.01)	2596235 *	OCEAN WAVE POWER PLANT
			<b>A47B 85/04</b> (2006.01)	2625986	Modular piece of furniture
			<b>A47D 11/00</b> (2006.01)	2625986	Modular piece of furniture

MKP (51)	Broj objave evropske prijava patenta (97)	Naziv pronalaska (54)	MKP (51)	Broj objave evropske prijava patenta (97)	Naziv pronalaska (54)
<b>A47D 9/00</b> (2006.01)	2625986	Modular piece of furniture	<b>A61K 31/282</b> (2006.01)	2595618 *	METHODS OF TREATING BREAST CANCER USING 4-IODO-3-NITROBENZAMIDE IN COMBINATION WITH ANTI-TUMOR AGENTS
<b>A47C 13/00</b> (2006.01)	2625986	Modular piece of furniture	<b>A61K 31/7068</b> (2006.01)	2595618 *	METHODS OF TREATING BREAST CANCER USING 4-IODO-3-NITROBENZAMIDE IN COMBINATION WITH ANTI-TUMOR AGENTS
<b>A47C 4/03</b> (2006.01)	2625986	Modular piece of furniture	<b>A61K 31/166</b> (2006.01)	2595618 *	METHODS OF TREATING BREAST CANCER USING 4-IODO-3-NITROBENZAMIDE IN COMBINATION WITH ANTI-TUMOR AGENTS
<b>A23C 3/037</b> (2006.01)	2595492 *	LACTOSE-REDUCED MILK-RELATED PRODUCT, AND A PROCESS AND MILK PROCESSING PLANT FOR ITS MANUFACTURE	<b>A61K 31/337</b> (2006.01)	2595618 *	METHODS OF TREATING BREAST CANCER USING 4-IODO-3-NITROBENZAMIDE IN COMBINATION WITH ANTI-TUMOR AGENTS
<b>A23C 9/12</b> (2006.01)	2595492 *	LACTOSE-REDUCED MILK-RELATED PRODUCT, AND A PROCESS AND MILK PROCESSING PLANT FOR ITS MANUFACTURE	<b>A61P 35/00</b> (2006.01)	2595618 *	METHODS OF TREATING BREAST CANCER USING 4-IODO-3-NITROBENZAMIDE IN COMBINATION WITH ANTI-TUMOR AGENTS
<b>A23C 9/142</b> (2006.01)	2595492 *	LACTOSE-REDUCED MILK-RELATED PRODUCT, AND A PROCESS AND MILK PROCESSING PLANT FOR ITS MANUFACTURE	<b>A61K 31/44</b> (2006.01)	2608667 *	PESTICIDAL COMPOSITIONS
<b>A61P 1/04</b> (2006.01)	2604601 *	HETERO RING COMPOUND	<b>A01N 43/16</b> (2006.01)	2608667 *	PESTICIDAL COMPOSITIONS
<b>A61P 37/08</b> (2006.01)	2604601 *	HETERO RING COMPOUND	<b>A61K 31/35</b> (2006.01)	2608667 *	PESTICIDAL COMPOSITIONS
<b>A61P 19/02</b> (2006.01)	2604601 *	HETERO RING COMPOUND	<b>C07D 315/00</b> (2006.01)	2608667 *	PESTICIDAL COMPOSITIONS
<b>C07D 401/14</b> (2006.01)	2604601 *	HETERO RING COMPOUND	<b>A01N 43/40</b> (2006.01)	2608667 *	PESTICIDAL COMPOSITIONS
<b>A61P 29/00</b> (2006.01)	2604601 *	HETERO RING COMPOUND	<b>E04F 21/18</b> (2006.01)	2573297	Movable structure for handling and installing panels or plates onto walls or ceilings
<b>A61K 31/5377</b> (2006.01)	2604601 *	HETERO RING COMPOUND	<b>B62B 1/00</b> (2006.01)	2573297	Movable structure for handling and installing panels or plates onto walls or ceilings
<b>A61P 35/02</b> (2006.01)	2604601 *	HETERO RING COMPOUND	<b>B62B 7/06</b> (2006.01)	2611670 *	FOLDING STROLLER IMPROVEMENTS
<b>A61P 11/06</b> (2006.01)	2604601 *	HETERO RING COMPOUND	<b>B62B 9/08</b> (2006.01)	2611670 *	FOLDING STROLLER IMPROVEMENTS
<b>A61P 43/00</b> (2006.01)	2604601 *	HETERO RING COMPOUND	<b>A61K 31/4196</b> (2006.01)	2640384 *	PRESELECTION OF SUBJECTS FOR THERAPEUTIC TREATMENT WITH OXYGEN SENSITIVE AGENTS BASED ON HYPOXIC STATUS
<b>A61P 17/06</b> (2006.01)	2604601 *	HETERO RING COMPOUND	<b>A61P 35/00</b> (2006.01)	2640384 *	PRESELECTION OF SUBJECTS FOR THERAPEUTIC TREATMENT WITH OXYGEN SENSITIVE AGENTS BASED ON HYPOXIC STATUS
<b>A61K 31/541</b> (2006.01)	2604601 *	HETERO RING COMPOUND	<b>A61K 31/436</b> (2006.01)	2640384 *	PRESELECTION OF SUBJECTS FOR THERAPEUTIC TREATMENT WITH OXYGEN SENSITIVE AGENTS BASED ON HYPOXIC STATUS
<b>A61P 37/02</b> (2006.01)	2604601 *	HETERO RING COMPOUND			
<b>A61K 31/55</b> (2006.01)	2604601 *	HETERO RING COMPOUND			
<b>A61P 37/06</b> (2006.01)	2604601 *	HETERO RING COMPOUND			
<b>A61K 39/12</b> (2006.01)	2632485 *	RECOMBINANT SUBUNIT DENGUE VIRUS VACCINE			
<b>A61P 35/04</b> (2006.01)	2595618 *	METHODS OF TREATING BREAST CANCER USING 4-IODO-3-NITROBENZAMIDE IN COMBINATION WITH ANTI-TUMOR AGENTS			

MKP (51)	Broj objave evropske prijava patenta (97)	Naziv pronalaska (54)	MKP (51)	Broj objave evropske prijava patenta (97)	Naziv pronalaska (54)
<b>A61K 31/506</b> (2006.01)	2640384 *	PRESELECTION OF SUBJECTS FOR THERAPEUTIC TREATMENT WITH OXYGEN SENSITIVE AGENTS BASED ON HYPOXIC STATUS	<b>G06K 7/08</b> (2006.01)	2628127 *	READ HEAD DEVICE WITH SLOT CONFIGURED TO REDUCE TORQUE
<b>A61K 31/502</b> (2006.01)	2640384 *	PRESELECTION OF SUBJECTS FOR THERAPEUTIC TREATMENT WITH OXYGEN SENSITIVE AGENTS BASED ON HYPOXIC STATUS	<b>C08F 8/00</b> (2006.01)	2635610 *	DUAL-CURE POLYMER SYSTEMS
<b>A61K 31/517</b> (2006.01)	2640384 *	PRESELECTION OF SUBJECTS FOR THERAPEUTIC TREATMENT WITH OXYGEN SENSITIVE AGENTS BASED ON HYPOXIC STATUS	<b>F24D 13/02</b> (2006.01)	2596293 *	HEATING DEVICE
<b>A61K 31/4439</b> (2006.01)	2640384 *	PRESELECTION OF SUBJECTS FOR THERAPEUTIC TREATMENT WITH OXYGEN SENSITIVE AGENTS BASED ON HYPOXIC STATUS	<b>A61K 31/4709</b> (2006.01)	2583677	Methods for treating HCV comprising at least two direct acting antiviral agent, ribavirin but not interferon.
<b>A61K 31/437</b> (2006.01)	2640384 *	PRESELECTION OF SUBJECTS FOR THERAPEUTIC TREATMENT WITH OXYGEN SENSITIVE AGENTS BASED ON HYPOXIC STATUS	<b>A61K 31/4025</b> (2006.01)	2583677	Methods for treating HCV comprising at least two direct acting antiviral agent, ribavirin but not interferon.
<b>A61K 31/395</b> (2006.01)	2640384 *	PRESELECTION OF SUBJECTS FOR THERAPEUTIC TREATMENT WITH OXYGEN SENSITIVE AGENTS BASED ON HYPOXIC STATUS	<b>A61K 31/4725</b> (2006.01)	2583677	Methods for treating HCV comprising at least two direct acting antiviral agent, ribavirin but not interferon.
<b>F16L 58/00</b> (2006.01)	2601431 *	CORROSION PROTECTION OF PIPES SUSPENDED IN SEAWATER	<b>A61P 31/14</b> (2006.01)	2583677	Methods for treating HCV comprising at least two direct acting antiviral agent, ribavirin but not interferon.
<b>B65G 1/137</b> (2006.01)	2514690	Warehouse guiding system for industrial trucks	<b>A61K 31/5377</b> (2006.01)	2583677	Methods for treating HCV comprising at least two direct acting antiviral agent, ribavirin but not interferon.
<b>B66F 9/075</b> (2006.01)	2514690	Warehouse guiding system for industrial trucks	<b>A61K 31/513</b> (2006.01)	2583677	Methods for treating HCV comprising at least two direct acting antiviral agent, ribavirin but not interferon.
<b>G05D 1/02</b> (2006.01)	2514690	Warehouse guiding system for industrial trucks	<b>A61K 31/4178</b> (2006.01)	2583677	Methods for treating HCV comprising at least two direct acting antiviral agent, ribavirin but not interferon.
<b>C07D 491/20</b> (2006.01)	2643325 *	SPIRO-AMINO-IMIDAZOLONE AND SPIRO-AMINO-DIHYDRO-PYRIMIDINONE COMPOUNDS AS BETA-SECRETASE MODULATORS AND METHODS OF USE	<b>A61K 31/497</b> (2006.01)	2583677	Methods for treating HCV comprising at least two direct acting antiviral agent, ribavirin but not interferon.
<b>A61K 31/527</b> (2006.01)	2643325 *	SPIRO-AMINO-IMIDAZOLONE AND SPIRO-AMINO-DIHYDRO-PYRIMIDINONE COMPOUNDS AS BETA-SECRETASE MODULATORS AND METHODS OF USE	<b>C07J 41/00</b> (2006.01)	2611821 *	PROCESS FOR PREPARING FLUTICASONE PROPIONATE/ FUROATE
<b>A61P 25/28</b> (2006.01)	2643325 *	SPIRO-AMINO-IMIDAZOLONE AND SPIRO-AMINO-DIHYDRO-PYRIMIDINONE COMPOUNDS AS BETA-SECRETASE MODULATORS AND METHODS OF USE	<b>C07J 31/00</b> (2006.01)	2611821 *	PROCESS FOR PREPARING FLUTICASONE PROPIONATE/ FUROATE
			<b>A61B 17/115</b> (2006.01)	2524655	Circular stapling instrument having a breakaway washer attachment member
			<b>E04F 21/18</b> (2006.01)	2573298	Plate support for an apparatus for mounting plates onto walls or ceilings
			<b>B07B 1/14</b> (2006.01)	2511014	Roller screen filter device
			<b>B07B 1/15</b> (2006.01)	2511014	Roller screen filter device
			<b>C07D 401/14</b> (2006.01)	2625175 *	CRYSTALLINE (R) - (E) -2- (4- (2- (5- (1- (3, 5 -DICHLOROPYRIDIN-4 -YL) ETHOXY) - 1H - INDAZOL - 3 - YL) VINYL) -1 H- PYRAZOL- 1 -YL) ETHANOL AND ITS USE AS FGFR INHIBITOR



MKP (51)	Broj objave evropske prijava patenta (97)	Naziv pronalaska (54)	MKP (51)	Broj objave evropske prijava patenta (97)	Naziv pronalaska (54)
<b>A61K 31/4439</b> (2006.01)	2625175 *	CRYSTALLINE (R) - (E) -2- (4- (2- (5- (1- (3, 5 -DICHLOROPYRIDIN-4 -YL) ETHOXY) - 1H - INDAZOL - 3 - YL) VINYL) -1 H- PYRAZOL- 1 -YL) ETHANOL AND ITS USE AS FGFR INHIBITOR	<b>C11D 3/00</b> (2006.01)	2627747 *	PRODUCT AND METHOD FOR THE REMOVAL OF BIOFILMS
<b>A61P 35/00</b> (2006.01)	2625175 *	CRYSTALLINE (R) - (E) -2- (4- (2- (5- (1- (3, 5 -DICHLOROPYRIDIN-4 -YL) ETHOXY) - 1H - INDAZOL - 3 - YL) VINYL) -1 H- PYRAZOL- 1 -YL) ETHANOL AND ITS USE AS FGFR INHIBITOR	<b>C11D 11/00</b> (2006.01)	2627747 *	PRODUCT AND METHOD FOR THE REMOVAL OF BIOFILMS
<b>C07D 221/06</b> (2006.01)	2640705 *	NOVEL ANTIVIRAL COMPOUNDS	<b>A61L 2/18</b> (2006.01)	2627747 *	PRODUCT AND METHOD FOR THE REMOVAL OF BIOFILMS
<b>C07D 221/08</b> (2006.01)	2640705 *	NOVEL ANTIVIRAL COMPOUNDS	<b>C07H 21/02</b> (2006.01)	2638056 *	USE OF 2',5'-OLIGOADENYLATE DERIVATIVE COMPOUNDS
<b>C07D 221/10</b> (2006.01)	2640705 *	NOVEL ANTIVIRAL COMPOUNDS	<b>A61K 31/7125</b> (2006.01)	2638056 *	USE OF 2',5'-OLIGOADENYLATE DERIVATIVE COMPOUNDS
<b>C07D 401/04</b> (2006.01)	2640705 *	NOVEL ANTIVIRAL COMPOUNDS	<b>A61P 31/14</b> (2006.01)	2638056 *	USE OF 2',5'-OLIGOADENYLATE DERIVATIVE COMPOUNDS
<b>C07D 417/04</b> (2006.01)	2640705 *	NOVEL ANTIVIRAL COMPOUNDS	<b>A61K 31/4196</b> (2006.01)	2616070 *	NOVEL TRIAZOLE DERIVATIVES WITH IMPROVED RECEPTOR ACTIVITY AND BIOAVAILABILITY PROPERTIES AS GHRELIN ANTAGONISTS OF GROWTH HORMONE SECRETAGOGUE RECEPTORS
<b>C07D 471/04</b> (2006.01)	2640705 *	NOVEL ANTIVIRAL COMPOUNDS	<b>C07D 401/14</b> (2006.01)	2616070 *	NOVEL TRIAZOLE DERIVATIVES WITH IMPROVED RECEPTOR ACTIVITY AND BIOAVAILABILITY PROPERTIES AS GHRELIN ANTAGONISTS OF GROWTH HORMONE SECRETAGOGUE RECEPTORS
<b>C07D 471/14</b> (2006.01)	2640705 *	NOVEL ANTIVIRAL COMPOUNDS	<b>C07D 403/06</b> (2006.01)	2616070 *	NOVEL TRIAZOLE DERIVATIVES WITH IMPROVED RECEPTOR ACTIVITY AND BIOAVAILABILITY PROPERTIES AS GHRELIN ANTAGONISTS OF GROWTH HORMONE SECRETAGOGUE RECEPTORS
<b>C07D 487/04</b> (2006.01)	2640705 *	NOVEL ANTIVIRAL COMPOUNDS	<b>C07D 413/14</b> (2006.01)	2616070 *	NOVEL TRIAZOLE DERIVATIVES WITH IMPROVED RECEPTOR ACTIVITY AND BIOAVAILABILITY PROPERTIES AS GHRELIN ANTAGONISTS OF GROWTH HORMONE SECRETAGOGUE RECEPTORS
<b>C07D 491/048</b> (2006.01)	2640705 *	NOVEL ANTIVIRAL COMPOUNDS	<b>A61P 5/06</b> (2006.01)	2616070 *	NOVEL TRIAZOLE DERIVATIVES WITH IMPROVED RECEPTOR ACTIVITY AND BIOAVAILABILITY PROPERTIES AS GHRELIN ANTAGONISTS OF GROWTH HORMONE SECRETAGOGUE RECEPTORS
<b>C07D 491/06</b> (2006.01)	2640705 *	NOVEL ANTIVIRAL COMPOUNDS			
<b>C07D 495/04</b> (2006.01)	2640705 *	NOVEL ANTIVIRAL COMPOUNDS			
<b>C07D 495/14</b> (2006.01)	2640705 *	NOVEL ANTIVIRAL COMPOUNDS			
<b>C07D 519/00</b> (2006.01)	2640705 *	NOVEL ANTIVIRAL COMPOUNDS			
<b>A61P 31/00</b> (2006.01)	2640705 *	NOVEL ANTIVIRAL COMPOUNDS			
<b>A61K 31/435</b> (2006.01)	2640705 *	NOVEL ANTIVIRAL COMPOUNDS			
<b>A61K 31/4355</b> (2006.01)	2640705 *	NOVEL ANTIVIRAL COMPOUNDS			
<b>A61K 31/437</b> (2006.01)	2640705 *	NOVEL ANTIVIRAL COMPOUNDS			
<b>A61K 31/519</b> (2006.01)	2640705 *	NOVEL ANTIVIRAL COMPOUNDS			
<b>C11D 3/386</b> (2006.01)	2627747 *	PRODUCT AND METHOD FOR THE REMOVAL OF BIOFILMS			

MKP (51)	Broj objave evropske prijava patenta (97)	Naziv pronalaska (54)	MKP (51)	Broj objave evropske prijava patenta (97)	Naziv pronalaska (54)
<b>A61K 38/16</b> (2006.01)	2621478 *	METHOD OF PREPARING A DRY POWDER FROM A WATER BACTERIA EXTRACT-CONCENTRATE	<b>G06F 19/00</b> (2011.01)	2455877	Method for diabetes management
<b>A61J 3/07</b> (2006.01)	2621478 *	METHOD OF PREPARING A DRY POWDER FROM A WATER BACTERIA EXTRACT-CONCENTRATE	<b>A61B 5/145</b> (2006.01)	2455877	Method for diabetes management
<b>A61K 9/48</b> (2006.01)	2621478 *	METHOD OF PREPARING A DRY POWDER FROM A WATER BACTERIA EXTRACT-CONCENTRATE	<b>A61K 31/55</b> (2006.01)	2640396 *	BENZODIAZEPINE DERIVATIVES, COMPOSITIONS AND METHODS FOR TREATING COGNITIVE IMPAIRMENT
<b>A61K 38/01</b> (2006.01)	2621478 *	METHOD OF PREPARING A DRY POWDER FROM A WATER BACTERIA EXTRACT-CONCENTRATE	<b>C07D 205/04</b> (2006.01)	2611774 *	DI-AZETIDINYL DIAMIDE AS MONOACYLGLYCEROL LIPASE INHIBITORS
<b>A61J 3/02</b> (2006.01)	2621478 *	METHOD OF PREPARING A DRY POWDER FROM A WATER BACTERIA EXTRACT-CONCENTRATE	<b>C07D 403/14</b> (2006.01)	2611774 *	DI-AZETIDINYL DIAMIDE AS MONOACYLGLYCEROL LIPASE INHIBITORS
<b>A61K 9/16</b> (2006.01)	2621478 *	METHOD OF PREPARING A DRY POWDER FROM A WATER BACTERIA EXTRACT-CONCENTRATE	<b>C07D 409/14</b> (2006.01)	2611774 *	DI-AZETIDINYL DIAMIDE AS MONOACYLGLYCEROL LIPASE INHIBITORS
<b>A61P 35/00</b> (2006.01)	2621478 *	METHOD OF PREPARING A DRY POWDER FROM A WATER BACTERIA EXTRACT-CONCENTRATE	<b>C07D 413/14</b> (2006.01)	2611774 *	DI-AZETIDINYL DIAMIDE AS MONOACYLGLYCEROL LIPASE INHIBITORS
<b>A01N 59/00</b> (2006.01)	2624701 *	METHOD FOR PRODUCING ELECTRO ACTIVATED WATER BY ELECTROLYSIS OF AN AQUEOUS SODIUM CHLORIDE SOLUTION	<b>C07D 417/12</b> (2006.01)	2611774 *	DI-AZETIDINYL DIAMIDE AS MONOACYLGLYCEROL LIPASE INHIBITORS
<b>C02F 1/467</b> (2006.01)	2624701 *	METHOD FOR PRODUCING ELECTRO ACTIVATED WATER BY ELECTROLYSIS OF AN AQUEOUS SODIUM CHLORIDE SOLUTION	<b>C07D 417/14</b> (2006.01)	2611774 *	DI-AZETIDINYL DIAMIDE AS MONOACYLGLYCEROL LIPASE INHIBITORS
<b>E03C 1/046</b> (2006.01)	2624701 *	METHOD FOR PRODUCING ELECTRO ACTIVATED WATER BY ELECTROLYSIS OF AN AQUEOUS SODIUM CHLORIDE SOLUTION	<b>C07D 513/04</b> (2006.01)	2611774 *	DI-AZETIDINYL DIAMIDE AS MONOACYLGLYCEROL LIPASE INHIBITORS
<b>A01P 1/00</b> (2006.01)	2624701 *	METHOD FOR PRODUCING ELECTRO ACTIVATED WATER BY ELECTROLYSIS OF AN AQUEOUS SODIUM CHLORIDE SOLUTION	<b>A61K 31/427</b> (2006.01)	2611774 *	DI-AZETIDINYL DIAMIDE AS MONOACYLGLYCEROL LIPASE INHIBITORS
<b>A61K 33/20</b> (2006.01)	2624701 *	METHOD FOR PRODUCING ELECTRO ACTIVATED WATER BY ELECTROLYSIS OF AN AQUEOUS SODIUM CHLORIDE SOLUTION	<b>A61K 31/429</b> (2006.01)	2611774 *	DI-AZETIDINYL DIAMIDE AS MONOACYLGLYCEROL LIPASE INHIBITORS
<b>A61K 41/00</b> (2006.01)	2598169 *	AN ANTIGEN SPECIFIC ULTRASOUND CONTRAST MEDIUM, A PROCESS FOR THE PREPARATION THEREOF AND ITS USES	<b>A61P 29/00</b> (2006.01)	2611774 *	DI-AZETIDINYL DIAMIDE AS MONOACYLGLYCEROL LIPASE INHIBITORS
<b>A61K 49/22</b> (2006.01)	2598169 *	AN ANTIGEN SPECIFIC ULTRASOUND CONTRAST MEDIUM, A PROCESS FOR THE PREPARATION THEREOF AND ITS USES	<b>C07D 401/12</b> (2006.01)	2640467 *	CRYSTALLINE FORM OF AN INHIBITOR OF MDM2/4 AND P53 INTERACTION
			<b>A61P 35/00</b> (2006.01)	2640467 *	CRYSTALLINE FORM OF AN INHIBITOR OF MDM2/4 AND P53 INTERACTION
			<b>A61K 31/495</b> (2006.01)	2640467 *	CRYSTALLINE FORM OF AN INHIBITOR OF MDM2/4 AND P53 INTERACTION
			<b>A61K 35/00</b> (2006.01)	2643317 *	BENZOXAZEPINES AS INHIBITORS OF P13K/MTOR AND METHODS OF THEIR USE AND MANUFACTURE
			<b>C07D 413/14</b> (2006.01)	2643317 *	BENZOXAZEPINES AS INHIBITORS OF P13K/MTOR AND METHODS OF THEIR USE AND MANUFACTURE
			<b>C07D 471/04</b> (2006.01)	2643317 *	BENZOXAZEPINES AS INHIBITORS OF P13K/MTOR AND METHODS OF THEIR USE AND MANUFACTURE

MKP (51)	Broj objave evropske prijava patenta (97)	Naziv pronalaska (54)	MKP (51)	Broj objave evropske prijava patenta (97)	Naziv pronalaska (54)
<b>C07D 513/14</b> (2006.01)	2643317 *	BENZOXAZEPINES AS INHIBITORS OF P13K/MTOR AND METHODS OF THEIR USE AND MANUFACTURE	<b>C07D 223/16</b> (2006.01)	2644597	Novel method for synthesising ivabradine and its pharmaceutically acceptable acid addition salts
<b>C07D 413/04</b> (2006.01)	2643317 *	BENZOXAZEPINES AS INHIBITORS OF P13K/MTOR AND METHODS OF THEIR USE AND MANUFACTURE	<b>C07D 401/12</b> (2006.01)	2638030 *	SALT(S) OF 7-CYCLOPENTYL-2-(5-PIPERAZIN-1-YL-PYRIDIN-2-YLAMINO)-7H-PYRROLO[2,3-D]PYRIMIDINE-6-CARBOXYLIC ACID DIMETHYLAMIDE AND PROCESSES OF MAKING THEREOF
<b>A61K 31/553</b> (2006.01)	2643317 *	BENZOXAZEPINES AS INHIBITORS OF P13K/MTOR AND METHODS OF THEIR USE AND MANUFACTURE	<b>A61K 31/519</b> (2006.01)	2638030 *	SALT(S) OF 7-CYCLOPENTYL-2-(5-PIPERAZIN-1-YL-PYRIDIN-2-YLAMINO)-7H-PYRROLO[2,3-D]PYRIMIDINE-6-CARBOXYLIC ACID DIMETHYLAMIDE AND PROCESSES OF MAKING THEREOF
<b>C07D 417/14</b> (2006.01)	2643317 *	BENZOXAZEPINES AS INHIBITORS OF P13K/MTOR AND METHODS OF THEIR USE AND MANUFACTURE	<b>A61P 35/00</b> (2006.01)	2638030 *	SALT(S) OF 7-CYCLOPENTYL-2-(5-PIPERAZIN-1-YL-PYRIDIN-2-YLAMINO)-7H-PYRROLO[2,3-D]PYRIMIDINE-6-CARBOXYLIC ACID DIMETHYLAMIDE AND PROCESSES OF MAKING THEREOF
<b>A61K 39/00</b> (2006.01)	2608803 *	DUAL VARIABLE DOMAIN IMMUNOGLOBULINS AND USES THEREOF	<b>F02B 75/26</b> (2006.01)	2633207 *	AXIAL PISTON MACHINES
<b>C07K 16/00</b> (2006.01)	2608803 *	DUAL VARIABLE DOMAIN IMMUNOGLOBULINS AND USES THEREOF	<b>F16H 23/08</b> (2006.01)	2633207 *	AXIAL PISTON MACHINES
<b>B22D 19/00</b> (2006.01)	2621649 *	HEAT EXCHANGER WITH DIE-CAST ELEMENTS AND METHOD FOR MANUFACTURING THE SAME	<b>F01B 3/00</b> (2006.01)	2633207 *	AXIAL PISTON MACHINES
<b>F27D 1/12</b> (2006.01)	2621649 *	HEAT EXCHANGER WITH DIE-CAST ELEMENTS AND METHOD FOR MANUFACTURING THE SAME	<b>F01B 3/02</b> (2006.01)	2633207 *	AXIAL PISTON MACHINES
<b>F28D 1/047</b> (2006.01)	2621649 *	HEAT EXCHANGER WITH DIE-CAST ELEMENTS AND METHOD FOR MANUFACTURING THE SAME	<b>F04B 1/22</b> (2006.01)	2633207 *	AXIAL PISTON MACHINES
<b>F28F 3/12</b> (2006.01)	2621649 *	HEAT EXCHANGER WITH DIE-CAST ELEMENTS AND METHOD FOR MANUFACTURING THE SAME	<b>F04B 27/08</b> (2006.01)	2633207 *	AXIAL PISTON MACHINES
<b>C07D 487/04</b> (2006.01)	2638045 *	AMINOALCOHOL SUBSTITUTED 2,3-DIHYDROIMIDAZO[1,2-C]QUINAZOLINE DERIVATIVES USEFUL FOR TREATING HYPER-PROLIFERATIVE DISORDERS AND DISEASES ASSOCIATED WITH ANGIOGENESIS	<b>E03D 11/02</b> (2006.01)	2562314	Flush toilet
<b>C07C 255/43</b> (2006.01)	2644597	Novel method for synthesising ivabradine and its pharmaceutically acceptable acid addition salts	<b>E03D 11/08</b> (2006.01)	2562314	Flush toilet
<b>C07C 215/08</b> (2006.01)	2644597	Novel method for synthesising ivabradine and its pharmaceutically acceptable acid addition salts	<b>A61M 16/06</b> (2006.01)	2603268 *	DEVICE AND SYSTEM FOR DELIVERY OF AN AEROSOL TO A PATIENT ON VENTILATORY SUPPORT
<b>C07C 229/34</b> (2006.01)	2644597	Novel method for synthesising ivabradine and its pharmaceutically acceptable acid addition salts	<b>A61M 16/14</b> (2006.01)	2603268 *	DEVICE AND SYSTEM FOR DELIVERY OF AN AEROSOL TO A PATIENT ON VENTILATORY SUPPORT
			<b>G01N 33/558</b> (2006.01)	2618153	Controlling fluid flow through an assay device
			<b>A61K 31/4184</b> (2006.01)	2603215 *	NOVEL D3 DOPAMINE RECEPTOR AGONISTS TO TREAT DYSKINESIA IN PARKINSON'S DISEASE

MKP (51)	Broj objave evropske prijava patenta (97)	Naziv pronalaska (54)	MKP (51)	Broj objave evropske prijava patenta (97)	Naziv pronalaska (54)
<b>C07K 16/28</b> (2006.01)	2609118 *	ANTI-OX40 ANTIBODIES AND METHODS OF USING THE SAME	<b>E21B 21/00</b> (2006.01)	2609169 *	DRILLING FLUID AND METHOD FOR DRILLING IN COAL-CONTAINING FORMATIONS
<b>C12N 15/13</b> (2006.01)	2609118 *	ANTI-OX40 ANTIBODIES AND METHODS OF USING THE SAME	<b>B60J 7/06</b> (2006.01)	2619023 *	CONSTRUCTION FOR A SLIDING ROOF, SLIDING ROOF SYSTEM, TRUCK WITH SLIDING ROOF SYSTEM, SLIDING CANVAS TRAILER WITH A SLIDING ROOF SYSTEM, TOP COVER CONSTRUCTION.
<b>A61K 39/395</b> (2006.01)	2609118 *	ANTI-OX40 ANTIBODIES AND METHODS OF USING THE SAME	<b>B60J 5/10</b> (2006.01)	2619023 *	CONSTRUCTION FOR A SLIDING ROOF, SLIDING ROOF SYSTEM, TRUCK WITH SLIDING ROOF SYSTEM, SLIDING CANVAS TRAILER WITH A SLIDING ROOF SYSTEM, TOP COVER CONSTRUCTION.
<b>A61P 35/00</b> (2006.01)	2609118 *	ANTI-OX40 ANTIBODIES AND METHODS OF USING THE SAME	<b>D21H 17/00</b> (2006.01)	2641941	Preparation of pigments
<b>G06F 3/02</b> (2006.01)	2610713 *	INPUT METHOD USING ALL OF THE FINGERS OF ONE HAND	<b>C09C 1/02</b> (2006.01)	2641941	Preparation of pigments
<b>H04M 1/02</b> (2006.01)	2610713 *	INPUT METHOD USING ALL OF THE FINGERS OF ONE HAND	<b>C12N 15/82</b> (2006.01)	2633044 *	A PLANT HOMOLOG TO AUTOPHAGY PROTEIN P62
<b>A61K 9/16</b> (2006.01)	2608775 *	PHARMACEUTICAL COMPOSITION AND ADMINISTRATIONS THEREOF	<b>C12N 15/09</b> (2006.01)	2633044 *	A PLANT HOMOLOG TO AUTOPHAGY PROTEIN P62
<b>A61K 31/47</b> (2006.01)	2608775 *	PHARMACEUTICAL COMPOSITION AND ADMINISTRATIONS THEREOF	<b>A61B 1/04</b> (2006.01)	2600759 *	SYSTEMS AND METHODS FOR OPTIMIZING AND MAINTAINING VISUALIZATION OF A SURGICAL FIELD DURING THE USE OF SURGICAL SCOPES
<b>E04C 2/04</b> (2006.01)	2643931 *	ACTUATOR AND METHOD OF MANUFACTURE THEREOF	<b>G02C 7/04</b> (2006.01)	2598935 *	COLORED CONTACT LENSES AND METHOD OF MAKING THE SAME
<b>H03K 17/96</b> (2006.01)	2643931 *	ACTUATOR AND METHOD OF MANUFACTURE THEREOF	<b>G01N 23/02</b> (2006.01)	2616798 *	SYSTEM AND METHOD FOR X-RAY INSPECTION
<b>H05B 37/02</b> (2006.01)	2643931 *	ACTUATOR AND METHOD OF MANUFACTURE THEREOF	<b>C07D 471/04</b> (2006.01)	2640723 *	CYCLOBUTYL SUBSTITUTED PYRROLOPYRIDINE AND PYRROLOPYRIMIDINE DERIVATIVES AS JAK INHIBITORS
<b>C07D 498/02</b> (2006.01)	2595994 *	PROCESS FOR PREPARING PYRANO - [2,3-C]PYRIDINE DERIVATIVES	<b>C07D 487/04</b> (2006.01)	2640723 *	CYCLOBUTYL SUBSTITUTED PYRROLOPYRIDINE AND PYRROLOPYRIMIDINE DERIVATIVES AS JAK INHIBITORS
<b>A61K 31/407</b> (2006.01)	2638046 *	SPIRO-OXINDOLE MDM2 ANTAGONISTS	<b>A61K 31/519</b> (2006.01)	2640723 *	CYCLOBUTYL SUBSTITUTED PYRROLOPYRIDINE AND PYRROLOPYRIMIDINE DERIVATIVES AS JAK INHIBITORS
<b>C07D 487/10</b> (2006.01)	2638046 *	SPIRO-OXINDOLE MDM2 ANTAGONISTS	<b>C07D 487/04</b> (2006.01)	2614063 *	SUBSTITUTED IMIDAZOPYRIDAZINES
<b>A61P 35/00</b> (2006.01)	2638046 *	SPIRO-OXINDOLE MDM2 ANTAGONISTS	<b>A61K 31/5025</b> (2006.01)	2614063 *	SUBSTITUTED IMIDAZOPYRIDAZINES
<b>C12N 15/13</b> (2006.01)	2621949 *	POLYPEPTIDES THAT BIND TO HUMAN COMPLEMENT COMPONENT C5	<b>A61P 35/00</b> (2006.01)	2614063 *	SUBSTITUTED IMIDAZOPYRIDAZINES
<b>C07K 16/18</b> (2006.01)	2621949 *	POLYPEPTIDES THAT BIND TO HUMAN COMPLEMENT COMPONENT C5			
<b>A61K 39/00</b> (2006.01)	2621949 *	POLYPEPTIDES THAT BIND TO HUMAN COMPLEMENT COMPONENT C5			
<b>C07K 16/46</b> (2006.01)	2621949 *	POLYPEPTIDES THAT BIND TO HUMAN COMPLEMENT COMPONENT C5			
<b>C09K 8/16</b> (2006.01)	2609169 *	DRILLING FLUID AND METHOD FOR DRILLING IN COAL-CONTAINING FORMATIONS			

MKP (51)	Broj objave evropske prijava patenta (97)	Naziv pronalaska (54)	MKP (51)	Broj objave evropske prijava patenta (97)	Naziv pronalaska (54)
<b>A61K 31/4985</b> (2006.01)	2616076 *	PHARMACEUTICAL COMPOSITIONS	<b>A61P 37/00</b> (2006.01)	2632921 *	POLYMORPHS AND SALTS OF 6-(1H-INDOL-4-YL)-4-(5-{ [4-(1-METHYLETHYL)-1-PI PERAZINYL]METHYL}-1,3-OXAZOL-2-YL)-1H-INDAZOLE AS PI3K INHIBITORS FOR USE IN THE TREATMENT OF E.G. RESPIRATORY DISORDERS
<b>A61K 9/70</b> (2006.01)	2613772 *	LOW-DOSE TRANSDERMAL PATCHES WITH HIGH DRUG RELEASE	<b>A61P 11/00</b> (2006.01)	2632921 *	POLYMORPHS AND SALTS OF 6-(1H-INDOL-4-YL)-4-(5-{ [4-(1-METHYLETHYL)-1-PI PERAZINYL]METHYL}-1,3-OXAZOL-2-YL)-1H-INDAZOLE AS PI3K INHIBITORS FOR USE IN THE TREATMENT OF E.G. RESPIRATORY DISORDERS
<b>A61K 31/565</b> (2006.01)	2613772 *	LOW-DOSE TRANSDERMAL PATCHES WITH HIGH DRUG RELEASE	<b>A61P 31/12</b> (2006.01)	2632921 *	POLYMORPHS AND SALTS OF 6-(1H-INDOL-4-YL)-4-(5-{ [4-(1-METHYLETHYL)-1-PI PERAZINYL]METHYL}-1,3-OXAZOL-2-YL)-1H-INDAZOLE AS PI3K INHIBITORS FOR USE IN THE TREATMENT OF E.G. RESPIRATORY DISORDERS
<b>A61K 31/57</b> (2006.01)	2613772 *	LOW-DOSE TRANSDERMAL PATCHES WITH HIGH DRUG RELEASE	<b>A61P 35/00</b> (2006.01)	2640406 *	TREATMENT OF CANCER WITH ELEVATED DOSAGES OF SOLUBLE FGFR1 FUSION PROTEINS
<b>A61B 5/0408</b> (2006.01)	2642915 *	MEASURING APPARATUS FOR THE REPETITIVE CONTACTLESS ASCERTAINMENT OF CHARACTERISTIC INTERVALS BETWEEN ELECTRICAL PULSES OF A BEATING HEART	<b>A61K 38/17</b> (2006.01)	2640406 *	TREATMENT OF CANCER WITH ELEVATED DOSAGES OF SOLUBLE FGFR1 FUSION PROTEINS
<b>A61H 35/00</b> (2006.01)	2642915 *	MEASURING APPARATUS FOR THE REPETITIVE CONTACTLESS ASCERTAINMENT OF CHARACTERISTIC INTERVALS BETWEEN ELECTRICAL PULSES OF A BEATING HEART	<b>A61K 31/4196</b> (2006.01)	2614824 *	THERAPEUTIC AGENT FOR PAIN
<b>A47K 3/022</b> (2006.01)	2642915 *	MEASURING APPARATUS FOR THE REPETITIVE CONTACTLESS ASCERTAINMENT OF CHARACTERISTIC INTERVALS BETWEEN ELECTRICAL PULSES OF A BEATING HEART	<b>A61K 31/4245</b> (2006.01)	2614824 *	THERAPEUTIC AGENT FOR PAIN
<b>C07D 413/14</b> (2006.01)	2632921 *	POLYMORPHS AND SALTS OF 6-(1H-INDOL-4-YL)-4-(5-{ [4-(1-METHYLETHYL)-1-PI PERAZINYL]METHYL}-1,3-OXAZOL-2-YL)-1H-INDAZOLE AS PI3K INHIBITORS FOR USE IN THE TREATMENT OF E.G. RESPIRATORY DISORDERS	<b>A61P 21/00</b> (2006.01)	2614824 *	THERAPEUTIC AGENT FOR PAIN
<b>A61K 31/422</b> (2006.01)	2632921 *	POLYMORPHS AND SALTS OF 6-(1H-INDOL-4-YL)-4-(5-{ [4-(1-METHYLETHYL)-1-PI PERAZINYL]METHYL}-1,3-OXAZOL-2-YL)-1H-INDAZOLE AS PI3K INHIBITORS FOR USE IN THE TREATMENT OF E.G. RESPIRATORY DISORDERS	<b>A61P 25/04</b> (2006.01)	2614824 *	THERAPEUTIC AGENT FOR PAIN
<b>A61P 35/00</b> (2006.01)	2632921 *	POLYMORPHS AND SALTS OF 6-(1H-INDOL-4-YL)-4-(5-{ [4-(1-METHYLETHYL)-1-PI PERAZINYL]METHYL}-1,3-OXAZOL-2-YL)-1H-INDAZOLE AS PI3K INHIBITORS FOR USE IN THE TREATMENT OF E.G. RESPIRATORY DISORDERS	<b>C07D 249/08</b> (2006.01)	2614824 *	THERAPEUTIC AGENT FOR PAIN
			<b>C07D 413/12</b> (2006.01)	2614824 *	THERAPEUTIC AGENT FOR PAIN
			<b>C10J 3/62</b> (2006.01)	2479244	Method for operating an assembly for energy generation
			<b>C10J 3/66</b> (2006.01)	2479244	Method for operating an assembly for energy generation
			<b>C10J 3/48</b> (2006.01)	2479244	Method for operating an assembly for energy generation
			<b>C10B 57/10</b> (2006.01)	2479244	Method for operating an assembly for energy generation
			<b>C12R 1/645</b> (2006.01)	2633085 *	USE OF MONASCUS IN ORGANIC ACID PRODUCTION
			<b>C12N 9/02</b> (2006.01)	2633085 *	USE OF MONASCUS IN ORGANIC ACID PRODUCTION

MKP (51)	Broj objave evropske prijava patenta (97)	Naziv pronalaska (54)	MKP (51)	Broj objave evropske prijava patenta (97)	Naziv pronalaska (54)
<b>C12P 7/56</b> (2006.01)	2633085 *	USE OF MONASCUS IN ORGANIC ACID PRODUCTION	<b>A61K</b> <b>39/395</b> (2006.01)	2635303 *	METHODS OF TREATING RHEUMATOID ARTHRITIS USING IL-17 ANTAGONISTS
<b>B64D 10/00</b> (2006.01)	2637927 *	METHODS AND DEVICE TO REDUCE SLOSH ENERGY ABSORPTION EFFECTS BY REDUCING BLOOD FLOW FROM THE CRANIUM	<b>C07K 16/24</b> (2006.01)	2635303 *	METHODS OF TREATING RHEUMATOID ARTHRITIS USING IL-17 ANTAGONISTS
<b>A61K</b> <b>31/497</b> (2006.01)	2635282 *	COMPOSITIONS AND METHODS FOR TREATING MYELOFIBROSIS	<b>A61K</b> <b>31/519</b> (2006.01)	2635303 *	METHODS OF TREATING RHEUMATOID ARTHRITIS USING IL-17 ANTAGONISTS
<b>A61K 9/48</b> (2006.01)	2635282 *	COMPOSITIONS AND METHODS FOR TREATING MYELOFIBROSIS	<b>A61B 6/00</b> (2006.01)	2599438 *	EVALUATION AID
<b>A61P 7/00</b> (2006.01)	2635282 *	COMPOSITIONS AND METHODS FOR TREATING MYELOFIBROSIS	<b>B01F 7/00</b> (2006.01)	2363200	Colloidal mixer and method, in particular for preparing building materials
<b>A61K 39/00</b> (2006.01)	2629791 *	HER2 DNA VACCINE AS ADJUNCT TREATMENT FOR CANCERS IN COMPANION ANIMALS	<b>B01F 7/18</b> (2006.01)	2363200	Colloidal mixer and method, in particular for preparing building materials
<b>A61K 38/08</b> (2006.01)	2599494	PKC inhibitors for the treatment of inflammatory disease or disorder	<b>B01F 7/22</b> (2006.01)	2363200	Colloidal mixer and method, in particular for preparing building materials
<b>A61K 38/18</b> (2006.01)	2599494	PKC inhibitors for the treatment of inflammatory disease or disorder	<b>B01F 13/10</b> (2006.01)	2363200	Colloidal mixer and method, in particular for preparing building materials
<b>A61K 38/00</b> (2006.01)	2599494	PKC inhibitors for the treatment of inflammatory disease or disorder	<b>C07D 223/16</b> (2006.01)	2611782 *	SALTS OF LORCASERIN WITH OPTICALLY ACTIVE ACIDS
<b>B65D 5/00</b> (2006.01)	2619098 *	FOLDING WALLET PACKAGING FOR CONFECTIONERY PRODUCTS, MORE PARTICULARLY BARS OR SLABS OF CHEWING GUM	<b>A61K 31/55</b> (2006.01)	2611782 *	SALTS OF LORCASERIN WITH OPTICALLY ACTIVE ACIDS
<b>B65D 85/60</b> (2006.01)	2619098 *	FOLDING WALLET PACKAGING FOR CONFECTIONERY PRODUCTS, MORE PARTICULARLY BARS OR SLABS OF CHEWING GUM	<b>A61P 3/04</b> (2006.01)	2611782 *	SALTS OF LORCASERIN WITH OPTICALLY ACTIVE ACIDS
<b>F23H 17/08</b> (2006.01)	2598801 *	WATER-COOLED SLIDING COMBUSTION GRATE HAVING A PARALLEL DRIVE	<b>A01N 45/00</b> (2006.01)	2533643 *	DERIVATIVES OF BETULIN
<b>F23H 7/08</b> (2006.01)	2598801 *	WATER-COOLED SLIDING COMBUSTION GRATE HAVING A PARALLEL DRIVE	<b>A61K 31/50</b> (2006.01)	2533643 *	DERIVATIVES OF BETULIN
<b>F23H 3/02</b> (2006.01)	2598801 *	WATER-COOLED SLIDING COMBUSTION GRATE HAVING A PARALLEL DRIVE	<b>A61K 31/56</b> (2006.01)	2533643 *	DERIVATIVES OF BETULIN
<b>H04M 3/42</b> (2006.01)	2609726 *	METHOD FOR NOTIFICATION OF A CALLED SUBSCRIBER IN THE ABSENCE OF SUFFICIENT CREDIT OF THE CALLING PARTY	<b>A61K 9/20</b> (2006.01)	2601936 *	COMPRESSED COMPOSITION
<b>H04M</b> <b>3/487</b> (2006.01)	2609726 *	METHOD FOR NOTIFICATION OF A CALLED SUBSCRIBER IN THE ABSENCE OF SUFFICIENT CREDIT OF THE CALLING PARTY	<b>A61P 1/04</b> (2006.01)	2601936 *	COMPRESSED COMPOSITION
			<b>A61K 47/38</b> (2006.01)	2601936 *	COMPRESSED COMPOSITION
			<b>A61K 47/26</b> (2006.01)	2601936 *	COMPRESSED COMPOSITION
			<b>A61K</b> <b>31/4439</b> (2006.01)	2601936 *	COMPRESSED COMPOSITION
			<b>C12M</b> <b>1/107</b> (2006.01)	2565259	Method and device for biogas production
			<b>A23L</b> <b>3/3463</b> (2006.01)	2603099 *	METHODS FOR ENHANCING THE STABILITY OF FOODS, BEVERAGES, AND COSMETICS USING NATURAL PRODUCTS DERIVED FROM NON-ALLERGENIC PROTEINACEOUS SOURCES

MKP (51)	Broj objave evropske prijava patenta (97)	Naziv pronalaska (54)	MKP (51)	Broj objave evropske prijava patenta (97)	Naziv pronalaska (54)
<b>A23L 3/3526</b> (2006.01)	2603099 *	METHODS FOR ENHANCING THE STABILITY OF FOODS, BEVERAGES, AND COSMETICS USING NATURAL PRODUCTS DERIVED FROM NON-ALLERGENIC PROTEINACEOUS SOURCES	<b>A61P 31/04</b> (2006.01)	2627320 *	FORMULATION COMPRISING A TYPE B LANTIBIOTIC
<b>A23L 3/3472</b> (2006.01)	2603099 *	METHODS FOR ENHANCING THE STABILITY OF FOODS, BEVERAGES, AND COSMETICS USING NATURAL PRODUCTS DERIVED FROM NON-ALLERGENIC PROTEINACEOUS SOURCES	<b>A61K 38/10</b> (2006.01)	2627320 *	FORMULATION COMPRISING A TYPE B LANTIBIOTIC
<b>C12N 15/09</b> (2006.01)	2612911 *	COMPOSITION FOR INDUCING PLURIPOTENT STEM CELL, AND USE THEREOF	<b>A61K 9/48</b> (2006.01)	2627320 *	FORMULATION COMPRISING A TYPE B LANTIBIOTIC
<b>C12N 7/00</b> (2006.01)	2612911 *	COMPOSITION FOR INDUCING PLURIPOTENT STEM CELL, AND USE THEREOF	<b>F03B 11/00</b> (2006.01)	2469257	A hydroelectric turbine testing method
<b>C12N 5/10</b> (2006.01)	2612911 *	COMPOSITION FOR INDUCING PLURIPOTENT STEM CELL, AND USE THEREOF	<b>E02B 17/02</b> (2006.01)	2469257	A hydroelectric turbine testing method
<b>C08G 77/42</b> (2006.01)	2625216 *	POLYMERIZABLE CHAIN-EXTENDED POLYSILOXANES WITH PENDANT HYDROPHILIC GROUPS	<b>F03B 17/06</b> (2006.01)	2469257	A hydroelectric turbine testing method
<b>C08G 77/442</b> (2006.01)	2625216 *	POLYMERIZABLE CHAIN-EXTENDED POLYSILOXANES WITH PENDANT HYDROPHILIC GROUPS	<b>F03B 13/26</b> (2006.01)	2469257	A hydroelectric turbine testing method
<b>C08L 83/10</b> (2006.01)	2625216 *	POLYMERIZABLE CHAIN-EXTENDED POLYSILOXANES WITH PENDANT HYDROPHILIC GROUPS	<b>E02D 15/08</b> (2006.01)	2469257	A hydroelectric turbine testing method
<b>G02B 1/04</b> (2006.01)	2625216 *	POLYMERIZABLE CHAIN-EXTENDED POLYSILOXANES WITH PENDANT HYDROPHILIC GROUPS	<b>G01M 10/00</b> (2006.01)	2469257	A hydroelectric turbine testing method
<b>C08G 77/28</b> (2006.01)	2625216 *	POLYMERIZABLE CHAIN-EXTENDED POLYSILOXANES WITH PENDANT HYDROPHILIC GROUPS	<b>F04B 1/04</b> (2006.01)	2530315	Fuel pump lubrication
<b>C08G 77/48</b> (2006.01)	2625216 *	POLYMERIZABLE CHAIN-EXTENDED POLYSILOXANES WITH PENDANT HYDROPHILIC GROUPS	<b>F02M 59/10</b> (2006.01)	2530315	Fuel pump lubrication
<b>C08F 283/12</b> (2006.01)	2625216 *	POLYMERIZABLE CHAIN-EXTENDED POLYSILOXANES WITH PENDANT HYDROPHILIC GROUPS	<b>F02M 59/44</b> (2006.01)	2530315	Fuel pump lubrication
<b>C08F 290/06</b> (2006.01)	2625216 *	POLYMERIZABLE CHAIN-EXTENDED POLYSILOXANES WITH PENDANT HYDROPHILIC GROUPS	<b>F02M 63/00</b> (2006.01)	2530315	Fuel pump lubrication
<b>C08G 77/20</b> (2006.01)	2625216 *	POLYMERIZABLE CHAIN-EXTENDED POLYSILOXANES WITH PENDANT HYDROPHILIC GROUPS	<b>A61M 15/00</b> (2006.01)	2613828 *	METERED-DOSE INHALER ACTUATOR, METERED-DOSE INHALER
			<b>C07D 487/04</b> (2006.01)	2603511 *	6-CYCLOALKYL-1, 5-DIHYDRO-PYRAZOLO [3, 4-D]PYRIMIDIN-4-ONE DERIVATIVES AND THEIR USE AS PDE9A INHIBITORS
			<b>A61K 31/519</b> (2006.01)	2603511 *	6-CYCLOALKYL-1, 5-DIHYDRO-PYRAZOLO [3, 4-D]PYRIMIDIN-4-ONE DERIVATIVES AND THEIR USE AS PDE9A INHIBITORS
			<b>A61P 25/28</b> (2006.01)	2603511 *	6-CYCLOALKYL-1, 5-DIHYDRO-PYRAZOLO [3, 4-D]PYRIMIDIN-4-ONE DERIVATIVES AND THEIR USE AS PDE9A INHIBITORS
			<b>A01N 43/42</b> (2006.01)	2608670 *	METHODS FOR TREATING ANTIPSYCHOTIC-INDUCED WEIGHT GAIN
			<b>A61K 31/44</b> (2006.01)	2608670 *	METHODS FOR TREATING ANTIPSYCHOTIC-INDUCED WEIGHT GAIN
			<b>C12P 21/08</b> (2006.01)	2608809 *	ANTIBODIES TO MATRIX METALLOPROTEINASE 9
			<b>A61K 39/395</b> (2006.01)	2608809 *	ANTIBODIES TO MATRIX METALLOPROTEINASE 9
			<b>B65D 17/00</b> (2006.01)	2607471	Wine packaged in aluminium containers
			<b>B67C 3/02</b> (2006.01)	2607471	Wine packaged in aluminium containers

MKP (51)	Broj objave evropske prijava patenta (97)	Naziv pronalaska (54)	MKP (51)	Broj objave evropske prijava patenta (97)	Naziv pronalaska (54)
<b>C12G 1/00</b> (2006.01)	2607471	Wine packaged in aluminium containers	<b>A61K 31/437</b> (2006.01)	2640386 *	COMBINATION OF CHECKPOINT KINASE 1 INHIBITORS AND WEE 1 KINASE INHIBITORS
<b>A61B 3/00</b> (2006.01)	2605694 *	SYSTEM AND METHOD FOR DETECTING AMYLOID PROTEINS	<b>C12N 15/11</b> (2006.01)	2638160 *	NUCLIONS AND RIBOCAPSIDS
<b>A61B 3/10</b> (2006.01)	2605694 *	SYSTEM AND METHOD FOR DETECTING AMYLOID PROTEINS	<b>C07H 21/00</b> (2006.01)	2638160 *	NUCLIONS AND RIBOCAPSIDS
<b>A61B 3/117</b> (2006.01)	2605694 *	SYSTEM AND METHOD FOR DETECTING AMYLOID PROTEINS	<b>C12N 15/10</b> (2006.01)	2638160 *	NUCLIONS AND RIBOCAPSIDS
<b>A61B 5/00</b> (2006.01)	2605694 *	SYSTEM AND METHOD FOR DETECTING AMYLOID PROTEINS	<b>C12Q 1/68</b> (2006.01)	2638160 *	NUCLIONS AND RIBOCAPSIDS
<b>B01D 35/05</b> (2006.01)	2621602 *	FLOATED SOLIDS SEPARATION	<b>A43B 7/12</b> (2006.01)	2640209 *	VAPOR-PERMEABLE SHOE WITH WATERPROOF AND VAPOR-PERMEABLE SOLE
<b>A61K 31/404</b> (2006.01)	2605770 *	ANTIFUNGAL AGENTS AND USES THEREOF	<b>A43B 13/16</b> (2006.01)	2640209 *	VAPOR-PERMEABLE SHOE WITH WATERPROOF AND VAPOR-PERMEABLE SOLE
<b>A61P 31/10</b> (2006.01)	2605770 *	ANTIFUNGAL AGENTS AND USES THEREOF	<b>A43B 13/12</b> (2006.01)	2640209 *	VAPOR-PERMEABLE SHOE WITH WATERPROOF AND VAPOR-PERMEABLE SOLE
<b>A61K 31/16</b> (2006.01)	2605770 *	ANTIFUNGAL AGENTS AND USES THEREOF	<b>C01G 49/08</b> (2006.01)	2598443 *	PROCESS FOR OBTAINING FUNCTIONALIZED NANOPARTICULATE MAGNETIC FERRITES FOR EASY DISPERSION AND MAGNETIC FERRITES OBTAINED THROUGH THE SAME
<b>A61K 31/351</b> (2006.01)	2605770 *	ANTIFUNGAL AGENTS AND USES THEREOF	<b>A01N 35/00</b> (2006.01)	2611294 *	ENHANCEMENT OF POTATO TUBER SPROUTING INHIBITORS USING VARIOUS COMBINATIONS OF AGENTS
<b>A61M 5/24</b> (2006.01)	2603262 *	CODING SYSTEM FOR A DRUG DELIVERY DEVICE AND DRUG DELIVERY SYSTEM	<b>A01N 35/02</b> (2006.01)	2611294 *	ENHANCEMENT OF POTATO TUBER SPROUTING INHIBITORS USING VARIOUS COMBINATIONS OF AGENTS
<b>E04F 15/12</b> (2006.01)	2374768	Base layer for floor coverings	<b>A01P 21/00</b> (2006.01)	2611294 *	ENHANCEMENT OF POTATO TUBER SPROUTING INHIBITORS USING VARIOUS COMBINATIONS OF AGENTS
<b>E04F 15/18</b> (2006.01)	2374768	Base layer for floor coverings	<b>E02F 9/06</b> (2006.01)	2520726	Device and method for removing material deposits from the reservoir of a hydrotechnical structure
<b>C04B 28/02</b> (2006.01)	2374768	Base layer for floor coverings	<b>E02F 5/28</b> (2006.01)	2520726	Device and method for removing material deposits from the reservoir of a hydrotechnical structure
<b>C04B 28/06</b> (2006.01)	2374768	Base layer for floor coverings	<b>E02B 3/02</b> (2006.01)	2520726	Device and method for removing material deposits from the reservoir of a hydrotechnical structure
<b>F24D 13/02</b> (2006.01)	2374768	Base layer for floor coverings	<b>E02F 3/47</b> (2006.01)	2520726	Device and method for removing material deposits from the reservoir of a hydrotechnical structure
<b>F24D 3/14</b> (2006.01)	2374768	Base layer for floor coverings	<b>E02F 7/06</b> (2006.01)	2520726	Device and method for removing material deposits from the reservoir of a hydrotechnical structure
<b>A61K 31/495</b> (2006.01)	2640386 *	COMBINATION OF CHECKPOINT KINASE 1 INHIBITORS AND WEE 1 KINASE INHIBITORS			
<b>A61K 31/551</b> (2006.01)	2640386 *	COMBINATION OF CHECKPOINT KINASE 1 INHIBITORS AND WEE 1 KINASE INHIBITORS			
<b>A61K 45/06</b> (2006.01)	2640386 *	COMBINATION OF CHECKPOINT KINASE 1 INHIBITORS AND WEE 1 KINASE INHIBITORS			
<b>A61P 35/00</b> (2006.01)	2640386 *	COMBINATION OF CHECKPOINT KINASE 1 INHIBITORS AND WEE 1 KINASE INHIBITORS			



MKP (51)	Broj objave evropske prijava patenta (97)	Naziv pronalaska (54)	MKP (51)	Broj objave evropske prijava patenta (97)	Naziv pronalaska (54)
<b>C07K 16/18</b> (2006.01)	2632951 *	DKK1 ANTIBODIES AND METHODS OF USE	<b>C07H 19/00</b> (2006.01)	2595980 *	METHODS AND COMPOUNDS FOR TREATING PARAMYXOVIRIDAE VIRUS INFECTIONS
<b>C07K 16/22</b> (2006.01)	2632951 *	DKK1 ANTIBODIES AND METHODS OF USE	<b>A23G 3/42</b> (2006.01)	2628397	Sucralose-containing sweetener compositions
<b>B65D 90/12</b> (2006.01)	2595903 *	PROTECTIVE FOOT FOR A UNIT LOAD, IN PARTICULAR CONCRETE TOWER SEGMENTS	<b>A23L 1/236</b> (2006.01)	2628397	Sucralose-containing sweetener compositions
<b>E04H 12/12</b> (2006.01)	2595903 *	PROTECTIVE FOOT FOR A UNIT LOAD, IN PARTICULAR CONCRETE TOWER SEGMENTS	<b>A23G 3/44</b> (2006.01)	2628397	Sucralose-containing sweetener compositions
<b>F03D 11/04</b> (2006.01)	2595903 *	PROTECTIVE FOOT FOR A UNIT LOAD, IN PARTICULAR CONCRETE TOWER SEGMENTS	<b>A23L 2/60</b> (2006.01)	2628397	Sucralose-containing sweetener compositions
<b>C02F 1/04</b> (2006.01)	2609038 *	A CONTAMINANT CONTROL SYSTEM IN AN EVAPORATIVE WATER TREATING SYSTEM	<b>F02B 21/00</b> (2006.01)	2625400 *	SELF-PRESSURE-REGULATING COMPRESSED AIR ENGINE COMPRISING AN INTEGRATED ACTIVE CHAMBER
<b>B01D 1/30</b> (2006.01)	2609038 *	A CONTAMINANT CONTROL SYSTEM IN AN EVAPORATIVE WATER TREATING SYSTEM	<b>F02M 31/04</b> (2006.01)	2625400 *	SELF-PRESSURE-REGULATING COMPRESSED AIR ENGINE COMPRISING AN INTEGRATED ACTIVE CHAMBER
<b>E21B 43/24</b> (2006.01)	2609038 *	A CONTAMINANT CONTROL SYSTEM IN AN EVAPORATIVE WATER TREATING SYSTEM	<b>F02M 31/16</b> (2006.01)	2625400 *	SELF-PRESSURE-REGULATING COMPRESSED AIR ENGINE COMPRISING AN INTEGRATED ACTIVE CHAMBER
<b>C09K 8/592</b> (2006.01)	2609038 *	A CONTAMINANT CONTROL SYSTEM IN AN EVAPORATIVE WATER TREATING SYSTEM	<b>F01B 17/02</b> (2006.01)	2625400 *	SELF-PRESSURE-REGULATING COMPRESSED AIR ENGINE COMPRISING AN INTEGRATED ACTIVE CHAMBER
<b>E21B 43/12</b> (2006.01)	2625381 *	ACTUATION DART FOR WELLBORE OPERATIONS, WELLBORE TREATMENT APPARATUS AND METHOD	<b>F01D 13/02</b> (2006.01)	2625400 *	SELF-PRESSURE-REGULATING COMPRESSED AIR ENGINE COMPRISING AN INTEGRATED ACTIVE CHAMBER
<b>E21B 34/14</b> (2006.01)	2625381 *	ACTUATION DART FOR WELLBORE OPERATIONS, WELLBORE TREATMENT APPARATUS AND METHOD	<b>B66C 1/12</b> (2006.01)	2550225 *	LIFTING UNIT FOR LIFTING A ROTOR OF A WIND ENERGY INSTALLATION
<b>E21B 23/08</b> (2006.01)	2625381 *	ACTUATION DART FOR WELLBORE OPERATIONS, WELLBORE TREATMENT APPARATUS AND METHOD	<b>C07D 237/32</b> (2006.01)	2619185 *	MATRIX METALLOPROTEINASE INHIBITORS
<b>E21B 33/12</b> (2006.01)	2625381 *	ACTUATION DART FOR WELLBORE OPERATIONS, WELLBORE TREATMENT APPARATUS AND METHOD	<b>C07D 253/08</b> (2006.01)	2619185 *	MATRIX METALLOPROTEINASE INHIBITORS
<b>C07D 233/64</b> (2006.01)	2638016 *	Process for the preparation of 3-(6-amino-pyridin-3yl)-2-acrylic acid derivatives	<b>C07D 265/26</b> (2006.01)	2619185 *	MATRIX METALLOPROTEINASE INHIBITORS
<b>C07D 233/84</b> (2006.01)	2638016 *	Process for the preparation of 3-(6-amino-pyridin-3yl)-2-acrylic acid derivatives	<b>C07D 401/12</b> (2006.01)	2619185 *	MATRIX METALLOPROTEINASE INHIBITORS
<b>C07D 309/10</b> (2006.01)	2595980 *	METHODS AND COMPOUNDS FOR TREATING PARAMYXOVIRIDAE VIRUS INFECTIONS	<b>C07D 403/12</b> (2006.01)	2619185 *	MATRIX METALLOPROTEINASE INHIBITORS
			<b>C07D 409/12</b> (2006.01)	2619185 *	MATRIX METALLOPROTEINASE INHIBITORS
			<b>A61K 31/502</b> (2006.01)	2619185 *	MATRIX METALLOPROTEINASE INHIBITORS

MKP (51)	Broj objave evropske prijava patenta (97)	Naziv pronalaska (54)	MKP (51)	Broj objave evropske prijava patenta (97)	Naziv pronalaska (54)
<b>A61K 31/53</b> (2006.01)	2619185 *	MATRIX METALLOPROTEINASE INHIBITORS	<b>E04F 13/12</b> (2006.01)	2630315 *	METAL SIDING HAVING A SECURE COVER
<b>A61K 31/536</b> (2006.01)	2619185 *	MATRIX METALLOPROTEINASE INHIBITORS	<b>E04F 13/08</b> (2006.01)	2630315 *	METAL SIDING HAVING A SECURE COVER
<b>A61P 29/00</b> (2006.01)	2619185 *	MATRIX METALLOPROTEINASE INHIBITORS	<b>A63F 9/24</b> (2006.01)	2598218 *	PAYMENT CARDS, DEVICES, SYSTEMS, AND METHODS FOR PROVIDING GAME ACTIONS WITH PAYMENT DATA, SOCIAL NETWORKING MECHANISMS AND INFORMATION EXCHANGE MECHANISMS
<b>E04F 13/08</b> (2006.01)	2619377 *	SELF-SUPPORTING MODULE FOR THE FACADE OF A BUILDING	<b>C07K 16/28</b> (2006.01)	2643354 *	NOVEL HOMOGENEOUS HUMANIZED ANTIPROLIFERATION ANTIBODIES
<b>E04B 1/76</b> (2006.01)	2619377 *	SELF-SUPPORTING MODULE FOR THE FACADE OF A BUILDING	<b>A61K 39/395</b> (2006.01)	2643354 *	NOVEL HOMOGENEOUS HUMANIZED ANTIPROLIFERATION ANTIBODIES
<b>E04B 2/92</b> (2006.01)	2619377 *	SELF-SUPPORTING MODULE FOR THE FACADE OF A BUILDING	<b>A61P 35/00</b> (2006.01)	2643354 *	NOVEL HOMOGENEOUS HUMANIZED ANTIPROLIFERATION ANTIBODIES
<b>A61B 18/12</b> (2006.01)	2540243	An electrosurgical instrument	<b>B05B 11/00</b> (2006.01)	2618940 *	DEVICE FOR DISPENSING A LIQUID AND METHOD OF MANUFACTURING SUCH A DEVICE
<b>C07D 487/04</b> (2006.01)	2601193 *	COMPOUNDS WITH ANTIBACTERIAL ACTIVITY AGAINST CLOSTRIDIUM	<b>C12N 15/62</b> (2006.01)	2633060 *	COVALENT CELLULOSOMES AND USES THEREOF
<b>A61K 31/53</b> (2006.01)	2601193 *	COMPOUNDS WITH ANTIBACTERIAL ACTIVITY AGAINST CLOSTRIDIUM	<b>C12N 9/24</b> (2006.01)	2633060 *	COVALENT CELLULOSOMES AND USES THEREOF
<b>A61P 31/04</b> (2006.01)	2601193 *	COMPOUNDS WITH ANTIBACTERIAL ACTIVITY AGAINST CLOSTRIDIUM	<b>C12N 9/42</b> (2006.01)	2633060 *	COVALENT CELLULOSOMES AND USES THEREOF
<b>G02B 1/12</b> (2006.01)	2598937 *	AMPHIPHILIC POLYSILOXANE PREPOLYMERS AND USES THEREOF	<b>C12N 15/56</b> (2006.01)	2633060 *	COVALENT CELLULOSOMES AND USES THEREOF
<b>C07F 7/10</b> (2006.01)	2598937 *	AMPHIPHILIC POLYSILOXANE PREPOLYMERS AND USES THEREOF	<b>C12P 7/10</b> (2006.01)	2633060 *	COVALENT CELLULOSOMES AND USES THEREOF
<b>B29D 11/00</b> (2006.01)	2598937 *	AMPHIPHILIC POLYSILOXANE PREPOLYMERS AND USES THEREOF	<b>C07K 14/33</b> (2006.01)	2633060 *	COVALENT CELLULOSOMES AND USES THEREOF
<b>G02C 7/04</b> (2006.01)	2598937 *	AMPHIPHILIC POLYSILOXANE PREPOLYMERS AND USES THEREOF	<b>C09D 5/00</b> (2006.01)	2643415 *	COATING COMPOSITION WITH SPARKLE EFFECT
<b>F02M 51/00</b> (2006.01)	2538066	Assembly for an electrically operated valve	<b>A61L 27/38</b> (2006.01)	2637711 *	INJECTABLE FORMULATIONS FOR ORGAN AUGMENTATION
<b>F02M 59/46</b> (2006.01)	2538066	Assembly for an electrically operated valve	<b>A61L 27/50</b> (2006.01)	2637711 *	INJECTABLE FORMULATIONS FOR ORGAN AUGMENTATION
<b>F02M 61/16</b> (2006.01)	2538066	Assembly for an electrically operated valve	<b>A61L 27/52</b> (2006.01)	2637711 *	INJECTABLE FORMULATIONS FOR ORGAN AUGMENTATION
<b>F02M 63/02</b> (2006.01)	2538066	Assembly for an electrically operated valve	<b>A61L 27/22</b> (2006.01)	2637711 *	INJECTABLE FORMULATIONS FOR ORGAN AUGMENTATION
<b>F02M 63/00</b> (2006.01)	2538066	Assembly for an electrically operated valve	<b>G01N 33/543</b> (2006.01)	2618149	Assay device having uniform flow around corners
<b>F16K 31/06</b> (2006.01)	2538066	Assembly for an electrically operated valve	<b>G01N 33/558</b> (2006.01)	2618149	Assay device having uniform flow around corners
<b>F16L 37/088</b> (2006.01)	2538066	Assembly for an electrically operated valve			

MKP (51)	Broj objave evropske prijava patenta (97)	Naziv pronalaska (54)	MKP (51)	Broj objave evropske prijava patenta (97)	Naziv pronalaska (54)
<b>G01N 33/543</b> (2006.01)	2618150	Assay device having multiple reagent cells	<b>C02F 3/20</b> (2006.01)	2609040 *	WATER TREATMENT AND REVITALIZATION SYSTEM AND METHOD
<b>G01N 33/558</b> (2006.01)	2618150	Assay device having multiple reagent cells	<b>B01F 5/12</b> (2006.01)	2609040 *	WATER TREATMENT AND REVITALIZATION SYSTEM AND METHOD
<b>H01R 13/62</b> (2006.01)	2617105 *	MAGNETICALLY ENSLAVED UNIPOLAR ELECTRICAL CONTACT ARRANGED FOR EMBEDDING IN THE SIDES OF GENERIC FRAMES AND IN PARTICULAR OF GLASS-CHAMBER FRAMES	<b>B01F 7/22</b> (2006.01)	2609040 *	WATER TREATMENT AND REVITALIZATION SYSTEM AND METHOD
<b>H01R 13/71</b> (2006.01)	2617105 *	MAGNETICALLY ENSLAVED UNIPOLAR ELECTRICAL CONTACT ARRANGED FOR EMBEDDING IN THE SIDES OF GENERIC FRAMES AND IN PARTICULAR OF GLASS-CHAMBER FRAMES	<b>F04D 13/08</b> (2006.01)	2609040 *	WATER TREATMENT AND REVITALIZATION SYSTEM AND METHOD
<b>H01R 13/24</b> (2006.01)	2617105 *	MAGNETICALLY ENSLAVED UNIPOLAR ELECTRICAL CONTACT ARRANGED FOR EMBEDDING IN THE SIDES OF GENERIC FRAMES AND IN PARTICULAR OF GLASS-CHAMBER FRAMES	<b>A61K 9/20</b> (2006.01)	2603205 *	USE OF BINDERS FOR MANUFACTURING STORAGE STABLE FORMULATIONS
<b>A61M 5/32</b> (2006.01)	2627383 *	CAP ASSEMBLY FOR A DRUG DELIVERY DEVICE	<b>A61K 31/485</b> (2006.01)	2603205 *	USE OF BINDERS FOR MANUFACTURING STORAGE STABLE FORMULATIONS
<b>A24F 47/00</b> (2006.01)	2614731	An atomizer for electronic cigarette	<b>A61K 31/4188</b> (2006.01)	2635588 *	CONDENSED IMIDAZOLYLIMIDAZOLES AS ANTIVIRAL COMPOUNDS
<b>G09B 29/10</b> (2006.01)	2613272 *	ELECTRONIC MAP DATA PROCESSING SYSTEM	<b>C07D 491/052</b> (2006.01)	2635588 *	CONDENSED IMIDAZOLYLIMIDAZOLES AS ANTIVIRAL COMPOUNDS
<b>G06F 17/30</b> (2006.01)	2613272 *	ELECTRONIC MAP DATA PROCESSING SYSTEM	<b>A61K 8/84</b> (2006.01)	2637639 *	TRANSFER RESISTANT COSMETICS AND METHOD OF MAKING
<b>G06Q 10/00</b> (2012.01)	2613272 *	ELECTRONIC MAP DATA PROCESSING SYSTEM	<b>A61Q 19/00</b> (2006.01)	2637639 *	TRANSFER RESISTANT COSMETICS AND METHOD OF MAKING
<b>E04F 13/14</b> (2006.01)	2605893 *	METHOD FOR PREPARING FLEXIBLE STONE CLADDINGS HAVING NATURAL SURFACE	<b>A61K 8/92</b> (2006.01)	2637639 *	TRANSFER RESISTANT COSMETICS AND METHOD OF MAKING
<b>B28D 1/00</b> (2006.01)	2605893 *	METHOD FOR PREPARING FLEXIBLE STONE CLADDINGS HAVING NATURAL SURFACE	<b>A61Q 1/00</b> (2006.01)	2637639 *	TRANSFER RESISTANT COSMETICS AND METHOD OF MAKING
<b>B44C 5/04</b> (2006.01)	2605893 *	METHOD FOR PREPARING FLEXIBLE STONE CLADDINGS HAVING NATURAL SURFACE	<b>A61K 8/72</b> (2006.01)	2637639 *	TRANSFER RESISTANT COSMETICS AND METHOD OF MAKING
<b>G06F 19/10</b> (2011.01)	2611941 *	GENE SIGNATURES FOR CANCER DIAGNOSIS AND PROGNOSIS	<b>A61K 8/97</b> (2006.01)	2637639 *	TRANSFER RESISTANT COSMETICS AND METHOD OF MAKING
<b>C12Q 1/68</b> (2006.01)	2611941 *	GENE SIGNATURES FOR CANCER DIAGNOSIS AND PROGNOSIS	<b>A61K 9/00</b> (2006.01)	2613765 *	ACTIVATED LEUKOCYTE CONDITIONED SUPERNATANT AND USES FOR WOUND HEALING
<b>C12N 15/11</b> (2006.01)	2611941 *	GENE SIGNATURES FOR CANCER DIAGNOSIS AND PROGNOSIS	<b>A61K 35/14</b> (2006.01)	2613765 *	ACTIVATED LEUKOCYTE CONDITIONED SUPERNATANT AND USES FOR WOUND HEALING
<b>C02F 1/74</b> (2006.01)	2609040 *	WATER TREATMENT AND REVITALIZATION SYSTEM AND METHOD	<b>A61L 15/32</b> (2006.01)	2613765 *	ACTIVATED LEUKOCYTE CONDITIONED SUPERNATANT AND USES FOR WOUND HEALING
			<b>A61P 17/02</b> (2006.01)	2613765 *	ACTIVATED LEUKOCYTE CONDITIONED SUPERNATANT AND USES FOR WOUND HEALING
			<b>A61K 31/4375</b> (2006.01)	2621491 *	2-PYRIDONE ANTIMICROBIAL COMPOSITIONS

MKP (51)	Broj objave evropske prijava patenta (97)	Naziv pronalaska (54)	MKP (51)	Broj objave evropske prijava patenta (97)	Naziv pronalaska (54)
<b>A61P 31/04</b> (2006.01)	2621491 *	2-PYRIDONE ANTIMICROBIAL COMPOSITIONS	<b>A61P 35/00</b> (2006.01)	2616063 *	HSP90 INHIBITORS FOR TREATING NON-SMALL CELL LUNG CANCERS IN WILD-TYPE EGFR AND/OR KRAS PATIENTS
<b>C12N 5/0735</b> (2010.01)	2611909 *	DIFFERENTIATION OF HUMAN EMBRYONIC STEM CELLS	<b>D21F 1/02</b> (2006.01)	2492392	Method for preparing aramid paper and the aramid paper obtained therefrom
<b>C12N 5/02</b> (2006.01)	2611909 *	DIFFERENTIATION OF HUMAN EMBRYONIC STEM CELLS	<b>D21H 13/26</b> (2006.01)	2492392	Method for preparing aramid paper and the aramid paper obtained therefrom
<b>C12N 5/071</b> (2010.01)	2611909 *	DIFFERENTIATION OF HUMAN EMBRYONIC STEM CELLS	<b>A61K 39/395</b> (2006.01)	2621531 *	ANTI-CD38 ANTIBODY AND LENALIDOMIDE OR BORTEZOMIB FOR THE TREATMENT OF MULTIPLE MYELOMA AND NHL
<b>A01N 43/80</b> (2006.01)	2601190 *	ISOXAZOLINE DERIVATIVES AS ANTIPARASITIC AGENTS	<b>C07K 16/28</b> (2006.01)	2621531 *	ANTI-CD38 ANTIBODY AND LENALIDOMIDE OR BORTEZOMIB FOR THE TREATMENT OF MULTIPLE MYELOMA AND NHL
<b>C07D 413/12</b> (2006.01)	2601190 *	ISOXAZOLINE DERIVATIVES AS ANTIPARASITIC AGENTS	<b>C07K 16/30</b> (2006.01)	2621531 *	ANTI-CD38 ANTIBODY AND LENALIDOMIDE OR BORTEZOMIB FOR THE TREATMENT OF MULTIPLE MYELOMA AND NHL
<b>C07D 413/14</b> (2006.01)	2601190 *	ISOXAZOLINE DERIVATIVES AS ANTIPARASITIC AGENTS	<b>A61P 35/00</b> (2006.01)	2621531 *	ANTI-CD38 ANTIBODY AND LENALIDOMIDE OR BORTEZOMIB FOR THE TREATMENT OF MULTIPLE MYELOMA AND NHL
<b>A61P 37/00</b> (2006.01)	2640715 *	QUINOLINE DERIVATIVES AS PIK3 INHIBITORS	<b>C12N 5/071</b> (2010.01)	2614143 *	IMMUNOTHERAPY OF CANCER USING GENETICALLY ENGINEERED GD2-SPECIFIC T CELLS
<b>A61K 31/506</b> (2006.01)	2640715 *	QUINOLINE DERIVATIVES AS PIK3 INHIBITORS	<b>C12N 5/0783</b> (2010.01)	2614143 *	IMMUNOTHERAPY OF CANCER USING GENETICALLY ENGINEERED GD2-SPECIFIC T CELLS
<b>C07D 413/14</b> (2006.01)	2640715 *	QUINOLINE DERIVATIVES AS PIK3 INHIBITORS	<b>A61K 31/353</b> (2006.01)	2543370	Compositions and Methods for Treating Herpes Simplex Virus
<b>A61P 35/00</b> (2006.01)	2640715 *	QUINOLINE DERIVATIVES AS PIK3 INHIBITORS	<b>A61P 31/22</b> (2006.01)	2543370	Compositions and Methods for Treating Herpes Simplex Virus
<b>C07D 401/14</b> (2006.01)	2640715 *	QUINOLINE DERIVATIVES AS PIK3 INHIBITORS	<b>A61P 31/12</b> (2006.01)	2543370	Compositions and Methods for Treating Herpes Simplex Virus
<b>A61P 29/00</b> (2006.01)	2640715 *	QUINOLINE DERIVATIVES AS PIK3 INHIBITORS	<b>A61K 31/34</b> (2006.01)	2642992 *	COMPOUNDS AND THEIR USE
<b>B65H 29/60</b> (2006.01)	2236447	Space Efficient Multi-Sheet Buffer Module and Modular Printing System	<b>A61P 31/00</b> (2006.01)	2642992 *	COMPOUNDS AND THEIR USE
<b>A62C 35/68</b> (2006.01)	2599525 *	AN AUTOMATED FIRE - FIGHTING COMPLEX INTEGRATING A TELEVISION SYSTEM	<b>C07D 507/00</b> (2006.01)	2642992 *	COMPOUNDS AND THEIR USE
<b>A62C 31/00</b> (2006.01)	2599525 *	AN AUTOMATED FIRE - FIGHTING COMPLEX INTEGRATING A TELEVISION SYSTEM	<b>C07C 51/41</b> (2006.01)	2630114 *	PROCESS FOR PRODUCING A LACTIC ACID-AMINE COMPLEX
<b>A61K 31/404</b> (2006.01)	2616063 *	HSP90 INHIBITORS FOR TREATING NON-SMALL CELL LUNG CANCERS IN WILD-TYPE EGFR AND/OR KRAS PATIENTS	<b>C07C 51/48</b> (2006.01)	2630114 *	PROCESS FOR PRODUCING A LACTIC ACID-AMINE COMPLEX
<b>A61K 31/4196</b> (2006.01)	2616063 *	HSP90 INHIBITORS FOR TREATING NON-SMALL CELL LUNG CANCERS IN WILD-TYPE EGFR AND/OR KRAS PATIENTS	<b>C07C 59/08</b> (2006.01)	2630114 *	PROCESS FOR PRODUCING A LACTIC ACID-AMINE COMPLEX
<b>A61K 31/423</b> (2006.01)	2616063 *	HSP90 INHIBITORS FOR TREATING NON-SMALL CELL LUNG CANCERS IN WILD-TYPE EGFR AND/OR KRAS PATIENTS			
<b>A61K 45/06</b> (2006.01)	2616063 *	HSP90 INHIBITORS FOR TREATING NON-SMALL CELL LUNG CANCERS IN WILD-TYPE EGFR AND/OR KRAS PATIENTS			

MKP (51)	Broj objave evropske prijava patenta (97)	Naziv pronalaska (54)	MKP (51)	Broj objave evropske prijava patenta (97)	Naziv pronalaska (54)
<b>C07C 51/295</b> (2006.01)	2630114 *	PROCESS FOR PRODUCING A LACTIC ACID-AMINE COMPLEX	<b>A61K 38/10</b> (2006.01)	2603232 *	STABLE FORMULATIONS OF LINALOTIDE
<b>C07K 14/00</b> (2006.01)	2596010 *	SIGNAL BIOMARKERS	<b>A61M 5/24</b> (2006.01)	2603259 *	CODING SYSTEM FOR A DRUG DELIVERY DEVICE AND DRUG DELIVERY SYSTEM
<b>C12P 21/08</b> (2006.01)	2596010 *	SIGNAL BIOMARKERS	<b>A61M 5/315</b> (2006.01)	2603259 *	CODING SYSTEM FOR A DRUG DELIVERY DEVICE AND DRUG DELIVERY SYSTEM
<b>B26D 1/547</b> (2006.01)	2643130 *	APPARATUS AND METHOD FOR CUTTING OUT A VEHICLE GLAZING PANEL	<b>C03C 3/118</b> (2006.01)	2616399 *	LOW DENSITY AND HIGH STRENGTH FIBER GLASS FOR BALLISTIC APPLICATIONS
<b>B26B 27/00</b> (2006.01)	2643130 *	APPARATUS AND METHOD FOR CUTTING OUT A VEHICLE GLAZING PANEL	<b>C03C 13/00</b> (2006.01)	2616399 *	LOW DENSITY AND HIGH STRENGTH FIBER GLASS FOR BALLISTIC APPLICATIONS
<b>B25B 11/00</b> (2006.01)	2643130 *	APPARATUS AND METHOD FOR CUTTING OUT A VEHICLE GLAZING PANEL	<b>B32B 17/00</b> (2006.01)	2616399 *	LOW DENSITY AND HIGH STRENGTH FIBER GLASS FOR BALLISTIC APPLICATIONS
<b>B60J 1/02</b> (2006.01)	2643130 *	APPARATUS AND METHOD FOR CUTTING OUT A VEHICLE GLAZING PANEL	<b>C08J 5/24</b> (2006.01)	2616399 *	LOW DENSITY AND HIGH STRENGTH FIBER GLASS FOR BALLISTIC APPLICATIONS
<b>B60J 1/00</b> (2006.01)	2643130 *	APPARATUS AND METHOD FOR CUTTING OUT A VEHICLE GLAZING PANEL	<b>C08K 7/14</b> (2006.01)	2616399 *	LOW DENSITY AND HIGH STRENGTH FIBER GLASS FOR BALLISTIC APPLICATIONS
<b>C07K 16/00</b> (2006.01)	2606063 *	IMPROVED ANTIBODIES OF THE CLASS IGG4	<b>C08J 5/04</b> (2006.01)	2616399 *	LOW DENSITY AND HIGH STRENGTH FIBER GLASS FOR BALLISTIC APPLICATIONS
<b>A61K 39/395</b> (2006.01)	2606063 *	IMPROVED ANTIBODIES OF THE CLASS IGG4	<b>E21B 43/14</b> (2006.01)	2625380 *	WIRELINE CONVEYED APPARATUS FOR WELLBORE FLUID TREATMENT
<b>C07D 403/04</b> (2006.01)	2621918 *	OXOPIPERAZINE-AZETIDINE AMIDES AND OXODIAZEPINE-AZETIDINE AMIDES AS MONOACYLGLYCEROL LIPASE INHIBITORS	<b>E21B 43/26</b> (2006.01)	2625380 *	WIRELINE CONVEYED APPARATUS FOR WELLBORE FLUID TREATMENT
<b>C07D 403/14</b> (2006.01)	2621918 *	OXOPIPERAZINE-AZETIDINE AMIDES AND OXODIAZEPINE-AZETIDINE AMIDES AS MONOACYLGLYCEROL LIPASE INHIBITORS	<b>E21B 34/14</b> (2006.01)	2625380 *	WIRELINE CONVEYED APPARATUS FOR WELLBORE FLUID TREATMENT
<b>C07D 409/14</b> (2006.01)	2621918 *	OXOPIPERAZINE-AZETIDINE AMIDES AND OXODIAZEPINE-AZETIDINE AMIDES AS MONOACYLGLYCEROL LIPASE INHIBITORS	<b>E21B 23/14</b> (2006.01)	2625380 *	WIRELINE CONVEYED APPARATUS FOR WELLBORE FLUID TREATMENT
<b>C07D 417/14</b> (2006.01)	2621918 *	OXOPIPERAZINE-AZETIDINE AMIDES AND OXODIAZEPINE-AZETIDINE AMIDES AS MONOACYLGLYCEROL LIPASE INHIBITORS	<b>B65G 47/14</b> (2006.01)	2517988	Device and method for singulating and/or sorting used beverage containers
<b>A61K 31/506</b> (2006.01)	2621918 *	OXOPIPERAZINE-AZETIDINE AMIDES AND OXODIAZEPINE-AZETIDINE AMIDES AS MONOACYLGLYCEROL LIPASE INHIBITORS	<b>G01T 3/00</b> (2006.01)	2628022 *	SELF-CALIBRATING, HIGHLY ACCURATE, LONG-LIVED, DUAL RHODIUM VANADIUM EMITTER NUCLEAR IN-CORE DETECTOR
<b>A61P 29/00</b> (2006.01)	2621918 *	OXOPIPERAZINE-AZETIDINE AMIDES AND OXODIAZEPINE-AZETIDINE AMIDES AS MONOACYLGLYCEROL LIPASE INHIBITORS	<b>A61K 47/32</b> (2006.01)	2591781 *	PARTICLE COATING PREPARATION
			<b>A61K 31/426</b> (2006.01)	2591781 *	PARTICLE COATING PREPARATION

MKP (51)	Broj objave evropske prijava patenta (97)	Naziv pronalaska (54)	MKP (51)	Broj objave evropske prijava patenta (97)	Naziv pronalaska (54)
<b>A61K 9/20</b> (2006.01)	2591781 *	PARTICLE COATING PREPARATION	<b>C12N 15/85</b> (2006.01)	2625277 *	EXPRESSION VECTOR FOR HIGH LEVEL EXPRESSION OF RECOMBINANT PROTEINS
<b>A61K 47/10</b> (2006.01)	2591781 *	PARTICLE COATING PREPARATION	<b>C07K 16/30</b> (2006.01)	2614086 *	METHODS FOR ASSESSING AND IDENTIFYING OR EVOLVING CONDITIONALLY ACTIVE THERAPEUTIC PROTEINS
<b>A61K 31/4184</b> (2006.01)	2595660 *	BENDAMUSTINE ANIONIC-CATIOINIC CYCLOPOLYSACCHARIDE COMPOSITIONS	<b>G01N 33/53</b> (2006.01)	2614086 *	METHODS FOR ASSESSING AND IDENTIFYING OR EVOLVING CONDITIONALLY ACTIVE THERAPEUTIC PROTEINS
<b>A61K 47/40</b> (2006.01)	2595660 *	BENDAMUSTINE ANIONIC-CATIOINIC CYCLOPOLYSACCHARIDE COMPOSITIONS	<b>G01N 33/574</b> (2006.01)	2614086 *	METHODS FOR ASSESSING AND IDENTIFYING OR EVOLVING CONDITIONALLY ACTIVE THERAPEUTIC PROTEINS
<b>A61P 35/00</b> (2006.01)	2595660 *	BENDAMUSTINE ANIONIC-CATIOINIC CYCLOPOLYSACCHARIDE COMPOSITIONS	<b>G01N 33/68</b> (2006.01)	2614086 *	METHODS FOR ASSESSING AND IDENTIFYING OR EVOLVING CONDITIONALLY ACTIVE THERAPEUTIC PROTEINS
<b>A61K 35/00</b> (2006.01)	2595619 *	METHODS OF TREATING METASTATIC BREAST CANCER WITH 4-iodo-3- nitrobenzamide and irinotecan	<b>C07C 43/00</b> (2006.01)	2640684 *	METHODS FOR ENHANCING OXYGENATION OF JEOPARDIZED TISSUE
<b>A61K 31/166</b> (2006.01)	2595619 *	METHODS OF TREATING METASTATIC BREAST CANCER WITH 4-iodo-3- nitrobenzamide and irinotecan	<b>A61B 1/267</b> (2006.01)	2600760 *	IMPROVEMENTS IN LARYNGOSCOPY
<b>A61P 35/04</b> (2006.01)	2595619 *	METHODS OF TREATING METASTATIC BREAST CANCER WITH 4-iodo-3- nitrobenzamide and irinotecan	<b>A61B 1/005</b> (2006.01)	2600760 *	IMPROVEMENTS IN LARYNGOSCOPY
<b>A61K 31/4745</b> (2006.01)	2595619 *	METHODS OF TREATING METASTATIC BREAST CANCER WITH 4-iodo-3- nitrobenzamide and irinotecan	<b>A01N 43/90</b> (2006.01)	2600719 *	2-SUBSTITUTED-8- ALKYL-7-OXO-7,8- DIHYDROPYRIDO[2,3-D] PYRIMIDINE-6- CARBONITRILES AND USES THEREOF
<b>A61M 5/315</b> (2006.01)	2529775	Resetting mechanism for a drug delivery device	<b>A61K 31/519</b> (2006.01)	2600719 *	2-SUBSTITUTED-8- ALKYL-7-OXO-7,8- DIHYDROPYRIDO[2,3-D] PYRIMIDINE-6- CARBONITRILES AND USES THEREOF
<b>C07D 213/30</b> (2006.01)	2603490 *	NOVEL TRPV3 MODULATORS	<b>A61K 31/505</b> (2006.01)	2600719 *	2-SUBSTITUTED-8- ALKYL-7-OXO-7,8- DIHYDROPYRIDO[2,3-D] PYRIMIDINE-6- CARBONITRILES AND USES THEREOF
<b>C07D 239/26</b> (2006.01)	2603490 *	NOVEL TRPV3 MODULATORS	<b>A61B 5/22</b> (2006.01)	2621340 *	APPARATUS FOR CLOSED KINETIC CHAIN MUSCLE STRENGTHENING AND/OR REHABILITATION OF THE SHOULDER JOINT AND OF THE UPPER LIMB
<b>C07D 405/06</b> (2006.01)	2603490 *	NOVEL TRPV3 MODULATORS	<b>A63B 23/12</b> (2006.01)	2621340 *	APPARATUS FOR CLOSED KINETIC CHAIN MUSCLE STRENGTHENING AND/OR REHABILITATION OF THE SHOULDER JOINT AND OF THE UPPER LIMB
<b>C07D 405/08</b> (2006.01)	2603490 *	NOVEL TRPV3 MODULATORS			
<b>A61K 31/4402</b> (2006.01)	2603490 *	NOVEL TRPV3 MODULATORS			
<b>A61K 31/4433</b> (2006.01)	2603490 *	NOVEL TRPV3 MODULATORS			
<b>A61K 31/505</b> (2006.01)	2603490 *	NOVEL TRPV3 MODULATORS			
<b>A61P 25/00</b> (2006.01)	2603490 *	NOVEL TRPV3 MODULATORS			
<b>A61P 29/00</b> (2006.01)	2603490 *	NOVEL TRPV3 MODULATORS			

MKP (51)	Broj objave evropske prijava patenta (97)	Naziv pronalaska (54)	MKP (51)	Broj objave evropske prijava patenta (97)	Naziv pronalaska (54)
<b>A61H 1/02</b> (2006.01)	2621340 *	APPARATUS FOR CLOSED KINETIC CHAIN MUSCLE STRENGTHENING AND/OR REHABILITATION OF THE SHOULDER JOINT AND OF THE UPPER LIMB	<b>A61K 31/445</b> (2006.01)	2611759 *	DEUTERATED ANALOGS OF PRIDOPIDINE USEFUL AS DOPAMINERGIC STABILIZERS
<b>B65F 1/14</b> (2006.01)	2643242 *	WASTE BIN HAVING A CONVERTER FOR CONVERTING MECHANICAL ENERGY INTO ELECTRICAL ENERGY	<b>A61P 25/00</b> (2006.01)	2611759 *	DEUTERATED ANALOGS OF PRIDOPIDINE USEFUL AS DOPAMINERGIC STABILIZERS
<b>A61K 31/137</b> (2006.01)	2600859 *	COMBINATIONS OF BETA - 3 ADRENERGIC RECEPTOR AGONISTS AND MUSCARINIC RECEPTOR ANTAGONISTS FOR TREATING OVERACTIVE BLADDER	<b>A01B 69/00</b> (2006.01)	2510774	Camera for monitoring machine functions of a vehicle and use of a camera
<b>A61K 31/216</b> (2006.01)	2600859 *	COMBINATIONS OF BETA - 3 ADRENERGIC RECEPTOR AGONISTS AND MUSCARINIC RECEPTOR ANTAGONISTS FOR TREATING OVERACTIVE BLADDER	<b>A01D 41/12</b> (2006.01)	2510774	Camera for monitoring machine functions of a vehicle and use of a camera
<b>A61P 13/10</b> (2006.01)	2600859 *	COMBINATIONS OF BETA - 3 ADRENERGIC RECEPTOR AGONISTS AND MUSCARINIC RECEPTOR ANTAGONISTS FOR TREATING OVERACTIVE BLADDER	<b>A01D 43/073</b> (2006.01)	2510774	Camera for monitoring machine functions of a vehicle and use of a camera
<b>A61K 31/706</b> (2006.01)	2616080 *	2' -FLUORO SUBSTITUTED CARBA-NUCLEOSIDE ANALOGS FOR ANTIVIRAL TREATMENT	<b>G03B 17/55</b> (2006.01)	2510774	Camera for monitoring machine functions of a vehicle and use of a camera
<b>C07H 7/06</b> (2006.01)	2616080 *	2' -FLUORO SUBSTITUTED CARBA-NUCLEOSIDE ANALOGS FOR ANTIVIRAL TREATMENT	<b>A01D 41/127</b> (2006.01)	2510774	Camera for monitoring machine functions of a vehicle and use of a camera
<b>C07H 21/04</b> (2006.01)	2616080 *	2' -FLUORO SUBSTITUTED CARBA-NUCLEOSIDE ANALOGS FOR ANTIVIRAL TREATMENT	<b>A01D 43/08</b> (2006.01)	2510774	Camera for monitoring machine functions of a vehicle and use of a camera
<b>A61P 31/16</b> (2006.01)	2616080 *	2' -FLUORO SUBSTITUTED CARBA-NUCLEOSIDE ANALOGS FOR ANTIVIRAL TREATMENT	<b>A01D 75/18</b> (2006.01)	2510774	Camera for monitoring machine functions of a vehicle and use of a camera
<b>C07D 513/04</b> (2006.01)	2603513 *	HETEROCYCLIC COMPOUND AND USE THEREOF	<b>C07D 413/14</b> (2006.01)	2643315 *	BENZOXAZEPINES AS INHIBITORS OF P13K/mTOR AND METHODS OF THEIR USE AND MANUFACTURE
<b>A61K 31/542</b> (2006.01)	2603513 *	HETEROCYCLIC COMPOUND AND USE THEREOF	<b>C07D 471/04</b> (2006.01)	2643315 *	BENZOXAZEPINES AS INHIBITORS OF P13K/mTOR AND METHODS OF THEIR USE AND MANUFACTURE
<b>A61P 25/00</b> (2006.01)	2603513 *	HETEROCYCLIC COMPOUND AND USE THEREOF	<b>A61K 31/5377</b> (2006.01)	2643315 *	BENZOXAZEPINES AS INHIBITORS OF P13K/mTOR AND METHODS OF THEIR USE AND MANUFACTURE
<b>C07B 59/00</b> (2006.01)	2611759 *	DEUTERATED ANALOGS OF PRIDOPIDINE USEFUL AS DOPAMINERGIC STABILIZERS	<b>A61P 35/00</b> (2006.01)	2643315 *	BENZOXAZEPINES AS INHIBITORS OF P13K/mTOR AND METHODS OF THEIR USE AND MANUFACTURE
<b>C07D 211/24</b> (2006.01)	2611759 *	DEUTERATED ANALOGS OF PRIDOPIDINE USEFUL AS DOPAMINERGIC STABILIZERS	<b>C07D 413/04</b> (2006.01)	2643315 *	BENZOXAZEPINES AS INHIBITORS OF P13K/mTOR AND METHODS OF THEIR USE AND MANUFACTURE
			<b>A61K 47/22</b> (2006.01)	2632436 *	SOLID DISPERSIONS CONTAINING AN APOPTOSIS-INDUCING AGENT
			<b>A61P 35/00</b> (2006.01)	2632436 *	SOLID DISPERSIONS CONTAINING AN APOPTOSIS-INDUCING AGENT
			<b>A61K 9/48</b> (2006.01)	2632436 *	SOLID DISPERSIONS CONTAINING AN APOPTOSIS-INDUCING AGENT

MKP (51)	Broj objave evropske prijava patenta (97)	Naziv pronalaska (54)	MKP (51)	Broj objave evropske prijava patenta (97)	Naziv pronalaska (54)
<b>A61K 47/26</b> (2006.01)	2632436 *	SOLID DISPERSIONS CONTAINING AN APOPTOSIS-INDUCING AGENT	<b>C07D 213/82</b> (2006.01)	2635556 *	BENZAMIDES AND NICOTINAMIDES AS SYK MODULATORS
<b>A61K 9/14</b> (2006.01)	2632436 *	SOLID DISPERSIONS CONTAINING AN APOPTOSIS-INDUCING AGENT	<b>C07C 309/14</b> (2006.01)	2625163 *	METHOD FOR THE PREPARATION OF (3S,3S') 4,4'-DISULFANEDIYLBIS (3-AMINOBTANE 1-SULFONIC ACID)
<b>A61K 47/38</b> (2006.01)	2632436 *	SOLID DISPERSIONS CONTAINING AN APOPTOSIS-INDUCING AGENT	<b>C07C 303/02</b> (2006.01)	2625163 *	METHOD FOR THE PREPARATION OF (3S,3S') 4,4'-DISULFANEDIYLBIS (3-AMINOBTANE 1-SULFONIC ACID)
<b>A61K 47/32</b> (2006.01)	2632436 *	SOLID DISPERSIONS CONTAINING AN APOPTOSIS-INDUCING AGENT	<b>G06F 17/50</b> (2006.01)	2628102 *	RAPID PROTOTYPING METHOD AND DEVICE
<b>A61K 31/437</b> (2006.01)	2632436 *	SOLID DISPERSIONS CONTAINING AN APOPTOSIS-INDUCING AGENT	<b>F03B 1/00</b> (2006.01)	2365209	Turbine wheel with strongly connected and force-fit blades
<b>A61K 47/44</b> (2006.01)	2632436 *	SOLID DISPERSIONS CONTAINING AN APOPTOSIS-INDUCING AGENT	<b>F03B 1/02</b> (2006.01)	2365209	Turbine wheel with strongly connected and force-fit blades
<b>A61K 47/12</b> (2006.01)	2632436 *	SOLID DISPERSIONS CONTAINING AN APOPTOSIS-INDUCING AGENT	<b>F01D 5/30</b> (2006.01)	2365209	Turbine wheel with strongly connected and force-fit blades
<b>A61K 47/34</b> (2006.01)	2632436 *	SOLID DISPERSIONS CONTAINING AN APOPTOSIS-INDUCING AGENT	<b>A61P 35/02</b> (2006.01)	2643321 *	IMIDAZO [1,2-B]PYRIDAZINE AND IMIDAZO [4,5-B] PYRIDINE DERIVATIVES AS JAK INHIBITORS
<b>C07D 207/26</b> (2006.01)	2621901 *	SELECTIVE ANDROGEN RECEPTOR MODULATORS	<b>C07D 471/04</b> (2006.01)	2643321 *	IMIDAZO [1,2-B]PYRIDAZINE AND IMIDAZO [4,5-B] PYRIDINE DERIVATIVES AS JAK INHIBITORS
<b>C07D 233/36</b> (2006.01)	2621901 *	SELECTIVE ANDROGEN RECEPTOR MODULATORS	<b>C07D 487/04</b> (2006.01)	2643321 *	IMIDAZO [1,2-B]PYRIDAZINE AND IMIDAZO [4,5-B] PYRIDINE DERIVATIVES AS JAK INHIBITORS
<b>C07D 263/24</b> (2006.01)	2621901 *	SELECTIVE ANDROGEN RECEPTOR MODULATORS	<b>A61K 31/5025</b> (2006.01)	2643321 *	IMIDAZO [1,2-B]PYRIDAZINE AND IMIDAZO [4,5-B] PYRIDINE DERIVATIVES AS JAK INHIBITORS
<b>C07D 417/04</b> (2006.01)	2621901 *	SELECTIVE ANDROGEN RECEPTOR MODULATORS	<b>A61P 37/06</b> (2006.01)	2643321 *	IMIDAZO [1,2-B]PYRIDAZINE AND IMIDAZO [4,5-B] PYRIDINE DERIVATIVES AS JAK INHIBITORS
<b>A61K 31/402</b> (2006.01)	2621901 *	SELECTIVE ANDROGEN RECEPTOR MODULATORS	<b>A61P 35/00</b> (2006.01)	2643321 *	IMIDAZO [1,2-B]PYRIDAZINE AND IMIDAZO [4,5-B] PYRIDINE DERIVATIVES AS JAK INHIBITORS
<b>A61K 31/4166</b> (2006.01)	2621901 *	SELECTIVE ANDROGEN RECEPTOR MODULATORS	<b>B24B 23/00</b> (2006.01)	2572828	Mobile structure for a tool supported on a pivoting arm
<b>A61K 31/421</b> (2006.01)	2621901 *	SELECTIVE ANDROGEN RECEPTOR MODULATORS	<b>B24B 55/10</b> (2006.01)	2572828	Mobile structure for a tool supported on a pivoting arm
<b>A61P 19/10</b> (2006.01)	2621901 *	SELECTIVE ANDROGEN RECEPTOR MODULATORS	<b>B24B 7/18</b> (2006.01)	2572828	Mobile structure for a tool supported on a pivoting arm
<b>A01N 25/00</b> (2006.01)	2635116 *	CONTROL OF PHENOXYALKANOIC ACID HERBICIDE-RESISTANT WEEDS WITH 4-AMINO-3-CHLORO-6-(4-CHLORO-2-FLUORO-3-METHOXYPHENYL) PYRIDINE-2-CARBOXYLIC ACID AND ITS SALTS OR ESTERS	<b>C07D 487/04</b> (2006.01)	2619207 *	4,7-DIHYDRO-PYRAZOLO[1,5-a]PYRAZIN-6-YLAMINE DERIVATIVES USEFUL AS INHIBITORS OF BETA-SECRETASE (BACE)
			<b>A61K 31/4985</b> (2006.01)	2619207 *	4,7-DIHYDRO-PYRAZOLO[1,5-a]PYRAZIN-6-YLAMINE DERIVATIVES USEFUL AS INHIBITORS OF BETA-SECRETASE (BACE)



MKP (51)	Broj objave evropske prijava patenta (97)	Naziv pronalaska (54)	MKP (51)	Broj objave evropske prijava patenta (97)	Naziv pronalaska (54)
<b>A61P 25/28</b> (2006.01)	2619207 *	4,7-DIHYDRO-PYRAZOLO[1,5-a]PYRAZIN-6-YLAMINE DERIVATIVES USEFUL AS INHIBITORS OF BETA-SECRETASE (BACE)	<b>H03K 5/08</b> (2006.01)	2533423	Method for detecting with a high temporal accuracy a threshold crossing instant by a signal
<b>C07D 413/14</b> (2006.01)	2619198 *	MODULATORS OF THE GPR119 RECEPTOR AND THE TREATMENT OF DISORDERS RELATED THERETO	<b>H03K 5/1534</b> (2006.01)	2533423	Method for detecting with a high temporal accuracy a threshold crossing instant by a signal
<b>A61K 31/506</b> (2006.01)	2619198 *	MODULATORS OF THE GPR119 RECEPTOR AND THE TREATMENT OF DISORDERS RELATED THERETO	<b>H04B 1/7163</b> (2011.01)	2533423	Method for detecting with a high temporal accuracy a threshold crossing instant by a signal
<b>A61P 3/00</b> (2006.01)	2619198 *	MODULATORS OF THE GPR119 RECEPTOR AND THE TREATMENT OF DISORDERS RELATED THERETO	<b>A61K 31/545</b> (2006.01)	2620152 *	PHARMACEUTICAL COMPOSITION WITH ANTIMICROBIAL ACTIVITY FOR PARENTERAL ADMINISTRATION AND PROCESS FOR PREPARING SAME
<b>A61K 31/337</b> (2006.01)	2629760 *	THERAPEUTIC NANOPARTICLES WITH HIGH MOLECULAR WEIGHT COPOLYMERS	<b>A61K 47/04</b> (2006.01)	2620152 *	PHARMACEUTICAL COMPOSITION WITH ANTIMICROBIAL ACTIVITY FOR PARENTERAL ADMINISTRATION AND PROCESS FOR PREPARING SAME
<b>A61K 47/30</b> (2006.01)	2629760 *	THERAPEUTIC NANOPARTICLES WITH HIGH MOLECULAR WEIGHT COPOLYMERS	<b>A61K 9/51</b> (2006.01)	2620152 *	PHARMACEUTICAL COMPOSITION WITH ANTIMICROBIAL ACTIVITY FOR PARENTERAL ADMINISTRATION AND PROCESS FOR PREPARING SAME
<b>A61K 9/16</b> (2006.01)	2629760 *	THERAPEUTIC NANOPARTICLES WITH HIGH MOLECULAR WEIGHT COPOLYMERS	<b>A61P 31/04</b> (2006.01)	2620152 *	PHARMACEUTICAL COMPOSITION WITH ANTIMICROBIAL ACTIVITY FOR PARENTERAL ADMINISTRATION AND PROCESS FOR PREPARING SAME
<b>A61K 47/48</b> (2006.01)	2629760 *	THERAPEUTIC NANOPARTICLES WITH HIGH MOLECULAR WEIGHT COPOLYMERS	<b>G09B 19/00</b> (2006.01)	2541532	A training device for an auto-injector
<b>A61K 47/36</b> (2006.01)	2629760 *	THERAPEUTIC NANOPARTICLES WITH HIGH MOLECULAR WEIGHT COPOLYMERS	<b>G09B 19/24</b> (2006.01)	2541532	A training device for an auto-injector
<b>A61J 3/06</b> (2006.01)	2635247 *	METHOD FOR PRODUCING MONOLITHIC TABLETS	<b>G09B 5/06</b> (2006.01)	2541532	A training device for an auto-injector
<b>E21B 43/26</b> (2006.01)	2619405 *	APPARATUS AND METHOD FOR FLUID TREATMENT OF A WELL	<b>G09B 23/28</b> (2006.01)	2541532	A training device for an auto-injector
<b>E21B 34/14</b> (2006.01)	2619405 *	APPARATUS AND METHOD FOR FLUID TREATMENT OF A WELL	<b>C12N 5/0735</b> (2010.01)	2611910 *	DIFFERENTIATION OF HUMAN EMBRYONIC STEM CELLS
<b>E21B 43/14</b> (2006.01)	2619405 *	APPARATUS AND METHOD FOR FLUID TREATMENT OF A WELL	<b>C12N 5/02</b> (2006.01)	2611910 *	DIFFERENTIATION OF HUMAN EMBRYONIC STEM CELLS
<b>A61K 9/20</b> (2006.01)	2611427 *	MODIFIED-RELEASE DOSAGE FORMS OF 5-HT2C AGONISTS USEFUL FOR WEIGHT MANAGEMENT& xA;	<b>C12N 5/071</b> (2010.01)	2611910 *	DIFFERENTIATION OF HUMAN EMBRYONIC STEM CELLS
<b>A61K 9/28</b> (2006.01)	2611427 *	MODIFIED-RELEASE DOSAGE FORMS OF 5-HT2C AGONISTS USEFUL FOR WEIGHT MANAGEMENT& xA;	<b>A61K 39/00</b> (2006.01)	2629792 *	METHOD OF STORING A VACCINE CONTAINING AN ALUMINUM ADJUVANT
<b>A61K 31/55</b> (2006.01)	2611427 *	MODIFIED-RELEASE DOSAGE FORMS OF 5-HT2C AGONISTS USEFUL FOR WEIGHT MANAGEMENT& xA;	<b>A61M 5/178</b> (2006.01)	2629792 *	METHOD OF STORING A VACCINE CONTAINING AN ALUMINUM ADJUVANT

MKP (51)	Broj objave evropske prijava patenta (97)	Naziv pronalaska (54)	MKP (51)	Broj objave evropske prijava patenta (97)	Naziv pronalaska (54)
<b>A61P 3/00</b> (2006.01)	2637667 *	IBAT INHIBITORS FOR TREATMENT OF METABOLIC DISORDERS AND RELATED CONDITIONS	<b>A61K 31/35</b> (2006.01)	2627181 *	HETEROARYLS AND USES THEREOF
<b>A61K 31/554</b> (2006.01)	2637667 *	IBAT INHIBITORS FOR TREATMENT OF METABOLIC DISORDERS AND RELATED CONDITIONS	<b>A61K 31/425</b> (2006.01)	2627181 *	HETEROARYLS AND USES THEREOF
<b>G06F 3/041</b> (2006.01)	2643812 *	METHOD FOR DISPLAYING AN ITEM ON A DISPLAY UNIT	<b>B09B 3/00</b> (2006.01)	2598259 *	METHOD FOR CLEANING UP MATERIALS THAT RESULT FROM THE RECYCLING OF FURNITURE, IN PARTICULAR MATTRESSES, BED BASES AND SEATS
<b>G06F 3/01</b> (2006.01)	2643812 *	METHOD FOR DISPLAYING AN ITEM ON A DISPLAY UNIT	<b>B27B 3/00</b> (2006.01)	2598259 *	METHOD FOR CLEANING UP MATERIALS THAT RESULT FROM THE RECYCLING OF FURNITURE, IN PARTICULAR MATTRESSES, BED BASES AND SEATS
<b>G06T 7/00</b> (2006.01)	2643812 *	METHOD FOR DISPLAYING AN ITEM ON A DISPLAY UNIT	<b>B29B 17/02</b> (2006.01)	2598259 *	METHOD FOR CLEANING UP MATERIALS THAT RESULT FROM THE RECYCLING OF FURNITURE, IN PARTICULAR MATTRESSES, BED BASES AND SEATS
<b>G06F 3/042</b> (2006.01)	2643812 *	METHOD FOR DISPLAYING AN ITEM ON A DISPLAY UNIT	<b>A01N 43/50</b> (2006.01)	2548437	Improved method for producing emulsifiable pesticide solutions
<b>C07D 471/04</b> (2006.01)	2611803 *	METHOD FOR THE PRODUCTION OF 5-FLUORO-1H-PYRAZOLO[3,4-B]PYRIDINE-3-CARBONITRILE	<b>A01N 25/30</b> (2006.01)	2548437	Improved method for producing emulsifiable pesticide solutions
<b>A24D 1/00</b> (2006.01)	2532258	A tar reducing cigar with filter section comprising expanded, cut tobacco stems	<b>A01N 25/02</b> (2006.01)	2548437	Improved method for producing emulsifiable pesticide solutions
<b>A24D 1/04</b> (2006.01)	2532258	A tar reducing cigar with filter section comprising expanded, cut tobacco stems	<b>A01N 53/00</b> (2006.01)	2548437	Improved method for producing emulsifiable pesticide solutions
<b>A24D 3/06</b> (2006.01)	2532258	A tar reducing cigar with filter section comprising expanded, cut tobacco stems	<b>A01N 37/42</b> (2006.01)	2548437	Improved method for producing emulsifiable pesticide solutions
<b>A61K 31/135</b> (2006.01)	2603212 *	USE OF RASAGILINE FOR THE TREATMENT OF OLFACTORY DYSFUNCTION	<b>A01N 43/653</b> (2006.01)	2548437	Improved method for producing emulsifiable pesticide solutions
<b>A61K 9/00</b> (2006.01)	2605752 *	OPHTHALMIC FORMULATIONS OF SQUALAMINE	<b>A01N 47/12</b> (2006.01)	2548437	Improved method for producing emulsifiable pesticide solutions
<b>A61K 31/56</b> (2006.01)	2605752 *	OPHTHALMIC FORMULATIONS OF SQUALAMINE	<b>A01N 47/20</b> (2006.01)	2548437	Improved method for producing emulsifiable pesticide solutions
<b>A61K 31/575</b> (2006.01)	2605752 *	OPHTHALMIC FORMULATIONS OF SQUALAMINE	<b>A01N 43/40</b> (2006.01)	2548437	Improved method for producing emulsifiable pesticide solutions
<b>A61K 47/26</b> (2006.01)	2605752 *	OPHTHALMIC FORMULATIONS OF SQUALAMINE	<b>B01D 53/52</b> (2006.01)	2632569 *	HIGH PRESSURE REDUCTION-OXIDATION DESULFURIZATION PROCESS
<b>A61K 47/28</b> (2006.01)	2605752 *	OPHTHALMIC FORMULATIONS OF SQUALAMINE	<b>B01D 53/78</b> (2006.01)	2632569 *	HIGH PRESSURE REDUCTION-OXIDATION DESULFURIZATION PROCESS
<b>A61K 47/32</b> (2006.01)	2605752 *	OPHTHALMIC FORMULATIONS OF SQUALAMINE	<b>B01D 53/96</b> (2006.01)	2632569 *	HIGH PRESSURE REDUCTION-OXIDATION DESULFURIZATION PROCESS
<b>A61K 47/36</b> (2006.01)	2605752 *	OPHTHALMIC FORMULATIONS OF SQUALAMINE	<b>H01R 4/06</b> (2006.01)	2562875	Pulling device for pulling a punch in a contact bush
<b>A61K 31/365</b> (2006.01)	2627181 *	HETEROARYLS AND USES THEREOF	<b>H01R 43/00</b> (2006.01)	2562875	Pulling device for pulling a punch in a contact bush
<b>A01N 43/78</b> (2006.01)	2627181 *	HETEROARYLS AND USES THEREOF	<b>A61M 5/24</b> (2006.01)	2603258 *	MECHANISM FOR PREVENTING SELECTION OF A DOSE
<b>A01N 43/16</b> (2006.01)	2627181 *	HETEROARYLS AND USES THEREOF			

MKP (51)	Broj objave evropske prijava patenta (97)	Naziv pronalaska (54)	MKP (51)	Broj objave evropske prijava patenta (97)	Naziv pronalaska (54)
<b>A61P 25/04</b> (2006.01)	2621496 *	CRYSTALLINE NALOXOL- PEG CONJUGATE	<b>B65D 43/02</b> (2006.01)	2517971	Material handling device
<b>A61K 33/42</b> (2006.01)	2621496 *	CRYSTALLINE NALOXOL- PEG CONJUGATE	<b>A61M 5/315</b> (2006.01)	2632512 *	DRUG DELIVERY DEVICE AND METHOD FOR ASSEMBLING A DRUG DELIVERY DEVICE
<b>A61K 31/194</b> (2006.01)	2621496 *	CRYSTALLINE NALOXOL- PEG CONJUGATE	<b>G01B 9/04</b> (2006.01)	2607889 *	FLUORESCENCE MICROSCOPE FOR MULTI-FLUORESCENCE IMAGE OBSERVATION, FLUORESCENCE IMAGE OBSERVATION METHOD USING THE SAME, AND MULTI-FLUORESCENCE IMAGE OBSERVATION SYSTEM
<b>A61K 31/765</b> (2006.01)	2621496 *	CRYSTALLINE NALOXOL- PEG CONJUGATE	<b>G01N 21/64</b> (2006.01)	2607889 *	FLUORESCENCE MICROSCOPE FOR MULTI-FLUORESCENCE IMAGE OBSERVATION, FLUORESCENCE IMAGE OBSERVATION METHOD USING THE SAME, AND MULTI-FLUORESCENCE IMAGE OBSERVATION SYSTEM
<b>A61K 31/485</b> (2006.01)	2621496 *	CRYSTALLINE NALOXOL- PEG CONJUGATE	<b>D04H 5/02</b> (2012.01)	2540892	Water dispersible nonwoven fabric material
<b>F24J 2/52</b> (2006.01)	2642218	A modular apparatus for architectural integration of frameless solar modules	<b>D04H 5/06</b> (2006.01)	2540892	Water dispersible nonwoven fabric material
<b>H01L 31/042</b> (2006.01)	2642218	A modular apparatus for architectural integration of frameless solar modules	<b>D04H 13/00</b> (2006.01)	2540892	Water dispersible nonwoven fabric material
<b>C07D 413/04</b> (2006.01)	2643316 *	BENZOXAZEPINES AS INHIBITORS OF P13K/MTOR AND METHODS OF THEIR USE AND MANUFACTURE	<b>A47L 13/17</b> (2006.01)	2540892	Water dispersible nonwoven fabric material
<b>A23J 1/14</b> (2006.01)	2605666 *	IMPROVED PRODUCTION OF PROTEIN SOLUTIONS FROM SOY	<b>A61K 8/02</b> (2006.01)	2540892	Water dispersible nonwoven fabric material
<b>A23J 3/16</b> (2006.01)	2605666 *	IMPROVED PRODUCTION OF PROTEIN SOLUTIONS FROM SOY	<b>A61K 31/33</b> (2006.01)	2603214 *	HETEROARYLS AND USES THEREOF
<b>C07K 16/32</b> (2006.01)	2606070 *	ANTIBODIES FOR EPIDERMAL GROWTH FACTOR RECEPTOR 3 (HER3)	<b>A61K 31/425</b> (2006.01)	2603214 *	HETEROARYLS AND USES THEREOF
<b>A61K 39/395</b> (2006.01)	2606070 *	ANTIBODIES FOR EPIDERMAL GROWTH FACTOR RECEPTOR 3 (HER3)	<b>B66D 1/50</b> (2006.01)	2554507	Cable tension measuring device
<b>A61P 35/00</b> (2006.01)	2606070 *	ANTIBODIES FOR EPIDERMAL GROWTH FACTOR RECEPTOR 3 (HER3)	<b>B30B 5/06</b> (2006.01)	2625030 *	COMPACTING CONVEYOR BELT PARTICULARLY FOR THE FEED OF PYROLYSIS, GASIFICATION AND COMBUSTION PLANTS
<b>C07K 16/28</b> (2006.01)	2576621 *	MONOCLONAL ANTIBODIES AGAINST HER2	<b>B30B 9/32</b> (2006.01)	2625030 *	COMPACTING CONVEYOR BELT PARTICULARLY FOR THE FEED OF PYROLYSIS, GASIFICATION AND COMBUSTION PLANTS
<b>A61K 39/00</b> (2006.01)	2576621 *	MONOCLONAL ANTIBODIES AGAINST HER2	<b>C07D 233/70</b> (2006.01)	2638017 *	CRYSTALLINE FORMS OF AN ALKOXYIMIDAZOL- 1-YLMETHYL BIPHENYL CARBOXYLIC ACID
<b>C07D 209/42</b> (2006.01)	2612850	Delta crystalline form of the arginine salt of perindopril, a process for its preparation, and pharmaceutical compositions containing it	<b>A61K 31/4174</b> (2006.01)	2638017 *	CRYSTALLINE FORMS OF AN ALKOXYIMIDAZOL- 1-YLMETHYL BIPHENYL CARBOXYLIC ACID
<b>A61K 31/403</b> (2006.01)	2612850	Delta crystalline form of the arginine salt of perindopril, a process for its preparation, and pharmaceutical compositions containing it			
<b>G06F 17/30</b> (2006.01)	2447859	System and method for acceleration of malware detection using antivirus cache			
<b>B65D 21/06</b> (2006.01)	2517971	Material handling device			

MKP (51)	Broj objave evropske prijava patenta (97)	Naziv pronalaska (54)	MKP (51)	Broj objave evropske prijava patenta (97)	Naziv pronalaska (54)
<b>A61P 9/00</b> (2006.01)	2638017 *	CRYSTALLINE FORMS OF AN ALKOXYIMIDAZOL-1-YLMETHYL BIPHENYL CARBOXYLIC ACID	<b>A61K 36/185</b> (2006.01)	2605831 *	METHOD FOR PRODUCING NON-ALCOHOLIC PLANT-BASED COMPOSITIONS, COMPOSITIONS PRODUCED IN SAID MANNER AND USE THEREOF
<b>A61K 9/113</b> (2006.01)	2616047 *	NON-AQUEOUS OILY INJECTABLE FORMULATION EXHIBITING PRESERVATIVE EFFICACY	<b>A61P 11/10</b> (2006.01)	2605831 *	METHOD FOR PRODUCING NON-ALCOHOLIC PLANT-BASED COMPOSITIONS, COMPOSITIONS PRODUCED IN SAID MANNER AND USE THEREOF
<b>A61K 9/107</b> (2006.01)	2616047 *	NON-AQUEOUS OILY INJECTABLE FORMULATION EXHIBITING PRESERVATIVE EFFICACY	<b>A61K 36/28</b> (2006.01)	2605831 *	METHOD FOR PRODUCING NON-ALCOHOLIC PLANT-BASED COMPOSITIONS, COMPOSITIONS PRODUCED IN SAID MANNER AND USE THEREOF
<b>A61K 31/728</b> (2006.01)	2616047 *	NON-AQUEOUS OILY INJECTABLE FORMULATION EXHIBITING PRESERVATIVE EFFICACY	<b>A61P 11/12</b> (2006.01)	2605831 *	METHOD FOR PRODUCING NON-ALCOHOLIC PLANT-BASED COMPOSITIONS, COMPOSITIONS PRODUCED IN SAID MANNER AND USE THEREOF
<b>H01L 29/18</b> (2006.01)	2603930 *	LED PACKAGE WITH EFFICIENT, ISOLATED THERMAL PATH	<b>A61K 36/235</b> (2006.01)	2605831 *	METHOD FOR PRODUCING NON-ALCOHOLIC PLANT-BASED COMPOSITIONS, COMPOSITIONS PRODUCED IN SAID MANNER AND USE THEREOF
<b>A61K 35/76</b> (2006.01)	2605783 *	ONCOLYTIC MEASLES VIRUS	<b>A61K 36/35</b> (2006.01)	2605831 *	METHOD FOR PRODUCING NON-ALCOHOLIC PLANT-BASED COMPOSITIONS, COMPOSITIONS PRODUCED IN SAID MANNER AND USE THEREOF
<b>C12N 15/45</b> (2006.01)	2605783 *	ONCOLYTIC MEASLES VIRUS	<b>A61K 31/55</b> (2006.01)	2611449 *	ADMINISTRATION OF LORCASERIN TO INDIVIDUALS WITH RENAL IMPAIRMENT
<b>A61P 35/00</b> (2006.01)	2605783 *	ONCOLYTIC MEASLES VIRUS	<b>A61P 3/04</b> (2006.01)	2611449 *	ADMINISTRATION OF LORCASERIN TO INDIVIDUALS WITH RENAL IMPAIRMENT
<b>C12N 9/10</b> (2006.01)	2605783 *	ONCOLYTIC MEASLES VIRUS	<b>A61M 5/28</b> (2006.01)	2595677 *	MEDICAMENT CARTRIDGES WITH NON-STANDARD DIMENSIONS
<b>C12N 9/78</b> (2006.01)	2605783 *	ONCOLYTIC MEASLES VIRUS	<b>A61J 1/06</b> (2006.01)	2595677 *	MEDICAMENT CARTRIDGES WITH NON-STANDARD DIMENSIONS
<b>C07K 19/00</b> (2006.01)	2605783 *	ONCOLYTIC MEASLES VIRUS	<b>B60K 28/06</b> (2006.01)	2596975 *	IDENTIFICATION AND SECURITY DEVICE USING SHORT-DISTANCE OCULAR BIOMETRY
<b>A61K 36/25</b> (2006.01)	2605831 *	METHOD FOR PRODUCING NON-ALCOHOLIC PLANT-BASED COMPOSITIONS, COMPOSITIONS PRODUCED IN SAID MANNER AND USE THEREOF	<b>G01N 33/497</b> (2006.01)	2596975 *	IDENTIFICATION AND SECURITY DEVICE USING SHORT-DISTANCE OCULAR BIOMETRY
<b>A61K 36/11</b> (2006.01)	2605831 *	METHOD FOR PRODUCING NON-ALCOHOLIC PLANT-BASED COMPOSITIONS, COMPOSITIONS PRODUCED IN SAID MANNER AND USE THEREOF	<b>B60R 25/04</b> (2013.01)	2596975 *	IDENTIFICATION AND SECURITY DEVICE USING SHORT-DISTANCE OCULAR BIOMETRY
<b>A61K 36/53</b> (2006.01)	2605831 *	METHOD FOR PRODUCING NON-ALCOHOLIC PLANT-BASED COMPOSITIONS, COMPOSITIONS PRODUCED IN SAID MANNER AND USE THEREOF			
<b>A61P 11/00</b> (2006.01)	2605831 *	METHOD FOR PRODUCING NON-ALCOHOLIC PLANT-BASED COMPOSITIONS, COMPOSITIONS PRODUCED IN SAID MANNER AND USE THEREOF			
<b>A61K 36/57</b> (2006.01)	2605831 *	METHOD FOR PRODUCING NON-ALCOHOLIC PLANT-BASED COMPOSITIONS, COMPOSITIONS PRODUCED IN SAID MANNER AND USE THEREOF			

MKP (51)	Broj objave evropske prijava patenta (97)	Naziv pronalaska (54)	MKP (51)	Broj objave evropske prijava patenta (97)	Naziv pronalaska (54)
<b>G06K 9/00</b> (2006.01)	2596975 *	IDENTIFICATION AND SECURITY DEVICE USING SHORT-DISTANCE OCULAR BIOMETRY	<b>A61K 31/505</b> (2006.01)	2635565 *	5 -CYANO-4, 6 -DIAMINOPYRIMIDINE OR 6 -AMINOPURINE DERIVATIVES AS PI3K-DELTA INHIBITORS
<b>C07K 1/18</b> (2006.01)	2598514 *	PROTEIN PURIFICATION	<b>A61P 29/00</b> (2006.01)	2635565 *	5 -CYANO-4, 6 -DIAMINOPYRIMIDINE OR 6 -AMINOPURINE DERIVATIVES AS PI3K-DELTA INHIBITORS
<b>C07K 1/36</b> (2006.01)	2598514 *	PROTEIN PURIFICATION	<b>A61P 19/02</b> (2006.01)	2635565 *	5 -CYANO-4, 6 -DIAMINOPYRIMIDINE OR 6 -AMINOPURINE DERIVATIVES AS PI3K-DELTA INHIBITORS
<b>A62B 17/00</b> (2006.01)	2407208	Protective suit with breathing air supply device	<b>A61P 35/00</b> (2006.01)	2635565 *	5 -CYANO-4, 6 -DIAMINOPYRIMIDINE OR 6 -AMINOPURINE DERIVATIVES AS PI3K-DELTA INHIBITORS
<b>A62B 9/00</b> (2006.01)	2407208	Protective suit with breathing air supply device	<b>A61P 37/00</b> (2006.01)	2635565 *	5 -CYANO-4, 6 -DIAMINOPYRIMIDINE OR 6 -AMINOPURINE DERIVATIVES AS PI3K-DELTA INHIBITORS
<b>A62B 9/02</b> (2006.01)	2407208	Protective suit with breathing air supply device	<b>C08F 2/00</b> (2006.01)	2625206 *	ACCELERATOR COMPOSITION FOR ELASTOMERS
<b>C21C 5/48</b> (2006.01)	2635715 *	SECTION FOR PROCESSING LIQUID METAL WITH GASES	<b>A61K 38/17</b> (2006.01)	2632952 *	ANTI-SOD1 ANTIBODIES AND USES THEREOF
<b>F27D 3/16</b> (2006.01)	2635715 *	SECTION FOR PROCESSING LIQUID METAL WITH GASES	<b>C07K 16/18</b> (2006.01)	2632952 *	ANTI-SOD1 ANTIBODIES AND USES THEREOF
<b>B22D 1/00</b> (2006.01)	2635715 *	SECTION FOR PROCESSING LIQUID METAL WITH GASES	<b>A61K 39/395</b> (2006.01)	2632952 *	ANTI-SOD1 ANTIBODIES AND USES THEREOF
<b>E03C 1/22</b> (2006.01)	2554755	Floor drainage system	<b>C07K 14/435</b> (2006.01)	2632952 *	ANTI-SOD1 ANTIBODIES AND USES THEREOF
<b>E03F 5/04</b> (2006.01)	2554755	Floor drainage system	<b>C12N 15/13</b> (2006.01)	2632952 *	ANTI-SOD1 ANTIBODIES AND USES THEREOF
<b>A47K 3/40</b> (2006.01)	2554755	Floor drainage system	<b>A61P 21/00</b> (2006.01)	2632952 *	ANTI-SOD1 ANTIBODIES AND USES THEREOF
<b>C07D 401/12</b> (2006.01)	2635565 *	5 -CYANO-4, 6 -DIAMINOPYRIMIDINE OR 6 -AMINOPURINE DERIVATIVES AS PI3K-DELTA INHIBITORS	<b>C07D 209/42</b> (2006.01)	2627632 *	SULPHONAMIDE COMPOUNDS AND METHODS OF MAKING AND USING SAME
<b>C07D 401/14</b> (2006.01)	2635565 *	5 -CYANO-4, 6 -DIAMINOPYRIMIDINE OR 6 -AMINOPURINE DERIVATIVES AS PI3K-DELTA INHIBITORS	<b>A61K 31/404</b> (2006.01)	2627632 *	SULPHONAMIDE COMPOUNDS AND METHODS OF MAKING AND USING SAME
<b>C07D 473/34</b> (2006.01)	2635565 *	5 -CYANO-4, 6 -DIAMINOPYRIMIDINE OR 6 -AMINOPURINE DERIVATIVES AS PI3K-DELTA INHIBITORS	<b>A61P 3/04</b> (2006.01)	2627632 *	SULPHONAMIDE COMPOUNDS AND METHODS OF MAKING AND USING SAME
<b>C07D 239/48</b> (2006.01)	2635565 *	5 -CYANO-4, 6 -DIAMINOPYRIMIDINE OR 6 -AMINOPURINE DERIVATIVES AS PI3K-DELTA INHIBITORS	<b>C07D 333/68</b> (2006.01)	2627632 *	SULPHONAMIDE COMPOUNDS AND METHODS OF MAKING AND USING SAME
<b>C07D 403/12</b> (2006.01)	2635565 *	5 -CYANO-4, 6 -DIAMINOPYRIMIDINE OR 6 -AMINOPURINE DERIVATIVES AS PI3K-DELTA INHIBITORS	<b>C07D 409/04</b> (2006.01)	2627632 *	SULPHONAMIDE COMPOUNDS AND METHODS OF MAKING AND USING SAME
<b>A61K 31/506</b> (2006.01)	2635565 *	5 -CYANO-4, 6 -DIAMINOPYRIMIDINE OR 6 -AMINOPURINE DERIVATIVES AS PI3K-DELTA INHIBITORS			
<b>A61K 31/52</b> (2006.01)	2635565 *	5 -CYANO-4, 6 -DIAMINOPYRIMIDINE OR 6 -AMINOPURINE DERIVATIVES AS PI3K-DELTA INHIBITORS			

MKP (51)	Broj objave evropske prijave patenta (97)	Naziv pronalaska (54)	MKP (51)	Broj objave evropske prijave patenta (97)	Naziv pronalaska (54)
<b>C07D 495/04</b> (2006.01)	2627632 *	SULPHONAMIDE COMPOUNDS AND METHODS OF MAKING AND USING SAME	<b>C07C 15/52</b> (2006.01)	2607300 *	PROCESS FOR PRODUCING HYDROGEN OR HEAVY HYDROGENS, AND HYDROGENATION (PROTIATION, DEUTERATION OR TRITIATION) OF ORGANIC COMPOUNDS USING SAME
<b>A61K 31/381</b> (2006.01)	2627632 *	SULPHONAMIDE COMPOUNDS AND METHODS OF MAKING AND USING SAME	<b>C07C 43/205</b> (2006.01)	2607300 *	PROCESS FOR PRODUCING HYDROGEN OR HEAVY HYDROGENS, AND HYDROGENATION (PROTIATION, DEUTERATION OR TRITIATION) OF ORGANIC COMPOUNDS USING SAME
<b>C07D 333/26</b> (2006.01)	2627632 *	SULPHONAMIDE COMPOUNDS AND METHODS OF MAKING AND USING SAME	<b>C01B 3/04</b> (2006.01)	2607300 *	PROCESS FOR PRODUCING HYDROGEN OR HEAVY HYDROGENS, AND HYDROGENATION (PROTIATION, DEUTERATION OR TRITIATION) OF ORGANIC COMPOUNDS USING SAME
<b>C07C 5/08</b> (2006.01)	2607300 *	PROCESS FOR PRODUCING HYDROGEN OR HEAVY HYDROGENS, AND HYDROGENATION (PROTIATION, DEUTERATION OR TRITIATION) OF ORGANIC COMPOUNDS USING SAME	<b>C07C 9/15</b> (2006.01)	2607300 *	PROCESS FOR PRODUCING HYDROGEN OR HEAVY HYDROGENS, AND HYDROGENATION (PROTIATION, DEUTERATION OR TRITIATION) OF ORGANIC COMPOUNDS USING SAME
<b>C07C 29/17</b> (2006.01)	2607300 *	PROCESS FOR PRODUCING HYDROGEN OR HEAVY HYDROGENS, AND HYDROGENATION (PROTIATION, DEUTERATION OR TRITIATION) OF ORGANIC COMPOUNDS USING SAME	<b>C07C 41/18</b> (2006.01)	2607300 *	PROCESS FOR PRODUCING HYDROGEN OR HEAVY HYDROGENS, AND HYDROGENATION (PROTIATION, DEUTERATION OR TRITIATION) OF ORGANIC COMPOUNDS USING SAME
<b>C01B 3/08</b> (2006.01)	2607300 *	PROCESS FOR PRODUCING HYDROGEN OR HEAVY HYDROGENS, AND HYDROGENATION (PROTIATION, DEUTERATION OR TRITIATION) OF ORGANIC COMPOUNDS USING SAME	<b>C07C 5/10</b> (2006.01)	2607300 *	PROCESS FOR PRODUCING HYDROGEN OR HEAVY HYDROGENS, AND HYDROGENATION (PROTIATION, DEUTERATION OR TRITIATION) OF ORGANIC COMPOUNDS USING SAME
<b>C07C 15/18</b> (2006.01)	2607300 *	PROCESS FOR PRODUCING HYDROGEN OR HEAVY HYDROGENS, AND HYDROGENATION (PROTIATION, DEUTERATION OR TRITIATION) OF ORGANIC COMPOUNDS USING SAME	<b>C07C 33/22</b> (2006.01)	2607300 *	PROCESS FOR PRODUCING HYDROGEN OR HEAVY HYDROGENS, AND HYDROGENATION (PROTIATION, DEUTERATION OR TRITIATION) OF ORGANIC COMPOUNDS USING SAME
<b>C07C 41/20</b> (2006.01)	2607300 *	PROCESS FOR PRODUCING HYDROGEN OR HEAVY HYDROGENS, AND HYDROGENATION (PROTIATION, DEUTERATION OR TRITIATION) OF ORGANIC COMPOUNDS USING SAME	<b>C01B 4/00</b> (2006.01)	2607300 *	PROCESS FOR PRODUCING HYDROGEN OR HEAVY HYDROGENS, AND HYDROGENATION (PROTIATION, DEUTERATION OR TRITIATION) OF ORGANIC COMPOUNDS USING SAME
<b>C07B 31/00</b> (2006.01)	2607300 *	PROCESS FOR PRODUCING HYDROGEN OR HEAVY HYDROGENS, AND HYDROGENATION (PROTIATION, DEUTERATION OR TRITIATION) OF ORGANIC COMPOUNDS USING SAME			

MKP (51)	Broj objave evropske prijava patenta (97)	Naziv pronalaska (54)	MKP (51)	Broj objave evropske prijava patenta (97)	Naziv pronalaska (54)
<b>C07C 15/24</b> (2006.01)	2607300 *	PROCESS FOR PRODUCING HYDROGEN OR HEAVY HYDROGENS, AND HYDROGENATION (PROTIATION, DEUTERATION OR TRITIATION) OF ORGANIC COMPOUNDS USING SAME	<b>A61P 19/06</b> (2006.01)	2610248 *	METHOD FOR PRODUCING PHENYL-SUBSTITUTED HETEROCYCLIC DERIVATIVE BY MEANS OF COUPLING METHOD USING A PALLADIUM COMPOUND
<b>C07C 41/24</b> (2006.01)	2607300 *	PROCESS FOR PRODUCING HYDROGEN OR HEAVY HYDROGENS, AND HYDROGENATION (PROTIATION, DEUTERATION OR TRITIATION) OF ORGANIC COMPOUNDS USING SAME	<b>A61P 43/00</b> (2006.01)	2610248 *	METHOD FOR PRODUCING PHENYL-SUBSTITUTED HETEROCYCLIC DERIVATIVE BY MEANS OF COUPLING METHOD USING A PALLADIUM COMPOUND
<b>C07C 5/09</b> (2006.01)	2607300 *	PROCESS FOR PRODUCING HYDROGEN OR HEAVY HYDROGENS, AND HYDROGENATION (PROTIATION, DEUTERATION OR TRITIATION) OF ORGANIC COMPOUNDS USING SAME	<b>H01L 31/048</b> (2006.01)	2521188	Photovoltaic module in the shape of an architectural element and process for the realization thereof
<b>C07C 33/20</b> (2006.01)	2607300 *	PROCESS FOR PRODUCING HYDROGEN OR HEAVY HYDROGENS, AND HYDROGENATION (PROTIATION, DEUTERATION OR TRITIATION) OF ORGANIC COMPOUNDS USING SAME	<b>A61K 9/28</b> (2006.01)	2605760 *	TABLET SLEEVE FOR IMPROVED PERFORMANCE
<b>C07C 1/26</b> (2006.01)	2607300 *	PROCESS FOR PRODUCING HYDROGEN OR HEAVY HYDROGENS, AND HYDROGENATION (PROTIATION, DEUTERATION OR TRITIATION) OF ORGANIC COMPOUNDS USING SAME	<b>A61K 9/20</b> (2006.01)	2605760 *	TABLET SLEEVE FOR IMPROVED PERFORMANCE
<b>C07C 29/143</b> (2006.01)	2607300 *	PROCESS FOR PRODUCING HYDROGEN OR HEAVY HYDROGENS, AND HYDROGENATION (PROTIATION, DEUTERATION OR TRITIATION) OF ORGANIC COMPOUNDS USING SAME	<b>A61K 9/00</b> (2006.01)	2611415 *	ADENOSINE A1 AGONISTS FOR THE TREATMENT OF GLAUCOMA AND OCULAR HYPERTENSION
<b>C07D 277/20</b> (2006.01)	2610248 *	METHOD FOR PRODUCING PHENYL-SUBSTITUTED HETEROCYCLIC DERIVATIVE BY MEANS OF COUPLING METHOD USING A PALLADIUM COMPOUND	<b>A61K 31/4427</b> (2006.01)	2611415 *	ADENOSINE A1 AGONISTS FOR THE TREATMENT OF GLAUCOMA AND OCULAR HYPERTENSION
<b>C07D 277/56</b> (2006.01)	2610248 *	METHOD FOR PRODUCING PHENYL-SUBSTITUTED HETEROCYCLIC DERIVATIVE BY MEANS OF COUPLING METHOD USING A PALLADIUM COMPOUND	<b>A61K 31/4439</b> (2006.01)	2611415 *	ADENOSINE A1 AGONISTS FOR THE TREATMENT OF GLAUCOMA AND OCULAR HYPERTENSION
<b>A61K 31/426</b> (2006.01)	2610248 *	METHOD FOR PRODUCING PHENYL-SUBSTITUTED HETEROCYCLIC DERIVATIVE BY MEANS OF COUPLING METHOD USING A PALLADIUM COMPOUND	<b>A61P 27/06</b> (2006.01)	2611415 *	ADENOSINE A1 AGONISTS FOR THE TREATMENT OF GLAUCOMA AND OCULAR HYPERTENSION
			<b>F21S 8/00</b> (2006.01)	2402645	Illumination device
			<b>F21S 8/08</b> (2006.01)	2402645	Illumination device
			<b>F21V 21/116</b> (2006.01)	2402645	Illumination device
			<b>F21Y 101/02</b> (2006.01)	2402645	Illumination device
			<b>F21W 131/103</b> (2006.01)	2402645	Illumination device
			<b>G06F 21/44</b> (2013.01)	2634724	Adapter for electronic devices
			<b>G06F 21/85</b> (2013.01)	2634724	Adapter for electronic devices
			<b>G06F 13/38</b> (2006.01)	2634724	Adapter for electronic devices
			<b>C07D 513/04</b> (2006.01)	2643327 *	BENZOXAZEPINES AS INHIBITORS OF MTOR AND METHODS OF THEIR USE AND MANUFACTURE
			<b>A61K 31/437</b> (2006.01)	2643327 *	BENZOXAZEPINES AS INHIBITORS OF MTOR AND METHODS OF THEIR USE AND MANUFACTURE

MKP (51)	Broj objave evropske prijava patenta (97)	Naziv pronalaska (54)	MKP (51)	Broj objave evropske prijava patenta (97)	Naziv pronalaska (54)
<b>A61P 31/14</b> (2006.01)	2583680	Mono (PSI-7977) or combination treatment of DAAs for use in treating HCV	<b>A61K 9/00</b> (2006.01)	2632429 *	ORAL PHARMACEUTICAL FILM FORMULATION FOR BITTER-TASTING DRUGS
<b>A61K 31/4725</b> (2006.01)	2583680	Mono (PSI-7977) or combination treatment of DAAs for use in treating HCV	<b>A61K 9/70</b> (2006.01)	2632429 *	ORAL PHARMACEUTICAL FILM FORMULATION FOR BITTER-TASTING DRUGS
<b>A61K 31/501</b> (2006.01)	2583680	Mono (PSI-7977) or combination treatment of DAAs for use in treating HCV	<b>A61K 31/554</b> (2006.01)	2637668 *	IBAT INHIBITORS FOR THE TREATMENT OF LIVER DISEASES
<b>A61P 31/12</b> (2006.01)	2583680	Mono (PSI-7977) or combination treatment of DAAs for use in treating HCV	<b>A61P 1/16</b> (2006.01)	2637668 *	IBAT INHIBITORS FOR THE TREATMENT OF LIVER DISEASES
<b>A61K 45/06</b> (2006.01)	2583680	Mono (PSI-7977) or combination treatment of DAAs for use in treating HCV	<b>C08K 9/00</b> (2006.01)	2612881	Fillers for foamed rigid polymer products
<b>A61K 31/7072</b> (2006.01)	2583680	Mono (PSI-7977) or combination treatment of DAAs for use in treating HCV	<b>C08J 9/04</b> (2006.01)	2612881	Fillers for foamed rigid polymer products
<b>A61K 31/4178</b> (2006.01)	2583680	Mono (PSI-7977) or combination treatment of DAAs for use in treating HCV	<b>C08J 9/00</b> (2006.01)	2612881	Fillers for foamed rigid polymer products
<b>A61K 31/513</b> (2006.01)	2583680	Mono (PSI-7977) or combination treatment of DAAs for use in treating HCV	<b>C08K 3/26</b> (2006.01)	2612881	Fillers for foamed rigid polymer products
<b>A61K 31/5377</b> (2006.01)	2583680	Mono (PSI-7977) or combination treatment of DAAs for use in treating HCV	<b>C08K 9/04</b> (2006.01)	2612881	Fillers for foamed rigid polymer products
<b>A61K 31/4709</b> (2006.01)	2583680	Mono (PSI-7977) or combination treatment of DAAs for use in treating HCV	<b>B27M 1/08</b> (2006.01)	2598297 *	AUTOMATED DOOR ASSEMBLY, PRESS, AND ADHESIVE THEREFOR
<b>C07D 417/00</b> (2006.01)	2640387 *	METHOD OF TREATMENT WITH BRAF INHIBITOR	<b>B27M 3/18</b> (2006.01)	2598297 *	AUTOMATED DOOR ASSEMBLY, PRESS, AND ADHESIVE THEREFOR
<b>A61K 31/44</b> (2006.01)	2640387 *	METHOD OF TREATMENT WITH BRAF INHIBITOR	<b>B27G 11/00</b> (2006.01)	2598297 *	AUTOMATED DOOR ASSEMBLY, PRESS, AND ADHESIVE THEREFOR
<b>C07D 417/14</b> (2006.01)	2640387 *	METHOD OF TREATMENT WITH BRAF INHIBITOR	<b>G07B 15/02</b> (2011.01)	2279919	Device and method for preventing a parked car from being stolen and monitoring a parked car
<b>G01N 33/53</b> (2006.01)	2640387 *	METHOD OF TREATMENT WITH BRAF INHIBITOR	<b>G08G 1/14</b> (2006.01)	2279919	Device and method for preventing a parked car from being stolen and monitoring a parked car
<b>C07D 401/00</b> (2006.01)	2640387 *	METHOD OF TREATMENT WITH BRAF INHIBITOR	<b>G07F 17/24</b> (2006.01)	2279919	Device and method for preventing a parked car from being stolen and monitoring a parked car
<b>C12Q 1/68</b> (2006.01)	2640387 *	METHOD OF TREATMENT WITH BRAF INHIBITOR	<b>B60R 25/10</b> (2006.01)	2279919	Device and method for preventing a parked car from being stolen and monitoring a parked car
<b>A61K 31/4045</b> (2006.01)	2632429 *	ORAL PHARMACEUTICAL FILM FORMULATION FOR BITTER-TASTING DRUGS	<b>A61K 9/00</b> (2006.01)	2600829 *	PHARMACEUTICAL FORMULATION COMPRISING A PHOSPHODIESTERASE INHIBITOR
<b>A61K 47/02</b> (2006.01)	2632429 *	ORAL PHARMACEUTICAL FILM FORMULATION FOR BITTER-TASTING DRUGS	<b>A61K 31/44</b> (2006.01)	2600829 *	PHARMACEUTICAL FORMULATION COMPRISING A PHOSPHODIESTERASE INHIBITOR
<b>A61K 47/26</b> (2006.01)	2632429 *	ORAL PHARMACEUTICAL FILM FORMULATION FOR BITTER-TASTING DRUGS	<b>A61P 11/06</b> (2006.01)	2600829 *	PHARMACEUTICAL FORMULATION COMPRISING A PHOSPHODIESTERASE INHIBITOR
<b>A61K 31/519</b> (2006.01)	2632429 *	ORAL PHARMACEUTICAL FILM FORMULATION FOR BITTER-TASTING DRUGS	<b>A61P 9/12</b> (2006.01)	2601180 *	HIGHLY CRYSTALLINE VALSARTAN
<b>A61K 47/44</b> (2006.01)	2632429 *	ORAL PHARMACEUTICAL FILM FORMULATION FOR BITTER-TASTING DRUGS			
<b>A61K 31/495</b> (2006.01)	2632429 *	ORAL PHARMACEUTICAL FILM FORMULATION FOR BITTER-TASTING DRUGS			



MKP (51)	Broj objave evropske prijava patenta (97)	Naziv pronalaska (54)	MKP (51)	Broj objave evropske prijava patenta (97)	Naziv pronalaska (54)
<b>A61K 31/41</b> (2006.01)	2601180 *	HIGHLY CRYSTALLINE VALSARTAN	<b>A61K 31/497</b> (2006.01)	2606045 *	OXADIAZOLE INHIBITORS OF LEUKOTRIENE PRODUCTION
<b>C07D 257/04</b> (2006.01)	2601180 *	HIGHLY CRYSTALLINE VALSARTAN	<b>A61K 31/4985</b> (2006.01)	2606045 *	OXADIAZOLE INHIBITORS OF LEUKOTRIENE PRODUCTION
<b>A41D 1/06</b> (2006.01)	2630507 *	ELECTRICAL SYSTEM, METHOD, AND APPARATUS OF FINGERPRINT SENSOR USING ACOUSTIC IMPEDIOGRAPHY	<b>A61K 31/506</b> (2006.01)	2606045 *	OXADIAZOLE INHIBITORS OF LEUKOTRIENE PRODUCTION
<b>G01H 5/00</b> (2006.01)	2630507 *	ELECTRICAL SYSTEM, METHOD, AND APPARATUS OF FINGERPRINT SENSOR USING ACOUSTIC IMPEDIOGRAPHY	<b>A61K 31/5365</b> (2006.01)	2606045 *	OXADIAZOLE INHIBITORS OF LEUKOTRIENE PRODUCTION
<b>G01R 27/28</b> (2006.01)	2630507 *	ELECTRICAL SYSTEM, METHOD, AND APPARATUS OF FINGERPRINT SENSOR USING ACOUSTIC IMPEDIOGRAPHY	<b>A61K 31/5377</b> (2006.01)	2606045 *	OXADIAZOLE INHIBITORS OF LEUKOTRIENE PRODUCTION
<b>G08G 1/14</b> (2006.01)	2309472	Parking guidance system and method for operating a parking guidance system	<b>A61K 31/541</b> (2006.01)	2606045 *	OXADIAZOLE INHIBITORS OF LEUKOTRIENE PRODUCTION
<b>G02C 7/04</b> (2006.01)	2598938 *	A SILICONE HYDROGEL LENS WITH A CROSSLINKED HYDROPHILIC COATING	<b>A61P 9/00</b> (2006.01)	2606045 *	OXADIAZOLE INHIBITORS OF LEUKOTRIENE PRODUCTION
<b>B29D 11/00</b> (2006.01)	2598938 *	A SILICONE HYDROGEL LENS WITH A CROSSLINKED HYDROPHILIC COATING	<b>A61P 9/10</b> (2006.01)	2606045 *	OXADIAZOLE INHIBITORS OF LEUKOTRIENE PRODUCTION
<b>B05D 5/06</b> (2006.01)	2598938 *	A SILICONE HYDROGEL LENS WITH A CROSSLINKED HYDROPHILIC COATING	<b>A61P 29/00</b> (2006.01)	2606045 *	OXADIAZOLE INHIBITORS OF LEUKOTRIENE PRODUCTION
<b>C07D 211/60</b> (2006.01)	2632898 *	HETEROCYCLIC TYROSINE KINASE INHIBITORS	<b>A61P 37/08</b> (2006.01)	2606045 *	OXADIAZOLE INHIBITORS OF LEUKOTRIENE PRODUCTION
<b>A61K 31/40</b> (2006.01)	2640189 *	3-DEUTERO-POMALIDOMIDE	<b>A61P 11/00</b> (2006.01)	2606045 *	OXADIAZOLE INHIBITORS OF LEUKOTRIENE PRODUCTION
<b>A01N 43/38</b> (2006.01)	2640189 *	3-DEUTERO-POMALIDOMIDE	<b>A01N 43/42</b> (2006.01)	2597954 *	DEUTERATED N-ETHYL-N-PHENYL-1,2-DIHYDRO-4-HYDROXY-5-CHLORO-1-METHYL-2-OXOQUINOLINE-3-CARBOXAMIDE, SALTS AND USES THEREOF
<b>C07D 413/10</b> (2006.01)	2606045 *	OXADIAZOLE INHIBITORS OF LEUKOTRIENE PRODUCTION	<b>H02G 3/22</b> (2006.01)	2333924	Wall bushing for feeding through cables, cable protection tubes or other conduits
<b>C07D 413/14</b> (2006.01)	2606045 *	OXADIAZOLE INHIBITORS OF LEUKOTRIENE PRODUCTION	<b>H02G 15/013</b> (2006.01)	2333924	Wall bushing for feeding through cables, cable protection tubes or other conduits
<b>C07D 417/12</b> (2006.01)	2606045 *	OXADIAZOLE INHIBITORS OF LEUKOTRIENE PRODUCTION	<b>A61B 17/064</b> (2006.01)	2517635	Staple cartridge with implantable compressible portion and insertion cap
<b>C07D 417/14</b> (2006.01)	2606045 *	OXADIAZOLE INHIBITORS OF LEUKOTRIENE PRODUCTION	<b>A61B 17/072</b> (2006.01)	2517635	Staple cartridge with implantable compressible portion and insertion cap
<b>C07D 471/04</b> (2006.01)	2606045 *	OXADIAZOLE INHIBITORS OF LEUKOTRIENE PRODUCTION	<b>C07D 487/04</b> (2006.01)	2598507 *	ANTICANCER DERIVATIVES, PREPARATION THEREOF AND THERAPEUTIC USE THEREOF
<b>C07D 487/04</b> (2006.01)	2606045 *	OXADIAZOLE INHIBITORS OF LEUKOTRIENE PRODUCTION	<b>A61P 35/00</b> (2006.01)	2598507 *	ANTICANCER DERIVATIVES, PREPARATION THEREOF AND THERAPEUTIC USE THEREOF
<b>C07D 498/04</b> (2006.01)	2606045 *	OXADIAZOLE INHIBITORS OF LEUKOTRIENE PRODUCTION	<b>C07D 223/16</b> (2006.01)	2611781 *	FAST-DISSOLVE DOSAGE FORMS OF 5-HT2C AGONISTS
<b>A61K 31/437</b> (2006.01)	2606045 *	OXADIAZOLE INHIBITORS OF LEUKOTRIENE PRODUCTION			
<b>A61K 31/4439</b> (2006.01)	2606045 *	OXADIAZOLE INHIBITORS OF LEUKOTRIENE PRODUCTION			
<b>A61K 31/444</b> (2006.01)	2606045 *	OXADIAZOLE INHIBITORS OF LEUKOTRIENE PRODUCTION			

MKP (51)	Broj objave evropske prijava patenta (97)	Naziv pronalaska (54)	MKP (51)	Broj objave evropske prijava patenta (97)	Naziv pronalaska (54)
<b>A61K 31/55</b> (2006.01)	2611781 *	FAST-DISSOLVE DOSAGE FORMS OF 5-HT2C AGONISTS	<b>E04C 3/08</b> (2006.01)	2616199 *	DEVICE AND METHOD FOR EXPANDING METAL ELEMENTS
<b>A61P 3/04</b> (2006.01)	2611781 *	FAST-DISSOLVE DOSAGE FORMS OF 5-HT2C AGONISTS	<b>H04N 7/26</b> (2006.01)	2625856 *	SYSTEMS AND METHODS FOR ERROR RESILIENT SCHEME FOR LOW LATENCY H.264 VIDEO CODING
<b>C07K 14/71</b> (2006.01)	2601214 *	VEGF ANTAGONIST COMPOSITIONS AND USES THEREOF	<b>H04N 7/68</b> (2006.01)	2625856 *	SYSTEMS AND METHODS FOR ERROR RESILIENT SCHEME FOR LOW LATENCY H.264 VIDEO CODING
<b>B32B 27/18</b> (2006.01)	2619007 *	PRODUCT INCLUDING LACTIC ACID BACTERIA AND A DESICCANT	<b>H04L 12/46</b> (2006.01)	2617166 *	METHOD AND APPARATUS FOR REDUCING RECEIVER IDENTIFICATION OVERHEAD IN IP BROADCAST NETWORKS
<b>B65D 81/26</b> (2006.01)	2619007 *	PRODUCT INCLUDING LACTIC ACID BACTERIA AND A DESICCANT	<b>H04L 12/18</b> (2006.01)	2617166 *	METHOD AND APPARATUS FOR REDUCING RECEIVER IDENTIFICATION OVERHEAD IN IP BROADCAST NETWORKS
<b>A23L 1/30</b> (2006.01)	2619007 *	PRODUCT INCLUDING LACTIC ACID BACTERIA AND A DESICCANT	<b>F16B 37/12</b> (2006.01)	2557322	Fixing arrangement
<b>C07D 409/06</b> (2006.01)	2616445 *	ESTROGEN RECEPTOR MODULATORS AND USES THEREOF	<b>A61K 39/00</b> (2006.01)	2618835 *	ANTIGEN-SPECIFIC T CELL RECEPTORS AND T CELL EPITOPES
<b>C07D 401/06</b> (2006.01)	2616445 *	ESTROGEN RECEPTOR MODULATORS AND USES THEREOF	<b>C07K 14/705</b> (2006.01)	2618835 *	ANTIGEN-SPECIFIC T CELL RECEPTORS AND T CELL EPITOPES
<b>A61K 31/416</b> (2006.01)	2616445 *	ESTROGEN RECEPTOR MODULATORS AND USES THEREOF	<b>C07K 14/47</b> (2006.01)	2618835 *	ANTIGEN-SPECIFIC T CELL RECEPTORS AND T CELL EPITOPES
<b>A61K 31/4192</b> (2006.01)	2616445 *	ESTROGEN RECEPTOR MODULATORS AND USES THEREOF	<b>C07K 14/045</b> (2006.01)	2618835 *	ANTIGEN-SPECIFIC T CELL RECEPTORS AND T CELL EPITOPES
<b>A61P 35/00</b> (2006.01)	2616445 *	ESTROGEN RECEPTOR MODULATORS AND USES THEREOF	<b>F01B 17/02</b> (2006.01)	2625385 *	MONO-ENERGY AND/OR DUAL-ENERGY ENGINE WITH COMPRESSED AIR AND/OR ADDITIONAL ENERGY, COMPRISING AN ACTIVE CHAMBER INCLUDED IN THE CYLINDER
<b>C07D 231/56</b> (2006.01)	2616445 *	ESTROGEN RECEPTOR MODULATORS AND USES THEREOF	<b>F02G 1/02</b> (2006.01)	2625385 *	MONO-ENERGY AND/OR DUAL-ENERGY ENGINE WITH COMPRESSED AIR AND/OR ADDITIONAL ENERGY, COMPRISING AN ACTIVE CHAMBER INCLUDED IN THE CYLINDER
<b>C07D 249/18</b> (2006.01)	2616445 *	ESTROGEN RECEPTOR MODULATORS AND USES THEREOF	<b>F24J 2/42</b> (2006.01)	2625385 *	MONO-ENERGY AND/OR DUAL-ENERGY ENGINE WITH COMPRESSED AIR AND/OR ADDITIONAL ENERGY, COMPRISING AN ACTIVE CHAMBER INCLUDED IN THE CYLINDER
<b>C12Q 1/68</b> (2006.01)	2611931 *	GENOMIC MARKERS FOR PREDICTION OF LONG-TERM RESPONSE TO GROWTH HORMONE (GH) THERAPY	<b>A61K 9/00</b> (2006.01)	2629757 *	BRIMONIDINE GEL COMPOSITIONS AND METHODS OF USE
<b>C08K 3/08</b> (2006.01)	2603617 *	COMPOSITE PRODUCTS AND MANUFACTURING METHOD	<b>A61K 9/06</b> (2006.01)	2629757 *	BRIMONIDINE GEL COMPOSITIONS AND METHODS OF USE
<b>C10L 5/14</b> (2006.01)	2603617 *	COMPOSITE PRODUCTS AND MANUFACTURING METHOD			
<b>C08K 3/22</b> (2006.01)	2603617 *	COMPOSITE PRODUCTS AND MANUFACTURING METHOD			
<b>C22B 1/244</b> (2006.01)	2603617 *	COMPOSITE PRODUCTS AND MANUFACTURING METHOD			
<b>B21D 47/04</b> (2006.01)	2616199 *	DEVICE AND METHOD FOR EXPANDING METAL ELEMENTS			

MKP (51)	Broj objave evropske prijava patenta (97)	Naziv pronalaska (54)	MKP (51)	Broj objave evropske prijava patenta (97)	Naziv pronalaska (54)
<b>A61K 47/32</b> (2006.01)	2629757 *	BRIMONIDINE GEL COMPOSITIONS AND METHODS OF USE	<b>A61K 39/12</b> (2006.01)	2598165 *	IMMUNOGENIC ANTI- INFLAMMATORY COMPOSITIONS
<b>A61K 31/498</b> (2006.01)	2629757 *	BRIMONIDINE GEL COMPOSITIONS AND METHODS OF USE	<b>C07K 16/24</b> (2006.01)	2635601 *	ANTI-IL-23 ANTIBODIES
<b>G01N 33/574</b> (2006.01)	2638395 *	METHODS OF TREATING CANCER	<b>A61K 8/19</b> (2006.01)	2637640 *	SHINY, TRANSFER RESISTANT LIPSTICK AND METHOD OF MAKING
<b>G01N 33/574</b> (2006.01)	2612151 *	BIOMARKERS AND METHODS OF TREATMENT	<b>A61Q 1/00</b> (2006.01)	2637640 *	SHINY, TRANSFER RESISTANT LIPSTICK AND METHOD OF MAKING
<b>A61K 39/00</b> (2006.01)	2612151 *	BIOMARKERS AND METHODS OF TREATMENT	<b>A61K 8/97</b> (2006.01)	2637640 *	SHINY, TRANSFER RESISTANT LIPSTICK AND METHOD OF MAKING
<b>C07D 303/16</b> (2006.01)	2638023 *	CRYSTALLINE SOLIDS OF A METAP-2 INHIBITOR AND METHODS OF MAKING AND USING SAME	<b>A61K 8/72</b> (2006.01)	2637640 *	SHINY, TRANSFER RESISTANT LIPSTICK AND METHOD OF MAKING
<b>A61K 31/336</b> (2006.01)	2638023 *	CRYSTALLINE SOLIDS OF A METAP-2 INHIBITOR AND METHODS OF MAKING AND USING SAME	<b>A61K 8/92</b> (2006.01)	2637640 *	SHINY, TRANSFER RESISTANT LIPSTICK AND METHOD OF MAKING
<b>A61P 3/00</b> (2006.01)	2638023 *	CRYSTALLINE SOLIDS OF A METAP-2 INHIBITOR AND METHODS OF MAKING AND USING SAME	<b>A61Q 1/04</b> (2006.01)	2637640 *	SHINY, TRANSFER RESISTANT LIPSTICK AND METHOD OF MAKING
<b>G01N 33/66</b> (2006.01)	2630501 *	IMPROVED IDENTIFICATION OF PRE-DIABETES USING A COMBINATION OF MEAN GLUCOSE AND 1,5-ANHYDROGLUCITOL MARKERS	<b>C07D 239/42</b> (2006.01)	2640710 *	CRYSTALLINE PHARMACEUTICALLY ACTIVE INGREDIENTS
<b>G01N 33/68</b> (2006.01)	2630501 *	IMPROVED IDENTIFICATION OF PRE-DIABETES USING A COMBINATION OF MEAN GLUCOSE AND 1,5-ANHYDROGLUCITOL MARKERS	<b>C07D 403/12</b> (2006.01)	2630139 *	AMINO-PYRROLIDINE- AZETIDINE DIAMIDES AS MONOACYLGLYCEROL LIPASE INHIBITORS
<b>G01N 33/72</b> (2006.01)	2630501 *	IMPROVED IDENTIFICATION OF PRE-DIABETES USING A COMBINATION OF MEAN GLUCOSE AND 1,5-ANHYDROGLUCITOL MARKERS	<b>A61P 29/00</b> (2006.01)	2630139 *	AMINO-PYRROLIDINE- AZETIDINE DIAMIDES AS MONOACYLGLYCEROL LIPASE INHIBITORS
<b>A61P 1/00</b> (2006.01)	2598165 *	IMMUNOGENIC ANTI- INFLAMMATORY COMPOSITIONS	<b>C07D 417/14</b> (2006.01)	2630139 *	AMINO-PYRROLIDINE- AZETIDINE DIAMIDES AS MONOACYLGLYCEROL LIPASE INHIBITORS
<b>G01N 33/48</b> (2006.01)	2598165 *	IMMUNOGENIC ANTI- INFLAMMATORY COMPOSITIONS	<b>C07D 405/14</b> (2006.01)	2630139 *	AMINO-PYRROLIDINE- AZETIDINE DIAMIDES AS MONOACYLGLYCEROL LIPASE INHIBITORS
<b>A61P 29/00</b> (2006.01)	2598165 *	IMMUNOGENIC ANTI- INFLAMMATORY COMPOSITIONS	<b>A61K 31/427</b> (2006.01)	2630139 *	AMINO-PYRROLIDINE- AZETIDINE DIAMIDES AS MONOACYLGLYCEROL LIPASE INHIBITORS
<b>A61P 35/00</b> (2006.01)	2598165 *	IMMUNOGENIC ANTI- INFLAMMATORY COMPOSITIONS	<b>A61K 31/381</b> (2006.01)	2630139 *	AMINO-PYRROLIDINE- AZETIDINE DIAMIDES AS MONOACYLGLYCEROL LIPASE INHIBITORS
<b>A61K 39/00</b> (2006.01)	2598165 *	IMMUNOGENIC ANTI- INFLAMMATORY COMPOSITIONS	<b>A61K 31/4025</b> (2006.01)	2630139 *	AMINO-PYRROLIDINE- AZETIDINE DIAMIDES AS MONOACYLGLYCEROL LIPASE INHIBITORS
<b>A61K 39/02</b> (2006.01)	2598165 *	IMMUNOGENIC ANTI- INFLAMMATORY COMPOSITIONS	<b>C07D 409/14</b> (2006.01)	2630139 *	AMINO-PYRROLIDINE- AZETIDINE DIAMIDES AS MONOACYLGLYCEROL LIPASE INHIBITORS
			<b>A61P 25/00</b> (2006.01)	2630139 *	AMINO-PYRROLIDINE- AZETIDINE DIAMIDES AS MONOACYLGLYCEROL LIPASE INHIBITORS

MKP (51)	Broj objave evropske prijava patenta (97)	Naziv pronalaska (54)	MKP (51)	Broj objave evropske prijava patenta (97)	Naziv pronalaska (54)
<b>A61P 35/00</b> (2006.01)	2631233 *	ANTAGONIST FOR MUTATED ANDROGEN RECEPTOR	<b>B02C 13/14</b> (2006.01)	2635379 *	MILL FOR GRINDING RUBBISH
<b>A61K 31/506</b> (2006.01)	2631233 *	ANTAGONIST FOR MUTATED ANDROGEN RECEPTOR	<b>B02C 13/20</b> (2006.01)	2635379 *	MILL FOR GRINDING RUBBISH
<b>A61K 31/496</b> (2006.01)	2631233 *	ANTAGONIST FOR MUTATED ANDROGEN RECEPTOR	<b>B60K 28/02</b> (2006.01)	2633376 *	CONTROL SYSTEM WITH SOLID STATE TOUCH SENSOR FOR COMPLEX SURFACE GEOMETRY
<b>A61P 5/26</b> (2006.01)	2631233 *	ANTAGONIST FOR MUTATED ANDROGEN RECEPTOR	<b>B60W 50/08</b> (2012.01)	2633376 *	CONTROL SYSTEM WITH SOLID STATE TOUCH SENSOR FOR COMPLEX SURFACE GEOMETRY
<b>C07D 401/12</b> (2006.01)	2631233 *	ANTAGONIST FOR MUTATED ANDROGEN RECEPTOR	<b>B60W 40/08</b> (2012.01)	2633376 *	CONTROL SYSTEM WITH SOLID STATE TOUCH SENSOR FOR COMPLEX SURFACE GEOMETRY
<b>C07D 403/12</b> (2006.01)	2631233 *	ANTAGONIST FOR MUTATED ANDROGEN RECEPTOR	<b>G05G 9/02</b> (2006.01)	2633376 *	CONTROL SYSTEM WITH SOLID STATE TOUCH SENSOR FOR COMPLEX SURFACE GEOMETRY
<b>A61P 7/04</b> (2006.01)	2632479 *	FVIII PEPTIDES FOR IMMUNE TOLERANCE INDUCTION AND IMMUNODIAGNOSTICS	<b>B65D 47/32</b> (2006.01)	2601105 *	VIAL PREPARATION METHOD AND SYSTEM
<b>A61K 38/37</b> (2006.01)	2632479 *	FVIII PEPTIDES FOR IMMUNE TOLERANCE INDUCTION AND IMMUNODIAGNOSTICS	<b>B65B 31/02</b> (2006.01)	2601105 *	VIAL PREPARATION METHOD AND SYSTEM
<b>C07K 14/755</b> (2006.01)	2632479 *	FVIII PEPTIDES FOR IMMUNE TOLERANCE INDUCTION AND IMMUNODIAGNOSTICS	<b>E05D 7/08</b> (2006.01)	2611980 *	GUIDE ASSEMBLY
<b>A23J 1/14</b> (2006.01)	2642873 *	ASTRINGENCY IN SOY PROTEIN SOLUTIONS	<b>E05D 7/02</b> (2006.01)	2611980 *	GUIDE ASSEMBLY
<b>A23J 3/16</b> (2006.01)	2642873 *	ASTRINGENCY IN SOY PROTEIN SOLUTIONS	<b>E05D 15/26</b> (2006.01)	2611980 *	GUIDE ASSEMBLY
<b>B29C 53/08</b> (2006.01)	2608946 *	BENDING PVC PROFILES USING LASER AND PLC CONTROLLING SYSTEM	<b>B31F 5/06</b> (2006.01)	2627504 *	COMPONENT CARRIER REEL SPLICING TAPE
<b>G05B 19/19</b> (2006.01)	2608946 *	BENDING PVC PROFILES USING LASER AND PLC CONTROLLING SYSTEM	<b>C09J 7/02</b> (2006.01)	2627504 *	COMPONENT CARRIER REEL SPLICING TAPE
<b>C07D 409/04</b> (2006.01)	2595983 *	2,3,5-TRISUBSTITUTED THIOPHENE COMPOUNDS AND USES THEREOF	<b>H04B 1/38</b> (2006.01)	2302815	Helmet-attachable communication device
<b>C07D 409/14</b> (2006.01)	2595983 *	2,3,5-TRISUBSTITUTED THIOPHENE COMPOUNDS AND USES THEREOF	<b>C07H 21/00</b> (2006.01)	2625188 *	MOLECULAR DETERMINANT-BASED TYPING OF KIR ALLELES AND KIR-LIGANDS
<b>C07D 413/04</b> (2006.01)	2595983 *	2,3,5-TRISUBSTITUTED THIOPHENE COMPOUNDS AND USES THEREOF	<b>G01N 33/48</b> (2006.01)	2625188 *	MOLECULAR DETERMINANT-BASED TYPING OF KIR ALLELES AND KIR-LIGANDS
<b>C07D 413/14</b> (2006.01)	2595983 *	2,3,5-TRISUBSTITUTED THIOPHENE COMPOUNDS AND USES THEREOF	<b>F16L 39/00</b> (2006.01)	2638317 *	DEVICE FOR THE SECURED CONNECTION OF TWO END FITTINGS, PARTICULARLY OF A PIPE
<b>C07D 417/14</b> (2006.01)	2595983 *	2,3,5-TRISUBSTITUTED THIOPHENE COMPOUNDS AND USES THEREOF	<b>F16L 19/00</b> (2006.01)	2638317 *	DEVICE FOR THE SECURED CONNECTION OF TWO END FITTINGS, PARTICULARLY OF A PIPE
<b>C07D 487/04</b> (2006.01)	2595983 *	2,3,5-TRISUBSTITUTED THIOPHENE COMPOUNDS AND USES THEREOF	<b>A61K 9/70</b> (2006.01)	2632443 *	PREPARATION OF ORODISPERSIBLE FILMS
<b>C07D 498/04</b> (2006.01)	2595983 *	2,3,5-TRISUBSTITUTED THIOPHENE COMPOUNDS AND USES THEREOF	<b>C08G 14/06</b> (2006.01)	2609129 *	PHENOLIC RESIN, METHOD FOR PREPARING SAME, SIZING COMPOSITION FOR MINERAL FIBERS AND RESULTING PRODUCT
<b>A61K 31/381</b> (2006.01)	2595983 *	2,3,5-TRISUBSTITUTED THIOPHENE COMPOUNDS AND USES THEREOF			
<b>A61P 31/12</b> (2006.01)	2595983 *	2,3,5-TRISUBSTITUTED THIOPHENE COMPOUNDS AND USES THEREOF			

MKP (51)	Broj objave evropske prijava patenta (97)	Naziv pronalaska (54)	MKP (51)	Broj objave evropske prijava patenta (97)	Naziv pronalaska (54)
<b>C09J 161/34</b> (2006.01)	2609129 *	PHENOLIC RESIN, METHOD FOR PREPARING SAME, SIZING COMPOSITION FOR MINERAL FIBERS AND RESULTING PRODUCT	<b>C07D 417/14</b> (2006.01)	2595981 *	NOVEL HETARYL (THIO)CARBOXAMIDE COMPOUNDS FOR CONTROLLING INVERTEBRATE PESTS
<b>C03C 25/34</b> (2006.01)	2609129 *	PHENOLIC RESIN, METHOD FOR PREPARING SAME, SIZING COMPOSITION FOR MINERAL FIBERS AND RESULTING PRODUCT	<b>A01N 43/60</b> (2006.01)	2595981 *	NOVEL HETARYL (THIO)CARBOXAMIDE COMPOUNDS FOR CONTROLLING INVERTEBRATE PESTS
<b>C08K 5/053</b> (2006.01)	2609129 *	PHENOLIC RESIN, METHOD FOR PREPARING SAME, SIZING COMPOSITION FOR MINERAL FIBERS AND RESULTING PRODUCT	<b>A01N 43/80</b> (2006.01)	2595981 *	NOVEL HETARYL (THIO)CARBOXAMIDE COMPOUNDS FOR CONTROLLING INVERTEBRATE PESTS
<b>C08K 5/21</b> (2006.01)	2609129 *	PHENOLIC RESIN, METHOD FOR PREPARING SAME, SIZING COMPOSITION FOR MINERAL FIBERS AND RESULTING PRODUCT	<b>F16M 13/02</b> (2006.01)	2601432 *	IN-WALL DOCK FOR A TABLET COMPUTER
<b>F16L 59/00</b> (2006.01)	2609129 *	PHENOLIC RESIN, METHOD FOR PREPARING SAME, SIZING COMPOSITION FOR MINERAL FIBERS AND RESULTING PRODUCT	<b>G06F 1/16</b> (2006.01)	2601432 *	IN-WALL DOCK FOR A TABLET COMPUTER
<b>C07D 401/12</b> (2006.01)	2595981 *	NOVEL HETARYL (THIO)CARBOXAMIDE COMPOUNDS FOR CONTROLLING INVERTEBRATE PESTS	<b>F16M 11/10</b> (2006.01)	2601432 *	IN-WALL DOCK FOR A TABLET COMPUTER
<b>C07D 401/14</b> (2006.01)	2595981 *	NOVEL HETARYL (THIO)CARBOXAMIDE COMPOUNDS FOR CONTROLLING INVERTEBRATE PESTS	<b>F16K 17/04</b> (2006.01)	2559926	Safety valve
<b>C07D 403/12</b> (2006.01)	2595981 *	NOVEL HETARYL (THIO)CARBOXAMIDE COMPOUNDS FOR CONTROLLING INVERTEBRATE PESTS	<b>C07D 277/68</b> (2006.01)	2643307 *	NITROBENZOTHIAZOLE DERIVATIVES AND USE THEREOF FOR TREATING TUBERCULOSIS
<b>C07D 403/14</b> (2006.01)	2595981 *	NOVEL HETARYL (THIO)CARBOXAMIDE COMPOUNDS FOR CONTROLLING INVERTEBRATE PESTS	<b>A61P 31/00</b> (2006.01)	2643307 *	NITROBENZOTHIAZOLE DERIVATIVES AND USE THEREOF FOR TREATING TUBERCULOSIS
<b>C07D 407/14</b> (2006.01)	2595981 *	NOVEL HETARYL (THIO)CARBOXAMIDE COMPOUNDS FOR CONTROLLING INVERTEBRATE PESTS	<b>A61K 31/428</b> (2006.01)	2643307 *	NITROBENZOTHIAZOLE DERIVATIVES AND USE THEREOF FOR TREATING TUBERCULOSIS
<b>C07D 413/12</b> (2006.01)	2595981 *	NOVEL HETARYL (THIO)CARBOXAMIDE COMPOUNDS FOR CONTROLLING INVERTEBRATE PESTS	<b>C07D 417/12</b> (2006.01)	2643307 *	NITROBENZOTHIAZOLE DERIVATIVES AND USE THEREOF FOR TREATING TUBERCULOSIS
<b>C07D 417/12</b> (2006.01)	2595981 *	NOVEL HETARYL (THIO)CARBOXAMIDE COMPOUNDS FOR CONTROLLING INVERTEBRATE PESTS	<b>C07D 489/12</b> (2006.01)	2619212 *	BUPRENORPHINE ANALOGS
			<b>A61K 31/485</b> (2006.01)	2619212 *	BUPRENORPHINE ANALOGS
			<b>A61P 25/04</b> (2006.01)	2619212 *	BUPRENORPHINE ANALOGS
			<b>B24D 3/14</b> (2006.01)	2567784	Bonded abrasive article
			<b>A61K 31/46</b> (2006.01)	2623499 *	1,2,4-TRIAZOLONE DERIVATIVE
			<b>A61P 25/00</b> (2006.01)	2623499 *	1,2,4-TRIAZOLONE DERIVATIVE
			<b>A61P 29/00</b> (2006.01)	2623499 *	1,2,4-TRIAZOLONE DERIVATIVE
			<b>A61K 31/5377</b> (2006.01)	2623499 *	1,2,4-TRIAZOLONE DERIVATIVE
			<b>A61P 25/08</b> (2006.01)	2623499 *	1,2,4-TRIAZOLONE DERIVATIVE

MKP (51)	Broj objave evropske prijava patenta (97)	Naziv pronalaska (54)	MKP (51)	Broj objave evropske prijava patenta (97)	Naziv pronalaska (54)
<b>A61K 31/5386</b> (2006.01)	2623499 *	1,2,4-TRIAZOLONE DERIVATIVE	<b>G01V 3/10</b> (2006.01)	2606379 *	METAL DETECTOR AND GROUND-PENETRATING RADAR HYBRID HEAD AND MANUFACTURING METHOD THEREOF
<b>A61P 25/14</b> (2006.01)	2623499 *	1,2,4-TRIAZOLONE DERIVATIVE	<b>C12N 9/64</b> (2006.01)	2635677 *	MODIFIED FACTOR IX POLYPEPTIDES AND USES THEREOF
<b>C07D 249/12</b> (2006.01)	2623499 *	1,2,4-TRIAZOLONE DERIVATIVE	<b>A61K 9/00</b> (2006.01)	2608769 *	HUMIDIFIED PARTICLES COMPRISING A THERAPEUTICALLY ACTIVE SUBSTANCE
<b>A61P 7/10</b> (2006.01)	2623499 *	1,2,4-TRIAZOLONE DERIVATIVE	<b>D04H 1/56</b> (2006.01)	2603626 *	PROCESS AND APPARATUS FOR SPINNING FIBRES AND IN PARTICULAR FOR PRODUCING A FIBROUS-CONTAINING NONWOVEN
<b>A61P 25/18</b> (2006.01)	2623499 *	1,2,4-TRIAZOLONE DERIVATIVE	<b>D01D 4/02</b> (2006.01)	2603626 *	PROCESS AND APPARATUS FOR SPINNING FIBRES AND IN PARTICULAR FOR PRODUCING A FIBROUS-CONTAINING NONWOVEN
<b>A61K 31/4196</b> (2006.01)	2623499 *	1,2,4-TRIAZOLONE DERIVATIVE	<b>D01D 5/098</b> (2006.01)	2603626 *	PROCESS AND APPARATUS FOR SPINNING FIBRES AND IN PARTICULAR FOR PRODUCING A FIBROUS-CONTAINING NONWOVEN
<b>A61P 9/12</b> (2006.01)	2623499 *	1,2,4-TRIAZOLONE DERIVATIVE	<b>H02M 5/16</b> (2006.01)	2549638	Power supply assembly for a reactor for polysilicon production with a frequency converter
<b>A61P 25/22</b> (2006.01)	2623499 *	1,2,4-TRIAZOLONE DERIVATIVE	<b>C11D 1/37</b> (2006.01)	2638137 *	BALL-SHAPED TOILET BLOCKS BASED ON ANIONIC SURFACTANTS
<b>A61K 31/454</b> (2006.01)	2623499 *	1,2,4-TRIAZOLONE DERIVATIVE	<b>C11D 3/50</b> (2006.01)	2638137 *	BALL-SHAPED TOILET BLOCKS BASED ON ANIONIC SURFACTANTS
<b>A61P 17/02</b> (2006.01)	2623499 *	1,2,4-TRIAZOLONE DERIVATIVE	<b>C11D 17/00</b> (2006.01)	2638137 *	BALL-SHAPED TOILET BLOCKS BASED ON ANIONIC SURFACTANTS
<b>A61P 25/28</b> (2006.01)	2623499 *	1,2,4-TRIAZOLONE DERIVATIVE	<b>E03D 9/02</b> (2006.01)	2638137 *	BALL-SHAPED TOILET BLOCKS BASED ON ANIONIC SURFACTANTS
<b>A61K 31/4545</b> (2006.01)	2623499 *	1,2,4-TRIAZOLONE DERIVATIVE	<b>C11D 3/48</b> (2006.01)	2638137 *	BALL-SHAPED TOILET BLOCKS BASED ON ANIONIC SURFACTANTS
<b>A61P 17/14</b> (2006.01)	2623499 *	1,2,4-TRIAZOLONE DERIVATIVE	<b>G06Q 20/00</b> (2012.01)	2638512 *	METHOD OF CONDUCTING FINANCIAL TRANSACTIONS WHERE A PAYER'S FINANCIAL ACCOUNT INFORMATION IS ENTERED ONLY ONCE WITH A PAYMENT SYSTEM
<b>A61P 25/36</b> (2006.01)	2623499 *	1,2,4-TRIAZOLONE DERIVATIVE	<b>F16L 19/06</b> (2006.01)	2609354 *	TUBE CONNECTION
<b>A61K 31/553</b> (2006.01)	2623499 *	1,2,4-TRIAZOLONE DERIVATIVE	<b>A61K 31/785</b> (2006.01)	2632435 *	LIPOSOMAL DRUG COMPOSITION CONTAINING A POLYMERIC GUANIDINE DERIVATIVE
<b>A61P 25/16</b> (2006.01)	2623499 *	1,2,4-TRIAZOLONE DERIVATIVE	<b>A61P 35/00</b> (2006.01)	2632435 *	LIPOSOMAL DRUG COMPOSITION CONTAINING A POLYMERIC GUANIDINE DERIVATIVE
<b>B65B 65/00</b> (2006.01)	2578502	Method and apparatus for producing cut to length bars in a steel mill			
<b>B23D 36/00</b> (2006.01)	2578502	Method and apparatus for producing cut to length bars in a steel mill			
<b>B65B 27/10</b> (2006.01)	2578502	Method and apparatus for producing cut to length bars in a steel mill			
<b>B21B 15/00</b> (2006.01)	2578502	Method and apparatus for producing cut to length bars in a steel mill			
<b>A61N 5/01</b> (2006.01)	2605828 *	AUTOMATED TREATMENT PLANNING FOR RADIATION THERAPY			
<b>G01S 13/02</b> (2006.01)	2606379 *	METAL DETECTOR AND GROUND-PENETRATING RADAR HYBRID HEAD AND MANUFACTURING METHOD THEREOF			

MKP (51)	Broj objave evropske prijave patenta (97)	Naziv pronalaska (54)	MKP (51)	Broj objave evropske prijave patenta (97)	Naziv pronalaska (54)
<b>A61K 47/24</b> (2006.01)	2632435 *	LIPOSOMAL DRUG COMPOSITION CONTAINING A POLYMERIC GUANIDINE DERIVATIVE	<b>F02M 63/00</b> (2006.01)	2535554	Electro-valve for discharging common rail
<b>A61K 9/127</b> (2006.01)	2632435 *	LIPOSOMAL DRUG COMPOSITION CONTAINING A POLYMERIC GUANIDINE DERIVATIVE	<b>F16K 31/06</b> (2006.01)	2535554	Electro-valve for discharging common rail
<b>A61K 9/00</b> (2006.01)	2632435 *	LIPOSOMAL DRUG COMPOSITION CONTAINING A POLYMERIC GUANIDINE DERIVATIVE	<b>A61K 39/21</b> (2006.01)	2621528 *	VACCINE
<b>A61K 31/155</b> (2006.01)	2632435 *	LIPOSOMAL DRUG COMPOSITION CONTAINING A POLYMERIC GUANIDINE DERIVATIVE	<b>F03D 11/04</b> (2006.01)	2640912 *	A SAFETY NET FOR MOUNTING IN A WIND TURBINE TOWER
<b>B29B 17/02</b> (2006.01)	2635418 *	IMPROVEMENTS IN WASTE PROCESSING	<b>E04G 21/32</b> (2006.01)	2640912 *	A SAFETY NET FOR MOUNTING IN A WIND TURBINE TOWER
<b>F26B 23/02</b> (2006.01)	2635418 *	IMPROVEMENTS IN WASTE PROCESSING	<b>A61K 31/4188</b> (2006.01)	2640383 *	METHOD FOR TREATING BREAST CANCER AND OVARIAN CANCER
<b>C10J 3/66</b> (2006.01)	2635418 *	IMPROVEMENTS IN WASTE PROCESSING	<b>C07D 413/14</b> (2006.01)	2643319 *	BENZOXAZEPINES AS INHIBITORS OF PI3K/MTOR AND METHODS OF THEIR USE AND MANUFACTURE
<b>B04B 15/02</b> (2006.01)	2635418 *	IMPROVEMENTS IN WASTE PROCESSING	<b>A61K 31/423</b> (2006.01)	2643319 *	BENZOXAZEPINES AS INHIBITORS OF PI3K/MTOR AND METHODS OF THEIR USE AND MANUFACTURE
<b>H01B 15/00</b> (2006.01)	2635418 *	IMPROVEMENTS IN WASTE PROCESSING	<b>A61P 1/12</b> (2006.01)	2637646 *	A PHARMACEUTICAL COMBINATION COMPRISING AN IBAT INHIBITOR AND A BILE ACID BINDER
<b>C07D 235/30</b> (2006.01)	2606036 *	NEW COMPOUNDS	<b>A61K 9/52</b> (2006.01)	2637646 *	A PHARMACEUTICAL COMBINATION COMPRISING AN IBAT INHIBITOR AND A BILE ACID BINDER
<b>A61K 31/4184</b> (2006.01)	2606036 *	NEW COMPOUNDS	<b>A61K 31/785</b> (2006.01)	2637646 *	A PHARMACEUTICAL COMBINATION COMPRISING AN IBAT INHIBITOR AND A BILE ACID BINDER
<b>A61P 11/00</b> (2006.01)	2606036 *	NEW COMPOUNDS	<b>A61K 31/554</b> (2006.01)	2637646 *	A PHARMACEUTICAL COMBINATION COMPRISING AN IBAT INHIBITOR AND A BILE ACID BINDER
<b>A61P 29/00</b> (2006.01)	2606036 *	NEW COMPOUNDS	<b>A61P 1/16</b> (2006.01)	2637646 *	A PHARMACEUTICAL COMBINATION COMPRISING AN IBAT INHIBITOR AND A BILE ACID BINDER
<b>A61P 11/00</b> (2006.01)	2630149 *	QUINAZOLIN-4 (3H) -ONE DERIVATIVES USED AS PI3 KINASE INHIBITORS	<b>A61P 3/00</b> (2006.01)	2637646 *	A PHARMACEUTICAL COMBINATION COMPRISING AN IBAT INHIBITOR AND A BILE ACID BINDER
<b>C07D 487/04</b> (2006.01)	2630149 *	QUINAZOLIN-4 (3H) -ONE DERIVATIVES USED AS PI3 KINASE INHIBITORS	<b>C07C 323/52</b> (2006.01)	2614049 *	PLEUROMUTILIN DERIVATIVES FOR USE IN THE TREATMENT OF DISEASES MEDIATED BY MICROBES
<b>A61P 19/02</b> (2006.01)	2630149 *	QUINAZOLIN-4 (3H) -ONE DERIVATIVES USED AS PI3 KINASE INHIBITORS	<b>A61K 31/215</b> (2006.01)	2614049 *	PLEUROMUTILIN DERIVATIVES FOR USE IN THE TREATMENT OF DISEASES MEDIATED BY MICROBES
<b>A61P 11/06</b> (2006.01)	2630149 *	QUINAZOLIN-4 (3H) -ONE DERIVATIVES USED AS PI3 KINASE INHIBITORS	<b>A61P 31/00</b> (2006.01)	2614049 *	PLEUROMUTILIN DERIVATIVES FOR USE IN THE TREATMENT OF DISEASES MEDIATED BY MICROBES
<b>A61P 17/00</b> (2006.01)	2630149 *	QUINAZOLIN-4 (3H) -ONE DERIVATIVES USED AS PI3 KINASE INHIBITORS			
<b>A61K 31/519</b> (2006.01)	2630149 *	QUINAZOLIN-4 (3H) -ONE DERIVATIVES USED AS PI3 KINASE INHIBITORS			
<b>A61P 35/00</b> (2006.01)	2630149 *	QUINAZOLIN-4 (3H) -ONE DERIVATIVES USED AS PI3 KINASE INHIBITORS			
<b>F02M 61/12</b> (2006.01)	2535554	Electro-valve for discharging common rail			
<b>F02M 63/02</b> (2006.01)	2535554	Electro-valve for discharging common rail			

MKP (51)	Broj objave evropske prijava patenta (97)	Naziv pronalaska (54)	MKP (51)	Broj objave evropske prijava patenta (97)	Naziv pronalaska (54)
<b>C07D 413/12</b> (2006.01)	2640698 *	NAMPT AND ROCK INHIBITORS	<b>A01P 21/00</b> (2006.01)	2635278 *	PESTICIDAL COMPOSITIONS AND PROCESSES RELATED THERETO
<b>C07D 471/04</b> (2006.01)	2640698 *	NAMPT AND ROCK INHIBITORS	<b>C07D 417/14</b> (2006.01)	2635278 *	PESTICIDAL COMPOSITIONS AND PROCESSES RELATED THERETO
<b>C07D 403/12</b> (2006.01)	2640698 *	NAMPT AND ROCK INHIBITORS	<b>A01P 13/00</b> (2006.01)	2635278 *	PESTICIDAL COMPOSITIONS AND PROCESSES RELATED THERETO
<b>A61P 9/10</b> (2006.01)	2640698 *	NAMPT AND ROCK INHIBITORS	<b>A01H 5/10</b> (2006.01)	2635278 *	PESTICIDAL COMPOSITIONS AND PROCESSES RELATED THERETO
<b>C07D 209/44</b> (2006.01)	2640698 *	NAMPT AND ROCK INHIBITORS	<b>A61K 31/444</b> (2006.01)	2635278 *	PESTICIDAL COMPOSITIONS AND PROCESSES RELATED THERETO
<b>A61P 35/00</b> (2006.01)	2640698 *	NAMPT AND ROCK INHIBITORS	<b>A01P 9/00</b> (2006.01)	2635278 *	PESTICIDAL COMPOSITIONS AND PROCESSES RELATED THERETO
<b>C07D 407/12</b> (2006.01)	2640698 *	NAMPT AND ROCK INHIBITORS	<b>A01N 25/34</b> (2006.01)	2635278 *	PESTICIDAL COMPOSITIONS AND PROCESSES RELATED THERETO
<b>A61K 31/407</b> (2006.01)	2640698 *	NAMPT AND ROCK INHIBITORS	<b>A01P 11/00</b> (2006.01)	2635278 *	PESTICIDAL COMPOSITIONS AND PROCESSES RELATED THERETO
<b>A61K 31/4035</b> (2006.01)	2640698 *	NAMPT AND ROCK INHIBITORS	<b>C07D 211/58</b> (2006.01)	2619180 *	5-HT2B RECEPTOR ANTAGONISTS
<b>C07D 407/14</b> (2006.01)	2640698 *	NAMPT AND ROCK INHIBITORS	<b>A61P 11/00</b> (2006.01)	2619180 *	5-HT2B RECEPTOR ANTAGONISTS
<b>A61N 1/05</b> (2006.01)	2629839 *	OPTICAL CONTROL OF CARDIAC FUNCTION	<b>A61K 31/4468</b> (2006.01)	2619180 *	5-HT2B RECEPTOR ANTAGONISTS
<b>A01P 7/04</b> (2006.01)	2635278 *	PESTICIDAL COMPOSITIONS AND PROCESSES RELATED THERETO	<b>C04B 35/581</b> (2006.01)	2595940 *	POLYCRYSTALLINE ALUMINUM NITRIDE MATERIAL AND METHOD OF PRODUCTION THEREOF
<b>A01P 17/00</b> (2006.01)	2635278 *	PESTICIDAL COMPOSITIONS AND PROCESSES RELATED THERETO	<b>H01L 21/683</b> (2006.01)	2595940 *	POLYCRYSTALLINE ALUMINUM NITRIDE MATERIAL AND METHOD OF PRODUCTION THEREOF
<b>A01P 5/00</b> (2006.01)	2635278 *	PESTICIDAL COMPOSITIONS AND PROCESSES RELATED THERETO	<b>H01L 23/15</b> (2006.01)	2595940 *	POLYCRYSTALLINE ALUMINUM NITRIDE MATERIAL AND METHOD OF PRODUCTION THEREOF
<b>A01P 23/00</b> (2006.01)	2635278 *	PESTICIDAL COMPOSITIONS AND PROCESSES RELATED THERETO	<b>B65D 41/14</b> (2006.01)	2639178 *	SEALING MEMBER FOR CONTAINER
<b>C07D 401/14</b> (2006.01)	2635278 *	PESTICIDAL COMPOSITIONS AND PROCESSES RELATED THERETO	<b>B65D 47/36</b> (2006.01)	2639178 *	SEALING MEMBER FOR CONTAINER
<b>A01P 3/00</b> (2006.01)	2635278 *	PESTICIDAL COMPOSITIONS AND PROCESSES RELATED THERETO	<b>B65D 41/20</b> (2006.01)	2639178 *	SEALING MEMBER FOR CONTAINER
<b>A01P 15/00</b> (2006.01)	2635278 *	PESTICIDAL COMPOSITIONS AND PROCESSES RELATED THERETO	<b>B65D 53/04</b> (2006.01)	2639178 *	SEALING MEMBER FOR CONTAINER
<b>A61K 31/4439</b> (2006.01)	2635278 *	PESTICIDAL COMPOSITIONS AND PROCESSES RELATED THERETO	<b>A61M 5/145</b> (2006.01)	2600922 *	CARTRIDGE HOLDER AND METHOD FOR ASSEMBLING A CARTRIDGE UNIT FOR A DRUG DELIVERY DEVICE
<b>A01P 7/02</b> (2006.01)	2635278 *	PESTICIDAL COMPOSITIONS AND PROCESSES RELATED THERETO	<b>A61M 5/315</b> (2006.01)	2600922 *	CARTRIDGE HOLDER AND METHOD FOR ASSEMBLING A CARTRIDGE UNIT FOR A DRUG DELIVERY DEVICE
<b>A01P 19/00</b> (2006.01)	2635278 *	PESTICIDAL COMPOSITIONS AND PROCESSES RELATED THERETO	<b>C07D 471/04</b> (2006.01)	2624698 *	FUORO[3,2-d]PYRIMIDINE COMPOUNDS
<b>C07D 401/04</b> (2006.01)	2635278 *	PESTICIDAL COMPOSITIONS AND PROCESSES RELATED THERETO			
<b>A01P 1/00</b> (2006.01)	2635278 *	PESTICIDAL COMPOSITIONS AND PROCESSES RELATED THERETO			



MKP (51)	Broj objave evropske prijava patenta (97)	Naziv pronalaska (54)	MKP (51)	Broj objave evropske prijava patenta (97)	Naziv pronalaska (54)
<b>C07D 239/42</b> (2006.01)	2624698 *	FURO[3,2-d]PYRIMIDINE COMPOUNDS	<b>C12N 15/13</b> (2006.01)	2606065 *	IMPROVED ANTI-SERUM ALBUMIN BINDING VARIANTS
<b>A01N 43/54</b> (2006.01)	2624698 *	FURO[3,2-d]PYRIMIDINE COMPOUNDS	<b>C07D 401/14</b> (2006.01)	2638033 *	COMPOUNDS USEFUL FOR INHIBITING CHK1
<b>A61B 17/128</b> (2006.01)	2627260 *	SURGICAL CLAMPING DEVICES AND TOOLS FOR USE THEREWITH	<b>A61K 31/4995</b> (2006.01)	2638033 *	COMPOUNDS USEFUL FOR INHIBITING CHK1
<b>A61B 17/00</b> (2006.01)	2627260 *	SURGICAL CLAMPING DEVICES AND TOOLS FOR USE THEREWITH	<b>A61P 35/00</b> (2006.01)	2638033 *	COMPOUNDS USEFUL FOR INHIBITING CHK1
<b>A61B 17/122</b> (2006.01)	2627260 *	SURGICAL CLAMPING DEVICES AND TOOLS FOR USE THEREWITH	<b>E01C 5/00</b> (2006.01)	2619369 *	IMPROVEMENTS RELATING TO TILES OR PAVING PIECES
<b>A61K 39/00</b> (2006.01)	2632482 *	CHIMERIC CD27 RECEPTORS FOR REDIRECTING T CELLS TO CD70-POSITIVE MALIGNANCIES	<b>C12P 7/64</b> (2006.01)	2636747 *	PROCESS FOR PREPARING BIODIESEL FROM RENEWABLE GREASE WITH LIPASE AS CATALYST AND ONLINE DEHYDRATION
<b>F16D 1/116</b> (2006.01)	2606250 *	PROTECTIVE CASING WITH A MOVABLE LEVER FOR A COUPLING SPLINED YOKE WITH A SAFETY PIN	<b>A61B 17/24</b> (2006.01)	2611369 *	DEVICES FOR DILATING A PARANASAL SINUS OPENING AND FOR TREATING SINUSITIS
<b>F16D 3/38</b> (2006.01)	2606250 *	PROTECTIVE CASING WITH A MOVABLE LEVER FOR A COUPLING SPLINED YOKE WITH A SAFETY PIN	<b>A61B 17/34</b> (2006.01)	2611369 *	DEVICES FOR DILATING A PARANASAL SINUS OPENING AND FOR TREATING SINUSITIS
<b>F16D 3/84</b> (2006.01)	2606250 *	PROTECTIVE CASING WITH A MOVABLE LEVER FOR A COUPLING SPLINED YOKE WITH A SAFETY PIN	<b>A61F 2/18</b> (2006.01)	2611369 *	DEVICES FOR DILATING A PARANASAL SINUS OPENING AND FOR TREATING SINUSITIS
<b>C10L 5/38</b> (2006.01)	2614130 *	FUEL AND COMBUSTIBLE MIXTURE USED AS A SUBSTITUTE FOR FOSSIL FUELS IN THERMOELECTRIC POWER PLANTS, INDUSTRIAL AND CENTRAL HEATING FURNACES	<b>A61M 29/00</b> (2006.01)	2611369 *	DEVICES FOR DILATING A PARANASAL SINUS OPENING AND FOR TREATING SINUSITIS
<b>C10L 7/02</b> (2006.01)	2614130 *	FUEL AND COMBUSTIBLE MIXTURE USED AS A SUBSTITUTE FOR FOSSIL FUELS IN THERMOELECTRIC POWER PLANTS, INDUSTRIAL AND CENTRAL HEATING FURNACES	<b>C09K 5/18</b> (2006.01)	2619279 *	FLEXIBLE CONTAINER HAVING A BUILT-IN AUTO -HEATING OR AUTO - REFRIGERATING ELEMENT.
<b>C10L 8/00</b> (2006.01)	2614130 *	FUEL AND COMBUSTIBLE MIXTURE USED AS A SUBSTITUTE FOR FOSSIL FUELS IN THERMOELECTRIC POWER PLANTS, INDUSTRIAL AND CENTRAL HEATING FURNACES	<b>B65D 77/04</b> (2006.01)	2619279 *	FLEXIBLE CONTAINER HAVING A BUILT-IN AUTO -HEATING OR AUTO - REFRIGERATING ELEMENT.
<b>C01B 3/08</b> (2006.01)	2614130 *	FUEL AND COMBUSTIBLE MIXTURE USED AS A SUBSTITUTE FOR FOSSIL FUELS IN THERMOELECTRIC POWER PLANTS, INDUSTRIAL AND CENTRAL HEATING FURNACES	<b>B65D 75/58</b> (2006.01)	2619279 *	FLEXIBLE CONTAINER HAVING A BUILT-IN AUTO -HEATING OR AUTO - REFRIGERATING ELEMENT.
<b>C07K 16/18</b> (2006.01)	2606065 *	IMPROVED ANTI-SERUM ALBUMIN BINDING VARIANTS	<b>F25D 5/02</b> (2006.01)	2619279 *	FLEXIBLE CONTAINER HAVING A BUILT-IN AUTO -HEATING OR AUTO - REFRIGERATING ELEMENT.
			<b>B65D 81/32</b> (2006.01)	2619279 *	FLEXIBLE CONTAINER HAVING A BUILT-IN AUTO -HEATING OR AUTO - REFRIGERATING ELEMENT.
			<b>B65D 81/34</b> (2006.01)	2619279 *	FLEXIBLE CONTAINER HAVING A BUILT-IN AUTO -HEATING OR AUTO - REFRIGERATING ELEMENT.
			<b>C07C 231/02</b> (2006.01)	2621893 *	PROCESS FOR THE PREPARATION OF AMINO ACID DERIVATIVES

MKP (51)	Broj objave evropske prijava patenta (97)	Naziv pronalaska (54)	MKP (51)	Broj objave evropske prijava patenta (97)	Naziv pronalaska (54)
<b>C07C 231/12</b> (2006.01)	2621893 *	PROCESS FOR THE PREPARATION OF AMINO ACID DERIVATIVES	<b>A61K 8/02</b> (2006.01)	2613755 *	PEEL -OFF POLYVINYL FACIAL MASK FOR TREATMENT OF SKIN CONDITIONS COMPRISING A HIGH CONCENTRATON OF RETINOIC ACID
<b>C07C 231/18</b> (2006.01)	2621893 *	PROCESS FOR THE PREPARATION OF AMINO ACID DERIVATIVES	<b>A61K 8/37</b> (2006.01)	2613755 *	PEEL -OFF POLYVINYL FACIAL MASK FOR TREATMENT OF SKIN CONDITIONS COMPRISING A HIGH CONCENTRATON OF RETINOIC ACID
<b>C07C 237/22</b> (2006.01)	2621893 *	PROCESS FOR THE PREPARATION OF AMINO ACID DERIVATIVES	<b>A61K 8/67</b> (2006.01)	2613755 *	PEEL -OFF POLYVINYL FACIAL MASK FOR TREATMENT OF SKIN CONDITIONS COMPRISING A HIGH CONCENTRATON OF RETINOIC ACID
<b>C07D 489/12</b> (2006.01)	2635586 *	METHOD FOR THE MANUFACTURING OF NALTREXONE	<b>A61K 8/81</b> (2006.01)	2613755 *	PEEL -OFF POLYVINYL FACIAL MASK FOR TREATMENT OF SKIN CONDITIONS COMPRISING A HIGH CONCENTRATON OF RETINOIC ACID
<b>C07D 489/08</b> (2006.01)	2635586 *	METHOD FOR THE MANUFACTURING OF NALTREXONE	<b>A61Q 19/02</b> (2006.01)	2613755 *	PEEL -OFF POLYVINYL FACIAL MASK FOR TREATMENT OF SKIN CONDITIONS COMPRISING A HIGH CONCENTRATON OF RETINOIC ACID
<b>E21B 29/00</b> (2006.01)	2640930 *	KOBE SUB, WELLBORE TUBING STRING APPARATUS AND METHOD	<b>A61Q 19/08</b> (2006.01)	2613755 *	PEEL -OFF POLYVINYL FACIAL MASK FOR TREATMENT OF SKIN CONDITIONS COMPRISING A HIGH CONCENTRATON OF RETINOIC ACID
<b>E21B 17/00</b> (2006.01)	2640930 *	KOBE SUB, WELLBORE TUBING STRING APPARATUS AND METHOD	<b>B65H 29/24</b> (2006.01)	2394940	Stacking device for stacking flat workpieces
<b>E21B 34/14</b> (2006.01)	2640930 *	KOBE SUB, WELLBORE TUBING STRING APPARATUS AND METHOD	<b>B65H 29/46</b> (2006.01)	2394940	Stacking device for stacking flat workpieces
<b>E21B 43/12</b> (2006.01)	2640930 *	KOBE SUB, WELLBORE TUBING STRING APPARATUS AND METHOD	<b>B65H 31/24</b> (2006.01)	2394940	Stacking device for stacking flat workpieces
<b>E21B 23/00</b> (2006.01)	2640930 *	KOBE SUB, WELLBORE TUBING STRING APPARATUS AND METHOD	<b>A61K 9/16</b> (2006.01)	2608777 *	COMPOSITIONS AND METHODS FOR CARDIAC THERAPY
<b>A61M 11/00</b> (2006.01)	2635336 *	BREATHING APPARATUS	<b>A61K 9/08</b> (2006.01)	2608777 *	COMPOSITIONS AND METHODS FOR CARDIAC THERAPY
<b>A61K 47/34</b> (2006.01)	2595608 *	PHARMACEUTICAL DEPOT FOR 5-FLUORO-2 [[ (1S) -1- (5-FLUORO-2-PYRIDYL) ETHYL]AMINO]-6-[(5-ISOPROPOXY-1H-PYRAZOL-3-YL)AMINO]PYRIDINE-3-CARBONITRILE	<b>A61K 47/38</b> (2006.01)	2608777 *	COMPOSITIONS AND METHODS FOR CARDIAC THERAPY
<b>A61K 31/444</b> (2006.01)	2595608 *	PHARMACEUTICAL DEPOT FOR 5-FLUORO-2 [[ (1S) -1- (5-FLUORO-2-PYRIDYL) ETHYL]AMINO]-6-[(5-ISOPROPOXY-1H-PYRAZOL-3-YL)AMINO]PYRIDINE-3-CARBONITRILE	<b>A61K 31/498</b> (2006.01)	2608777 *	COMPOSITIONS AND METHODS FOR CARDIAC THERAPY
<b>A61K 9/16</b> (2006.01)	2595608 *	PHARMACEUTICAL DEPOT FOR 5-FLUORO-2 [[ (1S) -1- (5-FLUORO-2-PYRIDYL) ETHYL]AMINO]-6-[(5-ISOPROPOXY-1H-PYRAZOL-3-YL)AMINO]PYRIDINE-3-CARBONITRILE	<b>A61K 38/43</b> (2006.01)	2608777 *	COMPOSITIONS AND METHODS FOR CARDIAC THERAPY
<b>A61P 19/02</b> (2006.01)	2595608 *	PHARMACEUTICAL DEPOT FOR 5-FLUORO-2 [[ (1S) -1- (5-FLUORO-2-PYRIDYL) ETHYL]AMINO]-6-[(5-ISOPROPOXY-1H-PYRAZOL-3-YL)AMINO]PYRIDINE-3-CARBONITRILE	<b>A61K 35/12</b> (2006.01)	2608777 *	COMPOSITIONS AND METHODS FOR CARDIAC THERAPY
			<b>A61P 9/00</b> (2006.01)	2608777 *	COMPOSITIONS AND METHODS FOR CARDIAC THERAPY

MKP (51)	Broj objave evropske prijava patenta (97)	Naziv pronalaska (54)	MKP (51)	Broj objave evropske prijava patenta (97)	Naziv pronalaska (54)
<b>A61K 31/00</b> (2006.01)	2621481 *	DUAL INHIBITORS OF MET AND VEGF FOR THE TREATMENT OF CASTRATION- RESISTANT PROSTATE CANCER AND OSTEOBLASTIC BONE METASTASES	<b>A61K 9/08</b> (2006.01)	2616046 *	AQUEOUS DRUG DELIVERY SYSTEM COMPRISING OFF - FLAVOR MASKING AGENT
<b>A61K 31/47</b> (2006.01)	2621481 *	DUAL INHIBITORS OF MET AND VEGF FOR THE TREATMENT OF CASTRATION- RESISTANT PROSTATE CANCER AND OSTEOBLASTIC BONE METASTASES	<b>A61K 9/16</b> (2006.01)	2616046 *	AQUEOUS DRUG DELIVERY SYSTEM COMPRISING OFF - FLAVOR MASKING AGENT
<b>A61P 35/00</b> (2006.01)	2621481 *	DUAL INHIBITORS OF MET AND VEGF FOR THE TREATMENT OF CASTRATION- RESISTANT PROSTATE CANCER AND OSTEOBLASTIC BONE METASTASES	<b>A61K 31/167</b> (2006.01)	2616046 *	AQUEOUS DRUG DELIVERY SYSTEM COMPRISING OFF - FLAVOR MASKING AGENT
<b>A61P 35/04</b> (2006.01)	2621481 *	DUAL INHIBITORS OF MET AND VEGF FOR THE TREATMENT OF CASTRATION- RESISTANT PROSTATE CANCER AND OSTEOBLASTIC BONE METASTASES	<b>A61K 31/192</b> (2006.01)	2616046 *	AQUEOUS DRUG DELIVERY SYSTEM COMPRISING OFF - FLAVOR MASKING AGENT
<b>G06F 3/12</b> (2006.01)	2549375	Method for producing at least one printing ink carrier and method for producing one or more printed products	<b>A61K 31/616</b> (2006.01)	2616046 *	AQUEOUS DRUG DELIVERY SYSTEM COMPRISING OFF - FLAVOR MASKING AGENT
<b>B60J 7/06</b> (2006.01)	2595825 *	STRUCTURE FOR A SLIDING ROOF, SLIDING ROOF SYSTEM, TRUCK WITH SLIDING ROOF SYSTEM, CURTAINSIDER TRAILER WITH A SLIDING ROOF SYSTEM	<b>A23L 2/00</b> (2006.01)	2616046 *	AQUEOUS DRUG DELIVERY SYSTEM COMPRISING OFF - FLAVOR MASKING AGENT
<b>C07D 471/04</b> (2006.01)	2643322 *	SALTS AND CRYSTALLINE FORMS OF AN APOPTOSIS-INDUCING AGENT	<b>F24J 2/46</b> (2006.01)	2625472 *	METHOD AND APPARATUS FOR MAKING STATIONERY PARABOLIC SOLAR COLLECTOR
<b>A61K 31/437</b> (2006.01)	2643322 *	SALTS AND CRYSTALLINE FORMS OF AN APOPTOSIS-INDUCING AGENT	<b>E04H 5/02</b> (2006.01)	2625472 *	METHOD AND APPARATUS FOR MAKING STATIONERY PARABOLIC SOLAR COLLECTOR
<b>A61P 35/00</b> (2006.01)	2643322 *	SALTS AND CRYSTALLINE FORMS OF AN APOPTOSIS-INDUCING AGENT	<b>E04H 14/00</b> (2006.01)	2625472 *	METHOD AND APPARATUS FOR MAKING STATIONERY PARABOLIC SOLAR COLLECTOR
<b>A61P 37/00</b> (2006.01)	2643322 *	SALTS AND CRYSTALLINE FORMS OF AN APOPTOSIS-INDUCING AGENT	<b>A61K 39/00</b> (2006.01)	2640415 *	CROSS PROTECTIVE EPITOPES OF ASPERGILLUS FUMIGATUS AND CANDIDA ALBICANS
<b>F16F 6/00</b> (2006.01)	2598773 *	ELECTRICITY GENERATING SHOCK ABSORBERS	<b>C07K 14/725</b> (2006.01)	2640415 *	CROSS PROTECTIVE EPITOPES OF ASPERGILLUS FUMIGATUS AND CANDIDA ALBICANS
<b>F16F 15/03</b> (2006.01)	2598773 *	ELECTRICITY GENERATING SHOCK ABSORBERS	<b>A61P 31/10</b> (2006.01)	2640415 *	CROSS PROTECTIVE EPITOPES OF ASPERGILLUS FUMIGATUS AND CANDIDA ALBICANS
<b>A61K 39/175</b> (2006.01)	2595652 *	PARAPOXVIRUS VECTORS	<b>G01N 33/569</b> (2006.01)	2640415 *	CROSS PROTECTIVE EPITOPES OF ASPERGILLUS FUMIGATUS AND CANDIDA ALBICANS
<b>C12N 15/863</b> (2006.01)	2595652 *	PARAPOXVIRUS VECTORS	<b>A41B 9/02</b> (2006.01)	2597978 *	MEN'S BRIEFS WITH SEPARATE SPACE FOR PENIS
			<b>B27N 3/00</b> (2006.01)	2598261 *	METHOD FOR RECYCLING FURNITURE, IN PARTICULAR BED BASES, WEB OF MATERIAL OBTAINED BY SUCH A METHOD, AND ASSOCIATED RECYCLING INSTALLATION
			<b>B09B 3/00</b> (2006.01)	2598261 *	METHOD FOR RECYCLING FURNITURE, IN PARTICULAR BED BASES, WEB OF MATERIAL OBTAINED BY SUCH A METHOD, AND ASSOCIATED RECYCLING INSTALLATION

MKP (51)	Broj objave evropske prijave patenta (97)	Naziv pronalaska (54)	MKP (51)	Broj objave evropske prijave patenta (97)	Naziv pronalaska (54)
<b>C07K 14/365</b> (2006.01)	2601209 *	GENOMICS OF ACTINOPLANES UTAHENSIS	<b>A61K 31/35</b> (2006.01)	2643022 *	FAST DISINTEGRATING COMPOSITIONS COMPRISING NABILONE AND RANDOMLY METHYLATED BETA CYCLODEXTRIN
<b>C12N 15/11</b> (2006.01)	2601209 *	GENOMICS OF ACTINOPLANES UTAHENSIS	<b>C12N 5/00</b> (2006.01)	2601287 *	DIPEPTIDES TO ENHANCE YIELD AND VIABILITY FROM CELL CULTURES
<b>C12P 19/26</b> (2006.01)	2601209 *	GENOMICS OF ACTINOPLANES UTAHENSIS	<b>C12N 5/10</b> (2006.01)	2601287 *	DIPEPTIDES TO ENHANCE YIELD AND VIABILITY FROM CELL CULTURES
<b>G06Q 20/00</b> (2012.01)	2628139 *	METHODS FOR TRANSFERRING FUNDS USING A PAYMENT SERVICE WHERE FINANCIAL ACCOUNT INFORMATION IS ONLY ENTERED ONCE WITH A PAYMENT SERVICE AND NEED NOT BE RE-ENTERED FOR FUTURE TRANSFERS	<b>C07K 5/06</b> (2006.01)	2601287 *	DIPEPTIDES TO ENHANCE YIELD AND VIABILITY FROM CELL CULTURES
<b>A61P 1/00</b> (2006.01)	2629790 *	Method to increase the growth velocity of human infants	<b>C07K 14/045</b> (2006.01)	2627352 *	NOVEL ANTIGEN
<b>A61K 38/43</b> (2006.01)	2629790 *	Method to increase the growth velocity of human infants	<b>A61K 39/245</b> (2006.01)	2627352 *	NOVEL ANTIGEN
<b>A61K 31/23</b> (2006.01)	2526936	Particle size distribution of cetyl myristate and/or cetyl palmitate	<b>A61K 48/00</b> (2006.01)	2621512 *	USE OF METEORIN FOR THE TREATMENT OF ALLODYNIA, HYPERALGESIA, SPONTANEOUS PAIN AND PHANTOM PAIN
<b>C08G 64/20</b> (2006.01)	2634202 *	PROCESS FOR PRODUCING POLYCONDENSATION POLYMER, AND POLYMERIZER	<b>A61P 25/02</b> (2006.01)	2621512 *	USE OF METEORIN FOR THE TREATMENT OF ALLODYNIA, HYPERALGESIA, SPONTANEOUS PAIN AND PHANTOM PAIN
<b>A61K 31/573</b> (2006.01)	2637670 *	PREVENTION OF ADVERSE EFFECTS CAUSED BY CD3 SPECIFIC BINDING DOMAINS	<b>A61P 25/04</b> (2006.01)	2621512 *	USE OF METEORIN FOR THE TREATMENT OF ALLODYNIA, HYPERALGESIA, SPONTANEOUS PAIN AND PHANTOM PAIN
<b>A61K 39/395</b> (2006.01)	2637670 *	PREVENTION OF ADVERSE EFFECTS CAUSED BY CD3 SPECIFIC BINDING DOMAINS	<b>A61K 38/17</b> (2006.01)	2621512 *	USE OF METEORIN FOR THE TREATMENT OF ALLODYNIA, HYPERALGESIA, SPONTANEOUS PAIN AND PHANTOM PAIN
<b>C07K 16/28</b> (2006.01)	2637670 *	PREVENTION OF ADVERSE EFFECTS CAUSED BY CD3 SPECIFIC BINDING DOMAINS	<b>A61K 9/00</b> (2006.01)	2621512 *	USE OF METEORIN FOR THE TREATMENT OF ALLODYNIA, HYPERALGESIA, SPONTANEOUS PAIN AND PHANTOM PAIN
<b>A61M 5/315</b> (2006.01)	2529774	Resetting mechanism for a drug delivery device	<b>E03D 11/02</b> (2006.01)	2562315	Flush toilet
<b>A61B 17/115</b> (2006.01)	2524658	Improved anvil and cartridge alignment configuration for a circular stapler	<b>C11B 1/10</b> (2006.01)	2616531 *	REFINED VEGETABLE OIL AND A METHOD OF PRODUCING IT
<b>A61B 17/29</b> (2006.01)	2524658	Improved anvil and cartridge alignment configuration for a circular stapler	<b>C11B 3/00</b> (2006.01)	2616531 *	REFINED VEGETABLE OIL AND A METHOD OF PRODUCING IT
<b>A61K 31/50</b> (2006.01)	2640391 *	PYRIDAZINE DERIVATIVES, COMPOSITIONS AND METHODS FOR TREATING COGNITIVE IMPAIRMENT	<b>C11B 3/06</b> (2006.01)	2616531 *	REFINED VEGETABLE OIL AND A METHOD OF PRODUCING IT
<b>A61K 47/48</b> (2006.01)	2643022 *	FAST DISINTEGRATING COMPOSITIONS COMPRISING NABILONE AND RANDOMLY METHYLATED BETA CYCLODEXTRIN	<b>C11B 3/08</b> (2006.01)	2616531 *	REFINED VEGETABLE OIL AND A METHOD OF PRODUCING IT
<b>A61K 9/00</b> (2006.01)	2643022 *	FAST DISINTEGRATING COMPOSITIONS COMPRISING NABILONE AND RANDOMLY METHYLATED BETA CYCLODEXTRIN	<b>G01N 33/543</b> (2006.01)	2616810 *	PREPARATION OF A MOLECULAR RECOGNITION ELEMENT

MKP (51)	Broj objave evropske prijava patenta (97)	Naziv pronalaska (54)	MKP (51)	Broj objave evropske prijava patenta (97)	Naziv pronalaska (54)
<b>C07D 487/04</b> (2006.01)	2619206 *	2' -FLUORO SUBSTITUTED CARBA-NUCLEOSIDE ANALOGS FOR ANTIVIRAL TREATMENT	<b>A61P 9/10</b> (2006.01)	2601949	Pharmaceutical compositions
<b>A61K 31/41</b> (2006.01)	2619206 *	2' -FLUORO SUBSTITUTED CARBA-NUCLEOSIDE ANALOGS FOR ANTIVIRAL TREATMENT	<b>A61K 31/155</b> (2006.01)	2601949	Pharmaceutical compositions
<b>C07D 211/16</b> (2006.01)	2629851 *	PIPERIDIN-4-YL- AZETIDINE DIAMIDES AS MONOACYLGLYCEROL LIPASE INHIBITORS	<b>A61P 13/12</b> (2006.01)	2601949	Pharmaceutical compositions
<b>C07D 417/12</b> (2006.01)	2629851 *	PIPERIDIN-4-YL- AZETIDINE DIAMIDES AS MONOACYLGLYCEROL LIPASE INHIBITORS	<b>A61K 31/382</b> (2006.01)	2601949	Pharmaceutical compositions
<b>A61K 31/4523</b> (2006.01)	2629851 *	PIPERIDIN-4-YL- AZETIDINE DIAMIDES AS MONOACYLGLYCEROL LIPASE INHIBITORS	<b>A61P 9/14</b> (2006.01)	2601949	Pharmaceutical compositions
<b>A61P 29/00</b> (2006.01)	2629851 *	PIPERIDIN-4-YL- AZETIDINE DIAMIDES AS MONOACYLGLYCEROL LIPASE INHIBITORS	<b>A61K 31/64</b> (2006.01)	2601949	Pharmaceutical compositions
<b>C07D 417/14</b> (2006.01)	2629851 *	PIPERIDIN-4-YL- AZETIDINE DIAMIDES AS MONOACYLGLYCEROL LIPASE INHIBITORS	<b>A61P 27/02</b> (2006.01)	2601949	Pharmaceutical compositions
<b>C07D 205/04</b> (2006.01)	2629851 *	PIPERIDIN-4-YL- AZETIDINE DIAMIDES AS MONOACYLGLYCEROL LIPASE INHIBITORS	<b>A61K 45/00</b> (2006.01)	2601949	Pharmaceutical compositions
<b>C07K 14/47</b> (2006.01)	2643349 *	DESIGNED REPEAT PROTEINS BINDING TO SERUM ALBUMIN	<b>A61P 43/00</b> (2006.01)	2601949	Pharmaceutical compositions
<b>B65D 51/26</b> (2006.01)	2494941	Container for transporting dental objects	<b>A61P 3/10</b> (2006.01)	2601949	Pharmaceutical compositions
<b>A61C 19/02</b> (2006.01)	2494941	Container for transporting dental objects	<b>C07D 335/02</b> (2006.01)	2601949	Pharmaceutical compositions
<b>A61K 38/07</b> (2006.01)	2627669 *	CYTOKINE BIOMARKERS AS PREDICTIVE BIOMARKERS OF CLINICAL RESPONSE FOR GLATIRAMER ACETATE	<b>A61K 31/4439</b> (2006.01)	2601949	Pharmaceutical compositions
<b>C07K 14/47</b> (2006.01)	2627669 *	CYTOKINE BIOMARKERS AS PREDICTIVE BIOMARKERS OF CLINICAL RESPONSE FOR GLATIRAMER ACETATE	<b>A61P 25/00</b> (2006.01)	2601949	Pharmaceutical compositions
<b>A61P 19/08</b> (2006.01)	2627669 *	CYTOKINE BIOMARKERS AS PREDICTIVE BIOMARKERS OF CLINICAL RESPONSE FOR GLATIRAMER ACETATE	<b>A47J 43/07</b> (2006.01)	2615954 *	KNIFE FOR A CUTTING DISC FOR A CUTTING MACHINE
<b>A61K 38/06</b> (2006.01)	2627669 *	CYTOKINE BIOMARKERS AS PREDICTIVE BIOMARKERS OF CLINICAL RESPONSE FOR GLATIRAMER ACETATE	<b>B26D 1/00</b> (2006.01)	2615954 *	KNIFE FOR A CUTTING DISC FOR A CUTTING MACHINE
<b>A61K 38/00</b> (2006.01)	2627669 *	CYTOKINE BIOMARKERS AS PREDICTIVE BIOMARKERS OF CLINICAL RESPONSE FOR GLATIRAMER ACETATE	<b>G02C 5/22</b> (2006.01)	2616875 *	MINIATURISED ELASTIC HINGE, IN PARTICULAR FOR EYEGLASSES
<b>A61P 5/50</b> (2006.01)	2601949	Pharmaceutical compositions	<b>A61P 25/00</b> (2006.01)	2643056 *	PHAGOCYTIC ACTIVITY AS A MARKER OF SYNUCLEINOPATHIC DISEASE
			<b>C07D 231/22</b> (2006.01)	2603495 *	4-[-2-[[5-METHYL-1-(2- NAPHTALENYL)-1H- PYRAZOL-3-YL]OXY] ETHYL]MORPHOLINE HYDROCHLORIDE AMORPHOUS SOLID FORMS
			<b>A61P 25/16</b> (2006.01)	2603495 *	4-[-2-[[5-METHYL-1-(2- NAPHTALENYL)-1H- PYRAZOL-3-YL]OXY] ETHYL]MORPHOLINE HYDROCHLORIDE AMORPHOUS SOLID FORMS
			<b>A61P 25/00</b> (2006.01)	2603495 *	4-[-2-[[5-METHYL-1-(2- NAPHTALENYL)-1H- PYRAZOL-3-YL]OXY] ETHYL]MORPHOLINE HYDROCHLORIDE AMORPHOUS SOLID FORMS

MKP (51)	Broj objave evropske prijava patenta (97)	Naziv pronalaska (54)	MKP (51)	Broj objave evropske prijava patenta (97)	Naziv pronalaska (54)
<b>A61K 31/4152</b> (2006.01)	2603495 *	4-[-2-[[[5-METHYL-1-(2-NAPHTALENYL)-1H-PYRAZOL-3-YL]OXY]ETHYL]MORPHOLINE HYDROCHLORIDE AMORPHOUS SOLID FORMS	<b>A61K 31/4439</b> (2006.01)	2640385 *	PRESELECTION OF SUBJECTS FOR THERAPEUTIC TREATMENT BASED ON HYPOXIC STATUS
<b>G01N 33/48</b> (2006.01)	2619574 *	MOLECULAR DIAGNOSTIC TEST FOR CANCER	<b>A61P 43/00</b> (2006.01)	2636671 *	ORGANIC AMINE SALT OF AMINOBENZOIC ACID DERIVATIVE, AND METHOD FOR PRODUCING SAME
<b>C12N 9/88</b> (2006.01)	2633042 *	MODIFIED VALENCENE SYNTHASE POLYPEPTIDES, ENCODING NUCLEIC ACID MOLECULES AND USES THEREOF	<b>C07D 333/32</b> (2006.01)	2636671 *	ORGANIC AMINE SALT OF AMINOBENZOIC ACID DERIVATIVE, AND METHOD FOR PRODUCING SAME
<b>C12P 1/00</b> (2006.01)	2633042 *	MODIFIED VALENCENE SYNTHASE POLYPEPTIDES, ENCODING NUCLEIC ACID MOLECULES AND USES THEREOF	<b>A61K 31/381</b> (2006.01)	2636671 *	ORGANIC AMINE SALT OF AMINOBENZOIC ACID DERIVATIVE, AND METHOD FOR PRODUCING SAME
<b>C12N 15/82</b> (2006.01)	2633042 *	MODIFIED VALENCENE SYNTHASE POLYPEPTIDES, ENCODING NUCLEIC ACID MOLECULES AND USES THEREOF	<b>A61P 7/04</b> (2006.01)	2636671 *	ORGANIC AMINE SALT OF AMINOBENZOIC ACID DERIVATIVE, AND METHOD FOR PRODUCING SAME
<b>F42B 12/66</b> (2006.01)	2635870 *	PROJECTILE FOR USE WITH A RIFLED BARREL	<b>B03B 5/32</b> (2006.01)	2598250 *	DEVICE FOR SEPARATING PARTICLES OF DIFFERENT SYNTHETIC MATERIALS
<b>A61K 31/502</b> (2006.01)	2640385 *	PRESELECTION OF SUBJECTS FOR THERAPEUTIC TREATMENT BASED ON HYPOXIC STATUS	<b>B04B 1/20</b> (2006.01)	2598250 *	DEVICE FOR SEPARATING PARTICLES OF DIFFERENT SYNTHETIC MATERIALS
<b>A61K 31/506</b> (2006.01)	2640385 *	PRESELECTION OF SUBJECTS FOR THERAPEUTIC TREATMENT BASED ON HYPOXIC STATUS	<b>E05D 7/00</b> (2006.01)	2557258	Adjustable hinge for window or door frames
<b>A61K 31/436</b> (2006.01)	2640385 *	PRESELECTION OF SUBJECTS FOR THERAPEUTIC TREATMENT BASED ON HYPOXIC STATUS	<b>C07D 473/04</b> (2006.01)	2611807 *	POLYMORPHS OF (S)-1-(4,4,6,6,6-PENTADEUTERO-5-HYDROXYHEXYL)-3,7-DIMETHYL-1H-PURINE-2,6(3H,7H)DIONE
<b>A61K 31/395</b> (2006.01)	2640385 *	PRESELECTION OF SUBJECTS FOR THERAPEUTIC TREATMENT BASED ON HYPOXIC STATUS	<b>B01D 15/08</b> (2006.01)	2627425 *	PROCESSES FOR PURIFICATION OF PROTEINS
<b>A61K 31/4196</b> (2006.01)	2640385 *	PRESELECTION OF SUBJECTS FOR THERAPEUTIC TREATMENT BASED ON HYPOXIC STATUS	<b>C07K 16/26</b> (2006.01)	2598531 *	METHODS AND COMPOSITIONS FOR LIVER CANCER THERAPY
<b>A61P 35/00</b> (2006.01)	2640385 *	PRESELECTION OF SUBJECTS FOR THERAPEUTIC TREATMENT BASED ON HYPOXIC STATUS	<b>H01L 31/052</b> (2006.01)	2571063	Solar generator apparatus with elastically cable-controlled tracking
<b>A61K 31/437</b> (2006.01)	2640385 *	PRESELECTION OF SUBJECTS FOR THERAPEUTIC TREATMENT BASED ON HYPOXIC STATUS	<b>C07D 279/08</b> (2006.01)	2640712 *	2-PIPERAZIN-1-YL-4H-1,3-BENZOTHIAZIN-4-ONE DERIVATIVES AND THEIR USE FOR THE TREATMENT OF MAMMALIAN INFECTIONS
<b>A61K 39/395</b> (2006.01)	2640385 *	PRESELECTION OF SUBJECTS FOR THERAPEUTIC TREATMENT BASED ON HYPOXIC STATUS	<b>A61K 31/5415</b> (2006.01)	2640712 *	2-PIPERAZIN-1-YL-4H-1,3-BENZOTHIAZIN-4-ONE DERIVATIVES AND THEIR USE FOR THE TREATMENT OF MAMMALIAN INFECTIONS
<b>A61K 31/517</b> (2006.01)	2640385 *	PRESELECTION OF SUBJECTS FOR THERAPEUTIC TREATMENT BASED ON HYPOXIC STATUS	<b>A61P 31/06</b> (2006.01)	2640712 *	2-PIPERAZIN-1-YL-4H-1,3-BENZOTHIAZIN-4-ONE DERIVATIVES AND THEIR USE FOR THE TREATMENT OF MAMMALIAN INFECTIONS
			<b>A61M 5/315</b> (2006.01)	2600924 *	ASSEMBLY FOR A DRUG DELIVERY DEVICE, PISTON ROD AND DRUG DELIVERY DEVICE
			<b>E05D 3/00</b> (2006.01)	2603656 *	A HINGE

MKP (51)	Broj objave evropske prijava patenta (97)	Naziv pronalaska (54)	MKP (51)	Broj objave evropske prijava patenta (97)	Naziv pronalaska (54)
<b>E05D 7/04</b> (2006.01)	2603656 *	A HINGE	<b>A61K 39/395</b> (2006.01)	2637690 *	IMPROVED HIGH CONCENTRATION ANTI-TNF $\alpha$ ANTIBODY LIQUID FORMULATIONS
<b>E05D 7/06</b> (2006.01)	2603656 *	A HINGE	<b>H04L 12/24</b> (2006.01)	2617164 *	SYSTEM AND METHOD FOR TRAFFIC ANALYSIS
<b>E05D 11/10</b> (2006.01)	2603656 *	A HINGE	<b>G06F 17/30</b> (2006.01)	2617164 *	SYSTEM AND METHOD FOR TRAFFIC ANALYSIS
<b>C07K 14/605</b> (2006.01)	2611825 *	SOLID PHASE SYNTHESIS OF H(GLY2)GLP-2	<b>H04L 29/06</b> (2006.01)	2617164 *	SYSTEM AND METHOD FOR TRAFFIC ANALYSIS
<b>C07K 1/04</b> (2006.01)	2611825 *	SOLID PHASE SYNTHESIS OF H(GLY2)GLP-2	<b>C07D 403/04</b> (2006.01)	2635567 *	INDOLE DERIVATIVES
<b>A61B 10/02</b> (2006.01)	2621344 *	APPARATUS, METHOD, AND SYSTEM FOR THE AUTOMATED IMAGING AND EVALUATION OF EMBRYOS, OOCYTES, AND STEM CELLS	<b>C07D 403/14</b> (2006.01)	2635567 *	INDOLE DERIVATIVES
<b>C07D 487/04</b> (2006.01)	2640725 *	HETEROCYCLIC-SUBSTITUTED PYRROLOPYRIDINES AND PYRROLOPYRIMIDINES AS JAK INHIBITORS	<b>C07D 413/12</b> (2006.01)	2635567 *	INDOLE DERIVATIVES
<b>A61K 9/20</b> (2006.01)	2598124 *	THREE-PHASE CONTROLLED-RELEASE TABLET COMPRISING MELATONIN AND PROCESS OF PREPARATION	<b>A61K 31/404</b> (2006.01)	2635567 *	INDOLE DERIVATIVES
<b>A61K 31/4045</b> (2006.01)	2598124 *	THREE-PHASE CONTROLLED-RELEASE TABLET COMPRISING MELATONIN AND PROCESS OF PREPARATION	<b>A61P 29/00</b> (2006.01)	2635567 *	INDOLE DERIVATIVES
<b>A61P 25/00</b> (2006.01)	2598124 *	THREE-PHASE CONTROLLED-RELEASE TABLET COMPRISING MELATONIN AND PROCESS OF PREPARATION	<b>C07D 217/26</b> (2006.01)	2595960 *	SALT AND SOLVATES OF A TETRAHYDROISOQUINOLINE DERIVATIVE
<b>A61M 15/00</b> (2006.01)	2643039 *	INHALER	<b>G01N 33/487</b> (2006.01)	2520932	Test strip for a medical meter
<b>C07D 307/82</b> (2006.01)	2595978 *	NOVEL PROCESS FOR THE PREPARATION OF DRONEDARONE	<b>B32B 7/06</b> (2006.01)	2637861 *	A LAMINATE FOR USE IN PACKAGES, A METHOD OF MAKING A RECLOSABLE LAMINATE AND USE THEREOF
<b>A61K 9/06</b> (2006.01)	2605753 *	TOPICAL GEL COMPOSITION	<b>B32B 7/12</b> (2006.01)	2637861 *	A LAMINATE FOR USE IN PACKAGES, A METHOD OF MAKING A RECLOSABLE LAMINATE AND USE THEREOF
<b>A61K 47/32</b> (2006.01)	2605753 *	TOPICAL GEL COMPOSITION	<b>B32B 27/32</b> (2006.01)	2637861 *	A LAMINATE FOR USE IN PACKAGES, A METHOD OF MAKING A RECLOSABLE LAMINATE AND USE THEREOF
<b>A61K 9/00</b> (2006.01)	2605753 *	TOPICAL GEL COMPOSITION	<b>B32B 27/36</b> (2006.01)	2637861 *	A LAMINATE FOR USE IN PACKAGES, A METHOD OF MAKING A RECLOSABLE LAMINATE AND USE THEREOF
<b>A61K 31/498</b> (2006.01)	2605753 *	TOPICAL GEL COMPOSITION	<b>B65D 77/20</b> (2006.01)	2637861 *	A LAMINATE FOR USE IN PACKAGES, A METHOD OF MAKING A RECLOSABLE LAMINATE AND USE THEREOF
<b>A61K 47/10</b> (2006.01)	2605753 *	TOPICAL GEL COMPOSITION	<b>C09J 7/02</b> (2006.01)	2637861 *	A LAMINATE FOR USE IN PACKAGES, A METHOD OF MAKING A RECLOSABLE LAMINATE AND USE THEREOF
<b>B64C 5/02</b> (2006.01)	2605961 *	DEVICE FOR SANDBLASTING USES EXHAUST GAS FROM A JET ENGINE FOR BLASTING	<b>C08J 7/04</b> (2006.01)	2637861 *	A LAMINATE FOR USE IN PACKAGES, A METHOD OF MAKING A RECLOSABLE LAMINATE AND USE THEREOF
<b>F02K 99/00</b> (2009.01)	2605961 *	DEVICE FOR SANDBLASTING USES EXHAUST GAS FROM A JET ENGINE FOR BLASTING			

MKP (51)	Broj objave evropske prijava patenta (97)	Naziv pronalaska (54)	MKP (51)	Broj objave evropske prijava patenta (97)	Naziv pronalaska (54)
<b>E01B 7/24</b> (2006.01)	2557229	Heating device for rails	<b>C07D 491/10</b> (2006.01)	2598498 *	HETERO-BICYCLIC DERIVATIVES AS HCV INHIBITORS
<b>B32B 37/12</b> (2006.01)	2607076 *	PERSPECTIVE FILM AND PREPARING METHOD THEREOF	<b>G06K 7/08</b> (2006.01)	2628128 *	SYSTEMS AND METHODS FOR FINANCIAL TRANSACTION THROUGH MINIATURIZED CARD READER WITH DECODING ON A SELLER'S MOBILE DEVICE
<b>B32B 38/14</b> (2006.01)	2607076 *	PERSPECTIVE FILM AND PREPARING METHOD THEREOF	<b>A01G 9/12</b> (2006.01)	2608655 *	DEVICE FOR PROCESSING LEADERS OF CONIFERS, GROWTH INHIBITOR DEVICE, AND BIRD PERCH DEVICE
<b>B41M 1/00</b> (2006.01)	2607076 *	PERSPECTIVE FILM AND PREPARING METHOD THEREOF	<b>A01G 13/10</b> (2006.01)	2608655 *	DEVICE FOR PROCESSING LEADERS OF CONIFERS, GROWTH INHIBITOR DEVICE, AND BIRD PERCH DEVICE
<b>B32B 27/00</b> (2006.01)	2607076 *	PERSPECTIVE FILM AND PREPARING METHOD THEREOF	<b>A01M 29/00</b> (2011.01)	2608655 *	DEVICE FOR PROCESSING LEADERS OF CONIFERS, GROWTH INHIBITOR DEVICE, AND BIRD PERCH DEVICE
<b>B32B 27/10</b> (2006.01)	2607076 *	PERSPECTIVE FILM AND PREPARING METHOD THEREOF	<b>A01G 13/02</b> (2006.01)	2608655 *	DEVICE FOR PROCESSING LEADERS OF CONIFERS, GROWTH INHIBITOR DEVICE, AND BIRD PERCH DEVICE
<b>A61K 39/00</b> (2006.01)	2621524 *	IMPROVED VACCINE COMPOSITIONS	<b>B60J 1/00</b> (2006.01)	2635452 *	WINDSCREEN INSTALLATION APPARATUS AND METHOD
<b>A61K 39/12</b> (2006.01)	2621524 *	IMPROVED VACCINE COMPOSITIONS	<b>B62D 65/06</b> (2006.01)	2635452 *	WINDSCREEN INSTALLATION APPARATUS AND METHOD
<b>A61K 39/145</b> (2006.01)	2621524 *	IMPROVED VACCINE COMPOSITIONS	<b>B25B 11/00</b> (2006.01)	2635452 *	WINDSCREEN INSTALLATION APPARATUS AND METHOD
<b>A61K 39/39</b> (2006.01)	2621524 *	IMPROVED VACCINE COMPOSITIONS	<b>C12N 7/00</b> (2006.01)	2640831 *	INFLUENZA VIRUS NEUTRALIZING AGENTS THAT MIMIC THE BINDING SITE OF AN INFLUENZA NEUTRALIZING ANTIBODY
<b>C12N 5/074</b> (2010.01)	2598633 *	LIVER ORGANOID, USES THEREOF AND CULTURE METHOD FOR OBTAINING THEM	<b>A61K 39/395</b> (2006.01)	2640831 *	INFLUENZA VIRUS NEUTRALIZING AGENTS THAT MIMIC THE BINDING SITE OF AN INFLUENZA NEUTRALIZING ANTIBODY
<b>A61P 5/18</b> (2006.01)	2642980 *	PEDIATRIC FORMULATION	<b>H01L 31/052</b> (2006.01)	2620987	Devices and systems for concentration / collection of solar energy and industrial and household applications
<b>A61K 9/14</b> (2006.01)	2642980 *	PEDIATRIC FORMULATION	<b>H01L 31/058</b> (2006.01)	2620987	Devices and systems for concentration / collection of solar energy and industrial and household applications
<b>A61K 9/00</b> (2006.01)	2642980 *	PEDIATRIC FORMULATION	<b>C07F 7/18</b> (2006.01)	2634171 *	23-YNE-VITAMIN D3 DERIVATIVE
<b>A61B 17/072</b> (2006.01)	2517641	Staple cartridge comprising a variable thickness compressible portion	<b>A61P 19/10</b> (2006.01)	2634171 *	23-YNE-VITAMIN D3 DERIVATIVE
<b>C07D 401/14</b> (2006.01)	2598498 *	HETERO-BICYCLIC DERIVATIVES AS HCV INHIBITORS	<b>C07C 401/00</b> (2006.01)	2634171 *	23-YNE-VITAMIN D3 DERIVATIVE
<b>A61K 31/47</b> (2006.01)	2598498 *	HETERO-BICYCLIC DERIVATIVES AS HCV INHIBITORS	<b>A61K 31/593</b> (2006.01)	2634171 *	23-YNE-VITAMIN D3 DERIVATIVE
<b>A61K 31/4704</b> (2006.01)	2598498 *	HETERO-BICYCLIC DERIVATIVES AS HCV INHIBITORS			
<b>A61P 31/12</b> (2006.01)	2598498 *	HETERO-BICYCLIC DERIVATIVES AS HCV INHIBITORS			
<b>C07D 403/14</b> (2006.01)	2598498 *	HETERO-BICYCLIC DERIVATIVES AS HCV INHIBITORS			
<b>C07D 417/14</b> (2006.01)	2598498 *	HETERO-BICYCLIC DERIVATIVES AS HCV INHIBITORS			
<b>C07D 471/04</b> (2006.01)	2598498 *	HETERO-BICYCLIC DERIVATIVES AS HCV INHIBITORS			



MKP (51)	Broj objave evropske prijava patenta (97)	Naziv pronalaska (54)	MKP (51)	Broj objave evropske prijava patenta (97)	Naziv pronalaska (54)
<b>F21S 9/03</b> (2006.01)	2638319 *	ADJUSTABLE SOLAR CHARGED LAMP	<b>E04B 1/76</b> (2006.01)	2524780	Tensioning assembly and method for its production
<b>F21V 14/00</b> (2006.01)	2638319 *	ADJUSTABLE SOLAR CHARGED LAMP	<b>A43C 7/04</b> (2006.01)	2601852	Binding assembly
<b>F21V 17/00</b> (2006.01)	2638319 *	ADJUSTABLE SOLAR CHARGED LAMP	<b>A43C 7/00</b> (2006.01)	2601852	Binding assembly
<b>F21V 21/30</b> (2006.01)	2638319 *	ADJUSTABLE SOLAR CHARGED LAMP	<b>A43C 7/08</b> (2006.01)	2601852	Binding assembly
<b>C07D 223/16</b> (2006.01)	2607354	Process for the synthesis of ivabradine and addition salts thereof and its pharmaceutically acceptable acid	<b>A61K 31/403</b> (2006.01)	2601942	Novel combination of 4-{3-[cis-hexahydrocyclopenta[c]pyrrol-2(1h)-yl]propoxy}benzamide and an acetylcholinesterase inhibitor, and pharmaceutical compositions containing same
<b>H01R 25/14</b> (2006.01)	2330694	Power take-off adapter for conductor track	<b>A61P 25/28</b> (2006.01)	2601942	Novel combination of 4-{3-[cis-hexahydrocyclopenta[c]pyrrol-2(1h)-yl]propoxy}benzamide and an acetylcholinesterase inhibitor, and pharmaceutical compositions containing same
<b>H01R 29/00</b> (2006.01)	2330694	Power take-off adapter for conductor track	<b>A61K 31/13</b> (2006.01)	2601942	Novel combination of 4-{3-[cis-hexahydrocyclopenta[c]pyrrol-2(1h)-yl]propoxy}benzamide and an acetylcholinesterase inhibitor, and pharmaceutical compositions containing same
<b>A61K 39/395</b> (2006.01)	2632492 *	METHODS FOR DETERMINING DIFFERENCES IN ALPHA-4 INTEGRIN ACTIVITY BY CORRELATING DIFFERENCES IN sVCAM AND/OR sMAdCAM LEVELS	<b>A61K 36/03</b> (2006.01)	2548564	Pharmaceutical agent, nutrition for a patient and weight reduction method
<b>B02C 13/04</b> (2006.01)	2603322 *	A METHOD AND A SYSTEM FOR THE MANUFACTURE OF A PLASTICS FILLING MATERIAL	<b>A61K 36/81</b> (2006.01)	2548564	Pharmaceutical agent, nutrition for a patient and weight reduction method
<b>B68G 1/00</b> (2006.01)	2603322 *	A METHOD AND A SYSTEM FOR THE MANUFACTURE OF A PLASTICS FILLING MATERIAL	<b>A61K 36/71</b> (2006.01)	2548564	Pharmaceutical agent, nutrition for a patient and weight reduction method
<b>B02C 13/284</b> (2006.01)	2603322 *	A METHOD AND A SYSTEM FOR THE MANUFACTURE OF A PLASTICS FILLING MATERIAL	<b>A61K 36/185</b> (2006.01)	2548564	Pharmaceutical agent, nutrition for a patient and weight reduction method
<b>B02C 18/18</b> (2006.01)	2603322 *	A METHOD AND A SYSTEM FOR THE MANUFACTURE OF A PLASTICS FILLING MATERIAL	<b>A61P 3/04</b> (2006.01)	2548564	Pharmaceutical agent, nutrition for a patient and weight reduction method
<b>A61K 31/69</b> (2006.01)	2613788 *	BORON-CONTAINING SMALL MOLECULES	<b>A61K 36/72</b> (2006.01)	2548564	Pharmaceutical agent, nutrition for a patient and weight reduction method
<b>C07F 5/02</b> (2006.01)	2613788 *	BORON-CONTAINING SMALL MOLECULES	<b>H04L 29/08</b> (2006.01)	2638684 *	SYSTEMS FOR DETECTING, COLLECTING, COMMUNICATING, AND USING INFORMATION ABOUT ENVIRONMENTAL CONDITIONS AND OCCURRENCES
<b>A61P 31/04</b> (2006.01)	2613788 *	BORON-CONTAINING SMALL MOLECULES	<b>G01D 4/00</b> (2006.01)	2638684 *	SYSTEMS FOR DETECTING, COLLECTING, COMMUNICATING, AND USING INFORMATION ABOUT ENVIRONMENTAL CONDITIONS AND OCCURRENCES
<b>B27K 5/04</b> (2006.01)	2524780	Tensioning assembly and method for its production			
<b>B05B 15/12</b> (2006.01)	2524780	Tensioning assembly and method for its production			
<b>B07B 9/02</b> (2006.01)	2524780	Tensioning assembly and method for its production			
<b>B07B 15/00</b> (2006.01)	2524780	Tensioning assembly and method for its production			
<b>B27L 11/00</b> (2006.01)	2524780	Tensioning assembly and method for its production			
<b>F26B 17/00</b> (2006.01)	2524780	Tensioning assembly and method for its production			
<b>B05B 13/02</b> (2006.01)	2524780	Tensioning assembly and method for its production			

MKP (51)	Broj objave evropske prijava patenta (97)	Naziv pronalaska (54)	MKP (51)	Broj objave evropske prijava patenta (97)	Naziv pronalaska (54)
<b>G08B 25/00</b> (2006.01)	2638684 *	SYSTEMS FOR DETECTING, COLLECTING, COMMUNICATING, AND USING INFORMATION ABOUT ENVIRONMENTAL CONDITIONS AND OCCURRENCES	<b>A61P 3/00</b> (2006.01)	2635563 *	CRYSTALLINE FORMS OF HYDROCHLORIDE SALT OF (4A-R,9A-S) -1- (1H - BENZOIMIDAZOLE- 5 -CARBONYL) -2, 3, 4, 4A, 9, 9A - HEXAHYDRO -1H- INDENO [2, 1 -B]PYRIDINE- 6 -CARBONITRILE AND THEIR USE AS HSD 1 INHIBITORS
<b>A41F 15/00</b> (2006.01)	2597983 *	SELF-ADJUSTING BRA STRAP	<b>A61K 31/4468</b> (2006.01)	2616074 *	PIPERIDINYL-SUBSTITUTED LACTAMS AS GPR119 MODULATORS
<b>A41C 3/00</b> (2006.01)	2597983 *	SELF-ADJUSTING BRA STRAP	<b>A61K 31/454</b> (2006.01)	2616074 *	PIPERIDINYL-SUBSTITUTED LACTAMS AS GPR119 MODULATORS
<b>A47J 19/02</b> (2006.01)	2600926 *	DEVICE FOR SUPPLYING MICRONIZED MEDICAL SALT	<b>A61P 3/04</b> (2006.01)	2616074 *	PIPERIDINYL-SUBSTITUTED LACTAMS AS GPR119 MODULATORS
<b>A61G 10/02</b> (2006.01)	2600926 *	DEVICE FOR SUPPLYING MICRONIZED MEDICAL SALT	<b>C07D 413/14</b> (2006.01)	2616074 *	PIPERIDINYL-SUBSTITUTED LACTAMS AS GPR119 MODULATORS
<b>A61M 15/02</b> (2006.01)	2600926 *	DEVICE FOR SUPPLYING MICRONIZED MEDICAL SALT	<b>A61B 17/072</b> (2006.01)	2517647	Tissue thickness compensator comprising portions having different properties
<b>A47J 42/32</b> (2006.01)	2600926 *	DEVICE FOR SUPPLYING MICRONIZED MEDICAL SALT	<b>A61K 9/20</b> (2006.01)	2635264 *	FORMULATIONS COMPRISING POLYETHYLENE GLYCOL
<b>A61M 16/00</b> (2006.01)	2600926 *	DEVICE FOR SUPPLYING MICRONIZED MEDICAL SALT	<b>A61P 1/10</b> (2006.01)	2635264 *	FORMULATIONS COMPRISING POLYETHYLENE GLYCOL
<b>A61M 15/00</b> (2006.01)	2600926 *	DEVICE FOR SUPPLYING MICRONIZED MEDICAL SALT	<b>A61K 31/765</b> (2006.01)	2635264 *	FORMULATIONS COMPRISING POLYETHYLENE GLYCOL
<b>A01N 43/54</b> (2006.01)	2603081 *	BESYLATE SALT OF A BTK INHIBITOR	<b>A61K 31/365</b> (2006.01)	2624827 *	PICROPODOPHYLLIN POLYMORPHS B OR C FOR USE IN CANCER THERAPY
<b>C07D 471/22</b> (2006.01)	2603081 *	BESYLATE SALT OF A BTK INHIBITOR	<b>A61P 3/10</b> (2006.01)	2624827 *	PICROPODOPHYLLIN POLYMORPHS B OR C FOR USE IN CANCER THERAPY
<b>C07D 471/04</b> (2006.01)	2603081 *	BESYLATE SALT OF A BTK INHIBITOR	<b>A61P 25/28</b> (2006.01)	2624827 *	PICROPODOPHYLLIN POLYMORPHS B OR C FOR USE IN CANCER THERAPY
<b>E04B 9/18</b> (2006.01)	2470729 *	Assembled component and method for producing an assembled component	<b>A61P 35/00</b> (2006.01)	2624827 *	PICROPODOPHYLLIN POLYMORPHS B OR C FOR USE IN CANCER THERAPY
<b>F16B 5/07</b> (2006.01)	2470729 *	Assembled component and method for producing an assembled component	<b>A47G 19/16</b> (2006.01)	2596725 *	DISPOSABLE STRAINER FOR INFUSING TEA WITH A SQUEEZING SYSTEM
<b>F16B 5/10</b> (2006.01)	2470729 *	Assembled component and method for producing an assembled component	<b>A61K 47/26</b> (2006.01)	2627319 *	PHARMACEUTICAL COMPOSITIONS CONTAINING A DGAT1 INHIBITOR
<b>C07D 401/06</b> (2006.01)	2635563 *	CRYSTALLINE FORMS OF HYDROCHLORIDE SALT OF (4A-R,9A-S) -1- (1H - BENZOIMIDAZOLE- 5 -CARBONYL) -2, 3, 4, 4A, 9, 9A - HEXAHYDRO -1H- INDENO [2, 1 -B]PYRIDINE- 6 -CARBONITRILE AND THEIR USE AS HSD 1 INHIBITORS	<b>A61K 47/38</b> (2006.01)	2627319 *	PHARMACEUTICAL COMPOSITIONS CONTAINING A DGAT1 INHIBITOR
<b>A61K 31/435</b> (2006.01)	2635563 *	CRYSTALLINE FORMS OF HYDROCHLORIDE SALT OF (4A-R,9A-S) -1- (1H - BENZOIMIDAZOLE- 5 -CARBONYL) -2, 3, 4, 4A, 9, 9A - HEXAHYDRO -1H- INDENO [2, 1 -B]PYRIDINE- 6 -CARBONITRILE AND THEIR USE AS HSD 1 INHIBITORS	<b>A61K 47/20</b> (2006.01)	2627319 *	PHARMACEUTICAL COMPOSITIONS CONTAINING A DGAT1 INHIBITOR

MKP (51)	Broj objave evropske prijave patenta (97)	Naziv pronalaska (54)	MKP (51)	Broj objave evropske prijave patenta (97)	Naziv pronalaska (54)
<b>A61K 9/20</b> (2006.01)	2627319 *	PHARMACEUTICAL COMPOSITIONS CONTAINING A DGAT1 INHIBITOR	<b>C07D 233/64</b> (2006.01)	2616434 *	PRODRUGS OF GUANFACINE
<b>A61K 31/444</b> (2006.01)	2627319 *	PHARMACEUTICAL COMPOSITIONS CONTAINING A DGAT1 INHIBITOR	<b>A61K 31/155</b> (2006.01)	2616434 *	PRODRUGS OF GUANFACINE
<b>E06B 3/92</b> (2006.01)	2639391	Sliding and pivoting leaf system	<b>G01N 33/574</b> (2006.01)	2638397 *	METHODS OF TREATING CANCER
<b>E05D 15/06</b> (2006.01)	2639391	Sliding and pivoting leaf system	<b>B01J 27/10</b> (2006.01)	2639234 *	CRYSTALLINE 6,7-UNSATURATED-7-CARBAMOYL MORPHINANE DERIVATIVE, AND METHOD FOR PRODUCING SAME
<b>E05D 15/58</b> (2006.01)	2639391	Sliding and pivoting leaf system	<b>C07D 271/06</b> (2006.01)	2639234 *	CRYSTALLINE 6,7-UNSATURATED-7-CARBAMOYL MORPHINANE DERIVATIVE, AND METHOD FOR PRODUCING SAME
<b>A61K 31/775</b> (2006.01)	2635290 *	NOVEL SELF-ASSEMBLING POLYPHENOL-QUINONOID POLYMER DERIVATIVES AND USES THEREOF	<b>A61K 31/485</b> (2006.01)	2639234 *	CRYSTALLINE 6,7-UNSATURATED-7-CARBAMOYL MORPHINANE DERIVATIVE, AND METHOD FOR PRODUCING SAME
<b>C08G 65/38</b> (2006.01)	2635290 *	NOVEL SELF-ASSEMBLING POLYPHENOL-QUINONOID POLYMER DERIVATIVES AND USES THEREOF	<b>A61P 1/08</b> (2006.01)	2639234 *	CRYSTALLINE 6,7-UNSATURATED-7-CARBAMOYL MORPHINANE DERIVATIVE, AND METHOD FOR PRODUCING SAME
<b>A61K 35/00</b> (2006.01)	2635290 *	NOVEL SELF-ASSEMBLING POLYPHENOL-QUINONOID POLYMER DERIVATIVES AND USES THEREOF	<b>A61P 1/10</b> (2006.01)	2639234 *	CRYSTALLINE 6,7-UNSATURATED-7-CARBAMOYL MORPHINANE DERIVATIVE, AND METHOD FOR PRODUCING SAME
<b>C07D 487/04</b> (2006.01)	2643324 *	ANTIFUNGAL 5,6-DIHYDRO-4H-PYRROLO[1,2-A][1,4]-BENZODIAZEPINES AND 6H-PYRROLO[1,2-A][1,4]BENZODIAZEPINES SUBSTITUTED WITH PHENYL DERIVATIVES	<b>C07D 489/08</b> (2006.01)	2639234 *	CRYSTALLINE 6,7-UNSATURATED-7-CARBAMOYL MORPHINANE DERIVATIVE, AND METHOD FOR PRODUCING SAME
<b>A61K 31/5517</b> (2006.01)	2643324 *	ANTIFUNGAL 5,6-DIHYDRO-4H-PYRROLO[1,2-A][1,4]-BENZODIAZEPINES AND 6H-PYRROLO[1,2-A][1,4]BENZODIAZEPINES SUBSTITUTED WITH PHENYL DERIVATIVES	<b>A61K 9/16</b> (2006.01)	2629755 *	PROCESS FOR MAKING MULTIPARTICULATE GASTRORETENTIVE DOSAGE FORMS
<b>A61P 31/10</b> (2006.01)	2643324 *	ANTIFUNGAL 5,6-DIHYDRO-4H-PYRROLO[1,2-A][1,4]-BENZODIAZEPINES AND 6H-PYRROLO[1,2-A][1,4]BENZODIAZEPINES SUBSTITUTED WITH PHENYL DERIVATIVES	<b>A61K 9/20</b> (2006.01)	2629755 *	PROCESS FOR MAKING MULTIPARTICULATE GASTRORETENTIVE DOSAGE FORMS
<b>F02M 59/46</b> (2006.01)	2557307	Pump head for a fuel pump	<b>A61K 9/00</b> (2006.01)	2629755 *	PROCESS FOR MAKING MULTIPARTICULATE GASTRORETENTIVE DOSAGE FORMS
<b>F02M 63/02</b> (2006.01)	2557307	Pump head for a fuel pump	<b>A43B 7/08</b> (2006.01)	2621301 *	VAPOR-PERMEABLE SHOE WITH WATERPROOF AND VAPOR-PERMEABLE SOLE
<b>A61K 39/00</b> (2006.01)	2598164 *	PERIPHERAL BLOOD SPARC ANTIBODIES AND USES THEREOF	<b>A43B 7/12</b> (2006.01)	2621301 *	VAPOR-PERMEABLE SHOE WITH WATERPROOF AND VAPOR-PERMEABLE SOLE
<b>A61B 17/15</b> (2006.01)	2613718 *	POSITIONING APPARATUS AND METHOD FOR A PROSTHETIC IMPLANT	<b>A43B 13/12</b> (2006.01)	2621301 *	VAPOR-PERMEABLE SHOE WITH WATERPROOF AND VAPOR-PERMEABLE SOLE
<b>H04L 12/28</b> (2006.01)	2636188 *	APPARATUS AND METHODS FOR MULTIMODE INTERNETWORKING CONNECTIVITY	<b>A43B 9/12</b> (2006.01)	2621301 *	VAPOR-PERMEABLE SHOE WITH WATERPROOF AND VAPOR-PERMEABLE SOLE
<b>C07C 279/24</b> (2006.01)	2616434 *	PRODRUGS OF GUANFACINE			

MKP (51)	Broj objave evropske prijava patenta (97)	Naziv pronalaska (54)	MKP (51)	Broj objave evropske prijava patenta (97)	Naziv pronalaska (54)
<b>A43B 13/42</b> (2006.01)	2621301 *	VAPOR-PERMEABLE SHOE WITH WATERPROOF AND VAPOR-PERMEABLE SOLE	<b>H04L 27/00</b> (2006.01)	2567461 *	METHOD AND APPARATUS FOR DETECTING A PARITY ERROR IN A SEQUENCE OF DQPSK SYMBOLS OF A DIGITAL TRANSMISSION SYSTEM
<b>A61K 31/27</b> (2006.01)	2619179 *	MATRIX METALLOPROTEINASE INHIBITORS	<b>H04L 27/233</b> (2006.01)	2567461 *	METHOD AND APPARATUS FOR DETECTING A PARITY ERROR IN A SEQUENCE OF DQPSK SYMBOLS OF A DIGITAL TRANSMISSION SYSTEM
<b>A61K 31/4035</b> (2006.01)	2619179 *	MATRIX METALLOPROTEINASE INHIBITORS	<b>H04L 1/00</b> (2006.01)	2567461 *	METHOD AND APPARATUS FOR DETECTING A PARITY ERROR IN A SEQUENCE OF DQPSK SYMBOLS OF A DIGITAL TRANSMISSION SYSTEM
<b>A61K 31/53</b> (2006.01)	2619179 *	MATRIX METALLOPROTEINASE INHIBITORS	<b>H04L 1/00</b> (2006.01)	2567461 *	METHOD AND APPARATUS FOR DETECTING A PARITY ERROR IN A SEQUENCE OF DQPSK SYMBOLS OF A DIGITAL TRANSMISSION SYSTEM
<b>C07D 401/12</b> (2006.01)	2619179 *	MATRIX METALLOPROTEINASE INHIBITORS	<b>E21F 1/00</b> (2006.01)	2598718 *	METHOD AND SYSTEM FOR TUNNEL VENTILATION IN NORMAL CONDITIONS AND IN CONDITIONS OF FIRE
<b>C07C 271/28</b> (2006.01)	2619179 *	MATRIX METALLOPROTEINASE INHIBITORS	<b>E21F 1/08</b> (2006.01)	2598718 *	METHOD AND SYSTEM FOR TUNNEL VENTILATION IN NORMAL CONDITIONS AND IN CONDITIONS OF FIRE
<b>A61P 11/00</b> (2006.01)	2619179 *	MATRIX METALLOPROTEINASE INHIBITORS	<b>C12P 7/46</b> (2006.01)	2619314 *	DICARBOXYLIC ACID PRODUCTION PROCESS
<b>C07D 209/48</b> (2006.01)	2619179 *	MATRIX METALLOPROTEINASE INHIBITORS	<b>A61K 31/16</b> (2006.01)	2635285 *	HETEROARYL COMPOUNDS AND USES THEREOF
<b>A61P 19/02</b> (2006.01)	2619179 *	MATRIX METALLOPROTEINASE INHIBITORS	<b>A61K 31/506</b> (2006.01)	2635285 *	HETEROARYL COMPOUNDS AND USES THEREOF
<b>C07D 253/04</b> (2006.01)	2619179 *	MATRIX METALLOPROTEINASE INHIBITORS	<b>C04B 28/14</b> (2006.01)	2643276 *	CALCIUM SULPHATE-BASED PRODUCTS AND METHODS FOR THE MANUFACTURE THEREOF
<b>A61P 35/00</b> (2006.01)	2619179 *	MATRIX METALLOPROTEINASE INHIBITORS	<b>A61K 38/22</b> (2006.01)	2611458 *	USE OF AVE0010 FOR THE MANUFACTURE OF A MEDICAMENT FOR THE TREATMENT OF DIABETES MELLITUS TYPE 2
<b>E21B 43/26</b> (2006.01)	2643547 *	METHOD AND APPARATUS FOR SETTING A WELLBORE PACKER	<b>C07K 14/575</b> (2006.01)	2611458 *	USE OF AVE0010 FOR THE MANUFACTURE OF A MEDICAMENT FOR THE TREATMENT OF DIABETES MELLITUS TYPE 2
<b>E21B 23/06</b> (2006.01)	2643547 *	METHOD AND APPARATUS FOR SETTING A WELLBORE PACKER	<b>A61P 3/10</b> (2006.01)	2611458 *	USE OF AVE0010 FOR THE MANUFACTURE OF A MEDICAMENT FOR THE TREATMENT OF DIABETES MELLITUS TYPE 2
<b>E21B 23/04</b> (2006.01)	2643547 *	METHOD AND APPARATUS FOR SETTING A WELLBORE PACKER	<b>A61P 3/08</b> (2006.01)	2611458 *	USE OF AVE0010 FOR THE MANUFACTURE OF A MEDICAMENT FOR THE TREATMENT OF DIABETES MELLITUS TYPE 2
<b>E21B 33/124</b> (2006.01)	2643547 *	METHOD AND APPARATUS FOR SETTING A WELLBORE PACKER	<b>A61P 3/04</b> (2006.01)	2611458 *	USE OF AVE0010 FOR THE MANUFACTURE OF A MEDICAMENT FOR THE TREATMENT OF DIABETES MELLITUS TYPE 2
<b>G01N 33/543</b> (2006.01)	2618152	Assay device having controllable sample size			
<b>G01N 33/558</b> (2006.01)	2618152	Assay device having controllable sample size			
<b>G01R 21/00</b> (2006.01)	2622357 *	UTILITY DEVICE MANAGEMENT			
<b>H03M 13/37</b> (2006.01)	2567461 *	METHOD AND APPARATUS FOR DETECTING A PARITY ERROR IN A SEQUENCE OF DQPSK SYMBOLS OF A DIGITAL TRANSMISSION SYSTEM			

MKP (51)	Broj objave evropske prijava patenta (97)	Naziv pronalaska (54)	MKP (51)	Broj objave evropske prijava patenta (97)	Naziv pronalaska (54)
<b>C07D 471/04</b> (2006.01)	2611802 *	BICYCLIC AZA HETEROCYCLES, AND USE THEREOF	<b>A61K 47/18</b> (2006.01)	2616091 *	STABILIZATION OF IMMUNOGLOBULINS AND OTHER PROTEINS THROUGH AQUEOUS FORMULATIONS WITH SODIUM CHLORIDE AT WEAK ACIDIC TO NEUTRAL PH
<b>C07D 487/04</b> (2006.01)	2611802 *	BICYCLIC AZA HETEROCYCLES, AND USE THEREOF	<b>A61K 9/00</b> (2006.01)	2616091 *	STABILIZATION OF IMMUNOGLOBULINS AND OTHER PROTEINS THROUGH AQUEOUS FORMULATIONS WITH SODIUM CHLORIDE AT WEAK ACIDIC TO NEUTRAL PH
<b>A61K 31/437</b> (2006.01)	2611802 *	BICYCLIC AZA HETEROCYCLES, AND USE THEREOF	<b>A61K 38/00</b> (2006.01)	2616091 *	STABILIZATION OF IMMUNOGLOBULINS AND OTHER PROTEINS THROUGH AQUEOUS FORMULATIONS WITH SODIUM CHLORIDE AT WEAK ACIDIC TO NEUTRAL PH
<b>A61K 31/519</b> (2006.01)	2611802 *	BICYCLIC AZA HETEROCYCLES, AND USE THEREOF	<b>C07D 403/14</b> (2006.01)	2627651 *	ANTI-VIRAL COMPOUNDS
<b>A61P 9/00</b> (2006.01)	2611802 *	BICYCLIC AZA HETEROCYCLES, AND USE THEREOF	<b>A61K 47/48</b> (2006.01)	2628489	PEG oligomer-fentanyl conjugates
<b>A61P 9/04</b> (2006.01)	2611802 *	BICYCLIC AZA HETEROCYCLES, AND USE THEREOF	<b>A61P 25/28</b> (2006.01)	2632254 *	DEUTERIUM ENRICHED RASAGILINE
<b>A61P 9/12</b> (2006.01)	2611802 *	BICYCLIC AZA HETEROCYCLES, AND USE THEREOF	<b>A61K 31/135</b> (2006.01)	2632254 *	DEUTERIUM ENRICHED RASAGILINE
<b>A61P 9/14</b> (2006.01)	2611802 *	BICYCLIC AZA HETEROCYCLES, AND USE THEREOF	<b>C07C 309/29</b> (2006.01)	2632254 *	DEUTERIUM ENRICHED RASAGILINE
<b>A61P 9/10</b> (2006.01)	2611802 *	BICYCLIC AZA HETEROCYCLES, AND USE THEREOF	<b>C07C 211/42</b> (2006.01)	2632254 *	DEUTERIUM ENRICHED RASAGILINE
<b>A61P 7/02</b> (2006.01)	2611802 *	BICYCLIC AZA HETEROCYCLES, AND USE THEREOF	<b>C07C 309/04</b> (2006.01)	2632254 *	DEUTERIUM ENRICHED RASAGILINE
<b>A61P 13/12</b> (2006.01)	2611802 *	BICYCLIC AZA HETEROCYCLES, AND USE THEREOF	<b>A01N 33/02</b> (2006.01)	2632254 *	DEUTERIUM ENRICHED RASAGILINE
<b>A61K 38/48</b> (2006.01)	2616091 *	STABILIZATION OF IMMUNOGLOBULINS AND OTHER PROTEINS THROUGH AQUEOUS FORMULATIONS WITH SODIUM CHLORIDE AT WEAK ACIDIC TO NEUTRAL PH	<b>A61B 19/00</b> (2006.01)	2598074 *	BONE TRACKING WITH A GYROSCOPE SENSOR IN COMPUTER-ASSISTED SURGERY
<b>A61K 39/395</b> (2006.01)	2616091 *	STABILIZATION OF IMMUNOGLOBULINS AND OTHER PROTEINS THROUGH AQUEOUS FORMULATIONS WITH SODIUM CHLORIDE AT WEAK ACIDIC TO NEUTRAL PH	<b>A61B 17/56</b> (2006.01)	2598074 *	BONE TRACKING WITH A GYROSCOPE SENSOR IN COMPUTER-ASSISTED SURGERY
<b>A61K 47/02</b> (2006.01)	2616091 *	STABILIZATION OF IMMUNOGLOBULINS AND OTHER PROTEINS THROUGH AQUEOUS FORMULATIONS WITH SODIUM CHLORIDE AT WEAK ACIDIC TO NEUTRAL PH	<b>A61B 5/11</b> (2006.01)	2598074 *	BONE TRACKING WITH A GYROSCOPE SENSOR IN COMPUTER-ASSISTED SURGERY
			<b>G01C 19/02</b> (2006.01)	2598074 *	BONE TRACKING WITH A GYROSCOPE SENSOR IN COMPUTER-ASSISTED SURGERY
			<b>A61P 25/00</b> (2006.01)	2620433 *	SUBSTITUTED AMIDE COMPOUND
			<b>C07D 277/20</b> (2006.01)	2620433 *	SUBSTITUTED AMIDE COMPOUND

MKP (51)	Broj objave evropske prijava patenta (97)	Naziv pronalaska (54)	MKP (51)	Broj objave evropske prijava patenta (97)	Naziv pronalaska (54)
<b>A61P 35/00</b> (2006.01)	2620433 *	SUBSTITUTED AMIDE COMPOUND	<b>A61P 35/00</b> (2006.01)	2640704 *	NAMPT INHIBITORS
<b>A61P 9/00</b> (2006.01)	2620433 *	SUBSTITUTED AMIDE COMPOUND	<b>C03C 3/118</b> (2006.01)	2616400 *	LOW DENSITY AND HIGH STRENGTH FIBER GLASS FOR REINFORCEMENT APPLICATIONS
<b>C07D 417/12</b> (2006.01)	2620433 *	SUBSTITUTED AMIDE COMPOUND	<b>C03C 13/00</b> (2006.01)	2616400 *	LOW DENSITY AND HIGH STRENGTH FIBER GLASS FOR REINFORCEMENT APPLICATIONS
<b>A61K 31/426</b> (2006.01)	2620433 *	SUBSTITUTED AMIDE COMPOUND	<b>B32B 17/00</b> (2006.01)	2616400 *	LOW DENSITY AND HIGH STRENGTH FIBER GLASS FOR REINFORCEMENT APPLICATIONS
<b>C07D 277/56</b> (2006.01)	2620433 *	SUBSTITUTED AMIDE COMPOUND	<b>C08J 5/24</b> (2006.01)	2616400 *	LOW DENSITY AND HIGH STRENGTH FIBER GLASS FOR REINFORCEMENT APPLICATIONS
<b>A61K 31/341</b> (2006.01)	2620433 *	SUBSTITUTED AMIDE COMPOUND	<b>C08K 7/14</b> (2006.01)	2616400 *	LOW DENSITY AND HIGH STRENGTH FIBER GLASS FOR REINFORCEMENT APPLICATIONS
<b>A61P 43/00</b> (2006.01)	2620433 *	SUBSTITUTED AMIDE COMPOUND	<b>C08J 5/04</b> (2006.01)	2616400 *	LOW DENSITY AND HIGH STRENGTH FIBER GLASS FOR REINFORCEMENT APPLICATIONS
<b>A61K 31/427</b> (2006.01)	2620433 *	SUBSTITUTED AMIDE COMPOUND	<b>C07C 323/58</b> (2006.01)	2640697 *	4-SUBSTITUTED-3- PHENYLSULFANYLMETHYL- BICYCLO[3.1.0]HEXANE COMPOUNDS AS MGLUR 2/3 ANTAGONISTS
<b>C07D 307/68</b> (2006.01)	2620433 *	SUBSTITUTED AMIDE COMPOUND	<b>A61K 31/10</b> (2006.01)	2640697 *	4-SUBSTITUTED-3- PHENYLSULFANYLMETHYL- BICYCLO[3.1.0]HEXANE COMPOUNDS AS MGLUR 2/3 ANTAGONISTS
<b>A61P 29/00</b> (2006.01)	2620433 *	SUBSTITUTED AMIDE COMPOUND	<b>C07D 417/00</b> (2006.01)	2609093 *	SALT COMPOUND
<b>A61P 13/00</b> (2006.01)	2620433 *	SUBSTITUTED AMIDE COMPOUND	<b>A01N 25/00</b> (2006.01)	2613629 *	ORAL VETERINARY PREPARATIONS
<b>C07D 209/42</b> (2006.01)	2612851	Process for the preparation of the L-arginine salt of perindopril	<b>A61K 9/00</b> (2006.01)	2613629 *	ORAL VETERINARY PREPARATIONS
<b>C07D 217/06</b> (2006.01)	2640704 *	NAMPT INHIBITORS	<b>A61K 39/205</b> (2006.01)	2613629 *	ORAL VETERINARY PREPARATIONS
<b>C07D 401/12</b> (2006.01)	2640704 *	NAMPT INHIBITORS	<b>B65D 75/42</b> (2006.01)	2613629 *	ORAL VETERINARY PREPARATIONS
<b>C07D 405/12</b> (2006.01)	2640704 *	NAMPT INHIBITORS	<b>A23L 1/30</b> (2006.01)	2526785	Process for producing a phytoextract from vegetation waters and olive oil pomaces
<b>C07D 409/12</b> (2006.01)	2640704 *	NAMPT INHIBITORS	<b>C02F 1/04</b> (2006.01)	2526785	Process for producing a phytoextract from vegetation waters and olive oil pomaces
<b>C07D 409/14</b> (2006.01)	2640704 *	NAMPT INHIBITORS	<b>C02F 1/44</b> (2006.01)	2526785	Process for producing a phytoextract from vegetation waters and olive oil pomaces
<b>C07D 413/12</b> (2006.01)	2640704 *	NAMPT INHIBITORS	<b>C02F 3/34</b> (2006.01)	2526785	Process for producing a phytoextract from vegetation waters and olive oil pomaces
<b>C07D 471/04</b> (2006.01)	2640704 *	NAMPT INHIBITORS	<b>A61K 36/63</b> (2006.01)	2526785	Process for producing a phytoextract from vegetation waters and olive oil pomaces
<b>A61K 31/4375</b> (2006.01)	2640704 *	NAMPT INHIBITORS			
<b>A61K 31/496</b> (2006.01)	2640704 *	NAMPT INHIBITORS			
<b>A61K 31/472</b> (2006.01)	2640704 *	NAMPT INHIBITORS			
<b>A61K 31/4725</b> (2006.01)	2640704 *	NAMPT INHIBITORS			
<b>A61P 29/00</b> (2006.01)	2640704 *	NAMPT INHIBITORS			
<b>A61P 37/00</b> (2006.01)	2640704 *	NAMPT INHIBITORS			
<b>A61P 9/00</b> (2006.01)	2640704 *	NAMPT INHIBITORS			

MKP (51)	Broj objave evropske prijava patenta (97)	Naziv pronalaska (54)	MKP (51)	Broj objave evropske prijava patenta (97)	Naziv pronalaska (54)
<b>A23L 1/212</b> (2006.01)	2526785	Process for producing a phytoextract from vegetation waters and olive oil pomaces	<b>C07C 7/10</b> (2006.01)	2611887 *	SULFONE REMOVAL FROM AN OXIDIZED HYDROCARBON FUEL
<b>C12P 7/56</b> (2006.01)	2633027 *	PROCESS FOR POLYLACTIC ACID PRODUCTION USING MONASCUS	<b>B29C 65/18</b> (2006.01)	2643144 *	ELECTRICALLY OPERATED MACHINE FOR COVERING BOOK COVERS AND SEALING ENVELOPES AND ARTICLES OF VARIOUS KIND
<b>C12R 1/645</b> (2006.01)	2633027 *	PROCESS FOR POLYLACTIC ACID PRODUCTION USING MONASCUS	<b>B42C 15/00</b> (2006.01)	2643144 *	ELECTRICALLY OPERATED MACHINE FOR COVERING BOOK COVERS AND SEALING ENVELOPES AND ARTICLES OF VARIOUS KIND
<b>C12N 1/14</b> (2006.01)	2633027 *	PROCESS FOR POLYLACTIC ACID PRODUCTION USING MONASCUS	<b>B65B 51/14</b> (2006.01)	2643144 *	ELECTRICALLY OPERATED MACHINE FOR COVERING BOOK COVERS AND SEALING ENVELOPES AND ARTICLES OF VARIOUS KIND
<b>A61K 31/42</b> (2006.01)	2611298 *	BICYCLIC OXAZOLE AND THIAZOLE COMPOUNDS AND THEIR USE AS ALLOSTERIC MODULATORS OF MGLUR5 RECEPTORS	<b>A61K 36/185</b> (2006.01)	2605785 *	METHOD FOR PRODUCING NON-ALCOHOLIC COMPOSITIONS, COMPOSITIONS PRODUCED IN SAID MANNER AND USE THEREOF
<b>A01N 43/76</b> (2006.01)	2611298 *	BICYCLIC OXAZOLE AND THIAZOLE COMPOUNDS AND THEIR USE AS ALLOSTERIC MODULATORS OF MGLUR5 RECEPTORS	<b>A61K 36/53</b> (2006.01)	2605785 *	METHOD FOR PRODUCING NON-ALCOHOLIC COMPOSITIONS, COMPOSITIONS PRODUCED IN SAID MANNER AND USE THEREOF
<b>A61K 31/505</b> (2006.01)	2616077 *	ANTI-CANCER ACTIVITY OF NOVEL BICYCLIC HETEROCYCLES	<b>B22D 11/06</b> (2006.01)	2629907 *	TWIN ROLL CONTINUOUS CASTER
<b>C22B 21/04</b> (2006.01)	2639320 *	METHOD FOR PRODUCING ALUMINIUM BY METALLOTHERMIC REDUCTION OF TRICHLORIDE WITH MAGNESIUM AND APPARATUS FOR CARRYING OUT SAID METHOD	<b>A61K 31/52</b> (2006.01)	2635287 *	ADMINISTRATION OF NEDD8-ACTIVATING ENZYME INHIBITOR
<b>G01N 33/574</b> (2006.01)	2643698 *	BIOMARKERS FOR PREDICTING THE EFFICACY OF AN IMMUNOTHERAPY AGAINST CANCER	<b>A61P 35/00</b> (2006.01)	2635287 *	ADMINISTRATION OF NEDD8-ACTIVATING ENZYME INHIBITOR
<b>A61K 39/00</b> (2006.01)	2643698 *	BIOMARKERS FOR PREDICTING THE EFFICACY OF AN IMMUNOTHERAPY AGAINST CANCER	<b>B23B 27/22</b> (2006.01)	2636472 *	CUTTING INSERT, CUTTING TOOL, AND METHOD FOR MANUFACTURING CUT PRODUCT USING SAME
<b>H04W 52/14</b> (2009.01)	2645786 *	METHOD AND BASE STATION FOR ADJUSTING UPLINK GRANT PHYSICAL DOWNLINK CONTROL CHANNEL OF UE	<b>B23B 27/04</b> (2006.01)	2636472 *	CUTTING INSERT, CUTTING TOOL, AND METHOD FOR MANUFACTURING CUT PRODUCT USING SAME
<b>C07D 211/22</b> (2006.01)	2601177 *	N-ACYLSULFONAMIDE APOPTOSIS PROMOTERS	<b>B23B 27/14</b> (2006.01)	2636472 *	CUTTING INSERT, CUTTING TOOL, AND METHOD FOR MANUFACTURING CUT PRODUCT USING SAME
<b>A61K 31/445</b> (2006.01)	2601177 *	N-ACYLSULFONAMIDE APOPTOSIS PROMOTERS	<b>E21B 43/10</b> (2006.01)	2598714 *	WELLBORE LATERAL LINER PLACEMENT SYSTEM
<b>A61P 35/00</b> (2006.01)	2601177 *	N-ACYLSULFONAMIDE APOPTOSIS PROMOTERS	<b>C07D 417/14</b> (2006.01)	2643311 *	BICYCLIC GPR119 MODULATORS
<b>A61P 35/02</b> (2006.01)	2601177 *	N-ACYLSULFONAMIDE APOPTOSIS PROMOTERS	<b>A61P 19/00</b> (2006.01)	2643311 *	BICYCLIC GPR119 MODULATORS
<b>C10G 19/02</b> (2006.01)	2611887 *	SULFONE REMOVAL FROM AN OXIDIZED HYDROCARBON FUEL	<b>A61K 31/444</b> (2006.01)	2643311 *	BICYCLIC GPR119 MODULATORS
<b>C10G 67/10</b> (2006.01)	2611887 *	SULFONE REMOVAL FROM AN OXIDIZED HYDROCARBON FUEL	<b>C07D 471/04</b> (2006.01)	2643311 *	BICYCLIC GPR119 MODULATORS

MKP (51)	Broj objave evropske prijava patenta (97)	Naziv pronalaska (54)	MKP (51)	Broj objave evropske prijava patenta (97)	Naziv pronalaska (54)
<b>C07D 401/12</b> (2006.01)	2643311 *	BICYCLIC GPR119 MODULATORS	<b>B01D</b> <b>17/038</b> (2006.01)	2608866 *	SYSTEM AND METHOD FOR SEPARATING FLUIDS AND CREATING MAGNETIC FIELDS
<b>A61P 3/04</b> (2006.01)	2643311 *	BICYCLIC GPR119 MODULATORS	<b>A61L 101/32</b> (2006.01)	2629807 *	WATER-BASED AIR FRESHENER COMPOSITIONS, SYSTEMS, AND METHODS OF USE THEREOF
<b>C07D 401/14</b> (2006.01)	2643311 *	BICYCLIC GPR119 MODULATORS	<b>A61L 9/01</b> (2006.01)	2629807 *	WATER-BASED AIR FRESHENER COMPOSITIONS, SYSTEMS, AND METHODS OF USE THEREOF
<b>A61P 3/10</b> (2006.01)	2643311 *	BICYCLIC GPR119 MODULATORS	<b>A61L 9/12</b> (2006.01)	2629807 *	WATER-BASED AIR FRESHENER COMPOSITIONS, SYSTEMS, AND METHODS OF USE THEREOF
<b>C07D 491/08</b> (2006.01)	2643311 *	BICYCLIC GPR119 MODULATORS	<b>B65G 67/20</b> (2006.01)	2627592 *	APPARATUS AND METHOD FOR LOADING AND UNLOADING CONTAINERS
<b>C07D 413/14</b> (2006.01)	2643311 *	BICYCLIC GPR119 MODULATORS	<b>B65G 67/08</b> (2006.01)	2627592 *	APPARATUS AND METHOD FOR LOADING AND UNLOADING CONTAINERS
<b>A61P 9/00</b> (2006.01)	2643311 *	BICYCLIC GPR119 MODULATORS	<b>B65G</b> <b>57/112</b> (2006.01)	2627592 *	APPARATUS AND METHOD FOR LOADING AND UNLOADING CONTAINERS
<b>A61K</b> <b>31/506</b> (2006.01)	2643311 *	BICYCLIC GPR119 MODULATORS	<b>B01D 63/04</b> (2006.01)	2614880	Membrane device for filtering and separating fluids
<b>F02M 59/46</b> (2006.01)	2538067	Assembly for an electrically operated valve	<b>B01D 65/00</b> (2006.01)	2614880	Membrane device for filtering and separating fluids
<b>F02M 63/00</b> (2006.01)	2538067	Assembly for an electrically operated valve	<b>H01L 21/02</b> (2006.01)	2410556	Sodium sputtering doping method for large scale CIGS based thin film photovoltaic materials
<b>F02M 63/02</b> (2006.01)	2538067	Assembly for an electrically operated valve	<b>H01L 21/36</b> (2006.01)	2410556	Sodium sputtering doping method for large scale CIGS based thin film photovoltaic materials
<b>F02M 51/00</b> (2006.01)	2538067	Assembly for an electrically operated valve	<b>B27N 3/00</b> (2006.01)	2598260 *	METHOD FOR RECYCLING FURNITURE MATERIALS, IN PARTICULAR MATTRESS, BOX-SPRING, AND SEAT MATERIALS, SHEET OF MATERIAL OBTAINED BY SUCH A METHOD, AND RELATED RECYCLING FACILITY
<b>F16K 31/06</b> (2006.01)	2538067	Assembly for an electrically operated valve	<b>B29B 17/02</b> (2006.01)	2598260 *	METHOD FOR RECYCLING FURNITURE MATERIALS, IN PARTICULAR MATTRESS, BOX-SPRING, AND SEAT MATERIALS, SHEET OF MATERIAL OBTAINED BY SUCH A METHOD, AND RELATED RECYCLING FACILITY
<b>F16L 37/098</b> (2006.01)	2538067	Assembly for an electrically operated valve			
<b>F02M 61/16</b> (2006.01)	2538067	Assembly for an electrically operated valve			
<b>A61M 11/00</b> (2006.01)	2537548	A method and apparatus for controlling and monitoring of an apparatus for generating an aerosol during administration of a dose of a substance by way of inhalation			
<b>A61M 11/06</b> (2006.01)	2537548	A method and apparatus for controlling and monitoring of an apparatus for generating an aerosol during administration of a dose of a substance by way of inhalation			
<b>A61M 15/00</b> (2006.01)	2537548	A method and apparatus for controlling and monitoring of an apparatus for generating an aerosol during administration of a dose of a substance by way of inhalation			
<b>C07K 16/46</b> (2006.01)	2627672 *	HUMAN ANTI-TAU ANTIBODIES			
<b>C07K 16/18</b> (2006.01)	2627672 *	HUMAN ANTI-TAU ANTIBODIES			
<b>B01D 53/02</b> (2006.01)	2608866 *	SYSTEM AND METHOD FOR SEPARATING FLUIDS AND CREATING MAGNETIC FIELDS			



MKP (51)	Broj objave evropske prijava patenta (97)	Naziv pronalaska (54)	MKP (51)	Broj objave evropske prijava patenta (97)	Naziv pronalaska (54)
<b>B09B 3/00</b> (2006.01)	2598260 *	METHOD FOR RECYCLING FURNITURE MATERIALS, IN PARTICULAR MATTRESS, BOX-SPRING, AND SEAT MATERIALS, SHEET OF MATERIAL OBTAINED BY SUCH A METHOD, AND RELATED RECYCLING FACILITY	<b>B41K 1/50</b> (2006.01)	2522524	Marking device for marking balls, use of such a marking device and method for producing such a marking device
<b>G01N 33/53</b> (2006.01)	2603794 *	DUAL FUNCTION IN VITRO TARGET BINDING ASSAY FOR THE DETECTION OF NEUTRALIZING ANTIBODIES AGAINST TARGET ANTIBODIES	<b>B41K 1/52</b> (2006.01)	2522524	Marking device for marking balls, use of such a marking device and method for producing such a marking device
<b>G01N 33/68</b> (2006.01)	2603794 *	DUAL FUNCTION IN VITRO TARGET BINDING ASSAY FOR THE DETECTION OF NEUTRALIZING ANTIBODIES AGAINST TARGET ANTIBODIES	<b>G02B 6/36</b> (2006.01)	2625557 *	OPTICAL HEAD FOR PERFORMING AN ATMOSPHERIC MEASUREMENT, AND RELATED SYSTEM AND MANUFACTURING METHOD
<b>G01N 33/564</b> (2006.01)	2603794 *	DUAL FUNCTION IN VITRO TARGET BINDING ASSAY FOR THE DETECTION OF NEUTRALIZING ANTIBODIES AGAINST TARGET ANTIBODIES	<b>G02B 7/00</b> (2006.01)	2625557 *	OPTICAL HEAD FOR PERFORMING AN ATMOSPHERIC MEASUREMENT, AND RELATED SYSTEM AND MANUFACTURING METHOD
<b>C07C 333/08</b> (2006.01)	2619177 *	MATRIX METALLOPROTEINASE INHIBITORS	<b>A61K 31/133</b> (2006.01)	2611433 *	NON-HYGROSCOPIC SALTS OF 5-HT <sub>2C</sub> AGONISTS
<b>A61K 31/192</b> (2006.01)	2619177 *	MATRIX METALLOPROTEINASE INHIBITORS	<b>A61K 38/10</b> (2006.01)	2613794 *	TREATMENT OF CONSTIPATION-PREDOMINANT IRRITABLE BOWEL SYNDROME
<b>A61K 31/325</b> (2006.01)	2619177 *	MATRIX METALLOPROTEINASE INHIBITORS	<b>A61P 1/00</b> (2006.01)	2613794 *	TREATMENT OF CONSTIPATION-PREDOMINANT IRRITABLE BOWEL SYNDROME
<b>C07C 309/60</b> (2006.01)	2619177 *	MATRIX METALLOPROTEINASE INHIBITORS	<b>A61P 43/00</b> (2006.01)	2613794 *	TREATMENT OF CONSTIPATION-PREDOMINANT IRRITABLE BOWEL SYNDROME
<b>C07C 321/28</b> (2006.01)	2619177 *	MATRIX METALLOPROTEINASE INHIBITORS	<b>A61K 39/395</b> (2006.01)	2611463 *	IDENTIFICATION AND ENRICHMENT OF CELL SUBPOPULATIONS
<b>A61P 11/00</b> (2006.01)	2619177 *	MATRIX METALLOPROTEINASE INHIBITORS	<b>A01N 43/52</b> (2006.01)	2624696 *	BENZIMIDAZOLE DERIVATIVES AS PI3 KINASE INHIBITORS
<b>A61P 19/02</b> (2006.01)	2619177 *	MATRIX METALLOPROTEINASE INHIBITORS	<b>A61K 31/4164</b> (2006.01)	2624696 *	BENZIMIDAZOLE DERIVATIVES AS PI3 KINASE INHIBITORS
<b>A61P 35/00</b> (2006.01)	2619177 *	MATRIX METALLOPROTEINASE INHIBITORS	<b>G02B 27/12</b> (2006.01)	2596400 *	NANO-OPTIC REFRACTIVE OPTICS
<b>B41K 1/26</b> (2006.01)	2522524	Marking device for marking balls, use of such a marking device and method for producing such a marking device	<b>A01N 37/34</b> (2006.01)	2595481 *	CONTROL AGENT FOR SOFT ROT AND CONTROL METHOD FOR THE SAME
<b>B41K 1/28</b> (2006.01)	2522524	Marking device for marking balls, use of such a marking device and method for producing such a marking device	<b>A01N 43/653</b> (2006.01)	2595481 *	CONTROL AGENT FOR SOFT ROT AND CONTROL METHOD FOR THE SAME
			<b>A01N 43/54</b> (2006.01)	2595481 *	CONTROL AGENT FOR SOFT ROT AND CONTROL METHOD FOR THE SAME
			<b>A01N 37/50</b> (2006.01)	2595481 *	CONTROL AGENT FOR SOFT ROT AND CONTROL METHOD FOR THE SAME
			<b>A01N 47/34</b> (2006.01)	2595481 *	CONTROL AGENT FOR SOFT ROT AND CONTROL METHOD FOR THE SAME

MKP (51)	Broj objave evropske prijava patenta (97)	Naziv pronalaska (54)	MKP (51)	Broj objave evropske prijava patenta (97)	Naziv pronalaska (54)
<b>A01N 37/32</b> (2006.01)	2595481 *	CONTROL AGENT FOR SOFT ROT AND CONTROL METHOD FOR THE SAME	<b>C12N 5/0735</b> (2010.01)	2611907 *	DIFFERENTIATION OF PLURIPOTENT STEM CELLS
<b>A01N 43/56</b> (2006.01)	2595481 *	CONTROL AGENT FOR SOFT ROT AND CONTROL METHOD FOR THE SAME	<b>C12N 5/071</b> (2010.01)	2611907 *	DIFFERENTIATION OF PLURIPOTENT STEM CELLS
<b>A01N 41/06</b> (2006.01)	2595481 *	CONTROL AGENT FOR SOFT ROT AND CONTROL METHOD FOR THE SAME	<b>B65D 17/34</b> (2006.01)	2621820 *	LID FOR BEVERAGE CAN
<b>A01N 47/38</b> (2006.01)	2595481 *	CONTROL AGENT FOR SOFT ROT AND CONTROL METHOD FOR THE SAME	<b>B65D 47/18</b> (2006.01)	2616352 *	HEAD FOR DISPENSING A LIQUID AS A DRIP
<b>A01N 43/36</b> (2006.01)	2595481 *	CONTROL AGENT FOR SOFT ROT AND CONTROL METHOD FOR THE SAME	<b>B65D 49/04</b> (2006.01)	2616352 *	HEAD FOR DISPENSING A LIQUID AS A DRIP
<b>A01N 47/44</b> (2006.01)	2595481 *	CONTROL AGENT FOR SOFT ROT AND CONTROL METHOD FOR THE SAME	<b>B65D 81/26</b> (2006.01)	2616352 *	HEAD FOR DISPENSING A LIQUID AS A DRIP
<b>A01N 43/40</b> (2006.01)	2595481 *	CONTROL AGENT FOR SOFT ROT AND CONTROL METHOD FOR THE SAME	<b>B65D 47/32</b> (2006.01)	2616352 *	HEAD FOR DISPENSING A LIQUID AS A DRIP
<b>A01N 53/00</b> (2006.01)	2595481 *	CONTROL AGENT FOR SOFT ROT AND CONTROL METHOD FOR THE SAME	<b>B65D 51/16</b> (2006.01)	2616352 *	HEAD FOR DISPENSING A LIQUID AS A DRIP
<b>A01N 43/50</b> (2006.01)	2595481 *	CONTROL AGENT FOR SOFT ROT AND CONTROL METHOD FOR THE SAME	<b>A61K 31/496</b> (2006.01)	2642999 *	METHODS OF TREATMENT USING SELECTIVE BCL-2 INHIBITORS
<b>A01P 3/00</b> (2006.01)	2595481 *	CONTROL AGENT FOR SOFT ROT AND CONTROL METHOD FOR THE SAME	<b>A61P 37/00</b> (2006.01)	2642999 *	METHODS OF TREATMENT USING SELECTIVE BCL-2 INHIBITORS
<b>A61P 1/00</b> (2006.01)	2629789 *	METHOD TO INCREASE THE ABSORPTION OF UNSATURATED FATTY ACIDS BY HUMAN INFANTS	<b>A61K 31/37</b> (2006.01)	2595624 *	ADVERSE SIDE-EFFECTS ASSOCIATED WITH ADMINISTRATION OF AN ANTI-HYALURONAN AGENT AND METHODS FOR AMELIORATING OR PREVENTING THE SIDE- EFFECTS
<b>A61K 38/43</b> (2006.01)	2629789 *	METHOD TO INCREASE THE ABSORPTION OF UNSATURATED FATTY ACIDS BY HUMAN INFANTS	<b>A61K 31/42</b> (2006.01)	2595624 *	ADVERSE SIDE-EFFECTS ASSOCIATED WITH ADMINISTRATION OF AN ANTI-HYALURONAN AGENT AND METHODS FOR AMELIORATING OR PREVENTING THE SIDE- EFFECTS
<b>F24J 2/20</b> (2006.01)	2625470 *	SOLAR COLLECTOR	<b>A61K 31/573</b> (2006.01)	2595624 *	ADVERSE SIDE-EFFECTS ASSOCIATED WITH ADMINISTRATION OF AN ANTI-HYALURONAN AGENT AND METHODS FOR AMELIORATING OR PREVENTING THE SIDE- EFFECTS
<b>C12N 1/14</b> (2006.01)	2633028 *	USE OF MONASCUS IN ORGANIC ACID PRODUCTION	<b>A61K 38/47</b> (2006.01)	2595624 *	ADVERSE SIDE-EFFECTS ASSOCIATED WITH ADMINISTRATION OF AN ANTI-HYALURONAN AGENT AND METHODS FOR AMELIORATING OR PREVENTING THE SIDE- EFFECTS
<b>C12R 1/645</b> (2006.01)	2633028 *	USE OF MONASCUS IN ORGANIC ACID PRODUCTION	<b>A61P 43/00</b> (2006.01)	2595624 *	ADVERSE SIDE-EFFECTS ASSOCIATED WITH ADMINISTRATION OF AN ANTI-HYALURONAN AGENT AND METHODS FOR AMELIORATING OR PREVENTING THE SIDE- EFFECTS
<b>A61B 17/04</b> (2006.01)	2566402 *	SELF-RETAINING SYSTEMS HAVING LASER-CUT RETAINERS			
<b>A61B 17/08</b> (2006.01)	2566402 *	SELF-RETAINING SYSTEMS HAVING LASER-CUT RETAINERS			
<b>D02J 3/10</b> (2006.01)	2566402 *	SELF-RETAINING SYSTEMS HAVING LASER-CUT RETAINERS			
<b>D02J 3/02</b> (2006.01)	2566402 *	SELF-RETAINING SYSTEMS HAVING LASER-CUT RETAINERS			
<b>C12N 5/02</b> (2006.01)	2611907 *	DIFFERENTIATION OF PLURIPOTENT STEM CELLS			

MKP (51)	Broj objave evropske prijava patenta (97)	Naziv pronalaska (54)	MKP (51)	Broj objave evropske prijava patenta (97)	Naziv pronalaska (54)
<b>A61P 29/00</b> (2006.01)	2595624 *	ADVERSE SIDE-EFFECTS ASSOCIATED WITH ADMINISTRATION OF AN ANTI-HYALURONAN AGENT AND METHODS FOR AMELIORATING OR PREVENTING THE SIDE-EFFECTS	<b>A61P 35/00</b> (2006.01)	2598491 *	SUBSTITUTED 4-(4-FLUORO-3-(PIPERAZINE-1-CARBONYL)BENZYL) PHTHALAZIN-1(2H)-ONE DERIVATIVES AS POLY (ADP-RIBOSE) POLYMERASE- 1 INHIBITORS
<b>A61P 7/10</b> (2006.01)	2595624 *	ADVERSE SIDE-EFFECTS ASSOCIATED WITH ADMINISTRATION OF AN ANTI-HYALURONAN AGENT AND METHODS FOR AMELIORATING OR PREVENTING THE SIDE-EFFECTS	<b>A61K 38/46</b> (2006.01)	2613798 *	USE OF LYOSOMAL ACID LIPASE FOR TREATING LYOSOMAL ACID LIPASE DEFICIENCY IN PATIENTS
<b>A61P 21/00</b> (2006.01)	2595624 *	ADVERSE SIDE-EFFECTS ASSOCIATED WITH ADMINISTRATION OF AN ANTI-HYALURONAN AGENT AND METHODS FOR AMELIORATING OR PREVENTING THE SIDE-EFFECTS	<b>A61K 31/366</b> (2006.01)	2613798 *	USE OF LYOSOMAL ACID LIPASE FOR TREATING LYOSOMAL ACID LIPASE DEFICIENCY IN PATIENTS
<b>A61P 35/00</b> (2006.01)	2595624 *	ADVERSE SIDE-EFFECTS ASSOCIATED WITH ADMINISTRATION OF AN ANTI-HYALURONAN AGENT AND METHODS FOR AMELIORATING OR PREVENTING THE SIDE-EFFECTS	<b>A61K 31/397</b> (2006.01)	2613798 *	USE OF LYOSOMAL ACID LIPASE FOR TREATING LYOSOMAL ACID LIPASE DEFICIENCY IN PATIENTS
<b>H02G 3/08</b> (2006.01)	2643911 *	SINGLE-LINE SEAL	<b>A61K 31/135</b> (2006.01)	2613798 *	USE OF LYOSOMAL ACID LIPASE FOR TREATING LYOSOMAL ACID LIPASE DEFICIENCY IN PATIENTS
<b>H02G 3/22</b> (2006.01)	2643911 *	SINGLE-LINE SEAL	<b>A61P 3/06</b> (2006.01)	2613798 *	USE OF LYOSOMAL ACID LIPASE FOR TREATING LYOSOMAL ACID LIPASE DEFICIENCY IN PATIENTS
<b>H02G 15/013</b> (2006.01)	2643911 *	SINGLE-LINE SEAL	<b>A61K 39/395</b> (2006.01)	2632954 *	MEANS AND METHODS FOR TREATING DLBCL
<b>A61K 31/502</b> (2006.01)	2598491 *	SUBSTITUTED 4-(4-FLUORO-3-(PIPERAZINE-1-CARBONYL)BENZYL) PHTHALAZIN-1(2H)-ONE DERIVATIVES AS POLY (ADP-RIBOSE) POLYMERASE- 1 INHIBITORS	<b>C07K 16/28</b> (2006.01)	2632954 *	MEANS AND METHODS FOR TREATING DLBCL
<b>C07D 237/32</b> (2006.01)	2598491 *	SUBSTITUTED 4-(4-FLUORO-3-(PIPERAZINE-1-CARBONYL)BENZYL) PHTHALAZIN-1(2H)-ONE DERIVATIVES AS POLY (ADP-RIBOSE) POLYMERASE- 1 INHIBITORS	<b>C07K 16/46</b> (2006.01)	2632954 *	MEANS AND METHODS FOR TREATING DLBCL
<b>C07D 403/12</b> (2006.01)	2598491 *	SUBSTITUTED 4-(4-FLUORO-3-(PIPERAZINE-1-CARBONYL)BENZYL) PHTHALAZIN-1(2H)-ONE DERIVATIVES AS POLY (ADP-RIBOSE) POLYMERASE- 1 INHIBITORS	<b>A61P 35/00</b> (2006.01)	2632954 *	MEANS AND METHODS FOR TREATING DLBCL
			<b>C12N 15/09</b> (2006.01)	2644693	Biologically active polypeptide expressed on the surface of a cell
			<b>C12N 1/20</b> (2006.01)	2644693	Biologically active polypeptide expressed on the surface of a cell
			<b>C12N 9/18</b> (2006.01)	2644693	Biologically active polypeptide expressed on the surface of a cell
			<b>C12N 5/10</b> (2006.01)	2644693	Biologically active polypeptide expressed on the surface of a cell
			<b>C12N 15/70</b> (2006.01)	2644693	Biologically active polypeptide expressed on the surface of a cell
			<b>C12Q 1/04</b> (2006.01)	2596119 *	METHODS FOR DETECTION OF RARE SUBPOPULATIONS OF CELLS AND HIGHLY PURIFIED COMPOSITIONS OF CELLS
			<b>C12N 5/071</b> (2010.01)	2596119 *	METHODS FOR DETECTION OF RARE SUBPOPULATIONS OF CELLS AND HIGHLY PURIFIED COMPOSITIONS OF CELLS

MKP (51)	Broj objave evropske prijava patenta (97)	Naziv pronalaska (54)	MKP (51)	Broj objave evropske prijava patenta (97)	Naziv pronalaska (54)
<b>C12N 5/0735</b> (2010.01)	2596119 *	METHODS FOR DETECTION OF RARE SUBPOPULATIONS OF CELLS AND HIGHLY PURIFIED COMPOSITIONS OF CELLS	<b>A61K 31/4745</b> (2006.01)	2600870 *	PUMP SYSTEMS AND METHODS FOR STORING AND DISPENSING A PLURALITY OF PRECISELY MEASURED UNIT-DOSES OF IMIQUIMOD CREAM
<b>G01N 33/533</b> (2006.01)	2596119 *	METHODS FOR DETECTION OF RARE SUBPOPULATIONS OF CELLS AND HIGHLY PURIFIED COMPOSITIONS OF CELLS	<b>A61P 35/00</b> (2006.01)	2640367 *	BENZOXAZEPINES AS INHIBITORS OF PI3K/MTOR AND METHODS OF THEIR USE AND MANUFACTURE
<b>E06B 9/00</b> (2006.01)	2601371 *	CLAMPING DEVICE	<b>G01N 33/00</b> (2006.01)	2640367 *	BENZOXAZEPINES AS INHIBITORS OF PI3K/MTOR AND METHODS OF THEIR USE AND MANUFACTURE
<b>E06B 9/02</b> (2006.01)	2601371 *	CLAMPING DEVICE	<b>A61K 31/00</b> (2006.01)	2640367 *	BENZOXAZEPINES AS INHIBITORS OF PI3K/MTOR AND METHODS OF THEIR USE AND MANUFACTURE
<b>A47B 67/04</b> (2006.01)	2621307 *	FEEDING STATION FOR PETS AND CABINET HAVING SUCH A FEEDING STATION	<b>F21S 6/00</b> (2006.01)	2530371	An electronic candle
<b>A47B 88/20</b> (2006.01)	2621307 *	FEEDING STATION FOR PETS AND CABINET HAVING SUCH A FEEDING STATION	<b>A61P 31/16</b> (2006.01)	2620436 *	SUBSTITUTED POLYCYCLIC CARBAMOYL PYRIDONE DERIVATIVE PRODRUG
<b>G05D 11/13</b> (2006.01)	2616385 *	BEVERAGE DISPENSING SYSTEM	<b>C07D 471/04</b> (2006.01)	2620436 *	SUBSTITUTED POLYCYCLIC CARBAMOYL PYRIDONE DERIVATIVE PRODRUG
<b>B67D 3/00</b> (2006.01)	2616385 *	BEVERAGE DISPENSING SYSTEM	<b>A61K 31/53</b> (2006.01)	2620436 *	SUBSTITUTED POLYCYCLIC CARBAMOYL PYRIDONE DERIVATIVE PRODRUG
<b>B60K 15/03</b> (2006.01)	2625053 *	PRESSURE TANK	<b>A61P 43/00</b> (2006.01)	2620436 *	SUBSTITUTED POLYCYCLIC CARBAMOYL PYRIDONE DERIVATIVE PRODRUG
<b>F17C 1/00</b> (2006.01)	2625053 *	PRESSURE TANK	<b>C07D 401/12</b> (2006.01)	2621917 *	CRYSTALLINE OXALATE SALTS OF A DIAMIDE COMPOUND
<b>C08L 25/08</b> (2006.01)	2639183 *	PUSH-THROUGH PACK PACKAGING	<b>A61K 31/444</b> (2006.01)	2621917 *	CRYSTALLINE OXALATE SALTS OF A DIAMIDE COMPOUND
<b>B65D 65/02</b> (2006.01)	2639183 *	PUSH-THROUGH PACK PACKAGING	<b>A61P 11/08</b> (2006.01)	2621917 *	CRYSTALLINE OXALATE SALTS OF A DIAMIDE COMPOUND
<b>B65D 83/04</b> (2006.01)	2639183 *	PUSH-THROUGH PACK PACKAGING	<b>H04B 5/00</b> (2006.01)	2633702 *	PAIRING OR ASSOCIATING ELECTRONIC DEVICES
<b>C08K 3/00</b> (2006.01)	2639183 *	PUSH-THROUGH PACK PACKAGING	<b>H04R 25/00</b> (2006.01)	2633702 *	PAIRING OR ASSOCIATING ELECTRONIC DEVICES
<b>C08J 5/18</b> (2006.01)	2639183 *	PUSH-THROUGH PACK PACKAGING	<b>C25C 3/08</b> (2006.01)	2619518 *	SYSTEM AND METHOD FOR CONTROL OF SIDE LAYER FORMATION IN AN ALUMINIUM ELECTROLYSIS CELL
<b>B65D 75/34</b> (2006.01)	2639183 *	PUSH-THROUGH PACK PACKAGING	<b>F27D 1/12</b> (2006.01)	2619518 *	SYSTEM AND METHOD FOR CONTROL OF SIDE LAYER FORMATION IN AN ALUMINIUM ELECTROLYSIS CELL
<b>F02G 5/02</b> (2006.01)	2495422	Combustion engine	<b>A61M 5/315</b> (2006.01)	2624893 *	DRIVE MECHANISM FOR A DRUG DELIVERY DEVICE AND DRUG DELIVERY DEVICE
<b>A47F 7/024</b> (2006.01)	2586340	Ring holder, system comprising ring holder and ring display and method for connecting a ring with a ring holder			
<b>E03D 13/00</b> (2006.01)	2627836 *	INSERT FOR THE DRAINAGE OPENING OF A URINAL			
<b>E03D 9/00</b> (2006.01)	2627836 *	INSERT FOR THE DRAINAGE OPENING OF A URINAL			
<b>C07K 16/28</b> (2006.01)	2640749 *	SILENT FC VARIANTS OF ANTI-CD40 ANTIBODIES			
<b>B67B 5/00</b> (2006.01)	2600870 *	PUMP SYSTEMS AND METHODS FOR STORING AND DISPENSING A PLURALITY OF PRECISELY MEASURED UNIT-DOSES OF IMIQUIMOD CREAM			

MKP (51)	Broj objave evropske prijava patenta (97)	Naziv pronalaska (54)	MKP (51)	Broj objave evropske prijava patenta (97)	Naziv pronalaska (54)
<b>A61M 5/00</b> (2006.01)	2624893 *	DRIVE MECHANISM FOR A DRUG DELIVERY DEVICE AND DRUG DELIVERY DEVICE	<b>C07K 16/00</b> (2006.01)	2596114 *	DOMAIN INSERTION IMMUNOGLOBULIN
<b>A61P 3/00</b> (2006.01)	2595970 *	DERIVATIVES OF OXADIAZOLE AND PYRIDAZINE, THEIR PREPARATION AND THEIR APPLICATION IN THERAPEUTICS	<b>A61K 39/00</b> (2006.01)	2596114 *	DOMAIN INSERTION IMMUNOGLOBULIN
<b>C07D 237/20</b> (2006.01)	2595970 *	DERIVATIVES OF OXADIAZOLE AND PYRIDAZINE, THEIR PREPARATION AND THEIR APPLICATION IN THERAPEUTICS	<b>C12N 5/00</b> (2006.01)	2596114 *	DOMAIN INSERTION IMMUNOGLOBULIN
<b>A61K 31/425</b> (2006.01)	2595970 *	DERIVATIVES OF OXADIAZOLE AND PYRIDAZINE, THEIR PREPARATION AND THEIR APPLICATION IN THERAPEUTICS	<b>C12P 21/06</b> (2006.01)	2596114 *	DOMAIN INSERTION IMMUNOGLOBULIN
<b>C07D 271/06</b> (2006.01)	2595970 *	DERIVATIVES OF OXADIAZOLE AND PYRIDAZINE, THEIR PREPARATION AND THEIR APPLICATION IN THERAPEUTICS	<b>C07H 21/04</b> (2006.01)	2596114 *	DOMAIN INSERTION IMMUNOGLOBULIN
<b>A61K 31/00</b> (2006.01)	2637648 *	PHARMACEUTICAL COMPOSITION, METHODS FOR TREATING AND USES THEREOF	<b>A61K 47/02</b> (2006.01)	2627606 *	METHOD FOR PURIFYING DIATOMACEOUS EARTH SUITABLE FOR PHARMACEUTICAL USE
<b>A61K 31/341</b> (2006.01)	2637648 *	PHARMACEUTICAL COMPOSITION, METHODS FOR TREATING AND USES THEREOF	<b>C01B 33/12</b> (2006.01)	2627606 *	METHOD FOR PURIFYING DIATOMACEOUS EARTH SUITABLE FOR PHARMACEUTICAL USE
<b>A61K 38/28</b> (2006.01)	2637648 *	PHARMACEUTICAL COMPOSITION, METHODS FOR TREATING AND USES THEREOF	<b>C04B 33/02</b> (2006.01)	2627606 *	METHOD FOR PURIFYING DIATOMACEOUS EARTH SUITABLE FOR PHARMACEUTICAL USE
<b>A61P 3/10</b> (2006.01)	2637648 *	PHARMACEUTICAL COMPOSITION, METHODS FOR TREATING AND USES THEREOF	<b>C07D 453/02</b> (2006.01)	2630145 *	CARBONATE DERIVATIVES FOR THE TREATMENT OF COUGH
<b>A61K 9/70</b> (2006.01)	2613771 *	TRANSDERMAL THERAPEUTIC SYSTEMS WITH CRYSTALLIZATION-INHIBITING PROTECTIVE FILM (RELEASE LINER)	<b>A61K 31/439</b> (2006.01)	2630145 *	CARBONATE DERIVATIVES FOR THE TREATMENT OF COUGH
<b>C07D 239/47</b> (2006.01)	2619186 *	PROCESS FOR PREPARING PAN-CDK INHIBITORS OF THE FORMULA (I), AND INTERMEDIATES IN THE PREPARATION	<b>A61P 11/14</b> (2006.01)	2630145 *	CARBONATE DERIVATIVES FOR THE TREATMENT OF COUGH
<b>G01N 33/68</b> (2006.01)	2630495 *	METHODS FOR DETERMINING ANTI-DRUG ANTIBODY ISOTYPES	<b>B01D 11/04</b> (2006.01)	2600955 *	SEPARATION PROCESS
<b>G01N 33/558</b> (2006.01)	2630495 *	METHODS FOR DETERMINING ANTI-DRUG ANTIBODY ISOTYPES	<b>B01D 17/04</b> (2006.01)	2600955 *	SEPARATION PROCESS
<b>C12P 21/08</b> (2006.01)	2596114 *	DOMAIN INSERTION IMMUNOGLOBULIN	<b>C10G 27/04</b> (2006.01)	2600955 *	SEPARATION PROCESS
			<b>C10G 33/06</b> (2006.01)	2600955 *	SEPARATION PROCESS
			<b>A61K 31/437</b> (2006.01)	2611444 *	HETEROCYCLYL COMPOUNDS AS HISTAMINE H3 RECEPTOR LIGANDS
			<b>A61K 31/496</b> (2006.01)	2611444 *	HETEROCYCLYL COMPOUNDS AS HISTAMINE H3 RECEPTOR LIGANDS
			<b>A61K 31/55</b> (2006.01)	2611444 *	HETEROCYCLYL COMPOUNDS AS HISTAMINE H3 RECEPTOR LIGANDS
			<b>A61K 31/5517</b> (2006.01)	2611444 *	HETEROCYCLYL COMPOUNDS AS HISTAMINE H3 RECEPTOR LIGANDS
			<b>C07D 413/12</b> (2006.01)	2611444 *	HETEROCYCLYL COMPOUNDS AS HISTAMINE H3 RECEPTOR LIGANDS
			<b>C07D 417/12</b> (2006.01)	2611444 *	HETEROCYCLYL COMPOUNDS AS HISTAMINE H3 RECEPTOR LIGANDS
			<b>C07D 471/04</b> (2006.01)	2611444 *	HETEROCYCLYL COMPOUNDS AS HISTAMINE H3 RECEPTOR LIGANDS

MKP (51)	Broj objave evropske prijava patenta (97)	Naziv pronalaska (54)	MKP (51)	Broj objave evropske prijava patenta (97)	Naziv pronalaska (54)
<b>C07D 498/04</b> (2006.01)	2611444 *	HETEROCYCLYL COMPOUNDS AS HISTAMINE H3 RECEPTOR LIGANDS	<b>A61K</b> <b>31/4995</b> (2006.01)	2637663 *	COMBINATION THERAPY WITH AN ANTITUMOR ALKALOID
<b>A61P 23/00</b> (2006.01)	2611444 *	HETEROCYCLYL COMPOUNDS AS HISTAMINE H3 RECEPTOR LIGANDS	<b>A61K 31/69</b> (2006.01)	2637663 *	COMBINATION THERAPY WITH AN ANTITUMOR ALKALOID
<b>A61P 25/00</b> (2006.01)	2611444 *	HETEROCYCLYL COMPOUNDS AS HISTAMINE H3 RECEPTOR LIGANDS	<b>A61K 45/06</b> (2006.01)	2637663 *	COMBINATION THERAPY WITH AN ANTITUMOR ALKALOID
<b>G06Q 20/00</b> (2012.01)	2628140 *	PAYMENT METHODS WITH A PAYMENT SERVICE AND TABS SELECTED BY A FIRST PARTY AND OPENED BY A SECOND PARTY AT ANY GEOGRAPHIC LOCATION OF THE FIRST PARTY'S MOBILE DEVICE	<b>A61K 38/15</b> (2006.01)	2637663 *	COMBINATION THERAPY WITH AN ANTITUMOR ALKALOID
<b>E03D 9/08</b> (2006.01)	2354337	Sanitary washing apparatus	<b>A61P 35/00</b> (2006.01)	2637663 *	COMBINATION THERAPY WITH AN ANTITUMOR ALKALOID
<b>B05B 1/34</b> (2006.01)	2354337	Sanitary washing apparatus	<b>A61P 35/02</b> (2006.01)	2637663 *	COMBINATION THERAPY WITH AN ANTITUMOR ALKALOID
<b>B05B 7/04</b> (2006.01)	2354337	Sanitary washing apparatus	<b>A61K</b> <b>31/513</b> (2006.01)	2637663 *	COMBINATION THERAPY WITH AN ANTITUMOR ALKALOID
<b>F23H 7/08</b> (2006.01)	2598800 *	HYDRAULIC DRIVE FOR A SLIDING COMBUSTION GRATE	<b>A61K</b> <b>31/519</b> (2006.01)	2637663 *	COMBINATION THERAPY WITH AN ANTITUMOR ALKALOID
<b>C07K 1/16</b> (2006.01)	2601207 *	METHOD OF PRODUCING AND PURIFYING AN ACTIVE SOLUBLE SIALYLTRANSFERASE	<b>A61K</b> <b>31/7068</b> (2006.01)	2637663 *	COMBINATION THERAPY WITH AN ANTITUMOR ALKALOID
<b>C07K 1/18</b> (2006.01)	2601207 *	METHOD OF PRODUCING AND PURIFYING AN ACTIVE SOLUBLE SIALYLTRANSFERASE	<b>A61K</b> <b>39/395</b> (2006.01)	2608808 *	TREATMENT FOR NEOPLASTIC DISEASES
<b>C07K 1/22</b> (2006.01)	2601207 *	METHOD OF PRODUCING AND PURIFYING AN ACTIVE SOLUBLE SIALYLTRANSFERASE	<b>A61K 38/17</b> (2006.01)	2608808 *	TREATMENT FOR NEOPLASTIC DISEASES
<b>C07K 14/46</b> (2006.01)	2601207 *	METHOD OF PRODUCING AND PURIFYING AN ACTIVE SOLUBLE SIALYLTRANSFERASE	<b>A61K 38/20</b> (2006.01)	2608808 *	TREATMENT FOR NEOPLASTIC DISEASES
<b>C07K 14/47</b> (2006.01)	2601207 *	METHOD OF PRODUCING AND PURIFYING AN ACTIVE SOLUBLE SIALYLTRANSFERASE	<b>A61P 35/00</b> (2006.01)	2608808 *	TREATMENT FOR NEOPLASTIC DISEASES
<b>A61M</b> <b>5/315</b> (2006.01)	2529773	Resetting mechanism for a drug delivery device	<b>C07D 213/73</b> (2006.01)	2598482 *	ARYLCYCLOPROPYLAMINE BASED DEMETHYLASE INHIBITORS OF LSD1 AND THEIR MEDICAL USE
<b>A01N 43/52</b> (2006.01)	2549874 *	SUBSTITUTED IMIDAZO[1,2-B] PYRIDAZINE DERIVATIVES, PHARMACEUTICAL COMPOSITIONS, AND METHODS OF USE AS BETA- SECRETASE INHIBITORS	<b>C07D 237/20</b> (2006.01)	2598482 *	ARYLCYCLOPROPYLAMINE BASED DEMETHYLASE INHIBITORS OF LSD1 AND THEIR MEDICAL USE
<b>A61K</b> <b>31/415</b> (2006.01)	2549874 *	SUBSTITUTED IMIDAZO[1,2-B] PYRIDAZINE DERIVATIVES, PHARMACEUTICAL COMPOSITIONS, AND METHODS OF USE AS BETA- SECRETASE INHIBITORS	<b>C07D 239/42</b> (2006.01)	2598482 *	ARYLCYCLOPROPYLAMINE BASED DEMETHYLASE INHIBITORS OF LSD1 AND THEIR MEDICAL USE
			<b>C07D 241/20</b> (2006.01)	2598482 *	ARYLCYCLOPROPYLAMINE BASED DEMETHYLASE INHIBITORS OF LSD1 AND THEIR MEDICAL USE
			<b>C07D 261/14</b> (2006.01)	2598482 *	ARYLCYCLOPROPYLAMINE BASED DEMETHYLASE INHIBITORS OF LSD1 AND THEIR MEDICAL USE
			<b>C07D 263/48</b> (2006.01)	2598482 *	ARYLCYCLOPROPYLAMINE BASED DEMETHYLASE INHIBITORS OF LSD1 AND THEIR MEDICAL USE

MKP (51)	Broj objave evropske prijava patenta (97)	Naziv pronalaska (54)	MKP (51)	Broj objave evropske prijava patenta (97)	Naziv pronalaska (54)
<b>C07D 277/40</b> (2006.01)	2598482 *	ARYLCYCLOPROPYLAMINE BASED DEMETHYLASE INHIBITORS OF LSD1 AND THEIR MEDICAL USE	<b>A61P 3/10</b> (2006.01)	2643310 *	4- (5-CYANO-PYRAZOL-1-YL) -PIPERIDINE DERIVATIVES AS GPR 119 MODULATORS
<b>C07D 285/12</b> (2006.01)	2598482 *	ARYLCYCLOPROPYLAMINE BASED DEMETHYLASE INHIBITORS OF LSD1 AND THEIR MEDICAL USE	<b>C07D 401/14</b> (2006.01)	2643310 *	4- (5-CYANO-PYRAZOL-1-YL) -PIPERIDINE DERIVATIVES AS GPR 119 MODULATORS
<b>C07D 401/12</b> (2006.01)	2598482 *	ARYLCYCLOPROPYLAMINE BASED DEMETHYLASE INHIBITORS OF LSD1 AND THEIR MEDICAL USE	<b>C07D 403/14</b> (2006.01)	2643310 *	4- (5-CYANO-PYRAZOL-1-YL) -PIPERIDINE DERIVATIVES AS GPR 119 MODULATORS
<b>C07D 413/12</b> (2006.01)	2598482 *	ARYLCYCLOPROPYLAMINE BASED DEMETHYLASE INHIBITORS OF LSD1 AND THEIR MEDICAL USE	<b>A61K 31/454</b> (2006.01)	2643310 *	4- (5-CYANO-PYRAZOL-1-YL) -PIPERIDINE DERIVATIVES AS GPR 119 MODULATORS
<b>C07D 417/12</b> (2006.01)	2598482 *	ARYLCYCLOPROPYLAMINE BASED DEMETHYLASE INHIBITORS OF LSD1 AND THEIR MEDICAL USE	<b>C07D 401/04</b> (2006.01)	2643310 *	4- (5-CYANO-PYRAZOL-1-YL) -PIPERIDINE DERIVATIVES AS GPR 119 MODULATORS
<b>C07D 271/07</b> (2006.01)	2598482 *	ARYLCYCLOPROPYLAMINE BASED DEMETHYLASE INHIBITORS OF LSD1 AND THEIR MEDICAL USE	<b>A61K 35/12</b> (2006.01)	2603226 *	TREATMENT OF DIABETES WITH PANCREATIC ENDOCRINE PRECURSOR CELLS
<b>C07D 271/113</b> (2006.01)	2598482 *	ARYLCYCLOPROPYLAMINE BASED DEMETHYLASE INHIBITORS OF LSD1 AND THEIR MEDICAL USE	<b>A61K 38/18</b> (2006.01)	2603226 *	TREATMENT OF DIABETES WITH PANCREATIC ENDOCRINE PRECURSOR CELLS
<b>C07D 253/07</b> (2006.01)	2598482 *	ARYLCYCLOPROPYLAMINE BASED DEMETHYLASE INHIBITORS OF LSD1 AND THEIR MEDICAL USE	<b>A61K 38/22</b> (2006.01)	2603226 *	TREATMENT OF DIABETES WITH PANCREATIC ENDOCRINE PRECURSOR CELLS
<b>A61K 31/44</b> (2006.01)	2598482 *	ARYLCYCLOPROPYLAMINE BASED DEMETHYLASE INHIBITORS OF LSD1 AND THEIR MEDICAL USE	<b>A61P 3/10</b> (2006.01)	2603226 *	TREATMENT OF DIABETES WITH PANCREATIC ENDOCRINE PRECURSOR CELLS
<b>A61K 47/34</b> (2006.01)	2605795 *	INTRAVAGINAL DEVICES, METHODS OF MAKING, AND USES THEREOF	<b>A61K 39/395</b> (2006.01)	2608807 *	NOTUM PROTEIN MODULATORS AND METHODS OF USE
<b>C07D 223/16</b> (2006.01)	2607353	New method for synthesising ivabradine and its added salts with a pharmaceutically acceptable acid.	<b>C07K 16/22</b> (2006.01)	2608807 *	NOTUM PROTEIN MODULATORS AND METHODS OF USE
<b>A61K 31/426</b> (2006.01)	2586442 *	SUSTAINED-RELEASE THERAPEUTIC AGENT FOR HYPERTENSION AND RENAL DYSFUNCTION	<b>C07K 16/40</b> (2006.01)	2608807 *	NOTUM PROTEIN MODULATORS AND METHODS OF USE
<b>A61P 9/12</b> (2006.01)	2586442 *	SUSTAINED-RELEASE THERAPEUTIC AGENT FOR HYPERTENSION AND RENAL DYSFUNCTION	<b>C12Q 1/68</b> (2006.01)	2625293 *	MICRORNAs (MIRNA) AS BIOMAKERS FOR THE IDENTIFICATION OF FAMILIAL AND NON-FAMILIAL COLORECTAL CANCER
<b>A61P 13/12</b> (2006.01)	2586442 *	SUSTAINED-RELEASE THERAPEUTIC AGENT FOR HYPERTENSION AND RENAL DYSFUNCTION	<b>A61P 1/12</b> (2006.01)	2632550 *	METHODS AND COMPOSITIONS FOR TREATING HIV-ASSOCIATED DIARRHEA
<b>A61P 19/06</b> (2006.01)	2586442 *	SUSTAINED-RELEASE THERAPEUTIC AGENT FOR HYPERTENSION AND RENAL DYSFUNCTION	<b>B01J 19/00</b> (2006.01)	2621626 *	HEATER AND RELATED METHODS THEREFOR
<b>A61K 31/506</b> (2006.01)	2643310 *	4- (5-CYANO-PYRAZOL-1-YL) -PIPERIDINE DERIVATIVES AS GPR 119 MODULATORS	<b>C01B 33/107</b> (2006.01)	2621626 *	HEATER AND RELATED METHODS THEREFOR
			<b>C07D 477/20</b> (2006.01)	2630147 *	A PROCESS FOR THE PREPARATION OF PURE MEROPENEM TRIHYDRATE

MKP (51)	Broj objave evropske prijave patenta (97)	Naziv pronalaska (54)	MKP (51)	Broj objave evropske prijave patenta (97)	Naziv pronalaska (54)
<b>E01F 8/00</b> (2006.01)	2601352 *	AN IMPROVEMENT OF A SUPPORTING STRUCTURE FOR AN ANTI-NOISE BARRIER WHEREIN FOUNDATIONS AND LIFTING POST ARE REALIZED IN A SINGLE ELEMENT AND RELATIVE ASSEMBLY METHOD	<b>A01N 43/66</b> (2006.01)	2615912 *	LIQUID AGRICULTURAL FORMULATIONS OF IMPROVED STABILITY
<b>E04H 17/20</b> (2006.01)	2601352 *	AN IMPROVEMENT OF A SUPPORTING STRUCTURE FOR AN ANTI-NOISE BARRIER WHEREIN FOUNDATIONS AND LIFTING POST ARE REALIZED IN A SINGLE ELEMENT AND RELATIVE ASSEMBLY METHOD	<b>A01N 43/90</b> (2006.01)	2615912 *	LIQUID AGRICULTURAL FORMULATIONS OF IMPROVED STABILITY
<b>A61K 39/395</b> (2006.01)	2635304 *	FOLATE RECEPTOR ALPHA AS A DIAGNOSTIC AND PROGNOSTIC MARKER FOR FOLATE RECEPTOR ALPHA-EXPRESSING CANCERS	<b>A61K 38/19</b> (2006.01)	2618830 *	FORMULATIONS FOR BOVINE GRANULOCYTE COLONY STIMULATING FACTOR AND VARIANTS THEREOF
<b>G01N 33/574</b> (2006.01)	2635304 *	FOLATE RECEPTOR ALPHA AS A DIAGNOSTIC AND PROGNOSTIC MARKER FOR FOLATE RECEPTOR ALPHA-EXPRESSING CANCERS	<b>C07K 14/535</b> (2006.01)	2618830 *	FORMULATIONS FOR BOVINE GRANULOCYTE COLONY STIMULATING FACTOR AND VARIANTS THEREOF
<b>G01N 33/82</b> (2006.01)	2635304 *	FOLATE RECEPTOR ALPHA AS A DIAGNOSTIC AND PROGNOSTIC MARKER FOR FOLATE RECEPTOR ALPHA-EXPRESSING CANCERS	<b>A61P 29/00</b> (2006.01)	2618830 *	FORMULATIONS FOR BOVINE GRANULOCYTE COLONY STIMULATING FACTOR AND VARIANTS THEREOF
<b>A61K 31/437</b> (2006.01)	2613784 *	A TRANSDERMAL DRUG ADMINISTRATION DEVICE	<b>G10L 21/02</b> (2013.01)	2608197 *	METHOD, DEVICE, AND SYSTEM FOR NOISE REDUCTION IN MULTI-MICROPHONE ARRAY
<b>A61K 31/445</b> (2006.01)	2613784 *	A TRANSDERMAL DRUG ADMINISTRATION DEVICE	<b>H04R 3/02</b> (2006.01)	2608197 *	METHOD, DEVICE, AND SYSTEM FOR NOISE REDUCTION IN MULTI-MICROPHONE ARRAY
<b>A61K 9/00</b> (2006.01)	2613784 *	A TRANSDERMAL DRUG ADMINISTRATION DEVICE	<b>A61C 17/34</b> (2006.01)	2618776 *	REPLACEABLE HEAD PART FOR AN ELECTRIC TOOTHBRUSH
<b>A61K 9/70</b> (2006.01)	2613784 *	A TRANSDERMAL DRUG ADMINISTRATION DEVICE	<b>A61C 17/22</b> (2006.01)	2618776 *	REPLACEABLE HEAD PART FOR AN ELECTRIC TOOTHBRUSH
<b>A01N 43/54</b> (2006.01)	2615912 *	LIQUID AGRICULTURAL FORMULATIONS OF IMPROVED STABILITY	<b>A61K 31/44</b> (2006.01)	2595628 *	DRUG COMBINATIONS WITH FLUORO-SUBSTITUTED OMEGA-CARBOXYARYL DIPHENYL UREA FOR THE TREATMENT AND PREVENTION OF DISEASES AND CONDITIONS
<b>A01N 43/40</b> (2006.01)	2615912 *	LIQUID AGRICULTURAL FORMULATIONS OF IMPROVED STABILITY	<b>A61K 31/505</b> (2006.01)	2595628 *	DRUG COMBINATIONS WITH FLUORO-SUBSTITUTED OMEGA-CARBOXYARYL DIPHENYL UREA FOR THE TREATMENT AND PREVENTION OF DISEASES AND CONDITIONS
<b>A01N 31/00</b> (2006.01)	2615912 *	LIQUID AGRICULTURAL FORMULATIONS OF IMPROVED STABILITY	<b>A61K 31/519</b> (2006.01)	2595628 *	DRUG COMBINATIONS WITH FLUORO-SUBSTITUTED OMEGA-CARBOXYARYL DIPHENYL UREA FOR THE TREATMENT AND PREVENTION OF DISEASES AND CONDITIONS
<b>A01N 37/10</b> (2006.01)	2615912 *	LIQUID AGRICULTURAL FORMULATIONS OF IMPROVED STABILITY	<b>A61P 35/00</b> (2006.01)	2595628 *	DRUG COMBINATIONS WITH FLUORO-SUBSTITUTED OMEGA-CARBOXYARYL DIPHENYL UREA FOR THE TREATMENT AND PREVENTION OF DISEASES AND CONDITIONS
<b>A01P 13/00</b> (2006.01)	2615912 *	LIQUID AGRICULTURAL FORMULATIONS OF IMPROVED STABILITY			
<b>A01N 25/32</b> (2006.01)	2615912 *	LIQUID AGRICULTURAL FORMULATIONS OF IMPROVED STABILITY			



MKP (51)	Broj objave evropske prijava patenta (97)	Naziv pronalaska (54)	MKP (51)	Broj objave evropske prijava patenta (97)	Naziv pronalaska (54)
<b>C07D 487/04</b> (2006.01)	2598505 *	SUBSTITUTED IMIDAZO[1,2-B]PYRIDAZINES	<b>C02F 1/66</b> (2006.01)	2623467	Process for the preparation of an aqueous solution comprising at least one earth alkali hydrogen carbonate and its use
<b>A61K</b> <b>31/5025</b> (2006.01)	2598505 *	SUBSTITUTED IMIDAZO[1,2-B]PYRIDAZINES	<b>C01F 5/24</b> (2006.01)	2623467	Process for the preparation of an aqueous solution comprising at least one earth alkali hydrogen carbonate and its use
<b>A61K</b> <b>31/427</b> (2006.01)	2617715 *	GLYCINE TRANSPORTER INHIBITOR	<b>C02F 1/68</b> (2006.01)	2623467	Process for the preparation of an aqueous solution comprising at least one earth alkali hydrogen carbonate and its use
<b>A61K</b> <b>31/5377</b> (2006.01)	2617715 *	GLYCINE TRANSPORTER INHIBITOR	<b>C02F 1/52</b> (2006.01)	2623467	Process for the preparation of an aqueous solution comprising at least one earth alkali hydrogen carbonate and its use
<b>A61K</b> <b>31/437</b> (2006.01)	2617715 *	GLYCINE TRANSPORTER INHIBITOR	<b>A61N 1/30</b> (2006.01)	2643048 *	USER-ACTIVATED SELF- CONTAINED CO-PACKAGED IONTOPHORETIC DRUG DELIVERY SYSTEM
<b>A61P 25/04</b> (2006.01)	2617715 *	GLYCINE TRANSPORTER INHIBITOR	<b>A61N 1/32</b> (2006.01)	2643048 *	USER-ACTIVATED SELF- CONTAINED CO-PACKAGED IONTOPHORETIC DRUG DELIVERY SYSTEM
<b>A61K</b> <b>31/4439</b> (2006.01)	2617715 *	GLYCINE TRANSPORTER INHIBITOR	<b>C12P 21/08</b> (2006.01)	2611829 *	NOVEL ANTIGEN BINDING PROTEINS
<b>A61P 25/08</b> (2006.01)	2617715 *	GLYCINE TRANSPORTER INHIBITOR	<b>C07K 16/18</b> (2006.01)	2611829 *	NOVEL ANTIGEN BINDING PROTEINS
<b>C07D 233/90</b> (2006.01)	2617715 *	GLYCINE TRANSPORTER INHIBITOR	<b>C07H 21/00</b> (2006.01)	2611829 *	NOVEL ANTIGEN BINDING PROTEINS
<b>A61K</b> <b>31/444</b> (2006.01)	2617715 *	GLYCINE TRANSPORTER INHIBITOR	<b>F03D 1/00</b> (2006.01)	2607685	Bolt mounting and tightening robot for wind turbines
<b>A61P 25/14</b> (2006.01)	2617715 *	GLYCINE TRANSPORTER INHIBITOR	<b>F03D 11/04</b> (2006.01)	2607685	Bolt mounting and tightening robot for wind turbines
<b>A61K</b> <b>31/4178</b> (2006.01)	2617715 *	GLYCINE TRANSPORTER INHIBITOR	<b>C07D 487/04</b> (2006.01)	2604610 *	PHTHALAZINONE KETONE DERIVATIVE, PREPARATION METHOD THEREOF, AND PHARMACEUTICAL USE THEREOF
<b>A61K</b> <b>31/4709</b> (2006.01)	2617715 *	GLYCINE TRANSPORTER INHIBITOR	<b>A61K</b> <b>31/5025</b> (2006.01)	2604610 *	PHTHALAZINONE KETONE DERIVATIVE, PREPARATION METHOD THEREOF, AND PHARMACEUTICAL USE THEREOF
<b>A61P 25/18</b> (2006.01)	2617715 *	GLYCINE TRANSPORTER INHIBITOR	<b>A61K</b> <b>31/502</b> (2006.01)	2604610 *	PHTHALAZINONE KETONE DERIVATIVE, PREPARATION METHOD THEREOF, AND PHARMACEUTICAL USE THEREOF
<b>A61K</b> <b>31/4196</b> (2006.01)	2617715 *	GLYCINE TRANSPORTER INHIBITOR	<b>C07D 403/12</b> (2006.01)	2604610 *	PHTHALAZINONE KETONE DERIVATIVE, PREPARATION METHOD THEREOF, AND PHARMACEUTICAL USE THEREOF
<b>A61K</b> <b>31/4725</b> (2006.01)	2617715 *	GLYCINE TRANSPORTER INHIBITOR	<b>A61P 43/00</b> (2006.01)	2604610 *	PHTHALAZINONE KETONE DERIVATIVE, PREPARATION METHOD THEREOF, AND PHARMACEUTICAL USE THEREOF
<b>A61K</b> <b>31/422</b> (2006.01)	2617715 *	GLYCINE TRANSPORTER INHIBITOR			
<b>A61K</b> <b>31/497</b> (2006.01)	2617715 *	GLYCINE TRANSPORTER INHIBITOR			
<b>A61K</b> <b>31/4245</b> (2006.01)	2617715 *	GLYCINE TRANSPORTER INHIBITOR			
<b>A61K</b> <b>31/506</b> (2006.01)	2617715 *	GLYCINE TRANSPORTER INHIBITOR			
<b>C01F 11/18</b> (2006.01)	2623467	Process for the preparation of an aqueous solution comprising at least one earth alkali hydrogen carbonate and its use			

MKP (51)	Broj objave evropske prijava patenta (97)	Naziv pronalaska (54)	MKP (51)	Broj objave evropske prijava patenta (97)	Naziv pronalaska (54)
<b>A61P 35/00</b> (2006.01)	2604610 *	PHTHALAZINONE KETONE DERIVATIVE, PREPARATION METHOD THEREOF, AND PHARMACEUTICAL USE THEREOF	<b>A61M 5/20</b> (2006.01)	2640444 *	NEEDLE MAGAZINE FOR MEDICATION INJECTION DEVICE
<b>A01N 43/54</b> (2006.01)	2632265 *	SYNERGISTIC HERBICIDAL COMPOSITION CONTAINING PENOXSULAM AND ORYZALIN	<b>A61M 5/00</b> (2006.01)	2640444 *	NEEDLE MAGAZINE FOR MEDICATION INJECTION DEVICE
<b>A01P 13/00</b> (2006.01)	2632265 *	SYNERGISTIC HERBICIDAL COMPOSITION CONTAINING PENOXSULAM AND ORYZALIN	<b>A61M 5/34</b> (2006.01)	2640444 *	NEEDLE MAGAZINE FOR MEDICATION INJECTION DEVICE
<b>E21B 34/06</b> (2006.01)	2619403 *	DELAYED OPENING WELLBORE TUBULAR PORT CLOSURE	<b>A61M</b> <b>5/142</b> (2006.01)	2640444 *	NEEDLE MAGAZINE FOR MEDICATION INJECTION DEVICE
<b>H04Q 1/14</b> (2006.01)	2625868 *	DYNAMIC-JUNCTION APPARATUS FOR MULTIPAIRS TELEPHONE CABLES	<b>B60D 1/00</b> (2006.01)	2643175 *	ATTACHMENT DEVICE FOR TRAILER TOW BAR
<b>C07K</b> <b>14/705</b> (2006.01)	2598528 *	T CELL RECEPTORS	<b>B60D 1/02</b> (2006.01)	2643175 *	ATTACHMENT DEVICE FOR TRAILER TOW BAR
<b>F24J 2/08</b> (2006.01)	2598810 *	DEVICE FOR THE CAPTURE OF SOLAR ENERGY WITH HIGH ANGULAR EFFICIENCY.	<b>B60D 1/54</b> (2006.01)	2643175 *	ATTACHMENT DEVICE FOR TRAILER TOW BAR
<b>F24J 2/14</b> (2006.01)	2598810 *	DEVICE FOR THE CAPTURE OF SOLAR ENERGY WITH HIGH ANGULAR EFFICIENCY.	<b>C07C 211/31</b> (2006.01)	2632892 *	DITERPENOID DERIVATIVES ENDOWED OF BIOLOGICAL PROPERTIES
<b>F24J 2/24</b> (2006.01)	2598810 *	DEVICE FOR THE CAPTURE OF SOLAR ENERGY WITH HIGH ANGULAR EFFICIENCY.	<b>C07C 251/34</b> (2006.01)	2632892 *	DITERPENOID DERIVATIVES ENDOWED OF BIOLOGICAL PROPERTIES
<b>G02F 1/00</b> (2006.01)	2598810 *	DEVICE FOR THE CAPTURE OF SOLAR ENERGY WITH HIGH ANGULAR EFFICIENCY.	<b>C07C 251/54</b> (2006.01)	2632892 *	DITERPENOID DERIVATIVES ENDOWED OF BIOLOGICAL PROPERTIES
<b>A47J 36/38</b> (2006.01)	2603125 *	FRYER WITH PERFORATED COVER	<b>A61K 31/15</b> (2006.01)	2632892 *	DITERPENOID DERIVATIVES ENDOWED OF BIOLOGICAL PROPERTIES
<b>A47J 37/12</b> (2006.01)	2603125 *	FRYER WITH PERFORATED COVER	<b>C07D 211/46</b> (2006.01)	2632892 *	DITERPENOID DERIVATIVES ENDOWED OF BIOLOGICAL PROPERTIES
<b>B01D 53/14</b> (2006.01)	2637765 *	A NOVEL SYSTEM FOR ADSORBING AND SEPARATING SUSPENDED GASEOUS IMPURITIES FROM EFFLUENT GASES AND THEREBY RECOVERY OF VALUE ADDED PRODUCTS	<b>A61K</b> <b>31/496</b> (2006.01)	2632463 *	ARIPIPRAZOLE COMPOSITIONS AND METHODS FOR ITS TRANSDERMAL DELIVERY
<b>B01D 53/80</b> (2006.01)	2637765 *	A NOVEL SYSTEM FOR ADSORBING AND SEPARATING SUSPENDED GASEOUS IMPURITIES FROM EFFLUENT GASES AND THEREBY RECOVERY OF VALUE ADDED PRODUCTS	<b>A63H 3/02</b> (2006.01)	2598220 *	STUFFED TOYS HAVING INTERCHANGEABLE SCENT PACKETS AND METHODS AND SYSTEMS INCLUDING SUCH STUFFED TOYS
<b>A61M</b> <b>5/158</b> (2006.01)	2640444 *	NEEDLE MAGAZINE FOR MEDICATION INJECTION DEVICE	<b>A63H 3/00</b> (2006.01)	2598220 *	STUFFED TOYS HAVING INTERCHANGEABLE SCENT PACKETS AND METHODS AND SYSTEMS INCLUDING SUCH STUFFED TOYS
<b>A61M 5/32</b> (2006.01)	2640444 *	NEEDLE MAGAZINE FOR MEDICATION INJECTION DEVICE	<b>A61K 9/50</b> (2006.01)	2623096	Pharmaceutical composition with slow release of trimetazidine
			<b>A61K</b> <b>31/495</b> (2006.01)	2623096	Pharmaceutical composition with slow release of trimetazidine
			<b>A61M 5/24</b> (2006.01)	2603261 *	CONNECTOR FOR A DRUG DELIVERY DEVICE RESERVOIR
			<b>B65D 41/54</b> (2006.01)	2603261 *	CONNECTOR FOR A DRUG DELIVERY DEVICE RESERVOIR

MKP (51)	Broj objave evropske prijava patenta (97)	Naziv pronalaska (54)	MKP (51)	Broj objave evropske prijava patenta (97)	Naziv pronalaska (54)
<b>G09F 3/03</b> (2006.01)	2603261 *	CONNECTOR FOR A DRUG DELIVERY DEVICE RESERVOIR	<b>A61K 31/795</b> (2006.01)	2611413 *	SKIN COMPOSITIONS AND METHODS OF USE THEREOF
<b>A61M 39/10</b> (2006.01)	2603261 *	CONNECTOR FOR A DRUG DELIVERY DEVICE RESERVOIR	<b>A61K 8/89</b> (2006.01)	2611413 *	SKIN COMPOSITIONS AND METHODS OF USE THEREOF
<b>A61P 7/06</b> (2006.01)	2640394 *	PROTECTION OF RENAL TISSUES FROM ISCHEMIA THROUGH INHIBITION OF THE PROLIFERATIVE KINASES CDK4 AND CDK6	<b>A61K 31/74</b> (2006.01)	2611413 *	SKIN COMPOSITIONS AND METHODS OF USE THEREOF
<b>A61K 31/506</b> (2006.01)	2640394 *	PROTECTION OF RENAL TISSUES FROM ISCHEMIA THROUGH INHIBITION OF THE PROLIFERATIVE KINASES CDK4 AND CDK6	<b>A61Q 19/00</b> (2006.01)	2611413 *	SKIN COMPOSITIONS AND METHODS OF USE THEREOF
<b>A61P 7/00</b> (2006.01)	2640394 *	PROTECTION OF RENAL TISSUES FROM ISCHEMIA THROUGH INHIBITION OF THE PROLIFERATIVE KINASES CDK4 AND CDK6	<b>A61K 39/395</b> (2006.01)	2624857 *	INNOVATIVE DISCOVERY OF THERAPEUTIC, DIAGNOSTIC, AND ANTIBODY COMPOSITIONS RELATED PROTEIN FRAGMENTS OF TRYPTOPHANYL TRNA SYNTHETASES
<b>A61K 31/519</b> (2006.01)	2640394 *	PROTECTION OF RENAL TISSUES FROM ISCHEMIA THROUGH INHIBITION OF THE PROLIFERATIVE KINASES CDK4 AND CDK6	<b>A61P 3/00</b> (2006.01)	2624857 *	INNOVATIVE DISCOVERY OF THERAPEUTIC, DIAGNOSTIC, AND ANTIBODY COMPOSITIONS RELATED PROTEIN FRAGMENTS OF TRYPTOPHANYL TRNA SYNTHETASES
<b>A61K 31/505</b> (2006.01)	2640394 *	PROTECTION OF RENAL TISSUES FROM ISCHEMIA THROUGH INHIBITION OF THE PROLIFERATIVE KINASES CDK4 AND CDK6	<b>A61K 38/08</b> (2006.01)	2624857 *	INNOVATIVE DISCOVERY OF THERAPEUTIC, DIAGNOSTIC, AND ANTIBODY COMPOSITIONS RELATED PROTEIN FRAGMENTS OF TRYPTOPHANYL TRNA SYNTHETASES
<b>C08G 61/10</b> (2006.01)	2596043 *	UNIT COMPRISING POROUS ORGANIC POLYMERS AND USE THEREOF I	<b>A61P 9/00</b> (2006.01)	2624857 *	INNOVATIVE DISCOVERY OF THERAPEUTIC, DIAGNOSTIC, AND ANTIBODY COMPOSITIONS RELATED PROTEIN FRAGMENTS OF TRYPTOPHANYL TRNA SYNTHETASES
<b>C02F 1/52</b> (2006.01)	2623466	Process for the preparation of an aqueous solution comprising at least one earth alkali hydrogen carbonate and its use	<b>A61P 29/00</b> (2006.01)	2624857 *	INNOVATIVE DISCOVERY OF THERAPEUTIC, DIAGNOSTIC, AND ANTIBODY COMPOSITIONS RELATED PROTEIN FRAGMENTS OF TRYPTOPHANYL TRNA SYNTHETASES
<b>C02F 1/66</b> (2006.01)	2623466	Process for the preparation of an aqueous solution comprising at least one earth alkali hydrogen carbonate and its use	<b>A61K 38/16</b> (2006.01)	2624857 *	INNOVATIVE DISCOVERY OF THERAPEUTIC, DIAGNOSTIC, AND ANTIBODY COMPOSITIONS RELATED PROTEIN FRAGMENTS OF TRYPTOPHANYL TRNA SYNTHETASES
<b>C02F 1/68</b> (2006.01)	2623466	Process for the preparation of an aqueous solution comprising at least one earth alkali hydrogen carbonate and its use	<b>A61K 38/10</b> (2006.01)	2624857 *	INNOVATIVE DISCOVERY OF THERAPEUTIC, DIAGNOSTIC, AND ANTIBODY COMPOSITIONS RELATED PROTEIN FRAGMENTS OF TRYPTOPHANYL TRNA SYNTHETASES
<b>C01F 11/18</b> (2006.01)	2623466	Process for the preparation of an aqueous solution comprising at least one earth alkali hydrogen carbonate and its use	<b>C07D 471/04</b> (2006.01)	2614061 *	QUINOLINE AND QUINOXALINE DERIVATIVES AS KINASE INHIBITORS
<b>C01F 5/24</b> (2006.01)	2623466	Process for the preparation of an aqueous solution comprising at least one earth alkali hydrogen carbonate and its use	<b>A61K 31/519</b> (2006.01)	2614061 *	QUINOLINE AND QUINOXALINE DERIVATIVES AS KINASE INHIBITORS
<b>A61P 17/00</b> (2006.01)	2611413 *	SKIN COMPOSITIONS AND METHODS OF USE THEREOF			

MKP (51)	Broj objave evropske prijava patenta (97)	Naziv pronalaska (54)	MKP (51)	Broj objave evropske prijava patenta (97)	Naziv pronalaska (54)
<b>A61P 9/00</b> (2006.01)	2614061 *	QUINOLINE AND QUINOXALINE DERIVATIVES AS KINASE INHIBITORS	<b>A61P 25/00</b> (2006.01)	2608801 *	INNOVATIVE DISCOVERY OF THERAPEUTIC, DIAGNOSTIC, AND ANTIBODY COMPOSITIONS RELATED TO PROTEIN FRAGMENTS OF TYROSYL- tRNA SYNTHETASES
<b>A61P 25/28</b> (2006.01)	2614061 *	QUINOLINE AND QUINOXALINE DERIVATIVES AS KINASE INHIBITORS	<b>A61K 38/16</b> (2006.01)	2608801 *	INNOVATIVE DISCOVERY OF THERAPEUTIC, DIAGNOSTIC, AND ANTIBODY COMPOSITIONS RELATED TO PROTEIN FRAGMENTS OF TYROSYL- tRNA SYNTHETASES
<b>A61P 29/00</b> (2006.01)	2614061 *	QUINOLINE AND QUINOXALINE DERIVATIVES AS KINASE INHIBITORS	<b>A61K 39/395</b> (2006.01)	2608801 *	INNOVATIVE DISCOVERY OF THERAPEUTIC, DIAGNOSTIC, AND ANTIBODY COMPOSITIONS RELATED TO PROTEIN FRAGMENTS OF TYROSYL- tRNA SYNTHETASES
<b>A61B 18/12</b> (2006.01)	2540242	An electrosurgical instrument and apparatus for use with the instrument	<b>A61K 38/10</b> (2006.01)	2608801 *	INNOVATIVE DISCOVERY OF THERAPEUTIC, DIAGNOSTIC, AND ANTIBODY COMPOSITIONS RELATED TO PROTEIN FRAGMENTS OF TYROSYL- tRNA SYNTHETASES
<b>A61B 18/14</b> (2006.01)	2540242	An electrosurgical instrument and apparatus for use with the instrument	<b>A61K 38/08</b> (2006.01)	2608801 *	INNOVATIVE DISCOVERY OF THERAPEUTIC, DIAGNOSTIC, AND ANTIBODY COMPOSITIONS RELATED TO PROTEIN FRAGMENTS OF TYROSYL- tRNA SYNTHETASES
<b>A61P 37/00</b> (2006.01)	2598477 *	PERIPHERALLY RESTRICTED FAAH INHIBITORS	<b>A01N 43/54</b> (2006.01)	2611301 *	SYNERGISTIC HERBICIDAL COMPOSITION CONTAINING PENOX SULAM AND BENTAZON
<b>A61P 29/00</b> (2006.01)	2598477 *	PERIPHERALLY RESTRICTED FAAH INHIBITORS	<b>A01N 43/88</b> (2006.01)	2611301 *	SYNERGISTIC HERBICIDAL COMPOSITION CONTAINING PENOX SULAM AND BENTAZON
<b>C07C 271/56</b> (2006.01)	2598477 *	PERIPHERALLY RESTRICTED FAAH INHIBITORS	<b>A01P 13/02</b> (2006.01)	2611301 *	SYNERGISTIC HERBICIDAL COMPOSITION CONTAINING PENOX SULAM AND BENTAZON
<b>A61K 31/27</b> (2006.01)	2598477 *	PERIPHERALLY RESTRICTED FAAH INHIBITORS	<b>A01N 43/90</b> (2006.01)	2611301 *	SYNERGISTIC HERBICIDAL COMPOSITION CONTAINING PENOX SULAM AND BENTAZON
<b>E05B 1/00</b> (2006.01)	2325419	Safety door handle	<b>A61K 9/00</b> (2006.01)	2600830 *	DRY POWDER FORMULATION COMPRISING A PHOSPHODIESTERASE INHIBITOR
<b>E05B 65/20</b> (2006.01)	2325419	Safety door handle	<b>A61K 31/44</b> (2006.01)	2600830 *	DRY POWDER FORMULATION COMPRISING A PHOSPHODIESTERASE INHIBITOR
<b>E05B 15/04</b> (2006.01)	2325419	Safety door handle	<b>A61P 11/06</b> (2006.01)	2600830 *	DRY POWDER FORMULATION COMPRISING A PHOSPHODIESTERASE INHIBITOR
<b>C09C 3/04</b> (2006.01)	2623564	Installation for the purification of minerals, pigments and/or fillers and/or the preparation of precipitated earth alkali carbonate			
<b>C09C 1/02</b> (2006.01)	2623564	Installation for the purification of minerals, pigments and/or fillers and/or the preparation of precipitated earth alkali carbonate			
<b>H04B 3/54</b> (2006.01)	2625794 *	METHOD AND APPARATUS FOR REMOTE METERING THE CONSUMPTION OF ELECTRICITY OVER POWER LINE NETWORK			
<b>A61K 48/00</b> (2006.01)	2608801 *	INNOVATIVE DISCOVERY OF THERAPEUTIC, DIAGNOSTIC, AND ANTIBODY COMPOSITIONS RELATED TO PROTEIN FRAGMENTS OF TYROSYL- tRNA SYNTHETASES			
<b>A61P 29/00</b> (2006.01)	2608801 *	INNOVATIVE DISCOVERY OF THERAPEUTIC, DIAGNOSTIC, AND ANTIBODY COMPOSITIONS RELATED TO PROTEIN FRAGMENTS OF TYROSYL- tRNA SYNTHETASES			

MKP (51)	Broj objave evropske prijava patenta (97)	Naziv pronalaska (54)	MKP (51)	Broj objave evropske prijava patenta (97)	Naziv pronalaska (54)
<b>C25B 9/00</b> (2006.01)	2596155 *	MEMBRANE ELECTRO - CATALYTIC SYSTEM AND PROCESS FOR OBTAINING FUEL GAS FROM WATER	<b>A61P 43/00</b> (2006.01)	2599774 *	CONDENSED RING PYRIDINE COMPOUND
<b>C25B 13/04</b> (2006.01)	2596155 *	MEMBRANE ELECTRO - CATALYTIC SYSTEM AND PROCESS FOR OBTAINING FUEL GAS FROM WATER	<b>A61K 31/5377</b> (2006.01)	2599774 *	CONDENSED RING PYRIDINE COMPOUND
<b>C01B 3/58</b> (2006.01)	2596155 *	MEMBRANE ELECTRO - CATALYTIC SYSTEM AND PROCESS FOR OBTAINING FUEL GAS FROM WATER	<b>C07D 405/12</b> (2006.01)	2599774 *	CONDENSED RING PYRIDINE COMPOUND
<b>C07D 471/08</b> (2006.01)	2619205 *	MONOHYDRATE OF AN AZAADAMANTANE DERIVATIVE	<b>A61P 29/00</b> (2006.01)	2599774 *	CONDENSED RING PYRIDINE COMPOUND
<b>A61K 31/439</b> (2006.01)	2619205 *	MONOHYDRATE OF AN AZAADAMANTANE DERIVATIVE	<b>A61P 25/04</b> (2006.01)	2599774 *	CONDENSED RING PYRIDINE COMPOUND
<b>A61P 25/00</b> (2006.01)	2619205 *	MONOHYDRATE OF AN AZAADAMANTANE DERIVATIVE	<b>C07D 217/26</b> (2006.01)	2599774 *	CONDENSED RING PYRIDINE COMPOUND
<b>A61P 25/28</b> (2006.01)	2619205 *	MONOHYDRATE OF AN AZAADAMANTANE DERIVATIVE	<b>C07D 237/34</b> (2006.01)	2599774 *	CONDENSED RING PYRIDINE COMPOUND
<b>H04W 4/02</b> (2009.01)	2601800 *	TRANSFER AND MODIFICATION OF LOCATION RELATED DATA DURING AN ONGOING LOCATION SESSION	<b>H02K 3/28</b> (2006.01)	2638620 *	ELECTRIC MACHINE COMPRISING A SINGLE- TOOTH WINDING WITH GROUPED PHASES
<b>G01S 5/00</b> (2006.01)	2601800 *	TRANSFER AND MODIFICATION OF LOCATION RELATED DATA DURING AN ONGOING LOCATION SESSION	<b>H02K 19/36</b> (2006.01)	2638620 *	ELECTRIC MACHINE COMPRISING A SINGLE- TOOTH WINDING WITH GROUPED PHASES
<b>A61B 17/04</b> (2006.01)	2629679 *	A FIXING DEVICE FOR SUTURE THREADS TO BE INSERTED INTO A BONE TISSUE	<b>A61K 31/496</b> (2006.01)	2616440 *	ARYLOSULFONAMIDES FOR THE TREATMENT OF CNS DISEASES
<b>A61B 17/00</b> (2006.01)	2629679 *	A FIXING DEVICE FOR SUTURE THREADS TO BE INSERTED INTO A BONE TISSUE	<b>A61P 25/00</b> (2006.01)	2616440 *	ARYLOSULFONAMIDES FOR THE TREATMENT OF CNS DISEASES
<b>A61F 2/08</b> (2006.01)	2629679 *	A FIXING DEVICE FOR SUTURE THREADS TO BE INSERTED INTO A BONE TISSUE	<b>C07D 209/40</b> (2006.01)	2616440 *	ARYLOSULFONAMIDES FOR THE TREATMENT OF CNS DISEASES
<b>A61K 31/4725</b> (2006.01)	2599774 *	CONDENSED RING PYRIDINE COMPOUND	<b>C07D 235/30</b> (2006.01)	2616440 *	ARYLOSULFONAMIDES FOR THE TREATMENT OF CNS DISEASES
<b>C07D 401/12</b> (2006.01)	2599774 *	CONDENSED RING PYRIDINE COMPOUND	<b>C07D 275/04</b> (2006.01)	2616440 *	ARYLOSULFONAMIDES FOR THE TREATMENT OF CNS DISEASES
<b>A61K 31/553</b> (2006.01)	2599774 *	CONDENSED RING PYRIDINE COMPOUND	<b>C07D 319/20</b> (2006.01)	2616440 *	ARYLOSULFONAMIDES FOR THE TREATMENT OF CNS DISEASES
<b>C07D 495/04</b> (2006.01)	2599774 *	CONDENSED RING PYRIDINE COMPOUND	<b>C07D 413/12</b> (2006.01)	2616440 *	ARYLOSULFONAMIDES FOR THE TREATMENT OF CNS DISEASES
<b>A61K 31/541</b> (2006.01)	2599774 *	CONDENSED RING PYRIDINE COMPOUND	<b>A61K 38/47</b> (2006.01)	2537528	Pharmaceutical or nutritional compositions containing galactosidase, and their use
<b>C07D 413/12</b> (2006.01)	2599774 *	CONDENSED RING PYRIDINE COMPOUND	<b>C12N 9/38</b> (2006.01)	2537528	Pharmaceutical or nutritional compositions containing galactosidase, and their use
			<b>C12N 9/40</b> (2006.01)	2537528	Pharmaceutical or nutritional compositions containing galactosidase, and their use
			<b>A61P 1/04</b> (2006.01)	2537528	Pharmaceutical or nutritional compositions containing galactosidase, and their use
			<b>C12Q 1/68</b> (2006.01)	2619325 *	A METHOD FOR DETECTING, QUANTIFYING AND MAPPING DAMAGE AND/OR REPAIR OF DNA STRANDS

MKP (51)	Broj objave evropske prijava patenta (97)	Naziv pronalaska (54)	MKP (51)	Broj objave evropske prijava patenta (97)	Naziv pronalaska (54)
<b>C07D 519/00</b> (2006.01)	2615096 *	QUINOXALINE COMPOUND	<b>C09B 69/00</b> (2006.01)	2630196 *	CYANINE DYES AND THEIR CONJUGATES
<b>A61K 31/4985</b> (2006.01)	2615096 *	QUINOXALINE COMPOUND	<b>C07D 403/14</b> (2006.01)	2640719 *	ANTIVIRAL COMPOUNDS
<b>A61P 13/02</b> (2006.01)	2615096 *	QUINOXALINE COMPOUND	<b>A61K 31/4178</b> (2006.01)	2640719 *	ANTIVIRAL COMPOUNDS
<b>A61P 43/00</b> (2006.01)	2615096 *	QUINOXALINE COMPOUND	<b>C07D 405/14</b> (2006.01)	2640719 *	ANTIVIRAL COMPOUNDS
<b>C07D 487/04</b> (2006.01)	2615096 *	QUINOXALINE COMPOUND	<b>A61K 31/4184</b> (2006.01)	2640719 *	ANTIVIRAL COMPOUNDS
<b>G01N 33/574</b> (2006.01)	2627671 *	ESTROGEN RECEPTOR ALPHA POLYPEPTIDE SEQUENCE, DIAGNOSTIC AND THERAPEUTIC APPLICATIONS THEREOF	<b>C07D 493/04</b> (2006.01)	2640719 *	ANTIVIRAL COMPOUNDS
<b>C07K 14/72</b> (2006.01)	2627671 *	ESTROGEN RECEPTOR ALPHA POLYPEPTIDE SEQUENCE, DIAGNOSTIC AND THERAPEUTIC APPLICATIONS THEREOF	<b>C07D 491/10</b> (2006.01)	2640719 *	ANTIVIRAL COMPOUNDS
<b>C12N 5/00</b> (2006.01)	2627671 *	ESTROGEN RECEPTOR ALPHA POLYPEPTIDE SEQUENCE, DIAGNOSTIC AND THERAPEUTIC APPLICATIONS THEREOF	<b>C07D 495/04</b> (2006.01)	2640719 *	ANTIVIRAL COMPOUNDS
<b>C07K 16/28</b> (2006.01)	2627671 *	ESTROGEN RECEPTOR ALPHA POLYPEPTIDE SEQUENCE, DIAGNOSTIC AND THERAPEUTIC APPLICATIONS THEREOF	<b>C07D 471/08</b> (2006.01)	2640719 *	ANTIVIRAL COMPOUNDS
<b>B63B 25/22</b> (2006.01)	2581301	Containers stowage device	<b>A61P 31/12</b> (2006.01)	2640719 *	ANTIVIRAL COMPOUNDS
<b>C07D 491/00</b> (2006.01)	2595988 *	TRICYCLIC COMPOUNDS AND METHDS OF MAKING AND USING SAME	<b>C07D 417/14</b> (2006.01)	2640719 *	ANTIVIRAL COMPOUNDS
<b>C07D 493/00</b> (2006.01)	2595988 *	TRICYCLIC COMPOUNDS AND METHDS OF MAKING AND USING SAME	<b>A61K 31/4188</b> (2006.01)	2640719 *	ANTIVIRAL COMPOUNDS
<b>C07D 513/00</b> (2006.01)	2595988 *	TRICYCLIC COMPOUNDS AND METHDS OF MAKING AND USING SAME	<b>C07D 513/04</b> (2006.01)	2640719 *	ANTIVIRAL COMPOUNDS
<b>A61K 31/353</b> (2006.01)	2595988 *	TRICYCLIC COMPOUNDS AND METHDS OF MAKING AND USING SAME	<b>A61K 47/20</b> (2006.01)	2623100 *	PREPARATION FOR IMPROVING SOLUBILITY OF POORLY SOLUBLE DRUG
<b>A61K 31/425</b> (2006.01)	2595988 *	TRICYCLIC COMPOUNDS AND METHDS OF MAKING AND USING SAME	<b>A61K 47/36</b> (2006.01)	2623100 *	PREPARATION FOR IMPROVING SOLUBILITY OF POORLY SOLUBLE DRUG
<b>A61K 31/4738</b> (2006.01)	2595988 *	TRICYCLIC COMPOUNDS AND METHDS OF MAKING AND USING SAME	<b>A61K 47/38</b> (2006.01)	2623100 *	PREPARATION FOR IMPROVING SOLUBILITY OF POORLY SOLUBLE DRUG
<b>A61P 3/04</b> (2006.01)	2595988 *	TRICYCLIC COMPOUNDS AND METHDS OF MAKING AND USING SAME	<b>A61K 9/20</b> (2006.01)	2623100 *	PREPARATION FOR IMPROVING SOLUBILITY OF POORLY SOLUBLE DRUG
<b>C09B 23/00</b> (2006.01)	2630196 *	CYANINE DYES AND THEIR CONJUGATES	<b>A61K 9/48</b> (2006.01)	2623100 *	PREPARATION FOR IMPROVING SOLUBILITY OF POORLY SOLUBLE DRUG
<b>G01N 33/58</b> (2006.01)	2630196 *	CYANINE DYES AND THEIR CONJUGATES	<b>A61K 31/405</b> (2006.01)	2623100 *	PREPARATION FOR IMPROVING SOLUBILITY OF POORLY SOLUBLE DRUG
<b>C09B 23/08</b> (2006.01)	2630196 *	CYANINE DYES AND THEIR CONJUGATES	<b>A61K 47/02</b> (2006.01)	2623100 *	PREPARATION FOR IMPROVING SOLUBILITY OF POORLY SOLUBLE DRUG
			<b>A61K 31/426</b> (2006.01)	2623100 *	PREPARATION FOR IMPROVING SOLUBILITY OF POORLY SOLUBLE DRUG
			<b>C07K 16/22</b> (2006.01)	2643351 *	MULTISPECIFIC ANTIGEN BINDING PROTEINS TARGETING HGF
			<b>A61M 5/24</b> (2006.01)	2603263 *	DIFFERENTIATION FOR A DRUG DELIVERY DEVICE

MKP (51)	Broj objave evropske prijava patenta (97)	Naziv pronalaska (54)	MKP (51)	Broj objave evropske prijava patenta (97)	Naziv pronalaska (54)
<b>A61M 5/315</b> (2006.01)	2603263 *	DIFFERENTIATION FOR A DRUG DELIVERY DEVICE	<b>F24F 3/00</b> (2006.01)	2532407	Air purification device and method
<b>A61F 13/15</b> (2006.01)	2628472	Method of forming bonds between discrete components of disposable articles	<b>A61K 31/4188</b> (2006.01)	2624831 *	PHARMACEUTICAL COMBINATIONS
<b>F16L 37/24</b> (2006.01)	2369215	Connector	<b>A61K 31/4745</b> (2006.01)	2624831 *	PHARMACEUTICAL COMBINATIONS
<b>A61K 9/14</b> (2006.01)	2635258 *	DRUG FORMULATIONS	<b>A61P 35/00</b> (2006.01)	2624831 *	PHARMACEUTICAL COMBINATIONS
<b>A61K 9/26</b> (2006.01)	2635258 *	DRUG FORMULATIONS	<b>A61K 31/337</b> (2006.01)	2640377 *	FGFR1 EXTRACELLULAR DOMAIN COMBINATION THERAPIES
<b>C07D 403/04</b> (2006.01)	2603502 *	4 - AMINOQUINAZOLIN-2 - YL - 1 - PYRRAZOLE - 4 - CARBOXYLIC ACID COMPOUNDS AS PROLYL HYDROXYLASE INHIBITORS	<b>A61K 31/475</b> (2006.01)	2640377 *	FGFR1 EXTRACELLULAR DOMAIN COMBINATION THERAPIES
<b>C07D 403/14</b> (2006.01)	2603502 *	4 - AMINOQUINAZOLIN-2 - YL - 1 - PYRRAZOLE - 4 - CARBOXYLIC ACID COMPOUNDS AS PROLYL HYDROXYLASE INHIBITORS	<b>A61K 31/519</b> (2006.01)	2640377 *	FGFR1 EXTRACELLULAR DOMAIN COMBINATION THERAPIES
<b>C07D 413/14</b> (2006.01)	2603502 *	4 - AMINOQUINAZOLIN-2 - YL - 1 - PYRRAZOLE - 4 - CARBOXYLIC ACID COMPOUNDS AS PROLYL HYDROXYLASE INHIBITORS	<b>A61K 38/18</b> (2006.01)	2640377 *	FGFR1 EXTRACELLULAR DOMAIN COMBINATION THERAPIES
<b>C07D 417/14</b> (2006.01)	2603502 *	4 - AMINOQUINAZOLIN-2 - YL - 1 - PYRRAZOLE - 4 - CARBOXYLIC ACID COMPOUNDS AS PROLYL HYDROXYLASE INHIBITORS	<b>A61K 45/06</b> (2006.01)	2640377 *	FGFR1 EXTRACELLULAR DOMAIN COMBINATION THERAPIES
<b>C07D 405/14</b> (2006.01)	2603502 *	4 - AMINOQUINAZOLIN-2 - YL - 1 - PYRRAZOLE - 4 - CARBOXYLIC ACID COMPOUNDS AS PROLYL HYDROXYLASE INHIBITORS	<b>A61P 35/00</b> (2006.01)	2640377 *	FGFR1 EXTRACELLULAR DOMAIN COMBINATION THERAPIES
<b>A61K 31/517</b> (2006.01)	2603502 *	4 - AMINOQUINAZOLIN-2 - YL - 1 - PYRRAZOLE - 4 - CARBOXYLIC ACID COMPOUNDS AS PROLYL HYDROXYLASE INHIBITORS	<b>A61K 39/395</b> (2006.01)	2640377 *	FGFR1 EXTRACELLULAR DOMAIN COMBINATION THERAPIES
<b>A61K 31/55</b> (2006.01)	2603502 *	4 - AMINOQUINAZOLIN-2 - YL - 1 - PYRRAZOLE - 4 - CARBOXYLIC ACID COMPOUNDS AS PROLYL HYDROXYLASE INHIBITORS	<b>A61K 31/4745</b> (2006.01)	2640377 *	FGFR1 EXTRACELLULAR DOMAIN COMBINATION THERAPIES
<b>A61P 9/00</b> (2006.01)	2603502 *	4 - AMINOQUINAZOLIN-2 - YL - 1 - PYRRAZOLE - 4 - CARBOXYLIC ACID COMPOUNDS AS PROLYL HYDROXYLASE INHIBITORS	<b>A61K 31/513</b> (2006.01)	2640377 *	FGFR1 EXTRACELLULAR DOMAIN COMBINATION THERAPIES
<b>A61P 3/10</b> (2006.01)	2603502 *	4 - AMINOQUINAZOLIN-2 - YL - 1 - PYRRAZOLE - 4 - CARBOXYLIC ACID COMPOUNDS AS PROLYL HYDROXYLASE INHIBITORS	<b>A61K 31/555</b> (2006.01)	2640377 *	FGFR1 EXTRACELLULAR DOMAIN COMBINATION THERAPIES
<b>B01D 46/00</b> (2006.01)	2532407	Air purification device and method	<b>A61K 31/704</b> (2006.01)	2640377 *	FGFR1 EXTRACELLULAR DOMAIN COMBINATION THERAPIES
<b>B01D 53/00</b> (2006.01)	2532407	Air purification device and method	<b>A61K 31/7048</b> (2006.01)	2640377 *	FGFR1 EXTRACELLULAR DOMAIN COMBINATION THERAPIES
<b>B03C 3/00</b> (2006.01)	2532407	Air purification device and method	<b>A61K 33/24</b> (2006.01)	2640377 *	FGFR1 EXTRACELLULAR DOMAIN COMBINATION THERAPIES
			<b>A61K 38/17</b> (2006.01)	2640377 *	FGFR1 EXTRACELLULAR DOMAIN COMBINATION THERAPIES
			<b>C07K 19/00</b> (2006.01)	2640377 *	FGFR1 EXTRACELLULAR DOMAIN COMBINATION THERAPIES
			<b>A61K 31/4412</b> (2006.01)	2611805 *	FUSED TRIAZOLES FOR THE TREATMENT OR PROPHYLAXIS OF MILD COGNITIVE IMPAIRMENT

MKP (51)	Broj objave evropske prijava patenta (97)	Naziv pronalaska (54)	MKP (51)	Broj objave evropske prijava patenta (97)	Naziv pronalaska (54)
<b>A61K 31/437</b> (2006.01)	2611805 *	FUSED TRIAZOLES FOR THE TREATMENT OR PROPHYLAXIS OF MILD COGNITIVE IMPAIRMENT	<b>A61P 29/00</b> (2006.01)	2637649 *	COMPOUNDS AND METHODS FOR TREATING PAIN
<b>A61P 25/28</b> (2006.01)	2611805 *	FUSED TRIAZOLES FOR THE TREATMENT OR PROPHYLAXIS OF MILD COGNITIVE IMPAIRMENT	<b>A61P 29/02</b> (2006.01)	2637649 *	COMPOUNDS AND METHODS FOR TREATING PAIN
<b>C07D 471/04</b> (2006.01)	2611805 *	FUSED TRIAZOLES FOR THE TREATMENT OR PROPHYLAXIS OF MILD COGNITIVE IMPAIRMENT	<b>A61P 25/04</b> (2006.01)	2637649 *	COMPOUNDS AND METHODS FOR TREATING PAIN
<b>C07D 401/12</b> (2006.01)	2625172 *	NEW CRYSTALLINE FORMS OF THE SODIUM SALT OF (4- {4- [5- ( 6 - TRIFLUOROMETHYL - PYRIDIN- 3 - YLAMINO ) - PYRIDIN- 2 -YL]-PHENYL} - CYCLOHEXYL) -ACETIC ACID	<b>F02M 59/02</b> (2006.01)	2557306	Fuel pump
<b>A61K 31/415</b> (2006.01)	2625172 *	NEW CRYSTALLINE FORMS OF THE SODIUM SALT OF (4- {4- [5- ( 6 - TRIFLUOROMETHYL - PYRIDIN- 3 - YLAMINO ) - PYRIDIN- 2 -YL]-PHENYL} - CYCLOHEXYL) -ACETIC ACID	<b>F02M 59/44</b> (2006.01)	2557306	Fuel pump
<b>A61P 3/04</b> (2006.01)	2625172 *	NEW CRYSTALLINE FORMS OF THE SODIUM SALT OF (4- {4- [5- ( 6 - TRIFLUOROMETHYL - PYRIDIN- 3 - YLAMINO ) - PYRIDIN- 2 -YL]-PHENYL} - CYCLOHEXYL) -ACETIC ACID	<b>F04B 1/04</b> (2006.01)	2557306	Fuel pump
<b>G01N 33/50</b> (2006.01)	2631646 *	BIOMARKER FOR ALZHEIMER'S DISEASE OR MILD COGNITIVE IMPAIRMENT	<b>G06K 9/00</b> (2006.01)	2638507 *	HIGH THROUGHPUT, OPTICAL METHOD AND SYSTEM FOR DETERMINING THE EFFECT OF A TEST SUBSTANCE ON LIVING CELLS
<b>G01N 33/92</b> (2006.01)	2631646 *	BIOMARKER FOR ALZHEIMER'S DISEASE OR MILD COGNITIVE IMPAIRMENT	<b>G06T 7/00</b> (2006.01)	2638507 *	HIGH THROUGHPUT, OPTICAL METHOD AND SYSTEM FOR DETERMINING THE EFFECT OF A TEST SUBSTANCE ON LIVING CELLS
<b>G01N 33/15</b> (2006.01)	2631646 *	BIOMARKER FOR ALZHEIMER'S DISEASE OR MILD COGNITIVE IMPAIRMENT	<b>B01L 3/00</b> (2006.01)	2638507 *	HIGH THROUGHPUT, OPTICAL METHOD AND SYSTEM FOR DETERMINING THE EFFECT OF A TEST SUBSTANCE ON LIVING CELLS
<b>G01N 33/68</b> (2006.01)	2631646 *	BIOMARKER FOR ALZHEIMER'S DISEASE OR MILD COGNITIVE IMPAIRMENT	<b>C12M 1/34</b> (2006.01)	2638507 *	HIGH THROUGHPUT, OPTICAL METHOD AND SYSTEM FOR DETERMINING THE EFFECT OF A TEST SUBSTANCE ON LIVING CELLS
<b>A61K 31/00</b> (2006.01)	2637649 *	COMPOUNDS AND METHODS FOR TREATING PAIN	<b>G01N 15/06</b> (2006.01)	2638507 *	HIGH THROUGHPUT, OPTICAL METHOD AND SYSTEM FOR DETERMINING THE EFFECT OF A TEST SUBSTANCE ON LIVING CELLS
<b>A61K 31/4164</b> (2006.01)	2637649 *	COMPOUNDS AND METHODS FOR TREATING PAIN	<b>G01N 15/14</b> (2006.01)	2638507 *	HIGH THROUGHPUT, OPTICAL METHOD AND SYSTEM FOR DETERMINING THE EFFECT OF A TEST SUBSTANCE ON LIVING CELLS
<b>A61K 31/675</b> (2006.01)	2637649 *	COMPOUNDS AND METHODS FOR TREATING PAIN	<b>G01N 35/00</b> (2006.01)	2638507 *	HIGH THROUGHPUT, OPTICAL METHOD AND SYSTEM FOR DETERMINING THE EFFECT OF A TEST SUBSTANCE ON LIVING CELLS
<b>A61K 38/00</b> (2006.01)	2637649 *	COMPOUNDS AND METHODS FOR TREATING PAIN	<b>A47C 7/38</b> (2006.01)	2635159 *	NECK REST
			<b>B60N 2/48</b> (2006.01)	2635159 *	NECK REST
			<b>B63B 3/06</b> (2006.01)	2433858	A modular system for realising chambers joined to one another



MKP (51)	Broj objave evropske prijava patenta (97)	Naziv pronalaska (54)	MKP (51)	Broj objave evropske prijava patenta (97)	Naziv pronalaska (54)
<b>B63B 35/38</b> (2006.01)	2433858	A modular system for realising chambers joined to one another	<b>B01D 61/20</b> (2006.01)	2598231 *	A FILTRATION METHOD FOR OPERATING A FILTRATION MODULE WITH GAS FEED AT ITS PERMEATE SIDE TO PREVENT BACKFLOW OF PERMEATE
<b>E02B 3/06</b> (2006.01)	2433858	A modular system for realising chambers joined to one another	<b>B01D 65/00</b> (2006.01)	2598231 *	A FILTRATION METHOD FOR OPERATING A FILTRATION MODULE WITH GAS FEED AT ITS PERMEATE SIDE TO PREVENT BACKFLOW OF PERMEATE
<b>E01D 15/14</b> (2006.01)	2433858	A modular system for realising chambers joined to one another	<b>C12H 1/06</b> (2006.01)	2598231 *	A FILTRATION METHOD FOR OPERATING A FILTRATION MODULE WITH GAS FEED AT ITS PERMEATE SIDE TO PREVENT BACKFLOW OF PERMEATE
<b>E04B 1/343</b> (2006.01)	2433858	A modular system for realising chambers joined to one another	<b>B01D 65/02</b> (2006.01)	2598231 *	A FILTRATION METHOD FOR OPERATING A FILTRATION MODULE WITH GAS FEED AT ITS PERMEATE SIDE TO PREVENT BACKFLOW OF PERMEATE
<b>B65B 55/20</b> (2006.01)	2616345 *	METHOD AND DEVICE FOR FILLING PACKETS WITH PADDING IN THE FORM OF BULK MATERIAL	<b>A61M 5/145</b> (2006.01)	2600921 *	METHOD AND SYSTEM FOR RETAINING A CARTRIDGE IN A HOLDER
<b>B65D 81/09</b> (2006.01)	2616345 *	METHOD AND DEVICE FOR FILLING PACKETS WITH PADDING IN THE FORM OF BULK MATERIAL	<b>F16K 11/074</b> (2006.01)	2616724 *	FLUID-DIRECTING MULTIPOINT ROTARY VALVE
<b>B65B 1/22</b> (2006.01)	2616345 *	METHOD AND DEVICE FOR FILLING PACKETS WITH PADDING IN THE FORM OF BULK MATERIAL	<b>F23D 1/00</b> (2006.01)	2369230	Burner with tangential spiral intake elbow
<b>B82Y 5/00</b> (2011.01)	2627360 *	SILICA NANOPARTICLES DOPED WITH MULTIPLE DYES FEATURING HIGHLY EFFICIENT ENERGY TRANSFER AND TUNABLE STOKES-SHIFT	<b>F23C 7/00</b> (2006.01)	2369230	Burner with tangential spiral intake elbow
<b>A61K 49/00</b> (2006.01)	2627360 *	SILICA NANOPARTICLES DOPED WITH MULTIPLE DYES FEATURING HIGHLY EFFICIENT ENERGY TRANSFER AND TUNABLE STOKES-SHIFT	<b>H02K 9/197</b> (2006.01)	2636131 *	WIND ENERGY INSTALLATION HAVING A SYNCHRONOUS GENERATOR, AND SLOWLY ROTATING SYNCHRONOUS GENERATOR
<b>A61K 39/00</b> (2006.01)	2640727 *	ALANINYL MAYTANSINOL ANTIBODY CONJUGATES	<b>H02K 7/18</b> (2006.01)	2636131 *	WIND ENERGY INSTALLATION HAVING A SYNCHRONOUS GENERATOR, AND SLOWLY ROTATING SYNCHRONOUS GENERATOR
<b>A61K 31/535</b> (2006.01)	2640727 *	ALANINYL MAYTANSINOL ANTIBODY CONJUGATES	<b>F03D 9/00</b> (2006.01)	2636131 *	WIND ENERGY INSTALLATION HAVING A SYNCHRONOUS GENERATOR, AND SLOWLY ROTATING SYNCHRONOUS GENERATOR
<b>C07D 491/12</b> (2006.01)	2640727 *	ALANINYL MAYTANSINOL ANTIBODY CONJUGATES	<b>C07K 16/24</b> (2006.01)	2643352 *	ANTIGEN BINDING PROTEINS TO ONCOSTATIN M (OSM)
<b>F01M 13/04</b> (2006.01)	2614228 *	SYSTEM AND METHOD FOR MONITORING BLOW-BY IN A COMBUSTION ENGINE	<b>A47B 73/00</b> (2006.01)	2595503 *	BOTTLE RACK
<b>F02D 41/22</b> (2006.01)	2614228 *	SYSTEM AND METHOD FOR MONITORING BLOW-BY IN A COMBUSTION ENGINE	<b>A61L 2/025</b> (2006.01)	2601982 *	METHOD FOR PROCESSING BONE GRAFT MATERIAL USING TEETH, AND BONE GRAFT MATERIAL PROCESSED THEREBY
<b>F02D 41/00</b> (2006.01)	2614228 *	SYSTEM AND METHOD FOR MONITORING BLOW-BY IN A COMBUSTION ENGINE			
<b>F01M 13/02</b> (2006.01)	2614228 *	SYSTEM AND METHOD FOR MONITORING BLOW-BY IN A COMBUSTION ENGINE			
<b>B01D 61/10</b> (2006.01)	2598231 *	A FILTRATION METHOD FOR OPERATING A FILTRATION MODULE WITH GAS FEED AT ITS PERMEATE SIDE TO PREVENT BACKFLOW OF PERMEATE			

MKP (51)	Broj objave evropske prijava patenta (97)	Naziv pronalaska (54)	MKP (51)	Broj objave evropske prijava patenta (97)	Naziv pronalaska (54)
<b>A61L 27/36</b> (2006.01)	2601982 *	METHOD FOR PROCESSING BONE GRAFT MATERIAL USING TEETH, AND BONE GRAFT MATERIAL PROCESSED THEREBY	<b>C07D 257/04</b> (2006.01)	2640689 *	SUBSTITUTED CARBAMOYL CYCLOALKYL ACETIC ACID DERIVATIVES AS NEP INHIBITORS
<b>A61F 2/28</b> (2006.01)	2601982 *	METHOD FOR PROCESSING BONE GRAFT MATERIAL USING TEETH, AND BONE GRAFT MATERIAL PROCESSED THEREBY	<b>A61K 31/192</b> (2006.01)	2640689 *	SUBSTITUTED CARBAMOYL CYCLOALKYL ACETIC ACID DERIVATIVES AS NEP INHIBITORS
<b>C12N 5/071</b> (2010.01)	2601982 *	METHOD FOR PROCESSING BONE GRAFT MATERIAL USING TEETH, AND BONE GRAFT MATERIAL PROCESSED THEREBY	<b>C07D 213/55</b> (2006.01)	2640689 *	SUBSTITUTED CARBAMOYL CYCLOALKYL ACETIC ACID DERIVATIVES AS NEP INHIBITORS
<b>A61K 39/395</b> (2006.01)	2624865 *	STABILIZED FORMULATIONS CONTAINING ANTI-INTERLEUKIN-4 RECEPTOR (IL-4R) ANTIBODIES	<b>C07C 235/40</b> (2006.01)	2640689 *	SUBSTITUTED CARBAMOYL CYCLOALKYL ACETIC ACID DERIVATIVES AS NEP INHIBITORS
<b>C07K 16/28</b> (2006.01)	2624865 *	STABILIZED FORMULATIONS CONTAINING ANTI-INTERLEUKIN-4 RECEPTOR (IL-4R) ANTIBODIES	<b>A61K 31/341</b> (2006.01)	2640689 *	SUBSTITUTED CARBAMOYL CYCLOALKYL ACETIC ACID DERIVATIVES AS NEP INHIBITORS
<b>C12N 15/82</b> (2006.01)	2627771 *	METHODS FOR ALTERING THE REACTIVITY OF PLANT CELL WALLS	<b>C07D 207/16</b> (2006.01)	2640689 *	SUBSTITUTED CARBAMOYL CYCLOALKYL ACETIC ACID DERIVATIVES AS NEP INHIBITORS
<b>C12N 5/10</b> (2006.01)	2627771 *	METHODS FOR ALTERING THE REACTIVITY OF PLANT CELL WALLS	<b>A61P 9/08</b> (2006.01)	2640689 *	SUBSTITUTED CARBAMOYL CYCLOALKYL ACETIC ACID DERIVATIVES AS NEP INHIBITORS
<b>A01H 5/00</b> (2006.01)	2627771 *	METHODS FOR ALTERING THE REACTIVITY OF PLANT CELL WALLS	<b>A61K 31/4402</b> (2006.01)	2640689 *	SUBSTITUTED CARBAMOYL CYCLOALKYL ACETIC ACID DERIVATIVES AS NEP INHIBITORS
<b>A01H 5/10</b> (2006.01)	2627771 *	METHODS FOR ALTERING THE REACTIVITY OF PLANT CELL WALLS	<b>C07D 307/52</b> (2006.01)	2640689 *	SUBSTITUTED CARBAMOYL CYCLOALKYL ACETIC ACID DERIVATIVES AS NEP INHIBITORS
<b>C12N 15/54</b> (2006.01)	2627771 *	METHODS FOR ALTERING THE REACTIVITY OF PLANT CELL WALLS	<b>A61K 31/216</b> (2006.01)	2640689 *	SUBSTITUTED CARBAMOYL CYCLOALKYL ACETIC ACID DERIVATIVES AS NEP INHIBITORS
<b>C12N 15/62</b> (2006.01)	2627771 *	METHODS FOR ALTERING THE REACTIVITY OF PLANT CELL WALLS	<b>F03D 7/02</b> (2006.01)	2556246 *	METHOD FOR OPERATING A WIND ENERGY PLANT IN ICING CONDITIONS
<b>H04M 9/08</b> (2006.01)	2627065 *	MULTI-RECEIVER END ECHO CANCELLATION METHOD AND SYSTEM	<b>F03D 11/00</b> (2006.01)	2556246 *	METHOD FOR OPERATING A WIND ENERGY PLANT IN ICING CONDITIONS
<b>A61K 31/40</b> (2006.01)	2640689 *	SUBSTITUTED CARBAMOYL CYCLOALKYL ACETIC ACID DERIVATIVES AS NEP INHIBITORS	<b>B65H 75/14</b> (2006.01)	2522611	Reels with corrugated flanges and undercuts
<b>C07C 235/36</b> (2006.01)	2640689 *	SUBSTITUTED CARBAMOYL CYCLOALKYL ACETIC ACID DERIVATIVES AS NEP INHIBITORS	<b>B65H 75/50</b> (2006.01)	2522611	Reels with corrugated flanges and undercuts
<b>C07D 235/00</b> (2006.01)	2640689 *	SUBSTITUTED CARBAMOYL CYCLOALKYL ACETIC ACID DERIVATIVES AS NEP INHIBITORS	<b>B29C 45/44</b> (2006.01)	2522611	Reels with corrugated flanges and undercuts
<b>A61K 31/437</b> (2006.01)	2640689 *	SUBSTITUTED CARBAMOYL CYCLOALKYL ACETIC ACID DERIVATIVES AS NEP INHIBITORS	<b>A43B 3/26</b> (2006.01)	2635145 *	SOLE FOR SHOES HAVING ONE OR MORE VERTICAL ELEMENTS FOLDED OVER EACH OTHER, EXTENSIBLE AND ADAPTABLE TO THE DIFFERENT WIDTH OF THE ASSEMBLY LAST OF THE UPPER AND TO THE VARIATION OF THE CONFORMATION OF THE FOOT, EVEN PERMANENTLY

MKP (51)	Broj objave evropske prijava patenta (97)	Naziv pronalaska (54)	MKP (51)	Broj objave evropske prijava patenta (97)	Naziv pronalaska (54)
<b>A43B 13/18</b> (2006.01)	2635145 *	SOLE FOR SHOES HAVING ONE OR MORE VERTICAL ELEMENTS FOLDED OVER EACH OTHER, EXTENSIBLE AND ADAPTABLE TO THE DIFFERENT WIDTH OF THE ASSEMBLY LAST OF THE UPPER AND TO THE VARIATION OF THE CONFORMATION OF THE FOOT, EVEN PERMANENTLY	<b>A61K 47/36</b> (2006.01)	2624815 *	ORAL VACCINE FAST-DISSOLVING DOSAGE FORM USING STARCH
<b>A43B 13/16</b> (2006.01)	2635145 *	SOLE FOR SHOES HAVING ONE OR MORE VERTICAL ELEMENTS FOLDED OVER EACH OTHER, EXTENSIBLE AND ADAPTABLE TO THE DIFFERENT WIDTH OF THE ASSEMBLY LAST OF THE UPPER AND TO THE VARIATION OF THE CONFORMATION OF THE FOOT, EVEN PERMANENTLY	<b>A61K 31/31</b> (2006.01)	2598136 *	DISPERSIONS OF RASAGILINE CITRATE
<b>B29D 35/00</b> (2010.01)	2635145 *	SOLE FOR SHOES HAVING ONE OR MORE VERTICAL ELEMENTS FOLDED OVER EACH OTHER, EXTENSIBLE AND ADAPTABLE TO THE DIFFERENT WIDTH OF THE ASSEMBLY LAST OF THE UPPER AND TO THE VARIATION OF THE CONFORMATION OF THE FOOT, EVEN PERMANENTLY	<b>C07C 211/00</b> (2006.01)	2598136 *	DISPERSIONS OF RASAGILINE CITRATE
<b>B29D 35/12</b> (2010.01)	2635145 *	SOLE FOR SHOES HAVING ONE OR MORE VERTICAL ELEMENTS FOLDED OVER EACH OTHER, EXTENSIBLE AND ADAPTABLE TO THE DIFFERENT WIDTH OF THE ASSEMBLY LAST OF THE UPPER AND TO THE VARIATION OF THE CONFORMATION OF THE FOOT, EVEN PERMANENTLY	<b>A61K 49/04</b> (2006.01)	2626085 *	LIQUID PREPARATION FOR ORAL ADMINISTRATION WHICH CAN BE USED IN CT COLONOGRAPHY, AND COMPOSITION FOR IMAGING DIGESTIVE TRACT
<b>C07D 519/00</b> (2006.01)	2640731 *	IMIDAZOLE DERIVATIVES AS PDE10A ENZYME INHIBITORS	<b>C07K 16/00</b> (2006.01)	2601218 *	DUAL VARIABLE DOMAIN IMMUNOGLOBULINS AND USES THEREOF
<b>A61K 31/519</b> (2006.01)	2640731 *	IMIDAZOLE DERIVATIVES AS PDE10A ENZYME INHIBITORS	<b>E04H 6/42</b> (2006.01)	2603651 *	ARRANGEMENT FOR ORIENTING MULTI-TRACK VEHICLES IN THE DIRECTION OF TRAVEL IN CAR PARKS
<b>A61P 25/24</b> (2006.01)	2640731 *	IMIDAZOLE DERIVATIVES AS PDE10A ENZYME INHIBITORS	<b>E01F 9/08</b> (2006.01)	2603651 *	ARRANGEMENT FOR ORIENTING MULTI-TRACK VEHICLES IN THE DIRECTION OF TRAVEL IN CAR PARKS
<b>A61P 25/18</b> (2006.01)	2640731 *	IMIDAZOLE DERIVATIVES AS PDE10A ENZYME INHIBITORS	<b>F01N 3/20</b> (2006.01)	2541010	Pump assembly
<b>A61P 25/00</b> (2006.01)	2640731 *	IMIDAZOLE DERIVATIVES AS PDE10A ENZYME INHIBITORS	<b>C08F 6/00</b> (2006.01)	2635609 *	POSTTREATMENT AND SYSTEM FOR POSTTREATMENT OF PELLETIZED POLYOLEFIN RESINS
<b>A61K 9/00</b> (2006.01)	2624815 *	ORAL VACCINE FAST-DISSOLVING DOSAGE FORM USING STARCH	<b>B01J 8/00</b> (2006.01)	2635609 *	POSTTREATMENT AND SYSTEM FOR POSTTREATMENT OF PELLETIZED POLYOLEFIN RESINS
<b>A61K 39/145</b> (2006.01)	2624815 *	ORAL VACCINE FAST-DISSOLVING DOSAGE FORM USING STARCH	<b>C08F 10/00</b> (2006.01)	2635609 *	POSTTREATMENT AND SYSTEM FOR POSTTREATMENT OF PELLETIZED POLYOLEFIN RESINS
			<b>A01H 1/04</b> (2006.01)	2621261 *	A GENE EXPRESSION SIGNATURE FOR THE SELECTION OF HIGH ENERGY USE EFFICIENT PLANTS
			<b>C12N 15/82</b> (2006.01)	2621261 *	A GENE EXPRESSION SIGNATURE FOR THE SELECTION OF HIGH ENERGY USE EFFICIENT PLANTS
			<b>C07D 495/04</b> (2006.01)	2640729 *	INHIBITORS OF HIV REPLICATION
			<b>A61K 31/4365</b> (2006.01)	2640729 *	INHIBITORS OF HIV REPLICATION
			<b>A61P 31/18</b> (2006.01)	2640729 *	INHIBITORS OF HIV REPLICATION

MKP (51)	Broj objave evropske prijava patenta (97)	Naziv pronalaska (54)	MKP (51)	Broj objave evropske prijava patenta (97)	Naziv pronalaska (54)
<b>B32B 15/06</b> (2006.01)	2625034 *	AN ANTI-SCRATCH AND ANTI-SLIP DEVICE FOR LIFTING LOADS, PREFERABLY THROUGH THE USE OF A LIFT FORK	<b>A61K 47/22</b> (2006.01)	2613769 *	MELT-EXTRUDED SOLID DISPERSIONS CONTAINING AN APOPTOSIS-INDUCING AGENT
<b>B32B 15/08</b> (2006.01)	2625034 *	AN ANTI-SCRATCH AND ANTI-SLIP DEVICE FOR LIFTING LOADS, PREFERABLY THROUGH THE USE OF A LIFT FORK	<b>A61K 47/26</b> (2006.01)	2613769 *	MELT-EXTRUDED SOLID DISPERSIONS CONTAINING AN APOPTOSIS-INDUCING AGENT
<b>B32B 15/10</b> (2006.01)	2625034 *	AN ANTI-SCRATCH AND ANTI-SLIP DEVICE FOR LIFTING LOADS, PREFERABLY THROUGH THE USE OF A LIFT FORK	<b>A61K 47/32</b> (2006.01)	2613769 *	MELT-EXTRUDED SOLID DISPERSIONS CONTAINING AN APOPTOSIS-INDUCING AGENT
<b>B66F 9/12</b> (2006.01)	2625034 *	AN ANTI-SCRATCH AND ANTI-SLIP DEVICE FOR LIFTING LOADS, PREFERABLY THROUGH THE USE OF A LIFT FORK	<b>E21B 4/14</b> (2006.01)	2593628 *	TWO-PORT PERCUSSION MOLE
<b>A61L 27/04</b> (2006.01)	2637603 *	SPECIALLY DESIGNED MAGNESIUM-ALUMINUM ALLOYS AND MEDICAL USES THEREOF IN A HEMODYNAMIC ENVIRONMENT	<b>A61K 31/522</b> (2006.01)	2595630 *	USE OF A2B ADENOSINE RECEPTOR ANTAGONISTS FOR TREATING PULMONARY HYPERTENSION
<b>A61F 2/06</b> (2013.01)	2637603 *	SPECIALLY DESIGNED MAGNESIUM-ALUMINUM ALLOYS AND MEDICAL USES THEREOF IN A HEMODYNAMIC ENVIRONMENT	<b>A61P 9/12</b> (2006.01)	2595630 *	USE OF A2B ADENOSINE RECEPTOR ANTAGONISTS FOR TREATING PULMONARY HYPERTENSION
<b>G01N 33/543</b> (2006.01)	2618151	Low volume assay device having increased sensitivity	<b>A61P 11/00</b> (2006.01)	2595630 *	USE OF A2B ADENOSINE RECEPTOR ANTAGONISTS FOR TREATING PULMONARY HYPERTENSION
<b>G01N 33/558</b> (2006.01)	2618151	Low volume assay device having increased sensitivity	<b>A61K 31/00</b> (2006.01)	2595630 *	USE OF A2B ADENOSINE RECEPTOR ANTAGONISTS FOR TREATING PULMONARY HYPERTENSION
<b>A23L 1/318</b> (2006.01)	2624707 *	PROCESS FOR REDUCING OIL AND FAT CONTENT IN COOKED FOOD WITH PEA PROTEIN	<b>B65D 75/54</b> (2006.01)	2502848	Container, in particular bag or bucket and device for producing this container
<b>A23L 1/00</b> (2006.01)	2624707 *	PROCESS FOR REDUCING OIL AND FAT CONTENT IN COOKED FOOD WITH PEA PROTEIN	<b>B65B 61/20</b> (2006.01)	2502848	Container, in particular bag or bucket and device for producing this container
<b>A61K 9/14</b> (2006.01)	2613769 *	MELT-EXTRUDED SOLID DISPERSIONS CONTAINING AN APOPTOSIS-INDUCING AGENT	<b>B65D 25/20</b> (2006.01)	2502848	Container, in particular bag or bucket and device for producing this container
<b>A61K 9/20</b> (2006.01)	2613769 *	MELT-EXTRUDED SOLID DISPERSIONS CONTAINING AN APOPTOSIS-INDUCING AGENT	<b>A01N 43/72</b> (2006.01)	2627180 *	GROWTH INHIBITION OF PERENNIAL FORAGE GRASSES WITH PYROXSULAM
<b>A61K 31/437</b> (2006.01)	2613769 *	MELT-EXTRUDED SOLID DISPERSIONS CONTAINING AN APOPTOSIS-INDUCING AGENT	<b>A61K 9/19</b> (2006.01)	2603204 *	FORMULATIONS FOR INFUSION OF TYPE B LANTIBIOTICS
<b>A61K 47/02</b> (2006.01)	2613769 *	MELT-EXTRUDED SOLID DISPERSIONS CONTAINING AN APOPTOSIS-INDUCING AGENT	<b>A61K 38/10</b> (2006.01)	2603204 *	FORMULATIONS FOR INFUSION OF TYPE B LANTIBIOTICS
			<b>A61K 47/26</b> (2006.01)	2603204 *	FORMULATIONS FOR INFUSION OF TYPE B LANTIBIOTICS
			<b>A61K 9/00</b> (2006.01)	2603204 *	FORMULATIONS FOR INFUSION OF TYPE B LANTIBIOTICS
			<b>C07K 1/16</b> (2006.01)	2415779	Method of producing and purifying an active soluble sialyltransferase
			<b>C07K 1/18</b> (2006.01)	2415779	Method of producing and purifying an active soluble sialyltransferase

MKP (51)	Broj objave evropske prijava patenta (97)	Naziv pronalaska (54)	MKP (51)	Broj objave evropske prijava patenta (97)	Naziv pronalaska (54)
<b>C07K 1/22</b> (2006.01)	2415779	Method of producing and purifying an active soluble sialyltransferase	<b>A61K 31/497</b> (2006.01)	2518067	Derivatives of N-[(1H-pyrazol-1-YL)aryl]-1H-indole or 1H- indazole-3-carboxamide and their therapeutic uses as P2Y12 antagonists
<b>C07K 14/46</b> (2006.01)	2415779	Method of producing and purifying an active soluble sialyltransferase	<b>A61K 31/501</b> (2006.01)	2518067	Derivatives of N-[(1H-pyrazol-1-YL)aryl]-1H-indole or 1H- indazole-3-carboxamide and their therapeutic uses as P2Y12 antagonists
<b>C07K 14/47</b> (2006.01)	2415779	Method of producing and purifying an active soluble sialyltransferase	<b>A61K 31/506</b> (2006.01)	2518067	Derivatives of N-[(1H-pyrazol-1-YL)aryl]-1H-indole or 1H- indazole-3-carboxamide and their therapeutic uses as P2Y12 antagonists
<b>C07D 403/12</b> (2006.01)	2518067	Derivatives of N-[(1H-pyrazol-1-YL)aryl]-1H-indole or 1H- indazole-3-carboxamide and their therapeutic uses as P2Y12 antagonists	<b>A61P 9/00</b> (2006.01)	2518067	Derivatives of N-[(1H-pyrazol-1-YL)aryl]-1H-indole or 1H- indazole-3-carboxamide and their therapeutic uses as P2Y12 antagonists
<b>C07D 403/14</b> (2006.01)	2518067	Derivatives of N-[(1H-pyrazol-1-YL)aryl]-1H-indole or 1H- indazole-3-carboxamide and their therapeutic uses as P2Y12 antagonists	<b>C07D 401/14</b> (2006.01)	2518067	Derivatives of N-[(1H-pyrazol-1-YL)aryl]-1H-indole or 1H- indazole-3-carboxamide and their therapeutic uses as P2Y12 antagonists
<b>C07D 405/14</b> (2006.01)	2518067	Derivatives of N-[(1H-pyrazol-1-YL)aryl]-1H-indole or 1H- indazole-3-carboxamide and their therapeutic uses as P2Y12 antagonists	<b>A61K 31/428</b> (2006.01)	2621490 *	PROPARGYL-TRIFLUOROMETHOXY-AMINOBENZOTHAZOLE DERIVATIVES, THEIR PREPARATION AND USE
<b>C07D 409/14</b> (2006.01)	2518067	Derivatives of N-[(1H-pyrazol-1-YL)aryl]-1H-indole or 1H- indazole-3-carboxamide and their therapeutic uses as P2Y12 antagonists	<b>C07K 14/47</b> (2006.01)	2640739 *	INHIBITORS OF APOPTOSIS AND USES THEREOF
<b>C07D 413/14</b> (2006.01)	2518067	Derivatives of N-[(1H-pyrazol-1-YL)aryl]-1H-indole or 1H- indazole-3-carboxamide and their therapeutic uses as P2Y12 antagonists	<b>H01L 31/052</b> (2006.01)	2609629 *	PHOTOVOLTAIC MODULE AND METHOD FOR IMPROVED REVERSE BIAS, REVERSE CURRENT AND HOTSPOT PROTECTION
<b>C07D 471/04</b> (2006.01)	2518067	Derivatives of N-[(1H-pyrazol-1-YL)aryl]-1H-indole or 1H- indazole-3-carboxamide and their therapeutic uses as P2Y12 antagonists	<b>H01L 31/042</b> (2006.01)	2609629 *	PHOTOVOLTAIC MODULE AND METHOD FOR IMPROVED REVERSE BIAS, REVERSE CURRENT AND HOTSPOT PROTECTION
<b>C07D 471/08</b> (2006.01)	2518067	Derivatives of N-[(1H-pyrazol-1-YL)aryl]-1H-indole or 1H- indazole-3-carboxamide and their therapeutic uses as P2Y12 antagonists	<b>H01L 31/05</b> (2006.01)	2609629 *	PHOTOVOLTAIC MODULE AND METHOD FOR IMPROVED REVERSE BIAS, REVERSE CURRENT AND HOTSPOT PROTECTION
<b>C07D 487/04</b> (2006.01)	2518067	Derivatives of N-[(1H-pyrazol-1-YL)aryl]-1H-indole or 1H- indazole-3-carboxamide and their therapeutic uses as P2Y12 antagonists	<b>H01L 31/068</b> (2012.01)	2609629 *	PHOTOVOLTAIC MODULE AND METHOD FOR IMPROVED REVERSE BIAS, REVERSE CURRENT AND HOTSPOT PROTECTION
<b>C07D 487/08</b> (2006.01)	2518067	Derivatives of N-[(1H-pyrazol-1-YL)aryl]-1H-indole or 1H- indazole-3-carboxamide and their therapeutic uses as P2Y12 antagonists	<b>H01L 25/04</b> (2006.01)	2609629 *	PHOTOVOLTAIC MODULE AND METHOD FOR IMPROVED REVERSE BIAS, REVERSE CURRENT AND HOTSPOT PROTECTION
<b>A61K 31/455</b> (2006.01)	2518067	Derivatives of N-[(1H-pyrazol-1-YL)aryl]-1H-indole or 1H- indazole-3-carboxamide and their therapeutic uses as P2Y12 antagonists	<b>H01L 27/142</b> (2006.01)	2609629 *	PHOTOVOLTAIC MODULE AND METHOD FOR IMPROVED REVERSE BIAS, REVERSE CURRENT AND HOTSPOT PROTECTION
<b>A61K 31/439</b> (2006.01)	2518067	Derivatives of N-[(1H-pyrazol-1-YL)aryl]-1H-indole or 1H- indazole-3-carboxamide and their therapeutic uses as P2Y12 antagonists			

MKP (51)	Broj objave evropske prijava patenta (97)	Naziv pronalaska (54)	MKP (51)	Broj objave evropske prijava patenta (97)	Naziv pronalaska (54)
<b>H01L 31/0216</b> (2006.01)	2609629 *	PHOTOVOLTAIC MODULE AND METHOD FOR IMPROVED REVERSE BIAS, REVERSE CURRENT AND HOTSPOT PROTECTION	<b>A61K 31/216</b> (2006.01)	2628724 *	ARYLOXYUREA COMPOUND AND PEST CONTROL AGENT
<b>H01L 31/0224</b> (2006.01)	2609629 *	PHOTOVOLTAIC MODULE AND METHOD FOR IMPROVED REVERSE BIAS, REVERSE CURRENT AND HOTSPOT PROTECTION	<b>A61K 31/421</b> (2006.01)	2628724 *	ARYLOXYUREA COMPOUND AND PEST CONTROL AGENT
<b>C07D 213/30</b> (2006.01)	2616441 *	PYRIDINE COMPOUNDS AND THE USES THEREOF	<b>A61K 31/17</b> (2006.01)	2628724 *	ARYLOXYUREA COMPOUND AND PEST CONTROL AGENT
<b>C07D 403/12</b> (2006.01)	2616441 *	PYRIDINE COMPOUNDS AND THE USES THEREOF	<b>A61K 31/4196</b> (2006.01)	2628724 *	ARYLOXYUREA COMPOUND AND PEST CONTROL AGENT
<b>C07D 213/46</b> (2006.01)	2616441 *	PYRIDINE COMPOUNDS AND THE USES THEREOF	<b>A61K 31/4409</b> (2006.01)	2628724 *	ARYLOXYUREA COMPOUND AND PEST CONTROL AGENT
<b>C07D 403/14</b> (2006.01)	2616441 *	PYRIDINE COMPOUNDS AND THE USES THEREOF	<b>A61K 31/341</b> (2006.01)	2628724 *	ARYLOXYUREA COMPOUND AND PEST CONTROL AGENT
<b>C07D 213/74</b> (2006.01)	2616441 *	PYRIDINE COMPOUNDS AND THE USES THEREOF	<b>A61K 31/426</b> (2006.01)	2628724 *	ARYLOXYUREA COMPOUND AND PEST CONTROL AGENT
<b>A61K 31/4418</b> (2006.01)	2616441 *	PYRIDINE COMPOUNDS AND THE USES THEREOF	<b>A61K 31/197</b> (2006.01)	2628724 *	ARYLOXYUREA COMPOUND AND PEST CONTROL AGENT
<b>C07D 213/79</b> (2006.01)	2616441 *	PYRIDINE COMPOUNDS AND THE USES THEREOF	<b>A61K 31/42</b> (2006.01)	2628724 *	ARYLOXYUREA COMPOUND AND PEST CONTROL AGENT
<b>A61K 31/4439</b> (2006.01)	2616441 *	PYRIDINE COMPOUNDS AND THE USES THEREOF	<b>A01N 47/34</b> (2006.01)	2628724 *	ARYLOXYUREA COMPOUND AND PEST CONTROL AGENT
<b>C07D 213/81</b> (2006.01)	2616441 *	PYRIDINE COMPOUNDS AND THE USES THEREOF	<b>A61K 31/41</b> (2006.01)	2628724 *	ARYLOXYUREA COMPOUND AND PEST CONTROL AGENT
<b>A61K 31/444</b> (2006.01)	2616441 *	PYRIDINE COMPOUNDS AND THE USES THEREOF	<b>A61K 31/4402</b> (2006.01)	2628724 *	ARYLOXYUREA COMPOUND AND PEST CONTROL AGENT
<b>C07D 213/84</b> (2006.01)	2616441 *	PYRIDINE COMPOUNDS AND THE USES THEREOF	<b>A01P 7/02</b> (2006.01)	2628724 *	ARYLOXYUREA COMPOUND AND PEST CONTROL AGENT
<b>A61P 23/00</b> (2006.01)	2616441 *	PYRIDINE COMPOUNDS AND THE USES THEREOF	<b>A61K 31/415</b> (2006.01)	2628724 *	ARYLOXYUREA COMPOUND AND PEST CONTROL AGENT
<b>C07D 401/04</b> (2006.01)	2616441 *	PYRIDINE COMPOUNDS AND THE USES THEREOF	<b>A61K 31/4406</b> (2006.01)	2628724 *	ARYLOXYUREA COMPOUND AND PEST CONTROL AGENT
<b>C07D 401/12</b> (2006.01)	2616441 *	PYRIDINE COMPOUNDS AND THE USES THEREOF	<b>C07C 275/64</b> (2006.01)	2628724 *	ARYLOXYUREA COMPOUND AND PEST CONTROL AGENT
<b>C08F 10/00</b> (2006.01)	2625208 *	: METHOD OF PREPARATION OF NUCLEATED SEMI-CRYSTALLINE POLYMER	<b>A61K 31/381</b> (2006.01)	2628724 *	ARYLOXYUREA COMPOUND AND PEST CONTROL AGENT
<b>C08F 2/44</b> (2006.01)	2625208 *	: METHOD OF PREPARATION OF NUCLEATED SEMI-CRYSTALLINE POLYMER	<b>A61K 31/44</b> (2006.01)	2628724 *	ARYLOXYUREA COMPOUND AND PEST CONTROL AGENT
<b>C08K 3/00</b> (2006.01)	2625208 *	: METHOD OF PREPARATION OF NUCLEATED SEMI-CRYSTALLINE POLYMER	<b>A61K 31/277</b> (2006.01)	2628724 *	ARYLOXYUREA COMPOUND AND PEST CONTROL AGENT
<b>C08K 5/00</b> (2006.01)	2625208 *	: METHOD OF PREPARATION OF NUCLEATED SEMI-CRYSTALLINE POLYMER	<b>A61K 31/4245</b> (2006.01)	2628724 *	ARYLOXYUREA COMPOUND AND PEST CONTROL AGENT
<b>B65D 17/00</b> (2006.01)	2607470	Packaging wine in aluminium containers	<b>A61K 47/48</b> (2006.01)	2616103 *	ASYMMETRIC BIFUNCTIONAL SILYL MONOMERS AND PARTICLES THEREOF AS PRODRUGS AND DELIVERY VEHICLES FOR PHARMACEUTICAL, CHEMICAL AND BIOLOGICAL AGENTS
<b>C12G 1/00</b> (2006.01)	2607470	Packaging wine in aluminium containers			
<b>B67C 3/02</b> (2006.01)	2607470	Packaging wine in aluminium containers			

MKP (51)	Broj objave evropske prijava patenta (97)	Naziv pronalaska (54)	MKP (51)	Broj objave evropske prijava patenta (97)	Naziv pronalaska (54)
<b>A61K 9/00</b> (2006.01)	2596783	Pharmaceutical composition for the preparation of infusion solutions of antimicrobial preparations, its production process	<b>A61K 9/16</b> (2006.01)	2618819 *	PHARMACEUTICAL FORMULATIONS CONTAINING RIFAXIMIN, PROCESSES FOR THEIR OBTAINMENT AND METHOD OF TREATING INTESTINAL DISEASE
<b>A61K 9/08</b> (2006.01)	2596783	Pharmaceutical composition for the preparation of infusion solutions of antimicrobial preparations, its production process	<b>A61K 9/20</b> (2006.01)	2618819 *	PHARMACEUTICAL FORMULATIONS CONTAINING RIFAXIMIN, PROCESSES FOR THEIR OBTAINMENT AND METHOD OF TREATING INTESTINAL DISEASE
<b>A61F 2/00</b> (2006.01)	2611876 *	ADHESIVE STRUCTURE WITH STIFF PROTRUSIONS ON ADHESIVE SURFACE	<b>A61K 31/44</b> (2006.01)	2618819 *	PHARMACEUTICAL FORMULATIONS CONTAINING RIFAXIMIN, PROCESSES FOR THEIR OBTAINMENT AND METHOD OF TREATING INTESTINAL DISEASE
<b>A61B 17/08</b> (2006.01)	2611876 *	ADHESIVE STRUCTURE WITH STIFF PROTRUSIONS ON ADHESIVE SURFACE	<b>A61K 31/506</b> (2006.01)	2635284 *	HETEROCYCLIC COMPOUNDS AND USES THEREOF
<b>A61L 31/04</b> (2006.01)	2611876 *	ADHESIVE STRUCTURE WITH STIFF PROTRUSIONS ON ADHESIVE SURFACE	<b>A61K 31/16</b> (2006.01)	2635284 *	HETEROCYCLIC COMPOUNDS AND USES THEREOF
<b>A61L 31/06</b> (2006.01)	2611876 *	ADHESIVE STRUCTURE WITH STIFF PROTRUSIONS ON ADHESIVE SURFACE	<b>H04W 72/12</b> (2009.01)	2606701 *	ARBITRATION BETWEEN MULTIPLE WIRELESS PROTOCOLS IN A WIRELESS DEVICE
<b>B29C 33/52</b> (2006.01)	2611876 *	ADHESIVE STRUCTURE WITH STIFF PROTRUSIONS ON ADHESIVE SURFACE	<b>C07K 16/28</b> (2006.01)	2614081 *	ANTI-VEGFR-3 ANTIBODY COMPOSITIONS
<b>C09J 7/00</b> (2006.01)	2611876 *	ADHESIVE STRUCTURE WITH STIFF PROTRUSIONS ON ADHESIVE SURFACE	<b>B65D 17/32</b> (2006.01)	2611705 *	RECLOSING CAN FOR FOOD PRODUCT
<b>A61K 47/48</b> (2006.01)	2537532	Cathepsin-binding compounds bound to a nanodevice and their diagnostic and therapeutic use	<b>A01N 43/90</b> (2006.01)	2597956 *	SYNERGISTIC HERBICIDAL COMPOSITIONS CONTAINING PYROXSULAM AND SULFOSULFURON
<b>A61K 49/00</b> (2006.01)	2537532	Cathepsin-binding compounds bound to a nanodevice and their diagnostic and therapeutic use	<b>A01N 47/36</b> (2006.01)	2597956 *	SYNERGISTIC HERBICIDAL COMPOSITIONS CONTAINING PYROXSULAM AND SULFOSULFURON
<b>A61K 49/18</b> (2006.01)	2537532	Cathepsin-binding compounds bound to a nanodevice and their diagnostic and therapeutic use	<b>A01N 25/00</b> (2006.01)	2597956 *	SYNERGISTIC HERBICIDAL COMPOSITIONS CONTAINING PYROXSULAM AND SULFOSULFURON
<b>A61P 35/00</b> (2006.01)	2537532	Cathepsin-binding compounds bound to a nanodevice and their diagnostic and therapeutic use	<b>A01P 13/00</b> (2006.01)	2597956 *	SYNERGISTIC HERBICIDAL COMPOSITIONS CONTAINING PYROXSULAM AND SULFOSULFURON
<b>A61P 29/00</b> (2006.01)	2537532	Cathepsin-binding compounds bound to a nanodevice and their diagnostic and therapeutic use	<b>E04B 1/76</b> (2006.01)	2543791	Method for making façades of buildings
<b>A61K 9/127</b> (2006.01)	2537532	Cathepsin-binding compounds bound to a nanodevice and their diagnostic and therapeutic use	<b>E04F 13/08</b> (2006.01)	2543791	Method for making façades of buildings
<b>C07D 405/12</b> (2006.01)	2537532	Cathepsin-binding compounds bound to a nanodevice and their diagnostic and therapeutic use	<b>G01N 33/52</b> (2006.01)	2628013 *	BIOMARKERS OF BRAIN INJURY
<b>C07K 7/02</b> (2006.01)	2537532	Cathepsin-binding compounds bound to a nanodevice and their diagnostic and therapeutic use	<b>G01N 33/68</b> (2006.01)	2628013 *	BIOMARKERS OF BRAIN INJURY

MKP (51)	Broj objave evropske prijava patenta (97)	Naziv pronalaska (54)	MKP (51)	Broj objave evropske prijava patenta (97)	Naziv pronalaska (54)
<b>G01N 33/53</b> (2006.01)	2628013 *	BIOMARKERS OF BRAIN INJURY	<b>A61M 25/04</b> (2006.01)	2640453 *	AN ASSEMBLY WITH A GUIDE WIRE AND A FIXATOR FOR ATTACHING TO A BLOOD VESSEL
<b>C07D 487/22</b> (2006.01)	2635585 *	HIGH-EFFICIENCY CATALYSTS, PREPARATION AND USE THEREOF	<b>E04H 15/56</b> (2006.01)	2407614	Base structure for a tent and tent with such a base structure
<b>A61K 39/00</b> (2006.01)	2635585 *	HIGH-EFFICIENCY CATALYSTS, PREPARATION AND USE THEREOF	<b>E04F 15/024</b> (2006.01)	2407614	Base structure for a tent and tent with such a base structure
<b>A61K 47/48</b> (2006.01)	2635585 *	HIGH-EFFICIENCY CATALYSTS, PREPARATION AND USE THEREOF	<b>E04B 5/02</b> (2006.01)	2407614	Base structure for a tent and tent with such a base structure
<b>A61K 39/00</b> (2006.01)	2640414 *	IMMUNOGLOBULIN CLEAVAGE FRAGMENTS VACCINE COMPOSITIONS	<b>C07D 307/87</b> (2006.01)	2595979 *	PROCESS FOR THE PURIFICATION OF PHARMACEUTICALLY ACCEPTABLE SALTS
<b>F24J 2/52</b> (2006.01)	2562487	Assembly of multiple frames for holding board-shaped elements on a surface and side profile for a frame for use in such an assembly	<b>C40B 30/04</b> (2006.01)	2640876 *	METHOD OF AND SYSTEM FOR PRINTING IN-WELL CALIBRATION FEATURES
<b>E04D 1/12</b> (2006.01)	2562487	Assembly of multiple frames for holding board-shaped elements on a surface and side profile for a frame for use in such an assembly	<b>E06B 3/667</b> (2006.01)	2594722	Plug connector
<b>E04D 1/34</b> (2006.01)	2562487	Assembly of multiple frames for holding board-shaped elements on a surface and side profile for a frame for use in such an assembly	<b>G01D 5/14</b> (2006.01)	2630449 *	TESTER FOR DETERMINATION OF MACHINE ROTATION DIRECTION AND ACCURACY OF STATOR WINDING CONNECTION
<b>H01L 31/048</b> (2006.01)	2562487	Assembly of multiple frames for holding board-shaped elements on a surface and side profile for a frame for use in such an assembly	<b>C07D 249/12</b> (2006.01)	2619188 *	SUBSTITUTED N-PHENETHYLTRIAZOLONEACETAMIDES AND USE THEREOF
<b>A61K 31/422</b> (2006.01)	2603216 *	HETEROARYLS AND USES THEREOF	<b>A61K 31/4196</b> (2006.01)	2619188 *	SUBSTITUTED N-PHENETHYLTRIAZOLONEACETAMIDES AND USE THEREOF
<b>C03B 37/08</b> (2006.01)	2522637	Bushing Assembly for Producing Fibers from Molten Mineral Material	<b>A61P 9/00</b> (2006.01)	2619188 *	SUBSTITUTED N-PHENETHYLTRIAZOLONEACETAMIDES AND USE THEREOF
<b>D06F 57/08</b> (2006.01)	2527516	Stabilizing base for a clothes horse	<b>A61K 36/48</b> (2006.01)	2617412	Composition for topical treatment
<b>D06F 57/10</b> (2006.01)	2527516	Stabilizing base for a clothes horse	<b>A61K 36/68</b> (2006.01)	2617412	Composition for topical treatment
<b>D06F 57/06</b> (2006.01)	2527516	Stabilizing base for a clothes horse	<b>A61P 29/00</b> (2006.01)	2617412	Composition for topical treatment
<b>A47J 31/44</b> (2006.01)	2613678 *	A BREWING DEVICE	<b>A61K 9/12</b> (2006.01)	2617412	Composition for topical treatment
<b>A62C 31/00</b> (2006.01)	2599524 *	AUTOMATED NITROGEN-WATER FIRE - FIGHTING COMPLEX	<b>A61K 36/185</b> (2006.01)	2617412	Composition for topical treatment
<b>A62C 5/00</b> (2006.01)	2599524 *	AUTOMATED NITROGEN-WATER FIRE - FIGHTING COMPLEX	<b>A61K 36/09</b> (2006.01)	2617412	Composition for topical treatment
<b>A62C 35/68</b> (2006.01)	2599524 *	AUTOMATED NITROGEN-WATER FIRE - FIGHTING COMPLEX	<b>A61K 36/73</b> (2006.01)	2617412	Composition for topical treatment
<b>G02C 7/10</b> (2006.01)	2506064	Method of making and prescribing tinted lenses	<b>C07K 14/47</b> (2006.01)	2643348 *	IMPROVED CAPPING MODULES FOR DESIGNED ANKYRIN REPEAT PROTEINS
<b>B29D 11/00</b> (2006.01)	2506064	Method of making and prescribing tinted lenses	<b>G06K 19/06</b> (2006.01)	2619714 *	TWO-DIMENSIONAL IDENTIFICATION PATTERN, ARTICLE INCLUDING SUCH A PATTERN, AND METHODS FOR MARKING AND IDENTIFYING SUCH A PATTERN
			<b>G06F 19/00</b> (2011.01)	2455875	System and method for diabetes management



MKP (51)	Broj objave evropske prijava patenta (97)	Naziv pronalaska (54)	MKP (51)	Broj objave evropske prijava patenta (97)	Naziv pronalaska (54)
<b>G01N 27/327</b> (2006.01)	2455875	System and method for diabetes management	<b>C10L 1/19</b> (2006.01)	2639286	Process for the production of fuel and fuel additives capable for use for internal combustion engines and the fuels and fuel additives obtained
<b>A61B 5/145</b> (2006.01)	2455875	System and method for diabetes management	<b>C10L 1/223</b> (2006.01)	2639286	Process for the production of fuel and fuel additives capable for use for internal combustion engines and the fuels and fuel additives obtained
<b>A61M 16/06</b> (2006.01)	2632525 *	BUTTERFLY NASAL MASK	<b>C10L 10/08</b> (2006.01)	2639286	Process for the production of fuel and fuel additives capable for use for internal combustion engines and the fuels and fuel additives obtained
<b>C10G 3/00</b> (2006.01)	2639286	Process for the production of fuel and fuel additives capable for use for internal combustion engines and the fuels and fuel additives obtained	<b>G06F 17/30</b> (2006.01)	2606442 *	CONTENT SERVER
<b>C10L 1/02</b> (2006.01)	2639286	Process for the production of fuel and fuel additives capable for use for internal combustion engines and the fuels and fuel additives obtained	<b>G06Q 30/00</b> (2012.01)	2606442 *	CONTENT SERVER
<b>C10G 67/04</b> (2006.01)	2639286	Process for the production of fuel and fuel additives capable for use for internal combustion engines and the fuels and fuel additives obtained	<b>C07D 403/14</b> (2006.01)	2635571 *	NOVEL INHIBITORS OF HEPATITIS C VIRUS
<b>C10G 47/04</b> (2006.01)	2639286	Process for the production of fuel and fuel additives capable for use for internal combustion engines and the fuels and fuel additives obtained	<b>A61K 31/4025</b> (2006.01)	2635571 *	NOVEL INHIBITORS OF HEPATITIS C VIRUS
<b>C10G 47/06</b> (2006.01)	2639286	Process for the production of fuel and fuel additives capable for use for internal combustion engines and the fuels and fuel additives obtained	<b>A61K 31/12</b> (2006.01)	2635571 *	NOVEL INHIBITORS OF HEPATITIS C VIRUS
<b>C10G 47/10</b> (2006.01)	2639286	Process for the production of fuel and fuel additives capable for use for internal combustion engines and the fuels and fuel additives obtained	<b>C07D 471/04</b> (2006.01)	2637502 *	MUTANT-SELECTIVE EGFR INHIBITORS AND USES THEREOF
<b>C10L 1/04</b> (2006.01)	2639286	Process for the production of fuel and fuel additives capable for use for internal combustion engines and the fuels and fuel additives obtained	<b>C07D 239/42</b> (2006.01)	2637502 *	MUTANT-SELECTIVE EGFR INHIBITORS AND USES THEREOF
<b>C10L 1/14</b> (2006.01)	2639286	Process for the production of fuel and fuel additives capable for use for internal combustion engines and the fuels and fuel additives obtained	<b>A01N 43/54</b> (2006.01)	2637502 *	MUTANT-SELECTIVE EGFR INHIBITORS AND USES THEREOF
<b>C10L 1/16</b> (2006.01)	2639286	Process for the production of fuel and fuel additives capable for use for internal combustion engines and the fuels and fuel additives obtained	<b>A61P 35/00</b> (2006.01)	2624828 *	PICROPODOPHYLLIN MONOHYDRATE OR POLYMORPH A IN CANCER THERAPY
<b>C10L 1/183</b> (2006.01)	2639286	Process for the production of fuel and fuel additives capable for use for internal combustion engines and the fuels and fuel additives obtained	<b>A61P 25/28</b> (2006.01)	2624828 *	PICROPODOPHYLLIN MONOHYDRATE OR POLYMORPH A IN CANCER THERAPY
<b>C10L 1/188</b> (2006.01)	2639286	Process for the production of fuel and fuel additives capable for use for internal combustion engines and the fuels and fuel additives obtained	<b>A61K 31/365</b> (2006.01)	2624828 *	PICROPODOPHYLLIN MONOHYDRATE OR POLYMORPH A IN CANCER THERAPY
			<b>A61P 3/10</b> (2006.01)	2624828 *	PICROPODOPHYLLIN MONOHYDRATE OR POLYMORPH A IN CANCER THERAPY
			<b>F02D 41/20</b> (2006.01)	2546499	Electrical drive arrangement for a fuel injection system
			<b>C07H 19/02</b> (2006.01)	2596004 *	METHODS FOR THE PREPARATION OF DIASTEROMERICALLY PURE PHOSPHORAMIDATE PRODRUGS

MKP (51)	Broj objave evropske prijava patenta (97)	Naziv pronalaska (54)	MKP (51)	Broj objave evropske prijava patenta (97)	Naziv pronalaska (54)
<b>C07H 19/10</b> (2006.01)	2596004 *	METHODS FOR THE PREPARATION OF DIASTEROMERICALLY PURE PHOSPHORAMIDATE PRODRUGS	<b>C07D 487/04</b> (2006.01)	2625179 *	PROCESS FOR PREPARING AN INTERMEDIATE OF SITAGLIPTIN VIA ENZYMATIC CONVERSION
<b>C07H 19/20</b> (2006.01)	2596004 *	METHODS FOR THE PREPARATION OF DIASTEROMERICALLY PURE PHOSPHORAMIDATE PRODRUGS	<b>C12N 9/02</b> (2006.01)	2625179 *	PROCESS FOR PREPARING AN INTERMEDIATE OF SITAGLIPTIN VIA ENZYMATIC CONVERSION
<b>C07H 1/00</b> (2006.01)	2596004 *	METHODS FOR THE PREPARATION OF DIASTEROMERICALLY PURE PHOSPHORAMIDATE PRODRUGS	<b>C12P 17/18</b> (2006.01)	2625179 *	PROCESS FOR PREPARING AN INTERMEDIATE OF SITAGLIPTIN VIA ENZYMATIC CONVERSION
<b>C07H 1/06</b> (2006.01)	2596004 *	METHODS FOR THE PREPARATION OF DIASTEROMERICALLY PURE PHOSPHORAMIDATE PRODRUGS	<b>H01P 1/06</b> (2006.01)	2601706 *	POWER DUAL-BAND ROTARY JOINT OPERATING ON TWO DIFFERENT BANDS
<b>C07D 309/10</b> (2006.01)	2596004 *	METHODS FOR THE PREPARATION OF DIASTEROMERICALLY PURE PHOSPHORAMIDATE PRODRUGS	<b>H01P 1/16</b> (2006.01)	2601706 *	POWER DUAL-BAND ROTARY JOINT OPERATING ON TWO DIFFERENT BANDS
<b>C12N 15/82</b> (2006.01)	2603591 *	COMPOSITIONS AND METHODS COMPRISING SEQUENCES HAVING HYDROXYPHENYLPYRUVATE DIOXYGENASE (HPPD) ACTIVITY	<b>C12N 15/82</b> (2006.01)	2643464 *	BRASSICA GAT EVENT DP-073496-4 AND COMPOSITIONS AND METHODS FOR THE IDENTIFICATION AND/OR DETECTION THEREOF
<b>C12Q 1/68</b> (2006.01)	2603591 *	COMPOSITIONS AND METHODS COMPRISING SEQUENCES HAVING HYDROXYPHENYLPYRUVATE DIOXYGENASE (HPPD) ACTIVITY	<b>G01N 33/68</b> (2006.01)	2598888 *	ANALYTICAL METHOD FOR FAB AND FAB' MOLECULES
<b>G01N 33/573</b> (2006.01)	2603591 *	COMPOSITIONS AND METHODS COMPRISING SEQUENCES HAVING HYDROXYPHENYLPYRUVATE DIOXYGENASE (HPPD) ACTIVITY	<b>C07D 257/04</b> (2006.01)	2616450 *	SULFONAMIDE COMPOUNDS
<b>A01H 5/00</b> (2006.01)	2603591 *	COMPOSITIONS AND METHODS COMPRISING SEQUENCES HAVING HYDROXYPHENYLPYRUVATE DIOXYGENASE (HPPD) ACTIVITY	<b>C07D 307/82</b> (2006.01)	2616450 *	SULFONAMIDE COMPOUNDS
<b>A01H 5/10</b> (2006.01)	2603591 *	COMPOSITIONS AND METHODS COMPRISING SEQUENCES HAVING HYDROXYPHENYLPYRUVATE DIOXYGENASE (HPPD) ACTIVITY	<b>C07D 333/34</b> (2006.01)	2616450 *	SULFONAMIDE COMPOUNDS
<b>C12N 9/02</b> (2006.01)	2603591 *	COMPOSITIONS AND METHODS COMPRISING SEQUENCES HAVING HYDROXYPHENYLPYRUVATE DIOXYGENASE (HPPD) ACTIVITY	<b>C07D 333/62</b> (2006.01)	2616450 *	SULFONAMIDE COMPOUNDS
<b>F04B 1/04</b> (2006.01)	2530316	Fuel pump lubrication	<b>C07D 405/12</b> (2006.01)	2616450 *	SULFONAMIDE COMPOUNDS
<b>F02M 59/10</b> (2006.01)	2530316	Fuel pump lubrication	<b>C07D 417/12</b> (2006.01)	2616450 *	SULFONAMIDE COMPOUNDS
<b>F02M 59/44</b> (2006.01)	2530316	Fuel pump lubrication	<b>C07D 409/04</b> (2006.01)	2616450 *	SULFONAMIDE COMPOUNDS
<b>F02M 63/00</b> (2006.01)	2530316	Fuel pump lubrication	<b>C07D 417/14</b> (2006.01)	2616450 *	SULFONAMIDE COMPOUNDS
			<b>C07D 409/12</b> (2006.01)	2616450 *	SULFONAMIDE COMPOUNDS
			<b>C07C 311/21</b> (2006.01)	2616450 *	SULFONAMIDE COMPOUNDS
			<b>C07D 409/14</b> (2006.01)	2616450 *	SULFONAMIDE COMPOUNDS
			<b>C07C 311/29</b> (2006.01)	2616450 *	SULFONAMIDE COMPOUNDS
			<b>C07D 413/12</b> (2006.01)	2616450 *	SULFONAMIDE COMPOUNDS
			<b>A61K 31/41</b> (2006.01)	2616450 *	SULFONAMIDE COMPOUNDS
			<b>C07D 413/04</b> (2006.01)	2616450 *	SULFONAMIDE COMPOUNDS
			<b>A61K 31/422</b> (2006.01)	2616450 *	SULFONAMIDE COMPOUNDS

MKP (51)	Broj objave evropske prijava patenta (97)	Naziv pronalaska (54)	MKP (51)	Broj objave evropske prijava patenta (97)	Naziv pronalaska (54)
<b>C07D 413/14</b> (2006.01)	2616450 *	SULFONAMIDE COMPOUNDS	<b>A61K 9/50</b> (2006.01)	2600852 *	BECLOMETHASONE DIPROPIONATE COMPOSITIONS IN MODIFIED-RELEASE GASTRO-RESISTANT MICROSPHERES AND PROCESS FOR OBTAINING THEM
<b>A61K 31/381</b> (2006.01)	2616450 *	SULFONAMIDE COMPOUNDS			
<b>C07D 417/04</b> (2006.01)	2616450 *	SULFONAMIDE COMPOUNDS			
<b>A61K 31/4436</b> (2006.01)	2616450 *	SULFONAMIDE COMPOUNDS	<b>A61P 1/12</b> (2006.01)	2600852 *	BECLOMETHASONE DIPROPIONATE COMPOSITIONS IN MODIFIED-RELEASE GASTRO-RESISTANT MICROSPHERES AND PROCESS FOR OBTAINING THEM
<b>A61K 31/517</b> (2006.01)	2608793 *	USE OF A RECEPTOR-TYPE KINASE MODULATOR FOR TREATING POLYCYSTIC KIDNEY DISEASE			
<b>A61P 13/12</b> (2006.01)	2608793 *	USE OF A RECEPTOR-TYPE KINASE MODULATOR FOR TREATING POLYCYSTIC KIDNEY DISEASE	<b>F16J 15/34</b> (2006.01)	2606261 *	PUMP SEAL
<b>A01N 43/40</b> (2006.01)	2632262 *	SYNERGISTIC HERBICIDAL COMPOSITION CONTAINING FLUROXYPYR AND QUINCLORAC	<b>A61P 35/00</b> (2006.01)	2640366 *	BENZOXAZEPINES AS INHIBITORS OF PI3K/MTOR AND METHODS OF THEIR USE AND MANUFACTURE
<b>A01P 13/00</b> (2006.01)	2632262 *	SYNERGISTIC HERBICIDAL COMPOSITION CONTAINING FLUROXYPYR AND QUINCLORAC	<b>G01N 33/00</b> (2006.01)	2640366 *	BENZOXAZEPINES AS INHIBITORS OF PI3K/MTOR AND METHODS OF THEIR USE AND MANUFACTURE
<b>C07D 307/80</b> (2006.01)	2595976 *	PROCESS FOR PREPARING AMINOBENZOYL BENZOFURAN DERIVATIVES	<b>A61K 31/00</b> (2006.01)	2640366 *	BENZOXAZEPINES AS INHIBITORS OF PI3K/MTOR AND METHODS OF THEIR USE AND MANUFACTURE
<b>F03B 17/00</b> (2006.01)	2535558	Method and device for generating drive power by causing pressure differentials in a closed gas/fluid system	<b>B07B 13/10</b> (2006.01)	2598256 *	SEPARATION APPARATUS
<b>C07D 487/04</b> (2006.01)	2630148 *	PROCESS FOR THE PREPARATION OF ANAGRELIDE AND ANALOGUES THEREOF	<b>B07B 13/11</b> (2006.01)	2598256 *	SEPARATION APPARATUS
<b>A01K 67/027</b> (2006.01)	2618656 *	HUMAM SIRPAalpha TRANSGENIC ANIMALS AND THEIR METHODS OF USE	<b>B07B 13/16</b> (2006.01)	2598256 *	SEPARATION APPARATUS
<b>A61K 39/395</b> (2006.01)	2624867 *	METHODS FOR TREATING PSORIASIS	<b>E04C 3/09</b> (2006.01)	2573291	Thin-walled cold-formed lightweight structural profile element and method for producing such a profile element
<b>A61P 1/04</b> (2006.01)	2600852 *	BECLOMETHASONE DIPROPIONATE COMPOSITIONS IN MODIFIED-RELEASE GASTRO-RESISTANT MICROSPHERES AND PROCESS FOR OBTAINING THEM	<b>E04C 3/08</b> (2006.01)	2573291	Thin-walled cold-formed lightweight structural profile element and method for producing such a profile element
<b>A61K 31/573</b> (2006.01)	2600852 *	BECLOMETHASONE DIPROPIONATE COMPOSITIONS IN MODIFIED-RELEASE GASTRO-RESISTANT MICROSPHERES AND PROCESS FOR OBTAINING THEM	<b>G06F 17/50</b> (2006.01)	2378444	Method, device and computer program product for determining an electromagnetic near field of a field excitation source for an electrical system
			<b>A61F 13/15</b> (2006.01)	2596778	Apparatus and method for applying short machine direction adhesive patches to a carrier layer
			<b>G01N 33/68</b> (2006.01)	2611462 *	PEPTIDE OR PEPTIDE COMPLEX BINDING TO 2 INTEGRIN AND METHODS AND USES INVOLVING THE SAME

MKP (51)	Broj objave evropske prijava patenta (97)	Naziv pronalaska (54)	MKP (51)	Broj objave evropske prijava patenta (97)	Naziv pronalaska (54)
<b>A61P 3/10</b> (2006.01)	2611462 *	PEPTIDE OR PEPTIDE COMPLEX BINDING TO 2 INTEGRIN AND METHODS AND USES INVOLVING THE SAME	<b>G01N 33/574</b> (2006.01)	2619585 *	USE OF MYELOID CELL BIOMARKERS FOR THE DIAGNOSIS OF CANCER
<b>A61K 39/395</b> (2006.01)	2611462 *	PEPTIDE OR PEPTIDE COMPLEX BINDING TO 2 INTEGRIN AND METHODS AND USES INVOLVING THE SAME	<b>C02F 1/42</b> (2006.01)	2616395 *	A METHOD FOR THE REMOVAL OF ORGANIC CHEMICALS AND ORGANOMETALLIC COMPLEXES FROM PROCESS WATER OR OTHER STREAMS OF A MINERAL PROCESSING PLANT USING ZEOLITE
<b>A61P 17/06</b> (2006.01)	2611462 *	PEPTIDE OR PEPTIDE COMPLEX BINDING TO 2 INTEGRIN AND METHODS AND USES INVOLVING THE SAME	<b>A01N 43/54</b> (2006.01)	2627179 *	METHODS FOR INHIBITING CELL PROLIFERATION IN EGFR-DRIVEN CANCERS
<b>C07K 16/28</b> (2006.01)	2611462 *	PEPTIDE OR PEPTIDE COMPLEX BINDING TO 2 INTEGRIN AND METHODS AND USES INVOLVING THE SAME	<b>A61K 31/505</b> (2006.01)	2627179 *	METHODS FOR INHIBITING CELL PROLIFERATION IN EGFR-DRIVEN CANCERS
<b>A61P 9/10</b> (2006.01)	2611462 *	PEPTIDE OR PEPTIDE COMPLEX BINDING TO 2 INTEGRIN AND METHODS AND USES INVOLVING THE SAME	<b>E06B 9/28</b> (2006.01)	2643539 *	VENETIAN BLIND FOR INTERNAL USE WITH SLATS FIXED TO UPRIGHT CARRIER SLATS, DESIGNED FOR INCLUSION IN A GLASS-ENCLOSED CHAMBER
<b>A61P 35/00</b> (2006.01)	2611462 *	PEPTIDE OR PEPTIDE COMPLEX BINDING TO 2 INTEGRIN AND METHODS AND USES INVOLVING THE SAME	<b>E06B 7/082</b> (2006.01)	2643539 *	VENETIAN BLIND FOR INTERNAL USE WITH SLATS FIXED TO UPRIGHT CARRIER SLATS, DESIGNED FOR INCLUSION IN A GLASS-ENCLOSED CHAMBER
<b>A61P 29/00</b> (2006.01)	2611462 *	PEPTIDE OR PEPTIDE COMPLEX BINDING TO 2 INTEGRIN AND METHODS AND USES INVOLVING THE SAME	<b>A61K 31/405</b> (2006.01)	2614051 *	P53-MDM2 ANTAGONISTS
<b>A61P 37/02</b> (2006.01)	2611462 *	PEPTIDE OR PEPTIDE COMPLEX BINDING TO 2 INTEGRIN AND METHODS AND USES INVOLVING THE SAME	<b>A61P 35/00</b> (2006.01)	2614051 *	P53-MDM2 ANTAGONISTS
<b>A61B 17/02</b> (2006.01)	2632344 *	SINGLE USE, DISPOSABLE, TISSUE SUSPENDER DEVICE	<b>C07D 209/42</b> (2006.01)	2614051 *	P53-MDM2 ANTAGONISTS
<b>A61B 17/04</b> (2006.01)	2632344 *	SINGLE USE, DISPOSABLE, TISSUE SUSPENDER DEVICE	<b>C07D 209/30</b> (2006.01)	2614051 *	P53-MDM2 ANTAGONISTS
<b>A61B 17/00</b> (2006.01)	2632344 *	SINGLE USE, DISPOSABLE, TISSUE SUSPENDER DEVICE	<b>C07D 209/14</b> (2006.01)	2614051 *	P53-MDM2 ANTAGONISTS
<b>A61K 36/886</b> (2006.01)	2595643 *	ANTI-VIRAL PROPERTIES OF ALOE VERA AND ACQUIRED IMMUNE DEFICIENCY SYNDROME (AIDS) TREATMENT	<b>C07D 209/26</b> (2006.01)	2614051 *	P53-MDM2 ANTAGONISTS
<b>A61P 31/18</b> (2006.01)	2595643 *	ANTI-VIRAL PROPERTIES OF ALOE VERA AND ACQUIRED IMMUNE DEFICIENCY SYNDROME (AIDS) TREATMENT	<b>A61K 31/404</b> (2006.01)	2614051 *	P53-MDM2 ANTAGONISTS
<b>A61K 31/715</b> (2006.01)	2595643 *	ANTI-VIRAL PROPERTIES OF ALOE VERA AND ACQUIRED IMMUNE DEFICIENCY SYNDROME (AIDS) TREATMENT	<b>B29C 44/44</b> (2006.01)	2599606	Method for the realization of objects of polystyrene covered with a hardened layer of polymeric material, preferably objects of decor and furniture
			<b>B29C 37/00</b> (2006.01)	2599606	Method for the realization of objects of polystyrene covered with a hardened layer of polymeric material, preferably objects of decor and furniture
			<b>B05D 1/02</b> (2006.01)	2599606	Method for the realization of objects of polystyrene covered with a hardened layer of polymeric material, preferably objects of decor and furniture
			<b>A61P 25/08</b> (2006.01)	2604602 *	HETEROARYL-PYRAZOLE DERIVATIVE

MKP (51)	Broj objave evropske prijava patenta (97)	Naziv pronalaska (54)	MKP (51)	Broj objave evropske prijava patenta (97)	Naziv pronalaska (54)
<b>C07D 403/04</b> (2006.01)	2604602 *	HETEROARYL-PYRAZOLE DERIVATIVE	<b>H01M</b> <b>10/0525</b> (2010.01)	2638597 *	HIGH PERFORMANCE LITHIUM OR LITHIUM ION CELL
<b>A61P 25/28</b> (2006.01)	2604602 *	HETEROARYL-PYRAZOLE DERIVATIVE	<b>H01M 4/66</b> (2006.01)	2638597 *	HIGH PERFORMANCE LITHIUM OR LITHIUM ION CELL
<b>A61K</b> <b>31/4155</b> (2006.01)	2604602 *	HETEROARYL-PYRAZOLE DERIVATIVE	<b>H01M 4/62</b> (2006.01)	2638597 *	HIGH PERFORMANCE LITHIUM OR LITHIUM ION CELL
<b>A61P 25/36</b> (2006.01)	2604602 *	HETEROARYL-PYRAZOLE DERIVATIVE	<b>H01M</b> <b>10/0566</b> (2010.01)	2638597 *	HIGH PERFORMANCE LITHIUM OR LITHIUM ION CELL
<b>A61K</b> <b>31/4245</b> (2006.01)	2604602 *	HETEROARYL-PYRAZOLE DERIVATIVE	<b>C07D 471/04</b> (2006.01)	2638040 *	RADIOLABELLED mGLuR2 PET LIGANDS
<b>C07D 403/14</b> (2006.01)	2604602 *	HETEROARYL-PYRAZOLE DERIVATIVE	<b>C07K 16/22</b> (2006.01)	2611831 *	TREATMENT OF MYOCARDIAL INFARCTION USING TGF - BETA ANTAGONISTS
<b>A61P 25/20</b> (2006.01)	2604602 *	HETEROARYL-PYRAZOLE DERIVATIVE	<b>C07K 16/28</b> (2006.01)	2611831 *	TREATMENT OF MYOCARDIAL INFARCTION USING TGF - BETA ANTAGONISTS
<b>A61P 25/22</b> (2006.01)	2604602 *	HETEROARYL-PYRAZOLE DERIVATIVE	<b>A61K</b> <b>39/395</b> (2006.01)	2611831 *	TREATMENT OF MYOCARDIAL INFARCTION USING TGF - BETA ANTAGONISTS
<b>A61K</b> <b>31/4439</b> (2006.01)	2604602 *	HETEROARYL-PYRAZOLE DERIVATIVE	<b>A61P 9/10</b> (2006.01)	2611831 *	TREATMENT OF MYOCARDIAL INFARCTION USING TGF - BETA ANTAGONISTS
<b>C07D 413/04</b> (2006.01)	2604602 *	HETEROARYL-PYRAZOLE DERIVATIVE	<b>B65D 5/42</b> (2006.01)	2635499 *	IMPROVEMENTS IN AND RELATING TO PACKAGING
<b>A61P 25/04</b> (2006.01)	2604602 *	HETEROARYL-PYRAZOLE DERIVATIVE	<b>B65D 65/00</b> (2006.01)	2635499 *	IMPROVEMENTS IN AND RELATING TO PACKAGING
<b>C07D 413/14</b> (2006.01)	2604602 *	HETEROARYL-PYRAZOLE DERIVATIVE	<b>B65G 49/06</b> (2006.01)	2595906 *	APPARATUS FOR THE APPLICATION OF SPACER ELEMENTS ONTO PLATES
<b>F16K 3/26</b> (2006.01)	2535622	Valve assembly	<b>C10B 27/06</b> (2006.01)	2625248 *	COKING PLANT AND METHOD FOR CONTROLLING SAID PLANT
<b>C01B 17/02</b> (2006.01)	2643266 *	METHOD AND SYSTEM FOR GENERATING SULFUR SEEDS AND GRANULES	<b>C10B 41/08</b> (2006.01)	2625248 *	COKING PLANT AND METHOD FOR CONTROLLING SAID PLANT
<b>C01B 17/00</b> (2006.01)	2643266 *	METHOD AND SYSTEM FOR GENERATING SULFUR SEEDS AND GRANULES	<b>C12Q 1/00</b> (2006.01)	2625280 *	IGF-1 DEPENDENT MODULATION OF VSELS
<b>B01J 2/12</b> (2006.01)	2643266 *	METHOD AND SYSTEM FOR GENERATING SULFUR SEEDS AND GRANULES	<b>G01N 33/53</b> (2006.01)	2601525 *	USE OF HMGB1 AS A BIOLOGICAL MARKER OF BOWEL INFLAMMATORY CONDITIONS, NON- INVASIVE METHOD FOR ITS DETECTION IN FECAL SAMPLES AND KIT THEREOF
<b>A61M</b> <b>5/315</b> (2006.01)	2574358	Use of a spring in a drug delivery device	<b>A44B 11/00</b> (2006.01)	2615937 *	BELT BUCKLE THAT CAN BE DETACHED WITHOUT TOOLS AND THAT HAS AN INTEGRATED CONTAINER FOR CHECK CARDS, IDENTITY CARDS, A DRIVER'S LICENSE, AND THE LIKE
<b>A61M 5/24</b> (2006.01)	2574358	Use of a spring in a drug delivery device			
<b>A61K</b> <b>39/395</b> (2006.01)	2624866 *	TUMOR SPECIFIC ANTIBODIES AND USES THEREFOR			
<b>C07K 16/00</b> (2006.01)	2624866 *	TUMOR SPECIFIC ANTIBODIES AND USES THEREFOR			
<b>C12N 9/72</b> (2006.01)	2640834 *	A NOVEL PROCESS FOR THE PURIFICATION OF TISSUE PLASMINOGEN ACTIVATOR			
<b>C12N 9/48</b> (2006.01)	2640834 *	A NOVEL PROCESS FOR THE PURIFICATION OF TISSUE PLASMINOGEN ACTIVATOR			
<b>H01M 4/36</b> (2006.01)	2638597 *	HIGH PERFORMANCE LITHIUM OR LITHIUM ION CELL			

MKP (51)	Broj objave evropske prijava patenta (97)	Naziv pronalaska (54)	MKP (51)	Broj objave evropske prijava patenta (97)	Naziv pronalaska (54)
<b>A61M 5/24</b> (2006.01)	2637719 *	DOSE SETTING MECHANISM AND DRUG DELIVERY DEVICE	<b>A61K 31/439</b> (2006.01)	2643295 *	GLYCINE DERIVATIVES AND THEIR USE AS MUSCARINIC RECEPTOR ANTAGONISTS
<b>A61M 5/315</b> (2006.01)	2637719 *	DOSE SETTING MECHANISM AND DRUG DELIVERY DEVICE	<b>A61P 11/08</b> (2006.01)	2643295 *	GLYCINE DERIVATIVES AND THEIR USE AS MUSCARINIC RECEPTOR ANTAGONISTS
<b>C11C 5/00</b> (2006.01)	2611895 *	DECORATIVE CANDLE AND METHOD	<b>A61P 29/02</b> (2006.01)	2643295 *	GLYCINE DERIVATIVES AND THEIR USE AS MUSCARINIC RECEPTOR ANTAGONISTS
<b>B61H 13/20</b> (2006.01)	2627548 *	RAILWAY TRUCK MOUNTED BRAKE RIGGING HAVING RAISED CONNECTION OF FORCE-TRANSMITTING MEMBER WITH TRANSFER LEVER	<b>C07K 16/00</b> (2006.01)	2640742 *	A COLLECTION AND METHODS FOR ITS USE
<b>B61H 1/00</b> (2006.01)	2627548 *	RAILWAY TRUCK MOUNTED BRAKE RIGGING HAVING RAISED CONNECTION OF FORCE-TRANSMITTING MEMBER WITH TRANSFER LEVER	<b>C12N 15/10</b> (2006.01)	2640742 *	A COLLECTION AND METHODS FOR ITS USE
<b>C04B 26/02</b> (2006.01)	2601151 *	COMPOSITE BUILDING MATERIALS AND METHODS OF MANUFACTURE	<b>C07C 69/753</b> (2006.01)	2626428	Method for enzymatic synthesis of (7S)-3,4-dimethoxybicyclo[4.2.0]octa-1,3,5-triene-7-carboxylic acid or the esters thereof, and use for the synthesis of ivabradine and the salts thereof
<b>C04B 30/02</b> (2006.01)	2601151 *	COMPOSITE BUILDING MATERIALS AND METHODS OF MANUFACTURE	<b>C07C 213/08</b> (2006.01)	2626428	Method for enzymatic synthesis of (7S)-3,4-dimethoxybicyclo[4.2.0]octa-1,3,5-triene-7-carboxylic acid or the esters thereof, and use for the synthesis of ivabradine and the salts thereof
<b>C04B 26/16</b> (2006.01)	2601151 *	COMPOSITE BUILDING MATERIALS AND METHODS OF MANUFACTURE	<b>C07C 62/34</b> (2006.01)	2626428	Method for enzymatic synthesis of (7S)-3,4-dimethoxybicyclo[4.2.0]octa-1,3,5-triene-7-carboxylic acid or the esters thereof, and use for the synthesis of ivabradine and the salts thereof
<b>C04B 18/30</b> (2006.01)	2601151 *	COMPOSITE BUILDING MATERIALS AND METHODS OF MANUFACTURE	<b>C07C 217/58</b> (2006.01)	2626428	Method for enzymatic synthesis of (7S)-3,4-dimethoxybicyclo[4.2.0]octa-1,3,5-triene-7-carboxylic acid or the esters thereof, and use for the synthesis of ivabradine and the salts thereof
<b>C04B 26/12</b> (2006.01)	2601151 *	COMPOSITE BUILDING MATERIALS AND METHODS OF MANUFACTURE	<b>C07D 223/16</b> (2006.01)	2626428	Method for enzymatic synthesis of (7S)-3,4-dimethoxybicyclo[4.2.0]octa-1,3,5-triene-7-carboxylic acid or the esters thereof, and use for the synthesis of ivabradine and the salts thereof
<b>B65D 83/14</b> (2006.01)	2627454 *	DEVICE FOR DISTRIBUTING ADHESIVE	<b>C12P 7/40</b> (2006.01)	2626428	Method for enzymatic synthesis of (7S)-3,4-dimethoxybicyclo[4.2.0]octa-1,3,5-triene-7-carboxylic acid or the esters thereof, and use for the synthesis of ivabradine and the salts thereof
<b>B65D 83/28</b> (2006.01)	2627454 *	DEVICE FOR DISTRIBUTING ADHESIVE	<b>C12P 7/62</b> (2006.01)	2626428	Method for enzymatic synthesis of (7S)-3,4-dimethoxybicyclo[4.2.0]octa-1,3,5-triene-7-carboxylic acid or the esters thereof, and use for the synthesis of ivabradine and the salts thereof
<b>B65D 83/30</b> (2006.01)	2627454 *	DEVICE FOR DISTRIBUTING ADHESIVE			
<b>B05C 17/005</b> (2006.01)	2627454 *	DEVICE FOR DISTRIBUTING ADHESIVE			
<b>C07D 207/12</b> (2006.01)	2643295 *	GLYCINE DERIVATIVES AND THEIR USE AS MUSCARINIC RECEPTOR ANTAGONISTS			
<b>C07D 451/10</b> (2006.01)	2643295 *	GLYCINE DERIVATIVES AND THEIR USE AS MUSCARINIC RECEPTOR ANTAGONISTS			
<b>C07D 453/02</b> (2006.01)	2643295 *	GLYCINE DERIVATIVES AND THEIR USE AS MUSCARINIC RECEPTOR ANTAGONISTS			
<b>A61K 31/40</b> (2006.01)	2643295 *	GLYCINE DERIVATIVES AND THEIR USE AS MUSCARINIC RECEPTOR ANTAGONISTS			
<b>A61K 31/46</b> (2006.01)	2643295 *	GLYCINE DERIVATIVES AND THEIR USE AS MUSCARINIC RECEPTOR ANTAGONISTS			

MKP (51)	Broj objave evropske prijava patenta (97)	Naziv pronalaska (54)	MKP (51)	Broj objave evropske prijava patenta (97)	Naziv pronalaska (54)
<b>C12P 41/00</b> (2006.01)	2626428	Method for enzymatic synthesis of (7S)-3,4-dimethoxybicyclo[4.2.0]octa-1,3,5-triene-7-carboxylic acid or the esters thereof, and use for the synthesis of ivabradine and the salts thereof	<b>H01H 36/00</b> (2006.01)	2590197	Magnetic sensor designed to operate with a corresponding magnet and magnetic contact comprising said magnetic sensor and corresponding magnet
<b>G06F 13/38</b> (2006.01)	2523117	Interface module for HW block	<b>B65D 51/28</b> (2006.01)	2616354 *	CLOSING DEVICE FOR A CONTAINER AND CONTAINER COMPRISING SAID CLOSING DEVICE
<b>F42B 12/40</b> (2006.01)	2630436 *	MULTI-MARKER MARKING SYSTEM	<b>A61L 2/12</b> (2006.01)	2598176 *	METHOD FOR DISINFECTING BEDDING ITEMS BY MICROWAVES, IN PARTICULAR MATTRESSES, AND RELATED FACILITY
<b>A61F 2/00</b> (2006.01)	2635197 *	CLOSURE DEVICE, DEPLOYMENT APPARATUS, AND METHOD OF DEPLOYING A CLOSURE DEVICE	<b>H04N 21/41</b> (2011.01)	2619991 *	PROGRAMMABLE MULTIMEDIA CONTROL SYSTEM HAVING A TACTILE REMOTE CONTROL
<b>A61B 17/03</b> (2006.01)	2635197 *	CLOSURE DEVICE, DEPLOYMENT APPARATUS, AND METHOD OF DEPLOYING A CLOSURE DEVICE	<b>H04N 21/436</b> (2011.01)	2619991 *	PROGRAMMABLE MULTIMEDIA CONTROL SYSTEM HAVING A TACTILE REMOTE CONTROL
<b>A61B 17/08</b> (2006.01)	2635197 *	CLOSURE DEVICE, DEPLOYMENT APPARATUS, AND METHOD OF DEPLOYING A CLOSURE DEVICE	<b>H04N 5/44</b> (2011.01)	2619991 *	PROGRAMMABLE MULTIMEDIA CONTROL SYSTEM HAVING A TACTILE REMOTE CONTROL
<b>A61L 31/02</b> (2006.01)	2635197 *	CLOSURE DEVICE, DEPLOYMENT APPARATUS, AND METHOD OF DEPLOYING A CLOSURE DEVICE	<b>H04M 1/725</b> (2006.01)	2619991 *	PROGRAMMABLE MULTIMEDIA CONTROL SYSTEM HAVING A TACTILE REMOTE CONTROL
<b>C07C 237/22</b> (2006.01)	2640691 *	PROCESS FOR PREPARING LACOSAMIDE	<b>G06F 1/16</b> (2006.01)	2619991 *	PROGRAMMABLE MULTIMEDIA CONTROL SYSTEM HAVING A TACTILE REMOTE CONTROL
<b>C07C 229/22</b> (2006.01)	2640691 *	PROCESS FOR PREPARING LACOSAMIDE	<b>C12Q 1/68</b> (2006.01)	2643470 *	COMPOSITIONS AND METHODS FOR DIAGNOSING AND TREATING DISEASES AND DISORDERS ASSOCIATED WITH D-DT
<b>C07C 233/47</b> (2006.01)	2640691 *	PROCESS FOR PREPARING LACOSAMIDE	<b>G01N 33/53</b> (2006.01)	2643470 *	COMPOSITIONS AND METHODS FOR DIAGNOSING AND TREATING DISEASES AND DISORDERS ASSOCIATED WITH D-DT
<b>A61P 31/18</b> (2006.01)	2640720 *	BIFUNCTIONAL MOLECULES WITH ANTIBODY-RECRUITING AND ENTRY INHIBITORY ACTIVITY AGAINST THE HUMAN IMMUNODEFICIENCY VIRUS	<b>C12Q 1/00</b> (2006.01)	2643470 *	COMPOSITIONS AND METHODS FOR DIAGNOSING AND TREATING DISEASES AND DISORDERS ASSOCIATED WITH D-DT
<b>A61K 31/496</b> (2006.01)	2640720 *	BIFUNCTIONAL MOLECULES WITH ANTIBODY-RECRUITING AND ENTRY INHIBITORY ACTIVITY AGAINST THE HUMAN IMMUNODEFICIENCY VIRUS	<b>A61K 39/395</b> (2006.01)	2611464 *	NOVEL MODULATORS AND METHODS OF USE
<b>C07D 405/14</b> (2006.01)	2640720 *	BIFUNCTIONAL MOLECULES WITH ANTIBODY-RECRUITING AND ENTRY INHIBITORY ACTIVITY AGAINST THE HUMAN IMMUNODEFICIENCY VIRUS	<b>C07D 413/14</b> (2006.01)	2625177 *	NOVEL GPR 119 AGONISTS
<b>A23L 1/0524</b> (2006.01)	2600734 *	"GUMDROPS WITH FLUID FILLING AND METHOD OF OBTAINING THEM"	<b>C07D 417/14</b> (2006.01)	2625177 *	NOVEL GPR 119 AGONISTS
<b>A23G 3/54</b> (2006.01)	2600734 *	"GUMDROPS WITH FLUID FILLING AND METHOD OF OBTAINING THEM"	<b>A61K 31/506</b> (2006.01)	2625177 *	NOVEL GPR 119 AGONISTS
			<b>A61P 3/10</b> (2006.01)	2625177 *	NOVEL GPR 119 AGONISTS

MKP (51)	Broj objave evropske prijava patenta (97)	Naziv pronalaska (54)	MKP (51)	Broj objave evropske prijava patenta (97)	Naziv pronalaska (54)
<b>F42B 12/40</b> (2006.01)	2630215 *	COMBINED THERMAL AND CHEMILUMINESCENT REACTION SYSTEM	<b>E21B 19/24</b> (2006.01)	2643542 *	VALVE APPARATUS AND IMPROVED RAM
<b>C09K 11/07</b> (2006.01)	2630215 *	COMBINED THERMAL AND CHEMILUMINESCENT REACTION SYSTEM	<b>E21B 33/06</b> (2006.01)	2643542 *	VALVE APPARATUS AND IMPROVED RAM
<b>F42B 12/36</b> (2006.01)	2630215 *	COMBINED THERMAL AND CHEMILUMINESCENT REACTION SYSTEM	<b>A01N 25/02</b> (2006.01)	2611292 *	NEONICOTINYL FORMULATIONS
<b>C07D 471/04</b> (2006.01)	2635578 *	2-ARYLIMIDAZO[1,2-B] PYRIDAZINE, 2-PHENYLIMIDAZO[1,2-A] PYRIDINE, AND 2-PHENYLIMIDAZO[1,2-A] PYRAZINE DERIVATIVES	<b>A01N 25/30</b> (2006.01)	2611292 *	NEONICOTINYL FORMULATIONS
<b>C07D 487/04</b> (2006.01)	2635578 *	2-ARYLIMIDAZO[1,2-B] PYRIDAZINE, 2-PHENYLIMIDAZO[1,2-A] PYRIDINE, AND 2-PHENYLIMIDAZO[1,2-A] PYRAZINE DERIVATIVES	<b>A01N 51/00</b> (2006.01)	2611292 *	NEONICOTINYL FORMULATIONS
<b>A61K 31/5025</b> (2006.01)	2635578 *	2-ARYLIMIDAZO[1,2-B] PYRIDAZINE, 2-PHENYLIMIDAZO[1,2-A] PYRIDINE, AND 2-PHENYLIMIDAZO[1,2-A] PYRAZINE DERIVATIVES	<b>A61K 9/00</b> (2006.01)	2522342	A topical formulation for treatment of hyperkeratotic skin
<b>A61P 35/00</b> (2006.01)	2635578 *	2-ARYLIMIDAZO[1,2-B] PYRIDAZINE, 2-PHENYLIMIDAZO[1,2-A] PYRIDINE, AND 2-PHENYLIMIDAZO[1,2-A] PYRAZINE DERIVATIVES	<b>A61P 31/10</b> (2006.01)	2522342	A topical formulation for treatment of hyperkeratotic skin
<b>A61K 47/48</b> (2006.01)	2640422 *	POLYMERIC CONJUGATES OF ACTIVE PRINCIPLES, THEIR PROCESS OF PREPARATION AND THEIR POLYMERIC INTERMEDIATES	<b>A61K 31/19</b> (2006.01)	2522342	A topical formulation for treatment of hyperkeratotic skin
<b>A61P 35/00</b> (2006.01)	2640422 *	POLYMERIC CONJUGATES OF ACTIVE PRINCIPLES, THEIR PROCESS OF PREPARATION AND THEIR POLYMERIC INTERMEDIATES	<b>A61P 17/12</b> (2006.01)	2522342	A topical formulation for treatment of hyperkeratotic skin
<b>C12N 15/82</b> (2006.01)	2622082 *	GENERATION OF VIROSOME PARTICLES	<b>A61K 45/06</b> (2006.01)	2522342	A topical formulation for treatment of hyperkeratotic skin
<b>A61K 39/145</b> (2006.01)	2622082 *	GENERATION OF VIROSOME PARTICLES	<b>A61K 31/17</b> (2006.01)	2522342	A topical formulation for treatment of hyperkeratotic skin
<b>C07D 487/04</b> (2006.01)	2595987 *	NEW AMINOPYRAZOLOQUINAZOLINES	<b>A61K 9/16</b> (2006.01)	2605756 *	FUNCTIONAL FOOD COMPOSITIONS AND METHODS
<b>C07D 493/14</b> (2006.01)	2595987 *	NEW AMINOPYRAZOLOQUINAZOLINES	<b>A61K 9/50</b> (2006.01)	2605756 *	FUNCTIONAL FOOD COMPOSITIONS AND METHODS
<b>C07D 495/14</b> (2006.01)	2595987 *	NEW AMINOPYRAZOLOQUINAZOLINES	<b>G06F 19/00</b> (2011.01)	2603622 *	PANCREATIC CANCER BIOMARKERS AND USES THEREOF
<b>C07D 498/14</b> (2006.01)	2595987 *	NEW AMINOPYRAZOLOQUINAZOLINES	<b>C40B 30/04</b> (2006.01)	2603622 *	PANCREATIC CANCER BIOMARKERS AND USES THEREOF
<b>A61K 31/517</b> (2006.01)	2595987 *	NEW AMINOPYRAZOLOQUINAZOLINES	<b>E21B 43/12</b> (2006.01)	2619404 *	WELLBORE FRAC TOOL WITH INFLOW CONTROL
<b>A61P 35/00</b> (2006.01)	2595987 *	NEW AMINOPYRAZOLOQUINAZOLINES	<b>E21B 43/25</b> (2006.01)	2619404 *	WELLBORE FRAC TOOL WITH INFLOW CONTROL
			<b>E21B 34/14</b> (2006.01)	2619404 *	WELLBORE FRAC TOOL WITH INFLOW CONTROL
			<b>D05C 17/02</b> (2006.01)	2635734 *	METHOD OF MANUFACTURING A CARPET OR CARPET TILE, CARPET OR CARPET TILE OBTAINED BY PERFORMING THE MANUFACTURING METHOD, AND SUPPORT MATERIAL FOR USE IN THE METHOD
			<b>G07F 17/32</b> (2006.01)	2636031 *	APPARATUS AND SYSTEM FOR REVEALING GRAPHICAL ITEMS ON A MULTI-TOUCH INTERFACE
			<b>G06F 3/048</b> (2013.01)	2636031 *	APPARATUS AND SYSTEM FOR REVEALING GRAPHICAL ITEMS ON A MULTI-TOUCH INTERFACE



MKP (51)	Broj objave evropske prijava patenta (97)	Naziv pronalaska (54)
<b>F01L 7/12</b> (2006.01)	2598728 *	DISCHARGE VALVE ASSEMBLY FOR TWO-STROKE ENGINE, PROVIDED WITH COOLING, NON-CONTACTING SEAL AND SELF-CLEANING
<b>F02B 33/04</b> (2006.01)	2598728 *	DISCHARGE VALVE ASSEMBLY FOR TWO-STROKE ENGINE, PROVIDED WITH COOLING, NON-CONTACTING SEAL AND SELF-CLEANING
<b>F01L 7/02</b> (2006.01)	2598728 *	DISCHARGE VALVE ASSEMBLY FOR TWO-STROKE ENGINE, PROVIDED WITH COOLING, NON-CONTACTING SEAL AND SELF-CLEANING
<b>A61K 39/395</b> (2006.01)	2629796 *	ANTIBODIES
<b>G06Q 30/00</b> (2012.01)	2601628 *	METHODS FOR USING A SHOPPING BAG OF REUSABLE TYPE WITH IDENTIFICATION OF DIGITAL TYPE
<b>G07C 9/00</b> (2006.01)	2601628 *	METHODS FOR USING A SHOPPING BAG OF REUSABLE TYPE WITH IDENTIFICATION OF DIGITAL TYPE
<b>C01B 31/02</b> (2006.01)	2616391 *	CARBON NANOSTRUCTURES AND NETWORKS PRODUCED BY CHEMICAL VAPOR DEPOSITION
<b>B01J 35/00</b> (2006.01)	2616391 *	CARBON NANOSTRUCTURES AND NETWORKS PRODUCED BY CHEMICAL VAPOR DEPOSITION
<b>B01J 37/16</b> (2006.01)	2616391 *	CARBON NANOSTRUCTURES AND NETWORKS PRODUCED BY CHEMICAL VAPOR DEPOSITION
<b>A61B 3/113</b> (2006.01)	2632322 *	METHOD OF DETERMINING REFLECTIONS OF LIGHT
<b>G06F 3/01</b> (2006.01)	2632322 *	METHOD OF DETERMINING REFLECTIONS OF LIGHT
<b>G06T 7/00</b> (2006.01)	2632322 *	METHOD OF DETERMINING REFLECTIONS OF LIGHT
<b>A61K 31/351</b> (2006.01)	2629756 *	PHARMACEUTICAL TOPICAL COMPOSITION OF MUPIROCIN
<b>A61K 9/06</b> (2006.01)	2629756 *	PHARMACEUTICAL TOPICAL COMPOSITION OF MUPIROCIN
<b>A61K 9/00</b> (2006.01)	2629756 *	PHARMACEUTICAL TOPICAL COMPOSITION OF MUPIROCIN

MKP (51)	Broj objave evropske prijava patenta (97)	Naziv pronalaska (54)
<b>A61K 47/46</b> (2006.01)	2629756 *	PHARMACEUTICAL TOPICAL COMPOSITION OF MUPIROCIN
<b>B29D 11/00</b> (2006.01)	2637847 *	METHOD FOR MAKING CONTACT LENSES
<b>H04L 29/06</b> (2006.01)	2636203 *	AUTHENTICATION IN SECURE USER PLANE LOCATION (SUPL) SYSTEMS
<b>H04W 4/02</b> (2009.01)	2636203 *	AUTHENTICATION IN SECURE USER PLANE LOCATION (SUPL) SYSTEMS
<b>C07C 1/04</b> (2006.01)	2598464 *	PROCESS FOR PRODUCING A METHANE-CONTAINING GAS FROM SYNTHESIS GAS AND METHANE PRODUCTION PLANT FOR CARRYING OUT THE PROCESS
<b>C10L 3/08</b> (2006.01)	2598464 *	PROCESS FOR PRODUCING A METHANE-CONTAINING GAS FROM SYNTHESIS GAS AND METHANE PRODUCTION PLANT FOR CARRYING OUT THE PROCESS
<b>A61F 6/18</b> (2006.01)	2632398 *	AN INSERTER FOR AN INTRAUTERINE SYSTEM
<b>C07K 1/36</b> (2006.01)	2598516 *	PROCESS FOR PURIFYING PROTEINS
<b>C07K 16/24</b> (2006.01)	2598516 *	PROCESS FOR PURIFYING PROTEINS
<b>C07K 14/245</b> (2006.01)	2598516 *	PROCESS FOR PURIFYING PROTEINS
<b>C07D 401/12</b> (2006.01)	2606042 *	DISUBSTITUTED TETRAHYDOFURANYL COMPOUNDS AS ANTAGONISTS OF THE BRADYKININ B1 RECEPTOR
<b>C07D 401/14</b> (2006.01)	2606042 *	DISUBSTITUTED TETRAHYDOFURANYL COMPOUNDS AS ANTAGONISTS OF THE BRADYKININ B1 RECEPTOR
<b>C07D 403/12</b> (2006.01)	2606042 *	DISUBSTITUTED TETRAHYDOFURANYL COMPOUNDS AS ANTAGONISTS OF THE BRADYKININ B1 RECEPTOR
<b>A61K 31/455</b> (2006.01)	2606042 *	DISUBSTITUTED TETRAHYDOFURANYL COMPOUNDS AS ANTAGONISTS OF THE BRADYKININ B1 RECEPTOR
<b>A61K 31/506</b> (2006.01)	2606042 *	DISUBSTITUTED TETRAHYDOFURANYL COMPOUNDS AS ANTAGONISTS OF THE BRADYKININ B1 RECEPTOR

MKP (51)	Broj objave evropske prijava patenta (97)	Naziv pronalaska (54)	MKP (51)	Broj objave evropske prijava patenta (97)	Naziv pronalaska (54)
<b>A61K 31/501</b> (2006.01)	2606042 *	DISUBSTITUTED TETRAHYDOFURANYL COMPOUNDS AS ANTAGONISTS OF THE BRADYKININ B1 RECEPTOR	<b>A61P 35/00</b> (2006.01)	2621486 *	SUBSTITUTED N-(2-ARYLAMINO)ARYL SULFONAMIDE-CONTAINING COMBINATIONS
<b>A61P 29/00</b> (2006.01)	2606042 *	DISUBSTITUTED TETRAHYDOFURANYL COMPOUNDS AS ANTAGONISTS OF THE BRADYKININ B1 RECEPTOR	<b>A61M 5/315</b> (2006.01)	2624894 *	DRIVE MECHANISM FOR A DRUG DELIVERY DEVICE AND DRUG DELIVERY DEVICE
<b>A61P 11/00</b> (2006.01)	2606042 *	DISUBSTITUTED TETRAHYDOFURANYL COMPOUNDS AS ANTAGONISTS OF THE BRADYKININ B1 RECEPTOR	<b>F24F 13/14</b> (2006.01)	2592359	Fire protection flap with a housing and a pivotable shut-off valve which can be pivoted around a pivoting axle, in particular a central pivoting axle
<b>A61P 19/02</b> (2006.01)	2606042 *	DISUBSTITUTED TETRAHYDOFURANYL COMPOUNDS AS ANTAGONISTS OF THE BRADYKININ B1 RECEPTOR	<b>F24F 13/02</b> (2006.01)	2592359	Fire protection flap with a housing and a pivotable shut-off valve which can be pivoted around a pivoting axle, in particular a central pivoting axle
<b>A61P 17/00</b> (2006.01)	2606042 *	DISUBSTITUTED TETRAHYDOFURANYL COMPOUNDS AS ANTAGONISTS OF THE BRADYKININ B1 RECEPTOR	<b>G01N 33/50</b> (2006.01)	2619577 *	BIOMARKERS OF RENAL INJURY
<b>A61P 9/08</b> (2006.01)	2638042 *	PIPERIDINONE CARBOXAMIDE AZAINDANE CGRP RECEPTOR ANTAGONISTS	<b>G01N 33/68</b> (2006.01)	2619577 *	BIOMARKERS OF RENAL INJURY
<b>C07D 471/10</b> (2006.01)	2638042 *	PIPERIDINONE CARBOXAMIDE AZAINDANE CGRP RECEPTOR ANTAGONISTS	<b>A61K 31/00</b> (2006.01)	2632445 *	NOVEL DRUG TARGET SITE WITHIN GP120 OF HIV
<b>A61K 31/519</b> (2006.01)	2638042 *	PIPERIDINONE CARBOXAMIDE AZAINDANE CGRP RECEPTOR ANTAGONISTS	<b>C12Q 1/70</b> (2006.01)	2632445 *	NOVEL DRUG TARGET SITE WITHIN GP120 OF HIV
<b>A61K 31/437</b> (2006.01)	2638042 *	PIPERIDINONE CARBOXAMIDE AZAINDANE CGRP RECEPTOR ANTAGONISTS	<b>G01N 33/50</b> (2006.01)	2632445 *	NOVEL DRUG TARGET SITE WITHIN GP120 OF HIV
<b>A61K 38/17</b> (2006.01)	2630963	SPARC angiogenic domain and methods of use	<b>C40B 30/02</b> (2006.01)	2632445 *	NOVEL DRUG TARGET SITE WITHIN GP120 OF HIV
<b>A61P 35/00</b> (2006.01)	2630963	SPARC angiogenic domain and methods of use	<b>C10L 5/00</b> (2006.01)	2638131 *	METHODS AND COMPOSITIONS FOR DRYING COAL
<b>B63B 25/00</b> (2006.01)	2607224	Buoyant body, in particular container ship	<b>B05C 5/00</b> (2006.01)	2464466 *	VAPOR SHEATH FOR LIQUID DISPENSING NOZZLE
<b>B63B 25/12</b> (2006.01)	2607224	Buoyant body, in particular container ship	<b>B08B 3/08</b> (2006.01)	2464466 *	VAPOR SHEATH FOR LIQUID DISPENSING NOZZLE
<b>F02M 21/02</b> (2006.01)	2607224	Buoyant body, in particular container ship	<b>A61K 31/165</b> (2006.01)	2640372 *	PRESELECTION OF SUBJECTS FOR THERAPEUTIC TREATMENT WITH ELESCLOMOL BASED ON HYPOXIC STATUS
<b>A61K 31/17</b> (2006.01)	2621486 *	SUBSTITUTED N-(2-ARYLAMINO)ARYL SULFONAMIDE-CONTAINING COMBINATIONS	<b>A61P 35/00</b> (2006.01)	2640372 *	PRESELECTION OF SUBJECTS FOR THERAPEUTIC TREATMENT WITH ELESCLOMOL BASED ON HYPOXIC STATUS
<b>A61K 31/18</b> (2006.01)	2621486 *	SUBSTITUTED N-(2-ARYLAMINO)ARYL SULFONAMIDE-CONTAINING COMBINATIONS	<b>A61K 31/439</b> (2006.01)	2621494 *	USE OF MAGNESIUM STEARATE IN DRY POWDER FORMULATIONS FOR INHALATION
<b>A61K 31/44</b> (2006.01)	2621486 *	SUBSTITUTED N-(2-ARYLAMINO)ARYL SULFONAMIDE-CONTAINING COMBINATIONS	<b>A61K 9/00</b> (2006.01)	2621494 *	USE OF MAGNESIUM STEARATE IN DRY POWDER FORMULATIONS FOR INHALATION
			<b>A61K 31/192</b> (2006.01)	2637654 *	TOPICAL ORGANIC ACID SALT COMPOSITIONS SUITABLE FOR TREATING INFECTIONS

MKP (51)	Broj objave evropske prijave patenta (97)	Naziv pronalaska (54)	MKP (51)	Broj objave evropske prijave patenta (97)	Naziv pronalaska (54)
<b>A61K 31/19</b> (2006.01)	2637654 *	TOPICAL ORGANIC ACID SALT COMPOSITIONS SUITABLE FOR TREATING INFECTIONS	<b>E21B 23/06</b> (2006.01)	2625376 *	WELLBORE PACKER BACK-UP RING ASSEMBLY, PACKER AND METHOD
<b>A61P 31/10</b> (2006.01)	2637654 *	TOPICAL ORGANIC ACID SALT COMPOSITIONS SUITABLE FOR TREATING INFECTIONS	<b>G02C 11/08</b> (2006.01)	2598940 *	FRAME FOR GLASSES, MASKS FOR PROFESSIONAL OR SPORTS USE, AND THE LIKE
<b>A61P 31/22</b> (2006.01)	2637654 *	TOPICAL ORGANIC ACID SALT COMPOSITIONS SUITABLE FOR TREATING INFECTIONS	<b>A61F 9/02</b> (2006.01)	2598940 *	FRAME FOR GLASSES, MASKS FOR PROFESSIONAL OR SPORTS USE, AND THE LIKE
<b>C07D 491/20</b> (2006.01)	2601197 *	AMINO-ISO-INDOLE, AMINO-AZA-ISO-INDOLE, AMINO-DIHYDROISOQUINOLINE AND AMINO-BENZOXAZINE COMPOUNDS AS BETA-SECRETASE MODULATORS AND METHODS OF USE	<b>G02C 5/12</b> (2006.01)	2598940 *	FRAME FOR GLASSES, MASKS FOR PROFESSIONAL OR SPORTS USE, AND THE LIKE
<b>C07D 491/22</b> (2006.01)	2601197 *	AMINO-ISO-INDOLE, AMINO-AZA-ISO-INDOLE, AMINO-DIHYDROISOQUINOLINE AND AMINO-BENZOXAZINE COMPOUNDS AS BETA-SECRETASE MODULATORS AND METHODS OF USE	<b>G02C 5/14</b> (2006.01)	2598940 *	FRAME FOR GLASSES, MASKS FOR PROFESSIONAL OR SPORTS USE, AND THE LIKE
<b>C07D 498/20</b> (2006.01)	2601197 *	AMINO-ISO-INDOLE, AMINO-AZA-ISO-INDOLE, AMINO-DIHYDROISOQUINOLINE AND AMINO-BENZOXAZINE COMPOUNDS AS BETA-SECRETASE MODULATORS AND METHODS OF USE	<b>A61K 31/221</b> (2006.01)	2608784 *	TREATMENT OF HYPERTENSION AND/OR PREVENTION OR TREATMENT OF HEART FAILURE IN A MAMMAL RECEIVING ANTI-COAGULANT THERAPY
<b>C07D 498/22</b> (2006.01)	2601197 *	AMINO-ISO-INDOLE, AMINO-AZA-ISO-INDOLE, AMINO-DIHYDROISOQUINOLINE AND AMINO-BENZOXAZINE COMPOUNDS AS BETA-SECRETASE MODULATORS AND METHODS OF USE	<b>A61K 31/41</b> (2006.01)	2608784 *	TREATMENT OF HYPERTENSION AND/OR PREVENTION OR TREATMENT OF HEART FAILURE IN A MAMMAL RECEIVING ANTI-COAGULANT THERAPY
<b>A61K 31/436</b> (2006.01)	2601197 *	AMINO-ISO-INDOLE, AMINO-AZA-ISO-INDOLE, AMINO-DIHYDROISOQUINOLINE AND AMINO-BENZOXAZINE COMPOUNDS AS BETA-SECRETASE MODULATORS AND METHODS OF USE	<b>A61P 9/00</b> (2006.01)	2608784 *	TREATMENT OF HYPERTENSION AND/OR PREVENTION OR TREATMENT OF HEART FAILURE IN A MAMMAL RECEIVING ANTI-COAGULANT THERAPY
<b>A61K 31/437</b> (2006.01)	2601197 *	AMINO-ISO-INDOLE, AMINO-AZA-ISO-INDOLE, AMINO-DIHYDROISOQUINOLINE AND AMINO-BENZOXAZINE COMPOUNDS AS BETA-SECRETASE MODULATORS AND METHODS OF USE	<b>A61P 9/04</b> (2006.01)	2608784 *	TREATMENT OF HYPERTENSION AND/OR PREVENTION OR TREATMENT OF HEART FAILURE IN A MAMMAL RECEIVING ANTI-COAGULANT THERAPY
<b>A61K 31/537</b> (2006.01)	2601197 *	AMINO-ISO-INDOLE, AMINO-AZA-ISO-INDOLE, AMINO-DIHYDROISOQUINOLINE AND AMINO-BENZOXAZINE COMPOUNDS AS BETA-SECRETASE MODULATORS AND METHODS OF USE	<b>A61P 9/12</b> (2006.01)	2608784 *	TREATMENT OF HYPERTENSION AND/OR PREVENTION OR TREATMENT OF HEART FAILURE IN A MAMMAL RECEIVING ANTI-COAGULANT THERAPY
<b>E21B 33/129</b> (2006.01)	2625376 *	WELLBORE PACKER BACK-UP RING ASSEMBLY, PACKER AND METHOD	<b>C09K 11/02</b> (2006.01)	2616522 *	ANISTROPIC SEMICONDUCTOR NANOPARTICLES
			<b>C09K 11/56</b> (2006.01)	2616522 *	ANISTROPIC SEMICONDUCTOR NANOPARTICLES
			<b>C09K 11/70</b> (2006.01)	2616522 *	ANISTROPIC SEMICONDUCTOR NANOPARTICLES

MKP (51)	Broj objave evropske prijava patenta (97)	Naziv pronalaska (54)	MKP (51)	Broj objave evropske prijava patenta (97)	Naziv pronalaska (54)
<b>C09K 11/74</b> (2006.01)	2616522 *	ANISTROPIC SEMICONDUCTOR NANOPARTICLES	<b>B65D 83/14</b> (2006.01)	2613829 *	METERED-DOSE INHALER AND METHOD OF USING THE SAME
<b>C09K 11/88</b> (2006.01)	2616522 *	ANISTROPIC SEMICONDUCTOR NANOPARTICLES	<b>C07D 249/12</b> (2006.01)	2616448 *	SUBSTITUTED PHENYLACETATE AND PHENYLPROPANE AMIDES AND USE THEREOF
<b>A61K 8/86</b> (2006.01)	2637638 *	LIPSTICK AND OTHER COSMETICS AND METHOD OF MAKING	<b>C07D 409/04</b> (2006.01)	2616448 *	SUBSTITUTED PHENYLACETATE AND PHENYLPROPANE AMIDES AND USE THEREOF
<b>A61Q 1/04</b> (2006.01)	2637638 *	LIPSTICK AND OTHER COSMETICS AND METHOD OF MAKING	<b>A61K 31/4196</b> (2006.01)	2616448 *	SUBSTITUTED PHENYLACETATE AND PHENYLPROPANE AMIDES AND USE THEREOF
<b>A61Q 1/00</b> (2006.01)	2637638 *	LIPSTICK AND OTHER COSMETICS AND METHOD OF MAKING	<b>A61P 9/00</b> (2006.01)	2616448 *	SUBSTITUTED PHENYLACETATE AND PHENYLPROPANE AMIDES AND USE THEREOF
<b>A61K 8/97</b> (2006.01)	2637638 *	LIPSTICK AND OTHER COSMETICS AND METHOD OF MAKING	<b>C07D 403/14</b> (2006.01)	2621921 *	SOLID STATE FORMS OF A POTENT HCV INHIBITOR
<b>A61K 8/19</b> (2006.01)	2637638 *	LIPSTICK AND OTHER COSMETICS AND METHOD OF MAKING	<b>A01C 15/00</b> (2006.01)	2567606	Shutter for spreading device
<b>A61K 8/72</b> (2006.01)	2637638 *	LIPSTICK AND OTHER COSMETICS AND METHOD OF MAKING	<b>A01C 3/06</b> (2006.01)	2567606	Shutter for spreading device
<b>A61K 8/92</b> (2006.01)	2637638 *	LIPSTICK AND OTHER COSMETICS AND METHOD OF MAKING	<b>A61K 36/235</b> (2006.01)	2621505 *	METHOD FOR PRODUCING PLANT-BASED ALCOHOL- FREE COMPOSITIONS, COMPOSITIONS PRODUCED IN THIS WAY, AND USE OF SAID COMPOSITIONS
<b>A61K 9/14</b> (2006.01)	2605755 *	PARTICULATE SUBSTANCES COMPRISING CERAMIC PARTICLES FOR DELIVERY OF BIOMOLECULES	<b>A61K 36/35</b> (2006.01)	2621505 *	METHOD FOR PRODUCING PLANT-BASED ALCOHOL- FREE COMPOSITIONS, COMPOSITIONS PRODUCED IN THIS WAY, AND USE OF SAID COMPOSITIONS
<b>A61K 38/00</b> (2006.01)	2605755 *	PARTICULATE SUBSTANCES COMPRISING CERAMIC PARTICLES FOR DELIVERY OF BIOMOLECULES	<b>A61K 36/57</b> (2006.01)	2621505 *	METHOD FOR PRODUCING PLANT-BASED ALCOHOL- FREE COMPOSITIONS, COMPOSITIONS PRODUCED IN THIS WAY, AND USE OF SAID COMPOSITIONS
<b>A61K 47/02</b> (2006.01)	2605755 *	PARTICULATE SUBSTANCES COMPRISING CERAMIC PARTICLES FOR DELIVERY OF BIOMOLECULES	<b>A61K 36/28</b> (2006.01)	2621505 *	METHOD FOR PRODUCING PLANT-BASED ALCOHOL- FREE COMPOSITIONS, COMPOSITIONS PRODUCED IN THIS WAY, AND USE OF SAID COMPOSITIONS
<b>C01B 33/18</b> (2006.01)	2605755 *	PARTICULATE SUBSTANCES COMPRISING CERAMIC PARTICLES FOR DELIVERY OF BIOMOLECULES	<b>A61P 11/10</b> (2006.01)	2621505 *	METHOD FOR PRODUCING PLANT-BASED ALCOHOL- FREE COMPOSITIONS, COMPOSITIONS PRODUCED IN THIS WAY, AND USE OF SAID COMPOSITIONS
<b>A61K 48/00</b> (2006.01)	2605755 *	PARTICULATE SUBSTANCES COMPRISING CERAMIC PARTICLES FOR DELIVERY OF BIOMOLECULES	<b>A61K 36/25</b> (2006.01)	2621505 *	METHOD FOR PRODUCING PLANT-BASED ALCOHOL- FREE COMPOSITIONS, COMPOSITIONS PRODUCED IN THIS WAY, AND USE OF SAID COMPOSITIONS
<b>A61K 31/70</b> (2006.01)	2605755 *	PARTICULATE SUBSTANCES COMPRISING CERAMIC PARTICLES FOR DELIVERY OF BIOMOLECULES			
<b>A61M 15/00</b> (2006.01)	2613829 *	METERED-DOSE INHALER AND METHOD OF USING THE SAME			
<b>A61J 1/20</b> (2006.01)	2613829 *	METERED-DOSE INHALER AND METHOD OF USING THE SAME			
<b>B05B 11/00</b> (2006.01)	2613829 *	METERED-DOSE INHALER AND METHOD OF USING THE SAME			

MKP (51)	Broj objave evropske prijava patenta (97)	Naziv pronalaska (54)	MKP (51)	Broj objave evropske prijava patenta (97)	Naziv pronalaska (54)
<b>A61P 11/12</b> (2006.01)	2621505 *	METHOD FOR PRODUCING PLANT-BASED ALCOHOL-FREE COMPOSITIONS, COMPOSITIONS PRODUCED IN THIS WAY, AND USE OF SAID COMPOSITIONS	<b>C07H 3/04</b> (2006.01)	2596113 *	GALACTO-OLIGOSACCHARIDE-CONTAINING COMPOSITION AND A METHOD OF PRODUCING IT
<b>A61K 36/11</b> (2006.01)	2621505 *	METHOD FOR PRODUCING PLANT-BASED ALCOHOL-FREE COMPOSITIONS, COMPOSITIONS PRODUCED IN THIS WAY, AND USE OF SAID COMPOSITIONS	<b>C07H 3/06</b> (2006.01)	2596113 *	GALACTO-OLIGOSACCHARIDE-CONTAINING COMPOSITION AND A METHOD OF PRODUCING IT
<b>A61K 36/53</b> (2006.01)	2621505 *	METHOD FOR PRODUCING PLANT-BASED ALCOHOL-FREE COMPOSITIONS, COMPOSITIONS PRODUCED IN THIS WAY, AND USE OF SAID COMPOSITIONS	<b>A61K 31/427</b> (2006.01)	2637659 *	SGC STIMULATORS
<b>A61K 36/185</b> (2006.01)	2621505 *	METHOD FOR PRODUCING PLANT-BASED ALCOHOL-FREE COMPOSITIONS, COMPOSITIONS PRODUCED IN THIS WAY, AND USE OF SAID COMPOSITIONS	<b>A61K 31/4439</b> (2006.01)	2637659 *	SGC STIMULATORS
<b>A61P 11/00</b> (2006.01)	2621505 *	METHOD FOR PRODUCING PLANT-BASED ALCOHOL-FREE COMPOSITIONS, COMPOSITIONS PRODUCED IN THIS WAY, AND USE OF SAID COMPOSITIONS	<b>A61K 31/444</b> (2006.01)	2637659 *	SGC STIMULATORS
<b>C07K 16/24</b> (2006.01)	2625199 *	METHODS OF TREATING PSORIASIS USING IL-17 ANTAGONISTS	<b>A61K 31/497</b> (2006.01)	2637659 *	SGC STIMULATORS
<b>A61K 39/395</b> (2006.01)	2625199 *	METHODS OF TREATING PSORIASIS USING IL-17 ANTAGONISTS	<b>A61K 31/506</b> (2006.01)	2637659 *	SGC STIMULATORS
<b>C12P 19/02</b> (2006.01)	2596113 *	GALACTO-OLIGOSACCHARIDE-CONTAINING COMPOSITION AND A METHOD OF PRODUCING IT	<b>C07D 401/04</b> (2006.01)	2637659 *	SGC STIMULATORS
<b>C12P 19/12</b> (2006.01)	2596113 *	GALACTO-OLIGOSACCHARIDE-CONTAINING COMPOSITION AND A METHOD OF PRODUCING IT	<b>C07D 401/14</b> (2006.01)	2637659 *	SGC STIMULATORS
<b>C12P 19/14</b> (2006.01)	2596113 *	GALACTO-OLIGOSACCHARIDE-CONTAINING COMPOSITION AND A METHOD OF PRODUCING IT	<b>C07D 403/04</b> (2006.01)	2637659 *	SGC STIMULATORS
<b>C12P 19/18</b> (2006.01)	2596113 *	GALACTO-OLIGOSACCHARIDE-CONTAINING COMPOSITION AND A METHOD OF PRODUCING IT	<b>C07D 407/14</b> (2006.01)	2637659 *	SGC STIMULATORS
<b>A23L 1/09</b> (2006.01)	2596113 *	GALACTO-OLIGOSACCHARIDE-CONTAINING COMPOSITION AND A METHOD OF PRODUCING IT	<b>C07D 413/14</b> (2006.01)	2637659 *	SGC STIMULATORS
			<b>C07D 417/04</b> (2006.01)	2637659 *	SGC STIMULATORS
			<b>C07D 417/14</b> (2006.01)	2637659 *	SGC STIMULATORS
			<b>A61P 7/02</b> (2006.01)	2637659 *	SGC STIMULATORS
			<b>A61P 9/08</b> (2006.01)	2637659 *	SGC STIMULATORS
			<b>E04D 13/12</b> (2006.01)	2633135 *	ROOF PROVIDED WITH A SAFETY SYSTEM
			<b>E04G 21/32</b> (2006.01)	2633135 *	ROOF PROVIDED WITH A SAFETY SYSTEM
			<b>A61K 31/675</b> (2006.01)	2640362 *	THERAPEUTIC COMPOSITIONS COMPRISING RILPIVIRINE HCL AND TENOFOVIR DISOPROXIL FUMARATE
			<b>A61K 31/513</b> (2006.01)	2640362 *	THERAPEUTIC COMPOSITIONS COMPRISING RILPIVIRINE HCL AND TENOFOVIR DISOPROXIL FUMARATE

MKP (51)	Broj objave evropske prijava patenta (97)	Naziv pronalaska (54)	MKP (51)	Broj objave evropske prijava patenta (97)	Naziv pronalaska (54)
<b>A61P 31/18</b> (2006.01)	2640362 *	THERAPEUTIC COMPOSITIONS COMPRISING RILPIVIRINE HCL AND TENOFOVIR DISOPROXIL FUMARATE	<b>C07D 231/18</b> (2006.01)	2609081 *	SULFONYLPIPERAZINE DERIVATIVES THAT INTERACT WITH GLUCOKINASE REGULATORY PROTEIN FOR THE TREATMENT OF DIABETES
<b>A61K 31/505</b> (2006.01)	2640362 *	THERAPEUTIC COMPOSITIONS COMPRISING RILPIVIRINE HCL AND TENOFOVIR DISOPROXIL FUMARATE	<b>C07D 239/42</b> (2006.01)	2609081 *	SULFONYLPIPERAZINE DERIVATIVES THAT INTERACT WITH GLUCOKINASE REGULATORY PROTEIN FOR THE TREATMENT OF DIABETES
<b>A61K 9/20</b> (2006.01)	2640362 *	THERAPEUTIC COMPOSITIONS COMPRISING RILPIVIRINE HCL AND TENOFOVIR DISOPROXIL FUMARATE	<b>C07D 241/04</b> (2006.01)	2609081 *	SULFONYLPIPERAZINE DERIVATIVES THAT INTERACT WITH GLUCOKINASE REGULATORY PROTEIN FOR THE TREATMENT OF DIABETES
<b>G10L 21/02</b> (2006.01)	2437260	Sound signal processing device	<b>C07D 277/36</b> (2006.01)	2609081 *	SULFONYLPIPERAZINE DERIVATIVES THAT INTERACT WITH GLUCOKINASE REGULATORY PROTEIN FOR THE TREATMENT OF DIABETES
<b>C07F 5/02</b> (2006.01)	2632927 *	BORONATES AS ARGINASE INHIBITORS	<b>C07D 333/34</b> (2006.01)	2609081 *	SULFONYLPIPERAZINE DERIVATIVES THAT INTERACT WITH GLUCOKINASE REGULATORY PROTEIN FOR THE TREATMENT OF DIABETES
<b>C07F 5/04</b> (2006.01)	2632927 *	BORONATES AS ARGINASE INHIBITORS	<b>C07D 405/12</b> (2006.01)	2609081 *	SULFONYLPIPERAZINE DERIVATIVES THAT INTERACT WITH GLUCOKINASE REGULATORY PROTEIN FOR THE TREATMENT OF DIABETES
<b>A61K 31/69</b> (2006.01)	2632927 *	BORONATES AS ARGINASE INHIBITORS	<b>C07D 409/12</b> (2006.01)	2609081 *	SULFONYLPIPERAZINE DERIVATIVES THAT INTERACT WITH GLUCOKINASE REGULATORY PROTEIN FOR THE TREATMENT OF DIABETES
<b>C12N 15/62</b> (2006.01)	2622078 *	FUSION PROTEIN FOR SECRETORY PROTEIN EXPRESSION	<b>C07D 409/14</b> (2006.01)	2609081 *	SULFONYLPIPERAZINE DERIVATIVES THAT INTERACT WITH GLUCOKINASE REGULATORY PROTEIN FOR THE TREATMENT OF DIABETES
<b>C07K 14/245</b> (2006.01)	2622078 *	FUSION PROTEIN FOR SECRETORY PROTEIN EXPRESSION	<b>C07D 413/14</b> (2006.01)	2609081 *	SULFONYLPIPERAZINE DERIVATIVES THAT INTERACT WITH GLUCOKINASE REGULATORY PROTEIN FOR THE TREATMENT OF DIABETES
<b>A61K 35/74</b> (2006.01)	2622078 *	FUSION PROTEIN FOR SECRETORY PROTEIN EXPRESSION			
<b>A61K 39/04</b> (2006.01)	2622078 *	FUSION PROTEIN FOR SECRETORY PROTEIN EXPRESSION			
<b>H01Q 1/12</b> (2006.01)	2599160 *	ANTENNA FIXING UNIT.			
<b>H01Q 1/32</b> (2006.01)	2599160 *	ANTENNA FIXING UNIT.			
<b>C07D 213/30</b> (2006.01)	2609081 *	SULFONYLPIPERAZINE DERIVATIVES THAT INTERACT WITH GLUCOKINASE REGULATORY PROTEIN FOR THE TREATMENT OF DIABETES			
<b>C07D 213/71</b> (2006.01)	2609081 *	SULFONYLPIPERAZINE DERIVATIVES THAT INTERACT WITH GLUCOKINASE REGULATORY PROTEIN FOR THE TREATMENT OF DIABETES			
<b>C07D 213/74</b> (2006.01)	2609081 *	SULFONYLPIPERAZINE DERIVATIVES THAT INTERACT WITH GLUCOKINASE REGULATORY PROTEIN FOR THE TREATMENT OF DIABETES			

MKP (51)	Broj objave evropske prijava patenta (97)	Naziv pronalaska (54)	MKP (51)	Broj objave evropske prijava patenta (97)	Naziv pronalaska (54)
<b>C07D 417/12</b> (2006.01)	2609081 *	SULFONYLPIPERAZINE DERIVATIVES THAT INTERACT WITH GLUCOKINASE REGULATORY PROTEIN FOR THE TREATMENT OF DIABETES	<b>A61K 31/5377</b> (2006.01)	2616442 *	INHIBITORS OF PI3K-DELTA AND METHODS OF THEIR USE AND MANUFACTURE
<b>C07D 491/08</b> (2006.01)	2609081 *	SULFONYLPIPERAZINE DERIVATIVES THAT INTERACT WITH GLUCOKINASE REGULATORY PROTEIN FOR THE TREATMENT OF DIABETES	<b>C07D 495/04</b> (2006.01)	2616442 *	INHIBITORS OF PI3K-DELTA AND METHODS OF THEIR USE AND MANUFACTURE
<b>C07D 498/08</b> (2006.01)	2609081 *	SULFONYLPIPERAZINE DERIVATIVES THAT INTERACT WITH GLUCOKINASE REGULATORY PROTEIN FOR THE TREATMENT OF DIABETES	<b>C07D 413/14</b> (2006.01)	2619197 *	OXADIAZOLE INHIBITORS OF LEUKOTRIENE PRODUCTION
<b>A61K 9/16</b> (2006.01)	2526931	Wet granulation methods of cetyl myristate and/or cetyl palmitate	<b>A61K 31/497</b> (2006.01)	2619197 *	OXADIAZOLE INHIBITORS OF LEUKOTRIENE PRODUCTION
<b>A61K 31/22</b> (2006.01)	2526931	Wet granulation methods of cetyl myristate and/or cetyl palmitate	<b>A61P 11/00</b> (2006.01)	2619197 *	OXADIAZOLE INHIBITORS OF LEUKOTRIENE PRODUCTION
<b>A61P 35/00</b> (2006.01)	2616442 *	INHIBITORS OF PI3K-DELTA AND METHODS OF THEIR USE AND MANUFACTURE	<b>F28F 1/40</b> (2006.01)	2635868 *	DEVICE FOR OPTIMIZING THE TRANSMISSION OF HEAT IN A PIPE FOR CONVEYING EXHAUST GASES IN A HEAT EXCHANGE APPARATUS
<b>C07D 215/06</b> (2006.01)	2616442 *	INHIBITORS OF PI3K-DELTA AND METHODS OF THEIR USE AND MANUFACTURE	<b>F28F 13/06</b> (2006.01)	2635868 *	DEVICE FOR OPTIMIZING THE TRANSMISSION OF HEAT IN A PIPE FOR CONVEYING EXHAUST GASES IN A HEAT EXCHANGE APPARATUS
<b>A61K 31/52</b> (2006.01)	2616442 *	INHIBITORS OF PI3K-DELTA AND METHODS OF THEIR USE AND MANUFACTURE	<b>F28F 13/12</b> (2006.01)	2635868 *	DEVICE FOR OPTIMIZING THE TRANSMISSION OF HEAT IN A PIPE FOR CONVEYING EXHAUST GASES IN A HEAT EXCHANGE APPARATUS
<b>C07D 241/44</b> (2006.01)	2616442 *	INHIBITORS OF PI3K-DELTA AND METHODS OF THEIR USE AND MANUFACTURE	<b>C07D 231/20</b> (2006.01)	2619182 *	PHARMACEUTICAL COMPOSITION
<b>A61K 31/4709</b> (2006.01)	2616442 *	INHIBITORS OF PI3K-DELTA AND METHODS OF THEIR USE AND MANUFACTURE	<b>A61K 31/415</b> (2006.01)	2619182 *	PHARMACEUTICAL COMPOSITION
<b>C07D 401/14</b> (2006.01)	2616442 *	INHIBITORS OF PI3K-DELTA AND METHODS OF THEIR USE AND MANUFACTURE	<b>A61P 29/00</b> (2006.01)	2619182 *	PHARMACEUTICAL COMPOSITION
<b>A61K 31/47</b> (2006.01)	2616442 *	INHIBITORS OF PI3K-DELTA AND METHODS OF THEIR USE AND MANUFACTURE	<b>A61K 38/48</b> (2006.01)	2621520 *	COLLAGENASE G AND COLLAGENASE H COMPOSITIONS FOR THE TREATMENT OF DISEASES INVOLVING ALTERATIONS OF COLLAGEN
<b>C07D 405/12</b> (2006.01)	2616442 *	INHIBITORS OF PI3K-DELTA AND METHODS OF THEIR USE AND MANUFACTURE	<b>A61K 47/36</b> (2006.01)	2621520 *	COLLAGENASE G AND COLLAGENASE H COMPOSITIONS FOR THE TREATMENT OF DISEASES INVOLVING ALTERATIONS OF COLLAGEN
<b>A61K 31/497</b> (2006.01)	2616442 *	INHIBITORS OF PI3K-DELTA AND METHODS OF THEIR USE AND MANUFACTURE	<b>G09F 21/02</b> (2006.01)	2637154	Method for producing a label, particularly for items of clothing.
<b>C07D 413/14</b> (2006.01)	2616442 *	INHIBITORS OF PI3K-DELTA AND METHODS OF THEIR USE AND MANUFACTURE	<b>G09F 7/06</b> (2006.01)	2637154	Method for producing a label, particularly for items of clothing.
<b>A61K 31/551</b> (2006.01)	2616442 *	INHIBITORS OF PI3K-DELTA AND METHODS OF THEIR USE AND MANUFACTURE	<b>B01F 5/12</b> (2006.01)	2640501 *	TWO COMPARTMENT CONTAINER
<b>C07D 473/34</b> (2006.01)	2616442 *	INHIBITORS OF PI3K-DELTA AND METHODS OF THEIR USE AND MANUFACTURE	<b>C07D 307/80</b> (2006.01)	2595977 *	PROCESS FOR PREPARING BENZOFURAN DERIVATIVES SUBSTITUTED AT POSITION 5

MKP (51)	Broj objave evropske prijava patenta (97)	Naziv pronalaska (54)	MKP (51)	Broj objave evropske prijava patenta (97)	Naziv pronalaska (54)
<b>C07C 251/16</b> (2006.01)	2595977 *	PROCESS FOR PREPARING BENZOFURAN DERIVATIVES SUBSTITUTED AT POSITION 5	<b>A61K 31/454</b> (2006.01)	2625174 *	CO-CRYSTALS AND SALTS OF CCR3-INHIBITORS
<b>C07C 39/04</b> (2006.01)	2595977 *	PROCESS FOR PREPARING BENZOFURAN DERIVATIVES SUBSTITUTED AT POSITION 5	<b>A61P 31/00</b> (2006.01)	2625174 *	CO-CRYSTALS AND SALTS OF CCR3-INHIBITORS
<b>A61K 31/343</b> (2006.01)	2595977 *	PROCESS FOR PREPARING BENZOFURAN DERIVATIVES SUBSTITUTED AT POSITION 5	<b>C12N 7/08</b> (2006.01)	2637688 *	NORTH AMERICAN PORCINE REPRODUCTIVE AND RESPIRATORY SYNDROME (PRRS) VIRUS AND USES THEREOF
<b>A61P 9/00</b> (2006.01)	2595977 *	PROCESS FOR PREPARING BENZOFURAN DERIVATIVES SUBSTITUTED AT POSITION 5	<b>C07K 14/08</b> (2006.01)	2637688 *	NORTH AMERICAN PORCINE REPRODUCTIVE AND RESPIRATORY SYNDROME (PRRS) VIRUS AND USES THEREOF
<b>A61B 19/00</b> (2006.01)	2611378 *	PROXIMITY-TRIGGERED COMPUTER-ASSISTED SURGERY SYSTEM AND METHOD	<b>A61K 39/12</b> (2006.01)	2637688 *	NORTH AMERICAN PORCINE REPRODUCTIVE AND RESPIRATORY SYNDROME (PRRS) VIRUS AND USES THEREOF
<b>A61B 17/56</b> (2006.01)	2611378 *	PROXIMITY-TRIGGERED COMPUTER-ASSISTED SURGERY SYSTEM AND METHOD	<b>A61K 31/427</b> (2006.01)	2600883 *	COMPOSITION COMPRISING GLUTATHIONE REDUCTASE AND OXIDIZED GLUTATHIONE, AND THERAPEUTIC USES THEREOF
<b>C08G 63/78</b> (2006.01)	2598553 *	COMPOSITIONS COMPRISING POLYMERS PREPARED FROM 2-HYDROXYALKYL ACIDS	<b>A61K 38/44</b> (2006.01)	2600883 *	COMPOSITION COMPRISING GLUTATHIONE REDUCTASE AND OXIDIZED GLUTATHIONE, AND THERAPEUTIC USES THEREOF
<b>C08L 67/04</b> (2006.01)	2598553 *	COMPOSITIONS COMPRISING POLYMERS PREPARED FROM 2-HYDROXYALKYL ACIDS	<b>A61K 38/06</b> (2006.01)	2600883 *	COMPOSITION COMPRISING GLUTATHIONE REDUCTASE AND OXIDIZED GLUTATHIONE, AND THERAPEUTIC USES THEREOF
<b>A61K 9/00</b> (2006.01)	2598553 *	COMPOSITIONS COMPRISING POLYMERS PREPARED FROM 2-HYDROXYALKYL ACIDS	<b>A61P 31/12</b> (2006.01)	2600883 *	COMPOSITION COMPRISING GLUTATHIONE REDUCTASE AND OXIDIZED GLUTATHIONE, AND THERAPEUTIC USES THEREOF
<b>C08G 63/08</b> (2006.01)	2598553 *	COMPOSITIONS COMPRISING POLYMERS PREPARED FROM 2-HYDROXYALKYL ACIDS	<b>A61P 39/06</b> (2006.01)	2600883 *	COMPOSITION COMPRISING GLUTATHIONE REDUCTASE AND OXIDIZED GLUTATHIONE, AND THERAPEUTIC USES THEREOF
<b>G02B 27/01</b> (2006.01)	2605056	System for observing an eye-related display	<b>A01N 47/06</b> (2006.01)	2629619 *	HERBICIDAL COMPOSITION
<b>F02M 59/36</b> (2006.01)	2535553	Inlet Valve Arrangement for a Fuel Pump	<b>A01N 47/38</b> (2006.01)	2629619 *	HERBICIDAL COMPOSITION
<b>F04B 49/22</b> (2006.01)	2535553	Inlet Valve Arrangement for a Fuel Pump	<b>A01N 43/80</b> (2006.01)	2629619 *	HERBICIDAL COMPOSITION
<b>F04B 53/10</b> (2006.01)	2535553	Inlet Valve Arrangement for a Fuel Pump	<b>A01P 13/02</b> (2006.01)	2629619 *	HERBICIDAL COMPOSITION
<b>B01L 7/00</b> (2006.01)	2637789 *	HEATING AND COOLING LOW VOLUME BIOLOGICAL REACTION VESSELS	<b>A01N 41/10</b> (2006.01)	2629619 *	HERBICIDAL COMPOSITION
<b>C07D 401/14</b> (2006.01)	2625174 *	CO-CRYSTALS AND SALTS OF CCR3-INHIBITORS	<b>B21J 13/03</b> (2006.01)	2529855	Device for heating die holders
<b>C07D 211/58</b> (2006.01)	2625174 *	CO-CRYSTALS AND SALTS OF CCR3-INHIBITORS			
<b>C07D 213/81</b> (2006.01)	2625174 *	CO-CRYSTALS AND SALTS OF CCR3-INHIBITORS			
<b>C07D 401/04</b> (2006.01)	2625174 *	CO-CRYSTALS AND SALTS OF CCR3-INHIBITORS			



MKP (51)	Broj objave evropske prijave patenta (97)	Naziv pronalaska (54)
<b>B23P 19/02</b> (2006.01)	2529855	Device for heating die holders
<b>B30B 15/02</b> (2006.01)	2529855	Device for heating die holders
<b>B21J 13/08</b> (2006.01)	2529855	Device for heating die holders
<b>B21J 17/02</b> (2006.01)	2529855	Device for heating die holders
<b>B21D 37/16</b> (2006.01)	2529855	Device for heating die holders
<b>A61G 15/10</b> (2006.01)	2616032 *	ADAPTER MATTRESS FOR DENTAL CHAIRS
<b>A61K 31/7105</b> (2006.01)	2623119 *	GLIOMA TREATMENT METHOD, GLIOMA EXAMINATION METHOD, METHOD OF DELIVERING A DESIRED MATERIAL TO A GLIOMA, AND DRUG USED IN SAID METHODS
<b>A61K 38/00</b> (2006.01)	2623119 *	GLIOMA TREATMENT METHOD, GLIOMA EXAMINATION METHOD, METHOD OF DELIVERING A DESIRED MATERIAL TO A GLIOMA, AND DRUG USED IN SAID METHODS
<b>A61K 39/395</b> (2006.01)	2623119 *	GLIOMA TREATMENT METHOD, GLIOMA EXAMINATION METHOD, METHOD OF DELIVERING A DESIRED MATERIAL TO A GLIOMA, AND DRUG USED IN SAID METHODS
<b>A61K 45/00</b> (2006.01)	2623119 *	GLIOMA TREATMENT METHOD, GLIOMA EXAMINATION METHOD, METHOD OF DELIVERING A DESIRED MATERIAL TO A GLIOMA, AND DRUG USED IN SAID METHODS
<b>A61P 35/00</b> (2006.01)	2623119 *	GLIOMA TREATMENT METHOD, GLIOMA EXAMINATION METHOD, METHOD OF DELIVERING A DESIRED MATERIAL TO A GLIOMA, AND DRUG USED IN SAID METHODS
<b>G01N 33/53</b> (2006.01)	2625525 *	SPARC MICROENVIRONMENT SIGNATURE, PLASMA SPARC, AND LDH AS PROGNOSTIC BIOMARKERS IN THE TREATMENT OF CANCER



# INDEKS PODNOSITELJA ZAHTEVA ZA PROŠIRENJE EVROPSKIH PRIJAVA PATENTA

## INDEX ON NUMBER OF APPLICATIONS FOR EXTENSION OF EUROPEAN PATENT APPLICATION

Podnosilac evropske prijave patenta (71)	MKP (51)	Broj objave evropske prijave patenta (97)	Naziv pronalaska (54)
Lifescan Scotland Limited	<b>A61B 51/145</b> (2006.01) <b>G06F 19/00</b> (2011.01)	2455876	System and method for diabetes management
Biofilm IP, LLC	<b>C08G 77/50</b> (2006.01) <b>C08L 83/14</b> (2006.01)	2601245 *	CYCLOSILOXANE-SUBSTITUTED POLYSILOXANE COMPOUNDS, COMPOSITIONS CONTAINING THE COMPOUNDS AND METHODS OF USE THEREOF
Magic Mitten Limited	<b>A61M 21/02</b> (2006.01)	2629825 *	INFANT CALMING AID
University Of Idaho	<b>C12N 5/04</b> (2006.01)	2603578 *	COMPOSITIONS AND METHODS FOR INHIBITING POTATO PATHOGENS
PQ Corporation	<b>C01B 33/12</b> (2006.01) <b>C01B 33/16</b> (2006.01)	2609033 *	SILICA HYDROGEL IMPREGNATED WITH TIO2 AND METHOD OF MAKING SAME
Novartis AG	<b>C08G 77/42</b> (2006.01) <b>C08G 77/46</b> (2006.01) <b>C08G 77/442</b> (2006.01) <b>G02B 1/04</b> (2006.01) <b>C08L 83/10</b> (2006.01) <b>C08G 77/20</b> (2006.01)	2625217 *	CHAIN-EXTENDED POLYSILOXANE CROSSLINKERS WITH DANGLING HYDROPHILIC POLYMER CHAINS
Rigel Pharmaceuticals, Inc.	<b>C07D 213/82</b> (2006.01) <b>C07D 295/04</b> (2006.01) <b>C07D 401/12</b> (2006.01) <b>C07D 401/14</b> (2006.01) <b>C07D 405/12</b> (2006.01) <b>C07D 409/12</b> (2006.01) <b>C07D 413/12</b> (2006.01) <b>C07D 471/10</b> (2006.01) <b>A61K 31/4427</b> (2006.01) <b>A61K 31/501</b> (2006.01) <b>A61K 31/5377</b> (2006.01) <b>A61P 3/10</b> (2006.01) <b>A61P 9/10</b> (2006.01)	2598483 *	AMPK-ACTIVATING HETEROCYCLIC COMPOUNDS AND METHODS FOR USING THE SAME
Kalamazoo Holdings, Inc.	<b>B01D 11/02</b> (2006.01) <b>A23L 1/30</b> (2006.01) <b>A61K 36/00</b> (2006.01)	2632559 *	SIMPLE PROCESS TO PRODUCE AND SEPARATE WATER SOLUBLE AND OIL SOLUBLE ANTIOXIDATIVE FLAVORING COMPOSITIONS FROM LABIATAE HERBS USING GREEN SOLVENTS
CSL Limited	<b>A61K 39/395</b> (2006.01) <b>A61P 37/06</b> (2006.01) <b>C07K 16/28</b> (2006.01) <b>A61P 35/02</b> (2006.01)	2606069 *	HUMANIZED ANTI-INTERLEUKIN 3 RECEPTOR ALPHA CHAIN ANTIBODIES
Takeda Pharmaceutical Company Limited	<b>C07D 413/14</b> (2006.01) <b>C07D 417/06</b> (2006.01) <b>C07D 417/14</b> (2006.01) <b>C07D 267/10</b> (2006.01) <b>C07D 413/04</b> (2006.01) <b>C07D 413/06</b> (2006.01) <b>C07D 413/10</b> (2006.01) <b>C07D 413/12</b> (2006.01)	2625170 *	1,4-OXAZEPANE DERIVATIVES
Regeneron Pharmaceuticals, Inc.	<b>C12N 15/85</b> (2006.01) <b>C12N 9/64</b> (2006.01) <b>C07K 16/46</b> (2006.01) <b>C07K 16/28</b> (2006.01) <b>C07K 16/40</b> (2006.01) <b>A01K 67/027</b> (2006.01)	2578688	ADAM6 mice
H. Lundbeck A/S	<b>A61K 51/04</b> (2006.01) <b>G01N 33/60</b> (2006.01) <b>A61K 101/02</b> (2006.01) <b>C07B 59/00</b> (2006.01) <b>C07D 471/04</b> (2006.01)	2637704 *	RADIOLABELLED PHENYLIMIDAZOLE-BASED LIGANDS

Podnosilac evropske prijave patenta (71)	MKP (51)	Broj objave evropske prijave patenta (97)	Naziv pronalaska (54)
Sanofi-Aventis Deutschland GmbH	<b>A61M 5/24</b> (2006.01)	2621562 *	NON-DETACHABLE RESERVOIR HOLDER FOR A DRUG DELIVERY DEVICE
Norgine B.V.	<b>A61K 31/765</b> (2006.01) <b>A61P 35/00</b> (2006.01)	2635289 *	PEG OR PEG BLOCK COPOLYMERS FOR TREATING COLORECTAL CANCER
Qualcomm Incorporated	<b>H04W 64/00</b> (2009.01) <b>H04W 4/02</b> (2009.01) <b>H04L 29/08</b> (2006.01) <b>G01S 19/49</b> (2010.01)	2601801 *	DETERMINING LOCATION OF A TARGET DEVICE BASED ON RELATIVE CHANGE IN LOCATION INFORMATION
A TLC S.r.l.	<b>H04B 3/02</b> (2006.01) <b>H04L 12/10</b> (2006.01) <b>H04L 25/02</b> (2006.01)	2601746 *	METHOD AND DEVICE FOR COUPLING A DC SUPPLY LINE TO A TELEPHONE LINE OR COAXIAL CABLE
Immunogen, Inc.	<b>A61K 39/395</b> (2006.01)	2632490 *	NOVEL EGFR-BINDING MOLECULES AND IMMUNOCONJUGATES THEREOF
Novomatic AG	<b>G07F 17/32</b> (2006.01) <b>G06F 3/048</b> (2013.01)	2636030 *	METHOD AND SYSTEM FOR SECRETLY REVEALING ITEMS ON A MULTI-TOUCH INTERFACE
Eisai R&D Management Co., Ltd.	<b>A61K 31/505</b> (2006.01) <b>A61K 31/506</b> (2006.01) <b>A61K 31/4174</b> (2006.01) <b>A61K 45/00</b> (2006.01) <b>A61K 31/7048</b> (2006.01) <b>A61K 31/444</b> (2006.01) <b>A61K 38/00</b> (2006.01) <b>A61K 31/4196</b> (2006.01) <b>A61P 31/10</b> (2006.01) <b>A61K 31/427</b> (2006.01) <b>A61P 43/00</b> (2006.01) <b>A61K 31/496</b> (2006.01)	2636409 *	COMBINED PHARMACEUTICAL COMPOSITION AS ANTIFUNGAL AGENT
Savant Systems LLC.	<b>H04N 21/475</b> (2011.01) <b>H04N 21/41</b> (2011.01) <b>H04L 12/28</b> (2006.01)	2619993 *	PROGRAMMABLE MULTIMEDIA CONTROLLER WITH FLEXIBLE USER ACCESS AND SHARED DEVICE CONFIGURATIONS
Taisho Pharmaceutical Co., Ltd.	<b>A61K 31/417</b> (2006.01) <b>A61P 25/04</b> (2006.01) <b>C07D 231/14</b> (2006.01) <b>A61K 31/4245</b> (2006.01) <b>A61P 25/20</b> (2006.01) <b>A61K 31/42</b> (2006.01) <b>A61P 25/18</b> (2006.01) <b>A61K 31/415</b> (2006.01) <b>A61K 31/496</b> (2006.01) <b>A61P 25/30</b> (2006.01) <b>A61K 31/4174</b> (2006.01) <b>A61P 25/08</b> (2006.01) <b>C07D 231/12</b> (2006.01) <b>A61K 31/4709</b> (2006.01) <b>A61P 25/28</b> (2006.01) <b>A61K 31/4439</b> (2006.01) <b>A61P 25/22</b> (2006.01) <b>A61K 31/4155</b> (2006.01) <b>A61K 31/506</b> (2006.01) <b>A61P 43/00</b> (2006.01)	2599775 *	ETHINYL-PYRAZOLE DERIVATIVE
ZaCh System S.p.A.	<b>C07D 213/50</b> (2006.01)	2639221	Process for preparing a ketosulfone derivative

Podnosilac evropske prijave patenta (71)	MKP (51)	Broj objave evropske prijave patenta (97)	Naziv pronalaska (54)
Omeros Corporation	<b>A61K 31/5377</b> (2006.01) <b>A61P 25/30</b> (2006.01) <b>A61K 31/55</b> (2006.01) <b>A61K 31/454</b> (2006.01) <b>A61P 25/18</b> (2006.01) <b>A61K 31/485</b> (2006.01) <b>A61P 25/24</b> (2006.01) <b>A61K 31/4178</b> (2006.01) <b>A61P 25/00</b> (2006.01) <b>A61K 31/551</b> (2006.01) <b>A61P 25/36</b> (2006.01) <b>A61K 31/4162</b> (2006.01) <b>A61P 25/34</b> (2006.01) <b>A61K 31/4439</b> (2006.01) <b>A61P 25/32</b> (2006.01) <b>A61K 31/519</b> (2006.01) <b>A61K 31/44</b> (2006.01) <b>A61P 25/08</b> (2006.01)	2640395 *	TREATMENT OF ADDICTION AND IMPULSE-CONTROL DISORDERS USING PDE7 INHIBITORS
KRKA, tovarna zdravil, d.d., Novo mesto	<b>A61K 9/16</b> (2006.01) <b>A61K 9/20</b> (2006.01) <b>A61K 9/48</b> (2006.01) <b>A61K 9/50</b> (2006.01) <b>A61K 31/4184</b> (2006.01) <b>A61K 31/4422</b> (2006.01)	2632438 *	MULTILAYER PHARMACEUTICAL COMPOSITION COMPRISING TELMISARTAN AND AMLODIPINE
H. Lundbeck A/S	<b>A61K 31/495</b> (2006.01) <b>A61P 25/00</b> (2006.01)	2608789 *	THERAPEUTIC USES OF 1-[2-(2,4-DIMETHYL-PHENYLSULFANYL)PHENYL]PIPERAZINE
Faes Farma, S.A.	<b>A61K 31/137</b> (2006.01) <b>A61K 31/341</b> (2006.01) <b>A61K 31/381</b> (2006.01) <b>A61K 31/4184</b> (2006.01) <b>A61K 31/4402</b> (2006.01) <b>A61K 31/519</b> (2006.01) <b>A61K 31/52</b> (2006.01) <b>C07C 211/27</b> (2006.01) <b>C07C 211/29</b> (2006.01) <b>C07C 217/58</b> (2006.01) <b>C07C 255/58</b> (2006.01) <b>C07D 233/58</b> (2006.01) <b>C07D 235/08</b> (2006.01) <b>C07D 473/16</b> (2006.01) <b>C07D 473/34</b> (2006.01)	2642987 *	DIPHENYL-AMINE DERIVATIVES: USES, PROCESS OF SYNTHESIS AND PHARMACEUTICAL COMPOSITIONS
SANOFI	<b>C07D 213/74</b> (2006.01) <b>C07D 239/42</b> (2006.01)	2603491 *	PROCESS FOR THE PREPARATION OF ENANTIOMERIC FORMS OF 2,3-DIAMINOPROPIONIC ACID DERIVATIVES
Eli Lilly and Company	<b>C07K 16/18</b> (2006.01) <b>G01N 33/577</b> (2006.01) <b>A61K 39/395</b> (2006.01) <b>A61P 25/28</b> (2006.01)	2603523 *	ANTI-N3pGlu AMYLOID BETA PEPTIDE ANTIBODIES AND USES THEREOF
R.P. Scherer Technologies, LLC	<b>A61K 9/48</b> (2006.01) <b>A61K 9/50</b> (2006.01) <b>A23L 1/30</b> (2006.01)	2603208 *	PROCESS OF MANUFACTURING A STABLE SOFTGEL CAPSULE CONTAINING MICROENCAPSULATED PROBIOTIC BACTERIA
SMI S.p.A.	<b>B29C 49/56</b> (2006.01)	2591905	Machine for the blowing or stretch blow moulding of bottles in polymeric material
OTO S.p.A.	<b>B66F 9/075</b> (2006.01) <b>B62D 11/08</b> (2006.01)	2535308	A traction axle for work machines.
Isaf Bus Components S.r.l.	<b>E05F 15/04</b> (2006.01) <b>F15B 15/06</b> (2006.01)	2543807	Rotary actuator for moving a swivel swing door, particularly in vehicles
Amgen Inc.	<b>C07K 16/22</b> (2006.01) <b>A61P 19/08</b> (2006.01) <b>A61P 21/00</b> (2006.01)	2606066 *	ANTIBODIES THAT BIND MYOSTATIN, COMPOSITIONS AND METHODS
Novartis AG	<b>C07D 239/28</b> (2006.01) <b>C07D 239/30</b> (2006.01) <b>C07D 401/04</b> (2006.01)	2621908 *	MANUFACTURING PROCESS FOR PYRIMIDINE DERIVATIVES

Podnosilac evropske prijave patenta (71)	MKP (51)	Broj objave evropske prijave patenta (97)	Naziv pronalaska (54)
The Ohio State University Research Foundation	<b>A61K 31/07</b> (2006.01) <b>A61K 47/00</b> (2006.01)	2640368 *	CONTROLLED RELEASE MUCOADHESIVE SYSTEMS
The Regents of The University of Michigan	<b>A61K 31/07</b> (2006.01) <b>A61K 47/00</b> (2006.01)	2640368 *	CONTROLLED RELEASE MUCOADHESIVE SYSTEMS
Messer Group GmbH	<b>F25D 3/11</b> (2006.01) <b>B01J 2/06</b> (2006.01)	2522935	Device for pelletising or granulating a fluid or paste material
Messer Industriegase GmbH	<b>F25D 3/11</b> (2006.01) <b>B01J 2/06</b> (2006.01)	2522935	Device for pelletising or granulating a fluid or paste material
SANOFI	<b>G01N 33/49</b> (2006.01) <b>G01N 33/86</b> (2006.01)	2619575 *	METHOD FOR THE DETECTION AND/OR QUANTIFICATION OF THE INTERACTION OF PLATELETS WITH INTERACTION PARTNERS
OSI Pharmaceuticals, LLC	<b>C07D 487/04</b> (2006.01)	2598506 *	PROCESS FOR THE PREPARATION OF THE COMPOUND OSI - 906
Purdue Pharma L.P.	<b>C07D 471/08</b> (2006.01) <b>A61P 9/06</b> (2006.01) <b>A61K 31/517</b> (2006.01) <b>A61P 25/02</b> (2006.01) <b>C07D 239/74</b> (2006.01) <b>A61P 25/28</b> (2006.01) <b>C07D 239/84</b> (2006.01) <b>A61P 25/06</b> (2006.01) <b>C07D 401/12</b> (2006.01) <b>A61P 25/24</b> (2006.01) <b>C07D 401/04</b> (2006.01) <b>A61P 25/08</b> (2006.01) <b>C07D 403/12</b> (2006.01) <b>A61P 25/14</b> (2006.01)	2625169 *	QUINAZOLINE COMPOUNDS AS SODIUM CHANNEL BLOCKERS
Theravance, Inc.	<b>C07D 401/12</b> (2006.01) <b>C07D 207/08</b> (2006.01) <b>A61P 11/00</b> (2006.01) <b>A61K 31/40</b> (2006.01)	2627630 *	SEROTONIN REUPTAKE INHIBITORS
Moog Unna GmbH	<b>H02J 7/34</b> (2006.01) <b>H02J 9/00</b> (2006.01)	2523305	Emergency energy supply device and method for supplying emergency energy
Exelixis, Inc.	<b>C07D 473/04</b> (2006.01) <b>A61K 31/52</b> (2006.01) <b>C07D 471/10</b> (2006.01)	2616469 *	INHIBITORS OF PI3K-DELTA AND METHODS OF THEIR USE AND MANUFACTURE
Dragic, Mile	<b>F03B 13/18</b> (2006.01)	2596235 *	OCEAN WAVE POWER PLANT
Pintore, Isa	<b>A47B 85/04</b> (2006.01) <b>A47D 11/00</b> (2006.01) <b>A47D 9/00</b> (2006.01) <b>A47C 13/00</b> (2006.01) <b>A47C 4/03</b> (2006.01)	2625986	Modular piece of furniture
Condorelli, Alessandro	<b>A47B 85/04</b> (2006.01) <b>A47D 11/00</b> (2006.01) <b>A47D 9/00</b> (2006.01) <b>A47C 13/00</b> (2006.01) <b>A47C 4/03</b> (2006.01)	2625986	Modular piece of furniture
Arla Foods Amba	<b>A23C 3/037</b> (2006.01) <b>A23C 9/12</b> (2006.01) <b>A23C 9/142</b> (2006.01)	2595492 *	LACTOSE-REDUCED MILK-RELATED PRODUCT, AND A PROCESS AND MILK PROCESSING PLANT FOR ITS MANUFACTURE

Podnosilac evropske prijave patenta (71)	MKP (51)	Broj objave evropske prijave patenta (97)	Naziv pronalaska (54)
Astellas Pharma Inc.	<b>A61P 1/04</b> (2006.01) <b>A61P 37/08</b> (2006.01) <b>A61P 19/02</b> (2006.01) <b>C07D 401/14</b> (2006.01) <b>A61P 29/00</b> (2006.01) <b>A61K 31/5377</b> (2006.01) <b>A61P 35/02</b> (2006.01) <b>A61P 11/06</b> (2006.01) <b>A61P 43/00</b> (2006.01) <b>A61P 17/06</b> (2006.01) <b>A61K 31/541</b> (2006.01) <b>A61P 37/02</b> (2006.01) <b>A61K 31/55</b> (2006.01) <b>A61P 37/06</b> (2006.01)	2604601 *	HETERO RING COMPOUND
Merck Sharp & Dohme Corp.	<b>A61K 39/12</b> (2006.01)	2632485 *	RECOMBINANT SUBUNIT DENGUE VIRUS VACCINE
BiPar Sciences, Inc.	<b>A61P 35/04</b> (2006.01) <b>A61K 31/282</b> (2006.01) <b>A61K 31/7068</b> (2006.01) <b>A61K 31/166</b> (2006.01) <b>A61K 31/337</b> (2006.01) <b>A61P 35/00</b> (2006.01)	2595618 *	METHODS OF TREATING BREAST CANCER USING 4-iodo-3-nitrobenzamide in combination with anti-tumor agents
Dow AgroSciences LLC	<b>A61K 31/44</b> (2006.01) <b>A01N 43/16</b> (2006.01) <b>A61K 31/35</b> (2006.01) <b>C07D 315/00</b> (2006.01) <b>A01N 43/40</b> (2006.01)	2608667 *	PESTICIDAL COMPOSITIONS
M.B.H. Developpement	<b>E04F 21/18</b> (2006.01) <b>B62B 1/00</b> (2006.01)	2573297	Movable structure for handling and installing panels or plates onto walls or ceilings
Britax Childcare Pty Ltd.	<b>B62B 7/06</b> (2006.01) <b>B62B 9/08</b> (2006.01)	2611670 *	FOLDING STROLLER IMPROVEMENTS
Synta Pharmaceuticals Corp.	<b>A61K 31/4196</b> (2006.01) <b>A61P 35/00</b> (2006.01) <b>A61K 31/436</b> (2006.01) <b>A61K 31/506</b> (2006.01) <b>A61K 31/502</b> (2006.01) <b>A61K 31/517</b> (2006.01) <b>A61K 31/4439</b> (2006.01) <b>A61K 31/437</b> (2006.01) <b>A61K 31/395</b> (2006.01)	2640384 *	PRESELECTION OF SUBJECTS FOR THERAPEUTIC TREATMENT WITH OXYGEN SENSITIVE AGENTS BASED ON HYPOXIC STATUS
Flexlife Limited	<b>F16L 58/00</b> (2006.01)	2601431 *	CORROSION PROTECTION OF PIPES SUSPENDED IN SEAWATER
Deutsche Post AG	<b>B65G 1/137</b> (2006.01) <b>B66F 9/075</b> (2006.01) <b>G05D 1/02</b> (2006.01)	2514690	Warehouse guiding system for industrial trucks
Amgen Inc.	<b>C07D 491/20</b> (2006.01) <b>A61K 31/527</b> (2006.01) <b>A61P 25/28</b> (2006.01)	2643325 *	SPIRO-AMINO-IMIDAZOLONE AND SPIRO-AMINO-DIHYDRO-PYRIMIDINONE COMPOUNDS AS BETA-SECRETASE MODULATORS AND METHODS OF USE
Square, Inc.	<b>G06K 7/08</b> (2006.01)	2628127 *	READ HEAD DEVICE WITH SLOT CONFIGURED TO REDUCE TORQUE
The Regents of the University of Colorado, A Body Corporate	<b>C08F 8/00</b> (2006.01)	2635610 *	DUAL-CURE POLYMER SYSTEMS
Thermo Engineering S.r.l.	<b>F24D 13/02</b> (2006.01)	2596293 *	HEATING DEVICE
Abbvie Inc.	<b>A61K 31/4709</b> (2006.01) <b>A61K 31/4025</b> (2006.01) <b>A61K 31/4725</b> (2006.01) <b>A61P 31/14</b> (2006.01) <b>A61K 31/5377</b> (2006.01) <b>A61K 31/513</b> (2006.01) <b>A61K 31/4178</b> (2006.01) <b>A61K 31/497</b> (2006.01)	2583677	Methods for treating HCV comprising at least two direct acting antiviral agent, ribavirin but not interferon.

Podnosilac evropske prijave patenta (71)	MKP (51)	Broj objave evropske prijave patenta (97)	Naziv pronalaska (54)
Cadila Healthcare Limited	<b>C07J 41/00</b> (2006.01) <b>C07J 31/00</b> (2006.01)	2611821 *	PROCESS FOR PREPARING FLUTICASONE PROPIONATE/FUROATE
Ethicon Endo-Surgery, Inc.	<b>A61B 17/115</b> (2006.01)	2524655	Circular stapling instrument having a breakaway washer attachment member
M.B.H. Developpement	<b>E04F 21/18</b> (2006.01)	2573298	Plate support for an apparatus for mounting plates onto walls or ceilings
August Müller GmbH & Co. KG	<b>B07B 1/14</b> (2006.01) <b>B07B 1/15</b> (2006.01)	2511014	Roller screen filter device
Eli Lilly and Company	<b>C07D 401/14</b> (2006.01) <b>A61K 31/4439</b> (2006.01) <b>A61P 35/00</b> (2006.01)	2625175 *	CRYSTALLINE (R) - (E) -2- (4- (2- (5- (1- (3, 5 -DICHLOROPYRIDIN-4 -YL) ETHOXY) - 1H - INDAZOL - 3 - YL) VINYL) -1 H- PYRAZOL- 1 -YL) ETHANOL AND ITS USE AS FGFR INHIBITOR
Katholieke Universiteit Leuven	<b>C07D 221/06</b> (2006.01) <b>C07D 221/08</b> (2006.01) <b>C07D 221/10</b> (2006.01) <b>C07D 401/04</b> (2006.01) <b>C07D 417/04</b> (2006.01) <b>C07D 471/04</b> (2006.01) <b>C07D 471/14</b> (2006.01) <b>C07D 487/04</b> (2006.01) <b>C07D 491/048</b> (2006.01) <b>C07D 491/06</b> (2006.01) <b>C07D 495/04</b> (2006.01) <b>C07D 495/14</b> (2006.01) <b>C07D 519/00</b> (2006.01) <b>A61P 31/00</b> (2006.01) <b>A61K 31/435</b> (2006.01) <b>A61K 31/4355</b> (2006.01) <b>A61K 31/437</b> (2006.01) <b>A61K 31/519</b> (2006.01)	2640705 *	NOVEL ANTIVIRAL COMPOUNDS
Realco SA	<b>C11D 3/386</b> (2006.01) <b>C11D 3/00</b> (2006.01) <b>C11D 11/00</b> (2006.01) <b>A61L 2/18</b> (2006.01)	2627747 *	PRODUCT AND METHOD FOR THE REMOVAL OF BIOFILMS
Institut National De La Recherche Agronomique (INRA)	<b>C11D 3/386</b> (2006.01) <b>C11D 3/00</b> (2006.01) <b>C11D 11/00</b> (2006.01) <b>A61L 2/18</b> (2006.01)	2627747 *	PRODUCT AND METHOD FOR THE REMOVAL OF BIOFILMS
Protea Biopharma N.V.	<b>C07H 21/02</b> (2006.01) <b>A61K 31/7125</b> (2006.01) <b>A61P 31/14</b> (2006.01)	2638056 *	USE OF 2',5'-OLIGOADENYLATE DERIVATIVE COMPOUNDS
Æterna Zentaris GmbH	<b>A61K 31/4196</b> (2006.01) <b>C07D 401/14</b> (2006.01) <b>C07D 403/06</b> (2006.01) <b>C07D 413/14</b> (2006.01) <b>A61P 5/06</b> (2006.01)	2616070 *	NOVEL TRIAZOLE DERIVATIVES WITH IMPROVED RECEPTOR ACTIVITY AND BIOAVAILABILITY PROPERTIES AS GHRELIN ANTAGONISTS OF GROWTH HORMONE SECRETAGOGUE RECEPTORS
Centre National de la Recherche Scientifique	<b>A61K 31/4196</b> (2006.01) <b>C07D 401/14</b> (2006.01) <b>C07D 403/06</b> (2006.01) <b>C07D 413/14</b> (2006.01) <b>A61P 5/06</b> (2006.01)	2616070 *	NOVEL TRIAZOLE DERIVATIVES WITH IMPROVED RECEPTOR ACTIVITY AND BIOAVAILABILITY PROPERTIES AS GHRELIN ANTAGONISTS OF GROWTH HORMONE SECRETAGOGUE RECEPTORS
University of Montpellier I	<b>A61K 31/4196</b> (2006.01) <b>C07D 401/14</b> (2006.01) <b>C07D 403/06</b> (2006.01) <b>C07D 413/14</b> (2006.01) <b>A61P 5/06</b> (2006.01)	2616070 *	NOVEL TRIAZOLE DERIVATIVES WITH IMPROVED RECEPTOR ACTIVITY AND BIOAVAILABILITY PROPERTIES AS GHRELIN ANTAGONISTS OF GROWTH HORMONE SECRETAGOGUE RECEPTORS
University of Montpellier II	<b>A61K 31/4196</b> (2006.01) <b>C07D 401/14</b> (2006.01) <b>C07D 403/06</b> (2006.01) <b>C07D 413/14</b> (2006.01) <b>A61P 5/06</b> (2006.01)	2616070 *	NOVEL TRIAZOLE DERIVATIVES WITH IMPROVED RECEPTOR ACTIVITY AND BIOAVAILABILITY PROPERTIES AS GHRELIN ANTAGONISTS OF GROWTH HORMONE SECRETAGOGUE RECEPTORS



Podnosilac evropske prijave patenta (71)	MKP (51)	Broj objave evropske prijave patenta (97)	Naziv pronalaska (54)
Golub, Emil	<b>A61K 38/16</b> (2006.01) <b>A61J 3/07</b> (2006.01) <b>A61K 9/48</b> (2006.01) <b>A61K 38/01</b> (2006.01) <b>A61J 3/02</b> (2006.01) <b>A61K 9/16</b> (2006.01) <b>A61P 35/00</b> (2006.01)	2621478 *	METHOD OF PREPARING A DRY POWDER FROM A WATER BACTERIA EXTRACT-CONCENTRATE
Meier, René	<b>A01N 59/00</b> (2006.01) <b>C02F 1/467</b> (2006.01) <b>E03C 1/046</b> (2006.01) <b>A01P 1/00</b> (2006.01) <b>A61K 33/20</b> (2006.01)	2624701 *	METHOD FOR PRODUCING ELECTRO ACTIVATED WATER BY ELECTROLYSIS OF AN AQUEOUS SODIUM CHLORIDE SOLUTION
Sabino, Giuseppe	<b>A61K 41/00</b> (2006.01) <b>A61K 49/22</b> (2006.01)	2598169 *	AN ANTIGEN SPECIFIC ULTRASOUND CONTRAST MEDIUM, A PROCESS FOR THE PREPARATION THEREOF AND ITS USES
Lifescan Scotland Limited	<b>G06F 19/00</b> (2011.01) <b>A61B 5/145</b> (2006.01)	2455877	Method for diabetes management
Agenebio, Inc.	<b>A61K 31/55</b> (2006.01)	2640396 *	BENZODIAZEPINE DERIVATIVES, COMPOSITIONS AND METHODS FOR TREATING COGNITIVE IMPAIRMENT
Janssen Pharmaceutica, N.V.	<b>C07D 205/04</b> (2006.01) <b>C07D 403/14</b> (2006.01) <b>C07D 409/14</b> (2006.01) <b>C07D 413/14</b> (2006.01) <b>C07D 417/12</b> (2006.01) <b>C07D 417/14</b> (2006.01) <b>C07D 513/04</b> (2006.01) <b>A61K 31/427</b> (2006.01) <b>A61K 31/429</b> (2006.01) <b>A61P 29/00</b> (2006.01)	2611774 *	DI-AZETIDINYL DIAMIDE AS MONOACYLGLYCEROL LIPASE INHIBITORS
Novartis AG	<b>C07D 401/12</b> (2006.01) <b>A61P 35/00</b> (2006.01) <b>A61K 31/495</b> (2006.01)	2640467 *	CRYSTALLINE FORM OF AN INHIBITOR OF MDM2/4 AND P53 INTERACTION
Exelixis, Inc.	<b>A61K 35/00</b> (2006.01) <b>C07D 413/14</b> (2006.01) <b>C07D 471/04</b> (2006.01) <b>C07D 513/14</b> (2006.01) <b>C07D 413/04</b> (2006.01) <b>A61K 31/553</b> (2006.01) <b>C07D 417/14</b> (2006.01)	2643317 *	BENZOXAZEPINES AS INHIBITORS OF P13K/MTOR AND METHODS OF THEIR USE AND MANUFACTURE
Abbvie Inc.	<b>A61K 39/00</b> (2006.01) <b>C07K 16/00</b> (2006.01)	2608803 *	DUAL VARIABLE DOMAIN IMMUNOGLOBULINS AND USES THEREOF
Unical AG S.p.A.	<b>B22D 19/00</b> (2006.01) <b>F27D 1/12</b> (2006.01) <b>F28D 1/047</b> (2006.01) <b>F28F 3/12</b> (2006.01)	2621649 *	HEAT EXCHANGER WITH DIE-CAST ELEMENTS AND METHOD FOR MANUFACTURING THE SAME
Bayer Intellectual Property GmbH	<b>C07D 487/04</b> (2006.01)	2638045 *	AMINOALCOHOL SUBSTITUTED 2,3-DIHYDROIMIDAZO[1,2-C]QUINAZOLINE DERIVATIVES USEFUL FOR TREATING HYPERPROLIFERATIVE DISORDERS AND DISEASES ASSOCIATED WITH ANGIOGENESIS
Les Laboratoires Servier	<b>C07C 255/43</b> (2006.01) <b>C07C 215/08</b> (2006.01) <b>C07C 229/34</b> (2006.01) <b>C07D 223/16</b> (2006.01)	2644597	Novel method for synthesising ivabradine and its pharmaceutically acceptable acid addition salts
Novartis AG	<b>C07D 401/12</b> (2006.01) <b>A61K 31/519</b> (2006.01) <b>A61P 35/00</b> (2006.01)	2638030 *	SALT(S) OF 7-CYCLOPENTYL-2 -(5-PIPERAZIN-1-YL-PYRIDIN-2-YLAMINO)-7H-PYRROLO[2,3-D]PYRIMIDINE-6-CARBOXYLIC ACID DIMETHYLAMIDE AND PROCESSES OF MAKING THEREOF
Astex Therapeutics Limited	<b>C07D 401/12</b> (2006.01) <b>A61K 31/519</b> (2006.01) <b>A61P 35/00</b> (2006.01)	2638030 *	SALT(S) OF 7-CYCLOPENTYL-2 -(5-PIPERAZIN-1-YL-PYRIDIN-2-YLAMINO)-7H-PYRROLO[2,3-D]PYRIMIDINE-6-CARBOXYLIC ACID DIMETHYLAMIDE AND PROCESSES OF MAKING THEREOF

Podnosilac evropske prijave patenta (71)	MKP (51)	Broj objave evropske prijave patenta (97)	Naziv pronalaska (54)
Duke Engines Limited	<b>F02B 75/26</b> (2006.01) <b>F16H 23/08</b> (2006.01) <b>F01B 3/00</b> (2006.01) <b>F01B 3/02</b> (2006.01) <b>F04B 1/22</b> (2006.01) <b>F04B 27/08</b> (2006.01)	2633207 *	AXIAL PISTON MACHINES
TOTO LTD.	<b>E03D 11/02</b> (2006.01) <b>E03D 11/08</b> (2006.01)	2562314	Flush toilet
Takeda GmbH	<b>A61M 16/06</b> (2006.01) <b>A61M 16/14</b> (2006.01)	2603268 *	DEVICE AND SYSTEM FOR DELIVERY OF AN AEROSOL TO A PATIENT ON VENTILATORY SUPPORT
ORTHO-CLINICAL DIAGNOSTICS, INC.	<b>G01N 33/558</b> (2006.01)	2618153	Controlling fluid flow through an assay device
Philadelphia Health and Education Corporation	<b>A61K 31/4184</b> (2006.01)	2603215 *	NOVEL D3 DOPAMINE RECEPTOR AGONISTS TO TREAT DYSKINESIA IN PARKINSON'S DISEASE
University of Medicine and Dentistry New Jersey Medica School	<b>A61K 31/4184</b> (2006.01)	2603215 *	NOVEL D3 DOPAMINE RECEPTOR AGONISTS TO TREAT DYSKINESIA IN PARKINSON'S DISEASE
Board of Regents, The University of Texas System	<b>C07K 16/28</b> (2006.01) <b>C12N 15/13</b> (2006.01) <b>A61K 39/395</b> (2006.01) <b>A61P 35/00</b> (2006.01)	2609118 *	ANTI-OX40 ANTIBODIES AND METHODS OF USING THE SAME
Kang, Dong-Koo	<b>G06F 3/02</b> (2006.01) <b>H04M 1/02</b> (2006.01)	2610713 *	INPUT METHOD USING ALL OF THE FINGERS OF ONE HAND
Vertex Pharmaceuticals Incorporated	<b>A61K 9/16</b> (2006.01) <b>A61K 31/47</b> (2006.01)	2608775 *	PHARMACEUTICAL COMPOSITION AND ADMINISTRATIONS THEREOF
Saint-Gobain Placo SAS	<b>E04C 2/04</b> (2006.01) <b>H03K 17/96</b> (2006.01) <b>H05B 37/02</b> (2006.01)	2643931 *	ACTUATOR AND METHOD OF MANUFACTURE THEREOF
Glaxo Group Limited	<b>C07D 498/02</b> (2006.01)	2595994 *	PROCESS FOR PREPARING PYRANO - [2,3-C] PYRIDINE DERIVATIVES
The Regents of The University of Michigan	<b>A61K 31/407</b> (2006.01) <b>C07D 487/10</b> (2006.01) <b>A61P 35/00</b> (2006.01)	2638046 *	SPIRO-OXINDOLE MDM2 ANTAGONISTS
Ascenta Licensing Corporation	<b>A61K 31/407</b> (2006.01) <b>C07D 487/10</b> (2006.01) <b>A61P 35/00</b> (2006.01)	2638046 *	SPIRO-OXINDOLE MDM2 ANTAGONISTS
SANOFI	<b>A61K 31/407</b> (2006.01) <b>C07D 487/10</b> (2006.01) <b>A61P 35/00</b> (2006.01)	2638046 *	SPIRO-OXINDOLE MDM2 ANTAGONISTS
Alexion Pharmaceuticals, Inc.	<b>C12N 15/13</b> (2006.01) <b>C07K 16/18</b> (2006.01) <b>A61K 39/00</b> (2006.01) <b>C07K 16/46</b> (2006.01)	2621949 *	POLYPEPTIDES THAT BIND TO HUMAN COMPLEMENT COMPONENT C5
TECH-STAR FLUID SYSTEMS INC.	<b>C09K 8/16</b> (2006.01) <b>E21B 21/00</b> (2006.01)	2609169 *	DRILLING FLUID AND METHOD FOR DRILLING IN COAL-CONTAINING FORMATIONS
VBG Group Truck Equipment N.V.	<b>B60J 7/06</b> (2006.01) <b>B60J 5/10</b> (2006.01)	2619023 *	CONSTRUCTION FOR A SLIDING ROOF, SLIDING ROOF SYSTEM, TRUCK WITH SLIDING ROOF SYSTEM, SLIDING CANVAS TRAILER WITH A SLIDING ROOF SYSTEM, TOP COVER CONSTRUCTION.
Omya Development AG	<b>D21H 17/00</b> (2006.01) <b>C09C 1/02</b> (2006.01)	2641941	Preparation of pigments
Instytut Biochemii i Biofizyki PAN	<b>C12N 15/82</b> (2006.01) <b>C12N 15/09</b> (2006.01)	2633044 *	A PLANT HOMOLOG TO AUTOPHAGY PROTEIN P62
Minimally Invasive Devices, LLC	<b>A61B 1/04</b> (2006.01)	2600759 *	SYSTEMS AND METHODS FOR OPTIMIZING AND MAINTAINING VISUALIZATION OF A SURGICAL FIELD DURING THE USE OF SURGICAL SCOPES
Novartis AG	<b>G02C 7/04</b> (2006.01)	2598935 *	COLORLED CONTACT LENSES AND METHOD OF MAKING THE SAME
Smiths Heimann GmbH	<b>G01N 23/02</b> (2006.01)	2616798 *	SYSTEM AND METHOD FOR X-RAY INSPECTION

Podnosilac evropske prijave patenta (71)	MKP (51)	Broj objave evropske prijave patenta (97)	Naziv pronalaska (54)
Incyte Corporation	<b>C07D 471/04</b> (2006.01) <b>C07D 487/04</b> (2006.01) <b>A61K 31/519</b> (2006.01)	2640723 *	CYCLOBUTYL SUBSTITUTED PYRROLOPYRIDINE AND PYRROLOPYRIMIDINE DERIVATIVES AS JAK INHIBITORS
Bayer Intellectual Property GmbH	<b>C07D 487/04</b> (2006.01) <b>A61K 31/5025</b> (2006.01) <b>A61P 35/00</b> (2006.01)	2614063 *	SUBSTITUTED IMIDAZOPYRIDAZINES
VIIV Healthcare Company	<b>A61K 31/4985</b> (2006.01)	2616076 *	PHARMACEUTICAL COMPOSITIONS
Bayer Intellectual Property GmbH	<b>A61K 9/70</b> (2006.01) <b>A61K 31/565</b> (2006.01) <b>A61K 31/57</b> (2006.01)	2613772 *	LOW-DOSE TRANSDERMAL PATCHES WITH HIGH DRUG RELEASE
Human Research Institut für Gesundheitstechnologie und Präventionsforschung GmbH	<b>A61B 5/0408</b> (2006.01) <b>A61H 35/00</b> (2006.01) <b>A47K 3/022</b> (2006.01)	2642915 *	MEASURING APPARATUS FOR THE REPETITIVE CONTACTLESS ASCERTAINMENT OF CHARACTERISTIC INTERVALS BETWEEN ELECTRICAL PULSES OF A BEATING HEART
Puff, Henry	<b>A61B 5/0408</b> (2006.01) <b>A61H 35/00</b> (2006.01) <b>A47K 3/022</b> (2006.01)	2642915 *	MEASURING APPARATUS FOR THE REPETITIVE CONTACTLESS ASCERTAINMENT OF CHARACTERISTIC INTERVALS BETWEEN ELECTRICAL PULSES OF A BEATING HEART
Software + Systeme Erfurt GmbH	<b>A61B 5/0408</b> (2006.01) <b>A61H 35/00</b> (2006.01) <b>A47K 3/022</b> (2006.01)	2642915 *	MEASURING APPARATUS FOR THE REPETITIVE CONTACTLESS ASCERTAINMENT OF CHARACTERISTIC INTERVALS BETWEEN ELECTRICAL PULSES OF A BEATING HEART
Breithuber, Raimund	<b>A61B 5/0408</b> (2006.01) <b>A61H 35/00</b> (2006.01) <b>A47K 3/022</b> (2006.01)	2642915 *	MEASURING APPARATUS FOR THE REPETITIVE CONTACTLESS ASCERTAINMENT OF CHARACTERISTIC INTERVALS BETWEEN ELECTRICAL PULSES OF A BEATING HEART
Glaxo Group Limited	<b>C07D 413/14</b> (2006.01) <b>A61K 31/422</b> (2006.01) <b>A61P 35/00</b> (2006.01) <b>A61P 37/00</b> (2006.01) <b>A61P 11/00</b> (2006.01) <b>A61P 31/12</b> (2006.01)	2632921 *	POLYMORPHS AND SALTS OF 6-(1H-INDOL-4-YL)-4-(5- { [4-(1-METHYLETHYL)-1-PI PERAZINYLY] METHYL} -1,3-OXAZOL-2-YL)-1H-INDAZOLE AS PI3K INHIBITORS FOR USE IN THE TREATMENT OF E.G. RESPIRATORY DISORDERS
Five Prime Therapeutics, Inc.	<b>A61P 35/00</b> (2006.01) <b>A61K 38/17</b> (2006.01)	2640406 *	TREATMENT OF CANCER WITH ELEVATED DOSAGES OF SOLUBLE FGFR1 FUSION PROTEINS
Astellas Pharma Inc.	<b>A61K 31/4196</b> (2006.01) <b>A61K 31/4245</b> (2006.01) <b>A61P 21/00</b> (2006.01) <b>A61P 25/04</b> (2006.01) <b>C07D 249/08</b> (2006.01) <b>C07D 413/12</b> (2006.01)	2614824 *	THERAPEUTIC AGENT FOR PAIN
GEHA Stiftung	<b>C10J 3/62</b> (2006.01) <b>C10J 3/66</b> (2006.01) <b>C10J 3/48</b> (2006.01) <b>C10B 57/10</b> (2006.01)	2479244	Method for operating an assembly for energy generation
Total Raffinage Marketing	<b>C12R 1/645</b> (2006.01) <b>C12N 9/02</b> (2006.01) <b>C12P 7/56</b> (2006.01)	2633085 *	USE OF MONASCUS IN ORGANIC ACID PRODUCTION
WEST VIRGINIA UNIVERSITY	<b>B64D 10/00</b> (2006.01)	2637927 *	METHODS AND DEVICE TO REDUCE SLOSH ENERGY ABSORPTION EFFECTS BY REDUCING BLOOD FLOW FROM THE CRANIUM
TargeGen, Inc.	<b>A61K 31/497</b> (2006.01) <b>A61K 9/48</b> (2006.01) <b>A61P 7/00</b> (2006.01)	2635282 *	COMPOSITIONS AND METHODS FOR TREATING MYELOFIBROSIS
Meriel Limited	<b>A61K 39/00</b> (2006.01)	2629791 *	HER2 DNA VACCINE AS ADJUNCT TREATMENT FOR CANCERS IN COMPANION ANIMALS
Healor Ltd.	<b>A61K 38/08</b> (2006.01) <b>A61K 38/18</b> (2006.01) <b>A61K 38/00</b> (2006.01)	2599494	PKC inhibitors for the treatment of inflammatory disease or disorder

Podnosilac evropske prijave patenta (71)	MKP (51)	Broj objave evropske prijave patenta (97)	Naziv pronalaska (54)
Perfetti Van Melle S.p.A.	<b>B65D 5/00</b> (2006.01) <b>B65D 85/60</b> (2006.01)	2619098 *	FOLDING WALLET PACKAGING FOR CONFECTIONERY PRODUCTS, MORE PARTICULARLY BARS OR SLABS OF CHEWING GUM
Doikos Investments, Ltd.	<b>F23H 17/08</b> (2006.01) <b>F23H 7/08</b> (2006.01) <b>F23H 3/02</b> (2006.01)	2598801 *	WATER-COOLED SLIDING COMBUSTION GRATE HAVING A PARALLEL DRIVE
Nicolaescu, Gheorghe	<b>H04M 3/42</b> (2006.01) <b>H04M 3/487</b> (2006.01)	2609726 *	METHOD FOR NOTIFICATION OF A CALLED SUBSCRIBER IN THE ABSENCE OF SUFFICIENT CREDIT OF THE CALLING PARTY
Novartis AG	<b>A61K 39/395</b> (2006.01) <b>C07K 16/24</b> (2006.01) <b>A61K 31/519</b> (2006.01)	2635303 *	METHODS OF TREATING RHEUMATOID ARTHRITIS USING IL-17 ANTAGONISTS
National University Corporation, Tohoku University	<b>A61B 6/00</b> (2006.01)	2599438 *	EVALUATION AID
Mitaya Manufacturing Co., Ltd.	<b>A61B 6/00</b> (2006.01)	2599438 *	EVALUATION AID
MAT Mischanlagentechnik GmbH	<b>B01F 7/00</b> (2006.01) <b>B01F 7/18</b> (2006.01) <b>B01F 7/22</b> (2006.01) <b>B01F 13/10</b> (2006.01)	2363200	Colloidal mixer and method, in particular for preparing building materials
Arena Pharmaceuticals, Inc.	<b>C07D 223/16</b> (2006.01) <b>A61K 31/55</b> (2006.01) <b>A61P 3/04</b> (2006.01)	2611782 *	SALTS OF LORCASERIN WITH OPTICALLY ACTIVE ACIDS
GlaxoSmithKline LLC	<b>A01N 45/00</b> (2006.01) <b>A61K 31/50</b> (2006.01) <b>A61K 31/56</b> (2006.01)	2533643 *	DERIVATIVES OF BETULIN
Eisai R&D Management Co., Ltd.	<b>A61K 9/20</b> (2006.01) <b>A61P 1/04</b> (2006.01) <b>A61K 47/38</b> (2006.01) <b>A61K 47/26</b> (2006.01) <b>A61K 31/4439</b> (2006.01)	2601936 *	COMPRESSED COMPOSITION
Conviotec GmbH	<b>C12M 1/107</b> (2006.01)	2565259	Method and device for biogas production
Kalamazoo Holdings, Inc.	<b>A23L 3/3463</b> (2006.01) <b>A23L 3/3526</b> (2006.01) <b>A23L 3/3472</b> (2006.01)	2603099 *	METHODS FOR ENHANCING THE STABILITY OF FOODS, BEVERAGES, AND COSMETICS USING NATURAL PRODUCTS DERIVED FROM NON-ALLERGENIC PROTEINACEOUS SOURCES
Dnavec Corporation	<b>C12N 15/09</b> (2006.01) <b>C12N 7/00</b> (2006.01) <b>C12N 5/10</b> (2006.01)	2612911 *	COMPOSITION FOR INDUCING PLURIPOTENT STEM CELL, AND USE THEREOF
Novartis AG	<b>C08G 77/42</b> (2006.01) <b>C08G 77/442</b> (2006.01) <b>C08L 83/10</b> (2006.01) <b>G02B 1/04</b> (2006.01) <b>C08G 77/28</b> (2006.01) <b>C08G 77/48</b> (2006.01) <b>C08F 283/12</b> (2006.01) <b>C08F 290/06</b> (2006.01) <b>C08G 77/20</b> (2006.01)	2625216 *	POLYMERIZABLE CHAIN-EXTENDED POLYSILOXANES WITH PENDANT HYDROPHILIC GROUPS
Novacta Biosystems Limited	<b>A61P 31/04</b> (2006.01) <b>A61K 38/10</b> (2006.01) <b>A61K 9/48</b> (2006.01)	2627320 *	FORMULATION COMPRISING A TYPE B LANTIBIOTIC
Openhydro IP Limited	<b>F03B 11/00</b> (2006.01) <b>E02B 17/02</b> (2006.01) <b>F03B 17/06</b> (2006.01) <b>F03B 13/26</b> (2006.01) <b>E02D 15/08</b> (2006.01) <b>G01M 10/00</b> (2006.01)	2469257	A hydroelectric turbine testing method
Delphi Technologies Holding S.à.r.l.	<b>F04B 1/04</b> (2006.01) <b>F02M 59/10</b> (2006.01) <b>F02M 59/44</b> (2006.01) <b>F02M 63/00</b> (2006.01)	2530315	Fuel pump lubrication

Podnosilac evropske prijave patenta (71)	MKP (51)	Broj objave evropske prijave patenta (97)	Naziv pronalaska (54)
CHIESI FARMACEUTICI S.p.A.	<b>A61M 15/00</b> (2006.01)	2613828 *	METERED-DOSE INHALER ACTUATOR, METERED-DOSE INHALER
Boehringer Ingelheim International GmbH	<b>C07D 487/04</b> (2006.01) <b>A61K 31/519</b> (2006.01) <b>A61P 25/28</b> (2006.01)	2603511 *	6-CYCLOALKYL-1, 5-DIHYDRO-PYRAZOLO [3, 4-D]PYRIMIDIN-4-ONE DERIVATIVES AND THEIR USE AS PDE9A INHIBITORS
Alkermes Pharma Ireland Limited	<b>A01N 43/42</b> (2006.01) <b>A61K 31/44</b> (2006.01)	2608670 *	METHODS FOR TREATING ANTIPSYCHOTIC-INDUCED WEIGHT GAIN
Gilead Biologics, Inc.	<b>C12P 21/08</b> (2006.01) <b>A61K 39/395</b> (2006.01)	2608809 *	ANTIBODIES TO MATRIX METALLOPROTEINASE 9
Barokes PTY Ltd.	<b>B65D 17/00</b> (2006.01) <b>B67C 3/02</b> (2006.01) <b>C12G 1/00</b> (2006.01)	2607471	Wine packaged in aluminium containers
Cognoptix, Inc.	<b>A61B 3/00</b> (2006.01) <b>A61B 3/10</b> (2006.01) <b>A61B 3/117</b> (2006.01) <b>A61B 5/00</b> (2006.01)	2605694 *	SYSTEM AND METHOD FOR DETECTING AMYLOID PROTEINS
World Water Works, Inc.	<b>B01D 35/05</b> (2006.01)	2621602 *	FLOATED SOLIDS SEPARATION
MethylGene Inc.	<b>A61K 31/404</b> (2006.01) <b>A61P 31/10</b> (2006.01) <b>A61K 31/16</b> (2006.01) <b>A61K 31/351</b> (2006.01)	2605770 *	ANTIFUNGAL AGENTS AND USES THEREOF
Sanofi-Aventis Deutschland GmbH	<b>A61M 5/24</b> (2006.01)	2603262 *	CODING SYSTEM FOR A DRUG DELIVERY DEVICE AND DRUG DELIVERY SYSTEM
Uzin Utz AG	<b>E04F 15/12</b> (2006.01) <b>E04F 15/18</b> (2006.01) <b>C04B 28/02</b> (2006.01) <b>C04B 28/06</b> (2006.01) <b>F24D 13/02</b> (2006.01) <b>F24D 3/14</b> (2006.01)	2374768	Base layer for floor coverings
Array Biopharma, Inc.	<b>A61K 31/495</b> (2006.01) <b>A61K 31/551</b> (2006.01) <b>A61K 45/06</b> (2006.01) <b>A61P 35/00</b> (2006.01) <b>A61K 31/437</b> (2006.01)	2640386 *	COMBINATION OF CHECKPOINT KINASE 1 INHIBITORS AND WEE 1 KINASE INHIBITORS
Webb, Nigel L.	<b>C12N 15/11</b> (2006.01) <b>C07H 21/00</b> (2006.01) <b>C12N 15/10</b> (2006.01) <b>C12Q 1/68</b> (2006.01)	2638160 *	NUCLIONS AND RIBOCAPSIDS
Geox S.p.A.	<b>A43B 7/12</b> (2006.01) <b>A43B 13/16</b> (2006.01) <b>A43B 13/12</b> (2006.01)	2640209 *	VAPOR-PERMEABLE SHOE WITH WATERPROOF AND VAPOR-PERMEABLE SOLE
Nanum Nanotecnologia S/A	<b>C01G 49/08</b> (2006.01)	2598443 *	PROCESS FOR OBTAINING FUNCTIONALIZED NANOPARTICULATE MAGNETIC FERRITES FOR EASY DISPERSION AND MAGNETIC FERRITES OBTAINED THROUGH THE SAME
Washington State University Researchfoundation	<b>A01N 35/00</b> (2006.01) <b>A01N 35/02</b> (2006.01) <b>A01P 21/00</b> (2006.01)	2611294 *	ENHANCEMENT OF POTATO TUBER SPROUTING INHIBITORS USING VARIOUS COMBINATIONS OF AGENTS
BRA turbo Ing AG	<b>E02F 9/06</b> (2006.01) <b>E02F 5/28</b> (2006.01) <b>E02B 3/02</b> (2006.01) <b>E02F 3/47</b> (2006.01) <b>E02F 7/06</b> (2006.01)	2520726	Device and method for removing material deposits from the reservoir of a hydrotechnical structure
Amgen Inc.	<b>C07K 16/18</b> (2006.01) <b>C07K 16/22</b> (2006.01)	2632951 *	DKK1 ANTIBODIES AND METHODS OF USE
Wobben Properties GmbH	<b>B65D 90/12</b> (2006.01) <b>E04H 12/12</b> (2006.01) <b>F03D 11/04</b> (2006.01)	2595903 *	PROTECTIVE FOOT FOR A UNIT LOAD, IN PARTICULAR CONCRETE TOWER SEGMENTS
Kemex Ltd.	<b>C02F 1/04</b> (2006.01) <b>B01D 1/30</b> (2006.01) <b>E21B 43/24</b> (2006.01) <b>C09K 8/592</b> (2006.01)	2609038 *	A CONTAMINANT CONTROL SYSTEM IN AN EVAPORATIVE WATER TREATING SYSTEM

Podnosilac evropske prijave patenta (71)	MKP (51)	Broj objave evropske prijave patenta (97)	Naziv pronalaska (54)
Packers Plus Energy Services Inc.	<b>E21B 43/12</b> (2006.01) <b>E21B 34/14</b> (2006.01) <b>E21B 23/08</b> (2006.01) <b>E21B 33/12</b> (2006.01)	2625381 *	ACTUATION DART FOR WELLBORE OPERATIONS, WELLBORE TREATMENT APPARATUS AND METHOD
SANOFI	<b>C07D 233/64</b> (2006.01) <b>C07D 233/84</b> (2006.01)	2638016 *	Process for the preparation of 3-(6-amino-pyridin-3yl)-2-acrylic acid derivatives
Gilead Sciences, Inc.	<b>C07D 309/10</b> (2006.01) <b>C07H 19/00</b> (2006.01)	2595980 *	METHODS AND COMPOUNDS FOR TREATING PARAMYXOVIRIDAE VIRUS INFECTIONS
Krüger GmbH & Co. KG	<b>A23G 3/42</b> (2006.01) <b>A23L 1/236</b> (2006.01) <b>A23G 3/44</b> (2006.01) <b>A23L 2/60</b> (2006.01)	2628397	Sucralose-containing sweetener compositions
Motor Development International S.A.	<b>F02B 21/00</b> (2006.01) <b>F02M 31/04</b> (2006.01) <b>F02M 31/16</b> (2006.01) <b>F01B 17/02</b> (2006.01) <b>F01D 13/02</b> (2006.01)	2625400 *	SELF-PRESSURE-REGULATING COMPRESSED AIR ENGINE COMPRISING AN INTEGRATED ACTIVE CHAMBER
Wobben Properties GmbH	<b>B66C 1/12</b> (2006.01)	2550225 *	LIFTING UNIT FOR LIFTING A ROTOR OF A WIND ENERGY INSTALLATION
Ranbaxy Laboratories Limited	<b>C07D 237/32</b> (2006.01) <b>C07D 253/08</b> (2006.01) <b>C07D 265/26</b> (2006.01) <b>C07D 401/12</b> (2006.01) <b>C07D 403/12</b> (2006.01) <b>C07D 409/12</b> (2006.01) <b>A61K 31/502</b> (2006.01) <b>A61K 31/53</b> (2006.01) <b>A61K 31/536</b> (2006.01) <b>A61P 29/00</b> (2006.01)	2619185 *	MATRIX METALLOPROTEINASE INHIBITORS
Pro Energy Systems S.r.l.	<b>E04F 13/08</b> (2006.01) <b>E04B 1/76</b> (2006.01) <b>E04B 2/92</b> (2006.01)	2619377 *	SELF-SUPPORTING MODULE FOR THE FACADE OF A BUILDING
Lina Medical ApS	<b>A61B 18/12</b> (2006.01)	2540243	An electrosurgical instrument
Elanco Animal Health Ireland Limited	<b>C07D 487/04</b> (2006.01) <b>A61K 31/53</b> (2006.01) <b>A61P 31/04</b> (2006.01)	2601193 *	COMPOUNDS WITH ANTIBACTERIAL ACTIVITY AGAINST CLOSTRIDIUM
Novartis AG	<b>G02B 1/12</b> (2006.01) <b>C07F 7/10</b> (2006.01) <b>B29D 11/00</b> (2006.01) <b>G02C 7/04</b> (2006.01)	2598937 *	AMPHIPHILIC POLYSILOXANE PREPOLYMERS AND USES THEREOF
Delphi Technologies Holding S.à.r.l.	<b>F02M 51/00</b> (2006.01) <b>F02M 59/46</b> (2006.01) <b>F02M 61/16</b> (2006.01) <b>F02M 63/02</b> (2006.01) <b>F02M 63/00</b> (2006.01) <b>F16K 31/06</b> (2006.01) <b>F16L 37/088</b> (2006.01)	2538066	Assembly for an electrically operated valve
Arcelormittal Investigación y Desarrollo SL	<b>E04F 13/12</b> (2006.01) <b>E04F 13/08</b> (2006.01)	2630315 *	METAL SIDING HAVING A SECURE COVER
Dynamics Inc.	<b>A63F 9/24</b> (2006.01)	2598218 *	PAYMENT CARDS, DEVICES, SYSTEMS, AND METHODS FOR PROVIDING GAME ACTIONS WITH PAYMENT DATA, SOCIAL NETWORKING MECHANISMS AND INFORMATION EXCHANGE MECHANISMS
Pierre Fabre Medicament	<b>C07K 16/28</b> (2006.01) <b>A61K 39/395</b> (2006.01) <b>A61P 35/00</b> (2006.01)	2643354 *	NOVEL HOMOGENEOUS HUMANIZED ANTIPROLIFERATION ANTIBODIES
GB Developpement	<b>B05B 11/00</b> (2006.01)	2618940 *	DEVICE FOR DISPENSING A LIQUID AND METHOD OF MANUFACTURING SUCH A DEVICE

Podnosilac evropske prijave patenta (71)	MKP (51)	Broj objave evropske prijave patenta (97)	Naziv pronalaska (54)
Total Raffinage Marketing	<b>C12N 15/62</b> (2006.01) <b>C12N 9/24</b> (2006.01) <b>C12N 9/42</b> (2006.01) <b>C12N 15/56</b> (2006.01) <b>C12P 7/10</b> (2006.01) <b>C07K 14/33</b> (2006.01)	2633060 *	COVALENT CELLULOSOMES AND USES THEREOF
Le Centre National de la Recherche Scientifique (CNRS)	<b>C12N 15/62</b> (2006.01) <b>C12N 9/24</b> (2006.01) <b>C12N 9/42</b> (2006.01) <b>C12N 15/56</b> (2006.01) <b>C12P 7/10</b> (2006.01) <b>C07K 14/33</b> (2006.01)	2633060 *	COVALENT CELLULOSOMES AND USES THEREOF
L'Université de la Méditerranée	<b>C12N 15/62</b> (2006.01) <b>C12N 9/24</b> (2006.01) <b>C12N 9/42</b> (2006.01) <b>C12N 15/56</b> (2006.01) <b>C12P 7/10</b> (2006.01) <b>C07K 14/33</b> (2006.01)	2633060 *	COVALENT CELLULOSOMES AND USES THEREOF
L'Université de Provence	<b>C12N 15/62</b> (2006.01) <b>C12N 9/24</b> (2006.01) <b>C12N 9/42</b> (2006.01) <b>C12N 15/56</b> (2006.01) <b>C12P 7/10</b> (2006.01) <b>C07K 14/33</b> (2006.01)	2633060 *	COVALENT CELLULOSOMES AND USES THEREOF
L'Institut National des Sciences Appliquées (INSA)	<b>C12N 15/62</b> (2006.01) <b>C12N 9/24</b> (2006.01) <b>C12N 9/42</b> (2006.01) <b>C12N 15/56</b> (2006.01) <b>C12P 7/10</b> (2006.01) <b>C07K 14/33</b> (2006.01)	2633060 *	COVALENT CELLULOSOMES AND USES THEREOF
Brillux GmbH & Co. KG	<b>C09D 5/00</b> (2006.01)	2643415 *	COATING COMPOSITION WITH SPARKLE EFFECT
Tengion, Inc.	<b>A61L 27/38</b> (2006.01) <b>A61L 27/50</b> (2006.01) <b>A61L 27/52</b> (2006.01) <b>A61L 27/22</b> (2006.01)	2637711 *	INJECTABLE FORMULATIONS FOR ORGAN AUGMENTATION
ORTHO-CLINICAL DIAGNOSTICS, INC.	<b>G01N 33/543</b> (2006.01) <b>G01N 33/558</b> (2006.01)	2618149	Assay device having uniform flow around corners
ORTHO-CLINICAL DIAGNOSTICS, INC.	<b>G01N 33/543</b> (2006.01) <b>G01N 33/558</b> (2006.01)	2618150	Assay device having multiple reagent cells
Pellini S.p.A.	<b>H01R 13/62</b> (2006.01) <b>H01R 13/71</b> (2006.01) <b>H01R 13/24</b> (2006.01)	2617105 *	MAGNETICALLY ENSLAVED UNIPOLAR ELECTRICAL CONTACT ARRANGED FOR EMBEDDING IN THE SIDES OF GENERIC FRAMES AND IN PARTICULAR OF GLASS-CHAMBER FRAMES
Sanofi-Aventis Deutschland GmbH	<b>A61M 5/32</b> (2006.01)	2627383 *	CAP ASSEMBLY FOR A DRUG DELIVERY DEVICE
Shenzhen First Union Technology Co., Ltd.	<b>A24F 47/00</b> (2006.01)	2614731	An atomizer for electronic cigarette
Kabushiki Kaisha Toshiba	<b>G09B 29/10</b> (2006.01) <b>G06F 17/30</b> (2006.01) <b>G06Q 10/00</b> (2012.01)	2613272 *	ELECTRONIC MAP DATA PROCESSING SYSTEM
Toshiba Solutions Corporation	<b>G09B 29/10</b> (2006.01) <b>G06F 17/30</b> (2006.01) <b>G06Q 10/00</b> (2012.01)	2613272 *	ELECTRONIC MAP DATA PROCESSING SYSTEM
Sasvári, Gábor	<b>E04F 13/14</b> (2006.01) <b>B28D 1/00</b> (2006.01) <b>B44C 5/04</b> (2006.01)	2605893 *	METHOD FOR PREPARING FLEXIBLE STONE CLADDINGS HAVING NATURAL SURFACE
Myriad Genetics, Inc.	<b>G06F 19/10</b> (2011.01) <b>C12Q 1/68</b> (2006.01) <b>C12N 15/11</b> (2006.01)	2611941 *	GENE SIGNATURES FOR CANCER DIAGNOSIS AND PROGNOSIS

Podnosilac evropske prijave patenta (71)	MKP (51)	Broj objave evropske prijave patenta (97)	Naziv pronalaska (54)
Stone, Steve	<b>G06F 19/10</b> (2011.01) <b>C12Q 1/68</b> (2006.01) <b>C12N 15/11</b> (2006.01)	2611941 *	GENE SIGNATURES FOR CANCER DIAGNOSIS AND PROGNOSIS
Gutin, Alexander	<b>G06F 19/10</b> (2011.01) <b>C12Q 1/68</b> (2006.01) <b>C12N 15/11</b> (2006.01)	2611941 *	GENE SIGNATURES FOR CANCER DIAGNOSIS AND PROGNOSIS
Wagner, Susanne	<b>G06F 19/10</b> (2011.01) <b>C12Q 1/68</b> (2006.01) <b>C12N 15/11</b> (2006.01)	2611941 *	GENE SIGNATURES FOR CANCER DIAGNOSIS AND PROGNOSIS
Reid, Julia E.	<b>G06F 19/10</b> (2011.01) <b>C12Q 1/68</b> (2006.01) <b>C12N 15/11</b> (2006.01)	2611941 *	GENE SIGNATURES FOR CANCER DIAGNOSIS AND PROGNOSIS
Qwtip LLC	<b>C02F 1/74</b> (2006.01) <b>C02F 3/20</b> (2006.01) <b>B01F 5/12</b> (2006.01) <b>B01F 7/22</b> (2006.01) <b>F04D 13/08</b> (2006.01)	2609040 *	WATER TREATMENT AND REVITALIZATION SYSTEM AND METHOD
Euro-Celtique S.A.	<b>A61K 9/20</b> (2006.01) <b>A61K 31/485</b> (2006.01)	2603205 *	USE OF BINDERS FOR MANUFACTURING STORAGE STABLE FORMULATIONS
Gilead Sciences, Inc.	<b>A61K 31/4188</b> (2006.01) <b>C07D 491/052</b> (2006.01)	2635588 *	CONDENSED IMIDAZOLYLIMIDAZOLES AS ANTIVIRAL COMPOUNDS
Coty Inc.	<b>A61K 8/84</b> (2006.01) <b>A61Q 19/00</b> (2006.01) <b>A61K 8/92</b> (2006.01) <b>A61Q 1/00</b> (2006.01) <b>A61K 8/72</b> (2006.01) <b>A61K 8/97</b> (2006.01)	2637639 *	TRANSFER RESISTANT COSMETICS AND METHOD OF MAKING
Macrocare, Ltd.	<b>A61K 9/00</b> (2006.01) <b>A61K 35/14</b> (2006.01) <b>A61L 15/32</b> (2006.01) <b>A61P 17/02</b> (2006.01)	2613765 *	ACTIVATED LEUKOCYTE CONDITIONED SUPERNATANT AND USES FOR WOUND HEALING
Evolva SA	<b>A61K 31/4375</b> (2006.01) <b>A61P 31/04</b> (2006.01)	2621491 *	2-PYRIDONE ANTIMICROBIAL COMPOSITIONS
Janssen Biotech, Inc.	<b>C12N 5/0735</b> (2010.01) <b>C12N 5/02</b> (2006.01) <b>C12N 5/071</b> (2010.01)	2611909 *	DIFFERENTIATION OF HUMAN EMBRYONIC STEM CELLS
AH USA 42 LLC	<b>A01N 43/80</b> (2006.01) <b>C07D 413/12</b> (2006.01) <b>C07D 413/14</b> (2006.01)	2601190 *	ISOXAZOLINE DERIVATIVES AS ANTIPARASITIC AGENTS
Amgen Inc.	<b>A61P 37/00</b> (2006.01) <b>A61K 31/506</b> (2006.01) <b>C07D 413/14</b> (2006.01) <b>A61P 35/00</b> (2006.01) <b>C07D 401/14</b> (2006.01) <b>A61P 29/00</b> (2006.01)	2640715 *	QUINOLINE DERIVATIVES AS PIK3 INHIBITORS
Xerox Corporation	<b>B65H 29/60</b> (2006.01)	2236447	Space Efficient Multi-Sheet Buffer Module and Modular Printing System
Joint-Stock Company "Engineering Centre of Fire Robots Technology "FR"	<b>A62C 35/68</b> (2006.01) <b>A62C 31/00</b> (2006.01)	2599525 *	AN AUTOMATED FIRE - FIGHTING COMPLEX INTEGRATING A TELEVISION SYSTEM
Synta Pharmaceuticals Corp.	<b>A61K 31/404</b> (2006.01) <b>A61K 31/4196</b> (2006.01) <b>A61K 31/423</b> (2006.01) <b>A61K 45/06</b> (2006.01) <b>A61P 35/00</b> (2006.01)	2616063 *	HSP90 INHIBITORS FOR TREATING NON-SMALL CELL LUNG CANCERS IN WILD-TYPE EGFR AND/OR KRAS PATIENTS
Zhong, Zhou	<b>D21F 1/02</b> (2006.01) <b>D21H 13/26</b> (2006.01)	2492392	Method for preparing aramid paper and the aramid paper obtained therefrom
MorphoSys AG	<b>A61K 39/395</b> (2006.01) <b>C07K 16/28</b> (2006.01) <b>C07K 16/30</b> (2006.01) <b>A61P 35/00</b> (2006.01)	2621531 *	ANTI-CD38 ANTIBODY AND LENALIDOMIDE OR BORTEZOMIB FOR THE TREATMENT OF MULTIPLE MYELOMA AND NHL



Podnosilac evropske prijave patenta (71)	MKP (51)	Broj objave evropske prijave patenta (97)	Naziv pronalaska (54)
Baylor College Of Medicine	<b>C12N 5/071</b> (2010.01) <b>C12N 5/0783</b> (2010.01)	2614143 *	IMMUNOTHERAPY OF CANCER USING GENETICALLY ENGINEERED GD2-SPECIFIC T CELLS
Georgia Health Sciences University Research Institute, Inc.	<b>A61K 31/353</b> (2006.01) <b>A61P 31/22</b> (2006.01) <b>A61P 31/12</b> (2006.01)	2543370	Compositions and Methods for Treating Herpes Simplex Virus
Allegra Therapeutics GmbH	<b>A61K 31/34</b> (2006.01) <b>A61P 31/00</b> (2006.01) <b>C07D 507/00</b> (2006.01)	2642992 *	COMPOUNDS AND THEIR USE
Plaxica Limited	<b>C07C 51/41</b> (2006.01) <b>C07C 51/48</b> (2006.01) <b>C07C 59/08</b> (2006.01) <b>C07C 51/295</b> (2006.01)	2630114 *	PROCESS FOR PRODUCING A LACTIC ACID-AMINE COMPLEX
Otago Innovation Limited	<b>C07K 14/00</b> (2006.01) <b>C12P 21/08</b> (2006.01)	2596010 *	SIGNAL BIOMARKERS
Belron Hungary Kft-Zug Branch	<b>B26D 1/547</b> (2006.01) <b>B26B 27/00</b> (2006.01) <b>B25B 11/00</b> (2006.01) <b>B60J 1/02</b> (2006.01) <b>B60J 1/00</b> (2006.01)	2643130 *	APPARATUS AND METHOD FOR CUTTING OUT A VEHICLE GLAZING PANEL
UCB Pharma, S.A.	<b>C07K 16/00</b> (2006.01) <b>A61K 39/395</b> (2006.01)	2606063 *	IMPROVED ANTIBODIES OF THE CLASS IGG4
Janssen Pharmaceutica, N.V.	<b>C07D 403/04</b> (2006.01) <b>C07D 403/14</b> (2006.01) <b>C07D 409/14</b> (2006.01) <b>C07D 417/14</b> (2006.01) <b>A61K 31/506</b> (2006.01) <b>A61P 29/00</b> (2006.01)	2621918 *	OXOPIPERAZINE-AZETIDINE AMIDES AND OXODIAZEPINE-AZETIDINE AMIDES AS MONOACYLGLYCEROL LIPASE INHIBITORS
Ironwood Pharmaceuticals, Inc.	<b>A61K 38/10</b> (2006.01)	2603232 *	STABLE FORMULATIONS OF LINACLOTIDE
Forest Laboratories Holdings Limited	<b>A61K 38/10</b> (2006.01)	2603232 *	STABLE FORMULATIONS OF LINACLOTIDE
Sanofi-Aventis Deutschland GmbH	<b>A61M 5/24</b> (2006.01) <b>A61M 5/315</b> (2006.01)	2603259 *	CODING SYSTEM FOR A DRUG DELIVERY DEVICE AND DRUG DELIVERY SYSTEM
PPG Industries Ohio, Inc.	<b>C03C 3/118</b> (2006.01) <b>C03C 13/00</b> (2006.01) <b>B32B 17/00</b> (2006.01) <b>C08J 5/24</b> (2006.01) <b>C08K 7/14</b> (2006.01) <b>C08J 5/04</b> (2006.01)	2616399 *	LOW DENSITY AND HIGH STRENGTH FIBER GLASS FOR BALLISTIC APPLICATIONS
Packers Plus Energy Services Inc.	<b>E21B 43/14</b> (2006.01) <b>E21B 43/26</b> (2006.01) <b>E21B 34/14</b> (2006.01) <b>E21B 23/14</b> (2006.01)	2625380 *	WIRELINE CONVEYED APPARATUS FOR WELLBORE FLUID TREATMENT
Brenner, Stefan	<b>B65G 47/14</b> (2006.01)	2517988	Device and method for singulating and/or sorting used beverage containers
Areva NP Inc.	<b>G01T 3/00</b> (2006.01)	2628022 *	SELF-CALIBRATING, HIGHLY ACCURATE, LONG-LIVED, DUAL RHODIUM VANADIUM EMITTER NUCLEAR IN-CORE DETECTOR
Teijin Pharma Limited	<b>A61K 47/32</b> (2006.01) <b>A61K 31/426</b> (2006.01) <b>A61K 9/20</b> (2006.01) <b>A61K 47/10</b> (2006.01)	2591781 *	PARTICLE COATING PREPARATION
Supratek Pharma, Inc.	<b>A61K 31/4184</b> (2006.01) <b>A61K 47/40</b> (2006.01) <b>A61P 35/00</b> (2006.01)	2595660 *	BENDAMUSTINE ANIONIC-CATIOINIC CYCLOPOLYSACCHARIDE COMPOSITIONS
BiPar Sciences, Inc.	<b>A61K 35/00</b> (2006.01) <b>A61K 31/166</b> (2006.01) <b>A61P 35/04</b> (2006.01) <b>A61K 31/4745</b> (2006.01)	2595619 *	METHODS OF TREATING METASTATIC BREAST CANCER WITH 4-IODO-3-NITROBENZAMIDE AND IRINOTECAN
Sanofi-Aventis Deutschland GmbH	<b>A61M 5/315</b> (2006.01)	2529775	Resetting mechanism for a drug delivery device

Podnosilac evropske prijave patenta (71)	MKP (51)	Broj objave evropske prijave patenta (97)	Naziv pronalaska (54)
AbbVie Inc.	<b>C07D 213/30</b> (2006.01) <b>C07D 239/26</b> (2006.01) <b>C07D 405/06</b> (2006.01) <b>C07D 405/08</b> (2006.01) <b>A61K 31/4402</b> (2006.01) <b>A61K 31/4433</b> (2006.01) <b>A61K 31/505</b> (2006.01) <b>A61P 25/00</b> (2006.01) <b>A61P 29/00</b> (2006.01)	2603490 *	NOVEL TRPV3 MODULATORS
Cadila Healthcare Limited	<b>C12N 15/85</b> (2006.01)	2625277 *	EXPRESSION VECTOR FOR HIGH LEVEL EXPRESSION OF RECOMBINANT PROTEINS
Halozyyme, Inc.	<b>C07K 16/30</b> (2006.01) <b>G01N 33/53</b> (2006.01) <b>G01N 33/574</b> (2006.01) <b>G01N 33/68</b> (2006.01)	2614086 *	METHODS FOR ASSESSING AND IDENTIFYING OR EVOLVING CONDITIONALLY ACTIVE THERAPEUTIC PROTEINS
Mast Therapeutics, Inc.	<b>C07C 43/00</b> (2006.01)	2640684 *	METHODS FOR ENHANCING OXYGENATION OF JEOPARDIZED TISSUE
Hales, Paul Christopher	<b>A61B 1/267</b> (2006.01) <b>A61B 1/005</b> (2006.01)	2600760 *	IMPROVEMENTS IN LARYNGOSCOPY
Temple University - Of The Commonwealth System of Higher Education	<b>A01N 43/90</b> (2006.01) <b>A61K 31/519</b> (2006.01) <b>A61K 31/505</b> (2006.01)	2600719 *	2-SUBSTITUTED-8-ALKYL-7-OXO-7,8-DIHYDROPYRIDO[2,3-D]PYRIMIDINE-6-CARBONITRILES AND USES THEREOF
Europhyseo	<b>A61B 5/22</b> (2006.01) <b>A63B 23/12</b> (2006.01) <b>A61H 1/02</b> (2006.01)	2621340 *	APPARATUS FOR CLOSED KINETIC CHAIN MUSCLE STRENGTHENING AND/OR REHABILITATION OF THE SHOULDER JOINT AND OF THE UPPER LIMB
HERA S.p.A.	<b>B65F 1/14</b> (2006.01)	2643242 *	WASTE BIN HAVING A CONVERTER FOR CONVERTING MECHANICAL ENERGY INTO ELECTRICAL ENERGY
Altherx Inc.	<b>A61K 31/137</b> (2006.01) <b>A61K 31/216</b> (2006.01) <b>A61P 13/10</b> (2006.01)	2600859 *	COMBINATIONS OF BETA - 3 ADRENERGIC RECEPTOR AGONISTS AND MUSCARINIC RECEPTOR ANTAGONISTS FOR TREATING OVERACTIVE BLADDER
Gilead Sciences, Inc.	<b>A61K 31/706</b> (2006.01) <b>C07H 7/06</b> (2006.01) <b>C07H 21/04</b> (2006.01) <b>A61P 31/16</b> (2006.01)	2616080 *	2'-FLUORO SUBSTITUTED CARBA-NUCLEOSIDE ANALOGS FOR ANTIVIRAL TREATMENT
Takeda Pharmaceutical Company Limited	<b>C07D 513/04</b> (2006.01) <b>A61K 31/542</b> (2006.01) <b>A61P 25/00</b> (2006.01)	2603513 *	HETEROCYCLIC COMPOUND AND USE THEREOF
IVAX INTERNATIONAL GMBH	<b>C07B 59/00</b> (2006.01) <b>C07D 211/24</b> (2006.01) <b>A61K 31/445</b> (2006.01) <b>A61P 25/00</b> (2006.01)	2611759 *	DEUTERATED ANALOGS OF PRIDOPIDINE USEFUL AS DOPAMINERGIC STABILIZERS
CLAAS Selbstfahrende Erntemaschinen GmbH	<b>A01B 69/00</b> (2006.01) <b>A01D 41/12</b> (2006.01) <b>A01D 43/073</b> (2006.01) <b>G03B 17/55</b> (2006.01) <b>A01D 41/127</b> (2006.01) <b>A01D 43/08</b> (2006.01) <b>A01D 75/18</b> (2006.01)	2510774	Camera for monitoring machine functions of a vehicle and use of a camera
Exelixis, Inc.	<b>C07D 413/14</b> (2006.01) <b>C07D 471/04</b> (2006.01) <b>A61K 31/5377</b> (2006.01) <b>A61P 35/00</b> (2006.01) <b>C07D 413/04</b> (2006.01)	2643315 *	BENZOXAZEPINES AS INHIBITORS OF P13K/mTOR AND METHODS OF THEIR USE AND MANUFACTURE

Podnosilac evropske prijave patenta (71)	MKP (51)	Broj objave evropske prijave patenta (97)	Naziv pronalaska (54)
Abbvie Inc.	<b>A61K 47/22</b> (2006.01) <b>A61P 35/00</b> (2006.01) <b>A61K 9/48</b> (2006.01) <b>A61K 47/26</b> (2006.01) <b>A61K 9/14</b> (2006.01) <b>A61K 47/38</b> (2006.01) <b>A61K 47/32</b> (2006.01) <b>A61K 31/437</b> (2006.01) <b>A61K 47/44</b> (2006.01) <b>A61K 47/12</b> (2006.01) <b>A61K 47/34</b> (2006.01)	2632436 *	SOLID DISPERSIONS CONTAINING AN APOPTOSIS-INDUCING AGENT
Radius Health, Inc	<b>C07D 207/26</b> (2006.01) <b>C07D 233/36</b> (2006.01) <b>C07D 263/24</b> (2006.01) <b>C07D 417/04</b> (2006.01) <b>A61K 31/402</b> (2006.01) <b>A61K 31/4166</b> (2006.01) <b>A61K 31/421</b> (2006.01) <b>A61P 19/10</b> (2006.01)	2621901 *	SELECTIVE ANDROGEN RECEPTOR MODULATORS
Dow AgroSciences LLC	<b>A01N 25/00</b> (2006.01)	2635116 *	CONTROL OF PHENOXYALKANOIC ACID HERBICIDE-RESISTANT WEEDS WITH 4-AMINO-3-CHLORO-6-(4-CHLORO-2-FLUORO-3-METHOXYPHENYL)PYRIDINE-2-CARBOXYLIC ACID AND ITS SALTS OR ESTERS
Portola Pharmaceuticals, Inc.	<b>C07D 213/82</b> (2006.01)	2635556 *	BENZAMIDES AND NICOTINAMIDES AS SYK MODULATORS
Quantum Genomics	<b>C07C 309/14</b> (2006.01) <b>C07C 303/02</b> (2006.01)	2625163 *	METHOD FOR THE PREPARATION OF (3S,3S') 4,4'-DISULFANEDIYLBIS (3-AMINO BUTANE 1-SULFONIC ACID)
Phidias Technologies	<b>G06F 17/50</b> (2006.01)	2628102 *	RAPID PROTOTYPING METHOD AND DEVICE
Unterlercher, Bernhard	<b>F03B 1/00</b> (2006.01) <b>F03B 1/02</b> (2006.01) <b>F01D 5/30</b> (2006.01)	2365209	Turbine wheel with strongly connected and force-fit blades
Almirall S.A.	<b>A61P 35/02</b> (2006.01) <b>C07D 471/04</b> (2006.01) <b>C07D 487/04</b> (2006.01) <b>A61K 31/5025</b> (2006.01) <b>A61P 37/06</b> (2006.01) <b>A61P 35/00</b> (2006.01)	2643321 *	IMIDAZO [1,2-B]PYRIDAZINE AND IMIDAZO [4,5-B] PYRIDINE DERIVATIVES AS JAK INHIBITORS
M.B.H. Developpement	<b>B24B 23/00</b> (2006.01) <b>B24B 55/10</b> (2006.01) <b>B24B 7/18</b> (2006.01)	2572828	Mobile structure for a tool supported on a pivoting arm
Janssen Pharmaceutica, N.V.	<b>C07D 487/04</b> (2006.01) <b>A61K 31/4985</b> (2006.01) <b>A61P 25/28</b> (2006.01)	2619207 *	4,7-DIHYDRO-PYRAZOLO[1,5-a]PYRAZIN-6-YLAMINE DERIVATIVES USEFUL AS INHIBITORS OF BETA-SECRETASE (BACE)
Arena Pharmaceuticals, Inc.	<b>C07D 413/14</b> (2006.01) <b>A61K 31/506</b> (2006.01) <b>A61P 3/00</b> (2006.01)	2619198 *	MODULATORS OF THE GPR119 RECEPTOR AND THE TREATMENT OF DISORDERS RELATED THERETO
Bind Therapeutics, Inc.	<b>A61K 31/337</b> (2006.01) <b>A61K 47/30</b> (2006.01) <b>A61K 9/16</b> (2006.01) <b>A61K 47/48</b> (2006.01) <b>A61K 47/36</b> (2006.01)	2629760 *	THERAPEUTIC NANOPARTICLES WITH HIGH MOLECULAR WEIGHT COPOLYMERS
AbbVie Inc.	<b>A61J 3/06</b> (2006.01)	2635247 *	METHOD FOR PRODUCING MONOLITHIC TABLETS
Abbvie Deutschland GmbH & Co. KG	<b>A61J 3/06</b> (2006.01)	2635247 *	METHOD FOR PRODUCING MONOLITHIC TABLETS
Packers Plus Energy Services Inc.	<b>E21B 43/26</b> (2006.01) <b>E21B 34/14</b> (2006.01) <b>E21B 43/14</b> (2006.01)	2619405 *	APPARATUS AND METHOD FOR FLUID TREATMENT OF A WELL
Arena Pharmaceuticals, Inc.	<b>A61K 9/20</b> (2006.01) <b>A61K 9/28</b> (2006.01) <b>A61K 31/55</b> (2006.01)	2611427 *	MODIFIED-RELEASE DOSAGE FORMS OF 5-HT <sub>2C</sub> AGONISTS USEFUL FOR WEIGHT MANAGEMENT & xA;

Podnosilac evropske prijave patenta (71)	MKP (51)	Broj objave evropske prijave patenta (97)	Naziv pronalaska (54)
Thales Italia S.p.A.	<b>H03K 5/08</b> (2006.01) <b>H03K 5/1534</b> (2006.01) <b>H04B 1/7163</b> (2011.01)	2533423	Method for detecting with a high temporal accuracy a threshold crossing instant by a signal
Limonov, Viktor Lvovich	<b>A61K 31/545</b> (2006.01) <b>A61K 47/04</b> (2006.01) <b>A61K 9/51</b> (2006.01) <b>A61P 31/04</b> (2006.01)	2620152 *	PHARMACEUTICAL COMPOSITION WITH ANTIMICROBIAL ACTIVITY FOR PARENTERAL ADMINISTRATION AND PROCESS FOR PREPARING SAME
Alk AG	<b>G09B 19/00</b> (2006.01) <b>G09B 19/24</b> (2006.01) <b>G09B 5/06</b> (2006.01) <b>G09B 23/28</b> (2006.01)	2541532	A training device for an auto-injector
Janssen Biotech, Inc.	<b>C12N 5/0735</b> (2010.01) <b>C12N 5/02</b> (2006.01) <b>C12N 5/071</b> (2010.01)	2611910 *	DIFFERENTIATION OF HUMAN EMBRYONIC STEM CELLS
Sanofi Pasteur	<b>A61K 39/00</b> (2006.01) <b>A61M 5/178</b> (2006.01)	2629792 *	METHOD OF STORING A VACCINE CONTAINING AN ALUMINUM ADJUVANT
Albireo AB	<b>A61P 3/00</b> (2006.01) <b>A61K 31/554</b> (2006.01)	2637667 *	IBAT INHIBITORS FOR TREATMENT OF METABOLIC DISORDERS AND RELATED CONDITIONS
Kienzl, Thomas	<b>G06F 3/041</b> (2006.01) <b>G06F 3/01</b> (2006.01) <b>G06T 7/00</b> (2006.01) <b>G06F 3/042</b> (2006.01)	2643812 *	METHOD FOR DISPLAYING AN ITEM ON A DISPLAY UNIT
Bayer Pharma Aktiengesellschaft	<b>C07D 471/04</b> (2006.01)	2611803 *	METHOD FOR THE PRODUCTION OF 5-FLUORO-1H-PYRAZOLO[3,4-B]PYRIDINE-3-CARBONITRILE
Scandinavian Tobacco Group Lummen N.V.	<b>A24D 1/00</b> (2006.01) <b>A24D 1/04</b> (2006.01) <b>A24D 3/06</b> (2006.01)	2532258	A tar reducing cigar with filter section comprising expanded, cut tobacco stems
Teva Pharmaceutical Industries Ltd.	<b>A61K 31/135</b> (2006.01)	2603212 *	USE OF RASAGILINE FOR THE TREATMENT OF OLFACTORY DYSFUNCTION
OHR Pharmaceutical, Inc.	<b>A61K 9/00</b> (2006.01) <b>A61K 31/56</b> (2006.01) <b>A61K 31/575</b> (2006.01) <b>A61K 47/26</b> (2006.01) <b>A61K 47/28</b> (2006.01) <b>A61K 47/32</b> (2006.01) <b>A61K 47/36</b> (2006.01)	2605752 *	OPHTHALMIC FORMULATIONS OF SQUALAMINE
Millennium Pharmaceuticals, Inc.	<b>A61K 31/365</b> (2006.01) <b>A01N 43/78</b> (2006.01) <b>A01N 43/16</b> (2006.01) <b>A61K 31/35</b> (2006.01) <b>A61K 31/425</b> (2006.01)	2627181 *	HETEROARYLS AND USES THEREOF
Ecoval Environnement	<b>B09B 3/00</b> (2006.01) <b>B27B 3/00</b> (2006.01) <b>B29B 17/02</b> (2006.01)	2598259 *	METHOD FOR CLEANING UP MATERIALS THAT RESULT FROM THE RECYCLING OF FURNITURE, IN PARTICULAR MATTRESSES, BED BASES AND SEATS
Agriphar S.A.	<b>A01N 43/50</b> (2006.01) <b>A01N 25/30</b> (2006.01) <b>A01N 25/02</b> (2006.01) <b>A01N 53/00</b> (2006.01) <b>A01N 37/42</b> (2006.01) <b>A01N 43/653</b> (2006.01) <b>A01N 47/12</b> (2006.01) <b>A01N 47/20</b> (2006.01) <b>A01N 43/40</b> (2006.01)	2548437	Improved method for producing emulsifiable pesticide solutions
MERICHEM COMPANY	<b>B01D 53/52</b> (2006.01) <b>B01D 53/78</b> (2006.01) <b>B01D 53/96</b> (2006.01)	2632569 *	HIGH PRESSURE REDUCTION-OXIDATION DESULFURIZATION PROCESS
CEMBRE S.p.A.	<b>H01R 4/06</b> (2006.01) <b>H01R 43/00</b> (2006.01)	2562875	Pulling device for pulling a punch in a contact bush
Sanofi-Aventis Deutschland GmbH	<b>A61M 5/24</b> (2006.01)	2603258 *	MECHANISM FOR PREVENTING SELECTION OF A DOSE

Podnosilac evropske prijave patenta (71)	MKP (51)	Broj objave evropske prijave patenta (97)	Naziv pronalaska (54)
AstraZeneca AB	<b>A61P 25/04</b> (2006.01) <b>A61K 33/42</b> (2006.01) <b>A61K 31/194</b> (2006.01) <b>A61K 31/765</b> (2006.01) <b>A61K 31/485</b> (2006.01)	2621496 *	CRYSTALLINE NALOXOL-PEG CONJUGATE
Nektar Therapeutics	<b>A61P 25/04</b> (2006.01) <b>A61K 33/42</b> (2006.01) <b>A61K 31/194</b> (2006.01) <b>A61K 31/765</b> (2006.01) <b>A61K 31/485</b> (2006.01)	2621496 *	CRYSTALLINE NALOXOL-PEG CONJUGATE
Brandoni Solare S.p.A.	<b>F24J 2/52</b> (2006.01) <b>H01L 31/042</b> (2006.01)	2642218	A modular apparatus for architectural integration of frameless solar modules
Exelixis, Inc.	<b>C07D 413/04</b> (2006.01)	2643316 *	BENZOXAZEPINES AS INHIBITORS OF P13K/MTOR AND METHODS OF THEIR USE AND MANUFACTURE
Burcon Nutrascience (MB) Corp.	<b>A23J 1/14</b> (2006.01) <b>A23J 3/16</b> (2006.01)	2605666 *	IMPROVED PRODUCTION OF PROTEIN SOLUTIONS FROM SOY
Novartis AG	<b>C07K 16/32</b> (2006.01) <b>A61K 39/395</b> (2006.01) <b>A61P 35/00</b> (2006.01)	2606070 *	ANTIBODIES FOR EPIDERMAL GROWTH FACTOR RECEPTOR 3 (HER3)
Genmab A/S	<b>C07K 16/28</b> (2006.01) <b>A61K 39/00</b> (2006.01)	2576621 *	MONOCLONAL ANTIBODIES AGAINST HER2
Les Laboratoires Servier	<b>C07D 209/42</b> (2006.01) <b>A61K 31/403</b> (2006.01)	2612850	Delta crystalline form of the arginine salt of perindopril, a process for its preparation, and pharmaceutical compositions containing it
Kaspersky Lab, ZAO	<b>G06F 17/30</b> (2006.01)	2447859	System and method for acceleration of malware detection using antivirus cache
CANADA POST CORPORATION	<b>B65D 21/06</b> (2006.01) <b>B65D 43/02</b> (2006.01)	2517971	Material handling device
Sanofi-Aventis Deutschland GmbH	<b>A61M 5/315</b> (2006.01)	2632512 *	DRUG DELIVERY DEVICE AND METHOD FOR ASSEMBLING A DRUG DELIVERY DEVICE
Nanoentek Inc.	<b>G01B 9/04</b> (2006.01) <b>G01N 21/64</b> (2006.01)	2607889 *	FLUORESCENCE MICROSCOPE FOR MULTI-FLUORESCENCE IMAGE OBSERVATION, FLUORESCENCE IMAGE OBSERVATION METHOD USING THE SAME, AND MULTI-FLUORESCENCE IMAGE OBSERVATION SYSTEM
Suominen Corporation	<b>D04H 5/02</b> (2012.01) <b>D04H 5/06</b> (2006.01) <b>D04H 13/00</b> (2006.01) <b>A47L 13/17</b> (2006.01) <b>A61K 8/02</b> (2006.01)	2540892	Water dispersible nonwoven fabric material
Millennium Pharmaceuticals, Inc.	<b>A61K 31/33</b> (2006.01) <b>A61K 31/425</b> (2006.01)	2603214 *	HETEROARYLS AND USES THEREOF
Pizzamiglio, Cristian	<b>B66D 1/50</b> (2006.01)	2554507	Cable tension measuring device
NSE Industry S.p.A.	<b>B30B 5/06</b> (2006.01) <b>B30B 9/32</b> (2006.01)	2625030 *	COMPACTING CONVEYOR BELT PARTICULARLY FOR THE FEED OF PYROLYSIS, GASIFICATION AND COMBUSTION PLANTS
Theravance, Inc.	<b>C07D 233/70</b> (2006.01) <b>A61K 31/4174</b> (2006.01) <b>A61P 9/00</b> (2006.01)	2638017 *	CRYSTALLINE FORMS OF AN ALKOXYIMIDAZOL-1-YLMETHYL BIPHENYL CARBOXYLIC ACID
LG Life Sciences Ltd	<b>A61K 9/113</b> (2006.01) <b>A61K 9/107</b> (2006.01) <b>A61K 31/728</b> (2006.01)	2616047 *	NON-AQUEOUS OILY INJECTABLE FORMULATION EXHIBITING PRESERVATIVE EFFICACY
Cree, Inc.	<b>H01L 29/18</b> (2006.01)	2603930 *	LED PACKAGE WITH EFFICIENT, ISOLATED THERMAL PATH
Lauer, Ulrich M.	<b>A61K 35/76</b> (2006.01) <b>C12N 15/45</b> (2006.01) <b>A61P 35/00</b> (2006.01) <b>C12N 9/10</b> (2006.01) <b>C12N 9/78</b> (2006.01) <b>C07K 19/00</b> (2006.01)	2605783 *	ONCOLYTIC MEASLES VIRUS

Podnosilac evropske prijave patenta (71)	MKP (51)	Broj objave evropske prijave patenta (97)	Naziv pronalaska (54)
Bitzer, Michael	<b>A61K 35/76</b> (2006.01) <b>C12N 15/45</b> (2006.01) <b>A61P 35/00</b> (2006.01) <b>C12N 9/10</b> (2006.01) <b>C12N 9/78</b> (2006.01) <b>C07K 19/00</b> (2006.01)	2605783 *	ONCOLYTIC MEASLES VIRUS
Lampe, Johanna	<b>A61K 35/76</b> (2006.01) <b>C12N 15/45</b> (2006.01) <b>A61P 35/00</b> (2006.01) <b>C12N 9/10</b> (2006.01) <b>C12N 9/78</b> (2006.01) <b>C07K 19/00</b> (2006.01)	2605783 *	ONCOLYTIC MEASLES VIRUS
Zimmermann, Martina	<b>A61K 35/76</b> (2006.01) <b>C12N 15/45</b> (2006.01) <b>A61P 35/00</b> (2006.01) <b>C12N 9/10</b> (2006.01) <b>C12N 9/78</b> (2006.01) <b>C07K 19/00</b> (2006.01)	2605783 *	ONCOLYTIC MEASLES VIRUS
Berchtold, Susanne	<b>A61K 35/76</b> (2006.01) <b>C12N 15/45</b> (2006.01) <b>A61P 35/00</b> (2006.01) <b>C12N 9/10</b> (2006.01) <b>C12N 9/78</b> (2006.01) <b>C07K 19/00</b> (2006.01)	2605783 *	ONCOLYTIC MEASLES VIRUS
Lange, Sebastian	<b>A61K 35/76</b> (2006.01) <b>C12N 15/45</b> (2006.01) <b>A61P 35/00</b> (2006.01) <b>C12N 9/10</b> (2006.01) <b>C12N 9/78</b> (2006.01) <b>C07K 19/00</b> (2006.01)	2605783 *	ONCOLYTIC MEASLES VIRUS
Neubert, Wolfgang J.	<b>A61K 35/76</b> (2006.01) <b>C12N 15/45</b> (2006.01) <b>A61P 35/00</b> (2006.01) <b>C12N 9/10</b> (2006.01) <b>C12N 9/78</b> (2006.01) <b>C07K 19/00</b> (2006.01)	2605783 *	ONCOLYTIC MEASLES VIRUS
Bossow, Sascha	<b>A61K 35/76</b> (2006.01) <b>C12N 15/45</b> (2006.01) <b>A61P 35/00</b> (2006.01) <b>C12N 9/10</b> (2006.01) <b>C12N 9/78</b> (2006.01) <b>C07K 19/00</b> (2006.01)	2605783 *	ONCOLYTIC MEASLES VIRUS
Maria Clementine Martin Klosterfrau Vertriebsgesellschaft mbH	<b>A61K 36/25</b> (2006.01) <b>A61K 36/11</b> (2006.01) <b>A61K 36/53</b> (2006.01) <b>A61P 11/00</b> (2006.01) <b>A61K 36/57</b> (2006.01) <b>A61K 36/185</b> (2006.01) <b>A61P 11/10</b> (2006.01) <b>A61K 36/28</b> (2006.01) <b>A61P 11/12</b> (2006.01) <b>A61K 36/235</b> (2006.01) <b>A61K 36/35</b> (2006.01)	2605831 *	METHOD FOR PRODUCING NON-ALCOHOLIC PLANT-BASED COMPOSITIONS, COMPOSITIONS PRODUCED IN SAID MANNER AND USE THEREOF
Arena Pharmaceuticals, Inc.	<b>A61K 31/55</b> (2006.01) <b>A61P 3/04</b> (2006.01)	2611449 *	ADMINISTRATION OF LORCASERIN TO INDIVIDUALS WITH RENAL IMPAIRMENT
Sanofi-Aventis Deutschland GmbH	<b>A61M 5/28</b> (2006.01) <b>A61J 1/06</b> (2006.01)	2595677 *	MEDICAMENT CARTRIDGES WITH NON-STANDARD DIMENSIONS
Valls Chaparro, Isaac	<b>B60K 28/06</b> (2006.01) <b>G01N 33/497</b> (2006.01) <b>B60R 25/04</b> (2013.01) <b>G06K 9/00</b> (2006.01)	2596975 *	IDENTIFICATION AND SECURITY DEVICE USING SHORT-DISTANCE OCULAR BIOMETRY
López Roca, Sergio	<b>B60K 28/06</b> (2006.01) <b>G01N 33/497</b> (2006.01) <b>B60R 25/04</b> (2013.01) <b>G06K 9/00</b> (2006.01)	2596975 *	IDENTIFICATION AND SECURITY DEVICE USING SHORT-DISTANCE OCULAR BIOMETRY

Podnosilac evropske prijave patenta (71)	MKP (51)	Broj objave evropske prijave patenta (97)	Naziv pronalaska (54)
UCB Pharma, S.A.	<b>C07K 1/18</b> (2006.01) <b>C07K 1/36</b> (2006.01)	2598514 *	PROTEIN PURIFICATION
Tesimax - Altinger GmbH	<b>A62B 17/00</b> (2006.01) <b>A62B 9/00</b> (2006.01) <b>A62B 9/02</b> (2006.01)	2407208	Protective suit with breathing air supply device
SHEMIGON, Mikhail Vladimirovich	<b>C21C 5/48</b> (2006.01) <b>F27D 3/16</b> (2006.01) <b>B22D 1/00</b> (2006.01)	2635715 *	SECTION FOR PROCESSING LIQUID METAL WITH GASES
Zhivchenko, Vladimir Semyonovich	<b>C21C 5/48</b> (2006.01) <b>F27D 3/16</b> (2006.01) <b>B22D 1/00</b> (2006.01)	2635715 *	SECTION FOR PROCESSING LIQUID METAL WITH GASES
Geberit International AG	<b>E03C 1/22</b> (2006.01) <b>E03F 5/04</b> (2006.01) <b>A47K 3/40</b> (2006.01)	2554755	Floor drainage system
Amgen Inc.	<b>C07D 401/12</b> (2006.01) <b>C07D 401/14</b> (2006.01) <b>C07D 473/34</b> (2006.01) <b>C07D 239/48</b> (2006.01) <b>C07D 403/12</b> (2006.01) <b>A61K 31/506</b> (2006.01) <b>A61K 31/52</b> (2006.01) <b>A61K 31/505</b> (2006.01) <b>A61P 29/00</b> (2006.01) <b>A61P 19/02</b> (2006.01) <b>A61P 35/00</b> (2006.01) <b>A61P 37/00</b> (2006.01)	2635565 *	5 -CYANO-4, 6 -DIAMINOPYRIMIDINE OR 6 -AMINOPURINE DERIVATIVES AS PI3K- DELTA INHIBITORS
Vanderbilt Chemicals, LLC	<b>C08F 2/00</b> (2006.01)	2625206 *	ACCELERATOR COMPOSITION FOR ELASTOMERS
The University of Massachusetts	<b>A61K 38/17</b> (2006.01) <b>C07K 16/18</b> (2006.01) <b>A61K 39/395</b> (2006.01) <b>C07K 14/435</b> (2006.01) <b>C12N 15/13</b> (2006.01) <b>A61P 21/00</b> (2006.01)	2632952 *	ANTI-SOD1 ANTIBODIES AND USES THEREOF
Zafgen, Inc.	<b>C07D 209/42</b> (2006.01) <b>A61K 31/404</b> (2006.01) <b>A61P 3/04</b> (2006.01) <b>C07D 333/68</b> (2006.01) <b>C07D 409/04</b> (2006.01) <b>C07D 495/04</b> (2006.01) <b>A61K 31/381</b> (2006.01) <b>C07D 333/26</b> (2006.01)	2627632 *	SULPHONAMIDE COMPOUNDS AND METHODS OF MAKING AND USING SAME
Shiono Chemical Co., Ltd.	<b>C07C 5/08</b> (2006.01) <b>C07C 29/17</b> (2006.01) <b>C01B 3/08</b> (2006.01) <b>C07C 15/18</b> (2006.01) <b>C07C 41/20</b> (2006.01) <b>C07B 31/00</b> (2006.01) <b>C07C 15/52</b> (2006.01) <b>C07C 43/205</b> (2006.01) <b>C01B 3/04</b> (2006.01) <b>C07C 9/15</b> (2006.01) <b>C07C 41/18</b> (2006.01) <b>C07C 5/10</b> (2006.01) <b>C07C 33/22</b> (2006.01) <b>C01B 4/00</b> (2006.01) <b>C07C 15/24</b> (2006.01) <b>C07C 41/24</b> (2006.01) <b>C07C 5/09</b> (2006.01) <b>C07C 33/20</b> (2006.01) <b>C07C 1/26</b> (2006.01) <b>C07C 29/143</b> (2006.01)	2607300 *	PROCESS FOR PRODUCING HYDROGEN OR HEAVY HYDROGENS, AND HYDROGENATION (PROTIATION, DEUTERATION OR TRITIATION) OF ORGANIC COMPOUNDS USING SAME

Podnosilac evropske prijave patenta (71)	MKP (51)	Broj objave evropske prijave patenta (97)	Naziv pronalaska (54)
Teijin Pharma Limited	<b>C07D 277/20</b> (2006.01) <b>C07D 277/56</b> (2006.01) <b>A61K 31/426</b> (2006.01) <b>A61P 19/06</b> (2006.01) <b>A61P 43/00</b> (2006.01)	2610248 *	METHOD FOR PRODUCING PHENYL-SUBSTITUTED HETEROCYCLIC DERIVATIVE BY MEANS OF COUPLING METHOD USING A PALLADIUM COMPOUND
Quagliato, Giovanni Battista	<b>H01L 31/048</b> (2006.01)	2521188	Photovoltaic module in the shape of an architectural element and process for the realization thereof
McNeil-PPC, Inc.	<b>A61K 9/28</b> (2006.01) <b>A61K 9/20</b> (2006.01)	2605760 *	TABLET SLEEVE FOR IMPROVED PERFORMANCE
Bayer Intellectual Property GmbH	<b>A61K 9/00</b> (2006.01) <b>A61K 31/4427</b> (2006.01) <b>A61K 31/4439</b> (2006.01) <b>A61P 27/06</b> (2006.01)	2611415 *	ADENOSINE A1 AGONISTS FOR THE TREATMENT OF GLAUCOMA AND OCULAR HYPERTENSION
Hempel, Armin	<b>F21S 8/00</b> (2006.01) <b>F21S 8/08</b> (2006.01) <b>F21V 21/116</b> (2006.01) <b>F21Y 101/02</b> (2006.01) <b>F21W 131/103</b> (2006.01)	2402645	Illumination device
APPLE INC.	<b>G06F 21/44</b> (2013.01) <b>G06F 21/85</b> (2013.01) <b>G06F 13/38</b> (2006.01)	2634724	Adapter for electronic devices
Exelixis, Inc.	<b>C07D 513/04</b> (2006.01) <b>A61K 31/437</b> (2006.01)	2643327 *	BENZOXAZEPINES AS INHIBITORS OF MTOR AND METHODS OF THEIR USE AND MANUFACTURE
Abbvie Inc.	<b>A61P 31/14</b> (2006.01) <b>A61K 31/4725</b> (2006.01) <b>A61K 31/501</b> (2006.01) <b>A61P 31/12</b> (2006.01) <b>A61K 45/06</b> (2006.01) <b>A61K 31/7072</b> (2006.01) <b>A61K 31/4178</b> (2006.01) <b>A61K 31/513</b> (2006.01) <b>A61K 31/5377</b> (2006.01) <b>A61K 31/4709</b> (2006.01)	2583680	Mono (PSI-7977) or combination treatment of DAAs for use in treating HCV
Glaxosmithkline Intellectual Property (No. 2) Limited	<b>C07D 417/00</b> (2006.01) <b>A61K 31/44</b> (2006.01) <b>C07D 417/14</b> (2006.01) <b>G01N 33/53</b> (2006.01) <b>C07D 401/00</b> (2006.01) <b>C12Q 1/68</b> (2006.01)	2640387 *	METHOD OF TREATMENT WITH BRAF INHIBITOR
Hexal AG	<b>A61K 31/4045</b> (2006.01) <b>A61K 47/02</b> (2006.01) <b>A61K 47/26</b> (2006.01) <b>A61K 31/519</b> (2006.01) <b>A61K 47/44</b> (2006.01) <b>A61K 31/495</b> (2006.01) <b>A61K 9/00</b> (2006.01) <b>A61K 9/70</b> (2006.01)	2632429 *	ORAL PHARMACEUTICAL FILM FORMULATION FOR BITTER-TASTING DRUGS
Albireo AB	<b>A61K 31/554</b> (2006.01) <b>A61P 1/16</b> (2006.01)	2637668 *	IBAT INHIBITORS FOR THE TREATMENT OF LIVER DISEASES
Omya Development AG	<b>C08K 9/00</b> (2006.01) <b>C08J 9/04</b> (2006.01) <b>C08J 9/00</b> (2006.01) <b>C08K 3/26</b> (2006.01) <b>C08K 9/04</b> (2006.01)	2612881	Fillers for foamed rigid polymer products
Masonite Corporation	<b>B27M 1/08</b> (2006.01) <b>B27M 3/18</b> (2006.01) <b>B27G 11/00</b> (2006.01)	2598297 *	AUTOMATED DOOR ASSEMBLY, PRESS, AND ADHESIVE THEREFOR
E.B.M.-Elektro-Bau-Montage GmbH & Co. KG	<b>G07B 15/02</b> (2011.01) <b>G08G 1/14</b> (2006.01) <b>G07F 17/24</b> (2006.01) <b>B60R 25/10</b> (2006.01)	2279919	Device and method for preventing a parked car from being stolen and monitoring a parked car



Podnosilac evropske prijave patenta (71)	MKP (51)	Broj objave evropske prijave patenta (97)	Naziv pronalaska (54)
Chiesi Farmaceutici S.p.A.	<b>A61K 9/00</b> (2006.01) <b>A61K 31/44</b> (2006.01) <b>A61P 11/06</b> (2006.01)	2600829 *	PHARMACEUTICAL FORMULATION COMPRISING A PHOSPHODIESTERASE INHIBITOR
Novartis AG	<b>A61P 9/12</b> (2006.01) <b>A61K 31/41</b> (2006.01) <b>C07D 257/04</b> (2006.01)	2601180 *	HIGHLY CRYSTALLINE VALSARTAN
Sonavation, Inc.	<b>A41D 1/06</b> (2006.01) <b>G01H 5/00</b> (2006.01) <b>G01R 27/28</b> (2006.01)	2630507 *	ELECTRICAL SYSTEM, METHOD, AND APPARATUS OF FINGERPRINT SENSOR USING ACOUSTIC IMPEDIOGRAPHY
E.B.M.-Elektro-Bau-Montage GmbH & Co. KG	<b>G08G 1/14</b> (2006.01)	2309472	Parking guidance system and method for operating a parking guidance system
Novartis AG	<b>G02C 7/04</b> (2006.01) <b>B29D 11/00</b> (2006.01) <b>B05D 5/06</b> (2006.01)	2598938 *	A SILICONE HYDROGEL LENS WITH A CROSSLINKED HYDROPHILIC COATING
Biogen Idec MA Inc.	<b>C07D 211/60</b> (2006.01)	2632898 *	HETEROCYCLIC TYROSINE KINASE INHIBITORS
Sunesis Pharmaceuticals, Inc.	<b>C07D 211/60</b> (2006.01)	2632898 *	HETEROCYCLIC TYROSINE KINASE INHIBITORS
Deuteria Pharmaceuticals, Inc.	<b>A61K 31/40</b> (2006.01) <b>A01N 43/38</b> (2006.01)	2640189 *	3-DEUTERO-POMALIDOMIDE
Boehringer Ingelheim International GmbH	<b>C07D 413/10</b> (2006.01) <b>C07D 413/14</b> (2006.01) <b>C07D 417/12</b> (2006.01) <b>C07D 417/14</b> (2006.01) <b>C07D 471/04</b> (2006.01) <b>C07D 487/04</b> (2006.01) <b>C07D 498/04</b> (2006.01) <b>A61K 31/437</b> (2006.01) <b>A61K 31/4439</b> (2006.01) <b>A61K 31/444</b> (2006.01) <b>A61K 31/497</b> (2006.01) <b>A61K 31/4985</b> (2006.01) <b>A61K 31/506</b> (2006.01) <b>A61K 31/5365</b> (2006.01) <b>A61K 31/5377</b> (2006.01) <b>A61K 31/541</b> (2006.01) <b>A61P 9/00</b> (2006.01) <b>A61P 9/10</b> (2006.01) <b>A61P 29/00</b> (2006.01) <b>A61P 37/08</b> (2006.01) <b>A61P 11/00</b> (2006.01)	2606045 *	OXADIAZOLE INHIBITORS OF LEUKOTRIENE PRODUCTION
Teva Pharmaceutical Industries Ltd.	<b>A01N 43/42</b> (2006.01)	2597954 *	DEUTERATED N-ETHYL-N-PHENYL-1,2-DIHYDRO-4-HYDROXY-5-CHLORO-1-METHYL-2-OXOQUINOLINE-3-CARBOXAMIDE, SALTS AND USES THEREOF
gabo Systemtechnik GmbH	<b>H02G 3/22</b> (2006.01) <b>H02G 15/013</b> (2006.01)	2333924	Wall bushing for feeding through cables, cable protection tubes or other conduits
Ethicon Endo-Surgery, Inc.	<b>A61B 17/064</b> (2006.01) <b>A61B 17/072</b> (2006.01)	2517635	Staple cartridge with implantable compressible portion and insertion cap
SANOFI	<b>C07D 487/04</b> (2006.01) <b>A61P 35/00</b> (2006.01)	2598507 *	ANTICANCER DERIVATIVES, PREPARATION THEREOF AND THERAPEUTIC USE THEREOF
Arena Pharmaceuticals, Inc.	<b>C07D 223/16</b> (2006.01) <b>A61K 31/55</b> (2006.01) <b>A61P 3/04</b> (2006.01)	2611781 *	FAST-DISSOLVE DOSAGE FORMS OF 5-HT2C AGONISTS
Genzyme Corporation	<b>C07K 14/71</b> (2006.01)	2601214 *	VEGF ANTAGONIST COMPOSITIONS AND USES THEREOF
Biogaia AB	<b>B32B 27/18</b> (2006.01) <b>B65D 81/26</b> (2006.01) <b>A23L 1/30</b> (2006.01)	2619007 *	PRODUCT INCLUDING LACTIC ACID BACTERIA AND A DESICCANT

Podnosilac evropske prijave patenta (71)	MKP (51)	Broj objave evropske prijave patenta (97)	Naziv pronalaska (54)
Aragon Pharmaceuticals, Inc.	<b>C07D 409/06</b> (2006.01) <b>C07D 401/06</b> (2006.01) <b>A61K 31/416</b> (2006.01) <b>A61K 31/4192</b> (2006.01) <b>A61P 35/00</b> (2006.01) <b>C07D 231/56</b> (2006.01) <b>C07D 249/18</b> (2006.01)	2616445 *	ESTROGEN RECEPTOR MODULATORS AND USES THEREOF
Merck Serono S.A.	<b>C12Q 1/68</b> (2006.01)	2611931 *	GENOMIC MARKERS FOR PREDICTION OF LONG-TERM RESPONSE TO GROWTH HORMONE (GH) THERAPY
Onesteel NSW Pty Limited	<b>C08K 3/08</b> (2006.01) <b>C10L 5/14</b> (2006.01) <b>C08K 3/22</b> (2006.01) <b>C22B 1/244</b> (2006.01)	2603617 *	COMPOSITE PRODUCTS AND MANUFACTURING METHOD
Protektorwerk Florenz Maisch GmbH & Co. KG	<b>B21D 47/04</b> (2006.01) <b>E04C 3/08</b> (2006.01)	2616199 *	DEVICE AND METHOD FOR EXPANDING METAL ELEMENTS
Blue Jeans Network, Inc.	<b>H04N 7/26</b> (2006.01) <b>H04N 7/68</b> (2006.01)	2625856 *	SYSTEMS AND METHODS FOR ERROR RESILIENT SCHEME FOR LOW LATENCY H.264 VIDEO CODING
Marlink AS	<b>H04L 12/46</b> (2006.01) <b>H04L 12/18</b> (2006.01)	2617166 *	METHOD AND APPARATUS FOR REDUCING RECEIVER IDENTIFICATION OVERHEAD IN IP BROADCAST NETWORKS
Delphi Technologies Holding S.à.r.l.	<b>F16B 37/12</b> (2006.01)	2557322	Fixing arrangement
Biontech AG	<b>A61K 39/00</b> (2006.01) <b>C07K 14/705</b> (2006.01) <b>C07K 14/47</b> (2006.01) <b>C07K 14/045</b> (2006.01)	2618835 *	ANTIGEN-SPECIFIC T CELL RECEPTORS AND T CELL EPITOPES
Universitätsmedizin der Johannes Gutenberg-Universität Mainz	<b>A61K 39/00</b> (2006.01) <b>C07K 14/705</b> (2006.01) <b>C07K 14/47</b> (2006.01) <b>C07K 14/045</b> (2006.01)	2618835 *	ANTIGEN-SPECIFIC T CELL RECEPTORS AND T CELL EPITOPES
TRON - Translationale Onkologie an der Universitätsmedizin der Johannes Gutenberg-Universität Mainz gemeinnützige GmbH	<b>A61K 39/00</b> (2006.01) <b>C07K 14/705</b> (2006.01) <b>C07K 14/47</b> (2006.01) <b>C07K 14/045</b> (2006.01)	2618835 *	ANTIGEN-SPECIFIC T CELL RECEPTORS AND T CELL EPITOPES
Motor Development International S.A.	<b>F01B 17/02</b> (2006.01) <b>F02G 1/02</b> (2006.01) <b>F24J 2/42</b> (2006.01)	2625385 *	MONO-ENERGY AND/OR DUAL-ENERGY ENGINE WITH COMPRESSED AIR AND/OR ADDITIONAL ENERGY, COMPRISING AN ACTIVE CHAMBER INCLUDED IN THE CYLINDER
Galderma S.A.	<b>A61K 9/00</b> (2006.01) <b>A61K 9/06</b> (2006.01) <b>A61K 47/32</b> (2006.01) <b>A61K 31/498</b> (2006.01)	2629757 *	BRIMONIDINE GEL COMPOSITIONS AND METHODS OF USE
Endocyte, Inc.	<b>G01N 33/574</b> (2006.01)	2638395 *	METHODS OF TREATING CANCER
Genentech, Inc.	<b>G01N 33/574</b> (2006.01) <b>A61K 39/00</b> (2006.01)	2612151 *	BIOMARKERS AND METHODS OF TREATMENT
Zafgen, Inc.	<b>C07D 303/16</b> (2006.01) <b>A61K 31/336</b> (2006.01) <b>A61P 3/00</b> (2006.01)	2638023 *	CRYSTALLINE SOLIDS OF A METAP-2 INHIBITOR AND METHODS OF MAKING AND USING SAME
Glycomark, Inc.	<b>G01N 33/66</b> (2006.01) <b>G01N 33/68</b> (2006.01) <b>G01N 33/72</b> (2006.01)	2630501 *	IMPROVED IDENTIFICATION OF PRE-DIABETES USING A COMBINATION OF MEAN GLUCOSE AND 1,5-ANHYDROGLUCITOL MARKERS
Qu Biologics Inc	<b>A61P 1/00</b> (2006.01) <b>G01N 33/48</b> (2006.01) <b>A61P 29/00</b> (2006.01) <b>A61P 35/00</b> (2006.01) <b>A61K 39/00</b> (2006.01) <b>A61K 39/02</b> (2006.01) <b>A61K 39/12</b> (2006.01)	2598165 *	IMMUNOGENIC ANTI-INFLAMMATORY COMPOSITIONS

Podnosilac evropske prijave patenta (71)	MKP (51)	Broj objave evropske prijave patenta (97)	Naziv pronalaska (54)
Boehringer Ingelheim International GmbH	<b>C07K 16/24</b> (2006.01)	2635601 *	ANTI-IL-23 ANTIBODIES
Coty Inc.	<b>A61K 8/19</b> (2006.01) <b>A61Q 1/00</b> (2006.01) <b>A61K 8/97</b> (2006.01) <b>A61K 8/72</b> (2006.01) <b>A61K 8/92</b> (2006.01) <b>A61Q 1/04</b> (2006.01)	2637640 *	SHINY, TRANSFER RESISTANT LIPSTICK AND METHOD OF MAKING
Egis Gyógyszergyár Nyilvánosan Működő Részvénytársaság	<b>C07D 239/42</b> (2006.01)	2640710 *	CRYSTALLINE PHARMACEUTICALLY ACTIVE INGREDIENTS
Janssen Pharmaceutica, N.V.	<b>C07D 403/12</b> (2006.01) <b>A61P 29/00</b> (2006.01) <b>C07D 417/14</b> (2006.01) <b>C07D 405/14</b> (2006.01) <b>A61K 31/427</b> (2006.01) <b>A61K 31/381</b> (2006.01) <b>A61K 31/4025</b> (2006.01) <b>C07D 409/14</b> (2006.01) <b>A61P 25/00</b> (2006.01)	2630139 *	AMINO-PYRROLIDINE-AZETIDINE DIAMIDES AS MONOACYLGLYCEROL LIPASE INHIBITORS
Astellas Pharma Inc.	<b>A61P 35/00</b> (2006.01) <b>A61K 31/506</b> (2006.01) <b>A61K 31/496</b> (2006.01) <b>A61P 5/26</b> (2006.01) <b>C07D 401/12</b> (2006.01) <b>C07D 403/12</b> (2006.01)	2631233 *	ANTAGONIST FOR MUTATED ANDROGEN RECEPTOR
Baxter International Inc	<b>A61P 7/04</b> (2006.01) <b>A61K 38/37</b> (2006.01) <b>C07K 14/755</b> (2006.01)	2632479 *	FVIII PEPTIDES FOR IMMUNE TOLERANCE INDUCTION AND IMMUNODIAGNOSTICS
Baxter Healthcare SA	<b>A61P 7/04</b> (2006.01) <b>A61K 38/37</b> (2006.01) <b>C07K 14/755</b> (2006.01)	2632479 *	FVIII PEPTIDES FOR IMMUNE TOLERANCE INDUCTION AND IMMUNODIAGNOSTICS
Burcon Nutrascience (MB) Corp.	<b>A23J 1/14</b> (2006.01) <b>A23J 3/16</b> (2006.01)	2642873 *	ASTRINGENCY IN SOY PROTEIN SOLUTIONS
Turanjanin, Uros	<b>B29C 53/08</b> (2006.01) <b>G05B 19/19</b> (2006.01)	2608946 *	BENDING PVC PROFILES USING LASER AND PLC CONTROLLING SYSTEM
Novartis AG	<b>C07D 409/04</b> (2006.01) <b>C07D 409/14</b> (2006.01) <b>C07D 413/04</b> (2006.01) <b>C07D 413/14</b> (2006.01) <b>C07D 417/14</b> (2006.01) <b>C07D 487/04</b> (2006.01) <b>C07D 498/04</b> (2006.01) <b>A61K 31/381</b> (2006.01) <b>A61P 31/12</b> (2006.01)	2595983 *	2,3,5-TRISUBSTITUTED THIOPHENE COMPOUNDS AND USES THEREOF
Chrysopoeia S.r.l.	<b>B02C 13/14</b> (2006.01) <b>B02C 13/20</b> (2006.01)	2635379 *	MILL FOR GRINDING RUBBISH
Uico, Inc.	<b>B60K 28/02</b> (2006.01) <b>B60W 50/08</b> (2012.01) <b>B60W 40/08</b> (2012.01) <b>G05G 9/02</b> (2006.01)	2633376 *	CONTROL SYSTEM WITH SOLID STATE TOUCH SENSOR FOR COMPLEX SURFACE GEOMETRY
Hospira Australia Pty Ltd	<b>B65D 47/32</b> (2006.01) <b>B65B 31/02</b> (2006.01)	2601105 *	VIAL PREPARATION METHOD AND SYSTEM
RMD Industries Pty Ltd	<b>E05D 7/08</b> (2006.01) <b>E05D 7/02</b> (2006.01) <b>E05D 15/26</b> (2006.01)	2611980 *	GUIDE ASSEMBLY
Rome, Patrick	<b>B31F 5/06</b> (2006.01) <b>C09J 7/02</b> (2006.01)	2627504 *	COMPONENT CARRIER REEL SPLICING TAPE
Chia Soon Electronics Co., Ltd.	<b>H04B 1/38</b> (2006.01)	2302815	Helmet-attachable communication device
St. Jude Children's Research Hospital	<b>C07H 21/00</b> (2006.01) <b>G01N 33/48</b> (2006.01)	2625188 *	MOLECULAR DETERMINANT-BASED TYPING OF KIR ALLELES AND KIR-LIGANDS

Podnosilac evropske prijave patenta (71)	MKP (51)	Broj objave evropske prijave patenta (97)	Naziv pronalaska (54)
JPB Systeme	<b>F16L 39/00</b> (2006.01) <b>F16L 19/00</b> (2006.01)	2638317 *	DEVICE FOR THE SECURED CONNECTION OF TWO END FITTINGS, PARTICULARLY OF A PIPE
Hexal AG	<b>A61K 9/70</b> (2006.01)	2632443 *	PREPARATION OF ORODISPERSIBLE FILMS
Saint-Gobain Isover	<b>C08G 14/06</b> (2006.01) <b>C09J 161/34</b> (2006.01) <b>C03C 25/34</b> (2006.01) <b>C08K 5/053</b> (2006.01) <b>C08K 5/21</b> (2006.01) <b>F16L 59/00</b> (2006.01)	2609129 *	PHENOLIC RESIN, METHOD FOR PREPARING SAME, SIZING COMPOSITION FOR MINERAL FIBERS AND RESULTING PRODUCT
Mallier, Jean-Louis	<b>C08G 14/06</b> (2006.01) <b>C09J 161/34</b> (2006.01) <b>C03C 25/34</b> (2006.01) <b>C08K 5/053</b> (2006.01) <b>C08K 5/21</b> (2006.01) <b>F16L 59/00</b> (2006.01)	2609129 *	PHENOLIC RESIN, METHOD FOR PREPARING SAME, SIZING COMPOSITION FOR MINERAL FIBERS AND RESULTING PRODUCT
BASF SE	<b>C07D 401/12</b> (2006.01) <b>C07D 401/14</b> (2006.01) <b>C07D 403/12</b> (2006.01) <b>C07D 403/14</b> (2006.01) <b>C07D 407/14</b> (2006.01) <b>C07D 413/12</b> (2006.01) <b>C07D 417/12</b> (2006.01) <b>C07D 417/14</b> (2006.01) <b>A01N 43/60</b> (2006.01) <b>A01N 43/80</b> (2006.01)	2595981 *	NOVEL HETARYL (THIO)CARBOXAMIDE COMPOUNDS FOR CONTROLLING INVERTEBRATE PESTS
Savant Systems LLC.	<b>F16M 13/02</b> (2006.01) <b>G06F 1/16</b> (2006.01) <b>F16M 11/10</b> (2006.01)	2601432 *	IN-WALL DOCK FOR A TABLET COMPUTER
Goetze KG Armaturen	<b>F16K 17/04</b> (2006.01)	2559926	Safety valve
SANOFI	<b>C07D 277/68</b> (2006.01) <b>A61P 31/00</b> (2006.01) <b>A61K 31/428</b> (2006.01) <b>C07D 417/12</b> (2006.01)	2643307 *	NITROBENZOTHAZOLE DERIVATIVES AND USE THEREOF FOR TREATING TUBERCULOSIS
Purdue Pharma L.P.	<b>C07D 489/12</b> (2006.01) <b>A61K 31/485</b> (2006.01) <b>A61P 25/04</b> (2006.01)	2619212 *	BUPRENORPHINE ANALOGS
3M Innovative Properties Co.	<b>B24D 3/14</b> (2006.01)	2567784	Bonded abrasive article
TAISHO PHARMACEUTICAL CO., LTD	<b>A61K 31/46</b> (2006.01) <b>A61P 25/00</b> (2006.01) <b>A61P 29/00</b> (2006.01) <b>A61K 31/5377</b> (2006.01) <b>A61P 25/08</b> (2006.01) <b>A61K 31/5386</b> (2006.01) <b>A61P 25/14</b> (2006.01) <b>C07D 249/12</b> (2006.01) <b>A61P 7/10</b> (2006.01) <b>A61P 25/18</b> (2006.01) <b>A61K 31/4196</b> (2006.01) <b>A61P 9/12</b> (2006.01) <b>A61P 25/22</b> (2006.01) <b>A61K 31/454</b> (2006.01) <b>A61P 17/02</b> (2006.01) <b>A61P 25/28</b> (2006.01) <b>A61K 31/4545</b> (2006.01) <b>A61P 17/14</b> (2006.01) <b>A61P 25/36</b> (2006.01) <b>A61K 31/553</b> (2006.01) <b>A61P 25/16</b> (2006.01)	2623499 *	1,2,4-TRIAZOLONE DERIVATIVE
Pong, David Teng	<b>B65B 65/00</b> (2006.01) <b>B23D 36/00</b> (2006.01) <b>B65B 27/10</b> (2006.01) <b>B21B 15/00</b> (2006.01)	2578502	Method and apparatus for producing cut to length bars in a steel mill

Podnosilac evropske prijave patenta (71)	MKP (51)	Broj objave evropske prijave patenta (97)	Naziv pronalaska (54)
BOARD OF REGENTS, THE UNIVERSITY OF TEXAS SYSTEM	<b>A61N 5/01</b> (2006.01)	2605828 *	AUTOMATED TREATMENT PLANNING FOR RADIATION THERAPY
Niitek, Inc.	<b>G01S 13/02</b> (2006.01) <b>G01V 3/10</b> (2006.01)	2606379 *	METAL DETECTOR AND GROUND-PENETRATING RADAR HYBRID HEAD AND MANUFACTURING METHOD THEREOF
Catalyst Biosciences, Inc.	<b>C12N 9/64</b> (2006.01)	2635677 *	MODIFIED FACTOR IX POLYPEPTIDES AND USES THEREOF
Takeda GmbH	<b>A61K 9/00</b> (2006.01)	2608769 *	HUMIDIFIED PARTICLES COMPRISING A THERAPEUTICALLY ACTIVE SUBSTANCE
BOMA ENGINEERING SRL	<b>D04H 1/56</b> (2006.01) <b>D01D 4/02</b> (2006.01) <b>D01D 5/098</b> (2006.01)	2603626 *	PROCESS AND APPARATUS FOR SPINNING FIBRES AND IN PARTICULAR FOR PRODUCING A FIBROUS-CONTAINING NONWOVEN
AEG Power Solutions B.V.	<b>H02M 5/16</b> (2006.01)	2549638	Power supply assembly for a reactor for polysilicon production with a frequency converter
Henkel AG & Co. KGaA	<b>C11D 1/37</b> (2006.01) <b>C11D 3/50</b> (2006.01) <b>C11D 17/00</b> (2006.01) <b>E03D 9/02</b> (2006.01) <b>C11D 3/48</b> (2006.01)	2638137 *	BALL-SHAPED TOILET BLOCKS BASED ON ANIONIC SURFACTANTS
Square, Inc.	<b>G06Q 20/00</b> (2012.01)	2638512 *	METHOD OF CONDUCTING FINANCIAL TRANSACTIONS WHERE A PAYER'S FINANCIAL ACCOUNT INFORMATION IS ENTERED ONLY ONCE WITH A PAYMENT SYSTEM
Whirlux APS	<b>F16L 19/06</b> (2006.01)	2609354 *	TUBE CONNECTION
Mindinvest Holdings Ltd.	<b>A61K 31/785</b> (2006.01) <b>A61P 35/00</b> (2006.01) <b>A61K 47/24</b> (2006.01) <b>A61K 9/127</b> (2006.01) <b>A61K 9/00</b> (2006.01) <b>A61K 31/155</b> (2006.01)	2632435 *	LIPOSOMAL DRUG COMPOSITION CONTAINING A POLYMERIC GUANIDINE DERIVATIVE
Chinook End-Stage Recycling Limited	<b>B29B 17/02</b> (2006.01) <b>F26B 23/02</b> (2006.01) <b>C10J 3/66</b> (2006.01) <b>B04B 15/02</b> (2006.01) <b>H01B 15/00</b> (2006.01)	2635418 *	IMPROVEMENTS IN WASTE PROCESSING
Boehringer Ingelheim International GmbH	<b>C07D 235/30</b> (2006.01) <b>A61K 31/4184</b> (2006.01) <b>A61P 11/00</b> (2006.01) <b>A61P 29/00</b> (2006.01)	2606036 *	NEW COMPOUNDS
Respivert Limited	<b>A61P 11/00</b> (2006.01) <b>C07D 487/04</b> (2006.01) <b>A61P 19/02</b> (2006.01) <b>A61P 11/06</b> (2006.01) <b>A61P 17/00</b> (2006.01) <b>A61K 31/519</b> (2006.01) <b>A61P 35/00</b> (2006.01)	2630149 *	QUINAZOLIN-4 (3H) -ONE DERIVATIVES USED AS PI3 KINASE INHIBITORS
Delphi Technologies Holding S.à.r.l.	<b>F02M 61/12</b> (2006.01) <b>F02M 63/02</b> (2006.01) <b>F02M 63/00</b> (2006.01) <b>F16K 31/06</b> (2006.01)	2535554	Electro-valve for discharging common rail
GlaxoSmithKline Biologicals S.A.	<b>A61K 39/21</b> (2006.01)	2621528 *	VACCINE
Catonets Licens ApS	<b>F03D 11/04</b> (2006.01) <b>E04G 21/32</b> (2006.01)	2640912 *	A SAFETY NET FOR MOUNTING IN A WIND TURBINE TOWER
Takeda Pharmaceutical Company Limited	<b>A61K 31/4188</b> (2006.01)	2640383 *	METHOD FOR TREATING BREAST CANCER AND OVARIAN CANCER
Exelixis, Inc.	<b>C07D 413/14</b> (2006.01) <b>A61K 31/423</b> (2006.01)	2643319 *	BENZOXAZEPINES AS INHIBITORS OF PI3K/MTOR AND METHODS OF THEIR USE AND MANUFACTURE

Podnosilac evropske prijave patenta (71)	MKP (51)	Broj objave evropske prijave patenta (97)	Naziv pronalaska (54)
Albireo AB	<b>A61P 1/12</b> (2006.01) <b>A61K 9/52</b> (2006.01) <b>A61K 31/785</b> (2006.01) <b>A61K 31/554</b> (2006.01) <b>A61P 1/16</b> (2006.01) <b>A61P 3/00</b> (2006.01)	2637646 *	A PHARMACEUTICAL COMBINATION COMPRISING AN IBAT INHIBITOR AND A BILE ACID BINDER
Nabriva Therapeutics AG	<b>C07C 323/52</b> (2006.01) <b>A61K 31/215</b> (2006.01) <b>A61P 31/00</b> (2006.01)	2614049 *	PLEUROMUTILIN DERIVATIVES FOR USE IN THE TREATMENT OF DISEASES MEDIATED BY MICROBES
AbbVie Inc.	<b>C07D 413/12</b> (2006.01) <b>C07D 471/04</b> (2006.01) <b>C07D 403/12</b> (2006.01) <b>A61P 9/10</b> (2006.01) <b>C07D 209/44</b> (2006.01) <b>A61P 35/00</b> (2006.01) <b>C07D 407/12</b> (2006.01) <b>A61K 31/407</b> (2006.01) <b>A61K 31/4035</b> (2006.01) <b>C07D 407/14</b> (2006.01)	2640698 *	NAMPT AND ROCK INHIBITORS
The Research Foundation of State University of New York	<b>A61N 1/05</b> (2006.01)	2629839 *	OPTICAL CONTROL OF CARDIAC FUNCTION
Dow AgroSciences LLC	<b>A01P 7/04</b> (2006.01) <b>A01P 17/00</b> (2006.01) <b>A01P 5/00</b> (2006.01) <b>A01P 23/00</b> (2006.01) <b>C07D 401/14</b> (2006.01) <b>A01P 3/00</b> (2006.01) <b>A01P 15/00</b> (2006.01) <b>A61K 31/4439</b> (2006.01) <b>A01P 7/02</b> (2006.01) <b>A01P 19/00</b> (2006.01) <b>C07D 401/04</b> (2006.01) <b>A01P 1/00</b> (2006.01) <b>A01P 21/00</b> (2006.01) <b>C07D 417/14</b> (2006.01) <b>A01P 13/00</b> (2006.01) <b>A01H 5/10</b> (2006.01) <b>A61K 31/444</b> (2006.01) <b>A01P 9/00</b> (2006.01) <b>A01N 25/34</b> (2006.01) <b>A01P 11/00</b> (2006.01)	2635278 *	PESTICIDAL COMPOSITIONS AND PROCESSES RELATED THERETO
Janssen Pharmaceutica, N.V.	<b>C07D 211/58</b> (2006.01) <b>A61P 11/00</b> (2006.01) <b>A61K 31/4468</b> (2006.01)	2619180 *	5-HT2B RECEPTOR ANTAGONISTS
Hexatech Inc.	<b>C04B 35/581</b> (2006.01) <b>H01L 21/683</b> (2006.01) <b>H01L 23/15</b> (2006.01)	2595940 *	POLYCRYSTALLINE ALUMINUM NITRIDE MATERIAL AND METHOD OF PRODUCTION THEREOF
Rho, Hee Kwon	<b>B65D 41/14</b> (2006.01) <b>B65D 47/36</b> (2006.01) <b>B65D 41/20</b> (2006.01) <b>B65D 53/04</b> (2006.01)	2639178 *	SEALING MEMBER FOR CONTAINER
Sanofi-Aventis Deutschland GmbH	<b>A61M 5/145</b> (2006.01) <b>A61M 5/315</b> (2006.01)	2600922 *	CARTRIDGE HOLDER AND METHOD FOR ASSEMBLING A CARTRIDGE UNIT FOR A DRUG DELIVERY DEVICE
AbbVie Inc.	<b>C07D 471/04</b> (2006.01) <b>C07D 239/42</b> (2006.01) <b>A01N 43/54</b> (2006.01)	2624698 *	FURO[3,2-d]PYRIMIDINE COMPOUNDS
Surgiclamp Pty Ltd	<b>A61B 17/128</b> (2006.01) <b>A61B 17/00</b> (2006.01) <b>A61B 17/122</b> (2006.01)	2627260 *	SURGICAL CLAMPING DEVICES AND TOOLS FOR USE THEREWITH
Baylor College Of Medicine	<b>A61K 39/00</b> (2006.01)	2632482 *	CHIMERIC CD27 RECEPTORS FOR REDIRECTING T CELLS TO CD70-POSITIVE MALIGNANCIES

Podnosilac evropske prijave patenta (71)	MKP (51)	Broj objave evropske prijave patenta (97)	Naziv pronalaska (54)
Cerjak D.o.o.	<b>F16D 1/116</b> (2006.01) <b>F16D 3/38</b> (2006.01) <b>F16D 3/84</b> (2006.01)	2606250 *	PROTECTIVE CASING WITH A MOVABLE LEVER FOR A COUPLING SPLINED YOKE WITH A SAFETY PIN
Cor Brevis D.o.o.	<b>C10L 5/38</b> (2006.01) <b>C10L 7/02</b> (2006.01) <b>C10L 8/00</b> (2006.01) <b>C01B 3/08</b> (2006.01)	2614130 *	FUEL AND COMBUSTIBLE MIXTURE USED AS A SUBSTITUTE FOR FOSSIL FUELS IN THERMOELECTRIC POWER PLANTS, INDUSTRIAL AND CENTRAL HEATING FURNACES
GlaxoSmithKline Intellectual Property Development Limited	<b>C07K 16/18</b> (2006.01) <b>C12N 15/13</b> (2006.01)	2606065 *	IMPROVED ANTI-SERUM ALBUMIN BINDING VARIANTS
Eli Lilly and Company	<b>C07D 401/14</b> (2006.01) <b>A61K 31/4995</b> (2006.01) <b>A61P 35/00</b> (2006.01)	2638033 *	COMPOUNDS USEFUL FOR INHIBITING CHK1
Little, Keith	<b>E01C 5/00</b> (2006.01)	2619369 *	IMPROVEMENTS RELATING TO TILES OR PAVING PIECES
Tsinghua University	<b>C12P 7/64</b> (2006.01)	2636747 *	PROCESS FOR PREPARING BIODIESEL FROM RENEWABLE GREASE WITH LIPASE AS CATALYST AND ONLINE DEHYDRATION
Sinusys Corporation	<b>A61B 17/24</b> (2006.01) <b>A61B 17/34</b> (2006.01) <b>A61F 2/18</b> (2006.01) <b>A61M 29/00</b> (2006.01)	2611369 *	DEVICES FOR DILATING A PARANASAL SINUS OPENING AND FOR TREATING SINUSITIS
Sarcinella, Giuseppe	<b>C09K 5/18</b> (2006.01) <b>B65D 77/04</b> (2006.01) <b>B65D 75/58</b> (2006.01) <b>F25D 5/02</b> (2006.01) <b>B65D 81/32</b> (2006.01) <b>B65D 81/34</b> (2006.01)	2619279 *	FLEXIBLE CONTAINER HAVING A BUILT-IN AUTO -HEATING OR AUTO - REFRIGERATING ELEMENT.
UCB Pharma GmbH	<b>C07C 231/02</b> (2006.01) <b>C07C 231/12</b> (2006.01) <b>C07C 231/18</b> (2006.01) <b>C07C 237/22</b> (2006.01)	2621893 *	PROCESS FOR THE PREPARATION OF AMINO ACID DERIVATIVES
H. Lundbeck A/S	<b>C07D 489/12</b> (2006.01) <b>C07D 489/08</b> (2006.01)	2635586 *	METHOD FOR THE MANUFACTURING OF NALTREXONE
Packers Plus Energy Services Inc.	<b>E21B 29/00</b> (2006.01) <b>E21B 17/00</b> (2006.01) <b>E21B 34/14</b> (2006.01) <b>E21B 43/12</b> (2006.01) <b>E21B 23/00</b> (2006.01)	2640930 *	KOBE SUB, WELLBORE TUBING STRING APPARATUS AND METHOD
Insleep Technologies, LLC	<b>A61M 11/00</b> (2006.01)	2635336 *	BREATHING APPARATUS
AstraZeneca AB	<b>A61K 47/34</b> (2006.01) <b>A61K 31/444</b> (2006.01) <b>A61K 9/16</b> (2006.01) <b>A61P 19/02</b> (2006.01)	2595608 *	PHARMACEUTICAL DEPOT FOR 5-FLUORO-2 [ (1S) -1- (5-FLUORO-2-PYRIDYL)ETHYL]AMINO]-6-[[5-ISOPROPOXY-1H-PYRAZOL-3-YL)AMINO] PYRIDINE-3-CARBONITRILE
Laboratori Farmaceutici Krymi S.p.A.	<b>A61K 8/02</b> (2006.01) <b>A61K 8/37</b> (2006.01) <b>A61K 8/67</b> (2006.01) <b>A61K 8/81</b> (2006.01) <b>A61Q 19/02</b> (2006.01) <b>A61Q 19/08</b> (2006.01)	2613755 *	PEEL -OFF POLYVINYL FACIAL MASK FOR TREATMENT OF SKIN CONDITIONS COMPRISING A HIGH CONCENTRATON OF RETINOIC ACID
Bäumer, Josef	<b>B65H 29/24</b> (2006.01) <b>B65H 29/46</b> (2006.01) <b>B65H 31/24</b> (2006.01)	2394940	Stacking device for stacking flat workpieces
The Regents of The University of California	<b>A61K 9/16</b> (2006.01) <b>A61K 9/08</b> (2006.01) <b>A61K 47/38</b> (2006.01) <b>A61K 31/498</b> (2006.01) <b>A61K 38/43</b> (2006.01) <b>A61K 35/12</b> (2006.01) <b>A61P 9/00</b> (2006.01)	2608777 *	COMPOSITIONS AND METHODS FOR CARDIAC THERAPY

Podnosilac evropske prijave patenta (71)	MKP (51)	Broj objave evropske prijave patenta (97)	Naziv pronalaska (54)
Ventrix, Inc.	<b>A61K 9/16</b> (2006.01) <b>A61K 9/08</b> (2006.01) <b>A61K 47/38</b> (2006.01) <b>A61K 31/498</b> (2006.01) <b>A61K 38/43</b> (2006.01) <b>A61K 35/12</b> (2006.01) <b>A61P 9/00</b> (2006.01)	2608777 *	COMPOSITIONS AND METHODS FOR CARDIAC THERAPY
Exelixis, Inc.	<b>A61K 31/00</b> (2006.01) <b>A61K 31/47</b> (2006.01) <b>A61P 35/00</b> (2006.01) <b>A61P 35/04</b> (2006.01)	2621481 *	DUAL INHIBITORS OF MET AND VEGF FOR THE TREATMENT OF CASTRATION- RESISTANT PROSTATE CANCER AND OSTEOBLASTIC BONE METASTASES
CeWe Color AG & Co. OHG	<b>G06F 3/12</b> (2006.01)	2549375	Method for producing at least one printing ink carrier and method for producing one or more printed products
VBG Group Truck Equipment N.V.	<b>B60J 7/06</b> (2006.01)	2595825 *	STRUCTURE FOR A SLIDING ROOF, SLIDING ROOF SYSTEM, TRUCK WITH SLIDING ROOF SYSTEM, CURTAINSIDER TRAILER WITH A SLIDING ROOF SYSTEM
Abbvie Inc.	<b>C07D 471/04</b> (2006.01) <b>A61K 31/437</b> (2006.01) <b>A61P 35/00</b> (2006.01) <b>A61P 37/00</b> (2006.01)	2643322 *	SALTS AND CRYSTALLINE FORMS OF AN APOPTOSIS-INDUCING AGENT
The Research Foundation Of State University Of New York	<b>F16F 6/00</b> (2006.01) <b>F16F 15/03</b> (2006.01)	2598773 *	ELECTRICITY GENERATING SHOCK ABSORBERS
AH USA 42 LLC	<b>A61K 39/175</b> (2006.01) <b>C12N 15/863</b> (2006.01)	2595652 *	PARAPOXVIRUS VECTORS
Bev-RX, Inc.	<b>A61K 9/08</b> (2006.01) <b>A61K 9/16</b> (2006.01) <b>A61K 31/167</b> (2006.01) <b>A61K 31/192</b> (2006.01) <b>A61K 31/616</b> (2006.01) <b>A23L 2/00</b> (2006.01)	2616046 *	AQUEOUS DRUG DELIVERY SYSTEM COMPRISING OFF - FLAVOR MASKING AGENT
Ozkul, Tarik	<b>F24J 2/46</b> (2006.01) <b>E04H 5/02</b> (2006.01) <b>E04H 14/00</b> (2006.01)	2625472 *	METHOD AND APPARATUS FOR MAKING STATIONERY PARABOLIC SOLAR COLLECTOR
Cell Medica Ltd	<b>A61K 39/00</b> (2006.01) <b>C07K 14/725</b> (2006.01) <b>A61P 31/10</b> (2006.01) <b>G01N 33/569</b> (2006.01)	2640415 *	CROSS PROTECTIVE EPITOPES OF ASPERGILLUS FUMIGATUS AND CANDIDA ALBICANS
Delija, Frane	<b>A41B 9/02</b> (2006.01)	2597978 *	MEN'S BRIEFS WITH SEPARATE SPACE FOR PENIS
Ecoval Environnement	<b>B27N 3/00</b> (2006.01) <b>B09B 3/00</b> (2006.01)	2598261 *	METHOD FOR RECYCLING FURNITURE, IN PARTICULAR BED BASES, WEB OF MATERIAL OBTAINED BY SUCH A METHOD, AND ASSOCIATED RECYCLING INSTALLATION
Bayer Intellectual Property GmbH	<b>C07K 14/365</b> (2006.01) <b>C12N 15/11</b> (2006.01) <b>C12P 19/26</b> (2006.01)	2601209 *	GENOMICS OF ACTINOPLANES UTAHENSIS
Square, Inc.	<b>G06Q 20/00</b> (2012.01)	2628139 *	METHODS FOR TRANSFERRING FUNDS USING A PAYMENT SERVICE WHERE FINANCIAL ACCOUNT INFORMATION IS ONLY ENTERED ONCE WITH A PAYMENT SERVICE AND NEED NOT BE RE-ENTERED FOR FUTURE TRANSFERS
Swedish Orphan Biovitrum AB (Publ)	<b>A61P 1/00</b> (2006.01) <b>A61K 38/43</b> (2006.01)	2629790 *	Method to increase the growth velocity of human infants
Deva Holding Anonim Sirketi	<b>A61K 31/23</b> (2006.01)	2526936	Particle size distribution of cetyl myristate and/or cetyl palmitate
Asahi Kasei Chemicals Corporation	<b>C08G 64/20</b> (2006.01)	2634202 *	PROCESS FOR PRODUCING POLYCONDENSATION POLYMER, AND POLYMERIZER



Podnosilac evropske prijave patenta (71)	MKP (51)	Broj objave evropske prijave patenta (97)	Naziv pronalaska (54)
Amgen Research (Munich) GmbH	<b>A61K 31/573</b> (2006.01) <b>A61K 39/395</b> (2006.01) <b>C07K 16/28</b> (2006.01)	2637670 *	PREVENTION OF ADVERSE EFFECTS CAUSED BY CD3 SPECIFIC BINDING DOMAINS
Sanofi-Aventis Deutschland GmbH	<b>A61M 5/315</b> (2006.01)	2529774	Resetting mechanism for a drug delivery device
Ethicon Endo-Surgery, Inc.	<b>A61B 17/115</b> (2006.01) <b>A61B 17/29</b> (2006.01)	2524658	Improved anvil and cartridge alignment configuration for a circular stapler
Agenebio, Inc.	<b>A61K 31/50</b> (2006.01)	2640391 *	PYRIDAZINE DERIVATIVES, COMPOSITIONS AND METHODS FOR TREATING COGNITIVE IMPAIRMENT
AOP Orphan Pharmaceuticals AG	<b>A61K 47/48</b> (2006.01) <b>A61K 9/00</b> (2006.01) <b>A61K 31/35</b> (2006.01)	2643022 *	FAST DISINTEGRATING COMPOSITIONS COMPRISING NABILONE AND RANDOMLY METHYLATED BETA CYCLODEXTRIN
Amgen Inc.	<b>C12N 5/00</b> (2006.01) <b>C12N 5/10</b> (2006.01) <b>C07K 5/06</b> (2006.01)	2601287 *	DIPEPTIDES TO ENHANCE YIELD AND VIABILITY FROM CELL CULTURES
GlaxoSmithKline Biologicals S.A.	<b>C07K 14/045</b> (2006.01) <b>A61K 39/245</b> (2006.01)	2627352 *	NOVEL ANTIGEN
NsGene A/S	<b>A61K 48/00</b> (2006.01) <b>A61P 25/02</b> (2006.01) <b>A61P 25/04</b> (2006.01) <b>A61K 38/17</b> (2006.01) <b>A61K 9/00</b> (2006.01)	2621512 *	USE OF METEORIN FOR THE TREATMENT OF ALLODYNIA, HYPERALGESIA, SPONTANEOUS PAIN AND PHANTOM PAIN
TOTO LTD.	<b>E03D 11/02</b> (2006.01)	2562315	Flush toilet
Palsgaard A/S	<b>C11B 1/10</b> (2006.01) <b>C11B 3/00</b> (2006.01) <b>C11B 3/06</b> (2006.01) <b>C11B 3/08</b> (2006.01)	2616531 *	REFINED VEGETABLE OIL AND A METHOD OF PRODUCING IT
Fachhochschule Nordwestschweiz Hochschule Für Life Sciences	<b>G01N 33/543</b> (2006.01)	2616810 *	PREPARATION OF A MOLECULAR RECOGNITION ELEMENT
Gilead Sciences, Inc.	<b>C07D 487/04</b> (2006.01) <b>A61K 31/41</b> (2006.01)	2619206 *	2'-FLUORO SUBSTITUTED CARBA-NUCLEOSIDE ANALOGS FOR ANTIVIRAL TREATMENT
Janssen Pharmaceutica N.V.	<b>C07D 211/16</b> (2006.01) <b>C07D 417/12</b> (2006.01) <b>A61K 31/4523</b> (2006.01) <b>A61P 29/00</b> (2006.01) <b>C07D 417/14</b> (2006.01) <b>C07D 205/04</b> (2006.01)	2629851 *	PIPERIDIN-4-YL-AZETIDINE DIAMIDES AS MONOACYLGLYCEROL LIPASE INHIBITORS
Molecular Partners AG	<b>C07K 14/47</b> (2006.01)	2643349 *	DESIGNED REPEAT PROTEINS BINDING TO SERUM ALBUMIN
Speiko - Dr. Speier GmbH	<b>B65D 51/26</b> (2006.01) <b>A61C 19/02</b> (2006.01)	2494941	Container for transporting dental objects
Teva Pharmaceutical Industries Ltd.	<b>A61K 38/07</b> (2006.01) <b>C07K 14/47</b> (2006.01) <b>A61P 19/08</b> (2006.01) <b>A61K 38/06</b> (2006.01) <b>A61K 38/00</b> (2006.01)	2627669 *	CYTOKINE BIOMARKERS AS PREDICTIVE BIOMARKERS OF CLINICAL RESPONSE FOR GLATIRAMER ACETATE
Taisho Pharmaceutical Co., Ltd.	<b>A61P 5/50</b> (2006.01) <b>A61P 9/10</b> (2006.01) <b>A61K 31/155</b> (2006.01) <b>A61P 13/12</b> (2006.01) <b>A61K 31/382</b> (2006.01) <b>A61P 9/14</b> (2006.01) <b>A61K 31/64</b> (2006.01) <b>A61P 27/02</b> (2006.01) <b>A61K 45/00</b> (2006.01) <b>A61P 43/00</b> (2006.01) <b>A61P 3/10</b> (2006.01) <b>C07D 335/02</b> (2006.01) <b>A61K 31/4439</b> (2006.01) <b>A61P 25/00</b> (2006.01)	2601949	Pharmaceutical compositions

Podnosilac evropske prijave patenta (71)	MKP (51)	Broj objave evropske prijave patenta (97)	Naziv pronalaska (54)
AB Hällde Maskiner	<b>A47J 43/07</b> (2006.01) <b>B26D 1/00</b> (2006.01)	2615954 *	KNIFE FOR A CUTTING DISC FOR A CUTTING MACHINE
Ideal S.R.L.	<b>G02C 5/22</b> (2006.01)	2616875 *	MINIATURISED ELASTIC HINGE, IN PARTICULAR FOR EYEGLASSES
Elan Pharmaceuticals, Inc.	<b>A61P 25/00</b> (2006.01)	2643056 *	PHAGOCYtic ACTIVITY AS A MARKER OF SYNucleinOPATHIC DISEASE
Laboratorios del. Dr. Esteve, S.A.	<b>C07D 231/22</b> (2006.01) <b>A61P 25/16</b> (2006.01) <b>A61P 25/00</b> (2006.01) <b>A61K 31/4152</b> (2006.01)	2603495 *	4-[2-[[5-METHYL-1-(2-NAPHTALENYL)-1H-PYRAZOL-3-YL]OXY]ETHYL]MORPHOLINE HYDROCHLORIDE AMORPHOUS SOLID FORMS
Almac Diagnostics Limited	<b>G01N 33/48</b> (2006.01)	2619574 *	MOLECULAR DIAGNOSTIC TEST FOR CANCER
Davison, Timothy	<b>G01N 33/48</b> (2006.01)	2619574 *	MOLECULAR DIAGNOSTIC TEST FOR CANCER
Allylix, Inc.	<b>C12N 9/88</b> (2006.01) <b>C12P 1/00</b> (2006.01) <b>C12N 15/82</b> (2006.01)	2633042 *	MODIFIED VALENCENE SYNTHASE POLYPEPTIDES, ENCODING NUCLEIC ACID MOLECULES AND USES THEREOF
Advanced Ballistic Concepts LLC	<b>F42B 12/66</b> (2006.01)	2635870 *	PROJECTILE FOR USE WITH A RIFLED BARREL
Synta Pharmaceuticals Corp.	<b>A61K 31/502</b> (2006.01) <b>A61K 31/506</b> (2006.01) <b>A61K 31/436</b> (2006.01) <b>A61K 31/395</b> (2006.01) <b>A61K 31/4196</b> (2006.01) <b>A61P 35/00</b> (2006.01) <b>A61K 31/437</b> (2006.01) <b>A61K 39/395</b> (2006.01) <b>A61K 31/517</b> (2006.01) <b>A61K 31/4439</b> (2006.01)	2640385 *	PRESELECTION OF SUBJECTS FOR THERAPEUTIC TREATMENT BASED ON HYPOXIC STATUS
Nissan Chemical Industries, Ltd.	<b>A61P 43/00</b> (2006.01) <b>C07D 333/32</b> (2006.01) <b>A61K 31/381</b> (2006.01) <b>A61P 7/04</b> (2006.01)	2636671 *	ORGANIC AMINE SALT OF AMINOBENZOIC ACID DERIVATIVE, AND METHOD FOR PRODUCING SAME
Cassani, Stefano	<b>B03B 5/32</b> (2006.01) <b>B04B 1/20</b> (2006.01)	2598250 *	DEVICE FOR SEPARATING PARTICLES OF DIFFERENT SYNTHETIC MATERIALS
MasterLAB S.r.l. - Unipersonale	<b>E05D 7/00</b> (2006.01)	2557258	Adjustable hinge for window or door frames
Concert Pharmaceuticals Inc.	<b>C07D 473/04</b> (2006.01)	2611807 *	POLYMORPHS OF (S)-1-(4,4,6,6,6-PENTAdeutero-5-Hydroxyhexyl)-3-7-DIMETHYL-1H-PURINE-2,6(3H,7H)DIONE
AbbVie Inc.	<b>B01D 15/08</b> (2006.01)	2627425 *	PROCESSES FOR PURIFICATION OF PROTEINS
Les Laboratoires Servier	<b>C07K 16/26</b> (2006.01)	2598531 *	METHODS AND COMPOSITIONS FOR LIVER CANCER THERAPY
INSERM (Institut National de la Santé et de la Recherche Médicale)	<b>C07K 16/26</b> (2006.01)	2598531 *	METHODS AND COMPOSITIONS FOR LIVER CANCER THERAPY
Centre National de la Recherche Scientifique (CNRS)	<b>C07K 16/26</b> (2006.01)	2598531 *	METHODS AND COMPOSITIONS FOR LIVER CANCER THERAPY
TOPPER SUN ENERGY TECHNOLOGY CO., LTD.	<b>H01L 31/052</b> (2006.01)	2571063	Solar generator apparatus with elastically cable-controlled tracking
Luo, Chia Ching	<b>H01L 31/052</b> (2006.01)	2571063	Solar generator apparatus with elastically cable-controlled tracking
Ecole Polytechnique Fédérale de Lausanne (EPFL)	<b>C07D 279/08</b> (2006.01) <b>A61K 31/5415</b> (2006.01) <b>A61P 31/06</b> (2006.01)	2640712 *	2-PIPERAZIN-1-YL-4H-1,3-BENZOTHIAZIN-4-ONE DERIVATIVES AND THEIR USE FOR THE TREATMENT OF MAMMALIAN INFECTIONS
Sanofi-Aventis Deutschland GmbH	<b>A61M 5/315</b> (2006.01)	2600924 *	ASSEMBLY FOR A DRUG DELIVERY DEVICE, PISTON ROD AND DRUG DELIVERY DEVICE

Podnosilac evropske prijave patenta (71)	MKP (51)	Broj objave evropske prijave patenta (97)	Naziv pronalaska (54)
Manfred Frank Patent Holdings Limited	<b>E05D 3/00</b> (2006.01) <b>E05D 7/04</b> (2006.01) <b>E05D 7/06</b> (2006.01) <b>E05D 11/10</b> (2006.01)	2603656 *	A HINGE
Takeda GmbH	<b>C07K 14/605</b> (2006.01) <b>C07K 1/04</b> (2006.01)	2611825 *	SOLID PHASE SYNTHESIS OF H(GLY2)GLP-2
Auxogyn, Inc.	<b>A61B 10/02</b> (2006.01)	2621344 *	APPARATUS, METHOD, AND SYSTEM FOR THE AUTOMATED IMAGING AND EVALUATION OF EMBRYOS, OOCYTES, AND STEM CELLS
Incyte Corporation	<b>C07D 487/04</b> (2006.01)	2640725 *	HETEROCYCLIC-SUBSTITUTED PYRROLOPYRIDINES AND PYRROLOPYRIMIDINES AS JAK INHIBITORS
Ambros Pharma S.r.l.	<b>A61K 9/20</b> (2006.01) <b>A61K 31/4045</b> (2006.01) <b>A61P 25/00</b> (2006.01)	2598124 *	THREE-PHASE CONTROLLED-RELEASE TABLET COMPRISING MELATONIN AND PROCESS OF PREPARATION
Vectura Delivery Devices Limited	<b>A61M 15/00</b> (2006.01)	2643039 *	INHALER
SANOFI	<b>C07D 307/82</b> (2006.01)	2595978 *	NOVEL PROCESS FOR THE PREPARATION OF DRONEDARONE
Galderma S.A.	<b>A61K 9/06</b> (2006.01) <b>A61K 47/32</b> (2006.01) <b>A61K 9/00</b> (2006.01) <b>A61K 31/498</b> (2006.01) <b>A61K 47/10</b> (2006.01)	2605753 *	TOPICAL GEL COMPOSITION
Winterskov, Bo	<b>B64C 5/02</b> (2006.01) <b>F02K 99/00</b> (2009.01)	2605961 *	DEVICE FOR SANDBLASTING USES EXHAUST GAS FROM A JET ENGINE FOR BLASTING
AbbVie Biotechnology Ltd	<b>A61K 39/395</b> (2006.01)	2637690 *	IMPROVED HIGH CONCENTRATION ANTI-TNFalpha ANTIBODY LIQUID FORMULATIONS
Online Userfacts AS	<b>H04L 12/24</b> (2006.01) <b>G06F 17/30</b> (2006.01) <b>H04L 29/06</b> (2006.01)	2617164 *	SYSTEM AND METHOD FOR TRAFFIC ANALYSIS
Richter Gedeon Nyrt.	<b>C07D 403/04</b> (2006.01) <b>C07D 403/14</b> (2006.01) <b>C07D 413/12</b> (2006.01) <b>A61K 31/404</b> (2006.01) <b>A61P 29/00</b> (2006.01)	2635567 *	INDOLE DERIVATIVES
Spinifex Pharmaceuticals Pty Ltd	<b>C07D 217/26</b> (2006.01)	2595960 *	SALT AND SOLVATES OF A TETRAHYDROISOQUINOLINE DERIVATIVE
Sanofi-Aventis Deutschland GmbH	<b>G01N 33/487</b> (2006.01)	2520932	Test strip for a medical meter
Danapak Flexibles A/S	<b>B32B 7/06</b> (2006.01) <b>B32B 7/12</b> (2006.01) <b>B32B 27/32</b> (2006.01) <b>B32B 27/36</b> (2006.01) <b>B65D 77/20</b> (2006.01) <b>C09J 7/02</b> (2006.01) <b>C08J 7/04</b> (2006.01)	2637861 *	A LAMINATE FOR USE IN PACKAGES, A METHOD OF MAKING A RECLOSABLE LAMINATE AND USE THEREOF
Accomandita Tecnologie Speciali Energia SPA in Breve Accomandita T.S.E. SPA	<b>E01B 7/24</b> (2006.01)	2557229	Heating device for rails
Wen, Minghua	<b>B32B 37/12</b> (2006.01) <b>B32B 38/14</b> (2006.01) <b>B41M 1/00</b> (2006.01) <b>B32B 27/00</b> (2006.01) <b>B32B 27/10</b> (2006.01)	2607076 *	PERSPECTIVE FILM AND PREPARING METHOD THEREOF
Eurocine Vaccines AB	<b>A61K 39/00</b> (2006.01) <b>A61K 39/12</b> (2006.01) <b>A61K 39/145</b> (2006.01) <b>A61K 39/39</b> (2006.01)	2621524 *	IMPROVED VACCINE COMPOSITIONS

Podnosilac evropske prijave patenta (71)	MKP (51)	Broj objave evropske prijave patenta (97)	Naziv pronalaska (54)
Koninklijke Nederlandse Akademie van Wetenschappen	<b>C12N 5/074</b> (2010.01)	2598633 *	LIVER ORGANOID, USES THEREOF AND CULTURE METHOD FOR OBTAINING THEM
Amgen Inc.	<b>A61P 5/18</b> (2006.01) <b>A61K 9/14</b> (2006.01) <b>A61K 9/00</b> (2006.01)	2642980 *	PEDIATRIC FORMULATION
Ethicon Endo-Surgery, Inc.	<b>A61B 17/072</b> (2006.01)	2517641	Staple cartridge comprising a variable thickness compressible portion
Janssen R&D Ireland	<b>C07D 401/14</b> (2006.01) <b>A61K 31/47</b> (2006.01) <b>A61K 31/4704</b> (2006.01) <b>A61P 31/12</b> (2006.01) <b>C07D 403/14</b> (2006.01) <b>C07D 417/14</b> (2006.01) <b>C07D 471/04</b> (2006.01) <b>C07D 491/10</b> (2006.01)	2598498 *	HETERO-BICYCLIC DERIVATIVES AS HCV INHIBITORS
Square, Inc.	<b>G06K 7/08</b> (2006.01)	2628128 *	SYSTEMS AND METHODS FOR FINANCIAL TRANSACTION THROUGH MINIATURIZED CARD READER WITH DECODING ON A SELLER'S MOBILE DEVICE
Thøstesen, Svend Erik	<b>A01G 9/12</b> (2006.01) <b>A01G 13/10</b> (2006.01) <b>A01M 29/00</b> (2011.01) <b>A01G 13/02</b> (2006.01)	2608655 *	DEVICE FOR PROCESSING LEADERS OF CONIFERS, GROWTH INHIBITOR DEVICE, AND BIRD PERCH DEVICE
Belron Hungary Kft - Zug Branch	<b>B60J 1/00</b> (2006.01) <b>B62D 65/06</b> (2006.01) <b>B25B 11/00</b> (2006.01)	2635452 *	WINDSCREEN INSTALLATION APPARATUS AND METHOD
Sea Lane Biotechnologies, llc.	<b>C12N 7/00</b> (2006.01) <b>A61K 39/395</b> (2006.01)	2640831 *	INFLUENZA VIRUS NEUTRALIZING AGENTS THAT MIMIC THE BINDING SITE OF AN INFLUENZA NEUTRALIZING ANTIBODY
Arfak Energie	<b>H01L 31/052</b> (2006.01) <b>H01L 31/058</b> (2006.01)	2620987	Devices and systems for concentration / collection of solar energy and industrial and household applications
Teijin Pharma Limited	<b>C07F 7/18</b> (2006.01) <b>A61P 19/10</b> (2006.01) <b>C07C 401/00</b> (2006.01) <b>A61K 31/593</b> (2006.01)	2634171 *	23-YNE-VITAMIN D3 DERIVATIVE
Katsaros, Stephen	<b>F21S 9/03</b> (2006.01) <b>F21V 14/00</b> (2006.01) <b>F21V 17/00</b> (2006.01) <b>F21V 21/30</b> (2006.01)	2638319 *	ADJUSTABLE SOLAR CHARGED LAMP
Les Laboratoires Servier	<b>C07D 223/16</b> (2006.01)	2607354	Process for the synthesis of ivabradine and addition salts thereof and its pharmaceutically acceptable acid
Nordic Aluminium Oyj	<b>H01R 25/14</b> (2006.01) <b>H01R 29/00</b> (2006.01)	2330694	Power take-off adapter for conductor track
Elan Pharmaceuticals, Inc.	<b>A61K 39/395</b> (2006.01)	2632492 *	METHODS FOR DETERMINING DIFFERENCES IN ALPHA-4 INTEGRIN ACTIVITY BY CORRELATING DIFFERENCES IN sVCAM AND/OR sMAdCAM LEVELS
Fossfill ApS	<b>B02C 13/04</b> (2006.01) <b>B68G 1/00</b> (2006.01) <b>B02C 13/284</b> (2006.01) <b>B02C 18/18</b> (2006.01)	2603322 *	A METHOD AND A SYSTEM FOR THE MANUFACTURE OF A PLASTICS FILLING MATERIAL
Anacor Pharmaceuticals, Inc.	<b>A61K 31/69</b> (2006.01) <b>C07F 5/02</b> (2006.01) <b>A61P 31/04</b> (2006.01)	2613788 *	BORON-CONTAINING SMALL MOLECULES

Podnosilac evropske prijave patenta (71)	MKP (51)	Broj objave evropske prijave patenta (97)	Naziv pronalaska (54)
Glesser, Erika	<b>B27K 5/04</b> (2006.01) <b>B05B 15/12</b> (2006.01) <b>B07B 9/02</b> (2006.01) <b>B07B 15/00</b> (2006.01) <b>B27L 11/00</b> (2006.01) <b>F26B 17/00</b> (2006.01) <b>B05B 13/02</b> (2006.01) <b>E04B 1/76</b> (2006.01)	2524780	Tensioning assembly and method for its production
Jin Jiang City, Shoes-Lock Co., Ltd.	<b>A43C 7/04</b> (2006.01) <b>A43C 7/00</b> (2006.01) <b>A43C 7/08</b> (2006.01)	2601852	Binding assembly
Les Laboratoires Servier	<b>A61K 31/403</b> (2006.01) <b>A61P 25/28</b> (2006.01) <b>A61K 31/13</b> (2006.01)	2601942	Novel combination of 4-{3-[cis-hexahydrocyclopenta[c]pyrrol-2(1h)-yl]propoxy} benzamide and an acetylcholinesterase inhibitor, and pharmaceutical compositions containing same
Schnappinger, Uta	<b>A61K 36/03</b> (2006.01) <b>A61K 36/81</b> (2006.01) <b>A61K 36/71</b> (2006.01) <b>A61K 36/185</b> (2006.01) <b>A61P 3/04</b> (2006.01) <b>A61K 36/72</b> (2006.01)	2548564	Pharmaceutical agent, nutrition for a patient and weight reduction method
Landis + Gyr Innovations, Inc.	<b>H04L 29/08</b> (2006.01) <b>G01D 4/00</b> (2006.01) <b>G08B 25/00</b> (2006.01)	2638684 *	SYSTEMS FOR DETECTING, COLLECTING, COMMUNICATING, AND USING INFORMATION ABOUT ENVIRONMENTAL CONDITIONS AND OCCURRENCES
Stretchline Intellectual Properties Limited	<b>A41F 15/00</b> (2006.01) <b>A41C 3/00</b> (2006.01)	2597983 *	SELF-ADJUSTING BRA STRAP
Tecno Sun S.r.L.	<b>A47J 19/02</b> (2006.01) <b>A61G 10/02</b> (2006.01) <b>A61M 15/02</b> (2006.01) <b>A47J 42/32</b> (2006.01) <b>A61M 16/00</b> (2006.01) <b>A61M 15/00</b> (2006.01)	2600926 *	DEVICE FOR SUPPLYING MICRONIZED MEDICAL SALT
Celgene Avilomics Research, Inc.	<b>A01N 43/54</b> (2006.01) <b>C07D 471/22</b> (2006.01) <b>C07D 471/04</b> (2006.01)	2603081 *	BESYLATE SALT OF A BTK INHIBITOR
Protektorwerk Florenz Maisch GmbH & Co. KG	<b>E04B 9/18</b> (2006.01) <b>F16B 5/07</b> (2006.01) <b>F16B 5/10</b> (2006.01)	2470729 *	Assembled component and method for producing an assembled component
Boehringer Ingelheim International GmbH	<b>C07D 401/06</b> (2006.01) <b>A61K 31/435</b> (2006.01) <b>A61P 3/00</b> (2006.01)	2635563 *	CRYSTALLINE FORMS OF HYDROCHLORIDE SALT OF (4A-R,9A-S) -1- (1H - BENZOIMIDAZOLE-5 -CARBONYL) -2, 3, 4, 4A, 9, 9A - HEXAHYDRO -1H- INDENO [2, 1 -B]PYRIDINE- 6 -CARBONITRILE AND THEIR USE AS HSD 1 INHIBITORS
Array Biopharma, Inc.	<b>A61K 31/4468</b> (2006.01) <b>A61K 31/454</b> (2006.01) <b>A61P 3/04</b> (2006.01) <b>C07D 413/14</b> (2006.01)	2616074 *	PIPERIDINYL-SUBSTITUTED LACTAMS AS GPR119 MODULATORS
Ethicon Endo-Surgery, Inc.	<b>A61B 17/072</b> (2006.01)	2517647	Tissue thickness compensator comprising portions having different properties
Norgine B.V.	<b>A61K 9/20</b> (2006.01) <b>A61P 1/10</b> (2006.01) <b>A61K 31/765</b> (2006.01)	2635264 *	FORMULATIONS COMPRISING POLYETHYLENE GLYCOL
Axelar AB	<b>A61K 31/365</b> (2006.01) <b>A61P 3/10</b> (2006.01) <b>A61P 25/28</b> (2006.01) <b>A61P 35/00</b> (2006.01)	2624827 *	PICROPODOPHYLLIN POLYMORPHS B OR C FOR USE IN CANCER THERAPY
Merinova, Elena Arkadyevna	<b>A47G 19/16</b> (2006.01)	2596725 *	DISPOSABLE STRAINER FOR INFUSING TEA WITH A SQUEEZING SYSTEM

Podnosilac evropske prijave patenta (71)	MKP (51)	Broj objave evropske prijave patenta (97)	Naziv pronalaska (54)
Novartis AG	<b>A61K 47/26</b> (2006.01) <b>A61K 47/38</b> (2006.01) <b>A61K 47/20</b> (2006.01) <b>A61K 9/20</b> (2006.01) <b>A61K 31/444</b> (2006.01)	2627319 *	PHARMACEUTICAL COMPOSITIONS CONTAINING A DGAT1 INHIBITOR
Sunflex Aluminiumsysteme GmbH	<b>E06B 3/92</b> (2006.01) <b>E05D 15/06</b> (2006.01) <b>E05D 15/58</b> (2006.01)	2639391	Sliding and pivoting leaf system
ABRA Pharmaceuticals sàrl	<b>A61K 31/775</b> (2006.01) <b>C08G 65/38</b> (2006.01) <b>A61K 35/00</b> (2006.01)	2635290 *	NOVEL SELF-ASSEMBLING POLYPHENOL-QUINONOID POLYMER DERIVATIVES AND USES THEREOF
Janssen Pharmaceutica, N.V.	<b>C07D 487/04</b> (2006.01) <b>A61K 31/5517</b> (2006.01) <b>A61P 31/10</b> (2006.01)	2643324 *	ANTIFUNGAL 5,6-DIHYDRO-4H-PYRROLO[1,2-A][1,4]-BENZODIAZEPINES AND 6H-PYRROLO[1,2-A][1,4]-BENZODIAZEPINES SUBSTITUTED WITH PHENYL DERIVATIVES
Delphi Technologies Holding S.à.r.l.	<b>F02M 59/46</b> (2006.01) <b>F02M 63/02</b> (2006.01)	2557307	Pump head for a fuel pump
Abraxis BioScience, LLC	<b>A61K 39/00</b> (2006.01)	2598164 *	PERIPHERAL BLOOD SPARC ANTIBODIES AND USES THEREOF
The Cleveland Clinic Foundation	<b>A61B 17/15</b> (2006.01)	2613718 *	POSITIONING APPARATUS AND METHOD FOR A PROSTHETIC IMPLANT
Lee, Chooi Tian	<b>H04L 12/28</b> (2006.01)	2636188 *	APPARATUS AND METHODS FOR MULTIMODE INTERNETWORKING CONNECTIVITY
Shire LLC	<b>C07C 279/24</b> (2006.01) <b>C07D 233/64</b> (2006.01) <b>A61K 31/155</b> (2006.01)	2616434 *	PRODRUGS OF GUANFACINE
Endocyte, Inc.	<b>G01N 33/574</b> (2006.01)	2638397 *	METHODS OF TREATING CANCER
Shionogi & Co., Ltd.	<b>B01J 27/10</b> (2006.01) <b>C07D 271/06</b> (2006.01) <b>A61K 31/485</b> (2006.01) <b>A61P 1/08</b> (2006.01) <b>A61P 1/10</b> (2006.01) <b>C07D 489/08</b> (2006.01)	2639234 *	CRYSTALLINE 6,7-UNSATURATED-7-CARBAMOYL MORPHINANE DERIVATIVE, AND METHOD FOR PRODUCING SAME
Meliatys	<b>A61K 9/16</b> (2006.01) <b>A61K 9/20</b> (2006.01) <b>A61K 9/00</b> (2006.01)	2629755 *	PROCESS FOR MAKING MULTIPARTICULATE GASTRORETENTIVE DOSAGE FORMS
Geox S.p.A.	<b>A43B 7/08</b> (2006.01) <b>A43B 7/12</b> (2006.01) <b>A43B 13/12</b> (2006.01) <b>A43B 9/12</b> (2006.01) <b>A43B 13/42</b> (2006.01)	2621301 *	VAPOR-PERMEABLE SHOE WITH WATERPROOF AND VAPOR-PERMEABLE SOLE
Ranbaxy Laboratories Limited	<b>A61K 31/27</b> (2006.01) <b>A61K 31/4035</b> (2006.01) <b>A61K 31/53</b> (2006.01) <b>C07D 401/12</b> (2006.01) <b>C07C 271/28</b> (2006.01) <b>A61P 11/00</b> (2006.01) <b>C07D 209/48</b> (2006.01) <b>A61P 19/02</b> (2006.01) <b>C07D 253/04</b> (2006.01) <b>A61P 35/00</b> (2006.01)	2619179 *	MATRIX METALLOPROTEINASE INHIBITORS
Packers Plus Energy Services Inc.	<b>E21B 43/26</b> (2006.01) <b>E21B 23/06</b> (2006.01) <b>E21B 23/04</b> (2006.01) <b>E21B 33/124</b> (2006.01)	2643547 *	METHOD AND APPARATUS FOR SETTING A WELLBORE PACKER
ORTHO-CLINICAL DIAGNOSTICS, INC.	<b>G01N 33/543</b> (2006.01) <b>G01N 33/558</b> (2006.01)	2618152	Assay device having controllable sample size
Landis + Gyr Innovations, Inc.	<b>G01R 21/00</b> (2006.01)	2622357 *	UTILITY DEVICE MANAGEMENT
Huawei Technologies Co., Ltd.	<b>H03M 13/37</b> (2006.01) <b>H04L 27/00</b> (2006.01) <b>H04L 27/233</b> (2006.01) <b>H04L 1/00</b> (2006.01)	2567461 *	METHOD AND APPARATUS FOR DETECTING A PARITY ERROR IN A SEQUENCE OF DQPSK SYMBOLS OF A DIGITAL TRANSMISSION SYSTEM

Podnosilac evropske prijave patenta (71)	MKP (51)	Broj objave evropske prijave patenta (97)	Naziv pronalaska (54)
Pavetic, Josip	<b>E21F 1/00</b> (2006.01) <b>E21F 1/08</b> (2006.01)	2598718 *	METHOD AND SYSTEM FOR TUNNEL VENTILATION IN NORMAL CONDITIONS AND IN CONDITIONS OF FIRE
DSM IP Assets B.V.	<b>C12P 7/46</b> (2006.01)	2619314 *	DICARBOXYLIC ACID PRODUCTION PROCESS
Roquette Frères SA	<b>C12P 7/46</b> (2006.01)	2619314 *	DICARBOXYLIC ACID PRODUCTION PROCESS
Celgene Avilomics Research, Inc.	<b>A61K 31/16</b> (2006.01) <b>A61K 31/506</b> (2006.01)	2635285 *	HETEROARYL COMPOUNDS AND USES THEREOF
Saint-Gobain Placo SAS	<b>C04B 28/14</b> (2006.01)	2643276 *	CALCIUM SULPHATE-BASED PRODUCTS AND METHODS FOR THE MANUFACTURE THEREOF
Sanofi-Aventis Deutschland GmbH	<b>A61K 38/22</b> (2006.01) <b>C07K 14/575</b> (2006.01) <b>A61P 3/10</b> (2006.01) <b>A61P 3/08</b> (2006.01) <b>A61P 3/04</b> (2006.01)	2611458 *	USE OF AVE0010 FOR THE MANUFACTURE OF A MEDICAMENT FOR THE TREATMENT OF DIABETES MELLITUS TYPE 2
Bayer Intellectual Property GmbH	<b>C07D 471/04</b> (2006.01) <b>C07D 487/04</b> (2006.01) <b>A61K 31/437</b> (2006.01) <b>A61K 31/519</b> (2006.01) <b>A61P 9/00</b> (2006.01) <b>A61P 9/04</b> (2006.01) <b>A61P 9/12</b> (2006.01) <b>A61P 9/14</b> (2006.01) <b>A61P 9/10</b> (2006.01) <b>A61P 7/02</b> (2006.01) <b>A61P 13/12</b> (2006.01)	2611802 *	BICYCLIC AZA HETEROCYCLES, AND USE THEREOF
Baxter International Inc	<b>A61K 38/48</b> (2006.01) <b>A61K 39/395</b> (2006.01) <b>A61K 47/02</b> (2006.01) <b>A61K 47/18</b> (2006.01) <b>A61K 9/00</b> (2006.01) <b>A61K 38/00</b> (2006.01)	2616091 *	STABILIZATION OF IMMUNOGLOBULINS AND OTHER PROTEINS THROUGH AQUEOUS FORMULATIONS WITH SODIUM CHLORIDE AT WEAK ACIDIC TO NEUTRAL PH
Baxter Healthcare SA	<b>A61K 38/48</b> (2006.01) <b>A61K 39/395</b> (2006.01) <b>A61K 47/02</b> (2006.01) <b>A61K 47/18</b> (2006.01) <b>A61K 9/00</b> (2006.01) <b>A61K 38/00</b> (2006.01)	2616091 *	STABILIZATION OF IMMUNOGLOBULINS AND OTHER PROTEINS THROUGH AQUEOUS FORMULATIONS WITH SODIUM CHLORIDE AT WEAK ACIDIC TO NEUTRAL PH
Abbvie Inc.	<b>C07D 403/14</b> (2006.01)	2627651 *	ANTI-VIRAL COMPOUNDS
Nektar Therapeutics	<b>A61K 47/48</b> (2006.01)	2628489	PEG oligomer-fentanyl conjugates
Teva Pharmaceutical Industries Ltd.	<b>A61P 25/28</b> (2006.01) <b>A61K 31/135</b> (2006.01) <b>C07C 309/29</b> (2006.01) <b>C07C 211/42</b> (2006.01) <b>C07C 309/04</b> (2006.01) <b>A01N 33/02</b> (2006.01)	2632254 *	DEUTERIUM ENRICHED RASAGILINE
Orthosoft, Inc.	<b>A61B 19/00</b> (2006.01) <b>A61B 17/56</b> (2006.01) <b>A61B 5/11</b> (2006.01) <b>G01C 19/02</b> (2006.01)	2598074 *	BONE TRACKING WITH A GYROSCOPE SENSOR IN COMPUTER-ASSISTED SURGERY
Astellas Pharma Inc.	<b>A61P 25/00</b> (2006.01) <b>C07D 277/20</b> (2006.01) <b>A61P 35/00</b> (2006.01) <b>A61P 9/00</b> (2006.01) <b>C07D 417/12</b> (2006.01) <b>A61K 31/426</b> (2006.01) <b>C07D 277/56</b> (2006.01) <b>A61K 31/341</b> (2006.01) <b>A61P 43/00</b> (2006.01) <b>A61K 31/427</b> (2006.01) <b>C07D 307/68</b> (2006.01) <b>A61P 29/00</b> (2006.01) <b>A61P 13/00</b> (2006.01)	2620433 *	SUBSTITUTED AMIDE COMPOUND
Les Laboratoires Servier	<b>C07D 209/42</b> (2006.01)	2612851	Process for the preparation of the L-arginine salt of perindopril

Podnosilac evropske prijave patenta (71)	MKP (51)	Broj objave evropske prijave patenta (97)	Naziv pronalaska (54)
Abbvie Inc.	<b>C07D 217/06</b> (2006.01) <b>C07D 401/12</b> (2006.01) <b>C07D 405/12</b> (2006.01) <b>C07D 409/12</b> (2006.01) <b>C07D 409/14</b> (2006.01) <b>C07D 413/12</b> (2006.01) <b>C07D 471/04</b> (2006.01) <b>A61K 31/4375</b> (2006.01) <b>A61K 31/496</b> (2006.01) <b>A61K 31/472</b> (2006.01) <b>A61K 31/4725</b> (2006.01) <b>A61P 29/00</b> (2006.01) <b>A61P 37/00</b> (2006.01) <b>A61P 9/00</b> (2006.01) <b>A61P 35/00</b> (2006.01)	2640704 *	NAMPT INHIBITORS
PPG Industries Ohio, Inc.	<b>C03C 3/118</b> (2006.01) <b>C03C 13/00</b> (2006.01) <b>B32B 17/00</b> (2006.01) <b>C08J 5/24</b> (2006.01) <b>C08K 7/14</b> (2006.01) <b>C08J 5/04</b> (2006.01)	2616400 *	LOW DENSITY AND HIGH STRENGTH FIBER GLASS FOR REINFORCEMENT APPLICATIONS
Eli Lilly and Company	<b>C07C 323/58</b> (2006.01) <b>A61K 31/10</b> (2006.01)	2640697 *	4-SUBSTITUTED-3-PHENYLSULFANYLMETHYL-BICYCLO[3.1.0]HEXANE COMPOUNDS AS MGLUR 2/3 ANTAGONISTS
SGC Pharma Inc.	<b>C07D 417/00</b> (2006.01)	2609093 *	SALT COMPOUND
IDT Biologika GmbH	<b>A01N 25/00</b> (2006.01) <b>A61K 9/00</b> (2006.01) <b>A61K 39/205</b> (2006.01) <b>B65D 75/42</b> (2006.01)	2613629 *	ORAL VETERINARY PREPARATIONS
Phenofarm S.r.l.	<b>A23L 1/30</b> (2006.01) <b>C02F 1/04</b> (2006.01) <b>C02F 1/44</b> (2006.01) <b>C02F 3/34</b> (2006.01) <b>A61K 36/63</b> (2006.01) <b>A23L 1/212</b> (2006.01)	2526785	Process for producing a phytoextract from vegetation waters and olive oil pomaces
Total Research & Technology Feluy SA	<b>C12P 7/56</b> (2006.01) <b>C12R 1/645</b> (2006.01) <b>C12N 1/14</b> (2006.01)	2633027 *	PROCESS FOR POLYLACTIC ACID PRODUCTION USING MONASCUS
Vanderbilt University	<b>A61K 31/42</b> (2006.01) <b>A01N 43/76</b> (2006.01)	2611298 *	BICYCLIC OXAZOLE AND THIAZOLE COMPOUNDS AND THEIR USE AS ALLOSTERIC MODULATORS OF MGLUR5 RECEPTORS
Katholieke Universiteit Leuven, K.U. Leuven R&D	<b>A61K 31/505</b> (2006.01)	2616077 *	ANTI-CANCER ACTIVITY OF NOVEL BICYCLIC HETEROCYCLES
Begunov, Albert Ivanovich	<b>C22B 21/04</b> (2006.01)	2639320 *	METHOD FOR PRODUCING ALUMINIUM BY METALLOTHERMIC REDUCTION OF TRICHLORIDE WITH MAGNESIUM AND APPARATUS FOR CARRYING OUT SAID METHOD
Immatics Biotechnologies GmbH	<b>G01N 33/574</b> (2006.01) <b>A61K 39/00</b> (2006.01)	2643698 *	BIOMARKERS FOR PREDICTING THE EFFICACY OF AN IMMUNOTHERAPY AGAINST CANCER
China Mobile Communications Corporation	<b>H04W 52/14</b> (2009.01)	2645786 *	METHOD AND BASE STATION FOR ADJUSTING UPLINK GRANT PHYSICAL DOWNLINK CONTROL CHANNEL OF UE
AstraZeneca AB	<b>C07D 211/22</b> (2006.01) <b>A61K 31/445</b> (2006.01) <b>A61P 35/00</b> (2006.01) <b>A61P 35/02</b> (2006.01)	2601177 *	N-ACYLSULFONAMIDE APOPTOSIS PROMOTERS
MERICHEM COMPANY	<b>C10G 19/02</b> (2006.01) <b>C10G 67/10</b> (2006.01) <b>C07C 7/10</b> (2006.01)	2611887 *	SULFONE REMOVAL FROM AN OXIDIZED HYDROCARBON FUEL
Colibri' System S.p.A.	<b>B29C 65/18</b> (2006.01) <b>B42C 15/00</b> (2006.01) <b>B65B 51/14</b> (2006.01)	2643144 *	ELECTRICALLY OPERATED MACHINE FOR COVERING BOOK COVERS AND SEALING ENVELOPES AND ARTICLES OF VARIOUS KIND



Podnosilac evropske prijave patenta (71)	MKP (51)	Broj objave evropske prijave patenta (97)	Naziv pronalaska (54)
Maria Clementine Martin Klosterfrau Vertriebsgesellschaft mbH	<b>A61K 36/185</b> (2006.01) <b>A61K 36/53</b> (2006.01)	2605785 *	METHOD FOR PRODUCING NON-ALCOHOLIC COMPOSITIONS, COMPOSITIONS PRODUCED IN SAID MANNER AND USE THEREOF
Castrip LLC	<b>B22D 11/06</b> (2006.01)	2629907 *	TWIN ROLL CONTINUOUS CASTER
Millennium Pharmaceuticals, Inc.	<b>A61K 31/52</b> (2006.01) <b>A61P 35/00</b> (2006.01)	2635287 *	ADMINISTRATION OF NEDD8-ACTIVATING ENZYME INHIBITOR
Kyocera Corporation	<b>B23B 27/22</b> (2006.01) <b>B23B 27/04</b> (2006.01) <b>B23B 27/14</b> (2006.01)	2636472 *	CUTTING INSERT, CUTTING TOOL, AND METHOD FOR MANUFACTURING CUT PRODUCT USING SAME
Packers Plus Energy Services Inc.	<b>E21B 43/10</b> (2006.01)	2598714 *	WELLBORE LATERAL LINER PLACEMENT SYSTEM
Lupin Limited	<b>C07D 417/14</b> (2006.01) <b>A61P 19/00</b> (2006.01) <b>A61K 31/444</b> (2006.01) <b>C07D 471/04</b> (2006.01) <b>C07D 401/12</b> (2006.01) <b>A61P 3/04</b> (2006.01) <b>C07D 401/14</b> (2006.01) <b>A61P 3/10</b> (2006.01) <b>C07D 491/08</b> (2006.01) <b>C07D 413/14</b> (2006.01) <b>A61P 9/00</b> (2006.01) <b>A61K 31/506</b> (2006.01)	2643311 *	BICYCLIC GPR119 MODULATORS
Delphi Technologies Holding S.à.r.l.	<b>F02M 59/46</b> (2006.01) <b>F02M 63/00</b> (2006.01) <b>F02M 63/02</b> (2006.01) <b>F02M 51/00</b> (2006.01) <b>F16K 31/06</b> (2006.01) <b>F16L 37/098</b> (2006.01) <b>F02M 61/16</b> (2006.01)	2538067	Assembly for an electrically operated valve
Secura-Nova Spolka z Ograniczona Opdowiedzialnoscia	<b>A61M 11/00</b> (2006.01) <b>A61M 11/06</b> (2006.01) <b>A61M 15/00</b> (2006.01)	2537548	A method and apparatus for controlling and monitoring of an apparatus for generating an aerosol during administration of a dose of a substance by way of inhalation
Biogen IDEC International Neuroscience GmbH	<b>C07K 16/46</b> (2006.01) <b>C07K 16/18</b> (2006.01)	2627672 *	HUMAN ANTI-TAU ANTIBODIES
University of Zurich	<b>C07K 16/46</b> (2006.01) <b>C07K 16/18</b> (2006.01)	2627672 *	HUMAN ANTI-TAU ANTIBODIES
Qwtip LLC	<b>B01D 53/02</b> (2006.01) <b>B01D 17/038</b> (2006.01)	2608866 *	SYSTEM AND METHOD FOR SEPARATING FLUIDS AND CREATING MAGNETIC FIELDS
Agilex Flavor&Fragrances	<b>A61L 101/32</b> (2006.01) <b>A61L 9/01</b> (2006.01) <b>A61L 9/12</b> (2006.01)	2629807 *	WATER-BASED AIR FRESHENER COMPOSITIONS, SYSTEMS, AND METHODS OF USE THEREOF
Sanofi-Aventis U.S. LLC	<b>B65G 67/20</b> (2006.01) <b>B65G 67/08</b> (2006.01) <b>B65G 57/112</b> (2006.01)	2627592 *	APPARATUS AND METHOD FOR LOADING AND UNLOADING CONTAINERS
TIG Automation GmbH	<b>B01D 63/04</b> (2006.01) <b>B01D 65/00</b> (2006.01)	2614880	Membrane device for filtering and separating fluids
Stion Corporation	<b>H01L 21/02</b> (2006.01) <b>H01L 21/36</b> (2006.01)	2410556	Sodium sputtering doping method for large scale CIGS based thin film photovoltaic materials
Ecoval Environnement	<b>B27N 3/00</b> (2006.01) <b>B29B 17/02</b> (2006.01) <b>B09B 3/00</b> (2006.01)	2598260 *	METHOD FOR RECYCLING FURNITURE MATERIALS, IN PARTICULAR MATTRESS, BOX-SPRING, AND SEAT MATERIALS, SHEET OF MATERIAL OBTAINED BY SUCH A METHOD, AND RELATED RECYCLING FACILITY
Amgen Inc.	<b>G01N 33/53</b> (2006.01) <b>G01N 33/68</b> (2006.01) <b>G01N 33/564</b> (2006.01)	2603794 *	DUAL FUNCTION IN VITRO TARGET BINDING ASSAY FOR THE DETECTION OF NEUTRALIZING ANTIBODIES AGAINST TARGET ANTIBODIES

Podnosilac evropske prijave patenta (71)	MKP (51)	Broj objave evropske prijave patenta (97)	Naziv pronalaska (54)
Ranbaxy Laboratories Limited	<b>C07C 333/08</b> (2006.01) <b>A61K 31/192</b> (2006.01) <b>A61K 31/325</b> (2006.01) <b>C07C 309/60</b> (2006.01) <b>C07C 321/28</b> (2006.01) <b>A61P 11/00</b> (2006.01) <b>A61P 19/02</b> (2006.01) <b>A61P 35/00</b> (2006.01)	2619177 *	MATRIX METALLOPROTEINASE INHIBITORS
Lehmann, Annette	<b>B41K 1/26</b> (2006.01) <b>B41K 1/28</b> (2006.01) <b>B41K 1/50</b> (2006.01) <b>B41K 1/52</b> (2006.01)	2522524	Marking device for marking balls, use of such a marking device and method for producing such a marking device
Leosphere	<b>G02B 6/36</b> (2006.01) <b>G02B 7/00</b> (2006.01)	2625557 *	OPTICAL HEAD FOR PERFORMING AN ATMOSPHERIC MEASUREMENT, AND RELATED SYSTEM AND MANUFACTURING METHOD
Arena Pharmaceuticals, Inc.	<b>A61K 31/133</b> (2006.01)	2611433 *	NON-HYGROSCOPIC SALTS OF 5-HT2C AGONISTS
Ironwood Pharmaceuticals, Inc.	<b>A61K 38/10</b> (2006.01) <b>A61P 1/00</b> (2006.01) <b>A61P 43/00</b> (2006.01)	2613794 *	TREATMENT OF CONSTIPATION-PREDOMINANT IRRITABLE BOWEL SYNDROME
Forest Laboratories Holdings Limited	<b>A61K 38/10</b> (2006.01) <b>A61P 1/00</b> (2006.01) <b>A61P 43/00</b> (2006.01)	2613794 *	TREATMENT OF CONSTIPATION-PREDOMINANT IRRITABLE BOWEL SYNDROME
Stem Centrx, Inc.	<b>A61K 39/395</b> (2006.01)	2611463 *	IDENTIFICATION AND ENRICHMENT OF CELL SUBPOPULATIONS
GlaxoSmithKline LLC	<b>A01N 43/52</b> (2006.01) <b>A61K 31/4164</b> (2006.01)	2624696 *	BENZIMIDAZOLE DERIVATIVES AS PI3 KINASE INHIBITORS
University of Pittsburgh - Of The Commonwealth System of Higher Education	<b>G02B 27/12</b> (2006.01)	2596400 *	NANO-OPTIC REFRACTIVE OPTICS
Ishihara Sangyo Kaisha, Ltd.	<b>A01N 37/34</b> (2006.01) <b>A01N 43/653</b> (2006.01) <b>A01N 43/54</b> (2006.01) <b>A01N 37/50</b> (2006.01) <b>A01N 47/34</b> (2006.01) <b>A01N 37/32</b> (2006.01) <b>A01N 43/56</b> (2006.01) <b>A01N 41/06</b> (2006.01) <b>A01N 47/38</b> (2006.01) <b>A01N 43/36</b> (2006.01) <b>A01N 47/44</b> (2006.01) <b>A01N 43/40</b> (2006.01) <b>A01N 53/00</b> (2006.01) <b>A01N 43/50</b> (2006.01) <b>A01P 3/00</b> (2006.01)	2595481 *	CONTROL AGENT FOR SOFT ROT AND CONTROL METHOD FOR THE SAME
Swedish Orphan Biovitrum AB (Publ)	<b>A61P 1/00</b> (2006.01) <b>A61K 38/43</b> (2006.01)	2629789 *	METHOD TO INCREASE THE ABSORPTION OF UNSATURATED FATTY ACIDS BY HUMAN INFANTS
Inova Lisec Technologiezentrum GmbH	<b>F24J 2/20</b> (2006.01)	2625470 *	SOLAR COLLECTOR
Total Raffinage Marketing	<b>C12N 1/14</b> (2006.01) <b>C12R 1/645</b> (2006.01)	2633028 *	USE OF MONASCUS IN ORGANIC ACID PRODUCTION
Ethicon, LLC	<b>A61B 17/04</b> (2006.01) <b>A61B 17/08</b> (2006.01) <b>D02J 3/10</b> (2006.01) <b>D02J 3/02</b> (2006.01)	2566402 *	SELF-RETAINING SYSTEMS HAVING LASER-CUT RETAINERS
Janssen Biotech, Inc.	<b>C12N 5/02</b> (2006.01) <b>C12N 5/0735</b> (2010.01) <b>C12N 5/071</b> (2010.01)	2611907 *	DIFFERENTIATION OF PLURIPOTENT STEM CELLS
Clean Canned ApS	<b>B65D 17/34</b> (2006.01)	2621820 *	LID FOR BEVERAGE CAN

Podnosilac evropske prijave patenta (71)	MKP (51)	Broj objave evropske prijave patenta (97)	Naziv pronalaska (54)
Laboratoires Thèa	<b>B65D 47/18</b> (2006.01) <b>B65D 49/04</b> (2006.01) <b>B65D 81/26</b> (2006.01) <b>B65D 47/32</b> (2006.01) <b>B65D 51/16</b> (2006.01)	2616352 *	HEAD FOR DISPENSING A LIQUID AS A DRIP
AbbVie Inc.	<b>A61K 31/496</b> (2006.01) <b>A61P 37/00</b> (2006.01)	2642999 *	METHODS OF TREATMENT USING SELECTIVE BCL-2 INHIBITORS
Halozyyme, Inc.	<b>A61K 31/37</b> (2006.01) <b>A61K 31/42</b> (2006.01) <b>A61K 31/573</b> (2006.01) <b>A61K 38/47</b> (2006.01) <b>A61P 43/00</b> (2006.01) <b>A61P 29/00</b> (2006.01) <b>A61P 7/10</b> (2006.01) <b>A61P 21/00</b> (2006.01) <b>A61P 35/00</b> (2006.01)	2595624 *	ADVERSE SIDE-EFFECTS ASSOCIATED WITH ADMINISTRATION OF AN ANTI-HYALURONAN AGENT AND METHODS FOR AMELIORATING OR PREVENTING THE SIDE-EFFECTS
Rehau AG & Co	<b>H02G 3/08</b> (2006.01) <b>H02G 3/22</b> (2006.01) <b>H02G 15/013</b> (2006.01)	2643911 *	SINGLE-LINE SEAL
Cadila Healthcare Limited	<b>A61K 31/502</b> (2006.01) <b>C07D 237/32</b> (2006.01) <b>C07D 403/12</b> (2006.01) <b>A61P 35/00</b> (2006.01)	2598491 *	SUBSTITUTED 4-(4-FLUORO-3-(PIPERAZINE-1-CARBONYL)BENZYL)PHTHALAZIN-1(2H)-ONE DERIVATIVES AS POLY (ADP-RIBOSE) POLYMERASE- 1 INHIBITORS
Synageva BioPharma Corp.	<b>A61K 38/46</b> (2006.01) <b>A61K 31/366</b> (2006.01) <b>A61K 31/397</b> (2006.01) <b>A61K 31/135</b> (2006.01) <b>A61P 3/06</b> (2006.01)	2613798 *	USE OF LYSOSOMAL ACID LIPASE FOR TREATING LYSOSOMAL ACID LIPASE DEFICIENCY IN PATIENTS
Amgen Research (Munich) GmbH	<b>A61K 39/395</b> (2006.01) <b>C07K 16/28</b> (2006.01) <b>C07K 16/46</b> (2006.01) <b>A61P 35/00</b> (2006.01)	2632954 *	MEANS AND METHODS FOR TREATING DLBCL
IP Bewertungs AG (IPB)	<b>C12N 15/09</b> (2006.01) <b>C12N 1/20</b> (2006.01) <b>C12N 9/18</b> (2006.01) <b>C12N 5/10</b> (2006.01) <b>C12N 15/70</b> (2006.01)	2644693	Biologically active polypeptide expressed on the surface of a cell
Advanced Cell Technology, Inc.	<b>C12Q 1/04</b> (2006.01) <b>C12N 5/071</b> (2010.01) <b>C12N 5/0735</b> (2010.01) <b>G01N 33/533</b> (2006.01)	2596119 *	METHODS FOR DETECTION OF RARE SUBPOPULATIONS OF CELLS AND HIGHLY PURIFIED COMPOSITIONS OF CELLS
Schröcker, Siegfried	<b>E06B 9/00</b> (2006.01) <b>E06B 9/02</b> (2006.01)	2601371 *	CLAMPING DEVICE
Probst, Franz	<b>A47B 67/04</b> (2006.01) <b>A47B 88/20</b> (2006.01)	2621307 *	FEEDING STATION FOR PETS AND CABINET HAVING SUCH A FEEDING STATION
Strauss Water Ltd	<b>G05D 11/13</b> (2006.01) <b>B67D 3/00</b> (2006.01)	2616385 *	BEVERAGE DISPENSING SYSTEM
Elpigaz Sp. z o.o.	<b>B60K 15/03</b> (2006.01) <b>F17C 1/00</b> (2006.01)	2625053 *	PRESSURE TANK
Asahi Kasei Chemicals Corporation	<b>C08L 25/08</b> (2006.01) <b>B65D 65/02</b> (2006.01) <b>B65D 83/04</b> (2006.01) <b>C08K 3/00</b> (2006.01) <b>C08J 5/18</b> (2006.01) <b>B65D 75/34</b> (2006.01)	2639183 *	PUSH-THROUGH PACK PACKAGING
Behr GmbH & Co. KG	<b>F02G 5/02</b> (2006.01)	2495422	Combustion engine
beeline GmbH	<b>A47F 7/024</b> (2006.01)	2586340	Ring holder, system comprising ring holder and ring display and method for connecting a ring with a ring holder
Urimat Holding AG	<b>E03D 13/00</b> (2006.01) <b>E03D 9/00</b> (2006.01)	2627836 *	INSERT FOR THE DRAINAGE OPENING OF A URINAL
Novartis AG	<b>C07K 16/28</b> (2006.01)	2640749 *	SILENT FC VARIANTS OF ANTI-CD40 ANTIBODIES

Podnosilac evropske prijave patenta (71)	MKP (51)	Broj objave evropske prijave patenta (97)	Naziv pronalaska (54)
Medicis Pharmaceutical Corporation	<b>B67B 5/00</b> (2006.01) <b>A61K 31/4745</b> (2006.01)	2600870 *	PUMP SYSTEMS AND METHODS FOR STORING AND DISPENSING A PLURALITY OF PRECISELY MEASURED UNIT-DOSES OF IMIQUIMOD CREAM
Exelixis, Inc.	<b>A61P 35/00</b> (2006.01) <b>G01N 33/00</b> (2006.01) <b>A61K 31/00</b> (2006.01)	2640367 *	BENZOXAZEPINES AS INHIBITORS OF PI3K/MTOR AND METHODS OF THEIR USE AND MANUFACTURE
Nantong Ya Tai Candle Arts & Crafts Co., Ltd.	<b>F21S 6/00</b> (2006.01)	2530371	An electronic candle
Shanghai Q Mall & Co. Ltd.	<b>F21S 6/00</b> (2006.01)	2530371	An electronic candle
Shionogi & Co., Ltd.	<b>A61P 31/16</b> (2006.01) <b>C07D 471/04</b> (2006.01) <b>A61K 31/53</b> (2006.01) <b>A61P 43/00</b> (2006.01)	2620436 *	SUBSTITUTED POLYCYCLIC CARBAMOYL PYRIDONE DERIVATIVE PRODRUG
Theravance, Inc.	<b>C07D 401/12</b> (2006.01) <b>A61K 31/444</b> (2006.01) <b>A61P 11/08</b> (2006.01)	2621917 *	CRYSTALLINE OXALATE SALTS OF A DIAMIDE COMPOUND
Cochlear Ltd.	<b>H04B 5/00</b> (2006.01) <b>H04R 25/00</b> (2006.01)	2633702 *	PAIRING OR ASSOCIATING ELECTRONIC DEVICES
Goodtech Recovery Technology AS	<b>C25C 3/08</b> (2006.01) <b>F27D 1/12</b> (2006.01)	2619518 *	SYSTEM AND METHOD FOR CONTROL OF SIDE LAYER FORMATION IN AN ALUMINIUM ELECTROLYSIS CELL
Sanofi-Aventis Deutschland GmbH	<b>A61M 5/315</b> (2006.01) <b>A61M 5/00</b> (2006.01)	2624893 *	DRIVE MECHANISM FOR A DRUG DELIVERY DEVICE AND DRUG DELIVERY DEVICE
SANOFI	<b>A61P 3/00</b> (2006.01) <b>C07D 237/20</b> (2006.01) <b>A61K 31/425</b> (2006.01) <b>C07D 271/06</b> (2006.01)	2595970 *	DERIVATIVES OF OXADIAZOLE AND PYRIDAZINE, THEIR PREPARATION AND THEIR APPLICATION IN THERAPEUTICS
Boehringer Ingelheim International GmbH	<b>A61K 31/00</b> (2006.01) <b>A61K 31/341</b> (2006.01) <b>A61K 38/28</b> (2006.01) <b>A61P 3/10</b> (2006.01)	2637648 *	PHARMACEUTICAL COMPOSITION, METHODS FOR TREATING AND USES THEREOF
Bayer Intellectual Property GmbH	<b>A61K 9/70</b> (2006.01)	2613771 *	TRANSDERMAL THERAPEUTIC SYSTEMS WITH CRYSTALLIZATION-INHIBITING PROTECTIVE FILM (RELEASE LINER)
Bayer Pharma Aktiengesellschaft	<b>C07D 239/47</b> (2006.01)	2619186 *	PROCESS FOR PREPARING PAN-CDK INHIBITORS OF THE FORMULA (I), AND INTERMEDIATES IN THE PREPARATION
Nestec S.A. CT-IAM	<b>G01N 33/68</b> (2006.01) <b>G01N 33/558</b> (2006.01)	2630495 *	METHODS FOR DETERMINING ANTI-DRUG ANTIBODY ISOTYPES
Amgen, Inc	<b>C12P 21/08</b> (2006.01) <b>C07K 16/00</b> (2006.01) <b>A61K 39/00</b> (2006.01) <b>C12N 5/00</b> (2006.01) <b>C12P 21/06</b> (2006.01) <b>C07H 21/04</b> (2006.01)	2596114 *	DOMAIN INSERTION IMMUNOGLOBULIN
EGIS GYÓGYSZERGYÁR Nyilvánosan Működő Részvénytársaság	<b>A61K 47/02</b> (2006.01) <b>C01B 33/12</b> (2006.01) <b>C04B 33/02</b> (2006.01)	2627606 *	METHOD FOR PURIFYING DIATOMACEOUS EARTH SUITABLE FOR PHARMACEUTICAL USE
Onp Holding SE	<b>A61K 47/02</b> (2006.01) <b>C01B 33/12</b> (2006.01) <b>C04B 33/02</b> (2006.01)	2627606 *	METHOD FOR PURIFYING DIATOMACEOUS EARTH SUITABLE FOR PHARMACEUTICAL USE
Chiesi Farmaceutici S.p.A.	<b>C07D 453/02</b> (2006.01) <b>A61K 31/439</b> (2006.01) <b>A61P 11/14</b> (2006.01)	2630145 *	CARBONATE DERIVATIVES FOR THE TREATMENT OF COUGH
MERICHEM COMPANY	<b>B01D 11/04</b> (2006.01) <b>B01D 17/04</b> (2006.01) <b>C10G 27/04</b> (2006.01) <b>C10G 33/06</b> (2006.01)	2600955 *	SEPARATION PROCESS

Podnosilac evropske prijave patenta (71)	MKP (51)	Broj objave evropske prijave patenta (97)	Naziv pronalaska (54)
Suven Life Sciences Limited	<b>A61K 31/437</b> (2006.01) <b>A61K 31/496</b> (2006.01) <b>A61K 31/55</b> (2006.01) <b>A61K 31/5517</b> (2006.01) <b>C07D 413/12</b> (2006.01) <b>C07D 417/12</b> (2006.01) <b>C07D 471/04</b> (2006.01) <b>C07D 498/04</b> (2006.01) <b>A61P 23/00</b> (2006.01) <b>A61P 25/00</b> (2006.01)	2611444 *	HETEROCYCLYL COMPOUNDS AS HISTAMINE H3 RECEPTOR LIGANDS
Square, Inc.	<b>G06Q 20/00</b> (2012.01)	2628140 *	PAYMENT METHODS WITH A PAYMENT SERVICE AND TABS SELECTED BY A FIRST PARTY AND OPENED BY A SECOND PARTY AT ANY GEOGRAPHIC LOCATION OF THE FIRST PARTY'S MOBILE DEVICE
TOTO LTD.	<b>E03D 9/08</b> (2006.01) <b>B05B 1/34</b> (2006.01) <b>B05B 7/04</b> (2006.01)	2354337	Sanitary washing apparatus
Doikos Investments, Ltd.	<b>F23H 7/08</b> (2006.01)	2598800 *	HYDRAULIC DRIVE FOR A SLIDING COMBUSTION GRATE
Biogenerix GmbH	<b>C07K 1/16</b> (2006.01) <b>C07K 1/18</b> (2006.01) <b>C07K 1/22</b> (2006.01) <b>C07K 14/46</b> (2006.01) <b>C07K 14/47</b> (2006.01)	2601207 *	METHOD OF PRODUCING AND PURIFYING AN ACTIVE SOLUBLE SIALYLTRANSFERASE
Sanofi-Aventis Deutschland GmbH	<b>A61M 5/315</b> (2006.01)	2529773	Resetting mechanism for a drug delivery device
High Point Pharmaceuticals, LLC	<b>A01N 43/52</b> (2006.01) <b>A61K 31/415</b> (2006.01)	2549874 *	SUBSTITUTED IMIDAZO[1,2-B]PYRIDAZINE DERIVATIVES, PHARMACEUTICAL COMPOSITIONS, AND METHODS OF USE AS BETA-SECRETASE INHIBITORS
Pharma Mar S.A.	<b>A61K 31/4995</b> (2006.01) <b>A61K 31/69</b> (2006.01) <b>A61K 45/06</b> (2006.01) <b>A61K 38/15</b> (2006.01) <b>A61P 35/00</b> (2006.01) <b>A61P 35/02</b> (2006.01) <b>A61K 31/513</b> (2006.01) <b>A61K 31/519</b> (2006.01) <b>A61K 31/7068</b> (2006.01)	2637663 *	COMBINATION THERAPY WITH AN ANTITUMOR ALKALOID
XBiotech, Inc	<b>A61K 39/395</b> (2006.01) <b>A61K 38/17</b> (2006.01) <b>A61K 38/20</b> (2006.01) <b>A61P 35/00</b> (2006.01)	2608808 *	TREATMENT FOR NEOPLASTIC DISEASES
Oryzon Genomics, S.A.	<b>C07D 213/73</b> (2006.01) <b>C07D 237/20</b> (2006.01) <b>C07D 239/42</b> (2006.01) <b>C07D 241/20</b> (2006.01) <b>C07D 261/14</b> (2006.01) <b>C07D 263/48</b> (2006.01) <b>C07D 277/40</b> (2006.01) <b>C07D 285/12</b> (2006.01) <b>C07D 401/12</b> (2006.01) <b>C07D 413/12</b> (2006.01) <b>C07D 417/12</b> (2006.01) <b>C07D 271/07</b> (2006.01) <b>C07D 271/113</b> (2006.01) <b>C07D 253/07</b> (2006.01) <b>A61K 31/44</b> (2006.01)	2598482 *	ARYLCYCLOPROPYLAMINE BASED DEMETHYLASE INHIBITORS OF LSD1 AND THEIR MEDICAL USE
Tsao, Jiaxiang	<b>A61K 47/34</b> (2006.01)	2605795 *	INTRAVAGINAL DEVICES, METHODS OF MAKING, AND USES THEREOF
Teva Women's Health, Inc.	<b>A61K 47/34</b> (2006.01)	2605795 *	INTRAVAGINAL DEVICES, METHODS OF MAKING, AND USES THEREOF
Les Laboratoires Servier	<b>C07D 223/16</b> (2006.01)	2607353	New method for synthesising ivabradine and its added salts with a pharmaceutically acceptable acid.

Podnosilac evropske prijave patenta (71)	MKP (51)	Broj objave evropske prijave patenta (97)	Naziv pronalaska (54)
Teijin Pharma Limited	<b>A61K 31/426</b> (2006.01) <b>A61P 9/12</b> (2006.01) <b>A61P 13/12</b> (2006.01) <b>A61P 19/06</b> (2006.01)	2586442 *	SUSTAINED-RELEASE THERAPEUTIC AGENT FOR HYPERTENSION AND RENAL DYSFUNCTION
Pfizer Inc	<b>A61K 31/506</b> (2006.01) <b>A61P 3/10</b> (2006.01) <b>C07D 401/14</b> (2006.01) <b>C07D 403/14</b> (2006.01) <b>A61K 31/454</b> (2006.01) <b>C07D 401/04</b> (2006.01)	2643310 *	4- (5-CYANO-PYRAZOL-1-YL) -PIPERIDINE DERIVATIVES AS GPR 119 MODULATORS
Janssen Biotech, Inc.	<b>A61K 35/12</b> (2006.01) <b>A61K 38/18</b> (2006.01) <b>A61K 38/22</b> (2006.01) <b>A61P 3/10</b> (2006.01)	2603226 *	TREATMENT OF DIABETES WITH PANCREATIC ENDOCRINE PRECURSOR CELLS
Stem Centrx, Inc.	<b>A61K 39/395</b> (2006.01) <b>C07K 16/22</b> (2006.01) <b>C07K 16/40</b> (2006.01)	2608807 *	NOTUM PROTEIN MODULATORS AND METHODS OF USE
Baylor Research Institute	<b>C12Q 1/68</b> (2006.01)	2625293 *	MICRORNAS (MIRNA) AS BIOMAKERS FOR THE IDENTIFICATION OF FAMILIAL AND NON-FAMILIAL COLORECTAL CANCER
Hospital Clínic de Barcelona	<b>C12Q 1/68</b> (2006.01)	2625293 *	MICRORNAS (MIRNA) AS BIOMAKERS FOR THE IDENTIFICATION OF FAMILIAL AND NON-FAMILIAL COLORECTAL CANCER
Centro de Investigacion en Red de Enfermedades Hepaticas y Digestivas	<b>C12Q 1/68</b> (2006.01)	2625293 *	MICRORNAS (MIRNA) AS BIOMAKERS FOR THE IDENTIFICATION OF FAMILIAL AND NON-FAMILIAL COLORECTAL CANCER
Salix Pharmaceuticals, Ltd.	<b>A61P 1/12</b> (2006.01)	2632550 *	METHODS AND COMPOSITIONS FOR TREATING HIV-ASSOCIATED DIARRHEA
Napo Pharmaceuticals Inc	<b>A61P 1/12</b> (2006.01)	2632550 *	METHODS AND COMPOSITIONS FOR TREATING HIV-ASSOCIATED DIARRHEA
GTAT Corporation	<b>B01J 19/00</b> (2006.01) <b>C01B 33/107</b> (2006.01)	2621626 *	HEATER AND RELATED METHODS THEREFOR
Ranbaxy Laboratories Limited	<b>C07D 477/20</b> (2006.01)	2630147 *	A PROCESS FOR THE PREPARATION OF PURE MEROPENEM TRIHYDRATE
Urbantech S.R.L.	<b>E01F 8/00</b> (2006.01) <b>E04H 17/20</b> (2006.01)	2601352 *	AN IMPROVEMENT OF A SUPPORTING STRUCTURE FOR AN ANTI-NOISE BARRIER WHEREIN FOUNDATIONS AND LIFTING POST ARE REALIZED IN A SINGLE ELEMENT AND RELATIVE ASSEMBLY METHOD
Morphotek, Inc.	<b>A61K 39/395</b> (2006.01) <b>G01N 33/574</b> (2006.01) <b>G01N 33/82</b> (2006.01)	2635304 *	FOLATE RECEPTOR ALPHA AS A DIAGNOSTIC AND PROGNOSTIC MARKER FOR FOLATE RECEPTOR ALPHA-EXPRESSING CANCERS
Orexo AB	<b>A61K 31/437</b> (2006.01) <b>A61K 31/445</b> (2006.01) <b>A61K 9/00</b> (2006.01) <b>A61K 9/70</b> (2006.01)	2613784 *	A TRANSDERMAL DRUG ADMINISTRATION DEVICE
Dow AgroSciences LLC	<b>A01N 43/54</b> (2006.01) <b>A01N 43/40</b> (2006.01) <b>A01N 31/00</b> (2006.01) <b>A01N 37/10</b> (2006.01) <b>A01P 13/00</b> (2006.01) <b>A01N 25/32</b> (2006.01) <b>A01N 43/66</b> (2006.01) <b>A01N 43/90</b> (2006.01)	2615912 *	LIQUID AGRICULTURAL FORMULATIONS OF IMPROVED STABILITY
Eli Lilly and Company	<b>A61K 38/19</b> (2006.01) <b>C07K 14/535</b> (2006.01) <b>A61P 29/00</b> (2006.01)	2618830 *	FORMULATIONS FOR BOVINE GRANULOCYTE COLONY STIMULATING FACTOR AND VARIANTS THEREOF
Goertek Inc.	<b>G10L 21/02</b> (2013.01) <b>H04R 3/02</b> (2006.01)	2608197 *	METHOD, DEVICE, AND SYSTEM FOR NOISE REDUCTION IN MULTI-MICROPHONE ARRAY
GlaxoSmithKline Consumer Healthcare GmbH & Co.KG.	<b>A61C 17/34</b> (2006.01) <b>A61C 17/22</b> (2006.01)	2618776 *	REPLACEABLE HEAD PART FOR AN ELECTRIC TOOTHBRUSH

Podnosilac evropske prijave patenta (71)	MKP (51)	Broj objave evropske prijave patenta (97)	Naziv pronalaska (54)
Bayer HealthCare LLC	<b>A61K 31/44</b> (2006.01) <b>A61K 31/505</b> (2006.01) <b>A61K 31/519</b> (2006.01) <b>A61P 35/00</b> (2006.01)	2595628 *	DRUG COMBINATIONS WITH FLUORO-SUBSTITUTED OMEGA-CARBOXYARYL DIPHENYL UREA FOR THE TREATMENT AND PREVENTION OF DISEASES AND CONDITIONS
Bayer Intellectual Property GmbH	<b>C07D 487/04</b> (2006.01) <b>A61K 31/5025</b> (2006.01)	2598505 *	SUBSTITUTED IMIDAZO[1,2-B]PYRIDAZINES
TAISHO PHARMACEUTICAL CO., LTD	<b>A61K 31/427</b> (2006.01) <b>A61K 31/5377</b> (2006.01) <b>A61K 31/437</b> (2006.01) <b>A61P 25/04</b> (2006.01) <b>A61K 31/4439</b> (2006.01) <b>A61P 25/08</b> (2006.01) <b>C07D 233/90</b> (2006.01) <b>A61K 31/444</b> (2006.01) <b>A61P 25/14</b> (2006.01) <b>A61K 31/4178</b> (2006.01) <b>A61K 31/4709</b> (2006.01) <b>A61P 25/18</b> (2006.01) <b>A61K 31/4196</b> (2006.01) <b>A61K 31/4725</b> (2006.01) <b>A61K 31/422</b> (2006.01) <b>A61K 31/497</b> (2006.01) <b>A61K 31/4245</b> (2006.01) <b>A61K 31/506</b> (2006.01)	2617715 *	GLYCINE TRANSPORTER INHIBITOR
Omya Development AG	<b>C01F 11/18</b> (2006.01) <b>C02F 1/66</b> (2006.01) <b>C01F 5/24</b> (2006.01) <b>C02F 1/68</b> (2006.01) <b>C02F 1/52</b> (2006.01)	2623467	Process for the preparation of an aqueous solution comprising at least one earth alkali hydrogen carbonate and its use
Nupathe Inc.	<b>A61N 1/30</b> (2006.01) <b>A61N 1/32</b> (2006.01)	2643048 *	USER-ACTIVATED SELF-CONTAINED CO-PACKAGED IONTOPHORETIC DRUG DELIVERY SYSTEM
GlaxoSmithKline Intellectual Property Development Limited	<b>C12P 21/08</b> (2006.01) <b>C07K 16/18</b> (2006.01) <b>C07H 21/00</b> (2006.01)	2611829 *	NOVEL ANTIGEN BINDING PROTEINS
Johst, Kenneth	<b>F03D 1/00</b> (2006.01) <b>F03D 11/04</b> (2006.01)	2607685	Bolt mounting and tightening robot for wind turbines
Jagd, Lars	<b>F03D 1/00</b> (2006.01) <b>F03D 11/04</b> (2006.01)	2607685	Bolt mounting and tightening robot for wind turbines
Bovin, Jonas	<b>F03D 1/00</b> (2006.01) <b>F03D 11/04</b> (2006.01)	2607685	Bolt mounting and tightening robot for wind turbines
Marinitsch, Gerald	<b>F03D 1/00</b> (2006.01) <b>F03D 11/04</b> (2006.01)	2607685	Bolt mounting and tightening robot for wind turbines
Jiangsu Hansoh Pharmaceutical Co., Ltd.	<b>C07D 487/04</b> (2006.01) <b>A61K 31/5025</b> (2006.01) <b>A61K 31/502</b> (2006.01) <b>C07D 403/12</b> (2006.01) <b>A61P 43/00</b> (2006.01) <b>A61P 35/00</b> (2006.01)	2604610 *	PHTHALAZINONE KETONE DERIVATIVE, PREPARATION METHOD THEREOF, AND PHARMACEUTICAL USE THEREOF
Dow AgroSciences LLC	<b>A01N 43/54</b> (2006.01) <b>A01P 13/00</b> (2006.01)	2632265 *	SYNERGISTIC HERBICIDAL COMPOSITION CONTAINING PENOXSULAM AND ORYZALIN
Packers Plus Energy Services Inc.	<b>E21B 34/06</b> (2006.01)	2619403 *	DELAYED OPENING WELLBORE TUBULAR PORT CLOSURE
Cirulli, Gabriele Maria	<b>H04Q 1/14</b> (2006.01)	2625868 *	DYNAMIC-JUNCTION APPARATUS FOR MULTIPAIRS TELEPHONE CABLES
Immunocore Ltd.	<b>C07K 14/705</b> (2006.01)	2598528 *	T CELL RECEPTORS
Ohikia S.R.L.	<b>F24J 2/08</b> (2006.01) <b>F24J 2/14</b> (2006.01) <b>F24J 2/24</b> (2006.01) <b>G02F 1/00</b> (2006.01)	2598810 *	DEVICE FOR THE CAPTURE OF SOLAR ENERGY WITH HIGH ANGULAR EFFICIENCY.
BY ME S.R.L.	<b>A47J 36/38</b> (2006.01) <b>A47J 37/12</b> (2006.01)	2603125 *	FRYER WITH PERFORATED COVER

Podnosilac evropske prijave patenta (71)	MKP (51)	Broj objave evropske prijave patenta (97)	Naziv pronalaska (54)
Dhananjay, Digambar Pande	<b>B01D 53/14</b> (2006.01) <b>B01D 53/80</b> (2006.01)	2637765 *	A NOVEL SYSTEM FOR ADSORBING AND SEPARATING SUSPENDED GASEOUS IMPURITIES FROM EFFLUENT GASES AND THEREBY RECOVERY OF VALUE ADDED PRODUCTS
Eli Lilly and Company	<b>A61M 5/158</b> (2006.01) <b>A61M 5/32</b> (2006.01) <b>A61M 5/20</b> (2006.01) <b>A61M 5/00</b> (2006.01) <b>A61M 5/34</b> (2006.01) <b>A61M 5/142</b> (2006.01)	2640444 *	NEEDLE MAGAZINE FOR MEDICATION INJECTION DEVICE
Appoloni, Omar	<b>B60D 1/00</b> (2006.01) <b>B60D 1/02</b> (2006.01) <b>B60D 1/54</b> (2006.01)	2643175 *	ATTACHMENT DEVICE FOR TRAILER TOW BAR
SIGMA-TAU Industrie Farmaceutiche Riunite S.p.A.	<b>C07C 211/31</b> (2006.01) <b>C07C 251/34</b> (2006.01) <b>C07C 251/54</b> (2006.01) <b>A61K 31/15</b> (2006.01) <b>C07D 211/46</b> (2006.01)	2632892 *	DITERPENOID DERIVATIVES ENDOWED OF BIOLOGICAL PROPERTIES
Transdermal Research Pharm Laboratories, LLC	<b>A61K 31/496</b> (2006.01)	2632463 *	ARIPIRAZOLE COMPOSITIONS AND METHODS FOR ITS TRANSDERMAL DELIVERY
Scentsy, Inc.	<b>A63H 3/02</b> (2006.01) <b>A63H 3/00</b> (2006.01)	2598220 *	STUFFED TOYS HAVING INTERCHANGEABLE SCENT PACKETS AND METHODS AND SYSTEMS INCLUDING SUCH STUFFED TOYS
Les Laboratoires Servier	<b>A61K 9/50</b> (2006.01) <b>A61K 31/495</b> (2006.01)	2623096	Pharmaceutical composition with slow release of trimetazidine
Sanofi-Aventis Deutschland GmbH	<b>A61M 5/24</b> (2006.01) <b>B65D 41/54</b> (2006.01) <b>G09F 3/03</b> (2006.01) <b>A61M 39/10</b> (2006.01)	2603261 *	CONNECTOR FOR A DRUG DELIVERY DEVICE RESERVOIR
The University of North Carolina At Chapel Hill	<b>A61P 7/06</b> (2006.01) <b>A61K 31/506</b> (2006.01) <b>A61P 7/00</b> (2006.01) <b>A61K 31/519</b> (2006.01) <b>A61K 31/505</b> (2006.01)	2640394 *	PROTECTION OF RENAL TISSUES FROM ISCHEMIA THROUGH INHIBITION OF THE PROLIFERATIVE KINASES CDK4 AND CDK6
The Brigham and Women's Hospital	<b>A61P 7/06</b> (2006.01) <b>A61K 31/506</b> (2006.01) <b>A61P 7/00</b> (2006.01) <b>A61K 31/519</b> (2006.01) <b>A61K 31/505</b> (2006.01)	2640394 *	PROTECTION OF RENAL TISSUES FROM ISCHEMIA THROUGH INHIBITION OF THE PROLIFERATIVE KINASES CDK4 AND CDK6
G-Zero Therapeutics	<b>A61P 7/06</b> (2006.01) <b>A61K 31/506</b> (2006.01) <b>A61P 7/00</b> (2006.01) <b>A61K 31/519</b> (2006.01) <b>A61K 31/505</b> (2006.01)	2640394 *	PROTECTION OF RENAL TISSUES FROM ISCHEMIA THROUGH INHIBITION OF THE PROLIFERATIVE KINASES CDK4 AND CDK6
Blücher GmbH	<b>C08G 61/10</b> (2006.01)	2596043 *	UNIT COMPRISING POROUS ORGANIC POLYMERS AND USE THEREOF I
Omya Development AG	<b>C02F 1/52</b> (2006.01) <b>C02F 1/66</b> (2006.01) <b>C02F 1/68</b> (2006.01) <b>C01F 11/18</b> (2006.01) <b>C01F 5/24</b> (2006.01)	2623466	Process for the preparation of an aqueous solution comprising at least one earth alkali hydrogen carbonate and its use
Living Proof, Inc.	<b>A61P 17/00</b> (2006.01) <b>A61K 31/795</b> (2006.01) <b>A61K 8/89</b> (2006.01) <b>A61K 31/74</b> (2006.01) <b>A61Q 19/00</b> (2006.01)	2611413 *	SKIN COMPOSITIONS AND METHODS OF USE THEREOF



Podnosilac evropske prijave patenta (71)	MKP (51)	Broj objave evropske prijave patenta (97)	Naziv pronalaska (54)
aTyr Pharma, Inc.	<b>A61K 39/395</b> (2006.01) <b>A61P 3/00</b> (2006.01) <b>A61K 38/08</b> (2006.01) <b>A61P 9/00</b> (2006.01) <b>A61P 29/00</b> (2006.01) <b>A61K 38/16</b> (2006.01) <b>A61K 38/10</b> (2006.01)	2624857 *	INNOVATIVE DISCOVERY OF THERAPEUTIC, DIAGNOSTIC, AND ANTIBODY COMPOSITIONS RELATED PROTEIN FRAGMENTS OF TRYPTOPHANYL TRNA SYNTHETASES
Pangu Biopharma Limited	<b>A61K 39/395</b> (2006.01) <b>A61P 3/00</b> (2006.01) <b>A61K 38/08</b> (2006.01) <b>A61P 9/00</b> (2006.01) <b>A61P 29/00</b> (2006.01) <b>A61K 38/16</b> (2006.01) <b>A61K 38/10</b> (2006.01)	2624857 *	INNOVATIVE DISCOVERY OF THERAPEUTIC, DIAGNOSTIC, AND ANTIBODY COMPOSITIONS RELATED PROTEIN FRAGMENTS OF TRYPTOPHANYL TRNA SYNTHETASES
UCB Pharma, S.A.	<b>C07D 471/04</b> (2006.01) <b>A61K 31/519</b> (2006.01) <b>A61P 9/00</b> (2006.01) <b>A61P 25/28</b> (2006.01) <b>A61P 29/00</b> (2006.01)	2614061 *	QUINOLINE AND QUINOXALINE DERIVATIVES AS KINASE INHIBITORS
Lina Medical ApS	<b>A61B 18/12</b> (2006.01) <b>A61B 18/14</b> (2006.01)	2540242	An electrosurgical instrument and apparatus for use with the instrument
The Regents of the University of California	<b>A61P 37/00</b> (2006.01) <b>A61P 29/00</b> (2006.01) <b>C07C 271/56</b> (2006.01) <b>A61K 31/27</b> (2006.01)	2598477 *	PERIPHERALLY RESTRICTED FAAH INHIBITORS
Università Degli Studi Di Urbino "Carlo Bo"	<b>A61P 37/00</b> (2006.01) <b>A61P 29/00</b> (2006.01) <b>C07C 271/56</b> (2006.01) <b>A61K 31/27</b> (2006.01)	2598477 *	PERIPHERALLY RESTRICTED FAAH INHIBITORS
Universita Degli Studi di Parma	<b>A61P 37/00</b> (2006.01) <b>A61P 29/00</b> (2006.01) <b>C07C 271/56</b> (2006.01) <b>A61K 31/27</b> (2006.01)	2598477 *	PERIPHERALLY RESTRICTED FAAH INHIBITORS
Huf Hülsbeck & Fürst GmbH & Co. KG	<b>E05B 1/00</b> (2006.01) <b>E05B 65/20</b> (2006.01) <b>E05B 15/04</b> (2006.01)	2325419	Safety door handle
Omya International AG	<b>C09C 3/04</b> (2006.01) <b>C09C 1/02</b> (2006.01)	2623564	Installation for the purification of minerals, pigments and/or fillers and/or the preparation of precipitated earth alkali carbonate
Enel Distribuzione S.p.A.	<b>H04B 3/54</b> (2006.01)	2625794 *	METHOD AND APPARATUS FOR REMOTE METERING THE CONSUMPTION OF ELECTRICITY OVER POWER LINE NETWORK
aTyr Pharma, Inc.	<b>A61K 48/00</b> (2006.01) <b>A61P 29/00</b> (2006.01) <b>A61P 25/00</b> (2006.01) <b>A61K 38/16</b> (2006.01) <b>A61K 39/395</b> (2006.01) <b>A61K 38/10</b> (2006.01) <b>A61K 38/08</b> (2006.01)	2608801 *	INNOVATIVE DISCOVERY OF THERAPEUTIC, DIAGNOSTIC, AND ANTIBODY COMPOSITIONS RELATED TO PROTEIN FRAGMENTS OF TYROSYL-tRNA SYNTHETASES
Pangu Biopharma Limited	<b>A61K 48/00</b> (2006.01) <b>A61P 29/00</b> (2006.01) <b>A61P 25/00</b> (2006.01) <b>A61K 38/16</b> (2006.01) <b>A61K 39/395</b> (2006.01) <b>A61K 38/10</b> (2006.01) <b>A61K 38/08</b> (2006.01)	2608801 *	INNOVATIVE DISCOVERY OF THERAPEUTIC, DIAGNOSTIC, AND ANTIBODY COMPOSITIONS RELATED TO PROTEIN FRAGMENTS OF TYROSYL-tRNA SYNTHETASES
Dow AgroSciences LLC	<b>A01N 43/54</b> (2006.01) <b>A01N 43/88</b> (2006.01) <b>A01P 13/02</b> (2006.01) <b>A01N 43/90</b> (2006.01)	2611301 *	SYNERGISTIC HERBICIDAL COMPOSITION CONTAINING PENOXSULAM AND BENTAZON
Chiesi Farmaceutici S.p.A.	<b>A61K 9/00</b> (2006.01) <b>A61K 31/44</b> (2006.01) <b>A61P 11/06</b> (2006.01)	2600830 *	DRY POWDER FORMULATION COMPRISING A PHOSPHODIESTERASE INHIBITOR

Podnosilac evropske prijave patenta (71)	MKP (51)	Broj objave evropske prijave patenta (97)	Naziv pronalaska (54)
S.C. Centrul De Cercetare Pentru Materiale Macrom	<b>C25B 9/00</b> (2006.01) <b>C25B 13/04</b> (2006.01) <b>C01B 3/58</b> (2006.01)	2596155 *	MEMBRANE ELECTRO - CATALYTIC SYSTEM AND PROCESS FOR OBTAINING FUEL GAS FROM WATER
AbbVie Inc.	<b>C07D 471/08</b> (2006.01) <b>A61K 31/439</b> (2006.01) <b>A61P 25/00</b> (2006.01) <b>A61P 25/28</b> (2006.01)	2619205 *	MONOHYDRATE OF AN AZAADAMANTANE DERIVATIVE
Qualcomm Incorporated	<b>H04W 4/02</b> (2009.01) <b>G01S 5/00</b> (2006.01)	2601800 *	TRANSFER AND MODIFICATION OF LOCATION RELATED DATA DURING AN ONGOING LOCATION SESSION
NCS Lab S.r.l.	<b>A61B 17/04</b> (2006.01) <b>A61B 17/00</b> (2006.01) <b>A61F 2/08</b> (2006.01)	2629679 *	A FIXING DEVICE FOR SUTURE THREADS TO BE INSERTED INTO A BONE TISSUE
Astellas Pharma Inc.	<b>A61K 31/4725</b> (2006.01) <b>C07D 401/12</b> (2006.01) <b>A61K 31/553</b> (2006.01) <b>C07D 495/04</b> (2006.01) <b>A61K 31/541</b> (2006.01) <b>C07D 413/12</b> (2006.01) <b>A61P 43/00</b> (2006.01) <b>A61K 31/5377</b> (2006.01) <b>C07D 405/12</b> (2006.01) <b>A61P 29/00</b> (2006.01) <b>A61P 25/04</b> (2006.01) <b>C07D 217/26</b> (2006.01) <b>C07D 237/34</b> (2006.01)	2599774 *	CONDENSED RING PYRIDINE COMPOUND
Erneo	<b>H02K 3/28</b> (2006.01) <b>H02K 19/36</b> (2006.01)	2638620 *	ELECTRIC MACHINE COMPRISING A SINGLE-TOOTH WINDING WITH GROUPED PHASES
Adamed sp. z o.o.	<b>A61K 31/496</b> (2006.01) <b>A61P 25/00</b> (2006.01) <b>C07D 209/40</b> (2006.01) <b>C07D 235/30</b> (2006.01) <b>C07D 275/04</b> (2006.01) <b>C07D 319/20</b> (2006.01) <b>C07D 413/12</b> (2006.01)	2616440 *	ARYLOSULFONAMIDES FOR THE TREATMENT OF CNS DISEASES
Promefarm S.r.l.	<b>A61K 38/47</b> (2006.01) <b>C12N 9/38</b> (2006.01) <b>C12N 9/40</b> (2006.01) <b>A61P 1/04</b> (2006.01)	2537528	Pharmaceutical or nutritional compositions containing galactosidase, and their use
Genomic Vision	<b>C12Q 1/68</b> (2006.01)	2619325 *	A METHOD FOR DETECTING, QUANTIFYING AND MAPPING DAMAGE AND/OR REPAIR OF DNA STRANDS
Astellas Pharma Inc.	<b>C07D 519/00</b> (2006.01) <b>A61K 31/4985</b> (2006.01) <b>A61P 13/02</b> (2006.01) <b>A61P 43/00</b> (2006.01) <b>C07D 487/04</b> (2006.01)	2615096 *	QUINOXALINE COMPOUND
Université Libre de Bruxelles	<b>G01N 33/574</b> (2006.01) <b>C07K 14/72</b> (2006.01) <b>C12N 5/00</b> (2006.01) <b>C07K 16/28</b> (2006.01)	2627671 *	ESTROGEN RECEPTOR ALPHA POLYPEPTIDE SEQUENCE, DIAGNOSTIC AND THERAPEUTIC APPLICATIONS THEREOF
University of Crete - School of Medicine	<b>G01N 33/574</b> (2006.01) <b>C07K 14/72</b> (2006.01) <b>C12N 5/00</b> (2006.01) <b>C07K 16/28</b> (2006.01)	2627671 *	ESTROGEN RECEPTOR ALPHA POLYPEPTIDE SEQUENCE, DIAGNOSTIC AND THERAPEUTIC APPLICATIONS THEREOF
CNRS	<b>G01N 33/574</b> (2006.01) <b>C07K 14/72</b> (2006.01) <b>C12N 5/00</b> (2006.01) <b>C07K 16/28</b> (2006.01)	2627671 *	ESTROGEN RECEPTOR ALPHA POLYPEPTIDE SEQUENCE, DIAGNOSTIC AND THERAPEUTIC APPLICATIONS THEREOF
Université Pierre et Marie Curie	<b>G01N 33/574</b> (2006.01) <b>C07K 14/72</b> (2006.01) <b>C12N 5/00</b> (2006.01) <b>C07K 16/28</b> (2006.01)	2627671 *	ESTROGEN RECEPTOR ALPHA POLYPEPTIDE SEQUENCE, DIAGNOSTIC AND THERAPEUTIC APPLICATIONS THEREOF

Podnosilac evropske prijave patenta (71)	MKP (51)	Broj objave evropske prijave patenta (97)	Naziv pronalaska (54)
IPP Ingenieur Partner Pool GmbH	<b>B63B 25/22</b> (2006.01)	2581301	Containers stowage device
Zafgen, Inc.	<b>C07D 491/00</b> (2006.01) <b>C07D 493/00</b> (2006.01) <b>C07D 513/00</b> (2006.01) <b>A61K 31/353</b> (2006.01) <b>A61K 31/425</b> (2006.01) <b>A61K 31/4738</b> (2006.01) <b>A61P 3/04</b> (2006.01)	2595988 *	TRICYCLIC COMPOUNDS AND METHODS OF MAKING AND USING SAME
LI-COR, INC.	<b>C09B 23/00</b> (2006.01) <b>G01N 33/58</b> (2006.01) <b>C09B 23/08</b> (2006.01) <b>C09B 69/00</b> (2006.01)	2630196 *	CYANINE DYES AND THEIR CONJUGATES
Gilead Sciences, Inc.	<b>C07D 403/14</b> (2006.01) <b>A61K 31/4178</b> (2006.01) <b>C07D 405/14</b> (2006.01) <b>A61K 31/4184</b> (2006.01) <b>C07D 493/04</b> (2006.01) <b>C07D 491/10</b> (2006.01) <b>C07D 495/04</b> (2006.01) <b>C07D 471/08</b> (2006.01) <b>A61P 31/12</b> (2006.01) <b>C07D 417/14</b> (2006.01) <b>A61K 31/4188</b> (2006.01) <b>C07D 513/04</b> (2006.01)	2640719 *	ANTIVIRAL COMPOUNDS
Shionogi & Co., Ltd.	<b>A61K 47/20</b> (2006.01) <b>A61K 47/36</b> (2006.01) <b>A61K 47/38</b> (2006.01) <b>A61K 9/20</b> (2006.01) <b>A61K 9/48</b> (2006.01) <b>A61K 31/405</b> (2006.01) <b>A61K 47/02</b> (2006.01) <b>A61K 31/426</b> (2006.01)	2623100 *	PREPARATION FOR IMPROVING SOLUBILITY OF POORLY SOLUBLE DRUG
Glaxo Group Limited	<b>C07K 16/22</b> (2006.01)	2643351 *	MULTISPECIFIC ANTIGEN BINDING PROTEINS TARGETING HGF
Sanofi-Aventis Deutschland GmbH	<b>A61M 5/24</b> (2006.01) <b>A61M 5/315</b> (2006.01)	2603263 *	DIFFERENTIATION FOR A DRUG DELIVERY DEVICE
Curt G. Joa, Inc.	<b>A61F 13/15</b> (2006.01)	2628472	Method of forming bonds between discrete components of disposable articles
VAG-Armaturen GmbH	<b>F16L 37/24</b> (2006.01)	2369215	Connector
AbbVie Inc.	<b>A61K 9/14</b> (2006.01) <b>A61K 9/26</b> (2006.01)	2635258 *	DRUG FORMULATIONS
Abbvie Deutschland GmbH & Co. KG	<b>A61K 9/14</b> (2006.01) <b>A61K 9/26</b> (2006.01)	2635258 *	DRUG FORMULATIONS
Janssen Pharmaceutica, N.V.	<b>C07D 403/04</b> (2006.01) <b>C07D 403/14</b> (2006.01) <b>C07D 413/14</b> (2006.01) <b>C07D 417/14</b> (2006.01) <b>C07D 405/14</b> (2006.01) <b>A61K 31/517</b> (2006.01) <b>A61K 31/55</b> (2006.01) <b>A61P 9/00</b> (2006.01) <b>A61P 3/10</b> (2006.01)	2603502 *	4 - AMINOQUINAZOLIN-2-YL - 1 - PYRRAZOLE - 4 - CARBOXYLIC ACID COMPOUNDS AS PROLYL HYDROXYLASE INHIBITORS
Chan, Yiu Ming	<b>B01D 46/00</b> (2006.01) <b>B01D 53/00</b> (2006.01) <b>B03C 3/00</b> (2006.01) <b>F24F 3/00</b> (2006.01)	2532407	Air purification device and method
Novartis AG	<b>A61K 31/4188</b> (2006.01) <b>A61K 31/4745</b> (2006.01) <b>A61P 35/00</b> (2006.01)	2624831 *	PHARMACEUTICAL COMBINATIONS

Podnosilac evropske prijave patenta (71)	MKP (51)	Broj objave evropske prijave patenta (97)	Naziv pronalaska (54)
Five Prime Therapeutics, Inc.	<b>A61K 31/337</b> (2006.01) <b>A61K 31/475</b> (2006.01) <b>A61K 31/519</b> (2006.01) <b>A61K 38/18</b> (2006.01) <b>A61K 45/06</b> (2006.01) <b>A61P 35/00</b> (2006.01) <b>A61K 39/395</b> (2006.01) <b>A61K 31/4745</b> (2006.01) <b>A61K 31/513</b> (2006.01) <b>A61K 31/555</b> (2006.01) <b>A61K 31/704</b> (2006.01) <b>A61K 31/7048</b> (2006.01) <b>A61K 33/24</b> (2006.01) <b>A61K 38/17</b> (2006.01) <b>C07K 19/00</b> (2006.01)	2640377 *	FGFR1 EXTRACELLULAR DOMAIN COMBINATION THERAPIES
Takeda Pharmaceutical Company Limited	<b>A61K 31/4412</b> (2006.01) <b>A61K 31/437</b> (2006.01) <b>A61P 25/28</b> (2006.01) <b>C07D 471/04</b> (2006.01)	2611805 *	FUSED TRIAZOLES FOR THE TREATMENT OR PROPHYLAXIS OF MILD COGNITIVE IMPAIRMENT
Novartis AG	<b>C07D 401/12</b> (2006.01) <b>A61K 31/415</b> (2006.01) <b>A61P 3/04</b> (2006.01)	2625172 *	NEW CRYSTALLINE FORMS OF THE SODIUM SALT OF (4- {4- [5- ( 6 - TRIFLUOROMETHYL - PYRIDIN- 3 - YLAMINO ) - PYRIDIN- 2 -YL]- PHENYL} - CYCLOHEXYL) -ACETIC ACID
Eisai R&D Management Co., Ltd.	<b>G01N 33/50</b> (2006.01) <b>G01N 33/92</b> (2006.01) <b>G01N 33/15</b> (2006.01) <b>G01N 33/68</b> (2006.01)	2631646 *	BIOMARKER FOR ALZHEIMER'S DISEASE OR MILD COGNITIVE IMPAIRMENT
Akron Molecules GmbH	<b>A61K 31/00</b> (2006.01) <b>A61K 31/4164</b> (2006.01) <b>A61K 31/675</b> (2006.01) <b>A61K 38/00</b> (2006.01) <b>A61P 29/00</b> (2006.01) <b>A61P 29/02</b> (2006.01) <b>A61P 25/04</b> (2006.01)	2637649 *	COMPOUNDS AND METHODS FOR TREATING PAIN
Delphi Technologies Holding S.à.r.l.	<b>F02M 59/02</b> (2006.01) <b>F02M 59/44</b> (2006.01) <b>F04B 1/04</b> (2006.01)	2557306	Fuel pump
AbbVie Inc.	<b>G06K 9/00</b> (2006.01) <b>G06T 7/00</b> (2006.01) <b>B01L 3/00</b> (2006.01) <b>C12M 1/34</b> (2006.01) <b>G01N 15/06</b> (2006.01) <b>G01N 15/14</b> (2006.01) <b>G01N 35/00</b> (2006.01)	2638507 *	HIGH THROUGHPUT, OPTICAL METHOD AND SYSTEM FOR DETERMINING THE EFFECT OF A TEST SUBSTANCE ON LIVING CELLS
Ekornes ASA	<b>A47C 7/38</b> (2006.01) <b>B60N 2/48</b> (2006.01)	2635159 *	NECK REST
Stem S.r.l.	<b>B63B 3/06</b> (2006.01) <b>B63B 35/38</b> (2006.01) <b>E02B 3/06</b> (2006.01) <b>E01D 15/14</b> (2006.01) <b>E04B 1/343</b> (2006.01)	2433858	A modular system for realising chambers joined to one another
B&W Solutions GmbH	<b>B65B 55/20</b> (2006.01) <b>B65D 81/09</b> (2006.01) <b>B65B 1/22</b> (2006.01)	2616345 *	METHOD AND DEVICE FOR FILLING PACKETS WITH PADDING IN THE FORM OF BULK MATERIAL
Kotem Maschinenbau GmbH	<b>B65B 55/20</b> (2006.01) <b>B65D 81/09</b> (2006.01) <b>B65B 1/22</b> (2006.01)	2616345 *	METHOD AND DEVICE FOR FILLING PACKETS WITH PADDING IN THE FORM OF BULK MATERIAL
Alma Mater Studiorum -Universita' di Bologna	<b>B82Y 5/00</b> (2011.01) <b>A61K 49/00</b> (2006.01)	2627360 *	SILICA NANOPARTICLES DOPED WITH MULTIPLE DYES FEATURING HIGHLY EFFICIENT ENERGY TRANSFER AND TUNABLE STOKES-SHIFT
Genentech, Inc.	<b>A61K 39/00</b> (2006.01) <b>A61K 31/535</b> (2006.01) <b>C07D 491/12</b> (2006.01)	2640727 *	ALANINYL MAYTANSINOL ANTIBODY CONJUGATES

Podnosilac evropske prijave patenta (71)	MKP (51)	Broj objave evropske prijave patenta (97)	Naziv pronalaska (54)
Daf Trucks N.V.	<b>F01M 13/04</b> (2006.01) <b>F02D 41/22</b> (2006.01) <b>F02D 41/00</b> (2006.01) <b>F01M 13/02</b> (2006.01)	2614228 *	SYSTEM AND METHOD FOR MONITORING BLOW-BY IN A COMBUSTION ENGINE
X-Flow B.V.	<b>B01D 61/10</b> (2006.01) <b>B01D 61/20</b> (2006.01) <b>B01D 65/00</b> (2006.01) <b>C12H 1/06</b> (2006.01) <b>B01D 65/02</b> (2006.01)	2598231 *	A FILTRATION METHOD FOR OPERATING A FILTRATION MODULE WITH GAS FEED AT ITS PERMEATE SIDE TO PREVENT BACKFLOW OF PERMEATE
Sanofi-Aventis Deutschland GmbH	<b>A61M 5/145</b> (2006.01)	2600921 *	METHOD AND SYSTEM FOR RETAINING A CARTRIDGE IN A HOLDER
Gulf Sea Ventures LLC	<b>F16K 11/074</b> (2006.01)	2616724 *	FLUID-DIRECTING MULTI-PORT ROTARY VALVE
Hitachi Power Europe GmbH	<b>F23D 1/00</b> (2006.01) <b>F23C 7/00</b> (2006.01)	2369230	Burner with tangential spiral intake elbow
Wobben Properties GmbH	<b>H02K 9/197</b> (2006.01) <b>H02K 7/18</b> (2006.01) <b>F03D 9/00</b> (2006.01)	2636131 *	WIND ENERGY INSTALLATION HAVING A SYNCHRONOUS GENERATOR, AND SLOWLY ROTATING SYNCHRONOUS GENERATOR
Glaxo Group Limited	<b>C07K 16/24</b> (2006.01)	2643352 *	ANTIGEN BINDING PROTEINS TO ONCOSTATIN M (OSM)
Lange, Frank	<b>A47B 73/00</b> (2006.01)	2595503 *	BOTTLE RACK
Um, In Woong	<b>A61L 2/025</b> (2006.01) <b>A61L 27/36</b> (2006.01) <b>A61F 2/28</b> (2006.01) <b>C12N 5/071</b> (2010.01)	2601982 *	METHOD FOR PROCESSING BONE GRAFT MATERIAL USING TEETH, AND BONE GRAFT MATERIAL PROCESSED THEREBY
Regeneron Pharmaceuticals, Inc.	<b>A61K 39/395</b> (2006.01) <b>C07K 16/28</b> (2006.01)	2624865 *	STABILIZED FORMULATIONS CONTAINING ANTI-INTERLEUKIN-4 RECEPTOR (IL-4R) ANTIBODIES
Bayer CropScience NV	<b>C12N 15/82</b> (2006.01) <b>C12N 5/10</b> (2006.01) <b>A01H 5/00</b> (2006.01) <b>A01H 5/10</b> (2006.01) <b>C12N 15/54</b> (2006.01) <b>C12N 15/62</b> (2006.01)	2627771 *	METHODS FOR ALTERING THE REACTIVITY OF PLANT CELL WALLS
Goertek Inc.	<b>H04M 9/08</b> (2006.01)	2627065 *	MULTI-RECEIVER END ECHO CANCELLATION METHOD AND SYSTEM
Novartis AG	<b>A61K 31/40</b> (2006.01) <b>C07C 235/36</b> (2006.01) <b>C07D 235/00</b> (2006.01) <b>A61K 31/437</b> (2006.01) <b>C07D 257/04</b> (2006.01) <b>A61K 31/192</b> (2006.01) <b>C07D 213/55</b> (2006.01) <b>C07C 235/40</b> (2006.01) <b>A61K 31/341</b> (2006.01) <b>C07D 207/16</b> (2006.01) <b>A61P 9/08</b> (2006.01) <b>A61K 31/4402</b> (2006.01) <b>C07D 307/52</b> (2006.01) <b>A61K 31/216</b> (2006.01)	2640689 *	SUBSTITUTED CARBAMOYL-CYCLOALKYL ACETIC ACID DERIVATIVES AS NEP INHIBITORS
Wobben Properties GmbH	<b>F03D 7/02</b> (2006.01) <b>F03D 11/00</b> (2006.01)	2556246 *	METHOD FOR OPERATING A WIND ENERGY PLANT IN ICING CONDITIONS
Carris Reels, Inc.	<b>B65H 75/14</b> (2006.01) <b>B65H 75/50</b> (2006.01) <b>B29C 45/44</b> (2006.01)	2522611	Reels with corrugated flanges and undercuts
AL.PI. S.R.L.	<b>A43B 3/26</b> (2006.01) <b>A43B 13/18</b> (2006.01) <b>A43B 13/16</b> (2006.01) <b>B29D 35/00</b> (2010.01) <b>B29D 35/12</b> (2010.01)	2635145 *	SOLE FOR SHOES HAVING ONE OR MORE VERTICAL ELEMENTS FOLDED OVER EACH OTHER, EXTENSIBLE AND ADAPTABLE TO THE DIFFERENT WIDTH OF THE ASSEMBLY LAST OF THE UPPER AND TO THE VARIATION OF THE CONFORMATION OF THE FOOT, EVEN PERMANENTLY

Podnosilac evropske prijave patenta (71)	MKP (51)	Broj objave evropske prijave patenta (97)	Naziv pronalaska (54)
H. Lundbeck A/S	<b>C07D 519/00</b> (2006.01) <b>A61K 31/519</b> (2006.01) <b>A61P 25/24</b> (2006.01) <b>A61P 25/18</b> (2006.01) <b>A61P 25/00</b> (2006.01)	2640731 *	IMIDAZOLE DERIVATIVES AS PDE10A ENZYME INHIBITORS
R.P. Scherer Technologies, LLC	<b>A61K 9/00</b> (2006.01) <b>A61K 39/145</b> (2006.01) <b>A61K 47/36</b> (2006.01)	2624815 *	ORAL VACCINE FAST-DISSOLVING DOSAGE FORM USING STARCH
Teva Pharmaceutical Industries Ltd.	<b>A61K 31/31</b> (2006.01) <b>C07C 211/00</b> (2006.01)	2598136 *	DISPERSIONS OF RASAGILINE CITRATE
Ajinomoto Co., Inc.	<b>A61K 49/04</b> (2006.01)	2626085 *	LIQUID PREPARATION FOR ORAL ADMINISTRATION WHICH CAN BE USED IN CT COLONOGRAPHY, AND COMPOSITION FOR IMAGING DIGESTIVE TRACT
AbbVie Inc.	<b>C07K 16/00</b> (2006.01)	2601218 *	DUAL VARIABLE DOMAIN IMMUNOGLOBULINS AND USES THEREOF
Karisch, Franz	<b>E04H 6/42</b> (2006.01) <b>E01F 9/08</b> (2006.01)	2603651 *	ARRANGEMENT FOR ORIENTING MULTI-TRACK VEHICLES IN THE DIRECTION OF TRAVEL IN CAR PARKS
Delphi Technologies Holding S.à.r.l.	<b>F01N 3/20</b> (2006.01)	2541010	Pump assembly
Rahim, Waseem	<b>C08F 6/00</b> (2006.01) <b>B01J 8/00</b> (2006.01) <b>C08F 10/00</b> (2006.01)	2635609 *	POSTTREATMENT AND SYSTEM FOR POSTTREATMENT OF PELLETIZED POLYOLEFIN RESINS
Sander, Robert	<b>C08F 6/00</b> (2006.01) <b>B01J 8/00</b> (2006.01) <b>C08F 10/00</b> (2006.01)	2635609 *	POSTTREATMENT AND SYSTEM FOR POSTTREATMENT OF PELLETIZED POLYOLEFIN RESINS
Yanosik, John	<b>C08F 6/00</b> (2006.01) <b>B01J 8/00</b> (2006.01) <b>C08F 10/00</b> (2006.01)	2635609 *	POSTTREATMENT AND SYSTEM FOR POSTTREATMENT OF PELLETIZED POLYOLEFIN RESINS
Bayer CropScience NV	<b>A01H 1/04</b> (2006.01) <b>C12N 15/82</b> (2006.01)	2621261 *	A GENE EXPRESSION SIGNATURE FOR THE SELECTION OF HIGH ENERGY USE EFFICIENT PLANTS
Universiteit Gent	<b>A01H 1/04</b> (2006.01) <b>C12N 15/82</b> (2006.01)	2621261 *	A GENE EXPRESSION SIGNATURE FOR THE SELECTION OF HIGH ENERGY USE EFFICIENT PLANTS
VIB VZM	<b>A01H 1/04</b> (2006.01) <b>C12N 15/82</b> (2006.01)	2621261 *	A GENE EXPRESSION SIGNATURE FOR THE SELECTION OF HIGH ENERGY USE EFFICIENT PLANTS
VIIV Healthcare UK Limited	<b>C07D 495/04</b> (2006.01) <b>A61K 31/4365</b> (2006.01) <b>A61P 31/18</b> (2006.01)	2640729 *	INHIBITORS OF HIV REPLICATION
Giannetti, Mirco	<b>B32B 15/06</b> (2006.01) <b>B32B 15/08</b> (2006.01) <b>B32B 15/10</b> (2006.01) <b>B66F 9/12</b> (2006.01)	2625034 *	AN ANTI-SCRATCH AND ANTI-SLIP DEVICE FOR LIFTING LOADS, PREFERABLY THROUGH THE USE OF A LIFT FORK
Transluminal Technologies, LLC	<b>A61L 27/04</b> (2006.01) <b>A61F 2/06</b> (2013.01)	2637603 *	SPECIALLY DESIGNED MAGNESIUM-ALUMINUM ALLOYS AND MEDICAL USES THEREOF IN A HEMODYNAMIC ENVIRONMENT
ORTHO-CLINICAL DIAGNOSTICS, INC.	<b>G01N 33/543</b> (2006.01) <b>G01N 33/558</b> (2006.01)	2618151	Low volume assay device having increased sensitivity
Proteus Industries, Inc.	<b>A23L 1/318</b> (2006.01) <b>A23L 1/00</b> (2006.01)	2624707 *	PROCESS FOR REDUCING OIL AND FAT CONTENT IN COOKED FOOD WITH PEA PROTEIN
Abbvie Inc.	<b>A61K 9/14</b> (2006.01) <b>A61K 9/20</b> (2006.01) <b>A61K 31/437</b> (2006.01) <b>A61K 47/02</b> (2006.01) <b>A61K 47/22</b> (2006.01) <b>A61K 47/26</b> (2006.01) <b>A61K 47/32</b> (2006.01)	2613769 *	MELT-EXTRUDED SOLID DISPERSIONS CONTAINING AN APOPTOSIS-INDUCING AGENT

Podnosilac evropske prijave patenta (71)	MKP (51)	Broj objave evropske prijave patenta (97)	Naziv pronalaska (54)
Abbott GmbH & Co. KG	<b>A61K 9/14</b> (2006.01) <b>A61K 9/20</b> (2006.01) <b>A61K 31/437</b> (2006.01) <b>A61K 47/02</b> (2006.01) <b>A61K 47/22</b> (2006.01) <b>A61K 47/26</b> (2006.01) <b>A61K 47/32</b> (2006.01)	2613769 *	MELT-EXTRUDED SOLID DISPERSIONS CONTAINING AN APOPTOSIS-INDUCING AGENT
Geo-Mole Limited	<b>E21B 4/14</b> (2006.01)	2593628 *	TWO-PORT PERCUSSION MOLE
Gilead Sciences, Inc.	<b>A61K 31/522</b> (2006.01) <b>A61P 9/12</b> (2006.01) <b>A61P 11/00</b> (2006.01) <b>A61K 31/00</b> (2006.01)	2595630 *	USE OF A2B ADENOSINE RECEPTOR ANTAGONISTS FOR TREATING PULMONARY HYPERTENSION
Knauf Gips KG	<b>B65D 75/54</b> (2006.01) <b>B65B 61/20</b> (2006.01) <b>B65D 25/20</b> (2006.01)	2502848	Container, in particular bag or bucket and device for producing this container
Dow AgroSciences LLC	<b>A01N 43/72</b> (2006.01)	2627180 *	GROWTH INHIBITION OF PERENNIAL FORAGE GRASSES WITH PYROXSULAM
Novacta Biosystems Limited	<b>A61K 9/19</b> (2006.01) <b>A61K 38/10</b> (2006.01) <b>A61K 47/26</b> (2006.01) <b>A61K 9/00</b> (2006.01)	2603204 *	FORMULATIONS FOR INFUSION OF TYPE B LANTIBIOTICS
BioGeneriX AG	<b>C07K 1/16</b> (2006.01) <b>C07K 1/18</b> (2006.01) <b>C07K 1/22</b> (2006.01) <b>C07K 14/46</b> (2006.01) <b>C07K 14/47</b> (2006.01)	2415779	Method of producing and purifying an active soluble sialyltransferase
SANOFI	<b>C07D 403/12</b> (2006.01) <b>C07D 403/14</b> (2006.01) <b>C07D 405/14</b> (2006.01) <b>C07D 409/14</b> (2006.01) <b>C07D 413/14</b> (2006.01) <b>C07D 471/04</b> (2006.01) <b>C07D 471/08</b> (2006.01) <b>C07D 487/04</b> (2006.01) <b>C07D 487/08</b> (2006.01) <b>A61K 31/455</b> (2006.01) <b>A61K 31/439</b> (2006.01) <b>A61K 31/497</b> (2006.01) <b>A61K 31/501</b> (2006.01) <b>A61K 31/506</b> (2006.01) <b>A61P 9/00</b> (2006.01) <b>C07D 401/14</b> (2006.01)	2518067	Derivatives of N-[(1H-pyrazol-1-YL)aryl]-1H-indole or 1H-indazole-3-carboxamide and their therapeutic uses as P2Y12 antagonists
Teva Pharmaceutical Industries Ltd.	<b>A61K 31/428</b> (2006.01)	2621490 *	PROPARGYL-TRIFLUOROMETHOXY-AMINOBENZOTHAZOLE DERIVATIVES, THEIR PREPARATION AND USE
Centre National de la Recherche Scientifique CNRS	<b>C07K 14/47</b> (2006.01)	2640739 *	INHIBITORS OF APOPTOSIS AND USES THEREOF
Université de Montpellier 2	<b>C07K 14/47</b> (2006.01)	2640739 *	INHIBITORS OF APOPTOSIS AND USES THEREOF
Universite de Montpellier 1	<b>C07K 14/47</b> (2006.01)	2640739 *	INHIBITORS OF APOPTOSIS AND USES THEREOF
Innotech Solar ASA	<b>H01L 31/052</b> (2006.01) <b>H01L 31/042</b> (2006.01) <b>H01L 31/05</b> (2006.01) <b>H01L 31/068</b> (2012.01) <b>H01L 25/04</b> (2006.01) <b>H01L 27/142</b> (2006.01) <b>H01L 31/0216</b> (2006.01) <b>H01L 31/0224</b> (2006.01)	2609629 *	PHOTOVOLTAIC MODULE AND METHOD FOR IMPROVED REVERSE BIAS, REVERSE CURRENT AND HOTSPOT PROTECTION

Podnosilac evropske prijave patenta (71)	MKP (51)	Broj objave evropske prijave patenta (97)	Naziv pronalaska (54)
Purdue Pharma LP	<b>C07D 213/30</b> (2006.01) <b>C07D 403/12</b> (2006.01) <b>C07D 213/46</b> (2006.01) <b>C07D 403/14</b> (2006.01) <b>C07D 213/74</b> (2006.01) <b>A61K 31/4418</b> (2006.01) <b>C07D 213/79</b> (2006.01) <b>A61K 31/4439</b> (2006.01) <b>C07D 213/81</b> (2006.01) <b>A61K 31/444</b> (2006.01) <b>C07D 213/84</b> (2006.01) <b>A61P 23/00</b> (2006.01) <b>C07D 401/04</b> (2006.01) <b>C07D 401/12</b> (2006.01)	2616441 *	PYRIDINE COMPOUNDS AND THE USES THEREOF
Polymer Institute Brno, Spol. S R.O.	<b>C08F 10/00</b> (2006.01) <b>C08F 2/44</b> (2006.01) <b>C08K 3/00</b> (2006.01) <b>C08K 5/00</b> (2006.01)	2625208 *	: METHOD OF PREPARATION OF NUCLEATED SEMI-CRYSTALLINE POLYMER
Barokes PTY Ltd.	<b>B65D 17/00</b> (2006.01) <b>C12G 1/00</b> (2006.01) <b>B67C 3/02</b> (2006.01)	2607470	Packaging wine in aluminium containers
Nippon Soda Co., Ltd.	<b>A61K 31/216</b> (2006.01) <b>A61K 31/421</b> (2006.01) <b>A61K 31/17</b> (2006.01) <b>A61K 31/4196</b> (2006.01) <b>A61K 31/4409</b> (2006.01) <b>A61K 31/341</b> (2006.01) <b>A61K 31/426</b> (2006.01) <b>A61K 31/197</b> (2006.01) <b>A61K 31/42</b> (2006.01) <b>A01N 47/34</b> (2006.01) <b>A61K 31/41</b> (2006.01) <b>A61K 31/4402</b> (2006.01) <b>A01P 7/02</b> (2006.01) <b>A61K 31/415</b> (2006.01) <b>A61K 31/4406</b> (2006.01) <b>C07C 275/64</b> (2006.01) <b>A61K 31/381</b> (2006.01) <b>A61K 31/44</b> (2006.01) <b>A61K 31/277</b> (2006.01) <b>A61K 31/4245</b> (2006.01)	2628724 *	ARYLOXYUREA COMPOUND AND PEST CONTROL AGENT
The University of North Carolina At Chapel Hill	<b>A61K 47/48</b> (2006.01)	2616103 *	ASYMMETRIC BIFUNCTIONAL SILYL MONOMERS AND PARTICLES THEREOF AS PRODRUGS AND DELIVERY VEHICLES FOR PHARMACEUTICAL, CHEMICAL AND BIOLOGICAL AGENTS
Limonov, Viktor Lvovich	<b>A61K 9/00</b> (2006.01) <b>A61K 9/08</b> (2006.01)	2596783	Pharmaceutical composition for the preparation of infusion solutions of antimicrobial preparations, its production process
ETHICON ENDO-SURGERY, INC.	<b>A61F 2/00</b> (2006.01) <b>A61B 17/08</b> (2006.01) <b>A61L 31/04</b> (2006.01) <b>A61L 31/06</b> (2006.01) <b>B29C 33/52</b> (2006.01) <b>C09J 7/00</b> (2006.01)	2611876 *	ADHESIVE STRUCTURE WITH STIFF PROTRUSIONS ON ADHESIVE SURFACE
Agency for Science, Technology and Research	<b>A61F 2/00</b> (2006.01) <b>A61B 17/08</b> (2006.01) <b>A61L 31/04</b> (2006.01) <b>A61L 31/06</b> (2006.01) <b>B29C 33/52</b> (2006.01) <b>C09J 7/00</b> (2006.01)	2611876 *	ADHESIVE STRUCTURE WITH STIFF PROTRUSIONS ON ADHESIVE SURFACE



Podnosilac evropske prijave patenta (71)	MKP (51)	Broj objave evropske prijave patenta (97)	Naziv pronalaska (54)
J. Stefan Institute	<b>A61K 47/48</b> (2006.01) <b>A61K 49/00</b> (2006.01) <b>A61K 49/18</b> (2006.01) <b>A61P 35/00</b> (2006.01) <b>A61P 29/00</b> (2006.01) <b>A61K 9/127</b> (2006.01) <b>C07D 405/12</b> (2006.01) <b>C07K 7/02</b> (2006.01)	2537532	Cathepsin-binding compounds bound to a nanodevice and their diagnostic and therapeutic use
Schaschke, Norbert	<b>A61K 47/48</b> (2006.01) <b>A61K 49/00</b> (2006.01) <b>A61K 49/18</b> (2006.01) <b>A61P 35/00</b> (2006.01) <b>A61P 29/00</b> (2006.01) <b>A61K 9/127</b> (2006.01) <b>C07D 405/12</b> (2006.01) <b>C07K 7/02</b> (2006.01)	2537532	Cathepsin-binding compounds bound to a nanodevice and their diagnostic and therapeutic use
ALFA WASSERMANN S.p.A.	<b>A61K 9/16</b> (2006.01) <b>A61K 9/20</b> (2006.01) <b>A61K 31/44</b> (2006.01)	2618819 *	PHARMACEUTICAL FORMULATIONS CONTAINING RIFAXIMIN, PROCESSES FOR THEIR OBTAINMENT AND METHOD OF TREATING INTESTINAL DISEASE
R.P. Scherer Technologies, LLC	<b>A61K 9/48</b> (2006.01)	2600849 *	FILM-FORMING COMPOSITION FOR SOFT CAPSULES
Celgene Avilomics Research, Inc.	<b>A61K 31/506</b> (2006.01) <b>A61K 31/16</b> (2006.01)	2635284 *	HETEROCYCLIC COMPOUNDS AND USES THEREOF
Qualcomm Incorporated	<b>H04W 72/12</b> (2009.01)	2606701 *	ARBITRATION BETWEEN MULTIPLE WIRELESS PROTOCOLS IN A WIRELESS DEVICE
ImClone LLC	<b>C07K 16/28</b> (2006.01)	2614081 *	ANTI-VEGFR-3 ANTIBODY COMPOSITIONS
E.V.D.S. BVBA	<b>B65D 17/32</b> (2006.01)	2611705 *	RECLOSING CAN FOR FOOD PRODUCT
Dow AgroSciences LLC	<b>A01N 43/90</b> (2006.01) <b>A01N 47/36</b> (2006.01) <b>A01N 25/00</b> (2006.01) <b>A01P 13/00</b> (2006.01)	2597956 *	SYNERGISTIC HERBICIDAL COMPOSITIONS CONTAINING PYROXSULAM AND SULFOSULFURON
Tecnodima S.r.l.	<b>E04B 1/76</b> (2006.01) <b>E04F 13/08</b> (2006.01)	2543791	Method for making façades of buildings
The Johns Hopkins University	<b>G01N 33/52</b> (2006.01) <b>G01N 33/68</b> (2006.01) <b>G01N 33/53</b> (2006.01)	2628013 *	BIOMARKERS OF BRAIN INJURY
Inkidia S.R.L.	<b>C07D 487/22</b> (2006.01) <b>A61K 39/00</b> (2006.01) <b>A61K 47/48</b> (2006.01)	2635585 *	HIGH-EFFICIENCY CATALYSTS, PREPARATION AND USE THEREOF
Janssen Biotech, Inc.	<b>A61K 39/00</b> (2006.01)	2640414 *	IMMUNOGLOBULIN CLEAVAGE FRAGMENTS VACCINE COMPOSITIONS
Milboro Aktiengesellschaft	<b>F24J 2/52</b> (2006.01) <b>E04D 1/12</b> (2006.01) <b>E04D 1/34</b> (2006.01) <b>H01L 31/048</b> (2006.01)	2562487	Assembly of multiple frames for holding board-shaped elements on a surface and side profile for a frame for use in such an assembly
Millennium Pharmaceuticals, Inc.	<b>A61K 31/422</b> (2006.01)	2603216 *	HETEROARYLS AND USES THEREOF
Umicore AG & Co. KG	<b>C03B 37/08</b> (2006.01)	2522637	Bushing Assembly for Producing Fibers from Molten Mineral Material
Borgato SRL	<b>D06F 57/08</b> (2006.01) <b>D06F 57/10</b> (2006.01) <b>D06F 57/06</b> (2006.01)	2527516	Stabilizing base for a clothes horse
Scanomat A/S	<b>A47J 31/44</b> (2006.01)	2613678 *	A BREWING DEVICE
Joint-Stock Company "Engineering Centre of Fire Robots Technology "FR"	<b>A62C 31/00</b> (2006.01) <b>A62C 5/00</b> (2006.01) <b>A62C 35/68</b> (2006.01)	2599524 *	AUTOMATED NITROGEN- WATER FIRE - FIGHTING COMPLEX
ChromaGen Vision LLC	<b>G02C 7/10</b> (2006.01) <b>B29D 11/00</b> (2006.01)	2506064	Method of making and prescribing tinted lenses

Podnosilac evropske prijave patenta (71)	MKP (51)	Broj objave evropske prijave patenta (97)	Naziv pronalaska (54)
Chromagen Limited	<b>G02C 7/10</b> (2006.01) <b>B29D 11/00</b> (2006.01)	2506064	Method of making and prescribing tinted lenses
Endovascular Development AB	<b>A61M 25/04</b> (2006.01)	2640453 *	AN ASSEMBLY WITH A GUIDE WIRE AND A FIXATOR FOR ATTACHING TO A BLOOD VESSEL
Haltec Hallensysteme GmbH	<b>E04H 15/56</b> (2006.01) <b>E04F 15/024</b> (2006.01) <b>E04B 5/02</b> (2006.01)	2407614	Base structure for a tent and tent with such a base structure
H. Lundbeck A/S	<b>C07D 307/87</b> (2006.01)	2595979 *	PROCESS FOR THE PURIFICATION OF PHARMACEUTICALLY ACCEPTABLE SALTS
Aushon Biosystems	<b>C40B 30/04</b> (2006.01)	2640876 *	METHOD OF AND SYSTEM FOR PRINTING IN-WELL CALIBRATION FEATURES
CERA Handelsgesellschaft mbH	<b>E06B 3/667</b> (2006.01)	2594722	Plug connector
University of Maribor	<b>G01D 5/14</b> (2006.01)	2630449 *	TESTER FOR DETERMINATION OF MACHINE ROTATION DIRECTION AND ACCURACY OF STATOR WINDING CONNECTION
Bayer Intellectual Property GmbH	<b>C07D 249/12</b> (2006.01) <b>A61K 31/4196</b> (2006.01) <b>A61P 9/00</b> (2006.01)	2619188 *	SUBSTITUTED N-PHENETHYLTRIAZOLONEACETAMIDES AND USE THEREOF
Maria Clementine Martin Klosterfrau Vertriebsgesellschaft mbH	<b>A61K 36/48</b> (2006.01) <b>A61K 36/68</b> (2006.01) <b>A61P 29/00</b> (2006.01) <b>A61K 9/12</b> (2006.01) <b>A61K 36/185</b> (2006.01) <b>A61K 36/09</b> (2006.01) <b>A61K 36/73</b> (2006.01)	2617412	Composition for topical treatment
Molecular Partners AG	<b>C07K 14/47</b> (2006.01)	2643348 *	IMPROVED CAPPING MODULES FOR DESIGNED ANKYRIN REPEAT PROTEINS
SICPA HOLDING SA	<b>G06K 19/06</b> (2006.01)	2619714 *	TWO-DIMENSIONAL IDENTIFICATION PATTERN, ARTICLE INCLUDING SUCH A PATTERN, AND METHODS FOR MARKING AND IDENTIFYING SUCH A PATTERN
Lifescan Scotland Limited	<b>G06F 19/00</b> (2011.01) <b>G01N 27/327</b> (2006.01) <b>A61B 5/145</b> (2006.01)	2455875	System and method for diabetes management
Insleep Technologies, LLC	<b>A61M 16/06</b> (2006.01)	2632525 *	BUTTERFLY NASAL MASK
Baecke, Martin	<b>A61M 16/06</b> (2006.01)	2632525 *	BUTTERFLY NASAL MASK
Borgward, Marcel	<b>A61M 16/06</b> (2006.01)	2632525 *	BUTTERFLY NASAL MASK
MOL Magyar Olaj- és Gázipari Nyrt.	<b>C10G 3/00</b> (2006.01) <b>C10L 1/02</b> (2006.01) <b>C10G 67/04</b> (2006.01) <b>C10G 47/04</b> (2006.01) <b>C10G 47/06</b> (2006.01) <b>C10G 47/10</b> (2006.01) <b>C10L 1/04</b> (2006.01) <b>C10L 1/14</b> (2006.01) <b>C10L 1/16</b> (2006.01) <b>C10L 1/183</b> (2006.01) <b>C10L 1/188</b> (2006.01) <b>C10L 1/19</b> (2006.01) <b>C10L 1/223</b> (2006.01) <b>C10L 10/08</b> (2006.01)	2639286	Process for the production of fuel and fuel additives capable for use for internal combustion engines and the fuels and fuel additives obtained

Podnosilac evropske prijave patenta (71)	MKP (51)	Broj objave evropske prijave patenta (97)	Naziv pronalaska (54)
OLAJTERV FÉVÁLLAKOZÓ és Tervező Zrt.	<b>C10G 3/00</b> (2006.01) <b>C10L 1/02</b> (2006.01) <b>C10G 67/04</b> (2006.01) <b>C10G 47/04</b> (2006.01) <b>C10G 47/06</b> (2006.01) <b>C10G 47/10</b> (2006.01) <b>C10L 1/04</b> (2006.01) <b>C10L 1/14</b> (2006.01) <b>C10L 1/16</b> (2006.01) <b>C10L 1/183</b> (2006.01) <b>C10L 1/188</b> (2006.01) <b>C10L 1/19</b> (2006.01) <b>C10L 1/223</b> (2006.01) <b>C10L 10/08</b> (2006.01)	2639286	Process for the production of fuel and fuel additives capable for use for internal combustion engines and the fuels and fuel additives obtained
Pannon Egyetem	<b>C10G 3/00</b> (2006.01) <b>C10L 1/02</b> (2006.01) <b>C10G 67/04</b> (2006.01) <b>C10G 47/04</b> (2006.01) <b>C10G 47/06</b> (2006.01) <b>C10G 47/10</b> (2006.01) <b>C10L 1/04</b> (2006.01) <b>C10L 1/14</b> (2006.01) <b>C10L 1/16</b> (2006.01) <b>C10L 1/183</b> (2006.01) <b>C10L 1/188</b> (2006.01) <b>C10L 1/19</b> (2006.01) <b>C10L 1/223</b> (2006.01) <b>C10L 10/08</b> (2006.01)	2639286	Process for the production of fuel and fuel additives capable for use for internal combustion engines and the fuels and fuel additives obtained
Magyar Tudományos Akadémia Kémiai Kutatóközpont	<b>C10G 3/00</b> (2006.01) <b>C10L 1/02</b> (2006.01) <b>C10G 67/04</b> (2006.01) <b>C10G 47/04</b> (2006.01) <b>C10G 47/06</b> (2006.01) <b>C10G 47/10</b> (2006.01) <b>C10L 1/04</b> (2006.01) <b>C10L 1/14</b> (2006.01) <b>C10L 1/16</b> (2006.01) <b>C10L 1/183</b> (2006.01) <b>C10L 1/188</b> (2006.01) <b>C10L 1/19</b> (2006.01) <b>C10L 1/223</b> (2006.01) <b>C10L 10/08</b> (2006.01)	2639286	Process for the production of fuel and fuel additives capable for use for internal combustion engines and the fuels and fuel additives obtained
Dancing Sun Limited	<b>G06F 17/30</b> (2006.01) <b>G06Q 30/00</b> (2012.01)	2606442 *	CONTENT SERVER
Theravance, Inc.	<b>C07D 403/14</b> (2006.01) <b>A61K 31/4025</b> (2006.01) <b>A61K 31/12</b> (2006.01)	2635571 *	NOVEL INHIBITORS OF HEPATITIS C VIRUS
Celgene Avilomics Research, Inc.	<b>C07D 471/04</b> (2006.01) <b>C07D 239/42</b> (2006.01) <b>A01N 43/54</b> (2006.01)	2637502 *	MUTANT-SELECTIVE EGFR INHIBITORS AND USES THEREOF
Axelar AB	<b>A61P 35/00</b> (2006.01) <b>A61P 25/28</b> (2006.01) <b>A61K 31/365</b> (2006.01) <b>A61P 3/10</b> (2006.01)	2624828 *	PICROPODOPHYLLIN MONOHYDRATE OR POLYMORPH A IN CANCER THERAPY
Delphi Technologies Holding S.à.r.l.	<b>F02D 41/20</b> (2006.01)	2546499	Electrical drive arrangement for a fuel injection system
Gilead Sciences, Inc.	<b>C07H 19/02</b> (2006.01) <b>C07H 19/10</b> (2006.01) <b>C07H 19/20</b> (2006.01) <b>C07H 1/00</b> (2006.01) <b>C07H 1/06</b> (2006.01) <b>C07D 309/10</b> (2006.01)	2596004 *	METHODS FOR THE PREPARATION OF DIASTEROMERICALLY PURE PHOSPHORAMIDATE PRODRUGS

Podnosilac evropske prijave patenta (71)	MKP (51)	Broj objave evropske prijave patenta (97)	Naziv pronalaska (54)
Pioneer Hi-Bred International Inc.	<b>C12N 15/82</b> (2006.01) <b>C12Q 1/68</b> (2006.01) <b>G01N 33/573</b> (2006.01) <b>A01H 5/00</b> (2006.01) <b>A01H 5/10</b> (2006.01) <b>C12N 9/02</b> (2006.01)	2603591 *	COMPOSITIONS AND METHODS COMPRISING SEQUENCES HAVING HYDROXYPHENYLPYRUVATE DIOXYGENASE (HPPD) ACTIVITY
Delphi Technologies Holding S.à.r.l.	<b>F04B 1/04</b> (2006.01) <b>F02M 59/10</b> (2006.01) <b>F02M 59/44</b> (2006.01) <b>F02M 63/00</b> (2006.01)	2530316	Fuel pump lubrication
Cadila Healthcare Limited	<b>C07D 487/04</b> (2006.01) <b>C12N 9/02</b> (2006.01) <b>C12P 17/18</b> (2006.01)	2625179 *	PROCESS FOR PREPARING AN INTERMEDIATE OF SITAGLIPTIN VIA ENZYMATIC CONVERSION
G.E.M. Elettronica S.r.L.	<b>H01P 1/06</b> (2006.01) <b>H01P 1/16</b> (2006.01)	2601706 *	POWER DUAL-BAND ROTARY JOINT OPERATING ON TWO DIFFERENT BANDS
Pioneer Hi-Bred International Inc.	<b>C12N 15/82</b> (2006.01)	2643464 *	BRASSICA GAT EVENT DP-073496-4 AND COMPOSITIONS AND METHODS FOR THE IDENTIFICATION AND/OR DETECTION THEREOF
E.I. DUPONT DE NEMOURS AND COMPANY	<b>C12N 15/82</b> (2006.01)	2643464 *	BRASSICA GAT EVENT DP-073496-4 AND COMPOSITIONS AND METHODS FOR THE IDENTIFICATION AND/OR DETECTION THEREOF
UCB Pharma, S.A.	<b>G01N 33/68</b> (2006.01)	2598888 *	ANALYTICAL METHOD FOR FAB AND FAB' MOLECULES
Kancera AB	<b>C07D 257/04</b> (2006.01) <b>C07D 307/82</b> (2006.01) <b>C07D 333/34</b> (2006.01) <b>C07D 333/62</b> (2006.01) <b>C07D 405/12</b> (2006.01) <b>C07D 417/12</b> (2006.01) <b>C07D 409/04</b> (2006.01) <b>C07D 417/14</b> (2006.01) <b>C07D 409/12</b> (2006.01) <b>C07C 311/21</b> (2006.01) <b>C07D 409/14</b> (2006.01) <b>C07C 311/29</b> (2006.01) <b>C07D 413/12</b> (2006.01) <b>A61K 31/41</b> (2006.01) <b>C07D 413/04</b> (2006.01) <b>A61K 31/422</b> (2006.01) <b>C07D 413/14</b> (2006.01) <b>A61K 31/381</b> (2006.01) <b>C07D 417/04</b> (2006.01) <b>A61K 31/4436</b> (2006.01)	2616450 *	SULFONAMIDE COMPOUNDS
Symphony Evolution, Inc.	<b>A61K 31/517</b> (2006.01) <b>A61P 13/12</b> (2006.01)	2608793 *	USE OF A RECEPTOR-TYPE KINASE MODULATOR FOR TREATING POLYCYSTIC KIDNEY DISEASE
Dow AgroSciences LLC	<b>A01N 43/40</b> (2006.01) <b>A01P 13/00</b> (2006.01)	2632262 *	SYNERGISTIC HERBICIDAL COMPOSITION CONTAINING FLUROXYPYR AND QUINCLORAC
SANOFI	<b>C07D 307/80</b> (2006.01)	2595976 *	PROCESS FOR PREPARING AMINOBENZOYLBENZOFURAN DERIVATIVES
Akbayir, Zeki	<b>F03B 17/00</b> (2006.01)	2535558	Method and device for generating drive power by causing pressure differentials in a closed gas/fluid system
Shire LLC	<b>C07D 487/04</b> (2006.01)	2630148 *	PROCESS FOR THE PREPARATION OF ANAGRELIDE AND ANALOGUES THEREOF
Yale University, Inc.	<b>A01K 67/027</b> (2006.01)	2618656 *	HUMAM SIRPAalpha TRANSGENIC ANIMALS AND THEIR METHODS OF USE
AbbVie Inc.	<b>A61K 39/395</b> (2006.01)	2624867 *	METHODS FOR TREATING PSORIASIS
Sofar SPA	<b>A61P 1/04</b> (2006.01) <b>A61K 31/573</b> (2006.01) <b>A61K 9/50</b> (2006.01) <b>A61P 1/12</b> (2006.01)	2600852 *	BECLOMETHASONE DIPROPIONATE COMPOSITIONS IN MODIFIED-RELEASE GASTRO-RESISTANT MICROSPHERES AND PROCESS FOR OBTAINING THEM
Lobepro, Inc.	<b>F16J 15/34</b> (2006.01)	2606261 *	PUMP SEAL

Podnosilac evropske prijave patenta (71)	MKP (51)	Broj objave evropske prijave patenta (97)	Naziv pronalaska (54)
Exelixis, Inc.	<b>A61P 35/00</b> (2006.01) <b>G01N 33/00</b> (2006.01) <b>A61K 31/00</b> (2006.01)	2640366 *	BENZOXAZEPINES AS INHIBITORS OF PI3K/MTOR AND METHODS OF THEIR USE AND MANUFACTURE
Inashco R&D B.V.	<b>B07B 13/10</b> (2006.01) <b>B07B 13/11</b> (2006.01) <b>B07B 13/16</b> (2006.01)	2598256 *	SEPARATION APPARATUS
Protektorwerk Florenz Maisch GmbH & Co. KG	<b>E04C 3/09</b> (2006.01) <b>E04C 3/08</b> (2006.01)	2573291	Thin-walled cold-formed lightweight structural profile element and method for producing such a profile element
CST-Computer Simulation Technology AG	<b>G06F 17/50</b> (2006.01)	2378444	Method, device and computer program product for determining an electromagnetic near field of a field excitation source for an electrical system
Curt G. Joa, Inc.	<b>A61F 13/15</b> (2006.01)	2596778	Apparatus and method for applying short machine direction adhesive patches to a carrier layer
SANOFI	<b>G01N 33/68</b> (2006.01) <b>A61P 3/10</b> (2006.01) <b>A61K 39/395</b> (2006.01) <b>A61P 17/06</b> (2006.01) <b>C07K 16/28</b> (2006.01) <b>A61P 9/10</b> (2006.01) <b>A61P 35/00</b> (2006.01) <b>A61P 29/00</b> (2006.01) <b>A61P 37/02</b> (2006.01)	2611462 *	PEPTIDE OR PEPTIDE COMPLEX BINDING TO 2 INTEGRIN AND METHODS AND USES INVOLVING THE SAME
Vectec S.A.	<b>A61B 17/02</b> (2006.01) <b>A61B 17/04</b> (2006.01) <b>A61B 17/00</b> (2006.01)	2632344 *	SINGLE USE, DISPOSABLE, TISSUE SUSPENDER DEVICE
North Texas Medical Associates	<b>A61K 36/886</b> (2006.01) <b>A61P 31/18</b> (2006.01) <b>A61K 31/715</b> (2006.01)	2595643 *	ANTI-VIRAL PROPERTIES OF ALOE VERA AND ACQUIRED IMMUNE DEFICIENCY SYNDROME (AIDS) TREATMENT
Immatics Biotechnologies GmbH	<b>G01N 33/574</b> (2006.01)	2619585 *	USE OF MYELOID CELL BIOMARKERS FOR THE DIAGNOSIS OF CANCER
Vale S.A.	<b>C02F 1/42</b> (2006.01)	2616395 *	A METHOD FOR THE REMOVAL OF ORGANIC CHEMICALS AND ORGANOMETALLIC COMPLEXES FROM PROCESS WATER OR OTHER STREAMS OF A MINERAL PROCESSING PLANT USING ZEOLITE
Dong, Jie	<b>C02F 1/42</b> (2006.01)	2616395 *	A METHOD FOR THE REMOVAL OF ORGANIC CHEMICALS AND ORGANOMETALLIC COMPLEXES FROM PROCESS WATER OR OTHER STREAMS OF A MINERAL PROCESSING PLANT USING ZEOLITE
Xu, Manqui	<b>C02F 1/42</b> (2006.01)	2616395 *	A METHOD FOR THE REMOVAL OF ORGANIC CHEMICALS AND ORGANOMETALLIC COMPLEXES FROM PROCESS WATER OR OTHER STREAMS OF A MINERAL PROCESSING PLANT USING ZEOLITE
ARIAD Pharmaceuticals, Inc	<b>A01N 43/54</b> (2006.01) <b>A61K 31/505</b> (2006.01)	2627179 *	METHODS FOR INHIBITING CELL PROLIFERATION IN EGFR-DRIVEN CANCERS
Pellini S.p.A.	<b>E06B 9/28</b> (2006.01) <b>E06B 7/082</b> (2006.01)	2643539 *	VENETIAN BLIND FOR INTERNAL USE WITH SLATS FIXED TO UPRIGHT CARRIER SLATS, DESIGNED FOR INCLUSION IN A GLASS-ENCLOSED CHAMBER
University of Pittsburgh - Of The Commonwealth System of Higher Education	<b>A61K 31/405</b> (2006.01) <b>A61P 35/00</b> (2006.01) <b>C07D 209/42</b> (2006.01) <b>C07D 209/30</b> (2006.01) <b>C07D 209/14</b> (2006.01) <b>C07D 209/26</b> (2006.01) <b>A61K 31/404</b> (2006.01)	2614051 *	P53-MDM2 ANTAGONISTS
Caponi, Annarita	<b>B29C 44/44</b> (2006.01) <b>B29C 37/00</b> (2006.01) <b>B05D 1/02</b> (2006.01)	2599606	Method for the realization of objects of polystyrene covered with a hardened layer of polymeric material, preferably objects of decor and furniture

Podnosilac evropske prijave patenta (71)	MKP (51)	Broj objave evropske prijave patenta (97)	Naziv pronalaska (54)
Taisho Pharmaceutical Co., Ltd.	<b>A61P 25/08</b> (2006.01) <b>C07D 403/04</b> (2006.01) <b>A61P 25/28</b> (2006.01) <b>A61K 31/4155</b> (2006.01) <b>A61P 25/36</b> (2006.01) <b>A61K 31/4245</b> (2006.01) <b>C07D 403/14</b> (2006.01) <b>A61P 25/20</b> (2006.01) <b>A61P 25/22</b> (2006.01) <b>A61K 31/4439</b> (2006.01) <b>C07D 413/04</b> (2006.01) <b>A61P 25/04</b> (2006.01) <b>C07D 413/14</b> (2006.01)	2604602 *	HETEROARYL-PYRAZOLE DERIVATIVE
Delphi Technologies Holding S.à.r.l.	<b>F16K 3/26</b> (2006.01)	2535622	Valve assembly
Brimrock International Inc.	<b>C01B 17/02</b> (2006.01) <b>C01B 17/00</b> (2006.01) <b>B01J 2/12</b> (2006.01)	2643266 *	METHOD AND SYSTEM FOR GENERATING SULFUR SEEDS AND GRANULES
Sanofi-Aventis Deutschland GmbH	<b>A61M 5/315</b> (2006.01) <b>A61M 5/24</b> (2006.01)	2574358	Use of a spring in a drug delivery device
The University Of North Carolina At Charlotte Office Of Technology Transfer	<b>A61K 39/395</b> (2006.01) <b>C07K 16/00</b> (2006.01)	2624866 *	TUMOR SPECIFIC ANTIBODIES AND USES THEREFOR
Cadila Healthcare Limited	<b>C12N 9/72</b> (2006.01) <b>C12N 9/48</b> (2006.01)	2640834 *	A NOVEL PROCESS FOR THE PURIFICATION OF TISSUE PLASMINOGEN ACTIVATOR
Leyden Energy, Inc.	<b>H01M 4/36</b> (2006.01) <b>H01M 10/0525</b> (2010.01) <b>H01M 4/66</b> (2006.01) <b>H01M 4/62</b> (2006.01) <b>H01M 10/0566</b> (2010.01)	2638597 *	HIGH PERFORMANCE LITHIUM OR LITHIUM ION CELL
Janssen Pharmaceuticals, Inc.	<b>C07D 471/04</b> (2006.01)	2638040 *	RADIOLABELLED mGluR2 PET LIGANDS
Genzyme Corporation	<b>C07K 16/22</b> (2006.01) <b>C07K 16/28</b> (2006.01) <b>A61K 39/395</b> (2006.01) <b>A61P 9/10</b> (2006.01)	2611831 *	TREATMENT OF MYOCARDIAL INFARCTION USING TGF - BETA ANTAGONISTS
Corcel IP Limited	<b>B65D 5/42</b> (2006.01) <b>B65D 65/00</b> (2006.01)	2635499 *	IMPROVEMENTS IN AND RELATING TO PACKAGING
Nort S.r.L.	<b>B65G 49/06</b> (2006.01)	2595906 *	APPARATUS FOR THE APPLICATION OF SPACER ELEMENTS ONTO PLATES
Arcelormittal Maizières Research S.A.	<b>C10B 27/06</b> (2006.01) <b>C10B 41/08</b> (2006.01)	2625248 *	COKING PLANT AND METHOD FOR CONTROLLING SAID PLANT
University Of Louisville Research Foundation, Inc.	<b>C12Q 1/00</b> (2006.01)	2625280 *	IGF-1 DEPENDENT MODULATION OF VSELS
D.M.G. Italia Srl	<b>G01N 33/53</b> (2006.01)	2601525 *	USE OF HMGB1 AS A BIOLOGICAL MARKER OF BOWEL INFLAMMATORY CONDITIONS, NON-INVASIVE METHOD FOR ITS DETECTION IN FECAL SAMPLES AND KIT THEREOF
Ölzant, Eveline	<b>A44B 11/00</b> (2006.01)	2615937 *	BELT BUCKLE THAT CAN BE DETACHED WITHOUT TOOLS AND THAT HAS AN INTEGRATED CONTAINER FOR CHECK CARDS, IDENTITY CARDS, A DRIVER'S LICENSE, AND THE LIKE
Sanofi-Aventis Deutschland GmbH	<b>A61M 5/24</b> (2006.01) <b>A61M 5/315</b> (2006.01)	2637719 *	DOSE SETTING MECHANISM AND DRUG DELIVERY DEVICE
RAREEARTH, LLC	<b>C11C 5/00</b> (2006.01)	2611895 *	DECORATIVE CANDLE AND METHOD
Wabtec Holding Corp.	<b>B61H 13/20</b> (2006.01) <b>B61H 1/00</b> (2006.01)	2627548 *	RAILWAY TRUCK MOUNTED BRAKE RIGGING HAVING RAISED CONNECTION OF FORCE-TRANSMITTING MEMBER WITH TRANSFER LEVER

Podnosilac evropske prijave patenta (71)	MKP (51)	Broj objave evropske prijave patenta (97)	Naziv pronalaska (54)
Material Innovations, LLC	<b>C04B 26/02</b> (2006.01) <b>C04B 30/02</b> (2006.01) <b>C04B 26/16</b> (2006.01) <b>C04B 18/30</b> (2006.01) <b>C04B 26/12</b> (2006.01)	2601151 *	COMPOSITE BUILDING MATERIALS AND METHODS OF MANUFACTURE
Rathor AG	<b>B65D 83/14</b> (2006.01) <b>B65D 83/28</b> (2006.01) <b>B65D 83/30</b> (2006.01) <b>B05C 17/005</b> (2006.01)	2627454 *	DEVICE FOR DISTRIBUTING ADHESIVE
Chiesi Farmaceutici S.p.A.	<b>C07D 207/12</b> (2006.01) <b>C07D 451/10</b> (2006.01) <b>C07D 453/02</b> (2006.01) <b>A61K 31/40</b> (2006.01) <b>A61K 31/46</b> (2006.01) <b>A61K 31/439</b> (2006.01) <b>A61P 11/08</b> (2006.01) <b>A61P 29/02</b> (2006.01)	2643295 *	GLYCINE DERIVATIVES AND THEIR USE AS MUSCARINIC RECEPTOR ANTAGONISTS
MorphoSys AG	<b>C07K 16/00</b> (2006.01) <b>C12N 15/10</b> (2006.01)	2640742 *	A COLLECTION AND METHODS FOR ITS USE
Les Laboratoires Servier	<b>C07C 69/753</b> (2006.01) <b>C07C 213/08</b> (2006.01) <b>C07C 62/34</b> (2006.01) <b>C07C 217/58</b> (2006.01) <b>C07D 223/16</b> (2006.01) <b>C12P 7/40</b> (2006.01) <b>C12P 7/62</b> (2006.01) <b>C12P 41/00</b> (2006.01)	2626428	Method for enzymatic synthesis of (7S)-3,4-dimethoxybicyclo[4.2.0]octa-1,3,5-triene-7-carboxylic acid or the esters thereof, and use for the synthesis of ivabradine and the salts thereof
Telefonaktiebolaget L M Ericsson (publ)	<b>G06F 13/38</b> (2006.01)	2523117	Interface module for HW block
Cyalume Technologies, Inc	<b>F42B 12/40</b> (2006.01)	2630436 *	MULTI-MARKER MARKING SYSTEM
Transluminal Technologies, Inc.	<b>A61F 2/00</b> (2006.01) <b>A61B 17/03</b> (2006.01) <b>A61B 17/08</b> (2006.01) <b>A61L 31/02</b> (2006.01)	2635197 *	CLOSURE DEVICE, DEPLOYMENT APPARATUS, AND METHOD OF DEPLOYING A CLOSURE DEVICE
UCB Pharma GmbH	<b>C07C 237/22</b> (2006.01) <b>C07C 229/22</b> (2006.01) <b>C07C 233/47</b> (2006.01)	2640691 *	PROCESS FOR PREPARING LACOSAMIDE
Yale University, Inc.	<b>A61P 31/18</b> (2006.01) <b>A61K 31/496</b> (2006.01) <b>C07D 405/14</b> (2006.01)	2640720 *	BIFUNCTIONAL MOLECULES WITH ANTIBODY-RECRUITING AND ENTRY INHIBITORY ACTIVITY AGAINST THE HUMAN IMMUNODEFICIENCY VIRUS
Perfetti Van Melle S.p.A.	<b>A23L 1/0524</b> (2006.01) <b>A23G 3/54</b> (2006.01)	2600734 *	"GUMDROPS WITH FLUID FILLING AND METHOD OF OBTAINING THEM"
Tsec S.r.l.	<b>H01H 36/00</b> (2006.01)	2590197	Magnetic sensor designed to operate with a corresponding magnet and magnetic contact comprising said magnetic sensor and corresponding magnet
Biofarma SPA	<b>B65D 51/28</b> (2006.01)	2616354 *	CLOSING DEVICE FOR A CONTAINER AND CONTAINER COMPRISING SAID CLOSING DEVICE
Ecoval Environnement	<b>A61L 2/12</b> (2006.01)	2598176 *	METHOD FOR DISINFECTING BEDDING ITEMS BY MICROWAVES, IN PARTICULAR MATTRESSES, AND RELATED FACILITY
Savant Systems LLC.	<b>H04N 21/41</b> (2011.01) <b>H04N 21/436</b> (2011.01) <b>H04N 5/44</b> (2011.01) <b>H04M 1/725</b> (2006.01) <b>G06F 1/16</b> (2006.01)	2619991 *	PROGRAMMABLE MULTIMEDIA CONTROL SYSTEM HAVING A TACTILE REMOTE CONTROL
Yale University	<b>C12Q 1/68</b> (2006.01) <b>G01N 33/53</b> (2006.01) <b>C12Q 1/00</b> (2006.01)	2643470 *	COMPOSITIONS AND METHODS FOR DIAGNOSING AND TREATING DISEASES AND DISORDERS ASSOCIATED WITH D-DT
Stem Centrx, Inc.	<b>A61K 39/395</b> (2006.01)	2611464 *	NOVEL MODULATORS AND METHODS OF USE

Podnosilac evropske prijave patenta (71)	MKP (51)	Broj objave evropske prijave patenta (97)	Naziv pronalaska (54)
Cadila Healthcare Limited	<b>C07D 413/14</b> (2006.01) <b>C07D 417/14</b> (2006.01) <b>A61K 31/506</b> (2006.01) <b>A61P 3/10</b> (2006.01)	2625177 *	NOVEL GPR 119 AGONISTS
Cyalume Technologies, Inc	<b>F42B 12/40</b> (2006.01) <b>C09K 11/07</b> (2006.01) <b>F42B 12/36</b> (2006.01)	2630215 *	COMBINED THERMAL AND CHEMILUMINESCENT REACTION SYSTEM
Hengrui (USA) Ltd.	<b>C07D 471/04</b> (2006.01) <b>C07D 487/04</b> (2006.01) <b>A61K 31/5025</b> (2006.01) <b>A61P 35/00</b> (2006.01)	2635578 *	2-ARYLIMIDAZO[1,2-B]PYRIDAZINE, 2-PHENYLIMIDAZO[1,2-A]PYRIDINE, AND 2-PHENYLIMIDAZO[1,2-A]PYRAZINE DERIVATIVES
SANOFI	<b>A61K 47/48</b> (2006.01) <b>A61P 35/00</b> (2006.01)	2640422 *	POLYMERIC CONJUGATES OF ACTIVE PRINCIPLES, THEIR PROCESS OF PREPARATION AND THEIR POLYMERIC INTERMEDIATES
Centre National de la Recherche Scientifique (C.N.R.S.)	<b>A61K 47/48</b> (2006.01) <b>A61P 35/00</b> (2006.01)	2640422 *	POLYMERIC CONJUGATES OF ACTIVE PRINCIPLES, THEIR PROCESS OF PREPARATION AND THEIR POLYMERIC INTERMEDIATES
Universite Paul Sabatier Toulouse III	<b>A61K 47/48</b> (2006.01) <b>A61P 35/00</b> (2006.01)	2640422 *	POLYMERIC CONJUGATES OF ACTIVE PRINCIPLES, THEIR PROCESS OF PREPARATION AND THEIR POLYMERIC INTERMEDIATES
Franvax S.r.l.	<b>C12N 15/82</b> (2006.01) <b>A61K 39/145</b> (2006.01)	2622082 *	GENERATION OF VIROSOME PARTICLES
Boehringer Ingelheim International GmbH	<b>C07D 487/04</b> (2006.01) <b>C07D 493/14</b> (2006.01) <b>C07D 495/14</b> (2006.01) <b>C07D 498/14</b> (2006.01) <b>A61K 31/517</b> (2006.01) <b>A61P 35/00</b> (2006.01)	2595987 *	NEW AMINOPYRAZOLOQUINAZOLINES
Hunting Energy Services (Well Intervention) Ltd	<b>E21B 19/24</b> (2006.01) <b>E21B 33/06</b> (2006.01)	2643542 *	VALVE APPARATUS AND IMPROVED RAM
Cheminova A/S	<b>A01N 25/02</b> (2006.01) <b>A01N 25/30</b> (2006.01) <b>A01N 51/00</b> (2006.01)	2611292 *	NEONICOTINYL FORMULATIONS
Auxilium Cura Innovatio	<b>A61K 9/00</b> (2006.01) <b>A61P 31/10</b> (2006.01) <b>A61K 31/19</b> (2006.01) <b>A61P 17/12</b> (2006.01) <b>A61K 45/06</b> (2006.01) <b>A61K 31/17</b> (2006.01)	2522342	A topical formulation for treatment of hyperkeratotic skin
Clearfarma Industries Ltd.	<b>A61K 9/16</b> (2006.01) <b>A61K 9/50</b> (2006.01)	2605756 *	FUNCTIONAL FOOD COMPOSITIONS AND METHODS
Somalogic, Inc.	<b>G06F 19/00</b> (2011.01) <b>C40B 30/04</b> (2006.01)	2603622 *	PANCREATIC CANCER BIOMARKERS AND USES THEREOF
Packers Plus Energy Services Inc.	<b>E21B 43/12</b> (2006.01) <b>E21B 43/25</b> (2006.01) <b>E21B 34/14</b> (2006.01)	2619404 *	WELLBORE FRAC TOOL WITH INFLOW CONTROL
Interface European Manufacturing B.V.	<b>D05C 17/02</b> (2006.01)	2635734 *	METHOD OF MANUFACTURING A CARPET OR CARPET TILE, CARPET OR CARPET TILE OBTAINED BY PERFORMING THE MANUFACTURING METHOD, AND SUPPORT MATERIAL FOR USE IN THE METHOD
Novomatic AG	<b>G07F 17/32</b> (2006.01) <b>G06F 3/048</b> (2013.01)	2636031 *	APPARATUS AND SYSTEM FOR REVEALING GRAPHICAL ITEMS ON A MULTI-TOUCH INTERFACE
E2F di Esposti Federici Ettore	<b>F01L 7/12</b> (2006.01) <b>F02B 33/04</b> (2006.01) <b>F01L 7/02</b> (2006.01)	2598728 *	DISCHARGE VALVE ASSEMBLY FOR TWO-STROKE ENGINE, PROVIDED WITH COOLING, NON-CONTACTING SEAL AND SELF-CLEANING
Oxford Biotherapeutics Ltd.	<b>A61K 39/395</b> (2006.01)	2629796 *	ANTIBODIES
Carnevale, Vittoria	<b>G06Q 30/00</b> (2012.01) <b>G07C 9/00</b> (2006.01)	2601628 *	METHODS FOR USING A SHOPPING BAG OF REUSABLE TYPE WITH IDENTIFICATION OF DIGITAL TYPE



Podnosilac evropske prijave patenta (71)	MKP (51)	Broj objave evropske prijave patenta (97)	Naziv pronalaska (54)
Delft Enterprises B.V.	<b>C01B 31/02</b> (2006.01) <b>B01J 35/00</b> (2006.01) <b>B01J 37/16</b> (2006.01)	2616391 *	CARBON NANOSTRUCTURES AND NETWORKS PRODUCED BY CHEMICAL VAPOR DEPOSITION
IT-universitetet I København	<b>A61B 3/113</b> (2006.01) <b>G06F 3/01</b> (2006.01) <b>G06T 7/00</b> (2006.01)	2632322 *	METHOD OF DETERMINING REFLECTIONS OF LIGHT
Laboratorios Ojer Pharma S.L.	<b>A61K 31/351</b> (2006.01) <b>A61K 9/06</b> (2006.01) <b>A61K 9/00</b> (2006.01) <b>A61K 47/46</b> (2006.01)	2629756 *	PHARMACEUTICAL TOPICAL COMPOSITION OF MUPIROCIN
Novartis AG	<b>B29D 11/00</b> (2006.01)	2637847 *	METHOD FOR MAKING CONTACT LENSES
Qualcomm Incorporated	<b>H04L 29/06</b> (2006.01) <b>H04W 4/02</b> (2009.01)	2636203 *	AUTHENTICATION IN SECURE USER PLANE LOCATION (SUPL) SYSTEMS
ThyssenKrupp Uhde GmbH	<b>C07C 1/04</b> (2006.01) <b>C10L 3/08</b> (2006.01)	2598464 *	PROCESS FOR PRODUCING A METHANE-CONTAINING GAS FROM SYNTHESIS GAS AND METHANE PRODUCTION PLANT FOR CARRYING OUT THE PROCESS
Bayer Oy	<b>A61F 6/18</b> (2006.01)	2632398 *	AN INSERTER FOR AN INTRAUTERINE SYSTEM
UCB Pharma, S.A.	<b>C07K 1/36</b> (2006.01) <b>C07K 16/24</b> (2006.01) <b>C07K 14/245</b> (2006.01)	2598516 *	PROCESS FOR PURIFYING PROTEINS
Boehringer Ingelheim International GmbH	<b>C07D 401/12</b> (2006.01) <b>C07D 401/14</b> (2006.01) <b>C07D 403/12</b> (2006.01) <b>A61K 31/455</b> (2006.01) <b>A61K 31/506</b> (2006.01) <b>A61K 31/501</b> (2006.01) <b>A61P 29/00</b> (2006.01) <b>A61P 11/00</b> (2006.01) <b>A61P 19/02</b> (2006.01) <b>A61P 17/00</b> (2006.01)	2606042 *	DISUBSTITUTED TETRAHYDOFURANYL COMPOUNDS AS ANTAGONISTS OF THE BRADYKININ B1 RECEPTOR
Merck Sharp & Dohme Corp.	<b>A61P 9/08</b> (2006.01) <b>C07D 471/10</b> (2006.01) <b>A61K 31/519</b> (2006.01) <b>A61K 31/437</b> (2006.01)	2638042 *	PIPERIDINONE CARBOXAMIDE AZAINDANE CGRP RECEPTOR ANTAGONISTS
Abraxis BioScience, LLC	<b>A61K 38/17</b> (2006.01) <b>A61P 35/00</b> (2006.01)	2630963	SPARC angiogenic domain and methods of use
Technolog GmbH Handels- und Beteiligungsgesellschaft Für Technologie	<b>B63B 25/00</b> (2006.01) <b>B63B 25/12</b> (2006.01) <b>F02M 21/02</b> (2006.01)	2607224	Buoyant body, in particular container ship
Bayer Intellectual Property GmbH	<b>A61K 31/17</b> (2006.01) <b>A61K 31/18</b> (2006.01) <b>A61K 31/44</b> (2006.01) <b>A61P 35/00</b> (2006.01)	2621486 *	SUBSTITUTED N-(2-ARYLAMINO)ARYL SULFONAMIDE-CONTAINING COMBINATIONS
Sanofi-Aventis Deutschland GmbH	<b>A61M 5/315</b> (2006.01)	2624894 *	DRIVE MECHANISM FOR A DRUG DELIVERY DEVICE AND DRUG DELIVERY DEVICE
TROX GmbH	<b>F24F 13/14</b> (2006.01) <b>F24F 13/02</b> (2006.01)	2592359	Fire protection flap with a housing and a pivotable shut-off valve which can be pivoted around a pivoting axle, in particular a central pivoting axle
University of Pittsburgh of the Commonwealth System of Higher Education	<b>G01N 33/50</b> (2006.01) <b>G01N 33/68</b> (2006.01)	2619577 *	BIOMARKERS OF RENAL INJURY
KFLP Biotech, LLC A Delaware Limited Liability Company	<b>A61K 31/00</b> (2006.01) <b>C12Q 1/70</b> (2006.01) <b>G01N 33/50</b> (2006.01) <b>C40B 30/02</b> (2006.01)	2632445 *	NOVEL DRUG TARGET SITE WITHIN GP120 OF HIV
Ross Technology Corporation	<b>C10L 5/00</b> (2006.01)	2638131 *	METHODS AND COMPOSITIONS FOR DRYING COAL
GlaxoSmithKline LLC	<b>B05C 5/00</b> (2006.01) <b>B08B 3/08</b> (2006.01)	2464466 *	VAPOR SHEATH FOR LIQUID DISPENSING NOZZLE

Podnosilac evropske prijave patenta (71)	MKP (51)	Broj objave evropske prijave patenta (97)	Naziv pronalaska (54)
Synta Pharmaceuticals Corp.	<b>A61K 31/165</b> (2006.01) <b>A61P 35/00</b> (2006.01)	2640372 *	PRESELECTION OF SUBJECTS FOR THERAPEUTIC TREATMENT WITH ELESCLOMOL BASED ON HYPOXIC STATUS
Chiesi Farmaceutici S.p.A.	<b>A61K 31/439</b> (2006.01) <b>A61K 9/00</b> (2006.01)	2621494 *	USE OF MAGNESIUM STEARATE IN DRY POWDER FORMULATIONS FOR INHALATION
Biocepta Corporation	<b>A61K 31/192</b> (2006.01) <b>A61K 31/19</b> (2006.01) <b>A61P 31/10</b> (2006.01) <b>A61P 31/22</b> (2006.01)	2637654 *	TOPICAL ORGANIC ACID SALT COMPOSITIONS SUITABLE FOR TREATING INFECTIONS
Amgen Inc.	<b>C07D 491/20</b> (2006.01) <b>C07D 491/22</b> (2006.01) <b>C07D 498/20</b> (2006.01) <b>C07D 498/22</b> (2006.01) <b>A61K 31/436</b> (2006.01) <b>A61K 31/437</b> (2006.01) <b>A61K 31/537</b> (2006.01)	2601197 *	AMINO-ISO-INDOLE, AMINO-AZA-ISO-INDOLE, AMINO-DIHYDROISOQUINOLINE AND AMINO-BENZOXAZINE COMPOUNDS AS BETA-SECRETASE MODULATORS AND METHODS OF USE
Packers Plus Energy Services Inc.	<b>E21B 33/129</b> (2006.01) <b>E21B 23/06</b> (2006.01)	2625376 *	WELLBORE PACKER BACK-UP RING ASSEMBLY, PACKER AND METHOD
Geox S.p.A.	<b>G02C 11/08</b> (2006.01) <b>A61F 9/02</b> (2006.01) <b>G02C 5/12</b> (2006.01) <b>G02C 5/14</b> (2006.01)	2598940 *	FRAME FOR GLASSES, MASKS FOR PROFESSIONAL OR SPORTS USE, AND THE LIKE
Novartis AG	<b>A61K 31/221</b> (2006.01) <b>A61K 31/41</b> (2006.01) <b>A61P 9/00</b> (2006.01) <b>A61P 9/04</b> (2006.01) <b>A61P 9/12</b> (2006.01)	2608784 *	TREATMENT OF HYPERTENSION AND/OR PREVENTION OR TREATMENT OF HEART FAILURE IN A MAMMAL RECEIVING ANTI-COAGULANT THERAPY
Yissum Research Development Company of the Hebrew University of Jerusalem Ltd.	<b>C09K 11/02</b> (2006.01) <b>C09K 11/56</b> (2006.01) <b>C09K 11/70</b> (2006.01) <b>C09K 11/74</b> (2006.01) <b>C09K 11/88</b> (2006.01)	2616522 *	ANISTROPIC SEMICONDUCTOR NANOPARTICLES
Coty Inc.	<b>A61K 8/86</b> (2006.01) <b>A61Q 1/04</b> (2006.01) <b>A61Q 1/00</b> (2006.01) <b>A61K 8/97</b> (2006.01) <b>A61K 8/19</b> (2006.01) <b>A61K 8/72</b> (2006.01) <b>A61K 8/92</b> (2006.01)	2637638 *	LIPSTICK AND OTHER COSMETICS AND METHOD OF MAKING
AUSTRALIAN NUCLEAR SCIENCE & TECHNOLOGY ORGANISATION	<b>A61K 9/14</b> (2006.01) <b>A61K 38/00</b> (2006.01) <b>A61K 47/02</b> (2006.01) <b>C01B 33/18</b> (2006.01) <b>A61K 48/00</b> (2006.01) <b>A61K 31/70</b> (2006.01)	2605755 *	PARTICULATE SUBSTANCES COMPRISING CERAMIC PARTICLES FOR DELIVERY OF BIOMOLECULES
CHIESI FARMACEUTICI S.p.A.	<b>A61M 15/00</b> (2006.01) <b>A61J 1/20</b> (2006.01) <b>B05B 11/00</b> (2006.01) <b>B65D 83/14</b> (2006.01)	2613829 *	METERED-DOSE INHALER AND METHOD OF USING THE SAME
Bayer Intellectual Property GmbH	<b>C07D 249/12</b> (2006.01) <b>C07D 409/04</b> (2006.01) <b>A61K 31/4196</b> (2006.01) <b>A61P 9/00</b> (2006.01)	2616448 *	SUBSTITUTED PHENYLACETATE AND PHENYLPROPANE AMIDES AND USE THEREOF
Boehringer Ingelheim International GmbH	<b>C07D 403/14</b> (2006.01)	2621921 *	SOLID STATE FORMS OF A POTENT HCV INHIBITOR
Ets. Joskin S.A.	<b>A01C 15/00</b> (2006.01) <b>A01C 3/06</b> (2006.01)	2567606	Shutter for spreading device

Podnosilac evropske prijave patenta (71)	MKP (51)	Broj objave evropske prijave patenta (97)	Naziv pronalaska (54)
Maria Clementine Martin Klosterfrau Vertriebsgesellschaft mbH	<b>A61K 36/235</b> (2006.01) <b>A61K 36/35</b> (2006.01) <b>A61K 36/57</b> (2006.01) <b>A61K 36/28</b> (2006.01) <b>A61P 11/10</b> (2006.01) <b>A61K 36/25</b> (2006.01) <b>A61P 11/12</b> (2006.01) <b>A61K 36/11</b> (2006.01) <b>A61K 36/53</b> (2006.01) <b>A61K 36/185</b> (2006.01) <b>A61P 11/00</b> (2006.01)	2621505 *	METHOD FOR PRODUCING PLANT-BASED ALCOHOL-FREE COMPOSITIONS, COMPOSITIONS PRODUCED IN THIS WAY, AND USE OF SAID COMPOSITIONS
Novartis AG	<b>C07K 16/24</b> (2006.01) <b>A61K 39/395</b> (2006.01)	2625199 *	METHODS OF TREATING PSORIASIS USING IL-17 ANTAGONISTS
Arla Foods Amba	<b>C12P 19/02</b> (2006.01) <b>C12P 19/12</b> (2006.01) <b>C12P 19/14</b> (2006.01) <b>C12P 19/18</b> (2006.01) <b>A23L 1/09</b> (2006.01) <b>C07H 3/04</b> (2006.01) <b>C07H 3/06</b> (2006.01)	2596113 *	GALACTO-OLIGOSACCHARIDE-CONTAINING COMPOSITION AND A METHOD OF PRODUCING IT
Ironwood Pharmaceuticals, Inc.	<b>A61K 31/427</b> (2006.01) <b>A61K 31/4439</b> (2006.01) <b>A61K 31/444</b> (2006.01) <b>A61K 31/497</b> (2006.01) <b>A61K 31/506</b> (2006.01) <b>C07D 401/04</b> (2006.01) <b>C07D 401/14</b> (2006.01) <b>C07D 403/04</b> (2006.01) <b>C07D 407/14</b> (2006.01) <b>C07D 413/14</b> (2006.01) <b>C07D 417/04</b> (2006.01) <b>C07D 417/14</b> (2006.01) <b>A61P 7/02</b> (2006.01) <b>A61P 9/08</b> (2006.01)	2637659 *	SGC STIMULATORS
Flesst B.V.	<b>E04D 13/12</b> (2006.01) <b>E04G 21/32</b> (2006.01)	2633135 *	ROOF PROVIDED WITH A SAFETY SYSTEM
Gilead Sciences, Inc.	<b>A61K 31/675</b> (2006.01) <b>A61K 31/513</b> (2006.01) <b>A61P 31/18</b> (2006.01) <b>A61K 31/505</b> (2006.01) <b>A61K 9/20</b> (2006.01)	2640362 *	THERAPEUTIC COMPOSITIONS COMPRISING RILPIVIRINE HCL AND TENOFOVIR DISOPROXIL FUMARATE
Janssen R&D Ireland	<b>A61K 31/675</b> (2006.01) <b>A61K 31/513</b> (2006.01) <b>A61P 31/18</b> (2006.01) <b>A61K 31/505</b> (2006.01) <b>A61K 9/20</b> (2006.01)	2640362 *	THERAPEUTIC COMPOSITIONS COMPRISING RILPIVIRINE HCL AND TENOFOVIR DISOPROXIL FUMARATE
Roland Corporation	<b>G10L 21/02</b> (2006.01)	2437260	Sound signal processing device
Mars, Incorporated	<b>C07F 5/02</b> (2006.01) <b>C07F 5/04</b> (2006.01) <b>A61K 31/69</b> (2006.01)	2632927 *	BORONATES AS ARGINASE INHIBITORS
Abera Bioscience AB	<b>C12N 15/62</b> (2006.01) <b>C07K 14/245</b> (2006.01) <b>A61K 35/74</b> (2006.01) <b>A61K 39/04</b> (2006.01)	2622078 *	FUSION PROTEIN FOR SECRETORY PROTEIN EXPRESSION
Calereo Antenne S.p.A.	<b>H01Q 1/12</b> (2006.01) <b>H01Q 1/32</b> (2006.01)	2599160 *	ANTENNA FIXING UNIT.

Podnosilac evropske prijave patenta (71)	MKP (51)	Broj objave evropske prijave patenta (97)	Naziv pronalaska (54)
Amgen Inc.	<b>C07D 213/30</b> (2006.01) <b>C07D 213/71</b> (2006.01) <b>C07D 213/74</b> (2006.01) <b>C07D 231/18</b> (2006.01) <b>C07D 239/42</b> (2006.01) <b>C07D 241/04</b> (2006.01) <b>C07D 277/36</b> (2006.01) <b>C07D 333/34</b> (2006.01) <b>C07D 405/12</b> (2006.01) <b>C07D 409/12</b> (2006.01) <b>C07D 409/14</b> (2006.01) <b>C07D 413/14</b> (2006.01) <b>C07D 417/12</b> (2006.01) <b>C07D 491/08</b> (2006.01) <b>C07D 498/08</b> (2006.01)	2609081 *	SULFONYLPIPERAZINE DERIVATIVES THAT INTERACT WITH GLUCOKINASE REGULATORY PROTEIN FOR THE TREATMENT OF DIABETES
Deva Holding Anonim Sirketi	<b>A61K 9/16</b> (2006.01) <b>A61K 31/22</b> (2006.01)	2526931	Wet granulation methods of cetyl myristate and/or cetyl palmitate
Exelixis, Inc.	<b>A61P 35/00</b> (2006.01) <b>C07D 215/06</b> (2006.01) <b>A61K 31/52</b> (2006.01) <b>C07D 241/44</b> (2006.01) <b>A61K 31/4709</b> (2006.01) <b>C07D 401/14</b> (2006.01) <b>A61K 31/47</b> (2006.01) <b>C07D 405/12</b> (2006.01) <b>A61K 31/497</b> (2006.01) <b>C07D 413/14</b> (2006.01) <b>A61K 31/551</b> (2006.01) <b>C07D 473/34</b> (2006.01) <b>A61K 31/5377</b> (2006.01) <b>C07D 495/04</b> (2006.01)	2616442 *	INHIBITORS OF PI3K-DELTA AND METHODS OF THEIR USE AND MANUFACTURE
Boehringer Ingelheim International GmbH	<b>C07D 413/14</b> (2006.01) <b>A61K 31/497</b> (2006.01) <b>A61P 11/00</b> (2006.01)	2619197 *	OXADIAZOLE INHIBITORS OF LEUKOTRIENE PRODUCTION
Unical AG S.p.A.	<b>F28F 1/40</b> (2006.01) <b>F28F 13/06</b> (2006.01) <b>F28F 13/12</b> (2006.01)	2635868 *	DEVICE FOR OPTIMIZING THE TRANSMISSION OF HEAT IN A PIPE FOR CONVEYING EXHAUST GASES IN A HEAT EXCHANGE APPARATUS
Eisai R&D Management Co., Ltd.	<b>C07D 231/20</b> (2006.01) <b>A61K 31/415</b> (2006.01) <b>A61P 29/00</b> (2006.01)	2619182 *	PHARMACEUTICAL COMPOSITION
Proteos Biotech S.L.U.	<b>A61K 38/48</b> (2006.01) <b>A61K 47/36</b> (2006.01)	2621520 *	COLLAGENASE G AND COLLAGENASE H COMPOSITIONS FOR THE TREATMENT OF DISEASES INVOLVING ALTERATIONS OF COLLAGEN
Ribbontex s.r.l.	<b>G09F 21/02</b> (2006.01) <b>G09F 7/06</b> (2006.01)	2637154	Method for producing a label, particularly for items of clothing.
La Prairie, Inc.	<b>B01F 5/12</b> (2006.01)	2640501 *	TWO COMPARTMENT CONTAINER
SANOFI	<b>C07D 307/80</b> (2006.01) <b>C07C 251/16</b> (2006.01) <b>C07C 39/04</b> (2006.01) <b>A61K 31/343</b> (2006.01) <b>A61P 9/00</b> (2006.01)	2595977 *	PROCESS FOR PREPARING BENZOFURAN DERIVATIVES SUBSTITUTED AT POSITION 5
Orthosoft, Inc.	<b>A61B 19/00</b> (2006.01) <b>A61B 17/56</b> (2006.01)	2611378 *	PROXIMITY-TRIGGERED COMPUTER-ASSISTED SURGERY SYSTEM AND METHOD
Université de Genève	<b>C08G 63/78</b> (2006.01) <b>C08L 67/04</b> (2006.01) <b>A61K 9/00</b> (2006.01) <b>C08G 63/08</b> (2006.01)	2598553 *	COMPOSITIONS COMPRISING POLYMERS PREPARED FROM 2-HYDROXYALKYL ACIDS
Grunert, Joachim Rainer	<b>G02B 27/01</b> (2006.01)	2605056	System for observing an eye-related display
Delphi Technologies Holding S.à.r.l.	<b>F02M 59/36</b> (2006.01) <b>F04B 49/22</b> (2006.01) <b>F04B 53/10</b> (2006.01)	2535553	Inlet Valve Arrangement for a Fuel Pump
BG Research Ltd	<b>B01L 7/00</b> (2006.01)	2637789 *	HEATING AND COOLING LOW VOLUME BIOLOGICAL REACTION VESSELS

Podnosilac evropske prijave patenta (71)	MKP (51)	Broj objave evropske prijave patenta (97)	Naziv pronalaska (54)
Boehringer Ingelheim International GmbH	<b>C07D 401/14</b> (2006.01) <b>C07D 211/58</b> (2006.01) <b>C07D 213/81</b> (2006.01) <b>C07D 401/04</b> (2006.01) <b>A61K 31/454</b> (2006.01) <b>A61P 31/00</b> (2006.01)	2625174 *	CO-CRYSTALS AND SALTS OF CCR3-INHIBITORS
Zoetis LLC	<b>C12N 7/08</b> (2006.01) <b>C07K 14/08</b> (2006.01) <b>A61K 39/12</b> (2006.01)	2637688 *	NORTH AMERICAN PORCINE REPRODUCTIVE AND RESPIRATORY SYNDROME (PRRS) VIRUS AND USES THEREOF
Cattarini Mastelli, Giulia	<b>A61K 31/427</b> (2006.01) <b>A61K 38/44</b> (2006.01) <b>A61K 38/06</b> (2006.01) <b>A61P 31/12</b> (2006.01) <b>A61P 39/06</b> (2006.01)	2600883 *	COMPOSITION COMPRISING GLUTATHIONE REDUCTASE AND OXIDIZED GLUTATHIONE, AND THERAPEUTIC USES THEREOF
Cattarini Mastelli, Laura	<b>A61K 31/427</b> (2006.01) <b>A61K 38/44</b> (2006.01) <b>A61K 38/06</b> (2006.01) <b>A61P 31/12</b> (2006.01) <b>A61P 39/06</b> (2006.01)	2600883 *	COMPOSITION COMPRISING GLUTATHIONE REDUCTASE AND OXIDIZED GLUTATHIONE, AND THERAPEUTIC USES THEREOF
Ansovini, Raffaele	<b>A61K 31/427</b> (2006.01) <b>A61K 38/44</b> (2006.01) <b>A61K 38/06</b> (2006.01) <b>A61P 31/12</b> (2006.01) <b>A61P 39/06</b> (2006.01)	2600883 *	COMPOSITION COMPRISING GLUTATHIONE REDUCTASE AND OXIDIZED GLUTATHIONE, AND THERAPEUTIC USES THEREOF
Ishihara Sangyo Kaisha, Ltd.	<b>A01N 47/06</b> (2006.01) <b>A01N 47/38</b> (2006.01) <b>A01N 43/80</b> (2006.01) <b>A01P 13/02</b> (2006.01) <b>A01N 41/10</b> (2006.01)	2629619 *	HERBICIDAL COMPOSITION
G & P GmbH	<b>B21J 13/03</b> (2006.01) <b>B23P 19/02</b> (2006.01) <b>B30B 15/02</b> (2006.01) <b>B21J 13/08</b> (2006.01) <b>B21J 17/02</b> (2006.01) <b>B21D 37/16</b> (2006.01)	2529855	Device for heating die holders
Bacchiocchi, Danilo	<b>A61G 15/10</b> (2006.01)	2616032 *	ADAPTER MATTRESS FOR DENTAL CHAIRS
Riken	<b>A61K 31/7105</b> (2006.01) <b>A61K 38/00</b> (2006.01) <b>A61K 39/395</b> (2006.01) <b>A61K 45/00</b> (2006.01) <b>A61P 35/00</b> (2006.01)	2623119 *	GLIOMA TREATMENT METHOD, GLIOMA EXAMINATION METHOD, METHOD OF DELIVERING A DESIRED MATERIAL TO A GLIOMA, AND DRUG USED IN SAID METHODS
Abraxis BioScience, LLC	<b>G01N 33/53</b> (2006.01)	2625525 *	SPARC MICROENVIRONMENT SIGNATURE, PLASMA SPARC, AND LDH AS PROGNOSTIC BIOMARKERS IN THE TREATMENT OF CANCER



**OBJAVA POVUČENIH ZAHTJEVA ZA PROŠIRENJE EVROPSKIH PRIJAVA  
PATENTA**  
**PUBLICATION OF WITHDRAWN REQUESTS FOR EXTENSION OF EUROPEAN  
PATENT APPLICATION**

Broj objave evropske prijava patenta  (97)	MKP  (51)	Datum kada je zahtev za proširenje evropske prijava patenta povučen	Zahtev objavljen u CGIS-u broj	Naziv pronalaska  (54)	Podnosilac evropske prijave patenta  (71)
2614731	A24F 47/00	11.07.2013	4/2013	An atomizer for electronic ciga- rette	Shenzhen First Union Technology Co., Ltd.
2603656 *	E05D 3/00 E05D 7/04 E05D 7/06 E05D 11/10	27.06.2013	4/2013	A HINGE	Manfred Frank Patent Holdings Limited





OBJAVA PROŠIRENIH EUROPSKIH PATENATA  
PUBLICATION OF EXTENDED EUROPEAN PATENTS

- (51) **C07D249/12**  
**A61K31/4196**  
**A61K31/427**  
**A61K31/4439**  
**A61K31/444**  
**A61K31/497**  
**A61K31/501**  
**A61K31/506**  
**A61K31/538**  
**A61P7/02**  
**A61P9/10**  
**A61P11/00**  
**A61P35/00**  
**C07D401/04**  
**C07D401/14**  
**C07D403/04**  
**C07D405/14**  
**C07D409/04**  
**C07D413/14**  
**C07D417/04**
- (11) **01340**  
(21) **P-2011-54**
- (22) 22.03.2007.
- (30) 2006083486 24.03.2006. JP  
786687 P 29.03.2006. US  
2006162594 12.06.2006. JP  
804878 P 15.06.2006. US  
2006218819 10.08.2006. JP  
838418 P 18.08.2006. US
- (86) PCT/JP2007/055813 22.03.2007.
- (87) WO 2007/111212 04.10.2007.
- (96) 07739256.1 22.03.2007.
- (97) EP 2000465 15.12.2010 2010/50 EN
- (54) (ME) **DERIVAT TRIAZOLONA**  
(EN) TRIAZOLONE DERIVATIVE
- (73) Eisai R&D Management Co., Ltd. 6-10, Koishikawa 4-chome, Bunkyo-ku, Tokyo 112-8088 JP
- (72) CLARK, Richard; Tsukuba-shi, Ibaraki 300-2635 JP  
MATSUURA, Fumiyoshi; Tsukuba-shi, Ibaraki 300-2635 JP  
KIRA, Kazunobu; Tsukuba-shi, Ibaraki 300-2635 JP  
HIROTA, Shinsuke; Tsukuba-shi, Ibaraki 300-2635 JP  
AZUMA, Hiroshi; Tsukuba-shi, Ibaraki 300-2635 JP  
NAGAKURA, Tadashi; Tsukuba-shi, Ibaraki 300-2635 JP  
HORIZOE, Tatsuo; Tsukuba-shi, Ibaraki 300-2635 JP  
TABATA, Kimiyo; Tsukuba-shi, Ibaraki 300-2635 JP

KUSANO, Kazutomi; Tsukuba-shi, Ibaraki 300-2635 JP

OMAE, Takao; Tsukuba-shi, Ibaraki 300-2635 JP

INOUE, Atsushi; Tsukuba-shi, Ibaraki 300-2635 JP

(74) Stanković Mugoša Ana, Trg Republike 13, Podgorica ME

(57) Jedinjenje odabrano od 4-([2-fluor-3-(2-hidroksietoksi)-5-metoksifenil]-(5-okso-1-pirimidin-2-il-4,5-dihidro-1H-[1,2,4]triazol-3-il)metil)amino)benzamidina

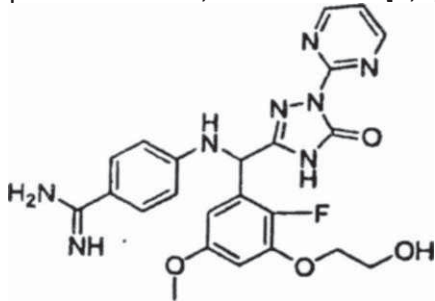

4-{3-[(4-karbamimidofenilamino)-(8-metoksi-4H-benzo[1,3]dioksin-6-il)metil]-5-okso-4,5-dihidro-[1,2,4]triazol-1-il}tiazol-5-karboksilne kiseline

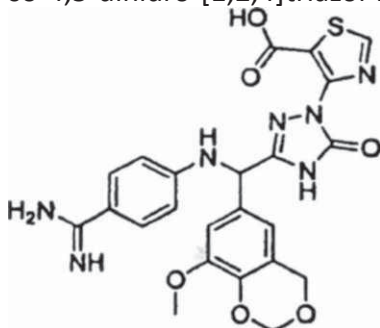

i 4-(3-[(4-karbamimidofenilamino)-[2-fluor-3-(2-hidroksietoksi)-5-metoksifenil]metil]-5-okso-4,5-dihidro[1,2,4]triazol-1-il)tiazol-5-karboksilne kiseline

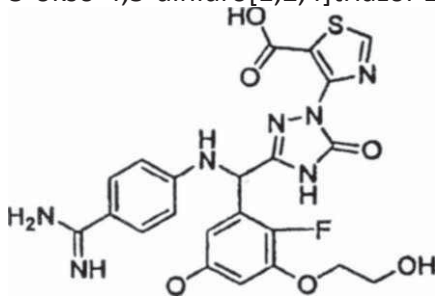

Ili njegova farmaceutski prihvatljiva so.

Patent sadrži još 7 patentnih zahtjeva.

- (51) **A61K9/46** (11) **01300**  
**A61K9/20** (21) **P-2011-87**
- (22) 30.12.2004.
- (30) 533619 P 31.12.2003. US  
615665 P 04.10.2004. US
- (86) PCT/US2004/043703 30.12.2004.
- (87) WO 2005/065319 21.07.2005.
- (96) 04815716.8 30.12.2004.
- (97) EP 1708686 16.02.2011. 2011/07 EN
- (54) (ME) **UGLAVNOM LINEARNE EFERVESCENTNE ORALNE DOZNE FORME FENTANILA I METODE DAVANJA**  
(EN) **GENERALLY LINEAR EFFERVESCENT ORAL FENTANYL DOSAGE FORM AND METHODS OF ADMINISTERING**
- (73) CIMA LABS INC. 10000 Valley View Road, Eden Prairie, MN 55344-9361 US
- (72) MOE, Derek 7284 Weston Lane North, Maple Grove, MN 55311 US  
AGARWAL, Vikas 3305 56th Avenue North, Plymouth, MN 55446 US  
HABIB, Walid 9945 Hemlock Way North, Maple Grove, MN 55369 US
- (74) Radulović Božidar, Jovana Tomaševića 9/III, Podgorica ME
- (57) Dozna forma naznačena time da obuhvata: 90 do 880 mikrograma fentanila, izračunato kao slobodna baza fentanila, ili ekvivalentnu količinu soli od toga, efervescentni par u količini od 5 do 85% težine dozne forme, pH podešavajuću supstancu u količini od 0,5 do 25% težine dozne forme, škrob glikolat u količini od 0,25 do 20% težine dozne forme, i manitol, pomenuta dozna forma je podesna za dostavljanje pomenutog fentanila preko oralne sluznice pacijenta bukalnom, gingivalnom ili sublingvalnom primenom. Patent sadrži još 19 patentnih zahtjeva.

- (51) **C07D489/00**  
**C07D489/08**
- (11) **01299**  
(21) **P-2011-91**
- (22) 30.03.2005.
- (30) 557492 P 30.03.2004. US  
601534 P 13.08.2004. US  
620072 P 18.10.2004. US  
648625 P 31.01.2005. US  
651778 P 10.02.2005. US
- (86) PCT/US2005/010666 30.03.2005.
- (87) WO 2005/097801 20.10.2005.
- (96) 05730345.5 30.03.2005.
- (97) EP 1730151 09.03.2011. 2011/10 EN
- (54) (ME) **PROCES ZA DOBIJANJE OKSIKODON HIDROHLORIDA SA MANJE OD 25 PPM 14-HIDROKSIKODEINONA**  
(ME) PROCESS FOR PREPARING OXYCODONE HYDROCHLORIDE HAVING LESS THAN 25 PPM 14-HYDROXYCODEINONE
- (73) EURO-CELTIQUE S.A. 2, avenue Charles de Gaulle, 1653 Luxembourg LU
- (72) CHAPMAN, Robert, 4 Jefferson Court, Downingtown, PA 19335 US  
RIDER, Lonn, S. 18 Barbs Hill Road, Foster, RI 02825 US  
HONG, Qi 31 Grape Shot Road, Sharon, MA 02607 US  
KYLE, Donald 29 Weatherfield Drive, Newtown, PA 18940 US  
KUPPER, Robert 755 Major Potter Road, East Greenwich, RI 02818 US
- (74) Lutovac Branislav, Bulevar Crnojevića 93, Podgorica ME
- (57) Proces za dobijanje kompozicije oksikodon hidrohlorida, koja ima sadržaj 14-hidroksikodeinona manji od 25 ppm, reagovanjem neke kompozicije baze oksikodona, koja sadrži jedinjenje 8,14-dihidroksi-7,8-dihidroksikodeinon, sa hlorovodoničnom kiselinom, u kome se 8,14-dihidroksi-7,8-dihidroksikodeinon konvertuje u 14-hidroksikodeinon, a 14-hidroksikodeinon u oksikodon.  
Patent sadrži još 25 patentnih zahtjeva.

(51) **A01N45/02**  
**A01N47/24**  
**A01N43/90**  
**A01N43/84**  
**A01N43/653**  
**A01N43/54**  
**A01N43/40**  
**A01N43/36**  
**A01N37/38**  
**A01N37/34**  
**A01P3/00**

(11) **01328**  
(21) **P-2011-115**

(22) 06.10.2005.

(30) 20040022401 08.10.2004. GB

(86) PCT/EP2005/010755 06.10.2005.

(87) WO 20067037632 13.04.2006.

(96) 05798443.7 06.10.2005.

(97) EP 1802198 30.03.2011 2011/13 EN

(54) (ME) **SINERGISTIČKE FUNGICIDNE KOMPOZICIJE**  
(EN) SYNERGISTIC FUNGICIDAL COMPOSITIONS

(73) Syngenta Participations AG  
Schwarzwaldallee 215, 4058 Basel CH

(72) WALTER, Harald Syngenta Crop Protection AG Schwarzwaldallee 215 CH-4058 Basel CH  
CORSI, Camilla Syngenta Crop Protection AG Schwarzwaldallee 215 CH-4058 Basel CH  
EHRENFREUND, Josef Syngenta Crop Protection AG, Werk Rosental Schwarzwaldallee 215  
CH-4058 Basel CH

LAMBERTH, Clemens Syngenta Crop Protection AG Schwarzwaldallee 215 CH-4058 Basel CH  
TOBLER, Hans Syngenta Crop Protection AG Schwarzwaldallee 215 CH-4058 Basel CH

(74) Radulović Božidar, Jovana Tomaševića 9/III, Podgorica ME

(57) Metod za kontrolu fitopatogenih gljiva na korisnim biljkama ili na njihovom propagacionom materijalu, naznačen time, da obuhvata aplikaciju na korisne biljke, na njihov lokus ili na njihov propagacioni materijal kombinaciju komponenti A) i B) u sinergistički efektivnoj količini, a gde komponenta A) je neko jedinjenje sa formulom I

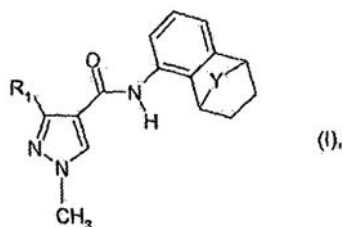

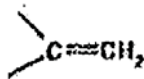
Gdje R1 je difluorometil ili trifluorometil; Y je -CHR2- ili , a R2 je vodonik ili C1 -C6alkil: ili neki tautomer takvog jedinjenja; a komponenta B) je neko jedinjenje koje je izabrano iz grupe koja obuhvata Azoksistrobin; Pikoksistrobin; Ciprokonazol; Difeno-konazol; Propikonazol; Fludioksonil; Ciprodinil; Fenpropimorf; Fenpropidin; neko jedinjenje sa formulom F-1

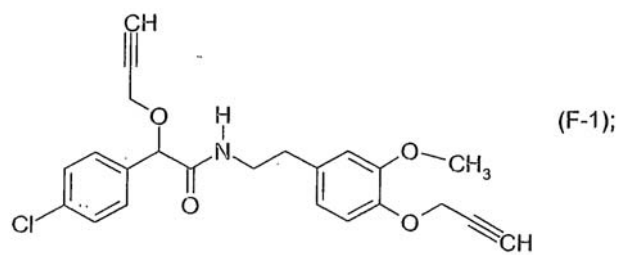

neko jedinjenje sa formulom B-1

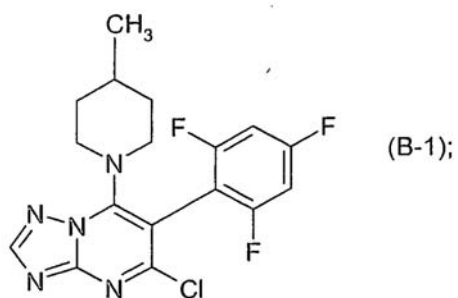

Hlorotalonil, Epoksikonazol i Protiokonazol.  
Patent sadrži još 10 patentnih zahtjeva.

(51) **C07D489/08**  
**A61K31/485**  
**A61P25/32**

(11) **01295**  
 (21) **P-2012-11**

(22) 23.04.2009.

(30) 20080155092 24.04.2008. EP

(86) PCT/EP2009/054875 23.04.2009.

(87) WO 2009/130270 29.10.2009.

(96) 09734161.4 23.04.2009.

(97) EP 2307420 30.11.2011. 2011/48 EN

(54) (ME) **PROLIJEKOVI NALMEFEN DI-ESTERA**  
 (EN) NALMEFENE DI-ESTER PRODRUGS

(73) Janssen Pharmaceutica NV Turnhoutseweg 30, 2340 Beerse BE

(72) GUILLAUME, Michel, Joseph, Maurice, André Janssen Pharmaceutica NV, Turnhoutseweg 30 B-2340 Beerse BE

GAEKENS, Tim; Janssen Pharmaceutica NV, Turnhoutseweg 30 B-2340 Beerse BE

(74) Radulović Božidar, Jovana Tomaševića 9/III, Podgorica ME

(57) Jedinjenje, naznačeno time, da je predstavljeno formulom(I)

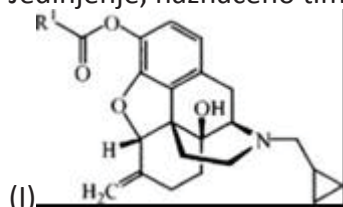

uključujući i bilo koju njegovu stereohemijski izomernu formu, gdje R1 je C16-20 alkilok-sikarbonilC2-4 alkil; ili neku njegovu farmaceutski prihvatljivu kiselu adicijonu so ili neku njegovu rastvorenu materiju.

Patent sadrži još 12 patentnih zahtjeva.

(51) **C07D213/74**  
**C07D239/42**  
**C07D401/04**  
**C07D401/10**  
**A61K31/44**  
**A61K31/506**  
**A61P19/00**  
**A61P17/00**  
**A61P35/00**  
**A61P37/00**  
**A61P31/00**  
**C07D413/10**

(11) **01301**  
(21) **P-2012-16**

(22) 08.08.2008

(30) 20070002261 10.08.2007. ES

20080382011 13.03.2008. EP

(86) PCT/EP2008/006573 08.08.2008.

(87) WO 2009/021696 19.02.2009.

(96) 08785465.9 08.08.2008.

(97) EP 2178840 14.12.2011 2011/50 EN

(54) (ME) **DERIVATI AZABIFENILAMINO BENZOIČNE KISELINE KAO INHIBITORI DEHIDROGENAZE DIHIDROOROTATA (DHODH)**

(EN) **AZABIPHENYLAMINO BENZOIC ACID DERIVATIVES AS DHODH INHIBITORS**

(73) Almirall, S.A.; Ronda General Mitre 151, 08022 Barcelona ES

(72) CASTRO PALOMINO LARIA, Julio, Cesar C/Enrique Granados 29 4 [deg], E-08330 Premia de Mar (Barcelona) ES

TERRICABRAS BELART, Emma C/Francesc Cabanes 1-3, 2[deg] 1a, E-08190 Sant Cugat Del Valles Barcelona ES

ERRA SOLA, Montserrat Riera Blanca 46, Atico 1a, Esc. A, E-08903 L' Hospitalet de Llobregat (Barcelona) ES

NAVARRO ROMERO, Eloisa c/Comte d'Urgell 20, 1[deg] 2a, E-08011 Barcelona ES

FONQUERNA POU, Silvia Pg de l'Havana 2-4, Esc D, Baixos 3, E-08030 Barcelona ES

CARDUS FIGUERAS, Aranzazu C/del Rio 21 4[deg] 1a, E-08780 Palleja Barcelona ES

LOZOYA TORIBIO, Maria, Estrella C/Brodadores. 6F, E-08100 Mollet del Valles, Barcelona ES

(74) Đakonović Vido, Bajova 9, Cetinje ME

(57) Jedinjenje iz formule (I) za upotrebu u liječenju ili sprečavanju patološkog stanja ili oboljenja prijemčivog na poboljšanje pomoću inhibicije dehidrogenaze dihidroorotata

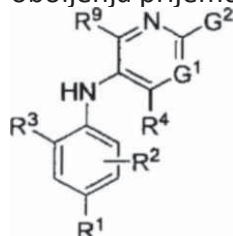

gdje se: R<sup>1</sup> bira iz grupe koja sadrži atome vodonika, atome halogena, C1-4 alkil, C3-4 cikloalkil, -CF<sub>3</sub> i -OCF<sub>3</sub>

R<sup>2</sup> bira iz grupe koja sadrži atome vodonika, atome halogena i C1-4 alkil grupu, R<sup>3</sup> bira iz grupe koja sadrži -COOR<sup>5</sup>, -CONHR<sup>5</sup>, tetrazolil, -SO<sub>2</sub>NHR<sup>5</sup> i -CONHSO<sub>2</sub>R<sup>5</sup> grupe, gde se R<sup>5</sup> bira iz grupe koja se sastoji od atoma vodonika i linearnih ili razgranatih C1-4 alkil grupa, R<sup>4</sup>



bira iz grupe koja sadrži atom vodonika, i C1-4 alkil grupu R9 bira iz grupe koja sadrži atom vodonika i fenil gupu, G1 predstavlja grupu koja se bira iz N i CR6 gde se R6 bira iz grupe koja sadrži atome vodonika, atome halogena, C1-4alkil, C3-4 cikloalkil, C1-4 alkoksi, -CF<sub>3</sub>, -OCF<sub>3</sub>, monociklični N-koji sadrži C5-7 heteroaril, monociklični N-koji sadrži C3-7 heterociklične grupe i C6-10 aril grupu koja se opciono zamenjuje sa jednim ili više supstituenata izabranih iz atoma halogena i C1-4alkil grupe, G2 predstavlja grupu izabranu iz: atoma vodonika, hidroksi grupe, atoma halogena, C3-4cikloalkil grupe, C1-4alkoksi grupe i -NRaRb, pri čemu Ra predstavlja C1-4alkil grupu i Rb se bira iz grupe koja sadrži C1-4alkil grupu i C1-4alkoksi - C1-4alkil grupu, ili Ra i Rb zajedno sa atomom azota na koji su spojeni, čine zasićeni 6 do 8-člani heterociklični prsten opciono sadrže jedan atom kiseonika kao dodatni heteroatom. monociklični ili biciklični 5 do 10-člani heteroaromatični prsten koji sadrži jedan ili više atoma azota koji se opciono zamenjuje jednim ili više supstituenata izabranih iz atoma halogena, C1-4alkil, C1-4 alkoksi, C3-4 cikloalkil, C3-4 cikloalkoksi, -CF<sub>3</sub>, -OCF<sub>3</sub>, i -CONR<sub>7</sub>R<sub>8</sub>, gde se R<sub>7</sub> i R<sub>8</sub> nezavisno biraju iz atoma vodonika, linearne ili razgranate C1-4 alkil grupe, C3-7 cikloalkil grupe, ili R<sub>7</sub> i R<sub>8</sub> zajedno sa atomom azota za koji su spojeni čine grupe iz formule

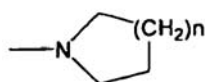

gde je n celobrojna promjenljiva od 0 do 3, i • fenil grupa koja se opciono zamenjuje sa jednim ili više supstituenata izabranih iz atoma halogena, C1-4 alkil, hidroksi, C1-4 alkoksi, C3-4 cikloalkil, C3-4 cikloalkoksi, cijano, -CF<sub>3</sub>, -OCF<sub>3</sub>, -CONR<sub>7</sub>R<sub>8</sub>, oksadiazolil, triazolil, pirazolil i imidazolil grupa, gde se oksadiazolil, triazolil, pirazolil i imidazolil grupe opciono zamenjuju sa C1-4 alkil ili C3-7 cikloalkil grupom i gde se R<sub>7</sub> i R<sub>8</sub> nezavisno biraju iz atoma vodonika, linearne ili razgranate C1-4 alkil grupe, C3-7 cikloalkil grupe, ili R<sub>7</sub> i R<sub>8</sub> zajedno sa atomom azota na koji su spojeni, čine grupu iz formule

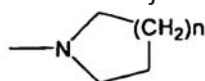

gde je n cjelobrojna promenljiva od 0 do 3 ili G2 zajedno sa R6 obrazuje nearomatičnu C5-10 karbocikličnu grupu ili C6-10 aril grupu, i farmaceutski prihvatljive soli i njihove okside azota.

Patent sadrži još 14 patentnih zahtjeva.

- (51) **C07D205/04**  
**A61K31/397**  
**A61P3/00**
- (22) 10.10.2005.  
(30) 0410845 14.10.2004. FR  
(86) PCT/FR2005/002489 10.10.2005.  
(87) WO 2006/040464 20.04.2006.  
(96) 05809316.2 10.10.2005.  
(97) EP 1802571 23.11.2011. 2011/47 FR
- (54) (ME) **POSTUPAK I INTERMEDIJERI U DOBIJANJU DERIVATA N-(1-BENZHIDRIL-AZETIDIN-3-IL)-N-FENIL-METILSULFO NAMIDA**  
(EN) **METHOD AND INTERMEDIATES FOR THE PREPARATION OF DERIVATIVES OF N-(1-BENZHYDRYL-AZETIDIN-3-YL)-N-PHENYL-METHYLSULPHONAMIDE**
- (73) Aventis Pharma S.A. 20, avenue Raymond Aron, 92160 Antony FR  
(72) BOFFELLI, Philippe 21 rue des Polyanthas, F-93110 ROSNY SOUS BOIS FR  
DELTHIL, Michel 4 Allée des Peupliers, F-93130 NOISY LE SEC FR  
GRONDARD, Luc 9 Square Babord, F-91080 COURCOURONNES FR  
LAMPILAS, Maxime 60 rue Veuve Aublet, F-93230 ROMAINVILLE FR  
MALPART, Joël 77 Allée Arnoul Greban Rés."les Jardins d'Olivet" F-45160 OLIVET FR  
MUTTI, Stéphane 122 Avenue du Maréchal Joffre, F-94170 LE PERREUX SUR MARNE FR  
NAIT BOUDA, Lahlou 18 Avenue Marx Dormoy, F-93140 BONDY FR  
RIEKE-ZAPP, Joerg Arndstrasse 50, 60325 FRANKFURT AM MAIN DE
- (74) Ćupić Branislav, Dalmatinska 10, Podgorica ME
- (57) Postupak sinteze derivata opšte fomule (I) u kojoj R i R' R'' predstavljaju, nezavisno jedan od drugog, jedan ili više radikala vodonika, halogena (Cl, F, Br, I), cijano, nitro, alkil linearan ili razgranat, od 1 do 6 atoma ugljenika, alkoksi linearan ili razgranat, od 1 do 6 atoma ugljenika, alkil karboksilat, linearan ili razgranat, od 1 do 6 atoma ugljenika, trifluorometil, trifluorometoksi, a R''' predstavlja alkil grupu ili perfluoroalkil, linearan ili razgranat, sa 1 do 6 atoma ugljenika, ili aril grupu, eventualno supstituisanu jednim ili više R'' radikala.

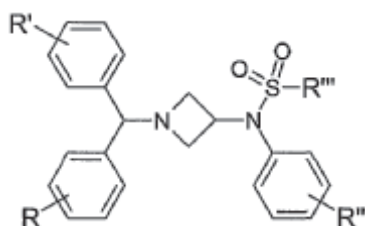

naznačen time, što se kondenzuje sulfonat formule (II), u kojoj R, R' predstavljaju, nezavisno jedan od drugog, jedan ili više radikala vodonika, halogena (Cl, F, Br, I), cijano, nitro, alkil linearan ili razgranat, od 1 do 6 atoma ugljenika, alkoksi linearan ili razgranat, od 1 do 6 atoma ugljenika, alkil karboksilat, linearan ili razgranat, od 1 do 6 atoma ugljenika, trifluorometil, trifluorometoksi, a Rl predstavlja metil, trifluorometil radikal, C4F9, C8F17 ili fenil eventualno supstituisan ostatkom metil, bromo ili nitro

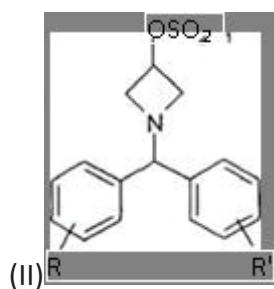

sa sulfonamidom formule (III) u kojoj R'' predstavlja jedan ili više radikala vodonika, halogena (Cl, F, Br, I), cijano, nitro, alkil linearan ili razgranat, od 1 do 6 atoma ugljenika, alkoksi linearan ili razgranat, od 1 do 6 atoma ugljenika, alkil karboksilat, linearan ili razgranat, od 1 do 6 atoma ugljenika, trifluorometil, trifluorometoksi, a R''' predstavlja alkil grupu ili perfluoroalkil, linearan ili razgranat, sa 1 do 6 atoma ugljenika, ili aril grupu, eventualno supstituisanu jednim ili više R'' radikala.

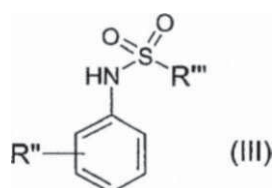

u nekom organskom rastvaraču, eventualno u prisustvu vode, na temperaturi između 20°C i 150°C, u prisustvu neke neorganske ili organske baze i nekog agensa za prenos faze. Patent sadrži još 15 patentnih zahtjeva.

- (51) **A61K31/519**  
**A61K31/704**  
**A61K31/7068**  
**A61K45/06**  
**A61P35/02**
- (11) **01298**  
(21) **P-2012-20**
- (22) 27.12.2007.  
(30) 0611492 28.12.2006 FR  
(86) PCT/FR2007/002171 27.12.2007.  
(87) WO 2008/102075 28.08.2008.  
(96) 07872446.5 27.12.2007.  
(97) EP 2107906 23.11.2011. 2011/47 FR
- (54) (ME) **NOVA TERAPEUTSKA PRIMJENA U TRETIRANJU LEUKEMIJE**  
(EN) NOVEL THERAPEUTIC USE FOR TREATING LEUKAEMIA
- (73) SANOFI 174, AVENUE DE FRANCE, 75013 PARIS FR
- (72) BOURRIE, Bernard c/o Sanofi-Aventis, Département Brevets, 174, avenue de France F-75013 Paris FR  
CASELLAS, Pierre c/o Sanofi-Aventis, Département Brevets, 174, avenue de France F-75013 Paris FR
- (74) Čupić Branislav, Dalmatinska 10, Podgorica ME
- (57) Jedinjenje N-[2-(2,1,3-benzotiazol-5-ilamino)-6-(2,6-dihlorofenil)pirido[2,3-d]pirimidin -7-il]-N'-(1,1-dimetiletil)-urea ili neki njegov hidrat, so ili solvat, za upotrebu u lečenju mijeloidnih leukemija, davanjem intraperitonealno, ili intravenozno pa zatim intraperitonealno, ili intravenoznim davanjem, pa posle oralnim.  
Patent sadrži još 10 patentnih zahtjeva.

- (51) **C07D405/04**  
**A61K31/501**  
(22) 22.05.2007.  
(30) 06114615 29.05.2006. EP  
06120117 05.09.2006. EP  
(86) PCT/EP2007/054940 22.05.2007.  
(87) WO 2007/137968 06.12.2007.  
(96) 07729379.3 22.05.2007.  
(97) EP 2079732 21.12.2011. 2011/51 EN  
(54) (ME) **3-(1,3-BENZODIOKSOL-5-IL)-6-(4-CIKLOPROPILPIPERAZIN-1-IL)- PIRIDAZIN, NJEGOVE SOLI I SOLVATI I NJEGOVA UPOTREBA KAO ANTAGONISTA HISTAMIN H3 RECEPTORA**  
(EN) 3- (1, 3-BENZODIOXOL-5-YL) -6- (4-CYCLOPROPYLPIPERAZIN-1-YL) - PYRIDAZINE, ITS SALTS AND SOLVATES AND ITS USE AS HISTAMINE H3 RECEPTOR ANTAGONIST  
(73) High Point Pharmaceuticals, LLC 4170 Mendenhall Oaks Parkway, High Point, NC 27265 US  
(72) HOHLWEG, Rolf, Nederste Torpenvej 29, DK-3050 Humlebaek DK  
(74) Čupić Branislav, Dalmatinska 10, Podgorica ME  
(57) 3-(1,3-Benzodioxol-5-il)-6-(4-ciklopropilpiperazin-1-il)piridazin i njegove farmaceutski prihvatljive soli i solvati.  
Patent sadrži još 16 patentnih zahtjeva.

- (51) **C07D495/04**  
**C07D519/00**  
**A61K31/519**  
**A61P11/00**
- (22) 16.10.2008.  
(30) 20070118901 19.10.2007. EP  
(86) PCT/EP2008/063999 16.10.2008.  
(87) WO 2009/050248 23.04.2009.  
(96) 08839793.0 16.10.2008.  
(97) EP 2215092 25.01.2012. 2012/04 DE
- (54) (ME) **SUPSTITUISANI PIPERIDINO-DIHIDROTIENOPIRIMIDINI**  
(EN) SUBSTITUTEDPIPERIDINO-DIHYDROTHIENOPYRIMIDINES
- (73) Boehringer Ingelheim International GmbH Binger Strasse 173, 55216 Ingelheim am Rhein DE
- (72) POUZET, Pascale; Boehringer Ingelheim GmbH, CD Patents, Binger Strasse 173, 55216 Ingelheim am Rhein DE  
ANDERSKEWITZ, Ralf; BoehringerIngelheim GmbH, CD Patents, Binger Strasse 173, 55216 Ingelheim am Rhein DE  
DOLLINGER, Horst; Boehringer Ingelheim GmbH, CD Patents, Binger Strasse 173, 55216 Ingelheim am Rhein DE  
FIEGEN, Dennis; Boehringer Ingelheim GmbH, CD Patents, Binger Strasse 173, 55216 Ingelheim am Rhein DE  
FOX, Thomas; Boehringer Ingelheim GmbH, CD Patents, Binger Strasse 173, 55216 Ingelheim am Rhein DE  
GOEGGEL, Rolf; Boehringer Ingelheim GmbH, CD Patents, Binger Strasse 173, 55216 Ingelheim am Rhein DE  
HOENKE, Christoph; Boehringer Ingelheim GmbH, CD Patents, Binger Strasse 173, 55216 Ingelheim am Rhein DE  
MARTYRES, Domnic; Boehringer Ingelheim GmbH, CD Patents, Binger Strasse 173, 55216 Ingelheim am Rhein DE  
NICKOLAUS, Peter; Boehringer Ingelheim GmbH, CD Patents, Binger Strasse 173, 55216 Ingelheim am Rhein DE  
KLINDER, Klaus; Boehringer Ingelheim GmbH, CD Patents, Binger Strasse 173, 55216 Ingelheim am Rhein DE
- (74) Radulović Božidar, Jovana Tomaševića 9/III, Podgorica ME
- (57)

## 1. Jedinjenja formule 1

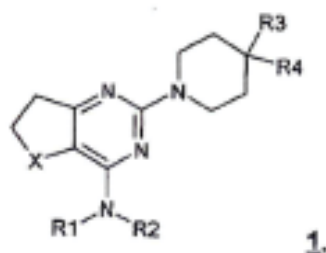

pri čemu

**X** označava SO ili SO<sub>2</sub>,

**R<sup>1</sup>** označava H, C<sub>1-5</sub>-alkil,

**R<sup>2</sup>** je H ili grupa izabrana između C<sub>1-10</sub>-alkila i C<sub>2-6</sub>-alkenila, koji može biti eventualno supstituisan sa jednom ili više grupa koje su izabrane između halogena i C<sub>1-3</sub>-fluoralkila ili koji može biti eventualno supstituisan sa jednom ili više grupa koje su izabrane između OR<sup>2.1</sup>, COOR<sup>2.1</sup>, CONR<sup>2.2</sup>R<sup>2.3</sup>, SR<sup>2.1</sup>, SO-R<sup>2.1</sup>, SO<sub>2</sub>-R<sup>2.1</sup>, C<sub>6-10</sub>-arila, -het, hetarila, mono- ili bicikličnog -C<sub>3-10</sub>-cikloalkila, CH<sub>2</sub>-NR<sup>2.2</sup>R<sup>2.3</sup> i NR<sup>2.2</sup>R<sup>2.3</sup>, koji dalje može biti eventualno supstituisan sa jednom ili više grupa koje su izabrane između OH, halogena, OR<sup>2.1</sup>, okso, CF<sub>3</sub>, CHF<sub>2</sub>, CH<sub>2</sub>F, C<sub>1-6</sub>-alkila, C<sub>1-6</sub>-alkanola, C<sub>6-10</sub>-arila, COOR<sup>2.1</sup>, CH<sub>2</sub>-NR<sup>2.2</sup>R<sup>2.3</sup> i NR<sup>2.2</sup>R<sup>2.3</sup>,

pri čemu

**het** označava tro- do jedanaestočlani, mono- ili biciklični, zasićeni ili delimično zasićeni, eventualno anelirani ili eventualno premošćeni heterociklus, koji sadrži 1, 2, 3 ili 4 heteroatoma koji su izabrani nezavisno jedan od drugog između N, S ili O, i pri čemu

**hetaril** je peto- do desetočlani, mono- ili biciklični, eventualno anelirani heteroaril, koji sadrži 1, 2, 3 ili 4 heteroatoma koji su izabrani nezavisno jedan od drugog između N, S ili O,

i pri čemu

**cikloalkil** može biti zasićen ili delimično zasićen,

pri čemu je  $R^{2,1}$  H ili je grupa izabrana između  $C_{1-6}$ -alkila,  $C_{1-6}$ -alkanola,  $C_{3-7}$ -haloalkila, mono- ili bicikličnog  $C_{3-10}$ -cikloalkila,  $C_{6-10}$ -aril- $C_{1-6}$ -alkilena, hetaril- $C_{1-6}$ -alkilena, het- $C_{1-6}$ -alkilena,  $C_{3-10}$ -cikloalkil- $C_{1-6}$ -alkilena, mono- ili bicikličnog  $C_{6-10}$ -arila, heteroarila i -het,

koji može biti eventualno supstituisan sa jednom ili više grupa koje su izabrane između OH, O-( $C_{1-3}$ -alkila), halogena,  $C_{1-6}$ -alkila i  $C_{6-10}$ -arila,

pri čemu  $R^{2,2}$  i  $R^{2,3}$  nezavisno jedan od drugog označavaju H ili grupu izabranu između  $C_{1-6}$ -alkila, mono- ili bicikličnog  $C_{3-10}$  cikloalkila,  $C_{6-10}$ -aril- $C_{1-6}$ -alkilena, hetaril- $C_{1-6}$ -alkilena, mono- ili bicikličnog  $C_{6-10}$ -arila, het, hetarila, CO-NH<sub>2</sub>, CO-NHCH<sub>3</sub>, -CO-N(CH<sub>3</sub>)<sub>2</sub>, SO<sub>2</sub>-( $C_{1-2}$ -alkila), CO- $R^{2,1}$  i COOR<sup>2,1</sup>, koji može biti eventualno supstituisan sa jednom ili više grupa koje su izabrane između OH, halogena,  $C_{1-6}$ -alkila,  $C_{6-10}$ -arila i COOR<sup>2,1</sup>,

iii

$R^2$  označava mono- ili policiklični  $C_{3-10}$  cikloalkil, koji može eventualno biti premošćen jednom ili više puta sa  $C_{1-3}$ -alkil grupama i koji može biti eventualno supstituisan sa grupom koja je izabrana između linearnih ili razgranatih  $C_{1-6}$ -alkanola,  $C_{1-3}$ -fluoroalkila,  $C_{1-3}$ -alkilen-OR<sup>2,1</sup>, OR<sup>2,1</sup>, COOR<sup>2,1</sup>, -SO<sub>2</sub>-NR<sup>2,2</sup>R<sup>2,3</sup>, het, -NH-CO-O-( $C_{1-6}$ -alkila), -NH-CO-( $C_{1-6}$ -alkila), -NH-CO-O-( $C_{6-10}$ -arila), -NH-CO-( $C_{6-10}$ -arila), -NH-CO-O-hetarila, -NH-CO-hetarila, -NH-CO-O-( $C_{1-3}$ -alkilen)-( $C_{6-10}$ -arila), -NH-CO-( $C_{1-3}$ -alkilen)-( $C_{6-10}$ -arila), -N( $C_{1-3}$ -alkil)-CO-( $C_{1-6}$ -alkila), -N( $C_{1-3}$ -alkil)-CO-O-( $C_{6-10}$ -arila), -N( $C_{1-3}$ -alkil)-CO-( $C_{6-10}$ -arila), -N( $C_{1-3}$ -alkil)-CO-O-hetarila, -N( $C_{1-3}$ -alkil)-CO-hetarila, -N( $C_{1-3}$ -alkil)-CO-O-( $C_{1-3}$ -alkilen)-( $C_{6-10}$ -arila), -N( $C_{1-3}$ -alkil)-CO-( $C_{1-3}$ -alkilen)-( $C_{6-10}$ -arila),  $C_{6-10}$ -arila,  $C_{1-6}$ -alkila,  $C_{6-10}$ -aril- $C_{1-6}$ -alkilena, hetaril- $C_{1-6}$ -alkilena, mono- ili bicikličnih  $C_{3-10}$  cikloalkila i NR<sup>2,2</sup>R<sup>2,3</sup>,



koji može biti eventualno supstituisan sa jednom ili više grupa koje su izabrane između OH, OR<sup>2,1</sup>, okso, halogena, CF<sub>3</sub>, CHF<sub>2</sub>, CH<sub>2</sub>F, C<sub>1-6</sub>-alkila, C<sub>9-10</sub>-arila i NR<sup>2,2</sup>R<sup>2,3</sup>,

ii

**R<sup>2</sup>** označava mono- ili policiklični C<sub>9-10</sub>-aril, koji može biti eventualno supstituisan sa OH, SH ili halogenom ili sa jednom ili više grupa koje su izabrane između OR<sup>2,1</sup>, COOR<sup>2,1</sup>, NR<sup>2,2</sup>R<sup>2,3</sup>, CH<sub>2</sub>-NR<sup>2,2</sup>R<sup>2,3</sup>, C<sub>3-10</sub>-cikloalkila, het, C<sub>1-6</sub>-alkila, C<sub>1-3</sub>-fluoralkila, CF<sub>3</sub>, CHF<sub>2</sub>, CH<sub>2</sub>F, C<sub>9-10</sub>-aril-C<sub>1-6</sub>-alkilena, het-C<sub>1-6</sub>-alkilena, hetaril-C<sub>1-6</sub>-alkilena, C<sub>9-10</sub>-arila, SO<sub>2</sub>-CH<sub>3</sub>, SO<sub>2</sub>-CH<sub>2</sub>CH<sub>3</sub> i SO<sub>2</sub>-NR<sup>2,2</sup>R<sup>2,3</sup>, koji može dalje eventualno biti supstituisan sa jednom ili više grupa koje su izabrane između OH, OR<sup>2,1</sup>, CF<sub>3</sub>, CHF<sub>2</sub>, CH<sub>2</sub>F, okso, halogena, CF<sub>3</sub>, CHF<sub>2</sub>, CH<sub>2</sub>F, C<sub>1-6</sub>-alkila, C<sub>9-10</sub>-arila i NR<sup>2,2</sup>R<sup>2,3</sup>,

iii

**R<sup>2</sup>** označava grupu koja je izabrana između het i hetarila, koji može biti eventualno supstituisan sa jednom ili više grupa koje su izabrane između halogena, OH, okso, CF<sub>3</sub>, CHF<sub>2</sub> i CH<sub>2</sub>F ili sa jednom ili više grupa koje su izabrane između OR<sup>2,1</sup>, C<sub>1-3</sub>-alkilen-OR<sup>2,1</sup>, SR<sup>2,1</sup>, SO-R<sup>2,1</sup>, SO<sub>2</sub>-R<sup>2,1</sup>, COOR<sup>2,1</sup>, COR<sup>2,1</sup>, C<sub>1-6</sub>-alkanola, mono- ili bicikličnog C<sub>3-10</sub>-cikloalkila, C<sub>9-10</sub>-arila, C<sub>1-6</sub>-alkila, C<sub>9-10</sub>-aril-C<sub>1-6</sub>-alkilena, hetaril-C<sub>1-6</sub>-alkilena, het, hetarila, C<sub>1-3</sub>-alkilen-OR<sup>2,1</sup> i NR<sup>2,2</sup>R<sup>2,3</sup>, koji može dalje eventualno biti supstituisan sa jednom ili više grupa koje su izabrane između OH, OR<sup>2,1</sup>, okso, halogena, CF<sub>3</sub>, CHF<sub>2</sub>, CH<sub>2</sub>F, C<sub>1-6</sub>-alkila, C<sub>9-10</sub>-arila i NR<sup>2,2</sup>R<sup>2,3</sup>,

iii pri čemu

**NR<sup>1</sup>R<sup>2</sup>** zajedno označavaju heterociklični C<sub>4,7</sub> prsten, koji može biti eventualno premošćen, koji sadrži 1, 2 ili 3 heteroatoma koji su izabrani između N, O i S i koji može biti eventualno supstituisan sa jednom ili više grupa koje su izabrane između OH, OR<sup>2,1</sup>, C<sub>1-3</sub>-alkilen-OR<sup>2,1</sup>, okso, halogena, C<sub>1-6</sub>-alkila, C<sub>9-10</sub>-arila, COOR<sup>2,1</sup>, CH<sub>2</sub>-NR<sup>2,2</sup>-COO-R<sup>2,1</sup>, CH<sub>2</sub>-NR<sup>2,2</sup>-CO-R<sup>2,1</sup>, CH<sub>2</sub>-NR<sup>2,2</sup>-CO-CH<sub>2</sub>-NR<sup>2,2</sup>R<sup>2,3</sup>, CH<sub>2</sub>-NR<sup>2,2</sup>-SO<sub>2</sub>-C<sub>1-3</sub>-alkila, CH<sub>2</sub>-NR<sup>2,2</sup>-SO<sub>2</sub>-NR<sup>2,2</sup>R<sup>2,3</sup>, CH<sub>2</sub>-NR<sup>2,2</sup>-CO-NR<sup>2,2</sup>R<sup>2,3</sup>, CO-NR<sup>2,2</sup>R<sup>2,3</sup>, CH<sub>2</sub>-NR<sup>2,2</sup>R<sup>2,3</sup> i NR<sup>2,2</sup>R<sup>2,3</sup>,

i pri čemu

**R<sup>3</sup>** je C<sub>9-10</sub>-aril, koji može biti eventualno supstituisan na orto, para ili meta poziciji sa jednom, dve ili tri grupe koje su izabrane nezavisno jedna od druge između fluora, hlora,

broma, hidroksi, CN, C<sub>1-6</sub>-alkila, C<sub>1-3</sub>-fluoralkila, -C<sub>1-3</sub>-alkilen-OR<sup>2,1</sup>, C<sub>1-3</sub>-alkilen-NR<sup>2,2</sup>R<sup>2,3</sup>, -NR<sup>2,2</sup>R<sup>2,3</sup>, O-R<sup>2,1</sup>, SO-R<sup>2,1</sup>, SO<sub>2</sub>-R<sup>2,1</sup>, COOR<sup>2,1</sup>,

-CO-NH-(C<sub>1-6</sub>-alkilen)-hetarila, -CO-NH-hetarila, -CO-N(CH<sub>3</sub>)-het,

-CO-N(CH<sub>3</sub>)-(C<sub>1-3</sub>-alkilen)-het, -CO-N(CH<sub>3</sub>)-(C<sub>1-3</sub>-alkilen)-hetarila, -CO-N(C<sub>3-7</sub>-cikloalkil)-

het, -CO-NR<sup>2,2</sup>R<sup>2,3</sup>, -CO-NH-(C<sub>1-6</sub>-alkilen)-het, NR<sup>2,2</sup>-CO-R<sup>2,1</sup>, C<sub>6-10</sub>-arila, C<sub>6-10</sub>-aril-C<sub>1-2</sub>-alkilena, het-C<sub>1-2</sub>-alkilena, -het, -CO-het, CO-N(CH<sub>3</sub>)-C<sub>3-7</sub>-cikloalkila, C<sub>3-7</sub>-cikloalkila, C<sub>3-7</sub>-cikloalkil-C<sub>1-2</sub>-alkilena, hetaril-C<sub>1-2</sub>-alkilena i hetarila,

pri čemu ove grupe mogu biti eventualno supstituisane sa jednom ili više grupa koje su izabrane između OH, halogena, -C<sub>1-3</sub>-fluoralkila, okso, metila i fenila,

ili pri čemu

**R<sup>2</sup>** je grupa izabrana između het i hetarila, koji može biti eventualno supstituisan sa jednom ili više grupa koje su izabrane između halogena, C<sub>1-3</sub>-fluoralkila, CN, OH, okso, -C<sub>1-6</sub>-alkila, -C<sub>1-3</sub>-alkilen-NR<sup>2,2</sup>R<sup>2,3</sup>, -NR<sup>2,2</sup>R<sup>2,3</sup>, SO-R<sup>2,1</sup>, SO<sub>2</sub>-R<sup>2,1</sup>, -O-R<sup>2,1</sup>, -COOR<sup>2,1</sup>, SO<sub>2</sub>-(CH<sub>2</sub>-CH<sub>3</sub>), C<sub>6-10</sub>-arila, het, C<sub>3-7</sub>-cikloalkila i hetarila,

koji može dalje eventualno biti supstituisan sa jednom ili više grupa koje su izabrane između OH, halogena, -C<sub>1-3</sub>-fluoralkila, C<sub>1-6</sub>-alkila, C<sub>6-10</sub>-arila,

-COO(C<sub>1-3</sub>-alkila) i O-(C<sub>1-3</sub>-alkila).

ili pri čemu

**R<sup>2</sup>** označava -O-R<sup>2,1</sup>.

pri čemu je **R<sup>2,1</sup>** grupa izabrana između -C<sub>1-6</sub>-alkila, -C<sub>6-10</sub>-arila, -C<sub>1-3</sub>-alkilen-C<sub>6-10</sub>-arila, hetarila i het,

koji može eventualno biti supstituisan na orto, para ili meta poziciji sa jednom, dve ili tri grupe koje su izabrane nezavisno jedna od druge između fluora, hlora, broma, hidroksi, CN, C<sub>1-6</sub>-alkila, C<sub>1-3</sub>-fluoralkila, CO-(C<sub>1-6</sub>-alkila), -CO-(C<sub>1-3</sub>-fluoralkila), -CO-NH-(C<sub>1-6</sub>-alkilen)-hetarila, -CO-N(C<sub>1-3</sub>-alkil)-(C<sub>1-6</sub>-alkilen)-hetarila,

-CO-N(C<sub>1-3</sub>-alkil)-het, -CO-N(C<sub>3-7</sub>-cikloalkil)-het, -C<sub>1-3</sub>-alkilen-OR<sup>2,1</sup>,

-C<sub>1-3</sub>-alkilen-NR<sup>2,2</sup>R<sup>2,3</sup>, -NR<sup>2,2</sup>R<sup>2,3</sup>, O-R<sup>2,1</sup>, SO-R<sup>2,1</sup>, SO<sub>2</sub>-R<sup>2,1</sup>, COOH, COO-(C<sub>1-6</sub>-alkila),

-O-C<sub>1-3</sub>-alkilen-N(C<sub>1-3</sub>-alkil)<sub>2</sub>, CO-NR<sup>2,2</sup>R<sup>2,3</sup>, NR<sup>2,2</sup>-CO-R<sup>2,1</sup>, C<sub>6-10</sub>-arila,

C<sub>6-10</sub>-aril-C<sub>1-2</sub>-alkilena, het-C<sub>1-2</sub>-alkilena, -CO-het, het, -CO-C<sub>3-7</sub>-cikloalkila, -

CO-N(C<sub>1-3</sub>-alkil)-C<sub>3-7</sub>-cikloalkila, C<sub>3-7</sub>-cikloalkila, C<sub>3-7</sub>-cikloalkil-C<sub>1-2</sub>-alkilena,

hetaril-C<sub>1-2</sub>-alkilena i hetarila,

koji može dalje eventualno biti supstituisan sa 1, 2, 3 ili 4 grupe koje su izabrane nezavisno jedna od druge između F, Cl, Br, metila, O-metila, etila, O-etila, OH, okso i CF<sub>3</sub>,

i pri čemu

**R<sup>4</sup>** označava H, CN, OH, CF<sub>3</sub>, CHF<sub>2</sub>, CH<sub>2</sub>F, F, metil, etil, -O-(C<sub>1-3</sub>-alkil), -C<sub>1-3</sub>-alkilen-OH, -COO(C<sub>1-3</sub>-alkil), -CO-het, -(C<sub>1-2</sub>-alkilen)-NH-SO<sub>2</sub>-(C<sub>1-2</sub>-alkil), -(C<sub>1-2</sub>-alkilen)-N(C<sub>1-3</sub>-alkil)-SO<sub>2</sub>-(C<sub>1-2</sub>-alkil), -(C<sub>1-2</sub>-alkilen)-O-(C<sub>1-2</sub>-alkilen)-C<sub>6-10</sub>-aril, -C<sub>1-3</sub>-alkilen-O-C<sub>1-3</sub>-alkil, -(C<sub>1-2</sub>-alkilen)-N(C<sub>1-3</sub>-alkil)-CO-(C<sub>1-2</sub>-alkil), -NH-CO-(C<sub>1-3</sub>-alkilen)-O-(C<sub>1-3</sub>-alkil), -C<sub>1-3</sub>-alkilen-NH-CO-(C<sub>1-3</sub>-alkil), -C<sub>1-3</sub>-alkilen-NH-CO-(C<sub>1-3</sub>-alkilen)-N(C<sub>1-3</sub>-alkil)<sub>2</sub>, -O-(C<sub>1-2</sub>-alkilen)-(C<sub>6-10</sub>-aril), -C<sub>1-3</sub>-alkilen-NH-CO-(C<sub>1-3</sub>-alkilen)-O-(C<sub>1-3</sub>-alkil), -CO-(C<sub>6-10</sub>-aril), -(C<sub>1-2</sub>-alkilen)-N(C<sub>1-3</sub>-alkil)-CO-(C<sub>1-2</sub>-alkilen)-O-(C<sub>1-3</sub>-alkil), pri čemu aril u gore navedenim grupama može dalje eventualno biti supstituisan sa jednom ili više drugih grupa koje su izabrane između F, Cl, Br, metila, etila, propila, izopropila, ciklopropila, -O-metila, -O-etila, -O-propila, -O-izopropila, -O-ciklopropila, -OH i CF<sub>3</sub>,

ili pri čemu

**R<sup>3</sup> i R<sup>4</sup>** zajedno formiraju mono- ili biciklični, nezasićeni, zasićeni ili delimično zasićeni heterociklus, koji sadrži 1, 2 ili 3 heteroatoma koji su izabrani između N, O i S i koji može biti eventualno supstituisan sa jednom ili više grupa koje su izabrane između halogena, OH, okso, C<sub>1-3</sub>-fluoralkila, CN, C<sub>1-3</sub>-alkila, -O-R<sup>2,1</sup>, -COOR<sup>2,1</sup>, SO-R<sup>2,1</sup>, SO<sub>2</sub>-R<sup>2,1</sup>, -C<sub>1-3</sub>-alkilen-NR<sup>2,2</sup>R<sup>2,3</sup>, -NR<sup>2,2</sup>R<sup>2,3</sup>, C<sub>6-10</sub>-arila, C<sub>3-7</sub>-cikloalkila, het i hetarila,

kao i njihove farmakološki prihvatljive soli, diastereomeri, enantiomeri, racemati, hidrati ili solvati.

**Patent sadrži još 49 patentnih zahtjeva.**

(51) **A61K31/58**  
**A61K9/20**  
**A61K9/16**  
**A61K9/50**  
**A61P25/22**

(11) **01332**  
(21) **P-2012-30**

(22) 09.06.2006.

(30) 688905P 09.06.2005. US

(96) 10000305.2 09.06.2006.

(97) EP 2168585 28.12.2011. 2011/52 EN

(54) (ME) **FARMACEUTSKE KOMPOZICIJE NEUROAKTIVNOG STEROIDA I NJIHOVA UPOTREBA**

(EN) PHARMACEUTICAL COMPOSITIONS OF A NEUROACTIVE STEROID AND USES THEREOF

(73) Euro-Celtique S.A. 2, avenue Charles de Gaulle, 1653 Luxembourg LU

(72) WOODWARD, Richard M.; 02035 Welsh Valley Road Phoenixville, PA 19460-4638 US

(74) Lutovac Branislav, Bulevar Crnojevića 93, Podgorica ME

(57) Farmaceutska kompozicija koja sadrži 3 $\alpha$ -hidroksi-3 $\beta$ -metoksimetil-21-(1'-imidazolil)-5 $\alpha$ -pregnan-20-on ili njegovu farmaceutski prihvatljivu so ili solvat, i jedan ili više farmaceutski prihvatljivih ekscipijenata, za upotrebu u tretmanu opsesivno kompulsivnog poremećaja, postraumatskog stresnog poremećaja ili poremećaja socijalne uznemirenosti kod humanog subjekta, gde kompozicija obezbeđuje ravnotežni sadržaj 3 $\alpha$ -hidroksi-3 $\beta$ -metoksimetil-21-(1'-imidazolil)-5 $\alpha$ -pregnan-20-ona u plazmi, u opsegu od 5 ng/mL do 500 ng/mL u trajanju od 6 h do 24 h posle ordiniranja.  
Patent sadrži još 6 patentnih zahtjeva.

- (51) **A61K31/205**  
**A61K31/221**  
**A61K31/7004**  
**A61P9/10**
- (22) 21.06.2005.  
(30) RM20040346 13.07.2004. IT  
(86) PCT/EP2005/006657 21.06.2005.  
(87) WO 2006/005415 19.01.2006.  
(96) 05755616.9 21.06.2005.  
(97) EP 1773314 25.01.2012. 2012/04 EN
- (54) (ME) **UPOTREBA L-KARNITINA ZA LIJEČENJE KARDIOVASKULARNIH BOLESTI**  
(EN) **USE OF L-CARNITINE FOR THE TREATMENT OF CARDIOVASCULAR DISEASES**
- (73) SIGMA-TAU Industrie Farmaceutiche Riunite S.p.A. Viale Shakespeare 47, 00144 Roma IT  
(72) KOVERECH, Alcardo; Via Pontina, km 30, 400, 00040 Pomezia IT  
(74) Đakonović Vido, Bajova 9, Cetinje ME
- (57) Kombinovana upotreba L-karnitina ili jedne od njegovih farmaceutski prihvatljivih soli i glukoze za dobijanje lijeka korisnog za smanjenje broja dana koje pacijenti sa infarktom provedu na intenzivnoj njezi u bolnici i za smanjenje broja epizoda srčane insuficijencije poslije infarkta, gdje se L-karnitin dozira intravenozno u roku od 6 sati od pojave početaka simptoma akutnog infarkta miokarda, prema početnoj dozi od 9 grama dnevno je naznačena time što se dozira u kombinaciji sa 1000-1500 mL 5 % rastvora glukoze tokom 5 dana, poslije čega se liječenje L-karnitinom nastavlja prema dozi od 4 grama dnevno, oralno.  
Patent sadrži još 5 patentnih zahtjeva.

(51) **C07D401/14**  
**C07D401/06**  
**C07D401/04**  
**C07D417/06**  
**C07D417/14**  
**C07D211/70**  
**C07D409/14**  
**C07D513/04**  
**C07D413/14**  
**C07D407/14**  
**C07D471/04**  
**A61K31/4545**  
**A61P13/02**

(11) **01342**  
(21) **P-2012-34**

(22) 01.08.2008.

(30) 953677 P 02.08.2007. US  
45175 P 15.04.2008. US

(86) PCT/EP2008/006351 01.08.2008.

(87) WO 2009/015897 05.02.2009.

(96) 08785292.7 01.08.2008.

(97) EP 2178858 28.12.2011. 2011/52 EN

(54) (ME) **NOVA HETEROCIKLIČNA JEDINJENJA KAO MGLU5 ANTAGONISTI**  
(EN) **NOVEL HETEROCYCLIC COMPOUNDS AS MGLU5 ANTAGONISTS**

(73) Recordati Ireland Limited Raheens East Ringaskiddy, County Cork (IE)

(72) LEONARDI, Amedeo Via Poliziano 16, I-20154 Milano IT  
MOTTA, Gianni Via Ungaretti 10, I-20030 Barlassina IT  
RIVA, Carlo Via Piermarini 3, I-21100 Varese IT  
POGGESI, Elena Via Ricciarelli 37, I-20148 Milano IT  
GRAZIANI, Davide Via Tavazzano 16, I-20155 Milano IT  
LONGHI, Matteo Marco Via Solferino 4, I-21053 Castellanza, Varese IT

(74) Lutovac Branislav, Bulevar Crnojevića 93, Podgorica ME

(57) Jedinjenje koje ima opštu formulu I

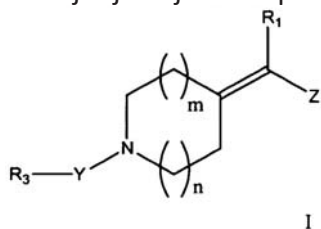

Gdje Z predstavlja grupu formule  $-C=C-R_2$  ili  $-CH=CH-R_2$ ;  $R_1$  predstavlja atom vodonika ili halogena, ili hidroksi, cijano, C1-C6alkil, C1-C6alkilkarbonil, C1-C6 alkoksi, C1-C6 alkoksi-karbonil, C1-C6 alkilkarboniloksi, C1-C6 alkoksikarboniloksi, C1-C6 alkiltio, di-(C1-C6 alkil)-amino ili C3- C14 cikloalkil grupu;  $R_2$  predstavlja opciono supstituisanu mono- ili biciklo C1-C9 heterocikličnu grupu koja sadrži od 1 do 3 heteroatoma izabrana od azota, kiseonika i sumpora. opciono supstituisanu mono-, bi- ili tricikličnu C6- C14aril grupu, opciono supstituisanu C1-C6alkil grupu, opciono supstituisanu C2-C6alkilenil grupu ili opciono supstituisanu C3-C6cikloalkil grupu, ili  $R_2$  predstavlja grupu  $-C(O)-R_{2A}$ , gde  $R_{2A}$  je definisan kao gore  $R_2$ ;  $R_3$  predstavlja atom vodonika, opciono supstituisanu C1-C6alkil grupu, opciono supstituisanu mono-, bi- ili tricikličnu C1-C14 heterocikličnu grupu koja sadrži 1 do 3 heteroatoma

izabrana od azota, kiseonika i sumpora, opciono supstituisanu mono, bi ili tricikličnu C6-C14 aril grupu, opciono supstituisanu C3-C6cikloalkil grupu ili opciono supstituisanu C3-C6cikloalkenil grupu, Y predstavlja grupu formule -C(O)-, -C(S)-, -NH-C(O)-, -N(C1-C6 alkil)-C(O)-, -O-C(O)-, -NH-C(S)-, -N(C1-C6alkil)-C(S)-, -O-C(S)- ili -SO<sub>2</sub>- ili je odsutan, m je 0, 1 ili 2; n je 0,1 ili 2; supstituenti za svaku opciono supstituisanu grupu su atom halogena ili okso, nitro, cijano, hidroksi, karbamoil, C1-C6 alkilsulfonil, C1-C6alkiltio, C1-C6alkilkarbonil ili C1-C6alkilkarbonil-(C1-C6)alkil grupa ili grupa formule -NR\*R\* gde svaki R\* nezavisno predstavlja atom vodonika ili C1-C6 alkil, C1-C6 alkilkarbonil, fenil ili benzil grupu, ili C1-C6 alkil, C2-C6 aleknil, C2-C6 alkinil ili C1-C6 alkoksi grupa, od kojih svaki može opciono imati 1 do 8 nezavisno odabranih supstituenata od okso, halo, cijano, nitro, amino, hidroksi ili fenil, C3-C9 mono- ili bicikloalkil grupa koja opciono ima od 1 do 3 nezavisno odabrana supstituenta C1-C6alkil, okso, halo, cijano, nitro, amino, hidroksi ili fenil, ili grupa formula -A, -O-A, -C(O)-A, -(CH<sub>2</sub>)<sub>q</sub>-A, -NR\*\*<sup>-</sup>-A, -C(O)NR\*\*<sup>-</sup>-A, -NR\*\*C(O)-A ili -OC(O)-A, gde A predstavlja fenil grupu ili C1-C8 heterocikličnu grupu koja sadrži od 1 do 3 heteroatoma izabranih od azota, kiseonika i sumpora, od kojih svaka A grupa može imati od 1 do 3 nezavisno odabranih supstituenata od halo, hidroksi, cijano, nitro i C1-C6 alkil; svaki R\*\* nezavisno predstavlja atom vodonika ili C1-C6alkil grupu i q je 0 ili celi broj od 1 do 6; uz uslov da ukoliko Z predstavlja grupu formule -CH=CH-R<sub>2</sub>, tada R<sub>1</sub> predstavlja atom vodonika, a okso i hidroksi su isključeni iz mogućih supstituenata, ili njegov enantiomer, diastereoizomer, N-oksid ili farmaceutski prihvatljiva so. Patent sadrži još 14 patentnih zahtjeva.

- (51) **A61K31/7076**  
**A61K38/21**  
**A61P25/00**
- (11) **01333**  
(21) **P-2012-35**
- (22) 20.12.2005.
- (30) 638669 P 22.12.2004. US  
04106909 22.12.2004. EP
- (86) PCT/EP2005/056954 20.12.2005.
- (87) WO 2006/067141 29.06.2006.
- (96) 05823474.1 20.12.2005.
- (97) EP 1827461 29.02.2012. 2012/09 EN
- (54) (ME) **KLADRIBINSKI REŽIM ZA LIJEČENJE MULTIPLE SKLEROZE**  
(EN) CLADRIBINE REGIMEN FOR TREATING MULTIPLE SCLEROSIS
- (73) Merck Serono SA Centre Industriel, 1267 Coinsins, Vaud CH  
(72) DE LUCA, Giampiero; Chemin De Conches 15b, CH-1231 Conches CH  
YTHIER, Arnaud; Route de Vireloup 88, 1239 Collex-Bossy CH  
MUNAFO, Alain; Rue des Pressoirs 6, 1180 Tartegnin CH  
LOPEZ-BRESNAHAN, Maria; 145 South Great Road, Lincoln, MA 01773 US
- (74) Ćupić Branislav, Dalmatinska 10, Podgorica ME
- (57) Kladribinska farmaceutska formulacija, namijenjena upotrebi u liječenju multiple skleroze, naznačena time što formulaciju treba primijeniti oralno, prema sljedećim koracima, niže: period uvođenja, koji traje od 2 mjeseca do 4 mjeseca kada navedenu kladribinsku farmaceutsku formulaciju treba primjenjivati i kada je ukupna doza kladribina postignuta na kraju perioda uvođenja od otprilike 1,7 mg/kg do otprilike 3,5 mg/kg; period bez kladribina, koji traje od 8 mjeseci do 10 mjeseci, kada se ne primijenjuje kladribin; period održavanja, koji traje od 2 mjeseca do 4 mjeseca, kada navedenu kladribinsku farmaceutsku formulaciju treba primjenjivati i kada je ukupna doza kladribina postignuta na kraju perioda održavanja manja od ukupne doze kladribina postignute na kraju perioda uvođenja (i);(iv) period bez kladribina, kada se ne primijenjuje kladribin.  
Patent sadrži još 17 patentnih zahtjeva.



- (51) **A61K39/395**  
**A61K39/09**  
**A61K39/295**  
**A61K39/02**
- (22) 31.03.2006.  
(30) 669605P 08.04.2005. US  
(86) PCT/US2006/012354 31.03.2006.  
(87) WO 2006/110381 19.10.2006.  
(96) 06740419.4 31.03.2006.  
(97) EP 1868645 07.03.2012. 2012/10 EN
- (54) (ME) **POLIVALENTNI PRIPRAVAK KONJUGATA PNEUMOKOKNOG POLISAHARIDA S PROTEINOM**  
(EN) MULTIVALENT PNEUMOCOCCAL POLYSACCHARIDE-PROTEIN CONJUGATE COMPOSITION
- (73) Wyeth LLC Five Giralda Farms, Madison, NJ 07940 US  
(72) HAUSDORFF, William, P. Avenue De La Chapelle,19 B-1200 Woluwe Saint-lambert BE  
SIBER, George, Rainer 160 West 66th Street, New York, NY 10023 US  
PARADISO, Peter, R. 445 Freedom View Lane, Valley Forge, PA 19481 US  
(74) Ćupić Branislav, Dalmatinska 10, Podgorica ME
- (57) Polivalentni imunogeni pripravak, naznačen tome što sadrži: 13 različitih polisaharidno-proteinskih konjugata, kao i fiziološki prihvatljiv vehikulum, gdje svaki od konjugata sadrži kapsularni polisaharid iz različitih serotipova bakterije Streptococcus pneumoniae, konjugiran s proteinom-nosačem, gdje su kapsularni polisaharidi dobiveni iz serotipova 1, 3, 4, 5, 6A, 6B, 7F, 9V, 14, 18C, 19A, 19F i 23F, a protein-nosač je CRM197.  
Patent sadrži još 7 patentnih zahtjeva.

- (51) **A61K31/4412**  
**A61K31/513**  
**A61K31/53**  
**A61K45/00**  
**A61P35/00**  
**A61K47/22**
- (11) **01335**  
(21) **P-2012-42**
- (22) 27.04.2005.  
(30) 566180 P 29.04.2004. US  
(86) PCT/JP2005/008450 27.04.2005.  
(87) WO 2005/105086 10.11.2005.  
(96) 05738545.2 27.04.2005.  
(97) EP 1750703 11.01.2012. 2012/02 EN
- (54) (ME) **POSTUPAK SMANJENJA GASTROINTESTINALNE TOKSIČNOSTI USLED ADMINISTRACIJE TEGAFURA**  
(EN) METHOD FOR REDUCING GASTROINTESTINAL TOXICITY DUE TO THE ADMINISTRATION OF TEGAFUR
- (73) TAIHO PHARMACEUTICAL CO., LTD. 1-27, Kandanshiki-cho, Chiyoda-ku, Tokyo 101-0054 JP  
(72) TAHARA, Takeshi 45-1-301 Mitakedai, Aoba-ku, Yokohama-shi, Kanagawa 2270047JP  
AMBE, Hiroshi 3-15-24, Nishi-ohi, Shinagawa-ku, Tokyo 1400015 JP  
KURITANI, Jun 6 Hullet Road 08-01 Hullet Rise, Singapore 229159 SG  
NOMURA, Naruo, preminuo JP
- (74) Čupić Branislav, Dalmatinska 10, Podgorica ME
- (57) Kompozicija koja sadrži (A) terapijski delotvornu količinu tegafura, (B) inhibitora dihidropirimidin dehidrogenaze u količini koja je efiksna za povećanje antitumorskog efekta i (C) oksonsku kiselinu ili njenu farmaceutski prihvatljivu so u količini koja je efiksna za supresiju gastrointestinalne toksičnosti za upotrebu u lečenju pacijenta obolelog od kancera koji je suspenzibilan na tretiranje sa 5-FU, pri čemu je tretman izveden na prazan stomak, odnosno najmanje jedan sat pre obroka, pri čemu su komponente istovremeno administrirane, i administrirano je 0.1 do 5 mol inhibitora dihidropirimidin dehidrogenaze i 0.1 do 5 mol oksonske kiseline i njene farmaceutski prihvatljive soli po 1 molu tegafura i povećanje antitumorski efekat tegafura uz smanjenje gastrointestinalne toksičnosti kod pacijenata kojima je ovakav tretman potreban.  
Patent sadrži još 26 patentnih zahtjeva.

(51) **C07D471/08**  
**C07D487/08**  
**A61K31/529**  
**A61P25/00**  
**A61P29/00**  
**A61P35/00**

(11) **01363**  
(21) **P-2012-45**

(22) 12.06.2009.

(30) 0803299 13.06.2008. FR

(86) PCT/FR2009/051118 12.06.2009.

(87) WO 2009/150388 17.12.2009.

(96) 09761939.9 12.06.2009.

(97) EP 2297148 04.01.2012. 2012/01 FR

(54) (ME) **NOVI DERIVATI (PIPERANIZIL PONTE)-1-ALKANONA I NJIHOVA UPOTREBA KAO INHIBITORA p75**

(EN) **NOVEL DERIVATIVES OF (BRIDGED PIPERAZINYL)-1-ALCANONE AND USE THEREOF AS p75 INHIBITORS**

(73) SANOFI, 54, rue La Boétie, 75008 Paris FR

(72) BARONI, Marco C/o Sanofi-aventis, Département Brevets, 174 Avenue de France F-75013 Paris FR

BONO, Françoise C/o Sanofi-aventis, Département Brevets, 174 Avenue de France F-75013 Paris FR

DELBARY-GOSSART, Sandrine C/o Sanofi-aventis, Département Brevets, 174 Avenue de France F-75013 Paris FR

(74) Ćupić Branislav, Dalmatinska 10, Podgorica ME

(57) Jedinjenje koje odgovara formuli (I):

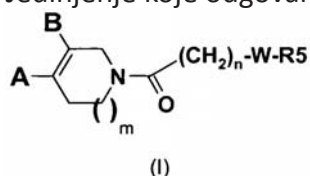

u kojoj:

m predstavlja 0 ili 1 ;

A predstavlja :

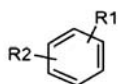

i B predstavlja atom vodonika ili A predstavlja atom vodonika i B predstavlja

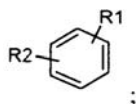

- W-je j heterocikl sa azotom izabran od :

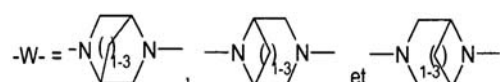

I 1-3 odgovaraju 1, 2, ili 3 ; - n odgovara 1 ili 2 ; R1 predstavlja atom halogena, (C1-C4)alkil

grupu, trifluormetil radikal, (C1-C4)alkoksi grupu ili trifluormetoksi radikal; R2 predstavlja atom vodonika, atom halogena, (C1-C4)alkil grupu, trifluormetil radikal, (C1-C4)alkoksi grupu, trifluormetoksi radikal, COOR grupu ili CONH2 grupu; -R5 predstavlja grupu formule :

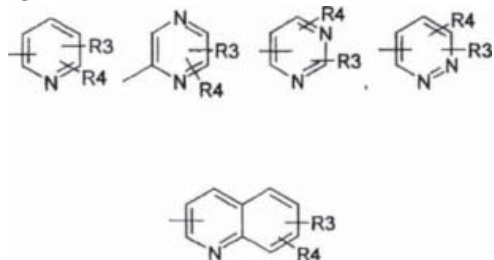

Ili u kojoj R3 i R4 koji se nalaze na jednom od raspoloživih položaja, nezavisno predstavljaju vodonika atom, halógena atom, (C1-C4)alkil grupu, (C1-C4)alkoksi grupu, trifluormetil radikal, trifluormetoksi'radikal, cijano radikal, COOH grupu, COOalkil grupu, CONH2 grupu, CONR6R7 grupu ili NHCOR grupu ; -R, R6 i R7 prestavljaju C1-C6 alkil grupu; u obliku baze ili adicione soli sa kiselinom

Patent sadrži još 15 patentnih zahtjeva.

- (51) **C12N15/16**  
**C07K14/605**  
**C12P21/02**  
**A61K38/26**
- (22) 22.11.2004.  
(30) 20030523667P 21.11.2003. US  
(86) PCT/IB2004/004439 22.11.2004.  
(87) WO 2005/067368 28.07.2005.  
(96) 04821092.6 22.11.2004.  
(97) EP 1704234 18.01.2012. 2012/03 EN
- (54) **(ME) POSTUPAK ZA PROIZVODNJU PEPTIDA 2 NALIK NA GLUKAGON I NJIHOVIH ANALOGA**  
**(EN) PRODUCTION OF GLUCAGON LIKE PEPTIDE 2 AND ANALOGS**
- (73) NPS Pharmaceuticals, Inc.550 Hills Drive, 3rd Floor, Bedminster, NJ 07921 US  
Nycomed GmbH Byk-Gulden-Strasse 2; 78467 Konstanz DE
- (72) SASAKI, Ken; 43 Rosedale Heights Drive Thornhill, Ontario L4J 4T7 CA  
WILLIAMSON, Vanessa Jane; 50 Division Street, Guelph, Ontario, N1H 1R2 CA  
ARAUJO, Alberto de; 3431 Nighthawk Trail, Mississauga, Ontario L5N 6G4 CA  
WALCZYK, Ewa; 15790 Horseshoe Hill Road, Caledon, Ontario L0N 1C0 CA
- (74) Radulović Božidar, Jovana Tomaševića 9/III, Podgorica ME
- (57) Jednolančani proteinski multimer koji obuhvata najmanje dvije jedinice GLP-2 peptida spojenog dvostruko sa veznikom koji obezbjeđuje u okviru multimera mjesto kiselinskog razdvajanja na njegovom N-kraju, i mjesto razdvajanja enzima na njegovom C-kraju, gde razdvajanje pomenutog multimera sa kiselinom i enzimom oslobađa pomenute jedinice GLP-2 peptida, od kojih svaka ima autentične N- i C-terminalne ostatke i gdje kiselinsko mjesto razdvajanja ima sekvencu Asp-Pro i mjesto razdvajanja enzima je odabrano od mesta razdvajanja enterokinaze koje ima sekvencu Asp-Asp-Asp-Asp-Liz, mjesto razdvajanja faktora Xa ima sekvencu Ile-Glu-Glu-Arg i mjesto razdvajanja trombina ima sekvencu Val-Ser-Gli-Pro-Arg.  
Patent sadrži još 13 patentnih zahtjeva.

(51) **A01N 43/56**(11) **01423**(21) **P-2012-52**

(22) 23.04.2008.

(30) 07008370 25.04.2007 EP

(96) 10157587.6 23.04.2008.

(97) EP 2206431 29.02.2012. 2012/09 EN

(54) (ME) **FUNGICIDNI SASTAVI**

(EN) FUNGICIDAL COMPOSITIONS

(73) Syngenta Participations AG, Schwarzwaldallee 215 4058 Basel CH

(72) TOBLER, Hans Birsigstrasse 129 4054, Basel CH

WALTER, Harald Syngenta Crop Protection Münchwilen AG, Schaffhau 4332, Stein CH

HAAS, Ulrich Johannes Syngenta Crop Protection Münchwilen AG, Schaffhau 4332, Stein CH

(74) Radulović Božidar, Jovana Tomaševića 9/III, Podgorica ME

(57) Sastav pogodan za kontrolisanje bolesti prouzrokovanih fitopatogenim organizmima uključujući (A) jedinjenje formule I

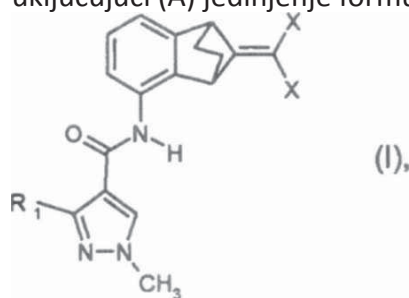

naznačen time da je R<sub>1</sub> difluorometil ili trifluorometil, a X hlora, fluoro, ili bromo; i (B) jedinjenje biksafen.

Patent sadrži još 11 patentnih zahtjeva.

(51) **C07D 401/04**  
**C07D 401/14**  
**A61K 31/45**  
**A61K 31/517**

(11) **01421**  
(21) **P-2012-60**

(22) 25.09.2007.  
(30) 847471P 26. 09. 2006 US  
(86) PCT/US2007/020765 25.09.2007.  
(87) WO 2008/039489 03.04.2008.  
(96) 07838876.6 25.09.2007.  
(97) EP 2066656 25.04.2012. 2012/17 EN

(54) (ME) **5-SUPSTITUISANI DERIVATI KINAZOLINONA KAO PROTIVTUMORSKA SREDSTVA**

(EN) 5-SUBSTITUTED QUINAZOLINONE DERIVATIVES AS ANTITUMOR AGENTS 5-

(73) CELGENE CORPORATION, 86 Morris Avenue Summit, NJ 07901 US  
(72) MULLER, George W. P.O. Box 3688 Rancho Santa Fe, CA 92067 US  
MAN, Hon-Wah 27 Grant Way Princeton NJ 08540 US  
(74) Ćupić Branislav, Dalmatinska 10, Podgorica ME  
(57) Spoj formule (II):

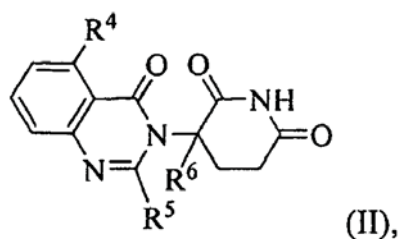

ili njegova farmaceutski prihvatljiva sol, solvat ili stereoizomer, naznačen time što: R4 je: halogen;  $-(CH_2)_nOH$ ; (C1-C6)alkil, izborno supstituisan s jednim ili više halogena; ili (C1-C6)alkoksi, izborno supstituisan s jednim ili više halogena;  
R5 je: vodonik;  $-(CH_2)_nOH$ ; fenil;  $-O-(C1-C6)alkil$ ; ili (C1-C6)alkil, izborno supstituisan s jednim ili više halogena; R6 je: vodonik; ili (C1-C6)alkil, izborno supstituisan s jednim ili više halogena; i n je 0, 1 ili 2.

Patent sadrži još 13 patentnih zahtjeva.

(51) **C07D 413/04**  
**C07D 413/14**  
**A61K 31/454**  
**A61P 25/00**

(11) **01426**  
(21) **P-2012-62**

(22) 21.11.2006.  
(30) 739107 P 21. 11. 2005. US  
(86) PCT/ EP2006/011150 21.11.2006.  
(87) WO 2007/057229 24.05.2007.  
(96) 06829087.3 21.11.2006.  
(97) EP 1951718 29.02.2012. 2012/09 EN

(54) (ME) **JEDINJENJA 4-OXSADIAZOLIL-PIPERIDINA I NJIHOVA UPOTREBA**  
(EN) **4-OXADIAZOLYL-PIPERIDINE COMPOUNDS AND USE THEREOF**

(73) Purdue Pharma, LP One Stamford Forum 201 Tresser Boulevard, Stamford, CT 06901 US

(72) TAFESSE, Laykea, 11 Abbington Lane, Robbinsville, NJ 08691 US

(74) Lutovac Branislav, Bulevar Crnojevića 93, Podgorica ME

(57) Jedinjenje formule (I):

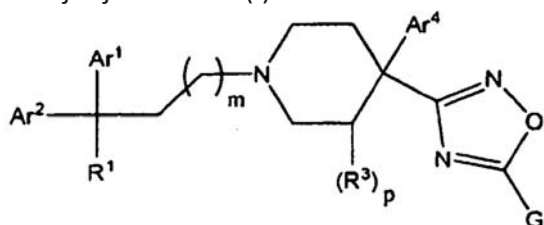

ili njihove farmaceutski prihvatljive soli, gdje:

Ar1 je fenil koji je nesupstituisan ili supstituisan sa jednom ili više R2 grupa; Ar2 je fenil koji je nesupstituisan ili supstituisan sa jednom, dvije ili tri R2 grupe; Ar4 je fenil koji je nesupstituisan ili supstituisan sa jednom, dvije ili tri R2 grupe; G je -H, -C(O)(CH<sub>2</sub>)<sub>n</sub>CO<sub>2</sub>R<sub>4</sub>, -C(O)(CH<sub>2</sub>)<sub>n</sub>R<sub>5</sub>, -(C<sub>1</sub>-C<sub>5</sub>alkilen)C(O)OR<sub>4</sub> ili -(C<sub>1</sub>-C<sub>5</sub>alkilen)R<sub>5</sub>; R<sub>1</sub>= -H, -C(O)NH<sub>2</sub>, -C(O)NHOH, -CO<sub>2</sub>R<sub>4</sub>, -CHO, -CN, -(C<sub>1</sub>-C<sub>4</sub>alkil), -C(O)NH(C<sub>1</sub>-C<sub>4</sub>alkil), -C(O)N(C<sub>1</sub>-C<sub>4</sub>alkil)<sub>2</sub>, -CF<sub>3</sub>, -CHF<sub>2</sub>, -CH<sub>2</sub>F,

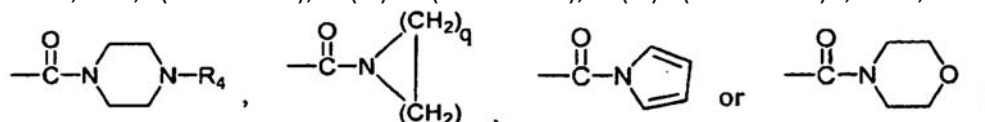

R<sub>2</sub> i R<sub>3</sub> su svaki nezavisno -halogen, - C<sub>1</sub>-C<sub>3</sub> alkil, -O(C<sub>1</sub>-C<sub>3</sub>alkil), -NH(C<sub>1</sub>-C<sub>3</sub> alkil), -N(C<sub>1</sub>-C<sub>3</sub>alkil)<sub>2</sub>, -CF<sub>3</sub> ili -OCF<sub>3</sub>; R<sub>4</sub>= -H, - C<sub>1</sub>- C<sub>10</sub> alkil, -CH<sub>2</sub>O(C<sub>1</sub>-C<sub>4</sub> alkil), -CH<sub>2</sub>N(C<sub>1</sub>-C<sub>4</sub>alkil)<sub>2</sub> ili -CH<sub>2</sub>NH(C<sub>1</sub>-C<sub>4</sub>alkil); R<sub>5</sub> = -NH<sub>2</sub>, -NHSO<sub>2</sub>R<sub>4</sub>, -C(O)NH<sub>2</sub>, -C(O)NHOH, -SO<sub>2</sub>NH<sub>2</sub>, -C(O)NH(C<sub>1</sub>-C<sub>4</sub> alkil), -C(O)N(C<sub>1</sub>- C<sub>4</sub>alkil)<sub>2</sub>, -SO<sub>2</sub>NH(C<sub>1</sub>-C<sub>4</sub>alkil), -SO<sub>2</sub>N(C<sub>1</sub>-C<sub>4</sub>alkil)<sub>2</sub>, -H, -OH, -CN, ili -C<sub>3</sub>-C<sub>8</sub> cikloalkil, fenil, naftil, antril, fenantril, -(5 do 7-člani) heteroaril svaki C<sub>3</sub>-C<sub>8</sub> cikloalkil, fenil, naftil, antril, fenantril, -(5 do 7-člani) heteroaril je nesupstituisan ili supstituisan sa jednom ili više R<sub>2</sub> grupa;

m= cio broj od 0 do 4;

n = cio broj od 1 do 4;

p = 0 ili 1; i

q = cio broj od 1 do 6

Patent sadrži još 28 patentnih zahtjeva.



(51) **A47J 31/30**(11) **01430**(21) **P-2012-63**

(22) 16.05.2012.

(86) PCT/ EP2008/062511 19.09.2008.

(87) WO /2010/031440 25.03.2010.

(96) 08804445.8 19.09.2008.

(97) EP 2326222 22.02.2012. 2010/08 EN

(54) **(ME) LIMENKA SA SIGURNOSNIM POKLOPCEM ZA IMPROVIZIRANU PRIPREMU NAPITAKA PUTEM EKSTRAKCIJE I/ILI INFUZIJE****(EN) CAN FOR THE EXTEMPORANEOUS PREPARATION OF BEVERAGES BY EXTRACTION AND/OR INFUSION, PROVIDED WITH A SAFETY LID**

(73) Brizio, Adriana, Via Sole, 18, 6977 Ruvigliana CH

(72) BRIZIO, Adriana, Via Sole, 18, 6977 Ruvigliana CH

(74) Radulović Božidar, Jovana Tomaševića 9/III, Podgorica ME

(57) Limenka (10; 10A; 10B; 10C) za improvizovanu pripremu napitaka putem ekstrakcije i/ili infuzije, gde limenka ima poklopac (18; 18A; 18B; 18C) i sadrži prvu komoru (12), predviđenu da sakuplja konačni napitak, drugu komoru (14), koja sadrži tečnost za piće, i filter (16) koji sadrži supstancu sposobnu da proizvede zahtevan napitak putem ekstrakcije i/ili infuzije, pri čemu je predviđeno da se limenka postavi na izvor toplote nakon otvaranja poklopca (18, 18A; 18B; 18C) i aktiviranja filtera (16) od strane korisnika, gde poklopac (18; 18A; 18B; 18C) sadrži: spoljašnji obod (22; 22B) predviđen da ostane pričvršćen za bočni zid limenke (20) nakon otvaranja limenke; unutrašnji uklonivi deo (24, 24A, 24B; 24C) predviđen za kidanje da bi se limenka otvorila; i unapred definisanu liniju kidanja (34) koja razdvaja pomenuti unutrašnji uklonivi deo (24; 24A; 24B; 24C) od pomenutog spoljašnjeg oboda (22; 22B); naznačena time što je linija kidanja (34) obezbeđena u anularnom delu (28; 28A, 28B, 28C) koji formira deo poklopca (18; 18A, 18B; 18C) i izrađena je od plastičnog materijala, pri čemu je spoljašnji deo (32; 32B) anularnog dela (28; 28A, 28B, 28C) deo spoljašnjeg oboda (22; 22B), dok je unutrašnji deo (24; 24A; 24B; 24C) deo unutrašnjeg uklonivog dela (24; 24A; 24B; 24C).

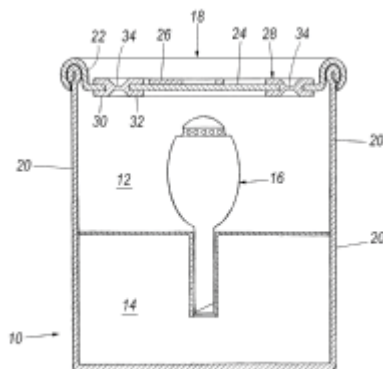
**Fig. 1**

Patent sadrži još 11 patentnih zahtjeva.

- (51) **C07D 309/10**  
**A61K 31/351**
- (11) **01422**  
(21) **P-2012-72**
- (22) 11.03.2005.
- (30) 102004012676 16.03.2004. DE  
102004040168 18. 08. 2004. DE  
102004061145 16.12.2004. DE  
05002628 09.02.2005 EP
- (86) PCT/ 2005EP002618 11.03.2005.
- (87) WO 2005092877 06.10.2005.
- (96) 05715979.0 11.03.2005.
- (97) EP 1730131 09.05.2012. 2012/19 DE
- (54) (ME) **DERIVATI BENZOLA SUPSTITUISANI GLUKOPIRANOZILOM, LJEKOVI KOJI SADRŽE NAVEDENA JEDINJENJA, NJHOVA PRIMJENA I NJHOV POSTUPAK PROIZVODNJE**  
(EN) **GLUCOPYRANOSYL-SUBSTITUTED BENZOL DERIVATIVES, DRUGS CONTAINING SAID COMPOUNDS, THE USE THEREOF AND METHOD FOR THE PRODUCTION**
- (73) Boehringer Ingelheim International GmbH, Binger Strasse 173, 55216 Ingelheim am Rhein DE
- (72) HIMMELSBACH, Frank Ahornweg 16 88441 Mittelbiberach DE  
ECKHARDT, Matthias Kirschenweg 7 88400 Biberach DE  
EICKELMANN, Peter Nelkenweg 9 88441 Mittelbiberach DE  
BARSOUMIAN, Edward Leon 2-6-18-801 Nishi-Midorigaoka Toyonaka, Osaka 560-0005 JP  
THOMAS, Leo Georg-Schinbain-Str. 221 88400 Biberach DE
- (74) Radulović Božidar, Jovana Tomaševića 9/III, Podgorica ME
- (57) Derivati benzola supstituisani glukopiranozilom opšte formule I

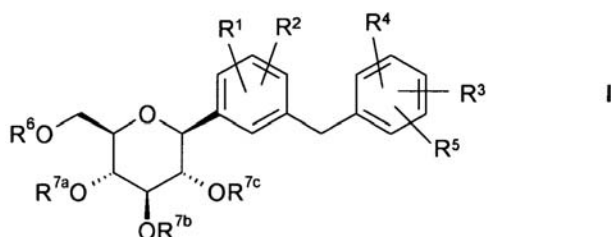

u kojoj R1 je izabrano između sledećih značenja: vodonik, fluor, hlor, brom, jod, C1-4-alkil, C2-6-alkinil, C1-4-alkoksi, C2-4-alkenil-C1-4-alkoksi, C2-4-alkinil- C1-4-alkoksi, metil grupa supstituisana sa 1 do 3 atoma fluora, -etil grupa supstituisana sa 1 do 5 atoma fluora, metoksi grupa supstituisana sa 1 do 3 atoma fluora, etoksi grupa supstituisana sa 1 do 5 atoma fluora, C1-4-alkil grupa supstituisana sa hidroksi- ili C1-3-alkoksi grupom, C2-4-alkoksi grupa supstituisana sa hidroksi- ili C1-3-alkoksi grupom, C2-6-alkenil, C3-6-cikloalkil, C3-6-cikloalkil- C1-3-alkil, C3-7-cikloalkoksi, C3-6-cikloalkil- C1-3-alkoksi, C5-7-cikloalkeniloksi, hidroksi, amino, nitro ili cijano, pri čemu u C5-6-cikloalkil grupama metilen grupa može biti zamenjena sa O, R2 označava vodonik, fluor, hlor, brom, hidroksi, C1-4-alkil, C1-4-alkoksi, cijano ili nitro, pri čemu alkil- ili alkoksi grupa može biti jednostruko ili višestruko supstituisana sa fluorom, i R3 je izabrano između sledećih značenja: tri-(C1-4-alkil)silil- C1-6-alkil, C2-6-alkin-1-il, C2-6-alken-1-il, amino, C1-3-alkilamino, di-(C1-3-alkil)amino, piperidin-1-il, piperidin-2-on-1-il, piperidin-1-il, piperidin-2-on-1-il, morfolin-4-il, morfolin-3-on-4-il, piperazin-1-il, 4(C1-3-alkil)piperazin-1-il, nitro, C3-7-cikloalkiloksi, C5-7-cikloalkeniloksi, C3-7-cikloalkilsulfanil, C3-7-cikloalkilsulfinil, C3-7-cikloalkilsuifonil, C5-7-cikloalkenilsulfanil,

C5-7-cikloalkenilsulfinil, C5-7-cikloalkenilsulfonil, pri čemu napred navedene alkinil i alkenil grupe mogu biti jednostruko ili dvostruko supstituisane sa fluorom ili hlorom, a prvenstveno sa fluorom, i pri čemu napred navedene alkinil i alkenil grupe mogu biti jednostruko ili dvostruko supstituisane sa istim ili različitim radikalima L1, pri čemu napred navedeni cikloalkil i cikloalkenil prstenovi nezavisno jedan od drugog mogu biti jednostruko ili dvostruko supstituisani sa fluorom i C1-3-alkilom, i pri čemu u napred navedenim cikloalkil i cikloalkenil prstenovima jedna ili dve metilen grupe nezavisno jedna od druge mogu biti zamenjene sa O, S, CO, SO, SO<sub>2</sub> ili NRN, a prvenstveno sa O, CO, S, SO<sub>2</sub> ili NRN, te najpoželjnije sa O ili CO, R4, R5 nezavisno jedna od drugog označavaju vodonik, fluor, hlor, brom, jod, cijano, nitro, C1-3-alkil, C1-3-alkoksi, metil ili metoksi koji su supstituisani sa 1 do 3 atoma fluora, RN označava H, C1-4-alkil, C1-4-alkilkarbonil ili C1-4-alkilsulfonil, L1 su nezavisno jedan od drugog izabrani iz grupe koja se sastoji od sledećih: hidroksi-, cijano-, nitro-, C 3-7-cikloalkil, aril-, heteroaril-, C1-4-alkilkarbonil-, arilkarbonil-, heteroarilkarbonil-, aminokarbonil-, C1-4-alkilaminokarbonil-, di-(C1-3-alkil) aminokarbonil-, piperidin-1-ilkarbonil-, piperidin-1-ilkarbonil-, morfolin-4-ilkarbonil, arilaminokarbonil-, heteroarilamino-karbonil-, C1-4-alkoksikarbonil-, aril- C1-3-alkoksikarbonil-, heteroaril- C1-3-alkoksikarbonil-, C1-3-alkiloksi-, ariloksi-, heteroariloksi-, C1-4-alkilsulfanil-, arilsulfanil-, heteroarilsulfanil-, C1-4-alkilsulfinil-, arilsulfinil-, heteroarilsulfinil-, C1-4-alkilsulfonil-, arilsulfonil- i heteroarilsulfonil-; i L2 su nezavisno jedan od drugog izabrani iz grupe koja se sastoji od sledećih: fluor, hlor, brom, jod, C1-3-alkil, difluometil, trifluometil, C1-3-alkoksi, difluormetoksi, trifluormetoksi i cijano; i R6 označava vodonik, (C1-6-alkil)oksikarbonil ili C1-6-alkilkarbonil, R7a, R7b, R7c označavaju vodonik, pri čemu se pod aril grupama pomenutim u definiciji gore navedenih radikala podrazumevaju fenil ili naftil grupe, koje nezavisno jedna od druge mogu biti jednostruko ili dvostruko supstituisane sa istim ili različitim radikalima L2; i pod heteroaril grupama pomenutim u definiciji gore navedenih radikala se podrazumevaju pirolil, furanil, tienil, piridil, indolil, benzofuranil, benzotiofenil, hinolinil, izohinolinil ili tetrazolil grupa, ili se podrazumeva pirolil, furanil, tienil ili piridil grupa, u kojoj su jedna ili dve metin grupe zamenjene sa atomom azota, ili se podrazumeva indolil, benzofuranil, benzotiofenil, hinolinil ili izohinolinil grupa, u kojoj su jedna do tri metin grupe zamenjene sa atomom azota, pri čemu napred navedene heteroaril grupe nezavisno jedna od druge mogu biti jednostruko ili dvostruko supstituisane sa istim ili različitim radikalima L2; pri čemu, ukoliko nije drugačije navedeno, gore navedene alkil grupe mogu biti linearne ili razgranate, njihovi tautomeri, njihovi stereoizomeri, njihove smeše i njihove soli.

Patent sadrži još 46 patentnih zahtjeva.

- (51) **A61M 5/20** (11) **01424**  
**A61M 5/24** (21) **P-2012-74**
- (22) 17.02.2005.
- (30) 20040100647 18. 02. 2004. EP
- (96) 10010976.8 17.02.2005.
- (97) EP 2298391 28.03.2012. 2012/13 EN
- (54) (ME) **PRENOSIVI ELEKTRONSKI UREĐAJ ZA UBRIZGAVANJE TEČNOG LIJEKA**  
 (EN) PORTABLE ELECTRONIC INJECTION DEVICE FOR INJECTING LIQUID MEDICATION
- (73) Ares Trading S.A., Zone Industrielle de l'Ourietaz, 1170 Aubonne CH
- (72) PONGPAIROCHANA, Vincent, Route de Belmont 47 1093 La Conversion CH  
 MACLEAN, Timothy, John Flat 3, 1 Edward Street, Bathwick, Bath and South East Somerset, BA2 4DU GB  
 PRASSER, Robert, Althofnerstr. 20 9330 Althofen AT  
 LAUCHAR, Gerhard, Silberstr. 21 9334 Silbereg AT  
 WURMBAUER, Werner, Tessedorferstr. 117 9020 Klagenfurt AT  
 KOGLER, Gerhard, Bunsenweg 57/5 9330 Althofen AT
- (74) Anđelić Branislav, Svetozara Markovića 12, Podgorica ME
- (57) Uređaj za isporuku lijeka koji se sastoji od kućišta (81), vrata (88) koja, u svojoj otvorenoj poziciji, dopuštaju umetanje/uklanjanje kontejnera sa lijekom (83) u/iz navedenog kućišta (81), mehanizma za otvaranje vrata (89, 123, 125, 126, 82) radi otvaranje/zatvaranja navedenih vrata (88), i potiskujućeg člana (84) koji može biti pomjeren aksijalno iz svoje uvučene pozicije, lociran van navedenog kontejnera za lijek (83), da uđe u navedeni kontejner za lijek (83) i potisne tečni lijek koji se sadrži u navedenom kontejneru za lijek (83) van navedenog kontejnera za lijek (83) da ga isporuči pacijentu, i onda se vrati u svoju uvučenu poziciju, naznačen time, što se sastoji od mehanizma za zabavljanje (94, 129) za automatsko zabavljanje dugmeta za otvaranje vrata (89) nađenog mehanizma za otvaranje vrata (89, 123, 125, 126, 82), da spriječi otvaranje navedenih vrata (88), kada je navedeni potiskujući član (84) unutar navedenog kontejnera za lek (83) i za automatsko otključavanje navedenog dugmeta za otvaranje vrata (89) kada je navedeni potiskujući član (84) u svojoj uvučenoj poziciji.

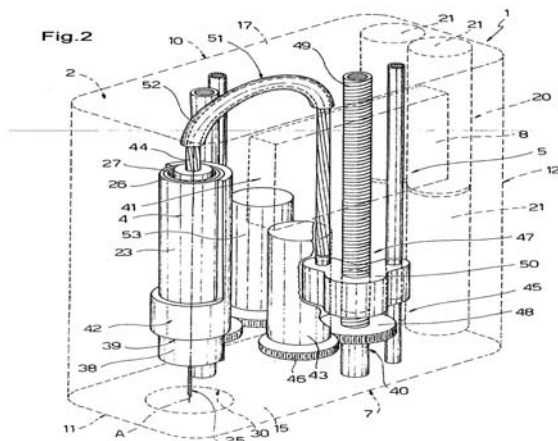

Patent sadrži još 3 patentna zahtjeva.

(51) **C07D215/26**

(11) **01433**

(21) **P-2012-76**

(22) 08.02.2008.

(30) 20070000362 09.02.2007. ES

(86) PCT/EP2008/000975 08.02.2008.

(87) WO 2008/095720 14.08.2008.

(96) 08707620.4 08.02.2008.

(97) EP 2121615 28.03.2012. 2012/13 EN

(54) (ME) **NAPADISILATNA SO 5-(2-{{6-(2,2-DIFLUORO-2-FENILETOKSI)HEKSIL} AMINO} -1-HIDROKSJETIL)-8-HIDROKSIHINOLIN-2(1H)-ONA KAO AGONIST BETA 2 ADRENERGIJSKOG RECEPTORA**

(EN) NAPADISYLATE SALT OF 5-(2-{{6-(2,2-DIFLUORO-2-PHENYLETHOXY) HEXYL}AMINO}-1-HYDROXYETHYL)-8-HYDROXYQUINOLIN-2(1H)-ONE AS AGONIST OF THE BETA 2 ADRENERGIC RECEPTOR

(73) Almirall, S.A. Ronda General Mitre 151, 08022 Barcelona ES

(72) PUIG DURAN, Carlos; C/Asturias 93, 2 2, E-08024 Barcelona ES

MOYES VALLS, Enrique; C/Jaume Piquet 4, E-08017 Barcelona ES

(74) Đakonović Vido, Bajova 9, Cetinje ME

(57) Kristalna mononapadisilatna i/ili heminapadisilatna so 5-(2-{{6-(2,2-difluoro-2-feniletoksi) heksil}amino}-1-hidroksietil)-8-hidroksihinolin-2(1/-)-ona i njeni farmaceutski prihvatljivi solvati.

Patent sadrži još 16 patentnih zahtjeva.

- (51) **A61K31/496**  
**A61P15/00**
- (11) **01343**  
(21) **P-2011-162**
- (22) 06.11.2006.
- (30) 20050734405P 08.11.2005 US  
20060831015P 14.07.2006 US
- (86) PCT/2006EP/68118 06.11.2006
- (87) WO2007054476 18.05.2007
- (96) 06829937.9 06.11.2006
- (97) EP1948177 24.08.2011. 2011/34 EN
- (54) (ME) **PRIMJENA FLIBANSERINA ZA LIJEČENJE POREMEĆAJA SEKSUALNE ŽELJE U PREMENOPAUZI**  
(EN) USE OF FLIBANSERIN FOR THE TREATMENT OF PRE-MENOPAUSAL SEXUAL DESIRE DISORDERS
- (73) Boehringer Ingelheim International GmbH Binger Strasse 173, 55216 Ingelheim am Rhein DE
- (72) POLLENTIER, Stephane, Boschmansweg 17 NL-1871 AW Schoorl NL  
PYKE, Robert, 23 Eastview Drive New Fairfield, Connecticut 06812 US
- (74) Radulović Božidar, Jovana Tomaševića 9/III, Podgorica ME
- (57) Primena flibanserina, opciono u obliku slobodne baze, farmaceutski prihvatljivih kiselih adictonih soli i/ili opciono u obliku njegovih hidrata i/ili solvata za dobijanje leka za lečenje poremećaja seksualne želje kod žena u premenopauzi, gde se lek primenjuje jednom dnevno neprekidno tokom jednog vremenskog perioda.  
Preostalih patentnih zahtjeva je 13.

(51) **C07F9/58**  
**A61K31/44**  
**A61P1/00**  
**A61P11/06**  
**A61P19/02**  
**A61P25/28**  
**A61P29/00**

(11) **01307**  
(21) **P-2011-168**

(22) 25.01.2008.

(30) 20070887981P 02.02.2007. US

(86) PCT/IB2008/000229 25.01.2008.

(87) WO 2008093227 07.08.2008.

(96) 08702351.1 25.01.2008.

(97) EP 2114970 03.08.2011. 2011/31 EN

(54) (ME) **TRICIKLİČKI SPOJEVI I NJIHOVA UPOTREBA KAO MODULATORA**  
**GLUKOKORTIKOIDNIH RECEPTORA**

(EN) TRICYCLIC COMPOUNDS AND THEIR USE AS GLUCOCORTICOID RECEPTOR MODULATORS

(73) Pfizer Products Inc. Eastern Point Road, Groton, CT 06340 US

(72) DEVRAJ, Rajesh, Venkateswaran, Pfizer Global Research&Development 700 Chesterfield Parkway West Chesterfield, MO 63017 US

DE CRESCENZO, Gary, A., 7345 Spruce Hill Court, St. Charles, MO 63304 US

HU, Xiao, Pfizer Global Research and Development 700 Chesterfield Parkway West Chesterfield, Missouri 63017 US

JEROME, Kevin, DeWayne, Pfizer Global Research and Development 700 Chesterfield Parkway West Chesterfield, MO 63017 US

OBUKOWICZ, Mark, Gerard Pfizer Global Research and Development 700 Chesterfield Parkway West, Chesterfield, Missouri 63017 US

OLSON, Lisa, 4 Circle Drive, Hopkinton, Massachusetts 01748 US

RUCKER, Paul, Vincent, 2390 Rising Glen Way Apt. 101, Carlsbad, California 92008 US

WEBBER, Ronald, Keith, Pfizer Global Research and Development 700 Chesterfield Parkway West Chesterfield, Missouri 63017 US

(74) Čupić Branislav, Dalmatinska 10, Podgorica ME

(57) Spoj, naznačen time što ima formulu 1:

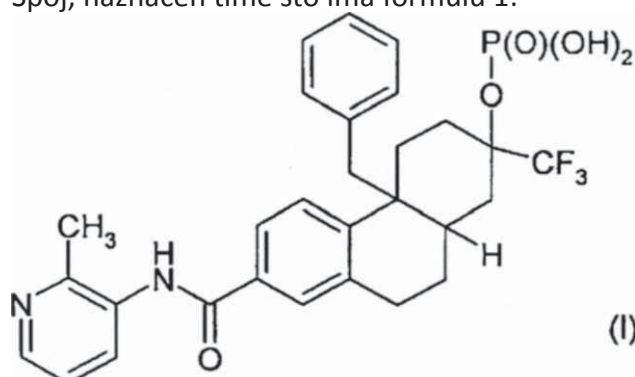

ili njegova sol.

Preostalih patentnih zahtjeva je 7.

- (51) **A61K31/445**  
**A61P13/10**  
**A61P25/04**  
**A61P25/22**  
**A61P25/14**  
**A61P25/28**
- (11) **01308**  
(21) **P/2011-49**
- (22) 05.10.2007.  
(30) 20060829966P 18.10.2006. US  
20070965210P 17.08.2007. US  
(86) PCT/IB2007/003202 05.10.2007.  
(87) WO2008047229 24.04.2008.  
(96) 07848827.7 05.10.2007.  
(97) EP2076508 05.01.2011. 2011/01 EN
- (54) (ME) **JEDINJENJA BIARIL ETRA UREE**  
(EN) BIARYL ETHER UREA COMPOUNDS
- (73) Pfizer Products Inc. Eastern Point Road, Groton, CT 06340 US  
(72) FAY, Lorraine Kathleen, Pfizer Global Research and Development Ann Arbor Laboratories  
2800 Plymouth Road Ann Arbor, MI 48105 US  
JOHNSON, Douglas Scott, Pfizer Global Research and Development Eastern Point Road Gro-  
ton, CT 06340 US  
LAZERWITH, Scott Edward, 853 Commodore Drive 336, San Bruno, CA 94066 US  
MORRIS, Mark Anthony, 7046 Rachel Drive Ypsilanti, MI 48197 US  
WANG, Lijuan Jane, Pfizer Global Research & Development 700 Chesterfield Parkway West  
Chesterfield, MO 63017 US  
MEYERS, Marvin Jay, Pfizer Global Research & Development 700 Chesterfield Parkway West  
Chesterfield, MO 63017 US  
KESTEN, Suzanne Ross, Pfizer Global Research & Development Ann Arbor Laboratories 2800  
Plymouth, MI 48105 US  
STIFF, Cory Michael, Pfizer Global Research and Development Eastern Point Road Groton,  
CT 06340 US
- (74) Ćupić Branislav, Dalmatinska 10, Podgorica ME  
(57)



1. Jedinjenje Formule I,

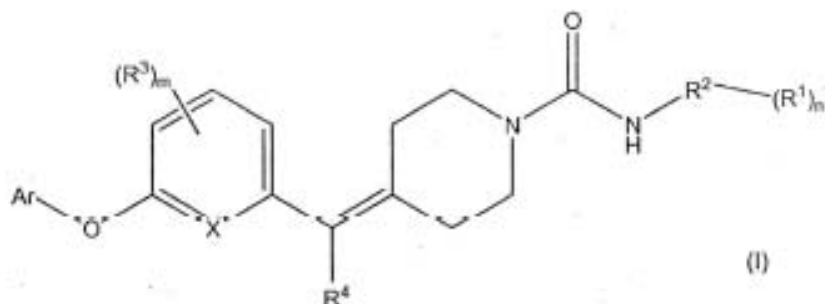

naznačeno time, što su:

$R^1$  svaki nezavisno, predstavlja vodonik, -OH, halogen, haloalkil, -C<sub>1</sub>-C<sub>6</sub>alkil, -O-C<sub>1</sub>-C<sub>6</sub>alkil, -S-C<sub>1</sub>-C<sub>6</sub>alkil, aril, heteroaril, -O-aril, -O-heteroaril, -NH<sub>2</sub>, -NHC(O)C<sub>1</sub>-C<sub>6</sub>alkil, -(CH<sub>2</sub>)<sub>0-3</sub>-C<sub>3</sub>-C<sub>6</sub>cikloalkil, -NHC(O)C<sub>3</sub>-C<sub>6</sub>cikloalkil, -NHC<sub>1</sub>-C<sub>6</sub>alkil, CN, -C(O)NR'R'' ili -C(O)C<sub>1</sub>-C<sub>6</sub>alkil; gde je svaka -C<sub>1</sub>-C<sub>6</sub>alkil grupa u  $R^1$  opciono supstituisana sa -O-C<sub>1</sub>-C<sub>6</sub>alkil grupom, ili sa 1 do 3 -OH supstituenta;

$R'$  i  $R''$  se nezavisno biraju između H ili C<sub>1</sub>-C<sub>6</sub>alkil;

$R^2$  je aril, heteroaril, -C(O)-aril ili -C(O)-heteroaril;

$R^3$  svaki nezavisno, je vodonik, halogen, haloalkil, -C<sub>1</sub>-C<sub>6</sub>alkil, -O-C<sub>1</sub>-C<sub>6</sub>alkil, -S-C<sub>1</sub>-C<sub>6</sub>alkil, -(CH<sub>2</sub>)<sub>0-3</sub>-C<sub>3</sub>-C<sub>6</sub>cikloalkil, -S-C<sub>3</sub>-C<sub>6</sub>cikloalkil i -O-C<sub>3</sub>-C<sub>6</sub>cikloalkil; a pomenute grupe C<sub>1</sub>-C<sub>6</sub>alkil, -O-C<sub>1</sub>-C<sub>6</sub>alkil, -S-C<sub>1</sub>-C<sub>6</sub>alkil, -(CH<sub>2</sub>)<sub>0-3</sub>-C<sub>3</sub>-C<sub>6</sub>cikloalkil, -S-C<sub>3</sub>-C<sub>6</sub>cikloalkil i -O-C<sub>3</sub>-C<sub>6</sub>cikloalkil;

C<sub>6</sub>cikloalkil i -O-C<sub>3</sub>-C<sub>6</sub>cikloalkil u R<sup>3</sup>, su opciono supstituisane sa od 1 do 4 halogen, haloalkil, -O-haloalkil, -C<sub>1</sub>-C<sub>6</sub>alkil ili -O(C<sub>1</sub>-C<sub>6</sub>alkil) supstituenta;

R<sup>4</sup> je vodonik, -C<sub>1</sub>-C<sub>6</sub>alkil, fenil, -(CH<sub>2</sub>)<sub>0-3</sub>-C<sub>3</sub>-C<sub>6</sub>cikloalkil ili halogen; gde su -C<sub>1</sub>-C<sub>6</sub>alkil, fenil i -(CH<sub>2</sub>)<sub>0-3</sub>-C<sub>3</sub>-C<sub>6</sub>cikloalkil grupe u pomenutom R<sup>4</sup> opciono supstituisane sa 1 do 4 halogen, -C<sub>1</sub>-C<sub>6</sub>alkil ili -O(C<sub>1</sub>-C<sub>6</sub>alkil) supstituenta;

X je N, C ili CH;

m je 0, 1, 2, 3 ili 4;

n je 0, 1, 2, 3 ili 4; i

Ar je aril, -CH<sub>2</sub>-aril ili heteroaril, pri čemu su pomenute aril, -CH<sub>2</sub>-aril i heteroaril grupe opciono i nezavisno supstituisane sa 1 do 4 supstituenta, koji se biraju između vodonik, -C<sub>1</sub>-C<sub>6</sub>alkil, -C<sub>2</sub>-C<sub>6</sub>alkenil, -C<sub>2</sub>-C<sub>6</sub>alkinil, -(CH<sub>2</sub>)<sub>0-3</sub>-C<sub>3</sub>-C<sub>6</sub>cikloalkil, halogen, haloalkil, -O-haloalkil, -C(O)C<sub>1</sub>-C<sub>6</sub>alkil, -O-C<sub>1</sub>-C<sub>6</sub>alkil, -S-C<sub>1</sub>-C<sub>6</sub>alkil, -O-C<sub>2</sub>-C<sub>6</sub>alkenil, -O-C<sub>2</sub>-C<sub>6</sub>alkinil, CN, aril, heterociklil ili heteroaril; a pomenuti -C<sub>1</sub>-C<sub>6</sub>alkil, -(CH<sub>2</sub>)<sub>0-3</sub>-C<sub>3</sub>-C<sub>6</sub>cikloalkil, -C(O)C<sub>1</sub>-C<sub>6</sub>alkil, -O(C<sub>1</sub>-C<sub>6</sub>alkil), -S-C<sub>1</sub>-C<sub>6</sub>alkil, aril, -CH<sub>2</sub>-aril, heterociklil i heteroaril supstituenti na Ar, su opciono i nezavisno supstituisani sa 1 do 4 -C<sub>1</sub>-C<sub>6</sub>alkil, -C<sub>1</sub>-C<sub>6</sub>alkoksi, -OH ili halogen supstituentima;

ili njegova farmaceutski prihvatljiva so.

2. Jedinjenje prema Zahtevu 1, naznačeno time, što Ar predstavlja fenil, pirimidinil, piridil, benzotiazol; a R<sup>2</sup> je izoksazol, piridil, pirazinil ili piridazinil; m je 0, 1 ili 2; n je 0 do 2; i X je C ili CH; ili njegova farmaceutski prihvatljiva so.

3. Jedinjenje prema Zahtevu 1 koje ima Formulu III:

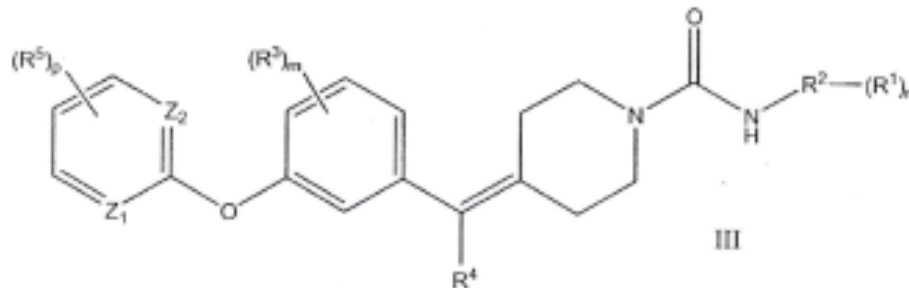

naznačeno time, što su:

**Patent sadrži još 13 patentnih zahtjeva.**

- (51) **C07D401/14**  
**C07D401/04**  
**A61K31/4439**  
**A61P35/00**
- (22) 15.08.2005.
- (30) 20040605244P 26.08.2004. US  
 20050690803P 14.06.2005. US
- (86) PCT/IB2005/002695 15.08.2005.
- (87) WO2006021881 02.03.2006.
- (96) 05782821.2 15.08.2005 .
- (97) EP1784396 22.12.2010. 2010/51 EN
- (54) (ME) **PIRAZOLOM SUPSTITUIRANI HETEROARILNI SPOJEVI KAO INHIBITORI  
 PROTEINSKIH KINAZA**  
 (EN) PYRAZOLE-SUBSTITUTED AMINOHETEROARYL COMPOUNDS AS PROTEIN KINASE INHIBITORS
- (73) Pfizer Inc. 235 East 42nd Street, New York, NY 10017 US
- (72) CUI, Jingrong Jean, Pfizer Global R&D Agouron/Pfizer La Jolla, 10770, Science Ctr Drive San Diego, CA 92121 US  
 FUNK, Lee Andrew, Pfizer Global R&DAgouron/Pfizer La Jolla, 10770, Science Ctr Drive San Diego, CA 92121 US  
 JIA, Lei, Pfizer Global R&D Agouron/Pfizer La Jolla, 10770, Science Ctr Drive San Diego, CA 92121 US  
 KUNG, Pei-Pei, Pfizer Global R&D Agouron/Pfizer La Jolla, 10770, Science Ctr Drive San Diego, CA 92121 US  
 MENG, Jerry Jialun, Pfizer Global R&D Agouron/Pfizer La Jolla, 10770, Science Ctr Drive San Diego, CA 92121 US  
 NAMBU, Mitchell David, Pfizer Global R&D Agouron/Pfizer La Jolla, 10770, Science Ctr Drive San Diego, CA 92121 US  
 PAIRISH, Mason Alan, Pfizer Global R&D Agouron/Pfizer La Jolla, 10770, Science Ctr Drive San Diego, CA 92121 US  
 SHEN, Hong, Pfizer Global R&D Agouron/Pfizer La Jolla, 10770, Science Ctr Drive San Diego, CA 92121 US  
 TRAN-DUBE, Michelle Bich, Pfizer Global R&D Agouron/Pfizer La Jolla, 10770, Science Ctr Drive San Diego, CA 92121 US
- (74) Ćupić Branislav, Dalmatinska 10, Podgorica ME

1. Spoj formule I

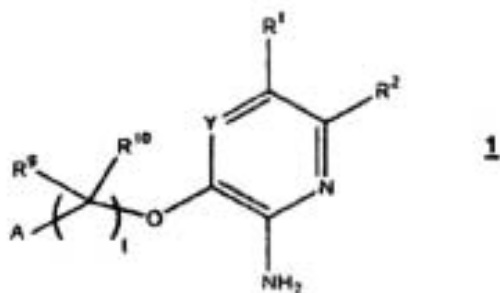

naznačen time Stec:

Y je CR<sup>12</sup>;

A je fenil, supstituiran s jednom, dvije ili tri skupine R<sup>3</sup>;

R<sup>1</sup> se bira između

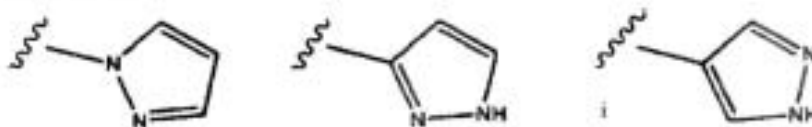

izborno supstituiranih s jednom, dvije ili tri skupine R<sup>3</sup>;

R<sup>2</sup> je vodik;

svaki R<sup>3</sup> je neovisno halogen, C<sub>1-12</sub> alkil, C<sub>2-12</sub> alkenil, C<sub>2-12</sub> alkinil, C<sub>3-12</sub> cikloalkil, C<sub>6-17</sub> aril, 3-12-eročlani heterocicli, 5-12-eročlani heteroaril, -S(O)<sub>n</sub>R<sup>4</sup>, -SO<sub>2</sub>NR<sup>4</sup>R<sup>5</sup>, -S(O)<sub>n</sub>OR<sup>4</sup>, -NO<sub>2</sub>, -NR<sup>4</sup>R<sup>5</sup>, -CN, -C(O)R<sup>4</sup>, -OC(O)R<sup>4</sup>, -O(CR<sup>6</sup>R<sup>7</sup>)<sub>n</sub>R<sup>4</sup>, -O(CR<sup>6</sup>R<sup>7</sup>)(CR<sup>6</sup>R<sup>7</sup>)<sub>n</sub>NR<sup>4</sup>R<sup>5</sup>, -O(CR<sup>6</sup>R<sup>7</sup>)(CR<sup>6</sup>R<sup>7</sup>)<sub>n</sub>OR<sup>4</sup>, -NR<sup>4</sup>C(O)R<sup>4</sup>, -(CR<sup>6</sup>R<sup>7</sup>)<sub>n</sub>C(O)OR<sup>4</sup>, -(CR<sup>6</sup>R<sup>7</sup>)<sub>n</sub>OR<sup>4</sup>, -(CR<sup>6</sup>R<sup>7</sup>)<sub>n</sub>C(O)NR<sup>4</sup>R<sup>5</sup>, -C(-NR<sup>6</sup>)NR<sup>4</sup>R<sup>5</sup>, -NR<sup>4</sup>C(O)NR<sup>4</sup>R<sup>5</sup> ili -NR<sup>4</sup>S(O)<sub>n</sub>R<sup>4</sup>;

svaki R<sup>4</sup>, R<sup>5</sup>, R<sup>6</sup> i R<sup>7</sup> je neovisno vodik, halogen, C<sub>1-12</sub> alkil, C<sub>2-12</sub> alkenil, C<sub>2-12</sub> alkinil, C<sub>3-12</sub> cikloalkil, C<sub>6-17</sub> aril, 3-12-eročlani heterocicli, 5-12-eročlani heteroaril;

R<sup>9</sup> je metil, a R<sup>10</sup> je vodik;

R<sup>12</sup> je vodik;

(57)

svaki  $R^{13}$  je neovisno halogen,  $C_{1-12}$  alkil,  $C_{2-12}$  alkenil,  $C_{2-12}$  alkinil,  $-S(O)_pR^4$ ,  $-SO_2NR^4R^5$ ,  $-S(O)_pOR^4$ ,  $-NO_2$ ,  $-NR^4R^5$ ,  $-CN$ ,  $-OC(O)R^4$ ,  $-O(CR^6R^7)_nR^4$ ,  $-NR^4C(O)R^5$ ,  $-(CR^6R^7)_nC(O)OR^4$ ,  $-(CR^6R^7)_nOR^4$ ,  $C(=NR^6)NR^4R^5$ ,  $-NR^4C(O)NR^5R^6$ ,  $-NR^4S(O)_pR^5$ ,  $-(CR^6R^7)_n(3-12\text{-eročlani heteroalicykli})$ ,  $-(CR^6R^7)_n(C_{3-12}\text{ cikloalkil})$ ,  $-(CR^6R^7)_n(C_{6-12}\text{ aril})$ ,  $-(CR^6R^7)_n(5-12\text{-eročlani heteroaril})$ ,  $-(CR^6R^7)_nC(O)NR^4R^5$  ili  $-(CR^6R^7)_nC(O)R^4$ , gdje se skupine  $R^{13}$  na susjednim atomima se može kombinirati kako bi se dobilo  $C_{6-12}$  arilnu, 5-12-eročlanu heteroarilnu,  $C_{3-12}$  cikloalkilnu ili 3-12-eročlanu heteroalicykličku skupinu, gdje svaki vodik u  $R^{13}$  može izborno biti zamijenjen s  $R^7$ ;

svaki m je neovisno 0, 1 ili 2;

svaki n je neovisno 0, 1, 2, 3 ili 4;

t je 1, i

svaki p je neovisno 1 ili 2;

ili njegova farmaceutski prihvatljiva sol, hidrat ili solvat,

uz uvjet da spoj nije 3-[1-(2,6-diklor-3-fluorfenil)etoksi]-5-{1-[2-(pirolidin-1-il)etil]-1*H*-pirazol-4-il}piridin-2-ilamin, 3-[1-(2,6-diklor-3-fluorfenil)etoksi]-5-{1-[2-(diizopropilamino)etil]-1*H*-pirazol-4-il}piridin-2-ilamin, 3-[1-(2,6-diklor-3-fluorfenil)etoksi]-5-{1-[2-(morfolin-4-il)etil]-1*H*-pirazol-4-il}piridin-2-ilamin ili 3-[1-(2,6-diklor-3-fluorfenil)etoksi]-5-(1-metil-1*H*-pirazol-4-il)piridin-2-ilamin.

2. Spoj u skladu s patentnim zahtjevom 1, naznačen time što je spoj formule **2b**

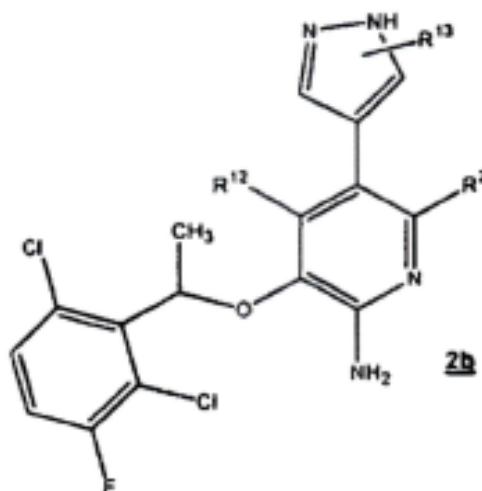

ili njegova farmaceutski prihvatljiva sol, hidrat ili solvat.

3. Spoj u skladu s patentnim zahtjevom 1, naznačen time što je spoj formule **3b**

**Patent sadrži još 47 patentnih zahtjeva.**

- (51) **A61K31/439**  
**A61P11/06**  
**A61P11/08**
- (11) **01336**  
(21) **P-2011-178**
- (22) 31.01.2008.  
(30) 20070902843P 21.02.2007. US  
(86) PCT/EP2008/000782 31.01.2008.  
(87) WO2008101591 28.08.2008.  
(96) 08707469.6 31.01.2008.  
(97) EP2120936 22.06.2011. 2011/25 EN
- (54) (ME) **NOVE METODE**  
(EN) NOVEL METHODS
- (73) Almirall, S.A. Ronda General Mitre 151, 08022 Barcelona ES  
(72) BELETA SUPERVIA, Jorge, San Rafael, 54-56, 2 2a E-08173 Sant Cugat del Valles ES  
(74) Čupić Branislav, Dalmatinska 10, Podgorica ME
- (57) Aclidinium za upotrebu u liječenju ili sprečavanju neke respiratorne bolesti ili stanja kod pacijenta putem inhalacije, pri čemu pacijent boluje ili je podložan stanju koje može biti pogoršano sistemskom antimuskularnom aktivnošću.  
Preostalih patentnih zahtjeva je 12.

- (51) **A61K31/485**  
**A61K9/22**  
**A61K9/32**
- (11) **01339**  
(21) **P-2011-27**
- (22) 24.08.2007.  
(30) 20060840244P 25.08.2006. US  
(96) 09156843.6 24.08.2007.  
(97) EP2082742 01.12.2010. 2010/48 EN
- (54) (ME) **FARMACEUTSKI DOZNI OBLICI REZISTENTNI NA ZLOUPOTREBU KOJI SADRŽE OPIOIDNI ANALGETIK**  
(EN) TAMPER RESISTANT ORAL PHARMACEUTICAL DOSAGE FORMS COMPRISING AN OPIOID ANALGESIC
- (73) Purdue Pharma LP One Stamford Forum 201 Tresser Boulevard, Stamford, CT 06901 US  
(72) MCKENNA, William Henry 10 Longmeadow Road Yonkers, NY 10704 US  
MANNION, Richard Owen 3860 Green Ridge Road Furlong, PA 18925 US  
O'DONNELL, Edward Patrick 38 Chestnut Court Basking Ridge, NJ 07920 US  
HUANG, Haiyong Hugh 33 Ketley Place Princeton, NJ 08540 US
- (74) Lutovac Branislav, Bulevar Crnojevića 93, Podgorica ME
- (57) Čvrst oralni farmaceutski dozni oblik sa produženim oslobađanjem, koji sadrži formulaciju matrice sa produženim oslobađanjem, a formulacija matrice sa produženim oslobađanjem sadrži kompoziciju koja sadrži (1) bar jedan polietilen oksid koji na osnovu reoloških merenja ima približnu molekulsku težinu od najmanje 1,000,000; i (2) bar jedan aktivan agens; i gde je formulacija matrice sa produženim oslobađanjem očvršćavana na temperaturi od oko 60°C u toku vremenskog perioda od oko 1 minut i ima silu stvaranja naprsline od bar 110N kada se podvrgne testu utiskivanja.  
Preostalih patentnih zahtjeva je 29.

(51) **A01N43/56**(11) **01322**(21) **P-2011-35**

(22) 23.04.2008.

(30) 20070008370 25.04.2007. EP

(86) PCT/EP2008/003279 23.04.2008.

(87) WO2008131901 06.11.2008.

(96) 08749078.5 23.04.2008.

(97) EP2150113 08.12.2010. 2010/49 EN

(54) (ME) **FUNGICIDNE KOMPOZICIJE**  
(EN) **FUNGICIDAL COMPOSITIONS**

(73) Syngenta Participations AG Schwarzwaldallee 215, 4058 Basel CH

(72) TOBLER, Hans Birsigstrasse 129 CH-4054 Basel CH

WALTER, Harald Syngenta Crop Protection Mönchwilen AG Schwauffhauserstrasse CH-4332 Stein CH

HAAS, Ulrich, Johannes Syngenta Crop Protection Mönchwilen AG Schaffhauserstrasse CH-4332 Stein CH

(74) Radulović Božidar, Jovana Tomaševića 9/III, Podgorica ME

(57) Kompozicija prikladna za kontrolu bolesti koje su uzrokovane preko fitopatogena, naznačena time, da obuhvata (A) jedinjenje sa formulom I gde R, je difluorometil ili trifluorometil, a X je hloro, fluoro ili bromo; i (B) najmanje jedno jedinjenje koje je izabrano iz grupe koja obuhvata (BI) strobilurin fungicid.

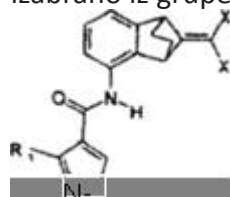

Preostalih patentnih zahtjeva je 12.



(51) **C07K14/52**

(11) **01320**

(21) **P-2011-47**

(22) 25.07.2007.

(30) 20060014755 25.07.2006. GB

(86) PCT/IB2007/003026 25.07.2007.

(87) WO2008012689 31.01.2008.

(96) 07825334.1 25.07.2007.

(97) EP2076532 01.12.2010. 2011/48 EN

(54) (ME) **DERIVATI CITOKINA**

(EN) CYTOKINE DERIVATIVES

(73) Mintaka Foundation for Medical Research Chemin des Aulx 14, 1228 Plan-les-Ouates CH

(72) HARTLEY, Oliver Dept. of Structural Biology and Bioinformatics Centre Médical

Universitaire 1 rue Michel Servet CH-1211 Genève 4 CH

(74) Radulović Božidar, Jovana Tomaševića 9/III, Podgorica ME

(57) Polipeptid koji ima N-terminalni dio i C-terminalni dio, naznačen time da N-terminalni dio sadrži potpisnu sekvencu QGP[P ili L] i sekvenca amino kiseline, navedenog C-terminalnog dijela je u barem 70 % identična sa SEQ ID NO: 1.

Preostalih patentnih zahtjeva je 14.

- (51) **C07D471/04** (11) **01338**  
**A61K31/519** (21) **P-2011-157**  
**A61P35/00**
- (22) 03.09.2007.  
(30) US20060845065P 15.09.2006.  
US20070947852P 03.07.2007.  
US20070952628P 30.07.2007.  
(86) PCT/IB2007/002578 03.09.2007.  
(87) WO2008032162 20.03.2008.  
(96) 07804890.7 03.09.2007.  
(97) EP2074122 29.06.2011. 2011/26 EN
- (54) (ME) **SPOJEVI PIRIDO(2,3-d)PIRIMIDINONA I NJIHOVA UPOTREBA KAO INHIBITORI PI3**  
(EN) PYRIDO (2, 3-D) PYRIMIDINONE COMPOUNDS AND THEIR USE AS PI3 INHIBITORS
- (73) Pfizer Products Inc. Eastern Point Road, Groton, CT 06340 US
- (72) HENG, Hengmiao Agouron Pharmaceuticals, Inc. A Pfizer Company 10777 Science Center Drive San Diego, CA 92121 US  
BHUMRALKAR, Dilip 25343 Silver Aspen Way 338 Valencia, California 91381 US  
DRESS, Klaus, Ruprecht Agouron Pharmaceuticals, Inc. A Pfizer Company 10777 Science Center Drive San Diego, California 92121 US  
HOFFMAN, Jacqui, Elizabet Agouron Pharmaceuticals, Inc. A Pfizer Company 10777 Science Center Drive San Diego, California 92121 US  
JOHNSON, Mary, Catherine Agouron Pharmaceuticals, Inc. A Pfizer Company 10777 Science Center Drive San Diego, California 92121 US  
KANIA, Robert, Steven Agouron Pharmaceuticals, Inc. A Pfizer Company 10777 Science Center Drive San Diego, California 92121 US  
LE, Phuong, Thi, Quy Agouron Pharmaceuticals, Inc. A Pfizer Company 10777 Science Center Drive San Diego, California 92121 US  
NAMBU, Mitchell, David 3105 Ducommun Avenue San Diego, California 92122 US  
PAIRISH, Mason, Alan Agouron Pharmaceuticals, Inc. A Pfizer Company 10777 Science Center Drive San Diego, California 92121 US  
PLEWE, Michael, Bruno Agouron Pharmaceuticals, Inc. A Pfizer Company 10777 Science Center Drive San Diego, California 92121 US  
TRAN, Khanh, Tuan Agouron Pharmaceuticals, Inc. A Pfizer Company 10777 Science Center Drive San Diego, California 92121 US
- (74) Čupić Branislav, Dalmatinska 10, Podgorica ME
- (57)

1. Spoj Formule (I)

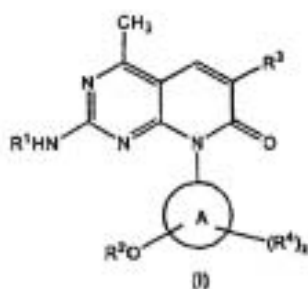

ili njegova sol,

maznačen time što:

R<sup>1</sup> je H ili (C<sub>1</sub> do C<sub>6</sub>) alkil, izborno supstituiran s najmanje jednom skupinom R<sup>5</sup>,

A je 3- do 10-eročlana cikloalkilna skupina;

R<sup>2</sup> je (C<sub>1</sub> do C<sub>6</sub>) alkil, supstituiran s najmanje jednom skupinom R<sup>6</sup>, (C<sub>7</sub> do C<sub>10</sub>) cikloalkil, (C<sub>2</sub> do C<sub>6</sub>) cikloheteroalkil, (C<sub>4</sub> do C<sub>14</sub>) aril, (C<sub>2</sub> do C<sub>6</sub>) heteroaril, -NR<sup>7</sup>R<sup>8</sup> ili -N-CR<sup>9</sup>R<sup>10</sup>, gdje je svaki od navedenih (C<sub>1</sub> do C<sub>10</sub>) cikloalkila, (C<sub>2</sub> do C<sub>6</sub>) cikloheteroalkila, (C<sub>4</sub> do C<sub>14</sub>) arila, te (C<sub>2</sub> do C<sub>6</sub>) heteroarila izborno supstituiran s najmanje jednom skupinom R<sup>6</sup>;

R<sup>3</sup> je (C<sub>1</sub> do C<sub>6</sub>) alkil, (C<sub>7</sub> do C<sub>10</sub>) cikloalkil, (C<sub>2</sub> do C<sub>6</sub>) cikloheteroalkil, (C<sub>2</sub> do C<sub>6</sub>) alkenil, (C<sub>2</sub> do C<sub>6</sub>) alkinil, halogen, cijano, -(CH<sub>2</sub>)<sub>6</sub>C(O)OR<sup>11</sup>, -(CH<sub>2</sub>)<sub>6</sub>C(O)N(R<sup>12</sup>R<sup>13</sup>), COR<sup>12</sup>, (C<sub>4</sub> do C<sub>14</sub>) aril ili (C<sub>2</sub> do C<sub>6</sub>) heteroaril, gdje su navedeni (C<sub>1</sub> do C<sub>6</sub>) alkil, (C<sub>7</sub> do C<sub>10</sub>) cikloalkil, (C<sub>2</sub> do C<sub>6</sub>) cikloheteroalkil, (C<sub>2</sub> do C<sub>6</sub>) alkenil, (C<sub>2</sub> do C<sub>6</sub>) alkinil, (C<sub>4</sub> do C<sub>14</sub>) aril i (C<sub>2</sub> do C<sub>6</sub>) heteroaril izborno supstituirani s najmanje jednom skupinom R<sup>7</sup>;

svaki R<sup>4</sup> je neovisno -OH, halogen, CF<sub>3</sub>, -NR<sup>14</sup>R<sup>15</sup>, (C<sub>1</sub> do C<sub>6</sub>) alkil, (C<sub>1</sub> do C<sub>6</sub>) alkenil, (C<sub>1</sub> do C<sub>6</sub>) alkinil, (C<sub>1</sub> do C<sub>6</sub>) alkoksi, cijano, (C<sub>7</sub> do C<sub>10</sub>) cikloalkil, (C<sub>2</sub> do C<sub>6</sub>) cikloheteroalkil, (C<sub>4</sub> do C<sub>14</sub>) aril, (C<sub>2</sub> do C<sub>6</sub>) heteroaril, -C(O)R<sup>17</sup>, -C(O)NR<sup>18</sup>R<sup>19</sup>, -S(O)<sub>2</sub>R<sup>17</sup>, -S(O)<sub>2</sub>NR<sup>18</sup>R<sup>19</sup>, -NR<sup>18</sup>S(O)<sub>2</sub>R<sup>17</sup>, -(CH<sub>2</sub>)<sub>6</sub>C(O)OR<sup>20</sup>, -(CH<sub>2</sub>)<sub>6</sub>C(O)N(R<sup>21</sup>R<sup>22</sup>), -OC(O)R<sup>17</sup>, -NR<sup>18</sup>C(O)R<sup>17</sup> ili -NR<sup>18</sup>C(O)N(R<sup>21</sup>R<sup>22</sup>), gdje je svaki od navedenih (C<sub>1</sub> do C<sub>6</sub>) alkila, (C<sub>1</sub> do C<sub>6</sub>) alkenila, (C<sub>1</sub> do C<sub>6</sub>) alkinila, (C<sub>1</sub> do C<sub>6</sub>) alkoksi, (C<sub>7</sub> do C<sub>10</sub>) cikloalkila, (C<sub>2</sub> do C<sub>6</sub>) cikloheteroalkila, (C<sub>4</sub> do C<sub>14</sub>) arila, te (C<sub>2</sub> do C<sub>6</sub>) heteroarila izborno supstituiran s najmanje jednom skupinom R<sup>7</sup>;

svaki R<sup>5</sup> je neovisno -OH, halogen, CF<sub>3</sub>, -NR<sup>14</sup>R<sup>15</sup>, (C<sub>1</sub> do C<sub>6</sub>) alkil, (C<sub>1</sub> do C<sub>6</sub>) alkoksi, cijano, (C<sub>7</sub> do C<sub>10</sub>) cikloalkil, (C<sub>2</sub> do C<sub>6</sub>) cikloheteroalkil, (C<sub>4</sub> do C<sub>14</sub>) aril, (C<sub>2</sub> do C<sub>6</sub>) heteroaril, -S(O)<sub>2</sub>R<sup>17</sup>, -S(O)<sub>2</sub>NR<sup>18</sup>R<sup>19</sup>, -C(O)R<sup>17</sup> ili -C(O)NR<sup>18</sup>R<sup>19</sup>, gdje je svaki od navedenih (C<sub>1</sub> do C<sub>6</sub>) alkila, (C<sub>1</sub> do C<sub>6</sub>) alkoksi, (C<sub>7</sub> do C<sub>10</sub>) cikloalkila, (C<sub>2</sub> do C<sub>6</sub>) cikloheteroalkila, (C<sub>4</sub> do C<sub>14</sub>) arila, te (C<sub>2</sub> do C<sub>6</sub>) heteroarila izborno supstituiran s najmanje jednom skupinom R<sup>7</sup>;

svaki  $R^6$  je neovisno -OH, (C<sub>1</sub> do C<sub>6</sub>) alkinil, cijano, (C<sub>3</sub> do C<sub>10</sub>) cikloalkil, (C<sub>2</sub> do C<sub>6</sub>) cikloheteroalkil, (C<sub>6</sub> do C<sub>14</sub>) aril, (C<sub>2</sub> do C<sub>6</sub>) heteroaril, -C(O)R<sup>12</sup>, -C(O)NR<sup>11a</sup>R<sup>11b</sup>, -S(O)<sub>m</sub>R<sup>12</sup>, -S(O)<sub>m</sub>NR<sup>11a</sup>R<sup>11b</sup>, -NR<sup>11a</sup>S(O)<sub>m</sub>R<sup>12</sup>, -(CH<sub>2</sub>)<sub>6</sub>C(O)OR<sup>10</sup>, -(CH<sub>2</sub>)<sub>6</sub>C(O)N(R<sup>13a</sup>R<sup>13b</sup>), -OC(O)R<sup>12</sup>, -NR<sup>11a</sup>C(O)R<sup>12</sup> ili -NR<sup>11a</sup>C(O)N(R<sup>13a</sup>R<sup>13b</sup>), gdje je svaki od navedenih (C<sub>1</sub> do C<sub>6</sub>) alkinila, (C<sub>3</sub> do C<sub>10</sub>) cikloalkila, (C<sub>2</sub> do C<sub>6</sub>) cikloheteroalkila, (C<sub>6</sub> do C<sub>14</sub>) arila, te (C<sub>2</sub> do C<sub>6</sub>) heteroarila izborno supstituiran s najmanje jednom skupinom R<sup>17</sup>;

svaki od R<sup>7a</sup> i R<sup>7b</sup> je neovisno H, (C<sub>1</sub> do C<sub>6</sub>) alkil, (C<sub>2</sub> do C<sub>6</sub>) alkenil, (C<sub>2</sub> do C<sub>6</sub>) alkinil, (C<sub>2</sub> do C<sub>10</sub>) cikloalkil ili (C<sub>6</sub> do C<sub>10</sub>) aril, gdje je svaki od navedenih (C<sub>1</sub> do C<sub>6</sub>) alkila, (C<sub>2</sub> do C<sub>6</sub>) alkenila, (C<sub>2</sub> do C<sub>6</sub>) alkinila, (C<sub>2</sub> do C<sub>10</sub>) cikloalkila, te (C<sub>6</sub> do C<sub>10</sub>) arila izborno supstituiran s najmanje jednom skupinom R<sup>9</sup>; ili se R<sup>7a</sup> i R<sup>7b</sup> može uzeti zajedno s atomom dujika kako bi tvorili 5- do 8-člani heterociklični prsten, gdje navedeni heterociklični prsten ima 1 do 3 heteroatoma u prstenu, koje se bira iz skupine koju čine N, O i S, te gdje je navedeni 5- do 8-člani cikloheteroalkilni prsten izborno supstituiran s najmanje jednom skupinom R<sup>9</sup>;

svaki od R<sup>8a</sup> i R<sup>8b</sup> je neovisno H, (C<sub>1</sub> do C<sub>6</sub>) alkil ili (C<sub>3</sub> do C<sub>10</sub>) cikloalkil, gdje je svaki od navedenih (C<sub>1</sub> do C<sub>6</sub>) alkila i (C<sub>3</sub> do C<sub>10</sub>) cikloalkila izborno supstituiran s najmanje jednom skupinom R<sup>9</sup>;

svaki R<sup>8</sup> je neovisno -OH, halogen, CF<sub>3</sub>, -NR<sup>13a</sup>R<sup>13b</sup>, (C<sub>1</sub> do C<sub>6</sub>) alkil, (C<sub>1</sub> do C<sub>6</sub>) alkenil, (C<sub>1</sub> do C<sub>6</sub>) alkinil, (C<sub>1</sub> do C<sub>6</sub>) alkoksi, cijano, (C<sub>3</sub> do C<sub>10</sub>) cikloalkil, (C<sub>2</sub> do C<sub>6</sub>) cikloheteroalkil, (C<sub>6</sub> do C<sub>14</sub>) aril, (C<sub>2</sub> do C<sub>6</sub>) heteroaril, -C(O)R<sup>12</sup>, -C(O)NR<sup>11a</sup>R<sup>11b</sup>, -S(O)<sub>m</sub>R<sup>12</sup>, -S(O)<sub>m</sub>NR<sup>11a</sup>R<sup>11b</sup>, -NR<sup>11a</sup>S(O)<sub>m</sub>R<sup>12</sup>, -(CH<sub>2</sub>)<sub>6</sub>C(O)OR<sup>10</sup>, -(CH<sub>2</sub>)<sub>6</sub>C(O)N(R<sup>13a</sup>R<sup>13b</sup>), -OC(O)R<sup>12</sup>, -NR<sup>11a</sup>C(O)R<sup>12</sup> ili -NR<sup>11a</sup>C(O)N(R<sup>13a</sup>R<sup>13b</sup>), gdje je svaki od navedenih (C<sub>1</sub> do C<sub>6</sub>) alkila, (C<sub>1</sub> do C<sub>6</sub>) alkenila, (C<sub>1</sub> do C<sub>6</sub>) alkinila, (C<sub>1</sub> do C<sub>6</sub>) alkoksi, (C<sub>3</sub> do C<sub>10</sub>) cikloalkila, (C<sub>2</sub> do C<sub>6</sub>) cikloheteroalkila, (C<sub>6</sub> do C<sub>14</sub>) arila, te (C<sub>2</sub> do C<sub>6</sub>) heteroarila izborno supstituiran s najmanje jednom skupinom R<sup>17</sup>;

svaki R<sup>10</sup> je neovisno H, ili (C<sub>1</sub> do C<sub>6</sub>) alkil;

R<sup>11a</sup> i R<sup>11b</sup> svaki od je neovisno H, (C<sub>1</sub> do C<sub>6</sub>) alkil, (C<sub>2</sub> do C<sub>6</sub>) cikloheteroalkil, (C<sub>2</sub> do C<sub>6</sub>) heteroaril ili (C<sub>6</sub> do C<sub>14</sub>) aril, gdje je svaki od navedenih (C<sub>1</sub> do C<sub>6</sub>) alkila, (C<sub>2</sub> do C<sub>6</sub>) cikloheteroalkila, (C<sub>2</sub> do C<sub>6</sub>) heteroarila, te (C<sub>6</sub> do C<sub>14</sub>) arila izborno supstituiran s najmanje jednom skupinom R<sup>17</sup>;

svaki od R<sup>12</sup> je neovisno (C<sub>1</sub> do C<sub>6</sub>) alkil, (C<sub>3</sub> do C<sub>10</sub>) cikloalkil, (C<sub>2</sub> do C<sub>6</sub>) cikloheteroalkil, (C<sub>2</sub> do C<sub>6</sub>) heteroaril ili (C<sub>6</sub> do C<sub>14</sub>) aril, gdje je svaki od navedenih (C<sub>1</sub> do C<sub>6</sub>) alkila, (C<sub>3</sub> do C<sub>10</sub>) cikloalkila, (C<sub>2</sub> do C<sub>6</sub>) cikloheteroalkila, (C<sub>2</sub> do C<sub>6</sub>) heteroarila, te (C<sub>6</sub> do C<sub>14</sub>) arila izborno supstituiran s najmanje jednom skupinom R<sup>17</sup>;

svaki od R<sup>13</sup> je neovisno -OH, halogen, CF<sub>3</sub>, (C<sub>1</sub> do C<sub>6</sub>) alkil, (C<sub>1</sub> do C<sub>6</sub>) alkenil, (C<sub>1</sub> do C<sub>6</sub>) alkinil, (C<sub>1</sub> do C<sub>6</sub>) alkoksi, cijano, (C<sub>3</sub> do C<sub>10</sub>) cikloalkil, (C<sub>2</sub> do C<sub>6</sub>) cikloheteroalkil, (C<sub>6</sub> do C<sub>14</sub>) aril, (C<sub>2</sub> do C<sub>6</sub>) heteroaril, amino, karbonil, C-amido, sulfinil, S-sulfonamido, C-karboksil, N-amido ili N-karbamil;

svaki m je neovisno 1 ili 2;

svaki n je neovisno 0, 1, 2, 3 ili 4; i

svaki z je cijeli broj, kojeg se neovisno bira između 0, 1, 2, 3, 4, 5, 6, 7 ili 8.

2. Spoj ili sol u skladu s patentnim zahtjevom 1, naznačen time što A je cikloheksil.
3. Spoj ili sol u skladu s patentnim zahtjevom 1 ili 2, naznačen time što R<sup>5</sup> je (C<sub>6</sub> do C<sub>14</sub>) aril ili (C<sub>2</sub> do C<sub>6</sub>) heteroaril, gdje su navedeni (C<sub>6</sub> do C<sub>14</sub>) aril ili (C<sub>2</sub> do C<sub>6</sub>) heteroaril izborno supstituirani s najmanje jednom skupinom R<sup>8</sup>.
4. Spoj u skladu s patentnim zahtjevom 1, naznačen time što ga se bira iz skupine koju čine: 2-amino-6-(5-fluoro-6-metoksipiridin-3-il)-8-[*trans*-4-(2-hidroksietoksi)cikloheksil]-4-metilpirido[2,3-*d*]pirimidin-7(8*H*)-on; 2-amino-8-[*trans*-4-(2-hidroksietoksi)cikloheksil]-6-(6-metoksipiridin-3-il)-4-metilpirido[2,3-*d*]pirimidin-7(8*H*)-on; 2-amino-8-[*trans*-4-(2-hidroksietoksi)cikloheksil]-4-metil-6-kinolin-3-ilpirido[2,3-

**Patent sadrži još 15 patentnih zahtjeva.**

- (51) **A61K45/06**  
**A61P13/10**
- (22) 21.12.2007.
- (30) 20060871719P 22.12.2006 US
- (86) PCT/EP2007/011313 21.12.2007.
- (87) WO2008077599 03.07.2008.
- (96) 07857036.3 21.12.2007.
- (97) EP2125021 08.06.2011. 2011/23 EN
- (54) (ME) **KOMBINOVANA TERAPIJA LIGANADA  $\alpha 2\delta$  I NSAID ZA POREMEĆAJE DONJEG URINARNOG TRAKTA**  
(EN) COMBINATION THERAPY OF LOWER URINARY TRACT DISORDERS WITH ALPHA 2DELTA LIGANDS AND NSAIDS
- (73) Recordati Ireland Limited Raheens East Ringaskiddy, County Cork IE
- (72) LEONARDI, Amedeo, Via Poliziano, 16 20154 Milano IT  
GUARNERI, Luciano, Via Canova, 18 20024 Garbagnate Milanese IT  
ANGELICO, Patrizia, Via Vittorio Alfieri 60 20099 Sesto San Giovanni IT
- (74) Lutovac Branislav, Bulevar Crnojevića 93, Podgorica ME
- (57) Ligand podjedinice  $\alpha 2\delta$  kalcijumovog kanala ( $A2d$ ) koji se bira iz grupe koju čine: gabapentin, pregabalin, (1R,5R,6S)-6-aminometil-6-karboksimetil-biciklo[3.2.0]heptan, 3-(1-aminometilcikloheksilmetil)-4H-1,2,4-oksadiazol-5-on, 5-(1-aminometil-cikloheksilmetil)-1H-tetrazol, (3S,4S)-(1-aminometil-1-karboksimetil-3,4-dimetil-ciklopentan, (1a,3a,5a)-(3-aminometil-3-karboksimetil-biciklo[3.2.0]heptan, (3S,5R)-3-aminometil-5-metiloktanska kiselina, (3S,5R)-3-amino-5-metil-heptanska kiselina, (3S,5R)-3-amino-5-metiloktanska kiselina, (3S,5R)-3-amino-5-metilnonanska kiselina, (2S,4S)-4-(3-hlorofenoksi)-prolin ili (2S,4S)-4-(3-fluorobenzil)-prolin, ili smeša dva ili više navedenih, za upotrebu u tretmanu urinarne inkontinencije kod subjekta koji pati od nekog poremećaja donjeg urinarnog trakta, u kombinaciji sa prethodno, istovremeno ili naknadno ordiniranim nesteroidnim anti-inflamatornim lekom (NSAID).  
Preostalih patentnih zahtjeva je 10.

- (51) **A61K31/353**  
**A61K31/357**  
**A61P3/04**
- (11) **01344**  
(21) **P-2011-166**
- (22) 19.12.2006.  
(30) 20050751499P 19.12.2005. US  
20060611938 18.12.2006. US  
(86) PCT/US06/048681 19.12.2006.  
(87) WO2007075833 05.07.2007.  
(96) 06847860.1 19.12.2006.  
(97) EP 1968574 10.08.2011. 2011/32 EN
- (54) (ME) **UPOTREBA DERIVATA BENZO-KONDEZOVANIH HETEROCIKLIČNIH  
SULFAMIDA ZA LIJEČENJE GOJAZNOSTI**  
(EN) USE OF BENZO-FUSED HETEROCYCLE SULFAMIDE DERIVATIVES FOR THE TREATMENT  
OF OBESITY
- (73) Janssen Pharmaceutica N.V. Turnhoutseweg 30, 2340 Beerse BE  
(72) SWINTOSKY, Smith, Virginia L. Hatfield, Pennsylvania 19440 US  
REITZ, Allen B. 109 Greenbriar Road Lansdale, Pennsylvania 19446 US  
(74) Radulović Božidar, Jovana Tomaševića 9/III, Podgorica ME

1. Spoj formule (I):

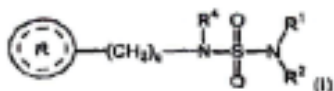

ili njegova farmaceutski prihvatljiva sol za upotrebu kod liječenja pretilosti, poticanje gubitka težine ili suzbijanje apetita **naznačen time** da:

R<sup>1</sup> i R<sup>2</sup> su svaki nezavisno odabrani iz skupine koju čine vodik i niži alkil;

R<sup>4</sup> je odabran iz skupine koju sačinjavaju vodik i niži alkil;

a je cijeli broj od 1 do 2;



je odabran iz skupine koju sačinjavaju

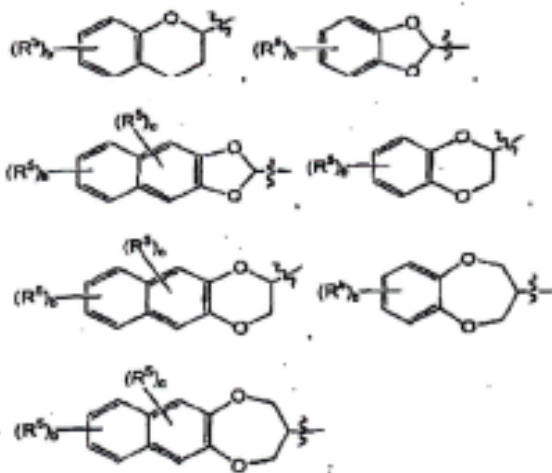

pri čemu b je cijeli broj od 0 do 4; i gdje a je cijeli broj od 0 do 2;

svaki R<sup>5</sup> je nezavisno odabran iz skupine koja sadrži halogen i niži alkil;

pri čemu "niži alkil" se odnosi na spoj ugljikovog lanca sa 1-4 atoma ugljika, pod uvjetom da kada

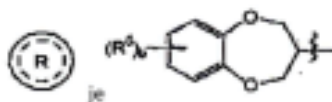

(57)

je ili

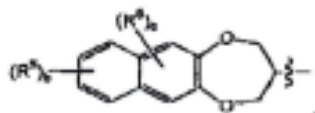

tada a je 1.

2. Spoj ili njegova farmaceutski prihvatljiva sol prema zahtjevu 1, **naznačen time** da:

$R^1$  i  $R^2$  su svaki nezavisno odabrani iz skupine koju čine vodik i niži alkil;

$R^3$  je odabran iz skupine koju sačinjavaju vodik i niži alkil;

a je cijeli broj od 1 do 2;



je odabran iz skupine koju sačinjavaju

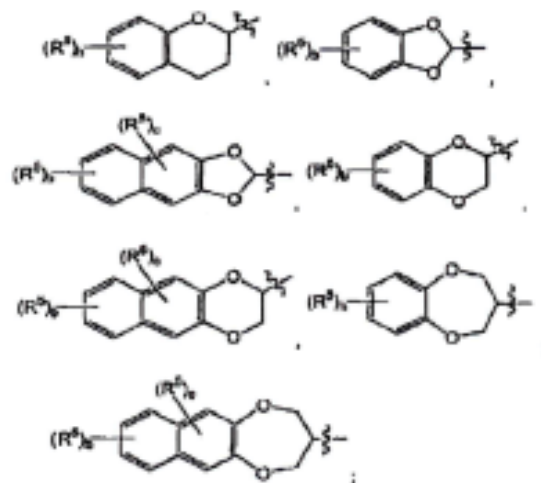

gdje je cijeli broj od 0 do 2; gdje e je cijeli broj od 0 do 1;

svaki  $R^5$  je Nezavisno odabran iz skupine koja sadrži halogen i niži alkil ;

pri čemu "niži alkil" se odnosi na spoj ugljikovog lanca sa 1-4 atoma ugljika,

pod uvjetom da kada

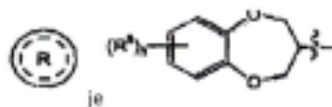

ili

**Patent sadrži još 8 patentnih zahtjeva.**



(51) **C07C217/10**  
**C07C217/26**  
**C07C233/43**  
**C07C275/32**  
**C07D215/26**  
**C07D233/74**  
**A61K31/135**  
**A61K31/415**  
**A61K31/47**  
**A61P11/00**

(11) **01296**  
(21) **P-2011-169**

(22) 17.05.2006.

(30) 20050001229 20.05.2005. ES

(86) PCT/EP2006/004680 17.05.2006.

(87) WO2006/122788 23.11.2006.

(96) 06742964.7 17.05.2006.

(97) EP1885684 13.07.2011. 2011/28 EN

(54) (ME) **DERIVATI 4-(2-AMINO-1-HIDROKSJETIL) FENOL KAO AGONISTI BETA-2 ADRENERGIČKIH RECEPTORA**

(EN) DERIVATIVES OF 4-(2-AMINO-1-HYDROXYETHYL)PHENOL AS AGONISTS OF THE BETA-2 ADRENERGIC RECEPTOR

(73) Almirall, S.A. Ronda General Mitre 151 08022 Barcelona ES

(72) UIG DURAN, Carlos, Asturias 93, 2 2 E-08024 Barcelona ES

CRESPO CRESPO, Maria, Isabel Comte d'Urgell 259, 6 3 E-08036 Barcelona ES

CASTRO PALOMINO LARIA, Julio, Cesar Mossen Jacint Verdaguer 139, 1 1 E-08330 Premià de Mar ES

GUAL ROIG, Silvia, d'En Majo 2, Esc. E 4 2 E-08349 Cabrera de Mar ES

NAVARRO ROMERO, Eloisa, Comte d'Urgell 20, 1 2 E-08011 Barcelona ES

(74) Čupić Branislav, Dalmatinska 10, Podgorica ME

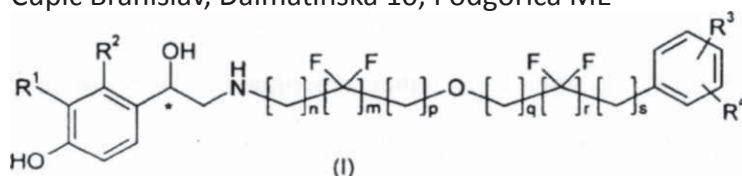

(57) Jedinjenje formule (I):  
gdeje:

R1 grupa odabrana između -CH<sub>2</sub>OH, -NHC(O)H i

R2 je atom hidrogena; ili R1 zajedno sa R2 čine grupu -NH-C(O)-CH=CH- gde je nitrogeni atom vezan za atom uglja u fenilnom prstenu koji drži R1 i atom uglja je vezan za atom uglja u fenilnom prstenu koji drži R2

R3 je odabran između hidrogenih i atoma halógena ili grupa odabranih između -SO-R5, SO<sub>2</sub>-R5, -NH-CO-NH<sub>2</sub>, -CO-NH<sub>2</sub>, hidantoin, C<sub>n</sub>-alkil, C<sup>^</sup>alkoski i -SO<sub>2</sub>NR<sub>5</sub>R<sub>6</sub>

R4 je odabran između atoma hidrogena, atoma halógena i C<sub>1-4</sub>alkil grupa

R5 je C<sup>^</sup>alkil grupa ili C<sup>^</sup>cikloalkil

R6 je nezavisno odabran između atoma hidrogena, i C<sup>^</sup>alkil grupa n, p i q su nezavisno 0, 1, 2, 3 ili 4 m i s su nezavisno 0, 1, 2 ili 3 r je 0, 1 ili 2 pri čemu: najmanje jedno od m i r nije 0 zbir n+m+p+q+r+s je 7, 8, 9, 10, 11, 12, ili 13 zbir q+r+s je 2, 3, 4, 5 ili 6 ili farmaceutski prihvatljiva so, rastvor ili stereoisomer istog.

A preostalih patentnih zahtjeva je 24.

- (51) **A61K31/4745** (11) **01321**  
**A61P35/00** (21) **P-2011-172**
- (22) 08.06.2005.
- (30) 2004RM00288 11.06.2004. IT
- (86) PCT/IT2005/000320 08.06.2005.
- (87) WO2005120643 22.12.2005.
- (96) 05761294.7 08.06.2005.
- (97) EP1773451 24.08.2011 2011/34 EN
- (54) (ME) **UPOTREBA 7-T-BUTOKSIIMINOMETILKAMPTOTECINA ZA DOBIJANJE LIJEKA ZA LIJEČENJE NEOPLAZMI MATERICE.**  
 (EN) USE OF 7-T-BUTOXYIMINOMETHYLCAMPTOTHECIN FOR TREATING UTERINE NEOPLASMS
- (73) SIGMA-TAU Industrie Farmaceutiche Riunite S.p.A.Viale Shakespeare 47, 00144 Roma IT
- (72) CARMINATI, Paolo, c/o Sigma-Tau Industrie Farmaceutische Riunite S.p.A. Via Pontina, Km. 30, 400 I-00040 Pomezia IT  
 CORSI, Marco, c/o Sigma-Tau Industrie Farmaceutische Riunite S.p.A. Via Pontina, Km. 30, 400 I-00040 Pomezia IT  
 ZANNA, Claudio, c/o Sigma-Tau Industrie Farmaceutische Riunite S.p.A. Via Pontina, Km. 30,400 I-00040 Pomezia IT  
 CAVALLI, Franco, Inst. Oncologico Svizzera Italiana Div. di Oncologia Medica Ospedale Regionale di Bellinzona e Valli CH-6500 Bellinzona CH  
 GIANNI, Luca, Inst. Naz. per lo Studio e la Cura de i Tumori Via Venezian, 1 I-20133 Milano IT  
 SESSA, Cristiana, Inst. Oncologico della Svizzera Italiana Div. di Oncologia Medica Ospedale Regionale di Bellinzona e Valli CH-6500 Bellinzona CH
- (74) Đakonović Vido, Bajova 9, Cetinje ME
- (57) Upotreba 7-t-butoksiiminometilkamptotecina za dobijanje ljeka za liječenje neoplazmi materice.  
 Preostalih patentnih zahtjeva je 5.

(51) **A01N43/56**(11) **01323**(21) **P-2011-177**

(22) 23.04.2008.

(30) 20070008370 25.04.2007. EP

(96) 10157572.8 23.04.2008.

(97) EP2193714 03.08.2011. 2011/31 EN

(54) **(ME)FUNGICIDNE KOMPOZICIJE**  
(EN) FUNGICIDAL COMPOSITIONS

(73) Syngenta Participations AG Schwarzwaldallee 215 4058 Basel CH

(72) TOBLER, Hans, Birsigstrasse 129 4054, Basel CH

WALTER, Harald, Syngenta Crop Protection Münchwilen AG, Schaffhau 4332, Stein CH

HAAS, Ulrich, Johannes Syngenta Crop Protection Münchwilen AG, Schaffhau 4332, Stein CH

(74) Radulović Božidar, Jovana Tomaševića 9/III, Podgorica ME

(57) Smeša koja je podesna za kontrolisanje bolesti koje uzrokuju fitopatogeni, naznačena time što sadrži (A) jedinjenje formule (I)

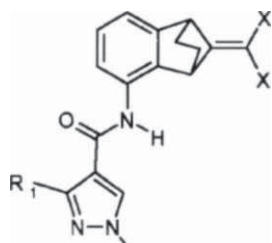

(I),

gde je R<sub>1</sub> difluorometil ili trifluorometil i X je hloro, fluoro ili bromo; i (B) bar jedno jedinjenje odabrano iz grupe (B2) azol fungicida.

Preostalih patentnih zahtjeva je 12.

(51) **A01N43/56**(11) **01317**(21) **P-2011-179**

(22) 23.04.2008.

(30) 20070008370 25.04.2007. EP

(96) 10157590.0 23.04.2008.

(97) EP2201839 24.08.2011. 2011/34 EN

(54) (ME) **FUNGICIDNE KOMPOZICIJE**  
(EN) **FUNGICIDAL COMPOSITIONS**

(73) Syngenta Participations AG Schwarzwaldallee 215 4058 Basel CH

(72) TOBLER, Hans, Birsigstrasse 129 4054, Basel CH

WALTER, Harald, Syngenta Crop Protection Münchwilen AG, Schaffhauserstrasse 4332, Stein CH

HAAS, Ulrich Johannes Syngenta Crop Protection Münchwilen AG, Schaffhauserstrasse 4332, Stein CH

(74) Radulović Božidar, Jovana Tomaševića 9/III, Podgorica ME

(57) Smeša koja je podesna za kontrolisanje bolesti koje uzrokuju fitopatogeni, naznačena time što sadrži (A) jedinjenje formule (1)

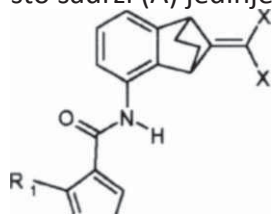

N-Nx

Ch<sub>3</sub> (I),gde je R<sub>i</sub> difluorometil ili trifluorometil i X je hlora, fluoro ili bromo; i (B) jedinjenje fluopiram.

Preostalih patentnih zahtjeva je 11.

- (51) **A61K47/10**  
**A61K47/18**  
**A61K38/24**  
**A61K9/00**
- (22) 09.02.2009.  
(30) 20080151231 08.02.2008. EP  
(86) PCT/EP2009/051451 09.02.2009.  
(87) WO2009098318 13.08.2009.  
(96) 09708298.6 09.02.2009.  
(97) EP2249869 07.09.2011. 2011/38 EN
- (54) (ME) **TEČNI PREPARAT FSH**  
(EN) LIQUID FORMULATION OF FSH
- (73) BioGeneriX AG High-Tech-Park Mannheim Janderstrasse 3, 68199 Mannheim DE  
(72) STOLZENBERGER, Sascha, Lilienthalstrasse 15a 64347 Griesheim DE  
KOHLE, Erich, Kapellenweg 7 64646 Heppenheim DE  
(74) Radulović Božidar, Jovana Tomaševića 9/III, Podgorica ME  
(57) Tečni farmaceutski preparat koji obuhvata folikul-stimulirajući hormon (FSH) ili njegovu varijantu, kao i benzalkonijum hlorid i benzil alkohol kao sredstva za čuvanje.  
Preostalih patentnih zahtjeva je 14.

- (51) **A61K31/4412** (11) **01304**  
**A61P11/00** (21) **P-2011-186**
- (22) 03.03.2010.
- (30) 20090266753P 04.12.2009. US  
20100684543 08.01.2010. US
- (96) 10250378.6 03.03.2010.
- (97) EP2308491 07.09.2011. 2011/36 EN
- (54) (ME) **PIRFENIDONSKA TERAPIJA I INDUKTORI CITOHROMA P450**  
(EN) PIRFENIDONE THERAPY AND INDUCERS OF CYTOCHROME P450
- (73) Intermune, Inc. 3280 Bayshore Boulevard, Brisbane, CA 94005-1021 US
- (72) BRADFORD, Williamson, Ziegler PO Box 566, Ross, California 94957 US  
SZWARCBERG, Javier, 2173 Bunker Hill Drive, San Mateo, California 94402 US
- (74) Lutovac Branislav, Bulevar Crnojevića 93, Podgorica ME
- (57) Pirfenidon za upotrebu u lečenju pacijenta kome je potrebna pirfenidonska terapija, naznačen time, što lečenje obuhvata izbegavanje ili prekidistovremene upotrebe ili zajedničkog davanja jakog induktora citohroma P450 1A2 (CAP1A2) da se izbegne smanjena izloženost pirfenidonu, gde je jakinduktor dim cigareta, pušenje ili rifampicin. Preostalih patentnih zahtjeva je 12.

- (51) **A61K9/16** (11) **01305**  
**A61K31/505** (21) **P-2011-187**
- (22) 06.06.2007.
- (30) 20060115029 06.06.2006. EP
- (86) PCT/EP07/055607 06.06.2007.
- (87) WO2007141308 13.12.2007.
- (96) 07729974.1 06.06.2007.
- (97) EP2029110 31.08.2011. 2011/35 EN
- (54) (ME) **PROCES ZA PRIPREMANJE RASPRŠIVANJEM OSUŠENIH FORMULACIJA TMC125**  
(EN) PROCESS FOR PREPARING SPRAY DRIED FORMULATIONS OF TMC125
- (73) Tibotec Pharmaceuticals, Eastgate Village Eastgate Little Island, Co Cork IE
- (72) KIEKENS, Filip, Rene Irene, Mosselgoren 44, B-2440 Geel BE  
VOORSPOELS, Jody, Firmin Marceline, Zevekotestraat 15, B-8970 Reningelst BE  
BAERT, Lieven, Elvire Colette, Jozef Van Walleghemstraat 11, B-8200 Brugge 2 BE
- (74) Radulović Božidar, Jovana Tomaševića 9/III, Podgorica ME
- (57) Proces za proizvodnju krutog farmaceutskog praha, naznačen time, da obuhvata sledeće korake: obezbeđivanje punjenja sa mešavinom mikrokristalne celuloze i rastvora polimera koji se rastvara u vodi i jedinjenja TMC125; sušenje raspršivanjem punjenja sa mešavinom iz koraka (a) sa ciljem da se dobije kruta disperzija jedinjenja TMC125 i polimera uz pomoć unošenja punjenja sa mešavinom u vidu kapi u komoru za sušenje raspršivanjem preko naprava za atomizovanje.  
Preostalih patentnih zahtjeva je 15.
- (

51) **A01N43/56**(11) **01313**(21) **P-2011-188**

(22) 23.04.2008.

(30) 20070008370 25.04.2007. EP

(96) 10157576.9 23.04.2008.

(97) EP2196088 24.08.2011. 2011/34 EN

(54) (ME) **FUNGICIDNE KOMPOZICIJE**  
(EN) **FUNGICIDAL COMPOSITIONS**

(73) Syngenta Participations AG, Schwarzwaldallee 215, 4058 Basel CH

(72) TOBLER, Hans, Birsigstrasse 129 4054, Basel CH

WALTER, Harald, Syngenta Crop Protection Münchwilen AG, Schaffhauserstrasse 4332, Stein CH

HAAS, Ulrich, Johannes Syngenta Crop Protection Münchwilen AG, Schaffhauserstrasse 4332, Stein CH

(74) Radulović Božidar, Jovana Tomaševića 9/III, Podgorica ME

(57) Smeša koja je podesna za kontrolisanje bolesti koje uzrokuju fitopatogeni, naznačena time što sadrži (A) jedinjenje formule (I) gde je Ri difluorometil ili trifluorometil i X je hlоро, fluoro ili bromo; i (B) jedinjenje fenpropimorf.

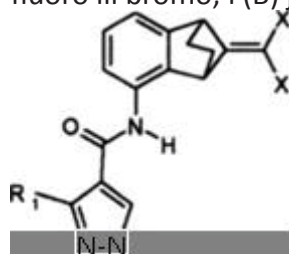

Preostalih patentnih zahtjeva je 11.



(51) **A01N43/56**(11) **01314**(21) **P-2011-189**

(22) 23.04.2008.

(30) 20070008370 25.04.2007. EP

(96) 10157577.7 23.04.2008.

(97) EP2193715 31.08.2011. 2011/35 EN

(54) (ME) **FUNGICIDNE KOMPOZICIJE**  
(EN) **FUNGICIDAL COMPOSITIONS**

(73) Syngenta Participations AG, Schwarzwaldallee 215, 4058 Basel CH

(72) TOBLER, Hans, Birsigstrasse 129 4054, Basel CH

WALTER, Harald Syngenta Crop Protection Mönchwilen AG, Schaffhauserstrasse 4332, Stein CH

HAAS, Ulrich, Johannes Syngenta Crop Protection Mönchwilen AG, Schaffhauserstrasse 4332, Stein CH

(74) Radulović Božidar, Jovana Tomaševića 9/III, Podgorica ME

(57) Smeša koja je podesna za kontrolisanje bolesti koje uzrokuju fitopatogeni, naznačena time što sadrži (A) jedinjenje formule (I)

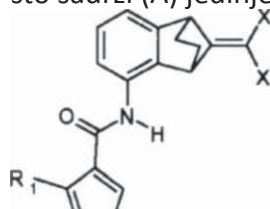

N-N

\

(I).

gde je R<sub>1</sub> difluorometil ili trifluorometil i X je hlora, fluoro ili bromo; i (B) jedinjenje ciprodi-  
nil. Smeša prema zahtevu.

Preostalih patentnih zahtjeva je 11.

- (51) **A61K39/02**  
**A61P31/04**  
**A61P31/12**
- (22) 23.09.2005.  
(30) 20040959757 06.10.2004. US  
(86) PCT/IB2005/003111 23.09.2005.  
(87) WO2006038115 13.04.2006.  
(96) 05789769.6 23.09.2005.  
(97) EP1799253 14.09.2011. 2011/37 EN
- (54) (ME) **MULTIVALENTNE PSEĆE VAKCINE PROTIV LEPTOSPIRA BRATISLAVA I DRUGIH PATOGENA**  
(EN) MULTIVALENT CANINE VACCINES AGAINST LEPTOSPIRA BRATISLAVA AND OTHER PATHOGENS
- (73) Zoetis P LLC, 100 Campus Drive, Florham Park, New Jersey 07932 US  
(72) FRANTZ, Joseph, c/o Pfizer Inc., 601 West Cornhusker Highway Lincoln, NE 68501 US  
NEWBY, Thomas Jack, c/o Pfizer Inc., 601 West Cornhusker Highway Lincoln, NE 68501 US  
TUCKER, Cassius McAllister, c/o Pfizer Global R&D, 7000 Portage Road Kalamazoo, MI 49001-0199 US
- (74) Ćupić Branislav, Dalmatinska 10, Podgorica ME
- (57) Kompozicija vakcine z upotrebu u imunizciju pasa protiv infekcije izazvane sa Leptospir bratislava a koja sadrži Leptospira ćelijske preparate Leptospira bratstva i nosač. Preostalih patentnih zahtjeva je 18.

(51) **A01N43/56**(11) **01315**(21) **P-2011-193**

(22) 23.04.2008.

(30) 20070008370 25.04.2007. EP

(96) 10157584.3 23.04.2008.

(97) EP2204093 07.09.2011. 2011/36 EN

(54) **(ME) FUNGICIDNE KOMPOZICIJE**  
(EN) **FUNGICIDAL COMPOSITIONS**

(73) Syngenta Participations AG, Schwarzwaldallee 215, 4058 Basel CH

(72) TOBLER, Hans, Birsigstrasse 129 4054, Basel CH

WALTER, Harald, Syngenta Crop Protection Münchwilen AG, Schaffhauserstrasse 4332, Stein CH

HAAS, Ulrich, Johannes Syngenta Crop Protection Münchwilen AG, Schaffhauserstrasse 4332, Stein CH

(74) Radulović Božidar, Jovana Tomaševića 9/III, Podgorica ME

(57) Kompozicija prikladna za kontrolu bolesti koje uzrokovane preko fitopatogena, naznačena time, da obuhvata (A) jedinjenje sa formulom I

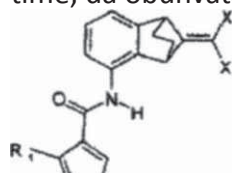

0),

gde R<sub>1</sub> je difluorometil ili trifluorometil, a X je hlora, fluoro ili bromo; i (B) jedinjenje fenpropidin.

Preostalih patentnih zahtjeva je 11.

- (51) **C07D487/04**  
**C07D245/04**  
**C07K5/078**  
**A61K38/05**  
**A61K31/33**  
**A61P31/14**  
**C07K5/06**
- (22) 28.07.2006.
- (30) EP20050107073 29.07.2005. EP  
 EP20050107416 11.08.2005. EP
- (96) 06764267.8 28.07.2006.
- (97) EP1912997 14.09.2011. 2011/37 EN
- (54) (ME) **MAKROCIKLIČKI INHIBITORI VIRUSA HEPATITISA C**  
 (EN) **MACROCYCLIC INHIBITORS OF HEPATITIS C VIRUS**
- (73) Tibotec Pharmaceuticals Lunastigen 7, S-141 44 Huddinge SE  
 Medivir Aktiebolag Eastgate Village Eastgate Little Island, Co Cork IE
- (72) RABOISSON, Pierre, Jean-Marie, Bernard Sint Pancratiuslaan 26 B-1933 Sterrebeek BE  
 DE KOCK, Herman, Augustinus Wolfseind 10 B-2370 Arendonk BE  
 HU, Lili, Vrouw Van Mechelenstraat 28 B-2800 Mechelen BE  
 SURLERAUX, Dominique, Louis, Nestor, Ghislain Rue de la scaillée, 13 B-1440 Braine-le-  
 château BE  
 SIMMEN, Kenneth, Alan Boterbloemenlaan 35 B-3080 Tervuren BE  
 SALVADOR ODÉN, Lourdes Medivir AB, Lunastigen 7 S-141 44 Huddinge SE  
 NILSSON, Karl, Magnus Medivir AB, Lunastigen 7 S-141 44 Huddinge SE  
 ROSENQUIST, sa Annica, Kristina Medivir AB, Lunastigen 7 S-141 44 Huddinge SE  
 SAMUELSSON, Bengt, Bertil Medivir AB, Lunastigen 7 S-141 44 Huddinge4 SE
- (74) Radulović Božidar, Jovana Tomaševića 9/III, Podgorica ME

1. Jedinjenje, naznačeno time, da je predstavljeno sledećom formulom

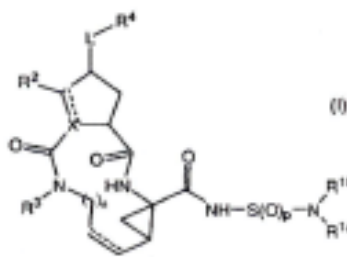

i njegovi *N*-oksidi, soli i stereoisomeri, gde svaka isprekidana linija (predstavljena sa - - - -) predstavlja neku opcionalnu dvostruku vezu;

**X** je N, CH, a kada **X** sadrži dvostruku vezu, tada je C;

**R<sup>1a</sup>** i **R<sup>1b</sup>** su, nezavisno, vodonik, C<sub>3-7</sub>cikloalkil, aril, Het, C<sub>1-6</sub>alkoksi, C<sub>1-6</sub>alkil ponekad supstituisan sa halo, C<sub>1-6</sub>alkoksi, cijano, polihaloC<sub>1-6</sub>alkoksi, C<sub>3-7</sub>cikloalkil, aril ili sa Het; ili **R<sup>1a</sup>** i **R<sup>1b</sup>** zajedno sa azotom na kojeg su spojeni formiraju od 4 do 6-člani zasićeni, delomično ne-zasićeni ili potpuno ne-zasićeni heterociklički prsten koji ponekad sadrži dodatna 1 do 3 heteroatoma od koji je svaki nezavisno izabran iz azota, kiseonika i sumpora i gde pomenuti heterociklički prsten može da ponekad bude supstituisan sa jednim ili dva supstituenta od kojih je svaki nezavisno izabran iz grupe koja obuhvata halo, C<sub>1-6</sub>alkil, polihaloC<sub>1-6</sub>alkil, hidroksi, C<sub>1-6</sub>alkoksi, polihaloC<sub>1-6</sub>alkoksi, C<sub>1-6</sub>alkoksiC<sub>1-6</sub>alkil, karboksil, C<sub>1-6</sub>alkilkarbonil, cijano, mono- i diC<sub>1-6</sub>alkilamino, aril i arilC<sub>1-6</sub>alkil;

**L** je direktna veza, -O-, -O-C<sub>1-6</sub>alkandiil-, -O-CO-, -O-C(=O)-NR<sup>5a</sup>- ili -O-C(=O)-NR<sup>5b</sup>-C<sub>1-6</sub>alkandiil-;

**R<sup>2</sup>** je vodonik, a kada **X** je C ili CH, **R<sup>2</sup>** može takođe da bude i C<sub>1-6</sub>alkil;

**R<sup>3</sup>** je vodonik, C<sub>1-6</sub>alkil, C<sub>1-6</sub>alkoksiC<sub>1-6</sub>alkil, C<sub>3-7</sub>cikloalkil, amino, mono- ili diC<sub>1-6</sub>alkilamino;

**R<sup>4</sup>** je aril ili zasićeni, delomično ne-zasićeni ili kompletno ne-zasićeni 5 ili 6-člani monociklički ili 9 do 12-člani biciklički heterociklički prstenski sistem gde pomenuti prstenski sistem sadrži jedan azot, a ponekad i jedan do tri dodatna heteroatoma koja su

(57)

izabrana iz grupe koja sadrži kiseonik, sumpor i azot i gde preostali članovi prstena su atomi ugljenika; gde pomenuti prstenski sistem može ponekad da bude supstituisan sa bilo kojim ugljenikovim ili azotnim prstenskim atomom sa jedan, dva, tri ili četiri supstituenata od kojih je svaki nezavisno izabran iz C<sub>3-7</sub>cikloalkila, arila, Het, -C(-O)NR<sup>5a</sup>R<sup>5b</sup>, -C(-O)R<sup>7</sup>, -C(-O)OR<sup>6a</sup> i C<sub>1-6</sub>alkila koji je ponekad supstituisan sa C<sub>3-7</sub>cikloalkilom, arilom, Het, -C(-O)NR<sup>5a</sup>R<sup>5b</sup>, -NR<sup>5a</sup>R<sup>5b</sup>, -C(-O)R<sup>7</sup>, -NR<sup>5a</sup>C(=O)R<sup>7</sup>, -NR<sup>5a</sup>SO<sub>2</sub>R<sup>8</sup>, -SO<sub>2</sub>R<sup>8</sup>, -SO<sub>2</sub>NR<sup>5a</sup>R<sup>5b</sup>, -C(-O)OR<sup>6</sup> ili -NR<sup>5a</sup>C(=O)OR<sup>6a</sup>; i gde pomenuti supstituenti ili bilo koji ugljenikov atom iz heterocikličkog prstena mogu takode da budu izabrani iz C<sub>1-6</sub>alkoksi, hidroksi, halo, polihalo- C<sub>1-6</sub>alkila, C<sub>1-6</sub>alkiltio, okso, cijano, nitro, azido, -NR<sup>5a</sup>R<sup>5b</sup>, -NR<sup>5a</sup>C(-O)R<sup>7</sup>, -NR<sup>5a</sup>SO<sub>2</sub>R<sup>8</sup>, -SO<sub>2</sub>R<sup>8</sup>, -SO<sub>2</sub>NR<sup>5a</sup>R<sup>5b</sup>, -C(-O)OH i -NR<sup>5a</sup>C(-O)OR<sup>6a</sup>;

**n** je 3, 4, 5 ili 6;

**p** je 1 ili 2;

svaki od **R<sup>5a</sup>** i **R<sup>5b</sup>** je, nezavisno, vodonik, C<sub>3-7</sub>cikloalkil, aril, Het, C<sub>1-6</sub>alkil koji je ponekad supstituisan sa halo, C<sub>1-6</sub>alkoksi, cijano, polihaloC<sub>1-6</sub>alkoksi, C<sub>3-7</sub>cikloalkilom, arilom ili sa Het;

**R<sup>6</sup>** je vodonik, C<sub>2-6</sub>alkenil, C<sub>3-7</sub>cikloalkil, Het ili C<sub>1-6</sub>alkil koji je ponekad supstituisan sa C<sub>3-7</sub>cikloalkilom, arilom ili Het;

**R<sup>6a</sup>** je C<sub>2-6</sub>alkenil, C<sub>3-7</sub>cikloalkil, Het ili C<sub>1-6</sub>alkil koji je ponekad supstituisan sa C<sub>3-7</sub>cikloalkilom, arilom ili Het;

**R<sup>7</sup>** je vodonik, C<sub>1-6</sub>alkil, C<sub>3-7</sub>cikloalkil ili aril;

**R<sup>8</sup>** je vodonik, polihaloC<sub>1-6</sub>alkil, C<sub>3-7</sub>cikloalkil, aril, Het ili C<sub>1-6</sub>alkil koji je ponekad supstituisan sa C<sub>3-7</sub>cikloalkilom, arilom ili Het; aril kao grupa ili deo grupe je fenil, naftil, indanil ili 1,2,3,4-tetra-hidronaftil, a svaki od njih može da ponekad bude supstituisan sa jednim, dva ili tri supstituenata koja su izabrana iz halo, C<sub>1-6</sub>alkila, polihaloC<sub>1-6</sub>alkila, hidroksi, C<sub>1-6</sub>alkoksi, polihaloC<sub>1-6</sub>alkoksi, C<sub>1-6</sub>alkoksiC<sub>1-6</sub>alkila, karboksila, C<sub>1-6</sub>alkilkarbonila, C<sub>1-6</sub>alkoksi-karbonila, cijano, nitro, amino, mono- ili diC<sub>1-6</sub>alkilamino, aminokarbonila, mono- ili diC<sub>1-6</sub>alkilaminokarbonila, azido, merkpto, C<sub>3-7</sub>cikloalkila, fenila, piridila, tiazolila, pirazolila, piroolidinila, piperidinila, piperazinila, 4-C<sub>1-6</sub>alkilpiperazinila, 4-C<sub>1-6</sub>alkilkarbonil-piperazinila i morfolinila; gde pomenute morfolinilne i piperidinilne grupe mogu da ponekad budu supstituisane sa jednim ili dva C<sub>1-6</sub>alkil radikala; a pomenute fenilne, piridilne, tiazolilne, pirazolilne grupe mogu ponekad da budu supstituisane sa 1, 2 ili 3 supstituenta od kojih je svaki nezavisno izabran iz C<sub>1-6</sub>alkila, C<sub>1-6</sub>alkoksi, halo, amino, mono- ili diC<sub>1-6</sub>alkilamino;

Het, kao grupa ili deo grupe, je 5 ili 6-člani zasićeni, delomično ne-zasićeni ili kompletno ne-zasićeni heterociklički prsten koji sadrži 1 do 4 heteroatoma od kojih je svaki nezavisno izabran iz azota, kiseonika i sumpora i koji je ponekad kondenzovan sa nekim benzenskim prstenom, a gde pomenuta grupa Het kao celo može ponekad da bude supstituisana sa jednim, dva ili tri supstituenta od kojih je svaki nezavisno izabran iz grupe koja obuhvata halo, C<sub>1-6</sub>alkil, polihaloC<sub>1-6</sub>alkil, hidroksi, C<sub>1-6</sub>alkoksi, polihaloC<sub>1-6</sub>alkoksi, C<sub>1-6</sub>alkoksiC<sub>1-6</sub>alkil, karboksil, C<sub>1-6</sub>alkilkarbonil, C<sub>1-6</sub>alkoksikarbonil, cijano, nitro, amino, mono- ili diC<sub>1-6</sub>alkilamino, amino-karbonil, mono- ili diC<sub>1-6</sub>alkilaminokarbonil, C<sub>3-7</sub>cikloalkil, fenil, piridil, tiazolil, pirazolil, piroldinil, piperidinil, piperazinil, 4-C<sub>1-6</sub>alkilpiperazinil, 4-C<sub>1-6</sub>alkilkarbonil-piperazinil i morfolinil; gde pomenute morfolinilne i piperidinilne grupe mogu ponekad da budu supstituisane sa jednim ili dva C<sub>1-6</sub>alkil radikalima; a pomenute fenilne, piridilne, tiazolilne, pirazolilne grupe mogu ponekad da budu supstituisane sa 1, 2 ili 3 supstituenta od kojih je svaki nezavisno izabran iz C<sub>1-6</sub>alkila, C<sub>1-6</sub>alkoksi, halo, amino, mono- ili diC<sub>1-6</sub>alkilamino.

2. Jedinjenje u skladu sa zahtevom 1, **naznačeno time**, da pomenuto jedinjenje ima formulu (I-c), (I-d) ili (I-e):

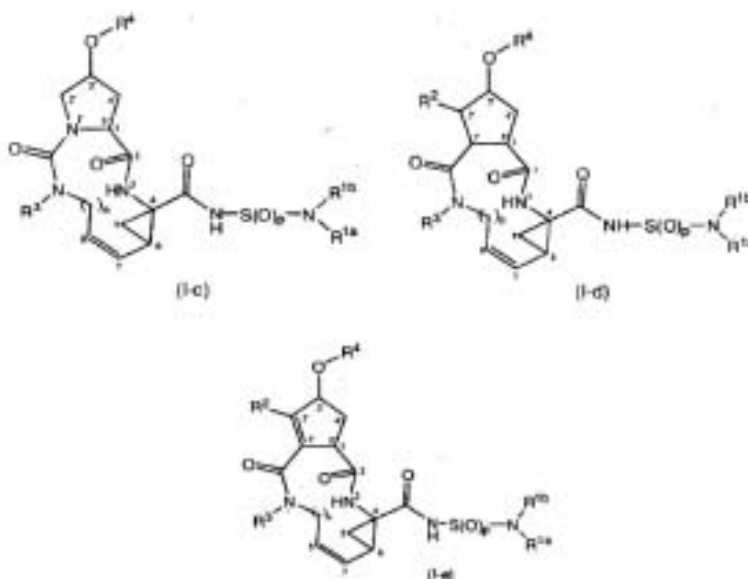

Patent sadrži još 15 patentnih zahtjeva.

- (51) **A61K9/20**  
**A61K9/28**  
**A61P25/16**
- (11) **01316**  
(21) **25.07.2005.**
- (22) P-2011-195  
(30) 20040019248 13.08.2004. EP  
(86) PCT/EP2005/053610 25.07.2005.  
(87) WO2006015944 16.02.2006.  
(96) 05763065.9 25.07.2005.  
(97) EP1789021 09.11.2011. 2011/45 EN
- (54) (ME) **FORMULACIJA TABLETE SA PRODUŽENIM OSLOBAĐANJEM KOJI SADRŽI PRAMIPEKSOL ILI NJEGOVU FARMACEUTSKI PRIHVATLJIVU SO**  
(EN) EXTENDED RELEASE TABLET FORMULATION CONTAINING PRAMIPEXOLE OR A PHARMACEUTICALLY ACCEPTABLE SALT THEREOF
- (73) Boehringer Ingelheim International GmbH Binger Strasse 173, 55216 Ingelheim am Rhein DE
- (72) FRIEDL, Thomas, Hans-Liebherr-Str. 48/4 88416 Ochsenhausen DE  
EISENREICH, Wolfram, Zehntstadelweg 22/1 89079 Ulm DE
- (74) Radulović Božidar, Jovana Tomaševića 9/III, Podgorica ME
- (57) Formulacija tablete sa produženim oslobađanjem koja sadrži pramipeksol ili njegovu farmaceutski prihvatljivu so u matriksu, matriks koji sadrži polimere koji bubre u vodi, gde je jedan od navedenih polimera preželatinizirani škrob, gde je drugi od navedenih polimera anjonski polimer i gde formulacija tablete sa produženim oslobađanjem dalje sadrži polimer koji bubri u vodi koji nije preželatinizirani škrob ili anjonski polimer. Preostalih patentnih zahtjeva je 15.



- (51) **C07D335/00**  
**C07D409/04**  
**C07D409/10**  
**C07D409/12**  
**C07D409/14**  
**C07D417/10**  
**C07D495/04**  
**A61K31/4178**  
**A61K31/382**  
**A61P3/10**
- (22) 10.01.2006.  
(30) 20050002913 07.01.2005. JP  
20050233912 12.08.2005. JP  
(86) PCT/JP2006/300135 10.01.2006.  
(87) WO2006073197 13.07.2006.  
(96) 06711505.5 10.01.2006.  
(97) EP1845095 07.09.2011. 2011/36
- (54) (ME) **DERIVATI 1-TIO-D-GLUCITOLA**  
(EN) 1-THIO-D-GLUCITOL DERIVATIVES
- (73) TAISHO PHARMACEUTICAL CO., LTD, 24-1 Takada 3-chome Toshima-ku, Tokyo 170-8633 JP  
(72) KAKINUMA, Hiroyuki c/o Taisho Pharmaceutical Co., Ltd., 24-1, Takada 3-chome, Toshima-ku, Tokyo, 1708633 JP  
HASHIMOTO, Yuko c/o Taisho Pharmaceutical Co., Ltd., 24-1, Takada 3-chome, Toshima-ku, Tokyo, 1708633 JP  
OI, Takahiro c/o Taisho Pharmaceutical Co., Ltd., 24-1, Takada 3-chome, Toshima-ku, Tokyo, 1708633 JP  
TAKAHASHI, Hitomi c/o Taisho Pharmaceutical Co., Ltd., 24-1, Takada 3-chome, Toshima-ku, Tokyo, 1708633 JP  
(74) Radulović Božidar, Jovana Tomaševića 9/III, Podgorica ME

1. Jedinjenje 1-tio-D-glucitola sa formulom I koja sledi, ili farmaceutski prihvatljiva so takvog jedinjenja, ili hidrat takve soli ili takvog jedinjenja:

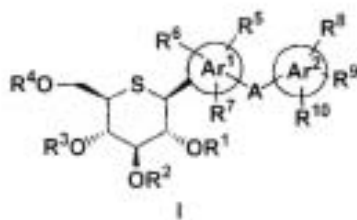

[naznačeno time što:

$R^1$ ,  $R^2$ ,  $R^3$  i  $R^4$  mogu da budu isti ili različiti, a svaki predstavlja atom vodonika,  $C_{1-6}$  alkil grupu,  $-CO_2R^{42}$ ,  $-COR^{41}$ , ili  $C_{7-12}$  aralkil grupu opciono supstituisanu jednim ili većim brojem supstituenata izabranih iz grupe koja se sastoji od halogenih atoma,  $-NO_2$  i  $-OMe$  (gde  $R^{42}$  predstavlja  $C_{1-6}$  alkil grupu a  $R^{41}$  predstavlja  $C_{1-6}$  alkil grupu,  $C_{7-10}$  aralkil grupu ili tenil grupu);

A predstavlja  $-(CH_2)_n-$ ,  $-CONH(CH_2)_n-$ ,  $-NHCO(CH_2)_n-$ ,  $-O-$ ,  $-S-$ ,  $-NH-$ , ili  $-(CH_2)_nCH=CH-$  (gde n označava ceo broj od 0 do 3);

$Ar^1$  predstavlja arilensku grupu, heteroarilensku grupu ili heterocikloalkilensku grupu;

$Ar^2$  predstavlja aril grupu, heteroaril grupu ili heterocikloalkil grupu, a  $R^5$ ,  $R^6$ ,  $R^7$ ,  $R^8$ ,  $R^9$  i  $R^{10}$  su isti ili različiti, a svaki predstavlja (i) atom vodonika; (ii) halogeni atom; (iii) hidroksilnu grupu; (iv)  $C_{1-6}$  alkil grupu opciono supstituisanu jednim ili većim brojem supstituenata izabranih iz grupe koja se sastoji od halogenih atoma i hidroksilne grupe; (v)  $-(CH_2)_m-Q$  (gde m označava ceo broj od 0 do 4, a Q označava  $-CHO$ ,  $-NH_2$ ,  $-NO_2$ ,  $-CN$ ,  $-CO_2H$ ,  $-SO_3H$ ,  $-OR^{41}$ ,  $-CO_2R^{43}$ ,  $-CONH_2$ ,  $-CONHR^{44}$ ,  $-CONR^{45}R^{45}$ ,  $-COR^{40}$ ,  $-OCOR^{42}$ ,  $-SR^{41}$ ,  $-SOR^{42}$ ,  $-SO_2R^{43}$ ,  $-NHC(O)H$ ,  $-NHCOR^{42}$ ,  $-NHCO_2R^{44}$ ,  $-NHCONH_2$ ,  $-NHSO_2R^{44}$ ,  $-NHR^{46}$  ili  $-NR^{47}R^{47}$  (gde  $R^{45}$ ,  $R^{44}$ ,  $R^{45}$ ,  $R^{46}$  i  $R^{47}$ , svaki za sebe predstavlja  $C_{1-6}$  alkil grupu,  $R^{41}$  predstavlja  $C_{1-6}$  alkil grupu opciono supstituisanu halogenim atomom(ima),  $R^{42}$ ,  $R^{42}$ ,  $R^{43}$  i  $R^{44}$  predstavljaju, svaki za sebe,  $C_{1-6}$  alkil grupu,  $C_{7-10}$  aralkil grupu, fenil grupu ili  $C_{3-7}$  cikloalkil grupu, a  $R^{41}$ ,  $R^{42}$ ,  $R^{43}$  i  $R^{44}$  predstavljaju, svaki za sebe,  $C_{1-6}$  alkil grupu, fenil grupu ili tozil grupu); (vi)  $-O-(CH_2)_{m'}-Q$  (gde  $m'$  označava ceo broj od 1 do 4,

(57)

a Q označava hidroksilnu grupu,  $-\text{CO}_2\text{H}$ ,  $-\text{ORC}^2$ ,  $-\text{CO}_2\text{R}^{18}$ ,  $-\text{CONH}_2$ ,  $-\text{CONHR}^{19}$ ,  $-\text{CONR}^{20}\text{R}^{21}$ ,  $-\text{NH}_2$ ,  $-\text{NHR}^{21}$ ,  $-\text{NR}^{22}\text{R}^{22}$  ili  $-\text{NHCO}_2\text{R}^{25}$  (gde  $\text{R}^{18}$ ,  $\text{R}^{19}$ ,  $\text{R}^{20}$ ,  $\text{R}^{21}$  i  $\text{R}^{22}$ , svaki za sebe, predstavlja  $\text{C}_{1-6}$  alkil grupu,  $\text{R}^{22}$  predstavlja  $\text{C}_{1-6}$  alkil grupu opciono supstituisanu halogenim atomom(ima), a  $\text{R}^{25}$  predstavlja  $\text{C}_{1-6}$  alkil grupu,  $\text{C}_{7-10}$  aralkil grupu, fenil grupu ili  $\text{C}_{3-7}$  cikloalkil grupu); (vii)  $-\text{OR}^f$  gde  $\text{R}^f$  predstavlja  $\text{C}_{3-7}$  cikloalkil grupu opciono supstituisanu jednim ili većim brojem supstituenata izabranih iz grupe koja se sastoji od halogenih atoma, hidroksilne grupe,  $\text{C}_{1-6}$  alkil grupe i  $-\text{OR}^{13}$  (gde  $\text{R}^{13}$  predstavlja  $\text{C}_{1-6}$  alkil grupu); aril grupu opciono supstituisanu jednim ili većim brojem supstituenata izabranih iz grupe koja se sastoji od halogenih atoma, hidroksilne grupe,  $\text{C}_{1-6}$  alkil grupe i  $-\text{OR}^{14}$  (gde  $\text{R}^{14}$  predstavlja  $\text{C}_{1-6}$  alkil grupu);  $\text{C}_{7-10}$  aralkil grupu opciono supstituisanu jednim ili većim brojem supstituenata izabranih iz grupe koja se sastoji od halogenih atoma, hidroksilne grupe,  $\text{C}_{1-6}$  alkil grupe i  $-\text{OR}^{15}$  (gde  $\text{R}^{15}$  predstavlja  $\text{C}_{1-6}$  alkil grupu); ili heterocikloalkil grupu opciono supstituisanu jednim ili većim brojem supstituenata izabranih iz grupe koja se sastoji od halogenih atoma, hidroksilne grupe,  $\text{C}_{1-6}$  alkil grupe i  $-\text{OR}^{16}$  (gde  $\text{R}^{16}$  predstavlja  $\text{C}_{1-6}$  alkil grupu); (viii)  $-\text{NHR}^g$  (gde  $\text{R}^g$  predstavlja  $\text{C}_{7-10}$  aralkil grupu opciono supstituisanu jednim ili većim brojem supstituenata izabranih iz grupe koja se sastoji od halogenih atoma, hidroksilne grupe,  $\text{C}_{1-6}$  alkil grupe i  $-\text{OR}^{17}$  (gde  $\text{R}^{17}$  predstavlja  $\text{C}_{1-6}$  alkil grupu); (ix)  $-\text{C}_{3-7}$  cikloalkil grupu opciono supstituisanu jednim ili većim brojem supstituenata izabranih iz grupe koja se sastoji od halogenih atoma, hidroksilne grupe,  $\text{C}_{1-6}$  alkil grupe i  $-\text{OR}^{18}$  (gde  $\text{R}^{18}$  predstavlja  $\text{C}_{1-6}$  alkil grupu); (x) aril grupu opciono supstituisanu jednim ili većim brojem supstituenata izabranih iz grupe koja se sastoji od halogenih atoma, hidroksilne grupe,  $\text{C}_{1-6}$  alkil grupe i  $-\text{OR}^{19}$  (gde  $\text{R}^{19}$  predstavlja  $\text{C}_{1-6}$  alkil grupu); (xi)  $\text{C}_{7-10}$  aralkil grupu opciono supstituisanu jednim ili većim brojem supstituenata izabranih iz grupe koja se sastoji od halogenih atoma, hidroksilne grupe,  $\text{C}_{1-6}$  alkil grupe i  $-\text{OR}^{20}$  (gde  $\text{R}^{20}$  predstavlja  $\text{C}_{1-6}$  alkil grupu); (xii) heteroaril grupu opciono supstituisanu jednim ili većim brojem supstituenata izabranih iz grupe koja se sastoji od halogenih atoma, hidroksilne grupe,  $\text{C}_{1-6}$  alkil grupe i  $-\text{OR}^{21}$  (gde  $\text{R}^{21}$  predstavlja  $\text{C}_{1-6}$  alkil grupu); (xiii) heterocikloalkil grupu opciono supstituisanu jednim ili većim brojem supstituenata izabranih iz grupe koja se sastoji od halogenih atoma, hidroksilne grupe,  $\text{C}_{1-6}$  alkil grupe i  $-\text{OR}^{22}$  (gde  $\text{R}^{22}$  predstavlja  $\text{C}_{1-6}$  alkil grupu); (xiv)  $\text{C}_{2-6}$  alkenil grupu; ili (xv)  $\text{C}_{2-6}$  alkinil grupu].

**Patent sadrži još 29 patentnih zahtjeva.**

- (51) **C07D471/04**  
**C07D487/04**  
**A61K31/395**  
**A61P17/00**  
**A61P35/00**  
**A61P37/00**
- (22) 12.12.2006.
- (30) 20050749905P 13.12.2005. US  
 20060810231P 02.06.2006. US  
 20060850625P 10.10.2006. US  
 20060856872P 03.11.2006. US  
 20060859404P 16.11.2006. US
- (86) PCT/US2006/047369 12.12.2006.
- (87) WO2007070514 21.06.2007.
- (96) 06839328.9 12.12.2006.
- (97) EP1966202 21.09.2011. 2011/38 EN
- (54) (ME) **HETEROARIL SUPSTITUIRANI PIROLO[2,3-B]PIRIDINI I PIROLO[2,3-B]PIRIMIDINI KAO INHIBITORI JANUS KINAZE**  
 (EN) HETEROARYL SUBSTITUTED PYRROLO[2,3-B]PYRIDINES AND PYRROLO[2,3-B]PYRIMIDINES AS JANUS KINASE INHIBITORS
- (73) Incyte Corporation Experimental Station, Route 141 & Henry Clay Road, Building E336/225, Wilmington, DE 19880 US
- (72) RODGERS, James, D. 2 Hillside Lane Landenberg, Pennsylvania 19350 US  
 SHEPARD, Stacey, 3407 Avalon Ct. Voorhees, NJ 08043 US  
 MADUSKUIE, Thomas P. 613 Foulkstone Road Wilmington, DE 19803 US  
 WANG, Haisheng, 207 Hockessin Circle Hockessin, DE 19707 US  
 FALAHATPISHEH, Nikoo 1822 Foulk Road Wilmington, DE 19810 US  
 RAFALSKI, Maria, 908 Fairthorne Avenue Greenville, DE 19807 US  
 ARVANITIS, Argyrios, G. 101 Willow Glen Drive Kennett Square, PA 19348 US  
 STORACE, Louis, 1409 Bohemia Mill Road Middletown, DE 19709 US  
 JALLURI, Ravi Kumar, 234 Honey Locust Drive Avondale, PA 19311 US  
 FRIDMAN, Jordan, S. 50 Willow Creek Lane Newark, DE 19711 US  
 VADDI, Krishna, 108 Forest Drive Kennett Square, PA 19348 US
- (74) Radulović Božidar, Jovana Tomaševića 9/III, Podgorica ME

1. Spoj formule I:

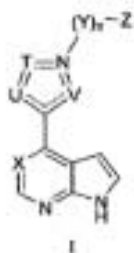

ili njegova farmaceutski prihvatljiva sol, naznačen time da:

T, U, i V su nezavisno odabrani od O, S, N, CR<sup>3</sup>, i NR<sup>6</sup>;

pri čemu 5-člani prsten koji formira atom ugljika, atom dušika, U, T, i V je aromatski;

X je N ili CR<sup>4</sup>;

n je 0; ili

n je 1 i Y je C<sub>1-4</sub> alkilen, C<sub>2-4</sub> alkenilen, (CR<sup>11</sup>R<sup>12</sup>)<sub>2</sub>C(O)(CR<sup>11</sup>R<sup>12</sup>)<sub>2</sub>,

(CR<sup>11</sup>R<sup>12</sup>)<sub>2</sub>C(O)NR<sup>6</sup>(CR<sup>11</sup>R<sup>12</sup>)<sub>2</sub>, (CR<sup>11</sup>R<sup>12</sup>)<sub>2</sub>C(O)O(CR<sup>11</sup>R<sup>12</sup>)<sub>2</sub> ili (CR<sup>11</sup>R<sup>12</sup>)<sub>2</sub>OC(O)(CR<sup>11</sup>R<sup>12</sup>)<sub>2</sub>,

pri čemu navedeni C<sub>1-4</sub> alkilen ili C<sub>2-4</sub> alkenilen, je proizvodno supstituiran sa 1, 2, ili 3 halo, OH, CN, amino, C<sub>1-4</sub> alkilamino, ili C<sub>2-4</sub> dialkilamino;

Z je aril, cikloalkil, heteroaril, ili heterocikloalkil, svaki proizvodno supstituiran sa 1, 2,

3, 4, 5, ili 6 nezavisnih supstituenata odabranih od halo, C<sub>1-4</sub> alkila, C<sub>2-4</sub> alkenila, C<sub>2-4</sub>

alkinila, C<sub>1-4</sub> haloalkila, C<sub>1-4</sub> hidroksialkila, C<sub>1-4</sub> cijanoalkila, Cy<sup>1</sup>, CN, NO<sub>2</sub>, OR<sup>2</sup>, SR<sup>2</sup>,

C(O)R<sup>b</sup>, C(O)NR<sup>c</sup>R<sup>d</sup>, C(O)OR<sup>e</sup>, OC(O)R<sup>b</sup>, OC(O)NR<sup>c</sup>R<sup>d</sup>, NR<sup>c</sup>R<sup>e</sup>, NR<sup>c</sup>C(O)R<sup>b</sup>, NR<sup>c</sup>C(O)NR<sup>d</sup>,

NR<sup>c</sup>C(O)OR<sup>e</sup>, S(O)R<sup>b</sup>, S(O)NR<sup>c</sup>R<sup>d</sup>, S(O)<sub>2</sub>R<sup>b</sup>, NR<sup>c</sup>S(O)<sub>2</sub>R<sup>b</sup>, i S(O)<sub>2</sub>NR<sup>c</sup>R<sup>d</sup>;

Cy<sup>1</sup> je nezavisno odabran od arila, heteroarila, cikloalkila, i heterocikloalkila, svaki

proizvodno supstituiran sa 1, 2, 3, 4 ili 5 supstituenata nezavisno odabranih od halo,

C<sub>1-4</sub> alkila, C<sub>2-4</sub> alkenila, C<sub>2-4</sub> alkinila, C<sub>1-4</sub> haloalkila, CN, NO<sub>2</sub>, OR<sup>e</sup>, SR<sup>e</sup>, C(O)R<sup>f</sup>,

C(O)NR<sup>c</sup>R<sup>e</sup>, C(O)OR<sup>e</sup>, OC(O)R<sup>e</sup>, OC(O)NR<sup>c</sup>R<sup>e</sup>, NR<sup>c</sup>R<sup>e</sup>, NR<sup>c</sup>C(O)R<sup>e</sup>, NR<sup>c</sup>C(O)OR<sup>e</sup>

S(O)R<sup>e</sup>, S(O)NR<sup>c</sup>R<sup>e</sup>, S(O)<sub>2</sub>R<sup>e</sup>, i S(O)<sub>2</sub>NR<sup>c</sup>R<sup>e</sup>;

R<sup>4</sup> je H;

(57)

$R^2$  je H, halo,  $C_{1-4}$  alkil,  $C_{2-4}$  alkenil,  $C_{2-4}$  alkinil,  $C_{1-4}$  haloalkil, CN,  $NO_2$ ,  $OR^7$ ,  $SR^7$ ,  $C(O)R^8$ ,  $C(O)NR^9R^{10}$ ,  $C(O)OR^7$ ,  $OC(O)R^8$ ,  $OC(O)NR^9R^{10}$ ,  $NR^9R^{10}$ ,  $NR^9C(O)R^8$ ,  $NR^9C(O)OR^7$ ,  $S(O)R^8$ ,  $S(O)NR^9R^{10}$ ,  $S(O)_2R^8$ ,  $NR^9S(O)_2R^8$  ili  $S(O)_2NRR^{10}$ ;

$R^6$  je H,  $C_{1-4}$  alkil,  $C_{2-4}$  alkenil,  $C_{2-4}$  alkinil,  $C_{1-4}$  haloalkil,  $OR^7$ ,  $C(O)R^8$ ,  $C(O)NR^9R^{10}$ ,  $C(O)OR^7$ ,  $S(O)R^8$ ,  $S(O)NR^9R^{10}$ ,  $S(O)_2R^8$ , ili  $S(O)_2NR^9R^{10}$ ;

$R^7$  je H,  $C_{1-6}$  alkil,  $C_{1-6}$  haloalkil,  $C_{2-6}$  alkenil,  $C_{2-6}$  alkinil, aril, cikloalkil, heteroaril, heterocikloalkil, arilalkil, heteroarilalkil, cikloalkilalkil ili heterocikloalkilalkil;

$R^8$  je H,  $C_{1-6}$  alkil,  $C_{1-6}$  haloalkil,  $C_{2-6}$  alkenil,  $C_{2-6}$  alkinil, aril, cikloalkil, heteroaril, heterocikloalkil, arilalkil, heteroarilalkil, cikloalkilalkil ili heterocikloalkilalkil;

$R^9$  i  $R^{10}$  su nezavisno odabrani od H,  $C_{1-10}$  alkila,  $C_{1-6}$  haloalkila,  $C_{2-6}$  alkenila,  $C_{2-6}$  alkinila,  $C_{1-6}$  alkilkarbonila, arilkarbonila,  $C_{1-6}$  alkilsulfonila, arilsulfonila, arila, heteroarila, cikloalkila, heterocikloalkila, arilalkila, heteroarilalkila, cikloalkilalkila i heterocikloalkilalkila;

ili  $R^9$  i  $R^{10}$  zajedno sa atomom dušika na koji su spojeni formiraju 4-, 5-, 6- ili 7-članu heterocikloalkilnu skupinu;

$R^{11}$  i  $R^{12}$  su nezavisno odabrani od H, halo, OH, CN,  $C_{1-4}$  alkila,  $C_{1-4}$  haloalkila,  $C_{2-4}$  alkenila,  $C_{2-4}$  alkinila,  $C_{1-4}$  hidroksialkila,  $C_{1-4}$  cijanoalkila, arila, heteroarila, cikloalkila, te heterocikloalkila;

$R^8$  i  $R^9$  su nezavisno odabrani od H,  $C_{1-6}$  alkila,  $C_{1-6}$  haloalkila,  $C_{2-6}$  alkenila,  $C_{2-6}$  alkinila, arila, cikloalkila, heteroarila, heterocikloalkila, arilalkila, heteroarilalkila, cikloalkilalkila i heterocikloalkilalkila, pri čemu navedeni  $C_{2-6}$  alkil,  $C_{1-6}$  haloalkil,  $C_{2-6}$  alkenil,  $C_{2-6}$  alkinil, aril, cikloalkil, heteroaril, heterocikloalkil, arilalkil, heteroarilalkil, cikloalkilalkil ili heterocikloalkilalkil je proizvoljno supstituiran sa 1, 2, ili 3 supstituenta nezavisno odabrana od OH, CN, amino, halo,  $C_{1-6}$  alkila,  $C_{1-6}$  haloalkila, arila, arilalkila, heteroarila, heteroarilalkila, cikloalkila i heterocikloalkila;

$R^8$  i  $R^9$  su nezavisno odabrani od H,  $C_{1-6}$  alkila,  $C_{1-6}$  haloalkila,  $C_{2-6}$  alkenila,  $C_{2-6}$  alkinila, arila, cikloalkila, heteroarila, heterocikloalkila, arilalkila, heteroarilalkila, cikloalkilalkila i heterocikloalkilalkila, pri čemu navedeni  $C_{1-6}$  alkil,  $C_{1-6}$  haloalkil,  $C_{2-6}$  alkenil,  $C_{2-6}$  alkinil, aril, cikloalkil, heteroaril, heterocikloalkil, arilalkil, heteroarilalkil, cikloalkilalkil ili heterocikloalkilalkil je proizvoljno supstituiran sa 1, 2, ili 3 supstituenta nezavisno odabrana od OH, CN, amino, halo,  $C_{1-6}$  alkila,  $C_{1-6}$  haloalkila,  $C_{1-6}$  haloalkila, arila, arilalkila, heteroarila, heteroarilalkila, cikloalkila i heterocikloalkila;

$R^c$  i  $R^d$  su nezavisno odabrani od H,  $C_{1-10}$  alkila,  $C_{1-6}$  haloalkila,  $C_{2-6}$  alkenila,  $C_{2-6}$  alkinila, arila, heteroarila, cikloalkila, heterocikloalkila, arilalkila, heteroarilalkila, cikloalkilalkila i heterocikloalkilalkila, pri čemu navedeni  $C_{1-10}$  alkil,  $C_{1-6}$  haloalkil,  $C_{2-6}$  alkenil,  $C_{2-6}$  alkinil, aril, heteroaril, cikloalkil, heterocikloalkil, arilalkil, heteroarilalkil, cikloalkilalkil ili heterocikloalkilalkil je proizvoljno supstituiran sa 1, 2, ili 3 supstituenta nezavisno odabrana od OH, CN, amino, halo,  $C_{1-6}$  alkila,  $C_{1-6}$  haloalkila,  $C_{1-6}$  haloalkila, arila, arilalkila, heteroarila, heteroarilalkila, cikloalkila ili heterocikloalkila;

ili  $R^c$  i  $R^d$  zajedno sa atomom dušika na koji su spojeni formiraju 4-, 5-, 6- ili 7-članu heterocikloalkilnu skupinu proizvoljno supstituiranu sa 1, 2, ili 3 supstituenta nezavisno odabrana od OH, CN, amino, halo,  $C_{1-6}$  alkila,  $C_{1-6}$  haloalkila,  $C_{1-6}$  haloalkila, arila, arilalkila, heteroarila, heteroarilalkila, cikloalkila i heterocikloalkila;

$R^e$  i  $R^f$  su nezavisno odabrani od H,  $C_{1-10}$  alkila,  $C_{1-6}$  haloalkila,  $C_{2-6}$  alkenila,  $C_{2-6}$  alkinila, arila, heteroarila, cikloalkila, heterocikloalkila, arilalkila, heteroarilalkila, cikloalkilalkila i heterocikloalkilalkila, pri čemu navedeni  $C_{1-10}$  alkil,  $C_{1-6}$  haloalkil,  $C_{2-6}$  alkenil,  $C_{2-6}$  alkinil, aril, heteroaril, cikloalkil, heterocikloalkil, arilalkil, heteroarilalkil, cikloalkilalkil ili heterocikloalkilalkil je proizvoljno supstituiran sa 1, 2, ili 3 supstituenta nezavisno odabrana od OH, CN, amino, halo,  $C_{1-6}$  alkila,  $C_{1-6}$  haloalkila,  $C_{1-6}$  haloalkila, arila, arilalkila, heteroarila, heteroarilalkila, cikloalkila i heterocikloalkila;

ili  $R^e$  i  $R^f$  zajedno sa atomom dušika na koji su spojeni formiraju 4-, 5-, 6- ili 7-članu heterocikloalkilnu skupinu proizvoljno supstituiranu sa 1, 2, ili 3 supstituenta nezavisno odabrana od OH, CN, amino, halo,  $C_{1-6}$  alkila,  $C_{1-6}$  haloalkila,  $C_{1-6}$  haloalkila, arila, arilalkila, heteroarila, heteroarilalkila, cikloalkila i heterocikloalkila;

p je 0, 1, 2, 3, 4, 5, ili 6; i

q je 0, 1, 2, 3, 4, 5 ili 6.

2. Spoj prema zahtjevu 1, ili njegova farmaceutski prihvatljiva sol, **naznačen time** da X je N.
3. Spoj prema zahtjevu 1, ili njegova farmaceutski prihvatljiva sol, **naznačen time** da X je  $CR^4$ .

**Patent sadrži još 87 patentnih zahtjeva.**

- (51) **C07D489/08**  
**A61K31/485**  
**A61P25/30**
- (11) **01319**  
(21) **P-2011-200**
- (22) 23.04.2009.  
(30) 20080155094 24.04.2008. EP  
(86) PCT/EP2009/054882 23.04.2009.  
(87) WO2009130272 29.10.2009.  
(96) 09733923.8 23.04.2009.  
(97) EP2291380 07.09.2011. 2011/36 EN
- (54) (ME) **PROLIJEKOVI NALMEFENA**  
(EN) NALMEFENE PRODRUGS
- (73) Janssen Pharmaceutica N.V. Turnhoutseweg 30, 2340 Beerse BE  
(72) GUILLAUME Michel, Joseph, Maurice, André Janssen Pharmaceutica NV, Turnhoutseweg 30 B-2340 Beerse BE  
GAEKENS, Tim, Janssen Pharmaceutica NV, Turnhoutseweg 30 B-2340 Beerse BE  
(74) Radulović Božidar, Jovana Tomaševića 9/III, Podgorica ME  
(57) Jedinjenje, naznačeno time, daje predstavljeno sa formulom (1)

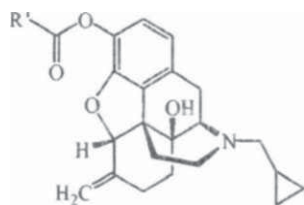

uključujući i bilo koje njegove stereohemijski izomerne forme, gde R1 je C6-i6alkil ili Cs-  
ioalkilamino:ili neku njegovu farmaceutski prihvatljivu kiselu adiconu so ili neku njegovu  
rastvorenu materiju.

Preostalih patentnih zahtjeva je 15.



- (51) **A61K31/4412** (11) **01303**  
**A61P11/00** (21) **P-2011-205**
- (22) 03.03.2010.
- (30) 20090266815P 04.12.2009. US  
20100684879 08.01.2010. US
- (96) 10250379.4 03.03.2010.
- (97) EP2324831 28.09.2011. 2011/39 EN
- (54) **(ME) PIRFENIDONSKA TERAPIJA KOJOM SE IZBJEGAVA UPOTREBA FLUVOKSAMINA**  
**(EN) PIRFENIDONE THERAPY AVOIDING FLUVOXAMINE**
- (73) Intermune, Inc. 3280 Bayshore Boulevard, Brisbane, CA 94005-1021 US
- (72) BRADFORD, Williamson, Ziegler PO Box 566, Ross, California 94957 US  
SZWARCBERG, Javier, 2173 Bunker Hill Drive, San Mateo, California 94402 US
- (74) Lutovac Branislav, Bulevar Crnojevića 93, Podgorica ME
- (57) Pirfenidon za upotrebu u lečenju pacijenta kome je potrebna terapija pirfenidona, naznačen time, što lečenje obuhvata izbegavanje, sprečavanje primene ili prekidanje istovremene upotrebe fluvoksamina.  
Preostalih patentnih zahtjeva je 12.

(51) **D21H17/67**  
**D21H17/68**  
**D21H19/38**  
**D21H19/40**  
**D21H21/52**  
**C01F11/18**  
**C09C1/02**

(11) **01431**  
(21) **P-2012-89**

(22) 21.09.2009.

(96) EP 09170864.4 21.09.2009.

(97) EP 2302131 18.04.2012. 2012/16 EN

(54) (ME) **VODENE SUSPENZIJE KOJE SADRŽE SITNE ČESTICE KALCIJUM  
KARBONATA ZA PRIMJENU U PREMAZIVANJU PAPIRA**

(EN) AQUEOUS SLURRIES COMPRISING FINE CALCIUM CARBONATE PARTICLES FOR THEIR  
USE IN PAPER COATINGS

(73) Omya Development AG, Baslerstrasse 42, 4665 Oftringen, CH

(72) BLUVOL, Guillermo, Sängetelmatten 6, 5014 Gretzenbach CH

KÄSSBERGER, Michael, Schauensee 32, 6204 Sempach, CH

GANE, Patrick, A.C., Studenweg 8, 4852 Rothrist CH

(74) Lutovac Branislav, Bulevar Crnojevića 93, Podgorica ME

(57) Vodena suspenzija koja sadrži mineralni materijal i ima sadržaj čvrste supstance veći od 78 tež.%, naznačen time, što ima procenat P5 u odnosu na težinu čestica koje imaju prečnik manji od 5.0 u,m, od 98.5% do 90%, procenat P2 u odnosu na težinu čestica koje imaju prečnik manji od 2.0 u,m, od 96% do 80%, a gde je odnos P2/P5 od 0.98 do 0.85.  
Preostalih patentnih zahtjeva je 14.

- (51) **A61K51/06**  
**A61K51/12**  
**A61P35/00**  
**A61K103/10**
- (11) **01432**  
(21) **P-2012-90**
- (22) 25.07.2008.  
(30) 20070756750 26.07.2007. FR  
20070952094P 26.07.2007. US  
(86) PCT/EP2008/059825 25.07.2008.  
(87) WO2009/013358 29.01.2009.  
(96) 08775355.4 25.07.2008.  
(97) EP2175888 13.06.2012 2012/24 EN
- (54) (ME) **RADIOFARMACEUTSKE KOMPOZICIJE KOJE SADRŽE POLISAHARIDE KALEMLJENE SA POLIAMINIMA**  
(EN) **RADIOPHARMAZEUTISCHE ZUSAMMENSETZUNGEN DIE POLYAMINE GEPFROPFTE POLYSACCHARIDE ENTHALTEN**
- (73) Laboratoires Cyclopharma, Biopole Clermont Limagne 63360 Saint Beuzire FR  
(72) DENIZOT, Benoît, 219 rue du général Albert Buchalet, F-74130 Bonneville FR  
LACOEUILLE, Franck, 22 rue Grégoire Lachèse, F-49100 Angers FR  
LE JEUNE, Jean Jacques, 38 Suvigner F-49240 Avrille FR  
HINDRE, François, 45 Bd de la Duchesse Anne F-35700 Rennes FR
- (74) Lutovac Branislav, Bulevar Crnojevića 93, Podgorica ME
- (57) Postupak za dobijanje kompozicije koja sadrži polisaharid koji ima jednu ili više kompleksirajućih grupa dobijenih kovalentim vezivanjem putreskina  $\text{NH}_2(\text{CH}_2)_4\text{NH}_2$ , spermina  $\text{H}_2\text{N}(\text{CH}_2)_3\text{NH}(\text{CH}_2)_4\text{NH}(\text{CH}_2)_3\text{NH}_2$ , spermidina  $\text{NH}_2(\text{CH}_2)_3\text{NH}(\text{CH}_2)_4\text{NH}_2$  ili kadaverina  $\text{NH}_2(\text{CH}_2)_5\text{NH}_2$  sa pomenutim polisaharidom, a sve ili neke od pomenutih kompleksirajućih grupa obrazuju kompleks sa bar jednim polivalentnim metalom, a pomenuti postupak obuhvata korake: i) dovođenja polisaharida u kontakt sa kontrolisanim oksidacionim sredstvom; ii) dovođenje oksidovanih polisaharida u kontakt sa kompleksirajućim jedinjenjem izabranim od putreskina, spermina, spermidina ili kadaverina; iii) opciono dovođenje polisaharida dobijenog u stupnju ii) u kontakt sa redukujućim sredstvom; i iv) dovođenje polisaharida dobijenog u stupnju ii) ili stupnju iii) u kontakt sa polivalentnom metalnom solju, a polivalentna metalna soje  $^{99m}\text{Tc}$ .  
Preostalih patentnih zahtjeva je 13.

- (51) **A61K31/485**  
**A61K9/22**  
**A61K9/32**
- (11) **01429**  
(21) **24.08.2007.**
- (22) P-2012-92  
(30) 20060840244P 25. 08. 2006. US  
(96) EP 10192641.8 24.08.2007.  
(97) EP 2292229 23/05/2012. 2012/21 EN
- (54) (ME) **FARMACEUTSKI DOZNI OBLICI REZISTENTNI NA ZLOUPOTREBU KOJI SADRŽE OPIOIDNI ANALGETIK**  
(EN) TAMPER RESISTANT ORAL PHARMACEUTICAL DOSAGE FORMS COMPRISING AN OPIOID ANALGESIC
- (73) Purdue Pharma LP One Stamford Forum 201 Tresser Boulevard Stamford, CT 06901 US  
(72) MANNION, Richard, Owen 3860 Green Ridge Road Furlong, PA 18925 US  
HUANG, Haiyong, Hugh 33 Ketley Place Princeton, NJ 08540 US  
MCKENNA, William, Henry 10 Longmeadow Road Yonkers, NY 10704 US  
O'DONNELL, Edward, P. 38 Chestnut Court Basking Ridge, NJ 07920 US
- (74) Lutovac Branislav, Bulevar Crnojevića 93, Podgorica ME
- (57) Čvrst oralni farmaceutski dozni oblik sa produženim oslobađanjem, koji sadrži formulaciju matrice sa produženim oslobađanjem, a formulacija matrice sa produženim oslobađanjem sadrži kompoziciju koja sadrži bar (1) najmanje jedan polietilen oksid koji na osnovu reoloških merenja ima približnu molekulsku težinu od najmanje 1,000,000; i (2) najmanje jedan aktivan agens izabran od opioidnih analgetika, gde je opioidni analgetik hidromorfon hidrohlorid i dozni oblik sadrži od 1 mg do oko 100 mg hidromorfon hidrohlorida; i gde kompozicija sadrži bar oko 80 mas.% polietilen oksida koji na osnovu reoloških merenja ima približnu molekulsku težinu bar 1,000,000.  
Preostalih patentnih zahtjeva je 22.

- (51) **A61K31/485**  
**A61K9/22**  
**A61K9/32**
- (11) **01428**  
(21) **P-2012-96**
- (22) 24.08.2007.  
(30) 20060840244P 25. 08. 2006. US  
(96) EP 10192644.2 24.08.2007.  
(97) EP 2292230 23.05.2012. 2012/21 EN
- (54) (ME) **FARMACEUTSKI DOZNI OBLICI REZISTENTNI NA ZLOUPOTREBU KOJI SADRŽE OPIOIDNI ANALGETIK**  
(EN) TAMPER RESISTANT ORAL PHARMACEUTICAL DOSAGE FORMS COMPRISING AN OPIOID ANALGESIC FARMACEUTSKI DOZNI OBLICI REZISTENTNI NA ZLOUPOTREBU KOJI SADRŽE OPIOIDNI ANALGETIK
- (73) Purdue Pharma LP One Stamford Forum 201 Tresser Boulevard Stamford, CT 06901 US  
(72) MANNION, Richard, Owen 3860 Green Ridge Road Furlong, PA 18925 US  
HUANG, Haiyong Hugh, 33 Ketley Place Princeton, NJ 08540 US  
MCKENNA, William Henry, 10 Longmeadow Road Yonkers, NY 10704 US  
O'DONNELL, Edward, P. 38 Chestnut Court Basking Ridge, NJ 07920 US
- (74) Lutovac Branislav, Bulevar Crnojevića 93, Podgorica ME
- (57) Čvrst oralni farmaceutski dozni oblik sa produženim oslobađanjem, koji sadrži formulaciju matrice sa produženim oslobađanjem koja je očvršćavana na temperaturi od bar oko 60°C u toku vremenskog perioda od bar oko 1 minuta, a formulacija matrice sa produženim oslobađanjem sadrži kompoziciju koja sadrži bar (1) najmanje jedan polietilen oksid koji na osnovu reoloških merenja ima molekulsku težinu od najmanje 1,000,000; i (2) najmanje jedan aktivan agens izabran od opioidnih analgetika, i gde kompozicija sadrži bar oko 80 mas.% polietilen oksida.  
Preostalih patentnih zahtjeva je 42.

- (51) **C09C 1/02** (11) **01441**  
**D21H 17/67** (21) **P-2012-61**
- (22) 15.06.2009.
- (96) 09162727.3 15.06.2009.
- (97) EP 2264108 15.02.2012. 2012/07 EN
- (54) (ME) **POSTUPAK ZA DOBIJANJE POVRŠINSKI IZREAGOVANOG KALCIJUM KARBONATA PRIMJENOM SLABE KISELINE**  
(EN) **PROCESS TO PREPARE A SURFACE-REACTED CALCIUM CARBONATE IMPLEMENTING A WEAK ACID**
- (73) Omya Development AG Baslerstrasse 42, 4665 Oftringen CH
- (72) GANE, Patrick, Arthur Charles; Studenweg 8, 4852, Rothrist CH  
GERARD, Daniel E., Riehenring 7, 4058, Basel CH
- (74) Lutovac Branislav, Bulevar Crnojevića 93, Podgorica ME
- (57) Postupak za dobijanje površinski izreagovanog kalcijum karbonata u vodenoj sredini koji se sastoji od sledećih koraka: obezbeđenje najmanje jednog mlevenog prirodnog kalcijum karbonata (MPKK); obezbeđenje najmanje jedne vodo-rastvorne kiseline; obezbeđenje gasovitog CO<sub>2</sub>; dovođenje u kontakt navedenog MPKK iz koraka a) sa navedenom kiselinom iz koraka b) i sa navedenim CO<sub>2</sub> iz koraka c); naznačen time, što:  
(i) navedena(e) kiselina(e) iz koraka b) svaka ima(ju) pKa veću od 2,5 i manju ili jednaku 7, mereno na 20°C, vezanu za jonizaciju njihovog prvog dostupnog vodonika, a odgovarajući anjon koji nastaje gubitkom ovog prvog dostupnog vodonika može da formira vodo-rastvorne kalcijumove soli;  
(ii) posle dovođenja u kontakt navedene(ih) kiseline(a) sa navedenim MPKK, nastaje najmanje jedna vodo-rastvorna so, koja u slučaju soli koja sadrži vodonik ima pKa veću od 7, mereno na 20°C, vezanu za jonizaciju prvog dostupnog vodonika, i dodatno anjon soli koji je sposoban da formira vodo-nerastvorne kalcijumove soli.  
Patent sadrži još 19 patentnih zahtjeva.

- (51) **A61K 33/04**  
**A61K 36/06**  
**A61K 38/28**  
**A61K 45/06**
- (22) 07.11.2005.
- (30) 727015 P 14.10.2005. US  
726922 P 14.10.2005. US  
727018 P 14.10.2005. US  
726951 P 14.10.2005. US
- (96) 05024235.3 07.11.2005.
- (97) EP 1774972 29.02.2012. 2012/09 EN
- (54) (ME) **UPOTREBA SELENSKIH KVASACA U LIJEČENJU ALCHAJMEROVE BOLESTI**  
(EN) USE OF SELENIUM YEASTS IN THE TREATMENT OF ALZHEIMERS DISEASE
- (73) Alltech, Inc. 3031 Catnip Hill Pike, Nicholasville, KY 40356 US
- (72) PEARSE LYONS, Thomas 67 Avenue of Champions, Nicholasville, KY 40356 US  
POWER, Ronan 1213 Jekyll Drive, Lexington, Kentucky 40513 US
- (74) Lutovac Branislav, Bulevar Crnojevića 93, Podgorica ME
- (57) Upotreba kompozicije koja sadrži osušeni, nevijabilni kvasac obogaćen selenom, gdje ukupan sadržaj selena pomenutog kvasca čini dva procenta ili manje neorganskog selena, u proizvodnji lijeka, što je lijek formulisan za davanje subjektu pod uslovima u kojima je smanjena ekspresija komplementnog gena u cerebralnom korteksu pomenutog subjekta za liječenje ili prevenciju Alchajmerove bolesti.  
Patent sadrži još 21 patentni zahtjev.

- (51) **A61K 9/127**  
**A61K 9/00**  
**A61K 31/495**  
**A61P 37/08**
- (22) 06.05.2005.  
(30) 842433 11.05.2004. US  
(86) PCT/GB2005/001758 06.05.2005.  
(87) WO 2005/107711 17.11.2005.  
(96) 05742190.1 06.05.2005.  
(97) EP 1771155 21.03.2012. 2012/12 EN
- (54) (ME) **POSTUPAK I KOMPOZICIJA ZA LIJEČENJE RINITISA**  
(EN) METHOD AND COMPOSITION FOR TREATING RHINITIS
- (73) Biolipox AB P.O. Box 303, 751 05 Uppsala SE  
(72) PERESWETOFF-MORATH, Lena, Biolipox AB, c/o Orexo AB, PO Box 303, 751 05 Uppsala SE  
CARLSSON, Anders, MediGelium AB, S:t Göransgatan 80, 112 38 Stockholm SE  
(74) Lutovac Branislav, Bulevar Crnojevića 93, Podgorica ME  
(57) Homogena farmaceutska kompozicija pogodna za liječenje rinitisa nazalnim ili okularnim davajem, koja sadrži cviter jon cetirizina, polarni lipidni lipozom i farmaceutske-prihvatljiv vodeni nosač, u kojoj koncentracija cetirizina varira ali ne više od  $\pm 50\%$  kada se poredi sa koncentracijama unutar i izvan struktura lipozoma.  
Patent sadrži još 59 patentnih zahtjeva.



- (51) **A61K9/20** (11) **01437**  
**A61K31/485** (21) **P-2012-93**  
**A61K9/22**
- (22) 25.07.2007.  
(30) 20060001754 27.01.2006. EP  
(86) PCT/IB2007/003026 25.07.2007.  
(87) WO2008012689 31.01.2008.  
(96) 07704144.0 25.01.2007.  
(97) EP1986650 13.06.2012. 2012/24 EN
- (54) (ME) **DOZNI OBLICI OTPORNI NA MIJENJANJE**  
(EN) TAMPER RESISTANT DOSAGE FORMS
- (73) EURO-CELTIQUE S.A. 2, avenue Charles de Gaulle 1653 Luxembourg LU  
(72) FLEISCHER, Wolfgang, Posener Strasse 6, 55218 Ingelheim DE  
LEUNER, Christian, Blauwiesenweg 65, 60439 Frankfurt DE  
SCHERER, Sabine, Lubentiusstrasse 2, 65553 Limburg-Dietkirchen DE  
(74) Radulović Božidar, Jovana Tomaševića 9/III, Podgorica ME
- (57) Upotreba određene količine antagonista opijata dovoljne da najmanje u potpunosti antagonizuje terapijsku količinu agonista opijata, pri čemu se i agonist opijata i antagonist opijata daju intravenski istovremeno, u vidu doznog oblika kontrolisanog oslobađanja koji obuhvata formulaciju homogenog matriksa za kontrolisano oslobađanje koja obuhvata hidrofobni materijal, uključujući najmanje jedan hidrofobni polimer, gde je hidrofobni polimer etil celuloza, i najmanje jedan masni alkohol ili masnu kiselinu odabrane od C12 do C36 alifatičnih alkohola ili kiselina, i pomenutu terapijsku količinu agonista opijata i pomenutu dovoljnu količinu antagonista opijata, da se spreči formiranje ekstrakta pomenute formulacije matriksa za oslobađanje koja sadrži agonist opijata putem procedure ekstrakcije u jednom koraku koja obuhvata korake: drobljenja formulacije jednog doznog oblika upotrebom sprave za drobljenje pilula ili avana, ili upotrebom dve kašike, pri čemu je drobljenje obavljeno najmanje 4 puta korišćenjem kašika, ekstrakcije zdrobljene formulacije jednog doznog oblika na kašici koristeći 2 ml ključale česmenske vode kao agensa za ekstrakciju i upaljača za cigarete kao naprave za zagrevanje tokom perioda vremena neophodnog da voda proključa, i filtriranja rastvora korišćenjem vate, pri čemu je antagonist opijata prisutan u pomenutom ekstraktu u procentu težinske količine, zasnovane na ukupnoj količini antagonista opijata u doznom obliku, što je više od 20 %-poena manje od procenta težine količine agonista opijata prisutnog u ekstraktu, zasnovanoj na ukupnoj količini agonista opijata u doznom obliku, i gde je agonist opijata oksikodon hlorovodonik i antagonist opijata je naloksen hlorovodonik koji su prisutni u doznom obliku u odnosu 2:1.  
Preostalih patentnih zahtjeva je 14.

- (51) **A61K9/00**  
**A61K38/16**
- (11) **01438**  
(21) **15.04.2010.**
- (22) P-2012-100
- (30) 20100337011P 29.01.2010. US  
20090271340P 20.07.2009. US  
20090271009P 15.07.2009. US
- (96) 10160099.7 15.04.2010.
- (97) EP2275086 14.03.2012. 2012/11 EN
- (54) (ME) **FORMULACIJE GLATIRAMER ACETATA SMANJENE ZAPREMINE I  
POSTUPCI PRIMJENE**  
(EN) REDUCED VOLUME FORMULATION OF GLATIRAMER ACETATE AND METHODS OF ADMINISTRATION
- (73) TEVA PHARMACEUTICAL INDUSTRIES, LTD 5 Basel Street, P.O. Box 3190, 49131 Petach-Tikva IL
- (72) ALTMAN, Ayelet, Halukey Nahal 5, Hod-haSharon IL  
SALT KILL, Doris, 634 East 61 Street Kansas City, MO 64110 US  
TOMLINSON, Dalton, L 10211 Delmar Lane Overland Park, KS 66207 US  
EL-GAD, Tomer, Beerli 40, Rehovot IL
- (74) Radulović Božidar, Jovana Tomaševića 9/III, Podgorica ME
- (57) Pojedinačna doza od 0,5 ml vodenog farmaceutskog rastvora, naznačena time što sadrži, u rastvoru, 20 mg glatiramer acetata i 20 mg manitola.  
Preostalih patentnih zahtjeva je 14.

- (51) **A61K31/724**  
**A61K31/135**  
**A61K9/20**  
**A61K31/496**  
**A61K45/06**  
**A61K47/40**
- (22) 06.04.2010.  
(96) 10159137.8 06.04.2010.  
(97) EP2374450 27.06.2012. 2012/26 EN
- (54) (ME) **KOMPOZICIJE FLUPENTIKSOLA**  
(EN) FLUPENTIXOL COMPOSITIONS
- (73) H. Lundbeck A/S Ottiliavej 9, 2500 Valby DK  
(72) OLSEN, Flemming, Enok H. Lundbeck A/S, Pinievangen 96, 3450, Allerød DK  
(74) Radulović Božidar, Jovana Tomaševića 9/III, Podgorica ME  
(57) Čvrsta farmaceutska kompozicija koja obuhvata flupentiksol ili njihove farmaceutski prihvatljive soli i ciklodekstrin.  
Preostalih patentnih zahtjeva je 9.
- (11) **01439**  
(21) **P-2012-102**

- (51) **B65D5/66** (11) **01440**  
**B65D85/10** (21) **P-2012-137**
- (22) 18.11.2010.  
(30) 20090014501 20.11.2009. EP  
(86) PCT/EP2010/007007 18.11.2010.  
(87) WO2011/060930 26.05.2011.  
(96) 10781838.7 18.11.2010.  
(97) EP2376334 07.11.2012. 2012/45 EN
- (54) (ME) **PAKOVANJE ZA DUVANSKE PROIZVODE**  
(EN) PACKAGE FOR TOBACCO-RELATED ARTICLES
- (73) Imperial Tobacco Limited P.O. Box 244 Upton Road Southville, Bristol BS99 7UJ GB  
(72) HOLLOWAY, Steve, c/o Imperial Tobacco International, Farnham House, arnham Lane, Farnham Royal, Slough SL2 3RQ GB  
COLLINS, Tim, c/o path design, 3 Northfields Prospect, Northfields, London W18 1 PE GB  
KNORR, Solvey, c/o Reemtsma Cigarettenfabriken GmbH, Albert-Einstein-Ring 7 22761 Hamburg DE  
SOUTHEY, Neil, c/o Imperial Tobacco International, Farnham House, Farnham Lane, Farnham Royal, Slough SL2 3RQ GB  
JENKINS, Paul, c/o Imperial Tobacco International, Farnham House, Farnham Lane, Farnham Royal, Slough SL2 3RQ GB  
BUCKINGHAM, Alistair, c/o Imperial Tobacco International, Farnham House, Farnham Lane, Farnham Royal, Slough SL2 3RQ GB  
WOLFGGRAMM, Regine, c/o Reemtsma Cigarettenfabriken GmbH, Albert-Einstein-Ring 7 22761 Hamburg DE  
GURKE, Inga, c/o Reemtsma Cigarettenfabriken GmbH, Albert-Einstein-Ring 7 22761 Hamburg DE  
NOVAK, Slavomir, c/o Reemtsma Cigarettenfabriken GmbH, Albert-Einstein-Ring 7 22761 Hamburg DE  
DEVIVIER, Guillaume, c/o Altadis, 4, Rue Andre Dessaux, F-45404 Fleury, Les Aubrais, Cedex FR
- (74) Ćupić Branislav, Dalmatinska 10, Podgorica ME
- (57) Pakovanje za duvanske proizvode ima: spoljašnji omotač (2, 92, 102, 112) sa prednjim zidom (10, 120), zadnjim zidom (12), dva bočna zida (14), jedan naspram drugog, koji povezuju prednji zid (10, 120) i zadnji zid (12), kao i gornju stranicu (18); poklopac (4, 94, 104, 105, 114) konstruisan tako da zatvara gornju stranicu (18) spoljašnjeg omotača (2, 92, 102, 112) kada je u zatvorenom stanju, pri čemu je poklopac (4, 94, 104, 105, 114) zakretno povezan sa zadnjim zidom (12) ili jednim od bočnih zidova (14) spoljašnjeg omotača (2, 92, 102, 112) na liniji (22) savijanja i gde se on zakreće oko linije (22) savijanja za prelazak iz zatvorenog u otvoreno stanje; unutrašnji omotač (6, 96, 106, 107, 116) konstruisan za smeštanje većeg broja duvanskih proizvoda i pomerljivo postavljen u spoljašnji omotač (2, 92, 102, 112), pri čemu je unutrašnji omotač (6, 96, 106, 107, 116) pomerljiv iz uvučenog položaja u izvučeni položaj što omogućava pristup pušačkim proizvodima; isečak (20, 93, 103, 122) na bar jednom od zidova spoljašnjeg omotača (2, 92, 102, 112) izabran iz sledeće grupe zidova: prednji zid (10, 120), zadnji zid (12) ili dva bočna zida (14), pri čemu je isečak (20, 93, 103, 122) konstruisan tako da izlaže pogledu deo unutrašnjeg omotača (6, 96, 106, 107, 116) i omogućava prenos sile na unutrašnji omotač (6, 96, 106, 107, 116) za pomeranje unutrašnjeg omotača (6, 96, 106, 107, 116); vezni deo (50, 115) između dela unutrašnjeg omotača (6, 96, 106, 107, 116) i poklopcu (4, 94, 104, 105, 114), koji je spregnut sa poklopcem (4, 94, 104, 105, 114) na rastojanju od

linije savijanja (22) manjem od dimenzije poklopca (4, 94, 104, 105, 114), a u pravcu normalnom na liniju (22) savijanja i koji je konstruisan za pritiskivanje poklopca (4, 94, 104, 105, 119) u otvoren položaj kada je unutrašnji omotač (6, 96, 106, 107, 116) pomeren u izvučeni položaj i za povlačenje poklopca (4, 94, 104, 105, 114) u zatvoreno stanje kada je unutrašnji omotač (6, 96, 106, 107, 116) pomeren u uvučeni položaj.

Preostalih patentnih zahtjeva je 39.

- (51) **A61K9/20**  
**A61K9/00**  
**A61K31/428**  
**A61K31/4745**
- (11) **01442**  
(21) **P-2010-207**
- (22) 25.07.2005.  
(30) 20040019248 13.08.2004. EP  
(86) PCT/EP2005/053602 25.07.2005.  
(87) WO2006015942 16.02.2006.  
(96) 05777774.0 25.07.2005.  
(97) EP1781260 03.11.2010. 2010/44 EN
- (54) (ME) **TABLETNA FORMULACIJA SA PRODUŽENIM OTPUŠTANJEM KOJA SADRŽI PRAMIPEKSOL ILI NJEGOVU FARMACEUTSKI PRIHVATLJIVU SO, POSTUPAK ZA PROIZVODNJU ISTE I NJENA PRIMJE**  
(EN) EXTENDED RELEASE TABLET FORMULATION CONTAINING PRAMIPEXOLE OR A PHARMACEUTICALLY ACCEPTABLE SALT THEREOF, METHOD FOR MANUFACTURING THE SAME AND USE THEREOF
- (73) Boehringer Ingelheim International GmbH Binger Strasse 173 55216 Ingelheim am Rhein DE
- (72) FRIEDL, Thomas Hans-Liebherr-Str. 48/4, 88416 OCHSENHAUSEN DE  
EISENREICH, Wolfram Kirchstrasse 16/1, 89081 ULM DE
- (74) Radulović Božidar, Jovana Tomaševića 9/III, Podgorica ME
- (57) Tabletna formulacija sa produženim otpuštanjem obuhvata pramipeksol ili njegovu farmaceutski prihvatljivu so u matriksu koji sadrži bar dva polimera koji bubre u vodi, osim preželatinizovanog škroba, i pri čemu bar jedan od dva polimera je anjonski polimer. Preostalih patentnih zahtjeva je 13.

- (51) **A61K31/352**  
**A61P29/02**  
**A61P1/08**
- (22) 14.06.2006.
- (30) 20050691361P 16.06.2005. US  
20050726509P 12.10.2005. US
- (86) PCT/EP2006/005761 14.06.2006.
- (87) WO2006133941 21.12.2006.
- (96) 06754384.3 14.06.2006.
- (97) EP1901734 24.11.2010. 2010/47 EN
- (54) (ME) **KOMPOZICIJE KOJE SADRŽE KRISTALNI TRANS-(+/-)-DELTA-9-TETRAHIDROKANABINOL**  
(EN) COMPOSITIONS COMPRISING CRYSTALLINE TRANS-(+/-)-DELTA-9-TETRAHYDRO-CANNABINOL
- (73) EURO-CELIQUE S.A. 2, avenue Charles de Gaulle, 1653 Luxembourg LU
- (72) KUPPER, Robert, J. 755 Major Potter Road East Greenwich, RI 02818 US
- (74) Lutovac Branislav, Bulevar Crnojevića 93, Podgorica ME
- (57) Farmaceutska kompozicija, koja sadrži trans-(±)-A9-tetrahidrokanabinol u kristalnom obliku i neki farmaceutski prihvatljiv nosač, za upotrebu kao medikament.  
Preostalih patentnih zahtjeva je 40.

- (51) **B65D5/66** (11) **01448**  
**B65D85/10** (21) **P-2012-125**
- (22) 18.11.2010.  
(30) 20090014501 20.11.2009. EP  
(86) PCT/EP2010/007008 18.11.2010.  
(87) WO2011060931 26.05.2011.  
(96) 10781839.5 18.11.2010.  
(97) EP2376335 31.10.2012.
- (54) (ME) **PAKOVANJE ZA DUVANSKE PROIZVODE**  
(EN) PACKAGE FOR TOBACCO-RELATED ARTICLES
- (73) Imperial Tobacco Limited P.O. Box 244 Upton Road Southville, Bristol BS99 7UJ GB  
(72) HOLLOWAY, Steve c/o Imperial Tobacco International, Farnham House, Farnham Lane, Farnham Royal Slough SL2 3RQ GB  
COLLINS, Tim c/o path design, 3 Northfields Prospect, Northfields London SW18 1 PE GB  
KNORR, Solvey c/o Reemtsma Cigarettenfabriken GmbH, Albert-Einstein-Ring 7 22761 Hamburg DE  
SOUTHEY, Neil c/o Imperial Tobacco International, Farnham House, Farnham Lane, Farnham Royal Slough SL2 3RQ GB  
WOLFGRAMM, Regine c/o Reemtsma Cigarettenfabriken GmbH, Albert-Einstein-Ring 7 22761 Hamburg / DE  
GURKE, Inga c/o Reemtsma Cigarettenfabriken GmbH, Albert-Einstein-Ring 7 22761 Hamburg DE  
DEVIVIER, Guillaume c/o Altadis, 4 rue André Dessaux, 45404 Fleury Les Aubrais, Cedex FR
- (74) Čupić Branislav, Dalmatinska 10, Podgorica ME
- (57) Pakovanje za duvanske proizvode ima omotač (2, 92, 102, 112, 132, 152, 182) sa prednjim zidom (10, 120, 134, 154, 184), zadnjim zidom (12, 135, 155, 185), dva naspramna bočna zida (14, 122, 138), koji povezuju prednji zid (10, 120, 134, 154, 184) i zadnji zid (12, 135, 155, 185), kao i gornju stranicu (18); i poklopac (4, 94, 104, 105, 114, 140, 160, 190) konstruisan tako da zatvara gornju stranicu (18) omotača (2, 92, 102, 112, 132, 152, 182) kada je zatvoren, gde je poklopac (4, 94, 104, 105, 114, 140, 160, 190) zakretno povezan sa zadnjim zidom (12, 135, 155, 185) ili jednim od bočnih zidova (14, 122, 138) omotača (2, 92, 102, 112, 132, 152, 182) po liniji (22, 145, 164, 193) savijanja i gde se on može zakretati oko linije (22, 145, 164, 193) savijanja za promenu položaja iz zatvorenog u otvoren; pri čemu poklopac (4, 94, 104, 105, 114, 140, 160, 190) ima gornji zid (24, 142, 161, 191) sa prednjom ivicom (26), zadnjom ivicom (28), dve bočne ivice (30) i donju stranicu (32) i konstruisan je tako da zatvara gornju stranicu (18) omotača (2, 92, 102, 112, 132, 152, 182) kada je poklopac (4, 94, 104, 105, 114, 140, 160, 190) u zatvorenom položaju; pri čemu se kosi ivični zid (34, 124, 146, 166, 194) pruža bar od ivice (26) gornjeg zida (24, 142, 161, 191) naspram linije (22, 145, 164, 193) savijanja poklopca (4, 94, 104, 105, 114, 140, 160, 190) i gde se taj kosi ivični zid (34, 124, 146, 166, 194) uklapa u omotač (2, 92, 102, 112, 132, 152, 182) kada je poklopac (4, 94, 104, 105, 114, 140, 160, 190) u zatvorenom položaju tako da je kosi ivični zid smešten u omotač i u opštem slučaju nije vidljiv.



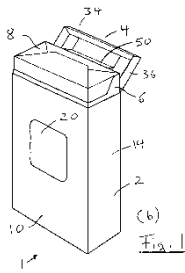

Preostalih patentnih zahtjeva je 17.

(51) **B65D85/76**(11) **01447****B65D25/10**(21) **P-2012-132**

(22) 25.10.2010.

(30) 20090005441 12.11.2009. FR

(96) 10188698.4 25.10.2010.

(97) EP2322451 29.08.2012. 2012/45 EN

(54) (ME) **PAKOVANJE ZA PREHRAMBENE PROIZVODE KOJI SE MOGU NPODIJELITI U PORCIJU**(EN) **PACKAGING OF A FOOD PRODUCT IN PORTIONS**

(73) BONGRAIN S.A. 42, rue Rieussec, 78220 Viroflay FR

(72) Bonnin, Yves 12, Chemin de Bazemont, 78580 Maule FR

Ravelet, Sébastien 7, Rue Jaroslava Foglara, 60200 Brno CZ

(74) Radulović Božidar, Jovana Tomaševića 9/III, Podgorica ME

(57) Preklopivo pakovanje za prehrambeni proizvod koji se može podeliti u porcije, sadrži, referišući se na sklopljeno pakovanje: bočnu traku (400, 410, 420, 430, 700, 710, 800, 1100, 1200) koja ima dve longitudinalne ivice (401-402, 431-432, 704-705, 711-712, 1101-1102, 1201-1202) povezane sa dve krajnje ivice (403-404, 433-434, 702-703, 713-714, 1104-1105, 1204-1205) i koja ima najmanje jednu krivinu i/ili liniju (411, 424, 706-707) savijanja da bi se formirao prostor za skladištenje prehrambenog proizvoda (P); zaptivnu membranu (500, 600, 900, 1000, 1300) koja ima donji deo (501, 601, 901, 1001, 1301) i poklopac (502, 602, 902, 1002, 1302), koji su pričvršćeni za zasebne podužne ivice, i bočni granični deo (503, 603, 903, 1003, 1303) pričvršćen za krajnje ivice trake, tako da je prehrambeni proizvod zatvoren u skladišnom prostoru, pri čemu je membrana na odlepljiv način pričvršćena za krajnje ivice, za celu prvu longitudinalnu ivicu i za najmanje jedan deo druge longitudinalne ivice.

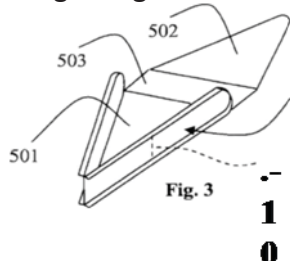

Preostalih patentnih zahtjeva je 14.

- (51) **A61K9/107**  
**A61K39/39**  
**B01F13/00**  
**A61K39/145**  
**B01F3/08**  
**B01F5/06**  
**B01F5/10**  
**B01F13/10**  
**A61K9/00**  
**B01F7/0**
- (11) **01443**  
(21) **P-2012-135**
- (22) 03.12.2010.  
(30) 20090283548P 03.12.2009. US.  
(96) 10252052.5 03.12.2010.  
(97) EP2380558 12.09.2012. 2012/37 EN
- (54) (ME) **METOD INTERAKCIJE I KOMORE SA POVRATNIM PRITISKOM ZA MIKROFLUIDIZACIJU**  
(EN) ARRANGING INTERACTION AND BACK PRESSURE CHAMBERS FOR MICROFLUIDIZATION
- (73) Novartis AG Lichtstrasse 35 4056 Basel CH  
(72) Rueckl, Harald Hortgasse 1, 36304 Alsfeld DE  
Scheffczik, Hanno Brueder-Grimm-Strasse 16, 35039 Marburg DE  
(74) Radulović Božidar, Jovana Tomaševića 9/III, Podgorica ME
- (57) Metod za proizvodnju emulzije ulja-u-vodi koji sadrži: prolazak prve emulzije, koja ima prvu prosečnu veličinu uljnih kapljica, kroz mikrofluidizacioni uređaj tako da se formira druga emulzija koja ima drugu prosečnu veličinu uljnih kapljica, koja je manja od prve prosečne veličine uljnih kapljica; i filtraciju druge emulzije; u kojem mikrofluidizacioni uređaj uključuje interakcionu komoru koja sadrži više kanala Z-tipa i komoru povratnog pritiska koja ima bar jedan kanal, i u kojem je komora povratnog pritiska postavljena posle interakcione komore.  
Preostalih patentnih zahtjeva je 16.

- (51) **C09C 1/02** (11) **01441**  
**D21H 17/67** (21) **P-2012-61**
- (22) 15.06.2009.
- (96) 09162727.3 15.06.2009.
- (97) EP 2264108 15.02.2012. 2012/07 EN
- (54) (ME) **POSTUPAK ZA DOBIJANJE POVRŠINSKI IZREAGOVANOG KALCIJUM KARBONATA PRIMJENOM SLABE KISELINE**  
(EN) **PROCESS TO PREPARE A SURFACE-REACTED CALCIUM CARBONATE IMPLEMENTING A WEAK ACID**
- (73) Omya Development AG Baslerstrasse 42, 4665 Oftringen CH
- (72) Gane, Patrick Arthur Charles; Studenweg 8, 4852, Rothrist CH  
Gerard, Daniel E.; Riehenring 7, 4058, Basel CH
- (74) Lutovac Branislav, Bulevar Crnojevića 93, Podgorica ME
- (57) Postupak za dobijanje površinski izreagovanog kalcijum karbonata u vodenoj sredini koji se sastoji od sledećih koraka: obezbeđenje najmanje jednog mlevenog prirodnog kalcijum karbonata (MPKK); obezbeđenje najmanje jedne vodo-rastvorne kiseline; obezbeđenje gasovitog CO<sub>2</sub>; dovođenje u kontakt navedenog MPKK iz koraka a) sa navedenom kiselinom iz koraka b) i sa navedenim CO<sub>2</sub> iz koraka c); naznačen time, što:
- (i) navedena(e) kiselina(e) iz koraka b) svaka ima(ju) pKa veću od 2,5 i manju ili jednaku 7, mereno na 20°C, vezanu za jonizaciju njihovog prvog dostupnog vodonika, a odgovarajući anjon koji nastaje gubitkom ovog prvog dostupnog vodonika može da formira vodo-rastvorne kalcijumove soli;
- (ii) posle dovođenja u kontakt navedene(ih) kiseline(a) sa navedenim MPKK, nastaje najmanje jedna vodo-rastvorna so, koja u slučaju soli koja sadrži vodonik ima pKa veću od 7, mereno na 20°C, vezanu za jonizaciju prvog dostupnog vodonika, i dodatno anjon soli koji je sposoban da formira vodo-nerastvorne kalcijumove soli.
- Patent sadrži još 19 patentnih zahtjeva.

- (51) **A61K 33/04**  
**A61K 36/06**  
**A61K 38/28**  
**A61K 45/06**
- (22) 07.11.2005.
- (30) 727015 P 14.10.2005. US  
726922 P 14.10.2005. US  
727018 P 14.10.2005. US  
726951 P 14.10.2005. US
- (96) 05024235.3 07.11.2005.
- (97) EP 1774972 29.02.2012. 2012/09 EN
- (54) (ME) **UPOTREBA SELENSKIH KVASACA U LIJEČENJU ALCHAJMEROVE BOLESTI**  
(EN) USE OF SELENIUM YEASTS IN THE TREATMENT OF ALZHEIMERS DISEASE
- (73) Alltech, Inc. 3031 Catnip Hill Pike, Nicholasville, KY 40356 US
- (72) Pearse Lyons, Thomas 67 Avenue of Champions, Nicholasville, KY 40356 US  
Power, Ronan 1213 Jekyll Drive, Lexington, Kentucky 40513 US
- (74) Lutovac Branislav, Bulevar Crnojevića 93, Podgorica ME
- (57) Upotreba kompozicije koja sadrži osušeni, nevijabilni kvasac obogaćen selenom, gdje ukupan sadržaj selena pomenutog kvasca čini dva procenta ili manje neorganskog selena, u proizvodnji lijeka, što je lijek formulisan za davanje subjektu pod uslovima u kojima je smanjena ekspresija komplementnog gena u cerebralnom korteksu pomenutog subjekta za liječenje ili prevenciju Alchajmerove bolesti.  
Patent sadrži još 21 patentni zahtjev.

(51) **A61K 9/127**  
**A61K 9/00**  
**A61K 31/495**  
**A61P 37/08**

(11) **01436**  
(21) **P-2012-77**

(22) 06.05.2005.

(30) 842433 11.05.2004. US

(96) PCT/GB2005/001758 06.05.2005.

(97) WO 2005/107711 17.11.2005.

(54) (ME) **POSTUPAK I KOMPOZICIJA ZA LIJEČENJE RINITISA**  
(EN) **METHOD AND COMPOSITION FOR TREATING RHINITIS**

(73) Biolipox AB P.O. Box 303, 751 05 Uppsala SE

(72) PERESWETOFF-MORATH, Lena Biolipox AB, c/o Orexo AB, PO Box 303, 751 05 Uppsala SE  
CARLSSON, Anders MediGelium AB, S:t Göransgatan 80, 112 38 Stockholm SE

(74) Lutovac Branislav, Bulevar Crnojevića 93, Podgorica ME

(57) Homogena farmaceutska kompozicija pogodna za liječenje rinitisa nazalnim ili okularnim davajem, koja sadrži cviter jon cetirizina, polarni lipidni lipozom i farmaceutski-prihvatljiv vodeni nosač, u kojoj koncentracija cetirizina varira ali ne više od  $\pm 50\%$  kada se poredi sa koncentracijama unutar i izvan struktura lipozoma.

Patent sadrži još 59 patentnih zahtjeva.



# ŽIGOVI

## TRADEMARKS

Službeni glasnik Zavoda za intelektualnu svojinu Crne Gore  
Official Gazette of the Montenegrin Intellectual Property Office

# 13/2013



Zavod za intelektualnu svojinu Crne Gore  
ul. Rimski trg br. 46,  
81000 Podgorica,  
Crna Gora





**MEĐUNARODNI KODOVI ZA IDENTIFIKACIJU BIBLIOGRAFSKIH  
PODATAKA O ŽIGOVIMA PREMA WIPO ST 60**  
RECOMMENDATION CONCERNING BIBLIOGRAFIC DATA RELATING TO  
TRADEMARKS- WIPO-ST. 60

<b>CRNOGORSKI</b>	<b>MDK</b>	<b>ENGLESKI</b>
REGISTRARSKI BROJ	<b>111</b>	NUMBER OF THE REGISTRATION
DATUM REGISTRACIJE	<b>151</b>	DATE OF THE REGISTRATION
OČEKIVANI DATUM PRESTANKA VAŽENJA ŽIGA	<b>181</b>	EXPECTED EXPIRATION DATE OF THE REGISTRATION
BROJ PRIJAVE	<b>210</b>	NUMBER OF THE APPLICATION
DATUM PODNOŠENJA PRIJAVE	<b>220</b>	DATE OF FILING OF THE APPLICATION
PODACI O IZLOŽBENOM PRAVU PRVENSTVA	<b>230</b>	DATA CONCERNING EXHIBITIONS
PODACI O PRAVU PRVENSTVA NA OSNOVU PARISKE KONVENCIJE	<b>300</b>	DATA RELATING TO PRIORITU UNDER THE PARIS CONVENTION
DATUM OBJAVLJIVANJA PRIJAVE	<b>442</b>	DATA OF PUBLICATION OF APPLICATION
SPISAK ROBA I USLUGA PREMA NIČANSKOJ KLASIFIKACIJI ROBA I USLUGA	<b>511</b>	LIST OF GOODS AND SERVICES ACCORDING THE NICE CLASSIFICATION OF GOODS AND SERVICE
IZJAVA PODNOSIOCA PRIJAVE DA NE TRAŽE EKSKLUZIVNO PRAVO ZA POJEDINE NEDINSTIKTIVNE ELEMENTE ZNAKA	<b>526</b>	DISCLAIMER
IZGLED ZNAKA	<b>540</b>	REPRODUCTION OF THE MARK
NAZNAKA O PRIRODI ILI VRSTI ZNAKA	<b>550</b>	INDICATION RELATING TO THE NATURE OR KIND OF MARK
INFORMACIJA O ZATRAŽENIM BOJAMA NA ZNAKU	<b>591</b>	INFORMATION CONCERNING THE COLORS CLAIMED
PODACI O PODNOSIOCU PRIJAVE	<b>731</b>	NAME AND ADRESS OF THE APPLICANT
IME I ADRESA NOSIOCA ŽIGA	<b>732</b>	NAME AND ADDRESS OF THE HOLDER OF THE REGISTRATION
INFORMACIJA O ZATRAŽENIM BOJAMA NA ZNAKU	<b>591</b>	INFORMATION CONCERNING THE COLORS CLAIMED
PODACI O PODNOSIOCU PRIJAVE	<b>731</b>	NAME AND ADRESS OF THE APPLICANT
IME I ADRESA NOSIOCA ŽIGA	<b>732</b>	NAME AND ADDRESS OF THE HOLDER OF THE REGISTRATION
IME I ADRESA PUNOMOĆNIKA	<b>740</b>	NAME AND ADDRESS OF THE REPRESENTATIVE



## OBAVJEŠTENJE NOTICE

Obavještavamo korisnike da se od 7-og broja Crnogorskog glasnika za intelektualnu svojinu koji se objavljuje na web stranici Zavoda za intelektualnu svojinu Crne Gore, u elektronskoj formi, odnosno od 20.12.2011 godine (Glasnik broj 7/2011) uvodi objava prijave za registraciju žiga. Stupanjem na snagu Pravilnika o postupku za priznanje, promjenama, obnovi i međunarodnoj registraciji žiga ("Sl. list CG" broj 55/11) stekli su se uslovi da Zavod postupa u skladu sa odredbom člana 29 stav 1 Zakona o žigu i uredne prijave, za koje nije utvrđen razlog za odbijanje registracije iz člana 28 ovog zakona, objavi u Službenom glasilu.

Od dana objavljivanja prijave u Službenom glasilu, shodno odredbi člana 30 stav 1 Zakona o žigu, pravna i fizička lica ili udruženja proizvođača roba ili usluga, pružaoci usluga, trgovci i potrošači mogu, u roku od 90 dana od datuma objavljivanja prijave, dostaviti Zavodu obrazloženo mišljenje u pisanoj formi o apsolutnim razlozima za odbijanje registracije iz člana 6 Zakona o žigu.

U roku od 90 dana od dana objavljivanja prijave u Službenom glasilu, nosilac ranijeg žiga ili sticalac licence, na osnovu ovlašćenja nosioca žiga, mogu zbog razloga iz čl. 7 i 8 Zakona o žigu, u roku od 90 dana od dana objavljivanja prijave, shodno odredbi člana 31 stav 1 i 2 Zakona o žigu podnijeti Zavodu Prigovor za odbijanje registracije žiga.



- (210) **2009-492** (442) **20.12.2013.**  
 (220) 06.08.2009.  
 (731) **MESOPROMET DOO**, BIJELO POLJE ME



- (540)  
 (550) I  
 (511) **Klasa 29:** Meso, riba, živina i divljač, mesne prerađevine, sušeno i kuvano voće i povrće, žele i džemovi, kompoti, jaja, mlijeko i mliječni proizvodi, jestiva ulja i masti, a naročito, svježe juneće i teleće meso i prerađevine od junećeg i telećeg mesa, svježe svinjsko meso i prerađevine od svinjskog mesa, svježe ovčije i jagnjeće meso i prerađevine od ovčijeg i jagnjećeg mesa, pileće i ćureće meso i prerađevine od pilećeg i ćurećeg mesa, gotova jela, grašak sa junećim mesom, grašak sa faširanom šniclom, pasulj sa suvim junećim mesom, pasulj sa junećom kobasicom, pasulj sa faširanom šniclom, ćufte u parađaz sosu, boranija sa junećim mesom, pasulj sa slaninom, grašak sa svinjskim mesom, svinjski paprikaš.

- (210) **2010-63** (442) **20.12.2013.**  
 (220) 15.03.2010.  
 (731) **BROADBAND MONTENEGRO D.O.O.** BBM, BULEVAR REVOLUCIJE 66, PODGORICA ME



- (540)  
 (550) I  
 (511) **Klasa 35:** Oglašavanje, vođenje poslova, poslovno upravljanje, kancelarijski poslovi.  
**Klasa 37:** Građevinsko konstruisanje, popravljjanje, usluge instaliranja (instalacione usluge).  
**Klasa 38:** Telekomunikacije.  
**Klasa 39:** Transportne usluge, pakovanje i skladištenje robe, organizovanje putovanja.  
**Klasa 43:** usluge obezbjeđivanja hrane i pića, privremeni smještaj.

- (210) **2011-115** (442) **20.12.2013.**  
 (220) 09.03.2011.  
 (731) **BOSNALIJEK**, FARMACEUTSKA I HEMIJSKA INDUSTRIJA DD, JUKIĆEVA 53, SARAJEVO BA

# METROZOL

(540)

(550) I

(740) Radulović Božidar, Jovana Tomaševića 9/III, Podgorica ME

(511) **Klasa 05:** Farmaceutski proizvodi.

---

(210) **2011-116**

(442) **20.12.2013.**

(220) 09.03.2011.

(731) **BOSNALIJEK**, FARMACEUTSKA I HEMIJSKA INDUSTRIJA DD, JUKIĆEVA 53, SARAJEVO BA

# DOXAT

(540)

(550) I

(740) Radulović Božidar, Jovana Tomaševića 9/III, Podgorica ME

(511) **Klasa 05:** Farmaceutski proizvodi.

---

(210) **2011-121**

(442) **20.12.2013.**

(220) 11.03.2011.

(731) **DOMPE S.P.A.** LACOLITA CAMPO DI PILE SNC, 67100 L AQUILA AQ IT

# ARTROSILENE

(540)

(550) I

(740) Popović Miladin, Đoka Miraševića 21/III, Podgorica ME

(511) **Klasa 05:** Farmaceutski i veterinarski preparati, sanitarni preparati za medicinsku upotrebu, dijetetske supstance prilagođene za upotrebu u medicini, hrana za bebe, flasteri, materijali za zavijanje, materijali za plombiranje zuba, zubarska smola, dezinfekciona sredstva, preparati za uništavanje štetočina, fungicidi, herbicidi.

---

(210) **2011-122**

(442) **20.12.2013.**

(220) 11.03.2011.

(731) **DOMPE S.P.A.** LACOLITA CAMPO DI PILE SNC, 67100 L AQUILA AQ IT

# FLUIFORT

(540)

(550) I

(740) Popović Miladin, Đoka Miraševića 21/III, Podgorica ME

(511) **Klasa 05:** Farmaceutski i veterinarski preparati, sanitarni preparati za medicinsku upotrebu, dijetetske supstance prilagođene za upotrebu u medicini, hrana za bebe, flasteri, materijali za zavijanje, materijali za plombiranje zuba, zubarska smola, dezinfekciona sredstva, preparati za uništavanje štetočina, fungicidi, herbicidi.

(210) **2011-123**

(442) **20.12.2013.**

(220) 11.03.2011.

(731) **DOMEN DOO**, BUL. DŽ. VAŠINGTONA BB PODGORICA ME



(540)

(550) I

(511) **Klasa 35:** Oglašavanje, oglašavanje putem štampanih i elektronskih medija.

**Klasa 38:** Telekomunikacije, registracija internet domena.

(210) **2011-124**

(442) **20.12.2013.**

(220) 11.03.2011.

(731) **DOMEN DOO**, BUL. DŽ. VAŠINGTONA BB PODGORICA ME



## Express yourself.

(540)

(550) I

(511) **Klasa 35:** Oglašavanje, oglašavanje putem štampanih i elektronskih medija.

**Klasa 38:** Telekomunikacije, registracija internet domena.

(210) **2011-15** (442) **20.12.2013.**  
(220) 13.01.2011.

(731) **HERCULES INCORPORATED**, HERCULES PLAZA, 1313 NORTH MARKET STREET, WILMINGTON, DELAWARE 19894-001 US

## CULMINAL

(540)

(550) I

(740) Čupić Branislav, Dalmatinska 10, Podgorica ME

(511) **Klasa 01:** Hemijski proizvodi i hemijske kompozicije koje se koriste u proizvodnji boja, premaza i industrijskih ljepila, hemijski proizvodi i hemijske kompozicije koje se koriste u proizvodnji proizvoda za građevinarstvo, kao što su maker, gips, keramika, smjese za popunjavanje, supstance za popunjavanje, cement za pločice, i cement, polimeri koji se rastvaraju u vodi, metilceluloza i etri celuloze koji se koriste u industriji, polimeri koji se rastvaraju u vodi, metilceluloza i etri celuloze koji se koriste u proizvodnji boja, premaza i industrijskim ljepilima, polimeri koji se rastvaraju u vodi, metilceluloza i etri celuloze koji se koriste u proizvodnji proizvoda za građevinarstvo, kao što su malter, gips, keramika, materijal za ispunu, supstance za popunjavanje, cement za pločice, i cement, hemijski proizvodi i hemijske kompozicije koje se koriste kao reološki modifikatori, vezivni materijali, emulgatori, pomoćne supstance za ravnomjerno upijanje vlage, stabilizator, pomoćne supstance za suspenziju, i zaštitni koloidi, polimeri koji se rastvaraju u vodi, metilceluloza i etri celuloze koji se koriste kao reološki modifikatori, vezivni materijali, emulgatori, pomoćne supstance za ravnomjerno upijanje vlage, stabilizator, zaštitni koloidi.

(210) **2011-152** (442) **20.12.2013.**  
(220) 30.03.2011.

(731) **BILIM ILAC SAN. VE TIC A.S. MASALK MAHALLESI**, SUMER SOKAK BR. 4 SISLIMASALK INSTANBUL TR



(540)

(550) I

(511) **Klasa 05:** Farmaceutski i veterinarski preparati, sanitarni preparati za medicinsku upotrebu, dijetetske supstance prilagođene za upotrebu u medicini, hrana za bebe, flastere, materijali za zavijanje, materijali za plombiranje zuba, zubarske smole, dezinfekciona sredstva, preparati za uništavanje štetočina, fungicidi, herbicidi, sanitarni preparati za upotrebu u medicini i za ličnu higijenu, dezodoransi koji nisu za ličnu upotrebu, cigarete bez duvana za medicinske svrhe.

(210) **2011-153** (442) **20.12.2013.**



(220) 30.03.2011.

(731) **BILIM ILAC** SAN. VE TIC A.S. MASALK MAHALLESI, SUMER SOKAK BR. 4 SISLIMASALK INSTANBUL TR

Zimaks

(540)

(550) I

(511) **Klasa 05:** Farmaceutski i veterinarski preparati, sanitarni preparati za medicinsku upotrebu, dijetetske supstance prilagođene za upotrebu u medicini, hrana za bebe, flastere, materijali za zavijanje, materijali za plombiranje zuba, zubarske smole, dezinfekciona sredstva, preparati za uništavanje štetočina, fungicidi, herbicidi, sanitarni preparati za upotrebu u medicini i za ličnu higijenu, dezodoransi koji nisu za ličnu upotrebu, cigarete bez duvana za medicinske svrhe.

(210) **2011-154**

(442) **20.12.2013.**

(220) 30.03.2011.

(731) **BILIM ILAC** SAN. VE TIC A.S. MASALK MAHALLESI, SUMER SOKAK BR. 4 SISLIMASALK INSTANBUL TR

Ulcorex

(540)

(550) I

(511) **Klasa 05:** Farmaceutski i veterinarski preparati, sanitarni preparati za medicinsku upotrebu, dijetetske supstance prilagođene za upotrebu u medicini, hrana za bebe, flastere, materijali za zavijanje, materijali za plombiranje zuba, zubarske smole, dezinfekciona sredstva, preparati za uništavanje štetočina, fungicidi, herbicidi, sanitarni preparati za upotrebu u medicini i za ličnu higijenu, dezodoransi koji nisu za ličnu upotrebu, cigarete bez duvana za medicinske svrhe.

(210) **2011-155**

(442) **20.12.2013.**

(220) 30.03.2011.

(731) **BILIM ILAC** SAN. VE TIC A.S. MASALK MAHALLESI, SUMER SOKAK BR. 4 SISLIMASALK INSTANBUL TR

Muscoflex

(540)

(550) I

(511) **Klasa 05:** Farmaceutski i veterinarski preparati, sanitarni preparati za medicinsku upotrebu, dijetetske supstance prilagođene za upotrebu u medicini, hrana za bebe, flastere, materijali za zavijanje, materijali za plombiranje zuba, zubarske smole, dezinfekciona sredstva, preparati za uništavanje štetočina, fungicidi, herbicidi, sanitarni preparati za upotrebu u medicini i za ličnu higijenu, dezodoransi koji nisu za ličnu upotrebu, cigarete bez duvana za medicinske svrhe.

(210) **2011-156**

(442) **20.12.2013.**

(220) 30.03.2011.

(731) **BILIM ILAC** SAN. VE TIC A.S. MASALK MAHALLESI, SUMER SOKAK BR. 4 SISLIMASALK  
INSTANBUL TR

## Klamoks

(540)

(550) I

(511) **Klasa 05:** Farmaceutski i veterinarski preparati, sanitarni preparati za medicinsku upotrebu, dijetetske supstance prilagođene za upotrebu u medicini, hrana za bebe, flastere, materijali za zavijanje, materijali za plombiranje zuba, zubarske smole, dezinfekciona sredstva, preparati za uništavanje štetočina, fungicidi, herbicidi, sanitarni preparati za upotrebu u medicini i za ličnu higijenu, dezodoransi koji nisu za ličnu upotrebu, cigarete bez duvana za medicinske svrhe.

---

(210) **2011-157**

(442) **20.12.2013.**

(220) 30.03.2011.

(731) **BILIM ILAC** SAN. VE TIC A.S. MASALK MAHALLESI, SUMER SOKAK BR. 4 SISLIMASALK  
INSTANBUL TR

## Forsef

(540)

(550) I

(511) **Klasa 05:** Farmaceutski i veterinarski preparati, sanitarni preparati za medicinsku upotrebu, dijetetske supstance prilagođene za upotrebu u medicini, hrana za bebe, flastere, materijali za zavijanje, materijali za plombiranje zuba, zubarske smole, dezinfekciona sredstva, preparati za uništavanje štetočina, fungicidi, herbicidi, sanitarni preparati za upotrebu u medicini i za ličnu higijenu, dezodoransi koji nisu za ličnu upotrebu, cigarete bez duvana za medicinske svrhe.

---

(210) **2011-158**

(442) **20.12.2013.**

(220) 30.03.2011.

(731) **BILIM ILAC** SAN. VE TIC A.S. MASALK MAHALLESI, SUMER SOKAK BR. 4 SISLIMASALK  
INSTANBUL TR

## Diloxol

(540)

(550) I

(511) **Klasa 05:** Farmaceutski i veterinarski preparati, sanitarni preparati za medicinsku upotrebu, dijetetske supstance prilagođene za upotrebu u medicini, hrana za bebe, flastere, materijali za zavijanje, materijali za plombiranje zuba, zubarske smole, dezinfekciona sredstva, preparati za uništavanje štetočina, fungicidi, herbicidi, sanitarni preparati za upotrebu u medicini i za ličnu higijenu, dezodoransi koji nisu za ličnu upotrebu, cigarete bez duvana za medicinske svrhe.

---

(210) **2011-159**

(442) **20.12.2013.**

(220) 30.03.2011.

(731) **BILIM ILAC** SAN. VE TIC A.S. MASALK MAHALLESI, SUMER SOKAK BR. 4 SISLIMASALK INSTANBUL TR

Coronis

(540)

(550) I

(511) **Klasa 05:** Farmaceutski i veterinarski preparati, sanitarni preparati za medicinsku upotrebu, dijetetske supstance prilagođene za upotrebu u medicini, hrana za bebe, flastere, materijali za zavijanje, materijali za plombiranje zuba, zubarske smole, dezinfekciona sredstva, preparati za uništavanje štetočina, fungicidi, herbicidi, sanitarni preparati za upotrebu u medicini i za ličnu higijenu, dezodoransi koji nisu za ličnu upotrebu, cigarete bez duvana za medicinske svrhe.

(210) **2011-181**

(442) **20.12.2013.**

(220) 12.04.2011.

(731) **BOSNALIJEK DD**, JUKIĆEVA 53, 71000 SARAJEVO BA

**ESBESUL**

(540)

(550) I

(740) Radulović Božidar, Jovana Tomaševića 9/III, Podgorica ME

(511) **Klasa 05:** Farmaceutski proizvodi.

(210) **2011-196**

(442) **20.12.2013.**

(220) 26.04.2011.

(731) **MEDOCHEMIE LTD.** CONSTANTINOUPOLEOS STREET 3011, LIMASSOL CY

**MOXILEN**

(540)

(550) I

(740) Popović Miladin, Đoka Miraševića 21/III, Podgorica ME

(511) **Klasa 05:** Farmaceutski proizvodi.

(210) **2011-198**

(442) **20.12.2013.**

(220) 26.04.2011.

(731) **MEDOCHEMIE LTD.** CONSTANTINOUPOLEOS STREET 3011, LIMASSOL CY

## ARNETIN

(540)

(550) I

(740) Popović Miladin, Đoka Miraševića 21/III, Podgorica ME

(511) **Klasa 05:** Farmaceutski proizvodi.

---

(210) **2011-199**

(442) **20.12.2013.**

(220) 26.04.2011.

(731) **MEDOCHEMIE LTD.** CONSTANTINOUPOLEOS STREET 3011, LIMASSOL CY

## MABRON

(540)

(550) I

(740) Popović Miladin, Đoka Miraševića 21/III, Podgorica ME

(511) **Klasa 05:** Farmaceutski proizvodi.

---

(210) **2011-200**

(442) **20.12.2013.**

(220) 26.04.2011.

(731) **MEDOCHEMIE LTD.** CONSTANTINOUPOLEOS STREET 3011, LIMASSOL CY

## AZEPTIL

(540)

(550) I

(740) Popović Miladin, Đoka Miraševića 21/III, Podgorica ME

(511) **Klasa 05:** Farmaceutski proizvodi.

---

(210) **2011-201**

(442) **20.12.2013.**

(220) 26.04.2011.

(731) **MEDOCHEMIE LTD.** CONSTANTINOUPOLEOS STREET 3011, LIMASSOL CY

## RILCAPTON

(540)

(550) I

(740) Popović Miladin, Đoka Miraševića 21/III, Podgorica ME

(511) **Klasa 05:** farmaceutski proizvodi.

(210) **2011-203**

(442) **20.12.2013.**

(220) 27.04.2011.

(731) **REMEDICA LTD**, AHARNON STR, IPSONAS INDUSTRIAL ESTATE, LIMASSOL CY

## Mycoril

(540)

(550) I

(511) **Klasa 05:** Farmaceutski i veterinarski preparati, sanitarni preparati za medicinsku upotrebu, dijetetske supstance prilagođene za upotrebu u medicini, hrana za bebe, flasteri, materijali za zavijanje, materijali za plombiranje zuba, zubarske smole, dezinfekciona sredstva, preparati za uništavanje štetočina, fungicidi, herbicidi, sanitarni preparati za upotrebu u medicini i za ličnu higijenu, dezodoransi koji nisu za ljudsku upotrebu, cigarete bez duvana za medicinske svrhe.

(210) **2011-204**

(442) **20.12.2013.**

(220) 27.04.2011.

(731) **REMEDICA LTD**, AHARNON STR, IPSONAS INDUSTRIAL ESTATE, LIMASSOL CY

## Imuprin

(540)

(550) I

(511) **Klasa 05:** Farmaceutski i veterinarski preparati, sanitarni preparati za medicinsku upotrebu, dijetetske supstance prilagođene za upotrebu u medicini, hrana za bebe, flasteri, materijali za zavijanje, materijali za plombiranje zuba, zubarske smole, dezinfekciona sredstva, preparati za uništavanje štetočina, fungicidi, herbicidi, sanitarni preparati za upotrebu u medicini i za ličnu higijenu, dezodoransi koji nisu za ljudsku upotrebu, cigarete bez duvana za medicinske svrhe.

(210) **2011-205**

(442) **20.12.2013.**

(220) 27.04.2011.

(731) **REMEDICA LTD**, AHARNON STR, IPSONAS INDUSTRIAL ESTATE, LIMASSOL CY

## Cyclovax

(540)

(550) I

(511) **Klasa 05:** Farmaceutski i veterinarski preparati, sanitarni preparati za medicinsku upotrebu, dijetetske supstance prilagođene za upotrebu u medicini, hrana za bebe, flasteri, materijali za zavijanje, materijali za plombiranje zuba, zubarske smole, dezinfekciona sredstva, preparati za uništavanje štetočina, fungicidi, herbicidi, sanitarni preparati za upotrebu u medicini i za ličnu higijenu, dezodoransi koji nisu za ljudsku upotrebu, cigarete bez duvana

za medicinske svrhe.

(210) **2011-206** (442) **20.12.2013.**  
(220) 27.04.2011.

(731) **REMEDICA LTD**, AHARNON STR, IPSONAS INDUSTRIAL ESTATE, LIMASSOL CY

Clavomid

(540)

(550) I

(511) **Klasa 05:** Farmaceutski i veterinarski preparati, sanitarni preparati za medicinsku upotrebu, dijetetske supstance prilagođene za upotrebu u medicini, hrana za bebe, flasteri, materijali za zavijanje, materijali za plombiranje zuba, zubarske smole, dezinfekciona sredstva, preparati za uništavanje štetočina, fungicidi, herbicidi, sanitarni preparati za upotrebu u medicini i za ličnu higijenu, dezodoransi koji nisu za ljudsku upotrebu, cigarete bez duvana za medicinske svrhe.

(210) **2011-207** (442) **20.12.2013.**  
(220) 27.04.2011.

(731) **REMEDICA LTD**, AHARNON STR, IPSONAS INDUSTRIAL ESTATE, LIMASSOL CY

Aremed

(540)

(550) I

(511) **Klasa 05:** Farmaceutski i veterinarski preparati, sanitarni preparati za medicinsku upotrebu, dijetetske supstance prilagođene za upotrebu u medicini, hrana za bebe, flasteri, materijali za zavijanje, materijali za plombiranje zuba, zubarske smole, dezinfekciona sredstva, preparati za uništavanje štetočina, fungicidi, herbicidi, sanitarni preparati za upotrebu u medicini i za ličnu higijenu, dezodoransi koji nisu za ljudsku upotrebu, cigarete bez duvana za medicinske svrhe.

(210) **2011-215** (442) **20.12.2013.**  
(220) 04.05.2011.

(731) **DOMPE S.P.A.** LOCALITA CAMPO DI PILE SNC, 67100 L'AQUILA AQ IT

MIOTENS

(540)

(550) I

(740) Popović Miladin, Đoka Miraševića 21/III, Podgorica ME

(511) **Klasa 05:** Farmaceutski i veterinarski preparati, sanitarni preparati za medicinsku upotrebu, dijetetske supstance prilagođene za upotrebu u medicini, hrana za bebe, flasteri, materijali za zavijanje, materijali za plombiranje zuba, zubarska smola, dezinfekciona sredstva,

preparati za uništavanje štetočina, fungicidi, herbicidi.

(210) **2011-235** (442) **20.12.2013.**

(220) 17.05.2011.

(731) **ALKALOID AD** SKOPLJE, BUL. ALEKSANDAR MAKEDONSKI 12, SKOPLJE MK



(540)

(550) I

(740) Popović Miladin, Đoka Miraševića 21/III, Podgorica ME

(511) **Klasa 03:** Šamponi.

(210) **2011-236** (442) **20.12.2013.**

(220) 17.05.2011.

(731) **ALKALOID AD** SKOPLJE, BUL. ALEKSANDAR MAKEDONSKI 12, SKOPLJE MK



(540) \_\_\_\_\_

(550) I

(740) Popović Miladin, Đoka Miraševića 21/III, Podgorica ME

(511) **Klasa 03:** Šamponi.

(210) **2011-237** (442) **20.12.2013.**

(220) 17.05.2011.

(731) **ALKALOID AD** SKOPLJE, BUL. ALEKSANDAR MAKEDONSKI 12, SKOPLJE MK



(540)

(550) I

(740) Popović Miladin, Đoka Miraševića 21/III, Podgorica ME

(511) **Klasa 03:** Šamponi.

(210) **2011-245**

(442) **20.12.2013.**

(220) 20.05.2011.

(731) **MATICA CRNOGORSKA**, BEOGRADSKA 24 C PODGORICA ME



**MATICA**  
**crnogorska**

(540)

(550) I

(511) Klasa 41, Obrazovne usluge, pripremanje obuke, razonoda, sportske i kulturne aktivnosti.

(210) **2011-287**

(442) **20.12.2013.**

(220) 16.06.2011.

(731) **TEVA PHARMACEUTICAL INDUSTRIES LTD.** SCIENC BASED INDUSTRIES CAMPUS, HAR HOTZVIM, P.O. BOX 1142, JERUSALIM, 921010 IL

**TACNI**

(540)



(550) I

(740) Popović Miladin, Đoka Miraševića 21/III, Podgorica ME

(511) **Klasa 05:** Imunosupresanti za pacijente nakon transplatancije čvrstih organa i u slučaju akutnog odbacivanja.(210) **2011-382**(442) **20.12.2013.**

(220) 26.07.2011.

(731) **GLOSARIJ DOO**, VOJISAVLJEVIĆA 76, PODGORICA ME

LITAK®

(540)

(550) I

(511) **Klasa 05:** Farmaceutski preparat.(210) **2011-383**(442) **20.12.2013.**

(220) 26.07.2011.

(731) **GLOSARIJ DOO**, VOJISAVLJEVIĆA 76, PODGORICA ME

DACIN®

(540)

(550) I

(511) **Klasa 05:** Farmaceutski preparat.(210) **2011-402**(442) **20.12.2013.**

(220) 09.08.2011.

(731) **MERIZO LLC**, 24-3 MARSHALA ZHUKOVA AV2 MOSCOW 123308 RU

(540)

(550) I

(740) Ćosović Dejan, 13. jula 1/5, Budva ME

(511) **Klasa 33:** Vodka.(210) **2011-474**(442) **20.12.2013.**

(220) 03.10.2011.

(731) **MONTENEGRO TOBACO COMPANY**, MOJKOVAC ME

(540)

(550) I

(511) **Klasa 34:** Cigareta.(210) **2011-475**(442) **20.12.2013.**

(220) 03.10.2011.

(731) **MONTENEGRO TOBACO COMPANY**, MOJKOVAC ME

(540)

(550) I

(511) **Klasa 34:** Cigareta.(210) **2011-506**(442) **20.12.2013.**

(220) 14.10.2011.

(731) **OCTAPHARMA AG**, SEIDENSTRASSE 2 8853 LACHEN CH

The logo for 'Human Albumin 5% Octapharma' features the product name in a white, serif font, centered on a dark rectangular background.

(540)

(550) I

(740) Čupić Branislav, Dalmatinska 10, Podgorica ME

(511) **Klasa 05:** Farmaceutski proizvodi, naime proizvodi izvedeni od krvne plazme, naročito albumin.(210) **2011-507**(442) **20.12.2013.**

(220) 14.10.2011.

(731) **OCTAPHARMA AG**, SEIDENSTRASSE 2 8853 LACHEN CH

## Human Albumin 20% Octapharma

(540)

(550) I

(740) Ćupić Branislav, Dalmatinska 10, Podgorica ME

(511) **Klasa 05:** Farmaceutski proizvodi, naime proizvodi izvedeni od krvne plazme, naročito albumin.(210) **2011-511**(442) **20.12.2013.**

(220) 17.10.2011.

(731) **THE COCA-COLA COMPANY**, ONE COCA-COLA PLAZA, ATLANTA, GEORGIA 30313 US

## FRUITIZZ

(540)

(550) I

(740) Popović Miladin, Đoka Miraševića 21/III, Podgorica ME

(511) **Klasa 32:** Piva, mineralne i sodne vode i ostala bezalkoholna pića, voćna pića i voćni sokovi, sirupi i drugi preparati za proizvodnju pića.(210) **2011-523**(442) **20.12.2013.**

(220) 27.10.2011.

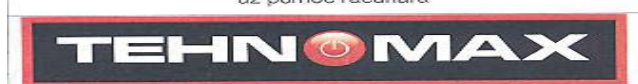
(731) **DOO V.S. COMMERCE-PODGORICA**, UL .PETE PROLETERSKE BB, PODGORICA ME

(540)

(550) I

(511) **Klasa 39:** Prevoz, ambalažiranje i uskladištenje proizvoda, organiziranje putovanja.(210) **2011-527**(442) **20.12.2013.**

(220) 31.10.2011.

(731) **VISA INTERNATIONAL SERVICE ASSOCIATION**, 900 METRO CENTER BOULEVARD, FOSTER CITY, CALIFORNIA, 94404 US

## V.ME

(540)

(550) I

(740) Čejović Vladimir, 13. jula 21, Podgorica ME

(511) **Klasa 09:** Kompjuterski softver za obradu elektronskog plaćanja i prenos sredstava drugima i od drugih, softver koji se može preuzeti koji omogućava postavljanje, povezivanje,

pokazivanje, prikazivanje, označavanje, blogovanje, dijeljenje ili pružanje elektronskih medija ili informacija preko interneta na drugi način, magnetno-kodirane kartice i kartice sa integrisanim kolima za finansijske aplikacije, mašinski čitljive, platne kartice sa bar kodovima, aparati za očitavanje magnetno-kodiranih kartica i kartica sa integrisanim kolima.

**Klasa 35:** Obrada podataka i upravljanje bazama podataka u oblasti bankarstva, pružanje on-line kompjuterskog veb sajta koji obezbjeđuje podatke o finansijskim transakcijama, promotivni podsticaji, popusti, takmičenja i klađenja, pružanje analitičkih podataka koji se odnose na polje bankarskih i finansijskih usluga, pružanje sigurnog, on-line pristupa interfejsu za korisnike interneta za upotrebu u preuzimanju i analiziranju finansijskih informacija, pružanje informacija o proizvodima u cilju oglašavanja i prodaje.

**Klasa 36:** Finansijske usluge, bankarstvo, plaćanje računa, usluge kreditnih kartica, usluge debitnih kartica, usluge pripejd kartica, elektronski platni promet, usluge transfera novca, usluge plaćanja u elektronskoj trgovini, usluge mjesta prodaje i mjesta transakcije, usluge transakcijskih ovlašćenja i poravnanja, usluge obrade elektronskog platnog prometa, usluge autentifikacije i verifikacije platnog prometa, usluge elektronskog prenosa sredstava, pružanje finansijskih usluga preko bežične mreže, uređaji za globalnu kompjutersku mrežu i mobilnu komunikaciju, formiranje namjenskih računa koji se koriste za kupovinu roba i usluga na internetu, usluge za olakšano plaćanje sa osobe na osobu, sigurne elektronske transakcije preko interneta kako bi se olakšala elektronska trgovina, usluge plaćanja računa sa daljine, informacije o plaćanju usluga o upravljanju, širenje finansijskih informacija putem globalne računarske mreže, bežične mreže i mobilnih komunikacijskih uređaja.

**Klasa 38:** Telekomunikacione usluge, koje omogućavaju siguran elektronski prenos informacija o nalogu i srodne informacije u oblasti finansijskih usluga, elektronski prenos računa i plaćanje takvih računa putem kompjuterskih terminala povezanih sa mrežama i internetom, obezbjeđivanje pristupa sajtovima trećim licima tako što se korisnicima omogućava da se prijave kroz univerzalno korisničko ime i lozinku preko interneta i drugih komunikacionih mreža.

**Klasa 42:** Obezbeđivanje sistema zasnovanog na mreži i onlajn portala za analizu finansijskih podataka, obezbjeđivanje veb sajta koji sadrži tehnologiju koja omogućava korisnicima da kreiraju lični onlajn servis informacija, obezbjeđivanje sistema zasnovanog na mreži za prikazivanje i dijeljenje lokacije korisnika da pronađe, locira i uzajamno djeluje sa drugima, obezbjeđivanje sistema zasnovanog na mreži koji omogućavaju korisnicima da obavljaju sigurne transakcije plaćanja u elektronskoj trgovini.

(210) **2011-531**

(442) **20.12.2013.**

(220) 03.11.2011.

(731) **NBA PROPERTIES, INC.** OLYMPIC TOWER BLDG. 645 FIFTH AVENUE, NEW YORK, NY 10022 US



(540)

(550) I

(740) Popović Miladin, Đoka Miraševića 21/III, Podgorica ME

(511) **Klasa 25:** Odeća, naime čarape, obuća, cipele za košarku, patike za košarku, majice, košulje, polo majice, dukserice, donji delovi trenerke, pantalone, majice na bretele, džemperi, kratke pantalone, pidžame, sportske majice, ragbi majice, vunene majice, kaiševi, kravate, spavačice, šeširi, kape, štitnici na kačketima, trenerke, donji delovi trenerki, dresovi, jakne, vetrovke, kišne krznene jakne, kaputi, portikle za bebe ne od papira, trake za glavu, narukvice, kecelje, donje rublje, bokserice, široke pantalone, štitnici za uši, rukavice, bokserske rukavice, šalovi, pletene i štrikane majice, trikotažne haljine, haljine, dresovi i uniforme za navijačice, odeća za plivanje, odela za kupanje, kupaci kostimi, bikini, tamkini kupaći kostimi, gaćice za plivanje, gaćice za kupanje, šorcevi za surfovanje, šorcevi za kupanje, marama za plažu, pokrivala za kupaći kostim, ogrtači za kupaći kostim, sandale, sandale za plažu, šeširi za plažu, štitnici za sunce, kape za plivanje, kape za kupanje, nova pokrivala za glavu sa prikačenim umecima.

**Klasa 28:** Igračke, igre i sportske stvari, naime košarkaške lopte, loptice za golf, lopte za igralište, sportske lopte, gumene lopte i penaste lopte, plišane lopte za igru, plastične lopte za igru, mrežice za košarku, table za košarku, minijaturne table za košarku, pumpe i igle za naduvavanje košarkaških lopti, štapovi za golf, torbe za golf, podmetači za golf, oprema za golf, naime, alat za popravku golf terena, kupice na koje se stavlja lopta, markeri lopti, torbe za golf opremu, pokrivala za glave golf štapova, rukavice za golf, kutije za golf lopte, elektronske table za košarkaške igrice na tabli, table za košarkaške igrice, košarkaške igrice, akcione igrice, društvene igrice za odrasle i decu, trivia informacione igrice i elektronske video arkađne igrice, košarkaška torbica koja se sastoji od mrežice i zviždaljke, lutke, dekorativne lutke, lutke za kolekciju, akcione figure za igru, akcione figure karikature, punjene igračke, nove plišane igračke sa perikom, puzle, montažni blokovi za igre, ukrasi za Božićnu jelku i Božićne čarape, vozila za igru u obliku automobila, kamiona, vozova i kombija, svi sa temom košarke, nove penaste igračke u obliku prsta ili trofeja, igrački trofeji, karte za igru, igrice sa kartama, igračke koje prave zvuk, igračke za kućne ljubimce, igračke za plažu, naime lopte za plažu, lopte na naduvavanje, kantice za igru, lopatice za igru, igračke za pesak, kutijice za pesak, gumene igračke za vodu, oprema za bazen, naime plivačka oprema za plutanje, oprema za plutanje u bazenu, igračke za splavanje na vodi, penasta oprema za plutanje, gume za plivanje, gume za plivanje u bazenu, penaste gume, daske za plivanje, daske za surfovanje, peraja za plivanje, peraja za surfovanje, mišići za plutanje i krila za pomoć pri plivanju u rekreativne svrhe, odbojkaške torbice za igru koje se sastoje od lopte, mrežice, sporednih stvari i zviždaljke, i vaterpolo torbice za igru koje se sastoje od lopte, mrežice i zviždaljke, dekorativne igračke od tkanine koje se puštaju da lete na vetru.

**Klasa 41,** Razonoda i obrazovne usluge u smislu televizijskih događaja i radio programa u polju košarke i prikazivanja uživo košarkaških igara i košarkaških priredbi, usluge produkcije i distribucije radio i televizijskih programa o košarkaškim igrama, košarkaškim događajima i programima iz oblasti košarke, usluge vođenja i organizovanja košarkaških klinika i kampova, klinika i kampova za trenere, klinika i kampova za plesne timove i košarkaške igre, usluge rasonode u vidu ličnog pojavljivanja u kostimiziranim maskotama ili u plesnim timovima na košarkaškim igrama i priredbama, klinikama, kampovima, promocijama i drugim događajima, specijalnim događajima i žurkama vezanim za košarku, usluge kluba obožavalaca, usluge rasonode, naime one koje pružaju veb-sajt predstavljanje multimedijjskih sadržaja u vidu najvažnijih televizijskih događaja, interaktivnih najvažnijih televizijskih događaja, video snimaka, video strim snimaka, interaktivnih video izbora najvažnijih događaja, radio programa, najvažnijih radijskih događaja i audio snimaka u polju košarke, usluge obezbeđivanja vesti i informacija u vidu statistika i drugih stvari u polju košarke, onlajn igrice koje se ne

mogu preuzimati, naime kompjuterske igrice, video igrice, interaktivne video igrice, akcione igrice, arkadne igrice, društvene igrice za odrasle i decu, igre na tabli, puzzle, trivia igrice, usluge elektronskog izdavaštva, naime, izdavanje magazina, vodiča, biltena, bojanki i igrice kod kojih se igrači određuju putem interneta, sve u vezi sa košarkom, usluge obezbeđivanja onlajn kompjuterske baze podataka u polju košarke

(210) **2011-532**

(442) **20.12.2013.**

(220) 03.11.2011.

(731) **NBA PROPERTIS, INC, OLYMPIC TOWER BLDG. 645 FIFTH AVENUE, NEW YORK, NY 10022 US**



(540)

(550) I

(740) Popović Miladin, Đoka Miraševića 21/III, Podgorica ME

(511) **Klasa 25:** Odeća, naime čarape, obuća, cipele za košarku, patike za košarku, majice, košulje, polo majice, dukserice, donji delovi trenerke, pantalone, majice na bretele, džemperi, kratke pantalone, pidžame, sportske majice, ragbi majice, vunene majice, kaiševi, kravate, spavačice, šeširi, kape, štitnici na kačketima, trenerke, donji delovi trenerki, dresovi, jakne, vetrovke, kišne krznene jakne, kaputi, portikle za bebe ne od papira, trake za glavu, narukvice, kecelje, donje rublje, bokserice, široke pantalone, štitnici za uši, rukavice, bokzerske rukavice, šalovi, pletene i štrikane majice, trikotažne haljine, haljine, dresovi i uniforme za navijačice, odeća za plivanje, odela za kupanje, kupaci kostimi, bikini, tamkini kupaći kostimi, gaćice za plivanje, gaćice za kupanje, šorcevi za surfovanje, šorcevi za kupanje, marame za plažu, pokrivala za kupaći kostim, ogrtači za kupaći kostim, sandale, sandale za plažu, šeširi za plažu, štitnici za sunce, kape za plivanje, kape za kupanje, nova pokrivala za glavu sa prikačenim umecima.

**Klasa 28:** Igračke, igre i sportske stvari, naime košarkaške lopte, loptice za golf, lopte za igralište, sportske lopte, gumene lopte i penaste lopte, plišane lopte za igru, plastične lopte za igru, mrežice za košarku, table za košarku, minijaturne table za košarku, pumpe i igle za naduvavanje košarkaških lopti, štapovi za golf, torbe za golf, podmetači za golf, oprema za golf, naime, alat za popravku golf terena, kupice na koje se stavlja lopta, markeri lopti, torbe za golf opremu, pokrivala za glave golf štapova, rukavice za golf, kutije za golf lopte, elektronske table za košarkaške igrice na tabli, table za košarkaške igrice, košarkaške igrice, akcione igrice, društvene igrice za odrasle i decu, trivia informacione igrice i elektronske video arka- da igrice, košarkaška torbica koja se sastoji od mrežice i zviždaljke, lutke, dekorativne lutke, lutke za kolekciju, akcione figure za igru, akcione figure karikature, punjene igračke, nove plišane igračke sa perikom, puzzle, montažni blokovi za igre, ukrasi za Božićnu jelku i Božićne

čarape, vozila za igru u obliku automobila, kamiona, vozova i kombija, svi sa temom košarke, nove penaste igračke u obliku prsta ili trofeja, igrački trofeji, karte za igru, igrice sa kartama, igračke koje prave zvuk, igračke za kućne ljubimce, igračke za plažu, naime lopte za plažu, lopte na naduvavanje, kantice za igru, lopatice za igru, igračke za pesak, kutijice za pesak, gumene igračke za vodu, oprema za bazen, naime plivačka oprema za plutanje, oprema za plutanje u bazenu, igračke za splavarenje na vodi, penasta oprema za plutanje, gume za plivanje, gume za plivanje u bazenu, penaste gume, daske za plivanje, daske za surfovanje, peraja za plivanje, peraja za surfovanje, mišići za plutanje i krila za pomoć pri plivanju u rekreativne svrhe, odbojkaške torbice za igru koje se sastoje od lopte, mrežice, sporednih stvari i zviždaljke, i vaterpolo torbice za igru koje se sastoje od lopte, mrežice i zviždaljke, dekorativne igračke od tkanine koje se puštaju da lete na vetru.

**Klasa 41:** Razonoda i obrazovne usluge u smislu televizijskih događaja i radio programa u polju košarke i prikazivanja uživo košarkaških igara i košarkaških priredbi, usluge produkcije i distribucije radio i televizijskih sou programa o košarkaškim igrama, košarkaškim događajima i programima iz oblasti košarke, usluge vođenja i organizovanja košarkaških klinika i kampova, klinika i kampova za trenere, klinika i kampova za plesne timove i košarkaške igre, usluge rasonode u vidu ličnog pojavljivanja u kostimiziranim maskotama ili u plesnim timovima na košarkaškim igrama i priredbama, klinikama, kampovima, promocijama i drugim događajima, specijalnim događajima i žurkama vezanim za košarku, usluge kluba obožavalaca, usluge rasonode, naime one koje pružaju vebsajt predstavljanje multimedijjskih sadržaja u vidu najvažnijih televizijskih događaja, interaktivnih najvažnijih televizijskih događaja, video snimaka, video strim snimaka, interaktivnih video izbora najvažnijih događaja, radio programa, najvažnijih radijskih događaja i audio snimaka u polju košarke, usluge obezbeđivanja vesti i informacija u vidu statistika i drugih stvari u polju košarke, onlajn igrice koje se ne mogu preuzimati, naime kompjuterske igrice, video igrice, interaktivne video igrice, akcijske igrice, arkadne igrice, društvene igrice za odrasle i decu, igre na tabli, puzzle, trivia igrice, usluge elektronskog izdavaštva, naime, izdavanje magazina, vodiča, biltena, bojanki i igrice kod kojih se igrači određuju putem interneta, sve u vezi sa košarkom, usluge obezbeđivanja onlajn kompjuterske baze podataka u polju košarke.

(210) **2011-533**

(442) **20.12.2013.**

(220) 03.11.2011.

(731) **NBA PROPERTIES, INC.** OLYMPIC TOWER BLDG. 645 FIFTH AVENUE, NEW YORK, NY 10022 US



(540) \_\_\_\_\_

(550) I

(740) Popović Miladin, Đoka Miraševića 21/III, Podgorica ME

(511) **Klasa 25:** Odeća, naime čarape, obuća, cipele za košarku, patike za košarku, majice, košulje, polo majice, dukserice, donji delovi trenerke, pantalone, majice na bretele, džemperi, kratke pantalone, pidžame, sportske majice, ragbi majice, vunene majice, kaiševi, kravate, spavaćice, šeširi, kape, štitnici na kačketima, trenerke, donji delovi trenerki, dresovi, jakne, vetrovke, kišne krznene jakne, kaputi, portikle za bebe ne od papira, trake za glavu, narukvice, kecelje, donje rublje, bokserice, široke pantalone, štitnici za uši, rukavice, bokserske rukavice, šalovi, pletene i štrikane majice, trikotažne haljine, haljine, dresovi i uniforme za navijačice, odeća za plivanje, odela za kupanje, kupaci kostimi, bikini, tamkini kupaći kostimi, gaćice za plivanje, gaćice za kupanje, šorcevi za surfovanje, šorcevi za kupanje, marama za plažu, pokrivala za kupaći kostim, ogrtači za kupaći kostim, sandale, sandale za plažu, šeširi za plažu, štitnici za sunce, kape za plivanje, kape za kupanje, nova pokrivala za glavu sa prikačenim umecima.

**Klasa 28:** Igračke, igre i sportske stvari, naime košarkaške lopte, loptice za golf, lopte za igralište, sportske lopte, gumene lopte i penaste lopte, plišane lopte za igru, plastične lopte za igru, mrežice za košarku, table za košarku, minijaturne table za košarku, pumpe i igle za naduvavanje košarkaških lopti, štapovi za golf, torbe za golf, podmetači za golf, oprema za golf, naime, alat za popravku golf terena, kupice na koje se stavlja lopta, markeri lopti, torbe za golf opremu, pokrivala za glave golf štapova, rukavice za golf, kutije za golf lopte, elektronske table za košarkaške igrice na tabli, table za košarkaške igrice, košarkaške igrice, akcione igrice, društvene igrice za odrasle i decu, trivia informacione igrice i elektronske video arkađne igrice, košarkaška torbica koja se sastoji od mrežice i zviždaljke, lutke, dekorativne lutke, lutke za kolekciju, akcione figure za igru, akcione figure karikature, punjene igračke, nove plišane igračke sa perikom, puzzle, montažni blokovi za igre, ukrasi za Božićnu jelku i Božićne čarape, vozila za igru u obliku automobila, kamiona, vozova i kombija, svi sa temom košarke, nove penaste igračke u obliku prsta ili trofeja, igrački trofeji, karte za igru, igrice sa kartama, igračke koje prave zvuk, igračke za kućne ljubimce, igračke za plažu, naime lopte za plažu, lopte na naduvavanje, kantice za igru, lopatice za igru, igračke za pesak, kutijice za pesak, gumene igračke za vodu, oprema za bazen, naime plivačka oprema za plutanje, oprema za plutanje u bazenu, igračke za splavanje na vodi, penasta oprema za plutanje, gume za plivanje, gume za plivanje u bazenu, penaste gume, daske za plivanje, daske za surfovanje, peraja za plivanje, peraja za surfovanje, mišići za plutanje i krila za pomoć pri plivanju u rekreativne svrhe, odbojkaške torbice za igru koje se sastoje od lopte, mrežice, sporednih stvari i zviždaljke, i vaterpolo torbice za igru koje se sastoje od lopte, mrežice i zviždaljke, dekorativne igračke od tkanine koje se puštaju da lete na vetru.

**Klasa 41:** Razonoda i obrazovne usluge u smislu televizijskih događaja i radio programa u polju košarke i prikazivanja uživo košarkaških igara i košarkaških priredbi, usluge produkcije i distribucije radio i televizijskih sou programa o košarkaškim igrama, košarkaškim događajima i programima iz oblasti košarke, usluge vođenja i organizovanja košarkaških klinika i kampova, klinika i kampova za trenere, klinika i kampova za plesne timove i košarkaške igre, usluge rasonode u vidu ličnog pojavljivanja u kostimiziranim maskotama ili u plesnim timovima na košarkaškim igrama i priredbama, klinikama, kampovima, promocijama i drugim događajima, specijalnim događajima i žurkama vezanim za košarku, usluge kluba obožavalaca, usluge rasonode, naime one koje pružaju vebsajt predstavljanje multimedijjskih sadržaja u vidu najvažnijih televizijskih događaja, interaktivnih najvažnijih televizijskih događaja, video snimaka, video strim snimaka, interaktivnih video izbora najvažnijih događaja, radio programa, najvažnijih radijskih događaja i audio snimaka u polju košarke, usluge obezbeđivanja vesti i informacija u vidu statistika i drugih stvari u polju košarke, onlajn igrice koje se ne mogu preuzimati, naime kompjuterske igrice, video igrice, interaktivne video igrice, akcio-



ne igrice, arkadne igrice, društvene igrice za odrasle i decu, igre na tabli, puzzle, trivia igrice, usluge elektronskog izdavaštva, naime, izdavanje magazina, vodiča, biltena, bojanki i igrica kod kojih se igrači određuju putem interneta, sve u vezi sa košarkom, usluge obezbeđivanja onlajn komputerske baze podataka u polju košarke.

(210) **2011-534**

(442) **20.12.2013.**

(220) 03.11.2011.

(731) **NBA PROPERTIES, INC**, OLYMPIC TOWER BLDG. 645 FIFTH AVENUE, NEW YORK, NY 10022 US



(540)

(550) I

(740) Popović Miladin, Đoka Miraševića 21/III, Podgorica ME

(511) **Klasa 25:** Odeća, naime čarape, obuća, cipele za košarku, patike za košarku, majice, košulje, polo majice, dukserice, donji delovi trenerke, pantalone, majice na bretele, džemper, kratke pantalone, pidžame, sportske majice, ragbi majice, vunene majice, kaiševi, kravate, spavaćice, šeširi, kape, štitnici na kačketima, trenerke, donji delovi trenerki, dresovi, jakne, vetrovke, kišne krznene jakne, kaputi, portikle za bebe ne od papira, trake za glavu, narukvice, kecelje, donje rublje, bokserice, široke pantalone, štitnici za uši, rukavice, bokzerske rukavice, šalovi, pletene i štrikane majice, trikotažne haljine, haljine, dresovi i uniforme za navijačice, odeća za plivanje, odela za kupanje, kupaci kostimi, bikini, tamkini kupaći kostimi, gaćice za plivanje, gaćice za kupanje, šorcevi za surfovanje, šorcevi za kupanje, marama za plažu, pokrivala za kupaći kostim, ogrtači za kupaći kostim, sandale, sandale za plažu, šeširi za plažu, štitnici za sunce, kape za plivanje, kape za kupanje, nova pokrivala za glavu sa prikačenim umecima.

**Klasa 28:** Igračke, igre i sportske stvari, naime košarkaške lopte, loptice za golf, lopte za igralište, sportske lopte, gumene lopte i penaste lopte, plišane lopte za igru, plastične lopte za igru, mrežice za košarku, table za košarku, minijaturne table za košarku, pumpe i igle za naduvavanje košarkaških lopti, štapovi za golf, torbe za golf, podmetači za golf, oprema za golf, naime, alat za popravku golf terena, kupice na koje se stavlja lopta, markeri lopti, torbe za golf opremu, pokrivala za glave golf štapova, rukavice za golf, kutije za golf lopte, elektronske table za košarkaške igrice na tabli, table za košarkaške igrice, košarkaške igrice, akcione igrice, društvene igrice za odrasle i decu, trivia informacione igrice i elektronske video arkadne igrice, košarkaška torbica koja se sastoji od mrežice i zviždaljke, lutke, dekorativne lutke, lutke za kolekciju, akcione figure za igru, akcione figure karikature, punjene igračke, nove plišane igračke sa perikom, puzzle, montažni blokovi za igre, ukrasi za Božićnu jelku i Božićne čarape, vozila za igru u obliku automobila, kamiona, vozova i kombija, svi sa temom košarke, nove penaste igračke u obliku prsta ili trofeja, igrački trofeji, karte za igru, igrice sa kartama, igračke koje prave zvuk, igračke za kućne ljubimce, igračke za plažu, naime lopte za plažu,

lopte na naduvavanje, kantice za igru, lopatice za igru, igračke za pesak, kutijice za pesak, gumene igračke za vodu, oprema za bazen, naime plivačka oprema za plutanje, oprema za plutanje u bazenu, igračke za splavanje na vodi, penasta oprema za plutanje, gume za plivanje, gume za plivanje u bazenu, penaste gume, daske za plivanje, daske za surfovanje, peraja za plivanje, peraja za surfovanje, mišići za plutanje i krila za pomoć pri plivanju u rekreativne svrhe, odbojkaške torbice za igru koje se sastoje od lopte, mrežice, sporednih stvari i zviždaljke, i vaterpolo torbice za igru koje se sastoje od lopte, mrežice i zviždaljke, dekorativne igračke od tkanine koje se puštaju da lete na vetru.

**Klasa 41:** Razonoda i obrazovne usluge u smislu televizijskih događaja i radio programa u polju košarke i prikazivanja uživo košarkaških igara i košarkaških priredbi, usluge produkcije i distribucije radio i televizijskih programa o košarkaškim igrama, košarkaškim događajima i programima iz oblasti košarke, usluge vođenja i organizovanja košarkaških klinika i kampova, klinika i kampova za trenere, klinika i kampova za plesne timove i košarkaške igre, usluge rasonode u vidu ličnog pojavljivanja u kostimiziranim maskotama ili u plesnim timovima na košarkaškim igrama i priredbama, klinikama, kampovima, promocijama i drugim događajima, specijalnim događajima i žurkama vezanim za košarku, usluge kluba obožavalaca, usluge rasonode, naime one koje pružaju veb-sajt predstavljanje multimedijjskih sadržaja u vidu najvažnijih televizijskih događaja, interaktivnih najvažnijih televizijskih događaja, video snimaka, video strim snimaka, interaktivnih video izbora najvažnijih događaja, radio programa, najvažnijih radijskih događaja i audio snimaka u polju košarke, usluge obezbeđivanja vesti i informacija u vidu statistika i drugih stvari u polju košarke, onlajn igrice koje se ne mogu preuzimati, naime kompjuterske igrice, video igrice, interaktivne video igrice, akcijske igrice, arkadne igrice, društvene igrice za odrasle i decu, igre na tabli, puzzle, trivia igrice, usluge elektronskog izdavaštva, naime, izdavanje magazina, vodiča, biltena, bojanki i igrice kod kojih se igrači određuju putem interneta, sve u vezi sa košarkom, usluge obezbeđivanja onlajn kompjuterske baze podataka u polju košarke.

(210) **2011-535** (442) **20.12.2013.**  
(220) 03.11.2011.

(731) **WM. WRIGLEY JR. COMPANY**, 410 NORTH MICHIGAN AVENUE, CHICAGO, IL 60611 US

## FUNKY FRUIT

(540)  
(550) I  
(740) Čejović Vladimir, 13. jula 21, Podgorica ME

(511) **Klasa 30:** Slatkiši, žvakaće gume, žvakaće gume od kojih mogu da se prave veliki baloni, bombone, dražeje pepermintna, mali okrugli bomboni (drops) i pastile.

(210) **2011-541** (442) **20.12.2013.**  
(220) 08.11.2011.

(731) **JX NIPPON OIL&ENERGY CORPORATION**, 6-3 OTEMACHI 2-CHOME, HIUDAKU, TOKYO 100-8162 JP

# ENEOS

(540)

(550) I

(740) Radulović Božidar, Jovana Tomaševića 9/III, Podgorica ME

(511) **Klasa 01:** Tečnost za prenosnike snage.

**Klasa 04:** Mašinsko i motorno ulje, goriva, tečna goriva, industrijska ulja, mineralna ulja i masti za industrijsku upotrebu (ne za gorivo), nemineralna ulja i masti za industrijsku upotrebu (ne za gorivo), mazivna ulja, industrijska maziva, tečnost za prenosnike snage.

---

(210) **2011-542**

(442) **20.12.2013.**

(220) 08.11.2011.

(731) **JX NIPPON OIL&ENERGY CORPRATION**, 6-3 OTEMACHI 2-CHOME, CHIUDAKU, TOKYO 100-8162 JP

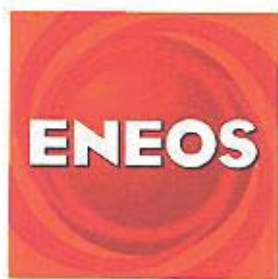

(540)

(550) I

(740) Radulović Božidar, Jovana Tomaševića 9/III, Podgorica ME

(511) **Klasa 01:** Tečnost za prenosnike snage.

**Klasa 04:** Mašinsko i motorno ulje, goriva, tečna goriva, industrijska ulja, mineralna ulja i masti za industrijsku upotrebu (ne za gorivo), nemineralna ulja i masti za industrijsku upotrebu (ne za gorivo), mazivna ulja, industrijska maziva, tečnost za prenosnike snage.

---

(210) **2011-543**

(442) **20.12.2013.**

(220) 09.11.2011.

(731) **GOOGLE INC**, 1600 AMPHITHEATRE PARKWAY, MOUNTAIN VIEW, CA 94043 US

# ANDROID

(540)

(550) I

(740) Ćupić Branislav, Dalmatinska 10, Podgorica ME

(511) **Klasa 11:** Uređaji za osvjetljavanje, grijanje, proizvodnju pare, kuvanje, hlađenje, sušenje, ventilaciju, snabdjevanje vodom i sanitarne svrhe, sijalice, mikrotalasne rerne, frižideri, zamrzivači, električni aparati, šporeti za kuvanje, rerne za kuvanje, električne peći, električne lampe, plafonske lampe i lusteri, zidne lampe, mašine za sušenje veša, klima uređaji, električni grijači, električni ventilatori, plafonski ventilatori, peći.

**Klasa 16:** Hartija, karton i proizvodi od ovih materijala, koji nisu obuhvaćeni drugim klasama, štampane stvari, knjigovezački materijal, fotografije, kancelarijski materijal, ljepila za kancelarijsku ili kućnu upotrebu, materijali za umjetnike, kičice, pisaće mašine i kancelarijski pribor (izuzev namještaja), materijal za nastavu i obuku (izuzev aparata), plastični materijali za pakovanje (koji nisu obuhvaćeni drugim klasama), štamparska slova, klišeji, knjige, časopisi, bilteni, priručnici, sveske, blokovi za bilješke, pera, čestitke, sličice, dckali, ljepljive poruke, rokovnici i adresari, olovke, patent-olovke, rezači za olovke, korektori, razglednice, ljepkovi, futrole za olovke, spjalice, heftalice, municija za heftalice, klipbordi, kompleti za pisači sto, poster, podsjetnici, pritiskivači za hartiju, kalendari, omoti za knjige.

**Klasa 25:** Odjeća, naročito košulje, majice sa kratkim rukavima, šeširi, kape, dječija odjeća, obuća, pokrivala za glavu.

**Klasa 28:** Igre, igračke, gimnastički i sportski artikli koji nisu obuhvaćeni drugim klasama, ukrasi za jelku, kolekcionarske igračke-figure, arkadne igrice, stone igre, društvene igre, igre sa kartama, loptice za igre, video igre koje se pokreću novcem ili žetonom, ručne jedinice za igranje elektronskih igara, akcione figure, edukativne igračke, vozila-igračke, plišane igračke, roboti-igračke, zmajevi i oprema za zmajevu, vodene igračke, igračke na navijanje, lutke i oprema za lutke, leteći diskovi (frisbiji), igračke koje govore, muzički instrumenti-igračke, alati-igračke, kocke za igranje, maske-igračke, marionete, karte za igranje.

**Klasa 35:** Oглаšavanje, poslovni menadžment, poslovna ad'ministracija, kancelarijski poslovi, online maloprodajne usluge

**Klasa 38:** Telekomunikacije, prenos podataka putem globalne kompjuterske mreže, striming audio, video i audio-vizuelnih materijala putem globalne kompjuterske mreže,

**Klasa 41:** Obrazovne usluge, obučavanje, razonoda, sportske i kulturne aktivnosti, obezbjeđivanje onlajn resursa i vodiča za razvoj softvera, obezbjeđivanje onlajn žurnala, naročito blogova u oblasti razvoja softvera, onlajn usluge u vezi igara, usluge u vezi igara za mobilne uređaje.

**Klasa 42:** Naučne i tehnološke usluge i istraživanje i projektovanje u vezi navedenih usluga, usluge industrijske analize i istraživanja, projektovanje i razvoj kompjuterskog hardvera i softvera, kompjuterske usluge, snabdjevanje aplikacionim uslugama (application service provider, ASP), naročito hosting kompjuterskih softverskih aplikacija.

(210) **2011-544**

(442) **20.12.2013.**

(220) 09.11.2011.

(731) **GOOGLE INC.** 1600 AMPHITHEATRE PARKWAY, MOUNTAIN VIEW, CA 94043 US

ANDROID

(540)

(550) I

(740) Ćupić Branislav, Dalmatinska 10, Podgorica ME

(511) **Klasa 09:** Aparati i instrumenti naučni, pomorski, geodetski, fotografski, kinematografski, optički, za vaganje, mjerenje, signalizaciju, kontrolu (inspekciju), pomoć (spasavanje) i nastavu, aparati i instrumenti za provođenje, prekidanje, transformisanje, akumuliranje, regulisanje ili kontrolu električne energije, aparati za snimanje, prenos ili reprodukovanje zvuka ili slike, magnetski nosioci podataka, diskovi za snimanje, automatske prodajne mašine i mehanizmi za aparate koji se pokreću novcem ili žetonom, registar-kase, računске mašine, oprema za obradu podataka i kompjuteri, aparati za gašenje požara, kompjuterski softver, kompjuterski hardver, mobilni telefoni, mobilni periferni uređaji, kompjuteri, televizori, tablet kompjuteri, noutbuk kompjuteri, laptop kompjuteri, čipovi za integrisana kola, mikročipovi, torbe za kamere, torbe za kamkodere, termostati, televizori, radio aparati, telefoni, daljinski upravljači za radio, televizore i stereo uređaje, konzole za video igrice, DVD plejeri, video rekorderi, digitalni video rekorderi, MP3 plejeri, audio pojačala, kompjuterski serveri, printeri, skeneri, fotokopir aparati, kompjuterski monitori, faks uređaji, mrežni ruteri, tastature, kompjuterski miševi, eksterni kompjuterski hard diskovi, kamkoderi, kamere, kalkulatori, GPS navigacioni uređaji, audio komponente, slušalice, audio zvučnici, audio i video prijemnici, personalni digitalni asistenti (PDA), set-top uređaji, sistemi za kućni bioskop, video projektori, filmski projektori, sigurnosni alarmi, detektori vatre i dima, detektori radara, audio i video oprema za vozila, punjači baterija, adapteri (strujni), telefonske sekretarice, kompleti slušalica sa mikrofonom, električni prekidači za svijetlo.

**Klasa 11:** Uređaji za osvjetljavanje, grijanje, proizvodnju pare, kuvanje, hlađenje, sušenje, ventilaciju, snabdjevanje vodom i sanitarne svrhe, sijalice, mikrotalasne rerne, frižideri, zamrzivači, električni aparati, šporeti za kuvanje, rerne za kuvanje, električne peći, električne lampe, plafonske lampe i lusteri, zidne lampe, mašine za sušenje veša, klima uređaji, električni grijači, električni ventilatori, plafonski ventilatori, peći.

**Klasa 16:** Hartija, karton i proizvodi od ovih materijala, koji nisu obuhvaćeni drugim klasama, štampane stvari, knjigovezački materijal, fotografije, kancelarijski materijal, ljepila za kancelarijsku ili kućnu upotrebu, materijali za umjetnike, kičice, pisaće mašine i kancelarijski pribor (izuzev nameštaja), materijal za nastavu i obuku (izuzev aparata), plastični materijali za pakovanje (koji nisu obuhvaćeni drugim klasama), štamparska slova, klišeji, knjige, časopisi, bilteni, priručnici, sveske, blokovi za bilješke, pera, čestitke, sličice, dekali, ljepljive poruke, rokovnici i adresari, olovke, patent-olovke, rezači za olovke, korektori, razglednice, ljepkovi, futrole za olovke, spajalice, heftalice, municija za heftalice, klipbordi, kompleti za pisači sto, posted, podsjetnici, pritiskivači za hartiju, kalendrad, omoti za knjige.

**Klasa 25:** Odjeća, naročito košulje, majice sa kratkim rukavima, šeširi, kape, dječija odjeća, obuća, pokrivala za glavu.

**Klasa 28:** Igre, igračke, gimnastički i sportski artikli koji nisu obuhvaćeni drugim klasama, ukrasi za jelku, kolekcionarske igračke-figure, arkadne igrice, stone igre, društvene igre, igre sa kartama, loptice za igre, video igre koje se pokreću novcem ili žetonom, ručne jedinice za igranje elektronskih igara, akcione figure, edukativne igračke, vozila-igračke, plišane igračke, roboti-igračke, zmajevi i oprema za zmajevе, vodene igračke, igračke na navijanje, lutke i oprema za lutke, leteći diskovi (frisbiji), igračke koje govore, muzički instrumenti-igračke, alati-igračke, kocke za igranje, maske-igračke, marionete, karte za igranje.

**Klasa 35:** Oglašavanje, poslovni menadžment, poslovna administracija, kancelarijski poslovi, online maloprodajne usluge.

**Klasa 38:** Telekomunikacije, prenos podataka putem globalne kompjuterske mreže, striming audio, video i audio-vizuelnih materijala p'item globalne kompjuterske mreže.

**Klasa 41:** Obrazovne usluge, obučavanje, razonoda, sportske i kulturne aktivnosti, obezbjeđivanje onlajn resursa i vodiča za razvoj softvera, obezbjeđivanje onlajn žurnala, naročito

blogova u oblasti razvoja softvera, onlajn usluge u vezi igara, usluge u vezi igara za mobilne uređaje.

**Klasa 42:** Naučne i tehnološke usluge i istraživanje i projektovanje u vezi navedenih usluga, usluge industrijske analize i istraživanja, projektovanje i razvoj kompjuterskog hardvera i softvera, kompjuterske usluge, snabdjevanje aplikacionim uslugama (application service provider, ASP), naročito hosting kompjuterskih softverskih aplikacija.

(210) **2011-560** (442) **20.12.2013.**  
(220) 15.11.2011.

(731) **HERSHEY CHOCOLATE&CONFECTIONERY COPRORATION**, 100 CRYSTAL A DRIVE HERSHEY PENNSYLVANIA 17033 US

## ICE BREAKERS

(540)

(550) I

(740) Popović Miladin, Đoka Miraševića 21/III, Podgorica ME

(511) **Klasa 30:** Kafa, čaj, kakao, šećer, pirinač, tapioka, sago, zamjena kafe, brašno i proizvodi od žitarica, hleb, kolači i poslastice, sladoledi, med, melasa, kvasac, prašak za pecivo, so, senf, sirće, sosovi (kao dodaci), začini, led, a naročito slatkiši, bombone, gume za žvakanje i bombone od mente.

(210) **2011-565** (442) **20.12.2013.**  
(220) 18.11.2011.

(731) **MDS COMPANY D.O.O.** MAKEDONSKA F17, BAR, DEMO METOVIĆ, PODGRAD BB, STARI BAR, BAR ME



(540)

(550) I

(511) **Klasa 29:** Meso, riba, živina i divljač, mesne prerađevine, konzervisano, zamrznuto, sušeno i kuvano voće i povrće, želei, džemovi, kompoti, jaja, mlijeko i mlječni proizvodi, jestiva ulja i masti.

(210) **2011-571** (442) **20.12.2013.**  
(220) 23.11.2011.

(731) **MAKPROGRES** DOO, ILIDENSKA BB, 2310 VINICA MK



(540)

(550) I

(740) Radulović Božidar, Jovana Tomaševića 9/III, Podgorica ME

(511) **Klasa 29:** Meso, riba, živina i divljač, mesne prerađevine, konzervisano, smrznuto, sušeno i kuvano voće i povrće, želei, džemovi, kompoti, jaja, mlijeko i mlječni proizvodi, jestiva ulja i masti.**Klasa 30:** kafa, čaj, kakao, šećer, pirinač, tapioka, sago, zamjena kafe, brašno i proizvodi od žitarica, hljeb, kolači, poslastice, sladoledi, med, melasa, kvasac, prašak za pecivo, so, senf, sirće, sosovi (kao začini), začini, led.**Klasa 31:** poljoprivredni, vrtlarski i šumarski proizvodi i zrnevlje koji nisu uključeni u druge klase, žive životinje, svježe voće i povrće, sjeme, prirodne biljke i cvijeće, hrana za životinje, slad.(210) **2011-577**(442) **20.12.2013.**

(220) 23.11.2011.

(300) 758/11 24.05.2011. RS

(731) **ORTAČKO ADVOKATSKO DRUŠTVO BOJOVIĆ DAŠIĆ KOJOVIĆ, DOBROČINA 38, BEOGRAD RS**

BDK

(540)

(550) I

(740) Ivanović R. Đorđe, Lovćenska 23, Cetinje ME

(511) **Klasa 35:** Oglašavanje, vođenje poslova, poslovno upravljanje, kancelarijski poslovi.**Klasa 45:** Pravne usluge, usluge obezbeđenja radi zaštite imovine i lica, individualne i društvene usluge koje pružaju drugi, radi zadovoljavanja potreba pojedinaca.(210) **2011-587**(442) **20.12.2013.**

(220) 02.12.2011.

(731) **LG LIFE SCIENCES, LTD. 92, SINMUNNO 2-GA JONGNO-GU SEUL KR****FACTIVE**

(540)

(550) I

(740) Popović Miladin, Đoka Miraševića 21/III, Podgorica ME

(511) **Klasa 05:** Farmaceutski i medicinski preparati i supstance.

(210) **2011-591** (442) **20.12.2013.**  
(220) 05.12.2011.

(300) 85/365811. 07.07.2011. US

(731) **RAZOR USA LLC**, A DELAWARE LIMITED LIABILITY COMPANY, 16200-A CARMERITA ROAD, CERRITOS, CALIFORNIA 90703 US

# RAZR

(540)

(550) I

(740) Ćosović Dejan, 13. jula 1/5, Budva ME

(511) **Klasa 09:** Kompjuteri, tablet kompjuteri i ostali pribori kao što su, priključna mjesta za druge uređaje, oslonci, držaci i oslonci za držanje i punjenje kompjutera, torbe za kompjutere, zaštitne maske za kompjutere, zaštitne i ukrasne maske, zaštite za ekrane, naročito montirani ili plastični ulošci poznatiji kao maske za zaštitu kompjutera, eksterni i navigacioni uređaji naročito, tastature, miševi, kugle za kretanje miša i olovke koje se koriste za korišćenje kompjutera, memorije za kompjuter, narodto hard diskovi, portabl i pokretne memorije za kompjutere, mrežna oprema, naročito modemi, ruteri i uređaji koji se koriste za priključivanje na mrežu i tzv. gateway, baterije, adapteri, kablovi za kompjutere, konektori za kablove, daljinski upravljači, slušalice, zvučnici, sistemi za ozvučenje za upotrebu na kompjuteru, mikrofoni i web kamere koje se koriste za kompjuter i kompjuterske softvere.

(210) **2011-593** (442) **20.12.2013.**  
(220) 05.12.2011.

(731) **APATINSKA PIVARA** APATIN DOO, TRG OSLOBOĐENJA 5, APATIN RS



(540) a Ničanskoj klasifikaciji

(550) I

(740) Božović Vesko, Rimski trg 50/11, Podgorica ME

(511) **Klasa 32:** Bezalkoholno piće od biljnih ekstrata.

(210) **2011-601** (442) **20.12.2013.**



(220) 07.12.2011.

(731) **BORIS RAŠKOVIĆ**, JOVANA TOMAŠEVIĆA 9/3 PODGORICA ME  
**MIRO PEROVIĆ**, SERDARA JOLA PILETIĆA 28/1 PODGORICA ME

Naljepiti izgled znaka a verbalni znak odštampati



(540)

(550) I

(511) **Klasa 29:** Meso, riba, živina i divljač, mesne prerađevine, konzervisano, zamrznuto, sušeno i kuvano voće i povrće, želei, džemovi, kompoti, jaja, mlijeko i mliječni proizvodi, jestiva ulja i masti, pića na bazi mlijeka (u kojima mlijeko preovladava).**Klasa 30:** Kafa, čaj, kakao, šećer, pirinač, tapioka, sago, zamjena kafe, brašno i proizvodi od žitarica, hljeb, kolači i poslastice, sladoled, med, melasa, kvasac, prašak za pecivo, so, senf, sirće, sosovi (kao dodaci), začini, led, pića od kakaoa, kafe ili na bazi čokolade.**Klasa 32:** Pivo, mineralne i sodne vode i druga bezalkoholna pića, pića od voća i voćni sokovi, sirupi i drugi preparati za proizvodnju pića, bezalkoholna pića, pića od mlijeka (u kojima mlijeko preovladava), pića sa kafom, kakaom ili čokoladom.(210) **2011-602**(442) **20.12.2013.**

(220) 07.12.2011.

(731) **BORIS RAŠKOVIĆ**, JOVANA TOMAŠEVIĆA 9/3 PODGORICA ME  
**MIRO PEROVIĆ**, SERDARA JOLA PILETIĆA 28/1 PODGORICA ME

Naljepiti izgled znaka a verbalni znak odštampati

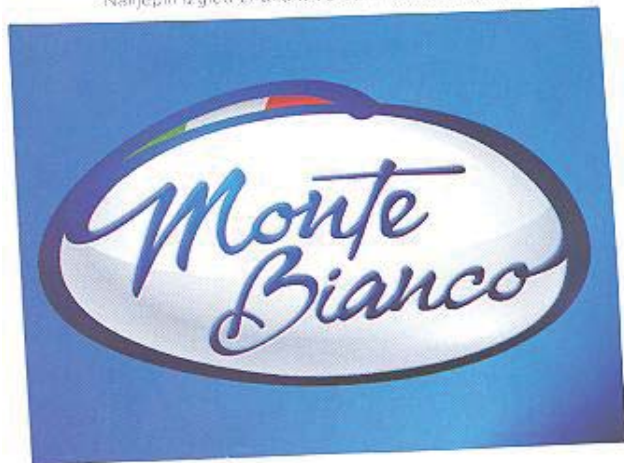

(540)

(550) I

(511) **Klasa 29:** Meso, riba, živina i divljač, Mesne prerađevine, konzervisano, zamrznuto, sušeno i kuvano voće i povrće, želei, džemovi, kompoti, jaja, mlijeko i mliječni proizvodi, jestiva ulja i masti, pića na bazi mlijeka (u kojima mlijeko preovladava), prehrambeni proizvodi biljnog porijekla (u raznim klasama).

**Klasa 30:** Kafa, čaj, kakao, šećer, pirinač, tapioka, sago, zamjena kafe, brašno i proizvodi od žitarica, hljeb, kolači i poslastice, sladoled, med, melasa, kvasac, prašak za pecivo, so, senf, sirće, sosovi (kao dodaci), začini, led, pića od kakaoa, kafe ili na bazi čokolade, određeni prehrambeni proizvodi biljnog porijekla.

**Klasa 31:** Poljoprivredni, vrtlarski i šumarski proizvodi i zrnavlje koji nijesu uključeni u druge klase, žive životinje, svježe voće i povrće, sjeme, prirodne biljke i cvijeće, hrana za životinje, slad, pirinač.

(210) **2011-603**

(442) **20.12.2013.**

(220) 09.12.2011.

(300) 2584822

16.06.2011. GB

(731) **BRITISH AMERICAN TOBACCO (BRANDS) INC.** 2711 CENTERVILLE ROAD, SUITE 300, WILMINGTON, DELAWARE 19808 US



(540)

(550) I

(740) Popović Miladin, Đoka Miraševića 21/III, Podgorica ME

(511) **Klasa 34:** Cigarete, duvan, proizvodi od duvana, upaljači, šibice, artikli za pušače.

(210) **2011-604**

(442) **20.12.2013.**

(220) 09.12.2011.

(300) 2584821

16.06.2011. GB

(731) **BRITISH AMERICAN TOBACCO (BRANDS) INC.** 2711 CENTERVILLE ROAD, SUITE 300, WILMINGTON, DELAWARE 19808 US



(540)

(550) I

(740) Popović Miladin, Đoka Miraševića 21/III, Podgorica ME

(511) **Klasa 34:** Cigarete, duvan, proizvodi od duvana, upaljači, šibice, artikli za pušače.

---

(210) **2011-605** (442) **20.12.2013.**  
(220) 09.12.2011.

(731) **FOUR ROSES DISTILLERY LLC**, 1224 BONDS MILL ROAD, LAWRENCEBURG, KENTUCKY 40342 US

## FOUR ROSES

(540)  
(550) I  
(740) Čejović Vladimir, 13. jula 21, Podgorica ME  
(511) **Klasa 33:** Viski.

---

(210) **2011-606** (442) **20.12.2013.**  
(220) 12.12.2011.

(731) **13 JUL-PLANTAŽE A.D.** PODGORICA ME  
Ukus koji se pamti

(540)  
(550) I  
(511) **Klasa 33:** Alkoholna pića (izuzev piva).  
**Klasa 35:** Oglašavanje, vođenje poslova, poslovno upravljanje, kancelarijski poslovi.

---

(210) **2011-607** (442) **20.12.2013.**  
(220) 12.12.2011.

(731) **13 JUL-PLANTAŽE A.D.** PODGORICA ME  
Strast koja traje

(540)  
(550) I  
(511) **Klasa 33:** Alkoholna pića (izuzev piva).  
**Klasa 35:** Oglašavanje, vođenje poslova, poslovno upravljanje, kancelarijski poslovi.

---

(210) **2011-608** (442) **20.12.2013.**  
(220) 12.12.2011.

(731) **13 JUL-PLANTAŽE A.D.** PODGORICA ME



Ničanskoj klasifikaciji:

- (540) 13 | 14 | 15 | 16 | 17 | 18 | 19 | 20 | 21 | 22 | 23 | 24 | 25  
 (550) I  
 (511) **Klasa 33:** Alkoholna pića (izuzev pivo).

(210) **2011-609** (442) **20.12.2013.**

(220) 12.12.2011.

(731) **13 JUL-PLANTAŽE A.D.** PODGORICA ME

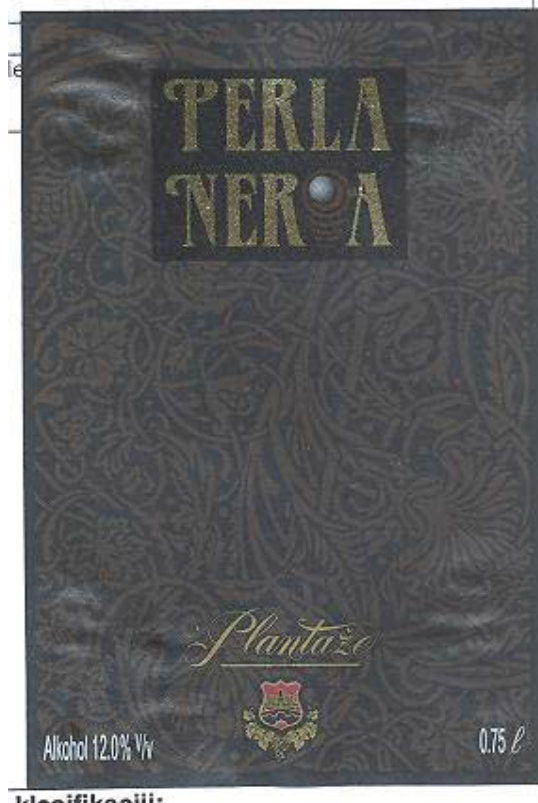

(540) **klasifikaciji:**

(550) I

(511) **Klasa 33:** Alkoholna pića (izuzev piva).

(210) **2011-610** (442) **20.12.2013.**

(220) 12.12.2011.

(731) **13 JUL-PLANTAŽE A.D.** PODGORICA ME



(540) **13 JUL-PLANTAŽE**

(550) I

(511) **Klasa 33:** Alkoholna pića (izuzev piva).

(210) **2011-611** (442) **20.12.2013.**

(220) 12.12.2011.

(731) **13 JUL-PLANTAŽE A.D.** PODGORICA ME



(540)

(550) I

(511) **Klasa 33:** Alkoholna pića (izuzev piva).

(210) **2011-612** (442) **20.12.2013.**

(220) 12.12.2011.

(731) **13 JUL-PLANTAŽE A.D.** PODGORICA ME



(540)

(550) I

(511) **Klasa 33:** Alkoholna pića (izuzev piva).(210) **2011-613**(442) **20.12.2013.**

(220) 12.12.2011.

(731) **TAMRON CO. LTD.** 1385, HASUNUMA, MINUMA-KU, SAITIMA-SHI, SAITIMA-KEN JP

# TAMRON

(540)

(550) I

(740) Lutovac Branislav, Bulevar Crnojevića 93, Podgorica ME

(511) **Klasa 09:** Aparati i instrumenti naučni, pomorski, geodetski, fotografski, kinematografski, optički, zavaganje, merenje, signalizaciju, kontrolu (inspekciju), spasavanje i nastavu, aparati i instrumenti za provođenje, isključivanje, transformisanje, akumuliranje, regulisanje ili kontrolisanje električne energije, aparati za snimanje, prenos i reprodukovanje zvuka ili slike, magnetni nosioci podataka, diskovi za snimanje, automatske mašine i mehanizmi za aparate koji se pokreću novcem ili žetonom, registarkase, računске mašine, oprema za obradu podataka i kompjuteri, aparati za gašenje požara, a naročito optički uređaji i komponente za ulazno/izlazne uređaje (uključujući skenere, kopir aparate, faks mašine i štampače), uređaji za snimanje (uključujući optičke medije), ekrani, posebno projektovana ogledala za primjenu u laserskoj tehnologiji, polarizovani razdvajajući snopova, prizme, tanki zaštitni filmovi i prevlake, optički motori za LCD projektore, uređaji za laserske optičke sisteme, dihidridna ogledala, dihidridne prizme, objektivske jedinice za digitalne kamere, objektivske jedinice za video kamere, objektivske jedinice za kamere na mobilnim telefonima, optički aparati i instrumenti uključujući probne ploče za provjeru preciznosti površine sočiva, fotoaparati sa ugradjenim optičkim zumom, digitalni fotoaparati, fotoaparati srednjeg formata, CCTV kamere, druge kamere, objektiv i sočiva, uključujući i fotografske objektivne, objektivne za CCTV kamere, objektivne za video kamere, objektivne za kamere na mobilnim telefonima,

asferna sočiva, sferna sočiva, projekcijska sočiva, sočiva za motorizovani zum, vari-fokalna sočiva, sočiva fiksnog fokusa za nadzor, zamenjiva sočiva za digitalne fotoaparate i druge fotoaparate, sočiva za nadzorne kamere, sočiva za automatizacija u industriji, objektivne sa uvećavajućim zumom, širokougaone objektivne, teleobjektivne, makro objektivne, sočiva sa fiksnom fokalnom dužinom, infracrvene objektivne, filteri (fotografski), tele-konvertori, fotografske kapuljače, jednonožni stalci, torbe za fotoaparate za nošenje preko ramena, torbice za fotoaparate, futrole za fotoaparate, poklopci za objektivne, adapteri za montažu, filmske pregrade, tražila, drugi djelovi i pribor za digitalne fotoaparate i druge fotoaparate, kinematografski aparati i instrumenti, interferometri, sferometri, farbe za livenje, plastične livene komponente, naočari za oči, kontaktna sočiva, mašine i aparati za telekomunikaciju i njihovi djelovi i pribor, infracrvene kamere, objektivske jedinice za infracrvene kamere, kamere za vozila, sočiva za kamere za vozila, objektivske jedinice za kamere za vozila, panoramske kamere, optički sistemi za osvetljenja na vozilima, kamere za daleko infracrveno područje, zamjenjiva sočiva za kamere za daleko infracrveno područje, objektivske jedinice za daleko infracrveno područje, sočiva za daleko infracrveno područje, kupola kamere, riblje oko objektivni.

(210) **2011-614** (442) **20.12.2013.**

(220) 12.12.2011.

(731) **WOLVERINE INTERNATIONAL**, L.P. (A CAYMAN ISLANDS CORPORATION), 4TH FLOOR, SCOTIA CENTRE P.O. BOX 268 GRAND CAYMAN KY1-1104 KY

## CUSHE

(540)

(550) I

(740) Ćupić Branislav, Dalmatinska 10, Podgorica ME

(511) **Klasa 25:** Odjeća, obuća, pokrivala za glavu.

(210) **2011-615** (442) **20.12.2013.**

(220) 12.12.2011.

(731) **WOLVERINE INTERNATIONAL**, L.P.(A CAYMAN ISLAND CORPORATION), 4TH FLOOR, SCOTIA CENTRE P.O. BOX 268 GRAND CAYMAN KY1-1104 KY

## SHUCOON

(540)

(550) I

(740) Ćupić Branislav, Dalmatinska 10, Podgorica ME

(511) **Klasa 25:** Odjeća, obuća, pokrivala za glavu.

(210) **2011-616**(442) **20.12.2013.**

(220) 12.12.2011.

(731) **DURMUS YASAR** VE OGULLARI BOYA VERNİK VE RECİNE FABRIKALARI ANONİM SİRKETİ, SANAYİ CADDESİ, NO.37, BORNOVA İZMİR TR

(540)

(550) I

(740) Popović Miladin, Đoka Miraševića 21/III, Podgorica ME

(511) **Klasa 01:** Hemijski proizvodi koji se upotrebljavaju u industriji, nauci i fotografiji, kao i u poljoprivredi, hortikulturi i šumarstvu, neprerađene vještačke smole, neprerađene plastične materije, đubriva, smješe za gašenje požara, preparati za kaljenje i zavarivanje, hemijske supstance za očuvanje namirnica, materije za štavljenje, ljepljive supstance koje se upotrebljavaju u industriji.**Klasa 02:** Boje, firnajzi, lakovi, sredstva za zaštitu od rđe i truljenja drveta, materije za bojenje, sredstva za nagrizanje, sirove prirodne smole, metali u obliku listova i praha za slikare, dekoratere, štampare i umjetnike.(210) **2011-617**(442) **20.12.2013.**

(220) 12.12.2011.

(731) **DYO BOYA FABRIKALARI** SANAYİ VE TİCARET ANONİM SİRKETİ, SEHİT FETHİ BEY CADDESİ NO.120 İZMİR TR

# DEWILUX

(540)

(550) I

(740) Popović Miladin, Đoka Miraševića 21/III, Podgorica ME

(511) **Klasa 01:** Hemijski proizvodi koji se upotrebljavaju u industriji, nauci i fotografiji, kao i u poljoprivredi, hortikulturi i šumarstvu, neprerađene vještačke smole, neprerađene plastične materije, đubriva, smješe za gašenje požara, preparati za kaljenje i zavarivanje, hemijske supstance za očuvanje namirnica, materije za štavljenje, ljepljive supstance koje se upotrebljavaju u industriji.**Klasa 02:** Boje, firnajzi, lakovi, sredstva za zaštitu od rđe i truljenja drveta, materije za bojenje, sredstva za nagrizanje, sirove prirodne smole, metali u obliku listova i praha za slikare, dekoratere, štampare i umjetnike.(210) **2011-618**(442) **20.12.2013.**

(220) 12.12.2011.

(731) **JOHNSON CONTROLS TECHNOLOGY COMPANY**, 915 EAST 32ND STREET SITY



OF HOLLAND STATE OF MICHIGAN 49423 US

## POWERFRAME

(540)

(550) I

(740) Popović Miladin, Đoka Miraševića 21/III, Podgorica ME

(511) **Klasa 09:** Baterije, provodne mreže za baterije i punjači baterija.

---

(210) **2011-619**

(442) **20.12.2013.**

(220) 12.12.2011.

(731) **HTC CORPRATION** (A TAIWANESE COMPANY), NO. 23, XINGHUA ROAD, TAOYUAN CITY, TAOYUAN COUNTRY 330, TAIWAN, R.O.C. TW



(540)

(550) I

(740) Čejović Vladimir, 13. jula 21, Podgorica ME

(511) **Klasa 09:** Mobilni telefoni, smartfoni, bežični telefoni, bežični uređaji, prenosivi kompjuteri i lični digitalni asistenti, kompjuterski hardver i softver za mobilne, prenosive i bežične uređaje, korisnički interfejs softver, kompjuterski hardver i softver za korisnički interfejsing, telekomunikacije i telekomunikacijske usluge, kompjuterski hardver i softver za prenošenje i prijem glasa, slike, podataka, audio, video i multimedijalnog sadržaja, bežični modemi, slušalice, slušalice sa funkcijom bežičnog prenosa, kablovi za konekciju, držači, nosači, maske, baterije, adapteri, punjači, futrole, punjači za vozila, držači za vozila, daljinski upravljači, tastature, mikrofoni, zvučnici, kožne torbice za mobilne telefone.

**Klasa 37:** Dijagnostika, popravka, održavanje i konsultantske usluge za mobilne telefone, smartfone, bežične telefone, bežične uređaje, prenosive kompjutere, lične digitalne asistente, dijagnostika, popravka, održavanje i konsultantske usluge za bežične modeme, slušalice, slušalice sa funkcijom bežičnog prenosa, kablovima za konekciju, držačima, nosačima, maskama, baterijama, adapterima, punjačima, futrolama, punjačima za vozila, držačima za vozila, daljinskim upravljačima, tastaturama, mikrofonomima, zvučnicima, kožnim torbicama za mobilne telefone.

---

(210) **2011-620**

(442) **20.12.2013.**

(220) 12.12.2011.

(731) **13 JUL-PLANTAŽE A.D.** PODGORICA ME



(540) ličanekei klasifikaciji:

(550) I

(511) **Klasa 33:** Alkoholna pića (izuzev piva).

(210) **2011-621**

(442) **20.12.2013.**

(220) 13.12.2011.

(731) **BONES GROUP** D.O.O. KUMODRAŠKA BR. 260 11152 BEOGRAD RS



(540)

(550) I

(511) **Klasa 03:** Krema za ruke.

**Klasa 05:** Farmaceutski preparati. u medicini, hrana za bebe, flasteri, materijali za zavijanje, materijali za plombiranje zuba, zubarska smola, dezinfekciona sredstva, preparati za uništavanje štetocina, fungicidi, herbicidi.

(210) **2011-622**

(442) **20.12.2013.**

(220) 13.12.2011.

(731) **BONERS GROUP** D.O.O, KUMODRAŠKA BR. 260 11152 BEOGRAD RS



(540)

(550) I

(511) **Klasa 03:** Pasta za zube.

**Klasa 05:** Farmaceutski, veterinarski i sanitarni preparati, dijetetske supstance prilagođene za upotrebu u medicini, hrana za bebe, flasteri, materijali za zavijanje, materijali za plom-biranje zuba, zubarska smola, dezinfekciona sredstva, preparati za uništavanje štetocina, fungicidi, herbicidi.

(210) **2011-623**(442) **20.12.2013.**

(220) 13.12.2011.

(731) **BONES GROUP** D.O.O. KUMODRAŠKA BR. 260 11152 BEOGRAD RS

(540)

(550) I

(511) **Klasa 03:** Krema za ruke.

**Klasa 05:** Farmaceutski, veterinarski i sanitarni preparati, dijetetske supstance prilagođene za upotrebu u medicini, hrana za bebe, flasteri, materijali za zavijanje, materijali za plom-biranje zuba, zubarska smola, dezinfekciona sredstva, preparati za uništavanje štetocina, fungicidi, herbicidi.

(210) **2011-624**(442) **20.12.2013.**

(220) 13.12.2011.

(731) **ARTEKS** D.O.O. SVETOLIKA LAZAREVCA 25, 31230 ARILJE RS



(540)

(550) I

(740) Čupić Branislav, Dalmatinska 10, Podgorica ME

(511) **Klasa 18:** Koža i imitacija kože, proizvodi izrađeni od ovih materijala koji nisu uključeni u druge klase, životinjska koža, koferi i putne torbe.**Klasa 24:** Tekstil i tekstilni proizvodi koji nisu obuhvaćeni drugim klasama, prekrivači za krevete i stolove.**Klasa 25:** Odjela za muškarce, jakne, pantalone, šorcevi, košulje, majice, žaketi, džins, pižame, donji veš, kravate, kaiševi, cipele, patike, obuća za sport, sokne, trenerke, sportska odjeća, maramice, maramice.**Klasa 35:** Oglašavanje, vođenje poslova, poslovno upravljanje, kancelarijski poslovi.(210) **2011-625**(442) **20.12.2013.**

(220) 13.12.2011.

(731) **JAMES SOMMERS**, AN INDIVIDUAL OF THE UNITED STATES, 7095 HOLLYWOOD BLVD. 90028 LOS ANGELES US

## WILDFOX

(540)

(550) I

(740) Čejović Vladimir, 13. jula 21, Podgorica ME

(511) **Klasa 25:** Odjeća, pokrivala za glavu, obuća.(210) **2011-626**(442) **20.12.2013.**

(220) 13.12.2011.

(731) **HUHTAMAKI FINANCE** B.V. A DUTCH CORPORATION JUPITERSTRAAT 102 2132 HE HOOFDORP NL

## JOLLY RANCHER

(540)

(550) I

(740) Popović Miladin, Đoka Miraševića 21/III, Podgorica ME

(511) **Klasa 30:** Slatkiši, poslastice, gume za žvakanje, smrznute poslastice naime, vocni sladoledi, zacinjeni led, sladoledi, sladoledi na štapić, poslastice od sladoleda, smrznuti jogurt, smrznuti jogurt na štapić, šerbet.

(210) **2011-627** (442) **20.12.2013.**  
(220) 13.12.2011.

(731) **FASHIONET AG**, GARTENSTRASSE 70 CH-4052 BASEL CH

**FASHIONET**

(540)

(550) I

(740) Popović Miladin, Đoka Miraševića 21/III, Podgorica ME

(511) **Klasa 35:** Administrativne usluge u vezi sa transportom, skladištenjem, otpremanjem, distribucijom, namještanjem i pakovanjem odjevnih predmeta i modnih dodataka.

**Klasa 39:** Transport, skladištenje, otpremanje, distribucija, namještanje i pakovanje odjevnih predmeta i modnih dodataka.

(210) **2011-628** (442) **20.12.2013.**  
(220) 14.12.2011.

(731) **13 JUL-PLANTAŽE A.D.** PODGORICA ME

*Plantaže*  
2012  
*Црногорски*  
**ПРВИЈЕНАЦ**  
*Eau De Vie Du Montenegro*



50.0% %

1 lit.

(540)

(550) I

(511) **Klasa 33:** Alkoholna pića (izuzev piva).

(210) **2011-629** (442) **20.12.2013.**

(220) 14.12.2011.

(731) **FINANZ ST.HONORE** B.V. PRINS BERNHARDPLEIN 200 1097 JB AMSTERDAM NL

NAVY

(540)

(550) I

(740) Ćupić Branislav, Dalmatinska 10, Podgorica ME

(511) **Klasa 03:** Preparati za bjeljenje i druge supstance za pranje, preparati za čišćenje, poliranje, uklanjanje masti i brušenje, sapuni, parfimerija, eterična ulja, kozmetički proizvodi, losioni za kosu, preparati za njegu zuba, toaletne vode, kolonjske vode, mirisi.

(210) **2011-630**

(442) **20.12.2013.**

(220) 14.12.2011.

(300) 63265 13.10.2011. RS

(731) **GALENIKA** A.D. BATAJNIČKI DRUM BB, 11080 BEOGRAD RS

SCILOPRAM  
СЦИЛОПРАМ

(540)

(550) I

(740) Kovačević Aleksandar, Kružni put bb, Cetinje ME

(511) **Klasa 05:** Farmaceutski preparati.

(210) **2011-631**

(442) **20.12.2013.**

(220) 14.12.2011.

(300) 62703 10.05.2011. RS

(731) **GALENIKA** A.D. BATAJNIČKI DRUM BB, 11080 BEOGRAD RS

LEFLOGAL  
ЛЕФЛОГАЛ

(540)

(550) I

(740) Kovačević Aleksandar, Kružni put bb, Cetinje ME

(511) **Klasa 05:** Farmaceutski preparati.

(210) **2011-632**

(442) **20.12.2013.**

(220) 14.12.2011.

(300) 62735 19.05.2011. RS

(731) **GALENIKA** A.D. BATAJNIČKI DRUM BB, 11080 BEOGRAD RS

**TELUKA**  
**ТЕЛУКА**

(540)

(550) I

(740) Kovačević Aleksandar, Kružni put bb, Cetinje ME

(511) **Klasa 05:** Farmaceutski preparati.

---

(210) **2011-633**

(442) **20.12.2013.**

(220) 14.12.2011.

(300) 62733 19.05.2011.RS

(731) **GALENIKA** A.D. BATAJNIČKI DRUM BB, 11080 BEOGRAD RS

**ELEPHOGAL**  
**ЕЛЕФОГАЛ**

(540)

(550) I

(740) Kovačević Aleksandar, Kružni put bb, Cetinje ME

(511) **Klasa 05:** Farmaceutski preparati.

---

(210) **2011-634**

(442) **20.12.2013.**

(220) 14.12.2011.

(300) 62731 19.05.2011. RS

(731) **GALENIKA** A.D. BATAJNIČKI DRUM BB, 11080 BEOGRAD RS

**LINDOMEM**  
**ЛИНДОМЕМ**

(540)

(550) I

(511) **Klasa 05:** Farmaceutski preparati.

---

(210) **2011-635**

(442) **20.12.2013.**

(220) 14.12.2011.

(300) 62734 19.05.2011. RS

(731) **GALENIKA** A.D. BATAJNIČKI DRUM BB, 11080 BEOGRAD RS

**PARIZOL**  
**ПАРИЗОЛ**

(540)

(550) I

(740) Kovačević Aleksandar, Kružni put bb, Cetinje ME

(511) **Klasa 05:** Farmaceutski preparati.

---

(210) **2011-636**

(442) **20.12.2013.**

(220) 14.12.2011.

(300) 62736 19.05.2011. RS

(731) **GALENIKA** A.D. BATAJNIČKI DRUM BB, 11080 BEOGRAD RS

**KVINAP PLUS**  
**КВИНАП ПЛУС**

(540)

(550) I

(740) Kovačević Aleksandar, Kružni put bb, Cetinje ME

(511) **Klasa 05:** Farmaceutski preparati.

---

(210) **2011-637**

(442) **20.12.2013.**

(220) 14.12.2011.

(300) 62732 19.05.2011. RS

(731) **GALENIKA** A.D. BATAJNIČKI DRUM BB, 11080 BEOGRAD RS

**KVINAP**  
**КВИНАП**

(540)



(550) I  
(740) Kovačević Aleksandar, Kružni put bb, Cetinje ME  
(511) **Klasa 05:** Farmaceutski preparati.

---

(210) **2011-638** (442) **20.12.2013.**  
(220) 14.12.2011.  
(300) 62497 25.03.2011. RS  
(731) **GALENIKA** A.D. BATAJNIČKI DRUM BB, 11080 BEOGRAD RS

**GALOSART PLUS**  
**ГАЛОСАРТ ПЛУС**

(540)  
(550) I  
(740) Kovačević Aleksandar, Kružni put bb, Cetinje ME  
(511) **Klasa 05:** Farmaceutski preparati.

---

(210) **2011-639** (442) **20.12.2013.**  
(220) 14.12.2011.  
(300) 62499 25.03.2011. RS  
(731) **GALENIKA** A.D. BATAJNIČKI DRUM BB, 11080 BEOGRAD RS

**NEBIGAL**  
**НЕБИГАЛ**

(540)  
(550) I  
(740) Kovačević Aleksandar, Kružni put bb, Cetinje ME  
(511) **Klasa 05:** Farmaceutski preparati.

---

(210) **2011-640** (442) **20.12.2013.**  
(220) 14.12.2011.  
(300) 62500 25.03.2011. RS  
(731) **GALENIKA** A.D. BATAJNIČKI DRUM BB, 11080 BEOGRAD RS

TELARTAN  
ТЕЛАРТАН

(540)

(550) I

(740) Kovačević Aleksandar, Kružni put bb, Cetinje ME

(511) **Klasa 05:** Farmaceutski preparati.

---

(210) **2011-641**

(442) **20.12.2013.**

(220) 14.12.2011.

(300) 62498 25.03.2011. RS

(731) **GALENIKA** A.D. BATAJNIČKI DRUM BB, 11080 BEOGRAD RS

FOSINOP  
ФОСИНОП

(540)

(550) I

(740) Kovačević Aleksandar, Kružni put bb, Cetinje ME

(511) **Klasa 05:** Farmaceutski preparati.

---

(210) **2011-642**

(442) **20.12.2013.**

(220) 14.12.2011.

(731) **GALENIKA** A.D. BATAJNIČKI DRUM BB, 11080 BEOGRAD RS

LANOPROGAL  
ЛАНПРОГАЛ

(540)

(550) I

(740) Kovačević Aleksandar, Kružni put bb, Cetinje ME

(511) **Klasa 05:** Farmaceutski preparati.

---

(210) **2011-643**

(442) **20.12.2013.**

(220) 14.12.2011.

(731) **JOHNSON CONTROLS TECHNOLOGY COMPANY**, 915 EAST 32ND STREET CITY OF HOLLAND STATE OF MICHIGAN 49423 US



(540) \_\_\_\_\_

(550) I

(740) Popović Miladin, Đoka Miraševića 21/III, Podgorica ME

(511) **Klasa 09:** Baterije, provodne mreže za baterije i punjači baterija.

---

(210) **2011-644**

(442) **20.12.2013.**

(220) 14.12.2011.

(731) **JONHSON CONTROLS TECHNOLOGY COMPANY**, 915 EAST 32ND STREET CITY OF HOLLAND STATE OF MICHIGAN 49423 US



(540)

(550) I

(740) Popović Miladin, Đoka Miraševića 21/III, Podgorica ME

(511) **Klasa 09:** Baterije, provodne mreže za baterije i punjači baterija.

---

(210) **2011-645**

(442) **20.12.2013.**

(220) 14.12.2011.

(731) **TEVA OPERATINS POLAND** SP.Z.O.O, EMILII PLATER 53 00-113 WARSZAWA PL

## AVIOMARIN

(540)

(550) I

(740) Popović Miladin, Đoka Miraševića 21/III, Podgorica ME

(511) **Klasa 05:** Farmaceutski preparati za lijekove koji se koriste za prevenciju i liječenje mučnine, povraćanja i vrtoglavice.

(210) **2011-646**

(442) **20.12.2013.**

(220) 14.12.2011.

(731) **HENRI-LLOYD LIMITED**, SMITHFOLD LANE, WORSLEY, MANCHESTER, M280GP GB



(540)

(550) I

(740) Radulović Božidar, Jovana Tomaševića 9/III, Podgorica ME

(511) **Klasa 25:** Nepromočiva ili vodootporna odjeća, odela za preživljavanje, jakne, pantalone, kombinezon-pantalone, vjetrovke, krznene jakne, zaštitna odjela i jakne, kaputi, pokrivala za glavu, košulje, obuća, čarape, marame, kravate, pletena odjeća, prsluci, sigurnosni proizvodi za moreplovstvo, naročito kaiševi i sigurnosna užad.

(210) **2011-647**

(442) **20.12.2013.**

(220) 14.12.2011.

(731) **ŽITO PREHRAMBENA INDUSTRIJA**, D.D. ŠMARTINSKA CESTA 154, 1000 LJUBLJANA SI



(540)

(550) I

(740) Radulović Božidar, Jovana Tomaševića 9/III, Podgorica ME

(511) **Klasa 05:** Ljekovite trave i ljekoviti čajevi.

**Klasa 30:** Čajevi.

(210) **2011-648**

(442) **20.12.2013.**

(220) 15.12.2011.

(731) **ASTEX PHARMACEUTICALS, INC**, 4140 DUBLIN BLVD. SUITE 200, DUBLIN, CALIFORNIA 94568 US

**DACOGEN**

(540)

(550) I

(740) Lutovac Branislav, Bulevar Crnojevića 93, Podgorica ME

(511) **Klasa 05:** Framaceutski proizvodi za liječenje raka imunoloških poremećaja.

(210) **2011-649**

(442) **20.12.2013.**

(220) 15.12.2011.

(731) **SANYANG INDUSTRY CO. LTD**, 3 CHUNG HUA ROAD, HUKOU, HSINCHU, TAIWAN R.O.C. TW



(540)

(550) I

(740) Lutovac Branislav, Bulevar Crnojevića 93, Podgorica ME

(511) **Klasa 12:** Vozila, automobili, motocikli, ATV vozila, kolica za starije osobe, električni motocikli, sportski motocikli, električni skuteri, električni bicikli, motocikli za vodu, delovi i oprema sa svu napred navedenu robu.

**Klasa 37:** Održavanje i popravka vozila, održavanje i popravka automobila, održavanje i popravka motocikala, pranje automobila, pranje motocikala, zaštita automobila od rdje, zaštita motocikala od rdje, podmazivanje automobila, podmazivanje motocikala, čišćenje automobila, čišćenje motocikala, usluge servisnih stanica za automobile, usluge servisnih stanica za motocikle, vulkaniziranje automobilskih guma, vulkaniziranje guma za motocikle, ugradnja, održavanje i popravka mašina iz oblasti automobila, ugradnja, održavanje i popravka mašina iz oblasti motocikala.

(210) **2011-650**

(442) **20.12.2013.**

(220) 15.12.2011.

(731) **EUROPAPERESS HOLDING D.O.O.** KORANSKA 2, ZAGREB HR

REVIIJA ZA ZDRAVLJE I DUG ŽIVOT  
**DOKTOR**  
 U KUĆI

(540)

(550) I

(740) Lutovac Branislav, Bulevar Crnojevića 93, Podgorica ME

(511) **Klasa 09:** naučni, nautički, geodetski, fotografski, kinematografski i optički aparati i instrumenti kao i aparati i instrumenti za vaganje, mjerenje, signalizaciju, kontrolu (inspekciju), za pomoć (spašavanje) i za obuku, aparati i instrumenti za vođenje, distribuiranje, transformiranje, akumuliranje, podešavanje ili upravljanje električne struje, aparati za snimanje, prenos, reprodukciju zvuka ili slika, magnetne podloge za snimanje, akustične ploče, automati i mehanizmi za automatske uređaje koji se pokreću uz prethodno ubacivanje metalnih novčića, registarske kase, računari, oprema za obradu podataka i računara, uređaji za gašenje požara, a pogotovo elektronske publikacije.

**Klasa 16:** Papir, karton i proizvodi od tih materijala koji nisu obuhvaćeni drugim klasama, a pogotovo novine, časopisi, magazini, publikacije, knjige, štamparski proizvodi, proizvodi za uvezivanje knjiga, fotografije, pribor za pisanje, ljepila (ljepljive tvari za papirne proizvode ili za domaćinstvo), slikarski pribor, kistovi, pisaće mašine i kancelarijski pribor (osim namještaja), oprema za nastavu i obuku (osim aparata), plastični materijali za ambalažu (koji nisu obuhvaćeni drugim razredima), štamparska slova, klišeji.

**Klasa 35:** oglašavanje i reklamiranje, vođenje komercijalnih poslova, komercijalna administracija, kancelarijski poslovi.

**Klasa 38:** Telekomunikacije.

**Klasa 41:** Obuka, stručno osposobljavanje, razonoda, sportske i kulturne djelatnosti.

(210) **2011-651**(442) **20.12.2013.**

(220) 15.12.2011.

(731) **EUROPAPRESS HOLDING** D.O.O. KORANSKA 2, ZAGREB HR

GLORIA GLAM

(540)

(550) I

(740) Lutovac Branislav, Bulevar Crnojevića 93, Podgorica ME

(511) **Klasa 09:** Naučni, nautički, geodetski, fotografski, kinematografski i optički aparati i instrumenti kao i aparati i instrumenti za vaganje, mjerenje, signalizaciju, kontrolu (inspekciju), za pomoć (spašavanje) i za obuku, aparati i instrumenti za vođenje, distribuiranje, transformiranje, akumuliranje, podešavanje ili upravljanje električne struje, aparati za snimanje, prenos, reprodukciju zvuka ili slika, magnetne podloge za snimanje, akustične ploče, automati i mehanizmi za automatske uređaje koji se pokreću uz prethodno ubacivanje me-

talnih novčića, registarske kase, računari, oprema za obradu podataka i računara, uređaji za gašenje požara, a pogotovo elektronske publikacije.

**Klasa 16:** Papir, karton i proizvodi od tih materijala koji nisu obuhvaćeni drugim klasama, a pogotovo novine, časopisi, magazini, publikacije, knjige, štamparski proizvodi, proizvodi za uvezivanje knjiga, fotografije, pribor za pisanje, ljepila (ljepljive tvari za papirne proizvode ili za domaćinstvo), slikarski pribor, kistovi, pisaće mašine i kancelarijski pribor (osim namještaja), oprema za nastavu i obuku (osim aparata), plastični materijali za ambalažu (koji nisu obuhvaćeni drugim razredima), štamparska slova, klišeji.

**Klasa 35:** Oglašavanje i reklamiranje, vodenje komercijalnih poslova, komercijalna administracija, kancelarijski poslovi.

**Klasa 38:** Telekomunikacije.

**Klasa 41:** Obuka, stručno osposobljavanje, razonoda, sportske i kulturne djelatnosti.

(210) **2011-652** (442) **20.12.2013.**

(220) 15.12.2011.

(731) **EUROPAPRESS HOLDING** D.O.O. KORANSKA 2, ZAGREB HR

GLAM

(540)

(550) I

(740) Lutovac Branislav, Bulevar Crnojevića 93, Podgorica ME

(511) **Klasa 09:** naučni, nautički, geodetski, fotografski, kinematografski i optički aparati i instrumenti kao i aparati i instrumenti za vaganje, mjerenje, signalizaciju, kontrolu (inspekciju), za pomoć (spašavanje) i za obuku, aparati i instrumenti za vođenje, distribuiranje, transformiranje, akumuliranje, podešavanje ili upravljanje električne struje, aparati za snimanje, prenos, reprodukciju zvuka ili slika, magnetne podloge za snimanje, akustične ploče, automati i mehanizmi za automatske uređaje koji se pokreću uz prethodno ubacivanje metalnih novčića, registarske kase, računari, oprema za obradu podataka i računara, uređaji za gašenje požara, a pogotovo elektronske publikacije.

**Klasa 16:** Papir, karton i proizvodi od tih materijala koji nisu obuhvaćeni drugim klasama, a pogotovo novine, časopisi, magazini, publikacije, knjige, štamparski proizvodi, proizvodi za uvezivanje knjiga, fotografije, pribor za pisanje, ljepila (ljepljive tvari za papirne proizvode ili za domaćinstvo), slikarski pribor, kistovi, pisaće mašine i kancelarijski pribor (osim namještaja), oprema za nastavu i obuku (osim aparata), plastični materijali za ambalažu (koji nisu obuhvaćeni drugim razredima), štamparska slova, klišeji.

**Klasa 35:** Oglašavanje i reklamiranje, vodenje komercijalnih poslova, komercijalna administracija, kancelarijski poslovi.

**Klasa 38:** Telekomunikacije.

**Klasa 41:** Obuka, stručno osposobljavanje, razonoda, sportske i kulturne djelatnosti.

(210) **2011-657** (442) **20.12.2013.**

(220) 15.12.2011.

(731) **NINE WEST DEVELOPMENT COPORATION**, 1007 ORANGE SREET, SUITE 225, WILMINGTON, DELAWARE 19801 US

## LOVE FURY KISS

(540)

(550) I

(740) Čejović Vladimir, 13. jula 21, Podgorica ME

(511) **Klasa 03:** Sredstva za bijeljenje i druge supstance za upotrebu u perionicama, preparati za čišćenje, poliranje, ribanje i nagrizanje, sapuni, parfimerija, eterična ulja, kozmetika, losioni za kosu, paste za zube, parfemi, toaletna voda, kolonska voda, mirisni sprejevi, sapuni, sredstva za čišćenje kože, losioni za kožu i kreme, hidratne kreme, losioni i ulja za sunčanje, kozmetički proizvodi, naime, puderi za lice i tijelo, podloga za šminku, sjaj za tijelo, sjaj za lice, karmin, olovke za usne, rumenilo, sjenka za oči, krema za područje oko očiju, ajlajner, maskara i olovke za obrve, gel za tuširanje, soli za kupanje, proizvodi za njegu kose, naime šampon i regeneratorski.

(210) **2011-658**

(442) **20.12.2013.**

(220) 15.12.2011.

(731) **AATELLAS DEUTCHLAND GMBH**, GEORG BRAUCHLE RING 64-66, MUNCHEN DE

# RIBOMUSTIN

(540)

(550) I

(740) Popović Miladin, Đoka Miraševića 21/III, Podgorica ME

(511) **Klasa 05:** Farmaceutski, veterinarski i sanitarni proizvodi za medicinske svrhe, farmaceutski proizvodi dostupni samo na recept, naime citostatički (rast ćelija, inhibiranje kancera) preparati za medicinske svrhe.

**Klasa 16:** Štampane stvari, kancelarijski materijal, materijal za obuku i nastavu (izuzev aparata).

**Klasa 41:** Obrazovne usluge i pripremanje obuke.

**Klasa 42:** Naučne i tehnološke usluge i istraživanje i projektovanje u vezi sa navedenim uslugama.

**Klasa 44:** Farmaceutske usluge uključujući pravljenje recepata, farmaceutske i medicinske savjetodavne usluge, usluge dijagnostikovanja, usluge medicinskog liječenja.

(210) **2011-659**

(442) **20.12.2013.**

(220) 15.12.2011.

(731) **ASTELLAS DEUTSCHLAND GMBH**, GEORG BRAUCHLE RING 64-66 MUNCHEN DE





(540)

(550) I

(740) Popović Miladin, Đoka Miraševića 21/III, Podgorica ME

(511) **Klasa 05:** Farmaceutski, veterinarski i sanitarni proizvodi za medicinske farmaceutski proizvodi dostupni samo na recept, naime citostatički (rast ćelija, inhibiranje kancera) preparati za medicinske svrhe.

**Klasa 16:** Štampane stvari, kancelarijski materijal, materijal za obuku i nastavu (izuzev aparata).

**Klasa 41:** Obrazovne usluge i pripremanje obuke.

**Klasa 42:** Naučne i tehnološke usluge i istraživanje i projektovanje u vezi sa navedenim uslugama.

**Klasa 44:** Farmaceutske usluge uključujući pravljenje recepata, farmaceutske i medicinske savjetodavne usluge, usluge dijagnostikovanja, usluge medicinskog liječenja.

(210) **2011-660**(442) **20.12.2013.**

(220) 16.12.2011.

(731) **ALKALOID AD** SKOPLJE, BUL. ALEKSANAR MAKEDONSKI 12, SKOPLJE RM

(540)

(550) I

(740) Popović Miladin, Đoka Miraševića 21/III, Podgorica ME

(511) **Klasa 05:** Dječija pasta za zube.

(210) **2011-661**(442) **20.12.2013.**

(220) 16.12.2011.

(731) **SIX CONTINENTS HOTELS, INC,** 3 RAVINIA DRIVE, ATLANTA GEORGIA US

## HOLIDAY INN

(540)

(550) I

(740) Mihailović Vojislav, Hilendarska 5, Beograd (SR)

(511) **Klasa 43:** Hotelske usluge, usluge motela, usluge obezbeđivanja smeštaja, usluge privremenog smeštaja, usluge rezervacije za hotelski smeštaj i za druge vrste smeštaja, usluge informacija o odmoru i planiranju u vezi sa smeštajem, usluge barova, usluge koktel odmarališta i organizovanja i održavanja koktela i usluge noćnih barova, usluge kafea, restorana i snek barova, usluge kateringa za obezbeđenje hrane i pića, usluge obezbeđivanja prostora za održavanje konferencija, sastanaka i izložbi, usluge prijave i odjave u hotelima, usluge elektronskih informacija koje se odnose na hotele, savetodavne usluge i usluge konsultacije koje se odnose na gore navedeno.

---

(210) **2011-662**

(442) **20.12.2013.**

(220) 16.12.2011.

(731) **INTER-CONTINENTAL HOTELS CORPRATION**, THREE RAVINIA DRIVE, ATLANTA GEORGIA 30346 US

## SIX CONTINENTS CLUB

(540)

(550) I

(740) Mihailović Vojislav, Hilendarska 5, Beograd (SR)

(511) **Klasa 39:** Prevođenje i skladištenje, naročito organizovanje paket aranžmana za putovanja i ture, za hotelske goste.

**Klasa 42:** Hotelske i restoranske usluge, usluge vratara, usluge konferencijskih centara, obezbeđivanje poslovnih prostora i opreme za hotelske goste, usluge koktel barova i noćnih klubova.

---

(210) **2011-663**

(442) **20.12.2013.**

(220) 16.12.2011.

(731) **PEROND RICARD ARGENTINA S.R.L.** JULUY 1197, BELLA VISTA, BUENOS AIRES B1661KTA AR

## SANTA SILVIA

(540)

(550) I

(740) Mihailović Vojislav, Hilendarska 5, Beograd (SR)

(511) **Klasa 33:** Žestoka alkoholna pića, liker, kokteli, alkoholna pića.

---

(210) **2011-666**(442) **20.12.2013.**

(220) 16.12.2011.

(731) **PERNOD RICARD USA**, LLC, 100 MANHATTANVILLE ROAD, PURCHASE, NEW YORK 10577 US

(540)

(550) I, F

(740) Mihailović Vojislav, Hilandarska 5, Beograd (SR)

(511) **Klasa 33:** Alkoholna pića, prije svega viski.(210) **2011-668**(442) **20.12.2013.**

(220) 16.12.2011.

(731) **VAHGUARD TRADEMARK HOLDINGS USA**, INC. 600 CORPORATE PARK DRIVE, ST. LOUIS, MISSORI 63105 US

(540)

(550) I

(740) Čejović Vladimir, 13. jula 21, Podgorica ME

(511) **Klasa 39:** Iznajmljivanje vozila i usluge rezervacija.(210) **2011-671**(442) **20.12.2013.**

(220) 20.12.2011.

(731) **UNILEVER N.V.** WEENA 455 3013 AL ROTTERDAM NL

(540)

(550) I

(740) Popović Miladin, Đoka Miraševića 21/III, Podgorica ME

(511) **Klasa 03:** Deterdženti, preparati i supstance, sve za pranje rublja, preparati za omekšava-

nje rublja, preparati za izbjeljivanje, preparati za čišćenje, poliranje, odmaščivanje i abrazivni preparati, preparati za pranje sudova, sapuni, za pranje ruku, preparatima impregnirani ubrusi supstance za čišćenje i poliranje.

(210) **2011-672**

(442) **20.12.2013.**

(220) 20.12.2011.

(731) **RUSSELL BRANDS, LLC, ONE FRUIT OF THE LOOM DRIVE, BOWLING GREEN, KENTUCKY 42103 US**

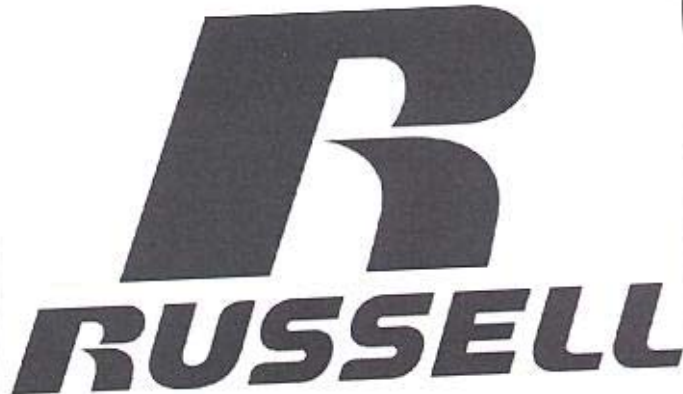

(540)

(550) I

(740) Čejović Vladimir, 13. jula 21, Podgorica ME

(511) **Klasa 18:** Torbe, sportske torbe, atletske torbe, trake za upotrebu u sportu, novčanici i tašne, putne torbe, putne vreće i rančevi.

**Klasa 25:** Odjeća, obuća, pokrivala za glavu, sportska odjeća, sportska obuća, pokrivala za glavu za upotrebu u sportu.

**Klasa 28:** Torbe prilagođene za nošenje sportskih artikala, gimnastički i sportski artikli i oprema.

**Klasa 35:** Maloprodajne usluge u vezi sa prodajom torbi, sportskih torbi, atletskih torbi, traka za upotrebu u sportu, novčanika i tašni, putnih torbi, putnih vreća i rančeva, odjeće, obuća, pokrivala za glavu, sportske odjeće, sportske obuća, pokrivala za glavu za upotrebu u sportu, torbi prilagođenih za nošenje sportskih artikala, gimnastičkih i sportskih artikala i opreme, usluge u vezi reklamnih torbi, sportskih torbi, atletskih torbi, traka za upotrebu u sportu, novčanika i tašni, putnih torbi, putnih vreća i rančeva, odjeće, obuća, pokrivala za glavu, sportske odjeće, sportske obuća, pokrivala za glavu za upotrebu u sportu, torbi prilagođenih za nošenje sportskih artikala, gimnastičkih i sportskih artikala i opreme.

(210) **2011-673**

(442) **20.12.2013.**

(220) 20.12.2011.

(731) **RUSSELL BRANDS, LLC, ONE FRUIT OF THE LOOM DRIVE, BOWLING GREEN, KENTUCKY 42103 US**



(540)

(550) I

(740) Čejović Vladimir, 13. jula 21, Podgorica ME

(511) **Klasa 18:** Torbe, sportske torbe, atletske torbe, trake za upotrebu u sportu, novčanici i tašne, putne torbe, putne vreće i rančevi.

**Klasa 25:** Odjeća, obuća, pokrivala za glavu, sportska odjeća, sportska obuća, pokrivala za glavu za upotrebu u sportu.

**Klasa 28:** Torbe prilagođene za nošenje sportskih artikala, gimnastički i sportski artikli i oprema.

**Klasa 35:** Maloprodajne usluge u vezi sa prodajom torbi, sportskih torbi, atletskih torbi, traka za upotrebu u sportu, novčanika i tašni, putnih torbi, putnih vreća i rančeva, odjeće, obuća, pokrivala za glavu, sportske odjeće, sportske obuća, pokrivala za glavu za upotrebu u sportu, torbi prilagođenih za nošenje sportskih artikala, gimnastičkih i sportskih artikala i opreme, usluge u vezi reklamnih torbi, sportskih torbi, atletskih torbi, traka za upotrebu u sportu, novčanika i tašni, putnih torbi, putnih vreća i rančeva, odjeće, obuća, pokrivala za glavu, sportske odjeće, sportske obuća, pokrivala za glavu za upotrebu u sportu, torbi prilagođenih za nošenje sportskih artikala, gimnastičkih i sportskih artikala i opreme.

(210) **2011-674**

(442) **20.12.2013.**

(220) 20.12.2011.

(731) **RUSSELL BRANDS, LLC, ONE FRUIT OF THE LOOM DRIVE, BOWLING GREEN, KENTUCKY 42103 US**



(540)

(550) I

(740) Čejović Vladimir, 13. jula 21, Podgorica ME

(511) **Klasa 18:** Torbe, sportske torbe, atletske torbe, trake za upotrebu u sportu, novčanici i tašne, putne torbe, putne vreće i rančevi.

**Klasa 25:** Odjeća, obuća, pokrivala za glavu, sportska odjeća, sportska obuća, pokrivala za glavu za upotrebu u sportu.

**Klasa 28:** Torbe prilagođene za nošenje sportskih artikala, gimnastički i sportski artikli i oprema.

**Klasa 35:** Maloprodajne usluge u vezi sa prodajom torbi, sportskih torbi, atletskih torbi, traka za upotrebu u sportu, novčanika i tašni, putnih torbi, putnih vreća i rančeva, odjeće, obuća, pokrivala za glavu, sportske odjeće, sportske obuća, pokrivala za glavu za upotrebu u sportu, torbi prilagođenih za nošenje sportskih artikala, gimnastičkih i sportskih artikala i opreme, usluge u vezi reklamnih torbi, sportskih torbi, atletskih torbi, traka za upotrebu u sportu, novčanika i tašni, putnih torbi, putnih vreća i rančeva, odjeće, obuća, pokrivala za

glavu, sportske odjeće, sportske obuće, pokrivala za glavu za upotrebu u sportu, torbi prilagođenih za nošenje sportskih artikala, gimnastičkih i sportskih artikala i opreme.

(210) **2011-677** (442) **20.12.2013.**  
(220) 21.12.2011.

(731) **SCHERING CORPORATION**, 2000 GALLOPING HILL ROAD, KENILWORTH, NEW JERSEY 07033 US

PURESEA

(540)  
(550) I  
(740) Ćupić Branislav, Dalmatinska 10, Podgorica ME  
(511) **Klasa 05:** Farmaceutski preparati.

(210) **2011-678** (442) **20.12.2013.**  
(220) 21.12.2011.

(731) **UNIVERSAL CITY STUDIOS LLC**, (A DELAWARE LIMITED LIABILITY COMPANY), 100 UNIVERSAL CITY PLAZA, UNIVERSAL CITY, CALIFORNIA 91608 US



(540)  
(550) I, F  
(740) Radulović Božidar, Jovana Tomaševića 9/III, Podgorica ME  
(511) **Klasa 09:** Aparati i instrumenti naučni, pomorski, geodetski, električni, fotografski, kinematografski, optički, za vaganje, merenje, signalizaciju, kontrolu (inspekciju), spasavanje i nastavu, aparati i instrumenti za sprovođenje, uključivanje, pretvaranje, akumuliranje, regulisanje i kontrolu struje, aparati za snimanje, prenos i reprodukovanje zvuka ili slike, magnetni nosioci podataka, diskovi za snimanje, automatske mašine i mehanizmi za aparate koji se pokreću novcem ili žetonom, register kase, računске mašine, oprema za obradu podataka i kompjuteri, aparati za gašenje požara.

**Klasa 41:** Obrazovne usluge, pripremanje obuke, razonoda, sportske i kulturne aktivnosti.

(210) **2011-679** (442) **20.12.2013.**  
(220) 21.12.2011.

(731) **UNIVERSAL CITY STUDIOS LLC**, (A DELAWARE LIMITED LIABILITY COMPANY), 100

UNIVERSAL CITY PLAZY, UNIVERSAL CITY, CALIFORNIA 91608 US



(540)

(550) I, F

(740) Radulović Božidar, Jovana Tomaševića 9/III, Podgorica ME

(511) **Klasa 09:** Aparati i instrumenti naučni, pomorski, geodetski, električni, fotografski, kinematografski, optički, za vaganje, merenje, signalizaciju, kontrolu (inspekciju), spasavanje i nastavu, aparati i instrumenti za sprovođenje, uključivanje, pretvaranje, akumuliranje, regulisanje i kontrolu struje, aparati za snimanje, prenos i reprodukovanje zvuka ili slike, magnetni nosioci podataka, diskovi za snimanje, automatske mašine i mehanizmi za aparate koji se pokreću novcem ili žetonom, register kase, računске mašine, oprema za obradu podataka i kompjuteri, aparati za gašenje požara.

**Klasa 41:** Obrazovne usluge, pripremanje obuke, razonoda, sportske i kulturne aktivnosti.

(210) **2011-680**

(442) **20.12.2013.**

(220) 21.12.2011.

(731) **PHAMANOVA DOO**, INDUSTRIJSKA 8, OBRENOVAC RS

## BABYTIME

(540)

(550) I

(740) Kojić Ivana, Serdara Jola Piletića bb, Podgorica ME

(511) **Klasa 05:** Farmaceutski preparati.

(210) **2011-681**

(442) **20.12.2013.**

(220) 21.12.2011.

(731) **PHAMANOVA DOO**, INDUSTRIJSKA 8, OBRENOVAC RS

**SIRUP**  
OD BELOG SLEZA



(540)

(550) I

(740) Kojić Ivana, Serdara Jola Piletića bb, Podgorica ME

(511) **Klasa 05:** Sirup od bijelog sleza.

(210) **2011-682**

(442) **20.12.2013.**

(220) 21.12.2011.

(731) **PHAMANOVA DOO**, INDUSTRIJSKA 8, OBRENOVAC RS

**SIRUP**  
OD JAGORČEVINE



(540)

(550) I

(740) Kojić Ivana, Serdara Jola Piletića bb, Podgorica ME

(511) **Klasa 05:** Sirup od jagorčevine.

(210) **2011-683**

(442) **20.12.2013.**

(220) 21.12.2011.

(731) **PHAMANOVA DOO**, INDUSTRIJSKA 8, OBRENOVAC RS



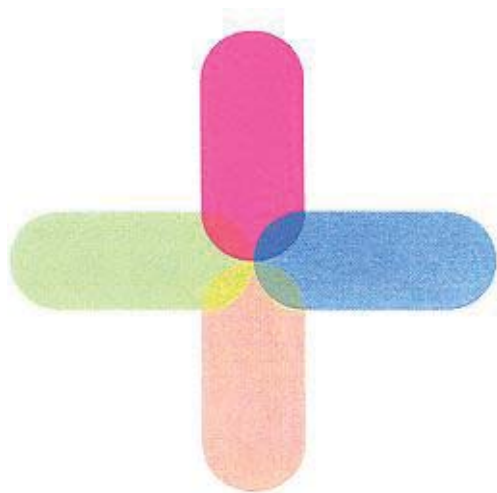

(540)

(550) I

(740) Kojić Ivana, Serdara Jola Piletića bb, Podgorica ME

(511) **Klasa 03:** Sredstva za beljenje i druge supstance za upotrebu u perionicama, preparati za čišćenje, poliranje, ribanje i nagrizanje, sapuni, parfimerija, eterična ulja, kozmetika, losioni za kosu, paste za zube.

**Klasa 05:** Farmaceutski i veterinarski preparati, sanitarni preparati za medicinsku upotrebu, djetetske supstance prilagođene za upotrebu u medicini, hrana za bebe, flasteri, materijali za zavijanje, materijali za plombiranje zuba, zubarska smola, dezinfekciona sredstva, preparati za uništavanje štetočina, fungicidi, herbicidi.

**Klasa 30:** Kafa, čaj, kakao, šećer, pirinač, tapioka, sago, zamena kafe, brašno i proizvodi od žitarica, hleb, kolači, poslastice, sladoledi, med, melasa, kvasac, prašak za pecivo, so, senf, sirće, sosovi (kao začini), začini, led.

**Klasa 32:** Pivo, mineralne i sodne vode i druga bezalkoholna pića, pića od voća i voćni sokovi, sirupi i drugi preparati za proizvodnju pića.

**Klasa 42:** Naučne i tehnološke usluge i istraživanje i projektovanje u vezi navedenih usluga, usluge industrijske analize i istraživanja, projektovanje i razvoj kompjuterskog hardvera i softvera.

---

(210) **2011-684**

(442) **20.12.2013.**

(220) 21.12.2011.

(731) **PHAMANOVA DOO**, INDUSTRIJSKA 8, OBRENOVAC RS

## Gastroloc

(540)

(550) I

(740) Kojić Ivana, Serdara Jola Piletića bb, Podgorica ME

(511) **Klasa 05:** Farmaceutski preparati.

---

(210) **2011-685**

(442) **20.12.2013.**

(220) 21.12.2011.

(731) **PHAMANOVA DOO**, INDUSTRIJSKA 8, OBRENOVAC RS

## LOFOCIN

(540)

(550) I

(740) Kojić Ivana, Serdara Jola Piletića bb, Podgorica ME

(511) **Klasa 05:** Farmaceutski preparati.(210) **2011-686**(442) **20.12.2013.**

(220) 21.12.2011.

(731) **TIKKURILA DOO**, HAJDUK VELJKOVA BB, ŠABAC RS

(540)

(550) I

(740) Kojić Ivana, Serdara Jola Piletića bb, Podgorica ME

(511) **Klasa 01:** Hemijski proizvodi koji se upotrebljavaju u industriji, nauci, fotografiji, poljoprivredi i šumarstvu, neprerađene veštačke smole, neprerađene plastične materije, đubriva, smeše za gašenje vatre, preparati za kaljenje i zavarivanje, hemijske supstance za konzervisanje namirnica, materije za štavljenje, lepljive supstance koje se upotrebljavaju u industriji.

**Klasa 02:** Boje, firnajzi, lakovi, sredstva za zaštitu od rđe i truljenja drveta, materije za bojenje, sredstva za nagrizanje, sirove prirodne smole, metali u obliku listova i praha za slikare, dekoratere, štampare i umetnike.

**Klasa 03:** Sredstva za beljenje i druge supstance za upotrebu u perionicama, preparati za čišćenje, poliranje, ribanje i nagrizanje, sapuni, parfimerija, eterična ulja, kozmetika, losioni za kosu, paste za zube.

(210) **2011-687**(442) **20.12.2013.**

(220) 21.12.2011.

(731) **TIKKURILA DOO**, HAJDUK VELJKOVA BB, ŠABAC RS



(540)

(550) I

(740) Kojić Ivana, Serdara Jola Piletića bb, Podgorica ME

(511) **Klasa 01:** Hemijski proizvodi koji se upotrebljavaju u industriji, nauci, fotografiji, poljoprivredi i šumarstvu, neprerađene veštačke smole, neprerađene plastične materije, đubriva, smeše za gašenje vatre, preparati za kaljenje i zavarivanje, hemijske supstance za konzervisanje namirnica, materije za štavljenje, lepljive supstance koje se upotrebljavaju u industriji.

**Klasa 02:** Boje, firnajzi, lakovi, sredstva za zaštitu od rđe i truljenja drveta, materije za bojenje, sredstva za nagrizanje, sirove prirodne smole, metali u obliku listova i praha za slikare, dekoratere, štampare i umetnike.

(210) **2011-688**(442) **20.12.2013.**

(220) 21.12.2011.

(731) **TIKKURILA DOO**, HAJDUK VELJKOVA BB, ŠABAC RS

# Linea

(540)

(550) I

(740) Kojić Ivana, Serdara Jola Piletića bb, Podgorica ME

(511) **Klasa 01:** Hemijski proizvodi koji se upotrebljavaju u industriji, nauci, fotografiji, poljoprivredi i šumarstvu, neprerađene veštačke smole, neprerađene plastične materije, đubriva, smeše za gašenje vatre, preparati za kaljenje i zavarivanje, hemijske supstance za konzervisanje namirnica, materije za štavljenje, lepljive supstance koje se upotrebljavaju u industriji.

**Klasa 02:** Boje, firnajzi, lakovi, sredstva za zaštitu od rđe i truljenja drveta, materije za bojenje, sredstva za nagrizanje, sirove prirodne smole, metali u obliku listova i praha za slikare, dekoratere, štampare i umetnike.

(210) **2011-689**(442) **20.12.2013.**

(220) 21.12.2011.

(731) **TIKKURILA DOO**, HAJDUK VELJKOVA BB, ŠABAC RS

# Linea plus

(540)

(550) I

(740) Kojić Ivana, Serdara Jola Piletića bb, Podgorica ME

(511) **Klasa 01:** Hemijski proizvodi koji se upotrebljavaju u industriji, nauci, fotografiji, poljoprivredi i šumarstvu, neprerađene veštačke smole, neprerađene plastične materije, đubriva, smeše za gašenje vatre, preparati za kaljenje i zavarivanje, hemijske supstance za konzervisanje namirnica, materije za štavljenje, lepljive supstance koje se upotrebljavaju u industriji.

**Klasa 02:** Boje, firnajzi, lakovi, sredstva za zaštitu od rđe i truljenja drveta, materije za bojenje, sredstva za nagrizanje, sirove prirodne smole, metali u obliku listova i praha za slikare, dekoratere, štampare i umetnike.

---

(210) **2011-690**

(442) **20.12.2013.**

(220) 21.12.2011.

(731) **TIKKURILA DOO**, HAJDUK VELJKOVA BB, ŠABAC RS

## EFFECTA

(540)

(550) I

(740) Kojić Ivana, Serdara Jola Piletića bb, Podgorica ME

(511) **Klasa 01:** Hemijski proizvodi koji se upotrebljavaju u industriji, nauci, fotografiji, poljoprivredi i šumarstvu, neprerađene veštačke smole, neprerađene plastične materije, đubriva, smeše za gašenje vatre, preparati za kaljenje i zavarivanje, hemijske supstance za konzervisanje namirnica, materije za štavljenje, lepljive supstance koje se upotrebljavaju u industriji.

**Klasa 02:** Boje, firnajzi, lakovi, sredstva za zaštitu od rđe i truljenja drveta, materije za bojenje, sredstva za nagrizanje, sirove prirodne smole, metali u obliku listova i praha za slikare, dekoratere, štampare i umetnike.

---

(210) **2011-692**

(442) **20.12.2013.**

(220) 21.12.2011.

(731) **COLGATE PALMOLIVE COMPANY**, A DELAWARE CORPORATION, 300 PARK AVENUE, NEW YORK, NY 10022 US

## KOLYNOS FLUOR

(540)

(550) I

(740) Kojić Ivana, Serdara Jola Piletića bb, Podgorica ME

(511) **Klasa 03:** Paste i praškovi za čišćenje zuba, preparati za negu zuba i desni, kremovi za brijanje.

**Klasa 05:** Antiseptički rastvori i dezinfekciona sredstva koja ubijaju klice.

**Klasa 21:** Četkice za zube.

---

(210) **2011-693**

(442) **20.12.2013.**

(220) 21.12.2011.

(731) **COLGATE PALMOLIVE COMPANY**, A DELAWARE CORPORATION, 300 PARK AVENUE, NEW YORK, NY 10022 US

## VEL

(540)

(550) I

(740) Kojić Ivana, Serdara Jola Piletića bb, Podgorica ME

(511) **Klasa 03:** Sredstva za bijeljenje i druge supstance za pranje, sredstva za čišćenje, poliranje, uklanjanje masti i brušenje, sapuni, parfimerija, eterična ulja, kozmetički proizvodi, losioni za kosu, preparati za negu zuba.

---

(210) **2011-694**

(442) **20.12.2013.**

(220) 21.12.2011.

(731) **COLGATE PALMOLIVE COMPANY**, A DELAWARE CORPORATION, 300 PARK AVENUE, NEW YORK, NY 10022 US

## DYNAMO

(540)

(550) I

(740) Kojić Ivana, Serdara Jola Piletića bb, Podgorica ME

(511) **Klasa 03:** Sredstva za bijeljenje i druge supstance za pranje, sredstva za čišćenje, poliranje, uklanjanje masti i brušenje, sapuni, parfimerija, eterična ulja, kozmetički proizvodi, losioni za kosu, preparati za negu zuba.

---

(210) **2011-695** (442) **20.12.2013.**  
(220) 21.12.2011.

(731) **COLGATE PALMOLIVE COMPANY**, A DELAWARE CORPORATIN, 300 PARK AVENUE,  
NEW YORK, NY 10022 US

## OLA

(540)

(550) I

(740) Kojić Ivana, Serdara Jola Piletića bb, Podgorica ME

(511) **Klasa 03:** Sredstva za bijeljenje i druge supstance za pranje, sredstva za čišćenje, poliranje, uklanjanje masti i brušenje, sapuni, parfimerija, eterična ulja, kozmetički proizvodi, losioni za kosu, preparati za njegu zuba.

---

(210) **2011-696** (442) **20.12.2013.**  
(220) 21.12.2011.

(731) **COLGATE PALMOLIVE COMPANY**, A DELAWARE CORPORATION, 300 PARK AVENUE,  
NEW YORK, NY 10022 US

## PAIC

(540)

(550) I

(740) Kojić Ivana, Serdara Jola Piletića bb, Podgorica ME

(511) **Klasa 03:** Parfimerija, sapuni i toaletni preparati za ličnu upotrebu.

---

(210) **2011-697** (442) **20.12.2013.**  
(220) 21.12.2011.

(731) **COLGATE PALMOLIVE COMPANY**, A DELAWARE CORPORATION, 300 PARK AVENUE,  
NEW YORK, NY 10022 US

## ACTION

(540)

(550) I

(740) Kojić Ivana, Serdara Jola Piletića bb, Podgorica ME

(511) **Klasa 03:** Sredstva za pranje (izuzev sapuna svih vrsta), sredstva za bijeljenje i ispiranje, sredstva za čišćenje i poliranje (izuzev onih koja su namijenjena koži i izuzev sapuna svih vrsta).

---

(210) **2011-698** (442) **20.12.2013.**  
(220) 21.12.2011.

(731) **COLGATE PALMOLIVE COMPANY**, A DELAWARE CORPRATION, 300 PARK AVENUE,  
NEW YORK, NY 10022 US

## SOFLAN

(540)

(550) I

(740) Kojić Ivana, Serdara Jola Piletića bb, Podgorica ME

(511) **Klasa 03:** Deterdženti za fine tkanine, sredstva za bijeljenje i druge supstance za pranje, sredstva za čišćenje, poliranje, uklanjanje masti i brušenje, sapuni, parfimerija, eterična ulja, kozmetički proizvodi, losioni za kosu, preparati za njegu zuba.(210) **2011-699**(442) **20.12.2013.**

(220) 21.12.2011.

(731) **COLGATE PALMOLIVE COMPANY**, A DELAWARE CORPORATION, 300 PARK AVENUE, NEW YORK, NY 10022 US

## COLGATE FRESH CONFIDENCE

(540)

(550) I

(740) Kojić Ivana, Serdara Jola Piletića bb, Podgorica ME

(511) **Klasa 03:** Zubna pasta i sredstva za pranje zuba.(210) **2011-700**(442) **20.12.2013.**

(220) 21.12.2011.

(731) **COLGATE PALMOLIVE COMPANY**, A DELAWARE CORPORATION, 300 PARK AVENUE, NEW YORK, NY 10022 US

(540)

(550) I

(740) Kojić Ivana, Serdara Jola Piletića bb, Podgorica ME

(511) **Klasa 03:** Pasta za zube i voda za ispiranje usta.(210) **2011-701**(442) **20.12.2013.**

(220) 21.12.2011.

(731) **COLGATE PALMOLIVE COMPANY**, A DELAWARE CORPORATION, 300 PARK AVENUE, NEW YORK, NY 10022 US

## PAX

(540)

(550) I

(740) Kojić Ivana, Serdara Jola Piletića bb, Podgorica ME

(511) **Klasa 03:** Sredstva za bijeljenje i druge supstance za pranje, sredstva za čišćenje, poliranje, uklanjanje masti i brušenje, sapuni, parfimerija, eterična ulja, kozmetički proizvodi, losioni za kosu, preparati za njegu zuba.

---

(210) **2011-702**

(442) **20.12.2013.**

(220) 21.12.2011.

(731) **COLGATE PALMOLIVE COMPANY**, A DELAWARE CORPORATION, 300 PARK AVENUE, NEW YORK, NY 10022 US

## COLGATE HERBAL

(540)

(550) I

(740) Kojić Ivana, Serdara Jola Piletića bb, Podgorica ME

(511) **Klasa 03:** Zubna pasta i tečnost za ispiranje usta.

---

(210) **2011-703**

(442) **20.12.2013.**

(220) 21.12.2011.

(731) **COLGATE PALMOLIVE COMPANY**, A DELAWARE CORPORATION, 300 PARK AVENUE, NEW YORK, NY 10022 US

## GERMDEFENSE

(540)

(550) I

(740) Kojić Ivana, Serdara Jola Piletića bb, Podgorica ME

(511) **Klasa 03:** Pasta za zube i voda za ispiranje usta.

---

(210) **2011-704**

(442) **20.12.2013.**

(220) 21.12.2011.

(731) **COLGATE PALMOLIVE COMPANY**, A DELAWARE CORPORATION, 300 PARK AVENUE, NEW YORK, NY 10022 US





(540)

(550) I

(740) Kojić Ivana, Serdara Jola Piletića bb, Podgorica ME

(511) **Klasa 03:** Pasta za zube i voda za ispiranje usta.(210) **2011-705**(442) **20.12.2013.**

(220) 21.12.2011.

(731) **COLGATE PALMOLIVE COMPANY**, A DELAWARE CORPORATION, 300 PARK AVENUE, NEW YORK, NY 10022 US

(540)

(550) I

(740) Kojić Ivana, Serdara Jola Piletića bb, Podgorica ME

(511) **Klasa 03:** Pasta za zube i voda za ispiranje usta.(210) **2011-706**(442) **20.12.2013.**

(220) 21.12.2011.

(731) **COLGATE PALMOLIVE COMPANY**, A DELAWARE CORPORATION, 300 PARK AVENUE, NEW YORK, NY 10022 US

(540)

(550) I

(740) Kojić Ivana, Serdara Jola Piletića bb, Podgorica ME

(511) **Klasa 03:** Pasta za zube i voda za ispiranje usta.(210) **2011-707**(442) **20.12.2013.**

(220) 21.12.2011.

(731) **COLGATE PALMOLIVE COMPANY**, A DELAWARE CORPORATION, 300 PARK AVENUE, NEW YORK, NY 10022 US



(540)

(550) I

(740) Kojić Ivana, Serdara Jola Piletića bb, Podgorica ME

(511) **Klasa 03:** Pasta za zube i voda za ispiranje usta.(210) **2011-708**(442) **20.12.2013.**

(220) 21.12.2011.

(731) **COLGATE PALMOLIVE COMPANY**, A DELAWARE CORPORATION, 300 PARK AVENUE, NEW YORK, NY 10022 US

(540)

(550) I

(740) Kojić Ivana, Serdara Jola Piletića bb, Podgorica ME

(511) **Klasa 03:** Pasta za zube i voda za ispiranje usta.(210) **2011-709**(442) **20.12.2013.**

(220) 21.12.2011.

(731) **COLGATE PALMOLIVE COMPANY**, A DELAWARE CORPORATION, 300 PARK AVENUE, NEW YORK, NY 10022 US

(540)

(550) I

(740) Kojić Ivana, Serdara Jola Piletića bb, Podgorica ME

(511) **Klasa 03:** Pasta za zube i voda za ispiranje usta.(210) **2011-710**(442) **20.12.2013.**

(220) 21.12.2011.

(731) **COLGATE PALMOLIVE COMPANY**, A DELAWARE CORPORATION, 300 PARK AVENUE, NEW YORK, NY 10022 US

## COLGATE

(540)

(550) I

(740) Kojić Ivana, Serdara Jola Piletića bb, Podgorica ME

(511) **Klasa 30:** Žvakaća guma i tablete za žvakanje.

---

(210) **2011-711**

(442) **20.12.2013.**

(220) 21.12.2011.

(731) **COLGATE PALMOLIVE COMPANY**, A DELAWARE CORPORATION, 300 PARK AVENUE, NEW YORK, NY 10022 US

## SOUPLINE

(540)

(550) I

(740) Kojić Ivana, Serdara Jola Piletića bb, Podgorica ME

(511) **Klasa 03:** Pasta za zube i voda za ispiranje usta.

---

(210) **2011-712**

(442) **20.12.2013.**

(220) 22.12.2011.

(731) **THE COCA-COLA COMPANY**, ONE COCA-COLA PLAZA, ATLANTA, GA 30313 US



(540)

(550) I

(740) Popović Miladin, Đoka Miraševića 21/III, Podgorica ME

(511) **Klasa 32:** Piva, mineralne i sodne vode i ostala bezalkoholna pića, pića od voća i voćni sokovi, sirupi i drugi preparati za proizvodnju pića.

(210) **2011-713** (442) **20.12.2013.**  
(220) 22.12.2011.

(731) **ASCOM NETWORK TESTING AB**, SKELLEFTEHAMNVAGEN 206, 936 35 URSVIKEN SE

## TEMS

(540)

(550) I

(740) Čejović Vladimir, 13. jula 21, Podgorica ME

(511) **Klasa 09:** Ispitna oprema za analizu/pronalaženje grešaka (kvarova) u digitalnim mobilnim telefonskim mrežama (radio interfejs).

(210) **2011-714** (442) **20.12.2013.**  
(220) 22.12.2011.

(731) **GARAGE INTERNATIONAL LUX SARL**, 1 ALLEE SCHEFFER, SUITE 2.05.1, L-2520, LUXEMBOURG LU

## GARAGE

(540)

(550) I

(740) Čejović Vladimir, 13. jula 21, Podgorica ME

(511) **Klasa 03:** Parfimerija, eterična ulja, kozmetika.

**Klasa 18:** Torbe, naprtnjače.

**Klasa 35:** Usluge maloprodajnih objekata u vezi sa parfimerijom, eteričnim uljima, kozmetikom, torbama, naprtnjačama, odjećom, obućom, pokrivalima za glavu.

(210) **2011-715** (442) **20.12.2013.**  
(220) 22.12.2011.

(731) **GARAGE INTERNATIONAL LUX SARL**, 1 ALLEE SCHEFFER, SUITE 2.05.1, L-2520, LUXEMBOURG LU

## GARAGE

(540)

(550) I

(740) Čejović Vladimir, 13. jula 21, Podgorica ME

(511) **Klasa 03:** Parfimerija, eterična ulja, kozmetika.

**Klasa 18:** Torbe, naprtnjače.

**Klasa 35:** Usluge maloprodajnih objekata u vezi sa parfimerijom, eteričnim uljima, kozmetikom, torbama, naprtnjačama, odjećom, obućom, pokrivalima za glavu.

(210) **2011-716** (442) **20.12.2013.**  
(220) 22.12.2011.

(731) **GARAGE INTERNATIONAL LUX SARL**, 1 ALLEE SCHEFFER, SUITE 2.05.1, L-2520, LUXEMBOURG LU



(540)

(550) I

(740) Čejović Vladimir, 13. jula 21, Podgorica ME

(511) **Klasa 03:** Parfimerija, eterična ulja, kozmetika.

**Klasa 18:** Torbe, naprtnjače.

**Klasa 35:** Usluge maloprodajnih objekata u vezi sa parfimerijom, eteričnim uljima, kozmetikom, torbama, naprtnjačama, odjećom, obućom, pokrivalima za glavu.

(210) **2011-717**

(442) **20.12.2013.**

(220) 22.12.2011.

(731) **GARAGE INTERNATIONAL LUX SARL**, 1 ALLEE SCHEFFER, SUITE 2.05.1, L-2520, LUXEMBOURG LU

**GRG**

(540)

(550) I

(740) Čejović Vladimir, 13. jula 21, Podgorica ME

(511) **Klasa 03:** Parfimerija, eterična ulja, kozmetika.

**Klasa 18:** Torbe, naprtnjače.

**Klasa 25:** Odjeća, obuća, pokrivala za glavu.

**Klasa 35:** Usluge maloprodajnih objekata u vezi sa parfimerijom, eteričnim uljima, kozmetikom, torbama, naprtnjačama, odjećom, obućom, pokrivalima za glavu.

(210) **2011-719**

(442) **20.12.2013.**

(220) 22.12.2011.

(731) **GARAGE INTERNATIONAL LUX SARL**, 1 ALLEE SCHEFFER, SUITE 2.05.1, L-2520, LUXEMBOURG LU

**DYNAMITE**

(540)

(550) I

(740) Čejović Vladimir, 13. jula 21, Podgorica ME

(511) **Klasa 18:** Torbe, naprtnjače.

**Klasa 25:** Odjeća, obuća, pokrivala za glavu.

**Klasa 35:** Usluge maloprodajnih objekata u vezi sa parfimerijom, eteričnim uljima, kozmetikom, torbama, naprtnjačama, odjećom, obućom, pokrivalima za glavu.

(210) **2011-720** (442) **20.12.2013.**  
(220) 22.12.2011.

(731) **GARAGE INTERNATIONAL LUX SARL**, 1 ALLEE SCHEFFER, SUITE 2.05.1, L-2520, LUXEMBOURG LU



(540)

(550) I

(740) Čejović Vladimir, 13. jula 21, Podgorica ME

(511) **Klasa 18:** Torbe, naprtnjače.

**Klasa 25:** Odjeća, obuća, pokrivala za glavu.

**Klasa 35:** Usluge maloprodajnih objekata u vezi sa parfimerijom, eteričnim uljima, kozmetikom, torbama, naprtnjačama, odjećom, obućom, pokrivalima za glavu.

(210) **2011-721** (442) **20.12.2013.**  
(220) 22.12.2011.

(731) **GARAGE INTERNATIONAL LUX SARL**, 1 ALLEE SCHEFFER, SUITE 2.05.1, L-2520, LUXEMBOURG LU



(540)

(550) I

(740) Čejović Vladimir, 13. jula 21, Podgorica ME

(511) **Klasa 03:** Parfimerija, eterična ulja, kozmetika.

**Klasa 18:** Torbe, naprtnjače.

**Klasa 35:** Usluge maloprodajnih objekata u vezi sa parfimerijom, eteričnim uljima, kozmetikom, torbama, naprtnjačama, odjećom, obućom, pokrivalima za glavu.

(210) **2011-722** (442) **20.12.2013.**  
(220) 22.12.2011.

(300) 1,542,87 09.10.2010. CA

(731) **COLLIERS INTERNATIONAL PROPERTY CONSULTANTS, INC.** 1209 ORANGE STREET WILMINGTON, DELAWARE 19801 US

## ACCELERATING SUCCESS

(540)

(550) I

(740) Čejović Vladimir, 13. jula 21, Podgorica ME

(511) **Klasa 16:** Štampane i elektronske publikacije, naime časopisi, bilteni i brošure, koji uglavnom sadrže članke o opštim temama u vezi sa nepokretnom imovinom, nekretninama, komercijalnom imovinom, stambenim objektima, industrijskom svojinom, zgradama i firmama. Štampanim edukativnim materijalima, naime, udžbenicima, vodičima, radnim svjeskama, radnim materijalima, formularima, procjenama i uputstvima za upotrebu, blokovima za bilježenje, blokovima za pisanje, instrumentima za pisanje.

**Klasa 35:** Pružanje usluga istraživanja tržišta i analize usluga u vezi sa nepokretnom imovinom, nekretninama, komercijalnom svojinom, rezidencijalnim objektima, industrijskom svojinom, zgradama i firmama. Aukcijske usluge.

**Klasa 36:** Pružanje konsultantskih, agencijskih i brokerskih usluga drugima u vezi sa izgradnjom nekretnina, planiranjem nekretnina, upravljanjem projektima vezanim za nekretnine, investicijama u nekretnine, rukovođenjem nekretninama, finansisjskim uslugama u vezi sa nekretninama, upravljanjem nekretninama, procjenom poreza na nekretnine, marketingom nekretnina, prodajom i kupovinom nekretnina, izdavanjem i iznajmljivanjem nekretnina, procjenom i vrjednovanjem nekretnina i posredovanjem u poslovima s nekretninama. Pružanje konsultantskih, agencijskih i brokerskih usluga drugima u vezi sa izgradnjom, planiranjem, upravljanjem projektima, investicijama, rukovođenjem, upravljanjem, prodajom i kupovinom nekretnina, izdavanjem i iznajmljivanjem, procjenom i vrjednovanjem i preuzimanjem i spajanjem komercijalne svojine, rezidencijalnih objekata, industrijske svojine, zgrada i firmi.

(210) **2011-723**

(442) **20.12.2013.**

(220) 22.12.2011.

(731) **NVO STUDIO LUBARDA COSMOPOLITAN**, PIPERSKA 370/III 29S, PODGORICA ME



(540)

(550) I

(511) **Klasa 35:** Usluge reklamnih agencija i usluge kao što je davanje prospekata direktno ili poštom ili distribucija uzoraka. Ova klasa može da se odnosi na reklamiranje u vezi sa drugim uslugama, kao što su one sa bankarskim zajmovima ili reklamiranje putem radia.

**Klasa 41:** Organizovanje izložbi ili prezentacije knjiga, književne večeri u kulturne i obrazovne svrhe, sportskog takmičenja.

(210) **2011-724** (442) **20.12.2013.**  
(220) 26.12.2011.

(731) **VIDKRITE AKTSIONERNE TOVARISTVO ISKRA**, UL. VULETSKA 14, 79066 LVIV  
UA



(540)

(550) I

(740) Ćupić Branislav, Dalmatinska 10, Podgorica ME

(511) **Klasa 11:** Aparati za osvetljavanje, grijanje, proizvodnju pare, kuvanje, hlađenje, sušenje, ventilaciju, snabdjevanje vodom i sanitame svrhe.

**Klasa 21:** Kućne ili kuhinjske sprave i posude (koje nisu od dragocjenih metala ili sa prevlakama od njih), češljevi i suđeri, četke (izuzev kičica), materijali za pravljenje četki, artikli koji se koriste pri čišćenju, čelična vuna, neprerađeno ili poluprerađeno staklo (osim stakla koje se koristi u građevinarstvu), staklarija, porcelan, grnčarija i lončarija koja nije obuhvaćena drugim klasama.

(210) **2011-725** (442) **20.12.2013.**  
(220) 26.12.2011.

(731) **GENERAL MOTORS LLC**, 300 RENAISSANCE CENTER, DETROIT, MICHIGAN 48265-3000 US

**XTS**

(540)

(550) I, V

(740) Radulović Božidar, Jovana Tomaševića 9/III, Podgorica ME

(511) **Klasa 12:** Motorna vozila.

(210) **2011-726** (442) **20.12.2013.**  
(220) 27.12.2011.

(731) **ZEKO.ME** D.O.O. MOSKOVSKA BB, PODGORICA ME



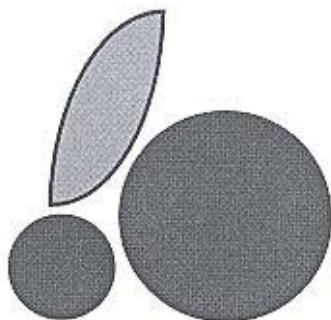

”ZEKO.ME”

(540)

(550) I

(511) **Klasa 42:** Projektovanje i razvoj kompjuterskog hardvera i softvera.

(210) **2011-730**

(442) **20.12.2013.**

(220) 28.12.2011.

(731) **CRNOGORSKO SERTIFIKACIONO TIJELO** D.O.O. BULEVAR SV. PETRA CETINJSKOG 91, PODGORICA ME



(540)

(550) I

(511) **Klasa 35:** Oglašavanje, vođenje poslova, poslovno upravljanje, kancelarijski poslovi.

**Klasa 42:** Naučne i tehnološke usluge i istraživanje i projektovanje u vezi navedenih usluga, usluge industrijske analize i istraživanje.

(210) **2011-731**

(442) **20.12.2013.**

(220) 28.12.2011.

(731) **WM.WRIGLEY JR.COMPANY**, 410 NORTH MICHIGAN AVENUE, CHICAGO, IL 60611 US

**EVOLUTION**

(540)

(550) I

(740) Čejović Vladimir, 13. jula 21, Podgorica ME

(511) **Klasa 30:** Konditorski proizvodi, žvakaće gume, žvakaće gume od kojih mogu da se prave veliki baloni, bombone, dražeje pepermint, mali okrugli bomboni (drops) i pastile.

(210) **2011-732**

(442) **20.12.2013.**

(220) 29.12.2011.

(731) **DP BEVERAGES LIMITED**, PO BOX 309GT UGLAND HO USE SOUTH CHURCH STREET,  
GEORGE TOWN KY

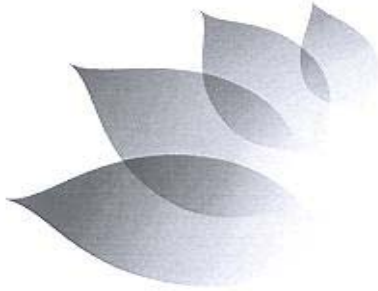

(540)

(550) I

(740) Popović Miladin, Đoka Miraševića 21/III, Podgorica ME

(511) **Klasa 30:** Kafa, čaj, kakao, šećer, pirinač, tapioka, sago, zamena kafe, brašno i proir žitari-  
ca, hleb, kolači i poslastice, sladoledi, med, melasa, kvasac, pre pecivo, so, senf, sirće, sosovi  
(kao dodaci), začini, led.

**Klasa 32:** Piva, mineralne i sodne vode i ostala bezalkoholna pića, voćna pića sokovi, sirupi i  
drugi preparati za proizvodnju pića.

(210) **2011-733**

(442) **20.12.2013.**

(220) 29.12.2011.

(731) **DP BEVERAGES LIMITED**, PO BOX 309GT UGLAND HOUSE SOUTH CHURCH STREET,  
GEORGE TOWN KY

**FUZE TEA**

(540)

(550) I

(740) Popović Miladin, Đoka Miraševića 21/III, Podgorica ME

(511) **Klasa 30:** Kafa, čaj, kakao, šećer, pirinač, tapioka, sago, zamena kafe, brašno i proir žitari-  
ca, hleb, kolači i poslastice, sladoledi, med, melasa, kvasac, pre pecivo, so, senf, sirće, sosovi  
(kao dodaci), začini, led.

**Klasa 32:** Piva, mineralne i sodne vode i ostala bezalkoholna pića, voćna pića sokovi, sirupi i  
drugi preparati za proizvodnju pića.

(210) **2011-735**

(442) **20.12.2013.**

(220) 30.12.2011.

(731) **CORPORATION HABANOS**, S.A. AVENIDA 3RA NO.2006, ENTRE 20 Y 22, MIRAMAR,  
PLAYA CIUDAD DE LA HABANA CU



(540)

(550) I

(740) Stanković Mugoša Ana, Trg Republike 13, Podgorica ME

(511) **Klasa 34:** Duvan, uključujući cigare, cigarete, cigarilose, rezani duvan za lule, artikli za pušače, uključujući pepeljare, nožice za cigare, kutije za šibice, kutije za cigare, šibice.(210) **2011-736**(442) **20.12.2013.**

(220) 30.12.2011.

(731) **CORPORATION HABANOS**, S.A. AVENIDA 3RA NO.2006, ENTRE 20 Y 22, MIRAMAR, PLAYA CIUDAD DE LA HABANA CU

(540)

(550) I

(740) Stanković Mugoša Ana, Trg Republike 13, Podgorica ME

(511) **Klasa 34:** Duvan, uključujući cigare, cigarete, cigarilose, rezani duvan za lule, artikli za pušače, uključujući pepeljare, nožice za cigare, kutije za šibice, kutije za cigare, šibice.(210) **2011-737**(442) **20.12.2013.**

(220) 30.12.2011.

(731) **CORPORATION HABANOS**, S.A. AVENIDA 3RA NO.2006, ENTRE 20 Y 22, MIRAMAR, PLAYA CIUDAD DE LA HABANA CU



(540)

(550) I

(740) Stanković Mugoša Ana, Trg Republike 13, Podgorica ME

(511) **Klasa 34:** Duvan, uključujući cigare, cigarete, cigarilose, rezani duvan za lule, artikli za pušače, uključujući pepeljare, nožiče za cigare, kutije za šibice, kutije za cigare, šibice.(210) **2011-738**(442) **20.12.2013.**

(220) 30.12.2011.

(731) **CORPORATION HABANOS**, S.A. AVENIDA 3RA NO.2006, ENTRE 20 Y 22, MIRAMAR, PLAYA CIUDAD DE LA HABANA CU

(540)

(550) I

(740) Stanković Mugoša Ana, Trg Republike 13, Podgorica ME

(511) **Klasa 34:** Duvan, uključujući cigare, cigarete, cigarilose, rezani duvan za lule, artikli za pušače, uključujući pepeljare, nožiče za cigare, kutije za šibice, kutije za cigare, šibice.(210) **2011-739**(442) **20.12.2013.**

(220) 30.12.2011.

(731) **CORPORATION HABANOS**, S.A. AVENIDA 3RA NO.2006, ENTRE 20 Y 22, MIRAMAR, PLAYA CIUDAD DE LA HABANA CU



(540)

(550) I

(740) Stanković Mugoša Ana, Trg Republike 13, Podgorica ME

(511) **Klasa 34:** Duvan, uključujući cigare, cigarete, cigarilose, rezani duvan za lule, artikli za pušače, uključujući pepeljare, nožice za cigare, kutije za šibice, kutije za cigare, šibice.(210) **2011-740**(442) **20.12.2013.**

(220) 30.12.2011.

(731) **CORPORATION HABANOS**, S.A. AVENIDA 3RA NO.2006, ENTRE 20 Y 22, MIRAMAR, PLAYA CIUDAD DE LA HABANA CU

(540)

(550) I

(740) Stanković Mugoša Ana, Trg Republike 13, Podgorica ME

(511) **Klasa 34:** Duvan, uključujući cigare, cigarete, cigarilose, rezani duvan za lule, artikli za pušače, uključujući pepeljare, nožice za cigare, kutije za šibice, kutije za cigare, šibice.(210) **2011-741**(442) **20.12.2013.**

(220) 30.12.2011.

(731) **CORPORATION HABANOS**, S.A. AVENIDA 3RA NO.2006, ENTRE 20 Y 22, MIRAMAR, PLAYA CIUDAD DE LA HABANA CU

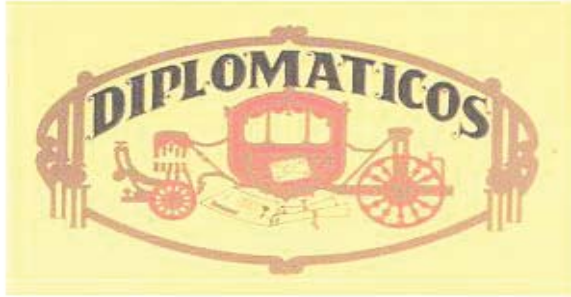

(540)

(550) I

(740) Stanković Mugoša Ana, Trg Republike 13, Podgorica ME

(511) **Klasa 34:** Duvan, uključujući cigare, cigarete, cigarilose, rezani duvan za lule, artikli za pušače, uključujući pepeljare, nožice za cigare, kutije za šibice, kutije za cigare, šibice.(210) **2011-742**(442) **20.12.2013.**

(220) 30.12.2011.

(731) **CORPORATION HABANOS**, S.A. AVENIDA 3RA NO.2006, ENTRE 20 Y 22, MIRAMAR, PLAYA CIUDAD DE LA HABANA CU

(540)

(550) I

(740) Stanković Mugoša Ana, Trg Republike 13, Podgorica ME

(511) **Klasa 34:** Duvan, uključujući cigare, cigarete, cigarilose, rezani duvan za lule, artikli za pušače, uključujući pepeljare, nožice za cigare, kutije za šibice, kutije za cigare, šibice.(210) **2011-743**(442) **20.12.2013.**

(220) 30.12.2011.

(731) **CORPORATION HABANOS**, S.A. AVENIDA 3RA NO.2006, ENTRE 20 Y 22, MIRAMAR, PLAYA CIUDAD DE LA HABANA CU



(540)

(550) I

(740) Stanković Mugoša Ana, Trg Republike 13, Podgorica ME

(511) **Klasa 34:** Duvan, uključujući cigare, cigarete, cigarilose, rezani duvan za lule, artikli za pušače, uključujući pepeljare, nožice za cigare, kutije za šibice, kutije za cigare, šibice.(210) **2011-744**(442) **20.12.2013.**

(220) 30.12.2011.

(731) **CORPORATION HABANOS**, S.A. AVENIDA 3RA NO.2006, ENTRE 20 Y 22, MIRAMAR, PLAYA CIUDAD DE LA HABANA CU

(540)

(550) I

(740) Stanković Mugoša Ana, Trg Republike 13, Podgorica ME

(511) **Klasa 34:** Duvan, uključujući cigare, cigarete, cigarilose, rezani duvan za lule, artikli za pušače, uključujući pepeljare, nožice za cigare, kutije za šibice, kutije za cigare, šibice.(210) **2011-745**(442) **20.12.2013.**

(220) 30.12.2011.

(731) **CORPORATION HABANOS**, S.A. AVENIDA 3RA NO.2006, ENTRE 20 Y 22, MIRAMAR, PLAYA CIUDAD DE LA HABANA CU



(540)

(550) I

(740) Stanković Mugoša Ana, Trg Republike 13, Podgorica ME

(511) **Klasa 34:** Duvan, uključujući cigare, cigarete, cigarilose, rezani duvan za lule, artikli za pušače, uključujući pepeljare, nožiče za cigare, kutije za šibice, kutije za cigare, šibice.(210) **2011-746**(442) **20.12.2013.**

(220) 30.12.2011.

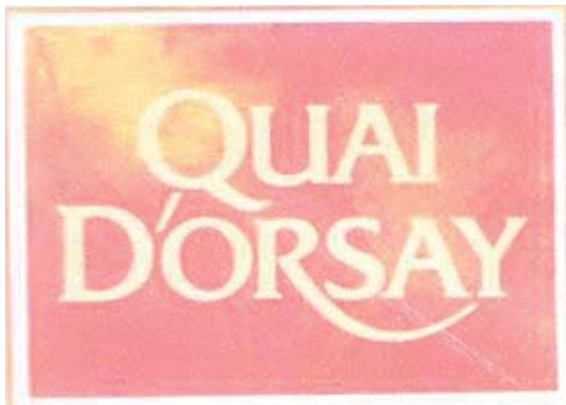
(731) **CORPORATION HABANOS, S.A. AVENIDA 3RA NO.2006, ENTRE 20 Y 22, MIRAMAR, PLAYA CIUDAD DE LA HABANA CU**

(540)

(550) I

(740) Stanković Mugoša Ana, Trg Republike 13, Podgorica ME

(511)

**Klasa 34:** Duvan, uključujući cigare, cigarete, cigarilose, rezani duvan za lule, artikli za pušače, uključujući pepeljare, nožiče za cigare, kutije za šibice, kutije za cigare, šibice.(210) **2011-747**(442) **20.12.2013.**

(220) 30.12.2011.

(731) **CORPORATION HABANOS, S.A. AVENIDA 3RA NO.2006, ENTRE 20 Y 22, MIRAMAR, PLAYA CIUDAD DE LA HABANA CU**





(540)

(550) I

(740) Stanković Mugoša Ana, Trg Republike 13, Podgorica ME

(511) **Klasa 34:** Duvan, uključujući cigare, cigarete, cigarilose, rezani duvan za lule, artikli za pušače, uključujući pepeljare, nožice za cigare, kutije za šibice, kutije za cigare, šibice.

(210) **2011-751**

(442) **20.12.2013.**

(220) 30.12.2011.

(731) **THE COCA-COLA COMPANY**, ONE COCA-COLA PLAZA, ATLANTA, GEORGIA 30313 US



(540)

(550) I

(740) Popović Miladin, Đoka Miraševića 21/III, Podgorica ME

(511) **Klasa 16:** Hartija, karton i proizvodi od njih, koji nijesu uključeni u druge klase, štamparske stvari, knjigovezački materijal, fotografije, kancelarijski materijal, ljepila za kancelarijske i kućne potrebe, umjetnički materijali, kičice, pisaće mašine i kancelarijski rekviziti (izuzev namještaja), materijali za obuku i nastavu (izuzev aparata), plastični materijal za pakovanje (koji nije uključen u druge klase), štamparska slova, klišeji.

**Klasa 21:** Kućne ili kuhinjske sprave i posude, češljevi i sunđereri, četke (izuzev kičica), materijali za pravljenje četki, artikli koji se koriste pri čišćenju, čelična vuna, neprerađeno ili polupreradađeno staklo (osim stakla koje se koristi u građevinarstvu), staklarija, porcelan i grnčarija koja nije uključena u druge klase.

**Klasa 25:** Odjeća, obuća, pokrivala za glavu.

**Klasa 28:** Igre i igračke, gimnastički i sportski artikli koji nijesu obuhvaćeni drugim klasama, ukrasi za jelke.

**Klasa 32:** Piva, mineralne i sodne vode i ostala bezalkoholna pića, voćna pića i voćni sokovi, sirupi i drugi preparati za proizvodnju pića.

**Klasa 41:** Obrazovne usluge, pripremanje obuke, razonoda, sportske i kulturne aktivnosti.

(210) **2011-752** (442) **20.12.2013.**  
(220) 30.12.2011.

(731) **THE COCA-COLA COMPANY**, ONE COCA-COLA PLAZA, ATLANTA, GEORGIA 30313 US

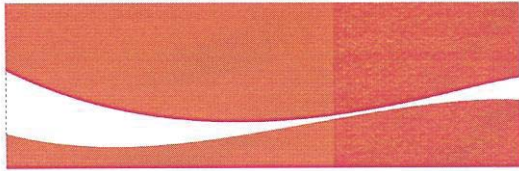

(540)

(550) I

(740) Popović Miladin, Đoka Miraševića 21/III, Podgorica ME

(511) **Klasa 32:** Piva, mineralne i sodne vode i ostala bezalkoholna pića, voćna pića i voćni sokovi, sirupi i drugi preparati za proizvodnju pića.

(210) **2011-753** (442) **20.12.2013.**  
(220) 30.12.2011.

(731) **THE COCA-COLA COMPANY**, ONE COCA-COLA PLAZA, ATLANTA, GEORGIA 30313 US



(540)

(550) I

(740) Popović Miladin, Đoka Miraševića 21/III, Podgorica ME

(511) **Klasa 16:** Hartija, karton i proizvodi od njih, koji nijesu uključeni u druge klase, štamparske stvari, knjigovezački materijal, fotografije, kancelarijski materijal, ljepljiva za kancelarijske i kućne potrebe, umjetnički materijali, kičice, pisaće mašine i kancelarijski rekviziti (izuzev namještaja), materijali za obuku i nastavu (izuzev aparata), plastični materijal za pakovanje (koji nije uključen u druge klase), štamparska slova, klišeji.

**Klasa 21:** Kućne ili kuhinjske sprave i posude, češljevi i sunđeri, četke (izuzev kičica), materijali za pravljenje četki, artikli koji se koriste pri čišćenju, čelična vuna, neprerađeno ili polupreradaeno staklo (osim stakla koje se koristi u građevinarstvu), staklarija, porcelan i grnčarija koja nije uključena u druge klase.

**Klasa 25:** Odjeća, obuća, pokrivala za glavu.

**Klasa 28:** Igre i igračke, gimnastički i sportski artikli koji nijesu obuhvaćeni drugim klasama, ukrasi za jelke.

**Klasa 32:** Piva, mineralne i sodne vode i ostala bezalkoholna pića, voćna pića i voćni sokovi, sirupi i drugi preparati za proizvodnju pića.

**Klasa 41:** Obrazovne usluge, pripremanje obuke, razonoda, sportske i kulturne aktivnosti.

(210) **2011-754**

(442) **20.12.2013.**

(220) 30.12.2011.

(731) **THE COCA-COLA COMPANY**, ONE COCA-COLA PLAZA, ATLANTA, GEORGIA 30313 US



(540)

(550) I

(740) Popović Miladin, Đoka Miraševića 21/III, Podgorica ME

(511) **Klasa 16:** Hartija, karton i proizvodi od njih, koji nijesu uključeni u druge klase, štamparske stvari, knjigovezački materijal, fotografije, kancelarijski materijal, ljepljiva za kancelarijske i kućne potrebe, umjetnički materijali, kičice, pisaće mašine i kancelarijski rekviziti (izuzev namještaja), materijali za obuku i nastavu (izuzev aparata), plastični materijal za pakovanje (koji nije uključen u druge klase), štamparska slova, klišeji.

**Klasa 21:** Kućne ili kuhinjske sprave i posude, češljevi i sunđer, četke (izuzev kičica), materijali za pravljenje četki, artikli koji se koriste pri čišćenju, čelična vuna, neprerađeno ili polupreradađeno staklo (osim stakla koje se koristi u građevinarstvu), staklarija, porcelan i grnčarija koja nije uključena u druge klase.

**Klasa 25:** Odjeća, obuća, pokrivala za glavu.

**Klasa 28:** Igre i igračke, gimnastički i sportski artikli koji nijesu obuhvaćeni drugim klasama, ukrasi za jelke.

**Klasa 32:** Piva, mineralne i sodne vode i ostala bezalkoholna pića, voćna pića i voćni sokovi, sirupi i drugi preparati za proizvodnju pića.

**Klasa 41:** Obrazovne usluge, pripremanje obuke, razonoda, sportske i kulturne aktivnosti.

(210) 2012-1

(442) **20.12.2013.**

(220) 05.01.2012.

(731) **THE GOODYEAR TIRE&RUBBER COMPANY**, 1144 EAST MARKET STREET, AKRON, OHIO 44316 US

## ULTRAGRIP

(540)

(550) I  
 (740) Čejović Vladimir, 13. jula 21, Podgorica ME  
 (511) **Klasa 12:** Gume.

(210) 2012-10 (442) **20.12.2013.**  
 (220) 12.01.2012.

(300) 2011 07732 02.11.2011. RO

(731) **JT INTERNATIONAL S.A.** 1, RUE DE LA GABELLE, 1211 GENEVA 26 CH

SOBRANIE SUPREME

(540) |  
 (550) I  
 (740) Čejović Vladimir, 13. jula 21, Podgorica ME

(511) **Klasa 34:** Duvan, prerađen ili neprerađen, duvan za pušenje, duvan za lule, duvan za ručno uvijanje, duvan za žvakanje, snus duvan, cigarete, cigare, cigarilosi, supstance za pušenje koje se prodaju odvojeno ili miješane sa duvanom, a koje nisu za medicinske svrhe ili u svrhe liječenja, duvan za ušmrkavanje, artikli za pušače uključeni u klasu 34, papir za cigarete, tube za cigarete i šibice.

(210) 2012-11 (442) **20.12.2013.**  
 (220) 12.01.2012.

(300) 1591/2011 04.11.2011. RS

(731) **JT INTERNATIONAL S.A.** 1, RUE DE LA GABELLE, 1211 GENEVA 26 CH

REFINE

(540)  
 (550) I  
 (740) Čejović Vladimir, 13. jula 21, Podgorica ME

(511) **Klasa 34:** Duvan, prerađen ili neprerađen, duvan za pušenje, duvan za lule, duvan za ručno uvijanje, duvan za žvakanje, snus duvan, cigarete, cigare, cigarilosi, supstance za pušenje koje se prodaju odvojeno ili miješane sa duvanom, a koje nisu za medicinske svrhe ili u svrhe liječenja, duvan za ušmrkavanje, artikli za pušače, papir za cigarete, tube za cigarete i šibice.

(210) 2012-12 (442) **20.12.2013.**  
 (220) 12.01.2012.

(731) **JT INTERNATIONAL S.A.** 1, RUE DE LA GABELLE, 1211 GENEVA 26 CH

# CONTRAST

(540)

(550) I

(740) Čejović Vladimir, 13. jula 21, Podgorica ME

(511) **Klasa 34:** Duvan, prerađen ili neprerađen, duvan za pušenje, duvan za lule, duvan za ručno uvijanje, duvan za žvakanje, snus duvan, cigarete, cigare, cigarilosi, supstance za pušenje koje se prodaju odvojeno ili miješane sa duvanom, a koje nisu za medicinske svrhe ili u svrhe liječenja, duvan za ušmrkavanje, artikli za pušače, papir za cigarete, tube za cigarete i šibice.

(210) 2012-13

(442) **20.12.2013.**

(220) 12.01.2012.

(731) **UNILEVER N.V.** WEENA 455 3013 AL ROTTERDAM NL



(540)

(550) I

(740) Popović Miladin, Đoka Miraševića 21/III, Podgorica ME

(511) **Klasa 03:** Sapun, medicinski sapun, preparati za čišćenje, parfimerija, eterična ulja, dezodoransi i anti-perspiranti, preparati za negu kose, šamponi i balzami, farbe za kosu, preparati za oblikovanje frizura, nemedicinski toaletni preparati, preparati za kupanje i tuširanje, preparati za negu kože, ulja, kreme i losioni za kožu, preparati za brijanje, preparati za korišćenje prije brijanja i posle brijanja, kolonjska voda, preparati za depilaciju, preparati za potamnjivanje i preparati za zaštitu od sunca, kozmetički preparati, šminka i preparati za skidanje šminke, vazelin, preparati za negu usana, puder u prahu, vata za kozmetičke namjene, pamučni štapići za kozmetičke namjene, maramice, jastučići ili maramice impregnirane ili natopljene losionom za čišćenje ili kozmetičkim losionom, maske za lice, pakovanja za lice.

(210) 2012-14

(442) **20.12.2013.**

(220) 12.01.2012.

(731) **UNILEVER N.V.** WEENA 455 3013 AL ROTTERDAM NL

# POND'S

(540)

(550) I

(740) Popović Miladin, Đoka Miraševića 21/III, Podgorica ME

(511) **Klasa 05:** Farmaceutski preparati, dezinfekciona sredstva i antiseptici, dezodoransi i preparati za osvježavanje vazduha, sanitarni proizvodi i preparati, zubarska smola, zavoji, flasteri, materijali za zavijanje, medicinski preparati za kožu i kosu, medicinski preparati za usne, preparati za lečenje i/ili ublažavanje opekotina, vazelin za medicinske namene, dijetetske supstance za medicinsku upotrebu, biljni preparati za medicinske namene, biljni dodaci i biljni ekstrakti, medicinski biljni napici, vitamini, minerali, dodaci ishrani.

(210) 2012-15

(442) **20.12.2013.**

(220) 12.01.2012.

(731) **UNILEVER N.V.** WEENA 455 3013 AL ROTTERDAM NL



(540)

(550) I

(740) Popović Miladin, Đoka Miraševića 21/III, Podgorica ME

(511) **Klasa 03:** Sapun, medicinski sapun, preparati za čišćenje, parfimerija, eterična ulja, dezodoransi i anti-perspiranti, preparati za negu kose, šamponi i balzami, farbe za kosu, preparati za oblikovanje frizura, nemedicinski toaletni preparati, preparati za kupanje i tuširanje, preparati za njegu kože, ulja, kreme i losioni za kožu, preparati za brijanje, preparati za korišćenje prije brijanja i posle brijanja, kolonjska voda, preparati za depilaciju, preparati za potamnjivanje i preparati za zaštitu od sunca, kozmetički preparati, šminka i preparati za skidanje šminke, vazelin, preparati za njegu usana, puder u prahu, vata za kozmetičke namjene, pamučni štapići za kozmetičke namjene, maramice, jastučići ili maramice impregnirane.

rane ili natopljene losionom za čišćenje ili kozmetičkim losionom, maske za lice, pakovanja za lice.

(210) **2012-152** (442) **20.12.2013.**

(220) 12.03.2012.

(300) CTM 12.01.2012. 10557346

(731) **THE PROCTER&GAMBLE COMPANY**, THE PROCTER&GAMBLE PLAZA, CINCINNATI, OHIO 45202 US

рачунара



(540)

(550) I

(740) Lutovac Branislav, Bulevar Crnojevića 93, Podgorica ME

(511) **Klasa 03:** Sredstva za bijeljenje i druge supstance za upotrebu kod pranja veša, preparati za čišćenje, poliranje, ribanje i nagrizanje, sapuni.

(210) **2012-153** (442) **20.12.2013.**

(220) 12.03.2012.

(731) **MONTEINFORM** D.O.O. MAINSKI PUT BB, BUDVA ME

(540) MONTEINFORM

(550) I

(511) **Klasa 09:** Oprema za pružanje usluga prenosa govora preko internet protokola, mobilni, fiksni i radio telefonski aparati, računari i računarska oprema, oprema za prenos data podataka.

**Klasa 38:** Telekomunikacije, prenos govora preko internet protokola, usluga povratnog poziva (Call back), usluge telefonskih govornica.

**Klasa 39:** Pružanje i posredovanje u pružanju turističkih usluga.

(210) **2012-154** (442) **20.12.2013.**

(220) 12.03.2012.

(731) **PRONTO-TEL COMPANY** DOO, MEDITERANSKA 4, BUDVA ME

(540) PRONTOTEL

(550) I, V

(511) **Klasa 09:** Oprema za pružanje usluga prenosa govora preko internet protokola, mobilni, fiksni i radio telefonski aparati, računari i računarska oprema, oprema za prenos data podataka.

taka.

**Klasa 38:** Telekomunikacije, prenos govora preko internet protokola, usluga povratnog poziva (Call back), usluge telefonskih govornica.

**Klasa 39:** Pružanje i posredovanje u pružanju turističkih usluga.

---

(210) **2012-155** (442) **20.12.2013.**

(220) 14.03.2012.

(731) **JOHNSON CONTROLS HYBRID AND RECYCLING GMBH**, AM LEINEUFER 51, 30419, HANNOVER DE

(540) VARTA

(550) I

(740) Popović Miladin, Đoka Miraševića 21/III, Podgorica ME

(511) **Klasa 09:** Industrijske baterije.

---

(210) **2012-156** (442) **20.12.2013.**

(220) 14.03.2012.

(731) **JOHNSON CONTROLS HYBRID AND RECYCLING GMBH**, AM LEINEUFER 51, 30419, HANNOVER DE



(540)

(550) I

(740) Popović Miladin, Đoka Miraševića 21/III, Podgorica ME

(511) **Klasa 09:** Industrijske baterije.

---

(210) **2012-157** (442) **20.12.2013.**

(220) 16.03.2012.

(731) **MSD CONSUMER CARE, INC.** 3030 JACKSON AVENUE, MEMPHIS, TENNESSEE 38151 US

(540) SOLARCAINE

(550) I

(740) Čupić Branislav, Dalmatinska 10, Podgorica ME

(511) **Klasa 05:** Farmaceutski preparati.

---

(210) **2012-158** (442) **20.12.2013.**

(220) 19.03.2012.

(731) **CROSSCARE LIMITED**, BROOMHILL ROAD, TALLAGHT, DUBLIN 24 IE

(540) COLIEF

(550) I

(740) Popović Miladin, Đoka Miraševića 21/III, Podgorica ME



(511) **Klasa 05:** Preparati za smanjenje intolerancije na laktozu kod dojenčadi, dodatak ishrani koji se dodaje u mlijeko bebama.

(210) 2012-16 (442) **20.12.2013.**  
(220) 12.01.2012.

(731) **UNILEVER N.V.** WEENA 455 3013 AL ROTTERDAM NL

POND'S

(540)

(550) I

(740) Popović Miladin, Đoka Miraševića 21/III, Podgorica ME

(511) **Klasa 03:** Sapun, medicinski sapun, preparati za čišćenje, parfimerija, eterična ulja, dezodoransi i anti-perspiranti, preparati za negu kose, šamponi i balzami, farbe za kosu, preparati za oblikovanje frizura, nemedicinski toaletni preparati, preparati za kupanje i tuširanje, preparati za njegu kože, ulja, kreme i losioni za kožu, preparati za brijanje, preparati za korišćenje prije brijanja i posle brijanja, kolonjska voda, preparati za depilaciju, preparati za potamnivanje i preparati za zaštitu od sunca, kozmetički preparati, šminka i preparati za skidanje šminke, vazelin, preparati za njegu usana, puder u prahu, vata za kozmetičke namjene, pamučni štapići za kozmetičke namjene, maramice, jastučići ili maramice impregnirane ili natopljene losionom za čišćenje ili kozmetičkim losionom, maske za lice, pakovanja za lice.

(210) **2012-160** (442) **20.12.2013.**  
(220) 20.03.2012.

(731) **ABBOT LABORATORIES**, 100 ABBOTT PARK ROAD, ABBOT PARK, ILLINOIS 60064 US

(540) ABBVIE

(550) I

(740) Popović Miladin, Đoka Miraševića 21/III, Podgorica ME

(511) **Klasa 05:** Farmaceutski preparati, veterinarski preparati, sanitarni preparati za upotrebu u medicini, dijeteske supstance prilagođene za upotrebu u medicini.

**Klasa 42:** usluge medicinskog istraživanja, usluge naučnog i tehnološkog istraživanja u vezi sa njima.

(210) **2012-161** (442) **20.12.2013.**  
(220) 27.03.2012.

(731) **FEDERAL-MOGUL PRODUCTS, INC.** 26555 NORTHWESTERN HIGHWAY, SOUTHFIELD, MICHIGAN 48033 US

(540) WAGNER

(550) I

(740) Radulović Božidar, Jovana Tomaševića 9/III, Podgorica ME

(511) **Klasa 12:** kočnice, kočione pločice, kočione papučice, kočine obloge, kočioni rotori, kočioni bubnjevi, kočioni blokovi, kočioni hardver, kvačila i obloge za kvačila, hidraulika kočnica

i kvačila.

(210) **2012-162** (442) **20.12.2013.**  
(220) 28.03.2012.

(731) **BAYER AKTIENGESELLSCHAFT**, KAISER-WILHELM-ALLEE, 51373 LEVERKUSEN  
DE

(540) CANES-NAIL

(550) I

(740) Čejović Vladimir, 13. jula 21, Podgorica ME

(511) **Klasa 03:** Kozmetika.

**Klasa 05:** Farmaceutski preparati, sanitarni preparati za upotrebu u medicini, flasteri, materijali za zavijanje, dezinfekciona sredstva.

**Klasa 08:** Strugalice.

(210) **2012-163** (442) **20.12.2013.**  
(220) 28.03.2012.

(731) **TOA KAB USHIKI KAISHA(TOA CORPORATION)**, 2-1, MINATOJIMANAKAMCHI 7-CHOME, CHUO-KU, KOBE-SHI, HYOGO-KEN JP

(540) TOA

(550) I

(740) Popović Miladin, Đoka Miraševića 21/III, Podgorica ME

(511) **Klasa 09:** Aparati i instrumenti naučni, pomorski, geodetski, fotografski, kinematografski, optički, za vaganje, za mjerenje, signalizaciju, kontrolu (inspekciju), spasavanje i nastavu, aparati i instrumenti za provođenje, prekid, transformaciju, akumulaciju, regulisanje ili kontrolu električne energije, aparati za snimanje, prenos i reprodukovanje zvuka ili slike, magnetni nosači podataka, diskovi za snimanje, kompakt diskovi, DVD i drugi digitalni nosači podataka, mehanizmi za aparate koji se pokreću novcem ili žetonom, register kase, računarske mašine, oprema za obradu podataka, računari, računarski softver, aparati za gašenje požara, naročito: antene, antenski pojačivači, slušalice, bežični prijemnici, bežični predajnici, punjači za baterije, mikrofoni, infracrveni komunikacioni sistemi, razglasi, oprema za razglase i zvučne sisteme, stalci za uređaje i aparate za ozvučenje, pojačala, regulatori za zvučnik, stalaže za zvučne uređaje i aparate, stalaže za uređaje i aparate za video nadzor, monitori za zvučnu opremu, transformatori, procesori zvučnog signala, zvučne miksete, kutije za skladištenje uređaja i aparata za emitovanje na stalažama i u ormanima, razvodne table za uređaje i aparate za emitovanje na stalažama i u ormanima, ventilacioni paneli za upotrebu na stalažama i u ormanima za uređaje i aparate za emitovanje, audio plejeri, uređaji za snimanje i premotavanje zvuka, uređaji za prenos i prijem zvučnog signala, programatori za električne uređaje, nosači zvuka, memorijske kartice za snimanje zvuka, razvodnici za električnu opremu, strujni napajači, kontrolne table za razglasni sistem, priključci za zvučni signal, regulatori zvučnog signala, konvertori zvučnog signala, mjerači impedanse, prigušivači, zvučnici i sastavni djelovi, megafoni, predajnici i prijemnici zvuka putem mreža, mrežni zvučni uređaji, interfon sistemi, interfon centrale, interfon stanice, konferencijski sistemi, električne oglasne table, oprema za emitovanje signala za uzbunu, sistemi za video nadzor, priključci za video signal, uređaji za prenos i prijem video signala, prekidači za monitore, uređaji za kompenzaciju video signala, objektivni za kamere video nadzora, kontrolne table za rukovanje video opremom, regulatori za opremu video nadzora, kamere za video nadzor, maske za kamere video nadzora, uređaji za prenos sinhronizovanog video signala, električni spojevi za kamere video nadzora, hard disk jedinice, digitalni video rekorderi, kućišta za

kamere video nadzora, video monitori, konvertori video signala, uređaji za snimanje putem mreže, instalacioni držači za audio uređaje i video uređaje, baterije, uređaji za distribuciju signala, priključci za audio signal i video signal, kompjuterski softver, snimljen, kompjuterski softver koji se može preuzimati, kompjuterski softver za potrebe snimanja, pojačavanja, reprodukovanja i prenošenja zvukova, kablovi za audio i video signal.

(210) **2012-165** (442) **20.12.2013.**

(220) 02.04.2012.

(731) **D.O.O ŠIMŠIĆ-MONTIMILK** ZA PROIZVODNJU I USLUGE, LAZINE BB DANILOVGRAD ME



(540)

(550) I

(511) **Klasa 29:** Jaja, mlijeko i mliječni proizvodi.

(210) 2012-17 (442) **20.12.2013.**

(220) 12.01.2012.

(731) **UNILEVER N.V.** WEENA 455 3013 AL ROTTERDAM NL

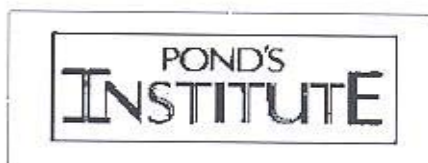

(540)

(550) I

(740) Popović Miladin, Đoka Miraševića 21/III, Podgorica ME

(511) **Klasa 44:** Usluge salona ljepote, frizerske usluge, usluge manikira i pedikira, aromaterapija, usluge sunčanja, usluge sauna, solarijuma i masaža, pružanje informacija i savjetodavne usluge vezane za zdravlje, dijete, vježbe, način života, zdravstvenu zaštitu, njegu ljepote, njegu kože, parfimeriju, dezodoranse, ishranu i ličnu higijenu.

(210) **2012-170** (442) **20.12.2013.**

(220) 05.04.2012.

(731) **ROCKY&PISTOLATO CASCH&CARRY**, VOJISAVLJEVIĆA 88, PODGORICA ME



(540)

(550) I

(740) Rašković Boris, Jovana Tomaševića 9/3, Podgorica ME

(511) **Klasa 14:** Dragocjeni metali i njihove legure i proizvodi od dragocjenih metala ili sa prevlakom od njih Nakit, drago kamenje, časovničarski i hronometrijski uređaji, Nakit (imitacije nakita i nakit od plemenitih metala i dragulje), dugmad za manžetne, igle za kravate.

**Klasa 18:** Koža, imitacija kože, proizvodi izrađeni od ovih materijala, životinjska koža, krzno, koferi i putne torbe, kišobrani i suncobrani, štapovi za hodanje.

**Klasa 25:** Odjeća, obuća, pokrivala za glavu.

(210) **2012-172**

(442) **20.12.2013.**

(220) 05.04.2012.

(731) **BASF SE**, CARL-BOSCH-STRASSE 38, LUDWIGSHAFEN AM RHEIN DE

(540) TECTANET

(550) I

(740) Stanković Mugoša Ana, Trg Republike 13, Podgorica ME

(511) **Klasa 05:** Preparati za uništavanje i suzbijanje štetočina, fungicidi, herbicidi, pesticidi.

(210) **2012-173**

(442) **20.12.2013.**

(220) 05.04.2012.

(731) **EXXON MOBIL CORPORATION**, 5959 LAS COLINAS BOULEVARD, IRVING, TEXAS 75039-2298 US

(540) DTE

(550) I

(740) Ćupić Branislav, Dalmatinska 10, Podgorica ME

(511) **Klasa 04:** Ulje i maziva za podmazivanje.

(210) **2012-174**

(442) **20.12.2013.**

(220) 05.04.2012.

(300) 61133/2011 05.10.2011. CH

(731) **JT INTERNATIONAL S.A.** 1, RUE DE LA GABELE, 1211 GENEVA 26 CH



(540)

(550) I

(740) Čejović Vladimir, 13. jula 21, Podgorica ME

(511) **Klasa 34:** Duvan, prerađen ili neprerađen, duvan za pušenje, duvan za lule, duvan za ručno uvijanje, duvan za žvakanje, snus duvan, cigarete, cigare, cigarilosi, supstance za pušenje koje se prodaju odvojeno ili miješane sa duvanom, a koje nisu za medicinske svrhe ili u svrhe liječenja, duvan za ušmrkavanje, artikli za pušače uključeni u klasu 34, papir za cigarete, tube za cigarete i šibice.

(210) 2012-18

(442) **20.12.2013.**

(220) 12.01.2012.

(731) **UNILEVER N.V.** WEENA 455 3013 AL ROTTERDAM NL

(540)

(550) I

(740) Popović Miladin, Đoka Miraševića 21/III, Podgorica ME

(511) **Klasa 03:** Sapun, medicinski sapun, preparati za čišćenje, parfimerija, eterična ulja, dezodoransi i anti-perspiranti, preparati za negu kose, šamponi i balzami, farbe za kosu, preparati za oblikovanje frizura, nemedicinski toaletni preparati, preparati za kupanje i tuširanje, preparati za njegu kože, ulja, kreme i losioni za kožu, preparati za brijanje, preparati za korišćenje prije brijanja i posle brijanja, kolonjska voda, preparati za depilaciju, preparati za potamnivanje i preparati za zaštitu od sunca, kozmetički preparati, šminka i preparati za skidanje šminke, vazelin, preparati za njegu usana, puder u prahu, vata za kozmetičke namjene, pamučni štapići za kozmetičke namjene, maramice, jastučići ili maramice impregnirane ili natopljene losionom za čišćenje ili kozmetičkim losionom, maske za lice, pakovanja za lice.

(210) **2012-188**(442) **20.12.2013.**

(220) 12.04.2012.

(731) **ALKALOID AD-SKOPLJE**, BUL. ALEKSANDAR MAKEDONSKI 12, SKOPLJE MK

YOUNG  
DERM  
body milk



(540)

(550) T

(740) Popović Miladin, Đoka Miraševića 21/III, Podgorica ME

(511) **Klasa 03:** Podloga za šminku za kombinovanu i masnu kožu.

(210) 2012-19

(442) **20.12.2013.**

(220) 13.01.2012.

(731) **ABBOTT MEDICAL OPTICS INC.** 1700 E.ST. ANDREW PLACE, SANTA ANA, CALIFORNIA 92705-4933 US

## UNFOLDER

(540)

(550) I

(740) Popović Miladin, Đoka Miraševića 21/III, Podgorica ME

(511) **Klasa 10:** Hirurški, medicinski, zubarski i veterinarski aparati i instrumenti, vještački udovi, oči i zubi, ortopedski artikli, hirurški materijali za zašivanje, naročito hirurški ručni alati, medicinski aparati i instrumenti, naime, sistem za implantaciju intraokularnog sočiva.

(210) 2012-2

(442) **20.12.2013.**

(220) 09.01.2012.

(731) **RODRIGO MIGUELL FONT**, AVINGUDA DE VALLVIDRERA 44, BARCELONA ES



(540)

(550) I

(740) Radulović Božidar, Jovana Tomaševića 9/III, Podgorica ME

(511) **Klasa 12:** Vozila, uređaji za kretanje po zemlji, po vodi ili po zraku, posebno, komponente, dodatna oprema i rezervni dijelovi za vozila, spojke i prijenosni uređaji za kopnena vozila, komponente za rashladne sistave, ispušne lonce, amortizacijske sistave, motore ili strojeve (mehaničke), prijenosne i upravljačke komponente za vozila.

(210) 2012-20

(442) **20.12.2013.**

(220) 13.01.2012.

(731) **DC COMICS**, 1700 BROADWAY NEW YORK, NY 10019 US



(540)

(550) I

(740) Popović Miladin, Đoka Miraševića 21/III, Podgorica ME

(511) **Klasa 03:** Sredstva za beljenje i druge supstance za upotrebu u perionicama, preparati za čišćenje, poliranje, ribanje i nagrizanje, sapuni, parfimerija, eterična ulja, kozmetika, losioni za kosu, paste za zube, posebno kozmetika, naime ruž za usne, sjaj za usne i ne-medicinski melem za usne, maskara, lak za nokte, puder za lice, krema za lice, losion za telo i gel za telo, puder za telo, ulje za kupanje, gel za kupanje i ne-medicinske soli za kupanje, krema i losion za ruke, krema i losion za telo, preparat za sunčanje, naime krema i losion, krema za brijanje i losion posle brijanja, losioni za čišćenje kože i ne-medicinske kupke za kupanje, dezodorans za telo, kolonjska voda i parfem, sapuni, naime, tečni sapun za kupanje, sapun u gelu i tvrdi sapun, pasta za zube, deterdžent u obliku sapuna, naime, tečni i u obliku praška, omekšivač veša, dezodorans u obliku sapuna, sapun za kožu, i šampon i balzam.

**Klasa 09:** Aparati i instrument naučni, pomorski, geodetski, fotografski, kinematografski, optički, za vaganje, merenje, signalizaciju, kontrolu (inspekciju), spasavanje i nastavu, aparati i instrumenti za provodenje, prekid, transformaciju, akumulaciju, regulisanje ili kontrolu električne energije, aparati za snimanje, prenos i reprodukovanje zvuka ili slike, magnetni nosioci podataka, diskovi za snimanje, automatske mašine i mehanizmi za aparate koji se pokreću novcem ili žetonom, registar kase, računске mašine, oprema za obradu podataka i kompjuteri, aparati za gašenje požara, posebno filmovi u kojima je tematika komedija, drama, akcija, avantura i/ili animacija i filmovi za emitovanje na televiziji u kojima je tematika komedija, drama, akcija, avantura i/ili animacija, audio video diskovi, i digitalni višenamenski diskovi (DVD) koji sadrže muziku, komediju, dramu, akciju, avanturu i/ili animaciju, stereo slušalice, baterije, bežični telefoni, CD plejeri, kompjuterski CD ROM diskovi koji sadrže igre, telefon i/ili radio pejdžeri, kompakt disk plejeri, radio, podloge za miša, naočare za vid, naočare za sunce i futrole za njih, oprema za igre koja se prodaje kao jedinica za igranje grupnih, računarskih igrica u zatvorenom prostiru, softver koji se može preuzimati za kori-

šćenje u igranju online računarskih igrica, softver za računarske igrice koji se može preuzimati, softver za računarske igrice za korišćenje na mobilnim telefonima, programi za video i računarske igrice, kertridži za video igrice, računarske i video igrice koje su dizajnirane za hardverske platforme, naime, konzole za igrice i personalne računare, CD-ROM-ovi i digitalni višenamenski diskovi (DVD) za računarske igrice i računarski programi, naime, softver koji povezuje digitalizovane video i audio medije na globalnu računarsku mrežu, audio-vizuelni medijski sadržaji koji se mogu preuzimati iz oblasti zabave koji prikazuju animirane filmove, televizijske serije, komedije, i drame, računarski softver, naime, računarski softver za kontinuirano emitovanje audio-vizuelnih medijskih sadržaja preko interneta, računarski softver za kontinuirano emitovanje i skladištenje audio-vizuelnih medijskih sadržaja, audio i video plejeri koji se mogu preuzimati za medijske sadržaje samultimedijalnim i interaktivnim funkcijama, softver za video pretragu i pravljenje zabeleški, softver za zaštitu sadržaja, softver za upravljanje bazama podataka, softver za sinhronizaciju baza podataka, računarski programi za pristup, nasumično pretraživanje i precizno pretraživanje online baza podataka, softveri koji omogućavaju korisnicima da igraju i programiraju audio, video, tekstualne i multimedijalne sadržaje zabavnog karaktera, softver za računarske aplikacije za kontinuirano emitovanje i skladištenje audio-vizuelnih medijskih sadržaja, softver za računarske aplikacije za kontinuirano emitovanje audio-vizuelnih medijskih sadržaja preko interneta, računarski softver koji se može preuzimati za kontinuirano emitovanje audio-vizuelnih medijskih sadržaja preko interneta, računarski softver koji se može preuzimati za kontinuirano emitovanje i skladištenje audio-vizuelnih medijskih sadržaja, publikacije koje se mogu preuzimati u obliku knjiga koje sadrže likove iz animiranih filmova, akcionih avantura, komedija i/ili drama, stripovi, knjige za decu, priručnici za igrice, časopisi koji sadrže likove iz animiranih filmova, akcionih avantura, komedija i/ili dramskih filmova, bojanke, dečije interaktivne knjige i časopisi iz oblasti zabave, oprema za mobilne telefone, naime oprema za slušalice, futrole za mobilni telefon i maske za mobilni telefon, kodirane magnetne kartice, naime, telefonske kartice, kreditne kartice, gotovinske kartice, debitne kartice i magnetne kartice, i dekorativni magneti.

**Klasa 14:** Dragoceni metali i njihove legure i proizvodi od dragocenih metala ili sa prevlakom od njih, koji nisu uključeni u druge klase, nakit, bižuterija, drago kamenje, časovničarski i hronometrijski instrumenti. posebno satovi (časovnici), ručni satovi, nakit, naime narukvice, narukvice oko članka, broševi, lanci, amajlije, manžetne, minđuše, značke, ogrlice, ukrasne igle, privesci i prstenje, šnale za kaiševe.

**Klasa 16:** Hartija, karton i proizvodi od njih, koji nisu uključeni u druge klase, štampane stvari, knjigovezački materijal, fotografije, kancelarijski materijal, lepila za kancelarijske i kućne potrebe, umetnički materijali, kičice, pisaće mašine i kancelarijski rekviziti (izuzev nameštaja), materijali za obuku i nastavu (izuzev aparata), plastični materijal za pakovanje (koji nije uključen u druge klase), štamparska slova, klišeji, posebno štampane stvari i proizvodi od papira, naime knjige koje sadrže likove iz animiranih filmova, akcionih avantura, komedija i/ili dramskih filmova, stripovi, knjige za decu, uputstva za video igrice, časopisi koji sadrže likove iz animiranih filmova, akcionih avantura, komedija i/ili dramskih filmova, bojanke, interaktivne knjige za decu, kancelarijski materijal, papir za pisanje, koverta, sveske, dnevnici, beležnice, čestitke, kolekcionarske karte, litografije, hemijske olovke, olovke, pernice za njih, gumice, bojice, flomasteri, olovke u boji, pribor za slikanje, krede i table, dekorativne nalepnice, preslikači, poster, lepljive plastične folije sa papirom koji se može skinuti za montiranje slika u dekorativne svrhe, montirane i/ili nemontirane fotografije, pokrivala za knjige, markeri za knjige, kalendari, ukrasni papir za pakovanje, pokloni od papira i dekoracije od papira, naime, papirne salvete, papirni podmetači, krep papir, pozivnice, papirni stolnjaci, papirni ukrasi za torte, štampane aplikacije za vez ili tkanine, štampane aplikacije



za kostime, pidžame, dukserice i majice.

**Klasa 18:** Koža i imitacija kože, proizvodi izradeni od ovih materijala koji nisu uključeni u druge klase, životinjska koža, koferi i putne torbe, kišobrani, suncobrani i štapovi za hodanje, bičevi, saračka i sedlarska roba, posebno atletske torbe, rančevi za bebe, rančevi, torbe za plažu, torbe za knjige, torbe za pelene, velike sportske torbe, torbe za teretanu, velike ručne tašne, male torbice za novae, torbice za nošenje oko struka, ruksaci, sportske torbe za nošenje oko struka, torbe za kupovinu, kišobrani, novčanici, modni detalji napravljeni od kože, naime novčanici, ručne tašne i kaiševi.

**Klasa 25:** Odeća, obuća, pokrivala za glavu, odeća za muškarce, žene i decu - naime, majice, majice kratkih rukava, dukserice, trenerke za trčanje, pantalone, gaće, šorcevi, majice bez rukava, odeća za kišu, dečije krpene portikle, suknje, bluze, haljine, tregeri, veste, jakne, kaputi, kišni kaputi, odela za sneg, kravate, kućne haljine, šeširi, kape, štitnici za sunce, rukavice, remeni (kaiševi), marama, odeća za spavanje, pidžame, žensko rublje, donji veš, čizme, cipele, patike, sandale, sokne, kratke sokne, čarape-papučice, kupaće gaćice i kostimi i maske za maskenbal i Noć Veštica prodavani u vezi sa istim.

**Klasa 28:** Igre i igračke, gimnastički i sportski artikli koji nisu obuhvaćeni drugim klasama, ukrasi za jelke, igračke i sportski proizvodi, uključujući igre i igračke - naime, akcijske figurice i dodaci za iste, setovi za igranje za akcijske figurice, nameštaj za igračke, plišane igračke, baloni, igračke za kupanje u kadi, igračke za jahanje na njima, oprema prodavana kao celina za igranje kartaških igara, igračke vozila, lutke, leteći diskovi, jedinice elektronske ručne igre, igraća oprema prodavana kao celina za igranje stonih igara, kartaških igara, manipulativnih igara, igara u salonu i igara sa metama akcijskog tipa, samostojeće igraće mašine sa video izlazom, slagalice i manipulative puzzle, papirnate maske za lice, skejtbordovi, klizaljke za led, igračke koje prskaju vodu, lopte - naime, lopte za igralište, fudbalske lopte, bejzbol lopte, košarkaške lopte, rukavice za bejzbol, plovci za plivanje za rekreativnu upotrebu, plutajuće table za plivanje za rekreativnu upotrebu, table za surfovanje, table za plivanje za rekreativnu upotrebu, peraje za plivanje, igračke posuđe i posude za pečenje, igračke banke, igračke snežne kugle, papirnati šeširi za zabave, i ukrasi za jelku.

**Klasa 41:** Obrazovne usluge, pripremanje obuke, razonoda, sportske i kulturne aktivnosti, usluge razonode, naime, pružanje video igrice online, pružanje kompjuterskih igrice online, pružanje privremenog korišćenja video igrice koje se ne mogu preuzeti (downloadovati), usluge produkcije softvera za video i kompjuterske igrice, usluge razonode u pogledu živih nastupa, komedija, drama, animiranih, i reality televizijskih serija, produkcija živih nastupa, komedija, drama, animiranih i reality televizijskih serija, distribucija i prikazivanje živih nastupa, komedija, drama i animiranih bioskopskih filmova, produkcija živih nastupa, komedija, drama i animiranih bioskopskih filmova, pozorišne predstave kako animirane tako i uživo, internet usluge koje pružaju informacije putem elektronske globalne kompjuterske mreže u oblasti razonode a posebno u vezi sa igricama, muzikom, filmovima, i televizijom, usluge pružanja web stranica koji sadrže filmske klipove (isečke), fotografije i druge multimedijalne materijale, usluge pružanja vesti o trenutnim događajima i razonodi, i informacija u vezi sa obrazovanjem i kulturnim događajima, putem globalne kompjuterske mreže, i pružanje informacija za razonodu i konkretna razonoda putem elektronske globalne komunikacione mreže a u vidu živih nastupa, komedija, drama i animiranih programa i produkcije živih nastupa, komedija, drama i animiranih filmova za distribuciju putem globalne kompjuterske mreže, usluge pružanja kompjuterske igrice kojoj se može pristupiti putem telekomunikacione mreže, i pružanje usluga elektronskog izdavaštva, naime, online izdavanje tekstova i grafičkih radova drugih koji sadrže članke, price, scenarija, stripove, strategijske vodiče, fotografije i vizuelne materijale, usluge zabavnih parkova, usluge vožnji u zabavnim parkovima, živi ili unapred snimljeni nastupi i/ili filmovi, usluge informisanja o razonodi i/ili rekrea-

ciji, usluge klubova za razonodu.

(210) **2012-26** (442) **20.12.2013.**  
(220) 19.01.2012.

(731) **SHIMANO** INC. 3-77 OIMATSU-CHO, SAKAI-KU, SAKAI CITY OSAKA JP

## HG-EV

(540)

(550) I

(740) Popović Miladin, Đoka Miraševića 21/III, Podgorica ME

(511) **Klasa 12:** Električne bicikle, bicikle, delovi i oprema za bicikle, naime, glavčine, unutrašnje glavčine menjača, glavčine dinama za bicikle, glavčine za brzo otpuštanje poluge menjača, otp usne poluge menjača, poluge za menjanje brzina, prednji prenosni mehanizmi, zadnji prenosni mehanizmi, vođice lanca, pomoćni zupčanici za menjanje brzina (skretači lanca), zupčanici, dizalice za bicikle, lanci za bicikle, sajle, obrtaljke, komplet obrtaljka, prednji lančanici za točak, pedale za bicikle, klipseri (korpice za stopala), poluge kočnica, prednje kočnice, zadnje kočnice, sajle za kočnice, kočne papuče, obruči, točkovi, lanci za kočenje, klipovi za kočenje, donje spone, nosači za sedišta, mehanizmi za brzo otpuštanje nosača sedišta, glavni delovi za sklapanje rama viljuški, amortizeri, upravljači, drške upravljača, ručice upravljača, krajevi drške upravljača, uporišta sedišta, sedišta, prenosni mehanizmi kojima upravlja kompjuter, pokazivači pozicije brzine bicikla.

(210) **2012-3** (442) **20.12.2013.**  
(220) 10.01.2012.

(731) **SHIMANO** INC. 3-77 OIMATSCU-CHO, SAKAI CITY, OSAKA JP

## SHIMANO DOC

(540)

(550) I

(740) Popović Miladin, Đoka Miraševića 21/III, Podgorica ME

(511) **Klasa 09:** Računari za bicikle, merači utroška energije za bicikle.

**Klasa 12:** Električne bicikle, bicikle, delovi i oprema za bicikle, naime, glavčine, unutrašnje glavčine menjača, glavčine dinama za bicikle, glavčine za brzo otpuštanje poluge menjača, otp usne poluge menjača, poluge za menjanje brzina, prednji prenosni mehanizmi, zadnji prenosni mehanizmi, vođice lanca, pomoćni zupčanici za menjanje brzina (skretači lanca), zupčanici, dizalice za bicikle, lanci za bicikle, sajle, obrtaljke, komplet obrtaljka, prednji lančanici za točak, pedale za bicikle, klipseri (korpice za stopala), poluge kočnica, prednje kočnice, zadnje kočnice, sajle za kočnice, kočne papuče, obruči, točkovi, lanci za kočenje, klipovi za kočenje, donje spone, nosači za sedišta, mehanizmi za brzo otpuštanje nosača sedišta, glavni delovi za sklapanje rama viljuški, amortizeri, upravljači, drške upravljača, ručice upravljača, krajevi drške upravljača, uporišta sedišta, sedišta, prenosni mehanizmi kojima upravlja kompjuter, pokazivači pozicije brzine bicikla.

(210) **2012-30** (442) **20.12.2013.**

(220) 23.01.2012.

(731) **MEGA DISPOSABLES** S.A. 148 DEKELIAS STREET, 136 78 AHARNES GR



(540)

(550) I

(740) Radulović Božidar, Jovana Tomaševića 9/III, Podgorica ME

(511) **Klasa 05:** Higijenski ulošci.

(210) **2012-31**

(442) **20.12.2013.**

(220) 23.01.2012.

(731) **MEGA DISPOSABLES** S.A. 148 DEKELIAS STREET, 136 78 AHARNES GR

## BABYCARE BY MEGA

(540)

(550) I

(740) Radulović Božidar, Jovana Tomaševića 9/III, Podgorica ME

(511) **Klasa 03:** Vlažne maramice.

(210) **2012-32**

(442) **20.12.2013.**

(220) 23.01.2012.

(731) **PRINGLE OF SCOTLAND LIMITED**, QUARTER ONE, 15 LAURISTON PLACE, EDINBURG, EH3 9EP SCOTLAND UK

## PRINGLE

(540)

(550) I

(740) Čejović Vladimir, 13. jula 21, Podgorica ME

(511) **Klasa 25:** Odjeća, obuća, pokrivala za glavu.

(210) **2012-33** (442) **20.12.2013.**

(220) 24.01.2012.

(731) **VIACOM INTERNATIONAL INC.** 1515 BROADWAY, NEW YORK, NY 10036 US



(540)

(550) I

(740) Lutovac Branislav, Bulevar Crnojevića 93, Podgorica ME

(511) **Klasa 38:** Radio-difuzne i telekomunikacijske usluge, kablovske i satelitske usluge prenosa, wireless usluge za mobilne telefone, omogućavanje download-ovanja melodija, muzike, mp3, grafika, igrice, slika i informacija za bežične mobilne uređaje, pružanje bežičnog prenosa pri upload-vanju i download-ovanju melodija, glasova, muzike, mp3, grafika, igrice, slika, informacija i novosti preko globalne kompjuterske mreže do mobilnog uređaja sa bežičnom komunikacijom, glasanje preko mobilnog uređaja sa bežičnom komunikacijom, slanje i primanje glasova preko mobilnog, slanje i primanje zvučnih i tekstualnih poruka između mobilnih uređaja sa bežičnom komunikacijom, omogućavanje glasanja online preko interneta ili uređaja za bežičnu komunikaciju, internet usluge koje podrazumijevaju usluge komunikacije, uglavnom transmisije strimovanih zvukova i zvučno-vizuelnih snimaka preko interneta.

**Klasa 41:** Zabava, proizvodnja, priprema, izlaganje, distribucija i iznajmljivanje tv i radio programa i filmova, animiranih filmova, zvučnih i video snimaka kroz interaktivne i neinteraktivne medije, među kojima je internet, produkcija zabave uživo, produkcija tv zabave, muzički tv programi, objavljivanje knjiga, časopisa i mjesečnika, proizvodnja i izdavanje obrazovnih i nastavnih sredstava, organizacija, proizvodnja i prezentacija događaja u obrazovne, kulturne ili zabavne svrhe, kroz interaktivne i neinteraktivne medije, organizacija, produkcija i prezentacija takmičenja, igara, kvizova, izložbi, sportskih događaja, predstava, putujućih predstava, organizovanih događaja, pozorišnih izvođenja, koncerata, predstava uživo, događaja sa učešćem publike, organizacija interaktivnih igara, proizvodnja sms-kviz programa, zabava i obrazovanje, sve navedene usluge takodje prenijete preko globalne kompjuterske mreže i drugih (interaktivnih) komunikacijskih mreža, uključujući internet.

(210) **2012-34** (442) **20.12.2013.**

(220) 24.01.2012.

(731) **GOOGLE INC.** 1600 AMPHITHEATRE PARKWAY, MOUNTAIN VIEW, CA 94043, US

# ZAGAT

(540)

(550) I

(740) Čupić Branislav, Dalmatinska 10, Podgorica ME

(511) **Klasa 09:** Aparati i instrumenti naučni, pomorski, geodetski, fotografski, kinematografski, optički, za vaganje, mjerenje, signalizaciju, kontrolu (inspekciju), pomoć (spasavanje) i nastavu, aparati i instrumenti za provođenje, prekidanje, transformisanje, akumuliranje, regulisanje ili kontrolu električne energije, aparati za snimanje, prenos ili reprodukovanje zvuka ili slike, magnetski nosioci podataka, kompakt diskovi, DVD diskovi i drugi digitalni mediji za snimanje, mehanizmi za aparate koji se pokreću novcem ili žetonom, registar-kase, računске mašine, oprema za obradu podataka, kompjuteri, kompjuterski softver, uključujući kompjuterski softver koji se može preuzimati elektronskim putem (daunlodovati).

**Klasa 20:** Namještaj, ogledala, ramovi, proizvodi (koji nisu obuhvaćeni drugim klasama) od drveta, plute, trske, rogoza, pruća, roga, kosti, slonovače, kitove kosti, školjke, ćilibara, sedefa, sepiolita, i zamjena svih ovih materijala, ili od plastike, ploče i table (osim metalnih).

**Klasa 25:** Odjeća, obuća i pokrivala glave.

**Klasa 35:** Oglašavanje, usluge poslovnih imenika, poslovni menadžment, poslovna administracija, kancelarijski poslovi.

**Klasa 41:** Obrazovne usluge, obučavanje, razonoda, sportske i kulturne aktivnosti, pružanje on-lajn elektronskih publikacija.

**Klasa 42:** Naučne i tehnološke usluge i istraživanje i projektovanje u vezi navedenih usluga, usluge industrijske analize i istraživanja, projektovanje i razvoj kompjuterskog hardvera i softvera, uključujući softver koji se ne može preuzimati elektronskim putem.

**Klasa 45:** Lične i društvene usluge koje pružaju drugi radi zadovoljavanja potreba pojedinaca, usluge društvenih onlajn mreža.

(210) **2012-35**

(442) **20.12.2013.**

(220) 24.01.2012.

(300) 11\*1290 07.10.2011. LT

(731) **JT INTERNATIONAL S.A**, 1,RUE DE LA GABELLE, 1211 GENEVA 26 CH



(540)

(550) I

(740) Čejović Vladimir, 13. jula 21, Podgorica ME

(511) **Klasa 34:** Duvan, prerađen ili neprerađen, duvan za pušenje, duvan za lule, duvan za ručno uvijanje, duvan za žvakanje, snus duvan, cigarete, cigare, cigarilos, supstance za pušenje koje se prodaju odvojeno ili miješane sa duvanom, a koje nisu za medicinske svrhe ili u svr-

he liječenja, duvan za ušmrkavanje, artikli za pušače uključeni u klasu 34, papir za cigarete, tube za cigarete i šibice.

---

(210) **2012-36** (442) **20.12.2013.**

(220) 24.01.2012.

(731) **JT INTERNATIONAL S.A**, 1, RUE DE LA GABELLE, 1211 GENEVA 26 CH



(540)

(550) I

(740) Čejović Vladimir, 13. jula 21, Podgorica ME

(511) **Klasa 34:** Duvan, prerađen ili neprerađen, duvan za pušenje, duvan za lule, duvan za ručno uvijanje, duvan za žvakanje, snus duvan, cigarete, cigare, cigarilosi, supstance za pušenje koje se prodaju odvojeno ili miješane sa duvanom, a koje nisu za medicinske svrhe ili u svrhe liječenja, duvan za ušmrkavanje, artikli za pušače uključeni u klasu 34, papir za cigarete, tube za cigarete i šibice.

---

(210) **2012-37** (442) **20.12.2013.**

(220) 24.01.2012.

(731) **JT INTERNATIONAL S.A**, 1, RUE DE LA GABELLE, 1211 GENEVA 26 CH



(540)

(550) I

(740) Čejović Vladimir, 13. jula 21, Podgorica ME

(511) **Klasa 34:** Duvan, prerađen ili neprerađen, duvan za pušenje, duvan za lule, duvan za ručno uvijanje, duvan za žvakanje, snus duvan, cigarete, cigare, cigarilosi, supstance za pušenje koje se prodaju odvojeno ili miješane sa duvanom, a koje nisu za medicinske svrhe ili u svr-

he liječenja, duvan za ušmrkavanje, artikli za pušače uključeni u klasu 34, papir za cigarete, tube za cigarete i šibice.

---

(210) **2012-38** (442) **20.12.2013.**

(220) 24.01.2012.

(731) **JT INTERNATIONAL S.A**, 1, RUE DE LA GABELLE, 1211 GENEVA 26 CH



(540)

(550) I

(740) Čejović Vladimir, 13. jula 21, Podgorica ME

(511) **Klasa 34:** Duvan, prerađen ili neprerađen, duvan za pušenje, duvan za lule, duvan za ručno uvijanje, duvan za žvakanje, snus duvan, cigarete, cigare, cigarilosi, supstance za pušenje koje se prodaju odvojeno ili miješane sa duvanom, a koje nisu za medicinske svrhe ili u svrhe liječenja, duvan za ušmrkavanje, artikli za pušače uključeni u klasu 34, papir za cigarete, tube za cigarete i šibice.

---

(210) **2012-39** (442) **20.12.2013.**

(220) 24.01.2012.

(731) **JT INTERNATIONAL S.A**, 1, RUE DE LA GABELLE, 1211 GENEVA 26 CH



(540)

(550) I

(740) Čejović Vladimir, 13. jula 21, Podgorica ME

(511) **Klasa 34:** Duvan, prerađen ili neprerađen, duvan za pušenje, duvan za lule, duvan za ručno uvijanje, duvan za žvakanje, snus duvan, cigarete, cigare, cigarilosi, supstance za pušenje koje se prodaju odvojeno ili miješane sa duvanom, a koje nisu za medicinske svrhe ili u svr-

he liječenja, duvan za ušmrkavanje, artikli za pušače uključeni u klasu 34, papir za cigarete, tube za cigarete i šibice.

(210) **2012-4** (442) **20.12.2013.**  
(220) 12.01.2012.

(731) **EMPERSA CUBANA DEL TABACO (CUBATABACO)**, O' REILLY 104 ENTRE TACON Y MERCADERES, HABANA VIEJA, LA HABANA CU



(540)

(550) I

(740) Stanković Mugoša Ana, Trg Republike 13, Podgorica ME

(511) **Klasa 34:** Duvan, uključujući cigare, cigarete, cigarilose, rezani duvan za rule, artikli za pušače, uključujući pepeljare, nožice za cigare, kutije za šibice, kutije za cigare, šibice.

(210) **2012-40** (442) **20.12.2013.**  
(220) 24.01.2012.

(731) **JT INTERNATIONAL S.A**, 1, RUE DE LA GABELLE, 1211 GENEVA 26 CH



(540)

(550) I

(740) Čejović Vladimir, 13. jula 21, Podgorica ME

(511) **Klasa 34:** Duvan, prerađen ili neprerađen, duvan za pušenje, duvan za lule, duvan za ručno uvijanje, duvan za žvakanje, snus duvan, cigarete, cigare, cigarilosi, supstance za pušenje koje se prodaju odvojeno ili miješane sa duvanom, a koje nisu za medicinske svrhe ili u svrhe liječenja, duvan za ušmrkavanje, artikli za pušače uključeni u klasu 34, papir za cigarete,



tube za cigarete i šibice.

(210) **2012-5** (442) **20.12.2013.**  
(220) 12.01.2012.

(731) **EMPERSA CUBANA DEL TABACO (CUBATABACO)**, O' REILLY 104 ENTRE TACON Y MERCADERES, HABANA VIEJA, LA HABANA CU



(540)

(550) I

(740) Stanković Mugoša Ana, Trg Republike 13, Podgorica ME

(511) **Klasa 34:** Duvan, uključujući cigare, cigarete, cigarilose, rezani duvan za rule, artikli za pušače, uključujući pepeljare, nožiče za cigare, kutije za šibice, kutije za cigare, šibice.

(210) **2012-6** (442) **20.12.2013.**  
(220) 12.01.2012.

(731) **EMPERSA CUBANA DEL TABACO (CUBATABACO)**, O' REILLY 104 ENTRE TACON Y MERCADERES, HABANA VIEJA, LA HABANA CU



(540)

(550) I

(740) Stanković Mugoša Ana, Trg Republike 13, Podgorica ME

(511) **Klasa 34:** Duvan, uključujući cigare, cigarete, cigarilose, rezani duvan za rule, artikli za pušače, uključujući pepeljare, nožiče za cigare, kutije za šibice, kutije za cigare, šibice.

(210) **2012-7** (442) **20.12.2013.**  
(220) 12.01.2012.

(731) **JT INTERNATIONAL S.A**, 1, RUE DE LA GABELLE, 1211 GENEVA 26 CH

## SOBRANIE CONTOUR

(540)

(550) I

(740) Čejović Vladimir, 13. jula 21, Podgorica ME

(511) **Klasa 34:** Duvan, prerađen ili neprerađen, duvan za pušenje, duvan za lule, duvan za ručno uvijanje, duvan za žvakanje, snus duvan, cigarete, cigare, cigarilosi, supstance za pušenje koje se prodaju odvojeno ili miješane sa duvanom, a koje nisu za medicinske svrhe ili u svrhe liječenja, duvan za ušmrkavanje, artikli za pušače uključeni u klasu 34, papir za cigarete, tube za cigarete i šibice.

---

(210) **2012-8**

(442) **20.12.2013.**

(220) 12.01.2012.

(300) 2011 07730 02.11.2011. RO

(731) **JT INTERNATIONAL S.A**, 1, RUE DE LA GABELLE, 1211 GENEVA 26 CH

## DISCERN

(540)

(550) I

(740) Čejović Vladimir, 13. jula 21, Podgorica ME

(511) **Klasa 34:** Duvan, prerađen ili neprerađen, duvan za pušenje, duvan za lule, duvan za ručno uvijanje, duvan za žvakanje, snus duvan, cigarete, cigare, cigarilosi, supstance za pušenje koje se prodaju odvojeno ili miješane sa duvanom, a koje nisu za medicinske svrhe ili u svrhe liječenja, duvan za ušmrkavanje, artikli za pušače uključeni u klasu 34, papir za cigarete, tube za cigarete i šibice.

---

(210) **2012-9**

(442) **20.12.2013.**

(220) 12.01.2012.

(300) 2011 07731 02.11.2011. RO

(731) **JT INTERNATIONAL S.A**, 1, RUE DE LA GABELLE, 1211 GENEVA 26 CH

## ELEVATE

(540)

(550) I

(740) Čejović Vladimir, 13. jula 21, Podgorica ME

(511) **Klasa 34:** Duvan, prerađen ili neprerađen, duvan za pušenje, duvan za lule, duvan za ručno uvijanje, duvan za žvakanje, snus duvan, cigarete, cigare, cigarilosi, supstance za pušenje koje se prodaju odvojeno ili miješane sa duvanom, a koje nisu za medicinske svrhe ili u svrhe liječenja, duvan za ušmrkavanje, artikli za pušače uključeni u klasu 34, papir za cigarete, tube za cigarete i šibice.

(210) **2011-182**(442) **20.12.2013.**

(220) 12.04.2011.

(731) **FINLANDIA VODKA WORLDWIDE LTD**, PORKKALANKATU 24, 00180 HELSINKI FI

(540)

(550) I

(740) Ćupić Branislav, Dalmatinska 10, Podgorica ME

(511) **Klasa 25:** Alkoholna pića, uključujući žestoka pića.(210) **2011-718**(442) **20.12.2013.**

(220) 22.12.2011.

(731) **GARAGE INTERNATIONAL LUX SARL**, 1 ALLEE SCHEFFER, SUITE 2.05.1, L-2520, LUXEMBOURG LU**GRG BY GARAGE**

(540)

(550) I

(740) Čejović Vladimir, 13. jula 21, Podgorica ME

(511) **Klasa 03:** Parfimerija, eterična ulja, kozmetika.**Klasa 18:** Torbe, naprtnjače.

**Klasa 25:** Odjeća, obuća, pokrivala za glavu.

**Klasa 35:** Usluge maloprodajnih objekata u vezi sa parfimerijom, eteričnim uljima, kozmetikom, torbama, naprtnjačama, odjećom, obućom, pokrivalima za glavu.

---

(210) **2012-100** (442) **20.12.2013.**  
(220) 20.02.2012.

(731) **ADIDAS INTERNATIONAL MARKETING BV**, HOODOORDDREEF 9A, 1101 BA  
AMSTERDAM ZO NL

(540) FIT FOAM

(550) I, V

(740) Radulović Božidar, Jovana Tomaševića 9/III, Podgorica ME

(511) **Klasa 25:** Obuća, odjeća.

---

(210) **2012-101** (442) **20.12.2013.**  
(220) 20.02.2012.

(731) **ADIDAS INTERNATIONAL MARKETING BV**, HOODOORDDREEF 9A, 1101 BA  
AMSTERDAM ZO NL

(540) NASTASE

(550) I, V

(740) Radulović Božidar, Jovana Tomaševića 9/III, Podgorica ME

(511) **Klasa 25:** Obuća, odjeća.

---

(210) **2012-102** (442) **20.12.2013.**  
(220) 20.02.2012.

(731) **ADIDAS INTERNATIONAL MARKETING BV**, HOODOORDDREEF 9A, 1101 BA  
AMSTERDAM ZO NL

(540) MICOACH

(550) I, V

(740) Radulović Božidar, Jovana Tomaševića 9/III, Podgorica ME

(511) **Klasa 25:** Obuća, odjeća.

---

(210) **2012-103** (442) **20.12.2013.**  
(220) 20.02.2012.

(731) **ADIDAS INTERNATIONAL MARKETING BV**, HOODOORDDREEF 9A, 1101 BA  
AMSTERDAM ZO NL

(540) STAN SMITH

(550) I, V

(740) Radulović Božidar, Jovana Tomaševića 9/III, Podgorica ME

(511) **Klasa 25:** Obuća za slobodno vrijeme, atletska obuća.

---

(210) **2012-104** (442) **20.12.2013.**  
(220) 20.02.2012.

(731) **ADIDAS INTERNATIONAL MARKETING BV**, HOODOORDDREEF 9A, 1101 BA  
AMSTERDAM ZO NL

(540) POWERWEB

(550) I, V

(740) Radulović Božidar, Jovana Tomaševića 9/III, Podgorica ME

(511) **Klasa 25:** Obuća, odjeća.

(210) **2012-105** (442) **20.12.2013.**  
(220) 20.02.2012.

(731) **ADIDAS INTERNATIONAL MARKETING BV**, HOODOORDDREEF 9A, 1101 BA AMSTERDAM ZO NL

(540) FORMOTION

(550) I, V

(740) Radulović Božidar, Jovana Tomaševića 9/III, Podgorica ME

(511) **Klasa 25:** Obuća, odjeća.

(210) **2012-106** (442) **20.12.2013.**  
(220) 21.02.2012.

(731) **MERCK SHARP&DOHME CORP. ONE MERCK DRIVE**, WHITEHOUSE STATION, NEW JERSEY 08889 US

(540) JACORIN

(550) I

(740) Ćupić Branislav, Dalmatinska 10, Podgorica ME

(511) **Klasa 05:** Farmaceutski preparati za ljudsku upotrebu.

(210) **2012-107** (442) **20.12.2013.**  
(220) 21.02.2012.

(731) **MERCK SHARP&DOHME CORP. ONE MERCK DRIVE**, WHITEHOUSE STATION, NEW JERSEY 08889 US

(540) JUVICOR

(550) I

(740) Ćupić Branislav, Dalmatinska 10, Podgorica ME

(511) **Klasa 05:** Farmaceutski preparati za ljudsku upotrebu.

(210) **2012-108** (442) **20.12.2013.**  
(220) 21.02.2012.

(731) **PETROLEO BRASILEIRO S.A.-PETROBRAS**, AVENIDA REPUBLICA DO CHILE, 65 CENTRO-CEP, 20.031-912, RIO DE JANEIRO, RJ BR

(540) PETROBRAS

(550) I, V

(740) Radulović Božidar, Jovana Tomaševića 9/III, Podgorica ME

(511) **Klasa 01:** Hemijski proizvodi za upotrebu u industriji, naročito motorna ulja i aditivi za benzin, fertilajzeri za upotrebu u poljoprivredi i domaćinstvu, hemikalije za upotrebu u proizvodnji boja i premaza kao i smola a sve sa namenom u proizvodnji inženjerskih plastika.

**Klasa 04:** Butani, aromatski petrolejski ekstrakti ulja za industrijsku upotrebu, prirodni gas, benzin, rafinerijsko rezidualno benzinsko gorivo, naročito metan, etan, etilen, propani i kombinacije istih, gorivno ulje, dizel ulja i goriva, goriva za mlazne (jet) motore, lož ulja za grejanje, emulzivno gorivo za industrijske mašine, nehemijski aditivi koji su po svojoj prirodni sintetički bazni lubrikanti za upotrebu u proizvodnji lubrikanata za različite svrhe, lubrikanti, industrijska ulja, naročito mešavine ugljenih-mineralnih ulja, baznih ulja, ulja za cilindre dizel motora, ulja za osovine-vretena, ulje za gasne turbine, ulje za upotrebu u elektrici i ulje od škrljaca.

**Klasa 35:** Oglašavanje, poslovno upravljanje, poslovna administracija, kancelarijsko poslovanje, usluge agencija za uvoz i izvoz na polju uljnih-naftnih proizvoda, proizvoda uljnih-naftnih rafinerija i dalje obrađenih rafinerijskih proizvoda, usluge maloprodaje u vezi sa uljnim-naftnim proizvodima, proizvodima rafinerija i dalje obrađenih proizvoda rafinerija.

**Klasa 37:** Usluge servisa, usluge servisiranja vozila, uključujući punjenje gorivom, pranje i čišćenje vozila, podmazivanje vozila, održavanje vozila i održavanje i popravka automobila.

**Klasa 39:** Transportne usluge, pakovanje i skladištenje robe, usluge organizovanja putovanja, transport proizvoda kamionom i brodom, skladištenje ulja-nafte i gasa, prenos ulja-nafte i gasa putem cevovoda.

**Klasa 40:** Obrada materijala, naročito obrada sirovih mineralnih ulja u rafinerijama, proizvodnja paleta i linija proizvoda u oblasti mineralnih ulja a po porudžbini i specifikacijama drugih, rafinisanje ulja-nafte i goriva, naročito obrada stena koje sadrže petrolej, naročito škrljaca.

**Klasa 42:** Usluge istraživanja naftnih nalazišta, usluge razvoja u oblasti nafte, naročito usluge bušenja, postavljanja bušotina i testiranja u vezi sa naftom i uljem-naftom iz uljanih škrljaca.

(210) **2012-109**

(442) **20.12.2013.**

(220) 22.02.2012.

(300) 85/4342240

28.09.2011. US

(731) **INTERNATIONAL TRUCK INTELLECTUAL PRPERTY COMPANY, LLC**, 2701 NAVISTAR DRIVE, SUITE 7-3E, LISLE, IL 60532 US

(540) SARATOGA

(550) I

(740) Ćupić Branislav, Dalmatinska 10, Podgorica ME

(511) **Klasa 12:** Oklopna suvozemna vozila.

(210) **2012-110**

(442) **20.12.2013.**

(220) 22.02.2012.

(731) **AVON PRODUCTS, INC** WORLD HEADQUARTERS, 1345 AVENUE OF THE AMERICAS, NEW YORK, NY 10105-0196 US

(540) Budite najbolji uz najbolje

(550) I

(740) Ćupić Branislav, Dalmatinska 10, Podgorica ME

(511) **Klasa 35:** Oglašavanje, vođenje poslova, vođenje administracije, kancelarijski poslovi, usluge distribucije, usluge maloprodaje u radnjama, prodaja od vrata do vrata, direktno savjetovanje putem nezavisnih predstavnika prodaje, i to telefonom, kataloškom prodajom i putem globalne kompjuterske mreže, a sve u vezi sa njegovom ljepote, odjećom, toaletnim preparatima, kozmetikom, nakitom, proizvodima lične njege, nutritivnim dodacima, opremom za vježbanje i fitnesa, sportskom opremom, knjigama, snimljenim video i audio trakama, CD-ova i poklona, usluge promotivnih i reklamnih kampanja na polju angažovanja nezavisnih predstavnika prodaje.

**Klasa 41:** Obrazovanje, usluge treninga, zabave, sportskih i kulturnih aktivnosti, usluge poslovnog obrazovanja i usluge treninga za razvoj i postizanje odgovarajućeg vodstva, usluge edukativno-poslovnog programa za izvršne direktore, zaposlene, saradnike i agente, usluge poslovnog treninga, savjetodavne usluge poslovnog treninga, edukativne usluge putem pružanja nastave, seminara, konferencija i radionica na polju maloprodaje i trgovine proizvodima i distribucije materijala za treninge u vezi sa istim, obrazovne usluge putem održa-

vanja konferencija, nastave, seminara i radionica na polju zdravlja, ishrane, fitnesa, finansija, vježbi, stila, frizura i/ili ljepote.

---

(210) **2012-111** (442) **20.12.2013.**  
(220) 22.02.2012.

(731) **DELTA AIR LINES, INC**, 1030 DELTA BOULEVARD ATLANTA, GEORGIA US

(540) SKY PRIORITY

(550) I

(740) Popović Miladin, Đoka Miraševića 21/III, Podgorica ME

(511) **Klasa 39:** Usluge transporta u vazдушnom saobraćaju i usluge transporta u vazдушnom saobraćaju koje obezbeđuju program za dodatne nagrade i stimulaciju za frekventna vazдушna putovanja, usluge tranzitnih salona za odmor i relaksaciju putnika, usluge specijalizovanih povlašćenih vazduhoplovnih servisa sa odeljenjem za rezervacije, usluge unapređivanja procesa čekiranja na aerodromu, usluge ubrzavanja procedura za pozive na čekanju, usluge čekiranja sa pravom prvenstva, usluge čekiranja za posebno privilegovane putnike, usluge namenskog servisnog centra i usluge VIP prolaza (club lanes), usluge posebnih prioriteta i ubrzanja bezbednosne obrade, usluge ubrzavanja procedura izlaska i vazduhoplovnih servisa za ukrcavanje, usluge unapređivanja smeštaja na rezervisanim i nerezervisanim sedištima, usluge unapređivanja ličnog prostora uz poseban zabavni program, usluge računarskog povezivanja u vazдушnom saobraćaju, usluge unapređivanja služenja obroka i usluge vrednosnih vaučera za elitne putnike, usluge isporuke prioritarnog prtljaga, usluge povećanog i poboljšanog korisničkog servisa za elitne putnike u međunarodnoj klasi 39.

---

(210) **2012-112** (442) **20.12.2013.**  
(220) 22.02.2012.

(731) **FARMACEUTSKA HEMISKA KOZMETIČKA INDUSTRIJA ALKALOID AD-**  
SKOPLJE, BUL. ALEKSANADAR MAKEDONSKI BR. 12, SKOPLJE MK

(540) BECUTAN

(550) I

(740) Popović Miladin, Đoka Miraševića 21/III, Podgorica ME

(511) **Klasa 03:** dječji sapun sa ekstraktom kamilice i d-pantenolom.

---

(210) **2012-113** (442) **20.12.2013.**  
(220) 23.02.2012.

(731) **GOODY'S S.A.** SOCIETE ANONYME OF CATERING SERVICES 10, ZIRIDI STREET, MAROU-  
USSI, ATTICA 151 23 GR

(540) FLOCAFE

(550) I

(740) Čupić Branislav, Dalmatinska 10, Podgorica ME

(511) **Klasa 30:** Kafa, čaj, kakao, šećer, pirinač, tapioka, sago, zamjena kafe, brašno i proizvodi od žitarica, hleb, kolači, poslastice, sladoledi, med, melasa, kvasac, prašak za pecivo, so, senf, sirće, sosovi (kao začini), začini, led.

**Klasa 43:** Usluge obezbeđivanja hrane i pića, usluge restorana uključujući restorane brze hrane, organizacija i vođenje restorana, usluge kateringa, organizacija prijema.

---

(210) **2012-114** (442) **20.12.2013.**  
(220) 23.02.2012.

(731) **GOODY'S S.A.** Societe Anonyme of Catering Services 10, Ziridi street, Maroussi, Attica 151 23 GR

(540) FLOCAFE

(550) I

(740) Ćupić Branislav, Dalmatinska 10, Podgorica ME

(511) **Klasa 30:** Kafa, čaj, kakao, šećer, pirinač, tapioka, sago, zamjena kafe, brašno i proizvodi od žitarica, hleb, kolači, poslastice, sladoledi, med, melasa, kvasac, prašak za pecivo, so, senf, sirće, sosovi (kao začini), začini, led.

**Klasa 43:** Usluge obezbjeđivanja hrane i pića, usluge restorana uključujući restorane brze hrane, organizacija i vođenje restorana, usluge kateringa, organizacija prijema.

(210) **2012-115**

(442) **20.12.2013.**

(220) 23.02.2012.

(731) **GOODY'S S.A.** Societe Anonyme of Catering Services 10, Ziridi street, Maroussi, Attica 151 23 GR

(540) GOODY'S

(550) I

(740) Ćupić Branislav, Dalmatinska 10, Podgorica ME

(511) **Klasa 16:** Hartija, karton i proizvodi od njih, koji nisu uključeni u druge klase, štampane stvari, knjigovezački materijal, fotografije, kancelarijski materijal, ljepila za kancelarijske i kućne potrebe, umjetnički materijali, kičice, pisaće mašine i kancelarijski rekviziti (izuzev namještaja), materijali za obuku i nastavu (izuzev aparata), plastični materijali za pakovanje (koji nisu uključeni u druge klase), karte za igru, štamparska slova, klišeji.

**Klasa 29:** Meso, riba, živina i divljač, mesne prerađevine, konzervisano, sušeno i kuvano voće i povrće, želei, džemovi, kompoti, jaja, mlijeko i mliječni proizvodi, jestiva ulja i masti.

**Klasa 30:** Kafa, čaj, kakao, šećer, pirinač, tapioka, sago, zamjena kafe, brašno i proizvodi od žitarica, hleb, kolači, poslastice, sladoledi, med, melasa, kvasac, prašak za pecivo, so, senf, sirće, sosovi (kao začini), začini,

**Klasa 43:** Usluge obezbjeđivanja hrane i pića, usluge restorana uključujući restorane brze hrane, organizacija i vođenje restorana, usluge kateringa, organizacija prijema.

(210) **2012-116**

(442) **20.12.2013.**

(220) 23.02.2012.

(731) **Kawasho Foods Corporation**, 7-1, Otemachi 2-chome, Chiyoda-ku, Tokyo JP

(540) Geisha

(550) I

(740) Ćupić Branislav, Dalmatinska 10, Podgorica ME

(511) **Klasa 29:** Meso, riba, živina, divljač, voće i povrće, u konzervama, u flašama na drugi način konzervirano.

(210) **2012-118**

(442) **20.12.2013.**

(220) 24.02.2012.

(731) **ADRIATIC MARINAS** doo, Obala bb, 85320 Tivat ME

(540) Premier Marina in the Adriatic

(550) V

(740) Đurović Savo, Dom Vojske, Seljanovo b.b. Tivat ME

(511) **Klasa 36:** Osiguranje, finansijski poslovi, novčani (monetarni) poslovi, poslovi vezani za



nepokretnosti.

**Klasa 39:** Transportne usluge, pakovanje i skladištenje robe, organizovanje putovanja.

**Klasa 41:** Obrazovne usluge, pripremanje obuke, razonoda, sportske i kulturne aktivnosti.

**Klasa 43:** Usluge obezbjeđivanja hrane i pića, privremeni smeštaj.

**Klasa 44:** Medicinske usluge, veterinarske usluge, higijenska zaštita i nega lepote za ljude ili životinje, agrikulturne, hortikulturne i šumarske usluge.

---

(210) **2012-119** (442) **20.12.2013.**

(220) 24.02.2012.

(731) **ADRIATIC MARINAS** doo, Obala bb, 85320 Tivat ME

(540) Premier Marina in the World

(550) V

(740) Đurović Savo, Dom Vojske, Seljanovo b.b. Tivat ME

(511) **Klasa 36:** Osiguranje, finansijski poslovi, novčani (monetarni) poslovi, poslovi vezani za nepokretnosti.

**Klasa 39:** Transportne usluge, pakovanje i skladištenje robe, organizovanje putovanja

**Klasa 41:** Obrazovne usluge, pripremanje obuke, razonoda, sportske i kulturne aktivnosti.

**Klasa 43:** Usluge obezbjeđivanja hrane i pića, privremeni smeštaj.

**Klasa 44:** Medicinske usluge, veterinarske usluge, higijenska zaštita i nega lepote za ljude ili životinje, agrikulturne, hortikulturne i šumarske usluge.

---

(210) **2012-120** (442) **20.12.2013.**

(220) 24.02.2012.

(731) **ADRIATIC MARINAS** doo, Obala bb, 85320 Tivat ME

(540) Yachting Homeport in the Adriatic

(550) V

(740) Đurović Savo, Dom Vojske, Seljanovo b.b. Tivat ME

(511) **Klasa 36:** Osiguranje, finansijski poslovi, novčani (monetarni) poslovi, poslovi vezani za nepokretnosti.

**Klasa 39:** Transportne usluge, pakovanje i skladištenje robe, organizovanje putovanja

**Klasa 41:** Obrazovne usluge, pripremanje obuke, razonoda, sportske i kulturne aktivnosti.

**Klasa 43:** Usluge obezbjeđivanja hrane i pića, privremeni smeštaj.

**Klasa 44:** Medicinske usluge, veterinarske usluge, higijenska zaštita i nega lepote za ljude ili životinje, agrikulturne, hortikulturne i šumarske usluge.

---

(210) **2012-121** (442) **20.12.2013.**

(220) 24.02.2012.

(731) **ADRIATIC MARINAS** doo, Obala bb, 85320 Tivat ME

(540) Yachting Homeport in the Mediterranean

(550) V

(740) Đurović Savo, Dom Vojske, Seljanovo b.b. Tivat ME

(511) **Klasa 36:** Osiguranje, finansijski poslovi, novčani (monetarni) poslovi, poslovi vezani za nepokretnosti.

**Klasa 39:** Transportne usluge, pakovanje i skladištenje robe, organizovanje putovanja

**Klasa 41:** Obrazovne usluge, pripremanje obuke, razonoda, sportske i kulturne aktivnosti.

**Klasa 43:** Usluge obezbjeđivanja hrane i pića, privremeni smeštaj.

**Klasa 44:** Medicinske usluge, veterinarske usluge, higijenska zaštita i nega lepote za ljude ili životinje, agrikulturne, hortikulturne i šumarske usluge.

---

(210) **2012-122** (442) **20.12.2013.**

(220) 24.02.2012.

(731) **ADRIATIC MARINAS** doo, Obala bb, 85320 Tivat ME

(540) Ychting Homeport in the World

(550) V

(740) Đurović Savo, Dom Vojske, Seljanovo b.b. Tivat ME

(511) **Klasa 36:** Osiguranje, finansijski poslovi, novčani (monetarni) poslovi, poslovi vezani za nepokretnosti.

**Klasa 39:** Transportne usluge, pakovanje i skladištenje robe, organizovanje putovanja

**Klasa 41:** Obrazovne usluge, pripremanje obuke, razonoda, sportske i kulturne aktivnosti.

**Klasa 43:** Usluge obezbjeđivanja hrane i pića, privremeni smeštaj.

**Klasa 44:** Medicinske usluge, veterinarske usluge, higijenska zaštita i nega lepote za ljude ili životinje, agrikulturne, hortikulturne i šumarske usluge.

---

(210) **2012-123** (442) **20.12.2013.**

(220) 24.02.2012.

(731) **ADRIATIC MARINAS** doo, Obala bb, 85320 Tivat ME

(540) Premier Marina in the Mediterraeen

(550) V

(740) Đurović Savo, Dom Vojske, Seljanovo b.b. Tivat ME

(511) **Klasa 36:** Osiguranje, finansijski poslovi, novčani (monetarni) poslovi, poslovi vezani za nepokretnosti.

**Klasa 39:** Transportne usluge, pakovanje i skladištenje robe, organizovanje putovanja

**Klasa 41:** Obrazovne usluge, pripremanje obuke, razonoda, sportske i kulturne aktivnosti.

**Klasa 43:** Usluge obezbjeđivanja hrane i pića, privremeni smeštaj.

**Klasa 44:** Medicinske usluge, veterinarske usluge, higijenska zaštita i nega lepote za ljude ili životinje, agrikulturne, hortikulturne i šumarske usluge.

---

(210) **2012-124** (442) **20.12.2013.**

(220) 24.02.2012.

(731) **Merck Sharp&Dohme Corp.** One Merck Drive, Whitehouse Station, New Jersey 08889 US

(540) TESLITA

(550) I

(740) Ćupić Branislav, Dalmatinska 10, Podgorica ME

(511) **Klasa 05:** Farmaceutski preparati za prevenciju i liječenje dijabetesa.

---

(210) **2012-125** (442) **20.12.2013.**

(220) 24.02.2012.

(731) **BUSINESS WIRE**, Inc. 44 Montgomery Street, 39th Flor, San Francisco, California 94104 US

## BUSINESS WIRE

(540)

(550) I

(740) Ćupić Branislav, Dalmatinska 10, Podgorica ME

(511) **Klasa 09:** Elektronski bilteni, saopštenja i vijesti (novosti).

**Klasa 38:** Elektronski prenos poruka i slika, podataka i dokumenata, preko kompjuterskog terminala, interneta, satelitskog i bežičnog prenosa, elektronska pošta, faksimilni prenos.

**Klasa 41:** Objavljivanje (izdavanje) biltena, saopštenja i vijesti (novosti).

---

(210) **2012-126**

(442) **20.12.2013.**

(220) 24.02.2012.

(731) **Philip Morris Brands Sarl**, Quai Jeanrenaud 3, Neuchatel 2000 CH

(540) TWIST

(550) I

(740) Kojić Ivana, Serdara Jola Piletića bb, Podgorica ME

(511) **Klasa 34:** Duvan, sirov ili prerađen, duvanski proizvodi, naročito cigare, cigarete, cigarilosi/male cigarete, duvan za ručno uvijanje cigareta, duvan za lule, duvan za žvakanje, duvan za šmrkanje, kretek, snus (duvan u prahu), zamena za duvan (za nemedicinsku upotrebu), artikli za pušaće, naročito papir za cigarete i lule, fiiteri za cigarete, kutije za duvan (od neplemenitih metala), tabakere (kutije za cigarete) i pepeljare (od neplemenitih metala), lule, ručni aparati/spravice za uvijanje cigareta, upaljači, šibice.

---

(210) **2012-128**

(442) **20.12.2013.**

(220) 27.02.2012.

(731) **GENERAL MOTORS LLC** (kompanija organizovana po propisima države Delaware), 300 Renaissance Center, Detroit, Michigan 48265-3000 US

(540) STINGRAY

(550) I

(740) Radulović Božidar, Jovana Tomaševića 9/III, Podgorica ME

(511) **Klasa 12:** Automobili.

---

(210) **2012-129**

(442) **20.12.2013.**

(220) 28.02.2012.

(731) **SKKR ALDINA**, Korać Mirsad, Miladina Radulovića 103, Novi Pazar RS



(540)

(550) I

(511) **Klasa 25:** odjeća, obuća, pokrivala za glavu, pantalone, košulje, jakne, majice, donji veš, čarape, kape, kačketi, šeširi, cipele, čizme, sandale, papuče, patike.

(210) **2012-130**(442) **20.12.2013.**

(220) 29.02.2012.

(731) **PETROL. SLOVENSKA ENERGETSKA DRUŽBA** D.D. LJUBLJANA, DUNAJSKA C.50, 1527 LJUBLJANA SI



(540)

(550) I

(740) Popović Miladin, Đoka Miraševića 21/III, Podgorica ME

(511) **Klasa 16:** Hartija, karton i proizvodi od njih, koji nisu uključeni u druge klase, štampane stvari, knjigovezački materijal, fotografije, kancelarijski materijal, lepkovi za kancelarijske i kućne potrebe, umetnički materijali, kičice, pisaće mašine i kancelarijski pribor (izuzev nameštaja), materijali za obuku i nastavu (izuzev aparata), plastični materijal za pakovanje (koji nije uključen u druge klase), štamparska slova, klišeji.

**Klasa 18:** Koža i imitacija kože, proizvodi izradeni od ovih materijala koji nisu uključeni u druge klase, životinjska koža, krzno, koferi i putne torbe, kišobrani i suncobrani, štapovi za hodanje, bičevi, saračka i sedlarska roba.

**Klasa 25:** Odeća, obuća, pokrivala za glavu.

**Klasa 28:** Igre i igračke, gimnastički i sportski artikli koji nisu obuhvaćeni drugim klasama, ukrasi za jelke.

**Klasa 29:** Meso, riba, živina i divljač, mesne prerađevine, konzervisano, zamrznuto sušeno i kuvano voće i povrće, želei, džemovi, kompoti, jaja, mleko i mlečni proizvodi, jestiva ulja i masti.

**Klasa 30:** Kafa, čaj, kakao i zamena kafe, pirinač, tapioca i sago, brašno i proizvodi od žitarica, hleb, kolači i poslastice, sladoledi, šećer, med, melasa, kvasac, prašak za pecivo, so, senf,

sirće, sosovi (kao dodaci), začini, led.

**Klasa 32:** Pivo, mineralne i sodne vode i druga bezalkoholna pića, voćni napici i voćni sokovi, sirupi i drugi preparati za proizvodnju pića.

**Klasa 33:** Alkoholna pića (izuzev piva).

**Klasa 35:** Oglašavanje, vođenje poslova, poslovno upravljanje, kancelarijski poslovi.

**Klasa 43:** Usluge obezbeđivanja hrane i pića, privremeni smeštaj.

---

(210) **2012-131**

(442) **20.12.2013.**

(220) 29.02.2012.

(731) **PETROL, SLOVENSKA ENERGETSKA DRUŽBA** D.D. LJUBLJANA, Dunajska C.50, 1527 Ljubljana SI

## HIP SHOP

(540)

(550) I

(740) Popović Miladin, Đoka Miraševića 21/III, Podgorica ME

(511) **Klasa 16:** Hartija, karton i proizvodi od njih, koji nisu uključeni u druge klase, štampane stvari, knjigovezački materijal, fotografije, kancelarijski materijal, lepkovi za kancelarijske i kućne potrebe, umetnički materijali, kičice, pisaće mašine i kancelarijski pribor (izuzev nameštaja), materijali za obuku i nastavu (izuzev aparata), plastični materijal za pakovanje (koji nije uključen u druge klase), štamparska slova, klišeji.

**Klasa 18:** Koža i imitacija kože, proizvodi izradeni od ovih materijala koji nisu uključeni u druge klase, životinjska koža, krzno, koferi i putne torbe, kišobrani i suncobrani, štapovi za hodanje, bičevi, saračka i sedlarska roba.

**Klasa 25:** Odeća, obuća, pokrivala za glavu.

**Klasa 28:** Igre i igračke, gimnastički i sportski artikli koji nisu obuhvaćeni drugim klasama, ukrasi za jelke.

**Klasa 29:** Meso, riba, živina i divljač, mesne prerađevine, konzervisano, zamrznuto sušeno i kuvano voće i povrće, želei, džemovi, kompoti, jaja, mleko i mlečni proizvodi, jestiva ulja i masti.

**Klasa 30:** Kafa, čaj, kakao i zamena kafe, pirinač, tapioca i sago, brašno i proizvodi od žitarica, hleb, kolači i poslastice, sladoledi, šećer, med, melasa, kvasac, prašak za pecivo, so, senf, sirće, sosovi (kao dodaci), začini, led.

**Klasa 32:** Pivo, mineralne i sodne vode i druga bezalkoholna pića, voćni napici i voćni sokovi, sirupi i drugi preparati za proizvodnju pića.

**Klasa 33:** Alkoholna pića (izuzev piva).

**Klasa 35:** Oglašavanje, vođenje poslova, poslovno upravljanje, kancelarijski poslovi.

**Klasa 43:** Usluge obezbeđivanja hrane i pića, privremeni smeštaj.

---

(210) **2012-132**

(442) **20.12.2013.**

(220) 29.02.2012.

(300) 047 698.5/09 31.08.2011. DE

(731) **Deutche Telecom AG**, Friedrich-Ebert-Allee 140, 53113 Bonn DE

(540) VIDEOMEET

(550) I

(740) Popović Miladin, Đoka Miraševića 21/III, Podgorica ME

(511) **Klasa 09:** Kompjuterski softver, kompjuterski softver za upotrebu u organizaciji, prenosu, manipulisanju i pregledanju teksta, podataka i audio datoteka na elektronskim uređajima, komunikacioni softver, komunikacioni softver za stvaranje i prenos audio i video sadržaja putem Interneta, komunikacioni softver za smještaj i održavanje internetske stranice (hosting), spajanje, upravljanje, raspoređivanje i strujanje (streaming) konferencijskih poziva kompjuterske mreže, video konferencijski pozivi i instant slanje i primanje poruka putem Interneta.

**Klasa 38:** Elektronski prenos podataka i dokumenata putem kompjuterskih terminala i Internet mreže, komunikacione usluge, naime prenos vijesti uživo i prethodno snimljenih vijesti, slika, audio i audio-vizuelnog sadržaja putem Interneta, usluge slanja i primanja video poruka, instant slanje i primanje poruka i usluge video konferencija, strujanje (streaming) audio-vizuelnog materijala na Internetu.

**Klasa 41:** Usluge snimanja poruka uživo ili prethodno snimljenih poruka, slika, zvuka i audio-vizuelnog sadržaja putem Interneta.

**Klasa 42:** Usluge dizajniranja kompjuterskog softvera i hardvera za upotrebu u telekomunikacijama i prenos audio i video podataka putem Interneta, kompjuterske usluge u vezi sa elektronskim skladištenjem podataka i dizajniranjem kompjuterskog softvera, odnosno za upotrebu u telekomunikacijama, prenosu podataka i audio prinosu, pružanje upotrebe kompjuterskog softvera on-line, pružanje on-line softvera za preuzimanje.

(210) **2012-133**

(442) **20.12.2013.**

(220) 01.03.2012.

(731) **JOHNSON&JOHNSON** (NEW JERSEY CORPORATION), ONE JOHNSON&JOHNSON PLAZA, NEW BRUNSWICK, NEW JERSEY US

(540) CLEAN & CLEAR

(550) I

(740) Radulović Božidar, Jovana Tomaševića 9/III, Podgorica ME

(511) **Klasa 03:** Kozmetički i toaletni proizvodi za negu kože i kose, sredstva za pranje tela, proizvodi za čišćenje, skrab za lice.

**Klasa 05:** Medicinski proizvodi za čišćenje kože, medicinska sredstva za pranje lica i tela, i medicinski skrab za lice i telo, medicinske trake za nos za tretiranje mitisera, medicinski flasteri za akne, preparati za tretiranje akni, medicinski proizvodi za skupljanje tkiva, medicinska sredstva za davanje vlažnosti koži i za čišćenje kože.

**Klasa 16:** Ubrusi za jednokratnu upotrebu koji nisu impregnirani hemijskim proizvodima ili jedinjenjima za upotrebu kao kozmetički upijajući listovi za upijanje masnoće sa lica.

**Klasa 21:** Uređaji za eksfolijaciju i čišćenje, naročito, ručni Uređaji sa baterijskim napajanjem koji se koriste za čišćenje i eksfolijaciju kože, jastučići za eksfolijaciju lica.

(210) **2012-134**

(442) **20.12.2013.**

(220) 02.03.2012.

(731) **YANMAR CO. LTD.** 1-9, Tsurunicho, Kita-ku, Osaka JP

(540) YANMAR

(550) I

(740) Ćupić Branislav, Dalmatinska 10, Podgorica ME

(511) **Klasa 04:** Mineralna ulja i maziva za industrijsku upotrebu (ne za gorivo), ne-mineralna ulja i maziva za industrijsku upotrebu (osim za goriva), goriva, voskovi (sirovi materijal), čvrsta maziva, sirovo ulje ili rafinisano ulje, industrijsko ulje, motorno ulje, lubrikanti, dizel ulje za sagorijevanje, lako ulje, ulje za motore sa unutrašnjim sagorijevanjem, ulje za sagorijevanje.

**Klasa 07:** Generatori struje sa sistemima za iskorišćenje otpadne toplote, poljoprivredne alatke (osim onih kojima se ručno upravlja), poljoprivredne mašine kao što su kombajni, rasađivač pirinča, vezači, pokretne vršalice, aparati i uređaji za razdvajanje opne od zrna pirinča, motorni orači, sjekači za grmlje, rasađivači i sijačice za povrće, kosačice, motori i pogonske mašine (osim za suvozemna vozila), djelovi i oprema za sve vrste motora i pogonske mašine svih vrsta (osim za suvozemna vozila), dizel motori, benzinski motori, motori za plovila, kompresori za plovila, ležaj osovine klipa, klipovi, osovine klipa, karike, klipni prsteni, filteri za gorivo, pumpe, pumpe-mašine, gasne toplotne pumpe, generatori struje kao što su dizel generatori, benzinski generator, gasni generator, građevinske mašine i aparati, mašine i alati za utovar-istovar, djelovi i oprema za iste, građevinske mašine, ekskavatori, utovarivači, kopačice, buldožeri, nosači, plugovi za snijeg, potopivi uređaji za čišćenje ribarskih mreža, automatski odstranjivači ljuske za pirinač, sorter po bojama, odvijlač kamenčića sa pirinča, abrazivni aparat za poliranje pirinča, separator zrna pirinča, čistač zrna pirinča, mašine za razvrstavanje po debljini, mašine za razvrstavanje po usjeku, pomoćni dodaci za mlinove.

**Klasa 11:** Klima uređaji, gasne toplotne pumpe-sistemi klima, uređaja, bojleri, uređaji i instalacije za rashladivanje, kućišta za rashladivanje, aparati za sušenje stočne hrane, izmjenjivaci toplote, pokretni uređaji za osvjetljavanje.

**Klasa 12:** Motorizovani nosači za sve terene, motori i stojevi za suvozemna vozila, plovila kao što su jahte i pecaroški brodovi i njihovi djelovi i oprema, traktori i traktori za poljoprivredu.

**Klasa 16:** Kutije od papira ili kartona, papir za pakovanje, kese koverta, vrećice za pakovanje od papira ili plastike.

**Klasa 37:** Usluge za instalaciju i popravku opreme za grijanje, usluge instalacije i popravke klima uređaja.

(210) **2012-135**

(442) **20.12.2013.**

(220) 05.03.2012.

(300) 2011 08899 20.12.2011. RO

(731) **JT International** S.A. 1, rue de la Gabele 1211 Geneva 26 CH

(540) SOBRANIE ULTIMO

(550) I

(740) Čejović Vladimir, 13. jula 21, Podgorica ME

(511) **Klasa 34:** Duvan, prerađen ili neprerađen, duvan za pušenje, duvan za lule, duvan za ručno uvijanje, duvan za žvakanje, snus duvan, cigarete, cigare, cigarilosi, supstance za pušenje koje se prodaju odvojeno ili miješane sa duvanom, a koje nisu za medicinske svrhe ili u svrhe liječenja, duvan za ušmrkavanje, artikli za pušaće uključeni u klasu 34, papir za cigarete, tube za cigarete i šibice.

(210) **2012-136**

(442) **20.12.2013.**

(220) 05.03.2012.

(300) 2011 08897 20.12.2011. RO

(731) **JT International** S.A. 1, rue de la Gabele 1211 Geneva 26 CH

(540) SOBRANIE DISTINCT

(550) I

(740) Čejović Vladimir, 13. jula 21, Podgorica ME

(511) **Klasa 34:** Duvan, prerađen ili neprerađen, duvan za pušenje, duvan za lule, duvan za ručno uvijanje, duvan za žvakanje, snus duvan, cigarete, cigare, cigarilosi, supstance za pušenje koje se prodaju odvojeno ili miješane sa duvanom, a koje nisu za medicinske svrhe ili u svrhe liječenja, duvan za ušmrkavanje, artikli za pušače uključeni u klasu 34, papir za cigarete, tube za cigarete i šibice.

(210) **2012-137**

(442) **20.12.2013.**

(220) 05.03.2012.

(300) 2011 08898 20.12.2011. RO

(731) **JT International S.A.** 1, rue de la Gabele 1211 Geneva 26 CH

(540) SOBRANIE SUPREMACY

(550) I

(740) Čejović Vladimir, 13. jula 21, Podgorica ME

(511) **Klasa 34:** Duvan, prerađen ili neprerađen, duvan za pušenje, duvan za lule, duvan za ručno uvijanje, duvan za žvakanje, snus duvan, cigarete, cigare, cigarilosi, supstance za pušenje koje se prodaju odvojeno ili miješane sa duvanom, a koje nisu za medicinske svrhe ili u svrhe liječenja, duvan za ušmrkavanje, artikli za pušače uključeni u klasu 34, papir za cigarete, tube za cigarete i šibice.

(210) **2012-138**

(442) **20.12.2013.**

(220) 05.03.2012.

(731) **Nanyang Brothers Tobacco Company Limited**, 9 Tsing Yeung Circuit, Tuen Mun, New Territories, Hong Kong HK

紅 雙 喜

(540)

(550) I

(740) Otašević Đuro, Serdara Jola Piletića bb, Podgorica ME

(511) **Klasa 34:** Cigarete, duvan, artikli za pušače, šibice.

(210) **2012-139**

(442) **20.12.2013.**

(220) 05.03.2012.

(731) **Nanyang Brothers Tobacco Company Limited**, 9 Tsing Yeung Circuit, Tuen Mun, New Territories, Hong Kong HK



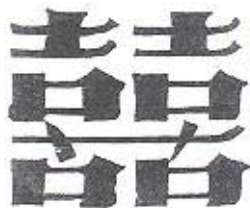

(540)

(550) I

(740) Otašević Đuro, Serdara Jola Piletića bb, Podgorica ME

(511) **Klasa 34:** Cigarete, duvan, artikli za pušače, šibice.(210) **2012-140**(442) **20.12.2013.**

(220) 05.03.2012.

(731) **Nanyang Brothers Tobacco Company Limited**, 9 Tsing Yeung Circuit, Tuen Mun, New Territories, Hong Kong HK

(540) DOUBLE HAPPINESS

(550) I

(740) Otašević Đuro, Serdara Jola Piletića bb, Podgorica ME

(511) **Klasa 34:** Cigarete, duvan, artikli za pušače, šibice.(210) **2012-141**(442) **20.12.2013.**

(220) 05.03.2012.

(731) **Nanyang Brothers Tobacco Company Limited**, 9 Tsing Yeung Circuit, Tuen Mun, New Territories, Hong Kong HK

(540)

(550) I

(740) Otašević Đuro, Serdara Jola Piletića bb, Podgorica ME

(511) **Klasa 34:** Cigarete, duvan, artikli za pušače, šibice.(210) **2012-142**(442) **20.12.2013.**

(220) 06.03.2012.

(731) **SK HOLDING CO. LTD.** 99 Seorin-dong Jongro-gu, Seul KR



(540)

(550) I

(740) Popović Miladin, Đoka Miraševića 21/III, Podgorica ME

(511) **Klasa 09:** Poluprovodnici, silikonski vaferi, integrisana kola, memorijske kartice, poluprovodnički čipovi, poluprovodničke memorije, poluprovodnički memorijski uređaj, aparati instrumenti naučni, pomorski, geodetski, fotografski, kinematografski, optički, za vaganje, mjerenje, signalizaciju, kontrolu (inspekciju), spašavanje i nastavu, aparati i instrumenti za provođenje, prekid, transformaciju, akumulaciju, regulisanje ili kontrolu elektriciteta, aparati za snimanje, prenos ili reprodukovanje zvuka ili slike, magnetni nosači podataka, diskovi za snimanje, kompakt diskovi, DVD-ovi i drugi digitalni medijumi za snimanje, mehanizmi za aparate koji se pokreću novcem ili žetonom, registar kase, računске mašine, oprema za obradu podataka, računari, računarski softver, aparati za gašenje požara.

(210) **2012-143**

(442) **20.12.2013.**

(220) 07.03.2012.

(731) **Alloy Rods Global, Inc.** 1105 N. Market Street, Suite 1300, Wilmington Delaware 19899-8985 US



(540)

(550) I

(740) Popović Miladin, Đoka Miraševića 21/III, Podgorica ME

(511) **Klasa 09:** Šipke za zavarivanje.

(210) **2012-144**

(442) **20.12.2013.**

(220) 07.03.2012.

(731) **ALLOY RODS GLOBAL, INC.** 1105 N.MARKET STREET, SUITE 1300, WILMINGTON DE-LAWARE 19899-8985 US

(540) DUAL SHIELD

(550) I

(740) Popović Miladin, Đoka Miraševića 21/III, Podgorica ME

(511) **Klasa 09:** Elektrode za elektro lučno zavarivanje i aparati za električno lučno zavarivanje i njihovi djelovi.

(210) **2012-145**

(442) **20.12.2013.**

(220) 08.03.2012.

(731) **Japan Tobacco** Inc. 2-2-1 Toranomom, Minato-ku Tokio JP

(540) WINSTON FREE XSTYLE

(550) I

(740) Čejović Vladimir, 13. jula 21, Podgorica ME

(511) **Klasa 34:** Duvan, prerađen ili neprerađen, duvan za pušenje, duvan za lule, duvan za ručno uvijanje, duvan za žvakanje, snus duvan, cigarete, cigare, cigarilosi, supstance za pušenje koje se prodaju odvojeno ili miješane sa duvanom, a koje nisu za medicinske svrhe ili u svrhe liječenja, duvan za ušmrkavanje, artikli za pušaće uključeni u klasu 34, papir za cigarete, tube za cigarete i šibice.

(210) **2012-146**

(442) **20.12.2013.**

(220) 08.03.2012.

(731) **EURO-PRO OPERATING LLC** (DELAWARE LIMITED LIABILITY COMPANY), 180 WELLS AVENUE, SUITE 200, NEWTON, MASSACHUSETTS 02459 US

(540) EURO-PRO

(550) I

(740) Radulović Božidar, Jovana Tomaševića 9/III, Podgorica ME

(511) **Klasa 07:** Mašine i mašinski alati, motori i pogonske mašine (osim za suvozemna vozila), mašinske spojnice i transmisioni elementi (osim za suvozemna vozila), poljoprivredne sprave osim onih kojima se ručno upravlja, inkubatori za jaja, automatske mašine za prodaju, usisivači, šivaće mašine, višenamenske mašine za čišćenje na paru i kuhinjski električni uređaji, naročito, blenderi za hranu za upotrebu u domaćinstvu, mikseri, seckalice, aparati za ceđenje voća i sokovnici i uređaji za obradu hrane.

**Klasa 09:** Aparati i instrumenti naučni, pomorski, geodetski, fotografski, kinematografski, optički, za vaganje, merenje, signalizaciju, kontrolu (inspekciju), spašavanje i nastavu, aparati i instrumenti za provođenje, prekid, transformaciju, akumulaciju, regulisanje ili kontrolu električne energije, aparati za snimanje, prenos i reprodukovanje zvuka ili slike, magnetni nosači podataka, diskovi za snimanje, kompakt diskovi, DVD i drugi digitalni nosači podataka, mehanizmi za aparate koji se pokreću novcem ili žetonom, registar kase, računске mašine, oprema za obradu podataka, računari, računarski softver, aparati za gašenje požara, pegle na paru i električne pegle za upotrebu u domaćinstvu.

**Klasa 11:** Aparati za osvetljavanje, grejanje, proizvodnju pare, kuvanje, hladenje, sušenje, ventilaciju, snabdevanje vodom i za sanitarne svrhe, uređaji za precišćavanje vazduha za upotrebu u domaćinstvu i uređaji za povećavanje vlažnosti vazduha, aparati za prženje i grilovanje.

**Klasa 21:** Kućne ili kuhinjske sprave i posude (ne od dragocenih metala ili sa prevlakom od njih), češljevi i sunderi, četke (izuzev kičica), materijali za pravljenje četki, pribor za čišćenje, čelicna vuna, neprerađeno ili poluprerađeno staklo (osim stakla koje se koristi u građevinarstvu), staklarija, porcelan i grnčarija koja nije uključena u druge klase, posude za kuvanje, naročito tiganji za prženje, metalne šerpe za kuvanje, lonci i poklopci, posude za pečenje.

(210) **2012-147** (442) **20.12.2013.**  
(220) 08.03.2012.

(731) **Euro-pro Operating LLC** (Delaware Limited Liability Company), 180 Wells Avenue, Suite 200, Newton, Massachusetts 02459 US

(540) SHARK

(550) I

(740) Radulović Božidar, Jovana Tomaševića 9/III, Podgorica ME

(511) **Klasa 07:** Mašine i mašinski alati, motori i pogonske mašine (osim za suvozemna vozila), mašinske spojnice i transmisioni elementi (osim za suvozemna vozila), poljoprivredne sprave osim onih kojima se ručno upravlja, inkubatori za jaja, automatske mašine za prodaju, usisivači i višenamenske mašine za čišćenje na paru za upotrebu u domaćinstvu.

**Klasa 09:** Pegle na paru za upotrebu u domaćinstvu, električne pegle za upotrebu u domaćinstvu.

(210) **2012-148** (442) **20.12.2013.**  
(220) 08.03.2012.

(731) **KONSTA DOO**, Đjenovići bb, Herceg Novi ME



(540)

(550) I

(511) **Klasa 14:** Dragoceni metali i njihove legure i proizvodi od dragocenih metala ili sa prevlakom od njih, koji nisu uključeni u druge klase, nakit, drago kamenje, časovničarski i hronometrijski instrumenti.

**Klasa 16:** Hartija, karton i proizvodi od njih, koji nisu uključeni u druge klase.

**Klasa 18:** Koža i imitacija kože, proizvodi izrađeni od ovih materijala koji nisu uključeni u druge klase, životinjska koža, krzno, koferi i putne torbe, kišobrani, suncobrani i štapovi za hodanje, bičevi, saračka i sedlarska oprema.

**Klasa 20:** Nameštaj, ogledala, okviri za slike.

**Klasa 21:** Kućne ili kuhinjske sprave i posude češljevi i sunđer, četke (izuzev kičica), materijali za pravljenje četki, artikli koji se koriste pri čišćenju, čelična vuna, neprerađeno ili poluprerađeno staklo (osim stakla koje se koristi u građevinarstvu), staklarija, porcelan, fajans, grnčarija i lončarija koja nije uključena u druge klase.

**Klasa 25:** Odeća, obuća, pokrivala za glavu.

**Klasa 26:** Čipka i vez, trake (pantljike) i gajtani, dugmad, kopče i petlje, špenadle i igle, veštačko cveće.

**Klasa 28:** Igre i igračke.

(210) **2012-149** (442) **20.12.2013.**  
(220) 12.03.2012.

(731) **RIBNICA COMMERCE D.O.O, ZELENICA BB, PODGORICA ME**



(550) I

(511) **Klasa 35:** Uvoz sledeće robe: Sektor prehrane, konzervisana tunjevina pekarski proizvodi sokovi kornifleksi konzervisano povrće maslinovo i jestivo ulje brašno suvo voće i povrće, Sektor sitnih kućanskih aparata i predmeta za opštu upotrebu, kućanski aparati (pegle, fenovi, kafemati, depilatori, kuvala za vodu, radijatori, tosteri, sokovnici), predmeti za opštu upotrebu (čaje, šolje, lonci, tanjiri, escajg), Sektor profesionalne opreme za trgovinske i ugostiteljske objekte, oprema za markete i trgovine: (rashladne vitrine, ormari, mesoreznice, kafemati, metalne police) oprema za ugostiteljske objekte i hotele (profesionalne kuhinje, pica peći, konvektomati, mikseri, hamburger prese).

(210) **2012-150** (442) **20.12.2013.**  
(220) 12.03.2012.

(731) **RIBNICA COMMERCE D.O.O, ZELENICA BB, PODGORICA ME**



(550) I

(511) **Klasa 35:** Uvoz sledeće robe: Sektor prehrane, konzervisana tunjevina pekarski proizvodi sokovi kornifleksi konzervisano povrće maslinovo i jestivo ulje brašno suvo voće i povrće, Sektor sitnih kućanskih aparata i predmeta za opštu upotrebu, kućanski aparati (pegle, fenovi, kafemati, depilatori, kuvala za vodu, radijatori, tosteri, sokovnici), predmeti za opštu upotrebu (čaje, šolje, lonci, tanjiri, escajg), Sektor profesionalne opreme za trgovinske i ugostiteljske objekte, oprema za markete i trgovine: (rashladne vitrine, ormari, mesoreznice, kafemati, metalne police) oprema za ugostiteljske objekte i hotele (profesionalne kuhinje, pica peći, konvektomati, mikseri, hamburger prese).

(210) **2012-151** (442) **20.12.2013.**  
(220) 12.03.2012.

(731) **RIBNICA COMMERCE D.O.O, ZELENICA BB, PODGORICA ME**



(550) I

(511) **Klasa 35:** Uvoz sledeće robe: Sektor prehrane, konzervisana tunjevina pekarski proizvodi sokovi kornifleksi konzervisano povrće maslinovo i jestivo ulje brašno suvo voće i povrće, Sektor sitnih kućanskih aparata i predmeta za opštu upotrebu, kućanski aparati (pegle, fenovi, kafemati, depilatori, kuvala za vodu, radijatori, tosteri, sokovnici), predmeti za opštu upotrebu (čaje, šolje, lonci, tanjiri, escajg), Sektor profesionalne opreme za trgovinske i ugostiteljske objekte, oprema za markete i trgovine: (rashladne vitrine, ormari, mesoreznice, kafemati, metalne police) oprema za ugostiteljske objekte i hotele (profesionalne kuhinje, pica peći, konvektomati, mikseri, hamburger prese).

(210) 2012-167

(442) 20.12.2013.

(220) 04.04.2012.

(731) THE COCA-COLA COMPANY, ONE COCA-COLA PLAZA, ATLANTA, GEORGIA 30313 US



(540)

(550) I

(740) Popović Miladin, Đoka Miraševića 21/III, Podgorica ME

(511) **Klasa 21:** Kućne ili kuhinjske sprave i posude, češljevi i sunđeri, četke (izuzev kičica), materijali za pravljenje četki, pribor za čišćenje, čelična vuna, neprerađeno ili poluprerađeno staklo (osim stakla koje se koristi u građevinarstvu), staklarija, porcelan i grnčanja koja nije uključena u druge klase.

**Klasa 32:** Pivo, mineralne i sodne vode i druga bezalkoholna pića, voćni napici i voćni sokovi, sirupi i drugi preparati za proizvodnju pića.

(210) 2012-175

(442) 20.12.2013.

(220) 06.04.2012.

(731) THE COCA-COLA COMPANY, ONE COCA-COLA PLAZA, ATLANTA, GEORGIA 30313 US



(540)

(550) I

(740) Popović Miladin, Đoka Miraševića 21/III, Podgorica ME

(511) **Klasa 06:** Obični metali i njihove legure, metalni građevinski materijali, metalne prenosive konstrukcije, materijali od metala za železničke šine, neelektrični kablovi i žice od običnog metala, bravarski proizvodi, mali metalni gvoždarski proizvodi, cevčice i cevi od metala, sefovi, proizvodi od običnih metala koji nisu uključeni u druge klase, rude.

**Klasa 16:** Hartija, karton i proizvodi od njih, koji nijesu uključeni u druge klase, štampane stvari, knjigovezački materijal, fotografije, kancelarijski materijal, lepkovi za kancelarijske i kućne

potrebe, umetnički materijali, kičice, pisaće mašine i kancelarijski pribor (izuzev nameštaja), materijali za obuku i nastavu (izuzev aparata), plastični materijal za pakovanje (koji nije uključen u druge klase), štamparska slova, klišeji.

**Klasa 21:** Kućne ili kuhinjske sprave i posude, češljevi i sunđeri, četke (izuzev kičica), materijali za pravljenje četki, pribor za čišćenje, čelična vuna, neprerađeno ili poluprerađeno staklo (osim stakla koje se koristi u građevinarstvu), staklarija, porcelan i grnčarija koja nije uključena u druge klase.

**Klasa 25:** Odeća, obuća, pokrivala za glavu.

**Klasa 28:** Igre i igračke, gimnastički i sportski artikli koji nijesu obuhvaćeni drugim klasama, ukrasi za jelke.

**Klasa 32:** Pivo, mineralne i sodne vode i druga bezalkoholna pića, voćni napici i voćni sokovi, sirupi i drugi preparati za proizvodnju pića.

**Klasa 41:** Obrazovne usluge, pripremanje obuke, razonoda, sportske i kulturne aktivnosti.

(210) **2012-176**

(442) **20.12.2013.**

(220) 09.04.2012.

(731) **ALKALOID AD** SKOPLJE, BUL. ALEKSANDAR MAKEDONSKI 12, SKOPLJE MK



(540) \_\_\_\_\_

(550) I

(740) Popović Miladin, Đoka Miraševića 21/III, Podgorica ME

(511) **Klasa 03:** Šampon i penušava kupka za djecu.

(210) **2012-177**

(442) **20.12.2013.**

(220) 09.04.2012.

(731) **ALKALOID AD** SKOPLJE, BUL. ALEKSANDAR MAKEDONSKI 12, SKOPLJE MK

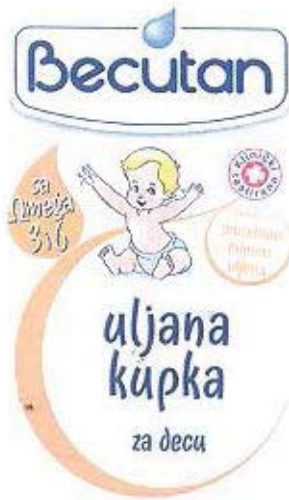

(540)

(550) I

(740) Popović Miladin, Đoka Miraševića 21/III, Podgorica ME

(511) **Klasa 03:** Uljana kupka za djecu.(210) **2012-179**(442) **20.12.2013.**

(220) 10.04.2012.

(731) **SVJETLOST-MONT**, BULEVAR REVOLUCIJE G-12, BAR ME

(540)

(550) I, V, T

(740) VIS LEGIS D.O.O. POSLOVNI CENTAR G-9, BAR ME

(511) **Klasa 39:** Transportne usluge, pakovanje i skladištenje robe, organizovanje putovanja.**Klasa 41:** Obrazovne usluge, pripremanje obuke, razonoda, sportske i kulturne aktivnosti.**Klasa 43:** Usluge obezbeđivanja hrane i pića, privremeni smeštaj.(210) **2012-183**(442) **20.12.2013.**

(220) 12.04.2012.

(731) **THE COCA-COLA COMPANY**, ONE COCA-COLA PLAZA, ATLANTA, GEORGIA 30313 US





(540)

(550) I

(740) Popović Miladin, Đoka Miraševića 21/III, Podgorica ME

(511) **Klasa 16:** Hartija, karton i proizvodi od njih, koji nijesu uključeni u druge klase, štampane stvari, knjigovezački materijal, fotografije, kancelarijski materijal, lepkovi za kancelarijske i kućne potrebe, umetnički materijali, kičice, pisaće mašine i kancelarijski pribor (izuzev nameštaja), materijali za obuku i nastavu (izuzev aparata), plastični materijal za pakovanje (koji nije uključen u druge klase), štamparska slova, klišeji.

**Klasa 25:** Odeća, obuća, pokrivala za glavu.

**Klasa 28:** Igre i igračke, gimnastički i sportski artikli koji nijesu obuhvaćeni drugim klasama, ukrasi za jelke.

**Klasa 29:** Meso, riba, živina i divljač, mesne prerađevine, konzervisano, zamrznuto, sušeno i kuvano voće i povrće, želei, džemovi, kompoti, jaja, mleko i mlečni proizvodi, jestiva ulja i masti.

**Klasa 30:** Kafa, čaj, kakao, šećer, pirinač, tapioka, sago, zamena kafe, brašno i proizvodi od žitarica, hleb, kolači i poslastice, sladoledi, med, melasa, kvasac, prašak za pecivo, so, senf, sirće, sosovi (kao dodaci), začini, led.

**Klasa 32:** Pivo, mineralne i sodne vode i druga bezalkoholna pića, voćni napici i voćni sokovi, sirupi i drugi preparati za proizvodnju pića.

**Klasa 41:** Obrazovne usluge, pripremanje obuke, razonoda, sportske i kulturne aktivnosti.

(210) **2012-184**

(442) **20.12.2013.**

(220) 12.04.2012.

(731) **ALKALOID AD** Skoplje, Bul. Aleksandar Makedonski 12, Skoplje MK



(540) ni klasifikovano

(550) T

(740) Popović Miladin, Đoka Miraševića 21/III, Podgorica ME

(511) **Klasa 03:** Krema za njegu masne i problematične kože.

(210) **2012-185**

(442) **20.12.2013.**

(220) 12.04.2012.

(731) **ALKALOID AD** Skoplje, Bul. Aleksandar Makedonski 12, Skoplje MK



(540)

(550) T

(740) Popović Miladin, Đoka Miraševića 21/III, Podgorica ME

(511) **Klasa 03:** Krema za njegu masne i problematične kože.

(210) **2012-186**

(442) **20.12.2013.**

(220) 12.04.2012.

(731) **ALKALOID AD** Skoplje, Bul. Aleksandar Makedonski 12, Skoplje MK



(540)

(550) T

(740) Popović Miladin, Đoka Miraševića 21/III, Podgorica ME

(511) **Klasa 03:** Mleko za tijelo za normalnu do suve kože.(210) **2012-187**(442) **20.12.2013.**

(220) 12.04.2012.

(731) **ALKALOID AD** Skoplje, Bul. Aleksandar Makedonski 12, Skoplje MK

(540) \_\_\_\_\_

(550) T

(740) Popović Miladin, Đoka Miraševića 21/III, Podgorica ME

(511) **Klasa 03:** Podloga za šminku za kombinovanu i masnu kožu.(210) **2012-189**(442) **20.12.2013.**

(220) 12.04.2012.

(731) **Engel&Volkers Marken GmbH&Co.KG**, Dorfstrabe 34a, 22113 Oststeinbek-Havighorst DE

(540) ENGEL &amp; VÖLKERS

(550) I, V

(740) Radulović Božidar, Jovana Tomaševića 9/III, Podgorica ME

(511) **Klasa 35:** Komercijalne informacije i saveti za potrošače u vezi sa vozilima za kretanje po vodi, posebno novih i polovnih čamaca/brodova, kao i jahti, pripremanje ugovora za treća lica u vezi sa sticanjem/kupovinom i prodajom čamaca/brodova i jahti, organizovanje ugovora za treća lica u vezi sa zakupom čarter jahti i čarter čamaca/brodova.

**Klasa 39:** Iznajmljivanje čamaca/ brodova i jahti, organizovanje najma čamaca/brodova i jahti, tzv. čartering jahti, brokerski poslovi u vezi sa plovilima.

(210) **2012-190**

(442) **20.12.2013.**

(220) 12.04.2012.

(731) **Engel&Volkers Marken GmbH&Co.KG**, Dorfstrabe 34a, 22113 Oststeinbek-Havighorst DE

**E&V**

(540)

(550) I, V

(740) Radulović Božidar, Jovana Tomaševića 9/III, Podgorica ME

(511) **Klasa 35:** Komercijalne informacije i saveti za potrošače u vezi sa vozilima za kretanje po vodi, posebno novih i polovnih čamaca/brodova, kao i jahti, pripremanje ugovora za treća lica u vezi sa sticanjem/kupovinom i prodajom čamaca/brodova i jahti, organizovanje ugovora za treća lica u vezi sa zakupom čarter jahti i čarter čamaca/brodova.

**Klasa 39:** Iznajmljivanje čamaca/ brodova i jahti, organizovanje najma čamaca/brodova i jahti, tzv. čartering jahti, brokerski poslovi u vezi sa plovilima.

(210) **2012-191**

(442) **20.12.2013.**

(220) 12.04.2012.

(731) **NVO OMNIBUS**, Bul. Ivana Crnojevića 67, Podgorica ME



(540)

(550) F

(740) Bojović Zoran, 27. Marta 60, Podgorica ME

(511) **Klasa 38:** Forumi za vođenje debata (omogućavanje održavanja foruma za vođenje debata).

**Klasa 41:** Filmovi (prikazivanje igranih filmova), filmovi (proizvodnja filmova), izložbe (organizovanje izložbi), koncerti (organizovanje i vođenje koncerata).

(210) **2012-192**

(442) **20.12.2013.**

(220) 12.04.2012.

(731) **S.C.Johnson & Son, Inc**, 1525 Howe Street, Racine, Wisconsin 53403-22036 US



(540)

(550) I

(740) Čejović Vladimir, 13. jula 21, Podgorica ME

(511) **Klasa 03:** Preparati za čišćenje, poliranje, ribanje i nagrizanje, sredstva za bijeljenje i druge supstance za upotrebu na tkaninama, maramice za jednokratnu upotrebu impregnirane hemikalijama ili jedinjenjima za upotrebu u domaćinstvu, preparati za uklanjanje laka, preparati u obliku voska za upotrebu na završenim i nezavršenim površinama, preparati za uklanjanje voska, preparati za otpušavanje odvoda, preparati za poliranje cipela, kreme za cipele, preparati za čišćenje cipela, sapuni, deterdženti.

**Klasa 05:** Sredstva za uklanjanje mikroba i sredstva za dezinfekciju.

**Klasa 21:** Kuhinjski i pribor za domaćinstva za čišćenje, poliranje, ribanje, nagrizanje i voskiranje, sušeri, četke, krpe, odjeća za čišćenje, odjeća impregnisana rastvorom za čišćenje.

(210) **2012-193**

(442) **20.12.2013.**

(220) 12.04.2012.

(731) **WM.WRIGLEY JR. COMPANY**, 410 NORTH MICHIGAN AVENUE, CHICAGO, IL 60611 US

(540) WINTERFRESH GREEN ICE

(550) I

(740) Čejović Vladimir, 13. jula 21, Podgorica ME

(511) **Klasa 30:** Konditorski proizvodi, žvakaće gume, žvakaće gume od kojih mogu da se prave veliki baloni, bombone, dražeje pepermintna, mali okrugli bomboni (drops) i pastile.

(210) **2012-194**

(442) **20.12.2013.**

(220) 12.04.2012.

(731) **JT International** S.A. 1, rue de la Gabelle, 1211 Geneva 26 CH

(540) Glamour

(550) I

(740) Čejović Vladimir, 13. jula 21, Podgorica ME

(511) **Klasa 34:** Duvan, prerađen ili neprerađen, duvan za pušenje, duvan za lule, duvan za ručno uvijanje, duvan za žvakanje, snus duvan, cigarete, cigare, cigarilos, supstance za pušenje koje se prodaju odvojeno ili miješane sa duvanom, a koje nisu za medicinske svrhe ili u svrhe liječenja, duvan za ušmrkavanje, artikli za pušače uključeni u klasu 34, papir za cigarete, tube za cigarete i šibice.

(210) **2012-195**(442) **20.12.2013.**

(220) 12.04.2012.

(731) **POSLOVNI CENTAR MERCATOR** d.d, Dunajska cesta 107, 1000 Ljubljana SI

(540) RODA

(550) I

(740) Radulović Božidar, Jovana Tomaševića 9/III, Podgorica ME

(511) **Klasa 03:** Preparati za izbjeljivanje i druge supstance za upotrebu u perionicama, preparati za čišćenje, poliranje, ribanje i nagrizanje, sapuni, parfimerija, eterična ulja, kozmetika, losioni za kosu, paste za zube.

**Klasa 25:** Odjeća, obuća, pokrivala za glavu.

**Klasa 28:** Igre i igračke, gimnastičke i sportski artikli koji nisu uključeni u druge klase, ukrasi za jelke.

**Klasa 29:** Meso, riba, živina i divljač, mesne prerađevine, konzervisano, smrznuto, sušeno i kuvano voće i povrće, želei, džemovi, kompoti, jaja, mlijeko i mliječni proizvodi, jestiva ulja i masti.

**Klasa 30:** Kafa, čaj, kakao, šećer, pirinač, tapioka, sago, zamena kafe, brašno i proizvodi od žitarica, hljeb, kolači i poslastice, sladoledi, med, melasa, kvasac, prašak za pecivo, so, senf, sirće, umaci (začini), začini, led za osveženje.

**Klasa 31:** Poljoprivredni, hortikulturalni i proizvodi u šumarstvu i žitarice koji nisu uključeni u druge klase, žive životinje, svježe voće i povrće, sjemenke, prirodne biljke i cvijeće, hrana za životinje, slad.

**Klasa 32:** Pivo, mineralna i gazirana voda i druga bezalkoholna pića, voćni napitci i voćni sokovi, sirupi i drugi preparati za pravljenje pića.

**Klasa 33:** Alkoholna pića (osim piva).

**Klasa 34:** duvan, proizvodi pušače, šibice.

**Klasa 35:** Oglašavanje, poslovni menadžment, poslovna administracija, kancelarijski poslovi.

**Klasa 39:** Saobraćaj, skladištenje i pakovanje robe, organizovanje putovanja.

**Klasa 43:** Usluge obezbjeđivanja hrane i pića, privremeni smeštaj.

(210) **2012-196**(442) **20.12.2013.**

(220) 12.04.2012.

(300) 201171328

14.10.2011. SI

(731) **POSLOVNI CENTAR MERCATOR** d.d, Dunajska cesta 107, 1000 Ljubljana SI

 The logo for 'RODA' features the word in a stylized, blue, serif font. A red and white graphic element, resembling a stylized 'R' or a decorative flourish, is positioned to the left of the 'O'.

(540)

(550) I, G

(740) Radulović Božidar, Jovana Tomaševića 9/III, Podgorica ME

(511) **Klasa 03:** Preparati za izbjeljivanje i druge supstance za upotrebu u perionicama, preparati za čišćenje, poliranje, ribanje i nagrizanje, sapuni, parfimerija, eterična ulja, kozmetika, losioni za kosu, paste za zube.

**Klasa 25:** Odjeća, obuća, pokrivala za glavu.

**Klasa 28:** Igre i igračke, gimnastičke i sportski artikli koji nisu uključeni u druge klase, ukrasi za jelke.

**Klasa 29:** Meso, riba, živina i divljač, mesne prerađevine, konzervisano, smrznuto, sušeno i kuvano voće i povrće, želei, džemovi, kompoti, jaja, mlijeko i mliječni proizvodi, jestiva ulja i masti.

**Klasa 30:** Kafa, čaj, kakao, šećer, pirinač, tapioka, sago, zamena kafe, brašno i proizvodi od žitarica, hljeb, kolači i poslastice, sladoledi, med, melasa, kvasac, prašak za pecivo, so, senf, sirće, umaci (začini), začini, led za osveženje.

**Klasa 31:** Poljoprivredni, hortikulturalni i proizvodi u šumarstvu i žitarice koji nisu uključeni u druge klase, žive životinje, svježe voće i povrće, sjemenke, prirodne biljke i cvijeće, hrana za životinje, slad.

**Klasa 32:** Pivo, mineralna i gazirana voda i druga bezalkoholna pića, voćni napitci i voćni sokovi, sirupi i drugi preparati za pravljenje pića.

**Klasa 33:** Alkoholna pića (osim piva).

**Klasa 34:** duvan, proizvodi pušače, šibice.

**Klasa 35:** Oglašavanje, poslovni menadžment, poslovna administracija, kancelarijski poslovi.

**Klasa 39:** Saobraćaj, skladištenje i pakovanje robe, organizovanje putovanja.

**Klasa 43:** Usluge obezbeđivanja hrane i pića, privremeni smeštaj.

(210) **2012-197**(442) **20.12.2013.**

(220) 17.04.2012.

(731) **THE COCA-COLA COMPANY**, ONE COCA-COLA PLAZA, ATLANTA, GEORGIA 30313 US

(540)

(550) I

(740) Popović Miladin, Đoka Miraševića 21/III, Podgorica ME

(511) **Klasa 16:** Hartija, karton i proizvodi od njih, koji nijesu uključeni u druge klase, štampane stvari, knjigovezački materijal, fotografije, kancelarijski materijal, lepkovi za kancelarijske i kućne potrebe, umetnički materijali, kičice, pisaće mašine i kancelarijski pribor (izuzev nameštaja), materijali za obuku i nastavu (izuzev aparata), plastični materijal za pakovanje (koji nije uključen u druge klase), štamparska slova, kliše.

**Klasa 25:** Odeća, obuća, pokrivala za glavu.

**Klasa 28:** Igre i igračke, gimnastički i sportski artikli koji nijesu obuhvaćeni drugim klasama, ukrasi za jelke.

**Klasa 29:** Meso, riba, živina i divljač, mesne prerađevine, konzervisano, zamrznuto, sušeno i kuvano voće i povrće, želei, džemovi, kompoti, jaja, mleko i mlečni proizvodi, jestiva ulja i masti.

**Klasa 30:** Kafa, čaj, kakao, šećer, pirinač, tapioka, sago, zamena kafe, brašno i proizvodi od žitarica, hleb, kolači i poslastice, sladoledi, med, melasa, kvasac, prašak za pecivo, so, senf, sirće, sosovi (kao dodaci), začini, led.

**Klasa 30:** Kafa, čaj, kakao, šećer, pirinač, tapioka, sago, zamena kafe, brašno i proizvodi od žitarica, hleb, kolači i poslastice, sladoledi, med, melasa, kvasac, prašak za pecivo, so, senf, sirće, sosovi (kao dodaci), začini, led.

**Klasa 41:** Obrazovne usluge, pripremanje obuke, razonoda, sportske i kulturne aktivnosti.

(210) **2012-198**

(442) **20.12.2013.**

(220) 17.04.2012.

(731) **THE COCA-COLA COMPANY**, ONE COCA-COLA PLAZA, ATLANTA, GEORGIA 30313 US



(540) \_\_\_\_\_

(550) I

(740) Popović Miladin, Đoka Miraševića 21/III, Podgorica ME

(511) **Klasa 16:** Hartija, karton i proizvodi od njih, koji nijesu uključeni u druge klase, štampane stvari, knjigovezački materijal, fotografije, kancelarijski materijal, lepkovi za kancelarijske i kućne potrebe, umetnički materijali, kičice, pisaće mašine i kancelarijski pribor (izuzev nameštaja), materijali za obuku i nastavu (izuzev aparata), plastični materijal za pakovanje (koji nije uključen u druge klase), štamparska slova, kliše.

**Klasa 25:** Odeća, obuća, pokrivala za glavu.

**Klasa 28:** Igre i igračke, gimnastički i sportski artikli koji nijesu obuhvaćeni drugim klasama, ukrasi za jelke.

**Klasa 29:** Meso, riba, živina i divljač, mesne prerađevine, konzervisano, zamrznuto, sušeno i



kuvano voće i povrće, želei, džemovi, kompoti, jaja, mleko i mlečni proizvodi, jestiva ulja i masti.

**Klasa 30:** Kafa, čaj, kakao, šećer, pirinač, tapioka, sago, zamena kafe, brašno i proizvodi od žitarica, hleb, kolači i poslastice, sladoledi, med, melasa, kvasac, prašak za pecivo, so, senf, sirće, sosovi (kao dodaci), začini, led.

**Klasa 32:** Pivo, mineralne i sodne vode i druga bezalkoholna pića, voćni napici i voćni sokovi, sirupi i drugi preparati za proizvodnju pića.

**Klasa 41:** Obrazovne usluge, pripremanje obuke, razonoda, sportske i kulturne aktivnosti.

(210) **2012-200** (442) **20.12.2013.**  
(220) 17.04.2012.

(731) **WM.WRIGLEY JR. COMPANY**, 410 NORTH MICHIGAN AVENUE, CHICAGO, IL 60611 US

(540) WINTERFRESH POLAR ICE

(550) I

(740) Čejović Vladimir, 13. jula 21, Podgorica ME

(511) **Klasa 30:** Konditorski proizvodi, žvakaće gume, žvakaće gume od kojih mogu da se prave veliki baloni, bombone, dražeje pepermint, mali okrugli bomboni (drops) i pastile.

(210) **2012-203** (442) **20.12.2013.**  
(220) 18.04.2012.

(731) **NIKE INTERNATIONAL LTD.** A BERMUDA COMPANY ONE BOWERMAN DRIVE, BEAVERTON, OR 97005-6453 US

(540) MERCURIAL

(550) I

(740) Čejović Vladimir, 13. jula 21, Podgorica ME

(511) **Klasa 25:** Obuća, odjeća, pokrivala za glavu.

**Klasa 28:** Sportska oprema, naime, fudbalske lopte, štitnici za cjevanice, zaštitni jastučići za igranje fudbala, torbe specijalno prilagođene za nošenje sportske opreme i sportskih lopti.

(210) **2012-204** (442) **20.12.2013.**  
(220) 18.04.2012.

(731) **PREDRAG KOVAČEVIĆ**, SAVSKA 14, PODGORICA ME



**MOGUL CRNA GORA**

(540) \_\_\_\_\_

(550) I

(511) **Klasa 01:** Hemijski proizvod koji se upotrebljavaju u industriji, nauci, fotografiji, poljopri-

vredi, hortikulturi i šumarstvu, neprerađene neveštačke smole, neprerađene neplastične materije, đubriva, smješe za gašenje vatre, preparati za kaljenje i zavarivanje, hemijske supstance za očuvanje namirnica, materije za štavljenje, ljepljive supstance koje se upotrebljavaju u industriji.

**Klasa 03:** Sredstva za bijeljenje i druge spustance za upotrebu u perionicama, preparati za čišćenje, poliranje, ribanje i nagrizanje, sapuni, parfimerija, eterična ulja, kozmetika, losioni za kosu, paste za zube.

**Klasa 04:** Industrijska ulja i masti, maziva, goriva (uključujući i motorna tečna goriva) i materije za osvjetljavanje, svijeće i fitilji za osvetljavanje, jedinjenja za skupljanje prašine vlaženjem i vezivanjem.

**Klasa 05:** Farmaceutski i veterinarski preparati, sanitarni preparati za medicinsku upotrebu, djetetske supstance prilagođene za upotrebu u medicini, hrana za bebe, flasteri, materijali za zavijanje, materijali za plombiranje zuba, zubarska smola, dezinfekciona sredstva, preparati za uništavanje štetocina, fungicidi, herbicidi.

**Klasa 07:** Mašine i mašinski alati, motori i pogonske mašine (osim za suvozemna vozila), mašinske spojnice i transmisioni elementi (osim za suvozemna vozila), poljoprivredne sprave osim onih kojima se ručnom pravlja, inkubator za jaja.

**Klasa 09:** Aparati i instrumenti naučni, pomorski, geodetski, fotografski, kinematografski, optički, za vaganje, mjerenje, signalizaciju, kontrolu (inspekciju), spasavanje i nastavu, kontrolu električne energije, aparati za snimanje, prenos i reprodukciju zvuka i slike, magnetni nosioci podataka, diskovi za snimanje, automatske mašine i mehanizmi za aparate koji se pokreću novcem ili žetonom, registar kase, računске mašine, oprema za obradu podataka i kompjuteri, aparati za gašenje požara, aparati i instrumenti za provođenje, prekid, transformaciju, akumulaciju, regulisanje.

**Klasa 12:** Vozila, aparati zakretanje po zemlji, vazduhu ili vodi.

**Klasa 35:** Oglašavanje, vođenje poslova, poslovno upravljanje, kancelarijski poslovi.

**Klasa 39:** Transportne usluge, pakovanje i skladištenje robe, organizovanje putovanja.

(210) **2012-205**

(442) **20.12.2013.**

(220) 19.04.2012.

(731) **CANON KABUSHIKI KAISHA**, 30-2, Shimomaruko 3-chome, Ohta-ku, Tokyo JP



(540)

(550) I

(740) Čosović Dejan, 13. jula 1/5, Budva ME

(511) **Klasa 02:** Boje, firnajzi, lakovi, sredstva za zaštitu od rđe i truljenja drveta, materije za bojenje, sredstva za nagrizanje, sirove prirodne smole, metali u obliku listova i praha za slikare, dekoratere, štampare i umetnike, mastilo za inkdžet štampe, fotokopir mašine, telefakse, kasete sa mastilom (uključujući kasete sa mastilom opremljene glavom za štampanje) za inkdžet štampe, fotokopir mašine, telefakse, toner za laserske štampe, fotokopir mašine, telefakse, kasete sa tonerom za laserske štampe, fotokopir mašine, telefakse.

**Klasa 09:** Aparati i instrumenti naučni, pomorski, geodetski, fotografski, kinematografski, optički, za vaganje, merenje, signalizaciju, kontrolu (inspekciju), spašavanje i nastavu, aparati i instrumenti za provođenje, prekid, transformaciju, akumulaciju, regulisanje ili kontrolu

električne energije, aparati za snimanje, prenos i reprodukovanje zvuka ili slike, magnetni nosači podataka, diskovi za snimanje, kompakt diskovi, DVD i drugi digitalni nosači podataka, mehanizmi za aparate koji se pokreću novcem ili žetonom, registar kase, računске mašine, oprema za obradu podataka, računari, računarski softver, aparati za gašenje požara, kamere, digitalne kamere, video kamkorderi, elektronske računске mašine, fotokopir mašine, telefaksi, skeneri, laserski štampači, inkdžet štampači, delovi i pribor za navedene proizvode, to jest, baterije, punjači za baterije, adapteri za automobilske akumulatore, adapteri naizmenične struje, kućišta za kamere, digitalne kamere, video kamkordere, remeni za kamere, digitalne kamere, video kamkordere, torbe za kamere, digitalne kamere, video kamkordere, tronošci, računarski softver za digitalne kamere, video kamkordere, inkdžet štampače, laserske štampače, fotokopir mašine, telefakse, skenerne.

---

(210) **2012-206** (442) **20.12.2013.**  
(220) 20.04.2012.

(731) **FARMACEUTSKO-HEMIJSKA INDUSTRIJA ZDRAVLJE AD**, VLAJKOVA 199, LE-SKOVAC RS

(540) ANZOVIP

(550) I

(740) Popović Miladin, Đoka Miraševića 21/III, Podgorica ME

(511) **Klasa 05:** Farmaceutski i veterinarski preparati, sanitarni proizvodi za upotrebu u medicini, dijeteska hrana i supstance prilagođene za upotrebu u medicini i veterinarsku upotrebu, hrana za bebe, dijetetski dodaci (dodaci ishrani) za ljude i životinje, flasteri, materijali za zavijanje, materijali za plombiranje zuba, zubarska smola, dezinfekciona sredstva, preparati za unštavanje stetocina, fungicidi, herbicidi.

---

(210) **2012-207** (442) **20.12.2013.**  
(220) 20.04.2012.

(300) 85/451808 20.10.2011. US

(731) **INTERNATIONAL TRUCK INTELLECTUAL PROPERTY COMPANY**, 4201 WINFILED ROAD, WARRENVILLE, ILLINOIS 60555 US

(540) PUREPAC LOG SUPPORT

(550) I

(740) Ćupić Branislav, Dalmatinska 10, Podgorica ME

(511) **Klasa 35:** Marketinške usluge u vezi rezervnih djelova za vojna vozila.

**Klasa 36:** Garantni programi koji pružaju garancije za proizvode koje su proizvela druga lica, naime rezervni djelovi za vojna vozila.

---

(210) **2012-209** (442) **20.12.2013.**  
(220) 20.04.2012.

(731) **NVO ORGANIZACIJA CRNOGORSKIH STUDENATA U INOSTRANSTVU /**  
**ORANIZACIJA OF MONTENEGRINS STUDYING ABROAD**, BEOGRADSKA 16, PODGORICA ME



(540)

(550) I

(511) **Klasa 41:** Akademska i profesionalna saradnja i orijentacija, organizovanje i vođenje, seminara, razgovora, konferencija i kongresa, organizovanje slobodnih aktivnosti i razonode za članove, međunarodna saradnja.

(210) **2012-21**(442) **20.12.2013.**

(220) 13.01.2012.

(731) **DC COMICS**, 1700 Brodway New York, NY 10019 US

**DC  
ENTERTAINMENT**

(540)

(550) I

(740) Popović Miladin, Đoka Miraševića 21/III, Podgorica ME

(511) **Klasa 03:** Sredstva za bijeljenje i druge spustance za upotrebu u perionicama, preparati za čišćenje, poliranje, ribanje i nagrizanje, sapuni, parfimerija, eterična ulja, kozmetika, losioni za kosu, paste za zube, posebno kozmetika, naime ruž za usne, sjaj za usne i ne-medicinski melem za usne, maskara, lak za nokte, puder za lice, krema za lice, losion za telo i gel za telo, puder za telo, ulje za kupanje, gel za kupanje i ne-medicinske soli za kupanje, krema i losion za ruke, krema i losion za telo, preparat za suncanje, naime krema i losion, krema za brijanje i losion posle brijanja, losioni za čišćenje kože i ne-medicinske kupke za kupanje, dezodorans za telo, kolonjska voda i parfem, sapuni, naime, tečni sapun za kupanje, sapun u gelu i tvrdi sapun, pasta za zube, deterdžent u obliku sapuna, naime, tečni i u obliku praška, omekšivač veša, dezodorans u obliku sapuna, sapun za kožu, i šampon i balzam.

**Klasa 09:** Aparati i instrumenti naučni, pomorski, geodetski, fotografski, kinematografski, optički, za vaganje, merenje, signalizaciju, kontrolu (inspekciju), spašavanje i nastavu, aparati i instrumenti za provođenje, prekid, transformaciju, akumulaciju, regulisanje ili kontrolu

električne energije, aparati za snimanje, prenos i reprodukovanje zvuka ili slike, magnetni nosioci podataka, diskovi za snimanje, automatske mašine i mehanizmi za aparate koji se pokreću novcem ili žetonom, registar kase, računске mašine, oprema za obradu podataka i kompjuteri, aparati za gašenje požara, posebno filmovi u kojima je tematika komedija, drama, akcija, avantura i/ili animacija i filmovi za emitovanje na televiziji u kojima je tematika komedija, drama, akcija, avantura i/ili animacija, audio video diskovi, i digitalni višenamenski diskovi (DVD) koji sadrže muziku, komediju, dramu, akciju, avanturu i/ili animaciju, stereo slušalice, baterije, bežični telefoni, CD plejeri, kompjuterski CD ROM diskovi koji sadrže igre, telefon i/ili radio pejdžeri, kompakt disk plejeri, radio, podloge za miša, naočare za vid, naočare za sunce i futrole za njih, oprema za igre koja se prodaje kao jedinica za igranje grupnih, računarskih igrica u zatvorenom prostiru, softver koji se može preuzimati za korišćenje u igranju online računarskih igrica, softver za računarske igrice koji se može preuzimati, softver za računarske igrice za korišćenje na mobilnim telefonima, programi za video i računarske igrice, kertridži za video igrice, računarske i video igrice koje su dizajnirane za hardverske platforme, naime, konzole za igrice i personalne računare, CD-ROM-ovi i digitalni višenamenski diskovi (DVD) za računarske igrice i računarski programi, naime, softver koji povezuje digitalizovane video i audio medije na globalnu računarsku mrežu, audio-vizuelni medijski sadržaji koji se mogu preuzimati iz oblasti zabave koji prikazuju animirane filmove, televizijske serije, komedije, i drame, računarski softver, naime, računarski softver za kontinuirano emitovanje audio-vizuelnih medijskih sadržaja preko interneta, računarski softver za kontinuirano emitovanje i skladištenje audio-vizuelnih medijskih sadržaja, audio i video plejeri koji se mogu preuzimati za medijske sadržaje sa multimedijalnim i interaktivnim funkcijama, softver za video pretragu i pravljenje zabeleški, softver za zaštitu sadržaja, softver za upravljanje bazama podataka, softver za sinhronizaciju baza podataka, računarski programi za pristup, nasumično pretraživanje i precizno pretraživanje online baza podataka, softveri koji omogućavaju korisnicima da igraju i programiraju audio, video, tekstualne i multimedijalne sadržaje zabavnog karaktera, softver za računarske aplikacije za kontinuirano emitovanje i skladištenje audio-vizuelnih medijskih sadržaja, softver za računarske aplikacije za kontinuirano emitovanje audio-vizuelnih medijskih sadržaja preko interneta, računarski softver koji se može preuzimati za kontinuirano emitovanje audio-vizuelnih medijskih sadržaja preko interneta, računarski softver koji se može preuzimati za kontinuirano emitovanje i skladištenje audio-vizuelnih medijskih sadržaja, publikacije koje se mogu preuzimati u obliku knjiga koje sadrže likove iz animiranih filmova, akcionih avantura, komedija i/ili drama, stripovi, knjige za decu, priručnici za igrice, časopisi koji sadrže likove iz animiranih filmova, akcionih avantura, komedija i/ili dramskih filmova, bojanke, dečije interaktivne knjige i časopisi iz oblasti zabave, oprema za mobilne telefone, naime oprema za slušalice, futrole za mobilni telefon i maske za mobilni telefon, kodirane magnetne kartice, naime, telefonske kartice, kreditne kartice, gotovinske kartice, debitne kartice i magnetne kartice, i dekorativni magneti.

**Klasa 14:** Dragoceni metali i njihove legure i proizvodi od dragocenih metala ili sa prevlakom od njih, koji nisu uključeni u druge klase, nakit, bižuterija, drago kamenje, časovničarski i hronometrijski instrumenti. posebno satovi (časovnici), ručni satovi, nakit, naime narukvice, narukvice oko članka, broševi, lanci, amajlije, manžetne, minduše, značke, ogrlice, ukrasne igle, privesci i prstenje, šnale za kaiševе.

**Klasa 16:** Hartija, karton i proizvodi od njih, koji nisu uključeni u druge klase, štampane stvari, knjigovezački materijal, fotografije, kancelarijski materijal, lepila za kancelarijske i kućne potrebe, umetnički materijali, kičice, pisaće mašine i kancelarijski rekviziti (izuzev nameštaja), materijali za obuku i nastavu (izuzev aparata), plastični materijal za pakovanje (koji nije uključen u druge klase), štamparska slova, klišeji, posebno štampane stvari i proizvodi od

papira, naime knjige koje sadrže likove iz animiranih filmova, akcionih avantura, komedija i/ili dramskih filmova, stripovi, knjige za decu, uputstva za video igrice, časopisi koji sadrže likove iz animiranih filmova, akcionih avantura, komedija i/ili dramskih filmova, bojanke, interaktivne knjige za decu, kancelarijski materijal, papir za pisanje, koverta, sveske, dnevnici, beležnice, čestitke, kolekcionarske karte, litografije, hemijske olovke, olovke, pernice za njih, gumice, bojice, flomasteri, olovke u boji, pribor za slikanje, krede i table, dekorativne nalepnice, preslikači, poster, lepljive plastične folije sa papirom koji se može skinuti za montiranje slika u dekorativne svrhe, montirane i/ili nemontirane fotografije, pokrivala za knjige, markeri za knjige, kalendari, ukrasni papir za pakovanje, pokloni od papira i dekoracije od papira, naime, papirne salvete, papirni podmetači, krep papir, pozivnice, papirni stolnjaci, papirni ukrasi za torte, štampane aplikacije za vez ili tkanine, štampane aplikacije za kostime, pidžame, dukserice i majice.

**Klasa 18:** Koža i imitacija kože, proizvodi izradeni od ovih materijala koji nisu uključeni u druge klase, životinjska koža, koferi i putne torbe, kišobrani, suncobrani i štapovi za hodanje, bičevi, saračka i sedlarska roba, posebno atletske torbe, rančevi za bebe, rančevi, torbe za plažu, torbe za knjige, torbe za pelene, velike sportske torbe, torbe za teretanu, velike ručne tašne, male torbice za novac, torbice za nošenje oko struka, ruksaci, sportske torbe za nošenje oko struka, torbe za kupovinu, kišobrani, novčanici, modni detalji napravljeni od kože, naime novčanici, ručne tašne i kaiševi.

**Klasa 25:** Odeća, obuća, pokrivala za glavu, odeća za muškarce, žene i decu-naime, majice, majice kratkih rukava, dukserice, trenerke za trčanje, pantalone, gaće, šorcevi, majice bez rukava, odeća za kišu, dečije krpene portikle, suknje, bluže, haljine, tregeri, veste, jakne, kaputi, kišni kaputi, odela za sneg, kravate, kućne haljine, šeširi, kape, štitnici za sunce, rukavice, remeni (kaiševi), marama, odeća za spavanje, pidžame, žensko rublje, donji veš, čizme, cipele, patike, sandale, sokne, kratke sokne, čarape-papučice, kupaće gaćice i kostimi i maske za maskenbal i Noc Veštica prodavani u vezi sa istim.

**Klasa 28:** Igre i igračke, gimnastički i sportski artikli koji nisu obuhvaćeni drugim klasama, ukrasi za jelke, igračke i sportski proizvodi, uključujući igre i igračke-naime, akcijske figurice i dodaci za iste, setovi za igranje za akcijske figurice, nameštaj za igračke, plišane igračke, baloni, igračke za kupanje u kadi, igračke za jahanje na njima, oprema prodavana kao celina za igranje kartaških igara, igračke vozila, lutke, leteći diskovi, jedinice elektronske ručne igre, igrača oprema prodavana kao celina za igranje stonih igara, kartaških igara, manipulativnih igara, igara u salonu i igara sa metama akcijskog tipa, samostojeće igrice mašine sa video izlazom, slagalice i manipulativne puzzle, papirnate maske za lice, skejtbordovi, klizaljke za led, igračke koje prskaju vodu, lopte-naime, lopte za igralište, fudbalske lopte, bejzbol lopte, košarkaške lopte, rukavice za bejzbol, plovci za plivanje za rekreativnu upotrebu, plutajuće table za plivanje za rekreativnu upotrebu, table za surfovanje, table za plivanje za rekreativnu upotrebu, peraje za plivanje, igračke posude i posude za pečenje, igračke banke, igračke snežne kugle, papirnati šeširi za zabave, i ukrasi za jelku.

**Klasa 41:** Obrazovne usluge, pripremanje obuke, razonoda, sportske i kulturne aktivnosti, usluge razonode, naime, pružanje video igrice online, pružanje kompjuterskih igrica online, pružanje privremenog korišćenja video igrice koje se ne mogu preuzeti (downloadovati), usluge produkcije softvera za video i kompjuterske igrice, usluge razonode u pogledu živih nastupa, komedija, drama, animiranih, i reality televizijskih serija, produkcija živih nastupa, komedija, drama, animiranih i reality televizijskih serija, distribucija i prikazivanje živih nastupa, komedija, drama i animiranih bioskopskih filmova, produkcija živih nastupa, komedija, drama i animiranih bioskopskih filmova, pozorišne predstave kako animirane tako i uživo, internet usluge koje pružaju informacije putem elektronske globalne kompjuterske mreže u oblasti razonode a posebno u vezi sa igricama, muzikom, filmovima, i televizijom, usluge

pružanja web stranica koji sadrže filmske klipove (isecke), fotografije i druge multimedijalne materijale, usluge pružanja vesti o trenutnim događajima i razonodi, i informacija u vezi sa obrazovanjem i kulturnim događajima, putem globalne kompjuterske mreže, i pružanje informacija za razonodu i konkretna razonoda putem elektronske globalne komunikacione mreže a u vidu živih nastupa, komedija, drama i animiranih programa i produkcije živih nastupa, komedija, drama i animiranih filmova za distribuciju putem globalne kompjuterske mreže, usluge pružanja kompjuterske igrice kojoj se može pristupiti putem telekomunikacione mreže, i pružanje usluga elektronskog izdavaštva, naime, online izdavanje tekstova i grafičkih radova drugih koji sadrže članke, priče, scenarija, stripove, strategijske vodiče, fotografije i vizuelne materijale, usluge zabavnih parkova, usluge vožnji u zabavnim parkovima, živi ili unapred snimljeni nastupi i/ili filmovi, usluge informisanja o razonodi i/ili rekreaciji, usluge klubova za razonodu.

(210) **2012-210** (442) **20.12.2013.**

(220) 23.04.2012.

(731) **ALKALOID AD-SKOPLJE**, Bul. Aleksandar Makedonski 12, 1000 Skoplje MK



(540) \_\_\_\_\_

(550) I

(740) Popović Miladin, Đoka Miraševića 21/III, Podgorica ME

(511) **Klasa 03:** Losion za čišćenje masne i problematične kože.

(210) **2012-211** (442) **20.12.2013.**

(220) 23.04.2012.

(731) **BR INTERNATIONAL HOLDING** INC. C/O P.O.BOX 261031, JEBEL ALI, DUBAI AE

(540) BUSINESS ROYAL

(550) I

(740) Popović Miladin, Đoka Miraševića 21/III, Podgorica ME

(511) **Klasa 34:** Duvan, artikli za pušače, šibice, cigarete, cigarilosi, cigare, upaljači za pušače, burmut, lule za duvan, kese za duvan, duvan za žvakanje, papir za cigarete, filteri za cigarete.

(210) **2012-212** (442) **20.12.2013.**

(220) 24.04.2012.

(731) **INDUSTRIJA PIVA I SOKOVA TREBJESA AD** NIKŠIĆ, NJEGOŠEVA BR.18. NIKŠIĆ ME



(540)

(550) I

(740) Božović Vesko, Rimski trg 50/11, Podgorica ME

(511) **Klasa 32:** Pivo, mineralne i sodne vode i druga bezalkoholna pića, pića od voća i voćni sokovi, sirupi i drugi preparati za proizvodnju pića.

**Klasa 35:** Oglašavanje, vođenje poslova, poslovno upravljanje, kancelarijski poslovi, obuhvata usluge koje pružaju lica ili organizacije u pomoći u radu ili upravljanju preduzećima i u vođenju poslova preduzeća, usluge koje pružaju preduzeća koja se bave oglašavanjem (reklamiranjem), tako što, za račun drugih lica, komuniciraju sa javnošću (reklama) putem prenosa bilo kakvih informacija o proizvodima i uslugama omogućavajući potrošačima prigodan pogled na te proizvode i usluge, usluge koje se sastoje od upisivanja, uređivanja, obrade, prerade ili sistematizacije pisanih informacija i zapisa, usluge reklamnih agencija, distribuciju prospekata i uzoraka direktno ili poštom, izradu i korišćenje matematičkih i statističkih podataka, organizovanje sajмова i izložbi u komercijalne ili reklamne svrhe.

(210) **2012-213**

(442) **20.12.2013.**

(220) 26.04.2012.

(731) **STIEFEL LABORATORIES, INC. CORPORATION SERVICE COMPANY**, 2711 CENTERVILLE ROAD, SUITE 400, WILMINGTON, DELAWARE 19808 US

(540) ISOTREXIN

(550) I

(740) Lutovac Branislav, Bulevar Crnojevića 93, Podgorica ME

(511) **Klasa 05:** Farmaceutski preparati i supstance za liječenje dermatoloških oboljenja, stanja i poremećaja.

(210) **2012-214**

(442) **20.12.2013.**

(220) 26.04.2012.

(731) **TOYOTA JIDOSHA KABUSHIKI KAISHA** (ALSO TRADING AS TOYOTA MOTOR CORPORATION), 1, TOYOTA-CHO, TOYOTA-SHI, AICHI-KEN JP

(540) PROACE

(550) I

(740) Čejović Vladimir, 13. jula 21, Podgorica ME

(511) **Klasa 12:** Automobili i njihovi strukturalni djelovi.

(210) **2012-215**

(442) **20.12.2013.**

(220) 26.04.2012.



(731) **WM.WRIGLEY JR. COMPANY**, 1132 WEST BLACKHAWK STEET, CHICAGO, ILLINOIS 60642 US

(540) BREATHE IN.MOVE ON.

(550) I

(740) Čejović Vladimir, 13. jula 21, Podgorica ME

(511) **Klasa 30:** Konditorski proizvodi, naime žvakaće gume, žvakaće gume od kojih mogu da se prave veliki baloni, bombone i dražeje peperminta.

(210) **2012-217**

(442) **20.12.2013.**

(220) 27.04.2012.

(731) **NBA PROPERTIES, INC.**OLIMPIC TOWER BLDG. 645 FIFTH AVENUE NEW YORK, NY 10022 US



(540)

(550) I

(740) Popović Miladin, Đoka Miraševića 21/III, Podgorica ME

(511) **Klasa 25:** Odjeća, obuća, pokrivala za glavu.

**Klasa 28:** Igre i igračke, gimnastički i sportski artikli koji nijesu obuhvaćeni drugim klasama, ukrasi za jelke.

**Klasa 41:** Obrazovne usluge, pripremanje obuke, razonoda, sportske i kulturne aktivnosti.

(210) **2012-218**

(442) **20.12.2013.**

(220) 27.04.2012.

(731) **ALKALOID AD -SKOPLJE**, BUL.ALEKSANDAR MAKEDONSKI BR.12, 1000 SKOPLJE MK

(540) Nježno još od prvog dodira

(550) I

(740) Popović Miladin, Đoka Miraševića 21/III, Podgorica ME

(511) **Klasa 03:** Sapuni, kozmetika, preparati za negu zuba.

**Klasa 05:** Higijenski proizvodi za medicinsku upotrebu.

**Klasa 35:** Reklamiranje.

(210) **2012-219**

(442) **20.12.2013.**

(220) 30.04.2012.

(731) **GOOGLE INC.** 1600 AMPHITHEATRE PARKWAY, MOUNTAIN VIEW, CA 94043 US

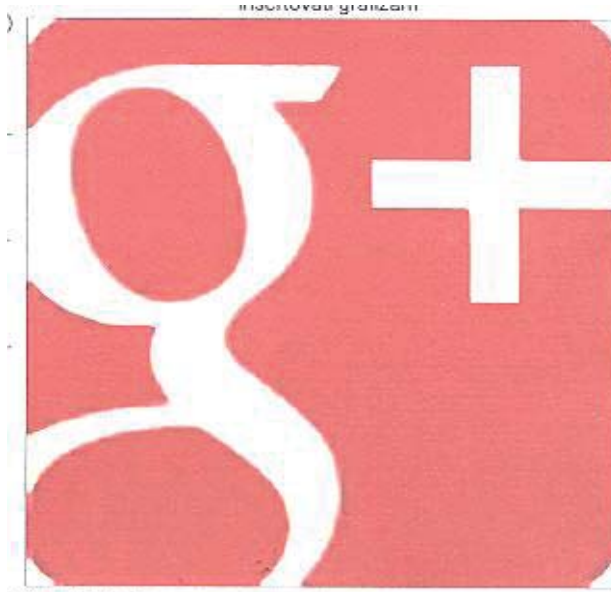

(540)

(550) I

(740) Ćupić Branislav, Dalmatinska 10, Podgorica ME

(511) **Klasa 09:** Kompjuterski softver za objavljivanje i razmjenu digitalnih medija i informacija preko globalnih kompjuterskih i komunikacionih mreža, programski alati za razvoj kompjuterskog softvera, kompjuterski softver koji se koristi kao programski interfejs aplikacije (API), kompjuterski softver za kreiranje indeksa informacija, indeksa veb-sajtova i indeksa drugih informacionih resursa.

**Klasa 38:** Telekomunikacione usluge, naročito, usluge elektronskog prenosa podataka i digitalnih poruka preko globalnih kompjuterskih i komunikacionih mreža, pružanje usluga onlajn foruma, čet soba (chat rooms) i elektronskih oglasnih tabli za prenos poruka među korisnicima u nespecijalizovanim oblastima, usluge digitalnog multimedijalnog emitovanja preko Interneta, naročito, postavljanje, prikazivanje i elektronski prenos podataka, audio i video sadržaja, obezbjeđivanje pristupa kompjuterskim bazama podataka u nespecijalizovanim oblastima.

**Klasa 41:** Usluge onlajn časopisa, naročito, blogova korisnički-definisanog sadržaja sa komentarima u oblasti društva, kulture i političkih vijesti, usluge elektronskog izdavaštva, naročito, objavljivanje digitalnih medija u formi elektronskih časopisa preko globalnih kompjuterskih i komunikacionih mreža sa komentarima u oblasti društva, kulture i političkih vijesti, usluge u oblasti razonode, naročito obezbjeđivanje privremene upotrebe interaktivnih igara za jednog ili više igrača koje se ne mogu preuzeti (non-downloadable) a koje se igraju preko globalnih kompjuterskih i komunikacionih mreža.

**Klasa 42:** Omogućavanje privremenog korišćenja onlajn softvera koji se ne može preuzeti (non-downloadable) za objavljivanje i razmjenu digitalnih medija i informacija preko globalnih kompjuterskih i komunikacionih mreža, omogućavanje privremenog korišćenja onlajn programskih alata za razvoj softvera koji se ne mogu preuzeti (non-downloadable), omogućavanje privremenog korišćenja onlajn softvera koji se ne može preuzeti (non-downloadable) koji se koristi kao programski interfejs aplikacije (API), omogućavanje privremenog korišćenja onlajn softvera koji se ne može preuzeti (non-downloadable) za kreiranje indeksa informacija, indeksa veb-sajtova i indeksa drugih informacionih resursa, usluge tehničke podrške, naročito, onlajn rješavanje problema kompjuterskog softvera za korisnike kompjuterskih programa koji se ne mogu preuzimati (non-downloadable), usluge hostinga na mreži za druge za organizovanje i održavanje sastanaka, društvenih događaja i interaktivnih tekstualnih, audio i video diskusija, pružanje onlajn mrežnog okruženja sa tehnologijom koja

omogućava korisnicima da razmjenjuju podatke.

**Klasa 45:** Usluge onlajn društvenih mreža.

(210) **2012-22**

(442) **20.12.2013.**

(220) 16.01.2012.

(731) **SHIMANO INC**, 3-77 Oimatsu-cho, Sakai-ku, Sakai City, Osaka JP



(540)

(550) I

(740) Popović Miladin, Đoka Miraševića 21/III, Podgorica ME

(511) **Klasa 12:** Djelovi za bicikle, naime, periferni dio točka na koji je priložena guma (felne), točkovi, spone (žice) točka.

(210) **2012-220**

(442) **20.12.2013.**

(220) 30.04.2012.

(731) **GOOGLE INC**. 1600 AMPHITHEATRE PARKWAY, MOUNTAIN VIEW, CA 94043 US



(540)

(550) I

(740) Ćupić Branislav, Dalmatinska 10, Podgorica ME

(511) **Klasa 35:** Promocija, oglašavanje i marketing brendova, proizvoda, usluga i onlajn veb-sajtova fizičkih lica, privrednih subjekata i neprofitnih organizacija, usluge istraživanja tržišta i informativne usluge.

(210) **2012-222**

(442) **20.12.2013.**

(220) 03.05.2012.

- (731) **BAYER CONSUMER CARE AG**, PETER MERIAN STR. 84, 4052 BASEL CH  
 (540) BEPANSCAR  
 (550) I  
 (740) Čejović Vladimir, 13. jula 21, Podgorica ME  
 (511) **Klasa 05:** Farmaceutski preparati.

(210) **2012-223** (442) **20.12.2013.**  
 (220) 04.05.2012.

- (731) **THE ABSOLUT COMPANY AKTIEBOLAG**, S-117 97 Stockholm SE  
 (540) ABSOLUT  
 (550) I  
 (740) Lutovac Branislav, Bulevar Crnojevića 93, Podgorica ME  
 (511) **Klasa 33:** Alkoholna pića (izuzev piva).

(210) **2012-224** (442) **20.12.2013.**  
 (220) 04.05.2012.

- (731) **IOCHPE-MAXION S/A**, RUA LUIGI GALVANI, 145, 13 ANDAR, 04575-020 SAO PAULO BR



- (540)  
 (550) I  
 (740) Čupić Branislav, Dalmatinska 10, Podgorica ME  
 (511) **Klasa 12:** Djelovi za suvozemna vozila, naime točkovi, šasije, uzdužne grede (lonžeroni), poprečne grede (stringeri), presovani djelovi i kovani djelovi, naime, konstrukcijski djelovi za kamione, autobuse, kombije, traktore i terenska vozila.

(210) **2012-225** (442) **20.12.2013.**  
 (220) 04.05.2012.

- (731) **IOCHPE-MAXION S/A**, RUA LUIGI GALVANI, 145, 13 ANDAR, 04575-020 SAO PAULO BR  
 (540) MAXION  
 (550) I  
 (740) Čupić Branislav, Dalmatinska 10, Podgorica ME  
 (511) **Klasa 12:** Djelovi za suvozemna vozila. naime točkovi, šasije, uzdužne grede (lonžeroni), poprečne grede (stringeri), presovani djelovi i kovani djelovi, naime, konstrukcijski djelovi za kamione, autobuse, kombije, traktore i terenska vozila.

(210) **2012-228** (442) **20.12.2013.**  
 (220) 04.05.2012.

- (731) **E.L.DU PONT DE NEMOURS AND COMPANY**, 1007 MARKET STREET, WILMIN-

GTON, DE 19898 US

(540) HOMEKS

(550) I

(740) Čejović Vladimir, 13. jula 21, Podgorica ME

(511) **Klasa 09:** Zaštitna odjeća.

**Klasa 16:** Papir i stvari napravljene od papira, uključujući papirne filtere.

**Klasa 17:** Električni izolacioni materijal, savitljive cijevi i crijeva.

**Klasa 22:** Ručno napravljena vlakna, vlakna i savitljivi tabak sličan papiru, materijali od sirovog vlaknastog tekstila.

**Klasa 23:** Pređe i konci napravljeni od tekstilnih materijala.

**Klasa 24:** Tkanine, obložene tkanine i slojevite tkanine.

**Klasa 25:** Odjeća.

(210) **2012-23**

(442) **20.12.2013.**

(220) 18.01.2012.

(731) **NBA PROPERTIES, INC.** OLYMPIC TOWER BLDG. 645 FIFTH AVENUE, NEWYORK, NY 10022 US



(540)

(550) I

(740) Popović Miladin, Đoka Miraševića 21/III, Podgorica ME

(511) **Klasa 41:** Razonoda i obrazovne usluge u smislu televizijskih događaja i radio programa u polju košarke i prikazivanja uživo košarkaških igara i košarkaških priredbi, usluge produkcije i distribucije radio i televizijskih šou programa o košarkaškim igrama, košarkaškim događajima i programima iz oblasti košarke, usluge vođenja i organizovanja košarkaških klubova i kampova, klinika i kampova za trenere, klinika i kampova za plesne timove i košarkaške igre, usluge rasonode u vidu ličnog pojavljivanja u kostimiziranim maskotama ili u plesnim timovima na košarkaškim igrama i priredbama, klinikama, kampovima, promocijama i drugim događajima, specijalnim događajima i žurkama vezanim za košarku, usluge kluba obožavatelaca, usluge rasonode, naime one koje pružaju vebsajt predstavljanje multimedijских sadržaja u vidu najvažnijih televizijskih događaja, interaktivnih najvažnijih televizijskih događaja, video snimaka, video strim snimaka, interaktivnih video izbora najvažnijih događaja, radio programa, najvažnijih radijskih događaja i audio snimaka u polju košarke, usluge obezbeđivanja vesti i informacija u vidu statistika i drugih stvari u polju košarke, onlajn igrice koje se ne mogu preuzimati, naime kompjuterske igrice, video igrice, interaktivne video igrice, akcijske igrice, arkadne igrice, društvene igrice za odrasle i decu, igre na tabli, puzzle, trivia igrice, usluge elektronskog izdavaštva, naime, izdavanje magazina, vodiča, biltena, bojanki i igrica kod kojih se igrači određuju putem interneta, sve u vezi sa košarkom, usluge obezbeđivanja onlajn kompjuterske baze podataka u polju košarke.

---

(210) **2012-231** (442) **20.12.2013.**  
(220) 08.05.2012.

(731) **THE COCA-COLA COMPANY** ONE COCA COLA PLAZA, ATLANTA, GEORGIA 30313 US  
(540) AQUARIUS

(550) I

(740) Popović Miladin, Đoka Miraševića 21/III, Podgorica ME

(511) **Klasa 32:** Pivo, svijetlo pivo i cmo pivo, mineralne i sodne vode i druga bezalkoholna pića, sirupi i drugi preparati za proizvodnju pića.

---

(210) **2012-232** (442) **20.12.2013.**  
(220) 08.05.2012.

(731) **THE COCA-COLA COMPANY** ONE COCA COLA PLAZA, ATLANTA, GEORGIA 30313 US  
(540) FANTA

(550) I

(740) Popović Miladin, Đoka Miraševića 21/III, Podgorica ME

(511) **Klasa 30:** Sladoledi i preparati za njihovo spravljanje.

**Klasa 32:** Šerbeti i preparati za njihovo spravljanje.

---

(210) **2012-233** (442) **20.12.2013.**  
(220) 08.05.2012.

(731) **THE COCA-COLA COMPANY** ONE COCA COLA PLAZA, ATLANTA, GEORGIA 30313 US



(540)

(550) I

(740) Popović Miladin, Đoka Miraševića 21/III, Podgorica ME

(511) **Klasa 30:** Sladoledi i preparati za njihovo spravljanje.

**Klasa 32:** Šerbeti i preparati za njihovo spravljanje.

---

(210) **2012-234** (442) **20.12.2013.**  
(220) 08.05.2012.

(731) **THE COCA-COLA COMPANY** ONE COCA COLA PLAZA, ATLANTA, GEORGIA 30313 US

(540)

(550) I

(740) Popović Miladin, Đoka Miraševića 21/III, Podgorica ME

(511) **Klasa 32:** Svijetlo pivo, tamno pivo i crno pivo, mineralne i sodne vode i druga bezalkoholna pića, sirupi i drugi preparati za proizvodnju pića.(210) **2012-235**(442) **20.12.2013.**

(220) 09.05.2012.

(731) **AKTIEBOLAGET ELECTROLUX**, S:T GORANSGATAN 143, SE-105 45 STOCKHOLM SE

(540)

(550) I

(740) Čupić Branislav, Dalmatinska 10, Podgorica ME

(511) **Klasa 07:** Usisivači, crijeva za usisivače, usisni nastavci i pribori za usisivače, cijevi kao djelovi mašina.(210) **2012-238**(442) **20.12.2013.**

(220) 14.05.2012.

(731) **SWISSOTEL MANAGEMENT GMBH**, BALZ-ZIMMERMANNSTRASSE 7 8302 KLOTEN CH

(540) SWISSOTEL

(550) I

(740) Popović Miladin, Đoka Miraševića 21/III, Podgorica ME

(511) **Klasa 35:** Poslovno upravljanje hotelima, konsalting za poslovno i hotelsko upravljanje koji je u vezi sa franšizingom, usluge maloprodaje, veleprodaje i prodaje, sastavljanje poštanskih lista, usluge porudžbine putem pošte i telefonom i usluge porudžbine putem drugih telekomunikacionih medija, direktno poštansko oglašavanje, poslovno savjetovanje i poslovno upravljanje, oglašavanje, usluge prikazivanja roba i druge usluge reklamiranja prodaje, analize tržišta i istraživanja tržišta, oglašavanje i reklamiranje prodaje u vezi sa hotelskim uslugama, sticanje i kupovina roba u ime drugih, aranžiranje izloga prodavnica, konsalting u vezi sa svim gore navedenim uslugama i svim drugim uslugama obuhvaćenim ovom klasom.(210) **2012-239**(442) **20.12.2013.**

(220) 15.05.2012.

(731) **ALKALOID AD-SKOPLJE**, BUL. ALEKSANDAR MAKEDONSKI BR. 12. SKOPLJE MK

(540) ZYGLIP

(550) I

(740) Popović Miladin, Đoka Miraševića 21/III, Podgorica ME

(511) **Klasa 05:** Hipolipemik.

(210) 2012-24

(442) **20.12.2013.**

(220) 18.01.2012.

(731) **NBA PROPERTIES, INC.** OLYMPIC TOWER BLDG. 645 FIFTH AVENUE, NEWYORK, NY 10022 US



(540)

(550) I

(740) Popović Miladin, Đoka Miraševića 21/III, Podgorica ME

(511) **Klasa 28:** Igračke, igre i sportske stvari, naime košarkaške lopte, loptice za golf, lopte za igralište, sportske lopte, gumene lopte i penaste lopte, plišane lopte za igru, plastične lopte za igru, mrežice za košarku, table za košarku, minijaturne table za košarku, pumpe i igle za naduvavanje košarkaških lopti, štapovi za golf, torbe za golf, podmetači za golf, oprema za golf, naime, alat za popravku golf terena, kupice na koje se stavlja lopta, markeri lopti, torbe za golf opremu, pokrivala za glave golf štapova, rukavice za golf, kutije za golf lopte, elektronske table za košarkaške igrice na tabli, table za košarkaške igrice, košarkaške igrice, akcione igrice, društvene igrice za odrasle i decu, trivia informacione igrice i elektronske video arkada igrice, košarkaška torbica koja se sastoji od mrežice i zviždaljke, lutke, dekorativne lutke, lutke za kolekciju, akcione figure za igru, akcione figure karikature, punjene igračke, nove plišane igračke sa perikom, puzzle, montažni blokovi za igre, ukrasi za Božićnu jelku i Božićne čarape, vozila za igru u obliku automobila, kamiona, vozova i kombija, svi sa temom košarke, nove penaste igračke u obliku prsta ili trofeja, igrački trofeji, karte za igru, igrice sa kartama, igračke koje prave zvuk, igračke za kućne ljubimce, igračke za plažu, naime lopte za plažu, lopte na naduvavanje, kantice za igru, lopatice za igru, igračke za pesak, kutijice za pesak, gumene igračke za vodu, oprema za bazen, naime plivačka oprema za plutanje, oprema za plutanje u bazenu, igračke za splavarenje na vodi, penasta oprema za plutanje, gume za plivanje, gume za plivanje u bazenu, penaste gume, daske za plivanje, daske za surfovanje, peraja za plivanje, peraja za surfovanje, mišici za plutanje i krila za pomoć pri plivanju u rekreativne svrhe, odbojkaške torbice za igru koje se sastoje od lopte, mrežice, sporednih stvari i zviždaljke, i vaterpolo torbice za igru koje se sastoje od lopte, mrežice i zviždaljke, dekorativne igračke od tkanine koje se puštaju da lete na vetru.

**Klasa 41:** Razonoda i obrazovne usluge u smislu televizijskih događaja i radio programa u polju košarke i prikazivanja uživo košarkaških igara i košarkaških priredbi, usluge produkcije i distribucije radio i televizijskih šou programa o košarkaškim igrama, košarkaškim događajima i programima iz oblasti košarke, usluge vođenja i organizovanja košarkaških klinika i kampova, klinika i kampova za trenere, klinika i kampova za plesne timove i košarkaške igre, usluge



razonode u vidu ličnog pojavljivanja u kostimiziranim maskotama ili u plesnim timovima na košarkaškim igrama i priredbama, klinikama, kampovima, promocijama i drugim događajima, specijalnim događajima i žurkama vezanim za košarku, usluge kluba obožavalaca, usluge razonode, naime one koje pružaju vebsajt predstavljanje multimedijjskih sadržaja u vidu najvažnijih televizijskih događaja, interaktivnih najvažnijih televizijskih događaja, video snimaka, video strim snimaka, interaktivnih video izbora najvažnijih događaja, radio programa, najvažnijih radijskih događaja i audio snimaka u polju košarke, usluge obezbeđivanja vesti i informacija u vidu statistika i drugih stvari u polju košarke, onlajn igrice koje se ne mogu preuzimati, naime kompjuterske igrice, video igrice, interaktivne video igrice, akcijske igrice, arkadne igrice, društvene igrice za odrasle i decu, igre na tabli, puzzle, trivia igrice, usluge elektronskog izdavaštva, naime, izdavanje magazina, vodiča, biltena, bojanki i igrica kod kojih se igrači određuju putem interneta, sve u vezi sa košarkom, usluge obezbeđivanja onlajn kompjuterske baze podataka u polju košarke.

(210) **2012-240** (442) **20.12.2013.**

(220) 17.05.2012.

(731) **FARMACEUTSKO-HEMIJSKA INDUSTRIJA ZDRAVLJE AD**, VLAJKOVA 199, LESKOVAC RS

(540) KOLBRIT

(550) I

(740) Popović Miladin, Đoka Miraševića 21/III, Podgorica ME

(511) **Klasa 05:** Farmaceutski i veterinarski preparati, sanitarni proizvodi za upotrebu u medicini, dijetetska hrana i supstance prilagođene za upotrebu u medicini ili veterinarsku upotrebu, hrana za bebe, dijetetski dodaci (dodaci ishrani) za ljude i životinje, flasteri, materijali za zavijanje, materijali za plombiranje zuba, zubarska smola, dezinfekciona sredstva, preparati za uništavanje štetocina, fungicidi, herbicidi.

(210) **2012-241** (442) **20.12.2013.**

(220) 18.05.2012.

(731) **FREMANTLEMEDIA LIMITED 1 STEPHEN STREET**, LONDON W1T 1AL UK, SIMCO LIMITED 9 DERRY STREET, LONDON W8 5 HY UK

(540) X FACTOR

(550) I

(740) Popović Miladin, Đoka Miraševića 21/III, Podgorica ME

(511) **Klasa 09:** Kinematografski filmovi, crtani filmovi, dijafilmovi, filmovi, magnetni zapisi, optički zapisi, magnetno-optički zapisi, zapisi na čvrstim podlogama, audio-vizuelni aparati za nastavu, aparati za zabavu adaptirani za upotrebu priključenjem na televizore, elektronske knjige i publikacije, elektronske igrice, interaktivne igrice adaptirane za upotrebu uz televizore, električni i video aparati i instrumenti za zabavu, multimedijalni diskovi i publikacije, multimedijalni zapisi i publikacije, laserski čitljivi diskovi, video diskovi i publikacije, kompjuterski softver, kompjuterski programi, kompjuterske igrice, softveri za interaktivne igrice za kompjutere, mobilne telefone i uređaje kojima se manualno rukuje, digitalni zapisi, mediji za cuvanje ili snimanje zvuka i/ili video zapisa i/ili podataka i/ili informacija, aparati i instrumenti za snimanje i/ili reprodukovanje zvuka i/ili video zapisa i/ili informacija, hologrami, flopi diskovi, zvucni zapisi, presnimljeni diskovi, snimljeni diskovi, kompakt diskovi, gramofonske ploce, audio kasete, kasete, video kasete, laserski diskovi, kompakt diskovi-interaktivni CD ROM-ovi, digitalni video diskovi (DVD), aparati i instrumenti za komunikaciju, telefoni, mobilni telefoni, punjači, punjači za mobilne telefone, hands-free aparati za mobilne

telefone, igrice za mobilne telefone, karaoke mašine, delovi i oprema za svu gorenavedenu robu, digitalne igrice, igrice za mobilne telefone, DVD igrice.

**Klasa 38:** Emitovanje, emitovanje televizijskog programa, emitovanje radio programa, emitovanje programa satelitske televizije, emitovanje programa kablovske televizije, telefonske komunikacije, interaktivne telefonske usluge, usluge telefonskih poruka, komunikacijske usluge putem radio talasa, telefona, Interneta, svetskog pretraživača, kablovskim putem, putem satelita, mikrotalasa i električnih mreža, telefonija.

**Klasa 41:** Usluge obrazovanja i razonode u formi televizijskih programa, radio programa, kablovskih, satelitskih i Internet programa, produkcija i prezentacija radio i televizijskog programa, kinematografskih filmova, predstava, video programa, DVD programa, kablovskih programa, satelitskih programa i/ili Internet programa, usluge organizovanja predstava, iznajmljivanje zvučnih zapisa i prethodno snimljenih predstava, filmova, radio i televizijskih performansa, produkcija video kasete i video diskova, usluge zabave putem radija, usluge zabave putem televizije, usluge zabave putem bioskopa, usluge zabave putem pozorišta, zabavne emisije koje uključuju igru (takmičenje), usluge razonode putem televizije koje uključuju i učestvovanje gledalaca putem telefona, interaktivna razonoda uz upotrebu mobilnog telefona, usluge omogućavanja igranja igrice putem Interneta (on-line), usluge organizovanja lota i igara na sreću, usluge pružanja zabave putem igrice, usluge igre, usluge klađenja, usluge opklada, usluge kazina, usluge organizovanja igara sa kartama i kazino turnira, takmičenja, nadmetanja, igara i/ili događaja, lutrija, omogućavanje bilo koje gore navedene usluge na mobilnim telefonima putem mreže mobilne telefonije, satelitskom komunikacijom, mikrotalasima ili drugim elektronskim, digitalnim i analognim medijom, uživo, elektronski, putem kompjuterske mreže, putem interneta, online ili putem televizijskog medija, organizovanje, produkcija i prezentacija događaja u obrazovne, kulturne ili zabavne svrhe, organizovanje, produkcija, upravljanje i prezentacija takmičenja, nadmetanja, igara, predstava koje uključuju igru, kvizova, dana zabave, izložbi, predstava, parada na tockovima (roads-hows), predstava na podijumima, rejvova, pozorišnih performansa, koncerata, performansa uživo i događaja u kojima se može učestvovati, usluge organizovanja i proizvodnje video klipova putem mobilne telefonije ili kompjuterske mreže za zabavu i/ili u obrazovne svrhe.

(210) **2012-242**

(442) **20.12.2013.**

(220) 18.05.2012.

(731) **PHILIP MORRIS OPERATIONS** A.D. NIŠ, BULEVAR 12. FEBRUARA 74, NIŠ RS



(540) \_\_\_\_\_

(550) I

(740) Kojić Ivana, Serdara Jola Piletića bb, Podgorica ME

(511) **Klasa 16:** Hartija, karton i proizvodi od njih koji nisu uključeni u druge klase, štampane stvari, knjigovezački materijal, fotografije, kancelarijski materijal, ljepila za kancelarijske i kućne potrebe, umjetnički materijali, kičice, pisaće mašine i kancelarijski rekviziti (izuzev

namještaja), materijali za obuku i nastavu (izuzev aparata), plastični materijal za pakovanje (koji nisu uključeni u druge klase), štamparska slova, klišeji.

**Klasa 25:** Odjeća, obuća, pokrivala za glavu.

**Klasa 41:** Obrazovne usluge, pripremanje obuke, razonoda, sportske i kulturne aktivnosti.

(210) **2012-243** (442) **20.12.2013.**

(220) 23.05.2012.

(731) **MARS, INCORPORATED**, 6885 ELM STREET, MCLEAN, VA 22101-3883 US

(540) LEFT TWIX.RIGHT TWIX.PICK A SIDE.

(550) I

(740) Čejović Vladimir, 13. jula 21, Podgorica ME

(511) **Klasa 29:** Meso, riba, živina i divljač, mesne prerađevine, konzervisano, zamrznuto, sušeno i kuvano voće i povrće, želei, džemovi, kompoti, jaja, mlijeko i mliječni proizvodi, mliječni proizvodi, mliječni napici, proizvodi pripremljeni za konzumiranje i koji se sastoje uglavnom od gore navedenih proizvoda.

**Klasa 30:** Kafa, čaj, kakao i vještačka kafa, pirinač, tapioka i sago, brašno i proizvodi od žitarica, hljeb, kolači i poslastice, ledene poslastice, šećer, med, melasa, kvasac, prašak za pecivo, so, senf, sirće, sosovi (kao dodaci), začini, led, zamjene kafe, čokolada za piće, table od žitarica, tjestenina, rezanci, biskviti, kolači, čokolada, sladoled, smrznuti slatkiši, pesto, bilje, proizvodi pripremljeni za konzumiranje i koji se sastoje uglavnom od gore navedenih proizvoda.

(210) **2012-244** (442) **20.12.2013.**

(220) 23.05.2012.

(731) **PEPSICO, INC.** 700 ANDERSON HILL ROAD, PURCHASE, NY 10577 US



(540) \_\_\_\_\_

(550) I

(740) Čejović Vladimir, 13. jula 21, Podgorica ME

(511) **Klasa 29:** Meso, riba, živina i divljač, mesne prerađevine, konzervisano, zamrznuto, sušeno i kuvano voće i povrće, želei, džemovi, kompoti, jaja, mlijeko i mliječni napitci proizvodi, jestiva ulja i masti.

**Klasa 30:** Kafa, čaj, kakao i zamjena kafe, pirinač, tapioka i sago, brašno i proizvodi od žitarica, hljeb, kolači i poslastice, sladoledi, šećer, med, melasa, kvasac, prašak za pecivo, so, senf, sirće, sosovi (kao dodaci), začini, led.

(210) **2012-245** (442) **20.12.2013.**

(220) 30.05.2012.

(731) **ALKALOID AD** SKOPLJE, BUL. ALEKSANDAR MAKEDONSKI 12, SKOPLJE MK

(540) AME

(550) I, V

(740) Popović Miladin, Đoka Miraševića 21/III, Podgorica ME

(511) **Klasa 03:** Sredstva za bijeljenje i druge supstance za upotrebu u perionicama, preparati za čišćenje, poliranje, ribanje i nagrizanje, sapuni, parfimerija, eterična ulja, kozmetika, losioni za kosu, paste za zube.

(210) **2012-246** (442) **20.12.2013.**  
(220) 30.05.2012.

(731) **ALKALOID AD** SKOPLJE, BUL. ALEKSANDAR MAKEDONSKI 12, SKOPLJE MK

(540) ASSO

(550) I, V

(740) Popović Miladin, Đoka Miraševića 21/III, Podgorica ME

(511) **Klasa 03:** Sredstva za bijeljenje i druge supstance za upotrebu u perionicama, preparati za čišćenje, poliranje, ribanje i nagrizanje, sapuni, parfimerija, eterična ulja, kozmetika, losioni za kosu, paste za zube.

(210) **2012-247** (442) **20.12.2013.**  
(220) 30.05.2012.

(731) **ALKALOID AD** SKOPLJE, BUL. ALEKSANDAR MAKEDONSKI 12, SKOPLJE MK

(540) BLACK-UP

(550) I, V

(740) Popović Miladin, Đoka Miraševića 21/III, Podgorica ME

(511) **Klasa 03:** Sredstva za bijeljenje i druge supstance za upotrebu u perionicama, preparati za čišćenje, poliranje, ribanje i nagrizanje, sapuni, parfimerija, eterična ulja, kozmetika, losioni za kosu, paste za zube.

(210) **2012-248** (442) **20.12.2013.**  
(220) 30.05.2012.

(731) **ALKALOID AD** SKOPLJE, BUL. ALEKSANDAR MAKEDONSKI 12, SKOPLJE MK

(540) SLIM-MIX

(550) I, V

(740) Popović Miladin, Đoka Miraševića 21/III, Podgorica ME

(511) **Klasa 05:** Čaj od ljekovitog bilja.

(210) 2012-25 (442) **20.12.2013.**  
(220) 18.01.2012.

(731) **NBA PROPERTIES, INC,** OLYMPIC TOWER BLDG. 645 FIFTH AVENUE, NEWYORK, NY 10022 US



(540)

(550) I

(740) Popović Miladin, Đoka Miraševića 21/III, Podgorica ME

(511) **Klasa 25:** Odeća, naime čarape, obuća, cipele za košarku, patike za košarku, majice, košulje, polo majice, dukserice, donji delovi trenerke, pantalone, majice na bretele, džemper, kratke pantalone, pidžame, sportske majice, ragbi majice, vunene majice, kaiševi, kravate, spavacice, šeširi, kape, štitnici na kasketima, trenerke, donji delovi trenerki, dresovi, jakne, vetrovke, kišne krznene jakne, kaputi, portikle za bebe ne od papira, trake za glavu, narukvice, kecelje, donje rublje, bokserice, široke pantalone, štitnici za uši, rukavice, bokserske rukavice, šalovi, pletene i štrikane majice, trikotažne haljine, haljine, dresovi i uniforme za navijacice, odeća za plivanje, odela za kupanje, kupaći kostimi, bikini, tamkini kupaći kostimi, gacice za plivanje, gacice za kupanje, šorcevi za surfovanje, šorcevi za kupanje, marama za plažu, pokrivala za kupaći kostim, ogrtači za kupaći kostim, sandale, sandale za plažu, šeširi za plažu, štitnici za sunce, kape za plivanje, kape za kupanje, nova pokrivala za glavu sa prikačenim umecima.

**Klasa 28:** Igračke, igre i sportske stvari, naime košarkaške lopte, loptice za golf, lopte za igralište, sportske lopte, gumene lopte i penaste lopte, plišane lopte za igru, plastične lopte za igru, mrežice za košarku, table za košarku, minijaturne table za košarku, pumpe i igle za naduvavanje košarkaških lopti, štapovi za golf, torbe za golf, podmetači za golf, oprema za golf, naime, alat za popravku golf terena, kupice na koje se stavlja lopta, markeri lopti, torbe za golf opremu, pokrivala za glave golf štapova, rukavice za golf, kutije za golf lopte, elektronske table za košarkaške igrice na tabli, table za košarkaške igrice, košarkaške igrice, akcione igrice, društvene igrice za odrasle i decu, trivia informacione igrice i elektronske video arkađne igrice, košarkaška torbica koja se sastoji od mrežice i zviždaljke, lutke, dekorativne lutke, lutke za kolekciju, akcione figure za igru, akcione figure karikature, punjene igračke, nove plišane igračke sa perikom, puzle, montažni blokovi za igre, ukrasi za Božićnu jelku i Božićne čarape, vozila za igru u obliku automobila, kamiona, vozova i kombija, svi sa temom košarke, nove penaste igračke u obliku prsta ili trofeja, igrački trofeji, karte za igru, igrice sa kartama, igračke koje prave zvuk, igračke za kućne ljubimce, igračke za plažu, naime lopte za plažu, lopte na naduvavanje, kantice za igru, lopatice za igru, igračke za pesak, kutijice za pesak, gumene igračke za vodu, oprema za bazen, naime plivačka oprema za plutanje, oprema za plutanje u bazenu, igračke za splavanje na vodi, penasta oprema za plutanje, gume za plivanje, gume za plivanje u bazenu, penaste gume, daske za plivanje, daske za surfovanje, peraja za plivanje, peraja za surfovanje, mišići za plutanje i krila za pomoć pri plivanju u rekreativne svrhe, odbojkaške torbice za igru koje se sastoje od lopte, mrežice, sporednih stvari i zviždaljke, i vaterpolo torbice za igru koje se sastoje od lopte, mrežice i zviždaljke, dekorativne igračke od tkanine koje se puštaju da lete na.

**Klasa 41:** Razonoda i obrazovne usluge u smislu televizijskih događaja i radio programa u polju košarke i prikazivanja uživo košarkaških igara i košarkaških priredbi, usluge produkcije i distribucije radio i televizijskih šou programa o košarkaškim igrama, košarkaškim događajima i programima iz oblasti košarke, usluge vođenja i organizovanja košarkaških klinika i kampova, klinika i kampova za trenere, klinika i kampova za plesne timove i košarkaške igre, usluge rasonode u vidu ličnog pojavljivanja u kostimiziranim maskotama ili u plesnim timovima na košarkaškim igrama i priredbama, klinikama, kampovima, promocijama i drugim događajima, specijalnim događajima i žurkama vezanim za košarku, usluge kluba obožavalaca, usluge rasonode, naime one koje pružaju veb-sajt predstavljanje multimedijjskih sadržaja u vidu najvažnijih televizijskih događaja, interaktivnih najvažnijih televizijskih događaja, video snimaka, video strim snimaka, interaktivnih video izbora najvažnijih događaja, radio programa, najvažnijih radijskih događaja i audio snimaka u polju košarke, usluge obezbeđivanja vesti i informacija u vidu statistika i drugih stvari u polju košarke, onlajn igrice koje se ne

mogu preuzimati, naime kompjuterske igrice, video igrice, interaktivne video igrice, akcione igrice, arkadne igrice, društvene igrice za odrasle i decu, igre na tabli, puzzle, trivia igrice, usluge elektronskog izdavaštva, naime, izdavanje magazina, vodiča, biltena, bojanki i igrica kod kojih se igrači određuju putem interneta, sve u vezi sa košarkom, usluge obezbeđivanja onlajn kompjuterske baze podataka u polju košarke.

(210) **2012-250**

(442) **20.12.2013.**

(220) 31.05.2012.

(300) 2604631

15.12.2011. UK

(731) **NICOVENTURES LIMITED**, 1. WATER STREET LONDON WC2R 3LA UK

(540) KUJU

(550) I

(740) Popović Miladin, Đoka Miraševića 21/III, Podgorica ME

(511) **Klasa 05:** Farmaceutski preparati, odnosno preparati za ljudsku upotrebu uključujući, ali ne ograničavajući se na transdermalne flastere, tablete za grlo i mikrotablete.

**Klasa 10:** Medicinski aparati, odnosno medicinski aparati za ljudsku upotrebu uključujući, ali ne ograničavajući se na, sprejeve za usta, sprejeve za nos i inhalatore.

**Klasa 34:** Zamjene za duvan, cigarete koje sadrže zamjenu za duvan, aparati koji sadrže nikotin, a koji nisu za medicinsku upotrebu, cigarete, duvan, duvanski proizvodi, upaljači, šibice, artikli za pušače.

(210) **2012-41**

(442) **20.12.2013.**

(220) 24.01.2012.

(731) **JT INTERNATIONAL S.A**, 1, RUE DE LA GABELLE, 1211 GENEVA 26 CH



(540) 

(550) I

(740) Čejović Vladimir, 13. jula 21, Podgorica ME

(511) **Klasa 34:** Duvan, prerađen ili neprerađen, duvan za pušenje, duvan za lule, duvan za ručno uvijanje, duvan za žvakanje, snus duvan, cigarete, cigare, cigarilosi, supstance za pušenje koje se prodaju odvojeno ili miješane sa duvanom, a koje nisu za medicinske svrhe ili u svrhe liječenja, duvan za ušmrkavanje, artikli za pušače uključeni u klasu 34, papir za cigarete, tube za cigarete i šibice.

(210) **2012-42**

(442) **20.12.2013.**

(220) 24.01.2012.

(731) **JT INTERNATIONAL S.A**, 1, RUE DE LA GABELLE,1211 GENEVA 26 CH



(540)

(550) I

(740) Čejović Vladimir, 13. jula 21, Podgorica ME

(511) **Klasa 34:** Duvan, prerađen ili neprerađen, duvan za pušenje, duvan za lule, duvan za ručno uvijanje, duvan za žvakanje, snus duvan, cigarete, cigare, cigarilosi, supstance za pušenje koje se prodaju odvojeno ili miješane sa duvanom, a koje nisu za medicinske svrhe ili u svrhe liječenja, duvan za ušmrkavanje, artikli za pušače uključeni u klasu 34, papir za cigarete, tube za cigarete i šibice.

(210) **2012-43**

(442) **20.12.2013.**

(220) 24.01.2012.

(731) **JT INTERNATIONAL S.A**, 1, RUE DE LA GABELLE,1211 GENEVA 26 CH



(540) \_\_\_\_\_

(550) I

(740) Čejović Vladimir, 13. jula 21, Podgorica ME

(511) **Klasa 34:** Duvan, prerađen ili neprerađen, duvan za pušenje, duvan za lule, duvan za ručno uvijanje, duvan za žvakanje, snus duvan, cigarete, cigare, cigarilosi, supstance za pušenje koje se prodaju odvojeno ili miješane sa duvanom, a koje nisu za medicinske svrhe ili u svr-

he liječenja, duvan za ušmrkavanje, artikli za pušače uključeni u klasu 34, papir za cigarete, tube za cigarete i šibice.

(210) **2012-44**

(442) **20.12.2013.**

(220) 24.01.2012.

(300) 11-1289

07.10.2011. LV

(731) **JT INTERNATIONAL S.A**, 1, RUE DE LA GABELLE, 1211 GENEVA 26 CH

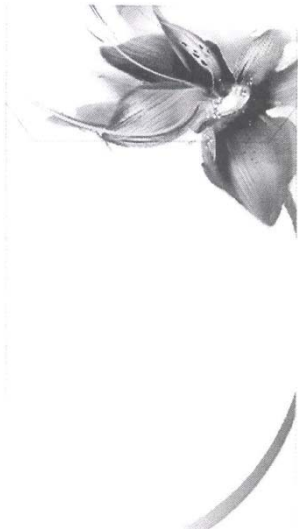

(540)

(550) I

(740) Čejović Vladimir, 13. jula 21, Podgorica ME

(511) **Klasa 34:** Duvan, prerađen ili neprerađen, duvan za pušenje, duvan za lule, duvan za ručno uvijanje, duvan za žvakanje, snus duvan, cigarete, cigare, cigarilosi, supstance za pušenje koje se prodaju odvojeno ili miješane sa duvanom, a koje nisu za medicinske svrhe ili u svrhe liječenja, duvan za ušmrkavanje, artikli za pušače uključeni u klasu 34, papir za cigarete, tube za cigarete i šibice.

(210) **2012-45**

(442) **20.12.2013.**

(220) 24.01.2012.

(731) **REVLON CONSUMER PRODUCTS CORPORATION** (A DELAWARE CORPORATION), 237 PARK AVENUE, NEW YORK, NY 10017 US

## REVLON

(540)

(550) I

(740) Čejović Vladimir, 13. jula 21, Podgorica ME

(511) **Klasa 03:** Sredstva za bijeljenje i druge supstance za upotrebu u perionicama, preparati za čišćenje, poliranje, ribanje i nagrizanje, sapuni, parfimerija, eterična ulja, kozmetika, losioni za kosu, paste za zube.



(210) **2012-46**(442) **20.12.2013.**

(220) 24.01.2012.

(731) **REVLON CONSUMER PRODUCTS CORPORATION** (A DELAWARE CORPORATION), 237 PARK AVENUE, NEW YORK, NY 10017 US**CHARLIE**

(540)

(550) I

(740) Čejović Vladimir, 13. jula 21, Podgorica ME

(511) **Klasa 03:** Sredstva za bijeljenje i druge supstance za upotrebu u perionicama, preparati za čišćenje, poliranje, ribanje i nagrizanje, sapuni, parfimerija, eterična ulja, kozmetika, losioni za kosu, paste za zube.(210) **2012-47**(442) **20.12.2013.**

(220) 25.01.2012.

(731) **ADRIATIC MARINAS** DOO, OBALA B.B. TIVAT ME**CASINO-ROYALE**

(540)

(550) I

(740) Đurović Savo, Dom Vojske, Seljanovo b.b. Tivat ME

(511) **Klasa 36:** Osiguranje, finansijski poslovi, novčani (monetarni) poslovi, poslovi vezani za nepokretnosti.**Klasa 39:** Transportne usluge, pakovanje i skladištenje robe, organizovanje putovanja.(210) **2012-48**(442) **20.12.2013.**

(220) 25.01.2012.

(731) **ADRIATIC MARINAS** DOO, OBALA B.B. TIVAT ME**PORTO MONTENEGRO**

(540)

(550) I

(740) Đurović Savo, Dom Vojske, Seljanovo b.b. Tivat ME

(511) **Klasa 36:** Osiguranje, finansijski poslovi, novčani (monetarni) poslovi, poslovi vezani za nepokretnosti.

**Klasa 39:** Transportne usluge, pakovanje i skladištenje robe, organizovanje putovanja.

---

(210) **2012-49**

(442) **20.12.2013.**

(220) 25.01.2012.

(731) **ADRIATIC MARINAS** DOO, OBALA B.B. TIVAT ME

CASINO ROYALE



PORTO MONTENEGRO

(540)

(550) I

(740) Đurović Savo, Dom Vojske, Seljanovo b.b. Tivat ME

(511) **Klasa 36:** Osiguranje, finansijski poslovi, novčani (monetarni) poslovi, poslovi vezani za nepokretnosti.

**Klasa 39:** Transportne usluge, pakovanje i skladištenje robe, organizovanje putovanja.

---

(210) **2012-50**

(442) **20.12.2013.**

(220) 25.01.2012.

(731) **ADRIATIC MARINAS** DOO, OBALA B.B. TIVAT ME

CASINO ROYALE

(540)

(550) I

(740) Đurović Savo, Dom Vojske, Seljanovo b.b. Tivat ME

(511) **Klasa 36:** Osiguranje, finansijski poslovi, novčani (monetarni) poslovi, poslovi vezani za nepokretnosti.

**Klasa 39:** Transportne usluge, pakovanje i skladištenje robe, organizovanje putovanja.

---

(210) **2012-51**

(442) **20.12.2013.**

(220) 25.01.2012.

(731) **ADRIATIC MARINAS** DOO, OBALA B.B. TIVAT ME



ROYAL MONTENEGRO GRAND RESORT

(540)

(550) I

(740) Đurović Savo, Dom Vojske, Seljanovo b.b. Tivat ME

(511) **Klasa 36:** Osiguranje, finansijski poslovi, novčani (monetarni) poslovi, poslovi vezani za nepokretnosti.

**Klasa 39:** Transportne usluge, pakovanje i skladištenje robe, organizovanje putovanja.

---

(210) **2012-52**

(442) **20.12.2013.**

(220) 25.01.2012.

(731) **ADRIATIC MARINAS** DOO, OBALA B.B. TIVAT ME



(540)

(550) I

(511) **Klasa 36:** Osiguranje, finansijski poslovi, novčani (monetarni) poslovi, poslovi vezani za nepokretnosti.

**Klasa 39:** Transportne usluge, pakovanje i skladištenje robe, organizovanje putovanja.

---

(210) **2012-53**

(442) **20.12.2013.**

(220) 25.01.2012.

(731) **ALKALOID AD** SKOPLJE, BUL. ALEKSANDAR MAKEDONSKI 12, SKOPLJE MK



(540)

(550) I

(740) Popović Miladin, Đoka Miraševića 21/III, Podgorica ME

(511) **Klasa 03:** Dnevna krema sa matičnim ćelijama jabuke i maslinovim uljem.(210) **2012-54**(442) **20.12.2013.**

(220) 25.01.2012.

(731) **ALKALOID AD** SKOPLJE, BUL. ALEKSANDAR MAKEDONSKI 12, SKOPLJE MK

(540)

(550) I

(740) Popović Miladin, Đoka Miraševića 21/III, Podgorica ME

(511) **Klasa 03:** Noćna krema sa matičnim ćelijama jabuke i maslinovim uljem.(210) **2012-55**(442) **20.12.2013.**

(220) 25.01.2012.

(731) **LES MILLS INTERNATIONAL LIMITED**, 22 CENTRE STREET, AUCKLAND NZ

# LES MILLS

(540)

(550) I

(740) Ćupić Branislav, Dalmatinska 10, Podgorica ME

(511) **Klasa 41:** Usluge rekreacije i treninga, sportske aktivnosti, usluge obrazovanja, kreiranje i vođenje časova i programa vježbi uz muziku, usluge teretana, usluge klubova vezanih za zdrav život, usluge sportskih klubova, usluge fitnes klubova, usluge vježbi sa instruktorom, usluge savjetovanja i treniranja, usluge pružanja prostora za vježbanje, usluge sportskih vježbi sa instruktorom, usluge treniranja i obuke, usluge informacija, savjeta i konsultacija u vezi sa nekim ili svim navedenim uslugama, objava štampanog materijala i elektronskih medija, uključujući objavu muzičkih i video zapisa u digitalnom formatu vezanih za programe i treninge fitnes klubova i klubova vezanih za zdrav život.

---

(210) **2012-56**

(442) **20.12.2013.**

(220) 25.01.2012.

(731) **LES MILLS INTERNATIONAL LIMITED, 22 CENTRE STREET, AUCKLAND NZ**

# BODYCOMBAT

(540)

(550) I

(740) Ćupić Branislav, Dalmatinska 10, Podgorica ME

(511) **Klasa 41:** Usluge rekreacije i treninga, sportske aktivnosti, usluge obrazovanja, kreiranje i vođenje časova i programa vježbi uz muziku, usluge teretana, usluge klubova vezanih za zdrav život, usluge sportskih klubova, usluge fitnes klubova, usluge vježbi sa instruktorom, usluge savjetovanja i treniranja, usluge pružanja prostora za vježbanje, usluge sportskih vježbi sa instruktorom, usluge treniranja i obuke, usluge informacija, savjeta i konsultacija u vezi sa nekim ili svim navedenim uslugama, objava štampanog materijala i elektronskih medija, uključujući objavu muzičkih i video zapisa u digitalnom formatu vezanih za programe i treninge fitnes klubova i klubova vezanih za zdrav život.

---

(210) **2012-57**

(442) **20.12.2013.**

(220) 25.01.2012.

(731) **LES MILLS INTERNATIONAL LIMITED, 22 CENTRE STREET, AUCKLAND NZ**

# BODYSTEP

(540)

(550) I

(740) Ćupić Branislav, Dalmatinska 10, Podgorica ME

(511) **Klasa 41:** Usluge rekreacije i treninga, sportske aktivnosti, usluge obrazovanja, kreiranje i vođenje časova i programa vježbi uz muziku, usluge teretana, usluge klubova vezanih za zdrav život, usluge sportskih klubova, usluge fitnes klubova, usluge vježbi sa instruktorom, usluge savjetovanja i treniranja, usluge pružanja prostora za vježbanje, usluge sportskih vježbi sa instruktorom, usluge treniranja i obuke, usluge informacija, savjeta i konsultacija u vezi sa nekim ili svim navedenim uslugama, objava štampanog materijala i elektronskih medija, uključujući objavu muzičkih i video zapisa u digitalnom formatu vezanih za programe i treninge fitnes klubova i klubova vezanih za zdrav život.

(210) **2012-58**(442) **20.12.2013.**

(220) 25.01.2012.

(731) **LES MILLS INTERNATIONAL LIMITED, 22 CENTRE STREET, AUCKLAND NZ**

# BODYATTACK

(540)

(550) I

(740) Ćupić Branislav, Dalmatinska 10, Podgorica ME

(511) **Klasa 41:** Usluge rekreacije i treninga, sportske aktivnosti, usluge obrazovanja, kreiranje i vođenje časova i programa vježbi uz muziku, usluge teretana, usluge klubova vezanih za zdrav život, usluge sportskih klubova, usluge fitnes klubova, usluge vježbi sa instruktorom, usluge savjetovanja i treniranja, usluge pružanja prostora za vježbanje, usluge sportskih vježbi sa instruktorom, usluge treniranja i obuke, usluge informacija, savjeta i konsultacija u vezi sa nekim ili svim navedenim uslugama, objava štampanog materijala i elektronskih medija, uključujući objavu muzičkih i video zapisa u digitalnom formatu vezanih za programe i treninge fitnes klubova i klubova vezanih za zdrav život.

(210) **2012-59**(442) **20.12.2013.**

(220) 25.01.2012.

(731) **LES MILLS INTERNATIONAL LIMITED, 22 CENTRE STREET, AUCKLAND NZ**

# BODYPUMP

(540)

(550) I

(740) Ćupić Branislav, Dalmatinska 10, Podgorica ME

(511) **Klasa 41:** Usluge rekreacije i treninga, sportske aktivnosti, usluge obrazovanja, kreiranje i vođenje časova i programa vježbi uz muziku, usluge teretana, usluge klubova vezanih za zdrav život, usluge sportskih klubova, usluge fitnes klubova, usluge vježbi sa instruktorom, usluge savjetovanja i treniranja, usluge pružanja prostora za vježbanje, usluge sportskih vježbi sa instruktorom, usluge treniranja i obuke, usluge informacija, savjeta i konsultacija u vezi sa nekim ili svim navedenim uslugama, objava štampanog materijala i elektronskih medija, uključujući objavu muzičkih i video zapisa u digitalnom formatu vezanih za programe i treninge fitnes klubova i klubova vezanih za zdrav život.

---

(210) **2012-60**

(442) **20.12.2013.**

(220) 25.01.2012.

(731) **LES MILLS INTERNATIONAL LIMITED, 22 CENTRE STREET, AUCKLAND NZ**

# BODYJAM

(540)

(550) I

(740) Ćupić Branislav, Dalmatinska 10, Podgorica ME

(511) **Klasa 41:** Usluge rekreacije i treninga, sportske aktivnosti, usluge obrazovanja, kreiranje i vođenje časova i programa vježbi uz muziku, usluge teretana, usluge klubova vezanih za zdrav život, usluge sportskih klubova, usluge fitnes klubova, usluge vježbi sa instruktorom, usluge savjetovanja i treniranja, usluge pružanja prostora za vježbanje, usluge sportskih vježbi sa instruktorom, usluge treniranja i obuke, usluge informacija, savjeta i konsultacija u vezi sa nekim ili svim navedenim uslugama, objava štampanog materijala i elektronskih medija, uključujući objavu muzičkih i video zapisa u digitalnom formatu vezanih za programe i treninge fitnes klubova i klubova vezanih za zdrav život.

---

(210) **2012-61**

(442) **20.12.2013.**

(220) 25.01.2012.

(731) **LES MILLS INTERNATIONAL LIMITED, 22 CENTRE STREET, AUCKLAND NZ**

## RPM

(540)

(550) I

(740) Ćupić Branislav, Dalmatinska 10, Podgorica ME

(511) **Klasa 41:** Usluge rekreacije i treninga, sportske aktivnosti, usluge obrazovanja, kreiranje i vođenje časova i programa vježbi uz muziku, usluge teretana, usluge klubova vezanih za zdrav život, usluge sportskih klubova, usluge fitnes klubova, usluge vježbi sa instruktorom, usluge savjetovanja i treniranja, usluge pružanja prostora za vježbanje, usluge sportskih vježbi sa instruktorom, usluge treniranja i obuke, usluge informacija, savjeta i konsultacija u vezi sa nekim ili svim navedenim uslugama, objava štampanog materijala i elektronskih medija, uključujući objavu muzičkih i video zapisa u digitalnom formatu vezanih za programe i treninge fitnes klubova i klubova vezanih za zdrav život.

---

(210) **2012-62**

(442) **20.12.2013.**

(220) 25.01.2012.

(731) **LES MILLS INTERNATIONAL LIMITED**, 22 CENTRE STREET, AUCKLAND NZ

## BODYVIVE

(540)

(550) I

(740) Ćupić Branislav, Dalmatinska 10, Podgorica ME

(511) **Klasa 41:** Usluge rekreacije i treninga, sportske aktivnosti, usluge obrazovanja, kreiranje i vođenje časova i programa vježbi uz muziku, usluge teretana, usluge klubova vezanih za zdrav život, usluge sportskih klubova, usluge fitnes klubova, usluge vježbi sa instruktorom, usluge savjetovanja i treniranja, usluge pružanja prostora za vježbanje, usluge sportskih vježbi sa instruktorom, usluge treniranja i obuke, usluge informacija, savjeta i konsultacija u vezi sa nekim ili svim navedenim uslugama, objava štampanog materijala i elektronskih medija, uključujući objavu muzičkih i video zapisa u digitalnom formatu vezanih za programe i treninge fitnes klubova i klubova vezanih za zdrav život.

---

(210) **2012-63**

(442) **20.12.2013.**

(220) 25.01.2012.

(731) **LES MILLS INTERNATIONAL LIMITED**, 22 CENTRE STREET, AUCKLAND NZ





(540)

(550) I

(740) Ćupić Branislav, Dalmatinska 10, Podgorica ME

(511) **Klasa 41:** Usluge rekreacije i treninga, sportske aktivnosti, usluge obrazovanja, kreiranje i vođenje časova i programa vježbi uz muziku, usluge teretana, usluge klubova vezanih za zdrav život, usluge sportskih klubova, usluge fitnes klubova, usluge vježbi sa instruktorom, usluge savjetovanja i treniranja, usluge pružanja prostora za vježbanje, usluge sportskih vježbi sa instruktorom, usluge treniranja i obuke, usluge informacija, savjeta i konsultacija u vezi sa nekim ili svim navedenim uslugama, objava štampanog materijala i elektronskih medija, uključujući objavu muzičkih i video zapisa u digitalnom formatu vezanih za programe i treninge fitnes klubova i klubova vezanih za zdrav život.

(210) **2012-64**(442) **20.12.2013.**

(220) 26.01.2012.

(300) 2012-000382

06.01.2012. JP

(731) **NIKON CORPORATION**, 12-1, YURAKUCHO 1-CHOME, CHIYODA-KU, TOKYO JP

# D4

(540)

(550) I

(740) Popović Miladin, Đoka Miraševića 21/III, Podgorica ME

(511) **Klasa 09:** Kamere, digitalne kamere, sočiva za kamere, baterije i punjači za baterije za kamere i digitalne kamere, daljinski upravljači za kamere i digitalne kamere, futrole za kamere i digitalne kamere, kaiševi za kamere i digitalne kamere, kompjuterski softver, futrole posebno napravljene za fotografske aparate i instrumente, filteri za ultraljubičaste zrake, za fotografiju, filteri (za fotografiju), blicevi (za fotografiju), baterijske lampe (za fotografiju), izbacivači blende (za fotografiju), blende (za fotografiju), slajdovi (za fotografiju), kalem (za fotografiju), postolja za fotografske aparate, transparencije (za fotografiju), viziri, fotografski, tripodi za kamere, epidijaskopi, mobilni telefoni, celularni telefoni, pametni telefoni,

zaštitne folije (filmovi) za digitalne kamere.

---

(210) **2012-65** (442) **20.12.2013.**  
(220) 27.01.2012.

(731) **FOUR ROSES DISTILLERY LLC**, 1224 BONDS MILL ROAD, LAWRENCEBURG, KENTUCKY 40342 US



(540)  
(550) I  
(740) Čejović Vladimir, 13. jula 21, Podgorica ME  
(511) **Klasa 33:** Viski.

---

(210) **2012-66** (442) **20.12.2013.**  
(220) 30.01.2012.

(731) **MIKASA CORPORATION**, A CORPORATION ORGANIZED UNDER THE LAW OF JAPAN, LOCATED AT NO.11-2, 3-CHOME, KUSUNOKI-CHO, NISHI KU, HIROSHIMA-SHI, HIROSHIMA-KEN JP

The logo for Mikasa Corporation, consisting of the word "MIKASA" in a large, bold, serif font.

(540)  
(550) I  
(740) Čupić Branislav, Dalmatinska 10, Podgorica ME  
(511) **Klasa 28:** Sportska oprema.

---

(210) **2012-67** (442) **20.12.2013.**  
(220) 30.01.2012.

(731) **MSD INTERNATIONAL HOLDINGS GMBH**, WEYSTRASSE 20, CH-6000 LUCERNE 6 CH

The logo for Reditabs, consisting of the word "REDITABS" in a large, bold, serif font.

(540)

(550) I  
(740) Ćupić Branislav, Dalmatinska 10, Podgorica ME  
(511) **Klasa 05:** Farmaceutski preparati.

---

(210) **2012-68** (442) **20.12.2013.**  
(220) 30.01.2012.  
(731) **D.O.O UDACA**, GORIČANI BB, GOLUBOVCI, PODGORICA ME



(540)  
(550) I  
(511) **Klasa 35:** Oglašavanje, vođenje poslova, razonoda, kancelarijski poslovi.  
**Klasa 41:** Obrazovne usluge, pripremanje obuke, razonoda, sportske i kulturne aktivnosti.  
**Klasa 42:** Naučne i tehnološke usluge i istraživanje i prorojektovanje u vezi navedenih usluga, usluge industrijske analize i istraživanja, projektovanje i razvoj kompjuterskog hardvera i softvera.

---

(210) **2012-69** (442) **20.12.2013.**  
(220) 31.01.2012.  
(300) 85454957 24.10.2011. US  
(731) **FORD MOTOR COMPANY**, ONE AMERICAN ROAD, DEARBORN, MICHIGAN 48126 US

## Ford Go Further

(540)  
(550) I  
(740) Popović Miladin, Đoka Miraševića 21/III, Podgorica ME  
(511) **Klasa 12:** Motorna vozila, naime automobili, kamioni, kombiji, terenska vozila (sport utility vehicles-SUV), i njihovi sastavni djelovi i motori.

---

(210) **2012-70** (442) **20.12.2013.**  
(220) 31.01.2012.  
(300) 85454955 24.10.2011. US  
(731) **FORD MOTOR COPANY**, ONE AMERICAN ROAD, DEARBORN, MICHIGAN 48126 US

## Ford Go Further

(540)

(550) I

(740) Popović Miladin, Đoka Miraševića 21/III, Podgorica ME

(511) **Klasa 35:** Usluge veleprodajne i maloprodajne distribucije novih i polovnih motornih vozila, njihovih delova i opreme, usluge promovisanja prodaje tuđih roba i usluga u automobilskoj industriji deljenjem promotivnih materijala i informacija o proizvodima putem onlajn globalne računarske mreže, kroz distribuciju štampanog materijala, audio i video snimaka, televizijskih i radio snimaka, onlajn oglašavanja, i promotivnih takmičenja, maloprodajne usluge u oblasti automobila, njihovih delova i opreme, usluge ovlašćene prodaje automobila na maloprodajnom nivou (ovlašćeni dileri).

---

(210) **2012-71**

(442) **20.12.2013.**

(220) 02.02.2012.

(731) **JT INTERNATIONAL S.A.** 1, RUE DE LA GABELLE 1211, GENEVA 26 CH

## RAW BEAUTY

(540)

(550) I

(740) Čejović Vladimir, 13. jula 21, Podgorica ME

(511) **Klasa 34:** Duvan, prerađen ili neprerađen, duvan za pušenje, duvan za lule, duvan za ručno uvijanje, duvan za žvakanje, snus duvan, cigarete, cigare, cigarilosi, supstance za pušenje koje se prodaju odvojeno ili miješane sa duvanom, a koje nisu za medicinske svrhe ili u svrhe liječenja, duvan za ušmrkavanje, artikli za pušače uključeni u klasu 34, papir za cigarete, tube za cigarete i šibice.

---

(210) **2012-72**

(442) **20.12.2013.**

(220) 02.02.2012.

(731) **JT INTERNATIONAL S.A.** 1, RUE DE LA GABELLE 1211, GENEVA 26 CH

## SOBRANIE LIQUID GOLD

(540)

(550) I

(740) Čejović Vladimir, 13. jula 21, Podgorica ME

(511) **Klasa 34:** Duvan, prerađen ili neprerađen, duvan za pušenje, duvan za lule, duvan za ručno uvijanje, duvan za žvakanje, snus duvan, cigarete, cigare, cigarilosi, supstance za pušenje koje se prodaju odvojeno ili miješane sa duvanom, a koje nisu za medicinske svrhe ili u svrhe liječenja, duvan za ušmrkavanje, artikli za pušače uključeni u klasu 34, papir za cigarete, tube za cigarete i šibice.

(210) **2012-73**

(442) **20.12.2013.**

(220) 02.02.2012.

(731) **JT INTERNATIONAL** S.A. 1, RUE DE LA GABELLE 1211, GENEVA 26 CH

## SUSPENDED BELIEF

(540)

(550) I

(740) Čejović Vladimir, 13. jula 21, Podgorica ME

(511) **Klasa 34:** Duvan, prerađen ili neprerađen, duvan za pušenje, duvan za lule, duvan za ručno uvijanje, duvan za žvakanje, snus duvan, cigarete, cigare, cigarilosi, supstance za pušenje koje se prodaju odvojeno ili miješane sa duvanom, a koje nisu za medicinske svrhe ili u svrhe liječenja, duvan za ušmrkavanje, artikli za pušače uključeni u klasu 34, papir za cigarete, tube za cigarete i šibice.

(210) **2012-74**

(442) **20.12.2013.**

(220) 02.02.2012.

(731) **JT INTERNATIONAL** S.A. 1, RUE DE LA GABELLE 1211, GENEVA 26 CH

## SOBRANIE MODERN HERITAGE

(540)

(550) I

(740) Čejović Vladimir, 13. jula 21, Podgorica ME

(511) **Klasa 34:** Duvan, prerađen ili neprerađen, duvan za pušenje, duvan za lule, duvan za ručno uvijanje, duvan za žvakanje, snus duvan, cigarete, cigare, cigarilosi, supstance za pušenje koje se prodaju odvojeno ili miješane sa duvanom, a koje nisu za medicinske svrhe ili u svrhe liječenja, duvan za ušmrkavanje, artikli za pušače uključeni u klasu 34, papir za cigarete, tube za cigarete i šibice.

(210) **2012-75**

(442) **20.12.2013.**

(220) 02.02.2012.

(731) **ABBOTT MEDICAL OPTICS** INC. 1700 E.ST. ANDREW PLACE, SANTA ANA, CA 92705 US

# TECNIS ITEC

(540)

(550) I

(740) Popović Miladin, Đoka Miraševića 21/III, Podgorica ME

(511) **Klasa 10:** Hirurški, medicinski, zubarski i veterinarski aparati i instrumenti, veštački udovi, oči i zubi, ortopedski artikli, hirurški materijali za zašivanje, naročito, hirurški ručni alati, medicinski aparati i instrumenti, naime, sistem za implantaciju i stavljanje intraokularnog sočiva.

(210) **2012-76**(442) **20.12.2013.**

(220) 08.02.2012.

(731) **BOSNALIJEK**, DD. JUKIĆEVA 53, SARAJEVO BA

## ARGEDIN

(540)

(550) I,V

(740) Radulović Božidar, Jovana Tomaševića 9/III, Podgorica ME

(511) **Klasa 05:** Farmaceutski proizvodi.

(210) **2012-77**(442) **20.12.2013.**

(220) 09.02.2012.

(731) **WM. WRIGLEY JR. COMPANY**, 410 NORTH MICHIGAN AVENUE, CHICAGO, IL 60611 US



(540)

(550) I

(740) Čejović Vladimir, 13. jula 21, Podgorica ME

(511) **Klasa 30:** Konditorski proizvodi, žvakaće gume, žvakaće gume od kojih mogu da se prave veliki baloni, bombone, dražeje pepermint, mali okrugli bomboni (drops) i pastile.

(210) **2012-78**(442) **20.12.2013.**

(220) 09.02.2012.

(731) **TOYOTA JIDOSHA KABUSHIKI KAISHA** (ASLO TRADING AS TOYOTA MOTOR CORPORATION), 1, TOYOTA -CHO, TOYOTA-CHI, AICHI-KEN JP

## THE POWER OF H

(540)

(550) I

(740) Čejović Vladimir, 13. jula 21, Podgorica ME

(511) **Klasa 12:** Automobili i njihovi strukturni djelovi.

---

(210) **2012-79**

(442) **20.12.2013.**

(220) 13.02.2012.

(731) **PODRAVKA** D.D. ANTE STARČEVIĆA 32, KOPRIVNICA HR



(540) Prevod Znaka

(550) I, F

(740) Radulović Božidar, Jovana Tomaševića 9/III, Podgorica ME

(511) **Klasa 30:** Mješavina za pripremu pečenja, začini za pripremu pečenja,

---

(210) **2012-80**

(442) **20.12.2013.**

(220) 13.02.2012.

(731) **PODRAVKA** D.D. ANTE STARČEVIĆA 32, KOPRIVNICA HR



(540)

(550) I, F

(740) Radulović Božidar, Jovana Tomaševića 9/III, Podgorica ME

(511) **Klasa 30:** Mješavina za pohanje, umaci.

(210) **2012-81**

(442) **20.12.2013.**

(220) 13.02.2012.

(731) **NISSAN JIDOSHA KABUSHIKI KAISHA** (ALSO TRADING AS NISSAN MOTOR CO.LTD.), NO.2 TAKARACHO, KANAGAWA-KU, YOKOHAMA-SHI, KANAGAWA-KEN JP



(540)

(550) I

(740) Popović Miladin, Đoka Miraševića 21/III, Podgorica ME

(511) **Klasa 01:** Hemijski proizvodi koji se upotrebljavaju u industriji, neprerađene vještačke smole, neprerađene plastične materije, smjese za gašenje požara, preparati za kaljenje i zavarivanje, materije za štavljenje, ljepljive supstance koje se upotrebljavaju u industriji, materijali (hemijski proizvodi) za oblaganje stakla, smjese (hemijski proizvodi) za popravku vjetrobrana, preparati (hemijski proizvodi) za odstranjivanje, zaptivači (hemijski proizvodi) za zaptivanje površina, materijali (hemijski proizvodi) za oblaganje radi osvjetljavanja i zaštite površine djelova vozila (šasijske, točka, gume), materijali (hemijski proizvodi) koji su otporni na vodu za prozore, zakisjeljena voda za punjenje akumulatora, aditivi (hemijski proizvodi-) za ulja, aditivi, hemijski proizvodi za rashladni uređaj klime, aditivi, hemijski proizvodi za motorno gorivo, tečnost za kočnice automobila, rashladne tečnosti za motore vozila, tečnost za servo upravljače kod automobila, epoksid za lijepljenje i punjenje kod opravki i održavanja automobila, hemijski preparati za popravku i održavanje automobila, brizgaljke



za čišćenje goriva, transmisiona tečnosti za automobile, aditivi za hladnjake za sprječavanje rde, anistatički preparati, izuzev onih za upotrebu u domaćinstvu.

**Klasa 02:** Boje, firnajzi, lakovi, sredstva za zaštitu od rđe, materije za bojenje, sredstva za nagrizanje, metali u obliku listova i praha za slikare, dekoratere, štampare i umjetnike. Podloga za šasijske automobile, masti za zaštitu od rđe za vozila, prajmeri, premazi za zaptivanje, podloga za površine koje će se farbati, preparati protiv rđe.

**Klasa 03:** Preparati za čišćenje, poliranje, ribanje i nagrizanje, parfimerija, eterična ulja, kozmetika, losioni za kosu, tečnosti za čišćenje vjetrobrana, tečnosti za čišćenje dijelova vozila, vosak za poliranje, preparati za sjaj i preparati za zaštitu spoljne površine automobila, antistatički preparati za upotrebu u domaćinstvima, parfemi, kolonjska voda, preparati za čišćenje automobila, preparati za uklanjanje rđe, preparati za uklanjanje naljepnica i boje, preparati za čišćenje prilikom uklanjanja zaptivača.

**Klasa 04:** Industrijska ulja i masti, maziva, jedinjenja za skupljanje prašine vlaženjem i vezivanjem, goriva (uključujući motorna tečna goriva) i materije za osvetljavanje, masti i maziva za vozila, motorna ulja, ulja za kočnice za automobile, ulje za servo upravljače za automobile, transmisiona maziva za automobil, mast za podmazivanje, ricinusovo ulje za tehničke svrhe.

**Klasa 05:** Farmaceutski i veterinarski preparati, sanitarni preparati za medicinsku upotrebu, dezodoransi, izuzev za ličnu upotrebu, kutije za Prvu pomoć, pune.

(210) **2012-82**

(442) **20.12.2013.**

(220) 13.02.2012.

(731) **NISSAN JIDOSHA KABUSHIKI KAISHA** (ALSO TRADING AS NISSAN MOTOR CO.LTD.), NO.2 TAKARACHO, KANAGAWA-KU, YOKOHAMA-SHI, KANAGAWA-KEN JP



(540)

(550) I

(740) Popović Miladin, Đoka Miraševića 21/III, Podgorica ME

(511) **Klasa 06:** Obični metali i njihove legure, bravarski proizvodi, mali metalni gvoždarski proizvodi, proizvodi od običnih metala koji nijesu uključeni u druge klase, čepovi za boce napravljeni od metala, kutije i držači za kartice (od metala), ploče za identifikaciju od metala, privezak za ključeve (kao nakit ili kao privezak) od ne-dragocjenih metala, skulpture i figure (figurice) automobila napravljene od običnog metala, kutije za alate od metala (prazne).

**Klasa 08:** Ručni alati i sprave (kojima se ručno upravlja), pribor za jelo, set za manikir, set za pedikir, sječiva (ručni alati), kliješta za zanoktice, pincete za zanoktice, rezači, alati za sječenje (ručni alati), alati za porublivanje (ručni alati), turpije (alati), alati za poliranje noktiju, električni i ne-električni, čekici (ručni alati), ručna bušilica (ručni alati), puferi i makaze za nokte, električni i ne-električni, turpije za nokte i kliješta, krckalice za orahe, makaze, šrafcižeri, kutije za brijanje, srebrnina (noževi, viljuške i kašike), ključevi za matice (ručni alati), stono posuđe (noževi, viljuške i kašike), ključevi (ručni alati).

**Klasa 14:** Dragocjeni metali i njihove legure i proizvodi od dragocjenih metala ili sa prevlakom od njih, koji nijesu uključeni u druge klase, časovničarski i hronometrijski instrumenti, čepovi za boce od dragocjenih metala, novčići za sakupljanje, dugmad za košulje, satovi i časovnici, privjesci za ključeve (nakit ili lančić) od dragocjenih metala, broševi (nakit), kopče za kravate od dragocjenih metala, ukrasni novi bedževi (dugmad).

**Klasa 16:** Hartija, karton i proizvodi od njih, koji nijesu uključeni u druge klase, štampane stvari, fotografije, kancelarijski materijal, držači za pasoše, omoti za knjige, kutije za poslovne kartice napravljene od kartona, držači za poslovne kartice (od ne-dragocjenih metala), kalendari, podmetači za čaše od papira, desktop držači za poslovne kartice, dnevници, kese za poklone, graficke umjetničke reprodukcije, kese za ručak, držači memoranduma, spajalice za novac, blokčići za bilješke, jastučići od papira, mjeraci papira, držači za olovke i hemijske olovke, čaše za držanje olovaka, olovke, hemijske olovke, foto albumi (koje se odnose i na knjige za uspomene), poster, štampani lozovi (ne igračke), naljepnice, naljepnice i crteži za gravuru, blokčići za pisanje, držači za blokčiće/rokovnike, sveske, držači za blokčiće, fascikle sa rajsferšlusom, trake za držanje ključeva.

**Klasa 18:** Koža i imitacija kože, i proizvodi izradeni od ovih materijala a koji nijesu uključeni u druge klase, koferi i putne torbe, suncobrani i štapovi za hodanje, torbe za kompjutere napravljene od kože, ruksaci, aktn-tašne, kutije za kartice i držači, torbe za kovani novac, koje nijesu napravljene od dragocjenog metala, fascikle, napravljene od kože, privjesci za ključeve i futrole napravljene od kože, etikete za prtljag, spajalice za novac (od kože), etikete sa imenom od kože, etikete za prtljag, bilježnice, napravljene od kože, držači za bilježnice, napravljene od kože, ručne torbe, kišobrani, novčanici, fascikle sa rajsferšlusom (od kože), industrijske posude za pakovanje, neseseri (ne popunjeni).

**Klasa 20:** Namještaj, ogledala, okviri za slike, proizvodi (koji nijesu obuhvaćeni drugim klasama) od drveta, plute, trske, rogoza, vrbovog pruća, roga, kosti, slonovače, kitove kosti, ćilibara, sedefa, morske pjene i zamjene svih ovih materijala, ili od plastike, čepovi za boce, ne od metala, otvarači za boce, nemetalni, stolice, ventilatori za ličnu upotrebu, ne električni, ramovi za slike, skulpture i figure (figurice) automobila napravljene od smole, jastuci (namještaj), madraci, kutije za alat (ne od metala).

**Klasa 21:** Kućne ili kuhinjske sprave i posude, staklarija, porcelan i grnčarija koja nije uključena u druge klase, čepovi za boce napravljene od metala, čaše od porcelana, roštilji za kampovanje, podmetači za čaše, ne od papira i drugačiji od stonog platna, rashladne torbe, dekorativni poslužavnici napravljene od kristala, staklarija za upotrebu u domaćinstvima, izolovane posude za piće, japanski štapici, držači za tetrapak boce (posude), korpe za piknik (opremljene), uključujući posude, bokali, prenosivi rashladni uređaji, boce od nerđajućeg čelika za višekratnu upotrebu, statue i figure (figurice) napravljene od stakla, toaletne torbe, opremljene, šolje za putovanja, visoke čaše bez postolja (sudovi za pijenje) napravljene od stakla, termos, napravljene od ne-dragocjenog metala, vaze.

**Klasa 24:** Tekstil i tekstilni proizvodi, koji nijesu obuhvaćeni drugim klasama, blokčići za krevete i stolove, podmetači (stolnjaci i salvete), peškiri za golf, blokčići, peškiri, baneri, zastave, ne od papira, blokčići za namještaj od tekstila, salvete od tekstila, tkanine (izuzev traka za porub kod tatami prostirki).

**Klasa 25:** Odjeća, obuća, pokrivala za glavu, kaiševi (odjeća), kape, marame od kašmira, replika delova trkačkog vozila Formule 1, naime rukavice vozača, replika delova trkačkog vozila Formule 1, naime trkačkog odijela, rukavice, majice za golf, šeširi, jakne, pletena odjeća, ženske bluze, kožne jakne, kravate, jakne sa kapuljačom, zaštitna radna odjeća (izuzev one za zaštitu od nezgode i povrede), marame, šalovi, majice, cipele, višeslojne jakne, viziri za sunce (pokrivala za glavu), džemperi, dukserice.

**Klasa 26:** Čipka i vez, trake i gajtani, dugmad, kopče i petlje, špenadle i igle, ukrasni novi bedževi (dugmad), broševi (dodaci odjeći), kopče (dodaci odjeći), kopče (cipele), kratki konop za ključeve, naočare za sunce, prenosiva elektronika, male flaše, bedževi.

**Klasa 27:** Tepisi, asure, prostirke i otirači, linoleum i drugi materijali za pokrivanje podova, blokčići za zidove (netekstilni), prostirke za prekrivanje prtljažnika automobila, patosnice za automobile, tepisi, prostirke za pod, prostirke, asure.

**Klasa 28:** Igre i igračke, gimnastički i sportski artikli koji nijesu obuhvaćeni drugim klasama, replika delova trkačkog vozila Formule 1, naime kontrolne table (igračka), replika delova trkačkog vozila Formule 1, naime rukavice vozača, daljinski upravljač za vozila igračke na baterije, alatka za opravku (dodatak za golf), replika delova trkačkog vozila Formule 1, naime sprave za prenos brzine preko ekrana (igračka), replika delova trkačkog vozila Formule 1, naime mini kacige (igračka), replika delova trkačkog vozila Formule 1, naime mini nosne membrane (igračka), replika delova trkačkog vozila Formule 1, naime mini upravljači (igračka), replika delova trkačkog vozila Formule 1, naime upravljači (igračka), loptice za golf, kupice za golf na koje se stavlja lopta, svjetlosne i zvucne igračke, vozila u minijaturnim kockastim kalupima, mala vozila (igračke), komplet za sastavljanje modela igračke, plišane igračke, kopije modela vozila, vozila igračke za vožnju na njima, skije, punjene igračke, igračke u formi kopije kaciga, igrice u boji, šah, igra dame (set za igru), karte za igranje, mašine za igranje i aparati, oprema za bilijar.

**Klasa 30:** Poslastice, čokolada, poslastice od nane, čaj, pića (na bazi čokolade), pića (na bazi kafe), pića (na bazi čaja), biskviti, bombone, kafa, kafa (nepržena), kolačići.

**Klasa 33:** Alkoholna pića (izuzev piva), Alkoholna pića koja sadrže voće, pića (destilovana), rakija, kokteli, žestoka alkoholna pića, vodka, viski, vino.

**Klasa 34:** Artikli za pušače, pepeljare za pušače, upaljači za pušače, kutije za cigare, kutije za cigarete.

(210) **2012-83**

(442) **20.12.2013.**

(220) 13.02.2012.

(731) **NISSAN JIDOSHA KABUSHIKI KAISHA** (ALSO TRADING AS NISSAN MOTOR CO.LTD.), NO.2 TAKARACHO, KANAGAWA-KU, YOKOHAMA-SHI, KANAGAWA-KEN JP



(540)

(550) I

(740) Popović Miladin, Đoka Miraševića 21/III, Podgorica ME

(511) **Klasa 35:** Usluge maloprodaje i veleprodaje različitih roba, naime automobila, njihovih djelova i opreme (isključujući njihov transport), usluge reklamiranja i publiciteta za automobile, promovisanje u svijesti javnosti električnih motornih vozila i promjena u načinu života koje oni proizvode, pružanje korisnicima proizvoda usluge vebisajtova koji pružaju

informacije o električnim automobilima i informacije koje se odnose na kupovinu takvih automobila, zastupništva u oblasti motornih vozila, pružanje informacija u vezi sa električnim vozilima, naime, potrošačke informacije o proizvodu i poređenje cijena, promovisanje roba i usluga drugih kroz administriranje podsticajnih nagradnih programa koji uključuju distribuciju EV (električnih vozila) i kreditiranje kilometara vožnje, informacione usluge, odnosno, pružanje informacija u oblasti poređenja cijena na polju benzina.

**Klasa 37:** Popravljanje ili održavanje automobila, električnih vozila uključujući električne automobile, karavane, kamione, kombije, terenska (SUV) vozila, autobuse, rekreativna vozila, sportske automobile, trkačke automobile, vagonete, viljuškare, i traktore za vuču (traktore), i strukturnih djelova i opreme za njih, pružanje informacija u vezi sa popravljanjem ili održavanjem automobila, električnih vozila uključujući električne automobile, karavane, kamione, kombije, terenska (SUV) vozila, autobuse, rekreativna vozila, sportske automobile, trkačke automobile, vagonete, viljuškare, i traktore za vuču (traktore), i strukturnih djelova i opreme za njih, popravljanje ili održavanje mašina i instrumenata za mjerenje ili testiranje, popravljanje ili održavanje mašina i aparata za distribuciju električne energije i kontrolu, popravljanje ili održavanje rotacionih konvertora, popravljanje ili održavanje modifikatora faze, popravljanje ili održavanje punjača, popravljanje ili održavanje baterija i ćelija, popravljanje ili održavanje motora sa unutrašnjim sagorijevanjem, popravljanje ili održavanje djelova motora sa unutrašnjim sagorijevanjem, popravljanje ili održavanje anlasera za motore i mašine, ne za kopnena vozila, popravljanje ili održavanje djelova AC motora i DC motora, popravljanje ili održavanje Ac generatora i DC generatora, popravljanje ili održavanje agregata, popravljanje ili održavanje električnih žica i kablova, popravljanje ili održavanje telekomunikacionih uređaja i aparata, popravljanje ili održavanje telefonskih aparata, popravljanje ili održavanje djelova i dodatne opreme za telekomunikacione mašine i aparate, popravljanje ili održavanje telematskih aparata za vozila, popravljanje ili održavanje aparata za automatsko obavješćavanje o završetku punjenja, popravljanje ili održavanje navigacionih sistema za vozila, popravljanje ili održavanje elektronskih mašina, aparata, i njihovih djelova, popravljanje ili održavanje sistema na daljinsku kontrolu, popravljanje ili održavanje elektroda, popravljanje ili održavanje magnetnih jezgra, popravljanje ili održavanje otpornosti žica, pružanje usluga pomoći na putu, naročito odgovaranje na telefonske pozive za pomoć pored puta, brzo mijenjanje guma, hitno snabdijevanje gorivom, punjenje baterija i hitno snabdijevanje baterijama, pružanje informacija o stanju vozila, naime status punjenja, potrebno vrijeme za potpuno punjenje, iskljucen status, napunjen, pružanje informacija o stanju vozila, naime status punjenja, potrebno vrijeme za potpuno punjenje, iskljucen status, napunjen, pružanje informacija o stanju vozila, naime, podsjećanje vozača da uključi vozilo radi punjenja baterija, usluge održavanja vozila, naime, pružanje elektronskih upozorenja putem interneta koja obavješćavaju vlasnike vozila o terminu za održavanje vozila.

**Klasa 38:** Usluge komunikacija putem mobilnih telefona, komunikacija putem kompjuterskih terminala, komunikacija putem telefona, iznajmljivanje/lizing komunikacione opreme, uključujući telefone, faks mašine, informacije o komunikacionim podacima (uključujući informacije putem kabla i radio komunikacionih mreža), komunikacija putem e-maila, informacije o komunikacionim mrežama putem kompjuterskih terminala, komunikacija putem VAN mreže, pružanje telekomunikacionih veza na globalnoj kompjuterskoj mreži, pružanje pristupa korisnicima globalno pozicioniranim signalima za navigacijske svrhe, pružanje korisnicima pristup internetu, komunikacija podacima sa slovima, slikama i zvucima putem e-maila i kompjutera, pružanje korisnicima pristup globalnoj kompjuterskoj mreži, telematska pomoć preko servisnog i alarmnog centra za transport i saobraćaj za povezivanje poziva u svrhu intervencije i pomoći osobama i vozilima u slučaju nezgode, kvara ili krađe, pružanje usluga za povezivanje i pristup elektronskim komunikacionim mrežama za prenos i

preuzimanje ili prijem audio, video ili multimedijalnog sadržaja, pružanje pristupa digitalnoj muzici na Internetu, telekomunikacije, naime primanje, koordiniranje i prosledivanje poziva na daljinu o stanju vozila, telekomunikacije, naime primanje, koordiniranje i prosledivanje udaljenih hitnih poziva, prijenos teksta, glasa i alarmnih poruka i signala, mera, zvuka, slika, videa, položaja, kretanja i stanja podataka između kopnenih vozila kao i između mašina/motora/baterija i mašina i raznih centara za obradu podataka i telematskih sistema, telefona ili personalnih računara, telekomunikacione usluge, naime, elektronski prijenos podataka za vlasnike vozila i vozače, u vezi sa postojećim podacima koji asistiraju u praćenju ukradenog vozila, pomoćni kompjuterski prijenos signala mehanizma za zaključavanje vozila, telematske usluge, naime, usluge nadgledanja energije, naime, pregled ili snimanje vremena ili nivoa upotrebe i kontrolisanje struje koju koriste izabrani uređaji putem telematskih sistema, telematske usluge, naime, usluge nadgledanja energije za druge, naime, pregled ili snimanje vremena ili nivoa upotrebe i kontrolisanje struje koju koriste izabrani uređaji putem telematskih sistema, telekomunikacije, naime, prijenos podataka, naime, informacije vezane za put i vožnju putem telematskih sistema, komunikacija putem telematskih sistema, naime, informacije u vezi sa prikazom puta i vožnjom. Telekomunikacije, naime, prijenos podataka, naime, opšte informacije kao što su informacije u vezi sa automobilom, saobraćajem i stanjem na putu, putem telematskih sistema, telekomunikacije, naime, prijenos podataka i aplikativnog softvera, telekomunikacione usluge, naime, elektronski prijenos glasovnih poruka i podataka.

**Klasa 39:** Informacije u vezi sa transportom, prevoz automobila, brodski prevoz, posredovanje u prevozu, usluge iznajmljivanja i lizinga vozila, pomoć u slučajevima kvara na motornom vozilu, uključujući i vuču i transport, transport putnika putem, morem i vazduhom, informacione usluge, naime, pružanje informacija o vremenu, vesti, informacije o saobraćaju, informacije u vezi sa dolascima letova i odlascima, GPS (Global Positioning' Sistem-globalni sistem za pozicioniranje) navigacione usluge, naime, pružanje prognoziranja vozačima smernica u vezi sa najboljom rutom, navigacione usluge putem Interneta i pomoć pri postavljanju destinacije, GPS (Global Positioning Sistem -globalni sistem za pozicioniranje) navigacione usluge, naime, glasovno rutiranje i pomoć na licu mesta i pružanje praktičnih usluga preko komponenti integrisanih u motornom vozilu, naime, predajnici, prijemnici, mikroprocesori, softver, mobilni telefoni, i električna struktura sve u interakciji sa globalnim sistemom za pozicioniranje i satelitskom tehnologijom i korisničkim servisnim centrom, obezbeđivanje mesta za punjenje vozila električnom energijom, usluge parkinga za vozila, iznajmljivanje vozila, pružanje informacija u vezi lokacije i dostupnosti benzinskih stanica, pružanje informacija u vezi lokacije i dostupnosti mesta za električno punjenje vozila.

**Klasa 41:** Obrazovne usluge, pripremanje obuke, razonoda, sportske i kulturne aktivnosti, planiranje, promocija, rukovanje i održavanje trka motornih vozila, sve usluge u vezi sa razonodom, sponzorske aktivnosti u vezi sa trkama motornih vozila, obezbeđivanje on-line magazina iz oblasti automobilizma, mode, razonode i stila, on-line publikacija elektronskih magazina, uputstvo za vožnju vozila, uputstvo za vožnju vozila, naime, pružanje informacija o ekonomičnoj vožnji, obezbeđivanje digitalne muzike (koja se ne može preuzeti) na Internetu.

**Klasa 42:** Usluge informisanja o vremenu, hosting on-line društvenog vebajta koji pruža informacije o električnim vozilima za vlasnike električnih vozila, sistem on-line usluga za upravljanje koji omogućava korisnicima da na daljinu vide, nadgledaju, programiraju, rukuju i kontrolišu sisteme baterija i air-condition sisteme u električnim vozilima, daljinski nadzor i snabdevanje rezultatima nivoa napunjenosti automobilske baterije, obezbeđivanje inspekcijskog programa za polovna vozila, usluge trgovine motornim vozilima, hitne usluge i usluge obezbeđivanja na putu naime, daljinsko zaključavanje i otključavanje vrata, detekcija i

obaveštavanje vlasnika vozila o istom, nadziranje punjenja baterije i obaveštavanje vozača o statusu punjenja. Nadziranje sistema električne energije koji se koristi u kopnenim vozilima, nadziranje sistema električne energije koji se koristi u kopnenim vozilima.

**Klasa 45:** Obezbeđivanje veb-sajtova koji pružaju informacije o promenama načina života proizilazim iz upotrebe električnih automobila, daljinski set i početno punjenje baterije i air-condition u električnom vozilu, usluge pružanja hitne pomoći na putu, naročito odgovaranje na pozive za hitnu pomoć za putnike koji su povredeni ili bolesni, usluge nadgledanja vozila u svrhu bezbednosti, naime, automatsko obaveštavanje o raspoređenosti vazdušnih jastuka, usluge automatskog obaveštavanja o sudaru i obaveštavanja operatera o abnormalnom statusu vozila, usluge pružanja hitne pomoći i bezbednosti na putu, naime, praćenje ukradenih vozila, detekcija i obaveštavanje vlasnika vozila o istom, upravljanje vozačima tinejdžerima, naime, nadgledanje, praćenje i upozoravanje vlasnika motornih vozila iz bezbednosnih i sigurnosnih razloga o tome da li je vozač tinejdžer prekoračio ograničenje brzine ili napustio prethodno ograničenu geografsku oblast korišćenjem globalnog sistema za pozicioniranje, domarske usluge za druge koje se sastoje u pravljenju rezervacija na daljinu za punjenje električnih vozila, a koje se pružaju preko telefona, putem e-maila ili tekstualnom porukom, domarske usluge za druge koje se sastoje u nameštaju na daljinu air-conditiona u vozilima, i koje se pružaju preko telefona, putem e-maila ili tekstualnom porukom, pravljenje rezervacija na mestima za električno punjenje vozila, domarske usluge za druge koje se sastoje iz pravljenja zatraženih ličnih aranžmana i rezervacija i pružanja informacija potrošačima kako bi zadovoljili licne potrebe, a sve se pružaju putem telefona, putem e-maila ili tekstualne poruke.

(210) **2012-84** (442) **20.12.2013.**  
(220) 13.02.2012.

(731) **NISSAN JIDOSHA KABUSHIKI KAISHA** (ALSO TRADING AS NISSAN MOTOR CO.LTD.), NO.2 TAKARACHO, KANAGAWA-KU, YOKOHAMA-SHI, KANAGAWA-KEN JP



(540)

(550) I

(740) Popović Miladin, Đoka Miraševića 21/III, Podgorica ME

(511) **Klasa 36:** Usluge osiguranja od automobilskih nesreća, usluge posredovanja pri zakupu-kupovini, usluge vezane za kreditne i gotovinske kartice, usluge pružanja finansijskih informacija, usluge finansiranja u vezi automobila, krediti na rate, izdavanje kreditnih kartica, procena polovnih automobila, osiguranje motornih vozila, pružanje sveobuhvatnih osiguravajućih/garantnih ugovora za motorna vozila i njihove delove.

(210) **2012-85** (442) **20.12.2013.**  
(220) 13.02.2012.

(731) **NISSAN JIDOSHA KABUSHIKI KAISHA** (ALSO TRADING AS NISSAN MOTOR CO.LTD.), NO.2 TAKARACHO, KANAGAWA-KU, YOKOHAMA-SHI, KANAGAWA-KEN JP



(540)

(550) I

(740) Popović Miladin, Đoka Miraševića 21/III, Podgorica ME

(511) **Klasa 07:** Mlazni motori, osim za suvozemna vozila, motori, osim za suvozemna vozila, električni motori, osim za suvozemna vozila, turbine, osim za suvozemna vozila, delovi za motore za suvozemna vozila, naime, izduvni lonac, segmenti klipa, prstenovi za podmazivanje, kaiševi, blokovi cilindra, dna motorske kućice, prilagođene presvlake, zamajci, kućišta zamajca, glave cilindra, poklopci ventila, poklopci motora, klipovi, klipni prstenovi, radilice i električni regulatori, remenice kolenastog vratila, izduvne grane, grane za usisavanje vazduha, grane za vodu, pumpe za gorivo, pumpe za vodu, pumpe za ubrizgavanje goriva, injektor za pumpe, kontrolori vremena ubrizgavanja goriva, filteri za gorivo, filteri za vazduh, filteri za ulje, prečistači vazduha, mehanički i električni regulatori, ventilatori sistema za hlađenje, hladnjaci za ulje, ventili, starteri, starteri motora, svećice, klinasti kaiš, kablovi visokog napona, kontaktne tačke, izduvne cevi, dihtunzi, radijatori, kompleti zaptivača, isparivači, karburatori, Uređaji za paljenje, magneti za paljenje, i delovi za svu gore navedenu robu obuhvaćenu klasom 7, super punjači, turbo punjači, turbo punjači za auspuhe, kompresori za vazduh, turbo kompresori, motori jednosmerne struje, generatori jednosmerne struje, motori naizmenične struje, generatori naizmenične struje, električni generatori, kompresori vazduha, pumpe za podmazivanje, hidraulične pumpe, pumpe za vazduh, pumpe za ulje, pumpe za gorivo, hidraulične pumpe, električni generatori, kontrolni ventili za pumpe, alternatori, vazdušni kondenzatori, i delovi za svu gore navedenu robu obuhvaćenu klasom 7, automatski nosači, mašine i aparati za rukovanje teretom, konvejeri, pneumatski transporteri, dizalice, i delovi za svu gore navedenu robu obuhvaćenu klasom 7.

(210) **2012-86**(442) **20.12.2013.**

(220) 13.02.2012.

(731) **NISSAN JIDOSHA KABUSHIKI KAISHA** (ALSO TRADING AS NISSAN MOTOR CO.LTD.), NO.2 TAKARACHO, KANAGAWA-KU, YOKOHAMA-SHI, KANAGAWA-KEN JP

(540)

(550) I

(740) Popović Miladin, Đoka Miraševića 21/III, Podgorica ME

(511) **Klasa 01:** Hemijski proizvodi koji se upotrebljavaju u industriji, neprerađene vještačke

smole, neprerađene plastične materije, smješe za gašenje požara, preparati za kaljenje i zavarivanje, materije za štavljenje, ljepljive supstance koje se upotrebljavaju u industriji, materijali (hemijski proizvodi) za oblaganje stakla, smjese (hemijski proizvodi) za popravku vjetromotora, preparati (hemijski proizvodi) za odstranjivanje, zaptivači (hemijski proizvodi) za zaptivanje površina, materijali (hemijski proizvodi) za oblaganje radi osvjjetljavanja i zaštite površine djelova vozila (šasije, točka, gume), materijali (hemijski proizvodi) koji su otporni na vodu za prozore, zakisjeljena voda za punjenje akumulatora, aditivi (hemijski proizvodi-) za ulja, aditivi, hemijski proizvodi za rashladni uređaj klime, aditivi, hemijski proizvodi za motorno gorivo, tečnost za kočnice automobila, rashladne tečnosti za motore vozila, tečnost za servo upravljače kod automobila, epoksid za lijepljenje i punjenje kod opravki i održavanja automobila, hemijski preparati za popravku i održavanje automobila, brizgaljke za čišćenje goriva, transmisione tečnosti za automobile, aditivi za hladnjake za sprječavanje rde, anistatički preparati, izuzev onih za upotrebu u domaćinstvu.

**Klasa 02:** Boje, firnajzi, lakovi, sredstva za zaštitu od rđe, materije za bojenje, sredstva za nagrizanje, metali u obliku listova i praha za slikare, dekoratere, štampare i umjetnike. Podloga za šasije automobila, masti za zaštitu od rđe za vozila, pražmeri, premazi za zaptivanje, podloga za površine koje će se farbati, preparati protiv rđe.

**Klasa 03:** Preparati za čišćenje, poliranje, ribanje i nagrizanje, parfimerija, eterična ulja, kozmetika, losioni za kosu, tečnosti za čišćenje vjetromotora, tečnosti za čišćenje djelova vozila, vosak za poliranje, preparati za sjaj i preparati za zaštitu spoljne površine automobila, antistatički preparati za upotrebu u domaćinstvima, parfemi, kolonjska voda, preparati za čišćenje automobila, preparati za uklanjanje rđe, preparati za uklanjanje naljepnica i boje, preparati za čišćenje prilikom uklanjanja zaptivača.

**Klasa 04:** Industrijska ulja i masti, maziva, jedinjenja za skupljanje prašine vlaženjem i vezivanjem, goriva (uključujući motorna tečna goriva) i materije za osvjjetljavanje, masti i maziva za vozila, motorna ulja, ulja za kočnice za automobile, ulje za servo upravljače za automobile, transmisiona maziva za automobil, mast za podmazivanje, ricinusovo ulje za tehničke svrhe.

**Klasa 05:** Farmaceutski i veterinarski preparati, sanitarni preparati za medicinsku upotrebu, dezodoransi, izuzev za ličnu upotrebu, kutije za Prvu pomoć, pune.

(210) **2012-87** (442) **20.12.2013.**

(220) 13.02.2012.

(731) **NISSAN JIDOSHA KABUSHIKI KAISHA** (ALSO TRADING AS NISSAN MOTOR CO.LTD.), NO.2 TAKARACHO, KANAGAWA-KU, YOKOHAMA-SHI, KANAGAWA-KEN JP

**I N F I N I T I**

(540)

(550) I

(740) Popović Miladin, Đoka Miraševića 21/III, Podgorica ME

(511) **Klasa 06:** Obični metali i njihove legure, bravarski proizvodi, mali metalni gvoždarski proizvodi, proizvodi od običnih metala koji nijesu uključeni u druge klase, čepovi za boce na-



pravljeni od metala, kutije i držači za kartice (od metala), ploče za identifikaciju od metala, privezak za ključeve (kao nakit ili kao privezak) od ne-dragocjenih metala, skulpture i figure (figurice) automobila napravljene od običnog metala, kutije za alate od metala (prazne).

**Klasa 08:** Ručni alati i sprave (kojima se ručno upravlja), pribor za jelo, set za manikir, set za pedikir, sječiva (ručni alati), kliješta za zanoktice, pincete za zanoktice, rezači, alati za sječenje (ručni alati), alati za porublivanje (ručni alati), turpije (alati), alati za poliranje noktiju, električni i ne-električni, čekici (ručni alati), ručna bušilica (ručni alati), puferi i makaze za nokte, električni i ne-električni, turpije za nokte i kliješta, krckalice za orahe, makaze, šrafci-geri, kutije za brijanje, srebrnina (noževi, viljuške i kašike), ključevi za matice (ručni alati), stono posude (noževi, viljuške i kašike), ključevi (ručni alati).

**Klasa 14:** Dragocjeni metali i njihove legure i proizvodi od dragocjenih metala ili sa prevlakom od njih, koji nijesu uključeni u druge klase, časovničarski i hronometrijski instrumenti, čepovi za boce od dragocjenih metala, novčići za sakupljanje, dugmad za košulje, satovi i časovnici, privjesci za ključeve (nakit ili lancic) od dragocjenih metala, broševi (nakit), kopče za kravate od dragocjenih metala, ukrasni novi bedževi (dugmad).

**Klasa 16:** Hartija, karton i proizvodi od njih, koji nijesu uključeni u druge klase, štampane stvari, fotografije, kancelarijski materijal, držači za pasoše, omoti za knjige, kutije za poslovne kartice napravljene od kartona, držači za poslovne kartice (od ne-dragocjenih metala), kalendari, podmetači za čaše od papira, desktop držači za poslovne kartice, dnevnici, kese za poklone, graficke umjetničke reprodukcije, kese za ručak, držači memorandumu, spajalice za novac, blokčići za bilješke, jastučići od papira, mjerači papira, držači za olovke i hemijske olovke, čaše za držanje olovaka, olovke, hemijske olovke, foto albumi (koje se odnose i na knjige za uspomene), poster, štampani lozovi (ne igračke), naljepnice, naljepnice i crteži za gravuru, blokčići za pisanje, držači za blokčiče/rokovnike, sveske, držači za blokčiče, fascikle sa rajsferšlusom, trake za držanje ključeva.

**Klasa 18:** Koža i imitacija kože, i proizvodi izradeni od ovih materijala a koji nijesu uključeni u druge klase, koferi i putne torbe, suncobrani i štapovi za hodanje, torbe za kompjutere napravljene od kože, ruksaci, akti- tašne, kutije za kartice i držači, torbe za kovani novac, koje nijesu napravljene od dragocjenog metala, fascikle, napravljene od kože, privjesci za ključeve i futrole napravljene od kože, etikete za prtljag, spajalice za novac (od kože), etikete sa imenom od kože, etikete za prtljag, bilježnice, napravljene od kože, držači za bilježnice, napravljene od kože, ručne torbe, kišobrani, novčanici, fascikle sa rajsferšlusom (od kože), industrijske posude za pakovanje, nesereri (ne popunjeni).

**Klasa 20:** Namještaj, ogledala, okviri za slike, proizvodi (koji nijesu obuhvaćeni drugim klasama) od drveta, plute, trske, rogoza, vrbovog pruca, roga, kosti, slonovace, kitove kosti, cilibara, sedefa, morske pjene i zamjene svih ovih materijala, ili od plastike, čepovi za boce, ne od metala, otvarači za boce, nemetalni, stolice, ventilatori za ličnu upotrebu, ne električni, ramovi za slike, skulpture i figure (figurice) automobila napravljene od smole, jastuci (namještaj), madraci, kutije za alat (ne od metala).

**Klasa 21:** Kućne ili kuhinjske sprave i posude, staklarija, porcelan i grnčarija koja nije uključena u druge klase, čepovi za boce napravljene od metala, čaše od porcelana, roštilji za kampovanje, podmetači za čaše, ne od papira i drugaciji od stonog platna, rashladne torbe, dekorativni poslužavnici napravljene od kristala, staklarija za upotrebu u domaćinstvima, izolovane posude za piće, japanski štapici, držači za tetrapak boce (posude), korpe za piknik (opremljene), uključujući posude, bokali, prenosivi rashladni uređaji, boce od nerđajućeg čelika za višekratnu upotrebu, statue i figure (figurice) napravljene od stakla, toaletne torbe, opremljene, šolje za putovanja, visoke čaše bez postolja (sudovi za pijenje) napravljene od stakla, termos, napravljene od ne-dragocjenog metala, vaze.

**Klasa 24:** Tekstil i tekstilni proizvodi, koji nijesu obuhvaćeni drugim klasama, blokčići za krevete i stolove, podmetači (stolnjaci i salvete), peškiri za golf, blokčići, peškiri, baneri, zastave, ne od papira, blokčići za namještaj od tekstila, salvete od tekstila, tkanine (izuzev traka za porub kod tatami prostirki).

**Klasa 25:** Odjeća, obuća, pokrivala za glavu, kaiševi (odjeća), kape, marame od kašmira, replika delova trkačkog vozila Formule 1, naime rukavice vozača, replika delova trkačkog vozila Formule 1, naime trkačkog odijela, rukavice, majice za golf, šeširi, jakne, pletena odjeća, ženske bluze, kožne jakne, kravate, jakne sa kapuljačom, zaštitna radna odjeća (izuzev one za zaštitu od nezgode i povrede), marame, šalovi, majice, cipele, višeslojne jakne, viziri za sunce (pokrivala za glavu), džemper, dukserice.

**Klasa 26:** Čipka i vez, trake i gajtani, dugmad, kopče i petlje, špenadle i igle, ukrasni novi bedževi (dugmad), broševi (dodaci odjeći), kopce (dodaci odjeći), kopče (cipele), kratki konop za ključeve, naočare za sunce, prenosiva elektronika, male flaše, bedževi.

**Klasa 27:** Tepisi, asure, prostirke i otirači, linoleum i drugi materijali za pokrivanje podova, blokčići za zidove (netekstilni), prostirke za prekrivanje prtljag automobila, patosnice za automobile, tepisi, prostirke za pod, prostirke, asure.

**Klasa 28:** Igre i igračke, gimnastički i sportski artikli koji nijesu obuhvaćeni drugim klasama, igračke na baterije, alatka za opravku (dodatak za golf), replika delova trkačkog vozila Formule 1, naime sprave za prenos brzine preko ekrana (igračka), replika delova trkačkog vozila Formule 1, naime mini kacige (igračka), replika delova trkačkog vozila Formule 1, naime mini nosne membrane (igračka), replika delova trkačkog vozila Formule 1, naime mini upravljači (igračka), replika delova trkačkog vozila Formule 1, naime upravljači (igračka), loptice za golf, kupice za golf na koje se stavlja lopta, svjetlosne i zvucne igračke, vozila u minijaturnim kockastim kalupima, mala vozila (igračke), komplet za sastavljanje modela igračke, plišane igračke, kopije modela vozila, vozila igračke za vožnju na njima, skije, punjene igračke, igračke u formi kopije kaciga, igrice u boji, šah, igra dame (set za igru), karte za igranje, mašine za igranje i aparati, oprema za bilijar, replika delova trkačkog vozila Formule 1, naime kontrolne table (igračka), replika delova trkačkog vozila Formule 1, naime rukavice vozača, daljinski upravljač za vozila.

**Klasa 30:** Poslastice, čokolada, poslastice od nane, čaj, pića (na bazi čokolade), pića (na bazi kafe), pića (na bazi čaja), biskviti, bombone, kafa, kafa (nepržena), kolačići.

**Klasa 34:** Artikli za pušače, pepeljare za pušače, upaljači za pušače, kutije za cigare, kutije za cigarete.

(210) **2012-88**

(442) **20.12.2013.**

(220) 13.02.2012.

(731) **NISSAN JIDOSHA KABUSHIKI KAISHA** (ALSO TRADING AS NISSAN MOTOR CO.LTD.), NO.2 TAKARACHO, KANAGAWA-KU, YOKOHAMA-SHI, KANAGAWA-KEN JP

**I N F I N I T I**

(540)

(550) I

(740) Popović Miladin, Đoka Miraševića 21/III, Podgorica ME

(511) **Klasa 35:** Usluge maloprodaje i veleprodaje različitih roba, naime automobila, njihovih djelova i opreme (isključujući njihov transport), usluge reklamiranja i publiciteta za automobile, promovisanje u svijesti javnosti električnih motornih vozila i promjena u načinu života koje oni proizvode, pružanje korisnicima proizvoda usluge veb-sajtova koji pružaju informacije o električnim automobilima i informacije koje se odnose na kupovinu takvih automobila, zastupništva u oblasti motornih vozila, pružanje informacija u vezi sa električnim vozilima, naime, potrošačke informacije o proizvodu i poređenje cijena, promovisanje roba i usluga drugih kroz administriranje podsticajnih nagradnih programa koji uključuju distribuciju EV (električnih vozila) i kreditiranje kilometara vožnje, informacione usluge, odnosno, pružanje informacija u oblasti poređenja cijena na polju benzina.

**Klasa 37:** Popravljanje ili održavanje automobila, električnih vozila uključujući električne automobile, karavane, kamione, kombije, terenska (SUV) vozila, autobuse, rekreativna vozila, sportske automobile, trkačke automobile, vagonete, viljuškare, i traktore za vuču (traktore), i strukturnih djelova i opreme za njih, pružanje informacija u vezi sa popravljanjem ili održavanjem automobila, električnih vozila uključujući električne automobile, karavane, kamione, kombije, terenska (SUV) vozila, autobuse, rekreativna vozila, sportske automobile, trkačke automobile, vagonete, viljuškare, i traktore za vuču (traktore), i strukturnih djelova i opreme za njih, popravljanje ili održavanje mašina i instrumenata za mjerenje ili testiranje, popravljanje ili održavanje mašina i aparata za distribuciju električne energije i kontrolu, popravljanje ili održavanje rotacionih konvertora, popravljanje ili održavanje modifikatora faze, popravljanje ili održavanje punjača, popravljanje ili održavanje baterija i ćelija, popravljanje ili održavanje motora sa unutrašnjim sagorijevanjem, popravljanje ili održavanje djelova motora sa unutrašnjim sagorijevanjem, popravljanje ili održavanje anlasera za motore i mašine, ne za kopnena vozila, popravljanje ili održavanje djelova AC motora i DC motora, popravljanje ili održavanje Ac generatora i DC generatora, popravljanje ili održavanje agregata, popravljanje ili održavanje električnih žica i kablova, popravljanje ili održavanje telekomunikacionih uređaja i aparata, popravljanje ili održavanje telefonskih aparata, popravljanje ili održavanje djelova i dodatne opreme za telekomunikacione mašine i aparate, popravljanje ili održavanje telematskih aparata za vozila, popravljanje ili održavanje aparata za automatsko obavješćavanje o završetku punjenja, popravljanje ili održavanje navigacionih sistema za vozila, popravljanje ili održavanje elektronskih mašina, aparata, i njihovih djelova, popravljanje ili održavanje sistema na daljinsku kontrolu, popravljanje ili održavanje elektroda, popravljanje ili održavanje magnetnih jezgra, popravljanje ili održavanje otpornosti žica, pružanje usluga pomoći na putu, naročito odgovaranje na telefonske pozive za pomoć pored puta, brzo mijenjanje guma, hitno snabdijevanje gorivom, punjenje baterija i hitno snabdijevanje baterijama, pružanje informacija o stanju vozila, naime status punjenja, potrebno vrijeme za potpuno punjenje, isključen status, napunjen, pružanje informacija o stanju vozila, naime status punjenja, potrebno vrijeme za potpuno punjenje, isključen status, napunjen, pružanje informacija o stanju vozila, naime, podsjećanje vozača da uključi vozilo radi punjenja baterija, usluge održavanja vozila, naime, pružanje elektronskih upozorenja putem interneta koja obavješćavaju vlasnike vozila o terminu za održavanje vozila.

**Klasa 38:** Usluge komunikacija putem mobilnih telefona, komunikacija putem kompjuterskih terminala, komunikacija putem telefona, Iznajmljivanje/lizing komunikacione opreme, uključujući telefone, faks mašine, informacije o komunikacionim podacima (uključujući informacije putem kabla i radio komunikacionih mreža), komunikacija putem e-maila, informacije o komunikacionim mrežama putem kompjuterskih terminala, komunikacija putem VAN mreže, pružanje telekomunikacionih veza na globalnoj kompjuterskoj mreži, pružanje

pristupa korisnicima globalno pozicioniranim signalima za navigacijske svrhe, pružanje korisnicima pristup internetu, komunikacija podacima sa slovima, slikama i zvucima putem e-maila i kompjutera, pružanje korisnicima pristup globalnoj kompjuterskoj mreži, telematska pomoć preko servisnog i alarmnog centra za transport i saobraćaj za povezivanje poziva u svrhu intervencije i pomoći osobama i vozilima u slučaju nezgode, kvara ili krađe, pružanje usluga za povezivanje i pristup elektronskim komunikacionim mrežama za prenos i preuzimanje ili prijem audio, video ili multimedijalnog sadržaja, pružanje pristupa digitalnoj muzici na Internetu, telekomunikacije, naime primanje, koordiniranje i prosledivanje poziva na daljinu o stanju vozila, telekomunikacije, naime primanje, koordiniranje i prosledivanje udaljenih hitnih poziva, prijenos teksta, glasa i alarmnih poruka i signala, mera, zvuka, slika, videa, položaja, kretanja i stanja podataka između kopnenih vozila kao i između mašina/motora/baterija i mašina i raznih centara za obradu podataka i telematskih sistema, telefona ili personalnih računara, Telekomunikacione usluge, naime, elektronski prijenos podataka za vlasnike vozila i vozače, u vezi sa postojećim podacima koji asistiraju u praćenju ukrađenog vozila, pomoćni kompjuterski prijenos signala mehanizma za zaključavanje vozila, telematske usluge, naime, usluge nadgledanja energije, naime, pregled ili snimanje vremena ili nivoa upotrebe i kontrolisanje struje koju koriste izabrani uređaji putem telematskih sistema, telematske usluge, naime, usluge nadgledanja energije za druge, naime, pregled ili snimanje vremena ili nivoa upotrebe i kontrolisanje struje koju koriste izabrani uređaji putem telematskih sistema, telekomunikacije, naime, prijenos podataka, naime, informacije vezane za put i vožnju putem telematskih sistema, komunikacija putem telematskih sistema, naime, informacije u vezi sa prikazom puta i vožnjom, telekomunikacije, naime, prijenos podataka, naime, opšte informacije kao što su informacije u vezi sa automobilom, saobraćajem i stanjem na putu, putem telematskih sistema, telekomunikacije, naime, prijenos podataka i aplikativnog softvera, telekomunikacione usluge, naime, elektronski prijenos glasovnih poruka i podataka.

**Klasa 39:** Informacije u vezi sa transportom, prevoz automobila, brodski prevoz, posredovanje u prevozu, usluge iznajmljivanja i lizinga vozila, pomoć u slučajevima kvara na motornom vozilu, uključujući i vucu i transport, transport putnika putem, morem i vazduhom, informacione usluge, naime, pružanje informacija o vremenu, vesti, informacije o saobraćaju, informacije u vezi sa dolascima letova i odlascima, GPS (Global Positioning Sistem-globalni sistem za pozicioniranje) navigacione usluge, naime, pružanje prognoziranja vozačima smernica u vezi sa najboljom rutom, navigacione usluge putem Interneta i pomoć pri postavljanju destinacije, GPS (Global Positioning Sistem globalni sistem za pozicioniranje) navigacione usluge, naime, glasovno rutiranje i pomoć na licu mesta i pružanje praktičnih usluga preko komponenti integrisanih u motornom vozilu, naime, predajnici, prijemnici, mikroprocesori, softver, mobilni telefoni, i električna striktura sve u interakciji sa globalnim sistemom za pozicioniranje i satelitskom tehnologijom i korisničkim servisnim centrom, obezbeđivanje mesta za punjenje vozila električnom energijom, usluge parkinga za vozila, iznajmljivanje vozila, pružanje informacija u vezi lokacije i dostupnosti benzinskih stanica, pružanje informacija u vezi lokacije i dostupnosti mesta za električno punjenje vozila.

**Klasa 41:** Obrazovne usluge, pripremanje obuke, razonoda, sportske i kulturne aktivnosti, planiranje, promocija, rukovanje i održavanje trka motornih vozila, sve usluge u vezi sa razonodom, sponzorske aktivnosti u vezi sa trkama motornih vozila, obezbeđivanje on-line magazina iz oblasti automobilizma, mode, razonode i stila, on-line publikacija elektronskih magazina. Uputstvo za vožnju vozila, uputstvo za vožnju vozila, naime, pružanje informacija o ekonomičnoj vožnji, obezbeđivanje digitalne muzike (koja se ne može preuzeti) na Internetu.

**Klasa 42:** Usluge informisanja o vremenu, hosting on-line društvenog vebajta koji pruža infor-

macije o električnim vozilima za vlasnike električnih vozila, sistem on-line usluga za upravljanje koji omogućava korisnicima da na daljinu vide, nadgledaju, programiraju, rukuju i kontrolišu sisteme baterija i air-condition sisteme u električnim vozilima, daljinski nadzor i snabdevanje rezultatima nivoa napunjenosti automobilske baterije, obezbeđivanje inspekcijskog programa za polovna vozila, usluge trgovine motornim vozilima, hitne usluge i usluge obezbeđivanja na putu naime, daljinsko zaključavanje i otključavanje vrata, detekcija i obaveštavanje vlasnika vozila o istom, nadziranje punjenja baterije i obaveštavanje vozača o statusu punjenja, nadziranje sistema električne energije koji se koristi u kopnenim vozilima, nadziranje sistema električne energije koji se koristi u kopnenim vozilima.

**Klasa 45:** Obezbeđivanje vebajtova koji pružaju informacije o promenama načina života proizašlim iz upotrebe električnih automobila, daljinski set i početno punjenje baterije i air-condition u električnom vozilu, usluge pružanja hitne pomoći na putu, naročito odgovaranje na pozive za hitnu pomoć za putnike koji su povredeni ili bolesni, usluge nadgledanja vozila u svrhu bezbednosti, naime, automatsko obaveštavanje o rasporedenosti vazdušnih jastuka, usluge automatskog obaveštavanja o sudaru i obaveštavanja operatera o abnormalnom statusu vozila, usluge pružanja hitne pomoći i bezbednosti na putu, naime, praćenje ukradenih vozila, detekcija i obaveštavanje vlasnika vozila o istom, upravljanje vozačima tinejdžerima, naime, nadgledanje, praćenje i upozoravanje vlasnika motornih vozila iz bezbednosnih i sigurnosnih razloga o tome da li je vozač tinejdžer prekoračio ograničenje brzine ili napustio prethodno ograničenu geografsku oblast korišćenjem globalnog sistema za pozicioniranje, domarske usluge za druge koje se sastoje u pravljenju rezervacija na daljinu za punjenje električnih vozila, a koje se pružaju preko telefona, putem e-maila ili tekstualnom porukom, domarske usluge za druge koje se sastoje u nameštanju na daljinu air-conditiona u vozilima, i koje se pružaju preko telefona, putem e-maila ili tekstualnom porukom, pravljenje rezervacija na mestima za električno punjenje vozila, domarske usluge za druge koje se sastoje iz pravljenja zatraženih ličnih aranžmana i rezervacija i pružanja informacija potrošačima kako bi zadovoljili licne potrebe, a sve se pružaju putem telefona, putem e-maila ili tekstualne poruke.

(210) **2012-89**

(442) **20.12.2013.**

(220) 13.02.2012.

(731) **NISSAN JIDOSHA KABUSHIKI KAISHA** (ALSO TRADING AS NISSAN MOTOR CO.LTD.), NO.2 TAKARACHO, KANAGAWA-KU, YOKOHAMA-SHI, KANAGAWA-KEN JP

**I N F I N I T I**

(540)

(550) I

(740) Popović Miladin, Đoka Miraševića 21/III, Podgorica ME

(511) **Klasa 36:** Finansijske usluge, uključujući finansijske usluge u vezi automobila, usluge kreditiranja, usluge iznajmljivanja, usluge posredovanja pri zakupu-kupovini, usluge kreditiranja uz stavljanje hipoteke na kuću, usluge kreditiranja obrtnog kapitala, usluge iznajmljivanja opreme, usluge prodaje i kupovine hartija od vrednosti pokrivenih imovinom (ABS)

i računa potraživanja, usluge prodaje i osiguranja, sve gore navedene usluge isključujući usluge vezane za kreditne kartice, usluge vezane za debitne kartice i usluge u vezi placanja.

(210) **2012-90** (442) **20.12.2013.**

(220) 13.02.2012.

(731) **NISSAN JIDOSHA KABUSHIKI KAISHA** (ALSO TRADING AS NISSAN MOTOR CO.LTD.), NO.2 TAKARACHO, KANAGAWA-KU, YOKOHAMA-SHI, KANAGAWA-KEN JP

**I N F I N I T I**

(540)

(550) I

(740) Popović Miladin, Đoka Miraševića 21/III, Podgorica ME

(511) **Klasa 07:** Mlazni motori, osim za suvozemna vozila, motori, osim za suvozemna vozila, električni motori, osim za suvozemna vozila, turbine, osim za suvozemna vozila, delovi za motore za suvozemna vozila, naime, izduvni lonac, segmenti klipa, prstenovi za podmazivanje, kaiševi, blokovi cilindra, dna motorske kućice, prilagođene presvlake, zamajci, kućišta zamajca, glave cilindra, poklopci ventila, poklopci motora, klipovi, klipni prstenovi, radilice i električni regultori, remenice kolenastog vratila, izduvne grane, grane za usisavanje vazduha, grane za vodu, pumpe za gorivo, pumpe za vodu, pumpe za ubrizgavanje goriva, injektor i za pumpe, kontrolori vremena ubrizgavanja goriva, filteri za gorivo, filteri za vazduh, filteri za ulje, prečistači vazduha, mehanički i električni regulatori, ventilatori sistema za hlađenje, hladnjaci za ulje, ventili, starteri, starteri motora, svećice, klinasti kaiš, kablovi visokog napona, kontaktne tacke, izduvne cevi, dihtunzi, radijatori, kompleti zaptivača, isparivaci, karburatori, Uređaji za paljenje, magneti za paljenje, i delovi za svu gore navedenu robu obuhvaćenu klasom 7, super punjači, turbo punjači, turbo punjači za auspuhe, kompresori za vazduh, turbo kompresori, motori jednosmerne struje, generatori jednosmerne struje, motori naizmjenične struje, generatori naizmjenične struje, električni generatori, kompresori vazduha, pumpe za podmazivanje, hidraulične pumpe, pumpe za vazduh, pumpe za ulje, pumpe za gorivo, hidraulične pumpe, električni generatori, kontrolni ventili za pumpe, alternatori, vazdušni kondenzatori, i delovi za svu gore navedenu robu obuhvaćenu klasom 7, automatski nosači, mašine i aparati za rukovanje teretom, konvejeri, pneumatski transporter i, dizalice, i delovi za svu gore navedenu robu obuhvaćenu klasom 7.

(210) **2012-91** (442) **20.12.2013.**

(220) 13.02.2012.

(731) **DRUŠTVO ZA TELEKOMUNIKCIJE MTEL** D.O.O. UL. KRALJA NIKOLE 27A, PODGORICA ME

## OPEN

(540)

(550) I

- (511) **Klasa 38:** Telekomunikacije, usluge mobilne radiotelefonije, GSM i UMTS mobilne radio usluge, prenos vijesti i slike posebno pomoću SMS i MMS servisa, omogućavanje pristupa internetu takode putem mobilnih radio veza, usluge elektronskog oglašavanja, ove usluge uključuju i (1) dozvoliti jednom licu da komunicira sa drugim, (2) prenos poruka od jedne osobe do druge i (3) stavljanja lica u položaj vizuelne ili govorne komunikacije sa drugim (radio i televizija), ova klasa uključuje posebno, usluge koje sadrže difuziju radio ili televizijskih programa.

(210) **2012-92**

(442) **20.12.2013.**

(220) 13.02.2012.

- (731) **DRUŠTVO ZA TELEKOMUNIKCIJE MTEL** D.O.O. UL. KRALJA NIKOLE 27A, PODGORICA ME

## OPEN TV

(540)

(550) I

- (511) **Klasa 38:** Telekomunikacije, usluge mobilne radiotelefonije, GSM i UMTS mobilne radio usluge, prenos vijesti i slike posebno pomoću SMS i MMS servisa, omogućavanje pristupa internetu takode putem mobilnih radio veza, usluge elektronskog oglašavanja, ove usluge uključuju i (1) dozvoliti jednom licu da komunicira sa drugim, (2) prenos poruka od jedne osobe do druge i (3) stavljanja lica u položaj vizuelne ili govorne komunikacije sa drugim (radio i televizija), ova klasa uključuje posebno, usluge koje sadrže difuziju radio ili televizijskih programa.

(210) **2012-93**

(442) **20.12.2013.**

(220) 13.02.2012.

- (731) **DRUŠTVO ZA TELEKOMUNIKCIJE MTEL** D.O.O. UL. KRALJA NIKOLE 27A, PODGORICA ME

## OPEN SAT

(540)

(550) I

(511) **Klasa 38:** Telekomunikacije, usluge mobilne radiotelefonije, GSM i UMTS mobilne radio usluge, prenos vijesti i slike posebno pomoću SMS i MMS servisa, omogućavanje pristupa internetu takode putem mobilnih radio veza, usluge elektronskog oglašavanja, ove usluge uključuju i (1) dozvoliti jednom licu da komunicira sa drugim, (2) prenos poruka od jedne osobe do druge i (3) stavljanja lica u položaj vizuelne ili govorne komunikacije sa drugim (radio i televizija), ova klasa uključuje posebno, usluge koje sadrže difuziju radio ili televizijskih programa.

(210) **2012-94** (442) **20.12.2013.**  
(220) 13.02.2012.

(731) **DRUŠTVO ZA TELEKOMUNIKCIJE MTEL** D.O.O. UL. KRALJA NIKOLE 27A, PODGORICA ME

### OPEN TV SAT

(540)  
(550) I

(511) **Klasa 38:** Telekomunikacije, usluge mobilne radiotelefonije, GSM i UMTS mobilne radio usluge, prenos vijesti i slike posebno pomoću SMS i MMS servisa, omogućavanje pristupa internetu takode putem mobilnih radio veza, usluge elektronskog oglašavanja, ove usluge uključuju i (1) dozvoliti jednom licu da komunicira sa drugim, (2) prenos poruka od jedne osobe do druge i (3) stavljanja lica u položaj vizuelne ili govorne komunikacije sa drugim (radio i televizija), ova klasa uključuje posebno, usluge koje sadrže difuziju radio ili televizijskih programa.

(210) **2012-95** (442) **20.12.2013.**  
(220) 14.02.2012.

(731) **BIOFARMA**, 50 RUE CARONT, 92284 SURESNES CEDEX, FRANCE FR

### PREXANOR

(540) insertovati grafizam  
(550) I

(740) Radulović Božidar, Jovana Tomaševića 9/III, Podgorica ME

(511) **Klasa 05:** Kardiovaskularni farmaceutski proizvodi.

(210) **2012-96** (442) **20.12.2013.**  
(220) 15.02.2012.

(731) **NISSAN JIDOSHA KABUSHIKI KAISHA** (ALSO TRADING AS NISSAN MOTOR CO.LTD.), NO.2 TAKARACHO, KANAGAWA-KU, YOKOHAMA-SHI, KANAGAWA-KEN JP

### SHIFT\_

(540)



(550) I

(740) Popović Miladin, Đoka Miraševića 21/III, Podgorica ME

(511) **Klasa 12:** Brodovi/čamci i djelovi i oprema za iste, automobili, električna vozila uključujući električne automobile, karavani, teretnjaci, kombiji, terenska vozila (SUV vozila), autobusi, rekreativna vozila (RV), sportski automobili, trkački automobili, kamioni, viljuškari, i traktori za vucu (traktori), i strukturni djelovi i oprema za iste, motorna vozila na dva točka, bicikli i djelovi i oprema za iste, kolica, auto-kiperi, auto-gurači, aparat za vuču automobila, traktori (mašine za vuču), motori i mašine za kopnena vozila, osovine za vozila, prijenosnici snage i zupčanici za mašine, amortizeri, kočnice, motori na naizmjeničnu struju/jednosmernu struju, za kopnena vozila, protiv-provalni alarmi za vozila, samolepljive gumene zakrpe za popravku unutrašnjih i spoljašnjih guma, sve uključeno u međunarodnu klasu 12.

**Klasa 37:** Popravljanje ili održavanje automobila, električnih vozila uključujući električne automobile, karavane, teretnjake, kombije, terenska vozila (SUV vozila), autobuse, rekreativna vozila (RV), sportske automobile, trkačke automobile, kamione, viljuškare, i traktore za vuču (traktore), i strukturnih djelova i opreme za iste, pružanje informacija o popravljanju ili održavanju automobila, električnih vozila uključujući električne automobile, karavana, teretnjaka, kombija, terenskih vozila (SUV vozila), autobusa, rekreativnih vozila (RV), sportskih automobila, trkačkih automobila, kamiona, viljuškara, i traktora za vuču (traktora), i strukturnih djelova i opreme za iste, popravljanje ili održavanje mašina i instrumenata za mjerenje ili testiranje, popravljanje ili održavanje mašina i aparata za distribuciju ili kontrolu električne energije, popravljanje ili održavanje rotacionih konvertora, popravljanje ili održavanje modifikatora faze.

(210) **2012-97**

(442) **20.12.2013.**

(220) 16.02.2012.

(731) **CRNOGORSKA KOMERCIJALNA BANKA** AD PODGORICA, MOSKOVSKA BB, PODGORICA ME



(540)

(550) I

(511) **Klasa 35:** Oglašavanje, vođenje poslova, poslovno upravljanje, kancelarijski poslovi.

**Klasa 36:** Osiguranje, finansijski poslovi, novčani (monetarni) poslovi, poslovi vezani za nepokretnosti.

**Klasa 38:** Telekomunikacije.

(210) **2012-99**

(442) **20.12.2013.**

(220) 20.02.2012.

(731) **ADIDAS INTERNATIONAL MARKETING BV**, HOODOORDDREEF 9A, 1101 BA  
AMSTERDAM ZO NL

(540) geoFIT

(550) I

(740) Radulović Božidar, Jovana Tomaševića 9/III, Podgorica ME

(511) **Klasa 25:** Obuća, odjeća.

---

- (111) 08488 (151) 10.09.2013.  
 (210) **2011-300** (442) **20.03.2013.**  
 (220) 21.06.2011.  
 (300) 37 9164746 02.03.2011. CN  
 (732) **CHONGING YUAN INNOVATION TECHONOLGY CO.LTD**, FENGHUANG,  
 SHAPINGBA DISTRICT, CHONGQING CN



- (540)  
 (550) I  
 (740) Čejović Vladimir, 13. jula 21, Podgorica ME  
 (511) **Klasa 12:** Lokomotive, amortizeri za vozila, automobilske šasije, točkovi za vozila, cycle-car vozila, električna vozila, motori za kopnena vozila, automobili, motorna vozila, motocikli.  
**Klasa 37:** Usluge građevinskog informisanja, izgradnja fabrika, građevinske usluge, usluge rudarskih iskopa, tapaciranje, održavanje i popravka motornih vozila, pranje vozila, usluge servisnih stanica za vozila (dosipanje goriva i održavanje), reparacija guma, usluge instaliranja, održavanja i popravke mašinerije.

- 
- (111) 08287 (151) 26.07.2013.  
 (210) **2011-498** (442) **20.03.2013.**  
 (220) 12.10.2011.  
 (732) **NOBEL ILAC SANAYII VE TICARET ANONIM SIRKETI**, INKILAP MAH., AKCAKOCA SK. NO.10. UMRANIYE, INSTANBUL TR

## ETOL

- (540)  
 (550) I  
 (740) Božović Vesko, Rimski trg 50/11, Podgorica ME  
 (511) **Klasa 05:** Farmaceutski preparati i supstance.

- 
- (111) 08511 (151) 24.09.2013.  
 (210) **2011-255** (442) **20.03.2013.**  
 (220) 24.5.2011.  
 (732) **PHARMASWISS SA**, BUNDESPLATZ 1 6300 ZUG CH

# LEVOMAX

(540)

(550) I

(740) Radulović Božidar, Jovana Tomaševića 9/III, Podgorica ME

(511) **Klasa 05:** Farmaceutski preparati-lijekovi.

(111) 08276

(151) 26.07.2013.

(210) **2011-477**

(442) **20.03.2013.**

(220) 03.10.2011.

(732) **STIEFEL LABORATORIES, INC,** CORPORATION SERVICE COMPANY, 2711 CENTERVILLE ROAD, SUITE 400, WILMINGTON, DELAWARE 19808 US

# BREVOXYL

(540)

(550) I

(740) Lutovac Branislav, Bulevar Crnojevića 93, Podgorica ME

(511) **Klasa 05:** Farmaceutski preparati i proizvodi, preparati na bazi benzoil peroksida za liječenje akni.

(111) 08520

(151) 12.09.2013.

(210) **2011-286**

(442) **20.03.2013.**

(220) 16.6.2011.

(732) **TREBJESA AD NIKŠIĆ,** NJEGOŠEVA BR. 18, NIKŠIĆ ME



(540)

(550) I

(740) Božović Vesko, Rimski trg 50/11, Podgorica ME

(511) **Klasa 32:** Pivo, mineralne i sodne vode i druga bezalkoholna pića, pića od voća i voćni

sokovi, sirupi i drugi preparati za proizvodnju pića.

**Klasa 35:** Oglašavanje, vođenje poslova, poslovno upravljanje, kancelarijski poslovi. Obuhvata, usluge koje pružaju iica ili organizacije u pomoći u radu ili upravljanju preduzećima i u vodenju poslova preduzeća, usluge koje pružaju preuzeća koja se bave oglašavanjem (reklamiranjem), tako što, za račun drugih lica, komuniciraju sa javnošću (reklama) putem prenosa bilo kakvih informacija o proizvodima i uslugama omogućavajući potrošačima prigodan pogled na te proizvode i usluge, usluge koje se sastoje od upisivanja, uređivanja, obrade, prerade ili sistematizacije pisanih informacija i zapisa, usiuge reklamnih agencija, distribuciju prospekata i uzoraka direktno ili poštom, izradu i korišćenje matematičkih i statističkih podataka, organizovanje sajмова i izložbi u komercijalne ili reklamne svrhe.

---

(111) 08496 (151) 10.09.2013.  
 (210) **2011-260** (442) **20.03.2013.**  
 (220) 25.05.2011.  
 (732) **HEMOFARM A.D.**, BEOGRADSKI PUT BB, VRŠAC RS

## PEPTIX

(540)  
 (550) I  
 (740) Popović Miladin, Đoka Miraševića 21/III, Podgorica ME  
 (511) **Klasa 05:** Farmaceutski i veterinarski preparati, sanitarni preparati za dijetetske supstance prilagođene za upotrebu u medicini, hi materijali za zavijanje, materijali za plombiranje zuba, zubarska sredstva, preparati za uništavanje štetočina, fungicidi, herbicidi.

---

(111) 08315 (151) 26.07.2013.  
 (210) **2011-272** (442) **20.03.2013.**  
 (220) 02.06.2011.  
 (732) **TEVA PHARMACEUTICALS INDUSTRIES LTD.**, SCIENCE BASED INDUSTRIES CAMPUS, HAR HOTZVIM. P.O BOX1142, JERUSALEM 91010 IL

## LAXADIN

(540)  
 (550) I  
 (740) Popović Miladin, Đoka Miraševića 21/III, Podgorica ME  
 (511) **Klasa 05:** Farmaceutski preparati za liječenje opstipacije.

---

(111) 08483 (151) 10.09.2013.  
 (210) **2011-459** (442) **20.03.2013.**  
 (220) 20.09.2011.  
 (732) **DIVERSEY, INC.**, 8310 16 STREET, STURTEVANT, WISCONSIN 53177 US

## DIVERSEY

(540)

(550) I

(740) Lutovac Branislav, Bulevar Crnojevića 93, Podgorica ME

(511) **Klasa 21:** Kućne ili kuhinjske sprave i posude (koji nisu od dragocjenih metala ili sa presvlakama od njih), češljevi i sunđeri, četke (izuzev kičica), materijali za pravljenje četki, artikli koji se koriste pri čišćenju, čelična vuna, neprerađeno ili polupreradaeno staklo (osim stakla koje se koristi u građevinarstvu), staklarija, porcelan, fajans, grnčarija i lončarija koja nije uključena u druge klase.

**Klasa 37:** Građevinsko konstruisanje, popravljjanje, usluge instaliranja (instalacione usluge).

**Klasa 41:** Obrazovne usluge, obezbjeđivanje obuke, razonoda, sportske i kulturne aktivnosti.

(111) 08478

(151) 10.09.2013.

(210) **2011-469**(442) **20.03.2013.**

(220) 28.09.2011.

(732) **TWENTIETX CENTURY FOX FILM CORPORATION**, 10201 WEST PICO BOULEVYRD, LOS ANGELES, CALIFORNIA 90035 US

## FOX MOVIES

(540)

(550) I

(740) Čejović Vladimir, 13. jula 21, Podgorica ME

(511) **Klasa 09:** Aparati i instrumenti naučni, pomorski, geodetski, fotografski, kinematografski, optički, za vaganje, mjerenje, signalizaciju, kontrolu (nadzor), spašavanje života i nastavu, aparati i instrumenti za spovođenje, prekidanje, transformaciju, akumuliranje, regulaciju ili kontrolu struje, aparati za snimanje, prenošenje ili reprodukciju zvuka ili slike, magnetni nosioci podataka, diskovi za snimanje, automatske mašine i mehanizmi za aparate koji se pokreću novcem ili žetonom, registar kase, računске mašine, oprema za obradu podataka i računari, aparati za gašenje požara, melodije, grafike, pozadine, igre i muzika koje se mogu preuzeti sa globalne kompjuterske mreže ili bežičnih uređaja, filmovi, televizijski programi i audio vizuelni sadržaji zajedno sa igranim filmom i televizijskom zabavom koji se mogu preuzeti sa Interneta, audio i video zapisi zajedno sa igranim filmom i televizijskom zabavom koji se mogu preuzeti sa Interneta, računarski softver i dodatci, unaprijed snimljene video trake, DVDi i CDi zajedno sa igranim filmom i televizijskom zabavom, podloge za miš, dekorativni magneti, naočare.

**Klasa 38:** Telekomunikacije, usluge televizijskog prenosa i emitovanja, usluge radio emitovanja.

**Klasa 41:** Obrazovanje, obezbjeđivanje obuke, zabava, sportske i kulturne aktivnosti, produkcija i distribucija televizijskih programa, igranih filmova i audio vizuelne zabave, usluge zabave, u smislu televizijskog programiranja, obezbjeđivanje on-line informacija na polju televizije, igranog filma i video zabave putem Interneta, obezbjeđivanje televizije, igranog filma i video zabave putem bežičnih uređaja, usluge zabave, u smislu zapisa i slika zajedno sa televizijskim emisijama i zabavom koje se ne mogu preuzeti a prenose se putem Internet i bežičnih komunikacionih mreža, usluge zabave, naime obezbjeđivanje on-line igrice za računar, on-line novine, naime blog za iznošenje ličnih informacija i mišljenja, organizovanje zabave

i kulturnih događaja, zabava u smislu takmičenja, nadmetanja i igara.

- 
- (111) 08482 (151) 10.09.2013.  
 (210) **2011-262** (442) **20.03.2013.**  
 (220) 26.05.2011.  
 (732) **B.D. BAGGIES LTD.**, 112 CAPITOL TRAIL, DE-19711, NEWARK, DELAWARE US



B. D. BAGGIES

- (540)  
 (550) I  
 (740) Čejović Vladimir, 13. jula 21, Podgorica ME  
 (511) **Klasa 25:** Odjeća, obuća, pokrivala za glavu, sportska odjeća i odjeća koja se nosi napo-  
 lju, košulje, duksevi, majce, trikotaža, donje rublje, čarape, šalovi, kaiševi (odjeća), rukavice  
 (odjeća).

- 
- (111) 08500 (151) 12.09.2013.  
 (210) **2011-446** (442) **20.03.2013.**  
 (220) 07.09.2011.  
 (732) **JT INTERNATIONAL S.A.**, 1, RUE DE LA GABELE, 1211 GENEVA 26 CH

SOBRANIE BEYOND COMPARE

- (540)  
 (550) I  
 (740) Čejović Vladimir, 13. jula 21, Podgorica ME  
 (511) **Klasa 34:** Duvan, koji je prerađen ili neprerađen, duvan za pušenje, duvan za lule, duvan  
 za savijanje, duvan za žvakanje, duvan za sisanje, cigarete, cigare, cigarilosi, supstance za  
 pušenje koje se prodaju odvojeno ili izmiješane sa duvanom, i koje nijesu za medicinsku  
 ili svrhu liječenja, burmut, artikli za pušaće uključeni u klasu 34, papir za cigarete, fišeci za  
 cigarete i šibice.

- 
- (111) 08498 (151) 12.09.2013.  
 (210) **2011-258** (442) **20.03.2013.**  
 (220) 24.05.2011.  
 (732) **INTEL CORPORATION**, 2200 MISSION COLLEGE BOULEVARD, SANTA CLARA, CALI-  
 FORNIA 95052-8119 US

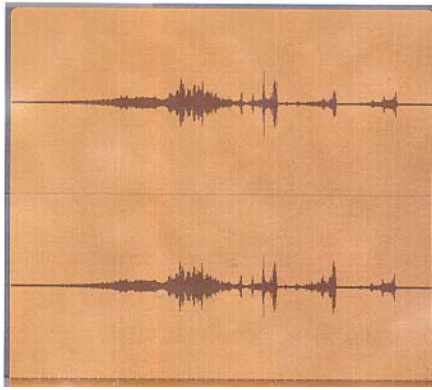

(540)

(550) M

(740) Čejović Vladimir, 13. jula 21, Podgorica ME

(511) **Klasa 09:** Računarski softver, 3D animacioni softver, 3D animaciona obrada tehnološkog softvera za srvaranje, proizvodnju, snimanje, prenošenje ili reprodukciju zvuka, snimka, filma, animiranog sadržaja, softverskog programa, grafike i slike, računarski softver za upotrebu digitalnih animacija i specijalnih efekata za slike, softver za izradu slika, grafika i teksta, softver za kontrolu i poboljšanje računara i audio opreme zvučnog kvaliteta, softver za igre na računaru, grafički softver računara, softver za elektronske igre, softver za igre, softver za video igre, softver za virtuelne video igre, interaktivne video igre sadržane u hardveru i softveru računara, računari, serveri, radne stanice, računarski hardver, matične ploče, ujedinjena strujna kola, poluprovodnici i procesori, ketridži za video igre, računarski softver za igranje video igara i računarske igre za igranje putem globalnih računara i komunikacionih mreža, računarski softver za kompresovanje i dekompresovanje podataka i video slika, prenosni i laptop računari, portabl računari, ručni računari, tablet računari, ultra mobilni računari, računarski softver koji obezbjeđuje pristup većem broju korisnika na globalnu računarsku informacionu mrežu, računarski upravljački softver, naime, računarski operacioni sistem softvera, računarski korisnički softver i drugi računarski softver, portabl video plejeri, lični uređaji za igre, visoko određeni disk plejeri, DVD plejeri.

**Klasa 41:** Servisi za zabavu, naime, produkcija igranih filmova, snimaka i filmova, nabavka televizije, snimaka i specijalnih efekata filmske produkcije, razvoj softvera za upotrebu u filmskoj produkciji, snimcima i filmovima, servisi animirane produkcije, servisi za produkciju multimedialnih softvera.

(111) 08502

(151) 12.09.2013.

(210) **2011-261**(442) **20.03.2013.**

(220) 25.05.2011.

(300) 43097 07.12.2010. TT

(732) **INTEL CORPORATION**, 2200 MISSION COLLEGE BOULEVARD, SANTA CLARA, CALIFORNIA 95052-8119 US





(540)

(550) I

(740) Čejović Vladimir, 13. jula 21, Podgorica ME

(511) **Klasa 09:** Računari, računarski periferni uređaji, računarski terminali, računarski hardver, mašine za kompjuterske igre, mikroprocesori, memorijske ploče, monitori, displeji, tastature, kablovi, modemi, štampači, disk drajvovi, adapteri, kartice za adaptere, konektori i drajveri, nepopunjeni mediji za skladištenje kompjuterskog sadržaja, magnetni nosači podataka, kompjuterski softver, kompjuterski softver za kreiranje, preuzimanje, prenos, prijem, uređivanje, izvlačenje, kodiranje, dekodiranje, prikazivanje, čuvanje i organizovanje teksta, grafike, slike, i elektronskih publikacija, kompjuterski softver i firmver, naime, operativni sistemi, programi za sinhronizaciju podataka i programi aplikacija za razvijanje pomoćnih alati za lične i ručne računare, kompjuterski hardver i softver za pružanje integrisane telefonske komunikacije sa kompjuterskim globalnim informacionim mrežama, prethodno snimljeni kompjuterski programi za lično upravljanje informacijama, softver za upravljanje bazama podataka, softver za prepoznavanje znakova, softver za upravljanje telefonijom, softver za elektronsku poštu i slanje poruka, pejdžing softver, softver za mobilni telefon, softver za sinhronizaciju baza podataka, kompjuterski programi za pristup, pregled i pretraživanje on-line baza podataka, kompjuterski softver za preusmeravanje poruka, elektronske pošte preko interneta, i / ili drugih podataka na jedan ili više elektronskih ručnih uređaja iz prodavnice podataka na ili u vezi sa ličnim računarima ili serverima, kompjuterski softver za sinhronizaciju podataka između daljinskih stanica ili uređaja i fiksnih stanica ili daljinskih stanica ili uređaja, elektronske publikacije koje se mogu preuzeti kao što su knjige, drame, pamfleti, brošure, bilteni, dnevne novine, magazini, i časopisi o širokom spektru tema od opšteg interesa, ručni digitalni elektronski uređaji i odgovarajući softver, MP3 i drugi audio plejeri u digitalnom formatu, ručni računari, tablet računari, lični digitalni asistenti, elektronski organizatori, elektronske sveske, mobilni digitalni elektronski uređaji, uređaji za globalni sistem pozicioniranja (GPS), telefoni, ručni i mobilni digitalni elektronski uređaji za slanje i primanje telefonskih poziva, faksova, elektronske pošte i drugih digitalnih podataka, bežični telefoni, mobilni telefoni, djelovi i pribor za mobilne telefone, faks mašine, telefonske sekretarice, kamere, uređaji za prenos videa preko telefona, softver i hardver za pronalaženje informacija preko telefona, elektronske ručne jedinice za bežični prijem, skladištenje i / ili prenos podataka i poruka, i elektronski uređaji koji omogućavaju korisniku da prate i upravljaju ličnim podacima, elektronska komunikaciona oprema i instrumenti, telekomunikacioni aparati i instrumenti, fontovi, slogovi, štamparski dizajni i simboli u obliku snimljenih podataka, čipovi, diskovi i trake koje sadrže ili su za snimanje kompjuterskih programa i softvera, ram memorija, rom memorija, solid state memorijski aparat, kompjuterske i elektronske igre, uputstva za rukovanje u obliku kojih se može čitati elektronskim putem, putem mašina ili putem računara za upotrebu sa, i koji se prodaju zajedno sa svom gore navedenom robom, aparati za skladištenje podataka, hard drajvovi, minijaturni hard disk drajvovi za

skladištenje podataka, audio-video diskovi, čitači kompaktnih diskova, i digitalni višenamjenski diskovi, podloge za miša, baterije, punjive baterije, punjači, punjači za električne baterije, slušalice, stereo slušalice, slušalice koje se stavljaju direktno u ušni kanal, stereo zvučnici, audio zvučnici, audio zvučnici za kućnu upotrebu, zvučnici za monitore, zvučnici za računare, zvučni sistemi za lični stereo, radio prijemnici, pojačala, aparati za snimanje i reprodukciju zvuka, električni fonografi, gramofoni, stereo uređaji za visoko kvalitetnu reprodukciju zvuka, magnetofoni i aparati za reprodukciju, zvučnici, jedinice sa više zvučnika, mikrofoni, digitalni audio i video uređaji, uređaji za snimanje i reprodukciju zvuka, uređaji za snimanje i reprodukciju pokretnih slika, uređaji za reprodukciju kompaktnih diskova, uređaji za snimanje i reprodukciju digitalnih višenamjenskih diskova, uređaji za snimanje i reprodukciju digitalnih audio kaseti, digitalni uređaji za reprodukciju muzike i/ili pokretnih slika, radio aparati, video kamere, audio, video, i digitalni mikseri, radio predajnici, zvučni uređaji za automobile, računarska oprema za upotrebu sa svom gore navedenom robom, elektronski aparati sa multimedijalnim funkcijama za upotrebu sa svom gore navedenom robom, elektronski aparati sa interaktivnim funkcijama za upotrebu sa svom gore navedenom robom, pribor, djelovi, oprema i aparati za testiranje za svu gore navedenu robu, djelovi i oprema za svu gore navedenu robu, pokrivači, torbe i futrole prilagođene ili oblikovane da sadrže svu gore navedenu robu, od kože, imitacije kože, tkanine, ili tekstilnih materijala.

- 
- (111) 08317 (151) 26.07.2013.  
 (210) **2011-301** (442) **20.03.2013.**  
 (220) 22.6.2011.  
 (732) **HELEN OF TROY LIMITED**, 13 8 AVENUE, BELLEVILLE, P.O. BOX 836E, ST.MICHAEL, BARBADOS BB

OXO

- (540)  
 (550) I  
 (740) Lutovac Branislav, Bulevar Crnojevića 93, Podgorica ME  
 (511) **Klasa 08:** Ručni alati i sprave s ručnim pokretanjem, noževi, viljuške i kašike, hladno oružje, mehaničke i električne sprave za brijanje.  
**Klasa 20:** Dječje visoke stolice, povišivači sjedišta za djecu, sjedišta za djecu za auto, vješalice, nemetalna zaštitna vrata(za djecu), nemetalne ljestvičaste stolice, dječje kutije/kovčezi, kukice na vakuum, nemetalne kukice, spojnice za kućnu upotrebu, prostirači za sudopere, namještaj, policica za alat koja se namješta na zid, police za izlaganje, sastav za skladištenje i organizaciju koji se sastoji od policica, ladica, ormara, košara i šipki za odjeću, police za cipele,  
**Klasa 21:** Pribor i posuđe za domaćinstvo ili za kuhinju, češljevi i sunđer, četke (osim kistova), materijali za četke, pribor za čišćenje, žica za struganje parketa, sirovo ili polu obrađeno staklo (osim građevinskog stakla), stakleni proizvodi, porculansko i keramičko posuđe koje nije obuhvaćeno drugim razredima.

- 
- (111) 08311 (151) 26.07.2013.

(210) **2011-293**(442) **20.03.2013.**

(220) 17.06.2011.

(732) **THE PROCTER&GAMBLE COMPANY**, ONE PROCTER&GAMBLE PLAZA, CINCINNATI, OHIO 45202 US

(540)

(550) I

(740) Lutovac Branislav, Bulevar Crnojevića 93, Podgorica ME

(511) **Klasa 08:** Sredstva za pranje, bijeljenje i druge supstance za upotrebu kod pranja veša, sapuni za upotrebu u domaćinstvu, nagrizajuća sredstva, preparati za poliranje, abrazivna sredstva, mirišljavi preparati za vazduh i tkanine.

(111) 08499

(151) 12.09.2013.

(210) **2011-502**(442) **20.03.2013.**

(220) 13.10.2011.

(732) **PFIZER INC.**, 235 EAST 42ND STREET, NEW YORK, NY 10017 US

## XALKORI

(540)

(550) I

(740) Čejović Vladimir, 13. jula 21, Podgorica ME

(511) **Klasa 05:** Farmaceutski i veterinarski preparati, sanitarni preparati koji se koriste u medicinske svrhe, dietetske supstance prilagođene za upotrebu u medicini, hrana za bebe, flasteri, materijali za zavijanje, materijali za plombiranje zuba, zubarska smola, dezinfekciona sredstva, preparati za uništavanje štetočina, fungicidi, herbicidi.

(111) 07296

(151) 29.01.2013.

(210) **2010-206**(442) **20.06.2012**

(220) 16.06.2010.

(732) SHARP KABUSHIKI KAISHA also trading as SHARP CORPORATION, 22-22, NAGAKIE-CHO, ABENO-KU, OSAKA 545-8522 JP



(540)

(550) I

(740) Popović Miladin, Đoka Miraševića 21/III, Podgorica ME

(511) **Klasa 09:** LCD televizijski prijemnici televizijski prijemnici LCD paneli LCD moduli LCD monitori kombinovani LCD televizori/monitori i DVD plejeri rikorderi sa optičkim diskom plejeri sa optičkim diskom DVD rikorderi DVD plejeri mobilni telefoni elektronski rečnici elektronski organizatori lični digitalni pomoćni uređaji elektronske računске marine kompjuteri prenosivi kompjuteri aparati za snimanje, prenos ili reprodukcija zvuka i slike u klasi 9.

(111) 08497

(151) 12.09.2013.

(210) **2011-493**(442) **20.03.2013.**

(220) 11.10.2011.

(732) **SUPREME PROTEN, INC,** 2231 LANDMARK PLACE, MANASGUAN, 08736 NEW YERSEY US

**Supreme**  
Protein

(540)

(550) I

(740) Čejović Vladimir, 13. jula 21, Podgorica ME

(511) **Klasa 05:** Hranljive namirnice, štangle za sportsku prehranu i proteinske štangle.

(111) 08286

(151) 26.07.2013.

(210) **2011-283**(442) **20.03.2013.**

(220) 10.06.2011.

(732) **DOO RATKOVIĆ-ALFA-CETINJE,** X CRNOGORSKE S-65 CETINJE ME

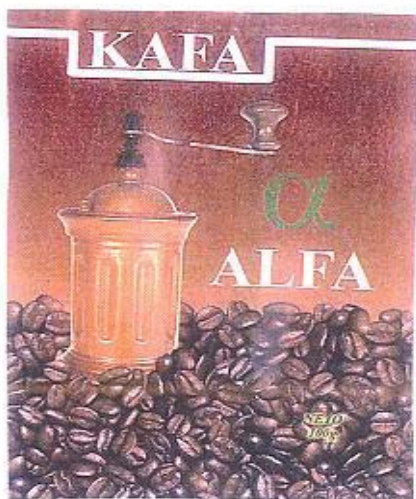

(540)

(550) I

(511) **Klasa 30:** Kafa, čaj, kakao, pirinač, tapioka, sago, zamjena kafe.

(111) 08507

(151) 12.09.2013.

(210) **2011-490**(442) **20.03.2013.**

(220) 10.10.2011.

(732) **REGENT HOSPITALITY WORLDWIDE, INC,** THE CENTRE MARK, 287-299 QUEEN S ROAD, SUITE 1408, 14/F, CENTRAL, HONG KONG CN

(540)

(550) I

(740) Čejović Vladimir, 13. jula 21, Podgorica ME

(511) **Klasa 35:** Oglašavanje, kancelarijski poslovi, poslovno upravljanje, savjetovanje, i administrativne usluge, upravljanje i rad hotela, restorana, nocnin klubova, barova, banja, rekreativnih i fitnes objekata, maloprodajnih objekata, šoping centara, kondominijuma, stambenih zgrada, i odmarališta sa pravom vremenskog korišćenja, usluge maloprodajnih radnji, usluge šoping centara, maloprodajne online usluge, maloprodajne katalogske usluge, usluge za potrošače od povjerenja i nagradni programi, usluge oglašavanja, usluge poslovnog upravljanja u vezi sa rekreativnim klubovima u odmaralištima, klubovima za odmor, nepokretnostima koje se dijele na vremenskoj osnovi, klubovima koji omogućavaju pravo korišćenja na vremenskoj osnovi proporcionalno udjelima članova, klubovima za privatni boravak, klubovima sa pravom korišćenja, i projektima dugotrajnog zakupa, usluge poslovnih centara, poslovno upravljanje, savjetovanje i pomoć u upravljanju vlasnicima jahti i onima koji upravljaju jahtama.

**Klasa 36:** Osiguranje, finansijski poslovi, novčani poslovi, poslovi vezani za nekretnine, razvoj nekretnina, lizing, upravljanje, iznajmljivanje i posredovanje u vezi sa stanovima, kondominijumima, privatnim vlasništvom, vlasništvom koje se dijeli na vremenskoj osnovi i ne-

kretninama svih vrsta i objektima i pogodnostima u vezi sa istima, finansiranje u vezi sa nekretninama, usluge u vezi sa kreditnim karticama, prikupljanje sredstava i donacija u dobrotvorne svrhe, obezbjeđivanje članstva za klubove koji omogućavaju pravo korišćenja na vremenskoj osnovi proporcionalno udjelima članova, klubove za privatni boravak, klubove sa pravom korišćenja, pružanje okalšica pri prodaji, razmjeni i trgovini vremena za odmor za članove rekreativnih klubova u okviru odmarališta, klubova za privatni boravak, klubova sa pravom korišćenja nepokretnosti koje se dijele na vremenskoj osnovi, klubova koji omogućavaju pravo korišćenja na vremenskoj osnovi proporcionalno udjelima članova, klubova za privatni boravak, klubova sa pravom korišćenja, organizovanje razmjene stanarskih prava između vlasnika nekretnina u okviru odmarališta.

**Klasa 39:** Transport, pakovanje i skladištenje robe, organizovanje putovanja, usluge turističkih agencija, rezervisanje prevoza, organizovanje i realizacija turističkih obilazaka i ponuda za odmor, organizovanje vazdušnog, kopnenog i pomorskog prevoza za pojedince i grupe, usluge kruzera, organizovanje krstarenja, usklađivanje putnih aranžmana za pojedince i grupe, organizovanje ponuda za odmor i turističkih obilazaka, usluge rezervacija rentiranja automobila, prtljaga i prevoz putnika, usluge u vezi sa poslovanjem garaža, parkinga, prtljaga, prenosa prtljaga, iznajmljivanja bicikala, i iznajmljivanja vozila za golf, usluge šofera i limuzina, usluge marine, usluge iznajmljivanja jahti i brodova.

**Klasa 41:** Obrazovanje, pripremanje obuke, razonoda, sportske i kulturne aktivnosti, usluge kazina, usluge kabarea, usluge noćnih klubova, organizovanje rezervacija karata za priredbe i druge zabavne događaje, usluge zdravstvenih i fitnes klubova, obezbjeđivanje uputstava i opreme u vezi sa fizičkim vježbama, obezbjeđivanje objekata i opreme za fitnes, vježbe, tenis, plivanje, rekreativne aktivnosti, vožnju biciklom, golf, sportove na vodi, vožnju čamcem, jahanje, skijanje i društvene namjene, jahting klubovi, usluge golf kluba, golf terena i uputstava za golf, usluge planiranja vjenčanja i usluge upravljanja, usluge planiranja događaja i usluge upravljanja, realizacija i organizovanje obrazovnih, zabavnih i kulturnih časova, programa, radionica i događaja, umjetničke izložbe, umjetničke galerije.

**Klasa 43:** Usluge obezbjeđivanja hrane i pića, hotelske usluge, usluge restorana, kateringa, bara i salona, usluge odmarališta i smještaja, obezbjeđivanje privremenog smještaja, obezbjeđivanje objekata opšte namjene za sastanke, konferencije, i izložbe, obezbjeđivanje objekata za banket i društvene namjene za specijalne prilike, usluge rezervacije za hotel i drugi smještaj, usluge hotela koje karakteriše program podsticajnih nagrada i program nagrada za korisnike.

**Klasa 44:** Medicinske usluge, veterinarske usluge, higijenska i kozmetička njega zaljude i životinje, usluge poljoprivrede, vrtlarstva i šumarstva, spa usluge, obezbjeđivanje tretmana za lice, kosu, kožu i tijelo, usluge manikira i pedikira, usluge masaže, i usluge depilacije tijela, i usluge kozmetičkog salona.

(111) 08509

(151) 12.09.2013.

(210) **2011-488**

(442) **20.03.2013.**

(220) 10.10.2011.

(732) **REGENT HOSPITALITY WORLDWIDE, INC, THE CENTRE MARK, 287-299 QUEEN S ROAD, SUITE 1408,14/F, CENTRAL, HONG KONG CN**

**REGENT**

(540)

(550) I

(740) Čejović Vladimir, 13. jula 21, Podgorica ME

(511) **Klasa 35:** Oglašavanje, kancelarijski poslovi, poslovno upravljanje, savjetovanje, i administrativne usluge, upravljanje i rad hotela, restorana, nocnin klubova, barova, banja, rekreativnih i fitnes objekata, maloprodajnih objekata, šoping centara, kondominijuma, stambenih zgrada, i odmarališta sa pravom vremenskog korišćenja, usluge maloprodajnih radnji, usluge šoping centara, maloprodajne online usluge, maloprodajne kataloške usluge, usluge za potrošače od povjerenja i nagradni programi, usluge oglašavanja, usluge poslovnog upravljanja u vezi sa rekreativnim klubovima u odmaralištima, klubovima za odmor, nepokretnostima koje se dijele na vremenskoj osnovi, klubovima koji omogućavaju pravo korišćenja na vremenskoj osnovi proporcionalno udjelima članova, klubovima za privatni boravak, klubovima sa pravom korišćenja, i projektima dugotrajnog zakupa, usluge poslovnih centara, poslovno upravljanje, savjetovanje i pomoć u upravljanju vlasnicima jahti i onima koji upravljaju jahtama.

**Klasa 36:** Osiguranje, finansijski poslovi, novčani poslovi, poslovi vezani za nekretnine, razvoj nekretnina, lizing, upravljanje, iznajmljivanje i posredovanje u vezi sa stanovima, kondominijumima, privatnim vlasništvom, vlasništvom koje se dijeli na vremenskoj osnovi i nekretninama svih vrsta i objektima i pogodnostima u vezi sa istima, finansiranje u vezi sa nekretninama, usluge u vezi sa kreditnim karticama, prikupljanje sredstava i donacija u dobrotvorne svrhe, obezbjeđivanje članstva za klubove koji omogućavaju pravo korišćenja na vremenskoj osnovi proporcionalno udjelima članova, klubove za privatni boravak, klubove sa pravom korišćenja, pružanje okalšica pri prodaji, razmjeni i trgovini vremena za odmor za članove rekreativnih klubova u okviru odmarališta, klubova za privatni boravak, klubova sa pravom korišćenja nepokretnosti koje se dijele na vremenskoj osnovi, klubova koji omogućavaju pravo korišćenja na vremenskoj osnovi proporcionalno udjelima članova, klubova za privatni boravak, klubova sa pravom korišćenja, organizovanje razmjene stanarskih prava između vlasnika nekretnina u okviru odmarališta.

**Klasa 39:** Transport, pakovanje i skladištenje robe, organizovanje putovanja, usluge turističkih agencija, rezervisanje prevoza, organizovanje i realizacija turističkih obilazaka i ponuda za odmor, organizovanje vazdušnog, kopnenog i pomorskog prevoza za pojedince i grupe, usluge kruzera, organizovanje krstarenja, usklađivanje putnih aranžmana za pojedince i grupe, organizovanje ponuda za odmor i turističkih obilazaka, usluge rezervacija rentiranja automobila, pratnja i prevoz putnika, usluge u vezi sa poslovanjem garaža, parkinga, prtljaga, prenosa prtljaga, iznajmljivanja bicikala, i iznajmljivanja vozila za golf, usluge šoferi i limuzina, usluge marine, usluge iznajmljivanja jahti i brodova.

**Klasa 41:** Obrazovanje, pripremanje obuke, razonoda, sportske i kulturne aktivnosti, usluge kazina, usluge kabarea, usluge noćnih klubova, organizovanje rezervacija karata za priredbe i druge zabavne događaje, usluge zdravstvenih i fitnes klubova, obezbjeđivanje uputstava i opreme u vezi sa fizičkim vježbama, obezbjeđivanje objekata i opreme za fitnes, vježbe, tenis, plivanje, rekreativne aktivnosti, vožnju biciklom, golf, sportove na vodi, vožnju čamcem, jahanje, skijanje i društvene namjene, jahting klubovi, usluge golf kluba, golf terena i uputstava za golf, usluge planiranja vjenčanja i usluge upravljanja, usluge planiranja događaja i usluge upravljanja, realizacija i organizovanje obrazovnih, zabavnih i kulturnih časova, programa, radionica i događaja, umjetničke izložbe, umjetničke galerije.

**Klasa 43:** Usluge obezbjeđivanja hrane i pića, hotelske usluge, usluge restorana, kateringa, bara i salona, usluge odmarališta i smještaja, obezbjeđivanje privremenog smještaja, obezbjeđivanje objekata opšte namjene za sastanke, konferencije, i izložbe, obezbjeđivanje objekata za banket i društvene namjene za specijalne prilike, usluge rezervacije za hotel i drugi smještaj, usluge hotela koje karakteriše program podsticajnih nagrada i program na-

grada za korisnike.

**Klasa 44:** Medicinske usluge, veterinarske usluge, higijenska i kozmetička njega zaljude i životinje, usluge poljoprivrede, vrtlarstva i šumarstva, spa usluge, obezbjeđivanje tretmana za lice, kosu, kožu i tijelo, usluge manikira i pedikira, usluge masaže, i usluge depilacije tijela, i usluge kozmetičkog salona.

- 
- (111) 08508 (151) 12.09.2013.  
 (210) **2011-468** (442) **20.03.2013.**  
 (220) 28.09.2011.  
 (732) **SHISEIDO COMPANY LIMITED**, 7-5-5 GINZA, CHUO-KU, 104-0061 TOKYO JP

SHISEIDO BENEFIANCE  
WRINKLERESIST 24

- (540)  
 (550) I  
 (740) Čejović Vladimir, 13. jula 21, Podgorica ME  
 (511) **Klasa 03:** Sapun, parfemi, kozmetika, kozmetički preparati za njegu kože, preparati za njegu kože, proizvodi za šmikanje, proizvodi za njegu kose.

- 
- (111) 08314 (151) 26.07.2013.  
 (210) **2011-487** (442) **20.03.2013.**  
 (220) 07.10.2011.  
 (732) **CORPORATION OF THE PRESIDENT OF THE CHURCH OF JESUS CHRIST OF LATTER-DAY SAINTS**, 50 EAST NORTH TEMPLE STREET, SALT LAKE CITY, UTAH 84150 US



- (540)  
 (550) I  
 (740) Ćupić Branislav, Dalmatinska 10, Podgorica ME  
 (511) **Klasa 41:** Obrazovne i nastavne usluge u vezi sa međunarodnom humanitarnom pomoći i razvojem, usluge humanitarne pomoći za jadne i siromašne, naime podučavanje o dobrim higijenskim i zdravstveno-sanitarnim postupcima  
**Klasa 43:** Usluge humanitarne pomoći i razvoja, naime, opskrbljivanje hranom, pićem, odjećom i zdravstveno-sanitarnim objektima, pružanje privremenog smještaja, omogućavanje sadržaja za rekreaciju.  
**Klasa 45:** Socijalne usluge i personalne usluge u vezi sa humanitarnom pomoći i razvojem,



usluge humanitarne pomoći i razvoja, naime, pružanje zdravstvenih usluga, usluge humanitarne pomoći i razvoja, naime, pružanje sanitarno-higijenskih usluga.

(111) 08278 (151) 26.07.2013.  
 (210) **2011-259** (442) **20.03.2013.**  
 (220) 25.05.2011.  
 (732) **COLGATE-PALMOLIVE COMPANY**, 300 PARK AVENUE, NEW YORK, NY 10022 US

## GOPURE

(540)  
 (550) I  
 (740) Čupić Branislav, Dalmatinska 10, Podgorica ME  
 (511) **Klasa 03:** Pasta za zube.

(111) 08349 (151) 10.09.2013.  
 (210) **2011-295** (442) **20.03.2013.**  
 (220) 17.06.2011.  
 (732) **ASTELLAS PHARMA EUROPE B.V.**, SYLVIUSWEG 62, 2333 Beleid NL

### LIPOBASE REPAIR

(540)  
 (550) I  
 (740) Popović Miladin, Đoka Miraševića 21/III, Podgorica ME  
 (511) **Klasa 03:** Kozmetika.  
**Klasa 05:** Farmaceutski i medicinski preparati, proizvodi i supstance, farmaceutski i medicinski preparati, proizvodi i supstance za ljudsku upotrebu.

(111) 08486 (151) 10.09.2013.  
 (210) **2011-472** (442) **20.03.2013.**  
 (220) 29.09.2011.  
 (732) **VISIOGEN INC**, 1700 EAST ST. ANDREW PLACE, P.O. BOX 25162, SANTA ANA, CALIFORNIA 92705-4933 US

### SYNCHRONY VU

(540)  
 (550) I  
 (740) Popović Miladin, Đoka Miraševića 21/III, Podgorica ME  
 (511) **Klasa 10:** Očni implanti i hirurški ručni instrumenti za umetanje intraokularnih sočiva.

(111) 08485 (151) 10.09.2013.  
 (210) **2011-257** (442) **20.03.2013.**  
 (220) 24.05.2011.  
 (732) **AMO UPPSALA AB**, BOX 6406, 751 36 UPPSALA SE

## HEALON ENDOCOAT

(540)

(550) I

(740) Popović Miladin, Đoka Miraševića 21/III, Podgorica ME

(511) **Klasa 05:** Farmaceutski preparati, naime, hijaluronska kiselina natrijumove soli.

(111) 08283

(151) 26.07.2013.

(210) **2011-473**(442) **20.03.2013.**

(220) 30.09.2011.

(732) **PODRAVKA D.D.**, ANTE STARČEVIĆA 32, 48000 KOPRIVNICA HR

(540)

(550) I

(740) Popović Miladin, Đoka Miraševića 21/III, Podgorica ME

(511) **Klasa 29:** Meso, riba, živina i divljač, mesne prerađevine, konzervisano, zamrznuto, sušeno i kuvano voće i povrće, želei, džemovi, kompoti, jaja, mleko i mlečni proizvodi, jestiva ulja i masti.**Klasa 30:** Kafa, čaj, kakao, šećer, pirinač, tapioka, sago, zamena kafe, brašno i proizvodi od žitarica, hleb, kolači i poslastice, sladoledi, med, melasa, kvasac, prašak za pecivo, so, senf, sirće, sosovi (kao dodaci), začini, led.

(111) 08346

(151) 10.09.2013.

(210) **2011-463**(442) **20.03.2013.**

(220) 22.09.2011.

(732) **JOHNSON OUTDOORS MARINE ELECTRONICS, INC.**, 678 HUMMINBIRD LANE, EUFAULA, ALABAMA 36027 US

## HUMMINBIRD

(540)

(550) I

(740) Lutovac Branislav, Bulevar Crnojevića 93, Podgorica ME

(511) **Klasa 09:** Aparati i instrument naučni, pomorski, geodetski, fotografski, kinematografski, optički, za vaganje, merenje, signalizaciju, kontrolu (inspekciju), spasavanje i nastavu, aparati i instrumenti za provodjenje, isključivanje, transformisanje, akumuliranje, regulisanje ili kontrolisanje električne energije, magnetni nosioci podataka, diskovi za snimanje, automatske mašine i mehanizmi za aparate koji se pokreću novcem ili žetonom, registar kase, računске mašine, aparati za gašenje požara, nautički elektronski uređaji, a naročito sonarni uređaji za merenje dubine i lociranje ribe, ploteri, elektronske mape i karte, ehografi i drugi tehnički uređaji i aparati za ribarenje i navigaciju, ultrazvučni nautički dubinomeri, dvo-

smjerni radio uređaji, navigacioni uređaji, i prateća oprema, aparati za snimanje, prenos i reprodukciju zvuka ili slike, oprema za obradu podataka i kompjuteri, i prateća oprema za naprijed navedenu robu.

- 
- (111) 08113 (151) 26.07.2013.  
 (210) **2011-291** (442) **20.03.2013.**  
 (220) 17.06.2011.
- (732) **THE PROCTER&GAMBLE COMPANY**, ONE PROCTER&GAMBLE PLAZA, CINCINNATI, OHIO 45202 US
- (540) | **LENOR TROPICAL FRESH** |  
 (550) |  
 (740) Lutovac Branislav, Bulevar Crnojevića 93, Podgorica ME
- (511) **Klasa 03:** Sredstva za beljenje i druge supstance za upotrebu kod pranja veša, preparati za čišćenje, poliranje, ribanje i nagrizanje, omekšivači za tekstil, sapuni za upotrebu u domaćinstvu.

- 
- (111) 08277 (151) 26.07.2013.  
 (210) **2011-297** (442) **20.03.2013.**  
 (220) 20.06.2011.
- (732) **ICONIX EUROPE LLC**, 1450 BROADWAY, NEW YORK, NY 10018 US

**ROCAWEAR**

- (540)  
 (550) |  
 (511) **Klasa 25:** Muška, ženska i dečija odjeća, naročito, džins, jakne, pantalone, majice sa kragom, majice, džemperi, uske ženske majice, prsluci, široke pantalone, pantalone, uske majice, polo majice, mantili, dukserice, dukserice sa kapuljačom, trenerke, helanke, šorcevi, bluže, potkošulje, haljine, suknje, donji veš, čarape, kaiševi, šalovi, pokrivala za glavu, obuća.

- 
- (111) 08505 (151) 10.09.2013.  
 (210) **2011-281** (442) **20.03.2013.**  
 (220) 10.06.2011.
- (732) **VLADIMIR RADONJIĆ**, FRUTAK BB, DANILOVGRAD ME



(540)

(550) I

(511) **Klasa 33:** Alkoholna pića – vino.

(111) 08487

(151) 10.09.2013.

(210) **2011-294**(442) **20.03.2013.**

(220) 17.06.2011.

(732) **NOVARTIS AG**, 4002 BASEL CH

## AEROCOMP

(540)

(550) I

(740) Popović Miladin, Đoka Miraševića 21/III, Podgorica ME

(511) **Klasa 05:** Farmaceutski preparati, naime bronhodilatatori i preparati protiv astme.

(111) 08295

(151) 26.07.2013.

(210) **2011-482**(442) **20.03.2013.**

(220) 04.10.2011.

(732) **ALKALOID AD-SKOPLJE**, BUL. ALEKSANDAR MAKEDONSKI 12, SKOPLJE MK



(540)

(550) I

(740) Popović Miladin, Đoka Miraševića 21/III, Podgorica ME

(511) **Klasa 03:** Pjenušava kupka sa kamilicom.

(111) 08299

(151) 26.07.2013.

(210) **2011-458**(442) **20.03.2013.**

(220) 20.09.2011.

(732) **ALKALOID AD -SKOPLJE**, BUL. ALEKSANDAR MAKEDONSKI 12, SKOPLJE MK

(540)

(550) I

(740) Popović Miladin, Đoka Miraševića 21/III, Podgorica ME

(511) **Klasa 03:** Šampon za djecu.

(111) 08280

(151) 26.07.2013.

(210) **2011-500**(442) **20.03.2013.**

(220) 12.10.2011.

(732) **ATE MY HEART INC.**, 1880 CENTURY PARK EAST, SUITE 1600 LOS ANGELES, CA 90067 US

## LADY GAGA FAME

(540)

(550) I

(740) Popović Miladin, Đoka Miraševića 21/III, Podgorica ME

(511) **Klasa 03:** Kozmetika, kozmetički preparati, šminka i preparati za skidanje šminke, ruž za usne, sjaj za usne, pomade za usne, držači za ruž za usne, ne-medicinski preparati za negu usana, krema za usne, mirisi, parfemi, eterična ulja, parfimerija, kolonjske vode, toaletne vode, parfimisana tečnost, parfemska voda, kolonjska voda, sjaj za usne i telo, losioni za lice, kreme, hidratanti, sredstva za čišćenje, kupke, piling kreme, sredstva za piling, i toneri, mleka za tijelo, ne-medicinski tretmani za lice u vidu emulzija za lice i maski za lice, losioni za kožu, kreme za kožu, balzami za kožu, hidratanti za kožu, hidratante maske za za kožu, i puderi, hidratanti za ruke, kreme i losioni, ne-medicinski losioni i kreme za stopala, preparati za uklanjanje bora, vještačke trepavice, ne-medicinska sredstva za higijenu, kupke, gelovi za tijelo, buteri za tijelo, sprejevi za tijelo, ulja i mirisi za tijelo, pilinzi za tijelo, puderi za tijelo, hidratanti za tijelo, losioni za tijelo, kreme za tijelo, pilinzi za tijelo, kreme za piling tijela, mirisi za tijelo, buteri za tijelo, učvršćujući gelovi i losioni za tijelo, maske za tijelo, gelovi za kupanje, ulja za kupanje, puderi za posle kupanje, kristali za kupanje, pena za kupanje, granule za kupanje, soli za kupanje, gelovi za tuširanje, kozmetički preparati za tuširanje, mirisni puderi, sapuni, mirisni sapuni, tečni sapuni, sapuni u prahu, toaletni sapuni, toaletna voda, preparati za brijanje, balzami za brijanje, kreme za brijanje, gelovi za brijanje, losioni za posle brijanja, abrazivni preparati za kožu, ne-medicinske kreme za kožu, i losioni za negu posekotina od brijača, preparati za zaštitu od sunca, preparati za sunčanje, ulja za sunčanje, losioni za posle sunčanja, preparati za samopotamnivanje, i kozmetički preparati za zaštitu od sunca, kreme za sunčanje, ne-medicinske masti za negu opekotina od sunca, kreme za aromaterapiju, losioni i ulja za aromaterapiju, dekorativne kutije za kozmetičke namene, preparati za negu i održavanje tijela, kože, kože glave, i kose, esencijalna ulja za ličnu upotrebu, kozmetička sredstva za skupljanje pora (astringenti), ulja za masažu, puderi od talka, penušave kupke, dezodoransi za ličnu upotrebu i negu tijela, sredstva za održavanje zuba, paste za zube, mirišljavi papir, sredstva za nanošenje šminke u vidu pamučnih tufera za kozmetičke svrhe, sve vrste pamučnih tufera za ličnu upotrebu i kozmetičke svrhe, kozmetički jastučići, vlažne kozmetičke maramice, vlažne kozmetičke maramice i ubrusi, maramice za bebe, preparati za negu noktiju, lakovi za nokte, lakovi za nokte - donji sloj, lakovi za nokte - gornji sloj, preparati za jačanje noktiju, preparati za čvrstinu noktiju, lakovi za ukrašavanje lakiranih noktiju, skidač laka za nokte, kreme za nokte, preparati za uklanjanje zanoktica, veštački nokti, i preparati za jačanje noktiju, preparati za negu kose, proizvodi za negu kose u vidu šampona, balzama, sredstava za ispiranje, pena, gelova, krema, losiona i sprejeva, farbe za kosu, losioni za kovrdžanje kose, preparati za trajne lokne, preparati za nijansiranje kose, boje za kosu, omekšivači za kosu, maskare za kosu, pomade za kosu, skidači farbe za kosu, preparati za opuštanje kose, i preparati za oblikovanje kose, potpuri, jastuci za aromaterapiju koji sadrže mješavinu suvih latica cveća i drugih aromatičnih biljaka (potpuri) u delovima tkanine, vrećice koje sadrže parfimisane preparate, i mješavine, kesice koje sadrže parfimisani prah za mirisanje odeće, jastučići za oči u obliku kesica koji sadrže mirise, mirisno keramičko kamenje, mirišljavi sprejevi za posteljinu i mirišljavi sprejevi za prostorije, mirisna ulja koja proizvode arome (mirise) nakon zagrevanja, mirisne borove šišarke, aromatične supstance koje proizvode miris nakon zagrevanja, mirisi za prostorije, mirisni fitilji za mirisne osveživače prostorija.

- (111) 08291 (151) 26.07.2013.  
 (210) **2011-504** (442) **20.03.2013.**  
 (220) 13.10.2011.  
 (732) **ALKALOID AD SKOPLJE**, BUL. ALEKSANDAR MAKEDONSKI 12, SKOPLJE MK



- (540)  
 (550) I  
 (740) Popović Miladin, Đoka Miraševića 21/III, Podgorica ME  
 (511) **Klasa 3:** Dječja krema.

- (111) 08292 (151) 26.07.2013.  
 (210) **2011-484** (442) **20.03.2013.**  
 (220) 04.10.2011.  
 (732) **ALKAOLID AD-SKOPLJE**, BUL. ALEKSANDAR MAKEDONSKI 12, SKOPLJE MK



- (540)  
 (550) I  
 (740) Popović Miladin, Đoka Miraševića 21/III, Podgorica ME  
 (511) **Klasa 03:** Puder za djecu.

- (111) 08312 (151) 26.07.2013  
 (210) **2011-292** (442) **20.03.2013.**  
 (220) 17.06.2011.  
 (732) **THE PROCTER&GAMBLE COMPANY**, ONE PROCTER&GAMBLE PLAZA, CINCINNATI, OHIO 45202 US

**ARIEL PROFESSIONAL**

- (540)  
 (550) I  
 (740) Lutovac Branislav, Bulevar Crnojevića 93, Podgorica ME  
 (511) **Klasa 03:** Sredstva za beljenje i druge supstance za upotrebu kod pranja veša, preparati za čišćenje, poliranje, nagrizajuća sredstva, abrazivna sredstva, sapuni.

- (111) 08289 (151) 26.07.2013.

(210) 2011-302

(442) 20.03.2013.

(220) 23.06.2011.

(732) **THE PROCTER&GAMBLE COMPANY**, ONE PROCTER&GAMBLE PLAZA, CINCINNATI, OHIO 45202 US

(540)

(550) I

(740) Lutovac Branislav, Bulevar Crnojevića 93, Podgorica ME

(511) **Klasa 05:** Ženski higijenski proizvodi kao što su higijenski ulošci, tamponi, dnevni ulošci, higijenske gaćice, interlabijalni ulošci za žensku higijenu, pelene za inkontinenciju, ulošci i gaćice za inkontinenciju.

(111) 08316

(151) 26.07.2013.

(210) 2011-278

(442) 20.03.2013.

(220) 07.06.2011.

(732) **TELEFONICA S.A.**, GRAN VIA 28, 28013 MADRID ES

The image shows the word 'vivo' in a bold, blue, lowercase sans-serif font. The letters are slightly rounded and have a consistent thickness.

(540)

(550) I

(740) Lutovac Branislav, Bulevar Crnojevića 93, Podgorica ME

(511) **Klasa 09:** Aparati i instrumenti naučni pomorski, geodetski, električni, fotografski, kinematografski, optički, za vaganje, mjerenje, signalizaciju, kontrolu (inspekciju), spasavanje i nastavu, aparati i instrumenti za provođenje, isključivanje, transformisanje, akumuliranje, regulisanje ili kontrolisanje električne energije, aparati za snimanje, prenos i reprodukciju zvuka ili slike, magnetni nosioci podataka, diskovi za snimanje, automatske mašine i mehanizmi za aparate koji se pokreću novcem ili žetonom, registarske kase, računске mašine, oprema za obradu podataka i kompjuteri, aparati za gašenje požara.**Klasa 35:** Oglašavanje, vođenje poslova, poslovno upravljanje, kancelarijski poslovi.**Klasa 38:** telekomunikacije.**Klasa 41:** Obrazovne usluge, obezbjeđivanje obuke, razonoda, sportske i kulturne aktivnosti.

(111) 08282

(151) 26.07.2013.

(210) 2011-499

(442) 20.03.2013.

(220) 12.10.2011.

(732) **NOBEL ILAC SANAYII TICARET ANONIM SIREKETI**, INKILAP MAH., AKCAKO-



CA SK. NO.10. UMRANIYE, INSTANBUL TR

## MYCOCUR

(540)

(550) I

(740) Božović Vesko, Rimski trg 50/11, Podgorica ME

(511) **Klasa 05:** Farmaceutski preparati supstance.

(111) 08514

(151) 24.09.2013.

(210) **2011-471**

(442) **20.03.2013.**

(220) 29.09.2011.

(732) **AB PH. NEDERMAN&CO**, BOX 602, 251 06 HELSINGBORG SE

## NEDERMAN

(540)

(550) I

(740) Ćupić Branislav, Dalmatinska 10, Podgorica ME

(511) **Klasa 07:** Mašine i mašinski alati, motori i pogonske mašine (osim za suvozemna vozila), djelovi mašina i pogonskih mašina, izduvni sistemi, uređaji za ekstrakciju, skupljači prašine, uređaji za razdvajanje dima i prašine, instalacije u zgradama za ekstrakciju izduvnih gasova iz vozila, pumpe, vakum pumpe i lubrikacione pumpe, pumpe za ekstrakciju gasova, tečnosti i pare, uređaji za razdvajanje uljane izmaglice, kompaktne jedinice, ventilatorski uređaji, filteri, obrtni ventili, oprema za čišćenje za industrijsku upotrebu, mašine za pranje veša, mašine za mljevenje, centrifugalne mašine, ciklonski odvajajući, sjekači, razdjelnici, mašine za peskiranje, usisivači, mašine za mljevenje, konvejeri, transportne jedinice, automatski kalemi i konvejeri za šmrkove, kablove, kanape i žice, djelovi i komponenti za svu gore navedenu robu.

**Klasa 11:** Aparati za osvjetljavanje, grijanje, proizvodnju pare, kuvanje, hlađenje, sušenje, ventilaciju, snabdjevanje vodom i za sanitarne svrhe, klima uređaji, aparati za ventilaciju i filtriranje i djelovi za iste, ventilatori i filteri za vazduh, ventilacione instalacije, filteri i ovlaživači za ventilacione sisteme, mobilni ventilatori i filterne jedinice, filteri za ventilacione jedinice, djelovi i komponenti za svu gore navedenu robu.

**Klasa 37:** Gradevinske konstrukcije, popravljavanje, usluge instaliranje (instalacione usluge).

(111) 08516

(151) 24.09.2013.

(210) **2011-263**

(442) **20.03.2013.**

(220) 27.05.2011.

(732) **PLAYBOY ENTERPRISES INTERNATIONAL INC**, 680 NORTH LAKE SHORE DRIVE, CHICAGO, ILLINOIS 60611 US

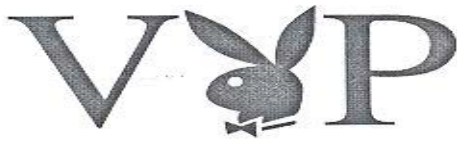

(540)

(550) I

(740) Ćupić Branislav, Dalmatinska 10, Podgorica ME

(511) **Klasa 18:** Koža i imitacije kože, artikli od ovih materijala, sirova koža i krzno, proizvodi od kože, sedlarska i tašnerska roba od kože i imitacije kože, škrinje i putne torbe, kišobrani, sun-cobrani i štapovi za hodanje, asesoari od kože, koferi, ručne torbe, kaiševi, kutije za pisma od kože, akten-tašne, futrole za ključeve, futrole na preklapanje, kožni ženski novčanici, privesci za ključeve od kože, papirne futrole, sportske torbe, futrole za vozačke dozvole, futrole za saobraćajne dozvole, ženski novčanici, futrole za kartice, muški novčanici, novčanici na preklapanje, mapa za spise, mapa za spise na rajsferšlus, torbe, tašne, futrole, bičevi, saračka i sedlarska oprema, torbe od kože, torbe od imitacije kože, torbe od plastičnih materijala, koferi, neseseri, male putne torbe, vreće, torbe od kože za kupovinu, torbe koje se nose preko ramena, suvenir-torbe, torbe-navlake za odijela, torbe od tekstila za kupovinu, prazne torbe za alat, torbe od frotira, futrole za kišobrane, manje putne torbe za kraći boravak.

**Klasa 24:** Tekstil i roba od tekstila, koja nije uključena u druge klase, prekrivači za krevete i stolove.

**Klasa 25:** Odjeća, obuća i pokrivala za glavu.

(111) 08515

(151) 24.09.2013.

(210) **2011-465**(442) **20.03.2013.**

(220) 23.09.2011.

(732) **OMAN PERFUMERY LLC**, P.O. BOX 307, CPO 111, SEEB OM

(540) za Ničanskoj klasifikaciji:

(550) I

(740) Radulović Božidar, Jovana Tomaševića 9/III, Podgorica ME

(511) **Klasa 03:** Mirisi, kozmetika, preparati za njegu kose uključujući šampone, sprejeve za kosu, losione za kosu, preparati za uvijanje kose, boje za kosu, neutralizatori za trajno uvijanje, sapuni, talk, kozmetički preparati za kupanje i tuširanje.toaletna oprema, kozmetički preparati za njegu kože, dezodoransi.

**Klasa 04:** Mirišljave svijeće.

**Klasa 05:** Mirisi za domaćinstvo.

(111) 08489

(151) 10.09.2013.

(210) **2011-265**

(442) **20.03.2013.**

(220) 27.05.2011.

(732) **HUNDAI MOTOR COMPANY**, 231 YANGJAE-DONG, SEOCHO-GU, SEOUL, 137-938 KR



(540)

(550) I

(740) Čejović Vladimir, 13. jula 21, Podgorica ME

(511) **Klasa 36:** Finansiranje zakupa, kreditno finansiranje, finansijske usluge u vezi sa mot vozilima, usluge davanja pozajmica, lizing finansiranje, konsulatntske usli vezi razvojnog finansiranja, finansijske usluge za razvoj, organizacija pozajmica, usluge bračnih pozajmica, finansiranje kupovine, konsluta usluge u vezi međunarodnih finansija, međunarodno bankarstvo, u međunarodnih investicionih fondova, vojno finansiranje, usluge def dragocjenosti, usluge sefova, konsultantske usluge u vezi finansija, brok usluge u vezi finansijskih instrumenata, upravljanje finansijskom imovinom pružanje informacija u oblasti finansija, finansijsko posredovanje, akvizi transfer monetarnih potraživanja, organizovanje finansijskih investicija, u agencija za prikupljanje novčanih potraživanja, usluge korporativnih pozajmica usluge domaćih berzanskih transakcija, pružanje informacija o dorr berzanskim transakcijama, finansiranje kredita za likvidnost, organizovanje pozajmica sa obezbjeđenjem, usluge hipotekarnih pozajmica, usluge tekućih računa, uslužna uplata i prijem novca, usluge zajmova, izdavanje sefova, ns dugova, konsultantske usluge u vezi zajmova, usluge debitnih kartica, u, hipotekarnih zajmova, usluge zajmova bez obezbjeđenja, usluge berza borkera putem bežičnih terminala, pružanje informacija u vezi finansiranja bežičnih komunikacija, usluge berzanskih brokera putem bežičnih komunik usluge finansiranja međunarodne trgovine, pružanje cjenovnih informac investivcionim fondovima, finansiranje kapitala, pozajmice obezbjeđenje, usluge jemstva, usluge jemstva, izdavanje lutrijskih organizovanje finansiranja za kupovinu nekretnina, usluge finansiranja indusrijskih usluge komercijalnog bankarstva, usluge investicionih fondova, pružanje informacija o cijeni terminskih ugovora, brokerske usluge u vezi termin tržišta, usluge potrošačkih kredita, usluge finansiranja izvoza, verifikacija čekova izdavanje čekova, finansijske usluge za nove tehnologije, usluge kreditnog t usluge kreditnih i gotovinskih kartica, izdavanje kreditnih kartica, usluge krec kartica, usluge povjerenika, izdavanje mjenica, razmjena čekova na p izdavanje i naplata obveznica, izdavanje čekova i kreditnih pisama, izdavanje putnih čekova, usluge penzionih fondova, administriranje prijema depc usluge prijema depozita, usluge devizne razmjene, pružanje informaci vrijednosti stranih valuta, izdavanje hartija od vrijednosti, usluge sigu posredovanja, bankarske usluge u vezi prenosa sredstava sa rač konsultacije u vezi bankarstva, bankarske usluge, usluge internet bankar prikupljanje rente, finansiranje kupovine na lizing, novčane pozajmice, plas sredstava, novčani transferi, prikupljanje sredstava, novčano posredovi unovčavavanje čekova, usluge direktne naplate, usluge bankomata, konsult

u oblasti kapitalnih investicija, usluge kapitalnih investicija, finans bankarstvo, finansijsko sponzorisanje, hipotekarno bankarstvo, us štedionica, usluge zajmova sa obezbjeđenjem, elektronski transfer sredst usluge trgovine terminskim opcijama putem berzanskih indeksa, broke usluge u vezi akcija i obveznica, pružanje tržišnih informacija o hartijama« vrijednosti, usluge berzanskih kota, usluge procjene berzanskih kota, pozaji sa nekretninama kao sredstvima obezbjeđenja, organizovanje finansiranje zajmova za nekretnine, usluge poslovanja sa hartijama od vrijednosti, broke usluge u vezi sa hartijama od vrijednosti, konsultacije u oblasti berzanj investiranja, kupovina obveznica, izdavanje obveznica, brokerske usluge u sa obveznicama, usluge agencije za naplatu dugova, garantovanje obav izdavanje vrijednosnih bonova, elektronski transfer sredstava pitelemekunikacija, usluge isplate penzija, finansijske usluge u vezi invest kapitalne investicije, otkup dugova, uslužno investiranje sreds obezbjeđivanje zajmova za školarinu, davanje u zakup bankomata, us gotovinskih kartica, kučno bankarstvo, razmjena novca, usluge osigur usluge osiguranja automobila, usluge zdravstvenog osiguranja, usluge osiguranja obrazovnih zadužbina, usluge osiguranja potrošačkih kredita, usluge provalnog osiguranja, uslužno polaganje kaucije, usluge osiguranja od r usluge ocjene osiguranja, usluge agencije za osiguranje, procena osiguranja konsultacije u vezi osiguranja, procjena gubitka osiguranja, savjetodavne u u vezi osiguranja, pružanje informacija o osiguranju, brokerske usluge u osiguranja, aktuarske usluge, usluge osiguranja nekretnina, usluge obave socijalnog osiguranja, usluge osiguranja od industrijskog akcidenta, osig robe u tranzitu, usluge osiguranja od nezgoda, usluge zajedničkog osigu usluge planiranje životnog osiguranja, usluge životnog osiguranja, osigurar gubitaka, usluge osiguranja u vezi sa sportom, usluge osiguranja zadu, osiguranje anuiteta, usluge sportskog osiguranja, usluge tranzitnog osiguranja usluge medicinskog osiguranja, usluge reosiguranja, osiguranje od profesionalne odgovornosti, usluge osiguranja od odgovornosti, usluge aviaionog osigu procjena rizika osiguranja, usluge protiv požarnog osiguranja, usluge kreditnih upita u vezi sa finansijama, kreditni upiti preduzeća, usluge kreditnih upita sa osiguranjem, usluge agencija za kreditne izveštaje, usluge kreditnih upita.

(111) 08284

(151) 26.07.2013.

(210) **2011-280**(442) **20.03.2013.**

(220) 08.06.2011.

(732) **TEVA PHARMACEUTICAL INDUSTRIES LTD**, SCIENC BASED INDUSTRIES CAMPUS, HAR HOTZVIM, P.O. BOX 1142, JERUSALIM, 921010 IL

(540)

(550) I

(740) Popović Miladin, Đoka Miraševića 21/III, Podgorica ME

(511) **Klasa 05:** Farmaceutski, veterinarski i sanitarni preparati, dijetetske supstance prilagođene za upotrebu u medicini, hrana za bebe, flasteri materijali za zavijanje, materijali za plombiranje zuba, zubarska smola, dezinfekciona sredstva, preparati za uništavanje štetočina, fungicidi, herbicidi.**Klasa 10:** Hirurški, medicinski, zubarski i veterinarski aparati i instrumenti, vještački udovi, oči i zubi, ortopedski artikli, hirurški materijali za zašivanje.

(111) 08285

(151) 26.07.2013.

(210) **2011-285**(442) **20.03.2013.**

(220) 10.06.2011.

(732) **BACARDI AND COMPANY LIMITED**, AEULESTRASSE 5, VADUZ LI

(540)

(550) I

(740) Popović Miladin, Đoka Miraševića 21/III, Podgorica ME

(511) **Klasa 33**: Tekila meksičkog porijekla.

(111) 08297

(151) 31.07.2013.

(210) **2011-481**(442) **20.03.2013.**

(220) 04.10.2011.

(732) **ALKALOID AD-SKOPLJE**, BUL. ALEKSANDAR MAKEDONSKI 12, SKOPLJE MK

(540)

(550) I

(740) Popović Miladin, Đoka Miraševića 21/III, Podgorica ME

(511) **Klasa 03**: Šampon za djecu.

(111) 08296

(151) 26.07.2013.

(210) **2011-480**(442) **20.03.2013.**

(220) 04.10.2011.

(732) **ALAKLOID AD-SKOPLJE**, BUL. ALEKSANDAR MAKEDONSKI 12, SKOPLJE MK



(540)

(550) I

(740) Popović Miladin, Đoka Miraševića 21/III, Podgorica ME

(511) **Klasa 03:** Hidratantno mlijeko.

(111) 08308

(151) 26.07.2013.

(210) **2011-279**(442) **20.03.2013.**

(220) 08.06.2011.

(732) **TEVA PHARMACEUTICAL INDUSTRIES LTD**, SCIENC BASED INDUSTRIES CAMPUS, HAR HOTZVIM, P.O. BOX 1142, JERUSALIM, 921010 IL

(540)

(550) I

(740) Popović Miladin, Đoka Miraševića 21/III, Podgorica ME

(511) **Klasa 05:** Farmaceutski, veterinarski i sanitarni preparati, dijetetske supstance prilagođene za upotrebu u medicini, hrana za bebe, flasteri materijali za zavijanje, materijali za plom-biranje zuba, zubarska smola, dezinfekciona sredstva, preparati za uništavanje štetočina, fungicidi, herbicidi.**Klasa 10:** Hirurški, medicinski, zubarski i veterinarski aparati i instrumenti, vještački udovi, oči i zubi, ortopedski artikli, hirurški materijali za zašivanje.

(111) 08309

(151) 26.07.2013.

(210) **2011-271**(442) **20.03.2013.**

(220) 02.06.2011.

(732) **BORA CREATIONS S.L.**, PASEO DE REVELLIN, NO 21, PLANTA 1, 51001 CEUTA ES

# CATRICE

(540)

(550) I

(740) Popović Miladin, Đoka Miraševića 21/III, Podgorica ME

(511) **Klasa 03:** Kozmetika, losioni za kosu, parfimerija, sapuni, eterična ulja.

(111) 08356

(151) 10.09.2013.

(210) **2011-460**

(442) **20.03.2013.**

(220) 20.09.2011.

(732) **JOHNSON OUTDOORS MARINE ELECTRONICS, INC**, 678 HUMMINBIRD LANE, EUFAULA, ALABAMA 36027 US

## MINN KOTA

(540)

(550) I

(740) Lutovac Branislav, Bulevar Crnojevića 93, Podgorica ME

(511) **Klasa 06:** Nastavci za kormilarenje (račice), nosači za montažu.

**Klasa 07:** Vanbrodski motori, (mali) manevarski brodski motori i ribarski motori, i delovi za njih, nosači za motore.

**Klasa 09:** Sidra, brodski akumulatori, punjači za akumulatore, merači za akumulatore, bežični instrumenti i aparati za upravljanje i kontrolu.

**Klasa 12:** Elise za prevozna sredstva.

(111) 08519

(151) 12.09.2013.

(210) **2011-276**

(442) **20.03.2013.**

(220) 03.06.2011.

(732) **PODRAVKA DD**, A.STARČEVA 32, KOPRIVNICA HR



(540)

(550) I

(740) Božović Vesko, Rimski trg 50/11, Podgorica ME

(511) **Klasa 29:** Konzervisano, sušeno i kuvano povrće.

**Klasa 30:** Sosovi (kao začini), začini.

(111) 08517

(151) 12.09.2013.

(210) **2011-496**

(442) **20.03.2013.**

(220) 12.10.2011.

(732) **ADRIATIC MARINAS DOO**, OBALA BB, TIVAT ME

Regent Porto Montenegro

(540)

(550) I

(511) **Klasa 43:** Usluge obezbjeđivanje hrane i pića, privremeni smještaj.

(111) 08503

(151) 12.09.2013.

(210) **2011-501**

(442) **20.03.2013.**

(220) 12.10.2011.

(732) INTERNATIONAL TRUCK INTELLECTUAL PRPERTY COMPANY, LLC 4201 WINFIELD ROAD, WARRENVILLE, IL 60555 US

MAXXPRO

(540)

(550) I

(511) **Klasa 12:** Oklopna vozila, vozila, odnosno aparati za kretanje po zemlji, vazduhu ili vodi.

**Klasa 13:** Vatreno oružje, municija i projektili, motorizovana vojna vozila za lansiranje projektila.

**Klasa 37:** Popravljanje i održavanje oklopnih vozila, vozila, odnosno aparata za kretanje po zemlji, vazduhu i vodi.

(111) 08345

(151) 10.09.2013.

(210) **2011-277**

(442) **20.03.2013.**

(220) 07.06.2011.

(732) **KOVING-M D.O.O** I PROLETERSKE B.B. BUDVA, PJ. PIPERSKA BB, PODGORICA ME

 koving·m

(540)

(550) I

(511) **Klasa 37:** Usluge instaliranja (instalacione usluge).

**Klasa 38:** Telekomunikacije.

**Klasa 42:** Naučne i tehnološke usluge i istraživanje i projektovanje u vezi navedenih usluga, projektovanje i razvoj.

(111) 08298

(151) 26.07.2013.



(210) 2011-479

(442) 20.03.2013.

(220) 04.10.2011.

(732) ALKALOID AD-SKOPLJE, BUL. ALEKSANDAR MAKEDONSKI 12, SKOPLJE MK



(540) \_\_\_\_\_

(550) I

(740) Popović Miladin, Đoka Miraševića 21/III, Podgorica ME

(511) **Klasa 03:** Dječija krema.

(111) 08504

(151) 12.09.2013.

(210) 2011-264

(442) 20.03.2013.

(220) 27.05.2011.

(732) HYUNDAI MOTOR COMPANY, 231,YANGJAE-DONG, SEOCHO-GU, SEOUL, 137-938 KR

HYUNDAI

(540)

(550) I

(740) Čejović Vladimir, 13. jula 21, Podgorica ME

(511) **Klasa 36:** Finansiranje zakupa, kreditno finansiranje, finansijske usluge u vezi sa mot vozilima, usluge davanja pozajmica, lizing finansiranje, konsultantske usli vezi razvojnog finansiranja, finansijske usluge za razvoj, organizacija pozajmica, usluge bračnih pozajmica, finansiranje kupovine, konsluta usluge u vezi međunarodnih finansija, međunarodno bankarstvo, u međunarodnih investicionih fondova, vojno finansiranje, usluge def dragocjenosti, usluge sefova, konsultantske usluge u vezi finansija, brok usluge u vezi finansijskih instrumenata, upravljanje finansijskom imovi pružanje informacija u oblasti finansija, finansijsko posredovanje, akvizi transfer monetarnih potraživanja, organizovanje finansijskih investicija, u agencija za prikupljanje novčanih potraživanja, usluge korporativnih pozaj usluge domaćih berzanskih transakcija, pružanje informacija o dorr berzanskim transakcijama, finansiranje kredita za likvidnost, organizovanje pozajmica sa obezbjeđenjem, usluge hipotekarnih pozajmica, usluge tek računa, uslužna uplata i prijem novca, usluge zajmova, izdavanje sefova, ns dugova, konsultantske usluge u vezi zajmova, usluge debitnih kartica, u, hipotekarnih zajmova, usluge zajmova bez obezbjeđenja, usluge berza borkera putem bežičnih terminala, pružanje informacija u vezi finansiranja p bežičnih komunikacija, usluge berzanskih brokera putem bežičnih komunik usluge finansiranja međunarodne trgovine, pružanje cjenovnih informac investivcionim fondovima, finansiranje venčr kapitala, pozajmice obezbjeđenje, usluge jemstva, usluge jemstva, izdavanje lutrijskih Hi organizovanje finansiranja za kupovinu nekretnina, usluge finansiranja indus usluge komercijalnog bankarstva, usluge investicionih fondova, pru, informacija o cijeni terminskih ugovora, brokerske usluge u vezi termin tržišta, usluge potrošačkih kredita, usluge finansiranja izvoza, verifikacija čel izdavanje čekova, finansijske usluge za nove tehnologije, usluge kreditnog t usluge kreditnih i gotovinskih kar-

tica, izdavanje kreditnih kartica, usluge krec kartica, usluge povjerenika, izdavanje mjenica, razmjena čekova na izdavanje i naplata obveznica, izdavanje čekova i kreditnih pisama, izda\ putnih čekova, usluge penzionih fondova, administriranje prijema depc usluge prijema depozita, usluge devizne razmjene, pružanje informaci vrijednosti stranih valuta, izdavanje hartija od vrijednosti, usluge sigu posredovanja, bankarske usluge u vezi prenosa sredstava sa rač konsultacije u vezi bankarstva, bankarske usluge, usluge internet bankar prikupljanje rente, finansiranje kupovine na lizing, novčane pozajmice, plas sredstava, novčani transferi, prikupljanje sredstava, novčano posredovi unovčavavanje čekova, usluge direktne naplate, usluge bankomata, konsult u oblasti kapitalnih investicija, usluge kapitalnih investicija, finans bankarstvo, finansijsko sponzorisane, hipotekarno bankarstvo, us štedionica, usluge zajmova sa obezbjeđenjem, elektronski transfer sredst usluge trgovine terminskim opcijama putem berzanskih indeksa, broke usluge u vezi akcija i obveznica, pružanje tržišnih informacija o hartijam« vrijednosti, usluge berzanskih kota, usluge procjene berzanskih kota, pozaji sa nekretninama kao sredstvima obezbjeđenja, organizovanje finansir zajmova za nekretnine, usluge poslovanja sa hartijama od vrijednosti, broke usluge u vezi sa hartijama od vrijednosti, konsultacije u oblasti berzanj investiranja, kupovina obveznica, izdavanje obveznica, brokerske usluge u sa obveznicama, usluge agencije za naplatu dugova, garantovanje obav izdavanje vrijednosnih bonova, elektronski transfer sredstava pitelemekomunikacija, usluge isplate penzija, finansijske usluge u vezi invesl kapitalne investicije, otkup dugova, uslužno investiranje sreds obezbjeđivanje zajmova za školarinu, davanje u zakup bankomata, us gotovinskih kartica, kućno bankarstvo, razmjena novca, usluge osigur usluge osiguranja automobila, usluge zdravstvenog osiguranja, usluge osigu obrazovnih zadužbina, usluge osiguranja potrošačkih kredita, usluge provalnog osiguranja, uslužno polaganje kaucije, usluge osiguranja od r usluge ocjene osiguranja, usluge agencije za osiguranje, procena osigui konsultacije u vezi osiguranja, procjena gubitka osiguranja, savjetodavne u u vezi osiguranja, pružanje informacija o osiguranju, brokerske usluge u osiguranja, aktuarske usluge, usluge osiguranja nekretnina, usluge obave socijalnog osiguranja, usluge osiguranja od industrijskog akcidenta, osiguranje robe u tranzitu, usluge osiguranja od nezgoda, usluge zajedničkog osigu usluge planiranje životnog osiguranja, usluge životnog osiguranja, osiguranje gubitaka, usluge osiguranja u vezi sa sportom, usluge osiguranja zadu, osiguranje anuiteta, usluge sportskog osiguranja, usluge tranzitnog osigu usluge medicinskog osiguranja, usluge reosiguranja, osiguranje od profesionalne odgovornosti, usluge osiguranja od odgovornosti, usluge aviaionog osiguranja procjena rizika osiguranja, usluge protiv požarnog osiguranja, usluge kreditnih upita u vezi sa finansijama, kreditni upiti preduzeća, usluge kreditnih upita sa osiguranjem, usluge agencija za kreditne izveštaje, usluge kreditnig upita.

(111) 08513

(151) 24.09.2013.

(210) **2011-485**(442) **20.03.2013.**

(220) 05.10.2011.

(732) **FORNAX D.O.O.**, UL. BULEVAR REVOLUCIJE 50/6, PODGORICA ME

(540)

(550) I

(511) **Klasa 09:** Aparati i instrumenti naučni, pomorski, geodetski, fotografski, kinematografski,

optički, za vaganje, merenje, signalizaciju, kontrolu (inspekciju), spasavanje i nastavu, aparati i instrumenti za provođenje, prekid, transformaciju, akumulaciju, regulisanje ili kontrolu električne energije, aparati za snimanje, prenos i reprodukovanje zvuka ili slike, magnetni nosioci podataka, diskovi za snimanje, automatske mašine i mehanizmi za aparate koji se pokreću novcem ili žetonom, registar kase, računске mašine, oprema za obradu podataka i kompjuteri, aparati za gašenje požara.

**Klasa 35:** Oglašavanje, vođenje poslova, poslovno upravljanje, kancelarijski poslovi.

**Klasa 42:** Naučne i tehnološke usluge i istraživanje i projektovanje u vezi navedenih usluga, usluge industrijske analize i istraživanja, projektovanje i razvoj kompjuterskog hardvera i softvera.

(111) 08294

(151) 26.07.2013.

(210) **2011-483**

(442) **20.03.2013.**

(220) 04.10.2011.

(732) **ALKALOID AD-SKOPLJE**, BUL. ALEKSANDAR MAKEDONSKI 12, SKOPLJE MK



(540)

(550) I

(740) Popović Miladin, Đoka Miraševića 21/III, Podgorica ME

(511) **Klasa 03:** Pjenušava kupka.

(111) 08479

(151) 10.09.2013.

(210) **2011-476**

(442) **20.03.2013.**

(220) 03.10.2011.

(732) **VIACOM INTERNATIONAL INC**, 1515 BROADWAY, NEW YORK, NY 10036 US

**VIACOM BLINK**

(540)

(550) I

(740) Lutovac Branislav, Bulevar Crnojevića 93, Podgorica ME

(511) **Klasa 38:** Radio-difuzne i telekomunikacijske usluge, kablovske i satelitske usluge prenosa, wireless za mobilne telefone, omogućavanje download-ovanja melodija, muzike, mp3, grafika, igrica, slika i informacija za mobilne uređaje sa bežičnom komunikacijom, pružanje bežičnog prenosa pri upload-vanju i download-ovanju melodija, glasova, muzike, mp3, grafika, igrica, slika, informacija i novosti preko globalne kompjuterske mreže do mobilnog uređaja sa bežičnom komunikacijom, glasanje preko mobilnog uređaja sa bežičnom komunikacijom, slanje i primanje glasova preko mobilnog, slanje i primanje zvučnih i tekstualnih

poruka između mobilnih uređaja sa bežičnom komunikacijom, omogućavanje glasanja online preko interneta ili bezicnog uređaja za komunikaciju, internet usluge koje podrazumijevaju usluge komunikacije, uglavnom transmisije strimovanih zvukova i zvučno-vizuelnih snimaka preko interneta.

**Klasa 41:** Zabava, proizvodnja, priprema, izlaganje, distribucija i iznajmljivanje tv i radio programa i filmova, animiranih filmova, zvučnih i video snimaka kroz interaktivne i neinteraktivne medije, među kojima je internet, produkcija zabave uživo, produkcija tv zabave, muzički tv programi, organizacija, produkcija i prezentacija nadmetanja, takmičenja, igara, kvizova, izložbi, sportskih događaja, predstava, putujućih predstava, organizovanih događaja, pozorišnih izvođenja, koncerata, predstava uživo, događaja sa učešćem publike, organizacija interaktivnih igara, zabava i obrazovanje, sve navedene usluge takođe prenijete preko globalne kompjuterske mreže i drugih (interaktivnih) komunikacijskih mreža, uključujući internet, obezbjeđivanje internet informativnog portala koji sadrži linkove koji vode ka novim pričama i člancima o trenutnim dešavanjima, pružanje website portala u oblasti muzike.

(111) 08512

(151) 24.09.2013.

(210) **2011-298**

(442) **20.03.2013.**

(220) 20.06.2011.

(732) **ICONIX EUROPE LLC**, 1450 BROADWAY NEW YORK, NY 10018 US

**ROCAWEAR**

(540)

(550) I

(511) **Klasa 18:** Torbe naročito tašne, tašna na rame, rančevi, poštanske torbe, sportske torbe, cegeri, putne torbe i prtljag.

(111) 08273

(151) 26.07.2013.

(210) **2011-284**

(442) **20.03.2013.**

(220) 10.06.2011.

(732) **BELUPO LJEKOVI I KOZMETIKA D.D.**, DANICA 5, KOPRIVNICA HR

**BELERIUS**

(540)

(550) I

(740) Popović Miladin, Đoka Miraševića 21/III, Podgorica ME

(511) **Klasa 05:** Farmaceutski proizvodi.

(111) 08490

(151) 10.09.2013.

(210) **2011-274**

(442) **20.03.2013.**

(220) 03.06.2011.

(732) **SCANIA CV AKTIEBOLAG**, 151 8 SODERTALJE SE

## SCANIA

(540)

(550) I

(740) Stanković Mugoša Ana, Trg Republike 13, Podgorica, (ME)

(511) **Klasa 07:** Mašine i mašine alatke.

**Klasa 12:** Vozila, aparati za kretanje po zemlji, vazduh ili voda.

---

(111) 08281

(151) 26.07.2013.

(210) **2011-478**

(442) **20.03.2013.**

(220) 04.10.2011.

(732) **SHANTHA BIOTECHNICS LIMITED**, FATEH MAIDAN ROAD BASHEERBAGH HYDERABAD 500 004 ANDHRA PRADESH IN

## SHANVAC

(540)

(550) I

(740) Popović Miladin, Đoka Miraševića 21/III, Podgorica ME

(511) **Klasa 05:** Farmaceutski proizvodi, vakcine.

---

(111) 08501

(151) 12.09.2013.

(210) **2011-290**

(442) **20.03.2013.**

(220) 16.06.2011.

(732) **NISSAN JIDOSHA KABUSHIKI KAISHA**, 2 TAKARACHO, KANAGAWA-KU, YOKOHAMA-SHI, KANAGAWA-KEN JP

## DATSUN

(540)

(550) I

(740) Čejović Vladimir, 13. jula 21, Podgorica ME

(511) **Klasa 12:** Brodovi/čamci i njihovi djelovi i oprema, automobili, električna vozila uključujući električne automobile, vagone, kamione, kombi vozila, vozila koja se koriste u sportske svrhe, autobuse, rekreativna vozila (RV), sportske automobile, trkačke automobile, kamione, viljuškare, traktore za vuču (traktori), i njihove strukturne djelove i opremu, motorna vozila na dva točka, bicikla i njihovi djelovi i oprema, teretna kolica, auto-istovarivači, auto-gurači, auto-tegljači, traktore (mehanizmi za vuču), motori i mehanizmi za kopnena vozila, osovine za vozila, prenosnici snage i zupčanici za mašine, amortizeri, kočnice, motori sa naizmjeničnom strujom / motori sa jednosmjernom strujom za kopnena vozila, alarmni uređaji protiv krađe vozila, ljepljive gumene zakrpe za popravku unutrašnjih guma ili guma, sve uključeno u međunarodnu klasu 12.

---

(111) 08510

(151) 12.09.2013.

(210) 2011-489

(442) 20.03.2013.

(220) 10.10.2011.

(732) **REGENT HOSPITALITY WORLDWIDE, INC**, THE CENTRE MARK, 287-299 QUEEN S ROAD, SUITE 1408, 14/F, CENTRAL, HONG KONG CN

(540)

(550) I

(740) Čejović Vladimir, 13. jula 21, Podgorica ME

(511) **Klasa 35:** Oglašavanje, kancelarijski poslovi, poslovno upravljanje, savjetovanje, i administrativne usluge, upravljanje i rad hotela, restorana, nocnin klubova, barova, banja, rekreativnih i fitnes objekata, maloprodajnih objekata, šoping centara, kondominijuma, stambenih zgrada, i odmarališta sa pravom vremenskog korišćenja, usluge maloprodajnih radnji, usluge šoping centara, maloprodajne online usluge, maloprodajne kataloge usluge, usluge za potrošače od povjerenja i nagradni programi, usluge oglašavanja, usluge poslovnog upravljanja u vezi sa rekreativnim klubovima u odmaralištima, klubovima za odmor, nepokretnostima koje se dijele na vremenskoj osnovi, klubovima koji omogućavaju pravo korišćenja na vremenskoj osnovi proporcionalno udjelima članova, klubovima za privatni boravak, klubovima sa pravom korišćenja, i projektima dugotrajnog zakupa, usluge poslovnih centara, poslovno upravljanje, savjetovanje i pomoć u upravljanju vlasnicima jahti i onima koji upravljaju jahtama.

**Klasa 36:** Osiguranje, finansijski poslovi, novčani poslovi, poslovi vezani za nekretnine, razvoj nekretnina, lizing, upravljanje, iznajmljivanje i posredovanje u vezi sa stanovima, kondominijumima, privatnim vlasništvom, vlasništvom koje se dijeli na vremenskoj osnovi i nekretninama svih vrsta i objektima i pogodnostima u vezi sa istima, finansiranje u vezi sa nekretninama, usluge u vezi sa kreditnim karticama, prikupljanje sredstava i donacija u dobrotvorne svrhe, obezbjeđivanje članstva za klubove koji omogućavaju pravo korišćenja na vremenskoj osnovi proporcionalno udjelima članova, klubove za privatni boravak, klubove sa pravom korišćenja, pružanje okalšica pri prodaji, razmjeni i trgovini vremena za odmor za članove rekreativnih klubova u okviru odmarališta, klubova za privatni boravak, klubova sa pravom korišćenja nepokretnosti koje se dijele na vremenskoj osnovi, klubova koji omogućavaju pravo korišćenja na vremenskoj osnovi proporcionalno udjelima članova, klubova za privatni boravak, klubova sa pravom korišćenja, organizovanje razmjene stanarskih prava između vlasnika nekretnina u okviru odmarališta.

**Klasa 39:** Transport, pakovanje i skladištenje robe, organizovanje putovanja, usluge turističkih agencija, rezervisanje prevoza, organizovanje i realizacija turističkih obilazaka i ponuda za odmor, organizovanje vazdušnog, kopnenog i pomorskog prevoza za pojedince i grupe, usluge kruzera, organizovanje krstarenja, usklađivanje putnih aranžmana za pojedince i grupe, organizovanje ponuda za odmor i turističkih obilazaka, usluge rezervacija rentiranja automobila, pratnja i prevoz putnika, usluge u vezi sa poslovanjem garaža, parkinga, prtljaga, prenosa prtljaga, iznajmljivanja bicikala, i iznajmljivanja vozila za golf, usluge šofera i limuzina, usluge marine, usluge iznajmljivanja jahti i brodova.

**Klasa 41:** Obrazovanje, pripremanje obuke, razonoda, sportske i kulturne aktivnosti, usluge kazina, usluge kabarea, usluge noćnih klubova, oraganizovanje rezervacija karata za priredbe

i druge zabavne događaje, usluge zdravstvenih i fitnes klubova, obezbjeđivanje uputstava i opreme u vezi sa fizičkim vježbama, obezbjeđivanje objekata i opreme za fitnes, vježbe, tenis, plivanje, rekreativne aktivnosti, vožnju biclom, golf, sportove na vodi, vožnju čamcem, jahanje, skijanje i društvene namjene, jahting klubovi, usluge golf kluba, golf terena i uputstava za golf, usluge planiranja vjenčanja i usluge upravljanja, usluge planiranja događaja i usluge upravljanja, realizacija i organizovanje obrazovnih, zabavnih i kulturnih časova, programa, radionica i događaja, umjetničke izložbe, umjetničke galerije.

**Klasa 43:** Usluge obezbjeđivanja hrane i pića, hotelske usluge, usluge restorana, kateringa, bara i salona, usluge odmarališta i smještaja, obezbjeđivanje privremenog smještaja, obezbjeđivanje objekata opšte namjene za sastanke, konferencije, i izložbe, obezbjeđivanje objekata za banket i društvene namjene za specijalne prilike, usluge rezervacije za hotel i drugi smještaj, usluge hotela koje karakteriše program podsticajnih nagrada i program nagrada za korisnike.

**Klasa 44:** Medicinske usluge, veterinarske usluge, higijenska i kozmetička njega za ljude i životinje, usluge poljoprivrede, vrtlarstva i šumarstva, spa usluge, obezbjeđivanje tretmana za lice, kosu, kožu i tijelo, usluge manikira i pedikira, usluge masaže, i uslugedepilacije tijela, i usluge kozmetičkog salona.

---

(111) 08279

(151) 26.07.2013.

(210) **2011-464**

(442) **20.03.2013.**

(220) 23.09.2011.

(732) **DECKERS OUTDOOR CORPORATION**, 495-A SOUTH FAIRVIEW AVENUE GOLETA, CALIFORNIA 93117 US

YTT

(540)

(550) I

(740) Popović Miladin, Đoka Miraševića 21/III, Podgorica ME

(511) **Klasa 25:** Obuća, odjeća, pokrivala za glavu.

---

(111) 08506

(151) 12.09.2013.

(210) **2011-266**

(442) **20.03.2013.**

(220) 27.05.2011.

(732) **PFIZER A.G.**, SCHARENMOOSSTRASSE 99, 8052 ZURICH CH

TOLANZA

(540)

(550) I

(740) Čejović Vladimir, 13. jula 21, Podgorica ME

(511) **Klasa 05:** Farmaceutski i veterinarski preparati, sanitarni preparati za medicinske svrhe, dietetske supstance prilagođene za upotrebu u medicini, hrana za bebe, flasteri, materijali za zavijanje, materijali za plombiranje zuba, zubarska smola, dezinfekciona sredstva, preparati za uništavanje štetočina, fungicidi, herbicidi.

(111) 08275

(151) 26.07.2013.

(210) **2011-288**(442) **20.03.2013.**

(220) 16.06.2011.

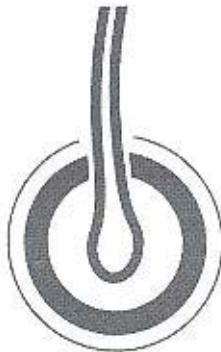
(732) **BOSNALIJEK**, JUKIĆEVA 53, SARAJEVO BA

PILFUD

(540)

(550) I

(740) Radulović Božidar, Jovana Tomaševića 9/III, Podgorica ME

(511) **Klasa 03:** Preparati za bijeljenje i ostale tvari za pranje rublja, preparati za čišćenje, poliranje, odmaščivanje i struganje, sapuni, parfimerijski proizvodi, eterična ulja, kozmetički proizvodi, losioni za kosu, proizvodi za njegu zubi. (heading)**Klasa 05:** Farmaceutski i veterinarski proizvodi, higijenski proizvodi za upotrebu u medicini, dijetne tvari za medicinske potrebe, hrana za dojenčad, flasteri, materijal za plombiranje zubi i za zubne otiske, dezinfekcijska sredstva, proizvodi za uništavanje životinjskih štetočina, fungicidi, herbicidi. (heading).

(111) 08288

(151) 26.07.2013.

(210) **2011-256**(442) **20.03.2013.**

(220) 24.05.2011.

(732) **PHARMASWISS** SA, BUNDESPLATZ 1, 6300 ZUG CH

# RAPIDOL

(540)

(550) I

(740) Radulović Božidar, Jovana Tomaševića 9/III, Podgorica ME

(511) **Klasa 05:** Farmaceutski preparati-dijetetske supstance prilagođene za upotrebu u medicini.

(111) 08348

(151) 10.09.2013.

(210) **2011-462**(442) **20.03.2013.**

(220) 21.09.2011.



(732) **VOĆAR DOO**, 76207 GORNJI RAHIC 112, BRČKO BA



(540)

(550) I

(740) Radulović Božidar, Jovana Tomaševića 9/III, Podgorica ME

(511) **Klasa 30**: Mješano čajno pecivo.

(111) 08347

(151) 10.09.2013.

(210) **2011-461**

(442) **20.03.2013.**

(220) 21.09.2011.

(732) **VOĆAR DOO**, 76207 GORNJI RAHIC 112, BRČKO BA



(540)

(550) I

(740) Radulović Božidar, Jovana Tomaševića 9/III, Podgorica ME

(511) **Klasa 30**: Punjeno čajno pecivo.

(111) 08272

(151) 26.07.2013.

(210) **2011-455**

(442) **20.03.2013.**

(220) 19.09.2011.

(732) **PODRAVKA D.D.**, ANTE STARČEVIĆA 32, KOPRIVNICA HR

*coolerica*

(540)

(550) I

(740) Popović Miladin, Đoka Miraševića 21/III, Podgorica ME

(511) **Klasa 16:** Papir, karton i proizvodi od tih materijala koji nisu obuhvaćeni drugim klasama, štamparski proizvodi, proizvodi za uvezivanje knjiga, fotografije, pribor za pisanje, ljepila (ljepljive tvari za papirnate proizvode ili za domaćinstvo), slikarski pribor, kistovi, pisaće mašine i kancelarijski pribor (osim namještaja), oprema za nastavu i obuku (osim aparata), plastični materijali za ambalažu (koji nisu obuhvaćeni drugim klasama), štamparska slova, klišeji.

**Klasa 35:** Oglašavanje i reklamiranje, vođenje komercijalnih poslova, komercijalna administracija, kancelarijski poslovi.

(111) 08293

(151) 26.07.2013.

(210) **2011-503**

(442) **20.03.2013.**

(220) 13.10.2011.

(732) **ALKALOID AD- SKOPLJE**, BUL. ALEKSANDAR MAKEDONSKI 12, SKOPLJE MK



(540)

(550) I

(740) Popović Miladin, Đoka Miraševića 21/III, Podgorica ME

(511) **Klasa 03:** Dječji sapun.

(111) 08300

(151) 26.07.2013.

(210) **2011-457**

(442) **20.03.2013.**

(220) 20.09.2011.

(732) **ALKALOID-AD-SKOPLJE**, BUL. ALEKSANDAR MAKEDONSKI 12, SKOPLJE MK



(540) koi klasifikaciji:

(550) I

(740) Popović Miladin, Đoka Miraševića 21/III, Podgorica ME

(511) **Klasa 03:** Ulje za njegu dečje kože.

(111) 08274

(151) 26.07.2013.

(210) **2011-282**

(442) **20.03.2013.**

(220) 10.06.2011.

(732) **KIPS D.O.O.**, NEZNANIH JUNAKA 143 PODGORICA ME



(540)

(550) I

(511) **Klasa 20:** Nameštaj, vrata i prozori od drveta, okviri za slike i ogledala.

**Klasa 35:** Vođenje trgovačkog poduzeća, posredovanje u prodaji, trgovina na malo i trgovina na veliko svim proizvodima, a naročito grubim građevinskim materijalom, željezom i crnom metalurgijom, elektroinstalacijama, vodovodnim i kanizacionim instalacijama, aparatima za grejanje, podovima i stilarijom, keramikom i sanitarijama, sanitarnom galanterijom, bojama, lakovima i izolacijama, alatima, pločastim materijalima belom tehnikom, tehničkom robom, nameštajem, malim kućanskim aparatima, dekorativnom rasvetom, posuđem, proizvodima od tekstila, proizvodima od plastike, tepisima, zavesama i tapetama.

**Klasa 37:** Popravljanja aparata, mašina, nameštaja, alata odnosno usluge kojima se neka stvar dovodi u prvobitno stanje usled dotrajalosti oštećenja, delimičnog uništenja, usluga održavanja stvari i objekata.

**Klasa 39:** Pakovanje i skladištenje robe, organizovanje putovanja.

**Klasa 43:** Usluge obezbeđenja hrane i pića za potrošnju, ishrana i smeštaj u hotelima, pansionima, kampovima, planinarskim domovima.

(111) 08518

(151) 12.09.2013.

(210) **2011-267**

(442) **20.03.2013.**

(220) 31.05.2011.

(732) **VLASINKA DOO**, BATAJNIČKI DRUM 14 -16 ZEMUN, BEOGRAD RS

## KAPI ŽIVOTA

(540)

(550) I

(740) Popović Miladin, Đoka Miraševića 21/III, Podgorica ME

(511) **Klasa 32:** Piva, mineralne i sodne vode i druga bezalkoholna pića, voćna pića i voćni sokovi, sirupi i drugi preparati za pravljenje pića.

(111) 08310

(151) 26.07.2013.

(210) **2011-296**(442) **20.03.2013.**

(220) 20.06.2011.

(732) **THE GILLETTE COMPANY**, ONE GILLETTE PARK, BOSTON, MA02127 US

## PROGLIDE

(540)

(550) I

(740) Lutovac Branislav, Bulevar Crnojevića 93, Podgorica ME

(511) **Klasa 08:** Brijači i noževi za brijanje, instrumenti za brijanje, dozne, kasete i patrone koje sadrže noževe za brijanje, delovi i dodaci za svu navedenu robu.

(111) 08290

(151) 26.07.2013.

(210) **2011-505**(442) **20.03.2013.**

(220) 13.10.2011.

(732) **ALKALOID AD-SKOPLJE**, BUL. ALEKSANDAR MAKEDONSKI 12, SKOPLJE MK

(540)

(550) I

(740) Popović Miladin, Đoka Miraševića 21/III, Podgorica ME

(511) **Klasa 03:** Dječja vitaminska mast.

(111) 08017

(151) 06.06.2013.

(210) **2010-128**(442) **20.06.2012**

(220) 23.04.2010.

(732) STRAUSS GROUP LTD, 49 HASIVIM ST, PETACH TIKVA 49517 IL



(540)

(550) I

(511) **Klasa 29:** Konzervisano, zamrznuto, sušeno i kuvano voće i povrće želei, džemovi, kompoti mlijeko i mlečni proizvodi jestiva ulja i masti salate i kuvana hrana

**Klasa 30:** Kafa, kakao, šećer, zamjena kafe brašno i proizvodi od žitarica, kolači i poslastice, sladoledi med, melasa sosovi (kao dodaci) začini

**Klasa 32:** Mineralne i sodne vode i druga bezalkoholna pića, pića od voća i voćni sokovi sirupi i drugi preparati za proizvodnju pića.

**Klasa 43:** Usluge obezbjeđivanja hrane i pića.

(111) 08024

(151) 24.06.2013.

(210) **2010-412**(442) **20.10.2012**

(220) 09.11.2010.

(732) **MR. JAMAL ABDUL NASSER MAHMOOD AL MAHAMID**, P.O. BOX 81450, DUBAI AE



(540)

(550) I

(740) Ćosović Dejan, 13. jula 1/5, Budva (ME)

(511) **Klasa 34:** Cigarete, cigare, duvan.

(111) 08307

(151) 30.07.2013.

(210) **2010-110**(442) **20.03.2013.**

(220) 14.04.2010.

(732) **DOO GORATON-PODGORICA ME**



(540)

(550) I

(511) **Klasa 09:** aparati i instrumenti naučni, pomorski, geodetski, fotografski, kinemato-grafski, optički, za vaganje, merenje, signalizaciju, kontrolu (inspekciju), spasavanje i nastavu, aparati i instrumenti za provođenje, prekid, transformaciju, akumulaciju, regulisanje i kontrolu elektriciteta, aparati za snimanje, prenos i reprodukovanje zvuka ili slike, magnetni nosioci podataka, diskovi za snimanje, automatske mašine i mehanizmi za aparate koji se pokreću novcem ili žetonom, registar kase, računске mašine, oprema za obradu podataka i kompjuteri, aparati za gašenje požara

**Klasa 15:** muzički instrumenti

**Klasa 35:** oglašavanje, vođenje poslova, poslovno upravljanje, kancelarijski poslovi

**Klasa 41:** obrazovne usluge, pripremanje obuke, razonoda, sportske i kulturne aktivnosti

(111) 08320

(151) 04.10.2013.

(210) **2009-255**(442) **20.10.2012**

(220) 20.05.2009.

(300) 1613/2005 28.11.2005.

RS

(732) **WIX-FILTRON SP ZOO**, WROCLAWSKA 145, 63-800 GOSTYN PL

## FILTRON

(540)

(550) I

(740) Čejović Vladimir, 13. jula 21, Podgorica ME

(511) **Klasa 07:** Filteri, filteri (dijelovi mašina ili motora), ulošci filtera, aparati za filtriranje i materijali, posebno za motore sa unutrašnjim sagorijevanjem.

**Klasa 12:** Vozila, aparati za kretanje po zemlji, vazduhu ili vodi, sve vrste filtera i uložaka za filtere za vozila i aparate za kretanje po zemlji, vazduhu i vodi, uređaji protiv zagadenja za motore i mašine koje njima pripadaju.

(111) 08321

(151) 04.10.2013.

(210) **2009-502**(442) **20.03.2013.**

(220) 11.08.2009.

(732) **TUTUNSKI KOMBINAT AD PRILEP**, UL. MARKSOVA BR. 101, PRILEP MK

## BRAND WHITE

(540)

(550) I

(740) Radulović Božidar, Jovana Tomaševića 9/III, Podgorica ME

(511) **Klasa 34:** Duvan za pušaće, artikli za pušaće, šibice.

(111) 08322

(151) 04.10.2013.

(210) **2010-404**(442) **20.03.2013.**

(220) 02.11.2010.

(732) **D-LINK CORPORATION**, NO.289, SINHU 3RD ROAD, NEIHU DISTRICT, TAIPEI CITY 114 TW**D-Link**

(540)

(550) I

(740) Radulović Božidar, Jovana Tomaševića 9/III, Podgorica ME

(511) **Klasa 09:** Mrežne kartice, interfejs kartice, čvorišta, prekidači, mostovi, ruter sa mostom, ruteri, napajanja, prenosioci, integrisana kola, integrisana kola sa velikim brojem elemenata, adapteri, koncentratori, primopredajnici, ethernet primopredajnici, magnetne trake ili diskovi ili CD-ROM-ovi snimljeni sa programima za mreže, kompjuterski programi, kompjuterski softveri, antene, zaštitni zid za rad na mreži (firewall), mrežni adapteri, modemi, kablovski modemi, kablovski ruteri, bežični kablovski modemi, bežični kablovski ruteri, PC kamere (kamere za personalne računare), uređaji za snimanje videa, TV tjuneri, AV konvertori (audio/video konvertori), IP kamere (kamere za internet protokol), kompakt fleš kartice, blutut modemi, blutut adapter, blutut slušalice, blutut adapteri za štampače, blutut pristupne jedinice, bežične mrežne kartice, bežične pristupne jedinice, bežični portali, bežični serveri za štampače, bežične kompakt fleš kartice, bežični konvertori, bežični audio adapteri, bežični medija plejeri, ruteri za kućnu upotrebu, VPN portali (portali za virtuelnu privatnu mrežu), VPN ruteri (ruteri za virtuelnu privatnu mrežu), PC zaštitni zid (firewall), serveri za štampače, IP telefoni (internet protokol telefoni), internet video telefoni, bežični ruteri za igranje igara, bežični adapteri za igranje igara, DMA (digitalni medija adapteri), internet kamere, jedinice za pohranjivanje podataka na mrežama, KVM prekidači (tastatura/video ekran/miš prekidači), USB fleš drajvovi (fleš drajvovi za univerzalnu serijsku magistralu), USB čvorišta (čvorišta za univerzalnu serijsku magistralu), USB adapteri (adapteri za univerzalnu serijsku magistralu), VoIP protokoli (protokoli za prenos glasa preko interneta), IP-PBX (internet protokol-privatne telefonske centrale), splitter, protokoli za bezbednost informacija, DSL modemi (modemi za digitalne pretplatničke linije), DSL ruteri (ruteri za digitalne pretplatničke linije), bežični DSL modemi, bežični DSL ruteri, ADSL modemi (modemi za asimetrične digitalne pretplatničke linije), ADSL ruteri (ruteri za asimetrične digitalne pretplatničke linije), VDSL prekidači (prekidači za DSL velike brzine), VDSL modemi (modemi za DSL velike brzine), SHDSL (pojedinačne digitalne pretplatničke linije sa visokim nivoom protoka), ISDN ruteri (ruteri za digitalnu telefoniju), ISDN terminal ruteri (terminal ruteri za digitalnu telefoniju), ISDN terminal adapteri (terminal adapteri za digitalnu telefoniju), CD plejeri, set-top box, analogni modemi, DSC (digitalni fotoaparati), internet radio, jedinice za skladištenje medija, MP3 plejer, CD-RW/DVD-RW (CD-ovi i DVD-ovi na kojima se može ponovo pisati), čitači kartica.

(111) 08323

(151) 04.10.2013.

(210) **2011-1**(442) **20.03.2013.**

(220) 04.01.2011.

(732) **ALFA WASSERMANN HUNGARY KFT**, 1054 BUDAPEST, GARIBALDI U.4. HU

## XIFAXAN

(540)

(550) I

(511) **Klasa 05:** Farmaceutski i veterinarski preparati, Sanitarni preparati za medicinsku upotrebu, Dijetetske supstance prilagođene za upotrebu u medicini, hrana za bebe, Flasteri, materijali za zavijanje, Materijali za plombiranje zuba, zubarska smola, Dezinfekciona sredstva, Preparati za uništavanje štetočina, Fungicidi, Herbicidi,

(111) 08324

(151) 04.10.2013.

(210) **2011-7**(442) **20.03.2013.**

(220) 10.01.2011.

(732) **REXALL SUNDOWN, INC**, 2100 SMITHTOWN AVENUE, RONKONKOMA, NEW YORK 11779 US

## OSTEO BI-FLEX

(540)

(550) I

(740) Lutovac Branislav, Bulevar Crnojevića 93, Podgorica ME

(511) **Klasa 05:** Vitamini, minerali, dijetetski i nutritivni dodaci ishrane.

(111) 08325

(151) 04.10.2013.

(210) **2011-8**(442) **20.03.2013.**

(220) 10.01.2011.

(732) **THE ESTER C COMPANY**, 2100 SMITHTOWN AVENUE, RONKONKOMA, NEW YORK 11779 US

## ESTER-C

(540)

(550) I

(740) Lutovac Branislav, Bulevar Crnojevića 93, Podgorica ME

(511) **Klasa 05:** Vitamini, minerali, dijetetski i nutritivni dodaci ishrane.

(111) 08326

(151) 04.10.2013.

(210) **2011-9**(442) **20.03.2013.**

(220) 10.01.2011.

(732) **SOLGAR HOLDINGS, INC.**, 2100 SMITHTOWN AVENUE, RONKONKOMA, NEW YORK 11779 US

## SOLGAR

(540)

(550) I



(740) Lutovac Branislav, Bulevar Crnojevića 93, Podgorica ME

(511) **Klasa 05:** Vitamini, dijetetski, hranljivi i biljni dodaci za ishranu.

(111) 08327

(151) 04.10.2013.

(210) **2011-13**

(442) **20.03.2013.**

(220) 11.01.2011.

(732) **SOLGAR HOLDINGS INC.**, 2100 SMITHTOWN AVENUE, RONKONKOMA, NEW YORK, 11779 US



(540)

(550) I

(740) Lutovac Branislav, Bulevar Crnojevića 93, Podgorica ME

(511) **Klasa 05:** Vitamini, dijetetski, hranljivi i biljni dodaci za ishranu.

(111) 08328

(151) 04.10.2013.

(210) **2011-17**

(442) **20.03.2013.**

(220) 13.01.2011.

(732) **MASTERCARD INTERNATIONAL INCORPORATED (DELAWARE CORPORATION)** 2000 PURCHASE STREET PURCHASE, NEW YORK 10577-2509 US

**MASTERCARD MONEYSEND**

(540)

(550) I

(740) Radulović Božidar, Jovana Tomaševića 9/III, Podgorica ME

(511) **Klasa 36:** Usluge osiguranje, finansijski poslovi, novčani (monetarni) poslovi, finansijske usluge, bankarske i kreditne usluge, obezbjeđivanje kreditnih kartica, debitnih kartica, potrošačkih kartica i vrednosnih kartica, bankarske usluge, usluge plaćanja, kreditne usluge, usluge naplate, usluge izdavanja gotovog novca, usluge pristupa deponovanim sredstvima, usluge plaćanja računa, usluge kreditnih kartica, debitnih kartica, potrošačkih kartica, vrednosnih kartica i kartica sa deponovanim sredstvima, usluge verifikacije čekova i unovčavanja čekova, usluge ATM mašina, obrada finansijskih transakcija direktno (onlajn) preko kompjuterske baze podataka i preko telekomunikacija, kao i na mestima prodaje, usluge obrade finansijskih transakcija koje vrše vlasnici kartica preko ATM mašina, obezbjeđivanje uvida u stanje računa i u podatke o uplatama i isplatama, vlasnicima kartica, preko ATM mašina, usluge poravnanja i autorizacije, usluge putničkog osiguranja, izdavanje i otkup putničkih čekova i putničkih vaučera, usluge provere platioca, verifikacija finansijskih informacija, šifrovanje i dešifrovanje finansijskih informacija, održavanje finansijskih podataka, usluge

transfera elektronskih fondova i usluge zamene valute, širenje finansijskih informacija preko interneta i drugih kompjuterskih mreža, usluge plaćanja na daljinu, usluge elektronskog plaćanja deponovanim sredstvima, obezbjeđivanje elektronskih fondova i transfera valuta, usluge elektronskog plaćanja, usluge korišćenja pretplatničkih telefonskih kartica, usluge izdavanja gotovine, i usluge overavanja transakcija i usluge poravnanja, obezbedenje debitnih i kreditnih usluga pomoću radio-frekventnih identifikacionih uređaja (transpondera), obezbjeđivanje debitnih i kreditnih usluga preko uređaja za komunikaciju i telekomunikaciju, usluge verifikacije čekova, usluge izdavanja i otkupa, sve u vezi sa putničkim čekovima i putničkim vaučerima, obezbjeđivanje finansijskih usluga za podršku uslugama vezanim za promet robe, preko sredstava mobilne telekomunikacije, uključujući usluge plaćanja preko bežičnih uređaja, obezbjeđivanje finansijskih usluga za podršku uslugama vezanim za promet robe direktno (onlajn), preko mreža ili drugih elektronskih sredstava korišćenjem elektronski digitalizovanih informacija, usluge berze vrijednosti, naročito usluge sigurne razmene vrijednosti, uključujući i elektronsku gotovinu, preko kompjuterske mreže kojoj se može pristupiti preko pametnih kartica, usluge plaćanja računa koje se obezbeđuju preko veb sajta, direktno (onlajn) elektronsko bankarstvo, finansijske usluge obezbedene preko telefona i putem globalne kompjuterske mreže ili interneta, obezbjeđivanje finansijskih usluga preko globalne kompjuterske mreže ili interneta, usluge vezane za nepokretnosti, usluge vezane za nepokretnu imovinu, usluge osiguranja nepokretnosti, osiguranje za vlasnike imovine, usluge osiguranja u vezi sa imovinom, finansiranje nepokretnosti, usluge posredovanja, vezane za nepokretnosti, ocena nepokretnosti, usluge agencija za nepokretnosti, procenjivanje nepokretnosti, administracija u vezi sa nepokretnostima, administracija finansijskih poslova u vezi sa nepokretnosti, obezbjeđivanje zajmova za nepokretnosti, usluge finansiranja u vezi sa razvojem nepokretnosti, usluge finansijskog posredovanja u vezi sa nepokretnostima, finansijske usluge u vezi sa nepokretnom imovinom i zgradama, finansijske usluge za kupovinu nepokretnosti, obezbjeđivanje ugovora o zajmu osiguranih hipotekom, uređivanje suvlasništva nad nepokretnostima, obezbjeđivanje finansiranja kupovine nepokretnosti, pomoć pri sticanju nepokretnosti i korišćenju nepokretnosti, usluge kapitalnog investiranja u nepokretnosti, usluge investiranja u komecijalno vlasništvo, finansijske usluge u vezi sa sticanjem nepokretnosti, finansijske usluge u vezi za prodajom vlasništva, finansijska procena nepokretnosti u slobodnom vlasništvu, finansijska procena nepokretnosti pod zakupom, organizovanje davanja u zakup nepokretnosti, organizovanje davanja na korišćenje nepokretnosti, davanje u zakup, davanje u zakup nepokretnosti, davanje u zakup slobodne imovine, usluge upravljanja posedom u vezi sa transakcijama vezanim za nepokretnosti, procenjivanje imovine, upravljanjem portfoliom imovine, upravljanje imovinom, savetodavne usluge vezane za vlasništvo nad nepokretnostima, savetodavne usluge vezane za procenu nepokretnosti, savetodavne usluge u vezi sa nepokretnostima koje pripadaju korporacijama, usluge kompjuterizovanih podataka u vezi sa nepokretnostima, konsultanske usluge u vezi sa nepokretnom imovinom, obezbjeđivanje informacija u vezi sa nepokretnostima, obezbjeđivanje informacija u vezi sa tržištem imovine, usluge istraživanja u vezi sa sticanjem nepokretnosti, usluge istraživanja u vezi sa aukcijom nepokretnosti.

(111) 08329

(151) 04.10.2013.

(210) **2011-18**(442) **20.03.2013.**

(220) 14.01.2011.

(732) **GENZYME CORPORATION**, 500 KENDALL STREET CAMBRIDGE, MASSACHUSETTS 02142 US

## REMNIQ

(540)

(550) I

(740) Radulović Božidar, Jovana Tomaševića 9/III, Podgorica ME

(511) **Klasa 05:** Farmaceutski i veterinarski preparati, sanitarni preparati za medicinske svrhe, dijetetske supstance za upotrebu u medicini, hrana za bebe, flasteri, materijal za zavijanje, materijali za plombiranje zuba, zubarska smola, dezinfekciona sredstva, preparati za uništavanje štetočina, fungicidi, herbicidi, naročito terapijska antitijela za upotrebu kao anti-limfocitična sredstva.

(111) 08330

(151) 04.10.2013.

(210) **2011-19**

(442) **20.03.2013.**

(220) 14.01.2011.

(732) **GENZYME CORPORATION**, 500 KENDALL STREET CAMBRIDGE, MASSACHUSETTS 02142 US

## KYNAMRO

(540)

(550) I

(740) Radulović Božidar, Jovana Tomaševića 9/III, Podgorica ME

(511) **Klasa 05:** Farmaceutski i veterinarski preparati, sanitarni preparati za medicinske svrhe, dijetetske supstance za upotrebu u medicini, hrana za bebe, flasteri, materijal za zavijanje, materijali za plombiranje zuba, zubarska smola, dezinfekciona sredstva, preparati za uništavanje štetočina, fungicidi, herbicidi, naročito terapijska antitijela za upotrebu kao anti-limfocitična sredstva.

(111) 08331

(151) 04.10.2013.

(210) **2011-20**

(442) **20.03.2013.**

(220) 14.01.2011.

(732) **GENZYME CORPORATION**, 500 KENDALL STREET CAMBRIDGE, MASSACHUSETTS 02142 US

## LEMTRADA

(540)

(550) I

(740) Radulović Božidar, Jovana Tomaševića 9/III, Podgorica ME

(511) **Klasa 05:** Farmaceutski i veterinarski preparati, sanitarni preparati za medicinske svrhe, dijetetske supstance za upotrebu u medicini, hrana za bebe, flasteri, materijal za zavijanje, materijali za plombiranje zuba, zubarska smola, dezinfekciona sredstva, preparati za uništavanje štetočina, fungicidi, herbicidi, naročito terapijska antitijela za upotrebu kao anti-limfocitična sredstva.

- 
- (111) 08332 (151) 04.10.2013.  
(210) **2011-21** (442) **20.03.2013.**  
(220) 14.01.2011.  
(732) **GENZYME CORPORATION**, 500 KENDALL STREET CAMBRIDGE, MASSACHUSETTS  
02142 US

## CAMPATH

- (540)  
(550) I  
(740) Radulović Božidar, Jovana Tomaševića 9/III, Podgorica ME  
(511) **Klasa 05:** Farmaceutski i veterinarski preparati, sanitarni preparati za medicinske svrhe, dijetetske supstance za upotrebu u medicini, hrana za bebe, flasteri, materijal za zavijanje, materijali za plombiranje zuba, zubarska smola, dezinfekciona sredstva, preparati za uništavanje štetočina, fungicidi, herbicidi, naročito terapijska antitijela za upotrebu kao anti-limfocitična sredstva.

- 
- (111) 08333 (151) 04.10.2013.  
(210) **2011-22** (442) **20.03.2013.**  
(220) 17.01.2011.  
(732) **KRKA TOVARNA ZDRAVIL**, DD, SMAJEVA CESTA 6, NOVO MESTO SI

## URTIRON

- (540)  
(550) I  
(740) Popović Miladin, Đoka Miraševića 21/III, Podgorica ME  
(511) **Klasa 05:** Farmaceutski proizvodi.

- 
- (111) 08334 (151) 04.10.2013.  
(210) **2011-23** (442) **20.03.2013.**  
(220) 17.01.2011.  
(732) **KRKA TOVARNA ZDRAVIL**, DD, SMAJEVA CESTA 6, NOVO MESTO SI

## ETOGEL

- (540)  
(550) I  
(740) Popović Miladin, Đoka Miraševića 21/III, Podgorica ME  
(511) **Klasa 05:** Farmaceutski proizvodi-lijekovi.

- 
- (111) 08335 (151) 04.10.2013.  
(210) **2011-27** (442) **20.03.2013.**  
(220) 24.01.2011.

(732) **GUESS? INC.**, 1444 SOUTH ALAMEDA STREET, LOS ANGELES, CA 90021 US

**PAUL MARCIANO**

(540)

(550) I

(740) Lutovac Branislav, Bulevar Crnojevića 93, Podgorica ME

(511) **Klasa 25:** Muška, ženska odeća, odeća za dečake i devojčice, decu i bebe, posebno donji veš, obuća, kupaći kostimi, kape, pokrivala za glavu, ogrtači, kućne haljine, spavaćice, odore, pidžame, čarape, rukavice, naramenice, kaiševi, kravate, potkošulje, čarape, majice, majice sa kratkim rukavima, donji delovi trenerke, gornji delovi trenerke, pleteni gornji delovi odeće, suknje, pantalone, šorcevi, duksevi, farmerke, prsluci, kaputi, jakne, radnička odela/kombinezoni, blejzeri, haljine, marame, bluze, džemperi (kardigani), ogrtači, majice za golf, odela za trčanje, rolke, odela i polo majice, ženske gaće, brushalteri, uske majice, kratke majice, steznici, grudnjaci, ženske duže gaće i bodi kombinezoni, muške slip gaće i bokserice.

(111) 08336

(151) 04.10.2013.

(210) **2011-28**

(442) **20.03.2013.**

(220) 24.01.2011.

(732) **GUESS? INC.**, 1444 SOUTH ALAMEDA STREET, LOS ANGELES, CA 90021 US

**GUESS by PAUL MARCIANO**

(540)

(550) I

(740) Lutovac Branislav, Bulevar Crnojevića 93, Podgorica ME

(511) **Klasa 25:** Muška, ženska odeća, odeća za dečake i devojčice, decu i bebe, posebno donji veš, obuća, kupaći kostimi, kape, pokrivala za glavu, ogrtači, kućne haljine, spavaćice, odore, pidžame, čarape, rukavice, naramenice, kaiševi, kravate, potkošulje, čarape, majice, majice sa kratkim rukavima, donji delovi trenerke, gornji delovi trenerke, pleteni gornji delovi odeće, suknje, pantalone, šorcevi, duksevi, farmerke, prsluci, kaputi, jakne, radnička odela/kombinezoni, blejzeri, haljine, marame, bluze, džemperi (kardigani), ogrtači, majice za golf, odela za trčanje, rolke, odela i polo majice, ženske gaće, brushalteri, uske majice, kratke majice, steznici, grudnjaci, ženske duže gaće i bodi kombinezoni, muške slip gaće i bokserice.

(111) 08337

(151) 04.10.2013.

(210) **2011-39**

(442) **20.03.2013.**

(220) 31.01.2011.

(732) **THE GILLETTE COMPANY**, ONE GILLETTE PARK, BOSTON, MA 02127 US

## DRY TECH

(540)

(550) I

(740) Lutovac Branislav, Bulevar Crnojevića 93, Podgorica ME

(511) **Klasa 03:** Antiperspiranti i dezodoransi za ličnu upotrebu.

(111) 08338

(151) 04.10.2013.

(210) **2011-41**(442) **20.03.2013.**

(220) 31.01.2011.

(732) **THE GILLETTE COMPANY**, ONE GILLETTE PARK, BOSTON, MA 02127 US

## MACH3

(540)

(550) I

(740) Lutovac Branislav, Bulevar Crnojevića 93, Podgorica ME

(511) **Klasa 03:** Sapuni, parfimerijski proizvodi, eterična ulja, kozmetika, losioni za kosu.

(111) 08339

(151) 04.10.2013.

(210) **2011-42**(442) **20.03.2013.**

(220) 31.01.2011.

(732) **BONGARIN S.A.**, 42 RUE RIEUSSEC, 78220 VIROFLAY FR

(540)

(550) I

(740) Lutovac Branislav, Bulevar Crnojevića 93, Podgorica ME

(511) **Klasa 29:** Mlijeko, sir i mliječni proizvodi, jestiva ulja i masti.

(111) 08340

(151) 04.10.2013.

(210) **2011-44**(442) **20.03.2013.**

(220) 31.01.2011.

(732) **BONGARIN S.A.**, 42 RUE RIEUSSEC, 78220 VIROFLAY FR

## GOZBAR

(540)

(550) I

(740) Lutovac Branislav, Bulevar Crnojevića 93, Podgorica ME

(511) **Klasa 29:** Mlijeko, sir i mliječni proizvodi, jestiva ulja i masti.

(111) 08341

(151) 04.10.2013.

(210) **2011-46**

(442) **20.03.2013.**

(220) 02.02.2011.

(732) **KIMBERLY-CLARK WORLDWIDE, INC, NEENAH, WISCONSIN 54956 US**

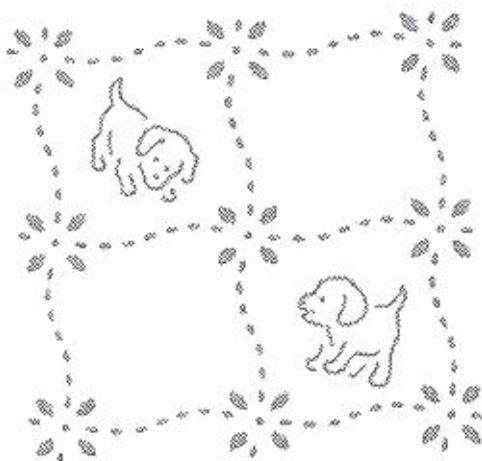

(540)

(550) I

(740) Lutovac Branislav, Bulevar Crnojevića 93, Podgorica ME

(511) **Klasa 03:** Vlažni papirni ubrusi i maramice za jednokratnu upotrebu, impregnirane jedinjenjima za ličnu higijenu.

**Klasa 16:** Upijajući papirni proizvodi kao što su maramice za lice, toalet papir, papirni ubrusi i papirne salvete.

(111) 08342

(151) 04.10.2013.

(210) **2011-66**

(442) **20.03.2013.**

(220) 09.02.2011.

(732) **CUMMINS INC., 500 JACKON SREET, COLUMBUS, INDIANA US**



(540)

(550) I

(740) Popović Miladin, Đoka Miraševića 21/III, Podgorica ME

(511) **Klasa 07:** Mašine i mašinski alati, motori i pogonske mašine (osim za suvozemna vozila), delovi i oprema za motore i pogonske mašine, mašinske spojnice i transmisioni elementi (osim za suvozemna vozila), poljoprivredne sprave koje se ne pokreću ručno, inkubatori za

jaja, motori sa sagorevanjem na dizel ili benzinski pogon i njihovi delovi, motori sa sagorevanjem, generatori električne energije i njihovi delovi, filteri za ulje, filteri za ulje, benzin, dizel gorivo i vazduh za motore i pogonske mašine, uređaji protiv zagađenja za motore, pogonske mašine i industrijske instalacije, turbo punjači i njihovi delovi, filteri za gorivo i sastavni delovi istih, filteri za ulje i vazduh i sastavni delovi istih, filteri za vazduh i ulje za mehaničke potrebe, hidraulični filteri za tečnosti za mehaničke potrebe, filteri za ulje, benzin, vazduh i gorivo za motore i pogonske mašine za suvozemna i brodska vozila, kanisteri i kućišta za sve prethodno navedene filtere, aparati, instalacije i filteri za redukciju emisije (ispuštanja) i redukciju buke za upotrebu kod pogonskih mašina.

**Klasa 12:** Vozila, aparati za kretanje po zemlji, vazduhu ili vodi, motori za vozila i delovi istih za upotrebu u vozilima, pumpe za vazduh (oprema za vozila), kvačila za suvozemna vozila, konverteri (obrtni momenat) za suvozemna vozila, pogonski lanci za suvozemna vozila, pogonski motori za suvozemna vozila, električna vozila, hidraulični sklop za vozila, motori, električni, za suvozemna vozila, prenosni lanci za suvozemna vozila, prenosne osovine za suvozemna vozila, osovine za suvozemna vozila, turbo punjači, vazdušni kompresori i raste-retni ventili turbokompresora, sve za suvozemna vozila, turbine za suvozemna vozila, vozila i sastavni delovi istih.

(111) 08343

(151) 04.10.2013.

(210) **2011-67**

(442) **20.03.2013.**

(220) 09.02.2011.

(732) **ENTERPRISE HOLDINGS INC**, 600 CORPORATE PARK DRIVE, ST. LOUIS, MISSOURI US

## ENTERPRISE

(540)

(550) I

(740) Popović Miladin, Đoka Miraševića 21/III, Podgorica ME

(511) **Klasa 35:** Usluge prodaje vozila, usluge upravljanja voznim parkom.

**Klasa 37:** Usluge popravke vozila.

**Klasa 39:** Usluge iznajmljivanja i lizinga vozila, i usluge rezervacije za iznajmljivanje i lizing vozila.

(111) 08344

(151) 04.10.2013.

(210) **2011-68**

(442) **20.03.2013.**

(220) 09.02.2011.

(732) **ENTERPRISE HOLDINGS, INC.**, 600 CORPORATE PARK DRIVE, ST. LOUIS, MISSOURI US



(540)

(550) I

(740) Popović Miladin, Đoka Miraševića 21/III, Podgorica ME



(511) **Klasa 35:** Usluge prodaje vozila, usluge upravljanja voznim parkom.

**Klasa 37:** Usluge popravke vozila.

**Klasa 39:** Usluge iznajmljivanja i lizinga vozila, i usluge rezervacije za iznajmljivanje i lizing vozila.

(111) 08350

(151) 04.10.2013.

(210) **2011-69**

(442) **20.03.2013.**

(220) 09.02.2011.

(732) **ENTERPRISE HOLDINGS, INC.**, 600 CORPORATE PARK DRIVE, ST. LOUIS, MISSOURI US



(540)

(550) I

(740) Popović Miladin, Đoka Miraševića 21/III, Podgorica ME

(511) **Klasa 35:** Usluge prodaje vozila, usluge upravljanja voznim parkom.

**Klasa 37:** Usluge popravke vozila.

**Klasa 39:** Usluge iznajmljivanja i lizinga vozila, i usluge rezervacije za iznajmljivanje i lizing vozila.

(111) 08351

(151) 04.10.2013.

(210) **2011-70**

(442) **20.03.2013.**

(220) 09.02.2011.

(732) **EXPRESS, LLC**, 1 EXPRESS DRIVE COLUMBUS, OHIO 43230 US

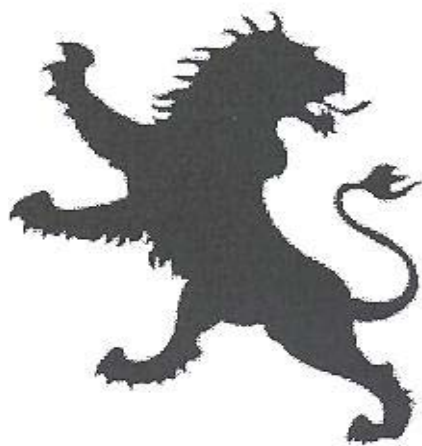

(540)

(550) I

(740) Radulović Božidar, Jovana Tomaševića 9/III, Podgorica ME

(511) **Klasa 09:** Naočare za sunce.

(111) 08352

(151) 04.10.2013.

(210) **2011-71**

(442) **20.03.2013.**

(220) 11.02.2011.

(732) **SKECHERS USA INC.II**, 228 MANHATTAN BEACH BLVD. MANHATTAN BEACH, CALIFORNIA 90266 US

## SHAPE-UPS

(540)

(550) I

(740) Ćupić Branislav, Dalmatinska 10, Podgorica ME

(511) **Klasa 25:** Obuća.

**Klasa 35:** Usluge maloprodaje takozvane online maloprodaje i usluge katalogske maloprodaje porudžbinama putem pošte, za obuću i odjeću.

(111) 08353

(151) 04.10.2013.

(210) **2011-72**

(442) **20.03.2013.**

(220) 11.02.2011.

(732) **SKECHERS USA INC.II**, 228 MANHATTAN BEACH BLVD. MANHATTAN BEACH, CALIFORNIA 90266 US



(540)

(550) I

(740) Ćupić Branislav, Dalmatinska 10, Podgorica ME

(511) **Klasa 25:** Obuća.

(111) 08354

(151) 04.10.2013.

(210) **2011-78**

(442) **20.03.2013.**

(220) 17.02.2011.

(732) **BANANA REPUBLIC ITM, INC**, 2 FOLSOM STREET, SAN FRANCISCO, CA 94105 US

## BANANA REPUBLIC

(540)

(550) I

(740) Lutovac Branislav, Bulevar Crnojevića 93, Podgorica ME

(511) **Klasa 16:** Papir, karton i proizvodi od ovih materijala koji pripadaju ovoj klasi, štampane stvari, knjige, korice za knjige, čestitke, kalendari, nalepnice, preslikači, nalepnice za auto, poster, kancelarijski materijal, blokovi za beleške, registratori, blokovi - podsetnici, agende, rokovnici, pisaći pribor, hemijske olovke, obične olovke, markeri, kutije za hemijske i obične olovke, etikete koje nisu od tekstila, fotografije, zastavice od kartona, papira i ojačanog papira, natpisi, podmetači/držači za papir sa oprugom, oglasne table, programi, albumi za slike, kutije za odlaganje slika, pelene za jednokratnu upotrebu, plastične kese za pelene za jednokratnu upotrebu, podmetači za stolove za presvlačenje beba, za jednokratnu upotrebu.

**Klasa 24:** Proizvodi od tekstila, tkanine ili plastičnog materijala (zamena za tkaninu) koji pripadaju ovoj klasi, rublje za upotrebu u domaćinstvu, posteljno rublje, stono rublje, rublje za kupatilo, peškiri, peškiri za ruke, prekrivači za krevete i stolove, salvete, etikete u ovoj klasi, zastavice i zastave koje nisu od papira, tekstili i tkanine (tkane i pletene), zavese, draperije, ćebad, zastavice od platna, čaršavi, jorgani, volani, ukrasni jastučići, portiklice za bebe, pokrivači od tkanine za podmetače za presvlačenje, podloge za presvlačenje beba.

**Klasa 26:** Čipka, vez, ukrasne mašne, ukrasne trake (pantljičke), dugmad, kopče, petlje, špenadle, igle, veštačko cveće, dekorativne zakrpe, perike, perje, pričvršćivači za rajferšluse, veštačko voće, čipke za obuću i odeću, detalji za kosu, štipaljke za kosu, šnale sa zatvaranjem "na klik", šnale, gumice za kosu od ukrasnog materijala, ukosnice, rajfovi, mašne za kosu, ukrasne kopče za kosu, klip šnale za kosu, ukrasi za kosu, šnalice, ukrasne trake za kosu, pričvršćivači za konjski rep.

(111) 08355

(151) 04.10.2013.

(210) **2011-79**

(442) **20.03.2013.**

(220) 17.02.2011.

(732) **GAP (ITM), INC**, A CALIFORNIA CORPORATION, 2 FOLSOM STREET, CA 94105 US

**GAP 1969**

(540)

(550) I

(740) Lutovac Branislav, Bulevar Crnojevića 93, Podgorica ME

(511) **Klasa 18:** Koža i imitacija kože, proizvodi izradeni od ovih materijala koji nisu uključeni u druge klase, životinjska koža, koferi i putne torbe, kišobrani, suncobrani i štapovi za hodanje, bičevi, saračka i sedlarska roba.

**Klasa 25:** Odeća, obuća, pokrivala za glavu.

**Klasa 35:** Oglašavanje, vođenje poslova, poslovno upravljanje, kancelarijski poslovi

(111) 08357

(151) 04.10.2013.

(210) **2011-80**

(442) **20.03.2013.**

(220) 17.02.2011.

(732) **KIKA MOBEL-HANDELSGESELLSCHAFT M.B.H.**, ANTON-SCHEIBLIN-GASSE 1, 3100 ST.POLTEN AT

**Kika**

(540)

(550) I

(740) Lutovac Branislav, Bulevar Crnojevića 93, Podgorica ME

(511) **Klasa 11:** Aparati za osvetljavanje, grejanje, proizvodnju pare, kuvanje, hlađenje, suše-

nje, ventilaciju, snabdevanje vodom i sanitame svrhe.

**Klasa 20:** Nameštaj, ogledala, okviri za slike, proizvodi (koji nisu obuhvaćeni drugim klasama) od drveta, plute, trske, rogoza, vrbovog pruća, roga, kosti, slonovače, kitove kosti, školjki, ćilibara, sedefa, morske pene, zamene svih ovih materijala, ili od plastike.

**Klasa 21:** Kućne ili kuhinjske sprave i posude (kpje nisu od dragocenih metala ili sa presvlakama od njih), češljevi i sunđeri, četke (izuzev kičica), materijali za pravljenje četki, artikli koji se koriste pri čišćenju, čelična vuna, neprerađeno ili polupreradađeno staklo (osim stakla koje se koristi u građevinarstvu), staklarija, porcelan, fajans, grnčarija i lončarija koja nije uključena u druge klase.

**Klasa 24:** Tekstil i tekstilni proizvodi koji nisu obuhvaćeni drugim klasama, prekrivači za krevete i stolove.

**Klasa 27:** Tepisi, ćilimi, prostirke i otirači, linoleum i drugi materijali za pokrivanje podova, prekrivači za zidove (netekstilni).

**Klasa 37:** Instaliranje kuhinja, instaliranje nameštaja, tapacerski radovi, stolarski radovi, parketarski radovi, hoblovanje i lakiranje podova, postavljanje (izuzev postavljanja podupirača, nosača i šipki) prekrivača od plastičnih materijala, gume i/ili linoleuma ili tekstilnih materijala, kačenje zavesa i postavljanje garnišni, čišćenje jorgana.

(111) 08358

(151) 04.10.2013.

(210) **2011-86**

(442) **20.03.2013.**

(220) 23.02.2011.

(732) **TENARIS CONNECTIONS BV**, LOCATELIKATE 1, 1076 AZ AMSTERDAM NL

## TENARIS

(540)

(550) I

(740) Popović Miladin, Đoka Miraševića 21/III, Podgorica ME

(511) **Klasa 06:** Obični metali i njihove legure, metalni građevinski materijali, metalne prenosne građevine, materijali od metala za željezničke sine, ne-električni kablovi i žice od običnog metala, bravarski proizvodi, mali metalni gvoždarski proizvodi, cevčice i cevi od metala, sefovi, proizvodi od običnih metala koji nisu uključeni u druge klase, rude.

(111) 08359

(151) 04.10.2013.

(210) **2011-87**

(442) **20.03.2013.**

(220) 23.02.2011.

(732) **TENARIS CONNECTIONS BV**, LOCATELIKATE 1, 1076 AZ AMSTERDAM NL

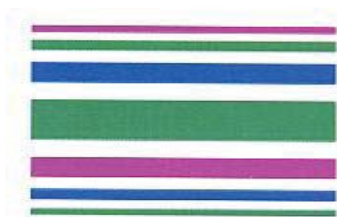

(540)

(550) I

(740) Popović Miladin, Đoka Miraševića 21/III, Podgorica ME

(511) **Klasa 06:** Obični metali i njihove legure, metalni građevinski materijali, metalne prenosne građevine, materijali od metala za željezničke sine, ne-električni kablovi i žice od običnog metala, bravarski proizvodi, mali metalni gvoždarski proizvodi, cevčice i cevi od metala, sefovi, proizvodi od običnih metala koji nisu uključeni u druge klase, rude.

(111) 08360

(151) 10.10.2013.

(210) **2011-97**

(442) **20.03.2013.**

(220) 28.02.2011.

(300) 85120819 01.09.2010.

US

(732) **BEST WESTREN INTERNATIONAL, INC.**, 6201 NORTH 24 TH PARKWAY, PHOENIX, ARIZONA 85016 US



(540)

(550) I

(740) Lutovac Branislav, Bulevar Crnojevića 93, Podgorica ME

(511) **Klasa 43:** Hotelske usluge.

(111) 08361

(151) 10.10.2013.

(210) **2011-98**

(442) **20.03.2013.**

(220) 28.02.2011.

(300) 85120792 01.09.2010. US.

(732) **BEST WESTERN INTERNATIONAL, INC.**, 6201 NORTH 24 TH PARKWAY, PHOENIX, ARIZONA 85016 US



(540)

(550) I

(740) Lutovac Branislav, Bulevar Crnojevića 93, Podgorica ME

(511) **Klasa 43:** Hotelske usluge.

(111) 08364

(151) 10.10.2013.

(210) **2011-101**

(442) **20.03.2013.**

(220) 02.03.2011.

(732) **CARPE DIEM GMBH&CO KG**, AM BRUNNEN 1, 5330 FUSCHL AM SEE AT



(540)

(550) I

(740) Ćupić Branislav, Dalmatinska 10, Podgorica ME

(511) **Klasa 32:** Bezalkoholni napitci, voćni napitci, voćni sokovi, limunade, osvježavajuća pića, uključujući pića koja sadrže čaj, šećer, saharozu, glukozu, fruktozu, kvasac i mliječnu kiselinu, energetska pića, izotonična, hipertonična i hipotonična pića (koja koriste sportisti i/ili za potrebe sportista), napitci od surutke, mineralne i sodne vode, sirupi, esencije i drugi preparati za proizvodnju pića kao i pjenušajuće tablete i pjenušajući praškovi za pića i bezalkoholne koktele, pivo, hranljivo pivo, pivo od slada, pivo od žita, tamno (porter) pivo, svijetlo (ale) pivo, stout pivo i lager pivo, bezalkoholna pića od slada, kvas (napitak koji se dobija fermentacijom raži).

(111) 08365

(151) 10.10.2013.

(210) **2011-105**(442) **20.03.2013.**

(220) 03.03.2011.

(732) **SAUDI ARABIA OIL COMPANY**, 1 EASTERN AVENUE, DHAHRAN, 31311 SA

## SADARA

(540)

(550) I

(740) Popović Miladin, Đoka Miraševića 21/III, Podgorica ME

(511) **Klasa 01:** Hemijski proizvodi i neprerđene plastične materije za dalju proizvodnju.

(111) 08366

(151) 10.10.2013.

(210) **2011-89**(442) **20.03.2013.**

(220) 24.02.2011.

(732) **NISSAN JIDOSHA KABUSHIKI KAISHA**, No.2 TAKARACHO, KANAGAWA-KU, YOKOHAMA-SHI, KANAGAWA-KEN JP

## NISSAN

(540)

(550) I

(740) Popović Miladin, Đoka Miraševića 21/III, Podgorica ME

(511) **Klasa 09:** Aparati i instrumenti za merenje, brojači, aparati za snimanje vremena, mašine i aparati za distribuciju ili kontrolu električne energije, električne razvodne kutije, rotacioni konvertori, fazni modifikatori, punjači, transformatori (strujni), baterije i ćelije, gorivne će-

lije, električne žice i kablovi, električni komunikacioni aparati i instrumenti, telefonski aparati, mašine i aparati za radio komunikaciju u vozilima, automobilski telematički aparati, odašiljači i prijemnici podataka opremljeni u automobilima, aparati za automatska obaveštenja o prestanku punjenja, navigacioni aparati za vozila (on-board kompjuteri), aparati za davanje obaveštenja o punjenju a koja glase „nije još ubačen punjač”, elektronske mašine i aparati, integrisana kola, električna kola, kompjuteri, kompjuterski softver, kompjuterski programi, sistemi daljinske kontrole za dopunjavanje, elektrode, magneti, naočare, upaljači za automobile, zaštitni uređaji protiv nesreća za ličnu upotrebu, invertori (strujni), aparati protiv krađe.

(111) 08367

(151) 10.10.2013.

(210) **2011-90**

(442) **20.03.2013.**

(220) 24.02.2011.

(732) **NISSAN JIDOSHA KABUSHIKI KAISHA**, No.2 TAKARACHO, KANAGAWA-KU, YOKOHAMA-SHI, KANAGAWA-KEN JP



(540)

(550) I

(740) Popović Miladin, Đoka Miraševića 21/III, Podgorica ME

(511) **Klasa 09:** Aparati i instrumenti za merenje, brojači, aparati za snimanje vremena, mašine i aparati za distribuciju ili kontrolu električne energije, električne razvodne kutije, rotacioni konvertori, fazni modifikatori, punjači, transformatori (strujni), baterije i ćelije, gorivne ćelije, električne žice i kablovi, električni komunikacioni aparati i instrumenti, telefonski aparati, mašine i aparati za radio komunikaciju u vozilima, automobilski telematički aparati, odašiljači i prijemnici podataka opremljeni u automobilima, aparati za automatska obaveštenja o prestanku punjenja, navigacioni aparati za vozila (on-board kompjuteri), aparati za davanje obaveštenja o punjenju a koja glase „nije još ubačen punjač”, elektronske mašine i aparati, integrisana kola, električna kola, kompjuteri, kompjuterski softver, kompjuterski programi, sistemi daljinske kontrole za dopunjavanje, elektrode, magneti, naočare, upaljači za automobile, zaštitni uređaji protiv nesreća za ličnu upotrebu, invertori (strujni), aparati protiv krađe.

(111) 08606

(151) 30.10.2013.

(210) **2010-390**

(442) **20.03.2013.**

(220) 25.10.2010.

(732) **KARBON GRAĐEVINSKI MATERIJALI D.O.O. TOPOLA**, BULEVAR VOŽDA KARĐORĐA 126, 3431 TOPOLA RS

## RAZILIT

(540)

(550) I

(511) **Klasa 01:** Ljepljive supstance koje se upotrebljavaju u industriji. hemijski proizvodi koji se upotrebljavaju u industriji, nauci, fotografiji, poljoprivredi, hortikulturi i šumarstvu, neprerađene vještačke smole, neprerađene plastične materije, đubriva, smeše za gašenje vatre, preparati za kaljenje i zavarivanje, hemijske supstance za očuvanje namirnica, materije za štavljenje,

**Klasa 02:** Boje, firnajzi, lakovi, sredstva za zaštitu od rđe i truljenja drveta, materije za bojenje, sredstva za nagrizanje, sirove prirodne smole, metali u obliku listova i praha za slikare, dekoratere, štampare i umjetnike.

**Klasa 19:** Građevinski materijali (nemetalni), čvrste nemetalne cijevi za građevine, asfalt, crna smola i bitumen, nemetalne prenosne građevine, spomenici, koji nisu od metala.

(111) 08607

(151) 30.10.2013.

(210) **2010-391**(442) **20.03.2013.**

(220) 25.10.2010.

(732) **KARBON GRAĐEVINSKI MATERIJALI D.O.O. TOPOLA**, BULEVAR VOŽDA KARADORĐA 126, 3431 TOPOLA RS

## POLIFLOR

(540)

(550) I

(511) **Klasa 01:** Leppljive supstance koje se upotrebljavaju u industriji. hemijski proizvodi koji se upotrebljavaju u industriji, nauci, fotografiji, poljoprivredi, hortikulturi i šumarstvu, neprerađene vještačke smole, neprerađene plastične materije, đubriva, smeše za gašenje vatre, preparati za kaljenje i zavarivanje, hemijske supstance za očuvanje namirnica, materije za štavljenje,

**Klasa 02:** Boje, firnajzi, lakovi, sredstva za zaštitu od rđe i truljenja drveta, materije za bojenje, sredstva za nagrizanje, sirove prirodne smole, metali u obliku listova i praha za slikare, dekoratere, štampare i umjetnike.

**Klasa 19:** Građevinski materijali (nemetalni), čvrste nemetalne cevi za građevine, asfalt, crna smola i bitumen, nemetalne prenosne građevine, spomenici, koji nisu od metala.

(111) 08608

(151) 30.10.2013.

(210) **2010-393**(442) **20.03.2013.**

(220) 25.10.2010.

(732) **KARBON GRAĐEVINSKI MATERIJALI D.O.O. TOPOLA**, BULEVAR VOŽDA KARADORĐA 126, 3431 TOPOLA RS

## KARBOSIL

(540)

(550) I

(511) **Klasa 01:** Leppljive supstance koje se upotrebljavaju u industriji. hemijski proizvodi koji se upotrebljavaju u industriji, nauci, fotografiji, poljoprivredi, hortikulturi i šumarstvu, neprerađene vještačke smole, neprerađene plastične materije, đubriva, smeše za gašenje vatre, preparati za kaljenje i zavarivanje, hemijske supstance za očuvanje namirnica, materije za



štavljenje,

**Klasa 02:** Boje, firnajzi, lakovi, sredstva za zaštitu od rđe i truljenja drveta, materije za bojenje, sredstva za nagrizanje, sirove prirodne smole, metali u obliku listova i praha za slikare, dekoratere, štampare i umjetnike.

**Klasa 19:** Građevinski materijali (nemetalni), čvrste nemetalne cevi za građevine, asfalt, crna smola i bitumen, nemetalne prenosne građevine, spomenici, koji nisu od metala.

(111) 08609

(151) 30.10.2013.

(210) **2010-431**

(442) **20.03.2013.**

(220) 18.11.2010.

(732) **ČISTI KRISTAL 000**, 6, UGOLNAYA, MYTISHCHI, MOSKOVSKA REGIJA, 141013 RU

## KALINKA

(540)

(550) I

(511) **Klasa 33:** Aperativi, Rakije, Vina, "Piquette"(komina,itd), Viski, Vodka, Džin, Digestivi (likeri i alkoholna pića), Kokteli na bazi alkohola, Alkoholni kokteli koji sadrže votku i/ili pelinkovac, Likeri, Alkoholna pića koja sadrže voće, Alkoholna pića, osim piva, Destilovana alkoholna pića, Žestoka alkoholna pića, Pića sa voćnim sokom koja sadrže alkohol, Medovina (hidromel), Likeri od nane, Likeri od ljekovitih biljaka, Rum, Sake, Jabukovače, Pirinčani alkohol, Alkoholni ekstrakti, Alkoholni voćni ekstrakti, Alkoholne esencije.

(111) 08610

(151) 30.10.2013.

(210) **2011-2**

(442) **20.03.2013.**

(220) 10.01.2011.

(732) **FRES&CO. DOO**, IVANA GORANA KOVAČIĆA 3, SUBOTICA RS



(540)

(550) I

(740) Popović Miladin, Đoka Miraševića 21/III, Podgorica ME

(511) **Klasa 32:** Piva, mineralne i sodne vode i druga bezalkoholna pića, pića od voća i voćni sokovi, sirupi i drugi preparati za proizvodnju pića.

(111) 08611

(151) 30.10.2013.

(210) **2011-3**

(442) **20.03.2013.**

(220) 10.01.2011.

(732) **FRESH&CO.DO0**, IVANA GORANA KOVAČIĆA 3, SUBOTICA RS

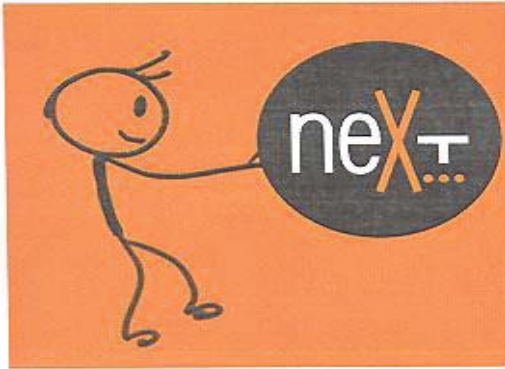

(540)

(550) I

(740) Popović Miladin, Đoka Miraševića 21/III, Podgorica ME

(511) **Klasa 32:** Piva, mineralne i sodne vode i druga bezalkoholna pića, pića od voća i voćni sokovi, sirupi i drugi preparati za proizvodnju pića.

(111) 08612

(151) 30.10.2013.

(210) **2011-5**(442) **20.03.2013.**

(220) 10.01.2011.

(300) 85/096,15329.07.2010.

US

(732) **MOTOROLA TRADEMARK HOLDINGS, LLC**, 600 NORTH US HIGHWAY 45, LIBERTYVILLE, IL 60048 US

MOTOROLA DEFY

(540)

(550) I

(740) Čejović Vladimir, 13. jula 21, Podgorica ME

(511) **Klasa 09:** Mobilni telefoni.

(111) 08613

(151) 30.10.2013.

(210) **2011-6**(442) **20.03.2013.**

(220) 10.01.2011.

(300) 85/116,68926.08.2010.

US

(732) **MOTOROLA TRADEMARK HOLDINGS, LLC**, 600 NORTH US HIGHWAY 45, LIBERTYVILLE, IL 60048 US

ATRIX

(540)

(550) I

(740) Čejović Vladimir, 13. jula 21, Podgorica ME

(511) **Klasa 09:** Mobilni telefoni i ručni mobilni uređaji za računanje.

(111) 08614

(151) 30.10.2013.

(210) **2011-14**(442) **20.03.2013.**

(220) 12.01.2011.

(732) **TOYOTA JIDOSHA KABUSHIKI KAISHA/ALSO TRADING AS TOYOTA MOTOR CORPORATION** 1, TOYOTA-CHO, TOYOTA-SHI, AICHI-KEN JP

GS250

- (540)  
 (550) I  
 (740) Čejović Vladimir, 13. jula 21, Podgorica ME  
 (511) **Klasa 12:** Automobili i njihovi strukturni djelovi.

- 
- (111) 08615 (151) 30.10.2013.  
 (210) **2011-30** (442) **20.03.2013.**  
 (220) 24.01.2011.

- (732) **THE QUAKER OATS COMPANY**, 555 WEST MONROE STREET, CHICAGO, ILLIONS 60661 US



- 
- (540)  
 (550) I  
 (740) Čejović Vladimir, 13. jula 21, Podgorica ME  
 (511) **Klasa 29:** Meso, riba, živina i divljač, mesne prerađevine, konzervisano, zamrznuto, sušeno i kuvano voće i povrće, želei, džemovi, kompoti, jaja, mlijeko i mliječni proizvodi, jestiva ulja i masti  
**Klasa 30:** Kafa, čaj, kakao, šećer, pirinac, tapioka, sago, zamjena kafe, brašno i proizvodi od žitarica, hljeb, kolači i poslastice, sladoledi, med, melasa, kvasac, prašak za pecivo, so, senf, sirće, sosevi (kao začini), začini, led

- 
- (111) 08616 (151) 30.10.2013.  
 (210) **2011-30** (442) **20.03.2013.**  
 (220) 24.01.2011.

- (732) **THE QUAKER OATS COMPANY**, 555 WEST MONROE STREET, CHICAGO, ILLIONS 60661 US



(540) \_\_\_\_\_

(550) I

(740) Čejović Vladimir, 13. jula 21, Podgorica ME

(511) **Klasa 29:** Meso, riba, živina i divljač, mesne prerađevine, konzervisano, zamrznuto, sušeno i kuvano voće i povrće, želei, džemovi, kompoti, jaja, mlijeko i mliječni proizvodi, jestiva ulja i masti

**Klasa 30:** Kafa, čaj, kakao, šećer, pirinac, tapioka, sago, zamjena kafe, brašno i proizvodi od žitarica, hljeb, kolači i poslastice, sladoledi, med, melasa, kvasac, prašak za pecivo, so, senf, sirće, sosevi (kao začini), začini, led

(111) 08617

(151) 30.10.2013.

(210) **2011-34**

(442) **20.03.2013.**

(220) 26.01.2011.

(732) **TOYOTA JIDOSHA KABUSHIKI KAISHA**, 1, TOYOTA-CHO, TOYOTA-SHI, AICHI-KEN JP

TOYOTA  
TOUCH & GO

(540)

(550) I

(740) Čejović Vladimir, 13. jula 21, Podgorica ME

(511) **Klasa 09:** Uređaj za prenos zvuka sa ekranom i navigacionim sistemom za automobile.

(111) 08618

(151) 30.10.2013.

(210) **2011-35**

(442) **20.03.2013.**

(220) 26.01.2011.

(732) **TOYOTA JIDOSHA KABUSHIKI KAISHA**, 1, TOYOTA-CHO, TOYOTA-SHI, AICHI-KEN JP

TOYOTA TOUCH

(540)

(550) I

(740) Čejović Vladimir, 13. jula 21, Podgorica ME

(511) **Klasa 09:** Uređaji za prenos zvuka sa ekranom za automobile.

(111) 08619

(151) 30.10.2013.

(210) **2011-47**

(442) **20.03.2013.**

(220) 02.02.2011.

(732) **MILLER BREWING INTERNATIONAL, INC**, 3939 WEST HIGHLAND BOULEVARD, MILWAUKEE, WISCONSIN 53208 US



(540)

(550) I

(740) Čejović Vladimir, 13. jula 21, Podgorica ME

(511) **Klasa 32:** Pivo, mineralne i sodne vode i druga bezalkoholna pića, pića od voća I voćni sokovi, sirupi i drugi preparati za proizvodnju pića.

(111) 08620

(151) 31.10.2013.

(210) **2011-49**

(442) **20.03.2013.**

(220) 04.02.2011.

(732) **INDUSTRIJA PIVA I SOKOVA TREBJESA AD. NIKŠIĆ**, NJEGOŠEVA 18, NIKŠIĆ ME



(540)

(550) I

(740) Božović Vesko, Rimski trg 50/11, Podgorica ME

(511) **Klasa 32:** pivo, mineralne i sodne vode i druga bezalkoholna pića, pića od voća i voćni sokovi, sirupi i drugi preparati za proizvodnju pića.

**Klasa 35:** oglašavanje, vodenje poslova, poslovno upravljanje, kancelarijski poslovi, usluge koje pružaju lica ili organizacije u pomoći u radu ili upravljanju preduzećima i u vodenju poslova preduzeća, usluge koje pružaju preduzeća koja se bave oglašavanjem (reklamiranjem), tako što, za račun drugih lica, komuniciraju sa javnošću (reklama) putem prenosa bilo kakvih informacija o proizvodima i uslugama omogućavajući potrošačima prigodan pogled na te proizvode i usluge, usluge koje se sastoje od upisivanja, uređivanja, obrade, prerade ili sistematizacije pisanih informacija i zapisa, usluge reklamnih agencija, distribuciju prospekata i

uzoraka direktno ili poštom, izradu i korišćenje matematičkih i statističkih podataka, organizovanje sajmova i izložbi u komercijalne ili reklamne svrhe.

(111) 08621

(151) 31.10.2013.

(210) **2011-50**

(442) **20.03.2013.**

(220) 04.02.2011.

(732) **INDUSTRIJA PIVA I SOKOVA TREBJESA AD. NIKŠIĆ**, NJEGOŠEVA 18, NIKŠIĆ ME



(540)

(550) I

(740) Božović Vesko, Rimski trg 50/11, Podgorica ME

(511) **Klasa 32:** pivo, mineralne i sodne vode i druga bezalkoholna pića, pića od voća i voćni sokovi, sirupi i drugi preparati za proizvodnju pića.

**Klasa 35:** oglašavanje, vodenje poslova, poslovno upravljanje, kancelarijski poslovi, usluge koje pružaju lica ili organizacije u pomoći u radu ili upravljanju preduzećima i u vodenju poslova preduzeća, usluge koje pružaju preuzeća koja se bave oglašavanjem (reklamiranjem), tako što, za račun drugih lica, komuniciraju sa javnošću (reklama) putem prenosa bilo kakvih informacija o proizvodima i uslugama omogućavajući potrošačima prigodan pogled na te proizvode i usluge, usluge koje se sastoje od upisivanja, uredivanja, obrade, prerade ili sistematizacije pisanih informacija i zapisa, usluge reklamnih agencija, distribuciju prospekata i uzoraka direktno ili poštom, izradu i korišćenje matematičkih i statističkih podataka, organizovanje sajmova i izložbi u komercijalne ili reklamne svrhe.

(111) 08622

(151) 31.10.2013.

(210) **2011-51**

(442) **20.03.2013.**

(220) 04.02.2011.

(732) **INDUSTRIJA PIVA I SOKOVA TREBJESA AD. NIKŠIĆ**, NJEGOŠEVA 18, NIKŠIĆ ME



(540)

(550) I

(740) Božović Vesko, Rimski trg 50/11, Podgorica ME

(511) **Klasa 32:** pivo, mineralne i sodne vode i druga bezalkoholna pića, pića od voća i voćni sokovi, sirupi i drugi preparati za proizvodnju pića.

**Klasa 35:** oglašavanje, vodenje poslova, poslovno upravljanje, kancelarijski poslovi, usluge koje pružaju lica ili organizacije u pomoći u radu ili upravljanju preduzećima i u vodenju poslova preduzeća, usluge koje pružaju preuzeća koja se bave oglašavanjem (reklamiranjem), tako što, za račun drugih lica, komuniciraju sa javnošću (reklama) putem prenosa bilo kakvih informacija o proizvodima i uslugama omogućavajući potrošačima prigodan pogled na te proizvode i usluge, usluge koje se sastoje od upisivanja, uređivanja, obrade, prerade ili sistematizacije pisanih informacija i zapisa, usluge reklamnih agencija, distribuciju prospekata i uzoraka direktno ili poštom, izradu i korišćenje matematičkih i statističkih podataka, organizovanje sajmova i izložbi u komercijalne ili reklamne svrhe.

(111) 08623

(151) 31.10.2013.

(210) **2011-52**(442) **20.03.2013.**

(220) 04.02.2011.

(732) **INDUSTRIJA PIVA I SOKOVA TREBJESA AD. NIKŠIĆ**, NJEGOŠEVA 18, NIKŠIĆ ME

(540)

(550) I

(740) Božović Vesko, Rimski trg 50/11, Podgorica ME

(511) **Klasa 32:** pivo, mineralne i sodne vode i druga bezalkoholna pića, pića od voća i voćni sokovi, sirupi i drugi preparati za proizvodnju pića.

**Klasa 35:** oglašavanje, vodenje poslova, poslovno upravljanje, kancelarijski poslovi, usluge koje

pružaju lica ili organizacije u pomoći u radu ili upravljanju preduzećima i u vodenju poslova preduzeća, usluge koje pružaju preuzeća koja se bave oglašavanjem (reklamiranjem), tako što, za račun drugih lica, komuniciraju sa javnošću (reklama) putem prenosa bilo kakvih informacija o proizvodima i uslugama omogućavajući potrošačima prigodan pogled na te proizvode i usluge, usluge koje se sastoje od upisivanja, uredivanja, obrade, prerade ili sistematizacije pisanih informacija i zapisa, usluge reklamnih agencija, distribuciju prospekata i uzoraka direktno ili poštom, izradu i korišćenje matematičkih i statističkih podataka, organizovanje sajmova i izložbi u komercijalne ili reklamne svrhe.

(111) 08624

(151) 31.10.2013.

(210) **2011-53**

(442) **20.03.2013.**

(220) 04.02.2011.

(732) **INDUSTRIJA PIVA I SOKOVA TREBJESA AD. NIKŠIĆ**, NJEGOŠEVA 18, NIKŠIĆ ME



(540)

(550) I

(740) Božović Vesko, Rimski trg 50/11, Podgorica ME

(511) **Klasa 32:** pivo, mineralne i sodne vode i druga bezalkoholna pića, pića od voća i voćni sokovi, sirupi i drugi preparati za proizvodnju pića.

**Klasa 35:** oglašavanje, vodenje poslova, poslovno upravljanje, kancelarijski poslovi, usluge koje pružaju lica ili organizacije u pomoći u radu ili upravljanju preduzećima i u vodenju poslova preduzeća, usluge koje pružaju preuzeća koja se bave oglašavanjem (reklamiranjem), tako što, za račun drugih lica, komuniciraju sa javnošću (reklama) putem prenosa bilo kakvih informacija o proizvodima i uslugama omogućavajući potrošačima prigodan pogled na te proizvode i usluge, usluge koje se sastoje od upisivanja, uredivanja, obrade, prerade ili sistematizacije pisanih informacija i zapisa, usluge reklamnih agencija, distribuciju prospekata i uzoraka direktno ili poštom, izradu i korišćenje matematičkih i statističkih podataka, organizovanje sajmova i izložbi u komercijalne ili reklamne svrhe.

(111) 08625

(151) 31.10.2013.

(210) **2011-54**

(442) **20.03.2013.**

(220) 04.02.2011.

(732) **INDUSTRIJA PIVA I SOKOVA TREBJESA AD. NIKŠIĆ**, NJEGOŠEVA 18, NIKŠIĆ ME



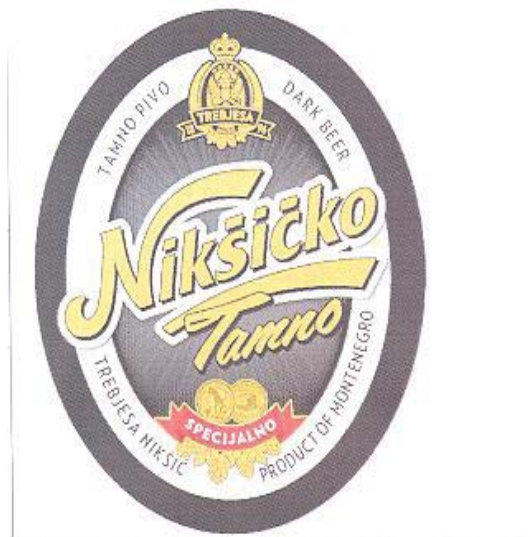

(540)

(550) I

(740) Božović Vesko, Rimski trg 50/11, Podgorica ME

(511) **Klasa 32:** pivo, mineralne i sodne vode i druga bezalkoholna pića, pića od voća i voćni sokovi, sirupi i drugi preparati za proizvodnju pića.

**Klasa 35:** oglašavanje, vodenje poslova, poslovno upravljanje, kancelarijski poslovi, usluge koje pružaju lica ili organizacije u pomoći u radu ili upravljanju preduzećima i u vodenju poslova preduzeća, usluge koje pružaju preuzeća koja se bave oglašavanjem (reklamiranjem), tako što, za račun drugih lica, komuniciraju sa javnošću (reklama) putem prenosa bilo kakvih informacija o proizvodima i uslugama omogućavajući potrošačima prigodan pogled na te proizvode i usluge, usluge koje se sastoje od upisivanja, uredivanja, obrade, prerade ili sistematizacije pisanih informacija i zapisa, usluge reklamnih agencija, distribuciju prospekata i uzoraka direktno ili poštom, izradu i korišćenje matematičkih i statističkih podataka, organizovanje sajмова i izložbi u komercijalne ili reklamne svrhe.

(111) 08626

(151) 31.10.2013.

(210) **2011-55**(442) **20.03.2013.**

(220) 04.02.2011.

(732) **INDUSTRIJA PIVA I SOKOVA TREBJESA AD. NIKŠIĆ**, NJEGOŠEVA 18, NIKŠIĆ ME



(540)

(550) I

(740) Božović Vesko, Rimski trg 50/11, Podgorica ME

(511) **Klasa 32:** pivo, mineralne i sodne vode i druga bezalkoholna pića, pića od voća i voćni sokovi, sirupi i drugi preparati za proizvodnju pića.

**Klasa 35:** oglašavanje, vodenje poslova, poslovno upravljanje, kancelarijski poslovi, usluge koje pružaju lica ili organizacije u pomoći u radu ili upravljanju preduzećima i u vodenju poslova preduzeća, usluge koje pružaju preuzeća koja se bave oglašavanjem (reklamiranjem), tako što, za račun drugih lica, komuniciraju sa javnošću (reklama) putem prenosa bilo kakvih informacija o proizvodima i uslugama omogućavajući potrošačima prigodan pogled na te proizvode i usluge, usluge koje se sastoje od upisivanja, uredivanja, obrade, prerade ili sistematizacije pisanih informacija i zapisa, usluge reklamnih agencija, distribuciju prospekata i uzoraka direktno ili poštom, izradu i korišćenje matematičkih i statističkih podataka, organizovanje sajмова i izložbi u komercijalne ili reklamne svrhe.

(111) 08627

(151) 31.10.2013.

(210) **2011-56**

(442) **20.03.2013.**

(220) 04.02.2011.

(732) **INDUSTRIJA PIVA I SOKOVA TREBJESA AD. NIKŠIĆ**, NJEGOŠEVA 18, NIKŠIĆ ME



(540)

(550) I

(740) Božović Vesko, Rimski trg 50/11, Podgorica ME

(511) **Klasa 32:** pivo, mineralne i sodne vode i druga bezalkoholna pića, pića od voća i voćni sokovi, sirupi i drugi preparati za proizvodnju pića.

**Klasa 35:** oglašavanje, vodenje poslova, poslovno upravljanje, kancelarijski poslovi, usluge koje pružaju lica ili organizacije u pomoći u radu ili upravljanju preduzećima i u vodenju poslova preduzeća, usluge koje pružaju preduzeća koja se bave oglašavanjem (reklamiranjem), tako što, za račun drugih lica, komuniciraju sa javnošću (reklama) putem prenosa bilo kakvih informacija o proizvodima i uslugama omogućavajući potrošačima prigodan pogled na te proizvode i usluge, usluge koje se sastoje od upisivanja, uređivanja, obrade, prerade ili sistematizacije pisanih informacija i zapisa, usluge reklamnih agencija, distribuciju prospekata i uzoraka direktno ili poštom, izradu i korišćenje matematičkih i statističkih podataka, organizovanje sajmova i izložbi u komercijalne ili reklamne svrhe.

(111) 08628

(151) 31.10.2013.

(210) **2011-57**

(442) **20.03.2013.**

(220) 04.02.2011.

(732) **INDUSTRIJA PIVA I SOKOVA TREBJESA AD. NIKŠIĆ**, NJEGOŠEVA 18, NIKŠIĆ ME



(540)

(550) I

(740) Božović Vesko, Rimski trg 50/11, Podgorica ME

(511) **Klasa 32:** pivo, mineralne i sodne vode i druga bezalkoholna pića, pića od voća i voćni sokovi, sirupi i drugi preparati za proizvodnju pića.

**Klasa 35:** oglašavanje, vodenje poslova, poslovno upravljanje, kancelarijski poslovi, usluge koje pružaju lica ili organizacije u pomoći u radu ili upravljanju preduzećima i u vodenju poslova preduzeća, usluge koje pružaju preuzeća koja se bave oglašavanjem (reklamiranjem), tako što, za račun drugih lica, komuniciraju sa javnošću (reklama) putem prenosa bilo kakvih informacija o proizvodima i uslugama omogućavajući potrošačima prigodan pogled na te proizvode i usluge, usluge koje se sastoje od upisivanja, uredivanja, obrade, prerade ili sistematizacije pisanih informacija i zapisa, usluge reklamnih agencija, distribuciju prospekata i uzoraka direktno ili poštom, izradu i korišćenje matematičkih i statističkih podataka, organizovanje sajmova i izložbi u komercijalne ili reklamne svrhe.

(111) 08629

(151) 31.10.2013.

(210) **2011-58**

(442) **20.03.2013.**

(220) 04.02.2011.

(732) **INDUSTRIJA PIVA I SOKOVA TREBJESA AD. NIKŠIĆ**, NJEGOŠEVA 18, NIKŠIĆ ME



(540)

(550) I

(740) Božović Vesko, Rimski trg 50/11, Podgorica ME

(511) **Klasa 32:** pivo, mineralne i sodne vode i druga bezalkoholna pića, pića od voća i voćni sokovi, sirupi i drugi preparati za proizvodnju pića.

**Klasa 35:** oglašavanje, vodenje poslova, poslovno upravljanje, kancelarijski poslovi, usluge koje pružaju lica ili organizacije u pomoći u radu ili upravljanju preduzećima i u vodenju poslova preduzeća, usluge koje pružaju preduzeća koja se bave oglašavanjem (reklamiranjem), tako što, za račun drugih lica, komuniciraju sa javnošću (reklama) putem prenosa bilo kakvih informacija o proizvodima i uslugama omogućavajući potrošačima prigodan pogled na te proizvode i usluge, usluge koje se sastoje od upisivanja, uređivanja, obrade, prerade ili sistematizacije pisanih informacija i zapisa, usluge reklamnih agencija, distribuciju prospekata i uzoraka direktno ili poštom, izradu i korišćenje matematičkih i statističkih podataka, organizovanje sajмова i izložbi u komercijalne ili reklamne svrhe.

(111) 08630

(151) 31.10.2013.

(210) **2011-59**(442) **20.03.2013.**

(220) 04.02.2011.

(732) **INDUSTRIJA PIVA I SOKOVA TREBJESA AD. NIKŠIĆ**, NJEGOŠEVA 18, NIKŠIĆ ME

(540)

(550) I

(740) Božović Vesko, Rimski trg 50/11, Podgorica ME

(511) **Klasa 32:** pivo, mineralne i sodne vode i druga bezalkoholna pića, pića od voća i voćni sokovi, sirupi i drugi preparati za proizvodnju pića.

**Klasa 35:** oglašavanje, vodenje poslova, poslovno upravljanje, kancelarijski poslovi, usluge koje pružaju lica ili organizacije u pomoći u radu ili upravljanju preduzećima i u vodenju poslova preduzeća, usluge koje pružaju preduzeća koja se bave oglašavanjem (reklamiranjem), tako što, za račun drugih lica, komuniciraju sa javnošću (reklama) putem prenosa bilo kakvih informacija o proizvodima i uslugama omogućavajući potrošačima prigodan pogled na te proizvode i usluge, usluge koje se sastoje od upisivanja, uredivanja, obrade, prerade ili sistematizacije pisanih informacija i zapisa, usluge reklamnih agencija, distribuciju prospekata i uzoraka direktno ili poštom, izradu i korišćenje matematičkih i statističkih podataka, organizovanje sajmova i izložbi u komercijalne ili reklamne svrhe.

(111) 08631

(151) 31.10.2013.

(210) **2011-60**(442) **20.03.2013.**

(220) 04.02.2011.

(732) **INDUSTRIJA PIVA I SOKOVA TREBJESA AD NIKŠIĆ**, NJEGOŠEVA 18, NIKŠIĆ ME

(540)

(550) I

(740) Božović Vesko, Rimski trg 50/11, Podgorica ME

(511) **Klasa 32:** pivo, mineralne i sodne vode i druga bezalkoholna pića, pića od voća i voćni sokovi, sirupi i drugi preparati za proizvodnju pića.

**Klasa 35:** oglašavanje, vodenje poslova, poslovno upravljanje, kancelarijski poslovi, usluge koje pružaju lica ili organizacije u pomoći u radu ili upravljanju preduzećima i u vodenju poslova preduzeća, usluge koje pružaju preduzeća koja se bave oglašavanjem (reklamiranjem), tako što, za račun drugih lica, komuniciraju sa javnošću (reklama) putem prenosa bilo kakvih informacija o proizvodima i uslugama omogućavajući potrošačima prigodan pogled na te proizvode i usluge, usluge koje se sastoje od upisivanja, uredivanja, obrade, prerade ili sistematizacije pisanih informacija i zapisa, usluge reklamnih agencija, distribuciju prospekata i uzoraka direktno ili poštom, izradu i korišćenje matematičkih i statističkih podataka, organizovanje sajmova i izložbi u komercijalne ili reklamne svrhe.

(111) 08632

(151) 31.10.2013.

(210) **2011-61**(442) **20.03.2013.**

(220) 04.02.2011.

(732) **INDUSTRIJA PIVA I SOKOVA TREBJESA AD NIKŠIĆ**, NJEGOŠEVA 18, NIKŠIĆ ME

**Uvijek među prijateljima**

(540)

(550) I

(740) Božović Vesko, Rimski trg 50/11, Podgorica ME

(511) **Klasa 32:** pivo, mineralne i sodne vode i druga bezalkoholna pića, pića od voća i voćni sokovi, sirupi i drugi preparati za proizvodnju pića.**Klasa 35:** oglašavanje, vodenje poslova, poslovno upravljanje, kancelarijski poslovi, usluge koje pružaju lica ili organizacije u pomoći u radu ili upravljanju preduzećima i u vodenju poslova preduzeća, usluge koje pružaju preuzeća koja se bave oglašavanjem (reklamiranjem), tako što, za račun drugih lica, komuniciraju sa javnošću (reklama) putem prenosa bilo kakvih informacija o proizvodima i uslugama omogućavajući potrošačima prigodan pogled na te proizvode i usluge, usluge koje se sastoje od upisivanja, uređivanja, obrade, prerade ili sistematizacije pisanih informacija i zapisa, usluge reklamnih agencija, distribuciju prospekata i uzoraka direktno ili poštom, izradu i korišćenje matematičkih i statističkih podataka, organizovanje sajmova i izložbi u komercijalne ili reklamne svrhe.

(111) 08633

(151) 31.10.2013.

(210) **2011-62**(442) **20.03.2013.**

(220) 04.02.2011.

(732) **INDUSTRIJA PIVA I SOKOVA TREBJESA AD NIKŠIĆ**, NJEGOŠEVA 18, NIKŠIĆ ME**Zajedno možemo mnogo**

(540)

(550) I

(740) Božović Vesko, Rimski trg 50/11, Podgorica ME

(511) **Klasa 32:** pivo, mineralne i sodne vode i druga bezalkoholna pića, pića od voća i voćni sokovi, sirupi i drugi preparati za proizvodnju pića**Klasa 35:** oglašavanje, vodenje poslova, poslovno upravljanje, kancelarijski poslovi, usluge koje pružaju lica ili organizacije u pomoći u radu ili upravljanju preduzećima i u vodenju poslova preduzeća, usluge koje pružaju preuzeća koja se bave oglašavanjem (reklamiranjem), tako što, za račun drugih lica, komuniciraju sa javnošću (reklama) putem prenosa bilo kakvih informacija o proizvodima i uslugama omogućavajući potrošačima prigodan pogled na te proizvode i usluge, usluge koje se sastoje od upisivanja, uređivanja, obrade, prerade ili sistematizacije pisanih informacija i zapisa, usluge reklamnih agencija, distribuciju prospekata i uzoraka direktno ili poštom, izradu i korišćenje matematičkih i statističkih podataka, organizovanje sajmova i izložbi u komercijalne ili reklamne svrhe.

(111) 08634

(151) 31.10.2013.

(210) **2011-73**(442) **20.03.2013.**

(220) 14.02.2011.

(732) **INDUSTRIJA PIVA I SOKOVA TREBJESA AD NIKŠIĆ**, NJEGOŠEVA 18, NIKŠIĆ ME



(540)

(550) I

(740) Božović Vesko, Rimski trg 50/11, Podgorica ME

(511) **Klasa 32:** pivo, mineralne i sodne vode i druga bezalkoholna pića, pića od voća i voćni sokovi, sirupi i drugi preparati za proizvodnju pića

**Klasa 35:** oglašavanje, vodenje poslova, poslovno upravljanje, kancelarijski poslovi, usluge koje pružaju lica ili organizacije u pomoći u radu ili upravljanju preduzećima i u vodenju poslova preduzeća, usluge koje pružaju preuzeća koja se bave oglašavanjem (reklamiranjem), tako što, za račun drugih lica, komuniciraju sa javnošću (reklama) putem prenosa bilo kakvih informacija o proizvodima i uslugama omogućavajući potrošačima prigodan pogled na te proizvode i usluge, usluge koje se sastoje od upisivanja, uredivanja, obrade, prerade ili sistematizacije pisanih informacija i zapisa, usluge reklamnih agencija, distribuciju prospekata i uzoraka direktno ili poštom, izradu i korišćenje matematičkih i statističkih podataka, organizovanje sajmova i izložbi u komercijalne ili reklamne svrhe.

(111) 08635

(151) 31.10.2013.

(210) **2011-75**(442) **20.03.2013.**

(220) 14.02.2011.

(732) **KAANE AMERICAN INTERNATIONAL TOBACCO CO. LTD**, PO BOX NO.61021, JEBEL ALI FREE ZONE, DUBAI AE

(540)

(550) I

(740) Čejović Vladimir, 13. jula 21, Podgorica ME

(511) **Klasa 34:** Cigarete, duvan i artikli za pušače.

(111) 08636

(151) 31.10.2013.



(210) **2011-76**(442) **20.03.2013.**

(220) 14.02.2011.

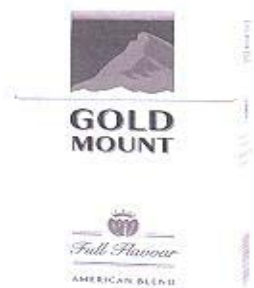
(732) **KAANE AMERICAN INTERNATIONAL TOBACCO CO. LTD.**, PO BOX NO.61021,  
JEBEL ALI FREE ZONE, DUBAI AE

(540)

(550) I

(740) Čejović Vladimir, 13. jula 21, Podgorica ME

(511) **Klasa 34:** Cigarete, duvan i artikli za pušače

(111) 08637

(151) 31.10.2013.

(210) **2011-82**(442) **20.03.2013.**

(220) 18.02.2011.

(732) **CHRYSLER GROUP LLC**, 100 CHRYSLER DRIVE, AUBURN HILLS, MICHIGAN 48326 US

## WAGONEER

(540)

(550) I

(740) Radulović Božidar, Jovana Tomaševića 9/III, Podgorica ME

(511) **Klasa 12:** Motorna vozila i djelovi za njih.

(111) 08638

(151) 31.10.2013.

(210) **2011-83**(442) **20.03.2013.**

(220) 21.02.2011.

(732) **CELGENE CORPORATION**, 86 MORRIS AVENUE, SUMMIT, 07901 NEW JERSEY US

## РЕВЛИМИД

(540)

(550) I

(740) Čejović Vladimir, 13. jula 21, Podgorica ME

(511) **Klasa 05:** Farmaceutski preparati, naime, citokinski inhibitori lijekova, farmaceutski preparati koji prilagođavaju imuni sistem, farmaceutski preparati za liječenje određenih vrsta raka.

(111) 08639

(151) 31.10.2013.

(210) **2011-84**(442) **20.03.2013.**

(220) 21.02.2011.

(732) **KABUSHIKI KAISHA TOSHIBA (TOSHIBA CORPORATION)**, 1-1, SHIBAURA 1-CHOME, MINATO-KU TOKYO JP**TOSHIBA**

(540)

(550) I

(740) Radulović Božidar, Jovana Tomaševića 9/III, Podgorica ME

(511) **Klasa 09:** Mašine za elektrolučno zavarivanje, mašine za sečenje metala (električnim lukom, gasom ili plazmom), mašine za lasersko zavarivanje, aparati za električno zavarivanje, ozonizatori, elektrolizeri (elektrolitičke ćelije), aparati za elektronsku kontrolu motora (za automobile), registar kase, mašine za brojanje ili sortiranje kovanog novca i žetona, ATM mašine, mašine za glasanje, mašine za naplaćivanje, mašine koje se pokreću novcem ili žetonom, oprema stanice za punjenje baterija, oprema za benzinske stanice, protivpožarni alarmi, protivgasni alarmi, DNK čipovi, aparati za testiranje DNK, drugi laboratorijski aparati i instrumenti, fokusirajuća ogledala, blicevi za fotografske svrhe, blic lampe za fotografske svrhe, kamere i fotografski aparati, druge fotografske mašine i aparati, kinematografske mašine i aparati, uveličavajuća stakla, drugi optički aparati i instrumenti, oprema za telemetriju, aparati za merenje kvaliteta vode, biohemijski analizatori, elektronske vage za merenje, oprema za testiranje za poluprovodnike, merači debljine na bazi X ili Gama zračenja, merači nivoa na bazi Gama zračenja, elektromagnetski merači protoka, pametni merači, merači struje, druge mašine i aparati za merenje i testiranje, punjači za električne baterije, utičnice, šukoi, utikači, transformatori, invertori, regulatori indukovanog napona, kondenzatori, automatski prekidači, prekidači, komutacioni sto, prekidači za svetlo, električni releji, konvertori, konektori, ispravljajući, osigurači, otpornici, statički kondenzatori, prekidači struje curenja, kutije sa prekidačima, limiteri, vakumski automatski prekidači, drugi uređaji i mašine za distribuciju ili kontrolu energije, rotacioni konvertori, modifikatori faza, fotonaponski paneli, kondicioneri snage, fotonaponski generatori energije i njihovi delovi, „suve“ baterije, akumulatori, fotonaponske ćelije, punjive baterije, solarne ćelije, gorivne ćelije, litijum-jonske baterije, druge baterije i ćelije, električna brojila, detektori struje curenja, osciloskopi, drugi električni ili magnetni merači i testeri, električne žice i kablovi, električne pegle, električni vikleri, električna zvona, telefonski setovi, mobilni telefoni, punjači za baterije za mobilne telefone, oprema za video-telefone, telefonske centrale, interfoni, primopredajnici, AC adapted, televizijski prijemnici (TV), televizijski odašiljači, televizijske kamere, CCTV (televizija zatvorenog kruga) kamere, CCTV (televizija zatvorenog kruga) monitori, druga televizijska oprema za CCTV, radio prijemnici sa satovima, radio uređaji za kola, drugi radio prijemnici, radio predajnici, mašine i aparati za emitovanje, radio komunikacione mašine i aparati, radio uređaji i mašine, faksimil mašine i njihovi delovi i oprema, kasetofoni, radio kasetofoni, tjuneri, gramofoni, mašine i aparati za snimanje zvuka, digitalni audio plejeri, CD plejeri, CD plejeri kombinovani sa kasetofonima, zvučnici, DVD plejeri, DVD rekorderi, DVD drajvovi, video kamere, video rekorderi, video disk plejeri, digitalni video disk rekorderi, digitalni foto ramovi, kamere za nadzor, digitalne kamere, digitalne video kamere, magnetne trake za rekordere, magnetne trake za video rekordere, video diskovi za video disk plejere, igle za gramofone, kertridži za gramofone, uređaji i jedinice za smanjenje brujanja za audio opremu, audio pojačivači, mikrofoni, slušalice, ekvilajzeri, antene, sistemi i instrumenti za javno obraćanje, drugi delovi i oprema za električne komunikacione mašine i aparate, druge električne komunikacione mašine i aparati, mašine sa elektrostatičkim postupkom

kopiranja, skeneri slika, vise namenski periferni uredaji koji imaju funkcije mašine za kopiranje, štampača, skenera i faksimil mašina, personalni računari, kompjuteri, USB memorije, štampači za upotrebu sa kompjuterima, aparati sa magnetnim trakama i disk sistemima za upotrebu sa kompjuterima, čitači kartica za upotrebu sa kompjuterima, displeji za kompjutere, displej monitori za kompjutere, tastature za kompjutere, miševi za kompjutere, procesori reči, čitači i/ili snimači memorijskih kartica sa integrisanim kolom, pametni telefoni, lični digitalni pomoćnici koji imaju funkcije internet konekcije, slanja i primanja elektronske pošte, videa i podataka, lični digitalni pomoćnici, štampači za digitalne kamere, hard disk drajvovi, delovi i oprema za elektrostatičke mašine za kopiranje i štampače, kompjuterski server, mašine i uredaji za POS sisteme (sistemi na mestu prodaje), njihovi delovi i pomoćna oprema, barkod čitači, barkod štampači, uređaji za zapisivanje i/ili čitanje Radio-Frekventne identifikacije (RFID), kiosk terminali, digitalni informativno-oglasni displeji, nedestruktivni uredaji za testiranje na bazi X zračenja, nedestruktivni ultrazvučni uređaji za testiranje, električni i/ili elektronski uredaji za velike displeje, rendgenske cevi, pojačivači rendgenske slike, elektronske cevi, detektori zračenja, druge elektronske cevi, poluprovodnici, integrisana kola, ploče sa štampanim kolima, SSD drajv, memorijske kartice sa integrisanim kolima, druga elektronska kola, kompjuterski programi snimljeni na trake, kompjuterski programi snimljeni na diskove, kompjuterski programi za medicinske dijagnostičke aparati i aparate za terapiju, kompjuterski hardver i kompjuterski programi za upravljanje informacijama u bolnici, kompjuterski hardver i kompjuterski programi za upravljanje elektronskim medicinskim slikama (Sistem za arhiviranje slika i komunikaciju [PACS]), kompjuterski programi, drugi kompjuterski programi i kompjuterski softver, LED displeji, displeji sa tečnim kristalom, LCD projektori, druge elektronske mašine, aparati i njihovi delovi, komunikacioni sateliti, drugi objekti koji se mogu lansirati, naočare (obične ili zaštitne), video igre, ručni uređaji za igranje igrica, elektronska kola i CD-ROM-ovi sa nasnimljenim programima za igrice koje se igraju iz ruke sa displejima sa tečnim kristalom, elektronska kola i CD-ROM-ovi sa nasnimljenim programima za automatsko izvođenje za elektronske muzičke instrumente, nasnimljeni video diskovi i video trake, elektronske publikacije, BD (blu-rej disk) plejeri, BD (blu-rej disk) rekorderi.

(111) 08640

(151) 31.10.2013.

(210) **2011-85**(442) **20.03.2013.**

(220) 22.02.2011.

(732) **CELGENE CORPORATION**, 86 MORRIS AVENUE, SUMMIT, 07901 NEW JERSEY US

## ИСТОДАКС

(540)

(550) I

(740) Čejović Vladimir, 13. jula 21, Podgorica ME

(511) **Klasa 05:** Farmaceutski preparati kao lijek protiv raka za ljudsku upotrebu.

(111) 08641

(151) 31.10.2013.

(210) **2011-88**(442) **20.03.2013.**

(220) 24.02.2011.

(732) **NETFLIX, INC** A CORPORATION OF DELAWARE, 100 WINCHESTER CIRCLE, LOS GATOS, CALIFORNIA 95032 US

## NETFLIX

(540)

(550) I

(740) Čejović Vladimir, 13. jula 21, Podgorica ME

(511) **Klasa 09:** aparati i instrumenti naučni, pomorski, geodetski, fotografski, kinemato-grafski, optički, za vaganje, mjerenje, signalizaciju, kontrolu (inspekciju), spašavanje i nastavu, aparati i instrumenti za provođenje, prekid, transformaciju, akumulaciju, regulisanje i kontrolu elektriciteta, aparati za snimanje, prenos i reprodukovanje zvuka ili slike, magnetni nosioci podataka, diskovi za snimanje, automatske mašine i mehanizmi za aparate koji se pokreću novcem ili žetonom, register kase, računске mašine, oprema za obradu podataka i kompjuteri, aparati za gašenje požara, kompjuterski hardver, firmver i softver, kompjuterski hardver, firmver, softver, aparati, instrumenti i materijali za snimanje, prenos i prijem audio, video i audio-vizuelnog sadržaja, kompjuterski hardver, firmver i softver za elektronske i uređaje za emitovanje, elektronski uređaji, uređaji za emitovanje, daljinski upravljači, audio, video i audio-vizuelni snimci i sadržaj omogućen preuzimanjem ili emitovanjem sa kompjutera i komunikacionih mreža, uključujući i internet.

**Klasa 35:** Oglašavanje, vođenje poslova, poslovno upravljanje, kancelarijski poslovi, usluge maloprodajnih radnji i kompjuterizovane on-lajn maloprodajne usluge opremljene unaprijed snimljenim video i audio zapisima, video i audio-vizuelnim snimcima i sadržajem.

**Klasa 38:** Komunikacione usluge, telekomunikacione usluge, usluge pristupa telekomunikacijama, usluge emitovanja putem kompjutera, interneta i drugih komunikacionih mreža, uključujući audio, video i audio-vizuelni sadržaj, usluge prenosa videa na zahtjev, video emitovanje, prenos glasa, podataka, slika, signala, poruka i informacija, komunikacija putem kompjutera, telekomunikacione veze sa elektronskim komunikacionim mrežama, usluge emitovanja, pružanje on-lajn oglasnih tabli za prenos poruka.

**Klasa 41:** Obrazovne usluge, pripremanje obuke, razonoda, sportske i kulturne aktivnosti, pružanje on-lajn obrazovnih i usluga zabave, iznajmljivanje video snimaka, unaprijed snimljenih video kaset, digitalnih video diskova, multimedijalnih snimaka, iznajmljivanje video snimaka, unaprijed snimljenih video kaset, digitalnih video diskova putem komunikacionih mreža, pružanje informacija, pregleda i ličnih preporuka u oblasti zabave, pružanje informacija, pregleda i ličnih preporuka u oblasti zabave putem komunikacionih mreža.

(111) 08642

(151) 31.10.2013.

(210) **2011-95**(442) **20.03.2013.**

(220) 25.02.2011.

(732) **CEMEX S.A.B.DE C.V.**, AVDA. CONSTITUCION 444 PTE., COL. CENTRO, 64000 MONTERREY, NUEVO LEON MX



(540)

(550) I

(740) Čejović Vladimir, 13. jula 21, Podgorica ME

(511) **Klasa 19:** nemetalni građevinski materijali kao što su cement, beton, malter, kamen, kreč, gips, šljunak, podovi, pečene i nepečene cigle, pločice, mozaik, nemetalne čvrste cijevi za građu, asfalt, smola, katran, ne metalna prenosiva građa kao što su moduli, paneli, una-

prijed izliveni stubovi i nemetalni spomenici/strukture.

- 
- (111) 08643 (151) 31.10.2013.  
 (210) **2011-102** (442) **20.03.2013.**  
 (220) 02.03.2011.  
 (300) 30 2011 000 703.9/09 25.01.2011. DE  
 (732) **ORACLE INTERNATIONAL CORPORATION**, 500 ORACLE PARKWAY REDWOOD SHORES, CALIFORNIA 94065 US

## SUPERCLUSTER

- (540)  
 (550) I  
 (740) Radulović Božidar, Jovana Tomaševića 9/III, Podgorica ME  
 (511) **Klasa 09:** Kompjuterski hardver i kompjuterski softver.

- 
- (111) 08644 (151) 31.10.2013.  
 (210) **2011-103** (442) **20.03.2013.**  
 (220) 03.03.2011.  
 (732) **CORDIS CORPORATION**, 430 ROUTE 22 BRIDGEWATER, NEW JERESEY 08807 US

## POWERFLEX

- (540)  
 (550) I  
 (740) Radulović Božidar, Jovana Tomaševića 9/III, Podgorica ME  
 (511) **Klasa 10:** Balon kateteri za angioplastiku.

- 
- (111) 08645 (151) 01.11.2013  
 (210) **2011-106** (442) **20.03.2013.**  
 (220) 03.03.2011.  
 (732) **NINE WEST DEVELOPMENT CORPORATION**, 1007 ORANGE STREET, SUITE 225, WILMINGTON, DELAWARE 19801 US

## LOVE FURY

- (540)  
 (550) I  
 (740) Čejović Vladimir, 13. jula 21, Podgorica ME  
 (511) **Klasa 03:** Parfemi, toaletne vode, mirisni sprejevi, sapuni, sredstva za čišćenje kože, losioni i kreme za kožu, hidrantne kreme, losioni i ulja za zatampljivanje kože, kozmetički proizvodi, naime, puderi za lice i tijelo, podloga, sjaj za tijelo, sjaj za lice, karmin, olovke za usne, rumenilo, sjenka za oči, krema za oči, ajlajner, maskara i olovke za obrve, gel za tuširanje, soli za kupanje, proizvodi za njegu kose, naime šampon i balsam, potpuri.

- 
- (111) 08646 (151) 01.11.2013.  
 (210) **2011-107** (442) **20.03.2013.**  
 (220) 07.03.2011.

(732) **JADRAN GALENSKI LABORATORIJ DD**, PULAC BB, RIJEKA HR

**KAO KAP VODE NA DLANU**

(540)

(550) I

(740) Popović Miladin, Đoka Miraševića 21/III, Podgorica ME

(511) **Klasa 01:** Hemijski proizvodi koji se upotrebljavaju u industriji, nauci, fotografiji, poljoprivredi, hortikulturi, šumarstvu, neprerađene vještačke smole, neprerađene plastične materije, đubriva, hemijske supstance za očuvanje namirnica, lepljive supstance koje se upotrebljavaju u industriji.

**Klasa 03:** Sredstva za beljenje i druge supstance za upotrebu u perionicama, preparati za čišćenje, poliranje, ribanje i nagrizanje, sapuni, parfimerija, eterična ulja, ulje za kozmetičke potrebe, ulje za parfimeriju, ulje za čišćenje, kozmetički proizvodi, kozmetički preparati za sunčanje, kozmetički proizvodi za negu kože, kozmetički preparati za kupanje, kozmetički proizvodi za mršavljenje, kreme za kozmetičke potrebe, toaletni proizvodi, losioni, losioni za kosu, šamponi, proizvodi za negu zuba, negu usta.

**Klasa 05:** Lekovi za humanu medicinu, medicinski proizvodi, farmaceutski i veterinarski proizvodi, hemijsko-farmaceutski proizvodi, hemijski reagensi za medicinske potrebe, kreme za medicinske potrebe, higijenski proizvodi za upotrebu u medicini, dijetetski proizvodi, dijetetske supstance za medicinske potrebe, biološki preparati za medicinske potrebe, lekoviti čajevi, masti za farmaceutske potrebe, masti za medicinske potrebe, medicinski čaj, medicinski napici, sirup za farmaceutske potrebe, vitaminski preparati, hrana za bebe, flasteri, materijali za zavijanje, materijali za plombiranje zuba, zubarska smola, losioni za farmaceutsku upotrebu, dezinfekciona sredstva, proizvodi za uništavanje životinjskih štetočina, fungicidi, herbicidi.

**Klasa 10:** Hirurški, medicinski, zubarski i veterinarski aparati, instrumenti i pomagala, ortopedski artikli, materijali za zašivanje.

**Klasa 30:** Kafa, čaj, kakao, šećer, pirinač, brašno i proizvodi od žitarica, pića, pastile (poslastice), hleb, kolači, poslastice, bombone, sladoled, med, melasa, alge, kvasac, prašak za pecivo, so, senf, sirće, sosovi (kao dodaci), mirođija, led za hlađenje.

**Klasa 35:** Oglašavanje i reklamiranje, vođenje komercijalnih poslova, komercijalna administracija, kancelarijski poslovi.

**Klasa 42:** Naučne usluge, usluge analiza (hemijske analize), bakteriološka istraživanja, biološka istraživanja, istraživanja u kozmetici, istraživanje i razvoj novih proizvoda, istraživanja u hemiji, kozmetička nauka (istraživanja u kozmetičkoj nauci).

**Klasa 44:** Medicinske usluge, higijenska nega i nega lepote za ljude, aromaterapija, estetska hirurgija, bolničke usluge, usluge farmaceuta, savetovanje o farmaciji, fizioterapija, klinike, kupke, usluge ulepšavanja, masaža, medicinska pomoć, oporavak, usluge sauna, usluge solarijuma, usluge banja, zdravstvene usluge.

(111) 08647

(151) 01.11.2013.

(210) **2011-108**

(442) **20.03.2013.**

(220) 07.03.2011.

(732) **JADRAN GALENSKI LABORATORIJ DD**, PULAC BB, RIJEKA HR



(540)

(550) I

(740) Popović Miladin, Đoka Miraševića 21/III, Podgorica ME

(511) **Klasa 01:** Hemijski proizvodi koji se upotrebljavaju u industriji, nauci, fotografiji, poljoprivredi, hortikulturi, šumarstvu, neprerađene vještačke smole, neprerađene plastične materije, đubriva, hemijske supstance za očuvanje namirnica, lepljive supstance koje se upotrebljavaju u industriji.

**Klasa 03:** Sredstva za beljenje i druge supstance za upotrebu u perionicama, preparati za čišćenje, poliranje, ribanje i nagrizanje, sapuni, parfimerija, eterična ulja, ulje za kozmetičke potrebe, ulje za parfimeriju, ulje za čišćenje, kozmetički proizvodi, kozmetički preparati za sunčanje, kozmetički proizvodi za negu kože, kozmetički preparati za kupanje, kozmetički proizvodi za mršavljenje, kreme za kozmetičke potrebe, toaletni proizvodi, losioni, losioni za kosu, šamponi, proizvodi za negu zuba, negu usta.

**Klasa 05:** Lekovi za humanu medicinu, medicinski proizvodi, farmaceutski i veterinarski proizvodi, hemijsko-farmaceutski proizvodi, hemijski reagensi za medicinske potrebe, kreme za medicinske potrebe, higijenski proizvodi za upotrebu u medicini, dijetetski proizvodi, dijetetske supstance za medicinske potrebe, biološki preparati za medicinske potrebe, lekoviti čajevi, masti za farmaceutske potrebe, masti za medicinske potrebe, medicinski čaj, medicinski napici, sirup za farmaceutske potrebe, vitaminski preparati, hrana za bebe, flasteri, materijali za zavijanje, materijali za plombiranje zuba, zubarska smola, losioni za farmaceutsku upotrebu, dezinfekciona sredstva, proizvodi za uništavanje životinjskih štetočina, fungicidi, herbicidi.

**Klasa 10:** Hirurški, medicinski, zubarski i veterinarski aparati, instrumenti i pomagala, ortopedski artikli, materijali za zašivanje.

**Klasa 30:** Kafa, čaj, kakao, šećer, pirinač, brašno i proizvodi od žitarica, pića, pastile (poslastice), hleb, kolači, poslastice, bombone, sladoled, med, melasa, alge, kvasac, prašak za pecivo, so, senf, sirće, sosovi (kao dodaci), mirođija, led za hlađenje.

**Klasa 35:** Oglašavanje i reklamiranje, vođenje komercijalnih poslova, komercijalna administracija, kancelarijski poslovi.

**Klasa 42:** Naučne usluge, usluge analiza (hemijske analize), bakteriološka istraživanja, biološka istraživanja, istraživanja u kozmetici, istraživanje i razvoj novih proizvoda, istraživanja u hemiji, kozmetička nauka (istraživanja u kozmetičkoj nauci).

**Klasa 44:** Medicinske usluge, higijenska nega i nega lepote za ljude, aromaterapija, estetska hirurgija, bolničke usluge, usluge farmaceuta, savetovanje o farmaciji, fizioterapija, klinike, kupke, usluge ulepšavanja, masaža, medicinska pomoć, oporavak, usluge sauna, usluge solarijuma, usluge banja, zdravstvene usluge.

(111) 08648

(151) 01.11.2013.

(210) **2011-109**

(442) **20.03.2013.**

(220) 07.03.2011.

(732) **JADRAN GALENISKI LABORATORIJ DD**, PULAC BB, RIJEKA HR



(540)

(550) I

(740) Popović Miladin, Đoka Miraševića 21/III, Podgorica ME

(511) **Klasa 01:** Hemijski proizvodi koji se upotrebljavaju u industriji, nauci, fotografiji, poljoprivredi, hortikulturi, šumarstvu, neprerađene vještačke smole, neprerađene plastične materije, đubriva, hemijske supstance za očuvanje namirnica, lepljive supstance koje se upotrebljavaju u industriji.

**Klasa 03:** Sredstva za beljenje i druge supstance za upotrebu u perionicama, preparati za čišćenje, poliranje, ribanje i nagrizanje, sapuni, parfimerija, eterična ulja, ulje za kozmetičke potrebe, ulje za parfimeriju, ulje za čišćenje, kozmetički proizvodi, kozmetički preparati za sunčanje, kozmetički proizvodi za negu kože, kozmetički preparati za kupanje, kozmetički proizvodi za mršavljenje, kreme za kozmetičke potrebe, toaletni proizvodi, losioni, losioni za kosu, šamponi, proizvodi za negu zuba, negu usta.

**Klasa 05:** Lekovi za humanu medicinu, medicinski proizvodi, farmaceutski i veterinarski proizvodi, hemijsko-farmaceutski proizvodi, hemijski reagensi za medicinske potrebe, kreme za medicinske potrebe, higijenski proizvodi za upotrebu u medicini, dijetetski proizvodi, dijetetske supstance za medicinske potrebe, biološki preparati za medicinske potrebe, lekoviti čajevi, masti za farmaceutske potrebe, masti za medicinske potrebe, medicinski čaj, medicinski napici, sirup za farmaceutske potrebe, vitaminski preparati, hrana za bebe, flasteri, materijali za zavijanje, materijali za plombiranje zuba, zubarska smola, losioni za farmaceutsku upotrebu, dezinfekciona sredstva, proizvodi za uništavanje životinjskih štetočina, fungicidi, herbicidi.

**Klasa 10:** Hirurški, medicinski, zubarski i veterinarski aparati, instrumenti i pomagala, ortopedski artikli, materijali za zašivanje.

**Klasa 30:** Kafa, čaj, kakao, šećer, pirinač, brašno i proizvodi od žitarica, pića, pastile (poslastice), hleb, kolači, poslastice, bombone, sladoled, med, melasa, alge, kvasac, prašak za pecivo, so, senf, sirće, sosovi (kao dodaci), mirođija, led za hlađenje.

**Klasa 35:** Oglašavanje i reklamiranje, vođenje komercijalnih poslova, komercijalna administracija, kancelarijski poslovi.

**Klasa 42:** Naučne usluge, usluge analiza (hemijske analize), bakteriološka istraživanja, biološka istraživanja, istraživanja u kozmetici, istraživanje i razvoj novih proizvoda, istraživanja u hemiji, kozmetička nauka (istraživanja u kozmetičkoj nauci).

**Klasa 44:** Medicinske usluge, higijenska nega i nega lepote za ljude, aromaterapija, estetska hirurgija, bolničke usluge, usluge farmaceuta, savetovanje o farmaciji, fizioterapija, klinike, kupke, usluge ulepšavanja, masaža, medicinska pomoć, oporavak, usluge sauna, usluge solarijuma, usluge banja, zdravstvene usluge.

(111) 08649

(151) 01.11.2013.

(210) **2011-113**

(442) **20.03.2013.**

(220) 09.03.2011.



(732) **BOSNALIJEK**, JUKIĆEVA 53, SARAJEVO BA

## MELPAMID

(540)

(550) I

(740) Radulović Božidar, Jovana Tomaševića 9/III, Podgorica ME

(511) **Klasa 05:** Farmaceutski proizvodi.

(111) 08650

(151) 01.11.2013.

(210) **2011-114**

(442) **20.03.2013.**

(220) 09.03.2011.

(732) **BOSNALIJEK**, FARMACEUTSKA I HEMIJSKA INDUSTRIJA, DD, JUKIĆEVA 53, SARAJEVO BA

## FLEXOFEN

(540)

(550) I

(740) Radulović Božidar, Jovana Tomaševića 9/III, Podgorica ME

(511) **Klasa 05:** Farmaceutski proizvodi.

(111) 08657

(151) 01.11.2013.

(210) **2009-486**

(442) **20.06.2013**

(220) 04.08.2009

(732) **DELTA PRONATURA DR KRASSUS DR.BECKMANN KG**, KURT-SCHUMACHER-RING 15 17, 63329 EGLSBACH DE



(540)

(550) I

(740) Dedić Tomislav, Bulevar Ivana Crnojevića 139 Podgorica ME

(511) **Klasa 01:** Hemijski proizvodi za zanatske svrhe, uključujući dodatne materije sredstvima za pranje i čišćenje, sredstva za čišćenje u oblasti zanatstva i industrije.

**Klasa 03:** Sredstva za pranje i beljenje, sredstva za čišćenje, poliranje, ribanje, odmaščivanje i brušenje, sapuni, sredstva za čišćenje (ukoliko su obuhvaćena klasom 03), posebno sredstva za uklanjanje mrlja, jaka sredstva za uklanjanje nečistoće i masnoće, višenamenska sredstva za čišćenje, sredstva za uklanjanje naslaga kamenca, sapuna, rđe, prljavštine, boje i ostalih naslaga odnosno ostataka, deterdženti.

**Klasa 05:** Sredstva za dezinfekciju, sredstva za čišćenje (ukoliko su obuhvaćena klasom 05)

(111) 08670

(151) 04.11.2013.

(210) **2010-141**

(442) **20.10.2012**

(220) 28.04.2010.

(732) **CRNOGORSKI TELEKOM**, MOSKOVSKA 29. PODGORICA ME

(540)

(550) I

(511) **Klasa 09:** Aparati i instrumenti naučni, pomorski, geodetski, fotografski kinematografski, optički, za vaganje, mjerenje, signalizaciju, kontrolu (inspekciju), spašavanje i nastavu, Aparati i instrumenti za provodjenje, prekid, transformaciju, akumulaciju, regulisanje ili kontrolu električne energije, aparati za snimanje, prenos i reprodukovanje zvuka ili slike, magnetni nosioci podataka, diskovi za snimanje, automatske mašine i mehanizmi koji se pokreću novcem ili žetonom, registar kase, računске mašine, oprema za obradu podataka i kompjuteri, aparati za gašenje požara

**Klasa 16:** Štampane stvari, fotografije, kancelarijski rekviziti (izuzev namještaja), materijali za obuku i nastavu (izuzev aparata)

**Klasa 35:** Oglašavanje, poslovno upravljanje, sistematizacija informacija u kompjuterske baze podataka, usluge prodaje (takodje preko Interneta i ostalih sredstava komunikacije)

**Klasa 36:** Osiguranje, finansijski poslovi, novčani poslovi, poslovi vezani za nepokretnosti

**Klasa 37:** Gradjevinsko konstruisanje, usluge instalacije, popravljanje i održavanje kompjutera i telekomunikacionih hardvera

**Klasa 38:** Telekomunikacije informacije o telekomunikacijama, usluge koje omogućavaju najmanje jednom licu da komunicira sa drugim koristeći čula i to, 1) dozvoljavanje jednom licu da komunicira sa drugim, 2) prenos poruka od jedne osobe do druge, 3) stavljanje lica u položaj vizuelne ili govorne komunikacije sa drugim (radio i televizija), komunikacija mobilnim telefonom, usluge koje sadrže difuziju radio ili televizijskih programa, emitovanje putem kablovske televizije, usluge prenosa podataka, slanje poruka, usluge telekonferencije, usluge govorne pošte, slanje poruka i slika uz pomoć kompjutera, komunikacija preko optičke mreže, elektronska pošta, pristup globalnoj kompjuterskoj mreži, izdavanje i održavanje telekomunikacione opreme, izdavanje modema, izdavanje telefona

**Klasa 41:** Obrazovne usluge, pripremanje obuke, razonoda, sportske i kulturne aktivnosti.

**Klasa 42:** Naučne i tehnološke usluge i istraživanje i projektovanje u vezi navedenih usluga, usluge industrijske analize i istraživanja, razvoj i projektovanje kompjuterskih hardvera i softvera, održavanje kompjuterskog softvera, tehničke konsultacije, dizajn kompjuterskog sistema, analize kompjuterskog sistema, usluge zaštite od kompjuterskog virusa, kreiranje i održavanje web stranica za druge.

(111) 08253

(151) 09.10.2013.

(210) **2011-522**(442) **20.03.2013.**

(220) 26.10.2011.

(732) **JONHSON CONTROLS HYBRID AND RECYCLING GMBH**, AM LEINNEUFER 51

30419, HANOVER DE



(540)

(550) I

(740) Popović Miladin, Đoka Miraševića 21/III, Podgorica ME

(511) **Klasa 09:** Akumulatori svih tipova koji se koriste kod vozila za transport ljudi i robe, uključujući automobile, kamione, čamce i motocikla, i djelovi i oprema za takve akumulatore, uključujući punjače za akumulatore, test aparate za akumulatore, kablove, žice, kućišta, kutije, aparate za praćenje akumulatora, prekidače, daljinske pokretače, zaštitnike za akumulatore, isključivače, konvertore, invertore, konektore, priključke, adaptore, ekstenzije, prstenje, aliator štupaljke, adaptore u vidu utičnica, utičnice za punjače, kablove za prespajanje, utičnice, kućišta za montiranje akumulatora, opremu za montiranje kućišta za akumulatore.

(111) 08252

(151) 10.10.2013.

(210) **2011-521**

(442) **20.03.2013.**

(220) 26.10.2011.

(732) **JONHSON CONTROS HYBRID AND RECYCLING GMBH**, AM LEINNEUFER 51  
30419, HANOVER DE

**VARTA**

(540)

(550) I

(740) Popović Miladin, Đoka Miraševića 21/III, Podgorica ME

(511) **Klasa 09:** Akumulatori svih tipova koji se koriste kod vozila za transport ljudi i robe, uključujući automobile, kamione, čamce i motocikla, i djelovi i oprema za takve akumulatore, uključujući punjače za akumulatore, test aparate za akumulatore, kablove, žice, kućišta, kutije, aparate za praćenje akumulatora, prekidače, daljinske pokretače, zaštitnike za akumulatore, isključivače, konvertore, invertore, konektore, priključke, adaptore, ekstenzije, prstenje, aliator štupaljke, adaptore u vidu utičnica, utičnice za punjače, kablove za prespajanje, utičnice, kućišta za montiranje akumulatora, opremu za montiranje kućišta za akumulatore.

(111) 08255

(151) 09.10.2013.

(210) **2011-579**

(442) **20.03.2013.**

(220) 28.11.2011.

(732) **MARINE STOCK LIMITED**, 1ST FLOOR, COLUMBUS CENTRE BUILDING, P.O. BOX 901.  
ROAD TOWN, TORTUGA VG

**BK**

(540)

(550) I, V

(740) Radulović Božidar, Jovana Tomaševića 9/III, Podgorica ME

(511) **Klasa 25:** Odjeća i obuća.

(111) 08254

(151) 09.10.2013.

(210) **2011-525**

(442) **20.03.2013.**

(220) 31.10.2011.

(732) **JOCKEY INTERNATIONAL INC.** 2300 60TH STREET, KENOSHA, WISCONSIN US

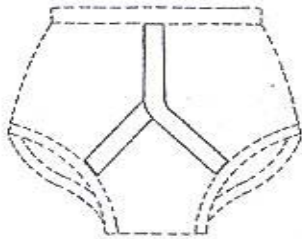

(540)

(550) I

(740) Lutovac Branislav, Bulevar Crnojevića 93, Podgorica ME

(511) **Klasa 25:** Muški veš.

(111) 08251

(151) 09.10.2013.

(210) **2011-510**

(442) **20.03.2013.**

(220) 14.10.2011.

(732) **RUBIN A.D.** NADE MARKOVIĆ 57, KRUŠEVAC RS



(540)

(550) I

(740) Radulović Božidar, Jovana Tomaševića 9/III, Podgorica ME

(511) **Klasa 16:** Hartija, karton i proizvodi od njih, koji nisu uključeni u druge klase, štampane stvari, fotografije, kancelarijski materijal, naročito etikete i naljepnice za proizvode i ambalaža za pakovanje proizvoda, štampani katalozi i marketinški materijal, sve navedeno za alkoholna pića, pivo, mineralne i sodne vode, pića od voća i voćne sokove, sirupe.

**Klasa 32:** Pivo, mineralne i sodne vode i druga bezalkoholna pića, pića od voća i voćni sokovi, sirupi i drugi preparati za proizvodnju pića.

**Klasa 33:** Alkoholna pića (izuzev piva).

(111) 08256

(151) 09.10.2013.

(210) **2011-582**

(442) **20.03.2013.**

(220) 30.11.2011.

(732) **BASF AGRO B.V.ARNHEM** (NL), ZWEIGNIEDERLASSUNG WADENSSWIL MOOSACHER-

STRASSE 2 AU

## ALIOS

(540)

(550) I

(740) Ćupić Branislav, Dalmatinska 10, Podgorica ME

(511) **Klasa 01:** Hemijski proizvodi koji se upotrebljavaju u poljoprivredi, hortikulturi i šumarstvu, naročito preparati za ojačanje biljke, preparati za regulisanje rasta biljaka, hemijski preparati za tretiranje sjemena, surfaktanti, prirodne i vještačke hemikalije za upotrebu kao seksualni mamci ili agensi za zbunjivanje insekata.,

**Klasa 05:** Preparati za uništavanje i borbu protiv štetočina, fungicidi, herbicidi, pesticidi.,

**Klasa 31:** Poljoprivredni, hortikulturni i šumarski proizvodi kao i žitarice i cerealijske koji nisu uključeni u drugim klasama, hrana za životinje.,

(111) 08257

(151) 09.10.2013.

(210) **2011-583**

(442) **20.03.2013.**

(220) 30.11.2011.

(732) **BASF SE, CARL-BOSCH-STRASSE 38 LUDWIGSHAFEN AM RHEIN DE**

## CYCOCEL

(540)

(550) I

(740) Ćupić Branislav, Dalmatinska 10, Podgorica ME

(511) **Klasa 01:** Hemijski proizvodi koji se upotrebljavaju u poljoprivredi, hortikulturi i šumarstvu, naročito preparati za ojačanje biljke, preparati za regulisanje rasta biljaka, hemijski preparati za tretiranje sjemena, surfaktanti, prirodne i vještačke hemikalije za upotrebu kao seksualni mamci ili agensi za zbunjivanje insekata.,

**Klasa 05:** Preparati za uništavanje i borbu protiv štetočina, fungicidi, herbicidi, pesticidi.,

(111) 08363

(151) 10.10.2013.

(210) **2011-12**

(442) **20.03.2013.**

(220) 11.01.2011.

(732) **BRISTOL-MYERS SQUIBB COMPANY A DELAWARE CORPORATION, 345 PARK AVENUE, NEW YORK, NY 10154 US**

## CCNU

(540)

(550) I

(740) Ćupić Branislav, Dalmatinska 10, Podgorica ME

(511) **Klasa 05:** Farmaceutski preparati za ljudsku upotrebu.

(111) 08362

(151) 10.10.2013.

(210) **2011-11**

(442) **20.03.2013.**

(220) 11.01.2011.

(732) **BRISTOL-MYERS SQUIBB SARL A FRENCH LIMITED LIABILITY COM-**

PANY, 3 RUE JOSEPH MONIER, 92500 RUEIL-MALMAISON FR

## UPSARIN

(540)

(550) I

(740) Ćupić Branislav, Dalmatinska 10, Podgorica ME

(511) **Klasa 05:** Farmaceutski preparati za ljudsku upotrebu.

(111) 08690

(151) 07.11.2013.

(210) **2010-384**

(442) **20.03.2013.**

(220) 25.10.2010.

(732) **KARBON GRADJEVINSKI MATERIJALI D.O.O. TOPOLA**, BULEVAR VOŽDA KARADORĐA 126, TOPOLA RS

## FUGAFIL

(540)

(550) I

(511) **Klasa 01:** Lepljive supstance koje se upotrebljavaju u industriji. hemijski proizvodi koji se upotrebljavaju u industriji, nauci, fotografiji, poljoprivredi, hortikulturi i šumarstvu, neprerađene vještačke smole, neprerađene plastične materije, đubriva, smeše za gašenje vatre, preparati za kaljenje i zavarivanje, hemijske supstance za očuvanje namirnica, materije za štavljenje.

**Klasa 02:** Boje, firnajzi. lakovi, sredstva za zaštitu od rđe i truljenja drveta, materije za bojenje, sredstva za nagrizanje, sirove prirodne smole, metali u obliku listova i praha za slikare, dekoratere, štampare i umjetnike.

**Klasa 19:** Građevinski materijali (nemetalni), čvrste nemetalne cevi za građevine, asfalt, crna smola i bitumen, nemetalne prenosne građevine, spomenici, koji nisu od metala.

(111) 08691

(151) 07.11.2013.

(210) **2010-385**

(442) **20.03.2013.**

(220) 25.10.2010.

(732) **KARBON GRADJEVINSKI MATERIJALI D.O.O. TOPOLA**, BULEVAR VOŽDA KARADORĐA 126, TOPOLA RS

## GLESTAR

(540)

(550) I

(511) **Klasa 01:** Lepljive supstance koje se upotrebljavaju u industriji. hemijski proizvodi koji se upotrebljavaju u industriji, nauci, fotografiji, poljoprivredi, hortikulturi i šumarstvu, neprerađene vještačke smole, neprerađene plastične materije, đubriva, smeše za gašenje vatre, preparati za kaljenje i zavarivanje, hemijske supstance za očuvanje namirnica, materije za štavljenje.

**Klasa 02:** Boje, firnajzi. lakovi, sredstva za zaštitu od rđe i truljenja drveta, materije za bojenje, sredstva za nagrizanje, sirove prirodne smole, metali u obliku listova i praha za slikare, dekoratere, štampare i umjetnike.

**Klasa 19:** Građevinski materijali (nemetalni), čvrste nemetalne cevi za građevine, asfalt, crna smola i bitumen, nemetalne prenosne građevine, spomenici, koji nisu od metala.

---

(111) 08692

(151) 07.11.2013.

(210) **2010-386**

(442) **20.03.2013.**

(220) 25.10.2010.

(732) **KARBON GRADJEVINSKI MATERIJALI D.O.O. TOPOLA**, BULEVAR VOŽDA KARADORĐA 126, TOPOLA RS

**KARBOGLET**

(540)

(550) I

(511) **Klasa 01:** Lepljive supstance koje se upotrebljavaju u industriji. hemijski proizvodi koji se upotrebljavaju u industriji, nauci, fotografiji, poljoprivredi, hortikulturi i šumarstvu, neprerađene vještačke smole, neprerađene plastične materije, đubriva, smeše za gašenje vatre, preparati za kaljenje i zavarivanje, hemijske supstance za očuvanje namirnica, materije za štavljenje.

**Klasa 02:** Boje, firnajzi. lakovi, sredstva za zaštitu od rđe i truljenja drveta, materije za bojenje, sredstva za nagrizanje, sirove prirodne smole, metali u obliku listova i praha za slikare, dekoratere, štampare i umjetnike.

**Klasa 19:** Građevinski materijali (nemetalni), čvrste nemetalne cevi za građevine, asfalt, crna smola i bitumen, nemetalne prenosne građevine, spomenici, koji nisu od metala.

---

(111) 08693

(151) 07.11.2013.

(210) **2010-387**

(442) **20.03.2013.**

(220) 25.10.2010.

(732) **KARBON GRADJEVINSKI MATERIJALI D.O.O. TOPOLA**, BULEVAR VOŽDA KARADORĐA 126, TOPOLA RS

**KARBOBET**

(540)

(550) I

(511) **Klasa 01:** Lepljive supstance koje se upotrebljavaju u industriji. hemijski proizvodi koji se upotrebljavaju u industriji, nauci, fotografiji, poljoprivredi, hortikulturi i šumarstvu, neprerađene vještačke smole, neprerađene plastične materije, đubriva, smeše za gašenje vatre, preparati za kaljenje i zavarivanje, hemijske supstance za očuvanje namirnica, materije za štavljenje.

**Klasa 02:** Boje, firnajzi. lakovi, sredstva za zaštitu od rđe i truljenja drveta, materije za bojenje, sredstva za nagrizanje, sirove prirodne smole, metali u obliku listova i praha za slikare, dekoratere, štampare i umjetnike.

**Klasa 19:** Građevinski materijali (nemetalni), čvrste nemetalne cevi za građevine, asfalt, crna smola i bitumen, nemetalne prenosne građevine, spomenici, koji nisu od metala.

---

(111) 08694

(151) 07.11.2013.

(210) **2010-388**

(442) **20.03.2013.**

(220) 25.10.2010.

(732) **KARBON GRADJEVINSKI MATERIJALI D.O.O. TOPOLA**, BULEVAR VOŽDA KARADORĐA 126, TOPOLA RS

**KARBOKRIL**

(540)

(550) I

(511) **Klasa 01:** Lepljive supstance koje se upotrebljavaju u industriji. hemijski proizvodi koji se upotrebljavaju u industriji, nauci, fotografiji, poljoprivredi, hortikulturi i šumarstvu, neprerađene vještačke smole, neprerađene plastične materije, đubriva, smeše za gašenje vatre, preparati za kaljenje i zavarivanje, hemijske supstance za očuvanje namirnica, materije za štavljenje.

**Klasa 02:** Boje, firnajzi. lakovi, sredstva za zaštitu od rđe i truljenja drveta, materije za bojenje, sredstva za nagrizanje, sirove prirodne smole, metali u obliku listova i praha za slikare, dekoratere, štampare i umjetnike.

**Klasa 19:** Građevinski materijali (nemetalni), čvrste nemetalne cevi za građevine, asfalt, crna smola i bitumen, nemetalne prenosne građevine, spomenici, koji nisu od metala.

(111) 08695

(151) 07.11.2013.

(210) **2010-389**(442) **20.03.2013.**

(220) 25.10.2010.

(732) **KARBON GRADJEVINSKI MATERIJALI D.O.O. TOPOLA**, BULEVAR VOŽDA KARADORĐA 126, TOPOLA RS

**KARBOKUL**

(540)

(550) I

(511) **Klasa 01:** Lepljive supstance koje se upotrebljavaju u industriji. hemijski proizvodi koji se upotrebljavaju u industriji, nauci, fotografiji, poljoprivredi, hortikulturi i šumarstvu, neprerađene vještačke smole, neprerađene plastične materije, đubriva, smeše za gašenje vatre, preparati za kaljenje i zavarivanje, hemijske supstance za očuvanje namirnica, materije za štavljenje.

**Klasa 02:** Boje, firnajzi. lakovi, sredstva za zaštitu od rđe i truljenja drveta, materije za bojenje, sredstva za nagrizanje, sirove prirodne smole, metali u obliku listova i praha za slikare, dekoratere, štampare i umjetnike.

**Klasa 19:** Građevinski materijali (nemetalni), čvrste nemetalne cevi za građevine, asfalt, crna smola i bitumen, nemetalne prenosne građevine, spomenici, koji nisu od metala.

(111) 08689

(151) 07.11.2013.

(210) **2009-579**(442) **20.03.2013.**

(220) 28.09.2009

(732) **HONDA MOTOR CO LTD**, 1-1 MINAMI-AOYAMA 2-CHOME, MINATO-KU, TOKYO JP

**EU Handy**

(540)

(550) I

(740) Radulović Božidar, Jovana Tomaševića 9/III, Podgorica ME

(511) **Klasa 07:** Generatori.



(111) 08696

(151) 07.11.2013.

(210) **2011-516**(442) **20.03.2013.**

(220) 20.10.2011.

(732) **KURARAY CO., LTD**, 1621, SAKAZU, KARUSHIKI CITY, OKOYAMA PREFECTURE JP

(540)

(550) I

(740) Popović Miladin, Đoka Miraševića 21/III, Podgorica ME

(511) **Klasa 01:** Hemijski proizvodi koji se upotrebljavaju u industriji, nauci i fotografiji, kao i u poljoprivredi, hortikulturi i šumarstvu, neprerađene vještačke smole, neprerađene plastične materije, đubriva, smješe za gašenje vatre, preparati za kaljenje i zavarivanje, hemijske supstance za očuvanje namirnica, materije za štavljenje, ljepljive supstance koje se upotrebljavaju u industriji, kopolimeri etilen-vinil alkohola.

**Klasa 16:** Hartija, karton i proizvodi od njih, koji nijesu uključeni u druge klase, ljepila za kancelarijske ili kućne potrebe, plastični materijali za uvijanje i pakovanje, koji nijesu uključeni u druge klase.

**Klasa 17:** Guma, gutaperka, kaučuk, azbest, liskun i proizvodi napravljeni od ovih materijala koji nijesu uključeni u druge klase, poluprerađeni plastični proizvodi, materijali za podbija-nje (podloške), zaptivanje i izolovanje, savitljive nemetalne cijevi, poluprerađena vještačka smola i poluprerađene plastične materije, posebno sastavljene od kopolimera etilen-vinil alkohola.

(111) 08697

(151) 07.11.2013.

(210) **2011-517**(442) **20.03.2013.**

(220) 21.10.2011.

(732) **SOCIETE DES PRODUITS NESTLE S.A.**, 1800 VEVEY CH

## JELLY FRUIT

(540)

(550) I

(740) Lutovac Branislav, Bulevar Crnojevića 93, Podgorica ME

(511) **Klasa 30:** Sladoled.

(111) 08699

(151) 07.11.2013.

(210) **2011-524**(442) **20.03.2013.**

(220) 27.10.2011.

(732) **ORION ELECTRIC CO. LTD** 41-1 LEHISA-CHO, ECHIZEN-CITY, FUKUI JP

## ORION

(540)

(550) I

(740) Radulović Božidar, Jovana Tomaševića 9/III, Podgorica ME

(511) **Klasa 09:** Radio prijemnici, Tejp rekorderi (Kasetofoni-na kojima se vrši snimanje), Tape Decks (dekovi za kasete), Tejp plejeri (kasetofoni sa kojih se pušta audio sadržaj), Stereo prijemnici, Gramofoni, Radio prijemnici za automobile, Stereo plejeri za automobile/Rekorderi, CD (kompakt disk) Plejeri, MD (mini disk) plejeri/Rekorderi, Memorijski plejeri/Rekorderi, Zvučnici, Tjuneri, Pojačala, Ekvalizatori, Slušalice, Sistemi kućnog bioskopa, Televizori sa katodnom cijevi, Digitalni Televizori, LCD televizori, Projekcijski televizori, Plazma televizori, LCD uređaj (Navigacioni sistemi za automobile, eto), STB (Set Top Box), Video plejeri/Rekorderi, Video tejp plejeri/Rekorderi, Video Disk Plejeri, Video kamere, Digitalni foto aparati / kamere, DVD Plejeri/Rekorderi, HDD Plejeri/Rekorderi, HD DVD Plejeri/Rekorderi, Blu-ray Disk Plejeri/Rekorderi, Faks mašine, Mobilni telefoni, Kompjuteri, Monitori za kompjutere, Štampači, Periferalna oprema za kompjutere, Bilo koji kompozitni uređaj koji se sastoji od dva ili više stavki gore pomenute robe, Mini komponentni sistemski stereo risiver sa iPOD Dokom, iPOD Dok sa DVD plejerom sve u jednom uređaju, i Sound bar zvučnik, IP -STB (Video na zahtjev stream plejer).

(111) 08700

(151) 07.11.2013.

(210) **2011-526**

(442) **20.03.2013.**

(220) 31.10.2011.

(732) **HEMOFARM A.D.**, BEOGRADSKI PUT BB, VRŠAC RS

**VISUS**

(540)

(550) I

(740) Popović Miladin, Đoka Miraševića 21/III, Podgorica ME

(511) **Klasa 05:** Farmaceutski proizvodi.

(111) 08705

(151) 07.11.2013.

(210) **2011-537**

(442) **20.03.2013.**

(220) 03.11.2011.

(732) **EDUCO CENTAR**, KRALJA NIKOLE 29, PODGORICA ME



**EDUCO CENTAR**

(540)

(550) I

(511) **Klasa 41:** Obrazovne usluge, pripremanja obuke, razonoda, sportske i kulturne aktivnosti.

(111) 08706

(151) 07.11.2013.

(210) **2011-538**

(442) **20.03.2013.**

(220) 04.11.2011.

(732) **BRITISH AMERICAN TOBACCO (BRANDS) INC.**, 2711 CENTERVILLE ROAD, SUITE 300, WILMINGTON, DELAWARE 19808 US



(540)

(550) I

(740) Popović Miladin, Đoka Miraševića 21/III, Podgorica ME

(511) **Klasa 34:** Cigarete, Duvan, proizvodi od duvana, upaljači, šibice, artikli za pušače.

(111) 08707

(151) 07.11.2013.

(210) **2011-539**(442) **20.03.2013.**

(220) 08.11.2011.

(732) **ABBOTT MEDICAL OPTICS INC**, 1700 E.ST. ANDREW PLACE, SANTE ANA, CALIFORNIA 92705-4933 US

## ELLIPS

(540)

(550) I

(740) Popović Miladin, Đoka Miraševića 21/III, Podgorica ME

(511) **Klasa 10:** Hirurški, medicinski, zubarski i veterinarski aparati i instrumenti, veštački udovi, oči i zubi, ortopedski artikli, hirurški materijali za zašivanje, naročito oftalmološki hirurški instrumenti, ručni uređaj koji se koristi u toku operacije katarakte i vitrektomije.

(111) 08709

(151) 07.11.2013.

(210) **2011-546**(442) **20.03.2013.**

(220) 09.11.2011.

(732) **CIRQUE DU SOLEIL I.I.I. .S.A.**, 16, AVENUE PASTEUR, L-2310 LU

## CIRQUE DU SOLEIL



(540)

(550) I

(740) Popović Miladin, Đoka Miraševića 21/III, Podgorica ME

(511) **Klasa 41:** Usluge razonode, naime, osmišljavanje, stvaranje, produkcija, i prezentacija pozorišnih predstava, osmišljavanje, stvaranje, produkcija, distribucija i prezentacija audiovizuelnih radova, produkcija multimedijalnih pozorišnih predstava, kazino usluge.

(111) 08710

(151) 07.11.2013.

(210) **2011-547**

(442) **20.03.2013.**

(220) 09.11.2011.

(732) **CIRQUE DU SOLEIL I.I.I. .S.A., 16, AVENUE PASTEUR, L-2310 LU**

**CIRQUE DU SOLEIL**

(540)

(550) I

(740) Popović Miladin, Đoka Miraševića 21/III, Podgorica ME

(511) **Klasa 41:** Usluge razonode, naime, osmišljavanje, stvaranje, produkcija, i prezentacija pozorišnih predstava, osmišljavanje, stvaranje, produkcija, distribucija i prezentacija audiovizuelnih radova, produkcija multimedijalnih pozorišnih predstava, kazino usluge.,

(111) 08711

(151) 07.11.2013.

(210) **2011-548**

(442) **20.03.2013.**

(220) 09.11.2011.

(732) **CIRQUE DU SOLEIL I.I.I. .S.A., 16, AVENUE PASTEUR, L-2310 LU**



(540)

(550) I

(740) Popović Miladin, Đoka Miraševića 21/III, Podgorica ME

(511) **Klasa 41:** Usluge razonode, naime, osmišljavanje, stvaranje, produkcija, i prezentacija pozorišnih predstava, osmišljavanje, stvaranje, produkcija, distribucija i prezentacija audiovizuelnih radova, produkcija multimedijalnih pozorišnih predstava, kazino usluge.

(111) 08712

(151) 07.11.2013.

(210) **2011-549**

(442) **20.03.2013.**

(220) 10.11.2011.

(732) **J.&P COATS, LIMITED, 1 GEORGE SQUARE, GLASGOW G2 1AL SCOTLAND UK**

**SONAL**

(540)

(550) I

(740) Popović Miladin, Đoka Miraševića 21/III, Podgorica ME

(511) **Klasa 23:** prediva i konci za tekstilnu upotrebu.

(111) 08713

(151) 07.11.2013.

(210) **2011-550**

(442) **20.03.2013.**

(220) 10.11.2011.

(732) **J.&P. COATS, LIMITED**, 1 GEORGE SQUARE, GLASGOW G2 1AL SCOTLAND UK

## APTAN

(540)

(550) I

(740) Popović Miladin, Đoka Miraševića 21/III, Podgorica ME

(511) **Klasa 23:** prediva i konci za tekstilnu upotrebu,

---

(111) 08714

(151) 07.11.2013.

(210) **2011-551**

(442) **20.03.2013.**

(220) 10.11.2011.

(732) **J.&P. COATS, LIMITED**, 1 GEORGE SQUARE, GLASGOW G2 1AL SCOTLAND UK

## DUAL DUTY

(540)

(550) I

(740) Popović Miladin, Đoka Miraševića 21/III, Podgorica ME

(511) **Klasa 23:** prediva i konci za tekstilnu upotrebu,

---

(111) 08715

(151) 07.11.2013.

(210) **2011-553**

(442) **20.03.2013.**

(220) 10.11.2011.

(732) **J.&P.COATS, LIMITED**, 1 GEORGE SQUARE, GLASGOW G2 1AL SCOTLAND UK

## GRAL

(540)

(550) I

(740) Popović Miladin, Đoka Miraševića 21/III, Podgorica ME

(511) **Klasa 23:** prediva i konci za tekstilnu upotrebu,

---

(111) 08716

(151) 07.11.2013.

(210) **2011-554**

(442) **20.03.2013.**

(220) 10.11.2011.

(732) **J.&P. COATS, LIMITED**, 1 GEORGE SQUARE, GLASGOW G2 1AL SCOTLAND UK

## GRAMAX

(540)

(550) I

(740) Popović Miladin, Đoka Miraševića 21/III, Podgorica ME

(511) **Klasa 23:** prediva i konci za tekstilnu upotrebu,

- (111) 08718 (151) 07.11.2013.  
 (210) **2011-562** (442) **20.03.2013.**  
 (220) 16.11.2011.  
 (732) **GENERAL MOTORS LLC**, 300 RENAISSANCE CENTER, DETROIT, MICHIGAN 48265-3000 US

**CHEVROLET MYLINK**

- (540)  
 (550) I  
 (740) Radulović Božidar, Jovana Tomaševića 9/III, Podgorica ME  
 (511) **Klasa 09:** elektronski moduli interfejsa koji se prodaju kao sastavni dio motornog vozila za kretanje po zemlji za žični i bežični interfejs ručnih i mobilnih elektronskih uredaja.

- (111) 08719 (151) 07.11.2013.  
 (210) **2011-563** (442) **20.03.2013.**  
 (220) 16.11.2011.  
 (732) **NIKON CORPORATION**, 12-1, YURAKUCHO 1-CHOME, CHIYODA-KU, TOKYO JP

**Nikon**

- (540)  
 (550) I  
 (740) Popović Miladin, Đoka Miraševića 21/III, Podgorica ME  
 (511) **Klasa 07:** Mašine i mašinski alati, motori i pogonske mašine (osim za suvozemna vozila), mašinske spojnice i transmisioni elementi (osim za suvozemna vozila), poljoprivredne sprave, inkubatori za jaja, mašine i sistemi za proizvodnju poluprovodnika, aparati za izlaganje poluprovodnika, mašine i sistemi za proizvodnju tecnog kristala, aparati za izlaganje tecnog kristala, aparati za testiranje poluprovodnika, aparati za testiranje tecnog kristala, mašine za poliranje i aparati za vafel, delovi i dodaci za mašine i sisteme za proizvodnju poluprovodnika, delovi i dodaci za mašine i sisteme za proizvodnju tecnog kristala, delovi i dodaci za aparate za izlaganje poluprovodnika, delovi i dodaci za aparate za izlaganje tecnog kristala, delovi i dodaci za aparate za testiranje poluprovodnika, delovi i dodaci za aparate za testiranje tecnog kristala, delovi i dodaci za mašine za poliranje i aparate za vafel.,  
**Klasa 14:** Dragoceni metali i njihove legure i proizvodi od dragocenih metala ili sa prevlakom od njih, koji nisu ukljuceni u druge klase, nakit, bižuterija, drago kamenje, casovnicarski i hronometrijski instrumenti, znanke, privesci za kljucveve od dragocenih metala.,  
**Klasa 16:** Hartija, karton i proizvodi od njih, koji nisu ukljuceni u druge klase, štampane stvari, knjigovezacki materijal, fotografije, kancelarijski materijal, lepila za kancelarijske i kucne potrebe, umetnicki materijali, kicice, pisace mašine i kancelarijski rekviziti (izuzev nameštaja), materijali za obuku i nastavu (izuzev aparata), plasticni materijal za pakovanje (koji nije ukljucen u druge klase), štamarska slova, klišeji, stalci za fotografije, kalendari, albumi, magazini (periodike), knjige, novine, stikeri (kancelarijski materijal), slicice.,  
**Klasa 18:** Koža i imitacija kože, proizvodi izradeni od ovih materijala koji nisu ukljuceni u druge klase, životinjska koža, koferi i putne torbe, kišobrani, suncobrani i štapovi za hodanje, bicevi, saracka i sedlarska roba, torbe sa vrpcom, postavljene torbice, futrole za kartice (novcanici), poslovne futrole za kartice, torbice za kljucveve, torbe za kupovinu, ranci, ruksaci,

ručne torbe.,

**Klasa 21:** Kućne ili kuhinjske sprave i posude (koje nisu od dragocenih metala ili sa prevlakama od njih), češljevi i sunderi, cetke (izuzev kicica), materijali za pravljenje cetki, artikli koji se koriste pri čišćenju, celicna vuna, nepreradeno ili polupreradeno staklo (osim stakla koje se koristi u građevinarstvu), staklarija, porcelan, fajans, grncarija i loncarija koja nije uključena u druge klase, čaše sa ravnim dnom, šolje, pljosnate boce za pića, boce za vodu, vacuum boce, čaše za pića, sudovi za pića, kutije za rucak.,

**Klasa 25:** Odeca, obuća, pokrivala za glavu, prsluci, muški prsluci, jakne, mantili, kape, šeširi, pokrivala za glavu, trake za rucne zglobove, sportske uniforme, kecelje, majice.,

**Klasa 37:** Građevinsko konstruisanje, popravljavanje, usluge instaliranja (instalacione usluge), instalacija mašina za proizvodnju poluprovodnika i sistema, instalacija mašina za proizvodnju tehničkih kristala i sistema, usluge popravke ili održavanja mašina za proizvodnju tehničkih kristala i sistema, usluge popravke ili održavanja mašina za proizvodnju poluprovodnika i sistema, usluge popravke ili održavanja fotografske opreme, usluge popravke ili održavanja kamera, usluge popravke ili održavanja digitalnih fotoaparata, usluge popravke ili održavanja sočiva fotoaparata, usluge popravke ili održavanja optičkih aparata i instrumenata, usluge popravke ili održavanja mikroskopa, usluge popravke ili održavanja dvogleda, usluge popravke ili održavanja teleskopa, usluge popravke ili održavanja daljinomera, instalacija aparata za testiranje poluprovodnika, instalacija aparata za testiranje tehničkih kristala, usluge popravke ili održavanja aparata za testiranje poluprovodnika, usluge popravke ili održavanja aparata za testiranje tehnološkog kristala, usluge popravke naocara, usluge popravke ili održavanja mašina i instrumenata za merenje ili ispitivanje, usluge popravke ili održavanje telekomunikacionih uređaja i aparata, usluge popravke ili održavanje elektronskih mašina i aparata, usluge popravke ili održavanje slušnih aparata, usluge popravke ili održavanje medicinskih aparata i instrumenata.

**Klasa 41:** Obrazovne usluge, pripremanje obuke, razonoda, sportske i kulturne aktivnosti, fotografija i pružanje informacija o fotografiji, pripremanje, vodenje i organizovanje seminara za fotografe i pružanje informacija o fotografiji, pripremanje, vodenje i organizovanje fotografskih klasa i pružanje informacija o fotografskim klasama, pripremanje, vodenje i organizovanje događaja u vezi sa fotografijama i pružanje informacija o događajima u vezi sa fotografijama, pripremanje, vodenje i organizovanje takmicenja u fotografisanju i pružanje informacija o fotografskim takmicenjima, iznajmljivanje kamera i delova i pribora za njih, pripremanje, vodenje i organizovanje izložbi fotografija i pružanje informacija o izložbama fotografija, obezbeđivanje prostora za izložbe fotografija i pružanje informacija o prostorima za izložbe fotografija, usluge digitalnog fotografisanja, pružanje on-line usluga digitalnog fotografisanja, fotografisanje, obrazovne i nastavne usluge vezane za fotografisanje, obrazovne i nastavne usluge vezane za održavanje, popravku i rad fotografske opreme i delova i pribora za njih, obrazovne i nastavne usluge vezane za održavanje, popravku i rad mašina i instrumenata za merenje ili testiranje i delova i pribora za njih, obrazovne i nastavne usluge vezane za održavanje, popravku i rad optičkih instrumenata i mašina i delova i pribora za njih, obrazovne i nastavne usluge vezane za održavanje, popravku i rad mašina i sistema za proizvodnju poluprovodnika (uključujući i aparate za testiranje poluprovodnika i drugih perifernih uređaja) i delova i pribora za njih, obrazovne i nastavne usluge vezane za održavanje, popravku i rad mašina i sistema za proizvodnju tehničkih kristala (uključujući i aparate za testiranje tehničkih kristala i drugih perifernih uređaja) i delova i pribora za njih, obrazovne i nastavne usluge vezane za održavanje, popravku i rad telekomunikacionih uređaja i aparata i delova i pribora za njih, obrazovne i nastavne usluge vezane za održavanje, popravku i rad elektronskih mašina i aparata i delova i pribora za njih, obrazovne i nastavne usluge vezane za održavanje, popravku i rad mašina i aparata za proizvodnju naocara i delova i pribora za

njih, pružanje usluga on-line elektronskih publikacija [koje se ne mogu preuzeti], pripremanje, vodenje i organizovanje seminara, i pružanje informacija o istim, usluge obezbjeđivanje datoteka slika i video datoteka [koje se ne mogu preuzeti] preko Interneta, iznajmljivanje optičkih mašina i instrumenata, iznajmljivanje mašina i instrumenata za merenje ili testiranje, planiranje, uređivanje i proizvodnja publikacija.

**Klasa 42:** Naučne i tehnološke usluge i istraživanje i projektovanje u vezi navedenih usluga, usluge industrijske analize i istraživanja, projektovanje i razvoj kompjuterskog hardvera i softvera, iznajmljivanje web servera, iznajmljivanje prostora za skladištenje podataka sa servera preko Interneta, obezbjeđivanje softvera za uređivanje i upravljanje fotografijama i filmovima preko Interneta [koji se ne mogu preuzeti], iznajmljivanje web servera za razgovor putem Interneta.,

- 
- (111) 08831 (151) 12.11.2013.  
 (210) **2011-564** (442) **20.03.2013.**  
 (220) 18.11.2011.  
 (732) **GENERAL MOTORS LLC**, 300 RENAISSANCE CENTER, CITY OF DETROIT, STATE OF MICHIGAN 48265-3000 US

### INTELLILINK

- (540)  
 (550) I  
 (740) Popović Miladin, Đoka Miraševića 21/III, Podgorica ME  
 (511) **Klasa 09:** Elektronski interfejs moduli koji se prodaju kao integralni delovi motornih drumskih vozila, za žični i bežični interfejs ručnih ili mobilnih elektronskih uređaja.

- 
- (111) 08834 (151) 12.11.2013.  
 (210) **2011-572** (442) **20.03.2013.**  
 (220) 23.11.2011.  
 (732) **THE HERSHEY COMPANY**, 100 CRYSTAL A DRIVE HERSHEY PENNSYLVANIA 17033 US

### HERSHEY'S SPECIAL DARK

- (540)  
 (550) I  
 (740) Popović Miladin, Đoka Miraševića 21/III, Podgorica ME  
 (511) **Klasa 30:** Čokolade, proizvodi od čokolade, bombone, slatkiši, poslastice, kakao, proizvodi od kakaoa, keksi, biskviti, poslastice od čokolade za pečenje, komadici, ljuspice i kriške za pečenje, instant čokoladni miks (za hladne i tople napitke), čokoladni premazi, bezalkoholni čokoladni likeri, čokoladom obloženi orasi, aromatizovani sirupi, naime, čokoladni sirupi, sirupi od jagode, karamel sirupi, butterscotch sirupi, aromatizovani sirupi od kikiriki putera, konditorski prelive za sladolede i za deserte, kolaci, pecivo, sladoled, poslastice od sladoleđa, smrznute poslastice, ne-mlecni, bezalkoholni napici na bazi čokolade, table od žitarica.

- 
- (111) 08835 (151) 12.11.2013.  
 (210) **2011-573** (442) **20.03.2013.**  
 (220) 23.11.2011.  
 (732) **THE HERSHEY COMPANY**, 100 CRYSTAL A DRIVE HERSHEY PENNSYLVANIA 17033 US



**HERSHEY'S KISSES**

(540)

(550) I

(740) Popović Miladin, Đoka Miraševića 21/III, Podgorica ME

(511) **Klasa 30:** Čokolade, proizvodi od čokolade, bombone, slatkiši, poslastice, kakao, proizvodi od kakaoa, keksi, biskviti, poslastice od čokolade za pečenje, komadici, ljuspice i kriške za pečenje, instant čokoladni miks (za hladne i tople napitke), konditorski prelive za sladoled i za deserte, kolaci, pecivo, sladoled, smrznute poslastice.,

(111) 08836

(151) 12.11.2013.

(210) **2011-575**(442) **20.03.2013.**

(220) 23.11.2011.

(732) **THE HERSHEY COMPANY**, 100 CRYSTAL A DRIVE HERSHEY PENNSYLVANIA 17033 US**REESE'S**

(540)

(550) I

(740) Popović Miladin, Đoka Miraševića 21/III, Podgorica ME

(511) **Klasa 30:** Čokolade, proizvodi od čokolade, slatkiši, čokolada sa ili bez dodataka kao što su orasi ili kikiriki puter, poslastice, konditorske ljuspice za pečenje ili kao prelive za hranu, keksi, biskviti, kolači, pecivo, pite, sladoled, poslastice od sladoleda, smrznute poslastice, gotovi deserti, aromatizovani sirupi, naime, čokoladni sirupi, sirupi sa ukusom kikiriki putera, čokolade i aromatizovani sirupi od kikiriki putera, konditorski prelive za sladoled i za deserte.

(111) 08839

(151) 12.11.2013.

(210) **2011-584**(442) **20.03.2013.**

(220) 30.11.2011.

(732) **BASF CORPORATION**, 100 CAMPUS DRIVE FLORHAM PARK, NJ 07932 US**CELEBRITY**

(540)

(550) I

(740) Ćupić Branislav, Dalmatinska 10, Podgorica ME

(511) **Klasa 01:** Preparati za uništavanje i borbu protiv štetočina, fungicidi, herbicidi, pesticidi.

(111) 08853

(151) 12.11.2013.

(210) **2011-595**(442) **20.03.2013.**

(220) 05.12.2011.

(732) **MB IMPEKS DOO**, JOVANA BIJELIĆA BB, BANJA LUKA BA



(540)

(550) I

(740) Radulović Božidar, Jovana Tomaševića 9/III, Podgorica ME

(511) **Klasa 05:** Gorki liker.

(111) 08971

(151) 07.11.2013.

(210) **2009-487**(442) **20.06.2013.**

(220) 04.08.2009

(732) **IMPERIAL TOBACCO LIMITED**, P.O. BOX 244 SOUTHVILLE, BRISTOL BS99 7 UJ, GB,

(540)

(550) I

(740) Dedić Tomislav, Bulevar Ivana Crnojevića 139 Podgorica ME

(511) **Klasa 34:** duvan prerađen ili sirov, proizvodi od duvana, cigarete, cigare, zamjene za duvan koje nisu medicinske kurativne svrhe, artikli za pušače i šibice,

(111) 08698

(151) 07.11.2013.

(210) **2011-519**(442) **20.03.2013.**

(220) 21.10.2011.

(732) **MITSUBISHI SHOJI KAISHA LTD.**, 3-1, MARUNOUCHI 2-CHOME, CHIUDA-KU, TOKYO JP

(540)

(550) I

(740) Čejović Vladimir, 13. jula 21, Podgorica ME

(511) **Klasa 22:** Užad, kanapi, mreže, šatori, nadstrešnice od cirade, cirade, jedra, vreće, ma-

terijali za punjenje i tapaciranje (dlake, kapok, perja, morska trava, itd.), sirove vlaknaste tekstilne materije.

**Klasa 23:** Pređa, konac.

**Klasa 24:** Salvete (na komad), prekrivači za krevete i stolove, tekstilna roba.

**Klasa 29:** Meso, riba, živina i divljač, mesne prerađevine, konzervisano, sušeno i kuvano voće i povrće, želei i džemovi, jaja, mlijeko i drugi mliječni proizvodi, jestiva ulja i masti, ukuvano voće, kiseli krastavci.

---

(111) 08701 (151) 07.11.2013.  
 (210) **2011-528** (442) **20.03.2013.**  
 (220) 31.10.2011.  
 (732) **ATLAS COPCO SECOROS AB, BOX 521,737 25 FAGERSTA SE**

### SECOROC

(540)  
 (550) I  
 (740) Čejović Vladimir, 13. jula 21, Podgorica ME  
 (511) **Klasa 07:** Mašinski alati, mašine za miniranje, rotacione mašine za rudnike, mašine za utovar, mašine za transport, aparati uključeni u klasu 7 a sve za upotrebu pri bušenju kamena i dijamanta, mašine za paljenje mina, bor-mašine, mašine za bušenje i mašine za jezgrovanje, mašine za lomljenje kamena, mašine za drobljenje minerala i rude zlata, ventilatori, pumpe, bušilice za kamen i aparati za utovar, sve uključeno u klasu 7, kompresori, i betonski finišeri, svi u vidu mašina, i svi djelovi i dodaci uključeni u klasu 7 za sve gore navedene robe.  
**Klasa 08:** Ručni alati i ručni instrumenti uključeni u klasu 8, i djelovi i dodaci uključeni u klasu 8 za sve gore navedene robe.

---

(111) 08704 (151) 07.11.2013.  
 (210) **2011-536** (442) **20.03.2013.**  
 (220) 03.11.2011.  
 (732) **WM. WRIGLEY JR. COMPANY, 410 NORTH MICHIGAN AVENUE, CHICAGO, IL 60611 US**

### CRAZY CHERRY

(540)  
 (550) I  
 (740) Čejović Vladimir, 13. jula 21, Podgorica ME  
 (511) **Klasa 30:** Slatkiši, žvakaće gume, žvakaće gume od kojih mogu da se prave veliki baloni, bombone, dražeje pepermint, mali okrugli bomboni (drops) i pastile.

---

(111) 08708 (151) 07.11.2013.  
 (210) **2011-540** (442) **20.03.2013.**  
 (220) 08.11.2011.  
 (732) **DUKAT D.D., MARIJANA ČAVIĆA 9, ZAGREB HR**

### DUKAT

(540)

(550) I

(740) Kojić Ivana, Serdar Jola Piletića bb, Podgorica ME

(511) **Klasa 29:** Meso, riba, živina i divljač, mesne prerađevine, konzervisano, sušeno i kuvano voće i povrće, želei, džemovi, kompoti, jaja, mlijeko i mliječni proizvodi, jestiva ulja i masti.**Klasa 30:** Kafa, čaj, kakao, šećer, pirinač, tapioka, sago, zamjena kafe, brašno i proizvodi od žitarica, hljeb, kolači, poslastice, sladoledi, med, melasa, kvasac, prašak za pecivo, so, senf, sirće, sosovi (kao začini), začini, led.**Klasa 32:** Pivo, mineralne i sodne vode i druga bezalkoholna pića, pića od voća i voćni sokovi, sirupi i drugi preparati za proizvodnju pića.

(111) 08717

(151) 07.11.2013.

(210) **2011-555**(442) **20.03.2013.**

(220) 14.11.2011.

(732) **S.C. JONSON&SON, INC.**, 1525 HOWE STREET, RACINE, WISCONSIN 53403-2236 US

RAID

(540)

(550) I

(740) Čejović Vladimir, 13. jula 21, Podgorica ME

(511) **Klasa 05:** Osvježivači vazduha, dezodoransi za vazduh, preparati koji pročišćavaju vazduh, sintizeri vazduha, dezodoransi za tkanine, dezodoransi za tepihe i sobe.

(111) 08832

(151) 12.11.2013.

(210) **2011-569**(442) **20.03.2013.**

(220) 22.11.2011.

(732) **CAESARS INTERACTIVE ENTERTAINMENT, INC**, ONE CAESARS PALACE DRIVE. LAS VEGAS, NEVADA 89109 US

WSOP

(540)

(550) I

(740) Radulović Božidar, Jovana Tomaševića 9/III, Podgorica ME

(511) **Klasa 41:** Usluge obezbjeđivanja elektronskih igara, usluge igranja igara, kockanja i kazina, usluge interaktivnog igranja igara, kockanja i kazina, uključujući obezbjeđivanje onlajn napred navedenih usluga putem kompjuterskih baza podataka ili interneta, usluge televizijske razonode, usluge organizovanja i omogućavanja igranja igara i takmičenja u zabavne svrhe, informacione, konsultantske i savetodavne usluge u vezi sa napred navedenim

(111) 08833

(151) 12.11.2013.

(210) **2011-570**(442) **20.03.2013.**

(220) 22.11.2011.

(732) **CAESARS INTERACTIVE ENTERTAINMENT, INC**, ONE CAESARS PALACE DRIVE. LAS VEGAS, NEVADA 89109 US



(540)

(550) I

(740) Radulović Božidar, Jovana Tomaševića 9/III, Podgorica ME

(511) **Klasa 41:** Usluge obezbjeđivanja elektronskih igara, usluge igranja igara, kockanja i kazina, usluge interaktivnog igranja igara, kockanja i kazina, uključujući obezbjeđivanje onlajn napred navedenih usluga putem kompjuterskih baza podataka ili interneta, usluge televizijske razonode, usluge organizovanja i omogućavanja igranja igara i takmicenja u zabavne svrhe, informacione, konsultantske i savetodavne usluge u vezi sa napred navedenim.,

(111) 08837

(151) 12.11.2013.

(210) **2011-578**(442) **20.03.2013.**

(220) 23.11.2011.

(732) **S2 YACHTS, INC.**, 725 EAST 40TH STREET, HOLLAND, MICHIGAN 49423 US

# TIARA

(540)

(550) I, V

(740) Radulović Božidar, Jovana Tomaševića 9/III, Podgorica ME

(511) **Klasa 12:** Brodovi i čamci i njihovi dodaci i oprema.

(111) 08838

(151) 12.11.2013.

(210) **2011-580**(442) **20.03.2013.**

(220) 28.11.2011.

(732) **MARINE STOCK LIMITED**, 1ST FLOOR, COLUMBUS CENTRE BUILDING, P.O.BOX 901. ROAD TOWN, TORTUGA VG

# BRITISH KNIGHTS

(540)

(550) I, V

(740) Radulović Božidar, Jovana Tomaševića 9/III, Podgorica ME

(511) **Klasa 25:** Odjeća i obuća.

(111) 08840

(151) 12.11.2013.

(210) **2011-588**(442) **20.03.2013.**

(220) 02.12.2011.

(732) **BASF AGRO B.V.ARNHEM (NL)**, ZWEIGNIEDERLASSUNG WADENSWIL MOOSACHER-STRASSE 2, AU CH

## MYTHIC

(540)

(550) I

(740) Stanković Mugoša Ana, Trg Republike 13, Podgorica ME

(511) **Klasa 05:** Preparati za uništavanje i suzbijanje štetočina, fungicidi, herbicidi, pesticidi.

(111) 08851

(151) 12.11.2013.

(210) **2011-589**(442) **20.03.2013.**

(220) 02.12.2011.

(732) **BASF SE**, CARL-BOSCH-STRABE 38 D-67056 LUDWIGSHAFEN AM RHEIN DE

## LINOPRAX

(540)

(550) I

(740) Stanković Mugoša Ana, Trg Republike 13, Podgorica ME

(511) **Klasa 01:** Hemikalije koje se koriste u poljoprivredi, hortikulturi i šumarstvu, naročito preparati za jačanje biljaka, preparati za regulisanje rasta biljaka, hemijski preparati za tretiranje sjemena, površinski-aktivna sredstva, prirodne ili vještačke hemikalije koje se koriste kao seksualni mamci ili agensi za zbimjivanje insekata.**Klasa 05:** Preparati za uništavanje i suzbijanje štetočina, fungicidi, herbicidi, pesticide.

(111) 08852

(151) 12.11.2013.

(210) **2011-590**(442) **20.03.2013.**

(220) 02.12.2011.

(732) **BASF AGRO B.V., ARNHEM (NL)**, ZWEIGNIEDERLASSUNG WADENSWIL MOOSACHERSTRASSE 2, AU CH

## MASAI

(540)

(550) I

(740) Stanković Mugoša Ana, Trg Republike 13, Podgorica ME

(511) **Klasa 05:** Preparati za uništavanje i suzbijanje štetočina, fungicidi, herbicidi, pesticidi.

(111) 08854

(151) 12.11.2013.

(210) **2011-596**(442) **20.03.2013.**

(220) 05.12.2011.

(732) **DUN&BRADSTREET INTERNATIONAL. LTD**, 103 JFK PARKWAY, SHORT HILLS, NEW JERSEY 07078 US

## DUN &amp; BRADSTREET

(540)

(550) I, V

(740) Radulović Božidar, Jovana Tomaševića 9/III, Podgorica ME

(511) **Klasa 35:** Usluge obezbeđivanja izveštaja o prodaji i tržištu za druge po narudžbini i/ili specifikaciji, usluge obezbeđivanja opštih poslovnih informacija koje se tiču prodaje, obima i pozicije, sprovođenje marketinških studija, usluge obezbeđivanja poslovnih informacija koje se odnose na oblast marketinga, demografije i statistike, pripisivanje i obezbeđivanje

identifikacionih brojeva privrednim društvima za primenu u svrhe olakšavanja automatizacije plaćanja preko platnih računa i druge poslovne svrhe i nabavljanje poslovnih statistika i informacija, pružanje prodajnih i marketinških informacija koje se odnose na poslovnu zajednicu prema zahtevima klijenata, usluge pripreme lista sa poštanskim adresama, kompjuterizovane markentiške savetodavne usluge koje se pružaju privrednim društvima, naročito, pružanje informacija za identifikaciju pravaca poslovanja preduzeća i odnosa između nacionalnih i međunarodnih kompanija, pružanje demografskih informacija o različitim poslovanjima u određenim geografskim oblastima, prikupljanje i širenje reklamnih sadržaja za druge, pripremanje listi kompanija za druge, pružanje poslovnih informacija pomoću prethodno snimljenih telefonskih poruka, usluge ocene dobavljača roba i usluga u odnosu na ukupni finansijski nivo, operativni nivo i nivo rizika

**Klasa 36:** Obezbeđivanje informacija o kreditima i naplatama potraživanja koje se odnose na poslovanje, usluge agencija za naplatu potraživanja, obezbeđivanje usluga vraćanja kredita i naplate potraživanja, obezbeđivanje izveštaja o kreditnom rejtingu, usluge finansijskih izveštaja koji se odnose na naplatu kredita i kreditne izveštaje, prodaju, finansije i kreditnu i finansijsku analizu, usluge finansijskog marketinga i istraživanja, obezbeđivanje kreditnog rejtinga i finansijskih izveštaja i analiza, sprovođenje dobrotvornih programa u kojem se od strane pokrovitelja duplira (uvećava) vrednost svake pojedinačne donacije, usluge obezbeđivanja finansijski podataka o kreditnoj istoriji, usluge obezbeđivanja informacija i usluge investicionog rejtinga, uključujući usluge kreditnih informacija koje se obezbeđuju preko kompjuterskog softvera, usluge naplate dugovanja, obezbeđivanje kreditnih izveštaja i informacija o kreditnom rejtingu pomoću prethodno snimljenih telefonskih poruka, analiza kreditnog rizika.

(111) 08855

(151) 12.11.2013.

(210) **2011-597**

(442) **20.03.2013.**

(220) 05.12.2011.

(732) **DUN&BRADSTREET INTERNATIONAL.LTD**, 103 JFK PARKWAY, SHORT HILLS, NEW JERSEY 07078 US

**DUNSRIGHT**

(540)

(550) I, V

(740) Radulović Božidar, Jovana Tomaševića 9/III, Podgorica ME

(511) **Klasa 35:** Usluge obezbeđivanja izveštaja o prodaji i tržištu za druge po narudžbini i/ili specifikaciji, usluge obezbeđivanja opštih poslovnih informacija koje se tiču prodaje, obima i pozicije, sprovođenje marketinških studija, usluge obezbeđivanja poslovnih informacija koje se odnose na oblast marketinga, demografije i statistike, pripisivanje i obezbeđivanje identifikacionih brojeva privrednim društvima za primenu u svrhe olakšavanja automatizacije plaćanja preko platnih računa i druge poslovne svrhe i nabavljanje poslovnih statistika i informacija, pružanje prodajnih i marketinških informacija koje se odnose na poslovnu zajednicu prema zahtevima klijenata, usluge pripreme lista sa poštanskim adresama, kompjuterizovane markentiške savetodavne usluge koje se pružaju privrednim društvima, naročito, pružanje informacija za identifikaciju pravaca poslovanja preduzeća i odnosa između nacionalnih i međunarodnih kompanija, pružanje demografskih informacija o različitim poslovanjima u određenim geografskim oblastima, prikupljanje i širenje reklamnih sadržaja za druge, pripremanje listi kompanija za druge, pružanje poslovnih informacija pomoću prethodno snimljenih telefonskih poruka, usluge ocene dobavljača roba i usluga u odnosu na ukupni finansijski nivo, operativni nivo i nivo rizika

**Klasa 36:** Obezbeđivanje informacija o kreditima i naplatama potraživanja koje se odnose na poslovanje, usluge agencija za naplatu potraživanja, obezbeđivanje usluga vraćanja kredita i naplate potraživanja, obezbeđivanje izveštaja o kreditnom rejtingu, usluge finansijskih izveštaja koji se odnose na naplatu kredita i kreditne izveštaje, prodaju, finansije i kreditnu i finansijsku analizu, usluge finansijskog marketinga i istraživanja, obezbeđivanje kreditnog rejtinga i finansijskih izveštaja i analiza, sprovođenje dobrotvornih programa u kojem se od strane pokrovitelja duplira(uvećava) vrednost svake pojedinačne donacije, usluge obezbeđivanja finansijski podataka o kreditnoj istoriji, usluge obezbeđivanja informacija i usluge investicionog rejtinga, uključujući usluge kreditnih informacija koje se obezbeđuju preko kompjuterskog softvera, usluge naplate dugovanja, obezbeđivanje kreditnih izveštaja i informacija o kreditnom rejtingu pomoću prethodno snimljenih telefonskih poruka, analiza kreditnog rizika.

(111) 08856

(151) 12.11.2013.

(210) **2011-598**

(442) **20.03.2013.**

(220) 05.12.2011.

(732) **DUN&BRADSTREET INTERNATIONAL**, LTD, 103 JFK PARKWAY, SHORT HILLS, NEW JERSEY 07078 US

**D-U-N-S**

(540)

(550) I, V

(740) Radulović Božidar, Jovana Tomaševića 9/III, Podgorica ME

(511) **Klasa 35:** Usluge obezbeđivanja izveštaja o prodaji i tržištu za druge po narudžbini i/ili specifikaciji, usluge obezbeđivanja opštih poslovnih informacija koje se tiču prodaje, obima i pozicije, sprovođenje marketinških studija, usluge obezbeđivanja poslovnih informacija koje se odnose na oblast marketinga, demografije i statistike, pripisivanje i obezbeđivanje identifikacionih brojeva privrednim društvima za primenu u svrhe olakšavanja automatizacije plaćanja preko platnih računa i druge poslovne svrhe i nabavljanje poslovnih statistika i informacija, pružanje prodajnih i marketinških informacija koje se odnose na poslovnu zajednicu prema zahtevima klijenata, usluge pripreme lista sa poštanskim adresama, kompjuterizovane marketinške savetodavne usluge koje se pružaju privrednim društvima, naročito, pružanje informacija za identifikaciju pravaca poslovanja preduzeća i odnosa između nacionalnih i međunarodnih kompanija, pružanje demografskih informacija o različitim poslovanjima u određenim geografskim oblastima, prikupljanje i širenje reklamnih sadržaja za druge, pripremanje listi kompanija za druge, pružanje poslovnih informacija pomoću prethodno snimljenih telefonskih poruka, usluge ocene dobavljača roba i usluga u odnosu na ukupni finansijski nivo, operativni nivo i nivo rizika

**Klasa 36:** Obezbeđivanje informacija o kreditima i naplatama potraživanja koje se odnose na poslovanje, usluge agencija za naplatu potraživanja, obezbeđivanje usluga vraćanja kredita i naplate potraživanja, obezbeđivanje izveštaja o kreditnom rejtingu, usluge finansijskih izveštaja koji se odnose na naplatu kredita i kreditne izveštaje, prodaju, finansije i kreditnu i finansijsku analizu, usluge finansijskog marketinga i istraživanja, obezbeđivanje kreditnog rejtinga i finansijskih izveštaja i analiza, sprovođenje dobrotvornih programa u kojem se od strane pokrovitelja duplira(uvećava) vrednost svake pojedinačne donacije, usluge obezbeđivanja finansijski podataka o kreditnoj istoriji, usluge obezbeđivanja informacija i usluge investicionog rejtinga, uključujući usluge kreditnih informacija koje se obezbeđuju preko



kompjuterskog softvera, usluge naplate dugovanja, obezbjeđivanje kreditnih izveštaja i informacija o kreditnom rejtingu pomoću prethodno snimljenih telefonskih poruka, analiza kreditnog rizika.

- 
- (111) 08857 (151) 12.11.2013.  
 (210) **2011-599** (442) **20.03.2013.**  
 (220) 05.12.2011.  
 (732) **DUN&BRADSTREET INTERNATIONAL, LTD**, 103 JFK PARKWAY, SHORT HILLS, NEW JERSEY 07078 US

**D&B**

- (540)  
 (550) I,V  
 (740) Radulović Božidar, Jovana Tomaševića 9/III, Podgorica ME  
 (511) **Klasa 35:** Usluge obezbeđivanja izveštaja o prodaji i tržištu za druge po narudžbini i/ili specifikaciji, usluge obezbeđivanja opštih poslovnih informacija koje se tiču prodaje, obima i pozicije, sprovođenje marketinških studija, usluge obezbeđivanja poslovnih informacija koje se odnose na oblast marketinga, demografije i statistike, pripisivanje i obezbeđivanje indentifikacionih brojeva privrednim društvima za primenu u svrhe olakšavanja automatizacije plaćanja preko platnih računa i druge poslovne svrhe i nabavljanje poslovnih statistika i informacija, pružanje prodajnih i marketinških informacija koje se odnose na poslovnu zajednicu prema zahtevima klijenata, usluge pripreme lista sa poštanskim adresama, kompjuterizovane markentiške savetodavne usluge koje se pružaju privrednim društvima, naročito, pružanje informacija za identifikaciju pravaca poslovanja preduzeća i odnosa između nacionalnih i međunarodnih kompanija, pružanje demografskih informacija o različitim poslovanjima u određenim geografskim oblastima, prikupljanje i širenje reklamnih sadržaja za druge, pripremanje listi kompanija za druge, pružanje poslovnih informacija pomoću prethodno snimljenih telefonskih poruka, usluge ocene dobavljača roba i usluga u odnosu na ukupni finansijski nivo, operativni nivo i nivo rizika

**Klasa 36:** Obezbeđivanje informacija o kreditima i naplatama potraživanja koje se odnose na poslovanje, usluge agencija za naplatu potraživanja, obezbeđivanje usluga vraćanja kredita i naplate potraživanja, obezbeđivanje izveštaja o kreditnom rejtingu, usluge finansijskih izveštaja koji se odnose na naplatu kredita i kreditne izveštaje, prodaju, finansije i kreditnu i finansijsku analizu, usluge finansijskog marketinga i istraživanja, obezbeđivanje kreditnog rejtinga i finansijskih izveštaja i analiza, sprovođenje dobrotvornih programa u kojem se od strane pokrovitelja duplira(uvećava) vrednost svake pojedinačne donacije, usluge obezbeđivanja finansijski podataka o kreditnoj istoriji, usluge obezbeđivanja informacija i usluge investicionog rejtinga, uključujući usluge kreditnih informacija koje se obezbeđuju preko kompjuterskog softvera, usluge naplate dugovanja, obezbeđivanje kreditnih izveštaja i informacija o kreditnom rejtingu pomoću prethodno snimljenih telefonskih poruka, analiza kreditnog rizika.

- 
- (111) 08858 (151) 12.11.2013.  
 (210) **2011-600** (442) **20.03.2013.**  
 (220) 06.12.2011.  
 (732) **THE GOODYEAR TIRE&RUBBER COMPANY**, 1144 EAST MARKET STREET,

AKRON, OHIO 44316 US

### MARATHON

(540)

(550) I

(740) Čejović Vladimir, 13. jula 21, Podgorica ME

(511) **Klasa 12:** gume za kamione za komercijalnu upotrebu.,

(111) 08702

(151) 15.11.2013.

(210) **2011-529**

(442) **20.03.2013.**

(220) 03.11.2011.

(300) 85/313107 05052011 35

US

(732) **PROJECT MANAGEMENT INSTITUTE, INC** 14 CAMPUS BOULEVARD NEWTON SQUAPARE, PA 19073, USA A PENNSYLVANIA, USA CORPORATION US

### PMI-ACP

(540)

(550) I

(740) Čejović Vladimir, 13. jula 21, Podgorica ME

(511) **Klasa 35:** Oglašavanje, onlajn oglašavanje na računarskoj mreži, propaganda, odnosi sa javnošću, pomoć (podrška) u poslovnom upravljanju, konsultacije u vezi sa poslovnim upravljanjem i organizacijom, pomoć (podrška) u komercijalnom ili industrijskom upravljanju, profesionalne poslovne konsultacije, konsultacije u vezi sa organizovanjem posla, konsultacije u vezi sa upravljanjem kadrovima, psihološki testovi u vezi sa odabirom kadrova, poslovne informacije, agencije koje nude usluge komercijalnih informacija, komercionalne informacije i savjeti za potrošače (prodavnice za savjetovanje potrošača), prikupljanje informacija u kompjutersku bazu podataka, usluge poslovnog istraživanja, organizovanje izložbi u komercijalne ili reklamne svrhe, organizovanje sajmov a u komercijalne ili reklamne svrhe, prezentacija robe u medijima za komunikaciju u maloprodajne svrhe, izlaganje (prikazivanje) robe, usluge udruženja, naime, promovisanje interesa profesije projektnog upravljanja, promovisanje javne svijesti o profesiji projektnog upravljanja, obezbedjivanje informacija o projektnom upravljanju, testiranje u svrhu utvrđivanja profesionalne kompetentnosti u profesiji projektnog upravljanja, provjera i praćenje akreditiva profesionalaca za projektno upravljanje, onlajn maloprodajne usluge u vezi sa knjigama, istraživanje u oblasti projektnog upravljanja koje se odnosi na poslovanje, sve gore navedeno u oblasti projektnog upravljanja,

(111) 08703

(151) 15.11.2013.

(210) **2011-530**

(442) **20.03.2013.**

(220) 03.11.2011.

(300) 85/313092 35

05.05.2011.

US

(732) **PROJECT MANAGEMENT INSTITUTE, INC**, 14 CAMPUS BOULEVARD NEWTON SQUAPARE, PA 19073, USA A PENNSYLVANIA, USA CORPORATION US

### PMI AGILE CERTIFIED PRACTITIONER (PMI-ACP)

(540)

(550) I

(740) Čejović Vladimir, 13. jula 21, Podgorica ME

(511) **Klasa 35:** Oglašavanje, onlajn oglašavanje na računarskoj mreži, propaganda, odnosi sa javnošću, pomoć (podrška) u poslovnom upravljanju, konsultacije u vezi sa poslovnim upravljanjem i organizacijom, pomoć (podrška) u komercijalnom ili industrijskom upravljanju, profesionalne poslovne konsultacije, konsultacije u vezi sa organizovanjem posla, konsultacije u vezi sa upravljanjem kadrovima, psihološki testovi u vezi sa odabirom kadrova, poslovne informacije, agencije koje nude usluge komercijalnih informacija, komercionalne informacije i savjeti za potrošače (prodavnice za savjetovanje potrošača), prikupljanje informacija u kompjutersku bazu podataka, usluge poslovnog istraživanja, organizovanje izložbi u komercijalne ili reklamne svrhe, organizovanje sajмова u komercijalne ili reklamne svrhe, prezentacija robe u medijima za komunikaciju u maloprodajne svrhe, izlaganje (prikazivanje) robe, usluge udruženja, naime, promovisanje interesa profesije projektnog upravljanja, promovisanje javne svijesti o profesiji projektnog upravljanja, obezbjedjivanje informacija o projektnom upravljanju, testiranje u svrhu utvrdjivanja profesionalne kompetentnosti u profesiji projektnog upravljanja, provjera i praćenje akreditiva profesionalaca za projektno upravljanje, onlajn maloprodajne usluge u vezi sa knjigama, istraživanje u oblasti projektnog upravljanja koje se odnosi na poslovanje, sve gore navedeno u oblasti projektnog upravljanja,

(111) 08652 (151) 01.03.2007

(210) **2010-486**

(220) 28.12.2010.

(300) 919452 28.09.2006.

(732) **ETERNIT AG**, IM BREITSPIEL 20, 69126 HEIDELBERG DE

**NATURA**

(540)

(550) I

(740) Radulović Božidar, Jovana Tomaševića 9/III, Podgorica ME

(511) **Klasa 19:** Građevinski materijal (nemetalni), posebno cementom povezane ploče za vanjske zidove građevina.

(111) 08651 (151) 01.11.2013.

(210) **2009-328**

(220) 27.05.2009.

(732) **AGRO-HARIBEC INC.** rue Tardif 1485, J4W 2M4 Brossard (Quebec) CA



(540)

(550) I

(740) Čolović Branko, Mediteranska 2 Budva (ME)

(511) **Klasa 29:** Kikiriki, pripremljeni, bademi, pripremljeni, bob konzervirani, crveni luk, konzervirani (povrće), čips (prženi krompirići), dagnje za jelo, nežive, datulje, divljač, džemovi, fileti riblji, pečurke konzervirane, grašak konzervirani, grožđice, suvo grožđe, kroketi, incuni (riba), jaja, jaja u prahu, jastozi, neživi, jela od ribe, jetra, jetrena pašteta, jogurt, supe od mesnih koncentrata, supe od povrća (sastojci za pripremanje supa od povrća), supe, čiste, mesne (bujoni), puter od kakao, ostriga, neživa, kaša voćna, kavijar, kefir, kiseli kupus, kobasice (salame), sušemi kokosovi orasi, konzerve od povrća, konzerve, mesne, konzerve, riblje, konzerve, voćne, konzervirana soja u zrnu za prehranu, krastavci, ukiseljeni, kristalizirano voće, ulje od kukuruza, sočiva, konzervirana (povrće), lososi, lovna divljač, ljuskari (rakovi) neživi, margarin, maslac, masline, konzervirane, maslinovo ulje, jestivo, masti, jestive, meso, mlijeko, pašteta, jetrena, meso od pernatih živina, pire od paradajza, povrće, konzervirano, povrće, kuvano, povrće, sušeno, pršuta, sok od paradajza za kuhinju, riba, riba, konzervirana, riba, usoljena, riblje brašno za ljudsku hranu, salame, salate od povrća, salate voćne, sirevi, slanina, konzervirano sojino zrnje za prehranu, suhomesnati proizvodi, ulje od suncokreta, jestivo, školjke, nežive, tofi, tripice, ulje jestivo, ušecereno voće, voće, konzervirano, voće, kuvano, voće, sušeno, zamrznuto, voće, povrće, konzervirano.

**Klasa 30:** Anis (seme), aromatični preparati za prehrambene potrebe, arome, bademi prženi u šećeru (poslastice), bademovo tijesto, beskvasni hljeb, brašno od boba, bomboni, brašno, cimet (mirođija), crni šećer, čaj, čokolada, dvopek, esencija za prehranu, fermenti za tijesto, brašno od gorušice, ječam, guljeni, ječam, tučeni, ječmeno brašno, jela od brašna, kakao, mirođija (začin), kari (začin), kafa, kafa nepržena, kečap, kolači, krekeri, krompirovo brašno za prehranu, griz, kuhinjska so, kukuruz, mljeveni, kukuruzne pahuljice, majonez, med, melasa, mirođija, musli, sirće, pahuljice od sušenih žitarica, pahuljice, kukuruzne, pahuljice, zobene, biber, prehrambena tjestenina, pšenično brašno za ljudsku upotrebu, pirinač, sirup od melase, slad za prehranu, sladoled, poslastičarski proizvodi, slatkiši, sojino brašno, šećer, tapioka, proizvodi od žitarica.

**Klasa 31:** agrumi (južno voće), kikiriki, neobrađeni, bademi, neobrađeni, biljke, belančevine za životinjsku prehranu, bob u svježem stanju, bobice (neobrađeni plodovi), sjeme bundeve, cikorija (koren cikorije), cikorija (salata), dagnje žive, pečurke, svježe, grašak, svježi, grožđe, svježe, hrana za životinje, jastozi, živi, ječam, kakao u zrnu, sirovi, ostrige, žive, kesteni, sveži, kokosovi orasi, krastavci, kromširi, kukuruz, sočiva, svježa, luk, svježi, lešnjaci, masline, svježe, mekinje od žita, mekušci, živi, orasi, paprika, pernate životinje, mladi luk, posije od žitarica (mekinje), povrće, svježe, pšenica, raž, riba, živa, riža (neobrađena riža), rogač, jestivi, salata, zelena, susam, seno, sjeme, slad za fabrike piva i alkohola, stočna repa, šećerna trska, školjke žive, voće svježe, zob, žito, životinje, žive.

**INDEKS NOSILACA ŽIGOVA**  
INDEX OF THE HOLDER OF THE REGISTRATION

(732)	(111)	(210)
AB PH. NEDERMAN&CO	08514	2011-471
ABBOTT MEDICAL OPTICS INC	08707	2011-539
ADRIATIC MARINAS DOO	08517	2011-496
AGRO-HARIBEC INC	08651	2009-328
ALFA WASSERMANN HANGARY KFT	08323	2011-1
ALKALOID AD-SKOPLJE	08290	2011-505
ALKALOID AD-SKOPLJE	08291	2011-504
ALKALOID AD-SKOPLJE	08292	2011-484
ALKALOID AD-SKOPLJE	08293	2011-503
ALKALOID AD-SKOPLJE	08294	2011-483
ALKALOID AD-SKOPLJE	08295	2011-482
ALKALOID AD-SKOPLJE	08296	2011-480
ALKALOID AD-SKOPLJE	08297	2011-481
ALKALOID AD-SKOPLJE	08298	2011-479
ALKALOID AD-SKOPLJE	08299	2011-458
ALKALOID AD-SKOPLJE	08300	2011-457
AMO UPPSALA AB	08485	2011-257
ASTELLAS PHARMA EUROPE B.V.	08349	2011-295
ATE MY HEART INC.	08280	2011-500
ATLAS COPCO	08701	2011-528
B.D. BAGGIES LTD.	08482	2011-262
BACARDI AND COMPANY LIMITED	08285	2011-285
BANANA REPULIC ITM, INC	08354	2011-78
BASF AGRO B.V. ARNHEM	08256	2011-582
BASF AGRO B.V. ARNHEM	08840	2011-588
BASF AGRO B.V. ARNHEM	08852	2011-590
BASF CORPORATION	08839	2011-584
BASF SE	08257	2011-583
BASF SE	08851	2011-589
BELUPO LJEKOVI I KOZMETIKA D.D.	08273	2011-284
BEST WESTERN INTERNATIONAL	08361	2011-98
BEST WESTREN INTERNATIONAL	08360	2011-97
BONGARIN S.A.	08339	2011-42
BONGARIN S.A.	08340	2011-44
BORA CREATIONS S.L.	08309	2011-271
BOSNALIJEK	08275	2011-288
BOSNALIJEK	08649	2011-113
BOSNALIJEK	08650	2011-114

(732)	(111)	(210)
BRISTOL-MYERS SGUIBB SARL A FRENCH LIMITED LIABILITY COMPANY	08362	2011-11
BRISTOL-MYERS SQUIBB COMPANY A DELAWARE CORPORATION	08363	2011-12
BRITISH AMERICAN TOBACCO (BRANDS) INC.	08706	2011-538
CAESARS INTERACTIVE ENTERTAINMENT, INC	08832	2011-569
CAESARS INTERACTIVE ENTERTAINMENT, INC	08833	2011-570
CARPE DIEM GMBH&CO KG	08364	2011-101
CELGENE CORPORATION	08638	2011-83
CELGENE CORPORATION	08640	2011-85
CEMEX S.A.B.DE C.V.	08642	2011-95
CHONGING YUAN INNOVATION TECHONOLGY CO.LTD	08488	2011-300
CHRYSLER GROUP LLC	08637	2011-82
CIRQUE DU SOLEIL I.I.I.	08709	2011-546
CIRQUE DU SOLEIL I.I.I.	08710	2011-547
CIRQUE DU SOLEIL I.I.I.	08711	2011-548
ČISTI KRISTAL OOO	08609	2010-431
COLGATE-PALMOLIVE COMPANY	08278	2011-259
CORDIS CORPORATION	08644	2011-103
CORPORATION OF THE PRESIDENT OF THE CHURCH OF JESUS CHRIST OF LATTER-DAY SAINTS	08314	2011-487
CRNOGORSKI TELEKOM	08670	2010-141
CUMMINS INC.	08342	2011-66
DECKERS OUTDOOR CORPORATION	08279	2011-464
DELTA PRONATURA DR KRASUSS DR.BECKMANN KG	08657	2009-486
DIVERSEY, INC.	08483	2011-459
D-LINK CORPORATION	08322	2010-404
DOO GORATON	08307	2010-110
DOO RATKOVIĆ-ALFA-CETINJE	08286	2011-283
DUKAT D.D.	08708	2011-540
DUN&BRADSTREET INTERNATIONAL	08854	2011-596
DUN&BRADSTREET INTERNATIONAL	08855	2011-597
DUN&BRADSTREET INTERNATIONAL	08856	2011-598
DUN&BRADSTREET INTERNATIONAL	08857	2011-599
EDUCO CENTAR	08705	2011-537
ENTERPRISE HOLDINGS	08343	2011-67
ENTERPRISE HOLDINGS	08344	2011-68
ENTERPRISE HOLDINGS	08350	2011-69
ETERNIT AG	08652	2010-486
EXPRESS, LLC	08351	2011-70
FORNAX D.O.O.	08513	2011-485
FRESH&CO. DOO	08610	2011-2
FRESH&CO.DOO	08611	2011-3

(732)	(111)	(210)
GAP (ITM), INC	08355	2011-79
GENERAL MOTORS LLC	08718	2011-562
GENERAL MOTORS LLC	08831	2011-564
GENZYME CORPORATION	08329	2011-18
GENZYME CORPORATION	08330	2011-19
GENZYME CORPORATION	08331	2011-20
GENZYME CORPORATION	08332	2011-21
GUESS? INC.	08335	2011-27
GUESS? INC.	08336	2011-28
HELEN OF TROY LIMITED	08317	2011-301
HEMOFARM A.D.	08496	2011-260
HEMOFARM A.D.	08700	2011-526
HONDA MOTOR CO LTD	08689	2009-579
HUNDAI MOTOR COMPANY	08489	2011-265
HUNDAI MOTOR COMPANY	08504	2011-264
ICONIX EUROPE LLC	08277	2011-297
ICONIX EUROPE LLC	08512	2011-298
IMPERIAL TOBACCO LIMITED	08971	2009-487
INDUSTRIJA PIVA I SOKOVA TREBJESA AD. NIKŠIĆ	08520	2011-286
INDUSTRIJA PIVA I SOKOVA TREBJESA AD. NIKŠIĆ	08620	2011-49
INDUSTRIJA PIVA I SOKOVA TREBJESA AD. NIKŠIĆ	08621	2011-50
INDUSTRIJA PIVA I SOKOVA TREBJESA AD. NIKŠIĆ	08622	2011-51
INDUSTRIJA PIVA I SOKOVA TREBJESA AD. NIKŠIĆ	08623	2011-52
INDUSTRIJA PIVA I SOKOVA TREBJESA AD. NIKŠIĆ	08624	2011-53
INDUSTRIJA PIVA I SOKOVA TREBJESA AD. NIKŠIĆ	08625	2011-54
INDUSTRIJA PIVA I SOKOVA TREBJESA AD. NIKŠIĆ	08626	2011-55
INDUSTRIJA PIVA I SOKOVA TREBJESA AD. NIKŠIĆ	08627	2011-56
INDUSTRIJA PIVA I SOKOVA TREBJESA AD. NIKŠIĆ	08628	2011-57
INDUSTRIJA PIVA I SOKOVA TREBJESA AD. NIKŠIĆ	08629	2011-58
INDUSTRIJA PIVA I SOKOVA TREBJESA AD. NIKŠIĆ	08630	2011-59
INDUSTRIJA PIVA I SOKOVA TREBJESA AD. NIKŠIĆ	08631	2011-60
INDUSTRIJA PIVA I SOKOVA TREBJESA AD. NIKŠIĆ	08632	2011-61
INDUSTRIJA PIVA I SOKOVA TREBJESA AD. NIKŠIĆ	08633	2011-62
INDUSTRIJA PIVA I SOKOVA TREBJESA AD. NIKŠIĆ	08634	2011-73
INTEL CORPORATION	08498	2011-258
INTEL CORPORATION	08502	2011-261
INTERNATIONAL TRUCK INTELLECTUAL PRPERTY COMPANY	08503	2011-501
J.&P. COATS, LIMITED	08712	2011-549
J.&P. COATS, LIMITED	08713	2011-550
J.&P. COATS, LIMITED	08714	2011-551
J.&P. COATS, LIMITED	08715	2011-553
J.&P. COATS, LIMITED	08716	2011-554

(732)	(111)	(210)
JADRAN GALENSKI LABORATORIJ DD	08646	2011-107
JADRAN GALENSKI LABORATORIJ DD	08647	2011-108
JADRAN GALENSKI LABORATORIJ DD	08648	2011-109
JOCKEY INTERNATIONAL INC	08254	2011-525
JOHNSON OUTDOORS MARINE ELECTRONICS	08346	2011-463
JOHNSON OUTDOORS MARINE ELECTRONICS	08356	2011-460
JONHSON CONTROLS HYBRID AND RECYCLING GMBH	08253	2011-522
JONHSON CONTROS HYBRID AND RECYCLING GMBH	08252	2011-521
JT INTERNATIONAL S.A.	08500	2011-446
KAANE AMERICAN INTERNATIONAL TOBACCO CO. LTD	08635	2011-75
KAANE AMERICAN INTERNATIONAL TOBACCO CO. LTD.	08636	2011-76
KABUSHIKI KAISHA TOSHIBA (TOSHIBA CORPORATION)	08639	2011-84
KARBON GRAĐEVINSKI MATERIJALI D.O.O.	08606	2010-390
KARBON GRAĐEVINSKI MATERIJALI D.O.O.	08607	2010-391
KARBON GRAĐEVINSKI MATERIJALI D.O.O.	08608	2010-393
KARBON GRAĐEVINSKI MATERIJALI D.O.O.	08690	2010-384
KARBON GRAĐEVINSKI MATERIJALI D.O.O.	08691	2010-385
KARBON GRAĐEVINSKI MATERIJALI D.O.O.	08692	2010-386
KARBON GRAĐEVINSKI MATERIJALI D.O.O.	08693	2010-387
KARBON GRAĐEVINSKI MATERIJALI D.O.O.	08694	2010-388
KARBON GRAĐEVINSKI MATERIJALI D.O.O.	08695	2010-389
KIKA MOBEL-HANDELSGESELLSCHAFT M.B.H.	08357	2011-80
KIMBERLY-CLARK WORLDWIDE	08341	2011-46
KIPS D.O.O.	08274	2011-282
KOVING-M D.O.O	08345	2011-277
KRKA TOVARNA ZDRAVIL	08333	2011-22
KRKA TOVARNA ZDRAVIL	08334	2011-23
KURARAY CO.	08696	2011-516
MARINE STOCK LIMITED	08255	2011-579
MARINE STOCK LIMITED	08838	2011-580
MASTERCARD INTERNATIONAL INCORPORATED (DELAWARE CORPORATION)	08328	2011-17
MB IMPEKS DOO	08853	2011-595
MILLER BREWING INTERNATIONAL	08619	2011-47
MITSUBISHI SHOJI KAISHA LTD	08698	2011-519
MOTOROLA TRADEMARK HOLDINGS	08612	2011-5
MOTOROLA TRADEMARK HOLDINGS	08613	2011-6
MR. JAMAL ABDUL NASSER MAHMOOD AL MAHAMID	08024	2010-412
NETFLIX	08641	2011-88
NIKON CORPORATION	08719	2011-563
NINE WEST DEVELOPMENT CORPORATION	08645	2011-106
NISSAN JIDOSHA KABUSHIKI KAISHA	08366	2011-89
NISSAN JIDOSHA KABUSHIKI KAISHA	08367	2011-90



(732)	(111)	(210)
NISSAN JIDOSHA KABUSHIKI KAISHA	08501	2011-290
NOBEL ILAC SANAYII TICARET ANONIM SIREKETI	08282	2011-499
NOBEL ILAC SANAYII TICARET ANONIM SIRKETI	08287	2011-498
NOVARTIS AG	08487	2011-294
OMAN PERFUMERY LLC	08515	2011-465
ORACLE INTERNATIONAL CORPORATION	08643	2011-102
ORION ELECTRIC CO. LTD	08699	2011-524
PFIZER A.G.	08506	2011-266
PFIZER INC.	08499	2011-502
PHARMASWISS	08288	2011-256
PHARMASWISS	08511	2011-255
PLAYBOY ENTERPRISES INTERNATIONAL INC	08516	2011-263
PODRAVKA D.D.	08272	2011-455
PODRAVKA D.D.	08283	2011-473
PODRAVKA D.D.	08519	2011-276
PROJECT MANAGEMENT INSTITUTE, INC	08702	2011-529
PROJECT MANAGEMENT INSTITUTE, INC	08703	2011-530
REGENT HOSPITALITY WORLDWIDE	08507	2011-490
REGENT HOSPITALITY WORLDWIDE	08509	2011-488
REGENT HOSPITALITY WORLDWIDE	08510	2011-489
REXALL SUNDOWN, INC	08324	2011-7
RUBIN A.D.	08251	2011-510
S.C. JONSON&SON, INC.	08717	2011-555
S2 YACHTS, INC.	08837	2011-578
SAUDI ARABIA OIL COMPANY	08365	2011-105
SCANIA CV AKTIEBOLAG	08490	2011-274
SHANTHA BIOTECHNICS LIMITED	08281	2011-478
SHARP KABUSHIKI KAISHA	07296	2010-206
SHISEIDO COMPANY LIMITED	08508	2011-468
SKECHERS USA INC.II	08352	2011-71
SKECHERS USA INC.II	08353	2011-72
SOCIETE DES PRODUITS NESTLE S.A.	08697	2011-517
SOLGAR HOLDINGS	08326	2011-9
SOLGAR HOLDINGS	08327	2011-13
STIEFEL LABORATORIES, INC	08276	2011-477
STRAUSS GROUP LTD	08017	2010-128
SUPREME PROTEN	08497	2011-493
TELEFONICA S.A.	08316	2011-278
TENARIS CONNECTIONS BV	08358	2011-86
TENARIS CONNECTIONS BV	08359	2011-87
TEVA PHARMACEUTICAL INDUSTRIES LTD	08284	2011-280
TEVA PHARMACEUTICAL INDUSTRIES LTD	08308	2011-279
TEVA PHARMACEUTICAL INDUSTRIES LTD	08315	2011-272

(732)	(111)	(210)
THE ESTER C COMPANY	08325	2011-8
THE GILLETTE COMPANY	08310	2011-296
THE GILLETTE COMPANY	08337	2011-39
THE GILLETTE COMPANY	08338	2011-41
THE GOODYEAR TIRE&RUBBER COMPANY	08858	2011-600
THE HERSHEY COMPANY	08834	2011-572
THE HERSHEY COMPANY	08835	2011-573
THE HERSHEY COMPANY	08836	2011-575
THE PROCTER&GAMBLE COMPANY	08113	2011-291
THE PROCTER&GAMBLE COMPANY	08289	2011-302
THE PROCTER&GAMBLE COMPANY	08311	2011-293
THE PROCTER&GAMBLE COMPANY	08312	2011-292
THE QUAKER OATS COMPANY	08615	2011-30
THE QUAKER OATS COMPANY	08616	2011-30
TOYOTA JIDOSHA KABUSHIKI KAISHA	08614	2011-14
TOYOTA JIDOSHA KABUSHIKI KAISHA	08617	2011-34
TOYOTA JIDOSHA KABUSHIKI KAISHA	08618	2011-35
TUTUNSKI KOMBINAT AD PRILEP	08321	2009-502
TWENTIETX CENTURY FOX FILM CORPORATION	08478	2011-469
VIACOM INTERNATIONAL INC	08479	2011-476
VISIOGEN INC	08486	2011-472
VLADIMIR RADONJIĆ	08505	2011-281
VLASINKA DOO	08518	2011-267
VOĆAR DOO	08347	2011-461
VOĆAR DOO	08348	2011-462
WIX-FILTRON SP ZOO	08320	2009-255
WM. WRIGLEY JR. COMPANY	08704	2011-536

**INDEKS BROJEVA ŽIGOVA**  
INDEX OF THE TRADEMARK NUMBERS

(210)	(111)	(210)	(111)	(210)	(111)
2009-255	08320	2011-30	08616	2011-95	08642
2009-328	08651	2011-34	08617	2011-97	08360
2009-486	08657	2011-35	08618	2011-98	08361
2009-487	08971	2011-39	08337	2011-101	08364
2009-502	08321	2011-41	08338	2011-102	08643
2009-579	08689	2011-42	08339	2011-103	08644
2010-110	08307	2011-44	08340	2011-105	08365
2010-128	08017	2011-46	08341	2011-106	08645
2010-141	08670	2011-47	08619	2011-107	08646
2010-206	07296	2011-49	08620	2011-108	08647
2010-384	08690	2011-50	08621	2011-109	08648
2010-385	08691	2011-51	08622	2011-113	08649
2010-386	08692	2011-52	08623	2011-114	08650
2010-387	08693	2011-53	08624	2011-255	08511
2010-388	08694	2011-54	08625	2011-256	08288
2010-389	08695	2011-55	08626	2011-257	08485
2010-390	08606	2011-56	08627	2011-258	08498
2010-391	08607	2011-57	08628	2011-259	08278
2010-393	08608	2011-58	08629	2011-260	08496
2010-404	08322	2011-59	08630	2011-261	08502
2010-412	08024	2011-60	08631	2011-262	08482
2010-431	08609	2011-61	08632	2011-263	08516
2010-486	08652	2011-62	08633	2011-264	08504
2011-1	08323	2011-66	08342	2011-265	08489
2011-2	08610	2011-67	08343	2011-266	08506
2011-3	08611	2011-68	08344	2011-267	08518
2011-5	08612	2011-69	08350	2011-271	08309
2011-6	08613	2011-70	08351	2011-272	08315
2011-7	08324	2011-71	08352	2011-274	08490
2011-8	08325	2011-72	08353	2011-276	08519
2011-9	08326	2011-73	08634	2011-277	08345
2011-11	08362	2011-75	08635	2011-278	08316
2011-12	08363	2011-76	08636	2011-279	08308
2011-13	08327	2011-78	08354	2011-280	08284
2011-14	08614	2011-79	08355	2011-281	08505
2011-17	08328	2011-80	08357	2011-282	08274
2011-18	08329	2011-82	08637	2011-283	08286
2011-19	08330	2011-83	08638	2011-284	08273
2011-20	08331	2011-84	08639	2011-285	08285
2011-21	08332	2011-85	08640	2011-286	08520
2011-22	08333	2011-86	08358	2011-288	08275
2011-23	08334	2011-87	08359	2011-290	08501
2011-27	08335	2011-88	08641	2011-291	08113
2011-28	08336	2011-89	08366	2011-292	08312
2011-30	08615	2011-90	08367	2011-293	08311

(210)	(111)	(210)	(111)	(210)	(111)
2011-294	08487	2011-510	08251	2011-600	08858
2011-295	08349	2011-516	08696		
2011-296	08310	2011-517	08697		
2011-297	08277	2011-519	08698		
2011-298	08512	2011-521	08252		
2011-300	08488	2011-522	08253		
2011-301	08317	2011-524	08699		
2011-302	08289	2011-525	08254		
2011-446	08500	2011-526	08700		
2011-455	08272	2011-528	08701		
2011-457	08300	2011-529	08702		
2011-458	08299	2011-530	08703		
2011-459	08483	2011-536	08704		
2011-460	08356	2011-537	08705		
2011-461	08347	2011-538	08706		
2011-462	08348	2011-539	08707		
2011-463	08346	2011-540	08708		
2011-464	08279	2011-546	08709		
2011-465	08515	2011-547	08710		
2011-468	08508	2011-548	08711		
2011-469	08478	2011-549	08712		
2011-471	08514	2011-550	08713		
2011-472	08486	2011-551	08714		
2011-473	08283	2011-553	08715		
2011-476	08479	2011-554	08716		
2011-477	08276	2011-555	08717		
2011-478	08281	2011-562	08718		
2011-479	08298	2011-563	08719		
2011-480	08296	2011-564	08831		
2011-481	08297	2011-569	08832		
2011-482	08295	2011-570	08833		
2011-483	08294	2011-572	08834		
2011-484	08292	2011-573	08835		
2011-485	08513	2011-575	08836		
2011-487	08314	2011-578	08837		
2011-488	08509	2011-579	08255		
2011-489	08510	2011-580	08838		
2011-490	08507	2011-582	08256		
2011-493	08497	2011-583	08257		
2011-496	08517	2011-584	08839		
2011-498	08287	2011-588	08840		
2011-499	08282	2011-589	08851		
2011-500	08280	2011-590	08852		
2011-501	08503	2011-595	08853		
2011-502	08499	2011-596	08854		
2011-503	08293	2011-597	08855		
2011-504	08291	2011-598	08856		
2011-505	08290	2011-599	08857		

INDEKS PO KLASAMA NIČANSKE KLASIFIKACIJE ROBA I USLUGA  
INDEX ACCORDING TO THE NICE CLASSIFICATION OF GOODS AND SERVICES

<b>Klasa 01</b>	08298	08349	08701	<b>Klasa 12</b>
08256	08299	08362		08320
08257	08300	08363	<b>Klasa 09</b>	08342
08365	08309	08485	07296	08356
08606	08312	08487	08252	08488
08607	08337	08496	08253	08490
08608	08338	08497	08307	08501
08646	08341	08499	08316	08503
08647	08349	08506	08322	08614
08648	08508	08511	08346	08637
08657	08515	08515	08351	08837
08690	08645	08638	08356	08858
08691	08646	08640	08366	
08692	08647	08646	08367	<b>Klasa 13</b>
08693	08648	08647	08478	08503
08694	08657	08648	08498	
08695		08649	08502	<b>Klasa 14</b>
08696	<b>Klasa 04</b>	08650	08513	08719
08839	08515	08657	08612	
08851		08700	08613	<b>Klasa 15</b>
	<b>Klasa 05</b>	08717	08617	08307
<b>Klasa 02</b>	08256	08840	08618	
08606	08257	08851	08639	<b>Klasa 16</b>
08607	08273	08852	08641	08251
08608	08275	08853	08643	08272
08690	08276		08670	08341
08691	08281	<b>Klasa 06</b>	08699	08354
08692	08282	08356	08718	08670
08693	08284	08358	08831	08696
08694	08287	08359		08719
08695	08288		<b>Klasa 10</b>	
	08289	<b>Klasa 07</b>	08284	<b>Klasa 17</b>
<b>Klasa 03</b>	08308	08320	08308	08696
08113	08315	08342	08486	
08275	08323	08356	08644	<b>Klasa 18</b>
08278	08324	08490	08646	08355
08280	08325	08514	08647	08512
08290	08326	08689	08648	08516
08291	08327	08701	08707	08719
08292	08329	08719		
08293	08330		<b>Klasa 11</b>	<b>Klasa 19</b>
08294	08331	<b>Klasa 08</b>	08357	08606
08295	08332	08310	08514	08607
08296	08333	08311		08608
08297	08334	08317		08642

08652	08838	08520	08513	08483
08690		08610	08520	08488
08691	<b>Klasa 26</b>	08611	08620	08503
08692	08354	08619	08621	08514
08693		08620	08622	08670
08694	<b>Klasa 27</b>	08621	08623	08719
08695	08357	08622	08624	
		08623	08625	<b>Klasa 38</b>
<b>Klasa 20</b>	<b>Klasa 29</b>	08624	08626	08316
08274	08017	08625	08627	08345
08317	08283	08626	08628	08478
08357	08339	08627	08629	08479
	08340	08628	08630	08641
<b>Klasa 21</b>	08519	08629	08631	08670
08317	08615	08630	08632	
08357	08616	08631	08633	<b>Klasa 39</b>
08483	08651	08632	08634	08274
08719	08698	08633	08641	08343
	08708	08634	08646	08344
<b>Klasa 22</b>		08708	08647	08350
08698	<b>Klasa 30</b>		08648	08507
	08017	<b>Klasa 33</b>	08670	08509
<b>Klasa 23</b>	08283	08251	08702	08510
08698	08286	08285	08703	
08712	08347	08505	08854	<b>Klasa 41</b>
08713	08348	08609	08855	08307
08714	08519		08856	08314
08715	08615	<b>Klasa 34</b>	08857	08316
08716	08616	08024		08478
	08646	08321	<b>Klasa 36</b>	08479
<b>Klasa 24</b>	08647	08500	08328	08483
08354	08648	08635	08489	08498
08357	08651	08636	08504	08507
08516	08697	08706	08507	08509
08698	08704	08971	08509	08510
	08708		08510	08641
<b>Klasa 25</b>	08834	<b>Klasa 35</b>	08670	08670
08254	08835	08272	08854	08705
08255	08836	08274	08855	08709
08277		08307	08856	08710
08279	<b>Klasa 31</b>	08316	08857	08711
08335	08256	08343		08719
08336	08651	08344	<b>Klasa 37</b>	08832
08352		08350	08274	08833
08353	<b>Klasa 32</b>	08352	08343	
08355	08017	08355	08344	<b>Klasa 42</b>
08482	08251	08507	08345	08345
08516	08364	08509	08350	08513
08719	08518	08510	08357	08646

08647  
08648  
08670  
08719

**Klasa 43**

08017  
08274  
08314  
08360  
08361  
08507  
08509  
08510  
08517

**Klasa 44**

08507  
08509  
08510  
08646  
08647  
08648

**Klasa 45**

08314





**OBJAVA ISPRAVKI  
CORRECTIONS**

U „Crnogorskom glasniku intelektualne svojine“ broj 12. od 20.06.2013. godine objavljeni su pogrešni podaci za žig **2011-131**

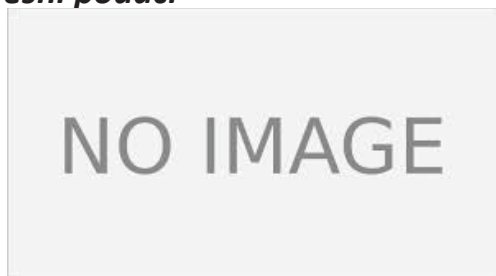
***Pogrešni podaci***

(540)

***Ispravni podaci*****OMNIVIT**

(540)

U „Crnogorskom glasniku intelektualne svojine“ broj 12. od 20.06.2013. godine objavljeni su pogrešni podaci za žig **2011-130**

***Pogrešni podaci***

(732) **CONVATEC INC.**, 200 HEADQUARTERS PARK DRIVE, SKILLMAN, NJ08558, US

***Ispravni podaci***

(732) ConvaTec Inc., a Delaware corporation

200 Headquarters Park Drive, Skillman, New Jersey 08558 US

U „Crnogorskom glasniku intelektualne svojine“ broj 12. od 20.06.2013. godine objavljeni su pogrešni podaci za žig **2011-183**

***Pogrešni podaci***

(732) **SCERING CORPRATION**, 2000 GALLOPING HILL ROAD, KENILWORTH, NEW JERSEY 07033, US

***Ispravni podaci***

(732) **MERCK SHARP & DOHME CORP**, One Merck, Whitehouse Station, New Jersey 08889 US

U „Crnogorskom glasniku intelektualne svojine“ broj 12. od 20.03.2013. godine objavljeni su pogrešni podaci za žig **2011-345**

***Pogrešni podaci***

(732) **COORS BREEWING COMPANY**, 1225 17 STREET, SUITE 3200 DENVER, COLORADO, 80202 US

***Ispravni podaci***

(732) **COORS BREWING COMPANY**, 1225 17th STREET, SUITE 3200 DENVER, COLORADO, 80202 US

U „Crnogorskom glasniku intelektualne svojine“ broj 12. od 20.06.2013. godine objavljeni su pogrešni podaci za žig **2011-184**

***Pogrešni podaci***

(732) **SCERING CORPRATION**, 2000 GALLOPING HILL ROAD, KENILWORTH, NEW JERSEY 07033, US

***Ispravni podaci***

(732) **MERCK SHARP & DOHME CORP**, One Merck, Whitehouse Station, New Jersey 08889 US

U „Crnogorskom glasniku intelektualne svojine“ broj 12. od 20.06.2013. godine objavljeni su pogrešni podaci za žig **2011-147**

***Pogrešni podaci***

(732) **Schering Corpration**, 2000 Galloping Hill Road, New Jersey 07033,US

(511) **Klasa 05**: Farmaceutski preparati , naročito za ljudsku upotrebu.

***Ispravni podaci***

(732) **MERCK SHARP & DOHME CORP**, One Merck, Whitehouse Station, New Jersey 08889 US

(511) **Klasa 05**: Farmaceutski preparati , naročito vakcine za ljudsku upotrebu.

U „Crnogorskom glasniku intelektualne svojine“ broj 12. od 20.06.2013. godine objavljeni su pogrešni podaci za žig **2011-187**

***Pogrešni podaci***

(732) **SCHERING CORPRATION**, 2000 GALLOPING HILL ROAD, KENILWORTH, NEW JERSEY 07033, US

***Ispravni podaci***

(732) **MERCK SHARP & DOHME CORP**, One Merck, Whitehouse Station, New Jersey 08889 US

U „Crnogorskom glasniku intelektualne svojine“ broj 12. od 20.06.2013. godine objavljeni su pogrešni podaci za žig **2011-234**

***Pogrešni podaci***

(732) **KRAFT FOODS GLOBAL BRANDS LLC**,A STATE OF DELAWARE LIMITED LIABILITY COMPANY, THREE LAKES DRIVE, NORTFIELD ILLINOIS 60093, US

***Ispravni podaci***

(732) **KRAFT FOODS GLOBAL BRANDS LLC**,A STATE OF DELAWARE LIMITED LIABILITY COMPANY, THREE LAKES DRIVE, NORTHIELD ILLINOIS 60093 US

U „Crnogorskom glasniku intelektualne svojine“ broj 12. od 20.06.2013. godine objavljeni su pogrešni podaci za žig **2011-387**

***Pogrešni podaci***

(731) **S.C. COMCEH S.A.**, STRADA BUURESTI, N.358 910048 CALARASI RO

***Ispravni podaci***

(731) **S.C. COMCEH S.A.**, Strada București, n 358, 910048 Călărași RO

U „Crnogorskom glasniku intelektualne svojine“ broj **12. od 20.06.2013.** godine objavljeni su pogrešni podaci prijave za žig **2010-381**

***Pogrešni podaci***

(731) **GLAHO SMITHKLINE LLC**, 2711 CENTERVILLE ROAD, SUITE 400, WILMINGTON, DELAWARE

19808 US

***Ispravni podaci***

(731) **GlaxoSmithKline LLC**, 2711 CENTERVILLE ROAD, SUITE 400, WILMINGTON, DELAWARE

19808 US



## OBAVJEŠTENJE NOTICE

### Objava upisa u Registar žigova CG priznatih žigova, registrovanih u Zavodu SCG, odnosno Zavodu Srbije, prije otvaranja Zavoda CG

Članom 65 stav 1 Zakona o žigu ("Sl.list CG", br. 72/10) priznata su prava na žigovima koji su registrovani i upisani u Registar žigova u Zavodu za intelektualnu svojinu Srbije i Crne Gore, odnosno Zavodu za intelektualnu svojinu Srbije do 28. maja 2008. godine (do dana otvaranja Zavoda za intelektualnu svojinu Crne Gore) do isteka njihovog trajanja.

Zavod je implementirao odredbu člana 65 stav 2 Zakona o žigu i izvršio upis u Registar, po službenoj dužnosti žigove za koje je izdao uvjerenja o važenju žiga u formi zabilješke u 2008. godini.

Zavod je implementirao odredbu stava 4 istog člana i donio rješenja o upisu u Registar žigova za koje su podnijeti zahtjevi u 2008. godini za obnovu važnosti žiga, prenos prava i promjenu imena i adrese shodno koja propisuje da se ti zahtjevi smatraju kao zahtjevi za upis u registar.

### MEĐUNARODNI KODOVI ZA IDENTIFIKACIJU BIBLIOGRAFSKIH PODATAKA O ŽIGOVIMA PREMA WIPO ST 60 RECOMMENDATION CONCERNING BIBLIOGRAFIC DATA RELATING TO TRADEMARKS- WIPO-ST. 60

CRNOGORSKI	MDK	ENGLESKI
REGISTARSKI BROJ CG	<b>111</b>	NUMBER OF THE REGISTRATION CG
REGISTARSKI BROJ SCG	<b>111</b>	NUMBER OF THE REGISTRATION SCG
BROJ PRIJAVE	<b>210</b>	NUMBER OF THE APPLICATION
IME I ADRESA NOSIOCA ŽIGA	<b>732</b>	NAME AND ADDRESS OF THE HOLDER OF THE REGISTRATION



(111) CG	(210) Ž	(732)	(111) SCG
07894	2002-306	<b>MSD International GmbH, a limited liability company of Switzerland;</b> Weystrasse 20, 6000 Lucerne 6, Switzerland	48950
07950	1997-913	<b>BAYERISCHE MOTOREN WERKE AG;</b> Petuelring 130, BMW Haus, D-800 Munchen 40, DE	44346
07947	1992-299	<b>RELIGIOUS TECHNOLOGY CENTER;</b> 1710 IVAR AVENUE, LOS ANGELES, CALIFORNIA, US	39128
07949	2003-1731	<b>Rolls-Royce Plc.;</b> 65 Buckingham Gate, London SW1E 6AT, Velika Britanija, GB	49788
07948	1955-104	<b>ROLLS-ROYCE PLC.;</b> 65 BUCKINGHAM GATE, LONDON, SW1E 6AT, ENGLSKA, GB	13402
07895	2006-112	<b>a limited liability company organized and existing under the laws of Netherlands;</b> Wim de Korverstraat 35, NL-5831, AN Boxmeer, Netherlands	52231
07954	1992-286	<b>RELIGIOUS TECHNOLOGY CENTER;</b> 1710 IVAR AVENUE, LOS ANGELES, CALIFORNIA, US	39015
07958	1992-316	<b>RELIGIOUS TECHNOLOGY CENTER;</b> 1710 IVAR AVENUE, LOS ANGELES, CALIFORNIA, US	39020
07956	1992-285	<b>RELIGIOUS TECHNOLOGY CENTER;</b> 1710 IVAR AVENUE, LOS ANGELES, CALIFORNIA, US	39014
07959	1992-308	<b>RELIGIOUS TECHNOLOGY CENTER;</b> 1710 IVAR AVENUE, LOS ANGELES, CALIFORNIA, US	39139
07921	1998-809	<b>AMERICAN-CIGARETTE COMPANY (OVERSEAS) LIMITED;</b> ZAHLERWEG 4, 6300 ZUG, ŠVAJCARSKA, CH	44307
07896	1996-1357	<b>SHELL BRANDS INTERNATIONAL AG;</b> Baareratte, 6340 Baar Switzerland (CH), CH	42299
07902	1996-1484	<b>SHELL BRANDS INTERNATIONAL AG;</b> Baareratte, 6340 Baar Switzerland, CH	43397
07901	1996-1359	<b>SHELL BRANDS INTERNATIONAL AG;</b> Baareratte, 6340 Baar Switzerland, CH	42301
07923	1987-613	<b>AMERICAN CIGARETTE COMPANY (OVERSEAS) LIMITED;</b> ZAHLERWEG 4, 6300 ZUG, ŠVAJCARSKA, CH	35662
07922	2004-111	<b>American-Cigarette Company (Overseas) Limited;</b> Zaehlerweg 4 Zug 6300, Švajcarska, CH	49544
07897	1953-38	<b>SHELL BRANDS INTERNATIONAL AG;</b> Baareratte, 6340 Baar Switzerland, CH	12629
08001	1997-1490	<b>PODRAVKA D.D. PREHRAMBENA INDUSTRIJA;</b> HR-48000 KOPRIVNICA, ANTE STARČEVIĆA 32, HR	43820
07910	1994-637	<b>SHELL BRANDS INTERNATIONAL AG;</b> Baareratte, 6340 Baar Switzerland, CH	40766
07905	1956-207	<b>SHELL BRANDS INTERNATIONAL AG;</b> Baareratte, 6340 Baar Switzerland, CH	13782
08010	1969-763	<b>MASSEY FERGUSON Corp.;</b> 4830 RIVER GREEN PARKWAY, DULUTH, GA 30136-2574, US	19194
08008	1997-1082	<b>PODRAVKA D.D., PREHRAMBENA INDUSTRIJA;</b> 48000 KOPRIVNICA, ANTE STARČEVIĆA 32, HR	43345
07977	1983-54	<b>RELIGIOUS TECHNOLOGY CENTER;</b> 1710 IVAR AVENUE, LOS ANGELES, CALIFORNIA, US	29004
07909	1971-83	<b>SHELL BRANDS INTERNATIONAL AG;</b> Baareratte, 6340 Baar Switzerland, CH	20256
07997	2002-1107	<b>PODRAVKA prehrambena industrija d.d.;</b> Ante Starčevića 32 HR-48000 Koprivnica, Hrvatska, HR	49422
07996	2002-1108	<b>PODRAVKA prehrambena industrija d.d.;</b> Ante Starčevića 32 HR-48000 Koprivnica, Hrvatska, HR	49423
07991	2003-156	<b>PODRAVKA prehrambena industrija d.d.;</b> Ante Starčevića 32, HR-48000 Koprivnica, HRVATSKA, HR	48883

07992	2002-1110	<b>PODRAVKA prehrambena industrija d.d.</b> ; Ante Starčevića 32 HR-48000 Koprivnica, Hrvatska, HR	49424
07990	2003-428	<b>PODRAVKA prehrambena industrija d.d.</b> ; Ante Starčevića 32, HR-48000 Koprivnica, HRVATSKA, HR	48655
07904	1972-378	<b>SHELL BRANDS INTERNATIONAL AG</b> ; Baarermatte, 6340 Baar Switzerland, CH	21581
07911	1996-1356	<b>SHELL BRANDS INTERNATIONAL AG</b> ; Baarermatte, 6340 Baar Switzerland, CH	42254
07914	1996-1354	<b>SHELL BRANDS INTERNATIONAL AG</b> ; Baarermatte, 6340 Baar Switzerland, CH	42252
07915	1973-461	<b>SHELL BRANDS INTERNATIONAL AG</b> ; Baarermatte, 6340 Baar Switzerland, CH	22098
07913	1965-125	<b>SHELL BRANDS INTERNATIONAL AG</b> ; Baarermatte, 6340 Baar, Switzerland, CH	16614
07912	1967-156	<b>SHELL BRANDS INTERNATIONAL AG</b> ; Baarermatte, 6340 Baar Switzerland, CH	17381
07927	1981-722	<b>BANG &amp; OLUFSEN A/S</b> ; PETER BANGS VEJ 15, DK-7600 STRUER, DK	31057
07916	1967-211	<b>SHELL BRANDS INTERNATIONAL AG</b> ; Baarermatte, 6340 Baar Switzerland, CH	17430
07928	1981-721	<b>BANG &amp; OLUFSEN A/S</b> ; PETER BANGS VEJ 15, DK-7600 STRUER, DK	31056
07919	1997-108	<b>CORPORACION HABANOS, S. A.</b> ; AVENIDA 3RA NO. 2006 ENTRE 20 Y 22, MIRAMAR, PLAYA CIUDAD DE LE HABANA REPUBLICA DE CUBA, CU	43717
07926	1983-369	<b>CORPORACION HABANOS, S.A.</b> ; Avenida 3ra No. 2006 entre 20 y 22, Miramar, Playa Ciudad de la Habana Republica de Cuba, CU	31745
07920	1997-107	<b>CORPORACION HABANOS, S.A.</b> ; AVENIDA 3RA NO. 2006 ENTRE 20 Y 22, MIRAMAR, PLAYA CIUDAD DE LA HABANA REPUBLICA DE CUBA, CU	43718
08019	1992-271	<b>RELIGIOUS TECHNOLOGY CENTER</b> ; 1710 IVAR AVENUE, LOS ANGELES, CALIFORNIA, US	39000
07936	1953-49	<b>SHELL BRANDS INTERNATIONAL AG</b> ; Baarermatte, 6340 Baar Switzerland, CH	12640
07937	1953-47	<b>SHELL BRANDS INTERNATIONAL AG</b> ; Baarermatte, 6340 Baar Switzerland, CH	12638
08045	1979-353	<b>BURGER KING CORPORATION</b> ; 5505 Blue Lagoon Drive, Miami, Florida 33126, US	26658
08042	1994-619	<b>British-American Tobacco Polska S.A.</b> ; Ul.Tytoniowa 16, 16-300 Augustow, PL	41759
08078	2006-2143	<b>Mondelez Europe GmbH</b> ; Lindbergh-Allee 1,8152 Glattpark,Švajcarska,CH	54160
08047	1946-253	<b>COLUMBIA PICTURES INDUSTRIES, INC. and COLUMBIA PICTURES INDUSTRIES, INC.</b> ; 711 FIFTH AVENUE, NEW YORK, NEW YORK 10022, US and 10202 W. Washington Blvd., Culver City, California, US	11300
08049	1982-200	<b>THRIFTY RENT-A-CAR SYSTEM, INC.</b> ; P.O.BOX 35250, TULSA, OKLAHOMA 74135, US	28744
08054	2006-799	<b>WPP Properties (Delaware General Partnership) and WPP Properties (Delaware General Partnership)</b> ; 1001 Front Street San Francisco, CA 94111, US and 1001 Front Street, San Francisco, CA94111, US	52914
08104	1997-1091	<b>PODRAVKA D.D., PREHRAMBENA INDUSTRIJA</b> ; 48000 KOPRIVNICA, ANTE STARČEVIĆA 32, HR	43728
08105	1997-1092	<b>PODRAVKA D.D., PREHRAMBENA INDUSTRIJA</b> ; 48000 KOPRIVNICA, ANTE STARČEVIĆA 32, HR	43709
08066	1997-322	<b>ELI LILLY AND COMPANY</b> ; LILLY CORPORATE CENTER, INDIANAPOLIS, INDIANA, US	40145
08106	1997-1094	<b>PODRAVKA D.D., PREHRAMBENA INDUSTRIJA</b> ; 48000 KOPRIVNICA, ANTE STARČEVIĆA 32, HR	43712
08107	1997-1096	<b>PODRAVKA D.D., PREHRAMBENA INDUSTRIJA</b> ; 48000 KOPRIVNICA, ANTE STARČEVIĆA 32, HR	43711
08094	1998-290	<b>Norske Skogindustrier ASA</b> ; N-7620 Skogn, Norveška, NO	43941



08096	1960-313	<b>JANTZEN APPAREL CORP. a Delaware Corporation;</b> CONCORD PLAZA, 3411 SILVERSIDE ROAD, WILMINGTON, DELAWARE, US	15171
08198	2006-979	<b>"DIJAMANT" A.D. industrija ulja Zrenjanin and DIJAMANT, AD ZA PROIZVODNJU ULJA, MASTI I MARGARINA;</b> Temišvarski drum 14, Zrenjanin, RS and Temišvarski drum 14, Zrenjanin, RS	52755
08100	1973-618	<b>WM. WRIGLEY JR. COMPANY;</b> 410 NORTH MICHIGAN AVENUE, CHICAGO, ILLINOIS, US	21984
08101	1972-503	<b>WM. WRIGLEY JR. COMPANY;</b> 410 NORTH MICHIGAN AVENUE, CHICAGO, ILLINOIS, US	21185
08218	1971-643	<b>WM. WRIGLEY JR. COMPANY;</b> 410 NORTH MICHIGAN AVENUE, CHICAGO, ILLINOIS 60611, US	20643
08217	1971-644	<b>WM. WRIGLEY JR. COMPANY;</b> 410 NORTH MICHIGAN AVENUE, CHICAGO, ILLINOIS, US	20691
08216	1971-645	<b>WM. WRIGLEY JR. COMPANY;</b> 410 NORTH MICHIGAN AVENUE, CHICAGO, ILLINOIS, US	20692
08215	1971-646	<b>WM. WRIGLEY JR. COMPANY;</b> 410 NORTH MICHIGAN AVENUE, CHICAGO, ILLINOIS, US	20644
08222	1965-194	<b>WM. WRIGLEY JR. COMPANY;</b> 410 NORTH MICHIGAN AVENUE, CHICAGO, ILLINOIS, US	16687
08219	1971-369	<b>Wm Wrigley Jr. Company;</b> 410 North Michigan Avenue, Chicago, Illinois 60611, US	20525
08220	1970-1036	<b>WM. WRIGLEY JR. COMPANY;</b> 410 NORTH MICHIGAN AVENUE, CHICAGO, ILLINOIS, US	20111
08224	1963-3	<b>WM. WRIGLEY JR. COMPANY;</b> 410 NORTH MICHIGAN AVENUE, CHICAGO, COOK, ILLINOIS, US	15855
08223	1963-4	<b>WM. WRIGLEY JR. COMPANY;</b> 410 NORTH MICHIGAN AVENUE, CHICAGO, COOK, ILLINOIS, US	15869
08221	1965-231	<b>WM. WRIGLEY JR. COMPANY;</b> 410 NORTH MICHIGAN AVENUE, CHICAGO, ILLINOIS, US	16700
08228	1927-64	<b>WM. WRIGLEY JR. COMPANY;</b> 410 NORTH MICHIGAN AVENUE, CHICAGO, COOK, ILLINOIS, US	5145
08227	1962-149	<b>WM. WRIGLEY JR. COMPANY;</b> 410 NORTH MICHIGAN AVENUE, CHICAGO, US	15680
08226	1963-2	<b>WM. WRIGLEY JR. COMPANY;</b> 410 NORTH MICHIGAN AVENUE, CHICAGO, COOK, ILLINOIS, US	15854
08231	2006-1819	<b>WM. WRIGLEY JR. COMPANY;</b> 410 North Michigan Avenue, Chicago, Illinois 60611, US	54076
08234	2003-790	<b>Wm. WRIGLEY Jr. Company;</b> 410 North Michigan Avenue, Chicago, Illinois 60611, US	48949
08235	2003-789	<b>Wm. WRIGLEY Jr. Company;</b> 410 North Michigan Avenue, Chicago, Illinois 60611, US	48948
08233	2005-606	<b>Wm. Wrigley Jr. Company;</b> 410 North Michigan Avenue, Chicago, Illinois 60611, US	51163
08229	2007-569	<b>Wm. WRIGLEY Jr. Company;</b> 410 North Michigan Avenue, Chicago, IL 60611, US	55083
08230	2006-182	<b>Wm. WRIGLEY Jr. Company;</b> 410 North Michigan Avenue, Chicago, IL 60611, US	52021
08232	2006-181	<b>Wm. WRIGLEY Jr. Company;</b> 410 North Michigan Avenue, Chicago, IL 60611. , US	52020
08154	1998-294	<b>ANHEUSER-BUSCH, LLC;</b> One Busch Place, St. Louis, Missouri 63118, US	43961
08268	2005-486	<b>SAPONIA - kemijska, prehrambena i farmaceutska industrija d.d.;</b> Osijek, Matije Gupca 2, HR	53169
08269	2006-950	<b>SAPONIA - kemijska, prehrambena i farmaceutska industrija d.d.;</b> Osijek, Matije Gupca 2, HR	53087
08080	2004-242	<b>NOVUS INTERNATIONAL, Inc.;</b> 20 Research Park Drive, St. Charles, Missouri 63304, US	49964

08082	1983-381	<b>NOVUS INTERNATIONAL, Inc.;</b> 20 Research Park Drive, St.Charles, Missouri 63304, US	29098
08081	1986-523	<b>NOVUS INTERNATIONAL, INC.;</b> 20 Research Park Drive, St. Charles, Missouri 63304, US	31314
08303	1990-108	<b>CHEVRON GLOBAL ENERGY,INC(Delaware Corporation);</b> 6001 BOLLINGER CANYON ROAD SAN RAMON, CALIFORNIA 94583, US	35145
08302	1988-70	<b>G.D. SEARLE LLC;</b> 100 ROUTE 206 NORTH PEAPACK, NJ 07977, US	32988
08301	1988-698	<b>Allison Transmission, Inc.;</b> 4700 West 10th Street, Indianapolis, Indiana 46222, US	33519
08305	1990-106	<b>CHEVRON GLOBAL ENERGY,INC(Delaware Corporation);</b> 6001 BOLLINGER CANYON ROAD SAN RAMON, CALIFORNIA 94583, US	35598
08304	1990-107	<b>CHEVRON GLOBAL ENERGY,INC(Delaware Corporation);</b> 6001 BOLLINGER CANYON ROAD SAN RAMON, CALIFORNIA 94583, US	36553
08306	1973-334	<b>CHIVAS BROTHERS (IP) LIMITED;</b> 111/113 RENFREW ROAD, PAISLEY, RENFREWSHIRE,PA3 4DY, GB	21503
07648	2001-1503	<b>Société Air France;</b> 45, rue de Paris, 95747 Roissy CDG Cedex, Francuska	47246
08169	1971-491	<b>BRITISH-AMERICAN TOBACCO COMPANY LIMITED;</b> Millbank, Knowle Green, I Staines, Middlesex, TW 18 1D4, GB	20575
08163	1953-230	<b>BRITISH AMERICAN TOBACCO (BRANDS) LIMITED;</b> Globe House, 4 Temple Place, London WC2R 2PG, GB	12917
08166	1995-795	<b>BRITISH AMERICAN TOBACCO (BRANDS) LIMITED;</b> Globe House, 4 Temple Place, London WC2R 2PG, GB	41036
08167	1973-583	<b>BRITISH AMERICAN TOBACCO (BRANDS) LIMITED;</b> Globe House, 4 Temple Place, London WC2R 2PG, GB	21777
05744	1992-1332	<b>KABUSHIKI KAISHA YOHJI DESIGN KANKYUJO;</b> 2-42, HIGASHISHINAGAWA 2-CHOME, SHINAGAWA-KU, TOKIO, JAPAN, JP	39790
08369	1977-772	<b>SONY KABUSHIKI KAISHA;</b> 7-35, KITASHINAGAWA 6-CHOME SHINAGAWA-KU, TOKYO, JP	25575
08371	1967-540	<b>SONY KABUSHIKI KAISHA (SONY CORPORATION);</b> KITASHINAGAWA, SHINAGAWA-KU, TOKYO, JP	17963
08451	1991-446	<b>Anheuser-Busch, LLC;</b> One Busch Place, St. Louis, Missouri 63118, US	38377
08373	1995-546	<b>INVISTA Technologies S.a.r.l. and INVISTA Technologies S.a.r.l.;</b> Three Little Falls Centre, 2801 Centerville Road, Wilmington, Delaware 19808, U.S.A., US and Talstrasse 80, 8001 Zurich, CH	43377
08375	1997-783	<b>Merrill Lynch &amp; Co., Inc.;</b> Merrill Lynch World Headquarters, North Tower, 4 World Financial Center, New York, New York 10080, US	43146
08374	1996-1114	<b>VIOLEX-BIC S.A. and BIC VIOLEX S.A.;</b> 145 65 ANIXI, ATTICA, GR and 145 65 Anixi, Attica, GR	43504
08376	1997-770	<b>Merrill Lynch &amp; Co., Inc.;</b> Merrill Lynch World Headquarters, North Tower, 4 World Financial Center, New York, New York 10080, US	42985
08372	2006-818	<b>Mitsubishi Chemical Media Co. Ltd.;</b> 6F, Ana Tamachi Building, 31-19 Shiba 5 Chome Minato-ku Tokyo 108-0014, JP	53815
08452	2002-389	<b>Fresenius Kabi AG;</b> Friedrichstr. 2-6, 60323 Frankfurt am Main, Deutschland, DE	47904
08458	1969-861	<b>NIPPON KAYAKU KABUSHIKI KAISHA;</b> 11-2, FUJIMI 1-CHOME, CHIYODA-KU, TOKYO, JP	19267
08457	2002-911	<b>Thorn Lighting Group;</b> 3 King George Close, GB	48621
08459	1991-1698	<b>AUTOMOBILES PEUGEOT;</b> 75, AVENUE DE LA GRANDE ARMEE, F-75116 PARIS, FR	36952
08460	1976-754	<b>CELITE CORPORATION;</b> 130 Castilian Drive,Santa Barbara,California 93117.US	26972
08461	1982-344	<b>WD-40 Manufacturing Company (California Corporation);</b> 1061 Cudahy Place, San Diego, California 92110, US	28884
08469	1973-56	<b>DYRUP A/S;</b> GLADSAXEVEJ 300, DK-2860 SOBORG, DK	21565
08473	2006-2618	<b>Deutsche Telekom AG;</b> Friedrich-Ebert-Allee 140.53113 Bonn, DE	54457
08471	2006-287	<b>T-Mobile International AG&amp;Co.KG;</b> Landgrabenweg 151 53227 Bonn, DE	52528

08470	2006-307	<b>T-Mobile International AG&amp;Co.KG</b> ; Landgrabenweg 151 53227 Bonn, DE	52533
08472	2006-1048	<b>Deutsche Telekom AG</b> ; Friedrich-Ebert-Alee 140, 53113 Bonn , DE	52724
08468	1965-233	<b>FIRESTONE POLYMERS, LLC</b> ; 381 WEST WILBETH AKRON, OHIO 44301, US	16712
08527	2001-1480	<b>PODRAVKA D.D. prehrambena industrija</b> ; Ulica Ante Starčevića 32, Koprivnica, HRVATSKA, HR	47333
03477	1960-306	<b>LEO PHARMA A / S</b> ; Industriparken 55, D-2750 Ballerup, DK	15168
08475	2006-1936	<b>Deutsche Telekom AG</b> ; Friedrich-Ebert-Allee 140, 53113 Bonn, DE	54016
08476	2006-1937	<b>Deutsche Telekom AG</b> ; Friedrich-Ebert-Allee 140, 53113 Bonn, DE	54020
08477	2006-256	<b>T-Mobile International AG&amp;Co. KG</b> ; Landgrabenweg 151 53227 Bonn, DE	54443
08474	2006-302	<b>T-Mobile International AG&amp;Co.KG</b> ; Landgrabenweg 151. 53227 Bonn, DE	53067
08553	2004-333	<b>HEMOS SCHREIBWARENERZEUGUNG GESELLSCHAFT m.b.H and HEMOS SCHREIBWARENERZEUGUNG GESELLSCHAFT m.b.H</b> ; Mahlerstrasse 9, Wien 1, Austrija, AT and Gersthoferstrasse 30/2, A-1180 Wien, Austrija , AT	49928
08538	1969-509	<b>Hipp &amp; Co.</b> ; Brunigstrasse 141, 6072 Sachseln, CH	19027
08550	2002-1493	<b>“Trebjesa” AD, Industrija piva i sokova</b> ; Njegoševa 18, Nikšić, YU	48480
08530	2006-1082	<b>DEUTSCHE TELEKOM AG</b> ; Friedrich-Ebert-Allee 140, 53113 Bonn, Germany, DE	52874
08551	2003-1307	<b>LOHMANN GmbH &amp; Co.KG</b> ; Irlicher Strasse 55, D-56567 Neuwied, Nemačka, DE	49280
08529	2006-254	<b>T-Mobile International AG&amp;Co.KG</b> ; Landgrabenweg 151 53227 Bonn, DE	54441
08549	2002-221	<b>Industrija piva i sokova, “TREBJESA” AD</b> ; Njegoševa 18, Nikšić, YU	47986
06406	2002-336	<b>Reckitt Benckiser Healthcare (UK) Limited</b> ; Dansom Lane, Hull, HU8 7DS, England, GB	47601
08555	1974-746	<b>UNITIKA LTD.</b> ; NO. 1-50, HIGASHI-HON-MACHI, AMAGASKI-SHI, HYOGO-KEN, JP	22593
08447	1983-72	<b>TIGER CORPORATION</b> ; 1-9, 2-CHOME GAMO, JOTO-KU, OSAKA, JP	29015
08446	1983-73	<b>TIGER CORPORATION</b> ; 1-9, 2-CHOME GAMO, JOTO-KU, OSAKA, JP	29016
08065	1994-74	<b>ELI LILLY AND COMPANY</b> ; LILLY CORPORATE CENTER, INDIANAPOLIS, INDIANA 46285, US	40143
08556	1977-596	<b>THE PROCTER &amp; GAMBLE COMPANY</b> ; ONE PROCTER & GAMBLE PLAZA, CINCINNATI, OHIO, US	26068
08559	1983-385	<b>BRIDGESTONE CORPORATION</b> ; 10-1, KYOBASHI 1-CHOME, CHUO-KU, TOKYO, JP	30251
08557	1981-615	<b>MITSUBOSHI BELTING LTD.</b> ; NO. 1-21, HAMAZOL-DORI 4-CHOME, NAGATA-KU, KOBE-SHI, HYOGO-KEN, JP	30103
08560	1992-245	<b>BRUNSWICK CORPORATION</b> ; ONE BRUNSWICK PLAZA, SKOKIE, ILLINOIS 60077, US	39101
08562	1992-246	<b>BRUNSWICK CORPORATION</b> ; One North Field Court,Lake Forest,Illinois 60045 US	39102
08561	1985-5	<b>MAZDA MOTOR CORPORATION</b> ; NO. 3-1, SHINCHI, FUCHU-CHO, AKI-GUN, HIROSHIMA-KEN, JP	29538
08565	1992-244	<b>BRUNSWICK CORPORATION</b> ; One North Field Court,Lake Forest,Illinois 60045 US	39100
08563	1980-160	<b>BP PLC</b> ; 1 ST JAMES'S SQUARE LONDON SW1Y 4PD, GB	27043
08564	1980-99	<b>BP PLC</b> ; 1 ST JAMES'S SQUARE LONDON SW1Y 4PD, GB	27028
8653	2004-708	<b>JVC Kenwood Corporation</b> ; 3-12, Moriyacho, Kanagawa-ku, Yokohama-shi, Kanagawa, Japan	50812
08655	1991-1317	<b>KRAFT FOODS GLOBAL BRANDS LLC</b> ; THREE LAKES DRIVE, NORTHFIELD, ILLINOIS 60093, US	38275
08576	1972-557	<b>PHILIP MORRIS PRODUCTS S.A.</b> ; Quai Jeanrenaud 3, CH-2000 Neuchatel, CH	21251
08585	1996-663	<b>PHILIP MORRIS PRODUCTS S.A.</b> ; Quai Jeanrenaud 3, CH-2000 Neuchatel, CH	41684
08584	1996-664	<b>PHILIP MORRIS PRODUCTS S.A.</b> ; Quai Jeanrenaud 3, CH-2000 Neuchatel, CH	41614
08583	1994-708	<b>PHILIP MORRIS PRODUCTS S.A.</b> ; Quai Jeanrenaud 3, CH-2000 Neuchatel, CH	40500
08586	2007-89	<b>HOME CENTERS (DIY) LTD.</b> ; 7 Tulipman St. Rishon Lezion, IL	55117

08595	1966-339	<b>OMRON CORPORATION</b> ; 801, Minamifudodo-cho, Horikawahigashuru, Shiokoji-dori, Shimogyo-ku, Kyoto-shi, Kyoto 600-8530, JP	17387
08598	1991-2316	<b>ASICS CORPORATION</b> ; 1-1 MINATOJIMA-NAKAMACHI 7-CHOME, CHUO-KU, KOBE CITY, HYOGO PREFECTURE, JP	36964
08597	1991-1161	<b>CARDO RAIL AKTIEBOLAG</b> ; PO Box 193, Roskildevagen 1B, 201 21 Malmo, SE	38274
08599	1991-2315	<b>ASICS CORPORATION</b> ; 1-1 MINATOJIMA-NAKAMACHI 7-CHOME, CHUO-KU, KOBE CITY, HYOGO PREFECTURE, JP	36963
08587	1997-387	<b>PHILIP MORRIS PRODUCTS S.A.</b> ; Quai Jeanrenaud 3, CH-2000 Neuchatel, CH	42839
08596	1979-361	<b>PHILIP MORRIS PRODUCTS S.A.</b> ; Quai Jeanrenaud 3, CH-2000 Neuchatel, CH	26864
08589	2005-1534	<b>PHILIP MORRIS PRODUCTS S.A., a Corporation of Switzerland</b> ; Quai Jeanrenaud 3, 2000 Neuchatel, Switzerland, CH	51834
08588	2003-1	<b>Philips Morris Products S.A.</b> ; Quai Jeanrenaud 3 2000 Neuchatel, Švajcarska, CH	48463
08591	2006-2967	<b>Carlsberg Srbija d.o.o.</b> ; Proleterska 17, Čelarevo, YU	54376
08590	2004-1299	<b>Philip Morris Products S.A.</b> ; Quai Jeanrenaud 3, CH 2000, Neuchatel, CH	53891



**DIZAJN**

**DESIGNS**

Službeni glasnik Zavoda za intelektualnu svojinu Crne Gore  
Official Gazette of the Montenegrin Intellectual Property Office

**13/2013**



Zavod za intelektualnu svojinu Crne Gore  
ul. Rimski trg br. 46,  
81000 Podgorica,  
Crna Gora



**MEĐUNARODNI KODOVI ZA IDENTIFIKACIJU BIBLIOGRAFSKIH  
PODATAKA O DIZAJNU PREMA WIPO CT.80**  
RECOMMENDATION CONCERNING BIBLIOGRAPHIC DATA RELATING TO  
INDUSTRIAL DESIGNS WIPO CT.80

<b>CRNOGORSKI</b>	<b>MDK</b>	<b>ENGLESKI</b>
Registarski broj	<b>11</b>	Number of registration
Datum registracije	<b>15</b>	Date of the registration
Očekivani datum isteka registracije	<b>18</b>	Expected expiration date of the registration
Broj prijave	<b>21</b>	Number of the application
Datum podnošenja prijave	<b>22</b>	Date of filing of the application
Podaci o izložbenom pravu prvenstva	<b>23</b>	Exhibition priority data
Broj prijavljenih dizajna	<b>28</b>	Number of industrial designs included in the application
Podaci o pravu prvenstva na osnovu Pariske konvencije	<b>30</b>	Data relating to priority under the Paris Convention
Klasa i podklasa Lokarnske klasifikacije	<b>51</b>	Class and subclass of the Locarno Classification
Naziv dizajna	<b>54</b>	Title of the industrial design
Prikaz	<b>55</b>	Reproduction of the industrial design (e.g., drawing, photograph) and explanations relating to the reproduction
Ime autora dizajna	<b>72</b>	Name of the creator
Ime i adresa nosioca prava	<b>73</b>	Name and address of the owner
Ime i adresa punomoćnika	<b>74</b>	Name and address of the representative





**OBJAVE DIZAJNA**  
PUBLICATION OF DESIGNS(11) **00107**

(21) D-2010/12

(22) 07.06.2010.

(28) 4

(30) 29/354,575 US

(54) **POSLASTICA**

(72) Anderson A. Bret, c/o Mars Snackfood US, 800 High Street, Hackettstown, NJ 07840 US

(73) Mars, Incorporated 6885 Elm Street, McLean, VA 22101-3883 US

(74) Jusić Jasna, Crnogorskih serdara bb, Podgorica ME

(55)

(51) **01-01**

(15) 18.10.2013.

(18) 07.06.2015.

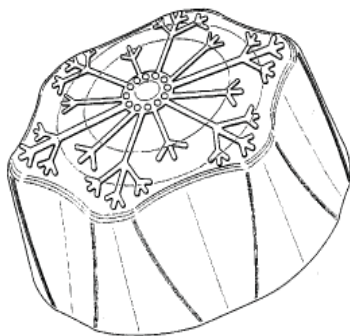

1.1



1.2

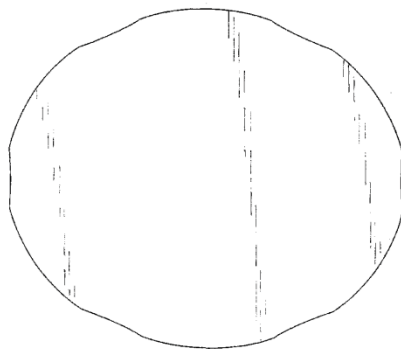

1.3

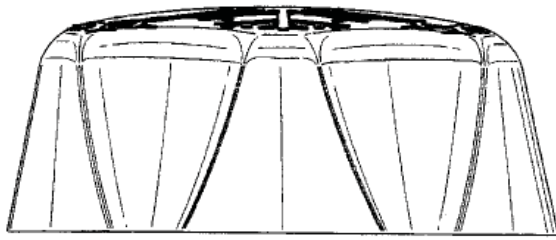

1.4

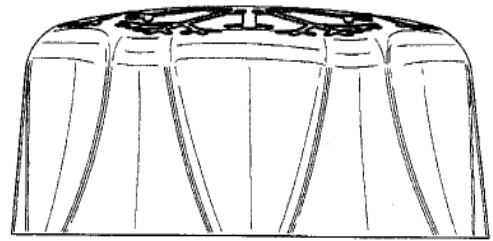

1.5

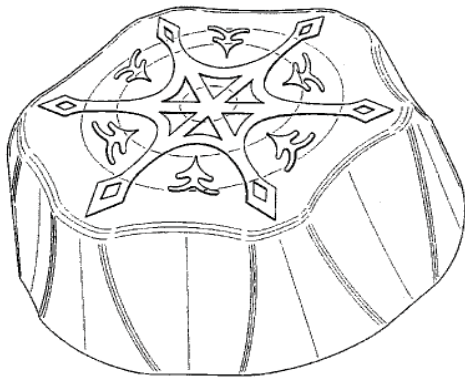

2.1

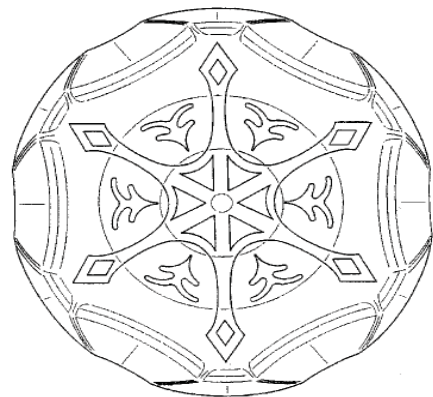

2.2

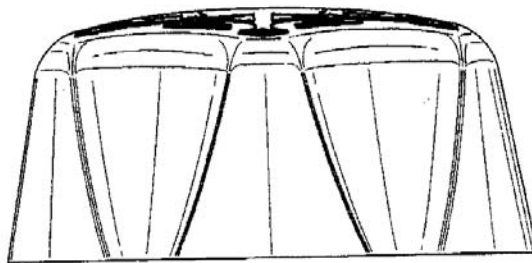

2.3

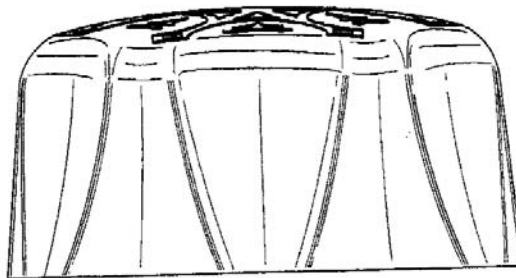

2.4

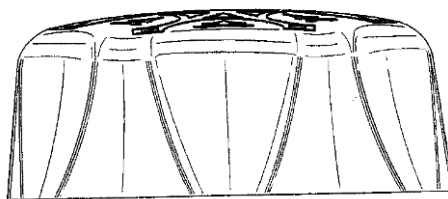

2.5

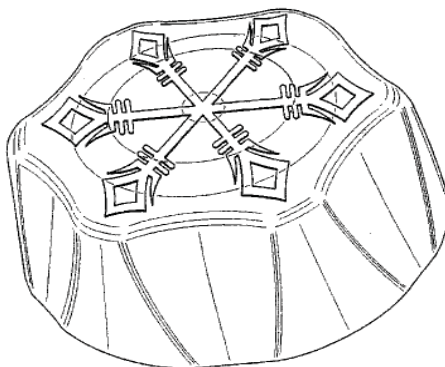

3.1

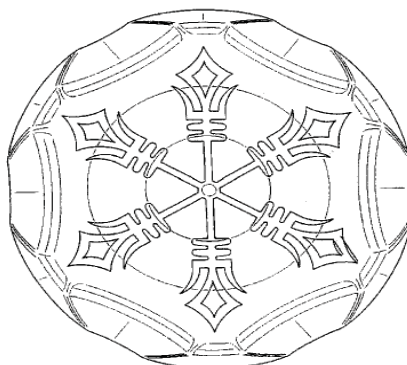

3.2

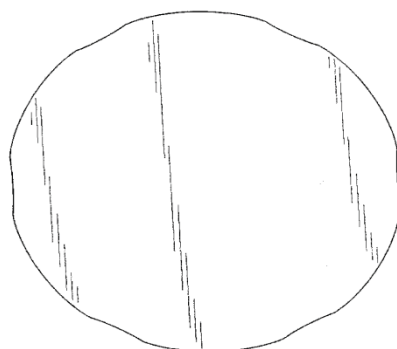

3.3

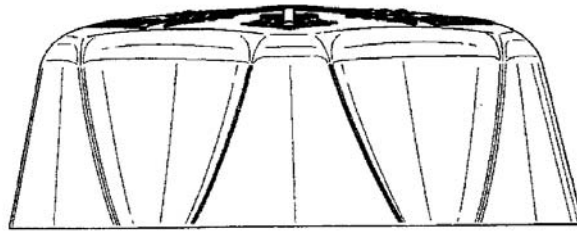

3.4

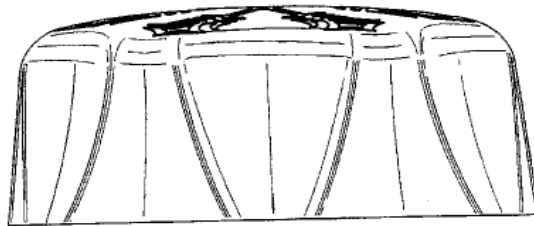

3.5

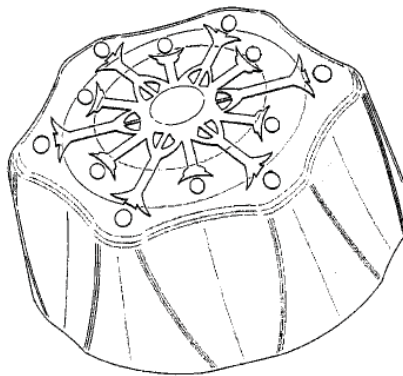

4.1

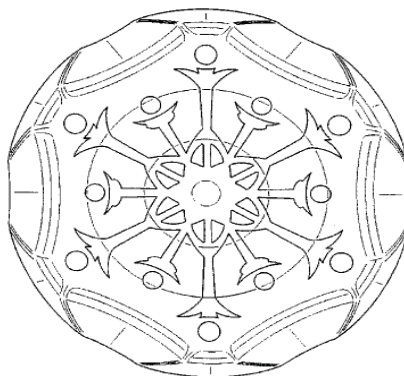

4.2

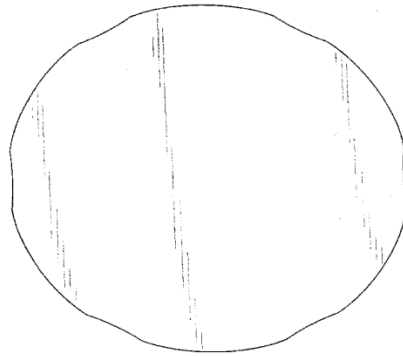

4.3

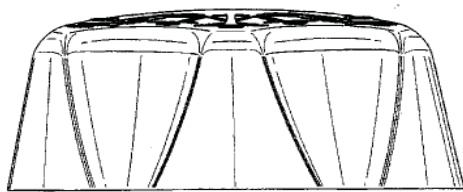

4.4

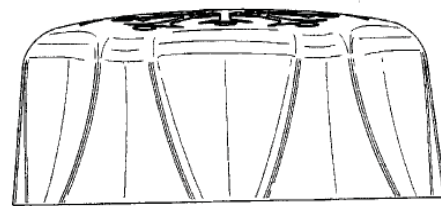

4.5

(11) **00110**

(21) D-2010/14

(22) 28.06.2010.

(28) 4

(54) **BOCA**

(72) Ilijevski Bojan, Bul. Jane Sandanski 46/3-4, Skoplje MK

(73) Farmaceutska hemijska kozmetička industrija ALKALOID AD Skoplje, Bulevar Aleksandar Makedonski 12, Skopje MK

(74) Popović Miladin, Đoka Miraševića 21/III, Podgorica ME

(51) **09-01**

(15) 18.10.2013.

(18) 28.06.2015.

(55)



1.1



1.2



1.3

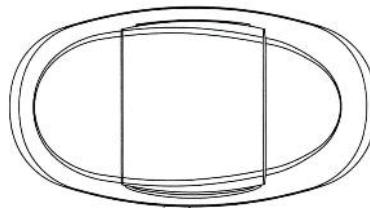

1.4



2.1



3.1



4.1

- |      |   |      |              |
|------|---|------|--------------|
| (11) | <b>00111</b>                              | (51) | <b>32-00</b> |
| (21) | D-2010/20                                 | (15) | 06.11.2013.  |
| (22) | 21.07.2010                                | (18) | 21.07.2015.  |
| (28) | 1   |      |              |
| (54) | <b>LOGOTIP</b>                            |      |              |
| (73) | Kosić Miško, Jakova Ostojića 3, Nikšić ME |      |              |



(55)

(11) **00108**

(21) D-2010/26

(22) 22.12.2010.

(28) 2

(30) 001725045 EM

(54) **RUČNA TORBA**

(72) Sassi Stefano, c/o Valentino S.p.A.-Via Turati, 16-18, I-20121 Milano IT

(73) Valentino S.p.A. Via Turati, 16/18 I-20121 Milano IT

(74) Jusić Jasna, Crnogorskih serdara bb, Podgorica ME

(55)

(51) **03-01**

(15) 31.07.2013.

(18) 22.12.2015.



1.1



1.2



1.3



1.4

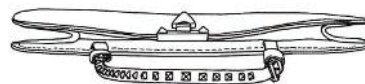

1.5

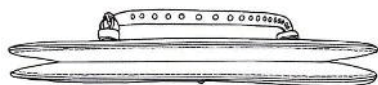

1.6

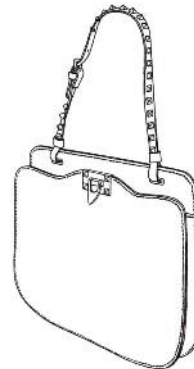

1.7





2.1



2.2



2.3



2.4



2.5



2.6



2.7

(11) **00106**

(21) D-2011/15

(22) 16.06.2011.

(28) 1

(30) 201130023696.7 CN

(54) **AUTOMOBIL**

(72) Zhang, Xinghai, Chongqing CN

Peng Zili Chongqing CN

(73) Chongqing Sokon Industry Group Stock Co., Ltd. No. 61-1 Jinqiao Road, Shapingba District, Chongqing, P.R. CN

(74) Čejović Vladimir, 13. jula 21, Podgorica ME

(55)

(51) **12-08**

(15) 18.10.2013.

(18) 16.06.2016.



1.1



1.2



1.3



1.4



1.5



1.6



1.7

- (11) **00109** (51) **09-05**  
 (21) D-2011/16 (15) 18.10.2013.  
 (22) 08.07.2011. (18) 08.07.2016.  
 (28) 2

(54) **AMBALAŽA-KESICA ZA KAFU**

(72) Valenček Ivan, Jovanke Radaković 31i, Beograd RS

(73) Food Industry doo Podgorica, Put Radomira Ivanovića 2, Podgorica ME

(55)



1.1



1.2



1.3



1.4



1.5



1.1



1.2



1.3



1.4



1.5

- (11) **00094**  
 (21) D-2011/18  
 (22) 18.08.2011.  
 (28) 5

- (51) **09-05**  
 (15) 18.10.2013.  
 (18) 18.08.2016.

(54) **PAKOVANJE MEKIH KAPSULA**

(72) Koala Creative Network, Intr. Nicolae Iorga 5, stan 3, sektor 1, Bukurešt RO

(73) Strauss Coffee B.V. Prof. J.H. Bavincklaan 2 NL-1183 AT, Amstelveen NL

(74) Plavša Desanka, Tadeuša Koščuška 8, Beograd RS

(55)



(11) **00095**

(21) D-2012-2

(22) 29.03.2012.

(28) 1

(54) **INSTRUMENT ZA PISANJE**

(72) Beloglazov Dmitry Aleksandrovich ul. Severnoe Chertanovo, d.4, korp. 402, kv. 124, Moscow 113648 RU

(73) Erich Krause Finland Oy Henry Fordin katu 5 N, 00150 Helsinki FI

(74) Čejović Vladimir, 13. jula 21, Podgorica ME

(55)

(51) **19-06**

(15) 18.10.2013.

(18) 29.03.2017.



1.1



1.2



1.3



1.4

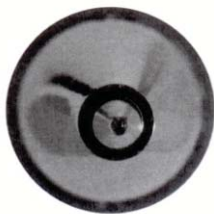

1.5



1.6



1.7

(11) **00096**

(21) D-2012-3

(22) 29.03.2012.

(28) 1

(54) **INSTRUMENT ZA PISANJE**

(72) Beloglazov Dmitry Aleksandrovich ul. Severnoe Chertanovo, d.4, korp. 402, kv. 124, Moscow 113648 RU

(73) Erich Krause Finland Oy Henry Fordin katu 5 N, 00150 Helsinki FI

(74) Čejović Vladimir, 13. jula 21, Podgorica ME

(55)

(51) **19-06**

(15) 18.10.2013.

(18) 29.03.2017.



1.1



1.2



1.3



1.4



1.5

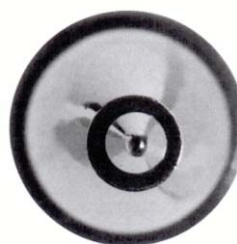

1.6

(11) **00097**

(21) D-2012-5

(22) 29.03.2012.

(28) 1

(54) **INSTRUMENT ZA PISANJE**

(72) Beloglazov Dmitry Aleksandrovich ul. Severnoe Chertanovo, d.4, korp. 402, kv. 124, Moscow 113648 RU

(73) Erich Krause Finland Oy Henry Fordin katu 5N, 00150 Helsinki FI

(74) Čejović Vladimir, 13. jula 21, Podgorica ME

(55)

(51) **19-06**

(15) 18.10.2013.

(18) 29.03.2017.



1.1



1.2



1.3



1.4



1.5



1.6

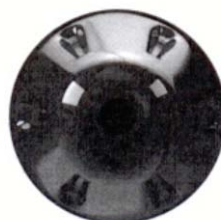

1.7



1.8



1.9



1.10



1.11



1.14



1.15



1.12



1.13



1.16



1.17



1.18



(11) **00100**

(21) D-2012-6

(22) 20.04.2012.

(28) 1

(54) **GRAFIČKI SIMBOL**

(72) Todd Brooks One Coca Cola Plaza, Atlanta, Georgia 30313 US

(73) The Coca-Cola Company One Coca-Cola Plaza Atlanta, Georgia 30313 US

(74) Jusić Jasna, Crnogorskih serdara bb, Podgorica ME

(55)

(51) **32-00**

(15) 18.10.2013.

(18) 20.04.2017.



1.1

(11) **00101**

(21) D-2012-7

(22) 20.04.2012.

(28) 1

(54) **GRAFIČKI SIMBOL**

(72) Todd Brooks One Coca Cola Plaza, Atlanta, Georgia 30313 US

(73) The Coca-Cola Company One Coca-Cola Plaza Atlanta, Georgia 30313 US

(74) Popović Miladin, Đoka Miraševića 21/III, Podgorica ME

(55)

(51) **32-00**

(15) 18.10.2013

(18) 20.04.2017.



1.1

(11) **00102**

(21) D-2012-8

(22) 23.04.2012.

(28) 1

(54) **GRAFIČKI DIZAJN**

(72) Todd Brooks One Coca Cola Plaza, Atlanta, Georgia 30313 US

(73) The Coca-Cola Company One Coca-Cola Plaza Atlanta, Georgia 30313 US

(74) Popović Miladin, Đoka Miraševića 21/III, Podgorica ME

(55)

(51) **32-00**

(15) 18.10.2013.

(18) 23.04.2017.

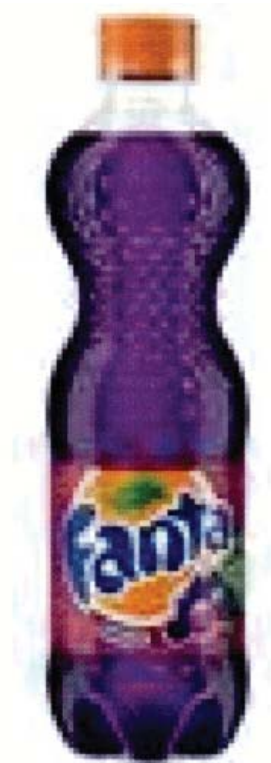

1.1

(11) **00103**

(21) D-2012-9

(22) 23.04.2012.

(28) 1

(54) **GRAFIČKI DIZAJN**

(72) Todd Brooks One Coca Cola Plaza, Atlanta, Georgia 30313 US

(73) The Coca-Cola Company One Coca-Cola Plaza Atlanta, Georgia 30313 US

(74) Popović Miladin, Đoka Miraševića 21/III, Podgorica ME

(55)

(51) **32-00**

(15) 18.10.2013.

(18) 23.04.2017.



1.1

(11) **00104**

(21) D-2012-10

(22) 23.04.2012.

(28) 1

(54) **GRAFIČKI DIZAJN**

(72) Todd Brooks One Coca Cola Plaza, Atlanta, Georgia 30313 US

(73) The Coca-Cola Company One Coca-Cola Plaza Atlanta, Georgia 30313 US

(74) Popović Miladin, Đoka Miraševića 21/III, Podgorica ME

(55)

(51) **32-00**

(15) 18.10.2013

(18) 23.04.2017.



1.1

(11) **00105**

(21) D-2012-11

(22) 23.04.2012.

(28) 1

(54) **GRAFIČKI DIZAJN**

(72) Todd Brooks One Coca Cola Plaza, Atlanta, Georgia 30313 US

(73) The Coca-Cola Company One Coca-Cola Plaza Atlanta, Georgia 30313 US

(74) Popović Miladin, Đoka Miraševića 21/III, Podgorica ME

(55)

(51) **32-00**

(15) 18.10.2013

(18) 23.04.2017.



1.1

(11) **00091**

(21) D-2012-12

(22) 08.05.2012.

(28) 6

(30) 001944984-0001-0006 EM

(54) **ORNAMENTACIJA (ZA AMBALAŽU PREHRAMBENOG PROIZVODA)**

(72) Fay Meadows; Nicholas Little, Martin Francis; James Nixon Jones Knowles Ritchie, 128 Albert Street, London, NW1 7NE GB

(73) Mars, Incorporated 6885 Elm Street, McLean, VA 22101-3883 US

(74) Jusić Jasna, Crnogorskih serdara bb, Podgorica ME

(55)

(51) **32-00**

(15) 18.10.2013.

(18) 08.05.2017.



1.1



2.1



3.1



4.1



5.1



6.1

(11) **00099**

(21) D-2012-13

(22) 11.05.2012.

(28) 3

(54) **DRŽAČ GROMOBRANA**

(72) Rauter Miran, Podkraj 35f, 3320 Velenje SI

(73) Hermi, d.o.o, Trnovlje pri Celju, Trnoveljska cesta 15, 3000 Celje SI

(74) Radulović Božidar, Jovana Tomaševića 9/III, Podgorica ME

(55)

(51) **08-08**

(15) 18.10.2013.

(18) 11.05.2017.

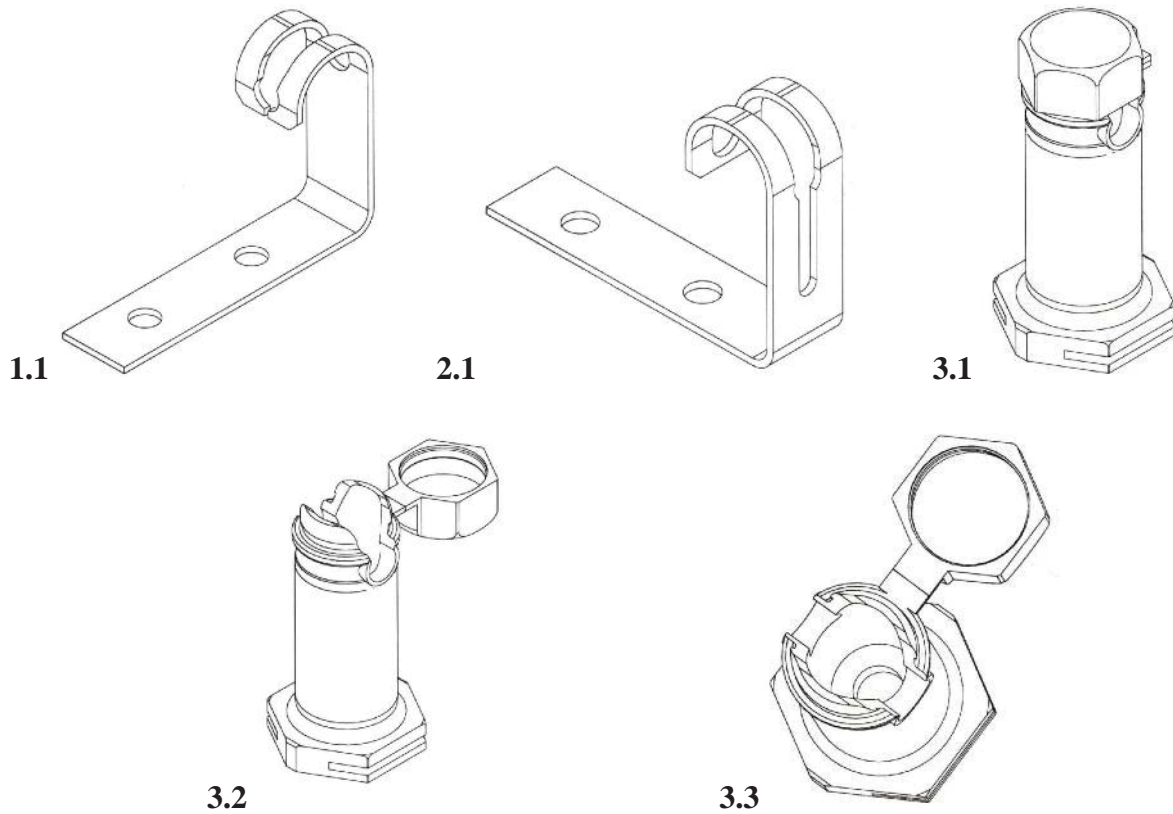



(11) **00092** (51) **32-00**

(21) D-2012-14 (15) 18.10.2013.

(22) 16.05.2012. (18) 16.05.2017.

(28) 6

(30) 001951344-0001-0006 EM

(54) **ORNAMENTACIJA (ZA AMBALAŽU PREHRAMBENOG PROIZVODA)**

(72) Shaun Clifford Bowen; George Frazer Hartley; Katherine Sarah Mc Alpine B&B Studio Ltd, 18 Charlotte Road, London, EC2A 3PB GB

(73) Mars, Incorporated 6885 Elm Street, McLean, VA 22101-3883 US

(74) Jusić Jasna, Crnogorskih serdara bb, Podgorica ME

(55)



1.1



2.1



3.1



4.1



5.1



6.1

(11) **00098**

(21) D-2012-17

(22) 08.08.2012.

(28) 1

(54) **MARKER**

(72) Beloglazov Dmitry Aleksandrovich ul. Severnoe Chertanovo, d.4, korp. 402, kv. 124, Moscow 113648 RU

(73) Erich Krause Finland Oy Henry Fordin katu 5 N, 00150 Helsinki FI

(74) Čejović Vladimir, 13. jula 21, Podgorica ME

(55)

(51) **19-06**

(15) 18.10.2013.

(18) 08.08.2017.



1.1



1.2



1.3



1.4



1.5



1.6



1.7



1.8



1.9

**INDEKS NOSILACA DIZAJNA**  
**INDEX OF INDUSTRIAL DESIGNS OWERS**

(73)	(51)	(21)	(22)	(11)
ALKALOID AD Skoplje	09-01	D-2010/14	28.06.2010.	00110
Chongqing Sokon Industry Group Stock Co.	12-08	D-2011/15	16.06.2011.	00106
Erich Krause Finland Oy Henry Fordin	19-06	D-2012-2	29.03.2012.	00095
Erich Krause Finland Oy Henry Fordin	19-06	D-2012-3	29.03.2012.	00096
Erich Krause Finland Oy Henry Fordin	19-06	D-2012-5	29.03.2012.	00097
Erich Krause Finland Oy Henry Fordin	19-06	D-2012-17	08.08.2012.	00098
Food Industry doo	09-05	D-2011/16	08.07.2011.	00109
Hermi, d.o.o	08-08	D-2012-13	11.05.2012.	00099
Kosić Miško	32-00	D-2010/20	21.07.2010	00111
Mars	32-00	D-2012-12	08.05.2012.	00091
Mars	32-00	D-2012-14	16.05.2012.	00092
Mars	01-01	D-2010/12	07.06.2010.	00107
Strauss Coffee B.V.	09-05	D-2011/18	18.08.2011.	00094
The Coca-Cola Company	32-00	D-2012-6	20.04.2012.	00100
The Coca-Cola Company	32-00	D-2012-7	20.04.2012.	00101
The Coca-Cola Company	32-00	D-2012-8	23.04.2012.	00102
The Coca-Cola Company	32-00	D-2012-9	23.04.2012.	00103
The Coca-Cola Company	32-00	D-2012-10	23.04.2012.	00104
The Coca-Cola Company	32-00	D-2012-11	23.04.2012.	00105
Valentino S.p.A.	03-01	D-2010/26	22.12.2010.	00108



**INDEX BROJEVA DIZAJNA**  
INDEX OF INDUSTRIAL DESIGNS NUMBERS

(11)	(21)
00091	D-2012-12
00092	D-2012-14
00094	D-2011/18
00095	D-2012-2
00096	D-2012-3
00097	D-2012-5
00098	D-2012-17
00099	D-2012-13
00100	D-2012-6
00101	D-2012-7
00102	D-2012-8
00103	D-2012-9
00104	D-2012-10
00105	D-2012-11
00106	D-2011/15
00107	D-2010/12
00108	D-2010/26
00109	D-2011/16
00110	D-2010/14
00111	D-2010/20



**INDEKS PO KLASAMA I PODKLASAMA LOKARNSKE KLASIFIKACIJE**  
**INDEX ACCORDING TO CLASSES SUBCLASSEN THE LOCARNO**  
**CLASSIFICATION**

(21)	(11)
D-2010/12	00107
D-2010/14	00110
D-2010/20	00111
D-2010/26	00108
D-2011/15	00106
D-2011/16	00109
D-2011/18	00094
D-2012-2	00095
D-2012-3	00096
D-2012-5	00097
D-2012-6	00100
D-2012-7	00101
D-2012-8	00102
D-2012-9	00103
D-2012-10	00104
D-2012-11	00105
D-2012-12	00091
D-2012-13	00099
D-2012-14	00092
D-2012-17	00098







# INFORMATOR

## INFORMATION

Službeni glasnik Zavoda za intelektualnu svojinu Crne Gore  
Official Gazette of the Montenegrin Intellectual Property Office

# 13/2013



Zavod za intelektualnu svojinu Crne Gore  
ul. Rimski trg br. 46,  
81000 Podgorica,  
Crna Gora



# INTELEKTUALNA SVOJINA

## AUTORSKO PRAVO I SRODNA PRAVA

## INDUSTRIJSKA SVOJINA

- \* Patenti
- \* Žigovi
- \* Industrijski dizajn
- \* Oznake geografskog porijekla roba i usluga
- \* Topografija integriranih kola

### AUTORSKO PRAVO

*(Koje se odnosi na duhovne tvorevine)*

- Kao što su naročito:
- \* Književna djela  
*(pisana, govorna, kompjuterski programi)*
  - \* Muzička djela
  - \* Dramska i dramsko-muzička djela
  - \* Koreografska i pantomimska djela
  - \* Djela likovnih umjetnosti iz područja slikarstva, vajarstva i arhitekture
  - \* Djela primjenjenih umjetnosti
  - \* Fotografiska djela
  - \* Kinematografska djela
  - \* Prevodi, obrade i druge prerade djela
  - \* Zbirke autorskih djela, podataka ili druge građe

### SRODNA PRAVA

- Koja se odnose:
- \* Izvođenja umjetnika izvođača
  - \* Fonograme
  - \* Emitovanja radija I televizije

CIP - Каталогизacija u publikaciji  
Centralna narodna biblioteka Crne Gore, Cetinje

347.77/78(497.16)

CRNOGORSKI glasnik intelektualne svojine : Službeni glasnik  
Zavoda za intelektualnu svojinu Crne Gore = Journal of intel-  
lectual properti in Montenegro = Official Gazete of the Intellec-  
tual Property Office of Montenegro / glavni i odgovorni urednik  
Novak Adžić - 2011, br.7 - 322. - Podgorica (Bulevar Revolucije  
9) : Zavod za intelektualnu svojinu Crne Gore, 2010. - 30 cm

Tromjesečno.

ISSN 1800-8003 = Crnogorski glasnik intelektualne svojine  
(Podgorica)

COBISS.CG-ID 15168784

