



CRNOGORSKI GLASNIK INTELEKTUALNE SVOJINE

INTELLECTUAL PROPERTY GAZETTE OF MONTENEGRO

Službeni glasnik Zavoda za intelektualnu svojinu Crne Gore
Official Gazette of the Montenegrin Intellectual Property Office

10/2012



Zavod za intelektualnu svojinu Crne Gore
ul. Rimski trg br. 46,
81000 Podgorica,
Crna Gora

CRNOGORSKI GLASNIK INTELEKTUALNE SVOJINE

Godina III

Datum objavljivanja: 20. 10. 2012. god.

Izdavač:

ZAVOD ZA INTELEKTUALNU
SVOJINU CRNE GORE
Rimski trg br. 46,
81000 Podgorica, Crna Gora

Za izdavača:

Novak Adžić, direktor

Glavni i odgovorni urednik:

Novak Adžić

Urednički odbor:

Novak Adžić, Predrag Malbaša,
Dušanka Perović, Milica Savić,
Gordana Tripković

Tehnički urednik:

Predrag Malbaša

Prevod:

Gordana Tripković

Dizajn:

Aleksandar-Saša Samardžić

OVAJ BROJ SLUŽBENOG GLASNIKA OBJAVLJEN JE U ELEKTRONSKOJ FORMI

Crnogorski glasnik intelektualne svojine službeno je glasilo Zavoda za intelektualnu svojinu Crne Gore. U Glasniku se objavljuju sve relevantnim zakonima i pravilnicima propisane informacije iz postupka dodjele prava industrijskog vlasništva, informacije o dodijeljenim pravima te o kasnijim promjenama u vezi s tim pravima, kao i ostale službene informacije.

The Montenegrinan intellectual property gazette is the official gazette of the State Intellectual Property Office of the Montenegro. The Gazette publishes all the information, prescribed by the relevant laws and regulations, relating to the industrial property granting procedure concerning granted rights and subsequent changes made in connection with such right, as well as other official information.

SADRŽAJ

DVOSLOVNE OZNAKE ZEMALJA, TERITORIJA I MEĐUNARODNIH ORGANIZACIJA TWO LETTER CODE COUNTRIES, TERRITORIES AND INTERNATIONAL ORGANIZATIONS	811
PATENTI	
PATENTS	813
MEĐUNARODNI KODOVI ZA IDENTIFIKACIJU BIBLIOGRAFSKIH PODATAKA O PATENTIMA PREMA WIPO STANDARDU ST. 9 RECOMMENDATION CONCERNING BIBLIOGRAFIC DATA ON AND RELATING TO PATENTS- WIPO-ST. 9.....	815
OBAVJEŠTENJE NOTICE	817
OBJAVE PRIJAVA PATENATA PUBLICATION OF PATENT APPLICATIONS.....	819
INDEKS NOSILACA PATENTA PATENT OWNER INDEX.....	875
INDEKS BROJEVA PRIJAVA PATENATA APPLICANTS NUMBER INDEX	881
INDEKS OBJAVLJENIH PRIJAVA PATENATA PREMA MKP INDEX OF PATENT APPLICANTS ACCORDINT TO IPC	885
OBJAVE ZAHTJEVA ZA PROŠIRENJE EVROPSKIH PRIJAVA PATENATA PUBLICATION OF REQUEST FOR THE EXTENSION OF THE EFFECTS OF EUROPEAN PATENT APPLICATIONS	889
INDEKS BROJEVA ZAHTJEVA ZA PROŠIRENJE EVROPSKIH PRIJAVA PATENTA INDEX ON NUMBER OF REQUESTS FOR EXTENSION ON EUROPEAN PATENT APPLICATIONS .	1149
INDEKS KLASIFIKACIJSKIH OZNAKA BROJEVA ZAHTJEVA ZA PROŠIRENJE EVROPSKIH PRIJAVA PATENTA PREMA MKP INDEX ON CLASSIFICATION MARKS ON REQUESTS FOR EXTENSION OF EUROPAN PATENT APPLICATION IN ACCORDANCE WITH THE INTERNATIONAL PATENT CLASSIFICATION ..	1231
INDEKS PODNOSITELJA ZAHTJEVA ZA PROŠIRENJE EVROPSKIH PRIJAVA PATENTA INDEX ON NUMBER OF APPLICATIONS FOR EXTENSION OF EUROPEAN PATENT APPLICATION	1415
OBJAVA POVUČENIH ZAHTJEVA ZA PROŠIRENJE EVROPSKIH PRIJAVA PATENTA PUBLICATION OF WITHDRAWN REQUESTS FOR EXTENSION OF EUROPEAN PATENT APPLICATION	1549
OBJAVA PROŠIRENIH EUROPSKIH PATENATA PUBLICATION OF EXTENDED EUROPEAN PATENTS.....	1551

ŽIGOVI	
TRADEMARKS.....	1603
MEĐUNARODNI KODOVI ZA IDENTIFIKACIJU BIBLIOGRAFSKIH PODATAKA O ŽIGOVIMA PREMA WIPO ST 60 RECOMMENDATION CONCERNING BIBLIOGRAFIC DATA RELATING TO TRADEMARKS- WIPO-ST. 60	1605
OBAVJEŠTENJE NOTICE	1607
OBJAVA PRIJAVA ŽIGOVA PUBLICATION OF TRADEMARK APPLICATIONS	1609
OBJAVA ŽIGOVA PUBLICATION OF TRADEMARKS	1615
OBJAVA ISPRAVKI CORRECTIONS.....	1753
OBJAVA UPISA U REGISTAR ŽIGOVA CRNE GORE PUBLICATION OF THE ENTRY TRADEMARK REGISTER MONTENEGRO	1757
DIZAJN	
DESIGNS.....	1769
MEĐUNARODNI KODOVI ZA IDENTIFIKACIJU BIBLIOGRAFSKIH PODATAKA O DIZAJNU PREMA WIPO CT.80 RECOMMENDATION CONCERNING BIBLIOGRAPHIC DATA RELATING TO INDUSTRIJAL DESIGNS WIPO CT.80	1771
OBJAVE DIZAJNA PUBLICATION OF DESIGNS	1773
INFORMATOR	
INFORMATION.....	1775

**DVOSLOVNE OZNAKE ZEMALJA, TERITORIJA I MEĐUNARODNIH
ORGANIZACIJA
(prema WIPO standardu ST. 3)**

AD	Andora	CF	Centralna Afrička Republika	GB	Velika Britanija
AE	Ujedinjeni Arapski Emirati	CG	Kongo	GC	Patentna kancelarija Savjeta za saradnju država Arapskog Zaliva (GCC)
AF	Afganistan	CH	Švajcarska	GD	Grenada
AG	Antigva i Barbuda	CI	Obala Bjelokosti	GE	Gruzija
AI	Angvila	CK	Kukova ostrva	GG	Guernsey
AL	Albanija	CL	Čile	GH	Gana
AM	Armenija	CM	Kamerun	GI	Gibraltar
AN	Holandski Antili	CN	Kina	GL	Grenland
AO	Angola	CO	Kolumbija	GM	Gambija
AP	Afrička regionalna organizacija za industrijsko vlasništvo (ARIPO)	CR	Kostarika	GN	Gvineja
AR	Argentina	CU	Kuba	GQ	Ekvatorska Gvineja
AT	Austrija	CV	Kabo Verde	GR	Grčka
AU	Australija	CY	Kipar	GS	Južna Džordžija i Ostrva Južni Sendvič
AW	Aruba	CZ	Češka Republika	GT	Gvatemala
AZ	Azerbejdžan	DE	Njemačka	GW	Gvineja-Bisao
BA	Bosna i Hercegovina	DJ	Džibuti	GY	Gvajana
BB	Barbados	DK	Danska	HK	Hongkong – Posebna administrativna regija
BD	Bangladeš	DM	Dominika	HN	NR Kine Honduras
BE	Belgija	DO	Dominikanska Republika	HR	Hrvatska
BF	Burkina Faso	DZ	Alžir	HT	Haiti
BG	Bugarska	EA	Evroazijska patentna organizacija (EAPO)	HU	Mađarska
BH	Bahrein	EC	Ekvador	IB	Međunarodna kancelarija Svjetske organizacije za intelektualno vlasništvo (WIPO)
BI	Burundi	EE	Estonija	ID	Indonezija
BJ	Benin	EG	Egipat	IE	Irska
BM	Bermudi	EH	Zapadna Sahara	IL	Izrael
BN	Brunej Darussalam	EM	Kancelarija za harmonizaciju Unutrašnjeg tržišta (žigovi i dizajn) (OHIM)	IM	Ostrvo Man
BO	Bolivija	EP	Evropska patentna kancelarija (EPO)	IN	Indija
BR	Brazil	ER	Eritreja	IQ	Irak
BS	Bahami	ES	Španija	IR	Iran (Islamska Republika)
BT	Butan	ET	Etiopija	IS	Island
BV	Ostrvo Buve	FI	Finska	IT	Italija
BW	Bocvana	FJ	Fidži	JE	Džersi
BX	Kancelarija za intelektualno vlasništvo Beneluksa (BOIP)	FK	Foklandska ostrva (Malvini)	JM	Jamajka
BY	Bjelorusija	FO	Farska Ostrva	JO	Jordan
BZ	Belize	FR	Francuska		
CA	Kanada	GA	Gabon		
CD	Demokratska Republika Kongo				

JP	Japan	NA	Namibija	SY	Sirijska Arapska Republika
KE	Kenija	NE	Niger	SZ	Svazi
KG	Kirgistan	NG	Nigerija	TC	Turska i Kajkoska Ostrva
KH	Kambodža	NI	Nikaragva	TD	Čad
KI	Kiribati	NL	Holandija	TG	Togo
KM	Komori	NO	Norveška	TH	Tajland
KN	Sveti Kristofor i Nevis	NP	Nepal	TJ	Tadžikistan
KP	Demokratska Narodna Republika Koreja	NR	Nauru	TL	Istočni Timor
KR	Republika Koreja	NZ	Novi Zeland	TM	Turkmenistan
KW	Kuvajt	OA	Afrička organizacija za intelektualno vlasništvo (OAPI)	TN	Tunis
KY	Kajmanska Ostrva	OM	Oman	TO	Tonga
KZ	Kazahstan	PA	Panama	TR	Turska
LA	Narodna Demokratska Republika Laos	PE	Peru	TT	Trinidad i Tobago
LB	Libanon	PG	Papuanska Nova Gvineja	TV	Tuvalu
LC	Sveta Lucija	PH	Filipini	TW	Tajvan, Kineska Pokrajina
LI	Lihtenštajn	PK	Pakistan	TZ	Ujedinjena Republika Tanzanija
LK	Šri Lanka	PL	Poljska	UA	Ukrajina
LR	Liberija	PT	Portugal	UG	Uganda
LS	Lesoto	PW	Palau	US	Sjedinjene Američke Države
LT	Litva	PY	Paragvaj	UY	Urugvaj
LU	Luksemburg	QA	Katar	UZ	Uzbekistan
LV	Latvija	QZ	Kancelarija Zajednice za biljne sorte (Evropska Unija) (CPVO)	VA	Sveta Stolica (Vatikan)
LY	Libijska Arapska Džamahirija	RO	Rumunija	VC	Sveti Vincent i Grenadini
MA	Maroko	RS	Srbija	VE	Venecuela
MC	Monako	RU	Ruska Federacija	VG	Britanska Djevičanska Ostrva
MD	Republika Moldavija	RW	Ruanda	VN	Vijetnam
ME	Crna Gora	SA	Saudijska Arabija	VU	Vanuatu
MG	Madagaskar	SB	Solomonska Ostrva	WO	Svjetska organizacije za intelektualno vlasništvo (WIPO) (Međunarodna kancelarija)
MK	Bivša Jugoslovenska Republika Makedonija	SC	Sejšeli	WS	Samoa
ML	Mali	SD	Sudan	XN	Nordijski institut za patente (NPI)
MM	Mianmar	SE	Švedska	YE	Jemen
MN	Mongolija	SG	Singapur	ZA	Južnoafrička Republika
MO	Makao	SH	Sveta Jelena	ZM	Zambija
MP	Sjeverna Marijanska Ostrva	SI	Slovenija	ZW	Zimbabve
MR	Mauritanija	SK	Slovačka		
MS	Montserrat	SL	Sijera Leone		
MT	Malta	SM	San Marino		
MU	Mauricijus	SN	Senegal		
MV	Maldivi	SO	Somalija		
MW	Malavi	SR	Surinam		
MX	Meksiko	ST	Sveti Toma i Princip		
MY	Malezija	SV	Salvador		
MZ	Mozambik				



PATENTI

PATENTS

Službeni glasnik Zavoda za intelektualnu svojinu Crne Gore
Official Gazette of the Montenegrin Intellectual Property Office

10/2012



Zavod za intelektualnu svojinu Crne Gore
ul. Rimski trg br. 46,
81000 Podgorica,
Crna Gora

MEĐUNARODNI KODOVI ZA IDENTIFIKACIJU BIBLIOGRAFSKIH PODATAKA O PATENTIMA PREMA WIPO STANDARDU ST. 9
RECOMMENDATION CONCERNING BIBLIOGRAFIC DATA ON AND RELATING TO PATENTS- WIPO-ST. 9

CRNOGORSKI	MDK	ENGLJSKI
IDENTIFIKATOR DOKUMENTA	10	IDENTIFICATION OF THE PATENT
BROJ DOKUMENTA	11	NUMBER OF THE PATENT
VRST DOKUMENTA	13	KIND-OF-DOCUMENT CODE ACCORDING TO WIPO STANDARD
BROJ PRIJAVE	21	NUMBER(S) ASSIGNED TO THE APPLICATION(S)
DATUM PODNOŠENJA PRIJAVE	22	DATE(S) OF FILING THE APPLICATION(S)
DATUM IZLAGANJA NA MEĐUNARODNOJ IZLOŽBI	23	DATE OF EXHIBITING AT THE INTERNATIONAL EXHIBITION
PODACI O PRAVU PRVJENSTVA	30	PRIORITY DATA
DATUM OBJAVLJIVANJA PRIJAVE	43	PUBLICATION DATE OF THE UNEXAMINED APPLICATION
DATUM OBJAVLJIVANJA PATENTA	45	PUBLICATION DATE OF REGISTERED PATENT
MEĐUNARODNA KLASIFIKACIJA PATENATA	51	INTERNATIONAL PATENT CLASSIFICATION CODE
NAZIV PRONALASKA	54	TITLE OF THE INVENTION
APSTRAKT ILI PATENTNI ZAHTJEV	57	ABSTRACT OR CLAIM
BROJ OSNOVNE PRIJAVE (ILI PATENTA) ZA KOJI SE PODNOSI DOPUNSKA PRIJAVA	61	NUMBER OF THE EARLIER APPLICATION (OR PATENT) TO WHICH THE PRESENT DOCUMENT IS AN ADDITION
BROJ PRVOBITNE PRIJAVE IZ KOJE JE PRIJAVA IZDOJENA	62	NUMBER OF THE EARLIER APPLICATION FROM WHICH THE PRESENT DOCUMENT HAS BEEN DIVIDED UP
IME PODNOSIOCA PRIJAVE	71	NAME OF THE APPLICANT
IME PRONALAZAČA	72	NAME OF THE INVENTOR
IME NOSIOCA PATENTA	73	NAME OF THE OWNER OF PATENT
IME PUNOMOĆNIKA	74	NAME OF THE REPRESENTATIVE
BROJ I DATUM PODNOŠENJA MEĐUNARODNE PRIJAVE	86	NUMBER AND FILING DATE OF THE INTERNATIONAL APPLICATION
BROJ I DATUM MEĐUNARODNE OBJAVE	87	NUMBER AND DATE OF THE PUBLICATION OF THE INTERNATIONAL APPLICATION

VRSTA DOKUMENTA		TYPES OF DOCUMENTS
OBJAVA PRIJAVA PATENATA	A	PUBLICATION OF PATENT APPLICATIONS
REGISTROVANI PATENTI	B	REGISTERED PATENTS

OBAVJEŠTENJE
NOTICE

Obavještavamo korisnike da se od 6-og broja Crnogorskog glasnika za intelektualnu svojinu koji se objavljuje na web stranici Zavoda za intelektualnu svojinu Crne Gore, u elektronskoj formi, odnosno od 10.10.2011 godine (Glasnik broj 6/2011) uvode promjene u objavi patentnih dokumenata.

Tako, objavljena prijava patenta (dokument A) sadrži i broj pod kojim je patent upisan u Registar patenata, (međunarodni kod 11 – broj dokumenta), koji je do sada bio objavljivan u svakom narednom broju Crnogorskog glasnika za intelektualnu svojinu. Kako Zavoda za intelektualnu svojinu Crne Gore, ispituje samo formalne uslove za priznavanje patenta, izmjenu uvodimo da bi svi podaci o priznatom patentu bili u istom broju Crnogorskog glasnika za intelektualnu svojinu, a ujedno i pojednostavili put do dodjele isprave, sve u skladu sa članom 40 Zakona o patenima ("Sl. list CG" broj 66/2008 i 40/2010).

(51) **C07C 213/10**
C07C 217/84
C07C 231/16
C07C 237/08

(11) **01027**

(13) **A**

(21) P-2010-136

(22) 27.02.2009

(30) 0801092 28.02.2008 FR

(86) PCT/FR2009/000215 27.02.2009

(87) WO/2009/118474 01.10.2009

(54) (ME) **POSTUPAK ZA DOBIJANJE KOMBRETASTATINA**

(EN) METHOD FOR PREPARING COMBRETASTATIN

(73) SANOFI-AVENTIS; 174 Avenue de France, F-75013 Paris (FR)

(72) FREDERIC, Marc; c/o Sanofi-aventis Département Brevets 174 avenue de France F-75013 Paris (FR)

LUTZ, Sylviane; c/o Sanofi-aventis Département Brevets 174 avenue de France F-75013 Paris (FR)

MALPART, Joël; c/o Sanofi-aventis Département Brevets 174 avenue de France F-75013 Paris (FR)

MASSON, Philippe; c/o Sanofi-aventis Département Brevets 174 avenue de France F-75013 Paris (FR)

MUTTI, Stéphane; c/o Sanofi-aventis Département Brevets 174 avenue de France F-75013 Paris (FR)

(74) Ćupić Branislav, Dalmatinska 10, Podgorica (ME)

(57) Ovaj pronalazak se odnosi na metod za dobijanje kombretastatina (A):u vidu baze ili adicione soli sa kisjelinom koji se sastoji u kuplovanju, u prisustvu baze i T3P, soli (Z)-amino jedinjenja, formule sa dvostrano zaštićenim derivatima L-serina formule u kojoj PG označava zaštitnu grupu aminske grupe, tako da se dobija jedinjenje formule (Z)-(Ib): -zatim uklanjanju zaštitne grupe i otvaranju prstena (Z)-(Ib) u prisustvu neke kisjeline, -i, po izboru, u dodavanju baze tako da se dobije kombretastatin formule (A) u vidu baze, so (Z)-amino jedinjenja, pošto je dobijena obogaćivanjem soli amono jedinjenja, formule: je (Z) izomer.

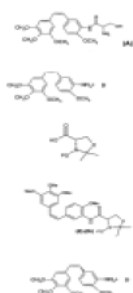

- (51) **A01N 35/00** (11) **01018**
A61K 31/12 (13) **A**
- (21) P-2010-143
 (22) 06.03.2009
 (30) 61/034,599 07.03.2008 US
 (86) PCT/US2009/036333 06.03.2009
 (87) WO/2009/111700 11.09.2009
- (54) (ME) **OKSADIAZOANTRACENSKA JEDINJENJA ZA LIJEČENJE DIABETESA**
 (EN) **OXADIAZOANTHRACENE COMPOUNDS FOR THE TREATMENT OF DIABETES**
- (73) TRANSTECH PHARMA, INC. [US/US]; 4170 Mendenhall Oaks Parkway High Point, NC 27265 (US)
- (72) MJALLI, Adnan, M.M. [US/US]; 6421 Ashton Park Drive Oak Ridge, NC 27310 (US)
 POLISETTI, Dharma, Rao [IN/US]; 3741 Deerfield Street High Point, NC 27265 (US)
 YOKUM, Thomas, Scott [US/US]; 5108 Hartridge Way Greensboro, NC 27407 (US)
 SANTHOSH, Kalpathy [IN/US]; 4132 Tutbury Drive Jamestown, NC 27282 (US)
 GUZEL, Mustafa [TR/US]; 4058 Gunsmith Court Jamestown, NC 27282 (US)
 BEHME, Christopher [US/US]; 3392 Cherrybrook Drive Jamestown, NC 27282 (US) (
 DAVIS, Stephen, Thomas [US/US]; 1 Wateroaks Court Durham, NC 27703 (US)
- (74) Čejović Vladimir, 13.jul 21, Podgorica (ME)
- (57) Ovaj pronalazak obezbjeđuje derivate oksadiazooantracena sa formulom (I).pri čemu su: A, B, C, R, R¹, R², R³, R⁴ i R⁵ kao što su ovde opisani. farmaceutske smješe koje sadrže derivate oksadiazooantracena, korišćenje derivata oksadiazooantracena za izradu farmaceutskih smješa, postupke njihovog korišćenja za liječenje i/ili prevenciju poremećaja ili bolesti, kao što je dijabetes, i intermedijere, koji su korisni za izradu derivata oksadiazooantracena sa Formulom (I).

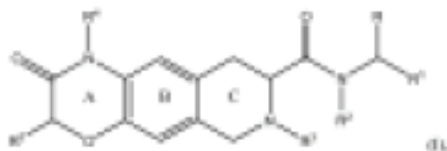

(51) **C07D 498/00**

(11) **01032**

(13) **A**

(21) P-2010-132

(22) 25.02.2009

(30) 61/031,329 25.02.2008 US

(86) PCT/US2009/035192 25.02.2009

(87) WO/2009/108730 3.09.2009

(54) (ME) **FORME RIFAKSIMINA I NJIHOVA UPOTREBA**

(EN) FORMS OF RIFAXIMIN AND USES THEREOF

(73) SALIX PHARMACEUTICALS, LTD. [US/US]; 1700 Perimeter Park Drive Morrisville, NC 27560 (US)

(72) GUSHURST, Karen, S.; 110 Heron Court West Lafayette, IN 47906 (US)

YANG, Donglai; 61 La Costa Drive Annandale, NJ 08801 (US)

ROE, Melanie; 3701 Nicolas Dr. Apt. A2 Lafayette, IN 47909 (US)

SCHULTHEISS, Nathan; 4104 Copper Valley Drive Lafayette, IN 47909 (US)

VLAHOVA, Petinka; 1041 Shootingstar Court West Lafayette, IN 47906 (US)

STULTS, Jeffrey, S.; 3064 Benton St. West Lafayette, IN 47906 (US)

HOUSTON, Travis, L.; 3240 Hendrickson Lane Lafayette, IN 47909 (US)

(74) Radulović Božidar, Jovana Tomaševića 9/III-1, Podgorica (ME)

(57) Ovaj se pronalazak odnosi na polimorfne, solne, hidrantne i amorfne forme rifaksimina, na njihovo korišćenje u medicinskim preparatima i na terapijske metode koji ih koriste.

(51) **A61K 35/00** (11) **01035**
A61K 35/76 (13) **A**
A61K 36/00

(21) P-2011-43

(22) 24.02.2011

(54) (ME) **LIJEK PROTIV VIRUSA GRIPA (H1N1)**

(EN) MEDICINE AGAINST SWINE FLU

(73) Šćepanović Željko, Sima Matavulja 13, Podgorica (ME)

(72) Šćepanović Željko, Sima Matavulja 13, Podgorica (ME)

(57) Sastav jednakih količina ljekovitog bilja:

1) Nadzemni dio podubice (*teucrium chamaerus*)

2) List i cvijet hajdučke trave (*achillea millefolium*)

3) Nadzemni dio pepeljuše (*teucrium polium*)

4) Gavranov kuk-trava (*teucrium scordium*)

5) Iva trava (*teucrium montanum*)

su farmaceutski prihvatljiv nosilac i mogu da budu korišćeni za tretiranje oboljelih od virusa gripa A i B i njihovih varijeteta. Hemijski sastav ljekovitog bilja koji je naprijed naveden djeluje na prouzrokovane virusne infekcije virusa tipa A i B i na H1N1.

- (51) **E21B 43/00** (11) **01033**
E21B 43/34 (13) **A**
- (21) P-2011-55
(22) 22.03.2011.
- (54) (ME) **REAGENS RDN-U ZA DOBIJANJE NAFTE**
(EN) REAGENT FOR OIL PRODUCTION
- (73) NHI d.o.o., M. Tita D-5, Bar (ME)
- (72) Njeftehimiženjering d.o.o., Tihvinska 24-46, 443011 Samara (RU)
- (57) Reagens za dobijanje nafte-univerzalni (RDN-U) namenjeni za naftnu industriju, koristi se za injekcione bušotine-izravnava profil brzog reagovanja i povećava koeficijent obuhvata sloja u procesu istiskivanja nafte kod natapanja bušotina. za eksploatacione bušotine-ograničava dotoka vode, smanjenje ili stabilizacija sadržaja vode u produktima eksploatacionih bušotina. Objekti primjene: injekcione i eksploatacione bušotine na nalazištima nafte.

(51) **F03B 13/00**

(11) **01016**

(13) **A**

(21) P-2012-44

(22) 03.04.2012.

(54) (ME) **AUTONOMNI I MEHANIČKI AGREGAT ZA PROIZVODNJU ELEKTRIČNE ENERGIJE**

(EN) AUTOMATIC MECHANICAL GENERATOR FOR PRODUCTION OF THE ELECTRICITY

(73) Bojović Milan, Njegoševa 4, Žabljak (ME)

(72) Bojović Milan, Njegoševa 4, Žabljak (ME)

(57) Novo konstruktivno rješenje u oblasti agregata za proizvodnju električne energije, a koje obezbjeđuje: ekonomičnu proizvodnju, nezavisnu proizvodnju od drugih izvora energije, ekološki čisto, pouzdanost u radu, jeftinu izradu, jednostavnu upotrebu i dr. Konstrukcija se sastoji u tome što se: na postolje (1) fiksiraju (zavare) stubovi (2) i (3), a na držač (19) pričvrsti generator (16) jednosmjerne energije sa remenicom (9), potom se elektromotor-agregat (15) jednosmjerne energije spoji sa remenicom (12), na stub (2) pričvrsti pretvarač (17) i potrošač (21) jednosmjerne energije, zatim se na osnovnu ploču (20) postavi baterija (14), na vratilo (4) montira zamajac (7) remenice (8) i (11) i ležajevi (5) i (6). Agregat funkcioniše tako što se: djelovanjem na prekidač (24) u položaj uključeno energija iz baterije (14) kablom (23) dovodi do elektromotora (15) koja pokreće remenicu (12) pa preko kajiša (13) i remenice (11) pokreće vratilo (4) sa remenicom (8) i zamajcem (7) kajišem (10) se preko remenice (9) pokreće generator (16). Energija iz baterije (14) kablovima (28) i (29) dovodi u pretvarač (17) koji pretvara jednosmjernu u naizmjeničnu energiju i kablom (32) naizmjenična energija odlazi do potrošača (33).

AUTONOMNI MEHANIČKI AGREGAT
ZA PROIZVODNJU ELEKTRIČNE ENERGIJE

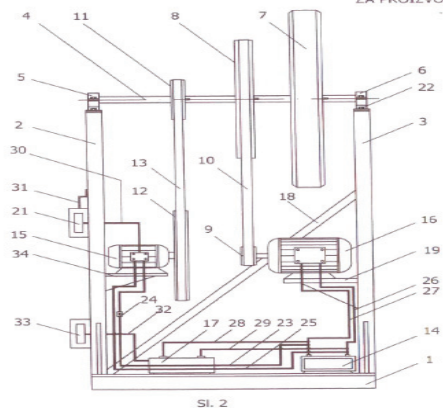

Si. 2

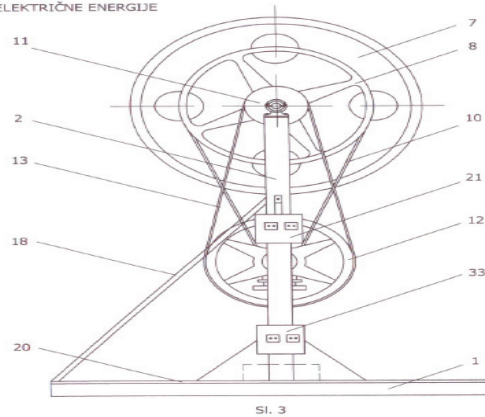

Si. 3

(51) **H01L 31/12**

(11) **01021**

(13) **A**

(21) P-2012-50

(22) 12.04.2012.

(54) (ME) **SAČASTI FOTONAPONSKI KOLEKTOR**
(EN) COMB ALLOCATED PHOTOVOLTAIC COLLECTOR

(73) Jovanovski Srđan, Makedonska ulica 21, Bar (ME)

(72) Jovanovski Srđan, Makedonska ulica 21, Bar (ME)

(57) Sačasti fotonaponski kolektor za razliku od konvencionalnih fotonaponskih kolektora sunčane energije omogućava potpuno korišćenje sunčane energije dospjele na kolektor. Sistem nema gubitka uslijed refleksije i paneli uvijek rade sa optimalnim stepenom iskorišćenja. Upotreba reflektora sunčane energije (1) obezbjeđuje povećanje gustine sunčanog ozračenja po jedinici površine što je neophodno radi postizanja maksimalnog stepena iskorišćenosti sistema. Konvenciono-konkavno sočivo (2) vrši sakupljanje i sabijanje energije u sistemu a istovremeno spriječava oticanje energije iz sistema. Na suprot sočiva se nalazi reflektivno-rasipajući sloj (4) koji služi za prelamanje i rasipanje upadnih sunčanih zraka na taj način da se oni ravnomjerno rasipaju po fotonaponskim panelima (3) unutar sistema i obezbijuje uglove refleksije takve da zraci ostanu unutar sistema.

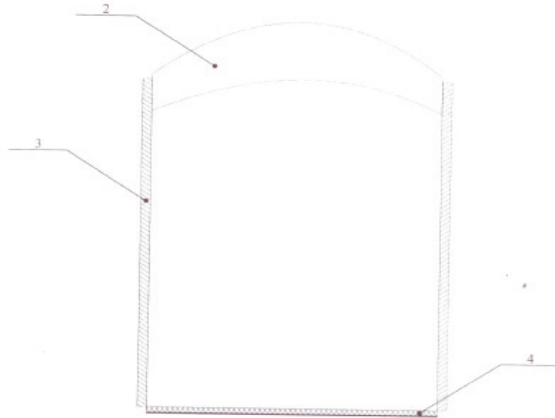

(51) F03G 6/00

(11) 01022

(13) A

(21) P-2012-65

(22) 24.05.2012

(54) (ME) MREŽASTI SLOJEVITI FOTONAPONSKI PANEL

(EN) NETTED MULTILAYER PHOTOVOLTIC PANEL

(73) Jovanovski Srđan, Makedonska ulica 21, Bar (ME)

(72) Jovanovski Srđan, Makedonska ulica 21, Bar (ME)

(57) Mrežasti slojeviti fotonaponski panel za razliku od konvencionalnih fotonaponskih panela omogućava potpuno iskorišćenje sunčane energije dospjele na panel. Sistem nema gubitaka uslijed refleksije energije koja ne može biti upijena silicijskim slojem i paneli uvijek rade sa optimalnim stepenom iskorišćenja. Upotreba prvog sloja (1) sa antirefleksivnim svojstvima i mogućnošću da propušta svjetlost samo u jednom pravcu povećava gustinu energije unutar sistema. Višestruki mrežasto raspoređeni slojevi silicijuma (2), (3), (4), omogućavaju bolje upijanje energije uz istovremeno vraćanje reflektivne energije u sistem. Sloj za refleksiju i disperziju (5) omogućava da se sva neiskorišćena energija vrati u sistem podjednako raspoređen. Optimalna radna temperatura sistema je postignuta vazдушnim hlađenjem (6) koje omogućava odvođenje toplote cirkulacijom vazduha kroz panel.

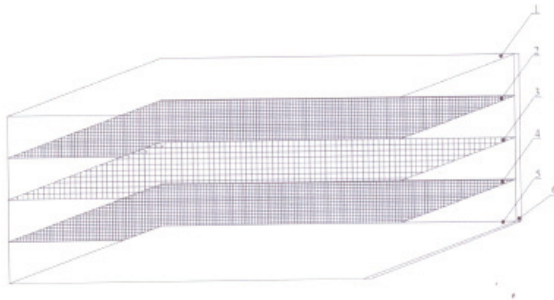

(51) E012B 9/00

(11) 01023

(13) A

(21) P-2012-66

(22) 24.05.2012.

(54) (ME) **HIDROGENERATOR POGONJEN VRTLOŽENIM KRETANJEM VODE**
(EN) HYDROGENERATOR PIWERED WITH WORTEX WATER FLOW

(73) Jovanovski Srđan, Makedonska ulica 21, Bar (ME)

(72) Jovanovski Srđan, Makedonska ulica 21, Bar (ME)

(57) Hidrogenerator pogonjen vrtložnim kretanjem vode za razliku od konvencionalnih hidrogeneratorskih omogućava mnogo bolje iskorišćenje hidropotencijala malih vodotokova. Sistem nema gubitaka uslijed trenja vode unutar cijevi i generator uvijek radi sa optimalnim stepenom iskorišćenja ukoliko količina vode na generatoru nije ispod propisane. Upotreba uvodnika vode (1) u sistem (2) uz pomoć žljebova (3) obezbjeđuje ubrzanje vode uslijed vrtložnog kretanja uzrokovanog gravitacijom i time se maksimalna brzina postiže pri izlasku vode (6) kroz okno (4) gdje je smješten generator (5). Izlazni kanal (7) mora imati kapacitet da primi svu vodu iz okna da nebi došlo do zagušenja. Kinetička energija koju posjeduje voda koja dospjeva na lopatice generatora je značajno veća od kinetičke energije koja bi imala voda da slobodno pada sa iste visine na lopatice generatora.

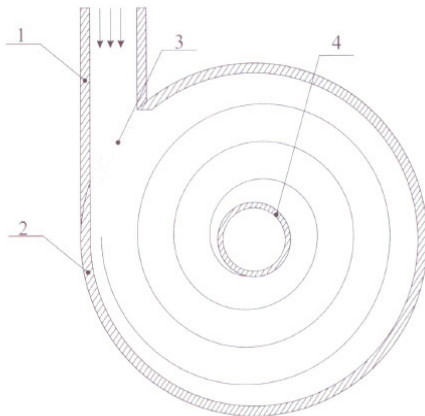

Slika 1/2.

(51) E02B 9/02
E02B 9/00
E02B 9/06
E02B 3/04
E02B 7/00
E02B 8/00
E02B 13/00
A01G 25/00

(11) 01034
(13) A

(21) P-2012-85
(22) 28.06.2012.

(54) (ME) **POSTUPAK KOJIM SE POVEĆAVA HIDROAKUMULACIONI PROSTOR I STVARA MOGUĆNOST NAPAJANJA I IZGRADNJE PRATEĆIH REVERZIBILNIH HIDROELEKTRANA**

(EN) PROCEDURE WHICH ENLARGES HYDROACCUMULATION SPACE AND CREATES POSSIBILITY FOR SUPPLY AND BUILD ACCOMPANYING

(73) Perović Slobodan, Milovana Kuća 1, Podgorica (ME)

(72) Perović Slobodan, Milovana Kuća 1, Podgorica (ME)

Kaluđerović Miodrag, Meše Selimovića 2/24, Podgorica (ME)

Radulović Mićko, Sitnička bb, Podgorica (ME)

(57) Postupak kojim se povećava HA prostor, kojeg prate odgovarajuće RHE, na slivnom području r. Zeta, Morača i Piva je predmet pronalaska. Pronalazak je iz oblasti hidroenergetike i vodoprivrede. Tehnički problem koji riješava postupak je nedostatak HA prostora i nedovoljne količine vode za proizvodnju električne energije, ili kombinacija jednog i drugog, u slivovima r. Zeta, r. Morača i r. Piva. Predloženi postupak rješava povećanje HA prostora kroz četiri faze, a odnose se na sliv: r Zeta prva i druga faza, r. Morača treća faza, r. Pive četvrta faza. Peta faza postupka odnosi se na oslobađanje poplavljenih površina i prevođenje istih u poljoprivredno zemljište, kao i obezbjeđenjem vode za navodnjavanje poljoprivrednih površina na nižim kotama od HA. Povezani rad HA i RHE po slivovima i zajedno je predmet pete faze postupka. Slika 1

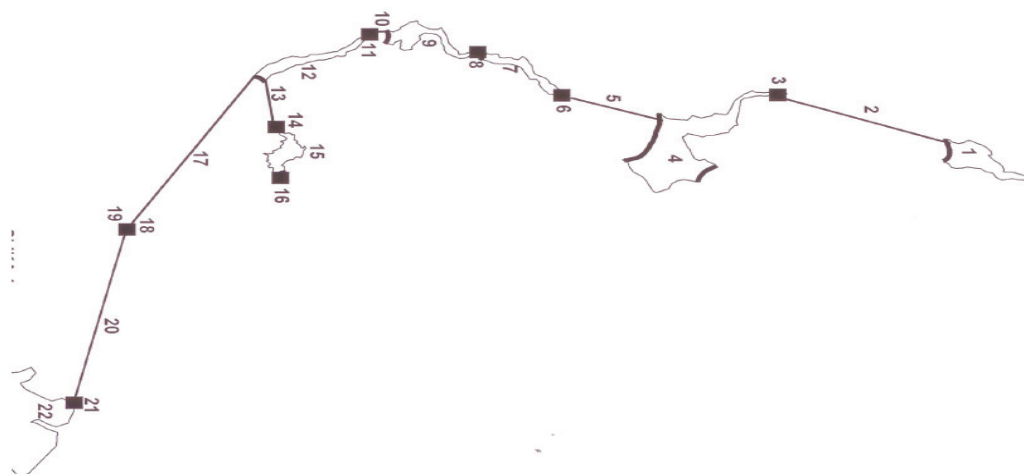

(51) **E02F 5/00**

(11) **01044**

(13) **A**

(21) P-2011-190

(22) 24.11.2011.

(54) (ME) **BLINDIRANO DROBILIČNO POSTROJENJE**

(EN) BLIND GRINDER INSTALLATIONS

(73) Mugoša V. Predrag, Velimira Terzića 15, Podgorica (ME)

(72) Mugoša V. Predrag, Velimira Terzića 15, Podgorica (ME)

(57) Riješenje "Blindirano drobilično postrojenje" dobija se na taj način što se neposredno iznad drobiličnog postrojenja postavlja primarna hala od montažno-demontažnih čeličnih elemenata i leksana i na tehnički prihvatljivom razmaku isto takva druga- sekundarna hala nad ovom-primarnom koja u cjelini upija gasove, prašinu i buku drobiličnog postrojenja, štiteći na taj način neposrednu okolinu od svih negativnih dejstava drobiličnog postrojenja, kojim putem se postiže potpuna ekološka zaštita prostora.

(51) **E03F 7/02**

(11) **01045**

(13) **A**

(21) P-2011-191

(22) 24.11.2011.

(54) (ME) **ROZETA-OTVARAČ**

(EN) ROSETTE-OPENER

(73) Mugoša V. Predrag, Velimira Terzića 15, Podgorica (ME)

(72) Mugoša V. Predrag, Velimira Terzića 15, Podgorica (ME)

(57) Riješenjem obrađena Rozeta otvarač zamišljena je kao funkcionalni otvarač sanitarnih armatura u kući i stanu bez povrede i oštećenja njihovih sklopova i uz stalnu dostupnost u okviru stana na koji način dopunski stvara sigurnost za redovne i hitne intervencije u stambenim i poslovnim objektima, a koja je izrađena od metala u jednom komadu dopunski niklovana ili izvedena u rost-frej čeliku.

(51) **E02B 3/4** (11) **01017**
E02B 9/02 (13) **A**

(21) P-2012-33
(22) 16.03.2012.

(54) (ME) **POSTUPCI I TEHNIČKA RIJEŠENJA KOJIMA SE SMANJUJU GUBICI VODE POPLAVNOG TALASA**

(EN) PROCEDURES AND TECHNICAL SOLUTIONS THAT REDUCES LOSSES OF WATER FLOOD WAVE

(73) Perović Slobodan, Milovana Kuča 1, Podgorica (ME)

(72) Perović Slobodan, Milovana Kuča 1, Podgorica (ME)

Kaluđerović Miodrag, Meše Selimovića 2/24, Podgorica (ME)

Radulović Mićko, Sitnička bb, Podgorica (ME)

Milić Dragan, Atinska 46, Podgorica (ME)

(57) Postupci i tehnička rješenja kojim se smanjuju gubici poplavnog talasa rijeke Zete u ponorima retenzije Vrtac (13), prevođenjem dijela voda rijeka Rastovac i Sušica u hidroakumulacije Krupac (5) i Slano (8), uz primjenu i drugih tehničkih rješenja za smanjenje poniranja ukupnih voda Nikšićkog polja su predmet pronalaska. Pronalazak je iz oblasti hidroenergetike i vodoprivrede. Prevodi se dio voda iz rijeka Rastovac i Sušica u hidroakumulaciju Krupac (5) koristeći maksimalne radne kote vodozahvata i transport vode zatvorenim sistemom-podzemnim cijevima. Povezuju se hidroakumulacije Krupac (5) i Slano (8) sa hidrotehničkim tunelom (6-7) većeg kapaciteta. Saniraju se ponorne zone hidroakumulacije Slano (8) izvođenjem inekcione zavjese iz potkopa, duž nove trase izvan Budoškog rasjeda (9-10) i izgrađuje se RHE Slano (11). Ugrađuje se Agregat broj 8 (23) maksimalnog kapaciteta. Aktivira se hidrotehnički sistem Liverovići (20-16), uz izgradnju RHE Norin (15) i RHE Liverovići (19).

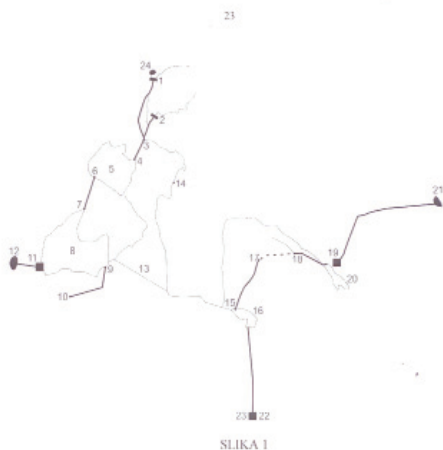

(51) F03D 1/00

(11) 01020

(13) A

(21) P-2012-37

(22) 22.03.2012.

(54) (ME) **GRAVITACIONI VJETROGENERATOR**

(EN) GRAVITACIONAL WINDGENERATOR

(73) Jovanovski Srđan, Makedonska ulica 21, Bar (ME)

(72) Jovanovski Srđan, Makedonska ulica 21, Bar (ME)

(57) Gravitacioni vjetrogenerator. za razliku od konvencionalnih vjetrogeneratora, neprekidno proizvodi električnu energiju bez direktnog uticaja lokalnih vjetrova na njegov rad. Neprestani rad gravitacionog vjetrogeneratora se obezbjeđuje vertikalnim usmjeravanjem strujanja vazduha kroz vertikalno postavljen provodnik vazduha (1) uz upotrebu razlike u pritiscima i temperaturi vazduha na krajevima provodnika. Upotrebom termoizolacionog akumulacionog sloja (4) u uzgonskom dijelu provodnika postiže se povećanje temperature vazduha dok izolacija zidova provodnika (5) sprječava promjenu karakteristika vazduha tokom dostizanja izlazne visine. Konstantno strujanje vazduha posjeduje fluktuacije koje se tačno određuju tokom konstruisanja samog provodnika vazduha i na osnovu njih se bira vjetrogenerator određenog radnog opsega i snage koji će neprekidno biti u pokretu i proizvoditi električnu energiju i koji ne podleže direktnim uticajima lokalnih vjetrova.

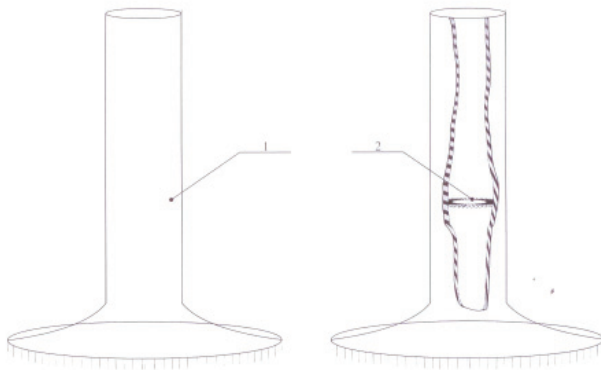

(51) **A61K 36/28**

(11) **01019**

A61K 36/14

(13) **A**

(21) **P-2012-40**

(22) 27.03.2012.

(54) (ME) **PROMELEM**

(EN) PROMELEM CREAM

(73) Nurković Suljo, Suho polje bb, Rožaje (ME)

(72) Nurković Suljo, Suho polje bb, Rožaje (ME)

(57) Mast za lokalni tretman kože sastoji se od ekstrakta bobica kleke, *Juniperus comm. fruct.*, u masnoj bazi, i dalje može da sadrži *Symphytum off.*, *Calendula off.*, *Plantago lanceolata*, *Matricaria chamomilla*, *Equiseti herba*, i / ili *Hypericum perforatum*.

(51) **A01G11/00**
C09K 17/00
B09C 1/00

(11) **01046**

(13) **A**

(21) P-2012-47

(22) 11.04.2012.

(54) (ME) **MOBILNI DEKONTAMINATOR TLA I VODA**

(EN) WATER AND EARTH DECONTAMINATOR MOBILE

(73) Mugoša V. Predrag, Velimira Terzića 15, Podgorica (ME)

(72) Mugoša V. Predrag, Velimira Terzića 15, Podgorica (ME)

(57) Mobilni dekontaminator tla i voda (DTV-250) napravljen je tako što su na odgovarajućoj autoprikolici, kamionetu ili manjoj barci instalirana dva plastična rezervoara različite zapremine, ujedno sa motornom pumpom putem koje se poliva zagađeno mjesto rastvaračem iz manjeg rezervoara, nakon čega se stvorena i opterećena pjena usisava u veći rezervoar uz sposobnost ove opreme da dođe na mjesto zagađenja i izvrši neophodnu radnu operaciju zaštite tla i voda, u kom pogledu čini novinu na ovom planu.

(51) **B09B 5/00**

(11) **01047**

(13) **A**

(21) P-2012-49

(22) 11.04.2012.

(54) (ME) **MOBILNA OPREMA ZA SPALJIVANJE OTPADA**

(EN) EQUIPMENT MOBILE TO BURN WASTE

(73) Mugoša V. Predrag, Velimira Terzića 15, Podgorica (ME)

(72) Mugoša V. Predrag, Velimira Terzića 15, Podgorica (ME)

(57) Mobilna oprema za spaljivanje (opasnog biološkog) otpada (MOSO-250) napravljena je na taj način što su na autoprikolici odnosno posebnom kamionetu instalirane dvije odvojene komore od kojih je u manjoj postavljen tank sa plinom, a u većoj gorionici za spaljivanje rizičnog otpada, uz instalirani filter za prečišćavanje gasova, na koji način tvore funkcionalnu cjelinu osposobljenu da dođe na određenu lokaciju i izvrši spaljivanje rizičnog otpada, u kom pogledu čini apsolutnu novinu na ovom planu.

- (51) **C07D 211/14** (11) **01030**
C07D 211/46 (13) **A**
- (21) P-771-08
 (22) 31.05.2000.
 (30) 99111126.1 08.06.1999 EP
 (86) PCT/EP2000/004953 31.05.2000
 (87) WO/2000/075109 14.12.2000
- (54) **(ME)DERIVATI ETANSUFONIL-PIPERIDINA**
(EN) ETHANESULFONYL-PIPERIDINE DERIVATIVES
- (73) F. HOFFMANN-LA ROCHE AG, 124, Grenzacherstrasse CH-4070 Basel (CH)
 (72) ALANINE, Alexander; 5, rue d'Altkirch F-68400 Riedisheim (FR)
 BURNER, Serge; 9, Rue de la Gendarmerie F-68480 Durmenach-Ferrette (FR)
 BUETTELDMANN, Bernd; Amselweg 14 D-79650 Schopfheim (DE)
 HEITZ NEIDHART, Marie-Paule; 9, rue du Steinler F-68220 Hagenthal-le-Bas (FR)
 JAESCHKE, Georg; Eulerstrasse 82 CH-4051 Basle (CH)
 PINARD, Emmanuel; 7, rue de Pujol F-68480 Linsdorf (FR)
 WYLER, René; Brandschenkestrasse 168 CH-8002 Zürich (CH)
- (74) Čejović Vladimir, 13.jul 21, Podgorica (ME)
- (57) Ovaj pronalazak se odnosi na jedinjenja opšte formule I u kojoj R¹ označava vodonik ili hidroksi, R² označava vodonik ili metil i x označava -O-ili-CH₂-, i njihove farmaceutski prihvatljive kisjelinke adicione soli. Pokazano je da ova jedinjenja imaju dobar afinitet prema NMDA receptora i otuda su prikladna u liječenju bolesti, pri čemu ova terapijska indikacije uključuju akutne oblike neurodegeneracije koji su prouzrokovani, npr., moždanim udarima ili moždanim traumama, hronične oblike neurodegeneracije kao što su Alchajmerova bolest, Parkinsonova bolest, Hatingtonova bolest ili ALS (amiotrofična lateralna skleroza), neurodegeneracije koja je u vezi sa bakterijskim ili virusnim infekcijama, i bolesti kao što su psihozofrenija, brižnost (anksioznost), depresija i hronični/akutni bol.

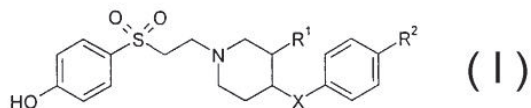

- (51) **C07K 14/47**
A61K 38/16
- (11) **01015**
(13) **A**
- (21) P-2009-175
(22) 21.12.2006.
(30) 2005-370388 22.12.2005. JP
2006-275843 06.10.2006. JP
(86) PCT/JP2006/326176 21.12.2006.
(87) WO 2007/072997 28.06.2007.
- (54) (ME) **DERIVATI METASTATINA I NJIHOVA UPOTREBA**
(EN) METASTIN DERIVATIVES AND USE THEREOF
- (73) TAKEDA PHARMACEUTICAL COMPANY LIMITED; 1-1, Doshomachi 4-chome, Chuo-ku, Osaka-shi, Osaka 5410045 (JP)
- (72) ASAMI, Taiji; TAKEDA PHARMACEUTICAL COMPANY LIMITED, 10, Wadai, Tsukuba-shi, Ibaraki 3004293 (JP)
NISHIZAWA, Naoki; c/o TAKEDA PHARMACEUTICAL COMPANY LIMITED, 10, Wadai, Tsukuba-shi, Ibaraki 3004293 (JP)
- (74) Ćupić Branislav, Dalmatinska 10, Podgorica (ME)
- (57) Ovaj pronalazak daje stabilne derivate metastina koji imaju odlične biološke aktivnosti (aktivnost suzbijanja metastaze kancera, aktivnost suzbijanja rasta kancera, aktivnost stimulacije izlučivanja gonadotropnog hormona, aktivnost stimulacije izlučivanja polnog hormona, itd). Supstancijom konstitutivnih aminokisjelina metastatina sa specifičnim aminokisjelinama u derivatu iz ovog pronalaska, znatno se poboljšavaju stabilnost u krvi, rastvorljivost, itd., smanjuje tendencija ka geliranju, farmakokinetika se takođe poboljšava, a pokazuje se odlična aktivnost u suzbijanju metastaze kancera ili aktivnost u suzbijanju rasta kancera. Pored toga, derivat metastina iz ovog pronalaska pokazuje efekte u suzbijanju izlučivanja gonadotropnog hormona, u suzbijanju izlučivanja polnog hormona. itd.

- (51) **A61K 39/395**
G01N 33/53
G01N 33/567
- (11) **01026**
(13) **A**
- (21) P-2010-76
(22) 14.11.2008.
(30) 60/988,481 16.11.2007. US
61/019,747 08.01.2008. US
(86) PCT/US2008/083659 14.11.2008.
(87) WO 2009/065054 22.05.2009.
- (54) (ME) **ANTITIJELA SPECIFIČNA ZA PROTOFIBRILNI OBLIK BETA-AMILOID
PROTEINA**
(EN) ANTIBODIES SPECIFIC FOR THE PROTOFIBRIL FORM OF BETA-AMYLOID PROTEIN
- (73) THE ROCKEFELLER UNIVERSITY, 1230 York Avenue New York, NY 10021-6399 (US)
(72) RAVETCH, Jeffrey; 500 Park Avenue New York, NY 10022 (US)
FUKUYAMA, Hidehiro; Strasbourg (FR)
(74) Kojić Ivana, Serdar Jola Piletića bb, Podgorica (ME)
(57) Opisana su izolovana antitijela, koja pokazuju određeni afinitet prema ponavljanju konformacionog epitopa protofibrilnog oblika humanog β -amiloid peptida u poređenju sa oblicima β -amiloid peptida male molekulske težine. Ova izolovana antitijela i sastavi u vezi s njima koji su farmaceutski efikasni mogu da budu korisni u terapijskom i/ili profilaktičkom liječenju Alchajmerove bolesti tako što efikasno blokiraju sposobnost protofibrilnog oblika β -amiloid peptida da obrazuju fibrilne oblike povezane s komplikacijama koje su u vezi s Alchajmerovom bolesti. Izolovana antitijela sadašnjeg otkrića su takođe korisna u različitim dijagnostičkim ispitivanjima i opremom u vezi s njima.

(51) **C07D 305/14**

(11) **01009**

(13) **A**

(21) P-2010-144

(22) 15.01.2009.

(30) 0800243 17.01.2008 FR

(86) PCT/FR2009/000042 15.01.2009.

(87) WO 2009/115655 24.09.2009.

(54) (ME) **KRISTALNI OBLICI DIMETOKSI DOCETAKSELA I POSTUPAK ZA NJIHOVO DOBIJANJE**

(EN) CRYSTALLINE FORMS OF DIMETHOXY DOCETEXEL AND METHODS FOR PREPARING SAME
(73) AVENTIS PHARMA S.A.; 20 avenue Raymond Aron F-92160 Antony (FR)

(72) BILLOT, Pascal; c/o Sanofi-Aventis Département Brevets 174 avenue de France F-75013 Paris (FR)

DUFRAIGNE, Marielle; c/o Sanofi-Aventis Département Brevets 174 avenue de France F-75013 Paris (FR)

ELMALEH, Hagit; c/o Sanofi-Aventis Département Brevets 174 avenue de France F-75013 Paris (FR)

GUILLIANI, Alexandre; c/o Sanofi-Aventis Département Brevets 174 avenue de France F-75013 Paris (FR)

MANGIN, Fabrice; c/o Sanofi-Aventis Département Brevets 174 avenue de France F-75013 Paris (FR)

RORTAIS, Patricia; c/o Sanofi-Aventis Département Brevets 174 avenue de France F-75013 Paris (FR)

ZASKE, Lionel; c/o Sanofi-Aventis Département Brevets 174 avenue de France F-75013 Paris (FR)

(74) Ćupić Branislav, Dalmatinska 10, Podgorica (ME)

(57) Predmet ovog pronalaska su anhidridi, solvati i etanol hetero-solvati i hidrati dimetoksi docetaksela ili (2R,3S)-3-terc-butoksikarbonilamino-2-hidroksi-3-fenilpropionat 4-acetoksi-2 α -benzoiloksi-5 β ,20-epoksi-1-hidroksi-7 β ,10 β -dimetoksi-9-okso-taks-I l-en-13 α -ila i postupak za njihovo dobijanje.

- (51) **A23C 11/06**
A23C 11/10
A23J 3/14
A23K 1/14
A23L 1/30
A23L 1/305
A23C 11/02
A61K 47/48
- (11) **01039**
(13) **A**
- (21) P-2010-116
(22) 22.01.2009
(30) PA200800079 22.01.2008 DK
61/022,542 22.01.2008 US
(86) PCT/EP2009/050696 22.01.2009
(87) WO 2009/092754 30.07.2009.
- (54) (ME) **KOMPOZICIJA KOJA SADRŽI PROTEIN I DISPERGOVANU MAST**
(EN) COMPOSITION COMPRISING PROTEIN AND DISPERSE FAT
- (73) Hamlet Protein A/S, Saturnvej 51 P.O. Box 130 DK-8700 Horsens (DK)
(72) HANSEN, KAAE, Ole; Skæring Strandvej 36 DK-8250 Egå (DK)
NEVE, Tommas; Ørnevænget 16 DK-8370 Hadsten (DK)
(74) Ćupić Branislav, Dalmatinska 10, Podgorica (ME)
- (57) Predmetni pronalazak se odnosi na metodu za dobijanje kompozicije koja sadrži proteine i masti, gdje data metoda obezbjeđuje jednostavan i jeftin način dobijanja proteinskih proizvoda koje sadrže mast, visoke nutritivne vrijednosti, kojima se lako manipulira i u isto vrijeme su veoma stabilni na oksidaciju i koalescenciju. Dalje, predmetni pronalazak se odnosi na metodu za dobijanje kompozicije koja sadrži protein i mast u dispergovanom obliku, metoda obuhvata sljedeće korake: (i) pripremanje suspenzije koja ima pH vrijednosti iznad 7.0, data suspenzija sadrži vodu, proteinski materijal, mast i po izboru alkalije; (ii) inkubaciju suspenzije dobijene u (i) na temperaturi u intervalu 50 - 150°C; (iii) homogenizaciju suspenzije dobijene u (ii) pri čemu se dobija disperzija; (iv) i, po potrebi, izlaganje disperzije dobijene u (iii) naknadnom tretmanu; gdje proteinski materijal u koraku (i) obuhvata proteinski materijal bljnoj bazi, i/ili proteinski materijal baziran na kvascu; i gdje suspenzija u koraku (i) obuhvata bar 5 tež. % masti kao suve materije. Predmetni pronalazak se takode odnosi na kompozicije dobijene ovom metodom i na kompozicije koje se mogu dobiti ovom metodom i dalje, na upotrebu ovih kompozicija.

(51) **C07D 471/04**
C07D 401/12
C07D 277/42
C07D 233/88
C07D 215/38
C07D 213/72
C07D 207/325
A61K 31/4709
A61K 31/4188
A61K 31/429
A61K 31/404
A61P 29/00
A61P 3/00
A61P 11/00

(11) **01010**
 (13) **A**

(21) P-2010-117

(22) 20.01.2009.

(30) 0800309 22.01.2008 (FR)

(86) PCT/FR2009/000051 20.01.2009

(87) WO 2009/112677 17.09.2009

(54) (ME) **BICIKLIČNI DERIVATI AZABICIKLIČNIH KARBOKSAMIDA, NJHOVO DOBIJANJE I TERAPEUTSKA UPOTREBA**

(EN) BICYCLIC DERIVATIVES OF AZABICYCLIC CARBOXAMIDES, PREPARATION THEREOF AND THERAPEUTIC USE THEREOF

(73) SANOFI-AVENTIS; 174 avenue de France F-75013 Paris (FR)

(72) DUBOIS, Laurent; c/o Sanofi-Aventis Département Brevets 174, avenue de4 France F-75013 Paris (FR)

EVANNO, Yannick; c/o Sanofi-Aventis Département Brevets 174, avenue de4 France F-75013 Paris (FR)

GILLE, Catherine; c/o Sanofi-Aventis Département Brevets 174, avenue de4 France F-75013 Paris (FR)

MALANDA, André; c/o Sanofi-Aventis Département Brevets 174, avenue de4 France F-75013 Paris (FR)

(74) Ćupić Branislav, Dalmatinska 10, Podgorica (ME)

(57) Pronalazak se odnosi na jedinjenja opste formule (I), gde X¹, X², X³ i X⁴ su, nezavisno jedan od drugog, atom azota ili C-R1 grupa; W je atom kiseonika ili sumpora; n je jednako 0, 1, 2 ili 3; Y je po izboru supstituisan aril ili heteroaril; A je grupa formule (II), Z¹, Z², Z³ i Z⁴ predstavljaju, nezavisno jedan od drugog, atom azota, atom ugljenika ili C-R2 grupu, Ra i Rb formiraju, zajedno sa atomom ugljenika koji ih nosi, ili delimično nezasićen cikloalkil, ili aril; ili heterocikl, ili heteroaril sa 5 do 7 članova u prstenu koji sadrži jedan do tri heteroatoma odabrano od O, S ili N; pri čemu je moguće da dati cikloalkul, dati aril, sati heterocikl ili dati heteroaril može da bude supstituisan jednim ili više R³ supstituenata; u obliku baze ili adicione soli sa kisjelinom, i takode u obliku hidrata ili solvata; Proces za njihovo dobijanje i njihova terapijska upotreba.

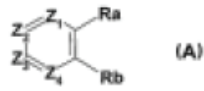
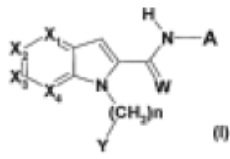

(51) **C07D 471/04**
A61P 11/00
A61K 31/437
A61P 3/00
A61P 29/00

(11) **01011**
 (13) **A**

(21) P-2010-119

(22) 20.01.2009.

(30) 0800310 22.01.2008. FR

(86) PCT/FR2009/000053 20.01.2009.

(87) WO 2009/112679 17.09.2009.

(54) (ME) **DERIVATI N-AZABICIKLIČNIH KARBOKSAMIDA, NJIHOVO DOBIJANJE I NJIHOVA TERAPEUTSKA PRIMJENA**

(EN) AZABICYCLIC CARBOXAMIDE DERIVATIVES, PREPARATION THEREOF AND THERAPEUTIC USE THEREOF

(73) SANOFI-AVENTIS; 174 avenue de France F-75013 Paris (FR)

(72) DUBOIS. Laurent; c/o Sanofi-Aventis Département Brevets 174, avenue de France F-75013 Paris (FR)

EVANNO, Yannick; c/o Sanofi-Aventis Département Brevets 174, avenue de France F-75013 Paris (FR)

LECLERC, Odile; c/o Sanofi-Aventis Département Brevets 174, avenue de France F-75013 Paris (FR)

MALANDA, André; c/o Sanofi-Aventis Département Brevets 174, avenue de France F-75013 Paris (FR)

(74) Čupić Branislav, Dalmatinska 10, Podgorica (ME)

(57) Predmet ovog pronalaska su jedinjenje opšte formule (I) gdje Xi, X2, X3, i X4 odgovaraju, nezavisno jedan od drugog, atomu azota ili jednoj grupi C-R1; W odgovara jednom atomu kiseonika ili sumpora; n je jednako 0, 1, 2, ili 3; Y odgovara jednom arilu ili jednom heteroarilu eventualno supstituisanom; A odgovara jednom bicikličnom heteroarilu formule (II) gde Z1, Z2, Z3 i Z4 odgovaraju, nezavisno jedan od drugog, jednom atomu ugljenika, jednom atomu azota ili jednoj grupi C-R2a, Z5, Z6 i Z7 odgovaraju, nezavisno jedan od drugog, jednom atomu azota ili jednoj grupi C-R2b ; Z8 odgovara jednom atomu ugljenika; u obliku baze ili adicione soli sa kisjelinom, kao i u obliku hidrata ili solvata. Postupak za njegovo dobijanje i njegova terapijska primena.

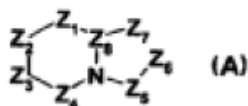
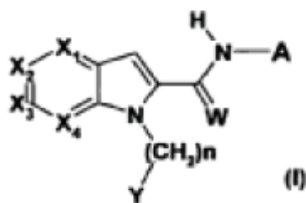

- (51) **C07D 471/04**
C07D 207/44
C07D 207/323
A61P 25/00
A61P 17/00
A61P 15/00
A61P 29/00
A61P 13/00
A61P 25/28
A61P 11/00
A61P 25/24
A61P 1/00

- (11) **01008**
(13) **A**

- (21) P-2010-113
(22) 20.01.2009.
(30) 08/00308 22.01.2008. FR
(86) PCT/FR2009/000052 20.01.2009.
(87) WO 2009/112678 17.09.2009.

(54) (ME) **DERIVATI AZABICIKLIČNIH KARBOKSAMIDA; NJIHOVO DOBIJANJE I NJIHOVA TERAPEUTSKA PRIMJENA**

(EN) AZABICYCLIC CARBOXAMIDE DERIVATIVES, PREPARATION THEREOF AND THERAPEUTIC USE THEREOF

- (73) SANOFI-AVENTIS; 174, avenue de France F-75013 Paris (FR)
(72) DUBOIS, Laurent; c/o Sanofi-Aventis Département Brevets 174, avenue de France F-75013 Paris (FR)
EVANNO, Yannick; c/o Sanofi-Aventis Département Brevets 174, avenue de France F-75013 Paris (FR)
MACHNIK, David; c/o Sanofi-Aventis Département Brevets 174, avenue de France F-75013 Paris (FR)
MALANDA, André; c/o Sanofi-Aventis Département Brevets 174, avenue de France F-75013 Paris (FR)

(74) Čupić Branislav, Dalmatinska 10, Podgorica (ME)

- (57) Pronalazak se odnosi na jedinjenja opšte formule (1) u kojoj X1, X2, X3 i X4, predstavljaju nezavisno jedan od drugog, atom azota ili grupu C-R1, Z2, Z3 i Z4 predstavljaju, nezavisno jedan od drugog, atom azota, ili grupu C-R2; Ra i Rb čine zajedno sa atomima ugljenika koji ih nose prsten od pet članova, ovaj prsten sadrži atom azota i atome ugljenika, ovaj prsten je delimično zasićen ili nezasićen i eventualno supstituisan sa jednim ili više supstituenata R3; W predstavljaju atom kiseonika ili sumpora; n jednako 0, 1, 2 ili 3; Y predstavlja aril ili heteroaril eventualno supstituisan; u obliku baze ili adicione soli sa nekom kisjelinom, kao i obliku hidrata ili solvata. Postupak dobijanja i primena u terapiji.

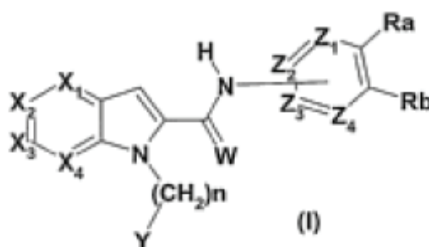

- (51) **C07D 401/12**
C07D 401/14
C07F 7/08
C07F 7/10
C07F 7/12
A61K 31/695
A61K 31/4439
A61P 25/00
A61P 3/00
A61P 13/00
A61P 15/00

- (11) **01012**
(13) **A**

- (21) P-2010-120
(22) 20.01.2009.
(30) 08/00343 23.01.2008. FR
(86) PCT/FR2009/000054 20.01.2009.
(87) WO 2009/109710 11.09.2009.

- (54) (ME) **DERIVATI INDOL-2-KARBOKSAMIDA I AZAINDOL-2-KARBOKSAMIDA SUPSTITUISANI SILANIL GRUPOM, NJHOVO DOBIJANJE I TERAPEUTSKA UPOTREBA**

(EN) DERIVATIVES OF INDOLE 2-CARBOXAMIDES AND AZAINDOLE 2-CARBOXAMIDES SUBSTITUTED BY A SILANYLE GROUP, PREPARATION THEREOF AND THERAPEUTIC USE THEREOF

- (73) SANOFI-VENTIS 174, avenue de France F-75013 Paris (FR)
(72) DUBOIS, Laurent; c/o Sanofi-Aventis Departement Brevets 174, avenue de France F-75013 Paris (FR)
EVANNO, Yannick; c/o Sanofi-Aventis Departement Brevets 174, avenue de France F-75013 Paris (FR)
MALANDA, Andre; c/o Sanofi-Aventis Departement Brevets 174, avenue de France F-75013 Paris (FR)
(74) Ćupić Branislav, Dalmatinska 10, Podgorica (ME)
(57) Pronalazak se odnosi na jedinjenja opšte formule (I) u kojoj G_1 , G_2 , G_3 i G_4 su, nezavisno jedan od drugog, C-X grupa ili atom azota; jedan od G_1 , G_2 , G_3 i G_4 i najviše jedan od G_1 , G_2 , G_3 i G_4 je C-X grupa gde X je $Si(X_1)(X_2)(X_3)$ grupa; n je 0, 1, 2 ili 3; Y je po izboru supstituisan aril ili heteroaril; Z_1, Z_2, Z_3, Z_4 su, nezavisno jedan od drugog, atom azota ili $C(R_6)$ grupa najmanje jedan je atoma azota ili $C(R_6)$ grupa; Z je ciklicni amin ili aciklicni amin; data jedinjenja mogu da budu u obliku baze ili adicione soli sa kisjelinom, kao i u obliku hidrata ili solvata. Pronalazak se takođe odnosi i na postupak dobijanja ovih derivata i na njihovu terapeutsku upotrebu.

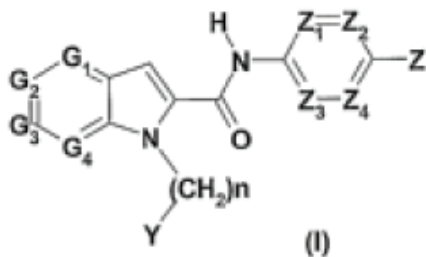

- (51) **A61K 31/357** (11) **01013**
A61K 31/37 (13) **A**
A61K 31/426
A61K 31/427
A61P 33/06
- (21) P-2010-126
(22) 05.02.2009.
(30) 0800618 06.02.2008. FR
(86) PCT/FR2009/000129 05.02.2009.
(87) WO 2009/115666 24.09.2009.
- (54) (ME) **KOMBINACIJA BIS-TIAZOLIJUM SOLI ILI NJENOG PREKURSORA I ARTEMIZININA ILI NJEGOVOG DERIVATA ZA LIJEČENJE AKUTNE MALARIJE**
(EN) COMBINATION OF A BIS-THIAZOLIUM SALT OR A PRECURSOR THEREOF AND ARTEMISININ OR A DERIVATIVE THEREOF FOR TREATING ACUTE MALARIA
- (73) SANOFI-AVENTIS 174 Avenue de France F-75013 Paris (FR)
CENTRE NATIONAL DE LA RECHERCHE SCIENTIFIQUE (CNRS) 3, rue Michel Ange F-75794 Paris Cedex 16 (FR)
UNIVERSITE MONTPELLIER II Case 403, Place Eugène Bataillon F-34095 Montpellier Cedex (FR)
- (72) FRAISSE, Laurent; c/o Sanofi-Aventis Département Brevets 174 avenue de France F-75013 PARIS (FR)
VIAL, Henri; 3 rue Michel-Ange F-75794 Paris Cedex 16 (FR)
WEIN, Sharon Aurore; 3 rue Michel-Ange F-75794 PARIS cedex 16 (FR)
- (74) Ćupić Branislav, Dalmatinska 10, Podgorica (ME)
- (57) Predmet pronalaska je kombinacija koja sadrži bis-tiazolijum so, odnosno jedinjenje formule (VI) ili njegove prekursore, i artemizinin ili njegov derivat. Takođe, predmet pronalaska je farmaceutska kompozicija koja sadrži najmanje jednu bis-10 tiazolijum so, odnosno jedinjenje formule (VI) ili njegov prekursor, i artemizinin ili njegov derivat. Dalje, predmet pronalaska je upotreba kombinacije za dobijanje jednog lijeka za liječenje ili prevenciju teških slučajeva malarije. Na kraju, predmet pronalaska je komplet za liječenje ili prevenciju teških slučajeva malarije.

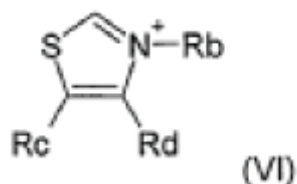

- (51) **A61K 31/165**
A61K 31/55
A61P 9/10
A61P 9/04
- (11) **01014**
(13) **A**
- (21) P-2010-129
(22) 12.02.2009.
(30) 0800800 14.02.2008. FR
(86) PCT/FR2009/000156 12.02.2009.
(87) WO 2009/115669 24.09.2009.
- (54) (ME) **SPOJ INHIBITORA IF STRUJE SINUSNOG NODUSA I BETA BLOKATORA**
(EN) COMBINATION OF A SINUSAL IF CURRENT INHIBITOR AND A BETA-BLOCKER
- (73) LES LABORATOIRES SERVIER, 35, rue de Verdun F-92284 Suresnes cedex (FR)
(72) LEREBOURS-PIGEONNIERE, Guy; 28 avenue de l'Europe F-92300 Levallois-Perret (FR)
CALVET, Jean-Henri; 93 rue de Turenne F-75003 Paris (FR)
(74) Čejović Vladimir, 13.jul 21, Podgorica (ME)
(57) Spoj inhibitora If struje sinusnog nodusa i β - blokatora i takođe farmaceutske smješe koje ga sadrže.

(51) E04H 12/10

(11) 01038

(13) A

(21) P-2012-81

(22) 21.06.2012.

(54) (ME) **REŠETKASTI STUBOVI "LAĐO" OD ČELIKA ILI AL-LEGURE ZA DISTRIBUCIJU ELEKTRIČNE ENERGIJE NAPONA VEĆEG ILI JEDNAKOG 110KV**
(EN) LATTICE TOWERS "LADJO" MADE OF STEEL OR AL-ALLOY FOR THE DISTRIBUTION ELECTRICAL ENERGY OF VOLTAGE OF 110KV END BIGGER

(73) Burić A. Milorad, Mila Radunovića bb, Podgorica, (ME)

(72) Burić A. Milorad, Mila Radunovića bb, Podgorica, (ME)

(57) Rešetkasti stubovi "LAĐO" (Slika 1) od čelika ili Al-legure za distribuciju električne energije napona većeg ili jednakog 110 kV. Vertikalne (V), kose (S) i horizontalne (H) grede izrađene su od okruglih, na krajevima deformisanih cijevi (1) i špojnice (2, "VESALPEĐO" ili neka druga spojnica), spojenih zavrtnjevima od Al-legure ili nerđajućeg ili pocinčanog čelika ili zakivcima od Al-legure (Slika 2.). Ovi rešetkasti stubovi predstavljaju pogodno i jeftino rješenje za izradu a naročito za transport i montažu.

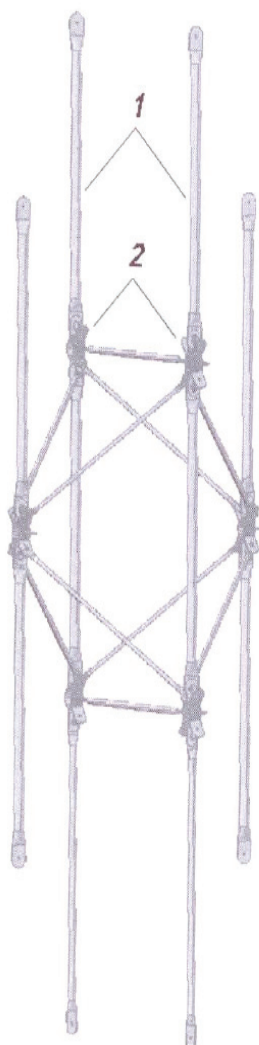

Slika 2. Detalj „A“

- (51) **C07D 471/04**
C07D 213/28
C07D 233/56
A61K 31/437
A61P 25/00
A61P 19/00
A61P 35/00
- (11) **01028**
(13) **A**
- (21) P-2010-152
(22) 20.03.2009.
(30) 0801584 21.03.2008. FR
(86) PCT/FR2009/000303 20.03.2009.
(87) WO 2009/144395 03.12.2009.
- (54) (ME) **VIŠESTRUKO SUPSTITUISANI DERIVATI 2-HETEROARIL-6-FENIL-
IMIDAZO[1,2- α]PIRIDINA, NJHOVO DOBIJANJE I TERAPEUTSKA PRIMJENA**
(EN) POLYSUBSTITUTED DERIVATIVES OF 2-HETEROARYL-6-PHENYL-IMIDAZO[1,2- α] PYRIDINES, AND PREPARATION AND THERAPEUTIC USE THEREOF
- (73) SANOFI-AVENTIS; 174 avenue de France F-75013 Paris (FR)
(72) ALMARIO GARCIA, Antonio; c/o Sanofi-aventis Département Brevets 174 avenue de France F-75013 Paris (FR)
DE PERETTI, Danielle; c/o Sanofi-aventis Département Brevets 174 avenue de France F-75013 Paris (FR)
EVANNO, Yannick; c/o Sanofi-aventis Département Brevets 174 avenue de France F-75013 Paris (FR)
LARDENOIS, Patrick; c/o Sanofi-aventis Département Brevets 174 avenue de France F-75013 Paris (FR)
MACHNIK, David; c/o Sanofi-aventis Département Brevets 174 avenue de France F-75013 Paris (FR)
RAKOTOARISOA, Nathalie; c/o Sanofi-aventis Département Brevets 174 avenue de France F-75013 Paris (FR)
- (74) Ćupić Branislav, Dalmatinska 10, Podgorica (ME)
- (57) Jedinjenja formule (I) u kojoj R1 predstavlja heteroaril ili heterocikličnu grupu po izboru supstituisanu sa, jednim ili više atoma ili grupa, X predstavlja od 1 do 4 supstituenata, koji su identični ili različiti jedan od drugog, izabrani od vodonika, halogena, (C1-C10) alkil, (C1-C10)alkoksi, NRaRb, nitro i cijano, pri čemu je moguće da (C1-C10)alkil grupa bude po izboru supstituisana sa jednom ili više grupa izabanih od halogena, (C1-C10) alkoksi, (C1-C10)haloalkoksi, NRaRb ili hidroksil; R predstavlja, na položaju 3, 5, 7 or 8 imidazo[1,2-a]piridina, od 1 do 4 substituenta, koji su identični ili različiti jedan od drugog, izabran od vodonika, halogena, (C1-C10)alkil, halo(C1-C10)alkil i (C1-C10)alkoksi; R2 i R3 predstavljaju, nezavisno jedan od drugog, atom vodonika, (C1-C10)alkil grupu po izboru supstituisanu sa Rf grupom, ili po izboru supstituisanu aril grupu; R4 predstavlja: atom vodonika; (C1-C10)alkil grupu po izboru supstituisan sa Rf grupom; ili po izboru supstituisanu aril grupu, u obliku baze ili adicione soli kisjeline.
Terapeutska upotreba ovih jedinjenja i proces za njihovu sintezu.

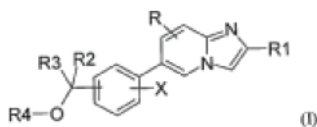

(51) **A61K 9/20**
A61K 31/64

(11) **01031**
(13) **A**

(21) P-2010-154

(22) 20.03.2009.

(30) 08/01561 21.03.2008. FR

(86) PCT/FR2009/000295 20.03.2009.

(87) WO 2009/125087 15.10.2009.

(54) (ME) **DJELJIVI GALENSKI OBLIK KOJI OMOGUĆAVA MODIFIKOVANO
OSLOBAĐANJE AKTIVNOG SASTOJKA**

(EN) DIVISIBLE GALENIC FORM ALLOWING MODIFIED RELEASE OF THE ACTIVE INGREDIENT

(73) LES LABORATOIRES SERVIER, 35 rue de Verdun F-92284 Suresnes Cedex (FR)

(72) FONKNECHTEN, Gilles; La Ferme du petit chêne Route de la Californie F-45240 Ligny Le Ribauld (FR)

GENTY, Patrick; 2 rue des fleurs F-45100 Orleans (FR)

PEAN, Jean-Manuel; 2bis rue Adolphe Crespin F-45000 Orleans (FR)

WUTHRICH, Patrick; 937, rue de la Loire F-45560 Saint Denis en Val (FR)

(74) Čejović Vladimir, 13.jul 21, Podgorica (ME)

(57) Djeljivi galenski oblik sa modifikovanim oslobađanjem aktivnog sastojka, pri čemu nepodijeljeni galenski oblik i dio navedenog oblika dobijen dijeljenjem na manje djelove imaju iste profile rastvaranja.

- (51) **C07D 213/28**
C07D 233/56
C07D 471/04
A61K 31/437
A61P 19/00
A61P 25/00
A61P 35/00
- (21) P-2010-155
(22) 20.03.2009.
(30) 0801581 21.03.2008. FR
(86) PCT/FR2009/000302 20.03.2009.
(87) WO 2009/144394 03.12.2009.
- (54) (ME) **VIŠESUPSTITUISANI DERIVATI 2-ARIL-6-FENIL-IMIDAZO[1,2- α] PIRIDINI, NJIHOVO DOBIJANJE I NJIHOVA UPOTREBA U TERAPIJI**
(EN) POLYSUBSTITUTED 2-ARYL-6-PHENYL-IMIDAZO[1,2- α]PYRIDINE DERIVATIVES, AND PREPARATION AND THERAPEUTIC USE THEREOF
- (73) SANOFI-AVENTIS; 174 avenue de France F-75013 Paris (FR)
(72) ALMARIO GARCIA, Antonio; c/o Sanofi-aventis Département Brevets 174 avenue de France F-75013 Paris (FR)
DE PERETTI, Danielle; c/o Sanofi-aventis Département Brevets 174 avenue de France F-75013 Paris (FR)
EVANNO, Yannick; c/o Sanofi-aventis Département Brevets 174 avenue de France F-75013 Paris (FR)
LARDENOIS, Patrick; c/o Sanofi-aventis Département Brevets 174 avenue de France F-75013 Paris (FR)
MALANDA, André; c/o Sanofi-aventis Département Brevets 174 avenue de France F-75013 Paris (FR)
RAKOTOARISOA, Nathalie; c/o Sanofi-aventis Département Brevets 174 avenue de France F-75013 Paris (FR)
- (74) Ćupić Branislav, Dalmatinska 10, Podgorica (ME)
- (57) Jedinjenja formule (I) u kojoj R1 predstavlja: heteroaril ili heterocikličnu grupu, koje obije po izboru mogu da budu supstituisane, X predstavlja od 1 do 4 supstituenata, koji su identični ili različiti jedan od drugog, izabrani od vodonika, halogena, (C₁-C₁₀)alkil, halo(C₁-C₁₀)alkoksi, (C₁-C₁₀)alkoksi, NRaRb, cijano ili nitro, R predstavlja, na položaju 3, 5, 7 or 8 imidazo[1,2- α]piridina, od 1 do 4 substituenta, koji su identični ili različiti jedan od drugog; R₂ i R₃ predstavljaju, nezavisno jedan od drugog, atom vodonika, ili po izboru supstituisanu (C₁-C₁₀)alkil grupu, ili po izboru supstituisanu aril grupu; R₂ i X mogu da formiraju, zajedno sa atomom ugljenika za koji vezani, ugljenicni prsten sa 5 do 7 atoma ugljenika; i R₄ predstavlja: atom vodonika; po izboru supstituisanu (C₁-C₁₀)alkil grupu; ili aril grupu po izboru supstituisanu jednim ili više supstituenata. Terapeutska upotreba ovih jedinjenja i procesi za njihovu sintezu.

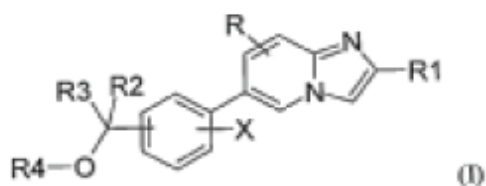

(51) **A61G 5/14**

(11) **01007**

(13) **A**

(21) P-2012-59

(22) 11.05.2012.

(54) (ME) **PRENOSNO POMOĆNO SJEDIŠTE SA VAZDUŠNIM PROTOKOM**
(EN) PORTABLE AIR FLOW PROMOTING SEAT CUSHION

(73) Petrušić Darko, Straševska 9, Nikšić (ME)

(72) Petrušić Darko, Straševska 9, Nikšić (ME)

(57) Prenosno pomoćno sjedište sa vazdušnim protokom koje se stavlja na stolicu ili na čvrstu podlogu namijenjeno je da pruži komfor, pri čemu je konfigurisano da obezbijedi ventilaciju, a time i hlađenje, naročito u oblasti prepona osobe koja sjedi. Sjedište je projektovano da sadrži ventilacione kanale koji omogućuju konvektivni tok vazduha, kako bi se omogućio protok hladnijeg okolnog vazduha u sjedište i zagrijanog vazduha iz sjedišta.

(51) F24J 2/06

(11) 01024

(13) A

(21) P-2012-67

(22) 24.05.2012.

(54) (ME) FOKUSNA SOLARNA TERMOELEKTRANA
(EN) FOCUSED SOLAR THERMO POWER PLANT

(73) Jovanovski Srđan, Makedonska ulica 21, Bar (ME)

(72) Jovanovski Srđan, Makedonska ulica 21, Bar (ME)

(57) Fokusna solarna termoelektrana koristi sunčevu energiju za proizvodnju pare koja će ekspanzijom pokretati turbinu. Za razliku od postojećih solarnih termoelektrana, u kombinaciji sa reflektorom energije (1) posjeduje sabirno sočivo (2) koje će svu energiju fokusirati u jednu tačku koja se po dizajnu nalazi u žižnoj daljini sočiva i pada na procjep (3) u tornju koji zbog svoje konstrukcije rasipa energiju unutar tornja a zahvaljujući sočivu (4) sprečava gubitak energije iz tornja. Istovremeno, unutrašnjost tornja je sastavljena od modula (5) kopji reflektuju energiju iz unutrašnjosti i fokusiraju je na cijevi generatora pare.

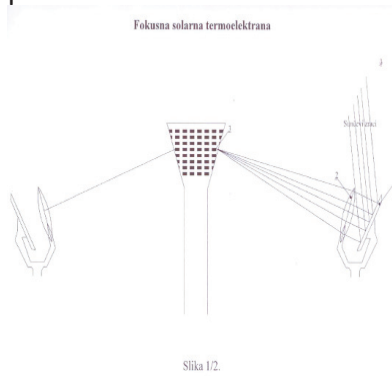

(51) H02N 2/00

(11) 01025

(13) A

(21) P-2012-68

(22) 24.05.2012.

(54) (ME) **ELEKTROMAGNETNI INERCIONI POGON**
(EN) ELECTROMAGNETIC INERTIAL DRIVE

(73) Jovanovski Srđan, Makedonska ulica 21, Bar (ME)

(72) Jovanovski Srđan, Makedonska ulica 21, Bar (ME)

(57) Elektromagnetni inercioni pogon predstavlja nov način korišćenja električne energije u pokretanju vozila bez direktnog uticaja podloge po kojoj se kreću na sam prenos. Pogon se sastoji od modifikovanog sistema koji uz pomoć ležišta (1) kroz koje se na magnetnom jastuku kreiranom uz pomoć magnetnih odbojnika (2) kreće namagnetisani element (3) koji prenosi impuls kretanja koji dobije stalnim ubrzanjem uz pomoć provodnika naizmjenične struje (4). Impuls se preko krajnjih odbojnika promjenjivog namagnetisanja (5) prenosi na ostatak sistema koji se pokreće.

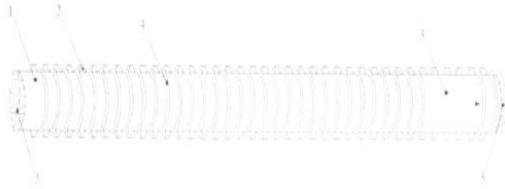

Slika 1.2.

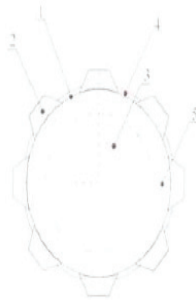

Slika 2.2.

(51) E04G 17/00

(11) 01036

(13) A

(21) P-2012-79

(22) 21.06.2012.

(54) (ME) **SPOJNICA ZA PROSTORNE KONSTRUKCIJE "ROTOR"**
(EN) **NODE FOR THE SPACE STRUCTURES "ROTOR"**

(73) Burić A. Milorad, Mila Radunovića bb, Podgorica, (ME)

(72) Burić A. Milorad, Mila Radunovića bb, Podgorica, (ME)

(57) Spojnica za prostorne rešetkaste konstrukcije „ROTOR” od čelika ili Al-legure. Ovim pronalaskom je dato riješenje spojnice od čelika ili Al-legure kod kojeg se spojnice (1,2, Slika 1) vezuju međusobno sa štapovima u obliku cijevi (3, 4, 5) od čelika ili Al-legure.

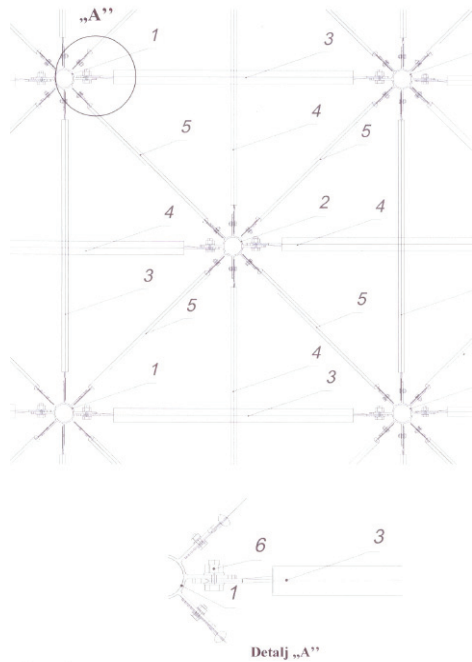

(51) E04H 12/10

(11) 01037

(13) A

(21) P-2012-80

(22) 21.06.2012.

(54) (ME) **STUBOVI "VEĐO" ZA RASVJETU OD AI-LEGURE**

(EN) COLUMNS "VEDJO" FOR THE LIGHTENING MADE OF AI-ALLOY

(73) Burić A. Milorad, Mila Radunovića bb, Podgorica, (ME)

(72) Burić A. Milorad, Mila Radunovića bb, Podgorica, (ME)

(57) Stubovi "VEĐO" od Al-legure, slika 1., izrađuju se od Al-profila dobijenih presovanjem, čiji je poprečni presjek prikazan na slici 1. Presjek A-A, i na taj način su maksimalno pogodni i jeftini za izradu.

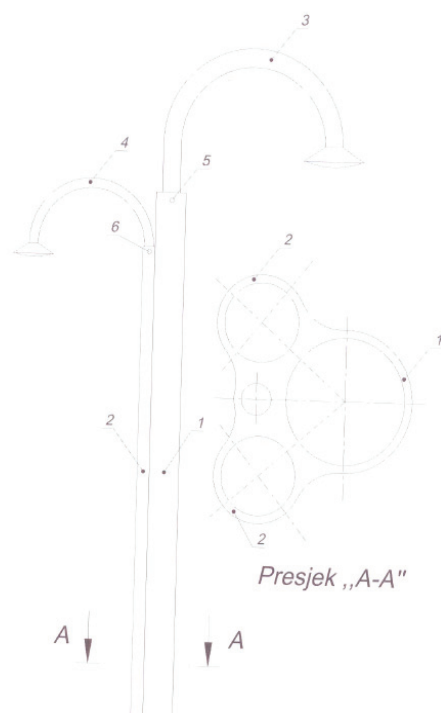

(51) E04B 1/08

(11) 01006

(13) A

(21) P-2012-29

(22) 13.03.2012.

(54) (ME) **LAKA NOSEĆA PROSTORNA KONSTRUKCIJA HALA, KROVOVA ZGRADA I DRUGIH OBJEKATA SA DVA NAGIBA KROVA "HAMING" OD ČELIKA ILI AL LEGURE**

(EN) LIGHT SUPPORT SPACE STRUCTURE WORKROOMS, ROOF HOUSES AND OTHER BUILDINGS WITH TWO GRADIENT ROOFS „HAMING“ MADE OF STEEL OR AL ALLOY

(73) Burić A. Milorad, Mila Radunovića bb, Podgorica, (ME)

(72) Burić A. Milorad, Mila Radunovića bb, Podgorica, (ME)

(57) Lake noseće prostorne konstrukcije hala, krovova zgrada i sličnih objekata sa dva nagiba krova "HAMING" od čelika ili Al legure. Štapovi (1, Sl. 2) su izrađeni od čeličnih ili aluminijskih cijevi koje su na svojim krajevima deformisane i vezu se sa spojnicom (2, Sl. 2) „VESALAPEĐO“, ili sa nekom drugom spojnicom, takođe izrađenom od čelika ili od Al legure. Veza štapova sa spojnica se u slučaju spojnice „VESALAPEĐO“ izvodi pomoću pocinčanih ili aluminijskih zavrtnjeva ili zakivaka od Al legura.

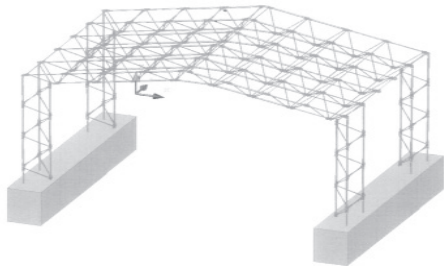

Slika 1. LAKA NOSEĆA PROSTORNA KONSTRUKCIJA HALE SA DVA NAGIBA KROVA "HAMING"



Slika 2. LAKA NOSEĆA PROSTORNA KONSTRUKCIJA HALE SA DVA NAGIBA KROVA "HAMING" SA SPOJNICOM „VESALAPEĐO“

- (51) **A61K 39/02** (11) **01000**
C07K 14/30 (13) **A**
- (21) **P-2010-78**
(22) 05.11.2008.
(30) 60/985,811 06.11.2007. US
(86) PCT/US2008/082454 05.11.2008.
(87) WO 2009/061798 14.05.2009.
- (54) **(ME) ŽIVA VAKCINA AVIRULENTNE MYCOPLASMA HYOPNEUMONIAE SA ADJUVANSOM**
(EN) MYCOPLASMA HYOPNEUMONIAE AVIRULENT-ADJUVANTED LIVE VACCINE
- (73) WYETH LLC; Five Giralda Farms Madison, New Jersey 07940 (US)
(72) CHU, Hsien-Jue; 15671 Cedar Lane Bonner Springs, Kansas 66012 (US)
XU, Zhichang; 2920 18th Avenue North Fort Dodge, Iowa 50501 (US)
LI, Wumin; 1519 Knollcrest Drive Fort Dodge, Iowa 50501 (US)
GIBSON, Nicole, Rae; 1645 220th Street Hombolt, Iowa 50548 (US)
- (74) Ćupić Branislav, Dalmatinska 10, Podgorica (ME)
- (57) Dati su imunogeni sastavi, vakcine i metodi za njihovo dobijanje i upotrebu. Ovi sastavi su efikasni u zaštiti od *M. hyopneumoniae*, minimizovanju žestine, spriječavanju i/ili ublažavanju infekcije *M. hyopneumoniom*. Davanje životinji jedne ili dvije doze ovdje opisanih sastava sa živom avirulentnom *M. hyopneumoniae* i adjuvansom efikasno je u stvaranju imuniteta kod životinje i zaštite od infekcije virulentnim sojem *M. hyopneumoniae*, čime se smanjuje ozbiljnost i/ili spriječava oboljenje izazvano jednim ili više virulentnih sojeva *M. hyopneumoniae*. Dati su takođe sastavi koji sadrže još jedan ili više antigena kao što su, na primjer, jedna ili više bakterija, bakterina, toksoida, i/ili virusa i/ili virusnih antigena. Dati su primjeri imunogenih sastava koji sadrže živu avirulentnu *M hyopneumoniae* sa adjuvansom i sastavi koji sadrže modifikovanu živu vakcinu himere svinjskog Circovirusa Tip 1-Tip 2 (cPCVI-2) u kombinaciji sa živom avirulentnom *M. hyopneumoniae* i adjuvansom.

- (51) **A61K 31/138**
A61P 3/00
A61P 3/04
A61P 3/06
A61P 3/10
- (11) **00996**
(13) **A**
- (21) P-2010-65
(22) 05.09.2008.
(30) 60/980,334 16.10.2007. US
(86) PCT/US2008/075433 05.09.2008.
(87) WO/2009/051908 23.04.2009
- (54) (ME) **TRANS-KLOMIFEN ZA METABOLIČKI SINDROM**
(EN) TRANS-CLOMIPHENE FOR METABOLIC SYNDROME
- (73) REPOS THERAPEUTICS INC.; 2408 Timberloch Place, Suite B-7 The Woodlands, TX 77380 (US)
- (72) VAN AS, Andre; 1273 Robynwood Lane West Chester, PA 19380 (US)
- (74) Čejović Vladimir, 13.jul 21, Podgorica (ME)
- (57) Predmetni pronalazak se odnosi na način primjene smješa koje sadrže antiestrogen, poželjno *trans*-klomifen, za liječenje metaboličkog sindroma u naslovu pronalaska. Pronalazak je takođe usmjeren na metode redukovanja povećane tolerancije glukoze u naslovu pronalaska putem primjene smješa koje sadrže antiestrogen, poželjno *trans*-klomifen.

- (51) **C07H 19/04**
A61K 31/706
A61P 35/00
- (11) **00997**
(13) **A**
- (21) P-2010-68
(22) 16.10.2008.
(30) 60/980,397 16.10.2007. US
(86) PCT/US2008/080163 16.10.2008.
(87) WO/2009/052287 23.04.2009.
- (54) (ME) **2'-FLUOR-2' -DEOKSITETRAHIDROURIDINI KAO INHIBITORI CITIDIN DEAMINAZE**
(EN) 2'-FLUORO-2' -DEOXYTETRAHYDROURIDINES AS CYTIDINE DEAMINASE INHIBITORS
- (73) EISAI INC.; 100 Tice Boulevard Woodcliff Lake, New Jersey 07677 (US)
(72) HAMILTON, Gregory, S.; 6501 Frederick Road Catonsville, Maryland 21228 (US)
TSUKAMOTO, Takashi; 4534 Kingscup Court Ellicott City, Maryland 21042 (US)
FERRARIS, Dana, V.; 1306 Hillcrest Drive Eldersburg, Maryland 21784 (US)
DUVALL, Bridget; 7801 Tucker Drive Nottingham, Maryland 21236 (US)
LAPIDUS, Rena; 7906 Ivy Lane Baltimore, Maryland 21208 (US)
- (74) Radulović Božidar, Jovana Tomaševića 9/III-1, Podgorica (ME)
- (57) Predmetni pronalazak odnosi se na određene derivate tetrahidrouridina, farmaceutske preparate i komplete koji sadrže takva jedinjenja i postupke za dobijanje takvih jedinjenja.

(51) **A01P 3/00**
A01N 43/40
A01N 43/78
A01N 43/56
A01N 43/80
A01N 43/653
C07D 261/00
A01N 43/90
C07D 277/00

(11) **00998**
 (13) **A**

(21) P-2010-70

(22) 23.10.2008.

(30) 61/000,002 23.10.2007. US

61/062,400 25.01.2008. US

(86) PCT/US2008/080850 23.10.2008.

(87) WO/2009/055514 30.04.2009

(54) (ME) **FUNGICIDNA JEDINJENJA I MJEŠAVINE**

(EN) **FUNGICIDAL COMPOUNDS AND MIXTURES**

(73) E. I. DU PONT DE NEMOURS AND COMPANY; 1007 Market Street Wilmington, DE 19898 (US)

(72) GREGORY, Vann; 15 South Townview Lane Newark, DE 19711 (US)

PASTERIS, Robert, James; 3208 Landsdowne Drive Wilmington, DE 19810 (US)

(74) Čejović Vladimir, 13.jul 21, Podgorica (ME)

(57) Izložena je fungicidna smješa, koja sadrži (a) najmanje jedno jedinjenje, koje je odabrano od jedinjenja sa Formulom 1, njihovih N-oksida i soli,

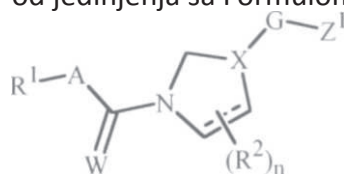

pri čemu su: R¹, R², A, G, W, Z¹, X, J i n kao što su definisani u izlaganju, i (b) najmanje jedno dodatno fungicidno jedinjenje. Takođe je izložen postupak za obuzdavanje biljnih bolesti, uzrokovanih gljivicnim biljnim patogenima, koji obuhvata primenu biljci ili biljnom delu ili biljnom semenu, fungicidno efektivne količine prethodno navedene smješe. Takođe je prikazana mešavina, koja sadrži komponentu (a) gore pomenute smješe i najmanje jedan insekticid.

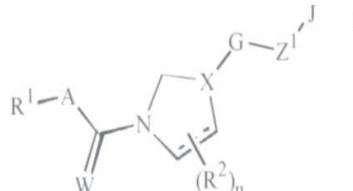
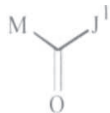
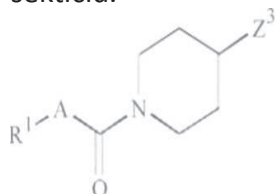

Takođe su izložena jedinjenja sa Formulom **1A**, **1B** i **1C**.

1A 1B

1C

pri čemu su:

R¹, R², A, G, W, Z¹, X, J, n, Z³, M i J¹ kao što definisani u izlaganju

(51) **C07K 14/705**

(11) **00999**

(13) **A**

(21) P-2010-75

(22) 29.10.2008.

(30) 60/000,800 29.10.2007. US

(86) PCT/US2008/012251 29.10.2008.

(87) WO/2009/058285 07.05.2009.

(54) **(ME) SVINJSKI DC-DIGN, ICAM-3 I LSECTin I NJIHOVA UPOTREBA**
(EN) PORCINE DC-SIGN, ICAM-3 AND LSECTin AND USES THEREOF

(73) VIRGINIA TECH INTELLECTUAL PROPERTIES, INC.; 2200 Kraft Drive Suite 1050 Blacksburg, VA 24060 (US)

(72) HUANG, Yaowei; 1708 Emerald Street Blacksburg, VA 24060 (US)

MENG, Xiang-Jin; 212 Flippin Circle Blacksburg, VA 24060 (US)

(74) Lutovac Branislav, Bulevar Crnojevića 93, Podgorica (ME)

(57) Ovaj pronalazak se odnosi na kloniranje, identifikaciju i karakterizaciju jedinstvenih kompletnih genomskih sekvenci koje kodiraju nove svinjske DC-SIGN i LSECTin proteine, uključujući nove nukleotidne sekvence od cDNK kompletne dužine i gena, oba pDC-SIGN gena i pLSECTin. Takođe su obezbijeđeni molekuli nukleinskih kiselina koji kodiraju novo otkrivene svinjske ICAM-3 izoforme iz svinjskih dendritičnih ćelija izvedenih (dobijenih) iz monocita i njihova upotreba. Posebno, pronalazak je fokusiran na izolovani molekul nukleinske kiseline koji obuhvata nukleotidnu sekvencu koja kodira jedan ili više svinjskih pDC-SIGN, svinjski ICAM-3, svinjski LSECTin, komplement nukleotidne sekvence ili finkcionalan, definisani dio nukleotidne sekvence ili proteinskog fuzionog proizvoda koji je vezan za protein koji može biti humanog ili svinjskog porekla. Dodatno su ovde opisane metode za izolaciju i kloniranje novih svinjskih gena i upotrebe novih nukleotidnih sekvenci u poboljšanim metodama za propagaciju (umnožavanje) virusa, posebno virisa sa omotačem. Pronalazak dalje uključuje nove transfektovane ćelije ili ćelijske linije koje mogu stabilno da eksprimiraju svinjske proteine, nova antitela i slične.

- (51) **A61K 31/4164**
A61P 35/00
C07D 233/00
- (11) **01001**
(13) **A**
- (21) P-2010-81
(22) 12.12.2008.
(30) 61/013,966 14.12.2007. US
(86) PCT/EP2008/067412 12.12.2008.
(87) WO/2009/077448 25.06.2009
- (54) (ME) **INHIBITORI KINEZINA KAO TERAPEUTSKA SREDSTVA ZA LIJEČENJE KANCERA**
(EN) KINESIN INHIBITORS AS CANCER THERAPEUTICS
- (73) NOVARTIS AG; Lichtstrasse 35 CH-4056 Basel (CH)
(72) ABRAMS, Tinya; c/o Novartis Vaccines and Diagnostics Inc. P.O. Box 8097 Emeryville, California 94608 (US)
BARSANTI, Paul; c/o Novartis Vaccines and Diagnostics Inc. P.O. Box 8097 Emeryville, California 94608 (US)
DUHL, David; c/o Novartis Vaccines and Diagnostics Inc. P.O. Box 8097 Emeryville, California 94608 (US)
FAURE, Michel; c/o Novartis Vaccines and Diagnostics Inc. P.O. Box 8097 Emeryville, California 94608 (US)
RENHOWE, Paul A.; 262 Stetson Drive Danville, c 94506 (US)
WALTER, Annette Olga; c/o Novartis Vaccines and Diagnostics Inc. P.O. Box 8097 Emeryville, c 94608 (US)
- (74) Čejović Vladimir, 13.jul 21, Podgorica (ME)
- (57) Pronalazak obezbjeđuje nova jedinjenja imidazola koja inhibiraju aktivnost kinezinskog proteina diobnog vretena (KSP, takođe nazvanog Eg5). Inhibitori KSP mogu umanjiti neželjenu ćelijsku proliferaciju i obiježbediti druge terapijske efekte. Pronalazak takođe obezbjeđuje farmaceutske kompozicije koje sadrže ova nova jedinjenja, kao i postupke za upotrebu novih inhibitora KSP i njihovih farmaceutskih kompozicija za tretiranje različitih vrsta kancera. Jedinjenja, kompozicije i postupci iz ovog pronalaska su posebno korisni za tretman različitih klasa kancera rezistentnih na tretmane konvencionalnim ljekovima, a koji su se pokazali postojano osjetljivim na jedinjenja iz ovog pronalaska.

(51) **A61K 39/15**

(11) **01002**

(13) **A**

(21) P-2010-83

(22) 21.11.2008.

(30) 07380323.1 21.11.2007. EP

(86) PCT/EP2008/065993 21.11.2008.

(87) WO 2009/065930 28.05.2009.

(54) (ME) **VAKCINA I IMUNOGENIČNE KOMPOZICIJE ZA VIRUS PLAVOG JEZIKA, POSTUPCI ZA NJIHOVU UPOTREBU I POSTUPCI ZA NJIHOVU IZRADU**

(EN) **BLUETONGUE VIRUS VACCINE AND IMMUNOGENIC COMPOSITIONS, METHODS OF USE AND METHODS OF PRODUCING SAME**

(73) WYETH FARMA, S.A.; Ctra. de Madrid-Burgos Km.23, Bifurcación Algete, San Sebastián de los Reyes, E-28700 Madrid (ES)

(72) PLANA DURAN, Joan; Ctra. Camprodan, "La Riba" Vall De Bianya, Olot E-17813 Gerona (ES)

(74) Ćupić Branislav, Dalmatinska 10, Podgorica (ME)

(57) Obezbijedene su imunogenične kompozicije i kompozicije vakcine i postupci za njihovu izradu i upotrebu, pri čemu su kompozicije efektivne u zaštiti od maksimalnog umanjivanja ozbiljnosti, prevenciji i/ili odlaganju infekcije preživara sa virusom plavog jezika. Primjena najmanje jedne doze kompozicije dvostruko inaktiviranog virusa plavog jezika sa adjuvantom na životinji, kako je ovdje otkriveno, je efikasna u obezbjeđivanju imuniteta životinje i zaštiti od infekcije sa virusom plavog jezika, na taj način redukujući ozbiljnost i/ili prevenciju oboljenja izazvanih jednim ili više sojeva ili serotipova virusa plavog jezika.

(51) **C07J 71/00**
A61K 31/58
C07J 7/00
A61P 11/06
A61P 5/46

(11) **01003**
 (13) **A**

(21) P-2010-84

(22) 17.11.2008.

(30) 60/991,354 30.11.2007. US

61/057,241 30.05.2008. US

61/079,555 10.07.2008. US

(86) PCT/IB2008/054801 17.11.2008.

(87) WO 2009/069032 04.06.2009.

(54) (ME) **NOVI AGONISTI GLUKOKORTIKOIDNOG RECEPTORA**
 (EN) **NOVEL GLUCOCORTICOID RECEPTOR AGONISTS**

(73) PFIZER LIMITED; Ramsgate Road Sandwich Kent CT13 9NJ (GB)

(72) GLOSSOP, Paul Alan; Pfizer Global Research and Development, Ramsgate Road Sandwich Kent CT13 9NJ (GB)

MILLAN, David Simon; Pfizer Global Research and Development, Ramsgate Road, Sandwich Kent CT13 9NJ (GB)

PRICE, David Anthony; Pfizer Global Research and Development, Eastern Point Road Groton, Connecticut 06340 (US)

(74) Ćupić Branislav, Dalmatinska 10, Podgorica (ME)

(57) Ovaj pronalazak se odnosi na nove agoniste glukokortikoidnog receptora formule (I) i na procese i međuproizvode za njihovu izradu. Ovaj pronalazak se takođe odnosi na farmaceutske kompozicije koje sadrže ova jedinjenja, na njihovu kombinaciju sa jednim ili više drugih terapijskih sredstava, kao i na njihovu upotrebu za tretman brojnih inflamatornih i alergijskih oboljenja, poremećaja i stanja

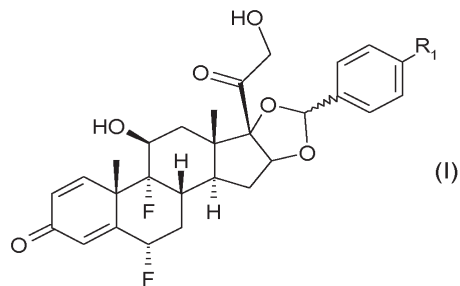

- (51) **A01N 43/80**
A01N 47/20
A01P 7/00
C07D 261/04
C07D 413/04
- (11) **01004**
(13) **A**
- (21) P-2010-86
(22) 18.12.2008.
(30) 0724757.0 19.12.2007 GB
0808471.7 09.05.2008 GB
(86) PCT/EP2008/010863 18.12.2008.
(87) WO 2009/077197 25.06.2009.
- (54) (ME) **JEDINJENJA SA INSEKTICIDNIM DJELOVANJEM**
(EN) INSECTICIDAL COMPOUNDS
- (73) SYNGENTA PARTICIPATIONS AG; Schwarzwaldallee 215, CH-4058 Basel (CH)
(72) JUNG, Pierre, Joseph, Marcel; Syngenta Crop Protection AG, Werk Stein,
Schaffhauserstrasse, CH-4332 Stein (CH)
RENOLD, Peter; Syngenta Crop Protection AG, Werk Stein, Schaffhauserstrasse, CH-4332
Stein (CH)
(74) Čejović Vladimir, 13.jul 21, Podgorica (ME)
(57) Jedinjenje formule (I)

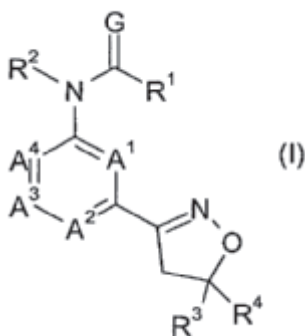

u kojoj su A^1 , A^2 , A^3 , A^4 , G^1 , R^1 , R^2 , R^3 i R^4 definisani u patentnom zahtjevu 1; ili njena so ili *N*-oksid. Osim toga, dati pronalazak se odnosi na postupke i intermedijere za dobljanje jedinjenja formule (I), na jedinejnja sa insekticidnim, akaricidnim, moluskicidnim ili nematocidnim djelovanjem koja ih obuhvataju i postupke za njihovu upotrebu za uništavanje i kontrolu (rasta) insekata, krpelja, mekušaca ili nematoda.

- (51) **C07K 16/24**
A61P 11/00
A61P 19/02
A61P 17/06
A61P 35/02

- (11) **01005**
 (13) **A**

- (21) P-2010-89
 (22) 12.11.2008.
 (30) 2007-294945 13.11.2007. JP
 PCT/JP2008/052471 14.02.2008. JP
 (86) PCT/US2008/012680 12.11.2008.
 (87) WO/2009/064399 22.05.2009.

- (54) (ME) **MONOKLONSKA ANTITIJELA KOJA SE VEZUJU ZA HGM-CSF I
 MEDICINSKI PREPARATI KOJI IH SADRŽE**

(EN) MONOCLONAL ANTIBODIES THAT BIND TO HGM-CSF AND MEDICAL COMPOSITIONS COMPRISING SAME

- (73) EVEC INC. Showa Building, Odori W5, Chuo-ku, Sapporo 060-0042 (JP)
 BOEHRINGER INGELHEIM INTERNATIONAL GMBH; Binger Strasse 173, 55216 Ingelheim Am Rhein (DE)
- (72) TAKADA, Kenzo; C/o Evec Inc. Showa Building, Odori W5 Chuo-ku Sapporo 060-0042 (JP)
 NAKAJIMA, Kantou; c/o Evec Inc. Showa Building, Odori W5 Chuo-ku Sapporo 060-0042 (JP)
 KISTLER, Barbara; C/o Boehringer Ingelheim International Gmbh, Binger Strasse 173, 55216 Ingelheim Am Rhein (DE)
 PARK, John; C/o Boehringer Ingelheim International Gmbh, Binger Strasse 173, 55216 Ingelheim Am Rhein (DE)
- (74) Radulović Božidar, Jovana Tomaševića 9/III-1, Podgorica (ME)

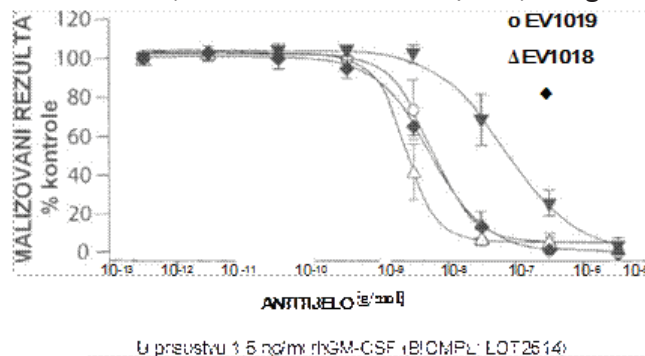

- U predmetnoj prijavi opisana su monoklonska anti-hGM-CSF antitijela i antigen-vezujuć fragmenti takvih antitijela, sa poboljšanim kapacitetom za neutralizaciju hGM-CSF aktivnosti. Takođe su obezbjeđeni farmaceutski preparati koji sadrže takva antitijela ili antigen-vezujuće fragmente. Predmetni pronalazak koristan je u liječenju različitih bolesti koje se dovode u vezu sa aberantnom ekspresijom hGM-CSF.
- (57)

- (51) **C07K 16/18** (11) **01075**
A61P 25/28 (13) **A**
- (21) P-2010-59
- (22) 02.10.2007.
- (30) 06020765.1 02.10.2006. EP
 06020766.9 02.10.2006. EP
 PCT/EP2006/011862 08.12.2006. EP
 60/943,289 11.06.2007. US
 60/943,499 12.06.2007. US
 PCT/US2007/073504 13.07.2007. US
- (86) PCT/US2007/021134 02.10.2007.
- (87) WO 2008/060364 22.05.2008.
- (54) (ME) **ANTITIJELA**
 (EN) ANTIBODIES
- (73) AC IMMUNE S.A; Epfl-pse Building B CH-1015 Lausanne (CH)
 GENENTECH, INC.; 1 Dna Way South San Francisco South San Francisco, CA 94080 (US)
- (72) PFEIFER, Andrea; Rte De Fenil 16a CH-1806 St.-légier (CH)
 PIHLGREN, Maria; Rue Du Centre 42a CH-1025 St. Sulpice (CH)
 MUHS, Andreas; Av. Des Cerisiers 39b CH-1009 Pully (CH)
 WATTS, Ryan; 524 Yale Drive San Mateo, CA 94402 (US)
- (74) Stanković-Mugoša Ana, Trg Republike 13, Podgorica (ME)
- (57) Ovaj pronalazak se odnosi na postupke (metode) i kompozicije (smješe) za terapijsku i dijagnostičku upotrebu u liječenju bolesti i poremećaja koji su prouzrokovani sa ili su vezani sa amiloidom ili amiloidu sličnim proteinima uključujući amiloidozu, grupu poremećaja i abnormalnosti vezanih sa amiloidnim proteinom kao što je Alchajmerova bolest. Ovaj pronalazak daje nove postupke (metode) i kompozicije (smješe) koji obuhvataju visoko specifična i visoko efikasna antitijela koja imaju sposobnost da specifično prepoznaju i vezuju se za specifične epitope iz oblasti j3-amiloidnih proteina. Ova antitijela koja su omogućena učenjem ovog pronalaska su naročito korisna (primenljiva) za liječenje bolesti i poremećaja koji su prouzrokovani sa ili su vezani sa amiloidom ili amiloidu sličnim proteinima uključujući amiloidozu, grupu bolesti i poremećaja vezanih sa formiranjem amiloidnih ploča (gomila) uključujući sekundarnu amiloidozu i amiloidozu vezanu sa starošću, uključujući, ali se ne ograničavajući samo na njih, neurološke poremećaje kao sto je Alchajmerova bolest (AB).

(51) F03H 5/00

(11) 01076

(13) A

(21) P-2012-3

(22) 10.01.2012.

(54) (ME) **PRETVARAČ OBRTNOG MOMENTA MOTORA U REAKTIVNU SILU POTISKA**

(EN) CONVERTOR OF THE ENGINE TORQUE INTO REACTIVE THRUST FORCE

(73) Ilinčić M. Zoran; ul. M. Bulatovića br. 15, Kolašin (ME)

(72) Ilinčić M. Zoran; ul. M. Bulatovića br. 15, Kolašin (ME)

(57) Suština pronalaska je u tome da u toku svakog obrtaja radna masa rotira po ekcentričnoj zatvorenoj površini i kao posledicu toga ima promjenjivu brzinu kretanja koja izaziva i promjenjive centrifugalne sile. Međutim, kako je promjena veličine centrifugalne sile takva da je zbir centrifugalnih i drugih dinamičkih sila u jednom smjeru veći nego zbir centrifugalnih i drugih dinamičkih sila u suprotnom smjeru, pojavljuje se reaktivna sila potiska (23) u smjeru u kom su veće centrifugalne sile. Zahvaljujući konstrukciji sa dva suprotnosmjerna motora, koji u toku rada razvijaju iste snage i brojeve obrtaja, ostale dinamičke sile i obrtni momenti se uravnotežavaju.

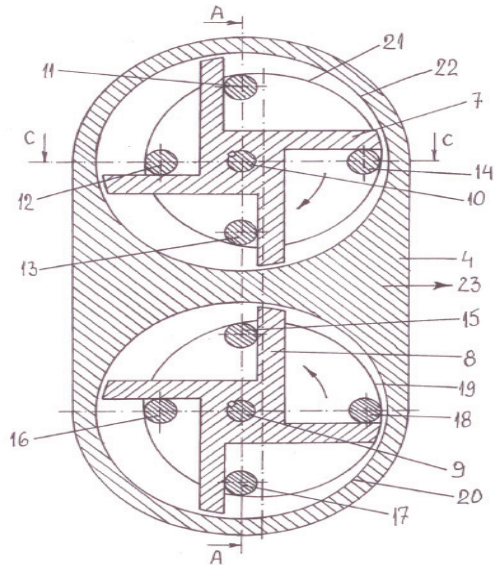

(51) F02D 13/02

(11) 01077

(13) A

(21) P-2012-22

(22) 29.02.2012.

(54) (ME) **UREĐAJ ZA KONTINUALNU PROMJENU ŠEME RAZVODA VENTILA KOD ČETVOROTAKTNOG MOTORA SUS**

(EN) DEVICE FOR CONTINUOUS VALVE DISTRIBUTION SCHEME CHANGE FOR FOUR STROKE INTERNAL COMBUSTION ENGINES

(73) Ilinčić M. Zoran; ul. M. Bulatovića br. 15, Kolašin (ME)

(72) Ilinčić M. Zoran; ul. M. Bulatovića br. 15, Kolašin (ME)

(57) Regulacija razvodne ventilske šeme pomoću ovog uređaja se vrši promjenom pritiska ulja u komori za ulje (4), što izaziva promjenu rastojanja između spoljnog podizača (3) i unutrašnjeg podizača (8). Sa povećanjem pritiska u komori za ulje (4), povećava se i ugao otvaranja i zatvaranja ventila. Takođe, sa povećanjem pritiska u komori za ulje (4) povećava se i hod ventila (10). U položaju kada sila u regulacionoj opruzi (11) postane veća od sile kojom je sabijena ventilska opruga (12), počinje sabijanje i ventilske opruge (12) i ventil (10) počinje da se otvara.

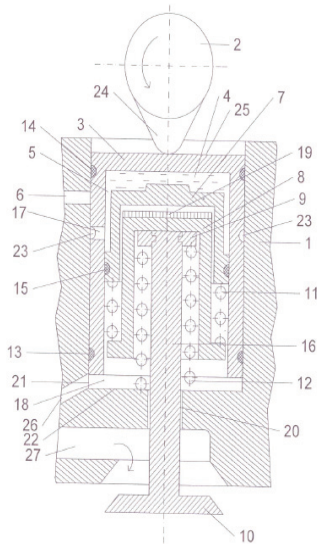

Slika 7.

(51) **A41J 19/00**(11) **01078**(13) **A**

(21) P-2012-36

(22) 21.03.2012.

(54) (ME) **PRESA ZA CIJEĐENJE VOĆA I POVRĆA SA ROTACIONIM KLIPOM**(EN) **PRESSING MACHINE FOR SQUEEZING FRUIT AND VEGETABLE WITH ROTARY PISTON**

(73) Ilinčić M. Zoran; ul. M. Bulatovića br. 15, Kolašin (ME)

(72) Ilinčić M. Zoran; ul. M. Bulatovića br. 15, Kolašin (ME)

(57) Radni proces cijedenja soka iz mase za cijedenje se odvija tako što se dejstvom spoljne sile smanjuje rastojanje između rotacionog klipa (4) i filtera za sok (24). U slučaju koji je opisan spoljna sila za aksijalno i rotaciono kretanje rotacionog klipa (4) je dobijena tako što se obrtni moment dvosmjernog elektromotora sa reduktorom (9), prenosi preko pogonskog vratila (10) na mali zupčanik (11), koji je u cilju smanjenja broja obrtaja u spregu sa velikim zupčanikom (13). Cilindar (3) ima u sebi prostor za masu za cijedenje (22) i treba da bude napravljen tako da može sa sigurnošću izdržati radni pritisak u masi za cijedenje koji se javlja prilikom procesa cijedenja. U donjem dijelu cilindra (3) se postavlja gruba rešetka (27), čija je funkcija da se na nju osloni filter za sok (24) i da iscijedeni sok, koji prođe kroz filter za sok (24) i otvore za prolaz soka (30), pa dalje kroz poprečne kanale za protok soka (29), dođe u kružni kanal za sok (21), pa odakle kroz otvor za izlazak soka (28) u posudu za sok (17). Posuda za sok (17) istovremeno služi i kao poklopac prese. Nakon što se masa za cijedenje stavi u prostor za masu za cijedenje (22), na vučno vreteno (5) se postavlja rotacioni klip (4).

Rotacioni klip na sebi ima unutrašnji zaptivač klipa (19) i spoljni zaptivač klipa (20), čija je funkcija da spriječe prolazak soka između rotacionog klipa (4) i cilindra (3). Pomoću pločice (16) se blokira da rotacioni klip (4) u toku rada sklizne sa vučnog vretena (5). Rotacioni klip (4) se pod dejstvom vučnog vretena (5), u radnom taktu, aksijalno kreće prema filteru za sok (24), uz istovremeno rotiranje, što omogućava zubima za drobljenje (23), da miješaju masu za cijedenje. Kretanja rotacionog klipa (4) stvara pritisak u prostoru za masu za cijedenje (22), što izaziva cijedenje soka iz mase za cijedenje.

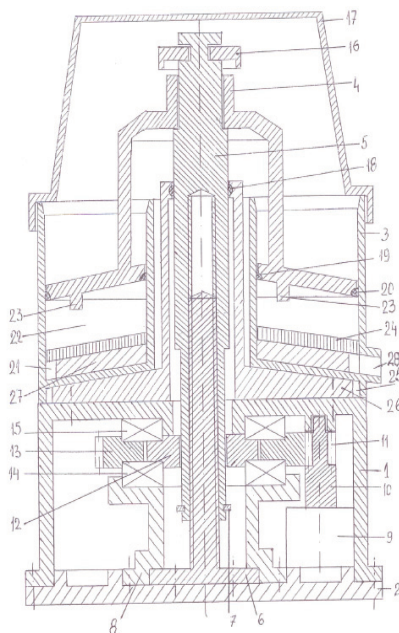

Slika 1.

(51) **F16F 15/32**

(11) **01079**

(13) **A**

(21) P-2012-41

(22) 29.03.2012.

(54) (ME) **BALANSIRANJE ROTORA OSLOJENOG NA ELASTIČNIM OSLOJNCIMA POMOĆU TEČNOSTI**

(EN) ROTOR BALANCING ON FLEXIBLE FOUNDATIONS BY THE MEANS OF LIQUID

(73) Ilinčić M. Zoran; ul. M. Bulatovića br. 15, Kolašin (ME)

(72) Ilinčić M. Zoran; ul. M. Bulatovića br. 15, Kolašin (ME)

(57) Suština ovog pronalaska je u tome da se njegovom primjenom omogućava automatsko uravnotežavanje sistema koji rotira i u slučajevima kada se pojavljuje masa koja izaziva debalans sistema, a čija se veličina i položaj mijenjaju tokom perioda rotacije. Balansiranje sistema koji rotira i koji tokom perioda rotacije ima promjenjivu veličinu debalansa i po položaju i po veličini, vrši se preko balansera koji u sebi sadrži određenu količinu tečnosti. Tečnost za balansiranje je smještena u centralnoj komori za balansiranje (16), i ta tečnost se u toku procesa rotacije rotora automatski preraspoređuje tako da dio te tečnosti iz centralne komore za tečnost (16) prelazi u komoru za tečnost (12, 13, 14 111 15) koja je dijagonalno suprotna položaju debalansa, kako bi poslužila kao kontramasa onoj masi koja izaziva debalans.



(51) E04H 9/02

(11) 01080

(13) A

(21) P-2012-75

(22) 04.06.2012.

(54) (ME) **AMORTIZER ZEMLJOTRESA**

(EN) EARTHQUAKE BUFFER

(73) Ilinčić M. Zoran; ul. M. Bulatovića br. 15, Kolašin (ME)

(72) Ilinčić M. Zoran; ul. M. Bulatovića br. 15, Kolašin (ME)

(57) Ovaj Amortizer zemljotresa obezbjeđuje da ne postoji čvrsta veza između Temelja građevine (4) i Građevine (5). Uz upotrebu ovog Amortizera zemljotresa se postiže da se horizontalno kretanje Temelja građevine (4) pretvara u kombinaciju horizontalnog i vertikalnog kretanja Građevine (5), pri čemu je veličina horizontalnog pomjeranja Građevine (5) manja od horizontalnog pomjeranja Temelja građevine (4) za isto vrijeme. To uslovljava istovremeno smanjenje veličina horizontalnih brzina i ubrzanja Građevine (5) u odnosu na slučaj kada ne bi bilo Amortizera zemljotresa. To dalje znači smanjenje horizontalnih inercionih sila, koje su osnovni razlog za moguće rušenje Građevine (5). Pravac horizontalnih pomjeranja Temelja građevine (4) nema uticaja na funkcionisanje ovog Amortizera zemljotresa. Ovaj Amortizer zemljotresa obezbjeđuje da ne postoji čvrsta veza između Temelja građevine (4) i Građevine (5).

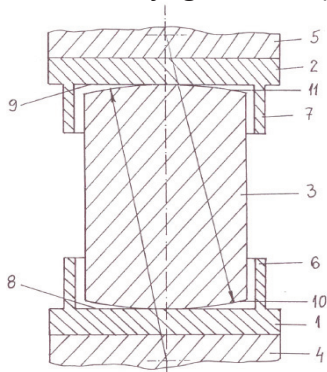

(51) C21D 9/32

(11) 01081

(13) A

(21) P-2012-86

(22) 02.07.2012.

(54) (ME) **UREĐAJ ZA KALJENJE ZUPČANIKA SA VRATILOM NA PRESAMA ZA KALJENJE**

(EN) THE DEVICE FOR HARDENING OF GEARS MITH SHAFT ON THE HARDENING PRESS

(73) Milatović Dragomir, Bul. Save Kovačevića br. 11, Podgorica (ME)

(72) Milatović Dragomir, Bul. Save Kovačevića br. 11, Podgorica (ME)

(57) Uređaj za centriranje i kaljenje zupčanika sa vratilom na presi za kaljenje /slika 1/ Uređaj se koristi pri Termičkoj obradi Radnog komada i sastoji se od: sklopa za centriranje koji čine čep 5 za centriranje, segmenti 6, vijci 8, nosač 4 segmenta i oslonci 7; sklopa za oslanjanje koji čine ploča 1 za oslanjanje i ploča 2 osnovna koje su povezane vijcima 10; pritiskivača 9 koji je vijcima 11 povezan za cilindar III prese i doboš 3 koji je vijcima 12 povezan za pritiskivač 9.

Usijani Radni komad se postavlja na ploču 2 osnovnu. Na Radni komad se postavlja sklop za centriranje 4,6,7 i 8 dok je čep 5 za centriranje uvijen u cilindar I prese. Pri spuštanju cilindra I, II i III prese čep 5 klizi po konusu segmenta 6, centriraju Radni komad i zadržavaju ga u vertikalnoj osi. Cilindar I prese prestaje da se kreće. Pri daljem spuštanju cilindra II i III pritiskivač 9 pritiska bočnu površinu većeg zupčanika, zadržavajući ga u osi komada. Doboš 3 istovremeno klizi po ivici ploče 1 za oslanjanje i zatvara konturu uređaja, sprečava rasipanje ulja koje kanalima »a« i »b« protiče i hladi Radni komad.

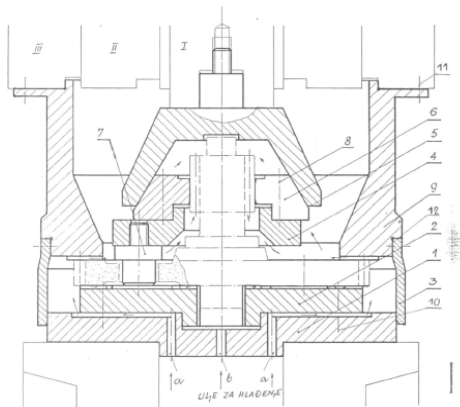

INDEKS NOSILACA PATENTA
PATENT OWNER INDEX

(73)	(51)	(21)
AC IMMUNE S.A GENENTECH, INC.	C07K 16/18 A61P 25/28	P-2010-59
AVENTIS PHARMA S.A.	C07D 305/14	P-2010-144
Bojović Milan	F03B 13/00	P-2012-44
Burić A. Milorad	E04H 12/10	P-2012-81
Burić A. Milorad	E04G 17/00	P-2012-79
Burić A. Milorad	E04H 12/10	P-2012-80
Burić A. Milorad	E04B 1/08	P-2012-29
E. I. DU PONT DE NEMOURS AND COMPANY	A01P 3/00 A01N 43/40 A01N 43/78 A01N 43/56 A01N 43/80 A01N 43/653 C07D 261/00 A01N 43/90 C07D 277/00	P-2010-70
EISAI INC.	C07H 19/04 A61K 31/706 A61P 35/00	P-2010-68
EVEC INC. BOEHRINGER INGELHEIM INTERNATIONAL GMBH	C07K 16/24 A61P 11/00 A61P 19/02 A61P 17/06 A61P 35/02	P-2010-89
F. HOFFMANN-LA ROCHE AG	C07D 211/14 C07D 211/46	P-2008-771

Hamlet Protein A/S	A23C 11/06 A23C 11/10 A23J 3/14 A23K 1/14 A23L 1/30 A23L 1/305 A23C 11/02 A61K 47/48	P-2010-116
Ilinčić M. Zoran	F03H 5/00	P-2012-3
Ilinčić M. Zoran	F02D 13/02	P-2012-22
Ilinčić M. Zoran	A41J 19/00	P-2012-36
Ilinčić M. Zoran	F16F 15/32	P-2012-41
Ilinčić M. Zoran	E04H 9/02	P-2012-75
Jovanovski Srđan	H01L 31/12	P-2012-50
Jovanovski Srđan	F03G 6/00	P-2012-65
Jovanovski Srđan	E012B 9/00	P-2012-66
Jovanovski Srđan	F03D 1/00	P-2012-37
Jovanovski Srđan	F24J 2/06	P-2012-67
Jovanovski Srđan	H02N 2/00	P-2012-68
LES LABORATOIRES SERVIER	A61K 9/20 A61K 31/64	P-2010-154
LES LABORATOIRES SERVIER	A61K 31/165 A61K 31/55 A61P 9/10 A61P 9/04	P-2010-129
Milatović Dragomir	C21D 9/32	P-2012-86
Mugoša V. Predrag	E02F 5/00	P-2011-190
Mugoša V. Predrag	E03F 7/02	P-2011-191

Mugoša V. Predrag	A01G11/00 C09K 17/00 B09C 1/00	P-2012-47
Mugoša V. Predrag	B09B 5/00	P-2012-49
NHI d.o.o.	E21B 43/00 E21B 43/34	P-2011-55
NOVARTIS AG	A61K 31/4164 A61P 35/00 C07D 233/00	P-2010-81
Nurković Suljo	A61K 36/28 A61K 36/14	P-2012-40
Perović Slobodan	E02B 9/02 E02B 9/00 E02B 9/06 E02B 3/04 E02B 7/00 E02B 8/00 E02B 13/00 A01G 25/00	P-2012-85
Perović Slobodan	E02B 3/4 E02B 9/02	P-2012-33
Petrušić Darko	A61G 5/14	P-2012-59
PFIZER LIMITED	C07J 71/00 A61K 31/58 C07J 7/00 A61P 11/06 A61P 5/46	P-2010-84
REPROS THERAPEUTICS INC.	A61K 31/138 A61P 3/00 A61P 3/04 A61P 3/06 A61P 3/10	P-2010-65
SALIX PHARMACEUTICALS, LTD.	C07D 498/00	P-2010-132
SANOFI-AVENTIS	C07C 213/10 C07C 217/84 C07C 231/16 C07C 237/08	P-2010-136

SANOFI-AVENTIS	C07D 471/04 C07D 401/12 C07D 277/42 C07D 233/88 C07D 215/38 C07D 213/72 C07D 207/325 A61K 31/4709 A61K 31/4188 A61K 31/429 A61K 31/404 A61P 29/00 A61P 3/00 A61P 11/00	P-2010-117
SANOFI-AVENTIS	C07D 471/04 A61P 11/00 A61K 31/437 A61P 3/00 A61P 29/00	P-2010-119
SANOFI-AVENTIS CENTRE NATIONAL DE LA RECHERCHE SCIENTIFIQUE (CNRS) UNIVERSITE MONTPELLIER II	A61K 31/357 A61K 31/37 A61K 31/426 A61K 31/427 A61P 33/06	P-2010-126
SANOFI-AVENTIS	C07D 471/04 C07D 213/28 C07D 233/56 A61K 31/437 A61P 25/00 A61P 19/00 A61P 35/00	P-2010-152
SANOFI-AVENTIS	C07D 213/28 C07D 233/56 C07D 471/04 A61K 31/437 A61P 19/00 A61P 25/00 A61P 35/00	P-2010-155

SANOFI-AVENTIS	C07D 471/04 C07D 207/44 C07D 207/323 A61P 25/00 A61P 17/00 A61P 15/00 A61P 29/00 A61P 13/00 A61P 25/28 A61P 11/00 A61P 25/24 A61P 1/00	P-2010-113
SANOFI-VENTIS 174	C07D 401/12 C07D 401/14 C07F 7/08 C07F 7/10 C07F 7/12 A61K 31/695 A61K 31/4439 A61P 25/00 A61P 3/00 A61P 13/00 A61P 15/00	P-2010-120
Šćepanović Željko	A61K 35/00 A61K 35/76 A61K 36/00	P-2011-43
SYNGENTA PARTICIPATIONS AG	A01N 43/80 A01N 47/20 A01P 7/00 C07D 261/04 C07D 413/04	P-2010-86
TAKEDA PHARMACEUTICAL COMPANY LIMITED	C07K 14/47 A61K 38/16	P-2009-175
THE ROCKEFELLER UNIVERSITY	A61K 39/395 G01N 33/53 G01N 33/567	P-2010-76
TRANSTECH PHARMA, INC.	A01N 35/00 A61K 31/12	P-2010-143
VIRGINIA TECH INTELLECTUAL PROPERTIES, INC.	C07K 14/705	P-2010-75
WYETH FARMA, S.A.	A61K 39/15	P-2010-83
WYETH LLC	A61K 39/02 C07K 14/30	P-2010-78

INDEKS BROJEVA PRIJAVA PATENATA
APPLICANTS NUMBER INDEX

(21)	(51)	(21)	(51)
P-2010-136	C07C 213/10 C07C 217/84 C07C 231/16 C07C 237/08	P-2009-175	C07K 14/47 A61K 38/16
P-2010-143	A01N 35/00 A61K 31/12	P-2010-76	A61K 39/395 G01N 33/53 G01N 33/567
P-2010-132	C07D 498/00	P-2010-144	C07D 305/14
P-2011-43	A61K 35/00 A61K 35/76 A61K 36/00	P-2010-116	A23C 11/06 A23C 11/10 A23J 3/14 A23K 1/14 A23L 1/30 A23L 1/305 A23C 11/02 A61K 47/48
P-2011-55	E21B 43/00 E21B 43/34	P-2010-117	C07D 471/04 C07D 401/12 C07D 277/42 C07D 233/88 C07D 215/38 C07D 213/72 C07D 207/325 A61K 31/4709 A61K 31/4188 A61K 31/429 A61K 31/404 A61P 29/00 A61P 3/00 A61P 11/00
P-2012-44	F03B 13/00	P-2010-119	C07D 471/04 A61P 11/00 A61K 31/437 A61P 3/00 A61P 29/00
P-2012-50	H01L 31/12	P-2010-113	C07D 471/04 C07D 207/44 C07D 207/323 A61P 25/00 A61P 17/00 A61P 15/00 A61P 29/00 A61P 13/00 A61P 25/28
P-2012-65	F03G 6/00		
P-2012-66	E012B 9/00		
P-2012-85	E02B 9/02 E02B 9/00 E02B 9/06 E02B 3/04 E02B 7/00 E02B 8/00 E02B 13/00 A01G 25/00		
P-2011-190	E02F 5/00		
P-2011-191	E03F 7/02		
P-2012-33	E02B 3/4 E02B 9/02		
P-2012-37	F03D 1/00		
P-2012-40	A61K 36/28 A61K 36/14		
P-2012-47	A01G11/00 C09K 17/00 B09C 1/00		
P-2012-49	B09B 5/00		
P-2008-771	C07D 211/14 C07D 211/46		

(21)	(51)	(21)	(51)
	A61P 11/00	P-2012-79	E04G 17/00
	A61P 25/24	P-2012-80	E04H 12/10
	A61P 1/00	P-2012-29	E04B 1/08
P-2010-120	C07D 401/12	P-2010-78	A61K 39/02
	C07D 401/14		C07K 14/30
	C07F 7/08	P-2010-65	A61K 31/138
	C07F 7/10		A61P 3/00
	C07F 7/12		A61P 3/04
	A61K 31/695		A61P 3/06
	A61K 31/4439		A61P 3/10
	A61P 25/00	P-2010-68	C07H 19/04
	A61P 3/00		A61K 31/706
	A61P 13/00		A61P 35/00
	A61P 15/00	P-2010-70	A01P 3/00
P-2010-126	A61K 31/357		A01N 43/40
	A61K 31/37		A01N 43/78
	A61K 31/426		A01N 43/56
	A61K 31/427		A01N 43/80
	A61P 33/06		A01N 43/653
P-2010-129	A61K 31/165		C07D 261/00
	A61K 31/55		A01N 43/90
	A61P 9/10		C07D 277/00
	A61P 9/04	P-2010-75	C07K 14/705
P-2012-81	E04H 12/10	P-2010-81	A61K 31/4164
P-2010-152	C07D 471/04		A61P 35/00
	C07D 213/28		C07D 233/00
	C07D 233/56	P-2010-83	A61K 39/15
	A61K 31/437	P-2010-84	C07J 71/00
	A61P 25/00		A61K 31/58
	A61P 19/00		C07J 7/00
	A61P 35/00		A61P 11/06
P-2010-154	A61K 9/20		A61P 5/46
	A61K 31/64	P-2010-86	A01N 43/80
P-2010-155	C07D 213/28		A01N 47/20
	C07D 233/56		A01P 7/00
	C07D 471/04		C07D 261/04
	A61K 31/437		C07D 413/04
	A61P 19/00	P-2010-89	C07K 16/24
	A61P 25/00		A61P 11/00
	A61P 35/00		A61P 19/02
P-2012-59	A61G 5/14		A61P 17/06
P-2012-67	F24J 2/06		A61P 35/02
P-2012-68	H02N 2/00		

(21)	(51)
P-2010-59	C07K 16/18 A61P 25/28
P-2012-3	F03H 5/00
P-2012-22	F02D 13/02
P-2012-36	A41J 19/00
P-2012-41	F16F 15/32
P-2012-75	E04H 9/02
P-2012-86	C21D 9/32

INDEKS OBJAVLJENIH PRIJAVA PATENATA PREMA MKP
INDEX OF PATENT APPLICANTS ACCORDINT TO IPC

(51)	(21)	(51)	(21)
A01G 25/00	P-2012-85	A61K 31/4164	P-2010-81
A01G11/00	P-2012-47	A61K 31/4188	P-2010-117
A01N 35/00	P-2010-143	A61K 31/426	P-2010-126
A01N 43/40	P-2010-70	A61K 31/427	P-2010-126
A01N 43/56	P-2010-70	A61K 31/429	P-2010-117
A01N 43/653	P-2010-70	A61K 31/437	P-2010-119
A01N 43/78	P-2010-70	A61K 31/437	P-2010-152
A01N 43/80	P-2010-70	A61K 31/437	P-2010-155
A01N 43/80	P-2010-86	A61K 31/4439	P-2010-120
A01N 43/90	P-2010-70	A61K 31/4709	P-2010-117
A01N 47/20	P-2010-86	A61K 31/55	P-2010-129
A01P 3/00	P-2010-70	A61K 31/58	P-2010-84
A01P 7/00	P-2010-86	A61K 31/64	P-2010-154
A23C 11/02	P-2010-116	A61K 31/695	P-2010-120
A23C 11/06	P-2010-116	A61K 31/706	P-2010-68
A23C 11/10	P-2010-116	A61K 35/00	P-2011-43
A23J 3/14	P-2010-116	A61K 35/76	P-2011-43
A23K 1/14	P-2010-116	A61K 36/00	P-2011-43
A23L 1/30	P-2010-116	A61K 36/14	P-2012-40
A23L 1/305	P-2010-116	A61K 36/28	P-2012-40
A41J 19/00	P-2012-36	A61K 38/16	P-2009-175
A61G 5/14	P-2012-59	A61K 39/02	P-2010-78
A61K 31/12	P-2010-143	A61K 39/15	P-2010-83
A61K 31/138	P-2010-65	A61K 39/395	P-2010-76
A61K 31/165	P-2010-129	A61K 47/48	P-2010-116
A61K 31/357	P-2010-126	A61K 9/20	P-2010-154
A61K 31/37	P-2010-126	A61P 1/00	P-2010-113
A61K 31/404	P-2010-117	A61P 11/00	P-2010-113

(51)	(21)	(51)	(21)
A61P 11/00	P-2010-117	A61P 33/06	P-2010-126
A61P 11/00	P-2010-119	A61P 35/00	P-2010-152
A61P 11/00	P-2010-89	A61P 35/00	P-2010-155
A61P 11/06	P-2010-84	A61P 35/00	P-2010-68
A61P 13/00	P-2010-113	A61P 35/00	P-2010-81
A61P 13/00	P-2010-120	A61P 35/02	P-2010-89
A61P 15/00	P-2010-113	A61P 5/46	P-2010-84
A61P 15/00	P-2010-120	A61P 9/04	P-2010-129
A61P 17/00	P-2010-113	A61P 9/10	P-2010-129
A61P 17/06	P-2010-89	B09B 5/00	P-2012-49
A61P 19/00	P-2010-152	B09C 1/00	P-2012-47
A61P 19/00	P-2010-155	C07C 213/10	P-2010-136
A61P 19/02	P-2010-89	C07C 217/84	P-2010-136
A61P 25/00	P-2010-113	C07C 231/16	P-2010-136
A61P 25/00	P-2010-120	C07C 237/08	P-2010-136
A61P 25/00	P-2010-152	C07D 207/323	P-2010-113
A61P 25/00	P-2010-155	C07D 207/325	P-2010-117
A61P 25/24	P-2010-113	C07D 207/44	P-2010-113
A61P 25/28	P-2010-113	C07D 211/14	P-2008-771
A61P 25/28	P-2010-59	C07D 211/46	P-2008-771
A61P 29/00	P-2010-113	C07D 213/28	P-2010-152
A61P 29/00	P-2010-117	C07D 213/28	P-2010-155
A61P 29/00	P-2010-119	C07D 213/72	P-2010-117
A61P 3/00	P-2010-117	C07D 215/38	P-2010-117
A61P 3/00	P-2010-119	C07D 233/00	P-2010-81
A61P 3/00	P-2010-120	C07D 233/56	P-2010-152
A61P 3/00	P-2010-65	C07D 233/56	P-2010-155
A61P 3/04	P-2010-65	C07D 233/88	P-2010-117
A61P 3/06	P-2010-65	C07D 261/00	P-2010-70
A61P 3/10	P-2010-65	C07D 261/04	P-2010-86

(51)	(21)	(51)	(21)
C07D 277/00	P-2010-70	E02B 7/00	P-2012-85
C07D 277/42	P-2010-117	E02B 8/00	P-2012-85
C07D 305/14	P-2010-144	E02B 9/00	P-2012-85
C07D 401/12	P-2010-117	E02B 9/02	P-2012-33
C07D 401/12	P-2010-120	E02B 9/02	P-2012-85
C07D 401/14	P-2010-120	E02B 9/06	P-2012-85
C07D 413/04	P-2010-86	E02F 5/00	P-2011-190
C07D 471/04	P-2010-113	E03F 7/02	P-2011-191
C07D 471/04	P-2010-117	E04B 1/08	P-2012-29
C07D 471/04	P-2010-119	E04G 17/00	P-2012-79
C07D 471/04	P-2010-152	E04H 12/10	P-2012-80
C07D 471/04	P-2010-155	E04H 12/10	P-2012-81
C07D 498/00	P-2010-132	E04H 9/02	P-2012-75
C07F 7/08	P-2010-120	E21B 43/00	P-2011-55
C07F 7/10	P-2010-120	E21B 43/34	P-2011-55
C07F 7/12	P-2010-120	F02D 13/02	P-2012-22
C07H 19/04	P-2010-68	F03B 13/00	P-2012-44
C07J 7/00	P-2010-84	F03D 1/00	P-2012-37
C07J 71/00	P-2010-84	F03G 6/00	P-2012-65
C07K 14/30	P-2010-78	F03H 5/00	P-2012-3
C07K 14/47	P-2009-175	F16F 15/32	P-2012-41
C07K 14/705	P-2010-75	F24J 2/06	P-2012-67
C07K 16/18	P-2010-59	G01N 33/53	P-2010-76
C07K 16/24	P-2010-89	G01N 33/567	P-2010-76
C09K 17/00	P-2012-47	H01L 31/12	P-2012-50
C21D 9/32	P-2012-86	H02N 2/00	P-2012-68
E012B 9/00	P-2012-66		
E02B 13/00	P-2012-85		
E02B 3/04	P-2012-85		
E02B 3/4	P-2012-33		

OBJAVE ZAHTJEVA ZA PROŠIRENJE EVROPSKIH PRIJAVA PATENATA PUBLICATION OF REQUEST FOR THE EXTENSION OF THE EFFECTS OF EUROPEAN PATENT APPLICATIONS

- | | | | |
|--|------------------------------|---|------------------------------|
| <p>(51) MKP
A61P 25/00 (2006.01)
A61K 31/165 (2006.01)
A61K 38/21 (2006.01)</p> <p>(86) US2010041274 08.07.2010
(96) 10731897.4 16.05.2012
(87) WO2011005907, 08.07.2010
(97) 2451449, 16.05.2012 en
(54) USE OF THE COMBINATION OF TERIFLUNOMIDE AND INTERFERON BETA FOR TREATING MULTIPLE SCLEROSIS
(71) Sanofi-Aventis U.S. LLC, 55 Corporate Drive, Bridgewater, NJ 08807, US
(72) BYRNES, William, c/o Sanofi-Aventis U.S. 1041 Route 202-206 Mail Code: BWD-303A, Bridgewater, New Jersey 08807, US
DOUILLET, Patrice, c/o Sanofi-Aventis 174 avenue de France, F-75014 Paris, FR
FRANGIN, Gerald, c/o Sanofi-Aventis 174 avenue de France, F-75014 Paris, FR</p> | <p>(97) 2451449 *</p> | <p>(51) MKP
G06F 3/041 (2006.01)
G06F 3/01 (2006.01)
G06F 3/048 (2006.01)</p> <p>(86) US2010026907 11.03.2010
(96) 10712201.2 18.01.2012
(87) WO2010105011, 11.03.2010
(97) 2406703, 18.01.2012 en
(54) SYSTEMS AND METHODS FOR FRICTION DISPLAYS AND ADDITIONAL HAPTIC EFFECTS
(71) Immersion Corporation, 801 Fox Lane, San Jose, CA 95131, US
(72) CRUZ-HERNANDEZ, Juan, Manuel, 4840 Ste-Catherine West, Montreal Québec H3Z 1T1, CA
GRANT, Danny, A., 1784 De Lunebourg, Laval Québec H7M 2A1, CA</p> | <p>(97) 2406703 *</p> |
| <p>(51) MKP
C10G 2/00 (2006.01)</p> <p>(86) JP2010063698 12.08.2010
(96) 10811701.1 11.07.2012
(87) WO2011024651, 12.08.2010
(97) 2474593, 11.07.2012 en
(54) SLURRY PREPARATION METHOD, SLURRY PREPARATION APPARATUS, HYDROCARBON SYNTHESIS REACTION APPARATUS, AND HYDROCARBON SYNTHESIS REACTION SYSTEM
(71) Nippon Steel Engineering Co., Ltd, 5-1, Osaki 1-chome Shinagawa-ku, Tokyo 141-8604, JP
Japan Oil, Gas and Metals National Corporation, 2-10-1, Toranomon, Minato-ku, Tokyo 105-0001, JP
Japan Petroleum Exploration Co., Ltd., 7-12, Marunouchi 1-chome Chiyoda-ku, Tokyo 100-0005, JP
JX Nippon Oil & Energy Corporation, 6-3, Otemachi 2-chome, Chiyoda-ku Tokyo 100-8162, JP
Cosmo Oil Co., Ltd., 1-1, Shibaura 1-chome Minato-ku, Tokyo 105-8528, JP
INPEX Corporation, 5-3-1 Akasaka Minato-ku, Tokyo 107-6332, JP
(72) ONISHI, Yasuhiro, c/o NIPPON STEEL ENGINEERING CO. LTD. Osaki Center Building 5-1 Osaki 1-chome Shinagawa-ku, Tokyo 141-8604, JP
SHINGU, Masaki, c/o JX Nippon Oil&Energy Corporation 6-3 Otemachi 2-chome Chiyoda-ku, Tokyo 100-8162, JP
TANAKA, Yuichi, c/o JX Nippon Oil&Energy Corporation 8 Chidori-cho Naka-ku, Yokohama-shi Kanagawa 231-0815, JP</p> | <p>(97) 2474593 *</p> | <p>(51) MKP
G06F 3/041 (2006.01)
G06F 3/01 (2006.01)
G06F 3/048 (2006.01)</p> <p>(86) US2010026900 11.03.2010
(96) 10712200.4 18.01.2012
(87) WO2010105006, 11.03.2010
(97) 2406702, 18.01.2012 en
(54) SYSTEMS AND METHODS FOR INTERFACES FEATURING SURFACE-BASED HAPTIC EFFECTS
(71) Immersion Corporation, 801 Fox Lane, San Jose, CA 95131, US
(72) CRUZ-HERNANDEZ, Juan, Manuel, 4840 Ste-Catherine West, Montreal Québec H3Z 1T1, CA
GRANT, Danny, A., 1784 De Lunebourg, Laval Québec H7M 2A1, CA
MODARRES, Ali, 3777 Cote-des-Neiges Apt. 520, Montreal Québec H3H 1V8, CA
GOSLINE, Andrew, 4085 Rue Rivard, Montreal Québec H2L 4J1, CA</p> | <p>(97) 2406702 *</p> |
| <p>(51) MKP
A61K 48/00 (2006.01)
C12N 5/16 (2006.01)</p> <p>(86) EP2010004760 03.08.2010
(96) 10742752.8 13.06.2012
(87) WO2011015347, 03.08.2010
(97) 2461833, 13.06.2012 en
(54) VACCINE COMPOSITION COMPRISING 5'-CAP MODIFIED RNA
(71) Johannes- Gutenberg-Universität Mainz, Saarstrasse 21, 55122 Mainz, DE
Biontech AG, Hölderlinstrasse 8, 55131 Mainz, DE
Uniwersytet Warszawski, Ul. Krakowskie Przedmiescie 26/28, 00-927 Warszawa, PL
(72) SAHIN, Ugur, Philipp-von-Zabern-Platz 1, 55116 Mainz, DE
KUHN, Andreas, Dr.-Karl-Schramm-Strasse 1, 55129 Mainz, DE
DARZYNKIEWICZ, Edward, Szkolna 22, PL-05-080 Izabelin-Hornówek, PL
JEMIELITY, Jacek, Romanska 1/78, PL-01-451 Warsaw, PL
KOWALSKA, Joanna, Sobieskiego 20/89, PL-26-600 Radom, PL</p> | <p>(97) 2461833 *</p> | <p>(51) MKP
F16L 55/164 (2006.01)</p> <p>(86) GB2010050634 16.04.2010
(96) 10720806.8 22.02.2012
(87) WO2010119296, 16.04.2010
(97) 2419670, 22.02.2012 en
(54) DELIVERY METHOD AND COMPOSITIONS
(71) Brinker Technology Limited, Cloverhill Road Bridge Of Don, Aberdeen, Aberdeenshire AB23 8FE, GB
(72) RYAN, Nicholas John, Waulkmill Coply, Aberdeenshire AB52 6XD, GB</p> | <p>(97) 2419670 *</p> |
| <p>(51) MKP
H04W 40/20 (2009.01)</p> <p>(86) CN2010077281 25.09.2010
(96) 10819887.0 08.08.2012
(87) WO2011038658, 25.09.2010
(97) 2485532, 08.08.2012 en
(54) METHOD, SYSTEM AND APPARATUS FOR ACQUIRING CELL LOCATION INFORMATION
(71) China Academy of Telecommunications Technology, 40, Xueyuan Road, Haidian District, Beijing 100191, CN
(72) ZHANG, Dajun, No.40 Xueyuan Road Haidian District, Beijing 100083, CN</p> | <p>(97) 2485532 *</p> | <p>(51) MKP
B67B 7/04 (2006.01)</p> <p>(96) 11155690.8 05.10.2011
(97) 2371758, 05.10.2011 en
(54) Perforating tip for a corkscrew
(71) Zanatta S.r.l., Via del Volontariato, 8/10/12, 25069 Villa Carcina (BS), IT
(72) Zanatta, Walter, c/o ZANATTA S.r.l. Via del Volontariato, 8/10/12, I-25069, Villa Carcina, BRESCIA, IT</p> | <p>(97) 2371758</p> |

- (51) MKP
C07D 401/14 (2006.01) (97) **2424859 ***
C07D 473/00 (2006.01)
A61P 35/00 (2006.01)
A61K 31/52 (2006.01)
(86) US2010032593 27.04.2010
(96) 10718364.2 07.03.2012
(87) WO2010126895, 27.04.2010
(97) 2424859, 07.03.2012 en
(54) INHIBITORS OF PI3 KINASE AND / OR MTOR
(71) Amgen, Inc, One Amgen Center Drive, Thousand Oaks, CA 91320-1799, US
(72) HERBERICH, Bradley, J., 1197 Ramona Dr., Newbury Park CA 91320, US
PETTUS, Liping, H., 3309 Big Cloud Circle, Thousand Oaks CA 91360, US
BOOKER, Shon, 71 McAfee Court, Thousand Oaks CA 91360, US
LIU, Longbin, 753 Rushing Creek Place, Thousand Oaks CA 91360, US
WU, Bin, 3090 Hollycrest Avenue, Thousand Oaks CA 91362, US
CEE, Victor, J., 2881 Capella Way, Thousand Oaks CA 91362, US
NISHIMURA, Nobuko, 24050 Arminta Street, West Hills CA 91304, US
WURZ, Ryan, 53 Ocatillo Avenue, Newbury Park CA 91320, US
D'ANGELO, Noel, 658 Warwick Avenue, Thousand Oaks CA 91360, US
NORMAN, Mark, H., 130 Venus Street, Thousand Oaks CA 91360, US
YANG, Kevin, 8871 Camino Real Avenue, San Gabriel CA 91775, US
HONG, Fang-Tsao, 822 Lynnmere Drive, Thousand Oaks CA 91360, US
REED, Anthony, B., 3101 Peninsula Road 304, Oxnard CA 93035, US
JACKSON, Claire, L., M., 1922 Deerfield Street, Thousand Oaks CA 91362, US
SMITH, Adrian, L., 106 Golden Glen Drive, Simi Valley CA 93065, US
ANDREWS, Kristin, 3154 Foxtail Court, Thousand Oaks CA 91362, US
LANMAN, Brian, A., 762 Deer Run Lane 246, Oak Park CA 91377, US
TADESSE, Seifu, 130 Marblehead Street, Simi Valley CA 93065, US
BO, Yunxin, Y., 419 Calle Veracruz, Thousand Oaks CA 91320, US
LIAO, Hongyu, 2342 Gillingham Circle, Thousand Oaks CA 91362, US
TAMAYO, Nuria, A., 4394 Camino de la Rosa, Newbury Park CA 91320, US
-
- (51) MKP
C12N 15/09 (2006.01) (97) **2478099 ***
(86) US2010002475 13.09.2010
(96) 10817543.1 25.07.2012
(87) WO2011034568, 13.09.2010
(97) 2478099, 25.07.2012 en
(54) METHOD AND COMPOSITION FOR TREATING ALZHEIMER-TYPE DEMENTIA
(71) Chase Pharmaceuticals Corporation, 1825 K Street N.W. Suite 520, Washington, DC 2006-1236, US
(72) CHASE, Thomas, N., 1623 31st. Street Nw, Washington DC 20007, US
CLARENCE-SMITH, Kathleen, E., 1623 31st Street Nw, Washington DC 20007, US
-
- (51) MKP
H01R 13/533 (2006.01) (97) **2390965**
E21B 17/20 (2006.01)
(96) 11167574.0 30.11.2011
(97) 2390965, 30.11.2011 en
(54) An electrical connector, particularly for a drill string
(71) PE.GAS.US. S.r.l., Via Roma 4, 10073 Cirie (TO), IT
(72) Alaria, Luigi, Via Nole 7, I-10070 GROSSO (Torino), IT
Canavera, Angelo, Via Verdi 20, I-10088 VOLPIANO (Torino), IT

- (51) MKP
A01H 5/10 (2006.01) (97) **2440034 ***
C12N 15/82 (2006.01)
(86) EP2010003438 09.06.2010
(96) 10725988.9 18.04.2012
(87) WO2010142424, 09.06.2010
(97) 2440034, 18.04.2012 en
(54) HIGH OIL CONTENT PLANTS
(71) Bayer BioScience N.V., Technologiepark 38, 9052 Gent, BE
(72) DEN BOER, Bart, Wilgenstraat 21, B-9820 Merelbeke, BE
-
- (51) MKP
A61K 39/395 (2006.01) (97) **2475387 ***
A61P 17/02 (2006.01)
C07K 16/40 (2006.01)
G01N 33/577 (2006.01)
A61K 31/00 (2006.01)
A61P 43/00 (2006.01)
(86) FI2010050689 07.09.2010
(96) 10815041.8 18.07.2012
(87) WO2011029996, 07.09.2010
(97) 2475387, 18.07.2012 en
(54) USE OF VAP-1 INHIBITORS FOR TREATING FIBROTIC CONDITIONS
(71) Biotie Therapies Corp., Tykistökatu 6, 20520 Turku, FI
The University of Birmingham, null, Edgbaston, Birmingham B15 2TT, GB
(72) WESTON, Christopher, 19 Prescott Road Pedmore, Stourbridge West Midlands DY9 7LB, GB
CLARIDGE, Lee, Charles, Flat 2 Charterfield Drive, Kingswinford West Midlands DY6 7SH, GB
ADAMS, David, 5 Pinfield Drive Barnt Green, Birmingham West Midlands B458XA, GB
SMITH, David, Valliuksenkatu 6, FI-21100 Naantali, FI
WESTERLUND, Nina, "-", deceased, FI
PIHLAVISTO, Marjo, Kuminakatu 10, FI-20780 Kaarina, FI
ÖSTERMAN, Thua, "-", deceased, FI
-
- (51) MKP
C07D 405/14 (2006.01) (97) **2406243 ***
A61K 31/5377 (2006.01)
C07D 407/04 (2006.01)
A61K 31/551 (2006.01)
C07D 405/12 (2006.01)
A61K 31/496 (2006.01)
C07D 407/12 (2006.01)
C07D 307/79 (2006.01)
C07D 413/04 (2006.01)
C07D 307/80 (2006.01)
C07D 413/12 (2006.01)
C07D 307/81 (2006.01)
C07D 417/12 (2006.01)
C07D 405/04 (2006.01)
C07D 493/10 (2006.01)
(86) JP2010054286 09.03.2010
(96) 10710111.5 18.01.2012
(87) WO2010104194, 09.03.2010
(97) 2406243, 18.01.2012 en
(54) BENZOFURAN DERIVATIVES
(71) Takeda Pharmaceutical Company Limited, 1-1 Doshomachi 4-chome Chuo-ku, Osaka-shi, Osaka 541-0045, JP
TSUKAMOTO, Tetsuya, c/o TAKEDA PHARMACEUTICAL COMPANY LIMITED 17-85 Jusohonmachi 2-chome Yodogawa-ku, Osaka-shi Osaka 532-0024, JP
WAKABAYASHI, Takeshi, c/o Takeda Pharmaceutical Company Limited, 26-1 Muraokahigashi 2-chome Fujisawa-shi, Kanagawa 2510012, JP
OHRA, Taiichi, c/o Takeda Pharmaceutical Company Limited, 26-1 Muraokahigashi 2-chome Fujisawa-shi, Kanagawa 2510012, JP

- (51) MKP
C08K 5/15 (2006.01) (97) **2464690 ***
 (86) US2010044373 04.08.2010
 (96) 10808539.0 20.06.2012
 (97) WO2011019557, 04.08.2010
 (97) 2464690, 20.06.2012 en
 (54) FORMULATIONS COMPRISING ISOSORBIDE-MODIFIED UNSATURATED POLYESTER RESINS AND LOW PROFILE ADDITIVES WHICH PRODUCE LOW SHRINKAGE MATRICES
 (71) Ashland Licensing And Intellectual Property, LLC, A Delaware Corporation 5200 Blazer Parkway, Dublin, OH 43017, US
 (72) ANDJELKOVIC, Dejan, D., 5974 Rings Road, Dublin OH 43016, US
 CULKIN, Darcy, A., 5895 Winslow Court, Dublin OH 43016, US
 LOZA, Roman, 6337 Manteo Drive, Dublin OH 43016, US
 SUMNER, Michael, J., 322 St. Andrews Drive, Dublin OH 43017, US
 TUFTS, Timothy, A., 9283 Riverside Drive, Powell OH 43017, US
 FISHER, Dennis, 146 Spring Hollow Lane, Westerville OH 43081, US

- (51) MKP
A61M 5/315 (2006.01) (97) **2475411 ***
 (86) EP2010062931 03.09.2010
 (96) 10752766.5 18.07.2012
 (87) WO2011026931, 03.09.2010
 (97) 2475411, 18.07.2012 en
 (54) DRIVE MECHANISM FOR DRUG DELIVERY DEVICE
 (71) Sanofi-Aventis Deutschland GmbH, Brüningstraße 50, 65929 Frankfurt, DE
 (72) JUGL, Michael, c/o Sanofi-Aventis Deutschland GmbH, 65926 Frankfurt am Main, DE
 SENDATZKI, Günther, c/o Sanofi-Aventis Deutschland GmbH, 65926 Frankfurt am Main, DE
 TEUCHER, Axel, c/o Sanofi-Aventis Deutschland GmbH, 65926 Frankfurt am Main, DE

- (51) MKP
F16K 11/074 (2006.01) (97) **2451631 ***
B29C 73/16 (2006.01)
 (86) DK2010050180 08.07.2010
 (96) 10739476.9 16.05.2012
 (87) WO2011003425, 08.07.2010
 (97) 2451631, 16.05.2012 en
 (54) VALVE FOR TYRE REPAIR KIT
 (71) Active Tools International (HK) Ltd., 25/F, Top Glory Tower 262 Gloucester Road, Causeway Bay Hong Kong, CN
 (72) EGELUND, Peter, Højlundsparken 49, DK-8355 Solbjerg, DK
 LÆTGAARD, Thomas, Baunehøjvej 15, DK-8700 Horsens, DK

- (51) MKP
G07D 3/12 (2006.01) (97) **2230646**
 (96) 10156565.3 22.09.2010
 (97) 2230646, 22.09.2010 en
 (54) Coin dispenser device
 (71) Alberici S.p.A., Via Miglioli, 23, 40024 Castel San Pietro Terme, (BO), IT
 (72) Alberici, Fabrizio, AGAZZANI & ASSOCIATI S.R.L. Viale Terme 2200/28, I-40024, Castel San Pietro Terme (BO), IT

- (51) MKP
A61K 31/443 (2006.01) (97) **2467366 ***
C07D 249/06 (2006.01)
A61K 31/4439 (2006.01)
C07D 261/08 (2006.01)
A61P 1/16 (2006.01)
C07D 413/04 (2006.01)
A61P 3/10 (2006.01)
A61K 31/42 (2006.01)
C07D 413/12 (2006.01)
A61P 35/00 (2006.01)
C07D 413/14 (2006.01)
A61K 31/4192 (2006.01)
 (86) EP2010005093 19.08.2010
 (96) 10747171.6 27.06.2012
 (87) WO2011020615, 19.08.2010
 (97) 2467366, 27.06.2012 en
 (54) NOVEL FXR (NR1H4) BINDING AND ACTIVITY MODULATING COMPOUNDS
 (71) Phenex Pharmaceuticals AG, Donnersbergweg 1, 67059 Ludwigshafen, DE
 (72) KREMOSER, Claus, Gugenmusweg 20, 69121 Heidelberg, DE
 ABEL, Ulrich, Gartenfeldstrasse 36, 61350 Bad Homburg, DE
 STEENECK, Christoph, Schulstrasse 8, 69221 Dossenheim, DE
 KINZEL, Olaf, Schlierbacher Landstrasse 15, 69118 Heidelberg, DE

- (51) MKP
A61K 31/4412 (2006.01) (97) **2377537**
A61P 11/00 (2006.01)
 (96) 11005708.0 19.10.2011
 (97) 2377537, 19.10.2011 en
 (54) Pirfenidone therapy and inducers of cytochrome P450
 (71) Intermune, Inc., 3280 Bayshore Boulevard, Brisbane, CA 94005-1021, US
 (72) Bradford, Williamson, Ziegler, P.O. Box 566, Ross California 94957, US
 Swarcberg, Javier, 2173 Bunker Hill Drive, San Mateo California 94402, US

- (51) MKP
A61K 39/13 (2006.01) (97) **2454364 ***
C12N 7/02 (2006.01)
 (86) EP2010059796 08.07.2010
 (96) 10729895.2 23.05.2012
 (87) WO2011006823, 08.07.2010
 (97) 2454364, 23.05.2012 en
 (54) PRODUCTION OF POLIO VIRUS AT HIGH TITERS FOR VACCINE PRODUCTION
 (71) Crucell Holland B.V., Archimedesweg 4, 2333 CN Leiden, NL
 (72) LEWIS, John, Alfred, 270 West Main Road, Little Compton Rhode Island 02837, US

- (51) MKP
C07C 275/24 (2006.01) (97) **2462110 ***
C07C 275/16 (2006.01)
C07C 273/02 (2006.01)
A61K 31/17 (2006.01)
A61P 11/00 (2006.01)
 (86) US2010043783 29.07.2010
 (96) 10806952.7 13.06.2012
 (87) WO2011017201, 29.07.2010
 (97) 2462110, 13.06.2012 en
 (54) DP2 ANTAGONIST AND USES THEREOF
 (71) Panmira Pharmaceuticals, LLC, 9535 Waples Street, Suite 100, San Diego, CA 92121, US
 (72) STEARNS, Brian, Andrew, 157 Beechtree Drive, Encinitas California 92024, US
 KING, Christopher, David, 7396 Escallonia Court, Carlsbad California 92011, US
 BRITTAIN, Jason, Edward, 1580 Chiswick Court, El Cajon California 92020, US
 HOLME, Kevin, Ross, 13644 Landfair Road, San Diego California 92130, US

- (51) MKP
C12N 15/11 (2006.01) (97) **2451823 ***
C07H 21/04 (2006.01)
C12N 5/07 (2010.01)
C12N 5/00 (2006.01)
- (86) US2010041099 06.07.2010
(96) 10797741.5 16.05.2012
(87) WO2011005786, 06.07.2010
(97) 2451823, 16.05.2012 en
(54) COMPOSITIONS AND METHODS FOR ENHANCING PRODUCTION OF A BIOLOGICAL PRODUCT
- (71) Alnylam Pharmaceuticals, Inc., 300 Third Street, 3rd Floor, Cambridge, MA 02142, US
- (72) ROSSOMANDO, Anthony, c/o Alnylam Pharmaceuticals Inc. 300 Third Street Third Floor, Cambridge, Massachusetts 02142, US
MARAGANORE, JohnM., c/o Alnylam Pharmaceuticals Inc. 300 Third Street Third Floor, Cambridge, Massachusetts 02142, US
POLLARD, Stuart, c/o Alnylam Pharmaceuticals Inc. 300 Third Street Third Floor, Cambridge, Massachusetts 02142, US
KOCISKO, David, c/o Alnylam Pharmaceuticals Inc. 300 Third Street Third Floor, Cambridge, Massachusetts 02142, US
MANOHARAN, Muthiah, c/o Alnylam Pharmaceuticals Inc. 300 Third Street Third Floor, Cambridge, Massachusetts 02142, US
HINKLE, Greg, c/o Alnylam Pharmaceuticals Inc. 300 Third Street Third Floor, Cambridge, Massachusetts 02142, US
BETTENCOURT, Brian, c/o Alnylam Pharmaceuticals Inc. 300 Third Street Third Floor, Cambridge, Massachusetts 02142, US
HOGAN, Shannon, c/o Alnylam Pharmaceuticals Inc. 300 Third Street Third Floor, Cambridge, Massachusetts 02142, US

- (51) MKP
C08J 5/12 (2006.01) (97) **2404953**
B29C 65/48 (2006.01)
C08J 3/11 (2006.01)
C09J 127/06 (2006.01)
C09J 155/02 (2006.01)
- (96) 10168926.3 11.01.2012
(97) 2404953, 11.01.2012 en
(54) Solvent based glue composition
- (71) Nordcoll A/S, Egeskovvej 12, 3490 Kvistgaard, DK
- (72) Jensen, Mikael, Nordvestvej 4, 3400, Hillerød, DK

- (51) MKP
C12P 21/08 (2006.01) (97) **2488658 ***
C12Q 1/70 (2006.01)
- (86) US2010052843 15.10.2010
(96) 10824164.7 22.08.2012
(87) WO2011047262, 15.10.2010
(97) 2488658, 22.08.2012 en
(54) DUAL VARIABLE DOMAIN IMMUNOGLOBULINS AND USES THEREOF
- (71) Abbott Laboratories, 100 Abbott Park Rd., Abbott Park, IL 60084, US
- (72) GHAYUR, Tariq, 1014 Washington Street, Holliston, Massachusetts 01746, US
KAMATH, Rajesh V., 27 Redland Street, Shrewsbury, Massachusetts 01545, US
LIU, Junjian, 14 Crimson Drive, Shrewsbury, Massachusetts 01545, US
HONORE, Marie P., 11 Oak Street Unit 34, Wellesley, Massachusetts 02482, US

- (51) MKP
A61B 17/06 (2006.01) (97) **2470078 ***
A61B 17/00 (2006.01)
A61B 7/04 (2006.01)
- (86) US2010046435 24.08.2010
(96) 10749555.8 04.07.2012
(87) WO2011025760, 24.08.2010
(97) 2470078, 04.07.2012 en
(54) BARBED SUTURES HAVING PLEDGET STOPPERS AND METHODS THEREFOR
- (71) Ethicon, Inc, U.S. Route 22, Somerville, NJ 08876, US
- (72) LINDH, David, C., SR., 138 Allens Corner Road, Flemington, NJ 08822, US
NAWROCKI, Jesse, G., 8 Grace Drive, Annandale, NJ 08801, US
FURMAN, Dennis, L., 3 Amy Drive, East Windsor, NJ 08520, US
HRISTOV, Krasimira, 903 Primrose Court, Belle Mead, NJ 08502, US
PERKINS, Jason, T., 4935 Long Drive, Bethlehem, PA 18020, US

- (51) MKP
A61M 5/315 (2006.01) (97) **2496290 ***
- (86) EP2010066552 01.11.2010
(96) 10775794.0 12.09.2012
(87) WO2011054775, 01.11.2010
(97) 2496290, 12.09.2012 en
(54) ASSEMBLY FOR A DRUG DELIVERY DEVICE AND DRUG DELIVERY DEVICE
- (71) Sanofi-Aventis Deutschland GmbH, Brüningstraße 50, 65929 Frankfurt, DE
- (72) NZIKE, Philippe, c/o Sanofi-Aventis Deutschland GmbH, 65926 Frankfurt am Main, DE
RAAB, Steffen, c/o Sanofi-Aventis Deutschland GmbH, 65926 Frankfurt am Main, DE
DASBACH, Uwe, c/o Sanofi-Aventis Deutschland GmbH, 65926 Frankfurt am Main, DE
BOESER, Uwe, c/o Sanofi-Aventis Deutschland GmbH, 65926 Frankfurt am Main, DE
BRÜGGEMANN, Ulrich, c/o Sanofi-Aventis Deutschland GmbH, 65926 Frankfurt am Main, DE

- (51) MKP
B29C 35/14 (2006.01) (97) **2461960 ***
B29B 15/10 (2006.01)
B29C 47/02 (2006.01)
B29C 70/50 (2006.01)
B29C 70/20 (2006.01)
- (86) EP2010061438 05.08.2010
(96) 10739943.8 13.06.2012
(87) WO2011015635, 05.08.2010
(97) 2461960, 13.06.2012 en
(54) MANUFACTURE AND USE OF A REINFORCED PROFILE
- (71) SOLVAY SA, Rue de Ransbeek, 310, 1120 Bruxelles, BE
- (72) BLOYAERT, Claudine, Avenue de la Croix de Bourgogne 9, B-1410 Waterloo, BE
DEHENNAU, Claude, Chemin des Postes 236, B-1410 Waterloo, BE

- (51) MKP
H01L 31/18 (2006.01) (97) **2481098 ***
- (86) EP2010062060 18.08.2010
(96) 10743156.1 01.08.2012
(87) WO2011035997, 18.08.2010
(97) 2481098, 01.08.2012 de
(54) METHOD AND DEVICE FOR CHARGING PHOTOVOLTAIC MODULES
- (71) Deutsche Landwirtschafts-Gesellschaft E.V., Eschborner Landstr. 122, 60489 Frankfurt am Main, DE
- (72) HUSCHKE, Wolfram, Straße des Friedens 19 OT Satzkom, 14476 Potsdam, DE
SÖGDING, Thorsten, Weinleseweg 2, 76829 Landau, DE
WEBER, Urban, Rosenweg 4, 55413 Weiler bei Bingen, DE

(51) MKP
A61K 31/506 (2006.01) (97) **2442810 ***
A61K 31/505 (2006.01)
A61P 25/28 (2006.01)
A61P 25/00 (2006.01)
(86) US2010038605 15.06.2010
(96) 10790028.4 25.04.2012
(87) WO2010147938, 15.06.2010
(97) 2442810, 25.04.2012 en
(54) REVERSAL OF L-DOPA-INDUCED DYSKINESIA BY NEURONAL NICOTINIC RECEPTOR LIGANDS
(71) Targacept Inc., 200 East First Street, Suite 300, Winston-Salem, NC 27101, US
(72) JORDAN, Kristen G., 1869 Curraghmore Road, Clemmons North Carolina 27012, US
LETCWORTH, Sharon Rae, 475 Bent Creek Trail, Kernersville North Carolina 27284, US
BENCHERIF, Merouane, 104 Brampton Court, Winston-Salem North Carolina 27106, US

(51) MKP
G01N 33/68 (2006.01) (97) **2496943 ***
(86) EP2010066808 04.11.2010
(96) 10771789.4 12.09.2012
(87) WO2011054900, 04.11.2010
(97) 2496943, 12.09.2012 en
(54) METHODS AND USES RELATING TO THE IDENTIFICATION OF COMPOUND INVOLVED IN PAIN AS WELL AS METHODS OF DIAGNOSING ALGESIA
(71) SANOFI, 54, rue de la Boétie, 75008 Paris, FR
(72) GEBAUER, Mathias, c/o Sanofi-Aventis Deutschland GmbH, 65926 Frankfurt am Main, DE
MICHAELIS, Martin, c/o Sanofi-Aventis Deutschland GmbH, 65926 Frankfurt, DE
DING-PFENNIGDORFF, Danping, c/o Sanofi-Aventis Deutschland GmbH, 65926 Frankfurt am Main, DE
SCHULTE, Anke, M., c/o Sanofi-Aventis Deutschland GmbH, 65926 Frankfurt am Main, DE
ZIEMEK, Daniel, 53 Barnad Ave, Watertown MA 02472, US
METZ-WEIDMANN, Christiane, c/o Sanofi-Aventis Deutschland GmbH, 65926 Frankfurt am Main, DE

(51) MKP
E03C 1/284 (2006.01) (97) **2404001 ***
E03F 5/04 (2006.01)
(86) IB2010000451 05.03.2010
(96) 10713505.5 11.01.2012
(87) WO2010100556, 05.03.2010
(97) 2404001, 11.01.2012 en
(54) WATER DRAIN SIPHON DEVICE, IN PARTICULAR FOR FLOOR SHOWERS AND SHOWER TRAYS
(71) VALSIR S.p.A., Località Merlaro, 2, 25078 Vestone (BS), IT
(72) CONFORTI, Marco, Via Alessandro Manzoni, 15, I-25087 Salo', IT

(51) MKP
A61K 45/06 (2006.01) (97) **2429518 ***
A61P 25/00 (2006.01)
A61P 25/28 (2006.01)
A61K 31/27 (2006.01)
A61K 31/439 (2006.01)
A61K 31/473 (2006.01)
A61K 31/445 (2006.01)
A61K 31/55 (2006.01)
(86) US2010034353 11.05.2010
(96) 10718403.8 21.03.2012
(87) WO2010132423, 11.05.2010
(97) 2429518, 21.03.2012 en
(54) TREATMENT OF COGNITIVE DISORDERS WITH CERTAIN ALPHA-7 NICOTINIC ACID RECEPTORS IN COMBINATION WITH ACETYLCHOLINESTERASE INHIBITORS
(71) Envivo Pharmaceuticals, Inc., 480 Arsenal Street Bldg. 1, Watertown, MA 02472, US
(72) KOENIG, Gerhard, 1662 Commonweath Avenue, Boston Massachusetts 02465, US
HILT, Dana, 204 Clocktower Drive 205, Waltham Massachusetts 02452, US

(51) MKP
G09F 3/02 (2006.01) (97) **2414000 ***
G09F 11/30 (2006.01)
A61M 5/31 (2006.01)
A61M 5/178 (2006.01)
B65C 3/06 (2006.01)
(86) EP2010053966 26.03.2010
(96) 10710347.5 08.02.2012
(87) WO2010112407, 26.03.2010
(97) 2414000, 08.02.2012 en
(54) DRUG DELIVERY DEVICE WITH INTEGRATED EXTENDABLE /RETRACTABLE INFORMATION DISPLAY ELEMENT
(71) Sanofi-Aventis Deutschland GmbH, Brüningstraße 50, 65929 Frankfurt, DE
(72) POMMEREAU, Christian, Sanofi-Aventis Deutschland GmbH, 65926 Frankfurt am Main, DE
RAAB, Steffen, Sanofi-Aventis Deutschland GmbH, 65926 Frankfurt am Main, DE

(51) MKP
G01N 33/574 (2006.01) (97) **2454598 ***
(86) US2010042182 15.07.2010
(96) 10800567.9 23.05.2012
(87) WO2011008990, 15.07.2010
(97) 2454598, 23.05.2012 en
(54) DRUG SELECTION FOR GASTRIC CANCER THERAPY USING ANTIBODY-BASED ARRAYS
(71) Prometheus Laboratories Inc., 9410 Carroll Park Drive, San Diego, CA 92121-5201, US
(72) SINGH, Sharat, 8171 Top of the Morning Way, Rancho Santa Fe California 92127, US
KIM, Phillip, 28 Exeter, Irvine California 92612, US
LIU, Xinjun, 12890 Caminito Diego, San Diego California 92130, US
YBARRONDO, Belen, 4570 Orchard Avenue, San Diego California 92107, US

(51) MKP
C07D 413/04 (2006.01) (97) **2459553 ***
A61K 31/4245 (2006.01)
A61P 35/00 (2006.01)
(86) EP2010060803 26.07.2010
(96) 10740196.0 06.06.2012
(87) WO2011012577, 26.07.2010
(97) 2459553, 06.06.2012 en
(54) FURAZANOBENZIMIDAZOLES AS PRODRUGS TO TREAT NEOPLASTIC OR AUTOIMMUNE DISEASES
(71) Basilea Pharmaceutica AG, Grenzacherstrasse 487, 4005 Basel, CH
(72) POHLMANN, Jens, Murbacherstrasse 37, CH-4056 Basel, CH
BACHMANN, Felix, Grellingerstrasse 38, CH-4052 Basel, CH

(51) MKP
B65D 41/46 (2006.01) (97) **2444334**
B65D 41/62 (2006.01)
(96) 10460040.8 25.04.2012
(97) 2444334, 25.04.2012 en
(54) Safety bottle cap
(71) CEDC International sp. z.o.o., ul. Kowanowska 48, 64-600 Oborniki Wielkopolskie, PL
(72) Klopocki, Marek, ul. Zmudzka 7, 81-554 Gdynia, PL

(51) MKP
A61M 5/32 (2006.01) (97) **2480274 ***
(86) IB2010002390 24.09.2010
(96) 10807344.6 01.08.2012
(87) WO2011036544, 24.09.2010
(97) 2480274, 01.08.2012 en
(54) ACTUATOR FOR SAFETY DEVICES FOR NEEDLES AND DISPOSABLE MEDICAL INSTRUMENTS
(71) Gargani, Mario, Via Primo Maggio 4, 50039 Vicchio (FI), IT
(72) Gargani, Mario, Via Primo Maggio 4, 50039 Vicchio (FI), IT

- (51) MKP
F16L 11/04 (2006.01) (97) **2431643**
(96) 11179489.7 21.03.2012
(97) 2431643, 21.03.2012 en
(54) Method and apparatus for the surface treatment of collapsible tubular sub-layers intended for the production of multy-layer tubes
(71) MANIFATTURA TUBI GOMMA S.p.A., Via Pigafetta 10/12, 36040 Grisignano di Zocco (Vicenza), IT
(72) MARCOLIN, DAVIDE, c/o MANIFATTURA TUBI GOMMA S.p.A. VIA PIGAFETTA 10/12, 36040 GRISIGNANO DI ZOCCO (VICENZA). IT
-
- (51) MKP
G09G 5/00 (2006.01) (97) **2407922 ***
G09G 5/36 (2006.01)
G06Q 50/00 (2012.01)
G06Q 10/00 (2012.01)
(86) JP2010071356 30.11.2010
(96) 10833407.9 18.01.2012
(87) WO2011065563, 30.11.2010
(97) 2407922, 18.01.2012 en
(54) HORSE BODY INFORMATION PROVISION SYSTEM, HORSE BODY STILL IMAGE DATA EXTRACTION METHOD, HORSE BODY STILL IMAGE DATA EXTRACTION PROGRAM, AND COMPUTER-READABLE RECORDING MEDIUM
(71) Rakuten, Inc., 4-12-3, Higashishinagawa Shinagawa-ku, Tokyo 140-0002, JP
(72) NAKAJIMA Yoshiaki, c/o Rakuten Inc. 4-12-3 Higashishinagawa Shinagawa-ku, Tokyo 140-0002, JP
SHIMOYAMA Shinichi, c/o Rakuten Inc. 4-12-3 Higashishinagawa Shinagawa-ku, Tokyo 140-0002, JP
-
- (51) MKP
A61K 9/20 (2006.01) (97) **2279728**
A61K 9/14 (2006.01)
A61K 9/16 (2006.01)
(96) 10171550.6 02.02.2011
(97) 2279728, 02.02.2011 en
(54) Solid dosage forms of HIV protease inhibitors
(71) Ranbaxy Laboratories Limited, Plot No. 90, Sector-32, Gurgaon - 122001, Haryana, IN
(72) Tiwari, Ravindra, S/o Yatindra Kumar Tiwari No. 1 Maruti Colony, Nayapura, Kota, 324002, Rajasthan, IN
Janakiraman, Kannayiram K., S/o Kaliya Perumal, 68/22 Theradi Pillayar Koil Street Chidambaram, Cuddalore, 608001, Tamil Nadu, IN
Agarwal, Ravindra, House No. 3DH 29, Sector - 5 Prabhath Nagar, Hiran Magari, Udaipur, 313002, Rajasthan, IN
Raghuvanshi, Rajeev Singh, 605, Ivory Towers, South City - I, Gurgaon, 122001, Haryana, IN
-
- (51) MKP
A61K 47/18 (2006.01) (97) **2440239 ***
A61K 47/48 (2006.01)
A61K 38/42 (2006.01)
(86) US2010038046 09.06.2010
(96) 10727289.0 18.04.2012
(87) WO2010144629, 09.06.2010
(97) 2440239, 18.04.2012 en
(54) HEMOGLOBIN COMPOSITIONS
(71) Prolong Pharmaceuticals, LLC, 300 Corporate Court Suite B, South Plainfield, NJ 07080, US
(72) ABUCHOWSKI, Abraham, 62 Bunnvale Road, Califon NJ 07830, US
SLOSHBERG, Steven, 2255 Balmoral Avenue, Union NJ 07083, US
O'HARE, Keith, 76 Cypress Drive, East Windsor NJ 08520, US
-
- (51) MKP
A61K 31/557 (2006.01) (97) **2461812 ***
A61K 31/5585 (2006.01)
A61P 11/00 (2006.01)
(86) EP2010061428 05.08.2010
(96) 10739941.2 13.06.2012
(87) WO2011015630, 05.08.2010
(97) 2461812, 13.06.2012 en
(54) COMPOSITION FOR THE TREATMENT OF CYSTIC FIBROSIS
(71) SciPharm SàRL, 33, rue Hiehli, 6131 Junglinster, LU
(72) FREISSMUTH, Michael, Billrothstr. 68, A-1190 Wien, AT
KOENIG, Xaver, Johannessteig 3, A-2340 Moedling, AT
GLOECKEL, Christina, Rosaliag. 9/33, A-1120 Wien, AT
-
- (51) MKP
C11D 1/44 (2006.01) (97) **2316914**
(96) 10175621.1 04.05.2011
(97) 2316914, 04.05.2011 en
(54) Adhesive detergent composition
(71) Bolton Manitoba SpA, Via G.B. Pirelli 19, 20124 Milano, IT
(72) Orlandini, Francesco Maurizio, Viale Resistenza 53/F, 26845, Codogno (LO), IT
Alderuccio, Gianni, Via Alfieri, 40, 20030 Bovisio Masciago (MB), IT
Curi, Paola, Via per Como 27, 22034, Brunate (CO), IT
-
- (51) MKP
H01R 9/24 (2006.01) (97) **2441128 ***
(86) EP2010001916 26.03.2010
(96) 10712336.6 18.04.2012
(87) WO2010142359, 26.03.2010
(97) 2441128, 18.04.2012 de
(54) TERMINAL STRIP
(71) ADC GmbH, Beeskowdamm 3-11, 14167 Berlin, DE
(72) MÜLLER, Manfred, Mühlenstrasse 2, 13187 Berlin, DE
-
- (51) MKP
C07D 213/16 (2006.01) (97) **2438045 ***
A61K 31/4406 (2006.01)
(86) EP2010057273 26.05.2010
(96) 10724026.9 11.04.2012
(87) WO2010139585, 26.05.2010
(97) 2438045, 11.04.2012 en
(54) CRYSTALLINE PHASES OF 2'-[[2-(4-METHOXY-PHENYL)-ACETYLAMINO]-METHYL]-BIPHENYL-2-CARBOXYLIC ACID (2-PYRIDIN-3-YL-ETHYL)-AMIDE
(71) Sanofi-Aventis Deutschland GmbH, Brüningstraße 50, 65929 Frankfurt, DE
(72) NAGEL, Norbert, c/o Sanofi-Aventis Deutschland GmbH, 65926 Frankfurt am Main, DE
BERCHTOLD, Harald, c/o Sanofi-Aventis Deutschland GmbH, 65926 Frankfurt am Main, DE
SCHUR, Michael, c/o Sanofi-Aventis Deutschland GmbH, 65926 Frankfurt am Main, DE
HOERSTERMANN, Dirk, c/o Sanofi-Aventis Deutschland GmbH, 65926 Frankfurt am Main, DE
-
- (51) MKP
C04B 2/10 (2006.01) (97) **2230223**
(96) 10156025.8 22.09.2010
(97) 2230223, 22.09.2010 de
(54) Method and device for producing calcium
(71) Messer Group GmbH, Otto-Volger-Strasse 3c, 65843 Sulzbach, DE
(72) Grohmann, Paul, Dreisteinstr. 43, A-2372, Gießhübl, DE
-
- (51) MKP
A01H 5/08 (2006.01) (97) **2495313 ***
A01H 5/10 (2006.01)
A01H 5/00 (2006.01)
C12N 15/09 (2006.01)
C12N 5/10 (2006.01)
(86) JP2010068858 25.10.2010
(96) 10826671.9 05.09.2012
(87) WO2011052539, 25.10.2010
(97) 2495313, 05.09.2012 en
(54) PRODUCTION METHOD FOR GENETICALLY MODIFIED PLANT CELLS
(71) National Institute Of Agrobiological Sciences, 1-2 Kannondai 2-chome Tsukuba-shi, Ibaraki 305-8602, JP
(72) TOKI, Seiichi, c/o National Institute of Agrobiological Sciences 2-1-2 Kannondai, Tsukuba-shi Ibaraki 305-8602, JP
OSAKABE, Keishi, c/o National Institute of Agrobiological Sciences 2-1-2 Kannondai, Tsukuba-shi Ibaraki 305-8602, JP

- (51) MKP
C22C 26/00 (2006.01) (97) **2462083 ***
B22F 1/02 (2006.01)
C04B 35/628 (2006.01)
C22C 29/02 (2006.01)
(86) US2010044241 03.08.2010
(96) 10742669.4 13.06.2012
(87) WO2011017318, 03.08.2010
(97) 2462083, 13.06.2012 en
(54) TOUGH COATED HARD PARTICLES CONSOLIDATED IN A TOUGH MATRIX MATERIAL
(71) Allomet Corporation, 509 Hahntown-Wendel Road, North Huntingdon, PA 15642, US
(72) KEANE, John, M., 36 Country Farm Lane, Harrison City PA 15636, US
GERMAN, Randall, M., 282 Surfview Court, Del Mar CA 92014, US

- (51) MKP
E03C 1/232 (2006.01) (97) **2467539 ***
(86) US2010045795 17.08.2010
(96) 10810506.5 27.06.2012
(87) WO2011022425, 17.08.2010
(97) 2467539, 27.06.2012 en
(54) CABLE ACTUATED DRAIN
(71) WCM Industries, Inc., 2121 Waynoka Road, Colorado Springs, CO 80915, US
(72) BALL, William, T., 1980 Inwood Circle, Colorado Springs CO 80904, US
PILARCZYK, Eric, 5942 Vallecito Drive, Colorado Springs CO 80923, US
HOGAN, Kevin, 8212 Linden Drive, Prairie Village KS 66208, US
RIESCO, Carl, 2317 S. Old Mill Avenue, Independence MO 64057, US
CARLSON, William, L., 12415 Latigo Boulevard, Elbert CO 80106, US

- (51) MKP
C07D 239/48 (2006.01) (97) **2435411 ***
C07D 401/12 (2006.01)
C07D 405/12 (2006.01)
A61P 35/00 (2006.01)
A61K 31/505 (2006.01)
(86) EP2010057408 28.05.2010
(96) 10724385.9 04.04.2012
(87) WO2010136559, 28.05.2010
(97) 2435411, 04.04.2012 en
(54) 2, 4 -DIAMINOPYRIMIDINES FOR THE TREATMENT OF DISEASES CHARACTERISED BY EXCESSIVE OR ABNORMAL CELL PROLIFERATION
(71) Boehringer Ingelheim International GmbH, Binger Strasse 173, 55216 Ingelheim am Rhein, DE
(72) SAPOUNTZIS, Ioannis, Boehringer Ingelheim GmbH Patents Germany Binger Strasse 173, 55216 Ingelheim am Rhein, DE
STADTMUELLER, Heinz, Boehringer Ingelheim GmbH Patents Germany Binger Strasse 173, 55216 Ingelheim am Rhein, DE
KUHNS, Daniel, Boehringer Ingelheim GmbH Patents Germany Binger Strasse 173, 55216 Ingelheim am Rhein, DE

- (51) MKP
C12M 1/00 (2006.01) (97) **2371940**
(96) 10158619.6 05.10.2011
(97) 2371940, 05.10.2011 en
(54) Process for bio-oil production involving the use of CO2
(71) B.T.Biochemical Tissues S.R.L., Viale Monastir Km 7,300, 09028 Sestu, IT
(72) Cao, Giacomo, Via Lione, 8, 09129 CAGLIARI, IT
Concas, Alessandro, Via Redipuglia, 80, 09100 CAGLIARI, IT

- (51) MKP
F24J 3/08 (2006.01) (97) **2491183 ***
E02D 5/30 (2006.01)
(86) CA2010001500 21.09.2010
(96) 10824336.1 29.08.2012
(87) WO2011047461, 21.09.2010
(97) 2491183, 29.08.2012 en
(54) PILE WITH INTEGRAL GEOTHERMAL CONDUIT LOOP RETAINING MEANS
(71) Desmeules, Alain, 1169 Seymour, Montréal, Québec H3H 2A4, CA
(72) Desmeules, Alain, 1169 Seymour, Montréal, Québec H3H 2A4, CA

- (51) MKP
C07D 233/70 (2006.01) (97) **2408751 ***
C07D 249/12 (2006.01)
C07D 409/04 (2006.01)
C07D 413/12 (2006.01)
A61K 31/4166 (2006.01)
A61K 31/4196 (2006.01)
A61K 31/422 (2006.01)
A61P 9/00 (2006.01)
(86) EP2010001565 12.03.2010
(96) 10709419.5 25.01.2012
(87) WO2010105770, 12.03.2010
(97) 2408751, 25.01.2012 de
(54) Substituted 2-acetamido-5-aryl-1,2,4-triazolones and use thereof
(71) Bayer Pharma Aktiengesellschaft, Müllerstrasse 178, 13353 Berlin, DE
(72) BRÜGGEMEIER, Ulf, Leysiefen 20, 42799 Leichlingen, DE
FÜRSTNER, Chantal, Arnoldstr. 33, 45478 Mülheim/Ruhr, DE
GEISS, Volker, Peddenkamp 58, 40883 Ratingen, DE
KELDENICH, Jörg, Damaschkeweg 49, 42113 Wuppertal, DE
KERN, Armin, Am Brucher Häuschen 105, 42109 Wuppertal, DE
DELBECK, Martina, Pastorsacker 6, 45239 Essen, DE
KOLKHOF, Peter, Falkenberg 121, 42113 Wuppertal, DE
KRETSCHMER, Axel, Am Acker 23, 42113 Wuppertal, DE
POOK, Elisabeth, Im Lehbruch 24, 42109 Wuppertal, DE
SCHMECK, Carsten, Carl-Friedrich-Goerdeler-Str. 24, 45472 Mülheim, DE
TRÜBEL, Hubert, Lante 23, 42281 Wuppertal, DE

- (51) MKP
A61K 31/506 (2006.01) (97) **2406253 ***
A61P 3/04 (2006.01)
A61K 31/497 (2006.01)
A61P 3/10 (2006.01)
C07D 405/14 (2006.01)
(86) IB2010050943 04.03.2010
(96) 10708644.9 18.01.2012
(87) WO2010103437, 04.03.2010
(97) 2406253, 18.01.2012 en
(54) BENZOFURANYL DERIVATIVES USED AS GLUCOKINASE INHIBITORS
(71) Pfizer Inc., 235 East 42nd Street, New York, NY 10017, US
(72) LING, Anthony Lai, 11314 Breckenridge Way, San Diego California 92131, US
PFEFFERKORN, Jeffrey Allen, Pfizer Global Research and Development Eastern Point Road Groton, CT 06340, US

- (51) MKP
C07D 417/14 (2006.01) (97) **2417108 ***
A61K 31/403 (2006.01)
C07D 209/96 (2006.01)
A61P 31/22 (2006.01)
C07D 401/12 (2006.01)
C07K 5/08 (2006.01)
C07D 401/14 (2006.01)
C07D 403/12 (2006.01)
C07D 403/14 (2006.01)
C07D 405/14 (2006.01)
(86) IB2010000784 09.04.2010
(96) 10722776.1 15.02.2012
(87) WO2010116248, 09.04.2010
(97) 2417108, 15.02.2012 en
(54) ORGANIC COMPOUNDS AND THEIR USES
(71) Novartis AG, Lichtstrasse 35, 4056 Basel, CH
(72) BRANDL, Trixi, Novartis Pharma AG Postfach, CH-4002 Basel, CH
RAMAN, Prakash, Novartis Institutes for BioMedical Research Inc. 400 Technology Square, Cambridge, Massachusetts 02139, US
RIGOLLIER, Pascal, Novartis Pharma AG Postfach, CH-4002 Basel, CH
SEEPERSAUD, Mohindra, Novartis Institutes for BioMedical Research Inc. 400 Technology Square, Cambridge, Massachusetts 02139, US
SIMIC, Oliver, Novartis Pharma AG Postfach, CH-4002 Basel, CH

- (51) MKP
B01D 53/02 (2006.01) (97) **2408538 ***
(86) US2010027700 17.03.2010
(96) 10754076.7 25.01.2012
(87) WO2010107942, 17.03.2010
(97) 2408538, 25.01.2012 en
(54) CARBON DIOXIDE CAPTURE/REGENERATION STRUCTURES AND TECHNIQUES
(71) Eisenberger, Peter, 170 Brooks Bend, Princeton, NJ 08540, US
Chichilnisky, Graciela, 335 Riverside Drive, New York, NY 10025, US
(72) Eisenberger, Peter, 170 Brooks Bend, Princeton, NJ 08540, US
Chichilnisky, Graciela, 335 Riverside Drive, New York, NY 10025, US
-
- (51) MKP
C12N 15/86 (2006.01) (97) **2412387 ***
C12N 15/864 (2006.01)
A61K 48/00 (2006.01)
C07K 14/65 (2006.01)
(86) ES2010070184 26.03.2010
(96) 10714045.1 01.02.2012
(87) WO2010109053, 26.03.2010
(97) 2412387, 01.02.2012 en
(54) METHODS AND COMPOSITIONS FOR THE TREATMENT OF CIRRHOSIS AND LIVER FIBROSIS
(71) Proyecto de Biomedicina Cima, S.L., Avda. Pío XII, 22 Oficina 1, 31008 Pamplona - Navarra, ES
(72) FORTES ALONSO, María Purificación, ICT (D.P.I) Avda Pio XII 53, 31008 Pamplona Navarra, ES
PRIETO VALTUENA, Jesús María, ICT (D.P.I) Avda Pio XII 53, 31008 Pamplona Navarra, ES
SOBREVALS, Luciano Matías, ICT (D.P.I) Avda Pio XII 53, 31008 Pamplona Navarra, ES
PETRY, Harald, Amsterdam Molecular Therapeutics
Meibergdreef 61, 1105 BA Amsterdam, NL
TIMMERMANS, Eric Jacobus Hubertus, Amsterdam Molecular Therapeutics Meibergdreef 61, 1105 BA Amsterdam, NL
-
- (51) MKP
A63B 63/00 (2006.01) (97) **2496321 ***
(86) NO2010000397 02.11.2010
(96) 10779059.4 12.09.2012
(87) WO2011053163, 02.11.2010
(97) 2496321, 12.09.2012 en
(54) COLLAPSIBLE GOAL DEVICE FOR BALL GAMES
(71) Parklife Innovations Ltd., 46 Foxwell Street, Worcester Hereford & Worcester WR5 2EP, GB
(72) Wennesland, Anders Alf, Amarisias Artemios 32A, 15124 Maroussi, GR
-
- (51) MKP
C09K 5/10 (2006.01) (97) **2380943**
G01M 3/22 (2006.01)
(86) 10425131.9 26.10.2011
(97) 2380943, 26.10.2011 en
(54) Fluorescent detector
(71) Berton, Gabriele, Via Sandro Pertini, 1/A, 24035 Curno (BG), IT
(72) Berton, Gabriele, Via Sandro Pertini, 1/A, 24035 Curno (BG), IT
-
- (51) MKP
G07D 9/00 (2006.01) (97) **2395484**
G07D 1/02 (2006.01)
(86) 11168405.6 14.12.2011
(97) 2395484, 14.12.2011 en
(54) Adapter for coin dispensing device
(71) Alberici S.p.A., Via Miglioli, 23, 40024 Castel San Pietro Terme, (BO), IT
(72) Alberici, Fabrizio, Alberici S.p.A. Viale Terme 2200/28, 40024 Castel San Pietro Terme (BO), IT
-
- (51) MKP
A61K 31/4188 (2006.01) (97) **2405908 ***
A61P 35/00 (2006.01)
A61K 31/7064 (2006.01)
A61K 31/18 (2006.01)
A61K 31/185 (2006.01)
A61K 31/436 (2006.01)
A61K 31/517 (2006.01)
(86) US2010027060 11.03.2010
(96) 10709139.9 18.01.2012
(87) WO2010105110, 11.03.2010
(97) 2405908, 18.01.2012 en
(54) PHARMACEUTICAL COMBINATIONS COMPRISING RDEA119/BAY 869766 FOR THE TREATMENT OF SPECIFIC CANCERS
(71) Ardea Biosciences, Inc., 4939 Directors Place, San Diego, CA 92121, US
(72) CHAPMAN, Mark, S., 3520 Vista de la Orilla, San Diego CA 92117, US
-
- (51) MKP
B60J 10/02 (2006.01) (97) **2459404 ***
B29C 45/14 (2006.01)
B60J 10/00 (2006.01)
(86) FR2010051575 26.07.2010
(96) 10752865.5 06.06.2012
(87) WO2011015764, 26.07.2010
(97) 2459404, 06.06.2012 fr
(54) JOINTED GLASS PANEL COMPRISING COMB-SHAPED INSERT, AND METHOD FOR MANUFACTURING SAID GLASS PANEL
(71) Saint-Gobain Glass France, 18, avenue d'Alsace, 92400 Courbevoie, FR
(72) KLEO, Christophe, 17 rue Coqueret, F-60350 Attichy, FR
MOTTELET, Béatrice, 14 Boulevard Gambetta, F-60200 Compiègne, FR
-
- (51) MKP
E04B 9/16 (2006.01) (97) **2422023 ***
E04B 1/38 (2006.01)
E04B 9/06 (2006.01)
E04B 9/00 (2006.01)
(86) NO2010000146 22.04.2010
(96) 10767356.8 29.02.2012
(87) WO2010123377, 22.04.2010
(97) 2422023, 29.02.2012 en
(54) METHOD AND APPARATUS FOR ATTACHING OBJECTS ON AND ABOVE A CEILING WITH UNATTACHED CEILING PANELS AND CEILING BEAMS
(71) Roman Empire AS, Liavegen 12, 1920 Sørumsand, NO
(72) ROMÁN, Øystein, Liavegen 12, 1920 Sørumsand, NO
-
- (51) MKP
G06K 17/00 (2006.01) (97) **2499746 ***
H04B 5/00 (2006.01)
(86) IB2010054412 30.09.2010
(96) 10773986.4 19.09.2012
(87) WO2011058455, 30.09.2010
(97) 2499746, 19.09.2012 en
(54) THE METHOD AND SOLUTION OF DATA TRANSMISSION FROM THE TRANSPONDER TO THE READER, ESPECIALLY IN PAYMENT SOLUTIONS WITH A MOBILE COMMUNICATION DEVICE
(71) Logomotion, S.r.O., Winterova 15, 921 01 Pie Any, SK
(72) FLOREK, Miroslav, Ing. Miroslav Florek Sedmokraskova 4, 821 01 Bratislava, SK

- (51) MKP
B61C 3/00 (2006.01) (97) **2464553 ***
 (86) US2010044819 08.08.2010
 (96) 10808567.1 20.06.2012
 (87) WO2011019624, 08.08.2010
 (97) 2464553, 20.06.2012 en
 (54) UTILITY SCALE ELECTRIC ENERGY STORAGE SYSTEM
 (71) Advanced Rail Energy Storage, LLC, 999 Third Avenue Suite 4400, Seattle, WA 9814, US
 (72) PEITZKE, William, R., 620 Lilac Drive, Montecito CA 93108, US
 BROWN, Matthew, B., 4621 Pescadero Ave., San Diego CA 92107, US
 ERDMAN, William, L., 103 Sanders Ranch Rd., Moraga CA 94556, US
 SCOTT, Robert, T., 1204 Callaway Dr. N, Shorewood IL 60404, US
 MOORHEAD, William, H., P.O. Box 922, Smithfield VA 3431, US
 BLODGETT, Douglas, C., 4083 Walnut Drive, Pleasanton CA 94566, US
 SCOTT, David, I., 862 St. Andrews Way, Frankfort IL 60423, US

- (51) MKP
C07K 16/28 (2006.01) (97) **2470569 ***
 (86) US2010052547 13.10.2010
 (96) 10777136.2 04.07.2012
 (87) WO2011047083, 13.10.2010
 (97) 2470569, 04.07.2012 en
 (54) ANTIBODIES AGAINST EPHA10
 (71) Oxford Biotherapeutics Ltd., 94A Milton Park, Abingdon, Oxon OX14 4RY, GB
 (72) ROHLFF, Christian, Oxford Bio Therapeutics Ltd. 94a Milton Park Abingdon, Oxon OX14 4RY, GB
 STAMPS, Alasdair, Oxford Biotherapeutics Ltd 94a Milton Park Abingdon, Oxon OX14 4RY, GB
 TERRETT, Jonathan Alexander, Oxford Biotherapeutics Inc. San Jose Biocenter 5941 Optical Court San Jose, CA 95138, US

- (51) MKP
A61K 9/20 (2006.01) (97) **2410994 ***
A61K 31/00 (2006.01)
 (86) EP2010053532 18.03.2010
 (96) 10709220.7 01.02.2012
 (87) WO2010108845, 18.03.2010
 (97) 2410994, 01.02.2012 en
 (54) PHARMACEUTICAL COMPOSITION CONTAINING LEVODOPA, ENTACAPONE AND CARBIDOPA
 (71) Laboratorios Lesvi, S.L., Avda. Barcelona 69, 08970 Sant Joan Despí - Barcelona, ES
 (72) PABLO ALBÁ, Pablo, Laboratorios Lesvi S.I. Avda. Barcelona 69, E-08970 Sant Joan Despí - Barcelona, ES
 ÚBEDA PÉREZ, Carmen, Laboratorios Lesvi S.I. Avda. Barcelona 69, E-08970 Sant Joan Despí - Barcelona, ES
 DíEZ MARTÍN, Ignacio, Laboratorios Lesvi S.I. Avda. Barcelona 69, E-08970 Sant Joan Despí - Barcelona, ES

- (51) MKP
G01N 33/573 (2006.01) (97) **2414842 ***
 (86) HU2010000036 01.04.2010
 (96) 10721197.1 08.02.2012
 (87) WO2010116196, 01.04.2010
 (97) 2414842, 08.02.2012 en
 (54) DIAGNOSIS OF AND TREATMENT GLUTEN-INDUCED AUTOIMMUNE DISEASES
 (71) University of Debrecen, Nagyerdei krt. 98, 4032 Debrecen, HU
 (72) KORPONAY-SZABÓ, Ilma, Alkotmány u. 20., H-1054 Budapest, HU
 FÉSÜS, László, Tessedik S. u. 156, H-4032 Debrecen, HU
 BAGOSSI, Péter, II/9 Nagy Lajos király tér 5, H-4032 Debrecen, HU
 CSÖSZ, Éva, Jerikó utca 2, H-4032 Debrecen, HU
 KIRÁLY, Róbert, Jerikó utca 20, H-4032 Debrecen, HU
 SIMON-VECSEI, Zsófia, 2/11 Hatvan utca 22/B, H-4025 Debrecen, HU
 MÁKI, Markku, Ketunkatu 10, FIN-33530 Tampere, FI

- (51) MKP
C03C 17/28 (2006.01) (97) **2429964 ***
 (86) HR2010000013 06.05.2010
 (96) 10737383.9 21.03.2012
 (87) WO2010131057, 06.05.2010
 (97) 2429964, 21.03.2012 en
 (54) PREPARATION FOR CHEMICAL TREATMENT OF GLASS, CERAMIC AND STONE SURFACES
 (71) RUDJER BOSKOVIC INSTITUTE, Bijenicka Cesta 54, 10000 Zagreb, HR
 (72) KOSANOVIC, Cleo, Rudjer Boskovic Institute Bijenicka cesta 54, 10000 Zagreb, HR
 SUBOTIC, Boris, Rudjer Boskovic Institute Bijenicka cesta 54, 10000 Zagreb, HR

- (51) MKP
A61H 1/00 (2006.01) (97) **2453864 ***
 (86) US2010042473 19.07.2010
 (96) 10800673.5 23.05.2012
 (87) WO2011009133, 19.07.2010
 (97) 2453864, 23.05.2012 en
 (54) SYSTEMS AND METHODS FOR DRIVING SEALED NEBULIZERS
 (71) Nektar Therapeutics, 201 Industrial Road, San Carlos, CA 94070, US
 (72) GORDON, Benjamin Morris, 26 Fendon Road, Cambridge Cambridgeshire CB1 7RT, GB
 GARDNER, Steven David, 9 Meadow Walk, Yaxley Cambridgeshire PE7 3EX, GB
 HAYES, Matthew James, 31 Tunwells Lane, Great Shelford Cambridge Cambridgeshire CB22 5LJ, GB

- (51) MKP
G01L 5/13 (2006.01) (97) **2280263**
G01G 19/12 (2006.01)
B60D 1/58 (2006.01)
 (96) 10170101.9 02.02.2011
 (97) 2280263, 02.02.2011 de
 (54) Supporting load measuring device and retrofitting method for a vehicle trailer device
 (71) Hein, Herr Thomas, Bahnhofstrasse 24, 97990 Weikersheim, DE
 Diemer, Herr Andreas, Eichenstrasse 6, 83104 Tuntenhausen, DE

- (51) MKP
C12P 21/08 (2006.01) (97) **2427211 ***
A61K 39/395 (2006.01)
 (86) US2010033387 03.05.2010
 (96) 10772644.0 14.03.2012
 (87) WO2010129469, 03.05.2010
 (97) 2427211, 14.03.2012 en
 (54) STABLE HIGH PROTEIN CONCENTRATION FORMULATIONS OF HUMAN ANTI-TNF-ALPHA-ANTIBODIES
 (71) Abbott Biotechnology Ltd., Clarendon House 2 Church Street, Hamilton HM 11, BM
 (72) FRAUNHOFER, Wolfgang, Thurston Road 88a, Newton, MA 02464, US
 KRAUSE, Hans-Jürgen, St. Killian-strasse 14, 67269 Grünstadt, DE
 NEU, Michael, Rathausstrasse 49, 68535 Edingen-Neckarhausen, DE

- (51) MKP
A01N 43/42 (2006.01) (97) **2448408 ***
A61K 31/44 (2006.01)
- (86) US2010040785 01.07.2010
(96) 10794765.7 09.05.2012
(87) WO2011002995, 01.07.2010
(97) 2448408, 09.05.2012 en
- (54) PHENYLETHANOIC ACID, PHENYLPROPANOIC ACID AND PHENYLPROPENOIC ACID CONJUGATES AND PRODRUGS OF HYDROCODONE, METHODS OF MAKING AND USE THEREOF
- (71) Kempfarm, Inc., 7 Hawkeye Dr., Suite 103, North Liberty, IA 52317, US
- (72) MICKLE, Travis, 3015 Wind Ridge Drive, Coralville Iowa 52241, US
GUENTHER, Sven, 913Forest Edge Circle, Coralville Iowa 52241, US
MICKLE, Christal, 3015 Wind Ridge Drive, Coralville Iowa 52241, US
CHI, Guochen, 245 Sadler Lane 303, North Liberty Iowa 52317, US
KANSKI, Jaroslaw, 209 Heartwood Crossing, Blacksburg Virginia 24060, US
MARTIN, Andrea, K., 2235 Shavers Farm Road, Fincastle Virginia 24090, US
BERA, Bindu, 400 Algonquin Ct., Blacksburg Virginia 24060, US
-
- (51) MKP
A61P 3/10 (2006.01) (97) **2445899 ***
A61P 25/00 (2006.01)
C07D 401/12 (2006.01)
A61K 31/4725 (2006.01)
- (86) US2010039731 24.06.2010
(96) 10729017.3 02.05.2012
(87) WO2010151611, 24.06.2010
(97) 2445899, 02.05.2012 en
- (54) NOVEL FUMARATE SALTS OF A HISTAMINE H3 RECEPTOR ANTAGONIST
- (71) SANOFI, 54 rue La Boétie, 75008 Paris, FR
- (72) LANGEVIN, Beverly C., c/o sanofi-aventis U.S. Inc. 1041 Route 202-206 Mail Code: BWD-303A, Bridgewater, New Jersey 08807, US
FARR, Robert Allan, c/o sanofi-aventis U.S. Inc. 1041 Route 202-206 Mail Code: BWD-303A, Bridgewater, New Jersey 08807, US
SHAH, Dinubhai H., c/o sanofi-aventis U.S. Inc. 1041 Route 202-206 Mail Code: BWD-303A, Bridgewater, New Jersey 08807, US
SHERER, Daniel, c/o sanofi-aventis U.S. Inc. 1041 Route 202-206 Mail Code: BWD-303A, Bridgewater, New Jersey 08807, US
-
- (51) MKP
E06B 3/46 (2006.01) (97) **2357306**
- (96) 10014960.8 17.08.2011
(97) 2357306, 17.08.2011 en
- (54) Universal counterframe for retractable sliding door panel
- (71) ECLISSE SRL, Via Sernaglia 76-C.P. 70, 31053 Pieve di Soligo (TV), IT
- (72) De Faveri, Luigi, Via Vittoria, 114, 31020 Refrontolo (TV), IT
-
- (51) MKP
A61K 38/10 (2006.01) (97) **2485751 ***
- (86) US2010051415 05.10.2010
(96) 10822514.5 15.08.2012
(87) WO2011044089, 05.10.2010
(97) 2485751, 15.08.2012 en
- (54) METHODS OF TREATING DEPRESSION AND OTHER RELATED DISEASES
- (71) Northwestern University, 633 Clark Street, Evanston, IL 60208, US
- (72) Moskal, Joseph, 801 Central Street, Evanston IL 60201, US
-
- (51) MKP
A61N 5/06 (2006.01) (97) **2398557 ***
A61B 18/20 (2006.01)
A61B 18/00 (2006.01)
- (86) US2010052664 14.10.2010
(96) 10774051.6 28.12.2011
(87) WO2011047149, 14.10.2010
(97) 2398557, 28.12.2011 en
- (54) POWER SUPPLY FOR LIGHT-BASED DERMATOLOGIC TREATMENT DEVICE
- (71) Shaser, Inc., 130 New Boston Street Suite 201, Woburn, MA 01801, US
- (72) OWENS, William, 8 Lomas Circle, Framingham, MA 01701, US
AARON, Arthur, 68 Gray Street, Arlington, MA 02476, US
ELY, Douglas, 386 Great Pond Road, North Andover, MA 01845, US
YONJAN, Bikram, 72 Oxford Street Unit 1B, Somerville, MA 02143, US
LAZAREV, Victor, 7 DUBY Drive, Billerica, MA 01821, US
-
- (51) MKP
A23L 1/30 (2006.01) (97) **2457576**
C12R 1/225 (2006.01)
A61P 19/06 (2006.01)
A61K 35/74 (2006.01)
- (96) 10460047.3 30.05.2012
(97) 2457576, 30.05.2012 en
- (54) New Lactobacillus reuteri strain useful in medical and veterinary prophylaxis and treatment
- (71) Eurochit Danuta Kruszewska, Al. Wilanowska 43 m 5, 02-765 Warszawa, PL
- (72) Kruszewska, Danuta, Al. Wilanowska 43 m 5, 02-765 Warszawa, PL
-
- (51) MKP
A61K 33/42 (2006.01) (97) **2411022 ***
- (86) US2010028962 26.03.2010
(96) 10756972.5 01.02.2012
(87) WO2010111681, 26.03.2010
(97) 2411022, 01.02.2012 en
- (54) COMPOSITIONS FOR BOWEL PREPARATION AND METHODS OF USE THEREOF
- (71) Salix Pharmaceuticals, Ltd., 8510 Colonnade Center Drive, Raleigh, NC 27615, US
- (72) PATTON, Stephana, 894 De Haro St., San Francisco CA 94107, US
-
- (51) MKP
C07K 16/28 (2006.01) (97) **2478012 ***
A61P 37/06 (2006.01)
- (86) EP2010005225 26.08.2010
(96) 10751563.7 25.07.2012
(87) WO2011032633, 26.08.2010
(97) 2478012, 25.07.2012 en
- (54) TREATMENT OF AUTOIMMUNE AND INFLAMMATORY DISEASES WITH EPRATUZUMAB
- (71) UCB Pharma S.A., Intellectual Property Department Allée de la Recherche 60, 1070 Brussels, BE
- (72) NOVOTNEY-BARRY, Anna-Marie, 86 Glen Cove Drive, Cartersville GA 30120, US
HULHOVEN, Réginald, 5A Meerbeeksesteenweg, B-3020 Veltem-Beisem, BE
PARKER, Gerald, L., 1 Ship Orchard Sutton Road Cookham, Berkshire SL6 9SY, GB
HOSKIN, Violet, A., 5720 Dornick Drive SW, Lilburn GA 30047, US
-
- (51) MKP
G01N 33/50 (2006.01) (97) **2491384 ***
- (86) EP2010065618 18.10.2010
(96) 10765465.9 29.08.2012
(87) WO2011048044, 18.10.2010
(97) 2491384, 29.08.2012 en
- (54) SYSTEM FOR DETERMINING UNPROCESSED AND PARTIALLY PROCESSED NEUROTOXIN TYPE A
- (71) Merz Pharma GmbH & Co. KGaA, Eckenheimer Landstrasse 100, 60318 Frankfurt am Main, DE
- (72) TAYLOR, Harold V., An den Drei Hohen 76, 60435 Frankfurt am Main, DE
EISELE, Karl-Heinz, Parlamentsplatz 2b, 60385 Frankfurt am Main, DE
BRÜNN, Cornelia, Gabriel-Max-Strasse 15, 10245 Berlin, DE

(51) MKP
A62B 17/00 (2006.01) (97) **2392386**
A62B 18/08 (2006.01)
(96) 11002828.9 07.12.2011
(97) 2392386, 07.12.2011 de
(54) View pane of a protective suit
(71) Tesimax - Altinger GmbH, Leimenstrasse 2, 75242 Neuhausen-Steinegg, DE
(72) Altinger, Sven, Bunsenstr. 30, 75173 Pforzheim, DE

(51) MKP
A61M 5/32 (2006.01) (97) **2403569 ***
(86) EP2010052786 04.03.2010
(96) 10706657.3 11.01.2012
(87) WO2010100241, 04.03.2010
(97) 2403569, 11.01.2012 en
(54) DRUG DELIVERY DEVICE WITH RETRACTABLE NEEDLE
(71) Sanofi-Aventis Deutschland GmbH, Brünningstraße 50, 65929 Frankfurt, DE
(72) LANIN, Irina, c/o Sanofi-Aventis Deutschland GmbH, 65926 Frankfurt am Main, DE
FORYS, Bernhard, c/o Sanofi-Aventis Deutschland GmbH, 65926 Frankfurt am Main, DE
CLARKE, Alastair, c/o Sanofi-Aventis UK London Road Crewe, Holmes Chapel Cheshire CW4 8BE, GB
EKMAN, Matthew, c/o Sanofi-Aventis UK London Road Crewe, Holmes Chapel Cheshire CW4 8BE, GB
GOODE, Kirsten, c/o Sanofi-Aventis UK London Road Crewe, Holmes Chapel Cheshire CW4 8BE, GB
HEALD, Michael, c/o Sanofi-Aventis UK London Road Crewe, Holmes Chapel Cheshire CW4 8BE, GB
HILES, John, c/o Sanofi-Aventis UK London Road Crewe, Holmes Chapel Cheshire CW4 8BE, GB
SMITH, Chris, c/o Sanofi-Aventis UK London Road Crewe, Holmes Chapel Cheshire CW4 8BE, GB
HAINS-GADD, Lilly, Treliske Queens Close, Oxford Oxfordshire OX2A 4HN, GB

(51) MKP
H01M 8/24 (2006.01) (97) **2337133**
H01M 8/02 (2006.01)
(96) 10180737.8 22.06.2011
(97) 2337133, 22.06.2011 en
(54) Fluid flow plate assemblies
(71) Industrial Technology Research Institute, No. 195, Sec. 4, Chung Hsing Road, Chutung, Hsinchu 31040, TW
(72) Chen, Chi-Chang, No. 180, Sec. 2, Yuanlu Rd. Puxin Township, 513, Taiwan, Changhua County, TW
Shiu, Huan-Ruei, No. 39, Donghu Village Cimei Township, 883, Taiwan, Penghu County, TW
Chang, Wen-Chen, 4F., No. 892, Sec. 4, Zhongxing Rd., Zhudong Township, 310, Taiwan, Hsinchu County, TW
Tsau, Fanghei, 4F., No. 6, Lane 54, Siwei 2nd Rd., Lingya Dist., 802, Taiwan, Kaohsiung City, TW
Jung, Shiqah-Ping, No. 98, Lane 668, Sec. 2, Zhongshan E. Rd. Xinxu Township, 327, Taiwan, Taoyuan County, TW

(51) MKP
A61K 39/15 (2006.01) (97) **2473190 ***
(86) US2010047096 30.08.2010
(96) 10752232.8 11.07.2012
(87) WO2011028652, 30.08.2010
(97) 2473190, 11.07.2012 en
(54) HETEROLOGOUS PRIME-BOOST IMMUNIZATION REGIMEN AGAINST BLUETONGUE VIRUS
(71) Wyeth LLC, Five Giralda Farms, Madison, NJ 07940, US
(72) BARTRAM, David James, 43 Leafy Lane Whiteley, Fareham Hampshire P015 7HL, GB

(51) MKP
G06T 11/60 (2006.01) (97) **2495645 ***
G06F 3/048 (2006.01)
(86) JP2010068740 22.10.2010
(96) 10826645.3 05.09.2012
(87) WO2011052513, 22.10.2010
(97) 2495645, 05.09.2012 en
(54) OBJECT CONTROL METHOD FOR DISPLAYING OBJECTS IN FRONT OF LINK ELEMENTS
(71) Rakuten, Inc., 4-12-3, Higashishinagawa Shinagawa-ku, Tokyo 140-0002, JP
(72) SUZUKI Hisashi, c/o Rakuten Inc. 4-12-3 Higashishinagawa Shinagawa-ku, Tokyo 140-0002, JP
MASUKO Soh, c/o Rakuten Inc. 4-12-3 Higashishinagawa Shinagawa-ku, Tokyo 140-0002, JP

(51) MKP
A01N 57/00 (2006.01) (97) **2485595 ***
(86) US2010050328 27.09.2010
(96) 10822429.6 15.08.2012
(87) WO2011043942, 27.09.2010
(97) 2485595, 15.08.2012 en
(54) COMBINATION THERAPY USING A BETA 3 ADRENERGIC RECEPTOR AGONIST AND AN ANTIMUSCARINIC AGENT
(71) Merck Sharp & Dohme Corp., 126 East Lincoln Avenue, Rahway NJ 07065-0907, US
(72) NAGABUKURO, Hiroshi, 33 Avenue Louis Pasteur, Boston Massachusetts 02115-5727, US
EDMONDSON, Scott, D., 126 East Lincoln Avenue, Rahway New Jersey 07065-0907, US
SINHAROY, Mary, Struthers, 126 East Lincoln Avenue, Rahway New Jersey 07065-0907, US
DENNEY, William, S., 770 Sumneytown Pike, West Point Pennsylvania 19486, US
FRENKL, Tara, L., P.O. Box 1000, Upper Gwynedd Pennsylvania 19454, US

(51) MKP
C07D 239/47 (2006.01) (97) **2448927 ***
C07D 413/12 (2006.01)
A61K 31/513 (2006.01)
A61K 31/5377 (2006.01)
C07D 403/12 (2006.01)
C07D 403/10 (2006.01)
A61P 35/00 (2006.01)
C07D 409/12 (2006.01)
C07D 413/06 (2006.01)
C07D 239/36 (2006.01)
C07D 403/06 (2006.01)
(86) FR2010051375 01.07.2010
(96) 10742014.3 09.05.2012
(87) WO2011001114, 01.07.2010
(97) 2448927, 09.05.2012 fr
(54) NOVEL (6-OXO-1, 6-DIHYDRO-PYRIMIDIN-2-YL)-AMIDE DERIVATIVES, PREPARATION THEREOF, AND PHARMACEUTICAL USE THEREOF AS AKT(PKB) PHOSPHORYLATION INHIBITORS
(71) SANOFI, 54 rue La Boétie, 75008 Paris, FR
(72) CARRY, Jean-Christophe, c/o Sanofi Département Brevets 174 Avenue de France, F-75013 Paris, FR
CERTAL, Victor, c/o Sanofi Département Brevets 174 Avenue de France, F-75013 Paris, FR
HALLEY, Frank, c/o Sanofi Département Brevets 174 Avenue de France, F-75013 Paris, FR
KARLSSON, Karl Andreas, c/o Sanofi Département Brevets 174 Avenue de France, F-75013 Paris, FR
SCHIO, Laurent, c/o Sanofi Département Brevets 174 Avenue de France, F-75013 Paris, FR
THOMPSON, Fabienne, c/o Sanofi Département Brevets 174 Avenue de France, F-75013 Paris, FR

- (51) MKP
C07D 333/34 (2006.01) (97) **2414343 ***
C07D 513/04 (2006.01)
- (86) EP2010053216 12.03.2010
(96) 10709204.1 08.02.2012
(87) WO2010103115, 12.03.2010
(97) 2414343, 08.02.2012 en
(54) PROCESS FOR PREPARING BRINZOLAMIDE
(71) Azad Pharmaceutical Ingredients AG, Friedbergstrasse 68, 8200 Schaffhausen, CH
(72) RAMAKRISHNAN, Arul, A-2, CSR Jubilant Residency Uma nagar Street No. 1 Kundenbagh Begumpet Andhra Pradesh, Hyderabad 500 016, IN
SONI, Anil Kumar, H.No. 5-1-41 Gowliguda Near Rammandir Andhra Pradesh, Hyderabad 500 095, IN
ADHIKARI, Sujit Das, Sahara apartments Talbanagar more Krishnapur Westbengal, Kolkotta 700 101, IN
RAO, Kommula Srinivasa, S/O Venkateshwara rao Pedapatnam Via-tatipaka Andhra Pradesh, EastGodavari district 533 249, IN
PAUL, Soumendu, 46 Meridian Enclave Nizampet Road, Hyderabad 500 085, IN
SRINIVASULU, Ganta, Plot no. 32 Sriram Nagar colony ECILX Road Kappra, Hyderabad, IN
-
- (51) MKP
H04W 24/10 (2009.01) (97) **2461621 ***
- (86) CN2010075589 30.07.2010
(96) 10803918.1 06.06.2012
(87) WO2011012085, 30.07.2010
(97) 2461621, 06.06.2012 en
(54) MEASUREMENT METHOD AND DEVICE FOR WIRELESS NETWORK COMMUNICATION SYSTEM
(71) China Academy of Telecommunications Technology, 40, Xueyuan Road, Haidian District, Beijing 100191, CN
(72) WANG, Yan, No. 40 Xueyuan Road Haidian District, Beijing 100083, CN
ZHAO, Jinbo, No. 40 Xueyuan Road Haidian District, Beijing 100083, CN
LIU, Meili, No. 40 Xueyuan Road Haidian District, Beijing 100083, CN
YANG, Xiaodong, No. 40 Xueyuan Road Haidian District, Beijing 100083, CN
-
- (51) MKP
H02K 7/18 (2006.01) (97) **2462258 ***
C25B 1/04 (2006.01)
F01D 1/00 (2006.01)
F01D 7/02 (2006.01)
H01M 8/08 (2006.01)
H01M 8/22 (2006.01)
F01D 17/06 (2006.01)
C25B 1/02 (2006.01)
F01D 25/30 (2006.01)
F01D 15/10 (2006.01)
- (86) AU2010000977 03.08.2010
(96) 10805875.1 13.06.2012
(87) WO2011014910, 03.08.2010
(97) 2462258, 13.06.2012 en
(54) ELECTROLYSIS CELL AND ELECTRICAL POWER UNIT INCORPORATING SAME
(71) Craft Holdings Wa Pty Ltd, Lot 106 Ti Tree Glen, Quinninup, Western Australia 6258, AU
(72) CRAFT, John Wayne, Lot 106 Ti Tree Glen, Quinninup Western Australia 6258, AU
-
- (51) MKP
H04N 1/00 (2006.01) (97) **2474155 ***
- (86) IB2010002558 02.09.2010
(96) 10773148.1 11.07.2012
(87) WO2011027227, 02.09.2010
(97) 2474155, 11.07.2012 en
(54) METHOD AND SYSTEM FOR DISPLAYING, MANAGING AND SELLING DIGITAL IMAGES
(71) Image Holdings, P.O. Box 10310 APO, Grand Cayman, KY1-1003, KY
(72) SMITH, Caine, P.O. Box 10310 APO, Grand Cayman KY1-1003, KY
BRYNLEY, Davies, P.O. Box 10310 APO, Grand Cayman KY1-1003, KY
-
- (51) MKP
A43B 23/24 (2006.01) (97) **2467038 ***
A44C 25/00 (2006.01)
A44C 27/00 (2006.01)
- (86) US2010045380 12.08.2010
(96) 10808787.5 27.06.2012
(87) WO2011019961, 12.08.2010
(97) 2467038, 27.06.2012 en
(54) RECONFIGURABLE SHOES AND APPAREL AND DOCKING ASSEMBLY THEREFOR
(71) Code Footwear, LLC, 11 N Vista de Catalina, Laguna Beach, California 92651, US
(72) SULLIVAN, Benjamin David, 5220 Fiore Terrace M406, San Diego California 92122, US
TRUITT, Nicole Justis, 7823 Camino Huerta, San Diego California 92122, US
-
- (51) MKP
A61K 31/506 (2006.01) (97) **2493878 ***
C07D 403/14 (2006.01)
A61K 31/497 (2006.01)
A61P 25/04 (2006.01)
C07D 401/14 (2006.01)
- (86) US2010054469 28.10.2010
(96) 10776874.9 05.09.2012
(87) WO2011053696, 28.10.2010
(97) 2493878, 05.09.2012 en
(54) PYRAZINES AS DELTA OPIOID RECEPTOR MODULATORS
(71) Janssen Pharmaceutica NV, Turnhoutseweg 30, 2340 Beerse, BE
(72) CONNOLLY, Peter, J., Welsh&Mckean Roads P.o. Box 776, Spring House, PA 19477, US
LIN, Shu-chen, 4895 Redfield Road, Doylestown, PA 18902, US
MACIELAG, Mark, J., Welsh&Mckean Roads P. O. Box 776, Spring House, PA 19477, US
ZHANG, Yue-mei, Welsh&Mckean Roads P. O. Box 776, Spring House, PA 19477, US
-
- (51) MKP
C07K 16/28 (2006.01) (97) **2421898 ***
G01N 33/574 (2006.01)
- (86) US2010031719 20.04.2010
(96) 10714548.4 29.02.2012
(87) WO2010123874, 20.04.2010
(97) 2421898, 29.02.2012 en
(54) ANTIBODIES SPECIFIC TO CADHERIN-17
(71) Oxford Biotherapeutics Ltd., 94A Milton Park, Abingdon, Oxon OX14 4RY, GB
(72) ROHLFF, Christian, Oxford BioTherapeutics Ltd. 94a Milton Park Abingdon, Oxon OX14 4RY, GB
TERRETT, Jonathan, Alexander, Oxford BioTherapeutics Inc. San Jose Biocenter 5941 Optical Court, San Jose, CA 95138, US
-
- (51) MKP
A01B 33/08 (2006.01) (97) **2232972**
- (96) 10156932.5 29.09.2010
(97) 2232972, 29.09.2010 en
(54) Rotary harrow
(71) Maschio Gaspardo S.p.A., Via Marcello 73, 35011 Campodarsego (PD), IT
(72) Maschio, Egidio, via Marcello, 38, 35011, Campodarsego (PD), IT
-
- (51) MKP
A61K 9/28 (2006.01) (97) **2410997 ***
A61K 9/16 (2006.01)
A61K 9/00 (2006.01)
- (86) GB2010000538 23.03.2010
(96) 10722162.4 01.02.2012
(87) WO2010109180, 23.03.2010
(97) 2410997, 01.02.2012 en
(54) COMPOSITION FOR THE ADMINISTRATION OF POLYMERIC DRUGS
(71) NTNU Technology Transfer AS, Sem Sælands vei 14, 7491 Trondheim, NO
(72) DRAGET, Kurt, Ingar, NTNU Technology Transfer AS Klaebuveien 153, N-7491 Trondheim, NO
TAYLOR, Catherine, NTNU Technology Transfer AS Klaebuveien 153, N-7491 Trondheim, NO

- (51) MKP
F02M 47/02 (2006.01) (97) **2290220**
F02M 63/00 (2006.01)
(96) 10171128.1 02.03.2011
(97) 2290220, 02.03.2011 en
(54) Fuel injector
(71) Delphi Technologies Holding S.à.r.l., Avenue de Luxembourg, 4940 Bascharage, LU
(72) Harcombe, Anthony, 1 Warren Avenue, Richmond, Surrey TW10 5DZ, GB
Hackett, Mervyn, 10 Canon Pugh Drive, Sudbury, Suffolk CO10 0UX, GB
Limmer, Andrew, Church House The Street, Bury St Edmunds, Suffolk IP29 4PA, GB
Harper, Mark, 25 Worcester Close, Hagley, Stourbridge, Worcestershire DY9 0NP, GB
Graham, Mark, 11A Druid Hill, Stoke Bishop, Bristol BS9 1EW, GB
-
- (51) MKP
B65G 47/82 (2006.01) (97) **2403788 ***
B65G 17/26 (2006.01)
(86) IB2010000413 01.03.2010
(96) 10732413.9 11.01.2012
(87) WO2010100543, 01.03.2010
(97) 2403788, 11.01.2012 en
(54) PLANT WITH A TRANSFERRING SHUTTLE FOR FEEDING PRODUCTS TO A PACKAGING MACHINE
(71) Eurosicma S.p.A., Via Arbe 27, 20125 Milano, IT
(72) REDAELLI, Marco, Via Gramsci 16, 20060 Cassina de' Pecchi, IT
-
- (51) MKP
B01D 35/143 (2006.01) (97) **2467332 ***
B01D 35/153 (2006.01)
C02F 1/00 (2006.01)
(86) IL2010000741 07.09.2010
(96) 10763864.5 27.06.2012
(87) WO2011030340, 07.09.2010
(97) 2467332, 27.06.2012 en
(54) LIQUID FILTER DEVICE
(71) Strauss Water Ltd, 49 Ha'Sivim Street, Petach Tikva 49517, IL
(72) WILDER, Haim, 7 Yehuda Halevi Street, 43555 Raanana, IL
RONEN, Rami, 12 HaGichon Street, 47204 Ramat HaSharon, IL
KRYSTAL, Eyal, 19/17 Hachia Street, 44250 Kfar Saba, IL
HIL LEL, Shlomo, Daphna 4, 71700 Modiin, IL
-
- (51) MKP
D06M 10/00 (2006.01) (97) **2406422 ***
(86) US2010026607 09.03.2010
(96) 10751261.8 18.01.2012
(87) WO2010104820, 09.03.2010
(97) 2406422, 18.01.2012 en
(54) ELECTRON BEAM WEB IRRADIATION APPARATUS AND PROCESS
(71) PCT Engineered Systems, LLC, 8700 Hillandale Road, Davenport, IA 52806, US
(72) DRENTER, John, 22124 Territorial Road, Davenport IA 52807-9703, US
-
- (51) MKP
C07D 405/12 (2006.01) (97) **2454243 ***
C07D 413/12 (2006.01)
C07D 417/12 (2006.01)
A61P 37/00 (2006.01)
A61K 31/41 (2006.01)
C07D 409/12 (2006.01)
C07D 257/04 (2006.01)
(86) EP2010060151 14.07.2010
(96) 10730193.9 23.05.2012
(87) WO2011006935, 14.07.2010
(97) 2454243, 23.05.2012 en
(54) TETRAZOLE DERIVATIVES
(71) Merck Serono SA, Centre Industriel, 1267 Coinsins, Vaud, CH
(72) CROSIGNANI, Stefano, 2 chemin de Champs-Fusy, F-01630 St Genis-Pouilly, FR
CLEVA, Christophe, Chez les Maures, F-74250 La Tour, FR
QUATTROPANI, Anna, Route de Chêne 2, Geneva 1207, CH
DESFORGES, Gwenaëlle, 23 rue du Salève, F-74100 Annemasse, FR
BOMBRUN, Agnes, 71 chemin des Cornillons, CH-1292 Chambesy, CH
-
- (51) MKP
A61K 31/555 (2006.01) (97) **2338495**
A61K 33/26 (2006.01)
A61P 7/06 (2006.01)
(96) 10192857.0 29.06.2011
(97) 2338495, 29.06.2011 en
(54) Iron bis-glycinate chelate for use in the oral treatment of anemia in patients with celiac disease
(71) Laboratori Baldacci S.P.A., Via San Michele degli Scalzi, 73, 56124 Pisa, IT
(72) Ame', Claudio Aldo, Via Carisio, 15, 10143 Torino, IT
Baldacci, Massimo, Via San Michele degli Scalzi, 73, 56124 Pisa, IT
-
- (51) MKP
E06B 3/02 (2006.01) (97) **2436865**
E06B 3/66 (2006.01)
(96) 10186396.7 04.04.2012
(97) 2436865, 04.04.2012 en
(54) Window
(71) Inles d.d., Kolodvorska ulica 22, 1310 Ribnica, SI
(72) Urh, Dusan, Cesta Notranjskega odreda 50, 1317 Sodrazica, SI
Frlil, Josef, Gersdorf 105, 8212 Pischelsdorf, AT
-
- (51) MKP
F23G 5/027 (2006.01) (97) **2478070 ***
C08J 11/00 (2006.01)
C10G 1/10 (2006.01)
B01D 11/04 (2006.01)
C10L 1/02 (2006.01)
(86) US2010049050 16.09.2010
(96) 10817806.2 25.07.2012
(87) WO2011034989, 16.09.2010
(97) 2478070, 25.07.2012 en
(54) DECOMPOSITION OF WASTE PLASTICS
(71) Envion Inc., 1027 33rd Street N.W., Washington, DC 20007, US
(72) MA, Myung, Duck, 510 S. Burnside Avenue Apartment 4E, Los Angeles, CA 90036, US
-
- (51) MKP
A61K 31/455 (2006.01) (97) **2413936 ***
A61K 31/513 (2006.01)
A61K 45/06 (2006.01)
A61K 47/48 (2006.01)
C07D 239/46 (2006.01)
(86) EP2010053970 26.03.2010
(96) 10711061.1 08.02.2012
(87) WO2010112411, 26.03.2010
(97) 2413936, 08.02.2012 en
(54) CO-CRYSTAL OF ETRAVIRINE AND NICOTINAMIDE
(71) Tibotec Pharmaceuticals, Eastgate Village Eastgate Little Island, Co Cork, IE
(72) SANSONE, Matthew F., 29 Hartwell Avenue, Lexington MA 02421, US
TAWA, Mark, 45 Flint Road, Acton MA 01720, US
REMENAR, Julius F., 65 Prospect St., Framingham MA 01701, US
BAERT, Lieven Elvire Colette, Jozef Van Wallegemstraat 11, B-8200 Brugge 2, BE
-
- (51) MKP
C07K 16/10 (2006.01) (97) **2430047 ***
(86) US2010034604 12.05.2010
(96) 10719210.6 21.03.2012
(87) WO2010132604, 12.05.2010
(97) 2430047, 21.03.2012 en
(54) NEUTRALIZING MOLECULES TO INFLUENZA VIRUSES
(71) Sea Lane Biotechnologies, Ilc., 356 Selby Lane, Atherton, CA 94027, US
(72) HOROWITZ, Lawrence, 362 Selby Lane, Atherton CA 94027, US
BHATT, Ramesh, 2729 Waltham Cross, Belmont CA 94002, US
KASHYAP, Arun, 35288 Sevem Drive, Newark CA 94560, US

- (51) MKP
B24D 3/34 (2006.01) (97) **2470330 ***
B24D 18/00 (2006.01)
B24B 7/22 (2006.01)
B24D 7/14 (2006.01)
(86) IB2010053281 19.07.2010
(96) 10740384.2 04.07.2012
(87) WO2011024086, 19.07.2010
(97) 2470330, 04.07.2012 en
(54) METHOD OF OBTAINING A TOOL FOR WORKING STONE MATERIALS
(71) Aros S.r.l., Via Einaudi 4/1E, 37010 Affi (Verona), IT
(72) Fioratti, Stefano, Via delle Mimose, I-25015 Desenzano - Bresica, IT
-
- (51) MKP
E04H 17/14 (2006.01) (97) **2336459**
E04F 11/18 (2006.01)
(96) 10192769.7 22.06.2011
(97) 2336459, 22.06.2011 en
(54) Orientable pickets fence assembly
(71) Ceccato, Nicola, Via Mohringen 15/C, 35041 Battaglia Terme, IT
Trolese, Igor, Via Attilano Oliveros 10, 35037 Teolo, IT
(72) Ceccato, Nicola, Via Mohringen 15/C, 35041 Battaglia Terme, IT
Trolese, Igor, Via Attilano Oliveros 10, 35037 Teolo, IT
-
- (51) MKP
A47K 4/00 (2006.01) (97) **2260749**
(96) 10165497.8 15.12.2010
(97) 2260749, 15.12.2010 en
(54) Modular toilet.
(71) Vaccari, Albano, Via S. Francesco d'Assisi n. 46, 47023 Cesena (FC), IT
(72) Vaccari, Albano, Via S. Francesco d'Assisi n. 46, 47023 Cesena (FC), IT
-
- (51) MKP
C10M 107/02 (2006.01) (97) **2406355 ***
C10G 9/00 (2006.01)
C08K 5/01 (2006.01)
C10G 11/00 (2006.01)
C10M 101/02 (2006.01)
C09J 183/04 (2006.01)
C08K 5/09 (2006.01)
C10G 45/58 (2006.01)
C08K 5/101 (2006.01)
C10G 47/00 (2006.01)
C08L 83/04 (2006.01)
C09D 7/06 (2006.01)
C09D 127/06 (2006.01)
(86) FR2010050425 11.03.2010
(96) 10716381.8 18.01.2012
(87) WO2010103244, 11.03.2010
(97) 2406355, 18.01.2012 fr
(54) LOW VOC HYDROCARBON DILUENT FOR CONSTRUCTION MATERIALS
(71) Total Raffinage Marketing, 24 Cours Michelet, 92800 Puteaux, FR
(72) WESTELYNCK, Antoine, 15 rue du Vexin, 78440 Brueil en Vexin, FR
-
- (51) MKP
G01N 1/31 (2006.01) (97) **2425227 ***
(86) US2010032510 27.04.2010
(96) 10719677.6 07.03.2012
(87) WO2010126866, 27.04.2010
(97) 2425227, 07.03.2012 en
(54) SAMPLE PREPARATION DEVICE AND ASSOCIATED METHOD
(71) Becton, Dickinson and Company, 1 Becton Drive, Franklin Lakes, NJ 07417, US
(72) FOX, William, Alan, 2729 Edgewood Ave., Burlington NC 27215, US
WILLIAMS, Ryan, Carl, 1424 Woodland Dr., Durham NC 27701, US
LANGHOFF, Brian, Reuben, 6218 Nat Rd., Julian NC 27283, US
-
- (51) MKP
A61M 5/315 (2006.01) (97) **2437822 ***
A61M 5/00 (2006.01)
(86) EP2010057491 28.05.2010
(96) 10722100.4 11.04.2012
(87) WO2010139644, 28.05.2010
(97) 2437822, 11.04.2012 en
(54) MEDICAMENT IDENTIFICATION SYSTEM FOR MULTI-DOSE INJECTION DEVICES
(71) Sanofi-Aventis Deutschland GmbH, Brüningstraße 50, 65929 Frankfurt, DE
(72) PLUMPTRE, David, 36 Shire Way Droitwich Spa, Worcestershire WR9 7RQ, GB
SMITH, Chris, c/o Sanofi-Aventis UK London Road Holmes Chapel, Cheshire CW48BE, GB
-
- (51) MKP
E03C 1/02 (2006.01) (97) **2480362 ***
B23B 47/28 (2006.01)
(86) US2010049621 21.09.2010
(96) 10819321.0 01.08.2012
(87) WO2011037906, 21.09.2010
(97) 2480362, 01.08.2012 en
(54) METHOD AND TEMPLATE FOR PRODUCING A TENSILE TEST COUPON
(71) McElroy Manufacturing, Inc., 833 North Fulton, Tulsa, Oklahoma 74115, US
(72) LAWRENCE, Jason A., 10904 East 98th Street North, Owasso, Oklahoma 74055, US
PERRAULT, James R., 215 E. 25th Street, Tulsa, Oklahoma 74114, US
O'CONNELL, Brian, 2811 South 100th East Avenue, Tulsa, Oklahoma 74129, US
-
- (51) MKP
A61K 39/395 (2006.01) (97) **2424566 ***
C12P 21/06 (2006.01)
(86) US2010033246 30.04.2010
(96) 10770449.6 07.03.2012
(87) WO2010127294, 30.04.2010
(97) 2424566, 07.03.2012 en
(54) DUAL VARIABLE DOMAIN IMMUNOGLOBULINS AND USES THEREOF
(71) Abbott Laboratories, 100 Abbott Park Rd., Abbott Park, IL 60064, US
(72) GHAYUR, Tariq, 1014 Washington Street, Holliston Massachusetts 01746, US
BROPHY, Susan E., 2477 Mallard Drive, Lindenhurst Illinois 60046, US
DEVARE, Sushil G., 2492 Farnsworth Lane, Northbrook Illinois 60062, US
GRENIER, Frank C., 218 South Second Avenue, Libertyville Illinois 60048, US
MOORE, Jeffrey A., 1578 Vineyard Drive, Gurnee Illinois 60031, US
RUAN, Qiaoqiao, 2629 West Autumn Drive, Round Lake Illinois 60073, US
TETIN, Sergey Y., 2680 Constitution Drive, Lindenhurst Illinois 60046, US
STEINHAUS, Jennifer M., 1104 Fairlawn Avenue, Libertyville Illinois 60048, US
LIU, Junjian, 14 Crimson Drive, Shrewsbury Massachusetts 01545, US
ALI, Saiman, 5 Kingman Lane, Hoffman Estates IL 60160, US
SYED, Hina, N., 1164 Vista Drive, Gurnee IL 60031, US
-
- (51) MKP
C07D 295/26 (2006.01) (97) **2421838 ***
(86) US2010031833 21.04.2010
(96) 10714823.1 29.02.2012
(87) WO2010123960, 21.04.2010
(97) 2421838, 29.02.2012 en
(54) ARYLSULFONAMIDE CCR3 ANTAGONISTS
(71) Axikin Pharmaceuticals, Inc., 10835 Road to the Cure, Suite 250, San Diego, CA 92121, US
(72) LY, Tai, Wei, 10824 Caminito Colorado, San Diego CA 92131, US
FORRESTER, Jared, Andrew, 968 Country Club Parkway, Castle Rock CO 80108, US

(51) MKP
A61F 13/15 (2006.01) (97) **2238955**
 (96) 10250726.6 13.10.2010
 (97) 2238955, 13.10.2010 en
 (54) Methods and apparatus for application of nested zero waste ear to traveling web
 (71) Curt G. Joa, Inc., 100 Crocker Avenue, Sheboygan Falls, Wisconsin 53085, US
 (72) McCabe, John, 1141 Partridge Run, Sheboygan Falls Wisconsin 53085, US
 Fritz, Jeff, N4989 Country Aire Road, Plymouth Wisconsin 53073, US
 Andrews, Robert E., N7488 Sunset Circle Drive, Sheboygan Wisconsin 53083, US

(51) MKP
H02B 13/055 (2006.01) (97) **2443712 ***
 (86) EP2010058317 14.06.2010
 (96) 10722374.5 25.04.2012
 (87) WO2010146022, 14.06.2010
 (97) 2443712, 25.04.2012 en
 (54) FLUORINATED KETONES AS A HIGH-VOLTAGE INSULATING MEDIUM
 (71) Ormazabal Anlagentechnik GmbH, Am Neuerhof 31, 47804 Krefeld, DE
 (72) GLASMACHER, Peter, Am Kerper Weiher 11a, 41352 Korschenbroich, DE

(51) MKP
F21Y 101/02 (2006.01) (97) **2401543 ***
F21V 29/00 (2006.01)
F21S 8/08 (2006.01)
F21V 15/01 (2006.01)
 (86) EP2010002031 30.03.2010
 (96) 10717521.8 04.01.2012
 (87) WO2010112205, 30.03.2010
 (97) 2401543, 04.01.2012 de
 (54) OUTDOOR LIGHTING UNIT
 (71) Vishay Electronic GmbH, Geheimrat-Rosenthal-Strasse 100, 95100 Selb, DE
 (72) DINC, Mustafa, Hegelmaierstrasse 1, 74076 Heilbronn, DE
 PIEPER, Norbert, Gausstrasse 3, 95100 Selb, DE
 SCHNORRENBURG, Gerd, Moorbachstrasse 44, 53949 Dahlem, DE

(51) MKP
A61K 38/17 (2006.01) (97) **2475427 ***
A61P 21/00 (2006.01)
A61P 19/08 (2006.01)
A61K 38/18 (2006.01)
 (86) US2010048322 09.09.2010
 (96) 10816109.2 18.07.2012
 (87) WO2011031901, 09.09.2010
 (97) 2475427, 18.07.2012 en
 (54) ACTRIIB ANTAGONISTS AND DOSING AND USES THEREOF
 (71) Acceleron Pharma, Inc., 128 Sidney Street, Cambridge, MA 02139, US
 (72) SEEHRA, Jasbir, 3 Lincoln Terrace, Lexington MA 02421-6818, US
 KNOPF, John, 147 Robbins Drive, Carlisle MA 01741, US
 ATTIE, Ken, 228 Marlborough Street, Boston, MA 02116, US

(51) MKP
A61K 31/702 (2006.01) (97) **2405918 ***
A61P 1/06 (2006.01)
A61P 1/14 (2006.01)
 (86) US2010027206 12.03.2010
 (96) 10751504.1 18.01.2012
 (87) WO2010105207, 12.03.2010
 (97) 2405918, 18.01.2012 en
 (54) PREBIOTIC OLIGOSACCHARIDES
 (71) DSM Food Specialties USA Inc., 45 Waterview Boulevard, Parsippany, New Jersey 07054, US
 The Regents of the University of California, 1111 Franklin Street, 12th Floor, Oakland, CA 94607-5200, US
 (72) BARBOZA, Mariana, 1112 Ovejas Avenue, Davis California 95616, US
 GERMAN, J. Bruce, 1001 Oeste Drive, Davis California 95616, US
 LEBRILLA, Carlito B., 3035 Mallorca Lane, Davis California 95618, US
 MILLS, David A., 1703 Colorado Lane, Davis California 95616, US
 FREEMAN, Samara, null, Dublin, IE
 KING, William Robert, Walnut Creek, California, US

(51) MKP
F04D 29/08 (2006.01) (97) **2486281 ***
F04D 13/08 (2006.01)
F04D 29/62 (2006.01)
 (86) IB2010054499 05.10.2010
 (96) 10768588.5 15.08.2012
 (87) WO2011042862, 05.10.2010
 (97) 2486281, 15.08.2012 en
 (54) SUBMERGED CENTRIFUGAL ELECTRIC PUMP
 (71) Pedrollo S.p.a., Via Enrico Fermi, 7, 37047 San Bonifacio (Verona), IT
 (72) PEDROLLO, Silvano, C/o Pedrollo S.p.a. Via E. Fermi 7, I-37047 San Bonifacio, IT

(51) MKP
C07C 279/22 (2006.01) (97) **2477962 ***
 (86) GB2010051544 15.09.2010
 (96) 10755227.5 25.07.2012
 (87) WO2011033296, 15.09.2010
 (97) 2477962, 25.07.2012 en
 (54) PRODRUGS OF GUANFACINE
 (71) Shire LLC, 9200 Brookfield Court, Florence, KY 41042, US
 (72) FRANKLIN, Richard, 3 Rosedene Gardens, Fleet Hampshire GU51 4NQ, GB
 TYSON, Robert, G., Holly Lodge, Whitesmocks Durham DH1 4LH, GB
 GOLDING, Bernard, T., 42 Dukesfield Shiremoor, Newcastle upon Tyne Tyne and Wear NE27 0EZ, GB
 WHOMSLEY, Rhys, Shire Pharmaceuticals Hampshire International Business Park, Basingstoke Hampshire RG24 8EP, GB

(51) MKP
C07D 487/04 (2006.01) (97) **2480552 ***
 (86) US2010049471 20.09.2010
 (96) 10763083.2 01.08.2012
 (87) WO2011035231, 20.09.2010
 (97) 2480552, 01.08.2012 en
 (54) 2'-FLUORO SUBSTITUTED CARBA-NUCLEOSIDE ANALOGS FOR ANTIVIRAL TREATMENT
 (71) Gilead Sciences, Inc., 333 Lakeside Drive, Foster City, CA 94404, US
 (72) CHO, Aesop, 1656 Notre Dame Drive, Mountain View, CA 94040, US
 KIM, Choung, U., 1750 Elizabeth Street, San Carlos, CA 94070, US
 METOBO, Samuel, E., 35329 Severn Drive, Newark, CA 94560, US
 RAY, Adrian, S., 19 Pilot Circle, Redwood City, CA 94065, US
 XU, Jie, 812 Rigel Lane, Foster City, CA 94404, US

- (51) MKP
A61M 5/24 (2006.01) (97) **2437813 ***
F16F 1/02 (2006.01)
- (86) EP2010057479 28.05.2010
(96) 10725072.2 11.04.2012
(87) WO2010139635, 28.05.2010
(97) 2437813, 11.04.2012 en
(54) BIASING MECHANISM FOR A CARTRIDGE OF A DRUG DELIVERY SERVICE
- (71) Sanofi-Aventis Deutschland GmbH, Brüningstraße 50, 65929 Frankfurt, DE
(72) PLUMPTRE, David, 36 Shire Way Droitwich Spa, Worcestershire WR9 7RQ, GB
-
- (51) MKP
A61K 31/517 (2006.01) (97) **2416777 ***
A61P 9/00 (2006.01)
A61K 9/00 (2006.01)
- (86) FR2010050672 07.04.2010
(96) 10723222.5 15.02.2012
(87) WO2010116090, 07.04.2010
(97) 2416777, 15.02.2012 fr
(54) THERAPEUTIC APPLICATIONS IN THE CARDIOVASCULAR FIELD OF QUINAZOLINEDIONE DERIVATIVES
- (71) SANOFI, 174, Avenue de France, 75013 Paris, FR
(72) JANIYAK, Philip, c/o sanofi-aventis Département Brevets 174 avenue de France, F-75013 Paris, FR
MARCINIAK, Gilbert, c/o sanofi-aventis Département Brevets 174 avenue de France, F-75013 Paris, FR
NAVE, Jean-François, c/o sanofi-aventis Département Brevets 174 avenue de France, F-75013 Paris, FR
VIVIANI, Fabrice, c/o sanofi-aventis Département Brevets 174 avenue de France, F-75013 Paris, FR
-
- (51) MKP
A61K 31/4985 (2006.01) (97) **2427192 ***
A61P 35/00 (2006.01)
- (86) US2010033825 06.05.2010
(96) 10717440.1 14.03.2012
(87) WO2010129740, 06.05.2010
(97) 2427192, 14.03.2012 en
(54) USE OF OSI-906 FOR TREATING ADRENOCORTICAL CARCINOMA
- (71) OSI Pharmaceuticals, LLC, 1 Bioscience Park Drive, Farmingdale, NY 11735, US
(72) BUCK, Elizabeth A., OSI Pharmaceuticals Inc. Broadhollow Bioscience Park 1 Bioscience Park Drive, Farmingdale, New York 11735, US
STEPHENS, Andrew W., OSI Pharmaceuticals Inc. 2860 Wilderness Place, Boulder, Colorado 80301, US
-
- (51) MKP
C07D 471/04 (2006.01) (97) **2470532 ***
A61P 35/00 (2006.01)
A61K 31/437 (2006.01)
A61P 13/12 (2006.01)
- (86) US2010047013 27.08.2010
(96) 10749745.5 04.07.2012
(87) WO2011025968, 27.08.2010
(97) 2470532, 04.07.2012 en
(54) 1H-PYRAZOLO [3, 4-B]PYRIDINE COMPOUNDS FOR INHIBITING RAF KINASE
- (71) Genentech, Inc., 1 DNA Way, South San Francisco, CA 94080-4990, US
Array Biopharma, Inc., 3200 Walnut Street, Boulder, CO 80301, US
(72) GRADL, Stefan, 1 DNA Way, South San Francisco, California 94080-4990, US
LAIRD, Ellen, 3200 Walnut Street, Boulder, Colorado 80301, US
MORENO, David, 3200 Walnut Street, Boulder, Colorado 80301, US
REN, Li, 3200 Walnut Street, Boulder, Colorado 80301, US
WENGLOWSKY, Steven Mark, 3055 O'Neal Parkway, Boulder, Colorado 80301, US
-
- (51) MKP
A61K 31/519 (2006.01) (97) **2493473 ***
A61P 25/18 (2006.01)
- (86) US2010054807 29.10.2010
(96) 10773821.3 05.09.2012
(87) WO2011053829, 29.10.2010
(97) 2493473, 05.09.2012 en
(54) DOSING REGIMEN ASSOCIATED WITH LONG-ACTING INJECTABLE PALIPERIDONE ESTERS
- (71) Janssen Pharmaceutica NV, Turnhoutseweg 30, 2340 Beerse, BE
(72) LEWYN-BRISCOE, Peter, H., 28 Sibelius Road, Newtown PA 18940, US
GASSMANN-MAYER, Cristiana, 8 Kings Court, Pennington NJ 08534, US
GOPAL, Srihari, 173 Berkley Avenue, Belle Mead NJ 08502, US
HOUGH, David, W., 102 Avonbrook Road, Wallingford PA 19086, US
REMMERIE, Bart, M. M., Tuinwijklaan 59, B-9000 Gent, BE
SAMTANI, Mahesh, N., 2 Sheppard Drive, Flemington NJ 08822, US
-
- (51) MKP
B29K 25/00 (2006.01) (97) **2415826 ***
C08J 9/18 (2006.01)
B29C 44/00 (2006.01)
C08K 3/36 (2006.01)
C08K 5/02 (2006.01)
C08L 25/04 (2006.01)
- (86) JP2010055568 29.03.2010
(96) 10758645.5 08.02.2012
(87) WO2010113874, 29.03.2010
(97) 2415826, 08.02.2012 en
(54) EXPANDABLE POLYSTYRENE RESIN PARTICLES AND PROCESS FOR PRODUCING SAME
- (71) Sekisui Plastics Co., Ltd., 4-4, Nishitenma 2-chome, Kita-ku, Osaka-shi, Osaka 530-0047, JP
(72) SAKAMOTO, Koji, C/O SEKISUI PLASTICS CO. LTD. 1259 Izumi Minakuchi-cho, Koka-shi Shiga 528-0056, JP
YAMADA, Kazumi, C/O SEKISUI PLASTICS CO. LTD. 1259 Izumi Minakuchi-cho, Koka-shi Shiga 528-0056, JP
CHINOMI, Ryosuke, C/O SEKISUI PLASTICS CO. LTD. 1336-2 Shimohemi, Koga-shi Ibaraki 306-0235, JP
-
- (51) MKP
C08L 9/00 (2006.01) (97) **2345695**
C08L 23/10 (2006.01)
- (96) 11000110.4 20.07.2011
(97) 2345695, 20.07.2011 de
(54) Elastomer-modified thermoplastic compound
- (71) Fraunhofer-Gesellschaft zur Förderung der angewandten Forschung e.V., Hansastrasse 27c, 80686 München, DE
(72) Hintemann, Damian, Richters Kamp 95, 48703 Stadtlohn, DE
Wack, Holger, Hüttemannstraße 40, 44137 Dortmund, DE
Berling, Jürgen, Meinbergsstraße 49, 44269 Dortmund, DE
-
- (51) MKP
C12Q 1/68 (2006.01) (97) **2403959 ***
- (86) EP2010052554 01.03.2010
(96) 10705608.7 11.01.2012
(87) WO2010100113, 01.03.2010
(97) 2403959, 11.01.2012 en
(54) BANK1 RELATED SNPS AND SLE AND/OR MS SUSCEPTIBILITY
- (71) Merck Serono S.A., Centre Industriel, 1267 Coinsins, CH
(72) WOJCIK, Jérôme, 218 Rue Combe de l'Eau, F-01220 Divonne les Bains, FR
ALARCÓN-RIQUELME, Marta, 7 Swedenborgsgatan, S-118 48 Stockholm, SE
CASTILLEJO-LÓPEZ, Casimiro, 22 Manbyle Lyse, S-755 97 Uppsala, SE

- (51) MKP
A61K 36/185 (2006.01) (97) **2453889 ***
A61K 36/45 (2006.01)
A61K 31/353 (2006.01)
A61K 31/04 (2006.01)
A61K 31/02 (2006.01)
A61K 36/70 (2006.01)
A61P 1/02 (2006.01)
(86) EP2010060161 14.07.2010
(96) 10734105.9 23.05.2012
(87) WO2011006938, 14.07.2010
(97) 2453889, 23.05.2012 en
(54) USE OF PROANTHOCYANIDINS FOR PRODUCTION OF AN ANTIADHESIVE PREPARATION
(71) Westfälische Wilhelms-Universität Münster, Schlossplatz 2, 48149 Münster, DE
(72) HENSEL, Andreas, Borkenfeld 97, 48161 Münster, DE
LECHTENBERG, Matthias, Wickenkamp 23, 48161 Münster, DE
PETEREIT, Frank, Pieperfeldweg 56a, 48329 Havixbeck, DE
LÖHR, Gesine, Hochstraße 18, 48151 Münster, DE
BEIKLER, Thomas, Christophstr. 71, 40225 Düsseldorf, DE
LOUIS, Andrea, Heinrich-Tenhumberg-Str. 4, 59302 Oelde, DE

- (51) MKP
A61P 25/24 (2006.01) (97) **2453885 ***
A61K 31/13 (2006.01)
(86) US2010041685 12.07.2010
(96) 10734866.6 23.05.2012
(87) WO2011008686, 12.07.2010
(97) 2453885, 23.05.2012 en
(54) EXO-S-MECAMYLAMINE METHOD, USE, AND COMPOUND FOR TREATMENT
(71) Targacept, Inc., 200 East First Street Suite 300, Winston-Salem, NC 27101, US
(72) DUNBAR, Geoffrey C., 300 Chadbourne Drive, Winston-Salem North Carolina 27104, US
BEAVER, Jessica, 868 Ridge Gate Drive, Lewisville North Carolina 27023, US
TOLER, Steven M., 4256 Saddlewood Forest Drive, Winston-Salem North Carolina 27106, US

- (51) MKP
B65D 75/30 (2006.01) (97) **2475591 ***
(86) US2010047939 07.09.2010
(96) 10757509.4 18.07.2012
(87) WO2011031654, 07.09.2010
(97) 2475591, 18.07.2012 en
(54) SOFT-SIDED FLEXIBLE BLISTER PACKAGE
(71) Kraft Foods Global Brands LLC, Three Lakes Drive, Northfield, IL 60093, US
(72) BOWERS, Paul, K., 28 Harvest Lane, Long Valley NJ 07853, US
GLYDON, James, 12 Federick Place, Cedar Knolls NJ 07927, US

- (51) MKP
C07K 14/415 (2006.01) (97) **2478006 ***
C12N 15/82 (2006.01)
(86) NL2010050612 20.09.2010
(96) 10760791.3 25.07.2012
(87) WO2011034433, 20.09.2010
(97) 2478006, 25.07.2012 en
(54) CLONING AND EXPLOITATION OF A FUNCTIONAL R-GENE FROM SOLANUM CHACOENSE
(71) Wageningen Universiteit, Droevendaalsesteeg 4, 6708 PB Wageningen, NL
(72) VOSSSEN, Jacobus Hubertus, Uiverweide 23, NL-6708 LA Wageningen, NL
NIJENHUIS, Maarten, Brunelsingel 64, NL-6841 KB Arnhem, NL
ARENS-DE REUVER, Marion Johanna Barbara, Fluitakker 2, NL-6721 ZD Bennekom, NL
VAN DER VOSSSEN, Edwin Andries Gerard, Oortlaan 20, NL-3572 ZM Utrecht, NL
JACOBSEN, Evert, Ritsema bosweg 77, NL-6706 BD Wageningen, NL
VISSER, Richard Gerardus Franciscus, Emmalaan 17, NL-6721 ET Bennekom, NL

- (51) MKP
B22C 9/06 (2006.01) (97) **2248615**
B29C 33/38 (2006.01)
(96) 10004761.2 10.11.2010
(97) 2248615, 10.11.2010 de
(54) Temperable tool and method for producing the same, tool holder frame for holding same
(71) Meissner Formentechnologie GmbH, Daimlerstrasse 5, 79585 Steinen, DE
(72) Meissner, Christoph, Gresgen 32, 79669 Zell i. W., DE
Haselwander, Jürgen, Waldstrasse 38, 79664 Wehr, DE

- (51) MKP
A61K 31/404 (2006.01) (97) **2459191 ***
A61K 31/53 (2006.01)
A61K 39/395 (2006.01)
(86) US2010043824 30.07.2010
(96) 10739450.4 06.06.2012
(87) WO2011014726, 30.07.2010
(97) 2459191, 06.06.2012 en
(54) MTOR INHIBITOR AND ANGIOGENESIS INHIBITOR COMBINATION THERAPY
(71) OSI Pharmaceuticals, LLC, 1 Bioscience Park Drive, Farmingdale, NY 11735, US
(72) BARR, Sharon, M., OSI Pharmaceuticals Inc. Broadhollow Bioscience Park 1 Bioscience Park Drive, Farmingdale, NY 11735, US
GOKHALE, Prafulla, C., OSI Pharmaceuticals Inc. 2860 Wilderness Place, Boulder, CO 80301, US
WILD, Robert, C., OSI Pharmaceuticals Inc. 2860 Wilderness Place, Boulder, CO 80301, US

- (51) MKP
A61K 39/395 (2006.01) (97) **2403531 ***
(86) US2010026424 05.03.2010
(96) 10749415.5 11.01.2012
(87) WO2010102251, 05.03.2010
(97) 2403531, 11.01.2012 en
(54) IL-17 BINDING PROTEINS
(71) Abbott Laboratories, 100 Abbott Park Rd., Abbott Park, IL 60084, US
(72) HUGUNIN, Margaret, 7 Indian Path, North Grafton, Massachusetts 01536, US
CLABBERS, Anca, 20 Haven Hill Road, Rutland, Massachusetts 01543, US
MURTAZA, Anwar, 30 Treetop Park, Westborough, Massachusetts 01581, US
WALLACE, Craig, 27 James Road, Sterling, Massachusetts 01564, US
McRAE, Bradford, L., 84 Pleasant Street, Northborough, Massachusetts 01532, US
BRYANT, Shaughn, H., 30 Marble Street, Worcester, Massachusetts 01603, US
KUTSKOVA, Yuliya, 183 Whitney Street, Northborough, Massachusetts 01532, US
LEDDY, Mary, R., 72 Peters Way, North Attleboro, Massachusetts 02760, US
MEMMOTT, John, E., 10 Cody Road, Framingham, Massachusetts 01701, US
HSIEH, Chung-Ming, 22 Olde Field Road, Newton, MA 02459, US
TARCSA, Edit, 1 Robin Circle, Westborough, Massachusetts 01581, US
ZHONG, Suju, 10 Westport Drive, Shrewsbury, Massachusetts 01545, US
PEREZ, Jennifer, M., 135 Longmeadow Avenue, Worcester, Massachusetts 01605, US

- (51) MKP
C12Q 1/68 (2006.01) (97) **2419737 ***
G01N 33/15 (2006.01)
A61P 35/00 (2006.01)
G01N 33/574 (2006.01)
- (86) US2010031112 14.04.2010
(96) 10765132.5 22.02.2012
(87) WO2010120942, 14.04.2010
(97) 2419737, 22.02.2012 en
(54) HISTONE MODIFICATION PATTERNS FOR CLINICAL DIAGNOSIS AND PROGNOSIS OF CANCER
(71) The Regents of the University of California, 1111 Franklin Street, 12th Floor, Oakland, CA 94607-5200, US
(72) DAWSON, David W., 902 Embury Street, Pacific Palisades California 90272, US
KURDISTANI, Siavash K., 1850 Midvale Avenue Unit 1, Los Angeles California 90025, US
SELIGSON, David B., 4424 Stewart Avenue, Los Angeles California 90066, US
-
- (51) MKP
C07D 241/06 (2006.01) (97) **2460798 ***
A61K 31/495 (2006.01)
- (86) ES2010000349 29.07.2010
(96) 10803937.1 06.06.2012
(87) WO2011012746, 29.07.2010
(97) 2460798, 06.06.2012 en
(54) APAF-1 INHIBITOR COMPOUNDS
(71) Laboratorios SALVAT, S.A., Calle Gall 30-36, 08950 Esplugues de Llobregat, Barcelona, ES
(72) MESSEGUER PEYPOCH, Àngel, C/ Gall 30-36, E-08950 Esplugues de Llobregat (Barcelona), ES
MOURE FERNÁNDEZ, Alejandra, C/ Gall 30-36, E-08950 Esplugues de Llobregat (Barcelona), ES
GONZÁLEZ PINACHO, Daniel, C/ Gall 30-36, E-08950 Esplugues de Llobregat (Barcelona), ES
MASIP MASIP, Isabel, C/ Gall 30-36, E-08950 Esplugues de Llobregat (Barcelona), ES
PEREZ PAYÁ, Enrique, C/ Gall 30-36, E-08950 Esplugues de Llobregat (Barcelona), ES
GARCIA VILLAR, Natividad, C/ Gall 30-36, E-08950 Esplugues de Llobregat (Barcelona), ES
MONLLEÓ MAS, Ester, C/ Gall 30-36, E-08950 Esplugues de Llobregat (Barcelona), ES
CATENA RUIZ, Juanlo, C/ Gall 30-36, E-08950 Esplugues de Llobregat (Barcelona), ES
-
- (51) MKP
C12N 1/26 (2006.01) (97) **2470639 ***
C12N 9/02 (2006.01)
E21B 43/16 (2006.01)
C09K 8/00 (2006.01)
- (86) US2010047038 27.08.2010
(96) 10749584.8 04.07.2012
(87) WO2011025984, 27.08.2010
(97) 2470639, 04.07.2012 en
(54) MICROBIAL ENHANCED OIL RECOVERY METHODS
(71) Geo Fossil Fuels, LLC, 14818 West 6th Avenue Unit A1, Golden, CO 80401, US
(72) KOHR, William J., 1308 Redwood Lane, Davis CA 95616, US
-
- (51) MKP
A61K 31/425 (2006.01) (97) **2485593 ***
A01N 43/78 (2006.01)
- (86) US2010051907 08.10.2010
(96) 10822733.1 15.08.2012
(87) WO2011044414, 08.10.2010
(97) 2485593, 15.08.2012 en
(54) COMBINATION
(71) GlaxoSmithKline LLC, One Franklin Plaza 200 North 16th Street, Philadelphia, PA 19102, US
(72) DUMBLE, Melissa, 20 Kingsbridges Road, Piscataway, NJ 08854, US
GILMER, Tona, Five Moore Drive, Research Triangle Park, NC 27709, US
KUMAR, Rakesh, 1250 South Collegeville Road, Collegeville, PA 19426, US
LAQUERRE, Sylvie, 709 Swedeland Road, King of Prussia, PA 19406, US
LEBOWITZ, Peter F., 1250 South Collegeville Road, Collegeville, PA 19426, US
MORRIS, Shannon, Renae, Five More Drive, Research Triangle Park, NC 27709, US
-
- (51) MKP
A23G 3/02 (2006.01) (97) **2470029 ***
A23G 3/00 (2006.01)
A23G 9/22 (2006.01)
F25C 1/22 (2006.01)
A23G 9/08 (2006.01)
- (86) IT2010000161 14.04.2010
(96) 10721208.6 04.07.2012
(87) WO2011128920, 14.04.2010
(97) 2470029, 04.07.2012 en
(54) METHOD FOR THE INDUSTRIAL PRODUCTION OF SINGLE SERVING PORTIONS OF ICE CREAM
(71) Mazzuto, Vincenzo, Via Fior d'Arancio n. 30, 74100 Taranto (TA), IT
(72) Mazzuto, Vincenzo, Via Fior d'Arancio n. 30, 74100 Taranto (TA), IT
-
- (51) MKP
C07K 16/10 (2006.01) (97) **2473525 ***
C12N 15/13 (2006.01)
A61K 39/42 (2006.01)
G01N 33/569 (2006.01)
- (86) US2010047586 01.09.2010
(96) 10836350.8 11.07.2012
(87) WO2011071574, 01.09.2010
(97) 2473525, 11.07.2012 en
(54) MONOCLONAL ANTIBODIES AGAINST GLYCOPROTEIN OF EBOLA SUDAN BONIFACE VIRUS
(71) United States Department of The Army, as represented by the Secretary of the Army, 504 Scott Street Office of the Staff Judge Advocate, Fort Detrick, Maryland 21702, US
(72) DYE, John M., 1905 Harpers Ct., Frederick Maryland 21702, US
KUEHNE, Ana I., 5596 Jollie Drive, Frederick Maryland 21702, US
GUEST, Shawn B., 501 Partridge Way, Frederick Maryland 21702, US
-
- (51) MKP
A61K 31/4965 (2006.01) (97) **2429526 ***
A61P 25/06 (2006.01)
A61P 25/08 (2006.01)
- (86) US2010034778 13.05.2010
(96) 10720094.1 21.03.2012
(87) WO2010132696, 13.05.2010
(97) 2429526, 21.03.2012 en
(54) RANOLAZINE FOR THE TREATMENT OF CNS DISORDERS
(71) Gilead Sciences, Inc., 333 Lakeside Drive, Foster City, CA 94404, US
(72) BELARDINELLI, Luiz, 205 Manzanita Ave., Palo Alto CA 94306, US
GEORGE, Alfred, 1514 Knox Valley Drive, Brentwood TN 37027, US
KAHLIG, Kristopher, 1606 Boscobel St., Nashville TN 37206, US
RAJAMANI, Sridharan, 2000 Walnut Ave. Q101, Fremont CA 94538, US
-
- (51) MKP
A61K 9/14 (2006.01) (97) **2449106 ***
C07H 21/02 (2006.01)
A61K 31/713 (2006.01)
C07K 14/775 (2006.01)
A61K 47/22 (2006.01)
C12N 15/113 (2010.01)
- (86) CA2010001031 30.06.2010
(96) 10793485.3 09.05.2012
(87) WO2011000108, 30.06.2010
(97) 2449106, 09.05.2012 en
(54) COMPOSITIONS AND METHODS FOR SILENCING APOLIPOPROTEIN B
(71) Protiva Biotherapeutics Inc., 100-8900 Glenlyon Parkway, Burnaby, British Columbia V5J 5J8, CA
(72) LEE, Amy C. H., 3315 Beaverbrook Drive, Burnaby British Columbia V3J 7Y2, CA
JUDGE, Adam, 1936 W. 11th Avenue East, Vancouver British Columbia V6J 2C6, CA
ROBBINS, Marjorie, 1124 10th Avenue East, Vancouver British Columbia V5J 5J8, CA
YAWORSKI, Ed, 23106-123B Avenue, Maple Ridge British Columbia V2X 9Z7, CA
MACLACHLAN, Ian, 13331 Sylvester Road, Mission British Columbia V2S 0B1, CA

(51) MKP
C07D 487/04 (2006.01) (97) **2496580 ***
A61K 31/55 (2006.01)
A61P 35/00 (2006.01)
A61P 43/00 (2006.01)
(86) EP2010061518 06.08.2010
(96) 10740654.8 12.09.2012
(87) WO2011054553, 06.08.2010
(97) 2496580, 12.09.2012 en
(54) BENZODIAZEPINE BROMODOMAIN INHIBITOR
(71) GlaxoSmithKline LLC, One Franklin Plaza 200 North 16th Street, Philadelphia, PA 19102, US
(72) GOSMINI, Romain Luc Marie, c/o Laboratoire GlaxoSmithKline Centre de Recherches Z.A. de Courtboeuf 25 Avenue du Quebec, F-91940 Les Ulis, FR
MIRGUET, Olivier, Laboratoire GlaxoSmithKline Centre de Recherches Z.A. de Courtboeuf 25 Avenue du Quebec, F-91940 Les Ulis, FR

(51) MKP
A61P 11/06 (2006.01) (97) **2491037 ***
A61P 11/00 (2006.01)
C07D 487/04 (2006.01)
A61P 17/00 (2006.01)
A61P 35/00 (2006.01)
A61P 19/02 (2006.01)
A61K 31/519 (2006.01)
(86) EP2010065746 19.10.2010
(96) 10771416.4 29.08.2012
(87) WO2011048111, 19.10.2010
(97) 2491037, 29.08.2012 en
(54) COMPOUNDS
(71) Respivert Limited, 50-100 Holmers Farm Way, High Wycombe Buckinghamshire HP12 4EG, GB
(72) KING-UNDERWOOD, John, Moorend Cottage School Lane, Pendock Worcestershire GL19 3PW, GB
ITO, Kazuhiro, c/o Respivert Limited Imperial College Biolncubator Level 1 Bessemer Building, Imperial College London SW7 2AZ, GB
MURRAY, Peter, John, c/o Respivert Limited Imperial College Biolncubator Level 1 Bessemer Building, Imperial College London SW7 2AZ, GB
HARDY, George, Sunny Bank Brightling Road, Robertsbridge East Sussex TN32 5EJ, GB
BROOKFIELD, Frederick, Arthur, C/o Evotec (UK) Limited 114 Milton Park, Abingdon Oxfordshire OX14 4SA, GB
BROWN, Christopher, John, C/o Evotec (UK) Limited 114 Milton Park, Abingdon Oxfordshire OX14 4SA, GB

(51) MKP
G06K 19/06 (2006.01) (97) **2449505 ***
G06K 7/14 (2006.01)
(86) EP2010059125 28.06.2010
(96) 10726505.0 09.05.2012
(87) WO2011000798, 28.06.2010
(97) 2449505, 09.05.2012 en
(54) CIRCULAR BAR-CODE FOR DRUG CONTAINER
(71) Sanofi-Aventis Deutschland GmbH, Brüningstraße 50, 65929 Frankfurt, DE
(72) RUPP, Paul, c/o Sanofi-Aventis Deutschland GmbH, 65926 Frankfurt am Main, DE

(51) MKP
F16K 15/06 (2006.01) (97) **2309160**
(96) 10178929.5 13.04.2011
(97) 2309160, 13.04.2011 de
(54) Device for metering a cryogenic medium
(71) Messer Group GmbH, Otto-Volger-Strasse 3c, 65843 Sulzbach, DE
Messer France S.A.S., 25, rue Auguste Blanche, 92816 Puteaux Cedex, FR
(72) Beaugé, Claude, 109 Rue de la Marne, 95610, Eragny-Sur-Oise, FR
Gockel, Frank, 10, rue de l'Eglise, 77410, Charny, FR

(51) MKP
C07D 403/12 (2006.01) (97) **2443106 ***
C07D 413/12 (2006.01)
A61K 31/506 (2006.01)
A61P 37/00 (2006.01)
A61P 29/00 (2006.01)
(86) EP2010058574 17.06.2010
(96) 10725721.4 25.04.2012
(87) WO2010146133, 17.06.2010
(97) 2443106, 25.04.2012 en
(54) HETEROCYCLYLAMINOPYRIMIDINES AS KINASE INHIBITORS
(71) Cellzome Limited, Chesterford Research Park, Little Chesterford Cambridgeshire CB10 1XL, GB
(72) SUNOSE, Mihiro, 18 Old Forge Way Sawston, Cambridge CB22 3BD, GB
MAJOR, Jeremy, 8 The Haven, Fullbourn, Cambridge CB21 5BG, GB
HARRISON, Richard, John, 30 Chalmers Road, Cambridge CB1 3SX, GB
FREEMAN, Jay, 30 The Lathes, Norwich NR3 3DY, GB
MOREL, Adeline, 11 The Maltings Saffron Walden, Essex CB10 1DY, GB

(51) MKP
E04C 3/08 (2006.01) (97) **2467545 ***
E04C 3/09 (2006.01)
(86) EP2010005834 23.09.2010
(96) 10763123.6 27.06.2012
(87) WO2011038860, 23.09.2010
(97) 2467545, 27.06.2012 de
(54) PROFILE ELEMENT AND METHOD FOR MANUFACTURING A PROFILE ELEMENT
(71) Protektorwerk Florenz Maisch GmbH & Co. KG, Viktoriastrasse 58, 76571 Gaggenau, DE
(72) MAISCH, Christof, Baden-Badener-Str. 15, 76571 Gaggenau, DE

(51) MKP
A61K 35/16 (2006.01) (97) **2416790 ***
G01N 33/50 (2006.01)
(86) US2010030031 06.04.2010
(96) 10762281.3 15.02.2012
(87) WO2010117976, 06.04.2010
(97) 2416790, 15.02.2012 en
(54) SPRAY-DRIED BLOOD PRODUCTS AND METHODS OF MAKING SAME
(71) Entegriion, Inc., 79 T W Alexander Drive 4401 Research Commons, Research Triangle Park, NC 27709, US
(72) FISCHER, Thomas, H., 3119 Wood Duck Lane, Hillsborough NC 27278, US
DACORTA, Joseph, A., 6019 Old North Carolina Route 86, Chapel Hill NC 27516, US
GALIGER, Michael Lawrence., 12039 Wicker Drive, Chapel Hill, North Carolina 27517, US

(51) MKP
F41A 23/24 (2006.01) (97) **2478323 ***
F41A 27/28 (2006.01)
(86) IL2010000766 16.09.2010
(96) 10769074.5 25.07.2012
(87) WO2011033514, 16.09.2010
(97) 2478323, 25.07.2012 en
(54) MULTI-WEAPONS SYSTEM
(71) Israel Military Industries Ltd., 64 Sderot Bialik P.O.B. 1044, 47100 Ramat Hasharon, IL
(72) KARAKOOKLY, Yuval, 14 Khativat Golany Street, 70700 Modiin, IL

(51) MKP
B65D 83/00 (2006.01) (97) **2447185**
(96) 11186791.7 02.05.2012
(97) 2447185, 02.05.2012 de
(54) Cylindrical packaging for pasty materials
(71) VG Nicolaus GmbH, Ulmer Strasse 18, 87437 Kempten, DE
Engel, Gottfried, Widumstrasse 16, 87452 Altusried, DE
Avemarg, Michael, Grasmückenweg 6, 87439 Kempten, DE
Ramspott, Walter, Buchenberger Weg 18, 87439 Kempten, DE

- (51) MKP
A61K 47/00 (2006.01) (97) **2403535 ***
C25D 5/00 (2006.01)
- (86) US2010026202 04.03.2010
(96) 10749323.1 11.01.2012
(87) WO2010102102, 04.03.2010
(97) 2403535, 11.01.2012 en
- (54) COMPATIBILIZED ELECTROLYTE FORMULATIONS
(71) Syngenta Participations AG, Schwarzwaldallee 215, 4058 Basel, CH
Jones III, Charles A., Syngenta Crop Protection Inc. 410 Swing Road, Greensboro, North Carolina 27409, US
Syngenta Limited, European Regional Centre Priestley Road Surrey Research Park, Guildford, Surrey GU2 7YH, GB
- (72) RAMSAY, Julia Lynne, Syngenta Jealott's Hill International Research Centre, Bracknell Berkshire RG42 6EY, GB
STOCK, David, Syngenta Jealott's Hill International Research Centre, Bracknell Berkshire RG42 6EY, GB
BELL, Gordon Alastair, Syngenta Jealott's Hill International Research Centre, Bracknell Berkshire RG42 6EY, GB
SCREPANTI, Claudio, Syngenta Jealott's Hill International Research Centre, Bracknell Berkshire RG42 6EY, GB
MILN, Colin Douglas, Syngenta Crop Protection Inc. 410 Swing Road, Greensboro North Carolina 27409, US
AGBAJE, Henry Ebum, Syngenta Crop Protection Inc. 410 Swing Road, Greensboro North Carolina 27409, US
RAMACHANDRAN, Ravi, Syngenta Crop Protection Canada Inc. 140 Research Lane, Guelph Ontario N1G4Z3, CA
JONES III, Charles A., Syngenta Crop protection, Inc. 410 Swing Road, Greensboro, North Carolina 27409, US
-
- (51) MKP
C12N 15/11 (2006.01) (97) **2451835 ***
C12N 9/68 (2006.01)
C07K 14/47 (2006.01)
A61K 38/48 (2006.01)
- (86) EP2010059902 09.07.2010
(96) 10734727.0 16.05.2012
(87) WO2011004011, 09.07.2010
(97) 2451835, 16.05.2012 en
- (54) VARIANTS OF PLASMINOGEN AND PLASMIN
(71) ThromboGenics N.V., Gaston Geenslaan 1, 3001 Heverlee, BE
(72) ZWAAL, Richard Reinier, Vluchtenboerstraat 18, B-9890 Gavere, BE
-
- (51) MKP
B65G 1/04 (2006.01) (97) **2403780 ***
- (86) HU2010000024 02.03.2010
(96) 10714468.5 11.01.2012
(87) WO2010100513, 02.03.2010
(97) 2403780, 11.01.2012 en
- (54) ARRANGEMENT FOR STORAGE, WAREHOUSE RACK AND HANDLING MACHINE PARTICULARLY FOR SUCH ARRANGEMENT
(71) Zombori, Antal, Jablonka út 35., 1037 Budapest, HU
(72) Zombori, Antal, Jablonka út 35., 1037 Budapest, HU
-
- (51) MKP
C07K 19/00 (2006.01) (97) **2448593 ***
A61K 39/00 (2006.01)
A61K 39/395 (2006.01)
C07K 16/10 (2006.01)
A61K 38/16 (2006.01)
A61K 39/42 (2006.01)
A61K 39/21 (2006.01)
- (86) EP2010059513 03.07.2010
(96) 10736997.7 09.05.2012
(87) WO2011000962, 03.07.2010
(97) 2448593, 09.05.2012 en
- (54) HIV RELATED PEPTIDES COMBINATION OR FUSION FOR USE IN HIV VACCINE COMPOSITION OR AS DIAGNOSTIC MEANS
(71) Bionor Immuno AS, P.O. Box 2870, 3702 Skien, NO
(72) GRØNVOLD, Maja, Sommerfelt, Akland, N-4950 Risør, NO
DALGLEISH, Angus, 7 Burden Lane, Cheaham Surrey SM2 7PT, GB
LANGE, Einar, Tønnes, Strømdalbakken 6, N-3744 Skien, NO
HOLMBERG, Jens, Olof, Hjalmskultgatan 15, S-254 41 Helsingborg, SE
BENGTSSON, Per, Ledungsgatan 12, S-217 74 Malmö, SE
SØRENSEN, Birger, Mejerlia 3, N-3744 Skien, NO
-
- (51) MKP
F25D 31/00 (2006.01) (97) **2467660 ***
- (86) IL2010000740 07.09.2010
(96) 10768815.2 27.06.2012
(87) WO2011030339, 07.09.2010
(97) 2467660, 27.06.2012 en
- (54) TEMPERATURE CONTROL SYSTEM FOR A LIQUID
(71) Strauss Water Ltd, 49 Ha'Sivim Street, Petach Tikva 49517, IL
(72) WILDER, Haim, 7 Yehuda Halevi Street, 43555 Raanana, IL
RONEN, Rami, 12 HaGichon Street, 47204 Ramat HaSharon, IL
KRYSTAL, Eyal, 19/17 Hatchia Street, 44250 Kfar Saba, IL
BAR-ON, Omri, Hachalutz 24 Street Beit Hakerem, 96222 Jerusalem, IL
-
- (51) MKP
C07D 211/46 (2006.01) (97) **2419409 ***
C07C 233/33 (2006.01)
- (86) EP2010054893 14.04.2010
(96) 10713940.4 22.02.2012
(87) WO2010119064, 14.04.2010
(97) 2419409, 22.02.2012 en
- (54) PROCESS FOR THE PREPARATION OF A BIPHENYL-2-YLCARBAMIC ACID ESTER
(71) Glaxo Group Limited, Glaxo Wellcome House Berkeley Avenue Greenford, Middlesex UB6 0NN, GB
(72) EDNEY, Dean, David, GlaxoSmithKline Gunnels Wood Road, Stevenage Hertfordshire SG1 2NY, GB
JOHN, Matthew, Peter, GlaxoSmithKline Gunnels Wood Road, Stevenage Hertfordshire SG1 2NY, GB
-
- (51) MKP
B32B 3/12 (2006.01) (97) **2421695 ***
- (86) US2010032047 22.04.2010
(96) 10767764.3 29.02.2012
(87) WO2010124084, 22.04.2010
(97) 2421695, 29.02.2012 en
- (54) SMART ENZYME-CONTAINING CATALYTIC PEELABLE COATINGS
(71) ICX-Agentase, 2240 William Pitt Way, Pittsburgh, Pennsylvania 15238, US
(72) WALKER, Jeremy P., 636 Allegheny River Blvd. Apartment 1, Oakmont, Pennsylvania 15139, US
GIDEL, Jonita Glenna, 903 Deely Street, Pittsburgh, Pennsylvania 15217, US
-
- (51) MKP
A61F 5/56 (2006.01) (97) **2437694 ***
- (86) US2010037475 04.06.2010
(96) 10722278.8 11.04.2012
(87) WO2010141868, 04.06.2010
(97) 2437694, 11.04.2012 en
- (54) APPARATUSES AND METHODS FOR MANDIBULAR PROTRUSION
(71) ZST Holdings, Inc., Suite 2500 450 1st Street SW, Calgary, AB, CA
(72) REMMERS, John, E., 3555 Chimney Rock Lane, Sedona AZ 86336, US
TAM, Hugo, 320 Springborough Way Sw, Calgary AB AB T3H 5M7, CA
MACARTNEY, Terry, 29 Sunhaven Close Se, Calgary AB AB T2X 2W1, CA
SANTOSHAM, Peter, 2712 Morley Trail Nw, Calgary AB AB T2M 4G7, CA
-
- (51) MKP
F02M 63/00 (2006.01) (97) **2409016 ***
- (86) EP2010053572 18.03.2010
(96) 10710290.7 25.01.2012
(87) WO2010106149, 18.03.2010
(97) 2409016, 25.01.2012 en
- (54) ACTUATOR ARRANGEMENT
(71) Delphi Technologies, Inc., P.O. Box 5052, Troy, Michigan 48007, US
(72) CANEPA-ANSON, Thomas, 18 Priory Court Wembley, London HA0 1XQ, GB
HARCOMBE, Anthony, 1 Warren Avenue Richmond, Surrey TW10 5DZ, GB
KHAN, Bashir, 82 Otley Drive Gantshill, London IG2 6QN, GB
GRAHAM, Mark, 11A Druid Hill Stoke Bishop, Bristol BS9 1EW, GB
HARPER, Mark, 25 Worcester Close Hagley Stourbridge, Worcestershire DY9 0NP, GB

- (51) MKP
C08F 10/00 (2006.01) (97) **2411424 ***
 (86) US2010026296 05.03.2010
 (96) 10713744.0 01.02.2012
 (87) WO2010102163, 05.03.2010
 (97) 2411424, 01.02.2012 en
 (54) CATALYSTS, PROCESSES FOR MAKING CATALYSTS, PROCESSES FOR MAKING POLYOLEFIN COMPOSITIONS AND POLYOLEFIN COMPOSITIONS
 (71) Dow Global Technologies LLC, P.O. Box 1967 2040 Dow Center, Midland, MI 48674, US
 (72) KUHLMAN, Roger, 117 Dewberry, Lake Jackson, TX 77566, US
 WHITEKER, Gregory, 1467 Trail Creek Court, Carmel, IN 46032, US

- (51) MKP
A61K 31/454 (2006.01) (97) **2417120 ***
A61P 31/00 (2006.01)
C07D 401/04 (2006.01)
A61P 35/00 (2006.01)
C07D 401/14 (2006.01)
A61P 37/00 (2006.01)
C07D 413/04 (2006.01)
C07D 413/14 (2006.01)
C07D 417/14 (2006.01)
A61K 31/4523 (2006.01)
 (86) EP2010054396 01.04.2010
 (96) 10712432.3 15.02.2012
 (87) WO2010115836, 01.04.2010
 (97) 2417120, 15.02.2012 en
 (54) SUBSTITUTED PIPERIDINES AS CCR3 ANTAGONISTS
 (71) Boehringer Ingelheim International GmbH, Binger Strasse 173, 55216 Ingelheim am Rhein, DE
 (72) GRUNDL, Marc, Boehringer Ingelheim GmbH CD Patents Binger Strasse 173, 55216 Ingelheim am Rhein, DE
 DOLLINGER, Horst, Boehringer Ingelheim GmbH CD Patents Binger Strasse 173, 55216 Ingelheim am Rhein, DE
 GIOVANNINI, Riccardo, Boehringer Ingelheim GmbH CD Patents Binger Strasse 173, 55216 Ingelheim am Rhein, DE
 HOENKE, Christoph, Boehringer Ingelheim GmbH CD Patents Binger Strasse 173, 55216 Ingelheim am Rhein, DE
 HOFFMANN, Matthias, Boehringer Ingelheim GmbH CD Patents Binger Strasse 173, 55216 Ingelheim am Rhein, DE
 KRIEGL, Jan, Boehringer Ingelheim GmbH CD Patents Binger Strasse 173, 55216 Ingelheim am Rhein, DE
 MARTYRES, Domic, Boehringer Ingelheim GmbH CD Patents Binger Strasse 173, 55216 Ingelheim am Rhein, DE
 RAST, Georg, Boehringer Ingelheim GmbH CD Patents Binger Strasse 173, 55216 Ingelheim am Rhein, DE
 SEITHER, Peter, Boehringer Ingelheim GmbH CD Patents Binger Strasse 173, 55216 Ingelheim am Rhein, DE

- (51) MKP
A61K 9/20 (2006.01) (97) **2482806 ***
A61K 45/06 (2006.01)
A61K 31/155 (2006.01)
 (86) EP2010064619 01.10.2010
 (96) 10759923.5 08.08.2012
 (87) WO2011039337, 01.10.2010
 (97) 2482806, 08.08.2012 en
 (54) PHARMACEUTICAL COMPOSITION, PHARMACEUTICAL DOSAGE FORM, PROCESS FOR THEIR PREPARATION, METHODS FOR TREATING AND USES THEREOF
 (71) Boehringer Ingelheim International GmbH, Binger Strasse 173, 55216 Ingelheim am Rhein, DE
 (72) SCHNEIDER, Peter, Boehringer Ingelheim GmbH Corporate Patents Binger Str. 173, 55216 Ingelheim am Rhein, DE
 EISENREICH, Wolfram, Boehringer Ingelheim GmbH Corporate Patents Binger Str. 173, 55216 Ingelheim am Rhein, DE
 PEARNCHOB, Nantharat, Boehringer Ingelheim GmbH Corporate Patents Binger Str. 173, 55216 Ingelheim am Rhein, DE

- (51) MKP
C12N 15/09 (2006.01) (97) **2431466 ***
A61K 48/00 (2006.01)
C12N 15/113 (2010.01)
A61P 29/00 (2006.01)
 (86) JP2011065737 08.07.2011
 (96) 11746147.5 21.03.2012
 (87) WO2012005368, 08.07.2011
 (97) 2431466, 21.03.2012 en
 (54) SINGLE-STRAND NUCLEIC ACID MOLECULE FOR CONTROLLING GENE EXPRESSION
 (71) Bonac Corporation, Fukuoka BIO Factory 4F 1488-4 Aikawa-machi, Kurume-shi, Fukuoka 839-0861, JP
 OHGI, Tadaaki, c/o BONAC CORPORATION Fukuoka BIO Factory 4F 1488-4, Aikawa-machi, Kurume-shi, Fukuoka 839-0861, JP
 HAYASHI, Hirotake, c/o BONAC CORPORATION Fukuoka BIO Factory 4F 1488-4, Aikawa-machi, Kurume-shi, Fukuoka 839-0861, JP
 SHIROHZU, Hisao, c/o BONAC CORPORATION Fukuoka BIO Factory 4F 1488-4, Aikawa-machi, Kurume-shi, Fukuoka 839-0861, JP
 HAMASAKI, Tomohiro, c/o BONAC CORPORATION Fukuoka BIO Factory 4F 1488-4, Aikawa-machi, Kurume-shi, Fukuoka 839-0861, JP
 ITOH, Akihiro, c/o BONAC CORPORATION Fukuoka BIO Factory 4F 1488-4, Aikawa-machi, Kurume-shi, Fukuoka 839-0861, JP
 SUZUKI, Hiroshi, c/o BONAC CORPORATION Fukuoka BIO Factory 4F 1488-4, Aikawa-machi, Kurume-shi, Fukuoka 839-0861, JP

- (51) MKP
A61K 39/395 (2006.01) (97) **2488201 ***
G01N 33/53 (2006.01)
 (86) US2010052849 15.10.2010
 (96) 10824167.0 22.08.2012
 (87) WO2011047266, 15.10.2010
 (97) 2488201, 22.08.2012 en
 (54) IL-1 BINDING PROTEINS
 (71) Abbott Laboratories, 100 Abbott Park Rd., Abbott Park, IL 60084, US
 (72) HSIEH, Chung-ming, 22 Olde Field Road, Newton Massachusetts 02459, US
 WU, Chengbin, 386 Prospect Street, Shrewsbury Massachusetts 01545, US
 MILLER, Renee, 47 Blain Road, N. Grosvenordale Connecticut 06255, US
 AMBROSI, Dominic J., 4231 Arbor Drive, Shrewsbury Massachusetts 01545, US

- (51) MKP
H01L 51/50 (2006.01) (97) **2455786 ***
H05B 33/02 (2006.01)
G02B 5/18 (2006.01)
- (86) JP2010062110 16.07.2010
(96) 10799936.9 23.05.2012
(87) WO2011007878, 16.07.2010
(97) 2455786, 23.05.2012 en
- (54) DIFFRACTION GRATING, ORGANIC EL ELEMENT USING SAME, AND METHOD FOR MANUFACTURING SAID DIFFRACTION GRATING AND ORGANIC EL ELEMENT
- (71) JX Nippon Oil & Energy Corporation, 6-3, Otemachi 2-chome, Chiyoda-ku Tokyo 100-8162, JP
Tokyo Institute of Technology, 2-12-1, Ookayama Meguro-ku, Tokyo 152-8550, JP
- (72) SEKI Takashi, c/o JX Nippon Oil & Energy Corporation 8 Chidori-cho Naka-ku, Yokohama-shi Kanagawa 231-0815, JP
NISHIMURA, Suzushi, c/o JX Nippon Oil & Energy Corporation 8, Chidori-cho, Naka-ku, Yokohama-shi,, Kanagawa, 2310815, JP
FUKUDA, Maki, c/o JX Nippon Oil & Energy Corporation 8, Chidori-cho, Naka-ku, Yokohama-shi,, Kanagawa, 2310815, JP
FUKUSHIMA, Madoka, c/o JX Nippon Oil & Energy Corporation 8, Chidori-cho, Naka-ku, Yokohama-shi,, Kanagawa, 2310815, JP
MASUYAMA, Satoshi, c/o JX Nippon Oil & Energy Corporation 8, Chidori-cho, Naka-ku, Yokohama-shi,, Kanagawa, 2310815, JP
TAKEZOE, Hideo, c/o Tokyo Institute of Technology 2-12-1, Ookayama, Meguro-ku, Tokyo, 1528550, JP
KOO, Won Hoe, c/o Tokyo Institute of Technology 2-12-1, Ookayama, Meguro-ku, Tokyo, 1528550, JP
JEONG, Soon Moon, c/o JX Nippon Oil & Energy Corporation 8, Chidori-cho, Naka-ku, Yokohama-shi, Kanagawa, JP
-
- (51) MKP
G02C 3/00 (2006.01) (97) **2460046 ***
- (86) US2010036830 01.06.2010
(96) 10827684.1 06.06.2012
(87) WO2011068559, 01.06.2010
(97) 2460046, 06.06.2012 en
- (54) EXPANDABLE EYEWEAR WITH SNAP-TOGETHER BRIDGE
- (71) Lando, Ron, 408 Tamal Plaza, Corte Madera, CA 94925, US
(72) Lando, Ron, 408 Tamal Plaza, Corte Madera, CA 94925, US
-
- (51) MKP
C07D 487/04 (2006.01) (97) **2491039 ***
A61K 31/505 (2006.01)
A61P 37/00 (2006.01)
A61P 35/00 (2006.01)
- (86) EP2010065700 19.10.2010
(96) 10775748.6 29.08.2012
(87) WO2011048082, 19.10.2010
(97) 2491039, 29.08.2012 en
- (54) HETEROCYCLYL PYRAZOLOPYRIMIDINE ANALOGUES AS JAK INHIBITORS
- (71) Cellzome Limited, Chesterford Research Park, Little Chesterford Cambridgeshire CB10 1XL, GB
- (72) RAMSDEN, Nigel, Sparrows Lodge Green Lane Fowlmere Royston, Herts SG8 7QP, GB
HARRISON, Richard John, 30 Chalmers Road, Cambridge CB1 3SX, GB
OXENFORD, Sally, 70 Millmead Way, Hertford, Herts, SG14 3YH, GB
BELL, Kathryn, 6 Malvern Road Hackney, London E8 3LT, GB
PITON, Nelly, 5 Munning Close, Newmarket, Suffolk, CB8 0GT, GB
DAGOSTIN, Claudio, 4 Roe Deer Close, Cambridge UK CB1 9YY, GB
BOUSSARD, Cyrille, 44 Harvey Way, Saffron Walden Essex CB10 2AP, GB
RATCLIFFE, Andrew, 76 Lime Grove, Doddinghurst Brentwood Essex CM15 0QY, GB
-
- (51) MKP
C07D 401/14 (2006.01) (97) **2421846 ***
C07D 401/06 (2006.01)
A61P 31/00 (2006.01)
A61K 31/496 (2006.01)
A61P 37/00 (2006.01)
A61P 29/00 (2006.01)
A61K 31/444 (2006.01)
A61K 31/5377 (2006.01)
A61P 35/00 (2006.01)
- (86) EP2010055293 21.04.2010
(96) 10714016.2 29.02.2012
(87) WO2010122069, 21.04.2010
(97) 2421846, 29.02.2012 en
- (54) 5-ALKYNYL-PYRIDINES
- (71) Boehringer Ingelheim International GmbH, Binger Strasse 173, 55216 Ingelheim am Rhein, DE
WUNBERG, Tobias, Boehringer Ingelheim GmbH Patents Germany Binger Strasse 173, 55216 Ingelheim am Rhein, DE
SCHNEIDER, Siegfried, Boehringer Ingelheim GmbH Patents Germany Binger Strasse 173, 55216 Ingelheim am Rhein, DE
VAN DER VEEN, Lars, Boehringer Ingelheim GmbH Patents Germany Binger Strasse 173, 55216 Ingelheim am Rhein, DE
-
- (51) MKP
A61K 39/395 (2006.01) (97) **2477655 ***
A61K 38/16 (2006.01)
A61K 38/17 (2006.01)
A61P 35/00 (2006.01)
A61P 25/00 (2006.01)
- (86) US2010048800 14.09.2010
(96) 10816281.9 25.07.2012
(87) WO2011032161, 14.09.2010
(97) 2477655, 25.07.2012 en
- (54) VACCINES DIRECTED TO LANGERHANS CELLS
- (71) Baylor Research Institute, 3310 Live Oak Street, Suite 501, Dallas, TX 75201, US
(72) BANCHEREAU, Jacques, F., 126 Lloyd Road, Montclair, NJ 07042, US
ZURAWSKI, Sandra, 7620 Jordan Lane, Midlothian, TX 76065, US
ZURAWSKI, Gerard, 7620 Jordan Lane, Midlothian, TX 76065, US
KLECHEVSKY, Eynav, 27 Hanna Street, 34817 Haifa, IL
OH, Sangkon, 45 Caterham Court, Baltimore, MD 21237, US
-
- (51) MKP
C07D 213/02 (2006.01) (97) **2424841 ***
C07D 401/12 (2006.01)
A61K 31/4412 (2006.01)
A61P 37/00 (2006.01)
- (86) US2010032632 27.04.2010
(96) 10719684.2 07.03.2012
(87) WO2010126914, 27.04.2010
(97) 2424841, 07.03.2012 en
- (54) PYRIDINONE ANTAGONISTS OF ALPHA-4 INTEGRINS
- (71) Elan Pharmaceuticals Inc., 800 Gateway Boulevard, South San Francisco, CA 94080, US
(72) XU, Ying-Zi, 793 Cereza Drive, Palo Alto California 94306, US
YUAN, Shendong, 2328 Elan Lane, San Ramon California 94582, US
WONE, David, 6170 Honeysuckle Drive, Newark California 94560, US
KONRADI, Andrei, 30 Victoria Road, Burlingame California 94010, US
-

- (51) MKP
B65B 31/06 (2006.01) (97) **2497558 ***
B65D 1/02 (2006.01)
C12H 1/07 (2006.01)
B01D 35/00 (2006.01)
(86) RU2010000629 28.10.2010
(96) 10828606.3 12.09.2012
(87) WO2011056096, 28.10.2010
(97) 2497558, 12.09.2012 en
(54) UNIVERSAL DEVICE FOR TREATING AND PURIFYING
A LIQUID PRODUCT CONTAINED IN A RESILIENT
DEFORMABLE CONTAINER AND FOR PREPARING A NEW
PRODUCT THAT DIFFERS FROM THE ORIGINAL
(71) Obschestvo S Ogranichennoi Otvetstvennostiyu "Eurostandart",
Ul. Irkutskaya 11-1, Moscow 107-497, RU
(72) ZHERDEV, Pavel Dmitrievich, ul. Tsentralnaya 70a, Mytitschi
Moskovskaya obl. 141021, RU
KISTEREV, Valeriy Evgenyevich, ul. 11-aya Parkovaya 38-57,
Moscow 105264, RU

- (51) MKP
A61P 3/06 (2006.01) (97) **2483298 ***
C12N 15/113 (2010.01)
C07K 14/47 (2006.01)
(86) IB2010054436 01.10.2010
(96) 10768579.4 08.08.2012
(87) WO2011039729, 01.10.2010
(97) 2483298, 08.08.2012 en
(54) USE OF SIRNA TARGETTING SIPA1L1 FOR THE
REDUCTION OF ADIPOGENESIS
(71) SANOFI, 54, rue de la Boétie, 75008 Paris, FR
(72) HALL, Diana, 3 Avenue du Grammont, CH-1007 Lausanne, CH
JIMENEZ, Maria, 17 avenue Préfaully VAUD, CH-1022
Chavannes-pres-Renens, CH
POUSSIN, Carine, 14 rue Bernard Moutardier, F-74500 Evian-
les-Bains, FR
THORENS, Bernard, Chemin de Polny 12, CH-1066 Epalinges,
CH

- (51) MKP
A61P 7/00 (2006.01) (97) **2464667 ***
A61P 37/00 (2006.01)
A61P 9/00 (2006.01)
A61P 11/00 (2006.01)
A61P 17/00 (2006.01)
A61K 31/737 (2006.01)
A61P 27/02 (2006.01)
A61P 19/00 (2006.01)
A61P 21/00 (2006.01)
C08B 37/00 (2006.01)
A61P 25/00 (2006.01)
(86) FR2010051703 12.08.2010
(96) 10761049.5 20.06.2012
(87) WO2011018588, 12.08.2010
(97) 2464667, 20.06.2012 fr
(54) N-ACYLATED OCTASACCHARIDES ACTIVATING
FGFS RECEPTORS, THEIR SYNTHESIS AND THEIR
THERAPEUTICAL APPLICATION
(71) SANOFI, 54 rue La Boétie, 75008 Paris, FR
(72) DRIGUEZ, Pierre Alexandre, c/o Sanofi-aventis Département
Brevets 174 avenue de France, F-75013 Paris, FR
DUCHAUSOY, Philippe, c/o Sanofi-aventis Département
Brevets 174 avenue de France, F-75013 Paris, FR
FONS, Pierre, c/o Sanofi-aventis Département Brevets 174
avenue de France, F-75013 Paris, FR
HERBERT, Corentin, c/o Sanofi-aventis Département Brevets
174 avenue de France, F-75013 Paris, FR
LASSALLE, Gilbert, c/o Sanofi-aventis Département Brevets
174 avenue de France, F-75013 Paris, FR

- (51) MKP
C07K 16/46 (2006.01) (97) **2494037 ***
C07K 14/705 (2006.01)
C07K 16/00 (2006.01)
C12N 5/0781 (2010.01)
C12N 15/62 (2006.01)
(86) EP2010006633 29.10.2010
(96) 10773585.4 05.09.2012
(87) WO2011050985, 29.10.2010
(97) 2494037, 05.09.2012 en
(54) CLONAL EXPANSION OF B CELLS
(71) Biontech AG, Hölderlinstrasse 8, 55131 Mainz, DE
Universitätsmedizin der Johannes Gutenberg-Universität
Mainz, Langenbeckstraße 1, 55131 Mainz, DE
(72) SAHIN, Ugur, Philipp-von-Zabern-Platz 1, 55116 Mainz, DE
TÜRECI, Özlem, Philipp-von-Zabern-Platz 1, 55116 Mainz, DE
SEPPMANN, Torsten, Altenauergasse 2, 55116 Mainz, DE
HOFF, Holger, Jakob-Steffan-Str. 12, 55122 Mainz, DE
SCHUMACHER, Jens, Keplerstr. 54, 69120 Heidelberg, DE

- (51) MKP
A61K 39/085 (2006.01) (97) **2461824 ***
A61K 39/116 (2006.01)
C12N 15/62 (2006.01)
(86) EP2010061314 03.08.2010
(96) 10737084.3 13.06.2012
(87) WO2011015591, 03.08.2010
(97) 2461824, 13.06.2012 en
(54) IMMUNOGENIC COMPOSITION COMPRISING ANTIGENIC S.
AUREUS PROTEINS
(71) GlaxoSmithKline Biologicals SA, Rue de l'Institut 89, 1330
Rixensart, BE
(72) CASTADO, Cindy, GlaxoSmithKline Biologicals s.a. Rue de
l'Institut 89, B-1330 Rixensart, BE
GERMAIN, Sophie, Marie, Jeanne, Valentine, GlaxoSmithKline
Biologicals s.a. Rue de l'Institut 89, B-1330 Rixensart, BE
GILBERT, Melanie, GlaxoSmithKline Biologicals s.a. Rue de
l'Institut 89, B-1330 Rixensart, BE

- (51) MKP
A61K 31/015 (2006.01) (97) **2478362 ***
G01N 33/53 (2006.01)
(86) US2010049545 20.09.2010
(96) 10817999.5 25.07.2012
(87) WO2011035274, 20.09.2010
(97) 2478362, 25.07.2012 en
(54) USE OF THE SPARC MICROENVIRONMENT SIGNATURE IN
THE TREATMENT OF CANCER
(71) Abraxis BioScience, LLC, 11755 Wilshire Boulevard Suite
2000, Los Angeles, CA 90025, US
(72) TRIEU, Vuong, 3965 North Ceanothus Place, Calabasas,
California 91302, US
DESAI, Neil, 11755 Wilshire Boulevard Suite 2000, Los
Angeles, California 90025, US

- (51) MKP
B32B 3/10 (2006.01) (97) **2498985 ***
(86) BR2010000267 16.08.2010
(96) 10829384.6 19.09.2012
(87) WO2011057368, 16.08.2010
(97) 2498985, 19.09.2012 en
(54) A PACKAGE FOR PAPER SHEETS
(71) Papéis Amália Ltda, Rua Edmundo Navarro de Andrade 2444
Parque Industrial, 13031-695 Campinas - SP, BR
(72) TERUEL, Nelson, Luis, Bertazzo, Rua Nilo Tordin 845 Reserva
Colonial, 13278-141 Valinhos - SP, BR

- (51) MKP
A61P 19/02 (2006.01) (97) **2445900 ***
C07D 471/04 (2006.01)
C07D 487/04 (2006.01)
A61K 31/444 (2006.01)
C07D 401/12 (2006.01)
A61K 31/4375 (2006.01)
C07D 401/14 (2006.01)
- (86) US2010039942 25.06.2010
(96) 10731874.3 02.05.2012
(87) WO2010151740, 25.06.2010
(97) 2445900, 02.05.2012 en
(54) POLYCYCLIC DERIVATIVES OF PYRIDINE AND THEIR USE IN THE TREATMENT OF (INTER ALIA) RHEUMATOID ARTHRITIS AND SIMILAR DISEASES
(71) Amgen, Inc, One Amgen Center Drive, Thousand Oaks, CA 91320-1799, US
(72) BUI, Minna Hue Thanh, 2445 25th Avenue, Oakland, California 94601, US
FISHER, Benjamin, 411 - 23rd Avenue, San Mateo, CA 94403, US
GONZALEZ LOPEZ DE TURISO, Felix, 10 De Sabla Road 509, San Mateo, California 94402, US
CHEN, Yi, 103 Muller Place, San Jose, CA 95126, US
HE, Xiao, 725 Crane Avenue, Foster City, California 94404, US
CUSHING, Timothy D., 1064 Glacier Avenue, Pacificia, California 94044, US
LUCAS, Brian, 133 10th Avenue, San Francisco, California 94118, US
DUQUETTE, Jason A., 460 Bayview Avenue, Millbrae, California 94030, US
HAO, Xiaolin, 637 Sandy Hook Court, Foster City, California 94404, US
JOHNSON, Michael G., 409 Clipper Street, San Francisco, California 94114, US
-
- (51) MKP
G06F 21/00 (2006.01) (97) **2410452**
(96) 11158984.2 25.01.2012
(97) 2410452, 25.01.2012 en
(54) Protection against malware on web resources
(71) Kaspersky Lab, ZAO, 10 Geroyev Panfilovtsev Street, Moscow 125363, RU
(72) Zaitsev, Oleg V., c/o KASPERSKY LAB ZAO 10/1, 1st Volokolamsky Proezd, Moscow 123060, RU
Denisov, Vitaly I., c/o KASPERSKY LAB ZAO 10/1, 1st Volokolamsky Proezd, Moscow 123060, RU
-
- (51) MKP
E21B 7/20 (2006.01) (97) **2378055**
E21B 7/28 (2006.01)
E21B 10/02 (2006.01)
(96) 10425119.4 19.10.2011
(97) 2378055, 19.10.2011 en
(54) A method for the reconstruction of wells through the removal of the old casing by using a single reverse-circulation perforation and relative device
(71) Landi di Stefano Chiarugi & C. S.a.s., Lungarno B. Buozzi n. 20, 56124 Pisa (PI), IT
Acque Ingegneria S.r.l., Via Bellatalla, 1, 56121 Ospedaletto (PI), IT
(72) Cempini, Nicola, Via Giotto n. 14A, 56010 Vicopisano (PI), IT
Chiarugi, Stefano, Via G. Galilei n. 45, 57014 Collesalveti fraz. Vicarello (LI), IT
-
- (51) MKP
H02M 3/335 (2006.01) (97) **2429071 ***
(86) RU2011000006 12.01.2011
(96) 11783809.4 14.03.2012
(87) WO2011145975, 12.01.2011
(97) 2429071, 14.03.2012 en
(54) AUTONOMOUS ELECTRICAL POWER SUPPLY SOURCE WITH A RECHARGING FUNCTION USING ONE RECHARGEABLE BATTERY
(71) Stepanov, Arkady Anatolievich, Ul. Novosibirskaya 12-12, Orsk, Orenburgskaya obl. 462420, RU
Khoryakov, Vladimir Vladimirovich, Ul. Aktyubinskaya 26, Orsk, Orenburgskaya obl. 462429, RU
(72) Stepanov, Arkady Anatolievich, Ul. Novosibirskaya 12-12, Orsk, Orenburgskaya obl. 462420, RU
-
- (51) MKP
C07D 417/12 (2006.01) (97) **2451794 ***
C07D 417/10 (2006.01)
C07D 285/08 (2006.01)
A61K 31/433 (2006.01)
(86) GB2010001315 08.07.2010
(96) 10759940.9 16.05.2012
(87) WO2011004162, 08.07.2010
(97) 2451794, 16.05.2012 en
(54) 1,2,4-THIAZOLIDIN-3-ONE DERIVATIVES AND THEIR USE IN THE TREATMENT OF CANCER
(71) BALTIC BIO AB, Sufflörgränd 14 Box 489, 90109 Umeå, SE
WESTMAN, Jacob, Medchemcon AB Blomsberg, S-740 21 Jälåsa, SE
HALLETT, Allan, Antisoma Research Limited BioPark Hertfordshire Broadwater Road Welwyn Garden City, Hertfordshire AL7 3AX, GB
VAGBERG, Jan, Brantstigen 8, S-192 54 Sollentuna, SE
-
- (51) MKP
C10G 2/00 (2006.01) (97) **2479241 ***
(86) JP2010065782 14.09.2010
(96) 10817149.7 25.07.2012
(87) WO2011034036, 14.09.2010
(97) 2479241, 25.07.2012 en
(54) METHOD FOR PRODUCING HYDROCARBON OIL AND SYNTHETIC REACTION SYSTEM
(71) Japan Oil, Gas and Metals National Corporation, 2-10-1, Toranomon, Minato-ku, Tokyo 105-0001, JP
INPEX Corporation, 5-3-1 Akasaka Minato-ku, Tokyo 107-6332, JP
JX Nippon Oil & Energy Corporation, 6-3, Otemachi 2-chome, Chiyoda-ku Tokyo 100-8162, JP
Japan Petroleum Exploration Co., Ltd., 7-12, Marunouchi 1-chome Chiyoda-ku, Tokyo 100-0005, JP
Cosmo Oil Co., Ltd., 1-1, Shibaura 1-chome Minato-ku, Tokyo 105-8528, JP
Nippon Steel Engineering Co., Ltd, 5-1, Osaki 1-chome Shinagawa-ku, Tokyo 141-8604, JP
(72) TASAKA, Kazuhiko, c/o JX Nippon Oil&Energy Corporation 8 Chidori-cho Naka-ku, Yokohama-shi Kanagawa 231-0815, JP
-
- (51) MKP
C09D 4/06 (2006.01) (97) **2475725 ***
A61Q 3/02 (2006.01)
(86) US2010047165 30.08.2010
(96) 10750001.9 18.07.2012
(87) WO2011031578, 30.08.2010
(97) 2475725, 18.07.2012 en
(54) REMOVABLE COLOR GEL BASECOAT FOR ARTIFICIAL NAIL COATINGS AND METHODS THEREFORE
(71) Creative Nail Design, Inc., 1125 Joshua Way, Vista, CA 92081, US
(72) CONGER, Chad, 1388 Dandelion Way, San Marcos, CA 92078, US
VU, Thong, H., 2027 Freedom Way, Vista, CA 92081, US
-
- (51) MKP
B28B 3/20 (2006.01) (97) **2429788 ***
B28B 11/08 (2006.01)
(86) EP2010055488 23.04.2010
(96) 10718928.4 21.03.2012
(87) WO2010130551, 23.04.2010
(97) 2429788, 21.03.2012 de
(54) METHOD AND PLANT FOR PRODUCING A CONCRETE BODY
(71) Monier Technical Centre GmbH, Frankfurter Landstrasse 2-4, 61440 Oberursel, DE
RÖWER, Maik, Glatzer Str. 15, 31683 Obernkirchen, DE
BÖHM, Benno, Birkhuhnweg 14, 46325 Borken, DE
MARCZOK, Burkhard, Auf dem Loh 14, 31737 Rinteln, DE

(51) MKP
A61K 31/38 (2006.01) (97) **2470538 ***
C07D 487/04 (2006.01)
C07D 495/04 (2006.01)
C07D 513/04 (2006.01)
A61P 35/00 (2006.01)
(86) US2010046955 27.08.2010
(96) 10749740.6 04.07.2012
(87) WO2011025940, 27.08.2010
(97) 2470538, 04.07.2012 en
(54) RAF INHIBITOR COMPOUNDS AND METHODS OF USE THEREOF
(71) Genentech, Inc., 1 DNA Way, South San Francisco, CA 94080-4990, US
Array Biopharma, Inc., 3200 Walnut Street, Boulder, CO 80301, US
(72) WEN, Zhaoyang, 1 DNA Way, South San Francisco, California 94080-4990, US
GRINA, Jonas, 3200 Walnut Street, South San Francisco, California 94080-4990, US
ALIAGAS, Ignacio, 1 DNA Way, South San Francisco, California 94080-4990, US
HANSEN, Joshua D., 3200 Walnut Street, Boulder, Colorado 80301, US
GRADL, Stefan, 1 DNA Way, South San Francisco, California 94080-4990, US
LAIRD, Ellen, 3200 Walnut Street, Boulder, Colorado 80301, US
GUNZNER, Janet, 1 DNA Way, South San Francisco, California 94080-4990, US
MORENO, David, 3200 Walnut Street, Boulder, Colorado 80301, US
MATHIEU, Simon, 1 DNA Way, South San Francisco, California 94080-4990, US
REN, Li, 3200 Walnut Street, Boulder, Colorado 80301, US
RUDOLPH, Joachim, 1 DNA Way, South San Francisco, California 94080-4990, US
PULK, Rebecca, 1 DNA Way, South San Francisco, California 94080-4990, US
WENGLOWSKY, Steven Mark, 3055 O'Neal Parkway, Boulder, Colorado 80301, US

(51) MKP
C07D 487/04 (2006.01) (97) **2438070 ***
A61P 25/00 (2006.01)
A61K 31/519 (2006.01)
(86) EP2010003385 04.06.2010
(96) 10722324.0 11.04.2012
(87) WO2010139483, 04.06.2010
(97) 2438070, 11.04.2012 en
(54) GLYCINE B ANTAGONISTS
(71) Merz Pharma GmbH & Co. KGaA, Eckenheimer Landstrasse 100, 60318 Frankfurt Main, DE
(72) HENRICH, Markus, Am Kreuzberg 1, 35516 Münzenberg, DE
BAUER, Angela, Im Münchfeld 29, 55122 Mainz, DE
KRÜGER, Björn, Deuil-la-Barre-Str. 63a, 60437 Frankfurt am Main, DE
KAUSS, Valerjans, Deglava 108/2-36, LV-1082 Riga, LV
MÜLLER, Sibylle, Mainzer Str. 6a, 55263 Wackernheim, DE
KUBAS, Holger, In der Brühlwiesen 27, 61352 Bad Homburg, DE
ROZHKOVS, Jevgenijs, Dzidrumu 6 Adazhi, LV-2164 Riga, LV
PISKUNOVA, Irene, Pernavas 10-3, LV-1012 Riga, LV

(51) MKP
A61M 5/31 (2006.01) (97) **2437812 ***
A61M 5/24 (2006.01)
A61M 5/315 (2006.01)
A61M 5/00 (2006.01)
(86) EP2010057473 28.05.2010
(96) 10723579.8 11.04.2012
(87) WO2010139634, 28.05.2010
(97) 2437812, 11.04.2012 en
(54) DOSE SETTING MECHANISM FOR PRIMING A DRUG DELIVERY DEVICE
(71) Sanofi-Aventis Deutschland GmbH, Brüningstraße 50, 65929 Frankfurt, DE
(72) PLUMPTRE, David, 36 Shire Way Droitwich Spa, Worcestershire WR9 7RQ, GB
DAVIES, James, 7 Old School Mews Cubbington Road Leamington Spa, Warwickshire CV32 7XB, GB
JONES, Christopher, 153 High Street Broadway, Worcestershire WR12 7AL, GB
VEASEY, Robert, 31 Lonsdale Road Lillington Leamington Spa, Warwickshire CV32 7EP, GB

(51) MKP
A63C 9/00 (2006.01) (97) **2349509 ***
(86) US2010047134 30.08.2010
(96) 10813095.6 03.08.2020
(87) WO2011028656, 30.08.2010
(97) 2349509, 03.08.2020 en
(54) BINDING FOR SNOWBOARD AND OTHER BOARD SPORTS
(71) Walker, Brendan, 131 Laroe Road, Chester, NY 10918, US
(72) Walker, Brendan, 131 Laroe Road, Chester, NY 10918, US

(51) MKP
C07D 401/12 (2006.01) (97) **2411368 ***
C07D 401/14 (2006.01)
C07D 401/02 (2006.01)
A61K 31/444 (2006.01)
A61P 35/00 (2006.01)
C07D 213/79 (2006.01)
C07D 213/82 (2006.01)
(86) FR2010050511 22.03.2010
(96) 10716566.4 01.02.2012
(87) WO2010109122, 22.03.2010
(97) 2411368, 01.02.2012 fr
(54) NICOTINAMIDE DERIVATIVES, PREPARATION THEREOF, AND THERAPEUTIC USE THEREOF AS ANTICANCER DRUGS
(71) SANOFI, 174, Avenue de France, 75013 Paris, FR
(72) ARIGON, Jérôme, c/o sanofi-aventis Département Brevets 174 avenue de France, F-75013 Paris, FR
BERNHART, Claude, c/o sanofi-aventis Département Brevets 174 avenue de France, F-75013F Paris, FR
BOUABOULA, Monsif, c/o sanofi-aventis Département Brevets 174 avenue de France, F-75013 Paris, FR
COMBET, Romain, c/o sanofi-aventis Département Brevets 174 avenue de France, F-75013 Paris, FR
HILAIRET, Sandrine, c/o sanofi-aventis Département Brevets 174 avenue de France, F-75013 Paris, FR
JEGHAM, Samir, c/o sanofi-aventis Département Brevets 174 avenue de France, F-75013 Paris, FR

(51) MKP
A01N 57/00 (2006.01) (97) **2473056 ***
C07C 403/00 (2006.01)
(86) US2010046782 26.08.2010
(96) 10814293.6 11.07.2012
(87) WO2011028596, 26.08.2010
(97) 2473056, 11.07.2012 en
(54) CHEMICAL COMPOUNDS
(71) GlaxoSmithKline LLC, One Franklin Plaza 200 North 16th Street, Philadelphia, PA 19102, US
(72) CHEN, Pingyun, c/o GaxoSmithKline Global Patente Five Moore Drive PO Box 13398, Research Triangle Park, NC 27709, US
COUCH, Ricky, c/o GaxoSmithKline Global Patente Five Moore Drive PO Box 13398, Research Triangle Park, NC 27709, US
DUAN, Maosheng, c/o GaxoSmithKline Global Patente Five Moore Drive PO Box 13398, Research Triangle Park, NC 27709, US
GRIMES, Richard, Martin, c/o GaxoSmithKline Global Patente Five Moore Drive PO Box 13398, Research Triangle Park, NC 27709, US
KAZMIERSKI, Wieslaw, Mieczyslaw, c/o GaxoSmithKline Global Patente Five Moore Drive PO Box 13398, Research Triangle Park, NC 27709, US
NORTON, Beth, Adams, c/o GaxoSmithKline Global Patente Five Moore Drive PO Box 13398, Research Triangle Park, NC 27709, US
TALLANT, Matthew, c/o GaxoSmithKline Global Patente Five Moore Drive PO Box 13398, Research Triangle Park, NC 27709, US

- (51) MKP
A61K 31/506 (2006.01) (97) **2474543 ***
A61K 31/5377 (2006.01)
A61K 31/4439 (2006.01)
A61K 31/426 (2006.01)
A61P 25/24 (2006.01)
C07D 491/052 (2006.01)
C07D 417/14 (2006.01)
C07D 495/04 (2006.01)
C07D 491/048 (2006.01)
(86) JP2010064988 02.09.2010
(96) 10813753.0 11.07.2012
(87) WO2011027805, 02.09.2010
(97) 2474543, 11.07.2012 en
(54) THERAPEUTIC AGENT FOR MOOD DISORDERS
(71) Kyowa Hakko Kirin Co., Ltd., 1-6-1, Ohtemachi Chiyoda-ku, Tokyo 100-8185, JP
(72) YAMADA, Koji, c/o Pharmacological Research Laboratories Kyowa Hakko Kirin Co., Ltd 1188, Shimotogari, Nagaizumi-cho, Sunto-gun Shizuoka 411-8731, JP
KANDA, Tomoyuki, c/o Pharmacological Research Laboratories Kyowa Hakko Kirin Co., Ltd 1188, Shimotogari, Nagaizumi-cho, Sunto-gun Shizuoka 411-8731, JP
-
- (51) MKP
A61K 31/4709 (2006.01) (97) **2433938 ***
C07D 495/04 (2006.01)
A61K 31/506 (2006.01)
C07D 417/14 (2006.01)
A61K 31/5377 (2006.01)
A61K 31/435 (2006.01)
A61P 25/14 (2006.01)
A61K 31/4355 (2006.01)
A61P 25/16 (2006.01)
A61K 31/4365 (2006.01)
C07D 491/048 (2006.01)
A61K 31/436 (2006.01)
A61P 43/00 (2006.01)
A61K 31/4439 (2006.01)
C07D 491/052 (2006.01)
(86) JP2010057563 28.04.2010
(96) 10769780.7 28.03.2012
(87) WO2010126082, 28.04.2010
(97) 2433938, 28.03.2012 en
(54) THERAPEUTIC AGENT FOR MOTOR DISORDERS
(71) Kyowa Hakko Kirin Co., Ltd., 1-6-1, Ohtemachi Chiyoda-ku, Tokyo 100-8185, JP
(72) UESAKA Noriaki, c/o Medicinal chemistry Research laboratories Kyowa Hakko Kirin Co., Ltd. 1188, Shimotogari, Nagaizumi-cho Sunto-gun, Shizuoka 411-8731, JP
SAWADA, Takashi, c/o Medicinal Chemistry research Laboratories Kyowa Hakko Kirin Co., Ltd 1188, Shimotogari, Nagaizumi-cho Sunto-gun, Shizuoka 411-8731, JP
KANDA, Tomoyuki, c/o Medicinal Chemistry research Laboratories Kyowa Hakko Kirin Co., Ltd 1188, Shimotogari, Nagaizumi-cho Sunto-gun, Shizuoka 411-8731, JP
-
- (51) MKP
B65G 47/84 (2006.01) (97) **2382146 ***
(86) IB2010053813 25.08.2010
(96) 10760006.6 02.11.2011
(87) WO2011048508, 25.08.2010
(97) 2382146, 02.11.2011 en
(54) A CONVEYOR FOR CONTAINERS, SUCH AS BOTTLES, TO BE PROCESSED AND FOR PROCESSED CONTAINERS FOR OPERATING MACHINES OF THE TYPE WITH A ROTARY CARROUSEL
(71) Makro Labelling S.r.l., Via Don Doride Bertoldi 91 Marmirolo, 46045 Mantova, IT
(72) GHIZZI, Gilberto, Via Tazzoli 10 Marmirolo, I-46045 Mantova, IT
-
- (51) MKP
C07C 205/02 (2006.01) (97) **2490998 ***
C07C 201/08 (2006.01)
(86) US2010048480 10.09.2010
(96) 10768630.5 29.08.2012
(87) WO2011049681, 10.09.2010
(97) 2490998, 29.08.2012 en
(54) PROCESS FOR DOWNSTREAM RECOVERY OF NITROALKANE USING DIVIDING WALL COLUMN
(71) Dow Global Technologies LLC, 2040 Dow Center, Midland, MI 48674, US
ANGUS Chemical Company, 1500 E. Lake Cook Road, Buffalo Grove, IL 60089, US
(72) SAWANT, Mahesh, C/9 Surabhi Enclave Nagras Road, Aundh Pune 411007, IN
TRAUTH, Daniel, M., 5817 Meadowbrook Lane, Crystal Lake IL 60014, US
PENDERGAST, JR., John, G., 60 Parsley Court, Lake Jackson TX 77566, US
-
- (51) MKP
C07D 403/02 (2006.01) (97) **2480235 ***
A61K 31/506 (2006.01)
(86) US2010050206 24.09.2010
(96) 10819534.8 01.08.2012
(87) WO2011038234, 24.09.2010
(97) 2480235, 01.08.2012 en
(54) NOVEL IODO PYRIMIDINE DERIVATIVES USEFUL FOR THE TREATMENT OF MACROPHAGE MIGRATION INHIBITORY FACTOR (MIF)-IMPLICATED DISEASES AND CONDITIONS
(71) University Of Louisville Research Foundation, Inc., 201 E. Jefferson Street Suite 215, Louisville, KY 40202, US
Advanced Cancer Therapeutics, LLC, 429 West Muhammad Ali Boulevard - suite 600, Louisville, KY 40202, US
(72) MITCHELL, Robert, Allin, 10704 Sunderland Road, Louisville KY 40243, US
TRENT, John, Olaf, 5516 Hempstead Road, Louisville KY 40207, US
CHAND, Pooran, 196 Highland View Drive, Birmingham AL 35242, US
TAPOLSKY, Gilles, Hugues, 5117 Long Knife Run, Louisville KY 40207, US
-
- (51) MKP
C12P 21/08 (2006.01) (97) **2499256 ***
C07K 16/28 (2006.01)
(86) US2010056245 10.11.2010
(96) 10830663.0 19.09.2012
(87) WO2011060076, 10.11.2010
(97) 2499256, 19.09.2012 en
(54) ANTI-C-MPL ANTIBODIES
(71) Amgen, Inc, One Amgen Center Drive, Thousand Oaks, CA 91320-1799, US
(72) WEI, Ping, 5811 Saint Laurent Drive, Agoura Hills, California 91301, US
WINTERS, Aaron G., 2501 Pierpont Boulevard, Ventura, California 93001, US
ABBOTT, Christina, 1167 Ramona Drive, Newbury Park, California 91230, US
-
- (51) MKP
H02G 3/14 (2006.01) (97) **2438664 ***
H01H 3/12 (2006.01)
(86) AT2010000131 28.04.2010
(96) 10720118.8 11.04.2012
(87) WO2010138980, 28.04.2010
(97) 2438664, 11.04.2012 de
(54) ELECTRICAL INSTALLATION UNIT
(71) Eaton GmbH, Eugenia 1, 3943 Schrems, AT
(72) JESCHKO, Robert, Allramstrasse 9/3/5, A-3943 Schrems, AT

- (51) MKP
C07D 239/34 (2006.01) (97) **2464634 ***
C07D 239/47 (2006.01)
C07D 401/12 (2006.01)
- (86) EP2010061840 13.08.2010
(96) 10744917.5 20.06.2012
(87) WO2011018518, 13.08.2010
(97) 2464634, 20.06.2012 en
- (54) REGIOSELECTIVE PREPARATION OF 2 -AMINO-5-TRIFLUOROMETHYLPYRIMIDINE DERIVATIVES
- (71) Boehringer Ingelheim International GmbH, Binger Strasse 173, 55216 Ingelheim am Rhein, DE
- (72) LINZ, Guenter, Boehringer Ingelheim GmbH Binger Str. 173, 55216 Ingelheim am Rhein, DE
KRAEMER, Gerd, Boehringer Ingelheim GmbH Binger Str. 173, 55216 Ingelheim am Rhein, DE
KUSSEROW, Sabrina, Boehringer Ingelheim GmbH Binger Str. 173, 55216 Ingelheim am Rhein, DE
SCHNAUBELT, Juergen, Boehringer Ingelheim GmbH Binger Str. 173, 55216 Ingelheim am Rhein, DE
-
- (51) MKP
A61K 31/438 (2006.01) (97) **2499139 ***
A61P 1/16 (2006.01)
A61P 3/10 (2006.01)
C07D 471/10 (2006.01)
- (86) IB2010054908 29.10.2010
(96) 10776438.3 19.09.2012
(87) WO2011058474, 29.10.2010
(97) 2499139, 19.09.2012 en
- (54) N1-PYRAZOLOSPIROKETONE ACETYL-COA CARBOXYLASE INHIBITORS
- (71) Pfizer Inc, 235 East 42nd Street, New York, NY 10017, US
- (72) BAGLEY, Scott, William, Pfizer Global Research&Development Eastern Point Road Groton, Connecticut 06340, US
GRIFFITH, David, Andrew, Pfizer Global Research&Development Eastern Point Road Groton, Connecticut 06340, US
KUNG, Daniel, Wei-Shung, Pfizer Global Research&Development Eastern Point Road Groton, Connecticut 06340, US
-
- (51) MKP
A01N 57/20 (2006.01) (97) **2403343 ***
A01N 41/06 (2006.01)
A01P 13/00 (2006.01)
- (86) GB2010000385 04.03.2010
(96) 10706320.8 11.01.2012
(87) WO2010100424, 04.03.2010
(97) 2403343, 11.01.2012 en
- (54) HERBICIDAL FORMULATIONS
- (71) Syngenta Limited, European Regional Centre Priestley Road Surrey Research Park, Guildford Surrey GU2 7YH, GB
- (72) RAMSAY, Julia, Lynne, c/o Syngenta Limited Jealott's Hill International Research Centre, Bracknell Berkshire RG42 6EY, GB
STOCK, David, Syngenta Limited Jealott's Hill International Research Centre, Bracknell Berkshire RG42 6EY, GB
BELL, Gordon, Alastair, Syngenta Limited Jealott's Hill International Research Centre, Bracknell Berkshire RG42 6EY, GB
SCREPANTI, Claudio, Syngenta Limited Jealott's Hill International Research Centre, Bracknell Berkshire RG42 6EY, GB
-
- (51) MKP
C12Q 1/68 (2006.01) (97) **2443253 ***
- (86) GB2010001169 15.06.2010
(96) 10725825.3 25.04.2012
(87) WO2010146349, 15.06.2010
(97) 2443253, 25.04.2012 en
- (54) STEM ACCELERATED ISOTHERMAL NUCLEIC ACID AMPLIFICATION TECHNOLOGY
- (71) Lumora Ltd, Staffords Chartered Accounts CPC1 Capital Park Fulbourne, Cambridge CB21 5XE, GB
- (72) TISI, Laurence Carlo, Lumora Ltd Staffords Chartered Accounts CPC1 Capital Park, Fulbourn Cambridge CB21 5XE, GB
GANDELMANN, Olga, Lumora Ltd Staffords Chartered Accounts CPC1 Capital Park, Fulbourn Cambridge CB21 5XE, GB
KIDDLE, Guy, Lumora Ltd Staffords Chartered Accounts CPC1 Capital Park, Fulbourn Cambridge CB21 5XE, GB
MCELGUNN, Cathal, Joseph, Lumora Ltd Staffords Chartered Accounts CPC1 Capital Park, Fulbourn Cambridge CB21 5XE, GB
-
- (51) MKP
F02B 33/30 (2006.01) (97) **2300699 ***
- (86) US2010029304 31.03.2010
(96) 10764849.5 30.03.2011
(87) WO2010120499, 31.03.2010
(97) 2300699, 30.03.2011 en
- (54) PART-LOAD CONTROL IN A SPLIT-CYCLE ENGINE
- (71) Scuderi Group, Llc, 1111 Elm Street, Suite No. 33, West Springfield, MA 01089, US
- (72) SCUDERI, Stephen, 1023 Shaker Road, Westfield MA 01085, US
-
- (51) MKP
C07K 16/40 (2006.01) (97) **2403880 ***
- (86) US2010026300 05.03.2010
(96) 10707196.1 11.01.2012
(87) WO2010102167, 05.03.2010
(97) 2403880, 11.01.2012 en
- (54) MATRIX METALLOPROTEINASE-7 (MMP-7) MONOCLONAL ANTIBODIES AND METHODS FOR THEIR USE IN THE DETECTION OF OVARIAN CANCER
- (71) Tripath Imaging, Inc., 780 Plantation Drive, Burlington, NC 27215, US
- (72) BAKER, Jeffrey, P., 16 Madrid Lane, Durham, NC 27704, US
CHEEK, Robert, L., 6135 Oscar Gammon Road, Mebane, NC 27302, US
DIXON, Eric, P., 3041 Weston Green Loop, Cary, NC 27513, US
FISCHER, Timothy, J., 6609 Swallowtail Lane, Raleigh, NC 27613, US
KNAPP, Steven, L., 110 Minnifer Court, Apex, NC 27539, US
SIMKINS, Stephen, G., 5309 April Wind Drive, Fuquay-Varina, NC 27526, US
WHITEHEAD, Clark, M., 2312 Brasstown Lane, Apex, NC 27502, US
-
- (51) MKP
C07D 471/04 (2006.01) (97) **2419427 ***
A61P 35/00 (2006.01)
A61K 31/437 (2006.01)
- (86) GB2010050617 15.04.2010
(96) 10718659.5 22.02.2012
(87) WO2010119284, 15.04.2010
(97) 2419427, 22.02.2012 en
- (54) BICYCLIC HETEROCYCLYL DERIVATIVES AS FGFR KINASE INHIBITORS FOR THERAPEUTIC USE
- (71) Astex Therapeutics Ltd., 436 Cambridge Science Park Milton Road, Cambridge CB4 0QA, GB
- (72) SAXTY, Gordon, c/o Astex Therapeutics Limited 436 Cambridge Science Park Milton Road Cambridge, Cambridgeshire CB4 0QA, GB
BERDINI, Valerio, c/o Astex Therapeutics Limited 436 Cambridge Science Park Milton Road Cambridge, Cambridgeshire CB4 0QA, GB
FREYNE, Eddy Jean Edgard, Jan Van Eycklei 8, B-2840 Rumst, BE
PAPANIKOS, Alexandra, Belgiëlei 138 bus 6, B-2018 Antwerpen, BE
BENDERITTER, Pascal, Chemin du Suchet 7B, 1350 Orbe, CH
EMBRECHTS, Werner Constant Johan, Bremstraat 7, B-2340 Beerse, BE
WROBLOWSKI, Berthold, Osseven 3, B-2350 Vosselaar, BE
AKKARI, Rhalid, 4 rue du Four, F-34270 Vacquières, FR

- (51) MKP
A61P 13/00 (2006.01) (97) **2490700 ***
A61K 33/14 (2006.01)
A61K 9/06 (2006.01)
A61P 15/02 (2006.01)
C11D 3/20 (2006.01)
(86) KR2010007068 15.10.2010
(96) 10825152.1 29.08.2012
(87) WO2011049327, 15.10.2010
(97) 2490700, 29.08.2012 en
(54) A SKIN EXTERNAL COMPOSITION COMPRISING A SALT AND SUGAR AS ACTIVE INGREDIENTS FOR PREVENTING AND TREATING VAGINOSIS AND THE USE THEREOF
(71) Choi, Won Seog, 1205 ChinHung Heitz Apt. 279-4, Dongseohak-dong Wansan-gu, Jeonju-si, Jeollabuk-do 560-120, KR
(72) CHOI, Won Seog, 1205 ChinHung Heitz Apt. 279-4, Dongseohak-dong Wansan-gu, Jeonju-si Jeollabuk-do 560-120, KR
KWON, Dong-Yeul, 701ho 106dong, DaeWoo Prugio Apt. Jangdae-dong Yuseong-gu, Daejeon 305-308, KR
-
- (51) MKP
C07C 231/24 (2006.01) (97) **2491006 ***
C07C 231/12 (2006.01)
C07C 233/87 (2006.01)
(86) EP2010065710 19.10.2010
(96) 10768482.1 29.08.2012
(87) WO2011048091, 19.10.2010
(97) 2491006, 29.08.2012 en
(54) PROCESS FOR PREPARING A PHENYLALANINE DERIVATIVE
(71) Glaxo Group Limited, Glaxo Wellcome House Berkeley Avenue Greenford, Middlesex UB6 0NN, GB
Mitsubishi Tanabe Pharma Corporation, 2-6-18 Kitahama, Chuo-Ku Osaka-shi, Osaka 541-8505, JP
(72) ADAMS, Joseph, Paul, GlaxoSmithKline Gunnels Wood Road, Stevenage Hertfordshire SG1 2NY, GB
KURODA, Toru, Mitsubishi Tanabe Pharma Corporation 2-6-18 Kitahama Chuo-ku Osaka-shi, Osaka 541-8505, JP
MATSUMAE, Hiroaki, Mitsubishi Tanabe Pharma Corporation 2-6-18 Kitahama Chuo-ku Osaka-shi, Osaka 541-8505, JP
STRACHAN, John, Bryce, GlaxoSmithKline Gunnels Wood Road, Stevenage Hertfordshire SG1 2NY, GB
YAGI, Nobuhiro, Mitsubishi Tanabe Pharma Corporation 2-6-18 Kitahama Chuo-ku Osaka-shi, Osaka 541-8505, JP
-
- (51) MKP
A61K 31/4468 (2006.01) (97) **2457570 ***
A61K 9/70 (2006.01)
A61K 47/06 (2006.01)
A61K 47/14 (2006.01)
A61K 47/32 (2006.01)
(86) JP2010062201 21.07.2010
(96) 10802265.8 30.05.2012
(87) WO2011010645, 21.07.2010
(97) 2457570, 30.05.2012 en
(54) FENTANYL-CONTAINING ADHESIVE PREPARATION FOR EXTERNAL USE
(71) Teikoku Seiyaku Co., Ltd., 567 Sanbonmatsu, Higashikagawa-shi, Kagawa 769-2695, JP
(72) NARUSE, Mamoru, 90, Miyagawauchi-Aza-Nakamura Donaricho, Awa-shi Tokushima 771-1508, JP
HATTORI, Kenichi, 154-3, Hayabuchi Kokufu-cho, Tokushima-shi Tokushima 779-3125, JP
MATSUSHITA, Kunihiko, 660-12, Mure Mure-cho, Takamatsu-shi Kagawa 761-0121, JP
-
- (51) MKP
C10G 1/04 (2006.01) (97) **2470620 ***
C10G 1/00 (2006.01)
(86) US2010045155 11.08.2010
(96) 10812485.0 04.07.2012
(87) WO2011025659, 11.08.2010
(97) 2470620, 04.07.2012 en
(54) SYSTEMS, METHODS AND COMPOSITIONS FOR THE SEPARATION AND RECOVERY OF HYDROCARBONS FROM PARTICULATE MATTER
(71) The Penn State Research Foundation, 200 Innovation Boulevard, University Park, PA 16802, US
(72) PAINTER, Paul, P.O. Box 64, Boalsburg, PA 16827, US
WILLIAMS, Phil, 117 N. Gill Street Apt. 1, State College, PA 16801, US
MANNEBACH, Ehren, 794 Country Club Lane, Fon du Lac, WI 54935, US
LUPINSKY, Aron, 137 S. Butz Street, State College, PA 16801, US
-
- (51) MKP
A61B 17/34 (2006.01) (97) **2424606 ***
A61M 25/00 (2006.01)
(86) EP2010055869 29.04.2010
(96) 10719593.5 07.03.2012
(87) WO2010125166, 29.04.2010
(97) 2424606, 07.03.2012 en
(54) INJECTION CATHETER FOR DELIVERING A THERAPEUTIC AGENT INTO A SUBSTRATE
(71) Cardio3 Biosciences S.A., Rue Edouard Belin 12, 1435 Mont-Saint-Guibert, BE
(72) LATERE DWAN'ISA, Jean-Pierre, rue Adolphe Bastin 21, B-5000 Namur, BE
HOMSY, Christian, Avenue des Sittelles 99, B-1150 Woluwe-Saint-Pierre, BE
BARTUNEK, Jozef, Eedstraat 82, B-9052 Gent, BE
GORDON-BERESFORD, Roland, Avenue Antoinette Herlin 11, B-1310 La Hulpe, BE
-
- (51) MKP
C07K 1/18 (2006.01) (97) **2445924 ***
C07K 1/22 (2006.01)
C07K 1/32 (2006.01)
(86) US2010039854 24.06.2010
(96) 10729997.6 02.05.2012
(87) WO2010151688, 24.06.2010
(97) 2445924, 02.05.2012 en
(54) CAPTURE PURIFICATION PROCESSES FOR PROTEINS EXPRESSED IN A NON-MAMMALIAN SYSTEM
(71) Amgen, Inc, One Amgen Center Drive, Thousand Oaks, CA 91320-1799, US
(72) SHULTZ, Joseph, Edward, 11675 Barranca Road, Santa Rosa Valley, CA 93012, US
HART, Roger, 6958 West Country Road 18, Loveland, CO 80537, US
-
- (51) MKP
C07C 309/82 (2006.01) (97) **2462111 ***
C07C 309/85 (2006.01)
C07C 311/28 (2006.01)
C07C 303/40 (2006.01)
C07C 303/38 (2006.01)
(86) EP2010004222 10.07.2010
(96) 10734043.2 13.06.2012
(87) WO2011009541, 10.07.2010
(97) 2462111, 13.06.2012 en
(54) PREPARATION OF (R)- AND (S)-N-(3, 4-DIFLUORO-2-(2-FLUORO-4-IODOPHENYLAMINO)--6-METHOXYPHENYL)-1-(2, 3-DIHYDROXYPROPYL)CYCLOPROPANE-1-SULFONAMIDE AND PROTECTED DERIVATIVES THEREOF
(71) Ardea Biosciences, Inc., 4939 Directors Place, San Diego, CA 92121, US
(72) MADERNA, Andreas, 54 Pyngyp Road, Stony Point New York 10980, US
VERNIER, Jean-Michel, 5150 Sea Mist Ct., San Diego CA 92121, US

- (51) MKP
F03B 13/12 (2006.01) (97) **2440775 ***
 (86) US2010037682 08.06.2010
 (96) 10786647.7 18.04.2012
 (87) WO2010144384, 08.06.2010
 (97) 2440775, 18.04.2012 en
 (54) WAVE ENERGY ELECTRICAL POWER GENERATION
 (71) Healy, James W., 48 N. Pepperell Road, Hollis, NH 03049-6429, US
 (72) Healy, James W., 48 N. Pepperell Road, Hollis, NH 03049-6429, US

- (51) MKP
C12N 15/11 (2006.01) (97) **2421971 ***
C12N 15/113 (2010.01)
 (86) NL2010050230 26.04.2010
 (96) 10718717.1 29.02.2012
 (87) WO2010123369, 26.04.2010
 (97) 2421971, 29.02.2012 en
 (54) OLIGONUCLEOTIDE COMPRISING AN INOSINE FOR TREATING DMD
 (71) Prosenza Technologies B.V., Wassenaarseweg 72, 2333 AL Leiden, NL
 (72) VAN DEUTEKOM, Judith Christina Theodora, Abeelstraat 13, 3329 AA Dordrecht, NL
 DE KIMPE, Josephus Johannes, Veilingstraat 175, 3521 BE Utrecht, NL
 PLATENBURG, Gerardus Johannes, Wijngaardenlaan 56, 2252 XR Voorschoten, NL

- (51) MKP
C12Q 1/68 (2006.01) (97) **2456884 ***
 (86) US2010042570 20.07.2010
 (96) 10734882.3 30.05.2012
 (87) WO2011011391, 20.07.2010
 (97) 2456884, 30.05.2012 en
 (54) SEQUENCES AND THEIR USE FOR DETECTION AND CHARACTERIZATION OF E. COLI O157:H7
 (71) E. I. Du Pont De Nemours And Company, Legal Patent Records Center 1007 Market Street, Wilmington, Delaware 19898, US
 (72) BURNS, Frank R., 2625 Sorrento Road, Philadelphia Pennsylvania 19131, US

- (51) MKP
C07D 487/04 (2006.01) (97) **2451812 ***
C07D 519/00 (2006.01)
A61K 31/519 (2006.01)
 (86) US2010041538 09.07.2010
 (96) 10732606.8 16.05.2012
 (87) WO2011006074, 09.07.2010
 (97) 2451812, 16.05.2012 en
 (54) SUBSTITUTED PYRAZOLO[1,5-a]PYRIMIDINE COMPOUNDS AS TRK KINASE INHIBITORS
 (71) Array BioPharma, Inc., 3200 Walnut Street, Boulder, CO 80301, US
 (72) ALLEN, Shelley, c/o Array BioPharma Inc. 3200 Walnut Street, Boulder, Colorado 80301, US
 ANDREWS, Steven S., c/o Array BioPharma Inc. 3200 Walnut Street, Boulder, Colorado 80301, US
 CONDROSKI, Kevin Ronald, c/o Array BioPharma Inc. 3200 Walnut Street, Boulder, Colorado 80301, US
 HAAS, Julia, c/o Array BioPharma Inc. 3200 Walnut Street, Boulder, Colorado 80301, US
 HUANG, Lily, c/o Array BioPharma Inc. 3200 Walnut Street, Boulder, Colorado 80301, US
 JIANG, Yutong, c/o Array BioPharma Inc. 3200 Walnut Street, Boulder, Colorado 80301, US
 KERCHER, Timothy, c/o Array BioPharma Inc. 3200 Walnut Street, Boulder, Colorado 80301, US
 SEO, Jeongbeob, c/o Array BioPharma Inc. 3200 Walnut Street, Boulder, Colorado 80301, US

- (51) MKP
B41F 7/16 (2006.01) (97) **2428359**
B41F 23/00 (2006.01)
B41M 5/00 (2006.01)
 (96) 10405223.8 14.03.2012
 (97) 2428359, 14.03.2012 de
 (54) Printer and method for printing on flat materials
 (71) Hoffmann Neopac AG, Eisenbahnstrasse 71, 3602 Thun, CH
 (72) Ludin, Guntmar Michael, Ziegeleistrasse 42, 3612 Steffisburg, CH
 Wagner, Michael, Blochstrasse 18, 3653 Oberhofen, CH

- (51) MKP
G06F 17/00 (2006.01) (97) **2488961 ***
 (86) EP2010006309 15.10.2010
 (96) 10771337.2 22.08.2012
 (87) WO2011045073, 15.10.2010
 (97) 2488961, 22.08.2012 en
 (54) PROCESS FOR THE AUTOMATED CLASSIFICATION AND ANALYSIS OF RAW DATA AND ITS USE IN THE OPTIMIZATION OF PROCESSES
 (71) KRKA, tovarna zdravil, d.d., Novo mesto, Smarjeska cesta 6, 8501 Novo mesto, SI
 (72) RUZIC, Milos, Ulica Milke Kerinove 9, 3000 Celje, SI
 PECAVAR, Anica, Gotna vas 18, 8000 Novo Mesto, SI

- (51) MKP
A47C 27/00 (2006.01) (97) **2488067 ***
A47G 9/00 (2006.01)
 (86) HR2010000024 19.07.2010
 (96) 10752616.2 22.08.2012
 (87) WO2011045622, 19.07.2010
 (97) 2488067, 22.08.2012 en
 (54) MULTILAYERED PROTECTIVE AND STIMULATING PAD FOR MATTRESSES
 (71) Pavletic D.O.O., Brune Francetica bb, 51000 Rijeka, HR
 (72) PAVLETIC, Marin, Hreljin 22, 51226 Hreljin, HR

- (51) MKP
C08K 9/02 (2006.01) (97) **2488581 ***
C01G 9/02 (2006.01)
C09C 1/02 (2006.01)
C09C 1/28 (2006.01)
C09C 1/30 (2006.01)
C09C 1/40 (2006.01)
C09C 1/56 (2006.01)
 (86) EP2010065499 15.10.2010
 (96) 10766049.0 22.08.2012
 (87) WO2011045408, 15.10.2010
 (97) 2488581, 22.08.2012 fr
 (54) CROSSLINKING INITIATOR
 (71) Societe Industrielle Liegeoise des Oxydes SA, Rue Joseph Wauters 144, 4480 Engis, BE
 (72) GUIDI, Tamizio, rue Maubeuge 51, B-4100 Seraing, BE
 ROUMACHE, Olivier, rue Camp de Corroy 43, B-4500 Huy, BE
 BRASSEUR, Jean-Louis, Joseph, rue Harkay 33, B-4400 Flemalle, BE

- (51) MKP
H04W 24/00 (2009.01) (97) **2464159 ***
 (86) CN2010075777 06.08.2010
 (96) 10806056.7 13.06.2012
 (87) WO2011015152, 06.08.2010
 (97) 2464159, 13.06.2012 en
 (54) METHOD, SYSTEM AND DEVICE FOR REPORTING UPLINK PILOT INTERFERENCE
 (71) China Academy of Telecommunications Technology, 40, Xueyuan Road, Haidian District, Beijing 100191, CN
 (72) GUO, Baojuan, No.40 Xueyuan Road Haidian District, Beijing 100083, CN
 ZHANG, Dajun, No.40 Xueyuan Road Haidian District, Beijing 100083, CN

- (51) MKP
C12N 15/79 (2006.01) (97) **2424991 ***
A61K 31/7088 (2006.01)
 (86) US2010001239 27.04.2010
 (96) 10772363.7 07.03.2012
 (87) WO2010129021, 27.04.2010
 (97) 2424991, 07.03.2012 en
 (54) GENE THERAPY FOR NEURODEGENERATIVE DISORDERS
 (71) Genzyme Corporation, 15 Pleasant Street Connector, Framingham, MA 01701-9322, US
 (72) PASSINI, Marco, A., 14 Nightingale Drive, Shrewsbury MA 01545, US
 SHIHABUDDIN, Lamya, 1933 Commonwealth Avenue, Brighton MA 02135, US
 CHENG, Seng, H., 10 Jennison Circle, Natick MA 01760, US

- (51) MKP
A61K 39/155 (2006.01) (97) **2445527 ***
(86) EP2010059006 24.06.2010
(96) 10728203.0 02.05.2012
(87) WO2010149743, 24.06.2010
(97) 2445527, 02.05.2012 en
(54) VACCINE
(71) ID Biomedical Corporation of Quebec, 525 Cartier Boulevard West, Laval, QC H7V 3S8, CA
GlaxoSmithKline Biologicals S.A., rue de l'Institut, 89, 1330 Rixensart, BE
(72) BLAIS, Normand, GlaxoSmithKline Biologicals Laval 525 Cartier Boulevard West, Laval, Québec H7V 3S8, CA
RHEAULT, Patrick, GlaxoSmithKline Biologicals Laval 525 Cartier Boulevard West, Laval, Québec H7V 3S8, CA
VAN-SCHERPENZEEL-THIM, Virginie, GlaxoSmithKline Biologicals s.a. rue de l'Institut 89, B-1330 Rixensart, BE
VASSILEV, Ventsislav, GlaxoSmithKline Biologicals s.a. rue de l'Institut 89, B-1330 Rixensart, BE
-
- (51) MKP
C07K 16/46 (2006.01) (97) **2480676 ***
C12N 15/85 (2006.01)
C07K 16/00 (2006.01)
A01K 67/027 (2006.01)
(86) US2011041370 22.06.2011
(96) 11728509.8 01.08.2012
(87) WO2011163314, 22.06.2011
(97) 2480676, 01.08.2012 en
(54) HYBRID LIGHT CHAIN MICE
(71) Regeneron Pharmaceuticals, Inc., 777 Old Saw Mill River Road, Tarrytown, NY 10591, US
(72) MACDONALD, Lynn, 16 Gedney Way, White Plains, NY 10605, US
STEVENS, Sean, 355 Berry Street 413, San Francisco, CA 94158, US
GURER, Cagan, 8 Pamela Lane, Valhalla, NY 10595, US
MURPHY, Andrew, J., 10 Newton Court, Croton-on-Hudson, NY 10520, US
HOSIAWA, Karolina, A., 14 Church Street 2nd Floor, Tarrytown, NY 10591, US
-
- (51) MKP
C12N 9/02 (2006.01) (97) **2491119 ***
(86) EP2010065754 19.10.2010
(96) 10771417.2 29.08.2012
(87) WO2011048119, 19.10.2010
(97) 2491119, 29.08.2012 en
(54) METHODS AND MEANS TO ALTER LIPID BIOSYNTHESIS BY TARGETING MULTIPLE ENZYMES TO SUBORGANELLE DOMAINS
(71) Bayer CropScience NV, J.E. Mommaertslaan 14, 1831 Diegem, BE
(72) FEUSSNER, Ivo, Calsowstrasse 12, 37085 Göttingen, DE
HEILMANN, Mareike, Hanssenstrasse 26, 37073 Göttingen, DE
-
- (51) MKP
A23K 1/16 (2006.01) (97) **2410871 ***
C11C 3/02 (2006.01)
(86) IB2010051126 16.03.2010
(96) 10719080.3 01.02.2012
(87) WO2010106488, 16.03.2010
(97) 2410871, 01.02.2012 en
(54) COMPOSITIONS CONTAINING C1 TO C7 ORGANIC ACID MONOGLYCERIDES AND GLYCEROL, THEIR PREPARATION AND USE AS ANTIBACTERIALS AND ANTI-MOULD AGENTS
(71) Cantini, Fernando, Via Scipione Ammirato 98, 50136 Firenze, IT
(72) Cantini, Fernando, Via Scipione Ammirato 98, 50136 Firenze, IT
-
- (51) MKP
A61M 5/50 (2006.01) (97) **2480276 ***
(86) EP2010063841 21.09.2010
(96) 10754526.1 01.08.2012
(87) WO2011036133, 21.09.2010
(97) 2480276, 01.08.2012 en
(54) ASSEMBLY FOR A DRUG DELIVERY DEVICE AND DRUG DELIVERY DEVICE
(71) Sanofi-Aventis Deutschland GmbH, Brüningstraße 50, 65929 Frankfurt, DE
(72) SCHABBACH, Michael, Sanofi-Aventis Deutschland GmbH, 65926 Frankfurt am Main, DE
HEGER, Serpil, Sanofi-Aventis Deutschland GmbH, 65926 Frankfurt am Main, DE
-
- (51) MKP
G06F 3/048 (2006.01) (97) **2406701 ***
G06F 3/041 (2006.01)
G06F 3/01 (2006.01)
(86) US2010026897 11.03.2010
(96) 10712199.8 18.01.2012
(87) WO2010105004, 11.03.2010
(97) 2406701, 18.01.2012 en
(54) SYSTEMS AND METHODS FOR USING MULTIPLE ACTUATORS TO REALIZE TEXTURES
(71) Immersion Corporation, 801 Fox Lane, San Jose, CA 95131, US
(72) CRUZ-HERNANDEZ, Juan, Manuel, 4840 Ste-Catherine West, Montreal Québec H3Z 1T1, CA
GRANT, Danny, A., 1784 DeLunebourg, Laval Québec H7M 2A1, CA
-
- (51) MKP
C12N 15/11 (2006.01) (97) **2451952 ***
(86) US2010041600 09.07.2010
(96) 10797951.0 16.05.2012
(87) WO2011006121, 09.07.2010
(97) 2451952, 16.05.2012 en
(54) SPARC ANTISENSE COMPOSITIONS AND USES THEREOF
(71) Abraxis BioScience, LLC, 11755 Wilshire Boulevard Suite 2000, Los Angeles, CA 90025, US
(72) TRIEU, Vuong, 3965 North Ceanothus Place, H, Calabasas California 91302, US
HWANG, Lam, 131 South 2nd Avenue, A, Arcadia California 91006, US
DESAI, Neil, 11755 Wilshire Boulevard Suite 2000, Los Angeles California 90025, US
-
- (51) MKP
A41D 19/015 (2006.01) (97) **2481310 ***
(86) ES2010000374 14.09.2010
(96) 10818440.9 01.08.2012
(87) WO2011036314, 14.09.2010
(97) 2481310, 01.08.2012 en
(54) ASEPTIC/PROTECTIVE MITT
(71) Pujal Laborda, Joan, Rambla Catalunya 5, 5°-3a., 08007 Barcelona, ES
(72) Pujal Laborda, Joan, Rambla Catalunya 5, 5°-3a., 08007 Barcelona, ES
-
- (51) MKP
G08B 1/08 (2006.01) (97) **2417591 ***
(86) US2010030411 08.04.2010
(96) 10762444.7 15.02.2012
(87) WO2010118242, 08.04.2010
(97) 2417591, 15.02.2012 en
(54) REDUCING MEDICAL ERROR
(71) Snif Labs, Inc., 108 Lincoln Street, Boston, MA 02111, US
(72) GIPS, Jonathan, Peter, 95 Mt. Vernon Street Apt. 11, Boston, MA 02108, US
LIANG, Philip, Angus, 11 Coombe Road, Causeway Bay Hong Kong, CN
AYLWARD, Ryan, Patrick, 120 Day Street Apartment 3, Boston, MA 02130, US
VALADE, Aaron, Douglas, 194 Brookline Street Apartment 6, Boston, MA 02118, US
-

- (51) MKP
C07D 235/26 (2006.01) (97) **2432766 ***
C07D 471/04 (2006.01)
A61K 31/4745 (2006.01)
A61P 35/00 (2006.01)
- (86) FR2010050948 17.05.2010
(96) 10728768.2 28.03.2012
(87) WO2010133794, 17.05.2010
(97) 2432766, 28.03.2012 fr
(54) ANTICANCER COMPOUND AND PHARMACEUTICAL COMPOSITION CONTAINING THE SAME
(71) SANOFI, 174, Avenue de France, 75013 Paris, FR
(72) CARRY, Jean-Christophe, Sanofi-Aventis Département Brevets 174 Avenue de France, F-75013 Paris, FR
CHEVE, Michel, Sanofi-Aventis Département Brevets 174 Avenue de France, F-75013 Paris, FR
CLERC, François, Sanofi-Aventis Département Brevets 174 Avenue de France, F-75013 Paris, FR
COMBEAU, Cécile, Sanofi-Aventis Département Brevets 174 Avenue de France, F-75013 Paris, FR
GONTIER, Sylvie, Sanofi-Aventis Département Brevets 174 Avenue de France, F-75013 Paris, FR
KRICK, Alain, Sanofi-Aventis Département Brevets 174 Avenue de France, F-75013 Paris, FR
LACHAUD, Sylvette, Sanofi-Aventis Département Brevets 174 Avenue de France, F-75013 Paris, FR
SCHIO, Laurent, Sanofi-Aventis Département Brevets 174 Avenue de France, F-75013 Paris, FR
-
- (51) MKP
H04B 10/10 (2006.01) (97) **2454829 ***
- (86) IT2010000314 16.07.2010
(96) 10747321.7 23.05.2012
(87) WO2011007380, 16.07.2010
(97) 2454829, 23.05.2012 en
(54) APPARATUS FOR TRANSFERRING DATA IN WIRELESS MODE TO A PORTABLE ELECTRONIC DEVICE BY MEANS OF LIGHT PULSES EMITTED FROM AN LCD MONITOR
(71) Agostini, Roberto, Largo Borgo Pace 10, 00138 Roma, IT
(72) Agostini, Roberto, Largo Borgo Pace 10, 00138 Roma, IT
-
- (51) MKP
C07D 231/14 (2006.01) (97) **2462108 ***
C07C 45/62 (2006.01)
C07C 45/64 (2006.01)
C07C 45/66 (2006.01)
C07C 251/44 (2006.01)
C07C 45/69 (2006.01)
C07C 49/693 (2006.01)
C07C 49/743 (2006.01)
- (86) EP2010059703 07.07.2010
(96) 10729880.4 13.06.2012
(87) WO2011015416, 07.07.2010
(97) 2462108, 13.06.2012 en
(54) PROCESS FOR THE PREPARATION OF PYRAZOLE CARBOXYLIC ACID AMIDES
(71) Syngenta Participations AG, Schwarzwaldallee 215, 4058 Basel, CH
(72) GRIBKOV, Denis, Syngenta Crop Protection Münchwilen AG Breitenloh 5, CH-4333 Münchwilen, CH
MÜLLER, Adrian, Syngenta Crop Protection Münchwilen AG Breitenloh 5, CH-4333 Münchwilen, CH
LAGGER, Martin, Syngenta Crop Protection Münchwilen AG Breitenloh 5, CH-4333 Münchwilen, CH
GIORDANO, Fanny, Syngenta Crop Protection AG Schwarzwaldallee 215, CH-4058 Basel, CH
-
- (51) MKP
A61M 5/178 (2006.01) (97) **2495002 ***
B65D 83/00 (2006.01)
A61M 5/31 (2006.01)
B05C 17/01 (2006.01)
- (86) JP2010004737 26.07.2010
(96) 10826255.1 05.09.2012
(87) WO2011052115, 26.07.2010
(97) 2495002, 05.09.2012 en
(54) SYRINGE, DEVICE FOR PRODUCING SYRINGE BODY, AND METHOD FOR PRODUCING SYRINGE BODY
(71) Ajinomoto Co., Inc., 15-1, Kyobashi 1-chome Chuo-ku, Tokyo 104-8315, JP
(72) MURAMATSU, Yasuhiro, c/o Ajinomoto Pharmaceuticals Co. Ltd. 649-1 Miyakami Shimizu-ku, Shizuoka-shi Shizuoka 424-0911, JP
-
- (51) MKP
C23C 16/505 (2006.01) (97) **2251454**
C23C 16/52 (2006.01)
C23C 16/54 (2006.01)
G01N 15/08 (2006.01)
A61B 5/15 (2006.01)
- (96) 10162760.2 17.11.2010
(97) 2251454, 17.11.2010 en
(54) Vessel coating and inspection
(71) CV Holdings, LLC., 1030 Riverfront Center, P.O.Box 710, Amsterdam, New York 12010, US
(72) Abrams, Robert S., 21 Marian Avenue, Albany, NY 12203, US
Felts, John T., 2624 Calhoun Street, Alameda, CA 94501, US
Fisk, Thomas E., 955 North Night Heron Drive, Green Valley, AZ 85614, US
-
- (51) MKP
A63F 9/34 (2006.01) (97) **2412413 ***
A63F 9/30 (2006.01)
A63F 9/02 (2006.01)
- (86) CN2010071224 23.03.2010
(96) 10755429.7 01.02.2012
(87) WO2010108429, 23.03.2010
(97) 2412413, 01.02.2012 en
(54) MAGNETIC PICKUP GAME DEVICE
(71) Basic Concepts International Ltd., Room 904, 9/F Chinachem Golden Plaza 77 Mody Road Tsimshatsui East, Kowloon, Hong Kong, CN
(72) MEYERS, Jon Andrew Norman, Room 904, 9/F Chinachem Golden Plaza 77 Mody Road Tsimshatsui East Kowloon, Hong Kong, CN
KOO, Lily, Room 904, 9/F Chinachem Golden Plaza 77 Mody Road Tsimshatsui East Kowloon, Hong Kong, CN
TZEMBELICOS, Dean, Room 904, 9/F Chinachem Golden Plaza 77 Mody Road Tsimshatsui East Kowloon, Hong Kong, CN
-
- (51) MKP
G06F 3/048 (2006.01) (97) **2498173 ***
- (86) JP2010071370 30.11.2010
(96) 10840842.8 12.09.2012
(87) WO2011080983, 30.11.2010
(97) 2498173, 12.09.2012 en
(54) OBJECT CONTROL METHOD, OBJECT CONTROL PROGRAM, AND WEB SERVER
(71) Rakuten, Inc., 4-12-3, Higashishinagawa Shinagawa-ku, Tokyo 140-0002, JP
(72) MASUKO Soh, c/o Rakuten Inc. 4-12-3 Higashishinagawa Shinagawa-ku, Tokyo 140-0002, JP
-
- (51) MKP
A61K 9/20 (2006.01) (97) **2403485 ***
A61K 31/205 (2006.01)
A61P 25/16 (2006.01)
- (86) EP2010052744 04.03.2010
(96) 10706259.8 11.01.2012
(87) WO2010100219, 04.03.2010
(97) 2403485, 11.01.2012 en
(54) PHARMACEUTICAL COMPOSITION CONTAINING RASAGILINE MESYLATE
(71) Sandoz AG, Lichtstrasse 35, 4056 Basel, CH
TALASILA, Kamalakar, c/o Sandoz Private Ltd Thane Development Center P.O. Sandoz Baug Kolshet Road, Thane 400 607, IN
(72) NARKHEDE, Hemant, c/o Sandoz Private Ltd Thane Development Center P.O. Sandoz Baug Kolshet Road, Thane 400 607, IN
DAROI, Atul, c/o Sandoz Private Ltd Thane Development Center P.O. Sandoz Baug Kolshet Road, Thane 400 607, IN

- (51) MKP
B29C 70/00 (2006.01) (97) **2433790 ***
F41H 5/04 (2006.01)
B32B 5/26 (2006.01)
- (86) CN2010000721 20.05.2010
(96) 10790338.7 28.03.2012
(87) WO2011069320, 20.05.2010
(97) 2433790, 28.03.2012 en
- (54) STAB-RESISTANT BALLISTIC-RESISTANT MATERIAL AND PRODUCTION PROCESS THEREOF
- (71) Hunan Zhongtai Special Equipment Co., Ltd., No.1 Taiping Street, Linli Economic Development Zone Hunan 415211, CN
- (72) ZHANG, Yuanjun, No.1 Taiping Street Linli Economic Development Zone, Hunan 415211, CN
YANG, Nianci, No.1 Taiping Street Linli Economic Development Zone, Hunan 415211, CN
ZHOU, Wanqi, No.1 Taiping Street Linli Economic Development Zone, Hunan 415211, CN
WU, Zhiqian, No.1 Taiping Street Linli Economic Development Zone, Hunan 415211, CN
GUO, Yong, No.1 Taiping Street Linli Economic Development Zone, Hunan 415211, CN
LIN, Mingqing, No.1 Taiping Street Linli Economic Development Zone, Hunan 415211, CN
WU, Chuangqing, No.1 Taiping Street Linli Economic Development Zone, Hunan 415211, CN
LIN, Haijun, No.1 Taiping Street Linli Economic Development Zone, Hunan 415211, CN
ZHOU, Yunbo, No.1 Taiping Street Linli Economic Development Zone, Hunan 415211, CN
GAO, Bo, No.1 Taiping Street Linli Economic Development Zone, Hunan 415211, CN
-
- (51) MKP
A01N 43/42 (2006.01) (97) **2442651 ***
A61K 31/47 (2006.01)
- (86) US2010001759 18.06.2010
(96) 10789873.6 25.04.2012
(87) WO2010147665, 18.06.2010
(97) 2442651, 25.04.2012 en
- (54) TREATMENT OF MULTIPLE SCLEROSIS WITH LAQUINIMOD
- (71) Teva Pharmaceutical Industries Ltd., 5 Basel Street P.O. Box 3190, 49131 Petah Tiqva, IL
- (72) TARCIC, Nora, Migdal David 29/1, Modiin, IL
BAR-ZOHAR, Dan, 10 Havazelet Street, 52365 Ramat-Gan, IL
KOFER, Dina, Hadafna 24, Kadima-Zoran, IL
-
- (51) MKP
A61K 31/195 (2006.01) (97) **2480225 ***
A61K 47/06 (2006.01)
A61K 9/00 (2006.01)
A61P 17/02 (2006.01)
A61K 31/185 (2006.01)
A61P 17/00 (2006.01)
- (86) US2010043599 28.07.2010
(96) 10805005.5 01.08.2012
(87) WO2011014588, 28.07.2010
(97) 2480225, 01.08.2012 en
- (54) DERMAL FORMULATIONS OF DP2 RECEPTOR ANTAGONISTS
- (71) Panmira Pharmaceuticals, LLC, 9535 Waples Street, Suite 100, San Diego, CA 92121, US
- (72) HUTCHINSON, John Howard, 3435 Richmond Street, San Diego California 92103, US
-
- (51) MKP
A61K 31/155 (2006.01) (97) **2424516 ***
- (86) IB2010001012 03.05.2010
(96) 10769389.7 07.03.2012
(87) WO2010125462, 03.05.2010
(97) 2424516, 07.03.2012 en
- (54) PENTAMIDINE COMBINATIONS FOR TREATING CANCER
- (71) Oncozyme Pharma Inc., 555 Rene Levesque Boulevard West 9th Floor, Montreal, Québec H2Z 1B1, CA
- (72) CHOW, Terry, 6252 Des Galleries d'Anjou Boulevard, Anjou, Québec H1M 1V8, CA
CHOW, Chiaoli, 6252 Des Galleries d'Anjou Boulevard, Anjou, Québec H1M 1V8, CA
GRILLER, David, 2026 Delmar Court, Ottawa, Ontario K1H 5R7, CA
-
- (51) MKP
A61M 5/31 (2006.01) (97) **2403564 ***
- (86) EP2010052529 01.03.2010
(96) 10706225.9 11.01.2012
(87) WO2010100104, 01.03.2010
(97) 2403564, 11.01.2012 en
- (54) MEDICATION DELIVERY DEVICE WITH FOLDABLE FINGER PAD
- (71) Sanofi-Aventis Deutschland GmbH, Brüningstraße 50, 65929 Frankfurt, DE
- (72) LANIN, Irina, c/o Sanofi-Aventis Deutschland GmbH, 65926 Frankfurt am Main, DE
FORYS, Bernhard, c/o Sanofi-Aventis Deutschland GmbH, 65926 Frankfurt, DE
CLARKE, Alastair, c/o Sanofi Aventis UK London Road, Holmes Chapel Cheshire Crewe CW48BE, GB
EKMAN, Matthew, c/o Sanofi Aventis UK London Road, Holmes Chapel Cheshire Crewe CW48BE, GB
GOODE, Kirsten, c/o Sanofi Aventis UK London Road, Holmes Chapel Cheshire Crewe CW48BE, GB
HEALD, Michael, c/o Sanofi Aventis UK London Road, Holmes Chapel Cheshire Crewe CW48BE, GB
HILES, John, c/o Sanofi Aventis UK London Road, Holmes Chapel Cheshire Crewe CW48BE, GB
SMITH, Chris, c/o Sanofi Aventis UK London Road, Holmes Chapel Cheshire Crewe CW48BE, GB
HAINS-GADD, Lilly, c/o Sanofi Aventis UK London Road, Holmes Chapel Cheshire Crewe CW48BE, GB
-
- (51) MKP
C07K 14/50 (2006.01) (97) **2427208 ***
A61K 38/18 (2006.01)
- (86) US2010033478 04.05.2010
(96) 10718381.6 14.03.2012
(87) WO2010129503, 04.05.2010
(97) 2427208, 14.03.2012 en
- (54) FGF21 MUTANTS AND USES THEREOF
- (71) Amgen, Inc, One Amgen Center Drive, Thousand Oaks, CA 91320-1799, US
- (72) BELOUSKI, Edward John, 4541 La Tuna Court, Camarillo California 93012, US
ELLISON, Murielle Marie, 645 Camino Manzanitas, Thousand Oaks California 91360, US
HAMBURGER, Agnes Eva, 3885 Calle Alta Vista, Thousand Oaks California 91320, US
HECHT, Randy Ira, 2569 Piccadilly Circle, Thousand Oaks California 91362, US
LI, Yue-Sheng, 3025 Shadow Hill Circle, Thousand Oaks California 91360, US
MICHAELS, Mark Leo, 5007 Texhoma Avenue, Encino California 91316, US
SUN, Jeonghoon, 4340 Camino De La Rosa, Thousand Oaks California 91320, US
XU, Jing, 1677 Glider Court, Thousand Oaks California 91320, US
-
- (51) MKP
A61M 15/00 (2006.01) (97) **2408498 ***
G06M 1/24 (2006.01)
- (86) GB2010050405 10.03.2010
(96) 10710406.9 25.01.2012
(87) WO2010103316, 10.03.2010
(97) 2408498, 25.01.2012 en
- (54) COUNTER
- (71) Euro-Celtique S.A., 2, avenue Charles de Gaulle, 1653 Luxembourg, LU
- (72) BACON, Raymond, Steep Farm Steep Petersfield, Hampshire GU32 2DB, GB
-
- (51) MKP
H05B 33/08 (2006.01) (97) **2409549 ***
- (86) EP2010002456 21.04.2010
(96) 10716766.0 25.01.2012
(87) WO2010121806, 21.04.2010
(97) 2409549, 25.01.2012 de
- (54) CIRCUIT FOR A LIGHT-EMITTING DIODE ASSEMBLY AND LIGHT EMITTING DIODE MODULE
- (71) Vishay Electronic GmbH, Geheimrat-Rosenthal-Strasse 100, 95100 Selb, DE
- (72) DINC, Mustafa, Hegelmaierstrasse 1, 74076 Heilbronn, DE

- (51) MKP
A61P 3/10 (2006.01) (97) **2406251 ***
C07D 403/12 (2006.01)
A61K 31/506 (2006.01)
- (86) GB2010050441 12.03.2010
(96) 10709053.2 18.01.2012
(87) WO2010103334, 12.03.2010
(97) 2406251, 18.01.2012 en
(54) COMPOUNDS FOR THE TREATMENT OF METABOLIC DISORDERS
- (71) Prosidion Limited, Windrush Court Watlington Road, Oxford, Oxfordshire OX4 6LT, GB
(72) SMYTH, Donald, Prosidion Limited Windrush Court Watlington Road Oxford, Oxfordshire OX4 6LT, GB
BARBA, Oscar, Prosidion Limited Windrush Court Watlington Road Oxford, Oxfordshire OX4 6LT, GB
STAROSKE, Thomas, Prosidion Limited Windrush Court Watlington Road Oxford, Oxfordshire OX4 6LT, GB
DUPREE, Tom, Banksia, Prosidion Limited Windrush Court Watlington Road Oxford, Oxfordshire OX4 6LT, GB
STEWART, Alan, John, William, Prosidion Limited Windrush Court Watlington Road Oxford, Oxfordshire OX4 6LT, GB
FRY, Peter, Timothy, Prosidion Limited Windrush Court Watlington Road Oxford, Oxfordshire OX4 6LT, GB
STONEHOUSE, David, French, Prosidion Limited Windrush Court Watlington Road Oxford, Oxfordshire OX4 6LT, GB
FYFE, Matthew, Colin, Thor, Prosidion Limited Windrush Court Watlington Road Oxford, Oxfordshire OX4 6LT, GB
SWAIN, Simon, Andrew, Prosidion Limited Windrush Court Watlington Road Oxford, Oxfordshire OX4 6LT, GB
SCHOFIELD, Karen, Lesley, Prosidion Limited Windrush Court Watlington Road Oxford, Oxfordshire OX4 6LT, GB
KRULLE, Thomas, Martin, Prosidion Limited Windrush Court Watlington Road Oxford, Oxfordshire OX4 6LT, GB
JEEVARATNAM, Revathy, Perpetua, Prosidion Limited Windrush Court Watlington Road Oxford, Oxfordshire OX4 6LT, GB
WITHALL, David, Matthew, Prosidion Limited Windrush Court Watlington Road Oxford, Oxfordshire OX4 6LT, GB

- (51) MKP
A01N 43/90 (2006.01) (97) **2434895 ***
- (86) US2010001444 13.05.2010
(96) 10775209.9 04.04.2012
(87) WO2010132127, 13.05.2010
(97) 2434895, 04.04.2012 en
(54) ORGANIC COMPOUNDS
- (71) Intra-Cellular Therapies, Inc., 3960 Broadway, New York, NY 10032, US
(72) FIENBERG, Allen, A., 3960 Broadway, New York, NY 10032, US
WENNOGLE, Lawrence, J., 3960 Broadway, New York, NY 10032, US
MATES, Sharon, 3960 Broadway, New York, NY 10032, US

- (51) MKP
C07D 401/12 (2006.01) (97) **2414347 ***
A61K 31/415 (2006.01)
A61P 11/00 (2006.01)
A61P 29/00 (2006.01)
- (86) GB2010050575 01.04.2010
(96) 10711930.7 08.02.2012
(87) WO2010112936, 01.04.2010
(97) 2414347, 08.02.2012 en
(54) P38MAP KINASE INHIBITOR
- (71) Respivert Limited, 50-100 Holmers Farm Way, High Wycombe Buckinghamshire HP12 4EG, GB
(72) ITO, Kazuhiro, Respivert Limited Imperial College Biolncubator Level 1 Bessemer Building Imperial College, London SW7 2AZ, GB
STRONG, Peter, Respivert Limited Imperial College Biolncubator Level 1 Bessemer Building Imperial College, London SW7 2AZ, GB
RAPEPORT, William Garth, Respivert Limited Imperial College Biolncubator Level 1 Bessemer Building Imperial College, London SW7 2AZ, GB
MURRAY, Peter John, Respivert Limited Imperial College Biolncubator Level 1 Bessemer Building Imperial College, London SW7 2AZ, GB
KING-UNDERWOOD, John, Moorend Cottage School Lane, Pendock Worcestershire GL19 3PW, GB
WILLIAMS, Jonathan Gareth, Sygnature Chemical Services Ltd Biocity Nottingham Pennyfoot Street, Nottingham Nottinghamshire NG1 1GF, GB
ONIONS, Stuart, Sygnature Chemical Services Ltd Biocity Nottingham Pennyfoot Street, Nottingham Nottinghamshire NG1 1GF, GB
CHARRON, Catherine Elisabeth, Respivert Limited Imperial College Biolncubator Level 1 Bessemer Building Imperial College, London SW7 2AZ, GB

- (51) MKP
C07K 16/18 (2006.01) (97) **2480577 ***
C07K 16/24 (2006.01)
C07K 16/46 (2006.01)
C07K 16/28 (2006.01)
- (86) GB2010001803 24.09.2010
(96) 10761060.2 01.08.2012
(87) WO2011036460, 24.09.2010
(97) 2480577, 01.08.2012 en
(54) DISULFIDE STABILISED MULTIVALENT ANTIBODIES
- (71) UCB Pharma, S.A., 60, allée de la Recherche, 1070 Brussels, BE
(72) ADAMS, Ralph, IPD UCB Celltech 208 Bath Road, Slough Berkshire SL1 3WE, GB
HANCOCK, Laura, IPD UCB Celltech 208 Bath Road, Slough Berkshire SL1 3WE, GB
HEYWOOD, Sam Philip, IPD UCB Celltech 208 Bath Road, Slough Berkshire SL1 3WE, GB

- (51) MKP
H04B 7/14 (2006.01) (97) **2485410 ***
- (86) CN2010077490 29.09.2010
(96) 10819916.7 08.08.2012
(87) WO2011038687, 29.09.2010
(97) 2485410, 08.08.2012 en
(54) TRANSMISSION METHOD, DETECTION METHOD AND EQUIPMENT FOR CONTROL CHANNELS OF A RELAY SYSTEM
- (71) China Academy of Telecommunications Technology, 40, Xueyuan Road, Haidian District, Beijing 100191, CN
(72) SHEN, Zukang, No.40 Xueyuan Road Haidian District, Beijing 100083, CN
PAN, Xueming, No.40 Xueyuan Road Haidian District, Beijing 100083, CN
XIAO, Guojun, No.40 Xueyuan Road Haidian District, Beijing 100083, CN
WANG, Libo, No.40 Xueyuan Road Haidian District, Beijing 100083, CN
ZHANG, Wenjian, No.40 Xueyuan Road Haidian District, Beijing 100083, CN

- (51) MKP
B21D 24/14 (2006.01) (97) **2428290**
(96) 11180851.5 14.03.2012
(97) 2428290, 14.03.2012 en
(54) A cushioning arrangement for presses
(71) Coskunöz Metal Form Makina Endüstriye Tic. A.S., Osb Mavi Cad. No: 5, Bursa, TR
(72) Yorukoglu, Sancar, Osb Mavi Cad. No: 5, Bursa, TR
Demir, Hakan, Osb Mavi Cad. No: 5, Bursa, TR
-
- (51) MKP
A61K 39/00 (2006.01) (97) **2456459 ***
C07K 7/14 (2006.01)
(86) AT2010000271 23.07.2010
(96) 10747785.3 30.05.2012
(87) WO2011009152, 23.07.2010
(97) 2456459, 30.05.2012 en
(54) VACCINE
(71) Affiris AG, Karl-Farkas-Gasse 22, 1030 Wien, AT
(72) STAFFLER, Günther, Juchgasse 8/10, A-1030 Vienna, AT
LÜHRS, Petra, Römersthalgasse 1/27, A-1110 Vienna, AT
MAIRHOFER, Andreas, Baumgasse 36/5, A-1030 Vienna, AT
MATTNER, Frank, Sieveringerstrasse 190, A-1190 Vienna, AT
SCHMIDT, Walter, Böcklinstrasse 19, A-1020 Vienna, AT
DOLISCHKA, Andrea, Richterergasse 8/9, A-1070 Vienna, AT
-
- (51) MKP
B25B 5/06 (2006.01) (97) **2432623 ***
B25B 5/10 (2006.01)
B25B 5/16 (2006.01)
(86) EP2010002778 06.05.2010
(96) 10721960.2 28.03.2012
(87) WO2010133297, 06.05.2010
(97) 2432623, 28.03.2012 de
(54) VARIABLE CLAMPING TOOL
(71) Siegmund, Bernd, Weihertalstrasse 11, 86845 Grossaitingen, DE
(72) Siegmund, Bernd, Weihertalstrasse 11, 86845 Grossaitingen, DE
-
- (51) MKP
A61M 5/315 (2006.01) (97) **2437825 ***
(86) EP2010057483 28.05.2010
(96) 10722349.7 11.04.2012
(87) WO2010139637, 28.05.2010
(97) 2437825, 11.04.2012 en
(54) RESETTING MECHANISM FOR A DRUG DELIVERY DEVICE
(71) Sanofi-Aventis Deutschland GmbH, Brüningstraße 50, 65929 Frankfurt, DE
(72) PLUMPTRE, David, 36 Shire Way Droitwich Spa, Worcestershire WR9 7RQ, GB
JONES, Christopher, 153 High Street, Broadway Worcestershire WR12 7AL, GB
-
- (51) MKP
F25D 23/00 (2006.01) (97) **2340726**
A23L 3/36 (2006.01)
F25D 3/00 (2006.01)
F25D 13/00 (2006.01)
(96) 10193862.9 06.07.2011
(97) 2340726, 06.07.2011 fr
(54) Freezer system for rind formation of a food product
(71) CEMMI-Construction-Etude de Matériel-Maintenance Industrielle, Z.A. de Troyalac'h Rue Nicolas Appert Saint-Evarzec, 29170 Fouesnant, FR
(72) Rolland, Joseph, La Motte, 56110, GOURIN, FR
-
- (51) MKP
C07D 471/04 (2006.01) (97) **2496559 ***
C07D 498/04 (2006.01)
C07D 221/10 (2006.01)
A61K 31/5377 (2006.01)
C07D 401/12 (2006.01)
C07D 401/14 (2006.01)
A61K 31/498 (2006.01)
C07D 401/06 (2006.01)
A61P 3/00 (2006.01)
C07D 417/06 (2006.01)
C07D 405/14 (2006.01)
A61K 31/473 (2006.01)
A61K 31/497 (2006.01)
(86) US2010055586 05.11.2010
(96) 10782081.3 12.09.2012
(87) WO2011057054, 05.11.2010
(97) 2496559, 12.09.2012 en
(54) ARYL- AND HETEROARYLCARBONYL DERIVATIVES OF HEXAHYDROINDENOPYRIDINE AND OCTAHYDROBENZOQUINOLINE
(71) Vitae Pharmaceuticals, Inc., 502 West Office Center Drive, Fort Washington, PA 19034, US
Boehringer Ingelheim International GmbH, Binger Strasse 173, 55216 Ingelheim am Rhein, DE
(72) ECKHARDT, Matthias, Boehringer Ingelheim GmbH Corporate Patents Binger Strasse 173, 55216 Ingelheim am Rhein, DE
PETERS, Stefan, Boehringer Ingelheim GmbH Corporate Patents Binger Strasse 173, 55216 Ingelheim am Rhein, DE
NAR, Herbert, Boehringer Ingelheim GmbH Corporate Patents Binger Strasse 173, 55216 Ingelheim am Rhein, DE
HIMMELSBACH, Frank, Boehringer Ingelheim GmbH Corporate Patents Binger Strasse 173, 55216 Ingelheim am Rhein, DE
ZHUANG, Linghang, 3135 Fox Drive, Chalfont, Pennsylvania 18914, US
-
- (51) MKP
B09B 3/00 (2006.01) (97) **2416899 ***
(86) EP2010054522 06.04.2010
(96) 10715168.0 15.02.2012
(87) WO2010115884, 06.04.2010
(97) 2416899, 15.02.2012 en
(54) WASTE TREATMENT METHOD
(71) AS & Partners S.R.L., Piazza San Sepolcro 1, 20123 Milano, IT
(72) SANNINO, Alessandro, Via Giovanni Gentile 25, I-73100 Lecce, IT
-
- (51) MKP
A61K 31/4178 (2006.01) (97) **2461808 ***
A61P 25/00 (2006.01)
A61P 25/28 (2006.01)
(86) EP2010004770 04.08.2010
(96) 10742753.6 13.06.2012
(87) WO2011015349, 04.08.2010
(97) 2461808, 13.06.2012 en
(54) METHODS FOR ENHANCING THE COGNITIVE FUNCTION
(71) UCB Pharma S.A., Intellectual Property Department Allée de la Recherche 60, 1070 Brussels, BE
(72) KENDA, Benoît, c/o UCB Pharma S.A. 60 Allée de la Recherche, B-1070 Brussels, BE
MATAGNE, Alain, c/o UCB Pharma S.A. 60 Allée de la Recherche, B-1070 Brussels, BE
-
- (51) MKP
H02G 1/04 (2006.01) (97) **2461441**
(96) 11191470.1 06.06.2012
(97) 2461441, 06.06.2012 en
(54) wheel for installing cables
(71) Linjeservice AS, Boks 15 Simensbråten, 1107 Oslo, NO
(72) Glavin, Terje, Bernt Knutsens vei 27, N-1127 Oslo, NO
Stenslie, Edmund, Skreja, N-2857 Skreja, NO

(51) MKP
C09C 1/02 (2006.01) (97) **2377900**
C09C 1/42 (2006.01)
(96) 10160235.7 19.10.2011
(97) 2377900, 19.10.2011 en
(54) Process to prepare surface-modified mineral material, resulting products and uses thereof
(71) Omya Development AG, Baslerstrasse 42, 4665 Oftringen, CH
(72) Wimmer, Guenter, Johannes-Kirschbaum-Strasse 2, 40667 Meerbusch, DE
Schoelkopf, Joachim, Buechbuehlstrasse 3, 8956 Killwangen, CH
Weitzel, Hans-Joachim, Hübeliacker 5a, 5034 Suhr, CH

(51) MKP
A61K 38/48 (2006.01) (97) **2403523 ***
C07K 14/435 (2006.01)
(86) US2010026444 05.03.2010
(96) 10708856.9 11.01.2012
(87) WO2010102262, 05.03.2010
(97) 2403523, 11.01.2012 en
(54) TEMPERATURE SENSITIVE MUTANTS OF MATRIX METALLOPROTEASE 1 UND USES THEREOF
(71) Halozyme, Inc., 11388 Sorrento Valley Road, San Diego, CA 92121, US
(72) BOOKBINDER, Louis, 14823 Gable Ridge Road, San Diego, CA 92128, US
FROST, Gregory I., 13662 Mercado Drive, Del Mar, CA 92014, US
KELLER, Gilbert A., 2523 Carmelita Avenue, Belmont, CA 94002, US
FREY, Gerhard Johann, 13768 Via Cima Bell, San Diego, CA 92129, US
CHANG, Hwai Wen, 1318 Shadow Hills Drive, San Marcos, CA 92069, US
SHORT, Jay Milton, 12985 Via Esperia, Del Mar, CA 92014, US

(51) MKP
A01N 43/66 (2006.01) (97) **2440056 ***
A61K 31/53 (2006.01)
(86) US2010037890 09.06.2010
(96) 10786737.6 18.04.2012
(87) WO2010144522, 09.06.2010
(97) 2440056, 18.04.2012 en
(54) UREIDOPHENYL SUBSTITUTED TRIAZINE DERIVATIVES AND THEIR THERAPEUTICAL APPLICATIONS
(71) Abraxis BioScience, LLC, 11755 Wilshire Boulevard Suite 2000, Los Angeles, CA 90025, US
(72) TAO, Chunlin, 1800 Camden Avenue No.301, Los Angeles CA 90025, US
WANG, Qinwei, 1112 South Cordova Street, Alhambra CA 91801, US
KORONIAK, Lukasz, Chocimska 28, PL-60688 Poznan, PL
POLAT, Tulay, 5750 West Centinela Avenue, No.224, Los Angeles CA 90045, US
NALLAN, Laxman, 930 North Monterey Street, No.236, Alhambra CA 91801, US
DESAI, Neil, 11755 Wilshire Boulevard, Suite 2000, Los Angeles CA 90025, US

(51) MKP
A61P 31/00 (2006.01) (97) **2435412 ***
A61P 35/00 (2006.01)
C07D 239/49 (2006.01)
A61K 31/505 (2006.01)
A61P 17/00 (2006.01)
A61P 11/00 (2006.01)
A61P 27/14 (2006.01)
(86) GB2010050822 20.05.2010
(96) 10721194.8 04.04.2012
(87) WO2010133882, 20.05.2010
(97) 2435412, 04.04.2012 en
(54) DISACCHARIN, DIFUMARIC ACID, DI-L-HYDROXY-2-NAPHTHOIC ACID AND MONO-BENZOIC ACID SALTS OF 4- (DIMETHYLAMINO)BUTYL 2- (4- ((2-AMINO-4-METHYL-6-(PENTYLAMINO) PYRIMIDIN- 5 -YL) METHYL) PHENYL) ACETATE
(71) AstraZeneca AB, null, 151 85 Södertälje, SE
Dainippon Sumitomo Pharma Co., Ltd., 6-8, Dosho-machi 2-chome Chuo-ku Osaka-shi, Osaka 541-8524, JP
(72) BENNETT, Nicholas James, AstraZeneca R&D Charnwood Bakewell Road, Loughborough Leicestershire LE11 5-RH, GB
MCINALLY, Thomas, AstraZeneca R&D Charnwood Bakewell Road, Loughborough Leicestershire LE11 5-RH, GB
PIMM, Austen, c/o AstraZeneca Intellectual Property AstraZeneca R&D Alderley Alderley Park, Macclesfield, Cheshire SK10 4TG, GB
THOM, Stephen, c/o AstraZeneca Intellectual Property AstraZeneca R&D Alderley Alderley Park, Macclesfield, Cheshire SK10 4TG, GB
ISOBE, Yoshiaki, c/o Dainippon Sumitomo Pharma Co., Ltd. 1-98, Kasugadenaka 3-chome Konohana-ku, Osaka-shi Osaka 554-0022, JP

(51) MKP
F01N 3/023 (2006.01) (97) **2410144**
F01N 9/00 (2006.01)
F01N 13/02 (2010.01)
(96) 10170039.1 25.01.2012
(97) 2410144, 25.01.2012 en
(54) Method of Controlling NOx Emissions in an Internal Combustion Engine
(71) Delphi Technologies Holding S.à.r.l., Avenue de Luxembourg, 4940 Bascharage, LU
(72) Parmentier, Michael, 6 RUE FOURNEAU, B-6747, CHATILLON, BE
Schmitt, Julien, 7 RUE DU VIEUX CHATEAU, 57970, KUNTZIG, FR

(51) MKP
A61H 3/02 (2006.01) (97) **2371338**
(96) 11160582.0 05.10.2011
(97) 2371338, 05.10.2011 en
(54) A walking aid
(71) Hateley, Brian Peter, 102 Garswood Road, Wigan WN4 0XS, GB
(72) Hateley, Brian Peter, 102 Garswood Road, Wigan WN4 0XS, GB

(51) MKP
C12N 15/10 (2006.01) (97) **2462226 ***
(86) US2010044083 02.08.2010
(96) 10739456.1 13.06.2012
(87) WO2011017251, 02.08.2010
(97) 2462226, 13.06.2012 en
(54) PROCESS AND DEVICE FOR COLLECTING NUCLEIC ACIDS OF MICROORGANISMS FROM A PARTICULATE SAMPLE
(71) E. I. Du Pont De Nemours And Company, Legal Patent Records Center 1007 Market Street, Wilmington, Delaware 19898, US
(72) STEICHEN, John, 1735 Flint Hill Road, Landenberg Pennsylvania 19350, US
DEMARCO, Daniel, 1517 N. Adams Street, Wilmington Delaware 19805, US
VARKEY, Stephen, 609 Candlestick Lane, Newark Delaware 19702, US

- (51) MKP
B29D 35/14 (2010.01) (97) **2464501 ***
B29C 33/00 (2006.01)
B29C 33/10 (2006.01)
B29C 45/34 (2006.01)
B29C 45/14 (2006.01)
B29C 45/00 (2006.01)
- (86) EP2010004742 03.08.2010
(96) 10741918.6 20.06.2012
(87) WO2011018171, 03.08.2010
(97) 2464501, 20.06.2012 en
(54) INJECTION MOULD WITH COMPENSATION CHAMBER FOR MOULDING TPU AND OTHER THERMOPLASTIC MATERIALS ON RUBBER TREAD.
(71) EUROSUOLE S.P.A., Via S. Pertini 8 Zona Industriale "A", 62012 Civitanova Marche MC, IT
(72) ERCOLI, Germano, Via Giacosa 62, 62012 Civitanova Marche (MC), IT
-
- (51) MKP
E05D 15/06 (2006.01) (97) **2476840**
(96) 11000235.9 18.07.2012
(97) 2476840, 18.07.2012 de
(54) Track roller device
(71) Sunflex Aluminiumsysteme GmbH, Im Ruttenberge 12, 57482 Wenden-Gerlingen, DE
(72) Schneider, Malte, Pirschweg 2 a, D-57482 Wenden, DE
-
- (51) MKP
F16B 13/14 (2006.01) (97) **2317158**
(96) 10188643.0 04.05.2011
(97) 2317158, 04.05.2011 en
(54) Wall plug for masonry walls provided with insulating layers of friable spongy materials
(71) Cirilli, Alessandro, 56, Via San Francesco, 60035 Jesi, IT
(72) Cirilli, Alessandro, 56, Via San Francesco, 60035 Jesi, IT
-
- (51) MKP
G01S 5/02 (2010.01) (97) **2483869 ***
G08B 13/00 (2006.01)
G07C 9/00 (2006.01)
G07C 5/02 (2006.01)
G07F 7/10 (2006.01)
- (86) US2010051141 01.10.2010
(96) 10763569.0 08.08.2012
(87) WO2011041688, 01.10.2010
(97) 2483869, 08.08.2012 en
(54) KEY DEVICE FOR MONITORING SYSTEMS
(71) Checkpoint Systems, Inc., 101 Wolf Drive, Thorofare, NJ 08086, US
(72) MERCIER, Michael, 10722 Eddings Drive, Charlotte NC 28270, US
WYATT, James, Gordon Jr., 910 Osprey Court, Waxhaw NC 28173, US
ECKERT, Lee, H., 1305 Waynewood Drive, Waxhaw NC 28173, US
SHAFER, Gary, Mark, 10338 Gunnison Lane, Charlotte NC 28277, US
-
- (51) MKP
A61P 3/10 (2006.01) (97) **2485724 ***
A61K 31/185 (2006.01)
- (86) EP2010064920 06.10.2010
(96) 10768898.8 15.08.2012
(87) WO2011042465, 06.10.2010
(97) 2485724, 15.08.2012 en
(54) SULFONAMIDES FOR THE PREVENTION OF DIABETES
(71) Dompé S.p.A., Località Campo di Pile snc, 67100 L'Aquila (AQ), IT
(72) PIEMONTI, Lorenzo, Diabetes Research Institute (HSR-DRI) San Raffaele Scientific Institute Via Olgettina 60, I-20132 Milano, IT
DAFFONCHIO, Luisa, c/o Dompé S.p.A. Località Campo di Pile snc, I-67100 L'Aquila AQ, IT
ALLEGRETTI, Marcello, c/o Dompé S.p.A. Località Campo di Pile snc, I-67100 L'Aquila AQ, IT
-
- (51) MKP
C07D 213/65 (2006.01) (97) **2445883 ***
C07C 311/07 (2006.01)
C07D 405/12 (2006.01)
A61K 31/443 (2006.01)
C07D 409/12 (2006.01)
A61K 31/4453 (2006.01)
C07D 295/096 (2006.01)
C07D 307/42 (2006.01)
A61K 31/381 (2006.01)
C07D 409/14 (2006.01)
A61K 31/4709 (2006.01)
C07D 333/38 (2006.01)
A61K 31/402 (2006.01)
C07D 307/22 (2006.01)
A61K 31/341 (2006.01)
- (86) IB2010052827 22.06.2010
(96) 10732448.5 02.05.2012
(87) WO2010150192, 22.06.2010
(97) 2445883, 02.05.2012 en
(54) HETEROCYCLIC SULFONAMIDES, USES AND PHARMACEUTICAL COMPOSITIONS THEREOF
(71) Pfizer Inc., 235 East 42nd Street, New York, NY 10017, US
FLIRI, Anton Franz Joseph, 206 Jerry Browne Road, Stonington Connecticut 06378, US
GALLASCHUN, Randall James, 131 Sisson Road, Lebanon Connecticut 06249, US
O'DONNELL, Christopher John, Pfizer Global Research and Development Eastern Point Road, Groton Connecticut 06340, US
SCHWARZ, Jacob Bradley, 7211 Balmoral Way, San Ramon California 94582, US
SEGELSTEIN, Barbara Eileen, 16 Woodland Lane, Gales Ferry Connecticut 06335, US
-
- (51) MKP
C07D 209/40 (2006.01) (97) **2366687**
C07D 209/88 (2006.01)
C07D 409/12 (2006.01)
A61P 35/00 (2006.01)
C07D 209/08 (2006.01)
A61K 31/404 (2006.01)
- (96) 11156199.9 21.09.2011
(97) 2366687, 21.09.2011 en
(54) Benzenesulfonamide derivatives and pharmaceutical composition thereof
(71) Purzer Pharmaceutical Co., Ltd., 12F-2, No.1 Guangfu S.Road Taipei 105, Taiwan, CN
(72) Chern, Ji-Wang, 9F., No.108, Ln. 77, Sec.4 Xinhai Rd. Wenshan Dist., Taipei City 116, TW
Chen, Grace Shiahuy, No.85, Ln.480, Sec.2 Fengshi Rd. Taichung County 420, Fengyuan City, TW
Chang, Pei-Teh, 4F., No.92, Sec.4 Minsheng E. Rd. Songshan Dist., Taipei City 105, TW
Chen, Kuan-Yu, No.39, Jingjian 1st Rd. Kuanyin Industrial Park Kuanyin Township, Taoyuan County 328, TW
Chen, Meng-Ling, No.31, Ln.4, Anhe 1st St., Anle Dist., Keelung City 204, TW
Lee, Hsueh-Yun, 4F, No. 24, Xinsheng St. Linkou Dist., New Taipei City 24445, TW
Huang, Chiung Hua, 8F.-3, No.222, Sec.2, Nanchang Rd Zhongzheng Dist, Taipei City 100, TW
Chiou, Chun-Tang, No.51, Ln.80, Linkou St. Xinyi Dist., Taipei City 110, TW
-

- (51) MKP
C07D 417/12 (2006.01) (97) **2493858 ***
A61K 31/44 (2006.01)
C07D 405/12 (2006.01)
A61K 31/5377 (2006.01)
A61K 31/42 (2006.01)
C07D 231/14 (2006.01)
A61K 31/438 (2006.01)
C07D 413/12 (2006.01)
A61K 31/416 (2006.01)
C07D 401/12 (2006.01)
A61K 31/497 (2006.01)
A61P 35/00 (2006.01)
C07D 403/12 (2006.01)
A61K 31/4523 (2006.01)
(86) FI2010000065 27.10.2010
(96) 10781918.7 05.09.2012
(87) WO2011051540, 27.10.2010
(97) 2493858, 05.09.2012 en
(54) ANDROGEN RECEPTOR MODULATING COMPOUNDS
(71) Orion Corporation, Orionintie 1, 02200 Espoo, FI
(72) WOHLFAHRT, Gerd, Vattuniemenkatu 14 C 35, FIN-00210 Helsinki, FI
TÖRMÄKANGAS, Olli, Rossinpolku 2 D 4, FIN-20380 Turku, FI
SALO, Harri, Puolikontie 6 C, FIN-20300 Turku, FI
HÖGLUND, Iisa, Kaniikintie 17, FIN-20300 Turku, FI
KARJALAINEN, Arja, Iltatie 4 B 6, FI-02210 Espoo, FI
KNUUTTILA, Pia, Väinämöisenkatu 5, FIN-20660 Littoinen, FI
HOLM, Patrik, Nilsbynkaari 77, FIN-21630 Lielähti TL, FI
RASKU, Sirpa, Kavaljeerintie 14 B 10, FI-01520 Vantaa, FI
VESALAINEN, Anniina, Kohmontie 10 A 26, FIN-20540 Turku, FI
-
- (51) MKP
A23L 1/176 (2006.01) (97) **2475266 ***
A23L 1/01 (2006.01)
(86) US2010048246 09.09.2010
(96) 10816068.0 18.07.2012
(87) WO2011031841, 09.09.2010
(97) 2475266, 18.07.2012 en
(54) EDIBLE SURFACE-MODIFYING PARTICLES AND METHODS FOR THEIR MANUFACTURE
(71) Durafizz, LLC, 35 Spinelli Place, Cambridge, MA 02138, US
(72) SOANE, David, 307 Hammond Street, Chestnut Hill MA 02467, US
FORTIN, Lauren, 29 Cortland Drive, Stow MA 01775, US
COURVILLE, George, 19 Ridgefield Road, Winchester MA 01890, US
-
- (51) MKP
A01N 59/08 (2006.01) (97) **2374353**
A61K 8/19 (2006.01)
A01N 59/06 (2006.01)
C02F 1/50 (2006.01)
D21H 21/36 (2006.01)
A01N 55/02 (2006.01)
(96) 10159511.4 12.10.2011
(97) 2374353, 12.10.2011 en
(54) Process to preserve aqueous preparations of mineral materials, preserved aqueous preparations of mineral materials and use of preservative compounds in aqueous preparations of mineral materials
(71) Omya Development AG, Baslerstrasse 42, 4665 Oftringen, CH
(72) Di Maiuta, Nicola, Amselweg 8, 4528 Zuchwil, CH
Schwarzentruber, Patrick, Untere Lättenstrasse 193, 5245 Habsburg, CH
-
- (51) MKP
C06B 23/00 (2006.01) (97) **2445852 ***
C06B 45/10 (2006.01)
C06B 21/00 (2006.01)
F42B 33/06 (2006.01)
A62D 3/02 (2007.01)
A62D 3/30 (2007.01)
(86) EP2010059015 24.06.2010
(96) 10725482.3 02.05.2012
(87) WO2010149750, 24.06.2010
(97) 2445852, 02.05.2012 en
(54) SYSTEMS AND METHODS FOR CHEMICAL AND/OR MECHANICAL REMEDIATION OF NITRO COMPOUNDS AND NITRATE ESTERS
(71) Maxamcorp Holding, S.L., Avda. del Partenon 16 - 5a Pl, 28042 Madrid, ES
(72) LUBBE, Carl Hermanus, 6546-A Roosevelt Avenue, Charleston West Virginia 25304, US
HARRIS, Delana, 10 A Dairy Road, Poca West Virginia 25159, US
BOTIJA GONZÁLEZ, José Manuel, Maxamcorp Holding S.I. Avda. del Partenón 16 - 5ª pl., E-28042 Madrid, ES
BEITIA GÓMEZ DE SEGURA, Fernando María, Maxamcorp Holding S.I. Avda. del Partenón 16 - 5ª pl., E-28042 Madrid, ES
-
- (51) MKP
A61K 9/50 (2006.01) (97) **2467132 ***
A61K 9/00 (2006.01)
A61K 8/11 (2006.01)
(86) IL2010001092 30.12.2010
(96) 10805340.6 27.06.2012
(87) WO2011080741, 30.12.2010
(97) 2467132, 27.06.2012 en
(54) CORE STABILIZED MICROCAPSULES, METHOD OF THEIR PREPARATION AND USES THEREOF
(71) Sol-Gel Technologies Ltd., Gloda Meir Street 7 Weizmann Science Park, Ness Ziona 74036, IL
(72) TOLEDANO, Ofer, 15A Emek Zvulon Street, 44623 Kfar Saba, IL
BAR-SIMANTOV, Haim, 22 Sarah Imenu Street, 71727 Modi'in, IL
SERTCHOOK, Hanan, 23 Katznelson Street, 70700 Gedera, IL
FIREMAN-SHORESH, Sharon, 37 Spinoza Street, 64384 Tel-Aviv, IL
MARCO-DAGAN, Dorit, 16 Hasne St., 52372 Ramat Gan, IL
-
- (51) MKP
H04W 24/04 (2009.01) (97) **2453693 ***
(86) CN2010075096 09.07.2010
(96) 10796741.6 16.05.2012
(87) WO2011003364, 09.07.2010
(97) 2453693, 16.05.2012 en
(54) METHOD AND DEVICE FOR MAINTAINING LONG TERM EVOLUTION BASE STATION
(71) China Academy of Telecommunications Technology, 40, Xueyuan Road, Haidian District, Beijing 100191, CN
(72) MA, Weiguo, No.40 Xueyuan Road Haidian District, Beijing 100083, CN
LIU, Bing, No.40 Xueyuan Road Haidian District, Beijing 100083, CN
TANG, Jiye, No.40 Xueyuan Road Haidian District, Beijing 100083, CN
WANG, Yan, No.40 Xueyuan Road Haidian District, Beijing 100083, CN
-
- (51) MKP
C12N 9/10 (2006.01) (97) **2499245 ***
C12P 21/02 (2006.01)
A61K 38/14 (2006.01)
C12N 15/54 (2006.01)
C12Q 1/68 (2006.01)
(86) US2010056230 10.11.2010
(96) 10830656.4 19.09.2012
(87) WO2011060069, 10.11.2010
(97) 2499245, 19.09.2012 en
(54) GLYCOSYL TRANSFERASE FROM CHINESE HAMSTER AND RELATED METHODS
(71) Momenta Pharmaceuticals, Inc., 675 West Kendall Street, Cambridge, MA 02142, US
(72) MEADOR III, James, W., 38 Gryzboska Circle, Framingham, MA 01702, US

- (51) MKP
A61K 31/337 (2006.01) (97) **2427187 ***
A61K 31/7068 (2006.01)
A61P 35/00 (2006.01)
- (86) FR2010050873 06.05.2010
(96) 10727466.4 14.03.2012
(87) WO2010128258, 06.05.2010
(97) 2427187, 14.03.2012 fr
(54) ANTITUMOR COMBINATION INCLUDING CABAZITAXEL AND CAPECITABINE
- (71) SANOFI, 174, Avenue de France, 75013 Paris, FR
(72) MAGHERINI, Emmanuelle, c/o Sanofi-Aventis Département Brevets 174 avenue de France, F-75013 Paris, FR
-
- (51) MKP
A61P 3/00 (2006.01) (97) **2377855**
A61P 9/00 (2006.01)
C07D 257/04 (2006.01)
A61K 31/41 (2006.01)
- (96) 10160292.8 19.10.2011
(97) 2377855, 19.10.2011 en
(54) A valsartanamide dinitrate derivative for the treatment of vascular and metabolic diseases
- (71) Cardiolyx AG, Hochbergerstrasse 60c, 4057 Basel, CH
(72) Sartor, Dirk, Holzbergstrasse 18, 64668, Rimbach, DE
Scherhag, Armin, Bannhollenweg 3, 4143, Dornach, CH
-
- (51) MKP
A61K 31/425 (2006.01) (97) **2442655 ***
A01N 43/78 (2006.01)
- (86) US2010039379 21.06.2010
(96) 10790329.6 25.04.2012
(87) WO2010148409, 21.06.2010
(97) 2442655, 25.04.2012 en
(54) COMPOSITIONS AND METHODS FOR TREATING AMYOTROPHIC LATERAL SCLEROSIS
- (71) Knopp Neurosciences, Inc., 2100 Wharton Street, Suite 615, Pittsburgh, PA 15203, US
(72) GRIBKOFF, Valentin, 142 Williams Road, Wallingford CT 06492, US
BOZIK, Michael, E., 108 Heidcrest Drive, Pittsburgh PA 15237, US
-
- (51) MKP
C12N 15/11 (2006.01) (97) **2451940 ***
C12N 5/00 (2006.01)
- (86) US2010041072 06.07.2010
(96) 10797723.3 16.05.2012
(87) WO2011005765, 06.07.2010
(97) 2451940, 16.05.2012 en
(54) BIOPROCESSING
- (71) Alnylam Pharmaceuticals, Inc., 300 Third Street, 3rd Floor, Cambridge, MA 02142, US
(72) ROSSOMANDO, Anthony, c/o Alnylam Pharmaceuticals, Inc. 300 Third Street Third Floor, Cambridge Massachusetts 02142, US
MARAGANORE, John, c/o Alnylam Pharmaceuticals, Inc. 300 Third Street Third Floor, Cambridge Massachusetts 02142, US
POLLARD, Stuart, c/o Alnylam Pharmaceuticals, Inc. 300 Third Street Third Floor, Cambridge Massachusetts 02142, US
KOCISKO, David, c/o Alnylam Pharmaceuticals, Inc. 300 Third Street Third Floor, Cambridge Massachusetts 02142, US
MANOHARAN, Muthiah, c/o Alnylam Pharmaceuticals, Inc. 300 Third Street Third Floor, Cambridge Massachusetts 02142, US
BORLAND, Todd, c/o Alnylam Pharmaceuticals, Inc. 300 Third Street Third Floor, Cambridge Massachusetts 02142, US
HOGAN, Shannon, c/o Alnylam Pharmaceuticals, Inc. 300 Third Street Third Floor, Cambridge Massachusetts 02142, US
-
- (51) MKP
C12M 1/12 (2006.01) (97) **2443224 ***
- (86) US2010039337 21.06.2010
(96) 10790320.5 25.04.2012
(87) WO2010148392, 21.06.2010
(97) 2443224, 25.04.2012 en
(54) NON-INVASIVE SENSING OF BIOPROCESS PARAMETERS
- (71) University of Maryland, Baltimore County, 1000 Hilltop Circle, Baltimore, MD 21250, US
(72) RAO, Govind, 10401 Northdale Road, Columbia Maryland 21044, US
KOSTOV, Yordan, 5495 Mystic Court, Columbia Maryland 21044, US
TOLOSA, Leah, 7196 Lasting Light Way, Columbia Maryland 21045, US
-
- (51) MKP
H04L 12/56 (2006.01) (97) **2478677 ***
- (86) EP2010063508 15.09.2010
(96) 10768194.2 25.07.2012
(87) WO2011032954, 15.09.2010
(97) 2478677, 25.07.2012 en
(54) AN APPARATUS FOR ANALYZING A DATA PACKET, A DATA PACKET PROCESSING SYSTEM AND A METHOD
- (71) Napatech A/S, Tobaksvej 23A, 2860 Søborg, DK
(72) CHRISTOPHERSEN, Jens, Klaus Nebs Vej 10C, DK-2830 Virum, DK
-
- (51) MKP
A61K 39/395 (2006.01) (97) **2429582 ***
- (86) US2010034704 13.05.2010
(96) 10775530.8 21.03.2012
(87) WO2010132659, 13.05.2010
(97) 2429582, 21.03.2012 en
(54) ANTI-HUMAN CD52 IMMUNOGLOBULINS
- (71) Genzyme Corporation, 500 Kendall Street, Cambridge, MA 02142, US
(72) ROBERTS, Bruce L., 108 Pine Hill Road, Southborough Massachusetts 01772, US
SHANKARA, Srinivas, 17 Sheryl Drive, Shrewsbury Massachusetts 01545, US
BRONDYK, William Harold, 52 Darby Drive, Mansfield Massachusetts 02048, US
SIDERS, William M., 618 Lisa Lane, Franklin Massachusetts 02038, US
-
- (51) MKP
E03D 9/08 (2006.01) (97) **2400070**
- (96) 11169852.8 28.12.2011
(97) 2400070, 28.12.2011 en
(54) Sanitary washing apparatus for private body parts
- (71) Toto Ltd., 1-1, Nakashima 2-chome, Kokurakita-ku, Kitakyushu-shi, Fukuoka 802-8601, JP
(72) Morotomi, Yo, c/o TOTO LTD. 1-1 Nakashima 2-chome, Kokurakita-ku., Kitakyushu-shi, Fukuoka 802-8601, JP
Matsushita, Koichiro, c/o TOTO LTD. 1-1 Nakashima 2-chome, Kokurakita-ku., Kitakyushu-shi, Fukuoka 802-8601, JP
Matsumoto, Satoru, c/o TOTO LTD. 1-1 Nakashima 2-chome, Kokurakita-ku., Kitakyushu-shi, Fukuoka 802-8601, JP
Ishii, Katsunori, c/o TOTO LTD. 1-1 Nakashima 2-chome, Kokurakita-ku., Kitakyushu-shi, Fukuoka 802-8601, JP
Yano, Yukiko, c/o TOTO LTD. 1-1 Nakashima 2-chome, Kokurakita-ku., Kitakyushu-shi, Fukuoka 802-8601, JP
-
- (51) MKP
A61K 38/27 (2006.01) (97) **2421548 ***
C07K 17/02 (2006.01)
A61K 38/16 (2006.01)
C07K 14/60 (2006.01)
A61K 31/366 (2006.01)
- (86) CA2010000548 20.04.2010
(96) 10766538.2 29.02.2012
(87) WO2010121352, 20.04.2010
(97) 2421548, 29.02.2012 en
(54) USE OF (HEXENOYL TRANS-3)HGRF(L-44)NH2 AND SIMVASTATIN IN COMBINATION THERAPY
- (71) Theratechnologies Inc., 2310, boulevard Alfred-Nobel, Montreal, Quebec H4S 2B4, CA
(72) MARSOLAIS, Christian, 177 Jasper, Ville Mont-Royal, Quebec H3P 1K1, CA

- (51) MKP
C12P 19/02 (2006.01) (97) **2435577 ***
- (86) US2010036058 25.05.2010
(96) 10781083.0 04.04.2012
(87) WO2010138502, 25.05.2010
(97) 2435577, 04.04.2012 en
- (54) PRODUCTION OF GLYCOPROTEINS
- (71) Momenta Pharmaceuticals, Inc., 675 West Kendall Street, Cambridge, MA 02142, US
- (72) COLLINS, Brian, 30 Country Club Drive, Arlington MA 02474, US
GUO, Tiffany, 207 General Lee Street, Langrange OH 44050, US
THIRUNEELAKANTAPILLAI, Lakshmanan, 7 Oceanview Drive Apt. 505, Boston MA 02125, US
MILLEA, Kevin, 142 Main Street, Saugus MA 01906, US
BULIK, Dorota, 240 Hawthorne Street, Malden, MA 2148, US

- (51) MKP
E04B 1/80 (2006.01) (97) **2340338 ***
- (86) SI2010000017 29.03.2010
(96) 10720209.5 06.07.2011
(87) WO2011031242, 29.03.2010
(97) 2340338, 06.07.2011 en
- (54) GAS FILLED INSULATION CONSTRUCTION PANEL
- (71) CBS Institut Celovite Gradbene Resitve, d.o.o., Prijateljjeva cesta 12, 8210 Trebnje, SI
Reflex d.o.o., Podgrad 4, 9250 Gornja Radgona, SI
- (72) KRALJ, Ale, Oki kega 25, 1000 Ljubljana, SI
HAJDINJAK, Rudi, Cresnjevcji 69, 9250 Gornja Radgona, SI

- (51) MKP
A61K 31/438 (2006.01) (97) **2460806 ***
- A61P 17/00 (2006.01)**
A61K 31/519 (2006.01)
A61P 17/06 (2006.01)
A61K 31/55 (2006.01)
A61P 19/02 (2006.01)
A61P 1/04 (2006.01)
A61P 21/04 (2006.01)
A61K 31/437 (2006.01)
A61P 11/06 (2006.01)
A61P 3/10 (2006.01)
A61P 25/00 (2006.01)
A61P 7/00 (2006.01)
C07D 519/00 (2006.01)
A61P 11/02 (2006.01)
- (86) JP2010062873 30.07.2010
(96) 10804531.1 06.06.2012
(87) WO2011013785, 30.07.2010
(97) 2460806, 06.06.2012 en
- (54) NITROGEN-CONTAINING SPIRO-RING COMPOUND AND MEDICINAL USE OF SAME
- (71) Japan Tobacco, Inc., 2-1, Toranomom 2-chome Minato-ku, Tokyo 105-8422, JP
- (72) NOJI, Satoru, c/o Central Pharmaceutical Research Institute of Japan Tobacco Inc. 1-1 Murasaki-cho, Takatsuki-shi Osaka 569-1125, JP
SHIOZAKI, Makoto, c/o Central Pharmaceutical Research Institute of Japan Tobacco Inc. 1-1 Murasaki-cho, Takatsuki-shi Osaka 569-1125, JP
MIURA, Tomoya, c/o Central Pharmaceutical Research Institute of Japan Tobacco Inc. 1-1 Murasaki-cho, Takatsuki-shi Osaka 569-1125, JP
HARA, Yoshinori, c/o Central Pharmaceutical Research Institute of Japan Tobacco Inc. 1-1 Murasaki-cho, Takatsuki-shi Osaka 569-1125, JP
YAMANAKA, Hiroshi, c/o Central Pharmaceutical Research Institute of Japan Tobacco Inc. 1-1 Murasaki-cho, Takatsuki-shi Osaka 569-1125, JP
MAEDA, Katsuya, c/o Central Pharmaceutical Research Institute of Japan Tobacco Inc. 1-1 Murasaki-cho, Takatsuki-shi Osaka 569-1125, JP
HORI, Akimi, c/o Central Pharmaceutical Research Institute of Japan Tobacco Inc. 1-1 Murasaki-cho, Takatsuki-shi Osaka 569-1125, JP
INOUE, Masafumi, c/o Central Pharmaceutical Research Institute of Japan Tobacco Inc. 1-1 Murasaki-cho, Takatsuki-shi Osaka 569-1125, JP
HASE, Yasunori, c/o Central Pharmaceutical Research Institute of Japan Tobacco Inc. 1-1 Murasaki-cho, Takatsuki-shi Osaka 569-1125, JP

- (51) MKP
C07K 19/00 (2006.01) (97) **2474558 ***
- C12N 15/62 (2006.01)**
A61P 31/04 (2006.01)
C12N 15/63 (2006.01)
A61K 38/16 (2006.01)
A61K 47/48 (2006.01)
C12P 21/02 (2006.01)
- (86) CN2010077351 27.09.2010
(96) 10813369.5 11.07.2012
(87) WO2011026447, 27.09.2010
(97) 2474558, 11.07.2012 en
- (54) NEW ANTIBIOTIC CONTAINING SIMULACRUM ANTIBODY, PREPARATION METHOD AND APPLICATION THEREOF
- (71) Protein Design Lab, Ltd., Qianshajian Sujiatuo Haidian District, Beijing 100095, CN
- (72) QIU, Xiaoqing, Huaxi Hospital of SICHUAN University No.37 Guoxuexiang, Chengdu Sichuan 610041, CN

- (51) MKP
A23J 1/14 (2006.01) (97) **2482670 ***
- A23J 3/16 (2006.01)**
A23L 2/02 (2006.01)
- (86) CA2010001017 30.06.2010
(96) 10793475.4 08.08.2012
(87) WO2011000098, 30.06.2010
(97) 2482670, 08.08.2012 en
- (54) PREPARATION OF SOY PROTEIN ISOLATE USING CALCIUM CHLORIDE EXTRACTION ("S703")
- (71) Burcon Nutrascience (MB) Corp., 1388 Waller Avenue, Winnipeg, Manitoba R3T 1P9, CA
- (72) SEGALL, Kevin, I., 31 Dunbar Crescent, Winnipeg Manitoba R3P 0W6, CA
SCHWEIZER, Martin, 117 Haig Avenue, Winnipeg Manitoba R2M 0E3, CA
GREEN, Brent, E., 24 Poplarwood Drive Box 603, Warren Manitoba R0C 3E0, CA
MEDINA, Sarah, 315 Wildwood Park, Winnipeg Manitoba R3T 0E5, CA
GOSNELL, Brandy, 118 Arden Avenue, Winnipeg Manitoba R2M 2K2, CA

- (51) MKP
E04H 15/32 (2006.01) (97) **2414605 ***
- E04H 15/64 (2006.01)**
E04B 1/343 (2006.01)
- (86) NO2010000123 31.03.2010
(96) 10759086.1 08.02.2012
(87) WO2010114388, 31.03.2010
(97) 2414605, 08.02.2012 en
- (54) SUPPORT PROFILE
- (71) Delta Systems AS, Storebotn Næringspark, 5300 Kleppstø, NO
- (72) STRAND, Gunnar, Landåslien 70, N-5097 Bergen, NO

- (51) MKP
A01G 3/037 (2006.01) (97) **2353366**
- (96) 11153174.5 10.08.2011
(97) 2353366, 10.08.2011 fr
- (54) Branche shear for cutting plants
- (71) Infaco S.A.S, Bois de Rozies - B.P.2, 81140 Cahuzac Sur Vere, FR
- (72) Delmas, Daniel, Bois de Rozies, 81140, CAHUZAC SUR VERE, FR

- (51) MKP
A61F 11/00 (2006.01) (97) **2453855 ***
A61B 17/34 (2006.01)
- (86) US2010042128 15.07.2010
(96) 10735391.4 23.05.2012
(87) WO2011008948, 15.07.2010
(97) 2453855, 23.05.2012 en
- (54) TYMPANIC MEMBRANE PRESSURE EQUALIZATION TUBE DELIVERY SYSTEM
- (71) Acclarent, Inc., 1525-B O'Brien Drive, Menlo Park, CA 94025, US
- (72) VRANY, Julie, D., 317 Blue Oak Lane, Los Altos CA 94022, US
LIU, Greg, 1244 Parkington Avenue, Sunnyvale CA 94087, US
CLOPP, Mathew, D., 3435 Notre Dame Drive, Santa Clara CA 95021, US
KNODEL, Bryan, 6050 W. Saskan Ranch Circle, Flagstaff AZ 86001, US
GROSS, Thomas, Daniel, 200 Kimble Avenue, Los Gatos CA 95030, US
HA, Hung, V., 2974 Delancey Court, San Jose CA 95135, US
GIROTRA, Rohit, 886-A De Haro Street, San Francisco CA 94107, US
ANDREAS, Bernard, H., 633 California Way, Redwood City CA 94062, US
MORRIS, John, H., 725 A Wisconsin Street, San Francisco CA 94107, US
WALKER, Jeffrey, A., 2687 Elston Street, Livermore CA 94550, US
-
- (51) MKP
F23D 14/70 (2006.01) (97) **2446192 ***
F23Q 3/00 (2006.01)
F23C 3/00 (2006.01)
F23D 14/10 (2006.01)
- (86) IB2010052908 25.06.2010
(96) 10759990.4 02.05.2012
(87) WO2010150228, 25.06.2010
(97) 2446192, 02.05.2012 en
- (54) BURNER
- (71) Ergo Design S.R.L., Via Sestri 29 A/3, 16154 Genova, IT
Lualdi, Ambrogio, Via Clerici 168, 20010 Marcallo Con Casone, Milano, IT
- (72) ARECCO, Stefano, Via Laviosa 9/12, I-16156 Genova, IT
GOLLO, Enrico, Via Privata del Roccolo 41/6 sc. C, I-16011 Arenzano, Genova, IT

- (51) MKP
A01N 37/18 (2006.01) (97) **2410844 ***
A01K 31/16 (2006.01)
- (86) US2010028653 25.03.2010
(96) 10756840.4 01.02.2012
(87) WO2010111483, 25.03.2010
(97) 2410844, 01.02.2012 en
- (54) INHIBITORS OF HEPATITIS C VIRUS REPLICATION
- (71) Merck Sharp & Dohme Corp., 126 East Lincoln Avenue, Rahway, NJ 07065-0907, US
- (72) LUDMERER, Steven, W., 126 East Lincoln Avenue, Rahway New Jersey 07065-0907, US
YAN, Man, 288 Fute Zhong Road Waigaoqiao Free Trade Zone, Shanghai 200131, CN
HU, Bin, 288 Fute Zhong Road Waigaoqiao Free Trade Zone, Shanghai 200131, CN
ZHU, Jian, 288 Fute Zhong Road Waigaoqiao Free Trade Zone, Shanghai 200131, CN
SOLL, Richard, 288 Fute Zhong Road Waigaoqiao Free Trade Zone, Shanghai 200131, CN
COBURN, Craig, A., 126 East Lincoln Avenue, Rahway New Jersey 07065-0907, US
SUN, Fei, 288 Fute Zhong Road Waigaoqiao Free Trade Zone, Shanghai 200131, CN
MCCAULEY, John, A., 126 East Lincoln Avenue, Rahway New Jersey 07065-0907, US
WANG, Xinghai, 288 Fute Zhong Road Waigaoqiao Free Trade Zone, Shanghai 200131, CN
LIU, Kun, 126 East Lincoln Avenue, Rahway New Jersey 07065-0907, US
ZHANG, Chengren, 288 Fute Zhong Road Waigaoqiao Free Trade Zone, Shanghai 200131, CN
VACCA, Joseph, P., 126 East Lincoln Avenue, Rahway New Jersey 07065-0907, US
ZHENG, Mingwei, 288 Fute Zhong Road Waigaoqiao Free Trade Zone, Shanghai 200131, CN
WU, Hao, 288 Fute Zhong Road Waigaoqiao Free Trade Zone, Shanghai 200131, CN
ZHONG, Bin, 288 Fute Zhong Road Waigaoqiao Free Trade Zone, Shanghai 200131, CN

- (51) MKP
A61K 31/205 (2006.01) (97) **2456433 ***
A61P 25/12 (2006.01)
A61P 25/00 (2006.01)
- (86) US2010042547 20.07.2010
(96) 10802755.8 30.05.2012
(87) WO2010113376, 20.07.2010
(97) 2456433, 30.05.2012 en
- (54) METHODS FOR THE PREPARATION AND USE OF AQUEOUS SOLUTIONS OF MAGNESIUM VALPROATE HYDRATE AND L-CARNITINE
- (71) Biolink Life Sciences, Inc., 250 Quade Drive, Cary, NC 27513, US
- (72) NELSON, Deanna J., 1505 Princess Anne Road, Raleigh North Carolina 27607, US

- (51) MKP
A61F 13/15 (2006.01) (97) **2332505**
- (86) 10251867.7 15.06.2011
(97) 2332505, 15.06.2011 en
- (54) Method and apparatus for stretching segmented stretchable film and application of the segmented film to a moving web
- (71) Curt G. Joa, Inc., 100 Crocker Avenue, Sheboygan Falls, Wisconsin 53085, US
- (72) McCabe, John A, 1141 Partridge Run, Sheboygan Falls Wisconsin 53085, US

- (51) MKP
C08F 2/18 (2006.01) (97) **2492288 ***
C08F 20/14 (2006.01)
- (86) JP2010068705 22.10.2010
(96) 10825052.3 29.08.2012
(87) WO2011049203, 22.10.2010
(97) 2492288, 29.08.2012 en
- (54) METHACRYLIC RESIN, MOLDED BODY THEREOF, AND METHOD FOR PRODUCING METHACRYLIC RESIN
- (71) Asahi Kasei Chemicals Corporation, 1-105, Kanda Jinbocho Chiyoda-ku, Tokyo 101-8101, JP
- (72) MURAKAMI, Fumiki, 1-105 Kanda Jinbocho Chiyoda-ku, Tokyo 101-8101, JP

- (51) MKP
B44C 1/10 (2006.01) (97) **2432649 ***
B44C 1/16 (2006.01)
B44C 1/18 (2006.01)
B44C 5/04 (2006.01)
(86) HU2010000058 20.05.2010
(96) 10777434.1 28.03.2012
(87) WO2010133904, 20.05.2010
(97) 2432649, 28.03.2012 en
(54) DECORATIVE ELEMENT FOR DECORATION OF SURFACES, PREFERABLY WALL SURFACES
(71) Bindics, Elek, Mátyás király u. 14, 2133 Szödliget, HU
(72) Bindics, Elek, Mátyás király u. 14, 2133 Szödliget, HU

- (51) MKP
A61K 31/407 (2006.01) (97) **2419431 ***
A61P 25/00 (2006.01)
C07D 487/08 (2006.01)
C07D 207/14 (2006.01)
C07C 233/77 (2006.01)
(86) FR2010050711 13.04.2010
(96) 10723665.5 22.02.2012
(87) WO2010119222, 13.04.2010
(97) 2419431, 22.02.2012 fr
(54) DERIVATIVES OF N-[(7-AZA-BICYCLO[2.2.1]HEPT-1-YL)-ARYL-METHYL]-BENZAMIDE, PREPARATION THEREOF, AND THERAPEUTIC USE THEREOF
(71) SANOFI, 174, Avenue de France, 75013 Paris, FR
(72) DARGAZANLI, Gihad, c/o Sanofi-Aventis Département Brevets 174 Avenue de France, F-75013 Paris, FR
ESTENNE-BOUHTOU, Geneviève, c/o Sanofi-Aventis Département Brevets 174 Avenue de France, F-75013 Paris, FR

- (51) MKP
C08L 85/02 (2006.01) (97) **2292696**
C08K 5/357 (2006.01)
C08K 5/5399 (2006.01)
C08L 79/04 (2006.01)
(96) 10173756.7 09.03.2011
(97) 2292696, 09.03.2011 en
(54) Method for improving flame retardant efficiency of phenoxyphosphazene compound, and prepreg, laminate, and laminate for printed circuit made by the method
(71) Guangdong Shengyi Sci. Tech Co., Ltd., no.411 Guangsui Rd., Wanjiang Zone Dongguan City Guangdong, CN
(72) He, Yueshan, Guangdong Shengyi SciTech Co., Ltd No. 411 Guangsu Road Wanjiang Zone, Dongguan City Guangdong, CN
Cheng, Tao, Guangdong Shengyi SciTech Co., Ltd No. 411 Guangsu Road Wanjiang Zone, Dongguan City Guangdong, CN
Su, Shiguo, Guangdong Shengyi SciTech Co., Ltd No. 411 Guangsu Road Wanjiang Zone, Dongguan City Guangdong, CN
Wang, Biwu, Guangdong Shengyi SciTech Co., Ltd No. 411 Guangsu Road Wanjiang Zone, Dongguan City Guangdong, CN
Li, Jie, Guangdong Shengyi SciTech Co., Ltd No. 411 Guangsu Road Wanjiang Zone, Dongguan City Guangdong, CN

- (51) MKP
B23B 37/00 (2006.01) (97) **2456585 ***
(86) FI2010050603 20.07.2010
(96) 10749671.3 30.05.2012
(87) WO2011009997, 20.07.2010
(97) 2456585, 30.05.2012 en
(54) HIGH CELLULOSE CONTENT, LAMINIFEROUS NONWOVEN FABRIC
(71) Suominen Corporation, P.O. Box 380, 33101 Tampere, FI
(72) ESCAFFRE, Pascale, 510 Chemin des Croix, F-38260 La côte Saint André, FR
MEIKLE, Gordon, Struanbeag Berrywell, Duns Berwickshire TD11 3HR, GB
NORTMAN, Brian, 233 E. Wentworth Lane, Appleton WI 54913, US

- (51) MKP
C07C 17/16 (2006.01) (97) **2443080 ***
(86) US2010039004 17.06.2010
(96) 10726761.9 25.04.2012
(87) WO2010148207, 17.06.2010
(97) 2443080, 25.04.2012 en
(54) PROCESS FOR THE PREPARATION OF 5-HT2C RECEPTOR AGONISTS
(71) Arena Pharmaceuticals, Inc., 6166 Nancy Ridge Drive, San Diego, CA 92121, US
(72) DEMATTEI, John, A., 8521 Clatsop Lane, San Diego CA 92129, US
CARLOS, Marlon, 1924 Knightsferry Drive, Chula Vista CA 91913, US
CASTRO, Ryan, O., 8706 Elford Court, San Diego CA 92129, US
CHUANG, Tsung-hsun, 16353 Los Rosales Street, San Diego CA 92127, US
HADD, Mark, Allen, 3829 Colina Dorada Apt. D-105, San Diego CA 92124, US
LU, Xiao-xiong, 17109 Russet Street, San Diego CA 92127, US
MACIAS, Mark, 12530 Salmon River Road, San Diego CA 92129, US
SHAW, Stephen, M., 11735 Stoney Peak Drive Apt. 141, San Diego CA 92128, US

- (51) MKP
A61K 8/49 (2006.01) (97) **2407146**
A61Q 11/00 (2006.01)
(96) 10007340.2 18.01.2012
(97) 2407146, 18.01.2012 en
(54) Use of acesulfame K as a flavour modulator
(71) Nutrinova Nutrition Specialties & Food Ingredients GmbH, Brüningsstrasse 50, 65929 Frankfurt am Main, DE
(72) Rathjen, Susanne, Erna-Stahl-Ring 54, 22337 Hamburg, DE

- (51) MKP
C12N 15/67 (2006.01) (97) **2454373 ***
(86) US2010042143 15.07.2010
(96) 10740787.6 23.05.2012
(87) WO2011008959, 15.07.2010
(97) 2454373, 23.05.2012 en
(54) ENHANCEMENT OF CELLULAR PRODUCTION THROUGH MECHANOTRANSDUCTION
(71) Abbott Laboratories, 100 Abbott Park Road, Abbott Park, IL 60064-6008, US
(72) PIPARIA, Reema, 100 Research Drive, Worcester MA 01605, US
CORREIA, Ivan, 55 Pond Street, Winchester MA 01890, US

- (51) MKP
H01L 31/18 (2006.01) (97) **2441096 ***
(86) IB2010052511 07.06.2010
(96) 10733036.7 18.04.2012
(87) WO2010143117, 07.06.2010
(97) 2441096, 18.04.2012 en
(54) METHOD FOR PRODUCING A SOLAR PANEL
(71) 3S Swiss Solar Systems AG, Schachenweg 24, 3250 Lyss, CH
ZAHND, Jürg, Schulweg 15, CH-3427 Utzenstorf, CH
LANGE, Ronald F. M., Wiesenstrasse 26, CH-3073 Gümligen, CH
GMUR, Markus, Schüsspromenade 16, CH- 2502 Biel, CH
POLO, Roman, Galgenfeldweg 1, CH 3006 Bern, CH

- (51) MKP
A01N 43/42 (2006.01) (97) **2440048 ***
A61K 31/47 (2006.01)
A61K 31/517 (2006.01)
- (86) US2010037986 09.06.2010
(96) 10786788.9 18.04.2012
(87) WO2010144586, 09.06.2010
(97) 2440048, 18.04.2012 en
(54) ISOQUINOLINE, QUINOLINE, AND QUINAZOLINE DERIVATIVES AS INHIBITORS OF HEDGEHOG SIGNALING
- (71) Abraxis BioScience, LLC, 11755 Wilshire Boulevard Suite 2000, Los Angeles, CA 90025, US
(72) TAO, Chunlin, 1800 Camden Avenue, 301, Los Angeles California 90025, US
SUN, Xiaowen, 10920 National Boulevard, 1, Los Angeles California 90064, US
HAN, Hongna, 1352 South Carmelina Avenue, 210, Los Angeles California 90025, US
KORONIAK, Lukasz, Chocimska 28, PL-60688 Poznan, PL
DESAI, Neil, 11755 Wilshire Boulevard, Suite 2000, Los Angeles California 90025, US
-
- (51) MKP
C07D 401/04 (2006.01) (97) **2491024 ***
A61K 31/4155 (2006.01)
A61P 25/00 (2006.01)
- (86) EP2010063609 16.09.2010
(96) 10757753.8 29.08.2012
(87) WO2011033018, 16.09.2010
(97) 2491024, 29.08.2012 en
(54) SUBSTITUTED N-PHENYL-1-(4-PYRIDINYL)-1H-PYRAZOL-3-AMINES
- (71) Janssen Pharmaceutica N.V., Turnhoutseweg 30, 2340 Beerse, BE
(72) MACDONALD, Gregor, James, c/o Janssen Pharmaceutica NV Turnhoutseweg 30, B-2340 Beerse, BE
THURING, Johannes, Wilhelmus, John, F., Belegstraat 26, B-2018 Antwerpen, BE
VAN DEN KEYBUS, Frans, Alfons, Maria, c/o Janssen Pharmaceutica NV Turnhoutseweg 30, B-2340 Beerse, BE
VAN ROOSBROECK, Yves, Emiel, Maria, c/o Janssen Pharmaceutica NV Turnhoutseweg 30, B-2340 Beerse, BE
-
- (51) MKP
C07D 487/04 (2006.01) (97) **2432784 ***
A61K 31/519 (2006.01)
A61P 35/00 (2006.01)
A61P 25/28 (2006.01)
A61P 37/00 (2006.01)
- (86) GB2010001000 19.05.2010
(96) 10721535.2 28.03.2012
(87) WO2010133836, 19.05.2010
(97) 2432784, 28.03.2012 en
(54) FUSED BICYCLIC PYRAZOLE DERIVATIVES AS KINASE INHIBITORS
- (71) UCB Pharma, S.A., 60, allée de la Recherche, 1170 Brussels, BE
(72) ALLEN, Daniel, Rees, BioFocus DPI Chesterford Research Park Saffron Walden, Essex CB10 1XL, GB
BROWN, Julien, Alistair, IPD UCB Celltech 208 Bath Road Slough, Berkshire SL1 3WE, GB
BÜRLI, Roland, BioFocus DPI Chesterford Research Park Saffron Walden, Essex CB10 1XL, GB
HAUGHAN, Alan, Findlay, BioFocus DPI Chesterford Research Park Saffron Walden, Essex CB10 1XL, GB
LANGHAM, Barry, John, IPD UCB Celltech 208 Bath Road Slough, Berkshire SL1 3WE, GB
MATTEUCCI, Mizio, BioFocus DPI Chesterford Research Park Saffron Walden, Essex CB10 1XL, GB
OWENS, Andrew, Pate, BioFocus DPI Chesterford Research Park Saffron Walden, Essex CB10 1XL, GB
RAPHY, Gilles, BioFocus DPI Chesterford Research Park Saffron Walden, Essex CB10 1XL, GB
SHARPE, Andrew, BioFocus DPI Chesterford Research Park Saffron Walden, Essex CB10 1XL, GB
-
- (51) MKP
H04W 4/06 (2009.01) (97) **2466923 ***
- (86) CN2010075906 11.08.2010
(96) 10807982.3 20.06.2012
(87) WO2011018037, 11.08.2010
(97) 2466923, 20.06.2012 en
(54) METHOD, APPARATUS AND SYSTEM FOR CONFIGURING MULTIMEDIA BROADCAST MULTICAST SERVICE (MBMS) CONTROL INFORMATION
- (71) China Academy of Telecommunications Technology, 40, Xueyuan Road, Haidian District, Beijing 100191, CN
(72) ZHANG, Dajun, No.40 Xueyuan Road Haidian District, Beijing 100083, CN
LIANG, Jing, No.40 Xueyuan Road Haidian District, Beijing 100083, CN
-
- (51) MKP
C07D 413/06 (2006.01) (97) **2483266 ***
C07D 413/14 (2006.01)
C07D 417/06 (2006.01)
A61P 3/06 (2006.01)
A61K 31/357 (2006.01)
C07D 405/14 (2006.01)
C07D 417/14 (2006.01)
C07D 405/06 (2006.01)
- (86) IN2010000650 29.09.2010
(96) 10810948.9 08.08.2012
(87) WO2011051961, 29.09.2010
(97) 2483266, 08.08.2012 en
(54) COMPOUNDS FOR THE TREATMENT OF DYSLIPIDEMIA AND RELATED DISEASES
- (71) Cadila Healthcare Limited, Zydus Tower Satellite Cross Roads, Ahmedabad 380 015, Gujarat, IN
(72) PINGALI, Harikishore, Cadila Healthcare Limited Zydus Tower Satellite Cross Roads Ahmedabad 380 015, Gujarat, IN
KALAPATAPU, V., V., M., Sairam, Cadila Healthcare Limited Zydus Tower Satellite Cross Roads Ahmedabad 380 015, Gujarat, IN
MAKADIA, Pankaj, Cadila Healthcare Limited Zydus Tower Satellite Cross Roads Ahmedabad 380 015, Gujarat, IN
JAIN, Mukul, R., Cadila Healthcare Limited Zydus Tower Satellite Cross Roads Ahmedabad 380 015, Gujarat, IN
-
- (51) MKP
C02F 3/34 (2006.01) (97) **2488458 ***
C02F 103/02 (2006.01)
C02F 1/00 (2006.01)
C02F 1/46 (2006.01)
C02F 1/44 (2006.01)
C02F 1/32 (2006.01)
C02F 5/02 (2006.01)
C02F 1/48 (2006.01)
- (86) EP2010006307 15.10.2010
(96) 10776297.3 22.08.2012
(87) WO2011045071, 15.10.2010
(97) 2488458, 22.08.2012 de
(54) COOLING SYSTEM COMPRISING A BIO-FILTER AND METHOD FOR OPERATING SAID SYSTEM
- (71) Dat Dynamic Aquabion Tower GmbH, Mörsenbroicher Weg 191, 40470 Düsseldorf, DE
(72) FLETTNER, Marc, Alexander, Mühlenbergweg 18, 40629 Düsseldorf, DE
SCHEEN, Jürgen, Roseggerstrasse 37, 44137 Dortmund, DE
-
- (51) MKP
A61F 3/00 (2006.01) (97) **2464249 ***
A61K 36/82 (2006.01)
A61P 25/00 (2006.01)
A61P 25/28 (2006.01)
A23L 2/52 (2006.01)
- (86) EP2011054825 29.03.2011
(96) 11711330.8 20.06.2012
(87) WO2011120969, 29.03.2011
(97) 2464249, 20.06.2012 de
(54) CONCENTRATION-ENHANCING DRINK
- (71) Huber, Johannes, Oskar-Jascha-Gasse 10, 1130 Wien, AT
(72) HUBER, Johannes, Oskar-Jascha-Gasse 10, 1130 Wien, AT

(51) MKP
C08G 63/80 (2006.01) (97) **2455415**
C08G 63/90 (2006.01)
C08G 63/08 (2006.01)
(96) 10191484.4 23.05.2012
(97) 2455415, 23.05.2012 de
(54) Method for manufacturing low-molecular resorbable polyesters, low-molecular resorbable polyester manufactured according to the method and application of same
(71) Evonik Röhm GmbH, Kirschenallee 45, 64293 Darmstadt, DE
(72) Bocionek, Dirk, Dr., Am Langenberg 11, 55218 Ingelheim am Rhein, DE
Enderle, Anja, Dr., Helmerichstrasse 24, 55437 Ockenheim, DE

(51) MKP
F42B 8/00 (2006.01) (97) **2486363 ***
F41A 33/04 (2006.01)
F41A 33/02 (2006.01)
(86) NO2010000357 08.10.2010
(96) 10822290.2 15.08.2012
(87) WO2011043673, 08.10.2010
(97) 2486363, 15.08.2012 en
(54) ELECTRONIC BLANK AMMUNITION
(71) Nimtec AS, Sverdrupsgt. 4, 3717 Skien, NO
(72) BOTTEN, Steffen, Lilleåsveien 14, N-3731 Skien, NO

(51) MKP
A61P 9/00 (2006.01) (97) **2416776 ***
A61P 43/00 (2006.01)
A61K 31/50 (2006.01)
A61K 31/195 (2006.01)
A61K 31/4985 (2006.01)
A61P 3/00 (2006.01)
(86) US2010030552 09.04.2010
(96) 10762501.4 15.02.2012
(87) WO2010118330, 09.04.2010
(97) 2416776, 15.02.2012 en
(54) USE OF TETRAHYDROBIOPTERIN AS A MARKER AND A THERAPEUTIC AGENT FOR FABRY DISEASE
(71) Baylor Research Institute, Suite 125, 3434 Live Oak Street, Dallas, TX 75204, US
(72) SCHIFFMANN, Raphael, 2125 Hillcroft Drive, Rockwall, TX 75087, US
BOTTIGLIERI, Teodoro, G., 3240 Lovers Lane, Dallas, TX 75225, US
ARNING, Erland, 8467 Muirwood Trail, Fort Worth, TX 76137, US
MOORE, David, F., 38 Maryland Avenue, 525, Rockville, MD 20850, US

(51) MKP
A61P 25/04 (2006.01) (97) **2493863 ***
C07D 417/12 (2006.01)
C07D 239/34 (2006.01)
C07D 401/12 (2006.01)
A61K 31/506 (2006.01)
C07D 403/12 (2006.01)
C07D 239/28 (2006.01)
C07D 413/12 (2006.01)
(86) US2010054478 28.10.2010
(96) 10776483.9 05.09.2012
(87) WO2011053701, 28.10.2010
(97) 2493863, 05.09.2012 en
(54) PHENOXY-SUBSTITUTED PYRIMIDINES AS OPIOID RECEPTOR MODULATORS
(71) Janssen Pharmaceutica NV, Turnhoutseweg 30, 2340 Beerse, BE
(72) COATS, Steven, J., 764 Alberta Drive, McDonough GA 30252, US
ZHANG, Yue-mei, Welsh&Mckean Roads P.o. Box 776, Spring House PA 19477, US
LIN, Shu-chen, 4895 Redfield Road, Doylestown PA 18902, US
LIU, Li, 271 Fox Chase Lane, Doylestown PA 18901, US
MISKOWSKI, Tamara, A., Welsh&Mckean Roads P.o. Box 776, Spring House PA 19477, US
DAX, Scott, L., 3 Quail Drive, Landenberg PA 19350, US
BRESLIN, Henry, Welsh&Mckean Roads P.o. Box 776, Spring House PA 19477, US
DE CORTE, Bart, L., Welsh&Mckean Roads P.o. Box 776, Spring House PA 19477, US
HE, Wei, 2002 Kestral Circle, Audubon PA 19493, US

(51) MKP
C07C 227/32 (2006.01) (97) **2380871**
(96) 10160022.9 26.10.2011
(97) 2380871, 26.10.2011 en
(54) A process for the preparation of isoserine derivatives
(71) Indena S.p.A., Via Ortles, 12, 20139 Milano, IT
(72) Fontana, Gabriele, c/o Indena S.p.A. Viale Ortles, 12, 20139, MILANO, IT
Gelmi, Maria Luisa, c/o Universita' Degli Studi Di Milano Dipartimento di Scienze Molecolari Applicate ai Biosistemi Via Venezian, 21, 20133, MILANO, IT
Gassa, Federico, Via Monte Cimone, 42, 21043, Castiglione Olona (VA), IT

(51) MKP
C07K 14/605 (2006.01) (97) **2491054 ***
(86) IN2010000683 18.10.2010
(96) 10812943.8 29.08.2012
(87) WO2011048614, 18.10.2010
(97) 2491054, 29.08.2012 en
(54) SHORT CHAIN PEPTIDOMIMETICS BASED ORALLY ACTIVE GLP-1 AGONIST AND GLUCAGON RECEPTOR ANTAGONIST
(71) Cadila Healthcare Limited, Zydus Tower Satellite Cross Roads, Ahmedabad 380 015 Gujarat, IN
(72) BAHEKAR, Rajesh, Cadila Healthcare Limited Zydus Tower Satellite Cross Roads, Ahmedabad 380 015 Gujarat, IN
JAIN, Mukul R., Cadila Healthcare Limited Zydus Tower Satellite Cross Roads, Ahmedabad 380 015 Gujarat, IN
PATEL, Pankaj R., Cadila Healthcare Limited Zydus Tower Satellite Cross Roads, Ahmedabad 380 015 Gujarat, IN

(51) MKP
A61M 16/00 (2006.01) (97) **2435117 ***
(86) IB2010052043 10.05.2010
(96) 10722414.9 04.04.2012
(87) WO2010136923, 10.05.2010
(97) 2435117, 04.04.2012 de
(54) VENTILATOR AND ADJUSTMENT METHOD THEREFOR
(71) IMT Information- Management- Technology Ag, Gewerbestrasse 8, 9470 Buchs, CH
(72) DAESCHER, Jakob, Dunkle Böngert 13, CH-7306 Fläsch, CH
FRIBERG, Harri, Fürst-Franz-Josef-Strasse 33, CH-9493 Mauren, CH

(51) MKP
B65D 85/10 (2006.01) (97) **2376334 ***
B65D 5/66 (2006.01)
(86) EP2010007007 18.11.2010
(96) 10781838.7 19.10.2011
(87) WO2011060930, 18.11.2010
(97) 2376334, 19.10.2011 en
(54) PACKAGE FOR TOBACCO-RELATED ARTICLES
(71) Imperial Tobacco Limited, P.O. Box 244 Upton Road, Southville, Bristol BS99 7UJ, GB
(72) BUCKINGHAM, Alistair, c/o Imperial Tobacco International Farnham House Farnham Lane Farnham Royal, Slough SL2 3RQ, GB
WOLFGGRAMM, Regine, c/o Reemtsma Cigarettenfabriken GmbH Albert-Einstein-Ring 7, 22761 Hamburg, DE
GURKE, Inga, c/o Reemtsma Cigarettenfabriken GmbH Albert-Einstein-Ring 7, 22761 Hamburg, DE
HOLLOWAY, Steve, c/o Imperial Tobacco International Farnham House Farnham Lane Farnham Royal, Slough SL2 3RQ, GB
NOVAK, Slavomir, c/o Reemtsma Cigarettenfabriken GmbH Albert-Einstein-Ring 7, 22761 Hamburg, DE
COLLINS, Tim, c/o path design 3 Northfields Prospect Northfields, London SW18 1 PE, GB
DEVIVIER, Guillaume, c/o Altadis 4, Rue Andre Dessaux F-45404 Fleury Les Aubrais, Cedex, FR
KNORR, Solvey, c/o Reemtsma Cigarettenfabriken GmbH Albert-Einstein-Ring 7, 22761 Hamburg, DE
JENKINS, Paul, c/o Imperial Tobacco International Farnham House Farnham Lane Farnham Royal, Slough SL2 3RQ, GB
SOUTHEY, Neil, c/o Imperial Tobacco International Farnham House Farnham Lane Farnham Royal, Slough SL2 3RQ, GB

- (51) MKP
A61K 31/519 (2006.01) (97) **2385948 ***
A61P 7/06 (2006.01)
C07D 513/16 (2006.01)
C07D 513/06 (2006.01)
- (86) IN2010000579 31.08.2010
(96) 10760108.0 16.11.2011
(87) WO2011045811, 31.08.2010
(97) 2385948, 16.11.2011 en
(54) FUSED THIAZOLO AND OXAZOLO PYRIMIDINONES
(71) Torrent Pharmaceuticals Limited, Torrent House Off Ashram Road Near Dinesh Hall 380 009 Ahmedabad, Gujarat, IN
(72) CHAUTHAIWALE, Vijay, Torrent Pharmaceuticals Limited Torrent Research Centre Dist. Gandhinagar Gujarat, Bhat 382 428, IN
SRIVASTAVA, Sanjay, Torrent Pharmaceuticals Limited Torrent Research Centre Dist. Gandhinagar Gujarat, Bhat 382 428, IN
BADANTHADKA, Murali, Torrent Pharmaceuticals Limited Torrent Research Centre Dist. Gandhinagar Gujarat, Bhat 382 428, IN
CHHIPA, Laxmikant, Torrent Pharmaceuticals Limited Torrent Research Centre Dist. Gandhinagar Gujarat, Bhat 382 428, IN
JAMADARKHANA, Prashant, G., Torrent Pharmaceuticals Limited Torrent Research Centre Dist. Gandhinagar Gujarat, Bhat 382 428, IN
GUPTA, Ramesh, Chandra, Torrent Pharmaceuticals Limited Torrent Research Centre Dist. Gandhinagar Gujarat, Bhat 382 428, IN
DESHPANDE, Shailesh, Torrent Pharmaceuticals Limited Torrent Research Centre Dist. Gandhinagar Gujarat, Bhat 382 428, IN
DUTT, Chaitanya, Torrent Pharmaceuticals Limited Torrent Research Centre Dist. Gandhinagar Gujarat, Bhat 382 428, IN
MOHANAN, Anookh, Torrent Pharmaceuticals Limited Torrent Research Centre Dist. Gandhinagar Gujarat, Bhat 382 428, IN
CHAUDHARI, Anita, Torrent Pharmaceuticals Limited Torrent Research Centre Dist. Gandhinagar Gujarat, Bhat 382 428, IN
-
- (51) MKP
C07D 487/04 (2006.01) (97) **2414363 ***
A61K 31/519 (2006.01)
- (86) EP2010054050 26.03.2010
(96) 10711065.2 08.02.2012
(87) WO2010112437, 26.03.2010
(97) 2414363, 08.02.2012 en
(54) 1-HETEROCYCLYL-1, 5-DIHYDRO-PYRAZOLO [3, 4-D] PYRIMIDIN-4-ONE DERIVATIVES AND THEIR USE AS PDE9A MODULATORS
(71) Boehringer Ingelheim International GmbH, Binger Strasse 173, 55216 Ingelheim am Rhein, DE
(72) GIOVANNINI, Riccardo, Boehringer Ingelheim GmbH CD Patents Binger Strasse 173, 55216 Ingelheim Am Rhein, DE
DORNER-CIOSSEK, Cornelia, Boehringer Ingelheim GmbH CD Patents Binger Strasse 173, 55216 Ingelheim Am Rhein, DE
EICKMEIER, Christian, Boehringer Ingelheim GmbH CD Patents Binger Strasse 173, 55216 Ingelheim Am Rhein, DE
FIEGEN, Dennis, Boehringer Ingelheim GmbH CD Patents Binger Strasse 173, 55216 Ingelheim Am Rhein, DE
FOX, Thomas, Boehringer Ingelheim GmbH CD Patents Binger Strasse 173, 55216 Ingelheim Am Rhein, DE
FUCHS, Klaus, Boehringer Ingelheim GmbH CD Patents Binger Strasse 173, 55216 Ingelheim Am Rhein, DE
HEINE, Niklas, Boehringer Ingelheim GmbH CD Patents Binger Strasse 173, 55216 Ingelheim Am Rhein, DE
ROSENBROCK, Holger, Boehringer Ingelheim GmbH CD Patents Binger Strasse 173, 55216 Ingelheim Am Rhein, DE
SCHAENZLE, Gerhard, Boehringer Ingelheim GmbH CD Patents Binger Strasse 173, 55216 Ingelheim Am Rhein, DE
-
- (51) MKP
A45C 11/00 (2006.01) (97) **2456334 ***
- (86) US2010042230 16.07.2010
(96) 10735396.3 30.05.2012
(87) WO2011011272, 16.07.2010
(97) 2456334, 30.05.2012 en
(54) PORTIONED PACKAGES FOR MAINTENANCE SOLUTIONS AND OPHTHALMIC LENSES
(71) Johnson & Johnson Vision Care Inc., 7500 Centurion Parkway, Jacksonville, FL 32256, US
(72) VOSS, Leslie, A., 12310 Windstream Lane, Jacksonville FL 32258, US
ABOUHALKAH, Dwight, 4314 Chelsea Harbor Drive, Jacksonville FL 32224, US
MORLEY, Catie, A., 337 Summerset Drive, St. Johns FL 32259, US
-
- (51) MKP
B65D 21/02 (2006.01) (97) **2394923**
B65D 71/50 (2006.01)
- (96) 11004711.5 14.12.2011
(97) 2394923, 14.12.2011 de
(54) Handle device for a plurality of containers
(71) Unsöld, Manfred, In den Hofäckern 17, 71726 Benningen, DE
(72) Unsöld, Manfred, In den Hofäckern 17, 71726 Benningen, DE
-
- (51) MKP
A61K 9/16 (2006.01) (97) **2475430 ***
A61K 31/4184 (2006.01)
A61K 31/425 (2006.01)
A61P 33/00 (2006.01)
- (86) IB2010054005 07.09.2010
(96) 10813424.8 18.07.2012
(87) WO2011027333, 07.09.2010
(97) 2475430, 18.07.2012 en
(54) GRANULATED ANTHELMINTIC PREPARATIONS AND DELIVERY SYSTEMS
(71) Cleverly, Douglas Robert, 66 Ernest George Drive RD1 Karaka Papakura, Auckland 2580, NZ
Mukhopadhyay, Debashis, 23 Wray Street Brockville, Dunedin, NZ
(72) Cleverly, Douglas Robert, 66 Ernest George Drive RD1 Karaka Papakura, Auckland 2580, NZ
Mukhopadhyay, Debashis, 23 Wray Street Brockville, Dunedin, NZ
-
- (51) MKP
D06F 57/00 (2006.01) (97) **2478147 ***
D06F 53/00 (2006.01)
- (86) HU2010000062 25.05.2010
(96) 10726186.9 25.07.2012
(87) WO2011033326, 25.05.2010
(97) 2478147, 25.07.2012 en
(54) AUXILIARY DEVICE
(71) Machács, Márton, Hegyalja út 76. fszt.3., 1118 Budapest, HU
(72) Machács, Márton, Hegyalja út 76. fszt.3., 1118 Budapest, HU
-
- (51) MKP
A01N 43/38 (2006.01) (97) **2490531 ***
A61K 31/40 (2006.01)
- (86) US2010053916 25.10.2010
(96) 10825802.1 29.08.2012
(87) WO2011050353, 25.10.2010
(97) 2490531, 29.08.2012 en
(54) METHOD FOR TREATING ANDROGEN RECEPTOR POSITIVE CANCERS
(71) Panacela Labs, Inc., 73 High Street, Buffalo, NY 14203, US
(72) GUROVA, Katerina, 61 Graystone Lane, Orchard Park NY 14127, US
NARIZHEVA, Natalia, 100 North Lake Drive 15, Orchard Park NY 14127, US

(51) MKP
A61K 31/54 (2006.01) (97) **2467142 ***
 (86) US2010045817 17.08.2010
 (96) 10810519.8 27.06.2012
 (87) WO2011022440, 17.08.2010
 (97) 2467142, 27.06.2012 en
 (54) HEAT SHOCK PROTEIN BINDING COMPOUNDS, COMPOSITIONS, AND METHODS FOR MAKING AND USING SAME
 (71) Memorial Sloan-Kettering Cancer Center, 1275 York Avenue, New York, NY 10065, US
 (72) CHIOSIS, Gabriela, 303 E. 60st., 34G, New York NY 10022, US
 TALDONE, Tony, 425 Main Street Apartment 12F, New York NY 10044, US
 RODINA, Anna, 179 Bennett Ave., 3H, New York NY 10040, US
 PATEL, Pallav, 4040 Presidential Blvd Apt. 2915, Philadelphia PA 19131, US
 KANG, Yanlong, Memorial Sloan-Kettering Cancer Center 1275 York Avenue, New York NY 10065, US

(51) MKP
B65D 25/50 (2006.01) (97) **2361840**
B65D 51/16 (2006.01)
 (96) 11001341.4 31.08.2011
 (97) 2361840, 31.08.2011 de
 (54) Canister
 (71) TBG Technische Beteiligungsgesellschaft AG, Gewerbestrasse 6, 6330 Cham, CH
 (72) Schlenker, Rudolf, Im Rötel 23, 6300 Zug, CH

(51) MKP
C07C 211/35 (2006.01) (97) **2448909 ***
C07C 209/62 (2006.01)
 (86) EP2010003924 28.06.2010
 (96) 10736978.7 09.05.2012
 (87) WO2011000541, 28.06.2010
 (97) 2448909, 09.05.2012 en
 (54) METHOD OF PREPARING 1-AMINO-1,3,3,5,5-PENTAMETHYLCYCLOHEXANE
 (71) Merz Pharma GmbH & Co. KGaA, Eckenheimer Landstrasse 100, 60318 Frankfurt Main, DE
 (72) KOLLER, Herbert, Quellenstrasse 155A/65, A-1100 Wien, AT
 PYERIN, Michael, Enzersdorferstrasse 3/2/8, 2345 Brunn am Gebirge, AT

(51) MKP
C07D 417/04 (2006.01) (97) **2473507 ***
C07D 417/14 (2006.01)
 (86) US2010047776 03.09.2010
 (96) 10759761.9 11.07.2012
 (87) WO2011028979, 03.09.2010
 (97) 2473507, 11.07.2012 en
 (54) STABLE SNS-595 COMPOSITIONS AND METHODS OF PREPARATION
 (71) Sunesis Pharmaceuticals, Inc., 395 Oyster Point Blvd., Suite 400, South San Francisco, CA 94080, US
 (72) SUDHAKAR, Anantha, 42356 Troyer Avenue, Fremont CA 94539, US
 JACOBS, Jeff, 505 Cornell Avenue, San Mateo CA 94402, US
 HASHASH, Ahmad, 3 Jib Court, Pleasant Hill CA 94523, US
 RITCHIE, Sean, 475 Kansas Way, Fremont CA 94539, US
 CHENG, Hengqin, 607 Portofino, Foster City CA 94404, US

(51) MKP
C07D 471/04 (2006.01) (97) **2430021 ***
A61K 31/437 (2006.01)
A61K 31/444 (2006.01)
A61K 31/445 (2006.01)
A61P 25/00 (2006.01)
 (86) EP2010002909 11.05.2010
 (96) 10721695.4 21.03.2012
 (87) WO2010130423, 11.05.2010
 (97) 2430021, 21.03.2012 en
 (54) 7-ARYL-1,2,4-TRIAZOLO[4,3-A]PYRIDINE DERIVATIVES AND THEIR USE AS POSITIVE ALLOSTERIC MODULATORS OF MGLUR2 RECEPTORS
 (71) Janssen Pharmaceuticals Inc., 1125 Trenton-Harbourton Road, Titusville NJ 08560, US
 Addex Pharma SA, 12 Chemin des Aulx, 1228 Plan-les-Ouates, CH
 (72) CID-NÚÑEZ, José, Maria, Janssen-Cilag S.A. Calle Jarama 75 Poligono Industrial, E-45007 Toledo, ES
 DE LUCAS OLIVARES, Ana, Isabel, Janssen-Cilag S.A. Calle Jarama 75 Poligono Industrial, E-45007 Toledo, ES
 TRABANCO-SUÁREZ, Andres, Avelino, Janssen-Cilag S.A. Calle Jarama 75 Poligono Industrial, E-45007 Toledo, ES
 MACDONALD, Gregor, James, Janssen Pharmaceutics NV Turnhoutseweg 30, B-2340 Beerse, BE

(51) MKP
A61K 31/437 (2006.01) (97) **2403482 ***
A61K 31/4468 (2006.01)
A61P 25/04 (2006.01)
A61K 9/16 (2006.01)
 (86) GB2010000374 02.03.2010
 (96) 10711246.8 11.01.2012
 (87) WO2010100414, 02.03.2010
 (97) 2403482, 11.01.2012 en
 (54) ABUSE RESISTANT FORMULATION
 (71) Orexo AB, Box 303, 751 05 Uppsala, SE
 BREDENBERG, Susanne, Orexo AB P O Box 303, S-751 05 Uppsala, SE
 DAHLGREN, Anna, Orexo AB P O Box 303, S-751 05 Uppsala, SE
 SÄGSTRÖM, Anders, Orexo AB P O Box 303, S-751 05 Uppsala, SE
 ENGGVIST, Hakan, Uppsala University Box 580, SE-751 23 Uppsala, SE

(51) MKP
C09D 7/12 (2006.01) (97) **2496649 ***
C09D 5/02 (2006.01)
 (86) FR2010052352 03.11.2010
 (96) 10792960.6 12.09.2012
 (87) WO2011055073, 03.11.2010
 (97) 2496649, 12.09.2012 fr
 (54) FILM-FORMING COMPOSITION CONTAINING AN AGENT CAPABLE OF TRAPPING FORMALDEHYDE
 (71) Saint-Gobain Adfors, 517, Avenue de la Boisse, 73000 Chambéry, FR
 (72) BLANCHARD, Benjamin, 17 rue Auguste Méry, F-95150 Taverny, FR
 CHUDA, Katarzyna, 3 rue Marguerite Chapon, 94800 Villejuif, FR

(51) MKP
C07C 211/00 (2006.01) (97) **2487158**
C07D 223/16 (2006.01)
 (96) 12290050.9 15.08.2012
 (97) 2487158, 15.08.2012 fr
 (54) New method for synthesising ivabradine and its added salts with a pharmaceutically acceptable acid.
 (71) Les Laboratoires Servier, 35, rue de Verdun, 92284 Suresnes Cedex, FR
 (72) Peglion, Jean-Louis, 5, allée des Bégonias, 78110 Le Vesinet, FR
 Dessinges, Aimée, Appt. 47, 8 Boulevard du Général de Gaulle, 92500 Rueil-Malmaison, FR

- (51) MKP
A61K 39/395 (2006.01) (97) **2419137 ***
(86) US2010031407 16.04.2010
(96) 10765266.1 22.02.2012
(87) WO2010121141, 16.04.2010
(97) 2419137, 22.02.2012 en
(54) COMPOSITIONS AND METHODS TO TREAT ACUTE MYELOGENOUS LEUKEMIA
(71) Biogen Idec MA Inc., 14 Cambridge Center, Cambridge, MA 02142, US
(72) MCLACHLAN, Karen, 948 Valley Avenue, Solana Beach, CA 92075, US
-
- (51) MKP
A61P 25/28 (2006.01) (97) **2454239 ***
C07D 401/14 (2006.01)
C07D 471/04 (2006.01)
A61K 31/4439 (2006.01)
C07D 403/10 (2006.01)
C07D 498/04 (2006.01)
C07D 487/04 (2006.01)
C07D 233/60 (2006.01)
C07D 405/14 (2006.01)
A61K 31/4178 (2006.01)
A61K 31/4196 (2006.01)
(86) EP2010060083 13.07.2010
(96) 10734963.1 23.05.2012
(87) WO2011006903, 13.07.2010
(97) 2454239, 23.05.2012 en
(54) SUBSTITUTED TRIAZOLE AND IMIDAZOLE DERIVATIVES AS GAMMA SECRETASE MODULATORS
(71) Janssen Pharmaceuticals Inc., 1125 Trenton-Harbourton Road, Titusville NJ 08560, US
(72) BERTHELOT, Didier, Jean-Claude, c/o Janssen Pharmaceutica NV Turnhoutseweg 30, B-2340 Beerse, BE
GIJSEN, Henricus, Jacobus, Maria, c/o Janssen Pharmaceutica NV Turnhoutseweg 30, B-2340 Beerse, BE
VELTER, Adriana, Ingrid, c/o Janssen Pharmaceutica NV Turnhoutseweg 30, B-2340 Beerse, BE
DE CLEYN, Michel, Anna, Jozef, c/o Janssen Pharmaceutica NV Turnhoutseweg 30, B-2340 Beerse, BE
WU, Tongfei, c/o Janssen Pharmaceutica NV Turnhoutseweg 30, B-2340 Beerse, BE
MINNE, Garrett, Berlund, c/o Janssen Pharmaceutica NV Turnhoutseweg 30, B-2340 Beerse, BE
OEHLRICH, Daniel, c/o Janssen Pharmaceutica NV Turnhoutseweg 30, B-2340 Beerse, BE
ROMBOUTS, Frederik, Jan, Rita, c/o Janssen Pharmaceutica NV Turnhoutseweg 30, B-2340 Beerse, BE
VAN BRANDT, Sven, Franciscus, Anna, c/o Janssen Pharmaceutica NV Turnhoutseweg 30, B-2340 Beerse, BE
BISCHOFF, François, Paul, c/o Janssen Pharmaceutica NV Turnhoutseweg 30, B-2340 Beerse, BE
SURKYN, Michel, c/o Janssen Pharmaceutica NV Turnhoutseweg 30, B-2340 Beerse, BE
PIETERS, Serge, Maria, Aloysius, c/o Janssen Pharmaceutica NV Turnhoutseweg 30, B-2340 Beerse, BE
-
- (51) MKP
B65D 88/16 (2006.01) (97) **2477912 ***
B65D 90/00 (2006.01)
B65D 90/04 (2006.01)
(86) EP2010063680 17.09.2010
(96) 10760646.9 25.07.2012
(87) WO2011033051, 17.09.2010
(97) 2477912, 25.07.2012 de
(54) PACKAGING CONTAINER FOR BITUMEN
(71) Polycube Systems GmbH, Mittoehnerstrasse 6, 2560 Berndorf, AT
(72) BUGL, Rosemarie, Klostertal 52, A-2770 Gutenstein, AT
KREGER, Michael, Ing. Eugen Essentherstrasse 24, A-2560 Berndorf, AT
-
- (51) MKP
A61K 31/047 (2006.01) (97) **2419176 ***
A61K 45/06 (2006.01)
A61K 9/00 (2006.01)
A61Q 19/00 (2006.01)
A61P 17/16 (2006.01)
A61K 31/01 (2006.01)
(86) EP2010055066 16.04.2010
(96) 10713974.3 22.02.2012
(87) WO2010119132, 16.04.2010
(97) 2419176, 22.02.2012 en
(54) PHARMACEUTICAL COMPOSITION COMPRISING GLYCEROL, WHITE SOFT PARAFFIN AND LIQUID PARAFFIN FOR THE TREATMENT OF UREMIC XEROSIS AND/OR PRURITUS
(71) Orfagen, 4 rue Marie Curie Parc Technologique, 31520 Ramonville Saint Agne, FR
(72) DUPUY, Patrick, 18 Rue de Verdun, F-31000 Toulouse, FR
-
- (51) MKP
G06F 17/30 (2006.01) (97) **2452277 ***
(86) NO2010000260 02.07.2010
(96) 10736851.6 16.05.2012
(87) WO2011005106, 02.07.2010
(97) 2452277, 16.05.2012 en
(54) METHODS, SYSTEMS AND DEVICES FOR PERFORMING INCREMENTAL UPDATES OF PARTIAL DATABASES
(71) Norsync Technology AS, General Birchs gate 16, 0454 Oslo, NO
(72) SJØGREN, Bjørn-Harald, Bekkestien 26B, N-1406 Ski, NO
-
- (51) MKP
A01N 33/08 (2006.01) (97) **2482654 ***
A01N 39/04 (2006.01)
A01N 33/04 (2006.01)
A01N 37/40 (2006.01)
A01N 57/20 (2006.01)
(86) EP2010064343 28.09.2010
(96) 10757774.4 08.08.2012
(87) WO2011039172, 28.09.2010
(97) 2482654, 08.08.2012 en
(54) LOW VOLATILE AMINE SALTS OF ANIONIC PESTICIDES
(71) BASF SE, null, 67056 Ludwigshafen, DE
XU, Wen, 1016 Whisper rock trail, Cary NC 27519, US
KIERKUS, Paul Ch., 1169 Hidden Hills Dr., Wake Forest NC 27517, US
BRUNT, Steven, 12025 Panleys Mill Circle, Raleigh NC 27614, US
BOWE, Steven, 425 Olde Thompson Creek Rd, Apex NC 27523, US
HIXSON, Adam, 8632 Paddle Wheel Dr., Raleigh NC 27615, US
CANNAN, Terrance M., 9009 Hometown Drive, Raleigh North Carolina 27615, US
-
- (51) MKP
A61K 8/97 (2006.01) (97) **2482830 ***
A61Q 19/02 (2006.01)
A61Q 19/08 (2006.01)
A61K 36/47 (2006.01)
A61P 29/00 (2006.01)
A61P 17/00 (2006.01)
(86) US2010051089 01.10.2010
(96) 10765542.5 08.08.2012
(87) WO2011041654, 01.10.2010
(97) 2482830, 08.08.2012 en
(54) EXTRACTS OF PHYLLANTHUS NIRURI
(71) Johnson & Johnson Consumer Companies, Inc., Grandview Road, Skillman, NJ 08558, US
(72) GARAY, Michelle, 100 Sky Manor Road, Pittstown NJ 08867, US
KAUR, Simarna, 1032 Shadowlawn Drive, Green Brook NJ 08812, US
SOUTHALL, Michael, 200 Berwyn Place, Lawrenceville NJ 08648, US
WEN, Ping, 15 Revere Road, Belle Mead NJ 08502, US
MAHMOOD, Khalid, 18 Benjamin Rush Lane, Princeton NJ 08540, US

- (51) MKP
A47K 3/34 (2006.01) (97) **2305085**
E05D 15/06 (2006.01)
(96) 10177837.1 06.04.2011
(97) 2305085, 06.04.2011 en
(54) Shower cabin with sliding door
(71) Antonio Lupi Desing S.P.A., Via Mazzini 73/75 Loc. Stabbia, 50050 Cerreto Guidi (Firenze), IT
(72) Tellatin, Nevio, Via Vicenza, 1/13, 35015 Galliera Veneta (Padova), IT
-
- (51) MKP
C25C 3/26 (2006.01) (97) **2425042 ***
C25C 3/00 (2006.01)
C25B 1/00 (2006.01)
C25C 1/00 (2006.01)
C25C 3/34 (2006.01)
(86) US2010001263 29.04.2010
(96) 10718749.4 07.03.2012
(87) WO2010126597, 29.04.2010
(97) 2425042, 07.03.2012 en
(54) PRIMARY PRODUCTION OF ELEMENTS
(71) Metal Oxygen Separation Technologies, Inc., 11 Michigan Drive, Natick, MA 01760-1334, US
(72) POWELL, Adam C., IV, 1170 Chestnut Street, Newton MA 02464-1309, US
DEREZINSKI, Steve J., III, 21 Pine Plain Road, Wellesley MA 02481-1143, US
-
- (51) MKP
A01N 43/90 (2006.01) (97) **2473052 ***
A61K 31/522 (2006.01)
(86) US2010047574 01.09.2010
(96) 10814449.4 11.07.2012
(87) WO2011028835, 01.09.2010
(97) 2473052, 11.07.2012 en
(54) SUBSTITUTED XANTHINE DERIVATIVES
(71) Concert Pharmaceuticals Inc., 99 Hayden Avenue, Suite 500, Lexington, MA 02421, US
(72) TUNG, Roger, D., 3 Burnham Road, Lexington Massachusetts 02420, US
LIU, Julie, F., 3 Whitman Circle, Lexington Massachusetts 02420, US
HARBESON, Scott, L., 203 Pemberton Street Apt.5, Cambridge Massachusetts 02140, US
-
- (51) MKP
C12N 7/02 (2006.01) (97) **2443233 ***
(86) US2010038897 16.06.2010
(96) 10790155.5 25.04.2012
(87) WO2010148143, 16.06.2010
(97) 2443233, 25.04.2012 en
(54) IMPROVED METHODS FOR PURIFICATION OF RECOMBINANT AAV VECTORS
(71) Genzyme Corporation, 500 Kendall Street, Cambridge, MA 02142, US
(72) SHELTON, Paulene, McLean, Quigley, 2339 Fairview Avenue E H, Seattle, WA 98102, US
GAGNON, Peter, S., 240 Avenida Vista Montana 7F, San Clemente, CA 92672, US
NICHOLS, Gina, 9021 Cascadia Anenue, Everett, WA 98208, US
THORNE, Barbara, A., 3626 - 223rd Avenue SE, Sammamish, WA 98075, US

- (51) MKP
A61P 35/00 (2006.01) (97) **2432556 ***
C07C 257/18 (2006.01)
A61K 31/47 (2006.01)
C07C 235/62 (2006.01)
A61K 31/44 (2006.01)
C07D 211/26 (2006.01)
A61K 31/445 (2006.01)
C07D 211/58 (2006.01)
C07C 311/20 (2006.01)
C07D 215/08 (2006.01)
C07D 401/06 (2006.01)
C07D 213/61 (2006.01)
C07D 213/75 (2006.01)
C07D 217/06 (2006.01)
C07C 259/18 (2006.01)
(86) FI2010000031 18.05.2010
(96) 10724546.6 28.03.2012
(87) WO2010133748, 18.05.2010
(97) 2432556, 28.03.2012 en
(54) PROTEASE INHIBITORS
(71) Orion Corporation, Orionintie 1, 02200 Espoo, FI
(72) GOSWAMI, Rajeev, 8 Mayur Vihar Shastradhara Road Dehradun 2480 001, Uttaranchal, IN
VUPPALA, Anil, Kumar, H.NO: 381/2 Railway quarters Nehru Nagar Kazipet Warangal 506 003, Andhra Pradesh, IN
VELUDANDI, Ramesh, 23-5-108 New Shayampet Hunter Road Hanam konda Warangal 506 001, Andhra Pradesh, IN
SISTLA, Ramesh, " Mohana" 03 1st Cross Reliable Tranquil layout Haralur Bangalore 560102, Karnataka, IN
GHADIYARAM, Chakshusmathi, 120 Krystal Olivine Bellandur Outer Ring Road Bangalore 560103, Kamataka, IN
RAMACHANDRA, Muralidhara, Villa 173 Adarsh Palm Retreat Outer Ring Road Belandur Post, Bangalore 560 037, IN
-
- (51) MKP
A61K 31/40 (2006.01) (97) **2434889 ***
A01N 43/36 (2006.01)
(86) US2010036046 25.05.2010
(96) 10781080.6 04.04.2012
(87) WO2010138496, 25.05.2010
(97) 2434889, 04.04.2012 en
(54) IAP INHIBITORS
(71) Tetralogic Pharmaceuticals Corp., 343 Phoenixville Pike, Malvern, PA 19355, US
(72) CONDON, Stephen, M., C/o Tetralogic Pharmaceuticals Corp. 343 Phoenixville Pike, Malvern, PA 19355, US
DENG, Yijun, C/o Tetralogic Pharmaceuticals Corp. 343 Phoenixville Pike, Malvern, PA 19355, US
LAPORTE, Matthew, G., C/o Tetralogic Pharmaceuticals Corp. 343 Phoenixville Pike Malvern, Malvern, PA 19355, US
-
- (51) MKP
A01H 5/00 (2006.01) (97) **2467010 ***
(86) US2010045869 18.08.2010
(96) 10810537.0 27.06.2012
(87) WO2011022469, 18.08.2010
(97) 2467010, 27.06.2012 en
(54) AAD-1 EVENT DAS-40278-9, RELATED TRANSGENIC CORN LINES, AND EVENT-SPECIFIC IDENTIFICATION THEREOF
(71) Dow AgroSciences, LLC, 9330 Zionsville Road, Indianapolis, Indiana 46268, US
(72) CUI, Yunxing, Cory, 13736 Royal Saddle Drive, Carmel IN 46032, US
KAISER, Tina, 702 Villiage Drive, Carmel IN 46032, US
BRYAN, Jill, 3260 N. Co. Rd. 80 E., Brownsburg IN 46112, US
ZHOU, Ning, 4776 Pebblepointe Pass, Zionsville IN 46077, US
MAUM, Donald, P.o. Box 1071, Kaunakakai HI 96748, US
GILLES, Greg, 14000 Cherry Tree Road, Camel IN 46033, US
WRIGHT, Terry, 14162 Charity Chase Circle, Westfield IN 46032, US
HAMILTON, Jennifer, 9330 Zionsville Road, Indianapolis IN 46268, US
VANOPDORP, Nathan, 27507 E. 1350th Street, Geneseo IL 61254, US
ARNOLD, Nicole, 9743 Mill Creek Place, Carmel IN 46032, US

- (51) MKP
B63B 25/16 (2006.01) (97) **2464563 ***
B63B 27/24 (2006.01)
B63J 2/12 (2006.01)
F17C 6/00 (2006.01)
F17C 9/02 (2006.01)
F17C 9/04 (2006.01)
- (86) NO2010000299 06.08.2010
(96) 10808415.3 20.06.2012
(87) WO2011019284, 06.08.2010
(97) 2464563, 20.06.2012 en
(54) A PLANT COMPRISING A TANK FOR STORING OF LIQUID NATURAL GAS (LNG) AS MARINE FUEL
(71) Rondane Teknologi AS, Nedre Fjørholmvei 21, 3132 Husøysund, NO
(72) JONAS, Jørn. M., Nedre Fjørholmvei 21, N-3132 Husøysund, NO
-
- (51) MKP
A61L 2/18 (2006.01) (97) **2445542 ***
A61L 2/16 (2006.01)
A61L 101/34 (2006.01)
A61L 2/26 (2006.01)
- (86) US2010039459 22.06.2010
(96) 10797563.3 02.05.2012
(87) WO2011005506, 22.06.2010
(97) 2445542, 02.05.2012 en
(54) SANITIZATION APPARATUSES, KITS, AND METHODS
(71) Cleanint, Llc, 3821 Concord Drive, Round Rock, TX 78665, US
(72) DAM, Tuan, 3821 Concord Drive, Round Rock TX 78665, US
-
- (51) MKP
G01D 4/00 (2006.01) (97) **2483637 ***
H04B 1/713 (2011.01)
H04W 4/06 (2009.01)
- (86) US2010050355 27.09.2010
(96) 10763543.5 08.08.2012
(87) WO2011041254, 27.09.2010
(97) 2483637, 08.08.2012 en
(54) METHODS AND SYSTEMS FOR DISTRIBUTING BROADCAST MESSAGES ON VARIOUS NETWORKS
(71) Cellnet Innovations, Inc., 30000 Mill Creek Avenue, Alpharetta, Georgia 30022, US
(72) BETTENDORFF, John, 428 Dewey Blvd., San Francisco, California 94116, US
CALVERT, Chris, 10405 Amberside Ct., Roswell, Georgia 30076, US
-
- (51) MKP
C07K 16/18 (2006.01) (97) **2483314 ***
C07K 16/28 (2006.01)
C07K 16/22 (2006.01)
A61P 35/00 (2006.01)
- (86) EP2010064695 01.10.2010
(96) 10768428.4 08.08.2012
(87) WO2011039370, 01.10.2010
(97) 2483314, 08.08.2012 en
(54) BISPECIFIC BINDING MOLECULES FOR ANTI-ANGIOGENESIS THERAPY
(71) Boehringer Ingelheim International GmbH, Binger Strasse 173, 55216 Ingelheim am Rhein, DE
(72) BORGES, Eric, BOEHRINGER INGELHEIM GMBH Corporate Patents Binger Strasse 173, 55216 Ingelheim Am Rhein, DE
GSCHWIND, Andreas, BOEHRINGER INGELHEIMGMBH Corporate Patents Binger Strasse 173, 55216 Ingelheim Am Rhein, DE
BOUCNEAU, Joachim, Salviapark 1 bus 1, 9840 De Pinte, BE
DE TAVERNIER, Evelyn, Molenberglaan 38, B-9080 Beerveelde, BE
KOLKMAN, Joost, Voetweg 13, B-9830 Sint-Martens-Latem, BE
MERCHIEERS, Pascal, Loopstraat 23, B-2460 Kasterlee, BE
VAN HOORICK, Diane, Warande 118, B-9270 Laarne, BE
-
- (51) MKP
F27D 13/00 (2006.01) (97) **2470849 ***
F27D 3/12 (2006.01)
- (86) CA2010001300 25.08.2010
(96) 10811060.2 04.07.2012
(87) WO2011022818, 25.08.2010
(97) 2470849, 04.07.2012 en
(54) MOVABLE SWEAT HEARTH FOR METAL MELTING FURNACE
(71) Novelis, Inc., 191 Evans Avenue, Toronto, ON M8Z 1J5, CA
(72) RAUCH, Edwin, L., 1701 State Route 48, Fulton, New York 13069, US
-
- (51) MKP
G06F 21/00 (2006.01) (97) **2388695**
G06F 9/445 (2006.01)
G06F 11/34 (2006.01)
- (96) 10193144.2 23.11.2011
(97) 2388695, 23.11.2011 en
(54) Adaptive configuration of conflicting applications
(71) Kaspersky Lab, ZAO, 10 Geroyev Panfilovtsev Street, Moscow 125363, RU
(72) Zaitsev, Oleg V., c/o Kaspersky Lab Zao 10/1, 1st Volokolamsky Proezd, Moscow 123060, RU
-
- (51) MKP
G01M 3/32 (2006.01) (97) **2251671**
G01N 33/00 (2006.01)
G01N 15/08 (2006.01)
- (96) 10162758.6 17.11.2010
(97) 2251671, 17.11.2010 en
(54) Outgassing method for inspecting a coated surface
(71) CV Holdings, LLC., 1030 Riverfront Center, P.O.Box 710, Amsterdam, New York 12010, US
(72) Fisk, Thomas E., 955 North Night Heron Drive, Green Valley, AZ 85614, US
Ferguson, John, 797 Greenwood Drive, Auburn, AL 36832, US
Freedman, Jonathan R., 2213 Brenton Lane, Auburn, AL 36830, US
-
- (51) MKP
A01N 43/42 (2006.01) (97) **2461683 ***
- (86) US2010044607 05.08.2010
(96) 10807186.1 13.06.2012
(87) WO2011017561, 05.08.2010
(97) 2461683, 13.06.2012 en
(54) BICYCLIC ARYL SPHINGOSINE 1-PHOSPHATE ANALOGS
(71) Biogen Idec MA Inc., 14 Cambridge Center, Cambridge, MA 02142, US
(72) THOMAS, Jermaine, 130 Library Street, Chelsea MA 02150, US
LIU, Xiaogao, 28 Tisdale Drive, Dover MA 02030, US
LIN, Edward, Yin-Shiang, 73 Thornton Rd, Chestnut Hill MA 02467, US
ZHENG, Guo, Zhu, 14 Meriam Street, Lexington MA 02420, US
MA, Bin, 276 Massachusetts Ave No.202, Arlington MA 02474, US
CALDWELL, Richard, D., 33 Aberdeen Road, Somerville MA 02144, US
GUCKIAN, Kevin, M., 51 Violetwood Circle, Marlborough MA 01752, US
KUMARAVEL, Gnanasambandam, 10 Perham Circle, Westford MA 01886, US
TAVERAS, Arthur, G., 6 Joslin Lane, Southborough MA 01772, US
-
- (51) MKP
A61P 35/00 (2006.01) (97) **2445912 ***
A61P 37/00 (2006.01)
C07D 471/04 (2006.01)
A61K 31/437 (2006.01)
A61P 29/00 (2006.01)
- (86) EP2010059067 25.06.2010
(96) 10728648.6 02.05.2012
(87) WO2010149771, 25.06.2010
(97) 2445912, 02.05.2012 en
(54) NOVEL COMPOUND USEFUL FOR THE TREATMENT OF DEGENERATIVE AND INFLAMMATORY DISEASES
(71) Galapagos N.V., Generaal de Wittelaan L11 A3, 2800 Mechelen, BE
(72) BLANC, Javier, Galapagos NV Generaal De Wittelaan L11/A3, B-2800 Mechelen, BE
MENET, Christel Jeanne Marie, Galapagos NV Generaal de Wittelaan L11/A3, 2800 Mechelen, BE

- (51) MKP
C12N 5/071 (2010.01) (97) **2471902 ***
A61L 27/38 (2006.01)
A61K 35/12 (2006.01)
- (86) ES2010070569 25.08.2010
(96) 10811319.2 04.07.2012
(87) WO2011023843, 25.08.2010
(97) 2471902, 04.07.2012 en
- (54) PRODUCTION OF ARTIFICIAL TISSUES BY MEANS OF TISSUE ENGINEERING USING AGAROSE-FIBRIN BIOMATERIALS
- (71) Servicio Andaluz De Salud, Avda. de la Constitución 18, 41071 Sevilla, ES
Universidad de Granada, Cuesta del Hospicio, s/n, 18071 Granada, ES
- (72) ALAMINOS MINGORANCE, Miguel, Fundación Progreso y Salud Consejería de salud Avenida Américo Vespucio 5 - blq. 2 2ª pl, E-41092 Sevilla, ES
MUÑOZ ÁVILA, José Ignacio, Fundación Progreso y Salud Consejería de salud Avenida Américo Vespucio 5 - blq. 2 2ª pl, E-41092 Sevilla, ES
GONZÁLEZ ANDRADES, Miguel, Fundación Progreso y Salud Consejería de salud Avenida Américo Vespucio 5 - blq. 2 2ª pl, E-41092 Sevilla, ES
MUÑOZ CAMPOS, Antonio, Fundación Progreso y Salud Consejería de salud Avenida Américo Vespucio 5 - blq. 2 2ª pl, E-41092 Sevilla, ES
GARZÓN BELLO, Ingrid Johanna, Fundación Progreso y Salud Consejería de salud Avenida Américo Vespucio 5 - blq. 2 2ª pl, E-41092 Sevilla, ES
-
- (51) MKP
B60M 3/04 (2006.01) (97) **2450223**
B65G 1/04 (2006.01)
- (96) 11188329.4 09.05.2012
(97) 2450223, 09.05.2012 fr
- (54) Automated storage systems including at least one track provided with a mechanism for halting a carriage.
- (71) Savoye, 18 Boulevard des Gorgets, 21000 Dijon, FR
(72) Kruger, Arnaud, 6 rue de Lamarche, 21270 VIELVERGE, FR
Ferrier, Gilles, Quartier de la Bastide, 48160 LE COLLET DE DEZE, FR
-
- (51) MKP
A24F 47/00 (2006.01) (97) **2493342 ***
- (86) EP2010006598 28.10.2010
(96) 10782535.8 05.09.2012
(87) WO2011050964, 28.10.2010
(97) 2493342, 05.09.2012 en
- (54) AN ELECTRICALLY HEATED SMOKING SYSTEM WITH IMPROVED HEATER
- (71) Philip Morris Products S.A., Quai Jeanrenaud 3, 2000 Neuchâtel, CH
(72) GREIM, Olivier, Chemin Des Sources, CH-1423 Villars-Burquin, CH
PLOJOUX, Julien, Rue Micheli-du-Crest, CH-1205, CH
RUSCIO, Dani, Route de Troub 29, CH-2088 Cressier, CH
-
- (51) MKP
G01T 1/29 (2006.01) (97) **2414864 ***
G01N 23/04 (2006.01)
A61B 6/02 (2006.01)
G21K 1/02 (2006.01)
- (86) US2010029409 31.03.2010
(96) 10764867.7 08.02.2012
(87) WO2010120525, 31.03.2010
(97) 2414864, 08.02.2012 en
- (54) INTERWOVEN MULTI-APERTURE COLLIMATOR FOR 3-DIMENSIONAL RADIATION IMAGING APPLICATIONS
- (71) Brookhaven Science Associates, 40 Brookhaven Avenue, Building 460, Upton, New York 11973-5000, US
(72) CUI, Yonggang, 337 Lake Pointe Drive, Middle Island NY 11953, US
JAMES, Ralph B., 57 East Margin Road, Ridge NY 11961, US
-
- (51) MKP
C07K 14/705 (2006.01) (97) **2440576 ***
A61P 3/00 (2006.01)
A61K 38/18 (2006.01)
- (86) US2010037779 08.06.2010
(96) 10786694.9 18.04.2012
(87) WO2010144452, 08.06.2010
(97) 2440576, 18.04.2012 en
- (54) METHODS FOR INCREASING THERMOGENIC ADIPOCYTES
- (71) Acceleron Pharma, Inc., 128 Sidney Street, Cambridge, MA 02139, US
- (72) KNOPF, John, 147 Robbins Drive, Carlisle, MA 01741, US
SEEHRA, Jasbir, 3 Lincoln Terrace, Lexington, MA 02421-6818, US
KUMAR, Ravindra, 421 Arlington Street, Acton, MA 01720, US
-
- (51) MKP
A61Q 3/02 (2006.01) (97) **2486067 ***
A45D 31/00 (2006.01)
C08F 251/02 (2006.01)
C09D 4/06 (2006.01)
A61K 8/91 (2006.01)
- (86) US2010047169 30.08.2010
(96) 10750003.5 15.08.2012
(87) WO2011043879, 30.08.2010
(97) 2486067, 15.08.2012 en
- (54) REMOVABLE PROTECTIVE TOPCOAT FOR ARTIFICIAL NAIL COATINGS AND METHODS THEREFORE
- (71) Creative Nail Design, Inc., 1125 Joshua Way, Vista, CA 92081, US
(72) VU, Thong, H., 2027 Freedom Way, Vista CA 92081, US
SCHOON, Douglas D., 33935 Crystal Lantern St, Dana Point, CA 92629, US
-
- (51) MKP
C08F 265/06 (2006.01) (97) **2419462 ***
C08F 265/04 (2006.01)
D21H 21/10 (2006.01)
C08F 265/10 (2006.01)
C08F 2/32 (2006.01)
- (86) EP2010002218 09.04.2010
(96) 10713841.4 22.02.2012
(87) WO2010118841, 09.04.2010
(97) 2419462, 22.02.2012 en
- (54) BIMOLECULAR INVERSE EMULSION POLYMER
- (71) Ashland Licensing and Intellectual Property LLC, 5200 Blazer Parkway, Dublin, OH 43017, US
(72) BROECHER, Markus, Westminsterstr. 93, 45470 Mühlheim an der Ruhr, DE
KANTO OEQUIST, Charlotta, Am Beyertzhof 20, 47906 Kempen, DE
SIEVERLING, Nathalie, Luegallee 83, 40454 Düsseldorf, DE
LINNEWEBER, Georg, Irisstr. 3, 41372 Niederkrüchten, DE
-
- (51) MKP
C12N 15/82 (2006.01) (97) **2467488 ***
A01H 5/00 (2006.01)
- (86) US2010045870 18.08.2010
(96) 10810538.8 27.06.2012
(87) WO2011022470, 18.08.2010
(97) 2467488, 27.06.2012 en
- (54) CONTROL OF AAD-1 MONOCOT VOLUNTEERS IN FIELDS OF DICOT CROPS
- (71) Dow AgroSciences, LLC, 9330 Zionsville Road, Indianapolis, Indiana 46268, US
(72) HANGER, Gregory, A., 5793 Coopers Hawk Drive, Carmel IN 46033, US
ROBINSON, Andrew, 7623 Hickory Road, Brownsburg IN 46112, US
SATCHIVI, Norbert, M., 3100 Cherub Court, Westfield IN 46074, US
CHAMBERS, Richard, 30 Kingfisher Way, Warriewood New South Wales 2102, AU
WRIGHT, Terry, 14162 Charity Chase Circle, Westfield IN 46032, US

- (51) MKP
C07K 16/28 (2006.01) (97) **2493926 ***
- (86) EP2010066276 27.10.2010
(96) 10770839.8 05.09.2012
(87) WO2011051350, 27.10.2010
(97) 2493926, 05.09.2012 en
(54) FUNCTION MODIFYING NAV 1.7 ANTIBODIES
(71) UCB Pharma, S.A., 60, allée de la Recherche, 1170 Brussels, BE
(72) MILLER, Karen Margrete, UCB Pharma S.A. 60 Allée de la Recherche, B-1070 Brussels, BE
DE RYCK, Marc Roger, UCB Pharma S.A. 60 Allée de la Recherche, B-1070 Brussels, BE
WOLFF, Christian Gilbert J., UCB Pharma S.A. 60 Allée de la Recherche, B-1070 Brussels, BE
LAWSON, Alastair David Griffiths, UCB Celltech 208 Bath Road Slough, Berkshire SL1 3WE, GB
FINNEY, Helene Margaret, UCB Celltech 208 Bath Road Slough, Berkshire SL1 3WE, GB
BAKER, Terence Seward, UCB Celltech 208 Bath Road Slough, Berkshire SL1 3WE, GB
-
- (51) MKP
C07D 401/12 (2006.01) (97) **2476677 ***
- (86) JP2010005489 07.09.2010
(96) 10815137.4 18.07.2012
(87) WO2011030537, 07.09.2010
(97) 2476677, 18.07.2012 en
(54) PROCESS FOR PRODUCTION OF 4-(5-METHYLPYRIDIN-2-YLAMINO)PIPERIDINE-1-CARBOXYLIC ACID DERIVATIVES
(71) Kyorin Pharmaceutical Co., Ltd., 5, Kanda Surugadai 2-chome Chiyoda-ku, Tokyo 101-8311, JP
(72) KAWAMURA, Koji, c/o Development Research Laboratories Kyorin Pharmaceutical Co. Ltd. 1848 Nogi Nogi-machi, Shimotsuga-gun Tochigi 329-0114, JP
MIYOSHI, Keita, c/o Discovery Research Laboratories Kyorin Pharmaceutical Co. Ltd. 2399-1 Nogi Nogi-machi, Shimotsuga-gun Tochigi 329-0114, JP
KOBAYASHI, Emi, c/o Head Office Kyorin Pharmaceutical Co. Ltd. 5 Kanda Surugadai 2-chome Chiyoda-ku, Tokyo 101-8311, JP
-
- (51) MKP
A61K 31/495 (2006.01) (97) **2482817 ***
A61P 9/00 (2006.01)
- (86) US2010050907 30.09.2010
(96) 10762834.9 08.08.2012
(87) WO2011041545, 30.09.2010
(97) 2482817, 08.08.2012 en
(54) METHODS OF TREATING ANEURYSMAL DILATATION, BLOOD VESSEL WALL WEAKNESS AND SPECIFICALLY ABDOMINAL AORTIC AND THORACIC ANEURYSM USING MATRIX METALLOPROTEASE-2 INHIBITORS
(71) Symphony Evolution, Inc., 7361 Calhoun Place, Suite 325, Rockville, MD 20850, US
(72) WOOD, Alastair, J.J., 955 Fifth Avenue Apt. 11A, New York, NY 10075, US
-
- (51) MKP
H04N 13/04 (2006.01) (97) **2437504 ***
G11B 20/10 (2006.01)
G11B 20/12 (2006.01)
G11B 27/00 (2006.01)
H04N 5/93 (2006.01)
- (86) JP2010003372 19.05.2010
(96) 10780222.5 04.04.2012
(87) WO2010137261, 19.05.2010
(97) 2437504, 04.04.2012 en
(54) RECORDING MEDIUM, REPRODUCTION DEVICE, INTEGRATED CIRCUIT, REPRODUCTION METHOD, AND PROGRAM
(71) Panasonic Corporation, 1006, Oaza Kadoma, Kadoma-shi Osaka 571-8501, JP
(72) LEICHSENDRING, Germano, c/o Panasonic Corporation IPROC 7F Twin 21 OBP Panasonic Tower 2-1-61 Shiromi, Chuo-ku, Osaka 540-6207, JP
OHTO, Hidetaka, c/o Panasonic Corporation IPROC 7F Twin 21 OBP Panasonic Tower 2-1-61 Shiromi, Chuo-ku, Osaka 540-6207, JP
-
- (51) MKP
A61K 9/20 (2006.01) (97) **2405915 ***
A61K 31/485 (2006.01)
A61P 25/04 (2006.01)
A61K 9/28 (2006.01)
- (86) EP2010053028 10.03.2010
(96) 10707534.3 18.01.2012
(87) WO2010103039, 10.03.2010
(97) 2405915, 18.01.2012 en
(54) IMMEDIATE RELEASE PHARMACEUTICAL COMPOSITIONS COMPRISING OXYCODONE AND NALOXONE
(71) Euro-Celtique S.A., 2, avenue Charles de Gaulle, 1653 Luxembourg, LU
(72) DANAGHER, Helen Kathleen, c/o Mundipharma Research Limited 191 Cambridge Science Park Milton Road, Cambridge Cam CB4 0GW, GB
HAYES, Geoffrey Gerard, c/o Mundipharma Research Limited 191 Cambridge Science Park Milton Road, Cambridge Cambridgeshire CB4 0GW, GB
HEUN, Gerhard Josef, c/o Mundipharma Research GmbH&Co. KG Höhenstraße 10, 65549 Limburg, DE
MOHAMMAD, Hassan, c/o Mundipharma Research Limited 191 Cambridge Science Park Milton Road, Cambridge Cambridgeshire CB4 0GW, GB
WALDEN, Malcolm, c/o Mundipharma Research Limited 191 Cambridge Science Park Milton Road, Cambridge Cambridgeshire CB4 0GW, GB
WHITEHOUSE, Jonathon Oliver, c/o Mundipharma Research Limited 191 Cambridge Science Park Milton Road, Cambridge Cambridgeshire CB4 0GW, GB
-
- (51) MKP
E06B 3/46 (2006.01) (97) **2336473**
- (96) 10011702.7 22.06.2011
(97) 2336473, 22.06.2011 en
(54) Case for counterframe for disappearing sliding door and counterframe with case of the door panel provided with a side for supporting hanging objects
(71) ECLISSE SRL, Via Sernaglia 76-C.P. 70, 31053 Pieve di Soligo (TV), IT
(72) De Faveri, Luigi, Via Vittoria, 114, 31020 Refrontolo (TV), IT
-
- (51) MKP
C07C 209/62 (2006.01) (97) **2448910 ***
C07C 211/35 (2006.01)
C07C 209/16 (2006.01)
- (86) EP2010003921 28.06.2010
(96) 10740144.0 09.05.2012
(87) WO2011000538, 28.06.2010
(97) 2448910, 09.05.2012 en
(54) METHOD OF PREPARING NERAMEXANE
(71) Merz Pharma GmbH & Co. KGaA, Eckenheimer Landstrasse 100, 60318 Frankfurt Main, DE
(72) KOLLER, Herbert, Quellenstrasse 155A/65, A-1100 Wien, AT
PYERIN, Michael, Enzersdorferstrasse 3/2/8, 2345 Brunn am Gebirge, AT
SBROGIÒ, Federico, Via Tecchio 62, 36075 Montecchio Maggiore, IT
-
- (51) MKP
G01D 5/12 (2006.01) (97) **2491335 ***
G01B 7/30 (2006.01)
B62D 15/02 (2006.01)
- (86) US2010053243 19.10.2010
(96) 10825537.3 29.08.2012
(87) WO2011049978, 19.10.2010
(97) 2491335, 29.08.2012 en
(54) MULTI-TURN SENSOR
(71) Bei Duncan Electronics, 170 Technology Drive, Irvine, California 92618, US
(72) PUTINIER, Rene, 2816 Eagle Crest Rd. F, Chino Hills, California 91709, US

(51) MKP
C07D 253/075 (2006.01) (97) **2430003 ***
A61P 25/08 (2006.01)
A61K 31/53 (2006.01)
(86) US2010034770 13.05.2010
(96) 10721887.7 21.03.2012
(87) WO2010132691, 13.05.2010
(97) 2430003, 21.03.2012 en
(54) OLIGOMER-CONTAINING SUBSTITUTED AROMATIC TRIAZINE COMPOUNDS
(71) Nektar Therapeutics, 455 Mission Bay Boulevard South, Suite 100, San Francisco, CA 94185, US
(72) RIGGS-SAUTHIER, Jennifer, 7917 Smoke Rise Road, Huntsville AL 35802, US
DENG, Bo-Liang, 209 Meadow Wood Drive, Madison AL 35756, US

(51) MKP
C12Q 1/68 (2006.01) (97) **2494074 ***
(86) US2010054810 29.10.2010
(96) 10827556.1 05.09.2012
(87) WO2011053831, 29.10.2010
(97) 2494074, 05.09.2012 en
(54) METHODS FOR DIAGNOSING IRRITABLE BOWEL SYNDROME
(71) Prometheus Laboratories Inc., 9410 Carroll Park Drive, San Diego, CA 92121-5201, US
(72) GONG, Hua, 12457 Carmel Park Drive, San Diego California 92130-2274, US
WANG, Shui, Long, 4555 Saddle Mountain Court, San Diego California 92130, US
SINGH, Sharat, 8171 Top of the Morning Way, Rancho Santa Fe California 92127, US

(51) MKP
G01C 21/00 (2006.01) (97) **2491342 ***
(86) US2010002393 01.09.2010
(96) 10825310.5 29.08.2012
(87) WO2011049595, 01.09.2010
(97) 2491342, 29.08.2012 en
(54) POWER MANAGEMENT SYSTEM AND METHOD FOR VEHICLE LOCATING UNIT
(71) Lojack Operating Company, Lp, 200 Lowder Brook Drive Suite 1000, Westwood, MA 02090, US
(72) JUSTICE, James, 10 The Paddock Lane, Medford MA 02052, US
RHODES, Jesse, 291 Prospect Street, Franklin MA 02038, US
GOODWIN, Michael, 25 Phillips Court, North Andover MA 01845, US

(51) MKP
A61K 9/12 (2006.01) (97) **2387391 ***
(86) DE2010000818 16.07.2010
(96) 10757384.2 23.11.2011
(87) WO2011009436, 16.07.2010
(97) 2387391, 23.11.2011 de
(54) METHOD FOR DEVELOPING A LIQUID COMPOSITION TO BE APPLIED TO THE SKIN AS A FOAM AND A COMPOSITION THAT CAN BE APPLIED TOPICALLY
(71) MIKA Pharma Gesellschaft für die Entwicklung und Vermarktung pharmazeutischer Produkte mbH, An der Rheinschanze 1, 67059 Ludwigshafen, DE
(72) SEIGFRIED, Bernd, G., Domholz 20, 67117 Limburgerhof, DE

(51) MKP
G01R 31/00 (2006.01) (97) **2414850 ***
G01R 29/08 (2006.01)
(86) FR2010050594 30.03.2010
(96) 10717686.9 08.02.2012
(87) WO2010112763, 30.03.2010
(97) 2414850, 08.02.2012 fr
(54) METHOD OF CHECKING THE DIRECTIVITY AND POLARIZATION OF COHERENT FIELD DISTRIBUTIONS IN A REVERBERANT MEDIUM
(71) Supelec, 3, rue Joliot-Curie Plateau de Moulon, 91192 Gif sur Yvette, FR
(72) COZZA, Andrea, 70 rue des Plantes, F-75014 Paris, FR
MOUSSA, Mouhamad, Houmam, Casier 8618 1 rue Joliot Curie, F-91190 Gif sur Yvette, FR

(51) MKP
A61B 5/026 (2006.01) (97) **2292142**
(96) 10169669.8 09.03.2011
(97) 2292142, 09.03.2011 en
(54) Method and device for evaluation of blood fluidity
(71) Adtex Inc., 2454-1, Kuraganomachi, Takasaki-shi, Gunma 370-1201, JP
(72) Koshino, Shinji, c/o ADTEX Inc. 2454-1, Kuragano-machi, Takasaki-shi Gunma 370-1201, JP
Shimizu, Hiroki, c/o ADTEX Inc. 2454-1, Kuragano-machi, Takasaki-shi Gunma 370-1201, JP
Sato, Hiroo, c/o ADTEX Inc. 2454-1, Kuragano-machi, Takasaki-shi Gunma 370-1201, JP

(51) MKP
A61B 1/00 (2006.01) (97) **2485632 ***
A61B 17/00 (2006.01)
(86) US2010051812 07.10.2010
(96) 10771594.8 15.08.2012
(87) WO2011044353, 07.10.2010
(97) 2485632, 15.08.2012 en
(54) LAPAROSCOPIC INSTRUMENT WITH ATTACHABLE END EFFECTOR
(71) Ethicon Endo-Surgery, Inc., 4545 Creek Road, Cincinnati, OH 45242, US
(72) NOBIS, Rudolph, H., 4594 Atrium Court, Mason, OH 45040, US
SPIVEY, James, T., 542 Missouri Avenue, Cincinnati, OH 45226, US
HUEY, Kevin, M., 353 W. 4th Street Unit 206, Cincinnati, OH 45202, US
HESS, Christopher, J., 1704 East Mcmillan Street, Cincinnati, OH 45206, US
CONLON, Sean, P., 6234c North Shadow Hill Way, Loveland, OH 45140, US

(51) MKP
E04H 7/22 (2006.01) (97) **2478171 ***
E04H 12/08 (2006.01)
E04G 11/06 (2006.01)
E04H 12/34 (2006.01)
(86) DK2010050232 14.09.2010
(96) 10754405.8 25.07.2012
(87) WO2011032559, 14.09.2010
(97) 2478171, 25.07.2012 en
(54) TUBULAR BUILDING STRUCTURE WITH HINGEDLY CONNECTED PLATFORM SEGMENT
(71) Andresen Towers A/S, Industrivej 12, 5550 Langeskov, DK
(72) KRYGER, Arne, Grønvangens 167, DK-5550 Langeskov, DK
RYHOLL, Lars, Norgesvej 17, DK-5500 Middelfart, DK

(51) MKP
C07D 401/14 (2006.01) (97) **2493513 ***
A61K 51/04 (2006.01)
(86) EP2010066237 27.10.2010
(96) 10768973.9 05.09.2012
(87) WO2011051324, 27.10.2010
(97) 2493513, 05.09.2012 en
(54) RADIOLABELLED PDE10 LIGANDS
(71) Janssen Pharmaceutica, N.V., Turnhoutseweg 30, 2340 Beerse, BE
(72) ANDRÉS-GIL, José, Ignacio, c/o Janssen-Cilag S.A. Calle Jarama 75 Poligono Industrial, E-45007 Toledo, ES
DE ANGELIS, Meri, c/o Janssen-Cilag S.A. Calle Jarama 75 Poligono Industrial, E-45007 Toledo, ES
BORMANS, Guy, Maurits, R., c/o Katholieke Universiteit Leuven Research&Development Minderbroedersstraat 8a, B-3000 Leuven, BE
CELEN, Sofie, Jeanne, Leopoldine, c/o Katholieke Universiteit Leuven Research&Development Minderbroedersstraat 8a, B-3000 Leuven, BE

- (51) MKP
C12N 15/113 (2010.01) (97) **2411517 ***
 (86) US2010028674 25.03.2010
 (96) 10710765.8 01.02.2012
 (87) WO2010111497, 25.03.2010
 (97) 2411517, 01.02.2012 en
 (54) RNA INTERFERENCE MEDIATED INHIBITION OF THE INTERCELLULAR ADHESION MOLECULE 1 (ICAM-1) GENE EXPRESSION USING SHORT INTERFERING NUCLEIC ACID (siNA)
 (71) Merck Sharp&Dohme Corp., 1700 Owens Street 4th Floor, San Francisco, California 94158, US
 (72) STRAPPS, Walter, 4th Floor 1700 Owens Street, San Francisco California 94158, US
 SHAH, Jyoti, 4th Floor 1700 Owens Street, San Francisco California 94158, US
 PICKERING, Victoria, 4th Floor 1700 Owens Street, San Francisco California 94158, US

- (51) MKP
C07D 233/86 (2006.01) (97) **2426113 ***
A61K 31/4164 (2006.01)
A61K 31/496 (2006.01)
A61K 31/551 (2006.01)
A61P 3/06 (2006.01)
A61P 3/10 (2006.01)
A61P 9/10 (2006.01)
A61P 17/00 (2006.01)
A61P 25/28 (2006.01)
A61P 29/00 (2006.01)
A61P 43/00 (2006.01)
C07D 401/04 (2006.01)
C07D 401/12 (2006.01)
C07D 401/14 (2006.01)
C07D 403/06 (2006.01)
C07D 405/04 (2006.01)
C07D 405/14 (2006.01)
C07D 491/048 (2006.01)
C07D 491/056 (2006.01)
 (86) JP2010003039 28.04.2010
 (96) 10769511.6 07.03.2012
 (87) WO2010125811, 28.04.2010
 (97) 2426113, 07.03.2012 en
 (54) CARBINOL COMPOUND HAVING HETEROCYCLIC LINKER
 (71) Kowa Company, Ltd., 6-29, Nishiki 3-chome Naka-ku, Nagoya-shi, Aichi-ken 460-8625, JP
 (72) KOURA, Minoru, c/o KOWA COMPANY, LTD. Tokyo New Drug Research Laboratories 2-17-43, Noguchi-cho, Higashimurayama-shi Tokyo 189-0022, JP
 SUMIDA, Hisashi, c/o KOWA COMPANY, LTD. Tokyo New Drug Research Laboratories 2-17-43, Noguchi-cho, Higashimurayama-shi Tokyo 189-0022, JP
 MATSUDA, Takayuki, c/o KOWA COMPANY, LTD. Tokyo New Drug Research Laboratories 2-17-43, Noguchi-cho, Higashimurayama-shi Tokyo 189-0022, JP
 WATANABE, Yuichiro, c/o KOWA COMPANY, LTD. Tokyo New Drug Research Laboratories 2-17-43, Noguchi-cho, Higashimurayama-shi Tokyo 189-0022, JP
 ENOMOTO, Takashi, c/o KOWA COMPANY, LTD. Tokyo New Drug Research Laboratories 2-17-43, Noguchi-cho, Higashimurayama-shi Tokyo 189-0022, JP
 SHIBUYA, Kimiyuki, c/o KOWA COMPANY, LTD. Tokyo New Drug Research Laboratories 2-17-43, Noguchi-cho, Higashimurayama-shi Tokyo 189-0022, JP
 KUROBUCHI, Sayaka, (deceased), JP

- (51) MKP
A01P 1/00 (2006.01) (97) **2458995 ***
A61K 31/69 (2006.01)
A61P 31/04 (2006.01)
A01N 55/08 (2006.01)
C07F 5/02 (2006.01)
A62D 3/36 (2007.01)
 (86) US2010043437 27.07.2010
 (96) 10737730.1 06.06.2012
 (87) WO2011017125, 27.07.2010
 (97) 2458995, 06.06.2012 en
 (54) TRISUBSTITUTED BORON-CONTAINING MOLECULES
 (71) Anacor Pharmaceuticals, Inc., 1020 East Meadow Circle, Palo Alto, CA 94303, US
 (72) PLATTNER, Jacob, J., 119 Via Floreado, Orinda CA 94563, US
 OU, Ligong, 1830 Holman Crescent N.W., Edmonton Alberta T6R 3M2, CA
 XIA, Yi, 338 El Carmelo Avenue, Palo Alto CA 94306, US
 JIA, Guofeng, 1247-104 Street N.W., Edmonton Alberta T6J 6E4, CA
 ALLEY, Michael, Richard Kevin, 3751 Lillick Drive, Santa Clara CA 95051, US
 SARASWAT, Neerja, 1720-49 A Street, Edmonton Alberta T6L 3K6, CA
 ZHOU, Yasheen, 452 Millfield Place, Moraga CA 94556, US
 RAMACHANDRAN, Sreekanth, 11615-28 Ave. NW Apt. 211A, Edmonton Alberta T6J 3Z8, CA
 SINGH, Rajeshwar, 1435 Loewen Ct., Edmonton Alberta T6R 2Y1, CA
 ZHOU, Ding, 2nd Floor Building 1B No. 528 Rui Qing Road Pu Dong Shanghai, 201201, CN
 CAO, Kathy, 867 Bremerton Dr., Sunnyvale CA 94087, US
 DING, Charles, 23 Treetop Lane, San Mateo CA 94402, US

- (51) MKP
A61K 9/00 (2006.01) (97) **2413899 ***
A61K 31/245 (2006.01)
A61K 31/4174 (2006.01)
A61P 23/02 (2006.01)
 (86) US2010001002 02.04.2010
 (96) 10714119.4 08.02.2012
 (87) WO2010114622, 02.04.2010
 (97) 2413899, 08.02.2012 en
 (54) DENTAL ANESTHETIC COMPRISING TETRACAINE AND A VASOCONSTRICTOR FOR INTRANASAL ADMINISTRATION
 (71) St. Renatus, LLC, 1000 Centre Avenue, Fort Collins, Colorado 80526, US
 (72) KOLLAR, Mark David, 5308 Golden Willow Drive, Fort Collins Colorado 80528, US

- (51) MKP
A01N 37/18 (2006.01) (97) **2405750 ***
A61K 31/16 (2006.01)
 (86) US2010027159 12.03.2010
 (96) 10751482.0 18.01.2012
 (87) WO2010105172, 12.03.2010
 (97) 2405750, 18.01.2012 en
 (54) COMBINATION THERAPY WITH THIOCOLCHICINE DERIVATIVES
 (71) Abraxis BioScience, LLC, 11755 Wilshire Boulevard Suite 2100, Los Angeles, CA 90025, US
 (72) DESAI, Neil, P., 11755 Wilshire Boulevard 20th Floor, Los Angeles CA 90025, US
 TRIEU, Vuong, 4003 Jim Bowie, Agoura Hills CA 91301, US

- (51) MKP
C07D 215/26 (2006.01) (97) **2406227 ***
A61K 31/4704 (2006.01)
A61P 11/00 (2006.01)
 (86) EP2010001582 12.03.2010
 (96) 10708935.1 18.01.2012
 (87) WO2010102831, 12.03.2010
 (97) 2406227, 18.01.2012 en
 (54) PROCESS FOR MANUFACTURING 5-(2-[[6-(2,2-DIFLUORO-2-PHENYLETHOXY) HEXYL]AMINO]-1-HYDROXYETHYL)-8-HYDROXYQUINOLIN-2(1H)-ONE.
 (71) Almírral S.A., Ronda del General Mitre, 151, 08022 Barcelona, ES
 (72) MARCHUETA HEREU, Iolanda, C/Laureá Miro 408-410, E-08980 Sant Feliu de Llobregat, ES
 MOYES VALLS, Enrique, C/Laureá Miro 408-410, E-08980 Sant Feliu de Llobregat, ES

- (51) MKP
C12N 5/10 (2006.01) (97) **2448970 ***
A61K 39/395 (2006.01)
A61P 25/00 (2006.01)
C07K 16/22 (2006.01)
C12N 15/13 (2006.01)
(86) IB2010001210 04.05.2010
(96) 10730827.2 09.05.2012
(87) WO2010128398, 04.05.2010
(97) 2448970, 09.05.2012 en
(54) ANTIBODIES AGAINST NERVE GROWTH FACTOR (NGF) WITH ENHANCED IN VIVO STABILITY
(71) Abbott Research B.V., Meeuwenlaan 4 P.O.Box 365, 8000 AJ Zwolle, NL
(72) POWELL, John, 28 Short Road Stretham, Ely Cambridgeshire CB6 3LS, GB
MAGINN, Mark, 53 High Street, Wilburton Cambridgeshire CB6 3RA, GB
CASSON, Duncan, The Paddock Pedlers Lane Therfield, Royston Hertfordshire SG8 9PX, GB
BEST, Andrea, 510 Buena Road, Lake Forest, IL 60045, US
HALL, Jerry A., 451 Cross Road, Gurnee, IL 60031, US
LIU, Wei, 1287 Derby Lane, Mundelein, IL 60060, US
DUTTA, Sandeep, 7303 Clem Drive, Gurnee, IL 60031, US
-
- (51) MKP
F16L 57/04 (2006.01) (97) **2270382**
(96) 10006789.1 05.01.2011
(97) 2270382, 05.01.2011 de
(54) Thin layer strip for coating metal components and method for applying a coating which forms a thin layer
(71) Rütgers Organics GmbH, Oppauer Straße 43, 68305 Mannheim, DE
(72) Friedel, Gerd, Freundenbergstraße 11, 69469 Weinheim, DE
Heidenreich, Thomas, Eugen-Richter-Straße 15, 68199 Mannheim, DE
Bender, Klaus, Pfarrstraße 8a, 35444 Biebertal, DE
-
- (51) MKP
D06M 13/10 (2006.01) (97) **2488596 ***
C09J 103/02 (2006.01)
E04B 1/74 (2006.01)
C03C 25/14 (2006.01)
C03C 25/24 (2006.01)
C03C 25/26 (2006.01)
C03C 25/32 (2006.01)
D04H 1/58 (2012.01)
D04H 1/64 (2012.01)
(86) FR2010052164 13.10.2010
(96) 10785105.7 22.08.2012
(87) WO2011045531, 13.10.2010
(97) 2488596, 22.08.2012 fr
(54) ADHESIVE COMPOSITION FOR MINERAL WOOL INCLUDING A REDUCING SUGAR AND A METAL SALT OF AN INORGANIC ACID, AND INSULATING PRODUCTS THUS OBTAINED.
(71) Saint-Gobain Isover, 18 Avenue d'Alsace, 92400 Courbevoie, FR
(72) JAFFRENNOU, Boris, 33 rue des Alouettes, F-75019 Paris, FR
OBERT, Edouard, 38 Avenue de la Gare Bâtiment C, F-60580 Coye La Foret, FR
PONS Y MOLL, Olivier, 256 rue de Crèvecoeur Hameau de Ronquerolles, F-60600 Agnetz, FR
LOHOU, Stéphane, 100 Avenue Simon Bolivar, 75019 Paris, FR
-
- (51) MKP
B32B 15/08 (2006.01) (97) **2459372 ***
B32B 17/10 (2006.01)
B29C 45/14 (2006.01)
(86) US2010043348 27.07.2010
(96) 10806881.8 06.06.2012
(87) WO2011017086, 27.07.2010
(97) 2459372, 06.06.2012 en
(54) THERMALLY RESPONSIVE COMPOSITE MATERIALS
(71) North Carolina State University, 920 Main Campus Drive Venture Building 22, Suite 400 Campus Box 8210, Raleigh, NC 27695-8210, US
(72) WALKER, Glenn, 317 Coorsdale Drive, Cary NC 27511-6643, US
SACHAR, Ravish, Wake Heart And Vascular Associates 3000 New Bern Avenue, Raleigh, NC 27610, US
DONG, Hua, Burlington Nuc Labs 2146 Box 7115 NCSU Campus, Raleigh, NC 27695, US

- (51) MKP
A61K 31/455 (2006.01) (97) **2406225 ***
A61P 37/00 (2006.01)
C07D 213/80 (2006.01)
(86) EP2010001550 11.03.2010
(96) 10708932.8 18.01.2012
(87) WO2010102826, 11.03.2010
(97) 2406225, 18.01.2012 en
(54) ADDITION SALTS OF AMINES CONTAINING HYDROXYL AND/OR CARBOXYLIC GROUPS WITH AMINO NICOTINIC ACID DERIVATIVES AS DHODH INHIBITORS
(71) Mirall S.A., Ronda del General Mitre, 151, 08022 Barcelona, ES
(72) PEREZ GARCIA, Juan, Bautista, C/ Laureá Mir 408-410, E-08980 Sant Feliu de Llobregat, ES
CARRERA CARRERA, Francesc, C/ Laureá Mir 408-410, E-08980 Sant Feliu de Llobregat, ES
GARCIA MARTIN, Digna, José, C/ Laureá Mir 408-410, E-08980 Sant Feliu de Llobregat, ES
BOIX BERNARDINI, Maria, Carmen, C/ Laureá Mir 408-410, E-08980 Sant Feliu de Llobregat, ES
-
- (51) MKP
B29C 35/16 (2006.01) (97) **2427315 ***
B29B 7/90 (2006.01)
B29B 17/00 (2006.01)
(86) NL2010050261 04.05.2010
(96) 10718318.8 14.03.2012
(87) WO2010128854, 04.05.2010
(97) 2427315, 14.03.2012 en
(54) PROCESS FOR MANUFACTURING A COMPOSITION COMPRISING RECYCLED PET BY CONTROLLED COOLING
(71) Echotect B.V., Lange Kleiweg 60F, 2288 GK Rijswijk, NL
(72) van Helden, Arend, Kuindert, Henry van de Veldestraat 2, NL-3822 EG Amersfoort, NL
-
- (51) MKP
C07H 21/04 (2006.01) (97) **2496594 ***
C12N 15/11 (2006.01)
(86) US2010048989 15.09.2010
(96) 10828710.3 12.09.2012
(87) WO2011056300, 15.09.2010
(97) 2496594, 12.09.2012 en
(54) METHODS AND COMPOSITIONS FOR MODULATING TAU LEVELS
(71) The J. David Gladstone Institutes, 1650 Owens Street, San Francisco, CA 94158, US
(72) GAN, Li, 1700 Easton Drive, Burlingame CA 94010, US
-
- (51) MKP
B24B 33/02 (2006.01) (97) **2475499 ***
B23Q 17/22 (2006.01)
B24B 5/40 (2006.01)
(86) GB2010051355 17.08.2010
(96) 10757253.9 18.07.2012
(87) WO2011030119, 17.08.2010
(97) 2475499, 18.07.2012 en
(54) BORE MACHINING METHOD AND APPARATUS
(71) Pipeline Technique Limited, The Welding Centre Smithy Road, Rothienorman, Aberdeenshire AB51 8ZE, GB
(72) HUTT, Graham, 8 Chemin des Chataigniers, F-34320 Nizas, FR

- (51) MKP
C07K 1/24 (2006.01) (97) **2477505 ***
A23J 1/14 (2006.01)
C07K 14/415 (2006.01)
- (86) CA2010001424 14.09.2010
(96) 10816512.7 25.07.2012
(87) WO2011032266, 14.09.2010
(97) 2477505, 25.07.2012 en
(54) CANOLA PROTEIN PRODUCT FROM SUPERNATANT
(71) Burcon Nutrascience (MB) Corp., 1388 Waller Avenue, Winnipeg, Manitoba R3T 1P9, CA
(72) MEDINA, Sarah, 315 Wildwood Park, Winnipeg Manitoba R3T 0E5, CA
SCHWEIZER, Martin, 117 Haig Avenue, Winnipeg Manitoba R2M 0E3, CA
GREEN, Brent, E., 24 Poplarwood Drive Box 603, Warren Manitoba R0C 3E0, CA
SEGALL, Kevin, I., 31 Dunbar Crescent, Winnipeg Manitoba R3P 0W6, CA
WILLARDSEN, Randy, 1933 Park Oak Drive, Roseville California 95661, US
LOGIE, James, 131-122 Willow Point Road, Winnipeg Manitoba R2J 2Y3, CA
-
- (51) MKP
B65B 39/00 (2006.01) (97) **2241507**
B65B 39/04 (2006.01)
B65B 31/04 (2006.01)
B65B 55/02 (2006.01)
- (96) 10157982.9 20.10.2010
(97) 2241507, 20.10.2010 en
(54) Apparatus for filling flexible containers with a fluid, for example foodstuffs, such as cream, yoghurt, fruit juices and purées, vegetables and similar
(71) Flextech S.r.l., Strada Alessandri acqui, 2/A, 15073 Castellazzo Bormida, IT
(72) Laguzzi, Fulvio, Strada Valmaggione, 52, 14017 Valfenera ASTI, IT
-
- (51) MKP
A61K 31/4523 (2006.01) (97) **2406247 ***
A61K 31/397 (2006.01)
C07D 413/14 (2006.01)
A61P 3/00 (2006.01)
C07D 401/12 (2006.01)
C07D 401/14 (2006.01)
C07D 403/14 (2006.01)
- (86) GB2010050440 12.03.2010
(96) 10709925.1 18.01.2012
(87) WO2010103333, 12.03.2010
(97) 2406247, 18.01.2012 en
(54) COMPOUNDS FOR THE TREATMENT OF METABOLIC DISORDERS
(71) Prosidion Limited, Windrush Court Watlington Road, Oxford, Oxfordshire OX4 6LT, GB
(72) JEEVARATNAM, Revathy, Perpetua, Prosidion Limited Windrush Court Watlington Road Oxford, Oxfordshire OX4 6LT, GB
SWAIN, Simon, Andrew, Prosidion Limited Windrush Court Watlington Road Oxford, Oxfordshire OX4 6LT, GB
KRULLE, Thomas, Martin, Prosidion Limited Windrush Court Watlington Road Oxford, Oxfordshire OX4 6LT, GB
PROCTER, Martin, James, Prosidion Limited Windrush Court Watlington Road Oxford, Oxfordshire OX4 6LT, GB
SAMBROOK-SMITH, Colin, Peter, Prosidion Limited Windrush Court Watlington Road Oxford, Oxfordshire OX4 6LT, GB
BARBA, Oscar, Prosidion Limited Windrush Court Watlington Road Oxford, Oxfordshire OX4 6LT, GB
SCHOFIELD, Karen, Lesley, Prosidion Limited Windrush Court Watlington Road Oxford, Oxfordshire OX4 6LT, GB
GATTRELL, William, Prosidion Limited Windrush Court Watlington Road Oxford, Oxfordshire OX4 6LT, GB
STONEHOUSE, David, French, Prosidion Limited Windrush Court Watlington Road Oxford, Oxfordshire OX4 6LT, GB
FYFE, Matthew, Colin, Thor, Prosidion Limited Windrush Court Watlington Road Oxford, Oxfordshire OX4 6LT, GB
STEWART, Alan, John, William, Prosidion Limited Windrush Court Watlington Road Oxford, Oxfordshire OX4 6LT, GB
FRY, Peter, Timothy, Prosidion Limited Windrush Court Watlington Road Oxford, Oxfordshire OX4 6LT, GB
SMYTH, Donald, Prosidion Limited Windrush Court Watlington Road Oxford, Oxfordshire OX4 6LT, GB
-
- (51) MKP
A61M 5/28 (2006.01) (97) **2403563 ***
A61M 5/32 (2006.01)
- (86) EP2010052789 04.03.2010
(96) 10706658.1 11.01.2012
(87) WO2010100244, 04.03.2010
(97) 2403563, 11.01.2012 en
(54) SEAL MEMBER FOR SYRINGE WITH RETRACTABLE NEEDLE
(71) Sanofi-Aventis Deutschland GmbH, Brüningstraße 50, 65929 Frankfurt, DE
(72) LANIN, Irina, c/o Sanofi-Aventis Deutschland GmbH, 65926 Frankfurt am Main, DE
FORYS, Bernhard, c/o Sanofi-Aventis Deutschland GmbH, 65926 Frankfurt am Main, DE
CLARKE, Alastair, c/o Sanofi-Aventis UK London Road Crewe, Holmes Chapel Cheshire CW4 8BE, GB
EKMAN, Matthew, c/o Sanofi-Aventis UK London Road Crewe, Holmes Chapel Cheshire CW4 8BE, GB
GOODE, Kirsten, c/o Sanofi-Aventis UK London Road Crewe, Holmes Chapel Cheshire CW4 8BE, GB
HEALD, Michael, c/o Sanofi-Aventis UK London Road Crewe, Holmes Chapel Cheshire CW4 8BE, GB
HILES, John, c/o Sanofi-Aventis UK London Road Crewe, Holmes Chapel Cheshire CW4 8BE, GB
SMITH, Chris, c/o Sanofi-Aventis UK London Road Crewe, Holmes Chapel Cheshire CW4 8BE, GB
MARTIN, Andrew, 16 Grove Road, Flats Bristol BS6 6TT, GB
-
- (51) MKP
A61K 31/375 (2006.01) (97) **2440551 ***
A61P 29/00 (2006.01)
C07D 407/04 (2006.01)
- (86) EP2010057979 08.06.2010
(96) 10724813.0 18.04.2012
(87) WO2010142663, 08.06.2010
(97) 2440551, 18.04.2012 fr
(54) UNSATURATED FATTY ACID MONOESTERS AND DIESTERS ON ASCORBIC ACID AND COSMETIC USES THEREOF
(71) Pierre Fabre Dermo-Cosmétique, 45, place Abel-Gance, 92100 Boulogne-Billancourt, FR
(72) POIGNY, Stéphane, 84 chemin de Roquettes, F-31600 Saubens, FR
DAUNES-MARION, Sylvie, 2 allée du Niger - Résidence Giacomo Bât. B - Apart.1058, F-31000 Toulouse, FR
CASTEX RIZZI, Nathalie, 47 allée de Carpentras, F-31770 Colomiers, FR
BOGDANOWICZ, Patrick, 32 Avenue Jean-Baptiste de Lamarck, F-31130 Balma, FR
-
- (51) MKP
G08B 17/10 (2006.01) (97) **2491543 ***
- (86) US2010053753 22.10.2010
(96) 10825745.2 29.08.2012
(87) WO2011050269, 22.10.2010
(97) 2491543, 29.08.2012 en
(54) MULTIFUNCTIONAL/MODULAR SMOKE ALARM DEVICE
(71) Casey, Daniel P., 615 18th Avenue East, Seattle, WA 98112, US
(72) Casey, Daniel P., 615 18th Avenue East, Seattle, WA 98112, US
-
- (51) MKP
F16H 48/12 (2006.01) (97) **2317179**
- (96) 10386014.4 04.05.2011
(97) 2317179, 04.05.2011 en
(54) Differential of automatic alterations of folding rhomb
(71) Stefanou, Loizos, 30 Chrysippou Street, 157 73 Zografos Attikis, GR
(72) Stefanou, Loizos, 30 Chrysippou Street, 157 73 Zografos Attikis, GR

-
- (51) MKP
F16L 37/14 (2006.01) (97) **2406530 ***
E04D 13/04 (2006.01)
- (86) IB2010000480 09.03.2010
(96) 10716025.1 18.01.2012
(87) WO2010103370, 09.03.2010
(97) 2406530, 18.01.2012 en
(54) WATER DRAIN ASSEMBLY, IN PARTICULAR FOR SIPHONIC ROOF DRAINAGE SYSTEMS
- (71) VALSIR S.p.A., Località Merlaro, 2, 25078 Vestone (BS), IT
(72) GIOVANNINI, Alessandro, Via Roma 54, I-25088 Toscolano Maderno, IT
ZANCA, Nicola, Via Colombo 22, I-25088 Toscolano Maderno, IT
CONFORTI, Marco, Via Alessandro Manzoni 15, I-25087 Salo', IT
-
- (51) MKP
A61M 36/14 (2006.01) (97) **2485771 ***
A61K 51/00 (2006.01)
- (86) US2010002707 07.10.2010
(96) 10822355.3 15.08.2012
(87) WO2011043816, 07.10.2010
(97) 2485771, 15.08.2012 en
(54) PHOSPHODIESTERASE 1-TARGETING TRACERS AND METHODS
- (71) Intra-Cellular Therapies, Inc., 3960 Broadway, New York, NY 10032, US
(72) LI, Peng, 3960 Broadway, New York NY 10032, US
WENNOGLE, Lawrence, P., 3960 Broadway, New York NY 10032, US
ZHAO, Jun, 3960 Broadway, New York NY 10032, US
ZHENG, Hailin, 3960 Broadway, New York NY 10032, US
-
- (51) MKP
A61K 31/506 (2006.01) (97) **2442809 ***
A61P 31/16 (2006.01)
- (86) US2010038988 17.06.2010
(96) 10726760.1 25.04.2012
(87) WO2010148197, 17.06.2010
(97) 2442809, 25.04.2012 en
(54) INHIBITORS OF INFLUENZA VIRUSES REPLICATION
- (71) Vertex Pharmaceuticals Incorporated, 130 Waverly Street, Cambridge, MA 02139, US
(72) DUFFY, John, P., 175 Carriage Hill Road, Northborough MA 01532, US
MALTAIS, Francois, 24 Randolph Drive, Tewksbury MA 01876, US
GERMANN, Ursula, A., 7 Nightingale Path, Newton, MA 02459, US
CHARIFSON, Paul, 7 Dartmouth Drive, Framingham MA 01701, US
FARMER, Luc, 19 Howe Lane, Foxboro MA 02035, US
PEROLA, Emanuele, 6 Lanark Road Unit 3, Brookline MA 02445, US
JONES, Steven, 68 Summer Street, Hyde Park, MA 02136, US
CLARK, Michael, P., 30 Kenney Lane, Concord MA 01742, US
GAO, Huai, 82 Summer Street Unit No.7, Arlington MA 02474, US
WANG, Tiansheng, 2 Dunbar Way, Concord MA 01742, US
BANDARAGE, Upul, K., 11 Bates Road, Lexington MA 02421, US
GU, Wenxin, 288 Highland Avenue Apt.209, Somerville MA 02144, US
WANNAMAKER, M., Woods, 213 Long Hill Road, Bolton MA 01740, US
BETHIEL, Randy, S., 314 Massachusetts Avenue, Lexington MA 02420, US
JACOBS, Dylan, H., 17 Webster Street Apt.37, Everett MA 02149, US
BYRN, Randal, 7 Pemberton Road, Wayland, MA 01778, US
COURT, John, J., 27 Ernies Drive, Littleton MA 01460, US
KENNEDY, Joseph, M., 103 9th Street 316, Charlestown MA 02129, US
ZHOU, Yi, 5 Deering Avenue, Lexington, MA 02421, US
DENG, Hongbo, 178 Woodland Road, Southborough MA 01772, US
LEDEBOER, Mark, W., 36 Faulkner Hill Road, Acton MA 01720, US
LIN, Chao, 4 Dean Road, Winchester, MA 01890, US
DRUTU, Ioana, 38 Fairview Avenue, Watertown MA 02472, US
LEDFORD, Brian, 53 Maple Street, Norton MA 02766, US
JIANG, Min, 5 South Rindge Avenue, Lexington, MA 02420, US
-
- (51) MKP
A01N 43/66 (2006.01) (97) **2440057 ***
A61K 31/53 (2006.01)
- (86) US2010037935 09.06.2010
(96) 10786759.0 18.04.2012
(87) WO2010144550, 09.06.2010
(97) 2440057, 18.04.2012 en
(54) TRIAZINE DERIVATIVES AND THEIR THERAPEUTICAL APPLICATIONS
- (71) Abraxis BioScience, LLC, 11755 Wilshire Boulevard Suite 2000, Los Angeles, CA 90025, US
(72) TAO, Chunlin, 1800 Camden Avenue, 301, Los Angeles California 90025, US
WANG, Qinwei, 1112 South Cordova Street, Alhambra California 91801, US
NALLAN, Laxman, 930 North Monterey Street, 236, Alhambra California 91801, US
POLAT, Tulay, 5750 West Centinela Avenue, 224, Los Angeles California 90045, US
HO, David, 11755 Wilshire Boulevard Suite 2000, Los Angeles California 90025, US
DESAI, Neil, P., 11755 Wilshire Boulevard Suite 2000, Los Angeles California 90025, US
-
- (51) MKP
A61K 31/437 (2006.01) (97) **2438066 ***
A61P 35/00 (2006.01)
C07D 471/04 (2006.01)
A61K 31/4196 (2006.01)
- (86) US2010037363 04.06.2010
(96) 10724213.3 11.04.2012
(87) WO2010141796, 04.06.2010
(97) 2438066, 11.04.2012 en
(54) PREPARATION AND USES OF 1,2,4-TRIAZOLO [1,5a] PYRIDINE DERIVATIVES
- (71) Cephalon, Inc., 41 Moores Road P.O. Box 4011, Frazer, PA 19355, US
(72) CURRY, Matthew A., 336 Baltusrol Drive, Coatesville Pennsylvania 19320, US
DORSEY, Bruce D., 1213 Meetinghouse Road, Ambler Pennsylvania 19002, US
DUGAN, Benjamin J., 437 Concord Road, Glen Mills Pennsylvania 19342, US
GINGRICH, Diane E., 23 Southwind Lane, Downingtown Pennsylvania 19335, US
MESAROS, Eugen F., 113 Lombardy Drive, Wallingford Pennsylvania 19086, US
MILKIEWICZ, Karen L., 428 Concord Avenue, Exton Pennsylvania 19341, US
-
- (51) MKP
B22D 27/04 (2006.01) (97) **2491169 ***
C30B 11/00 (2006.01)
C30B 35/00 (2006.01)
F27B 14/14 (2006.01)
C30B 29/06 (2006.01)
H05B 6/44 (2006.01)
H05B 6/36 (2006.01)
- (86) IB2010002685 20.10.2010
(96) 10788128.6 29.08.2012
(87) WO2011048473, 20.10.2010
(97) 2491169, 29.08.2012 en
(54) METHOD AND DEVICE FOR OBTAINING A MULTICRYSTALLINE SEMICONDUCTOR MATERIAL, IN PARTICULAR SILICON
- (71) Saet S.p.A., Via Torino 213, 10040 Leini, IT
(72) DUGHIERO, Fabrizio, Piazza Incoronata 11, I-35028 Piove di Sacco, IT
FORZAN, Michele, c/o SAET S.p.A. Via Torino 213, I-10040 Leini', IT
CISCATO, Dario, c/o SAET S.p.A. Via Torino 213, I-10040 Leini', IT
CESANO, Mariolino, Via Viancino 2 b, I-13047 San Germano Vercellese, IT
CRIVELLO, Fabrizio, c/o SAET S.p.A. Via Torino 213, I-10040 Leini', IT
BERNABINI, Paolo, c/o SAET S.p.A. Via Torino 213, I-10040 Leini', IT
-

- (51) MKP
H04W 88/00 (2009.01) (97) **2451241 ***
- (86) CN2010074016 17.06.2010
(96) 10793560.3 09.05.2012
(87) WO2011000265, 17.06.2010
(97) 2451241, 09.05.2012 en
- (54) SYNCHRONIZATION SCHEDULE METHOD, APPARATUS AND SYSTEM
- (71) China Academy of Telecommunications Technology, 40, Xueyuan Road, Haidian District, Beijing 100191, CN
(72) ZHANG, Dajun, No.40 Xueyuan Road Haidian District, Beijing 100083, CN
YANG, Xiaodong, No.40 Xueyuan Road Haidian District, Beijing 100083, CN
-
- (51) MKP
C12P 21/08 (2006.01) (97) **2449127 ***
- (86) US2010040724 01.07.2010
(96) 10794751.7 09.05.2012
(87) WO2011002968, 01.07.2010
(97) 2449127, 09.05.2012 en
- (54) POLYPEPTIDES AND METHOD OF TREATMENT
- (71) Glaxo Group Limited, Glaxo Wellcome House Berkeley Avenue Greenford, Middlesex UB6 0NN, GB
(72) BURDEN, Michael, Neil, Gunnels Wood Road, Stevenage Hertfordshire SG1 2NY, GB
HAMBLYN, Paul, Andrew, Gunnels Wood Road, Stevenage Hertfordshire SG1 2NY, GB
LARKIN, Jonathan, David, 709 Swedeland Road, King Of Prussia PA 19406, US
WHITE, John, Richard, 709 Swedeland Road, King Of Prussia PA 19406, US
-
- (51) MKP
A43B 3/24 (2006.01) (97) **2263487**
A43B 3/30 (2006.01)
A43C 11/14 (2006.01)
- (96) 10006035.9 22.12.2010
(97) 2263487, 22.12.2010 en
- (54) Shoe with interchangeable strap
- (71) LELLI KELLY S.p.A., Via Bocchi 233, 55013 Lammari, Capannori, IT
(72) Attilieni, Attilio, Via di Tofori n° 69, 55010 Tofori, Capannori, Lucca, IT
-
- (51) MKP
A61K 47/48 (2006.01) (97) **2440249 ***
- (86) US2010038416 11.06.2010
(96) 10723899.0 18.04.2012
(87) WO2010144869, 11.06.2010
(97) 2440249, 18.04.2012 en
- (54) COVALENT CONJUGATES COMPRISING A PROTEASE INHIBITOR, A WATER-SOLUBLE, NON-PEPTIDIC OLIGOMER AND A LIPOPHILIC MOIETY
- (71) Nektar Therapeutics, 455 Mission Bay Boulevard South Suite 100, San Francisco CA 94158, US
(72) RIGGS-SAUTHIER, Jennifer, 7917 Smoke Rise Road, Huntsville Alabama 35802, US
-
- (51) MKP
B65D 33/01 (2006.01) (97) **2493779 ***
B65B 1/22 (2006.01)
B65B 1/24 (2006.01)
- (86) HU201000112 25.10.2010
(96) 10779577.5 05.09.2012
(87) WO2011051739, 25.10.2010
(97) 2493779, 05.09.2012 en
- (54) IMPROVED PACKAGING CONTAINER WITH OVERPRESSURE RELIEF, PACKING METHOD AND SYSTEM
- (71) Mandzsu, Zoltan, Bod Peter Lejto 4, 1112 Budapest, HU IFJ. Mandzsu, József, Nyírfa u. 17., 2151 Fót, HU
Mandzsu, Jozsef, Id., Radvány u. 19, 1118 Budapest, HU
(72) Mandzsu, Zoltan, Bod Peter Lejto 4, 1112 Budapest, HU
Mandzsu, Jozsef, Id., Radvány u. 19, 1118 Budapest, HU
IFJ. Mandzsu, József, Nyírfa u. 17., 2151 Fót, HU
-
- (51) MKP
A61P 29/00 (2006.01) (97) **2429998 ***
C07D 231/12 (2006.01)
C07D 261/10 (2006.01)
C07D 277/22 (2006.01)
C07D 401/14 (2006.01)
A61K 31/439 (2006.01)
C07D 413/14 (2006.01)
A61P 25/00 (2006.01)
- (86) FR2010050912 11.05.2010
(96) 10728740.1 21.03.2012
(87) WO2010130943, 11.05.2010
(97) 2429998, 21.03.2012 fr
- (54) 5-MEMBERED HETEROCYCLIC COMPOUND CYCLOPENTA[C]PYRROLYLALKYL CARBAMATE DERIVATIVES, PREPARATION THEREOF, AND THERAPEUTIC USE THEREOF
- (71) SANOFI, 174, Avenue de France, 75013 Paris, FR
(72) ABOUABDELLAH, Ahmed, c/o sanofi-aventis Département Brevets 174 avenue de France, F-75013 Paris, FR
FAYOL, Aude, c/o sanofi-aventis Département Brevets 174 avenue de France, F-75013 Paris, FR
LOCHEAD, Alistair, c/o sanofi-aventis Département Brevets 174 avenue de France, F-75013 Paris, FR
SAADY, Mourad, c/o sanofi-aventis Département Brevets 174 avenue de France, F-75013 Paris, FR
VACHE, Julien, c/o sanofi-aventis Département Brevets 174 avenue de France, F-75013 Paris, FR
YAICHE, Philippe, c/o sanofi-aventis Département Brevets 174 avenue de France, F-75013 Paris, FR
-
- (51) MKP
B65D 21/02 (2006.01) (97) **2371727**
B65D 85/34 (2006.01)
B65D 6/00 (2006.01)
- (96) 10158400.1 05.10.2011
(97) 2371727, 05.10.2011 en
- (54) Crate
- (71) IFCO Systems GmbH, Zugspitzstrasse 7, 82049 Pullach, DE
(72) Orgeldinger, Wolfgang, Zugspitzstraße 7, 82049 Pullach, DE
-
- (51) MKP
C07C 237/06 (2006.01) (97) **2493571 ***
C07D 233/61 (2006.01)
A61P 11/06 (2006.01)
C07D 217/12 (2006.01)
C07D 277/30 (2006.01)
C07D 231/12 (2006.01)
C07D 333/52 (2006.01)
C07C 317/32 (2006.01)
C07D 317/58 (2006.01)
C07C 237/08 (2006.01)
C07D 213/61 (2006.01)
A61K 31/16 (2006.01)
C07D 311/04 (2006.01)
C07D 211/46 (2006.01)
C07D 319/14 (2006.01)
C07D 211/42 (2006.01)
C07D 213/56 (2006.01)
- (86) US2010054445 28.10.2010
(96) 10774098.7 05.09.2012
(87) WO2011059731, 28.10.2010
(97) 2493571, 05.09.2012 en
- (54) ALKYNYL DERIVATIVES USEFUL AS DPP-1 INHIBITORS
- (71) Janssen Pharmaceutica, N.V., Turnhoutseweg 30, 2340 Beerse, BE
(72) PARKER, Michael, H., 3587 Gray Fox Drive, Chalfont PA 18914, US
HLASTA, Dennis, J., 5008 Davis Drive, Doylestown PA 18902, US
HUANG, Yifang, 303 Walden Lane, Lansdale PA 19446, US
REITZ, Allen, B., 109 Greenbriar Road, Lansdale PA 19446, US
LAWSON, Edward, C., 82 Ervin Road, Pipersville PA 18947, US
SCHUBERT, Carsten, 1006 Hares Hill Road, Phoenixville PA 19460, US
STROBEL, Eric, 159 Buttercup Blvd., Warrington PA 18976, US
TOUNGE, Brett, 1014 Blue Rock Lane, Blue Bell PA 19422, US
WHITE, Kimberly, 100 Gwynedd Lea Drive, North Wales PA 19454, US
WINTERS, Michael, P., 17 Hunters Hill Drive, Morgantown PA 19543, US
GHOSH, Shyamali, 906 Patriot Lane, Norristown PA 19403, US

(51) MKP
C07D 403/14 (2006.01) (97) **2496572 ***
A61P 31/12 (2006.01)
A61K 31/4184 (2006.01)
(86) EP2010066668 03.11.2010
(96) 10771766.2 12.09.2012
(87) WO2011054834, 03.11.2010
(97) 2496572, 12.09.2012 en
(54) BENZIMIDAZOLE-IMIDAZOLE DERIVATIVES
(71) Janssen R&D Ireland, Eastgate Village, Eastgate, Little Island, County Cork, IE
(72) VANDYCK, Koen, Deurnestraat 74, B-3583 Paal-Beringen, BE
LAST, Stefaan Julien, Crauwelshoeve 59, B-2547 Lint, BE
HOUPIS, Ioannis Nicolaos, Van Eycklei 15, B-2018 Antwerp, BE
RABOISSON, Pierre Jean-Marie Bernard, Rue Jolie 3, B-1331 Rosieres, BE

(51) MKP
B29C 45/14 (2006.01) (97) **2414144 ***
B29C 45/16 (2006.01)
(86) FR2010050570 29.03.2010
(96) 10715991.5 08.02.2012
(87) WO2010112745, 29.03.2010
(97) 2414144, 08.02.2012 fr
(54) METHOD FOR MOULDING A PLASTIC PART WITH A METAL INSERT HELD IN PLACE BY MAGNETISATION, MOULDING DEVICE AND USE OF A MAGNET FOR SECURING SAID INSERT
(71) Saint-Gobain Glass France, 18, avenue d'Alsace, 92400 Courbevoie, FR
(72) DEPIERRE, Emmanuel, 169 rue de la Croix Blanche, F-60310 Thiescourt, FR
DEBAILLEUL, Romain, 14 Allée de la Montagne, F-60150 Villers-sur-Coudun, FR
ROZE, Jean-Pierre, 6 rue des Peupliers, F-60290 Cauffry, FR

(51) MKP
A61K 47/48 (2006.01) (97) **2482855 ***
(86) US2010050761 29.09.2010
(96) 10810996.8 08.08.2012
(87) WO2011056325, 29.09.2010
(97) 2482855, 08.08.2012 en
(54) OLIGOMER-CALCIMIMETIC CONJUGATES AND RELATED COMPOUNDS
(71) Nektar Therapeutics, 201 Industrial Road, San Carlos, CA 94070, US
(72) RIGGS-SAUTHIER, Jennifer, 7917 Smoke Rise Road, Huntsville AL 35802, US
CHENG, Lin, 14015 Earlwood Drive, Huntsville AL 35803, US
MARTIN, David, 447 Vermont Street, San Francisco CA 94107, US

(51) MKP
H01M 8/24 (2006.01) (97) **2333889**
H01M 8/02 (2006.01)
(96) 10180724.6 15.06.2011
(97) 2333889, 15.06.2011 en
(54) Fuel cell devices with biasing current collectors
(71) Industrial Technology Research Institute, No. 195, Sec. 4, Chung Hsing Road, Chutung., Hsinchu 31040, TW
(72) Chen, Chi-Chang, No. 180, Sec. 2, Yuanlu Rd. Puxin Township, Changhua County 513, Taiwan Chinese Taipei, TW
Shiu, Huan-Ruei, No. 39, Donghu Village Cimei Township, Penghu County 883 Chinese Taipei, TW
Chang, Wen-Chen, 4F., No. 892, Sec. 4, Zhongxing Rd., Zhudong Township, Hsinchu County 310 Chinese Taipei, TW
Tsau, Fanghei, 4F., No. 6, Lane 54, Siwei 2nd Rd., Lingya Dist., Kaohsiung City 802 Chinese Taipei, TW

(51) MKP
A61P 35/00 (2006.01) (97) **2427185 ***
A61K 31/167 (2006.01)
A61K 31/4412 (2006.01)
(86) FR2010050874 06.05.2010
(96) 10727467.2 14.03.2012
(87) WO2010128259, 06.05.2010
(97) 2427185, 14.03.2012 fr
(54) ANTITUMOR COMBINATION INCLUDING AVE8062 AND SORAFENIB
(71) SANOFI, 174, Avenue de France, 75013 Paris, FR
(72) DEMERS, Brigitte, C/o sanofi-aventis Département Brevets 174 Avenue de France, F-75013 Paris, FR
VRIGNAUD, Patricia, C/o sanofi-aventis Département Brevets 174 Avenue de France, F-75013 Paris, FR

(51) MKP
B29C 47/00 (2006.01) (97) **2461959 ***
(86) US2010044874 09.08.2010
(96) 10807285.1 13.06.2012
(87) WO2011017695, 09.08.2010
(97) 2461959, 13.06.2012 en
(54) MULTILAYERED COMPOSITE
(71) Zeus Industrial Products, Inc., 3737 Industrial Boulevard, Orangeburg, South Carolina 29118, US
(72) ANNEAUX, Bruce L., 413 Cannon Knoll Road, Lexington South Carolina 29073, US
BALLARD, Robert L., 2242 Griffith Drive, Orangeburg South Carolina 29118, US
GARNER, David P., 201 Beltrees Drive, Lexington South Carolina 29072, US

(51) MKP
A61K 31/4439 (2006.01) (97) **2456439 ***
A61K 31/185 (2006.01)
A61K 47/40 (2006.01)
A61K 47/30 (2006.01)
A61K 9/08 (2006.01)
A61K 9/10 (2006.01)
(86) US2010042508 20.07.2010
(96) 10802745.9 30.05.2012
(87) WO2011011351, 20.07.2010
(97) 2456439, 30.05.2012 en
(54) A STABLE PHARMACEUTICAL OMEPRAZOLE FORMULATION FOR ORAL ADMINISTRATION
(71) Vetegen, LLC, 674 Unionville Road Suite 105, Kennett Square, Pennsylvania 19348, US
(72) JUVONEN, Erik, 643 Woodview Road, Avondale Pennsylvania 19311, US
MICOLUCCI, Louis, Massimo, 226 Fernwood Road, Cochranville Pennsylvania 19330, US

(51) MKP
A61K 31/27 (2006.01) (97) **2403486 ***
A61K 9/20 (2006.01)
A61K 31/197 (2006.01)
(86) US2010026133 03.03.2010
(96) 10708059.0 11.01.2012
(87) WO2010102071, 03.03.2010
(97) 2403486, 11.01.2012 en
(54) SUSTAINED RELEASE ORAL DOSAGE FORMS OF AN R-BACLOFEN PRODRUG
(71) XenoPort, Inc., 3410 Central Expressway, Santa Clara, CA 95051, US
(72) EDGREN, David, E., 277 North Avalon Dr., Los Altos, CA 94022, US
KIDNEY, David, J., 611 South 13th St., San Jose, CA 95112, US
PARGAONKAR, Nikhil, 1181 W. Olive Ave., Sunnyvale, CA 94086, US
KIM, Derrick, K., 2138 Newport Way NW, Issaquah, WA 98027, US
YODER, Gorm, 14 Whitmore Place Apartment 5, Oakland, CA 94611, US
KARABORNI, Sami, 11753 Trinity Spring Court, Cupertino, CA 95014, US

- (51) MKP
F02M 51/06 (2006.01) (97) **2378107**
F02M 63/00 (2006.01)
H01L 41/053 (2006.01)
- (96) 10160355.3 19.10.2011
(97) 2378107, 19.10.2011 en
(54) Actuator arrangement for use in a fuel injector
(71) Delphi Technologies Holding S.à.r.l., Avenue de Luxembourg, 4940 Bascharage, LU
(72) Leblay, Arnaud, 2 rue de fontaine, 54620 Beuveville, FR
Aye, Andreas, 34 rue Albert Schweitzer, 8033 Strassen, LU
-
- (51) MKP
C07K 16/28 (2006.01) (97) **2408816 ***
- (86) US2010027422 16.03.2010
(96) 10708688.6 25.01.2012
(87) WO2010107752, 16.03.2010
(97) 2408816, 25.01.2012 en
(54) ALPHA-4-BETA-7 HETERODIMER SPECIFIC ANTAGONIST ANTIBODY
(71) Amgen Inc., Law Department One Amgen Center Drive, Thousand Oaks, CA 91320, US
(72) HSU, Hailing, 7264 Littler Court, Moorpark California 93021, US
FOLTZ, Ian, 2108 Knightswood Place, Burnaby British Columbia V5A 4B9, CA
ARORA, Taruna, 5380 Via Pisa, Thousand Oaks California 91320, US
JACOBSEN, Frederick, W., 1168 Homestake Place, Newbury Park California 91320, US
-
- (51) MKP
C07J 31/00 (2006.01) (97) **2432798 ***
C07J 41/00 (2006.01)
A61K 31/567 (2006.01)
A61P 5/36 (2006.01)
- (86) EP2010004149 07.07.2010
(96) 10735198.3 28.03.2012
(87) WO2011009531, 07.07.2010
(97) 2432798, 28.03.2012 de
(54) 17-HYDROXY-17-PENTAFLUORETHYL-ESTRA-4,9(10)-DIEN-11-ARYL DERIVATIVES, METHODS FOR THE PRODUCTION THEREOF AND USE THEREOF FOR TREATING DISEASES
(71) Bayer Pharma Aktiengesellschaft, Müllerstrasse 178, 13353 Berlin, DE
(72) SCHWEDE, Wolfgang, Magdeburger Str. 41a, 16548 Glienicke, DE
KLAR, Ulrich, Isegrimsteig 8, 13503 Berlin, DE
MÖLLER, Carsten, Pflugstr. 9a, 10115 Berlin, DE
ROTGERI, Andrea, Damwildsteig 21, 13503 Berlin, DE
BONE, Wilhelm, Drewitzer Str. 46, 13467 Berlin, DE
-
- (51) MKP
A61M 5/32 (2006.01) (97) **2488235 ***
- (86) EP2010065444 14.10.2010
(96) 10765443.6 22.08.2012
(87) WO2011054648, 14.10.2010
(97) 2488235, 22.08.2012 en
(54) CARTRIDGE HOLDER ASSEMBLY FOR A DRUG DELIVERY DEVICE
(71) Sanofi-Aventis Deutschland GmbH, Brüningstraße 50, 65929 Frankfurt, DE
(72) JUGL, Michael, c/o Sanofi-Aventis Deutschland GmbH, 65926 Frankfurt am Main, DE
SENDATZKI, Günther, c/o Sanofi-Aventis Deutschland GmbH, 65926 Frankfurt am Main, DE
TEUCHER, Axel, c/o Sanofi-Aventis Deutschland GmbH, 65926 Frankfurt am Main, DE
-
- (51) MKP
G06Q 20/00 (2012.01) (97) **2449512 ***
- (86) IB2010051779 23.04.2010
(96) 10717837.8 09.05.2012
(87) WO2010122520, 23.04.2010
(97) 2449512, 09.05.2012 en
(54) METHOD AND SYSTEM OF ELECTRONIC PAYMENT TRANSACTION, IN PARTICULAR BY USING CONTACTLESS PAYMENT MEANS
(71) Logomotion, s.r.o., Winterova 15, 921 01 Piestany, SK
(72) FLOREK, Miroslav, Ing. Miroslav Florek Sedmokraskova 4, 821 01 Bratislava, SK
MASARYK, Michal, Ing. Michal Masaryk, PhD. Medzilaborecká 7, 821 01 Bratislava, SK
-
- (51) MKP
C02F 1/68 (2006.01) (97) **2418177**
- (96) 10172771.7 15.02.2012
(97) 2418177, 15.02.2012 en
(54) Micronized CaCO3 slurry injection system for the remineralization of desalinated and fresh water
(71) Omya Development AG, Baslerstrasse 42, 4665 Oftringen, CH
Skovby, Michael, Wamplfenstr. 52, 8706 Meilen, CH
(72) Poffet, Martine, Wohlenstr. 29, 3043 Uetzingen, CH
Buri, Matthias, Mätteliweg 20, 4852 Rothst, CH
Blum, René Vinzenz, Sagiacher 3, 4915 St. Urban, CH
-
- (51) MKP
H02M 7/10 (2006.01) (97) **2387142 ***
- (86) RU2010000468 26.08.2010
(96) 10827217.0 16.11.2011
(87) WO2011053188, 26.08.2010
(97) 2387142, 16.11.2011 en
(54) COMBINED RECTIFIER
(71) Stepanov, Arkady Anatolievich, Ul. Novosibirskaya 12-12, Orsk, Orenburgskaya obl. 462420, RU
Khoryakov, Vladimir Vladimirovich, Ul. Aktyubinskaya 26, Orsk, Orenburgskaya obl. 462429, RU
Savin, Vladimir Valerievich, Ul. Kutuzova 58-12, Orsk, Orenburgskaya obl. 462404, RU
Berezhnoi, Viktor Yurievich, per. Chernogorsky, 16 Orsk, Orenburgskaya obl. 462429, RU
Kozhemyakin, Yury Alexandrovich, Ul. Sovetskaya 48-5, Novotroitsk, Orenburgskaya obl. 462353, RU
Gorozhanov, Maxim Alexandrovich, Ul. Molodezhnaya 2/A-19, Orsk, Orenburgskaya obl. 462411, RU
Zuev, Alexandr Vladimirovich, Ul. Kramatorskaya 3-9, Orsk, Orenburgskaya obl. 462428, RU
(72) The designation of the inventor has not yet been filed , null, null, null
-
- (51) MKP
C07D 405/04 (2006.01) (97) **2426124 ***
- (86) JP2010058040 12.05.2010
(96) 10774933.5 07.03.2012
(87) WO2010131676, 12.05.2010
(97) 2426124, 07.03.2012 en
(54) PROCESS FOR PRODUCING PYRIPYROPENE DERIVATIVE
(71) Meiji Seika Pharma Co., Ltd., 4-16, Kyobashi 2-chome Chuoku, Tokyo 104-8002, JP
(72) FUKUDA, Yoshimasa, c/o Meiji Seika Pharma Co., Ltd. 760 Morooka-cho Kouhoku-ku, Yokohama-shi Kanagawa 222-8567, JP
ANDO, Takashi, c/o Meiji Seika Pharma Co., Ltd. 760 Morooka-cho Kouhoku-ku, Yokohama-shi Kanagawa 222-8567, JP
GOTO, Kimihiko, c/o Meiji Seika Pharma Co., Ltd. 760 Morooka-cho Kouhoku-ku, Yokohama-shi Kanagawa 222-8567, JP
NAKANISHI, Nozomu, c/o Meiji Seika Pharma Co., Ltd. 760 Morooka-cho Kouhoku-ku, Yokohama-shi Kanagawa 222-8567, JP
WATANABE, Takashi, c/o Meiji Seika Pharma Co., Ltd. 760 Morooka-cho Kouhoku-ku, Yokohama-shi Kanagawa 222-8567, JP
KURIHARA, Kenichi, c/o Meiji Seika Pharma Co., Ltd. 760 Morooka-cho Kouhoku-ku, Yokohama-shi Kanagawa 222-8567, JP
MINOWA, Nobuto, c/o Meiji Seika Pharma Co., Ltd. 760 Morooka-cho Kouhoku-ku, Yokohama-shi Kanagawa 222-8567, JP
MITOMI, Masaaki, c/o Meiji Seika Pharma Co., Ltd. 760 Morooka-cho Kouhoku-ku, Yokohama-shi Kanagawa 222-8567, JP
-
- (51) MKP
A47K 7/00 (2006.01) (97) **2412644 ***
B65D 83/08 (2006.01)
- (86) JP2010055254 25.03.2010
(96) 10756172.2 01.02.2012
(87) WO2010110376, 25.03.2010
(97) 2412644, 01.02.2012 en
(54) PACKAGING BODY
(71) Unicharm Corporation, 182 Shimobun Kinesei-cho Shikokuchuo-shi, Ehime 799-0111, JP
(72) BANDO, Takeshi, c/o UNI-CHARM CORPORATION Technical Center 1531-7 Wadahama Toyohama-cho, Kanonji-shi Kagawa 769-1602, JP

- (51) MKP
E05C 1/10 (2006.01) (97) **2419588 ***
 (86) EP2010002310 15.04.2010
 (96) 10714202.8 22.02.2012
 (87) WO2010118867, 15.04.2010
 (97) 2419588, 22.02.2012 en
 (54) SNAP-ACTING LOCKING DEVICE, PARTICULARLY FOR LIDS, DOORS AND THE LIKE
 (71) Palazzoli S.p.A., Via Palazzoli, 31, 25128 Brescia, IT
 (72) LEVI, Bruno, Via Vittorio Emanuele II, 1, I-25122 Brescia, IT
-
- (51) MKP
A61K 31/4545 (2006.01) (97) **2413935 ***
A61P 25/24 (2006.01)
 (86) EP2010054249 30.03.2010
 (96) 10713885.1 08.02.2012
 (87) WO2010112529, 30.03.2010
 (97) 2413935, 08.02.2012 en
 (54) LOW DOSE PIPAMPERONE IN TREATING MOOD DISORDERS
 (71) PharmaNeuroBoost N.V., Alkerstraat 30A, 3570 Alken, BE
 (72) BUNTINX, Erik, Alkerstraat 28, B-3570 Alken, BE
-
- (51) MKP
A61P 25/16 (2006.01) (97) **2431034 ***
A61K 31/4045 (2006.01)
A61K 9/70 (2006.01)
A61K 47/32 (2006.01)
A61K 47/30 (2006.01)
A61K 47/34 (2006.01)
 (86) JP2010057245 23.04.2010
 (96) 10767158.8 21.03.2012
 (87) WO2010123103, 23.04.2010
 (97) 2431034, 21.03.2012 en
 (54) ADHESIVE PATCH-CONTAINING PACKAGE BAG AND METHOD FOR STORING ADHESIVE PATCH
 (71) Hisamitsu Pharmaceutical Co., Inc., 408, Tashirodaikan-machi, Tosu-shi, Saga 841-0017, JP
 (72) UCHIDA Naoyuki, c/o Tsukuba Research Laboratories of HISAMITSU PHARMACEUTICAL CO. INC. 25-11 Kannondai 1-chome, Tsukuba-shi Ibaraki 305-0856, JP
 TAKAGI Yuka, c/o Tsukuba Research Laboratories of HISAMITSU PHARMACEUTICAL CO. INC. 25-11 Kannondai 1-chome, Tsukuba-shi Ibaraki 305-0856, JP
 TAKADA Yasunori, c/o Tsukuba Research Laboratories of HISAMITSU PHARMACEUTICAL CO. INC. 25-11 Kannondai 1-chome, Tsukuba-shi Ibaraki 305-0856, JP
-
- (51) MKP
G01M 3/24 (2006.01) (97) **2483656 ***
F17D 5/06 (2006.01)
G01S 11/14 (2006.01)
 (86) IB2010002330 15.09.2010
 (96) 10768548.9 08.08.2012
 (87) WO2011039589, 15.09.2010
 (97) 2483656, 08.08.2012 en
 (54) SYSTEM AND METHOD FOR THE CONTINUOUS DETECTION OF IMPACTS ON PIPELINES FOR THE TRANSPORTATION OF FLUIDS, PARTICULARLY SUITABLE FOR UNDERWATER PIPELINES
 (71) ENI S.p.A., Piazzale E. Mattei 1, 00144 Rome, IT
 (72) DALMAZZONE, Mauro, Gianni, Via Vespucci 11, I-20093 Cologno Monzese (MI), IT
 DE LORENZO, Gianpietro, Via Amendola 17/c, I-20090 Segrate (MI), IT
 GIUNTA, Giuseppe, GIUNTA Giuseppe Via Fermi 2c, I-20097 San Donato Milanese (MI), IT
-
- (51) MKP
E04D 13/00 (2006.01) (97) **2236691**
G01M 3/16 (2006.01)
 (96) 10450038.4 06.10.2010
 (97) 2236691, 06.10.2010 de
 (54) Assembly and method for checking roofs
 (71) Fleischmann & Petschnig Dachdeckungs-Gesellschaft m.b.H., Rosentalerstrasse 87, 9020 Klagenfurt, AT
 (72) Petschnig, Otmar, Rosentalerstrasse 87, 9023 Klagenfurt, AT

- (51) MKP
A61K 31/4188 (2006.01) (97) **2454264 ***
A61P 29/00 (2006.01)
C07D 487/10 (2006.01)
A61P 37/08 (2006.01)
 (86) EP2010060154 14.07.2010
 (96) 10732371.9 23.05.2012
 (87) WO2011006936, 14.07.2010
 (97) 2454264, 23.05.2012 en
 (54) TRICYCLIC INDOLE-DERIVED SPIRO DERIVATIVES AS CRTH2 MODULATORS
 (71) Merck Serono S.A., Centre Industriel, 1267 Coinsins, CH
 (72) CROSIGNANI, Stefano, 2 chemin de Champs-Fusy, F-01630 St Genis-Pouilly, FR
 JORAND-LEBRUN, Catherine, Chef Lieu, Contamine-Sarzin 74270, FR
 GRIPPI-VALLOTTON, Tania, 63 rue Frémis, CH-1241 Puplinge, CH
-
- (51) MKP
A61N 1/34 (2006.01) (97) **2493553 ***
A61B 5/0408 (2006.01)
A61N 1/36 (2006.01)
A61N 1/04 (2006.01)
 (86) US2010052639 14.10.2010
 (96) 10774339.5 05.09.2012
 (87) WO2011056377, 14.10.2010
 (97) 2493553, 05.09.2012 en
 (54) OFFSET ELECTRODE
 (71) Ethicon, Inc, U.S. Route 22, Somerville, NJ 08876, US
 (72) BARE, Rex, O., 22467 Overlake Drive, Lake Forest CA 92630, US
 SARGENT, Bradley, 27562 Pasatiempo, Mission Viejo CA 92692, US
-
- (51) MKP
A61B 1/005 (2006.01) (97) **2496154 ***
A61B 17/128 (2006.01)
A61B 18/14 (2006.01)
A61M 25/10 (2006.01)
A61B 17/32 (2006.01)
A61B 17/34 (2006.01)
A61B 17/29 (2006.01)
A61B 17/00 (2006.01)
A61B 17/04 (2006.01)
 (86) US2010055267 03.11.2010
 (96) 10777182.6 12.09.2012
 (87) WO2011056848, 03.11.2010
 (97) 2496154, 12.09.2012 en
 (54) KITS AND PROCEDURES FOR NATURAL ORIFICE TRANSLUMENAL ENDOSCOPIC SURGERY
 (71) Ethicon Endo-Surgery, Inc., 4545 Creek Road, Cincinnati, OH 45242, US
 (72) GHABRIAL, Ragae, M., 3617 Nantucket Drive Apartment J, Loveland, OH 45140, US
 SPIVEY, James, T., 542 Missouri Avenue, Cincinnati, OH 45226, US
 BALLY, Kurt, R., 1741 Spring Meadow Drive, Lebanon 45036, US
 LINENKUGEL, Duane, A., 11999 Britesilks Lane, Cincinnati, OH 45249, US
 BAKOS, Gregory, J., 6330 Redwood Court, Mason 45040, US
 CARROLL, Kempton, K., 8388 Susanwoods Court, Cincinnati, OH 45249, US
 VAKHARIA, Omar, J., 2243 Sussex Avenue, Cincinnati, OH 45230, US
 TRUSTY, Robert, M., 12126 Coyote Court, Cincinnati, OH 45241, US

(51) MKP
C07D 471/04 (2006.01) (97) **2435432 ***
 (86) US2010036198 26.05.2010
 (96) 10721246.6 04.04.2012
 (87) WO2010138588, 26.05.2010
 (97) 2435432, 04.04.2012 en
 (54) APOPTOSIS-INDUCING AGENTS FOR THE TREATMENT OF CANCER AND IMMUNE AND AUTOIMMUNE DISEASES
 (71) Abbott Laboratories, 100 Abbott Park Rd., Abbott Park, IL 60064, US
 (72) DOHERTY, George, 1605 Bush Court, Libertyville Illinois 60048, US
 TAO, Zhi-Fu, 1532 Vineyard Drive, Gurnee Illinois 60031, US
 ELMORE, Steven, 239 Ash Lane, Northbrook Illinois 60062, US
 WANG, Gary T., 1904 Darnell Street, Libertyville Illinois 60048, US
 HASVOLD, Lisa, 522 Shakespeare Drive, Grayslake Illinois 60030, US
 WANG, Le, 338 East Colonial Drive, Vernon Hills Illinois 60061, US
 HEXAMER, Laura, 439 Gatewood Lane, Grayslake Illinois 60030, US
 WANG, Xilu, 34056 Sulkey Drive, Grayslake Illinois 60030, US
 KUNZER, Aaron R., 615 W. Burr Oak Drive, Arlington Illinois 60004, US
 WENDT, Michael, 1445 Maidstone Drive, Vernon Hills Illinois 60061, US
 DING, Hong, 7465 Clem Drive, Gurnee Illinois 60031, US
 SULLIVAN, Gerard, 1212 Tulip Tree Court, Lake Villa Illinois 60046, US
 BRUNCKO, Milan, 31231 Prairie Ridge, Green Oaks Illinois 60048, US
 SOUERS, Andrew J., 901 Hinman Apt. 3A, Evanston Illinois 60202, US
 HANSEN, Todd M., 191 Seymour Avenue, Grayslake Illinois 60030, US
 SONG, Xiaohong, 34037 Sulkey Drive, Grayslake Illinois 60030, US
 MANTEI, Robert, 4203 Carolyn Court, Franklin Wisconsin 53132, US

(51) MKP
C05G 3/02 (2006.01) (97) **2420484 ***
A01N 43/80 (2006.01)
A01P 13/02 (2006.01)
C05G 5/00 (2006.01)
 (86) JP2010056203 06.04.2010
 (96) 10764376.9 22.02.2012
 (87) WO2010119791, 06.04.2010
 (97) 2420484, 22.02.2012 en
 (54) GRANULAR FERTILIZER CONTAINING HERBICIDAL AGROCHEMICAL
 (71) Kumiai Chemical Industry CO., LTD., 4-26, Ikenohata 1-chome Taito-ku, Tokyo 110-8782, JP
 (72) KOBAYASHI Masanori, c/o Kumiai Chemical Industry Co. Ltd. 4-26 Ikenohata 1-chome Taito-ku, Tokyo 110-8782, JP
 KIKUCHI Taiji, c/o Kumiai Chemical Industry Co. Ltd. 4-26 Ikenohata 1-chome Taito-ku, Tokyo 110-8782, JP
 IKEUCHI Toshihiro, c/o Kumiai Chemical Industry Co. Ltd. 4-26 Ikenohata 1-chome Taito-ku, Tokyo 110-8782, JP

(51) MKP
G02B 6/35 (2006.01) (97) **2425286 ***
G01N 21/64 (2006.01)
 (86) US2010032761 28.04.2010
 (96) 10716716.5 07.03.2012
 (87) WO2010127001, 28.04.2010
 (97) 2425286, 07.03.2012 en
 (54) WAVEGUIDE-BASED DETECTION SYSTEM WITH SCANNING LIGHT SOURCE
 (71) Plc Diagnostics Inc., 5743 Corsa Avenue St. 224, Westlake Village, CA 91362, US
 (72) DUER, Reuven, 192 Odebolt Drive, Thousand Oaks CA 91360, US

(51) MKP
C12N 15/82 (2006.01) (97) **2449109 ***
 (86) US2010040778 01.07.2010
 (96) 10732575.5 09.05.2012
 (87) WO2011002992, 01.07.2010
 (97) 2449109, 09.05.2012 en
 (54) AXMI-205 PESTICIDAL GENE AND METHODS FOR ITS USE
 (71) Athenix Corporation, 108 T W Alexander Drive, Research Triangle Park, NC 27709, US
 (72) DESAI, Nalini, 100 Arcadia Lane, Chapel Hill NC 27514, US
 HINSON, Jill, 3510 Moriah Road, Rougemont NC 27572, US
 BALUSUBRAMANIAN, Deepa, 200 Oak Glen Place, Chapel Hill NC 27516, US
 SAMPSON, Kimberly, S., 5505 Frenchman's Creek Dr., Durham NC 27713, US
 TOMSO, Daniel, J., 114 Vista Del Rio Drive, Bahama NC 27503, US
 LEHTINEN, Duane, Alan, 521 Stonecroft Lane, Cary NC 27519, US
 DUCK, Nicholas, B., 1227 Tartarian Trail, Apex NC 27502, US

(51) MKP
A61K 9/20 (2006.01) (97) **2448563 ***
A61K 31/4709 (2006.01)
 (86) US2010040555 30.06.2010
 (96) 10732568.0 09.05.2012
 (87) WO2011002857, 30.06.2010
 (97) 2448563, 09.05.2012 en
 (54) 3-CYANOQUINOLINE TABLET FORMULATIONS AND USES THEREOF
 (71) Wyeth LLC, Five Giralda Farms, Madison, NJ 07940, US
 (72) KAUL, Goldi, 171 S. Broadway Apt. 1, Nyack, New York 10960, US
 CHATLAPALLI, Ramarao, 123 Hosner Mountain Road, Hopewell Junction, New York 12533, US
 NAGI, Arwinder, 9 Locust Drive, Thiells, New York 10984, US
 GHOSH, Krishnendu, 11 Hagan Court, Sparkill, New York 10976, US

(51) MKP
A61K 31/185 (2006.01) (97) **2429517 ***
A01N 37/00 (2006.01)
A61K 31/19 (2006.01)
A61K 31/192 (2006.01)
A61L 15/44 (2006.01)
A61P 31/10 (2006.01)
 (86) CA2010000685 29.04.2010
 (96) 10774450.0 21.03.2012
 (87) WO2010130028, 29.04.2010
 (97) 2429517, 21.03.2012 en
 (54) COMPOSITIONS SUITABLE FOR THE TOPICAL TREATMENT OF FUNGAL INFECTIONS OF THE SKIN AND NAILS
 (71) Biocepta Corporation, 120 Eglinton Avenue East, Suite 1100, Toronto, ON M4P 1E2, CA
 (72) MLADENOVICH, Peter, 1280 Greeniaus Road, Oakville, Ontario L6J 6Y5, CA

(51) MKP
A61F 13/15 (2006.01) (97) **2386281**
B65H 29/68 (2006.01)
 (96) 11250466.7 16.11.2011
 (97) 2386281, 16.11.2011 en
 (54) Method and apparatus for changing speed or direction of an article
 (71) Curt G. Joa, Inc., 100 Crocker Avenue, Sheboygan Falls, Wisconsin 53085, US
 (72) Meyer, Thomas C., W5162 Co. Road FF, Elkhart Lake, Wisconsin 53020, US
 Jenquin, Peter J., W6085 Whispering Lane, Plymouth, Wisconsin 53073, US

- (51) MKP
A01H 5/00 (2006.01) (97) **2473023 ***
C12N 15/52 (2006.01)
C12N 15/82 (2006.01)
(86) US2010047572 01.09.2010
(96) 10814447.8 11.07.2012
(87) WO2011028833, 01.09.2010
(97) 2473023, 11.07.2012 en
(54) HERBICIDE-TOLERANT PLANTS
(71) BASF Agrochemical Products, B.V., Groningsingel 1, 6835 EA Arnhem, NL
(72) MANKIN, Scots, L., 4800 Deerwood Drive, Raleigh, NC 27612, US
WENCK, Allan, R., 4315 Etta Road, Durham, NC 27705, US
NEUTEBOOM, Leon, 10 Seabury Way, Youngville, NC 27596, US

- (51) MKP
A61M 15/00 (2006.01) (97) **2408496 ***
(86) EP2010053433 17.03.2010
(96) 10709002.9 25.01.2012
(87) WO2010106090, 17.03.2010
(97) 2408496, 25.01.2012 en
(54) TRIGGER MECHANISM FOR A DRUG DELIVERY DEVICE
(71) Sanofi-Aventis Deutschland GmbH, Brüningstraße 50, 65929 Frankfurt, DE
(72) SMITH, Christopher James, c/o Sanofi-Aventis UK London Road Holmes Chapel, Crewe Cheshire CW4 8BE, GB

- (51) MKP
C12N 15/11 (2006.01) (97) **2432879 ***
A61K 31/7088 (2006.01)
A61P 3/04 (2006.01)
(86) IB2010052225 19.05.2010
(96) 10727888.9 28.03.2012
(87) WO2010134032, 19.05.2010
(97) 2432879, 28.03.2012 en
(54) USE OF INHIBITORS OF ZDHHC2 ACTIVITY FOR MODULATION OF ADIPOGENESIS
(71) SANOFI, 174, Avenue de France, 75013 Paris, FR
(72) HALL, Diana, 3 Avenue du Grammont, CH-1007 Lausanne, CH
JIMENEZ, Maria, 17 avenue Préfaully, CH-1022 Chavannes-Pres-Renens, CH
POUSSIN, Carine, 14 rue Bernard Moutardier, F-74500 Evian-les-Bains, FR
THORENS, Bernard, Chemin de Polny 12, CH-1066 Epalinges, CH

- (51) MKP
A01N 43/64 (2006.01) (97) **2485592 ***
A61K 31/41 (2006.01)
(86) US2010051598 06.10.2010
(96) 10822587.1 15.08.2012
(87) WO2011044213, 06.10.2010
(97) 2485592, 15.08.2012 en
(54) SYNERGISTIC FUNGICIDAL MIXTURES FOR FUNGAL CONTROL IN CEREALS
(71) Dow AgroSciences, LLC, 9330 Zionsville Road, Indianapolis, Indiana 46268, US
(72) OWEN, W. John, 12421 Pebblepointe Pass, Carmel, IN 46033, US
YAO, Chenglin, 14178 Esprit Drive, Westfield, IN 46074, US

- (51) MKP
B65G 57/10 (2006.01) (97) **2314530**
B65G 57/112 (2006.01)
B65G 57/18 (2006.01)
(96) 10188175.3 27.04.2011
(97) 2314530, 27.04.2011 en
(54) Mobile device for stacking wooden logs onto a pallet with raised sides
(71) Winkl, Peter, Feistritz 10, 9143 St. Michael ob Bleiburg, AT
(72) Winkl, Peter, Feistritz 10, 9143 St. Michael ob Bleiburg, AT

- (51) MKP
B05B 15/06 (2006.01) (97) **2383046**
D21F 1/32 (2006.01)
D21F 1/34 (2006.01)
(96) 11003359.4 02.11.2011
(97) 2383046, 02.11.2011 de
(54) Nozzle device
(71) Papiermaschinen-Systemtechnik GmbH, Moltkestrasse 1, 77654 Offenburg, DE
(72) Struck, Hans Joachim, W.-Blumenstock-Str. 17, 77654 Offenburg, DE
Fabiny, Lutz, Freudental 25, 77799 Ortenberg, DE

- (51) MKP
A61K 31/517 (2006.01) (97) **2467140 ***
(86) US2010046142 20.08.2010
(96) 10810654.3 27.06.2012
(87) WO2011022633, 20.08.2010
(97) 2467140, 27.06.2012 en
(54) METHOD OF THREATING CANCER
(71) Smithkline Beecham (Cork) Ltd., Curraghbinny, Carrigaline, County Cork, IE
(72) BING, Nan, Five Moore Drive, Durham NC 27709, US
BRILEY, Linda, Perry, Five Moore Drive, Durham NC 27709, US
BUDE, Laura, R., Five Moore Drive, Durham NC 27709, US
COX, Charles, J., New Frontiers Science Park Third Avenue, Harlow, Essex CM19 5AW, GB
SPRAGGS, Colin, F., New Frontiers Science Park Third Avenue, Harlow, Essex CM19 5AW, GB

- (51) MKP
B65D 21/02 (2006.01) (97) **2371725**
B65D 85/34 (2006.01)
B65D 6/00 (2006.01)
(96) 10158374.8 05.10.2011
(97) 2371725, 05.10.2011 en
(54) Crate
(71) IFCO Systems GmbH, Zugspitzstrasse 7, 82049 Pullach, DE
(72) Orgeldinger, Wolfgang, Zugspitzstraße 7, 82049 Pullach, DE

- (51) MKP
C07K 14/705 (2006.01) (97) **2464661 ***
(86) US2010045479 13.08.2010
(96) 10744821.9 20.06.2012
(87) WO2011020024, 13.08.2010
(97) 2464661, 20.06.2012 en
(54) METHODS OF MODULATING IMMUNE FUNCTION
(71) The Johns Hopkins University, 100 N. Charles Street, Baltimore, MD 21201, US
(72) CHEN, Lieping, 115 Sagewood Court, Sparks Glencoe MD 21152, US

- (51) MKP
A61K 31/167 (2006.01) (97) **2482799 ***
A61K 9/00 (2006.01)
A61K 31/573 (2006.01)
(86) EP2010005879 27.09.2010
(96) 10763317.4 08.08.2012
(87) WO2011038872, 27.09.2010
(97) 2482799, 08.08.2012 en
(54) PHARMACEUTICAL AEROSOL FORMULATIONS OF FORMOTEROL AND BECLOMETASONE DIPROPIONATE
(71) Chiesi Farmaceutici S.p.A., Via Palermo, 26/A, 43100 Parma, IT
(72) BRAMBILLA, Gaetano, c/o Chiesi Farmaceutici S.p.A. Via Palermo 26/A, I-43100 Parma, IT

- (51) MKP
B62D 33/02 (2006.01) (97) **2377640**
B23K 26/26 (2006.01)
B60P 1/28 (2006.01)
B62D 27/02 (2006.01)
(96) 10004970.9 19.10.2011
(97) 2377640, 19.10.2011 de
(54) Method of producing a basin body, in particular a tipping trough for a transport vehicle using laser welding process ; corresponding basin body, in particular a tipping trough for a transport vehicle and basin body for a transport vehicle
(71) Ferro Umformtechnik GmbH & Co. KG, David-Röntgen-Straße 15-25, 48703 Stadtlohn, DE
(72) Dünne, Heinrich, Steenacker 23, 48683 Ahaus-Graes, DE

- (51) MKP
A61P 37/00 (2006.01) (97) **2499144 ***
A61K 31/522 (2006.01)
A61P 25/00 (2006.01)
A61P 31/00 (2006.01)
C07D 487/04 (2006.01)
A61P 3/00 (2006.01)
A61P 9/02 (2006.01)
A61P 29/00 (2006.01)
A61P 27/02 (2006.01)
A61P 25/28 (2006.01)
C07D 495/04 (2006.01)
A61P 35/00 (2006.01)
(86) EP2010067306 11.11.2010
(96) 10784275.9 19.09.2012
(87) WO2011058110, 11.11.2010
(97) 2499144, 19.09.2012 en
(54) QUINOLINE AND QUINOXALINE DERIVATIVES AS KINASE INHIBITORS
(71) UCB Pharma, S.A., 60, allée de la Recherche, 1070 Brussels, BE
(72) BÜRLI, Roland, BioFocus DPI Chesterford Research Park Saffron Walden, Essex CB10 1XL, GB
HAUGHAN, Alan, Findlay, BioFocus DPI Chesterford Research Park Saffron Walden, Essex CB10 1XL, GB
MATTEUCCI, Mizio, BioFocus DPI Chesterford Research Park Saffron Walden, Essex CB10 1XL, GB
OWENS, Andrew, Pate, BioFocus DPI Chesterford Research Park Saffron Walden, Essex CB10 1XL, GB
RAPHY, Gilles, BioFocus DPI Chesterford Research Park Saffron Walden, Essex CB10 1XL, GB
SHARPE, Andrew, BioFocus DPI Chesterford Research Park Saffron Walden, Essex CB10 1XL, GB

- (51) MKP
G01N 33/574 (2006.01) (97) **2425252 ***
(86) EP2010002490 22.04.2010
(96) 10716294.3 07.03.2012
(87) WO2010124812, 22.04.2010
(97) 2425252, 07.03.2012 en
(54) IDENTIFICATION OF TUMOR-ASSOCIATED MARKERS FOR DIAGNOSIS AND THERAPY
(71) Johannes- Gutenberg-Universität Mainz, Saarstrasse 21, 55122 Mainz, DE
GANYMED Pharmaceuticals AG, Freiligrathstrasse 12, 55131 Mainz, DE
(72) SAHIN, Ugur, Philipp-von-Zabern-Platz 1, 55116 Mainz, DE
TÜRECI, Özlem, Philipp-von-Zabern-Platz 1, 55116 Mainz, DE
KOSLOWSKI, Michael, Autogenstrasse 50, 65933 Frankfurt, DE

- (51) MKP
C07D 401/00 (2006.01) (97) **2429993 ***
C07D 405/00 (2006.01)
C07D 213/55 (2006.01)
C07D 413/00 (2006.01)
A61K 31/44 (2006.01)
C07D 417/00 (2006.01)
A61K 31/5375 (2006.01)
C07D 471/04 (2006.01)
A61P 31/18 (2006.01)
C07D 498/06 (2006.01)
A61K 31/54 (2006.01)
C07D 491/06 (2006.01)
C07D 213/60 (2006.01)
(86) CA2010000707 13.05.2010
(96) 10774456.7 21.03.2012
(87) WO2010130034, 13.05.2010
(97) 2429993, 21.03.2012 en
(54) INHIBITORS OF HUMAN IMMUNODEFICIENCY VIRUS REPLICATION
(71) Gilead Sciences, Inc., 333 Lakeside Drive, Foster City, CA 94404, US
(72) BILODEAU, Francois, 2100 Cunard Street, Laval, Québec H7S 2G5, CA
TSANTRIZOS, Youla, S., 2100 Cunard Street, Laval, Québec H7S 2G5, CA
CARSON, Rebekah, J., 2100 Cunard Street, Laval, Québec H7S 2G5, CA
MORIN, Sebastien, Boehringer Ingelheim (Canada) Ltd., 2100 Cunard Street, Laval, Québec H7S 2G5, CA
FADER, Lee, 2100 Cunard Street, Laval, Québec H7S 2G5, CA
KAWAI, Stephen, 2100 Cunard Street, Laval, Québec H7S 2G5, CA
LAPLANTE, Steven, 2100 Cunard Street, Laval, Québec H7S 2G5, CA
BAILEY, Murray, D., 2100 Cunard Street, Laval, Québec H7S 2G5, CA
THIBEAULT, Carl, 2100 Cunard Street, Laval, Québec H7S 2G5, CA
YOAKIM, Christiane, 2100 Cunard Street, Laval, Québec H7S 2G5, CA
SURPRENANT, Simon, 2100 Cunard Street, Laval, Québec H7S 2G5, CA
SIMONEAU, Bruno, 2100 Cunard Street, Laval, Québec H7S 2G5, CA

- (51) MKP
E05D 15/06 (2006.01) (97) **2476841**
(96) 11000237.5 18.07.2012
(97) 2476841, 18.07.2012 de
(54) Device for securing a sliding wing of a sliding wing system
(71) Sunflex Aluminiumsysteme GmbH, Im Ruttenberge 12, 57482 Wenden-Gerlingen, DE
(72) Schneider, Malte, Pirschweg 2 a, D-57482 Wenden, DE

(51) MKP
A61K 31/5377 (2006.01) (97) **2403833 ***
A61K 31/497 (2006.01)
C07D 401/14 (2006.01)
A61P 5/50 (2006.01)
A61K 31/4375 (2006.01)
C07D 417/12 (2006.01)
A61P 35/02 (2006.01)
A61K 31/47 (2006.01)
C07D 417/14 (2006.01)
A61K 31/538 (2006.01)
A61K 31/501 (2006.01)
C07D 215/48 (2006.01)
C07D 413/14 (2006.01)
A61P 9/00 (2006.01)
A61K 31/519 (2006.01)
A61K 31/4709 (2006.01)
C07D 487/04 (2006.01)
C07D 401/12 (2006.01)
A61P 3/00 (2006.01)
A61K 31/506 (2006.01)
(86) US2010025963 02.03.2010
(96) 10749227.4 11.01.2012
(87) WO2010101949, 02.03.2010
(97) 2403833, 11.01.2012 en
(54) 8-SUBSTITUTED QUINOLINES AND RELATED ANALOGS AS SIRTUIN MODULATORS
(71) Sirtris Pharmaceuticals, Inc., 200 Technology Square, Suite 300, Cambridge, MA 02139, US
(72) VU, Chi, B., c/o Sirtris Pharmaceuticals Inc. 200 Technology Square Suite 300, Cambridge, MA 02139, US
CASAUBON, Rebecca, L., c/o Sirtris Pharmaceuticals Inc. 200 Technology Square Suite 300, Cambridge, MA 02139, US

(51) MKP
C08G 18/00 (2006.01) (97) **2473540 ***
(86) US2010046730 26.08.2010
(96) 10814287.8 11.07.2012
(87) WO2011028586, 26.08.2010
(97) 2473540, 11.07.2012 en
(54) STRUCTURAL URETHANE ADHESIVES COMPRISING AMIDE POLYOLS
(71) Ashland Licensing And Intellectual Property LLC, A Delaware Limited Liability Company 5200 Blazer Parkway, Dublin, OH 43017, US
(72) HARVEY, Raymond, Scott, 535 Haymore North, Worthington, OH 43085, US
GRAN, Amy, 5765 Pleasant Chapel Road, Mechanicsburg, OH 43044, US
VASILIEVA, Yulia, Alekseevna, 5050 Vail Pine Place, Dublin, OH 43017, US

(51) MKP
C07D 401/12 (2006.01) (97) **2419411 ***
C07D 409/12 (2006.01)
C07D 413/12 (2006.01)
A61K 31/498 (2006.01)
A61P 35/00 (2006.01)
C07D 403/04 (2006.01)
A61K 31/5377 (2006.01)
C07D 241/44 (2006.01)
(86) EP2010053891 25.03.2010
(96) 10710051.3 22.02.2012
(87) WO2010115719, 25.03.2010
(97) 2419411, 22.02.2012 en
(54) QUINOXALINE DERIVATIVES AND THEIR USE FOR TREATING BENIGN AND MALIGNANT TUMOUR DISORDERS
(71) Aeterna Zentaris GmbH, Weismüllerstraße 50, 60314 Frankfurt am Main, DE
(72) GERLACH, Matthias, Pfarrgasse 1, 63636 Brachtal, DE
SEIPELT, Irene, Hermannstraße 5, 63069 Offenbach, DE
GÜNTHER, Eckhard, Wingertstraße 176, 63477 Maintal, DE
SCHUSTER, Tilmann, Valentin-Hock-Str. 32, 63762 Großostheim, DE
POLYMEROPoulos, Emmanuel, Beethovenstraße 60, 60325 Frankfurt am Main, DE
CZECH, Michael, Kullmannstraße 2, 60435 Frankfurt am Main, DE
CLAUS, Eckhard, Victor-Slotsch-Straße 5, 60388 Frankfurt am Main, DE

(51) MKP
A61M 5/315 (2006.01) (97) **2414006 ***
(86) EP2010053968 26.03.2010
(96) 10710349.1 08.02.2012
(87) WO2010112409, 26.03.2010
(97) 2414006, 08.02.2012 en
(54) DRUG DELIVERY DEVICE WITH AN IMPROVED PISTON ROD
(71) Sanofi-Aventis Deutschland GmbH, Brüningstraße 50, 65929 Frankfurt, DE
(72) OAKLAND, Philip, 22 Swythamley Road Cheadle Heath Stockport, Cheshire SK3 ONE, GB

(51) MKP
A61K 47/26 (2006.01) (97) **2470172 ***
A61K 9/00 (2006.01)
A61K 47/14 (2006.01)
A61K 31/167 (2006.01)
(86) US2010046875 26.08.2010
(96) 10749576.4 04.07.2012
(87) WO2011028629, 26.08.2010
(97) 2470172, 04.07.2012 en
(54) PHARMACEUTICAL FORMULATIONS AND METHODS OF USE
(71) Nuvo Research Inc., 7560 Airport Road, Unit 10, Mississauga, ON L4T 4H4, CA
(72) BUYUKTIMKIN, Nadir, 11772 Carmel Creek Rd 105, San Diego California 92130, US
BUYUKTIMKIN, Servet, 11772 Carmel Creek Rd 105, San Diego, California 92130, US
SINGH, Jagat, 64 Grover Drive, Toronto Ontario M1C 4V7, CA
NEWSAM, John M., 528 Forward Street, La Jolla, California 92037-7528, US
KING-SMITH, Dominic, 2597 Soderblom Avenue, San Diego California 92122, US
KISAK, Edward, 3525 Bayside Lane Apt. B, San Diego California 92109, US
GALER, Bradley S., 1740 Lenape Road Bldg. 2, West Chester Pennsylvania 19382, US
DESAL, Tejas, 5483 Freshwater Drive, Mississauga, Ontario L5M 0K7, CA
RILEY, Christopher, 1055 Forest Street, Maryville Missouri 64468, US

(51) MKP
C03C 17/36 (2006.01) (97) **2406197 ***
(86) FR2010050391 08.03.2010
(96) 10714927.0 18.01.2012
(87) WO2010103224, 08.03.2010
(97) 2406197, 18.01.2012 fr
(54) SUBSTRATE PROVIDED WITH A STACK WITH THERMAL PROPERTIES AND COMPRISING HIGH REFRACTIVE INDEX LAYERS
(71) Saint-Gobain Glass France, 18, avenue d'Alsace, 92400 Courbevoie, FR
(72) GERARDIN, Hadia, 4 rue d'Orsel, F-75018 Paris, FR
REYMOND, Vincent, 22 Avenue Gabriel Péri, F-92160 Antony, FR

(51) MKP
A61K 31/4418 (2006.01) (97) **2429995 ***
C07D 213/76 (2006.01)
A61P 9/00 (2006.01)
(86) EP2010056572 12.05.2010
(96) 10719758.4 21.03.2012
(87) WO2010130796, 12.05.2010
(97) 2429995, 21.03.2012 en
(54) ARYL PYRIDINE AS ALDOSTERONE SYNTHASE INHIBITORS
(71) Novartis AG, Lichtstrasse 35, 4056 Basel, CH
(72) CHAMOIN, Sylvie, Novartis Pharma AG Postfach, CH-4002 Basel, CH
HU, Qi-Ying, Novartis Institutes for BioMedical Research Inc. 100 Technology Square, Cambridge, Massachusetts 02139, US
PAPILLON, Julien, Novartis Institutes for BioMedical Research Inc. 100 Technology Square, Cambridge, Massachusetts 02139, US

- (51) MKP
C07D 271/12 (2006.01) (97) **2406240 ***
A61K 31/4245 (2006.01)
C07D 235/02 (2006.01)
A61K 31/4184 (2006.01)
C07D 277/60 (2006.01)
C07D 498/10 (2006.01)
C07D 239/70 (2006.01)
A61K 31/4188 (2006.01)
C07D 491/10 (2006.01)
A61K 31/517 (2006.01)
C07D 487/10 (2006.01)
A61K 31/519 (2006.01)
C07D 403/06 (2006.01)
A61K 31/428 (2006.01)
C07D 405/12 (2006.01)
- (86) US2010027173 12.03.2010
(96) 10708684.5 18.01.2012
(87) WO2010105179, 12.03.2010
(97) 2406240, 18.01.2012 en
(54) INHIBITORS OF BETA-SECRETASE
(71) Boehringer Ingelheim International GmbH, Binger Strasse 173, 55216 Ingelheim am Rhein, DE
Vitaë Pharmaceuticals, Inc., 502 West Office Center Drive, Fort Washington, PA 19034, US
(72) CACATIAN, Salvacion, 89 Ramsgate Ct., Blue Bell Pennsylvania 19422, US
MORALES-RAMOS, Angel, 2310 Buckeye Circle, Blue Bell Pennsylvania 19422, US
CLAREMON, David, A., 1508 Aidenn Lair Road, Maple Glenn Pennsylvania 19002, US
SINGH, Suresh, 4 Adams Road, Kendall Park New Jersey 08824, US
DILLARD, Lawrence, W., 496 Kings Road, Yardley Pennsylvania 19067, US
VENKATRAMAN, Shankar, 114 Country Lane, Lansdale Pennsylvania 19446, US
FUCHS, Klaus, Klingensacker 27, D-88400 Mittelbiberach, DE
WU, Guosheng, 549 Palmer Farm Drive, Yardley Pennsylvania 19067, US
HEINE, Niklas, Georg-Schinbain-Strasse 66, D-88400 Biberach, DE
WU, Zhongren, 26 Casselberry Drive, Audubon Pennsylvania 19403, US
MCKEEVER, Brian, 29 Lakeside Drive, Lake Ronkonkoma New York 11779, US
ZHENG, Yajun, 605 Griffen Court, Hockessin Delaware 19707, US
LEFTHERIS, Katerina, 92 92 Richmond Drive, Skillman New Jersey 08558, US
YUAN, Jing, 537 Candlemaker Way, Lansdale Pennsylvania 19446, US
JIA, Lanqi, 106 Allison Road Apt. A2, Horsham Pennsylvania 19044, US
XU, Zhenrong, 3855 Blair Mill Road Apt. 235-B, Horsham Pennsylvania 19044, US

- (51) MKP
A61P 17/00 (2006.01) (97) **2500034 ***
A61P 37/08 (2006.01)
A61K 39/395 (2006.01)
A61P 17/04 (2006.01)
- (86) JP2010070627 12.11.2010
(96) 10830062.5 19.09.2012
(87) WO2011059110, 12.11.2010
(97) 2500034, 19.09.2012 en
(54) THERAPEUTIC AGENT FOR PSORIASIS OR ATOPIC DERMATITIS
(71) Kabushiki Kaisha Saiwai Medix, Kubota Bldg. 1F 1-12-17, Kandaizumi-cho Chiyoda-ku, Tokyo 101-0024, JP
(72) SHICHIRI, Masayoshi, 1-27-1-1206 Wakagi Itabashi-ku, Tokyo 174-0065, JP

- (51) MKP
C07D 237/24 (2006.01) (97) **2473479 ***
A61K 31/235 (2006.01)
C07D 213/81 (2006.01)
C07D 213/80 (2006.01)
C07C 233/75 (2006.01)
A61K 31/192 (2006.01)
C07C 237/42 (2006.01)
A61K 31/44 (2006.01)
C07D 213/30 (2006.01)
A61P 25/28 (2006.01)
C07C 235/56 (2006.01)
A61K 31/166 (2006.01)
- (86) GB2010001650 01.09.2010
(96) 10752907.5 11.07.2012
(87) WO2011027106, 01.09.2010
(97) 2473479, 11.07.2012 en
(54) THERAPEUTIC ARYL-AM I DO-ARYL COMPOUNDS AND THEIR USE
(71) King's College London, null, Strand, London WC2R 2LS, GB
CORCORAN, Jonathan Patrick Thomas, Wolfson Centre for Age-Related Diseases Wolfson Wing Hodgkin Building King's College, London, London SE1 1UL, GB
KALINDJIAN, Sarkis Barret, Wolfson Centre for Age-Related Diseases Wolfson Wing Hodgkin Building King's College, London, London SE1 1UL, GB
BORTHWICK, Alan David, 15 Temple Grove, London NW11 7UA, GB
ADAMS, David Reginald, 32 The Spinney High Wycombe, Bucks HP11 1QE, GB
BROWN, Jane Theresa, Sygnature Chemical Services Biocity Pennyfoot Street, Nottingham NG1 1GF, GB
TADDEI, David Michel Adrien, Sygnature Chemical Services Biocity Pennyfoot Street, Nottingham NG1 1GF, GB
SHIERS, Jason, John, Sygnature Chemical Services Biocity Pennyfoot Street, Nottingham NG1 1GF, GB

- (51) MKP
A61K 39/395 (2006.01) (97) **2421558 ***
- (86) US2010031740 20.04.2010
(96) 10714820.7 29.02.2012
(87) WO2010123891, 20.04.2010
(97) 2421558, 29.02.2012 en
(54) ADJUVANT CANCER THERAPY
(71) Genentech, Inc., One DNA Way, South San Francisco, CA 94080-4990, US
NSABP Foundation, Inc., Four Allegheny Center, 5th Floor, Pittsburgh, PA 15212, US
(72) FYFE, Gwendolyn, 20 La Ferrera Terrace, San Francisco California 94133, US
HEDRICK, Eric, 59 Hobart Avenue, Summit New Jersey 07901, US
MASS, Robert D., 106 Elinor Avenue, Mill Valley California 94941, US
WOLMARK, Norman, 1201 Murray Hill Avenue, Pittsburgh PA 15212, US

- (51) MKP
C08B 37/10 (2006.01) (97) **2427502 ***
- (86) IB2010051934 04.05.2010
(96) 10719113.2 14.03.2012
(87) WO2010128449, 04.05.2010
(97) 2427502, 14.03.2012 en
(54) NOVEL SULFATED OCTASACCHARIDE AND ITS USE AS ANTITHROMBOTIC
(71) SANOFI, 174, Avenue de France, 75013 Paris, FR
(72) MOURIER, Pierre, c/o sanofi-aventis Patent Department 174 avenue de France, F-75013 Paris, FR
VISKOV, Christian, c/o sanofi-aventis Patent Department 174 avenue de France, F-75013 Paris, FR

- (51) MKP
C11D 3/37 (2006.01) (97) **2449079 ***
A61K 8/81 (2006.01)
A61Q 5/02 (2006.01)
A61K 8/73 (2006.01)
(86) US2010040913 02.07.2010
(96) 10730337.2 09.05.2012
(87) WO2011003068, 02.07.2010
(97) 2449079, 09.05.2012 en
(54) CATIONIC SYNTHETIC POLYMERS WITH IMPROVED SOLUBILITY AND PERFORMANCE IN SURFACTANT-BASED SYSTEMS AND USE IN PERSONAL CARE AND HOUSEHOLD APPLICATIONS
(71) Hercules Incorporated, Hercules Plaza 1313 N. Market Street, Wilmington, DE 19894-0001, US
(72) BIERGANN, Patric, Grenzstr. 147, 47799 Krefeld, DE
ERAZO-MAJEWICZ, Paquita, 126 Stoney Ridge Road, Landenberg PA 19350, US
NAOULI, Nabil, 1839 Braken Avenue, Wilmington DE 19808, US

- (51) MKP
A61P 25/28 (2006.01) (97) **2456771 ***
C07D 491/048 (2006.01)
A61K 31/522 (2006.01)
(86) EP2010060586 21.07.2010
(96) 10734143.0 30.05.2012
(87) WO2011009897, 21.07.2010
(97) 2456771, 30.05.2012 en
(54) FUSED AMINODIHYDROPYRIMIDONE DERIVATIVES
(71) Eisai R&D Management Co., Ltd., 6-10, Koishikawa 4-chome Bunkyo-ku, Tokyo 112-8088, JP
(72) CASTRO PINEIRO, Jose, Luis, Eisai Limited European Knowledge Centre Mosquito Way, Hatfield Hertfordshire AL10 9SN, GB
HALL, Adrian, Eisai Limited European Knowledge Centre Mosquito Way, Hatfield Hertfordshire AL10 9SN, GB
MADIN, Andrew, Eisai Limited European Knowledge Centre Mosquito Way, Hatfield Hertfordshire AL10 9SN, GB
VO, Ngoc-Tri, Eisai Limited European Knowledge Centre Mosquito Way, Hatfield Hertfordshire AL10 9SN, GB

- (51) MKP
H04W 4/02 (2009.01) (97) **2498519 ***
(86) CN2010078415 04.11.2010
(96) 10827916.7 12.09.2012
(87) WO2011054302, 04.11.2010
(97) 2498519, 12.09.2012 en
(54) LOCATION METHOD, APPARATUS AND SYSTEM
(71) Datang Mobile Communications Equipment Co., Ltd, No. 40 Xueyuan Road Haidian District, Beijing 100083, CN
(72) ZHANG, Dajun, No.40 Xueyuan Road Haidian District, Beijing 100083, CN
FANG, Jiayi, No.40 Xueyuan Road Haidian District, Beijing 100083, CN
QUAN, Haiyang, No.40 Xueyuan Road Haidian District, Beijing 100083, CN

- (51) MKP
C12P 21/04 (2006.01) (97) **2438185 ***
(86) US2010037454 04.06.2010
(96) 10784174.4 11.04.2012
(87) WO2010141855, 04.06.2010
(97) 2438185, 11.04.2012 en
(54) METHODS OF MODULATING FUCOSYLATION OF GLYCOPROTEINS
(71) Momenta Pharmaceuticals, Inc., 675 West Kendall Street, Cambridge, MA 02142, US
(72) COLLINS, Brian, Edward, 30 Country Club Drive, Arlington MA 02474, US
THIRUNEELAKANTAPILLAI, Lakshmanan, 7 Oceanview Drive Apt.505, Boston MA 02125, US
BULIK, Dorota, A., 240 Hawthorne Street, Malden MA 02142, US
MILLEA, Kevin, 142 Main Street, Saugus MA 01906, US

- (51) MKP
G05B 13/04 (2006.01) (97) **2438487 ***
(86) US2010000940 30.03.2010
(96) 10719428.4 11.04.2012
(87) WO2010141046, 30.03.2010
(97) 2438487, 11.04.2012 en
(54) AUTOMATED PID CONTROLLER DESIGN
(71) The Mathworks, Inc., 3 Apple Hill Drive, Natick, MA 01760, US
(72) ERYILMAZ, Bora, 270 Babcock St. Apt. 20D, Boston MA 02215, US
CHEN, Rong, 5 Clearbrook Road, Tolland CT 06084, US
GAHINET, Pascal, 24 Wedgewood Drive, Hopkinton MA 01748, US

- (51) MKP
C07D 239/94 (2006.01) (97) **2411373 ***
(86) IB2010051343 26.03.2010
(96) 10713723.4 01.02.2012
(87) WO2010109443, 26.03.2010
(97) 2411373, 01.02.2012 en
(54) PROCESS FOR THE PREPARATION OF ERLOTINIB OR ITS PHARMACEUTICALLY ACCEPTABLE SALTS THEREOF
(71) Ranbaxy Laboratories Limited, 12th Floor, Devika Tower, 6 Nehru Place 9, New Delhi 110 019, IN
(72) MURUGESAN, Balaguru, D-28, Rajanarayan Gardens Periyanaiken Palayam SRKV (po) 641020 Coimbatore, Tamil Nadu, IN
VEMPALI, Anandam, S/o Shri Muneiah Vempali Chilamathuru Village Kapulur Post Naidupet Mandal Nellore 524126, Andhra Pradesh, IN
SATHYANARAYANA, Swargam, House No. 9-6-194 Ram Naga, Karim Nagar Andhra Pradesh 505002, IN
THAPER, Rajesh, Kumar, Vidushi Villa Flat No. 102 Plot No. 21 Nandi Nagar Road Road No. 14 Banjara Hills, Hyderabad 500034, IN
PRASAD, Mohan, House No. P-3/3 Phase II DLF Qutab Enclave, Gurgaon Haryana 122002, IN

- (51) MKP
A61L 2/06 (2006.01) (97) **2485772 ***
B65B 55/06 (2006.01)
A61L 2/24 (2006.01)
(86) EP2010065098 08.10.2010
(96) 10763192.1 15.08.2012
(87) WO2011042541, 08.10.2010
(97) 2485772, 15.08.2012 en
(54) STERILIZATION APPARATUS AND METHOD FOR CONTROLLING OF A STERILIZATION APPARATUS
(71) Sanofi-Aventis Deutschland GmbH, Brüningstraße 50, 65929 Frankfurt, DE
(72) HUEFNER, Gerhard, Sanofi-Aventis Deutschland GmbH, 65926 Frankfurt am Main, DE
HENRICH, Matthias, Sanofi-Aventis Deutschland GmbH, 65926 Frankfurt am Main, DE
WILLEMS, Michael, Sanofi-Aventis Deutschland GmbH, 65926 Frankfurt am Main, DE

- (51) MKP
A61K 31/496 (2006.01) (97) **2439204 ***
A61P 21/00 (2006.01)
C07D 409/14 (2006.01)
A61K 31/381 (2006.01)
A61P 7/06 (2006.01)
A61P 43/00 (2006.01)
A61K 31/4436 (2006.01)
A61P 9/10 (2006.01)
C07D 409/12 (2006.01)
A61P 3/10 (2006.01)
A61P 37/04 (2006.01)
C07D 333/38 (2006.01)
A61P 7/00 (2006.01)
A61P 37/06 (2006.01)
A61K 31/5377 (2006.01)
A61P 25/00 (2006.01)
A61K 38/00 (2006.01)
A61P 35/00 (2006.01)
A61K 38/22 (2006.01)
A61P 35/02 (2006.01)
(86) JP2010059552 04.06.2010
(96) 10783467.3 11.04.2012
(87) WO2010140685, 04.06.2010
(97) 2439204, 11.04.2012 en
(54) HETEROCYCLIC COMPOUND AND HEMATOPOIETIC STEM CELL AMPLIFIER
(71) Nissan Chemical Industries, Ltd., 7-1 Kanda-Nishiki-cho 3-chome, Chiyoda-ku Tokyo 101-0054, JP
(72) NISHINO, Taito, c/o Nissan Chemical Industries Ltd. 7-1, Kanda-Nishiki-cho 3-chome Chiyoda-ku, Tokyo 101-0054, JP
IWAMOTO, Shunsuke, c/o Nissan Chemical Industries Ltd. Chemical Research Laboratories 10-1, Tsuboi-Nishi 2-chome, Funabashi-shi Chiba 274-8507, JP
MIYAJI, Katsuaki, c/o Nissan Chemical Industries Ltd. Chemical Research Laboratories 10-1, Tsuboi-Nishi 2-chome, Funabashi-shi Chiba 274-8507, JP
-
- (51) MKP
C04B 35/63 (2006.01) (97) **2440506 ***
C04B 35/44 (2006.01)
C04B 35/626 (2006.01)
(86) AT2010000208 11.06.2010
(96) 10724992.2 18.04.2012
(87) WO2010141971, 11.06.2010
(97) 2440506, 18.04.2012 en
(54) YTTRIA-BASED SLURRY COMPOSITION
(71) Treibacher Industrie AG, Auer von Welsbach-Straße 1, 9330 Treibach-Althofen, AT
(72) TAUBER, Sigrun, Dr. Arthur Lemisch Strasse 16, A-9300 St. Veit an der Glan, AT
JANZ, Peter, Feldkirchnerstrasse 67, A-9020 Klagenfurt, AT
-
- (51) MKP
E04G 23/00 (2006.01) (97) **2438255 ***
B08B 3/02 (2006.01)
E04G 1/20 (2006.01)
E04G 23/08 (2006.01)
(86) SE2010000153 04.06.2010
(96) 10783651.2 11.04.2012
(87) WO2010140952, 04.06.2010
(97) 2438255, 11.04.2012 en
(54) WATER JET EJECTING DEVICE
(71) Conjet AB, P.O. Box 507, 136 25 Haninge, SE
(72) NILSSON, Kjell, Gustavsviksvägen 66, S-132 36 Saltsjö-Boo, SE
-
- (51) MKP
B60P 7/08 (2006.01) (97) **2383145**
(96) 10195752.0 02.11.2011
(97) 2383145, 02.11.2011 en
(54) Tensioning system and cargo space and vehicle provided with such a tensioning system
(71) Bosmans, Rutger Lucien Maria, Berkenstraat 2A, 3960 Zutendaal, BE
(72) Bosmans, Rutger Lucien Maria, Berkenstraat 2A, 3960 Zutendaal, BE
-
- (51) MKP
C07D 213/16 (2006.01) (97) **2496556 ***
C07D 317/06 (2006.01)
C07D 309/08 (2006.01)
A61K 31/085 (2006.01)
C07D 305/04 (2006.01)
C07C 235/54 (2006.01)
C07D 335/14 (2006.01)
(86) US2010055035 02.11.2010
(96) 10776045.6 12.09.2012
(87) WO2011053948, 02.11.2010
(97) 2496556, 12.09.2012 en
(54) ACYLAMINO-SUBSTITUTED CYCLIC CARBOXYLIC ACID DERIVATIVES AND THEIR USE AS PHARMACEUTICALS
(71) SANOFI, 54, rue de la Boétie, 75008 Paris, FR
(72) PERNERSTORFER, Josef, c/o Sanofi-aventis Deutschland GMBH Industriepark Hoechst Building K801, 65926 Frankfurt am Main, DE
KLEEMANN, Heinz-Werner, c/o Sanofi-aventis Deutschland GMBH Industriepark Hoechst Building K801, 65926 Frankfurt am Main, DE
SCHAEFER, Matthias, c/o Sanofi-aventis Deutschland GMBH Industriepark Hoechst Building K801, 65926 Frankfurt am Main, DE
SAFAROVA, Alena, c/o SANOFI-AVENTIS U.S 1041 Route 202-206 Mail Code: BWD-303A Bridgewater, New Jersey 08807, US
PATEK, Marcel, c/o Sanofi-aventis U.S. 1041 Route 202-206 Mail Code: BWD-303A Bridgewater, New Jersey 08807, US
-
- (51) MKP
A61K 31/4418 (2006.01) (97) **2461809 ***
A61K 31/4355 (2006.01)
A61K 31/435 (2006.01)
A61P 27/02 (2006.01)
(86) US2010043598 28.07.2010
(96) 10805004.8 13.06.2012
(87) WO2011014587, 28.07.2010
(97) 2461809, 13.06.2012 en
(54) OPHTHALMIC PHARMACEUTICAL COMPOSITIONS OF DP2 RECEPTOR ANTAGONISTS
(71) Panmira Pharmaceuticals, LLC, 9535 Waples Street, Suite 100, San Diego, CA 92121, US
(72) HUTCHINSON, John Howard, 3435 Richmond Street, San Diego California 92103, US
SEIDERS, Thomas, Jon, 5257 Soledad Mountain Road, San Diego California 92109, US
STOCK, Nicholas, Simon, 7087 Camino De Grazia No 150, San Diego California 92111, US
-
- (51) MKP
C07D 207/16 (2006.01) (97) **2459531 ***
A61K 31/4015 (2006.01)
A61K 9/16 (2006.01)
(86) EP2010004689 30.07.2010
(96) 10742739.5 06.06.2012
(87) WO2011012322, 30.07.2010
(97) 2459531, 06.06.2012 en
(54) SYNTHESIS AND USE OF VILDAGLIPTIN FOR THE PREPARATION OF PHARMACEUTICAL DOSAGE FORMS
(71) KRKA, D.D., Novo Mesto, Smarjeska cesta 6, 8501 Novo mesto, SI
(72) ZUPET, Rok, Janeza Rozica 6, 1000 Ljubljana, SI
SMODIS, Janez, Ul. Slavka Gruma 18, 8000 Novo Mesto, SI
STROPNIK, Tadej, Rusjanov trg 10, 1000 Ljubljana, SI
ANDERLUH, Marko, Cernigojeva 12, 1000 Ljubljana, SI
VRBINC, Miha, Gotna vas 20, 8000 Novo Mesto, SI
VRECER, Franc, Potok 5b, 8351 Straza, SI
PECAVAR, Anica, Gotna vas 18, 8000 Novo Mesto, SI
KUKEC, Simon, Tr i e 12d, 8295 Tr i ce, SI
-

- (51) MKP
A61K 39/36 (2006.01) (97) **2281836**
C07K 14/415 (2006.01)
C12N 15/62 (2006.01)
(96) 10171705.6 09.02.2011
(97) 2281836, 09.02.2011 en
(54) Hybrid proteins from *Parietaria judaica* major allergens and uses thereof
(71) LOFARMA S.p.A., Viale Cassala, 40, 20143 Milano, IT
(72) Mistrello, Giovanni, c/o LOFARMA S.p.A. Viale Cassala, 40, 20143 Milano, IT
Zanotta, Stefania, c/o LOFARMA S.p.A. Viale Cassala, 40, 20143 Milano, IT
Roncarolo, Daniela, c/o LOFARMA S.p.A. Viale Cassala, 40, 20143 Milano, IT
Falagjani, Paolo, c/o LOFARMA S.p.A. Viale Cassala, 40, 20143 Milano, IT
-
- (51) MKP
A61B 5/053 (2006.01) (97) **2408364 ***
(86) US2010027362 15.03.2010
(96) 10753942.1 25.01.2012
(87) WO2010107715, 15.03.2010
(97) 2408364, 25.01.2012 en
(54) SYSTEMS AND METHOD FOR CHARACTERISTIC PARAMETER ESTIMATION OF GASTRIC IMPEDANCE SPECTRA IN HUMANS
(71) Critical Perfusion, Inc., 2225 E. Bayshore Road, Suite 200, Palo Alto, CA 94303-3220, US
(72) BELTRAN, Nohra, E., Emma 44. Col. Nativitas, Mexico City, Df 03500, MX
DE FOLTER, Jozefus, J.M., 68 Watersid, Uxbridge UB8 8 2LQ, GB
GOODÍNEZ, Maria, M., Pase De Los Cedros 50a. Frace. Paseos Del Sur, Mexico City, D.f. 16010, MX
SACHRISTÁN, Emilio, Lera Cda Flor Silverstre 3-6 Col S. Andres, Totoltepec Mexico City, D.f. 14400, MX
-
- (51) MKP
H01L 31/042 (2006.01) (97) **2278627**
(96) 10170653.9 26.01.2011
(97) 2278627, 26.01.2011 fr
(54) Automatic localisation of photovoltaic modules in a photovoltaic field
(71) Photowatt International S.A., 33, rue Saint Honoré, ZI Champfleuri, 38300 Bourgoin-Jallieu, FR
(72) Allandrieu, Frantz, 10 chemin de la Tour - Pollet, 01800 Saint Maurice de Gourdans, FR
Arousseau, Valery, 50 rue des Capucines, 38110 St Clair de la Tour, FR
Dumas, Philippe, 183 route des Vignes, 38890 Saint Chef, FR
-
- (51) MKP
A61K 9/06 (2006.01) (97) **2459171 ***
A61K 47/48 (2006.01)
A61K 9/00 (2006.01)
(86) EP2010061160 30.07.2010
(96) 10736745.0 06.06.2012
(87) WO2011012719, 30.07.2010
(97) 2459171, 06.06.2012 en
(54) LONG ACTING INSULIN COMPOSITION
(71) Sanofi-Aventis Deutschland GmbH, Brüningstrasse 50, 65926 Frankfurt am Main, DE
(72) SPROGØE, Kennett, 1982 West Bayshore Road 327, 94303 Palo Alto CA, US
CLEEMANN, Felix, Turnerstrasse 114, 69126 Heidelberg, DE
HERSEL, Ulrich, Fritz-Frey-Strasse 2, 69121 Heidelberg, DE
KADEN-VAGT, Silvia, Langgewann 79-81, 69121 Heidelberg, DE
LEßMANN, Torben, Schimperstrasse 2, 68167 Mannheim, DE
RAU, Harald, Schwarzwaldstr. 51/2, 69124 Heidelberg, DE
WEGGE, Thomas, Kurfürstenanlage 45, 69115 Heidelberg, DE

- (51) MKP
A61K 31/4439 (2006.01) (97) **2412713 ***
A61P 1/04 (2006.01)
C07D 401/04 (2006.01)
(86) JP2010055257 25.03.2010
(96) 10756174.8 01.02.2012
(87) WO2010110378, 25.03.2010
(97) 2412713, 01.02.2012 en
(54) PYRAZOLE COMPOUND
(71) Takeda Pharmaceutical Company Limited, 1-1 Doshomachi 4-chome Chuo-ku, Osaka-shi, Osaka 541-0045, JP
(72) NISHIDA, Haruyuki, c/o TAKEDA PHARMACEUTICAL COMPANY LIMITED 17-85, Jusohonmachi 2-chome Yodogawa-ku, Osaka-shi Osaka 532-8686, JP
FUJIMORI, Ikuo, c/o c/o Takeda San Diego, Inc. 10410 Science Center Drive, San Diego, CA 92121, US
-
- (51) MKP
F02P 7/077 (2006.01) (97) **2375042**
F02D 35/02 (2006.01)
F02D 41/34 (2006.01)
(96) 10159319.2 12.10.2011
(97) 2375042, 12.10.2011 en
(54) Injection control method
(71) Delphi Technologies Holding S.à.r.l., Avenue de Luxembourg, 4940 Bascharage, LU
(72) Guerrassi, Noureddine, 14 haute rue, 41350 Vineuil, FR
Allezy, Pierre, 42 rue du chateau, 41370 Talcy, FR
-
- (51) MKP
A21B 1/46 (2006.01) (97) **2490544 ***
A21B 3/07 (2006.01)
(86) GR2010000046 20.10.2010
(96) 10781738.9 29.08.2012
(87) WO2011048435, 20.10.2010
(97) 2490544, 29.08.2012 en
(54) OVEN FOR FAST FOOD PREPARATION
(71) Kalliardos, Stergios, 8 N. Armenouli Str., 50100 Kozani, GR
Tsiokopoulos, Ioannis, 2nd Km Kozani - N. Nikopoli, 50100 Kozani, GR
(72) KALLIARDOS, Stergios, 8 N. Armenouli Str., 50100 Kozani, GR
-
- (51) MKP
A61K 31/4353 (2006.01) (97) **2443105 ***
A61K 31/4184 (2006.01)
C07D 487/04 (2006.01)
A61K 31/519 (2006.01)
A61P 25/00 (2006.01)
C07D 403/12 (2006.01)
(86) DK2010050147 17.06.2010
(96) 10725373.4 25.04.2012
(87) WO2010145668, 17.06.2010
(97) 2443105, 25.04.2012 en
(54) NOVEL PHENYLIMIDAZOLE DERIVATIVE AS PDE10A ENZYME INHIBITOR
(71) H. Lundbeck A/S, Ottiliavej 9, 2500 Valby, DK
(72) RITZEN, Andreas, Hyltebjerg Allé 48 B 3.tv., DK-2720 Vanløse, DK
KEHLER, Jan, Nymøllevej 28, DK-2800 Lyngby, DK
LANGGÅRD, Morten, Rågevej 20, DK-2600 Glostrup, DK
NIELSEN, Jacob, Dannebrogsgade 17 1.th., DK-1660 København V, DK
KILBURN, John Paul, Kærsgårdvej 7, DK-4690 Haslev, DK
FARAH, Mohamed M., 11 Sutherland Mount, Leeds LS9 6DP, GB

- (51) MKP
A01N 43/90 (2006.01) (97) **2496086 ***
A61K 31/519 (2006.01)
- (86) US2010055519 04.11.2010
(96) 10829123.8 12.09.2012
(87) WO2011057022, 04.11.2010
(97) 2496086, 12.09.2012 en
- (54) COMPOUNDS AND METHODS FOR KINASE MODULATION, AND INDICATIONS THEREFOR
- (71) Plexxikon, Inc., 91 Bolivar Drive Suite A, Berkeley, CA 94710, US
- (72) ZHANG, Jiazhong, 888 Foster City Blvd. Apt. Q4, Foster City, CA 94404, US
IBRAHIM, Prabha, N., 3380 Lubich Drive, Mountain View, CA 94040, US
BREMER, Ryan, 476 Weldon Avenue Apt. 3, Oakland, CA 94610, US
SPEVAK, Wayne, 1585 Campus Drive, Berkeley, California 94708, US
CHO, Hanna, 4363 Terrabella Place, Oakland, California 94619, US
-
- (51) MKP
E02B 11/00 (2006.01) (97) **2470722 ***
E03F 1/00 (2006.01)
- (86) EP2010064795 05.10.2010
(96) 10766016.9 04.07.2012
(87) WO2011042415, 05.10.2010
(97) 2470722, 04.07.2012 de
- (54) DRAINAGE BODY
- (71) ACO Severin Ahlmann GmbH & Co. KG, Am Ahlmannkai, 24768 Rendsburg, DE
- (72) CANNEY, James, 231 Castle Road, Bedford Bedfordshire MK40 3UB, GB
DAU, Thomas, Na de Hoss 10, 24594 Mörel, DE
ELIAS, Timo, Schützenstrasse 13, 65232 Taunusstein, DE
KUMAR, Prasanna, Glück-Auf-Allee 7, 24782 Büdelsdorf, DE
MEINCKE, Arne, Ringweg 6, 24251 Osdorf, DE
-
- (51) MKP
A47K 10/36 (2006.01) (97) **2421422 ***
A47K 5/12 (2006.01)
- (86) AT2010000102 14.04.2010
(96) 10717476.5 29.02.2012
(87) WO2010121276, 14.04.2010
(97) 2421422, 29.02.2012 de
- (54) SANITARY DISPENSER HAVING CAPACITIVE SENSOR
- (71) Hagleitner, Hans Georg, Lindenallee 11, 5700 Zell am See, AT
- (72) Hagleitner, Hans Georg, Lindenallee 11, 5700 Zell am See, AT
-
- (51) MKP
C07F 9/6561 (2006.01) (97) **2448950 ***
- (86) US2010040792 01.07.2010
(96) 10730679.7 09.05.2012
(87) WO2011002999, 01.07.2010
(97) 2448950, 09.05.2012 en
- (54) SYNTHESIS OF N4-(2, 2-DIMETHYL-4-[(DIHYDROGEN PHOSPHONOXY)-3-OXO-5-PYRIDO [1, 4]OXAZIN-6-YL)-5-FLUORO-N2-(3, 4, 5-TRIMETHOXYPHENYL)-2, 4-PYRIMIDINEDIAMINE DISODIUM SALT
- (71) Rigel Pharmaceuticals, Inc., 1180 Veterans Boulevard, South San Francisco, CA 94080, US
- (72) FELFER, Ulfried, Gattermeyerweg 13, A-4040 Linz, AT
GISELBRECHT, Karl-Heinz, Dr. Ignaz Semmelweis-strasse 3, A-4061 Langholzfeld, AT
WOLBERG, Michael, Herbert-scholz-strasse 22, D-93073 Neutraubling, DE
-
- (51) MKP
A61K 38/21 (2006.01) (97) **2451470 ***
C12P 21/02 (2006.01)
- (86) EP2010004130 07.07.2010
(96) 10737494.4 16.05.2012
(87) WO2011003600, 07.07.2010
(97) 2451470, 16.05.2012 en
- (54) METHOD FOR THE PURIFICATION OF INTERFERON- β
- (71) BioGeneriX AG, High-Tech-Park Neckarau Janderstrasse 3, 68199 Mannheim, DE
- (72) ARNOLD, Stefan, Marstallstrasse 49a, 68723 Schwetzingen, DE
SCHECKERMANN, Christian, Sägegasse 1c, 79238 Ehrenkirchen/Ehrenstätten, DE
-
- (51) MKP
A61K 38/57 (2006.01) (97) **2459213 ***
C07K 14/81 (2006.01)
C07K 16/38 (2006.01)
- (86) US2010043737 29.07.2010
(96) 10742942.5 06.06.2012
(87) WO2011014671, 29.07.2010
(97) 2459213, 06.06.2012 en
- (54) POLYPEPTIDES THAT BIND TISSUE INHIBITOR OF METALLOPROTEINASE TYPE THREE (TIMP-3), COMPOSITIONS AND METHODS
- (71) Amgen Inc., One Amgen Center Drive, Thousand Oaks, CA 91320, US
- (72) BLACK, Roy, A., 8062 30th Avenue NE, Seattle Washington 98115, US
LI, Peng, 1220 14th Avenue Apt. 201, San Francisco, California 94122, US
SILVERMAN, Joshua, 829 Dartshire Way, Sunnyvale California 94087, US
KING, Chadwick, T., 1325 Moody Avenue, North Vancouver British Columbia V7L 3T5, CA
-
- (51) MKP
B01B 1/06 (2006.01) (97) **2488266 ***
H01L 41/09 (2006.01)
- (86) US2010049553 21.09.2010
(96) 10771231.7 22.08.2012
(87) WO2011046714, 21.09.2010
(97) 2488266, 22.08.2012 en
- (54) SYSTEMS AND METHODS FOR PROVIDING HAPTIC FEEDBACK AT MULTIPLE RESONANCE FREQUENCIES
- (71) Immersion Corporation, 30 Rio Robles, San Jose, CA 95131, US
- (72) MODARRES, Ali, 3777 Cote-des-Neiges Apt. 520, Montreal, Québec H3H 1V8, CA
GREGORIO, Pedro, 7353 Dunver Crescent, Verdun, Québec H4H 2H6, CA
GRANT, Danny, A., 1784 De Lunebourg, Laval, Québec H7M 2A1, CA
-
- (51) MKP
G01N 33/564 (2006.01) (97) **2464976 ***
G01N 33/68 (2006.01)
- (86) US2010045343 12.08.2010
(96) 10749543.4 20.06.2012
(87) WO2011019929, 12.08.2010
(97) 2464976, 20.06.2012 en
- (54) METHODS OF DIAGNOSING AND TREATING AUTISM
- (71) The Regents of the University of California, 1111 Franklin Street 12th Floor, Oakland, CA 94607-5200, US
- (72) VAN DE WATER, Judy, 19670 County Road 79, Capay California 95607, US
BRAUNSCHWEIG, Daniel, 337 B Street, Davis California 95616, US
-
- (51) MKP
C07D 309/10 (2006.01) (97) **2451797 ***
- (86) EP2010059817 08.07.2010
(96) 10729901.8 16.05.2012
(87) WO2011003976, 08.07.2010
(97) 2451797, 16.05.2012 en
- (54) CRYSTALLISATION PROCESS FOR 1-(β -D-GLUCOPYRANOSYL)-4-METHYL-3-[5-(4-FLUOROPHENYL)-2-THIENYLMETHYL]BENZENE
- (71) Janssen Pharmaceutica, N.V., Turnhoutseweg 30, 2340 Beerse, BE
- (72) RAMMELOO, Thomas Joachim Landewald, Janssen Pharmaceutica NV Turnhoutseweg 30, B-2340 Beerse, BE
DE KEYSER, Ruben, Janssen Pharmaceutica NV Turnhoutseweg 30, B-2340 Beerse, BE
SCHILDERMANS, Gustaaf Jozef Petrus, Janssen Pharmaceutica NV Turnhoutseweg 30, B-2340 Beerse, BE

- (51) MKP
C02F 1/00 (2006.01) (97) **2471745**
B01D 35/153 (2006.01)
B01D 35/143 (2006.01)
(96) 12161543.9 04.07.2012
(97) 2471745, 04.07.2012 en
(54) Liquid filter device
(71) Strauss Water Ltd, 49 Ha'Sivim Street, Petach Tikva 49517, IL
(72) Wilder, Haim, 7 Yehuda Halevi Street, 43555 Raanana, IL
Ronen, Rami, 12 HaGichon Street, 47204 Ramat HaSharon, IL
Krystal, Eyal, 19/17 Hatchia Street, 44250 Kfar Saba, IL
Hillel, Shlomo, Daphna 4, 71700 Modiin, IL

- (51) MKP
A61P 5/50 (2006.01) (97) **2461820 ***
A61K 38/17 (2006.01)
A61K 38/28 (2006.01)
A61K 31/195 (2006.01)
(86) IB2010053499 02.08.2010
(96) 10757272.9 13.06.2012
(87) WO2011015984, 02.08.2010
(97) 2461820, 13.06.2012 en
(54) ORALLY ADMINISTERABLE PHARMACEUTICAL PREPARATION CONTAINING INSULIN
(71) Cera-Med Kft., Kútvölgyi u 1, 4225 Debrecen, HU
(72) Zoltán, Szilvássy Dr., Kútvölgyi u 1, H-4225 Debrecen, HU
Barna, Peitl Dr., Török István u 21, H-9023 Gy r, HU
József, Németh Dr., Dr. Heim Pál u 2 I/3, H-7623 Pécs, HU

- (51) MKP
G01N 33/50 (2006.01) (97) **2491385 ***
(86) US2010053386 20.10.2010
(96) 10769132.1 29.08.2012
(87) WO2011050069, 20.10.2010
(97) 2491385, 29.08.2012 en
(54) PROXIMITY-MEDIATED ASSAYS FOR DETECTING ONCOGENIC FUSION PROTEINS
(71) Prometheus Laboratories Inc., 9410 Carroll Park Drive, San Diego, CA 92121-5201, US
(72) SINGH, Sharat, 8171 Top of the Morning Way, Rancho Santa Fe California 92127, US
LIU, Xinjun, 12890 Caminito Diego, San Diego California 92130, US

- (51) MKP
C07D 401/06 (2006.01) (97) **2421837 ***
C07D 241/16 (2006.01)
(86) US2010031547 19.04.2010
(96) 10714546.8 29.02.2012
(87) WO2010123792, 19.04.2010
(97) 2421837, 29.02.2012 en
(54) PREPARATION OF C-PYRAZINE-METHYLAMINES
(71) OSI Pharmaceuticals, LLC, 1 Bioscience Park Drive, Farmingdale, NY 11735, US
(72) MAO, Yunyu, Osi Pharmaceuticals Inc. Broadhollow Bioscience Park 1 Bioscience Park Drive, Farmingdale, NY 11735, US
MULVIHILL, Kristen, Michelle, Osi Pharmaceuticals Inc. Broadhollow Bioscience Park 1 Bioscience Park Drive, Farmingdale, NY 11735, US
RECHKA, Josef, A., Osi Pharmaceuticals Inc. Broadhollow Bioscience Park 1 Bioscience Park Drive, Farmingdale, NY 11735, US
TAVARES-GRECO, Paula, A., Osi Pharmaceuticals Inc. Broadhollow Bioscience Park 1 Bioscience Park Drive, Farmingdale, NY 11735, US

- (51) MKP
A61P 29/00 (2006.01) (97) **2445499 ***
A61K 9/24 (2006.01)
A61P 19/02 (2006.01)
A61K 31/4439 (2006.01)
(86) SE2010050712 23.06.2010
(96) 10792418.5 02.05.2012
(87) WO2010151216, 23.06.2010
(97) 2445499, 02.05.2012 en
(54) METHOD FOR TREATING A PATIENT AT RISK FOR DEVELOPING AN NSAID-ASSOCIATED ULCER
(71) AstraZeneca AB, null, 151 85 Södertälje, SE
Pozen, Inc., 1414 Raleigh Road, Chapel Hill, NC 27517, US
(72) AULT, Brian, AstraZeneca R&D Wilmington 1800 Concord Pike P.O. Box 15437, Wilmington, DE 19850-5437, US
HWANG, Clara, AstraZeneca R&D Wilmington 1800 Concord Pike P.O. Box 15437, Wilmington, DE 19850-5437, US
ORLEMANS, Everardus, POZEN Inc. 1414 Raleigh Road, Chapel Hill, NC 27517, US
PLACHETKA, John R., POZEN Inc. 1414 Raleigh Road, Chapel Hill, NC 27517, US
SOSTEK, Mark, AstraZeneca R&D Wilmington 1800 Concord Pike P.O. Box 15437, Wilmington, DE 19850-5437, US

- (51) MKP
A61P 31/04 (2006.01) (97) **2476420 ***
A61K 9/14 (2006.01)
A61K 9/51 (2006.01)
A61K 47/04 (2006.01)
A61K 31/665 (2006.01)
(86) RU2011000322 11.05.2011
(96) 11827039.6 18.07.2012
(87) WO2012039642, 11.05.2011
(97) 2476420, 18.07.2012 en
(54) PHARMACEUTICAL COMPOSITION HAVING ANTIMICROBIAL AND FAST-HEALING ACTIVITY FOR EXTERNAL ADMINISTRATION, PROCESS FOR PREPARING SAME
(71) Limonov, Viktor Lvovich, ul. Raschupkina, 10-62, Moscow 121374, RU
(72) GAIDUL, Konstantin Valentinovich, ul. Bogatkova 260-71, Novosibirsk 630089, RU
DUSHKIN, Aleksandr Valerevich, ul. Arbuzova 5-144, 630117 Novosibirsk, RU
LIMONOV, Viktor Lvovich, ul. Rashchupkina, 10-62, Moscow 121374, RU

- (51) MKP
B22D 11/06 (2006.01) (97) **2411172 ***
(86) CA2010000462 25.03.2010
(96) 10755370.3 01.02.2012
(87) WO2010108280, 25.03.2010
(97) 2411172, 01.02.2012 en
(54) CONTINUOUS CASTING APPARATUS FOR CASTING STRIP OF VARIABLE WIDTH
(71) Novelis, Inc., 191 Evans Avenue, Toronto, ON M8Z 1J5, CA
(72) GODIN, Daniel, 3920 rue Maureault, Trois Rivieres Québec G9B 2C1, CA
LEBLANC, Rejean, 2252 Labrecque, Jonquiere Québec G7S 1K1, CA

- (51) MKP
C07D 405/14 (2006.01) (97) **2417130 ***
A61P 9/00 (2006.01)
C07D 309/14 (2006.01)
A61P 25/00 (2006.01)
C07D 335/02 (2006.01)
C07D 239/96 (2006.01)
A61K 31/517 (2006.01)
C07D 407/04 (2006.01)
A61P 37/00 (2006.01)
C07D 409/04 (2006.01)
A61P 29/00 (2006.01)
C07D 405/04 (2006.01)
A61P 11/00 (2006.01)
(86) FR2010050664 07.04.2010
(96) 10723214.2 15.02.2012
(87) WO2010116088, 07.04.2010
(97) 2417130, 15.02.2012 fr
(54) QUINAZOLINEDIONE DERIVATIVES, PREPARATION THEREOF AND VARIOUS THERAPEUTIC USES THEREOF
(71) SANOFI, 174, Avenue de France, 75013 Paris, FR
(72) CLAUSS, Annie, c/o Sanofi-Aventis Département Brevets 174 avenue de France, F-75013 Paris, FR
GLAESS, Christophe, c/o Sanofi-Aventis Département Brevets 174 avenue de France, F-75013 Paris, FR
MARCINIAK, Gilbert, c/o Sanofi-Aventis Département Brevets 174 avenue de France, F-75013 Paris, FR
NAVE, Jean-François, c/o Sanofi-Aventis Département Brevets 174 avenue de France, F-75013 Paris, FR
VIVET, Bertrand, c/o Sanofi-Aventis Département Brevets 174 avenue de France, F-75013 Paris, FR
-
- (51) MKP
C07C 317/44 (2006.01) (97) **2486004 ***
C07D 405/12 (2006.01)
C07D 275/02 (2006.01)
A61K 31/381 (2006.01)
C07D 277/30 (2006.01)
A61K 31/415 (2006.01)
C07D 307/54 (2006.01)
A61K 31/421 (2006.01)
C07D 263/32 (2006.01)
A61K 31/341 (2006.01)
C07D 333/24 (2006.01)
C07D 231/10 (2006.01)
A61K 31/277 (2006.01)
C07C 317/46 (2006.01)
A61K 31/192 (2006.01)
(86) US2010052050 08.10.2010
(96) 10765558.1 15.08.2012
(87) WO2011044506, 08.10.2010
(97) 2486004, 15.08.2012 en
(54) SULPHONE COMPOUNDS AND METHODS OF MAKING AND USING SAME
(71) Zafgen Corporation, 5 Cambridge Center, Fl 2, Cambridge, MA 02142, US
(72) DYKE, Hazel, Joan, 8/9 Spire Green Centre Flex Meadow, Harlow, Essex CM19 5TR, GB
CRAMP, Susan, Mary, 8/9 Spire Green Centre Flex Meadow, Harlow, Essex CM19 5TR, GB
PALLIN, Thomas, David, 8/9 Spire Green Centre Flex Meadow, Harlow, Essex CM19 5TR, GB
KULAGOWSKI, Janusz, Jozef, 8/9 Spire Green Centre Flex Meadow, Harlow, Essex CM19 5TR, GB
MONTANA, John, Gary, 8/9 Spire Green Centre Flex Meadow, Harlow, Essex CM19 5ST, GB
ZAHLER, Robert, 5 Cambridge Center F1 2, Cambridge, MA 02142, US
-
- (51) MKP
C07D 495/14 (2006.01) (97) **2499146 ***
A61P 37/00 (2006.01)
A61K 31/56 (2006.01)
C07D 495/04 (2006.01)
(86) EP2010067412 12.11.2010
(96) 10775841.9 19.09.2012
(87) WO2011058149, 12.11.2010
(97) 2499146, 19.09.2012 en
(54) TRICYCLIC PYRAZOL AMINE DERIVATIVES
(71) Merck Serono S.A., Centre Industriel, 1267 Coinsins, CH
(72) GAILLARD, Pascale, Domaine de la Prasle 243 route du Fer à Cheval Bat C2, F-74160 Collonge-sous-Salève, FR
JEANCLAUDE-ETTER, Isabelle, Chemin des Matelettes 5, CH-1293 Bellevue, CH
POMEL, Vincent, 228 chemin du Bois des Presses, F-74570 Groisy, FR
SEBILLE, Eric, Les Granges, F-01130 Le Poizat, FR
JEYAPRAKASHNARAYANAN, Seenisamy, 2027, 22nd C Main 14th Cross HSR Layout Sector 1, Bangalore 560 102, IN
MUZERELLE, Mathilde, 1 allée du Cèdre, F-74240 Gaillard, FR
-
- (51) MKP
E01B 31/13 (2006.01) (97) **2408967 ***
B21B 1/085 (2006.01)
(86) EP2010001426 08.03.2010
(96) 10709165.4 25.01.2012
(87) WO2010105749, 08.03.2010
(97) 2408967, 25.01.2012 en
(54) A METHOD OF ROLLING RAILS, APPARATUS FOR ROLLING RAILS AND RAIL PRODUCED ACCORDING TO SAID METHOD
(71) Tata Steel UK Ltd, 30 Millbank, London SW1P 4WY, GB
(72) SHIPTON, Damian, Gerard, 29 Axholme Road Scunthorpe, North Lincolnshire DN15 7HL, GB
GARNER, Keith, 126 Ferry Road West Scunthorpe, North Lincolnshire DN15 8UQ, GB
WRIGHT, Simon, Justin, 26 Church Street Hemswell, Lincolnshire DN21 5UQ, GB
-
- (51) MKP
C07D 239/48 (2006.01) (97) **2419423 ***
C07D 407/12 (2006.01)
A61K 31/506 (2006.01)
A61K 31/5377 (2006.01)
A61P 35/00 (2006.01)
C07D 403/12 (2006.01)
(86) EP2010054685 09.04.2010
(96) 10713207.8 22.02.2012
(87) WO2010118986, 09.04.2010
(97) 2419423, 22.02.2012 en
(54) FLUORO SUBSTITUTED PYRIMIDINE COMPOUNDS AS JAK3 INHIBITORS
(71) Cellzome Limited, Chesterford Research Park, Little Chesterford Cambridge CB10 1XL, GB
(72) HARRISON, Richard John, 30 Chalmers Road, Cambridge CB1 3SX, GB
HOBSON, Andrew, 30 Rustat Avenue, Cambridge CB1 3PF, GB
RAMSDEN, Nigel, Sparrows Lodge Green Lane Fowlmere Royston, Herts SG8 7QP, GB
-
- (51) MKP
C08L 95/00 (2006.01) (97) **2264094**
C08K 7/28 (2006.01)
C08K 7/00 (2006.01)
(96) 10165659.3 22.12.2010
(97) 2264094, 22.12.2010 en
(54) Waterproofing membrane based on bitumen modified with polymers containing hollow glass microspheres.
(71) Polyglass S.p.A., Viale Edoardo Jenner, 4, 20159 Milano, IT
(72) Drigo, Michele, c/o Polyglass S.p.A. Via dell'Artigianato, 34, 31047, PONTE DI PIAVE (TV), IT
Pascon, Daniele, Vicolo del Grano, 5, 31040, SALGAREDA (TV), IT

(51) MKP
A47L 13/20 (2006.01) (97) **2415381 ***
A47L 13/10 (2006.01)
A47L 13/17 (2006.01)
(86) JP2010055951 31.03.2010
(96) 10758843.6 08.02.2012
(87) WO2010114072, 31.03.2010
(97) 2415381, 08.02.2012 en
(54) CLEANING IMPLEMENT AND CLEANING BODY
(71) Uni-charm Corporation, 182 Shimobun Kinsei-cho
Shikokuchuo-shi, Ehime 799-0111, JP
(72) TANAKA Yoshinori, c/o UNI-CHARM CORPORATION Technical
Center 1531-7 Wadahama Toyohama-cho, Kanonji-shi Kagawa
769-1602, JP
FUKUZAWA Masumi, c/o UNI-CHARM CORPORATION
Technical Center 1531-7 Wadahama Toyohama-cho, Kanonji-
shi Kagawa 769-1602, JP

(51) MKP
A61K 39/395 (2006.01) (97) **2470210 ***
(86) US2010047030 27.08.2010
(96) 10812677.2 04.07.2012
(87) WO2011025978, 27.08.2010
(97) 2470210, 04.07.2012 en
(54) METHODS OF TREATMENT USING ANTI-OXIDIZED LDL
ANTIBODIES
(71) Genentech, Inc., 1 DNA Way, South San Francisco CA 94080-
4990, US
BioInvent International AB, Sölvegatan 41, 223 70 Lund, SE
Oregon Health and Science University, 3181 Southwest Sam
Jackson Park Road, Portland, Oregon 97239-3098, US
(72) BUNTING, Stuart, 220 Miramontes Avenue, Half Moon Bay, CA
94019, US
BULLENS, Sherron, PO Box 1983, El Granada, CA 94018, US
CARLSSON, Roland, Stenåldersvägen 99, 226 54 Lund, SV
FRENDEUS, Björn, Kryddgränden 3, SE-261 61 Landskrona,
SE
GLAZER, Steven, Magnoliavej 18, DK-2000 Frederiksberg, DK
GROVE, Kevin, 10670 Oriole Circle, Beaverton, OR 97007, US
VAN BRUGGEN, Nick, 142 Alberta Avenue, San Carlos, CA
94070, US

(51) MKP
A61N 1/36 (2006.01) (97) **2408519 ***
H04L 27/12 (2006.01)
H04R 25/00 (2006.01)
(86) AU2010000300 15.03.2010
(96) 10752992.7 25.01.2012
(87) WO2010105291, 15.03.2010
(97) 2408519, 25.01.2012 en
(54) TRANSCUTANEOUS MODULATED POWER LINK FOR A
MEDICAL IMPLANT
(71) Cochlear Limited, 14 Mars Road, Lane Cove, NSW 2066, AU
(72) MESKENS, Werner, 14 Mars Road, Lane Cove NSW 2066, AU

(51) MKP
B01D 53/83 (2006.01) (97) **2411123 ***
B01D 53/96 (2006.01)
C01D 7/00 (2006.01)
C01F 11/46 (2006.01)
F23J 15/04 (2006.01)
B01D 53/50 (2006.01)
B01D 53/75 (2006.01)
B01D 53/78 (2006.01)
(86) EP2010002983 14.05.2010
(96) 10725012.8 01.02.2012
(87) WO2010142369, 14.05.2010
(97) 2411123, 01.02.2012 de
(54) METHOD FOR TREATING EXHAUST GASES COMPRISING
SULFUR OXIDES
(71) DrySo Tec GmbH, Heinz-Bäcker-Str. 19, 45356 Essen, DE
MORUN, Bernd, Vollbergwinkel 5, 45259 Essen, DE
(72) SCHMIDT, Paul-Udo, Im Rosendahl 2a, 45721 Haltern am See,
DE

(51) MKP
F01N 3/037 (2006.01) (97) **2466085 ***
F24F 3/16 (2006.01)
F24F 5/00 (2006.01)
(86) KR2010005190 08.08.2010
(96) 10808319.7 20.06.2012
(87) WO2011019170, 08.08.2010
(97) 2466085, 20.06.2012 en
(54) CENTRIFUGAL, WET-TYPE AIR CLEANER
(71) Yun, Jang-Shik, 2506 Kukje Green Apartment 94-2 Dadai-2
dong Saha-gu, Busan 604-754, KR
(72) Yun, Jang-Shik, 2506 Kukje Green Apartment 94-2 Dadai-2
dong Saha-gu, Busan 604-754, KR

(51) MKP
A61P 35/00 (2006.01) (97) **2470526 ***
A61K 31/506 (2006.01)
C07D 401/14 (2006.01)
C07D 403/04 (2006.01)
(86) US2010046930 27.08.2010
(96) 10748211.9 04.07.2012
(87) WO2011025927, 27.08.2010
(97) 2470526, 04.07.2012 en
(54) COMPOUNDS AND COMPOSITIONS AS PROTEIN KINASE
INHIBITORS
(71) IRM LLC, 131 Front Street P.O. Box HM 2899, Hamilton HM
LX, BM
Novartis AG, Lichtstrasse 35, 4056 Basel, CH
(72) HUANG, Shenlin, 5768 Cape Jewels Trail, San Diego California
92130, US
JIN, Xianming, 3516 Sleeping Meadow Way, San Ramon
California 94582, US
LIU, Zuosheng, 3911 Tynebourne Circle, San Diego California
92130, US
POON, Daniel, 54 Lake Avenue, Piedmont California 94611, US
TELLEW, John, 617 Caminito de la Costa, La Jolla California
92037, US
WAN, Yongqin, 19 Santa Eugenia, Irvine California 92606, US
WANG, Xing, 10445 Monterey Ridge Drive, San Diego
California 92127, US
XIE, Yongping, 12596 Brickella Street, San Diego California
92129, US

(51) MKP
B32B 7/12 (2006.01) (97) **2475519 ***
F16S 1/12 (2006.01)
B32B 3/28 (2006.01)
B32B 1/08 (2006.01)
F16S 1/14 (2006.01)
(86) CA2010001404 09.09.2010
(96) 10814843.8 18.07.2012
(87) WO2011029186, 09.09.2010
(97) 2475519, 18.07.2012 en
(54) ASSEMBLY OF WET ELECTROSTATIC PRECIPITATOR
(71) Turbosonic Inc., 550 Parkside Drive Suite A-14, Waterloo,
Ontario N2L 5V4, CA
(72) MCGRATH, Paul, 42-7284 Bellshire Gate, Mississauga Ontario
L5N 8E4, CA
ALLAN, Robert A., 126 Pinehurst Crescent, Kitchener Ontario
N2N 1E4, CA

- (51) MKP
C12N 15/09 (2006.01) (97) **2407537 ***
A61K 39/395 (2006.01)
A61P 31/04 (2006.01)
C07K 16/12 (2006.01)
- (86) JP2010053828 09.03.2010
(96) 10750805.3 18.01.2012
(87) WO2010104052, 09.03.2010
(97) 2407537, 18.01.2012 en
(54) HUMANIZED PCRV ANTIBODY HAVING ANTI-PSEUDOMONAL ACTIVITY
- (71) Shionogi & Co., Ltd., 1-8, Doshomachi 3-chome Chuo-ku Osaka-shi, Osaka-shi, Osaka 5410045, JP
(72) YAMANO, Yoshinori, c/o Shionogi&Co. Ltd. 1-1, Futabacho 3-chome, Toyonaka-shi Osaka 561-0825, JP
NUMATA, Yoshito, c/o Shionogi&Co. Ltd. 12-4, Sagisu 5-chome Fukushima-ku, Osaka-shi Osaka 553-0002, JP
SATO, Takafumi, c/o Shionogi&Co. Ltd. 1-1, Futabacho 3-chome, Toyonaka-shi Osaka 561-0825, JP
TSUJI, Toshinaga, c/o Shionogi&Co. Ltd. Shionogi Innovation Center for Drug Discovery Nishi 11-chome Kita 21-jo Kita-ku, Sapporo-shi Hokkaido 001-0021, JP
KAWAMOTO, Keiko, c/o Shionogi&Co. Ltd. 12-4, Sagisu 5-chome Fukushima-ku, Osaka-shi Osaka 553-0002, JP
-
- (51) MKP
A61K 31/665 (2006.01) (97) **2427467 ***
A61P 35/00 (2006.01)
C07F 9/6561 (2006.01)
- (86) US2010034117 07.05.2010
(96) 10719188.4 14.03.2012
(87) WO2010129918, 07.05.2010
(97) 2427467, 14.03.2012 en
(54) TRIPTOLIDE PRODRUGS
- (71) Regents of the University of Minnesota, 1000 Westgate Drive, Suite 160, St. Paul, Minnesota 55114-8658, US
(72) GEORG, Ingrid Gunda, 1000 Westgate Drive Suite 160, St. Paul, Minnesota 55114-8658, US
PATIL, Satish Prakash, 1000 Westgate Drive Suite 160, St. Paul, Minnesota 55114-8658, US
SALUJA, Ashok K., 1000 Westgate Drive Suite 160, St. Paul, Minnesota 55114-8658, US
CHUGH, Rohit, 1000 Westgate Drive Suite 160, St. Paul, Minnesota 55114-8658, US
VICKERS, Selwyn, M., 1000 Westgate Drive Suite 160, St. Paul, MN 55114-8658, US
-
- (51) MKP
C07D 487/04 (2006.01) (97) **2406258 ***
C07D 471/04 (2006.01)
A61K 31/519 (2006.01)
A61P 37/00 (2006.01)
- (86) EP2010053165 12.03.2010
(96) 10707924.6 18.01.2012
(87) WO2010103094, 12.03.2010
(97) 2406258, 18.01.2012 en
(54) PYRIMIDINE DERIVATIVES AS mTOR INHIBITORS
- (71) Cellzome Limited, Chesterford Research Park, Little Chesterford Cambridgeshire CB10 1XL, GB
(72) LYNCH, Rosemary, 30 Violet Close, Cambridge CB1 9YW, GB
CANSFIELD, Andrew, 4 The Limes Harston, Cambridge CB22 7QT, GB
NIBLOCK, Helen Sarah, 20 Edmonstone Road, Dalkeith EH22 1QH, GB
HARDY, Daniel, 44 The Beacons, Stevenage SG1 6EA, GB
SCANLON, Jane Elizabeth, 28 Dale Way, Cambridge CB22 3LE, GB
ADREGO, Rita, 39 The Spike Radwinter Road, Essex CB11 3GA, GB
RAMSDEN, Nigel, Sparrows Lodge Green Lane Fowlmere Royston, Herts SG8 7QP, GB
-
- (51) MKP
C07K 14/71 (2006.01) (97) **2448964 ***
A61K 31/4745 (2006.01)
- (86) IB2010053054 02.07.2010
(96) 10734333.7 09.05.2012
(87) WO2011001413, 02.07.2010
(97) 2448964, 09.05.2012 en
(54) EXTRACELLULAR ALLOSTERIC INHIBITOR BINDING DOMAIN FROM A TYROSINE KINASE RECEPTOR
- (71) VIB VZW, Rijvisschestraat 120, 9052 Gent, BE
Vrije Universiteit Brussel, Pleinlaan 2, 1050 Brussel, BE
SANOFI, 54 rue La Boétie, 75008 Paris, FR
Life Sciences Research Partners VZW, Herestraat 49, 3000 Leuven, BE
(72) CARMELIET, Peter, Sappelenbos 10, B-3052 Blanden, BE
DE SMET, Frederik, Lennekemare 10, 3020 Winksele, BE
SCHYMKOWITZ, Joost, Attenrodestraat 15, B-3391 Meensel-Kiezegem, BE
ROUSSEAU, Frédéric, Stichelberg 18, B-1702 Groot-Bijgaarden, BE
HERBERT, Corentin, c/o Sanofi-Aventis département Brevets 174 avenue de France, F-75013 Paris, FR
-
- (51) MKP
G01N 25/48 (2006.01) (97) **2411792 ***
G01B 7/012 (2006.01)
G01N 35/00 (2006.01)
G01N 35/04 (2006.01)
- (86) US2010000857 24.03.2010
(96) 10726664.5 01.02.2012
(87) WO2010110872, 24.03.2010
(97) 2411792, 01.02.2012 en
(54) SYSTEM AND AUTO-ALIGNMENT METHOD FOR DETERMINING POSITION USING A DISCRETE CONTACT PROBE
- (71) PerkinElmer Health Sciences, Inc., 940 Winter Street, Waltham, MA 02451, US
(72) FERRARA, Keith, S., 135 Ripton Parish Lane, Stratford CT 06614, US
CAROZZA, Mario, 54 King Street, Danbury CT 06811, US
-
- (51) MKP
E21B 33/124 (2006.01) (97) **2427630 ***
E21B 34/14 (2006.01)
- (86) CA2010000727 07.05.2010
(96) 10771950.2 14.03.2012
(87) WO2010127457, 07.05.2010
(97) 2427630, 14.03.2012 en
(54) SLIDING SLEEVE SUB AND METHOD AND APPARATUS FOR WELLBORE FLUID TREATMENT
- (71) Packers Plus Energy Services Inc., Bow Valley Square 2 Suite 2200, 205 - 5 Avenue SW, Calgary, Alberta T2P 2V7, CA
(72) THEMIG, Daniel Jon, 256 Woodhaven Place SW, Calgary, Alberta T2W 5P9, CA
DESRANLEAU, Christopher Denis, 900, 407 - 2nd Street SW, Calgary, Alberta T2P 2Y3, CA
TRAHAN, Kevin O., 31 Silvermont Drive, The Woodlands, TX 77382, US
DELUCIA, Frank, 11415 Lakewood Estates, Houston, TX 77070, US
LUPIEN, Daniel P., 3359 - 25 Avenue, Edmonton, Alberta T6T 1Y4, CA
MAXWELL, Terrance Dean, 320 Clareview Station Drive NW Suite 2401, Edmonton, Alberta T5Y 0E5, CA
-
- (51) MKP
A61K 47/02 (2006.01) (97) **2427177 ***
A61K 31/4468 (2006.01)
A61K 9/16 (2006.01)
- (86) GB2010000910 07.05.2010
(96) 10718263.6 14.03.2012
(87) WO2010128300, 07.05.2010
(97) 2427177, 14.03.2012 en
(54) COMPOSITION FOR SUSTAINED DRUG DELIVERY COMPRISING GEOPOLYMERIC BINDER
- (71) Orexo AB, Box 303, 751 05 Uppsala, SE
(72) ENGQVIST, Håkan, Källörsgratan 6, S-74236 Östhammar, SE

- (51) MKP
C12P 21/08 (2006.01) (97) **2425010 ***
A61K 39/00 (2006.01)
- (86) US2010033231 30.04.2010
(96) 10770441.3 07.03.2012
(87) WO2010127284, 30.04.2010
(97) 2425010, 07.03.2012 en
- (54) DUAL VARIABLE DOMAIN IMMUNOGLOBULINS AND USES THEREOF
- (71) Abbott Laboratories, 100 Abbott Park Rd., Abbott Park, IL 60064, US
- (72) GHAYUR, Tariq, 1014 Washington Street, Holliston Massachusetts 01746, US
LIU, Junjian, 14 Crimson Drive, Shrewsbury Massachusetts 01545, US
KINGSBURY, Gillian, A., 46 Aqueduct Road, Wayland Massachusetts 01778, US
REILLY, Edward, B., 1136 Winners Circle, Libertyville Illinois 60048, US
MORGAN-LAPPE, Susan, E., 5419 North Canfield Avenue, Chicago Illinois 60656, US
-
- (51) MKP
C07K 14/11 (2006.01) (97) **2414386 ***
C12N 15/86 (2006.01)
- (86) US2010029825 02.04.2010
(96) 10712667.4 08.02.2012
(87) WO2010115133, 02.04.2010
(97) 2414386, 08.02.2012 en
- (54) NEWCASTLE DISEASE VIRUS VECTORED AVIAN VACCINES
- (71) Merial Limited, 3239 Satellite Blvd., Duluth, GA 30096, US
BUBLLOT, Michel, 3 rue Favre Garin, F-69630 Chaponost, FR
REYNARD, Frederic, 35 impasse des Magnanarelles, F-69720 Saint-Bonnet-de-Mure, FR
LE GROS, Francois-Xavier, 85 avenue Gadagne, F-69230 Saint Genis Laval, FR
-
- (51) MKP
A01N 37/46 (2006.01) (97) **2458981 ***
A01N 43/653 (2006.01)
A01N 47/24 (2006.01)
A01N 25/04 (2006.01)
- (86) EP2010060463 20.07.2010
(96) 10734491.3 06.06.2012
(87) WO2011012493, 20.07.2010
(97) 2458981, 06.06.2012 en
- (54) PESTICIDAL SUSPO-EMULSION COMPOSITIONS
- (71) BASF SE, null, 67056 Ludwigshafen, DE
ISRAELS, Rafel, Roonstrasse 61, 50674 Köln, DE
KLAMCZYNSKI, Katharine, Forststrasse 4, 67459 Böhl-Iggelheim, DE
KUHNS, Marco, Lindenstrasse 13, 67459 Böhl-Iggelheim, DE
SCHLOTTERBECK, Ulf, Burgstraße 20, 68165 Mannheim, DE
-
- (51) MKP
A61K 47/48 (2006.01) (97) **2459225 ***
A61P 25/16 (2006.01)
- (86) EP2010061162 30.07.2010
(96) 10739358.9 06.06.2012
(87) WO2011012721, 30.07.2010
(97) 2459225, 06.06.2012 en
- (54) CARRIER LINKED PRAMIPEXOLE PRODRUGS
- (71) Ascendis Pharma A/S, Tuborg Boulevard 12, 2900 Hellerup, DK
RAU, Harald, Talstrasse 41 i, 69221 Dossenheim, DE
BARON, Julia, Pleikartsförster Strasse 2, 69124 Heidelberg, DE
HERSEL, Ulrich, Fritz-Frey-Strasse 8, 69121 Heidelberg, DE
-
- (51) MKP
B64C 29/00 (2006.01) (97) **2338790**
- (96) 10075425.8 29.06.2011
(97) 2338790, 29.06.2011 en
- (54) VTOL aircraft with a thrust-to-weight ratio smaller than 1
- (71) Chen, Li Jing, 1E, 58 rue Jacques Kellner, 78380 Bougival, FR
(72) Chen, Li Jing, 1E, 58 rue Jacques Kellner, 78380 Bougival, FR

- (51) MKP
C07D 413/14 (2006.01) (97) **2424865 ***
A61K 31/535 (2006.01)
A61P 3/00 (2006.01)
A61P 5/00 (2006.01)
- (86) US2010033157 30.04.2010
(96) 10721215.1 07.03.2012
(87) WO2010127237, 30.04.2010
(97) 2424865, 07.03.2012 en
- (54) CYCLIC INHIBITORS OF 11BETA-HYDROXYSTEROID DEHYDROGENASE 1
- (71) Boehringer Ingelheim International GmbH, Binger Strasse 173, 55216 Ingelheim am Rhein, DE
Vitae Pharmaceuticals, Inc., 502 West Office Center Drive, Fort Washington, PA 19034, US
- (72) RENZ, Martin, Boehringer Ingelheim GmbH Corporate Patents, Binger Strasse 173., 55216 Ingelheim am Rhein, DE
SCHUELE, Martin, Boehringer Ingelheim GmbH Corporate Patents, Binger Strasse 173., 55216 Ingelheim am Rhein, DE
XU, Zhenrong, 3588 Blair Mill Road Apt. 235-B, Horsham Pennsylvania 19002, US
-
- (51) MKP
G06F 9/50 (2006.01) (97) **2388700**
- (96) 10195072.3 23.11.2011
(97) 2388700, 23.11.2011 en
- (54) Systems and methods for policy-based program configuration
- (71) Kaspersky Lab, ZAO, 10 Geroyev Panfilovtsev Street, Moscow 125363, RU
(72) Zaitsev, Oleg V., c/o KASPERSKY LAB ZAO 10/1 1st Volokolamsky Proezd, 123060, Moscow, RU
-
- (51) MKP
C07D 207/08 (2006.01) (97) **2436767 ***
C12N 15/113 (2010.01)
- (86) JP2011067292 28.07.2011
(96) 11748250.5 04.04.2012
(87) WO2012017919, 28.07.2011
(97) 2436767, 04.04.2012 en
- (54) SINGLE-STRANDED NUCLEIC ACID MOLECULE HAVING NITROGEN-CONTAINING ALICYCLIC SKELETON
- (71) Bonac Corporation, Fukuoka BIO Factory 4F 1488-4 Aikawa-machi, Kurume-shi, Fukuoka 839-0861, JP
(72) OHGI, Tadaaki, c/o BONAC CORPORATION Fukuoka BIO Factory 4F 1488-4, Aikawa-machi-Kurume-shi, Fukuoka 839-0861, JP
HAYASHI, Hirotake, c/o BONAC CORPORATION Fukuoka BIO Factory 4F 1488-4, Aikawa-machi-Kurume-shi, Fukuoka 839-0861, JP
SHIROHZU, Hisao, c/o BONAC CORPORATION Fukuoka BIO Factory 4F 1488-4, Aikawa-machi-Kurume-shi, Fukuoka 839-0861, JP
HAMASAKI, Tomohiro, c/o BONAC CORPORATION Fukuoka BIO Factory 4F 1488-4, Aikawa-machi-Kurume-shi, Fukuoka 839-0861, JP
ITOH, Akihiro, c/o BONAC CORPORATION Fukuoka BIO Factory 4F 1488-4, Aikawa-machi-Kurume-shi, Fukuoka 839-0861, JP
SUZUKI, Hiroshi, c/o BONAC CORPORATION Fukuoka BIO Factory 4F 1488-4, Aikawa-machi-Kurume-shi, Fukuoka 839-0861, JP
-
- (51) MKP
A61K 39/395 (2006.01) (97) **2488202 ***
- (86) US2010052934 15.10.2010
(96) 10824210.8 22.08.2012
(87) WO2011047328, 15.10.2010
(97) 2488202, 22.08.2012 en
- (54) ANTIBODY THERAPEUTICS WITH LOCAL ACTIVITY IN THE DIGESTIVE TRACT
- (71) Avaxia Biologics, Inc., 128 Spring Street, Suite 620, Lexington, MA 02421, US
(72) FOX, Barbara, S., 26 Pemberton Road, Wayland, MA 01778, US
STAFFORD, Douglas, C., 5743 Timber View Court, Fitchburg, WI 53711, US

- (51) MKP
A61K 31/4439 (2006.01) (97) **2421871 ***
C07D 513/04 (2006.01)
A61P 35/00 (2006.01)
- (86) EP2010055295 21.04.2010
(96) 10714018.8 29.02.2012
(87) WO2010122071, 21.04.2010
(97) 2421871, 29.02.2012 en
(54) THIA-TRIAZA-CYCLOPENTAZULENES AS PI3-KINASES INHIBITORS FOR THE TREATMENT OF CANCER
- (71) Boehringer Ingelheim International GmbH, Binger Strasse 173, 55216 Ingelheim am Rhein, DE
(72) VAN DER VEEN, Lars, Boehringer Ingelheim GmbH CD Patents Binger Strasse 173, 55216 Ingelheim am Rhein, DE
IMPAGNATIELLO, Maria, Boehringer Ingelheim GmbH CD Patents Binger Strasse 173, 55216 Ingelheim am Rhein, DE
McCONNELL, Darryl, Boehringer Ingelheim GmbH CD Patents Binger Strasse 173, 55216 Ingelheim am Rhein, DE
SCHNEIDER, Siegfried, Boehringer Ingelheim GmbH CD Patents Binger Strasse 173, 55216 Ingelheim am Rhein, DE
WUNBERG, Tobias, Boehringer Ingelheim GmbH CD Patents Binger Strasse 173, 55216 Ingelheim am Rhein, DE
-
- (51) MKP
C12N 5/16 (2006.01) (97) **2459721 ***
C12N 15/67 (2006.01)
C12N 15/79 (2006.01)
- (86) EP2010060469 20.07.2010
(96) 10740573.0 06.06.2012
(87) WO2011012496, 20.07.2010
(97) 2459721, 06.06.2012 en
(54) IMPROVED HUMAN LONG PENTRAXIN 3 EXPRESSION SYSTEM AND USES THEREOF
- (71) Tecnogen S.p.A., Località La Fagianeria, 81015 Piana di Monte Verna (Caserta), IT
(72) SASSANO, Marica, Via Giotto 7, I-81100 Caserta, IT
ESPOSITO, Adelaide, Via Volturmo 4, I-80028 Grumo Nevano (NA), IT
RIVIECCIO, Vincenzo, Via degli Emigranti 7, I-80059 Torre del Greco (NA), IT
CASSANI, Giovanni, Corso Garibaldi 26, I-27100 Pavia, IT
-
- (51) MKP
C10J 3/46 (2006.01) (97) **2459681 ***
C10B 53/00 (2006.01)
- (86) CA2011050123 01.03.2011
(96) 11750134.6 06.06.2012
(87) WO2011106895, 01.03.2011
(97) 2459681, 06.06.2012 en
(54) CARBON CONVERSION SYSTEM WITH INTEGRATED PROCESSING ZONES
- (71) Plasco Energy Group Inc., 1000 Innovation Drive, Suite 400, Kanata, Ontario K2K 3E7, CA
(72) BACON, Marc, 72 Hartsmere Drive, Stittsville Ontario K2S 2B7, CA
TSANGARIS, Andreas, 248 Madhu Crescent, Ottawa Ontario K2C 4J3, CA
-
- (51) MKP
C12Q 1/68 (2006.01) (97) **2473636 ***
- (86) US2010047721 02.09.2010
(96) 10814513.7 11.07.2012
(87) WO2011028933, 02.09.2010
(97) 2473636, 11.07.2012 en
(54) TYPE 1 INTERFERON DIAGNOSTIC
- (71) MedImmune, LLC, One MedImmune Way, Gaithersburg, MD 20878, US
(72) HIGGS, Brandon, 521 Coral Reef Drive, Gaithersburg, MD 20878, US
ZHU, Wei, 14507 Foolish Pleasure Road, Boyds, MD 20841, US
MOREHOUSE, Chris, 21 Woodmere Circle, Middletown, MD 21769, US
WHITE, Barbara, 3031 Drummond Drive, Finksburg, MD 21048, US
JALLAL, Bahija, 1116 Smokey Quartz, Potomac, MD 20854, US
YAO, Yihong, 14327 Harvest Moon Road, Boyds, MD 20854, US
-
- (51) MKP
C07D 401/12 (2006.01) (97) **2443092 ***
C07D 405/04 (2006.01)
C07D 215/60 (2006.01)
A61P 25/00 (2006.01)
C07D 401/04 (2006.01)
C07D 471/04 (2006.01)
C07D 491/04 (2006.01)
A61K 31/4375 (2006.01)
A61K 31/4704 (2006.01)
- (86) IB2010052349 26.05.2010
(96) 10725875.8 25.04.2012
(87) WO2010146488, 26.05.2010
(97) 2443092, 25.04.2012 en
(54) BICYCLIC AND TRICYCLIC COMPOUNDS AS KAT II INHIBITORS
- (71) Pfizer Inc., 235 East 42nd Street, New York, NY 10017, US
(72) CLAFFEY, Michelle Marie, Pfizer Global Research and Development Eastern Point Road, Groton, Connecticut 06340, US
DOUNAY, Amy Beth, Pfizer Global Research and Development Eastern Point Road, Groton, Connecticut 06340, US
GAN, Xinmin, Pfizer Global Research and Development Eastern Point Road, Groton, Connecticut 06340, US
HAYWARD, Matthew Merrill, Pfizer Global Research and Development Eastern Point Road, Groton, Connecticut 06340, US
RONG, Suobao, Pfizer Global Research and Development Eastern Point Road, Groton, Connecticut 06340, US
TUTTLE, Jamison Bryce, Pfizer Global Research and Development Eastern Point Road, Groton, Connecticut 06340, US
VERHOEST, Patrick Robert, Pfizer Global Research and Development Eastern Point Road, Groton, Connecticut 06340, US
-
- (51) MKP
A61L 31/10 (2006.01) (97) **2493524 ***
A61L 27/30 (2006.01)
A61L 27/34 (2006.01)
A61L 31/08 (2006.01)
A61L 17/00 (2006.01)
- (86) US2010054018 26.10.2010
(96) 10779108.9 05.09.2012
(87) WO2011056530, 26.10.2010
(97) 2493524, 05.09.2012 en
(54) ANTIMICROBIAL COATINGS WITH PREFERRED MICROSTRUCTURE FOR MEDICAL DEVICES
- (71) Ethicon, Inc, U.S. Route 22, Somerville, NJ 08876, US
(72) CICHOCKI, Frank, 3104 Glen Avenue, Easton PA 18045, US
HAMILTON, Michael, (jake), 776 Eves Drive Apt. 5B, Hillsborough NJ 08844, US
MING, Xintian, 75 Shaffer Road, Bridgewater NJ 08807, US
-
- (51) MKP
C07D 403/04 (2006.01) (97) **2483271 ***
A61P 9/00 (2006.01)
C07D 413/04 (2006.01)
A61P 5/00 (2006.01)
A61K 31/551 (2006.01)
C07D 471/14 (2006.01)
A61P 35/00 (2006.01)
A61K 31/554 (2006.01)
C07D 513/14 (2006.01)
A61P 11/00 (2006.01)
A61K 31/553 (2006.01)
C07D 498/14 (2006.01)
A61P 25/00 (2006.01)
- (86) IB2010054329 27.09.2010
(96) 10782688.5 08.08.2012
(87) WO2011036651, 27.09.2010
(97) 2483271, 08.08.2012 en
(54) PYRAZOLINE DIONE DERIVATIVES AS NADPH OXIDASE INHIBITORS
- (71) GenKyoTex SA, Chemin des Aulx 16, 1228 Plan-les-Ouates, CH
(72) PAGE, Patrick, Naxos Les Cyclades 1 Avenue de Genève, F-74160 Saint-Julien-en-Genevois, FR
GAGGINI, Francesca, Rue des Pecheries 14, CH-1205 Geneva, CH
LALEU, Benoît, 519 route du Poirier à l'Ane, F-74160 Collonges-sous-Salève, FR

(51) MKP
A61M 5/315 (2006.01) (97) **2482892 ***
 (86) EP2010064398 29.09.2010
 (96) 10759891.4 08.08.2012
 (87) WO2011039207, 29.09.2010
 (97) 2482892, 08.08.2012 en
 (54) DRIVE MECHANISM FOR A DRUG DELIVERY DEVICE
 (71) Sanofi-Aventis Deutschland GmbH, Brüningstraße 50, 65929 Frankfurt, DE
 (72) VEASEY, Robert, 31 Lonsdale Road Lillington Leamington Spa, Warwickshire CV32 7EP, GB
 BILTON, Simon Lewis, Flat 3 15 Clarendon Square Leamington Spa, Warwickshire CV32 5QT, GB
 JONES, Christopher, The Old Thatch Grafton Tewkesbury, Gloucestershire GL20 7AT, GB
 KOUYOUJIAN, Garen, 2A Plymouth Place Leamington Spa, Warwickshire CV31 1HN, GB
 MACDONALD, Catherine Anne, 23 Goggsbridge Lane Warwick, Warwickshire CV34 6JE, GB

(51) MKP
F16J 15/02 (2006.01) (97) **2458251**
F16L 13/14 (2006.01)
F16L 37/092 (2006.01)
F16L 41/08 (2006.01)
F16L 23/16 (2006.01)
 (96) 11190804.2 30.05.2012
 (97) 2458251, 30.05.2012 en
 (54) A composite sliding gasket for high-pressure joints
 (71) Coes Company Srl, Via Caduti del Lavoro, 9/A, 20096 Piol Tello (MI), IT
 (72) Bizzarrini, Giuseppe, COES Company Srl Via Caduti del lavoro, 9/A, 20096 Pioltello (MI), IT

(51) MKP
A61K 31/335 (2006.01) (97) **2424523 ***
A61K 9/12 (2006.01)
 (86) GB2010050672 23.04.2010
 (96) 10715337.1 07.03.2012
 (87) WO2010122356, 23.04.2010
 (97) 2424523, 07.03.2012 en
 (54) SUBLINGUAL SPRAY FORMULATION COMPRISING DIHYDROARTEMESININ
 (71) Londonpharma Ltd., Norwich Biocubator Norwich Research Park, Colney Lane, Norwich NR4 7UH, GB
 (72) ROSS, Calvin John, "-", Deceased, GB

(51) MKP
A61K 39/155 (2006.01) (97) **2445526 ***
C07K 14/135 (2006.01)
 (86) EP2010059008 24.06.2010
 (96) 10724879.1 02.05.2012
 (87) WO2010149745, 24.06.2010
 (97) 2445526, 02.05.2012 en
 (54) RECOMBINANT RSV ANTIGENS
 (71) GlaxoSmithKline Biologicals S.A., rue de l'Institut, 89, 1330 Rixensart, BE
 ID Biomedical Corporation of Quebec, 525 Cartier Boulevard West, Laval, QC H7V 3S8, CA
 (72) BAUDOUX, Guy Jean Marie Fernand Pierre, GlaxoSmithKline Biologicals s.a. rue de l'Institut 89, B-1330 Rixensart, BE
 BLAIS, Normand, GlaxoSmithKline Biologicals Laval 525 Cartier Boulevard West, Laval, Quebec H7V 3S8, CA
 CYR, Sonya L, GlaxoSmithKline Biologicals Laval 525 Cartier Boulevard West, Laval, Quebec H7V 3S8, CA
 RHEAULT, Patrick, GlaxoSmithKline Biologicals Laval 525 Cartier Boulevard West, Laval, Quebec H7V 3S8, CA
 RUELLE, Jean Louis, GlaxoSmithKline Biologicals s.a. rue de l'Institut 89, B-1330 Rixensart, BE

(51) MKP
F03G 6/00 (2006.01) (97) **2454480 ***
 (86) US2010041497 09.07.2010
 (96) 10736908.4 23.05.2012
 (87) WO2011008644, 09.07.2010
 (97) 2454480, 23.05.2012 en
 (54) POWER GENERATION SYSTEM
 (71) Global Power Enterprises, LLC, 4449 N. 38th St., Arlington, VA 22207, US
 (72) MUCHOW, David, J., 4449 N. 38th Street, Arlington VA 22207, US

(51) MKP
E05D 15/08 (2006.01) (97) **2476839**
E05D 15/06 (2006.01)
 (96) 11000194.8 18.07.2012
 (97) 2476839, 18.07.2012 de
 (54) Ground rail track for a sliding wing system
 (71) Sunflex Aluminiumsysteme GmbH, Im Ruttenberge 12, 57482 Wenden-Gerlingen, DE
 (72) Schneider, Ernst Josef, Pirschweg 2 b, D-57482 Wenden, DE

(51) MKP
B62D 1/06 (2006.01) (97) **2499036 ***
 (86) EP2010067193 10.11.2010
 (96) 10778631.1 19.09.2012
 (87) WO2011058049, 10.11.2010
 (97) 2499036, 19.09.2012 de
 (54) METHOD FOR APPLYING LEATHER TO VEHICLE INTERIOR PARTS
 (71) Wollsdorf Leder Schmidt & Co. Ges.m.b.H., Wollsdorf 80, 8181 Wollsdorf, AT
 (72) KRAUS-GÜNTNER, Elisabeth, Peesen 90, A-8160 Weiz, AT

(51) MKP
A61K 31/437 (2006.01) (97) **2430013 ***
C07D 401/14 (2006.01)
A61K 31/52 (2006.01)
C07D 403/04 (2006.01)
A61K 31/53 (2006.01)
C07D 403/14 (2006.01)
A61P 35/00 (2006.01)
C07D 471/04 (2006.01)
C07D 519/00 (2006.01)
C07D 487/04 (2006.01)
A61K 31/506 (2006.01)
 (86) US2010034596 12.05.2010
 (96) 10719514.1 21.03.2012
 (87) WO2010132598, 12.05.2010
 (97) 2430013, 21.03.2012 en
 (54) HETEROARYL COMPOUNDS AS PIKK INHIBITORS
 (71) Amgen, Inc, One Amgen Center Drive, Thousand Oaks, CA 91320-1799, US
 (72) COATS, James, R., 418 Oak Street, Somerville MA 02143, US
 YI, Shuyan, 18 Springfield St. Apt. 2, Cambridge MA 02139-1330, US
 COPELAND, Katrina, W., 17 Oakridge Road, Sudbury MA 01776, US
 NORMAN, Mark, 130 Venus Street, Thousand Oaks CA 91360, US
 HUANG, Hongbing, 11 Rockville Avenue, Lexington MA 02421, US
 STEC, Markian, 11210 Shadyridge Drive, Moorpark CA 93021, US
 LA, Daniel, 124 Park Street 3, Brookline MA 02446, US
 PETERSON, Emily, A., 60 Fairfield Street Apt. 3, Cambridge MA 02140, US
 BODE, Christiane, 156 3rd Street, Cambridge, MA 02141, US
 LEWIS, Richard, 722 Grove Street, Framingham MA 01701, US
 GRACEFFA, Russell, 2 Wingate Street, Hampton NH 03842, US
 CHOQUETTE, Deborah, 17 Blakely Road, Medford, MA 02155, US
 STELLWAGEN, John, 12 Elnew Avenue, Beverly MA 01915, US
 CHENG, Alan, C., 334 Harvard Street A6, Cambridge, MA 02139, US
 POTASHMAN, Michele, 19 Clary Street, Cambridge MA 02139, US
 BOEZIO, Alessandro, 54 Myrtle Street Unit 1, Somerville, MA 02145, US
 LIAO, Hongyu, 2342 Gillingham Circle, Thousand Oaks CA 91362, US

- (51) MKP
D01F 4/02 (2006.01) (97) **2483460 ***
D01D 5/00 (2006.01)
- (86) US2010050565 28.09.2010
(96) 10819652.8 08.08.2012
(87) WO2011038401, 28.09.2010
(97) 2483460, 08.08.2012 en
(54) DRAWN SILK EGEL FIBERS AND METHODS OF MAKING SAME
(71) Trustees Of Tufts College, Ballou Hall, Medford, MA 02155, US
(72) LO, Tim Jia-Ching, 83 Bristol Road Apt 1, Medford MA 02155, US
LEISK, Gary G, 1212 Evergreen Drive, Wilmington Massachusetts 01887, US
KAPLAN, David L, 46 Pond Street, Concord Massachusetts 01742, US
-
- (51) MKP
A61F 2/60 (2006.01) (97) **2496188 ***
- (86) US2010055793 08.11.2010
(96) 10829220.2 12.09.2012
(87) WO2011057177, 08.11.2010
(97) 2496188, 12.09.2012 en
(54) REPLACEABLE FAIRING FOR PROSTHETIC LIMB OR BRACE
(71) Bespoke Innovations, Inc., 321 Pacific Ave., 3rd Floor, San Francisco, CA 94111, US
(72) SUMMIT, Scott, 354 Panoramic Highway, Mill Valley, CA 94941, US
TRAUNER, Kenneth, B., 2684 Green Street, San Francisco, CA 94123, US
-
- (51) MKP
C07D 471/04 (2006.01) (97) **2462142 ***
C07D 487/04 (2006.01)
C07D 498/04 (2006.01)
C07D 513/04 (2006.01)
A61K 31/33 (2006.01)
A61P 25/00 (2006.01)
- (86) EP2010004749 03.08.2010
(96) 10745141.1 13.06.2012
(87) WO2011015343, 03.08.2010
(97) 2462142, 13.06.2012 en
(54) METABOTROPIC GLUTAMATE RECEPTOR MODULATORS
(71) Merz Pharma GmbH & Co. KGaA, Eckenheimer Landstrasse 100, 60318 Frankfurt am Main, DE
(72) HENRICH, Markus, Am Kreuzberg 1, 35516 M nzenberg, DE
WEIL, Tanja, 206 Ocean Drive 04/07 The Berth, 098627 Singapore, SG
HECHENBERGER, Mirko, Kapellenstr. 24, 65193 Wiesbaden, DE
MÜLLER, Sibylle, Mainzer Str. 6a 55263, Wackernheim, DE
KAUSS, Valerjans, Deglava 108/2-36, LV- 1082 Riga, LV
ZEMRIBO, Ronalds, Puku 3, LV-2008 Jurmala, LV
ERDMANE, Elina, Saikavas 5, LV-1019 Riga, LV
SMITS, Gints, Tiruma str. 8-12 LV-4033 Salacgriva, Limbazu District, LV
-
- (51) MKP
C11B 3/00 (2006.01) (97) **2494015 ***
C12N 9/16 (2006.01)
- (86) EP2010066234 27.10.2010
(96) 10774185.2 05.09.2012
(87) WO2011051322, 27.10.2010
(97) 2494015, 05.09.2012 de
(54) CLONING, EXPRESSION AND USE OF ACID PHOSPHOLIPASES
(71) AB Enzymes GmbH, Feldbergstrasse 78, 64293 Darmstadt, DE
(72) NGUYEN, Quoc, Khanh, Am Tannenber 9, 64385 Reichelsheim, DE
TITZE, Kornelia, Treppenstraße 9, 64367 Mühlthal, DE
SCHWARZ, Tatiana, Bahnstraße 169b, 64390 Erzhausen, DE
PALADINO, Silvia, Kreiswaldweg 18A, 64646 Heppenheim, DE
MARSCHNER, Volker, An der Laut 44, 64404 Bickenbach, DE
LORENZ, Patrick, Nibelungenstrasse 91, 64653 Lorsch, DE
-
- (51) MKP
C09K 11/07 (2006.01) (97) **2459674 ***
F42B 12/36 (2006.01)
F42B 12/40 (2006.01)
F42B 12/46 (2006.01)
- (86) US2010043334 27.07.2010
(96) 10740085.5 06.06.2012
(87) WO2011014484, 27.07.2010
(97) 2459674, 06.06.2012 en
(54) COMBINED THERMAL AND CHEMILUMINESCENT REACTION SYSTEM
(71) Cyalume Technologies, Inc, 96 Windsor Street, West Springfield MA 01089, US
(72) CRANOR, Earl, 24 Lincoln Park, Longmaeadow MA 01106, US
JACOB, Linda, 98 Maple Vale Drive, Woodbridge, CT 06525, US
-
- (51) MKP
B29C 49/64 (2006.01) (97) **2480390 ***
H05B 3/00 (2006.01)
F21V 7/00 (2006.01)
B29B 13/02 (2006.01)
B29C 49/68 (2006.01)
- (86) IB2010054062 09.09.2010
(96) 10760068.6 01.08.2012
(87) WO2011036593, 09.09.2010
(97) 2480390, 01.08.2012 en
(54) HEATING INSTALLATION AND REFLECTING DEVICE FOR A HEATING INSTALLATION.
(71) Speziallampenfabrik Dr. Fischer GmbH, Nikolaus-Otto-Strasse, 65582 Diez, DE
(72) MONTEIX, Serge, c/o PHILIPS IP&S - NL High Tech Campus 44, NL-5656 AE Eindhoven, NL
-
- (51) MKP
G01S 3/32 (2006.01) (97) **2267474**
H04B 7/185 (2006.01)
- (96) 10164470.6 29.12.2010
(97) 2267474, 29.12.2010 en
(54) Monopulse receiver and method
(71) Thrane & Thrane A/s, Lundtoftegardsvej 93D, 2800 Kongens Lyngby, DK
(72) Gothelf, Ulrich Vesterager, Brydegårdsvej 4, 2760 Måløv, DK
Schmelling, René, Ravnekærsevej 5, 2870 Dyssegård, DK
-
- (51) MKP
A61K 33/00 (2006.01) (97) **2493482 ***
A61P 3/00 (2006.01)
- (86) EP2010066288 27.10.2010
(96) 10776328.6 05.09.2012
(87) WO2011051357, 27.10.2010
(97) 2493482, 05.09.2012 en
(54) THERAPEUTIC GAS FOR THE TREATMENT OF MITOCHONDRIAL DISORDERS
(71) Cellgym Technologies GmbH, Knesebeckstrasse 68/69, 10623 Berlin, DE
(72) Cellgym Technologies GmbH, Knesebeckstrasse 68/69, 10623 Berlin, DE
-
- (51) MKP
C07K 16/24 (2006.01) (97) **2435481 ***
A61P 11/06 (2006.01)
C07K 16/46 (2006.01)
- (86) EP2010057228 26.05.2010
(96) 10722076.6 04.04.2012
(87) WO2010136481, 26.05.2010
(97) 2435481, 04.04.2012 en
(54) IL-13 BINDING PROTEIN
(71) Glaxo Group Limited, Glaxo Wellcome House Berkeley Avenue Greenford, Middlesex UB6 0NN, GB
(72) ASHMAN, Claire, GlaxoSmithKline Gunnels Wood Road, Stevenage Hertfordshire SG1 2NY, GB
ELLIS, Jonathan, Henry, GlaxoSmithKline Gunnels Wood Road, Stevenage Hertfordshire SG1 2NY, GB
HAMBLIN, Paul Andrew, GlaxoSmithKline Gunnels Wood Road, Stevenage Hertfordshire SG1 2NY, GB
LEWIS, Alan Peter, GlaxoSmithKline Gunnels Wood Road, Stevenage Hertfordshire SG1 2NY, GB
ORECCHIA, Martin, Anibal, GlaxoSmithKline Gunnels Wood Road, Stevenage Hertfordshire SG1 2NY, GB

- (51) MKP
A61P 11/10 (2006.01) (97) **2464346 ***
A61K 9/00 (2006.01)
A61P 11/00 (2006.01)
A61K 31/198 (2006.01)
A61K 33/06 (2006.01)
A61K 33/14 (2006.01)
- (86) US2011049342 26.08.2011
(96) 11757714.8 20.06.2012
(87) WO2012030647, 26.08.2011
(97) 2464346, 20.06.2012 en
(54) TREATMENT OF CYSTIC FIBROSIS USING CALCIUM LACTATE, LEUCINE AND SODIUM CHLORIDE IN A RESPIRAPLE DRY POWDER
- (71) Pulmatrix, Inc., 99 Hayden Avenue, Lexington, MA 02421, US
(72) LIPP, Michael M., 45A Flanagan Drive, Framingham Massachusetts 01701, US
CLARKE, Robert W., 10 Knollwood Road, Medfield Massachusetts 02052, US
HAVA, David L., 68 S. Main Street 2, Natick Massachusetts 01760, US
-
- (51) MKP
E06B 3/42 (2006.01) (97) **2273053**
E05D 15/06 (2006.01)
- (96) 10164505.9 12.01.2011
(97) 2273053, 12.01.2011 fr
(54) Schiebetür mit Entgleisungsschutz
(71) Saint-Gobain Seva, 43 Rue du Pont de Fer, 71105 Chalon sur Saone, FR
(72) Piponnier, Nicolas, 6 rue des Tonneliers, 71100 Chalon sur Saone, FR
-
- (51) MKP
C07D 417/14 (2006.01) (97) **2435431 ***
A61K 31/541 (2006.01)
- (86) EP2010003024 18.05.2010
(96) 10721001.5 04.04.2012
(87) WO2010136138, 18.05.2010
(97) 2435431, 04.04.2012 de
(54) SUBSTITUTED PIPERIDINES
(71) Bayer Pharma Aktiengesellschaft, Müllerstrasse 178, 13353 Berlin, DE
(72) GERDES, Christoph, Düsseldorf Str. 75, 51063 Köln, DE
GNOTH, Mark, Jean, Am Hang 53, 40822 Mettmann, DE
HEIMBACH, Dirk, Schanzenstrasse 125, 40549 Düsseldorf, DE
GERICKE, Kersten, Matthias, Funckstraße 54, 42115 Wuppertal, DE
RÖHRIG, Susanne, Dietrich-Bonhoeffer-Strasse 66, 40724 Hilden, DE
JESKE, Mario, Schneebacher Weg 20, 42699 Solingen, DE
CANCHO GRANDE, Yolanda, Christian-Hess Str. 79, 51373 Leverkusen, DE
BUCHMÜLLER, Anja, Baderweg 72a, 45259 Essen, DE
ZIMMERMANN, Katja, Bockumer Str. 370b, 40489 Düsseldorf, DE
BENDER, Eckhard, Gudrunstr. 6 Wohnung 9, 40764 Langenfeld, DE
-
- (51) MKP
A61K 31/05 (2006.01) (97) **2482809 ***
A61K 36/185 (2006.01)
A61K 36/77 (2006.01)
A61K 36/48 (2006.01)
A61K 36/28 (2006.01)
- (86) US2010051080 01.10.2010
(96) 10762844.8 08.08.2012
(87) WO2011041648, 01.10.2010
(97) 2482809, 08.08.2012 en
(54) COMPOSITIONS COMPRISING AN ANTI-INFLAMMATORY BLEND
- (71) Johnson & Johnson Consumer Companies, Inc., Grandview Road, Skillman, NJ 08558, US
(72) KAUR, Simarna, 1032 Shadowlawn Drive, Green Brook NJ 08812, US
SOUTHALL, Michael, 200 Berwyn Place, Lawrenceville NJ 08648, US
TUCKER-SAMARAS, Samantha, D., 71 West Valley Brook Road, Long Valley NJ 07853, US
MAHMOOD, Khalid, 23 Pheasant Run, South Hadley, MA 01075, US
SALIOU, Claude, 47 Berkeley Circle, Basking Ridge, NJ 07920, US
-
- (51) MKP
C07D 417/14 (2006.01) (97) **2445908 ***
A61K 31/4245 (2006.01)
A61P 3/10 (2006.01)
A61K 31/427 (2006.01)
C07D 417/12 (2006.01)
- (86) IN2010000426 21.06.2010
(96) 10747955.2 02.05.2012
(87) WO2010150280, 21.06.2010
(97) 2445908, 02.05.2012 en
(54) DISUBSTITUTED BENZAMIDE DERIVATIVES AS GLUCOKINASE (GK) ACTIVATORS
- (71) Cadila Healthcare Limited, Zydus Tower Satellite Cross Roads, Ahmedabad 380 015 Gujarat, IN
(72) KHARUL, Rajendra, Cadila Healthcare Limited Zydus Tower Satellite Cross Road, Ahmedabad 380 015 Gujarat, IN
-
- (51) MKP
A61K 31/437 (2006.01) (97) **2493888 ***
A61K 31/553 (2006.01)
A61K 31/4375 (2006.01)
A61K 31/5365 (2006.01)
C07D 487/04 (2006.01)
A61K 31/55 (2006.01)
A61K 31/4985 (2006.01)
C07D 471/04 (2006.01)
A61K 31/551 (2006.01)
C07D 519/00 (2006.01)
A61P 5/50 (2006.01)
- (86) US2010054880 29.10.2010
(96) 10830519.4 05.09.2012
(87) WO2011059839, 29.10.2010
(97) 2493888, 05.09.2012 en
(54) BICYCLIC PYRIDINES AND ANALOGS AS SIRTUIN MODULATORS
- (71) Sirtris Pharmaceuticals, Inc., 200 Technology Square, Suite 300, Cambridge, MA 02139, US
(72) NG, Pui, Yee, c/o Sirtris Pharmaceuticals Inc. 200 Technology Square Suite 300, Cambridge, MA 02139, US
BLUM, Charles, c/o Sirtris Pharmaceuticals Inc. 200 Technology Square Suite 300, Cambridge, MA 02139, US
MCPHERSON, Lauren, c/o Sirtris Pharmaceuticals Inc. 200 Technology Square Suite 300, Cambridge, MA 02139, US
PERNI, Robert, B., c/o Sirtris Pharmaceuticals Inc. 200 Technology Square Suite 300, Cambridge, MA 02139, US
VU, Chi, B., c/o Sirtris Pharmaceuticals Inc. 200 Technology Square Suite 300, Cambridge, MA 02139, US
AHMED, Mohammed, Mahmood, c/o GlaxoSmithKline R&D China Singapore Research Centre Biopolis At One-North 11 Biopolis Way; The Helios 06-10/11, Singapore 138667, SG
DISCH, Jeremy, S., c/o Sirtris Pharmaceuticals Inc. 200 Technology Square Suite 300, Cambridge, MA 02139, US
-
- (51) MKP
A61K 31/7076 (2006.01) (97) **2424546 ***
A61P 27/02 (2006.01)
C07H 19/167 (2006.01)
- (86) US2010033112 30.04.2010
(96) 10770402.5 07.03.2012
(87) WO2010127210, 30.04.2010
(97) 2424546, 07.03.2012 en
(54) METHOD OF REDUCING INTRAOCULAR PRESSURE IN HUMANS
- (71) Inotek Pharmaceuticals Corporation, 33 Hayden Avenue, Second Floor, Lexington, MA 02421, US
(72) BARMAN, Shikha, 2 Bonnievale Drive, Bedford MA 01730, US
BAUMGARTNER, Rudolf, A., 22 Munnings Drive, Sudbury MA 01776-1221, US
-

- (51) MKP
A61K 47/48 (2006.01) (97) **2485712 ***
A61K 31/519 (2006.01)
A61K 9/00 (2006.01)
A61K 9/06 (2006.01)
(86) EP2010064880 06.10.2010
(96) 10768897.0 15.08.2012
(87) WO2011042453, 06.10.2010
(97) 2485712, 15.08.2012 en
(54) SUBCUTANEOUS PALIPERIDONE COMPOSITION
(71) Ascendis Pharma A/S, Tuborg Boulevard 12, 2900 Hellerup, DK
(72) SPROGØE, Kennett, 1982 West Bayshore Road 327, CA 94303, US
HERSEL, Ulrich, Fritz-Frey-Strasse 8, 69121 Heidelberg, DE
RAU, Harald, Talstraße 41i, 69221 Dossenheim, DE
MAITRO, Guillaume, Rheingoldstr. 157, 68199 Mannheim, DE
WEGGE, Thomas, Kurfürstenanlage 45, 69115 Heidelberg, DE

- (51) MKP
C07J 71/00 (2006.01) (97) **2475676 ***
A61P 5/44 (2006.01)
A61K 31/58 (2006.01)
(86) EP2010005366 01.09.2010
(96) 10754274.8 18.07.2012
(87) WO2011029547, 01.09.2010
(97) 2475676, 18.07.2012 en
(54) Pregnane derivatives condensed in the 16,17 position with an N-substituted isoxazolidine ring as anti-inflammatory agents
(71) Chiesi Farmaceutici S.p.A., Via Palermo, 26/A, 43100 Parma, IT
(72) ARMANI, Elisabetta, Chiesi Farmaceutici S.p.A. Via Palermo 26/A, I-43100 Parma, IT
GHIDINI, Eleonora, Chiese Farmaceutici S.p.A. Via Palermo 26/A, I-43100 Parma, IT
PERETTO, Ilaria, Chiesi Farmaceutici S.p.A. Via Palermo 26/A, I-43100 Parma, IT
VIRDIS, Andrea, Chiesi Farmaceutici S.p.A. Via Palermo 26/A, I-43100 Parma, IT

- (51) MKP
C07D 265/32 (2006.01) (97) **2424847 ***
A61K 31/5375 (2006.01)
A61K 31/5377 (2006.01)
A61P 7/02 (2006.01)
C07D 413/12 (2006.01)
C07D 413/14 (2006.01)
(86) CA2010000656 28.04.2010
(96) 10769190.9 07.03.2012
(87) WO2010124385, 28.04.2010
(97) 2424847, 07.03.2012 en
(54) PROCESSES FOR THE PREPARATION OF RIVAROXABAN AND INTERMEDIATES THEREOF
(71) Apotex Pharmachem Inc., 34 Spalding Drive, Brantford, Ontario N3T 6B8, CA
(72) BODHURI, Prabhudas, 28 Hansford Drive, Brantford Ontario N3S 0B6, CA
WEERATUNGA, Gamini, 388 Valridge Drive, Ancaster Ontario L9G 0B1, CA

- (51) MKP
H04W 88/08 (2009.01) (97) **2461642 ***
H04B 7/26 (2006.01)
H04W 24/00 (2009.01)
(86) CN2010075592 30.07.2010
(96) 10803920.7 06.06.2012
(87) WO2011012087, 30.07.2010
(97) 2461642, 06.06.2012 en
(54) METHOD, DEVICE AND SYSTEM FOR TRANSMITTING SOUNDING REFERENCE SIGNALS
(71) China Academy of Telecommunications Technology, 40, Xueyuan Road, Haidian District Beijing 100191, CN
(72) PENG, Ying, No.40 Xueyuan Road Haidian District, Beijing 100083, CN
GAO, Qiubin, No.40 Xueyuan Road Haidian District, Beijing 100083, CN
YANG, Dingcheng, No.40 Xueyuan Road Haidian District, Beijing 100083, CN
MIAO, Deshan, No.40 Xueyuan Road Haidian District, Beijing 100083, CN

- (51) MKP
A61K 31/56 (2006.01) (97) **2490694 ***
A61P 9/00 (2006.01)
(86) EP2010065589 18.10.2010
(96) 10807525.0 29.08.2012
(87) WO2011048033, 18.10.2010
(97) 2490694, 29.08.2012 en
(54) METHODS AND SYSTEMS FOR PHARMACOGENOMIC TREATMENT OF CARDIOVASCULAR CONDITIONS
(71) Rostaquo S.p.A., Via Pontina, km 30, 400, 00040 Pomezia, (RM), IT
(72) BIANCHI, Giuseppe, Piazza Adigrat 4, I-20133 Milano, IT
FERRARI, Patrizia, Via Gasparotto 57/A, I-21100 Varese, IT
MACCIARDI, Fabio, Via Disciplini 18, I-20123 Milano, IT

- (51) MKP
C07K 16/28 (2006.01) (97) **2403878 ***
(86) US2010026315 05.03.2010
(96) 10708470.9 11.01.2012
(87) WO2010102175, 05.03.2010
(97) 2403878, 11.01.2012 en
(54) FULLY HUMAN ANTIBODIES SPECIFIC TO CADM1
(71) Oxford Biotherapeutics Ltd., 94A Milton Park, Abingdon, Oxon OX14 4RY, GB
Medarex, Inc., Route 206 & Province Line Road, Princeton, NJ 08540, US
(72) TERRETT, Jonathan, Alexander, Medarex Inc. 521 Cottonwood Drive, Milpitas, CA 95035, US
LEBLANC, Heidi, Medarex Inc. 521 Cottonwood Drive, Milpitas, CA 95035, US
HUANG, Haichun, Medarex Inc. 521 Cottonwood Drive, Milpitas, CA 95035, US
MEADDOUGH, Erika, Medarex Inc. 521 Cottonwood Drive, Milpitas, CA 95035, US
PAN, Chin, Medarex Inc. 521 Cottonwood Drive, Milpitas, CA 95035, US
CHEN, Bingliang, Medarex Inc. 521 Cottonwood Drive, Milpitas, CA 95035, US
RAO-NAIK, Chetana, Medarex Inc. 521 Cottonwood Drive, Milpitas, CA 95035, US

- (51) MKP
E05F 15/14 (2006.01) (97) **2241709**
E05F 17/00 (2006.01)
(86) 10380056.1 20.10.2010
(97) 2241709, 20.10.2010 en
(54) Simultaneous displacement device for sliding doors
(71) KLEIN IBÉRICA, S.A., Polígono Industrial Can Cuyás Ctra. N-150 a Sabadell, Km.1 Edificio Klein, 08110 Montcada i Reixac (Barcelona), ES
(72) Tarrega Lloret, Miguel Angel, Nena Casas, 20-22, 08017 Barcelona, ES

- (51) MKP
A01P 3/00 (2006.01) (97) **2451275 ***
A01N 43/50 (2006.01)
A01N 47/04 (2006.01)
(86) JP2010061736 06.07.2010
(96) 10734828.6 16.05.2012
(87) WO2011004901, 06.07.2010
(97) 2451275, 16.05.2012 en
(54) AGRICULTURAL OR HORTICULTURAL FUNGICIDE COMPOSITION AND ITS USE FOR CONTROLLING PLANT PATHOGENS
(71) Ishihara Sangyo Kaisha, Ltd., 3-15 Edobori 1-chome Nishi-ku, Osaka-shi, Osaka 550-0002, JP
(72) SUGIMOTO, Koji, c/o Ishihara Sangyo Kaisha, Ltd. Chuo Kenkyusho 3-1, Nishi-shibukawa 2-chome, Kusatsu-shi Shiga 525-0025, JP

- (51) MKP
C07D 403/04 (2006.01) (97) **2451792 ***
C07D 487/04 (2006.01)
C07D 253/06 (2006.01)
- (86) US2010041278 08.07.2010
(96) 10797821.5 16.05.2012
(87) WO2011005909, 08.07.2010
(97) 2451792, 16.05.2012 en
- (54) PROCESS FOR SUBSTITUTED 3-AMINO-5-OXO-4,5-DIHYDRO-[1,2,4]TRIAZINES
- (71) OSI Pharmaceuticals, LLC, 1 Bioscience Park Drive, Farmingdale, NY 11735, US
- (72) DONG, Hanqing, OSI Pharmaceuticals Inc. Broadhollow Bioscience Park 1 Bioscience Park Drive, Farmingdale, NY 11735, US
MAO, Yunyu, OSI Pharmaceuticals Inc. Broadhollow Bioscience Park 1 Bioscience Park Drive, Farmingdale, NY 11735, US
MULVIHILL, Kristen, Michelle, OSI Pharmaceuticals Inc. Broadhollow Bioscience Park 1 Bioscience Park Drive, Farmingdale, NY 11735, US
RECHKA, Josef, A., OSI Pharmaceuticals Inc. Broadhollow Bioscience Park 1 Bioscience Park Drive, Farmingdale, NY 11735, US
WERNER, Douglas, S., OSI Pharmaceuticals Inc. Broadhollow Bioscience Park 1 Bioscience Park Drive, Farmingdale, NY 11735, US

- (51) MKP
A61K 38/00 (2006.01) (97) **2416796 ***
- (86) US2010029782 02.04.2010
(96) 10762243.3 15.02.2012
(87) WO2010117901, 02.04.2010
(97) 2416796, 15.02.2012 en
- (54) Modified dnase compositions and methods of use thereof
- (71) Bio-Rad Laboratories, Inc., 1000 Alfred Nobel Drive, Hercules, CA 94547, US
- (72) RAMASWAMY, Gayathri, 31371 Mackinaw Street, Union City California 94587, US
WANG, Yan, 211 Juanita Way, San Francisco California 94127, US

- (51) MKP
A61K 31/4418 (2006.01) (97) **2459193 ***
A61P 7/02 (2006.01)
A61P 9/10 (2006.01)
- (86) EP2010060615 22.07.2010
(96) 10735284.1 06.06.2012
(87) WO2011012527, 22.07.2010
(97) 2459193, 06.06.2012 en
- (54) OTAMIXABAN FOR TREATMENT OF ELDERLY AND RENAL IMPAIRED NON-ST ELEVATION MYOCARDIAL INFARCTION PATIENTS
- (71) SANOFI, 54 rue La Boétie, 75008 Paris, FR
- (72) STECHL, Jens, c/o Sanofi-Aventis Deutschland GmbH, 65926 Frankfurt am Main, DE
MORYUSEF, Angèle, c/o Sanofi-Aventis 1041 Route 202-206 Mail Code: BWD-303A, Bridgewater, New Jersey 08807, US
GAUDIN, Christophe, c/o Sanofi-Aventis Département Brevets 174 Avenue de France, F-75013 Paris, FR
YTHIER-MOURY, Pascale, c/o Sanofi-Aventis Département Brevets 174 Avenue de France, F-75013 Paris, FR

- (51) MKP
C07D 417/08 (2006.01) (97) **2459547 ***
C07D 417/14 (2006.01)
A01N 43/78 (2006.01)
C07D 409/08 (2006.01)
C07D 401/08 (2006.01)
C07D 405/08 (2006.01)
- (86) GB2010001449 29.07.2010
(96) 10739389.4 06.06.2012
(87) WO2011012862, 29.07.2010
(97) 2459547, 06.06.2012 en
- (54) HERBICIDALLY ACTIVE HETEROARYL-SUBSTITUTED CYCLIC DIONES OR DERIVATIVES THEREOF
- (71) Syngenta Limited, European Regional Centre Priestley Road Surrey Research Park, Guildford Surrey GU2 7YH, GB
- (72) JEANMART, Stephane André Marie, c/o Syngenta Crop Protection Muenchwilten AG Schaffhauserstrasse, CH-4332 Stein, CH
LONGSTAFF, Adrian, c/o Syngenta Limited Jealott's Hill International Research Centre Bracknell, Berkshire RG42 6EY, GB
MATHEWS, Christopher John, c/o Syngenta Limited Jealott's Hill International Research Centre Bracknell, Berkshire RG42 6EY, GB
RUSSELL, Claire Janet, c/o Syngenta Limited Jealott's Hill International Research Centre Bracknell, Berkshire RG42 6EY, GB
VINER, Russell Colin, c/o Syngenta Limited Jealott's Hill International Research Centre Bracknell, Berkshire RG42 6EY, GB
WOOD, Frances Kathryn, c/o Syngenta Limited Jealott's Hill International Research Centre Bracknell, Berkshire RG42 6EY, GB

- (51) MKP
D04B 21/16 (2006.01) (97) **2280105**
- (86) 10168222.7 02.02.2011
(97) 2280105, 02.02.2011 en
- (54) Fabric for binding tape, and binding tape
- (71) Sumitomo Wiring Systems, Ltd., 1-14, Nishisuehiro-cho, Yokkaichi-shi, Mie 510-8503, JP
- (72) Doi, Masayuki, Sumitomo Wiring Systems, Ltd. 1-14, Nishisuehiro-c, Yokkaichi-shi Mie 510-8503, JP
Morii, Toshitsugu, Sumitomo Wiring Systems, Ltd. 1-14, Nishisuehiro-c, Yokkaichi-shi Mie 510-8503, JP
Tanase, Tsutomu, Tohkai Thermo Co., Ltd. 4-53, Ohi, Ogaki-City Gifu 503-0836, JP

- (51) MKP
A61P 27/02 (2006.01) (97) **2435075 ***
C07K 14/715 (2006.01)
C07K 16/22 (2006.01)
A61K 39/395 (2006.01)
C07K 16/24 (2006.01)
- (86) EP2010057246 26.05.2010
(96) 10721160.9 04.04.2012
(87) WO2010136492, 26.05.2010
(97) 2435075, 04.04.2012 en
- (54) ANTIGEN-BINDING PROTEINS
- (71) Glaxo Group Limited, Glaxo Wellcome House Berkeley Avenue Greenford, Middlesex UB6 0NN, GB
- (72) ADAMSON, Peter, GlaxoSmithKline Gunnels Wood Road, Stevenage Hertfordshire SG1 2NY, GB
ERTL, Peter, Franz, GlaxoSmithKline Gunnels Wood Road, Stevenage Hertfordshire SG1 2NY, GB
GERMASCHESKI, Volker, GlaxoSmithKline Gunnels Wood Road, Stevenage Hertfordshire SG1 2NY, GB
GOUGH, Gerald, Wayne, GlaxoSmithKline Gunnels Wood Road, Stevenage Hertfordshire SG1 2NY, GB
STEWART, Michael, GlaxoSmithKline Gunnels Wood Road, Stevenage Hertfordshire SG1 2NY, GB

- (51) MKP
C07D 409/14 (2006.01) (97) **2477983 ***
C07D 451/02 (2006.01)
C07D 451/06 (2006.01)
A61K 31/4439 (2006.01)
A61P 3/00 (2006.01)
- (86) GB2010001732 14.09.2010
(96) 10755215.0 25.07.2012
(87) WO2011033255, 14.09.2010
(97) 2477983, 25.07.2012 en
(54) (4-PHENYL-PIPERIDIN-1-YL)-[5-(1H-PYRAZOL-4-YL)-THIOPHEN-3-YL]-METHANONE COMPOUNDS AND THEIR USE
- (71) THE UNIVERSITY OF EDINBURGH, Old College, South Bridge Edinburgh EH8 9YL, GB
(72) WEBSTER, Scott, Peter, Endocrinology Unit Centre for Cardiovascular Science The Queen's Medical Research Institute University of Edinburgh, 47 Little France Crescent Edinburgh EH16 4TJ, GB
SECKL, Jonathan, Robert, Endocrinology Unit Centre for Cardiovascular Science The Queen's Medical Research Institute University of Edinburgh, 47 Little France Crescent Edinburgh EH16 4TJ, GB
WALKER, Brian, Robert, Endocrinology Unit Centre for Cardiovascular Science The Queen's Medical Research Institute University of Edinburgh, 47 Little France Crescent Edinburgh EH16 4TJ, GB
WARD, Peter, 3 Lowland Road, Pinner Middlesex HA5 1TY, GB
PALLIN, Thomas, David, Argenta Discovery 2009 Limited 8/9 Spire Green Centre Flex Meadow Harlow, Essex CM19 5TR, GB
DYKE, Hazel, Joan, Argenta Discovery 2009 Limited 8/9 Spire Green Centre Flex Meadow Harlow, Essex CM19 5TR, GB
PERRIOR, Trevor, Robert, Brook Farm Barn Lackford Bury St Edmunds, Suffolk IP28 6HL, GB
-
- (51) MKP
A61K 31/4439 (2006.01) (97) **2491028 ***
C07D 401/12 (2006.01)
A61K 31/437 (2006.01)
C07D 471/04 (2006.01)
- (86) US2010053142 19.10.2010
(96) 10768356.7 29.08.2012
(87) WO2011049917, 19.10.2010
(97) 2491028, 29.08.2012 en
(54) INDAZOLE AND PYRAZOLOPYRIDINE COMPOUNDS AS CCR1 RECEPTOR ANTAGONISTS
- (71) Boehringer Ingelheim International GmbH, Binger Strasse 173, 55216 Ingelheim, DE
(72) COOK, Brian Nicholas, Boehringer Ingelheim Pharmaceuticals Inc. 900 Ridgebury Road P.O. Box 368, Ridgefield, Connecticut 06877-0368, US
KUZMICH, Daniel, Boehringer Ingelheim Pharmaceuticals Inc. 900 Ridgebury Road P.O. Box 368, Ridgefield, Connecticut 06877-0368, US
MAO, Can, Boehringer Ingelheim Pharmaceuticals Inc. 900 Ridgebury Road P.O. Box 368, Ridgefield, Connecticut 06877-0368, US
RAZAVI, Hossein, Boehringer Ingelheim Pharmaceuticals Inc. 900 Ridgebury Road P.O. Box 368, Ridgefield, Connecticut 06877-0368, US
-
- (51) MKP
D21G 9/00 (2006.01) (97) **2412869**
- (96) 10171493.9 01.02.2012
(97) 2412869, 01.02.2012 de
(54) Method for producing sheet-like material
- (71) Mitsubishi HiTec Paper Europe GmbH, Niedernholz 23, 33699 Bielefeld, DE
(72) Bachmann, Bernhard, Prof. Dr., Untere Wende 42, 33739 Bielefeld, DE
Ueckerdt, Rainer, Prof. Dr. Dr., Brösener Straße 1, 12587 Berlin, DE
Penner, Hermann, Breslauer Straße 22 b, 33605 Bielefeld, DE
Becker, Dieter, Dr., Schultenhof 7, 49124 Georgsmarienhütte, DE
Rodewald, Stefan, Am Kleesbrock 10, 33719 Bielefeld, DE
Elsner, Christian, Krentrufer Straße 22 b, 33818 Leopoldshöhe, DE
-
- (51) MKP
A23L 1/216 (2006.01) (97) **2294925**
A23L 1/217 (2006.01)
A23B 7/02 (2006.01)
A23B 7/03 (2006.01)
- (96) 10015938.3 16.03.2011
(97) 2294925, 16.03.2011 de
(54) Chip mixture
- (71) Zweifel Pomy-Chips AG, Kesselstrasse 5, 8957 Spreitenbach, CH
(72) Blumenthal, Marco, Bäderstrasse 19, 5400 Baden, CH
-
- (51) MKP
A61K 31/74 (2006.01) (97) **2459201 ***
- (86) US2010043978 30.07.2010
(96) 10805132.7 06.06.2012
(87) WO2011014809, 30.07.2010
(97) 2459201, 06.06.2012 en
(54) HYDROGEL FORMULATION COMPRISING OXIDATIVE REDUCTIVE POTENTIAL WATER
- (71) Oculus Innovative Sciences, Inc., 1129 North McDowell Blvd., Petaluma, CA 94954, US
(72) NORTHEY, Robert, 17404 NE 12th St, Bellevue Washington 98008, US
-
- (51) MKP
B63B 3/28 (2006.01) (97) **2394905**
B63B 9/06 (2006.01)
E04B 9/06 (2006.01)
E04F 11/00 (2006.01)
- (96) 10165174.3 14.12.2011
(97) 2394905, 14.12.2011 de
(54) A unit comprising a frame proving shape and a support profile supporting a construction board
- (71) Knauf Gips KG, Am Bahnhof 7, 97346 Iphofen, DE
(72) Thorwart, Michael, Schindersberg 27, 97234 Reichenberg, DE
-
- (51) MKP
C07K 16/26 (2006.01) (97) **2488551 ***
- (86) EP2010006329 15.10.2010
(96) 10768878.0 22.08.2012
(87) WO2011045080, 15.10.2010
(97) 2488551, 22.08.2012 en
(54) MONOCLONAL ANTIBODIES TO PROGASTRIN AND THEIR USES
- (71) Biorealites S.A.S., 35 Rue de Verdun, 92284 Suresnes cedex, FR
Institut National de la Santé et de la Recherche Médicale (INSERM), 101, rue de Tolbiac, 75654 Paris Cedex 13, FR
Centre National de la Recherche Scientifique CNRS, 3 rue Michel Ange, 75794 Paris Cedex 16, FR
(72) PANNEQUIN, Julie, 13 rue Henri Barbusse, F-34200 Sète, FR
BOUDIER, Laure, 9 Lieu-dit Chamoiroux, F-03270 Busset, FR
JOURBERT, Dominique, 10 rue Gabriel Peri, F-34200 Sète, FR
HOLLANDE, Frédéric, 9 rue des Capriers, F-34790 Grabels, FR
-
- (51) MKP
C07D 491/04 (2006.01) (97) **2277882**
A61K 31/407 (2006.01)
- (96) 10290411.7 26.01.2011
(97) 2277882, 26.01.2011 fr
(54) Pipéridinic compounds, process for their préparation and pharmaceutical compositions containing them
- (71) Les Laboratoires Servier, 35, rue de Verdun, 92284 Suresnes Cedex, FR
(72) de Nanteuil, Guillaume, 12, rue du Chemin Vert, 92150 Suresnes, FR
Cimetiere, Bernard, 10, rue d'Austerlitz, 75012 Paris, FR
Dekeyne, Anne, 14, rue de St-Robert, 78720 Cernay la Ville, FR
Millan, Mark, 19, rue du Président Wilson, 78230 Le Pecq, FR

- (51) MKP
A61K 9/00 (2006.01) (97) **2424501 ***
 (86) JP2010057923 28.04.2010
 (96) 10719654.5 07.03.2012
 (87) WO2010126168, 28.04.2010
 (97) 2424501, 07.03.2012 en
 (54) SOLID PREPARATION
 (71) Takeda Pharmaceutical Company Limited, 1-1 Doshomachi
 4-chome Chuo-ku, Osaka-shi, Osaka 541-0045, JP
 (72) HOSHINA, Wataru, c/o TAKEDA PHARMACEUTICAL
 COMPANY LIMITED 17-85 Jusohonmachi 2-chome Yodogawa-
 ku, Osaka-shi Osaka 532-8686, JP
 FUKUTA, Makoto, c/o TAKEDA PHARMACEUTICAL
 COMPANY LIMITED 17-85 Jusohonmachi 2-chome Yodogawa-
 ku, Osaka-shi Osaka 532-8686, JP
 MARUNAKA, Shigeyuki, c/o TAKEDA PHARMACEUTICAL
 COMPANY LIMITED 17-85 Jusohonmachi 2-chome Yodogawa-
 ku, Osaka-shi Osaka 532-8686, JP

- (51) MKP
A61P 25/18 (2006.01) (97) **2454256 ***
C07D 471/04 (2006.01)
A61K 31/42 (2006.01)
 (86) EP2010004258 13.07.2010
 (96) 10732311.5 23.05.2012
 (87) WO2011006638, 13.07.2010
 (97) 2454256, 23.05.2012 en
 (54) PROCESS FOR THE SYNTHESIS OF PALIPERIDONE
 (71) KRKA, D.D., Novo Mesto, Smarjeska cesta 6, 8501 Novo
 mesto, SI
 (72) RUZIC, Milos, Milke Kerinove 9, 3000 CELJE, SI
 PECAVAR, Anica, Gotna vas 18, 8000 NOVO MESTO, SI
 PRUDIC, Darja, Smolenja vas 68c, 8000 NOVO MESTO, SI
 PLAPER, Igor, Smarjeske Toplice 128, 8220 Smarjeske Toplice,
 SI
 KLOBCAR, Andrej, Podbreznik HO, 8000 NOVO MESTO, SI
 PLEVNIK, Miha, Ulica Cankarjeve Brigade 16, 1295 Ivancna
 Gorica, SI

- (51) MKP
E04C 2/38 (2006.01) (97) **2464799 ***
 (86) SI2011000009 19.02.2011
 (96) 11714135.8 20.06.2012
 (87) WO2012050535, 19.02.2011
 (97) 2464799, 20.06.2012 en
 (54) BUILDING PANEL AS STRUCTURE OF EXTERNAL AND
 INNER PLATE WITH INTERMEDIATE INSULATION SPACE
 (71) CBS Institut Celovite Gradbene Resitve, d.o.o., Prijateljjeva
 cesta 12, 8210 Trebnje, SI
 (72) The designation of the inventor has not yet been filed , null, null

- (51) MKP
A61K 31/4025 (2006.01) (97) **2480531 ***
C07D 209/52 (2006.01)
C07D 405/04 (2006.01)
C07D 209/46 (2006.01)
A61P 29/00 (2006.01)
C07D 403/06 (2006.01)
C07D 493/04 (2006.01)
C07D 207/416 (2006.01)
C07D 401/06 (2006.01)
 (86) US2010049718 21.09.2010
 (96) 10757922.9 01.08.2012
 (87) WO2011035332, 21.09.2010
 (97) 2480531, 01.08.2012 en
 (54) PYRROLIDINONE CARBOXAMIDE DERIVATIVES AS
 CHEMERIN-R (CHEMR23) MODULATORS
 (71) ChemoCentryx, Inc., 850 Maude Avenue, Mountain View,
 California 94043, US
 (72) CHARVAT, Trevor T., 3320 Parkhaven Drive, San Jose,
 California 95132, US
 CHU, Hiufung, 50 Broadway 4, Milbrae, California 94030, US
 KRASINSKI, Antoni, 4125 De Mille Drive, San Jose, California
 95117, US
 LANGE, Christopher W., 6818 Cutting Blvd., El Cerrito,
 California 94530, US
 LELETI, Manmohan Reddy, 19608 Pruneridge Avenue 8304,
 Cupertino, California 95014, US
 POWERS, Jay P., 745 Rockaway Beach Avenue, Pacifica,
 California 94044, US
 PUNNA, Sreenivas, 1240 Vicente Drive Apt E, Sunnyvale,
 California 94086, US
 SULLIVAN, Timothy J., 409 Sycamore Street, San Carlos,
 California 94070, US
 UNGASHE, Solomon, 36641 Reynolds Drive, Fremont,
 California 94536, US

- (51) MKP
A61M 37/00 (2006.01) (97) **2464417 ***
A61N 7/00 (2006.01)
A61K 41/00 (2006.01)
 (86) US2010045622 16.08.2010
 (96) 10747998.2 20.06.2012
 (87) WO2011020097, 16.08.2010
 (97) 2464417, 20.06.2012 en
 (54) ULTRASONIC SURGICAL APPARATUS AND SILICON
 WAVEGUIDE AND METHODS FOR USE THEREOF
 (71) Ethicon Endo-Surgery, Inc., 4545 Creek Road, Cincinnati, OH
 45242, US
 (72) DIETZ, Timothy, G., 2 Elm Ledge, Terrace Park OH 45174, US
 DANNAHER, William D., 8907 Eldora Drive, Cincinnati Ohio
 45236, US
 HOUSER, Kevin L., 570 Foliage Lane, Springboro Ohio 45066,
 US
 OLSON, William A., 4067 Belle Terrace Lane, Lebanon Ohio
 45036, US
 RHEE, Sora, 353 West 4th Street, Cincinnati Ohio 45202, US
 STULEN, Foster B., 6245 Bridgewater Court, Mason Ohio
 45242, US
 WILLIS, John W., 5098 Palermo Road, Cincinnati Ohio 45244,
 US

- (51) MKP
C12N 15/87 (2006.01) (97) **2464384 ***
A61K 41/00 (2006.01)
A61P 35/00 (2006.01)
A61K 48/00 (2006.01)
A61K 9/00 (2006.01)
A61P 43/00 (2006.01)
 (86) GB2010001547 16.08.2010
 (96) 10747249.0 20.06.2012
 (87) WO2011018635, 16.08.2010
 (97) 2464384, 20.06.2012 en
 (54) PHOTSENSITIZING COMPOSITIONS
 (71) PCI Biotech AS, Strandveien 55, 1366 Lysaker, NO
 KLAIVENESS, Jo, Midtassen 5, N-1166 Oslo, NO
 HOGSET, Anders, PCI Biotech AS Strandveien 55, N-1366
 Lysaker, NO

- (51) MKP
C12N 15/90 (2006.01) (97) **2478100 ***
C12N 15/10 (2006.01)
- (86) EP2011055530 08.04.2011
(96) 11715196.9 25.07.2012
(87) WO2011124693, 08.04.2011
(97) 2478100, 25.07.2012 en
(54) METHOD OF GENERATING GENE MOSAICS
(71) Eviagenics S.A., Pépinière Paris Santé Cochin 29, rue du Faubourg Saint-Jacques, 75014 Paris, FR
(72) PANDJAITAN, Rudy, 13 rue Chabert, F-94700 Maisons-Alfort, FR
LUQUE, Alejandro, 1 rue Guy Moquet, F-75017 Paris, FR
-
- (51) MKP
A61P 35/00 (2006.01) (97) **2490689 ***
A61K 31/404 (2006.01)
A61K 31/40 (2006.01)
A61K 31/4709 (2006.01)
A61P 31/00 (2006.01)
A61P 29/00 (2006.01)
A61K 31/44 (2006.01)
- (86) US2010053245 19.10.2010
(96) 10825538.1 29.08.2012
(87) WO2011049979, 19.10.2010
(97) 2490689, 29.08.2012 en
(54) INJECTABLE FORMULATIONS FOR INTRA-ARTICULAR OR PERI-ARTICULAR ADMINISTRATION
(71) Panmira Pharmaceuticals, LLC, 9535 Waples Street, Suite 100, San Diego, CA 92121, US
(72) HUTCHINSON, John, Howard, 3435 Richmond Street, San Diego CA 92103, US
PRASIT, Petpiboon, Peppi, P.O. Box 3734, Rancho Santa Fe CA 92067, US
DEARMOND, Isabelle, Marguerite, 14444 Rock Rose, San Diego CA 92127, US
-
- (51) MKP
A61F 13/15 (2006.01) (97) **2345395**
- (96) 10252248.9 20.07.2011
(97) 2345395, 20.07.2011 en
(54) Apparatus and method for producing absorbent article with stretch film side panel and application of intermittent discrete components of an absorbent article
(71) Curt C. Joa. Inc., 100 Crooker Avenue, Sheboygan Falls WI 53085, US
(72) McCabe, John, 1141 Partridge Run, Sheboygan Falls Wisconsin 53085, US
-
- (51) MKP
C12N 15/113 (2010.01) (97) **2480668 ***
A61K 31/713 (2006.01)
C07H 21/02 (2006.01)
A61P 35/00 (2006.01)
- (86) US2010050077 23.09.2010
(96) 10777133.9 01.08.2012
(87) WO2011038160, 23.09.2010
(97) 2480668, 01.08.2012 en
(54) COMPOSITIONS AND METHODS FOR SILENCING GENES EXPRESSED IN CANCER
(71) Protiva Biotherapeutics Inc., 100-8900 Glenlyon Parkway, Burnaby, British Columbia V5J 5J8, CA
The Government of the United States of America, as represented by the Secretary of the Department of Health and Human Services, 6011 Executive Boulevard Suite 325, Rockville, Maryland 20852-3804, US
(72) JUDGE, Adam, 1936 W. 11th Avenue, Vancouver British Columbia V6J 2C6, CA
LEE, Yun-Han, 259 Congressional Lane Apt. 509, Rockville, MD 20852, US
MACLACHLAN, Ian, 13331 Sylvester Road, Mission British Columbia V2S 0B1, CA
THORGEIRSSON, Snorri, S., 9305 Kingsley Avenue, Bethesda, MD 20814, US
-
- (51) MKP
E01C 13/08 (2006.01) (97) **2388052**
A63C 19/02 (2006.01)
- (96) 11425083.0 23.11.2011
(97) 2388052, 23.11.2011 en
(54) Base for a playing field
(71) New Tennis System S.r.l., Via Roma, 15, 28074 Ghemme, Novara, IT
(72) Corsiero, Michele, c/o New Tennis System S.r.l. Via Roma, 15, 28074 Ghemme, Novara, IT
Corsiero, Davide, c/o New Tennis System S.r.l. Via Roma, 15, 28074 Ghemme, Novara, IT
Corsiero, Simone, c/o New Tennis System S.r.l. Via Roma, 15, 28074 Ghemme, Novara, IT
-
- (51) MKP
A61K 31/785 (2006.01) (97) **2413943 ***
A61K 31/795 (2006.01)
- (86) US2010028988 29.03.2010
(96) 10759250.3 08.02.2012
(87) WO2010114779, 29.03.2010
(97) 2413943, 08.02.2012 en
(54) CONTROLLED EXOTHERM OF CYANOACRYLATE FORMULATIONS
(71) Ethicon, Inc, U.S. Route 22, Somerville, NJ 08876, US
(72) BORDOLOI, Binoy, K., 8 Slack Court, Bridgewater NJ 08807, US
VANDER KLOK LOURY, Melanie, A., 4441 Archibald Way, Raleigh NC 27616, US
-
- (51) MKP
C07D 495/04 (2006.01) (97) **2470541 ***
A61K 31/519 (2006.01)
C07D 491/04 (2006.01)
C07D 487/04 (2006.01)
A61P 35/00 (2006.01)
- (86) US2010046970 27.08.2010
(96) 10750211.4 04.07.2012
(87) WO2011025947, 27.08.2010
(97) 2470541, 04.07.2012 en
(54) RAF INHIBITOR COMPOUNDS AND METHODS OF USE THEREOF
(71) Array Biopharma, Inc., 3200 Walnut Street, Boulder, CO 80301, US
Genentech, Inc., 1 DNA Way, South San Francisco, CA 94080-4990, US
(72) ALIAGAS, Ignacio, 1 DNA Way, South San Francisco, California 94080-4990, US
GRADL, Stefan, 1 DNA Way, South San Francisco, California 94080-4990, US
GUNZNER, Janet, 1 DNA Way, South San Francisco, California 94080-4990, US
MATHIEU, Simon, 1 DNA Way, South San Francisco, California 94080-4990, US
RUDOLPH, Joachim, 1 DNA Way, South San Francisco, California 94080-4990, US
WEN, Zhaoyang, 1 DNA Way, South San Francisco, California 94080-4990, US
WENGLOWSKY, Steven Mark, 3200 Walnut Street, Boulder, Colorado 80301, US
-
- (51) MKP
A63B 23/02 (2006.01) (97) **2424625 ***
- (86) US2010032791 28.04.2010
(96) 10770270.6 07.03.2012
(87) WO2010127016, 28.04.2010
(97) 2424625, 07.03.2012 en
(54) UPPER BODY EXERCISE DEVICE
(71) Sutton, Calvin Emanuel, 19630 Woodland Manor Place, Lutz, FL 33549, US
(72) Sutton, Calvin Emanuel, 19630 Woodland Manor Place, Lutz, FL 33549, US

(51) MKP
E21B 43/25 (2006.01) (97) **2478182 ***
E21B 43/26 (2006.01)
(86) US2010045791 17.08.2010
(96) 10817628.0 25.07.2012
(87) WO2011034679, 17.08.2010
(97) 2478182, 25.07.2012 en
(54) WATER HEATING APPARATUS FOR CONTINUOUS HEATED WATER FLOW AND METHOD FOR USE IN HYDRAULIC FRACTURING
(71) HEAT ON-THE-FLY, LLC, 1027 West 11th Avenue, Covington, LA 70433, US
(72) HEFLEY, Ransom, Mark, 1201 Bluestem Lane, Elk City OK 73644, US

(51) MKP
G06K 9/00 (2006.01) (97) **2440126 ***
A61B 5/0452 (2006.01)
G06F 17/00 (2006.01)
(86) US2010036084 25.05.2010
(96) 10726730.4 18.04.2012
(87) WO2010144249, 25.05.2010
(97) 2440126, 18.04.2012 en
(54) SYSTEMS AND METHODS FOR QUANTITATIVE ASSESSMENT OF CARDIAC ELECTRICAL EVENTS
(71) Newcardio, Inc., 2350 Mission College Boulevard Suite 1175, Santa Clara, CA 95054, US
(72) VAJDIC, Branislav, 18792 Withey Road, Monte Sereno California 95030, US

(51) MKP
A61K 9/16 (2006.01) (97) **2470166 ***
A61K 9/28 (2006.01)
A61K 9/50 (2006.01)
A61K 9/20 (2006.01)
(86) DK2010050216 23.08.2010
(96) 10805414.9 04.07.2012
(87) WO2011023194, 23.08.2010
(97) 2470166, 04.07.2012 en
(54) NEW COMPOSITIONS OF 1-[2-(2,4-DIMETHYL-PHENYLSULFANYL)-PHENYL]PIPERAZINE
(71) H. Lundbeck A/S, Ottiliavej 9, 2500 Valby, DK
(72) HØJER, Astrid-Maria, Ingvar Hjorts Vej 14, DK-2830 Virum, DK
DREWES, Pernille, Gundorf, Askimvej 15, DK-2830 Virum, DK
KATEB, Jens, Köpenhamnsvägen 9b, S-21743 Malmö, SE

(51) MKP
C05D 3/02 (2006.01) (97) **2463258**
C05G 3/00 (2006.01)
(96) 10015510.0 13.06.2012
(97) 2463258, 13.06.2012 fr
(54) Soil improvements and fertilizers by dynamic disintegration, their manufacturing method and their uses in agriculture
(71) Omya Development AG, Baslerstrasse 42, 4665 Oftringen, CH
(72) Gaumont, François-Xavier, 8, rue Blériot, 28000 Chartres, FR

(51) MKP
C07D 409/14 (2006.01) (97) **2475657 ***
A61P 31/12 (2006.01)
C07D 409/12 (2006.01)
C07D 417/12 (2006.01)
C07D 333/68 (2006.01)
C07D 413/12 (2006.01)
C07D 487/04 (2006.01)
C07D 493/04 (2006.01)
A61K 31/381 (2006.01)
(86) US2010042394 19.07.2010
(96) 10735402.9 18.07.2012
(87) WO2011011303, 19.07.2010
(97) 2475657, 18.07.2012 en
(54) INHIBITORS OF FLAVIVIRIDAE VIRUSES
(71) Gilead Sciences, Inc., 333 Lakeside Drive, Foster City, CA 94404, US
(72) CHONG, Lee, S., 37469 Marsten Drive, Newark CA 94560, US
WATKINS, William, J., 14275 Hilltop Way, Saratoga CA 95070, US
CLARKE, Michael O'neil, Hanrahan, 545 Seastorm Drive, Redwood City CA 94065, US
YE, Hong, 1108 Greyston Court, Richmond CA 94806, US
DOERFFLER, Edward, 2607 Royal Ann Drive, Union City CA 94587, US
LAZERWITH, Scott, E., 930 Scott Street 1, San Francisco CA 94115, US
LEW, Willard, 1437 Overland Drive, San Mateo CA 94403, US
LIU, Qi, 1200 E. Hillsdale Boulevard. Apt 16B, Foster City CA 94404, US
MERTZMAN, Michael, 2603 Carlmont Drive, Belmont CA 94002, US
CANALES, Eda, 419 Turner Terrace Apt. 9, San Mateo CA 94401, US
MORGANELLI, Philip, A., 3923 Webster Street, Oakland CA 94609, US

(51) MKP
A61K 9/127 (2006.01) (97) **2410991 ***
(86) US2010028324 23.03.2010
(96) 10756717.4 01.02.2012
(87) WO2010111271, 23.03.2010
(97) 2410991, 01.02.2012 en
(54) ORALLY BIOAVAILABLE LIPID-BASED CONSTRUCTS
(71) SDG, INC. (an Ohio Corporation), 10265 Carnegie Avenue, Cleveland, OH 44106, US
(72) GEHO, Blair, W., 533 Beachwood Drive, Wooster, OH 44691, US
LAU, John, R., 585 King Beach Drive, Howard, OH 43028, US

(51) MKP
C07K 14/62 (2006.01) (97) **2451437 ***
C12N 15/81 (2006.01)
A61K 9/10 (2006.01)
A61K 47/00 (2006.01)
(86) EP2010059436 02.07.2010
(96) 10730443.8 16.05.2012
(87) WO2011003822, 02.07.2010
(97) 2451437, 16.05.2012 de
(54) AQUEOUS PREPARATIONS COMPRISING METHIONINE
(71) Sanofi-Aventis Deutschland GmbH, Brüningstraße 50, 65929 Frankfurt, DE
(72) SCHOETTLE, Isabell, c/o Sanofi-Aventis Deutschland GmbH, 65926 Frankfurt am Main, DE
HAGENDORF, Annika, c/o Sanofi-Aventis Deutschland GmbH, 65926 Frankfurt am Main, DE
FUERST, Christiane, c/o Sanofi-Aventis Deutschland GmbH, 65926 Frankfurt am Main, DE
HAUCK, Gerrit, c/o Sanofi-Aventis Deutschland GmbH, 65926 Frankfurt am Main, DE
SIEFKE-HENZLER, Verena, c/o Sanofi-Aventis Deutschland GmbH, 65926 Frankfurt am Main, DE
KAMM, Walter, c/o Sanofi-Aventis Deutschland GmbH, 65926 Frankfurt am Main, DE
SCHNIEDERS, Julia, c/o Sanofi-Aventis Deutschland GmbH, 65926 Frankfurt am Main, DE

(51) MKP
A61K 38/31 (2006.01) (97) **2408472 ***
 (86) US2010000794 17.03.2010
 (96) 10753809.2 25.01.2012
 (87) WO2010107486, 17.03.2010
 (97) 2408472, 25.01.2012 en
 (54) USE OF SOMATOSTATIN OR AN ANALOGUE THEREOF IN COMBINATION WITH EXTERNAL RADIATION THERAPY
 (71) THE BOARD OF TRUSTEES OF THE LELAND STANFORD JUNIOR UNIVERSITY, 1705 El Camino Real, Palo Alto, CA 94306-1106, US
 (72) KATZNELSON, Laurence, 875 Blake Wilbur Drive, Stanford CA 94305-5821, US
 KNOX, Susan, J., 731 San Rafael Place, Stanford CA 94305, US

(51) MKP
C07D 413/14 (2006.01) (97) **2454250 ***
A61P 9/00 (2006.01)
C07D 491/048 (2006.01)
A61P 29/00 (2006.01)
C07D 407/14 (2006.01)
A61K 31/506 (2006.01)
A61K 31/437 (2006.01)
A61P 37/00 (2006.01)
A61K 31/4439 (2006.01)
C07D 401/12 (2006.01)
A61K 31/444 (2006.01)
C07D 401/14 (2006.01)
A61K 31/497 (2006.01)
C07D 471/04 (2006.01)
A61P 25/28 (2006.01)
 (86) US2010041739 12.07.2010
 (96) 10733116.7 23.05.2012
 (87) WO2011008709, 12.07.2010
 (97) 2454250, 23.05.2012 en
 (54) APOPTOSIS SIGNAL-REGULATING KINASE INHIBITORS
 (71) Gilead Sciences, Inc., 333 Lakeside Drive, Foster City, CA 94404, US
 (72) CORKEY, Britton, 355 Buena Vista Ave East Apt 415, San Francisco CA 94117, US
 GRAUPE, Michael, 1131 Banyan Way, Pacifica CA 94044, US
 KOCH, Keith, 384 Baker Lane, Erie CO 80516, US
 MELVIN, Lawrence S., 7623 Crestview Drive, Longmont CO 80504, US
 NOTTE, Gregory, 707 Highland Ave Apt 2, San Mateo CA 94401, US

(51) MKP
A61P 35/00 (2006.01) (97) **2459173 ***
A61K 9/00 (2006.01)
A61K 9/08 (2006.01)
A61K 31/55 (2006.01)
 (86) US2010002109 28.07.2010
 (96) 10739413.2 06.06.2012
 (87) WO2011014248, 28.07.2010
 (97) 2459173, 06.06.2012 en
 (54) PHARMACEUTICAL COMPOSITIONS FOR THE TREATMENT OF CANCER AND OTHER DISEASES OR DISORDERS
 (71) Millennium Pharmaceuticals, Inc., 40 Landsdowne Street, Cambridge, MA 02139, US
 (72) RAMANAN, Vijayalakshmi, 3324 Avalon Drive, Sharon MA 02067, US
 TOBIAS, Irene Sophie, 195 Binney Street, Cambridge MA 02142, US
 VERWIJS, Dauntel Specht, 4 Carter Drive, Framingham MA 01701, US
 SKWIERCZYNSKI, Raymond D., 122 Salem Street, Andover MA 01810, US

(51) MKP
A61K 31/485 (2006.01) (97) **2371357**
A61K 9/20 (2006.01)
C07D 489/08 (2006.01)
 (96) 11157837.3 05.10.2011
 (97) 2371357, 05.10.2011 en
 (54) Oral formulations and lipophilic salts of methyl naltrexone
 Wyeth LLC, Five Giralda Farms, Madison, NJ 07940, US
 (71) Shah, Syed M., 1 Ora Street, East Hanover, NJ 07936, US
 Diorio, Christopher Richard, 16 Booth Drive, Campbell Hall, NY 10916, US
 Ehrnsperger, Eric C., 23 Gerlach Drive, New City, NY 10956, US
 Meng, Xu, 10480 Gaylemon Lane, San Diego, CA 92130, US
 Shareffi, Kadum A., 32 Massachusetts Avenue, Congers, NY 10920, US
 Cohen, Jonathan Marc, 23 Jenna Drive, Monroe, NY 10950, US

(51) MKP
G09F 1/10 (2006.01) (97) **2493703 ***
B43L 5/02 (2006.01)
F16B 2/16 (2006.01)
B42F 15/06 (2006.01)
A47G 1/21 (2006.01)
 (86) IB2010054906 29.10.2010
 (96) 10793311.1 05.09.2012
 (87) WO2011051911, 29.10.2010
 (97) 2493703, 05.09.2012 en
 (54) DOCUMENTS-HANGING SHOWCASE WITHOUT THE UTILISATION OF CLIPS AND METHOD FOR ITS REALISATION
 (71) Bertaso, Luigi, Via Bellori 74, 37023 Lugo Di Grezzana (Verona), IT
 (72) Bertaso, Luigi, Via Bellori 74, 37023 Lugo Di Grezzana (Verona), IT

(51) MKP
A61M 25/00 (2006.01) (97) **2408505 ***
A61M 25/06 (2006.01)
 (86) US2010027837 18.03.2010
 (96) 10710518.1 25.01.2012
 (87) WO2010108017, 18.03.2010
 (97) 2408505, 25.01.2012 en
 (54) GUIDE SYSTEM WITH SUCTION
 (71) Acclarent, Inc., 1525-B O'Brien Drive, Menlo Park, CA 94025, US
 (72) CHANG, John, Y., 13080 Lorene Court, Mountain View CA 94040-3943, US
 GOLDFARB, Eric, 1506 Harbor Boulevard, Belmont CA 94002, US
 SWEI, Serena, 180 Albacore Lane, Foster City CA 94404, US
 PADER, Mei, Y., 38330 Farwell Drive, Fremont CA 94536, US
 GOTTESMAN, Michael, J., 595 Teredo Drive, Redwood Shores CA 94065, US
 NEWHAUSER, Richard, R., 632 California Way, Emerald Hills CA 94062, US

- (51) MKP
C07D 403/04 (2006.01) (97) **2452939 ***
C07D 403/06 (2006.01)
C07D 207/273 (2006.01)
- (86) KR2010003790 11.06.2010
(96) 10797246.5 16.05.2012
(87) WO2011004972, 11.06.2010
(97) 2452939, 16.05.2012 en
- (54) PIPERAZINYL 3-AMINOPYRROLIDINE DERIVATIVES AS A CCR2 ANTAGONIST
- (71) Yang Ji Chemical Co., Ltd., 638-6, Seonggok-dong Danwon-gu, Ansan, Gyeonggi-do 425-833, KR
- (72) LIM, Jee Woong, Pureunmaeul Byoksan Apt. 306-302 Sunae-dong Bundang-gu, Seongnam Gyeonggi-do 463-779, KR
KIM, Jong-Hoon, Ggummaeul Life Apt. 107-806 Gwiin-dong Dongan-gu, Anyang Gyeonggi-do 431-708, KR
OAK, Min-Ho, Hanyang Mokryeon Apt. 1312-403, Gwangjeong-dong Gunpo, Gyeonggi-do 435-710, KR
NA, Yongho, Taeyoung Apt. 103-205 Bono 3-dong Sangrok-gu, Ansan Gyeonggi-do 426-735, KR
OH, Youna, Samik Green Apt. 501-902 Myeongil 1-dong Gangdong-gu, Seoul 134-782, KR
KANG, So-Hee, DongGun Apt. 101-607 59-6, Byeon-dong Seo-gu, Daejeon 302-190, KR
LEE, Jung-Ok, Daewol Jugong Apt Greenville 8th Danji 812-1704, Jeongja 3-dong Jangan-gu, Suwon Gyeonggi-do 440-729, KR
SOHN, Jung-Duk, Daelim Apt. 113-2302 Seoksu 1-dong Manan-gu, Anyang Gyeonggi-do 430-705, KR
LEE, Seung-Woo, Poonglim Apt. 401 106 Samseong-dong Gangnam-gu, Seoul 135-090, KR

- (51) MKP
C04B 28/00 (2006.01) (97) **2385029**
- (96) 10290234.3 09.11.2011
(97) 2385029, 09.11.2011 en
- (54) Compositions and method for well cementing
- (71) Schlumberger Technology B.V., Parkstraat 83-90, 2514 JG The Hague, NL
Prad Research And Development Limited, Craigmuir Chambers Road Town Tortola, British Virgin Islands, VG
Services Pétroliers Schlumberger, 42, rue Saint Dominique, 75007 Paris, FR
Schlumberger Holdings Limited, P.O. Box 71 Craigmuir Chamber Road Town, Tortola, VG
- (72) Porcherie, Olivier, c/o Etudes et Productions Schlumberger 1, rue Henri Becquerel, 92142 Clamart Cedex, FR
Pershikova, Elena, c/o Etudes et Productions Schlumberger 1, rue Henri Becquerel, 92142 Clamart Cedex, FR
Evans, Nigel, c/o Etudes et Productions Schlumberger 1, rue Henri Becquerel, 92142 Clamart Cedex, FR
Achtal, Hafida, c/o Etudes et Productions Schlumberger 1, rue Henri Becquerel, 92142 Clamart Cedex, FR
Boubeguira, Yamina, c/o Etudes et Productions Schlumberger 1, rue Henri Becquerel, 92142 Clamart Cedex, FR
Zusatz, Benedicte, c/o Etudes et Productions Schlumberger 1, rue Henri Becquerel, 92142 Clamart Cedex, FR

- (51) MKP
B23K 26/08 (2006.01) (97) **2283963**
B23Q 1/01 (2006.01)
B23K 37/02 (2006.01)
B23Q 1/54 (2006.01)
B23Q 1/58 (2006.01)
B25J 17/02 (2006.01)
B23K 26/38 (2006.01)
- (96) 10169263.0 16.02.2011
(97) 2283963, 16.02.2011 en
- (54) Manipulator of low inertia for laser cutting machines for flat sheet metals
- (71) SALVAGNINI ITALIA S.p.A., Via Ing. Guido Salvagnini, 1, 36040 Sarego (VI), IT
- (72) Battheu, Claude, Viale Duca D'Aosta, 82, 39100 Bolzano, IT

- (51) MKP
A61K 31/195 (2006.01) (97) **2493468 ***
A61P 37/02 (2006.01)
- (86) US2010052768 15.10.2010
(96) 10768845.9 05.09.2012
(87) WO2011053468, 15.10.2010
(97) 2493468, 05.09.2012 en
- (54) AMINO-BENZOIC ACID DERIVATIVES FOR USE IN THE TREATMENT OF DIHYDROGENASE-RELATED DISORDERS
- (71) SANOFI, 54, rue de la Boétie, 75008 Paris, FR
- (72) MCLEAN, Larry Raymond, c/o sanofi U.S. 1041 Route 202-206 Mail Code: BWD-303A, Bridgewater, New Jersey 08807, US
SUBRAMANIAM, Arun, 6 Bernard Court, Lebanon, New Jersey 08833, US
VAZ, Roy J., c/o sanofi U.S. 1041 Route 202-206 Mail Code: BWD-303A, Bridgewater, New Jersey 08807, US
LI, Yi, c/o sanofi U.S. 1041 Route 202-206 Mail Code: BWD-303A, Bridgewater, New Jersey 08807, US

- (51) MKP
A61K 39/395 (2006.01) (97) **2406290 ***
C07K 16/30 (2006.01)
A61P 35/00 (2006.01)
C07K 19/00 (2006.01)
C12N 15/63 (2006.01)
C12N 15/62 (2006.01)
- (86) US2010026275 04.03.2010
(96) 10751210.5 18.01.2012
(87) WO2010104749, 04.03.2010
(97) 2406290, 18.01.2012 en
- (54) ANTIGEN PRESENTING CELL TARGETED CANCER VACCINES
- (71) Baylor Research Institute, 3310 Live Oak Street, Suite 501, Dallas, TX 75204, US
- (72) ZURAWSKI, Gerald, 7620 Jordan Lane, Midlothian, TX 76065, US
BANCHEREAU, Jacques, F., 6730 Northaven Road, Dallas, TX 75230, US
FLAMAR, Anne-Laure, 8650 Southwestern Blvd., Nr. 3914, Dallas, TX 75206, US
MONTES, Monica, 3005 Bryan St. Nr. 2313, Dallas, TX 75204, US
KLUCAR, Peter, 17811 Vail St. Apt. 3309, Dallas, TX 75287, US
AKAGAWA, Keiko, 1-9-13 2F Nishi-nakanobu, Shinagawa-ku 142-0054, JP

- (51) MKP
C07K 16/18 (2006.01) (97) **2430049 ***
G01N 33/68 (2006.01)
A61K 39/395 (2006.01)
A61P 25/28 (2006.01)
- (86) FR2010050915 11.05.2010
(96) 10728743.5 21.03.2012
(87) WO2010130946, 11.05.2010
(97) 2430049, 21.03.2012 fr
- (54) HUMANIZED ANTIBODIES SPECIFIC TO THE PROTOFIBRILLAR FORM OF THE BETA-AMYLOID PEPTIDE
- (71) SANOFI, 174, Avenue de France, 75013 Paris, FR
- (72) BAURIN, Nicolas, c/o Sanofi Département Brevets 174 avenue de France, F-75013 Paris, FR
BLANCHE, Francis, c/o Sanofi Département Brevets 174 avenue de France, F-75013 Paris, FR
CAMERON, Béatrice, c/o Sanofi Département Brevets 174 avenue de France, F-75013 Paris, FR
DUCHESNE, Marc, c/o Sanofi Département Brevets 174 avenue de France, F-75013 Paris, FR
MIKOL, Vincent, c/o Sanofi Département Brevets 174 avenue de France, F-75013 Paris, FR
NAIMI, Souad, c/o Sanofi Département Brevets 174 avenue de France, F-75013 Paris, FR
PRADIER, Laurent, c/o Sanofi Département Brevets 174 avenue de France, F-75013 Paris, FR
SHI, Yi, c/o Sanofi Département Brevets 174 avenue de France, F-75013 Paris, FR

- (51) MKP
C07D 487/08 (2006.01) (97) **2491018 ***
C07D 215/56 (2006.01)
- (86) US2010053628 21.10.2010
(96) 10775986.2 29.08.2012
(87) WO2011050215, 21.10.2010
(97) 2491018, 29.08.2012 en
- (54) PROCESS FOR PREPARING MODULATORS OF CYSTIC FIBROSIS TRANSMEMBRANE CONDUCTANCE REGULATOR
- (71) Vertex Pharmaceuticals Incorporated, 130 Waverly Street, Cambridge, MA 02139, US
- (72) AMBHAIKAR, Narendra, Bhalchandra, 404 Sri Sai Rithvik Enclave Kondapur White Fields, Hyderabad 500 084, IN
HUGHES, Robert, 10235 Arrow Rock Avenue, San Diego CA 92126, US
HURLEY, Dennis, James, 1513 Black Walnut Drive, San Marcos CA 92078, US
LEE, Elaine, Chungmin, 14 Waldo Road, Arlington, MA 02474, US
LITTLER, Benjamin, 7016 Ivy Street, Carlsbad CA 92011, US
NUMA, Mehdi, 3106 Jemez Drive, San Diego CA 92117, US
ROEPER, Stefanie, 101 Dudley Street, Medford, MA 02155, US
SHETH, Urvi, 9316 Babauta Road Unit 71, San Diego CA 92129, US
-
- (51) MKP
A61K 9/20 (2006.01) (97) **2477611 ***
A61K 31/277 (2006.01)
- (86) EP2010063439 14.09.2010
(96) 10752585.9 25.07.2012
(87) WO2011032929, 14.09.2010
(97) 2477611, 25.07.2012 en
- (54) (Z)-2-CYANO-3-HYDROXY-BUT-2-ENOIC ACID-(4'-TRIFLUORMETHYLPHENYL)-AMIDE TABLET FORMULATIONS WITH IMPROVED STABILITY
- (71) SANOFI, 54 rue La Boétie, 75008 Paris, FR
(72) HAUCK, Gerrit, Sanofi-Aventis Deutschland GmbH, 65926 Frankfurt am Main, DE
-
- (51) MKP
C07D 261/14 (2006.01) (97) **2483254 ***
A61K 31/495 (2006.01)
C07D 241/04 (2006.01)
A61K 31/44 (2006.01)
C07C 223/00 (2006.01)
A61P 25/28 (2006.01)
C07D 231/12 (2006.01)
A61K 31/4155 (2006.01)
C07D 265/30 (2006.01)
A61K 31/4965 (2006.01)
C07D 237/20 (2006.01)
A61K 31/42 (2006.01)
C07C 233/00 (2006.01)
A61P 25/16 (2006.01)
A61K 31/5375 (2006.01)
A61P 25/00 (2006.01)
- (86) CN2010001501 27.09.2010
(96) 10819801.1 08.08.2012
(87) WO2011038572, 27.09.2010
(97) 2483254, 08.08.2012 en
- (54) NOVEL COMPOUNDS
- (71) Glaxo Group Limited, Glaxo Wellcome House Berkeley Avenue Greenford, Middlesex UB6 0NN, GB
- (72) NICHOLS, Paula Louise, c/o GlaxoSmithKline Corporate Intellectual Property (CN9.25.1) 980 Great West Road, Brentford Middlesex TW8 9GS, GB
EATHERTON, Andrew John, c/o GlaxoSmithKline Corporate Intellectual Property (CN9.25.1) 980 Great West Road, Brentford Middlesex TW8 9GS, GB
BAMBOROUGH, Paul, c/o GlaxoSmithKline Corporate Intellectual Property (CN9.25.1) 980 Great West Road, Brentford Middlesex TW8 9GS, GB
JANDU, Karamjit Singh, c/o GlaxoSmithKline Corporate Intellectual Property (CN9.25.1) 980 Great West Road, Brentford Middlesex TW8 9GS, GB
PHILIPS, Oliver James, c/o GlaxoSmithKline Corporate Intellectual Property (CN9.25.1) 980 Great West Road, Brentford Middlesex TW8 9GS, GB
ANDREOTTI, Daniele, c/o GlaxoSmithKline Corporate Intellectual Property (CN9.25.1) 980 Great West Road, Brentford Middlesex TW8 9GS, GB
-
- (51) MKP
A61P 9/00 (2006.01) (97) **2483233 ***
A61P 11/00 (2006.01)
A61K 31/201 (2006.01)
C07C 205/50 (2006.01)
- (86) US2010051059 01.10.2010
(96) 10821313.3 08.08.2012
(87) WO2011041639, 01.10.2010
(97) 2483233, 08.08.2012 en
- (54) HETEROATOM CONTAINING SUBSTITUTED FATTY ACIDS
- (71) Miller, Raymond A., 5488 Elson Street SE, Magnolia, Ohio 44643, US
(72) Miller, Raymond A., 5488 Elson Street SE, Magnolia, Ohio 44643, US
-
- (51) MKP
A61K 31/00 (2006.01) (97) **2496221 ***
A61K 9/00 (2006.01)
A61K 9/20 (2006.01)
- (86) FR2010052369 04.11.2010
(96) 10792966.3 12.09.2012
(87) WO2011055083, 04.11.2010
(97) 2496221, 12.09.2012 fr
- (54) MULTILAYER PHARMACEUTICAL COMPOSITION THAT CAN BE DISPERSED IN WATER AND WHICH CONTAINS A COMBINATION OF ANTIMALARIAL AGENTS
- (71) SANOFI, 54 rue La Boétie, 75008 Paris, FR
(72) CHAN-SEW, Jonathan, c/o Sanofi-aventis Département Brevets 174 avenue de France, F-75013 Paris, FR
ELBAZ, Frantz, c/o Sanofi-aventis Département Brevets 174 avenue de France, F-75013 Paris, FR
-
- (51) MKP
A61K 38/08 (2006.01) (97) **2459207 ***
- (86) BR2010000253 30.07.2010
(96) 10742073.9 06.06.2012
(87) WO2011011847, 30.07.2010
(97) 2459207, 06.06.2012 en
- (54) PHARMACEUTICAL COMPOSITION FOR TREATING MEDICAL CONDITIONS AND A METHOD FOR TREATING ALIMENTARY DISORDERS AND RELATED DISEASES
- (71) SOCIEDADE BENEFICENTE DE SENHORAS HOSPITAL SÍRIO E LIBANÊS, Rua da Adma Jefet 91 Cerqueira César, 01308-050 São Paulo SP, BR
(72) STERMAN HEIMANN, Andrea, Via das Margaridas 413 Jd. Colibrí, 06713-330- Cotia-SP, BR
SQUARZONI DALE, Camila, Rua Viaza 407 Jardim Aeroporto, 04633-060- São Paulo- SP, BR
A. DEVI, Lakshmi, 9 Glenwood Avenue, New Rochelle NY 10801, US
-
- (51) MKP
A61M 5/32 (2006.01) (97) **2403571 ***
A61M 5/50 (2006.01)
- (86) EP2010052790 04.03.2010
(96) 10709188.6 11.01.2012
(87) WO2010100245, 04.03.2010
(97) 2403571, 11.01.2012 en
- (54) DRUG DELIVERY DEVICE WITH RETRACTABLE NEEDLE
- (71) Sanofi-Aventis Deutschland GmbH, Brüningstraße 50, 65929 Frankfurt, DE
(72) LANIN, Irina, Sanofi-Aventis Deutschland GmbH, 65926 Frankfurt am Main, DE
FORYS, Bernhard, Sanofi-Aventis Deutschland GmbH, 65926 Frankfurt am Main, DE
CLARKE, Alastair, Sanofi-Aventis UK London Road Crewe, Holmes Chapel Cheshire CW4 8BE, GB
EKMAN, Matthew, Sanofi-Aventis UK London Road, Cheshire CW4 8BE, GB
GOODE, Kirsten, Sanofi-Aventis UK London Road Crewe, Holmes Chapel Cheshire CW4 8BE, GB
HEALD, Michael, Sanofi-Aventis UK London Road Crewe, Holmes Chapel Cheshire CW4 8BE, GB
HILES, John, Sanofi-Aventis UK London Road Crewe, Holmes Chapel Cheshire CW4 8BE, GB
SMITH, Chris, Sanofi-Aventis UK London Road Crewe, Holmes Chapel Cheshire CW4 8BE, GB

-
- (51) MKP
B22D 11/06 (2006.01) (97) **2411171 ***
B22D 11/12 (2006.01)
- (86) CA2010000460 25.03.2010
(96) 10755369.5 01.02.2012
(87) WO2010108279, 25.03.2010
(97) 2411171, 01.02.2012 en
- (54) ADJUSTABLE SIDE DAM FOR CONTINUOUS CASTING APPARATUS
- (71) Novelis, Inc., 191 Evans Avenue, Toronto, ON M8Z 1J5, CA
(72) LUCE, Edward, 102 Sherwood Drive, Kingston Ontario K7M 2E3, CA
LEES, Eric, 3028 Campbell Road R.R. 3, Harrowsmith Ontario K0H 1V0, CA
GATENBY, Kevin, 1648 Grousewood Lane, Kingston Ontario K7L 5H6, CA
GODIN, Daniel, 3920 rue Maureault, Trois Rivieres Québec G9B 2C1, CA
LEBLANC, Rejean, 2252 Labrecque, Jonquiere Québec G7S 1K1, CA
-
- (51) MKP
A61P 35/00 (2006.01) (97) **2448924 ***
C07D 231/38 (2006.01)
A61K 31/415 (2006.01)
C07C 275/30 (2006.01)
- (86) FR2010051394 02.07.2010
(96) 10742179.4 09.05.2012
(87) WO2011001122, 02.07.2010
(97) 2448924, 09.05.2012 fr
- (54) PYRAZOLE DERIVATIVES, PREPARATION THEREOF, AND THERAPEUTIC USE THEREOF
- (71) SANOFI, 54 rue La Boétie, 75008 Paris, FR
(72) ABECASSIS, Pierre-Yves, c/o Sanofi-Aventis Département Brevets 174 avenue de France, F-75013 Paris, FR
DESMAZEAU, Pascal, c/o Sanofi-Aventis Département Brevets 174 avenue de France, F-75013 Paris, FR
TABART, Michel, c/o Sanofi-Aventis Département Brevets 174 avenue de France, F-75013 Paris, FR
-
- (51) MKP
A61K 35/74 (2006.01) (97) **2370085 ***
- (86) EP2010067765 18.11.2010
(96) 10781494.9 05.10.2011
(87) WO2011061259, 18.11.2010
(97) 2370085, 05.10.2011 en
- (54) TREATMENT OF CANCER OR TUMOR INDUCED BY THE RELEASE OF HEAT GENERATED BY VARIOUS CHAINS OF MAGNETOSOMES EXTRACTED FROM MAGNETOTACTIC BACTERIA AND SUBMITTED TO AN ALTERNATIVE MAGNETIC FIELD
- (71) Nanobacterie, 36 Boulevard Flandrin, 75016 Paris, FR
(72) ALPHANDERY, Edouard, 26 rue François Bonvin, F-75015 Paris, FR
FAURE, Stéphanie, 16 rue de la bannière, F-69003 Lyon, FR
CHEBBI, Imène, 75 rue de la République, F-95370 Montigny-les-Cormeilles, FR
-
- (51) MKP
C07C 307/06 (2006.01) (97) **2414325 ***
C07D 417/12 (2006.01)
- (86) US2010029633 01.04.2010
(96) 10713075.9 08.02.2012
(87) WO2010115000, 01.04.2010
(97) 2414325, 08.02.2012 en
- (54) METHOD OF PREPARING AN INHIBITOR OF CYTOCHROME P450 MONOOXYGENASE, AND INTERMEDIATES INVOLVED
- (71) Gilead Sciences, Inc., 333 Lakeside Drive, Foster City, CA 94404, US
(72) ZHOU, Zhongxin, 1021 Hayter Road, Edmonton Alberta T6S 1A1, CA
CULLEN, Aaron, 333 Lakeside Drive, Foster City California 94404, US
DOWDY, Eric, 333 Lakeside Drive, Foster City California 94404, US
TRAN, Duong, 1021 Hayter Road, Edmonton Alberta T6S 1A1, CA
KENT, Kenneth, 333 Lakeside Drive, Foster City California 94404, US
POLNIASZEK, Richard, 333 Lakeside Drive, Foster City California 94404, US
CORDEAU, Doug, 333 Lakeside Drive, Foster City California 94404, US
PFEIFFER, Steven, 333 Lakeside Drive, Foster City California 94404, US
EASTON, Leah, 333 Lakeside Drive, Foster City California 94404, US
YU, Richard, 333 Lakeside Drive, Foster City California 94404, US
-
- (51) MKP
A61K 31/40 (2006.01) (97) **2434890 ***
A01N 43/36 (2006.01)
- (86) US2010036320 27.05.2010
(96) 10781180.4 04.04.2012
(87) WO2010138666, 27.05.2010
(97) 2434890, 04.04.2012 en
- (54) IAP INHIBITORS
- (71) Tetralogic Pharmaceuticals Corp., 343 Phoenixville Pike, Malvern, PA 19355, US
(72) CONDON, Stephen, M., c/o Tetralogic Pharmaceuticals Corp. 343 Phoenixville Pike, Malvern, PA 19355, US
DENG, Yijun, c/o Tetralogic Pharmaceuticals Corp. 343 Phoenixville Pike, Malvern, PA 19355, US
ALEXANDER, Matthew, D., c/o Tetralogic Pharmaceuticals Corp. 343 Phoenixville Pike, Malvern, PA 19355, US
LAPORTE, Matthew, G., c/o Tetralogic Pharmaceuticals Corp. 343 Phoenixville Pike, Malvern, PA 19355, US
-
- (51) MKP
A61M 5/32 (2006.01) (97) **2403567 ***
- (86) EP2010052784 04.03.2010
(96) 10706265.5 11.01.2012
(87) WO2010100240, 04.03.2010
(97) 2403567, 11.01.2012 en
- (54) NEEDLE ASSEMBLY
- (71) Sanofi-Aventis Deutschland GmbH, Brüningstraße 50, 65929 Frankfurt, DE
(72) LANIN, Ursula, c/o Sanofi-Aventis Deutschland GmbH, 65926 Frankfurt am Main, DE
FORYS, Bernhard, c/o Sanofi-Aventis Deutschland GmbH, 65926 Frankfurt am Main, DE
CLARKE, Alastair, c/o Sanofi-Aventis UK London Road Crewe, Holmes Chapel Cheshire CW4 8BE, GB
EKMAN, Matthew, c/o Sanofi-Aventis UK London Road Crewe, Holmes Chapel Cheshire CW4 8BE, GB
GOODE, Kirsten, c/o Sanofi-Aventis UK London Road Crewe, Holmes Chapel Cheshire CW4 8BE, GB
HEALD, Michael, c/o Sanofi-Aventis UK London Road Crewe, Holmes Chapel Cheshire CW4 8BE, GB
HILES, John, c/o Sanofi-Aventis UK London Road Crewe, Holmes Chapel Cheshire CW4 8BE, GB
SMITH, Chris, Sanofi-Aventis UK London Road Crewe, Holmes Chapel Cheshire CW4 8BE, GB
MARTIN, Andrew, 16 Grove Road, Flats Bristol BS6 6TT, GB
-

(51) MKP
B21F 1/00 (2006.01) (97) **2427135 ***
A61C 7/02 (2006.01)

(86) US2010028903 26.03.2010
(96) 10772423.9 14.03.2012
(87) WO2010129110, 26.03.2010
(97) 2427135, 14.03.2012 en

(54) APPARATUS AND METHOD FOR CUSTOMIZED SHAPING OF ORTHODONTIC ARCHWIRES AND OTHER MEDICAL DEVICES

(71) OraMetrix, Inc., 2350 Campbell Creek Boulevard Suite 400, Richardson, TX 75082, US

(72) RIEMEIER, Friedrich, Thomasiusstr. 5, 10557 Berlin, DE
BUTSCHER, Werner, Rundlingsteig 15A, 13467 Berlin, DE
WITTE, Frank, Rheingoldstr. 37, 10318 Berlin, DE
RADINGER, Christoph, Richard-Wagner-Strasse 29, 14513 Teltow, DE
CORDELL, Andrew, 2308 Broken Point, Mckinney, TX 75070, US
SACHDEVA, Rohit, 4609 Kellner Place, Plano, TX 75093, US

(51) MKP
A61K 31/5415 (2006.01) (97) **2403840 ***
C07D 275/06 (2006.01)

(86) EP2010052609 02.03.2010
(96) 10706624.3 11.01.2012
(87) WO2010100139, 02.03.2010
(97) 2403840, 11.01.2012 en

(54) DERIVATIVES OF BENZOTHAZINES, PREPARATION THEREOF AND APPLICATION THEREOF AS DRUGS

(71) Pierre Fabre Medicament, 45, Place Abel Gance, 92100 Boulogne-Billancourt, FR

(72) PEREZ, Michel, 45 chemin de la Pique, F-81100 Castres, FR
LAMOTHE, Marie, 12 rue du Commandant Prat, F-81100 Castres, FR
JUNQUERO, Didier, 112 Chemin des Fourches, F-81100 Castres, FR
RIVAL, Yves, 40 rue François Mitterrand, F-81090 Lagarrigue, FR

(51) MKP
B24C 1/04 (2006.01) (97) **2414134 ***
B24C 3/04 (2006.01)

(86) IB2010051409 31.03.2010
(96) 10714077.4 08.02.2012
(87) WO2010113127, 31.03.2010
(97) 2414134, 08.02.2012 de

(54) DEVICE AND METHOD FOR WATER-JET CUTTING

(71) Bystronic Laser AG, Industriestrasse 21, 3362 Niederörn, CH

(72) MAURER, Walter, Mittlere Bühnenbergstrasse 61, CH-4665 Oftringen, CH
PUDE, Frank, Untere Sternengasse 19 B, CH-4500 Solothurn, CH
SCHWERMANN, Torben, Neufeldweg 2, CH-3373 Heimenhausen, CH

(51) MKP
A61P 43/00 (2006.01) (97) **2442870 ***
A61P 3/00 (2006.01)
A61P 15/00 (2006.01)
A61P 13/02 (2006.01)
C07D 498/04 (2006.01)
A61P 21/00 (2006.01)

(86) JP2010060408 14.06.2010
(96) 10727154.6 25.04.2012
(87) WO2010147226, 14.06.2010
(97) 2442870, 25.04.2012 en

(54) PYRAZINOXAZEPINE DERIVATIVES

(71) Takeda Pharmaceutical Company Limited, 1-1 Doshomachi 4-chome Chuo-ku, Osaka-shi, Osaka 541-0045, JP

(72) SASAKI, Shigekazu, c/o TAKEDA PHARMACEUTICAL COMPANY LIMITED, 26-1, Muraoka-Higashi 2-chome, Fujisawa, Kanagawa 251-0012, JP
KUSUMOTO, Tomokazu, c/o TAKEDA PHARMACEUTICAL COMPANY LIMITED, 26-1, Muraoka-Higashi 2-chome, Fujisawa, Kanagawa 251-0012, JP
NOMURA, Izumi, c/o TAKEDA PHARMACEUTICAL COMPANY LIMITED, 26-1, Muraoka-Higashi 2-chome, Fujisawa, Kanagawa 251-0012, JP
MAEZAKI, Hironobu, c/o TAKEDA PHARMACEUTICAL COMPANY LIMITED, 26-1, Muraoka-Higashi 2-chome, Fujisawa, Kanagawa 251-0012, JP

(51) MKP
A45D 31/00 (2006.01) (97) **2456335 ***
A61K 8/02 (2006.01)
A61K 8/35 (2006.01)
A61K 8/37 (2006.01)
A61K 8/42 (2006.01)
A61Q 3/02 (2006.01)

(86) US2010042395 19.07.2010
(96) 10737178.3 30.05.2012
(87) WO2011011304, 19.07.2010
(97) 2456335, 30.05.2012 en

(54) COMPOSITIONS FOR REMOVABLE GEL APPLICATIONS FOR NAILS AND METHODS OF THEIR USE

(71) Haile, Danny Lee, 12852 Larrylyn Drive, La Mirada, CA 90638, US

(72) Haile, Danny Lee, 12852 Larrylyn Drive, La Mirada, CA 90638, US

(51) MKP
F16K 31/30 (2006.01) (97) **2325407**
F16K 31/46 (2006.01)
F15C 1/16 (2006.01)
E03F 5/10 (2006.01)
F15D 1/00 (2006.01)

(96) 10191070.1 25.05.2011
(97) 2325407, 25.05.2011 en

(54) Bypass valve

(71) ACO Technologies plc, Hitchin Road, Shefford, Bedfordshire SG17 5JS, GB

(72) Canney, James, ACO Technologies plc Hitchin Road, Shefford, Hertfordshire SG17 5TE, GB
Robinson, Neill, ACO Technologies plc Hitchin Road, Shefford, Hertfordshire SG17 5TE, GB

(51) MKP
A61K 31/4545 (2006.01) (97) **2402012**
A61K 47/10 (2006.01)
A61P 11/02 (2006.01)
A61K 9/08 (2006.01)
A61P 37/08 (2006.01)
A61K 9/00 (2006.01)
G01N 30/02 (2006.01)
A61P 11/04 (2006.01)

(96) 11172101.5 04.01.2012
(97) 2402012, 04.01.2012 en

(54) Liquid formulations of rupatadine fumarate

(71) J. Uriach y Compania S.A., Av. Cami Reial, 51-57, 08184 Palau-solità i Plegamans (Barcelona), ES

(72) Suriol Ferrer, M Montserrat, Soler i Rovirosa nº18, 2º, E-08018 Barcelona, ES
Morlesin Capdevila, M Silvia, Fluvia 239-243, 4ª, E-08020 Barcelona, ES

(51) MKP
H03K 5/22 (2006.01) (97) **2491655 ***

(86) US2010002417 02.09.2010
(96) 10825312.1 29.08.2012
(87) WO2011049597, 02.09.2010
(97) 2491655, 29.08.2012 en

(54) FAST SETTLING, BIT SLICING COMPARATOR CIRCUIT

(71) Lojack Operating Company, Lp, 200 Lowder Brook Drive Suite 1000, Westwood, MA 02090, US

(72) FEDAN, Orest, 22 Betts Road, Belmont MA 02478, US
BOURQUE, Stephen, 45 New Estate Road, Littleton MA 01460, US

(51) MKP
A01H 3/00 (2006.01) (97) **2448400 ***

(86) EP2010003507 11.06.2010
(96) 10737477.9 09.05.2012
(87) WO2011000466, 11.06.2010
(97) 2448400, 09.05.2012 en

(54) IMPROVEMENT OF YIELD IN CROP PLANTS THROUGH SELECTION OF EPIGENETICALLY MODIFIED POPULATIONS

(71) Bayer CropScience N.V., 1831 Diagem J.E. Mommaertsiaan 14, Belgium, BE

(72) DE BLOCK, Marc, Abrikozenstraat 26, B-9820 Merelbeke, BE

- (51) MKP
A61P 31/04 (2006.01) (97) **2428214**
A61K 35/74 (2006.01)
A61P 15/02 (2006.01)
(96) 10176578.2 14.03.2012
(97) 2428214, 14.03.2012 en
(54) Compositions for the vaginal and oral administration of lactobacillus and uses thereof
(71) HSO Health Care GmbH, Nibelungengasse 1-3/38, 1010 Vienna, AT
(72) Kiss, Herbert, Brechergasse, 4, 1190, VIENNA, AT
-
- (51) MKP
A23L 1/305 (2006.01) (97) **2464363 ***
A61K 36/88 (2006.01)
A61K 36/78 (2006.01)
A61P 9/12 (2006.01)
(86) IB2010001994 11.08.2010
(96) 10808028.4 20.06.2012
(87) WO2011018700, 11.08.2010
(97) 2464363, 20.06.2012 en
(54) NATURAL EXTRACT FROM WHOLE BANANA FRUIT (MUSA SPP.)
(71) Medasani, Munisekhar, 402 Mahitha Enclave Madhura Nagar Andhara Pradesh State, Hyderabad 500038, IN
(72) Medasani, Munisekhar, 402 Mahitha Enclave Madhura Nagar Andhara Pradesh State, Hyderabad 500038, IN
-
- (51) MKP
C07D 403/12 (2006.01) (97) **2475648 ***
A61K 31/505 (2006.01)
A61P 37/00 (2006.01)
C07D 239/48 (2006.01)
A61K 31/506 (2006.01)
A61P 35/00 (2006.01)
(86) EP2010063077 07.09.2010
(96) 10771368.7 18.07.2012
(87) WO2011029807, 07.09.2010
(97) 2475648, 18.07.2012 en
(54) ORTHO SUBSTITUTED PYRIMIDINE COMPOUNDS AS JAK INHIBITORS
(71) Cellzome Limited, Chesterford Research Park, Little Chesterford Cambridge CB10 1XL, GB
(72) HARRISON, Richard, John, 30 Chalmers Road, Cambridge CB1 3SX, GB
HOBSON, Andrew, 77 Riverside Place, Cambridge, CB5 8JF, GB
RAMSDEN, Nigel, Sparrows Lodge Green Lane Fowlmere Royston, Herts SG8 7QP, GB
-
- (51) MKP
C12Q 1/68 (2006.01) (97) **2438194 ***
(86) US2010001611 02.06.2010
(96) 10783709.8 11.04.2012
(87) WO2010141085, 02.06.2010
(97) 2438194, 11.04.2012 en
(54) METHODS FOR SCREENING AND IDENTIFYING COMPOUNDS
(71) BioRelix, Inc., 5 Science Park at Yale 401 Winchester Avenue, New Haven, CT 06511, US
(72) MYUNG, Jayhyuk, 25 Deepwood Road, Woodbridge, CT 06525, US
BLOUNT, Kenneth, F., 3 Old Barn Lane, Guilford, CT 06436, US
FORBES, Christen, Douglas, 105 Village Street, North Haven, CT 06473, US
OSTERMAN, David, 75 Church Hill Road, Glastonbury, CT 06033, US
-
- (51) MKP
H04M 1/02 (2006.01) (97) **2456175**
G06F 1/16 (2006.01)
(96) 10191984.3 23.05.2012
(97) 2456175, 23.05.2012 en
(54) Portable electronic device including flexible display
(71) Research In Motion Limited, 295 Phillip Street, Waterloo, ON N2L 3W8, CA
(72) Ma, Ming-Lun Dave, 76574 - 305 Phillip Street, Waterloo Ontario N2L 3W8, CA

- (51) MKP
A61B 17/94 (2006.01) (97) **2410935 ***
A61B 17/34 (2006.01)
A61B 19/00 (2006.01)
(86) US2010028881 26.03.2010
(96) 10756938.6 01.02.2012
(87) WO2010111629, 26.03.2010
(97) 2410935, 01.02.2012 en
(54) CANNULA WITH INTEGRATED CAMERA AND ILLUMINATION
(71) Endosphere Surgical, Inc., 60 Longwood Avenue, 702, Brookline, MA 02446, US
(72) MCKINLEY, Arthur, C., 5 Willow Way, Westport MA 02790, US
PRENOVITZ, Melvin, B., 60 Longwood Avenue, 702, Brookline, MA 02446, US
MCKINLEY, Philip, E., 85 West Street, Westford MA 01886, US
PLOUFFE, Jesse, R., 3 Factory Road, Wilmington MA 01887, US
-
- (51) MKP
A61B 17/32 (2006.01) (97) **2453813 ***
A61B 18/14 (2006.01)
A61B 17/28 (2006.01)
(86) US2010041663 12.07.2010
(96) 10736913.4 23.05.2012
(87) WO2011008672, 12.07.2010
(97) 2453813, 23.05.2012 en
(54) ELECTROSURGERY GENERATOR FOR ULTRASONIC SURGICAL INSTRUMENTS
(71) Ethicon Endo-Surgery, Inc., 4545 Creek Road, Cincinnati, OH 45242, US
(72) WIENER, Eitan, T., 9519 Croton Drive, Cincinnati OH 45242, US
WITT, David, A., 1187 Chaucer Place, Maineville OH 45039, US
DINARDO, Brian, 10052 Old Farm Court, Cincinnati OH 45242, US
PRICE, Daniel, W., 185 Overlook Drive, Loveland OH 45140, US
GIORDANO, James, R., 5647 Chestnutview Lane, Milford OH 45150, US
WAN, Shan, 5667 Richmond Park Drive, Mason OH 45040, US
ALDRIDGE, Jeffrey, L., 106 W. Concord Drive, Lebanon OH 45036, US
YATES, David, C., 7534 Galway Court, West Chester OH 45069, US
MESSERLY, Jeffrey, D., 2181 Telegraph Court, Cincinnati OH 45244, US
NORVELL, David, K., 570 Doverdale Drive, Monroe OH 45050, US
-
- (51) MKP
A61K 31/19 (2006.01) (97) **2456431 ***
A61K 31/195 (2006.01)
A61K 31/198 (2006.01)
A61K 31/4172 (2006.01)
A61K 31/661 (2006.01)
A61K 31/675 (2006.01)
A61K 31/7004 (2006.01)
A61K 33/00 (2006.01)
A61K 33/06 (2006.01)
A61K 33/10 (2006.01)
A61P 7/08 (2006.01)
A61K 45/06 (2006.01)
(86) EP2010004458 21.07.2010
(96) 10744868.0 30.05.2012
(87) WO2011009601, 21.07.2010
(97) 2456431, 30.05.2012 en
(54) CELL PROTECTION IN DIALYSIS PATIENTS BY ADMINISTRATION OF A CREATINE COMPOUND
(71) Crearene Ltd., Lennox Paton Corporate Services Limited Fort Nassau Centre, Marlborough Street, Nassau, BS
(72) The designation of the inventor has not yet been filed , null, null, null

- (51) MKP
A61K 36/00 (2006.01) (97) **2473057 ***
A01N 65/00 (2009.01)
- (86) IN2010000584 02.09.2010
(96) 10813435.4 11.07.2012
(87) WO2011027364, 02.09.2010
(97) 2473057, 11.07.2012 en
(54) PICRORHIZA KURROA EXTRACT FOR PREVENTION, ELIMINATION AND TREATMENT OF INFECTION DISEASES
(71) Medasani, Munisekhar, S-1, Plot 31B Vimal Road 5 Jubilee Hills, Hyderabad 500 033 Andhra Pradesh, IN
(72) DIVI, Satyasayee Babu, 55-1-19 JR Nagar, Vishakapatnam 530 022 Andhra Pradesh, IN
-
- (51) MKP
C07D 471/04 (2006.01) (97) **2464646 ***
- (86) US2010045204 11.08.2010
(96) 10744808.6 20.06.2012
(87) WO2011019842, 11.08.2010
(97) 2464646, 20.06.2012 en
(54) PROCESS FOR THE PREPARATION OF CATHEPSIN S INHIBITORS
(71) Janssen Pharmaceutica, N.V., Turnhoutseweg 30, 2340 Beerse, BE
(72) LIANG, Jimmy, T., 13729 Tradition Street, San Diego CA 92128, US
MANI, Neelakandha, S., 13109 Russet Leaf Lane, San Diego CA 92129, US
-
- (51) MKP
H04W 16/00 (2009.01) (97) **2466939 ***
- (86) CN2010075912 11.08.2010
(96) 10807983.1 20.06.2012
(87) WO2011018038, 11.08.2010
(97) 2466939, 20.06.2012 en
(54) METHOD, DEVICE AND SYSTEM FOR DETERMINING RESOURCE LOCATIONS
(71) China Academy of Telecommunications Technology, 40, Xueyuan Road, Haidian District Beijing 100191, CN
(72) XING, Yanping, No.40 Xueyuan Road Haidian District, Beijing 100083, CN
LI, Xiaoka, No.40 Xueyuan Road Haidian District, Beijing 100083, CN
-
- (51) MKP
C10B 7/02 (2006.01) (97) **2424955 ***
C10L 5/40 (2006.01)
C10L 9/08 (2006.01)
C10B 53/02 (2006.01)
F26B 23/02 (2006.01)
C10B 49/02 (2006.01)
F27B 9/18 (2006.01)
F26B 17/00 (2006.01)
- (86) EP2011062131 15.07.2011
(96) 11738428.9 07.03.2012
(87) WO2012007574, 15.07.2011
(97) 2424955, 07.03.2012 de
(54) DEVICE AND METHOD FOR DRYING AND TORREIFYING AT LEAST ONE CARBON-CONTAINING SUBSTANCE STREAM IN A MULTIPLE-HEARTH FURNACE
(71) ThyssenKrupp Polysius AG, Graf-Galen-Strasse 17, 59269 Beckum, DE
(72) LAMPE, Karl, Martinstr. 12, 59320 Ennigerloh, DE
DENKER, Jürgen, Hansaring 33, 59269 Beckum, DE
BEYER, Christoph, Dürerstr. 9, 48147 Münster, DE
ERPELDING, Richard, F. Schauer Weg 3, 59494 Soest, DE
-
- (51) MKP
C12N 5/07 (2010.01) (97) **2496707 ***
C12P 21/08 (2006.01)
- (86) US2010055062 02.11.2010
(96) 10828964.6 12.09.2012
(87) WO2011056772, 02.11.2010
(97) 2496707, 12.09.2012 en
(54) ENGINEERED ANTI-TSLP ANTIBODY
(71) Merck Sharp & Dohme Corp., 126 East Lincoln Avenue, Rahway NJ 07065-0907, US
(72) PRESTA, Leonard, G., 901 California Avenue, Palo Alto, CA 94304, US
-
- (51) MKP
A61M 5/315 (2006.01) (97) **2453959 ***
- (86) EP2010059542 05.07.2010
(96) 10730453.7 23.05.2012
(87) WO2011006788, 05.07.2010
(97) 2453959, 23.05.2012 en
(54) DRUG DELIVERY DEVICE
(71) Sanofi-Aventis Deutschland GmbH, Brüningstraße 50, 65929 Frankfurt, DE
(72) TEUCHER, Axel, c/o Sanofi-Aventis Deutschland GmbH, 65926 Frankfurt am Main, DE
FORSTREUTER, Axel, c/o Sanofi-Aventis Deutschland GmbH, 65926 Frankfurt am Main, DE
-
- (51) MKP
C07K 16/28 (2006.01) (97) **2424897 ***
A61K 39/395 (2006.01)
A61P 31/18 (2006.01)
- (86) EP2010055863 29.04.2010
(96) 10721376.1 07.03.2012
(87) WO2010125162, 29.04.2010
(97) 2424897, 07.03.2012 en
(54) ANTI CXCR4 ANTIBODIES FOR THE TREATMENT OF HIV
(71) Pierre Fabre Medicament, 45, Place Abel Gance, 92100 Boulogne-Billancourt, FR
(72) KLINGUER-HAMOUR, Christine, 73 route de chez Diossaz Les Gottalles, F-74570 Groisy, FR
-
- (51) MKP
C07D 451/10 (2006.01) (97) **2432781 ***
A61K 31/46 (2006.01)
A61P 11/00 (2006.01)
- (86) EP2010056279 07.05.2010
(96) 10720148.5 28.03.2012
(87) WO2010133457, 07.05.2010
(97) 2432781, 28.03.2012 en
(54) SALTS OF TIOTROPIUM WITH 10-CAMPORSULFONIC ACID
(71) Adamed SP. Z O.O., Pienków 149, 05-152 Czosnow k/ Warszawy, PL
(72) MODRZEJEWSKA, Helena, ul. S. Baley 6/46, PL-02-132 Warszawa, PL
MAJKA, Zbigniew, Brzezówka 15, PL-39-102 Lubzina, PL
DZIEDZIC, Magdalena, Kolonia Peclawice 32, PL-28-210 Bogoria, PL
-
- (51) MKP
A61M 5/315 (2006.01) (97) **2437819 ***
- (86) EP2010057456 28.05.2010
(96) 10722095.6 11.04.2012
(87) WO2010139629, 28.05.2010
(97) 2437819, 11.04.2012 en
(54) INNER HOUSING FOR A DRUG DELIVERY DEVICE
(71) Sanofi-Aventis Deutschland GmbH, Brüningstraße 50, 65929 Frankfurt, DE
(72) PLUMPTRE, David, 36 Shire Way Droitwich Spa, Worcestershire WR9 7RQ, GB
-
- (51) MKP
A61P 25/00 (2006.01) (97) **2441459 ***
A61K 31/7076 (2006.01)
A61P 25/28 (2006.01)
- (86) ES2010070374 07.06.2010
(96) 10730196.2 18.04.2012
(87) WO2010142827, 07.06.2010
(97) 2441459, 18.04.2012 en
(54) 5'-METHYLTHIOADENOSINE NEUROPROTECTIVE PROPERTIES
(71) Proyecto de Biomedicina Cima, S.L., Avda. Pío XII, 22 Oficina 1, 31008 Pamplona - Navarra, ES
(72) VILLOSLADA DÍAZ, Pablo, ICT (D.P.I.) Avda. Pio XII 53, E-31008 Pamplona, ES

- (51) MKP
A61P 1/16 (2006.01) (97) **2450051 ***
A61P 31/14 (2006.01)
A61K 31/56 (2006.01)
A61P 43/00 (2006.01)
A61K 31/7056 (2006.01)
A61K 38/21 (2006.01)
- (86) JP2010060762 24.06.2010
(96) 10794066.0 09.05.2012
(87) WO2011001897, 24.06.2010
(97) 2450051, 09.05.2012 en
(54) MEDICINAL AGENT AND METHOD FOR TREATMENT OF INTRACTABLE CHRONIC HEPATITIS C
- (71) Meiji Seika Pharma Co., Ltd., 4-16, Kyobashi 2-chome Chuo-ku, Tokyo 104-8002, JP
(72) NOMOTO Kozo, c/o Meiji Seika Pharma Co., Ltd. 4-16 Kyobashi 2-chome Chuo-ku, Tokyo 104-8002, JP
MATSUI Daisuke, c/o Meiji Seika Pharma Co., Ltd. 4-16 Kyobashi 2-chome Chuo-ku, Tokyo 104-8002, JP
HIRANUMA Toyokazu, c/o Meiji Seika Pharma Co., Ltd. 4-16 Kyobashi 2-chome Chuo-ku, Tokyo 104-8002, JP
-
- (51) MKP
C07D 487/04 (2006.01) (97) **2491038 ***
A61K 31/407 (2006.01)
A61P 25/00 (2006.01)
- (86) US2010053606 21.10.2010
(96) 10773477.4 29.08.2012
(87) WO2011050198, 21.10.2010
(97) 2491038, 29.08.2012 en
(54) DISUBSTITUTED OCTAHY - DROPYRROLO [3,4-C] PYRROLES AS OREXIN RECEPTOR MODULATORS
- (71) Janssen Pharmaceutica N.V., Turnhoutseweg 30, 2340 Beerse, BE
(72) CHAI, Wenying, 4318 Corte Al Fresco, San Diego CA 92130, US
LETAVIC, Michael, A., 4379 Mistral Place, San Diego CA 92130, US
LY, Kiev, S., P.O. Box 927992, San Diego CA 92192, US
PIPPEL, Daniel, J., 13106 Caminito Mar Villa, Del Mar CA 92014, US
RUDOLPH, Dale, A., 12721 Alondra Court, San Diego CA 92128, US
STROTHER, Kathleen, C., 3429 Borreson Street, San Diego CA 92117, US
SAVALL, Brad, M., 9512 Ronda Avenue, San Diego CA 92123, US
SHAH, Chandravadan, R., 14213 Dalhouside Road, San Diego CA 92129, US
SHIREMAN, Brock, T., 12625 Birchbrook Court, Poway CA 92064, US
SOYODE-JOHNSON, Akinola, 8530 Costa Verde Blvd. 1409, San Diego CA 92122, US
STOCKING, Emily, M., 310 Melrose Avenue, Encinitas CA 92024, US
SWANSON, Devin, M., 3121 Morning Way, La Jolla CA 92037, US
-
- (51) MKP
C07K 16/00 (2006.01) (97) **2421897 ***
- (86) US2010031933 21.04.2010
(96) 10715636.6 29.02.2012
(87) WO2010124018, 21.04.2010
(97) 2421897, 29.02.2012 en
(54) FRAGMENTATION RESISTANT IgG1 Fc-CONJUGATES
- (71) Amgen Inc., One Amgen Center Drive, Thousand Oaks, CA 91320, US
(72) YAN, Boxu, 6428 165th Place S.E., Bellevue Washington 98006, US
HU, Zhonghua, 17841 Wayne Avenue North, Shoreline Washington 98133, US
KLEEMANN, Gerd Richard, 6570 81st Avenue S.E., Mercer Island Washington 98040, US
YATES, Zachary Adam, 16808 5th Avenue S.E., Bothell Washington 98012, US
ZHOU, Hongxing, 6324 151st Avenue S.E., Bellevue Washington 98006, US
-
- (51) MKP
G06F 7/04 (2006.01) (97) **2411906 ***
- (86) US2010000845 23.03.2010
(96) 10756462.7 01.02.2012
(87) WO2010110865, 23.03.2010
(97) 2411906, 01.02.2012 en
(54) IMPROVED MULTIPLEXER FOR A PIEZO CERAMIC IDENTIFICATION DEVICE
- (71) Sonavation, Inc., 357 Hiatt Drive, Palm Beach Gardens, FL 33418, US
(72) LIAUTAUD, Christian, 1501 Southwest 7th Street, Boca Raton FL 33486, US
SCHMITT, Rainer M., 86 Ironwood Way, Palm Beach Gardens Florida 33418, US
-
- (51) MKP
A61M 5/32 (2006.01) (97) **2427238 ***
- (86) HU2010000049 05.05.2010
(96) 10772069.0 14.03.2012
(87) WO2010128344, 05.05.2010
(97) 2427238, 14.03.2012 en
(54) PIVOTABLE NEEDLE PROTECTOR
- (71) Dispomedicor ZRT., Fűredi u. 98, 4032 Debrecen, HU
(72) NAGY, Antal, Bíró Péter u. 4, H-4220 Hajdúböszörmény, HU
GÁTI, Zoltán, Szepesi ut. 36/B, H-4030 Debrecen, HU
PERÉNYI, Vilmos, Jánosi út. 47, H-4028 Debrecen, HU
WITT, Wolfgang, Am Spielacker 10-12, 63571 Gelnhausen-Hailer, DE
SZILÁGYI, Sándor, Gyergyó u. 9. 9/55, H-4026 Debrecen, HU
JUHÁSZ, László, Jámor Lajos út. 33, H-4026 Debrecen, HU
-
- (51) MKP
A22C 21/00 (2006.01) (97) **2248429**
A22C 21/06 (2006.01)
- (96) 10156205.6 10.11.2010
(97) 2248429, 10.11.2010 en
(54) Apparatus and method for conveying organ packages to a processing station
- (71) Meijn Food Processing Technology B.V., Noordeinde 68, 1511 AE Oostzaan, NL
(72) Spijker, Remco, c/o Noordeinde 68, NL-1511 AE, OOSTZAAAN, NL
Jansen, Tom Cornelis, c/o Noordeinde 68, NL-1511 AE, Oostzaan, NL
van Steijn, Aloysius Christianus Maria, c/o Nooreinde 68, NL-1511 AE, OOSTZAAAN, NL
-
- (51) MKP
C07D 277/64 (2006.01) (97) **2430006 ***
C07D 285/06 (2006.01)
C07D 403/12 (2006.01)
C07D 413/14 (2006.01)
C07D 417/12 (2006.01)
A61K 31/403 (2006.01)
C07D 417/14 (2006.01)
A61P 29/00 (2006.01)
- (86) FR2010050913 11.05.2010
(96) 10728741.9 21.03.2012
(87) WO2010130944, 11.05.2010
(97) 2430006, 21.03.2012 fr
(54) CYCLOPENTA[C]PYRROLE-2-CARBOXYLATE DERIVATIVES, PREPARATION THEREOF, AND THERAPEUTIC USE THEREOF
- (71) SANOFI, 174, Avenue de France, 75013 Paris, FR
(72) ABOUABDELLAH, Ahmed, Sanofi-Aventis Département Brevets 174 Avenue de France, F-75013 Paris, FR
EVEN, Luc, Sanofi-Aventis Département Brevets 174 Avenue de France, F-75013 Paris, FR
FAYOL, Aude, Sanofi-Aventis Département Brevets 174 Avenue de France, F-75013 Paris, FR
VACHE, Julien, Sanofi-Aventis Département Brevets 174 Avenue de France, F-75013 Paris, FR
YAICHE, Philippe, Sanofi-Aventis Département Brevets 174 Avenue de France, F-75013 Paris, FR
-

- (51) MKP
H02P 9/00 (2006.01) (97) **2386753**
F03D 9/00 (2006.01)
H02P 9/30 (2006.01)
H02P 9/48 (2006.01)
(96) 10382117.9 16.11.2011
(97) 2386753, 16.11.2011 en
(54) Excitation circuit for an asynchronous generator and method for the excitation of an asynchronous generator
(71) Wind To Power System, S.l., Avda. De Bruselas 13, 1° D Alcobendas, 28108 Madrid, ES
(72) Arnaltes Gómez, Santiago, WIND TO POWER SYSTEM, S.L. Avda. de Bruselas 13, 1 D, E-28108, Alcobendas - Madrid, ES Santos Martin, David, WIND TO POWER SYSTEM, S.L. Avda. de Bruselas 13, 1 D, E-28108 Alcobendas - Madrid, ES Rodriguez Amendo, Jose Luis, WIND TO POWER SYSTEM, S.L. Avda. de Bruselas 13, 1 D, E-28108 Alcobendas - Madrid, ES
-
- (51) MKP
A61K 31/506 (2006.01) (97) **2474544 ***
A61K 31/5377 (2006.01)
A61K 31/4439 (2006.01)
A61K 31/426 (2006.01)
A61P 25/22 (2006.01)
C07D 491/052 (2006.01)
C07D 417/14 (2006.01)
C07D 495/04 (2006.01)
C07D 491/048 (2006.01)
(86) JP2010064989 02.09.2010
(96) 10813754.8 11.07.2012
(87) WO2011027806, 02.09.2010
(97) 2474544, 11.07.2012 en
(54) THERAPEUTIC AGENT FOR ANXIETY DISORDERS
(71) Kyowa Hakko Kirin Co., Ltd., 1-6-1, Ohtemachi Chiyoda-ku, Tokyo 100-8185, JP
(72) KASE, Junya, c/o Head Office, Kyowa Hakko Kirin Co., Ltd. 1-6-1, Otemachi, Chiyoda-ku, Tokyo 100-8185, JP KANDA, Tomoyuki, c/o Pharmacological Research Laboratories Kyowa Hakko Kirin Co., Ltd. 1188, Shimotogari Nagaizumi-cho, Sunto-gun, Shizuoka 411-8731, JP
-
- (51) MKP
C30B 11/00 (2006.01) (97) **2491168 ***
C30B 29/06 (2006.01)
B22D 27/04 (2006.01)
H05B 6/44 (2006.01)
H05B 6/36 (2006.01)
F27B 14/14 (2006.01)
C30B 35/00 (2006.01)
(86) IB2010002686 20.10.2010
(96) 10787881.1 29.08.2012
(87) WO2011048474, 20.10.2010
(97) 2491168, 29.08.2012 en
(54) DEVICE FOR OBTAINING A MULTICRYSTALLINE SEMICONDUCTOR MATERIAL, IN PARTICULAR SILICON, AND METHOD FOR CONTROLLING THE TEMPERATURE THEREIN
(71) Saet S.p.A., Via Torino 213, 10040 Leini, IT
(72) DUGHIERO, Fabrizio, Piazza Incoronata 11, I-35028 Piove Di Sacco, IT FORZAN, Michele, Via Polesine 2c, I-35142 Padova, IT CISCATO, Dario, Via Fogazzaro 2, I-35010 Gazzo, IT CESANO, Mariolino, Via Viancino 2b, I-13047 San Germano Vercellese, IT CRIVELLO, Fabrizio, Via castellamonte 9 Frazione Silva, I-10010 San Martino Canavese, IT BECHINI, Roberto, Via San Giovanni Bosco 58, I-10080 San Benigno Canavese, IT
-
- (51) MKP
A47C 23/06 (2006.01) (97) **2428140**
(96) 11005836.9 14.03.2012
(97) 2428140, 14.03.2012 de
(54) Slatted frame
(71) Fleischmann Alois & Co. KG, Möslweg 25, 39020 Goldrain/Latsch (BZ), IT
(72) Fleischmann, Alois, Möslweg 25, 39020 Goldrain/Latsch (BZ), IT
-
- (51) MKP
C07D 495/04 (2006.01) (97) **2454254 ***
C07D 401/14 (2006.01)
A61P 3/00 (2006.01)
C07D 417/14 (2006.01)
C07D 403/14 (2006.01)
C07D 407/14 (2006.01)
A61K 31/4184 (2006.01)
C07D 409/14 (2006.01)
C07D 413/14 (2006.01)
(86) US2010042340 16.07.2010
(96) 10734877.3 23.05.2012
(87) WO2011009084, 16.07.2010
(97) 2454254, 23.05.2012 en
(54) BENZIMIDAZOLE ANALOGUES FOR THE TREATMENT OR PREVENTION OF FLAVIVIRUS INFECTIONS
(71) Vertex Pharmaceuticals Incorporated, 130 Waverly Street, Cambridge, MA 02139, US
(72) MAXWELL, John, 69 Gifford Road, Hingham, Massachusetts 02043, US POISSON, Carl, 1170 de Louvan est, Montreal, Québec H2M 1B5, CA BENNANI, Youssef L., 119 Beacon Street, Boston, Massachusetts 02116, US KONG, Laval Chan Chun, 27 Levere Street, Kirkland, Québec H9J3XB, CA YANNOPOULOS, Constantin, 55 Poncelet Street Notre-Dame de l'Ile Perrot, Québec J7V 8X3, CA MORRIS, Mark, 37 Lowell Street, Somerville, Massachusetts 02143, US BUBENIK, Monica, 2775 Rue des Futaies, Mascouche, Québec J7K 4B8, CA BHISETTI, Govinda Rao, 19 Minute Man Lane, Lexington, Massachusetts 02421, US GIROUX, Simon, 27 Wheeler Street, 224, Cambridge, Massachusetts 02138, US FALARDEAU, Guy, 5635 Blv. Cleroux, Laval, Québec H7X 4A5, CA MARONE, Valerie, 71 Cedar Street Apt. 1, Somerville, Massachusetts 02143, US VAILLANCOURT, Louis, 2775 Rue des Futaies, Mascouche, Québec J7K 4B8, CA CADILHAC, Caroline, 4376 Oxford, Montreal, Québec H4A 2Y6, CA PIERCE, Albert C., 295 Harvard Street Apt. 911, Cambridge, Massachusetts 02138, US DAS, Sanjoy Kumar, 4451 King Street, Pierrefonds, Québec H9H 2G2, CA WANG, Jian, 12 Sagamore Road, Newton, Massachusetts 02461, US HENDERSON, James A., 345 Franklin Street Apt. 404, Cambridge, Massachusetts 02139, US LIU, Bingcan, 275 Armand-Frappier Blvd., Laval, Québec H7V 4A7, CA PEREIRA, Oswy Z., 12 Daudelin Street, Kirkland, Québec H9J 1LB, CA GREY, JR., Ronald, 51 Twelfth Street, Attleboro, Massachusetts 02703, US REDDY, T. Jagadeeswar, 12546 Bedford, Pierrefonds, Québec H9A 3K5, CA COTTRELL, Kevin M., 17B Roberts Road, Cambridge, Massachusetts 02138, US
-
- (51) MKP
C07D 473/34 (2006.01) (97) **2411391 ***
A61K 31/52 (2006.01)
A61P 35/00 (2006.01)
(86) US2010028554 24.03.2010
(96) 10722454.5 01.02.2012
(87) WO2010111432, 24.03.2010
(97) 2411391, 01.02.2012 en
(54) ATROPISOMERS OF 2-PURINYL-3-TOLYL-QUINAZOLINONE DERIVATIVES AND METHODS OF USE
(71) Gilead Calistoga LLC, 333 Lakeside Drive, Foster City, CA 94404, US
(72) EVARTS, Jerry, B., 333 Lakeside Drive, Foster City, CA 94404, US ULRICH, Roger, G., 333 Lakeside Drive, Foster City, CA 94404, US
-

(51) MKP
B01D 53/64 (2006.01) (97) **2482970 ***
B01J 20/02 (2006.01)
B01J 20/28 (2006.01)
B01D 53/02 (2006.01)
(86) US2010050598 28.09.2010
(96) 10819662.7 08.08.2012
(87) WO2011038415, 28.09.2010
(97) 2482970, 08.08.2012 en
(54) SORBENT FORMULATION FOR REMOVAL OF MERCURY FROM FLUE GAS
(71) CALGON CARBON CORPORATION, 500 Calgon Carbon Drive, Pittsburgh Pennsylvania 15205, US
(72) POLLACK, Nicholas R., 105 Boggs Avenue, Moon Pennsylvania 15108, US
HAYDEN, Richard A., 348 Lee Avenue, Pittsburgh Pennsylvania 15237, US

(51) MKP
G01N 33/48 (2006.01) (97) **2470898 ***
(86) US2010046520 24.08.2010
(96) 10814253.0 04.07.2012
(87) WO2011028540, 24.08.2010
(97) 2470898, 04.07.2012 en
(54) DETERMINING SENSITIVITY OF CELLS TO B-RAF INHIBITOR TREATMENT BY DETECTING KRAS MUTATION AND RTK EXPRESSION LEVELS
(71) Genentech, Inc., 1 DNA Way, South San Francisco, CA 94080, US
(72) HATZIVASSILIOU, Georgia, 552 Arkansas Street, San Francisco, California 94107, US
MALEK, Shiva, 1252 Bernal Avenue, Burlingame, California 94010, US

(51) MKP
H01M 8/02 (2006.01) (97) **2337131**
H01M 8/24 (2006.01)
(96) 10180639.6 22.06.2011
(97) 2337131, 22.06.2011 en
(54) Two-sided fluid flow plate assembly having parallel flow channels
(71) Industrial Technology Research Institute, No. 195, Sec. 4 Chung Hsing Road, Chutung Hsinchu 31040, Taiwan, TW
(72) Chen, Chi-Chang, No. 180, Sec. 2, Yuanlu Rd. Puxin Township, 513, Taiwan, Changhua County, TW
Shiu, Huan-Ruei, No. 39, Donghu Village Cimei Township, 883, Taiwan, Penghu County, TW
Chang, Wen-Chen, 4F., No. 892, Sec. 4, Zhongxing Rd., Zhudong Township, 310, Taiwan, Hsinchu County, TW
Tsau, Fanghei, 4F., No. 6, Lane 54, Siwei 2nd Rd., Lingya Dist., 802, Taiwan, Kaohsiung City, TW

(51) MKP
C12N 15/86 (2006.01) (97) **2497830 ***
C12N 15/63 (2006.01)
(86) ES2010070715 04.11.2010
(96) 10795406.7 12.09.2012
(87) WO2011054994, 04.11.2010
(97) 2497830, 12.09.2012 en
(54) REGULATED EXPRESSION SYSTEMS
(71) Proyecto de Biomedicina Cima, S.L., Avda. Pío XII, 22 Oficina 1, 31008 Pamplona - Navarra, ES
(72) GONZÁLEZ ASEGUINOLAZA, Gloria, ICT (D.P.I.) Avda. Pío XII 53, E-31008 Pamplona - Navarra, ES
PRIETO VALTUENA, Jesús María, ICT (D.P.I.) Avda. Pío XII 53, E-31008 Pamplona - Navarra, ES
VANRELL MAJÓ, Lucía María, ICT (D.P.I.) Avda. Pío XII 53, E-31008 Pamplona - Navarra, ES

(51) MKP
E21B 47/00 (2012.01) (97) **2418349 ***
E21B 43/00 (2006.01)
(86) RU2010000153 02.04.2010
(96) 10777995.1 15.02.2012
(87) WO2010134843, 02.04.2010
(97) 2418349, 15.02.2012 en
(54) METHOD FOR MONITORING THE OIL-FIELD DEVELOPMENT
(71) Mirsaetov, Oleg Marsimovich, Ul. Nagornaya 58-165, Izhevsk 426010, Udmurtstskaya Respublika, RU
Fedorov, Yury Viktorovich, Ul. Krasnogeriskaya 60-6, Izhevsk 426034, Udmurtstskaya Respublika, RU
(72) EMELYANOV, Dmitry Vasilievich, ul. Pushkinskaya 283-168 Izhevsk 426000, Udmurtstskaya Respublika, RU
AHMADULLIN, Bulat Gumarovich, ul. K. Marksa 428-6-1 Izhevsk 426000, Udmurtstskaya Respublika, RU

(51) MKP
A61P 25/02 (2006.01) (97) **2421535 ***
A61P 1/06 (2006.01)
A61K 31/496 (2006.01)
A61P 29/00 (2006.01)
(86) US2010032100 22.04.2010
(96) 10714829.8 29.02.2012
(87) WO2010124122, 22.04.2010
(97) 2421535, 29.02.2012 en
(54) HETEROAROMATIC AND AROMATIC PIPERAZINYL AZETIDINYL AMIDES AS MONOACYLGLYCEROL LIPASE INHIBITORS
(71) Janssen Pharmaceutica N.V., Turnhoutseweg 30, 2340 Beerse, BE
(72) FLORES, Christopher, M., Welsh&McKean Roads, Spring House PA 19477, US
NELEN, Marina, I., 665 Stockton Drive, Exton PA 19341, US
NULTON, Erica, L., 665 Stockton Drive, Exton PA 19341, US
PROUTY, Stephen, 3900 Woodland Avenue Bldg. 21 Room 302A Philadelphia, PA 19104, US
TODD, Matthew, 665 Stockton Drive, Exton PA 19341, US
ZHANG, Sui-Po, 665 Stockton Drive, Exton PA 19341, US

(51) MKP
G07F 17/32 (2006.01) (97) **2489022 ***
(86) IB2010002529 06.10.2010
(96) 10777095.0 22.08.2012
(87) WO2011030222, 06.10.2010
(97) 2489022, 22.08.2012 de
(54) ENTERTAINMENT MACHINE HAVING A SYMBOL GAMING UNIT
(71) Novomatic AG, Wiener Strasse 158, 2352 Gumpoldskirchen, AT
(72) GRAF, Johann, F., c/o Novomatic AG IP&Rechtsabteilung, Wiener Strasse 158, AT

(51) MKP
A01G 1/00 (2006.01) (97) **2397028**
A01G 9/02 (2006.01)
(96) 11170313.8 21.12.2011
(97) 2397028, 21.12.2011 de
(54) Plantable façade system
(71) Lichtblau, Andreas, Hochstrass 599, 3033 Hochstrass, AT
Glanz, Markus, Dammgasse 14, 2822 Bad Erlach, AT
Zecha, Jörg, Hochstrass 599, 3033 Hochstrass, AT
(72) Glanz, Markus, Dammgasse 14, 2822 Bad Erlach, AT
Lichtblau, Andreas, Hochstrass 599, 3033 Hochstrass, AT
Zecha, Jörg, Hochstrass 599, 3033 Hochstrass, AT
Schmidhammer, Alexander, Werthfeldstrasse 33, 3441 Baumgarten, AT

- (51) MKP
E04H 15/18 (2006.01) (97) **2486199 ***
E04C 3/00 (2006.01)
E04H 15/64 (2006.01)
E04H 15/48 (2006.01)
(86) FR2010052108 06.10.2010
(96) 10776789.9 15.08.2012
(87) WO2011051587, 06.10.2010
(97) 2486199, 15.08.2012 fr
(54) COLLAPSIBLE LATTICE BEAM, TRUSS AND CONSTRUCTION INCLUDING SUCH A BEAM
(71) Spantech France (Societe A Responsabilite Limitee), 1-3 rue du Commerce, 67116 Reichstett, FR
(72) DE VILLENFAGNE DE SORINNES, Derek, 45 avenue Victor Emmanuel III, B-1180 Bruxelles, BE
FRITZ, André, 8 rue des Saules, F-67930 Beinheim, FR
HINKER, Michel, 4 rue André Malraux, F-67170 Brumath, FR
-
- (51) MKP
A61K 31/4709 (2006.01) (97) **2406262 ***
C07D 239/94 (2006.01)
C07D 471/04 (2006.01)
A61K 31/517 (2006.01)
A61K 31/519 (2006.01)
C07D 403/12 (2006.01)
C07D 403/14 (2006.01)
A61K 31/4178 (2006.01)
A61P 35/00 (2006.01)
C07D 405/14 (2006.01)
(86) NZ2010000040 11.03.2010
(96) 10751067.9 18.01.2012
(87) WO2010104406, 11.03.2010
(97) 2406262, 18.01.2012 en
(54) PRODRUG FORMS OF KINASE INHIBITORS AND THEIR USE IN THERAPY
(71) Auckland UniServices Limited, Level 10, 70 Symonds Street, Auckland 1010, NZ
(72) SMAILL, Jeffrey, Bruce, 17 Parkfield Terrace Grafton, 1023 Auckland, NZ
PATTERSON, Adam Vorn, 18 Manuka Road Waiheke Island, 1008 Auckland, NZ
DENNY, William, Alexander, 165 Gossamer Drive Pakuranga Heights, 2010 Manukau, NZ
WILSON, William Robert, 199 Smith Road RD2, 2682 Waiuku, NZ
LU, Guo-Liang, 13A Woodward Road Mt Albert, 1025 Auckland, NZ
ANDERSON, Robert, Forbes, 56B Seaview Road Ramuera, 1050 Auckland, NZ
LEE, Ho Huat, 57A Disraeli Street Epsom, 1023 Auckland, NZ
ASHOORZADEH, Amir, 37 Bentleigh Avenue New Windsor, 0600 Auckland, NZ
HAY, Michael Patrick, 52 St Leonards Road Epsom, Auckland 1024, NZ
-
- (51) MKP
C07D 401/14 (2006.01) (97) **2427449 ***
A61K 31/4439 (2006.01)
(86) US2010033487 04.05.2010
(96) 10717402.1 14.03.2012
(87) WO2010129509, 04.05.2010
(97) 2427449, 14.03.2012 en
(54) VINYL INDAZOLYL COMPOUNDS
(71) Eli Lilly and Company, Lilly Corporate Center, Indianapolis, IN 46285, US
(72) CHEN, Daohong, Eli Lilly and Company Lilly Corporate Center, Indianapolis, Indiana 46285, US
LI, Hong-Yu, Eli Lilly and Company Lilly Corporate Center, Indianapolis, Indiana 46285, US
ZHAO, Genshi, Eli Lilly and Company Lilly Corporate Center, Indianapolis, Indiana 46285, US
-
- (51) MKP
H02J 9/00 (2006.01) (97) **2244353**
(96) 10003779.5 27.10.2010
(97) 2244353, 27.10.2010 en
(54) Energy saving device
(71) Alfa Electric Ltd., Ivyhouse Industrial Estate 14 Burgess Road, Hastings East Sussex TN35 4NR, GB
(72) Harrison, Richard, 14 Burgess Road, Hastings East Sussex TN35 4NR, GB
-
- (51) MKP
G01N 33/00 (2006.01) (97) **2470894 ***
(86) US2010047032 27.08.2010
(96) 10815898.1 04.07.2012
(87) WO2011031562, 27.08.2010
(97) 2470894, 04.07.2012 en
(54) SYNTHETIC MYCOTOXIN ADSORBENTS AND METHODS OF MAKING AND UTILIZING THE SAME
(71) Alltech, Inc., 3031 Catnip Hill Pike, Nicholasville, KY 40345, US
(72) YIANNIKOURIS, Alexandros, 3031 Catnip Hill Pike, Nicholasville Kentucky 40356, US
KWIATKOWSKI, Stefan, 3031 Catnip Hill Pike, Nicholasville KY 40356, US
KUDUPOJE, Manoj, Bojappa, 3031 Catnip Hill Pike, Nicholasville KY 40356, US
MATNEY, Clayton, 3031 Catnip Hill Pike, Nicholasville KY 40536, US
-
- (51) MKP
F24F 3/00 (2006.01) (97) **2464913 ***
(86) US2010045599 16.08.2010
(96) 10810440.7 20.06.2012
(87) WO2011022325, 16.08.2010
(97) 2464913, 20.06.2012 en
(54) MODULAR, SELF-CONTAINED, MOBILE CLEAN ROOM
(71) G-Con, LLC, 6161 Imperial Loop, College Station, TX 77845, US
(72) HOLTZ, R., Barry, 4018 Norfolk Street, Houston, TX 77027, US
ARLEDGE, Troy, 8769 Fm 2095, Gause TX 77857, US
MAPLES, Phillip, B., 1850 St. Charles Avenue, Pilot Point TX 76258, US
SHANAHAN, David, M., 5130 Yolanda Lane, Dallas TX 75229, US
-
- (51) MKP
A61P 17/00 (2006.01) (97) **2406222 ***
A61P 19/00 (2006.01)
A61K 31/506 (2006.01)
A61P 33/06 (2006.01)
A61P 35/00 (2006.01)
C07D 213/74 (2006.01)
A61P 37/00 (2006.01)
C07D 239/42 (2006.01)
A61K 31/44 (2006.01)
(86) EP2010001549 11.03.2010
(96) 10708733.0 18.01.2012
(87) WO2010102825, 11.03.2010
(97) 2406222, 18.01.2012 en
(54) ADDITION SALTS OF TROMETHAMINE WITH AZABIPHENYLAMINO BENZOIC ACID DERIVATIVES AS DHODH INHIBITORS
(71) Almirall S.A., Ronda del General Mitre, 151, 08022 Barcelona, ES
(72) GARCIA GONZALEZ, Nuria, c/o Laurea Miro 408-410, E-08980 Sant Feliu de Llobregat (Barcelona), ES
CARRERA CARRERA, Francesc, c/o Laurea Miro 408-410, E-08980 Sant Feliu de Llobregat (Barcelona), ES
JULIA JANE, Montserrat, c/o Laurea Miro 408-410, E-08980 Sant Feliu de Llobregat (Barcelona), ES
DEBETHUNE, Laurent, c/o Laurea Miro 408-410, E-08980 Sant Feliu de Llobregat (Barcelona), ES
SERRA MASIA, Xavier, c/o Laurea Miro 408-410, E-08980 Sant Feliu de Llobregat (Barcelona), ES
-

- (51) MKP
C07D 401/04 (2006.01) (97) **2408762 ***
C07D 401/14 (2006.01)
C07D 403/04 (2006.01)
C07D 407/14 (2006.01)
C07D 493/08 (2006.01)
A61K 31/4709 (2006.01)
A61K 31/4184 (2006.01)
A61P 35/00 (2006.01)
- (86) FR2010050483 18.03.2010
(96) 10715951.9 25.01.2012
(87) WO2010106290, 18.03.2010
(97) 2408762, 25.01.2012 fr
(54) HSP90 INHIBITING INDAZOLE DERIVATIVES, COMPOSITIONS CONTAINING SAME AND USE THEREOF
- (71) SANOFI, 174, Avenue de France, 75013 Paris, FR
(72) BERTIN, Luc, c/o sanofi-aventis Département Brevets 174 Avenue de France, F-75013 Paris, FR
CARRY, Jean-Christophe, c/o sanofi-aventis Département Brevets 174 Avenue de France, F-75013 Paris, FR
MAILLIET, Patrick, c/o sanofi-aventis Département Brevets 174 Avenue de France, F-75013 Paris, FR
MINOUX, Hervé, c/o sanofi-aventis Département Brevets 174 Avenue de France, F-75013 Paris, FR
PILORGE, Fabienne, c/o sanofi-aventis Département Brevets 174 Avenue de France, F-75013 Paris, FR
RUXER, Jean-Marie, c/o sanofi-aventis Département Brevets 174 Avenue de France, F-75013 Paris, FR
-
- (51) MKP
C07D 401/10 (2006.01) (97) **2440543 ***
C07D 213/64 (2006.01)
A61K 31/4412 (2006.01)
A61P 9/00 (2006.01)
- (86) US2010037090 02.06.2010
(96) 10784021.7 18.04.2012
(87) WO2010141600, 02.06.2010
(97) 2440543, 18.04.2012 en
(54) IMPROVED METHOD FOR SYNTHESIZING PIRFENIDONE
- (71) Intermune, Inc., 3280 Bayshore Boulevard, Brisbane, CA 94005-1021, US
(72) RADHAKRISHNAN, Ramachadran, 40623 Palatino Street, Fremont, CA 94539, US
CYR, Mike, 2034 Pembroke Bay Drive, League City, TX 77573, US
BOUTET, Sabine Marie-Francoise Brigitte, 6210 Waltway Drive, Houston, TX 77008, US
-
- (51) MKP
A61K 9/20 (2006.01) (97) **2456426 ***
A61K 31/295 (2006.01)
- (86) US2010042788 21.07.2010
(96) 10737206.2 30.05.2012
(87) WO2011011541, 21.07.2010
(97) 2456426, 30.05.2012 en
(54) FERRIC CITRATE DOSAGE FORMS
- (71) Keryx Biopharmaceuticals, Inc., 750 Lexington Avenue 20th Floor, New York, NY 10022, US
(72) LE, Henry Trong, 38 Priscilla Lane,, Englewood Cliffs, New Jersey 07632, US
-
- (51) MKP
C07D 498/04 (2006.01) (97) **2470545 ***
A61K 31/4985 (2006.01)
A61P 25/00 (2006.01)
- (86) EP2010062420 25.08.2010
(96) 10747619.4 04.07.2012
(87) WO2011023733, 25.08.2010
(97) 2470545, 04.07.2012 en
(54) ANHYDRATE FORMS OF A PYRIDINE DERIVATIVE
- (71) GlaxoSmithKline LLC, One Franklin Plaza 200 North 16th Street, Philadelphia, PA 19102, US
(72) CRAIG, Andrew, Simon, GlaxoSmithKline Gunnels Wood Road, Stevenage Hertfordshire SG1 2NY, GB
ISMAIL, Salima, Zarah, GlaxoSmithKline Gunnels Wood Road, Stevenage Hertfordshire SG1 2NY, GB
LAWRENCE, Ronnie, Maxwell, c/o GlaxoSmithKline Gunnels Wood Road, Stevenage Hertfordshire SG1 2NY, GB
-
- (51) MKP
A61Q 19/00 (2006.01) (97) **2415802 ***
C08G 77/388 (2006.01)
C08L 83/08 (2006.01)
A61K 8/898 (2006.01)
- (86) JP2010056289 31.03.2010
(96) 10758935.0 08.02.2012
(87) WO2010114175, 31.03.2010
(97) 2415802, 08.02.2012 en
(54) NOVEL ACYL ACIDIC AMINO ACID ESTER
- (71) Ajinomoto Co., Inc., 15-1, Kyobashi 1-chome Chuo-ku, Tokyo, 104-8315, JP
(72) SUGIMOTO, Takanori, c/o AJINOMOTO CO. INC. 1-1, Suzuki-cho Kawasaki-ku, Kawasaki-shi Kanagawa 210-8681, JP
HATTORI, Tatsuya, c/o AJINOMOTO CO. INC. 1-1, Suzuki-cho Kawasaki-ku, Kawasaki-shi Kanagawa 210-8681, JP
OOTAKE, Souichirou, c/o AJINOMOTO CO. INC. 1-1, Suzuki-cho Kawasaki-ku, Kawasaki-shi Kanagawa 210-8681, JP
-
- (51) MKP
A01N 37/18 (2006.01) (97) **2464224 ***
- (86) US2010044642 06.08.2010
(96) 10808554.9 20.06.2012
(87) WO2011019585, 06.08.2010
(97) 2464224, 20.06.2012 en
(54) METHODS FOR DRUG DELIVERY COMPRISING UNFOLDING AND FOLDING PROTEINS AND PEPTIDE NANOPARTICLES
- (71) Nanopax Pharma, Llc, 8037 Cripple Creek, Long Grove, Illinois 60047, US
(72) HU, Yiqiao, 1401 Mengminwei Building Nanjing University 22 Hankou Road Gulou, Nanjing, Jiangsu 210093, CN
WU, Jinhui, 1401 Mengminwei Building Nanjing University 22 Hankou Road Gulou, Nanjing, Jiangsu 210093, CN
DING, Dawei, 1401 Mengminwei Building Nanjing University 22 Hankou Road Gulou, Nanjing, Jiangsu 210093, CN
GONG, Guangming, 1401 Mengminwei Building Nanjing University 22 Hankou Road Gulou, Nanjing, Jiangsu 210093, CN
TANG, Xiaolei, 1401 Mengminwei Building Nanjing University 22 Hankou Road Gulou, Nanjing, Jiangsu 210093, CN
TONG, Chunhui, 1401 Mengminwei Building Nanjing University 22 Hankou Road Gulou, Nanjing, Jiangsu 210093, CN
ZHU, Yan, 1401 Mengminwei Building Nanjing University 22 Hankou Road Gulou, Nanjing, Jiangsu 210093, CN
LI, Shaoling, 783 Steuben Drive, Sunnyvale California 94087, US
-
- (51) MKP
A47B 88/04 (2006.01) (97) **2496115 ***
- (86) US2010055124 02.11.2010
(96) 10828978.6 12.09.2012
(87) WO2011056792, 02.11.2010
(97) 2496115, 12.09.2012 en
(54) CLOSING DEVICE FOR DRAWERS
- (71) Knappe & Vogt Manufacturing Company, 2700 Oak Industrial Drive NE, Grand Rapids, MI 49505, US
(72) BOKS, Michael, J., 7161 Oran Drive S.E., Grand Rapids, MI 49546, US
-
- (51) MKP
A47B 83/04 (2006.01) (97) **2277410**
- (96) 10163836.9 26.01.2011
(97) 2277410, 26.01.2011 en
(54) Modular piece of furniture with extractable chairs and tables
- (71) Adamo, Gabriele, Corso Camillo Finocchiaro Aprile n. 124, 90138 Palermo (PA), IT
(72) Adamo, Gabriele, Corso Camillo Finocchiaro Aprile n. 124, 90138 Palermo (PA), IT
-
- (51) MKP
C07K 16/40 (2006.01) (97) **2481758**
- (96) 11305089.2 01.08.2012
(97) 2481758, 01.08.2012 en
(54) Human antibodies to PSCK9 for use in methods of treating particular groups of subjects (11566)
- (71) SANOFI, 54 rue La Boétie, 75008 Paris, FR
(72) The designation of the inventor has not yet been filed , null, null, null

- (51) MKP
A01P 15/00 (2006.01) (97) **2442646 ***
A01N 43/22 (2006.01)
A61K 31/00 (2006.01)
- (86) US2010038768 16.06.2010
(96) 10727315.3 25.04.2012
(87) WO2010148053, 16.06.2010
(97) 2442646, 25.04.2012 en
(54) ECTOPARASITICIDAL METHODS AND FORMULATIONS
(71) Eli Lilly and Company, Lilly Corporate Center, Indianapolis, IN 46285, US
(72) MEYER, Jeffery, Alan, Eli Lilly and Company Lilly Corporate Center, Indianapolis, Indiana 46285, US
WHITE, William, Hunter, Eli Lilly and Company Lilly Corporate Center, Indianapolis, Indiana 46285, US
WINKLE, Joseph, Raymond, Eli Lilly and Company Lilly Corporate Center Indianapolis, Indiana 46285, US
-
- (51) MKP
C07C 45/69 (2006.01) (97) **2448901 ***
C07C 209/62 (2006.01)
C07C 211/35 (2006.01)
C07C 49/403 (2006.01)
- (86) EP2010003923 28.06.2010
(96) 10737261.7 09.05.2012
(87) WO2011000540, 28.06.2010
(97) 2448901, 09.05.2012 en
(54) METHOD OF PREPARING
3,3,5,5-TETRAMETHYLCYCLOHEXANONE
(71) Merz Pharma GmbH & Co. KGaA, Eckenheimer Landstrasse 100, 60318 Frankfurt Main, DE
(72) KOLLER, Herbert, Quellenstrasse 155A/65, A-1100 Wien, AT
PYERIN, Michael, Enzersdorferstrasse 3/2/8, A-2345 Brunn am Gebirge, AT
SBROGIÒ, Federico, via Tecchio 62, I-36075 Montecchio Maggiore, IT
-
- (51) MKP
A01N 43/04 (2006.01) (97) **2416651 ***
A61K 31/70 (2006.01)
- (86) US2010030556 09.04.2010
(96) 10762505.5 15.02.2012
(87) WO2010118334, 09.04.2010
(97) 2416651, 15.02.2012 en
(54) METHODS OF TREATING EDEMA RELATED TO ISCHEMIA-REPERFUSION
(71) The University of North Carolina At Chapel Hill, 308 Bynum Hall, Campus Box 4105, Chapel Hill, NC 27599-4105, US
(72) EGAN, Thomas, Michael, 741 Pinehurst Drive, Chapel Hill NC 27514, US
-
- (51) MKP
A61K 31/519 (2006.01) (97) **2432555 ***
C07D 487/04 (2006.01)
A61P 35/00 (2006.01)
- (86) US2010035783 21.05.2010
(96) 10720113.9 28.03.2012
(87) WO2010135650, 21.05.2010
(97) 2432555, 28.03.2012 en
(54) N-(HETERO)ARYL-PYRROLIDINE DERIVATIVES OF
PYRAZOL-4-YL-PYRROLO[2,3-d]PYRIMIDINES AND
PYRROL-3-YL-PYRROLO[2,3-d]PYRIMIDINES AS JANUS
KINASE INHIBITORS
(71) Incyte Corporation, Experimental Station Route 141 & Henry Clay Road Building E336, Wilmington, DE 19880, US
(72) RODGERS, James, D., 2 Hillside Lane, Landenberg, PA 19350, US
SHEPARD, Stacey, 3407 Avalon Ct., Voorhees, NJ 08043, US
ARVANITIS, Argyrios, G., 101 Willow Glen Drive, Kennett Square, PA 19348, US
WANG, Haisheng, 207 Hockessin Circle, Hockessin, DE 19707, US
STORACE, Louis, 1409 Bohemia Mill Road, Middletown, DE 19709, US
FOLMER, Beverly, 201 Deergrass Road, Hockessin, DE 19707, US
SHAO, Lixin, 22 Golf View Drive Apt. A5, Newark, DE 19702, US
ZHU, Wenyu, 21 Abel Place, Media, PA 19063, US
GLENN, Joseph P., 103 Deer Horn Dr., Mount Royal, NJ 08061, US
-
- (51) MKP
A61M 5/315 (2006.01) (97) **2482883 ***
- (86) EP2010064392 29.09.2010
(96) 10757778.5 08.08.2012
(87) WO2011039203, 29.09.2010
(97) 2482883, 08.08.2012 en
(54) DRUG DELIVERY DEVICE
(71) Sanofi-Aventis Deutschland GmbH, Brüningstraße 50, 65929 Frankfurt, DE
(72) PLUMPTRE, David, 36 Shire Way, Droitwich Spa Worcestershire WR9 7RQ, GB
LINDSAY, Adrew Mark, 130 Clarendon Road, Hinckley Leicestershire LE10 0PL, GB
MACDONALD, Catherine Anne, 23 Goggbridge Lane, Warwick Warwickshire CV34 6JE, GB
VEASEY, Robert, 31 Lonsdale Road Lillington Leamington Spa, Leamington Spa Warwickshire CV32 7EP, GB
JONES, Christopher, The Old Thatch Grafton, Tewkesbury Gloucestershire GL20 7AT, GB
KOUYOUJIAN, Garen, 2A Plymouth Place, Leamington Spa Warwickshire CV31 1HN, GB
-
- (51) MKP
A61K 47/48 (2006.01) (97) **2456469 ***
A61P 25/04 (2006.01)
A61P 25/36 (2006.01)
- (86) US2010042792 21.07.2010
(96) 10735413.6 30.05.2012
(87) WO2011011543, 21.07.2010
(97) 2456469, 30.05.2012 en
(54) OLIGOMER-OPIOID AGONIST CONJUGATES
(71) Nektar Therapeutics, 455 Mission Bay Boulevard South Suite 100, San Francisco CA 94158, US
(72) RIGGS-SAUTHIER, Jennifer, 7917 Smoke Rise Road, Huntsville AL 35802, US
DENG, Bo-Liang, 209 Meadow Wood Drive, Madison AL 35756, US
RILEY, Timothy, A., 211 Morningwalk Lane, Huntsville AL 35824, US
-
- (51) MKP
C12M 1/00 (2006.01) (97) **2474605**
- (96) 11165393.7 11.07.2012
(97) 2474605, 11.07.2012 en
(54) Container fermentor
(71) KHT s.r.o., Soltesovej 3474/1, 058 01 Poprad, SK
(72) Bencic, Mario, Soltesovej 3474/11, SK-058 01, Poprad, SK
Rusin, Jan, Partizanska 680/1, SK-058 01, Poprad, SK
-
- (51) MKP
A61K 39/395 (2006.01) (97) **2488199 ***
A61P 35/00 (2006.01)
C07K 14/525 (2006.01)
C07K 14/765 (2006.01)
C07K 16/28 (2006.01)
C07K 16/32 (2006.01)
C07K 16/46 (2006.01)
C07K 19/00 (2006.01)
- (86) US2010052712 14.10.2010
(96) 10775965.6 22.08.2012
(87) WO2011047180, 14.10.2010
(97) 2488199, 22.08.2012 en
(54) BISPECIFIC BINDING AGENTS TARGETING IGF-1R AND ERBB3 SIGNALLING AND USES THEREOF
(71) Merrimack Pharmaceuticals, Inc., One Kendall Square Suite B7201, Cambridge, MA 02139, US
Dyax Corp., 55 Network Drive Burlington, MA 01803, US
(72) SCHOEBERL, Birgit, 324 Windsor Street, Cambridge, MA 02141, US
NIELSEN, Ulrik, 18 Thomas Street, Quincy, MA 02169, US
KUDLA, Arthur, J., 37 Forest Court, Malden, MA 02148, US
MURUGANANDAM, Arumugam, 364 Rainbow Drive Opposite To Wipro Corporate Office Sarjapur Rd., Doddakannahalli Bangalore 560035, IN
BUCKLER, David, 6 Erick Court, Chester, NJ 07930, US
LUGOVSKOY, Alexey, Alexandrovich, 24 Center Street, Woburn, MA 01801, US
FITZGERALD, Jonathan, Basil, 32 Magnolia Street, Arlington, MA 02474, US
XU, Lihui, 106 Gerry Road, Chestnut Hill, MA 02467, US
KOHLI, Neeraj, 39 Shepard Street Apt. 17, Brighton, MA 02135, US
-

- (51) MKP
A61K 31/502 (2006.01) (97) **2475368 ***
A61P 35/00 (2006.01)
A61P 35/02 (2006.01)
- (86) US2010048247 09.09.2010
(96) 10755044.4 18.07.2012
(87) WO2011031842, 09.09.2010
(97) 2475368, 18.07.2012 en
- (54) N-4 (- ((3- (2 -AMINO-4 PYRIMIDINYL) -2 -PYRIDINYL) OXY) PHENYL) -4- (4-METHYL-2-THIENYL) -1-PHTHALAZINAMINE FOR USE IN THE TREATMENT OF ANTIMITOTIC AGENT RESISTANT CANCER
- (71) Amgen, Inc, One Amgen Center Drive, Thousand Oaks, CA 91320-1799, US
- (72) PAYTON, Marc, 149 S. Dewey Avenue, Newbury Park California 91320, US
KENDALL, Richard, 3246 Rickey Court, Thousand Oaks California 91360, US
-
- (51) MKP
F16L 11/00 (2006.01) (97) **2459919 ***
- (86) IB2010053438 28.07.2010
(96) 10803993.4 06.06.2012
(87) WO2011013081, 28.07.2010
(97) 2459919, 06.06.2012 en
- (54) BREATHING HOSE
- (71) Kast Silicone Ltd., 1 Kiryat Anavim St., 90833 Kibbutz Kiryat Anavim, IL
- (72) ZUCKER, Shlomo, 13 Kohav Hayam St., 40297 Mihmoret, IL
DVIR, Menachem, 2 Yitzhak Sade St., 46284 Herzlia, IL
-
- (51) MKP
A01P 7/00 (2006.01) (97) **2442648 ***
A01N 25/02 (2006.01)
A01N 47/40 (2006.01)
A01N 51/00 (2006.01)
A01N 43/40 (2006.01)
A01N 43/86 (2006.01)
- (86) EP2010058202 11.06.2010
(96) 10725134.0 25.04.2012
(87) WO2010145994, 11.06.2010
(97) 2442648, 25.04.2012 en
- (54) NMP-FREE FORMULATIONS OF NEONICOTINOIDS
- (71) NUFARM, 28 boulevard Camélinat, 92233 Gennevilliers, FR
GASSE, Jean-Jacques, 17 rue de la Fontaine Braie, F-27600 Saint-Aubin-sur-Gaillon, FR
DUCHAMP, Guillaume, 70 ter avenue Chandon, F-92230 Gennevilliers, FR
CANTERO, Maria, 32 rue Jean Jaurès, F-92230 Gennevilliers, FR
-
- (51) MKP
A61M 5/315 (2006.01) (97) **2482884 ***
- (86) EP2010064395 29.09.2010
(96) 10757779.3 08.08.2012
(87) WO2011039205, 29.09.2010
(97) 2482884, 08.08.2012 en
- (54) DRUG DELIVERY DEVICE AND DRIVE MEMBER FOR A DRUG DELIVERY DEVICE
- (71) Sanofi-Aventis Deutschland GmbH, Brüningstrasse 50, 65926 Frankfurt am Main, DE
PLUMPTRE, David, 36 Shire Way Droitwich Spa, Worcestershire WR9 7RQ, GB
LINDSAY, Adrew Mark, 130 Clarendon Road Hinckley, Leicestershire LE10 0PL, GB
MACDONALD, Catherine Anne, 23 Goggsbridge Lane Warwick, Warwickshire CV34 6JE, GB
VEASEY, Robert, 31 Lonsdale Road Lillington Leamington Spa GB, Warwickshire CV32 7EP, GB
JONES, Christopher, The Old Thatch Grafton Tewkesbury, Gloucestershire GL20 7AT, GB
KOUYOUMJIAN, Garen, 2A Plymouth Place Leamington Spa, Warwickshire CV31 1HN, GB
-
- (51) MKP
A61K 47/44 (2006.01) (97) **2485730 ***
A61K 31/444 (2006.01)
A61K 47/10 (2006.01)
A61K 47/12 (2006.01)
A61P 29/00 (2006.01)
A61K 9/00 (2006.01)
- (86) US2010052111 08.10.2010
(96) 10766200.9 15.08.2012
(87) WO2011044540, 08.10.2010
(97) 2485730, 15.08.2012 en
- (54) TOPICAL FORMULATION COMPRISING ETORICOXIB AND A ZWITTERIONIC SURFACTANT
- (71) Nuvo Research Inc., 7560 Airport Road, Unit 10, Mississauga, ON L4T 4H4, CA
- (72) BUYUKTIMKIN, Servet, 11772 Carmel Creek Road 105, San Diego, California 92130, US
BUYUKTIMKIN, Nadir, 11772 Carmel Creek Road 105, San Diego, California 92130, US
SINGH, Jagat, 64 Grover Drive, Toronto, Ontario M1C 4V7, CA
NEWSAM, John M., 528 Forward Street, La Jolla, California 92037-7528, US
KING-SMITH, Dominic, 2597 Soderblom Avenue, San Diego, California 92122, US
KISAK, Edward T., 3525 Bayside Lane Apt. B, San Diego, California 92109, US
GALER, Bradley S., 1740 Lenape Road Bldg. 2, West Chester, Pennsylvania 19382, US
-
- (51) MKP
C07D 209/52 (2006.01) (97) **2332910**
A61K 31/403 (2006.01)
A61P 25/00 (2006.01)
- (96) 10290642.7 15.06.2011
(97) 2332910, 15.06.2011 fr
- (54) New derivatives of azabicyclo[3.2.0]hept-3-yl, method for preparing same and pharmaceutical compositions containing them
- (71) Les Laboratoires Servier, 35, rue de Verdun, 92284 Suresnes Cedex, FR
- (72) Casara, Patrick, 740, Chemin Pré Seigneur, 78670 Villennes sur Seine, FR
Chollet, Anne-Marie, 27, avenue d'Aligre, 78230 Le Pecq, FR
Dhainaut, Alain, 7, rue des Guipières, 78400 Chatou, FR
Lestage, Pierre, 9, allée de la Grande Terre, 78170 La Celle Saint Cloud, FR
Panayi, Fany, 44, Bd de Rochechouart, 75018 Paris, FR
-
- (51) MKP
E05D 11/10 (2006.01) (97) **2256275**
E05F 1/00 (2006.01)
E05F 3/22 (2006.01)
- (96) 10163089.5 01.12.2010
(97) 2256275, 01.12.2010 fr
- (54) Rotation blocking device of a door and door equipped with such device
- (71) SAINT-GOBAIN SEVA, 43, rue du Pont de Fer B.P. 176, 71105 Chalons-sur-Saône, FR
- (72) Piponniau, Nicolas, 6 rue des Tonneliers, 71100 Chalons sur Saône, FR
L'Huillier, Philippe, Le Bourg, 71390 Sassangy, FR
-
- (51) MKP
C12Q 1/00 (2006.01) (97) **2414535 ***
- (86) US2010029399 31.03.2010
(96) 10759343.6 08.02.2012
(87) WO2010114897, 31.03.2010
(97) 2414535, 08.02.2012 en
- (54) BIOMARKERS RELATED TO INSULIN RESISTANCE AND METHODS USING THE SAME
- (71) Metabolon Inc., 800 Capitola Drive, Suite 1, Durham, NC 27713, US
- (72) HU, Yun, Fu, 107 Manora Lane, Chapel Hill, NC 27516, US
CHIRILA, Costel, 4 Lakemist Circle, Durham, NC 27713, US
ALEXANDER, Danny, 217 Midenhall Way, Cary, NC 27513, US
MILBURN, Michael, 508 Hollowridge Court, Cary, NC 27519, US
MITCHELL, Matthew, W., 516 High Ridge Drive, Durham, NC 27707, US
GALL, Walter, 312 West University Drive, Chapel Hill, NC 27516, US
LAWTON, Kay, A., 8016 Crooked Chute Court, Raleigh, NC 27612, US

- (51) MKP
H04W 16/28 (2009.01) (97) **2485520 ***
H04B 7/04 (2006.01)
- (86) CN2010077290 25.09.2010
(96) 10819890.4 08.08.2012
(87) WO2011038661, 25.09.2010
(97) 2485520, 08.08.2012 en
(54) METHOD AND DEVICE FOR COORDINATED SCHEDULING
(71) China Academy of Telecommunications Technology, 40, Xueyuan Road, Haidian District, Beijing 100191, CN
(72) GAO, Qiubin, No.40 Xueyuan Road Haidian District, Beijing 100083, CN
MIAO, Deshan, No.40 Xueyuan Road Haidian District, Beijing 100083, CN
HE, Hao, No.40 Xueyuan Road Haidian District, Beijing 100083, CN
SUN, Shaohui, No.40 Xueyuan Road Haidian District, Beijing 100083, CN
PENG, Ying, No.40 Xueyuan Road Haidian District, Beijing 100083, CN
-
- (51) MKP
C09C 1/02 (2006.01) (97) **2447328**
- (96) 10189374.1 02.05.2012
(97) 2447328, 02.05.2012 en
(54) Method for improving handleability of calcium carbonate containing materials
(71) Omya Development AG, Baslerstrasse 42, 4665 Oftringen, CH
(72) Gane, Patrick A.C., Studenweg 8, 4852 Rothrist, CH
Buri, Matthias, Mättelweg 20, 4852 Rothrist, CH
Blum, René Vinzenz, Sagiacher 3, 4915 St. Urban, CH
Rentsch, Samuel, Höfeweg 1, 4663 Aarburg, CH
-
- (51) MKP
F16L 13/007 (2006.01) (97) **2295841**
F16L 25/10 (2006.01)
F16L 13/16 (2006.01)
- (96) 10162558.0 16.03.2011
(97) 2295841, 16.03.2011 de
(54) Method for connecting tubes and tube connections
(71) ELB-Form GmbH, Riederstrasse 12, 6773 Vandans, AT
(72) Reiner, Markus, Paschweg 7, 6700, Bludenz, AT
-
- (51) MKP
C12P 21/04 (2006.01) (97) **2406388 ***
- (86) US2010027000 11.03.2010
(96) 10751427.5 18.01.2012
(87) WO2010105068, 11.03.2010
(97) 2406388, 18.01.2012 en
(54) OX40/TRAIL FUSION PROTEINS
(71) The Trustees Of The University Of Pennsylvania, Center for Technology Transfer 3160 Chestnut Street, Suite 200, Philadelphia PA 19104-6283, US
(72) TYKOCINSKI, Mark, L., 300 Linden Lane, Merion Station PA 19066, US
-
- (51) MKP
A61P 31/10 (2006.01) (97) **2476701 ***
C07K 14/805 (2006.01)
C07F 15/02 (2006.01)
A61K 38/42 (2006.01)
A61P 31/04 (2006.01)
C07D 487/22 (2006.01)
- (86) RU2010000488 08.09.2010
(96) 10815682.9 18.07.2012
(87) WO2011031187, 08.09.2010
(97) 2476701, 18.07.2012 en
(54) ANTIMICROBIAL AGENTS BASED ON HEMIN DERIVATIVES
(71) Obschestvo S Ogranichennoi Otvetstvennostiyu "Pharmenterprises", Pr-t Vernadskogo d. 86 Bldg. 5, Moscow 117571, RU
(72) NEBOLSIN, Vladimir Evgenievich, Severnoe Chertanovo 4-403-249, Moscow 117648, RU
ZHELTUKHINA, Galina Alexandrovna, ul. Iskry 13-1-292, Moscow 129344, RU
-
- (51) MKP
C12P 7/52 (2006.01) (97) **2478109 ***
C12N 15/52 (2006.01)
C12N 9/10 (2006.01)
C12N 9/88 (2006.01)
C12N 1/21 (2006.01)
- (86) EP2010063460 14.09.2010
(96) 10765977.3 25.07.2012
(87) WO2011032934, 14.09.2010
(97) 2478109, 25.07.2012 en
(54) METHOD FOR THE ENZYMATIC PRODUCTION OF 3-HYDROXY-S-METHYLBUTYRIC ACID FROM ACETONE AND ACETYL-COA
(71) Marlière, Philippe, Rue de Rolleghem, 173, 7700 Mouscron, BE
(72) Marlière, Philippe, Rue de Rolleghem, 173, 7700 Mouscron, BE
-
- (51) MKP
C07J 41/00 (2006.01) (97) **2408799 ***
A61K 31/573 (2006.01)
A61P 5/36 (2006.01)
- (86) HU2010000030 22.03.2010
(96) 10714358.8 25.01.2012
(87) WO2010106383, 22.03.2010
(97) 2408799, 25.01.2012 en
(54) NOVEL CRYSTALLINE FORM OF ANTIPROGESTIN CDB-4124
(71) Richter Gedeon Nyrt., Gyömrői út 19-21., 1103 Budapest, HU
(72) SÁNTA, Csaba, Szentmihályi út 25-27., H-1144 Budapest, HU
DEMETER, Ádám, Egyenes u. 8 A/61, H-1144 Budapest, HU
HAVASI, Balázs, Felvidék u. 59, H-1202 Budapest, HU
MAHÓ, Sándor, Rim u. 20, H-1183 Budapest, HU
-
- (51) MKP
G01F 1/58 (2006.01) (97) **2383548**
G01F 1/60 (2006.01)
- (96) 10161420.4 02.11.2011
(97) 2383548, 02.11.2011 de
(54) Measuring device and method for measuring the flow speed of a medium flowing through a measuring tube
(71) Zylum Beteiligungsgesellschaft mbH & Co. Patente II KG, Berliner Strasse 1, 12529 Schönefeld / Waltersdorf, DE
(72) Stange, Gerd, Prof. Dr., Kronkamp 39, 24589, Nortorf, DE
-
- (51) MKP
A61G 5/12 (2006.01) (97) **2473148 ***
- (86) IB2010002099 27.08.2010
(96) 10763423.0 11.07.2012
(87) WO2011024061, 27.08.2010
(97) 2473148, 11.07.2012 en
(54) SUPPORT AND CONTAINMENT STRUCTURE FOR PERSONS
(71) Galante, Marco, Via del Castello 73, 33043 Cividale Del Friuli, IT
(72) Galante, Marco, Via del Castello 73, 33043 Cividale Del Friuli, IT
-
- (51) MKP
A61K 39/00 (2006.01) (97) **2435093 ***
A61K 39/385 (2006.01)
A61K 47/48 (2006.01)
A61P 25/28 (2006.01)
- (86) EP2010057235 26.05.2010
(96) 10724360.2 04.04.2012
(87) WO2010136487, 26.05.2010
(97) 2435093, 04.04.2012 en
(54) ALBUMIN-AMYLOID PEPTIDE CONJUGATES AND USES THEREOF
(71) AracIón Biotech, S. L., Paseo de la Independencia 30 2° A, 50004 Zaragoza, ES
(72) SARASA BARRIO, J., Manuel, Baltasar Gracián 10 - pral. dcha., E-50005 Zaragoza, ES

(51) MKP
C07K 7/08 (2006.01) (97) **2499154 ***
C07K 14/47 (2006.01)
(86) US2010056042 09.11.2010
(96) 10782095.3 19.09.2012
(87) WO2011057272, 09.11.2010
(97) 2499154, 19.09.2012 en
(54) TREATMENTS FOR GASTROINTESTINAL DISORDERS
(71) Ironwood Pharmaceuticals, Inc., 301 Binney Street, Cambridge, MA 02142, US
(72) CURRIE, Mark, G., 18 Hall Avenue, Sterling MA 01564, US
FRETZEN, Angelika, 7 Avon Street, Somerville MA 02143, US
KESSLER, Marco, 35 Collins Street Unit 13, Danvers MA 01923, US
ZIMMER, Daniel, P., 453 Broadway Unit 2, Somerville MA 02145, US

(51) MKP
C07K 14/325 (2006.01) (97) **2459587 ***
C12N 15/82 (2006.01)
(86) US2010043871 30.07.2010
(96) 10739808.3 06.06.2012
(87) WO2011014749, 30.07.2010
(97) 2459587, 06.06.2012 en
(54) AXMI-192 FAMILY OF PESTICIDAL GENES AND METHODS FOR THEIR USE
(71) Athenix Corporation, 108 T W Alexander Drive, Research Triangle Park, NC 27709, US
(72) SAMPSON, Kimberly, S., 5505 Frenchman's Creek Dr., Durham NC 27713, US
TOMSO, Daniel, John, 114 Vista Del Rio Dr., Bahama NC 27503, US
GUO, Rong, 113 Brookbank Hill Place, Cary NC 27519, US

(51) MKP
A01N 37/02 (2006.01) (97) **2389806**
A01N 65/00 (2009.01)
A01N 37/04 (2006.01)
A01N 65/22 (2009.01)
A01P 7/00 (2006.01)
A01N 3/00 (2006.01)
A01P 21/00 (2006.01)
A01N 65/38 (2009.01)
A01N 65/42 (2009.01)
(96) 11167769.6 30.11.2011
(97) 2389806, 30.11.2011 en
(54) A natural composition for the treatment of plants, preparation and uses thereof
(71) Rao, Sebastiano, Via Duca degli Abruzzi, 385, 18038 Sanremo (IM), IT
(72) Rao, Sebastiano, Via Duca degli Abruzzi, 385, 18038 Sanremo (IM), IT

(51) MKP
C12Q 1/04 (2006.01) (97) **2428580 ***
(86) ES2010000176 21.04.2010
(96) 10772046.8 14.03.2012
(87) WO2010128178, 21.04.2010
(97) 2428580, 14.03.2012 en
(54) SMART PACKAGING FOR DETECTING MICROORGANISMS
(71) Universidad De Zaragoza, C/ Pedro Cerbuna 12, 50009 Zaragoza, ES
(72) NERÍN DE LA PUERTA, M. C. Cristina, C/ Pedro Cerbuna 12, E-50009 Zaragoza, ES
GUTIERREZ BARTOLOME, Laura, C/ Pedro Cerbuna 12, E-50009 Zaragoza, ES
SANCHEZ JARABO, Cristina, C/ Pedro Cerbuna 12, 50009 Zaragoza, ES

(51) MKP
A61K 31/727 (2006.01) (97) **2427198 ***
C08B 37/10 (2006.01)
C08B 37/00 (2006.01)
(86) IB2010051933 04.05.2010
(96) 10719112.4 14.03.2012
(87) WO2010128448, 04.05.2010
(97) 2427198, 14.03.2012 en
(54) USE OF AN ACYLATED OCTASACCHARIDE AS ANTITHROMBOTIC AGENT
(71) SANOFI, 174, Avenue de France, 75013 Paris, FR
(72) MOURIER, Pierre, c/o Sanofi-Aventis Patent Department 174 Avenue de France, F-75013 Paris, FR
VISKOV, Christian, c/o Sanofi-Aventis Patent Department 174 Avenue de France, F-75013 Paris, FR

(51) MKP
A61K 47/14 (2006.01) (97) **2424499 ***
A61K 47/02 (2006.01)
A61K 9/48 (2006.01)
A61K 47/00 (2006.01)
A61K 47/20 (2006.01)
A61K 31/5377 (2006.01)
A61K 9/00 (2006.01)
(86) US2010033075 30.04.2010
(96) 10717961.6 07.03.2012
(87) WO2010127193, 30.04.2010
(97) 2424499, 07.03.2012 en
(54) STABILIZED LIPID FORMULATION OF APOPTOSIS PROMOTER
(71) Abbott Laboratories, 100 Abbott Park Rd., Abbott Park, IL 60064, US
(72) CATRON, Nathaniel, 305 Lakeside Drive, Vernon Hills Illinois 60061, US
ZHANG, Geoff, 1014 Dawes Street, Libertyville Illinois 60048, US
SANZGIRI, Yeshwant, 1323 Deer Run, Gurnee Illinois 60031, US
SCHMITT, Eric, 319 Evergreen Court, Libertyville Illinois 60048, US
TONG, Ping, 6152 Indian Trail, Gurnee Illinois 60031, US
FICKES, Michael, 2311 Ridgeway Avenue, Evanston Illinois 60201, US
ZHOU, Deliang, 107 Alexandria Drive, Vernon Hills Illinois 60061, US
FISCHER, Cristina, 2821 North Augusta Drive, Wadsworth Illinois 60083, US
HAIGHT, Anthony R., 40381 Reed Court, Wadsworth Illinois 60083, US
HEEMSTRA, Katherine, 641 West Grand Avenue Apt. 4 Chicago, Illinois 60654, US

(51) MKP
C07D 277/56 (2006.01) (97) **2455372 ***
A61P 19/06 (2006.01)
C07D 277/20 (2006.01)
A61K 31/426 (2006.01)
(86) JP2010062291 14.07.2010
(96) 10799952.6 23.05.2012
(87) WO2011007895, 14.07.2010
(97) 2455372, 23.05.2012 en
(54) PROCESS FOR PRODUCING CRYSTALS OF POLYMORPHIC 2-(3-CYANO-4-ISOBUTYLOXYPHENYL)-4-METHYL-5-THIAZOLECARBOXYLIC ACID BY POOR-SOLVENT ADDITION METHOD
(71) Teijin Pharma Limited, 2-1, Kasumigaseki 3-chome Chiyoda-ku, Tokyo 100-0013, JP
(72) UEMURA, Akihito, c/o Teijin Pharma Limited Iwakuni Research Center 2-1, Hinode-cho, Iwakuni-shi Yamaguchi 740-0014, JP
NOGATA, Tomoaki, c/o Teijin Entech Co. Ltd. Iwakuni Factory 2-1, Hinode-cho, Iwakuni-shi Yamaguchi 740-0014, JP
TAKEYASU, Takumi, c/o Teijin Pharma Limited Iwakuni Research Center 2-1, Hinode-cho, Iwakuni-shi Yamaguchi 740-0014, JP

- (51) MKP
G06F 7/00 (2006.01) (97) **2460067 ***
G06F 17/00 (2006.01)
- (86) US2010044094 02.08.2010
(96) 10805167.3 06.06.2012
(87) WO2011014868, 02.08.2010
(97) 2460067, 06.06.2012 en
(54) SYSTEM AND METHOD FOR DETERMINING ROAD CONDITIONS
- (71) Baron Services, Inc., 4930 Research Drive, Huntsville, AL 35805, US
(72) GALLAGHER, Daniel, R., 4930 Research Drive, Huntsville AL 35805, US
DREISEWERD, Robert, J., 4930 Research Drive, Huntsville AL35805, US
MCHENRY, John, N., 4930 Research Drive, Huntsville AL 35805, US

- (51) MKP
C07D 405/14 (2006.01) (97) **2421825 ***
A61K 31/496 (2006.01)
C07D 405/12 (2006.01)
C07D 495/04 (2006.01)
C07D 409/14 (2006.01)
A61P 25/00 (2006.01)
C07D 403/12 (2006.01)
C07D 417/14 (2006.01)
C07D 409/12 (2006.01)
A61P 29/00 (2006.01)
C07D 413/12 (2006.01)
C07D 401/14 (2006.01)
C07D 417/12 (2006.01)
C07D 205/04 (2006.01)
C07D 413/14 (2006.01)
- (86) US2010032082 22.04.2010
(96) 10716205.9 29.02.2012
(87) WO2010124108, 22.04.2010
(97) 2421825, 29.02.2012 en
(54) AZETIDINYL DIAMIDES AS MONOACYLGLYCEROL LIPASE INHIBITORS
- (71) Janssen Pharmaceutica N.V., Turnhoutseweg 30, 2340 Beerse, BE
(72) LIN, Shu-chen, 4895 Redfield Road, Doylestown PA 18902, US
ZHU, Bin, Welsh&Mckean Roads, Spring House PA 19477, US
BIAN, Haiyan, 109 York Drive, Princeton NJ 08540, US
MCDONNELL, Mark, E., 1280 Sumneytown Pike, Lansdale PA 19446, US
CHEVALIER, Kristen, M., 407 Nottingham Lane, Collegeville PA 19426, US
PITIS, Philip, M., 108 Sunrise Drive, North Wales PA 19454, US
CONNOLLY, Peter, J., Welsh&Mckean Roads, Spring House PA 19477, US
ZHANG, Sui-po, 665 Stockton Drive, Exton PA 19341, US
FLORES, Christopher, M., Welsh&Mckean Roads, Spring House PA 19477, US
ZHANG, Yue-mei, Welsh&Mckean Roads, Spring House PA 19477, US
LIU, Li, 271 Fox Chase Lane, Doylestown PA 18901, US
CLEMENTE, Jose, 665 Stockton Drive, Exton PA 19341, US
MABUS, John, 9131 Rosewood Drive, East Greenville PA 18041, US
MACIELAG, Mark, J., Welsh&Mckean Roads, Spring House PA 19477, US

- (51) MKP
A61K 31/517 (2006.01) (97) **2485728 ***
C07D 239/22 (2006.01)
A61K 31/4166 (2006.01)
A61K 31/553 (2006.01)
A61K 31/4184 (2006.01)
A61K 31/554 (2006.01)
A61K 31/437 (2006.01)
C07D 217/14 (2006.01)
A61K 31/5513 (2006.01)
A61K 31/472 (2006.01)
C07D 235/26 (2006.01)
A61K 31/551 (2006.01)
C07D 239/96 (2006.01)
A61K 31/5377 (2006.01)
C07D 239/80 (2006.01)
- (86) EP2010006055 06.10.2010
(96) 10768182.7 15.08.2012
(87) WO2011042145, 06.10.2010
(97) 2485728, 15.08.2012 en
(54) WNT PATHWAY ANTAGONISTS
- (71) Siena Biotech S.p.a., Strada del Petriccio e Belriguardo 35, 53100 Siena, IT
(72) VARRONE, Maurizio, c/o Siena Biotech S.p.A. Strada del Petriccio e Belriguardo 35, I-53100 Siena, IT
NENCINI, Arianna, c/o Siena Biotech S.p.A. Strada del Petriccio e Belriguardo 35, I-53100 Siena, IT
QUINN, Joanna, Margaret, c/o Siena Biotech S.p.A. Strada del Petriccio e Belriguardo 35, I-53100 Siena, IT
CARICASOLE, Andrea, c/o Siena Biotech S.p.A. Strada del Petriccio e Belriguardo 35, I-53100 Siena, IT
BAKKER, Annette, Cornelia, c/o Siena Biotech S.p.A. Strada del Petriccio e Belriguardo 35, I-53100 Siena, IT
GAVIRAGHI, Giovanni, c/o Siena Biotech S.p.A. Strada del Petriccio e Belriguardo 35, I-53100 Siena, IT
SALERNO, Massimiliano, c/o Siena Biotech S.p.A. Strada del Petriccio e Belriguardo 35, I-53100 Siena, IT

- (51) MKP
G01N 33/50 (2006.01) (97) **2414830 ***
C12Q 1/44 (2006.01)
A61K 31/00 (2006.01)
- (86) EP2010054363 31.03.2010
(96) 10713892.7 08.02.2012
(87) WO2010115825, 31.03.2010
(97) 2414830, 08.02.2012 en
(54) MODULATION OF ADIPOSE TRIGLYCERIDE LIPASE FOR PREVENTION AND TREATMENT OF CACHEXIA, LOSS OF WEIGHT AND MUSCLE ATROPHY AND METHODS OF SCREENING THEREFOR
- (71) Zechner, Rudolf, Salfeldstrasse 73, 8054 Graz, AT
Höfler, Gerald, Sonnriegel 7, 8046 Stattegg, AT
Lass, Achim, Moserhofgasse 49/7/37, 8010 Graz, AT
Zimmermann, Robert, Fischergasse 23B, 8010 Graz, AT
Haemmerle, Günther, Josef-Poestion Str. 1, 8052 Graz, AT
Das, Suman, Elisabethstr. 85, 8010 Graz, AT
(72) Zimmermann, Robert, Fischergasse 23B, 8010 Graz, AT
Zechner, Rudolf, Salfeldstrasse 73, 8054 Graz, AT
Haemmerle, Günther, Josef-Poestion Str. 1, 8052 Graz, AT
Höfler, Gerald, Sonnriegel 7, 8046 Stattegg, AT
Das, Suman, Elisabethstr. 85, 8010 Graz, AT
Lass, Achim, Moserhofgasse 49/7/37, 8010 Graz, AT

- (51) MKP
C07D 401/04 (2006.01) (97) **2411380 ***
- (86) IB2010051341 26.03.2010
(96) 10713722.6 01.02.2012
(87) WO2010109442, 26.03.2010
(97) 2411380, 01.02.2012 en
(54) PROCESS FOR THE PREPARATION OF DESLORATADINE
- (71) Ranbaxy Laboratories Limited, Head Office: 12th Floor Devika Tower 06 Nehru Place New Delhi, Delhi 110019, IN
(72) MURUGESAN, Balaguru, D-28, Rajanarayan Gardens Periyanaiken Palayam SRKV (po) 641020 Coimbatore, Tamil Nadu, IN
SATHYANARAYANA, Swargam, H. No. 9-6-194 Ram Nagar, Karim Nagar Andhra Pradesh 505002, IN
PRASAD, Mohan, House No. P3/3 Phase - II DLF Qutab Enclave, Gurgaon Haryana 122002, IN

- (51) MKP
B32B 27/12 (2006.01) (97) **2454090 ***
(86) US2010038664 15.06.2010
(96) 10790054.0 23.05.2012
(87) WO2010147982, 15.06.2010
(97) 2454090, 23.05.2012 en
(54) FIBER COMPOSITE AND PROCESS OF MANUFACTURE
(71) Xene Corporation, 501 Kings Highway East, Fairfield, CT 06825, US
(72) SHENG, Hsu, Chien, c/o Handal&Morofsky 501 Kings Highway East, Fairfield, CT 06825, US
-
- (51) MKP
F24J 2/10 (2006.01) (97) **2478308 ***
F24J 2/14 (2006.01)
(86) IT2010000389 10.09.2010
(96) 10773717.3 25.07.2012
(87) WO2011033546, 10.09.2010
(97) 2478308, 25.07.2012 en
(54) A REFLECTING- PANEL HAVING A THIN MIRROR AND A SUPPORT MADE OF COMPOSITE MATERIAL SMC (SHEET MOULDING COMPOUND) FOR LINEAR PARABOLIC SOLAR CONCENTRATORS
(71) ENEA - Agenzia Nazionale Per Le Nuove Tecnologie, L'Energia e Lo Sviluppo Economico Sostenibile, Lungotevere Thaon di Revel 76, 00196 Roma, IT
(72) VIGNOLINI, Mauro, Via T. Inghirami 76, I-00179 Roma, IT
MILIOZZI, Adio, Via Campomicciolo 2/a, I-05100 Terni, IT
NICOLINI, Daniele, Via Mariano Marchicelli 26, I-00060 Formello (RM), IT
BENEDETTI, Arcangelo, Via Acqua Acetosa 2, I-00067 Morlupo (RM), IT
CARA, Giuseppe, Via S. Gennaro 157, I-00138 Roma, IT
NUNZI, Aldo, Via Bibbona 115, I-00148 Roma, IT
-
- (51) MKP
G07F 7/10 (2006.01) (97) **2430620 ***
G06Q 20/00 (2012.01)
G07F 7/08 (2006.01)
(86) IB2010052149 14.05.2010
(96) 10730522.9 21.03.2012
(87) WO2010131226, 14.05.2010
(97) 2430620, 21.03.2012 en
(54) CONTACTLESS PAYMENT DEVICE, METHOD OF CONTACTLESS TOP-UP OF ELECTRONIC MONEY ON A PAYMENT DEVICE
(71) Logomotion, s.r.o., Winterova 15, 921 01 Piestany, SK
(72) FLOREK, Miroslav, Sedmokráskova 4, 821 01 Bratislava, SK
MASARYK, Michal, Medzilaborecká 7, 821 01 Bratislava, SK
-
- (51) MKP
C11C 3/10 (2006.01) (97) **2464715 ***
(86) EP2010004950 12.08.2010
(96) 10744530.6 20.06.2012
(87) WO2011018228, 12.08.2010
(97) 2464715, 20.06.2012 de
(54) METHOD FOR MANUFACTURING BIODIESEL BY ACID TRANSESTERIFICATION, AND USE OF SULPHONIC ACID AS A CATALYST IN THE MANUFACTURE OF BIODIESEL
(71) Ingendoh, Axel, Engstenberger Höhe 10, 51519 Odenthal, DE
(72) BÖGER, Uwe, Piet-Mondrian Strasse 33, 51375 Leverkusen, DE
BECHER, Uwe, ... DE
-
- (51) MKP
B60R 19/34 (2006.01) (97) **2411246 ***
(86) IB2010051238 22.03.2010
(96) 10712570.0 01.02.2012
(87) WO2010109405, 22.03.2010
(97) 2411246, 01.02.2012 en
(54) BUMPER STRUCTURE
(71) Svimar S.R.L. Societa' per Lo Sviluppo Del Marketing e Della Ricerca, Via Cardinal Fossati, 5, 10141 Torino, IT
(72) DI MODUGNO, Francesca, Via Cascina Pianina 26, I-23873 Missaglia (LC), IT
-
- (51) MKP
C08B 37/00 (2006.01) (97) **2499167 ***
(86) US2010056064 09.11.2010
(96) 10829297.0 19.09.2012
(87) WO2011057286, 09.11.2010
(97) 2499167, 19.09.2012 en
(54) COMPOSITIONS AND METHODS FOR TREATING A DISORDER OR DEFECT IN SOFT TISSUE
(71) Drexel University, 3141 Chestnut Street, Philadelphia, PA 19104, US
(72) VRESILOVIC, Edward, 201 Kent Road, Ardmore PA 19047, US
JACKSON, Benjamin, 5 Twin Turus Lane, Chadds Ford PA 19317, US
SARKAR, Sumona, 401 North 33rd Street Apt. 1f, Philadelphia PA 19104, US
SCHAUER, Caroline, 200 Main Street, Hulmeville PA 19047, US
-
- (51) MKP
A61K 36/9066 (2006.01) (97) **2359820**
A61K 31/12 (2006.01)
A61P 25/28 (2006.01)
(96) 11250097.0 24.08.2011
(97) 2359820, 24.08.2011 en
(54) Shunt delivery of curcumin for the treatment Alzheimer Codman & Shurtleff, Inc., 325 Paramount Drive, Raynham, MA 02767, US
(72) DiAmauro, Thomas M., 3 Fitzgerald Lane, Southborough, MA 01772, US
Dextrateur, Alan, 15 Lyons Street, Franklin, MA 02038, US
Lilienfeld, Sean, 12 Terrapin Lane, Sharon, MA 02067, US
Venugopalan, Ramakrishna, 3 Morris Lane, Malvern PA 19355, US
-
- (51) MKP
G01N 33/50 (2006.01) (97) **2411805 ***
G01N 33/564 (2006.01)
G01N 33/68 (2006.01)
(86) EP2010053944 25.03.2010
(96) 10713322.5 01.02.2012
(87) WO2010108989, 25.03.2010
(97) 2411805, 01.02.2012 en
(54) NEW MARKER FOR DIAGNOSIS OF ACTIVE MULTIPLE SCLEROSIS
(71) Université Libre de Bruxelles, Avenue F. D. Roosevelt 50 CP 161, 1050 Bruxelles, BE
(72) STORDEUR, Patrick, Rue du Croissant 158, B-1190 Forest, BE
VILLÉE, Françoise, Rue de Chièvres 10, B-7322 Ville-pommeroeul, BE
VOKAER, Mathieu, Rue Marconi 167, B-1190 Forest, BE
OCMANT, Annick, Chaussée de Soignies, 34 J, B-7070 Le Roeulx, BE
GOLDMAN, Michel, Avenue Joseph Jongen 17, B-1180 Uccle, BE
-
- (51) MKP
A61M 5/145 (2006.01) (97) **2480268 ***
A61M 5/315 (2006.01)
(86) EP2010063842 21.09.2010
(96) 10762886.9 01.08.2012
(87) WO2011036134, 21.09.2010
(97) 2480268, 01.08.2012 en
(54) ASSEMBLY AND INDICATOR FOR A DRUG DELIVERY DEVICE
(71) Sanofi-Aventis Deutschland GmbH, Brüningstraße 50, 65929 Frankfurt, DE
(72) PLUMPTRE, David, 36 Shire Way, Doritwich Spa Worcestershire WR9 7RQ, GB
TERRY, Warren, 4 Glendower Approach, Warwick CV34 6ET, GB
VEASEY, Robert, 31 Lonsdale Road Lillington, Leamington Spa Warwickshire CV32 7EP, GB
JONES, Matthew, 8 The Furr Marsh, Warwick Warwickshire CV34 6DL, GB
CLAUGHTON, Timothy Giles, c/o Sanofi-Aventis London Road Holmes Chapel, Crewe Cheshire CW4 8BE, GB

- (51) MKP
C12N 15/82 (2006.01) (97) **2406278 ***
C07K 14/325 (2006.01)
A01H 5/00 (2006.01)
- (86) US2010026914 11.03.2010
(96) 10760469.6 18.01.2012
(87) WO2010141141, 11.03.2010
(97) 2406278, 18.01.2012 en
- (54) AXMI-001, AXMI-002, AXMI-030, AXMI-035, AND AXMI-045: INSECTICIDAL PROTEINS FROM BACILLUS THURINGIENSIS AND METHODS FOR THEIR USE
- (71) Athenix Corp., 3500 Paramount Parkway, Morrisville, NC 27560, US
- (72) CAROZZI, Nadine, 8308 Meadow Ridge Court, Raleigh NC 27615, US
DUCK, Nicholas, B., 1227 Tartarian Trail, Apex NC 27502, US
KOZIEL, Michael, G., 1601 Liatris Lane, Raleigh NC 27613, US
HARGISS, Tracy, 318 Oxfordshire Lane, Chapel Hill NC 27517, US
DETER, Rebekah, 7111 Indica Drive Apt. 536, Raleigh NC 27613, US
PETERS, Cheryl, L., 6308 Valley Estates Drive, Raleigh NC 27612, US
VOLRATH, Sandra, L., 4225 Pin Oak Drive, Durham NC 27707, US
TOMSO, Daniel, J., 114 Vista Del Rio Drive, Bahama NC 27503, US
-
- (51) MKP
B65H 26/00 (2006.01) (97) **2497731**
- (96) 12158665.5 12.09.2012
(97) 2497731, 12.09.2012 en
- (54) Apparatus and method for minimizing waste and improving quality and production in narrow web processing operations by automatic twist defect correction
- (71) Curt G. Joa, Inc., 100 Crocker Avenue, Sheboygan Falls Wisconsin 53085, US
- (72) DeNoble, Adam D, 2020 Cottonwood Court, De Pere, WI Wisconsin 54115, US
Brown, Jeffrey Dale, 5108 Evergreen Drive, Sheboygan, WI Wisconsin 53081, US
Andrews, Robert E, N7488 Sunset Circle Drive, Sheboygan, WI Wisconsin 53083, US
Hohm, Gottfried Jason, 1012 Falls Parc Drive Apt. 11, Sheboygan Falls, WI Wisconsin 53085, US
Faucher, Dennis J, 2415 N. 34th Street, Sheboygan, WI Wisconsin 53083, US
-
- (51) MKP
H01R 31/06 (2006.01) (97) **2315322**
H02J 7/00 (2006.01)
- (96) 10188105.0 27.04.2011
(97) 2315322, 27.04.2011 en
- (54) Docking station and device for use in a docking station
- (71) SA Shuang, 100 13551 Verdun Place, Richmond, BC V6V 1W5, CA
- (72) SA Shuang, 100 13551 Verdun Place, Richmond, BC V6V 1W5, CA
-
- (51) MKP
G01N 23/00 (2006.01) (97) **2459990 ***
- (86) CA2010001200 30.07.2010
(96) 10803791.2 06.06.2012
(87) WO2011011894, 30.07.2010
(97) 2459990, 06.06.2012 en
- (54) METHOD AND SYSTEM FOR IDENTIFYING A LIQUID PRODUCT IN LUGGAGE OR OTHER RECEPTACLE
- (71) Optosecurity Inc., 505 Blvd. du Parc Technologique, Québec QC G1P 4S9, CA
- (72) DROUIN, Stéphane, 1700 Rue Muir Apt. 2, Québec Québec G1S 2G6, CA
POULIN, Regis, 6707 Carré du Brulé, Québec Québec G2C 1K9, CA
PERRON, Luc, 1127 de la Châtelaine, Charlesbourg Quebec G2L 1A1, CA
GUDMUNDSON, Dan, 5 Rue des Jardins Mérici Apt. 304, Quebec Quebec G1S 4N7, CA
-
- (51) MKP
G06F 13/10 (2006.01) (97) **2479661 ***
G06F 3/14 (2006.01)
- (86) KR2010006384 17.09.2010
(96) 10817436.8 25.07.2012
(87) WO2011034367, 17.09.2010
(97) 2479661, 25.07.2012 en
- (54) TRIPLE DISPLAY DEVICE, AND COMPUTER EMPLOYING SAME
- (71) Lee, Eun Suk, 4th Fl., Hyundai-town 143-37 Samseong-2 dong Gangnam-gu, Seoul 135-877, KR
- (72) Lee, Eun Suk, 4th Fl., Hyundai-town 143-37 Samseong-2 dong Gangnam-gu, Seoul 135-877, KR
-
- (51) MKP
F01N 13/18 (2010.01) (97) **2432976 ***
F01N 3/20 (2006.01)
F01N 3/36 (2006.01)
- (86) EP2010057001 20.05.2010
(96) 10722669.8 28.03.2012
(87) WO2010133685, 20.05.2010
(97) 2432976, 28.03.2012 en
- (54) FLUID DOSING DEVICE
- (71) Delphi Technologies Holding S.à.r.l., Avenue de Luxembourg, 4940 Bascharage, LU
- (72) WRIGHT, Keith, 6 Kinross Close Walderslade Chatham, Kent ME5 7RS, GB
COOKE, Michael, 52 Burnt Oak Terrace Gillingham, Kent ME7 1DR, GB
THOMPSON, Phillip, 182 Station Road Rainham, Kent ME8 7PR, GB
COSTER, Simon, Lye Green House Lye Green, Sussex TN6 1UU, GB
OLDFIELD, Nick, 56 Castle Road Maidstone, Kent ME16 0PP, GB
HARDY, Martin, 71 Cedar Grove Hempstead Gillingham, Kent ME7 3QZ, GB
-
- (51) MKP
A61P 35/00 (2006.01) (97) **2486041 ***
C07D 487/04 (2006.01)
A61K 31/519 (2006.01)
- (86) US2010052011 08.10.2010
(96) 10765557.3 15.08.2012
(87) WO2011044481, 08.10.2010
(97) 2486041, 15.08.2012 en
- (54) HYDROXYL, KETO, AND GLUCURONIDE DERIVATIVES OF 3-(4-(7H-PYRROLO[2,3-D]PYRIMIDIN-4-YL)-1H-PYRAZOL-1-YL)-3-CYCLOPENTYLPROPANENITRILE
- (71) Incyte Corporation, Experimental Station Route 141 & Henry Clay Road Building E336/207, Wilmington, DE 19880, US
- (72) RODGERS, James, D., Experimental Station Route 141&Henry Clay Road Building 336, Wilmington, DE 19880, US
SHILLING, Adam, Experimental Station Route 141&Henry Clay Road Building 336, Wilmington, DE 19880, US
ARVANITIS, Argyrios, G., Experimental Station Route 141&Henry Clay Road Building 336, Wilmington, DE 19880, US
SHEPARD, Stacey, Experimental Station Route 141&Henry Clay Road Building 336, Wilmington, DE 19880, US
GALYA, Laurine, G., Experimental Station Route 141&Henry Clay Road Building 336, Wilmington, DE 19880, US
LI, Mei, Experimental Station Route 141&Henry Clay Road Building 336, Wilmington, DE 19880, US
NEDZA, Frank, M., Experimental Station Route 141&Henry Clay Road Building 336, Wilmington, DE 19880, US
-
- (51) MKP
G01N 33/50 (2006.01) (97) **2499489 ***
- (86) US2010056711 15.11.2010
(96) 10781559.9 19.09.2012
(87) WO2011060361, 15.11.2010
(97) 2499489, 19.09.2012 en
- (54) RISK FACTORS AND PREDICTION OF MYOCARDIAL INFARCTION
- (71) BG Medicine, Inc., 610N Lincoln Street, Waltham, MA 02451, US
- (72) ADOURIAN, Aram, S., 11 Bartkus Farm Road, Concord, MA 01742, US
GUO, Yu, 1862 Massachusetts Ave, Lunenburg, MA 01462, US
LI, Xiaohong, 490 Great Rd., 2-R, Acton, MA 01720, US
MUNTENDAM, Pieter, 642 Main Street, Boxford, MA 01921, US

(51) MKP
C07D 401/12 (2006.01) (97) **2499126 ***
A61P 35/00 (2006.01)
A61P 9/00 (2006.01)
C07D 487/04 (2006.01)
A61K 31/47 (2006.01)
A61P 37/00 (2006.01)
C07D 473/02 (2006.01)
A61P 27/02 (2006.01)
A61P 3/00 (2006.01)
A61P 25/28 (2006.01)
(86) EP2010067310 11.11.2010
(96) 10777004.2 19.09.2012
(87) WO2011058113, 11.11.2010
(97) 2499126, 19.09.2012 en
(54) FUSED BICYCLIC PYRIDINE AND PYRAZINE DERIVATIVES AS KINASE INHIBITORS
(71) UCB Pharma, S.A., 60, allée de la Recherche, 1070 Brussels, BE
(72) RAPHY, Gilles, BioFocus DPI Chesterford Research Park, Saffron Walden Essex CB10 1XL, GB
BÜRLI, Roland, BioFocus DPI Chesterford Research Park, Saffron Walden Essex CB10 1XL, GB
HAUGHAN, Alan, Findlay, BioFocus DPI Chesterford Research Park, Saffron Walden Essex CB10 1XL, GB

(51) MKP
A61M 5/24 (2006.01) (97) **2470243 ***
A61M 5/28 (2006.01)
A61M 5/315 (2006.01)
A61M 5/31 (2006.01)
A61M 5/34 (2006.01)
(86) EP2010062434 26.08.2010
(96) 10772991.5 04.07.2012
(87) WO2011023738, 26.08.2010
(97) 2470243, 04.07.2012 en
(54) ASSEMBLY KIT FOR PREPARING OF A PRE-FILLED SYRINGE
(71) Sanofi-Aventis Deutschland GmbH, Brüningstraße 50, 65929 Frankfurt, DE
(72) WAGNER, Daniel, c/o Sanofi-Aventis Deutschland GmbH, 65926 Frankfurt am Main, DE
KÜHN, Bernd, c/o Sanofi-Aventis Deutschland GmbH, 65926 Frankfurt am Main, DE
Möckel, Jörn, c/o Sanofi-Aventis Deutschland GmbH, 65926 Frankfurt am Main, DE

(51) MKP
G06Q 30/00 (2006.01) (97) **2330550**
(96) 10007804.7 08.06.2011
(97) 2330550, 08.06.2011 en
(54) Mediation of online trading services
(71) Sony Computer Entertainment Inc., 2-6-21, Minami-Aoyama Minato-ku, Tokyo 107-0062, JP
(72) Chopra, Vivek, c/o Sony Computer Entertainment Inc. 2-6-21 Minami-Aoyama Minami-ku, Tokyo 107-0062, JP
Gaxiola, David, c/o Sony Computer Entertainment Inc. 2-6-21 Minami-Aoyama Minami-ku, Tokyo 107-0062, JP
Szeto, Nicholas, c/o Sony Computer Entertainment Inc. 2-6-21 Minami-Aoyama Minami-ku, Tokyo 107-0062, JP
Maegawa, Hiroto, c/o Sony Computer Entertainment Inc. 2-6-21 Minami-Aoyama Minami-ku, Tokyo 107-0062, JP
lima, Shin, c/o Sony Computer Entertainment Inc. 2-6-21 Minami-Aoyama Minami-ku, Tokyo 107-0062, JP

(51) MKP
A61P 25/00 (2006.01) (97) **2421847 ***
A61K 31/496 (2006.01)
C07D 401/06 (2006.01)
C07D 409/06 (2006.01)
A61P 29/00 (2006.01)
C07D 417/06 (2006.01)
C07D 401/12 (2006.01)
C07D 205/04 (2006.01)
(86) US2010032092 22.04.2010
(96) 10717365.0 29.02.2012
(87) WO2010124116, 22.04.2010
(97) 2421847, 29.02.2012 en
(54) AZETIDINYL DIAMIDES AS MONOACYLGLYCEROL LIPASE INHIBITORS
(71) Janssen Pharmaceutica N.V., Turnhoutseweg 30, 2340 Beerse, BE
(72) MABUS, John, 9131 Rosewood Drive, East Greenville PA 18041, US
CONNOLLY, Peter, J., Welsh&Mckean Roads, Spring House PA 19477, US
ZHANG, Yue-mei, Welsh&Mckean Roads, Spring House PA 19477, US
FLORES, Christopher, M., Welsh&Mckean Roads, Spring House PA 19477, US
ZHANG, Sui-po, 665 Stockton Drive, Exton PA 19341, US
LIN, Shu-chen, 4895 Redfield Road, Doylestown PA 18902, US
ZHU, Bin, Welsh&Mckean Roads, Spring House PA 19477, US
LIU, Li, 271 Fox Chase Lane, Doylestown PA 18901, US
CLEMENTE, Jose, 665 Stockton Drive, Exton PA 19341, US
MACIELAG, Mark, J., Welsh&Mckean Roads, Spring House PA 19477, US
BIAN, Haiyan, 109 York Drive, Princeton NJ 08540, US
MCDONNELL, Mark, E., 1280 Sumneytown Pike, Lansdale PA 19446, US
CHEVALIER, Kristen, M., 407 Nottingham Lane, Collegeville PA 19426, US
PITIS, Philip, M., 108 Sunrise Drive, North Wales PA 19454, US

(51) MKP
F02M 61/06 (2006.01) (97) **2369166**
F02M 61/18 (2006.01)
(96) 10157224.6 28.09.2011
(97) 2369166, 28.09.2011 en
(54) Injection nozzle
(71) Delphi Technologies Holding S.à.r.l., Avenue de Luxembourg, 4940 Bascharage, LU
(72) Soteriou, Cecilia, Thornlea Cottage Brook, Lyndhurst, Hampshire SO43 7HD, GB
Balin, Marion, 54 route de Chambon, 41150, Onzain, FR

(51) MKP
A61K 39/12 (2006.01) (97) **2366708**
C07K 14/005 (2006.01)
C07K 16/10 (2006.01)
C12Q 1/70 (2006.01)
C07K 14/08 (2006.01)
C12N 7/00 (2006.01)
G01N 33/569 (2006.01)
C12N 15/40 (2006.01)
(96) 10157102.4 21.09.2011
(97) 2366708, 21.09.2011 en
(54) Canine astrovirus AstV strain Bari/08 identified in dogs with gastro-enteritis
(71) Martella, Vito, Via Pesce, 50, 70010 Casamassima (BA), IT
(72) Martella, Vito, Via Pesce, 50, 70010 Casamassima (BA), IT
Buonavoglia, Canio, Via Città Giardino, 53, 70016 Noicattaro (BA), IT
Decaro, Nicola, Via A. Fenicia, 15, 70126 Torre a Mare (BA), IT
Elia, Gabriella, Lungomare Nazario Sauro, 43, 70100 Bari, IT

(51) MKP
A47J 31/40 (2006.01) (97) **2316312**
(96) 10186713.3 04.05.2011
(97) 2316312, 04.05.2011 en
(54) Coffee machine
(71) Research, Investment & Development S.A.L. (Holding), JR Center, 6th Floor Jaleidib Highway, Beirut, LB
(72) Al Najjar, George Michel, Fanar-Roumieh-industriel zone, Café Najjar Buildi, Beirut, LB

- (51) MKP
B60J 7/08 (2006.01) (97) **2266826**
 (96) 10166678.2 29.12.2010
 (97) 2266826, 29.12.2010 fr
 (54) Automated covering device
 (71) Ets JOSKIN S.A., 39, Rue de Wergifosse, B-4630 Soumagne, BE
 (72) Joskin, Victor, Rue Large Voie, 8, B-4633, Soumagne, BE
-
- (51) MKP
A45C 7/00 (2006.01) (97) **2274998**
G06F 1/16 (2006.01)
A45C 11/38 (2006.01)
H04B 1/38 (2006.01)
A45C 13/00 (2006.01)
A45C 11/00 (2006.01)
H04M 1/18 (2006.01)
 (96) 10169290.3 19.01.2011
 (97) 2274998, 19.01.2011 en
 (54) Protective cover
 (71) SA Shuang, 100 13551 Verdun Place, Richmond, BC V6V 1W5, CA
 (72) SA Shuang, 100 13551 Verdun Place, Richmond, BC V6V 1W5, CA
-
- (51) MKP
H01J 37/32 (2006.01) (97) **2407998**
 (96) 10169735.7 18.01.2012
 (97) 2407998, 18.01.2012 en
 (54) Plasma processing in a capacitively-coupled reactor with trapezoidal-waveform excitation
 (71) Ecole Polytechnique, Route de Saclay, 91128 Palaiseau Cedex, FR
 Centre National de la Recherche Scientifique, 3, rue Michel Ange, 75016 Paris, FR
 (72) Booth, Jean-Paul, 19 rue des Sources, 91470, BOULLAY LES TROUX, FR
 Johnson, Erik, 22 bis rue de la Réunion, 75020, PARIS, FR
-
- (51) MKP
C07C 309/65 (2006.01) (97) **2493846 ***
A61P 25/04 (2006.01)
C07C 237/20 (2006.01)
A61P 29/00 (2006.01)
C07D 277/46 (2006.01)
C07D 295/12 (2006.01)
C07C 233/01 (2006.01)
A61P 11/00 (2006.01)
A61K 31/16 (2006.01)
C07D 211/06 (2006.01)
C07C 235/34 (2006.01)
A61K 31/18 (2006.01)
 (86) EP2010066324 28.10.2010
 (96) 10775775.9 05.09.2012
 (87) WO2011051375, 28.10.2010
 (97) 2493846, 05.09.2012 en
 (54) 2-ARYL-PROPIONAMIDE DERIVATIVES USEFUL AS BRADYKININ RECEPTOR ANTAGONISTS AND PHARMACEUTICAL COMPOSITIONS CONTAINING THEM
 (71) Dompé S.p.A., Località Campo di Pile snc, 67100 L'Aquila (AQ), IT
 (72) BECCARI, Andrea, c/o Dompé S.P.A. Località Campo di Pile, I-67100 L'Aquila, IT
 ARAMINI, Andrea, c/o Dompé S.P.A. Località Campo di Pile, I-67100 L'Aquila, IT
 BIANCHINI, Gianluca, Località Campo di Pile, I-67100 L'Aquila, IT
 MORICONI, Alessio, Località Campo di Pile, I-67100 L'Aquila, IT
-

- (51) MKP
A01N 43/40 (2006.01) (97) **2482657 ***
A61K 31/44 (2006.01)
 (86) US2010049697 21.09.2010
 (96) 10818037.3 08.08.2012
 (87) WO2011035324, 21.09.2010
 (97) 2482657, 08.08.2012 en
 (54) O-BENZYL NICOTINAMIDE ANALOGS AS MGLUR5 POSITIVE ALLOSTERIC MODULATORS
 (71) Vanderbilt University, Center for Technology Transfer and Commercialization 305 Kirkland Hall 2201 West End Avenue, Nashville, TN 37240, US
 Johnson & Johnson, Pharmaceuticals Research And Development Division Of Janssen-Cilag S.A. Calle Jarama 75 Poligona Industrial, 45007 Toledo, ES
 (72) CONN, P., Jeffrey, 9012 Grey Point Ct., Brentwood, TN 37027, US
 LINDSLEY, Craig, W., 401 Briery Court, Brentwood, TN 37027, US
 WEAVER, Charles, David, 3012 Bridlewood Trail, Franklin, TN 37067, US
 STAUFFER, Shaun, R., 9500 Wexcroft Drive, Brentwood, TN 37027, US
 WILLIAMS, Richard, 97 Lisburn Road, Belfast Northern BT9 7BL, IE
 MACDONALD, Gregor, James, Turnhouseweg 30, 2340 Beerse, BE
 BARTOLOME-NEBREDIA, Jose, Manuel, Johnson & Johnson Pharmaceuticals Research And Development Division Of Janssen-Cilag S.A. Calle Jarama 75 Poligona Industrial, 45007 Toledo, ES
 ZHOU, Ya, 406 Avoca Ave. Woodside Apt. B-3, Nashville, TN 37203, US
-
- (51) MKP
C07K 19/00 (2006.01) (97) **2406288 ***
C07K 16/18 (2006.01)
C12N 15/63 (2006.01)
A61K 39/395 (2006.01)
 (86) US2010026268 04.03.2010
 (96) 10751208.9 18.01.2012
 (87) WO2010104747, 04.03.2010
 (97) 2406288, 18.01.2012 en
 (54) ANTIGEN PRESENTING CELL TARGETED VACCINES
 (71) Baylor Research Institute, 3310 Live Oak Street, Suite 501, Dallas, TX 75201, US
 (72) ZURAWSKI, Gerard, 7620 Jordan Lane, Midlothian, TX 76065, US
 BANCHEREAU, Jacques, F., 6730 Northaven Road, Dallas, TX 75230, US
 FLAMAR, Anne-laure, 8650 Southwestern Blvd. 3914, Dallas, TX 75206, US
 LEVY, Yves, 7, Rue Royer Collard, F-75005 Paris, FR
 MONTES, Monica, 3005 Bryan St. 2313, Dallas, TX 75204, US
-
- (51) MKP
B08B 3/02 (2006.01) (97) **2383047**
B05B 15/06 (2006.01)
D21F 1/34 (2006.01)
 (96) 11003362.8 02.11.2011
 (97) 2383047, 02.11.2011 de
 (54) Nozzle device
 (71) Papiermaschinen-Systemtechnik GmbH, Moltkestrasse 1, 77654 Offenburg, DE
 (72) Struck, Hans Joachim, W.-Blumenstockstrasse 11, 77654 Offenburg, DE
Fabiny Lutz, Freudental 25, 77799 Ortenberg, DE
-

- (51) MKP
A61K 31/19 (2006.01) (97) **2467143 ***
A61K 31/60 (2006.01)
- (86) US2010045679 17.08.2010
(96) 10810452.2 27.06.2012
(87) WO2011022345, 17.08.2010
(97) 2467143, 27.06.2012 en
(54) BROAD SPECTRUM PRESERVATION BLENDS
(71) Arch Personal Care Products, L.P., 70 Tyler Place, South Plainfield, NJ 07080, US
(72) CICCOGNANI, Diana, T., 190 Mixville Road, Cheshire CT 06410, US
DINICOLA, Kevin, N., 22 Jacqueline Drive, Wolcott CT 06716, US
ROBERTS, Katherine, P., 260 Shagbark Drive, Derby CT 06418, US
SZYMCZAK, Laura, M., 58 Players Circle, Tinton Falls NJ 07724, US
-
- (51) MKP
C07D 487/04 (2006.01) (97) **2430026 ***
A61P 35/00 (2006.01)
A61K 31/52 (2006.01)
- (86) US2010001415 13.05.2010
(96) 10732492.3 21.03.2012
(87) WO2010132110, 13.05.2010
(97) 2430026, 21.03.2012 en
(54) HYDROCHLORIDE SALT OF ((1S,2S,4R)-4-{4-[(1S)-2,3-DIHYDRO-1H-INDEN-1-YLAMINO]-7H-PYRROLO [2,3-D]PYRIMIDIN-7-YL}-2-HYDROXYCYCLOPENTYL)METHYL SULFAMATE
(71) Millennium Pharmaceuticals, Inc., 40 Landsdowne Street, Cambridge, MA 02139, US
(72) ARMITAGE, Ian, G., 8 Concord Road, Stoneham, MA 02180, US
CHOPRA, Reenu, c/o SAFC Pharmorphix 250 Cambridge Science Park Milton Road, Cambridge CB4 0WE, GB
COOPER, Martin, Ian, 29 West Hill Road, Foxton Cambridge CB22 6SZ, GB
LANGSTON, Marianne, 164 Mill Road, North Andover, MA 01845, US
-
- (51) MKP
C07D 498/04 (2006.01) (97) **2477994 ***
A61K 31/519 (2006.01)
A61K 31/522 (2006.01)
A61P 25/00 (2006.01)
- (86) US2010048695 14.09.2010
(96) 10757346.1 25.07.2012
(87) WO2011034830, 14.09.2010
(97) 2477994, 25.07.2012 en
(54) SUBSTITUTED DIHYDRO BENZOCYCLOALKYLOXYMETHYL OXAZOLOPYRIMIDINONES, PREPARATION AND USE THEREOF
(71) SANOFI, 54 rue La Boétie, 75008 Paris, FR
(72) KOSLEY, Raymond Walter, Jr., c/o SANOFI-AVENTIS U.S. INC. 1041 Route 202-206 Mail Code: BWD-303A, Bridgewater, NJ 08807, US
SHER, Rosy, c/o SANOFI-AVENTIS U.S. INC. 1041 Route 202-206 Mail Code: BWD-303A, Bridgewater, NJ 08807, US
-
- (51) MKP
C08G 63/08 (2006.01) (97) **2455414**
C08G 63/90 (2006.01)
C08G 63/80 (2006.01)
- (96) 10191481.0 23.05.2012
(97) 2455414, 23.05.2012 de
(54) Process for the production of resorbable polyesters
(71) Evonik Röhm GmbH, Kirschenallee, 64293 Darmstadt, DE
(72) Bocionek, Dirk, Am Lagenberg 11, 55218 Ingelheim am Rhein, DE
Enderla, Anja, Helmerichstr. 24, 55437 Ockenheim, DE
-
- (51) MKP
C12P 21/08 (2006.01) (97) **2491129 ***
- (86) US2010053730 22.10.2010
(96) 10825739.5 29.08.2012
(87) WO2011050262, 22.10.2010
(97) 2491129, 29.08.2012 en
(54) DUAL VARIABLE DOMAIN IMMUNOGLOBULINS AND USES THEREOF
(71) Abbott Laboratories, 100 Abbott Park Rd., Abbott Park, IL 60064, US
(72) MORGAN-LAPPE, Susan E., 5419 North Canfield Avenue, Chicago Illinois 60656, US
LIU, Junjian, 14 Crimson Drive, Shrewsbury Massachusetts 01545, US
WANG, Jieyi, 29726 Butterfly Court, Lake Bluff Illinois 60044, US
REILLY, Edward B., 1136 Winners Circle, Libertyville Illinois 60048, US
YING, Hua, 15 Tyler Drive, Holden Massachusetts 01520, US
BELL, Randy L., 703 Federal Parkway, Lindenhrst Illinois 60046, US
GHAYUR, Tariq, 1014 Washington Street, Holliston Massachusetts 01746, US
LI, Yingchun, 103 Newfield Drive, Buffalo Grove Illinois 60089, US
NORVELL, Suzanne M., 4531 N. Krueger Road, Long Grove Illinois 60047, US
PHILLIPS, Andrew, 519 Garfield Avenue, Libertyville Illinois 60048, US
KINGSBURY, Gillian A., 46 Aqueduct Road, Wayland Massachusetts 01778, US
LIU, Zhihong, 1455 Greystone Drive, Gurnee Illinois 60031, US
-
- (51) MKP
E04F 13/04 (2006.01) (97) **2470732 ***
- (86) CH2010000193 05.08.2010
(96) 10744836.7 04.07.2012
(87) WO2011022849, 05.08.2010
(97) 2470732, 04.07.2012 de
(54) REINFORCING MESH FOR A REINFORCED MORTAR LAYER OR SPRAYED MORTAR LAYER ON AN UNDERLAYMENT, AND METHOD FOR THE INSTALLATION THEREOF AND REINFORCED MORTAR COATING PRODUCED THEREWITH
(71) S & P Clever Reinforcement Company AG, Seewernstrasse 127, 6423 Seewen, CH
(72) S & P Clever Reinforcement Company AG, Seewernstrasse 127, 6423 Seewen, CH
-
- (51) MKP
G01N 33/564 (2006.01) (97) **2494352 ***
G01N 33/50 (2006.01)
- (86) US2010054125 26.10.2010
(96) 10778763.2 05.09.2012
(87) WO2011056590, 26.10.2010
(97) 2494352, 05.09.2012 en
(54) ASSAYS FOR THE DETECTION OF ANTI-TNF DRUGS AND AUTOANTIBODIES
(71) Prometheus Laboratories Inc., 9410 Carroll Park Drive, San Diego, CA 92121-5201, US
(72) SINGH, Sharat, 8171 Top of the Morning Way, Rancho Santa Fe California 92127, US
WANG, Shui Long, 4555 Saddle Mountain Court, San Diego California 92130, US
OHRMUND, Linda, 3519 Tennyson Street, San Diego California 92106, US
-
- (51) MKP
A61F 2/06 (2006.01) (97) **2461766 ***
- (86) US2010044879 09.08.2010
(96) 10807287.7 13.06.2012
(87) WO2011017698, 09.08.2010
(97) 2461766, 13.06.2012 en
(54) PROSTHETIC DEVICE INCLUDING ELECTROSTATICALLY SPUN FIBROUS LAYER AND METHOD FOR MAKING THE SAME
(71) Zeus Industrial Products, Inc., 3737 Industrial Boulevard, Orangeburg, South Carolina 29118, US
(72) ANNEAUX, Bruce, L., 413 Cannon Knoll Road, Lexington South Carolina 29073, US
BALLARD, Robert, L., 2242 Griffith Drive, Orangeburg South Carolina 29118, US

- (51) MKP
B32B 17/10 (2006.01) (97) **2485886 ***
B32B 37/10 (2006.01)
B30B 5/02 (2006.01)
- (86) EP2010063470 14.09.2010
(96) 10760954.7 15.08.2012
(87) WO2011042285, 14.09.2010
(97) 2485886, 15.08.2012 de
(54) DEVICE AND METHOD FOR PRODUCING LAMINATED SAFETY GLASS
- (71) Fotoverbundglas Marl GmbH, Zechenstraße 7c, 45772 Marl, DE
(72) MUSCHIOL, Michael, Sachsenstraße 32, 45770 Marl, DE
-
- (51) MKP
A61K 47/36 (2006.01) (97) **2437784 ***
- (86) GB2010001097 03.06.2010
(96) 10722756.3 11.04.2012
(87) WO2010139957, 03.06.2010
(97) 2437784, 11.04.2012 en
(54) ALGINATE OLIGOMERS FOR USE IN OVERCOMING MULTIDRUG RESISTANCE IN BACTERIA
- (71) ALGIPHARMA AS, Industriveien 33, 1337 Sandvika, NO
(72) ONSØYEN, Edvar, AlgiPharma IPR AS Industriveien 33, N-1337 Sandvika, NO
MYRVOLD, Rolf, AlgiPharma IPR AS Industriveien 33, N-1337 Sandvika, NO
DESSEN, Arne, AlgiPharma IPR AS Industriveien 33, N-1337 Sandvika, NO
THOMAS, David, Tissue Engineering&Reparative Dentistry School of Dentistry Cardiff University Heath Park, Cardiff CF14 4XY, GB
WALSH, Timothy, Department of Medical Microbiology Cardiff University Heath Park, Cardiff CF14 4XY, GB
-
- (51) MKP
C07D 401/04 (2006.01) (97) **2484672 ***
C07D 495/04 (2006.01)
A01N 43/62 (2006.01)
A01N 43/46 (2006.01)
A01P 3/00 (2006.01)
C07D 498/04 (2006.01)
- (86) JP2010066384 22.09.2010
(96) 10818801.2 08.08.2012
(87) WO2011037128, 22.09.2010
(97) 2484672, 08.08.2012 en
(54) NITROGEN-CONTAINING HETEROCYCLIC COMPOUND AND SALT THEREOF, AND BACTERICIDE FOR AGRICULTURAL AND HORTICULTURAL USE
- (71) Nippon Soda Co., Ltd., 2-1, Ohtemachi 2-chome Chiyoda-ku, Tokyo 100-8165, JP
(72) MITANI Akira, c/o Odawara Research Center Nippon Soda Co. Ltd. 345 Takada, Odawara-shi Kanagawa 250-0280, JP
INAGAKI Jun, c/o Odawara Research Center Nippon Soda Co. Ltd. 345 Takada, Odawara-shi Kanagawa 250-0280, JP
KUWAHARA Raito, c/o Odawara Research Center Nippon Soda Co. Ltd. 345 Takada, Odawara-shi Kanagawa 250-0280, JP
SATO Motoaki, c/o Odawara Research Center Nippon Soda Co. Ltd. 345 Takada, Odawara-shi Kanagawa 250-0280, JP
-
- (51) MKP
A01N 43/38 (2006.01) (97) **2493304 ***
A61K 31/40 (2006.01)
- (86) US2010054054 26.10.2010
(96) 10827383.0 05.09.2012
(87) WO2011053575, 26.10.2010
(97) 2493304, 05.09.2012 en
(54) SPIROLACTAM DERIVATIVES AND USES OF SAME
- (71) H. Lundbeck A/S, Othilievej 9, 2500 Valby-Copenhagen, DK
(72) ZHOU, Hao, 73 Prospect St. Flr. 2, Paramus, NJ 07652, US
LI, Guiying, 76 Rutgers Place Apt. 1, River Edge, NJ 07661, US
DOLLER, Dario, 15 Quarterhorse Crossing, Sparta, NJ 07871, US
MA, Gil, 2306 Windsor Park Ct., Englewood, NJ 07631, US
-
- (51) MKP
C07D 417/14 (2006.01) (97) **2421860 ***
C07D 417/12 (2006.01)
A61K 31/496 (2006.01)
A61P 29/00 (2006.01)
A61P 25/00 (2006.01)
- (86) US2010032045 22.04.2010
(96) 10715456.9 29.02.2012
(87) WO2010124082, 22.04.2010
(97) 2421860, 29.02.2012 en
(54) AZETIDINYL DIAMIDES AS MONOACYLGLYCEROL LIPASE INHIBITORS
- (71) Janssen Pharmaceutica N.V., Turnhoutseweg 30, 2340 Beerse, BE
(72) FLORES, Christopher, M., Welsh&Mckean Roads, Spring House PA 19477, US
ZHANG, Yue-mei, Welsh&Mckean Roads, Spring House PA 19477, US
MACIELAG, Mark, J., Welsh&Mckean Roads, Spring House PA 19477, US
BIAN, Haiyan, 109 York Drive, Princeton NJ 08540, US
MCDONNELL, Mark, E., 1280 Sumneytown Pike, Lansdale PA 19446, US
CHEVALIER, Kristen, M., 407 Nottingham Lane, Collegeville PA 19426, US
PITIS, Philip, M., 108 Sunrise Drive, North Wales PA 19454, US
CONNOLLY, Peter, J., Welsh&Mckean Roads, Spring House PA 19477, US
ZHANG, Sui-po, 665 Stockton Drive, Exton PA 19341, US
LIN, Shu-chen, 4895 Redfield Road, Doylestown PA 18902, US
ZHU, Bin, Welsh&Mckean Roads, Spring House PA 19477, US
LIU, Li, 271 Fox Chase Lane, Doylestown PA 18901, US
CLEMENTE, Jose, 665 Stockton Drive, Exton PA 19341, US
MABUS, John, 9131 Rosewood Drive, East Greenville PA 18041, US
-
- (51) MKP
C07D 405/12 (2006.01) (97) **2462137 ***
A61P 9/00 (2006.01)
- (86) US2010044568 05.08.2010
(96) 10742387.3 13.06.2012
(87) WO2011017533, 05.08.2010
(97) 2462137, 13.06.2012 en
(54) CRYSTALLINE SALTS OF METHYL 2- ((R) - (3-CHLORO PHENYL)) ((R) -L- ((S) -2- (METHYLAMINO) -3- ((R) -TETRAHYDRO-2H-PYRAN-3-YL) PROPYL CARBAMOYL)
- (71) Vitae Pharmaceuticals, Inc., 502 West Office Center Drive, Fort Washington, PA 19034, US
(72) CLAREMON, David, A., 1508 Aidenn Lair Road, Maple Glen PA 19002, US
SIMPSON, Robert, D., 2001 N. Van Buren Street, Wilmington DE 19802, US
JIA, Lanqi, 105 Allison Road Apartment A2, Horsham PA 19044, US
-
- (51) MKP
A61K 31/37 (2006.01) (97) **2416771 ***
A61K 31/35 (2006.01)
A61P 1/00 (2006.01)
A61P 3/04 (2006.01)
A61P 3/00 (2006.01)
- (86) US2010030420 08.04.2010
(96) 10762450.4 15.02.2012
(87) WO2010118250, 08.04.2010
(97) 2416771, 15.02.2012 en
(54) METHODS AND COMPOSITIONS OF PI-3 KINASE INHIBITORS FOR TREATING FIBROSIS
- (71) Oncothyreon Inc., 2601 Fourth Avenue, Suite 500, Seattle, WA 98121, US
(72) HARDIE, William, 2012 South State Route 741, Lebanon OH 45036, US
KIRKMAN, Robert, 4439 95th Avenue, Yarrow Point WA 98004, US

- (51) MKP
C10G 11/00 (2006.01) (97) **2406356 ***
C10M 101/02 (2006.01)
C10G 45/58 (2006.01)
C10G 9/00 (2006.01)
C10M 107/02 (2006.01)
C10G 47/00 (2006.01)
A01N 25/02 (2006.01)
C10L 1/04 (2006.01)
C08K 5/01 (2006.01)
C10L 11/04 (2006.01)
C09D 11/02 (2006.01)
C09K 8/02 (2006.01)
- (86) FR2010050426 11.03.2010
(96) 10716382.6 18.01.2012
(87) WO2010103245, 11.03.2010
(97) 2406356, 18.01.2012 fr
(54) HYDRODEWAXED HYDROCARBON FLUID USED IN THE MANUFACTURE OF FLUIDS FOR INDUSTRIAL, AGRICULTURAL, OR DOMESTIC USE
(71) Total Raffinage Marketing, 24 Cours Michelet, 92800 Puteaux, FR
(72) WESTELYNCK, Antoine, 15 rue du Vexin, F-78440 Bruel en Vexin, FR
AUBRY, Christine, 14 chemin de l'Auberderie, F-78160 Marly le Roi, FR
WIESSLER, Achim, Dorotheenweg 10a, 49324 Melle, DE
-
- (51) MKP
C07K 14/705 (2006.01) (97) **2499161 ***
C07K 16/28 (2006.01)
A61P 35/00 (2006.01)
A61K 39/395 (2006.01)
- (86) EP2010006888 11.11.2010
(96) 10778877.0 19.09.2012
(87) WO2011057788, 11.11.2010
(97) 2499161, 19.09.2012 en
(54) ANTIBODIES SPECIFIC FOR CLAUDIN 6 (CLDN6)
(71) GANYMED Pharmaceuticals AG, Freiligrathstrasse 12, 55131 Mainz, DE
Johannes Gutenberg-Universität Mainz, Saarstrasse 21, 55128 Mainz, DE
(72) SAHIN, Ugur, Philipp-von-Zabern-Platz 1, 55116 Mainz, DE
TÜRECI, Özlem, Philipp-von-Zabern-Platz 1, 55116 Mainz, DE
KOSLOWSKI, Michael, Autogenstrasse 50, 65933 Frankfurt, DE
WALTER, Korden, Hüglerstrasse 3, 65203 Wiesbaden, DE
WÖLL, Stefan, Pommardstrasse 22a, 55299 Nackenheim, DE
KREUZBERG, Maria, Freiherr-vom-Stein Strasse 1, 55131 Mainz, DE
HUBNER, Bernd, Thelottstrasse 14, 80933 München, DE
ERDELJAN, Michael, Freiherr-vom-Stein-Strasse 11, 55131 Mainz, DE
-
- (51) MKP
C40B 50/06 (2006.01) (97) **2488867 ***
C40B 40/10 (2006.01)
C40B 30/04 (2006.01)
G01N 33/53 (2006.01)
- (86) US2010052660 14.10.2010
(96) 10824085.4 22.08.2012
(87) WO2011047146, 14.10.2010
(97) 2488867, 22.08.2012 en
(54) METHODS OF AFFINITY MATURING ANTIBODIES
(71) Janssen Biotech, Inc., 800/850 Ridgeview Drive, Horsham, PA 19044, US
(72) ALMAGRO, Juan-Carlos, 44 Harvard Avenue, nr. 5., Brookline, MA 02446, US
FRANSSON, Johan, 3210 Merryfield Road, San Diego, CA 92121, US
RAGHUNATHAN, Gopalan, 12620 Creekwood Court, San Diego, CA 92129, US
-
- (51) MKP
A61K 8/02 (2006.01) (97) **2480196 ***
A61Q 1/02 (2006.01)
A61K 8/64 (2006.01)
A61K 8/72 (2006.01)
- (86) US2010049853 22.09.2010
(96) 10819403.6 01.08.2012
(87) WO2011038022, 22.09.2010
(97) 2480196, 01.08.2012 en
(54) METHODS AND COMPOSITIONS FOR SELECTIVELY TREATING SKIN
(71) Johnson & Johnson Consumer Companies, Inc., 199 Grandview Road, Skillman, NJ 08558, US
(72) DALY, Susan, 9 Clark Court, Basking Ridge NJ 07920, US
-
- (51) MKP
C07D 409/14 (2006.01) (97) **2421823 ***
C07D 405/12 (2006.01)
C07D 205/04 (2006.01)
A61P 25/00 (2006.01)
C07D 403/14 (2006.01)
C07D 491/048 (2006.01)
A61K 31/496 (2006.01)
C07D 403/12 (2006.01)
C07D 417/14 (2006.01)
C07D 401/10 (2006.01)
C07D 417/12 (2006.01)
C07D 401/12 (2006.01)
A61P 29/00 (2006.01)
- (86) US2010032049 22.04.2010
(96) 10715457.7 29.02.2012
(87) WO2010124086, 22.04.2010
(97) 2421823, 29.02.2012 en
(54) AZETIDINYL DIAMIDES AS MONOACYLGLYCEROL LIPASE INHIBITORS
(71) Janssen Pharmaceutica N.V., Turnhoutseweg 30, 2340 Beerse, BE
(72) MABUS, John, 9131 Rosewood Drive, East Greenville PA 18041, US
CONNOLLY, Peter, J., Welsh&Mckean Roads, Spring House PA 19477, US
ZHANG, Sui-Po, 665 Stockton Drive, Exton PA 19341, US
FLORES, Christopher, M., Welsh&Mckean Roads, Spring House PA 19477, US
ZHANG, Yue-mei, Welsh&Mckean Roads, Spring House PA 19477, US
LIN, Shu-chen, 4895 Redfield Road, Doylestown PA 18902, US
ZHU, Bin, Welsh&Mckean Roads, Spring House PA 19477, US
LIU, Li, 271 Fox Chase Lane, Doylestown PA 18901, US
CLEMENTE, Jose, 665 Stockton Drive, Exton PA 19341, US
MACIELAG, Mark, J., Welsh&Mckean Roads, Spring House PA 19477, US
BIAN, Haiyan, 109 York Drive, Princeton NJ 08540, US
MCDONNELL, Mark, E., 1280 Sumneytown Pike, Lansdale PA 19446, US
CHEVALIER, Kristen, M., 407 Nottingham Lane, Colledgeville PA 19426, US
PITIS, Philip, M., 108 Sunrise Drive, North Wales PA 19454, US
-

- (51) MKP
C10G 47/36 (2006.01) (97) **2479243 ***
- (86) JP2010065860 14.09.2010
(96) 10817177.8 25.07.2012
(87) WO2011034064, 14.09.2010
(97) 2479243, 25.07.2012 en
- (54) METHOD OF HYDROCRACKING AND PROCESS FOR PRODUCING HYDROCARBON OIL
- (71) Japan Oil, Gas and Metals National Corporation, 2-10-1, Toranomon Minato-ku, Tokyo 105-0001, JP
INPEX Corporation, 5-3-1 Akasaka Minato-ku, Tokyo 107-6332, JP
JX Nippon Oil & Energy Corporation, 6-3, Otemachi 2-chome, Chiyoda-ku Tokyo 100-8162, JP
Japan Petroleum Exploration Co., Ltd., 7-12, Marunouchi 1-chome Chiyoda-ku, Tokyo 100-0005, JP
Cosmo Oil Co., Ltd., 1-1, Shibaura 1-chome Minato-ku, Tokyo 105-8528, JP
Nippon Steel Engineering Co., Ltd, 5-1, Osaki 1-chome Shinagawa-ku, Tokyo 141-8604, JP
- (72) TASAKA Kazuhiko, c/o JX Nippon Oil&Energy Corporation 8 Chidori-cho Naka-ku, Yokohama-shi Kanagawa 231-0815, JP
TANAKA Yuichi, c/o JX Nippon Oil&Energy Corporation 8 Chidori-cho Naka-ku, Yokohama-shi Kanagawa 231-0815, JP
IWAMA Marie, c/o JX Nippon Oil&Energy Corporation 8 Chidori-cho Naka-ku, Yokohama-shi Kanagawa 231-0815, JP

- (51) MKP
C08F 251/02 (2006.01) (97) **2486068 ***
- A61Q 3/02 (2006.01)**
A45D 31/00 (2006.01)
A61K 8/91 (2006.01)
C09D 4/06 (2006.01)
- (86) US2010047171 30.08.2010
(96) 10751752.6 15.08.2012
(87) WO2011043880, 30.08.2010
(97) 2486068, 15.08.2012 en
- (54) REMOVABLE COLOR LAYER FOR ARTIFICIAL NAIL COATINGS AND METHODS THEREFORE
- (71) Creative Nail Design, Inc., 1125 Joshua Way, Vista, CA 92081, US
- (72) VU, Thong, H., 2027 Freedom Way, Vista CA 92081, US
LARSEN, Diane, Marie, 2607 Pirineos Way 111, Carlsbad CA 92009, US
CONGER, Chad, 1388 Dandelion Way, San Marcos CA 92078, US
SCHOON Douglas D., 33935 Crystal Lantern St, Dana Point, CA 92629, US

- (51) MKP
G06F 3/041 (2006.01) (97) **2406704 ***
- G06F 3/01 (2006.01)**
G06F 3/048 (2006.01)
- (86) US2010026909 11.03.2010
(96) 10712202.0 18.01.2012
(87) WO2010105012, 11.03.2010
(97) 2406704, 18.01.2012 en
- (54) SYSTEMS AND METHODS FOR A TEXTURE ENGINE
- (71) Immersion Corporation, 801 Fox Lane, San Jose, CA 95131, US
- (72) CRUZ-HERNANDEZ, Juan, Manuel, 4840 Ste-Catherine West, Montreal Québec H3Z 1T1, CA
GRANT, Danny, A., 1784 De Lunebourg, Laval Québec H7M 2A1, CA

- (51) MKP
C07K 14/47 (2006.01) (97) **2414390 ***
- (86) US2010028946 26.03.2010
(96) 10722838.9 08.02.2012
(87) WO2010117694, 26.03.2010
(97) 2414390, 08.02.2012 en
- (54) CITRULLINATED PEPTIDES FOR DIAGNOSING AND PROGNOSING RHEUMATOID ARTHRITIS
- (71) Prometheus Laboratories Inc., 9410 Carroll Park Drive, San Diego, CA 92121-5201, US
- (72) LING, Nicholas Chi-Kwan, 5324 Bloch Street, San Diego California 92122, US
WANG, Shui Long, 4555 Saddle Mountain Court, San Diego California 92130, US
WANG, Dunrui, 16216 Palamino Mesa Place, San Diego California 92127, US
SINGH, Sharat, 8171 Top of the Morning Way, Rancho Sante Fe California 92127, US

- (51) MKP
C07D 405/04 (2006.01) (97) **2493880 ***
- A01N 43/56 (2006.01)**
- (86) US2010052228 12.10.2010
(96) 10768149.6 05.09.2012
(87) WO2011059619, 12.10.2010
(97) 2493880, 05.09.2012 en
- (54) HETEROBICYCLE-SUBSTITUTED AZOXYL BENZENE FUNGICIDES
- (71) E. I. du Pont de Nemours and Company, 1007 Market Street, Wilmington, DE 19898, US
- (72) ANDREASSI II, John Lawrence, 402 Wilson Court, Hockessin, Delaware 19707, US
TAGGI, Andrew, Edmund, 21 Tremont Court, Newark Delaware 19711, US

- (51) MKP
A61M 5/20 (2006.01) (97) **2403561 ***
- (86) EP2010052791 04.03.2010
(96) 10707024.5 11.01.2012
(87) WO2010100246, 04.03.2010
(97) 2403561, 11.01.2012 en
- (54) SYRINGE, AUTO-INJECTOR DEVICE AND SET OF AUTO-INJECTOR DEVICES AND SYRINGES
- (71) Sanofi-Aventis Deutschland GmbH, Brüningstraße 50, 65929 Frankfurt, DE
- (72) HEALD, Michael, c/o Sanofi-Aventis UK London Road Crewe, Holmes Chapel Cheshire CW4 8BE, GB

- (51) MKP
A61K 8/44 (2006.01) (97) **2371350**
- A61K 8/04 (2006.01)**
A61K 9/00 (2006.01)
A61K 9/107 (2006.01)
A61K 31/17 (2006.01)
A61K 9/12 (2006.01)
- (96) 10155548.0 05.10.2011
(97) 2371350, 05.10.2011 de
- (54) Foam formulas for treating animal skin illnesses
- (71) Neubourg Skin Care GmbH & Co. KG, Mergenthaler Strasse 40, 48268 Greven, DE
- (72) Neubourg, Thomas, Am Alten Kurbad 16, 59368, Werne, DE

- (51) MKP
C23C 14/02 (2006.01) (97) **2491161 ***
- A61L 31/08 (2006.01)**
C23C 14/32 (2006.01)
C23C 14/06 (2006.01)
C23C 14/35 (2006.01)
A61L 27/30 (2006.01)
- (86) EP2011052924 28.02.2011
(96) 11705583.0 29.08.2012
(87) WO201104384, 28.02.2011
(97) 2491161, 29.08.2012 en
- (54) SURFACE COATINGS FOR MEDICAL IMPLANTS
- (71) IMC Infomusic Consultants GmbH, Salztorgasse 6-8, 1010 Wien, AT
- (72) LAMMER, Johannes, Befeno 75, CH-6535 Roveredo, CH

- (51) MKP
C07C 205/02 (2006.01) (97) **2490999 ***
- C07C 201/08 (2006.01)**
- (86) US2010048482 10.09.2010
(96) 10755055.0 29.08.2012
(87) WO2011049682, 10.09.2010
(97) 2490999, 29.08.2012 en
- (54) ISOTHERMAL REACTOR FOR HYDROCARBON NITRATION
- (71) ANGUS Chemical Company, 1500 E. Lake Cook Road, Buffalo Grove, IL 60089, US
- (72) TRAUTH, Daniel, M., 5817 Meadowbrook Lane, Crystal Lake, IL 60014, US

- (51) MKP
C07D 471/04 (2006.01) (97) **2408773 ***
A61P 35/00 (2006.01)
- (86) US2010027929 19.03.2010
(96) 10711966.1 25.01.2012
(87) WO2010108074, 19.03.2010
(97) 2408773, 25.01.2012 en
(54) INHIBITORS OF PI3 KINASE
- (71) Amgen, Inc, One Amgen Center Drive, Thousand Oaks, CA 91320-1799, US
(72) BO, Yunxin, Y., 419 Calle Veracruz, Thousand Oaks California 91320, US
LIU, Longbin, 753 Rushing Creek Place, Thousand Oaks California 91360, US
NISHIMURA, Nobuko, 24050 Arminta Street, West Hills California 91304, US
NORMAN, Mark, H., 130 Venue Street, Thousand Oaks California 91360, US
SIEGMUND, Aaron, C., 311 Mariposa Drive, Ventura California 93001, US
TAMAYO, Nuria, A., 4394 Camino De La Rosa, Newbury Park California 91320, US
YANG, Kevin, 8871 Camino Real Avenue, San Gabriel California 91775, US

- (51) MKP
C07D 471/04 (2006.01) (97) **2464645 ***
A61K 31/437 (2006.01)
A61P 9/00 (2006.01)
A61K 31/519 (2006.01)
A61K 31/4985 (2006.01)
A61K 31/5025 (2006.01)
- (86) US2010043264 26.07.2010
(96) 10737724.4 20.06.2012
(87) WO2011014462, 26.07.2010
(97) 2464645, 20.06.2012 en
(54) FUSED HETEROCYCLIC COMPOUNDS AS ION CHANNEL MODULATORS
- (71) Gilead Palo Alto, Inc., 333 Lakeside Drive, Foster City, CA 94404, US
(72) NOTTE, Gregory, 707 Highland Ave Apt 2, San Mateo CA 94401, US
CORKEY, Britton, 355 Buena Vista Ave East Apt 415, San Francisco CA 94117, US
PARKHILL, Eric, 559 Lincoln Way 2, San Francisco CA 94122, US
ELZEIN, Elfatih, 4644 Creekwood Drive, Fremont CA 94555, US
PERRY, Thao, 5109 Adair Way, San Jose CA 95124, US
JIANG, Robert, 10340 Orange Avenue, Cupertino CA 95014, US
ZABLOCKI, Jeff, 1910 Noel Drive, Los Altos CA 94024, US
KALLA, Rao, 125 Connemara Way 9, Sunnyvale CA 94087, US
KOBAYASHI, Tetsuya, 1362 Arleen Avenue, Sunnyvale CA 94087, US
LI, Xiaofen, 161 Montelena Court, Mountain View CA 94040, US
KOLTUN, Dmitry, 1075 Grebe Street, Foster City CA 94404, US

- (51) MKP
A47K 10/16 (2006.01) (97) **2490970 ***
B65H 75/10 (2006.01)
- (86) IB2011000164 01.02.2011
(96) 11710281.4 29.08.2012
(87) WO2011092590, 01.02.2011
(97) 2490970, 29.08.2012 en
(54) CORE FOR A PRODUCT IN SHEET FORM WOUND AROUND THIS CORE, AND ROLL FORMED WITH SUCH A CORE
- (71) Georgia-Pacific France, 60, avenue de l'Europe, 92270 Bois-Colombes, FR
(72) BRENDLE, Damien, 19 rue de Normandie, 68320 Kunheim, FR
HOEFT, Benoît, 1 rue des Tilleuls, F-68320 Bischwihr, FR
LAURENT, Pierre, 10 route des 3 Epis, F-68230 Turckheim, FR
SIGWALT, René, 35 rue de Baltzenheim, F-68320 Kunheim, FR
RUPPEL, Rémy, 6 rue des Vosges, F-68320 Durrenentzen, FR

- (51) MKP
A61M 5/315 (2006.01) (97) **2437823 ***
- (86) EP2010057462 28.05.2010
(96) 10722345.5 11.04.2012
(87) WO2010139630, 28.05.2010
(97) 2437823, 11.04.2012 en
(54) DRUG DELIVERY DOSE SETTING MECHANISM WITH VARIABLE MAXIMUM DOSE
- (71) Sanofi-Aventis Deutschland GmbH, Brüningstraße 50, 65929 Frankfurt, DE
(72) PLUMPTRE, David, 36 Shire Way Droitwich Spa, Worcestershire WR9 7RQ, GB

- (51) MKP
H01H 85/046 (2006.01) (97) **2408277**
H05K 1/16 (2006.01)
H01H 85/041 (2006.01)
H05K 1/00 (2006.01)
- (96) 10007390.7 18.01.2012
(97) 2408277, 18.01.2012 de
(54) Fuse element
- (71) Schurter AG, Werkhofstrasse 8-12, 6002 Luzern, CH
(72) Blätter, Jans-Peter, Chriesbüel 15, Adligenswil, CH
Straub, Peter, Stolzengrabenstrasse 59, 6317 Oberwil/Zug, CH
Ramos, José, Leisibachstrasse 47, 6033 Buchrain, CH

- (51) MKP
C07K 16/00 (2006.01) (97) **2493506 ***
A61K 39/395 (2006.01)
- (86) US2010054662 29.10.2010
(96) 10827516.5 05.09.2012
(87) WO2011053763, 29.10.2010
(97) 2493506, 05.09.2012 en
(54) IL-17A ANTAGONISTS
- (71) Janssen Biotech, Inc., 800/850 Ridgeview Drive, Horsham, PA 19044, US
(72) ELLOSO, Merle, 145 King of Prussia Road, Radnor, PA 19087, US
MALIA, Thomas, 145 King of Prussia Road, Radnor, PA 19087, US
RUTZ, Mark, Lena-Christ-Strasse 48, 82152 Martinsried/Planegg, DE
NASO, Michael, 145 King of Prussia Road, Radnor, PA 19087, US
ALMAGRO, Juan, Carlos, 145 King of Prussia Road, Radnor, PA 19087, US
DUCATA, Daniela, Della, Lena-Christ-Strasse 48, 82152 Martinsried/Planegg, DE
RAUCHENBERGER, Robert, Lena-Christ-Strasse 48, 82152 Martinsried/Planegg, DE
LUO, Jinqun, 145 King of Prussia Road, Radnor, PA 19087, US
WU, Bingyuan, 145 King of Prussia Road, Radnor, PA 19087, US
SWEET, Raymond, 145 King of Prussia Road, Radnor, PA 19087, US
TAUDTE, Susann, 145 King of Prussia Road, Radnor, PA 19087, US
WU, Sheng-jiun, 145 King of Prussia Road, Radnor, PA 19087, US
OBMOLOVA, Galina, 145 King of Prussia Road, Radnor, PA 19087, US

- (51) MKP
B65D 65/40 (2006.01) (97) **2392455**
B32B 27/32 (2006.01)
B32B 15/08 (2006.01)
- (96) 11388002.5 07.12.2011
(97) 2392455, 07.12.2011 en
(54) Multilayered wrapping film and use thereof
- (71) Danapak Flexibles A/S, Strudsbergsvej 3, 4200 Slagelse, DK
(72) Johansen, Peter, Munkebjergvej 3, 2. sal, 5000 Odense C, DK
Dydensborg, Else, Skovbakken 69, 5260 Odense S, DK
Christensen, Lars, c/o Danapak Flexibles A/S Strudsbergsvej 3, 4200 Slagelse, DK

- (51) MKP
F16K 1/22 (2006.01) (97) **2251573**
(96) 10162735.4 17.11.2010
(97) 2251573, 17.11.2010 de
(54) Isolation or regulating fitting
(71) CTV-Armaturen GmbH, Konrad-Zuse-Strasse 5, 54552 Nerdlen, DE
(72) Lanser, Axel, Schwalbenweg 11, 54558 Gillenfeld, DE
-
- (51) MKP
H05B 7/144 (2006.01) (97) **2364058**
H02M 5/257 (2006.01)
(96) 10155566.2 07.09.2011
(97) 2364058, 07.09.2011 de
(54) Power supply assembly
(71) AEG Power Solutions B.V., Weerenweg 10, 1161 AH Zwanenburg, NL
(72) Wallmeier, Peter, Tilsiter Straße 59, 59556 Lippstadt, DE
-
- (51) MKP
C07D 471/04 (2006.01) (97) **2459557 ***
C07D 487/04 (2006.01)
A61K 31/437 (2006.01)
A61P 9/12 (2006.01)
(86) EP2010060679 23.07.2010
(96) 10739539.4 06.06.2012
(87) WO2011012538, 23.07.2010
(97) 2459557, 06.06.2012 en
(54) CYCLIC (AZA)INDOLIZINECARBOXAMIDES, THEIR PREPARATION AND THEIR USE AS PHARMACEUTICALS
(71) SANOFI, 54 rue La Boétie, 75008 Paris, FR
(72) STEINHAGEN, Henning, Sanofi-Aventis Deutschland GmbH Industriepark Höchst, 65926 Frankfurt am Main, DE
SCHEIPER, Bodo, Sanofi-Aventis Deutschland GmbH Industriepark Höchst, 65926 Frankfurt am Main, DE
MATTER, Hans, Sanofi-Aventis Deutschland GmbH Industriepark Höchst, 65926 Frankfurt am Main, DE
MCCORT, Gary, Sanofi-Aventis Département Brevets 174 avenue de France, F-75013 Paris, FR
BÉGIS, Guillaume, Sanofi-Aventis Département Brevets 174 avenue de France, F-75013 Paris, FR
GOBERVILLE, Pascale, Sanofi-Aventis Département Brevets 174 avenue de France, F-75013 Paris, FR
THIERS, Bérandère, Sanofi-Aventis Département Brevets 174 avenue de France, F-75013 Paris, FR
-
- (51) MKP
C02F 1/68 (2006.01) (97) **2497753**
(96) 11006007.6 12.09.2012
(97) 2497753, 12.09.2012 de
(54) Device for producing and metering calcium hypochlorite and comparable solutions
(71) INKA Holding und Immobilien GmbH & Co. KG, Willy-Brandt-Strasse 9, 97877 Wertheim, DE
(72) INKA Holding und Immobilien GmbH & Co. KG, Willy-Brandt-Strasse 9, 97877 Wertheim, DE
-
- (51) MKP
B62K 11/14 (2006.01) (97) **2308747**
B62D 51/00 (2006.01)
(96) 10185716.7 13.04.2011
(97) 2308747, 13.04.2011 en
(54) A drive control apparatus for two-wheeled vehicles
(71) Technomobility SRL, Viale Repubblica Dominicana, 34, 58100 Grosseto (GR), IT
(72) Tonani, Danilo, Technomobility SRL Viale Repubblica Dominicana, 34, 58100, Grosseto (GR), IT
Marinari, Daniele, Technomobility SRL Viale Repubblica Dominicana, 34, 58100, Grosseto (GR), IT
-
- (51) MKP
B01D 53/75 (2006.01) (97) **2416871 ***
B01D 53/78 (2006.01)
B01D 53/81 (2006.01)
B01D 53/96 (2006.01)
C21B 5/06 (2006.01)
B01D 53/50 (2006.01)
(86) EP2010002984 14.05.2010
(96) 10724274.5 15.02.2012
(87) WO2011009507, 14.05.2010
(97) 2416871, 15.02.2012 de
(54) METHOD FOR TREATING WASTE GASES, ESPECIALLY RESULTING FROM STEEL PRODUCTION
(71) DrySo Tec GmbH, Heinz-Bäcker-Str. 19, 45356 Essen, DE
(72) MORUN, Bernd, Vollbergwinkel 5, 45259 Essen, DE
SCHMIDT, Paul-Udo, Im Rosendahl 2a, 45721 Haltern am See, DE
-
- (51) MKP
C02F 1/68 (2006.01) (97) **2406188 ***
C02F 1/00 (2006.01)
C02F 1/76 (2006.01)
C02F 103/42 (2006.01)
(86) IB2010000474 08.03.2010
(96) 10716024.4 18.01.2012
(87) WO2010103368, 08.03.2010
(97) 2406188, 18.01.2012 en
(54) METHOD AND DEVICE FOR DISSOLVING SOLID SUBSTANCES IN WATER
(71) Marchi&Brevetti Interprise S.R.L. Con Unico Socio, Via Bortolotti 18, Modena, IT
(72) BARANI, Corrado, Via Cavalliera 8/F, I-41014 Castelvetro Di Modena, IT
-
- (51) MKP
C07K 16/18 (2006.01) (97) **2445937 ***
A61K 39/00 (2006.01)
C07K 16/46 (2006.01)
A61P 31/00 (2006.01)
(86) US2010039448 22.06.2010
(96) 10792563.8 02.05.2012
(87) WO2010151526, 22.06.2010
(97) 2445937, 02.05.2012 en
(54) BISPECIFIC ANTIBODIES THAT BIND TO COMPLEMENT PROTEINS
(71) ALEXION PHARMACEUTICALS, INC., 352 Knotter Drive, Cheshire, CT 06410, US
(72) TAMBURINI, Paul, P., 80 Devonshire Way, Kensington, CT 06037, US
-
- (51) MKP
A61F 5/00 (2006.01) (97) **2475337 ***
(86) US2010047659 02.09.2010
(96) 10752694.9 18.07.2012
(87) WO2011031619, 02.09.2010
(97) 2475337, 18.07.2012 en
(54) DETACHABLE ANTENNA FOR REMOTE BAND
(71) Ethicon Endo-Surgery, Inc., 4545 Creek Road, Cincinnati, OH 45242, US
(72) BYRUM, Randal, T., 370 Forest Edge Drive, South Lebanon OH 45065, US
CONLON, Sean, P., 6234C North Shadow Hill Way, Loveland OH 45140, US
GINGGEN, Alec J., 6 Murray Street, Plymouth MA 02360, US
SMITH, Bret, W., 4736 Eastport Drive, Kings Mill OH 45034, US
GARNER, Dean, L., 6605 Murray Avenue, 23C, Cincinnati OH 45227, US
DLUGOS, Daniel, F., 8072 Lois Lane, Middletown OH 45044, US

- (51) MKP
A61P 13/12 (2006.01) (97) **2421828 ***
A61P 11/00 (2006.01)
C07D 405/12 (2006.01)
A61P 9/10 (2006.01)
C07D 211/60 (2006.01)
A61K 31/4468 (2006.01)
A61P 9/02 (2006.01)
A61P 9/04 (2006.01)
(86) IN2010000253 22.04.2010
(96) 10747951.1 29.02.2012
(87) WO2010122580, 22.04.2010
(97) 2421828, 29.02.2012 en
(54) PIPERIDINE DERIVATIVES AS INHIBITORS OF RENIN
(71) Cadila Healthcare Limited, Zydus Tower Satellite Cross Roads, Ahmedabad 380 015, Gujarat, IN
(72) THOMBARE, Pravain, Cadila Healthcare Limited Zydus Tower Satellite Cross Roads Ahmedabad 380 015, Gujarat, IN
DESAI, Jigar, Cadila Healthcare Limited Zydus Tower Satellite Cross Roads Ahmedabad 380 015, Gujarat, IN
JAIN, Mukul, R., Cadila Healthcare Limited Zydus Tower Satellite Cross Roads Ahmedabad 380 015, Gujarat, IN

- (51) MKP
B65D 83/00 (2006.01) (97) **2361850**
(96) 11163211.3 31.08.2011
(97) 2361850, 31.08.2011 de
(54) Metering device
(71) Tomil s.r.o., Gen. Svatone 149/IV, 566 01 Vysoké Myto, CZ
(72) Müller, Tomas, Zamecek 443, 50008 Hradec Kralove, CZ

- (51) MKP
E04D 13/04 (2006.01) (97) **2406440 ***
F16L 37/14 (2006.01)
(86) IB2010000482 09.03.2010
(96) 10716026.9 18.01.2012
(87) WO2010103371, 09.03.2010
(97) 2406440, 18.01.2012 en
(54) WATER DRAIN ASSEMBLY, IN PARTICULAR FOR SIPHONIC ROOF DRAINAGE SYSTEMS
(71) VALSIR S.p.A., Località Merlaro, 2, 25078 Vestone (BS), IT
(72) GIOVANNINI, Alessandro, Via Roma 54, I-25088 Toscolano Maderno, IT
ZANCA, Nicola, Via Colombo 22, I-25088 Toscolano Maderno, IT
CONFORTI, Marco, Via Alessandro Manzoni 15, I-25087 Salò, IT

- (51) MKP
C12N 5/00 (2006.01) (97) **2435067 ***
A61P 9/00 (2006.01)
A61P 21/00 (2006.01)
A61K 38/19 (2006.01)
C07K 16/18 (2006.01)
A61K 39/395 (2006.01)
C07K 16/46 (2006.01)
(86) EP2010057283 26.05.2010
(96) 10726023.4 04.04.2012
(87) WO2010136508, 26.05.2010
(97) 2435067, 04.04.2012 en
(54) STEM CELL TARGETING
(71) Glaxo Group Limited, Glaxo Wellcome House Berkeley Avenue Greenford, Middlesex UB6 0NN, GB
(72) BALLARD, Victoria, GlaxoSmithKline 709 Swedeland Road, King of Prussia, Pennsylvania 19406, US
BATUWANGALA, Thil Dinuk, Domantis Limited 315 Cambridge Science Park, Cambridge Cambridgeshire CB4 0WG, GB
COULSTOCK, Edward, Domantis Limited 315 Cambridge Science Park, Cambridge Cambridgeshire CB4 0WG, GB
DE ANGELIS, Elena, Domantis Limited 315 Cambridge Science Park, Cambridge Cambridgeshire CB4 0WG, GB
EDELBERG, Jay, GlaxoSmithKline 709 Swedeland Road, King of Prussia, Pennsylvania 19406, US
ENEVER, Carolyn, Domantis Limited 315 Cambridge Science Park, Cambridge Cambridgeshire CB4 0WG, GB
HOLMES, Steve, Domantis Limited 315 Cambridge Science Park, Cambridge Cambridgeshire CB4 0WG, GB
JAWAD-ALAMI, Zahra, Domantis Limited 315 Cambridge Science Park, Cambridge Cambridgeshire CB4 0WG, GB

- (51) MKP
A61M 5/315 (2006.01) (97) **2437824 ***
(86) EP2010057467 28.05.2010
(96) 10722346.3 11.04.2012
(87) WO2010139631, 28.05.2010
(97) 2437824, 11.04.2012 en
(54) DOSE SETTING MECHANISM FOR PRIMING A DRUG DELIVERY DEVICE
(71) Sanofi-Aventis Deutschland GmbH, Brüningstraße 50, 65929 Frankfurt, DE
(72) PLUMPTRE, David, 36 Shire Way, Droitwich Spa Worcestershire WR9 7RQ, GB
JONES, Christopher, 153 High Street, Broadway Worcestershire WR12 7AL, GB
VEASEY, Robert, 31 Lonsdale Road, Lillington Warwickshire CV32 7EP, GB

- (51) MKP
C07D 513/04 (2006.01) (97) **2491045 ***
A61K 31/433 (2006.01)
A61P 25/08 (2006.01)
(86) EP2010006434 21.10.2010
(96) 10781818.9 29.08.2012
(87) WO2011047860, 21.10.2010
(97) 2491045, 29.08.2012 en
(54) 2-OXO-1-PYRROLIDINYL IMIDAZOTHIADIAZOLE DERIVATIVES
(71) UCB Pharma S.A., Intellectual Property Department Allée de la Recherche 60, 1070 Brussels, BE
(72) QUESNEL, Yannick, c/o UCB Pharma S.A. 60 allée de la Recherche, B-1070 Brussels, BE
TURET, Laurent, c/o UCB Pharma, S.A. 60, allée de la Recherche, B-1070 Bruxelles, BE
MERCIER, Joël, c/o UCB Pharma S.A. 60 allée de la Recherche, B-1070 Brussels, BE

- (51) MKP
A45D 20/12 (2006.01) (97) **2412272**
(96) 11003443.6 01.02.2012
(97) 2412272, 01.02.2012 en
(54) A silencer device for a hair dryer
(71) Parlux S.P.A., Via Goldoni 12, 20090 Trezzano Sul Naviglio (MI), IT
(72) Parodi, Paolo, Via Ippodromo 56, 20151 Mailand, IT

- (51) MKP
A61P 17/10 (2006.01) (97) **2421521 ***
A61K 9/00 (2006.01)
A61K 31/433 (2006.01)
A61P 17/00 (2006.01)
A61K 31/155 (2006.01)
(86) US2010032186 23.04.2010
(96) 10715466.8 29.02.2012
(87) WO2010124175, 23.04.2010
(97) 2421521, 29.02.2012 en
(54) STABLE TOPICAL COMPOSITIONS FOR 1,2,4-THIADIAZOLE DERIVATIVES
(71) Janssen Pharmaceuticals, Inc., 1125 Trenton-Harbourton Road, Titusville, NJ 08560, US
(72) CUI, Chengji, 3 Kentsdale Drive, Pennington NJ 08534, US
NG, Shirley, Mei-King, 8 Brian Drive, Bridgewater NJ 08807, US
WONG, George, 44 Ketcham Road, Belle Mead NJ 08502, US
YUSUF, Mohammed, 419 Elizabeth Way, Hatfield NJ 19440, US
ZHANG, Fa, 186 Monroe Avenue, Belle Mead NJ 08502, US

- (51) MKP
A61M 5/315 (2006.01) (97) **2482895 ***
(86) EP2010064330 28.09.2010
(96) 10763345.5 08.08.2012
(87) WO2011039163, 28.09.2010
(97) 2482895, 08.08.2012 en
(54) ASSEMBLY FOR A DRUG DELIVERY DEVICE
(71) Sanofi-Aventis Deutschland GmbH, Brüningstraße 50, 65929 Frankfurt, DE
(72) RAAB, Steffen, c/o Sanofi-Aventis Deutschland GmbH, 65926 Frankfurt am Main, DE
ARNHOLD, Sandra, c/o Sanofi-Aventis Deutschland GmbH, 65926 Frankfurt am Main, DE

- (51) MKP
A61K 31/4178 (2006.01) (97) **2485729 ***
A61P 31/10 (2006.01)
A61P 13/02 (2006.01)
A61K 31/439 (2006.01)
A61P 13/10 (2006.01)
A61K 31/341 (2006.01)
A61K 31/44 (2006.01)
A61P 15/02 (2006.01)
A61K 31/433 (2006.01)
(86) US2010051443 05.10.2010
(96) 10763957.7 15.08.2012
(87) WO2011044105, 05.10.2010
(97) 2485729, 15.08.2012 en
(54) TREATMENT WITH CHOLINERGIC AGONISTS
(71) Vivus, Inc., 1172 Castro Street, Mountain View, CA 94040, US
(72) NAJARIAN, Thomas, 2787 Rodman Drive, Los Osos CA 93402, US
UNKEL, Kathryn, Susan, 2787 Rodman Drive, Los Osos CA 93402, US
-
- (51) MKP
A61K 33/06 (2006.01) (97) **2448571 ***
A61K 9/00 (2006.01)
A61K 31/198 (2006.01)
A61P 11/00 (2006.01)
A61P 11/10 (2006.01)
A61K 33/14 (2006.01)
(86) US2011049333 26.08.2011
(96) 11757713.0 09.05.2012
(87) WO2012030645, 26.08.2011
(97) 2448571, 09.05.2012 en
(54) RESPIRABLY DRY POWDER COMPRISING CALCIUM LACTATE, SODIUM CHLORIDE AND LEUCINE
(71) Pulmatrix, Inc., 99 Hayden Avenue, Lexington, MA 02421, US
(72) LIPP, Michael M., 45A Flanagan Drive, Framingham Massachusetts 01701, US
SUNG, Jean C., 259 Putnam Avenue, Cambridge Massachusetts 02139, US
-
- (51) MKP
C07K 16/00 (2006.01) (97) **2419445 ***
(86) US2010031499 16.04.2010
(96) 10726697.5 22.02.2012
(87) WO2010121208, 16.04.2010
(97) 2419445, 22.02.2012 en
(54) NEW METHODS OF MAKING AN ANTIBODY AND COMPOSITIONS THEREOF
(71) Forsyth Dental Infirmary for Children, 140 The Fenway, Boston, MA 02115, US
(72) KAWAI, Toshihisa, 101 Monmouth Street Apt. 216, Brookline MA 02446, US
STASHENKO, Philip, P., 10 Newport Lane, Medfield MA 02052, US
HOSOKAWA, Yoshitaka, 4-16-1 Minamishowacho Tokushima, Tokushima 770-0944, JP
OHARA, Kazuhisa, 3-1-23-907 Shinonome Minam-ku, Hiroshima 734-0022, JP
-
- (51) MKP
C08G 61/10 (2006.01) (97) **2423241**
C08G 61/12 (2006.01)
C08J 9/00 (2006.01)
(96) 11005787.4 29.02.2012
(97) 2423241, 29.02.2012 de
(54) Unit with porous organic polymers and use of same
(71) Blücher GmbH, Mettmanner Strasse 25, 40699 Erkrath, DE
(72) Böhringer, Bertram, Dr., Bussardweg 33, 42115 Wuppertal, DE
Fichtner, Sven, Dipl.-Ing., Bunsenstrasse 5, 14727 Premnitz, DE
Kaskel, Stefan, Prof. Dr., c/o Technische Universität Dresden Institut für Anorganische Chemie Mommsenstrasse 6, 01069 Dresden, DE
Rose, Marcus, Dr., c/o Technische Universität Dresden Institut für Anorganische Chemie Mommsenstrasse 6, 01069 Dresden, DE
-
- (51) MKP
A61M 5/158 (2006.01) (97) **2427235 ***
F15C 5/00 (2006.01)
G01L 9/00 (2006.01)
A61M 5/142 (2006.01)
F16K 99/00 (2006.01)
(86) IB2010001211 05.05.2010
(96) 10728883.9 14.03.2012
(87) WO2010128399, 05.05.2010
(97) 2427235, 14.03.2012 en
(54) LOW-DEAD VOLUME MICROFLUIDIC CIRCUIT AND METHODS
(71) Cequr SA, Route Des Cerisiers 17, 1802 Corseaux, CH
(72) GRAVESEN, Peter, Hyldebaervej 6, DK-6430 Nordborg, DK
ARNDT, Heiko, Hafendamm 31, 24937 Flensburg, DE
-
- (51) MKP
A47J 45/06 (2006.01) (97) **2440096 ***
(86) EP2010057913 07.06.2010
(96) 10724496.4 18.04.2012
(87) WO2010142636, 07.06.2010
(97) 2440096, 18.04.2012 en
(54) PAN WITH AN INVERTED CURVED HANDLE
(71) Sanmiro S.R.L., Via Raffaello 4, 23861 Cesana Brianza (LC), IT
(72) FULIGNO, Daniele, Via Carnevali 6, I-61122 Pesaro (PU), IT
-
- (51) MKP
F02M 63/00 (2006.01) (97) **2372139**
F02M 51/06 (2006.01)
F02M 61/16 (2006.01)
(96) 10157760.9 05.10.2011
(97) 2372139, 05.10.2011 en
(54) Actuator Arrangement for use in a Fuel Injector
(71) Delphi Technologies Holding S.à.r.l., Avenue de Luxembourg, 4940 Bascharage, LU
(72) Winandy, Jean-Pierre, 75 Rue de Bastogne, 6700 Arlon, BE
Carpentier, Christophe, 22 Rue de Ducs de Lorraine, 57100 Thionville, FR
-
- (51) MKP
B66C 1/02 (2006.01) (97) **2354074**
B65G 47/00 (2006.01)
B65G 61/00 (2006.01)
(96) 11000780.4 10.08.2011
(97) 2354074, 10.08.2011 en
(54) Method and apparatus for assembling building shell elements
(71) Trimo d.d., Prijateljeva 12, 8210 Trebnje, SI
(72) Zupancic, Danijel, Muljava 8, 1295 Ivančna Gorica, SI
Santavec, Miha, Kalce 24j, 1370 Logatec, SI
-
- (51) MKP
C01F 11/18 (2006.01) (97) **2371766**
(96) 10003665.6 05.10.2011
(97) 2371766, 05.10.2011 en
(54) Process for obtaining precipitated calcium carbonate
(71) OMYA DEVELOPMENT AG, Baslerstrasse 42, 4665 Oftringen, CH
(72) Pohl, Michael, H.-v.-Tuerlin Strasse 11, 9500 Villach, AT
Rainer, Christian, Treffnerstrasse 62f, 9500 Villach, AT
Primusch, Gernot, Jungnickelstrasse 5/I/47, 9500 Villach, AT
-
- (51) MKP
A61K 31/19 (2006.01) (97) **2445340 ***
A61K 31/215 (2006.01)
A01N 37/28 (2006.01)
(86) US2010001801 21.06.2010
(96) 10792446.6 02.05.2012
(87) WO2010151318, 21.06.2010
(97) 2445340, 02.05.2012 en
(54) SUBSTITUTED HYDROXAMIC ACIDS AND USES THEREOF
(71) Millennium Pharmaceuticals, Inc., 40 Landsdowne Street, Cambridge, MA 02139, US
(72) BLACKBURN, Christopher, 25 Western Avenue, Natick MA 01760, US
CIAVARRI, Jeffrey, 30 Winthrop Avenue, Reading MA 01867, US
GIGSTAD, Kenneth, 18 Briarwood Drive, Westford MA 01886, US
XU, He, 2 Walden Drive 9, Natick MA 01760, US

- (51) MKP
A61M 11/00 (2006.01) (97) **2453962 ***
(86) US2010042471 19.07.2010
(96) 10800671.9 23.05.2012
(87) WO2011009131, 19.07.2010
(97) 2453962, 23.05.2012 en
(54) NEGATIVELY BIASED SEALED NEBULIZERS SYSTEMS AND METHODS
(71) Nektar Therapeutics, 201 Industrial Road, San Carlos, CA 94070, US
(72) BLAKEY, David Mark, 58 Penningtons, Bishop's Stortford Hertfordshire CM23 4LF, GB
DAY, Richard Francis, 47 Monkfield Lane, Great Cambourne Cambridgeshire CB23 6AH, GB
-
- (51) MKP
A61B 18/14 (2006.01) (97) **2480152 ***
G06F 3/00 (2006.01)
(86) US2010002588 22.09.2010
(96) 10819150.3 01.08.2012
(87) WO2011037621, 22.09.2010
(97) 2480152, 01.08.2012 en
(54) SYSTEMS AND METHODS FOR CONTROLLING USE AND OPERATION OF A FAMILY OF DIFFERENT TREATMENT DEVICES
(71) Mederi Therapeutics Inc., P.O. Box 134, Cos Cob, CT 06807, US
(72) SHIKHMAN, Oleg, 286 Strobel Rd., Trumbull, CT 06611, US
-
- (51) MKP
A61H 1/02 (2006.01) (97) **2311424**
(96) 10013626.6 20.04.2011
(97) 2311424, 20.04.2011 de
(54) Sling table for carrying out physiotherapy and rehabilitation and functional element for such a sling table
(71) Powersling GmbH & Co. KG, Württemberger Strasse 15, 78567 Fridingen, DE
(72) Bornkamp, Marc, WWendelinusweg 6, 78567 Fridingen, DE
-
- (51) MKP
F24F 13/08 (2006.01) (97) **2386699**
F24F 7/02 (2006.01)
E04D 13/00 (2006.01)
E04D 13/17 (2006.01)
(96) 11165651.8 16.11.2011
(97) 2386699, 16.11.2011 en
(54) Ventilated eaves closure
(71) Expo-Net Danmark A/S, Georg Jensens Vej 5, 9800 Hjørring, DK
(72) Klinkby, John, Urdsvej 1, 9800, Hjørring, DK
-
- (51) MKP
A61M 5/315 (2006.01) (97) **2475410 ***
(86) EP2010062924 03.09.2010
(96) 10749649.9 18.07.2012
(87) WO2011026928, 03.09.2010
(97) 2475410, 18.07.2012 en
(54) DRIVE MECHANISM FOR A MEDICATION DELIVERY DEVICE AND MEDICATION DELIVERY DEVICE
(71) Sanofi-Aventis Deutschland GmbH, Brüningstraße 50, 65929 Frankfurt, DE
(72) RAAB, Steffen, c/o Sanofi-Aventis Deutschland GmbH, 65926 Frankfurt am Main, DE
ARNHOLD, Sandra, Spessartstrasse 2, 64572 Büttelborn, DE
-
- (51) MKP
B01D 9/00 (2006.01) (97) **2477944 ***
C01B 31/36 (2006.01)
(86) US2010048765 14.09.2010
(96) 10817718.9 25.07.2012
(87) WO2011034850, 14.09.2010
(97) 2477944, 25.07.2012 en
(54) SUBLIMATION GROWTH OF SIC SINGLE CRYSTALS
(71) II-VI Incorporated, 375 Saxonburg Boulevard, Saxonburg, PA 16056, US
(72) GUPTA, Avinash, K., 40 Liberty Ridge, Basking Ridge New Jersey 07920, US
ZWIEMACK, Ilya, 155 Pond Drive, Washington Township New Jersey 07676, US
SEMENAS, Edward, 4192 Winchester Road, Allentown Pennsylvania 18104, US
RENGARAJAN, Varatharajan, 2400 Rachel Terrace Apt 12, Pine Brook New Jersey 07058, US
GETKIN, Marcus, L., 14 Oakwood Village Apt 9, Flanders New Jersey 07836, US
-
- (51) MKP
A61F 13/26 (2006.01) (97) **2461968 ***
B31C 3/00 (2006.01)
D21H 17/28 (2006.01)
D21H 27/00 (2006.01)
D21H 17/29 (2006.01)
D21H 19/54 (2006.01)
D21H 25/04 (2006.01)
(86) IB2010002190 11.06.2010
(96) 10759984.7 13.06.2012
(87) WO2011015951, 11.06.2010
(97) 2461968, 13.06.2012 en
(54) FIBROUS SHEET THAT DISINTEGRATES IN WATER, PROCESS FOR MANUFACTURING SAID FIBROUS SHEET, CORE CONSISTING OF STRIPS OF SAID FIBROUS SHEET
(71) Georgia-Pacific France, 60, avenue de l'Europe, 92270 Bois-Colombes, FR
(72) COLIN, Philippe, 14 rue du Quai, F-68040 Ingersheim, FR
DOZZI, Jean-Claude, 7a rue de la Gare, F-68230 Soultzbach-Les-Bains, FR
PROBST, Pierre, 11 rue des Camélias, F-68770 Ammerschwihr, FR
WISS, Véronique, 15 route de Sélestat, F-67390 Hessenheim, FR
RUPPEL, Rémy, 6 rue des Vosges, F-68320 Durrenentzen, FR
-
- (51) MKP
C12P 19/34 (2006.01) (97) **2467500 ***
C12Q 1/68 (2006.01)
(86) US2010045871 18.08.2010
(96) 10810539.6 27.06.2012
(87) WO2011022471, 18.08.2010
(97) 2467500, 27.06.2012 en
(54) DETECTION OF AAD-1 EVENT DAS-40278-9
(71) Dow AgroSciences, LLC, 9330 Zionsville Road, Indianapolis, Indiana 46268, US
(72) CUI, Yunxing, Cory, 13736 Royal Saddle Drive, Carmel, IN 46032, US
GREENE, Thomas, William, 4668 St. John Circle, Zionsville, IN 46077, US
NOVAK, Stephen, 509 Viburnum Run, Westfield, IN 46074, US
ZHOU, Ning, 4776 Pebblepointe Pass, Zionsville, IN 46077, US
-
- (51) MKP
A61K 35/74 (2006.01) (97) **2429555 ***
(86) EP2010056553 12.05.2010
(96) 10726918.5 21.03.2012
(87) WO2010130785, 12.05.2010
(97) 2429555, 21.03.2012 en
(54) NOVEL USE OF PROBIOTICS
(71) Valio Ltd., Meijeritie 6, 00370 Helsinki, FI
(72) KEKKONEN, Riina, Neoviuksenkatu 2 F 12, FIN-06400 Porvoo, FI

- (51) MKP
C07K 14/605 (2006.01) (97) **2483308 ***
A61K 39/395 (2006.01)
A61P 3/08 (2006.01)
C07K 14/575 (2006.01)
A61K 47/48 (2006.01)
C07K 16/18 (2006.01)
A61P 5/48 (2006.01)
(86) EP2010064020 23.09.2010
(96) 10762634.3 08.08.2012
(87) WO2011039096, 23.09.2010
(97) 2483308, 08.08.2012 en
(54) DRUG FUSIONS AND CONJUGATES WITH EXTENDED HALF LIFE
(71) Glaxo Group Limited, Glaxo Wellcome House Berkeley Avenue Greenford, Middlesex UB6 0NN, GB
(72) HAMILTON, Bruce, Domantis Limited 315 Cambridge Science Park, Cambridge Cambridgeshire CB4 0WG, GB
HERRING, Christopher, Domantis Limited 315 Cambridge Science Park, Cambridge Cambridgeshire CB4 0WG, GB
PAULIK, Mark, Andrew, GlaxoSmithKline Five Moore Drive P.O. Box 13398, Durham North Carolina 27703, US
-
- (51) MKP
C07D 498/22 (2006.01) (97) **2421869 ***
C07D 493/20 (2006.01)
A61K 31/357 (2006.01)
A61K 31/437 (2006.01)
A61P 31/00 (2006.01)
(86) IB2010051183 18.03.2010
(96) 10714069.1 29.02.2012
(87) WO2010122436, 18.03.2010
(97) 2421869, 29.02.2012 en
(54) RIFAMYCIN DERIVATIVES
(71) ALFA WASSERMANN S.p.A., Via Enrico Fermi, 1, 65020 Alanno (PE), IT
(72) VISCOMI, Giuseppe Claudio, 5 Via Ragazzi Del '99, I-40133 Bologna, IT
CAMPANA, Manuela, 5 Via Ragazzi Del '99, I-40133 Bologna, IT
FOLEGATTI, Mahena, 5 Via Ragazzi Del '99, I-40133 Bologna, IT
CANNATA, Vincenzo, 5 Via Ragazzi Del '99 c/o Alfa Wassermann S.p.A. Patents Dept., I-40133 Bologna, IT
RIGHI, Paolo, 5 Via Ragazzi Del '99 C/o Alfa Wassermann S.p.A. Patents Dept., I-40133 Bologna, IT
ROSINI, Goffredo, 5 Via Ragazzi Del '99 C/o Alfa Wassermann S.p.A. Patents Dept., I-40133 Bologna, IT
-
- (51) MKP
B65D 33/00 (2006.01) (97) **2435330 ***
(86) EP2010054416 01.04.2010
(96) 10713895.0 04.04.2012
(87) WO2010136243, 01.04.2010
(97) 2435330, 04.04.2012 en
(54) PAPER BAG WITH DETACHABLE CARD
(71) Guccini, Francesco, Via Istria 24/d, 08100 Nuoro, IT
(72) MURGIA, Nadia, via Mannironi 113, I-08100 Nuoro, IT
-
- (51) MKP
C07D 401/14 (2006.01) (97) **2445902 ***
(86) US2010039937 25.06.2010
(96) 10728552.0 02.05.2012
(87) WO2010151737, 25.06.2010
(97) 2445902, 02.05.2012 en
(54) HETEROCYCLIC COMPOUNDS AND THEIR USES AS INHIBITORS OF PI3K ACTIVITY
(71) Amgen, Inc, One Amgen Center Drive, Thousand Oaks, CA 91320-1799, US
(72) KOHN, Todd J., 818 North Delaware Street 412, San Mateo, California 94401, US
LOHMAN, Julia Winslow, 94A Sussex, San Francisco, California 94131, US
PATTAROPONG, Vatee, 1408 El Camino Real, Unit 1, Burlingame, California 94010, US
BROWN, Matthew, 398 West Portal Avenue, Nr. 301, San Francisco, California 94127, US
SEGANISH, Jennifer, 10 Happel Court, Scotch Plains, New Jersey 07076, US
CHEN, Yi, 103 Muller Place, San Jose, California 95126, US
SHIN, Youngsook, 64 Loop 22, Emeryville, California 94608, US
CUSHING, Timothy D., 1064 Glacier Avenue, Pacifica, California 94044, US
SIMARD, Jillian L., 2584 Bush Street, San Francisco, California 94115, US
GONZALEZ LOPEZ DE TURISO, Felix, 10 De Sabla Road 509, San Mateo, California 94402, US
HE, Xiao, 725 Crane Avenue, Foster City, California 94404, US
-
- (51) MKP
C07C 303/32 (2006.01) (97) **2419402 ***
C07C 211/35 (2006.01)
C07C 309/04 (2006.01)
A61K 31/13 (2006.01)
(86) EP2010002361 16.04.2010
(96) 10715503.8 22.02.2012
(87) WO2010118889, 16.04.2010
(97) 2419402, 22.02.2012 en
(54) SYNTHESIS OF 1-AMINO-1,3,3,5,5-PENTAMETHYLCYCLOHEXANE MESYLATE
(71) Merz Pharma GmbH & Co. KGaA, Eckenheimer Landstrasse 100, 60318 Frankfurt, DE
(72) HENRICH, Markus, Am Kreuzberg 1, 35516 Mützenberg, DE
NEGURA, Simona, Heidelberger Str. 83, 64285 Darmstadt, DE
TASI, Gergely, Dombóvári út 2. III. em. 6., HU-1117 Budapest, HU
KOCsÁN, Pál, Sport u. 6, HU-8229 Csopak, HU
SBROGIO, Federico, Via Tecchio 62, 36075 Montecchio Maggiore, IT
PYERIN, Michael, Enzersdorferstrasse 3/2/8, A-2345 Brunn am Gebirge, AT
KOLLER, Herbert, Quellenstrasse 155A/65, A-1100 Wien, AT
-
- (51) MKP
A61M 5/315 (2006.01) (97) **2482885 ***
(86) EP2010064399 29.09.2010
(96) 10757780.1 08.08.2012
(87) WO2011039208, 29.09.2010
(97) 2482885, 08.08.2012 en
(54) DRIVE MECHANISM FOR A DRUG DELIVERY DEVICE
(71) Sanofi-Aventis Deutschland GmbH, Brüningstraße 50, 65929 Frankfurt, DE
(72) VEASEY, Robert, 31 Lonsdale Road Lillington, Leamington Spa Warwickshire CV32 7EP, GB
BILTON, Simon Lewis, Flat 3 15 Clarendon Square, Leamington Spa Warwickshire CV32 5QT, GB
JONES, Christopher, The Old Thatch Grafton, Tewkesbury Gloucestershire GL20 7AT, GB
KOUYOUJIAN, Garen, 2A Plymouth Place, Leamington Spa Warwickshire CV31 1HN, GB
MACDONALD, Catherine Anne, 23 Goggbridge Lane, Warwick Warwickshire CV34 6JE, GB
-

(51) MKP
C07D 471/04 (2006.01) (97) **2470531 ***
A61K 31/437 (2006.01)
(86) EP2010062338 24.08.2010
(96) 10745639.4 04.07.2012
(87) WO2011023696, 24.08.2010
(97) 2470531, 04.07.2012 en
(54) METHYLPYRROLOPYRIDINECARBOXAMIDES
(71) Nycomed GmbH, Byk-Gulden-Strasse 2, 78467 Konstanz, DE
(72) STADLWIESER, Josef, Im Apfelgarten 3, 78465 Konstanz, DE
SCHMIDT, Beate, Allensbacher Str. 5, 78476 Allensbach, DE
BERNSMANN, Heiko, Schubertstr. 21, 60325 Frankfurt, DE
SUDAU, Alexander, Brucherweg 5 A, 42799 Leichlingen, DE
DUNKERN, Torsten, Humboldtstrasse 18, 41363 Jüchen
Gierath, DE
HUSSONG, Ragna, Schultheiß-Heschel-Ring 14, 78652
Deißlingen, DE
BENEDIKTUS, Ewald, Mondstrasse 18, 88400 Biberach, DE
PAHL, Andreas, Kirschplantage 17, 22926 Ahrensburg, DE

(51) MKP
A61P 11/00 (2006.01) (97) **2464359 ***
A61P 17/00 (2006.01)
A61P 19/00 (2006.01)
A61P 21/00 (2006.01)
A61P 9/00 (2006.01)
A61K 31/737 (2006.01)
A61P 25/00 (2006.01)
C08B 37/00 (2006.01)
A61P 27/02 (2006.01)
A61P 7/00 (2006.01)
A61P 37/00 (2006.01)
(86) FR2010051702 12.08.2010
(96) 10761048.7 20.06.2012
(87) WO2011018587, 12.08.2010
(97) 2464359, 20.06.2012 fr
(54) N-SULFATED OLIGOSACCHARIDES ACTIVATING
FGFS RECEPTORS, THEIR SYNTHESIS AND THEIR
THERAPEUTICAL APPLICATION
(71) SANOFI, 54 rue La Boétie, 75008 Paris, FR
(72) DUCHAUSSOY, Philippe, c/o sanofi-aventis Département
Brevets 174 avenue de France, F-75013 Paris, FR
FONS, Pierre, c/o sanofi-aventis Département Brevets 174
avenue de France, F-75013 Paris, FR
FROIDBISE, Alexandre, c/o sanofi-aventis Département Brevets
174 avenue de France, F-75013 Paris, FR

(51) MKP
A61K 31/365 (2006.01) (97) **2485725 ***
A61K 38/48 (2006.01)
A61K 47/44 (2006.01)
A61K 39/39 (2006.01)
A61K 39/00 (2006.01)
(86) US2010050630 29.09.2010
(96) 10779592.4 15.08.2012
(87) WO2011043962, 29.09.2010
(97) 2485725, 15.08.2012 en
(54) COMPOSITIONS COMPRISING ADJUVANT, MACROLIDE
AND PROTEINACEOUS ANTIGEN AND METHODS OF USE
THEREOF
(71) Wyeth LLC, Patent Law Department Five Giralda Farms,
Madison, NJ 07940, US
(72) FATTOHI, Nahla, 7 Tanager Lane, Robbinsville New Jersey
08691, US
NG, Terry Kaleung, 2027 No. 30th Ct., Fort Dodge Iowa 50501,
US

(51) MKP
A61K 9/08 (2006.01) (97) **2403476 ***
A61K 31/137 (2006.01)
A61K 31/5375 (2006.01)
A61K 47/10 (2006.01)
A61P 31/10 (2006.01)
(86) EP2010052817 05.03.2010
(96) 10707032.8 11.01.2012
(87) WO2010100252, 05.03.2010
(97) 2403476, 11.01.2012 en
(54) METHOD OF DISSOLVING ANTIFUNGAL AGENT, AND
COMPOSITIONS WITH A HIGH CONCENTRATION OF
ANTIFUNGAL AGENT, SUITABLE FOR APPLICATION TO THE
NAIL
(71) Galderma Research & Development, 2400 Route des Colles
Les Templiers, 06410 Biot, FR
(72) MALLARD, Claire, Domaine La Jouvencelle 1122 Chemins du
Château, F-06250 Mougins, FR
WILLCOX, Nathalie, 39 Chemin de la Dragonnière, F-06520
Magagnosc, FR

(51) MKP
A61L 27/58 (2006.01) (97) **2493518 ***
A61L 27/34 (2006.01)
A61L 29/06 (2006.01)
A61L 17/12 (2006.01)
A61L 31/14 (2006.01)
A61L 27/54 (2006.01)
A61L 27/18 (2006.01)
A61L 31/06 (2006.01)
A61L 29/14 (2006.01)
A61L 17/00 (2006.01)
A61L 31/10 (2006.01)
A61L 29/16 (2006.01)
A61L 29/08 (2006.01)
A61L 26/00 (2006.01)
A61L 31/16 (2006.01)
(86) US2010054020 26.10.2010
(96) 10773790.0 05.09.2012
(87) WO2011053562, 26.10.2010
(97) 2493518, 05.09.2012 en
(54) ABSORBABLE POLYETHYLENE DIGLYCOLATE
COPOLYMERS TO REDUCE MICROBIAL ADHESION TO
MEDICAL DEVICES AND IMPLANTS
(71) Ethicon, Inc, U.S. Route 22, Somerville, NJ 08876, US
(72) ANDJELIC, Sasa, 38 Oakland Place, Nanuet, NY 10954, US
PRIEWE, Joerg, Krummbogen 43, 24113 Kiel, DE

(51) MKP
F03D 3/00 (2006.01) (97) **2317128**
F03D 11/02 (2006.01)
(86) 10251789.3 04.05.2011
(97) 2317128, 04.05.2011 en
(54) Vertical axis wind turbine
(71) Hopewell Wind Power Limited, Pasea Estate Road Town,
Tortola, VI
(72) WU, Gordon Ying Sheung, 64th Floor Hopewell Centre 183
Queen's Road East, Hong Kong, HK
WU, Thomas Jefferson, 64th Floor Hopewell Centre 183
Queen's Road East, Hong Kong, HK

(51) MKP
G06F 21/00 (2006.01) (97) **2460113 ***
G06F 11/07 (2006.01)
(86) US2010043666 29.07.2010
(96) 10752652.7 06.06.2012
(87) WO2011014625, 29.07.2010
(97) 2460113, 06.06.2012 en
(54) AUTOMATED UNPACKING OF PORTABLE EXECUTABLE
FILES
(71) Reversinglabs Corporation, 169 Msgr. O'Brian Highway Apt.
802, Cambridge, MA 02141, US
(72) PERICIN, Tomislav, Matije Hudji 76/2, Sremska Mitrovica
22000, RS

- (51) MKP
C10M 107/24 (2006.01) (97) **2471896 ***
C10N 40/30 (2006.01)
C10M 107/34 (2006.01)
C10M 105/18 (2006.01)
C10N 30/10 (2006.01)
C09K 5/04 (2006.01)
C10N 30/08 (2006.01)
C10M 129/18 (2006.01)
C10M 137/08 (2006.01)
C10M 169/04 (2006.01)
C10N 30/06 (2006.01)
C10M 133/04 (2006.01)
(86) JP2010063810 16.08.2010
(96) 10811713.6 04.07.2012
(87) WO2011024663, 16.08.2010
(97) 2471896, 04.07.2012 en
(54) REFRIGERANT OIL FOR FREEZERS AND OPERATING FLUID COMPOSITION FOR FREEZERS
(71) JX Nippon Oil & Energy Corporation, 6-3, Otemachi 2-chome, Chiyoda-ku Tokyo 100-8162, JP
(72) TAKIGAWA Katsuya, c/o JX Nippon Oil & Energy Corporation 6-3, Otemachi 2-chome, Chiyoda-ku, Tokyo 1008162, JP
SHIMOMURA Yuji, c/o JX Nippon Oil & Energy Corporation 6-3, Otemachi 2-chome, Chiyoda-ku, Tokyo 1008162, JP
SAITO Masanori, c/o JX Nippon Oil & Energy Corporation 6-3, Otemachi 2-chome, Chiyoda-ku, Tokyo 1008162, JP
SAWADA Ken, c/o JX Nippon Oil & Energy Corporation 6-3, Otemachi 2-chome, Chiyoda-ku, Tokyo 1008162, JP
OKIDO Takeshi, c/o JX Nippon Oil&Energy Corporation 6-3, Otemachi 2-chome, Chiyoda-ku, Tokyo 1008162, JP
-
- (51) MKP
H04L 12/28 (2006.01) (97) **2406919 ***
(86) US2010026477 08.03.2010
(96) 10751224.6 18.01.2012
(87) WO2010104771, 08.03.2010
(97) 2406919, 18.01.2012 en
(54) USE OF SNMP FOR MANAGEMENT OF SMALL FOOTPRINT DEVICES
(71) Assa Abloy AB, Box 70340 Klarabergsviadukten 90, 107 23 Stockholm, SE
(72) GUTHERY, Scott, B., 2400 Beacon Street, 208, Chestnut Hill, MA 02467, US
-
- (51) MKP
A61F 2/90 (2006.01) (97) **2389906**
(96) 11166191.4 30.11.2011
(97) 2389906, 30.11.2011 en
(54) Stent
(71) Terumo Kabushiki Kaisha, 44-1, Hatagaya 2-chome, Shibuya-ku, Tokyo 151-0072, JP
(72) Mitsudo, Kazuaki, 597-11, Fukushima, Kurashiki-shi, Okayama 710-0048, JP
Kito, Takayuki, c/o Terumo Kabushiki Kaisha 1500 Inokuchi, Nakai-machi Ashigarakami-gun, Kanagawa 259-0151, JP
-
- (51) MKP
H01R 4/24 (2006.01) (97) **2486626 ***
(86) EP2010005896 28.09.2010
(96) 10779220.2 15.08.2012
(87) WO2011042127, 28.09.2010
(97) 2486626, 15.08.2012 en
(54) JUNCTION BOX, PARTICULARLY FOR LIGHTING LINES FOR TUNNELS
(71) Palazzoli S.p.A., Via Palazzoli, 31, 25128 Brescia, IT
(72) LEVI, Bruno, Via Vittorio Emanuele II 1, I-25122 Brescia, IT
-
- (51) MKP
E01F 15/08 (2006.01) (97) **2446088 ***
(86) AT2010000227 22.06.2010
(96) 10744649.4 02.05.2012
(87) WO2010148417, 22.06.2010
(97) 2446088, 02.05.2012 de
(54) TERMINATING ELEMENT
(71) Kirchdorfer Fertigteiholding GmbH, Feuerwerksanstalt, 2752 Wöllersdorf, AT
(72) BARNAS, Alexander, Matthäusgasse 6/25, A-1030 Wien, AT
SPITZER, Franz, Kirchauerstrasse 7, A-2831 Warth, AT

- (51) MKP
C07D 453/02 (2006.01) (97) **2451809 ***
(86) EP2010004204 09.07.2010
(96) 10732304.0 16.05.2012
(87) WO2011003624, 09.07.2010
(97) 2451809, 16.05.2012 en
(54) A PROCESS FOR THE PREPARATION AND PURIFICATION OF SOLIFENACIN SALTS
(71) KRKA, D.D., Novo Mesto, Smarjeska cesta 6, 8501 Novo mesto, SI
(72) KLJAJIC, Alen, Smrekarjeva ulica 4, 3000 Celje, SI
RUZIC, Milos, Milke Kerinove 9, 3000 Celje, SI
PRUDIC, Darja, Smolenja vas 68c, 8000 Novo Mesto, SI
PECAVAR, Anica, Gotna vas 18, 8000 Novo Mesto, SI
BUKOVEC, Polona, Regrca vas 37a, 8000 Novo Mesto, SI
ZUPET, Rok, Janeza Roszica 6, 1000 Ljubljana, SI
-
- (51) MKP
G06Q 20/00 (2012.01) (97) **2452300 ***
(86) IB2010053130 08.07.2010
(96) 10742584.5 16.05.2012
(87) WO2011004339, 08.07.2010
(97) 2452300, 16.05.2012 en
(54) METHOD AND SYSTEM OF CONTACTLESS AUTHENTICATION, AND CARRIER OF PIN CODE
(71) Logomotion, s.r.o., Winterova 15, 921 01 Piestany, SK
(72) HUBINÁK, Emil, JUDr. Emil Hubinák Beethovenova 4, 921 01 Pie any, SK
FLOREK, Miroslav, Ing. Miroslav Florek Sedmokráskova 4, 821 01 Bratislava, SK
MASARYK, Michal, Ing. Michal Masaryk PhD. Medzilaborecká 7, 821 01 Bratislava, SK
-
- (51) MKP
A61K 47/02 (2006.01) (97) **2459218 ***
A61K 47/10 (2006.01)
A61K 9/00 (2006.01)
A61P 1/10 (2006.01)
(86) GB2010001455 30.07.2010
(96) 10739973.5 06.06.2012
(87) WO2011012866, 30.07.2010
(97) 2459218, 06.06.2012 en
(54) SOLUTIONS COMPRISING POLYETHYLENE GLYCOL AND ELECTROLYTES
(71) Norgine BV, Hogehilweg 7, 1101 CA Amsterdam Zuid-Oost, NL
(72) SELDON, Chris, 10 James Terrace Ynysir Porth, Rhondda CF39 0EA, GB
PADFIELD, Dawn, Norgine Limited New Road Tir-Y-Berth Hengoed, Mid-Glamorgan CF82 8SJ, GB
MORRISSEY, Frances, Norgine Limited New Road Tir-Y-Berth Hengoed, Mid-Glamorgan CF82 8SJ, GB
-
- (51) MKP
D21C 9/10 (2006.01) (97) **2435629 ***
D21C 9/16 (2006.01)
(86) US2010036763 28.05.2010
(96) 10724941.9 04.04.2012
(87) WO2010138941, 28.05.2010
(97) 2435629, 04.04.2012 en
(54) MODIFIED CELLULOSE FROM CHEMICAL KRAFT FIBER AND METHODS OF MAKING AND USING THE SAME
GP Cellulose GmbH, Metallstrasse 9b, 6300 Zug, CH
(71) NONNI, Arthur, J., 108 Hidden Springs Lane, Peachtree City, GA 30269, US
COURCHENE, Charles, E., 3279 Woodrock Lane., Snellville, GA 30078, US
SLONE, Christopher, Michael, 1253 Breuer Mews Nw, Atlanta, GA 30318, US
ABITZ, Peter, R., 1088 Ashbury Drive, Decatur, GA 30030, US
-
- (51) MKP
B29C 67/00 (2006.01) (97) **2454080 ***
(86) EP2011057904 16.05.2011
(96) 11724143.0 23.05.2012
(87) WO2011144580, 16.05.2011
(97) 2454080, 23.05.2012 en
(54) IMPROVED STEREOLITHOGRAPHY MACHINE
(71) Dws S.R.L., Via Lago di Levico 3, 36010 Zane' (VI), IT
(72) BUSATO, Renzo, Via Pietro Berto 8/D, I-36035 Marano Vicentino (VI), IT

- (51) MKP
A61K 38/17 (2006.01) (97) **2461673 ***
A01K 67/027 (2006.01)
(86) US2010002173 05.08.2010
(96) 10806753.9 13.06.2012
(87) WO2011016861, 05.08.2010
(97) 2461673, 13.06.2012 en
(54) NOVEL REGULATORY PROTEINS AND INHIBITORS
(71) Intra-Cellular Therapies, Inc., 3960 Broadway, New York, NY 10032, US
(72) GREENGARD, Paul, The Rockefeller University 1230 York Avenue, New York, NY 10021-6399, US
LOU, Wenjie, The Rockefeller University 1230 York Avenue, New York, NY 10021-6399, US
HE, Gen, The Rockefeller University 1230 York Avenue, New York, NY 10021-6399, US
LI, Peng, Intra-cellular Therapies Inc. 3690 Broadway, New York, NY 10032, US
WENNOGLE, Lawrence, Intra-cellular Therapies Inc. 3690 Broadway, New York, NY 10032, US

- (51) MKP
B29D 35/12 (2010.01) (97) **2493347 ***
A43B 17/08 (2006.01)
A43B 7/08 (2006.01)
(86) EP2010066230 27.10.2010
(96) 10778597.4 05.09.2012
(87) WO2011051320, 27.10.2010
(97) 2493347, 05.09.2012 en
(54) Shoe with ventilation system.
(71) Gruppo Meccaniche Luciani S.r.l., 155 Via del Lavoro, 62014 Corridonia (MC), IT
(72) GRAZIANI, Giordano, 38 Via Beato Domenico da Montolmo, I-62014 Corridonia (mc), IT
PAGLIARI, Augusto, 119 Via Font'Orsola, I-62014 Corridonia (mc), IT

- (51) MKP
A61M 5/00 (2006.01) (97) **2437826 ***
A61M 5/315 (2006.01)
(86) EP2010057484 28.05.2010
(96) 10722350.5 11.04.2012
(87) WO2010139638, 28.05.2010
(97) 2437826, 11.04.2012 en
(54) DOSING MECHANISM FOR A DRUG DELIVERY DEVICE
(71) Sanofi-Aventis Deutschland GmbH, Brüningstraße 50, 65929 Frankfurt, DE
(72) JONES, Christopher, 153 High Street, Broadway Worcestershire WR12 7AL, GB

- (51) MKP
A61P 43/00 (2006.01) (97) **2440194 ***
A61K 31/395 (2006.01)
A61P 25/00 (2006.01)
A61K 31/045 (2006.01)
A61K 31/167 (2006.01)
(86) US2010037908 09.06.2010
(96) 10727283.3 18.04.2012
(87) WO2010144535, 09.06.2010
(97) 2440194, 18.04.2012 en
(54) METHODS AND COMPOSITIONS FOR THE INDUCTION OF HYPOTHERMIA
(71) The University of North Carolina At Chapel Hill, 308 Bynum Hall, Campus Box 4105, Chapel Hill, NC 27599-4105, US
(72) KATZ, Laurence, M., 1204 Killington Court, Chapel Hill NC 27517, US

- (51) MKP
C07C 269/06 (2006.01) (97) **2480526 ***
A61P 9/00 (2006.01)
C07C 309/15 (2006.01)
A61K 31/165 (2006.01)
C07C 271/28 (2006.01)
C07C 303/22 (2006.01)
(86) US2010002574 21.09.2010
(96) 10765695.1 01.08.2012
(87) WO2011037613, 21.09.2010
(97) 2480526, 01.08.2012 en
(54) CRYSTALLINE FORMS AND PROCESSES FOR THE PREPARATION OF PG12 RECEPTOR AGONISTS
(71) Arena Pharmaceuticals, Inc., 6166 Nancy Ridge Drive, San Diego, CA 92121, US
(72) BLACKBURN, Anthony C., 12633 Caminito Rosita, San Diego, California 92128, US
SHAKYA, Sagor Raj, 13009 Evening Creek Drive S. No. 11, San Diego, California 92128, US
DEMATTEI, John A., 8521 Clatsop Lane, San Diego, California 92129, US
CHUANG, Tsung-Hsun, 16353 Los Rosales Street, San Diego, California 92127, US

- (51) MKP
A61K 31/55 (2006.01) (97) **2496582 ***
C07D 487/04 (2006.01)
A61P 43/00 (2006.01)
A61P 35/00 (2006.01)
(86) EP2010066697 03.11.2010
(96) 10773325.5 12.09.2012
(87) WO2011054845, 03.11.2010
(97) 2496582, 12.09.2012 en
(54) BENZODIAZEPINE BROMODOMAIN INHIBITOR
(71) GlaxoSmithKline LLC, One Franklin Plaza 200 North 16th Street, Philadelphia, PA 19102, US
(72) BAILEY, James, GlaxoSmithKline Gunnels Wood Road, Stevenage Hertfordshire SG1 2NY, GB
GOSMINI, Romain, Luc, Marie, Laboratoire GlaxoSmithKline S.A.S. Centre de Recherches 25Avenue du Quebec ZA de Courtaboeuf, F-91951 Les Ulis, FR
MIRGUET, Olivier, Laboratoire GlaxoSmithKline S.A.S. Centre de Recherches 25 Avenue du Quebec ZA de Courtaboeuf, F-91951 Les Ulis, FR
WITHERINGTON, Jason, GlaxoSmithKline Gunnels Wood Road, Stevenage Hertfordshire SG1 2NY, GB

- (51) MKP
A01N 43/42 (2006.01) (97) **2437603 ***
(86) US2010037131 02.06.2010
(96) 10797501.3 11.04.2012
(87) WO2011005388, 02.06.2010
(97) 2437603, 11.04.2012 en
(54) METHODS OF TREATING HEPATIC ENCEPHALOPATHY
(71) Salix Pharmaceuticals, Ltd., 1700 Perimeter Park Drive, Morrisville, NC 27560, US
(72) FORBES, William, 1008 Heydon Court, Raleigh, NC 27614, US
BORTEY, Enoch, 225 Ocoee Falls Drive, Chapel Hill, NC 27517, US
MERCHANT, Kunal, 4702 Sycamore Shoals Road, Durham, NC 27705, US
SHAW, Audrey, 4425 Dula Street, Durham, NC 27705, US

- (51) MKP
C01B 7/09 (2006.01) (97) **2454190 ***
(86) US2010040620 30.06.2010
(96) 10800313.8 23.05.2012
(87) WO2011008573, 30.06.2010
(97) 2454190, 23.05.2012 en
(54) CONVERSION OF HYDROGEN BROMIDE TO ELEMENTAL BROMINE
(71) Marathon GTF Technology, Ltd., 5555 San Felipe, Houston, TX 77056-2799, US
(72) WAYCUILIS, John J., 14902 Quail Farms Road, Cypress Texas 77429, US
MOORE, Patrick K., 518 Circle Way, Lake Jackson Texas 77566, US
LISEWSKY, Greg A., 2922 Ocean Mist Court, Seabrook Texas 77586, US

- (51) MKP
A61F 13/15 (2006.01) (97) **2441419**
(96) 11184738.0 18.04.2012
(97) 2441419, 18.04.2012 en
(54) Method of providing a diaper with a contoured leg opening
(71) Curt G. Joa, Inc., PO Box 903, Sheboygan Falls, WI 53085-0903, US
(72) McCabe,, John A, 1141 Partridge Run, Sheboygan Falls, WI Wisconsin 53085, US
Fritz,, Jeff, N4989 Country Aire Road, Plymouth, WI Wisconsin 53073, US
Andrews,, Robert E, N7488 Sunset Circle Drive, Sheboygan Falls, WI Wisconsin 53083, US
-
- (51) MKP
A61K 31/513 (2006.01) (97) **2488182 ***
A61P 35/00 (2006.01)
(86) US2010052734 14.10.2010
(96) 10768670.1 22.08.2012
(87) WO2011047195, 14.10.2010
(97) 2488182, 22.08.2012 en
(54) TREATING NEUROTOXICITY ASSOCIATED WITH COMBINATIONS OF 5 - FU OR ITS PRODRUGS AND DPD INHIBITORS
(71) Adherex Technologies, Inc., 515 Legget Drive, Suite 800, Ottawa, ON K2K 3G4, CA
(72) SPECTOR, Thomas, 5216 Old Chapel Hill Road, Durham, North Carolina 27707, US
-
- (51) MKP
A61J 1/20 (2006.01) (97) **2459147 ***
(86) EP2010004676 30.07.2010
(96) 10771313.3 06.06.2012
(87) WO2011012313, 30.07.2010
(97) 2459147, 06.06.2012 en
(54) DEVICE/SYSTEM FOR MIXING LIQUIDS, DRUGS AND SOLUTIONS BEFORE ADMINISTRATION INTO THE HUMAN BODY
(71) Life Medical Division SRL, Via San Floriano 35 San Martino di Campagna, 33081 Aviano, IT
(72) PETRONE, Dario, Contrada Villa Franca Parco Bel Vedere, 85010 Pignola, IT
-
- (51) MKP
G10L 15/22 (2006.01) (97) **2497004 ***
G06F 3/01 (2006.01)
G10L 21/06 (2006.01)
(86) US2010054967 01.11.2010
(96) 10779869.6 12.09.2012
(87) WO2011056752, 01.11.2010
(97) 2497004, 12.09.2012 en
(54) SYSTEMS AND METHODS FOR HAPTIC CONFIRMATION OF COMMANDS
(71) Immersion Corporation, 30 Rio Robles, San Jose, CA 95134, US
(72) HEUBEL, Robert, W., 652 Begier Avenue, San Leandro, California 94577, US
RAMSAY, Erin, 2012 Harvard Avenue Apt. 104, Montreal, Québec H4A 2V9, CA
-
- (51) MKP
B32B 27/00 (2006.01) (97) **2399737**
(96) 11004438.5 28.12.2011
(97) 2399737, 28.12.2011 de
(54) Styrene polymer foam compound body
(71) Alporit AG, Industriestrasse 559, 5623 Boswil, CH
(72) Jenni, Daniel, Schinhaltenstrasse 8, 6370 Obersdorf, CH
Simmler, Hans, Alpenstrasse 8, 8636 Wald, CH
-
- (51) MKP
A61K 31/395 (2006.01) (97) **2482813 ***
C07D 269/00 (2006.01)
A61P 1/00 (2006.01)
A61K 31/352 (2006.01)
(86) US2010050661 29.09.2010
(96) 10821147.5 08.08.2012
(87) WO2011041369, 29.09.2010
(97) 2482813, 08.08.2012 en
(54) SALTS, SOLVATES, AND PHARMACEUTICAL COMPOSITIONS OF MACROCYCLIC GHRELIN RECEPTOR AGONISTS AND METHODS OF USING THE SAME
(71) Tranzyme Pharma Inc., 3001 12th Avenue Nord, Sherbrooke Québec J1H 5N4, CA
(72) HOVEYDA, Hamid R., 124 Berkendaalstraat, B-1050 Bruxelles, BE
VEZINA, Martin, 613 Salvail nord, La Présentation, Québec J0H 1B0, CA
FOURNIER, Eric, 66 Des Plaines, Laval, Québec H7R 1C1, CA
GAGNON, René, 1451 rue Leonard, Sherbrooke, Québec J1K 2L9, CA
BHERER, Patrick, 740 Rue McGregor 408, Sherbrooke, Québec J1L 1V7, CA
-
- (51) MKP
A61K 31/167 (2006.01) (97) **2438037 ***
A61P 25/02 (2006.01)
C07C 65/21 (2006.01)
C07C 235/24 (2006.01)
C07C 235/68 (2006.01)
C07C 311/51 (2006.01)
(86) EP2010003383 04.06.2010
(96) 10723940.2 11.04.2012
(87) WO2010139481, 04.06.2010
(97) 2438037, 11.04.2012 en
(54) GLYCINE B ANTAGONISTS
(71) Merz Pharma GmbH & Co. KGaA, Eckenheimer Landstrasse 100, 60318 Frankfurt Main, DE
(72) HENRICH, Markus, Am Kreuzberg 1, 35516 Münzenberg, DE
BAUER, Angela, Im Münchfeld 29, 55122 Mainz, DE
NAGEL, Jens, Ruhemannweg 57, 14959 Blankensee, DE
KAUSS, Valerjans, Deglava 108/2-36, 1082 Riga, LV
TRIFANOVA, Dina, Saulgozhu 2-44, 1055 Riga, LV
GRUNSTEINE, Ginta, Priedes 7 Silakrogs Ropazhu novads, 2133 Riga, LV
ROZHKOVS, Jevgenijs, Dzidrumu 6 Adazhi, 2164 Riga, LV
-
- (51) MKP
A61M 5/315 (2006.01) (97) **2448620 ***
(86) EP2010059126 28.06.2010
(96) 10730413.1 09.05.2012
(87) WO2011003762, 28.06.2010
(97) 2448620, 09.05.2012 en
(54) DRIVE MECHANISM AND DRUG DELIVERY DEVICE
(71) Sanofi-Aventis Deutschland GmbH, Brüningstraße 50, 65929 Frankfurt, DE
(72) MATTHIAS, Claudia, c/o Sanofi-Aventis Deutschland GmbH, 65926 Frankfurt am Main, DE
RAAB, Steffen, c/o Sanofi-Aventis Deutschland GmbH, 65926 Frankfurt am Main, DE
-
- (51) MKP
G01N 33/53 (2006.01) (97) **2443458 ***
G01N 33/566 (2006.01)
(86) US2010038881 16.06.2010
(96) 10790146.4 25.04.2012
(87) WO2010148130, 16.06.2010
(97) 2443458, 25.04.2012 en
(54) METHOD FOR MEASURING LIPOPROTEIN-SPECIFIC APOLIPOPROTEINS
(71) Maine Standards Company, LLC, 765 Roosevelt Trail Suite 9A, Windham, ME 04062, US
(72) CONTOIS, John, 765 Roosevelt Trail Suite 9A, Windham, ME 04062, US
-

- (51) MKP
B21D 39/04 (2006.01) (97) **2420332**
B21J 7/14 (2006.01)
B21J 13/08 (2006.01)
(96) 10425281.2 22.02.2012
(97) 2420332, 22.02.2012 en
(54) Gripper for holding the tools of a radial press
(71) OP S.r.l., Via Serpente, 97, 25131 Brescia, IT
(72) Ziliani, Massimo, c/o OP S.r.l. Via Serpente, 97, 25131 Brescia, IT
Piantoni, Daniele, c/o OP S.r.l. Via Serpente, 97, 25131 Brescia, IT
-
- (51) MKP
F04B 53/00 (2006.01) (97) **2456981 ***
F04B 53/16 (2006.01)
F02M 59/48 (2006.01)
(86) EP2010060440 19.07.2010
(96) 10734991.2 30.05.2012
(87) WO2011009839, 19.07.2010
(97) 2456981, 30.05.2012 en
(54) PUMP ASSEMBLY
(71) Delphi Technologies Holding S.à.r.l., Avenue de Luxembourg, 4940 Bascharage, LU
(72) HOPLEY, Daniel, 28 Elmstead Lane, Chislehurst Kent BR7 5EG, GB
-
- (51) MKP
C07C 57/26 (2006.01) (97) **2475635 ***
C07C 69/608 (2006.01)
C07D 493/18 (2006.01)
C07C 51/36 (2006.01)
C07C 67/303 (2006.01)
(86) IB2010002566 10.09.2010
(96) 10782673.7 18.07.2012
(87) WO2011030223, 10.09.2010
(97) 2475635, 18.07.2012 en
(54) PROCESS FOR THE PRODUCTION OF ARTEMISININ INTERMEDIATES
(71) SANOFI, 54 rue La Boétie, 75008 Paris, FR
(72) KRAFT, Volker, C/o Sanofi-aventis Deutschland GmbH, 65926 Frankfurt, DE
KRETZSCHMAR, Gerhard, C/o Sanofi-aventis Deutschland GmbH, 65926 Frankfurt, DE
ROSSEN, Kai, C/o Sanofi-aventis Deutschland GmbH, 65926 Frankfurt, DE
-
- (51) MKP
C07C 45/68 (2006.01) (97) **2444386 ***
C07C 45/80 (2006.01)
C07C 49/617 (2006.01)
C07C 49/683 (2006.01)
C07C 49/798 (2006.01)
(86) JP2010058133 13.05.2010
(96) 10789327.3 25.04.2012
(87) WO2010146951, 13.05.2010
(97) 2444386, 25.04.2012 en
(54) PROCESS FOR PREPARATION OF NORBORNENE DERIVATIVES
(71) JX Nippon Oil & Energy Corporation, 6-3, Otemachi 2-chome, Chiyoda-ku Tokyo 100-8162, JP
(72) KOMATSU Shinichi, c/o JX Nippon Oil & Energy Corporation 8 Chidori-cho Naka-ku, Yokohama-shi Kanagawa 231-0815, JP
SONE Hisashi, c/o JX Nippon Oil & Energy Corporation 8 Chidori-cho Naka-ku, Yokohama-shi Kanagawa 231-0815, JP
KOIKE Takeshi, c/o JX Nippon Oil & Energy Corporation 8 Chidori-cho Naka-ku, Yokohama-shi Kanagawa 231-0815, JP
KAWAHAMA Sayako, c/o JX Nippon Oil & Energy Corporation 8 Chidori-cho Naka-ku, Yokohama-shi Kanagawa 231-0815, JP
-
- (51) MKP
B08B 9/055 (2006.01) (97) **2409789**
F16J 15/32 (2006.01)
F16L 55/28 (2006.01)
(96) 11172996.8 25.01.2012
(97) 2409789, 25.01.2012 en
(54) Pipeline debris shearing device
(71) TDW Delaware, Inc., 1100 Market Street Suite 780, Wilmington, Delaware 19801, US
(72) Rankin, William J, 809 South Moccasin Place, Sapulpa, OK Oklahoma 74066, US
Logan, Matthew W, 4541 South 202nd East Avenue, Broken Arrow, OK Oklahoma 74014, US
Strong, Robert F, 12165 North 108th East Avenue, Collinsville, OK Oklahoma 74021, US
-
- (51) MKP
A01N 43/40 (2006.01) (97) **2493306 ***
A01N 43/18 (2006.01)
A01P 13/00 (2006.01)
A01N 43/76 (2006.01)
A01N 39/02 (2006.01)
(86) US2010054248 27.10.2010
(96) 10771881.9 05.09.2012
(87) WO2011056639, 27.10.2010
(97) 2493306, 05.09.2012 en
(54) SYNERGISTIC HERBICIDAL COMPOSITION CONTAINING FLUROXYPYR AND CYHALOFOP, METAMIFOP OR PROFOXYDIM
(71) Dow AgroSciences LLC, 9330 Zionsville Road, Indianapolis, IN 46268, US
(72) MANN, Richard, 1828 South 550 East, Franklin IN 46131, US
WEIMER, Monte, 9539 Gladstone Drive, Pittsboro IN 46167, US
MCVEIGH-NELSON, Andrea, 1333 Alimingo Drive, Indianapolis IN 46260, US
-
- (51) MKP
E04H 15/00 (2006.01) (97) **2410108**
E04H 15/32 (2006.01)
F22B 37/24 (2006.01)
(96) 11163469.7 25.01.2012
(97) 2410108, 25.01.2012 de
(54) Fixing system of a covering element
(71) Hitachi Power Europe GmbH, Schifferstrasse 80, 47059 Duisburg, DE
(72) Pauly, Axel, Ohmstr. 18, 45711 Datteln, DE
Furth, Thomas, Paulusstraße 12, 40237 Düsseldorf, DE
Blomeier, Marc, Gassstraße 39, 45731 Waltrop, DE
-
- (51) MKP
C08J 5/18 (2006.01) (97) **2390280**
C08K 9/04 (2006.01)
C09C 1/02 (2006.01)
C09C 3/08 (2006.01)
(96) 10164409.4 30.11.2011
(97) 2390280, 30.11.2011 en
(54) Treated mineral filler products, process for the preparation thereof and uses of same
(71) Omya Development AG, Baslerstrasse 42, 4665 Oftringen, CH
(72) Buri, Matthias, Mätteliweg 20, 4852 Rothrist, CH
Gane, Patrick A.C., Studenweg 8, 4852 Rothrist, CH
Rentsch, Samuel, Höhweg 1, 4663 Aarburg, CH
Burkhalter, René, Cuno Amiet Strasse 56, 3360 Herzogenbuchsee, CH

- (51) MKP
A01N 43/40 (2006.01) (97) **2488028 ***
A61K 31/445 (2006.01)
- (86) US2010051403 05.10.2010
(96) 10823840.3 22.08.2012
(87) WO2011046771, 05.10.2010
(97) 2488028, 22.08.2012 en
- (54) SUBSTITUTED PIPERIDINES THAT INCREASE p53 ACTIVITY AND THE USES THEREOF
- (71) Merck Sharp & Dohme Corp., 126 East Lincoln Avenue, Rahway NJ 07065-0907, US
- (72) BOGEN, Stephane, L., 2000 Galloping Hill Road, Kenilworth New Jersey 07033, US
MA, Yao, 320 Bent Street, Cambridge Massachusetts 02141, US
WANG, Yaolin, 2000 Galloping Hill Road, Kenilworth New Jersey 07033, US
LAHUE, Brian Robert, 320 Bent Street, Cambridge Massachusetts 02141, US
NAIR, Latha, G., 2000 Galloping Hill Road, Kenilworth New Jersey 07033, US
SHIZUKA, Manami, 320 Bent Street, Cambridge Massachusetts 02141, US
VOSS, Matthew Ernst, 2000 Galloping Hill Road, Kenilworth New Jersey 07033, US
KIROVA-SNOVER, Margarita, 21 Bolivar Avenue, Troy New York 12180, US
PAN, Weidong, 2000 Galloping Hill Road, Kenilworth New Jersey 07033, US
TIAN, Yuan, 320 Bent Street, Cambridge Massachusetts 02141, US
KULKARNI, Bheemashankar, A., 132 North Street 4, Newton Massachusetts 02460, US
GIBEAU, Craig, R., 320 Bent Street, Cambridge Massachusetts 02141, US
LIU, Yuan, 320 Bent Street, Cambridge Massachusetts 02141, US
SCAPIN, Giovanna, 2000 Galloping Hill Road, Kenilworth New Jersey 07033, US
RINDGEN, Diane, 2000 Galloping Hill Road, Kenilworth New Jersey 07033, US
DOLL, Ronald, J., 2000 Galloping Hill Road, Kenilworth New Jersey 07033, US
GUZI, Timothy, J., 320 Bent Street, Cambridge Massachusetts 02141, US
HICKLIN, Danny, J., 2000 Galloping Hill Road, Kenilworth New Jersey 07033, US
NOMEIR, Amin, 2000 Galloping Hill Road, Kenilworth New Jersey 07033, US
SEIDEL-DUGAN, Cynthia, 2000 Galloping Hill Road, Kenilworth New Jersey 07033, US
SHIPPS, Gerald, W., Jr., 320 Bent Street, Cambridge Massachusetts 02141, US
MACCOSS, Malcolm, 48 Rose Court, Freehold New Jersey 07728, US

- (51) MKP
C07D 211/96 (2006.01) (97) **2421829 ***
A61P 25/28 (2006.01)
A61K 31/445 (2006.01)
C07D 243/08 (2006.01)
C07D 295/26 (2006.01)
C07C 311/29 (2006.01)
C07D 241/04 (2006.01)
A61P 11/06 (2006.01)
C07D 403/04 (2006.01)
C07D 487/04 (2006.01)
- (86) US2010031828 21.04.2010
(96) 10714821.5 29.02.2012
(87) WO2010123956, 21.04.2010
(97) 2421829, 29.02.2012 en
- (54) 2,5-DISUBSTITUTED ARYLSULFONAMIDE CCR3 ANTAGONISTS
- (71) Axikin Pharmaceuticals, Inc., 10835 Road to the Cure, Suite 250, San Diego, CA 92121, US
- (72) LY, Tai, Wei, 10824 Caminito Colorado, San Diego CA 92131, US
TRAN, Marie Chantal, Siu-ying, 6620 N. Golden West Avenue, Arcadia CA 91007, US
RAAUM, Erik, Dean, 4020 N. Teewinot Road, Teton Village WY 83025, US

- (51) MKP
A61P 25/22 (2006.01) (97) **2454240 ***
A61K 31/4164 (2006.01)
A61P 25/28 (2006.01)
A61P 25/20 (2006.01)
A61K 31/4196 (2006.01)
A61P 25/30 (2006.01)
A61P 25/00 (2006.01)
A61P 43/00 (2006.01)
C07D 233/90 (2006.01)
A61P 25/24 (2006.01)
A61P 25/04 (2006.01)
C07D 249/10 (2006.01)
A61P 25/18 (2006.01)
- (86) JP2010062394 15.07.2010
(96) 10799955.9 23.05.2012
(87) WO2011007899, 15.07.2010
(97) 2454240, 23.05.2012 en
- (54) GLYCINE TRANSPORTER INHIBITORS
- (71) Taisho Pharmaceutical Co., Ltd., 24-1, Takada 3-chome Toshima-ku, Tokyo 170-8633, JP
- (72) OHTA, Hiroshi, c/o Taisho Pharmaceutical Co. Ltd. 24-1, Takada 3-chome Toshima-ku, Tokyo 170-8633, JP
SHIRASAKI, Yoshihisa, c/o Taisho Pharmaceutical Co. Ltd. 24-1, Takada 3-chome Toshima-ku, Tokyo 170-8633, JP
SHIMAZAKI, Youichi, c/o Taisho Pharmaceutical Co. Ltd. 24-1, Takada 3-chome Toshima-ku, Tokyo 170-8633, JP
HAYASHI, Masato, c/o Taisho Pharmaceutical Co. Ltd. 24-1, Takada 3-chome Toshima-ku, Tokyo 170-8633, JP
YASUHARA, Akito, c/o Taisho Pharmaceutical Co. Ltd. 24-1, Takada 3-chome Toshima-ku, Tokyo 170-8633, JP
ABE, Kumi, c/o Taisho Pharmaceutical Co. Ltd. 24-1, Takada 3-chome Toshima-ku, Tokyo 170-8633, JP
SAKAGAMI, Kazunari, c/o Taisho Pharmaceutical Co. Ltd. 24-1, Takada 3-chome Toshima-ku, Tokyo 170-8633, JP
SUN, Xiang-Min, c/o Taisho Pharmaceutical Co. Ltd. 24-1, Takada 3-chome Toshima-ku, Tokyo 170-8633, JP
YAMAMOTO, Shuji, c/o Taisho Pharmaceutical Co. Ltd. 24-1, Takada 3-chome Toshima-ku, Tokyo 170-8633, JP
ARAKI, Yuko, c/o Taisho Pharmaceutical Co. Ltd. 24-1, Takada 3-chome Toshima-ku, Tokyo 170-8633, JP

- (51) MKP
A61P 9/14 (2006.01) (97) **2473178 ***
A61K 36/63 (2006.01)
A61K 36/33 (2006.01)
- (86) EP2010005346 01.09.2010
(96) 10760244.3 11.07.2012
(87) WO2011026606, 01.09.2010
(97) 2473178, 11.07.2012 en
- (54) COMPOSITION FOR THE TREATMENT OF HEMORRHOIDS AND RELATED DISEASES
- (71) Bionap S.r.L., Via Badalà 6, 95010 S. Venerina (CT), IT
- (72) RIZZA, Luisa, c/o Bionap Srl Via Badalà 6, 95010 Santa Venerina (CT), IT
MUNAFO', Salvatore, c/o Bionap Srl Via Badalà 6, 95010 Santa Venerina (CT), IT
SERRAINO, Alberto, c/o Bionap Srl Via Badalà 6, 95010 Santa Venerina (CT), IT

- (51) MKP
A61K 31/496 (2006.01) (97) **2477626 ***
A61K 31/495 (2006.01)
A61P 25/24 (2006.01)
A61P 25/30 (2006.01)
A61K 31/4965 (2006.01)
- (86) US2010049405 17.09.2010
(96) 10817952.4 25.07.2012
(87) WO2011035212, 17.09.2010
(97) 2477626, 25.07.2012 en
- (54) ROLE OF N-2 HYDROXY-ETHYL-PIPERAZINE-N'-2-ETHANE SULFONIC ACID (HEPES) IN PAIN CONTROL AND REVERSAL OF DEMYELINIZATION INJURY
- (71) North Texas Medical Associates, 222 Sw 2nd Street Suite 201, Grand Prairie, TX 75051-1770, US
- (72) DANHOF, Ivan, E., 2322 Ingleside Drive, Grand Prairie, TX 75050, US

- (51) MKP
A23L 2/02 (2006.01) (97) **2448424 ***
A23J 3/16 (2006.01)
A23J 1/14 (2006.01)
- (86) CA2010001016 30.06.2010
(96) 10793474.7 09.05.2012
(87) WO2011000097, 30.06.2010
(97) 2448424, 09.05.2012 en
- (54) PRODUCTION OF ACID SOLUBLE SOY PROTEIN ISOLATES ("S800")
- (71) Burcon Nutrascience (MB) Corp., 1388 Waller Avenue, Winnipeg, Manitoba R3T 1P9, CA
- (72) SEGALL, Kevin, I., 31 Dunbar Crescent, Winnipeg Manitoba R3P 0W6, CA
SCHWEIZER, Martin, 117 Haig Avenue, Winnipeg Manitoba R2M 0E3, CA
GREEN, Brent, E., 24 Poplarwood Drive Box 603, Warren Manitoba R0C 3E0, CA
MEDINA, Sarah, 315 Wildwood Park, Winnipeg Manitoba R3T 0E5, CA
GOSNELL, Brandy, 118 Arden Avenue, Winnipeg Manitoba R2M 2K2, CA
-
- (51) MKP
B01J 37/04 (2006.01) (97) **2349531 ***
B01J 37/08 (2006.01)
B01J 37/03 (2006.01)
B01D 53/00 (2006.01)
B01J 21/06 (2006.01)
B01J 23/00 (2006.01)
B01J 23/847 (2006.01)
B01J 35/04 (2006.01)
- (86) AT2010000116 16.04.2010
(96) 10715483.3 03.08.2020
(87) WO2010121280, 16.04.2010
(97) 2349531, 03.08.2020 en
- (54) TRANSITION-METAL VANADATE OR MIXED TRANSITION-METAL / RARE EARTH VANADATE BASED CATALYST COMPOSITION FOR SELECTIVE CATALYTIC REDUCTION OF EXHAUST GASES
- (71) Treibacher Industrie AG, Auer von Welsbach-Straße 1, 9330 Treibach-Althofen, AT
- (72) SCHERMANZ, Karl, Buchbergstrasse 15, A-9314 Launsdorf, AT
SAGAR, Amod, Gurk-Au 43, A-9330 Althofen, AT
TROVARELLI, Alessandro, Via dei Pini 8/2, I-33010 Pagnacco (Udine), IT
CASANOVA, Marzia, Via Nazionale 44, I-33020 Ravascletto, IT
-
- (51) MKP
F21S 11/00 (2006.01) (97) **2452119 ***
F21S 19/00 (2006.01)
- (86) IB2010052759 18.06.2010
(96) 10734817.9 16.05.2012
(87) WO2011004278, 18.06.2010
(97) 2452119, 16.05.2012 en
- (54) TUBULAR SKYLIGHT
- (71) Bracale, Gennaro, Via Cesare Battisti 179, 21027 Ispra (Varese), IT
- (72) Bracale, Gennaro, Via Cesare Battisti 179, 21027 Ispra (Varese), IT

- (51) MKP
C07D 239/47 (2006.01) (97) **2473486 ***
C07D 251/18 (2006.01)
C07D 251/66 (2006.01)
C07D 401/04 (2006.01)
C07D 401/14 (2006.01)
C07D 403/04 (2006.01)
A61K 31/53 (2006.01)
A61K 31/506 (2006.01)
A61K 31/5377 (2006.01)
A61P 7/06 (2006.01)
- (86) EP2010062708 31.08.2010
(96) 10747859.6 11.07.2012
(87) WO2011026835, 31.08.2010
(97) 2473486, 11.07.2012 de
- (54) NOVEL PYRIMIDINE AND TRIAZINE HEPCIDINE ANTAGONISTS
- (71) VIFOR (INTERNATIONAL) AG, Rechenstrasse 37, 9001 St. Gallen, CH
- (72) COURTNEY, Stephen, Martin, 43 Fawkner Way, Stanford in the Vale SN7 8FF, GB
DÜRRENBARGER, Franz, Dorneckstrasse 127, CH-4143 Dornach, CH
DAVENPORT, Tara, Penny Red Faringdon Road Southmoor Abingdon, Oxon OX13 5AA, GB
BURCKHARDT, Susanna, Ackersteinstrasse 207, CH-8049 Zürich, CH
JAEGGER, Stefan, Nissenstrasse 14, 20251 Hamburg, DE
GEISSER, Peter, Otto, Marweesstrasse 8, CH-9014 St. Gallen, CH
RIDGILL, Mark Peter, 33 Lambs Farm Road, Horsham West Sussex RH12 4DB, GB
BUHR, Wilm, Zum Kirchwald 20, 78465 Konstanz, DE
SLACK, Mark, Vogt-Kölln-Strasse 136, 22527 Hamburg, DE
FUNK, Felix, Römerstrasse 177b, CH-8404 Winterthur, CH
YARNOLD, Christopher, John, 9 Mowbray Road, Didcot Oxon Oxfordshire OX11 8ST, GB
BAINBRIDGE, Julia, Marie, 1 Nunney Brook, Didcot Oxon Oxfordshire OX11 7FW, GB
YAU, Wei, Tsung, 34 Ouse Close, Didcot Oxon Oxfordshire OX11 7FE, GB
CORDEN, Vincent, Anthony, 6 Cowderoy Place, Stanford in the Vale Oxon SN7 8PG, GB
-
- (51) MKP
H04W 28/00 (2009.01) (97) **2485525 ***
H04W 16/28 (2009.01)
- (86) CN2010077428 28.09.2010
(96) 10819904.3 08.08.2012
(87) WO2011038675, 28.09.2010
(97) 2485525, 08.08.2012 en
- (54) METHOD AND DEVICE FOR PERFORMING SPACE COORDINATION AMONG CELLS
- (71) China Academy of Telecommunications Technology, 40, Xueyuan Road, Haidian District, Beijing 100191, CN
- (72) GAO, Qiubin, No.40 Xueyuan Road Haidian District, Beijing 100083, CN
MIAO, Deshan, No.40 Xueyuan Road Haidian District, Beijing 100083, CN
PENG, Ying, No.40 Xueyuan Road Haidian District, Beijing 100083, CN
SUN, Shaohui, No.40 Xueyuan Road Haidian District, Beijing 100083, CN

- (51) MKP
A61P 43/00 (2006.01) (97) **2419097 ***
A61K 31/155 (2006.01)
A61P 13/12 (2006.01)
A61K 31/4439 (2006.01)
A61P 25/00 (2006.01)
A61K 31/64 (2006.01)
A61P 27/02 (2006.01)
A61K 45/00 (2006.01)
A61P 3/10 (2006.01)
C07D 335/02 (2006.01)
A61P 5/50 (2006.01)
A61P 9/10 (2006.01)
A61K 31/382 (2006.01)
A61P 9/14 (2006.01)
(86) JP2010057196 16.04.2010
(96) 10764570.7 22.02.2012
(87) WO2010119990, 16.04.2010
(97) 2419097, 22.02.2012 en
(54) PHARMACEUTICAL COMPOSITIONS
(71) Taisho Pharmaceutical Co., Ltd., 24-1, Takada 3-chome
Toshima-ku, Tokyo 170-8633, JP
(72) TAKAHASHI, Teisuke, c/o Taisho Pharmaceutical Co. Ltd. 24-1
Takada 3-chome Toshima-ku, Tokyo 170-8633, JP
UCHIDA, Saeko, c/o Taisho Pharmaceutical Co. Ltd. 24-1
Takada 3-chome Toshima-ku, Tokyo 170-8633, JP
-
- (51) MKP
C09D 11/00 (2006.01) (97) **2305761**
(96) 10178359.5 06.04.2011
(97) 2305761, 06.04.2011 de
(54) Ink jet ink
(71) Österreichische Staatsdruckerei GmbH, Tenschertstr. 7, 1230
Wien, AT
Aerospace & Advanced Composites GmbH, Viktor-Kaplan-Str.
2, 2700 Wiener Neustadt, AT
(72) Stelzer, Nils, AIT Austrian Institute of Technology GmbH
Forschungszentrum, 2444, Seibersdorf, AT
Steiner, Hannes, AIT Austrian Institute of Technology GmbH
Forschungszentrum, 2444, Seibersdorf, AT
Gausterer, Reinhart, ÖSTERREICHISCHE
STAATSDRUCKEREI GMBH Tenschertstrasse 7, 1230, Wien,
AT
Baca, Lubos, Sturova 40, 90101, Malacky, SK
-
- (51) MKP
A61M 5/315 (2006.01) (97) **2482882 ***
(86) EP2010064389 29.09.2010
(96) 10757777.7 08.08.2012
(87) WO2011039201, 29.09.2010
(97) 2482882, 08.08.2012 en
(54) DRIVE MECHANISM FOR A DRUG DELIVERY DEVICE AND
RESILIENT ELEMENT FOR A DRIVE MECHANISM
(71) Sanofi-Aventis Deutschland GmbH, Brüningstraße 50, 65929
Frankfurt, DE
(72) Veasey, Robert, 31 Lonsdale Road Lillington, Leamington Spa
Warwickshire CV32 7EP, GB
Bilton, Simon Lewis, Flat 3 15 Clarendon Square, Leamington
Spa Warwickshire CV32 5QT, GB
Jones, Christopher, The Old Thatch Grafton, Tewkesbury
Gloucestershire GL20 7AT, GB
Kouyoumjian, Garen, 2A Plymouth Place, Leamington Spa
Warwickshire CV31 1HN, GB
MacDonald, Catherine Anne, 23 Goggbridge Lane, Warwick
Warwickshire CV34 6JE, GB
-
- (51) MKP
C07D 487/04 (2006.01) (97) **2488524 ***
A61K 31/519 (2006.01)
A61P 37/00 (2006.01)
(86) IB2010054447 01.10.2010
(96) 10771200.2 22.08.2012
(87) WO2011045702, 01.10.2010
(97) 2488524, 22.08.2012 en
(54) PYRROLO[2,3-D]PYRIMIDINE COMPOUNDS
(71) Pfizer Inc., 235 East 42nd Street, New York, NY 10017, US
ACKER, Brad Alan, 4233 Millers Ridge Drive, Saint Charles,
Missouri 63304, US
HARTMANN, Susan J., 613 West Essex Avenue, Kirkwood,
Missouri 63122, US
HUANG, Horng-Chih, 1126 Nooning Tree Drive, Chesterfield,
Missouri 63017, US
JACOBSEN, Eric Jon, 1503 Lace Bark Court, Chesterfield,
Missouri 63005, US
PROMO, Michele Ann, 539 N. Westover Blvd. Apt. 4122,
Albany, Georgia 31707, US
WOLFSON, Sergey Gregory, 15599 Hitchcock Road,
Chesterfield, Missouri 63017, US
XIE, Jin, Pfizer Global Research and Development 700
Chesterfield Parkway West, Chesterfield, Missouri 63017, US
-
- (51) MKP
C07D 491/22 (2006.01) (97) **2399919**
(96) 11182560.0 28.12.2011
(97) 2399919, 28.12.2011 en
(54) (S)-4,11-diethyl-3,14-dioxo-3,4,12,14-tetrahydro-1H-pyrano
[3',4':6,7] indolizino [1.2-b]quinoline-4,9-diyl bis([1,4'-
bipiperidine]-carboxylate and its use
(71) Cadila Healthcare Limited, Zydus Tower Satellite Cross Roads,
Ahmedabad 380 015, Gujarat, IN
(72) Charan, Ganpat Dan Shimbhu, Cadila Healthcare Limited Zydus
Tower, Satellite Cross Roads, Ahmedabad, 380 015 Gujarat, IN
Tanpure, Arun Ankush, Cadila Healthcare Limited Zydus Tower,
Satellite Cross Roads, Ahmedabad, 380 015 Gujarat, IN
Singh, Kumar Kamlesh Laxmi, Cadila Healthcare Limited Zydus
Tower, Satellite Cross Roads, Ahmedabad, 380 015 Gujarat, IN
-
- (51) MKP
G01N 33/50 (2006.01) (97) **2433125 ***
(86) US2010035616 20.05.2010
(96) 10721224.3 28.03.2012
(87) WO2010135555, 20.05.2010
(97) 2433125, 28.03.2012 en
(54) METHOD FOR DETERMINING THE CARDIO-GENERATIVE
POTENTIAL OF MAMMALIAN CELLS
(71) Mayo Foundation for Medical Education and Research, 200
First Street SW, Rochester, MN 55905, US
Cardio3 Biosciences S.A., Axis Business Parc Rue Edouard
Belin 12, 1435 Mont-Saint-Guibert, BE
(72) GORDON-BERESFORD, Roland, Avenue Antoinette Herlin 11,
B-1310 La Hulpe, BE
GAUSSIN, Vinciane, Avenue de l'Esplanade 6, B-1970
Wezembeek-Oppem, BE
HOMSY, Christian, Avenue des Sittelles 99, B-1150 Bruxelles,
BE
TERZIC, Andre, 803 8th Street S.W., Rochester, Minnesota
55902, US
BEHFAR, Atta, 1121 Plummer Circle S.W., Rochester,
Minnesota 55902, US
-
- (51) MKP
A61F 5/56 (2006.01) (97) **2493435 ***
(86) US2010052628 14.10.2010
(96) 10768666.9 05.09.2012
(87) WO2011059628, 14.10.2010
(97) 2493435, 05.09.2012 en
(54) FLUID FILLED IMPLANTS FOR TREATING OBSTRUCTIVE
SLEEP APNEA
(71) Ethicon. Inc., P.O. Box 151 Route 22, Somerville, NJ 08876,
US
(72) ROUSSEAU, Robert, A., 736 Geigel Hill Road, Ottsville, PA
18942, US

- (51) MKP
C07K 1/18 (2006.01) (97) **2414380 ***
C07K 1/20 (2006.01)
C07K 14/59 (2006.01)
- (86) EP2010002111 01.04.2010
(96) 10713424.9 08.02.2012
(87) WO2010115586, 01.04.2010
(97) 2414380, 08.02.2012 en
(54) METHOD FOR PURIFYING RECOMBINANT FSH
(71) BioGeneriX AG, High-Tech-Park Mannheim Janderstrasse 3, 68199 Mannheim, DE
(72) SCHECKERMANN, Christian, Sägegasse 1c, 79238 Ehrenkirchen/Ehrenstätten, DE
EICHINGER, Dietmar, Sternallee 1, 68723 Schwetzingen, DE
ARNOLD, Stefan, Marstallstrasse 49a, 68723 Schwetzingen, DE
-
- (51) MKP
A61P 9/10 (2006.01) (97) **2475681 ***
A61P 17/00 (2006.01)
C07K 14/515 (2006.01)
A61K 38/18 (2006.01)
- (86) EP2010063217 09.09.2010
(96) 10750131.4 18.07.2012
(87) WO2011029861, 09.09.2010
(97) 2475681, 18.07.2012 en
(54) PLGF-1 IN HOMODIMERIC FORM
(71) Dompé S.p.A., Via Campo di Pile snc, 67100 L'Aquila, IT
Geymonat S.p.A., Via S. Anna 2, 03012 Anagni (FR), IT
D'ANNIBALLE, Gaetano, Via Campo di Pile snc, I-67100 L'Aquila (AQ), IT
MARTIN, Franck, Via Campo di Pile snc, I-67100 L'Aquila (AQ), IT
SALVIA, Giuseppe, Via Andrea Doria 39, I-95123 Catania (CT), IT
-
- (51) MKP
C08G 69/26 (2006.01) (97) **2476717 ***
C08L 77/06 (2006.01)
- (86) JP2010065284 07.09.2010
(96) 10815339.6 18.07.2012
(87) WO2011030742, 07.09.2010
(97) 2476717, 18.07.2012 en
(54) POLYAMIDE AND POLYAMIDE COMPOSITION
(71) Asahi Kasei Chemicals Corporation, 1-105, Kanda Jinbocho Chiyoda-ku, Tokyo 101-8101, JP
(72) NITTO, Yu, 1-105 Kanda Jinbocho Chiyoda-ku, Tokyo 101-8101, JP
SHIKANO, Yasukazu, 1-105 Kanda Jinbocho Chiyoda-ku, Tokyo 101-8101, JP
IEDA, Shinji, 1-105 Kanda Jinbocho Chiyoda-ku, Tokyo 101-8101, JP
TERADA, Kazunori, 1-105 Kanda Jinbocho Chiyoda-ku, Tokyo 101-8101, JP
ARAMAKI, Masaaki, 1-105 Kanda Jinbocho Chiyoda-ku, Tokyo 101-8101, JP
-
- (51) MKP
C12Q 1/68 (2006.01) (97) **2411533 ***
- (86) EP2010053871 25.03.2010
(96) 10709859.2 01.02.2012
(87) WO2010127906, 25.03.2010
(97) 2411533, 01.02.2012 en
(54) GENETIC SEVERITY MARKERS IN MULTIPLE SCLEROSIS
(71) Merck Serono S.A., Centre Industriel, 1267 Coinsins, CH
ABDERRAHIM, Hadi, 170 avenue des Thermes, F-01220 Divonne les Bains, FR
WOJCIK, Jérôme, 218 Rue Combe de l'Eau, F-01220 Divonne Les Bains, FR
ESPOSITO, Federica, 4 Via Bergamo, I-24039 Sotto Il Monte Giovanni XXIII (BG), IT
DEBAILLEUL, Virginie, 555 Rue de Paruthiol, F-01630 Peron, FR
-
- (51) MKP
C07D 401/12 (2006.01) (97) **2426121 ***
A61K 31/4709 (2006.01)
A61P 11/00 (2006.01)
A61P 11/06 (2006.01)
A61P 43/00 (2006.01)
C07D 491/18 (2006.01)
- (86) JP2010057422 27.04.2010
(96) 10769723.7 07.03.2012
(87) WO2010126025, 27.04.2010
(97) 2426121, 07.03.2012 en
(54) QUATERNARY AMMONIUM SALT COMPOUND
(71) Teijin Pharma Limited, 2-1, Kasumigaseki 3-chome Chiyoda-ku, Tokyo 100-0013, JP
(72) MITSUYAMA, Etsuko, c/o Teijin Pharma Limited Tokyo Research Center 3-2 Asahigaoka 4-chome, Hino-shi Tokyo 191-0065, JP
HARA, Takayuki, c/o Teijin Pharma Limited Iwakuni Research Center 2-1 Hinode-cho, Iwakuni-shi Yamaguchi 740-0014, JP
IGARASHI, Junji, c/o Teijin Pharma Limited Tokyo Research Center 3-2 Asahigaoka 4-chome, Hino-shi Tokyo 191-0065, JP
SUGIYAMA, Hiroyuki, c/o Teijin Pharma Limited Tokyo Research Center 3-2 Asahigaoka 4-chome, Hino-shi Tokyo 191-0065, JP
YAMAMURA, Satoshi, c/o Teijin Pharma Limited Tokyo Research Center 3-2 Asahigaoka 4-chome, Hino-shi Tokyo 191-0065, JP
NOMURA, Johji, c/o Teijin Pharma Limited Tokyo Research Center 3-2 Asahigaoka 4-chome, Hino-shi Tokyo 191-0065, JP
SEGAWA, Kei, c/o Teijin Pharma Limited Tokyo Research Center 3-2 Asahigaoka 4-chome, Hino-shi Tokyo 191-0065, JP
-
- (51) MKP
B23K 20/12 (2006.01) (97) **2289659**
B29C 65/06 (2006.01)
F16B 37/06 (2006.01)
- (96) 10172958.0 02.03.2011
(97) 2289659, 02.03.2011 de
(54) Apparatus for frictionally connecting at least two plates through a connecting element with a system for measuring the applied load and the advancing length during connection
(71) EJOT GmbH & Co. KG, Untere Bienhecke, 57334 Bad Laasphe, DE
(72) Christ, Dr.-Ing. Eberhard, Bergstrasse 5, 99897 Tambach-Dietharz, DE
Thiem, Dipl.-Ing. Jörg, Schönauer Strasse 92, 98544 Zella-Mehlis, DE
Werkmeister, Marco, Talstrasse 37, 99894 Leinatal/ OT Engelsbach, DE
-
- (51) MKP
A23C 7/04 (2006.01) (97) **2408311 ***
A23C 9/14 (2006.01)
A23C 9/142 (2006.01)
A23C 21/00 (2006.01)
A23J 1/20 (2006.01)
A23L 1/29 (2006.01)
- (86) GB2010000478 17.03.2010
(96) 10710393.9 25.01.2012
(87) WO2010106319, 17.03.2010
(97) 2408311, 25.01.2012 en
(54) WHEY OR RAW MILK DEMINERALISATION AND FRACTIONATION.
(71) Separation Technologies Investments Limited, Mill Race Compton Abdale, Cheltenham GL54 4DR, GB
(72) SCOTT, Stephen Niall, 28 Gloucester Road Cheltenham, Gloucestershire GL51 8PA, GB
KRISHNAPILLAL, Ashok, The Wheel House Compton Abdale Cheltenham, Gloucestershire GL54 4DR, GB
-
- (51) MKP
G01N 33/50 (2006.01) (97) **2440924 ***
G01N 33/68 (2006.01)
- (86) EP2010058253 11.06.2010
(96) 10725154.8 18.04.2012
(87) WO2010142794, 11.06.2010
(97) 2440924, 18.04.2012 en
(54) IN VITRO METHOD FOR DETECTING GP91PHOX AS A MARKER OF OXIDATIVE STRESS
(71) Bios International S.r.l., Via Francesco Denza 27, 00197 Rome, IT
(72) VIOLI, Francesco, Via Trasone 68, I- 00199 Rome, IT
PIGNATELLI, Pasquale, Via Nerola 6, I- 00199 Rome, IT

- (51) MKP
C11C 5/00 (2006.01) (97) **2453002**
A61F 11/00 (2006.01)
- (96) 10190810.1 16.05.2012
(97) 2453002, 16.05.2012 de
(54) Ear candle
(71) Leschik, Udo, Westerwaldstrasse 3 33, 35630 Ehringshausen, DE
(72) Leschik, Udo, Westerwaldstrasse 3 33, 35630 Ehringshausen, DE
-
- (51) MKP
G01N 33/15 (2006.01) (97) **2470911 ***
G01N 33/53 (2006.01)
G01N 33/68 (2006.01)
- (86) US2010046689 25.08.2010
(96) 10815852.8 04.07.2012
(87) WO2011031493, 25.08.2010
(97) 2470911, 04.07.2012 en
(54) GALECTIN-3 AND CARDIAC RESYNCHRONIZATION THERAPY
(71) BG Medicine, Inc., 601 n. Lincoln Street, Waltham, MA 02451, US
(72) MUNTENDAM, Pieter, 642 Main Street, Boxford, MA 01921, US
-
- (51) MKP
C12P 21/06 (2006.01) (97) **2425008 ***
- (86) US2010032964 29.04.2010
(96) 10770329.0 07.03.2012
(87) WO2010127113, 29.04.2010
(97) 2425008, 07.03.2012 en
(54) TOLL-LIKE RECEPTOR 3 ANTAGONISTS
(71) Janssen Biotech, Inc., 800/850 Ridgeview Drive, Horsham, PA 19044, US
(72) CUNNINGHAM, Mark, 145 King Of Prussia Road, Radnor PA 19087, US
FENG, Yiqing, 145 King Of Prussia Road, Radnor PA 19087, US
HEERINGA, Katharine, 145 King Of Prussia Road, Radnor PA 19087, US
LUO, Jinquan, 145 King Of Prussia Road, Radnor PA 19087, US
RAUCHENBERGER, Robert, Lena-christ-strasse 48, 82490 Martinsried, DE
RUTZ, Mark, Lena-christ-strasse 48, 82490 Martinsried, DE
SAN MATEO, Lani, 145 King Of Prussia Road, Radnor PA 19087, US
SARISKY, Robert, Welsh & McKean Roads, Spring House PA 19477, US
SWEET, Raymond, 145 King Of Prussia Road, Radnor PA 19087, US
TENG, Fang, 145 King Of Prussia Road, Radnor PA 19087, US
TEPLYAKOV, Alexey, 145 King Of Prussia Road, Radnor PA 19087, US
WU, Sheng-jiun, 145 King Of Prussia Road, Radnor PA 19087, US
-
- (51) MKP
C07D 243/12 (2006.01) (97) **2415766 ***
A61P 1/04 (2006.01)
C07C 269/06 (2006.01)
A61P 35/00 (2006.01)
C07C 271/20 (2006.01)
A61P 35/02 (2006.01)
C07C 271/28 (2006.01)
A61P 43/00 (2006.01)
C07C 303/36 (2006.01)
C07B 61/00 (2006.01)
C07C 303/40 (2006.01)
C07C 311/16 (2006.01)
A61K 31/551 (2006.01)
- (86) JP2010002237 29.03.2010
(96) 10758238.9 08.02.2012
(87) WO2010113458, 29.03.2010
(97) 2415766, 08.02.2012 en
(54) METHOD FOR MANUFACTURING BENZODIAZEPINE DERIVATIVE
(71) Zeria Pharmaceutical Co., Ltd., 10-11, Nihonbashi Kobuna-cho Chuo-ku, Tokyo 103-8351, JP
(72) TERAUCHI, Masaru, c/o Zeria Pharmaceutical Co. Ltd. 10-11 Nihonbashi Kobuna-cho Chuo-ku, Tokyo 103-8351, JP
-
- (51) MKP
B01J 2/06 (2006.01) (97) **2305372**
- (96) 10178825.5 06.04.2011
(97) 2305372, 06.04.2011 de
(54) Device and method for pelletising or granulating a fluid or paste material
(71) Messer Group GmbH, Messer-Platz 1, 65812 Bad Soden, DE
Messer Austria GmbH, Industriestrasse 5, 2352 Gumpoldskirchen, AT
(72) Gockel, Frank, 10, rue de l'Eglise, 77410 Charny, FR
Kosock, Stefan, Am Riddershof 9, 47805 Krefeld, DE
Laimer, Walter, Hirtengasse 48, 7210 Mattersburg, AT
Lammertz, Monika, Kölner Str. 581, 47807 Krefeld, DE
Moser, Friedrich, Gerlingstr. 13, 47167 Duisburg, DE
-
- (51) MKP
A61F 5/56 (2006.01) (97) **2493436 ***
- (86) US2010052644 14.10.2010
(96) 10774048.2 05.09.2012
(87) WO2011053462, 14.10.2010
(97) 2493436, 05.09.2012 en
(54) FLEXIBLE IMPLANTS HAVING INTERNAL VOLUME SHIFTING CAPABILITIES FOR TREATING OBSTRUCTIVE SLEEP APNEA
(71) Ethicon, Inc., P.O. Box 151 Route 22, Somerville, NJ 08876, US
(72) ROUSSEAU, Robert, A., 736 Geigel Hill Road, Ottsville, PA 18942, US
-
- (51) MKP
A61F 2/64 (2006.01) (97) **2471496**
- (96) 12000014.6 04.07.2012
(97) 2471496, 04.07.2012 en
(54) Prosthetic knee used preferably for sports
(71) ART-LEG-d.o.o., Celjska cesta 8, 3310 Zalec, SI
(72) Zmago, Vidrih, Trdinova 34a, 8000 Nova Mesto, SI
-
- (51) MKP
C07D 413/04 (2006.01) (97) **2417131 ***
A61K 31/4523 (2006.01)
A61P 7/04 (2006.01)
- (86) SE2010050375 06.04.2010
(96) 10761933.0 15.02.2012
(87) WO2010117323, 06.04.2010
(97) 2417131, 15.02.2012 en
(54) ISOXAZOL-3(2H)-ONE ANALOGS AS THERAPEUTIC AGENTS
(71) AstraZeneca AB, null, 151 85 Södertälje, SE
(72) BOSTRÖM, Jonas, AstraZeneca R&D Mölndal, S-431 83 Mölndal, SE
CHENG, Leifeng, AstraZeneca R&D China Building 7, N° 898 Halei Road Zhangjiang Hi-Tech Park, Shanghai 201203, CN
FEX, Tomas, AstraZeneca R&D Mölndal, S-431 83 Mölndal, SE
KARLE, Michael, AstraZeneca R&D Mölndal, S-431 83 Mölndal, SE
PETTERSEN, Daniel, AstraZeneca R&D Mölndal, S-431 83 Mölndal, SE
SCHELL, Peter, AstraZeneca R&D Mölndal, S-431 83 Mölndal, SE
-
- (51) MKP
C09C 1/02 (2006.01) (97) **2423265**
C04B 14/28 (2006.01)
C04B 20/10 (2006.01)
C04B 28/02 (2006.01)
- (96) 10008803.8 29.02.2012
(97) 2423265, 29.02.2012 en
(54) Process for the preparation of cement, mortars, concrete compositions containing a calcium carbonate-based filler (pre)-treated with a superplasticizer, compositions and cement products obtained and their applications
(71) Omya Development AG, Baslerstrasse 42, 4665 Oftringen, CH
(72) Skovby, Michael, Wampflenstrasse 52, 8706 Meilen, CH
Gonnon, Pascal, 8 Allée des Marguerites, 01480 Villeneuve, FR

- (51) MKP
C12Q 1/68 (2006.01) (97) **2430183 ***
 (86) US2010035045 15.05.2010
 (96) 10719224.7 21.03.2012
 (87) WO2010132866, 15.05.2010
 (97) 2430183, 21.03.2012 en
 (54) ANTIPSYCHOTIC TREATMENT BASED ON DRD2 OR ANKK1 SNP GENOTYPE
 (71) Vanda Pharmaceuticals Inc., 9605 Medical Center Drive, Suite 300, Rockville, NY 20850, US
 (72) LAVEDAN, Christian, 22 Eldwick Court, Potomac MD 20854, US
 VOLPI, Simona, 7213 Bettendorf Court, Derwood MD 20855, US

- (51) MKP
A61P 29/00 (2006.01) (97) **2490766 ***
A61P 35/00 (2006.01)
C07K 5/00 (2006.01)
A61K 38/00 (2006.01)
 (86) EP2010063894 21.09.2010
 (96) 10760655.0 29.08.2012
 (87) WO2011047926, 21.09.2010
 (97) 2490766, 29.08.2012 en
 (54) NON-NATURAL MACROCYCLIC AMIDE HDAC6 INHIBITOR COMPOUNDS AND THEIR USES AS THERAPEUTIC AGENTS
 (71) SIGMA-TAU Industrie Farmaceutiche Riunite S.p.A., Viale Shakespeare 47, 00144 Roma, IT
 (72) GIANNINI, Giuseppe, Via Boezio 46/B, I-00040 Pomezia (RM), IT
 CABRI, Walter, Via Pisacane 5, I-20089 Rozzano (MI), IT
 HANESSIAN, Stephan, 65 Gales Court, Beaconsfield, Quebec H9W 5H3, CA
 AUZZAS, Luciana, Piazza Nazario Sauro 1, I-07100 Sassari, IT
 LARSSON, Andreas, Ostermalmsgatan 50, S-90332 Umea, SE

- (51) MKP
G06Q 30/00 (2006.01) (97) **2323095**
 (86) 10011799.3 18.05.2011
 (97) 2323095, 18.05.2011 en
 (54) Mediation of content-related services
 (71) Sony Computer Entertainment Inc., 2-6-21, Minami-Aoyama Minato-ku, Tokyo 107-0062, JP
 (72) Chopra, Vivek, Sony Computer Entertainment Inc. 2-6-21 Minami-Aoyama Minato-ku, Tokyo, 107-0062, JP
 Gaxiola, David, Sony Computer Entertainment Inc. 2-6-21 Minami-Aoyama Minato-ku, Tokyo, 107-0062, JP
 Marr, James, Sony Computer Entertainment Inc. 2-6-21 Minami-Aoyama Minato-ku, Tokyo, 107-0062, JP
 Detwiler, Stephen, Sony Computer Entertainment Inc. 2-6-21 Minami-Aoyama Minato-ku, Tokyo, 107-0062, JP
 Maegawa, Hiroto, Sony Computer Entertainment Inc. 2-6-21 Minami-Aoyama Minato-ku, Tokyo, 107-0062, JP
 Lima, Shin, Sony Computer Entertainment Inc. 2-6-21 Minami-Aoyama Minato-ku, Tokyo, 107-0062, JP

- (51) MKP
C07K 16/28 (2006.01) (97) **2440579 ***
 (86) GB2010001130 09.06.2010
 (96) 10723748.9 18.04.2012
 (87) WO2010142952, 09.06.2010
 (97) 2440579, 18.04.2012 en
 (54) ANTIBODIES
 (71) Affitech Research AS, Oslo Research Park Gaustadalléen 21, 0349 Oslo, NO
 (72) CICORTAS GUNNARSSON, Lavinia Diana, Tingstuveien 17A, N-0281 Oslo, NO
 PAUS, Didrik, Olav Aukrust vei 4b, N-0785 Oslo, NO

- (51) MKP
A61P 27/02 (2006.01) (97) **2493480 ***
A61K 31/7076 (2006.01)
 (86) US2010054040 26.10.2010
 (96) 10827379.8 05.09.2012
 (87) WO2011053569, 26.10.2010
 (97) 2493480, 05.09.2012 en
 (54) OPHTHALMIC FORMULATION AND METHOD OF MANUFACTURE THEREOF
 (71) Inotek Pharmaceuticals Corporation, 33 Hayden Avenue, Second Floor, Lexington, MA 02421, US
 (72) AVERY, Kenneth, L., 11 Whitewoodlane, Merrimack, NH 03054, US
 TAKRURI, Harun, 2900 Corete Portofino, Newport Beach, CA 92660, US

- (51) MKP
C12Q 1/00 (2006.01) (97) **2464741 ***
 (86) US2010044921 09.08.2010
 (96) 10808602.6 20.06.2012
 (87) WO2011019670, 09.08.2010
 (97) 2464741, 20.06.2012 en
 (54) METHODS OF DETECTING RESPONSES TO THERAPIES USING PERFORIN LEVELS
 (71) Nayak, Ramesh C., 9040 South Rita Road, Suite 1100, Tucson, AZ 85747, US
 (72) Nayak, Ramesh C., 9040 South Rita Road, Suite 1100, Tucson, AZ 85747, US

- (51) MKP
H04S 3/00 (2006.01) (97) **2360683**
G10L 19/00 (2006.01)
 (86) 11154910.1 24.08.2011
 (97) 2360683, 24.08.2011 en
 (54) Audio decoder and decoding method using efficient downmixing
 (71) Dolby Laboratories Licensing Corporation, 100 Potrero Avenue, San Francisco, CA 94103-4813, US
 Dolby International AB, Apollo Building, 3E Herikerbergweg 1-13, 1101 CN Amsterdam Zuidoost, NL
 (72) THESING, Robin, Baerenschanzstrasse 63, 90429, Nürnberg, DE
 SILVA, James, M., 2063 Lynwood Terrace, San Jose, CA 95128, US
 ANDERSEN, Robert, L., 1590 Golden Gate Avenue, Unit B, San Francisco, CA 94115, US

- (51) MKP
A61K 31/4412 (2006.01) (97) **2412708 ***
A61K 31/497 (2006.01)
C07D 401/04 (2006.01)
A61K 31/443 (2006.01)
A61K 31/506 (2006.01)
C07D 401/06 (2006.01)
A61K 31/4433 (2006.01)
A61K 31/5377 (2006.01)
C07D 401/10 (2006.01)
A61K 31/4436 (2006.01)
A61P 31/00 (2006.01)
A61K 31/4439 (2006.01)
A61P 31/16 (2006.01)
A61K 31/444 (2006.01)
A61P 31/18 (2006.01)
A61K 31/4545 (2006.01)
A61P 43/00 (2006.01)
C07D 213/80 (2006.01)
A61K 31/4709 (2006.01)
C07D 213/89 (2006.01)
 (86) JP2010054911 23.03.2010
 (96) 10756027.8 01.02.2012
 (87) WO2010110231, 23.03.2010
 (97) 2412708, 01.02.2012 en
 (54) SUBSTITUTED 3-HYDROXY-4-PYRIDONE DERIVATIVE
 (71) Shionogi & Co., Ltd., 1-8, Doshomachi 3-chome Chuo-ku Osaka-shi, Osaka 541-0045, JP
 (72) FUJISHITA, Toshio, 27-17, Hanayashiki 1-chome Kawanishi-shi, Hyogo 666-0035, JP
 MIKAMIYAMA, Minako, c/o Shionogi&Co. Ltd. 12-4, Sagisu 5-chome Fukushima-ku, Osaka-shi Osaka 553-0002, JP
 KAWAI, Makoto, c/o Shionogi&Co. Ltd. 12-4, Sagisu 5-chome Fukushima-ku, Osaka-shi Osaka 553-0002, JP
 AKIYAMA, Toshiyuki, c/o Shionogi&Co. Ltd. 12-4, Sagisu 5-chome Fukushima-ku, Osaka-shi Osaka 553-0002, JP

- (51) MKP
C12N 9/82 (2006.01) (97) **2451486 ***
A61P 35/02 (2006.01)
A61K 47/48 (2006.01)
- (86) EP2010059599 06.07.2010
(96) 10730170.7 16.05.2012
(87) WO2011003886, 06.07.2010
(97) 2451486, 16.05.2012 en
(54) PEGYLATED L-ASPARAGINASE
(71) Alize Pharma II, 15 Chemin Du Saquin Espace Europeen, 69130 Ecully, FR
(72) ABRIBAT, Thierry, 124 Chemin de Montray, F-69110 Sainte Foy Les Lyon, FR
-
- (51) MKP
B65F 1/06 (2006.01) (97) **2354041**
- (96) 11152547.3 10.08.2011
(97) 2354041, 10.08.2011 de
(54) Refuse receptacle with means for fixing a trash bag
(71) Hailo-Werk Rudolf Loh GmbH & Co. KG, Daimlerstrasse 8, 35708 Haiger, DE
(72) Fatrai, Alexander, Hintergasse 52a, 35216 Biedenkopf, DE
Phetkhajee, Kasem, Blüscherstr. 7, 57072 Siegen, DE
-
- (51) MKP
A61K 9/20 (2006.01) (97) **2460523 ***
A61K 47/04 (2006.01)
A61K 47/38 (2006.01)
A61K 31/506 (2006.01)
- (86) JP2010062568 27.07.2010
(96) 10804385.2 06.06.2012
(87) WO2011013639, 27.07.2010
(97) 2460523, 06.06.2012 en
(54) TABLET
(71) Takeda Pharmaceutical Company Limited, 1-1 Doshomachi 4-chome Chuo-ku, Osaka-shi, Osaka 541-0045, JP
(72) MURAKAWA, Yusuke, c/o Takeda Pharmaceutical Company Limited 17-85, Jusohonmachi 2-chome, Yodogawa-ku, Osaka-shi Osaka 532-0024, JP
OKABE, Takayuki, c/o TAKEDA PHARMACEUTICAL COMPANY LIMITED 17-85 Jusohonmachi 2-chome Yodogawa-ku, Osaka-shi Osaka 532-8686, JP
-
- (51) MKP
A61M 5/32 (2006.01) (97) **2403570 ***
- (86) EP2010052787 04.03.2010
(96) 10707023.7 11.01.2012
(87) WO2010100242, 04.03.2010
(97) 2403570, 11.01.2012 en
(54) DRUG DELIVERY DEVICE
(71) Sanofi-Aventis Deutschland GmbH, Brüningstraße 50, 65929 Frankfurt, DE
(72) LANIN, Irina, c/o Sanofi-Aventis Deutschland GmbH, 65926 Frankfurt am Main, DE
FORYS, Bernhard, c/o Sanofi-Aventis Deutschland GmbH, 65926 Frankfurt am Main, DE
CLARKE, Alastair, c/o Sanofi-Aventis UK London Road Crewe, Holmes Chapel Cheshire CW4 8BE, GB
EKMAN, Matthew, c/o Sanofi-Aventis UK London Road Crewe, Holmes Chapel Cheshire CW4 8BE, GB
GOODE, Kirsten, c/o Sanofi-Aventis UK London Road Crewe, Holmes Chapel Cheshire CW4 8BE, GB
HEALD, Michael, c/o Sanofi-Aventis UK London Road Crewe, Holmes Chapel Cheshire CW4 8BE, GB
HILES, John, c/o Sanofi-Aventis UK London Road Crewe, Holmes Chapel Cheshire CW4 8BE, GB
SMITH, Chris, c/o Sanofi-Aventis UK London Road, Crewe Holmes Chapel CW4 8BE, GB
-
- (51) MKP
H01F 41/02 (2006.01) (97) **2372726**
H01F 1/057 (2006.01)
- (96) 11159094.9 05.10.2011
(97) 2372726, 05.10.2011 en
(54) Rare-earth magnet, method of manufacturing rare-earth magnet and rotator
(71) TDK Corporation, 1-13-1, Nihonbashi, Chuo-ku, Tokyo 103-8272, JP
(72) Miwa, Masashi, c/o TDK Corporation 1-13-1, Nihonbashi, Chuo-ku Tokyo 103-8272, JP
Kawanaka, Yasuyuki, c/o TDK Corporation 1-13-1, Nihonbashi, Chuo-ku Tokyo 103-8272, JP
Oishi, Masahiro, c/o TDK Corporation 1-13-1, Nihonbashi, Chuo-ku Tokyo 103-8272, JP
-
- (51) MKP
C07H 17/02 (2006.01) (97) **2470552 ***
- (86) EP2010062461 26.08.2010
(96) 10747209.4 04.07.2012
(87) WO2011023754, 26.08.2010
(97) 2470552, 04.07.2012 en
(54) NOVEL CRYSTALLINE HETEROAROMATIC FLUOROGLYCOSIDE HYDRATES, PHARMACEUTICALS COMPRISING THESE COMPOUNDS AND THEIR USE
(71) SANOFI, 54 rue La Boétie, 75008 Paris, FR
(72) RIGAL, David, c/o Sanofi-Aventis Deutschland GmbH, 65926 Frankfurt am Main, DE
FISCHER, Franceska, c/o Sanofi-Aventis Deutschland GmbH, 65926 Frankfurt am Main, DE
BECKER, Bernd, c/o Sanofi-Aventis Deutschland GmbH, 65926 Frankfurt am Main, DE
FETH, Martin, c/o Sanofi-Aventis Deutschland GmbH, 65926 Frankfurt am Main, DE
NAGEL, Norbert, c/o Sanofi-Aventis Deutschland GmbH, 65926 Frankfurt am Main, DE
BAUMGARTNER, Bruno, c/o Sanofi-Aventis Deutschland GmbH, 65926 Frankfurt am Main, DE
BRÖCKELMANN, Martin, c/o Sanofi-Aventis Deutschland GmbH, 65926 Frankfurt am Main, DE
-
- (51) MKP
A61K 47/14 (2006.01) (97) **2440188 ***
A61K 31/197 (2006.01)
A61K 9/20 (2006.01)
A61K 9/48 (2006.01)
A61K 9/02 (2006.01)
- (86) EP2010003531 11.06.2010
(96) 10725043.3 18.04.2012
(87) WO2010142456, 11.06.2010
(97) 2440188, 18.04.2012 en
(54) SOLID COMPOSITIONS COMPRISING 5-AMINOLEVULINIC ACID
(71) Photocure ASA, Hoffsvæien 4, 0275 Oslo, NO
HELLAND, Oddveig Sellaeg, Kvernfaret 18, NO-0383 Oslo, NO
STENSRUD, Gry, Skogveien 75, N-1484 Nittedal, NO
KLEM, Bjorn, Fredriksborgveien 50B, NO-0286 Oslo, NO
BRAENDEN, Jon Erik, Kjelsasveien 95C, NO-0491 Oslo, NO
GODAL, Aslak, Gaustadveien 77, N-0372 Oslo, NO
KLAVENESS, Jo, Midtaasen 5, N-1166 Oslo, NO
-
- (51) MKP
C07D 213/803 (2006.01) (97) **2488497 ***
C07C 211/45 (2006.01)
C07C 211/64 (2006.01)
C07D 213/80 (2006.01)
- (86) EP2010006283 14.10.2010
(96) 10765586.2 22.08.2012
(87) WO2011045059, 14.10.2010
(97) 2488497, 22.08.2012 en
(54) PROCESS FOR MANUFACTURING 2-[(3,5-DIFLUORO-3'-METHOXY-1,1'-BIPHENYL-4-YL)AMINO]NICOTINIC ACID
(71) Almirall S.A., Ronda del General Mitre, 151, 08022 Barcelona, ES
(72) BOIX BERNARDINI, Maria, Carmen, C/ Laureá Mir 408-410, E-08980 Sant Feliu de Llobregat, ES

- (51) MKP
A61B 17/00 (2006.01) (97) **2485661 ***
A61B 17/29 (2006.01)
A61B 17/28 (2006.01)
A61B 18/08 (2006.01)
A61B 18/00 (2006.01)
(86) US2010051794 07.10.2010
(96) 10768131.4 15.08.2012
(87) WO2011044343, 07.10.2010
(97) 2485661, 15.08.2012 en
(54) SURGICAL INSTRUMENT
(71) Ethicon Endo-Surgery, Inc., 4545 Creek Road, Cincinnati, OH 45242, US
(72) TREES, Gregory, A., 9265 Hickory Hill Court, Loveland, OH 45140, US
BOUDREAUX, Chad, P., 10840 Lakehurst Court, Cincinnati, OH 45242, US
ANDREYKO, Michael, J., 8575 Clough Pike, Cincinnati, OH 45244, US
FELDER, Kevin, 2460 Downing Drive, Cincinnati, OH 45208, US
BATROSS, Jonathan, T., 7883 Yellowwood Drive, Mason, OH 45040, US
GIORDANO, James, R., 5647 Chestnutview Lane, Milford, OH 45150, US
MCFARLAND, Terry, A., 6396 Thistlewood Lane, Burlington, KY 41005, US

- (51) MKP
C07K 16/18 (2006.01) (97) **2403874 ***
C07K 16/00 (2006.01)
(86) US2010026410 05.03.2010
(96) 10707789.3 11.01.2012
(87) WO2010102241, 05.03.2010
(97) 2403874, 11.01.2012 en
(54) ANTIBODY FORMULATION
(71) Genentech, Inc., 1 DNA Way, MS49, South San Francisco, CA 94080-4990, US
(72) ESUE, Osi, 58 North El Camino Real 208, San Mateo, California 94401, US

- (51) MKP
A23J 1/14 (2006.01) (97) **2448423 ***
A23J 3/16 (2006.01)
A23L 2/02 (2006.01)
(86) CA2010001015 30.06.2010
(96) 10793473.9 09.05.2012
(87) WO2011000096, 30.06.2010
(97) 2448423, 09.05.2012 en
(54) PRODUCTION OF ACID SOLUBLE SOY PROTEIN ISOLATES ("S700")
(71) Burcon Nutrascience (MB) Corp., 1388 Waller Avenue, Winnipeg, Manitoba R3T 1P9, CA
(72) SCHWEIZER, Martin, 117 Haig Avenue, Winnipeg, Manitoba R2M 0E3, CA
SEGALL, Kevin, I., 31 Dunbar Crescent, Winnipeg, Manitoba R3P 0W6, CA
GREEN, Brent, E., 24 Poplarwood Drive Box 603, Warren, Manitoba R0C 3E0, CA
MEDINA, Sarah, 315 Wildwood Park, Winnipeg, Manitoba R3T 0E5, CA
GOSNELL, Brandy, 118 Arden Avenue, Winnipeg, Manitoba R2M 2K2, CA

- (51) MKP
G01N 33/577 (2006.01) (97) **2499494 ***
G01N 33/50 (2006.01)
G01N 33/68 (2006.01)
G01N 33/53 (2006.01)
(86) US2010055997 09.11.2010
(96) 10829274.9 19.09.2012
(87) WO2011057250, 09.11.2010
(97) 2499494, 19.09.2012 en
(54) REAGENTS AND METHODS FOR DETECTING PNH TYPE II WHITE BLOOD CELLS AND THEIR IDENTIFICATION AS RISK FACTORS FOR THROMBOTIC DISORDERS
(71) ALEXION PHARMACEUTICALS, INC., 352 Knottter Drive, Cheshire, CT 06410, US
(72) MOVALIA, Mayur, 21 Rosebud Lane, Brewer, ME 04412, US
ILLINGWORTH, Andrea, 150 Eaton Ridge, Holden, ME 04429, US
FAAS MCKNIGHT, Susan, 14 Stonewood Drive, Old Lyme, CT 06371, US
ROTHER, Russell, P., 10325 Forest Meadow Drive, Oklahoma City, OK 73151, US

- (51) MKP
C12P 21/06 (2006.01) (97) **2451840 ***
C07K 16/00 (2006.01)
(86) US2010040471 29.06.2010
(96) 10797631.8 16.05.2012
(87) WO2011005621, 29.06.2010
(97) 2451840, 16.05.2012 en
(54) DESIGN OF STABLE AND AGGREGATION FREE ANTIBODY FC MOLECULES THROUGH CH3 DOMAIN INTERFACE ENGINEERING
(71) Amgen Inc., One Amgen Center Drive, Thousand Oaks, CA 91320-1799, US
(72) KANNAN, Gunasekaran, 1168 Westlake Blvd, Unit B, Westlake Village, CA 91361, US
ZHOU, Hongxing, 6324 151st Avenue SE, Bellevue Washington 98006, US

- (51) MKP
A61K 39/12 (2006.01) (97) **2445525 ***
C07K 14/025 (2006.01)
(86) EP2010059024 24.06.2010
(96) 10727731.1 02.05.2012
(87) WO2010149752, 24.06.2010
(97) 2445525, 02.05.2012 en
(54) NOVEL HUMAN PAPILOMAVIRUS (HPV) PROTEIN CONSTRUCTS AND THEIR USE IN THE PREVENTION OF HPV DISEASE
(71) GlaxoSmithKline Biologicals S.A., rue de l'Institut, 89, 1330 Rixensart, BE
(72) BAUDOUX, Guy Jean Marie Fernand Pierre, GlaxoSmithKline Biologicals s.a. rue de l'Institut 89, B-1330 Rixensart, BE
COLAU, Brigitte Desiree Alberte, GlaxoSmithKline Biologicals s.a. rue de l'Institut 89, B-1330 Rixensart, BE
DENDOUGA, Najoua, GlaxoSmithKline Biologicals s.a. rue de l'Institut 89, B-1330 Rixensart, BE
GIANNINI, Sandra, GlaxoSmithKline Biologicals s.a. rue de l'Institut 89, B-1330 Rixensart, BE
LECRENIER, Nicolas Pierre Fernand, GlaxoSmithKline Biologicals s.a. Parc de la Noire Epine rue Fleming 20, B-1300 Wavre, BE

- (51) MKP
A61K 31/519 (2006.01) (97) **2405916 ***
A61P 35/00 (2006.01)
(86) US2010026903 11.03.2010
(96) 10708866.8 18.01.2012
(87) WO2010105008, 11.03.2010
(97) 2405916, 18.01.2012 en
(54) COMBINATIONS OF PHOSPHOINOSITIDE 3-KINASE INHIBITOR COMPOUNDS AND CHEMOTHERAPEUTIC AGENTS FOR THE TREATMENT OF HEMATOPOIETIC MALIGNANCIES
(71) Genentech, Inc., 1 DNA Way, South San Francisco, CA 94080, US
(72) EBENS, Allen, J., Jr., 1932 Arroyo Avenue, San Carlos California 94070, US
FRIEDMAN, Lori, 113 Arundel Road, San Carlos California 94070, US

- (51) MKP
E02B 3/20 (2006.01) (97) **2454417 ***
(86) EP2010059985 12.07.2010
(96) 10730478.4 23.05.2012
(87) WO2011006872, 12.07.2010
(97) 2454417, 23.05.2012 en
(54) DEVICE FOR PROTECTING A BERTHING PLACE
(71) Arco S.R.L., Via Andrea Costa 24/D, 40017 San Giovanni In Persiceto, IT
(72) MATTIOLI, Francesco, Via Bologna 15, I-40017 San Giovanni In Persiceto, IT
-
- (51) MKP
G06T 17/00 (2006.01) (97) **2417580 ***
G01S 13/95 (2006.01)
G06F 3/14 (2006.01)
(86) US2010029991 05.04.2010
(96) 10762267.2 15.02.2012
(87) WO2010117959, 05.04.2010
(97) 2417580, 15.02.2012 en
(54) SYSTEM FOR DRAPING METEOROLOGICAL DATA ON A THREE DIMENSIONAL TERRAIN IMAGE
(71) Baron Services, Inc., 4930 Research Drive, Huntsville, AL 35805, US
(72) WILCOX, Sherman, L., 4930 Research Drive, Huntsville AL 35805, US
DREISEWERD, Robert, J., 4930 Research Drive, Huntsville AL 35805, US
-
- (51) MKP
A61K 9/12 (2006.01) (97) **2435024 ***
A61P 11/00 (2006.01)
(86) US2010036650 28.05.2010
(96) 10727551.3 04.04.2012
(87) WO2010138862, 28.05.2010
(97) 2435024, 04.04.2012 en
(54) COMPOSITIONS FOR RESPIRATORY DELIVERY OF ACTIVE AGENTS AND ASSOCIATED METHODS AND SYSTEMS
(71) Pearl Therapeutics, Inc., 200 Saginaw Drive, Redwood City, CA 94063, US
(72) VEHRING, Reinhard, 200 Saginaw Drive, Redwood City, CA 94063, US
HARTMAN, Michael, Steven, 3820 Park Blvd. Apt. 23, Palo Alto, CA 94306, US
SMITH, Adrian, Edward, 2 Wilmington Acres Court, Emerald Hills, CA 94062, US
JOSHI, Vidya, B., 812 Seal Pointe Drive, Redwood City, CA 94065, US
DWIVEDI, Sarvajna, Kumar, 409 Whisper Lane, Redwood City, CA 94065, US
-
- (51) MKP
C07D 519/00 (2006.01) (97) **2430031 ***
C07D 471/04 (2006.01)
A61K 31/437 (2006.01)
A61P 25/00 (2006.01)
(86) EP2010002908 11.05.2010
(96) 10721118.7 21.03.2012
(87) WO2010130422, 11.05.2010
(97) 2430031, 21.03.2012 en
(54) 1,2,4-TRIAZOLO[4,3-A]PYRIDINE DERIVATIVES AND THEIR USE AS POSITIVE ALLOSTERIC MODULATORS OF MGLUR2 RECEPTORS
(71) Janssen Pharmaceuticals Inc., 1125 Trenton-Harbourton Road, Titusville NJ 08560, US
Addex Pharma SA, 12 Chemin des Aulx, 1228 Plan-les-Ouates, CH
(72) CID-NÚÑEZ, José Maria, Janssen-Cilag S.A. Calle Jarama 75 Poligono Industrial, 45007 Toledo, ES
DE LUCAS OLIVARES, Ana, Isabel, Janssen-Cilag S.A. Calle Jarama 75 Poligono Industrial, 45007 Toledo, ES
TRABANCO-SUÁREZ, Andrés, Avelino, Janssen-Cilag S.A. Calle Jarama 75 Poligono Industrial, 45007 Toledo, ES
MACDONALD, Gregor, James, Janssen Pharmaceutica NV Turnhoutseweg 30, B-2340 Beerse, BE
-
- (51) MKP
C12N 5/0783 (2010.01) (97) **2470566 ***
A61K 39/395 (2006.01)
C07K 16/24 (2006.01)
(86) US2010045420 13.08.2010
(96) 10745103.1 04.07.2012
(87) WO2011028390, 13.08.2010
(97) 2470566, 04.07.2012 en
(54) COMPOSITIONS AND METHODS FOR POTENTIATING INTERLEUKIN-35
(71) St. Jude Children's Research Hospital, 262 Danny Thomas Place, Memphis, TN 38105-2794, US
(72) COLLISON, Lauren, W., 262 Danny Thomas Place, Memphis, TN 38105-2794, US
VIGNALI, Dario, A., A., 2900 Waterleaf Drive, Germantown, TN 38138, US
-
- (51) MKP
G07F 11/54 (2006.01) (97) **2478499 ***
(86) IB2010002427 16.09.2010
(96) 10776412.8 25.07.2012
(87) WO2011033386, 16.09.2010
(97) 2478499, 25.07.2012 en
(54) METHOD AND SYSTEM OF DISPLAYING, MANAGING AND SELLING IMAGES IN AN EVENT PHOTOGRAPHY ENVIRONMENT
(71) Image Holdings, P.O. Box 10310 APO, Grand Cayman, KY1-1003, KY
(72) SMITH, Caine, P.O. Box 10310 APO, Grand Cayman KY1-1003, KY
BRYNLEY, Davies, P.O. Box 10310 APO, Grand Cayman KY1-1003, KY
WEIL, Daniel, 11 Needham Road, London W11 2RP, GB
-
- (51) MKP
H01R 13/24 (2006.01) (97) **2237378**
H01R 13/33 (2006.01)
H01R 43/16 (2006.01)
H01R 12/04 (2006.01)
H01R 12/22 (2006.01)
(96) 10002975.0 06.10.2010
(97) 2237378, 06.10.2010 de
(54) Contact device
(71) Amphenol-Tuchel Electronics GmbH, August-Häusser-Strasse 10, 74080 Heilbronn, DE
(72) Kuntz, Julio, Brunnensteige 14, 74861 Neudenu, DE
Stolz, Joachim, Elser-Ring 5, 74354 Besigheim, DE
-
- (51) MKP
C07C 51/41 (2006.01) (97) **2371800**
C07C 51/02 (2006.01)
C07C 51/46 (2006.01)
C07C 55/10 (2006.01)
C07C 51/44 (2006.01)
(96) 11160054.0 05.10.2011
(97) 2371800, 05.10.2011 en
(54) Processes for producing monoammonium succinate from fermentation broths containing diammonium succinate, monoammonium succinate and/or succinic acid, and conversion of monoammonium succinate to succinic acid
(71) BioAmber S.A.S., 1250 Rene-Levesque Boulevard, West Suite 4110, Montreal H3B 4W8, CA
(72) Fruchey, Olan S., 13 Greenbrier Avenue, Hurricane, WV 25526, US
Keen, Brian T., 108 Hughes Drive, Pinch, WV 25156, US
Albin, Brooke A., 1026 Gordon Drive, Charleston, WV 25303, US
Clinton, Nye A., 16 Christopher Drive, Hurricane, WV 25526, US
Dunuwila, Dilum, 394 Franklin Avenue, Princeton, NJ 08540, US
Dombek, Bernard D., 1620 Woodvale Drive, Charleston, WV 25314, US

- (51) MKP
A61K 31/4166 (2006.01) (97) **2429522 ***
 (86) US2010034297 11.05.2010
 (96) 10775359.2 21.03.2012
 (87) WO2010132390, 11.05.2010
 (97) 2429522, 21.03.2012 en
 (54) METHOD OF DECREASING UBIQUITYLATED PROTEIN LEVELS
 (71) The Regents of the University of California Office of Technology Transfer, 1111 Franklin Street, 12th Floor, Oakland, California 94607-5200, US
 ZENYAKU KOGYO KABUSHIKIKAISHA, 2-9 Nihonbashi-Muromachi 3-chome Chuo-ku, Tokyo 103-0022, JP
 (72) GREEN, Kim, Nicholas, 1438 Posada, Newport Beach, CA 92660, US
 OLTERS DORF, Tilman, 427 Bristol Road, Cardiff, CA 92007, US
 ROGERS, Sharon, 3427 S. Bloomington Drive West, St. George, UT 8470, US
 WEBER, Eckard, 4040 Miller Street, San Diego, CA 92103, US
 LAFERLA, Frank, 58 Harvey Court, Irvine, CA 92617, US

- (51) MKP
C07C 327/48 (2006.01) (97) **2441752 ***
 (86) JP2010060003 08.06.2010
 (96) 10786263.3 18.04.2012
 (87) WO2010143735, 08.06.2010
 (97) 2441752, 18.04.2012 en
 (54) METHOD FOR PRODUCING 4-SUBSTITUTED BENZOTHIOAMIDE DERIVATIVE
 (71) Teijin Pharma Limited, 2-1, Kasumigaseki 3-chome Chiyoda-ku, Tokyo 100-0013, JP
 (72) SUGIURA, Satoshi, c/o Teijin Pharma Limited Iwakuni Research Center 2-1 Hinode-cho, Iwakuni-shi Yamaguchi 740-0014, JP

- (51) MKP
A61K 31/5377 (2006.01) (97) **2414338 ***
A61P 11/00 (2006.01)
A61P 35/00 (2006.01)
C07D 239/94 (2006.01)
 (86) EP2011052149 14.02.2011
 (96) 11703876.0 08.02.2012
 (87) WO2011098607, 14.02.2011
 (97) 2414338, 08.02.2012 de
 (54) SALTS AND HYDRATES OF 4-[(3-CHLOR-4-FLUORO-PHENYL)AMINO]-6-(CIS-4-{N-[(MORPH-1-OLINO-4-YL) CARBONYL]-N-METHYL-AMINO}-CYCLOHEXANE-1-YLOXY)-7-METHOXY-QUINAZOLINE, THEIR USE AS DRUGS AND THEIR PRODUCTION
 (71) Boehringer Ingelheim International GmbH, Binger Strasse 173, 55216 Ingelheim am Rhein, DE
 (72) EGEN, Marc, Boehringer Ingelheim GmbH Corporate Patents Binger Str. 173, 55216 Ingelheim Am Rhein, DE
 RALL, Werner, Boehringer Ingelheim GmbH Corporate Patents Binger Str. 173, 55216 Ingelheim Am Rhein, DE
 SANTAGOSTINO, Marco, Boehringer Ingelheim GmbH Corporate Patents Binger Str. 173, 55216 Ingelheim Am Rhein, DE
 SCHNAUBELT, Juergen, Boehringer Ingelheim GmbH Corporate Patents Binger Str. 173, 55216 Ingelheim Am Rhein, DE
 SIEGER, Peter, Boehringer Ingelheim GmbH Corporate Patents Binger Str. 173, 55216 Ingelheim Am Rhein, DE
 SOYKA, Rainer, Boehringer Ingelheim GmbH Corporate Patents Binger Str. 173, 55216 Ingelheim Am Rhein, DE

- (51) MKP
G01N 33/52 (2006.01) (97) **2459752 ***
C12N 15/11 (2006.01)
C12Q 1/68 (2006.01)
 (86) US2010042889 22.07.2010
 (96) 10806843.8 06.06.2012
 (87) WO2011017013, 22.07.2010
 (97) 2459752, 06.06.2012 en
 (54) ENTEROCOCCUS AND FECAL BACTEROIDES FOR RAPID WATER QUALITY ASSESSMENT
 (71) The University of North Carolina at Chapel Hill, 308 Bynum Hall Campus Box 4105, Chapel Hill, NC 27599-4105, US
 (72) BLACKWOOD, Angelia, Denene, 217 Sea Gate Blvd., Newport, NC 28557, US
 NOBLE, Rachel, T., 150 Locust Lane, Beaufort, NC 28516, US

- (51) MKP
A61B 5/11 (2006.01) (97) **2451352 ***
 (86) IS2010000010 07.07.2010
 (96) 10745437.3 16.05.2012
 (87) WO2011004403, 07.07.2010
 (97) 2451352, 16.05.2012 en
 (54) METHOD FOR ACCURATE ASSESSMENT AND GRADED TRAINING OF SENSORIMOTOR FUNCTIONS
 (71) Kristjansson, Eythor, Skildinganesi 36, 101 Reykjavik, IS
 (72) Kristjansson, Eythor, Skildinganesi 36, 101 Reykjavik, IS

- (51) MKP
A61K 31/407 (2006.01) (97) **2470540 ***
A61P 25/28 (2006.01)
C07D 487/04 (2006.01)
 (86) US2010046671 25.08.2010
 (96) 10750210.6 04.07.2012
 (87) WO2011028580, 25.08.2010
 (97) 2470540, 04.07.2012 en
 (54) NOVEL FORMS OF A MULTICYCLIC COMPOUND
 (71) Cephalon, Inc., 41 Moores Road, Frazer, Pennsylvania 19355, US
 (72) FIELD, R. Scott, 1431 Heather Lane, West Chester, Pennsylvania 19380, US
 YAZDANIAN, Mehran, p306 2001 Hamilton Street, Philadelphia, Pennsylvania 19130, US
 HALTIWANGER, R. Curtis, 1262 Bridgewater Drive, West Chester, Pennsylvania 19380, US
 HE, Linli, 135 Pendula Court, West Chester, Pennsylvania 19380, US
 JACOBS, Martin J., 1447 Patterson Lane, West Chester, Pennsylvania 19380, US
 KRESS, Michael, 2595 Cold Spring Road, Lansdale, Pennsylvania 19446, US
 BIERLMAIER, Stephen, 246 Thornridge Drive, Thorndale, Pennsylvania 19372, US
 MCKEAN, Robert E., 16 Houndstooth Lane, Chester Springs, Pennsylvania 19425, US
 COURVOISIER, Laurent, 212 Turnberry Drive, Thorndale, Pennsylvania 19372, US
 PETRAITIS, Joseph, 9 Rabbit Run Lane, Glenmoore, Pennsylvania 19343, US
 CHRISTIE, Michael, 3 Hidden Lane, Phoenixville, Pennsylvania 19460, US
 MOWREY, Dale R., 1004 Davids Run, Phoenixville, Pennsylvania 19460, US

- (51) MKP
B01J 2/18 (2006.01) (97) **2473266 ***
A61K 9/16 (2006.01)
B01J 2/04 (2006.01)
 (86) EP2010062865 02.09.2010
 (96) 10759829.4 11.07.2012
 (87) WO2011026896, 02.09.2010
 (97) 2473266, 11.07.2012 en
 (54) METHOD AND APPARATUS FOR PREPARING MICRO-PARTICLES OF POLYSACCHARIDES
 (71) INNOVATION FACTORY S.R.L., Padriciano, 99, 34149 Trieste, IT
 Fondazione Carlo e Dirce Callerio Onlus, Via Fleming 22/31, 34127 Trieste, IT
 (72) COCCHIETTO, Moreno, Via del Ponzanino 17, I-34131 Trieste, IT
 VOINOVICH, Dario, Strada di Guardiella, I-34126 Trieste, IT
 ZORZIN, Laura, Via Levata 7, I-33050 Fiumicello, IT
 SAVA, Gianni, Via F.G. De' Guardi 2, I-34143 Trieste, IT

- (51) MKP
A61K 31/663 (2006.01) (97) **2403859 ***
A61P 25/00 (2006.01)
A61K 31/661 (2006.01)
C07F 9/12 (2006.01)
C07F 9/40 (2006.01)
- (86) US2010026419 05.03.2010
(96) 10708075.6 11.01.2012
(87) WO2010102248, 05.03.2010
(97) 2403859, 11.01.2012 en
(54) MOLECULAR TWEEZERS FOR THE TREATMENT OF AMYLOID-RELATED DISEASES
- (71) Universität Duisburg-Essen, Universitätsstrasse 2, 45141 Essen, DE
Department of Veterans Affairs, Office of the General Counsel, Washington, DC 20420, US
The Regents of the University of California, 1111 Franklin Street, 12th Floor, Oakland, CA 94607-5200, US
Massachusetts Institute of Technology, 77 Massachusetts Avenue, Cambridge, MA 02139-4307, US
- (72) KLARNER, Frank, Gerrit, Krockhausstr 141, 44797 Bochum, DE
TALBIERSKY, Peter, Adolph-Schmitt-Gasse 13, 3500 Krefms, AT
POLKOWSKA, Jolanta, Kuglerstr 30, 45144 Essen, DE
BASTOWSKI, Frank, Erlenkamp 4a, 38126 Braunschweig, DE
BITAN, Gal, 11655 Ohio Avenue, Los Angeles, California 90025, US
SINHA, Sharmistha, 1370 Veteran Avenue Apt. 115, Los Angeles, California 90024, US
SCHRADER, Thomas, Schwalbenweg 11, 40822 Mettmann, DE
LOMAKIN, Aleksey, 24 Bates Road, Swampscott, Massachusetts 01907, US
SHANMUGAM, Akila, 3180 10853 Rose Avenue, Los Angeles, California 90034, US
FRAUTSCHY, Sally, 18 Seaview Terrace, Santa Monica, California 90401, US

- (51) MKP
B23K 37/00 (2006.01) (97) **2338636**
B23K 9/32 (2006.01)
A42B 3/04 (2006.01)
A42B 3/22 (2006.01)
A61F 9/06 (2006.01)
F16P 1/06 (2006.01)
G10K 11/18 (2006.01)
- (96) 10192008.0 29.06.2011
(97) 2338636, 29.06.2011 en
(54) Anti-blinding device having wireless communication function
- (71) Otos Wing Co., Ltd., 234-12, Gasan-dong, Geumcheon-ku Seoul 153-801, KR
- (72) Huh, Moon Young, 234-12, Gasan-dong, Geumcheon-ku, 153-801 Seoul, KR

- (51) MKP
C07D 493/22 (2006.01) (97) **2473512 ***
C07C 69/96 (2006.01)
- (86) EP2010062811 01.09.2010
(96) 10751915.9 11.07.2012
(87) WO2011026865, 01.09.2010
(97) 2473512, 11.07.2012 en
(54) PHOTOCHEMICAL PROCESS FOR PRODUCING ARTEMISININ
- (71) SANOFI, 54 rue La Boétie, 75008 Paris, FR
- (72) DHAINAUT, Jildaz, C/O SANOFI AVENTIS 174 avenue de France, F-75013 Paris, FR
DLUBALA, Alain, C/O SANOFI AVENTIS 174 avenue de France, F-75013 Paris, FR
GUEVEL, Ronan, C/O SANOFI AVENTIS 174 avenue de France, F-75013 Paris, FR
MEDARD, Alain, C/O SANOFI AVENTIS 174 avenue de France, F-75013 Paris, FR
ODDON, Gilles, C/O SANOFI AVENTIS 174 avenue de France, F-75013 Paris, FR
RAYMOND, Nicolas, C/O SANOFI AVENTIS 174 avenue de France, F-75013 Paris, FR
TURCONI, Joël, C/O SANOFI AVENTIS 174 avenue de France, F-75013 Paris, FR

- (51) MKP
A61M 5/32 (2006.01) (97) **2488237 ***
- (86) US2010052894 15.10.2010
(96) 10773195.2 22.08.2012
(87) WO2011047298, 15.10.2010
(97) 2488237, 22.08.2012 en
(54) PALM ACTIVATED DRUG DELIVERY DEVICE
- (71) Janssen Biotech, Inc., 800/850 Ridgeview Drive, Horsham, PA 19044, US
- (72) OLSON, Lorin, P., 1230 Mount Herman Road, Scotts Valley, CA 95066, US
KRULEVITCH, Peter, 1122 Division Street, Pleasanton, CA 94566, US
GLENCROSS, James, 17/1 Links Gardens, Edinburgh Lothian EH6 7JG, GB
WANG, Jingli, 6102 Rainbow Drive, San Jose, CA 95129, US
FOLEY, Nicholas, 6 Afton Place, Edinburgh Midlothian EH5 3RB, GB
ZHAO, Mingqi, 1304 Payette Court, San Jose, CA 95129, US

- (51) MKP
F23K 3/02 (2006.01) (97) **2486327 ***
- (86) EP2010006150 08.10.2010
(96) 10770997.4 15.08.2012
(87) WO2011042194, 08.10.2010
(97) 2486327, 15.08.2012 de
(54) METERING SYSTEM, DENSE PHASE CONVEYING SYSTEM AND METHOD FOR SUPPLYING BULK MATERIAL IN POWDER FORM
- (71) Linde AG, Klosterhofstrasse 1, 80331 München, DE
- (72) KRETSCHMER, Horst, Am Wäldchen 5, 09600 Weissenhorn, DE
KLEEBERG, Jörg, Hornstrasse 1, 09599 Freiberg, DE
RÜGER, Dietmar, Carl-Bantzer-Strasse 7, 01728 Bannewitz-Goppeln, DE
SCHULZE, Olaf, Lindenweg 16, 09633 Tuttendorf, DE
FICHHORN, Christian, Schmiedestrasse 8, 09599 Freiberg, DE

- (51) MKP
F24J 2/04 (2006.01) (97) **2419679 ***
F24J 2/52 (2006.01)
F24J 2/46 (2006.01)
F24J 2/51 (2006.01)
- (86) FR2010000293 07.04.2010
(96) 10717186.0 22.02.2012
(87) WO2010119185, 07.04.2010
(97) 2419679, 22.02.2012 fr
(54) Moulded insulating collector
- (71) Sumika Polymer Compounds (France) SA, Avenue Marie Curie Z.I. du Bois-de-Leuze, 13310 Saint Martin de Crau, FR
- (72) NISHIO, Hideaki, 40 Blake House Gunwharf Quays, Portsmouth P01 3 TH, GB
GAALLOUL, Anis, 11 rue Pline, 2016 Carthage, TN
BOLLAERT, Franck, 25 rue Raoul Follereau, F-30000 Nîmes, FR

- (51) MKP
A61K 31/56 (2006.01) (97) **2419108 ***
A61K 31/57 (2006.01)
A61K 9/20 (2006.01)
- (86) EP2010054812 13.04.2010
(96) 10717084.7 22.02.2012
(87) WO2010119029, 13.04.2010
(97) 2419108, 22.02.2012 en
(54) METHOD FOR ON-DEMAND CONTRACEPTION
- (71) Laboratoire HRA Pharma, 15, rue Béranger, 75003 Paris, FR
- (72) ULMANN, André, 23 rue Pascal, F-75005 Paris, FR
GAINER, Erin, 18 rue de l'Atlas, F-75019 Paris, FR

- (51) MKP
C07D 209/46 (2006.01) (97) **2443089 ***
C07D 209/48 (2006.01)
C07D 405/12 (2006.01)
A61K 31/4035 (2006.01)
A61P 17/06 (2006.01)
(86) US2010038577 15.06.2010
(96) 10727607.3 25.04.2012
(87) WO2010147922, 15.06.2010
(97) 2443089, 25.04.2012 en
(54) DEUTERATED I SOINDOLINE- I, 3-DIONE DERIVATIVES AS PDE4 AND TNF-ALPHA INHIBITORS
(71) Concert Pharmaceuticals Inc., 99 Hayden Avenue, Suite 500, Lexington, MA 02421, US
(72) LIU, Julie, F., 3 Whitman Circle, Lexington MA 02420, US
-
- (51) MKP
A61G 12/00 (2006.01) (97) **2368535**
(96) 10157241.0 28.09.2011
(97) 2368535, 28.09.2011 de
(54) People monitoring system
(71) Polat, Candemir, Rüchiweg 7, 4106 Therwil, CH
(72) Polat, Candemir, Rüchiweg 7, 4106 Therwil, CH
-
- (51) MKP
G06F 19/00 (2011.01) (97) **2482810 ***
A61K 31/137 (2006.01)
A61P 37/06 (2006.01)
A61P 11/06 (2006.01)
(86) US2010049441 20.09.2010
(96) 10759777.5 08.08.2012
(87) WO2011041146, 20.09.2010
(97) 2482810, 08.08.2012 en
(54) DOSAGE REGIMEN OF AN S1P RECEPTOR MODULATOR
(71) Novartis AG, Lichtstrasse 35, 4056 Basel, CH
(72) BOULTON, Craig, Novartis Pharmaceuticals UK Limited Wimblerhurst Road, Horsham, West Essex RH 12 5AB, GB
BURTIN, Pascale, Novartis Pharma AG Postfach 4002, CH-4002 Basel, CH
DAVID, Olivier, Novartis Pharma AG Postfach 4002, CH-4002 Basel, CH
DE VERA, Ana, Novartis Pharma AG Postfach 4002, CH-4002 Basel, CH
DUMORTIER, Thomas, Novartis Pharma AG Postfach 4002, CH-4002 Basel, CH
HUNT, Irene, Novartis Pharma AG Postfach 4002, CH-4002 Basel, CH
SCHMOUDER, Robert, Novartis Institutes for BioMedical Research Inc. 220 Massachusetts Avenue, Cambridge, MA 02139, US
-
- (51) MKP
C07K 14/34 (2006.01) (97) **2486047 ***
(86) EP2010065047 07.10.2010
(96) 10762693.9 15.08.2012
(87) WO2011042516, 07.10.2010
(97) 2486047, 15.08.2012 en
(54) EXPRESSION SYSTEM
(71) GlaxoSmithKline Biologicals S.A., rue de l'Institut, 89, 1330 Rixensart, BE
(72) BLAIS, Normand, GlaxoSmithKline Biologicals Canada 525 Cartier Boulevard West, Laval, Québec H7V 3S8, CA
DEHOTTAI, Philippe Marc Helene, GlaxoSmithKline Biologicals s.a. Rue de l'Institut 89, B-1330 Rixensart, BE
DEWERCHIN, Marianne, GlaxoSmithKline Biologicals s.a. Rue de l'Institut 89, B-1330 Rixensart, BE
GOFFIN, Philippe, GlaxoSmithKline Biologicals s.a. Rue de l'Institut 89, B-1330 Rixensart, BE
MARTIN, Denis, GlaxoSmithKline Biologicals Canada 525 Cartier Boulevard West, Laval, Québec H7V 3S8, CA
-
- (51) MKP
C09K 17/32 (2006.01) (97) **2496663 ***
C09K 17/14 (2006.01)
(86) US2010055092 02.11.2010
(96) 10827642.9 12.09.2012
(87) WO2011053964, 02.11.2010
(97) 2496663, 12.09.2012 en
(54) RESIN SYSTEM WITH CARBON ADDITIVE
(71) J-Lok Co., P.O. Box 111253 258 Kappa Drive, Pittsburgh, PA 15238, US
(72) WHARTON, Richard, 180 Strong's Road, Irvona PA 16656, US
SIMMONS, W., Neal, 7801 Willardsville Station Road, Bahama, NC 27503, US
OLDSEN, John, G., 131 Wildwood Drive, Butler PA 16001, US
-
- (51) MKP
A47K 5/12 (2006.01) (97) **2322066**
(96) 10014191.0 18.05.2011
(97) 2322066, 18.05.2011 de
(54) Method and dispenser for releasing portions of a fluid
(71) Hagleitner, Hans Georg, Lindenallee 11, 5700 Zell am See, AT
(72) Hagleitner, Hans Georg, Lindenallee 11, 5700 Zell am See, AT
-
- (51) MKP
A61K 31/40 (2006.01) (97) **2411005 ***
A61K 31/4985 (2006.01)
A61P 9/00 (2006.01)
A61P 3/00 (2006.01)
(86) US2010028933 26.03.2010
(96) 10712234.3 01.02.2012
(87) WO2010111665, 26.03.2010
(97) 2411005, 01.02.2012 en
(54) METHODS FOR PREVENTING MAJOR ADVERSE CARDIOVASCULAR EVENTS WITH DPP-IV INHIBITORS
(71) Bristol-Myers Squibb Company, Route 206 & Province Line Road, Princeton, NJ 08543, US
AstraZeneca UK Limited, 15 Stanhope Gate, London W1K 1LN, GB
(72) FREDERICH, Robert, P.O. box 4000, Princeton NJ 08543-4000, US
EDELBERG, Jay, P.O. Box 4000, Princeton NJ 08543-4000, US
FIEDOREK, Fred, P.O. Box 4000, Princeton NJ 08543-4000, US
-
- (51) MKP
A61K 31/472 (2006.01) (97) **2439202 ***
C07D 295/104 (2006.01)
A61K 31/4709 (2006.01)
(86) ES2010000258 04.06.2010
(96) 10783009.3 11.04.2012
(87) WO2010139827, 04.06.2010
(97) 2439202, 11.04.2012 en
(54) INHIBITOR COMPOUNDS OF 11-BETA-HYDROXYSTERIOD DEHYDROGENASE TYPE 1
(71) Laboratorios SALVAT, S.A., Calle Gall 30-36, 08950 Esplugues de Llobregat, Barcelona, ES
(72) CATENA RUIZ, Juan Lorenzo, C/ Gall 30-36, E-08950 Esplugues de Llobregat (Barcelona), ES
SERRA COMAS, Carme, C/ Gall 30-36, E-08950 Esplugues de Llobregat (Barcelona), ES
REY PUIGGROS, Oscar, C/ Gall 30-36, E-08950 Esplugues de Llobregat (Barcelona), ES
ANTOLIN HERNANDEZ, Albert, C/ Gall 30-36, E-08950 Esplugues de Llobregat (Barcelona), ES
MONLLEO MAS, Ester, C/ Gall 30-36, E-08950 Esplugues de Llobregat (Barcelona), ES

- (51) MKP
C12N 9/64 (2006.01) (97) **2245150 ***
C07K 16/40 (2006.01)
A61K 38/43 (2006.01)
C12N 15/62 (2006.01)
C12N 5/10 (2006.01)
(86) EP2010001328 03.03.2010
(96) 10709961.6 03.11.2010
(87) WO2010099955, 03.03.2010
(97) 2245150, 03.11.2010 en
(54) PROTEASE FOR WOUND CONDITIONING AND SKIN CARE
(71) B.R.A.I.N. Biotechnology Research And Information Network AG, Darmstädter Strasse 34, 64673 Zwingenberg, DE
(72) NIEHAUS, Frank, Veilchenweg 5, 64646 Heppenheim, DE
ECK, Jürgen, Jakobsweg 48, 64625 Bensheim, DE
SCHULZE, Renate, Darmstädter Strasse 133, 64625 Bensheim, DE
-
- (51) MKP
A61K 9/10 (2006.01) (97) **2459220 ***
A61K 9/50 (2006.01)
A61K 47/10 (2006.01)
A61K 9/16 (2006.01)
A61K 9/28 (2006.01)
(86) EP2010061155 30.07.2010
(96) 10737075.1 06.06.2012
(87) WO2011012715, 30.07.2010
(97) 2459220, 06.06.2012 en
(54) BIODEGRADABLE POLYETHYLENE GLYCOL BASED WATER-INSOLUBLE HYDROGELS
(71) Ascendis Pharma A/S, Tuborg Boulevard 12, 2900 Hellerup, DK
(72) RAU, Harald, Talstr. 41, 69221 Dossenheim, DE
HERSEL, Ulrich, Fritz-Frey-Strasse 8, 69121 Heidelberg, DE
KRUSCH, Mathias, Am Hungerberg 15, 69434 Hirschhorn, DE
VETTER, Dirk, Ludolf-Kehl-Str. 18, 69120 Heidelberg, DE
VOIGT, Tobias, Handschuhseimer Landstr. 9/1, 69120 Heidelberg, DE
-
- (51) MKP
A23L 1/16 (2006.01) (97) **2418966 ***
A23L 1/39 (2006.01)
A23L 1/162 (2006.01)
A23L 1/00 (2006.01)
(86) EP2010054562 07.04.2010
(96) 10715182.1 22.02.2012
(87) WO2010118974, 07.04.2010
(97) 2418966, 22.02.2012 en
(54) WHOLEGRAIN INSTANT PASTA
(71) Nestec S.A., Avenue Nestlé 55, 1800 Vevey, CH
(72) BATTAINI, Giuseppe, Fürstenbergstr. 20, 78467 Konstanz, DE
-
- (51) MKP
A61M 5/32 (2006.01) (97) **2403568 ***
(86) EP2010052788 04.03.2010
(96) 10706266.3 11.01.2012
(87) WO2010100243, 04.03.2010
(97) 2403568, 11.01.2012 en
(54) NEEDLE UNIT
(71) Sanofi-Aventis Deutschland GmbH, Brüningstraße 50, 65929 Frankfurt, DE
(72) HEALD, Michael, c/o Sanofi-Aventis UK London Road Crewe, Holmes Chapel Cheshire CW4 8BE, GB
EKMAN, Matthew, c/o Sanofi-Aventis UK London Road Crewe, Holmes Chapel Cheshire CW4 8BE, GB
-
- (51) MKP
A61K 31/4706 (2006.01) (97) **2493573 ***
A61K 33/26 (2006.01)
A61P 33/06 (2006.01)
(86) FR2010052331 29.10.2010
(96) 10788113.8 05.09.2012
(87) WO2011051634, 29.10.2010
(97) 2493573, 05.09.2012 fr
(54) USE OF FERROQUINE IN THE TREATMENT OR PREVENTION OF MALARIA
(71) SANOFI, 54, rue de la Boétie, 75008 Paris, FR
(72) FRAISSE, Laurent, c/o sanofi-aventis Département Brevets 174 avenue de France, F-75013 Paris, FR
STRUXIANO, Annie, c/o sanofi-aventis Département Brevets 174 avenue de France, F-75013 Paris, FR
-
- (51) MKP
F01N 3/20 (2006.01) (97) **2388452**
(96) 10163458.2 23.11.2011
(97) 2388452, 23.11.2011 en
(54) Reagent dosing device
(71) Delphi Technologies Holding S.à.r.l., Avenue de Luxembourg, 4940 Bascharage, LU
(72) Hardy, Martin, 71 Cedar Grove Hempstead, Gillingham, Kent ME7 3QZ, GB
Panteny, Simon, 44 Castlemaine Avenue, Gillingham, Kent ME7 2QE, GB
-
- (51) MKP
A61K 31/4745 (2006.01) (97) **2421864 ***
C07D 471/04 (2006.01)
A61P 35/00 (2006.01)
(86) FR2010050773 22.04.2010
(96) 10723723.2 29.02.2012
(87) WO2010122272, 22.04.2010
(97) 2421864, 29.02.2012 fr
(54) 1-PYRAZOLO[4,3-C]ISOQUINOLINE DERIVATIVES, PREPARATION THEREOF AND THERAPEUTIC USE THEREOF
(71) SANOFI, 174, Avenue de France, 75013 Paris, FR
(72) DELETTRE, Georges, c/o sanofi-aventis Département Brevets 174 avenue de France, F-75013 Paris, FR
DEPRETS, Stéphanie, c/o sanofi-aventis Département Brevets 174 avenue de France, F-75013 Paris, FR
HALLEY, Frank, c/o sanofi-aventis Département Brevets 174 avenue de France, F-75013 Paris, FR
SCHIO, Laurent, c/o sanofi-aventis Département Brevets 174 avenue de France, F-75013 Paris, FR
THOMPSON, Fabienne, c/o sanofi-aventis Département Brevets 174 avenue de France, F-75013 Paris, FR
-
- (51) MKP
A61K 9/00 (2006.01) (97) **2424538 ***
A61P 17/02 (2006.01)
A61K 31/52 (2006.01)
A61K 31/519 (2006.01)
(86) EP2010055806 29.04.2010
(96) 10719314.6 07.03.2012
(87) WO2010125143, 29.04.2010
(97) 2424538, 07.03.2012 en
(54) USE OF ALLOPURINOL FOR THE TREATMENT OF HAND FOOT SKIN REACTION
(71) Advancell Advanced in Vitro Cell Technologies, S.A., Barcelona Science Park C/ Baldiri Reixac, 10 - 1ª planta, 08028 Barcelona, ES
Nobera Pharma, S.L., Mar Rojo, 6, 28760 Tres Cantos Madrid, ES
(72) RODEMER, Yolanda, Schlengen Weg 31, 26386 WilhelmsHaven-Rüstersiel, DE
-
- (51) MKP
G01S 15/96 (2006.01) (97) **2454607 ***
G01S 15/89 (2006.01)
(86) US2010039443 22.06.2010
(96) 10728530.6 23.05.2012
(87) WO2011008430, 22.06.2010
(97) 2454607, 23.05.2012 en
(54) DOWNSCAN IMAGING SONAR
(71) Navico, Inc., 12000 E. Skelly Drive, Tulsa, OK 74128-2486, US
(72) MAGUIRE, Brian, T., 4502 West Madison Pl., Broken Arrow OK 74012, US
-

- (51) MKP
A61K 38/26 (2006.01) (97) **2498801 ***
A61P 3/10 (2006.01)
A61K 47/18 (2006.01)
- (86) EP2010067249 11.11.2010
(96) 10776997.8 19.09.2012
(87) WO2011058082, 11.11.2010
(97) 2498801, 19.09.2012 de
(54) PHARMACEUTICAL COMPOSITION COMPRISING A GLP-1 AGONIST AND METHIONINE
(71) Sanofi-Aventis Deutschland GmbH, Brüningstraße 50, 65929 Frankfurt, DE
(72) BRUNNER-SCHWARZ, Anette, c/o Sanofi-Aventis Deutschland GmbH, 65926 Frankfurt, DE
MÜLLER, Werner, c/o Sanofi-Aventis Deutschland GmbH, 65926 Frankfurt am Main, DE
SIEFKE-HENZLER, Verena, c/o Sanofi-Aventis Deutschland GmbH, 65926 Frankfurt am Main, DE
-
- (51) MKP
G06F 19/00 (2011.01) (97) **2449492 ***
- (86) US2010040383 29.06.2010
(96) 10745033.0 09.05.2012
(87) WO2011002768, 29.06.2010
(97) 2449492, 09.05.2012 en
(54) ANALYTE TESTING METHOD AND SYSTEM
(71) Lifescan, Inc., 1000 Gibraltar Drive, Milpitas, CA 95035, US
(72) RAY, Pinaki, 1300 Valdez Way, Fremont, CA 94539, US
MATIAN, Greg, 896 Arcturus Circle, Foster City, CA 94404, US
SRINIVASAN, Aparna, 3656 Greymont Drive, San Jose, CA 95136, US
-
- (51) MKP
C07C 51/44 (2006.01) (97) **2371797**
C07D 307/08 (2006.01)
C07D 307/33 (2006.01)
C07C 51/41 (2006.01)
C07C 29/136 (2006.01)
C07C 51/02 (2006.01)
- (96) 11160441.9 05.10.2011
(97) 2371797, 05.10.2011 en
(54) Processes for the production of tetrahydrofuran, gamma-butyrolactone and/or butanediol from salts of succinic acid
(71) BioAmber International S.A.R.L., 49 Route d' Arlon, 1140 Luxembourg, LU
(72) Fruchey, Olan S., 13 Greenbrier Avenue, Hurricane, WV 25526, US
Manzer, Leo E., 328 Cassell Court, Wilmington, DE 19803, US
Dunuwila, Dilum, 394 Franklin Avenue, Princeton, NJ 08540, US
Keen, Brian T., 108 Hughes Drive, Pinch, WV 25156, US
Albin, Brooke A., 1026 Gordon Drive, Charleston, WV 25303, US
Clinton, Nye A., 16 Christopher Drive, Hurricane, WV 25526, US
Dombek, Bernard D., 1620 Woodvale Drive, Charleston, WV 25314, US
-
- (51) MKP
A61P 11/00 (2006.01) (97) **2470536 ***
C07D 487/04 (2006.01)
A61K 31/519 (2006.01)
- (86) EP2010062329 24.08.2010
(96) 10744949.8 04.07.2012
(87) WO2011023693, 24.08.2010
(97) 2470536, 04.07.2012 en
(54) METHYLPYRROLOPYRIMIDINECARBOXAMIDES
(71) Nycomed GmbH, Byk-Gulden-Strasse 2, 78467 Konstanz, DE
HUSSONG, Ragna, Schultheiß-Heschel-Ring 14, 78652 Deißlingen, DE
NIMZ, Olaf, Berchenstr. 71a, 78467 Konstanz, DE
STADLWIESER, Josef, Im Apfelfgarten 3, 78465 Konstanz, DE
MÜLLER, Matthias, Ackertorweg 2, 78462 Konstanz, DE
SCHMIDT, Beate, Allensbacher Str. 5, 78476 Allensbach, DE
VIERTELHAUS, Martin, Zasiusstr. 8, 78462 Konstanz, DE
BERNSMANN, Heiko, Schubertstr. 21, 60325 Frankfurt, DE
DUNKERN, Torsten, Humboldtstr. 18, 41363 Jüchen Gierath, DE
PAHL, Andreas, Kirschplantage 17, 22926 Ahrensburg, DE
BENEDIKTUS, Ewald, Mondstr. 18, 88400 Biberach, DE
-
- (51) MKP
C09C 1/02 (2006.01) (97) **2496648 ***
C01F 5/24 (2006.01)
- (86) EP2010066664 02.11.2010
(96) 10773085.5 12.09.2012
(87) WO2011054831, 02.11.2010
(97) 2496648, 12.09.2012 en
(54) PRECIPITATED MAGNESIUM CARBONATE
(71) Omya Development AG, Baslerstrasse 42, 4665 Oftringen, CH
(72) POHL, Michael, H.-v.-Tuerlin Strasse 11, A-9500 Villach, AT
RAINER, Christian, Treffnerstrasse 62f, A-9500 Villach, AT
ESSER, Markus, Friedrich-Ebert-Platz 6, 50169 Kerpen, DE
-
- (51) MKP
C07D 417/12 (2006.01) (97) **2421851 ***
C07D 409/12 (2006.01)
C07D 495/04 (2006.01)
C07D 403/14 (2006.01)
C07D 417/14 (2006.01)
A61K 31/496 (2006.01)
C07D 403/12 (2006.01)
A61P 29/00 (2006.01)
C07D 401/12 (2006.01)
A61P 25/00 (2006.01)
- (86) US2010032068 22.04.2010
(96) 10716203.4 29.02.2012
(87) WO2010124102, 22.04.2010
(97) 2421851, 29.02.2012 en
(54) AZETIDINYL DIAMIDES AS MONOACYLGLYCEROL LIPASE INHIBITORS
(71) Janssen Pharmaceutica, N.V., Turnhoutseweg 30, 2340 Beerse, BE
(72) LIN, Shu-Chen, 4895 Redfield Road, Doylestown PA 18902, US
ZHU, Bin, Welsh&McKean Roads, Spring House PA 19477, US
BIAN, Haiyan, 109 York Drive, Princeton NJ 08540, US
MCDONNELL, Mark, E., 1280 Sumneytown Pike, Lansdale PA 19446, US
CHEVALIER, Kristen, M., 407 Nottingham Lane, Collegeville PA 19426, US
PITIS, Philip, M., 108 Sunrise Drive, North Wales PA 19454, US
CONNOLLY, Peter, J., Welsh&McKean Roads, Spring House PA 19477, US
ZHANG, Sui-Po, 665 Stockton Drive, Exton PA 19341, US
FLORES, Christopher, M., Welsh&McKean Roads, Spring House PA 19477, US
ZHANG, Yue-Mei, Welsh&McKean Roads, Spring House PA 19477, US
LIU, Li, 271 Fox Chase Lane, Doylestown PA 18901, US
CLEMENTE, Jose, 665 Stockton Drive, Exton PA 19341, US
MABUS, John, 9131 Rosewood Drive, East Greenville PA 18041, US
MACIELAG, Mark, J., Welsh&McKean Roads, Spring House PA 19477, US
-
- (51) MKP
A61P 35/00 (2006.01) (97) **2483279 ***
C07K 16/46 (2006.01)
C07K 16/30 (2006.01)
A61K 31/537 (2006.01)
C12P 21/08 (2006.01)
C07D 498/18 (2006.01)
- (86) IB2010054417 30.09.2010
(96) 10768578.6 08.08.2012
(87) WO2011039721, 30.09.2010
(97) 2483279, 08.08.2012 en
(54) NEW MAYTANSINOIDS AND THE USE OF SAID MAYTANSINOIDS TO PREPARE CONJUGATES WITH AN ANTIBODY
(71) SANOFI, 54, rue de la Boétie, 75008 Paris, FR
(72) BOUCHARD, Hervé, c/o Sanofi-Aventis Département Brevets 174 avenue de France, F-75013 Paris, FR
COMMERCON, Alain, c/o Sanofi-Aventis Département Brevets 174 avenue de France, F-75013 Paris, FR
FROMOND, Claudia, c/o Sanofi-Aventis Département Brevets 174 avenue de France, F-75013 Paris, FR
MIKOL, Vincent, c/o Sanofi-Aventis Département Brevets 174 avenue de France, F-75013 Paris, FR
PARKER, Fabienne, c/o Sanofi-Aventis Département Brevets 174 avenue de France, F-75013 Paris, FR
SASSOON, Ingrid, c/o Sanofi-Aventis Département Brevets 174 avenue de France, F-75013 Paris, FR
TAVARES, Daniel, c/o ImmunoGen Inc. 830 Winter Street Waltham, Massachusetts 02451, US

- (51) MKP
A61M 5/32 (2006.01) (97) **2424598 ***
(86) EP2010055254 21.04.2010
(96) 10717101.9 07.03.2012
(87) WO2010124974, 21.04.2010
(97) 2424598, 07.03.2012 en
(54) NEEDLE REMOVER AND METHOD FOR REMOVING A NEEDLE
(71) Sanofi-Aventis Deutschland GmbH, Brüningstraße 50, 65929 Frankfurt, DE
(72) BODE, Andreas, Sanofi-Aventis Deutschland GmbH, 65926 Frankfurt am Main, DE
-
- (51) MKP
A61M 5/178 (2006.01) (97) **2437805 ***
A61M 5/315 (2006.01)
(86) EP2010057481 28.05.2010
(96) 10722348.9 11.04.2012
(87) WO2010139636, 28.05.2010
(97) 2437805, 11.04.2012 en
(54) A DRIVE MECHANISM FOR A DRUG DELIVERY DEVICE
(71) Sanofi-Aventis Deutschland GmbH, Brüningstraße 50, 65929 Frankfurt, DE
(72) PLUMPTRE, David, 36 Shire Way Droitwich Spa, Worcestershire WR9 7RQ, GB
JONES, Christopher, 153 High Street Broadway Worcestershire, WR12 7AL, GB
-
- (51) MKP
A61M 5/315 (2006.01) (97) **2485791 ***
A61M 5/24 (2006.01)
(86) EP2010065096 08.10.2010
(96) 10761032.1 15.08.2012
(87) WO2011042539, 08.10.2010
(97) 2485791, 15.08.2012 en
(54) DRIVE MECHANISM FOR DRUG DELIVERY DEVICES
(71) Sanofi-Aventis Deutschland GmbH, Brüningstraße 50, 65929 Frankfurt, DE
(72) HELMER, Michael, Sanofi-Aventis Deutschland GmbH, 65926 Frankfurt am Main, DE
MATTHIAS, Claudia, Sanofi-Aventis Deutschland GmbH, 65926 Frankfurt am Main, DE
NOBER, Peter, Hauptstraße 49, 54597 Rommersheim, DE
SHAHBAZFAR, Reza, Schachtstr. 2, 65183 Wiesbaden, DE
SCHÄFER, Benjamin, Ortsstr. 7, 35649 Bischoffen, DE
ZEIMETZ, Leo, Amselweg 4, 64572 Büttelbom, DE
-
- (51) MKP
C07D 401/08 (2006.01) (97) **2419418 ***
A61P 29/00 (2006.01)
C07D 403/08 (2006.01)
C07D 405/08 (2006.01)
C07D 413/08 (2006.01)
C07D 417/08 (2006.01)
A61K 31/4427 (2006.01)
A61K 31/437 (2006.01)
A61K 31/433 (2006.01)
A61P 3/10 (2006.01)
(86) US2010031255 15.04.2010
(96) 10714151.7 22.02.2012
(87) WO2010121036, 15.04.2010
(97) 2419418, 22.02.2012 en
(54) 4-AZETIDINYL-1-HETEROATOM LINKED-CYCLOHEXANE ANTAGONISTS OF CCR2
(71) Janssen Pharmaceutica, N.V., Turnhoutseweg 30, 2340 Beerse, BE
(72) ZHANG, Xuqing, 1728 Osprey Drive, Audubon PA 19403, US
HUFNAGEL, Heather Rae, 64 Glen Manor Lane, Glenmoore PA 19343, US
SUI, Zhihua, Welsh&Mckean Roads, Spring House PA 19477, US
-
- (51) MKP
A61K 9/00 (2006.01) (97) **2442789 ***
A61K 31/5377 (2006.01)
A61K 47/02 (2006.01)
A61K 9/10 (2006.01)
(86) US2010038526 14.06.2010
(96) 10724981.5 25.04.2012
(87) WO2010147899, 14.06.2010
(97) 2442789, 25.04.2012 en
(54) STABLE NANOPARTICULATE DRUG SUSPENSION
(71) Abbott Laboratories, 100 Abbott Park Rd., Abbott Park, IL 60064, US
(72) GOKHALE, Rajeev, 2250 Hanlon Road, Libertyville, Illinois 60048, US
MARSH, Kennan, C., 1499 McKinley Road, Lake Forest, Illinois 60045, US
SHI, Yi, 1404 James Court, Libertyville, Illinois 60048, US
-
- (51) MKP
E05C 19/00 (2006.01) (97) **2400090**
(96) 11166453.8 28.12.2011
(97) 2400090, 28.12.2011 en
(54) An anti-intrusion device for doors and windows in general
(71) De Gennaro, Roberto, Via Rodolfo Mondolfo, 9, 40139 Bogogna (BO), IT
(72) De Gennaro, Roberto, Via Rodolfo Mondolfo, 9, 40139 Bogogna (BO), IT
-
- (51) MKP
C07K 16/30 (2006.01) (97) **2407487**
C07K 16/32 (2006.01)
(96) 10169566.6 18.01.2012
(97) 2407487, 18.01.2012 en
(54) Multispecific modular antibody
(71) F-Star Biotechnologische Forschungs- und Entwicklungsges. M.B.H., Gastgebasse 5-13, 1230 Wien, AT
(72) Himmler, Gottfried, Donau-Oder-Kanal IV SW80, 2301 Gross-Enzersdorf, AT
Woisetschlaeger, Max, Balthasar-Krauss Gasse 44/3, 2380 Perchtoldsdorf, AT
-
- (51) MKP
F28D 21/00 (2006.01) (97) **2409105 ***
F28F 1/40 (2006.01)
F28F 21/08 (2006.01)
(86) EP2010052724 03.03.2010
(96) 10708516.9 25.01.2012
(87) WO2010105911, 03.03.2010
(97) 2409105, 25.01.2012 en
(54) TUBE FOR CONVEYING EXHAUST GASES IN HEAT EXCHANGE DEVICES, PARTICULARLY BOILERS FOR GENERATING HOT WATER OR STEAM
(71) UNICAL AG S.p.A., Via Roma, 123, 46033 Castel d'Ario (MN), IT
(72) JAHIER, Giovanni, Via Tezze 28, I-46100 Mantova, IT
-
- (51) MKP
G08B 21/00 (2006.01) (97) **2460937 ***
E01F 9/017 (2006.01)
(86) ES2010000293 07.07.2010
(96) 10806066.6 06.06.2012
(87) WO2011015678, 07.07.2010
(97) 2460937, 06.06.2012 en
(54) Highway protection barrier
(71) Sanchez De La Cruz, Jose Manuel, Avenida 308, 25, 08860 Castelldefels, Barcelona, ES
(72) Sanchez De La Cruz, Jose Manuel, Avenida 308, 25, 08860 Castelldefels, Barcelona, ES
-
- (51) MKP
H04L 5/00 (2006.01) (97) **2273715**
H04N 7/24 (2011.01)
(96) 10168544.4 12.01.2011
(97) 2273715, 12.01.2011 en
(54) Multipath data streaming over a wireless network
(71) Dejero Labs Inc., 180 King Street South Suite 140, Waterloo ON N2J 1P8, CA
(72) Frusina, Bogdan, 65 Orchid Cres., Kitchener Ontario N2E 3N3, CA
Horvath, Akos, 120 Mansion St., Unit 605, Kitchener Ontario N2H 0A1, CA

- (51) MKP
A61M 5/315 (2006.01) (97) **2437828 ***
(86) EP2010057490 28.05.2010
(96) 10722352.1 11.04.2012
(87) WO2010139643, 28.05.2010
(97) 2437828, 11.04.2012 en
(54) DRUG DELIVERY DEVICE INNER HOUSING HAVING HELICAL SPLINE
(71) Sanofi-Aventis Deutschland GmbH, Brüningstraße 50, 65929 Frankfurt, DE
(72) PLUMPTRE, David, 36 Shire Way, Droitwich Spa Worcestershire WR9 7RQ, GB
-
- (51) MKP
B29C 67/20 (2006.01) (97) **2366532**
B29C 44/56 (2006.01)
B29C 44/30 (2006.01)
B29C 44/34 (2006.01)
(96) 10156982.0 21.09.2011
(97) 2366532, 21.09.2011 en
(54) Apparatus and method for production of insulating and draining boards
(71) Ignucell AB, Box 217, 312 22 Laholm, SE
(72) Jalakas, Jonas, Hammarvägen 23, 134 60, INGARÖ, SE
-
- (51) MKP
C07K 14/20 (2006.01) (97) **2470908 ***
G01N 33/569 (2006.01)
(86) FR2010051787 27.08.2010
(96) 10763762.1 04.07.2012
(87) WO2010123914, 27.08.2010
(97) 2470908, 04.07.2012 fr
(54) PROTEINS USED FOR THE DIAGNOSIS OF LYME BORRELIOSIS
(71) Biomérieux, Chemin de l'Orme, 69280 Marcy L'etoile, FR
(72) LEVET, Lionel, 32 rue de la Glacière Bâtiment B1, F-69600 Oullins, FR
MEJAN-LETOURNEUR, Odile, 70 avenue du Point du Jour, F-69005 Lyon, FR
-
- (51) MKP
A61K 31/351 (2006.01) (97) **2427445 ***
A61P 11/00 (2006.01)
C07D 309/14 (2006.01)
(86) GB2010050736 05.05.2010
(96) 10719056.3 14.03.2012
(87) WO2010128324, 05.05.2010
(97) 2427445, 14.03.2012 en
(54) SUBSTITUTED 1-CYANOETHYLHETEROCYCLYL CARBOXAMIDE COMPOUNDS 750
(71) AstraZeneca AB, null, 151 85 Södertälje, SE
(72) FORD, Rhonan, AstraZeneca R&D Charnwood Bakewell Road Loughborough, Leicestershire LE11 5RH, GB
METE, Antonio, AstraZeneca R&D Charnwood Bakewell Road Loughborough, Leicestershire LE11 5RH, GB
MATHER, Andrew, AstraZeneca R&D Charnwood Bakewell Road Loughborough, Leicestershire LE11 5RH, GB
MILLICHIP, Ian, c/o AstraZeneca Intellectual Property AstraZeneca R&D Alderley Alderley Park Macclesfield, Cheshire, SK10 4TG, GB
-
- (51) MKP
F16K 25/00 (2006.01) (97) **2430344 ***
(86) FR2010050902 10.05.2010
(96) 10728733.6 21.03.2012
(87) WO2010130938, 10.05.2010
(97) 2430344, 21.03.2012 fr
(54) HIGH-PRESSURE HOMOGENISATION WITH A SILICON NITRIDE VALVE
(71) SANOFI, 174, Avenue de France, 75013 Paris, FR
(72) NAKACH, Mostafa, c/o sanofi-aventis Département Brevets 174 avenue de France, F-75013 Paris, FR
-
- (51) MKP
H04W 72/00 (2009.01) (97) **2413649**
(96) 10171125.7 01.02.2012
(97) 2413649, 01.02.2012 en
(54) Wireless communication method and system with collision avoidance protocol
(71) ABB Research Ltd., null, 8050 Zürich, CH
(72) Gidlund, Mikael, Dalgatan 2D, 85237, Sundsvall, SE
Xu, Youzhi, Bågvägen 41, 2 tr, 55629 Jönköping, SE
Zhang, Tingting, Violvägen 1, 85740 Sundsvall, SE
Shen, Wei, Grönborgsgatan 13, room 044, 85237 Sundsvall, SE
Yang, Dong, Bågvägen 41, 2 tr, 55629 Jönköping, SE
-
- (51) MKP
A61P 31/04 (2006.01) (97) **2457575**
C12R 1/225 (2006.01)
A61K 35/74 (2006.01)
A23L 1/30 (2006.01)
(96) 10460046.5 30.05.2012
(97) 2457575, 30.05.2012 en
(54) New method for obtaining a Lactobacillus reuteri strain useful in medical and veterinary prophylaxis and treatment
(71) Eurochit Danuta Kruszewska, Al. Wilanoswska 43 m 5, 02-765 Warszawa, PL
(72) Kruszewska, Danuta, Al. Wilanowska 43m5, 02-765 Warszawa, PL
-
- (51) MKP
A61M 5/315 (2006.01) (97) **2424597 ***
(86) EP2010055140 20.04.2010
(96) 10715800.8 07.03.2012
(87) WO2010124961, 20.04.2010
(97) 2424597, 07.03.2012 en
(54) AXIALLY ADJUSTABLE CONNECTION OF PISTON ROD TO PISTON FOR DRIVE MECHANISM OF A DRUG DELIVERY DEVICE
(71) Sanofi-Aventis Deutschland GmbH, Brüningstraße 50, 65929 Frankfurt, DE
(72) FORSTREUTER, Axel, c/o Sanofi-Aventis Deutschland GmbH, 65926 Frankfurt am Main, DE
HELMER, Michael, c/o Sanofi-Aventis Deutschland GmbH, 65926 Frankfurt am Main, DE
MATTHIAS, Claudia, c/o Sanofi-Aventis Deutschland GmbH, 65926 Frankfurt am Main, DE
NOBER, Peter, Hauptstraße 49, 54597 Rommersheim, DE
SHAHBAZFAR, Reza, Schachtstraße 2, 65183 Wiesbaden, DE
SCHÄFER, Benjamin, Ortsstraße 7, 35649 Bischofshofen, DE
ZEIMETZ, Leo, Amselweg 4, 64572 Büttelborn, DE
DASBACH, Uwe, c/o Sanofi-Aventis Deutschland GmbH, 65926 Frankfurt am Main, DE
-
- (51) MKP
E05F 3/10 (2006.01) (97) **2456941 ***
(86) EP2010004304 15.07.2010
(96) 10734693.4 30.05.2012
(87) WO2011009556, 15.07.2010
(97) 2456941, 30.05.2012 de
(54) DOOR CLOSER
(71) Dorma GmbH + Co. KG, Dorma Platz 1, 58256 Ennepetal, DE
(72) WALHORN, Oliver, Schlossstrasse 30, 33824 Werther, DE
-

- (51) MKP
B31C 3/00 (2006.01) (97) **2461967 ***
D21H 17/28 (2006.01)
D21H 17/29 (2006.01)
D21H 19/54 (2006.01)
D21H 25/04 (2006.01)
D21H 27/00 (2006.01)
- (86) IB2010002165 11.06.2010
(96) 10757826.2 13.06.2012
(87) WO2011015948, 11.06.2010
(97) 2461967, 13.06.2012 en
(54) FIBROUS SHEET THAT DISINTEGRATES IN WATER, PROCESS FOR MANUFACTURING SAID FIBROUS SHEET, CORE CONSISTING OF STRIPS OF SAID FIBROUS SHEET
- (71) Georgia-Pacific France, 60, avenue de l'Europe, 92270 Bois-Colombes, FR
(72) COLIN, Philippe, 14 rue du Quai, F-68040 Ingersheim, FR
DOZZI, Jean-Claude, 7a rue de la Gare, F-68230 Soultzbach-les-bains, FR
PROBST, Pierre, 11 rue des Camélias, F-68770 Ammerschwihr, FR
WISS, Véronique, 15 route de Sélestat, F-67390 Hessenheim, FR
RUPPEL, Rémy, 6 rue des Vosges, F-68320 Durrenentzen, FR
-
- (51) MKP
A23L 1/236 (2006.01) (97) **2432332 ***
A23L 1/00 (2006.01)
A23G 3/44 (2006.01)
A23G 3/42 (2006.01)
- (86) EP2010001625 15.03.2010
(96) 10710796.3 28.03.2012
(87) WO2010133267, 15.03.2010
(97) 2432332, 28.03.2012 de
(54) SUCRALOSE-CONTAINING ARTIFICIAL SWEETENER COMPOSITIONS
- (71) Krüger GmbH & Co. KG, Senefelderstrasse 44, 51469 Bergisch-Gladbach, DE
(72) KRÜGER, Willibert, Zaunkönigweg 5, 51467 Bergisch-Gladbach, DE
-
- (51) MKP
A01N 47/36 (2006.01) (97) **2498604 ***
A01N 39/04 (2006.01)
A01N 43/40 (2006.01)
- (86) US2010056468 12.11.2010
(96) 10782488.0 19.09.2012
(87) WO2011060230, 12.11.2010
(97) 2498604, 19.09.2012 en
(54) SYNERGISTIC HERBICIDAL COMPOSITION CONTAINING AMINOPYRALID AND SULFONYLUREAS
- (71) Dow AgroSciences, LLC, 9330 Zionsville Road, Indianapolis, IN 46268, US
(72) CORR, Ian, 16 Sutton Road RD4, New Plymouth 4374, NZ
LOVE, Christopher, 7/18 Park Avenue, Auchenflower Queensland 4066, AU
-
- (51) MKP
A61K 47/48 (2006.01) (97) **2403537 ***
- (86) EP2010052745 04.03.2010
(96) 10706648.2 11.01.2012
(87) WO2010100220, 04.03.2010
(97) 2403537, 11.01.2012 en
(54) INTERFERON ALPHA CARRIER PRODRUGS
- (71) Ascendis Pharma A/S, Tuborg Boulevard 12, 2900 Hellerup, DK
RAU, Harald, Schwarzwaldstr. 51/2, 69124 Heidelberg, DE
KADEN-VAGT, Silvia, Langgewann 79-81, 69121 Heidelberg, DE
-
- (51) MKP
C09C 3/10 (2006.01) (97) **2445973 ***
B29B 9/12 (2006.01)
C09C 1/02 (2006.01)
C08K 9/00 (2006.01)
- (86) IB2010052810 22.06.2010
(96) 10730249.9 02.05.2012
(87) WO2010150182, 22.06.2010
(97) 2445973, 02.05.2012 en
(54) PROCESS FOR MANUFACTURING A SURFACE-TREATED COMPACTED MATERIAL PROCESSABLE ON A SINGLE SCREW PLASTICS CONVERSION EQUIPMENT
- (71) Omya Development AG, Baslerstrasse 42, 4665 Oftringen, CH
AMMANN, Ernst, Kallernweg 2, CH-4812 Mühlethal, CH
KNERR, Michael, Wolfbachring 20, CH-4665 Oftringen, CH
HALDEMANN, Peter, Hallwylweg 13, CH-4852 Rothrist, CH
HERSCHE, Emil, Im Höfli 15, CH-8832 Wollerau, CH
-
- (51) MKP
A61M 5/24 (2006.01) (97) **2437811 ***
- (86) EP2010057471 28.05.2010
(96) 10722347.1 11.04.2012
(87) WO2010139632, 28.05.2010
(97) 2437811, 11.04.2012 en
(54) RESETTABLE DRUG DELIVERY DEVICE
- (71) Sanofi-Aventis Deutschland GmbH, Brüningstraße 50, 65929 Frankfurt, DE
(72) JONES, Christopher, 153 High Street Broadway, Worcestershire WR12 7AL, GB
-
- (51) MKP
A01N 37/12 (2006.01) (97) **2405749 ***
A01N 37/44 (2006.01)
A61K 31/195 (2006.01)
- (86) US2010002283 19.08.2010
(96) 10810282.3 18.01.2012
(87) WO2011022063, 19.08.2010
(97) 2405749, 18.01.2012 en
(54) LOW FREQUENCY GLATIRAMER ACETATE THERAPY
- (71) Yeda Research and Development Co., Ltd., P.O.Box 95, 76100 Rehovot, IL
(72) KLINGER, Ety, 16 Agadati Street, 39930 Tel Aviv, IL
-
- (51) MKP
A61K 31/722 (2006.01) (97) **2477633 ***
A23L 1/30 (2006.01)
A61K 36/185 (2006.01)
A61K 36/06 (2006.01)
A61K 36/234 (2006.01)
A61P 15/10 (2006.01)
A23L 1/29 (2006.01)
- (86) EP2010005689 16.09.2010
(96) 10760252.6 25.07.2012
(87) WO2011032697, 16.09.2010
(97) 2477633, 25.07.2012 en
(54) "DIETARY SUPPLEMENT STIMULATING THE MALE SEXUAL FUNCTION"
- (71) Tradapharma SAGL, Via G. Calgari, 3, 6900 Lugano, CH
IACONO, Fabrizio, Via Tasso, 480 Parco Matarazzo, 80127 Napoli, IT
-
- (51) MKP
C12N 5/0783 (2010.01) (97) **2470644 ***
- (86) US2010046505 24.08.2010
(96) 10814245.6 04.07.2012
(87) WO2011028531, 24.08.2010
(97) 2470644, 04.07.2012 en
(54) GENERATION OF CTL LINES WITH SPECIFICITY AGAINST MULTIPLE TUMOR ANTIGENS OR MULTIPLE VIRUSES
- (71) Baylor College Of Medicine, One Baylor Plaza, Houston, TX 77030-3411, US
Wilson Wolf Manufacturing, 33-5th Avenue N.W. Suite 700, New Brighton, MN, US
(72) LEEN, Ann Marie, 7530 Brompton Rd. Apt. 890, Houston, TX 77025, US
ROONEY, Cliona, 4802 Willow St., Bellaire, TX 77401, US
GERDEMANN, Ulrike, 7675 Phoenix Dr. Apt. 415, Houston, TX 77030, US
VERA, Juan, 5227 Maple St., Bellaire, TX 77401, US

- (51) MKP
C14C 15/00 (2006.01) (97) **2481821**
C14B 3/00 (2006.01)
- (96) 11000700.2 01.08.2012
(97) 2481821, 01.08.2012 en
(54) Process and device for treating leather
(71) Boxmark Leather proizvodnja in trgovina d.o.o., Industrijsko naselje 10, 2325 Kidricevo, SI
(72) Herga, Davorin, Moskanjci 88a, 2272 Gorisnica, SI
-
- (51) MKP
A61K 45/06 (2006.01) (97) **2404600**
A61P 9/04 (2006.01)
A61K 31/55 (2006.01)
A61K 31/4045 (2006.01)
- (96) 11290269.7 11.01.2012
(97) 2404600, 11.01.2012 fr
(54) Use of the combination of a sinus current If inhibitor and an inhibitor of the angiotensin conversion enzyme for treating cardiac insufficiency
(71) Les Laboratoires Servier, 35, rue de Verdun, 92284 Suresnes Cedex, FR
(72) Thuillez, Christian, 30, rue Louis Bouilhet, 76000 Rouen, FR
Mulder, Paulus, 15, Chemin du Mont à Cat, 76130 Mont Saint Aignan, FR
Vilaine, Jean-Paul, 21, rue des Vallées, 92290 Chatenay Malabry, FR
Fratacci, Marie-Dominique, 69, avenue Paul-Vaillant Couturier, 78390 Bois d'Arcy, FR
Lerebours-Piegeonniere, Guy, 28, avenue de l'Europe, 92300 Levallois-Perret, FR
Feldmann, Luc, 22, rue Tocqueville, 75017 Paris, FR
Roussel, Jérôme, 20, rue Pasteur, 78220 Viroflay, FR
-
- (51) MKP
A61C 8/00 (2006.01) (97) **2407121**
- (96) 10007281.8 18.01.2012
(97) 2407121, 18.01.2012 en
(54) Abutment system
(71) Nobel Biocare Services AG, Postfach, 8058 Zürich-Flughafen, CH
(72) Petersson, Henrik, Räntmästagatan 23B, 41658 Gothenburg, SE
Jörneus, Lars, Västra Ryabergsvägen 7A, 43961 Frillesås, SE
-
- (51) MKP
C10G 45/72 (2006.01) (97) **2497816 ***
C10G 45/02 (2006.01)
- (86) JP2010067927 13.10.2010
(96) 10828172.6 12.09.2012
(87) WO2011055612, 13.10.2010
(97) 2497816, 12.09.2012 en
(54) METHOD FOR HYDROFINING NAPHTHA FRACTION AND PROCESS FOR PRODUCING HYDROCARBON OIL
(71) Japan Oil, Gas and Metals National Corporation, 2-10-1, Toranomon, Minato-ku, Tokyo 105-0001, JP
INPEX Corporation, 5-3-1 Akasaka Minato-ku, Tokyo 107-6332, JP
JX Nippon Oil & Energy Corporation, 6-3, Otemachi 2-chome, Chiyoda-ku Tokyo 100-8162, JP
Japan Petroleum Exploration Co., Ltd., 7-12, Marunouchi 1-chome Chiyoda-ku, Tokyo 100-0005, JP
Cosmo Oil Co., Ltd., 1-1, Shibaura 1-chome Minato-ku, Tokyo 105-8528, JP
Nippon Steel Engineering Co., Ltd, 5-1, Osaki 1-chome Shinagawa-ku, Tokyo 141-8604, JP
(72) TASAKA Kazuhiko, c/o JX Nippon Oil&Energy Corporation 8 Chidori-cho Naka-ku, Yokohama-shi Kanagawa 231-0815, JP
TANAKA Yuichi, c/o JX Nippon Oil&Energy Corporation 8 Chidori-cho Naka-ku, Yokohama-shi Kanagawa 231-0815, JP
IWAMA Marie, c/o JX Nippon Oil&Energy Corporation 8 Chidori-cho Naka-ku, Yokohama-shi Kanagawa 231-0815, JP
-
- (51) MKP
G01L 9/00 (2006.01) (97) **2462418 ***
G01L 9/12 (2006.01)
G01L 9/04 (2006.01)
G01B 7/02 (2006.01)
- (86) FR2010051672 06.08.2010
(96) 10762734.1 13.06.2012
(87) WO2011015797, 06.08.2010
(97) 2462418, 13.06.2012 fr
(54) CAPACITIVE PRESSURE SENSOR INCORPORATING A TEMPERATURE MEASUREMENT AND COMPATIBLE WITH HOT ENVIRONMENTS
(71) Nanotec Solution, 237, chemin Puech du Teil, 30900 Nîmes, FR
(72) ROZIERE, Didier, 79 Impasse des Hêtres, F-30900 Nîmes, FR
-
- (51) MKP
A61K 9/00 (2006.01) (97) **2477603 ***
A61K 47/36 (2006.01)
A61K 47/42 (2006.01)
A61K 39/00 (2006.01)
A61K 39/395 (2006.01)
C07K 16/00 (2006.01)
C07K 16/06 (2006.01)
C12N 9/24 (2006.01)
- (86) US2010002545 16.09.2010
(96) 10760140.3 25.07.2012
(87) WO2011034604, 16.09.2010
(97) 2477603, 25.07.2012 en
(54) STABLE CO-FORMULATION OF HYALURONIDASE AND IMMUNOGLOBULIN, AND METHODS OF USE THEREOF
(71) Baxter Healthcare SA, Thurgauerstrasse 130, 8152 Glattpark (Opfikon), CH
Baxter International Inc, One Baxter Parkway, Deerfield, IL 60015, US
(72) TESCHNER, Wolfgang, Gestettengasse 19/14, A-1030 Wien, AT
SVATOS, Sonja, Kapellengasse 42, A-2413 Berg, AT
BRUCKSCHWAIGER, Leopold, Herminengasse 5/14, A-1020 Wien, AT
WEBER, Alfred, Skraupstrasse 24/42/8, A-1210 Wien, AT
SCHWARZ, Hans-Peter, Weimarer Strasse 76, A-1180 Wien, AT
LEI, Laura, 11452 Clarkson Road, Los Angeles CA 90064, US
-
- (51) MKP
A61K 31/5517 (2006.01) (97) **2419106 ***
A61P 35/02 (2006.01)
- (86) US2010030315 08.04.2010
(96) 10714407.3 22.02.2012
(87) WO2010120614, 08.04.2010
(97) 2419106, 22.02.2012 en
(54) BENZODIAZEPINE DERIVATIVE FOR THE TREATMENT OF HEMATOPOIETIC NEOPLASM AND LEUKEMIA
(71) Eli Lilly and Company, Lilly Corporate Center, Indianapolis, IN 46285, US
(72) CHEDID, Marcio, Eli Lilly And Company Lilly Corporate Center, Indianapolis, Indiana 46285, US
-
- (51) MKP
C07D 401/12 (2006.01) (97) **2403834 ***
C07D 401/14 (2006.01)
C07D 401/04 (2006.01)
C07D 403/12 (2006.01)
C07D 407/12 (2006.01)
C07D 231/12 (2006.01)
C07D 409/04 (2006.01)
C07D 231/20 (2006.01)
C07D 417/12 (2006.01)
C07D 231/38 (2006.01)
A61K 31/4155 (2006.01)
- (86) US2010026003 03.03.2010
(96) 10707187.0 11.01.2012
(87) WO2010101973, 03.03.2010
(97) 2403834, 11.01.2012 en
(54) Fungicidal pyrazoles
(71) E. I. du Pont de Nemours and Company, 1007 Market Street, Wilmington, DE 19898, US
(72) LONG, Jeffrey, Keith, 1210 Bruce Road, Wilmington Delaware 19803, US
HONG, Wonpyo, 8506 Marburg Manor Drive, Lutherville Maryland 21093, US
TAGGI, Andrew, Edmund, 21 Tremont Court, Newark Delaware 19711, US

- (51) MKP
G07C 9/00 (2006.01) (97) **2336982**
E05B 19/04 (2006.01)
H01H 13/06 (2006.01)
B60R 25/00 (2006.01)
E05B 47/06 (2006.01)
(96) 10191805.0 22.06.2011
(97) 2336982, 22.06.2011 de
(54) Mobile device
(71) Huf Hülsebeck & Fürst GmbH & Co. KG, Steeger Strasse 17, 42551 Velbert, DE
(72) Geldmacher, Alexander, Schuckert Straße 13, 42113, Wuppertal, DE
-
- (51) MKP
A61P 17/00 (2006.01) (97) **2417104 ***
A01N 31/16 (2006.01)
C07C 317/22 (2006.01)
A01N 39/00 (2006.01)
C07C 323/20 (2006.01)
A01N 41/10 (2006.01)
A61K 8/46 (2006.01)
A01P 1/00 (2006.01)
A61Q 5/08 (2006.01)
A61Q 19/02 (2006.01)
A61Q 19/08 (2006.01)
(86) EP2010054619 08.04.2010
(96) 10713194.8 15.02.2012
(87) WO2010115945, 08.04.2010
(97) 2417104, 15.02.2012 fr
(54) SULPHURATED DERIVATIVES OF RESORCINOL, PREPARATION OF SAME AND COSMETIC USES THEREOF
(71) Pierre Fabre Dermo-Cosmétique, 45, place Abel-Gance, 92100 Boulogne-Billancourt, FR
(72) POIGNY, Stéphane, 84 chemin des Roquettes, F-31600 Saubens, FR
-
- (51) MKP
C12Q 1/48 (2006.01) (97) **2446050 ***
C12N 9/10 (2006.01)
(86) EP2010059086 25.06.2010
(96) 10725211.6 02.05.2012
(87) WO2010149780, 25.06.2010
(97) 2446050, 02.05.2012 en
(54) TEST SYSTEM FOR MEASURING MEST ACTIVITY AS WELL AS METHODS AND USES INVOLVING THE SAME
(71) SANOFI, 54 rue La Boétie, 75008 Paris, FR
(72) MÜLLER, Günter, c/o Sanofi-Aventis Deutschland GmbH, 65926 Frankfurt am Main, DE
JUNG, Christian, c/o Sanofi-Aventis Deutschland GmbH, 65926 Frankfurt am Main, DE
ZHOU-LIU, Qing, c/o Sanofi Aventis Département Brevets 174 Avenue de France, F-75013 Paris, FR
BERNE, Pierre-Francois, c/o Sanofi Aventis Département Brevets 174 Avenue de France, F-75013 Paris, FR
CAPDEVILA, Cecile, c/o Sanofi Aventis Département Brevets 174 Avenue de France, F-75013 Paris, FR
-
- (51) MKP
C12Q 1/37 (2006.01) (97) **2473855 ***
G01N 33/573 (2006.01)
G01N 33/68 (2006.01)
(86) EP2010062525 27.08.2010
(96) 10749832.1 11.07.2012
(87) WO2011023786, 27.08.2010
(97) 2473855, 11.07.2012 en
(54) USE OF CATHEPSIN H
(71) SANOFI, 54 rue La Boétie, 75008 Paris, FR
(72) GEBAUER, Mathias, c/o Sanofi-Aventis Deutschland GmbH, 65926 Frankfurt am Main, DE
MICHAELIS, Martin, Unterlindau 72, 60323 Frankfurt, DE
DING-PFENNIGDORFF, Danping, c/o Sanofi-Aventis Deutschland GmbH, 65926 Frankfurt am Main, DE
SCHULTE, Anke M., c/o Sanofi-Aventis Deutschland GmbH, 65926 Frankfurt am Main, DE
METZ-WEIDMANN, Christiane, c/o Sanofi-Aventis Deutschland GmbH, 65926 Frankfurt am Main, DE
-
- (51) MKP
G07F 17/32 (2006.01) (97) **2413297**
(96) 11170023.3 01.02.2012
(97) 2413297, 01.02.2012 de
(54) Method for limiting the number of coin-operated entertainment machines a player can use.
(71) adp Gauselmann GmbH, Merkur-Allee 1-15, 32339 Espelkamp, DE
-
- (51) MKP
C07D 409/10 (2006.01) (97) **2488515 ***
C07D 409/14 (2006.01)
C07F 3/06 (2006.01)
(86) US2010052598 14.10.2010
(96) 10768162.9 22.08.2012
(87) WO2011047113, 14.10.2010
(97) 2488515, 22.08.2012 en
(54) PROCESS FOR THE PREPARATION OF COMPOUNDS USEFUL AS INHIBITORS OF SGLT2
(71) Janssen Pharmaceutica, N.V., Turnhoutseweg 30, 2340 Beerse, BE
(72) FARINA, Vittorio, c/o Turnhoutseweg 30, B-2340 Beerse, BE
LEMAIRE, Sebastien, Francois Emmanuel, c/o Turnhoutseweg 30, B-2340 Beerse, BE
HOUPIIS, Ioannis, N., c/o Turnhoutseweg 30, B-2340 Beerse, BE
-
- (51) MKP
G01N 33/53 (2006.01) (97) **2419732 ***
(86) US2010031197 15.04.2010
(96) 10765167.1 22.02.2012
(87) WO2010121000, 15.04.2010
(97) 2419732, 22.02.2012 en
(54) PRION-FREE NANOPARTICLE COMPOSITIONS AND METHODS
(71) Abraxis BioScience, LLC, 11755 Wilshire Boulevard Suite 2100, Los Angeles, CA 90025, US
(72) DESAI, Neil, P., 11755 Wilshire Boulevard Suite 2000, Los Angeles, CA 90025, US
PEYKOV, Viktor, 11755 Wilshire Boulevard Suite 2000, Los Angeles, CA 90025, US
SOON-SHIONG, Patrick, 149 South Barrington Avenue 311, Los Angeles, CA 90049, US
-
- (51) MKP
A61C 8/00 (2006.01) (97) **2407120**
(96) 10007280.0 18.01.2012
(97) 2407120, 18.01.2012 en
(54) Implant system
(71) Nobel Biocare Services AG, Postfach, 8058 Zürich-Flughafen, CH
(72) Petersson, Henrik, Röntmästargatan 23B, 41658 Gothenburg, SE
Jörneus, Lars, Västra Ryabergsvägen 7A, 43961 Frillesås, SE
-
- (51) MKP
A61K 39/395 (2006.01) (97) **2493924 ***
C07K 16/00 (2006.01)
(86) US2010054521 28.10.2010
(96) 10830460.1 05.09.2012
(87) WO2011059755, 28.10.2010
(97) 2493924, 05.09.2012 en
(54) DUAL VARIABLE DOMAIN IMMUNOGLOBULINS AND USES THEREOF
(71) Abbott Laboratories, 100 Abbott Park Rd., Abbott Park, IL 60064, US
(72) GHAYUR, Tariq, 1014 Washington Street, Holliston Massachusetts 01746, US
SALFELD, Jochen, G., 177 Old Westboro Road, No. Grafton Massachusetts 01536, US
MCPHERSON, Michael, J., 287 Pillsbury Road, Ashby Massachusetts 01431, US
HARRIS, Maria, C., 55 Trowbridge Lane, Shrewsbury Massachusetts 01545, US
LIU, Junjian, 14 Crimson Drive, Shrewsbury Massachusetts 01545, US
ISAKSON, Peter, C., 14 Hillside Avenue, Southborough Massachusetts 01772, US
GU, Jijie, 12 Tern Drive, Shrewsbury Massachusetts 01545, US

- (51) MKP
A61K 35/56 (2006.01) (97) **2435055 ***
 (86) IB2010001478 28.05.2010
 (96) 10740706.6 04.04.2012
 (87) WO2010136900, 28.05.2010
 (97) 2435055, 04.04.2012 en
 (54) METHODS OF USING KRILL OIL TO TREAT RISK FACTORS FOR METABOLIC DISORDERS AND OBESITY
 (71) Aker Biomarine ASA, P.O. Box 1423 Vika Fjordalleen 16, 0115 Oslo, NO
 (72) BRUHEIM, Inge, Martavegen 6A, N-6100 Volda, NO
 TILSETH, Snorre, Fantoftasen 27A, N-5027 Bergen, NO
 COHN, Jeffrey, 114 Pymont Bridge Road Camperdown, Sydney, NSW 2050, AU
 GRIINARI, Mikko, Kultatinnantie 1B, FI-02660 Espoo, FI
 BANNI, Sebastiano, Viale Poetto 98, I-09126 Cagliari, IT
 MANCINELLI, Daniele, Grimvegen 14, N-6150 Orsta, NO
 HOEM, Nils, Skovveien 6A, N-0257 Oslo, NO
 VIK, Hogne, Nils Larssons Vei 1, N-1359 Eiksmarka, NO

- (51) MKP
A61K 38/16 (2006.01) (97) **2483302 ***
C07K 14/705 (2006.01)
C12N 5/071 (2010.01)
 (86) IB2010002142 05.08.2010
 (96) 10755236.6 08.08.2012
 (87) WO2011039584, 05.08.2010
 (97) 2483302, 08.08.2012 en
 (54) PARSTATIN PEPTIDES
 (71) Tsopanoglou, Nikos, Eirinis 2 Platani 265 04 Rio-Patras, Achaia, GR
 Maragoudakis, Michael, Pentelis 22 Kefalari, 145 62 Kifisia, Attiki, GR
 Vinos, Stanley, The Smith Building, Second Floor Room M023 400 N.Broadway, Baltimore, MD 21287, US
 Strande, Jennifer, 8701 Watertown Plan Road, Milwaukee, WI, US
 Gartaganis, Sotirios, null, 265 00 Rio-Patras, GR
 Siablis, Dimitrios, null, 265 00 Rio-Patras, GR
 (72) Tsopanoglou, Nikos, Eirinis 2 Platani 265 04 Rio-Patras, Achaia, GR
 Maragoudakis, Michael, Pentelis 22 Kefalari, 145 62 Kifisia, Attiki, GR
 Vinos, Stanley, The Smith Building, Second Floor Room M023 400 N.Broadway, Baltimore, MD 21287, US
 Strande, Jennifer, 8701 Watertown Plan Road, Milwaukee, WI, US
 Gartaganis, Sotirios, null, 265 00 Rio-Patras, GR
 Siablis, Dimitrios, null, 265 00 Rio-Patras, GR

- (51) MKP
C07D 295/135 (2006.01) (97) **2430008 ***
 (86) DK2010050101 11.05.2010
 (96) 10719726.1 21.03.2012
 (87) WO2010130260, 11.05.2010
 (97) 2430008, 21.03.2012 en
 (54) STABLE FORMS OF N-(2,6-DIMETHYL-4-MORPHOLIN-4-YL-PHENYL)-3,3-DIMETHYL-BUTYRAMIDE
 (71) H. Lundbeck A/S, Ottiliavej 9, 2500 Valby, DK
 (72) TREPPENDAHL, Svend, Frederiksdalsvej 221, DK-2830 Virum, DK
 LILTORP, Karin, Bangsbo Plads 53, DK-2720 Vanløse, DK
 LOPEZ DE DIEGO, Heidi, Hælderne 5, DK-2850 Nærum, DK

- (51) MKP
A61F 2/84 (2006.01) (97) **2493430 ***
A61F 2/90 (2006.01)
A61F 2/00 (2006.01)
 (86) US2010054455 28.10.2010
 (96) 10779118.8 05.09.2012
 (87) WO2011053693, 28.10.2010
 (97) 2493430, 05.09.2012 en
 (54) INTRALUMINAL DEVICE WITH IMPROVED FLEXIBILITY AND DURABILITY
 (71) Cordis Corporation, 430 Route 22, Bridgewater, NJ 08807, US
 (72) WILLIAMSON, Michael, V., 304 Windmill Canyon Place, Clayton, CA 94517, US

- (51) MKP
C09C 1/02 (2006.01) (97) **2390285**
 (96) 10164408.6 30.11.2011
 (97) 2390285, 30.11.2011 en
 (54) Process for the preparation of surface treated mineral filler products and uses of same
 (71) Omya Development AG, Baslerstrasse 42, 4665 Oftringen, CH
 Buri, Matthias, Mätteliweg 20, 4852, Rothrist, CH
 Gane, Patrick A.C., Studenweg 8, 4852, Rothrist, CH
 Rentsch, Samuel, Höheweg 1, 4663, Aarburg, CH
 Burkhalter, René, Cuno Amiet Strasse 56, 3360, Herzogenbuchsee, CH

- (51) MKP
A61M 15/08 (2006.01) (97) **2445560 ***
 (86) IB2010052820 22.06.2010
 (96) 10791721.3 02.05.2012
 (87) WO2010150187, 22.06.2010
 (97) 2445560, 02.05.2012 en
 (54) NASAL INTERFACE DEVICE
 (71) Kast Silicone Ltd., 1 Kiryat Anavim St., 90833 Kibbutz Kiryat Anavim, IL
 (72) ZUCKER, Shlomo, 13 Kohav Hayam St., 40297 Mihmoret, IL
 DVIR, Menachem, 2 Yitzhak Sade St., 46284 Herzlia, IL

- (51) MKP
C07D 413/12 (2006.01) (97) **2470511 ***
A61K 31/53 (2006.01)
A61P 35/00 (2006.01)
C07D 239/48 (2006.01)
 (86) US2010047007 27.08.2010
 (96) 10749743.0 04.07.2012
 (87) WO2011025965, 27.08.2010
 (97) 2470511, 04.07.2012 en
 (54) RAF INHIBITOR COMPOUNDS AND METHODS OF USE THEREOF
 (71) Genentech, Inc., 1 DNA Way, South San Francisco, CA 94080-4990, US
 (72) ALIAGAS, Ignacio, 1 DNA Way, South San Francisco, California 94080-4990, US
 GRADL, Stefan, 1 DNA Way, South San Francisco, California 94080-4990, US
 GUNZNER, Janet, 1 DNA Way, South San Francisco, California 94080-4990, US
 MATHIEU, Simon, 1 DNA Way, South San Francisco, California 94080-4990, US
 PULK, Rebecca, 1 DNA Way, South San Francisco, California 94080-4990, US
 RUDOLPH, Joachim, 1 DNA Way, South San Francisco, California 94080-4990, US
 WEN, Zhaoyang, 1 DNA Way, South San Francisco, California 94080-4990, US

- (51) MKP
C07K 14/18 (2006.01) (97) **2456786 ***
C12N 15/867 (2006.01)
 (86) US2010042870 22.07.2010
 (96) 10737715.2 30.05.2012
 (87) WO2011011584, 22.07.2010
 (97) 2456786, 30.05.2012 en
 (54) LENTIVIRAL VECTORS PSEUDOTYPED WITH A SINDBIS VIRUS ENVELOPE GLYCOPROTEIN
 (71) Immune Design Corp, 1124 Columbia Street Suite 700, Seattle, WA 98104, US
 (72) ALLEN, James, M., 1124 Columbia Street Suite 700 Seattle, WA 98104, US
 VAN HOEVEN, Neal, S., 1124 Columbia Street Suite 700 Seattle, WA 98104, US
 LI, Jin Zhong, 1124 Columbia Street Suite 700 Seattle, Washington 98104, US
 SLOAN, Derek, D., 1124 Columbia Street Suite 700 Seattle, WA 98104, US
 DUBENSKY, Thomas W., Jr., 1124 Columbia Street Suite 700 Seattle, WA 98104, US

- (51) MKP
A61K 47/36 (2006.01) (97) **2415470 ***
A61K 31/357 (2006.01)
A61K 9/127 (2006.01)
A61K 47/02 (2006.01)
A61K 47/18 (2006.01)
A61K 47/24 (2006.01)
A61K 47/28 (2006.01)
A61K 47/34 (2006.01)
(86) JP2010055770 30.03.2010
(96) 10758755.2 08.02.2012
(87) WO2010113984, 30.03.2010
(97) 2415470, 08.02.2012 en
(54) LIPOSOME COMPOSITION
(71) Eisai R&D Management Co., Ltd., 6-10, Koishikawa 4-chome Bunkyo-ku, Tokyo 112-8088, JP
(72) KIKUCHI, Hiroshi, c/o Tsukuba Research Laboratories EISAI CO., LTD. 1-3, Tokodai 5-chome, Tsukuba-shi Ibaraki 300-2635, JP
HYODO, Kenji, c/o Tsukuba Research Laboratories EISAI CO., LTD. 1-3, Tokodai 5-chome, Tsukuba-shi Ibaraki 300-2635, JP
ISHIHARA, Hiroshi, c/o Tsukuba Research Laboratories EISAI CO., LTD. 1-3, Tokodai 5-chome, Tsukuba-shi Ibaraki 300-2635, JP
-
- (51) MKP
A61F 5/01 (2006.01) (97) **2301488**
(96) 10405177.6 30.03.2011
(97) 2301488, 30.03.2011 de
(54) Immobilizing rail
(71) MIC & Partners GmbH, Glattalstrasse 118a, 8052 Zürich, CH
(72) Natsis, Michael, Glattalstrasse 118A, 8052 Zürich, CH
-
- (51) MKP
C07H 21/04 (2006.01) (97) **2421881 ***
C12Q 1/68 (2006.01)
C12N 9/24 (2006.01)
(86) US2010031623 19.04.2010
(96) 10767592.8 29.02.2012
(87) WO2010123827, 19.04.2010
(97) 2421881, 29.02.2012 en
(54) ENGINEERED DEMETER 5-METHYLCYTOSINE DNA GLYCOSYLASE WITH IMPROVED YIELD, STABILITY AND SOLUBILITY
(71) The Regents of the University of California, 1111 Franklin Street, 12th Floor, Oakland, CA 94607, US
(72) HUH, Jin Hoe, 1111 Franklin Street, 12th Floor, Oakland, California 94530, US
FISCHER, Robert, 1423 Scott Street, El Cerrito, California 94530, US
-
- (51) MKP
D05B 25/00 (2006.01) (97) **2325363**
D05B 33/00 (2006.01)
(96) 10014746.1 25.05.2011
(97) 2325363, 25.05.2011 en
(54) Conveying device and sewing machine comprising said device
(71) VI.BE.MAC. S.p.A., Via Monte Pastello 7/I, 37057 San Giovanni Lupatoto (VR), IT
(72) Guerreschi, Carlo, Via Campanile Vecchio, 14, 37061 Ca' Di David (VR), IT
-
- (51) MKP
A61K 31/54 (2006.01) (97) **2485736 ***
(86) US2010051553 06.10.2010
(96) 10822567.3 15.08.2012
(87) WO2011044181, 06.10.2010
(97) 2485736, 15.08.2012 en
(54) IMINOTHIADIAZINE DIOXIDE COMPOUNDS AS BACE INHIBITORS, COMPOSITIONS, AND THEIR USE
(71) Merck Sharp & Dohme Corp., 126 East Lincoln Avenue, Rahway NJ 07065-0907, US
(72) SCOTT, Jack, D., 2000 Galloping Hill Road, Kenilworth, New Jersey 07033, US
STAMFORD, Andrew, W., 2000 Galloping Hill Road, Kenilworth, New Hampshire 07033, US
GILBERT, Eric, J., 2000 Galloping Hill Road, Kenilworth, New Jersey 07033, US
CUMMING, Jared, N., 2000 Galloping Hill Road, Kenilworth, New Jersey 07033, US
ISERLOH, Ulrich, 2000 Galloping Hill Road, Kenilworth, New Jersey 07033, US
MISIASZEK, Jeffrey, A., 2000 Galloping Hill Road, Kenilworth, New Jersey 07033, US
LI, Guoqing, 2000 Galloping Hill Road, Kenilworth, New Jersey 07033, US
-
- (51) MKP
E01B 3/34 (2006.01) (97) **2488698 ***
E01B 7/22 (2006.01)
(86) EP2010006208 12.10.2010
(96) 10776296.5 22.08.2012
(87) WO2011045018, 12.10.2010
(97) 2488698, 22.08.2012 de
(54) PRESTRESSED CONCRETE SLEEPER AND METHOD FOR TRANSPORTING AND INSTALLING A SWITCH HAVING PRESTRESSED CONCRETE SLEEPERS
(71) DB Netz AG, Theodor-Heuss-Allee 7, 60468 Frankfurt am Main, DE
RAIL.ONE GmbH, Ingolstädter Strasse 51, 92318 Neumarkt, DE
(72) SCHIMPF, Frithjof, Forststrasse 18, 65193 Wiesbaden, DE
MÜLLER, Hans-Dieter, In der Schomau 10, 44892 Bochum, DE
-
- (51) MKP
B21F 27/10 (2006.01) (97) **2485856 ***
B21F 27/20 (2006.01)
E04C 5/04 (2006.01)
B21F 23/00 (2006.01)
B23K 11/00 (2006.01)
(86) EP2010061909 16.08.2010
(96) 10745208.8 15.08.2012
(87) WO2011042240, 16.08.2010
(97) 2485856, 15.08.2012 de
(54) METHOD AND DEVICE FOR PRODUCING WELDED CONNECTIONS
(71) Häussler Innovation GmbH, Mozartstrasse 12, Kempten 87435, DE
(72) HÄUSSLER, Franz, Lechwiesenstrasse 50, 86983 Lechbruck am See, DE
HUNDEGGER, Hans, Auf der Geigerhalde 41, 87459 Pfronten-Weissbach, DE
-
- (51) MKP
C07C 309/73 (2006.01) (97) **2477970 ***
C07D 223/16 (2006.01)
C07C 309/66 (2006.01)
(86) FR2010000625 17.09.2010
(96) 10773114.3 25.07.2012
(87) WO2011033194, 17.09.2010
(97) 2477970, 25.07.2012 fr
(54) NOVEL METHOD FOR SYNTHESIZING IVABRADINE AND THE ADDITION SALTS THEREOF WITH A PHARMACEUTICALLY ACCEPTABLE ACID
(71) Les Laboratoires Servier, 35, rue de Verdun, 92284 Suresnes Cedex, FR
(72) PEGLION, Jean-Louis, 5 allée des Bégonias, F-78110 Le Vesinet, FR
CAIGNARD, Pascal, 34 avenue Gallieni, F-93800 Epinay-sur-Seine, FR
LERESTIF, Jean-Michel, 27 bis rue de la Briqueterie, F-76190 Yvetot, FR
LECOUVE, Jean-Pierre, 93 rue du Dr Vigné, F-76600 Le Havre, FR

- (51) MKP
A61K 31/558 (2006.01) (97) **2493870 ***
A61K 31/5377 (2006.01)
C07D 311/22 (2006.01)
- (86) GB2010051788 25.10.2010
(96) 10769052.1 05.09.2012
(87) WO2011051704, 25.10.2010
(97) 2493870, 05.09.2012 en
- (54) CHROMENONE DERIVATIVES WITH ANTI-TUMOUR ACTIVITY
- (71) AstraZeneca AB, null, 151 85 Södertälje, SE
(72) BARLAAM, Bernard, Christophe, AstraZeneca Pharma Z.I La Pompelle BP 1050, F-51689 Reims Cedex 2, FR
DEGORCE, Sebastien, Louis, AstraZeneca Pharma Z.I La Pompelle BP 1050, F-51689 Reims Cedex 2, FR
LAMBERT-VAN DER BREMPT, Christine, Marie, Paul, AstraZeneca Pharma Z.I La Pompelle BP 1050, F-51689 Reims Cedex 2, FR
MORGENTIN, Remy, Robert, AstraZeneca Pharma Z.I La Pompelle BP 1050, F-51689 Reims Cedex 2, FR
PLE, Patrick, AstraZeneca Pharma Z.I La Pompelle BP 1050, F-51689 Reims Cedex 2, FR
-
- (51) MKP
A61K 31/4412 (2006.01) (97) **2441455**
A61P 11/00 (2006.01)
A61K 31/135 (2006.01)
A61K 31/15 (2006.01)
A61K 31/44 (2006.01)
- (96) 11006411.0 18.04.2012
(97) 2441455, 18.04.2012 en
- (54) Methods of administering pirfenidone therapy
- (71) Intermune, Inc., 3280 Bayshore Boulevard, Brisbane, CA 94005, US
(72) Bradford, Williamson Ziegler, PO Box 566, Ross California 94957, US
-
- (51) MKP
C12N 5/074 (2010.01) (97) **2456863 ***
C12N 5/077 (2010.01)
- (86) EP2010060539 21.07.2010
(96) 10745189.0 30.05.2012
(87) WO2011009878, 21.07.2010
(97) 2456863, 30.05.2012 en
- (54) PLURIPOTENT STEM CELLS OBTAINED FROM DENTAL PULP
- (71) Universitat Internacional De Catalunya, C. Immaculada 22, 08017 Barcelona, ES
(72) AL-ATARI ABOU-ASI, Maher, C. Diputación 288 2º 2ª, E-08009 Barcelona, ES
CASALS FARRÉ, Núria, C. Terol 3, E-08860 Castelldefels (Barcelona), ES
GINER TARRIDA, Lluís, C. Josep Sentis 36, E-08193 Cerdanyola del Valles (Barcelona), ES
FERRÉS PADRÓ, Eduardo, C/ Santaló 69-71 1º 3ª, E-08021 Barcelona, ES
-
- (51) MKP
H05B 3/00 (2006.01) (97) **2483046 ***
B29C 49/64 (2006.01)
F21V 7/00 (2006.01)
B29B 13/02 (2006.01)
B29C 49/68 (2006.01)
- (86) IB2010054158 15.09.2010
(96) 10760089.2 08.08.2012
(87) WO2011039667, 15.09.2010
(97) 2483046, 08.08.2012 en
- (54) ARRANGEMENT OF A COUNTER REFLECTOR DEVICE FOR USE IN HEATING AN OBJECT, INSTALLATION AND METHOD OF HEATING
- (71) Speziallampenfabrik Dr. Fischer GmbH, Nikolaus-Otto-Strasse, 65582 Diez, DE
(72) MONTEIX, Serge, c/o PHILIPS IP&S - NL High Tech Campus 44, NL-5656 AE Eindhoven, NL
-
- (51) MKP
C07D 213/80 (2006.01) (97) **2412709 ***
C07D 309/32 (2006.01)
C07D 405/06 (2006.01)
- (86) JP2010055316 26.03.2010
(96) 10756205.0 01.02.2012
(87) WO2010110409, 26.03.2010
(97) 2412709, 01.02.2012 en
- (54) PROCESS FOR PRODUCING PYRONE AND PYRIDONE DERIVATIVES
- (71) Shionogi & Co., Ltd., 1-8, Doshomachi 3-chome Chuo-ku Osaka-shi, Osaka-shi, Osaka 5410045, JP
(72) SUMINO, Yukihito, c/o Shionogi & Co., Ltd. 12-4, Sagisu 5-chome Fukushima-ku, Osaka-shi Osaka 553-0002, JP
OKAMOTO, Kazuya, c/o Shionogi & Co., Ltd. Shionogi Innovation Center for Drug Discovery Nishi 11-chome Kita 21-jo Kita-ku, Sapporo-shi Hokkaido 001-0021, JP
MASUI, Moriyasu, c/o Shionogi & Co., Ltd. 12-4, Sagisu 5-chome Fukushima-ku, Osaka-shi Osaka 553-0002, JP
AKIYAMA, Toshiyuki, c/o Shionogi & Co., Ltd. 12-4, Sagisu 5-chome Fukushima-ku, Osaka-shi Osaka 553-0002, JP
-
- (51) MKP
F02B 67/06 (2006.01) (97) **2446162 ***
B60K 25/02 (2006.01)
F16D 13/42 (2006.01)
F16D 27/112 (2006.01)
F16D 15/00 (2006.01)
F04B 17/00 (2006.01)
- (86) CA2010000978 21.06.2010
(96) 10791115.8 02.05.2012
(87) WO2010148507, 21.06.2010
(97) 2446162, 02.05.2012 en
- (54) BALL RAMP CLUTCH
- (71) Magna Powertrain Inc., 50 Casimir Court, Concord, Ontario L4K 4J5, CA
(72) GREENE, Darrell F., 38 Aishford Road, Bradford Ontario L3Z 3E2, CA
-
- (51) MKP
C12N 9/50 (2006.01) (97) **2480661 ***
C12P 21/00 (2006.01)
- (86) GB2010001790 23.09.2010
(96) 10757621.7 01.08.2012
(87) WO201036454, 23.09.2010
(97) 2480661, 01.08.2012 en
- (54) BACTERIAL HOST STRAIN
- (71) UCB Pharma, S.A., 60, allée de la Recherche, 1170 Brussels, BE
(72) ELLIS, Mark, IPD UCB Celltech 208 Bath Road Slough, Berkshire SL1 3WE, GB
HUMPHREYS, David Paul, IPD UCB Celltech 208 Bath Road Slough, Berkshire SL1 3WE, GB
-
- (51) MKP
A61K 38/10 (2006.01) (97) **2404611 ***
A61P 17/00 (2006.01)
- (86) ES2010070121 04.03.2010
(96) 10748370.3 11.01.2012
(87) WO2010100310, 04.03.2010
(97) 2404611, 11.01.2012 en
- (54) Peptide for the prophylactic or therapeutic treatment of skin tumours in initial stages
- (71) ISDIN S.A., Diagonal 520, 08006 Barcelona, ES
(72) INSA BORONAT, Raul, C/ Rosa Sensat 27 B 1a, E-08005 Barcelona, ES
QUINTANILLA AVILA, Miguel, Instituto de Investigaciones Biomédicas Alberto Sols CSIC-UAM c/ Arturo Dupier 4, E-28029 Madrid, ES
DOTOR DE LAS HERRERÍAS, Javier, Digna Biotech S.L. Edificio Azysa c/ Etxesakan 28, E- 31180 Cizur Mayor, ES

- (51) MKP
B29C 65/02 (2006.01) (97) **2275358**
B29C 65/48 (2006.01)
B65D 43/16 (2006.01)
B29C 65/58 (2006.01)
B29C 65/78 (2006.01)
B29L 31/22 (2006.01)
B29C 65/08 (2006.01)
B29C 65/16 (2006.01)
(96) 10169604.5 19.01.2011
(97) 2275358, 19.01.2011 en
(54) A process and plant for obtaining a container body particularly suitable for packaging food products
(71) ISAP Packaging S.P.A., Lungadige Attiraglio, 67, 37124 Parona - Verona (VR), IT
(72) Simonazzi, Daniele, Via Osvaldo Piacentini, 48, 42049, Sant'Ilario d'Enza - RE, IT
-
- (51) MKP
A61K 33/14 (2006.01) (97) **2411021 ***
A61P 41/00 (2006.01)
A61K 33/40 (2006.01)
A61K 33/20 (2006.01)
(86) US2010027971 19.03.2010
(96) 10756641.6 01.02.2012
(87) WO2010111137, 19.03.2010
(97) 2411021, 01.02.2012 en
(54) METHOD FOR SUPPRESSING OR PREVENTING FIBROUS ADHESION FORMATION USING A MULTICOMPONENT AQUEOUS OXYCHLORINE COMPOSITION PREPARED ON-SITE
(71) Kross-Link Laboratories, Inc., 2506 Florin Court, Bellmore, NY 11710, US
(72) KROSS, Robert, D., 2506 Florin Court, Bellmore NY 11710, US
VILLANUEVA, Cleva, Mariano Escobedo 214 Dpto 504, Colonia Anahuac CP 11320, MX
-
- (51) MKP
A61K 31/702 (2006.01) (97) **2411017 ***
A61K 48/00 (2006.01)
A61K 9/00 (2006.01)
C12N 15/88 (2006.01)
(86) GB2010000534 23.03.2010
(96) 10723246.4 01.02.2012
(87) WO2010109176, 23.03.2010
(97) 2411017, 01.02.2012 en
(54) PARENTERAL PHARMACEUTICAL COMPOSITION FOR USE IN GENE THERAPY
(71) NTNU Technology Transfer AS, Sem Sælands vei 14, 7491 Trondheim, NO
(72) TAYLOR, Catherine, NTNU Technology Transfer AS
Klaebuveien 153, N-7491 Trondheim, NO
DRAGET, Kurt, Ingar, NTNU Technology Transfer AS
Klaebuveien 153, N-7491 Trondheim, NO
-
- (51) MKP
D21C 9/00 (2006.01) (97) **2414584 ***
D21D 1/00 (2006.01)
D21H 11/00 (2006.01)
D21H 11/18 (2006.01)
D21B 1/16 (2006.01)
(86) EP2010054231 30.03.2010
(96) 10713884.4 08.02.2012
(87) WO2010112519, 30.03.2010
(97) 2414584, 08.02.2012 en
(54) PROCESS FOR THE PRODUCTION OF NANO-FIBRILLAR CELLULOSE SUSPENSIONS
(71) Omya Development AG, Baslerstrasse 42, 4665 Oftringen, CH
(72) GANE, Patrick A.C., Studenweg 8, CH-4852 Rothrist, CH
SCHOELKOPF, Joachim, Buechbühlstrasse 3, CH-8956 Killwangen, CH
GANTENBEIN, Daniel, Vogesenstrasse 27, CH-4056 Basel, CH
SCHENKER, Michel, Baslerstrasse 9, CH-4665 Oftringen, CH
POHL, Michael, H.-v.-Tuerlin Strasse 11, A-9500 Villach, AT
KÜBLER, Beat, Sperberweg 36, CH-4104 Oberwil, CH
-
- (51) MKP
C07D 487/04 (2006.01) (97) **2483274 ***
A61K 31/519 (2006.01)
A61P 33/06 (2006.01)
(86) US2010050532 28.09.2010
(96) 10821105.3 08.08.2012
(87) WO2011041304, 28.09.2010
(97) 2483274, 08.08.2012 en
(54) ANTIMALARIAL AGENTS THAT ARE INHIBITORS OF DIHYDROOROTATE DEHYDROGENASE
(71) Board of Regents, The University of Texas System, 201 West Seventh Street, Austin, TX 78701, US
Monash University, Wellington Road, Clayton, Victoria 3800, AU
Medicines For Malaria Venture, International Center Cointrin Block G 20 Route De Pre-bois PO Box 1826, 1215 Geneva, CH
University of Washington, 4311 11th Avenue NE, Suite 500, Seattle, WA 98105-4608, US
Glaxosmithkline Investigacion y Desarrollo, S.L., Santiago Grisolia 2, 28760 Tres Cantos (Madrid), ES
(72) RATHOD, Pradipsinh, K., 8212 Densmore Ave. N, Seattle, WA 98103, US
FLOYD, David, 4 Harbourton Ridge Dr., Pennington, NJ 08534, US
BURROWS, Jeremy, Medicines For Malaria Venture International Center Cointrin Block G 20 Route De Pre-bois 1826, CH-1215 Geneva, CH
MARWAHA, Alka, 12529 35th Avenue Ne Apt. 103, Seattle, WA 98112, US
GUJJAR, Ramesh, 6500 25th Ave. Ne Apt. 203, Seattle, WA 98115, US
COTERON-LOPEZ, Jose, C/o Glaxo Smithkline Parque Tecnologico De Madrid Calle Doctor Severo Ochoa Tres Cantos, E-28760 Madrid, ES
PHILLIPS, Margaret, Dept. Of Pharmacology University Of Texas Southwestern Center 6001 Forest Oark ND8.120, Dallas, TX 75390-9041, US
CHARMAN, Susan, A., Centre For Drug Candidate Optimisation Monash Institute Of Pharmaceutical Sciences Monash University 381 Royal Parade, Victoria, Parkville, 3052, AU
MATTHEWS, David, 910 San Dieguito Dr., Encinitas, CA 92024, US
-
- (51) MKP
A23L 1/307 (2006.01) (97) **2429304 ***
A23C 9/12 (2006.01)
A23C 9/156 (2006.01)
A23C 9/127 (2006.01)
A23L 1/29 (2006.01)
(86) FI2010050361 04.05.2010
(96) 10719951.5 21.03.2012
(87) WO2010128207, 04.05.2010
(97) 2429304, 21.03.2012 en
(54) PRODUCT AND PROCESS FOR ITS PREPARATION
(71) Valio Ltd., Meijeritie 6, 00370 Helsinki, FI
(72) MYLLÄRINEN, Päivi, Suomenlinna B 17 as 5, FI-00190 Helsinki, FI
RAJAKARI, Kirsi, Punatulkuntie 4 A 2, FI-02660 Espoo, FI
-
- (51) MKP
A61K 38/00 (2006.01) (97) **2475375 ***
(86) US2010048317 09.09.2010
(96) 10816104.3 18.07.2012
(87) WO2011031896, 09.09.2010
(97) 2475375, 18.07.2012 en
(54) PI3 KINASE INHIBITORS AND USES THEREOF
(71) Avila Therapeutics, Inc., 100 Beaver Street, First Floor, Waltham, MA 02453-8425, US
(72) NIU, Deqiang, 30 Grapevine Avenue, Lexington, MA 02421, US
PETTER, Russell, C., 22 Robinwood Lane, Stow, MA 01775, US
SINGH, Juswinder, 94 Heritage Avenue, Ashland, MA 01721, US
KLUGE, Arthur, F., 111 Old County Road, Lincoln, MA 01773, US
MAZDIYASNI, Hormoz, 27 Bouffard Drive, Marlborough, MA 01752, US
ZHU, Zhendong, 8 Nipmuck Drive, Westborough, MA 01581, US
QIAO, Lixin, 49 Blanchard Street, Andover, MA 01810, US
KUNTZ, Kevin, 8 New Village Road, Woburn, MA 01801, US

- (51) MKP
C07H 19/00 (2006.01) (97) **2408794 ***
C12P 19/26 (2006.01)
A23C 9/146 (2006.01)
- (86) GB2010000479 17.03.2010
(96) 10710394.7 25.01.2012
(87) WO2010106320, 17.03.2010
(97) 2408794, 25.01.2012 en
(54) ISOLATION AND PURIFICATION OF COMPONENTS OF WHEY
(71) Separation Technologies Investments Limited, Mill Race Compton Abdale, Cheltenham GL54 4DR, GB
(72) SCOTT, Stephen, Niall, 28 Gloucester Road Cheltenham, Gloucestershire GL51 8PA, GB
KRISHNAPILLAI, Ashok, The Wheel House Compton Abdale Cheltenham, Gloucestershire GL54 4DR, GB
-
- (51) MKP
E04B 2/74 (2006.01) (97) **2454422 ***
- (86) EP2010004716 02.08.2010
(96) 10747813.3 23.05.2012
(87) WO2011023277, 02.08.2010
(97) 2454422, 23.05.2012 de
(54) PROFILED ELEMENT AND METHOD FOR PRODUCING A PROFILED ELEMENT
(71) Protektorwerk Florenz Maisch GmbH & Co. KG, Viktoriastrasse 58, 76571 Gaggenau, DE
(72) WILLERSCHEID, Heiner, Im Silberloch 2, 77886 Lauf, DE
STUDNIORZ, Thilo, Am Rosenkranz 43, 09306 Rochlitz, DE
HERTWECK, Theo, Karlsruherstr. 50, 76532 Baden-Baden - Hauenerberstein, DE
-
- (51) MKP
B29C 70/38 (2006.01) (97) **2314445**
B29B 11/16 (2006.01)
- (96) 10178614.3 27.04.2011
(97) 2314445, 27.04.2011 en
(54) A method for manufacturing a composite body and a composite body manufacturing arrangement
(71) Vestas Wind Systems A/S, Hedeager 44, 8200 Aarhus N, DK
(72) Holloway, Gary, 48 Mill Hill Road Cowes, Isle of Wight, PO31 7EG, GB
-
- (51) MKP
A61P 35/00 (2006.01) (97) **2488552 ***
C07K 16/28 (2006.01)
A61K 39/395 (2006.01)
- (86) US2010052366 12.10.2010
(96) 10765921.1 22.08.2012
(87) WO2011046958, 12.10.2010
(97) 2488552, 22.08.2012 en
(54) USE OF IL-17 RECEPTOR A ANTIGEN BINDING PROTEINS
(71) Amgen Inc., Law Department One Amgen Center Drive, Thousand Oaks, CA 91320-1799, US
(72) MARTIN, David Andrew, 6515 20th Avenue NE, Seattle Washington 98115, US
TOCKER, Joel, 23808 SE 44th Court, Issaquah Washington 98029, US
BAUMGARTNER, Scott W., 3020 Hollycrest Avenue, Thousand Oaks California 91362, US
FRANKO, Donna Christine, 124 Sycamore Grove Street, Simi Valley California 93065, US
-
- (51) MKP
H01M 2/16 (2006.01) (97) **2408043 ***
B32B 27/32 (2006.01)
- (86) JP2010053899 09.03.2010
(96) 10750830.1 18.01.2012
(87) WO2010104077, 09.03.2010
(97) 2408043, 18.01.2012 en
(54) LAMINATED SEPARATOR, POLYOLEFIN MICROPOROUS MEMBRANE, AND SEPARATOR FOR ELECTRICITY STORAGE DEVICE
(71) Asahi Kasei E-Materials Corporation, 1-105, Kanda Jinbocho, Chiyoda-ku Tokyo 101-8101, JP
(72) OHASHI, Masahiro, 1-105, Kanda Jinbocho Chiyoda-ku, Tokyo 101-8101, JP
AMEYAMA, Keitaro, 1-105, Kanda Jinbocho Chiyoda-ku, Tokyo 101-8101, JP
SAKAKIBARA, Yuzuru, 1-105, Kanda Jinbocho Chiyoda-ku, Tokyo 101-8101, JP
-
- (51) MKP
E21B 43/267 (2006.01) (97) **2469020**
- (96) 10016022.5 27.06.2012
(97) 2469020, 27.06.2012 en
(54) Process of hydraulic fracturing to create a layered proppant pack structure alongside the faces of the fracture to prevent formation fines to damage fracture conductivity
(71) Vercaemer, Claude, 8 Avenue Lowendal, 75007 Paris, FR
(72) Vercaemer, Claude, 8 Avenue Lowendal, 75007 Paris, FR
-
- (51) MKP
B41M 5/50 (2006.01) (97) **2392467**
B41M 5/00 (2006.01)
B41M 5/52 (2006.01)
- (96) 10165096.8 07.12.2011
(97) 2392467, 07.12.2011 en
(54) Substrate for ink-jet printing
(71) SAPPI Netherlands Services B.V., Biesenweg 16, 6211 AA Maastricht, NL
(72) Ballet, Wim, Arkstraat 61-1, 3620 Lanaken, BE
Lex, Rainer, Herrenweg 7, 4562 Biberist, CH
Wehs, Jan Philipp, Sulgenbachstrasse 14, 3007 Bern, CH
-
- (51) MKP
B65D 73/00 (2006.01) (97) **2289816**
B65D 75/58 (2006.01)
- (96) 10173101.6 02.03.2011
(97) 2289816, 02.03.2011 en
(54) Unitized package and method of making same
(71) AKI, Inc., 1700 Broadway, New York, NY 10019, US
(72) Greenland, Steven J., 329 Winnacunnet Road, Hampton, NH 03842, US
-
- (51) MKP
A01P 13/02 (2006.01) (97) **2493311 ***
A01N 43/54 (2006.01)
A01N 43/40 (2006.01)
- (86) US2010054221 27.10.2010
(96) 10773505.2 05.09.2012
(87) WO2011056631, 27.10.2010
(97) 2493311, 05.09.2012 en
(54) SYNERGISTIC HERBICIDAL COMPOSITION CONTAINING FLUROXYPYR AND PENOXSULAM, HALOSULFURON-METHYL, IMAZAMOX OR IMAZETHAPYR
(71) Dow AgroSciences LLC, 9330 Zionsville Road, Indianapolis, IN 46268, US
(72) MANN, Richard, 1828 South 550 East, Franklin IN 46131, US
WEIMER, Monte, 9539 Gladstone Drive, Pittsboro IN 46167, US
MCVEIGH-NELSON, Andrea, 1333 Alimingo Drive, Indianapolis IN 46260, US
ELLIS, Andrew, 324 Wetherbee St., Greenville MS 38701, US
-

- (51) MKP
A61K 31/519 (2006.01) (97) **2451813 ***
C07D 487/08 (2006.01)
A61P 25/00 (2006.01)
C07D 471/04 (2006.01)
A61P 35/00 (2006.01)
A61K 31/499 (2006.01)
A61P 17/00 (2006.01)
A61K 31/437 (2006.01)
A61P 37/00 (2006.01)
C07D 487/04 (2006.01)
A61P 27/00 (2006.01)
A61P 3/00 (2006.01)
(86) DK2010000105 08.07.2010
(96) 10732839.5 16.05.2012
(87) WO2011003418, 08.07.2010
(97) 2451813, 16.05.2012 en
(54) HETEROCYCLIC COMPOUNDS AS JAK RECEPTOR AND PROTEIN TYROSINE KINASE INHIBITORS
(71) Leo Pharma A/S, Patent Dept. Industriparken 55, 2750 Ballerup, DK
(72) NIELSEN, Simon Feldbæk, Åfaldet 72, DK-2730 Herlev, DK
GREVE, Daniel, Rodriguez, Kornvænget 20, DK-3660 Stenløse, DK
RYTTERSGAARD, Carsten, Skolestraede 1, DK-400 Roskilde, DK
GRUE-SØRENSEN, Gunnar, Thyrasvej 3, DK-4000 Roskilde, DK
OTTOSEN, Erik, Rytter, Lotusvej 6, DK-3650 Ølstykke, DK
POULSEN, Tina, Dahlerup, Stenlosevej 14, DK-2700 Bronshøj, DK
SCHOU, Søren, Christian, Nanortalikvej 22., DK-4000 Roskilde, DK
MURRAY, Anthony, Kollegiehaven 5, DK-2920 Charlottenlund, DK

- (51) MKP
C07C 209/16 (2006.01) (97) **2448908 ***
C07C 211/35 (2006.01)
C07C 209/62 (2006.01)
(86) EP2010003922 28.06.2010
(96) 10734673.6 09.05.2012
(87) WO2011000539, 28.06.2010
(97) 2448908, 09.05.2012 en
(54) METHOD OF PREPARING NERAMEXANE
(71) Merz Pharma GmbH & Co. KGaA, Eckenheimer Landstrasse 100, 60318 Frankfurt Main, DE
(72) KOLLER, Herbert, Quellenstrasse 155A/65, A-1100 Wien, AT
PYERIN, Michael, Enzersdorferstrasse 3/2/8, 2345 Brunn am Gebirge, AT
SBROGIO, Federico, Via Tecchio 62, 36075 Montecchio Maggiore, IT

- (51) MKP
G06F 1/32 (2006.01) (97) **2400369**
(96) 10305668.5 28.12.2011
(97) 2400369, 28.12.2011 en
(54) A method for polling a universal integrated circuit card and an integrated circuit having an independent polling circuit
(71) Motorola Mobility, Inc., 600 North US Highway 45, Libertyville, IL 60048, US
(72) Gasparini, Stephane, 1 Rue du Gue, Tournefeuille, 31170, FR
Buhot, Thomas, 56 rue Barrau, Toulouse, 31400, FR
Combes, Alain, L., 38 rue Reguelongue, Toulouse, 31100, FR

- (51) MKP
C07D 471/04 (2006.01) (97) **2403852 ***
A61K 31/4188 (2006.01)
A61P 11/00 (2006.01)
A61P 29/00 (2006.01)
(86) EP2010052799 05.03.2010
(96) 10706659.9 11.01.2012
(87) WO2010100249, 05.03.2010
(97) 2403852, 11.01.2012 en
(54) 3H-IMIDAZO [4, 5 -C]PYRIDINE- 6 -CARBOXAMIDES AS ANTI- INFLAMMATORY AGENTS
(71) Boehringer Ingelheim International GmbH, Binger Strasse 173, 55216 Ingelheim am Rhein, DE
(72) PELCMAN, Benjamin, Orexo AB Box 303, S-75105 Uppsala, SE
PFAU, Roland, Boehringer Ingelheim GmbH Binger Str. 173, 55216 Ingelheim Am Rhein, DE
PRIEPKE, Henning, Boehringer Ingelheim GmbH Binger Str. 173, 55216 Ingelheim Am Rhein, DE
ARNDT, Kirsten, Boehringer Ingelheim GmbH Binger Str. 173, 55216 Ingelheim Am Rhein, DE
ROENN, Robert, Orexo AB Box 303, S-75105 Uppsala, SE
DOODS, Henri, Boehringer Ingelheim GmbH Binger Str. 173, 55216 Ingelheim Am Rhein, DE
STENKAMP, Dirk, Boehringer Ingelheim GmbH Binger Str. 173, 55216 Ingelheim Am Rhein, DE
KLINDER, Klaus, Boehringer Ingelheim GmbH Binger Str. 173, 55216 Ingelheim Am Rhein, DE
SUNA, Edgars, Latvian Institute of Organic Synthesis 21 Aizkraukles Str., LV-1006 Riga, LV
MACK, Juergen, Boehringer Ingelheim GmbH Binger Str. 173, 55216 Ingelheim Am Rhein, DE
LUBRIKS, Dimitrijs, Latvian Institute of Organic Synthesis 21 Aizkraukles Str., LV-1006 Riga, LV
KUELZER, Raimund, Boehringer Ingelheim GmbH Binger Str. 173, 55216 Ingelheim Am Rhein, DE

- (51) MKP
A21C 9/04 (2006.01) (97) **2332413**
A21C 9/08 (2006.01)
(86) 10193380.2 15.06.2011
(97) 2332413, 15.06.2011 en
(54) An apparatus for portioning and positioning solid portions of food products and a process thereof
(71) Zenatti, Sandro, Via Capannina 5, 20094 Corsico (MI), IT
(72) Zenatti, Sandro, Via Capannina 5, 20094 Corsico (MI), IT

- (51) MKP
F41B 11/02 (2006.01) (97) **2476991**
F41B 11/22 (2006.01)
(86) 12150878.2 18.07.2012
(97) 2476991, 18.07.2012 de
(54) Retrofit magazin for a break-barrel air gun
(71) Koch, Günter, Magdalenenluster Weg 6, 18273 Güstrow, DE
(72) Koch, Günter, Magdalenenluster Weg 6, 18273 Güstrow, DE

- (51) MKP
E04F 15/18 (2006.01) (97) **2417311 ***
(86) US2010030170 07.04.2010
(96) 10714728.2 15.02.2012
(87) WO2010118084, 07.04.2010
(97) 2417311, 15.02.2012 en
(54) SYSTEMS AND METHODS FOR MODULAR FLOOR INSTALLATION
(71) Interface, Inc., 2859 Paces Ferry Road Suite 2000, Atlanta, Georgia 30339, US
(72) GALLAGHER, Kevin, C., 3330 Ridge Point, Atlanta Georgia 30339, US
GRAY, Keith, N., 3150 Palisades Court, Marietta Georgia 30067, US
FOLETTA, Robert, Henry, 4 Channel Road, Mt. Evelyn Victoria 3796, AU

- (51) MKP
C10M 169/04 (2006.01) (97) **2480643 ***
 (86) EP2010005670 15.09.2010
 (96) 10757040.0 01.08.2012
 (87) WO2011035865, 15.09.2010
 (97) 2480643, 01.08.2012 en
 (54) LUBRICANT COMPOSITIONS
 (71) Cognis IP Management GmbH, Henkelstrasse 67, 40589 Dusseldorf, DE
 (72) RINKLIEB, Ronny, Raderbroich 16b, 41352 Korschenbroich, DE
 RETTEMEYER, Dirk, Jettchenweg 11, 41836 Hückelhoven, DE
 SCHERER, Markus, Merheimerstr. 214, 50733 Köln, DE
-
- (51) MKP
C04B 14/30 (2006.01) (97) **2480316 ***
D04H 1/42 (2012.01)
F01N 3/28 (2006.01)
B01D 53/94 (2006.01)
 (86) US2010002584 22.09.2010
 (96) 10768826.9 01.08.2012
 (87) WO2011037617, 22.09.2010
 (97) 2480316, 01.08.2012 en
 (54) LOW SHEAR MOUNTING MAT FOR POLLUTION CONTROL DEVICES
 (71) Unifrax I LLC, 2351 Whirlpool Street, Niagara Falls, NY 14305-2413, US
 (72) BEAUHARNOIS, Mark, 210 Starin Avenue, Buffalo, New York 14214, US
 KUMAR, Amit, 20 Huntwood Court, Getzville, New York 14068, US
 STAHLMAN, Mark D., 10 South 67th St. Apt C, Niagara Falls, New York 14305, US
-
- (51) MKP
A61K 9/12 (2006.01) (97) **2435023 ***
A61P 11/00 (2006.01)
A61K 31/40 (2006.01)
A61K 9/00 (2006.01)
 (86) US2010036659 28.05.2010
 (96) 10721258.1 04.04.2012
 (87) WO2010138868, 28.05.2010
 (97) 2435023, 04.04.2012 en
 (54) COMPOSITON FOR PLUMONARY DELIVERY OF LONG-ACTING MUSCARINIC ANTAGONISTS AND LONG LONG-ACTING BETA 2 ADRENERGIC RECEPTOR AGONISTS AND ASSOCIATED METHODS AND SYSTEMS
 (71) Pearl Therapeutics, Inc., 200 Saginaw Drive, Redwood City, CA 94063, US
 (72) VEHRING, Reinhard, 200 Saginaw Drive, Redwood City, California 94063, US
 HARTMAN, Michael Steven, 3820 Park Blvd. Apt. 23, Palo Alto, California 94306, US
 SMITH, Adrian Edward, 2 Wilmington Acres Court, Emerald Hills, California 94062, US
 JOSHI, Vidya B., 812 Seal Pointe Drive, Redwood City, California 94065, US
 DWIVEDI, Sarvajna Kumar, 409 Whisper Lane, Redwood City, California 94065, US
-
- (51) MKP
A47J 31/36 (2006.01) (97) **2480490 ***
B67D 1/00 (2006.01)
 (86) NL2010050623 24.09.2010
 (96) 10763052.7 01.08.2012
 (87) WO2011037464, 24.09.2010
 (97) 2480490, 01.08.2012 en
 (54) BEVERAGE CARTRIDGE
 (71) Koninklijke Douwe Egberts B.V., Vleutensevaart 35, 3532 AD Utrecht, NL
 (72) BIEWENGA, Tjasse Willem, Hobbemalaan 50, NL-3723 ET Bilthoven, NL
-
- (51) MKP
B62D 25/08 (2006.01) (97) **2301825**
 (96) 10178808.1 30.03.2011
 (97) 2301825, 30.03.2011 de
 (54) Front end module for a motor vehicle
 (71) HBPO GmbH, Rixbecker Strasse 111, 59552 Lippstadt, DE
 (72) Opperbeck, Guido, Allaniaweg 6, 59558 Lippstadt, DE
 Schöning, Ralf, Probst-Ermward-Ring 41, 33442 Herzebrock-Clarholz, DE

- (51) MKP
A61K 38/17 (2006.01) (97) **2467153 ***
A61K 39/00 (2006.01)
C07K 7/06 (2006.01)
A61P 25/16 (2006.01)
A61P 25/28 (2006.01)
 (86) AT2010000303 20.08.2010
 (96) 10747562.6 27.06.2012
 (87) WO2011020133, 20.08.2010
 (97) 2467153, 27.06.2012 en
 (54) USE OF MIMOTOPES OF ALPHA-SYNUCLEIN EPITOPES FOR TREATING LEWY BODY DISEASES
 (71) Affiris AG, Karl-Farkas-Gasse 22, 1030 Wien, AT
 (72) MANDLER, Markus, Dieselgasse 5/115, A-1100 Vienna, AT
 WENINGER, Harald, Isbarygasse 14/18, A-1140 Vienna, AT
 SANTIC, Radmila, Antonigasse 78/15, A-1180 Vienna, AT
 LAHSNIG, Christian, Rochusgasse 3/7, A-3430 Tulln, AT
-
- (51) MKP
A61P 3/10 (2006.01) (97) **2454251 ***
A61K 31/4427 (2006.01)
C07D 401/12 (2006.01)
C07D 401/14 (2006.01)
 (86) US2010041645 12.07.2010
 (96) 10734412.9 23.05.2012
 (87) WO2011008663, 12.07.2010
 (97) 2454251, 23.05.2012 en
 (54) GPR119 AGONISTS
 (71) Eli Lilly and Company, Lilly Corporate Center, Indianapolis, IN 46285, US
 (72) BUENO MELENDO, Ana, Belen, Lilly S.a. Avenida de la Industria 30, 28108 Alcobendas Madrid, ES
 BARRETT, David, Gene, Eli Lilly And Company Lilly Corporate Center, Indianapolis Indiana 46285, US
 FRANCISKOVICH, Jeffrey, Bernard, Eli Lilly And Company Lilly Corporate Center, Indianapolis Indiana 46285, US
 LIU, Bin, Eli Lilly And Company Lilly Corporate Center, Indianapolis Indiana 46285, US
 TAKEUCHI, Kumiko, Eli Lilly And Company Lilly Corporate Center, Indianapolis Indiana 46285, US
-
- (51) MKP
B66F 9/12 (2006.01) (97) **2477931 ***
 (86) EP2010063815 20.09.2010
 (96) 10770740.8 25.07.2012
 (87) WO2011033111, 20.09.2010
 (97) 2477931, 25.07.2012 en
 (54) A LINKAGE SYSTEM FOR A FORKLIFT TRUCK
 (71) Terberg Kinglifter B.V., Baronieweg 23a, 3403 NL IJsselstein, NL
 (72) O'KEEFE, Eric, Mull Lodge Clones Road, Monaghan County Monaghan, IE
-
- (51) MKP
A61P 29/00 (2006.01) (97) **2482850 ***
A61K 47/16 (2006.01)
A61K 31/444 (2006.01)
A61K 47/10 (2006.01)
A61K 47/38 (2006.01)
 (86) US2010051001 30.09.2010
 (96) 10762838.0 08.08.2012
 (87) WO2011041609, 30.09.2010
 (97) 2482850, 08.08.2012 en
 (54) TOPICAL FORMULATIONS
 (71) Nuvo Research Inc., 7560 Airport Road, Unit 10, Mississauga, ON L4T 4H4, CA
 (72) BUYUKTIMKIN, Servet, 11772 Carmel Creek Road 105, San Diego California 92130, US
 BUYUKTIMKIN, Nadir, 11772 Carmel Creek Road 105, San Diego California 92130, US
 SINGH, Jagat, 64 Grover Drive, Toronto Ontario M1C 4V7, CA
 NEWSAM, John M., 528 Forward Street, La Jolla California 92037-7528, US
 KING-SMITH, Dominic, 2597 Soderblom Avenue, San Diego California 92122, US
 KISAK, Edward T., 3525 Bayside Lane Apt. B, San Diego California 92109, US
 GALER, Bradley S., 1740 Lenape Road Bldg. 2, West Chester Pennsylvania 19382, US

- (51) MKP
G01N 33/564 (2006.01) (97) **2473851 ***
(86) US2010047353 31.08.2010
(96) 10752957.0 11.07.2012
(87) WO2011026117, 31.08.2010
(97) 2473851, 11.07.2012 en
(54) USE OF AN IMMUNOREGULATORY NK CELL POPULATION FOR MONITORING THE EFFICACY OF ANTI-IL-2R ANTIBODIES IN MULTIPLE SCLEROSIS PATIENTS
(71) Abbott Biotherapeutics Corp., 1500 Seaport Boulevard, Redwood City CA 94063, US
(72) SHERIDAN III, James Peter, 1058 Tulane Drive, Mountain View California 94040, US
-
- (51) MKP
D04H 13/00 (2006.01) (97) **2480710 ***
B32B 3/26 (2006.01)
(86) US2010050227 24.09.2010
(96) 10819546.2 01.08.2012
(87) WO2011038248, 24.09.2010
(97) 2480710, 01.08.2012 en
(54) MULTI-LAYER HIGH MOISTURE BARRIER POLYLACTIC ACID FILM
(71) Toray Plastics (America), Inc., 50 Belver Avenue, N. Kingstown, RI 02852-7500, US
(72) PAOLILLI, Tracy, A., 109 Baycliff Drive, East Greenwich RI 02818, US
FITCH, John, J., 16 Evelin Circle, Middletown RI 02842, US
-
- (51) MKP
G05B 23/02 (2006.01) (97) **2290488**
(86) 10173203.0 02.03.2011
(97) 2290488, 02.03.2011 en
(54) A method and a system for adjusting alarm level of a component in a wind turbine
(71) Vestas Wind Systems A/S, Alsvej 21, 8940 Randers - SV, DK
(72) Zhou, Yu, c/o Vetas Wind Syst. A/S 1 Fusionopolis Way 06-10 Connexis North Tower, 138632, Singapore, SG
Zhang, Tie Ling, Blk 708 Clementi West Street 2 07-303, 120708, Singapore, SG
-
- (51) MKP
C02F 1/04 (2006.01) (97) **2475442 ***
B01D 1/28 (2006.01)
B01D 1/26 (2006.01)
B01D 1/30 (2006.01)
B01D 3/06 (2006.01)
B01D 1/16 (2006.01)
(86) IB2010053906 31.08.2010
(96) 10760026.4 18.07.2012
(87) WO2011027293, 31.08.2010
(97) 2475442, 18.07.2012 en
(54) MULTIPLE-EFFECT EVAPORATOR
(71) Isproma S.r.l., Via Boezio 6, 00193 Roma, IT
(72) CIGNA, Ranieri, c/o ISPROMA S.R.L. Via Boezio 6, I-00193 Roma, IT
FUMEL, Osvaldo, c/o ISPROMA S.R.L. Via Boezio 6, I-00193 Roma, IT
-
- (51) MKP
A47J 31/18 (2006.01) (97) **2453777 ***
(86) IB2010051704 19.04.2010
(96) 10718708.0 23.05.2012
(87) WO2011007266, 19.04.2010
(97) 2453777, 23.05.2012 en
(54) TURKISH COFFEE MACHINE
(71) Lovalvo, Sally Ann, Haremlik Gida, Dekorasyon Ve Ekipmanlari Ticaret Sanayi Limited Sirketi Tesvikiye Caddesi Sadun Apartmani, No:105 Kat : 6 Daire 13 Sisli, Istanbul, TR
Haremlik Gida, Dekorasyon Ve Ekipmanlari Ticaret Sirketi, Tesvikiye Caddesi Sadun Apartmani No:105 Kat : 6 Daire 13 Sisli, Istanbul, TR
(72) LOVALVO, Sally Ann, Haremlik Gida Dekorasyon Ve Ekipmanlari Ticaret Sanayi Limited Sirketi Tesvikiye Caddesi Sadun Apartmani, No:105 Kat : 6 Daire 13 Sisli Istanbul, TR
KOC, Caroline N., Haremlik Gida Dekorasyon Ve Ekipmanlari Ticaret Sanayi Limited Sirketi Tesvikiye Caddesi Sadun Apartmani, No:105 Kat : 6 Daire 13 Sisli Istanbul, TR
YENTUR, Nil Banu, HaremlikGida Dekorasyon Ve Ekipmanlari Ticaret Sanayi Limited Sirketi Tesvikiye Caddesi Sadun Apartmani, No:105 Kat : 6 Daire 13 Sisli Istanbul, TR
-
- (51) MKP
C07D 401/10 (2006.01) (97) **2421824 ***
A61K 31/496 (2006.01)
C07D 401/06 (2006.01)
C07D 417/14 (2006.01)
C07D 403/10 (2006.01)
A61P 29/00 (2006.01)
C07D 401/04 (2006.01)
C07D 417/06 (2006.01)
C07D 403/06 (2006.01)
A61P 25/00 (2006.01)
C07D 205/04 (2006.01)
C07D 409/06 (2006.01)
C07D 403/12 (2006.01)
C07D 405/12 (2006.01)
(86) US2010032089 22.04.2010
(96) 10715460.1 29.02.2012
(87) WO2010124114, 22.04.2010
(97) 2421824, 29.02.2012 en
(54) AZETIDINYL DIAMIDES AS MONOACYLGLYCEROL LIPASE INHIBITORS
(71) Janssen Pharmaceutica N.V., Turnhoutseweg 30, 2340 Beerse, BE
(72) MACIELAG, Mark, J., Welsh&Mckean Roads, Spring House PA 19477, US
FLORES, Christopher, M., Welsh&Mckean Roads, Spring House PA 19477, US
ZHANG, Sui-po, 665 Stockton Drive, Exton PA 19341, US
LIN, Shu-chen, 4895 Redfield Road, Doylestown PA 18902, US
CLEMENTE, Jose, 665 Stockton Drive, Exton PA 19341, US
LIU, Li, 271 Fox Chase Lane, Doylestown PA 18901, US
ZHU, Bin, Welsh&Mckean Roads, Spring House PA 19477, US
MABUS, John, 9131 Rosewood Drive, East Greenville PA 18041, US
BIAN, Haiyan, 109 York Drive, Princeton NJ 08540, US
MCDONNELL, Mark, E., 1280 Sumneytown Pike, Lansdale PA 19446, US
CHEVALIER, Kristen, M., 407 Nottingham Lane, Collegeville PA 19426, US
PITIS, Philip, M., 108 Sunrise Drive, North Wales PA 19454, US
CONNOLLY, Peter, J., Welsh&Mckean Roads, Spring House PA 19477, US
ZHANG, Yue-mei, Welsh&Mckean Roads, Spring House PA 19477, US
-
- (51) MKP
A61B 18/18 (2006.01) (97) **2459096 ***
A61B 18/02 (2006.01)
A61N 5/02 (2006.01)
(86) US2010043558 28.07.2010
(96) 10806929.5 06.06.2012
(87) WO2011017168, 28.07.2010
(97) 2459096, 06.06.2012 en
(54) ENERGY DELIVERY SYSTEMS AND USES THEREOF
(71) Neuwave Medical, Inc., 3529 Anderson Street, Madison, WI 53704, US
(72) VAN DER WEIDE, Daniel Warren, 4138 Hiawatha Drive, Madison Wisconsin 53711, US
LAESEKE, Paul F., 3311 Harvey Street Apt. C, Madison Wisconsin 53705, US
LEE JR., Fred T., 3810 Council Crest, Madison Wisconsin 53711, US
BRACE, Christopher Lee, 401 N. Franklin Avenue, Madison Wisconsin 53705, US
-
- (51) MKP
A61K 39/285 (2006.01) (97) **2405939 ***
C07K 14/07 (2006.01)
C12N 15/863 (2006.01)
(86) EP2010001545 11.03.2010
(96) 10708732.2 18.01.2012
(87) WO2010102822, 11.03.2010
(97) 2405939, 18.01.2012 en
(54) OPTIMIZED EARLY-LATE PROMOTER COMBINED WITH REPEATED VACCINATION FAVORS CYTOTOXIC T CELL RESPONSE AGAINST ANTIGENS IN REPLICATION DEFICIENT RECOMBINANT VIRUS VACCINES
(71) Bavarian Nordic A/S, Hejreskovvej 10 A, 3490 Kvistgaard, DK
(72) BRINKMANN, Kay, Edlingerstrasse 14, 81543 München, DE
BAUR, Karen, Daiserstrasse 15, 81371 München, DE
HAUSMANN, Jürgen, Alte Bundesstrasse 130, 79194 Gundelfingen, DE

- (51) MKP
A61K 31/505 (2006.01) (97) **2482819 ***
 (86) US2010050495 28.09.2010
 (96) 10819634.6 08.08.2012
 (87) WO2011038380, 28.09.2010
 (97) 2482819, 08.08.2012 en
 (54) COMBINATION
 (71) GlaxoSmithKline LLC, One Franklin Plaza 200 North 16th Street, Philadelphia, PA 19102, US
 (72) AUGER, Kurt, R., 1250 South Collegeville Road, Collegeville PA 19422, US
 BACHMAN, Kurtis, Earl, 1250 South Collegeville Road, Collegeville PA 19426, US
 GILMER, Tona, M., Five Moore Drive, Research Triangle Park NC 27709, US
 GREGER, James, G., Jr., 1250 South Collegeville Road, Collegeville PA 19426, US
 GRESHOCK, Joel, David, 1250 South Collegeville Road, Collegeville PA 19426, US
 LAQUERRE, Sylvie, 709 Swedeland Road, King Of Prussia PA 19406, US
 LIU, Li, 709 Swedeland Road, King Of Prussia PA 19406, US
 MORRIS, Shannon, Renae, Five Moore Drive, Research Triangle Park NC 27709, US

- (51) MKP
C07D 207/263 (2006.01) (97) **2496555 ***
A61K 31/4015 (2006.01)
A61P 25/28 (2006.01)
A61P 25/00 (2006.01)
 (86) EP2010066767 04.11.2010
 (96) 10776339.3 12.09.2012
 (87) WO2011054888, 04.11.2010
 (97) 2496555, 12.09.2012 en
 (54) 4R,5S-ENANTIOMER OF 2-(5-METHYL-2-OXO-4-PHENYL-PYRROLIDIN-1-YL)-ACETAMIDE WITH NOOTROPIC ACTIVITY
 (71) Grindeks, A Joint Stock Company, 53 Krustpils Street, 1057 Riga, LV
 (72) KALVINS, Ivars, 25 Libiesu street, LV-5052 Ikskile, LV
 LEBEDEVS, Antons, 50/3-56b, Kaivas street, LV-1021 Riga, LV
 CERNOBROVIJS, Aleksandrs, 17-25d, Upenu street, LV-1084 Riga, LV
 DAMBROVA, Maija, 15-7, A. Grina bulvaris, LV-1002 Riga, LV
 ZVEJNIECE, Liga, 35/2, Braslas street, LV-2167 Marupe, LV
 VORONA, Maksims, 19-10, Dammes street, LV-1069 Riga, LV
 VEINBERGS, Grigorij, 236-33, Brivibas gatve, LV-1039 Riga, LV

- (51) MKP
B43K 21/16 (2006.01) (97) **2493704 ***
 (86) US2010050225 24.09.2010
 (96) 10827309.5 05.09.2012
 (87) WO2011053420, 24.09.2010
 (97) 2493704, 05.09.2012 en
 (54) UNIVERSAL PENCIL MECHANISM
 (71) A.T.X. International, Inc., One Albion Road Suite 200, Lincoln, Rhode Island 02865, US
 (72) REEKIE, George, 102 King Phillip Avenue, Bristol, RI 02809, US
 ROSINSKI, Nicholas, M., 53 Ogden Street, Providence, RI 02906, US
 NIXON, Kerry, R., 4 Andover Drive, Warwick, RI 02886, US
 PAQUET, Richard, E., 9 Mayfield Street, Smithfield, RI 02917, US
 GAGNON, Richard, M., 612 Twin Brook Lane, Coventry, RI 02816, US
 MORGADO, Raymond, 952 Bark Street, Swansea, MA 02777, US
 TORNGREN, Frank, Axel, 39 Slater Street, Attleboro, MA 02703, US

- (51) MKP
A61K 31/437 (2006.01) (97) **2448941 ***
C07D 403/12 (2006.01)
C07D 487/04 (2006.01)
A61P 35/00 (2006.01)
 (86) US2010040906 02.07.2010
 (96) 10794815.0 09.05.2012
 (87) WO2011003065, 02.07.2010
 (97) 2448941, 09.05.2012 en
 (54) PYRAZOLOPYRIMIDINE JAK INHIBITOR COMPOUNDS AND METHODS
 (71) Genentech, Inc., 1 DNA Way, South San Francisco, CA 94080, US
 (72) LYSSIKATOS, Joseph P., 42 Alta Avenue, Piedmont California 94611, US
 ZHU, Bing-Yan, 135 Lois Lane, Palo Alto California 94303, US
 GIBBONS, Paul, 2792 24th Street, San Francisco California 94110, US
 SIU, Michael, 454 Chatham Road, Burlingame California 94010, US
 MENDONCA, Rohan, 3551 Ballantyne Drive, Pleasanton California 94588, US
 RAWSON, Thomas E., 140 Hamilton Avenue, Mountain View California 94043, US
 MAGNUSON, Steven R., 3288 South Bridgepoint Lane, Dublin California 94568, US
 HANAN, Emily, 1904 Woodside Road, Redwood City California 94061, US
 ZAK, Mark E., 401 South Norfolk Street 309, San Mateo California 94401, US
 LIU, Wendy, 343 Catamaran Street, Foster City California 94404, US
 ZHOU, Aihe, 1361 Stephen Way, San Jose California 95129, US
 PASTOR, Richard, 243 Waller Street, San Francisco California 94102, US

- (51) MKP
G05D 23/19 (2006.01) (97) **2457132 ***
H02J 3/14 (2006.01)
 (86) US2010042589 20.07.2010
 (96) 10757650.6 30.05.2012
 (87) WO2011011404, 20.07.2010
 (97) 2457132, 30.05.2012 en
 (54) ENERGY MANAGEMENT SYSTEM AND METHOD
 (71) Allure Energy, Inc., 2003 S. Lamar Boulevard Suite 9, Austin, TX 78704, US
 (72) IMES, Kevin, R., 7309 Tanaqua Lane, Austin TX 78739, US
 HOLLISTER, James, 2006 Chaparral Drive, Round Rock TX 78681, US

- (51) MKP
A61K 39/02 (2006.01) (97) **2421556 ***
 (86) US2010032149 23.04.2010
 (96) 10717367.6 29.02.2012
 (87) WO2010124154, 23.04.2010
 (97) 2421556, 29.02.2012 en
 (54) VACCINES COMPRISING ATTENUATED MYCOPLASMA BOVIS STRAINS AND METHOD FOR THE ATTENUATION
 (71) Boehringer Ingelheim Vetmedica, Inc., 2621 North Belt Highway, St. Joseph, MO 64506-2002, US
 (72) BECK, Michael, Boehringer Ingelheim Vetmedica Inc. 2621 North Belt Highway, St. Joseph Missouri 64506, US
 KNITTEL, Jeffrey, Boehringer Ingelheim Vetmedica Inc. 2621 North Belt Highway, St. Joseph Missouri 64506, US

- (51) MKP
C09K 11/06 (2006.01) (97) **2467445 ***
F21K 2/06 (2006.01)
F21L 17/00 (2006.01)
G08B 5/00 (2006.01)
F21L 26/00 (2006.01)
 (86) US2010045418 13.08.2010
 (96) 10745513.1 27.06.2012
 (87) WO2011022298, 13.08.2010
 (97) 2467445, 27.06.2012 en
 (54) CHEMILUMINESCENT SIGNALING DEVICES
 (71) Cyalume Technologies, Inc, 96 Windsor Street, West Springfield MA 01089, US
 (72) CRANOR, Earl, 24 Lincoln Park, Longmeadow, MA 01106, US
 DOMINGOS, Eric, 63 Francis Street, Chicopee, MA 01013, US

- (51) MKP
A61N 5/06 (2006.01) (97) **2461868 ***
(86) IL2010000584 22.07.2010
(96) 10806138.3 13.06.2012
(87) WO2011016020, 22.07.2010
(97) 2461868, 13.06.2012 en
(54) HANDHELD LOW-LEVEL LASER THERAPY APPARATUS
(71) Schlosser, Michael, 51 Sheerit Hapleita Street, 34987 Haifa, IL
(72) GERLITZ, Yonatan, 24 Uri Zvi Grinberg Street, 46479 Herzeliya, IL
-
- (51) MKP
A61F 2/06 (2006.01) (97) **2421470 ***
(86) US2010032427 26.04.2010
(96) 10767889.8 29.02.2012
(87) WO2010124286, 26.04.2010
(97) 2421470, 29.02.2012 en
(54) FLEXIBLE DEVICES
(71) Flexible Stenting Solutions, Inc., 23 Christopher Way, Suite 103, Eatontown, NJ 07724, US
(72) BEACH, Bradley, 822 13th Avenue, Belmar NJ 07719, US
BURPEE, Janet, 56 Buttonwood Drive, Fairhaven New Jersey 07704, US
-
- (51) MKP
C12N 15/09 (2006.01) (97) **2456869 ***
(86) US2010043101 23.07.2010
(96) 10802973.7 30.05.2012
(87) WO2011011716, 23.07.2010
(97) 2456869, 30.05.2012 en
(54) INHIBITORS OF MTOR KINASE AS ANTI-VIRAL AGENTS
(71) The Trustees of the University of Princeton, 4 New South Building P.O. Box 36, Princeton, New Jersey 08544-0836, US
(72) MOORMAN, Nathaniel, 26 Rickard Cout, Lawrence NJ 08648, US
SHENK, Thomas, 12 Boudinot St., Princeton NJ 08540, US
-
- (51) MKP
C07J 41/00 (2006.01) (97) **2462154 ***
A61K 31/573 (2006.01)
A61P 5/36 (2006.01)
(86) HU2010000088 05.08.2010
(96) 10747484.3 13.06.2012
(87) WO2011015892, 05.08.2010
(97) 2462154, 13.06.2012 en
(54) NOVEL CRYSTAL FORM OF CDB-4124 AND PROCESS FOR THE PREPARATION THEREOF
(71) Richter Gedeon Nyrt., Gyömr i út 19-21., 1103 Budapest, HU
BALÁZS, Attila, Sz l u. 71/A., H-2144 Kerepes, HU
CSÖRGEI, János, Párnás u.5/a, H-1213 Budapest, HU
DEMETER, Ádám, Egyenes u. 8. A/61., H-1144 Budapest, HU
SÁNTA, Csaba, Szentmihályi t 25-27., H-1144 Budapest, HU
-
- (51) MKP
B60R 25/10 (2006.01) (97) **2490922 ***
(86) US2010002253 16.08.2010
(96) 10825308.9 29.08.2012
(87) WO2011049593, 16.08.2010
(97) 2490922, 29.08.2012 en
(54) DUTY CYCLE ESTIMATION SYSTEM AND METHOD
(71) Lojack Operating Company, Lp, 200 Lowder Brook Drive Suite 1000, Westwood, MA 02090, US
(72) BOURQUE, Stephen, 45 New Estate Road, Littleton MA 01460, US
-
- (51) MKP
B29C 67/24 (2006.01) (97) **2427322 ***
B29B 7/90 (2006.01)
C04B 26/00 (2006.01)
B29B 7/00 (2006.01)
B29B 17/00 (2006.01)
(86) NL2010050260 04.05.2010
(96) 10718317.0 14.03.2012
(87) WO2010128853, 04.05.2010
(97) 2427322, 14.03.2012 en
(54) PROCESS FOR MANUFACTURING A SHAPED ARTICLE FROM A COMPOSITE MATERIAL COMPRISING A SOLID FILLER AND A THERMOPLASTIC BINDER
(71) Echotect B.V., Lange Kleiweg 60F, 2288 GK Rijswijk, NL
(72) VAN HELDEN, Arend Kuindert, Henry van de Veldestraat 2, NL-3822 EG Amersfoort, NL
-
- (51) MKP
A62C 2/12 (2006.01) (97) **2412409**
(96) 11175461.0 01.02.2012
(97) 2412409, 01.02.2012 en
(54) Single-body intumescent gaskets for cold and hot smoke sealing, in particular for fire dampers
(71) Posa S.P.A., Via San Francesco d'Assisi 330, 20047 Brugheiro (Monza-Brianza), IT
JT Finance, 36A, Rue de Molsheim, 67280 Urmatt, FR
(72) Lo Cicero, Federico, Residenza Parco 861, 20090 Segrate (Milano), IT
Ripa, Alberto, Via Ampere 109, 20131 Milano, IT
Passerini, Marco, Via Chiusure 31, 25057 Sale Marasino (Brescia), IT
Jung, Thierry, 36A, Rue de Molsheim, 67280 Urmatt, FR
-
- (51) MKP
A01K 67/027 (2006.01) (97) **2480675 ***
C07K 16/46 (2006.01)
C12N 15/85 (2006.01)
C07K 16/00 (2006.01)
(86) US2011041366 22.06.2011
(96) 11728508.0 01.08.2012
(87) WO2011163311, 22.06.2011
(97) 2480675, 01.08.2012 en
(54) MICE EXPRESSING ALIGHT CHAIN WITH HUMAN LAMBDA VARIABLE AND MOUSE CONSTANT REGIONS
(71) Regeneron Pharmaceuticals, Inc., 777 Old Saw Mill River Road, Tarrytown, NY 10591, US
(72) MACDONALD, Lynn, 16 Gedney Way, White Plains, NY 10605, US
STEVENS, Sean, 355 Berry Street 413, San Francisco, CA 94158, US
GURER, Cagan, 8 Pamela Lane, Valhalla, NY 10595, US
MURPHY, Andrew, J., 10 Newton Court, Croton-on-Hudson, NY 10520, US
HOSIAWA, Karolina, A., 14 Church Street 2nd Floor, Tarrytown, NY 10591, US
-
- (51) MKP
A61K 9/14 (2006.01) (97) **2477607 ***
(86) US2010047271 31.08.2010
(96) 10817659.5 25.07.2012
(87) WO2011034723, 31.08.2010
(97) 2477607, 25.07.2012 en
(54) IMPROVED DEVICE AND METHOD FOR DELIVERY OF A MEDICAMENT
(71) Philip Morris Products S.A., Quai Jeanrenaud 3, 2000 Neuchâtel, CH
(72) ROSE, Jed, E., 1823 Pleasant Green Road, Durham NC 27705, US
ROSE, Seth, D., 613 E. Balboa Drive, Tempe AZ 85282, US
TURNER, James, Edward, 508 Anderson Blvd. Apt. 4, Geneva IL 60134, US
MURUGESAN, Thangaraju, 503 Front Ridge Dr., Cary NC 27519, US
-
- (51) MKP
C12P 21/08 (2006.01) (97) **2494062 ***
C07H 21/04 (2006.01)
(86) US2010054261 27.10.2010
(96) 10828884.6 05.09.2012
(87) WO2011056644, 27.10.2010
(97) 2494062, 05.09.2012 en
(54) ANTI-GLP-1R ANTIBODIES AND THEIR USES
(71) Janssen Biotech, Inc., 800/850 Ridgeview Drive, Horsham, PA 19044, US
(72) O'NEIL, Karyn, 145 King of Prussia Road, Radnor, PA 19087, US
PICHA, Kristen, 145 King of Prussia Road, Radnor, PA 19087, US

(51) MKP
H04W 16/12 (2009.01) (97) **2443857 ***
 (86) EP2010003510 11.06.2010
 (96) 10730069.1 25.04.2012
 (87) WO2010145779, 11.06.2010
 (97) 2443857, 25.04.2012 en
 (54) METHOD, SYSTEM AND BASE STATION FOR SHARING OR JOINTLY USING ONE OF A GERAN (GSM EDGE RADIO ACCESS NETWORK) MOBILE RADIO ACCESS NETWORK
 (71) Deutsche Telekom AG, Friedrich-Ebert-Allee 140, 53113 Bonn, DE
 (72) KLATT, Axel, Zum Engelshof 41, 50996 Cologne, DE
SCHMITT, Harald, Jacobystr. 3a, 56170 Bendorf, DE

(51) MKP
A61K 31/593 (2006.01) (97) **2335704**
A61K 47/40 (2006.01)
A61K 45/06 (2006.01)
A61K 33/24 (2006.01)
A61P 19/00 (2006.01)
 (96) 10290628.6 22.06.2011
 (97) 2335704, 22.06.2011 fr
 (54) Pharmaceutical composition comprising a strontium salt, vitamine D and a cyclodextrine
 (71) Les Laboratoires Servier, 35, rue de Verdun, 92284 Suresnes Cedex, FR
 (72) Briault, Gilles, 6, rue de la Tuilerie, 45480 Saint Peravy Epreux, FR
 Quenault, Xavier, 160, rue Jean-Bordier, 45130 Baule, FR
 Poirier, Cécile, 138, rue du Faubourg Saint Jean, 45000 Orleans, FR
 Pean, Jean-Manuel, 2 bis, rue Adolphe Crespain, 45000 Orleans, FR

(51) MKP
A61K 9/16 (2006.01) (97) **2407162 ***
A61P 1/00 (2006.01)
A61P 1/04 (2006.01)
A61K 31/198 (2006.01)
 (86) JP2010054236 12.03.2010
 (96) 10750926.7 18.01.2012
 (87) WO2010104175, 12.03.2010
 (97) 2407162, 18.01.2012 en
 (54) COMPOSITION FOR ORAL ADMINISTRATION
 (71) Ajinomoto Co., Inc., 15-1, Kyobashi 1-chome Chuo-ku, Tokyo 104-8315, JP
 National University Corporation Gunma University, 2, Aramakimachi 4-chome, Maebashi-shi, Gunma 371-8510, JP
 FUJITA, Shinichi, c/o AJINOMOTO CO. INC. 1-1 Suzuki-cho Kawasaki-ku, Kawasaki-shi Kanagawa 210-8681, JP
 HOSAKA, Hiroko, c/o NATIONAL UNIVERSITY CORPORATION GUNMA UNIVERSITY 39-22 Showa-machi 3-chome, Maebashi-shi Gunma 371-8511, JP
 HANZAWA, Yoshiaki, c/o AJINOMOTO CO. INC. 1-1 Irifune 2-chome Chuo-ku, Tokyo 104-0042, JP
 ZAI, Hiroaki, c/o NATIONAL UNIVERSITY CORPORATION GUNMA UNIVERSITY 39-22 Showa-machi 3-chome, Maebashi-shi Gunma 371-8511, JP
 YASA, Noriko, c/o AJINOMOTO CO. INC. 1-1 Irifune 2-chome Chuo-ku, Tokyo 104-0042, JP
 NAGOSHI, Atsuto, c/o NATIONAL UNIVERSITY CORPORATION GUNMA UNIVERSITY 39-22 Showa-machi 3-chome, Maebashi-shi Gunma 371-8511, JP
 MATSUEDA, Hiroyuki, c/o AJINOMOTO CO. INC. 1-1 Irifune 2-chome Chuo-ku, Tokyo 104-0042, JP
 KIHARA, Hideaki, c/o AJINOMOTO CO. INC. 1-1 Irifune 2-chome Chuo-ku, Tokyo 104-0042, JP
 SHIMOYAMA, Yasuyuki, c/o NATIONAL UNIVERSITY CORPORATION GUNMA UNIVERSITY 39-22 Showa-machi 3-chome, Maebashi-shi Gunma 371-8511, JP
 KAWAMURA, Osamu, c/o NATIONAL UNIVERSITY CORPORATION GUNMA UNIVERSITY 39-22 Showa-machi 3-chome, Maebashi-shi Gunma 371-8511, JP
 KUSANO, Motoyasu, c/o NATIONAL UNIVERSITY CORPORATION GUNMA UNIVERSITY 39-22 Showa-machi 3-chome, Maebashi-shi Gunma 371-8511, JP

(51) MKP
A01N 43/50 (2006.01) (97) **2427058 ***
A61K 31/415 (2006.01)
 (86) US2010033471 04.05.2010
 (96) 10772665.5 14.03.2012
 (87) WO2010129500, 04.05.2010
 (97) 2427058, 14.03.2012 en
 (54) NEMATOCIDAL SULFONAMIDES
 (71) E. I. du Pont de Nemours and Company, 1007 Market Street, Wilmington, DE 19898, US
 (72) LAHM, George, P., 148 Fairhill Drive, Wilmington Delaware 19808, US
 LETT, Renee, Marie, 4 Auspice Circle, Newark Delaware 19711, US
 SMITH, Brenton, Todd, 914 Grandview Drive, Exton Pennsylvania 19341, US
 SMITH, Benjamin, Kenneth, 139 Scottfield Drive, Newark Delaware 19713, US
 DALY, C., Anne, 116 Littondale Court, Middletown Delaware 19709, US

(51) MKP
G06F 11/07 (2006.01) (97) **2460076 ***
G06F 21/00 (2006.01)
 (86) US2010043660 29.07.2010
 (96) 10765530.0 06.06.2012
 (87) WO2011014623, 29.07.2010
 (97) 2460076, 06.06.2012 en
 (54) PORTABLE EXECUTABLE FILE ANALYSIS
 (71) Reversinglabs Corporation, 169 Msgr. O'Brian Highway Apt. 802, Cambridge, MA 02141, US
 (72) PERICIN, Tomislav, Matijie Hudji 76/2, Sremska Mitrovica 22000, RS

(51) MKP
H04W 36/00 (2009.01) (97) **2436209 ***
 (86) US2010036713 28.05.2010
 (96) 10730620.1 04.04.2012
 (87) WO2010138903, 28.05.2010
 (97) 2436209, 04.04.2012 en
 (54) MECHANISM FOR APPLICATION MOBILITY IN A CELL SITE-BASED CONTENT DISTRIBUTION NETWORK
 (71) Sycamore Networks, Inc., 220 Mill Road, Chelmsford, MA 01824, US
 (72) CAO, Yang, 7 Joyce Circle, Westford, MA 01886, US
 HACK, Talbot, 2019 Day St., Ann Arbor, MI 48104, US
 NICOLAZZO, Michael, 729 S. 6th St., Philadelphia, PA 19147, US
 SUBERRI, Moshe, 21 Whyte Drive, Voorhees, NJ 08043, US
 TURNER, William, M., 173 Burr Road, Higganum, CT 06441, US

(51) MKP
G01N 15/08 (2006.01) (97) **2253735**
A61B 5/15 (2006.01)
C23C 16/54 (2006.01)
C23C 16/04 (2006.01)
C23C 16/52 (2006.01)
C23C 16/505 (2006.01)
 (96) 10162755.2 24.11.2010
 (97) 2253735, 24.11.2010 en
 (54) Vessel processing
 (71) CV Holdings, LLC., 1030 Riverfront Center, P.O.Box 710, Amsterdam, New York 12010, US
 (72) Abrams, Robert S., 21 Marian Avenue, Albany, NY 12203, US
 Feltz, John T., 2624 Calhoun Street, Alameda, CA 94501, US
 Fisk, Thomas E., 955 North Night Heron Drive, Green Valley, AZ 85614, US

(51) MKP
B65H 75/08 (2006.01) (97) **2319789**
B65H 75/18 (2006.01)
 (96) 10189906.0 11.05.2011
 (97) 2319789, 11.05.2011 en
 (54) Unwinding device
 (71) Crocco S.P.A., Via Monte Ortigara, 37, 36073 Cornedo Vicentino (VI), IT
 (72) Strappazzon, Franco, c/o Crocco S.p.A. Via Monte Ortigara, 37, 36073, Cornedo Vicentino (Vicenza), IT

- (51) MKP
C07D 471/10 (2006.01) (97) **2421865 ***
A01N 43/90 (2006.01)
- (86) EP2010054216 30.03.2010
(96) 10713606.1 29.02.2012
(87) WO2010115780, 30.03.2010
(97) 2421865, 29.02.2012 en
(54) SPIROHETEROCYCLIC PYRROLIDINE DIONE DERIVATIVES USED AS PESTICIDES
(71) Syngenta Participations AG, Schaffhauserstrasse, 4332 Stein, CH
(72) MUEHLEBACH, Michel, Syngenta Crop Protection Munchwilen AG Schaffhauserstrasse, CH-4332 Stein, CH
HUETER, Ottmar Franz, Syngenta Crop Protection Munchwilen AG Schaffhauserstrasse, CH-4332 Stein, CH
-
- (51) MKP
A61K 36/906 (2006.01) (97) **2416795 ***
A61K 31/40 (2006.01)
C07D 207/04 (2006.01)
- (86) US2010030130 06.04.2010
(96) 10762322.5 15.02.2012
(87) WO2010118055, 06.04.2010
(97) 2416795, 15.02.2012 en
(54) Inhibitors of cognitive decline
(71) Cognition Therapeutics, Inc., 2043 Sidney Street, Suite 261, Pittsburgh, PA 15203, US
(72) RISHTON, Gilbert M., 11934 Whalers Lane, Malibu, CA 90265, US
CATALANO, Susan, C/o Cognition Therapeutics Inc. 2043 Sidney Street Suite 261, Pittsburgh, PA 15203, US
-
- (51) MKP
A61K 31/519 (2006.01) (97) **2443120 ***
A61P 29/00 (2006.01)
C07D 471/04 (2006.01)
A61K 45/06 (2006.01)
- (86) GB2010001168 15.06.2010
(96) 10732402.2 25.04.2012
(87) WO2010146348, 15.06.2010
(97) 2443120, 25.04.2012 en
(54) NEW CRYSTALLINE FORM OF PEMIROLAST
(71) Cardoz AB, P O Box 2077, 103 12 Stockholm, SE
(72) PERLBERG, Anett, Niederhofweg 11, CH-4617 Gunzgen, CH
VIERTELHAUS, Martin, Zasiusstrasse 8, 78462 Konstanz, DE
ROSENSTRÖM, Ulrika, Cardoz AB Box 2077, S-103 12 Stockholm, SE
HORVATH, Karol, Syntagon Tallvägen 2 Box 2073, S-151 02 Södertälje, SE
-
- (51) MKP
A61K 39/00 (2006.01) (97) **2440242 ***
- (86) EP2010058017 08.06.2010
(96) 10721036.1 18.04.2012
(87) WO2010142685, 08.06.2010
(97) 2440242, 18.04.2012 en
(54) ADJUVANT COMPOSITIONS COMPRISING A NON-IONIC ISOTONICITY AGENT
(71) GlaxoSmithKline Biologicals S.A., rue de l'Institut, 89, 1330 Rixensart, BE
(72) HENDERICKX, Veronique, GlaxoSmithKline Biologicals s.a. rue de l'Institut 89, B-1330 Rixensart, BE
LEMOINE, Dominique Ingrid, GlaxoSmithKline Biologicals s.a. rue de l'Institut 89, B-1330 Rixensart, BE
-
- (51) MKP
F03D 3/06 (2006.01) (97) **2459871 ***
F03D 3/04 (2006.01)
F03D 3/00 (2006.01)
- (86) IB2010053481 30.07.2010
(96) 10754561.8 06.06.2012
(87) WO2011013105, 30.07.2010
(97) 2459871, 06.06.2012 en
(54) AEROGENERATOR WITH FREE INTERNAL FLOW ROTOR
(71) Chiarelli, Mario Rosario, Lungo Tazio Nuvolari n. 2 - Località Nodica, 56019 Vecchiano (PI), IT
Massai, Andrea, Via Gianni Rodari n. 1, 52027 San Giovanni Valdarno (AR), IT
Bolognesi, Paolo, Via dell'Aeroporto n. 67, 56121 Pisa (PI), IT
Russo, Giovanni, Via Padre Eugenio Barsanti n. 1A, 56121 Ospedaletto - Pisa (PI), IT
Atzeni, Davide, Via XXV Aprile n. 44 int. 23, 16036 Recco (GE), IT
(72) CHIARELLI, Mario Rosario, Lungo Tazio Nuvolari n.2 Località Nodica, 56019 Vecchiano (PI), IT
-
- (51) MKP
A61K 31/407 (2006.01) (97) **2491042 ***
C07D 487/08 (2006.01)
A61P 11/00 (2006.01)
- (86) US2010053633 21.10.2010
(96) 10774360.1 29.08.2012
(87) WO2011050220, 21.10.2010
(97) 2491042, 29.08.2012 en
(54) SOLID FORMS OF N-(4-(7-AZABICYCLO[2.2.1]HEPTAN-7-YL)-2-TRIFLUOROMETHYL)PHENYL)-4-OXO-5-(TRIFLUOROMETHYL)-1,4-DIHYDROQUINOLINE-3-CARBOXAMIDE
(71) Vertex Pharmaceuticals Inc., 130 Waverly Street, Cambridge, MA 02139-4242, US
(72) ZHANG, Beili, 4505 Shorepointe Way, San Diego CA 92130, US
KRAWIEC, Mariusz, 46 Littlefield Lane, Marlborough MA 01752, US
LUISSI, Brian, 26 Carriage House lane, Mansfield, MA 02048, US
MEDEK, Ales, 14 Lockland Road, Winchester MA 01890, US
-
- (51) MKP
A01N 43/54 (2006.01) (97) **2480085 ***
A61K 31/415 (2006.01)
A61K 31/505 (2006.01)
- (86) US2010049952 23.09.2010
(96) 10819438.2 01.08.2012
(87) WO2011038085, 23.09.2010
(97) 2480085, 01.08.2012 en
(54) COMBINATION
(71) GlaxoSmithKline LLC, One Franklin Plaza 200 North 16th Street, Philadelphia, PA 19102, US
(72) DUMBLE, Melissa, 20 Kingsbridge Road, Piscataway NJ 08854, US
GILMER, Tona, Five Moore Drive, Research Triangle Park NC 27709, US
KUMAR, Rakesh, 1250 South Collegeville Road, Collegeville PA 19426, US
LEBOWITZ, Peter, F., 1250 South Collegeville Road, Collegeville PA 19426, US
MORRIS, Shannon, Renae, Five Moore Drive, Research Triangle Park NC 27709, US
LAQUERRE, Sylvie, 709 Swedeland Road, King Of Prussia PA 19406, US
-
- (51) MKP
B60R 21/2165 (2011.01) (97) **2483111 ***
- (86) EP2010005814 23.09.2010
(96) 10810746.7 08.08.2012
(87) WO2011038856, 23.09.2010
(97) 2483111, 08.08.2012 de
(54) MOULDED TRIM COMPONENT FOR COVERING AN AIRBAG IN A MOTOR VEHICLE
(71) Johnson Controls Interiors GmbH & Co. KG, Mülhausener Strasse 35, 47929 Grefrath, DE
(72) THIELHOM, Peter, Bonnstrasse 6a, 45470 Mülheim/Ruhr, DE

- (51) MKP
A01N 37/12 (2006.01) (97) **2424357 ***
A01N 37/44 (2006.01)
A61K 31/195 (2006.01)
(86) US2010001282 29.04.2010
(96) 10770066.8 07.03.2012
(87) WO2010126605, 29.04.2010
(97) 2424357, 07.03.2012 en
(54) TREATMENT OF NEURODEGENERATION AND NEUROINFLAMMATION
(71) Biogen Idec MA Inc., 14 Cambridge Center, Cambridge, Massachusetts 02142, US
(72) LUKASHEV, Matvey, 3 Louis Rd., Tewksbury Massachusetts 01876, US

- (51) MKP
E04H 1/02 (2006.01) (97) **2494127 ***
(86) US2010042700 21.07.2010
(96) 10827296.4 05.09.2012
(87) WO2011053397, 21.07.2010
(97) 2494127, 05.09.2012 en
(54) PREFABRICATED CONTAINER HOUSE
(71) Shen, Kangna Nelson, 395 Broadway Apt. 7A, New York, NY 10013, US
(72) Shen, Kangna Nelson, 395 Broadway Apt. 7A, New York, NY 10013, US

- (51) MKP
C12N 15/82 (2006.01) (97) **2449108 ***
(86) EP2010003797 24.06.2010
(96) 10726917.7 09.05.2012
(87) WO2011000498, 24.06.2010
(97) 2449108, 09.05.2012 en
(54) METHODS AND MEANS FOR OBTAINING PLANTS WITH ENHANCED GLYPHOSATE TOLERANCE
(71) Bayer BioScience N.V., Technologiepark 38, 9052 Gent, BE
(72) RUITER, Rene, Blauwe Steenstraat 72, B-9070 Heusden (Destelbergen), BE
MEULEWAETER, Frank, Sparrenstraat 51, B-9820 Merelbeke, BE
VANDERSTRAETEN, Chantal, Frans Van Ryhovelaan 46, B-9000 Gent, BE

- (51) MKP
A61K 38/00 (2006.01) (97) **2464368 ***
(86) US2010045137 11.08.2010
(96) 10808681.0 20.06.2012
(87) WO2011019801, 11.08.2010
(97) 2464368, 20.06.2012 en
(54) CATHEPSIN C INHIBITORS
(71) Glaxo Group Limited, Glaxo Wellcome House Berkeley Avenue Greenford, Middlesex UB6 0NN, GB
(72) ANDERSON, Niall, Gunnels Wood Road Stevenage, Hertfordshire SG1 2NY, GB
BUSCH-PETERSEN, Jakob, 709 Swedeland Road, King Of Prussia PA 19406, US
EVANS, Brian, 18 Freman Drive Buntington, Hertfordshire SG9 9TD, GB
LI, Huijie, 709 Swedeland Road, King Of Prussia PA 19406, US
NEVINS, Neysa, 1250 South Collegeville Road, Collegeville PA 19426, US
PALOVICH, Michael, R., 709 Swedeland Road, King Of Prussia PA 19406, US
SOLLIS, Steven, L., Gunnels Wood Road Stevenage, Hertfordshire SG1 2NY, GB
WALL, Michael, D., Chesterford Research Park Saffron Walden, Essex CB10 1XL, GB
BULLION, Ann M., 709 Swedeland Road, King of Prussia Pennsylvania 19406, US

- (51) MKP
A61M 5/32 (2006.01) (97) **2498842 ***
(86) US2010053541 21.10.2010
(96) 10828793.9 19.09.2012
(87) WO2011056449, 21.10.2010
(97) 2498842, 19.09.2012 en
(54) SURGICAL NEEDLE COATINGS AND METHODS
(71) Ethicon, Inc., U.S. Route 22, Somerville, NJ 08876, US
(72) MAURER, Robert, 3 Mcelroy Lane, Montgomery, NJ 08502, US
BAR, S., Neil, 318 Thatcher Terrace, Hillsborough, NJ 08844, US
HINRICHS, Eric, 366 Cafferty Road, Bucks PA 18947, US
HAMILTON, Michael, 6002 April Street, San Angelo TX 76904, US
WILKES, Thomas, 1 Richmond Street Apt 3106, New Brunswick NJ 08901, US

- (51) MKP
C07D 261/18 (2006.01) (97) **2435409 ***
C07C 233/47 (2006.01)
A61K 31/21 (2006.01)
A61K 31/435 (2006.01)
C07D 213/82 (2006.01)
C07D 239/36 (2006.01)
C07D 271/06 (2006.01)
(86) EP2010057247 26.05.2010
(96) 10720165.9 04.04.2012
(87) WO2010136493, 26.05.2010
(97) 2435409, 04.04.2012 en
(54) SUBSTITUTED AMINOPROPIONIC DERIVATIVES AS NEPRILYSIN INHIBITORS
(71) Novartis AG, Lichtstrasse 35, 4056 Basel, CH
(72) COPPOLA, Gary Mark, 18 Aldersgate Circle, Budd Lake, New Jersey 07828, US
IWAKI, Yuki, Novartis Institutes for BioMedical Research Inc. 400 Technology Square, Cambridge, Massachusetts 02139, US
KARKI, Rajeshri Ganesh, Novartis Institutes for BioMedical Research Inc. 100 Technology Square, Cambridge, Massachusetts 02139, US
KAWANAMI, Toshio, Novartis Institutes for BioMedical Research Inc. 100 Technology Square, Cambridge, Massachusetts 0213, US
KSANDER, Gary Michael, Novartis Institutes for BioMedical Research Inc. 100 Technology Square, Cambridge, Massachusetts 0213, US
MOGI, Muneto, Novartis Institutes for BioMedical Research Inc. 100 Technology Square, Cambridge, Massachusetts 0213, US
SUN, Robert, Novartis Institutes for BioMedical Research Inc. 100 Technology Square, Cambridge, Massachusetts 0213, US

- (51) MKP
B60K 17/04 (2006.01) (97) **2329983**
B60K 7/00 (2006.01)
(96) 10163630.6 08.06.2011
(97) 2329983, 08.06.2011 en
(54) Wheel drive assembly and a spindle carrier
(71) Fairfield Manufacturing Company, Inc., US Route 52, South Lafayette IN 47903, US
(72) Schoon, Benjamin Warren, 8486 E100N, Lafayette, IN 47905, US

- (51) MKP
C07D 403/12 (2006.01) (97) **2427453 ***
C07D 403/14 (2006.01)
C07D 413/12 (2006.01)
C07D 413/14 (2006.01)
C07D 417/12 (2006.01)
A61K 31/416 (2006.01)
C07D 471/04 (2006.01)
A61P 25/28 (2006.01)
(86) EP2010056074 05.05.2010
(96) 10719325.2 14.03.2012
(87) WO2010145883, 05.05.2010
(97) 2427453, 14.03.2012 en
(54) NOVEL SUBSTITUTED INDAZOLE AND AZA-INDAZOLE DERIVATIVES AS GAMMA SECRETASE MODULATORS
(71) Janssen Pharmaceuticals, Inc., 1125 Trenton-Harbourton Road, Titusville, NJ 08560, US
(72) BISCHOFF, François, Paul, c/o Janssen Pharmaceutica NV Turnhoutseweg 30, B-2340 Beerse, BE
GIJSEN, Henricus, Jacobus, Maria, c/o Janssen Pharmaceutica NV Turnhoutseweg 30, B-2340 Beerse, BE
PIETERS, Serge, Maria, Aloysius, c/o Janssen Pharmaceutica NV Turnhoutseweg 30, B-2340 Beerse, BE
MINNE, Garrett, Berland, Turnhoutseweg 30, B-2340 Beerse, BE
-
- (51) MKP
C07D 417/12 (2006.01) (97) **2430012 ***
A61K 31/4523 (2006.01)
A61P 29/00 (2006.01)
A61P 25/00 (2006.01)
C07D 401/12 (2006.01)
C07D 413/12 (2006.01)
(86) FR2010050914 11.05.2010
(96) 10728742.7 21.03.2012
(87) WO2010130945, 11.05.2010
(97) 2430012, 21.03.2012 fr
(54) 7-AZA-SPIRO[3.5]NONANE-7-CARBOXYLATE DERIVATIVES, PREPARATION THEREOF, AND THERAPEUTIC USE THEREOF
(71) SANOFI, 174, Avenue de France, 75013 Paris, FR
(72) ABOUABDELLAH, Ahmed, c/o sanofi-aventis Département Brevets 174 Avenue de France, F-75013 Paris, FR
CHEREZE, Nathalie, c/o sanofi-aventis Département Brevets 174 Avenue de France, F-75013 Paris, FR
FAYOL, Aude, c/o sanofi-aventis Département Brevets 174 Avenue de France, F-75013 Paris, FR
LOCHEAD, Alistair, c/o sanofi-aventis Département Brevets 174 Avenue de France, F-75013 Paris, FR
SAADY, Mourad, c/o sanofi-aventis Département Brevets 174 Avenue de France, F-75013 Paris, FR
VACHE, Julien, c/o sanofi-aventis Département Brevets 174 Avenue de France, F-75013 Paris, FR
YAICHE, Philippe, c/o sanofi-aventis Département Brevets 174 Avenue de France, F-75013 Paris, FR
-
- (51) MKP
B29C 57/02 (2006.01) (97) **2368693**
F16L 47/08 (2006.01)
(96) 10425090.7 28.09.2011
(97) 2368693, 28.09.2011 en
(54) Belling machine for pipes made of thermoplastic material
(71) SICA S.P.A., Via Stroppata, 28, 48011 Alfonsine (Ravenna), IT
(72) Tabanelli, Giorgio, Via Cavatorta 11, 48010 Cotignola (Ravenna), IT
Altini, Patrik, Via Attilio Orioli 47, 48124 Fornace Zarattini (Ravenna), IT
-
- (51) MKP
F16L 11/08 (2006.01) (97) **2261542**
(96) 10380076.9 15.12.2010
(97) 2261542, 15.12.2010 en
(54) Pipe for water-supply systems
(71) ABN Pipe Systems, S.L.U., Ctra. Baños de Arteixo, 48, 15008 A Coruña, ES
(72) Vázquez Sánchez, Javier Antonio, Ctra. Baños de Arteixo, N° 48, 15008 - A Coruña, ES
-
- (51) MKP
C07K 14/605 (2006.01) (97) **2454282 ***
A61P 5/48 (2006.01)
A61K 38/26 (2006.01)
(86) DK2010000099 24.06.2010
(96) 10737252.6 23.05.2012
(87) WO2011006497, 24.06.2010
(97) 2454282, 23.05.2012 en
(54) ACYLATED GLUCAGON ANALOGUES
(71) Zealand Pharma A/S, Smedeland 36, 2600 Glostrup, DK
RIBER, Ditte, Degnemose Allé 64, DK-2700 Brønshøj, DK
MEIER, Eddi, Bringebacken 88, DK-3500 Værløse, DK
DAUGAARD, Jens, Rosengren, Bakkevej 6, DK-2830 Virum, DK
SKOVGAARD, Marie, Strandvejen 75A 3. th., DK-2100 Copenhagen Ø, DK
TOLBORG, Jakob, Lind, Bispevangen 35, DK-2750 Ballerup, DK
KAMPEN, Gita, Gærdebuen 18, DK-2850 Nærum, DK
BÆK, Camilla, Ærteberg, Kirkevej 18, DK-3450 Allerød, DK
-
- (51) MKP
E03D 9/08 (2006.01) (97) **2305903**
(96) 10175628.6 06.04.2011
(97) 2305903, 06.04.2011 en
(54) Washing device for user's private parts
(71) Toto Ltd., 1-1 Nakashima 2-chome Kokurakita-ku Kitakyushu-shi, Fukuoka 802-8601, JP
(72) Morotomi, Yo, TOTO LTD. 1-1 Nakashima 2-chome, Kokurakita-ku Kitakyushu-shi, Kitakyushu-shi Fukuoka 802-8601, JP
Umamoto, Ayumu, TOTO LTD. 1-1 Nakashima 2-chome, Kokurakita-ku Kitakyushu-shi, Kitakyushu-shi Fukuoka 802-8601, JP
Matsushita, Koichiro, TOTO LTD. 1-1 Nakashima 2-chome, Kokurakita-ku Kitakyushu-shi, Kitakyushu-shi Fukuoka 802-8601, JP
-
- (51) MKP
A01N 43/90 (2006.01) (97) **2461690 ***
A61K 31/52 (2006.01)
A61K 31/522 (2006.01)
(86) US2010044703 06.08.2010
(96) 10807229.9 13.06.2012
(87) WO2011017611, 06.08.2010
(97) 2461690, 13.06.2012 en
(54) LIPIDATED OXOADENINE DERIVATIVES
(71) GlaxoSmithKline Biologicals S.A., rue de l'Institut, 89, 1330 Rixensart, BE
(72) JOHNSON, David, Glaxosmithkline Biologicals S.A. Hamilton Old Corvallis Road 553-MT, Hamilton, MT 59840, US
-
- (51) MKP
A61K 31/4439 (2006.01) (97) **2432469 ***
C07D 401/06 (2006.01)
A61P 25/00 (2006.01)
(86) EP2010056824 18.05.2010
(96) 10721149.2 28.03.2012
(87) WO2010133598, 18.05.2010
(97) 2432469, 28.03.2012 en
(54) NOVEL PHARMACEUTICALLY ACCEPTABLE SALTS OF 4-(1H-IMIDAZOL-4-YLMETHYL)PYRIDINE AND THEIR THERAPEUTICAL USES
(71) BIOPROJET, 30, rue des Francs-Bourgeois, 75003 Paris, FR
(72) CAPET, Marc, Les Petites Rivières, F-35520 Melesse, FR
LABEEUW, Olivier, 9 rue Bellevue, F-35300 Fougeres, FR
BERREBI-BERTRAND, Isabelle, 11 rue de Vergéal, F-35740 Pace, FR
ROBERT, Philippe, 9 chemin de la Reine Iseult, F-35740 Pace, FR
LIGNEAU, Xavier, 4 Square du Vivier Louis, F-35760 Saint Gregoire, FR
LECOMTE, Jeanne-Marie, 30 rue des Francs-Bourgeois, F-75003 Paris, FR
SCHWARTZ, Jean-Charles, 9 villa Seurat, F-75014 Paris, FR
-

- (51) MKP
A61K 31/454 (2006.01) (97) **2438051 ***
C07D 401/04 (2006.01)
C07D 401/14 (2006.01)
A61K 31/4545 (2006.01)
A61P 3/10 (2006.01)
- (86) IB2010052377 27.05.2010
(96) 10724593.8 11.04.2012
(87) WO2010140092, 27.05.2010
(97) 2438051, 11.04.2012 en
(54) L- (PIPERIDIN-4-YL) -PYRAZOLE DERIVATIVES AS GPR 119 MODULATORS
- (71) Pfizer Inc., 235 East 42nd Street, New York, NY 10017, US
(72) MASCITTI, Vincent, Pfizer Global Research&Development Eastern Point Road, Groton, Connecticut 06340, US
MCCLURE, Kim Francis, Pfizer Global Research&Development Eastern Point Road, Groton, Connecticut 06340, US
MUNCHHOF, Michael John, Pfizer Global Research&Development Eastern Point Road, Groton, Connecticut 06340, US
ROBINSON, Jr., Ralph Pelton, Pfizer Global Research&Development Eastern Point Road, Groton, Connecticut 06340, US
FUTATSUGI, Kentaro, Pfizer Global Research and Development Eastern Point Road, Groton, Connecticut 06340, US
KUNG, Daniel, Wei-shung, Pfizer Global Research and Development Eastern Point Road, Groton, Connecticut 06340, US
LEFKER, Bruce, Allen, Pfizer Global Research and Development Eastern Point Road, Groton, Connecticut 06340, US
DENINNO, Michael, Paul, 11692 Carmel Creek Road, 107, San Diego, CA 92130, US
-
- (51) MKP
B65H 75/00 (2006.01) (97) **2449049 ***
C09J 7/02 (2006.01)
- (86) GB2010051056 25.06.2010
(96) 10738022.2 09.05.2012
(87) WO2011001166, 25.06.2010
(97) 2449049, 09.05.2012 en
(54) IMPROVED ADHESIVE SHEETED ROLL
- (71) ITW CS (UK) Limited, 99 Gresham Street, London EC2V 7NG, GB
(72) HAMILTON, Sheila, Nether Knockbuckle Hazelmere Road, Kilmacolin PA13 4JW, GB
-
- (51) MKP
H04M 1/02 (2006.01) (97) **2456174**
- (96) 10191962.9 23.05.2012
(97) 2456174, 23.05.2012 en
(54) Segmented portable electronic device and method of display
- (71) Research In Motion Limited, 295 Phillip Street, Waterloo, ON N2L 3W8, CA
(72) Kholiaif, Ahmad Mohammad Mohammad, 70542 - 295 Phillip Street, Waterloo Ontario N2L 3W8, CA
-
- (51) MKP
H01L 31/18 (2006.01) (97) **2457264 ***
H01L 31/042 (2006.01)
- (86) US2010040858 02.07.2010
(96) 10802642.8 30.05.2012
(87) WO2011011184, 02.07.2010
(97) 2457264, 30.05.2012 en
(54) SYSTEM AND METHOD FOR MAKING A PHOTOVOLTAIC UNIT
- (71) Sears, James B., 12708 Stanwyck Circle, Tampa, FL 33626, US
(72) Sears, James B., 12708 Stanwyck Circle, Tampa, FL 33626, US
-
- (51) MKP
A61K 39/395 (2006.01) (97) **2493504 ***
C07K 16/46 (2006.01)
C07K 16/28 (2006.01)
C07K 16/18 (2006.01)
- (86) EP2010066046 25.10.2010
(96) 10774177.9 05.09.2012
(87) WO2011051217, 25.10.2010
(97) 2493504, 05.09.2012 en
(54) STABLE ANTI-TNFR1 POLYPEPTIDES, ANTIBODY VARIABLE DOMAINS&ANTAGONISTS
- (71) Glaxo Group Limited, Glaxo Wellcome House Berkeley Avenue Greenford, Middlesex UB6 0NN, GB
(72) DE SILVA, Inusha, Domantis Limited 315 Cambridge Science Park, Cambridge Cambridgeshire CB4 0WG, GB
SEPP, Armin, Domantis Limited 315 Cambridge Science Park, Cambridge Cambridgeshire CB4 0WG, GB
STOOP, Adriaan Allart, Domantis Limited 315 Cambridge Science Park, Cambridge Cambridgeshire CB4 0WG, GB
-
- (51) MKP
C07D 233/64 (2006.01) (97) **2430002 ***
C07D 233/84 (2006.01)
C07D 401/06 (2006.01)
- (86) EP2010056426 11.05.2010
(96) 10721758.0 21.03.2012
(87) WO2010130718, 11.05.2010
(97) 2430002, 21.03.2012 en
(54) PROCESS FOR THE PREPARATION OF A COMPOUND USEFUL AS AN INHIBITOR OF TAFIA
- (71) SANOFI, 174, Avenue de France, 75013 Paris, FR
(72) ROSSEN, Kai, c/o Sanofi-Aventis Deutschland GmbH, 65926 Frankfurt am Main, DE
KRAFT, Volker, c/o Sanofi-Aventis Deutschland GmbH, 65926 Frankfurt am Main, DE
WEHLAN, Hermut, c/o Sanofi-Aventis Deutschland GmbH, 65926 Frankfurt am Main, DE
BIGOT, Antony, c/o sanofi-aventis Département Brevets 174 Avenue de France, F-75013 Paris, FR
CROCC-STUERGA, Véronique, c/o sanofi-aventis Département Brevets 174 Avenue de France, F-75013 Paris, FR
-
- (51) MKP
C10G 2/00 (2006.01) (97) **2412787 ***
C10G 45/10 (2006.01)
C10G 47/18 (2006.01)
C10G 65/02 (2006.01)
C10G 65/04 (2006.01)
B01J 23/42 (2006.01)
B01J 23/46 (2006.01)
- (86) JP2010001919 17.03.2010
(96) 10755620.1 01.02.2012
(87) WO2010109817, 17.03.2010
(97) 2412787, 01.02.2012 en
(54) METHOD FOR PRODUCING LIQUID FUEL AND SYSTEM FOR PRODUCING LIQUID FUEL
- (71) Japan Oil, Gas and Metals National Corporation, 2-10-1, Toranomon, Minato-ku, Tokyo 105-0001, JP
INPEX Corporation, 5-3-1 Akasaka Minato-ku, Tokyo 107-6332, JP
JX Nippon Oil & Energy Corporation, 6-3, Otemachi 2-chome, Chiyoda-ku Tokyo 100-8162, JP
Japan Petroleum Exploration Co., Ltd., 7-12, Marunouchi 1-chome Chiyoda-ku, Tokyo 100-0005, JP
Cosmo Oil Co., Ltd., 1-1, Shibaura 1-chome Minato-ku, Tokyo 105-8528, JP
Nippon Steel Engineering Co., Ltd, 5-1, Osaki 1-chome Shinagawa-ku, Tokyo 141-8604, JP
(72) IWAMA, Marie, c/o JX NIPPON OIL & Energy Corporation 6-3 Otemachi 2-chome Chiyoda-ku, Tokyo 100-8162, JP

- (51) MKP
A61K 39/395 (2006.01) (97) **2429583 ***
A61K 38/18 (2006.01)
- (86) US2010034741 13.05.2010
(96) 10775545.6 21.03.2012
(87) WO2010132683, 13.05.2010
(97) 2429583, 21.03.2012 en
(54) METHODS AND COMPOSITIONS FOR TREATING LUPUS
(71) Genzyme Corporation, 500 Kendall Street, Cambridge, MA 02142, US
(72) KAPLAN, Johanne M., 123 Mill Street, Sherborn Massachusetts 01770, US
ROBERTS, Bruce L., 108 Pine Hill Road, Southborough Massachusetts 01772, US
SIDERS, William M., 618 Lisa Lane, Franklin Massachusetts 02038, US
-
- (51) MKP
C07K 14/47 (2006.01) (97) **2435469 ***
A61K 39/00 (2006.01)
A61P 35/00 (2006.01)
- (86) EP2010057141 25.05.2010
(96) 10721024.7 04.04.2012
(87) WO2010136443, 25.05.2010
(97) 2435469, 04.04.2012 en
(54) CASB7439 CONSTRUCTS
(71) GlaxoSmithKline Biologicals S.A., rue de l'Institut, 89, 1330 Rixensart, BE
(72) BLAIS, Normand, GlaxoSmithKline Biologicals Canada 525 Cartier Boulevard West Laval, Québec H7V 3S8, CA
HARVEY, Martine, GlaxoSmithKline Biologicals Canada 525 Cartier Boulevard West Laval, Québec H7V 3S8, CA
PILORGET, Anthony, GlaxoSmithKline Biologicals Canada 525 Cartier Boulevard West Laval, Québec H7V 3S8, CA
RIOUX, Clément, GlaxoSmithKline Biologicals Canada 525 Cartier Boulevard West Laval, Québec H7V 3S8, CA
-
- (51) MKP
A61F 5/56 (2006.01) (97) **2493437 ***
- (86) US2010052649 14.10.2010
(96) 10774049.0 05.09.2012
(87) WO2011059629, 14.10.2010
(97) 2493437, 05.09.2012 en
(54) TONGUE SUSPENSION SYSTEM WITH HYOID-EXTENDER FOR TREATING OBSTRUCTIVE SLEEP APNEA
(71) Ethicon, Inc., P.O. Box 151 Route 22, Somerville, NJ 08876, US
(72) WEADOCK, Kevin S., 16 Strawberry Lane, Hillsborough, NJ 08844, US
ROUSSEAU, Robert A., 736 Geigel Hill Road, Ottsville, PA 18942, US
LINDH, David C. Sr., 138 Allens Corner Road, Flemington, NJ 08822, US
-
- (51) MKP
C12N 15/09 (2006.01) (97) **2450438 ***
C12N 9/42 (2006.01)
C12P 19/00 (2006.01)
- (86) JP2010061263 01.07.2010
(96) 10794231.0 09.05.2012
(87) WO2011002063, 01.07.2010
(97) 2450438, 09.05.2012 en
(54) CELLULASE PREPARATION CONTAINING ENDOGLUCANASES DERIVED FROM TWO DIFFERENT TYPES OF MICROORGANISMS
(71) Meiji Seika Pharma Co., Ltd., 4-16, Kyobashi 2-chome Chuo-ku, Tokyo 104-8002, JP
(72) OKAKURA Kaoru, c/o Meiji Seika Pharma, Ltd. 788 Kayama, Odawara-shi Kanagawa 250-0852, JP
MURASHIMA Koichiro, c/o Meiji Seika Pharma Ltd. 788 Kayama, Odawara-shi Kanagawa 250-0852, JP
-
- (51) MKP
C07C 205/43 (2006.01) (97) **2435398 ***
A61K 31/343 (2006.01)
C07D 307/80 (2006.01)
A61P 9/06 (2006.01)
- (86) EP2010057270 26.05.2010
(96) 10724024.4 04.04.2012
(87) WO2010136500, 26.05.2010
(97) 2435398, 04.04.2012 en
(54) PROCESS FOR THE PRODUCTION OF BENZOFURANS
(71) SANOFI, 174, Avenue de France, 75013 Paris, FR
(72) KRETZSCHMAR, Gerhard, c/o Sanofi-Aventis Deutschland GmbH, 65926 Frankfurt am Main, DE
KRAFT, Volker, c/o Sanofi-Aventis Deutschland GmbH, 65926 Frankfurt am Main, DE
OLPP, Thomas, c/o Sanofi-Aventis Deutschland GmbH, 65926 Frankfurt am Main, DE
ROSSEN, Kai, c/o Sanofi-Aventis Deutschland GmbH, 65926 Frankfurt am Main, DE
-
- (51) MKP
A01P 21/00 (2006.01) (97) **2464211 ***
A01N 63/00 (2006.01)
A01G 7/06 (2006.01)
A01N 43/38 (2006.01)
A01N 31/02 (2006.01)
- (86) US2010045424 13.08.2010
(96) 10808799.0 20.06.2012
(87) WO2011019984, 13.08.2010
(97) 2464211, 20.06.2012 en
(54) METHODS FOR VEGETATIVE PROPAGATION OF GRASS PLANTS
(71) Treefree Biomass Solutions, Inc., 210 South Hudson Street Suite 328, Seattle, WA 98134, US
(72) CARROLL, John, Todd, 625 South Machias Road, Snohomish Washington 98290, US
VOLOTIN, Norman, 2126 11th Avenue West, Seattle Washington 98119, US
-
- (51) MKP
H01R 33/945 (2006.01) (97) **2404351 ***
- (86) US2010025905 02.03.2010
(96) 10749196.1 11.01.2012
(87) WO2010101907, 02.03.2010
(97) 2404351, 11.01.2012 en
(54) OVERHEAD POWER CONNECTOR INTEGRITY ASSESSMENT BY APPLICATION OF THERMAL HISTORY DETECTORS
(71) Georgia Tech Research Corporation, Office Of Technology Licensing 505 10th Street NW, Atlanta, GA 30332-0415, US
(72) SPRINGER, Paul, LeBaron, III, 1181-R Davis Place, Atlanta GA 30297, US
-
- (51) MKP
E21B 43/14 (2006.01) (97) **2494146 ***
E21B 43/25 (2006.01)
E21B 34/14 (2006.01)
- (86) CA2010001728 29.10.2010
(96) 10825908.6 05.09.2012
(87) WO2011050477, 29.10.2010
(97) 2494146, 05.09.2012 en
(54) PLUG RETAINER AND METHOD FOR WELLBORE FLUID TREATMENT
(71) Packers Plus Energy Services Inc., Bow Valley Square 2 Suite 2200, 205 - 5 Avenue SW, Calgary, Alberta T2P 2V7, CA
(72) THEMIG, Daniel Jon, 256 Woodhaven Place SW, Calgary, Alberta T2W 5P9, CA
FEHR, James, 31 Woodfield Drive, Sherwood Park, Alberta T8A 4A1, CA
KENYON, Michael, c/o Bow Valley Square 2, Suite 2200 205-5 Avenue SW, Calgary, Alberta T2P 2V7, CA

- (51) MKP
A61K 9/00 (2006.01) (97) **2421504 ***
A61K 9/08 (2006.01)
A61K 31/13 (2006.01)
- (86) IB2010051573 12.04.2010
(96) 10717263.7 29.02.2012
(87) WO2010122442, 12.04.2010
(97) 2421504, 29.02.2012 en
- (54) PAEDIATRIC SOLUTIONS COMPRISING A BETA-BLOCKER
- (71) Pierre Fabre Dermo-Cosmétique, 45, place Abel-Gance, 92100 Boulogne, FR
- (72) CHAUMONT, Christine, C/O PIERRE FABRE DERMO-COSMETIQUE 45 place Abel Gance, F-92100 Boulogne-Billancourt, FR
CORDOLIANI, Jean-François, C/O PIERRE FABRE DERMO-COSMETIQUE 45 place Abel Gance, F-92100 Boulogne-Billancourt, FR
LEVERD, Elie, C/O PIERRE FABRE DERMO-COSMETIQUE 45 place Abel Gance, F-92100 Boulogne-Billancourt, FR
MUGUET, Valérie, C/O PIERRE FABRE DERMO-COSMETIQUE 45 place Abel Gance, F-92100 Boulogne-Billancourt, FR

- (51) MKP
A61B 5/107 (2006.01) (97) **2459073 ***
A61B 8/08 (2006.01)
- (86) CN2010075287 20.07.2010
(96) 10803888.6 06.06.2012
(87) WO2011012055, 20.07.2010
(97) 2459073, 06.06.2012 en
- (54) THREE-DIMENSIONAL (3D) ULTRASOUND IMAGING SYSTEM FOR ASSESSING SCOLIOSIS
- (71) The Hong Kong Polytechnic University, Hung Hom Kowloon, Hong Kong, CN
- (72) ZHENG, Yongping, Department of Health Technologies and Informatics The Hong Kong Polytechnic University, Hong Kong, CN
CHEUNG, James Chung Wai, Department of Health Technologies and Informatics The Hong Kong Polytechnic University, Hong Kong, CN

- (51) MKP
C07H 15/203 (2006.01) (97) **2483286 ***
A61K 31/7048 (2006.01)
- (86) EP2010064117 24.09.2010
(96) 10755201.0 08.08.2012
(87) WO2011039107, 24.09.2010
(97) 2483286, 08.08.2012 en
- (54) METHOD FOR THE PREPARATION OF A CRYSTALLINE FORM OF 1-CHLORO-4- (BETA-D-GLUCOPYRANOS-1-YL)-2-(4-((S)-TETRAHYDROFURAN-3-YLOXY)BENZYL)BENZENE
- (71) Boehringer Ingelheim International GmbH, Binger Strasse 173, 55216 Ingelheim am Rhein, DE
- (72) WEBER, Dirk, Boehringer Ingelheim GmbH Corporate Patents Binger Str. 173, 55216 Ingelheim Am Rhein, DE
RENNER, Svenja, Boehringer Ingelheim GmbH Corporate Patents Binger Str. 173, 55216 Ingelheim Am Rhein, DE
FIEDLER, Tobias, Boehringer Ingelheim GmbH Corporate Patents Binger Str. 173, 55216 Ingelheim Am Rhein, DE
ORLICH, Simone, Boehringer Ingelheim GmbH Corporate Patents Binger Str. 173, 55216 Ingelheim Am Rhein, DE

- (51) MKP
A61K 31/497 (2006.01) (97) **2438056 ***
C07D 403/14 (2006.01)
A61P 35/00 (2006.01)
C07D 401/12 (2006.01)
C07D 403/12 (2006.01)
- (86) US2010036808 01.06.2010
(96) 10783892.2 11.04.2012
(87) WO2010141406, 01.06.2010
(97) 2438056, 11.04.2012 en
- (54) AMINO PYRIMIDINE ANTICANCER COMPOUNDS
- (71) OSI Pharmaceuticals, LLC, 1 Bioscience Park Drive, Farmingdale, NY 11735, US
- (72) CREW, Andrew, P., Broadhollow Bioscience Park 1 Bioscience Park Drive, Farmingdale, NY 11735, US
VOLK, Brian, 21 Elaine Drive, Sayville, NY 11782, US
DONG, Hanqing, Broadhollow Bioscience Park 1 Bioscience Park Drive, Farmingdale, NY 11735, US
ZAHLER, Robert, 5 East Welling Avenue, Pennington, NJ 08534, US
FERRARO, Caterina, Broadhollow Bioscience Park 1 Bioscience Park Drive, Farmingdale, NY 11735, US
FOREMAN, Kenneth, Broadhollow Bioscience Park 1 Bioscience Park Drive, Farmingdale, NY 11735, US
GUPTA, Ramesh, C., Chem-Master International Inc. Chemistry Building Stony Brook University, Stony Brook, NY 11794-3400, US
CHILUKURI, Ramesh, Chem-Master International Inc. Chemistry Building Stony Brook University, Stony Brook, NY 11794-3400, US
STOLZ, Kathryn, M., Broadhollow Bioscience Park 1 Bioscience Park Drive, Farmingdale, NY 11735, US
CHEN, Xin, Broadhollow Bioscience Park 1 Bioscience Park Drive, Farmingdale, NY 11735, US
SHERMAN, Dan, Broadhollow Bioscience Park 1 Bioscience Park Drive, Farmingdale, NY 11735, US
APPARI, Rama, Devi, Chem-master International Inc. Chemistry Building Stony Brook University, Stony Brook, NY 11794-3400, US
LI, An-hu, Broadhollow Bioscience Park 1 Bioscience Park Drive, Farmingdale, NY 11735, US

- (51) MKP
B60R 25/02 (2006.01) (97) **2277750**
- (86) 10075219.5 26.01.2011
(97) 2277750, 26.01.2011 en
- (54) Armor-plated mechanical antitheft steering lock for automotive vehicles.
- (71) Zammito, Roberto, Via Cristoforo Colombo 7, 70054 Giovinazzo (BA), IT
- (72) Zammito, Roberto, Via Cristoforo Colombo 7, 70054 Giovinazzo (BA), IT

- (51) MKP
B01L 3/00 (2006.01) (97) **2443256 ***
C12Q 1/68 (2006.01)
G01N 27/447 (2006.01)
G01N 21/64 (2006.01)
- (86) GB2010001156 14.06.2010
(96) 10739381.1 25.04.2012
(87) WO2010146339, 14.06.2010
(97) 2443256, 25.04.2012 en
- (54) NUCLEIC ACID DETECTION
- (71) BG Research Ltd, 6 The Business Centre Harvard Way Kimbolton, Cambridgeshire PE28 0NJ, GB
- (72) EDGE, David, 41 Verdayne Gardens Warlingham, Surrey CR6 9RP, GB
NAZARETH, Nelson, 1 Clockwinders High Street Upper Dean, Cambs PE28 0ND, GB
WARD, David, 30 Fernie Road, Guisborough TS14 7LZ, GB

- (51) MKP
B01D 35/18 (2006.01) (97) **2414063 ***
- (86) EP2010054528 06.04.2010
(96) 10715170.6 08.02.2012
(87) WO2010115887, 06.04.2010
(97) 2414063, 08.02.2012 en
- (54) FILTER ASSEMBLY
- (71) Delphi Technologies Holding S.à.r.l., Avenue de Luxembourg, 4940 Bascharage, LU
- (72) HARDOUIN, Ghislain, 60 Rue Du Grain D'or, F-41120 Sambin, FR
DANIEL, Patrick, 40 Bis Rue Albert 1er, F-41000 Blois, FR

- (51) MKP
F16H 3/72 (2006.01) (97) **2405157**
B30B 1/26 (2006.01)
B30B 15/14 (2006.01)
F16H 57/02 (2012.01)
(96) 11172474.6 11.01.2012
(97) 2405157, 11.01.2012 en
(54) Planetary transmission with two inputs and one output
(71) Coskunoz Metal Form Makina Endüstrivec Tic A.S., OSB Mavi Cad. No. 5, Bursa, TR
(72) Yorukoglu, Sancar, COSKUNÖZ METAL FORM MAKINA ENDÜSTRİ VE TIC. A.S. OSB. Mavi Cad. No:5, Bursa, TR Beypars, Murat, COSKUNÖZ METAL FORM MAKINA ENDÜSTRİ VE TIC. A.S. OSB. Mavi Cad. No:5, Bursa, TR
-
- (51) MKP
A61K 39/00 (2006.01) (97) **2497493 ***
A61K 48/00 (2006.01)
C12N 15/09 (2006.01)
A61K 39/04 (2006.01)
A61P 31/06 (2006.01)
A61K 35/76 (2006.01)
(86) JP2010069435 01.11.2010
(96) 10826901.0 12.09.2012
(87) WO2011052771, 01.11.2010
(97) 2497493, 12.09.2012 en
(54) NEBULIZABLE TUBERCULOSIS VACCINE FOR TRANSNASAL ADMINISTRATION COMPRISING PARAMYXOVIRUS VECTOR
(71) Mie University, 1577, Kurimamachiya-cho Tsu-shi, Mie 514-8507, JP
Biocomo Co., Ltd., 1325 Komono Komono-cho, Mie-gun, Mie 510-1233, JP
National Institute of Biomedical Innovation, 6-8, Saito-Asagi 7-chome, Ibaraki-shi Osaka 567-0085, JP
(72) YASUTOMI, Yasuhiro, c/o Tsukuba Primate Research Center National Institute of Biomedical Innovation 1-1 Hachimandai, Tsukuba-shi Ibaraki 305-0843, JP
KAWANO, Mitsuo, c/o MIE University Graduate School of Medicine 2-174 Edobashi, Tsu-shi Mie 514-8507, JP
NOSAKA, Tetsuya, c/o MIE University Graduate School of Medicine 2-174 Edobashi, Tsu-shi Mie 514-8507, JP
FUKUMURA, Masayuki, 1325 Komono-cho, Mie-gun Mie 510-1233, JP
-
- (51) MKP
G06F 17/30 (2006.01) (97) **2363815**
(96) 10188307.2 07.09.2011
(97) 2363815, 07.09.2011 en
(54) System for permanent file deletion
(71) Kaspersky Lab, ZAO, 10 Geroyev Panfilovtsev Street, Moscow 125363, RU
(72) Zaitsev, Oleg V., c/o KASPERSKY LAB ZAO 10/1 1st Volokolamsky Proezd, 123060, Moscow, RU
-
- (51) MKP
A61K 45/00 (2006.01) (97) **2408479 ***
A61K 31/395 (2006.01)
A61K 31/4985 (2006.01)
A61P 35/00 (2006.01)
(86) US2010027753 18.03.2010
(96) 10709676.0 25.01.2012
(87) WO2010107968, 18.03.2010
(97) 2408479, 25.01.2012 en
(54) COMBINATION CANCER THERAPY COMPRISING ADMINISTRATION OF AN EGFR INHIBITOR AND AN IGF-1R INHIBITOR
(71) OSI Pharmaceuticals, LLC, 1 Bioscience Park Drive, Farmingdale, NY 11735, US
(72) FRANKLIN, Maryland, OSI Pharmaceuticals Inc. 2860 Wilderness Place, Boulder, CO 80301, US
WILD, Robert, C., OSI Pharmaceuticals Inc. 2860 Wilderness Place, Boulder, CO 80301, US
-
- (51) MKP
C12N 15/09 (2006.01) (97) **2423324 ***
C12Q 1/68 (2006.01)
(86) JP2010057135 22.04.2010
(96) 10767115.8 29.02.2012
(87) WO2010123058, 22.04.2010
(97) 2423324, 29.02.2012 en
(54) PROBE SET FOR IDENTIFICATION OF NUCLEOTIDE MUTATION, AND METHOD FOR IDENTIFICATION OF NUCLEOTIDE MUTATION
(71) Vertex Pharmaceuticals Incorporated, 130 Waverly Street, Cambridge, MA 02139, US
(72) KISHI, Yasuhiro, c/o MITSUBISHI TANABE PHARMA CORPORATION 2-6-18 Kitahama Chuo-ku, Osaka-shi Osaka 541-8505, JP
KAMIYA, Naohiro, c/o MITSUBISHI TANABE PHARMA CORPORATION 2-6-18 Kitahama Chuo-ku, Osaka-shi Osaka 541-8505, JP
-
- (51) MKP
C07D 519/00 (2006.01) (97) **2470547 ***
A61K 31/551 (2006.01)
A61P 35/00 (2006.01)
(86) FR2010051709 12.08.2010
(96) 10761055.2 04.07.2012
(87) WO2011023883, 12.08.2010
(97) 2470547, 04.07.2012 fr
(54) CONJUGATES OF PYRROLO[1,4]BENZODIAZEPINE DIMERS AS ANTICANCER AGENTS
(71) SANOFI, 54 rue La Boétie, 75008 Paris, FR
(72) COMMERÇON, Alain, c/o Sanofi-Aventis Département Brevets 174 avenue de France, F-75013 Paris, FR
GAUZY-LAZO, Laurence, c/o Sanofi-Aventis Département Brevets 174 avenue de France, F-75013 Paris, FR
-
- (51) MKP
A47B 43/00 (2006.01) (97) **2295021**
A61G 1/013 (2006.01)
A61G 21/00 (2006.01)
(96) 10163438.4 16.03.2011
(97) 2295021, 16.03.2011 en
(54) Collapsible cadaver rack
(71) TrailerLogic, LLC d.b.a. Mortuary Response Solutions, 4102 Highway 29 North, Belton, SC 29627, US
(72) Richardson, Michael, 103 Crepe Myrtle Lane, Anderson, SC 29625, US
-
- (51) MKP
A61K 36/80 (2006.01) (97) **2482832 ***
(86) IN2010000534 11.08.2010
(96) 10811381.2 08.08.2012
(87) WO2011024196, 11.08.2010
(97) 2482832, 08.08.2012 en
(54) PICRORHIZA KURROA EXTRACT FOR PREVENTION, ELIMINATION AND TREATMENT OF DNA BASED VIRUSES IN HUMANS AND IN BIOTECH INDUSTRY
(71) Medasani, Munisekhar, S-1, Plot 31B Vimal Road 5 Jubilee Hills, Hyderabad 500 033, Andhra Pradesh, IN
(72) DIVI, Satyasayee Babu, 55-1-19 JR Nagar, Vishakapatnam 530 022 Andhra Pradesh, IN
MEDASANI, Munisekhar., S-1, Plot 31B Vimal Road 5 Jubilee Hills, Hyderabad 500 033 Andhra Pradesh, IN
-
- (51) MKP
A01K 15/02 (2006.01) (97) **2255617**
(96) 10009608.0 01.12.2010
(97) 2255617, 01.12.2010 de
(54) Dog training device with chewable body
(71) Schwendinger, Markus, Gewerbestrasse 4, 87752 Schwaighausen, DE
(72) Schwendinger, Markus, Gewerbestrasse 4, 87752 Schwaighausen, DE

- (51) MKP
A61P 37/02 (2006.01) (97) **2406272 ***
C07J 63/00 (2006.01)
A61K 31/575 (2006.01)
A61P 29/00 (2006.01)
A61P 35/00 (2006.01)
(86) EP2010053045 10.03.2010
(96) 10708194.5 18.01.2012
(87) WO2010103046, 10.03.2010
(97) 2406272, 18.01.2012 en
(54) N-HYDROXY C29-AMIDE DERIVATIVES OF OLEANDRANE
(71) onepharm Research & Development GmbH, Veterinärplatz 1
Objekt 1 A, 1210 Wien, AT
(72) CLASSEN-HOUBEN, Dirk, Gerstnerstrasse 5/6, A-1150 Vienna,
AT
KUEENBURG, Bernhard, Billrothstraße 39/3/10, A-1190 Vienna,
AT
KOSMA, Paul, Endemanngasse 6-18/2/17, A-1230 Vienna, AT
JORDIS, Ulrich, Hasenauerstrasse 61, A-1180 Vienna, AT
STANETTY, Christian, Schadinagasse 10/28, A-1170 Vienna, AT
CZOLLNER, Laszlo, Neugasse6, 2603 Felixdorf, AT
-
- (51) MKP
A01N 25/34 (2006.01) (97) **2440045 ***
D21H 19/00 (2006.01)
(86) US2010038073 10.06.2010
(96) 10786819.2 18.04.2012
(87) WO2010144643, 10.06.2010
(97) 2440045, 18.04.2012 en
(54) NOVEL ARTICLE
(71) GlaxoSmithKline LLC, One Franklin Plaza 200 North 16th
Street, Philadelphia, PA 19102, US
(72) BIEDERMANN, Kimberly, 1500 Littleton Road, Parsippany NJ
07054, US
OHS, Philip, 1500 Littleton Road, Parsippany NJ 07054, US
-
- (51) MKP
B08B 9/00 (2006.01) (97) **2493515 ***
B65B 55/00 (2006.01)
A61L 2/10 (2006.01)
(86) FR2010052291 26.10.2010
(96) 10787852.2 05.09.2012
(87) WO2011051615, 26.10.2010
(97) 2493515, 05.09.2012 fr
(54) COOLED PULSED LIGHT TREATMENT DEVICE
(71) Claranor, 23 Chemin de la Rollande Agroparc, 84140
Montfavet, FR
(72) HOUE, Eric, 2 rue de la Croix Blanche, F-13860 Peyrolles En
Provence, FR
-
- (51) MKP
A23K 1/00 (2006.01) (97) **2403353 ***
(86) US2010026355 05.03.2010
(96) 10706895.9 11.01.2012
(87) WO2010102202, 05.03.2010
(97) 2403353, 11.01.2012 en
(54) COMPOSITION FOR CONTROLLING FISH
(71) Gregg, Kenneth William, 540 Valley Hall Drive, Atlanta, GA
30350, US
(72) Gregg, Kenneth William, 540 Valley Hall Drive, Atlanta, GA
30350, US
-
- (51) MKP
A61P 37/06 (2006.01) (97) **2485723 ***
A61K 31/18 (2006.01)
(86) EP2010064921 06.10.2010
(96) 10761018.0 15.08.2012
(87) WO2011042466, 06.10.2010
(97) 2485723, 15.08.2012 en
(54) INHIBITORS OF CXCR1/2 AS ADJUVANTS IN THE
TRANSPLANT OF PANCREATIC ISLETS
(71) Dompé S.p.A., Località Campo di Pile snc, 67100 L'Aquila AQ,
IT
(72) PIEMONTI, Lorenzo, Diabetes Research Institute (HSR-DRI) -
San Raffaele Scientific Institute Via Olgettina 60, 20132 Milano,
IT
DAFFONCHIO, Luisa, c/o Dompé S.p.A. Località Campo di Pile
snc, I-67100 L'Aquila AQ, IT
ALLEGRETTI, Marcello, c/o Dompé S.p.A. Località Campo di
Pile snc, I-67100 L'Aquila AQ, IT
-
- (51) MKP
A61P 29/00 (2006.01) (97) **2403849 ***
C07D 413/04 (2006.01)
C07D 413/14 (2006.01)
A61K 31/4245 (2006.01)
A61P 37/00 (2006.01)
(86) EP2010052613 02.03.2010
(96) 10705889.3 11.01.2012
(87) WO2010100142, 02.03.2010
(97) 2403849, 11.01.2012 en
(54) OXAZOLE PYRIDINE DERIVATIVES USEFUL AS S1P1
RECEPTOR AGONISTS
(71) Merck Serono S.A., Centre Industriel, 1267 Coinsins, CH
QUATTROPANI, Anna, Route de Chêne 2, CH-1207 Geneva,
CH
GERBER, Patrick, Pra-Riondet 19, CH-1163 Etoy, CH
DORBAIS, Jerome, 5 rue Burgat-Charvillon, F-74000 Annecy,
FR
-
- (51) MKP
C07D 417/14 (2006.01) (97) **2421861 ***
A01N 43/80 (2006.01)
(86) US2010031546 19.04.2010
(96) 10719453.2 29.02.2012
(87) WO2010123791, 19.04.2010
(97) 2421861, 29.02.2012 en
(54) SOLID FORMS OF AN AZOCYCLIC AMIDE
(71) E. I. du Pont de Nemours and Company, 1007 Market Street,
Wilmington, DE 19898, US
(72) HANAGAN, Mary, Ann, 108 Country Flower Road, Newark
Delaware 19711, US
OBERHOLZER, Matthew, Richard, 101 Stonecrop Road,
Wilmington Delaware 19810, US
PASTERIS, Robert, James, 842 Colorado Drive, Newark
Delaware 19713, US
SHAPIRO, Rafael, 1415 Fresno Road, Wilmington Delaware
19803, US
-
- (51) MKP
H04W 28/00 (2009.01) (97) **2498534 ***
H04W 52/00 (2009.01)
(86) CN2010076063 17.08.2010
(96) 10809558.9 12.09.2012
(87) WO2011020425, 17.08.2010
(97) 2498534, 12.09.2012 en
(54) CONFIGURATION METHOD, SYSTEM AND DEVICE FOR
UPLINK CHANNEL
(71) China Academy of Telecommunications Technology, 40,
Xueyuan Road, Haidian District Beijing 100191, CN
(72) PAN, Xueming, No.40 Xueyuan Road Haidian District, Beijing
100083, CN
XIAO, Guojun, No.40 Xueyuan Road Haidian District, Beijing
100083, CN
-
- (51) MKP
A61K 31/14 (2006.01) (97) **2491005 ***
C07C 229/12 (2006.01)
A61P 9/10 (2006.01)
(86) EP2010065924 22.10.2010
(96) 10773886.6 29.08.2012
(87) WO2011048201, 22.10.2010
(97) 2491005, 29.08.2012 en
(54) USE OF 4-[ETHYL(DIMETHYL)AMMONIO]BUTANOATE IN
THE TREATMENT OF CARDIOVASCULAR DISEASE
(71) Grindeks, A Joint Stock Company, 53 Krustpils Street, 1057
Riga, LV
(72) KALVINS, Ivars, 21 Aizkarules street, LV-1006 Riga, LV
DAMBROVA, Maija, 21 Aizkraukles street, LV-1006 Riga, LV
LIEPINS, Edgars, 21 Aizkraukles street, LV-1006 Riga, LV
PUGOVICS, Osvalds, Ilmalas Street 10-35, LV-1004 Riga, LV
VILSKERSTS, Reinis, "Indras" Baldone, Rigas raj., LV
KUKA, Janis, K. Helmana Street 5-40, LV-3004 Jelgava, LV
GRINBERGA, Solveiga, Dienvidu 7/korp.3 dz50, LV-2169
Salaspils, LV
LOZA, Einars, R zeknes pulka Street 17-65, LV-2010 Jurmala,
LV

- (51) MKP
G01S 15/89 (2006.01) (97) **2454606 ***
G01S 15/87 (2006.01)
- (86) US2010039441 22.06.2010
(96) 10729001.7 23.05.2012
(87) WO2011008429, 22.06.2010
(97) 2454606, 23.05.2012 en
(54) LINEAR AND CIRCULAR DOWNSCAN IMAGING SONAR
(71) Navico, Inc., 12000 E. Skelly Drive, Tulsa, OK 74128-2486, US
(72) COLEMAN, Aaron, R., 22585 E. 79th Street, Broken Arrow OK 74014, US
HANOCH, Jeffrey, W., 4213 N. Battle Creek Dr., Broken Arrow OK 74012, US
MAGUIRE, Brian, T., 4502 West Madison Pl., Broken Arrow OK 74012, US
-
- (51) MKP
A61K 9/19 (2006.01) (97) **2413916 ***
A61K 47/40 (2006.01)
A61K 47/26 (2006.01)
A61K 31/69 (2006.01)
A61P 35/00 (2006.01)
A61K 47/48 (2006.01)
- (86) US2010029597 01.04.2010
(96) 10712647.6 08.02.2012
(87) WO2010114982, 01.04.2010
(97) 2413916, 08.02.2012 en
(54) LYOPHILIZATION CAKES OF PROTEASOME INHIBITORS
(71) Cephalon, Inc., 41 Moores Road P.O. Box 4011, Frazer, PA 19355, US
Cephalon France, 20 Rue Charles Martigny, 94704 Maisons-Alfort Cedex, FR
(72) BRICOUT, Denis, 107 rue de Bry, F-94430 Chennevieres sur Marne, FR
CAMBOURIEUX, Helene, 3 voie Jacques Thibaud, F-94400 Virty sur Seine, FR
CAPPOLA, Michael, L., 84 Conestoga Road, Malvern PA 19355, US
FRATI, Nicole, 2 impasse de la Prairie, F-91360 Eipnay sur Orge, FR
PATEL, Piyush, R., 716 Scott Lane, Wallingford PA 19086, US
-
- (51) MKP
B23K 26/26 (2006.01) (97) **2388102**
B21B 15/00 (2006.01)
B23K 26/38 (2006.01)
- (96) 11004155.5 23.11.2011
(97) 2388102, 23.11.2011 en
(54) Method and apparatus for laser strip slicing
(71) Joining Technologies, Inc., 17 Connecticut South Drive, EAST GRANBY CT 06026, US
(72) Boynton, Scott, 806 Meadowview Drive, East Windsor CT 06088, US
Poepffel, Scott, 132 Tumbull Road, New Hartford CT 06057, US
-
- (51) MKP
G01B 11/03 (2006.01) (97) **2322901**
G01C 15/00 (2006.01)
G01S 17/89 (2006.01)
G01B 11/00 (2006.01)
G01S 17/48 (2006.01)
- (96) 10450162.2 18.05.2011
(97) 2322901, 18.05.2011 de
(54) Method for improving position and orientation measurement data
(71) Riegl Laser Measurement Systems GmbH, Riedenburgstraße 48, 3580 Horn, AT
(72) Rieger, Peter, Hauptstrasse 1, 3824 Grossau, AT
Ullrich, Andreas, Paracelsusgasse 6, 3003 Gablitz, AT
-
- (51) MKP
G01N 11/04 (2006.01) (97) **2249141**
- (96) 10162196.9 10.11.2010
(97) 2249141, 10.11.2010 en
(54) A viscometer and a method for operating the same
(71) Poulten Selfe & Lee Ltd., Russell House, Burnham Business Park, Burnham-on-Crouch Essex CM0 8TE, GB
(72) Gosling, Stephen J., Bækgade 10 Blans, 6400, Sønderborg, DK
Mylrea, Ian, Finchley House 51 High Road Rayleigh, Essex, SS6 7SE, GB
-
- (51) MKP
C07K 7/06 (2006.01) (97) **2440569 ***
A61K 38/08 (2006.01)
A61P 3/04 (2006.01)
- (86) SE2010050626 07.06.2010
(96) 10786455.5 18.04.2012
(87) WO2010144038, 07.06.2010
(97) 2440569, 18.04.2012 en
(54) MELANOCORTIN RECEPTOR-SPECIFIC PEPTIDES
(71) AstraZeneca AB, null, 151 85 Södertälje, SE
(72) DODD, John H., c/o Palatin Technologies, Inc. 4-C Cedar Brook Cedar Brook Corporate Center, Cranbury, NJ 08512, US
SHI, Yi-Qun, c/o Palatin Technologies, Inc. 4-C Cedar Brook Cedar Brook Corporate Center, Cranbury, NJ 08512, US
YANG, Wei, Palatin Technologies, Inc. 4-C Cedar Brook Cedar Brook Corporate Center, Cranbury, NJ 08512, US
-
- (51) MKP
C03B 33/10 (2006.01) (97) **2399874**
- (96) 11171049.7 28.12.2011
(97) 2399874, 28.12.2011 en
(54) Glass cutter
(71) Hitachi Displays, Ltd., 3300, Hayano, Mobara-shi Chiba 297-8622, JP
Panasonic Liquid Crystal Display Co., Ltd., 1-6, Megahida-cho, Shikama-ku, Himeji-shi Hyogo 672-8033, JP
(72) Tatemura, Makoto, c/o Hitachi Displays, Ltd. 3300, Hayano, Mobara-shi, Chiba, 297-8622, JP
Hamamoto, Tatsuo, c/o Hitachi Displays, Ltd. 3300, Hayano, Mobara-shi, Chiba, 297-8622, JP
Ishige, Hideaki, c/o Hitachi Displays, Ltd. 3300, Hayano, Mobara-shi, Chiba, 297-8622, JP
Sasaki, Susumu, c/o Hitachi Displays, Ltd. 3300, Hayano, Mobara-shi, Chiba, 297-8622, JP
Iwasaki, Shuji, c/o Hitachi Displays, Ltd. 3300, Hayano, Mobara-shi, Chiba, 297-8622, JP
Kuwaki, Katsunori, c/o Hitachi Displays, Ltd. 3300, Hayano, Mobara-shi, Chiba, 297-8622, JP
Takahashi, Katsuyuu, c/o Hitachi Displays, Ltd. 3300, Hayano, Mobara-shi, Chiba, 297-8622, JP
Tani, Hiroyuki, c/o Hitachi Displays, Ltd. 3300, Hayano, Mobara-shi, Chiba, 297-8622, JP
Azuma, Hitoshi, c/o Hitachi Displays, Ltd. Intellectual Property Division 3300, Hayano, Mobara-shi, Chiba, 297-8622, JP
Yaguchi, Tomio, c/o Hitachi Displays, Ltd. 3300, Hayano, Mobara-shi, Chiba, 297-8622, JP
-
- (51) MKP
C07C 209/62 (2006.01) (97) **2483234 ***
C07C 211/35 (2006.01)
- (86) EP2010005864 24.09.2010
(96) 10762600.4 08.08.2012
(87) WO2011035924, 24.09.2010
(97) 2483234, 08.08.2012 en
(54) METHOD OF PREPARING NERAMEXANE OR A SALT THEREOF
(71) Merz Pharma GmbH & Co. KGaA, Eckenheimer Landstrasse 100, 60318 Frankfurt, DE
(72) GOLD, Markus-Rene, Hauptstr. 13, 97753 Karlstadt, DE
KAUSS, Valerjans, Deglava 108/2-36, LV-1082 Riga, LV
JIRGENSONS, Aigars, Hospitalu iela 3-103, LV-1013 Riga, LV
-
- (51) MKP
C07D 413/14 (2006.01) (97) **2459555 ***
A61K 31/42 (2006.01)
A61P 7/00 (2006.01)
- (86) EP2010004688 30.07.2010
(96) 10740170.5 06.06.2012
(87) WO2011012321, 30.07.2010
(97) 2459555, 06.06.2012 en
(54) PROCESSES FOR CRYSTALLIZATION OF RIVAROXABAN
(71) KRKA, D.D., Novo Mesto, Smarjeska cesta 6, 8501 Novo mesto, SI
(72) ZUPANCIC, Silvo, Zupnca 4b, SI-8000 NOVO MESTO, SI
PECAVAR, Anica, Gotna vas 18, SI-8000 NOVO MESTO, SI

- (51) MKP
H01M 10/48 (2006.01) (97) **2296214**
(96) 10173383.0 16.03.2011
(97) 2296214, 16.03.2011 de
(54) Device for monitoring an energy storage device
(71) Hoppecke Advanced Battery Technology GmbH, Reichenbacher Str. 89a, 08056 Zwickau, DE
(72) Lehmann, Gerhard, Mühlenstraße 16, 79367, Weisweil, DE
-
- (51) MKP
A01P 3/00 (2006.01) (97) **2442659 ***
A01N 43/40 (2006.01)
(86) JP2010003727 04.06.2010
(96) 10727509.1 25.04.2012
(87) WO2010146791, 04.06.2010
(97) 2442659, 25.04.2012 en
(54) CONTROL AGENT FOR SOFT ROT AND CONTROL METHOD FOR THE SAME
(71) Ishihara Sangyo Kaisha, Ltd., 3-15 Edobori 1-chome Nishi-ku, Osaka-shi, Osaka 550-0002, JP
(72) KURATA, Yoshikazu, c/o ISK BIOSCIENCES K.K. 10-30 Fujimi 2-chome Chiyoda-ku, Tokyo 102-0071, JP
HAYASHI, Hiroyuki, c/o Ishihara Sangyo Kaisha Ltd. Chuo Kenkyusho 3-1 Nishi-shibukawa 2-chome, Kusatsu-shi Shiga 525-0025, JP
-
- (51) MKP
B63B 15/00 (2006.01) (97) **2243696**
(96) 10160928.7 27.10.2010
(97) 2243696, 27.10.2010 en
(54) Sailing boat with variable lift.
(71) Corbinelli, Giovanni, 107 Av. de Luxembourg, 4940 Bascharage, LU
(72) Corbinelli, Giovanni, Av. De Luxembourg, 107, 4940 Bascharage, LU
D'Onofrio, Mario, Rue De L'Eglise, 5, 4732 Petange, LU
Gabellieri, Emanuele, Via Fiorentina, 124, 50052 Certaldo (FI), IT
-
- (51) MKP
E01F 15/02 (2006.01) (97) **2408970 ***
E01F 15/04 (2006.01)
(86) AU2010000321 19.03.2010
(96) 10753008.1 25.01.2012
(87) WO2010105307, 19.03.2010
(97) 2408970, 25.01.2012 en
(54) IMPROVED ROAD BARRIER
(71) Industrial Galvanizers Corporation PTY, Ltd., Ingal Civil Products 57-65 Airds Road, Minto, NSW 2566, AU
(72) WALLACE, Hayden, 19 Fourth Avenue, Loftus New South Wales 2232, AU
COLQUHOUN, Terry, C/- Ingal Civil Products 57-65 Airds Road, Minto New South Wales 2566, AU
HARE, Henry, John, C/- Holmes Consulting Group Limited Level 5 123 Victoria Street, Christchurch 8144, NZ
WHITESIDE, Mark, C/- Holmes Consulting Group Limited Level 5 123 Victoria Street, Christchurch 8144, NZ
-
- (51) MKP
A61M 11/00 (2006.01) (97) **2444112 ***
(86) CN2010073613 07.06.2010
(96) 10788864.6 25.04.2012
(87) WO2010145468, 07.06.2010
(97) 2444112, 25.04.2012 en
(54) HIGH-FREQUENCY INDUCTION ATOMIZATION DEVICE
(71) Li, Wenbo, Shenyang Electric Power Machinery General Factory 6 Zhaogong North Street Tiexi District Shenyang, Liaoning 110026, CN
(72) Li, Wenbo, Shenyang Electric Power Machinery General Factory 6 Zhaogong North Street Tiexi District Shenyang, Liaoning 110026, CN
-
- (51) MKP
E06B 3/667 (2006.01) (97) **2374979**
(96) 11160320.5 12.10.2011
(97) 2374979, 12.10.2011 de
(54) Plug-connector
(71) CERA Handelsgesellschaft mbH, Gewerbepark - Fürgen 14., 87674 Ruderatshofen-Immenhofen, DE
(72) Rafeld-Cech, Karin, Frohnschwenden 77, 87499 Wildpoldsried, DE

- (51) MKP
C02F 11/12 (2006.01) (97) **2383232**
C02F 1/469 (2006.01)
B01D 57/02 (2006.01)
(96) 10161498.0 02.11.2011
(97) 2383232, 02.11.2011 en
(54) System and Method for the Concentration of a Slurry
(71) Omya Development AG, Baslerstrasse 42, 4665 Oftringen, CH
(72) Sötemann, Jörg, Italiener Strasse 35, 9500 Villach, AT
-
- (51) MKP
B32B 27/12 (2006.01) (97) **2470368 ***
B32B 33/00 (2006.01)
(86) IB2010002318 24.08.2010
(96) 10811344.0 04.07.2012
(87) WO2011024075, 24.08.2010
(97) 2470368, 04.07.2012 en
(54) MULTIPURPOSE LAMINATED STRETCH FABRIC
(71) Kulkarni, Sachin Hanmant, Welspun House 6th Floor Kamala City Senapati Bapat Marg, Lower Parel, Mumbai 400013, IN
(72) Kulkarni, Sachin Hanmant, Welspun House 6th Floor Kamala City Senapati Bapat Marg, Lower Parel, Mumbai 400013, IN
-
- (51) MKP
C07D 401/14 (2006.01) (97) **2403847 ***
A61K 31/47 (2006.01)
A61P 9/00 (2006.01)
(86) GB2010000361 02.03.2010
(96) 10706035.2 11.01.2012
(87) WO2010100405, 02.03.2010
(97) 2403847, 11.01.2012 en
(54) TRIAZINE DERIVATIVES AS KINASE INHIBITORS
(71) UCB Pharma, S.A., 60, allée de la Recherche, 1070 Brussels, BE
(72) OWENS, Andrew, Pate, BioFocus DPI Chesterford Research Park Saffron Walden, Essex CB10 1XL, GB
RAPHY, Gilles, BioFocus DPI Chesterford Research Park Saffron Walden, Essex CB10 1XL, GB
ALLEN, Daniel, Rees, BioFocus DPI Chesterford Research Park Saffron Walden, Essex CB10 1XL, GB
SAVILLE-STONES, Elizabeth, Anne, BioFocus DPI Chesterford Research Park Saffron Walden, Essex CB10 1XL, GB
BÜRLI, Roland, BioFocus DPI Chesterford Research Park Saffron Walden, Essex CB10 1XL, GB
SHARPE, Andrew, BioFocus DPI Chesterford Research Park Saffron Walden, Essex CB10 1XL, GB
HAUGHAN, Alan, Findlay, BioFocus DPI Chesterford Research Park Saffron Walden, Essex CB10 1XL, GB
NASH, David, John, BioFocus DPI Chesterford Research Park Saffron Walden, Essex CB10 1XL, GB
MATTEUCCI, Mizio, BioFocus DPI Chesterford Research Park Saffron Walden, Essex CB10 1XL, GB
MACDONALD, Jonathan, David, School of Chemistry University of Leeds, Leeds LS2 9JT, GB
-
- (51) MKP
B23D 49/10 (2006.01) (97) **2448706 ***
B26B 9/02 (2006.01)
B23D 61/12 (2006.01)
(86) SE2010050768 02.07.2010
(96) 10794464.7 09.05.2012
(87) WO2011002411, 02.07.2010
(97) 2448706, 09.05.2012 en
(54) SAW BLADE, KNIFE AND SAW
(71) Kapman AB, null, 811 81 Sandviken, SE
(72) SJÖHOLM, Henrik, S. Bäckvägen 1B, S-821 51 Bollnäs, SE

- (51) MKP
A61K 31/54 (2006.01) (97) **2488184 ***
 (86) US2010052242 12.10.2010
 (96) 10823916.1 22.08.2012
 (87) WO2011046894, 12.10.2010
 (97) 2488184, 22.08.2012 en
 (54) COMBINATION
 (71) GlaxoSmithKline LLC, One Franklin Plaza 200 North 16th Street, Philadelphia, PA 19102, US
 (72) AUGER, Kurt, 1250 South Collegeville Road, Collegeville PA 19426, US
 BACHMAN, Kurtis, Earl, 1250 South Collegeville Road, Collegeville PA 19426, US
 GRESHOCK, Joel, David, 1250 South Collegeville Road, Collegeville PA 19426, US
 GILMER, Tona, Five Moore Drive, Research Triangle Park NC 27709, US
 LAQUERRE, Sylvie, 709 Swedeland Road, King Of Prussia PA 19406, US
 MORRIS, Shannon, Renae, Five Moore Drive, Research Triangle Park NC 27709, US

- (51) MKP
C07D 241/04 (2006.01) (97) **2451789 ***
 (86) DK2010050177 07.07.2010
 (96) 10730348.9 16.05.2012
 (87) WO2011003423, 07.07.2010
 (97) 2451789, 16.05.2012 en
 (54) MANUFACTURE OF 4-((1R,3S)-6-CHLORO-3-PHENYL-INDAN-1-YL)-1,2,2-TRIMETHYL-PIPERAZINE AND 1-((1R,3S)-6-CHLORO-3-PHENYL-INDAN-1-YL)-3,3-DIMETHYL-PIPERAZINE
 (71) H. Lundbeck A/S, Othilievej 9, 2500 Valby, DK
 (72) TREPPENDAHL, Svend, Frederiksdalsvej 221, DK-2830 Virum, DK
 DAHL, Allan, Carsten, Vielstedvej 8 Vielsted, DK-4296 Nyrup, DK

- (51) MKP
C07D 405/12 (2006.01) (97) **2409976 ***
A61K 31/4178 (2006.01)
A61K 31/4196 (2006.01)
A61K 31/437 (2006.01)
A61K 31/4439 (2006.01)
A61P 25/08 (2006.01)
A61P 25/14 (2006.01)
A61P 25/18 (2006.01)
C07D 409/12 (2006.01)
A61P 25/20 (2006.01)
C07D 471/04 (2006.01)
A61P 25/22 (2006.01)
A61P 25/24 (2006.01)
A61P 25/28 (2006.01)
A61P 25/30 (2006.01)
A61P 43/00 (2006.01)
C07D 405/14 (2006.01)
 (86) JP2010054831 19.03.2010
 (96) 10753606.2 25.01.2012
 (87) WO2010107115, 19.03.2010
 (97) 2409976, 25.01.2012 en
 (54) GLYCINE TRANSPORTER INHIBITOR
 (71) Taisho Pharmaceutical Co., Ltd., 24-1, Takada 3-chome Toshima-ku, Tokyo 170-8633, JP
 SHIMAZAKI, Youichi, c/o Taisho Pharmaceutical Co. Ltd. 24-1 Takada 3-chome Toshima-ku, Tokyo 170-8633, JP
 SHIRASAKI, Yoshihisa, c/o Taisho Pharmaceutical Co. Ltd. 24-1 Takada 3-chome Toshima-ku, Tokyo 170-8633, JP
 SAKAGAMI, Kazunari, c/o Taisho Pharmaceutical Co. Ltd. 24-1 Takada 3-chome Toshima-ku, Tokyo 170-8633, JP
 HAYASHI, Masato, c/o Taisho Pharmaceutical Co. Ltd. 24-1 Takada 3-chome Toshima-ku, Tokyo 170-8633, JP
 SHIBATA, Tsuyoshi, c/o Taisho Pharmaceutical Co. Ltd. 24-1 Takada 3-chome Toshima-ku, Tokyo 170-8633, JP
 YASUHARA, Akito, c/o Taisho Pharmaceutical Co. Ltd. 24-1 Takada 3-chome Toshima-ku, Tokyo 170-8633, JP
 ARAKI, Yuko, c/o Taisho Pharmaceutical Co. Ltd. 24-1 Takada 3-chome Toshima-ku, Tokyo 170-8633, JP
 YAMAMOTO, Shuji, c/o Taisho Pharmaceutical Co. Ltd. 24-1 Takada 3-chome Toshima-ku, Tokyo 170-8633, JP
 ABE, Kumi, c/o Taisho Pharmaceutical Co. Ltd. 24-1 Takada 3-chome Toshima-ku, Tokyo 170-8633, JP
 OHTA, Hiroshi, c/o Taisho Pharmaceutical Co. Ltd. 24-1 Takada 3-chome Toshima-ku, Tokyo 170-8633, JP
 SUN, Xiang-Min, c/o Taisho Pharmaceutical Co. Ltd. 24-1 Takada 3-chome Toshima-ku, Tokyo 170-8633, JP

- (51) MKP
G01P 15/09 (2006.01) (97) **2464981 ***
 (86) US2010045275 12.08.2010
 (96) 10808737.0 20.06.2012
 (87) WO2011019879, 12.08.2010
 (97) 2464981, 20.06.2012 en
 (54) PROOF MASS FOR MAXIMIZED, BI-DIRECTIONAL AND SYMMETRIC DAMPING IN HIGH G-RANGE ACCELERATION SENSORS
 (71) Meggitt (San Juan Capistrano), Inc., 30700 Rancho Viejo Drive, San Juan Capistrano, CA 92675, US
 (72) WILNER, Leslie, Bruce, 842 Marshall Drive, Palo Alto CA 94303, US
 KWA, Tom, 1707 Fan Street, San Jose, CA 95133, US

- (51) MKP
A01N 43/54 (2006.01) (97) **2473049 ***
C07D 471/04 (2006.01)
C07D 471/22 (2006.01)
- (86) US2010047883 03.09.2010
(96) 10814585.5 11.07.2012
(87) WO2011029046, 03.09.2010
(97) 2473049, 11.07.2012 en
- (54) BRUTON'S TYROSINE KINASE INHIBITORS
(71) Biogen Idec MA Inc., 133 Boston Post Road, Weston, MA 02493, US
Sunesis Pharmaceuticals, Inc., 395 Oyster Point Blvd., Suite 400, South San Francisco, CA 94080, US
- (72) KUMARAVEL, Gnanasambandam, 10 Perham Circle, Westford MA 01886, US
TAVERAS, Art. 6 Joslin Lane, Southborough MA 01772, US
FAN, Junfa, 917 Catamaran Street Apt 3, Foster City CA 94404, US
GUAN, Bing, 80 Evelyn Road, Needham MA 02494, US
WANG, Deping, 52 Cannon Ball Road, Sharon MA 02067, US
CONLON, Patrick, 20 Eaton Street, Wakefield MA 01800, US
CUERVO, Julio, H., 40 Columbia Road, Arlington MA 02474, US
ZHONG, Min, 3704 Feather Lane, Palo Alto CA 94303, US
SILVIAN, Laura, 1325 Beacon Street, Waban MA 02468, US
JENKINS, Tracy, J., 44 Vincent Avenue, Belmont MA 02478, US
POWELL, Noel, 28 Carlisle Road, Westford MA 01886, US
SCOTT, Daniel, 42 Bradyll Road, Weston MA 02493, US
ERLANSON, Daniel, A., 1312 32nd Avenue, San Francisco CA 94122, US
BUI, Minna, 2445 25th Avenue, Oakland CA 94601, US
LUGOVSKOY, Alexey, A., 24 Center Street, Woburn MA 01801-2931, US
MARCOTTE, Doug, 6 Stratfield Street, Worcester MA 01604, US
HOPKINS, Brian, T., 169 Washington Street Apt. 13, Newton MA 02458, US
-
- (51) MKP
C12N 15/86 (2006.01) (97) **2498825 ***
C12N 15/864 (2006.01)
A61K 48/00 (2006.01)
- (86) EP2010067155 09.11.2010
(96) 10784730.3 19.09.2012
(87) WO2011054976, 09.11.2010
(97) 2498825, 19.09.2012 en
- (54) NOVEL VIRAL VECTOR CONSTRUCT FOR NEURON SPECIFIC CONTINUOUS DOPA SYNTHESIS IN VIVO
(71) Genepod Therapeutics Ab, Östra Vallgatan 59A, 223 61 Lund, SE
(72) BJÖRKLUND, Tomas, Östra Vallgatan 59A, S-223 61 Lund, SE
BJÖRKLUND, Anders, Lilla Sigridsgatan 2, S-223 50 Lund, SE
KIRIK, Deniz, Vipemöllevägen 103, S-224 66 Lund, SE
-
- (51) MKP
A61K 31/4412 (2006.01) (97) **2405907 ***
A61P 35/04 (2006.01)
A61K 31/18 (2006.01)
- (86) US2010027021 11.03.2010
(96) 10708872.6 18.01.2012
(87) WO2010105082, 11.03.2010
(97) 2405907, 18.01.2012 en
- (54) TREATMENT OF PANCREATIC CANCER
(71) Ardea Biosciences, Inc., 4939 Directors Place, San Diego, CA 92121, US
(72) CHAPMAN, Mark, S., 3520 Vista de la Orilla, San Diego CA 92117, US
-
- (51) MKP
C09B 23/00 (2006.01) (97) **2419478 ***
G01N 33/58 (2006.01)
C09B 23/01 (2006.01)
C09B 23/08 (2006.01)
- (86) US2010031434 16.04.2010
(96) 10715630.9 22.02.2012
(87) WO2010121163, 16.04.2010
(97) 2419478, 22.02.2012 en
- (54) FLUORESCENT IMAGING WITH SUBSTITUTED CYANINE DYES
(71) LI-COR, INC., 4647 Superior Street, Lincoln, NE 68504, US
(72) XU, Xinshe, 9220 Benziger Drive, Lincoln Nebraska 68526, US
DRANEY, Daniel R., 1800 Buckingham Drive, Lincoln Nebraska 68506, US

- (51) MKP
E04D 1/30 (2006.01) (97) **2401448 ***
F24J 2/04 (2006.01)
H01L 31/048 (2006.01)
- (86) IB2010052829 22.06.2010
(96) 10747072.6 04.01.2012
(87) WO2011107835, 22.06.2010
(97) 2401448, 04.01.2012 en
- (54) BUILDING COVER ELEMENT WITH AN INTEGRATED ENERGY PRODUCTION DEVICE
(71) Istituto Ricerche Per Lo Sviluppo Economico E Sociale S.R.L., Via Sicilia 50, 00187 Roma, IT
(72) BORGOMEIO, Francesco, Viale del Tintoretto 302, I-00142 Roma, IT
SANZI, Gianluca, Borgo Vittorio 31/A, I-00193 Roma, IT
-
- (51) MKP
A63B 23/02 (2006.01) (97) **2416852 ***
- (86) US2010030388 08.04.2010
(96) 10762435.5 15.02.2012
(87) WO2010118229, 08.04.2010
(97) 2416852, 15.02.2012 en
- (54) A SLIDING ABDOMINAL EXERCISE DEVICE
(71) Fitworx, LLC, 4998 Battery Lane Suite 209, Bethesda, Maryland 20814, US
(72) BOLAND, Kevin O., 4998 Battery Lane Suite 209, Bethesda, Maryland 20814, US
COBLYN, George H., 5020 Malden Dr., Bethesda, Maryland 20816, US
MARSCHALKO, Cornell S., 941 Saigon Rd., McLean, Virginia 22102, US
-
- (51) MKP
G01C 9/28 (2006.01) (97) **2322900**
- (96) 10014427.8 18.05.2011
(97) 2322900, 18.05.2011 de
- (54) Water level
(71) SOLA-Messwerkzeuge GmbH, Unteres Tobel 25, 6840 Götzis, AT
(72) Scheyer, Wolfgang, Am Hof 32, 6840 Götzis, AT
Zwing, Lukas, Kapuzinergasse 14, 6850 Dornbirn, AT
-
- (51) MKP
A61K 31/5377 (2006.01) (97) **2444400 ***
A61K 31/5383 (2006.01)
A61K 31/4985 (2006.01)
C07D 498/14 (2006.01)
A61K 31/53 (2006.01)
A61K 31/553 (2006.01)
A61P 31/16 (2006.01)
A61P 43/00 (2006.01)
C07D 471/04 (2006.01)
C07D 471/14 (2006.01)
- (86) JP2010060006 14.06.2010
(96) 10789443.8 25.04.2012
(87) WO2010147068, 14.06.2010
(97) 2444400, 25.04.2012 en
- (54) SUBSTITUTED POLYCYCLIC CARBAMOYLPIRIDONE DERIVATIVE
(71) Shionogi & Co., Ltd., 1-8, Doshomachi 3-chome Chuo-ku Osaka-shi, Osaka 541-0045, JP
(72) TOMITA, Kenji, c/o Shionogi&Co. Ltd. 12-4 Sagisu 5-chome Fukushima-ku, Osaka-shi Osaka 553-0002, JP
AKIYAMA, Toshiyuki, c/o Shionogi&Co. Ltd. 12-4 Sagisu 5-chome Fukushima-ku, Osaka-shi Osaka 553-0002, JP
MIKAMIYAMA, Hidenori, c/o Shionogi&Co. Ltd. 12-4 Sagisu 5-chome Fukushima-ku, Osaka-shi Osaka 553-0002, JP
TAKAYA, Kenji, c/o Shionogi&Co. Ltd. 12-4 Sagisu 5-chome Fukushima-ku, Osaka-shi Osaka 553-0002, JP
SUZUKI, Naoyuki, c/o Shionogi&Co. Ltd. 12-4 Sagisu 5-chome Fukushima-ku, Osaka-shi Osaka 553-0002, JP
KAWAI, Makoto, c/o Shionogi&Co. Ltd. 12-4 Sagisu 5-chome Fukushima-ku, Osaka-shi Osaka 553-0002, JP
TAODA, Yoshiyuki, c/o Shionogi&Co. Ltd. 12-4 Sagisu 5-chome Fukushima-ku, Osaka-shi Osaka 553-0002, JP
MIKAMIYAMA, Minako, 12-2, Nogami 3-chome Takarazuka-shi, Hyogo 665-0022, JP
MORIMOTO, Kenji, c/o Shionogi&Co. Ltd. 1-1 Futabacho 3-chome, Toyonaka-shi Osaka 561-0825, JP
KAGEYAMA, Chika, c/o Shionogi&Co. Ltd. 12-4 Sagisu 5-chome Fukushima-ku, Osaka-shi Osaka 553-0002, JP

- (51) MKP
B65D 85/34 (2006.01) (97) **2371740**
B65D 6/00 (2006.01)
B65D 21/02 (2006.01)
(96) 10158409.2 05.10.2011
(97) 2371740, 05.10.2011 en
(54) Crate
(71) IFCO Systems GmbH, Zugspitzstrasse 7, 82049 Pullach, DE
(72) Orgeldinger, Wolfgang, Zugspitzstraße 7, 82049 Pullach, DE
-
- (51) MKP
F21V 7/22 (2006.01) (97) **2477243 ***
F21Y 101/02 (2006.01)
C08G 69/26 (2006.01)
C08K 5/00 (2006.01)
C08K 9/00 (2006.01)
C08L 77/06 (2006.01)
H01L 33/60 (2010.01)
C08K 3/22 (2006.01)
(86) JP2010065296 07.09.2010
(96) 10815343.8 18.07.2012
(87) WO2011030746, 07.09.2010
(97) 2477243, 18.07.2012 en
(54) REFLECTOR FOR LIGHT-EMITTING DEVICE, AND LIGHT-EMITTING DEVICE
(71) Asahi Kasei Chemicals Corporation, 1-105, Kanda Jinbocho Chiyoda-ku, Tokyo 101-8101, JP
(72) HASHIMOTO Kazuhiko, 1-105 Kanda Jinbocho Chiyoda-ku, Tokyo 101-8101, JP
TERADA Kazunori, 1-105 Kanda Jinbocho Chiyoda-ku, Tokyo 101-8101, JP
KURAMOTO Masafumi, c/o Nichia Corporation 491-100 Oka Kaminaka-cho, Anan-shi Tokushima 774-8601, JP
KITANI Motohisa, c/o Nichia Corporation 491-100 Oka Kaminaka-cho, Anan-shi Tokushima 774-8601, JP
-
- (51) MKP
A61K 9/00 (2006.01) (97) **2453873 ***
A61K 47/10 (2006.01)
(86) GB2010001362 16.07.2010
(96) 10737362.3 23.05.2012
(87) WO2011007153, 16.07.2010
(97) 2453873, 23.05.2012 en
(54) IMPROVEMENTS IN AND RELATING TO COLON CLEANSING COMPOSITIONS
(71) Norgine BV, Hogehilweg 7, 1101 CA Amsterdam Zuid-Oost, NL
(72) ATTWELL, Mark, Norgine Limited New Road Tir-Y-Berth Hengoed, Mid-Glamorgan CF82 8SJ, GB
COCKETT, Alasdair, Norgine Limited New Road Tir-Y-Berth Hengoed, Mid-Glamorgan CF82 8SJ, GB
COX, Ian, Norgine Limited New Road Tir-Y-Berth Hengoed, Mid-Glamorgan CF82 8SJ, GB
GRANGER, Janet, Norgine Limited New Road Tir-Y-Berth Hengoed, Mid-Glamorgan CF82 8SJ, GB
OZA, Pankaj, Norgine Limited New Road Tir-Y-Berth Hengoed, Mid-Glamorgan CF82 8SJ, GB
PADFIELD, Dawn, Norgine Limited New Road Tir-Y-Berth Hengoed, Mid-Glamorgan CF82 8SJ, GB
PADFIELD, Nick, Norgine Limited New Road Tir-Y-Berth Hengoed, Mid-Glamorgan CF82 8SJ, GB
-
- (51) MKP
B01J 23/50 (2006.01) (97) **2468399**
B01D 53/86 (2006.01)
B01D 53/94 (2006.01)
(96) 10390001.5 27.06.2012
(97) 2468399, 27.06.2012 en
(54) Catalyst for the reduction of NO to N₂ with ethanol or ethanol and hydrogen under lean DENOX conditions
(71) Cyprus University of Technology, Akinhta Synergatikon Tamieftiriou P.O. Box 50329, 3603 Limassol, CY
(72) Costa, N. Costas, Arch. Kyprianou 31 Akinita Synergatikon Tamieftiriou P.O. Box 50329, 3603 Limassol, CY
Valanidou, Lilian, Arch. Kyprianou 31 Akinita Synergatikon Tamieftiriou P.O. Box 50329, 3603 Limassol, CY
Savva, Petros G., Arch. Kyprianou 31 Akinita Synergatikon Tamieftiriou P.O. Box 50329, 3603 Limassol, CY
Theologides, Christodoulos, Arch. Kyprianou 31 Akinita Synergatikon Tamieftiriou P.O. Box 50329, 3603 Limassol, CY
-
- (51) MKP
A43B 7/06 (2006.01) (97) **2488060 ***
A43B 7/08 (2006.01)
A43B 7/12 (2006.01)
(86) EP2010064852 05.10.2010
(96) 10768219.7 22.08.2012
(87) WO2011045210, 05.10.2010
2488060, 22.08.2012 en
(54) WATERPROOF AND VAPOR-PERMEABLE SOLE FOR SHOES AND SHOE PROVIDED WITH SAID SOLE
(71) Geox S.p.A., Via Feltrina Centro, 16, 31044 Montebelluna Località Biadene (Treviso), IT
(72) POLEGATO MORETTI, Mario, Via Fantin 96, I-31035 Crocetta Del Montello, IT
-
- (51) MKP
A61M 5/315 (2006.01) (97) **2437827 ***
A61M 5/50 (2006.01)
(86) EP2010057488 28.05.2010
(96) 10722351.3 11.04.2012
(87) WO2010139641, 28.05.2010
(97) 2437827, 11.04.2012 en
(54) SPINDLE AND BEARING COMBINATION AND DRUG DELIVERY DEVICE
(71) Sanofi-Aventis Deutschland GmbH, Brüningstraße 50, 65929 Frankfurt, DE
(72) PLUMPTRE, David, 36 Shire Way, Droitwich Spa Worcestershire WR9 7RQ, GB
-
- (51) MKP
A01N 45/00 (2006.01) (97) **2461691 ***
A61K 31/59 (2006.01)
(86) US2010044319 03.08.2010
(96) 10807065.7 13.06.2012
(87) WO2011017380, 03.08.2010
(97) 2461691, 13.06.2012 en
(54) THERAPEUTIC VITAMIN D SUN-PROTECTING FORMULATIONS AND METHODS FOR THEIR USE
(71) Avidas Pharmaceuticals LLC, 196 West Ashland Street, Doylestown, PA 18901, US
(72) GARDNER, Margaret, M., 135 Conshohocken State Road, Gladwyne PA 19035, US
PAMPLIN, Charles, L., III, 608 Sleepy Hollow Road, Chapel Hill NC 27517, US
-
- (51) MKP
A61K 31/505 (2006.01) (97) **2485732 ***
(86) US2010047142 30.08.2010
(96) 10822395.9 15.08.2012
(87) WO2011043876, 30.08.2010
(97) 2485732, 15.08.2012 en
(54) SYNERGISTIC FUNGICIDAL COMPOSITION CONTAINING 5-FLUOROCYTOSINE FOR FUNGAL CONTROL IN CEREALS
(71) Dow AgroSciences LLC, 9330 Zionsville Road, Indianapolis IN 46268-1054, US
(72) LORSBACH, Beth, 6034 Haverford Avenue, Indianapolis IN 46220, US
MEITL, Alice, 109 Adams Court, Lebanon IN 46052, US
OWEN, W. John, 12421 Pebblepointe Pass, Carmel IN 46033, US
YAO, Chenglin, 14178 Esprit Drive, Westfield IN 46074, US
-
- (51) MKP
H02J 13/00 (2006.01) (97) **2425510 ***
H02H 3/04 (2006.01)
(86) US2010030322 08.04.2010
(96) 10719439.1 07.03.2012
(87) WO2010126688, 08.04.2010
(97) 2425510, 07.03.2012 en
(54) HIGH VOLTAGE POWER LINE COMMUNICATION SYSTEM USING AN ENERGY HARVESTING POWER SUPPLY
(71) SSI Power LLC, 30 Georgia Avenue, Hampton, GA 30228, US
(72) SCHAFER, Bradley, John, 835 Virginia Park, Fayetteville GA 30215, US
ROSTRON, Joseph, Richard, 148 Darwish Drive, McDonough GA 30252-3636, US
ORTKIESE, Russell, Keith, 10846 Paladin Dr., Hampton GA 30228, US
ANAND, Raj, 203 Eagles Landing Way, McDonough GA 30253, US

- (51) MKP
B05D 7/24 (2006.01) (97) **2411162 ***
C04B 41/52 (2006.01)
- (86) US2010028333 23.03.2010
(96) 10756722.4 01.02.2012
(87) WO2010111279, 23.03.2010
(97) 2411162, 01.02.2012 en
(54) SELF-DISPERSIBLE COATED METAL OXIDE POWDER, AND PROCESS FOR PRODUCTION AND USE
(71) Kobo Products Inc., 3474 South Clinton Avenue, South Plainfield, NJ 07078, US
(72) SCHLOSSMAN, David, 3474 South Clinton Avenue, South Plainfield NJ 07078, US
SHAO, Yun, 3474 South Clinton Avenue, South Plainfield NJ 07078, US
ORR, Carl, 3474 South Clinton Avenue, South Plainfield NJ 07078, US
-
- (51) MKP
F02D 41/24 (2006.01) (97) **2410160**
- (96) 11174414.0 25.01.2012
(97) 2410160, 25.01.2012 en
(54) Method of providing trim data for a fuel injection device
(71) Delphi Technologies Holding S.à.r.l., Avenue de Luxembourg, 4940 Bascharage, LU
(72) Alsford, Henry, Flat 4, 18 Creffield Road, London, W5 3RP, GB
Heaslewood, Kevin, 46 North Hyde Lane, Heston, TW5 0EH, GB
Leese, Michael, 94 Roman Way, Bicester, Oxfordshire OX26 6FJ, GB
-
- (51) MKP
H02J 3/14 (2006.01) (97) **2427940 ***
H02H 3/04 (2006.01)
- (86) AT2010000132 28.04.2010
(96) 10721270.6 14.03.2012
(87) WO2010127375, 28.04.2010
(97) 2427940, 14.03.2012 de
(54) MONITORING APPARATUS
(71) Eaton GmbH, Eugenia 1, 3943 Schrems, AT
(72) KOCH, Michael, Heiligenstädterstraße 181/7, A-1190 Wien, AT
-
- (51) MKP
A61K 9/06 (2006.01) (97) **2413922 ***
A61K 9/08 (2006.01)
A61K 8/27 (2006.01)
A61K 8/34 (2006.01)
A61K 31/05 (2006.01)
A61K 33/30 (2006.01)
A61K 45/06 (2006.01)
A61K 9/00 (2006.01)
- (86) EP2010054393 01.04.2010
(96) 10712431.5 08.02.2012
(87) WO2010112577, 01.04.2010
(97) 2413922, 08.02.2012 en
(54) ANTIBACTERIAL COMPOSITION COMPRISING 4 -ISOPROPYL-3-METHYLPHENO AND ZINC IONS
(71) Glaxo Group Limited, Glaxo Wellcome House Berkeley Avenue Greenford, Middlesex UB6 0NN, GB
(72) AXE, Alison, GlaxoSmithKline St. George's Avenue, Weybridge Surrey KT13 0DE, GB
BRADSHAW, David, GlaxoSmithKline St. George's Avenue, Weybridge Surrey KT13 0DE, GB
LIPPERT, Frank, GlaxoSmithKline St. George's Avenue Weybridge Surrey, KT13 0DE, GB
MIDDLETON, Andrew, GlaxoSmithKline St. George's Avenue Weybridge Surrey, KT13 0DE, GB
NEWBY, Craig, Sinclair, GlaxoSmithKline St. George's Avenue Weybridge Surrey, KT13 0DE, GB
BURNETT, Gary, Robert, GlaxoSmithKline St. George's Avenue Weybridge, Surrey KT13 0DE, GB
-
- (51) MKP
H02H 1/00 (2006.01) (97) **2462670 ***
- (86) AT2010000193 01.06.2010
(96) 10730688.8 13.06.2012
(87) WO2011014895, 01.06.2010
(97) 2462670, 13.06.2012 de
(54) ELECTRICAL INSTALLATION ARRANGEMENT
(71) Eaton Industries (Austria) GmbH, Eugenia 1, 3943 Schrems, AT
(72) KOCH, Michael, Heiligenstädterstraße 181/7, A-1190 Wien, AT
-
- (51) MKP
C07K 16/30 (2006.01) (97) **2459595 ***
- (86) EP2010004663 30.07.2010
(96) 10746999.1 06.06.2012
(87) WO2011012309, 30.07.2010
(97) 2459595, 06.06.2012 en
(54) MUC1 ANTIBODIES
(71) Glycotope GmbH, Robert-Rössle-Strasse 10, 13125 Berlin, DE
(72) GOLETZ, Steffen, Robert-Rössle Strasse 10, 13125 Berlin, DE
DANIELCZYK, Antje, Gontardstrasse 11, 16341 Panketal, DE
STAHN, Renate, Eupener Str. 11a, 13125 Berlin, DE
KARSTEN, Uwe, Robert-Koch-Strasse 13, 16341 Panketal, DE
-
- (51) MKP
A61K 9/12 (2006.01) (97) **2435025 ***
A61P 11/00 (2006.01)
- (86) US2010036676 28.05.2010
(96) 10727553.9 04.04.2012
(87) WO2010138884, 28.05.2010
(97) 2435025, 04.04.2012 en
(54) RESPIRATORY DELIVERY OF ACTIVE AGENTS
(71) Pearl Therapeutics, Inc., 200 Saginaw Drive, Redwood City, CA 94063, US
(72) VEHRING, Reinhard, 200 Saginaw Drive, Redwood City, CA 94063, US
HARTMAN, Michael, Steven, 3820 Park Blvd. Apt. 23, Palo Alto, CA 94306, US
SMITH, Adrian, Edward, 2 Wilmington Acres Court, Emerald Hills, CA 94062, US
JOSHI, Vidya, B., 812 Seal Pointe Drive, Redwood City, CA 94065, US
DWIVEDI, Sarvajna, Kumar, 409 Whisper Lane, Redwood City, CA 94065, US
LECHUGA-BALLESTEROS, David, 1879 Blossom Hill Road, San Jose, CA 95124, US
-
- (51) MKP
C07F 9/09 (2006.01) (97) **2452944 ***
C07F 9/38 (2006.01)
A61P 31/04 (2006.01)
A61P 43/00 (2006.01)
A61K 31/662 (2006.01)
- (86) JP2010004453 08.07.2010
(96) 10796915.6 16.05.2012
(87) WO2011004604, 08.07.2010
(97) 2452944, 16.05.2012 en
(54) DIPHENYL SULFIDE DERIVATIVES AND MEDICINES CONTAINING SAME AS ACTIVE INGREDIENT
(71) Kyorin Pharmaceutical Co., Ltd., 5, Kanda Surugadai 2-chome Chiyoda-ku, Tokyo 101-8311, JP
(72) KOHNO, Yasushi, c/o Discovery Research Laboratories Kyorin Pharmaceutical Co. Ltd. 2399-1 Nogi Nogi-machi, Shimotsugagun Tochigi 329-0114, JP
FUJII, Kiyoshi, c/o Discovery Research Laboratories Kyorin Pharmaceutical Co. Ltd. 2399-1 Nogi Nogi-machi, Shimotsugagun Tochigi 329-0114, JP
TARU, Momoko, c/o Discovery Research Laboratories Kyorin Pharmaceutical Co. Ltd. 2399-1 Nogi Nogi-machi, Shimotsugagun Tochigi 329-0114, JP
MIYOSHI, Keita, c/o Discovery Research Laboratories Kyorin Pharmaceutical Co. Ltd. 2399-1 Nogi Nogi-machi, Shimotsugagun Tochigi 329-0114, JP
-

- (51) MKP
C07J 3/00 (2006.01) (97) **2437746 ***
A61K 31/56 (2006.01)
- (86) EP2010003204 26.05.2010
(96) 10722316.6 11.04.2012
(87) WO2010139411, 26.05.2010
(97) 2437746, 11.04.2012 de
(54) 17 BETA-ALKYL-17 ALPHA-OXY-ESTRADIENES
(71) Bayer Pharma Aktiengesellschaft, Müllerstrasse 178, 13353 Berlin, DE
(72) KÜNZER, Hermann, Turiner Str. 4, 13347 Berlin, DE
WINTERMANTEL, Tim, Maybachstr. 48a, 50670 Köln, DE
LIENAU, Philip, Jahnstr. 13., 10967 Berlin, DE
GERISCH, Michael, Schlieffenstr. 88, 42329 Wuppertal, DE
KÖHR, Silke, Fritz-Reuter-Allee 146, 12359 Berlin, DE
BOHLMANN, Rolf, Kuehler Weg 6a, 14055 Berlin, DE
LANG, Dieter, Wimmersberger Str. 60, 42553 Velbert, DE
KETTSCHAU, Georg, Kavalierrstr. 15, 13187 Berlin, DE
HOFFMANN, Jens, Walterstr. 13, 16567 Mühlentack, DE
HÜBNER, Jan, Alice- und Hella-Hirsch-Ring 14, 10317 Berlin, DE
SANDER, Michael, Hausacker 13., 51503 Rösrath
Hoffnungsthal, DE
HEINRICH, Nikolaus, Sponholzstr. 8, 12159 Berlin, DE
DENNER, Karsten, Str. 97 Nr. 38, 13156 Berlin, DE
-
- (51) MKP
A61M 5/315 (2006.01) (97) **2482876 ***
A61M 5/24 (2006.01)
- (86) EP2010064407 29.09.2010
(96) 10759643.9 08.08.2012
(87) WO2011039216, 29.09.2010
(97) 2482876, 08.08.2012 en
(54) Drive assembly and use of a spring in a drug delivery device
(71) Sanofi-Aventis Deutschland GmbH, Brüningstraße 50, 65929 Frankfurt, DE
(72) VEASEY, Robert, 31 Lonsdale Road Lillington Leamington Spa, Warwickshire CV32 7EP, GB
BILTON, Simon Lewis, Flat 3 15 Clarendon Square Leamington Spa, Warwickshire CV32 5QT, GB
JONES, Christopher, The Old Thatch Grafton Tewkesbury, Gloucestershire GL20 7AT, GB
KOUYOUJIAN, Garen, 2A Plymouth Place Leamington Spa, Warwickshire CV31 1HN, GB
MACDONALD, Catherine Anne, 23 Goggsbridge Lane Warwick, Warwickshire CV34 6JE, GB
-
- (51) MKP
A01N 43/90 (2006.01) (97) **2473053 ***
A61K 31/522 (2006.01)
- (86) US2010047708 02.09.2010
(96) 10814504.6 11.07.2012
(87) WO2011028922, 02.09.2010
(97) 2473053, 11.07.2012 en
(54) SUBSTITUTED XANTHINE DERIVATIVES
(71) Concert Pharmaceuticals Inc., 99 Hayden Avenue, Suite 500, Lexington, MA 02421, US
(72) TUNG, Roger D., 3 Burnham Road, Lexington Massachusetts 02420, US
LIU, Julie F., 3 Whitman Circle, Lexington Massachusetts 02420, US
HARBESON, Scott L., 203 Pemberton Street Apt. 5, Cambridge Massachusetts 02140, US
-
- (51) MKP
C08K 5/053 (2006.01) (97) **2464688 ***
C09J 167/00 (2006.01)
C08L 67/02 (2006.01)
G02B 6/02 (2006.01)
B24B 13/005 (2006.01)
C08L 63/00 (2006.01)
- (86) EP2010004954 12.08.2010
(96) 10745540.4 20.06.2012
(87) WO2011018231, 12.08.2010
(97) 2464688, 20.06.2012 de
(54) COMPOSITION, IN PARTICULAR A BLOCKING AGENT
COMPOSITION FOR FIXING BLANKS TO OPHTHALMIC OR
OPTICAL LENSES
(71) Schneider GmbH & Co. KG, Biegenstrasse 8-12, 35112 Fronhausen, DE
(72) SCHNEIDER, Gunter, Wilhelm-Roser-Strasse 21, 35037 Marburg, DE
HUTTENHUIS, Stephan, In der Struth 2, 35041 Marburg, DE
ACHENBACH, Ferdinand, Bornsbachweg 10, 35236 Breidenbach-Wolzhausen, DE
-
- (51) MKP
G01N 33/487 (2006.01) (97) **2448469 ***
A61B 5/00 (2006.01)
- (86) US2010040309 29.06.2010
(96) 10730654.0 09.05.2012
(87) WO2011008520, 29.06.2010
(97) 2448469, 09.05.2012 en
(54) ANALYTE TESTING METHODS AND DEVICE FOR
CALCULATING BASAL INSULIN THERAPY
(71) Lifescan, Inc., 1000 Gibraltar Drive, Milpitas, CA 95035, US
(72) SHADFORTH, Ian, 550 South Van Ness 207, San Francisco CA 94110, US
PRICE, David, 2691 Calle Alegre, Pleasanton CA 94566, US
SIEH, Zara, 487 Montori Court, Pleasanton CA 94566, US
MONTGOMERY, Brenda, 301 Charleston Greene, Malvern PA 19355, US
BERGMAN, Eric, 310 Nova Lane, Menlo Park CA 94205, US
-
- (51) MKP
C07D 487/04 (2006.01) (97) **2430024 ***
A61K 31/5025 (2006.01)
A61P 35/00 (2006.01)
- (86) GB2010050750 10.05.2010
(96) 10718682.7 21.03.2012
(87) WO2010131022, 10.05.2010
(97) 2430024, 21.03.2012 en
(54) [1,2,4]TRIAZOLO [4,3-B]PYRIDAZINES AS LIGANDS OF THE
ANDROGEN RECEPTOR
(71) AstraZeneca AB, null, 151 85 Södertälje, SE
(72) BRADBURY, Robert, Hugh, AstraZeneca R&D Alderley Alderley Park Macclesfield, Cheshire SK10 4TG, GB
RABOW, Alfred, Arthur, AstraZeneca R&D Alderley Alderley Park Macclesfield, Cheshire SK10 4TG, GB
-
- (51) MKP
A61K 38/48 (2006.01) (97) **2445517 ***
- (86) US2010039866 24.06.2010
(96) 10792683.4 02.05.2012
(87) WO2010151699, 24.06.2010
(97) 2445517, 02.05.2012 en
(54) METHODS FOR DIAGNOSING IRRITABLE BOWEL
SYNDROME
(71) Prometheus Laboratories Inc., 9410 Carroll Park Drive, San Diego, CA 92121-5201, US
(72) GONG, Hua, 12457 Carmel Park Drive, San Diego, California 92130-2274, US
WANG, Shui Long, 4555 Saddle Mountain Court, San Diego, California 92130, US
SINGH, Sharat, 8171 Top of the Morning Way, Rancho Santa Fe, California 92127, US
-

(51) MKP
C07D 213/74 (2006.01) (97) **2394994**
A61K 31/44 (2006.01)
(96) 11168652.3 14.12.2011
(97) 2394994, 14.12.2011 en
(54) One-pot process for the synthesis of dalfampridine
(71) Procos S.p.A., Via Matteotti 249, 28062 Cameri NO, IT
(72) Garavaglia, Fabio, Via Mazzini, 3, 28065 Cerano (NO), IT
Barozza, Alessandro, Via San Guniforte, 7, 20020 Nosate (MI), IT
Roletto, Jacopo, Via Pio XII, 80, 10135 Torino, IT
Paissoni, Paolo, Via Venaria 4/A, 10040 Druento (TO), IT

(51) MKP
A61K 38/47 (2006.01) (97) **2459212 ***
A61K 38/46 (2006.01)
(86) US2010043586 28.07.2010
(96) 10806936.0 06.06.2012
(87) WO2011017177, 28.07.2010
(97) 2459212, 06.06.2012 en
(54) COMPOSITIONS AND METHODS FOR TREATING GAUCHER DISEASE
(71) Shire Human Genetic Therapies, 700 Main Street, Cambridge, MA 02139, US
(72) DANIEL, Peter, F., 100 North Avenue, Natick MA 01760, US
HEARTLEIN, Michael, W., 167 Reed Farm Road, Boxborough MA 01719, US

(51) MKP
B63J 3/02 (2006.01) (97) **2499041 ***
B63J 3/04 (2006.01)
B63H 21/20 (2006.01)
(86) NO2010000405 09.11.2010
(96) 10828597.4 19.09.2012
(87) WO2011056079, 09.11.2010
(97) 2499041, 19.09.2012 en
(54) HYBRID PROPULSION SYSTEM FOR A VESSEL
(71) Rolls-Royce Marine AS, Power Electric Systems Bergen Box 80 Godvik, 5882 Bergen, NO
(72) HAUGLAND, Torbjörn, Janaflaten 28 Box 80 Godvik, N-5882 Bergen, NO

(51) MKP
G06K 19/077 (2006.01) (97) **2415001 ***
B32B 37/00 (2006.01)
(86) FR2010050592 30.03.2010
(96) 10717684.4 08.02.2012
(87) WO2010112761, 30.03.2010
(97) 2415001, 08.02.2012 fr
(54) INSERT FORMING AN ANTENNA AND SMART CARD COMPRISING SAME
(71) Imprimerie Nationale, 58 Boulevard Gouvion Saint Cyr, 75017 Paris, FR
(72) MICHAU, Pascal, Daniel, 187 avenue de Metz, F-59500 Douai, FR
ALLOYEZ, Gautier, Etienne, Jean, 21 rue Lefèvre d'Orval, F-59500 Douai, FR

(51) MKP
C12N 1/15 (2006.01) (97) **2468859 ***
D21H 17/22 (2006.01)
C12N 1/19 (2006.01)
C12N 1/21 (2006.01)
C12N 5/10 (2006.01)
A23K 1/16 (2006.01)
D21C 5/02 (2006.01)
C12N 9/42 (2006.01)
C12P 19/14 (2006.01)
C12N 15/09 (2006.01)
C12P 21/02 (2006.01)
(86) JP2010063844 17.08.2010
(96) 10809957.3 27.06.2012
(87) WO2011021616, 17.08.2010
(97) 2468859, 27.06.2012 en
(54) NOVEL PROTEIN HAVING B-GLUCOSIDASE ACTIVITY, AND USE THEREOF
(71) Meiji Seika Pharma Co., Ltd., 4-16, Kyobashi 2-chome Chuo-ku, Tokyo 104-8002, JP
(72) YOKOYAMA, Fumikazu, c/o Meiji Seika Pharma Co., Ltd. 788 Kayama, Odawara-shi Kanagawa 250-0852, JP
YOKOYAMA, Kengo, c/o Meiji Seika Pharma Co., Ltd. 788 Kayama, Odawara-shi Kanagawa 250-0852, JP
MAZUKA, Nobuko, c/o Meiji Seika Pharma Co., Ltd. 788 Kayama, Odawara-shi Kanagawa 250-0852, JP

(51) MKP
E05B 17/20 (2006.01) (97) **2476828**
E05B 15/00 (2006.01)
E05B 65/08 (2006.01)
E05D 15/06 (2006.01)
E05B 63/00 (2006.01)
(96) 11000234.2 18.07.2012
(97) 2476828, 18.07.2012 de
(54) Locking device
(71) Sunflex Aluminiumsysteme GmbH, Im Ruttenberge 12, 57482 Wenden-Gerlingen, DE
(72) Schneider, Malte, Pirschweg 2 a, D-57482 Wenden, DE

(51) MKP
H01R 9/05 (2006.01) (97) **2436088 ***
H01R 13/648 (2006.01)
(86) US2010034870 14.05.2010
(96) 10778167.6 04.04.2012
(87) WO2010135181, 14.05.2010
(97) 2436088, 04.04.2012 en
(54) COAXIAL CABLE CONNECTOR HAVING ELECTRICAL CONTINUITY MEMBER
(71) John Mezzalingua Associates, Inc., Legal Department 6176 East Molloy Rd, East Syracuse, New York 13057, US
(72) PURDY, Eric, 144 County Route 23A, Constantia New York 13044, US
MONTENA, Noah, 124 Buckingham Ave., Syracuse New York 13210, US

(51) MKP
C08F 8/00 (2006.01) (97) **2499170 ***
(86) US2010053552 21.10.2010
(96) 10828795.4 19.09.2012
(87) WO2011056453, 21.10.2010
(97) 2499170, 19.09.2012 en
(54) SURGICAL NEEDLE COATING AND METHODS
(71) Ethicon, Inc., U.S. Route 22, Somerville, NJ 08876, US
(72) MAURER, Robert, 3 Mcelroy Lane, Montgomery NJ 08502, US
BAR, S., Neil, 318 Thatcher Terrace, Hillsborough, NJ 08844, US
HINRICHS, Eric, 366 Cafferty Road, Bucks PA 18947, US
HAMILTON, Michael, 6002 April Street, San Angelo TX 76904, US
WILKES, Thomas, 1 Richmond Street Apt 3106, New Brunswick NJ 08901, US

(51) MKP
G09F 7/04 (2006.01) (97) **2377435**
A47G 1/06 (2006.01)
A47G 1/17 (2006.01)
(96) 10006759.4 19.10.2011
(97) 2377435, 19.10.2011 de
(54) Assembly for reversible attachment of representative works
(71) Schlink, Marcus, Traubenstraße 8, 9552 Bronschhofen, CH
(72) Schlink, Marcus, Traubenstraße 8, 9552 Bronschhofen, CH

- (51) MKP
A61K 38/18 (2006.01) (97) **2427207 ***
C07K 14/50 (2006.01)
- (86) US2010033614 04.05.2010
(96) 10717414.6 14.03.2012
(87) WO2010129600, 04.05.2010
(97) 2427207, 14.03.2012 en
(54) FGF21 MUTANTS AND USES THEREOF
(71) Amgen, Inc, One Amgen Center Drive, Thousand Oaks, CA 91320-1799, US
(72) BELOUSKI, Edward John, 4541 La Tuna Court, Camarillo, California 93012, US
ELLISON, Murielle Marie, 645 Camino Manzanas, Thousand Oaks, California 91360, US
HAMBURGER, Agnes Eva, 3885 Calle Alta Vista, Thousand Oaks, California 91320, US
HECHT, Randy Ira, 2569 Piccadilly Circle, Thousand Oaks, California 91362, US
LI, Yue-Sheng, 3025 Shadow Hill Circle, Thousand Oaks, California 91360, US
MICHAELS, Mark Leo, 5007 Texhoma Avenue, Encino, California 91316, US
SUN, Jeonghoon, 4340 Camino De La Rosa, Thousand Oaks, California 91320, US
XU, Jing, 1677 Glider Court, Thousand Oaks, California 91320, US
-
- (51) MKP
B65G 67/20 (2006.01) (97) **2483189 ***
- (86) FI2010050748 29.09.2010
(96) 10819957.1 08.08.2012
(87) WO2011039415, 29.09.2010
(97) 2483189, 08.08.2012 en
(54) METHOD AND DEVICE FOR FILLING A CONTAINER
(71) Järvensivu, Jouni, Fincumet Oy PL 7, 39701 Parkano, FI
(72) Järvensivu, Jouni, Fincumet Oy PL 7, 39701 Parkano, FI
-
- (51) MKP
A61P 1/04 (2006.01) (97) **2436683 ***
C07D 405/14 (2006.01)
A61P 3/10 (2006.01)
A61K 31/4184 (2006.01)
A61P 7/02 (2006.01)
A61K 31/423 (2006.01)
A61P 7/04 (2006.01)
A61K 31/428 (2006.01)
A61P 9/08 (2006.01)
A61K 31/454 (2006.01)
A61P 13/12 (2006.01)
A61K 31/4439 (2006.01)
A61P 9/10 (2006.01)
A61P 1/02 (2006.01)
- (86) JP2010003622 28.05.2010
(96) 10780309.0 04.04.2012
(87) WO2010137349, 28.05.2010
(97) 2436683, 04.04.2012 en
(54) AGENT FOR TREATMENT OR PREVENTION OF DISEASES ASSOCIATED WITH ACTIVITY OF NEUROTROPHIC FACTORS
(71) Sumitomo Chemical Company, Limited, 27-1, Shinkawa 2-chome Chuo-ku, Tokyo 104-8260, JP
(72) ISHIKAWA, Junichi, 1-1-21-202 Tamagawa Fukushima-ku, Osaka-shi Osaka 553-0004, JP
SAITO, Koichi, 4-3-20-405 Nakanoshima Kita-ku, Osaka-shi Osaka 530-0005, JP
OHE, Norihisa, 5-555-520 Gakuennaka, Nara-shi Nara 631-0035, JP
KOBAYASHI, Kentaro, 1-2-40-480 Hirata, Ibaraki-shi Osaka 567-0845, JP
-
- (51) MKP
C07H 19/19 (2006.01) (97) **2430032 ***
C07H 1/00 (2006.01)
- (86) EP2010056535 12.05.2010
(96) 10721447.0 21.03.2012
(87) WO2010130778, 12.05.2010
(97) 2430032, 21.03.2012 en
(54) METHOD FOR THE MANUFACTURE OF 2-FLUORO-ARA-ADENINE
(71) Alcafeu Management GmbH & Co. KG, Lilienthalstrasse 4, 15732 Schönefeld OT Waltersdorf, DE
(72) BERWE, Mathias, Brunsberge 10, 45549 Sprockhövel, DE
BOTHE, Clemens, Richard-Wagner-Str. 24, 51375 Leverkusen, DE
REHSE, Joachim, Am Kloster 12, 42799 Leichlingen, DE
-
- (51) MKP
A61K 45/06 (2006.01) (97) **2490688 ***
A61K 31/337 (2006.01)
A61P 35/00 (2006.01)
A61K 31/4196 (2006.01)
- (86) US2010053199 19.10.2010
(96) 10768357.5 29.08.2012
(87) WO2011049946, 19.10.2010
(97) 2490688, 29.08.2012 en
(54) COMBINATION CANCER THERAPY WITH HSP90 INHIBITORY COMPOUNDS
(71) Synta Pharmaceuticals Corp., 45 Hartwell Avenue, Lexington, MA 02421, US
(72) BLACKMAN, Ronald, K., 140 Sewall Avenue 2, Brookline Massachusetts 02446, US
FOLEY, Kevin, Paul, 4402 Merchant Square Place, Landsdale Pennsylvania 19446, US
PROIA, David, 30 Silver Lake Avenue, Newton Massachusetts 02458, US
-
- (51) MKP
G06F 17/30 (2006.01) (97) **2485163 ***
- (86) JP2011060187 26.04.2011
(96) 11788758.8 08.08.2012
(87) WO2012077369, 26.04.2011
(97) 2485163, 08.08.2012 en
(54) SERVER, DICTIONARY-GENERATION METHOD, DICTIONARY-GENERATION PROGRAM, AND COMPUTER-READABLE RECORDING MEDIUM WITH SAID PROGRAM RECORDED THEREON
(71) Rakuten, Inc., 4-12-3, Higashishinagawa Shinagawa-ku, Tokyo 140-0002, JP
(72) BANDARA Udana, c/o Rakuten Inc. 4-12-3 Higashishinagawa Shinagawa-ku, Tokyo 140-0002, JP
-
- (51) MKP
A01N 33/00 (2006.01) (97) **2488021 ***
A01N 43/90 (2006.01)
- (86) US2010052477 13.10.2010
(96) 10824006.0 22.08.2012
(87) WO2011047025, 13.10.2010
(97) 2488021, 22.08.2012 en
(54) COMPOSITIONS AND METHODS TO CONTROL OOMYCETE FUNGAL PATHOGENS
(71) Dow AgroSciences, LLC, 9330 Zionsville Road, Indianapolis, Indiana 46268, US
(72) PEARSON, Norman, 9622 Turnberry Court, Carmel IN 46032, US
LIU, Lei, 1501 Brookmill Court, Carmel IN 46032, US
EHR, Robert, 8693 Highwoods Lane, Indianapolis IN 46278, US
ATKINSON, John, 2044 Williams Glen Boulevard, Zionsville IN 46077, US

- (51) MKP
C07D 403/14 (2006.01) (97) **2496571 ***
 (86) EP2010066577 02.11.2010
 (96) 10771473.5 12.09.2012
 (87) WO2011054783, 02.11.2010
 (97) 2496571, 12.09.2012 en
 (54) PROCESSES FOR THE PREPARATION OF
 5-LIPOXYGENASE ACTIVATING PROTEIN INHIBITORS
 AND THEIR INTERMEDIATES
 (71) Glaxo Group Limited, Glaxo Wellcome House Berkeley
 Avenue, Greenford, Middlesex UB6 0NN, GB
 Panmira Pharmaceuticals, LLC, 9535 Waples Street, Suite 100,
 San Diego, CA 92121, US
 (72) CRAWFORD, Claire Frances, GlaxoSmithKline Gunnels Wood
 Road, Stevenage Hertfordshire SG1 2NY, GB
 GARCIA, Sandrine, GlaxoSmithKline Gunnels Wood Road,
 Stevenage Hertfordshire SG1 2NY, GB
 GRAHAM, Jonathan Paul, GlaxoSmithKline Gunnels Wood
 Road, Stevenage Hertfordshire SG1 2NY, GB
 HARLING, Sandra Jane, GlaxoSmithKline Gunnels Wood Road,
 Stevenage Hertfordshire SG1 2NY, GB
 HENLEY, Nicholas Paul, Glaxo SmithKline Gunnels Wood
 Road, Stevenage Hertfordshire SG1 2NY, GB
 HERMITAGE, Stephen Andrew, GlaxoSmithKline Gunnels
 Wood Road, Stevenage Hertfordshire SG1 2NY, GB
 HUTCHINSON, John Howard, Amira Pharmaceuticals Inc. 9535
 Waples Street Suite 100, San Diego, California 92121, US
 KEEL, Trevor Raymond, GlaxoSmithKline Gunnels Wood Road,
 Stevenage Hertfordshire SG1 2NY, GB
 KENNEDY, Andrew, GlaxoSmithKline Gunnels Wood Road,
 Stevenage Hertfordshire SG1 2N, GB
 MASON, Andrew McMurtrie, GlaxoSmithKline Gunnels Wood
 Road, Stevenage Hertfordshire SG1 2NY, GB
 SCOTT, Mark Simon, GlaxoSmithKline Gunnels Wood Road,
 Stevenage Hertfordshire SG1 2NY, GB
 SMITH, Neil Michael, GlaxoSmithKline Gunnels Wood Road,
 Stevenage Hertfordshire SG1 2NY, GB
 STOCK, Nicholas Simon, Amira Pharmaceuticals Inc. 9535
 Waples Street Suite 100, San Diego, California 92121, US
 TATENO, Yuichi, GlaxoSmithKline Gunnels Wood Road,
 Stevenage Hertfordshire SG1 2NY, GB
 TROUW, Leontine Saskia, GlaxoSmithKline Gunnels Wood
 Road, Stevenage Hertfordshire SG1 2NY, GB
 TURNER, Peter Graham, GlaxoSmithKline Gunnels Wood
 Road, Stevenage Hertfordshire SG1 2NY, GB
 WALLIS, Christopher John, GlaxoSmithKline Gunnels Wood
 Road, Stevenage Hertfordshire SG1 2NY, GB
 WILLACY, Robert David, GlaxoSmithKline Gunnels Wood Road,
 Stevenage Hertfordshire SG1 2NY, GB

- (51) MKP
A61K 38/17 (2006.01) (97) **2405932 ***
 (86) US2010027041 11.03.2010
 (96) 10751447.3 18.01.2012
 (87) WO2010105097, 11.03.2010
 (97) 2405932, 18.01.2012 en
 (54) Sparc angiogenic domain and methods of use
 (71) Abraxis BioScience, LLC, 11755 Wilshire Boulevard Suite
 2000, Los Angeles, CA 90025, US
 (72) TRIEU, Vuong, 3965 North Ceanothus Place, H, Calabasas
 California 91302, US
 KNAUER, Daniel, 1109 El Camino Drive, Costa Mesa California
 92626, US
 DESAI, Neil, 11755 Wilshire Boulevard Suite 2000, Los Angeles
 California 90025, US

- (51) MKP
A61M 5/315 (2006.01) (97) **2445553 ***
 (86) EP2010058942 23.06.2010
 (96) 10727725.3 02.05.2012
 (87) WO2010149717, 23.06.2010
 (97) 2445553, 02.05.2012 en
 (54) DRIVE MECHANISM FOR DRUG DELIVERY DEVICE
 (71) Sanofi-Aventis Deutschland GmbH, Brüningstraße 50, 65929
 Frankfurt, DE
 (72) NZIKE, Philippe, c/o Sanofi-Aventis Deutschland GmbH, 65926
 Frankfurt am Main, DE

- (51) MKP
C07K 14/505 (2006.01) (97) **2480569 ***
C07K 1/16 (2006.01)
 (86) EP2010005839 23.09.2010
 (96) 10759588.6 01.08.2012
 (87) WO2011035914, 23.09.2010
 (97) 2480569, 01.08.2012 en
 (54) PROCESS FOR THE PURIFICATION OF RECOMBINANT
 HUMAN ERYTHROPOIETIN (EPO), EPO THUS PURIFIED
 AND PHARMACEUTICAL COMPOSITIONS COMPRISING
 SAME
 (71) BioGeneriX AG, Graf-Arco-Straße 3, 89079 Ulm, DE
 (72) HINDERER, Walter, Dekan-Schuster-Strasse 25, 63110
 Rodgau, DE
 ARNOLD, Stefan, Marstallstrasse 49a, 68723 Schwetzingen,
 DE

- (51) MKP
A61K 31/4427 (2006.01) (97) **2419417 ***
A61K 31/437 (2006.01)
A61K 31/433 (2006.01)
C07D 401/08 (2006.01)
A61P 3/10 (2006.01)
C07D 403/08 (2006.01)
A61P 29/00 (2006.01)
C07D 413/08 (2006.01)
C07D 417/08 (2006.01)
C07D 471/04 (2006.01)
 (86) US2010031212 15.04.2010
 (96) 10714148.3 22.02.2012
 (87) WO2010121011, 15.04.2010
 (97) 2419417, 22.02.2012 en
 (54) 4-AZETIDINYL-1-HETEROARYL-CYCLOHEXANE
 ANTAGONISTS OF CCR2
 (71) Janssen Pharmaceutica, N.V., Turnhoutseweg 30, 2340 Beerse,
 BE
 (72) ZHANG, Xuqing, 1728 Osprey Drive, Audubon PA 19403, US
 HUFNAGEL, Heather, Rae, 64 Glen Manor Lane, Glenmoore
 PA 19343, US
 CAI, Chaozhong, 129 Banbury Ave, North Wales PA 19454, US
 LANter, James, Welsh&McKean Roads, Spring House PA
 19477, US
 MARKOTAN, Thomas, P., 506 Estate Road, Morgantown PA
 19543, US
 SUI, Zhihua, Welsh&McKean Roads, Spring House PA 19477,
 US

- (51) MKP
B01J 29/08 (2006.01) (97) **2424661 ***
B01J 37/00 (2006.01)
 (86) US2010032691 28.04.2010
 (96) 10770236.7 07.03.2012
 (87) WO2010126955, 28.04.2010
 (97) 2424661, 07.03.2012 en
 (54) ZEOLITE Y
 (71) PQ Corporation, 300 Lindenwood Drive Valleybrooke Corporate
 Center, Malvern, PA 19355-1740, US
 (72) COOPER, David Allen, 124 Harper Avenue, Morrisville, PA
 19067, US
 OUWEHAND, Cornelius, Brahmstraat 117, 1447 RK
 Purmerend, NL
 DOMOKOS, László, Schothorsterlaan 55, 3822 NA Amersfoort,
 NL
 ONG, Lay Hwa, Blk 652 Senja Link, 13-22, Senja Link 670652,
 SG

- (51) MKP
A61M 5/315 (2006.01) (97) **2485789 ***
A61M 5/00 (2006.01)
A61M 5/24 (2006.01)
- (86) EP2010065095 08.10.2010
(96) 10762927.1 15.08.2012
(87) WO2011042538, 08.10.2010
(97) 2485789, 15.08.2012 en
(54) DRUG DELIVERY DEVICE WITH CLEARANCE COMPENSATION MEANS
(71) Sanofi-Aventis Deutschland GmbH, Brüningsstraße 50, 65929 Frankfurt, DE
(72) HELMER, Michael, Sanofi-Aventis Deutschland GmbH, 65926 Frankfurt am Main, DE
MATTHIAS, Claudia, Sanofi-Aventis Deutschland GmbH, 65926 Frankfurt am Main, DE
ZEIMETZ, Leo, Amselweg 4, 64572 Büttelborn, DE
SHAHBAZFAR, Reza, Schachstr. 2, 65183 Wiesbaden, DE
SCHAEFFER, Benjamin, Ortstr. 7, 35649 Bischoffen, DE
MOSEBACH, Carsten, Frauenlobstraße 11, 55118 Mainz, DE
-
- (51) MKP
A22B 5/20 (2006.01) (97) **2409572**
- (96) 11005965.6 25.01.2012
(97) 2409572, 25.01.2012 en
(54) Machine for extracting material classified as hazardous from the medullary canal of sheep and goats
(71) Extracción de Médulas y Complementos, S.L., Cal Tet, s/n. - Urb. "La Rectoria", 17459 Campllong Gerona, ES
(72) Catafau Riera, Jaume, Cal Tet, s/n. - Urb. "La Rectoria", 17459 Campllong Girona, ES
-
- (51) MKP
A61K 9/20 (2006.01) (97) **2442799 ***
A61K 31/5377 (2006.01)
- (86) EP2010058680 18.06.2010
(96) 10725746.1 25.04.2012
(87) WO2010146179, 18.06.2010
(97) 2442799, 25.04.2012 en
(54) SOLID PHARMACEUTICAL COMPOSITION COMPRISING RIVAROXABAN
(71) Krka Tovarna Zdravil, D.D., Novo Mesto, Smarjeska cesta 6, 8501 Novo Mesto, SI
(72) SEDMAK, Gregor, Palmejeva 30, 1000 Ljubljana, SI
VREČER, Franc, Potok 5b, 8351 Straza pri Novem mestu, SI
MEZNAR, Klavdija, Ragovska ulica 21A, 8000 Novo mesto, SI
TROST, Sabina, Ljubljanska cesta 31, 1330 Kocevje, SI
BUKOVEC, Polona, Regra vas 37A, 8000 Novo mesto, SI
HVALEC, Miran, Seidlova cesta 62, 8000 Novo mesto, SI
-
- (51) MKP
A62B 1/14 (2006.01) (97) **2453988 ***
- (86) IB2010001614 01.07.2010
(96) 10742566.2 23.05.2012
(87) WO2011007225, 01.07.2010
(97) 2453988, 23.05.2012 en
(54) SAFETY DEVICE
(71) ALUDESIGN S.p.A., Via Torchio, 22, 24034 Cisano Bergamasco BG, IT
(72) PAGLIOLI, Carlo, c/o Aludesign S.p.A. Via Torchio 22, I-24034 Cisano Bergamasco (BG), IT
-
- (51) MKP
A61P 35/00 (2006.01) (97) **2490690 ***
A61K 31/506 (2006.01)
- (86) US2010053459 21.10.2010
(96) 10773472.5 29.08.2012
(87) WO2011050120, 21.10.2010
(97) 2490690, 29.08.2012 en
(54) METHOD OF TREATING PROLIFERATIVE DISORDERS AND OTHER PATHOLOGICAL CONDITIONS MEDIATED BY BCR-ABL, C-KIT, DDR1, DDR2 OR PDGF-R KINASE ACTIVITY
(71) Novartis AG, Lichtstrasse 35, 4056 Basel, CH
(72) SZCZUDLO, Tomasz, Novartis One Health Plaza, East Hanover, New Jersey 07936, US
WOODMAN, Richard, Novartis One Health Plaza, East Hanover, New Jersey 07936, US
YIN, Ophelia, 66 Henning Terrace, Denville, New Jersey 07834, US
-
- (51) MKP
H04W 72/04 (2009.01) (97) **2466979 ***
- (86) CN2010075944 12.08.2010
(96) 10807988.0 20.06.2012
(87) WO2011018043, 12.08.2010
(97) 2466979, 20.06.2012 en
(54) METHOD, SYSTEM AND DEVICE FOR USING TERMINAL IDENTIFIER
(71) China Academy of Telecommunications Technology, 40, Xueyuan Road, Haidian District, Beijing 100191, CN
(72) ZHAO, Yi, No.40 Xueyuan Road Haidian District, Beijing 100083, CN
LIANG, Jing, No.40 Xueyuan Road Haidian District, Beijing 100083, CN
LI, Haitao, No.40 Xueyuan Road Haidian District, Beijing 100083, CN
-
- (51) MKP
A01N 43/66 (2006.01) (97) **2440053 ***
A61K 31/53 (2006.01)
- (86) US2010037695 08.06.2010
(96) 10786656.8 18.04.2012
(87) WO2010144394, 08.06.2010
(97) 2440053, 18.04.2012 en
(54) BENZYL SUBSTITUTED TRIAZINE DERIVATIVES AND THEIR THERAPEUTICAL APPLICATIONS
(71) Abraxis BioScience, LLC, 11755 Wilshire Boulevard Suite 2000, Los Angeles, CA 90025, US
(72) TAO, Chunlin, 1800 Camden Avenue, No.301, Los Angeles CA 90025, US
WANG, Qinwei, 1112 South Cordova Street, Alhambra CA 91801, US
HO, David, 325 Kingfords Street, Monterey Park CA 91754, US
NALLAN, Laxman, 930 North Monterey Street, No.236, Alhambra CA 91801, US
POLAT, Tulay, 5750 West Centinela Avenue, No.224, Los Angeles CA 90045, US
SUN, Xiaowen, 10920 National Boulevard, No.1, Los Angeles CA 90064, US
DESAL, Neil, 11755 Wilshire Boulevard Suite 2000, Los Angeles CA 90025, US
-
- (51) MKP
C07D 401/12 (2006.01) (97) **2411364 ***
A61K 31/444 (2006.01)
A61P 35/00 (2006.01)
C07D 213/56 (2006.01)
- (86) FR2010050489 18.03.2010
(96) 10715954.3 01.02.2012
(87) WO2010109115, 18.03.2010
(97) 2411364, 01.02.2012 fr
(54) ANTICANCER COMPOUNDS, PREPARATION THEREOF, AND THERAPEUTIC USE THEREOF
(71) SANOFI, 174, Avenue de France, 75013 Paris, FR
(72) ARIGON, Jérôme, c/o Sanofi-Aventis Département Brevets 174 Avenue de France, F-75013 Paris, FR
BERNHART, Claude, c/o Sanofi-Aventis Département Brevets 174 Avenue de France, F-75013 Paris, FR
BOUABOULA, Monsif, c/o Sanofi-Aventis Département Brevets 174 Avenue de France, F-75013 Paris, FR
COMBET, Romain, c/o sanofi-aventis Département Brevets 174 avenue de France, F-75013 Paris, FR
JEGHAM, Samir, c/o Sanofi-Aventis Département Brevets 174 Avenue de France, F-75013 Paris, FR
HILAIRET, Sandrine, c/o sanofi-aventis Département Brevets 174 avenue de France, F-75013 Paris, FR
-
- (51) MKP
A61K 31/045 (2006.01) (97) **2458983 ***
A01N 31/00 (2006.01)
- (86) US2010044136 02.08.2010
(96) 10805177.2 06.06.2012
(87) WO2011014880, 02.08.2010
(97) 2458983, 06.06.2012 en
(54) INHIBITORS OF COGNITIVE DECLINE
(71) Cognition Therapeutics, Inc., 2043 Sidney Street, Suite 261, Pittsburgh, PA 15203, US
(72) RISHTON, Gilbert, M., 11934 Whalers Lane, Malibu CA 90265, US
CATALANO, Susan, C/o Cognition Therapeutics Inc. 2043 Sidney Street Suite 261, Pittsburgh, PA 15203, US

- (51) MKP
A61P 25/24 (2006.01) (97) **2499148 ***
A61K 31/4745 (2006.01)
C07D 498/04 (2006.01)
C07D 498/18 (2006.01)
C07F 7/08 (2006.01)
A61K 31/695 (2006.01)
A61P 1/06 (2006.01)
- (86) CH2010000191 03.08.2010
(96) 10743003.5 19.09.2012
(87) WO2011014973, 03.08.2010
(97) 2499148, 19.09.2012 en
(54) CONFORMATIONALLY CONSTRAINED, FULLY SYNTHETIC MACROCYCLIC COMPOUNDS
- (71) Polyphor Ag, Hegenheimermattweg 125, 4123 Allschwil, CH
(72) OBRECHT, Daniel, Im Eichacker 21, CH-4112 Bättwil, CH
ERMERT, Philipp, Steinbühlweg 31, CH-4123 Allschwil, CH
OUMOUCHE, Said, 39 rue du Soleil, F-68200 Mulhouse, FR
LACH, Franck, 21 rue Principale, F-51400 Les Grandes Loges, FR
LUTHER, Anatol, Max-Brombacher-Weg 10, 79589 Binzen, DE
MARX, Karsten, Birkenstrasse 44, CH-4055 Basel, CH
MÖHLE, Kerstin, Oberhausenstrasse 23, CH-8907 Wettswil, CH
-
- (51) MKP
A61P 25/20 (2006.01) (97) **2431355 ***
A61P 25/22 (2006.01)
A61P 25/24 (2006.01)
C07C 233/18 (2006.01)
A61P 9/00 (2006.01)
A61K 31/165 (2006.01)
A61P 1/00 (2006.01)
A61P 25/00 (2006.01)
A61P 5/00 (2006.01)
A61P 25/18 (2006.01)
- (86) CN2010070931 09.03.2010
(96) 10750350.0 21.03.2012
(87) WO2010102554, 09.03.2010
(97) 2431355, 21.03.2012 en
(54) NEW CRYSTALLINE FORM VI OF AGOMELATINE, PREPARATION METHOD AND APPLICATION THEREOF
- (71) Les Laboratoires Servier, 35, rue de Verdun, 92284 Suresnes Cedex, FR
(72) SHAN, Hanbin, No.1320 West Beijing Road, Shanghai 200040, CN
ZHANG, Peng, No.1320 West Beijing Road, Shanghai 200040, CN
YUAN, Zhedong, No.1320 West Beijing Road, Shanghai 200040, CN
JIANG, Xudong, No.1320 West Beijing Road, Shanghai 200040, CN
HUANG, Yu, No.1320 West Beijing Road, Shanghai 200040, CN
WANG, Hubo, No.1320 West Beijing Road, Shanghai 200040, CN
CAO, Xufeng, No.1320 West Beijing Road, Shanghai 200040, CN
CHENG, Xingdong, No.1320 West Beijing Road, Shanghai 200040, CN
YU, Xiong, No.1320 West Beijing Road, Shanghai 200040, CN
-
- (51) MKP
C07D 307/80 (2006.01) (97) **2435413 ***
- (86) EP2010057272 26.05.2010
(96) 10724025.1 04.04.2012
(87) WO2010136502, 26.05.2010
(97) 2435413, 04.04.2012 en
(54) PROCESS FOR THE PRODUCTION OF DRONEDARONE INTERMEDIATES
- (71) SANOFI, 174, Avenue de France, 75013 Paris, FR
(72) KRETZSCHMAR, Gerhard, Sanofi-Aventis Deutschland GmbH, 65926 Frankfurt am Main, DE
KRAFT, Volker, Sanofi-Aventis Deutschland GmbH, 65926 Frankfurt am Main, DE
ROSSEN, Kai, Sanofi-Aventis Deutschland GmbH, 65926 Frankfurt am Main, DE
GRÄSER, Joachim, Sanofi-Aventis Deutschland GmbH, 65926 Frankfurt am Main, DE
-
- (51) MKP
C12N 15/10 (2006.01) (97) **2479278**
C12N 15/79 (2006.01)
- (96) 11000572.5 25.07.2012
(97) 2479278, 25.07.2012 en
(54) Method for the construction of specific promoters
(71) Synpromics Ltd., 1 Newton Village, Dalkeith EH22 1SN Midlothian, GB
(72) Roberts, Michael L., 1 Newton Village, Dalkeith EH22 1SN Midlothian, GB
-
- (51) MKP
A61P 25/00 (2006.01) (97) **2475429 ***
C07D 489/02 (2006.01)
A61K 31/485 (2006.01)
- (86) US2010031956 21.04.2010
(96) 10815769.4 18.07.2012
(87) WO2011031350, 21.04.2010
(97) 2475429, 18.07.2012 en
(54) COMPOSITIONS COMPRISING ENZYME-CLEAVABLE KETONE-MODIFIED OPIOID PRODRUGS AND OPTIONAL INHIBITORS THEREOF
- (71) Signature Therapeutics, Inc., 75 Shoreway Road, Suite D, San Carlos, CA 94070, US
(72) JENKINS, Thomas E., 75 Shoreway Road Suite D. San Carlos, CA 94070, US
HUSFELD, Craig O., 75 Shoreway Road Suite D. San Carlos, California 94070, US
SEROOGY, Julie D., 75 Shoreway Road Suite D. San Carlos, CA 94070, US
WRAY, Jonathan W., 75 Shoreway Road Suite D. San Carlos, 94070, US
-
- (51) MKP
C07D 417/14 (2006.01) (97) **2445903 ***
A61K 31/4178 (2006.01)
C07D 407/14 (2006.01)
C07D 409/14 (2006.01)
A61P 35/00 (2006.01)
C07D 403/04 (2006.01)
C07D 403/14 (2006.01)
- (86) EP2010059029 24.06.2010
(96) 10730132.7 02.05.2012
(87) WO2010149755, 24.06.2010
(97) 2445903, 02.05.2012 en
(54) 1, 3-DISUBSTITUTED IMIDAZOLIDIN-2-ONE DERIVATIVES AS INHIBITORS OF CYP 17
- (71) Novartis AG, Lichtstrasse 35, 4056 Basel, CH
(72) BOCK, Mark G., Novartis Institutes for BioMedical Research Inc. 250 Massachusetts Avenue, Cambridge, MA 02139, US
GAUL, Christoph, Novartis Pharma AG Werk Klybeck Postfach, CH-4002 Basel, CH
GUMMADI, Venkateshwar Rao, 382, 3rd Cross 2nd Main South Avenue Layout Gottigere Bannerghatta Road, Bangalore 560 083, IN
SENGUPTA, Saumitra, 6/7 Central Park, Kolkata 700 032, IN
-

- (51) MKP
A61K 31/4439 (2006.01) (97) **2470508 ***
A61K 31/497 (2006.01)
A61K 31/416 (2006.01)
C07D 401/14 (2006.01)
A61P 29/00 (2006.01)
C07D 403/04 (2006.01)
A61P 19/02 (2006.01)
C07D 405/14 (2006.01)
C07D 401/04 (2006.01)
C07F 9/09 (2006.01)
C07D 231/54 (2006.01)
A61K 31/661 (2006.01)
- (86) US2010002360 27.08.2010
(96) 10757325.5 04.07.2012
(87) WO2011025541, 27.08.2010
(97) 2470508, 04.07.2012 en
(54) CANNABINOID RECEPTOR MODULATORS
(71) Arena Pharmaceuticals, Inc., 6166 Nancy Ridge Drive, San Diego, CA 92121, US
(72) JONES, Robert M., 10937 Corte luz del Sol, San Diego, California 92130, US
HAN, Sangdon, 9953 Fieldthorn Street, San Diego, California 92127, US
THORESEN, Lars, 7130 Shoreline Drive No. 1110, San Diego, California 92122, US
JUNG, Jae-Kyu, 16478 Camelas Walk, San Diego, California 92127, US
STRAH-PLEYNET, Sonja, 27 Melrose Avenue, Newton, Massachusetts 02466, US
ZHU, Xiuwen, 11367 Black Colt Lane, San Diego, California 92130, US
XIONG, Yifeng, 5036 Pearlman Way, San Diego, California 92130, US
YUE, Dawei, 11353 Nahama Lanc, San Diego, CA 92130, US
-
- (51) MKP
A61K 47/20 (2006.01) (97) **2498802 ***
A61K 38/28 (2006.01)
A61P 3/10 (2006.01)
A61K 38/26 (2006.01)
- (86) EP2010067250 11.11.2010
(96) 10776998.6 19.09.2012
(87) WO2011058083, 11.11.2010
(97) 2498802, 19.09.2012 de
(54) PHARMACEUTICAL COMPOSITION COMPRISING A GLP-1 AGONIST, AN INSULIN, AND METHIONINE
(71) Sanofi-Aventis Deutschland GmbH, Brünningstraße 50, 65929 Frankfurt, DE
(72) HAGENDORF, Annika, c/o Sanofi-Aventis Deutschland GmbH, 65926 Frankfurt am Main, DE
HAUCK, Gerrit, c/o Sanofi-Aventis Deutschland GmbH, 65926 Frankfurt am Main, DE
MÜLLER, Werner, c/o Sanofi-Aventis Deutschland GmbH, 65926 Frankfurt am Main, DE
SCHOETTLE, Isabell, c/o Sanofi-Aventis Deutschland GmbH, 65926 Frankfurt am Main, DE
SIEFKE-HENZLER, Verena, c/o Sanofi-Aventis Deutschland GmbH, 65926 Frankfurt am Main, DE
TERTSCH, Katrin, c/o Sanofi-Aventis Deutschland GmbH, 65926 Frankfurt am Main, DE
-

- (51) MKP
A61P 35/02 (2006.01) (97) **2403856 ***
A61P 35/00 (2006.01)
C07D 491/04 (2006.01)
A61K 31/4355 (2006.01)
- (86) US2010026381 05.03.2010
(96) 10708472.5 11.01.2012
(87) WO2010102219, 05.03.2010
(97) 2403856, 11.01.2012 en
(54) METHYLENEDIOXYBENZO [I]PHENANTHRIDINE DERIVATIVES USED TO TREAT CANCER
(71) University Of Medicine And Dentistry Of New Jersey, Office Of Patents And Licensing 1 Worlds Fair Drive, Suite 2100, Somerset, NJ 08873, US
Rutgers, The State University of New Jersey, Old Queens Building Somerset and George Streets, New Brunswick, NJ 08903, US
(72) LAVOIE, Edmond, J., Old Queens Building Somerset and George Streets, New Brunswick, New Jersey 08903, US
FENG, Wei, Old Queens Building Somerset and George Streets, New Brunswick, New Jersey 08903, US
LIU, Leroy, F., Office of Patents and Licensing One World's Fair Drive Suite 2100, Somerset, New Jersey 08873, US
-
- (51) MKP
H04W 72/04 (2009.01) (97) **2490496 ***
- (86) CN2010077429 28.09.2010
(96) 10823050.9 22.08.2012
(87) WO2011044820, 28.09.2010
(97) 2490496, 22.08.2012 en
(54) RESOURCE CONFIGURATION METHOD, EQUIPMENT AND SYSTEM FOR UPLINK CONTROL CHANNEL
(71) China Academy of Telecommunications Technology, 40, Xueyuan Road, Haidian District, Beijing 100191, CN
(72) LIN, Yanan, No.40 Xueyuan Road Haidian District, Beijing 100083, CN
SHEN, Zukang, No.40 Xueyuan Road Haidian District, Beijing 100083, CN
PAN, Xueming, No.40 Xueyuan Road Haidian District, Beijing 100083, CN
-
- (51) MKP
A47G 27/02 (2006.01) (97) **2440091 ***
A47G 27/04 (2006.01)
D06N 7/00 (2006.01)
D05C 17/02 (2006.01)
- (86) US2010038480 14.06.2010
(96) 10728496.0 18.04.2012
(87) WO2010144902, 14.06.2010
(97) 2440091, 18.04.2012 en
(54) CARPET TILES AND METHODS OF PRODUCING CARPET TILES WITH DIVERSITY OF COLOR AND TEXTURE
(71) Interface, Inc., 2859 Paces Ferry Road Suite 2000, Atlanta, Georgia 30339, US
(72) OAKEY, David, D., 868 Pineywoods Drive, LaGrange Georgia 30240, US
MACHELL, Bridget, 1704 Malco Drive, West Point, Georgia 31833, US
-
- (51) MKP
A61P 11/02 (2006.01) (97) **2421830 ***
A61K 31/18 (2006.01)
C07D 211/96 (2006.01)
A61P 29/00 (2006.01)
C07D 295/26 (2006.01)
A01N 43/62 (2006.01)
A61P 25/28 (2006.01)
C07D 241/04 (2006.01)
C07D 241/08 (2006.01)
- (86) US2010031832 21.04.2010
(96) 10714822.3 29.02.2012
(87) WO2010123959, 21.04.2010
(97) 2421830, 29.02.2012 en
(54) 2,5-DISUBSTITUTED ARYLSULFONAMIDE CCR3 ANTAGONISTS
(71) Axikin Pharmaceuticals, Inc., 10835 Road to the Cure, Suite 250, San Diego, CA 92121, US
(72) LY, Tai, Wei, 10824 Caminito Colorado, San Diego CA 92131, US
POTTER, Garrett, Thomas, 4205 Camino Ticino, San Diego CA 92122, US
-

- (51) MKP
A61K 9/00 (2006.01) (97) **2275086**
A61K 38/16 (2006.01)
 (96) 10160099.7 19.01.2011
 (97) 2275086, 19.01.2011 en
 (54) Reduced volume formulation of glatiramer acetate and methods of administration
 (71) TEVA PHARMACEUTICAL INDUSTRIES, LTD., 5 Basel Street, P.O. Box 3190, 49131 Petach-Tikva, IL
 (72) Altman, Ayelet, Halukey Nahal 5, Hod-haSharon, IL
 Saltkill, Doris, 634 East 61 Street, Kansas City, MO 64110, US
 Tomlinson, Dalton L., 10211 Delmar Lane, Overland Park, KS 66207, US
 El-Gad, Tomer, Beeri 40, Rehovot, IL

- (51) MKP
C10G 3/00 (2006.01) (97) **2305778**
C10L 1/02 (2006.01)
 (96) 10179216.6 06.04.2011
 (97) 2305778, 06.04.2011 en
 (54) Fuel and fuel additives capable for use for internal combustion engines and process for the production thereof
 (71) MOL Magyar Olaj- és Gázipari Nyrt., Október huszonharmadika utca 18., 1117 Budapest, HU
 OLAJTERV Fővállalkozó és Tervező Zrt., Lajos utca 103., 1036 Budapest, HU
 Pannon Egyetem, Egyetem utca. 10, 8200 Veszprém, HU
 Magyar Tudományos Akadémia Kémiai Kutatóközpont, Pusztaszeri út 59-67, 1025 Budapest, HU
 (72) Thernesz, Artur, MOL Nyrt. Egres utca 27., 2000, Szentendre, HU
 Boda, László, MOL Nyrt. Körtefa utca 13/3., 2440, Százhalombatta, HU
 Petró, József, MOL Nyrt. Rákóczi utca 40., 2440, Százhalombatta, HU
 Leveles, László, MOL Nyrt. Ponty utca 6., 2440, Százhalombatta, HU
 Wáhliné Horváth, Ilona, MOL Nyrt. Kodály Zoltán sétány 12. 1/5., 2440, Százhalombatta, HU
 Szalmásné Pécsvári, Gabriella, MOL Nyrt. Sas utca 10., 2440, Százhalombatta, HU
 Kelemen, Béla, MOL Nyrt. Zentai utca 25., 1222, Budapest, HU
 Vuk, Tibor, MOL Nyrt. Gagarin utca 7., 2837, Vértesszőlős, HU
 Rácz, László, MOL Nyrt. Újvilág utca 15., 1145, Budapest, HU
 Holló, András, MOL Nyrt. Meggyfa utca 4., 2440, Százhalombatta, HU
 Szerencsés, Zoltán, MOL Nyrt. Honfoglalás utca 13., 2045, Törökbálint, HU
 Kovács, Ferenc, MOL Nyrt. Budai Nagy Antal út 5/D, 2500, Esztergom, HU
 Kovács, Imre, MOL Nyrt. Széchenyi utca 48., 2462, Martonvásár, HU
 Tolvajné Németh, Krisztina, MOL Nyrt. Mátyás király utca 46., 2030, Érd, HU
 Arányi, László, OLAJTERV Zrt. Gömb utca 4/B 5/5, 1139, Budapest, HU
 Stéger, Csaba, OLAJTERV Zrt. Egressy út 31-33. D212, 1149, Budapest, HU
 Valyon, József, MTA Kémiai Kutatóközpont Lepke utca 8. fsz. 2., 1026, Budapest, HU
 Onestyák, György, MTA Kémiai Kutatóközpont Szabadság utca 11., 1165, Budapest, HU
 Hanscók, Jenő, Pannon Egyetem Zrínyi Miklós út 5/6, 8200, Veszprém, HU
 Krár, Márton, Pannon Egyetem Futó utca 4. II/9, 8400, Ajka, HU
 Nagy, Gábor, Pannon Egyetem Moroló utca 29., 7694, Hosszúhetény, HU
 Varga, Zoltán, Pannon Egyetem Március 15. utca 3/C, 8200, Veszprém, HU

- (51) MKP
E04H 4/14 (2006.01) (97) **2446098 ***
E04H 4/12 (2006.01)
F04D 15/00 (2006.01)
A63B 69/12 (2006.01)
 (86) EP2010003702 18.06.2010
 (96) 10730354.7 02.05.2012
 (87) WO2010149316, 18.06.2010
 (97) 2446098, 02.05.2012 de
 (54) WATER ATTRACTION DEVICE
 (71) WTS Kereskedelmi és Szolgáltató Kft., Közúzó u.7, 2000 Szentendre, HU
 (72) BOGNARNE FEJES, Veronika, Bajcsy Zsillinszky utca 94, H-7400 Kaposvár, HU

- (51) MKP
A61K 41/00 (2006.01) (97) **2464385 ***
A61K 9/00 (2006.01)
A61K 48/00 (2006.01)
C12N 15/87 (2006.01)
A61P 35/00 (2006.01)
A61P 43/00 (2006.01)
 (86) GB2010001548 16.08.2010
 (96) 10747250.8 20.06.2012
 (87) WO2011018636, 16.08.2010
 (97) 2464385, 20.06.2012 en
 (54) PHOTOCHEMICAL INTERNALIZATION METHOD
 (71) PCI Biotech AS, Strandveien 55, 1366 Lysaker, NO
 KLAVENESS, Jo, Midtaasen 5, N-1166 Oslo, NO
 HOGSET, Anders, PCI Biotech AS Strandveien 55, N-1366 Lysaker, NO

- (51) MKP
A61M 5/315 (2006.01) (97) **2482875 ***
A61M 5/24 (2006.01)
 (86) EP2010064408 29.09.2010
 (96) 10757781.9 08.08.2012
 (87) WO2011039217, 29.09.2010
 (97) 2482875, 08.08.2012 en
 (54) DRIVE ASSEMBLY, PISTON ROD, DRUG DELIVERY DEVICE, AND USE OF A SPRING
 (71) Sanofi-Aventis Deutschland GmbH, Brüningstraße 50, 65929 Frankfurt, DE
 (72) VEASEY, Robert, 31 Lonsdale Road Lillington Leamington Spa, Warwickshire CV32 7EP, GB
 BILTON, Simon, Lewis, Flat 3 15 Clarendon Square Leamington Spa, Warwickshire CV32 5QT, GB
 JONES, Christopher, The Old Thatch Grafton Tewkesbury, Gloucestershire GL20 7AT, GB
 KOUYOUJIAN, Garen, 2A Plymouth Place Leamington Spa, Warwickshire CV31 1HN, GB
 MACDONALD, Catherine, Anne, 23 Goggsbridge Lane Warwick, Warwickshire CV34 6JE, GB

- (51) MKP
C07K 14/705 (2006.01) (97) **2440577 ***
A61K 38/17 (2006.01)
A61P 3/00 (2006.01)
 (86) US2010037787 08.06.2010
 (96) 10792510.9 18.04.2012
 (87) WO2010151426, 08.06.2010
 (97) 2440577, 18.04.2012 en
 (54) TRUNCATED ACTRIIB-FC FUSION PROTEINS
 (71) Acceleron Pharma, Inc., 128 Sidney Street, Cambridge, MA 02139, US
 (72) SEEHRA, Jasbir, 3 Lincoln Terrace, Lexington, MA 02421-6818, US
 KUMAR, Ravindra, 421 Arlington Street, Acton, MA 01720, US

- (51) MKP
C07D 405/12 (2006.01) (97) **2493852 ***
A61K 31/444 (2006.01)
C07D 211/56 (2006.01)
A61K 31/397 (2006.01)
C07D 413/12 (2006.01)
A61K 31/4025 (2006.01)
C07D 451/04 (2006.01)
C07D 401/12 (2006.01)
A61K 31/40 (2006.01)
C07D 205/04 (2006.01)
C07D 453/02 (2006.01)
C07D 409/12 (2006.01)
A61K 31/4245 (2006.01)
C07D 207/09 (2006.01)
C07C 217/90 (2006.01)
- (86) US2010054497 28.10.2010
(96) 10776485.4 05.09.2012
(87) WO2011053706, 28.10.2010
(97) 2493852, 05.09.2012 en
(54) 4-SUBSTITUTED-2-PHENOXY-PHENYLAMINE DELTA OPIOID RECEPTOR MODULATORS
- (71) Janssen Pharmaceutica NV, Turnhoutseweg 30, 2340 Beerse, BE
- (72) LIU, Li, 271 Fox Chase Lane, Doylestown PA 18901, US
MACIELAG, Mark, J., Welsh&McKean Roads P.O. Box 776, Spring House PA 19477, US
DAX, Scott, L., 3 Quail Drive, Landenberg PA 19350, US
PITIS, Philip, M., 108 Sunrise Drive, North Wales PA 19454, US
COATS, Steven, J., 764 Alberta Drive, McDonough GA 30252, US
CONNOLLY, Peter, J., Welsh&McKean Roads P.O. Box 776, Spring House PA 19477, US
BIAN, Haiyan, 109 York Drive, Princeton NJ 08540, US
HE, Wei, 2002 Kestral Circle, Audubon PA 19493, US
CAI, Chaozhong, Welsh&McKean Roads P.O. Box 776, Spring House PA 19477, US
DE CORTE, Bart, L., Welsh&McKean Road P.O. Box 776, Spring House PA 19477, US
-
- (51) MKP
A61K 39/00 (2006.01) (97) **2451476 ***
C07H 21/02 (2006.01)
C12N 15/11 (2006.01)
- (86) US2010041106 06.07.2010
(96) 10797743.1 16.05.2012
(87) WO2011005793, 06.07.2010
(97) 2451476, 16.05.2012 en
(54) CELL-BASED BIOPROCESSING
- (71) Alnylam Pharmaceuticals, Inc., 300 Third Street, 3rd Floor, Cambridge, MA 02142, US
- (72) ROSSOMANDO, Anthony, c/o Alnylam Pharmaceuticals, Inc. 300 Third Street Third Floor, Cambridge Massachusetts 02142, US
MARAGANORE, John, c/o Alnylam Pharmaceuticals, Inc. 300 Third Street Third Floor, Cambridge Massachusetts 02142, US
POLLARD, Stuart, c/o Alnylam Pharmaceuticals, Inc. 300 Third Street Third Floor, Cambridge Massachusetts 02142, US
KOCISKO, David, c/o Alnylam Pharmaceuticals, Inc. 300 Third Street Third Floor, Cambridge Massachusetts 02142, US
MANOHARAN, Muthiah, c/o Alnylam Pharmaceuticals, Inc. 300 Third Street Third Floor, Cambridge Massachusetts 02142, US
HINKLE, Greg, c/o Alnylam Pharmaceuticals, Inc. 300 Third Street Third Floor, Cambridge Massachusetts 02142, US
BETTENCOURT, Brian, c/o Alnylam Pharmaceuticals, Inc. 300 Third Street Third Floor, Cambridge Massachusetts 02142, US
HOGAN, Shannon, c/o Alnylam Pharmaceuticals, Inc. 300 Third Street Third Floor, Cambridge Massachusetts 02142, US
-
- (51) MKP
H04N 7/24 (2011.01) (97) **2474164 ***
H04L 29/06 (2006.01)
H04N 7/16 (2011.01)
H04N 7/173 (2011.01)
H04N 5/265 (2006.01)
G06F 17/30 (2006.01)
- (86) IB2010002350 31.08.2010
(96) 10812876.0 11.07.2012
(87) WO2011039590, 31.08.2010
(97) 2474164, 11.07.2012 en
(54) METHODS AND SYSTEMS TO PERSONALIZE CONTENT STREAMS
- (71) Nieuwenhuys, Bruno, Strada Barajul Arges 15, Bucharest, RO
(72) Nieuwenhuys, Bruno, Strada Barajul Arges 15, Bucharest, RO
-
- (51) MKP
A61K 35/76 (2006.01) (97) **2427201 ***
A61P 33/06 (2006.01)
- (86) IN2010000287 03.05.2010
(96) 10747684.8 14.03.2012
(87) WO2010128524, 03.05.2010
(97) 2427201, 14.03.2012 en
(54) COMBINED MEASLES-MALARIA VACCINE
- (71) Cadila Healthcare Limited, Zydus Research Centre Zydus Tower, Satellite Cross Roads Gandhinagar-Sarkhej Highway, Ahmedabad 380 015, Gujarat, IN
- (72) GLUECK, Reinhard, Cadila Healthcare Limited Zydus Research Centre Zydus Tower Satellite Cross Roads, Gandhinagar-Sarkhej Highway Ahmedabad 380 015, IN
FAZIO, Agata, Etan Biotech S.r.l. Piazza Stesicora 59, I-95131 Catania, IT
GIANINO, Viviana, Etan Biotech S.r.l. Piazza Stesicoro 59, I-95131 Catania, IT
BILLETTER, Martin, Winterthurerstrasse 190, CH-8057 Zuerich, CH
-
- (51) MKP
H04L 12/56 (2006.01) (97) **2493128 ***
- (86) JP2010068154 15.10.2010
(96) 10824868.3 29.08.2012
(87) WO2011049019, 15.10.2010
(97) 2493128, 29.08.2012 en
(54) COMMUNICATION SYSTEM, FLOW CONTROL APPARATUS, FLOW TABLE UPDATING METHOD AND PROGRAM
- (71) NEC Corporation, 7-1, Shiba 5-chome Minato-ku, Tokyo 108-8001, JP
- (72) MIZUKOSHI, Yasuhiro, c/o NEC CORPORATION 7-1 Shiba 5-chome Minato-ku, Tokyo 108-8001, JP
-
- (51) MKP
E05D 15/06 (2006.01) (97) **2357305**
- (96) 10014961.6 17.08.2011
(97) 2357305, 17.08.2011 en
(54) Device for supporting and anchoring in a having condition the door panel in a counter-frame for retractable sliding doors
- (71) ECLISSE SRL, Via Sernaglia 76-C.P. 70, 31053 Pieve di Soligo (TV), IT
(72) De Faveri, Luigi, Via Vittoria, 114, 31020 Refrontolo (TV), IT
-
- (51) MKP
G06F 3/044 (2006.01) (97) **2462499 ***
- (86) FR2010051669 06.08.2010
(96) 10762732.5 13.06.2012
(87) WO2011015795, 06.08.2010
(97) 2462499, 13.06.2012 fr
(54) CAPACITIVE DETECTION DEVICE HAVING FUNCTION INTEGRATION
- (71) Nanotec Solution, 237, chemin Puech du Teil, 30900 Nîmes, FR
(72) ROZIERE, Didier, 79 Impasse des Hêtres, F-30900 Nîmes, FR
-
- (51) MKP
A61K 9/28 (2006.01) (97) **2448566 ***
A61K 9/48 (2006.01)
A61K 9/50 (2006.01)
- (86) US2010040737 01.07.2010
(96) 10730676.3 09.05.2012
(87) WO2011002972, 01.07.2010
(97) 2448566, 09.05.2012 en
(54) STABLE SHELLAC ENTERIC COATING FORMULATION FOR NUTRACEUTICAL AND PHARMACEUTICAL DOSAGE FORMS
- (71) Hercules Incorporated, Hercules Plaza 1313 N. Market Street, Wilmington, DE 19894-0001, US
(72) DURIG, Thomas, 5 Concord Way, Chadds Ford PA 19317, US
ZONG, Yuda, 1362 Brinton Run Road, West Chester PA 19382, US

- (51) MKP
C07C 323/61 (2006.01) (97) **2272826**
C07C 327/34 (2006.01)
C07D 205/04 (2006.01)
C07D 211/34 (2006.01)
C07D 213/55 (2006.01)
C07D 213/73 (2006.01)
A61P 9/00 (2006.01)
A61K 31/095 (2006.01)
A61P 7/02 (2006.01)
(96) 10290344.0 12.01.2011
(97) 2272826, 12.01.2011 fr
(54) 2-mercaptopentancarboxylic acid derivatives, the method for preparing them and the pharmaceutical compositions containing them
(71) Les Laboratoires Servier, 35, rue de Verdun, 92284 Suresnes Cedex, FR
Institut National des Sciences Appliquées de Rouen (INSA), Avenue de l'Université, 76801 St-Etienne du Rouvray Cedex, FR
Centre National de la Recherche Scientifique (C.N.R.S.), 3, rue Michel Ange, 75794 Paris Cedex 16, FR
Universite de Rouen, 1, rue Thomas Becket, 76821 Mont-Saint-Aignan Cédex, FR
(72) Gloanec, Philippe, 18, avenue de l'Abreuvoir, 78160 Marly le Roi, FR
De Nanteuil, Guillaume, 12, rue du Chemin Vert, 92150 Suresnes, FR
Parmentier, Jean-Gilles, 12, rue Edouard Naud, 92130 Issy les Moulineaux, FR
Guillouxic, Anne-Françoise, 52, rue Henri Barbusse, 92000 Nanterre, FR
Verbeuren, Tony, 60 bis, rue Aristide Briand, 78540 Vernouillet, FR
Rupin, Alain, 84, rue du Port, 37510 Savonnières, FR
Menecier, Philippe, 29, avenue Jacqueline, 78700 Conflans Sainte Honorine, FR
Vallez, Marie-Odile, 17, rue Lavoisier, 93100 Montreuil, FR
Quirion, Jean-Charles, 194, rue de Montfort, 27310 Bourg-Achard, FR
Jabault, Philippe, 89, allée de la Mare Sangsue, 76160 Preaux, FR
Boyer, Nicolas, 305, route de Charny, 74490 Saint Jeoire en Faucigny, FR

- (51) MKP
A61K 39/395 (2006.01) (97) **2411050 ***
(86) US2010000666 04.03.2010
(96) 10756449.4 01.02.2012
(87) WO2010110838, 04.03.2010
(97) 2411050, 01.02.2012 en
(54) ANTIBODY CONSTANT DOMAIN REGIONS AND USES THEREOF
(71) Vet Therapeutics, Inc., 2683 Via De La Valle Suite G-335, Del Mar, CA 92014, US
(72) HANSEN, Genevieve, Vet Therapeutics Inc. 2683 Via de la Valle Ste G-335, Del Mar, CA 92014, US

- (51) MKP
B23K 26/24 (2006.01) (97) **2485862 ***
B23K 26/03 (2006.01)
B23K 26/067 (2006.01)
B23K 26/42 (2006.01)
B23K 26/04 (2006.01)
(86) EP2010063779 20.09.2010
(96) 10755166.5 15.08.2012
(87) WO2011042292, 20.09.2010
(97) 2485862, 15.08.2012 de
(54) JOINING DEVICE FOR NON-POSITIVE JOINING BY MEANS OF A FILLER MATERIAL USING SENSORS
(71) Scansonic MI GmbH, Rudolf-Baschant-Str 2, 13086 Berlin, DE
Bayerische Motoren Werke AG, Gewerblicher Rechtsschutz AJ-3, 80788 München, DE
(72) BERNDL, Jürgen, Penkerstr. 10, 85405 Nandlstadt, DE
WALTER, Steffen, Lindenberger Weg 46, 13129 Berlin, DE
KISCHKE, Thomas, Ahornallee 17a, 16548 Glienicke, DE
HASCHKE, Igor, Korsörer Str. 23, 10437 Berlin, DE

- (51) MKP
A61K 31/55 (2006.01) (97) **2493460 ***
A61K 31/535 (2006.01)
A61K 31/00 (2006.01)
(86) US2010055016 01.11.2010
(96) 10827625.4 05.09.2012
(87) WO2011053938, 01.11.2010
(97) 2493460, 05.09.2012 en
(54) METHODS AND COMPOSITIONS FOR TREATING CANCER
(71) ARIAD Pharmaceuticals, Inc, 26 Landsdowne Street, Cambridge, MA 02139, US
(72) HUANG, Wei-sheng, 8 Mohegan Road, Acton MA 01720, US
RIVERA, Victor, M., 15 Lakeview Street, Arlington MA 02476, US
CLACKSON, Timothy, P., 3 Locke Lane, Lexington MA 02420, US
SHAKESPEARE, William, C., 2 Hubley Lane, Southbrough MA 01772, US
SQUILLACE, Rachel, M., 9 Wabash Road, Wilmington MA 01887, US
GOZGIT, Joseph, M., 15 Bemis Road, Wellesley MA 02481, US

- (51) MKP
B29C 45/14 (2006.01) (97) **2414145 ***
B29C 33/18 (2006.01)
B29C 33/38 (2006.01)
(86) FR2010050571 29.03.2010
(96) 10715992.3 08.02.2012
(87) WO2010112746, 29.03.2010
(97) 2414145, 08.02.2012 fr
(54) METHOD FOR MOULDING A PLASTIC PART WITH AN INSERT HELD IN PLACE BY MEANS OF SUCTION, MOULDING DEVICE AND USE
(71) Saint-Gobain Glass France, 18, avenue d'Alsace, 92400 Courbevoie, FR
(72) DEPIERRE, Emmanuel, 169 rue de la Croix Blanche, F-60310 Thiescourt, FR
DEBAILLEUL, Romain, 14 Allée de la Montagne, F-60150 Villers-sur-Coudun, FR
LEFEVRE, Pascal, 29 rue Victor Hugo, F-02300 Viry Noureuil, FR

- (51) MKP
A61K 39/395 (2006.01) (97) **2437790 ***
A61K 51/00 (2006.01)
A61K 47/48 (2006.01)
(86) US2010037046 02.06.2010
(96) 10783998.7 11.04.2012
(87) WO2010141566, 02.06.2010
(97) 2437790, 11.04.2012 en
(54) CONJUGATION METHODS
(71) Immunogen, Inc., 830 Winter Street, Waltham, MA 02451, US
(72) KELLOGG, Brenda A., 54 Greenleaf Avenue, Medford Massachusetts 02155, US
SINGH, Rajeeva, 40 Lanewood Avenue, Framingham Massachusetts 01701, US
CHARI, Ravi V.J., 174 Winchester Street, Newton Massachusetts 02461, US

- (51) MKP
A61K 9/00 (2006.01) (97) **2408426 ***
A61K 9/06 (2006.01)
A61K 47/32 (2006.01)
A61K 31/20 (2006.01)
A61K 31/201 (2006.01)
A61K 31/202 (2006.01)
- (86) IT2010000119 18.03.2010
(96) 10717302.3 25.01.2012
(87) WO2010106571, 18.03.2010
(97) 2408426, 25.01.2012 en
- (54) OPHTHALMIC COMPOSITIONS BASED ON POLYUNSATURATED OMEGA-3 AND OMEGA-6 FATTY ACIDS
- (71) TRB Chemedica International S.A., Rue Michel-Servet 12, 1211 Genève 12, CH
- (72) ALEO, Danilo, MEDIVIS S.r.l. Corso Italia 171, I-95127 Catania, IT
BARABINO, Stefano, Via Luigi Mercantini 8/5, I-16146 Genova, IT
MANGIAFICO, Sergio, MEDIVIS S.r.l. Corso Italia 171, I-95127 Catania, IT
ROLANDO, Maurizio, Via Gian Battista Monti 3, I-16151 Genova, IT
SAITA, Maria Grazia Antonietta, MEDIVIS S.r.l. Corso Italia 171, I-95127 Catania, IT
-
- (51) MKP
G02B 6/255 (2006.01) (97) **2460040 ***
- (86) US2010043686 29.07.2010
(96) 10745043.9 06.06.2012
(87) WO2011014638, 29.07.2010
(97) 2460040, 06.06.2012 en
- (54) SPLICED FIBER GLASS ROVINGS AND METHODS AND SYSTEMS FOR SPLICING FIBER GLASS ROVINGS
- (71) PPG Industries Ohio, Inc., 3800 West 143rd Street, Cleveland, OH 44111, US
- (72) LEEGSTRA, Piet, Garnizoenslaan 19, NL-9471 ML Zuidlaren, NL
MENG, Jian, 3740 Tea Olive Drive, Gastonia NC 28056, US
BOWLAND, Creig Dean, 3155 West Zion Church Road, Shelby, NC 28150, US
-
- (51) MKP
H04W 84/20 (2009.01) (97) **2400812**
- (96) 10167109.7 28.12.2011
(97) 2400812, 28.12.2011 en
- (54) Bluetooth networking
- (71) 9Solutions Oy, Teknologiantie 2, 90590 Oulu, FI
- (72) Herrala, Sami, Ylänkötie 8, 90650, Oulu, FI
Kylmänen, Jari, Alavainio 12, 90810, Kiviniemi, FI
Niemi, Jaakko, Hiomokatu 1 A4, 90520, Oulu, FI
-
- (51) MKP
C07D 401/00 (2006.01) (97) **2467372 ***
- (86) US2010002194 09.08.2010
(96) 10808442.7 27.06.2012
(87) WO2011019375, 09.08.2010
(97) 2467372, 27.06.2012 en
- (54) TREATMENT OF BDNF-RELATED DISORDERS USING LAQUINIMOD
- (71) Teva Pharmaceutical Industries Ltd., 5 Basel Street P.O. Box 3190, 49131 Petah Tiqva, IL
- (72) HAYARDENY, Liat, 37 Yehuda Hanasia St., Tel Aviv 69391, IL
-
- (51) MKP
G01N 33/569 (2006.01) (97) **2425251 ***
- (86) EP2010055432 23.04.2010
(96) 10714037.8 07.03.2012
(87) WO2010124998, 23.04.2010
(97) 2425251, 07.03.2012 en
- (54) MEANS AND METHODS FOR THE DETERMINATION OF THE AMOUNT OF NEUROTOXIN POLYPEPTIDE AND OF ITS CATALYTIC AND PROTEOLYTIC ACTIVITIES
- (71) Merz Pharma GmbH & Co. KGaA, Eckenheimer Landstrasse 100, 60318 Frankfurt am Main, DE
- (72) PFEIL, Michael, Am Hohlberg 10, 61462 Königstein, DE
FRIEDRICH, Josef, Im Warmet 13, 69231 Rauenberg, DE
-
- (51) MKP
C07D 401/12 (2006.01) (97) **2493862 ***
A61P 35/00 (2006.01)
A61K 31/4164 (2006.01)
C07D 407/12 (2006.01)
A61P 31/00 (2006.01)
C07D 409/12 (2006.01)
C07D 233/64 (2006.01)
A61K 31/4178 (2006.01)
C07D 413/12 (2006.01)
C07D 403/12 (2006.01)
A61P 37/00 (2006.01)
C07D 417/12 (2006.01)
- (86) US2010054289 27.10.2010
(96) 10779364.8 05.09.2012
(87) WO2011056652, 27.10.2010
(97) 2493862, 05.09.2012 en
- (54) IMIDAZOLE DERIVATIVES AS IDO INHIBITORS
- (71) Newlink Genetics Corporation, 2901 South Loop Drive, Suite 3900, Ames, IA 50010, US
- (72) MAUTINO, Mario, R., 4203 NE Trilein Drive, Ankeny IA 50021, US
KUMAR, Sanjeev, 2810 Strange Road Unit 1, Ames IA 50014, US
JAIPURI, Firoz, 2719 Laurel Street, Ames IA 50010, US
WALDO, Jesse, 306 Sycamore Boulevard, Huxley IA 50124, US
KESHARWANI, Tanay, 2927 Woodland Street, 4, Ames IA 50014, US
ZHANG, Xiaoxia, 3130 Turnberry Court Apartment 197, Ames IA 50014, US
-
- (51) MKP
C07D 233/60 (2006.01) (97) **2470510 ***
A61K 31/4164 (2006.01)
A61P 25/28 (2006.01)
- (86) US2010049934 23.09.2010
(96) 10757925.2 04.07.2012
(87) WO2011041198, 23.09.2010
(97) 2470510, 04.07.2012 en
- (54) SUBSTITUTED IMIDAZOLE DERIVATIVES FOR TREATMENT OF ALZHEIMERS DISEASE
- (71) TransTech Pharma, Inc., 4170 Mendenhall Oaks Parkway, High Point, NC 27265, US
- (72) JONES, David, 5262 Wolfpen Pleasant Hill Road, Milford, OH 45150, US
GOWDA, Raju, Bore, 601 Stafford Pointe Court, Oak Ridge, NC 27310, US
XIE, Rongyuan, 6407 Estes Court, Greensboro, NC 27410, US
-
- (51) MKP
A61K 39/395 (2006.01) (97) **2490720 ***
- (86) US2010053686 22.10.2010
(96) 10825726.2 29.08.2012
(87) WO2011050242, 22.10.2010
(97) 2490720, 29.08.2012 en
- (54) ANTI-GCC ANTIBODY MOLECULES AND RELATED COMPOSITIONS AND METHODS
- (71) Millennium Pharmaceuticals, Inc., 40 Landsdowne Street, Cambridge, MA 02139, US
Amgen British Columbia, 7990 Enterprise Street, Burnaby, BC V5A 1V7, CA
- (72) NAM, Samuel, S., 92 Blaisdell Street, Haverhill, MA 01832, US
GREENFIELD, Edward, A., 160 Poskus Street, Stoughton, MA 02072, US
BABCOOK, John, 4480 West 12th Avenue, Vancouver, BC V6R 2R2, CA
O'KEEFE, Theresa, 20 Richgrain Avenue, Waltham, MA 02453, US
QIN, Shixin, 14 Tuff Avenue, Lexington, MA 02421, US
-

(51) MKP
C07K 14/60 (2006.01) (97) **2421547 ***
A61K 31/427 (2006.01)
A61K 38/27 (2006.01)
A61K 38/16 (2006.01)
C07K 17/02 (2006.01)
(86) CA2010000547 20.04.2010
(96) 10766537.4 29.02.2012
(87) WO2010121351, 20.04.2010
(97) 2421547, 29.02.2012 en
(54) USE OF (HEXENOYL TRANS-3)HGRF(1-44)NH2 AND RITONAVIR IN COMBINATION THERAPY
(71) Theratechnologies Inc., 2310, boulevard Alfred-Nobel, Montreal, Quebec H4S 2B4, CA
(72) MARSOLAIS, Christian, 177 Jasper, Ville Mont-Royal, Quebec H3P 1K1, CA

(51) MKP
G01S 15/89 (2006.01) (97) **2299292**
G01F 23/296 (2006.01)
(96) 10275096.5 23.03.2011
(97) 2299292, 23.03.2011 en
(54) Scanning apparatus and method
(71) Oceanscan Limited, Denmore Road Bridge of Don, Aberdeen AB23 8JW, GB
(72) McKenzie, Graham, 65 Spital, Aberdeen, Aberdeenshire AB24 3HX, GB
Sandilands, Donald, Millbank Parkview Hatton, Peterhead, Aberdeenshire AB42 0LJ, GB
Auld, Robert, 32 Mameulah Road Newmachar, Aberdeen, Aberdeenshire AB21 0WW, GB
Monteiro, Manel, Edificio Ostende Rua Alegre 3,2 Andar Apartamento 8, 2765-392 Monte Estorie, PT
Svet, Victor, Apt. 5 Building 3 Fersman Street, Moscow 117312, RU
Beykov, Sergey, 117485, ul. Mikluho-Maklay, 39 Building 1, 203, Moscow, RU

(51) MKP
G01N 33/50 (2006.01) (97) **2473850 ***
G01N 33/74 (2006.01)
C12Q 1/68 (2006.01)
A61K 38/27 (2006.01)
(86) EP2010062652 30.08.2010
(96) 10747059.3 11.07.2012
(87) WO2011026815, 30.08.2010
(97) 2473850, 11.07.2012 en
(54) COMPOSITIONS AND METHODS FOR TREATING GROWTH HORMONE DEFICIENCY
(71) Merck Serono S.A., Centre Industriel, 1267 Coinsins, CH
(72) THEOCHARIS, Theo, Cardinal Str. 3, 50670 Cologne, DE
LARROQUE, Sylvain, Les Cyclades 3 - Bat. IOS, F-74160 Saint Julien en Genevois, FR
BERNARD, Laurence, 9, Avenue du Jura, F-01210 Ferney Voltaire, FR

(51) MKP
A61K 31/454 (2006.01) (97) **2480232 ***
C07D 401/06 (2006.01)
A61P 11/00 (2006.01)
A61P 29/00 (2006.01)
A61P 19/02 (2006.01)
A61P 1/00 (2006.01)
(86) US2010045828 18.08.2010
(96) 10747364.7 01.08.2012
(87) WO2011022449, 18.08.2010
(97) 2480232, 01.08.2012 en
(54) DISUBSTITUTED J4-(5-AMINOMETHYL-PHENYL)-PIPERIDIN-1-YL]-1H-INDOL-3-YL]-METHANONES
(71) SANOFI, 54 rue La Boétie, 75008 Paris, FR
(72) CHOI-SLEDESKI, Yong-Mi, c/o Sanofi-aventis U.S. 1041 Route 202-206 Mail Code: BWD-303A, Bridgewater, New Jersey 08807, US
GARDNER, Charles, J., 14 Lenape Road, Flemington, New Jersey 08822, US
LIANG, Guyan, c/o Sanofi-aventis U.S. 1041 Route 202-206 Mail Code: BWD-303A, Bridgewater, New Jersey 08807, US
POLI, Gregory, B., c/o Sanofi-aventis U.S. 1041 Route 202-206 Mail Code: BWD-303A, Bridgewater, New Jersey 08807, US
SHUM, Patrick, Wai-Kwok, c/o Sanofi-aventis U.S. 1041 Route 202-206 Mail Code: BWD-303A, Bridgewater, New Jersey 08807, US
STOKLOSA, Gregory, T., c/o Sanofi-aventis U.S. 1041 Route 202-206 Mail Code: BWD-303A, Bridgewater, New Jersey 08807, US
ZHAO, Zhicheng, c/o Sanofi-aventis U.S. 1041 Route 202-206 Mail Code: BWD-303A, Bridgewater, New Jersey 08807, US

(51) MKP
G06F 17/00 (2006.01) (97) **2491499 ***
G06Q 50/00 (2012.01)
(86) US2010053088 18.10.2010
(96) 10825481.4 29.08.2012
(87) WO2011049886, 18.10.2010
(97) 2491499, 29.08.2012 en
(54) INTEGRATED HEALTH DATA CAPTURE AND ANALYSIS SYSTEM
(71) Theranos, Inc., 3200 Hillview Ave., Palo Alto, CA 94304, US
(72) HOLMES, Elizabeth, A., 325 Channing, 118, Palo Alto CA 94301, US
GIBBONS, Ian, 831 La Mesa Drive, Portola Valley, CA 94028, US
YOUNG, Daniel L., 359 Moultrie Street, San Francisco, CA 94110, US
MICHELSON, Seth G., 1473 Mildred Avenue, San Jose, CA 95125, US

(51) MKP
A61K 31/198 (2006.01) (97) **2416770 ***
A61P 13/12 (2006.01)
(86) CH2010000065 10.03.2010
(96) 10707804.0 15.02.2012
(87) WO2010115291, 10.03.2010
(97) 2416770, 15.02.2012 en
(54) HEMODIALYSIS AND PERITONEAL DIALYSIS SOLUTIONS COMPRISING ONE OR MORE CREATINE COMPOUNDS
(71) Crearene Ltd., Lennox Paton Corporate Services Limited Fort Nassau Centre, Marlborough Street, Nassau, BS
(72) MÖDDEL, Michael, Hörnlstrasse 1b, 8108 Dällikon, CH
WALLIMANN, Theo, Schürmattstrasse 23, 8963 Bergdietikon, CH

- (51) MKP
C07C 247/06 (2006.01) (97) **2451790 ***
C07D 249/06 (2006.01)
A61P 35/04 (2006.01)
C07D 403/10 (2006.01)
A61K 31/4192 (2006.01)
C07D 413/10 (2006.01)
C07C 259/10 (2006.01)
C07D 403/04 (2006.01)
A61K 35/00 (2006.01)
A61P 35/02 (2006.01)
C07C 209/10 (2006.01)
(86) IN2010000455 07.07.2010
(96) 10809641.3 16.05.2012
(87) WO2011021209, 07.07.2010
(97) 2451790, 16.05.2012 en
(54) HISTONE DEACETYLASE INHIBITORS
(71) Anthem Biosciences Private Limited, 49 Canara Bank Road
Bommasandra Industrial Area Hosur Road, Bangalore,
Karnataka 560 009, IN
(72) SELVAKUMAR, Natesan, 94/95 NE Nisarga Layout
Bannerghatta, Bangalore 560 083 Karnataka, IN
RAJULU, Gavara, Govinda, Plot No. 72 Srivari Nilayam R. K.
Lakeview Hebbagodi, Bangalore 560 099 Karnataka, IN
PAZHANIMUTHU, Annamalai, 2/542.2 1st Floor Indira Gandhi
Nagar Basthi, Hosur 635109 Tamilnadu, IN
GANESH, Sambasivam, 1840, 22 main 14th cross HSR Layout
Sector I, Bangalore 560 034, Karnataka, IN
-
- (51) MKP
H01R 13/658 (2011.01) (97) **2465169 ***
H01B 11/06 (2006.01)
H01R 13/646 (2011.01)
(86) US2010029593 01.04.2010
(96) 10759393.1 20.06.2012
(87) WO2010114980, 01.04.2010
(97) 2465169, 20.06.2012 en
(54) CONDUCTIVE ELASTOMER AND METHOD OF APPLYING A
CONDUCTIVE COATING TO ELASTOMERIC SUBSTRATE
(71) John Mezzalingua Assoc., Inc., Legal Department 6176 E.
Molloy Rd., East Syracuse, New York 13057, US
(72) PURDY, Eric, 144 County Route 23A, Constantia New York
13044, US
-
- (51) MKP
C07D 261/14 (2006.01) (97) **2443100 ***
C07D 413/12 (2006.01)
C07D 413/14 (2006.01)
C07D 417/06 (2006.01)
C07D 417/12 (2006.01)
C07D 417/14 (2006.01)
A61K 31/42 (2006.01)
A61P 29/00 (2006.01)
(86) US2010037697 08.06.2010
(96) 10723895.8 25.04.2012
(87) WO2010147792, 08.06.2010
(97) 2443100, 25.04.2012 en
(54) COMPOUNDS WHICH SELECTIVELY MODULATE THE CB2
RECEPTOR
(71) Boehringer Ingelheim International GmbH, Binger Strasse 173,
55216 Ingelheim, DE
(72) BARTOLOZZI, Alessandra, Boehringer Ingelheim
Pharmaceuticals Inc. 900 Ridgebury Road P.O. Box 368,
Ridgefield, CT 06877-0368, US
KHOR, Someina, 114 Milton Park, Abingdon Oxfordshire OX14
4SA, GB
HICKEY, Eugene, Richard, Boehringer Ingelheim
Pharmaceuticals Inc. 900 Ridgebury Road P.O. Box 368,
Ridgefield, CT 06877-0368, US
ZAWADZKI, Przemyslaw, Selvita U1. Ostatnia 1C, PL-31-444
Krakow, PL
RIETHER, Doris, Boehringer Ingelheim Pharmaceuticals Inc.
900 Ridgebury Road P.O. Box 368, Ridgefield, CT 06877-0368,
US
WU, Lifen, Boehringer Ingelheim Pharmaceuticals Inc. 900
Ridgebury Road P.O. Box 368, Ridgefield, CT 06877-0368, US
ZINDELL, Renee, Boehringer Ingelheim Pharmaceuticals Inc.
900 Ridgebury Road P.O. Box 368, Ridgefield, CT 06877-0368,
US
BLUMIRE, Nigel, 114 Milton Park, Abingdon Oxfordshire OX14
4SA, GB
ERMANN, Monika, 114 Milton Park, Abingdon Oxfordshire
OX14 4SA, GB
GLENN, Edward, Thomas, 114 Milton Park, Abingdon
Oxfordshire OX14 4SA, GB
-
- (51) MKP
A47J 31/40 (2006.01) (97) **2311353**
A47J 31/60 (2006.01)
(96) 10187597.9 20.04.2011
(97) 2311353, 20.04.2011 fr
(54) Machine for the production of mixed beverages
(71) Cafés Folliet, 574 Rue de Chantabord, 73000 Chambéry, FR
(72) Folliet, Bernard, 441 chemin du Calvaire, 73000, CHAMBERY,
FR
-
- (51) MKP
A23J 1/14 (2006.01) (97) **2429310 ***
A23J 3/16 (2006.01)
(86) CA2010000633 23.04.2010
(96) 10774448.4 21.03.2012
(87) WO2010130026, 23.04.2010
(97) 2429310, 21.03.2012 en
(54) PRODUCTION OF CANOLA PROTEIN PRODUCT WITHOUT
HEAT TREATMENT ("C200CaC")
(71) Burcon Nutrascience (MB) Corp., 1388 Waller Avenue,
Winnipeg, Manitoba R3T 1P9, CA
(72) MEDINA, Sarah, 315 Wildwood Park, Winnipeg, Manitoba R3T
0E5, CA
SEGALL, Kevin I., 31 Dunbar Crescent, Winnipeg, Manitoba
R3P 0W6, CA
GREEN, Brent, E., 24 Poplarwood Drive Box 603, Warren,
Manitoba R0C 3E0, CA
SCHWEIZER, Martin, 117 Haig Avenue, Winnipeg, Manitoba
R2M 0E3, CA
-
- (51) MKP
F02D 41/22 (2006.01) (97) **2375038**
(96) 10159322.6 12.10.2011
(97) 2375038, 12.10.2011 en
(54) Diagnosis device and method using an in-cylinder pressure
sensor in an internal combustion engine
(71) Delphi Technologies Holding S.à.r.l., Avenue de Luxembourg,
4940 Bascharage, LU
(72) Guerrassi, Noureddine, 14 Haute Rue, 41350 Vineuil, FR
Allezy, Pierre, 42 Rue du Chateau, 41370 Talcay, FR
-

- (51) MKP
C07D 239/47 (2006.01) (97) **2483249 ***
A61K 31/506 (2006.01)
C07D 417/12 (2006.01)
A61P 35/00 (2006.01)
C07D 403/12 (2006.01)
(86) EP2010064628 01.10.2010
(96) 10759924.3 08.08.2012
(87) WO2011039344, 01.10.2010
(97) 2483249, 08.08.2012 en
(54) PYRIMIDINE DERIVATIVES AS PROTEIN TYROSINE KINASE 2 INHIBITORS
(71) Boehringer Ingelheim International GmbH, Binger Strasse 173, 55216 Ingelheim am Rhein, DE
(72) STADTMUELLER, Heinz, Boehringer Ingelheim GmbH Corporate Patents Binger Strasse 173, 55216 Ingelheim am Rhein, DE
SAPOUNTZIS, Ioannis, Boehringer Ingelheim GmbH Corporate Patents Binger Strasse 173, 55216 Ingelheim am Rhein, DE
-
- (51) MKP
C07D 211/42 (2006.01) (97) **2277863**
A61K 31/445 (2006.01)
A61K 31/4462 (2006.01)
A61P 25/00 (2006.01)
(96) 10290410.9 26.01.2011
(97) 2277863, 26.01.2011 fr
(54) Piperidine derivatives, process for their preparation and pharmaceutical compositions containing them
(71) Les Laboratoires Servier, 35, rue de Verdun, 92284 Suresnes Cedex, FR
Universite De Nantes I, 1 Quai de Tourville BP 13522, 44035 Nantes Cedex 1, FR
(72) Botez, Luliana, 53, rue Anatole France, 78800 Houilles, FR
Lebreton, Jacques, 1 bis, rue des Fleurs, 44300 Nantes, FR
Lestage, Pierre, 9, allée de la Grande Terre, 78170 La Celle Saint Cloud, FR
Louis, Caroline, 15, rue Daumier, 75016 Paris, FR
Mathe, Monique, 1, rue du Brouillard, 44300 Nantes, FR
Caignard, Daniel-Henri, 17, avenue des Coteaux, 95000 Boiseumont, FR
-
- (51) MKP
C07D 239/34 (2006.01) (97) **2451786 ***
(86) IN2010000464 12.07.2010
(96) 10779052.9 16.05.2012
(87) WO2011004402, 12.07.2010
(97) 2451786, 16.05.2012 en
(54) IMPROVED PROCESS FOR THE PREPARATION OF AMBRISENTAN AND NOVEL INTERMEDIATES THEREOF
(71) Cadila Healthcare Limited, Zydus Tower Satellite Cross Roads, Ahmedabad 380 015, Gujarat, IN
(72) SATA, Kaushik, Babubhai, Cadila Healthcare Limited Zydus Tower Satellite Cross Roads Ahmedabad 380 015, Gujarat, IN
PANDEY, Bipin, Cadila Healthcare Limited Zydus Tower Satellite Cross Roads Ahmedabad 380 015, Gujarat, IN
-
- (51) MKP
G01N 33/50 (2006.01) (97) **2470901 ***
G01N 33/564 (2006.01)
(86) US2010054699 29.10.2010
(96) 10773516.9 04.07.2012
(87) WO2011053777, 29.10.2010
(97) 2470901, 04.07.2012 en
(54) USE OF IMMUNOREGULATORY NK CELL POPULATIONS FOR PREDICTING THE EFFICACY OF ANTI-IL-2R ANTIBODIES IN MULTIPLE SCLEROSIS PATIENTS
(71) Abbott Biotherapeutics Corp., 1500 Seaport Boulevard, Redwood City CA 94063, US
(72) SHERIDAN III, James Peter, 1058 Tulane Drive, Mountain View California 94040, US
-
- (51) MKP
B65G 5/00 (2006.01) (97) **2406152 ***
E21F 17/16 (2006.01)
(86) CA2010000316 11.03.2010
(96) 10750271.8 18.01.2012
(87) WO2010102385, 11.03.2010
(97) 2406152, 18.01.2012 en
(54) PROCESS FOR SEQUESTRATION OF FLUIDS IN GEOLOGICAL FORMATIONS
(71) Dusseault, Maurice B., 15532 Lorne Court, White Rock, BC V4B 5J6, CA
Bilak, Roman, 49 MacEwan Park Close NW, Calgary, AB T3K 3Z6, CA
(72) Dusseault, Maurice B., 15532 Lorne Court, White Rock, BC V4B 5J6, CA
Bilak, Roman, 49 MacEwan Park Close NW, Calgary, AB T3K 3Z6, CA
-
- (51) MKP
H04N 13/04 (2006.01) (97) **2416581 ***
G11B 20/12 (2006.01)
H04N 5/92 (2006.01)
(86) JP2010002218 26.03.2010
(96) 10754843.0 08.02.2012
(87) WO2010116659, 26.03.2010
(97) 2416581, 08.02.2012 en
(54) RECORDING MEDIUM, REPRODUCING DEVICE, AND INTEGRATED CIRCUIT
(71) Panasonic Corporation, 1006, Oaza Kadoma, Kadoma-shi Osaka 571-8501, JP
(72) Taiji, Sasaki, c/o Panasonic Corporation Intellectual Property Rights Operations Company 7F Twin 21 OBP Panasonic Tower 2-1-61 Shiromi, Chuo-ku, Osaka 540-6207, JP
Hiroshi, Yahata, c/o Panasonic Corporation Intellectual Property Rights Operations Company 7F Twin 21 OBP Panasonic Tower 2-1-61 Shiromi, Chuo-ku, Osaka 540-6207, JP
Wataru, Ikeda, c/o Panasonic Corporation Intellectual Property Rights Operations Company 7F Twin 21 OBP Panasonic Tower 2-1-61 Shiromi, Chuo-ku, Osaka 540-6207, JP
Tomoki, Ogawa, c/o Panasonic Corporation Intellectual Property Rights Operations Company 7F Twin 21 OBP Panasonic Tower 2-1-61 Shiromi, Chuo-ku, Osaka 540-6207, JP
-
- (51) MKP
D21H 17/56 (2006.01) (97) **2438237 ***
D21H 17/46 (2006.01)
D21H 17/52 (2006.01)
D21H 19/80 (2006.01)
D21H 19/82 (2006.01)
D21H 19/36 (2006.01)
D21H 21/20 (2006.01)
D21H 19/40 (2006.01)
D21H 27/10 (2006.01)
D21H 19/62 (2006.01)
(86) US2010037064 02.06.2010
(96) 10722506.2 11.04.2012
(87) WO2010141581, 02.06.2010
(97) 2438237, 11.04.2012 en
(54) CATIONIC WET STRENGTH RESIN MODIFIED PIGMENTS IN WATER-BASED LATEX COATING APPLICATIONS
(71) Hercules Incorporated, Hercules Plaza 1313 N. Market Street, Wilmington, DE 19894-0001, US
(72) BRUNGARDT, Clement, L., 750 Waterway Road, Oxford PA 19363, US
-

- (51) MKP
C07D 211/34 (2006.01) (97) **2435406 ***
A61K 31/451 (2006.01)
- (86) EP2010057319 27.05.2010
(96) 10724047.5 04.04.2012
(87) WO2010136526, 27.05.2010
(97) 2435406, 04.04.2012 en
- (54) RESOLUTION OF (±)-METHYL PHENYL[4-[4-[[[4'-(TRIFLUOROMETHYL)-2-BIPHENYL]CARBONYL]AMINO]PHENYL]-1-PIPERIDINYL]ACETATE
- (71) Janssen Pharmaceutica, N.V., Turnhoutseweg 30, 2340 Beerse, BE
- (72) COPMANS, Alex Herman, Janssen Pharmaceutica NV Turnhoutseweg 30, B-2340 Beerse, BE
HOET, Jérôme Albert Joseph, Rue Pierre Flamand 263/2, B-1420 Braine-l'Alleud, BE
WILLEMSENS, Albert Louis Anna, Aanbeeldstraat 9, B-2340 Beerse, BE
COUCK, Wouter Louis J., Janssen Pharmaceutica NV Turnhoutseweg 30, B-2340 Beerse, BE
VAN DUN, Joannes Petrus, Janssen Pharmaceutica NV Turnhoutseweg 30, B-2340 Beerse, BE
-
- (51) MKP
A62B 18/08 (2006.01) (97) **2392385**
A62B 17/04 (2006.01)
- (96) 11001970.0 07.12.2011
(97) 2392385, 07.12.2011 de
- (54) Viewing pane frame for a protective suit
- (71) Tesimax - Altinger GmbH, Leimenstrasse 2, 75242 Neuhausen-Steinegg, DE
- (72) Altinger, Sven, Bunsenstr. 30, 75173 Pforzheim, DE
-
- (51) MKP
A01N 43/66 (2006.01) (97) **2440050 ***
A61K 31/53 (2006.01)
- (86) US2010037570 07.06.2010
(96) 10786616.2 18.04.2012
(87) WO2010144338, 07.06.2010
(97) 2440050, 18.04.2012 en
- (54) TRIAZINE DERIVATIVES AND THEIR THERAPEUTICAL APPLICATIONS
- (71) Abraxis BioScience, LLC, 11755 Wilshire Boulevard Suite 2000, Los Angeles, CA 90025, US
- (72) TAO, Chunlin, 1800 Camden Avenue, No.301, Los Angeles California 90025, US
WANG, Qinwei, 1112 South Cordova Street, Alhambra California 91801, US
NALLAN, Laxman, 930 North Monterey Street, No.236, Alhambra California 91801, US
POLAT, Tulay, 5750 West Centinela Avenue, No.224, Los Angeles California 90045, US
KORONIAK, Lukasz, Chocimska 28, PL-60688 Poznan, PL
DESAI, Neil, 11755 Wilshire Boulevard Suite 2000, Los Angeles California 90025, US
-
- (51) MKP
C08G 63/21 (2006.01) (97) **2325228**
C08G 63/47 (2006.01)
- (96) 10014367.6 25.05.2011
(97) 2325228, 25.05.2011 en
- (54) An aliphatic-aromatic copolyester, the preparation method and the use thereof
- (71) Zhejiang Hangzhou Xinfu Pharmaceutical Co. Ltd, Linan Economic Area Hangzhou, Zhejiang 311300, CN
- (72) Dai, Qingwen, Lin'An Economic, Hangzhou City Zhejiang Province 311300, CN
Jiang, Kai, Lin'An Economic, Hangzhou City Zhejiang Province 311300, CN
Lin, Guanyu, Lin'An Economic, Hangzhou City Zhejiang Province 311300, CN
Guo, Xinfu, Lin'An Economic, Hangzhou City Zhejiang Province 311300, CN
Bai, Yanbing, Lin'An Economic, Hangzhou City Zhejiang Province 311300, CN
Wang, Kang, Lin'An Economic, Hangzhou City Zhejiang Province 311300, CN
Liu, Zhaotao, Lin'An Economic, Hangzhou City Zhejiang Province 311300, CN
Sun, Xiaofeng, Lin'An Economic, Hangzhou City Zhejiang Province 311300, CN
-
- (51) MKP
G06F 3/01 (2006.01) (97) **2494425 ***
G06F 3/16 (2006.01)
- (86) US2010054212 27.10.2010
(96) 10776006.8 05.09.2012
(87) WO2011059703, 27.10.2010
(97) 2494425, 05.09.2012 en
- (54) SYSTEMS AND METHODS FOR HAPTIC AUGMENTATION OF VOICE-TO-TEXT CONVERSION
- (71) Immersion Corporation, 30 Rio Robles, San Jose, CA 95134, US
- (72) HEUBEL, Robert, W., 652 Begier Avenue, San Leandro California 94577, US
RAMSAY, Erin, 2012 Harvard Avenue Apt. 104, Montreal Québec H4A 2V9, CA
-
- (51) MKP
A61B 17/29 (2006.01) (97) **2410927 ***
A61B 17/00 (2006.01)
- (86) US2010028393 24.03.2010
(96) 10722816.5 01.02.2012
(87) WO2010111319, 24.03.2010
(97) 2410927, 01.02.2012 en
- (54) SURGICAL INSTRUMENTS FOR IN VIVO ASSEMBLY
- (71) Ethicon Endo-Surgery, Inc., 4545 Creek Road, Cincinnati, OH 45242, US
- (72) SPIVEY, James, T., 542 Missouri Avenue, Cincinnati OH 45226, US
-
- (51) MKP
A61K 39/00 (2006.01) (97) **2440243 ***
- (86) EP2010058018 08.06.2010
(96) 10721037.9 18.04.2012
(87) WO2010142686, 08.06.2010
(97) 2440243, 18.04.2012 en
- (54) IMMUNOGENIC COMPOSITIONS HAVING LOW SODIUM CHLORIDE CONCENTRATION
- (71) GlaxoSmithKline Biologicals S.A., rue de l'Institut, 89, 1330 Rixensart, BE
- (72) HENDERICKX, Veronique, GlaxoSmithKline Biologicals s.a. rue de l'Institut 89, B-1330 Rixensart, BE
LEMOINE, Dominique Ingrid, GlaxoSmithKline Biologicals s.a. rue de l'Institut 89, B-1330 Rixensart, BE
-
- (51) MKP
A61K 31/47 (2006.01) (97) **2424533 ***
- (86) US2010031743 20.04.2010
(96) 10770133.6 07.03.2012
(87) WO2010126743, 20.04.2010
(97) 2424533, 07.03.2012 en
- (54) SUBSTITUTED ISOQUINOLINE DERIVATIVES, PHARMACEUTICAL COMPOSITIONS, AND METHODS OF USE AS -SECRETASE INHIBITORS
- (71) High Point Pharmaceuticals, LLC, 4170 Mendenhall Oaks Parkway, High Point, NC 27265, US
- (72) MJALLI, Adnan M. M., 6421 Ashton Park Drive, Oak Ridge North Carolina 27310, US
GADDAM, Bapu, 3749 Single Leaf Circle, High Point North Carolina 27265, US
GOHIMUKKULA, Devi Reddy, 4061 Cobbler Court, Jamestown North Carolina 27282, US
POLISETTI, Dharma Rao, 3741 Deerfield Street, High Point North Carolina 27265, US
EL ABDELLAOUI, Hassan, 3365 Cherrybrook Drive, Jamestown North Carolina 27282, US
RAO, Mohan, 4914 Riding Ridge Drive, Greensboro North Carolina 27410, US
WANG, Pingzhen, 122 Kentland Ridge Drive, Kernersville North Carolina 27284, US
ANDREWS, Robert Carl, 3312 Morris Farm Drive, Jamestown North Carolina 27282, US
XIE, Rongyuan, 6407 Estes Court, Greensboro North Carolina 27410, US
REN, Tan, 8422 Pheasant Ridge Dr., Colfax North Carolina 27235, US

(51) MKP
A61K 38/00 (2006.01) (97) **2427203 ***
C07K 14/54 (2006.01)
C07K 16/24 (2006.01)
(86) IB2010001436 05.05.2010
(96) 10739395.1 14.03.2012
(87) WO2010128407, 05.05.2010
(97) 2427203, 14.03.2012 en
(54) ANTI-IL-17F ANTIBODIES AND METHODS OF USE THEREOF
(71) Novimmune S.A., 14 Ch. Des Aulx Plan-Les Aulx Plan-les-Ouates, 1228 Geneva, CH
(72) MASTERNAK, Krzysztof, Grand' Rue 15, CH-1146 Mollens, CH
ROUSSEAU, Francois, 105 Impasse Sous Le Clos, F-74160 Collonges Sous Saleve, FR

(51) MKP
C07C 275/24 (2006.01) (97) **2427425 ***
C07D 221/20 (2006.01)
C07C 311/06 (2006.01)
C07D 295/03 (2006.01)
C07C 311/19 (2006.01)
C07D 223/04 (2006.01)
C07D 205/04 (2006.01)
C07D 223/32 (2006.01)
C07D 207/06 (2006.01)
C07D 209/04 (2006.01)
C07D 207/08 (2006.01)
C07C 237/26 (2006.01)
C07D 211/34 (2006.01)
(86) US2010001350 07.05.2010
(96) 10765527.6 14.03.2012
(87) WO2010129057, 07.05.2010
(97) 2427425, 14.03.2012 en
(54) TETRACYCLINE COMPOUNDS
(71) Tetraphase Pharmaceuticals, Inc., 480 Arsenal Street, Suite 110, Watertown, MA 02472, US
(72) CHEN, Chi-li, 480 Arsenal Street Suite 110, Watertown MA 02472, US
CLARK, Roger, B., 20 Richard Road, Lexington MA 02421, US
DENG, Yonghong, 480 Arsenal Street Suite 110, Watertown MA 02472, US
HE, Minsheng, 480 Arsenal Street Suite 110, Watertown MA 02472, US
PLAMONDON, Louis, 65 Hamilton Road, Belmont MA 02478, US
SUN, Cuixiang, 480 Arsenal Street Suite 110, Watertown MA 02472, US
XIAO, Xiao-Yi, 3851 Torrey Hill Lane, San Diego CA 92130, US
RÖNN, Magnus, 3 Irving Street, Melrose, MA 02176-4817, US

(51) MKP
A61K 39/00 (2006.01) (97) **2456460 ***
(86) US2010043211 26.07.2010
(96) 10803008.1 30.05.2012
(87) WO2011011775, 26.07.2010
(97) 2456460, 30.05.2012 en
(54) METHODS AND COMPOSITIONS FOR TREATING AND PREVENTING DISEASE ASSOCIATED WITH AVB5 INTEGRIN
(71) The Regents of the University of California, 1111 Franklin Street, 12th Floor, Oakland, CA 94607, US
(72) SHEPPARD, Dean, 1006 Hubert Road, Oakland CA 94610, US
SU, George, 517 21st Avenue, San Francisco CA 94121, US
ATAKILIT, Amha, P.O. Box 20186, Oakland, CA 94620, US

(51) MKP
C12N 15/00 (2006.01) (97) **2459716 ***
A61K 31/70 (2006.01)
(86) US2010043951 30.07.2010
(96) 10805122.8 06.06.2012
(87) WO2011014794, 30.07.2010
(97) 2459716, 06.06.2012 en
(54) ADENOVIRAL-BASED VECTORS
(71) Paxvax, Inc., 3985A Sorrento Valley Boulevard, San Diego, California 92121, US
(72) MAYALL, Timothy, P., 3985A Sorrento Valley Boulevard, San Diego California 92121, US
ALEXANDER, Jeff, 3985A Sorrento Valley Boulevard, San Diego California 92121, US

(51) MKP
C07D 213/16 (2006.01) (97) **2483243 ***
C07D 211/18 (2006.01)
C07F 5/02 (2006.01)
(86) US2010049737 22.09.2010
(96) 10757923.7 08.08.2012
(87) WO2011037947, 22.09.2010
(97) 2483243, 08.08.2012 en
(54) SYNTHESIS OF (4-FLUORO-3-PIPERIDIN-4-YL-BENZYL)-CARBAMIC ACID TERT-BUTYL ESTER AND INTERMEDIATES THEREOF
(71) Sanofi-Aventis U.S. LLC, 55 Corporate Drive, Bridgewater, NJ 08807, US
(72) CHOY, Nakyen, c/o SANOFI-AVENTIS U.S. INC. 1041 Route 202-206 Mail Code: BWD-303A, Bridgewater, New Jersey 08807, US
SHAY, John J., Jr., c/o SANOFI-AVENTIS U.S. INC. 1041 Route 202-206 Mail Code: BWD-303A, Bridgewater, New Jersey 08807, US
SLEDESKI, Adam W., c/o SANOFI-AVENTIS U.S. INC. 1041 Route 202-206 Mail Code: BWD-303A, Bridgewater, New Jersey 08807, US

(51) MKP
C07D 239/95 (2006.01) (97) **2496237 ***
A61K 31/517 (2006.01)
A61P 35/00 (2006.01)
(86) US2010055428 04.11.2010
(96) 10774411.2 12.09.2012
(87) WO2011056957, 04.11.2010
(97) 2496237, 12.09.2012 en
(54) ENZYME INHIBITING COMPOUNDS
(71) Chelsea Therapeutics, Inc., 3530 Toringdon Way Suite 200, Charlotte, NC 28277, US
(72) ROBERTS, Michael J., 7805 Pemswood Street, Charlotte, North Carolina 28277, US

(51) MKP
G02B 27/00 (2006.01) (97) **2410358**
G02B 6/08 (2006.01)
G02B 6/42 (2006.01)
(96) 10170040.9 25.01.2012
(97) 2410358, 25.01.2012 en
(54) Imaging optics and optical device for mapping a curved image field
(71) EUROPEAN SPACE AGENCY, 8-10, rue Mario-Nikis, 75738 Paris Cédex 15, FR
(72) Guldemann, Benedikt, Pieter Bedijnstraat 22, 2202 VK Noordwijk, NL

(51) MKP
G06Q 50/00 (2012.01) (97) **2422314 ***
(86) US2010031659 19.04.2010
(96) 10767601.7 29.02.2012
(87) WO2010123837, 19.04.2010
(97) 2422314, 29.02.2012 en
(54) SYSTEMS AND METHODS FOR MANAGING PATENT LICENSES
(71) Mpeg LA, L.I.c., 5425 Wisconsin Avenue Suite 801, Chevy Chase, MD 20815, US
(72) HORN, Lawrence, 5805 Wiltshire Drive, Bethesda MD 20816, US
MLADINICH, Scott, 472 West Jamison Place, Littleton CO 80120, US
ZHENG, Lihua, 25 Church Street, Millburn NJ 07041, US

(51) MKP
B65B 35/54 (2006.01) (97) **2496481 ***
(86) US2010055614 05.11.2010
(96) 10829148.5 12.09.2012
(87) WO2011057068, 05.11.2010
(97) 2496481, 12.09.2012 en
(54) MULTI-SPEED RESIN CARTRIDGE PRODUCTION SYSTEM
(71) J-Lok Co., P.O. Box 111253 258 Kappa Drive, Pittsburgh, PA 15238, US
(72) VOGUS, Charles, B., 104 Stardust Court, Renfrew, Pennsylvania 16053, US
SIMMONS, Walter, John, 1016 Bedington Road, Martinsburg, West Virginia 25404, US
OLDSEN, John, G., 131 Wildwood Drive, Butler, Pennsylvania 16101, US

- (51) MKP
H01L 31/048 (2006.01) (97) **2422376 ***
F16B 5/02 (2006.01)
E04D 3/365 (2006.01)
E04D 13/18 (2006.01)
H01L 31/042 (2006.01)
(86) FR2010000319 20.04.2010
(96) 10718630.6 29.02.2012
(87) WO2010122241, 20.04.2010
(97) 2422376, 29.02.2012 fr
(54) ATTACHMENT PART FOR ASSEMBLING A MODULE, IN PARTICULAR A PHOTOVOLTAIC MODULE, ON A RIBBED METAL SHEET, ASSEMBLY AND USE THEREOF FOR MAKING A BUILDING COVER, AND RELATED METHOD OF PRODUCTION
(71) ArcelorMittal Construction France, Immeuble Hermès 20 rue Jacques Daguerre, 92500 Rueil Malmaison, FR
(72) CHABAS, Eric, 25 rue Massenet, F-77270 Villeparisis, FR
MASURE, David, 253 avenue Division Leclerc, F-92290 Chatenay Malabry, FR
DUFOSSE, Christophe, 1 rue du Plaisir, F-55800 Nettancourt, FR
CHEVALLIER, Didier, 47 rue de Fourneau, F-55290 Morley, FR
-
- (51) MKP
C30B 33/02 (2006.01) (97) **2406414 ***
H01L 29/32 (2006.01)
(86) NO2010000095 15.03.2010
(96) 10751066.1 18.01.2012
(87) WO2010104403, 15.03.2010
(97) 2406414, 18.01.2012 en
(54) PREVENTION OF CRACK PROPAGATION IN BRITTLE MATERIALS
(71) Innotech Solar ASA, Teknologiveien 12, 8512 Narvik, NO
(72) LOMMASSON, Timothy, C., Sætre terrasse 48, N-1389 Heggedal, NO
-
- (51) MKP
F02B 39/02 (2006.01) (97) **2440762 ***
B60K 11/02 (2006.01)
B60R 16/08 (2006.01)
B60R 17/00 (2006.01)
F02B 39/16 (2006.01)
(86) CA2010000907 09.06.2010
(96) 10785640.3 18.04.2012
(87) WO2010142042, 09.06.2010
(97) 2440762, 18.04.2012 en
(54) DUAL POWER INPUT FLUID PUMP
(71) Magna Powertrain Inc., 50 Casimir Court, Concord, Ontario L4K 4J5, CA
(72) LUTOSLAWSKI, Jaroslaw, 300 East Avenue, Scarborough Ontario M1C 2W4, CA
MUIZELAAR, Richard D., 2693 Jerring Mews, Mississauga Ontario L5L 2M7, CA
KOWALSKI, Andrew, 60 Southport St. 401, Toronto Ontario M6S 3N4, CA
-
- (51) MKP
A61K 31/713 (2006.01) (97) **2449101 ***
C12N 15/63 (2006.01)
C07K 14/33 (2006.01)
A61K 38/48 (2006.01)
C12N 9/52 (2006.01)
C07K 16/12 (2006.01)
C12N 1/21 (2006.01)
C12P 21/02 (2006.01)
(86) EP2010059398 01.07.2010
(96) 10726549.8 09.05.2012
(87) WO2011000929, 01.07.2010
(97) 2449101, 09.05.2012 en
(54) NEUROTOXINS EXHIBITING SHORTENED BIOLOGICAL ACTIVITY
(71) Merz Pharma GmbH & Co. KGaA, Eckenheimer Landstrasse 100, 60318 Frankfurt am Main, DE
(72) HOFMANN, Fred, An der Parforceheide 72, 14480 Potsdam, DE
FREVERT, Jürgen, Weimarer Straße 6 c/o Vorderhaus / Etage 2, 10625 Berlin, DE
-
- (51) MKP
A61K 47/14 (2006.01) (97) **2475357 ***
A61K 47/26 (2006.01)
A61K 9/10 (2006.01)
A61K 31/55 (2006.01)
A61K 47/36 (2006.01)
(86) PT2010000038 10.09.2010
(96) 10757859.3 18.07.2012
(87) WO2011031176, 10.09.2010
(97) 2475357, 18.07.2012 en
(54) ORAL SUSPENSION FORMULATIONS OF ESCLICARBAZEPINE ACETATE
(71) Bial-Portela & CA, S.A., À Avenida da Siderurgia Nacional, 4745-457 S. Mamede do Coronado, PT
(72) VASCONCELOS, Teófilo Cardoso de, À Av. da Siderurgia Nacional, P-4745-457 S. Mamede do Coronado, PT
SANTOS LIMA, Ricardo Jorge dos, À Av. da Siderurgia Nacional, P-4745-457 S. Mamede do Coronado, PT
CAMPOS COSTA, Rui Cerdeira de, À Av. da Siderurgia Nacional, P-4745-457 S. Mamede do Coronado, PT
COSTA BARROCAS, Pedro Miguel da, À Av. da Siderurgia Nacional, P-4745-457 S. Mamede do Coronado, PT
CASTRO PEREIRA, Lúgia Sofia de, À Av. da Siderurgia Nacional, P-4745-457 S. Mamede do Coronado, PT
-
- (51) MKP
A61K 9/12 (2006.01) (97) **2421503 ***
A61K 9/00 (2006.01)
A61K 31/335 (2006.01)
(86) GB2010050671 23.04.2010
(96) 10715336.3 29.02.2012
(87) WO2010122355, 23.04.2010
(97) 2421503, 29.02.2012 en
(54) SUBLINGUAL PHARMACEUTICAL COMPOSITION COMPRISING A NEUTRAL OIL
(71) Londonpharma Ltd., Norwich Biocubator Norwich Research Park, Colney Lane, Norwich NR4 7UH, GB
(72) BOULES, Clive, Room 204 Norwich Biocubator Colney Lane, Norwich Norfolk NR4 7UH, GB
-
- (51) MKP
A23P 1/12 (2006.01) (97) **2459012 ***
A23P 1/02 (2006.01)
A23L 1/10 (2006.01)
(86) CA2010001144 27.07.2010
(96) 10803766.4 06.06.2012
(87) WO2011011869, 27.07.2010
(97) 2459012, 06.06.2012 en
(54) AGGLOMERATES AND PREPARATION THEREOF
(71) Griffith Laboratories International, Inc., One Griffith Center, Alsip, IL 60803, US
(72) BAUR, Joachim N.C., 49 Forster Creek Drive, Newcastle Ontario L1B 1G4, CA
DARLEY, Kenneth S., 121 Pine Street, Whitby Ontario L1N 3X1, CA
HAZLETT, Luke, P., 59 Godstone Road 114, Toronto Ontario M2J 3C8, CA
PRISCIAC, John, J., 894 Douglas Avenue, Pickering Ontario L1W 1N6, CA
TURULJA, Jasna, 65 Via Avellino, Woodbridge Ontario L4H 0Y5, CA
-
- (51) MKP
G07D 9/00 (2006.01) (97) **2462566 ***
G07F 1/04 (2006.01)
(86) IB2010001940 04.08.2010
(96) 10806119.3 13.06.2012
(87) WO2011015941, 04.08.2010
(97) 2462566, 13.06.2012 de
(54) DEVICE FOR RECEIVING COINS
(71) Novomatic AG, Wiener Strasse 158, 2352 Gumpoldskirchen, AT
MÜHRENBURG, Roland, c/o Novomatic AG
IP&Rechtsabteilung Wiener Strasse 158, A-2352 Gumpoldskirchen, DE
SHAGEEV, D., c/o Novomatic AG IP&Rechtsabteilung Wiener Strasse 158, A-2352 Gumpoldskirchen, DE
ZANDER, Marko, c/o Novomatic AG IP&Rechtsabteilung Wiener Strasse 158, A-2352 Gumpoldskirchen, DE

- (51) MKP
C07D 413/14 (2006.01) (97) **2424864 ***
A61K 31/4439 (2006.01)
A61P 31/12 (2006.01)
A61K 31/422 (2006.01)
A61P 35/00 (2006.01)
A61P 11/00 (2006.01)
A61P 37/00 (2006.01)
- (86) EP2010055666 28.04.2010
(96) 10714892.6 07.03.2012
(87) WO2010125082, 28.04.2010
(97) 2424864, 07.03.2012 en
(54) OXAZOLE SUBSTITUTED INDAZOLES AS PI3-KINASE INHIBITORS
- (71) Glaxo Group Limited, Glaxo Wellcome House Berkeley Avenue Greenford, Middlesex UB6 0NN, GB
(72) HAMBLLIN, Julie, Nicole, GlaxoSmithKline Gunnels Wood Road, Stevenage Hertfordshire SG1 2NY, GB
JONES, Paul, Spencer, c/o GlaxoSmithKline Gunnels Wood Road, Stevenage Hertfordshire SG1 2NY, GB
KEELING, Suzanne, Elaine, c/o GlaxoSmithKline Gunnels Wood Road, Stevenage Hertfordshire SG1 2NY, GB
LE, Joelle, GlaxoSmithKline Gunnels Wood Road, Stevenage Hertfordshire SG1 2NY, GB
MITCHELL, Charlotte, Jane, GlaxoSmithKline Gunnels Wood Road, Stevenage Hertfordshire SG1 2NY, GB
PARR, Nigel, James, GlaxoSmithKline Gunnels Wood Road, Stevenage Hertfordshire SG1 2NY, GB
-
- (51) MKP
E04B 1/32 (2006.01) (97) **2414597 ***
- (86) RS2010000002 23.03.2010
(96) 10732758.7 08.02.2012
(87) WO2010095968, 23.03.2010
(97) 2414597, 08.02.2012 en
(54) PREFABRICATED CONSTRUCTION OBJECT WHICH IS BUILT FROM PREFABRICATED FEROCEMENT RIB ELEMENTS BY SANDWICH TYPE WHICH ARE EFFUSED IN MOULDS
- (71) Milinkovic, Mladen, Kej Oslobodjenja 13F/17, 411080 Zemun, RS
Milinkovic, Milenko, Brace Gavrajic 79, 11275 Boljevci, RS
(72) Milinkovic, Milenko, Brace Gavrajic 79, 11275 Boljevci, RS
Milinkovic, Mladen, Kej Oslobodjenja 13F/17, 411080 Zemun, RS
-
- (51) MKP
A01N 43/653 (2006.01) (97) **2493292 ***
A01N 25/32 (2006.01)
A01N 43/42 (2006.01)
A01P 13/00 (2006.01)
A01N 43/54 (2006.01)
A01N 43/56 (2006.01)
- (86) US2010054391 28.10.2010
(96) 10776227.0 05.09.2012
(87) WO2011059718, 28.10.2010
(97) 2493292, 05.09.2012 en
(54) SAFENING 6-AMINO-2-(SUBSTITUTED PHENYL)-5-SUBSTITUTED-4-PYRIMIDINECARBOXYLATE HERBICIDE INJURY ON CEREAL CROPS
- (71) Dow AgroSciences, LLC, 9330 Zionsville Road, Indianapolis, Indiana 46268, US
(72) SATCHIVI, Norbert, 3100 Cherub Court, Westfield IN 46074, US
SCHMITZER, Paul, 7960 North Whittier Place, Indianapolis IN 46250, US
-
- (51) MKP
A61K 47/36 (2006.01) (97) **2437783 ***
- (86) GB2010001096 03.06.2010
(96) 10722755.5 11.04.2012
(87) WO2010139956, 03.06.2010
(97) 2437783, 11.04.2012 en
(54) TREATMENT OF ACINETOBACTER WITH ALGINATE OLIGOMERS AND ANTIBIOTICS
- (71) ALGIPHARMA AS, Industriveien 33, 1337 Sandvika, NO
(72) ONSOYEN, Edvar, AlgiPharma AS Industriveien 33, N-1337 Sandvika, NO
MYRVOLD, Rolf, AlgiPharma AS Industriveien 33, N-1337 Sandvika, NO
DESSEN, Arne, AlgiPharma AS Industriveien 33, N-1337 Sandvika, NO
THOMAS, David, Tissue Engineering&Reparative Dentistry School of Dentistry Cardiff University Heath Park, Cardiff CF14 4XY, GB
WALSH, Timothy, Rutland, Department of Medical Microbiology Cardiff University Heath Park, Cardiff CF14 4XY, GB
-
- (51) MKP
C10J 3/56 (2006.01) (97) **2445999 ***
C10J 3/84 (2006.01)
C10J 3/48 (2006.01)
C10J 3/86 (2006.01)
- (86) DK2010050164 25.06.2010
(96) 10727659.4 02.05.2012
(87) WO2010149173, 25.06.2010
(97) 2445999, 02.05.2012 en
(54) METHOD AND SYSTEM FOR CLEANING OF AND HEAT RECOVERY FROM HOT GASES
- (71) Dall Energy Holding ApS, Sjaelsøvej 53, 3460 Birkerød, DK
(72) BENTZEN, Jens, Dall, Sjaelsøvej 53, DK-3460 Birkerød, DK
-
- (51) MKP
C07D 498/04 (2006.01) (97) **2451793 ***
C07D 513/02 (2006.01)
C07D 279/08 (2006.01)
- (86) US2010041034 06.07.2010
(96) 10731890.9 16.05.2012
(87) WO2011005738, 06.07.2010
(97) 2451793, 16.05.2012 en
(54) BACE INHIBITORS
- (71) Eli Lilly and Company, Lilly Corporate Center, Indianapolis, IN 46285, US
(72) AUDIA, James, Edmund, Eli Lilly and Company Lilly Corporate Center, Indianapolis, Indiana 46285, US
MERGOTT, Dustin, James, Eli Lilly and Company Lilly Corporate Center, Indianapolis, Indiana 46285, US
SHI, Chongsheng, Eric, Eli Lilly and Company Lilly Corporate Center, Indianapolis, Indiana 46285, US
VAUGHT, Grant, Mathews, Eli Lilly and Company Lilly Corporate Center, Indianapolis, Indiana 46285, US
WATSON, Brian, Morgan, Eli Lilly and Company Lilly Corporate Center, Indianapolis, Indiana 46285, US
WINNEROSKI, Leonard, Larry, Jr., Eli Lilly and Company Lilly Corporate Center, Indianapolis, Indiana 46285, US
-
- (51) MKP
B23F 5/22 (2006.01) (97) **2456588 ***
B23Q 1/28 (2006.01)
- (86) IB2010001764 21.07.2010
(96) 10759971.4 30.05.2012
(87) WO2011010210, 21.07.2010
(97) 2456588, 30.05.2012 en
(54) MACHINE FOR MAKING GEARS
- (71) Samp S.p.a. Con Unico Socio, Via Saliceto 15, Bentivoglio, IT
(72) AFFATICATI, Artemio, Via Buonarroti 5, I-21052 Busto Arsizio, IT
FRANCESCHET, Marco, Via Cavin di Sala 152, I-30035 Mirano, IT
MANARA, Mauro, Via Gaiba Natale 42, I-44011 Argenta, IT
PERRONE, Vito, Via Cristoforo Colombo 2, I-26013 Crema, IT

- (51) MKP
A24B 3/18 (2006.01) (97) **2444384 ***
A24B 15/00 (2006.01)
A24B 3/12 (2006.01)
A24B 15/32 (2006.01)
A24B 3/14 (2006.01)
A24B 15/10 (2006.01)
C07C 11/12 (2006.01)
A24B 15/18 (2006.01)
C07C 11/00 (2006.01)
A24B 15/28 (2006.01)
A24B 3/00 (2006.01)
A24B 15/30 (2006.01)
(86) CN2010073621 07.06.2010
(96) 10788865.3 25.04.2012
(87) WO2010145469, 07.06.2010
(97) 2444384, 25.04.2012 en
(54) USE OF NEOPHYTADIENE AS ADDITIVE FOR LIQUID CIGARETTE
(71) Li, Wenbo, Shenyang Electric Power Machinery General Factory 6 Zhaogong North Street Tiexi District Shenyang, Liaoning 110026, CN
(72) Li, Wenbo, Shenyang Electric Power Machinery General Factory 6 Zhaogong North Street Tiexi District Shenyang, Liaoning 110026, CN

- (51) MKP
A61M 3/02 (2006.01) (97) **2424590 ***
A61M 1/00 (2006.01)
(86) US2010001243 27.04.2010
(96) 10770055.1 07.03.2012
(87) WO2010126586, 27.04.2010
(97) 2424590, 07.03.2012 en
(54) IRRIGATION AND ASPIRATION DEVICES AND METHODS
(71) Aardvark Medical, Lic, One Embarcadero Center 37th Floor, San Francisco, CA 94111, US
(72) BAKER, Peter, Christensen, 55 Bolinas Avenue, Ross CA 91957, US
SLONE, Clinton, N., 1197 Church Street, San Francisco CA 94114, US
STRASSER, Michael, J., 546-B Presidio Blvd., San Francisco CA 94129, US
LOVETTE, James, M., 1180 Lobitos Creek Cut-Off, Half Moon Bay CA 94019, US
KING, Thomas, 1333 Gough St. Apt 1H, San Francisco CA 94109, US
TREADWELL, Richard, 48 Hill Point Ave., San Francisco CA 94117, US

- (51) MKP
A61K 39/395 (2006.01) (97) **2477653 ***
A61P 35/00 (2006.01)
C07K 16/28 (2006.01)
C07K 16/30 (2006.01)
C07K 16/46 (2006.01)
(86) EP2010063795 20.09.2010
(96) 10755167.3 25.07.2012
(87) WO2011033105, 20.09.2010
(97) 2477653, 25.07.2012 en
(54) DOSAGE REGIMEN FOR ADMINISTERING AN EPCAMXCD3 BISPECIFIC ANTIBODY
(71) Micromet AG, Staffelseestrasse 2, 81477 München, DE
(72) ZUGMEIER, Gerhard, Micromet AG Staffelseestr. 2, 82477 Munich, DE
KUFER, Peter, Micromet AG Staffelseestr. 2, 81477 Munich, DE
RÜTTINGER, Dominik, Micromet AG Staffelseestr. 2, 81477 Munich, DE
KAUBITZSCH, Sabine, Micromet AG Staffelseestr. 2, 81477 Munich, DE

- (51) MKP
C02F 1/66 (2006.01) (97) **2342164 ***
C02F 1/72 (2006.01)
C02F 9/00 (2006.01)
C02F 11/06 (2006.01)
C02F 101/20 (2006.01)
C02F 101/30 (2006.01)
(86) IB2010002418 27.09.2010
(96) 10793292.3 13.07.2011
(87) WO2011036550, 27.09.2010
(97) 2342164, 13.07.2011 en
(54) PROCESS FOR THE DISPOSAL OF WASTES, PARTICULARLY OF SLUDGES DERIVING FROM WASTE WATER DEPURATION
(71) Biolase S.p.A., Via San Primo 4, 20123 Milano, IT
(72) MONTEMURRO, Michele, Via Leopardi 26, I-00034 Colferro (Roma), IT

- (51) MKP
F24F 5/00 (2006.01) (97) **2339253**
F24F 12/00 (2006.01)
(96) 10196899.8 29.06.2011
(97) 2339253, 29.06.2011 fr
(54) Dwelling with passive air-conditioning system
(71) Garoni, M. Régis, 10 Rue des Muriers, 31270 Villeneuve Tolosane, FR
(72) Garoni, M. Régis, 10 Rue des Muriers, 31270 Villeneuve Tolosane, FR

- (51) MKP
C08F 36/04 (2006.01) (97) **2484701 ***
C08K 3/36 (2006.01)
C08L 15/00 (2006.01)
C08C 19/25 (2006.01)
(86) JP2010066431 22.09.2010
(96) 10820431.4 08.08.2012
(87) WO2011040312, 22.09.2010
(97) 2484701, 08.08.2012 en
(54) PRODUCTION METHOD FOR MODIFIED CONJUGATED DIENE POLYMER, MODIFIED CONJUGATED DIENE POLYMER, AND MODIFIED CONJUGATED DIENE POLYMER COMPOSITION
(71) Asahi Kasei Chemicals Corporation, 1-105, Kanda Jinbocho Chiyoda-ku, Tokyo 101-8101, JP
(72) YOSHIDA, Junichi, 1-105 Kanda Jinbocho Chiyoda-ku, Tokyo 101-8101, JP
SEKIKAWA, Shinichi, 1-105 Kanda Jinbocho Chiyoda-ku, Tokyo 101-8101, JP
MATSUDA, Takaaki, 1-105 Kanda Jinbocho Chiyoda-ku, Tokyo 101-8101, JP

- (51) MKP
A61K 9/20 (2006.01) (97) **2263657**
(96) 10163412.9 22.12.2010
(97) 2263657, 22.12.2010 en
(54) Controlled release lamotrigine formulations
(71) Ranbaxy Laboratories Limited, Plot No. 90, Sector-32, Gurgaon - 122001, Haryana, IN
(72) Bhavarisetti, Murali Krishna, S/o B.V. Satyanarayana D.No: 16-5, Ramalayam Street, Nandigama, Andhra Pradesh, 521185, Krishna, IN
Verma, Rajan K., House Number 1366-A Gali Sunaran, Najafgarh Delhi, 110043, New Delhi, IN
Singh, Romi Barat, A-14, Badshah Bagh Uttar Pradesh, Varanasi, 221002, IN
Barabde, Umesh Vinayakrao, S/o V.G. Barabde, Mudliyar Nagar Maharashtra, 444606, Amravati, IN

(51) MKP
C12N 15/12 (2006.01) (97) **2435558 ***
C12N 5/074 (2010.01)
C12N 5/10 (2006.01)
(86) US2010036456 27.05.2010
(96) 10781234.9 04.04.2012
(87) WO2010138750, 27.05.2010
(97) 2435558, 04.04.2012 en
(54) GENERATION OF GENETICALLY CORRECTED DISEASE-FREE INDUCED PLURIPOTENT STEM CELLS
(71) The Salk Institute for Biological Studies, 10010 North Torrey Pines Road, La Jolla, CA 92037, US
Center Of Regenerative Medicine Of Barcelona, Spain, Dr. Alguader 88 7th Floor, 08003 Barcelona, ES
(72) RAYA, Angel, Av. Roma 32-34 atico 1, esc. B, E-08015 Barcelona, ES
BUEREN, Juan Antonio, Calle Alfredo Marquerie N°5, E-28034 Madrid, ES
IZPISUA BELMONTE, Juan Carlos, 8435 Avenida de las Ondas, La Jolla California 92037, US

(51) MKP
H04W 72/12 (2009.01) (97) **2445293 ***
(86) CN2010073847 11.06.2010
(96) 10788904.0 25.04.2012
(87) WO2010145508, 11.06.2010
(97) 2445293, 25.04.2012 en
(54) METHOD, DEVICE AND SYSTEM FOR REPORTING POWER HEADROOM
(71) China Academy of Telecommunications Technology, 40, Xueyuan Road, Haidian District, Beijing 100191, CN
(72) ZHAO, Yali, No.40 Xueyuan Road Haidian District, Beijing 100083, CN
CHEN, Li, No.40 Xueyuan Road Haidian District, Beijing 100083, CN
LI, Guoqing, No.40 Xueyuan Road Haidian District, Beijing 100083, CN

(51) MKP
A61B 17/32 (2006.01) (97) **2448501 ***
(86) US2010040451 29.06.2010
(96) 10729765.7 09.05.2012
(87) WO2011002797, 29.06.2010
(97) 2448501, 09.05.2012 en
(54) ULTRASONIC DEVICE FOR CUTTING AND COAGULATING
(71) Ethicon Endo-Surgery, Inc., 4545 Creek Road, Cincinnati, OH 45242, US
(72) DANNAHER, William, D., 8907 Eldora Drive, Cincinnati, OH 45236, US
BERTKE, Brian, D., 416 Rossford Avenue, Fort Thomas, KY 41075, US
MORAN, Kenneth, 6234 Whileaway Drive, Loveland, OH 45140, US
ZINGMAN, Aron, O., 2333 Salutaris Avenue 4, Cincinnati, OH 45206, US
REED, Matthew, L., 4296 Shawnee Trail, Jamestown, OH 45335, US
PUMMIL, JR., Larry, A., 7457 Farmerville-Germantown Pike, Germantown, OH 45327, US
WEAVER, Robert, D., 8620 Haddix Road, Fairborn, OH 45324, US
FRAZIER, John, S., 3042 Regent Street, Kettering, OH 45409, US

(51) MKP
C12Q 1/02 (2006.01) (97) **2386651 ***
C12N 15/09 (2006.01)
(86) JP2010066962 29.09.2010
(96) 10820590.7 16.11.2011
(87) WO2011040475, 29.09.2010
(97) 2386651, 16.11.2011 en
(54) METHOD FOR SCREENING FOR SALTY TASTE CONTROL SUBSTANCE
(71) Ajinomoto Co., Inc., 15-1, Kyobashi 1-chome, Chuo-ku, Tokyo 104-8315, JP
(72) ISHIWATARI, Yutaka, c/o AJINOMOTO CO. INC. 1-1 Suzuki-cho Kawasaki-ku, Kawasaki-shi Kanagawa 210-8681, JP
KAI, Yuko, c/o AJINOMOTO CO. INC. 1-1 Suzuki-cho Kawasaki-ku, Kawasaki-shi Kanagawa 210-8681, JP
MAEKAWA, Takami, c/o AJINOMOTO CO. INC. 1-1 Suzuki-cho Kawasaki-ku, Kawasaki-shi Kanagawa 210-8681, JP
ETO, Yuzuru, c/o AJINOMOTO CO. INC. 1-1 Suzuki-cho Kawasaki-ku, Kawasaki-shi Kanagawa 210-8681, JP

(51) MKP
A61K 31/165 (2006.01) (97) **2435402 ***
C07C 233/45 (2006.01)
C07C 233/64 (2006.01)
C07C 233/57 (2006.01)
A61K 31/166 (2006.01)
(86) EP2010057213 26.05.2010
(96) 10726924.3 04.04.2012
(87) WO2010136474, 26.05.2010
(97) 2435402, 04.04.2012 en
(54) SUBSTITUTED AMINO BUTYRIC DERIVATIVES AS NEPRILYSIN INHIBITORS
(71) Novartis AG, Lichtstrasse 35, 4056 Basel, CH
(72) COPPOLA, Gary, Mark, 18 Aldersgate Circle, Budd Lake, New Jersey 07828, US
IWAKI, Yuki, Novartis Institutes for BioMedical Research Inc. 400 Technology Square, Cambridge, Massachusetts 02139, US
KARKI, Rajeshri, Ganesh, Novartis Institutes for BioMedical Research Inc. 100 Technology Square, Cambridge, Massachusetts 02139, US
KAWANAMI, Toshio, Novartis Institutes for BioMedical Research Inc. 100 Technology Square, Cambridge, Massachusetts 02139, US
KSANDER, Gary, Michael, Novartis Institutes for BioMedical Research Inc. 100 Technology Square, Cambridge, Massachusetts 02139, US
MOGI, Muneto, Novartis Institutes for BioMedical Research Inc. 100 Technology Square, Cambridge, Massachusetts 02139, US
SUN, Robert, Novartis Institutes for BioMedical Research Inc. 100 Technology Square, Cambridge, Massachusetts 02139, US

(51) MKP
C07K 16/46 (2006.01) (97) **2406283 ***
C12N 15/13 (2006.01)
A61P 11/06 (2006.01)
C07K 16/24 (2006.01)
A61K 39/395 (2006.01)
(86) GB2010000432 10.03.2010
(96) 10714046.9 18.01.2012
(87) WO2010103274, 10.03.2010
(97) 2406283, 18.01.2012 en
(54) ANTIBODY MOLECULES HAVING BINDING SPECIFICITY FOR HUMAN IL-13
(71) UCB Pharma, S.A., 60, allée de la Recherche, 1170 Brussels, BE
(72) GOZZARD, Neil, Ipd Ucb Celltech 208 Bath Road, Slough Berkshire SL1 3WE, GB
LAWSON, Alastair, David, Griffiths, Ipd Ucb Celltech 208 Bath Road, Slough Berkshire SL1 3WE, GB
LIGHTWOOD, Daniel, John, Ipd Ucb Celltech 208 Bath Road, Slough Berkshire SL1 3WE, GB
PALFRAMAN, Roger, Thomas, Ipd Ucb Celltech 208 Bath Road, Slough Berkshire SL1 3WE, GB
SMITH, Bryan, John, Ipd Ucb Celltech 208 Bath Road, Slough Berkshire SL1 3WE, GB
TYSON, Kerry, Louise, Ipd Ucb Celltech 208 Bath Road, Slough Berkshire SL1 3WE, GB

(51) MKP
B05B 1/30 (2006.01) (97) **2279792**
(86) 10170320.5 02.02.2011
(97) 2279792, 02.02.2011 de
(54) Spray gun
(71) Walther Spritz- und Lackiersysteme GmbH, Kärntner Strasse 22-30, 42327 Wuppertal, DE
(72) Bröker, Torsten, Schneppendahler Weg 4 a, 42799 Leichlingen, DE
Nickel, Holger, Friedrichstal 56, 42657 Solingen, DE

- (51) MKP
G01N 33/543 (2006.01) (97) **2430443 ***
G01N 33/574 (2006.01)
G01N 33/50 (2006.01)
G01N 33/533 (2006.01)
G01N 33/532 (2006.01)
G01N 33/535 (2006.01)
- (86) US2010034814 13.05.2010
(96) 10720095.8 21.03.2012
(87) WO2010132723, 13.05.2010
(97) 2430443, 21.03.2012 en
(54) BIOMARKERS FOR DETERMINING SENSITIVITY OF BREAST CANCER CELLS TO HER2-TARGETED THERAPY
(71) Prometheus Laboratories Inc., 9410 Carroll Park Drive, San Diego, CA 92121-5201, US
(72) KIM, Phillip, 28 Exeter, Irvine California 92612, US
LIU, Xinjun, 12890 Caminito Diego, San Diego California 92130, US
KIRKLAND, Richard, 3677 Brookshire Street, San Diego California 92111, US
LEE, Tani, 4454 Bertha Court, San Diego California 92117, US
YBARRONDO, Belen, 4570 Orchard Avenue, San Diego California 92107, US
SINGH, Sharat, 8171 Top of the Morning Way, Rancho Santa Fe California 92127, US
-
- (51) MKP
C09K 11/06 (2006.01) (97) **2430103 ***
C09D 11/10 (2006.01)
C09D 11/00 (2006.01)
B41M 3/14 (2006.01)
- (86) EP2010056350 10.05.2010
(96) 10719335.1 21.03.2012
(87) WO2010130681, 10.05.2010
(97) 2430103, 21.03.2012 en
(54) SECURE DOCUMENT COMPRISING LUMINESCENT CHELATES
(71) SICPA HOLDING SA, Avenue de Florissant 41, 1008 Prilly, CH
(72) ABOUTANOS, Vickie, Rue des Parcs 61, 2000 Neuchâtel, CH
TILLER, Thomas, Chemin du Cèdre 21, CH-1030 Bussigny, CH
REINHARD, Christine, Chemin de la Cure 8, 1008 Prilly, CH
RASCAGNÈRES, Stéphanie, Impasse du Colomby Charmois, F-74550 Orcier, FR
-
- (51) MKP
C07D 409/12 (2006.01) (97) **2411383 ***
A61K 31/4535 (2006.01)
A61P 25/00 (2006.01)
C07D 409/06 (2006.01)
- (86) FR2010050551 25.03.2010
(96) 10715985.7 01.02.2012
(87) WO2010109150, 25.03.2010
(97) 2411383, 01.02.2012 fr
(54) DERIVATIVES OF 3-ALKOXY-4,5-DIARYLTHIOPHENE-2-CARBOXAMIDE, PREPARATION THEREOF, AND THERAPEUTIC USE THEREOF
(71) SANOFI, 174, Avenue de France, 75013 Paris, FR
(72) DUCOUX, Jean-Philippe, c/o Sanofi-Aventis Département Brevets 174 avenue de France, F-75013 Paris, FR
RINALDI-CARMONA, Murielle, c/o Sanofi-Aventis Département Brevets 174 avenue de France, F-75013 Paris, FR
ROUQUETTE, Arnaud, c/o Sanofi-Aventis Département Brevets 174 avenue de France, F-75013 Paris, FR
-
- (51) MKP
A61P 35/00 (2006.01) (97) **2464651 ***
A61P 29/00 (2006.01)
C07H 17/08 (2006.01)
A61P 11/06 (2006.01)
C07D 498/04 (2006.01)
A61K 31/4433 (2006.01)
- (86) EP2010061822 13.08.2010
(96) 10743117.3 20.06.2012
(87) WO2011018510, 13.08.2010
(97) 2464651, 20.06.2012 en
(54) NEW MACROLIDES AND THEIR USE
(71) Basilea Pharmaceutica AG, Grenzacherstrasse 487, 4058 Basel, CH
(72) KELLENBERGER, Johannes, Laurenz, Hohlweg 7, CH-4125 Riehen, CH
DREIER, Jürg, Weisskirchweg 2, CH-4108 Witterswil, CH
-
- (51) MKP
C12N 15/82 (2006.01) (97) **2403948 ***
C07K 14/325 (2006.01)
- (86) US2010026308 05.03.2010
(96) 10707418.9 11.01.2012
(87) WO2010102172, 05.03.2010
(97) 2403948, 11.01.2012 en
(54) METHODS AND COMPOSITIONS FOR CONTROLLING PLANT PESTS
(71) Athenix Corporation, 3500 Paramount Parkway, Morrisville, NC 27560, US
(72) SAMPSON, Kimberly, S., 5505 Frenchman's Creek Drive, Durham, NC 27713, US
TOMSO, Daniel, J., 114 Vista Del Rio Drive, Bahama, NC 27503, US
-
- (51) MKP
A61K 9/20 (2006.01) (97) **2400954 ***
- (86) EP2010001262 01.03.2010
(96) 10705984.2 04.01.2012
(87) WO2010097243, 01.03.2010
(97) 2400954, 04.01.2012 en
(54) PROCESS FOR FORMING SOLID ORAL DOSAGE FORMS OF SOLIFENACIN AND ITS PHARMACEUTICALLY ACCEPTABLE SALTS
(71) Krka, D.D., Novo Mesto, Marjeska cesta 6, 8501 Novo mesto, SI
(72) VRBINC, Miha, Gotna vas 20, 8000 Novo Mesto, SI
VRECER, Franc, Potok 5B, 8351 Straza, SI
TURK, Urska, Kostialova 44a, 8000 Novo Mesto, SI
JURSIK, Urska, Igriska 8, 1000 Ljubljana, SI
-
- (51) MKP
E05B 21/06 (2006.01) (97) **2406442 ***
- (86) FI2010051006 08.12.2010
(96) 10803465.3 18.01.2012
(87) WO2011080384, 08.12.2010
(97) 2406442, 18.01.2012 en
(54) DISC TUMBLER CYLINDER LOCK AND KEY COMBINATION
(71) Abloy Oy, Wahlforsinkatu 20, 80100 Joensuu, FI
(72) KIISKI, Seppo, Viskaalintie 8, FI-80230 Joensuu, FI
-
- (51) MKP
H04L 29/06 (2006.01) (97) **2472817**
- (96) 11167561.7 04.07.2012
(97) 2472817, 04.07.2012 en
(54) System and method for optimization of execution of security tasks in local network
(71) Kaspersky Lab, ZAO, 10 Geroyev Panfilovtsev Street, Moscow 125363, RU
(72) Kulaga, Andrey A., c/o KASPERSKY LAB ZAO 10/1 1st Volokolamsky Proezd, 123060 Moscow, RU
Tikhomirov, Anton V., c/o KASPERSKY LAB ZAO 10/1 1st Volokolamsky Proezd, 123060 Moscow, RU
-
- (51) MKP
F24C 11/00 (2006.01) (97) **2425183 ***
- (86) US2010034204 10.05.2010
(96) 10770502.2 07.03.2012
(87) WO2010127371, 10.05.2010
(97) 2425183, 07.03.2012 en
(54) HEATING DEVICE HAVING ELECTRIC AND FUEL POWERED HEAT SOURCES
(71) The Schawbel Corporation, 26 Crosby Drive, Bedford, MA 01730, US
(72) WANG, Wender, 100 Crosby Drive, Bedford MA 01730, US
SHAPIRO, Stephen, 100 Crosby Drive, Bedford MA 01730, US
-

- (51) MKP
A61K 31/665 (2006.01) (97) **2476419 ***
A61K 47/04 (2006.01)
A61P 31/04 (2006.01)
A61K 9/51 (2006.01)
(86) RU2011000321 11.05.2011
(96) 11827038.8 18.07.2012
(87) WO2012039641, 11.05.2011
(97) 2476419, 18.07.2012 en
(54) PHARMACEUTICAL COMPOSITION HAVING ANTIMICROBIAL AND ANTI-INFLAMMATORY ACTIVITY FOR PARENTERAL ADMINISTRATION, PROCESS FOR PREPARING SAME
(71) Limonov, Viktor Lvovich, ul. Raschupkina, 10-62, Moscow 121374, RU
(72) GAIDUL, Konstantin Valentinovich, ul. Bogatkova 260-71, Novosibirsk 630089, RU
DUSHKIN, Aleksandr Valerevich, ul. Arbuzova 5-144, Novosibirsk 630117, RU
-
- (51) MKP
A61K 31/4412 (2006.01) (97) **2324831**
A61P 11/00 (2006.01)
(96) 10250379.4 25.05.2011
(97) 2324831, 25.05.2011 en
(54) Methods of administering pifrenidone therapy
(71) Intermune, Inc., 3280 Bayshore Boulevard, Brisbane, CA 94005-1021, US
(72) Bradford, Williamson Ziegler, PO Box 566, Ross, California 94957, US
Szwarcberg, Javier, 2173 Bunker Hill Drive, San Mateo, California 94402, US
-
- (51) MKP
C03B 7/06 (2006.01) (97) **2429959 ***
F23N 5/02 (2006.01)
(86) US2010031855 21.04.2010
(96) 10716188.7 21.03.2012
(87) WO2010126754, 21.04.2010
(97) 2429959, 21.03.2012 en
(54) SYSTEM AND METHOD FOR CONTROLLING TEMPERATURE IN A FOREHEARTH
(71) Owens-Brockway Glass Container INC., One Michael Owens Way, Perrysburg, OH 43551, US
(72) PERRY, Philip, D., 25688 Normandy W., Perrysburg OH 43551, US
SUNG, C., Oscar, 8826 Linden Lake Road, Sylvania OH 43560, US
GAERKE, Dale, A., 25300 Appaloosa Court, Perrysburg OH 43551, US
-
- (51) MKP
C07C 45/34 (2006.01) (97) **2487149 ***
C07C 255/17 (2006.01)
C07B 61/00 (2006.01)
C07C 253/30 (2006.01)
C07C 49/17 (2006.01)
C07C 49/175 (2006.01)
(86) JP2010067734 08.10.2010
(96) 10822129.2 15.08.2012
(87) WO2011043459, 08.10.2010
(97) 2487149, 15.08.2012 en
(54) METHOD FOR PRODUCING KETONE
(71) JX Nippon Oil & Energy Corporation, 6-3, Otemachi 2-chome, Chiyoda-ku Tokyo 100-8162, JP
Osaka University, 1-1, Yamadaoka, Suita-shi Osaka 565-0871, JP
(72) KANEDA Kiyotomi, c/o Osaka University 1-1 Yamadaoka, Suita-shi Osaka 565-0871, JP
SONE Hisashi, c/o JX Nippon Oil&Energy Corporation 8 Chidori-cho Naka-ku, Yokohama-shi Kanagawa 231-0815, JP
-
- (51) MKP
C07C 69/76 (2006.01) (97) **2454227 ***
(86) US2010041825 13.07.2010
(96) 10800415.1 23.05.2012
(87) WO2011008756, 13.07.2010
(97) 2454227, 23.05.2012 en
(54) SYNTHESIS OF PROSTANOIDS
(71) Irix Pharmaceuticals, 101 Technology Place, Florence, SC 29501, US
(72) YIANNIKOUROS, George, Petros, 1864 Brigadoone Lane, Florence, SC 29505, US
KALARITIS, Panos, 719 Muirfield Place, Florence, SC 29501, US
GAMAGE, Chaminda, Priyapushpa, 1414 H Willow Trace Drive, Florence, SC 29501, US
ABERNATHY, Stephanie, Bosse, 419 Spruce Street, Florence, SC 29501, US
-
- (51) MKP
G01L 9/00 (2006.01) (97) **2491364 ***
(86) NO2010000367 19.10.2010
(96) 10825254.5 29.08.2012
(87) WO2011049459, 19.10.2010
(97) 2491364, 29.08.2012 en
(54) SEPARATING MEMBRANE FOR PRESSURE SENSOR
(71) Presens AS, Postboks 16 Øvre Ullern, 0311 Oslo, NO
(72) SEEBERG, Bjørn, Erik, Hoysetervn. 50A, N-0768 Oslo, NO
-
- (51) MKP
A01N 45/00 (2006.01) (97) **2429297 ***
(86) US2010001436 14.05.2010
(96) 10780911.3 21.03.2012
(87) WO2010138158, 14.05.2010
(97) 2429297, 21.03.2012 en
(54) METHOD OF ADMINISTERING DOSE-SPARING AMOUNTS OF FORMOTEROL FUMARATE-BUDESONIDE COMBINATION PARTICLES BY INHALATION
(71) MAP Pharmaceuticals Inc, 2400 Bayshore Parkway, Suite 200, Mountain View, CA 94043, US
(72) COOK, Robert O., 42 Scott Dr., Hillsborough NJ 08844, CA
DE GUZMAN, Veronica, S., 664 College Ave., Palo Alto CA 94306, US
-
- (51) MKP
A61M 16/00 (2006.01) (97) **2319568**
A61M 16/16 (2006.01)
(96) 10010536.0 11.05.2011
(97) 2319568, 11.05.2011 de
(54) Device for moistening breathed air for artificial respiration
(71) ARTA PLAST AB, Antennvägen 1a, 135 48 Tyresö, SE
(72) Steg, Helge, Sveavägen 81, 113 50 Stockholm, SE
Hall, Leif, Förläkningsvägen 102, 145 60 Norsborg, SE
-
- (51) MKP
C07D 211/58 (2006.01) (97) **2341046**
C07D 491/22 (2006.01)
A61P 35/00 (2006.01)
A61K 31/4375 (2006.01)
(96) 10191501.5 06.07.2011
(97) 2341046, 06.07.2011 en
(54) Process for the preparation of 7-ethyl-10-[4-(1-piperidino)-1-piperidino] carbonyloxy-camptothecin hydrochloride trihydrate
(71) CADILA HEALTHCARE LIMITED, Zydus Tower, Satellite Cross Roads, Ahmedabad 380 015, Gujarat, IN
(72) Charan, Ganpat Dan Shimbhu, Cadila Healthcare Limited Zydus Tower Satellite Cross Roads, 380 015 Ahmedabad Gujarat, IN
Singh, Kumar Kamlesh Laxmi, Cadila Healthcare Limited Zydus Tower Satellite Cross Roads, 380 015 Ahmedabad Gujarat, IN
Tanpure, Arun Ankush, Cadila Healthcare Limited Zydus Tower Satellite Cross Roads, 380 015 Ahmedabad Gujarat, IN

- (51) MKP
A61P 25/00 (2006.01) (97) **2491031 ***
C07D 487/04 (2006.01)
C07D 471/04 (2006.01)
A61K 31/4353 (2006.01)
- (86) US2010053611 21.10.2010
(96) 10773478.2 29.08.2012
(87) WO2011050202, 21.10.2010
(97) 2491031, 29.08.2012 en
(54) FUSED HETEROCYCLIC COMPOUNDS AS OREXIN RECEPTOR MODULATORS
(71) Janssen Pharmaceutica N.V., Turnhoutseweg 30, 2340 Beerse, BE
(72) BRANSTETTER, Bryan, James, 3504 Paseo De Los Americanos 67, Oceanside CA 92056, US
LETAVIC, Michael, A., 4379 Mistral Place, San Diego CA 92130, US
LY, Kiev, S., P.O. Box 927992, San Diego CA 92192, US
RUDOLPH, Dale, A., 12721 Alondra Court, San Diego CA 92128, US
SAVALL, Brad, M., 9512 Ronda Avneue, San Diego CA 92123, US
SHAH, Chandravadan, R., 14213 Dalhousie Road, San Diego CA 92129, US
SHIREMAN, Brock, T., 12625 Birchbrook Court, Poway CA 92064, US
-
- (51) MKP
C07K 16/28 (2006.01) (97) **2493927 ***
(86) EP2010066279 27.10.2010
(96) 10770840.6 05.09.2012
(87) WO2011051351, 27.10.2010
(97) 2493927, 05.09.2012 en
(54) METHOD TO GENERATE ANTIBODIES TO ION CHANNELS
(71) UCB Pharma, S.A., 60, allée de la Recherche, 1170 Brussels, BE
(72) BAKER, Terence Seward, UCB Celltech 208 Bath Road, Slough Berkshire SL1 3WE, GB
-
- (51) MKP
A61P 9/00 (2006.01) (97) **2364972**
C07D 223/16 (2006.01)
A61K 31/55 (2006.01)
- (96) 11290091.5 14.09.2011
(97) 2364972, 14.09.2011 fr
(54) New method for synthesising ivabradine and its addition salts
(71) Les Laboratoires Servier, 35, rue de Verdun, 92284 Suresnes Cedex, FR
(72) Peglion, Jean-Louis, 5, allée des Bégonias, 78110 Le Vesinet, FR
Caignard, Pascal, 34, avenue Gallieni, 93800 Epinay-sur-Seine, FR
-
- (51) MKP
A61K 9/00 (2006.01) (97) **2427154 ***
A61F 6/14 (2006.01)
- (86) EP2010055948 03.05.2010
(96) 10715875.0 14.03.2012
(87) WO2010128004, 03.05.2010
(97) 2427154, 14.03.2012 en
(54) INTRAUTERINE SYSTEM FOR USE IN MEDICAL TREATMENT
(71) N.V. Organon, Kloosterstraat 6, 5349 AB Oss, NL
(72) DE GRAAFF, Wouter, N.V. Organon P.O. Box 20, NL-5340 BH Oss, NL
VEENSTRA, Harm, P.O. Box 20, NL-5340 BH Oss, NL
MULDERS, Titia Martine Truce, N.V. Organon P.O. Box 20, NL-5340 BH Oss, NL
-
- (51) MKP
A61P 35/00 (2006.01) (97) **2435068 ***
A61P 35/02 (2006.01)
G01N 33/574 (2006.01)
A61K 38/20 (2006.01)
A61K 39/395 (2006.01)
- (86) US2010036615 28.05.2010
(96) 10781290.1 04.04.2012
(87) WO2010138839, 28.05.2010
(97) 2435068, 04.04.2012 en
(54) USE OF 2 ANTI-SPARC ANTIBODIES TO PREDICT RESPONSE TO CHEMOTHERAPY
(71) Abraxis BioScience, LLC, 11755 Wilshire Boulevard Suite 2000, Los Angeles, CA 90025, US
(72) TRIEU, Vuong, 3965 North Ceanothus Place H, Calabasas, California 91302, US
DESAI, Neil, 11755 Wilshire Boulevard Suite 2000, Los Angeles, California 90025, US
KNAUER, Daniel, 1109 El Camino Drive, Costa Mesa, California 92626, US
-
- (51) MKP
A61K 35/74 (2006.01) (97) **2459203 ***
A61P 5/50 (2006.01)
A61P 29/00 (2006.01)
- (86) IB2010053482 30.07.2010
(96) 10747076.7 06.06.2012
(87) WO2011013106, 30.07.2010
(97) 2459203, 06.06.2012 en
(54) LACTIC ACID BACTERIA AND BIFIDOBACTERIA FOR TREATING ENDOTOXEMIA
(71) Danisco A/S, Langebrogade 1 PO Box 17, 1001 Copenhagen K, DK
(72) BURCELIN, Rémy, 2 rue Douledro, F-31750 Escalquens, FR
CARCANO, Didier, 52 Boulevard Saint-Germain, F-75005 Paris, FR
DESREUMAUX, Pierre, 121 Avenue du Parc Monceau, F-59800 Lille, FR
LAHTINEN, Sampo, Säästöpankintie 10, FI-02580 Siuntio, FI
RAUTONEN, Nina, Säynäväkuja 4B8, FI-02170 Espoo, FI
PUTAALA, Heli, Puoshaankuga 6, FI-02400 Kirkkonummi, FI
TIIHONEN, Kirsti, Rahapajankatu 3 C 21, FI-00160 Helsinki, FI
BARRANGOU, Rodolphe, 4818 Valor Way, Madison WI 53718, US
-
- (51) MKP
A61K 31/44 (2006.01) (97) **2448407 ***
A01N 43/42 (2006.01)
- (86) US2010040775 01.07.2010
(96) 10794762.4 09.05.2012
(87) WO2011002991, 01.07.2010
(97) 2448407, 09.05.2012 en
(54) BENZOIC ACID, BENZOIC ACID DERIVATIVES AND HETEROARYL CARBOXYLIC ACID CONJUGATES OF HYDROCODONE, PRODRUGS, METHODS OF MAKING AND USE THEREOF
(71) Kempharm, Inc., 7 Hawkeye Dr., Suite 103, North Liberty, IA 52317, US
(72) MICKLE, Travis, 3015 Wind Ridge Drive, Coralville Iowa 52241, US
GUENTHER, Sven, 913 Forest Edge Circle, Coralville Iowa 52241, US
MICKLE, Christal, 3015 Wind Ridge Drive, Coralville Iowa 52241, US
CHI, Guochen, 245 Sadler Lane 303, North Liberty Iowa 52317, US
KANSKI, Jaroslaw, 209 Heartwood Crossing, Blacksburg Virginia 24060, US
MARTIN, Andrea K., 2235 Shavers Farm Road, Fincastle Virginia 24090, US
BERA, Bindu, 400 Algonquin Ct., Blacksburg Virginia 24060, US

- (51) MKP
C12N 15/88 (2006.01) (97) **2449114 ***
C07H 21/00 (2006.01)
C07H 21/02 (2006.01)
C12N 15/87 (2006.01)
A61K 9/14 (2006.01)
C12N 15/113 (2010.01)
A61P 35/00 (2006.01)
A61K 31/713 (2006.01)
(86) CA2010001030 30.06.2010
(96) 10793484.6 09.05.2012
(87) WO2011000107, 30.06.2010
(97) 2449114, 09.05.2012 en
(54) NOVEL LIPID FORMULATIONS FOR DELIVERY OF THERAPEUTIC AGENTS TO SOLID TUMORS
(71) Protiva Biotherapeutics Inc., 100-8900 Glenlyon Parkway, Burnaby, British Columbia V5J 5J8, CA
(72) YAWORSKI, Ed, 23106-123B Avenue, Maple Ridge British Columbia V2X 9Z7, CA
REID, Stephen, Apt. 303 1430 Chesterfield Avenue, Surrey British Columbia V7M 2N4, CA
HEYES, James, 47-870 West 7th Avenue, Vancouver British Columbia V5Z 4C1, CA
JUDGE, Adam, 1936 W. 11th Avenue, Vancouver British Columbia V6J 2C6, CA
MACLACHLAN, Ian, 13331 Sylvester Road, Mission British Columbia V2S 0B1, CA
-
- (51) MKP
B65G 17/26 (2006.01) (97) **2403783 ***
(86) IB2010000417 01.03.2010
(96) 10740249.7 11.01.2012
(87) WO2010100545, 01.03.2010
(97) 2403783, 11.01.2012 en
(54) PLANT FOR FEEDING GROUPS OF PRODUCTS TO A PACKAGING MACHINE
(71) Eurosicma S.p.A., Via Arbe 27, 20125 Milano, IT
(72) REDAELLI, Marco, Via Gramsci 16, I-20060 Cassina de' Pecchi, IT
-
- (51) MKP
C07J 41/00 (2006.01) (97) **2427473 ***
C07J 9/00 (2006.01)
(86) IB2010051990 06.05.2010
(96) 10727869.9 14.03.2012
(87) WO2010128472, 06.05.2010
(97) 2427473, 14.03.2012 en
(54) METHOD FOR THE SYNTHESIS OF GLYCOCHOLIC ACID
(71) PRODOTTI CHIMICI E ALIMENTARI SPA, Via Novi 78, 15060 Basaluzzo (Alessandria), IT
(72) GALDI, Gianluca, Via Roma 160/1, I-16030 Pieve Ligure (Genova), IT
PARENTI, Massimo, Via F. Cavallotti 75, I-15067 Novi Ligure (Alessandria), IT
ZUCCOTTI, Pierfranca, Via Villalvernia 16/A, I-15068 Pozzolo Formigaro (Alessandria), IT
-
- (51) MKP
A61K 38/19 (2006.01) (97) **2403519 ***
(86) AT2010000056 05.03.2010
(96) 10709949.1 11.01.2012
(87) WO2010099556, 05.03.2010
(97) 2403519, 11.01.2012 de
(54) METHOD FOR PREVENTING AND TREATING HYPERPERMEABILITY
(71) Apeptico Forschung Und Entwicklung Gmbh, Mariahilferstrasse 136, 1050 Wien, AT
(72) FISCHER, Bernhard, Wilhelminenstrasse 95/C/17, A-1160 Wien, AT
LUCAS, Rudolf, Frits van den Berghelaan 83, B-2630 Aartselaar, BE
-
- (51) MKP
B60N 2/28 (2006.01) (97) **2499020 ***
B60N 2/26 (2006.01)
(86) AU2010001495 09.11.2010
(96) 10827736.9 19.09.2012
(87) WO2011054063, 09.11.2010
(97) 2499020, 19.09.2012 en
(54) CHILD SEAT WITH IMPACT PROTECTION
(71) Britax Childcare Pty Ltd., 99 Derby Road, Sunshine, VIC 3020, AU
(72) LUMLEY, Mike, 99 Derby Road, Sunshine VIC 3020, AU
BOYLE, Stuart, 99 Derby Road, Sunshine VIC 3020, AU
MACIEJCZYK, Wieslaw, 99 Derby Road, Sunshine VIC 3020, AU
-
- (51) MKP
A61K 31/425 (2006.01) (97) **2493312 ***
A01N 43/78 (2006.01)
(86) US2010053507 21.10.2010
(96) 10827338.4 05.09.2012
(87) WO2011053504, 21.10.2010
(97) 2493312, 05.09.2012 en
(54) SOLID PHARMACEUTICAL COMPOSITIONS CONTAINING AN INTEGRASE INHIBITOR
(71) Merck Sharp & Dohme Corp., 126 East Lincoln Avenue, Rahway NJ 07065-0907, US
(72) MAHJOUR, Majid, 770 Sumneytown Pike, West Point, Pennsylvania 19486, US
LI, Feng, 770 Sumneytown Pike, West Point, Pennsylvania 19486, US
MA, Decheng, 770 Sumneytown Pike, West Point, Pennsylvania 19486, US
SOTTHIVIRAT, Sutthilug, 770 Sumneytown Pike, West Point, Pennsylvania 19486, US
-
- (51) MKP
A61K 31/437 (2006.01) (97) **2445911 ***
A61P 19/02 (2006.01)
C07D 471/04 (2006.01)
(86) EP2010059064 25.06.2010
(96) 10724881.7 02.05.2012
(87) WO2010149769, 25.06.2010
(97) 2445911, 02.05.2012 en
(54) 5-PHENYL-[1,2,4]TRIAZOLO[1,5-A]PYRIDIN-2-YL CARBOXAMIDES AS JAK INHIBITORS
(71) Galapagos N.V., Generaal de Wittelaan L11 A3, 2800 Mechelen, BE
(72) MENET, Christel Jeanne Marie, Galapagos NV Generaal De Wittelaan L11/A3, B-2800 Mechelen, BE
SMITS, Koen Kurt, Galapagos NV Generaal De Wittelaan L11/A3, B-2800 Mechelen, BE
-
- (51) MKP
A01N 43/62 (2006.01) (97) **2470019 ***
A61K 31/55 (2006.01)
(86) US2010046452 24.08.2010
(96) 10812546.9 04.07.2012
(87) WO2011025771, 24.08.2010
(97) 2470019, 04.07.2012 en
(54) COMPOSITIONS FOR DELIVERY OF INSOLUBLE AGENTS
(71) Cardiokine Biopharma, LLC, 1255 Crescent Green Drive, Suite 250, Cary, NC 27518, US
(72) CHEN, Hailiang, 7689 Palmilla Drive No.1213, San Diego CA 92122, US
CHEN, Andrew, Xian, 4646 Bryson Ter, San Diego CA 92130, US
FRECH, Patricia, 76 Sumner Street, East Boston MA 02128, US
ABU-IZZA, Khawla, 28 Forest Park Road, Woburn MA 01801, US
SCHMIDT, Christoph, Seestrasse 109, 8002 Zurich, CH

- (51) MKP
C07K 16/28 (2006.01) (97) **2459593 ***
C07K 16/40 (2006.01)
A61P 27/02 (2006.01)
A61P 43/00 (2006.01)
- (86) EP2010060867 27.07.2010
(96) 10735014.2 06.06.2012
(87) WO2011012609, 27.07.2010
(97) 2459593, 06.06.2012 en
(54) ANTI-TGF-BETA RECEPTOR TYPE II SINGLE DOMAIN ANTIBODIES
(71) Glaxo Group Limited, Glaxo Wellcome House Berkeley Avenue Greenford, Middlesex UB6 0NN, GB
(72) DE WILDT, Rudolf Maria, GlaxoSmithKline Gunnels Wood Road, Stevenage Hertfordshire SG1 2NY, GB
DIMECH, Caroline J, GlaxoSmithKline Gunnels Wood Road, Stevenage Hertfordshire SG1 2NY, GB
HOLMES, Steve, Domantis Limited 315 Cambridge Science Park, Cambridge Cambridgeshire CB4 0WG, GB
STOOP, Adriaan Allart, Domantis Limited 315 Cambridge Science Park, Cambridge Cambridgeshire CB4 0WG, GB
-
- (51) MKP
B29C 65/08 (2006.01) (97) **2483057 ***
B29C 65/64 (2006.01)
B60J 10/02 (2006.01)
B29C 65/60 (2006.01)
B60R 13/06 (2006.01)
B60R 13/04 (2006.01)
- (86) FR2010052080 01.10.2010
(96) 10776778.2 08.08.2012
(87) WO2011039490, 01.10.2010
(97) 2483057, 08.08.2012 fr
(54) METHOD FOR FIXING AN ADDITIONAL PART TO A GLAZING OR A PROFILED RIM, FIXING DEVICE FOR FIXING SAID PART, AND GLAZING OBTAINED BY SAID METHOD
(71) Saint-Gobain Glass France, 18 avenue d'Alsace, 92400 Courbevoie, FR
(72) VERRAT, Adèle, 14 allée de la Montagne, F-60150 Villers-sur-Coudun, FR
FROISSARD, Loïc, 4 rue Soeur Thérèse Massin, F-60200 Compiègne, FR
-
- (51) MKP
G07F 17/32 (2006.01) (97) **2357622**
G07F 17/34 (2006.01)
- (96) 10193762.1 17.08.2011
(97) 2357622, 17.08.2011 de
(54) Method for operating a gaming device of an entertainment device
(71) adp Gauselmann GmbH, Merkur-Allee 1-15, 32339 Espelkamp, DE
-
- (51) MKP
H04B 7/26 (2006.01) (97) **2495886 ***
- (86) CN2010078231 29.10.2010
(96) 10826106.6 05.09.2012
(87) WO2011050743, 29.10.2010
(97) 2495886, 05.09.2012 en
(54) METHOD, APPARATUS AND SYSTEM FOR UPLINK SYNCHRONIZATION
(71) China Academy of Telecommunications Technology, 40, Xueyuan Road, Haidian District, Beijing 100191, CN
(72) XU, Fangli, No.40 Xueyuan Road Haidian District, Beijing 100083, CN
ZHAO, Yali, No.40 Xueyuan Road Haidian District, Beijing 100083, CN
LIU, Jiamin, No.40 Xueyuan Road Haidian District, Beijing 100083, CN
ZHAO, Yi, No.40 Xueyuan Road Haidian District, Beijing 100083, CN
-
- (51) MKP
A61K 9/00 (2006.01) (97) **2440208 ***
A61K 31/5377 (2006.01)
A61K 9/14 (2006.01)
- (86) US2010037795 08.06.2010
(96) 10724964.1 18.04.2012
(87) WO2010144464, 08.06.2010
(97) 2440208, 18.04.2012 en
(54) SOLID DISPERSIONS CONTAINING AN APOPTOSIS-PROMOTING AGENT
(71) Abbott Laboratories, 100 Abbott Park Rd., Abbott Park, IL 60064, US
(72) SCHMITT, Eric A., 319 Evergreen Court, Libertyville, Illinois 60048, US
TONG, Ping, 6152 Indian Trail, Gurnee, Illinois 60031, US
HEEMSTRA, Katherine, 641 W. Grand Avenue Apt. 4, Chicago, Illinois 60654, US
FISCHER, Cristina M., 2821 N. Augusta Drive, Wadsworth, Illinois 60083, US
WU, Huailiang, 8094 Rfd Breckenridge Drive, Long Grove, Illinois 60047, US
MILLER, Jonathan Mark, 1228 Meade Court, Lindenhurst, Illinois 60046, US
LI, Yanxia, 34056 Sulkey Drive, Grayslake, Illinois 60030, US
LAFOUNTAIN, Justin S., 659 W. Randolph Street Unit 913, Chicago, Illinois 60661, US
-
- (51) MKP
A61K 31/506 (2006.01) (97) **2443095 ***
A61P 37/00 (2006.01)
C07D 239/48 (2006.01)
C07D 403/12 (2006.01)
C07D 403/14 (2006.01)
- (86) EP2010058573 17.06.2010
(96) 10725720.6 25.04.2012
(87) WO2010146132, 17.06.2010
(97) 2443095, 25.04.2012 en
(54) SULFONAMIDES AND SULFAMIDES AS ZAP-70 INHIBITORS
(71) Cellzome Limited, Chesterford Research Park, Little Chesterford Cambridgeshire CB10 1XL, GB
(72) MAJOR, Jeremy, 8 The Haven, Fulbourn, Cambridge CB21 5BG, GB
PITON, Nelly, 40 Saffron Court Station Street, Saffron Walden CB11 3BH, GB
-
- (51) MKP
A61B 17/34 (2006.01) (97) **2459084 ***
A61B 19/00 (2006.01)
- (86) US2010042765 21.07.2010
(96) 10735412.8 06.06.2012
(87) WO2011014394, 21.07.2010
(97) 2459084, 06.06.2012 en
(54) SURGICAL ACCESS DEVICES WITH SORBENTS
(71) Ethicon Endo-Surgery, Inc., 4545 Creek Road, Cincinnati, OH 45242, US
(72) MORENO, Cesar, E., Jr., 514 Ezzard Charles Drive, Cincinnati OH 45214, US
MINNELLI, Patrick, J., 103 Burk Lane, Harrison OH 45030, US
GILKER, Thomas, A., 3434 Darwin Place, Cincinnati OH 45211, US
MUMAW, Daniel, J., 953 Long Lane, Milford OH 45150, US
MOLLERE, Rebecca, J., 6178 Spires Drive, Loveland OH 45140, US
TANGUAY, Randall, 4299 N. Sr 741, Lebanon OH 45036, US
FRANER, Paul, T., 6217 Rapid Run Road, Cincinnati OH 45233, US
-
- (51) MKP
A61K 47/48 (2006.01) (97) **2470216 ***
C07K 5/02 (2006.01)
- (86) GB2010001796 23.09.2010
(96) 10757623.3 04.07.2012
(87) WO2011036457, 23.09.2010
(97) 2470216, 04.07.2012 en
(54) PEPTIDE CLEARING AGENTS
(71) Mologic Ltd, Colworth Science Park, Sharnbrook, Beds MK44 1LQ, GB
(72) DAVIS, Paul, James, Mologic Ltd Colworth Science Park Sharnbrook, Bedfordshire MK44 1LQ, GB
SCHOUTEN, James, Alexander, Mologic Ltd Colworth Science Park Sharnbrook, Bedfordshire MK44 1LQ, GB

(51) MKP
A61K 9/127 (2006.01) (97) **2437726 ***
 (86) IB2010001557 03.06.2010
 (96) 10742250.3 11.04.2012
 (87) WO2010140061, 03.06.2010
 (97) 2437726, 11.04.2012 en
 (54) FORMULATIONS FOR THE TREATMENT OF DEEP TISSUE PAIN
 (71) Mayo, John Charles, Leverton House 13 Bedford Square, London WC1B 3RA, GB
 Vierl, Ulrich, Friedenstrasse 3, Groebenzell, DE
 Iliffe, George Langton, Leverton House 13 Bedford Square, London WC1B 3RA, GB
 Rother, Matthias, Larchenstrabe 3, 82166 Grafelfing, DE
 (72) Mayo, John Charles, Leverton House 13 Bedford Square, London WC1B 3RA, GB
 Iliffe, George Langton, Leverton House 13 Bedford Square, London WC1B 3RA, GB
 Vierl, Ulrich, Friedenstrasse 3, Groebenzell, DE
 Rother, Matthias, Larchenstrabe 3, 82166 Grafelfing, DE

(51) MKP
A61P 25/18 (2006.01) (97) **2298328**
A61P 25/28 (2006.01)
A61P 25/16 (2006.01)
A61K 35/44 (2006.01)
 (96) 10250970.0 23.03.2011
 (97) 2298328, 23.03.2011 en
 (54) Use of umbilical cord blood cells for the treatment of neurological disorders
 (71) Cryocenter, Ltd., Akademika Oparina Str. 4, Moscow 117997, RU
 (72) Ramanov, Yuriy Askoldovich, Kuusinena Str. 4/6 korpus "A", kv. 10, Moscow, RU
 Radaev, Sergey Maksimovich, Halturinskaya Str., 12 Korpus 1 kv. 30, Moscow, RU
 Morozova, Yana Vyacheslavovna, Rossiyskaya Str. 48 kv 7, Serpuhov, Moscow region, RU
 Smirnov, Vladimir Nikolaevich, B. Palashevskiy per., 3 kv. 7, Moscow, RU
 Klimov, Igor Aleksandrovich, Zeleny prospect, 42 kv. 101, Moscow, RU
 Khachatryan, William Aranovich, Vosstaniya Str., 43 kv. 7, Sankt-Petersburg, RU
 Proshkin, Sergey Dmitrievich, Osennyaya Str., 2 apart. 131, Moscow, RU
 Gavrilova, Svetlana Ivanovna, Dmitrovskiy proezd, 16 kv. 250, Moscow, RU
 Lebedev, Konstantin Eduardovich, Butlerova Str., 28 apart. 36, Sankt-Petersburg, RU
 Polyakov, Yuriy Izrailevich, Prospect Stachek, 59 kv. 328, Sankt-Petersburg, RU
 Boiko, Aleksey Nikolaevich, Baykalskaya Str., 40/17 kv. 277, Moscow, RU
 Medvedev, Svyatoslav Vsevodolovich, Kronverkskaya Str. 29/37 kv. 33, Sankt-Petersburg, RU
 Davydovskaya, Maria Vafaevna, Pyatnitskaya Str., 47 kv. 448, Moscow, RU
 Savchenko, Valeriy Grigorievich, Talalihina Str., 26 kv. 32, Moscow, RU
 Pavlova, Lyubov Konstantinovna, Bolshaya Spasskaya Str., 10 korpus 1 kv. 177, Moscow, RU
 Sukhikh, Gennadiy Tikhonovich, Udaltsova Str., 26 kv. 32, Moscow, RU
 Dubnitskaya, Etheri Broneslavovna, Adropova prospect, 35 kv. 8, Moscow, RU
 Paltsev, Mikhail Aleksandrovich, Obolenskiy per., 9 Korpus 8 Kv. 46, Moscow, RU
 Smulevich, Anatoliy Boleslavovich, Vorontsovskaya Str., 25 stroenie 1 kv. 9, Moscow, RU

(51) MKP
F01N 3/20 (2006.01) (97) **2402609**
F04B 53/16 (2006.01)
F04B 39/12 (2006.01)
 (96) 11169942.7 04.01.2012
 (97) 2402609, 04.01.2012 en
 (54) Pump for dosing fluids
 (71) Delphi Technologies Holding S.à.r.l., Avenue de Luxembourg, 4940 Bascharage, LU
 (72) Wright, Keith, 6 Kinross Close Walderslade, Chatham, Kent ME5 7RS, GB
 Cooke, Michael, 52 Burnt Oak Terrace, Gillingham, Kent ME7 1DR, GB
 Smith, Neil, 29 Hillingdon Road, Gravesend, Kent DA11 7LQ, GB
 Hardy, Martin, 71 Cedar Grove Hempstead, Gillingham, Kent ME7 3QZ, GB
 Lawford, Ivan, 61 Shakespeare Road, Gillingham, Kent ME7 5QN, GB
 Stanbury, Kevin, 34 Longfield Avenue High Halstow, Rochester, Kent ME3 8TD, GB

(51) MKP
A61K 31/517 (2006.01) (97) **2499129 ***
C07D 487/04 (2006.01)
A61P 35/00 (2006.01)
A61P 29/00 (2006.01)
C07D 403/04 (2006.01)
A61P 25/28 (2006.01)
A61P 9/00 (2006.01)
 (86) EP2010067304 11.11.2010
 (96) 10781864.3 19.09.2012
 (87) WO2011058108, 11.11.2010
 (97) 2499129, 19.09.2012 en
 (54) QUINOLINE AND QUINOXALINE DERIVATIVES AS KINASE INHIBITORS
 (71) UCB Pharma, S.A., 60, allée de la Recherche, 1170 Brussels, BE
 (72) ALLEN, Daniel, Rees, BioFocus DPI Chesterford Research Park, Saffron Walden Essex CB10 1XL, GB
 BÜRLI, Roland, BioFocus DPI Chesterford Research Park, Saffron Walden Essex CB10 1XL, GB
 HAUGHAN, Alan, Findlay, BioFocus DPI Chesterford Research Park, Saffron Walden Essex CB10 1XL, GB
 MATTEUCCI, Mizio, BioFocus DPI Chesterford Research Park, Saffron Walden Essex CB10 1XL, GB
 OWENS, Andrew, Pate, BioFocus DPI Chesterford Research Park, Saffron Walden Essex CB10 1XL, GB
 RAPHY, Gilles, BioFocus DPI Chesterford Research Park, Saffron Walden Essex CB10 1XL, GB
 SHARPE, Andrew, BioFocus DPI Chesterford Research Park, Saffron Walden Essex CB10 1XL, GB

(51) MKP
G07F 19/00 (2006.01) (97) **2452321 ***
 (86) IB2010001541 25.06.2010
 (96) 10742248.7 16.05.2012
 (87) WO2011004230, 25.06.2010
 (97) 2452321, 16.05.2012 de
 (54) DEVICE FOR MANAGING, RECEIVING, AND/OR DISPENSING OBJECTS OF VALUE
 (71) Novomatic AG, Wiener Strasse 158, 2352 Gumpoldskirchen, AT
 (72) MÜHRENBURG, Roland, c/o Novomatic AG IP&Rechtsabteilung Wiener Strasse 15, A-2352 Gumpoldskirchen, AT
 OCHS, Helmut, c/o Novomatic AG IP&Rechtsabteilung Wiener Strasse 15, A-2352 Gumpoldskirchen, AT
 ZANDER, Marko, c/o Novomatic AG IP&Rechtsabteilung Wiener Strasse 15, A-2352 Gumpoldskirchen, AT

- (51) MKP
B01J 2/22 (2006.01) (97) **2454011 ***
(86) US2010041797 13.07.2010
(96) 10742329.5 23.05.2012
(87) WO2011008737, 13.07.2010
(97) 2454011, 23.05.2012 en
(54) ENGINEERED AEROSOL PARTICLES, AND ASSOCIATED METHODS
(71) The University of North Carolina At Chapel Hill, 308 Bynum Hall, Campus Box 4105, Chapel Hill, NC 27599-4105, US
Liquidia Technologies, Inc., 419 Davis Drive Suite 100, Durham, NC 27713, US
(72) DESIMONE, Philip, 7315 Crescent Ridge, Chapel Hill NC 27615, US
MAYNOR, Benjamin, 3700 Northampton Road, Durham NC 27707, US
NAPIER, Mary, 106 Woods Walk Court, Carrboro NC 27510, US
PILLAI, Jonathan, 1002 Willow Dr. Apt. 105, Chapel Hill NC 27514, US
DESIMONE, Joseph, M., 7315 Crescent Ridge, Chapel Hill NC 27615, US
PATRICK, Will, 101 Quailview Dr., Chapel Hill NC 27516, US
LAAKER, Kyle, 2768 Ashbrook Dr., Lexington KY 40513, US
ZHANG, Hanjun, Building 20 Room 37 Dongsheng Shequ Xialu Hebei, 435004, CN
-
- (51) MKP
A61K 31/551 (2006.01) (97) **2497774**
C07D 498/04 (2006.01)
(96) 12290077.2 12.09.2012
(97) 2497774, 12.09.2012 fr
(54) Dihydro-oxazolobenzodiazepinone derivatives, processes for their preparation and pharmaceutical compositions comprising these compounds
(71) Les Laboratoires Servier, 35, rue de Verdun, 92284 Suresnes Cedex, FR
EGIS Gyógyszergyár Nyrt, Keresztúri út 30-38, 1106 Budapest, HU
(72) Ling, István, Almos vezér út. 44, 1141 Budapest, HU
Barkóczy, József, Szirom u. 4-6/B, 1016 Budapest, HU
Antoni, Ferenc, 12 Greenbank Rise, EH10 5RW Edinburgh, GB
Gacsályi, István, baross u. 67, 1201 Budapest, HU
Lévay, György, Gábor Aron u. 10, 2092 Budakeszi, HU
Spedding, Michael, 6, rue Ampère, 78110 le Vesinet, FR
Hársing, László, Afonya u. 9/a fszt. 1, H-1071 Budapest, HU
-
- (51) MKP
A01H 5/00 (2006.01) (97) **2473022 ***
C12N 15/52 (2006.01)
C12N 15/82 (2006.01)
(86) US2010047571 01.09.2010
(96) 10814446.0 11.07.2012
(87) WO2011028832, 01.09.2010
(97) 2473022, 11.07.2012 en
(54) HERBICIDE-TOLERANT PLANTS
(71) BASF Agrochemical Products, B.V., Groningsingel 1, 6835 EA Arnhem, NL
(72) MANKIN, Scots, L., 4800 Deerwood Drive, Raleigh, NC 27612, US
SCHOFI, Ulrich, 100 Hoboken Court, Apex, NC 27523, US
HONG, Haiping, 117 Melling Place, Cary, NC 27519, US
WENCK, Allan, R., 4315 Etta Road, Durham, NC 27705, US
NEUTEBOOM, Leon, 10 Seabury Way, Youngsville, NC 27596, US
WHITT, Sherry, R., 11412 Dunleith Drive, Raleigh, NC 27614, US
CARLSON, Dale, R., 600 Sawcut Lane, Apex, NC 27502, US
-
- (51) MKP
B65B 9/067 (2012.01) (97) **2465781**
B65B 9/087 (2012.01)
B29C 65/18 (2006.01)
B65B 43/04 (2006.01)
(96) 11009841.5 20.06.2012
(97) 2465781, 20.06.2012 en
(54) Horizontal packaging machine
(71) Eficiencia y Tecnología, S.A., Bellvei, 41-49, Nave 9 (pol.Ind. Can Salvatella), 08210 Barbera Del Vallés Barcelona, ES
(72) Broto Solano, Jose Ma, Bellvei, 41-49, Nave 9, 08210 Barbera del Vallés (Barcelona), ES
-
- (51) MKP
A61K 31/4535 (2006.01) (97) **2435427 ***
C07D 413/04 (2006.01)
A61K 31/4525 (2006.01)
C07D 413/14 (2006.01)
A61K 31/4545 (2006.01)
(86) EP2010003059 19.05.2010
(96) 10724697.7 04.04.2012
(87) WO2010136144, 19.05.2010
(97) 2435427, 04.04.2012 de
(54) SUBSTITUTED PIPERIDINES
(71) Bayer Pharma Aktiengesellschaft, Müllerstrasse 178, 13353 Berlin, DE
(72) GERDES, Christoph, Düsseldorf Str. 75, 51063 Köln, DE
GNOTH, Mark Jean, Am Hang 53, 40822 Mettmann, DE
HEIMBACH, Dirk, Schanzenstr. 125, 40549 Düsseldorf, DE
GERICKE, Kersten Matthias, Funckstr. 54, 42115 Wuppertal, DE
RÖHRIG, Susanne, Dietrich-Bonhoeffer Str. 66, 40724 Hilden, DE
JESKE, Mario, Schneebacher Weg 20, 42699 Solingen, DE
CANCHO GRANDE, Yolanda, Christian-Hess Str. 79, 51373 Leverkusen, DE
BUCHMÜLLER, Anja, Baderweg 72a, 45259 Essen, DE
ZIMMERMANN, Katja, Bockumer Str. 370b, 40489 Düsseldorf, DE
BENDER, Eckhard, Gudrunstr. 6 Wohnung 9, 40764 Langenfeld, DE
-
- (51) MKP
C07D 471/04 (2006.01) (97) **2411388 ***
A61K 31/437 (2006.01)
(86) US2010028535 24.03.2010
(96) 10711513.1 01.02.2012
(87) WO2010111418, 24.03.2010
(97) 2411388, 01.02.2012 en
(54) PROCESS FOR THE PRODUCTION OF FUSED, TRICYCLIC SULFONAMIDES
(71) Elan Pharmaceuticals Inc., 800 Gateway Boulevard, South San Francisco, CA 94080, US
(72) DAPPEN, Michael S., 740 Vernal Way, Emerald Hills California 94062, US
JAGODZINSKI, Jacek J., 1485 Kentfield Avenue, Redwood City California 94061, US
LATIMER, Lee H., 56 Sheridan Road, Oakland California 94618, US
WU, Jing, 524 Shorebird Circle Unit 15204, Redwood City California 94065, US
GODFREY, Jollie Duaine, Jr., 16 Wickford Avenue, Ewing New Jersey 08618, US
MATUNAS, Robert M., 213 Woodmill Drive, Cranbury New Jersey 08512, US
DRABB, Thomas W., 1804 S. Clinton Avenue, Trenton New Jersey 08610, US
PROBST, Gary, D., 155 Haight Street, Apt 107, San Francisco, CA 94102, US
-
- (51) MKP
C07C 53/126 (2006.01) (97) **2451771 ***
A61P 25/16 (2006.01)
C07C 53/122 (2006.01)
A61K 31/19 (2006.01)
C07C 211/42 (2006.01)
A61K 31/13 (2006.01)
C07C 57/12 (2006.01)
(86) EP2010059723 07.07.2010
(96) 10731734.9 16.05.2012
(87) WO2011003938, 07.07.2010
(97) 2451771, 16.05.2012 en
(54) SALTS OF RASAGILINE AND PHARMACEUTICAL PREPARATIONS THEREOF
(71) Ratiopharm GmbH, Graf-Arco-Strasse 3, 89079 Ulm, DE
(72) THYRANN, Thomas, Baselmattweg 148a, CH-4123 Allschwil, CH
JANSSEN, Christian, Burgstr. 10, 89171 Illerkirchberg, DE
GIDWANI, Ramesh Matoram, Coral 702 Nirmal Lifestyles L.B.S. Marg Mulund (West), Mumbai Maharashtra 400080, IN

- (51) MKP
C07K 16/00 (2006.01) (97) **2408814 ***
C12P 21/08 (2006.01)
- (86) US2010028060 19.03.2010
(96) 10754210.2 25.01.2012
(87) WO2010108153, 19.03.2010
(97) 2408814, 25.01.2012 en
- (54) CARRIER IMMUNOGLOBULINS AND USES THEREOF
(71) Amgen, Inc, One Amgen Center Drive, Thousand Oaks, CA 91320-1799, US
(72) WALKER, Kenneth, W., 175 Mesa Avenue, Newbury Park California 91320, US
LI, Yue-Sheng, 3025 Shadow Hill Circle, Thousand Oaks California 91360, US
BOONE, Thomas, C., 2715 Kelly Knoll Lane, Newbury Park California 91320, US
MIN, HoSung, 174-1 Jungja-dong Bundang-gu The Sharp Star Park 104dong 401ho, Sungnam-si, Gyeonggi-do, KR
TALVENHEIMO, Jane, 1363 Calle Pecos, Thousand Oaks California 91360, US
ARORA, Taruna, 5380 Via Pisa, Thousand Oaks California 91320, US
JACOBSEN, Frederick, W., 1168 Homestake Place, Newbury Park California 91320, US
DOELLGAST, George, (deceased), US

- (51) MKP
C07D 405/12 (2006.01) (97) **2440534 ***
C07D 239/48 (2006.01)
A61K 31/505 (2006.01)
C07D 401/12 (2006.01)
- (86) EP2010058154 10.06.2010
(96) 10725114.2 18.04.2012
(87) WO2010142766, 10.06.2010
(97) 2440534, 18.04.2012 en
- (54) PYRIMIDINE DERIVATIVES AS ZAP-70 INHIBITORS
(71) Cellzome Limited, Chesterford Research Park, Little Chesterford Cambridge CB10 1XL, GB
(72) RAMSDEN, Nigel, Sparrows Lodge Green Lane Fowlmere Royston, Herts SG8 7QP, GB
MAJOR, Jeremy, 10 Chigwell Court, Cambridge CB5 8TY, GB
MOREL, Adeline, 11 The Maltings Saffron Walden, Essex CB10 1DY, GB
SUNOSE, Mihiro, 18 Old Forge Way Sawston, Cambridge CB22 3BD, GB
PITON, Nelly, 40 Saffron Court Station Street, Saffron Walden CB11 3BH, GB

- (51) MKP
C10G 45/00 (2006.01) (97) **2474594 ***
C10G 2/00 (2006.01)
- (86) JP2010063701 12.08.2010
(96) 10811702.9 11.07.2012
(87) WO2011024652, 12.08.2010
(97) 2474594, 11.07.2012 en
- (54) HYDROCARBON SYNTHESIS REACTION APPARATUS, HYDROCARBON SYNTHESIS REACTION SYSTEM, AND HYDROCARBON SYNTHESIS REACTION METHOD
(71) INPEX Corporation, 5-3-1 Akasaka Minato-ku, Tokyo 107-6332, JP
Japan Oil, Gas and Metals National Corporation, 2-10-1, Toranomon, Minato-ku, Tokyo 105-0001, JP
Nippon Steel Engineering Co., Ltd, 5-1, Osaki 1-chome Shinagawa-ku, Tokyo 141-8604, JP
Japan Petroleum Exploration Co., Ltd., 7-12, Marunouchi 1-chome Chiyoda-ku, Tokyo 100-0005, JP
Cosmo Oil Co., Ltd., 1-1-1, Shibaura 1-chome, Minato-ku Tokyo 105-8528, JP
JX Nippon Oil & Energy Corporation, 6-3, Otemachi 2-chome, Chiyoda-ku Tokyo 100-8162, JP
(72) ONISHI, Yasuhiro, c/o NIPPON STEEL ENGINEERING CO. LTD. Osaki Center Building 5-1 Osaki 1-chome Shinagawa-ku, Tokyo 141-8604, JP
KATO, Yuzuru, c/o NIPPON STEEL ENGINEERING CO. LTD. Osaki Center Building 5-1 Osaki 1-chome Shinagawa-ku, Tokyo 141-8604, JP
YAMADA, Eiichi, c/o NIPPON STEEL ENGINEERING CO. LTD. Osaki Center Building 5-1 Osaki 1-chome Shinagawa-ku, Tokyo 141-8604, JP

- (51) MKP
C12P 7/06 (2006.01) (97) **2406383 ***
- (86) US2010026803 10.03.2010
(96) 10751346.7 18.01.2012
(87) WO2010104938, 10.03.2010
(97) 2406383, 18.01.2012 en
- (54) REDUCING CARBON DIOXIDE PRODUCTION AND INCREASING ETHANOL YIELD DURING MICROBIAL ETHANOL FERMENTATION
(71) Athena Biotechnologies, Inc., Delaware Technology Park 5 Innovation Way Suite 100, Newark, DE 19711, US
(72) MARRS, Barry, 7 Possum Tree Lane, Kennett Square PA 19348, US
SWALLA, Brian, M., 14 Nonesuch Cove Rd, Scarborough, ME 04074, US

- (51) MKP
C07D 207/16 (2006.01) (97) **2486008 ***
A61P 3/10 (2006.01)
A61K 31/401 (2006.01)
- (86) HU2010000106 07.10.2010
(96) 10773700.9 15.08.2012
(87) WO2011042765, 07.10.2010
(97) 2486008, 15.08.2012 en
- (54) INORGANIC SALT COMPLEXES OF VILDAGLIPTIN
(71) Egis Gyógyszergyár Nyilvánosan Működő Részvény-Társaság, Keresztúri út 30-38, 1106 Budapest, HU
(72) VOLK, Balázs, Atlasz u. 34, H-1165 Budapest, HU
DEBRECZENI, József, Harang u. 19., H-1037 Budapest, HU
NÉMETH, Gábor, Kövér Lajos u. 49/A, H-1149 Budapest, HU
BARKÓCZY, József, Szirom u. 4-6, H-1016 Budapest, HU
NAGY, Kálmán, Túrta u. 2/A, H-1025 Budapest, HU
RUZSICS, György, Dózsa Gy. u. 21, H-7191 Högyész, HU
MRAVIK, András, Ósagárd u. 41, H-1172 Budapest, HU
BRODA, Judit, Tűzkö u. 2, H-1118 Budapest, HU
KÖHEGYI, Imre, Lónyai u. 24, H-1093 Budapest, HU
DANCÓS, András, Tartsay V. u. 7, H-1183 Budapest, HU
PONGÓ, László, Hold u. 31, H-2144 Kerepes, HU
KESZTHELYI, Adrienn, Gyakorló u. 16. II/11, H-1106 Budapest, HU

- (51) MKP
A62C 35/02 (2006.01) (97) **2485811 ***
A62C 99/00 (2010.01)
A62D 1/02 (2006.01)
A62D 1/06 (2006.01)
- (86) CA2010001287 20.08.2010
(96) 10821504.7 15.08.2012
(87) WO2011041879, 20.08.2010
(97) 2485811, 15.08.2012 en
- (54) SYSTEM AND METHOD FOR SODIUM AZIDE BASED SUPPRESSION OF FIRES
(71) N2 Towers Inc., 175 Lahr Drive, Belleville, ON K8N 5S2, CA
(72) RICHARDSON, Adam T., 10 Forin Street, Belleville, Ontario K8N 2H6, CA
GOETZ, George, Unit 107 16033 East Primrose Drive, Fountain Hills, Arizona 85268, US

- (51) MKP
H01M 2/10 (2006.01) (97) **2413397**
H01M 10/50 (2006.01)
- (86) 11175043.6 01.02.2012
(97) 2413397, 01.02.2012 de
- (54) Device for holding a galvanic element, energy storage unit and energy storage stack
(71) Hoppecke Abt, Reichenbacher Str. 89a, 08056 Zwickau, DE
(72) Trantow, Sören, Agricolastr. 12, 09112 Chemnitz, DE
Schmidt, Torsten, Doberstauer Weg 13, 06166 Landsberg, DE
Reinhold, Stefan, Hermann-Kellner-Str. 2, 08058 Zwickau, DE

- (51) MKP
A61K 31/435 (2006.01) (97) **2427190 ***
A61P 31/04 (2006.01)
C07D 221/18 (2006.01)
(86) US2010001348 07.05.2010
(96) 10719818.6 14.03.2012
(87) WO2010129055, 07.05.2010
(97) 2427190, 14.03.2012 en
(54) 8-AZA TETRACYCLINE COMPOUNDS
(71) Tetrphase Pharmaceuticals, Inc., 480 Arsenal Street, Suite 110, Watertown, MA 02472, US
(72) CLARK, Roger, B., 20 Richard Road, Lexington MA 02421, US
HE, Minsheng, 480 Arsenal Street Suite 110, Watertown MA 02472, US
PLAMONDON, Louis, 65 Hamilton Road, Belmont MA 02478, US
XIAO, Xiao-Yi, 3851 Torrey Hill Lane, San Diego CA 92130, US
RONN, Magnus, 3 Irving Street, Melrose MA 02176, US

- (51) MKP
B60K 37/02 (2006.01) (97) **2490912 ***
B60K 11/08 (2006.01)
G01P 1/08 (2006.01)
G01D 13/26 (2006.01)
G01D 11/28 (2006.01)
(86) EP2010065351 13.10.2010
(96) 10768734.5 29.08.2012
(87) WO2011047996, 13.10.2010
(97) 2490912, 29.08.2012 de
(54) DISPLAY INSTRUMENT HAVING A POINTER
(71) Johnson Controls Automotive Electronics GmbH, Benzstraße 6, 75196 Remchingen, DE
(72) LUDEWIG, Bernd, Lessingstrasse 1, 69469 Weinheim, DE
DAURELLE, Jean-Yves, 35 rue de Naples, 75008 Paris, FR

- (51) MKP
A61F 9/06 (2006.01) (97) **2338446**
(96) 10192006.4 29.06.2011
(97) 2338446, 29.06.2011 en
(54) Method for controlling cartridge of welding helmet having display function of welding operation time
(71) Otos Wing Co., Ltd., 234-12, Gasan-dong, Geumcheon-ku Seoul 153-801, KR
(72) Huh, Moon Young, 234-12, Gasan-dong, Geumcheon-ku, 153-801, Seoul, KR

- (51) MKP
C07D 513/04 (2006.01) (97) **2448938 ***
A61K 31/52 (2006.01)
A61P 37/00 (2006.01)
A61P 29/00 (2006.01)
C07D 473/34 (2006.01)
(86) US2010040150 28.06.2010
(96) 10729035.5 09.05.2012
(87) WO2011008487, 28.06.2010
(97) 2448938, 09.05.2012 en
(54) PYRIMIDINONES AS PI3K INHIBITORS
(71) Incyte Corporation, Experimental Station Route 141 & Henry Clay Road Building 336, Wilmington, DE 19880, US
(72) LI, Yun-Long, 1 Pin Oak Drive, Chadds Ford Pennsylvania 19317, US
METCALF, Brian, W., 297 Lakefield Place, Moraga California 94556, US
COMBS, Andrew, P., 329 East Doe Run Road, Kennett Square Pennsylvania 19348, US

- (51) MKP
C07D 309/10 (2006.01) (97) **2486029 ***
(86) EP2010064120 24.09.2010
(96) 10762899.2 15.08.2012
(87) WO2011039108, 24.09.2010
(97) 2486029, 15.08.2012 en
(54) PROCESSES FOR PREPARING OF GLUCOPYRANOSYL-SUBSTITUTED BENZYL-BENZENE DERIVATIVES
(71) Boehringer Ingelheim International GmbH, Binger Straße 173, 55216 Ingelheim, DE
(72) WEBER, Dirk, Boehringer Ingelheim GmbH Corporate Patents Binger Str. 173, 55216 Ingelheim Am Rhein, DE
FIEDLER, Tobias, Boehringer Ingelheim GmbH Corporate Patents Binger Str. 173, 55216 Ingelheim Am Rhein, DE
FILSER, Christian, Boehringer Ingelheim GmbH Corporate Patents Binger Str. 173, 55216 Ingelheim Am Rhein, DE
HAMM, Rainer, Boehringer Ingelheim GmbH Corporate Patents Binger Str. 173, 55216 Ingelheim Am Rhein, DE
ORLICH, Simone, Boehringer Ingelheim GmbH Corporate Patents Binger Str. 173, 55216 Ingelheim Am Rhein, DE
POST, Matthias, Boehringer Ingelheim GmbH Corporate Patents Binger Str. 173, 55216 Ingelheim Am Rhein, DE
RENNER, Svenja, Boehringer Ingelheim GmbH Corporate Patents Binger Str. 173, 55216 Ingelheim Am Rhein, DE
WANG, Xiao-Jun, Boehringer Ingelheim Pharmaceuticals Inc. 900 Ridgebury Road, Ridgefield, Connecticut 06877, US
WIRTH, Thomas, Boehringer Ingelheim GmbH Corporate Patents Binger Str. 173, 55216 Ingelheim Am Rhein, DE

- (51) MKP
A23J 1/00 (2006.01) (97) **2417859 ***
A23J 3/00 (2006.01)
(86) RU2011000035 25.01.2011
(96) 11720609.4 15.02.2012
(87) WO2011078746, 25.01.2011
(97) 2417859, 15.02.2012 en
(54) CONCENTRATED PROTEIN PRODUCTS AND METHODS FOR PRODUCING SAME
(71) Ponomarev, Vasily Vasilievich, Kaluzhskaya pl. 1-1-33, Moscow 117049, RU
Bikbov, Takhir Mukhammedovich, Proezd Karamzina 9-1-185, Moscow 117463, RU
(72) Ponomarev, Vasily Vasilievich, Kaluzhskaya pl. 1-1-33, Moscow 117049, RU
Bikbov, Takhir Mukhammedovich, Proezd Karamzina 9-1-185, Moscow 117463, RU

- (51) MKP
C12N 15/68 (2006.01) (97) **2432884 ***
C12N 15/73 (2006.01)
C12N 15/63 (2006.01)
(86) US2010035979 24.05.2010
(96) 10720510.6 28.03.2012
(87) WO2010135742, 24.05.2010
(97) 2432884, 28.03.2012 en
(54) ANTIBIOTIC-FREE PLASMID
(71) Merial Ltd., 3239 Satellite Blvd., Duluth, GA 30096, US
(72) AUDONNET, Jean-christophe, 119 Rue De Crequi, F-69006 Lyon, FR
JOLIVET, Edmond, 933 Route De Jalloussieux, F-69530 Orlenas, FR

- (51) MKP
C10G 2/00 (2006.01) (97) **2474592 ***
(86) JP2010063684 12.08.2010
(96) 10811700.3 11.07.2012
(87) WO2011024650, 12.08.2010
(97) 2474592, 11.07.2012 en
(54) HYDROCARBON SYNTHESIS REACTION APPARATUS, HYDROCARBON SYNTHESIS REACTION SYSTEM, AND METHOD FOR COLLECTION OF LIQUID HYDROCARBON
(71) INPEX Corporation, 5-3-1 Akasaka Minato-ku, Tokyo 107-6332, JP
Japan Petroleum Exploration Co., Ltd., 7-12, Marunouchi 1-chome Chiyoda-ku, Tokyo 100-0005, JP
Cosmo Oil Co., Ltd., 1-1, Shibaura 1-chome Minato-ku, Tokyo 105-8528, JP
Japan Oil, Gas and Metals National Corporation, 2-10-1, Toranomon, Minato-ku, Tokyo 105-0001, JP
Nippon Steel Engineering Co., Ltd, 5-1, Osaki 1-chome Shinagawa-ku, Tokyo 141-8604, JP
JX Nippon Oil & Energy Corporation, 6-3, Otemachi 2-chome, Chiyoda-ku Tokyo 100-8162, JP
(72) ONISHI Yasuhiro, c/o NIPPON STEEL ENGINEERING CO. LTD. Osaki Center Building 5-1 Osaki 1-chome Shinagawa-ku, Tokyo 141-8604, JP
-
- (51) MKP
C10G 2/00 (2006.01) (97) **2500400 ***
C10G 47/36 (2006.01)
(86) JP2010068916 26.10.2010
(96) 10828213.8 19.09.2012
(87) WO2011055653, 26.10.2010
(97) 2500400, 19.09.2012 en
(54) METHOD OF HYDROCRACKING AND PROCESS FOR PRODUCING HYDROCARBON OIL
(71) Japan Oil, Gas and Metals National Corporation, 2-10-1, Toranomon, Minato-ku, Tokyo 105-0001, JP
INPEX Corporation, 5-3-1 Akasaka Minato-ku, Tokyo 107-6332, JP
JX Nippon Oil & Energy Corporation, 6-3, Otemachi 2-chome, Chiyoda-ku Tokyo 100-8162, JP
Japan Petroleum Exploration Co., Ltd., 7-12, Marunouchi 1-chome Chiyoda-ku, Tokyo 100-0005, JP
Cosmo Oil Co., Ltd., 1-1, Shibaura 1-chome Minato-ku, Tokyo 105-8528, JP
Nippon Steel Engineering Co., Ltd, 5-1, Osaki 1-chome Shinagawa-ku, Tokyo 141-8604, JP
(72) TASAKA, Kazuhiko, c/o JX Nippon Oil&Energy Corporation 8 Chidori-cho Naka-ku, Yokohama-shi Kanagawa 231-0815, JP
TANAKA, Yuichi, c/o JX Nippon Oil&Energy Corporation 8 Chidori-cho Naka-ku, Yokohama-shi Kanagawa 231-0815, JP
IWAMA, Marie, c/o JX Nippon Oil&Energy Corporation 8 Chidori-cho Naka-ku, Yokohama-shi Kanagawa 231-0815, JP
-
- (51) MKP
C12Q 1/68 (2006.01) (97) **2486146 ***
(86) EP2010005532 09.09.2010
(96) 10757568.0 15.08.2012
(87) WO2011042104, 09.09.2010
(97) 2486146, 15.08.2012 de
(54) METHOD FOR DETECTING GENE MODIFICATIONS BY MEANS OF ASYMMETRICAL PCR AND BLOCKING AGENTS
(71) Universität Duisburg-Essen, Universitätsstrasse 2, 45141 Essen, DE
(72) SCHULER, Martin, Rausenbergerstraße 4, 45133 Essen, DE
BREITENBÜCHER, Frank, Kardinal-Graf-Galen-Straße 26, 45468 Mülheim, DE
HOFFARTH, Sandra, Kardinal-Graf-Galen-Straße 26, 45468 Mülheim, DE
STERGAR, Sarah-Luise, Breddestraße 24, 45894 Gelsenkirchen, DE
-
- (51) MKP
A61K 35/34 (2006.01) (97) **2432482 ***
(86) EP2010057004 20.05.2010
(96) 10723556.6 28.03.2012
(87) WO2010133686, 20.05.2010
(97) 2432482, 28.03.2012 en
(54) PHARMACEUTICAL COMPOSITION FOR THE TREATMENT OF HEART DISEASES.
(71) Cardio3 Biosciences S.A., Axis Business Parc Rue Edouard Belin 12, 1435 Mont-Saint-Guibert, BE
(72) GAUSSIN, Vinciane, Avenue de l'Esplanade 6, B-1970 Wezembeek-oppem, BE
GORDON-BERESFORD, Roland, Avenue Antoinette Herlin 11, B-1310 La Hulpe, BE
HOMSY, Christian, Avenue des Sittelles 99, B-1150 Bruxelles, BE
-
- (51) MKP
E04B 2/02 (2006.01) (97) **2486198 ***
B32B 27/04 (2006.01)
B32B 7/04 (2006.01)
E04C 2/24 (2006.01)
E04C 1/40 (2006.01)
(86) AU2011001293 11.10.2011
(96) 11831841.9 15.08.2012
(87) WO2012048367, 11.10.2011
(97) 2486198, 15.08.2012 en
(54) A BUILDING PANEL, BUILDING SYSTEM AND METHOD OF CONSTRUCTING A BUILDING
(71) FBM Corporation Pty Ltd, 272 Camboon Road Unit 2, Malaga, Western Australia 6090, AU
(72) NAIDOO, Kubashen, Jerome, 17 Dalzell Turn, Kinross Western Australia 6028, AU
-
- (51) MKP
E03D 11/12 (2006.01) (97) **2491190 ***
(86) IB2010054728 19.10.2010
(96) 10787894.4 29.08.2012
(87) WO2011048544, 19.10.2010
(97) 2491190, 29.08.2012 en
(54) BELLOWS-LIKE FOLDABLE TOILET BOWL
(71) NON SOLO YACHTING s.a.s. di Salzano Alessandro e Grimaldi Orfeo Paolo, Via Pontecorvo SS Appia Km. 257,50, 82100 Benevento (BN), IT
(72) GRIMALDI, Folco, Via Belvedere 3, I-80067 Sorrento (NA), IT
-
- (51) MKP
B44C 1/26 (2006.01) (97) **2364864**
B44C 1/28 (2006.01)
B44C 5/04 (2006.01)
(96) 10002495.9 14.09.2011
(97) 2364864, 14.09.2011 fr
(54) System of ornamental stone floors and ornamental friezes and manufacturing process of ornamental stone floors and ornamental friezes
(71) Golay, Kevin, Chemin Pré-Polly 14, 1233 Bernex Genève, CH
(72) Golay, Kevin, Chemin Pré-Polly 14, 1233 Bernex Genève, CH
-
- (51) MKP
C07D 209/42 (2006.01) (97) **2454235 ***
(86) US2010042219 16.07.2010
(96) 10737165.0 23.05.2012
(87) WO2011009021, 16.07.2010
(97) 2454235, 23.05.2012 en
(54) PROCESSES FOR THE SYNTHESIS OF (2S, 3AR, 7AS)-OCTAHYDRO-1H-INDOLE CARBOXYLIC ACID AS AN INTERMEDIATE FOR TRANDOLAPRIL
(71) Abbott Laboratories, Department D377/AP6A-1 100 Abbott Park Road, Abbott Park, Illinois 60064, US
(72) CHEMBURKAR, Sanjay, R., 509 Prescott Lane, Gurnee IL 60031, US
REDDY, Rajarathnam, E., 1528 Arlington Lane, Gurnee IL 60031, US
REAMER, Douglas, M., 1660 Barrington Woods Drive, Brookfield WI 53045, US
PAVLINA, John, T., 7987 100th Avenue, Pleasant Prairie WI 53158, US
ULREY, Stephen, S., 160 Grafton Ct., Lake Bluff IL 60044, US
KOTECKI, Brian, J., 8451 S. Griffin Avenue, Oak Creek WI 53154, US

- (51) MKP
C12Q 1/68 (2006.01) (97) **2419529 ***
G01N 33/564 (2006.01)
G01N 33/68 (2006.01)
- (86) US2010030934 13.04.2010
(96) 10713793.7 22.02.2012
(87) WO2010120814, 13.04.2010
(97) 2419529, 22.02.2012 en
(54) INFLAMMATORY BOWEL DISEASE PROGNOSTICS
(71) Prometheus Laboratories Inc., 9410 Carroll Park Drive, San Diego, CA 92121-5201, US
(72) BARKEN, Derren, 11271 Corte Playa Corona, San Diego California 92124, US
PRINCEN, Fred, 610 Kirkwood Place, La Jolla California 92037, US
EGGLESTON, Leonard, 739 N. 97th Street, Seattle Washington 98103, US
SINGH, Sharat, 8171 Top of the Morning Way, Rancho Santa Fe California 92127, US
-
- (51) MKP
H04W 40/02 (2009.01) (97) **2350863 ***
G06F 15/16 (2006.01)
G06F 15/177 (2006.01)
- (86) US2010056908 16.11.2010
(96) 10813061.8 03.08.2011
(87) WO2011060454, 16.11.2010
(97) 2350863, 03.08.2011 en
(54) ESTABLISHING A MESH NETWORK WITH WIRED AND WIRELESS LINKS
(71) Ruckus Wireless, Inc., 880 West Maude Avenue, Suite 101, Sunnyvale, CA 94085, US
(72) MOK, Ron, c/o Ruckus Wireless, Inc. 880 West Maude Avenue, 101, Sunnyvale, CA 94085, US
KISH, William S., c/o Ruckus Wireless, Inc. 880 West Maude Avenue, 101, Sunnyvale, CA 94085, US
MIU, Allen, c/o Ruckus Wireless, Inc. 880 West Maude Avenue, 101, Sunnyvale, CA 94085, US
-
- (51) MKP
A61K 47/48 (2006.01) (97) **2411054 ***
C07K 16/18 (2006.01)
A61P 3/10 (2006.01)
- (86) EP2010053806 24.03.2010
(96) 10713875.2 01.02.2012
(87) WO2010108937, 24.03.2010
(97) 2411054, 01.02.2012 en
(54) DRUG FUSIONS AND CONJUGATES
(71) Glaxo Group Limited, Glaxo Wellcome House Berkeley Avenue Greenford, Middlesex UB6 0NN, GB
(72) HERRING, Christopher, Domantis Limited 315 Cambridge Science Park, Cambridge Cambridgeshire CB4 0WG, GB
HOLT, Lucy J., Domantis Limited 315 Cambridge Science Park, Cambridge Cambridgeshire CB4 0WG, GB
JESPER, Laurent S., Domantis Limited 315 Cambridge Science Park, Cambridge Cambridgeshire CB4 0WG, GB
MAYER, Sebastian, Domantis Limited 315 Cambridge Science Park, Cambridge Cambridgeshire CB4 0WG, GB
PUPECKA-SWIDER, Malgorzata, Domantis Limited 315 Cambridge Science Park, Cambridge Cambridgeshire CB4 0WG, GB
-
- (51) MKP
C07D 403/14 (2006.01) (97) **2421852 ***
A61P 25/00 (2006.01)
C07D 403/12 (2006.01)
A61P 29/00 (2006.01)
C07D 409/12 (2006.01)
C07D 401/14 (2006.01)
A61K 31/496 (2006.01)
C07D 405/14 (2006.01)
C07D 409/14 (2006.01)
C07D 401/12 (2006.01)
C07D 417/12 (2006.01)
C07D 413/12 (2006.01)
- (86) US2010032098 22.04.2010
(96) 10719479.7 29.02.2012
(87) WO2010124121, 22.04.2010
(97) 2421852, 29.02.2012 en
(54) HETEROAROMATIC AND AROMATIC PIPERAZINYL AZETIDINYL AMIDES AS MONOACYLGLYCEROL LIPASE INHIBITOR
(71) Janssen Pharmaceutica N.V., Turnhoutseweg 30, 2340 Beerse, BE
(72) NLEEN, Marina, I., 665 Stockton Drive, Exton PA 19341, US
FLORES, Christopher, M., Welsh&Mckean Roads, Spring House PA 19477, US
ZHU, Bin, Welsh&Mckean Roads, Spring House PA 19477, US
LIU, Li, 271 Fox Chase Lane, Doylestown PA 18901, US
NULTON, Erica, L., 665 Stockton Drive, Exton PA 19341, US
MACIELAG, Mark, J., Welsh&Mckean Roads, Spring House PA 19477, US
CLEMENTE, Jose, 665 Stockton Drive, Exton PA 19341, US
MCDONNELL, Mark, E., 1280 Sumneytown Pike, Landsdale PA 19446, US
PROUTY, Stephen, 3900 Woodland Avenue Bldg. 21 Room 302a Philadelphia, PA 19104, US
CHEVALIER, Kristen, M., 407 Nottingham Lane, Collegeville PA 19426, US
TODD, Matthew, 665 Stockton Drive, Exton PA 19341, US
DAX, Scott, L., 3 Quail Drive, Landenberg PA 19350, US
ZHANG, Sui-Po, 665 Stockton Drive, Exton PA 19341, US
-
- (51) MKP
A61N 7/00 (2006.01) (97) **2366430**
- (86) 10157051.3 21.09.2011
(97) 2366430, 21.09.2011 en
(54) Ultrasound application device
(71) Enraf Nonius B.V., Vareseweg 127, 3047 AT Rotterdam, NL
(72) van Groningen, Johannis, Melkweg 80, 3255 TJ, Oude Tonge, NL
Roodink, Petrus Alfonsus Maria, Pieter Floriszpad 1, 3223 SB, Hellevoetsluis, NL
-
- (51) MKP
C07D 487/22 (2006.01) (97) **2459567 ***
A61K 31/555 (2006.01)
A61P 31/00 (2006.01)
A61P 35/00 (2006.01)
- (86) EP2010061112 30.07.2010
(96) 10771346.3 06.06.2012
(87) WO2011012698, 30.07.2010
(97) 2459567, 06.06.2012 en
(54) PHTHALOCYANINE DERIVATIVE CONSISTING OF A MIXTURE OF 4 ISOMERS
(71) Molteni L. E. C. Dei Fratelli Alitti Societa' Di Esercizio S.P.A., Strada Statale 67 Tosco-Romagnola Localita Granatieri, 50018 Scandicci, IT
(72) RONCUCCI, Gabrio, Località Tresto 4, I-53036 Poggibonsi, IT
DEI, Donata, Località Santa Maria 60, I-53037 San Gimignano, IT
CHITI, Giacomo, Via Brasimone 14/2, I-59012 Prato, IT
NISTRI, Daniele, Via Medaglie d'Oro 43, I-59100 Prato, IT
-

- (51) MKP
H04W 28/04 (2009.01) (97) **2496009 ***
- (86) CN2010077839 18.10.2010
(96) 10826044.9 05.09.2012
(87) WO2011050681, 18.10.2010
(97) 2496009, 05.09.2012 en
- (54) METHOD, DEVICE AND SYSTEM FOR SYNCHRONIZING MBMS
- (71) Datang Mobile Communications Equipment Co., Ltd, No. 40 Xueyuan Road Haidian District, Beijing 100083, CN
- (72) ZHANG, Dajun, No.40 Xueyuan Road Haidian District, Beijing 100083, CN
YANG, Xiaodong, No.40 Xueyuan Road Haidian District, Beijing 100083, CN

- (51) MKP
A01N 43/66 (2006.01) (97) **2440051 ***
A61K 31/53 (2006.01)
- (86) US2010037590 07.06.2010
(96) 10786620.4 18.04.2012
(87) WO2010144345, 07.06.2010
(97) 2440051, 18.04.2012 en
- (54) TRIAZINE DERIVATIVES AND THEIR THERAPEUTICAL APPLICATIONS
- (71) Abraxis BioScience, LLC, 11755 Wilshire Boulevard Suite 2000, Los Angeles, CA 90025, US
- (72) TAO, Chunlin, 1800 Camden Avenue, 301, Los Angeles CA 90025, US
WANG, Qinwei, 1112 South Cordova Street, Alhambra CA 91801, US
POLAT, Tulay, 5750 West Centinela Avenue, 224, Los Angeles CA 90045, US
NALLAN, Laxman, 930 North Monterey Street, 236, Alhambra CA 91801, US
DESAI, Neil, 11755 Wilshire Boulevard Suite 2000, Los Angeles CA 90025, US

- (51) MKP
F24J 3/08 (2006.01) (97) **2406559 ***
- (86) GB2010050406 10.03.2010
(96) 10710614.8 18.01.2012
(87) WO2010103317, 10.03.2010
(97) 2406559, 18.01.2012 en
- (54) PERCUSSION MOLE
- (71) Geo-Mole Limited, Nether Court Abbey Farm Faversham, Kent ME13 7BL, GB
- (72) BRICE, Mark, c/o M A Brice & Son Moling Services Limited Nether Court Abbey Farm, Faversham Kent ME13 7BL, GB
BROWN, Les, c/o M A Brice & Son Moling Services Limited Nether Court Abbey Farm, Faversham Kent ME13 7BL, GB

- (51) MKP
A01N 59/10 (2006.01) (97) **2424348 ***
A01N 41/10 (2006.01)
A01P 1/00 (2006.01)
A01N 25/06 (2006.01)
A01N 59/16 (2006.01)
- (86) NO2010000150 23.04.2010
(96) 10718326.1 07.03.2012
(87) WO2010126376, 23.04.2010
(97) 2424348, 07.03.2012 en
- (54) COMPOSITION FOR STERILIZING SURFACES
- (71) Bakteriefritt AS, Østre Aker vei 243, 0976 Oslo, NO
- (72) ANDERSEN, Bjørg Marit, Gaustadveien 1A, N-0372 Oslo, NO
BERG, Erik Edvin, Solbakken Alle 5b, N-1086 Oslo, NO

- (51) MKP
C07C 51/09 (2006.01) (97) **2462098 ***
C07C 253/14 (2006.01)
C07C 61/40 (2006.01)
C07C 253/30 (2006.01)
C07C 255/35 (2006.01)
C07C 255/46 (2006.01)
- (86) EP2010004481 22.07.2010
(96) 10742083.8 13.06.2012
(87) WO2011015287, 22.07.2010
(97) 2462098, 13.06.2012 en
- (54) PROCESS FOR THE PREPARATION OF DERIVATIVES OF 1-(2-HALOBIPHENYL-4-YL)-CYCLOPROPANECARBOXYLIC ACID
- (71) Chiesi Farmaceutici S.p.A., Via Palermo, 26/A, 43100 Parma, IT
- (72) PIVETTI, Fausto, c/o Chiesi Farmaceutici S.p.A. Via Palermo 26/A, I-43100 Parma, IT
FORNARETTO, Maria Gioia, c/o Chiesi Farmaceutici S.p.A. Via Palermo 26/A, I-43100 Parma, IT
RE, Marco, c/o Chiesi Farmaceutici S.p.A. Via Palermo 26/A, I-43100 Parma, IT

- (51) MKP
B01J 21/00 (2006.01) (97) **2392548**
C01B 33/12 (2006.01)
- (96) 11163733.6 07.12.2011
(97) 2392548, 07.12.2011 en
- (54) Process for preparing an amorphous silica-alumina composition and relative amorphous silica-alumina composition
- (71) SASOL ITALY S.p.A., Via Vittor Pisani 20, 20124 Milan, IT
- (72) Rabaoli, Maria Roberta, Via Orazio, 7, 21052 Busto Arsizio (VA), IT
Clerici, Roberto, Via Voltorre, 4, 21026 Gavirate (VA), IT

- (51) MKP
A61P 11/00 (2006.01) (97) **2448922 ***
A61P 13/12 (2006.01)
A61P 35/00 (2006.01)
C07D 213/69 (2006.01)
A61P 25/28 (2006.01)
A61K 31/4422 (2006.01)
- (86) CA2010001027 05.07.2010
(96) 10793481.2 09.05.2012
(87) WO2011000104, 05.07.2010
(97) 2448922, 09.05.2012 en
- (54) FLUORINATED DERIVATIVES OF 3-HYDROXYPYRIDIN-4-ONES
- (71) Apotex Technologies Inc., 150 Signet Drive, Toronto, ON M9L 1T9, CA
- (72) TAM, Tim Fat, 155 Veneto Drive, Vaughan, Ontario L4L 8X6, CA
LEUNG-TOUNG, Regis, 5530 McFarren Blvd, Mississauga, Ontario L5M 5X9, CA
WANG, Yingsheng, 63 Woodlot Crescent, Toronto, Ontario M9W 6T3, CA
ZHAO, Yanqing, 9 Limelight Street, Toronto, Ontario L4E OP9, CA
XIN, Tao, 158 Rossi Drive, Woodbridge, Ontario L4H 0M8, CA
SHAH, Birenkumar, 63 Pallesche Drive, Brampton, Ontario L6P 2S1, CA
N'ZEMBA, Blaise, 22 Prudhomme, Brampton, Ontario L6R 0H1, CA
WODZINSKA, Jolanta Maria, 3494 Enniskillen Circle, Mississauga, Ontario L5C 2N1, CA
PREMYSLOVA, Maryna, 86 Pauline Ct, Vaughan, Ontario L4K 3G7, CA

- (51) MKP
G06F 21/00 (2006.01) (97) **2284750**
- (96) 10168401.7 16.02.2011
(97) 2284750, 16.02.2011 en
- (54) System and method for detecting obfuscated malware using code normalization
- (71) Kaspersky Lab, ZAO, 10 Geroyev Panfilovtsev Street, Moscow 125363, RU
- (72) Golovkin, Maxim Y., c/o KASPERSKY LAB ZAO, 10/1 1st Volokolamsky Proezd, 123060, Moscow, RU

- (51) MKP
E21B 47/12 (2012.01) (97) **2419605 ***
E21B 17/00 (2006.01)
- (86) NO2010000139 16.04.2010
(96) 10764709.1 22.02.2012
(87) WO2010120187, 16.04.2010
(97) 2419605, 22.02.2012 en
- (54) A COMMUNICATION ARRANGEMENT FOR TRANSMISSION OF COMMUNICATION SIGNALS ALONG A PIPE LINE
- (71) Sinvent AS, S.P. Andersensvei 5, 7465 Trondheim, NO
(72) JENSEN, Irene Anite, Sigurd Hoelsvei 3B, N-7024 Trondheim, NO
GRYTHE, Knut Harald, Adolf Øiensveg 5a, N-7036 Trondheim, NO
-
- (51) MKP
A01N 31/00 (2006.01) (97) **2461700 ***
A23K 1/18 (2006.01)
A23K 1/17 (2006.01)
A23K 1/16 (2006.01)
- (86) US2010044305 03.08.2010
(96) 10807056.6 13.06.2012
(87) WO2011017367, 03.08.2010
(97) 2461700, 13.06.2012 en
- (54) WATER AND FEED PRESERVATIVE
- (71) ANITOX CORPORATION, 1055 Progress Circle, Lawrenceville, GA 30043, US
(72) RICHARDSON, Kurt, 585 Pritchett Road, Maysville GA 30558, US
PIMENTEL, Julio, 3206 Windgate Drive, Buford GA 30519, US
WILSON, James, D., 7711 Lakeside Drive, Milton FL 32583, US
-
- (51) MKP
G06F 19/00 (2011.01) (97) **2449493 ***
- (86) US2010040443 29.06.2010
(96) 10748159.0 09.05.2012
(87) WO2011002791, 29.06.2010
(97) 2449493, 09.05.2012 en
- (54) SYSTEMS FOR DIABETES MANAGEMENT AND METHODS
- (71) Lifescan Scotland Limited, Beechwood Park North, Inverness IV2 3ED, GB
(72) JERDONEK, Ronald, 407 N. Alfred, Alexandria, VA 22314, US
LONGMUIR, Alistair, Alexandra Terrace, Forres Morayshire IV36 1DL, GB
RAJ, Siv, 12 Grove Court, Beaconsfield HP9 1QW, GB
MACRAE, Allan, 20a Culcabock Avenue, Inverness Invernesshire IV2 3RG, GB
WESELEY, Lisa, 10 Torino Lane, San Carlos, CA 94070, US
STEPHENS, Chris, 1034 Ringwood Avenue, Menlo Park, CA 94025, US
-
- (51) MKP
A61F 13/15 (2006.01) (97) **2415438**
- (96) 11250709.0 08.02.2012
(97) 2415438, 08.02.2012 en
- (54) Apparatus and method for minimizing waste and improving quality and production in web processing operations by automatic cuff defect correction
- (71) Curt C. Joa. Inc., 100 Crooker Avenue, Sheboygan Falls WI 53085, US
(72) Brown, Jeffrey Dale, 5108 Evergreen Drive, Sheboygan, Wisconsin 53081, US
Faucher, Dennis J., 2415 N. 34th Street, Sheboygan, Wisconsin 53083, US
Fritz, Jeffrey W., N4989 Country Aire Road, Plymouth, Wisconsin 53073, US
Gottfried, Jason Hohm, 1012 Falls Park Drive, Apt. 11, Sheboygan Falls, Wisconsin 53085, US
DeNoble, Adam D., 2020 Cottonwood Court, De Pere, Wisconsin 54115, US
Ferguson, Ryan Michael, 5109 Windward Court, Apt. 3, Sheboygan, Wisconsin 53083, US
-
- (51) MKP
A61P 37/06 (2006.01) (97) **2440554 ***
C07D 471/04 (2006.01)
A61K 31/4245 (2006.01)
C07D 413/04 (2006.01)
C07D 413/14 (2006.01)
- (86) EP2010057893 07.06.2010
(96) 10724789.2 18.04.2012
(87) WO2010142628, 07.06.2010
(97) 2440554, 18.04.2012 en
- (54) PYRAZOLE OXADIAZOLE DERIVATIVES AS S1P1 AGONISTS
- (71) Merck Serono S.A., Centre Industriel, 1267 Coinsins, CH
(72) QUATTROPANI, Anna, Route de Chêne 2, Geneva 1207, CH
BAKER-GLENN, Charles, c/o BIOFOCUS DPI Limited Chesterford Research Park, Saffron Walden Essex CB10 1 XL, GB
BLACKABY, Wesley, c/o BIOFOCUS DPI Limited Chesterford Research Park, Saffron Walden Essex CB10 1 XL, GB
KNIGHT, Chris, c/o BIOFOCUS DPI Limited Chesterford Research Park, Saffron Walden Essex CB10 1 XL, GB
-
- (51) MKP
C09C 1/00 (2006.01) (97) **2444460**
C09D 7/12 (2006.01)
C22B 34/14 (2006.01)
- (96) 10386016.9 25.04.2012
(97) 2444460, 25.04.2012 en
- (54) Milled expanded volcanic glass as lamellar filler
- (71) S&B Industrial Minerals S.A., A. Metaxa Strasse 15, 145 64 Kifissia Attikis, GR
(72) Dedeloudis, Christos, 199, El. Venizelou Strasse, 171 23 Nea Smyrni Attikis, GR
Karalis, Thanasis, 7, Eleftherias Strasse, 142 35 Alsoupoli Attikis, GR
-
- (51) MKP
H04L 29/06 (2006.01) (97) **2424177**
H04L 12/56 (2006.01)
- (96) 11178982.2 29.02.2012
(97) 2424177, 29.02.2012 en
- (54) Method and system for network data flow management
- (71) Sandvine Incorporated ULC, 408 Albert Street, Waterloo, ON N2L 3V3, CA
(72) Loach, Scot, 515 Willow Wood Drive, Waterloo, Ontario N2T 2S9, CA
-
- (51) MKP
B31D 1/06 (2006.01) (97) **2397318**
B31B 19/86 (2006.01)
- (96) 10425201.0 21.12.2011
(97) 2397318, 21.12.2011 en
- (54) Handle-forming machine
- (71) Flat System S.r.l., Via Trento e Trieste 17, 35012 Camposampiero, Padova, IT
(72) Zanarella, Paolo, Via Mantegna 9/7, 35010 Campo San Martino, Padova, IT
Zanchin, Marco, Via Guizze Basse 31, 35010 Loreggia, Padova, IT
-
- (51) MKP
B65D 33/28 (2006.01) (97) **2454163 ***
B31B 19/90 (2006.01)
- (86) DK2010050185 13.07.2010
(96) 10734024.2 23.05.2012
(87) WO2011006505, 13.07.2010
(97) 2454163, 23.05.2012 en
- (54) METHOD FOR MANUFACTURING DRAW STRING BAGS
- (71) Ulfoss Company Group A/S, Spannebaek 25, 4300 Holbaek, DK
(72) KNUDSEN, Hans Erik, Hovedgaden 10B, DK-4350 Ugerløse, DK

- (51) MKP
C09D 195/00 (2006.01) (97) **2380935**
E01C 7/35 (2006.01)
C08L 95/00 (2006.01)
(96) 11305450.6 26.10.2011
(97) 2380935, 26.10.2011 en
(54) Bituminous compositions
(71) Lafarge, 61 rue des Belles Feuilles BP40 Cedex 16, 75782 Paris, FR
(72) Harris, John, 1 Fossey Gardens, Claybrooke Magna Leicestershire LE17 5DT, GB
Bridges, Martin, 57 Rossly Road Whitwick, Coalville, Leicestershire LE67 5PU, GB
Gossling, Robert, 3 Gilbert Crescent Duffield, Derby DE56 4FW, GB
Wheeldon, Peter, 1 Boltby Close Acklam, Middlesbrough TS5 7NF, GB
Edwards, Paul, 18 Caythorpe Rise, Sherwood, Nottinghamshire NG5 3DJ, GB

- (51) MKP
A61K 39/395 (2006.01) (97) **2406289 ***
C07K 19/00 (2006.01)
C07K 16/08 (2006.01)
C12N 15/63 (2006.01)
C12N 15/62 (2006.01)
A61K 39/12 (2006.01)
(86) US2010026273 04.03.2010
(96) 10751209.7 18.01.2012
(87) WO2010104748, 04.03.2010
(97) 2406289, 18.01.2012 en
(54) ANTIGEN PRESENTING CELL TARGETED ANTI-VIRAL VACCINES
(71) Baylor Research Institute, 3310 Live Oak Street, Suite 501, Dallas, TX 75201, US
(72) ZURAWSKI, Gerard, 7620 Jordan Lane, Midlothian, TX 76065, US
BANCHEREAU, Jacques, F., 6730 Northaven Road, Dallas, TX 75230, US
FLAMAR, Anne-laure, 8650 Southwestern Blvd., 3914, Dallas, TX 75206, US
LEVY, Yves, 7, rue Royer Collard, F-75005 Paris, FR
MONTES, Monica, 3005 Bryan St., 2313, Dallas, TX 75204, US

- (51) MKP
A61P 29/00 (2006.01) (97) **2477625 ***
A61K 31/433 (2006.01)
A61P 35/00 (2006.01)
(86) US2010048813 14.09.2010
(96) 10816289.2 25.07.2012
(87) WO2011032169, 14.09.2010
(97) 2477625, 25.07.2012 en
(54) PHARMACEUTICAL COMPOSITIONS AND FORMULATIONS INCLUDING INHIBITORS OF THE PLECKSTRIN HOMOLOGY DOMAIN AND METHODS FOR USING SAME
(71) Phusis Therapeutics Inc., 7000 Fanning St. Suite 2115, Houston, TX 77030, US
(72) KIRKPATRICK, Lynn, D., 326 E. Cowan Drive, Houston TX 77007, US
JOHNSON, Jennifer, L., H., 9320 E. Barbara Jean Place, Tucson AZ 85710, US

- (51) MKP
A01N 43/90 (2006.01) (97) **2488033 ***
A61K 31/519 (2006.01)
(86) US2010052808 15.10.2010
(96) 10824148.0 22.08.2012
(87) WO2011047238, 15.10.2010
(97) 2488033, 22.08.2012 en
(54) COMBINATION
(71) GlaxoSmithKline LLC, One Franklin Plaza 200 North 16th Street, Philadelphia, PA 19102, US
(72) DUMBLE, Melissa, c/o GlaxoSmithKline Global Patents Dept. 1250 South Collegeville Road P. O. Box 5089, Collegeville, Pennsylvania 19426, US
KUMAR, Rakesh, c/o GlaxoSmithKline Global Patents Dept. 1250 South Collegeville Road P.O. Box 5089, Collegeville, Pennsylvania 19426, US
LAQUERRE, Sylvie, c/o GlaxoSmithKline Global Patents Dept. 1250 South Collegeville Road P. O. Box 5089, Collegeville, Pennsylvania 19426, US
LEBOWITZ, Peter, c/o GlaxoSmithKline Global Patents Dept. 1250 South Collegeville Road P. O. Box 5089, Collegeville, Pennsylvania 19426, US

- (51) MKP
A61N 1/36 (2006.01) (97) **2408516 ***
A61N 1/34 (2006.01)
(86) US2010026322 05.03.2010
(96) 10708852.8 25.01.2012
(87) WO2010102179, 05.03.2010
(97) 2408516, 25.01.2012 en
(54) ELECTRICAL STIMULATION DEVICE WITH ADDITIONAL SENSORY MODALITIES
(71) McNeil-PPC, Inc., 199 Grandview Avenue, Skillman, NJ 08558, US
(72) KRIKSUNOV, Leo, B., 5 Perry Lane, Ithaca, NY 14850, US
FURGIUELE, Naomi, 286 E. Swamp Road, Doylestown, PA 18901, US
GHAIM, Joshua, 988 Princeton-Kingston Road, Princeton, NJ 08540, US
OMER, Aliya, 561 10th Avenue Apartment 29D, New York City, NY 10036, US
ROBINSON, Ronni, 1213 Joseph Road, Ambler, PA 19002, US

- (51) MKP
E06B 3/54 (2006.01) (97) **2270305**
(96) 10163835.1 05.01.2011
(97) 2270305, 05.01.2011 en
(54) Adjusting device for the inclination of window frames and window frame
(71) Cirilli, Alessandro, 56, Via San Francesco, 60035 Jesi, IT
(72) Cirilli, Alessandro, 56, Via San Francesco, 60035 Jesi, IT

- (51) MKP
A01N 43/66 (2006.01) (97) **2440052 ***
A61K 31/53 (2006.01)
(86) US2010037614 07.06.2010
(96) 10786632.9 18.04.2012
(87) WO2010144359, 07.06.2010
(97) 2440052, 18.04.2012 en
(54) TRIAZINE DERIVATIVES AND THEIR THERAPEUTICAL APPLICATIONS
(71) Abraxis BioScience, LLC, 11755 Wilshire Boulevard Suite 2000, Los Angeles, CA 90025, US
(72) TAO, Chunlin, 1800 Camden Avenue, 301, Los Angeles California 90025, US
WANG, Qinwei, 1112 South Cordova Street, Alhambra California 91801, US
POLAT, Tulay, 5750 West Centinela Avenue, 224, Los Angeles California 90045, US
NALLAN, Laxman, 930 North Monterey Street, 236, Alhambra California 91801, US
HO, David, 325 Kingsfords Street, Monterey Park California 91754, US
DESAL, Neil, 11755 Wilshire Boulevard Suite 2000, Los Angeles California 90025, US

- (51) MKP
A61P 35/00 (2006.01) (97) **2468281 ***
A61P 35/04 (2006.01)
A61P 43/00 (2006.01)
C07D 215/48 (2006.01)
A61K 47/38 (2006.01)
A61K 31/47 (2006.01)
A61K 47/32 (2006.01)
A61K 47/36 (2006.01)
(86) JP2010063804 16.08.2010
(96) 10809938.3 27.06.2012
(87) WO2011021597, 16.08.2010
(97) 2468281, 27.06.2012 en
(54) QUINOLINE DERIVATIVE-CONTAINING PHARMACEUTICAL COMPOSITION
(71) Eisai R&D Management Co., Ltd., 6-10, Koishikawa 4-chome Bunkyo-ku, Tokyo 112-8088, JP
(72) BANDO Masashi, c/o EISAI CO. LTD. Kawashima Industrial Complex 1 Kawashimatakehaya-machi, Kakamigahara-shi Gifu 501-6195, JP
-
- (51) MKP
A61F 13/15 (2006.01) (97) **2412348**
B07C 5/342 (2006.01)
(96) 11250672.0 01.02.2012
(97) 2412348, 01.02.2012 en
(54) Apparatus and method for minimizing waste and improving quality and production in web processing operations by automated threading and re-threading of web materials
(71) CURT G. JOA, INC., Crocker Avenue, P.O. Box 903, Sheboygan Falls, Wisconsin 53085-0903, US
(72) Andrews, Robert E., N7488 Sunset Circle Drive, Sheboygan Wisconsin 53083, US
Fritz, Jeff W., N4989 Country Aire Road, Plymouth Wisconsin 53073, US
Hohm, Jason, 1012 Falls Parc Drive, Apt. 11, Sheboygan Falls Wisconsin 53085, US
Sayaovong, Song, 7007 W Glendale Avenue, Milwaukee Wisconsin 53085, US
Strains, Pete, W2840 County Road C, Sheboygan Falls Wisconsin 53085, US
Dodelin, Donald R., 1501 Maplewood Court, Woodstock Georgia 30189, US
-
- (51) MKP
C07C 209/62 (2006.01) (97) **2448896 ***
C07C 29/40 (2006.01)
C07C 211/35 (2006.01)
(86) EP2010003919 28.06.2010
(96) 10735189.2 09.05.2012
(87) WO2011000536, 28.06.2010
(97) 2448896, 09.05.2012 en
(54) METHOD OF PREPARING 1-HYDROXY-1,3,3,5,5-PENTAMETHYLCYCLOHEXANE
(71) Merz Pharma GmbH & Co. KGaA, Eckenheimer Landstrasse 100, 60318 Frankfurt, DE
(72) KOLLER, Herbert, Quellenstrasse 155A/65, A-Wien, AT
PYERIN, Michael, Enzersdorferstrasse 3/2/8, A-2345 Brunn am Gebirge, AT
SBROGIÒ, Federico, via Tecchio 62, I-36075 Montecchio Maggiore, IT
-
- (51) MKP
C07H 19/20 (2006.01) (97) **2424874 ***
A61K 31/708 (2006.01)
(86) EP2010055942 30.04.2010
(96) 10725631.5 07.03.2012
(87) WO2010125200, 30.04.2010
(97) 2424874, 07.03.2012 en
(54) NOVEL PHOSPHATE MODIFIED NUCLEOSIDES USEFUL AS SUBSTRATES FOR POLYMERASES AND AS ANTIVIRAL AGENTS
(71) Katholieke Universiteit Leuven, K.U. Leuven R&D, Minderbroedersstraat 8a, bus 5105, 3000 Leuven, BE
(72) HERDEWIJN, Piet, Olivierstraat 21, B-3111 Wezemaal, BE
MARLIÈRE, Philippe, 5 rue Gossec, F-75012 Paris, FR
-
- (51) MKP
A61K 31/4422 (2006.01) (97) **2406218 ***
C07D 211/90 (2006.01)
(86) EP2010053094 11.03.2010
(96) 10710263.4 18.01.2012
(87) WO2010103067, 11.03.2010
(97) 2406218, 18.01.2012 en
(54) Pharmaceutical combination of 5-fluorouracil and derivate of 1,4-dihydropyridine and its use in the treatment of cancer
(71) Grindeks, A Joint Stock Company, 53 Krustpils Street, 1057 Riga, LV
(72) STONANS, Ilmars, 53 Krustpils, LV-1057 Riga, LV
VIGANTE, Brigita, 21, Aizkraukles Street, 1006 Riga, LV
JASCENKO, Elina, 21, Aizkraukles Street, 1006 Riga, LV
PUBULIS, Kaspars, 53, Krustpils Street, Riga LV-1057, LV
DOMRACEVA, Ilona, 21, Aizkraukles Street, 1006 Riga, LV
JONANE-OSA, Indra, 53, Krustpils Street, Riga, LV-1057, LV
POIKANS, Janis, 21, Aizkraukles Street, 1006 Riga, LV
BRUVERE, Imanta, 21, Aizkraukles Street, 1006 Riga, LV
DUBURS, Gunars, 21 Aizkraukles, LV-1006 Riga, LV
ULDRIKIS, Janis, 21, Aizkraukles Street, 1006 Riga, LV
BISENIKS, Egils, 21 Aizkraukles street, LV-1006 Riga, LV
SESTAKOVA, Irina, 21, Aizkraukles Street, 1006 Riga, LV
KALVINS, Ivars, 21, Aizkraukles Street, 1006 Riga, LV
-
- (51) MKP
A61C 8/00 (2006.01) (97) **2419044 ***
(86) EP2010054946 15.04.2010
(96) 10715206.8 22.02.2012
(87) WO2010119092, 15.04.2010
(97) 2419044, 22.02.2012 en
(54) DENTAL IMPLANT ASSEMBLY COMPRISING A MAGNETIC TEMPORARY SCREW
(71) SUPERCHARGED PRODUCTION S.R.L., 2, Via Fagnani, 60019 Senigalla (AN), IT
(72) BAMBINI, Fabrizio, Via del Cavallo, I-60019 Senigallia (AN), IT
SANTARELLI, Andrea, Via Monte Carpegna 3, I-60035 Jesi (AN), IT
EMANUELLI, Monica, 3, Via Toti, I-60123 Ancona (IT), IT
PUTIGNANO, Angelo, 26, Via Pelliccia, I-60100 Ancona (IT), IT
PROCACCINI, Maurizio, 8, Piazza Lotario, I-00100 Roma, IT
-
- (51) MKP
B65G 7/04 (2006.01) (97) **2256066**
B65D 90/18 (2006.01)
(96) 10163745.2 01.12.2010
(97) 2256066, 01.12.2010 en
(54) Method for attaching a transport wheel arrangement to a container and a transport wheel arrangement of a container
(71) Yski, Pasi, Prantinkatu 3 B 5, 32700 Huittinen, FI
(72) Yski, Pasi, Prantinkatu 3 B 5, 32700 Huittinen, FI
-
- (51) MKP
G06F 21/00 (2006.01) (97) **2469445**
(96) 11161997.9 27.06.2012
(97) 2469445, 27.06.2012 en
(54) Optimization of anti-malware processing by automated correction of detection rules
(71) Kaspersky Lab, ZAO, 10 Geroyev Panfilovtsev Street, Moscow 125363, RU
(72) Zaitsev, Oleg V., c/o KASPERSKY LAB ZAO 10/1 1st Volokolamsky Proezd, 123060, Moscow, RU
Mashevsky, Yuri V., c/o KASPERSKY LAB ZAO 10/1 1st Volokolamsky Proezd, 123060, Moscow, RU
Denishchenko, Nikolay V., c/o KASPERSKY LAB ZAO 10/1 1st Volokolamsky Proezd, 123060, Moscow, RU
-

- (51) MKP
C07D 471/04 (2006.01) (97) **2424866 ***
C07D 487/04 (2006.01)
A61K 31/437 (2006.01)
A61P 25/28 (2006.01)
- (86) US2010031781 20.04.2010
(96) 10714549.2 07.03.2012
(87) WO2010126745, 20.04.2010
(97) 2424866, 07.03.2012 en
(54) SUBSTITUTED IMIDAZO[1,2-A]PYRIDINE DERIVATIVES, PHARMACEUTICAL COMPOSITIONS, AND METHODS OF USE AS -SECRETASE INHIBITORS
- (71) High Point Pharmaceuticals, LLC, 4170 Mendenhall Oaks Parkway, High Point, NC 27265, US
(72) MJALLI, Adnan, M.M., 6421 Ashton Park Drive, Oak Ridge, North Carolina 27310, US
HARI, Anitha, 3712 PembertonWay, High Point, North Carolina 27265, US
GADDAM, Bapu, 4414 Feldspar Court Apt. 2C, Greensboro, North Carolina 27409, US
GOHIMUKKULA, Devi, Reddy, 4061 Cobbler Ct., Jamestown, North Carolina 27282, US
POLISETTI, Dharna, R., 3741 Deerfield Street, High Point, North Carolina 27265, US
EL ABDELLAOUI, Hassan, 3365 Cherrybrook Drive, Jamestown, North Carolina 27265, US
RAO, Mohan, 4914 Riding Ridge Drive, Greensboro, North Carolina 27410, US
ANDREWS, Robert, C., 3312 Morris Farm Road, Jamestown, North Carolina 27282, US
XIE, Rongyuan, 6407 Estes Court, Greensboro, NC 27410, US
REN, Tan, 3988 Clubhouse Court Apt. 2D, High Point, North Carolina 27265, US

- (51) MKP
C08B 37/00 (2006.01) (97) **2427501 ***
C08B 37/10 (2006.01)
- (86) IB2010051932 04.05.2010
(96) 10719111.6 14.03.2012
(87) WO2010128447, 04.05.2010
(97) 2427501, 14.03.2012 en
(54) NOVEL SULFATED HEPTASACCHARIDE AND ITS USE AS ANTITHROMBOTIC AGENT
- (71) SANOFI, 174, Avenue de France, 75013 Paris, FR
(72) MOURIER, Pierre, c/o sanofi-aventis Patent Department 174 avenue de France, F-75013 Paris, FR
VISKOV, Christian, c/o sanofi-aventis Patent Department 174 avenue de France, F-75013 Paris, FR

- (51) MKP
A61K 9/00 (2006.01) (97) **2482768 ***
A61F 6/14 (2006.01)
- (86) FI2010050753 30.09.2010
(96) 10819959.7 08.08.2012
(87) WO2011039418, 30.09.2010
(97) 2482768, 08.08.2012 en
(54) AN INTRAUTERINE SYSTEM
- (71) Bayer Oy, Pansiontie 47, 20210 Turku, FI
(72) CALVO ALONSO, Ulla, Kontionkatu 4, FI-20760 Piispanristi, FI
MOEDE, Joachim, Piispanpelto 7 as 23, FI-20540 Turku, FI
LEHTINEN, Juha, Pyölinpellonkatu 14, FI-20300 Turku, FI
WAMPRECHT, Christian, Regattastrasse 20, 41472 Neuss, DE
JUKARAINEN, Harri, Vadelmakatu 3, FI-21620 Kuusisto, FI
SALLINEN, Pirjo, Sybelstrasse 24, 10629 Berlin, DE
JUTILA, Ilkka, Raadelmaantie 328, FI-20660 Littoinen, FI
SHAFIQ, Faisal, Am Wetscheshof 25, 47807 Krefeld, DE
LUKKARI-LAX, Eeva, Kiiltokallionpolku 4 C, FI-02180 Espoo, FI
TJÄDER, Taina, Untolantie 2 B 7, FI-20660 Littoinen, FI
LYYTIKÄINEN, Heikki, Onkitie 2, FI-21100 Naantali, FI
KORTESUO, Pirjo, Muddaistentie 139, FI-21600 Parainen, FI
KAUFHOLD, Wolfgang, Haferkamp 8, 51061 Cologne, DE
INKI, Pirjo, Lautapojankatu 8, FI-20780 Kaarina, FI
NIKANDER, Hannu, Säköyläntie 736, FI-21330 Paattinen, FI

- (51) MKP
C08G 63/00 (2006.01) (97) **2366725**
C08L 67/00 (2006.01)
C08K 7/22 (2006.01)
C08K 7/00 (2006.01)
- (96) 10425070.9 21.09.2011
(97) 2366725, 21.09.2011 en
(54) Composite material
(71) Temi S.r.l., Via Quintino Sella, 4, 20121 Milano, IT
(72) Randis, Filippo, c/o Temi S.r.l. Via Quintino Sella, 4, 20121 Milano, IT

- (51) MKP
C07D 413/14 (2006.01) (97) **2493877 ***
C07D 403/12 (2006.01)
A61P 25/04 (2006.01)
C07D 403/14 (2006.01)
A61K 31/506 (2006.01)
C07D 401/14 (2006.01)
- (86) US2010054489 28.10.2010
(96) 10776484.7 05.09.2012
(87) WO2011053705, 28.10.2010
(97) 2493877, 05.09.2012 en
(54) PYRIMIDINE COMPOUNDS AS DELTA OPIOID RECEPTOR MODULATORS
- (71) Janssen Pharmaceutica NV, Turnhoutseweg 30, 2340 Beerse, BE
(72) BIGNAN, Gilles, Welsh&McKean Roads P.O. Box 776, Spring House PA 19477, US
ZHANG, Yue-mei, Welsh&McKean Roads P.O. Box 776, Spring House PA 19477, US
CAI, Chaozhong, Welsh&McKean Roads P.O. Box 776, Spring House PA 19477, US
ZHU, Bin, Welsh&McKean Roads P.O. Box 776, Spring House PA 19477, US
DAX, Scott, L., 3 Quail Drive, Landenberg PA 19350, US
HE, Wei, 2002 Kestral Circle, Audubon PA 19493, US
DE CORTE, Bart, L., Welsh&McKean Roads P.O. Box 776, Spring House PA 19477, US
LIN, Shu-Chen, 4895 Redfield Road, Doylestown PA 18902, US
COATS, Steven, J., 764 Alberta Drive, McDonough GA 30252, US
LIU, Li, 271 Fox Chase Lane, Doylestown PA 18901, US
BIAN, Haiyan, 109 York Drive, Princeton NJ 08540, US
MACIELAG, Mark, J., Welsh&McKean Roads P.O. Box 776, Spring House PA 19477, US
CONNOLLY, Peter, J., Welsh&McKean Roads P.O. Box 776, Spring House PA 19477, US
PITIS, Philip, M., 108 Sunrise Drive, North Wales PA 19454, US

- (51) MKP
C07K 14/635 (2006.01) (97) **2421893 ***
- (86) IN2010000264 26.04.2010
(96) 10747683.0 29.02.2012
(87) WO2010128521, 26.04.2010
(97) 2421893, 29.02.2012 en
(54) SHORT-CHAIN PEPTIDES AS PARATHYROID HORMONE (PTH) RECEPTOR AGONIST
- (71) Cadila Healthcare Limited, Zydus Tower Satellite Cross Roads, Ahmedabad 380 015 Gujarat, IN
(72) BAHEKAR, Rajesh, Cadila healthcare Limited Zydus Tower Satellite Cross Roads, Ahmedabad 380 015 Gujarat, IN
JAIN, Mukul R., Cadila healthcare Limited Zydus Tower Satellite Cross Roads, Ahmedabad 380 015 Gujarat, IN
PATEL, Pankaj R., Cadila healthcare Limited Zydus Tower Satellite Cross Roads, Ahmedabad 380 015 Gujarat, IN

- (51) MKP
F16L 55/38 (2006.01) (97) **2464909 ***
- (86) US2010045158 11.08.2010
(96) 10808687.7 20.06.2012
(87) WO2011019808, 11.08.2010
(97) 2464909, 20.06.2012 en
(54) SPEED CONTROL DRIVE SECTION WITH FAILSAFE VALVE
- (71) TDW Delaware, Inc., 1100 Market Street, Suite 780, Wilmington, Delaware 19801, US
(72) LUDLOW, Jed, 1447 E. 1200 S., Bountiful Utah 84010, US
GLASS, Keith, 37 Luverne Avenue, Toronto Ontario M3H 1R7, CA
WARKENTIN, Jonathan, 287 Cornelius Pky., Toronto Ontario M3K 1T6, CA
LAURSEN, Paul, 34 Crossburn Drive, North York Ontario M3B 2Z2, CA

- (51) MKP
E03D 11/13 (2006.01) (97) **2333168**
E03D 11/12 (2006.01)
- (96) 10192496.7 15.06.2011
(97) 2333168, 15.06.2011 en
(54) Bellows-like foldable bidet
(71) NON SOLO YACHTING s.a.s. di Salzano Alessandro e Grimaldi Orfeo Paolo, Via Pontecorvo SS Appia Km. 257,50, 82100 Benevento (BN), IT
(72) Grimaldi, Folco, Via Belvedere 3, 80067 Sorrento (NA), IT
-
- (51) MKP
E04F 13/00 (2006.01) (97) **2366847**
E04B 1/74 (2006.01)
- (96) 10156981.2 21.09.2011
(97) 2366847, 21.09.2011 en
(54) Insulating and draining board
(71) Ignucell AB, Box 217, 312 22 Laholm, SE
(72) Jalakas, Jonas, Hammarvägen 23, 134 60 Ingarö, SE
-
- (51) MKP
H01T 4/08 (2006.01) (97) **2419976 ***
H02H 9/02 (2006.01)
- (86) US2010030962 14.04.2010
(96) 10765058.2 22.02.2012
(87) WO2010120834, 14.04.2010
(97) 2419976, 22.02.2012 en
(54) COAXIAL BROADBAND SURGE PROTECTOR
(71) John Mezzalingua Assoc., Inc., Legal Department 6176 E. Molloy Rd., East Syracuse, New York 13057, US
(72) MONTENA, Noah, 124 Buckingham Avenue, Syracuse New York 13210, US
-
- (51) MKP
A61P 29/00 (2006.01) (97) **2448943 ***
A61K 31/404 (2006.01)
C07D 491/22 (2006.01)
- (86) US2010040187 28.06.2010
(96) 10731662.2 09.05.2012
(87) WO2011002708, 28.06.2010
(97) 2448943, 09.05.2012 en
(54) ENANTIOMERS OF SPIRO-OXINDOLE COMPOUNDS AND THEIR USES AS THERAPEUTIC AGENTS
(71) Xenon Pharmaceuticals Inc., 3650 Gilmore Way, Burnaby, BC V5G 4W8, CA
(72) CHAFEEV, Mikhail, 1403 4788 Hazel Street, Burnaby British Columbia V5H 4V9, CA
FU, Jianmin, 3170 Quintette Crescent, Coquitlam British Columbia V3E 3B6, CA
CADIEUX, Jean-Jacques, 7 5090 East Hastings Street, Burnaby British Columbia V5B 1P6, CA
-
- (51) MKP
C07D 207/10 (2006.01) (97) **2459529 ***
C07D 215/06 (2006.01)
C07D 209/44 (2006.01)
C07D 217/04 (2006.01)
C07D 211/14 (2006.01)
C07D 241/08 (2006.01)
C07D 211/38 (2006.01)
C07D 401/12 (2006.01)
C07D 207/06 (2006.01)
A61P 25/00 (2006.01)
C07D 211/46 (2006.01)
C07D 403/12 (2006.01)
A61K 31/496 (2006.01)
C07D 407/12 (2006.01)
A61K 31/5377 (2006.01)
- (86) US2010040757 01.07.2010
(96) 10730019.6 06.06.2012
(87) WO2011002984, 01.07.2010
(97) 2459529, 06.06.2012 en
(54) SUBSTITUTED PHENOXYPROPYLCYCLOAMINE DERIVATIVES AS HISTAMINE-3 (H3) RECEPTOR LIGANDS
(71) Cephalon, Inc., 41 Moores Road P.O. Box 4011, Frazer, PA 19333, US
Cephalon France, 20 Rue Charles Martigny, 94704 Maisons-Alfort Cedex, FR
(72) BACON, Edward R., 1006 Skyline Circle, Audubon Pennsylvania 19403, US
BAILEY, Thomas, 217 Amanda Lane, Phoenixville Pennsylvania 19460, US
CHATTERJEE, Sankar, 1375 Indian Creek Drive, Wynnewood Pennsylvania 19096, US
DUNN, Derek, 122 Autumn Trail, Coatesville Pennsylvania 19320, US
HOSTETLER, Greg A., 7 Sheldrake Road, Newark Delaware 19713, US
HUDKINS, Robert L., 430 S. Saddlebrook Circle, Chester Springs Pennsylvania 19425, US
LESUR, Brigitte, 21 rue Hennemont, F-78100 Saint Germain En Laye, FR
SUNDAR, Babu G., 208 Sidesaddle Place, West Chester Pennsylvania 19382, US
YUE, Christophe, 4 Allee Mabilie, F-94300 Vincennes, FR
ZULLI, Allison L., 1020 Washington Place, Wayne Pennsylvania 19087, US
-
- (51) MKP
A61K 31/415 (2006.01) (97) **2453748 ***
A01N 43/56 (2006.01)
- (86) US2010042211 16.07.2010
(96) 10800585.1 23.05.2012
(87) WO2011009016, 16.07.2010
(97) 2453748, 23.05.2012 en
(54) TREATMENT METHOD
(71) Glaxo Wellcome Manufacturing Pte Ltd, 1 Pioneer Sector 1, Jurong 628413, SG
(72) MCLAUGHLIN, Megan M., c/o GlaxoSmithKline Global Patents 1250 South Collegeville Road P. O. Box 5089, Collegeville, Pennsylvania 19426, US
WURZELMANN, John Irving, c/o GlaxoSmithKline Global Patents Five Moore Drive P. O. Box 13398, Research Triangle Park, North Carolina 27709, US
XU, Chun-Fang, c/o GlaxoSmithKline Global Patents 980 Great West Road, Brentford Middlesex TW8 9GS, GB
-
- (51) MKP
A61L 29/08 (2006.01) (97) **2468319**
A61L 29/16 (2006.01)
- (96) 10460045.7 27.06.2012
(97) 2468319, 27.06.2012 en
(54) New nanoparticle useful in prophylaxis, diagnostics and medical and veterinary treatment
(71) Eurochit Danuta Kruszewska, Al. Wilanowska 43 m 5, 02-765 Warszawa, PL
(72) Kruszewska, Danuta, Al. Wilanowska 43m5, 02-765 Warszawa, PL

- (51) MKP
B65D 85/76 (2006.01) (97) **2322451**
B65D 25/10 (2006.01)
- (96) 10188698.4 18.05.2011
(97) 2322451, 18.05.2011 fr
(54) Packaging of a food product in portions
(71) BONGRAIN S.A., 42, Rue Rieussec, 78223 Viroflay, FR
(72) Bonnin, Yves, 12, Chemin de Bazemont, 78580 Maule, FR
Ravelet, Sébastien, 7, Rue Jaroslava Foglara, 60200 Brno, CZ
-
- (51) MKP
A01N 43/653 (2006.01) (97) **2443109 ***
C07D 405/06 (2006.01)
- (86) EP2010058539 17.06.2010
(96) 10725705.7 25.04.2012
(87) WO2010146114, 17.06.2010
(97) 2443109, 25.04.2012 en
(54) TRIAZOLE COMPOUNDS CARRYING A SULFUR SUBSTITUENT
(71) BASF SE, null, 67056 Ludwigshafen, DE
(72) ULMSCHNEIDER, Sarah, Balthasar-Neumann-Str. 17, 67246 Dirmstein, DE
DIETZ, Jochen, Pfintzstr. 7a, 76227 Karlsruhe, DE
RENNER, Jens, Balthasar-Neumann-Str. 17, 67246 Dirmstein, DE
GROTE, Thomas, Im Höhnhausen 18, 67157 Wachenheim, DE
GRAMMENOS, Wassilios, Alexander-Fleming-Str. 13, 67071 Ludwigshafen, DE
MÜLLER, Bernd, Stockingerstr. 7, 67227 Frankenthal, DE
LOHMANN, Jan Klaas, Mühltorstr. 2a, 67245 Lamsbheim, DE
VRETTOU-SCHULTES, Marianna, Am Oberen Luisenpark 22, 68165 Mannheim, DE
RIGGS, Richard, Mollstr. 56, 68165 Mannheim, DE
-
- (51) MKP
C07D 411/12 (2006.01) (97) **2445904 ***
A61K 31/4535 (2006.01)
A61K 31/454 (2006.01)
C07D 413/14 (2006.01)
A61K 31/506 (2006.01)
C07D 417/14 (2006.01)
C07D 411/14 (2006.01)
- (86) IN2010000418 17.06.2010
(96) 10747954.5 02.05.2012
(87) WO2010146605, 17.06.2010
(97) 2445904, 02.05.2012 en
(54) NOVEL GPR 119 AGONISTS
(71) Cadila Healthcare Limited, Zydus Tower Satellite Cross Roads, Ahmedabad 380 015, Gujarat, IN
(72) PINGALI, Harikishore, Cadila Healthcare Limited Zydus Tower Satellite Cross Roads, Ahmedabad 380 015, IN
ZAWARE, Pandurang, Cadila Healthcare Limited Zydus Tower Satellite Cross Roads, Ahmedabad 380 015, IN
JAIN, Mukul, Cadila Healthcare Limited Zydus Tower Satellite Cross Roads, Ahmedabad 380 015, IN
-
- (51) MKP
C07C 253/30 (2006.01) (97) **2493848 ***
C07D 257/04 (2006.01)
- (86) EP2010066041 25.10.2010
(96) 10768497.9 05.09.2012
(87) WO2011051213, 25.10.2010
(97) 2493848, 05.09.2012 en
(54) PROCESS FOR THE MANUFACTURE OF ORGANIC COMPOUNDS
(71) Novartis AG, Lichtstrasse 35, 4056 Basel, CH
(72) SEDELMEIER, Gottfried, Novartis Pharma AG Postfach, CH-4002 Basel, CH
RAMPF, Florian Andreas, Novartis Pharma AG Postfach, CH-4002 Basel, CH
GRIMLER, Dominique, Novartis Pharma AG Postfach, CH-4002 Basel, CH
-
- (51) MKP
C22C 38/46 (2006.01) (97) **2456901 ***
C22C 38/54 (2006.01)
C22C 38/00 (2006.01)
- (86) IB2010001759 20.07.2010
(96) 10795762.3 30.05.2012
(87) WO2011010206, 20.07.2010
(97) 2456901, 30.05.2012 en
(54) HEAT-RESISTANT AUSTENITIC STEEL HAVING HIGH RESISTANCE TO STRESS RELAXATION CRACKING
(71) Arcelormittal Investigación y Desarrollo SL, CL/Chavarri, 6, 48910 Sestao, Bizkaia, ES
CENTRO SVILUPPO MATERIALI S.p.A., Via di Castel Romano 100, 00128 Roma, IT
Netherlands Organization For Applied Scientific Research (TNO), P.O. Box 6072, 2600 JA Delft, NL
(72) BONNEFOIS, Bernard, 5 Parc du Morambeau, F-71670 Le Breuil, FR
FANICA, Amélie, Les Blignys, F-71390 Cersot, FR
COUDREUSE, Lionel, 39 rue Paillard, F-42100 Saint-Etienne, FR
ORIANA, Tassa, c/o Centro Sviluppo Materiali S.p.A. Via di Castel Romano 100, I-00128 Rome, IT
VAN WORTEL, Johannes, Cornelis, Rhiendersevoetpad 1, NL-6971 GA Brummen, NL
-
- (51) MKP
A61K 9/70 (2006.01) (97) **2489340 ***
A61L 15/58 (2006.01)
A61F 13/02 (2006.01)
- (86) JP2010067140 30.09.2010
(96) 10823292.7 22.08.2012
(87) WO2011046024, 30.09.2010
(97) 2489340, 22.08.2012 en
(54) ADHESIVE PATCH
(71) Hisamitsu Pharmaceutical Co., Inc., 408, Tashirodaikan-machi, Tosu-shi, Saga 841-0017, JP
(72) TSURUTA Mitsutoshi, c/o HISAMITSU PHARMACEUTICAL CO. INC. 11-1 Marunouchi 1-chome Chiyoda-ku, Tokyo 100-6221, JP
ISHIMATSU Kentaro, c/o HISAMITSU PHARMACEUTICAL CO. INC. 11-1 Marunouchi 1-chome Chiyoda-ku, Tokyo 100-6221, JP
TAKADA Kiyotaka, c/o HISAMITSU PHARMACEUTICAL CO. INC. 408 Tashirodaikan-machi, Tosu-shi Saga 841-0017, JP
-
- (51) MKP
C12N 9/14 (2006.01) (97) **2435562 ***
C12N 9/68 (2006.01)
C12N 15/82 (2006.01)
A61K 38/16 (2006.01)
C12N 5/04 (2006.01)
- (86) US2010036253 26.05.2010
(96) 10730613.6 04.04.2012
(87) WO2010138631, 26.05.2010
(97) 2435562, 04.04.2012 en
(54) COMPOSITIONS AND METHODS FOR PRODUCTION OF AGLYCOSYLATED PLASMINOGEN
(71) Biolex Therapeutics, Inc., 158 Credle Street, Pittsboro, NC 27312, US
(72) DICKEY, Lynn, F., 111 Buckden Place, Cary NC 27511, US
GASDASKA, John, R., 102 Lisa Drive, Carrboro NC 27510, US
COX, Kevin, M., 1916 Sunset Drive, Raleigh NC 27608, US
-
- (51) MKP
A61K 31/4412 (2006.01) (97) **2308491**
A61P 11/00 (2006.01)
- (96) 10250378.6 13.04.2011
(97) 2308491, 13.04.2011 en
(54) Pirfenidone therapy and inducers of cytochrome P450
(71) Intermune, Inc., 3280 Bayshore Boulevard, Brisbane, CA 94005-1021, US
(72) Bradford, Williamson Ziegler, PO Box 566, Ross, California 94957, US
Szwarcberg, Javier, 2173 Bunker Hill Drive, San Mateo, California 94402, US

- (51) MKP
A61F 2/44 (2006.01) (97) **2389903**
(96) 11167529.4 30.11.2011
(97) 2389903, 30.11.2011 fr
(54) System for performing arthrodesis between two vertebrae and installation accessories
(71) Prosteel, 11-13 avenue de l'Europe BP 12122, 31521 Ramonville Cedex, FR
Minelli, Nadia, 56 rue Romain Rolland, 31520 Ramonville Saint Agne, FR
Gille, Olivier, 15 rue François Planté, 33600 Pessac, FR
Renaud, Christian, Chemin Lucien Calmels, 81160 Arthes, FR
Limito, Jean-François, 10 Rue d'Estienne d'Orves, 31130 Balma, FR
(72) Gille, Olivier, 15 rue Francois Planté, 33600 Pessac, FR
Renaud, Christian, Chemin Lucien Calmels, 81160 Arthes, FR
-
- (51) MKP
C07H 1/00 (2006.01) (97) **2470551 ***
C07H 17/02 (2006.01)
(86) EP2010062462 26.08.2010
(96) 10745265.8 04.07.2012
(87) WO2011023755, 26.08.2010
(97) 2470551, 04.07.2012 en
(54) METHOD FOR PRODUCING PYRAZOLE GLYCOSIDE DERIVATIVES
(71) SANOFI, 54 rue La Boétie, 75008 Paris, FR
(72) PODESCHWA, Michael, c/o Sanofi-Aventis Deutschland GmbH, 65926 Frankfurt am Main, DE
RIGAL, David, c/o Sanofi-Aventis Deutschland GmbH, 65926 Frankfurt am Main, DE
ROSSEN, Kai, c/o Sanofi-Aventis Deutschland GmbH, 65926 Frankfurt am Main, DE
OTTO, Bernhard, c/o Sanofi-Aventis Deutschland GmbH, 65926 Frankfurt am Main, DE
WEHLAN, Hermut, c/o Sanofi-Aventis Deutschland GmbH, 65926 Frankfurt am Main, DE
WOLLMANN, Theodor Andreas, c/o Sanofi-Aventis Deutschland GmbH, 65926 Frankfurt am Main, DE
BECKER, Bernd, c/o Sanofi-Aventis Deutschland GmbH, 65926 Frankfurt am Main, DE
KULITZSCHER, Berndt, c/o Sanofi-Aventis Deutschland GmbH, 65926 Frankfurt am Main, DE
SCHAEFER, Alexander, c/o Sanofi-Aventis Deutschland GmbH, 65926 Frankfurt am Main, DE
-
- (51) MKP
A61B 10/00 (2006.01) (97) **2286919**
G01N 1/40 (2006.01)
B01L 3/00 (2006.01)
B01L 3/14 (2006.01)
(96) 10167532.0 23.02.2011
(97) 2286919, 23.02.2011 fr
(54) Filtration device for analyses
(71) Advance Invest, 85 rue Henri Barbusse, 92190 Meudon, FR
(72) Gabrielli, Marco, 3 Rue Alphonse Daudet, 95170, DEUIL LA BARRE, FR
-
- (51) MKP
G07F 17/00 (2006.01) (97) **2452318 ***
G07F 19/00 (2006.01)
(86) IB2010001552 25.06.2010
(96) 10742249.5 16.05.2012
(87) WO2011004231, 25.06.2010
(97) 2452318, 16.05.2012 de
(54) DEVICE FOR CONDUCTING MONETARY TRANSACTIONS
(71) Novomatic AG, Wiener Strasse 158, 2352 Gumpoldskirchen, AT
(72) MÜHRENBURG, Roland, c/o Novomatic AG IP&Rechtsabteilung Wiener Strasse 15, A-2352 Gumpoldskirchen, AT
ZANDER, Marko, c/o Novomatic AG IP&Rechtsabteilung Wiener Strasse 15, A-2352 Gumpoldskirchen, AT
BORNSCHEIN, Jürgen, c/o Novomatic AG IP&Rechtsabteilung Wiener Strasse 15, A-2352 Gumpoldskirchen, AT
RINDERSPACHER, Marc, c/o Novomatic AG IP&Rechtsabteilung Wiener Strasse 15, A-2352 Gumpoldskirchen, AT
-
- (51) MKP
B01D 21/24 (2006.01) (97) **2477708 ***
B01D 21/01 (2006.01)
(86) CA2010000634 22.04.2010
(96) 10816504.4 25.07.2012
(87) WO2011032258, 22.04.2010
(97) 2477708, 25.07.2012 en
(54) PROCESS FOR FLOCCULATING AND DEWATERING OIL SAND MATURE FINE TAILINGS
(71) Suncor Energy Inc., 112, 4 Avenue S.W., Calgary, Alberta T2P 2V5, CA
(72) REVINGTON, Adrian Peter, 506 105 Loutit Road Fort McMurray (Alberta), T9K 2N5, CA
OMOTOSO, Oladipo, 514 Caldwell Court Edmonton (Alberta), T6M 2X4, CA
WELLS, Patrick Sean, 125 Roy Lane Fort McMurray (Alberta), T9J 1L9, CA
HANN, Thomas Charles, Box 67 RR2 Site 4 Onoway (Alberta), TOE 1V0, CA
WEISS, Marvin Harvey, Site 12 Comp 12 RR9 Calgary (Alberta), T2J 5G5, CA
BUGG, Trevor, 189 Hillcrest Drive Fort McMurray (Alberta), T9H 3T9, CA
EASTWOOD, Jamie, 182 Bird Crescent Fort McMurray (Alberta), T9H 4T3, CA
YOUNG, Stephen Joseph, 117 Brebeuf Crescent Fort McMurray (Alberta), T9K 1W7, CA
O'NEILL, Hugues Robert, 148 Beaton Place Fort McMurray (Alberta), T9K 2B3, CA
SANCHEZ, Ana, Christina, 217 Parry Crescent, Fort McMurray Alberta T9K 2T5, CA
-
- (51) MKP
B08B 7/00 (2006.01) (97) **2403661 ***
B08B 1/00 (2006.01)
(86) GB2010050372 03.03.2010
(96) 10707653.1 11.01.2012
(87) WO2010100491, 03.03.2010
(97) 2403661, 11.01.2012 en
(54) CLEANING CONTACT CLEANING ROLLERS
(71) T H Group Limited, River Drive, Inchinnan Renfrewshire PA4 9RT, GB
(72) HAMILTON, Sheila, Nether Knockbuckle Hazelmere Road, Kilmacalm PA13 4JW, GB
-
- (51) MKP
C07D 271/06 (2006.01) (97) **2414342 ***
A61K 31/4245 (2006.01)
A61P 37/00 (2006.01)
(86) EP2010054103 29.03.2010
(96) 10713159.1 08.02.2012
(87) WO2010112461, 29.03.2010
(97) 2414342, 08.02.2012 en
(54) OXADIAZOLE DERIVATIVES
(71) Merck Serono S.A., Centre Industriel, 1267 Coinsins, CH
(72) QUATTROPANI, Anna, Route de Chêne 2, CH-1207 Geneva, CH
MONTAGNE, Cyril, 1 rue de Lyon, F-01630 Saint Genis-Pouilly, FR
SAUER, Wolfgang, 71 chemin des Cornillons, CH-1292 Chambesy, CH
CROSIGNANI, Stefano, 2 chemin de Champs-Fusy, F-01630 St Genis-Pouilly, FR
BOMBURUN, Agnes, 71 chemin des Cornillons, CH-1292 Chambesy, CH
-
- (51) MKP
A61K 36/00 (2006.01) (97) **2475374 ***
(86) EP2010005433 03.09.2010
(96) 10754864.6 18.07.2012
(87) WO2011026637, 03.09.2010
(97) 2475374, 18.07.2012 en
(54) METHODS FOR ISOLATING ALKALOIDS FROM PLANTS
(71) Kallimopoulos, Thomas, Dr., Benckiserstrasse 47, 67059 Ludwigshafen, DE
(72) Kallimopoulos, Thomas, Dr., Benckiserstrasse 47, 67059 Ludwigshafen, DE

- (51) MKP
A61P 25/00 (2006.01) (97) **2483257 ***
C07D 285/36 (2006.01)
A61K 31/554 (2006.01)
C07D 285/06 (2006.01)
C07D 309/24 (2006.01)
- (86) HU2010000103 29.09.2010
(96) 10818064.7 08.08.2012
(87) WO2011039554, 29.09.2010
(97) 2483257, 08.08.2012 en
(54) 2,3,4-BENZOTHIADIAZEPINE-2,2-DIOXIDE DERIVATIVES
(71) EGIS GYÓGYSZERGYÁR Nyilvánosan Működő Részvénytársaság, Keresztúri út 30-38, 1106 Budapest, HU
(72) SIMIG, Gyula, Hollósy S. u. 25., H-1126 Budapest, HU
NAGY, Katalin, Szécsényi u. 124., H-8400 Ajka, HU
GACSÁLYI, István, Baross u. 67., H-1201 Budapest, HU
LÉVAY, György, Gábor Áron u. 10., H-2092 Budakeszi, HU
SZÉNÁSI, Gábor, Lobogó u. 6/b., H-2096 Üröm, HU
VOLK, Balázs, Atlasz u. 34., H-1165 Budapest, HU
HÁRSING, László, Gábor, Dembinszky u. 8., H-1071 Budapest, HU
BERTHA, Ferenc, Pásztorfalva u. 57., H-1171 Budapest, HU
KOMPAGNE, Hajnalka, Kőérberki u. 5/b., H-1221 Budapest, HU
MOLNAR, Balázs, Fenyves u. 3., H-2117 Isaszeg, HU
MARKÓ, Bernadett, Pásztorfalva út. 14., H-1171 Budapest, HU
FETTER, József, Fácán sor 47., H-2100 Gödöllő, HU
GIGLER, Gábor, Etele u. 73., H-1119 Budapest, HU
BARKÓCZY, József, Szior u. 4-6., H-1016 Budapest, HU
KIRICSI, Péter, Erzsébet u.23., H-1043 Budapest, HU

- (51) MKP
C09B 67/20 (2006.01) (97) **2495288 ***
C09B 67/02 (2006.01)
C09B 67/46 (2006.01)
G02B 5/22 (2006.01)
G02B 5/20 (2006.01)
- (86) JP2010069024 27.10.2010
(96) 10826749.3 05.09.2012
(87) WO2011052617, 27.10.2010
(97) 2495288, 05.09.2012 en
(54) DIKETOPYRROLOPYRROLE PIGMENT DISPERSING AGENT, PIGMENT COMPOSITION USING SAME, COLORED COMPOSITION, AND COLOR FILTER
(71) Toyo Ink SC Holdings Co., Ltd., 3-13, Kyobashi 2-chome Chuo-ku, Tokyo 104-8377, JP
Toyocolor Co., Ltd., 3-13, Kyobashi 2-chome, Chuo-ku Tokyo 104-8381, JP
(72) FUJIKI, Masayuki, c/o Toyocolor Co., Ltd. 3-13 Kyobashi 2-chome Chuo-ku, Tokyo 104-8381, JP
IKEDA, Ryo, c/o Toyocolor Co., Ltd. 3-13 Kyobashi 2-chome Chuo-ku, Tokyo 104-8381, JP

- (51) MKP
H01R 9/05 (2006.01) (97) **2417671 ***
H01R 13/646 (2011.01)
- (86) US2010029725 02.04.2010
(96) 10762239.1 15.02.2012
(87) WO2010117890, 02.04.2010
(97) 2417671, 15.02.2012 en
(54) COMPRESSION CONNECTOR FOR COAXIAL CABLE WITH STAGGERED SEIZURE OF OUTER AND CENTER CONDUCTOR AND CENTER CONDUCTOR SEIZING MECHANISM
(71) John Mezzalingua Associates, Inc., 6176 East Molloy Rd., East Syracuse, NY 13057-0278, US
(72) MONTENA, Noah, 124 Buckingham Avenue, Syracuse NY 13210, US
JACKSON, David, 4479 Winding Creek Road, Manlius NY 13104, US
ROBB, Daniel, 208 East Avenue, East Syracuse NY 13057, US
CHAWGO, Shawn, 8443 Rollercoaster Drive, Cicero NY 13039, US

- (51) MKP
A01N 25/24 (2006.01) (97) **2498598 ***
A01N 25/26 (2006.01)
- (86) US2010056439 12.11.2010
(96) 10830755.4 19.09.2012
(87) WO2011060210, 12.11.2010
(97) 2498598, 19.09.2012 en
(54) METHODS FOR GENERATING HIGH ASPECT RATIO POLYMERIC PARTICLES COMPRISING AN ACTIVE INGREDIENT
(71) Syngenta Participations AG, Schwarzwaldallee 215, 4058 Basel, CH
(72) FOWLER, Jeffrey, Syngenta Crop Protection Inc. 410 Swing Road, Greensboro North Carolina 27409, US
SEJONG, Kim, Syngenta Crop Protection Inc. 410 Swing Road, Greensboro North Carolina 27409, US

- (51) MKP
C07K 14/435 (2006.01) (97) **2483300 ***
C07K 7/06 (2006.01)
A61K 38/10 (2006.01)
A61P 19/10 (2006.01)
C07K 14/475 (2006.01)
C07K 17/08 (2006.01)
A61P 3/10 (2006.01)
A61K 38/18 (2006.01)
C07K 7/08 (2006.01)
A61P 21/06 (2006.01)
A61P 17/00 (2006.01)
A61P 3/04 (2006.01)
A61K 38/08 (2006.01)
C12N 15/12 (2006.01)
- (86) NZ2010000191 29.09.2010
(96) 10820883.6 08.08.2012
(87) WO2011040823, 29.09.2010
(97) 2483300, 08.08.2012 en
(54) SYNTHETIC MYOSTATIN PEPTIDE ANTAGONISTS
(71) Covita Limited, Agresearch Limited 5th Floor Tower Block Ruakura Research Centre East Street, Hamilton 3214, NZ
(72) BOWER, Robert Syndecombe, 47 Cormorant Crescent, Peregian Beach Queensland 4073, AU
MOURA, Monica Senna Salerno de, 8 East Street, Claudelands Hamilton 3214, NZ
NICHOLAS, Gina Diane, ., ., NZ
BERRY, Carole Judith, ., ., NZ
THOMAS, Mark Francis, ., ., NZ

- (51) MKP
A01N 43/06 (2006.01) (97) **2453746 ***
A01N 43/12 (2006.01)
A61K 31/38 (2006.01)
- (86) US2010042225 16.07.2010
(96) 10800590.1 23.05.2012
(87) WO2011009023, 16.07.2010
(97) 2453746, 23.05.2012 en
(54) TAZAROTENE DERIVATIVES
(71) Stiefel Laboratories, Inc., 20 TW Alexander Dr., Research Triangle Park, NC 27709, US
(72) GE, Xue, 3160 Porter Dr, Palo Alto CA 94304, US
WONG, Hansen, 415 Firloch Ave Apt 2, Sunnyvale, CA 94086, US
CHERN, Wendy, Huang, 3160 Porter Dr, Palo Alto CA 94304, US
HOFLAND, Hans, 3160 Porter Dr, Palo Alto CA 94304, US
BISHOP, Michael, J., 5 Moore Drive, Research Triangle Park NC 27709, US
CAI, Xin, Frank, c/o 3160 Porter Dr, Palo Alto, CA 94304, US
COLBORN, Alan, 20 TW Alexander Dr., Research Triangle Park NC 27709, US

- (51) MKP
C07D 413/14 (2006.01) (97) **2486024 ***
C07D 271/06 (2006.01)
A61K 31/506 (2006.01)
A61P 5/00 (2006.01)
A61P 37/00 (2006.01)
(86) US2010051727 07.10.2010
(96) 10765724.9 15.08.2012
(87) WO2011044307, 07.10.2010
2486024, 15.08.2012 en
(54) PHENYLOXADIAZOLE DERIVATIVES AS PGDS INHIBITORS
(71) SANOFI, 54, rue de la Boétie, 75008 Paris, FR
(72) VANDEUSEN, Christopher L., c/o Sanofi-aventis U.S. 1041
Route 202-206 Mail Code: BWD-303A, Bridgewater, New
Jersey 08807, US
WEIBERTH, Franz J., c/o Sanofi-aventis U.S. 1041 Route 202-
206 Mail Code: BWD-303A, Bridgewater, New Jersey 08807,
US
GILL, Harpal S., c/o Sanofi-aventis U.S. 1041 Route 202-206
Mail Code: BWD-303A, Bridgewater, New Jersey 08807, US
LEE, George, c/o Sanofi-aventis U.S. 1041 Route 202-206 Mail
Code: BWD-303A, Bridgewater, New Jersey 08807, US
HILLEGASS, Andrea, c/o Sanofi-aventis U.S. 1041 Route 202-
206 Mail Code: BWD-303A, Bridgewater, New Jersey 08807,
US
-
- (51) MKP
B29D 35/00 (2010.01) (97) **2416675 ***
B29D 35/08 (2010.01)
A43B 7/06 (2006.01)
A43B 7/12 (2006.01)
B29C 44/12 (2006.01)
(86) EP2010054040 26.03.2010
(96) 10711389.6 15.02.2012
(87) WO2010115737, 26.03.2010
(97) 2416675, 15.02.2012 en
(54) SHOE WITH VENTILATION SYSTEM OBTAINED BY DIRECT
INJECTION METHOD ON UPPER AND MOULD THEREFOR
(71) Gruppo Meccaniche Luciani S.R.L., 155 Via del Lavoro, 62014
Corridonia (MC), IT
(72) GRAZIANI, Giordano, 38 Via Beato Domenico da Montolmo,
I-62014 Corridonia (mc), IT
PAGLIARI, Augusto, 119 Via Font'Orsola, I-62014 Corridonia
(mc), IT
-
- (51) MKP
G01N 33/50 (2006.01) (97) **2406628 ***
(86) EP2010053063 11.03.2010
(96) 10709198.5 18.01.2012
(87) WO2010103058, 11.03.2010
(97) 2406628, 18.01.2012 en
(54) METHOD OR SYSTEM USING BIOMARKERS FOR THE
MONITORING OF A TREATMENT
(71) Boehringer Ingelheim International GmbH, Binger Strasse 173,
55216 Ingelheim am Rhein, DE
(72) ARAO, Tokuzo, 377-2 Ohno-Higashi, Osaka-Sayama Osaka
589-8511, JP
KUDO, Kanae, 377-2 Ohno-Higashi, Osaka-Sayama Osaka
589-8511, JP
NAKAGAWA, Kazuhiko, 377-2 Ohno-Higashi, Osaka-Sayama
Osaka 589-8511, JP
NISHIO, Kazuto, 377-2 Ohno-Higashi, Osaka-Sayama Osaka
589-8511, JP
-
- (51) MKP
A61M 5/315 (2006.01) (97) **2437831 ***
A61M 5/00 (2006.01)
(86) EP2010057489 28.05.2010
(96) 10725073.0 11.04.2012
(87) WO2010139642, 28.05.2010
(97) 2437831, 11.04.2012 en
(54) DOSE SETTING MECHANISM FOR A DRUG DELIVERY
DEVICE
(71) Sanofi-Aventis Deutschland GmbH, Brüningstraße 50, 65929
Frankfurt, DE
(72) PLUMPTRE, David, 36 Shire Way Droitwich Spa,
Worcestershire WR9 7RQ, GB
-
- (51) MKP
C12N 15/82 (2006.01) (97) **2451830 ***
C07K 14/415 (2006.01)
(86) NL2010050433 07.07.2010
(96) 10734839.3 16.05.2012
(87) WO2011005090, 07.07.2010
(97) 2451830, 16.05.2012 en
(54) METHOD FOR INCREASING THE RESISTANCE OF A PLANT
OR A PART THEREOF TO A PATHOGEN, METHOD FOR
SCREENING THE RESISTANCE OF A PLANT OR PART
THEREOF TO A PATHOGEN, AND USE THEREOF
(71) Wageningen Universiteit, Costerweg 50, 6701 BH Wageningen,
NL
(72) DE WIT, Peter Jozef Gerard Marie, Ercalaan 9, NL-3911 XM
Rhenen, NL
STERGIOPOULOS, Ioannis, Marijkeweg 28-3C-8, NL-6709 PD
Wageningen, NL
KEMA, Gerrit Haatje Jan, Bergweg 41, NL-3904 HM
Veenendaal, NL
-
- (51) MKP
A61M 5/315 (2006.01) (97) **2437821 ***
(86) EP2010057486 28.05.2010
(96) 10722098.0 11.04.2012
(87) WO2010139640, 28.05.2010
(97) 2437821, 11.04.2012 en
(54) SPINDLE FOR A DRUG DELIVERY DEVICE
(71) Sanofi-Aventis Deutschland GmbH, Brüningstraße 50, 65929
Frankfurt, DE
(72) PLUMPTRE, David, 36 Shire Way Droitwich Spa
Worcestershire, WR9 7RQ, GB
-
- (51) MKP
A61K 31/337 (2006.01) (97) **2470173 ***
A61K 9/20 (2006.01)
(86) US2010046684 25.08.2010
(96) 10812593.1 04.07.2012
(87) WO2011025838, 25.08.2010
(97) 2470173, 04.07.2012 en
(54) COMBINATION THERAPY WITH NANOPARTICLE
COMPOSITIONS OF TAXANE AND HEDGEHOG INHIBITORS
(71) Abraxis BioScience, LLC, 11755 Wilshire Boulevard Suite
2100, Los Angeles, CA 90025, US
(72) TAO, Chunlin, 1800 Camden Avenue Suite No.301, Los Angeles
CA 90025, US
DESAI, Neil, P., 11755 Wilshire Boulevard Suite 2100, Los
Angeles CA 90025, US
SOON-SHIONG, Patrick, 149 South Barrington Avenue No.311,
Los Angeles CA 90049, US
-
- (51) MKP
C08L 27/00 (2006.01) (97) **2485905 ***
B60C 19/00 (2006.01)
G01M 1/36 (2006.01)
C08L 71/02 (2006.01)
(86) EP2010065125 08.10.2010
(96) 10763699.5 15.08.2012
(87) WO2011042549, 08.10.2010
(97) 2485905, 15.08.2012 en
(54) COMPOSITION, METHOD AND SYSTEM FOR BALANCING A
ROTARY SYSTEM
(71) Carnehammar, Lars Bertil, Sonnenbergstrasse 126, 8032
Zürich, CH
(72) RONLAN, Alvin, Östermalmsgatan 103, S-114 59 Stockholm,
SE
-
- (51) MKP
A61K 9/14 (2006.01) (97) **2477608 ***
(86) US2010048588 13.09.2010
(96) 10817696.7 25.07.2012
(87) WO2011034809, 13.09.2010
(97) 2477608, 25.07.2012 en
(54) ORAL SOLID DOSAGE FORM CONTAINING
NANOPARTICLES AND PROCESS OF FORMULATING THE
SAME USING FISH GELATIN
(71) R.P. Scherer Technologies, LLC, C/o CSC Services of Nevada,
Inc. 502 East John Street, Carson City NV 89706, US
(72) BAH, Deepak, 809 Royal Oaks Court, Monmouth Junction NJ
08852, US
CROWLEY, Kieran, James, 315 Harrison Avenue, Highland
Park NJ 08904, US
YU, Danny, P.O. Box 1015, Somerville NJ 08876, US

- (51) MKP
G06F 3/01 (2006.01) (97) **2418562**
(96) 10172813.7 15.02.2012
(97) 2418562, 15.02.2012 en
(54) Modelling of hand and arm position and orientation
(71) Deutsches Primatenzentrum GmbH, Kellnerweg 4, 37077 Göttingen, DE
(72) Scherberger, Hansjörg, Petrikirchstrasse 40, 37077 Göttingen, DE
Schaffelhofer, Stefan, Gosslerstrasse 33, 37075 Göttingen, DE
-
- (51) MKP
F28D 7/00 (2006.01) (97) **2341119**
C10L 9/08 (2006.01)
C10B 53/02 (2006.01)
C10L 9/00 (2006.01)
C10B 49/14 (2006.01)
(96) 10195579.7 06.07.2011
(97) 2341119, 06.07.2011 de
(54) Method and device for tempering an exothermic reaction
(71) Heete, Lars Christian, Brüner Str. 11, 46240 Bottrop, DE
(72) Heete, Lars Christian, Brüner Str. 11, 46240 Bottrop, DE
-
- (51) MKP
B32B 9/00 (2006.01) (97) **2440402 ***
B32B 33/00 (2006.01)
(86) US2010027693 17.03.2010
(96) 10786522.2 18.04.2012
(87) WO2010144167, 17.03.2010
(97) 2440402, 18.04.2012 en
(54) HYDROPHOBIC MATERIALS MADE BY VAPOR DEPOSITION COATING AND APPLICATIONS THEREOF
(71) Innovanano, Inc., 9 Dunster Lane, Winchester, MA 01890, US
(72) YUAN, Jikang, Flat C, 12/f Blk. 12 Cherry Mansions Whampoa Garden 9 Shung King Street Hung Hom, Kowloon, CN
DONG, He, 9 Dunster Lane, Winchester MA 01890, US
-
- (51) MKP
G08B 1/08 (2006.01) (97) **2491541 ***
(86) US2010002789 18.10.2010
(96) 10825326.1 29.08.2012
(87) WO2011049619, 18.10.2010
(97) 2491541, 29.08.2012 en
(54) SYNCHRONIZATION SYSTEM AND METHOD FOR ACHIEVING LOW POWER BATTERY OPERATION OF A VEHICLE LOCATING UNIT
(71) Lojack Operating Company, L.P., 200 Lowder Brook Road Suite 1000, Westwood, MA 02090, US
(72) GOODWIN, Michael, 25 Phillips Court, North Andover MA 01845, US
JUSTICE, James, 10 The Paddock Lane, Medford MA 02052, US
RHODES, Jesse, 291 Prospect Street, Franklin MA 02038, US
-
- (51) MKP
A61K 31/137 (2006.01) (97) **2419400 ***
A61K 31/135 (2006.01)
A61P 25/00 (2006.01)
C07C 211/27 (2006.01)
C07C 211/29 (2006.01)
C07C 211/35 (2006.01)
C07C 225/16 (2006.01)
C07C 225/18 (2006.01)
(86) US2010031230 15.04.2010
(96) 10714150.9 22.02.2012
(87) WO2010121022, 15.04.2010
(97) 2419400, 22.02.2012 en
(54) MONOAMINE REUPTAKE INHIBITORS
(71) RESEARCH TRIANGLE INSTITUTE, 3040 Cornwallis Road P.O. Box 12194, Research Triangle Park, NC 27709, US
(72) CARROLL, Frank Ivy, 5124 N. Willowhaven Dr., Durham North Carolina 27712, US
BLOUGH, Bruce, 3417 Trinity Farms Rd., Raleigh North Carolina 27607, US
ABRAHAM, Philip, 310 Homestead Dr., Cary North Carolina 27513, US
-
- (51) MKP
F02M 61/16 (2006.01) (97) **2392816**
C21D 7/10 (2006.01)
(96) 10164871.5 07.12.2011
(97) 2392816, 07.12.2011 en
(54) Stress Relief in Pressurized Fluid Flow System
(71) Delphi Technologies Holding S.à.r.l., Avenue de Luxembourg, 4940 Bascharage, LU
(72) Roques, Sylvain, 152 Western Avenue East Acton, London, W3 7TT, GB
-
- (51) MKP
A61K 38/48 (2006.01) (97) **2416800 ***
A61P 31/04 (2006.01)
(86) EP2011052831 25.02.2011
(96) 11708010.1 15.02.2012
(87) WO2011104352, 25.02.2011
(97) 2416800, 15.02.2012 en
(54) ORAL LACTOFERRIN IN THE TREATMENT OF SEVERE SEPSIS
(71) Agennix AG, Im Neuenheimer Feld 515, 69120 Heidelberg, DE
(72) VARADHACHARY, Atul, c/o Agennix AG Im Neuenheimer Feld 515, 69120 Heidelberg, DE
PETRAK, Karel, c/o Agennix AG Im Neuenheimer Feld 515, 69120 Heidelberg, DE
-
- (51) MKP
C10G 1/04 (2006.01) (97) **2475745 ***
(86) US2010048438 10.09.2010
(96) 10816159.7 18.07.2012
(87) WO2011031976, 10.09.2010
(97) 2475745, 18.07.2012 en
(54) BITUMEN SEPARATION COMPOSITIONS AND PROCESSES Vary Petrochem, LLC, 11103 Memphis Avenue, Brooklyn, Ohio 44144, US
(72) YEGGY, Robert, C., 5765 S. State Route 48, Maineville Ohio 45039, US
ALTAVILLA, Vito, J., 2183 Springer Avenue, Cincinnati Ohio 45208, US
-
- (51) MKP
G06Q 20/00 (2012.01) (97) **2425389 ***
(86) FR2010050820 29.04.2010
(96) 10727067.0 07.03.2012
(87) WO2010125318, 29.04.2010
(97) 2425389, 07.03.2012 fr
(54) METHOD FOR SUSPENDING AND ACTIVATING A SERVICE IN A MOBILE NETWORK
(71) Dhatim SARL, 7 rue de la Croix Martre, 91120 Palaiseau, FR
(72) BOURGEOIS, Thomas, 190 bis Avenue Jean Jaurès, F-92140 Clamart, FR
DE CHASTELLIER, Pierre, 155 rue du Faubourg Saint Denis, F-75010 Paris, FR
-
- (51) MKP
A61P 25/28 (2006.01) (97) **2430022 ***
C07D 519/00 (2006.01)
C07D 471/04 (2006.01)
A61K 31/437 (2006.01)
(86) EP2010002910 11.05.2010
(96) 10721696.2 21.03.2012
(87) WO2010130424, 11.05.2010
(97) 2430022, 21.03.2012 en
(54) 1,2,3-TRIAZOLO 4,3-A-PYRIDINE DERIVATIVES AND THEIR USE FOR THE TREATMENT OR PREVENTION OF NEUROLOGICAL AND PSYCHIATRIC DISORDERS
(71) Janssen Pharmaceuticals, Inc., 1125 Trenton-Harbourton Road, Titusville, NJ 08560, US
Addex Pharma SA, 12 Chemin des Aulx, 1228 Plan-les-Ouates, CH
(72) CID-NÚÑEZ, José, Maria, Janssen-Cilag S.A. Calle Jarama 75 Poligono Industrial, 45007 Toledo, ES
OEHLRICH, Daniel, Janssen Pharmaceuticals NV Turnhoutseweg 30, 2340 Beerse, BE
TRABANCO-SUÁREZ, Andrés, Avelino, Janssen-Cilag S.A. Calle Jarama 75 Poligono Industrial, 45007 Toledo, ES
TRESADERN, Gary, John, Janssen-Cilag S.A. Calle Jarama 75 Poligono Industrial, 45007 Toledo, ES
VEGA RAMIRO, Juan, Antonio, Janssen-Cilag S.A. Calle Jarama 75 Poligono Industrial, 45007 Toledo, ES
MACDONALD, Gregor, James, Janssen Pharmaceutica NV Turnhoutseweg 30, 2340 Beerse, BE
-

- (51) MKP
B23F 5/22 (2006.01) (97) **2456587 ***
B23Q 39/02 (2006.01)
- (86) IB2010001763 21.07.2010
(96) 10752151.0 30.05.2012
(87) WO2011010209, 21.07.2010
(97) 2456587, 30.05.2012 en
(54) A WORKING MACHINE FOR MAKING GEARS
(71) Samp S.p.a. Con Unico Socio, Via Saliceto 15, Bentivoglio, IT
(72) AFFATICATI, Artemio, Via Buonarroti 5, I-21052 Busto Arsizio, IT
PERRONE, Vito, Via Cristoforo Colombo 2, I-26013 Crema, IT
-
- (51) MKP
G01N 33/573 (2006.01) (97) **2419735 ***
- (86) EP2010054886 14.04.2010
(96) 10714250.7 22.02.2012
(87) WO2010119061, 14.04.2010
(97) 2419735, 22.02.2012 de
(54) METHOD FOR DETERMINING THE CBL-B EXPRESSION
(71) Medizinische Universität Innsbruck, Christoph-Probst-Platz
Innrain 52, 6020 Innsbruck, AT
Apeiron Biologics AG, Campus-Vienna-Biocenter 5, 1030 Wien, AT
(72) LOIBNER, Hans, Heimgasse 23, A-1230 Wien, AT
BAIER, Gottfried, Badhausstrasse 22c, A-6020 Innsbruck, AT
LAMETSCHWANDTNER, Günther, Stammgasse 7/6, A-1030 Wien, AT
SCHUSTER, Manfred, Josef Weilandstrasse 84, A-2191 Schrick, AT
GRUBER, Thomas, Winklweg 34, A-6364 Brixen i.T., AT
WOLF, Dominik, Raitis 11c, A-6162 Mutters, AT
-
- (51) MKP
E06C 1/383 (2006.01) (97) **2411615 ***
E06C 7/08 (2006.01)
E06C 9/06 (2006.01)
- (86) AU2010000352 24.03.2010
(96) 10755326.5 01.02.2012
(87) WO2010108230, 24.03.2010
(97) 2411615, 01.02.2012 en
(54) EMERGENCY ESCAPE LADDER
(71) Murphy, Russell Edward, 61A Carween Avenue, Mitcham, Victoria 3132, AU
(72) Murphy, Russell Edward, 61A Carween Avenue, Mitcham, Victoria 3132, AU
-
- (51) MKP
F03D 11/00 (2006.01) (97) **2414673 ***
- (86) US2010029156 30.03.2010
(96) 10759280.0 08.02.2012
(87) WO2010114819, 30.03.2010
(97) 2414673, 08.02.2012 en
(54) SEGMENTED WIND TURBINE
(71) Flodesign Wind Turbine Corporation, 380 Main Street, Wilbraham, MA 01095, US
(72) PRESZ Jr., Walter, M., 40 Grove Street, Wilbraham MA 01095, US
WERLE, Michael, J., 4 Porter Drive, West Hartford CT 06117, US
KENNEDY, Thomas, J. III, 3 Mirick Lane, Wilbraham MA 01095, US
KEELEY, William, Scott, 62 Baxter Street, Charlestown RI 02813, US
-
- (51) MKP
E02F 3/815 (2006.01) (97) **2369064**
E02F 9/28 (2006.01)
E01H 5/06 (2006.01)
A01B 31/00 (2006.01)
- (96) 11158998.2 28.09.2011
(97) 2369064, 28.09.2011 en
(54) Blade segment and blade assembly for a surface working vehicle
(71) Boundary Equipment Co. Ltd., 10740 181 Street, Edmonton AB T5S 1K8, CA
(72) Tutschek, Alex, 10740 - 181 Street, Edmonton, Alberta T5S 1K8, CA
Wowk, Dave, 86 Hidden Circle NW, Calgary, Alberta T3A 5G9, CA
Corabian, Mihai, 4125 - 147 Street, Edmonton, Alberta T6H 5V6, CA
Bogojevic, Dragan, 18011 - 76 Avenue, Edmonton, Alberta T5T 2E9, CA
-
- (51) MKP
D21H 21/16 (2006.01) (97) **2456919 ***
- (86) US2010042827 22.07.2010
(96) 10737436.5 30.05.2012
(87) WO2011011563, 22.07.2010
(97) 2456919, 30.05.2012 en
(54) SIZING COMPOSITION FOR HOT PENETRANT RESISTANCE
(71) Hercules Incorporated, Hercules Plaza 1313 N. Market Street, Wilmington, DE 19894-0001, US
(72) EHRHARDT, Susan, M., 213 Euclid Avenue, Haddonfield NJ 08033, US
-
- (51) MKP
A61P 31/12 (2006.01) (97) **2476440 ***
A61P 35/00 (2006.01)
A61K 47/48 (2006.01)
A61K 38/39 (2006.01)
C07K 14/025 (2006.01)
C07K 14/78 (2006.01)
A61K 38/16 (2006.01)
- (86) ES2010070590 10.09.2010
(96) 10768504.2 18.07.2012
(87) WO2011029980, 10.09.2010
(97) 2476440, 18.07.2012 en
(54) THERAPEUTIC COMPOSITIONS FOR THE TREATMENT OF HPV-INDUCED DISEASES
(71) Proyecto de Biomedicina Cima, S.L., Avda. Pío XII, 22 Oficina 1, 31008 Pamplona - Navarra, ES
(72) BERRAONDO LÓPEZ, Pedro, ICT (D.P.I.) Avda. Pío XII 53, E-31008 Pamplona - Navarra, ES
LASARTE SAGASTIBELZA, Juan José, ICT (D.P.I.) Avda. Pío XII 53, E-31008 Pamplona - Navarra, ES
MANSILLA PUERTA, Cristina, ICT (D.P.I.) Avda. Pío XII 53, E-31008 Pamplona - Navarra, ES
PRIETO VALTUEÑA, Jesús María, ICT (D.P.I.) Avda. Pío XII 53, E-31008 Pamplona - Navarra, ES
SAROBÉ UGARRIZA, Pablo, ICT (D.P.I.) Avda. Pío XII 53, E-31008 Pamplona - Navarra, ES
-
- (51) MKP
B29C 45/26 (2006.01) (97) **2263852**
B29C 33/30 (2006.01)
B29C 45/36 (2006.01)
B29C 33/76 (2006.01)
- (96) 10165395.4 22.12.2010
(97) 2263852, 22.12.2010 en
(54) Mold for plastics, particularly of the type of a mold for providing preforms of plastic bottles and the like
(71) Acqua Minerale San Benedetto S.P.A., Viale Kennedy 65, 30037 Scorze', IT
(72) Zoppas, Matteo, Via XX Settembre, 122, 31015 Conegliano TV, IT
-

- (51) MKP
C07D 213/74 (2006.01) (97) **2459535 ***
C07D 401/04 (2006.01)
C07D 401/12 (2006.01)
A61K 31/506 (2006.01)
A61P 29/00 (2006.01)
A61P 35/00 (2006.01)
- (86) EP2010060984 28.07.2010
(96) 10736734.4 06.06.2012
(87) WO2011012661, 28.07.2010
(97) 2459535, 06.06.2012 en
(54) PYRIDINE AND PYRAZINE DERIVATIVES AS PROTEIN KINASE MODULATORS
- (71) Novartis AG, Lichtstrasse 35, 4056 Basel, CH
(72) BARSANTI, Paul, A., Novartis Vaccines and Diagnostics Inc. 4560 Horton Street Emeryville, CA 94608-2916, US
HU, Cheng, Novartis Vaccines and Diagnostics Inc. 4560 Horton Street Emeryville, CA 94608-2916, US
JIN, Jeff, Novartis Vaccines and Diagnostics Inc. 4560 Horton Street Emeryville, CA 94608-2916, US
KEYES, Robert, Novartis Vaccines and Diagnostics Inc. 4560 Horton Street Emeryville, CA 94608-2916, US
KUCEJKO, Robert, Novartis Vaccines and Diagnostics Inc. 4560 Horton Street Emeryville, CA 94608-2916, US
LIN, Xiaodong, Novartis Vaccines and Diagnostics Inc. 4560 Horton Street Emeryville, CA 94608-2916, US
PAN, Yue, Novartis Vaccines and Diagnostics Inc. 4560 Horton Street Emeryville, CA 94608-2916, US
PFISTER, Keith, B., Novartis Vaccines and Diagnostics Inc. 4560 Horton Street Emeryville, CA 94608-2916, US
SENDZIK, Martin, Novartis Vaccines and Diagnostics Inc. 4560 Horton Street Emeryville, CA 94608-2916, US
SUTTON, James, Novartis Vaccines and Diagnostics Inc. 4560 Horton Street Emeryville, CA 94608-2916, US
WAN, Lifeng, Novartis Vaccines and Diagnostics Inc. 4560 Horton Street Emeryville, CA 94608-2916, US

- (51) MKP
C12P 21/06 (2006.01) (97) **2462237 ***
C07H 21/04 (2006.01)
- (86) US2010044693 06.08.2010
(96) 10807224.0 13.06.2012
(87) WO2011017606, 06.08.2010
(97) 2462237, 13.06.2012 en
(54) METHODS FOR IMPROVING RECOMBINANT PROTEIN EXPRESSION
- (71) Cmc Icos Biologics, Inc., 22021 20th Avenue SE, Bothell, WA 98021, US
(72) CLARKE, Howard, Robert, Grahame, 317 Trumpeter Way, Friday Harbor WA 98250, US

- (51) MKP
A01G 1/00 (2006.01) (97) **2493282 ***
- (86) FR2010052298 27.10.2010
(96) 10787856.3 05.09.2012
(87) WO2011051619, 27.10.2010
(97) 2493282, 05.09.2012 fr
(54) DEVICE FOR A VERTICAL OR ANGLED ARRANGEMENT OF THE HYDROPONIC CULTIVATION OF PLANTS
- (71) Modulogreen Vertical Solutions, 18-2H rue Isabel Carvalho, 5000-608 Vila Real, PT
(72) DOS SANTOS, José, 10 rue de la Forêt, F-91630 Avrainville, FR

- (51) MKP
G06F 3/041 (2006.01) (97) **2406705 ***
G06F 3/01 (2006.01)
G06F 3/048 (2006.01)
- (86) US2010026905 11.03.2010
(96) 10715618.4 18.01.2012
(87) WO2010105010, 11.03.2010
(97) 2406705, 18.01.2012 en
(54) SYSTEMS AND METHODS FOR USING TEXTURES IN GRAPHICAL USER INTERFACE WIDGETS
- (71) Immersion Corporation, 801 Fox Lane, San Jose, CA 95131, US
(72) CRUZ-HERNANDEZ, Juan Manuel, 4840 Ste - Catherine West, Montreal Québec H3Z 1T1, CA
GRANT, Danny A., 1784 de Lunebourg, Laval Québec H7M 2A1, CA
MODARRES, Ali, 3777 Cole-des-Neiges Apt. 520, Montreal Québec H3H 1V8, CA
GOSLINE, Andrew, 4085 Rue Rivard, Montreal Québec H2L 4J1, CA

- (51) MKP
C07K 16/18 (2006.01) (97) **2417158 ***
- (86) US2010030039 06.04.2010
(96) 10712681.5 15.02.2012
(87) WO2010117980, 06.04.2010
(97) 2417158, 15.02.2012 en
(54) DKK-1 ANTIBODIES
- (71) Eli Lilly and Company, Lilly Corporate Center, Indianapolis, IN 46285, US
(72) CHEDID, Marcio, Eli Lilly and Company Lilly Corporate Center, Indianapolis, Indiana 46285, US
DARLING, Ryan, James, Eli Lilly and Company Lilly Corporate Center, Indianapolis, Indiana 46285, US
GALVIN, Rachelle, Jeanette, Eli Lilly and Company Lilly Corporate Center, Indianapolis, Indiana 46285, US
SWANSON, Barbara, Anne, 1402 Willowspring Drive North, Encinitas California 92024, US

- (51) MKP
E21B 4/18 (2006.01) (97) **2494135 ***
E21B 23/14 (2006.01)
E21B 47/12 (2012.01)
- (86) EP2010066233 27.10.2010
(96) 10770834.9 05.09.2012
(87) WO2011051321, 27.10.2010
(97) 2494135, 05.09.2012 en
(54) DOWNHOLE APPARATUS
- (71) Maersk Oil Qatar A/S, Esplanaden 50, 1263 Copenhagen K, DK
(72) HEIJUNEN, Wilhelmus Hubertus Paulus Maria, St-Jakobusstrasse 4, 55442 Stromberg, DE
PETERS, Robert Bouke, Wellwood Mansions, Flat 8 250 North Deeside Road, Pitfoldels, Aberdeen AB15 9PB, GB

- (51) MKP
A61K 31/517 (2006.01) (97) **2419135 ***
A61K 39/395 (2006.01)
- (86) US2010030022 06.04.2010
(96) 10764915.4 22.02.2012
(87) WO2010120592, 06.04.2010
(97) 2419135, 22.02.2012 en
(54) COMBINATION THERAPY USING AN ANTI-EGFR AGENT(S) AND IGF-1R SPECIFIC INHIBITORS
- (71) Merck Sharp & Dohme Corp., 126 East Lincoln Avenue, Rahway, NJ 07065-0907, US
(72) SATHYANARAYANAN, Sriram, 126 East Lincoln Avenue, Rahway New Jersey 07065-0907, US
KASIBHATLA, Shailaja, 126 East Lincoln Avenue, Rahway New Jersey 07065-0907, US
WINTER, Christopher, 126 East Lincoln Avenue, Rahway New Jersey 07065-0907, US
CHASTAIN, Michael, 126 East Lincoln Avenue, Rahway New Jersey 07065-0907, US

- (51) MKP
A61H 33/02 (2006.01) (97) **2459145 ***
- (86) CZ2010000083 27.07.2010
(96) 10770957.8 06.06.2012
(87) WO2011012094, 27.07.2010
(97) 2459145, 06.06.2012 en
(54) BABY BATH, NAMELY FOR TODDLERS AND INFANTS
- (71) Koller, Rudolf, Kudlichgasse 36, 1100 Wien, AT
(72) Koller, Rudolf, Kudlichgasse 36, 1100 Wien, AT

- (51) MKP
C12N 5/10 (2006.01) (97) **2464664 ***
C07K 16/10 (2006.01)
C12N 15/13 (2006.01)
A61K 39/42 (2006.01)
C12N 15/63 (2006.01)
A61P 31/14 (2006.01)
A61K 47/48 (2006.01)
G01N 33/53 (2006.01)
A61K 38/00 (2006.01)
A61K 31/00 (2006.01)
(86) US2010045549 13.08.2010
(96) 10747357.1 20.06.2012
(87) WO2011020079, 13.08.2010
(97) 2464664, 20.06.2012 en
(54) ANTIBODIES AGAINST HUMAN RESPIRATORY SYNCYTIAL VIRUS (RSV) AND METHODS OF USE
(71) Crucell Holland B.V., Archimedesweg 4, 2333 CN Leiden, NL
(72) WILLIAMSON, Robert, Anthony, 5329 Chelsea Street, La Jolla, CA 92037, US
WADIA, Jehangir, 10686 Passerine Way, San Diego, CA 92121, US
PASCUAL, Gabriel, 6508 Dennison Street, San Diego, CA 92122, US
KEOGH, Elissa, 7999 Caminito Dia, 2, San Diego, CA 92122, US
-
- (51) MKP
E03D 9/02 (2006.01) (97) **2281756**
B65D 83/00 (2006.01)
(96) 10170608.3 09.02.2011
(97) 2281756, 09.02.2011 en
(54) Application device of sanitary hygiene products
(71) Bolton Manitoba SpA, Via G.B. Pirelli 19, 20124 Milano, IT
Nobbio, Alessio, c/o INGE S.p.A. Via Garibaldi, 190, 20024 Garbagnate Milanese (MI), IT
Partiti, David, Via E. Carpi, 21, 20131 Milano, IT
Baiguerra, Gianpaolo, Via Matteotti, 45H, 20020 Arese (MI), IT
Rosati, Massimo, Via San Giovanni Bosco, 12, 20052 Monza (MB), IT
Alderuccio, Gianni, Via Alfieri, 40, 20030 Bovisio Masciago (MB), IT
Pimazzoni, Massimiliano, Via Bach, 44, 21042 Caronno Pertusella (VA), IT
Curi, Paola, Via Per Como, 27, 22034 Brunate (CO), IT
-
- (51) MKP
F16B 13/00 (2006.01) (97) **2494125 ***
F16B 13/04 (2006.01)
F16B 13/12 (2006.01)
E04B 1/76 (2006.01)
F16B 5/06 (2006.01)
E04F 13/04 (2006.01)
E04F 13/08 (2006.01)
(86) EP2010064703 04.10.2010
(96) 10761004.0 05.09.2012
(87) WO2011051080, 04.10.2010
(97) 2494125, 05.09.2012 de
(54) PLASTERING SYSTEM AND PLASTIC ANCHOR/METAL SCREW ASSEMBLY FOR SAME
(71) SFS Intec Holding AG, Nefenstrasse 30, 9435 Heerbrugg, CH
(72) KORHONEN, Tero, Strömsviksvägen 2, S-73494 Strömsholm, SE
-
- (51) MKP
C07K 16/00 (2006.01) (97) **2473524 ***
C07H 21/00 (2006.01)
(86) US2010047543 01.09.2010
(96) 10814433.8 11.07.2012
(87) WO2011028811, 01.09.2010
(97) 2473524, 11.07.2012 en
(54) DUAL VARIABLE DOMAIN IMMUNOGLOBULINS AND USES THEREOF
(71) Abbott Laboratories, 100 Abbott Park Rd., Abbott Park, IL 60064, US
(72) GHAYUR, Tariq, 1014 Washington Street, Holliston Massachusetts 01746, US
LIU, Junjian, 14 Crimson Drive, Shrewsbury Massachusetts 01545, US
MANOJ, Sharmila, 1625 Fox Run Drive, Arlington Heights Illinois 60004, US
BROPHY, Susan E., 2477 Mallard Drive, Lindenhurst Illinois 60046, US
-
- (51) MKP
F16L 37/091 (2006.01) (97) **2494255 ***
(86) IB2010054867 27.10.2010
(96) 10787183.2 05.09.2012
(87) WO2011051895, 27.10.2010
(97) 2494255, 05.09.2012 en
(54) QUICK-FIT CONNECTION
(71) Giordano, Vincenza, Via Palestro 5, 25045 Castegnato, Brescia, IT
(72) Giordano, Vincenza, Via Palestro 5, 25045 Castegnato, Brescia, IT
-
- (51) MKP
C12N 1/21 (2006.01) (97) **2493930 ***
C07K 16/28 (2006.01)
C07K 16/46 (2006.01)
C12N 5/10 (2006.01)
C12N 1/19 (2006.01)
A61K 39/395 (2006.01)
C12N 15/09 (2006.01)
A61P 37/06 (2006.01)
C12N 1/15 (2006.01)
A61P 1/04 (2006.01)
C12P 21/08 (2006.01)
(86) JP2010069653 28.10.2010
(96) 10826929.1 05.09.2012
(87) WO2011052799, 28.10.2010
(97) 2493930, 05.09.2012 en
(54) COMPOSITIONS AND METHODS FOR TREATING INFLAMMATORY DISORDERS
(71) Eisai R&D Management Co., Ltd., 6-10, Koishikawa 4-chome Bunkyo-ku, Tokyo 112-8088, JP
(72) NISHIMURA, Miyuki, c/o KAN Research Institute Inc. Kobe MI R&D Center 6-7-3 Minatojima-minamimachi Chuo-ku, Kobe-shi Hyogo 650-0047, JP
SAKAMOTO, Yoshimasa, c/o KAN Research Institute Inc. Kobe MI R&D Center 6-7-3 Minatojima-minamimachi Chuo-ku, Kobe-shi Hyogo 650-0047, JP
KAWANO, Tetsu, c/o KAN Research Institute Inc. Kobe MI R&D Center 6-7-3 Minatojima-minamimachi Chuo-ku, Kobe-shi Hyogo 650-0047, JP
IMAI, Toshio, c/o KAN Research Institute Inc. Kobe MI R&D Center 6-7-3 Minatojima-minamimachi Chuo-ku, Kobe-shi Hyogo 650-0047, JP
-
- (51) MKP
C07K 16/18 (2006.01) (97) **2454285 ***
(86) EP2010060112 14.07.2010
(96) 10734965.6 23.05.2012
(87) WO2011006915, 14.07.2010
(97) 2454285, 23.05.2012 en
(54) IMPROVED ANTI-SERUM ALBUMIN BINDING SINGLE VARIABLE DOMAINS
(71) Glaxo Group Limited, Glaxo Wellcome House Berkeley Avenue Greenford, Middlesex UB6 0NN, GB
(72) COULSTOCK, Edward, Domantis Limited 315 Cambridge Science Park, Cambridge Cambridgeshire CB4 0WG, GB
DE ANGELIS, Elena, Domantis Limited 315 Cambridge Science Park, Cambridge Cambridgeshire CB40WG, GB
LIU, Haiqun, Domantis Limited 315 Cambridge Science Park, Cambridge Cambridgeshire CB4 0WG, GB
SCHON, Oliver, Domantis Limited 315 Cambridge Science Park, Cambridge Cambridgeshire CB4 0WG, GB
-
- (51) MKP
A61K 39/00 (2006.01) (97) **2480562 ***
C07K 7/00 (2006.01)
(86) US2010049466 20.09.2010
(96) 10819298.0 01.08.2012
(87) WO2011037859, 20.09.2010
(97) 2480562, 01.08.2012 en
(54) IDENTIFICATION OF ANTIGENIC PEPTIDES FROM MULTIPLE MYELOMA CELLS
(71) Janssen Pharmaceutica N.V., Turnhoutseweg 30, 2340 Beerse, BE
(72) CAI, Zeling, 10516 Corte Jardin Del Mar, San Diego, CA 92130, US
SHI, Wei-Xing, 11321 Carmel Creek Road, San Diego, CA 92130, US
LIU, Xuejun, P., 4644 Corte Sol Del Dios, San Diego, CA 92130, US
WU, Jiejun, 11383 Pacific Shores Way, San Diego, CA 92130, US

(51) MKP
A61P 3/04 (2006.01) (97) **2477989 ***
A61P 19/02 (2006.01)
C07D 471/04 (2006.01)
A61P 35/00 (2006.01)
A61K 31/4745 (2006.01)
A61P 13/12 (2006.01)
A61P 11/16 (2006.01)
A61P 9/10 (2006.01)
A61P 11/00 (2006.01)
A61P 43/00 (2006.01)
A61P 7/02 (2006.01)
A61P 31/04 (2006.01)
A61P 1/04 (2006.01)
(86) JP2010066637 17.09.2010
(96) 10817326.1 25.07.2012
(87) WO2011034215, 17.09.2010
(97) 2477989, 25.07.2012 en
(54) COMPOUNDS HAVING TAF1a INHIBITORY ACTIVITY
(71) Taisho Pharmaceutical Co., Ltd., 24-1, Takada 3-chome
Toshima-ku, Tokyo 170-8633, JP
(72) AMADA, Hideaki, c/o Taisho Pharmaceutical Co. Ltd. 24-1
Takada 3-chome Toshima-ku, Tokyo 170-8633, JP
MATSUDA, Daisuke, c/o Taisho Pharmaceutical Co. Ltd. 24-1
Takada 3-chome Toshima-ku, Tokyo 170-8633, JP
BOHNO, Ayako, c/o Taisho Pharmaceutical Co. Ltd. 24-1
Takada 3-chome Toshima-ku, Tokyo 170-8633, JP

(51) MKP
B65D 75/58 (2006.01) (97) **2371737**
(96) 10450050.9 05.10.2011
(97) 2371737, 05.10.2011 de
(54) Packaging with tear strip
(71) Constantia Patz Ges. m.b.H., Guntramsenstrasse 7, 2620
Loipersbach, AT
(72) Weber, Othmar, Dr. Karl-Rennerstrasse 91/E/5, 2630 Ternitz,
AT
Piesslinger, Johannes, Ing. F. Ritter-Strasse 1, 2822 Bad Erlach,
AT

(51) MKP
C07D 295/155 (2006.01) (97) **2427444 ***
C07D 307/88 (2006.01)
A61K 31/495 (2006.01)
C07D 405/08 (2006.01)
A61K 31/529 (2006.01)
C07D 407/08 (2006.01)
A61P 7/10 (2006.01)
C07D 413/08 (2006.01)
C07D 493/04 (2006.01)
C07D 487/08 (2006.01)
C07D 295/135 (2006.01)
(86) US2010032872 29.04.2010
(96) 10716982.3 14.03.2012
(87) WO2010129379, 29.04.2010
(97) 2427444, 14.03.2012 en
(54) INHIBITORS OF THE RENAL OUTER MEDULLARY
POTASSIUM CHANNEL
(71) Merck Sharp & Dohme Corp., 126 East Lincoln Avenue,
Rahway, NJ 07065-0907, US
(72) PASTERNAK, Alexander, 126 East Lincoln Avenue, Rahway
New Jersey 07065-0907, US
SHAHRIPOUR, Aurash, 126 East Lincoln Avenue, Rahway New
Jersey 07065-0907, US
TANG, Haifeng, 126 East Lincoln Avenue, Rahway New Jersey
07065-0907, US
TEUMELSAN, Nardos, H., 126 East Lincoln Avenue, Rahway
New Jersey 07065-0907, US
YANG, Lihu, 126 East Lincoln Avenue, Rahway New Jersey
07065-0907, US
ZHU, Yuping, 126 East Lincoln Avenue, Rahway New Jersey
07065-0907, US
WALSH, Shawn, P., 126 East Lincoln Avenue, Rahway New
Jersey 07065-0907, US

(51) MKP
A61K 45/00 (2006.01) (97) **2438917 ***
A61K 9/70 (2006.01)
A61K 31/404 (2006.01)
A61K 31/4045 (2006.01)
A61K 47/22 (2006.01)
A61P 25/16 (2006.01)
A61P 43/00 (2006.01)
(86) JP2010057807 07.05.2010
(96) 10777667.6 11.04.2012
(87) WO2010134433, 07.05.2010
(97) 2438917, 11.04.2012 en
(54) TRANSDERMAL PREPARATION
(71) Hisamitsu Pharmaceutical Co., Inc., 408, Tashirodaikan-machi,
Tosu-shi, Saga 841-0017, JP
(72) UCHIDA Naoyuki, c/o Tsukuba Research Laboratories of
HISAMITSU PHARMACEUTICAL CO. INC. 25-11 Kannondai
1-chome, Tsukuba-shi Ibaraki 305-0856, JP
TAKAGI Yuka, c/o Tsukuba Research Laboratories of
HISAMITSU PHARMACEUTICAL CO. INC. 25-11 Kannondai
1-chome, Tsukuba-shi Ibaraki 305-0856, JP
TAKADA Yasunori, c/o Tsukuba Research Laboratories of
HISAMITSU PHARMACEUTICAL CO. INC. 25-11 Kannondai
1-chome, Tsukuba-shi Ibaraki 305-0856, JP

(51) MKP
C07D 239/54 (2006.01) (97) **2462124 ***
(86) US2010044274 03.08.2010
(96) 10740817.1 13.06.2012
(87) WO2011017342, 03.08.2010
(97) 2462124, 13.06.2012 en
(54) MESOIONIC PESTICIDES
(71) E. I. du Pont de Nemours and Company, 1007 Market Street,
Wilmington, DE 19898, US
(72) ZHANG, Wenming, 21 Charles Pointe, Newark Delaware
19702, US
HOLYOKE JR, Caleb, William, 120 Country Club Drive, Newark
Delaware 19711, US
HUGHES, Kenneth Andrew, 213 Maple Leaf Drive, Rising Sun,
MD 21911, US
LAHM, George, P., 148 Fairhill Drive, Wilmington Delaware
19808, US
PAHUTSKI JR, Thomas, Francis, 50 Gomer Court, Elkton
Maryland 21921, US
TONG, My-Hanh, Thi, 4 Orchid Drive, Bear Delaware 19701,
US
XU, Ming, 25 South Perch Creek Drive, Newark Delaware
19702, US

(51) MKP
C01B 31/22 (2006.01) (97) **2368845**
(96) 10155042.4 28.09.2011
(97) 2368845, 28.09.2011 de
(54) Device and method for creating carbon dioxide snow
(71) Messer France S.A.S., 25, rue Auguste Blanche, 92816
Puteaux Cedex, FR
(72) Frère, Émilien, Messer France S.A.S. 15 avenue Gallieni
Appartement 18, 77100 Meaux, FR

(51) MKP
G01N 33/53 (2006.01) (97) **2478363 ***
(86) US2010049227 17.09.2010
(96) 10819278.2 25.07.2012
(87) WO2011037827, 17.09.2010
(97) 2478363, 25.07.2012 en
(54) IDENTIFICATION OF DISCRIMINANT PROTEINS THROUGH
ANTIBODY PROFILING, METHODS AND APPARATUS FOR
IDENTIFYING AN INDIVIDUAL
(71) Battelle Energy Alliance, LLC, P.O. Box 1625, Idaho Falls, ID
83415-3899, US
(72) APEL, William, A., P.O. Box 9729, Jackson, WY 83002, US
THOMPSON, Vicki, S., 2362 Hoopes Avenue, Idaho Falls, ID
83404, US
LACEY, Jeffrey, A., 3963 Willow Ridge Drive, Idaho Falls, ID
83406, US
GENTILLON, Cynthia, A., 1005 Periska Way, Idaho Falls, ID
83402, US

- (51) MKP
A01N 25/32 (2006.01) (97) **2485586 ***
A01N 25/04 (2006.01)
(86) US2010051282 04.10.2010
(96) 10763954.4 15.08.2012
(87) WO2011044022, 04.10.2010
(97) 2485586, 15.08.2012 en
(54) STABLE OIL-IN-WATER EMULSIONS
(71) Dow AgroSciences LLC, 9330 Zionsville Road, Indianapolis, IN 46268-1054, US
(72) KEENEY, Franklin, 12304 Windsor Drive, Carmel, IN 46033, US
LI, Mei, 13679 Cunningham Drive, Westfield, IN 46074, US
-
- (51) MKP
C12N 9/10 (2006.01) (97) **2421975 ***
C12N 15/82 (2006.01)
C12P 21/00 (2006.01)
(86) EP2010002487 19.04.2010
(96) 10715713.3 29.02.2012
(87) WO2010121818, 19.04.2010
(97) 2421975, 29.02.2012 en
(54) PRODUCTION OF MULTI-ANTENNARY N-GLYCAN STRUCTURES IN PLANTS
(71) Bayer BioScience N.V., Technologiepark 38, 9052 Gent, BE
Universiteit Gent, Sint-Pietersnieuwstraat 25, 9000 Gent, BE
(72) WETERINGS, Koen, 2805 Westwick Court, Raleigh, NC 27615, US
NAGELS, Bieke, Fernand Khnopffstraat 31, B-9200 Grembergen, BE
-
- (51) MKP
A61K 9/51 (2006.01) (97) **2435031 ***
(86) FR2010000401 28.05.2010
(96) 10727016.7 04.04.2012
(87) WO2010136676, 28.05.2010
(97) 2435031, 04.04.2012 fr
(54) FUNCTIONAL AMPHIPHILIC MOLECULE OR MACROMOLECULE FORMULATIONS WITH MULTIPLE COMPARTMENTS
(71) Université Bordeaux Segalen, 146, rue Léo Saignat, 33076 Bordeaux Cedex, FR
Université de la Méditerranée, Jardin du Pharo 58 Boulevard C. Livon, 13007 Marseille, FR
(72) BARTHELEMY, Philippe, 43 rue de Bordeaux, F-33700 Merignac, FR
KHIATI, Salim, 54 rue de Brach, F-33000 Bordeaux, FR
CAMPIO, Michel, 6 avenue de la Corse, F-13007 Marseille, FR
-
- (51) MKP
G01B 11/02 (2006.01) (97) **2427723 ***
(86) US2010033540 04.05.2010
(96) 10772694.5 14.03.2012
(87) WO2010129544, 04.05.2010
(97) 2427723, 14.03.2012 en
(54) METHODS AND COMPUTER PROGRAM PRODUCTS FOR QUANTITATIVE THREE-DIMENSIONAL IMAGE CORRECTION AND CLINICAL PARAMETER COMPUTATION IN OPTICAL COHERENCE TOMOGRAPHY
(71) Duke University, Office of Licensing and Ventures 2812 Erwin Road, Suite 306, Durham, NC 27705, US
(72) IZATT, Joseph, A., 10505 Leslie Drive, Raleigh NC 27615, US
KUO, Anthony, N., 2909 Ashland Drive, Durham NC 27705, US
ZHAO, Mingtao, 840 Louise Circle, Durham, NC 27705, US
-
- (51) MKP
B01F 5/10 (2006.01) (97) **2292321**
B01F 3/04 (2006.01)
B01F 5/04 (2006.01)
B01F 5/06 (2006.01)
(96) 10172361.7 09.03.2011
(97) 2292321, 09.03.2011 fr
(54) Facility for producing a homogeneous gas mixture using liquid and gaseous ingredients
(71) SDEL Alsace, 15, Rue de la Foret, 67550 Vendenheim, FR
(72) Ollier, Georges, 32, Boulevard Jacques Tête, 95300 Pontoise, FR
Kuntz, Jean-Pierre, 20, rue de la Gare, 67720 Weyersheim, FR
-
- (51) MKP
C07C 51/46 (2006.01) (97) **2371798**
C07D 307/08 (2006.01)
C07C 51/41 (2006.01)
C07C 51/44 (2006.01)
C07D 307/33 (2006.01)
C07C 55/10 (2006.01)
C07C 29/136 (2006.01)
C07C 31/20 (2006.01)
C07C 51/02 (2006.01)
(96) 11160486.4 05.10.2011
(97) 2371798, 05.10.2011 en
(54) Processes for the production of tetrahydrofuran, gamma-butyrolactone and/or butanediol from salts of succinic acid
(71) BioAmber International S.A.R.L., 49 route d' Arlon, 1140 Luxembourg, LU
(72) Fruchey, Olan S., 13 Greenbrier Avenue, Hurricane, WV 25526, US
Dunuwila, Dilum, 394 Franklin Avenue, Princeton, NJ 08540, US
Keen, Brian T., 108 Hughes Drive, Pinch, WV 25156, US
Albin, Brooke A., 1026 Gordon Drive, Charleston, WV 25303, US
Clinton, Nye A., 16 Christopher Drive, Hurricane, WV 25526, US
Dombek, Bernard D., 1620 Woodvale Drive, Charleston, WV 25314, US
Manzer, Leo E., 328 Cassell Court, Wilmington, DE 19803, US
-
- (51) MKP
A61M 25/01 (2006.01) (97) **2456499 ***
(86) US2010042540 20.07.2010
(96) 10802753.3 30.05.2012
(87) WO2011011373, 20.07.2010
(97) 2456499, 30.05.2012 en
(54) DEVICES AND METHODS FOR MINIMALLY INVASIVE ACCESS TO SINUSES AND TREATMENT OF SINUSITIS
(71) Covello, Leonard V., 10319 Applewood Ct., Munster, IN 46321, US
(72) Covello, Leonard V., 10319 Applewood Ct., Munster, IN 46321, US
-
- (51) MKP
C07D 513/04 (2006.01) (97) **2435443 ***
A61P 35/00 (2006.01)
A61K 31/47 (2006.01)
(86) US2010036312 27.05.2010
(96) 10721904.0 04.04.2012
(87) WO2010138665, 27.05.2010
(97) 2435443, 04.04.2012 en
(54) AMINOPYRAZOLE TRIAZOLOTHIADIAZOLE INHIBITORS OF C-MET PROTEIN KINASE
(71) Vertex Pharmaceuticals Incorporated, 130 Waverly Street, Cambridge, MA 02139, US
(72) LAUFFER, David, 254 Taylor Road, Stow MA 01775, US
LI, Pan, 3 Malt Lane, Lexington MA 02421, US
McGINTY, Kira, 1536 State Street, Schenectady NY 12304, US
-
- (51) MKP
C07C 227/06 (2006.01) (97) **2390246**
C07C 229/60 (2006.01)
(96) 11166961.0 30.11.2011
(97) 2390246, 30.11.2011 en
(54) Process for the preparation of aminaphtone
(71) Laboratori Baldacci S.P.A., Via San Michele degli Scalzi, 73, 56124 Pisa, IT
(72) Baldacci, Massimo, Via San Michele Degli Scalzi, 73, I-56124, Pisa, IT
-
- (51) MKP
H02K 21/14 (2006.01) (97) **2433349 ***
(86) FR2010050957 18.05.2010
(96) 10728776.5 28.03.2012
(87) WO2010133796, 18.05.2010
(97) 2433349, 28.03.2012 fr
(54) VERNIER MACHINE WITH INSERTED MAGNETS
(71) Erneo, Cap Alpha Avenue de l'Europe, 34830 Clapiers, FR
(72) JAC, Julien, Résidence Le Clos Margot 32 Rue Robert DESNOS, F-34070 Montpellier, FR
ZIEGLER, Nicolas, Philippe, Résidence Le Benjamin Bâtiment A, Appartement 208 690 rue de la Vieille Poste, F-34070 Montpellier, FR

- (51) MKP
C07H 19/10 (2006.01) (97) **2430035 ***
C07H 19/06 (2006.01)
A61K 31/7072 (2006.01)
- (86) EP2010056438 11.05.2010
(96) 10718207.3 21.03.2012
(87) WO2010130726, 11.05.2010
(97) 2430035, 21.03.2012 en
(54) URACYL SPIROOXETANE NUCLEOSIDES
(71) Janssen Products, L.P., 800/850 Ridgeway Drive, Horsham PA 19044, US
Medivir AB, Lunastigen 7, 141 44 Huddinge, SE
(72) JONCKERS, Tim, Hugo, Maria, Pastoor Wouterstraat 19 bus 5, B-2650 Edegem, BE
RABOISSON, Pierre, Jean-Marie, Bernard, Rue Jolie 3, B-1331 Rosieres, BE
VANDYCK, Koen, Deurnestraat 74, B-3583 Paal-Beringen, BE
VAN HOOFF, Steven, Maurice, Paula, Hundelgemsesteenweg 804, B-9820 Merelbeke, BE
HU, Lili, Vrouw van Mechelenstraat 28, B-2800 Mechelen, BE
TAHRI, Abdellah, Rue Maurice Albert Raskin 30, B-1070 Anderlecht, BE
-
- (51) MKP
A61L 15/16 (2006.01) (97) **2480260 ***
A61L 27/00 (2006.01)
A61L 15/64 (2006.01)
- (86) US2010048336 10.09.2010
(96) 10819241.0 01.08.2012
(87) WO2011037760, 10.09.2010
(97) 2480260, 01.08.2012 en
(54) COMPOSITE LAYERED HEMOSTASIS DEVICE
(71) Ethicon, Inc, U.S. Route 22, Somerville, NJ 08876-0151, US
(72) ANDJELIC, Sasa, 38 Oakland Place, Nanuet, NY 10954, US
-
- (51) MKP
A61M 11/06 (2006.01) (97) **2421588 ***
A61M 15/00 (2006.01)
A61M 11/02 (2006.01)
- (86) EP2010055345 22.04.2010
(96) 10717597.8 29.02.2012
(87) WO2010122103, 22.04.2010
(97) 2421588, 29.02.2012 en
(54) IMPROVED APPARATUS FOR THE AEROSOLIZATION OF LARGE VOLUMES OF DRY POWDER
(71) Nycomed GmbH, Byk-Gulden-Strasse 2, 78467 Konstanz, DE
(72) IWATSCHENKO, Peter, Bürgerholzweg 4, 91077 Neunkirchen, DE
POHLMANN, Gerhard, Am Gallweg 14, 31715 Meerbeck, DE
WINDT, Horst, Celler Weg 9a, 30938 Burgwedel, DE
KOCH, Wolfgang, Wendenborsteler Str. 35, 31634 Steimbke, DE
KIST, Michel, Friedhofstr. 27, 91353 Hausen, DE
-
- (51) MKP
A01F 15/08 (2006.01) (97) **2368419**
- (96) 10157313.7 28.09.2011
(97) 2368419, 28.09.2011 en
(54) A method of detecting a structure in a field, a method of steering an agricultural vehicle and an agricultural vehicle
(71) CLAAS Agrosystems GmbH & Co. KG, Bäckerkamp 19, 33330 Gütersloh, DE
(72) Blas, Morten Rufus, Nørrebrogade 180A, 3th floor, 2200, Copenhagen N, DK
Blanke, Mogens, Skovbakken 23, 3520, FARUM, DK
Madsen, Tommy Erthølle, Kongevejen 120B, 2830, Virum, DK
-
- (51) MKP
A61K 9/20 (2006.01) (97) **2405900 ***
A61K 31/4453 (2006.01)
- (86) IN2010000137 09.03.2010
(96) 10740754.6 18.01.2012
(87) WO2010103544, 09.03.2010
(97) 2405900, 18.01.2012 en
(54) A NOVEL SUSTAINED RELEASE COMPOSITION OF COMPOUNDS SELECTED FROM THE CLASS OF CENTRALLY ACTING MUSCLE RELAXANTS
(71) Patel, Dinesh Shantilal, 11/12 Udyog Nagar, S V Road Goregaon (West), Mumbai 400 104 Maharashtra, IN
Kurani, Shashikant Prabhudas, 11/12 Udyog Nagar, S V Road Goregaon (West), Mumbai 400 104 Maharashtra, IN
Patel, Sachin Dinesh, 11-12, Udyog Nagar S. V. Road, Goregaon (W), Mumbai 400 104, IN
(72) Patel, Dinesh Shantilal, 11/12 Udyog Nagar, S V Road Goregaon (West), Mumbai 400 104 Maharashtra, IN
Patel, Sachin Dinesh, 11-12, Udyog Nagar S. V. Road, Goregaon (W), Mumbai 400 104, IN
Kurani, Shashikant Prabhudas, 11/12 Udyog Nagar, S V Road Goregaon (West), Mumbai 400 104 Maharashtra, IN
-
- (51) MKP
C07D 471/04 (2006.01) (97) **2498775 ***
A61P 19/00 (2006.01)
A61K 31/4375 (2006.01)
- (86) EP2010006817 09.11.2010
(96) 10795923.1 19.09.2012
(87) WO2011057757, 09.11.2010
(97) 2498775, 19.09.2012 en
(54) NEW 7-PHENYL-[1,2,4]TRIAZOLO[4,3-A]PYRIDIN-3(2H)-ONE DERIVATIVES
(71) Almirall S.A., Ronda del General Mitre, 151, 08022 Barcelona, ES
(72) AIGUADE BOSCH, José, C/ Laureà Miró 408-410, E-08980 Sant Feliu de Llobregat (Barcelona), ES
CARRANCO MORUNO, Inés, C/ Laureà Miró 408-410, E-08980 Sant Feliu de Llobregat (Barcelona), ES
-
- (51) MKP
C07D 211/58 (2006.01) (97) **2399907**
- (96) 11182558.4 28.12.2011
(97) 2399907, 28.12.2011 en
(54) Solid Form of [1,4']-Bipiperidiny-1'-Carbonyl Chloride
(71) Cadila Healthcare Limited, Zydus Tower Satellite Cross Roads, Ahmedabad 380 015, Gujarat, IN
(72) Charan, Ganpat Dan Shimbhu, Cadila Healthcare Limited Zydus Tower, Satellite Cross Roads, Ahmedabad, 380 015 Gujarat, IN
Tanpure, Arun Ankush, Cadila Healthcare Limited Zydus Tower, Satellite Cross Roads, Ahmedabad, 380 015 Gujarat, IN
Singh, Kumar Kamlesh Laxmi, Cadila Healthcare Limited Zydus Tower, Satellite Cross Roads, Ahmedabad, 380 015 Gujarat, IN
-
- (51) MKP
G06F 3/044 (2006.01) (97) **2462498 ***
- (86) FR2010051668 06.08.2010
(96) 10762731.7 13.06.2012
(87) WO2011015794, 06.08.2010
(97) 2462498, 13.06.2012 fr
(54) DEVICE AND METHOD FOR CONTROL INTERFACE SENSITIVE TO A MOVEMENT OF A BODY OR OF AN OBJECT AND CONTROL EQUIPMENT INTEGRATING THIS DEVICE
(71) Nanotec Solution, 237, chemin Puech du Teil, 30900 Nîmes, FR
(72) ROZIERE, Didier, 79 Impasse des Hêtres, F-30900 Nîmes, FR

- (51) MKP
F41H 5/04 (2006.01) (97) **2427718 ***
(86) US2010033552 04.05.2010
(96) 10779355.6 14.03.2012
(87) WO2011014283, 04.05.2010
(97) 2427718, 14.03.2012 en
(54) COMPOSITE MATERIALS AND APPLICATIONS THEREOF
(71) PPG Industries Ohio, Inc., 3800 West 143rd Street, Cleveland, OH 44111, US
(72) PETERS, James, Carl, 359 Hunting Ridge Lane, Shelby North Carolina 28150, US
MORRIS, Steven, John, 217 Hillcrest Street, Shelby North Carolina 28152, US
PARKS, Steven, Joel, 208 Comanche Trail, Lexington North Carolina 27295, US
PUCKETT, Garry, Duran, 1301 Vista Drive, Shelby North Carolina 28150, US
VOTRUBA-DRZAL, Peter, Lawrence, 119 Yorkshire Drive, Pittsburgh Pennsylvania 15208, US
-
- (51) MKP
C07K 14/50 (2006.01) (97) **2443145 ***
(86) US2010038894 16.06.2010
(96) 10726758.5 25.04.2012
(87) WO2010148142, 16.06.2010
(97) 2443145, 25.04.2012 en
(54) CHIMERIC FGF19 POLYPEPTIDES AND USES THEREOF
(71) Amgen, Inc, One Amgen Center Drive, Thousand Oaks, CA 91320-1799, US
(72) Li, Yang, 1142 Cuesta Drive, Mountain View CA 94040, US
WU, Xinle, 1910 Bayview Avenue, Belmont CA 94002, US
WANG, Zhulun, 660 Glenbrook Drive, Palo Alto CA 94306, US
-
- (51) MKP
E03F 5/04 (2006.01) (97) **2333172**
(96) 10191780.5 15.06.2011
(97) 2333172, 15.06.2011 de
(54) Drainage device
(71) Dallmer GmbH & Co. KG, Wiebelsheidestrasse 25, 59757 Amsberg, DE
(72) Dallmer, Johannes, Binnerfeld 27, 59757 Amsberg, DE
-
- (51) MKP
F26B 17/10 (2006.01) (97) **2450421**
C10L 5/46 (2006.01)
(96) 10425346.3 09.05.2012
(97) 2450421, 09.05.2012 en
(54) Method for the production of a fuel from waste
(71) DFD Green Technology SRL, Via G. Viviani 4, 56029 Santa Croce sull'Arno (PI), IT
(72) Del, Carlo Dominico, Viale Roma n. 69, 55045 Marina di Pietrasanta (LU), IT
Del, Carlo Felicino, Via Sbarra N. 155, 55016 Porcari (LU), IT
-
- (51) MKP
C08J 9/14 (2006.01) (97) **2386585**
C08G 18/09 (2006.01)
C08G 18/50 (2006.01)
C08G 18/76 (2006.01)
B29C 44/34 (2006.01)
F25D 23/06 (2006.01)
(96) 10425126.9 16.11.2011
(97) 2386585, 16.11.2011 en
(54) Foam insulation unit
(71) Dow Global Technologies LLC, 2040 Dow Center, Midland, MI 48674, US
(72) Kramer, Hans, Weinhaldenstrasse 50, 8645 Kempraten-Jona, CH
Parenti, Vanni, Via G Piraon 2/a, 42012 Campagnola Emilia (RE), IT
Casati, Francois, Etzelstrasse 25, 8808 Pfäffikon, CH
Morley, Tim, Eisenhofstrasse 2, 8810 Horgen, CH
-
- (51) MKP
A01H 1/00 (2006.01) (97) **2489738 ***
A01H 5/00 (2006.01)
C12N 5/10 (2006.01)
C12N 15/29 (2006.01)
(86) JP2010068164 15.10.2010
(96) 10823470.9 22.08.2012
(87) WO2011046202, 15.10.2010
(97) 2489738, 22.08.2012 en
(54) GENE CONTROLLING FLOWERING HABIT/CLEISTOGAMY IN PLANTS, AND USE THEREOF
(71) National Institute Of Agrobiological Sciences, 1-2 Kannondai 2-chome Tsukuba-shi, Ibaraki 305-8602, JP
(72) KOMATSUDA Takao, c/o National Institute of Agrobiological Sciences 2-1-2 Kannondai, Tsukuba-shi Ibaraki 305-8602, JP
MATSUMOTO Takashi, c/o National Institute of Agrobiological Sciences 2-1-2 Kannondai, Tsukuba-shi Ibaraki 305-8602, JP
-
- (51) MKP
F16B 39/22 (2006.01) (97) **2496849 ***
(86) FR2010052358 03.11.2010
(96) 10792962.2 12.09.2012
(87) WO2011055077, 03.11.2010
(97) 2496849, 12.09.2012 fr
(54) SELF-LOCKING SCREWING ATTACHMENT DEVICE AND ASSEMBLY PROVIDED WITH SAME
(71) JPB Systeme, Allée des Pleus ZAC du Tuboeuf, 77170 Brie-Comte-Robert, FR
(72) MARC, Damien, 27 rue du Bel Air, F-77370 Nangis, FR
-
- (51) MKP
F16K 31/02 (2006.01) (97) **2312187**
G05D 23/19 (2006.01)
(96) 10405194.1 20.04.2011
(97) 2312187, 20.04.2011 de
(54) Device with a linearly adjustable lifting part
(71) Unovatis GmbH, Museumstrasse 54a, 38229 Salzgitter, DE
(72) Köhler, Ivo, Bärenfelsenstrasse 36, 4057 Basel, CH
Kernen, Roland, Luzertstrasse 2, 4132 Muttentz, CH
Seelmann, Christian, Gartenstrasse 17, 31174 Schellerten, DE
Namendorf, Hans-Joachim, Am Brunnen 7, 31162 Bad Salzdetfurth, DE
-
- (51) MKP
H01H 85/02 (2006.01) (97) **2419916 ***
H01H 85/25 (2006.01)
H01H 85/22 (2006.01)
(86) EP2010002316 15.04.2010
(96) 10715696.0 22.02.2012
(87) WO2010118871, 15.04.2010
(97) 2419916, 22.02.2012 en
(54) FUSE HOLDER, PARTICULARLY FOR INTERLOCKED SOCKETS AND ELECTRICAL APPARATUSES IN GENERAL
(71) Palazzoli S.p.A., Via Palazzoli, 31, 25128 Brescia, IT
(72) LEVI, Bruno, Via Vittorio Emanuele II, 1, 25122 - Brescia (BS), IT
-
- (51) MKP
C07D 237/28 (2006.01) (97) **2417111 ***
A61K 31/502 (2006.01)
A61P 29/00 (2006.01)
(86) FR2010050657 06.04.2010
(96) 10723208.4 15.02.2012
(87) WO2010116084, 06.04.2010
(97) 2417111, 15.02.2012 fr
(54) SUBSTITUTED 1-ALKYLCINNOLIN-4(1H)-ONE DERIVATIVES, PREPARATION THEREOF AND THERAPEUTIC APPLICATION OF SAME
(71) SANOFI, 174, Avenue de France, 75013 Paris, FR
(72) BARBAGALLO, Elodie, c/o Sanofi-Aventis Département Brevets 174 avenue de France, F-75013 Paris, FR
LEGEAY, Carole, c/o Sanofi-Aventis Département Brevets 174 avenue de France, F-75013 Paris, FR
RINALDI-CARMONA, Murielle, c/o Sanofi-Aventis Département Brevets 174 avenue de France, F-75013 Paris, FR
ROUX, Pascale, c/o Sanofi-Aventis Département Brevets 174 avenue de France, F-75013 Paris, FR
VERNHET, Claude, c/o Sanofi-Aventis Département Brevets 174 avenue de France, F-75013 Paris, FR

- (51) MKP
G01N 33/00 (2006.01) (97) **2451965 ***
C12Q 1/00 (2006.01)
- (86) US2010041396 08.07.2010
(96) 10797856.1 16.05.2012
(87) WO2011005982, 08.07.2010
(97) 2451965, 16.05.2012 en
(54) BACTERIAL ADHERENCE AND ANTI-ADHERENCE TO MUCUS, EPITHELIAL CELLS AND OTHER CELLS
(71) Alltech, Inc., 3031 Catnip Hill Pike, Nicholasville, KY 40345, US
(72) DAWSON, Karl, A., 4877 Wyndhurst, Lexington, KY 40515, US
MORAN, Colm, 10 chemin de Groupède, F-13600 La Ciotat, FR
APAJALAHTI, Juha, Kytöniityntie 24C, FIN-00670 Helsinki, FI
LAURAEUS, Marko, Paulatie 12, FIN-03100 Nummela, FI
-
- (51) MKP
E03D 11/14 (2006.01) (97) **2366838**
- (96) 11156539.6 21.09.2011
(97) 2366838, 21.09.2011 en
(54) Frame for fixing sanitary fixtures to a wall
(71) Raccorderie Metalliche S.p.A., Strada Sabbionetana, 59, 46010 Campitello di Marcaria, Mantova, IT
(72) Zanitoni, Marco, Via Don Beniamino Moi 55, 46010 Campitello di Marcaria MN, IT
Caleffi, Alberto, Via Marzabotto 33, 46010 Curtatone MN, IT
-
- (51) MKP
A61P 43/00 (2006.01) (97) **2460792 ***
C07D 409/06 (2006.01)
C07D 401/04 (2006.01)
C07D 409/14 (2006.01)
C07D 209/18 (2006.01)
C07D 401/06 (2006.01)
C07D 413/14 (2006.01)
A61K 31/404 (2006.01)
C07D 401/14 (2006.01)
C07D 417/06 (2006.01)
A61P 13/02 (2006.01)
C07D 409/04 (2006.01)
A61K 31/422 (2006.01)
C07D 405/04 (2006.01)
C07D 417/14 (2006.01)
A61K 31/427 (2006.01)
C07D 405/06 (2006.01)
A61K 31/4439 (2006.01)
C07D 405/14 (2006.01)
- (86) JP2010062532 26.07.2010
(96) 10804369.6 06.06.2012
(87) WO2011013623, 26.07.2010
(97) 2460792, 06.06.2012 en
(54) INDOLE DERIVATIVE AND PHARMACOLOGICALLY ACCEPTABLE SALT THEREOF
(71) Kissei Pharmaceutical Co., Ltd., 19-48, Yoshino, Matsumoto-shi Nagano 399-8710, JP
(72) KONDO, Tatsuhiro, c/o Central Research Laboratories Kissei Pharmaceutical Co. Ltd. 4365-1 Hotaka-Kashiwabara, Azumino-shi Nagano 399-8304, JP
KONDO, Atsushi, c/o Central Research Laboratories Kissei Pharmaceutical Co. Ltd. 4365-1 Hotaka-Kashiwabara, Azumino-shi Nagano 399-8304, JP
TATANI, Kazuya, c/o Central Research Laboratories Kissei Pharmaceutical Co. Ltd. 4365-1 Hotaka-Kashiwabara, Azumino-shi Nagano 399-8304, JP
KAWAMURA, Naohiro, c/o Central Research Laboratories Kissei Pharmaceutical Co. Ltd. 4365-1 Hotaka-Kashiwabara, Azumino-shi Nagano 399-8304, JP
-
- (51) MKP
A61K 39/21 (2006.01) (97) **2486138 ***
C12N 15/863 (2006.01)
- (86) EP2010006114 06.10.2010
(96) 10765582.1 15.08.2012
(87) WO2011042180, 06.10.2010
(97) 2486138, 15.08.2012 en
(54) GENERATION OF A BROAD T-CELL RESPONSE IN HUMANS AGAINST HIV
(71) Bavarian Nordic A/S, Hejreskovvej 10 A, 3490 Kvistgaard, DK
(72) CHAPLIN, Paul, Bürgerstrasse 9, 81925 Munich, DE
NICHOLS, Richard, Mendelssohnstrasse 34, 81245 Munich, DE

- (51) MKP
G01N 33/574 (2006.01) (97) **2419736 ***
A61K 31/715 (2006.01)
G01N 33/50 (2006.01)
- (86) US2010031480 16.04.2010
(96) 10715065.8 22.02.2012
(87) WO2010121196, 16.04.2010
(97) 2419736, 22.02.2012 en
(54) METHODS OF ASSESSING ACTIVITY OF A POLYSACCHARIDE COMPOSITION
(71) Momenta Pharmaceuticals, Inc., 675 West Kendall Street, Cambridge, MA 02142, US
(72) ZHOU, He, 128 Cross Street, Malden, MA 02148, US
DUFFNER, Jay, 29 Lawton Road, Shirley, MA 01464, US
GALCHEVA-GARGOVA, Zoya, 1025 Hancock Street Unit 4e, Quincy, MA 02169, US
KISHIMOTO, Takashi, Kei, 46 Coolidge Avenue, Lexington, MA 02420, US
SCHULTES, Birgit, 12 Monadnock Road, Arlington, MA 02476, US
-
- (51) MKP
C07D 235/20 (2006.01) (97) **2443094 ***
A61P 9/12 (2006.01)
A61K 31/4184 (2006.01)
- (86) EP2010058754 21.06.2010
(96) 10724533.4 25.04.2012
(87) WO2010146187, 21.06.2010
(97) 2443094, 25.04.2012 en
(54) PROCESS FOR THE PREPARATION OF TELMISARTAN
(71) Krka Tovarna Zdravil, D.D., Novo Mesto, Smarjeska cesta 6, 8501 Novo Mesto, SI
(72) ZUPANCIC, Silvo, Zupnca 4b, 8000 Novo mesto, SI
SEDMAC, Gregor, Palmejeva 30, 1000 Ljubljana, SI
VRECER, Franc, Potok 5b, 8351 Straza pri Novem mestu, SI
-
- (51) MKP
B65D 5/66 (2006.01) (97) **2376335 ***
B65D 85/10 (2006.01)
- (86) EP2010007008 18.11.2010
(96) 10781839.5 19.10.2011
(87) WO2011060931, 18.11.2010
(97) 2376335, 19.10.2011 en
(54) PACKAGE FOR TOBACCO-RELATED ARTICLES
(71) Imperial Tobacco Limited, P.O. Box 244 Upton Road, Southville, Bristol BS99 7UJ, GB
(72) HOLLOWAY, Steve, c/o Imperial Tobacco International Farnham House Farnham Lane Farnham Royal, Slough SL2 3RQ, GB
COLLINS, Tim, c/o path design 3 Northfields Prospect Northfields, London SW18 1 PE, GB
KNORR, Solvey, c/o Reemtsma Cigarettenfabriken GmbH Albert-Einstein-Ring 7, 22761 Hamburg, DE
SOUTHEY, Neil, c/o Imperial Tobacco International Farnham House Farnham Lane Farnham Royal, Slough SL2 3RQ, GB
WOLFGGRAMM, Regine, c/o Reemtsma Cigarettenfabriken GmbH Albert-Einstein-Ring 7, 22761 Hamburg, DE
GURKE, Inga, c/o Reemtsma Cigarettenfabriken GmbH Albert-Einstein-Ring 7, 22761 Hamburg, DE
DEVIVIER, Guillaume, c/o Altadis 4 rue André Dessaux 45404 Fleury, Les Aubrais, Cedex, FR
-
- (51) MKP
A61K 9/16 (2006.01) (97) **2493454 ***
- (86) US2010054431 28.10.2010
(96) 10774389.0 05.09.2012
(87) WO2011056702, 28.10.2010
(97) 2493454, 05.09.2012 en
(54) FAST DISSOLVING/DISINTEGRATING COATING COMPOSITIONS
(71) McNeil-PPC, Inc., 199 Grandview Avenue, Skillman, NJ 08558, US
(72) CHEN, Jen-chi, 80 Annamarie Drive, Morrisville PA 19067, US
BUNICK, Frank, J., 47 Long Ridge Road, Randolph NJ 07869, US
MCNALLY, Gerard, 177 Coldstream Drive, Berwyn PA 19312, US

- (51) MKP
E04G 5/14 (2006.01) (97) **2253778**
(96) 10163471.5 24.11.2010
(97) 2253778, 24.11.2010 en
(54) An advance guard rail
(71) Ui Property Limited, Level 15(A2) Financial Park Labuan Jalan Merdeka, 87000 Ft Labuan, MY
(72) Portejoie, Xavier, 20 Kingsmill Court 62/64 Bolton Street, 1, Dublin, IE
Breen, John, 13 Baymount Park Clontarf, 13, Dublin, IE
-
- (51) MKP
C07K 14/54 (2006.01) (97) **2445933 ***
C07K 14/53 (2006.01)
A61K 38/20 (2006.01)
A61K 38/19 (2006.01)
(86) GB2010001221 22.06.2010
(96) 10732728.0 02.05.2012
(87) WO2010149960, 22.06.2010
(97) 2445933, 02.05.2012 en
(54) AVIAN COLONY STIMULATING FACTOR 1 RECEPTOR BINDING PROTEINS
(71) University Court of the University of Edinburgh, Old College, South Bridge, Edinburgh EH8 9YL, GB
(72) HUME, David Arthur, The Roslin Institute The University of Edinburgh, Roslin EH25 9PS, GB
BURT, Dave, The Roslin Institute The University of Edinburgh, Roslin EH25 9PS, GB
SESTER, David, The Roslin Institute The University of Edinburgh, Roslin EH25 9PS, GB
GARCEAU, Valerie, The Roslin Institute The University of Edinburgh, Roslin EH25 9PS, GB
SMITH, Jacqueline, The Roslin Institute The University of Edinburgh, Roslin EH25 9PS, GB
PATON, Bob, The Roslin Institute The University of Edinburgh, Roslin EH25 9PS, GB
-
- (51) MKP
A61M 5/315 (2006.01) (97) **2482896 ***
(86) EP2010064390 29.09.2010
(96) 10763655.7 08.08.2012
(87) WO2011039202, 29.09.2010
(97) 2482896, 08.08.2012 en
(54) DRIVE MECHANISM FOR A DRUG DELIVERY DEVICE AND RESET MEMBER FOR A DRIVE MECHANISM
(71) Sanofi-Aventis Deutschland GmbH, Brüningstraße 50, 65929 Frankfurt, DE
(72) VEASEY, Robert, 31 Lonsdale Road Lillington, Leamington Spa Warwickshire CV32 7EP, GB
BILTON, Simon Lewis, Flat 3 15 Clarendon Square, Leamington Spa Warwickshire CV32 5QT, GB
JONES, Christopher, The Old Thatch Grafton, Tewkesbury Gloucestershire GL20 7AT, GB
KOUYOUUMJIAN, Garen, 2A Plymouth Place, Leamington Spa Warwickshire CV31 1HN, GB
MACDONALD, Catherine Anne, 23 Goggsbridge Lane, Warwick Warwickshire CV34 6JE, GB
-
- (51) MKP
A47C 27/08 (2006.01) (97) **2410892 ***
(86) HU2010000031 23.03.2010
(96) 10755498.2 01.02.2012
(87) WO2010109254, 23.03.2010
(97) 2410892, 01.02.2012 en
(54) UNIVERSAL BED INSERT, BUILT BY AIR MATTRESS, COMBINED WITH AIRTIGHT VALVES, AND METHOD FOR PRODUCING THEREOF
(71) Kovács, Attila, El d u. 4. 8. em. 33., 1105 Budapest, HU
Kovács, Krisztián, Elöd u. 4., 8. em. 33, 1105 Budapest, HU
(72) Kovács, Attila, El d u. 4. 8. em. 33., 1105 Budapest, HU
Kovács, Krisztián, Elöd u. 4., 8. em. 33, 1105 Budapest, HU
-
- (51) MKP
F16T 1/34 (2006.01) (97) **2414722 ***
(86) US2010001466 18.05.2010
(96) 10778041.3 08.02.2012
(87) WO2010134977, 18.05.2010
(97) 2414722, 08.02.2012 en
(54) PROGRAMMABLE STEAM TRAP APPARATUS
(71) Teva Pharmaceutical Industries Ltd., 5 Basel Street P.O. Box 3190, 49131 Petah Tiqva, IL
(72) ALONI, Yehoshua, Nof Harim St. 130, 44862 Kochav Yair-zur Yigal, IL
FAHIMIPOOR, Oren, Mapile Egoz St. 85, tel Avi 67437, IL
-
- (51) MKP
C07D 498/04 (2006.01) (97) **2456774 ***
A61K 31/5365 (2006.01)
A61P 25/28 (2006.01)
(86) EP2010060587 21.07.2010
(96) 10735280.9 30.05.2012
(87) WO2011009898, 21.07.2010
(97) 2456774, 30.05.2012 en
(54) FUSED AMINODIHYDRO-OXAZINE DERIVATIVES
(71) Eisai R&D Management Co., Ltd., 6-10, Koishikawa 4-chome Bunkyo-ku, Tokyo 112-8088, JP
(72) ELLARD, John Mark, Eisai Limited European Knowledge Centre Mosquito Way, Hatfield Hertfordshire AL10 9SN, GB
FARTHING, Christopher Neil, Eisai Limited European Knowledge Centre Mosquito Way, Hatfield Hertfordshire AL10 9SN, GB
HALL, Adrian, Eisai Limited European Knowledge Centre Mosquito Way, Hatfield Hertfordshire AL10 9SN, GB
-
- (51) MKP
G06F 21/00 (2006.01) (97) **2460075 ***
G06F 11/07 (2006.01)
(86) US2010043657 29.07.2010
(96) 10742940.9 06.06.2012
(87) WO2011014620, 29.07.2010
(97) 2460075, 06.06.2012 en
(54) REPAIRING PORTABLE EXECUTABLE FILES
(71) Reversinglabs Corporation, 169 Msgr. O'Brian Highway Apt. 802, Cambridge, MA 02141, US
(72) PERICIN, Tomislav, Matije Hudji 76/2, Sremska Mitrovica 22000, RS
-
- (51) MKP
A01N 43/66 (2006.01) (97) **2440054 ***
A61K 31/53 (2006.01)
(86) US2010037717 08.06.2010
(96) 10786665.9 18.04.2012
(87) WO2010144404, 08.06.2010
(97) 2440054, 18.04.2012 en
(54) PYRIDIL-TRIAZINE INHIBITORS OF HEDGEHOG SIGNALING
(71) Abraxis BioScience, LLC, 11755 Wilshire Boulevard Suite 2000, Los Angeles, CA 90025, US
(72) TAO, Chunlin, 1800 Camden Avenue, No.301, Los Angeles California 90025, US
HAN, Hongna, 1352 South Carolina Avenue, No.210, Los Angeles California 90025, US
SUN, Xiaowen, 10920 National Boulevard, No.1, Los Angeles California 90064, US
DESAL, Neil, 11755 Wilshire Boulevard Suite 2000, Los Angeles California 90025, US
-

- (51) MKP
C07D 401/10 (2006.01) (97) **2421848 ***
C07D 417/06 (2006.01)
C07D 413/06 (2006.01)
C07D 403/06 (2006.01)
A61P 29/00 (2006.01)
C07D 409/10 (2006.01)
C07D 403/04 (2006.01)
A61K 31/496 (2006.01)
C07D 403/10 (2006.01)
A61P 25/00 (2006.01)
C07D 409/06 (2006.01)
C07D 405/06 (2006.01)
(86) US2010032095 22.04.2010
(96) 10715461.9 29.02.2012
(87) WO2010124119, 22.04.2010
(97) 2421848, 29.02.2012 en
(54) AZETIDINYL DIAMIDES AS MONOACYLGLYCEROL LIPASE INHIBITORS
(71) Janssen Pharmaceutica N.V., Turnhoutseweg 30, 2340 Beerse, BE
(72) BIAN, Haiyan, 109 York Drive, Princeton NJ 08540, US
MCDONNELL, Mark, E., 1280 Sumneytown Pike, Lansdale PA 19446, US
LIN, Shu-Chen, 4895 Redfield Road, Doylestown PA 18902, US
ZHU, Bin, Welsh&McKean Roads, Spring House PA 19477, US
LIU, Li, 271 Fox Chase Lane, Doylestown PA 18901, US
CLEMENTE, Jose, 665 Stockton Drive, Exton PA 19341, US
MABUS, John, 9131 Rosewood Drive, East Greenville PA 18041, US
MACIELAG, Mark, J., Welsh&McKean Roads, Spring House PA 19477, US
CHEVALIER, Kristen, M., 407 Nottingham Lane, Collegeville PA 19426, US
PITIS, Philip, M., 108 Sunrise Drive, North Wales PA 19454, US
CONNOLLY, Peter, J., Welsh&McKean Roads, Spring House PA 19477, US
ZHANG, Sui-Po, 665 Stockton Drive, Exton PA 19341, US
FLORES, Christopher, M., Welsh&McKean Roads, Spring House PA 19477, US
ZHANG, Yue-Mei, Welsh&McKean Roads, Spring House PA 19477, US

- (51) MKP
A01N 43/54 (2006.01) (97) **2445346 ***
(86) US2010039685 23.06.2010
(96) 10792616.4 02.05.2012
(87) WO2010151601, 23.06.2010
(97) 2445346, 02.05.2012 en
(54) OXO-HETEROCYCLE FUSED PYRIMIDINE COMPOUNDS, COMPOSITIONS AND METHODS OF USE
(71) Genentech, Inc., 1 DNA Way, South San Francisco, CA 94080, US
(72) BERGERON, Philippe, 941 Dolores Street Apt. 1, San Francisco California 94110, US
COHEN, Frederick, 2001 McAllister Street 143, San Francisco California 94118, US
ESTRADA, Anthony, 7 Pyxie Lane, San Carlos California 94070, US
KOEHLER, Michael F.T., 516 Georgia Avenue, Palo Alto California 94306, US
LEE, Wendy, 121 Shadowhill Circle, San Ramon California 94583, US
LY, Cuong, 45 Westdale Avenue, Daly City California 94015, US
LYSSIKATOS, Joseph P., 42 Alta Avenue, Piedmont California 94611, US
PEI, Zhonghua, c/o Genentech Inc. 1 DNA Way MS-49 South San Francisco, California 94080, US
ZHAO, Xianrui, 619 North San Mateo Drive Apt. 102, San Mateo California 94401, US

- (51) MKP
G01N 33/574 (2006.01) (97) **2493503 ***
C07K 16/46 (2006.01)
A61K 39/395 (2006.01)
(86) EP2010066207 27.10.2010
(96) 10771102.0 05.09.2012
(87) WO2011051307, 27.10.2010
(97) 2493503, 05.09.2012 en
(54) DOSAGE REGIMEN FOR ADMINISTERING A CD19XCD3 BISPECIFIC ANTIBODY
(71) Amgen Research (Munich) GmbH, Staffelseestrasse 2, 81477 München, DE
(72) NAGORSEN, Dirk, c/o Micromet AG Staffelseestrasse 2, 81477 Munich, DE
KUFER, Peter, c/o Micromet AG Staffelseestrasse 2, 81477 Munich, DE
ZUGMAIER, Gerhard, c/o Micromet AG Staffelseestrasse 2, 81477 Munich, DE
BAEUERLE, Patrick, c/o Micromet AG Staffelseestrasse 2, 81477 Munich, DE

- (51) MKP
A61K 31/422 (2006.01) (97) **2421531 ***
A61K 9/20 (2006.01)
A61P 31/04 (2006.01)
A61K 9/06 (2006.01)
A61P 15/02 (2006.01)
A61P 13/02 (2006.01)
A61K 9/00 (2006.01)
A61P 15/00 (2006.01)
(86) EP2010055090 19.04.2010
(96) 10715790.1 29.02.2012
(87) WO2010121980, 19.04.2010
(97) 2421531, 29.02.2012 en
(54) USE OF NIFURATEL TO TREAT INFECTIONS CAUSED BY ATOPOBIUM SPECIES
(71) POLICHEM S.A., 50 Val Fleuri, 1526 Luxembourg, LU
(72) MAILLAND, Federico, Strada Regina 10, CH-6900 Lugano, CH

- (51) MKP
A61M 5/315 (2006.01) (97) **2437829 ***
(86) EP2010057495 28.05.2010
(96) 10722353.9 11.04.2012
(87) WO2010139645, 28.05.2010
(97) 2437829, 11.04.2012 en
(54) DOSE SETTING MECHANISM FOR A DRUG DELIVERY DEVICE
(71) Sanofi-Aventis Deutschland GmbH, Brüningstraße 50, 65929 Frankfurt, DE
(72) PLUMPTRE, David, 36 Shire Way Droitwich Spa, Worcestershire WR9 7RQ, GB

- (51) MKP
F24J 2/51 (2006.01) (97) **2302308**
(86) 10165360.8 30.03.2011
(97) 2302308, 30.03.2011 en
(54) Colored mineral wool
(71) Knauf Insulation Technology GmbH, Industriestraße 18, 9586 Fürnitz, AT
(72) Gorazd, Sebenik, Knauf Insulation Technology GmbH Patent department Industriestrasse 18, 9586 Fürnitz, AT
Smolej, Jure, Knauf Insulation Technology GmbH Patent department Industriestrasse 18, 9586 Fürnitz, AT

- (51) MKP
C07D 473/34 (2006.01) (97) **2445898 ***
C07D 473/38 (2006.01)
C07D 401/12 (2006.01)
A61P 29/00 (2006.01)
C07D 471/04 (2006.01)
C07D 487/04 (2006.01)
A61K 31/52 (2006.01)
A61K 31/517 (2006.01)
A61K 31/506 (2006.01)
- (86) US2010039931 25.06.2010
(96) 10728551.2 02.05.2012
(87) WO2010151735, 25.06.2010
(97) 2445898, 02.05.2012 en
(54) 4H-PYRIDO[1,2-A]PYRIMIDIN-4-ONE DERIVATIVES AS PI3K INHIBITORS
- (71) Amgen, Inc, One Amgen Center Drive, Thousand Oaks, CA 91320-1799, US
(72) CUSHING, Timothy D., 1064 Glacier Avenue, Pacificia, California 94044, US
HAO, Xiaolin, 637 Sandy Hook Court, Foster City, California 94404, US
LOHMAN, Julia Winslow, 94A Sussex, San Francisco, California 94131, US
SHIN, Youngsook, 64 Loop 22, Emeryville, California 94608, US
-
- (51) MKP
A61K 38/20 (2006.01) (97) **2475380 ***
C12N 15/00 (2006.01)
- (86) EP2010063389 13.09.2010
(96) 10751694.0 18.07.2012
(87) WO2011029931, 13.09.2010
(97) 2475380, 18.07.2012 en
(54) COMPOSITION FOR TREATMENT OF CXCL8-MEDIATED LUNG INFLAMMATION
- (71) Protaffin Biotechnologie AG, Impulszentrum Graz-West Reininghausstrasse 13a, 8020 Graz, AT
(72) KUNGL, Andreas, Strasserhofweg 77a, A-8045 Graz, AT
SLINGSBY, Jason, Zollerg. 39/4, A-1070 Wien, AT
ADAGE, Tiziana, Krottendorferstr. 86/8, A-8052 Graz, AT
REK, Angelika, Dreihackeng. 7/24, A-8020 Graz, AT
-
- (51) MKP
A01N 25/00 (2006.01) (97) **2488015 ***
A01C 1/06 (2006.01)
- (86) EP2010006161 06.10.2010
(96) 10765583.9 22.08.2012
(87) WO2011045004, 06.10.2010
(97) 2488015, 22.08.2012 en
(54) FUZZY COTTON SEEDS COMPRISING AN AQUEOUS POLYURETHANE COATING
- (71) Bayer Material Science AG, Kaiser-Wilhelm Allee, 51368 Leverkusen, DE
Bayer Cropscience LP, Patent Department 2 T.W. Alexander Drive, Research Triangle Park, NC 27709, US
(72) DÖRR, Sebastian, Weststr. 6, 40597 Düsseldorf, DE
SEEWALD, Eric, Witmakerstraat 7, NL-6211 JB Maastricht, NL
BREGGER, Thomas, 412 Keighley Forest Dr., Wake Forest, NC 27587, US
-
- (51) MKP
A61P 3/00 (2006.01) (97) **2493889 ***
A61K 31/5025 (2006.01)
A61P 25/00 (2006.01)
C07D 487/04 (2006.01)
- (86) EP2010066264 27.10.2010
(96) 10768978.8 05.09.2012
(87) WO2011051342, 27.10.2010
(97) 2493889, 05.09.2012 en
(54) IMIDAZO[1,2-b]PYRIDAZINE DERIVATIVES AND THEIR USE AS PDE10 INHIBITORS
- (71) Janssen Pharmaceutica, N.V., Turnhoutseweg 30, 2340 Beerse, BE
(72) PASTOR-FERNÁNDEZ, Joaquin, C/Hierbabuena 37 Urbanización La Hacienda Cobisa, E-45111 Toledo, ES
BARTOLOMÉ-NEBREDA, José, Manuel, c/o Janssen-Cilag S.A. Calle Jarama 75 Poligono Industrial, E-45007 Toledo, ES
MACDONALD, Gregor, James, c/o Janssen Pharmaceutica NV Turnhoutseweg 30, B-2340 Beerse, BE
CONDE-CEIDE, Susana, c/o Janssen-Cilag S.A. Calle Jarama 75 Poligono Industrial, E-45007 Toledo, ES
DELGADO-GONZÁLEZ, Óscar, c/o Janssen-Cilag S.A. Calle Jarama 75 Poligono Industrial, E-45007 Toledo, ES
VANHOOF, Greta, Constantia, Peter, c/o Janssen Pharmaceutica N.V. Turnhoutseweg 30, B-2340 Beerse, BE
VAN GOOL, Michiel, Luc, Maria, c/o Janssen-Cilag S.A. Calle Jarama 75 Poligono Industrial, E-45007 Toledo, ES
MARTÍN-MARTÍN, María, Luz, c/o Janssen-Cilag S.A. Calle Jarama 75 Poligono Industrial, E-45007 Toledo, ES
ALONSO-DE DIEGO, Sergio-Alvar, c/o Janssen-Cilag S.A. Calle Jarama 75 Poligono Industrial, E-45007 Toledo, ES
SWINNEY, Kelly, Ann, c/o Janssen Pharmaceutica NV Turnhoutseweg 30, 2340 Beerse, BE
LEYS, Carina, c/o Janssen Pharmaceutica NV Turnhoutseweg 30, 2340 Beerse, BE
WEERTS, Johan, Erwin, Edmond, c/o Janssen Pharmaceutica NV Turnhoutseweg 30, 2340 Beerse, BE
-
- (51) MKP
A61K 39/00 (2006.01) (97) **2480252 ***
- (86) US2010049924 23.09.2010
(96) 10819428.3 01.08.2012
(87) WO2011038069, 23.09.2010
(97) 2480252, 01.08.2012 en
(54) METHODS, COMPOSITIONS, AND KITS FOR REDUCING ANTI-ANTIBODY RESPONSES
- (71) XBiotech, Inc, 1055 West Hastings Street, Suite 300, Vancouver, BC V6E 2E9, CA
(72) SIMARD, John, 8201 East Riverside Drive, Bldg. 4 Suite 100, Austin, TX 78744, US
-
- (51) MKP
C07D 239/72 (2006.01) (97) **2406236 ***
- (86) US2010026656 09.03.2010
(96) 10751284.0 18.01.2012
(87) WO2010104851, 09.03.2010
(97) 2406236, 18.01.2012 en
(54) RHO KINASE INHIBITORS
- (71) Surface Logix, Inc., 50 Soldiers Field Place, Brighton, MA 02135, US
(72) SWEETNAM, Paul, 47 Gregory Street, Marblehead MA 01945, US
BARTOLOZZI, Alessandra, 34 Regency Drive, Norwalk CT 06851, US
CAMPBELL, Anthony, 4 Sheehan Circle, Framingham MA 01701, US
COLE, Bridget, 164 Summit Avenue, Quincy MA 02170, US
FOUDOULAKIS, Hope, 16 Anderson Road, Framingham MA 01701, US
KIRK, Brian, 725 Boston Post Road 11, Sudbury MA 01776, US
SESHADRI, Hemalatha, 58-8 Middlesex Road, Waltham MA 02452, US
RAM, Siya, 9 Grant Road, Winchester MA 01890, US

- (51) MKP
C01B 31/20 (2006.01) (97) **2464600 ***
C07C 275/00 (2006.01)
- (86) US2010045342 12.08.2010
(96) 10808768.5 20.06.2012
(87) WO2011019928, 12.08.2010
(97) 2464600, 20.06.2012 en
- (54) MODULARIZED SYSTEM AND METHOD FOR UREA PRODUCTION USING STRANDED NATURAL GAS
- (71) 4A Technologies, LLC, P.O. Box 64147, Lubbock, Texas 79464, US
- (72) SIMONTON, James L., 5420 100th Street, Lubbock Texas 79424, US
COLLINS, Terry R., 9707 West 32nd Street, Stillwater Oklahoma 74074, US
BERUVIDES, Mario G., 3423 94th Street, Lubbock Texas 79423, US
LOZADA, JR., Jessie, 6931 Hwy. 84, Shallowater Texas 79363, US

- (51) MKP
C07D 413/12 (2006.01) (97) **2480548 ***
A61K 31/437 (2006.01)
C07D 403/06 (2006.01)
A61P 29/00 (2006.01)
A61P 11/00 (2006.01)
C07D 471/04 (2006.01)
C07D 401/14 (2006.01)
A61P 9/00 (2006.01)
- (86) US2010049967 23.09.2010
(96) 10819445.7 01.08.2012
(87) WO2011038097, 23.09.2010
(97) 2480548, 01.08.2012 en
- (54) INDOLIZINE INHIBITORS OF 5-LIPOXYGENASE
- (71) Panmira Pharmaceuticals, LLC, 9535 Waples Street, Suite 100, San Diego, CA 92121, US
- (72) ROPPE, Jeffrey, Roger, 32182 Camino Guarda, Temecula CA 92592, US
PARR, Timothy, 8503 Lemon Avenue, La Mesa CA 91941, US
STEARNS, Brian, Andrew, 157 Beechtree Drive, Encinitas CA 92024, US

- (51) MKP
G06K 9/00 (2006.01) (97) **2411941 ***
G01H 17/00 (2006.01)
- (86) US2010000847 23.03.2010
(96) 10756464.3 01.02.2012
(87) WO2010110867, 23.03.2010
(97) 2411941, 01.02.2012 en
- (54) IMPROVED PIEZOELECTRIC IDENTIFICATION DEVICE AND APPLICATIONS THEREOF
- (71) Sonavation, Inc., 357 Hiatt Drive, Palm Beach Gardens, FL 33418, US
- (72) SCHMITT, Rainer, M., 86 Ironwood Way, Palm Beach Gardens FL 33418, US
LIAUTAUD, Christian, 1501 Southwest 7th Street, Boca Raton FL 33486, US

- (51) MKP
H01L 41/22 (2006.01) (97) **2443679 ***
H04R 17/00 (2006.01)
- (86) US2010001778 21.06.2010
(96) 10789879.3 25.04.2012
(87) WO2010147675, 21.06.2010
(97) 2443679, 25.04.2012 en
- (54) METHOD FOR MANUFACTURING A PIEZOELECTRIC CERAMIC BODY
- (71) Sonavation, Inc., 357 Hiatt Drive, Palm Beach Gardens, FL 33418, US
- (72) LIUFU, De, 15385 Whispering Willow Drive, Wellington, FL 33414, US
REGNIERE, Louis, 357 Hiatt Drive, Palm Beach Gardens, FL 33418, US

- (51) MKP
C07D 213/74 (2006.01) (97) **2406221 ***
C07D 239/42 (2006.01)
A61P 17/06 (2006.01)
A61P 19/00 (2006.01)
A61P 37/00 (2006.01)
- (86) EP2010001548 11.03.2010
(96) 10708145.7 18.01.2012
(87) WO2010102824, 11.03.2010
(97) 2406221, 18.01.2012 en
- (54) SODIUM SALT OF 5-CYCLOPROPYL-2-{[2-(2,6-DIFLUOROPHENYL)PYRIMIDIN-5-YL-AMINO]BENZOIC ACID AS DHODH INHIBITOR
- (71) Almirall S.A., Ronda del General Mitre, 151, 08022 Barcelona, ES
- (72) GARCIA GONZALEZ, Nuria, c/o Laurea Miro 408-410, E-08980 Sant Feliu de Llobregat (Barcelona), ES
CARRERA CARRERA, Francesc, c/o Laurea Miro 408-410, E-08980 Sant Feliu de Llobregat (Barcelona), ES
JULIA JANE, Montserrat, c/o Laurea Miro 408-410, E-08980 Sant Feliu de Llobregat (Barcelona), ES
DEBETHUNE, Laurent, c/o Laurea Miro 408-410, E-08980 Sant Feliu de Llobregat (Barcelona), ES
SERRA MASIA, Xavier, c/o Laurea Miro 408-410, E-08980 Sant Feliu de Llobregat (Barcelona), ES

- (51) MKP
C09C 3/12 (2006.01) (97) **2499206 ***
C09D 7/12 (2006.01)
B82Y 30/00 (2011.01)
C09D 5/08 (2006.01)
C09C 1/00 (2006.01)
- (86) US2010056198 10.11.2010
(96) 10793352.5 19.09.2012
(87) WO2011060050, 10.11.2010
(97) 2499206, 19.09.2012 en
- (54) COATING COMPOSITION
- (71) BYK-Chemie GmbH, Abelstrasse 45, 46483 Wesel, DE
- (72) MCMULLIN, Robert, 711 Andrea Court, Cheshire, Connecticut 06410, US
LEWCHIK, Fred, 176 Pheasant Run, Newington, Connecticut 06111, US
LESTER, Terry, 76 Grove Road, North Haven, Connecticut 06473, US

- (51) MKP
A61P 35/00 (2006.01) (97) **2483312 ***
A61K 39/395 (2006.01)
A61K 47/48 (2006.01)
C07K 16/28 (2006.01)
- (86) IB2010054422 30.09.2010
(96) 10765689.4 08.08.2012
(87) WO2011039724, 30.09.2010
(97) 2483312, 08.08.2012 en
- (54) ANTIBODIES THAT SPECIFICALLY BIND TO THE EPHA2 RECEPTOR
- (71) SANOFI, 54 rue La Boétie, 75008 Paris, FR
- (72) BOUCHARD, Hervé, c/o Sanofi-Aventis Département Brevets 174 Avenue de France, F-75013 Paris, FR
COMMERCON, Alain, c/o Sanofi-Aventis Département Brevets 174 Avenue de France, F-75013 Paris, FR
FROMOND, Claudia, c/o Sanofi-Aventis Département Brevets 174 Avenue de France, F-75013 Paris, FR
MIKOL, Vincent, c/o Sanofi-Aventis Département Brevets 174 Avenue de France, F-75013 Paris, FR
PARKER, Fabienne, c/o Sanofi-Aventis Département Brevets 174 Avenue de France, F-75013 Paris, FR
SASSOON, Ingrid, c/o Sanofi-Aventis Département Brevets 174 Avenue de France, F-75013 Paris, FR
TAVARES, Daniel, c/o ImmunoGen Inc. 830 Winter Street, Waltham Massachusetts 02451, US

- (51) MKP
G05B 9/02 (2006.01) (97) **2478420 ***
H04L 12/40 (2006.01)
H04L 12/413 (2006.01)
H04L 12/46 (2006.01)
H04L 12/66 (2006.01)
(86) EP2010063627 16.09.2010
(96) 10757754.6 25.07.2012
(87) WO2011033027, 16.09.2010
(97) 2478420, 25.07.2012 de
(54) CIRCUIT ASSEMBLY HAVING A CONVERTER PART
COMPRISING A CENTRAL CONTROL UNIT
(71) AEG Power Solutions B.V., Weerenweg 29, 1161 AH
Zwanenburg, NL
(72) BLACHA, Norbert, Petersbache 63, 59581 Warstein, DE
PECK, Andreas, Stockumer Weg 21, 59519 Mönnesee, DE
BRAND, Dieter, Haspeler Ring 10, 59581 Warstein, DE
-
- (51) MKP
H04N 5/44 (2011.01) (97) **2290955**
(96) 10170696.8 02.03.2011
(97) 2290955, 02.03.2011 fr
(54) Method for distributing digital data
(71) Quadrille Ingénierie, 1 Place Boieldieu, 75002 Paris, FR
Battas, Xavier, 38 avenue Jean Baptiste Clément, 92100
Boulogne, FR
Sully, Jean-Luc, 80 rue des Martyrs, 75018 Paris, FR
-
- (51) MKP
A61K 45/06 (2006.01) (97) **2416773 ***
A61P 35/00 (2006.01)
A61K 31/437 (2006.01)
A61K 31/4745 (2006.01)
A61K 31/7068 (2006.01)
(86) US2010030634 09.04.2010
(96) 10721579.0 15.02.2012
(87) WO2010118390, 09.04.2010
(97) 2416773, 15.02.2012 en
(54) CHECKPOINT KINASE 1 INHIBITORS FOR POTENTIATING
DNA DAMAGING AGENTS
(71) Array BioPharma, Inc., 3200 Walnut Street, Boulder, CO 80301,
US
(72) HUMPHRIES, Michael J., c/o Array BioPharma Inc. 3200
Walnut Street, Boulder, Colorado 80301, US
WINSKI, Shannon L., c/o Array BioPharma Inc. 3200 Walnut
Street, Boulder, Colorado 80301, US
-
- (51) MKP
A61P 13/12 (2006.01) (97) **2431365 ***
A61P 37/08 (2006.01)
A61P 17/06 (2006.01)
A61P 43/00 (2006.01)
C07D 401/06 (2006.01)
A61P 19/02 (2006.01)
C07D 401/14 (2006.01)
A61K 31/4427 (2006.01)
A61P 19/08 (2006.01)
C07D 405/14 (2006.01)
A61K 31/4439 (2006.01)
A61P 19/10 (2006.01)
C07D 409/14 (2006.01)
A61K 31/497 (2006.01)
A61P 35/00 (2006.01)
A61K 31/4545 (2006.01)
A61P 29/00 (2006.01)
C07D 413/14 (2006.01)
A61K 31/551 (2006.01)
A61P 35/02 (2006.01)
(86) JP2010058188 14.05.2010
(96) 10774995.4 21.03.2012
(87) WO2010131738, 14.05.2010
(97) 2431365, 21.03.2012 en
(54) AZETIDINE COMPOUND AND MEDICINAL USE THEREOF
(71) Japan Tobacco, Inc., 2-1, Toranomom 2-chome Minato-ku,
Tokyo 105-8422, JP
(72) IKEGASHIRA, Kazutaka, c/o Central Pharmaceutical Research
Institute of Japan Tobacco Inc. 1-1 Murasaki-cho, Takatsuki-shi
Osaka 569-1125, JP
IKENOGAMI, Taku, c/o Central Pharmaceutical Research
Institute of Japan Tobacco Inc. 1-1 Murasaki-cho, Takatsuki-shi
Osaka 569-1125, JP
OGAWA, Naoki, c/o Central Pharmaceutical Research Institute
of Japan Tobacco Inc. 1-1 Murasaki-cho, Takatsuki-shi Osaka
569-1125, JP
MATSUMOTO, Tatsuya, c/o Central Pharmaceutical Research
Institute of Japan Tobacco Inc. 1-1 Murasaki-cho, Takatsuki-shi
Osaka 569-1125, JP
OKA, Takahiro, c/o Central Pharmaceutical Research Institute
of Japan Tobacco Inc. 1-1 Murasaki-cho, Takatsuki-shi Osaka
569-1125, JP
MATSUO, Takuya, c/o Central Pharmaceutical Research
Institute of Japan Tobacco Inc. 1-1 Murasaki-cho, Takatsuki-shi
Osaka 569-1125, JP
YAMASAKI, Takayuki, c/o Central Pharmaceutical Research
Institute of Japan Tobacco Inc. 1-1 Murasaki-cho, Takatsuki-shi
Osaka 569-1125, JP
-
- (51) MKP
A61K 31/33 (2006.01) (97) **2456434 ***
A61P 25/28 (2006.01)
(86) US2010043166 23.07.2010
(96) 10738111.3 30.05.2012
(87) WO2011011766, 23.07.2010
(97) 2456434, 30.05.2012 en
(54) GALANTAMINE AMINO ACID AND PEPTIDE PRODRUGS
AND USES THEREOF
(71) Shire LLC, 9200 Brookfield Court, Florence, KY 41042, US
FRANKLIN, Richard, 3 Rosedene Gardens Fleet, Fleet GU51
4NQ, GB
GOLDING, Bernard, T., 42 Dukesfield Newcastle Upon Tyne,
Shiremoor NE27 0EZ, GB
TYSON, Robert, G., Holly Lodge Whitesmocks, Durham DH1
4LH, GB
-

- (51) MKP
C07D 401/12 (2006.01) (97) **2281822**
C07D 401/14 (2006.01)
C07D 403/12 (2006.01)
C07D 403/14 (2006.01)
C07D 413/14 (2006.01)
C07D 417/14 (2006.01)
A61K 31/404 (2006.01)
A61P 35/00 (2006.01)
(96) 10290436.4 09.02.2011
(97) 2281822, 09.02.2011 fr
(54) New dihydroindolone derivatives, method of preparing same and pharmaceutical compositions containing them
(71) Les Laboratoires Servier, 35, rue de Verdun, 92284 Suresnes Cedex, FR
(72) Ortuno, Jean-Claude, 5, avenue Marcel Hirbec, 78390 Bois d'Arcy, FR
Cordi, Alexis, 8bis, rue Ledru-Rollin, 92150 Suresnes, FR
Lacoste, Jean-Michel, , décédé, FR
Fejes, Imre, Attila út 117.3/5, 1012 Budapest, HU
Burbridge, Michael, 13, rue Emile Zola, 78480 Verneuil sur Seine, FR
Hickman, John, 126, boulevard Pereire, 75017 Paris, FR
Pierre, Alain, 9, chemin des Bois Janeaudes, 78580 Les Alluets Le Roi, FR
-
- (51) MKP
B01J 41/04 (2006.01) (97) **2384800**
B01J 47/02 (2006.01)
B01D 15/36 (2006.01)
C25D 3/56 (2006.01)
C25D 21/22 (2006.01)
(96) 10162272.8 09.11.2011
(97) 2384800, 09.11.2011 de
(54) Regeneration of alkaline zinc electrolytes by removing cyanidiones
(71) Dr.Ing. Max Schlötter GmbH & Co. KG, Am Talgraben 30, 73312 Geislingen/Steige, DE
(72) Jordan, Dr. Manfred, Panoramastr. 36, 73084, Salach, DE
Krauß, Dipl.-Ing. Ralph, Landhausweg 4, 73560, Böbingen, DE
Pfiz, Dr. Roland, Venzenweg 7, 89173, Lonsee, DE
-
- (51) MKP
A61M 5/20 (2006.01) (97) **2424594 ***
(86) US2010033012 29.04.2010
(96) 10770353.0 07.03.2012
(87) WO2010127146, 29.04.2010
(97) 2424594, 07.03.2012 en
(54) AUTOMATIC INJECTION DEVICE
(71) Abbott Biotechnology Ltd, Clarendon House, Hamilton HM 11, BM
(72) SHANG, Sherwin, S., 346 Southgate Drive, Vernon Hills IL 60061, US
OZDARYAL, Esra, 1665 Cranshire Ct., Deerfield IL 60015, US
PLEW, Marc, M., 2446 Lawson Blvd., Gurnee IL 60031, US
SZECHINSKI, William, P., 5954 N. Forest Glen, Chicago IL 60646, US
-
- (51) MKP
H04L 12/58 (2006.01) (97) **2490383**
(96) 11154119.9 22.08.2012
(97) 2490383, 22.08.2012 en
(54) Systems and methods of probing data transmissions for detecting spam bots
(71) Kaspersky Lab, ZAO, 10 Geroyev Panfilovtsev Street, Moscow 125363, RU
(72) Rybalko, Roman V., c/o KASPERSKY LAB, ZAO 10/1, 1st Volokolamsky Proezd, 123060, Moscow, RU

- (51) MKP
A61B 17/06 (2006.01) (97) **2498690 ***
(86) US2010053545 21.10.2010
(96) 10828794.7 19.09.2012
(87) WO2011056451, 21.10.2010
(97) 2498690, 19.09.2012 en
(54) SURGICAL NEEDLE COATINGS AND METHODS
(71) Ethicon, Inc., U.S. Route 22, Somerville, NJ 08876, US
(72) MAURER, Robert, 3 McElroy Lane, Montgomery, NJ 08502, US
BAR, S., Neil, 318 Thatcher Terrace, Hillsborough, NJ 08844, US
HINRICHS, Eric, 366 Cafferty Road, Bucks PA 18947, US
HAMILTON, Michael, 6002 April Street, San Angelo TX 76904, US
WILKES, Thomas, 1 Richmond Sreet Apt. 3106, New Brunswick NJ 08901, US
-
- (51) MKP
A01K 27/00 (2006.01) (97) **2498597 ***
(86) IT2010000360 06.08.2010
(96) 10763465.1 19.09.2012
(87) WO2011058588, 06.08.2010
(97) 2498597, 19.09.2012 en
(54) LEASH FOR DOGS OR OTHER DOMESTIC ANIMALS
(71) Primenove S.r.l., Via Mario Mantini 19, 65125 Pescara (PE), IT
(72) CATENA, Rocco, 19, Via Mario Mantini, 65025 Pescara, IT
-
- (51) MKP
A61K 47/48 (2006.01) (97) **2496262 ***
A61K 47/10 (2006.01)
A61K 9/08 (2006.01)
A61K 38/00 (2006.01)
A61K 9/00 (2006.01)
A61K 38/23 (2006.01)
(86) IB2010054927 01.11.2010
(96) 10787184.0 12.09.2012
(87) WO2011051916, 01.11.2010
(97) 2496262, 12.09.2012 en
(54) STABILIZED PROTEIN FORMULATIONS AND USE THEREOF
(71) Université de Genève, 24 rue du Général-Dufour, 1211 Genève 14, CH
Therapeomic AG, Tiefweg 50, 4125 Riehen, CH
(72) BORCHARD, Gerrit, Rue du Village 20c, CH-1273 Arzier, CH
MUELLER, Claudia, Rue de l'Encyclopédie 7, CH-1201 Genève, CH
CAPELLE, Martinus Anne Hobbe, Lerchenbergweg 26A, CH-4104 Oberwil, CH
ARVINTE, Tudor, Tiefweg 50, CH-4125 Riehen, CH
-
- (51) MKP
A61K 31/485 (2006.01) (97) **2437729 ***
A61K 45/06 (2006.01)
A61K 9/20 (2006.01)
A61K 9/16 (2006.01)
(86) GB2010050948 07.06.2010
(96) 10725263.7 11.04.2012
(87) WO2010140007, 07.06.2010
(97) 2437729, 11.04.2012 en
(54) TAMPER RESISTANT DOSAGE FORM COMPRISING A MATRIX AND MELT-EXTRUDED PARTICULATES COMPRISING A DRUG
(71) Euro-Celtique S.A., 2, avenue Charles de Gaulle, 1653 Luxembourg, LU
(72) MOHAMMAD, Hassan, Mundipharma Research Limited 191 Cambridge Science Park Milton Road Cambridge, Cambridgeshire CB4 0GW, GB

- (51) MKP
A61K 31/513 (2006.01) (97) **2448932 ***
C07D 413/06 (2006.01)
A61K 31/5377 (2006.01)
C07D 403/06 (2006.01)
A61P 35/00 (2006.01)
(86) FR2010051376 01.07.2010
(96) 10742015.0 09.05.2012
(87) WO2011001115, 01.07.2010
(97) 2448932, 09.05.2012 fr
(54) NOVEL 6-MORPHOLIN-4-YL-PYRIMIDIN-4-(3H)-ONE DERIVATIVES, AND THE PHARMACEUTICAL PREPARATION THEREOF AS AKT(PKB) PHOSPHORYLATION INHIBITORS
(71) SANOFI, 54 rue La Boétie, 75008 Paris, FR
(72) CERTAL, Victor, sanofi-aventis Département Brevets 174 avenue de France, F-75013 Paris, FR
FILOCHE-ROMMÉ, Bruno, sanofi-aventis Département Brevets 174 avenue de France, F-75013 Paris, FR
HALLEY, Frank, sanofi-aventis Département Brevets 174 avenue de France, F-75013 Paris, FR
KARLSSON, Karl Andreas, sanofi-aventis Département Brevets 174 avenue de France, F-75013 Paris, FR
THOMPSON, Fabienne, sanofi-aventis Département Brevets 174 avenue de France, F-75013 Paris, FR
-
- (51) MKP
G06F 19/00 (2011.01) (97) **2418596**
(96) 10425273.9 15.02.2012
(97) 2418596, 15.02.2012 en
(54) A system for monitoring patients that perform a medical self-check and relative method
(71) Akern S.r.l., Via Lisbona n. 32-34, 50065 Pontassieve (FI), IT
Marris, Jörg, Röderweg 15, 61462 Königstein, DE
(72) Talluri, Antonio, Via Montepilli n.8, 50012 Bagno a Ripoli (FI), IT
Marris, Jörg, Röderweg 15, 61462 Königstein, DE
-
- (51) MKP
A61P 31/20 (2006.01) (97) **2368547**
A61P 31/22 (2006.01)
A61P 31/18 (2006.01)
A61K 31/045 (2006.01)
A61K 31/122 (2006.01)
A61P 31/12 (2006.01)
A61P 31/14 (2006.01)
A61P 31/16 (2006.01)
(96) 10157930.8 28.09.2011
(97) 2368547, 28.09.2011 en
(54) Antiviral compositions comprising geraniol and carvone
(71) Cesa Alliance S.A., 43, Route d'Arlon, 8009 Strassen, LU
(72) Coppens, Christine, 43, route d'Arlon, 8009, Strassen, LU
-
- (51) MKP
A61K 9/00 (2006.01) (97) **2315580 ***
A61K 47/02 (2006.01)
A61K 47/12 (2006.01)
(86) US2010028906 26.03.2010
(96) 10711127.0 04.05.2011
(87) WO2010111644, 26.03.2010
(97) 2315580, 04.05.2011 en
(54) PHARMACEUTICAL FORMULATIONS AND METHODS FOR TREATING RESPIRATORY TRACT INFECTIONS
(71) Pulmatrix, Inc., 99 Hayden Avenue, Lexington, MA 02421, US
(72) LIPP, Michael M., 45A Flanagan Drive, Framingham Massachusetts 01701, US
CLARKE, Robert W., 60 Kings Road, Canton Massachusetts 02021, US
HAVA, David L., 68 S. Main Street, 2, Natick Massachusetts 01760, US
BATYCKY, Richard, 19 Bernard Street, Newton Massachusetts 02461, US
HANRAHAN, John, 69 Grayfield Avenue, West Roxbury Massachusetts 02132-2316, US
-
- (51) MKP
C23C 16/505 (2006.01) (97) **2251452**
G01N 15/08 (2006.01)
A61B 5/15 (2006.01)
(96) 10162756.0 17.11.2010
(97) 2251452, 17.11.2010 en
(54) Vessel processing
(71) CV Holdings, LLC., 1030 Riverfront Center, P.O.Box 710, Amsterdam, New York 12010, US
(72) Abrams, Robert S., 21 Marian Avenue, Albany, NY 12203, US
Felts, John T., 2624 Calhoun Street, Alameda, CA 94501, US
Fisk, Thomas E., 955 North Night Heron Drive, Green Valley, AZ 85614, US
Sagona, Peter J., 161 Ridgeview Drive, Pottstown, PA 19465, US
-
- (51) MKP
A61K 31/00 (2006.01) (97) **2435033 ***
A61K 31/155 (2006.01)
A61K 31/4439 (2006.01)
A61K 31/70 (2006.01)
A61P 3/10 (2006.01)
(86) US2010036120 26.05.2010
(96) 10720515.5 04.04.2012
(87) WO2010138535, 26.05.2010
(97) 2435033, 04.04.2012 en
(54) METHODS FOR TREATING TYPE 2 DIABETES IN PATIENTS RESISTANT TO PREVIOUS TREATMENT WITH OTHER ANTI-DIABETIC DRUGS EMPLOYING AN SGLT2 INHIBITOR AND COMPOSITIONS THEREOF
(71) Bristol-Myers Squibb Company, Route 206 & Province Line Road, Princeton, NJ 08543, US
AstraZeneca UK Limited, 15 Stanhope Gate, London W1K 1LN, GB
(72) STRUMPH, Paul, 102 Jamieson Drive, Pennington NJ 08534, US
MORAN, Stephanie, Rt. 206 and Province Line Road, Princeton NJ 08543, US
LIST, James, Rt. 206 and Province Line Road, Princeton NJ 08543, US
-
- (51) MKP
F24D 19/10 (2006.01) (97) **2434225 ***
F24D 17/00 (2006.01)
E03B 1/00 (2006.01)
F24H 1/48 (2006.01)
(86) KR2010003199 20.05.2010
(96) 10777957.1 28.03.2012
(87) WO2010134770, 20.05.2010
(97) 2434225, 28.03.2012 en
(54) COLD/HOT WATER SUPPLY SYSTEM WITH AN IMPROVED CONTROL UNIT
(71) PIP Co., Ltd, Sangnum Plaza 6 floor 1061-1, Jung-dong Wonmi-gu, Bucheon-si, Gyeonggi-do 420-020, KR
Kiseung Metal Co., Ltd., 361-5 YeounNam-dong Mapo-ku, Seoul 121-868, KR
(72) LEE, Yeong-Chun, 23-202 Seogyong Apt 102-5 Youkgok 1-dong Wonmi-gu, Bucheon-si Gyeonggi-do 420-835, KR

- (51) MKP
C07C 47/277 (2006.01) (97) **2475634 ***
(86) IN2010000607 13.09.2010
(96) 10803270.7 18.07.2012
(87) WO2011030356, 13.09.2010
(97) 2475634, 18.07.2012 en
(54) PROCESS FOR THE PREPARATION OF INDOLINE DERIVATIVES AND THEIR INTERMEDIATES THEREOF
(71) Sandoz AG, Lichtstrasse 35, 4056 Basel, CH
(72) JOSHI, Shreerang, Sandoz Private Limited Sandoz Baug Kolshet Road, Thane (West) 400 607 Maharashtra, IN
BHUTA, Sachin, Sandoz Private Limited Sandoz Baug Kolshet Road, Thane (West) 400 607 Maharashtra, IN
TALUKDAR, Sanjay, Sandoz Private Limited Sandoz Baug Kolshet Road, Thane (West) 400 607 Maharashtra, IN
SAWANT, Sudhir, Sandoz Private Limited Sandoz Baug Kolshet Road, Thane (West) 400 607 Maharashtra, IN
VENKATARAMAN, Deepak, Sandoz Private Limited Sandoz Baug Kolshet Road, Thane (West) 400 607 Maharashtra, IN
PISE, Abhinay, Sandoz Private Limited Sandoz Baug Kolshet Road, Thane (West) 400 607 Maharashtra, IN
METKAR, Shashikant, Sandoz Private Limited Sandoz Baug Kolshet Road, Thane (West) 400 607 Maharashtra, IN
CHAVAN, Dattatraya, Sandoz Private Limited Sandoz Baug Kolshet Road, Thane (West) 400 607 Maharashtra, IN
LUTHRA, Parven, Kumar, Sandoz Private Limited Sandoz Baug Kolshet Road, Thane (West) 400 607 Maharashtra, IN
-
- (51) MKP
B03D 1/01 (2006.01) (97) **2366456**
C22B 26/00 (2006.01)
C22B 26/20 (2006.01)
B03D 101/02 (2006.01)
(96) 10157099.2 21.09.2011
(97) 2366456, 21.09.2011 en
(54) Froth flotation process for the separation of silicates and alkaline earth metal carbonates using a collector comprising at least one hydrophobically modified polyalkyleneimine
(71) Omya Development AG, Baslerstrasse 42, 4665 Oftringen, CH
(72) Gane, Patrick A.C., Studenweg 8, 4852, Rothrist, CH
Buri, Matthias, Mätteliweg 20, 4852, Rothrist, CH
Rentsch, Samuel, Höhweg 1, 4663, Aarburg, CH
Sötemann, Jörg, Italiener Strasse 35, 9500, Villach, AT
-
- (51) MKP
G06Q 20/00 (2012.01) (97) **2425388 ***
(86) FR2010050819 29.04.2010
(96) 10727066.2 07.03.2012
(87) WO2010125317, 29.04.2010
(97) 2425388, 07.03.2012 fr
(54) METHOD FOR CHARGING FOR AND PROVIDING ACCESS TO A SERVICE FROM A MOBILE COMMUNICATION TERMINAL
(71) Dhatim SARL, 7 rue de la Croix Martre, 91120 Palaiseau, FR
(72) BOURGEOIS, Thomas, 190 bis Avenue Jean Jaurès, F-92140 Clamart, FR
DE CHASTELLIER, Pierre, 155 rue du Faubourg Saint Denis, F-75010 Paris, FR
-
- (51) MKP
C07K 16/18 (2006.01) (97) **2403875 ***
C07K 16/30 (2006.01)
G01N 33/577 (2006.01)
(86) US2010026319 05.03.2010
(96) 10707419.7 11.01.2012
(87) WO2010102177, 05.03.2010
(97) 2403875, 11.01.2012 en
(54) GLYCODELIN MONOCLONAL ANTIBODIES AND METHODS FOR THEIR USE IN THE DETECTION OF OVARIAN CANCER
(71) Tripath Imaging, Inc., 780 Plantation Drive, Burlington, NC 27215, US
(72) CHEEK, Robert, L., 6135 Oscar Gammon Road, Mebane, NC 27302, US
DIXON, Eric, P., 3041 Weston Green Loop, Cary, NC 27513, US
FISCHER, Timothy, J., 6609 Swallowtail Lane, Raleigh, NC 27613, US
GROELKE, John, W., 5221 Blakeley Lane, Raleigh, NC 27613, US
KNAPP, Steven, L., 110 Minnifer Court, Apex, NC 27539, US
SIMKINS, Stephen, G., 5309 April Wind Drive, Fuquay-Varina, NC 27526, US
WHITEHEAD, Clark, M., 2312 Brasstown Lane, Apex, NC 27502, US
-
- (51) MKP
A61P 29/00 (2006.01) (97) **2414377 ***
C07J 71/00 (2006.01)
A61K 31/58 (2006.01)
A61P 11/00 (2006.01)
A61P 11/06 (2006.01)
(86) SE2010050367 01.04.2010
(96) 10759128.1 08.02.2012
(87) WO2010114476, 01.04.2010
(97) 2414377, 08.02.2012 en
(54) NOVEL DERIVATIVES OF STEROIDALY3,2-C-PYRAZOLE COMPOUNDS WITH GLUCOCORTICOID ACTIVITY
(71) AstraZeneca AB, null, 151 85 Södertälje, SE
(72) BLADH, Håkan, c/o AstraZeneca Intellectual Property AstraZeneca R&D Södertälje, SE-151 85 Södertälje, SE
BURKAMP, Frank, c/o AstraZeneca Intellectual Property AstraZeneca R&D Södertälje, S-151 85 Södertälje, SE
GABOS, Balint, AstraZeneca R&D Lund, S-221 87 Lund, SE
HANSEN, Peter, AstraZeneca R&D Mölndal, SE-431 83 Mölndal, SE
-
- (51) MKP
A01N 43/54 (2006.01) (97) **2461685 ***
(86) US2010044285 03.08.2010
(96) 10739459.5 13.06.2012
(87) WO2011017351, 03.08.2010
(97) 2461685, 13.06.2012 en
(54) MIXTURES OF MESOIONIC PESTICIDES
(71) E. I. du Pont de Nemours and Company, 1007 Market Street, Wilmington, DE 19898, US
(72) HOLYOKE JR, Caleb, William, 120 Country Club Drive, Newark Delaware 19711, US
ZHANG, Wenming, 21 Charles Pointe, Newark Delaware 19702, US
TONG, My-Hanh, Thi, 4 Orchid Drive, Bear Delaware 19701, US
-
- (51) MKP
A01N 43/78 (2006.01) (97) **2485594 ***
A61K 31/425 (2006.01)
(86) US2010051909 08.10.2010
(96) 10822734.9 15.08.2012
(87) WO2011044415, 08.10.2010
(97) 2485594, 15.08.2012 en
(54) COMBINATION
(71) GlaxoSmithKline LLC, One Franklin Plaza 200 North 16th Street, Philadelphia, PA 19102, US
(72) DUMBLE, Melissa, 20 Kingsbridge Road, Piscataway, NJ 08854, US
GILMER, Tona, Five Moore Drive, Research Triangle Park, NC 27709, US
KUMAR, Rakesh, 1250 South Collegeville Road, Collegeville, PA 19426, US
LAQUERRE, Sylvie, 709 Swedeland Road, King of Prussia, PA 19406, US
LEBOWITZ, Peter, F., 1250 South Collegeville Road, Collegeville, PA 19426, US
MORRIS, Shannon, Renae, Five Moore Drive, Research Triangle Park, NC 27709, US
-
- (51) MKP
E04G 3/30 (2006.01) (97) **2410105**
F22B 37/24 (2006.01)
E04G 3/00 (2006.01)
(96) 11163479.6 25.01.2012
(97) 2410105, 25.01.2012 de
(54) Assembly of a covering element and an access facility or raised platform within a work room
(71) Hitachi Power Europe GmbH, Schifferstrasse 80, 47059 Duisburg, DE
(72) Furth, Thomas, Paulusstraße 12, 40237 Düsseldorf, DE
Pauly, Axel, Ohmstr. 18, 45711 Datteln, DE
Blomeier, Marc, Gasstraße 39, 45731 Waltrop, DE

- (51) MKP
A23C 9/14 (2006.01) (97) **2490547 ***
A23C 9/20 (2006.01)
- (86) SI2010000053 22.09.2010
(96) 10779348.1 29.08.2012
(87) WO2011037545, 22.09.2010
(97) 2490547, 29.08.2012 en
- (54) COMPOSITE DIETETIC MILK DRAUGHT AND METHOD FOR PRODUCTION OF COMPOSITE DIETETIC MILK DRAUGHT WITH REDUCED LEVEL OF URIC ACID AND PURINE COMPOUNDS
- (71) Cencic, Avrelija, Industrijska 5, 2342 Ruse, SI
(72) KOCIC, Gordana, Ul. Vojvode Misica 58/22, 18000 Nis, RS
NIKOLIC, Goran, Ul. Vase Pelagica 78/31, 18000 Nis, RS
STOJANOVIC, Dusica, Ul. Mokranjceva 32, 18000 Nis, RS
PAVLOVIC, Radmila, Bull Nikole Tesle 17/22, 18000 Nis, RS
JEVTOVIC -STOIMENOV, Tatjana, Bul Nikole Tesle 17/7, 18000 Nis, RS
SOKOLOVIC, Dusan, Ul Kragujevacka 46, 18000 Nis, RS
STOJANOVIC, Svetlana, Ul. Petra Velebita 16, 18000 Nis, RS
PAJOVIC, Snezana, Ul Glasinacka 11, 11000 Belgrade, RS
KOCIC, Radivoj, Ul Vojvode Misica 58/22, 18000 Nis, RS
CARLUCCIO, Francesco, IFC-CNR Institute of Clinical Physiology-national Council Reserch, Pisa Section Of Lecce, IT
KRAJNC, Ivan, Slomskov trg 15, 2000 Maribor, SI
MURUA TXOPITEA, Ander, Magdalenski trg 5, 2000 Maribor, SI
-
- (51) MKP
A61K 9/02 (2006.01) (97) **2440178 ***
- (86) HU2010000066 10.06.2010
(96) 10735083.7 18.04.2012
(87) WO2010143004, 10.06.2010
(97) 2440178, 18.04.2012 en
- (54) GLYCEROL-FREE OSMOTIC LAXATIVE SUPPOSITORY
- (71) Egis Gyógyszergyár Nyilvánosan M Kód Részvénytársaság, Keresztúri út 30-38, 1106 Budapest, HU
(72) MIKULÁSIK, Endre, Kossuth u. 60, H-8924 Alsónemesapáti, HU
SZAKÁLY, Péter, Rákóczi út 81, H-9900 Körmen, HU
-
- (51) MKP
A01N 43/54 (2006.01) (97) **2480084 ***
A61K 31/415 (2006.01)
A61K 31/505 (2006.01)
- (86) US2010049946 23.09.2010
(96) 10819435.8 01.08.2012
(87) WO2011038082, 23.09.2010
(97) 2480084, 01.08.2012 en
- (54) COMBINATION
- (71) GlaxoSmithKline LLC, One Franklin Plaza 200 North 16th Street, Philadelphia, PA 19102, US
(72) DUMBLE, Melissa, 20 Kingsbridge Road, Piscataway NJ 08854, US
GILMER, Tona, Five Moore Drive, Research Triangle Park NC 27709, US
KUMAR, Rakesh, 1250 South Collegeville Road, Collegeville PA 19426, US
LEBOWITZ, Peter, F., 1250 South Collegeville Road, Collegeville PA 19426, US
MORRIS, Shannon, Renae, Five Moore Drive, Research Triangle Park NC 27709, US
LAQUERRE, Sylvie, 709 Swedeland Road, King of Prussia PA 19406, US
-
- (51) MKP
C07D 405/14 (2006.01) (97) **2432777 ***
- (86) IB2010052260 20.05.2010
(96) 10722780.3 28.03.2012
(87) WO2010134052, 20.05.2010
(97) 2432777, 28.03.2012 en
- (54) PROCESS FOR THE PREPARATION OF OLMESARTAN MEDOXOMIL
- (71) Ranbaxy Laboratories Limited, Head Office: 12th Floor Devika Tower 06 Nehru Place New Delhi, Delhi 110019, IN
(72) KAPOOR, Ashwini, Kumar, House No. 411/412 Golden Residency N-1 CIDCO Aurangabad 431001, Maharashtra, IN
MEHTA, Hiten, Sharadchandra, Niyojan Nagar Samiti Near Manikbag Hall Ambawadi Ahmedabad 380015, Gujarat, IN
NATH, Asok, House No. 680 Sector - 14 Gurgaon 122001, Haryana, IN
PRASAD, Mohan, House No. P-3/3 Phase - II DLF Qutab Enclave Gurgaon 122001, Haryana, IN
-
- (51) MKP
A61K 31/505 (2006.01) (97) **2432768 ***
A61K 31/5377 (2006.01)
A61P 35/00 (2006.01)
C07D 239/49 (2006.01)
C07D 403/12 (2006.01)
C07D 401/12 (2006.01)
C07D 413/12 (2006.01)
- (86) GB2010050825 20.05.2010
(96) 10721195.5 28.03.2012
(87) WO2010133885, 20.05.2010
(97) 2432768, 28.03.2012 en
- (54) NOVEL PYRIMIDINE DERIVATIVES AND THEIR USE IN THE TREATMENT OF CANCER AND FURTHER DISEASES
- (71) Dainippon Sumitomo Pharma Co., Ltd., 6-8, Doshomachi 2-chome Chuo-ku Osaka-shi, Osaka 541-8524, JP
AstraZeneca AB, null, 151 85 Södertälje, SE
(72) BENNETT, Nicholas, James, c/o AstraZeneca Intellectual Property AstraZeneca R&D Alderley Alderley Park, Macclesfield Cheshire SK10 4TG, GB
MCINALLY, Thomas, c/o AstraZeneca Intellectual Property AstraZeneca R&D Alderley Alderley Par, Macclesfield Cheshire SK10 4TG, GB
THOM, Stephen, c/o AstraZeneca Intellectual Property AstraZeneca R&D Alderley Alderley Park, Macclesfield Cheshire SK10 4TG, GB
-
- (51) MKP
A47L 13/20 (2006.01) (97) **2433544 ***
A47L 13/10 (2006.01)
A46B 5/00 (2006.01)
A47L 13/24 (2006.01)
- (86) JP2010058620 21.05.2010
(96) 10777825.0 28.03.2012
(87) WO2010134593, 21.05.2010
(97) 2433544, 28.03.2012 en
- (54) CLEANER HOLDER AND CLEANING TOOL
- (71) Unicharm Corporation, 182 Shimobun Kinesei-cho Shikokuchuo-shi, Ehime 799-0111, JP
(72) TANAKA Yoshinori, c/o UNI-CHARM CORPORATION Technical Center 1531-7 Wadahama Toyohama-cho, Kanonji-shi Kagawa 769-1602, JP
FUKUZAWA Masumi, c/o UNI-CHARM CORPORATION Technical Center 1531-7 Wadahama Toyohama-cho, Kanonji-shi Kagawa 769-1602, JP
-
- (51) MKP
A01N 47/28 (2006.01) (97) **2445842 ***
C07C 273/18 (2006.01)
C02F 1/76 (2006.01)
A01N 25/02 (2006.01)
- (86) US2010039922 25.06.2010
(96) 10727323.7 02.05.2012
(87) WO2010151726, 25.06.2010
(97) 2445842, 02.05.2012 en
- (54) USE OF MONOCHLOROUREA TO TREAT INDUSTRIAL WATERS
- (71) Hercules Incorporated, Hercules Plaza 1313 N. Market Street, Wilmington, DE 19894-0001, US
(72) JERUSIK, Russell, J., 47 Springbrook Lane, Newark, DE 19711-2497, US
DAVID, Maren, 5910 McKinley Place, Excelsior, MN 55331, US
HENDERSON, Jay, C., 437 Brandywine Drive, Bear, DE 19701, US
-

(51) MKP
C12M 1/00 (2006.01) (97) **2446016 ***
 (86) DE2010050039 22.06.2010
 (96) 10740142.4 02.05.2012
 (87) WO2010149154, 22.06.2010
 (97) 2446016, 02.05.2012 de
 (54) METHOD FOR PRODUCING BIOMASS AND PHOTOBIOREACTOR FOR CULTIVATING PHOTOTROPHIC OR MIXOTROPHIC ORGANISMS OR CELLS
 (71) IGV Institut für Getreideverarbeitung GmbH, Arthur-Scheunert-Allee 40/41, 14558 Bergholz-Rehbrücke, DE
 (72) BRONESKE, Jürgen, Zinnaer Straße 14, 14947 Nuthe-Urstromtal, DE
 PULZ, Otto, Milanring 4, 14558 Nuthetal, DE
 ROTHE, Thomas, Anna-Seghers-Straße 7A, 14558 Nuthetal, DE
 SCHMIDT, Karsten, Heidekrautweg 9, 16348 Wandlitz, DE
 WEIDNER, Rainer, Maerkische Zeile 4, 15711 Königs Wusterhausen, DE

(51) MKP
A01N 43/42 (2006.01) (97) **2485589 ***
 (86) US2010047879 03.09.2010
 (96) 10814583.0 15.08.2012
 (87) WO2011029043, 03.09.2010
 (97) 2485589, 15.08.2012 en
 (54) HETEROARYL BTK INHIBITORS
 (71) Biogen Idec MA Inc., 133 Boston Post Road, Weston, MA 02493, US
 Sunesis Pharmaceuticals, Inc., 395 Oyster Point Blvd., Suite 400, South San Francisco, CA 94080, US
 (72) JENKINS, Tracy, J., 44 Vincent Avenue, Belmont MA 02478, US
 BUI, Minna, 2445 25th Avenue, Oakland CA 94601, US
 KUMARAVEL, Gnanasambandam, 10 Perham Circle, Westford MA 01886, US
 CONLON, Patrick, 20 Eaton Street, Wakefield MA 01800, US
 MARCOTTE, Doug, 6 Stratfield Street, Worcester MA 01604, US
 ERLANSON, Daniel, A., 1312 32nd Avenue, San Francisco CA 94122, US
 POWELL, Noel, 28 Carlisle Road, Westford MA 01886, US
 FAN, Junfa, 917 Catamaran Street Apt 3, Foster City CA 94404, US
 SCOTT, Daniel, 42 Bradyll Road, Weston MA 02493, US
 GUAN, Bing, 80 Evelyn Road, Needham MA 02494, US
 TAVERAS, Art, 6 Joslin Lane, Southborough MA 01772, US
 HOPKINS, Brian, T., 169 Washington Street Apt. 13, Newton MA 02458, US
 WANG, Deping, 52 Cannon Ball Road, Sharon MA 02067, US
 ISHCHEKNO, Alexey, 61 Bromfield Road 2, Somerville MA 02144, US
 ZHONG, Min, 3704 Feather Lane, Palo Alto CA 94303, US

(51) MKP
A61K 9/16 (2006.01) (97) **2386296**
A61K 31/352 (2006.01)
A61K 9/48 (2006.01)
A61K 9/50 (2006.01)
 (96) 11003147.3 16.11.2011
 (97) 2386296, 16.11.2011 de
 (54) New application forms for cineol
 (71) Maria Clementine Martin Klosterfrau Vertriebsgesellschaft mbH, Gereonsmühlengasse 1-11, 50670 Köln, DE
 (72) Greve, Harald, Dr., Schorlemerstrasse 3a, 40545 Düsseldorf, DE
 Duchatsch, Walter, Dr., Lendersbergstrasse 69, 53721 Siegburg, DE

(51) MKP
A23C 11/10 (2006.01) (97) **2471374 ***
 (86) KR2010002592 26.04.2010
 (96) 10815533.4 04.07.2012
 (87) WO2011030988, 26.04.2010
 (97) 2471374, 04.07.2012 en
 (54) METHOD AND SYSTEM FOR MANUFACTURING WHOLE SOY MILK
 (71) Kim, JongHae, Shinhan Technology Institute 100 Nochungil Dongmyun Hongchun, Gangwon 250-892, KR
 Kim, Michael J., 17960 Sherman Way, Apt. 211, Reseda, CA 91335, US
 (72) Kim, JongHae, Shinhan Technology Institute 100 Nochungil Dongmyun Hongchun, Gangwon 250-892, KR
 Kim, Michael J., 17960 Sherman Way, Apt. 211, Reseda, CA 91335, US

(51) MKP
A61K 47/14 (2006.01) (97) **2459221 ***
A61K 9/00 (2006.01)
A61K 31/519 (2006.01)
 (86) FR2010051611 29.07.2010
 (96) 10762950.3 06.06.2012
 (87) WO2011012816, 29.07.2010
 (97) 2459221, 06.06.2012 fr
 (54) PHARMACEUTICAL FORMULATION
 (71) SANOFI, 54 rue La Boétie, 75008 Paris, FR
 BURNOUF, Jean-Pierre, c/o Sanofi-Aventis Département Brevets 174 Avenue de France, F-75013 Paris, FR
 BENARD, Tsiala, c/o Sanofi-Aventis Département Brevets 174 Avenue de France, F-75013 Paris, FR

(51) MKP
A61K 9/16 (2006.01) (97) **2432456 ***
A61K 9/20 (2006.01)
A61K 31/55 (2006.01)
A61K 9/28 (2006.01)
 (86) US2010001434 14.05.2010
 (96) 10723816.4 28.03.2012
 (87) WO2010134965, 14.05.2010
 (97) 2432456, 28.03.2012 en
 (54) SOLID PHARMACEUTICAL COMPOSITIONS AND PROCESSES FOR THEIR PRODUCTION
 (71) Millennium Pharmaceuticals, Inc., 40 Landsdowne Street, Cambridge, MA 02139, US
 (72) MITTAL, Bhavishya, 51 Grampian Way, Weymouth MA 02188, US

(51) MKP
C08F 26/10 (2006.01) (97) **2427226 ***
A61L 27/14 (2006.01)
A61F 2/12 (2006.01)
 (86) US2010033580 04.05.2010
 (96) 10772713.3 14.03.2012
 (87) WO2010129573, 04.05.2010
 (97) 2427226, 14.03.2012 en
 (54) IMPLANT FILLING MATERIAL AND METHOD
 (71) Beisang, Arthur A., 5009 Lake Avenue, White Bear Lake, MN 55110, US
 Ersek, Robert A., 630 West 34th Street, Austin, Texas 78705, US
 Beisang lii, Arthur A., 4 Falcon Lane, North Oaks, Minnesota 55127, US
 Beisang, Daniel J., 4 Falcon Lanex, North Oaks, Minnesota 55127, US
 (72) Beisang, Arthur A., 5009 Lake Avenue, White Bear Lake, MN 55110, US
 Ersek, Robert A., 630 West 34th Street, Austin, Texas 78705, US
 Beisang lii, Arthur A., 4 Falcon Lane, North Oaks, Minnesota 55127, US
 Beisang, Daniel J., 4 Falcon Lanex, North Oaks, Minnesota 55127, US

- (51) MKP
A61P 25/04 (2006.01) (97) **2453900 ***
A61K 31/55 (2006.01)
C07D 223/04 (2006.01)
- (86) IB2010001747 16.07.2010
(96) 10743230.4 23.05.2012
(87) WO2011007247, 16.07.2010
(97) 2453900, 23.05.2012 en
(54) NOVEL CARBAMATE AMINO ACID AND PEPTIDE
PRODRUGS OF OPIOIDS AND USES THEREOF
(71) Shire LLC, 9200 Brookfield Court, Florence, KY 41042, US
(72) FRANKLIN, Richard, 3 Rosedene Gardens, Fleet GU51 4NQ,
GB
GOLDING, Bernard, T., 42 Dukesfield Shiremoor, Newcastle
upon Tyne NE27 0EZ, GB
TYSON, Robert, G., Holly Lodge Whitesmocks, Durham DH1 4
LH, GB
-
- (51) MKP
A61F 13/15 (2006.01) (97) **2446868**
- (96) 11186973.1 02.05.2012
(97) 2446868, 02.05.2012 en
(54) APPARATUS AND METHOD FOR THE APPLICATION OF A
CURVED RIBBON TO A TRAVELING WEB
(71) Curt G. Joa, Inc., 100 Crocker Avenue, Sheboygan Falls,
Wisconsin 53085, US
(72) Handziak, Perry, 5187 Lakeview Ridge Road, Belgium, WI
Wisconsin, US
-
- (51) MKP
A61K 31/497 (2006.01) (97) **2445502 ***
- (86) US2010039855 24.06.2010
(96) 10792677.6 02.05.2012
(87) WO2010151689, 24.06.2010
(97) 2445502, 02.05.2012 en
(54) HETEROCYCLIC COMPOUNDS FOR THE TREATMENT OF
NEUROLOGICAL AND PSYCHOLOGICAL DISORDERS
(71) Alkermes, Inc., 852 Winter Street, Waltham, MA 02451, US
(72) REMENAR, Julius, F., 9 Eaton Road, Framingham, MA 01701,
US
BLUMBERG, Laura, Cook, 37 Mill Street, Lincoln, MA 01773,
US
ZEIDAN, Tarek, A., 296 Lexington Street, Watertown, MA
02472, US
-
- (51) MKP
A61M 31/00 (2006.01) (97) **2427243 ***
- (86) US2010033746 05.05.2010
(96) 10772774.5 14.03.2012
(87) WO2010129686, 05.05.2010
(97) 2427243, 14.03.2012 en
(54) NOVEL FORMULATIONS OF VOLATILE ANESTHETICS AND
METHODS OF USE FOR REDUCING INFLAMMATION
(71) Vapogenix, Inc., 4030 Case Street, Houston, TX 77005, US
(72) SPAKEVICIUS, Danguole, 4030 Case Street, Houston, TX
77005, US
OZSOY, Hatice, 2515 Gramercy Street, Houston, TX 77030, US
-
- (51) MKP
A61N 2/02 (2006.01) (97) **2305346**
- (96) 10011480.0 06.04.2011
(97) 2305346, 06.04.2011 de
(54) Method for treating obesity
(71) Hesse, Albert, Platinweg 29, 57482 Wenden, DE
(72) Hesse, Albert, Platinweg 29, 57482 Wenden, DE
-
- (51) MKP
C09D 11/10 (2006.01) (97) **2414986 ***
B41M 3/14 (2006.01)
C09K 19/02 (2006.01)
G06K 1/12 (2006.01)
G07D 7/12 (2006.01)
G06Q 10/00 (2012.01)
- (86) EP2010054515 06.04.2010
(96) 10716308.1 08.02.2012
(87) WO2010115879, 06.04.2010
(97) 2414986, 08.02.2012 en
(54) IDENTIFICATION AND AUTHENTICATION USING
POLYMERIC LIQUID CRYSTAL MATERIAL MARKINGS
(71) SICPA HOLDING SA, Avenue de Florissant 41, 1008 Prilly, CH
(72) MARGUERETTAZ, Xavier, Rue du Guercet 93, CH-1920
Martigny, CH
GREMAUD, Frédéric, Chemin de la Belle-Luce 15, CH-1663
Epagny, CH
COMMEUREUC, Aurélien, Chemin du Chêne 8, CH-1112
Echichens, CH
ABOUTANOS, Vickie, Rue des Parcs 61, CH-2000 Neuchâtel,
CH
TILLER, Thomas, Chemin du Cèdre 21, CH-1030 Bussigny, CH
ROZUMEK, Olivier, Route de Monchuplyon 12, CH-1661 Le
Pâquier-Montbarry, CH
-
- (51) MKP
F24J 2/52 (2006.01) (97) **2362161**
- (96) 10169137.6 31.08.2011
(97) 2362161, 31.08.2011 en
(54) Panel mounting system
(71) B&L, Lodewijk De Raetstraat 3B, 3920 Lommel, BE
(72) Bienstman, Marc, Slachthuisstraat 123, B-2400, Mol, BE
-
- (51) MKP
C07D 493/08 (2006.01) (97) **2496583 ***
C07H 7/04 (2006.01)
A61P 3/10 (2006.01)
A61K 31/35 (2006.01)
A61P 3/04 (2006.01)
- (86) IB2010054775 21.10.2010
(96) 10776433.4 12.09.2012
(87) WO2011051864, 21.10.2010
(97) 2496583, 12.09.2012 en
(54) DIOXA-BICYCLO[3.2.1]OCTANE-2,3,4-TRIOL DERIVATIVES
(71) Pfizer Inc, 235 East 42nd Street, New York, NY 10017, US
(72) MASCITTI, Vincent, Pfizer Global Research and Development
Eastern Point Road, Groton, Connecticut 06340, US
-
- (51) MKP
A61K 31/519 (2006.01) (97) **2432472 ***
C07D 487/04 (2006.01)
A61P 35/00 (2006.01)
A61P 17/00 (2006.01)
A61P 27/02 (2006.01)
A61P 29/00 (2006.01)
- (86) US2010035728 21.05.2010
(96) 10721227.6 28.03.2012
(87) WO2010135621, 21.05.2010
(97) 2432472, 28.03.2012 en
(54) 3-[4-(7H-PYRROLO[2,3-D]PYRIMIDIN-4-YL)-1H-PYRAZOL-1-
YL]OCTANE- OR HEPTANE-NITRILE AS JAK INHIBITORS
(71) Incyte Corporation, Experimental Station Route 141 & Henry
Clay Road Building E336, Wilmington, DE 19880, US
(72) LI, Yun-Long, 1 Pin Oak Drive, Chadds Ford, Pennsylvania
19317, US
RODGERS, James D., 2 Hillside Lane, Landenberg,
Pennsylvania 19350, US
-

(51) MKP
G01N 33/569 (2006.01) (97) **2419734 ***
G01N 33/58 (2006.01)
 (86) US2010031425 16.04.2010
 (96) 10714813.2 22.02.2012
 (87) WO2010121154, 16.04.2010
 (97) 2419734, 22.02.2012 en
 (54) DIRECT FLUORESCENCE IMMUNOASSAY FOR VIRAL ANTIGENS
 (71) Diagnostic Hybrids, Inc., 1055 East State Street, Suite 100, Athens, OH 45701, US
 (72) SCHOLL, David, R., 8108 Rolling Hills Drive, Athens, OH 45701, US
 BROWN, James, L., 26 Pleasantview Drive, Athens, OH 45701, US
 JOLLICK, Joseph, 16069 Mansfield Road, Athens, OH 45701, US
 LOLLAR, Ronald, 8096 Rolling Heights Avenue, Athens, OH 45701, US

(51) MKP
C08G 77/00 (2006.01) (97) **2411449 ***
 (86) US2010025912 02.03.2010
 (96) 10756550.9 01.02.2012
 (87) WO2010110998, 02.03.2010
 (97) 2411449, 01.02.2012 en
 (54) IMPRINTED BIOMIMETIC CATALYSTS FOR CELLULOSE HYDROLYSIS
 (71) The Trustees Of The University Of Pennsylvania, Center for Technology Transfer 3160 Chestnut Street, Suite 200, Philadelphia, PA 19104-6283, US
 Roth, Stephen, 1105 Rose Glen Road, Gladwyne, PA 19036, US
 (72) ROTH, Stephen, 1105 Rose Glen Road, Gladwyne, PA 19036, US
 LEE, Daeyeon, 250 E Wynnewood Road Apt G9, Wynnewood, PA 19096, US

(51) MKP
C12Q 1/00 (2006.01) (97) **2430178 ***
 (86) US2010034899 14.05.2010
 (96) 10775596.9 21.03.2012
 (87) WO2010132771, 14.05.2010
 (97) 2430178, 21.03.2012 en
 (54) METHODS AND KITS FOR MEASURING TOXICITY AND OXIDATIVE STRESS IN LIVE CELLS
 (71) Lankenau Institute for Medical Research, 100 East Lancaster Avenue, Wynnewood, PA 19096, US
 (72) AYENE, Iramoudi, S., 3415 Tyson Road, Newtown Square, PA 19073, US

(51) MKP
C07D 473/34 (2006.01) (97) **2486039 ***
A61P 25/00 (2006.01)
A61P 25/28 (2006.01)
A61K 31/52 (2006.01)
A61K 31/538 (2006.01)
A61P 35/00 (2006.01)
 (86) US2010051872 07.10.2010
 (96) 10822718.2 15.08.2012
 (87) WO2011044394, 07.10.2010
 (97) 2486039, 15.08.2012 en
 (54) PURINE DERIVATIVES USEFUL AS HSP90 INHIBITORS
 (71) Sloan Kettering Institute For Cancer Research, 1275 York Avenue, New York, NY 10065, US
 (72) CHIOSIS, Gabriela, c/o Memorial Sloan-Kettering Cancer Center 1275 York Avenue, New York, New York 10065, US
 TALDONE, Tony, 425 Main Street Apartment 12F, New York, New York 10044, US
 SUN, Weilin, 475 Main Street Apartment 2B, New York, New York 10044, US

(51) MKP
A61K 38/16 (2006.01) (97) **2432488 ***
 (86) US2010028061 19.03.2010
 (96) 10754211.0 28.03.2012
 (87) WO2010108154, 19.03.2010
 (97) 2432488, 28.03.2012 en
 (54) SELECTIVE AND POTENT PEPTIDE INHIBITORS OF KV1.3
 (71) Amgen, Inc, One Amgen Center Drive, Thousand Oaks, CA 91320-1799, US
 (72) MIRANDA, Leslie P., 3586 Mapleknoll Place, Thousand Oaks California 91362, US
 JACOBSEN, Frederick W., 1168 Homestake Place, Newbury Park California 91320, US
 GEGG, Colin V., 736 Kenmore Circle, Newbury Park California 91320, US
 LI, Yue-Sheng, 3025 Shadow Hill Circle, Thousand Oaks California 91360, US
 HU, Shaw-Fen Sylvia, 986 Lynnmere Drive, Thousand Oaks California 91360, US
 BOONE, Thomas C., 2715 Kelly Knoll Lane, Newbury Park California 91320, US
 BELOUSKI, Edward J., 4541 La Tuna Court, Camarillo California 93012, US
 MURRAY, Justin K., 6879 Pecan Avenue, Moorpark California 91321, US
 SULLIVAN, John K., 1085 Rotella Street, Newbury Park California 91320, US
 ARORA, Taruna, 5380 Via Pisa, Thousand Oaks California 91320, US
 WALKER, Kenneth W., 175 Mesa Avenue, Newbury Park California 91320, US
 NGUYEN, Hung, 400 Paseo Camarillo 212, Camarillo California 93010, US

(51) MKP
G06Q 30/00 (2006.01) (97) **2249302**
G07F 17/40 (2006.01)
G07F 7/00 (2006.01)
 (96) 10161388.3 10.11.2010
 (97) 2249302, 10.11.2010 de
 (54) Device for ordering and/or booking and/or purchasing goods or services and ordering, booking or purchasing device
 (71) CoBox AG, Hasselborner Strasse 19-21, 35647 Waldsolms, DE
 (72) Baudisch, Ulrich, Finkenweg 17, 35647 Waldsolms, DE
 Gratz, Jörg, Nibelungenstr. 4, 65187 Wiesbaden, DE

(51) MKP
B60R 25/02 (2006.01) (97) **2275313**
 (96) 10167821.7 19.01.2011
 (97) 2275313, 19.01.2011 de
 (54) Blocking device for blocking an essential component of a motor vehicle, particularly for blocking a steering column of a motor vehicle
 (71) Huf Hülsbeck & Fürst GmbH & Co. KG, Steeger Strasse 17, 42551 Velbert, DE
 (72) Dr. Klein, Matthias, Karl-Riemer-Straße 14, 85221, Dachau, DE
 Pieper, Friedrich, Aventinstraße 20, 84513, Töging, DE
 Pieronczyk, Martin, Udldinger Straße 7, 85221, Dachau, DE
 Müller, Josef, Gartenstraße 1 a, 85254, Einsbach, DE
 Fraisse, Gaetan, 4, rue de la libération, 78640, Neauphle le Vieux, FR

(51) MKP
A23L 1/228 (2006.01) (97) **2415359 ***
 (86) JP2010055856 31.03.2010
 (96) 10758793.3 08.02.2012
 (87) WO2010114022, 31.03.2010
 (97) 2415359, 08.02.2012 en
 (54) USE OF PEPTIDE FOR IMPARTING BODY TASTE
 (71) Ajinomoto Co., Inc., 15-1, Kyobashi 1-chome Chuo-ku, Tokyo, 104-8315, JP
 (72) FUTAKI Fumie, c/o AJINOMOTO CO. INC. 1-1, Suzuki-cho Kawasaki-ku, Kawasaki-shi Kanagawa 210-8681, JP
 YASUDA Reiko, c/o AJINOMOTO CO. INC. 1-1, Suzuki-cho Kawasaki-ku, Kawasaki-shi Kanagawa 210-8681, JP
 SATO Seiichi, c/o AJINOMOTO CO. INC. 1-1, Suzuki-cho Kawasaki-ku, Kawasaki-shi Kanagawa 210-8681, JP
 MIYAKI Takashi, c/o AJINOMOTO CO. INC. 1-1, Suzuki-cho Kawasaki-ku, Kawasaki-shi Kanagawa 210-8681, JP
 MIYAMURA Naohiro, c/o AJINOMOTO CO. INC. 1-1, Suzuki-cho Kawasaki-ku, Kawasaki-shi Kanagawa 210-8681, JP
 ETO Yuzuru, c/o AJINOMOTO CO. INC. 1-1, Suzuki-cho Kawasaki-ku, Kawasaki-shi Kanagawa 210-8681, JP

- (51) MKP
A01B 3/46 (2006.01) (97) **2238818**
A01B 3/42 (2006.01)
(96) 10159287.1 13.10.2010
(97) 2238818, 13.10.2010 fr
(54) Reversible plough with a device for reducing the pressure
(71) Kuhn-Huard S.A., Zone Industrielle., 44142 Châteaubriant, FR
(72) Guermont, Jean-François, La Hunaudière, 44590, Sion Les Mines, FR
Herault, Vincent, La Drutière, 44470, Mauves Sur Loire, FR
-
- (51) MKP
A01B 49/02 (2006.01) (97) **2279652**
(96) 10170025.0 02.02.2011
(97) 2279652, 02.02.2011 de
(54) Grubber
(71) Treffler, Paul, Am Mühlgrund 4, 86554 Pöttmes-Echsheim, DE
(72) Treffler, Paul, Am Mühlgrund 4, 86554 Pöttmes-Echsheim, DE
-
- (51) MKP
A61K 31/4439 (2006.01) (97) **2408452 ***
A61K 45/06 (2006.01)
A61P 31/06 (2006.01)
(86) GB2010050445 16.03.2010
(96) 10710617.1 25.01.2012
(87) WO2010106355, 16.03.2010
(97) 2408452, 25.01.2012 en
(54) COMPOUND FOR THE TREATMENT OF TUBERCULOSIS
(71) AstraZeneca AB, null, 151 85 Södertälje, SE
(72) KAVERI, Das, AstraZeneca India Pvt Limited Bellary Road Hebbal, Bangalore 560 024, IN
MELNICK, David, Alan, AstraZeneca R&D Wilmington 1800 Concord Pike PO Box 15437 Wilmington, Delaware 19850-5437, US
RADHA, Shandil, AstraZeneca India Pvt Limited Bellary Road Hebbal, Bangalore 560 024, IN
-
- (51) MKP
G01N 33/68 (2006.01) (97) **2444815 ***
C07D 405/12 (2006.01)
G01N 33/533 (2006.01)
A61K 8/64 (2006.01)
(86) KR2010003853 15.06.2010
(96) 10789702.7 25.04.2012
(87) WO2010147375, 15.06.2010
(97) 2444815, 25.04.2012 en
(54) METHOD FOR SCREENING FOR SUBSTANCE WHICH INHIBITS INTERACTION BETWEEN BETAAMYLOID PEPTIDE AND VEGF AND INHIBITOR SEARCHED BY SAME
(71) Innopharmascreen Inc., 404 Hoseo Univ. 165 Sechul-ri Baebang-myeon, Asan-si, Chungcheongnam-do 336-851, KR
(72) KANG, In-Cheol, 103-302 Yeoksam Prugio Apt. Yeoksam 2-dong Gangnam-gu, Seoul 135-796, KR
PARK, Chan-Won, 306-1102 Samik 3-cha Apt. Geumgok-dong Gwonseon-gu, Suwon-si Gyeonggi-do 441-749, KR
-
- (51) MKP
B66C 23/36 (2006.01) (97) **2364949**
B66C 13/08 (2006.01)
(96) 11157928.0 14.09.2011
(97) 2364949, 14.09.2011 en
(54) Methods and apparatus for handling a tower section of a wind turbine with a crane
(71) Vestas Wind Systems A/S, Hedeager 44, 8200 Aarhus N, DK
(72) Botwright, Adrian, Engbakken 9, 8471, Sabro, DK
-
- (51) MKP
A61P 25/00 (2006.01) (97) **2421856 ***
A61K 31/496 (2006.01)
C07D 205/06 (2006.01)
A61P 29/00 (2006.01)
C07D 409/06 (2006.01)
C07D 405/06 (2006.01)
(86) US2010032086 22.04.2010
(96) 10716672.0 29.02.2012
(87) WO2010124112, 22.04.2010
(97) 2421856, 29.02.2012 en
(54) AZETIDINYL DIAMIDES AS MONOACYLGLYCEROL LIPASE INHIBITORS
(71) Janssen Pharmaceutica N.V., Turnhoutseweg 30, 2340 Beerse, BE
(72) LIN, Shu-chen, 4895 Redfield Road, Doylestown PA 18902, US
ZHU, Bin, Welsh&Mckean Roads, Spring House PA 19477, US
BIAN, Haiyan, 109 York Drive, Princeton NJ 08540, US
MCDONNELL, Mark, E., 1280 Sumneytown Pike, Lansdale PA 19446, US
CHEVALIER, Kristen, M., 407 Nottingham Lane, Collegeville PA 19426, US
PITIS, Philip, M., 108 Sunrise Drive, North Wales PA 19454, US
CONNOLLY, Peter, J., Welsh&Mckean Roads, Spring House PA 19477, US
ZHANG, Sui-po, 665 Stockton Drive, Exton PA 19341, US
FLORES, Christopher, M., Welsh&Mckean Roads, Spring House PA 19477, US
ZHANG, Yue-mei, Welsh&Mckean Roads, Spring House PA 19477, US
LIU, Li, 271 Fox Chase Lane, Doylestown PA 18901, US
CLEMENTE, Jose, 665 Stockton Drive, Exton PA 19341, US
MABUS, John, 9131 Rosewood Drive, East Greenville PA 18041, US
MACIELAG, Mark, J., Welsh&Mckean Roads, Spring House PA 19477, US
-
- (51) MKP
F27D 3/16 (2006.01) (97) **2430383 ***
F27D 3/12 (2006.01)
B01J 4/00 (2006.01)
(86) CA2011050124 01.03.2011
(96) 11750135.3 21.03.2012
(87) WO2011106896, 01.03.2011
(97) 2430383, 21.03.2012 en
(54) A LATERAL TRANSFER SYSTEM
(71) Plasco Energy Group Inc., 1000 Innovation Drive, Suite 400, Kanata, Ontario K2K 3E7, CA
PlascoEnergy IP Holdings, S.L., Bilbao, Schaffhausen Branch, Vordergasse 3, 88200 Schaffhausen, CH
(72) BACON, Marc, 72 Hartsmere Drive, Stittsville Ontario K2S 2B7, CA
TSANGARIS, Andreas, 248 Madhu Crescent, Ottawa Ontario K2C 4J3, CA
-
- (51) MKP
C07D 209/12 (2006.01) (97) **2419406 ***
(86) EP2010054732 09.04.2010
(96) 10713221.9 22.02.2012
(87) WO2010118997, 09.04.2010
(97) 2419406, 22.02.2012 en
(54) PROCESSES FOR THE SYNTHESIS OF BAZEDOXIFENE ACETATE AND INTERMEDIATES THEREOF
(71) Sandoz AG, Lichtstrasse 35, 4056 Basel, CH
(72) JOSHI, Shreerang, c/o Sandoz Private Limited, Kalwe Development Center-Emerald MIDC, Plot No. 8-A/2, 8-B T.T.C. Industrial Area, Kalwe Block Village-Digha, Opp. Thane-Belapur Road, Navi Mumbai 400 708, IN
BHUTA, Sachin, c/o Sandoz Private Limited, Kalwe Development Center-Emerald MIDC, Plot No. 8-A/2, 8-B T.T.C. Industrial Area, Kalwe Block Village-Digha, Opp. Thane-Belapur Road, Navi Mumbai 400 708, IN
TALUKDAR, Sanjay, c/o Sandoz Private Limited, Kalwe Development Center-Emerald MIDC, Plot No. 8-A/2, 8-B T.T.C. Industrial Area, Kalwe Block Village-Digha, Opp. Thane-Belapur Road, Navi Mumbai 400 708, IN
SAWANT, Sudhir, c/o Sandoz Private Limited, Kalwe Development Center-Emerald MIDC, Plot No. 8-A/2, 8-B T.T.C. Industrial Area, Kalwe Block Village-Digha, Opp. Thane-Belapur Road, Navi Mumbai 400 708, IN
VENKATRAMAN, Deepak, c/o Sandoz Private Limited, Kalwe Development Center-Emerald MIDC, Plot No. 8-A/2, 8-B T.T.C. Industrial Area, Kalwe Block Village-Digha, Opp. Thane-Belapur Road, Navi Mumbai 400 708, IN
-

(51) MKP
C07K 16/10 (2006.01) (97) **2430046 ***
A61K 39/42 (2006.01)
(86) EP2010056217 06.05.2010
(96) 10718169.5 21.03.2012
(87) WO2010130636, 06.05.2010
(97) 2430046, 21.03.2012 en
(54) HUMAN BINDING MOLECULES CAPABLE OF NEUTRALIZING INFLUENZA VIRUS H3N2 AND USES THEREOF
(71) Crucell Holland B.V., Archimedesweg 4, 2333 CN Leiden, NL
(72) THROSBY, Mark, Archimedesweg 4-6, NL-2333 CN Leiden, NL
FRIESEN, Robert Heinz Edward, Archimedesweg 4-6, NL-2333 CN Leiden, NL
KWAKS, Theodorus Hendrikus Jacobus, Archimedesweg 4-6, NL-2333 CN Leiden, NL
JONGENELEN, Mandy Antonia Catharina, Archimedesweg 4-6, NL-2333 CN Leiden, NL

(51) MKP
H04W 36/34 (2009.01) (97) **2480025 ***
H04W 88/02 (2009.01)
(86) CN2010076948 15.09.2010
(96) 10816701.6 25.07.2012
(87) WO2011032497, 15.09.2010
(97) 2480025, 25.07.2012 en
(54) METHOD, DEVICE AND SYSTEM FOR RECONFIGURING AGGREGATION CELL
(71) China Academy of Telecommunications Technology, 40, Xueyuan Road, Haidian District, Beijing 100191, CN
(72) ZHAO, Yi, No. 40 Xueyuan Road Haidian District, Beijing 100083, CN
LIANG, Jing, No. 40 Xueyuan Road Haidian District, Beijing 100083, CN
LIU, Jiamin, No. 40 Xueyuan Road Haidian District, Beijing 100083, CN
XU, Fangli, No. 40 Xueyuan Road Haidian District, Beijing 100083, CN

(51) MKP
C12N 15/10 (2006.01) (97) **2446032 ***
(86) US2010040052 25.06.2010
(96) 10729033.0 02.05.2012
(87) WO2010151808, 25.06.2010
(97) 2446032, 02.05.2012 en
(54) EXPRESSION OF SURROGATE LIGHT CHAINS
(71) Sea Lane Biotechnologies, Inc., 356 Selby Lane, Atherton, CA 94027, US
(72) HOROWITZ, Lawrence, 362 Selby Lane, Atherton, CA 94027, US
BHATT, Ramesh, 2729 Waltham Cross, Belmont, CA 94002, US

(51) MKP
G06F 3/023 (2006.01) (97) **2476044 ***
G06F 3/01 (2006.01)
(86) US2010047127 30.08.2010
(96) 10760482.9 18.07.2012
(87) WO2011031575, 30.08.2010
(97) 2476044, 18.07.2012 en
(54) SYSTEMS AND METHODS FOR HAPTICALLY-ENHANCED TEXT INTERFACES
(71) Immersion Corporation, 30 Rio Robles, San Jose, CA 95134, US
(72) ULLRICH, Christopher, J., 227 Palomares Avenue, Ventura California 93003, US
BIRNBAUM, David, 311 Oak Street, 327, Oakland California 94607, US
VACHON, Craig, 30 Rio Robles, San Jose California 95134, US
FLEMING, Jason, 3535 Laurant Way, San Jose California 95132, US

(51) MKP
H04L 9/08 (2006.01) (97) **2361462 ***
(86) SE2010050780 05.07.2010
(96) 10794465.4 31.08.2011
(87) WO2011002412, 05.07.2010
(97) 2361462, 31.08.2011 en
(54) METHOD FOR GENERATING AN ENCRYPTION/ DECRYPTION KEY
(71) Kelisec AB, Björn Backmans väg 2, 148 32 Ösmo, SE
(72) REVELL, Elise, Björn Barkmans Väg 2, S-148 32 Ösmo, SE

(51) MKP
F41H 7/02 (2006.01) (97) **2417415 ***
(86) US2010030418 08.04.2010
(96) 10762448.8 15.02.2012
(87) WO2010118248, 08.04.2010
(97) 2417415, 15.02.2012 en
(54) MINE RESISTANT ARMORED VEHICLE
(71) Force Protection Technologies, Inc., 9801 Highway 78, Ladson, SC 29456, US
(72) JOYNT, Vernon, P., c/o Force Protection Technologies Inc. 9801 Highway 78, Ladson, SC 29456, US
NORTH, John, W., c/o Force Protection Technologies Inc. 9801 Highway 78, Ladson, SC 29456, US
GEORGAS, Jonathan, W., c/o Force Protection Technologies Inc. 9801 Highway 78, Ladson, SC 29456, US
WHITE, James, E., c/o Force Protection Technologies Inc. 9801 Highway 78, Ladson, SC 29456, US
BORDERS, Thomas, E., III, c/o Force Protection Technologies Inc. 9801 Highway 78, Ladson, SC 29456, US
WILLIAMS, Michael, L., c/o Force Protection Technologies Inc. 9801 Highway 78, Ladson, SC 29456, US

(51) MKP
B29C 49/04 (2006.01) (97) **2353841**
B29C 49/48 (2006.01)
(96) 10006338.7 10.08.2011
(97) 2353841, 10.08.2011 fr
(54) Container for liquid and manufacturing method thereof
(71) Guenuchot, Claude, 1 Rue de la Condamine, 39260 Charchilla, FR
(72) Guenuchot, Claude, 1 Rue de la Condamine, 39260 Charchilla, FR

(51) MKP
H01H 85/32 (2006.01) (97) **2419917 ***
(86) EP2010002311 15.04.2010
(96) 10714203.6 22.02.2012
(87) WO2010118868, 15.04.2010
(97) 2419917, 22.02.2012 en
(54) FAULT SIGNALING DEVICE, PARTICULARLY FOR ELECTRICAL APPARATUSES SUCH AS INTERLOCKED SOCKETS
(71) Palazzoli S.p.A., Via Palazzoli, 31, 25128 Brescia, IT
(72) LEVI, Bruno, Via Vittorio Emanuele II, 1, I-25122 Brescia, IT

(51) MKP
C09K 8/32 (2006.01) (97) **2419487 ***
C09K 8/34 (2006.01)
(86) IB2010051625 14.04.2010
(96) 10717786.7 22.02.2012
(87) WO2010119413, 14.04.2010
(97) 2419487, 22.02.2012 fr
(54) FLUID FOR DEEP OFFSHORE DRILLING
(71) Total Raffinage Marketing, 24 Cours Michelet, 92800 Puteaux, FR
(72) LAMRANI-KERN, Samia, 29 rue d'Avron, F-94170 Le Perreux Sur Marne, FR

(51) MKP
C12Q 1/68 (2006.01) (97) **2491134 ***
(86) US2010053334 20.10.2010
(96) 10768847.5 29.08.2012
(87) WO2011050034, 20.10.2010
(97) 2491134, 29.08.2012 en
(54) GENETIC POLYMORPHISMS IN AGE-RELATED MACULAR DEGENERATION
(71) Genentech, Inc., 1 DNA Way, South San Francisco, CA 94080, US
(72) GRAHAM, Robert, c/o Genentech Inc. 1 DNA Way, South San Francisco California 94080, US

- (51) MKP
C12N 15/113 (2010.01) (97) **2478102 ***
(86) IB2010002331 17.09.2010
(96) 10816769.3 25.07.2012
(87) WO2011033371, 17.09.2010
(97) 2478102, 25.07.2012 en
(54) A METHOD OF MODIFYING THE CARBOHYDRATE CONTENT OF A PLANT
(71) Stellenbosch University, 4th Floor Victoria Street Stellenbosch, Western Cape Province 7600, ZA
South African Sugarcane Research Institute, Kwa-Skukela 170 Flanders Drive, 4300 Mount Edgecombe, ZA
(72) BOUSSIENGUI-BOUSSIENGUI, Gino, BP 3794, Liberville, GA
KOSSMAN, Jens, 27 Otto du Plessis Road, 7130 Somerset West, ZA
-
- (51) MKP
A61K 31/245 (2006.01) (97) **2389936**
A61P 25/06 (2006.01)
(96) 11166939.6 30.11.2011
(97) 2389936, 30.11.2011 en
(54) Aminaphthone for use in the treatment and/or prevention of migraine
(71) Laboratori Baldacci S.p.A., Via San Michele degli Scalzi, 73, 56124 Pisa, IT
(72) Baldacci, MASSIMO, Via San Michele Degli Scalzi, 73, I-56124, Pisa, IT
-
- (51) MKP
A61K 45/06 (2006.01) (97) **2435081 ***
A61P 11/00 (2006.01)
(86) EP2010003112 21.05.2010
(96) 10722614.4 04.04.2012
(87) WO2010136153, 21.05.2010
(97) 2435081, 04.04.2012 en
(54) A THERAPEUTIC COMBINATION COMPRISING A PULMONARY SURFACTANT AND A STEROID
(71) Chiesi Farmaceutici S.p.A., Via Palermo, 26/A, 43100 Parma, IT
(72) GIOSSI, Massimo, Via Palermo 26/A, I-43100 Parma, IT
RAZZETTI, Roberta, Via Palermo 26/A, I-43100 Parma, IT
CHIESI, Paolo, Via Palermo 26/A, I-43100 Parma, IT
-
- (51) MKP
A61K 31/136 (2006.01) (97) **2485722 ***
A61P 25/28 (2006.01)
(86) IB2010002852 08.10.2010
(96) 10785198.2 15.08.2012
(87) WO2011042812, 08.10.2010
(97) 2485722, 15.08.2012 en
(54) USE OF RASAGILINE FOR THE TREATMENT OF PROGRESSIVE SUPRANUCLEAR PALSY
(71) TEVA PHARMACEUTICAL INDUSTRIES, LTD., 5 Basel Street, P.O. Box 3190, 49131 Petah Tiqva, IL
(72) LORENZL, Stefan, Gaertnerweg 14, 82061 Neuried, DE
-
- (51) MKP
A61P 25/16 (2006.01) (97) **2445496 ***
A61K 31/381 (2006.01)
A61K 9/00 (2006.01)
A61K 9/70 (2006.01)
C07D 333/20 (2006.01)
(86) EP2010003796 24.06.2010
(96) 10728600.7 02.05.2012
(87) WO2010149363, 24.06.2010
(97) 2445496, 02.05.2012 en
(54) Pharmaceutical composition comprising rotigotine salts (acid or Na), especially for iontophoresis
(71) UCB Pharma GmbH, Alfred-Nobel-Strasse 10, 40789 Monheim, DE
(72) BOUWSTRA, J.A., Molenleede 57, NL-2991 WB Barendrecht, NL
ACKAERT, O.W.G.M.K., Sophiastraat 21, NL-4701 GS Rosendaal, NL
EIKELENBOOM, J., Kruidplein 11, NL-2034 MZ Haarlem, NL
WOLFF, Hans-Michael, Richard Wagner Str. 2, 40789 Monheim, DE
-
- (51) MKP
A61P 35/00 (2006.01) (97) **2452950 ***
C07K 16/30 (2006.01)
A61K 39/00 (2006.01)
A61P 1/00 (2006.01)
C12N 15/09 (2006.01)
A61K 39/395 (2006.01)
C12N 5/10 (2006.01)
(86) JP2010061526 07.07.2010
(96) 10797148.3 16.05.2012
(87) WO2011004837, 07.07.2010
(97) 2452950, 16.05.2012 en
(54) ANTIBODY HAVING ANTI-CANCER ACTIVITY
(71) ACTGen, Inc., 15-502 Akaho, Komagane-shi Nagano 399-4117, JP
(72) KAJIKAWA, Masunori, c/o ACTGen Inc. 15-502 Akaho, Komagane-shi Nagano 399-4117, JP
SUGIURA, Masahito, c/o ACTGen Inc. 15-502 Akaho, Komagane-shi Nagano 399-4117, JP
ATARASHI, Kazuyuki, c/o ACTGen Inc. 15-502 Akaho, Komagane-shi Nagano 399-4117, JP
SHIMIZU, Emi, c/o ACTGen Inc. 15-502 Akaho, Komagane-shi Nagano 399-4117, JP
MATSUMI, Chiemi, c/o ACTGen Inc. 15-502 Akaho, Komagane-shi Nagano 399-4117, JP
SAITOH, Yukie, c/o ACTGen Inc. 15-502 Akaho, Komagane-shi Nagano 399-4117, JP
-
- (51) MKP
E06B 1/02 (2006.01) (97) **2275637**
E06B 3/964 (2006.01)
E06B 3/06 (2006.01)
B29C 70/76 (2006.01)
E06B 3/88 (2006.01)
(96) 10007127.3 19.01.2011
(97) 2275637, 19.01.2011 de
(54) Door leaf
(71) Noblesse Türfüllungen GmbH & Co. KG, Ludwigstrasse 32, 76768 Berg/Pfalz, DE
(72) Berizzi, Hans Heinrich, Ludwigstrasse 32, 76768 Berg, DE
-
- (51) MKP
C03C 13/06 (2006.01) (97) **2462068 ***
C08J 5/08 (2006.01)
C03C 13/00 (2006.01)
C03C 3/087 (2006.01)
(86) US2010044275 03.08.2010
(96) 10744781.5 13.06.2012
(87) WO2011017343, 03.08.2010
(97) 2462068, 13.06.2012 en
(54) GLASS COMPOSITIONS AND FIBERS MADE THEREFROM
(71) PPG Industries Ohio, Inc., 3800 West 143rd Street, Cleveland, OH 44111, US
(72) Li, Hong, 1621 Norman Drive, Sewickley Pennsylvania 15143, US
WATSON, James, C., 444 Terrapin Lane, Lake Wylie South Carolina 29710, US
-
- (51) MKP
B09B 3/00 (2006.01) (97) **2475470 ***
(86) GB2010001613 27.08.2010
(96) 10752371.4 18.07.2012
(87) WO2011027098, 27.08.2010
(97) 2475470, 18.07.2012 en
(54) APPARATUS FOR PROCESSING WASTE MATERIAL WITH INWARDLY DIRECTED OPENING
(71) Chalabi, Rifat Al, No. 1, Nottingham Science Park, Jesse Boot Avenue University Boulevard, Nottingham Nottinghamshire NG7 2RU, GB
Perry, Ophneil Henry, No. 1, Nottingham Science Park, Jesse Boot Avenue University Boulevard, Nottingham Nottinghamshire NG7 2RU, GB
(72) TURNER, John, Henry, 8 Stonehill Close Ranskill, Retford, Nottinghamshire DN22 8NG, GB

(51) MKP
C07K 16/28 (2006.01) (97) **2470568 ***
 (86) US2010047006 27.08.2010
 (96) 10752666.7 04.07.2012
 (87) WO2011025964, 27.08.2010
 (97) 2470568, 04.07.2012 en
 (54) THERAPEUTIC DLL4 BINDING PROTEINS
 (71) Abbott Laboratories, 100 Abbott Park Rd., Abbott Park, IL 60064, US
 (72) BOGHAERT, Erwin, R., 4510 Springbrook Road, Pleasant Prairie WI 53158, US
 MORGAN-LAPPE, Susan, 5419 North Canfield Avenue, Chicago IL 60656, US
 GU, Jijie, 19 Crimson Drive, Shrewsbury MA 01545, US
 HARRIS, Maria, 55 Trowbridge Lane, Shrewsbury MA 01545, US
 HICKSON, Jonathan, A., 725 Northwind Lane, Lake Villa IL 60046, US
 HSIEH, Chung-Ming, 22 Olde Field Road, Newton MA 02459, US
 KUTSKOVA, Yuliya, 183 Whitney Street, Northborough MA 01532, US
 BENATUIL, Lorenzo, 33 Mohawk Drive, Northborough MA 01532, US
 LIU, Zhihong, 1455 Greystone Avenue, Gurnee IL 60031, US
 LI, Yingchun, 103 Newfield Drive, Buffalo Grove IL 60089, US

(51) MKP
A61K 31/4188 (2006.01) (97) **2413929 ***
A61K 31/4164 (2006.01)
A61P 25/28 (2006.01)
 (86) US2010029744 02.04.2010
 (96) 10759458.2 08.02.2012
 (87) WO2010115078, 02.04.2010
 (97) 2413929, 08.02.2012 en
 (54) METHOD OF TREATING COGNITIVE IMPAIRMENT
 (71) Zenyaku Kogyo Co., Ltd, 5-6-15, Otsuka Bunkyo, Tokyo 112-8650, JP
 (72) WEBER, Eckard, 4040 Miller Street, San Diego CA 92103, US

(51) MKP
C12N 15/52 (2006.01) (97) **2449107 ***
G01N 33/53 (2006.01)
C12N 15/29 (2006.01)
C12N 15/11 (2006.01)
C12N 15/63 (2006.01)
C07K 14/415 (2006.01)
 (86) AU2010000802 25.06.2010
 (96) 10793414.3 09.05.2012
 (87) WO2011000026, 25.06.2010
 (97) 2449107, 09.05.2012 en
 (54) TERPENE SYNTHASES FROM SANTALUM
 (71) The University Of Western Australia, 35 Stirling Highway, Crawley, WA 6009, AU
 University Of British Columbia, 103- 6190 Agronomy Road, Vancouver, BC V6T 1Z3, CA
 Forest Products Commission, Level 1, D Block 3 Baron-Hay Court, Kensington, WA 6151, AU
 (72) ZULAK, Katherine Grace, 4/121 Powell Stree, Joondanna Western Australia 6060, AU
 JONES, Christopher, 4/121 Powell Street, Joondanna Western Australia 6060, AU
 MONIODIS, Jessie, 2 Cobalt Street, Koondola Western Australia 6064, AU
 BOHLMANN, Joerg, 3706 West 29th, Vancouver British Columbia V6S 1T4, CA

(51) MKP
F02B 1/12 (2006.01) (97) **2449223 ***
F02B 19/10 (2006.01)
F02B 41/04 (2006.01)
F02B 75/02 (2006.01)
F02B 41/06 (2006.01)
F02B 19/02 (2006.01)
 (86) HU2010000076 29.06.2010
 (96) 10739991.7 09.05.2012
 (87) WO2011001194, 29.06.2010
 (97) 2449223, 09.05.2012 en
 (54) INTERNAL COMBUSTION ENGINE WITH SEPARATE COMBUSTION CHAMBER AND A METHOD TO ACHIEVE MODIFIED AND CONTROLLED AUTOIGNITION IN SAID CHAMBER
 (71) Polgár, Jenó, Deák tér 9., 9400 Sopron, HU
 (72) Polgár, Jenó, Deák tér 9., 9400 Sopron, HU

(51) MKP
A61B 17/06 (2006.01) (97) **2470083 ***
D04C 3/42 (2006.01)
A61B 17/00 (2006.01)
 (86) US2010046927 27.08.2010
 (96) 10749580.6 04.07.2012
 (87) WO2011025926, 27.08.2010
 (97) 2470083, 04.07.2012 en
 (54) AUTOMATED SYSTEMS AND METHODS FOR MAKING BRAIDED BARBED SUTURES
 (71) Ethicon, Inc, U.S. Route 22, Somerville, NJ 08876, US
 (72) LINDH, David, C., Sr., 138 Allens Corner Road, Flemington NJ 08822, US
 PERKINS, Jason, T., 4935 Long Drive, Bethlehem PA 18020, US
 HRISTOV, Krasimira, 903 Primrose Court, Belle Mead NJ 08502, US
 NAWROCKI, Jesse, G., 8 Grace Drive, Annandale NJ 08801, US
 TANNHAUSER, Robert, J., 265 Holland Court, Bridgewater NJ 08807, US

(51) MKP
E04F 11/16 (2006.01) (97) **2452028 ***
 (86) EP2010056383 10.05.2010
 (96) 10719338.5 16.05.2012
 (87) WO2011003650, 10.05.2010
 (97) 2452028, 16.05.2012 de
 (54) DEVICE FOR FIXING THE EDGE OF A FLOOR COVERING TO A PROFILED STRUCTURE
 (71) Küberit Profile Systems GmbH & Co. KG, Römerweg 9, 58513 Lüdenscheid, DE
 (72) SONDERMANN, Frank, Frenkhauser Höh 5, 57489 Drolshagen, DE

(51) MKP
C12P 21/00 (2006.01) (97) **2494045 ***
C12N 15/70 (2006.01)
C12N 15/00 (2006.01)
 (86) US2010054657 29.10.2010
 (96) 10830490.8 05.09.2012
 (87) WO2011059801, 29.10.2010
 (97) 2494045, 05.09.2012 en
 (54) SOLUTION ASSAY AND HIGH THROUGH-PUT SCREEN TO PROBE INTERACTION BETWEEN HUMAN CULLIN-RING LIGASE COMPLEX AND HIV-VIF PROTEIN
 (71) University Of Rochester, 601 Elmwood Avenue Box OTT, Rochester, NY 14642, US
 (72) SALTER, Jason, D., 520 East Avenue, Rochester NY 14607, US
 WEDEKIND, Joseph, E., 235 Mount Vernon Avenue, Rochester NY 14620, US
 SMITH, Harold, C., 1056 Farnsworth Road South, Rochester NY 14623, US

- (51) MKP
A01N 43/66 (2006.01) (97) **2440055 ***
A61K 31/53 (2006.01)
(86) US2010037739 08.06.2010
(96) 10786677.4 18.04.2012
(87) WO2010144423, 08.06.2010
(97) 2440055, 18.04.2012 en
(54) STYRYL-TRIAZINE DERIVATIVES AND THEIR THERAPEUTICAL APPLICATIONS
(71) Abraxis BioScience, LLC, 11755 Wilshire Boulevard Suite 2000, Los Angeles, CA 90025, US
(72) TAO, Chunlin, 1800 Camden Avenue, No. 301, Los Angeles California 90025, US
WANG, Qinwei, 1112 South Cordova Street, Alhambra California 91801, US
DESAI, Neil, 11755 Wilshire Boulevard, Suite 2000, Los Angeles California 90025, US
-
- (51) MKP
G06Q 20/00 (2012.01) (97) **2465080 ***
(86) US2010028257 23.03.2010
(96) 10716927.8 20.06.2012
(87) WO2011022088, 23.03.2010
(97) 2465080, 20.06.2012 en
(54) SYSTEM AND METHOD FOR TRANSFERRING MONEY FROM A MOBILE PHONE ACCOUNT
(71) Onebip S.r.l., Viale Montenero 70, 20135 Milano, IT
(72) MORTILLARO, Diego, Franco, Via Striscie, I-28-28046 Meina (Novara), IT
MARAS, Marko, Via Montenero, I-4-20135 Milano, IT
-
- (51) MKP
A61K 47/48 (2006.01) (97) **2493514 ***
A61K 41/00 (2006.01)
A61L 2/00 (2006.01)
C08G 65/329 (2006.01)
A61K 9/16 (2006.01)
A61P 43/00 (2006.01)
(86) EP2010066404 28.10.2010
(96) 10773062.4 05.09.2012
(87) WO2011051406, 28.10.2010
(97) 2493514, 05.09.2012 en
(54) STERILIZATION OF BIODEGRADABLE HYDROGELS
(71) Ascendis Pharma A/S, Tuborg Boulevard 12, 2900 Hellerup, DK
(72) RAU, Harald, Talstrasse 41i, 69221 Dossenheim, DE
VOIGT, Tobias, Handschuhseimer Landstr. 9/1, 69120 Heidelberg, DE
HERSEL, Ulrich, Fritz-Frey-Strasse 8, 69121 Heidelberg, DE
-
- (51) MKP
A61P 35/00 (2006.01) (97) **2493466 ***
A61K 31/56 (2006.01)
A61K 45/06 (2006.01)
A61K 31/164 (2006.01)
(86) IB2010054866 27.10.2010
(96) 10782039.1 05.09.2012
(87) WO2011051894, 27.10.2010
(97) 2493466, 05.09.2012 en
(54) NOVEL ANTITUMORAL USE OF CABAZITAXEL
(71) Aventis Pharma S.A., 20, avenue Raymond Aron, 92160 Antony, FR
(72) GUPTA, Sunil, c/o Sanofi-Aventis US, Inc. 1041 Routes 202-206 Mail Code: D-303A, Bridgewater, New Jersey 08807, US
-
- (51) MKP
A61K 31/4965 (2006.01) (97) **2448920 ***
C07D 215/14 (2006.01)
C07D 261/20 (2006.01)
C07D 295/26 (2006.01)
C07D 209/10 (2006.01)
A61P 25/00 (2006.01)
C07D 471/04 (2006.01)
C07D 213/30 (2006.01)
A61P 29/00 (2006.01)
A61P 35/00 (2006.01)
(86) FR2010051331 28.06.2010
(96) 10745348.2 09.05.2012
(87) WO2011001089, 28.06.2010
(97) 2448920, 09.05.2012 fr
(54) NOVEL BENZENESULFONAMIDE COMPOUNDS, METHOD FOR SYNTHESIZING SAME, AND USE THEREOF IN MEDICINE AS WELL AS IN COSMETICS
(71) Galderma Research & Development, 2400 Route des Colles Les Templiers, 06410 Biot, FR
(72) CLARY, Laurence, 334bd Honoré Teisseire, F-06480 La Colle sur Loup, FR
CHAMBON, Sandrine, « Le ParcAurée » - Bât. C 108 chemin de l'Olivet, F-06110 Le Cannet, FR
CHANTALAT, Laurent, Le Clos des Oliviers, entrée B 257, chemin Rabiac Estagnol, 06600 Antibes, FR
ROSIGNOLI, Carine, 22 Place des Arcades, F-06250 Mougins le Haut, FR
ROYE, Olivier, 633 A Boulevard des Claux, F-83440 Fayence, FR
PASCAL, Jean-Claude, 170 avenue de Gairaut, F-06100 Nice, FR
SCHUPPLI, Marlène, 20 Chemin Beaume Robert, F-06650 Le Rouret, FR
-
- (51) MKP
A61K 31/155 (2006.01) (97) **2451482 ***
A61K 45/06 (2006.01)
A61P 3/04 (2006.01)
A61P 3/10 (2006.01)
A61K 31/7034 (2006.01)
(86) US2010041136 07.07.2010
(96) 10735109.0 16.05.2012
(87) WO2011005811, 07.07.2010
(97) 2451482, 16.05.2012 en
(54) COMBINATION THERAPY FOR THE TREATMENT OF DIABETES
(71) Janssen Pharmaceutica, N.V., Turnhoutseweg 30, 2340 Beerse, BE
(72) LIANG, Yin, Welsh&McKean Roads, Spring House PA 19477, US
RYAN, John, 1431 Angela Court, Jamison PA 18929, US
WOLDU, Abraham, B., Welsh&McKean Roads, Spring House PA 19477, US
WU, Lisa, E., Welsh&McKean Roads, Spring House PA 19477, US
-
- (51) MKP
G01F 19/00 (2006.01) (97) **2449350 ***
(86) EP2010058891 23.06.2010
(96) 10725788.3 09.05.2012
(87) WO2011000750, 23.06.2010
(97) 2449350, 09.05.2012 en
(54) A MEASURING DEVICE
(71) Handy Baby Products Ltd, Unit 93 Newtown Way Malahide Road Industrial Park Coolock, Dublin 17, IE
(72) DELANEY, Martina, 19 Templeview Downs Clare Hall, Dublin 13, IE
-
- (51) MKP
C12C 11/00 (2006.01) (97) **2467465 ***
(86) US2010046211 20.08.2010
(96) 10810684.0 27.06.2012
(87) WO2011022682, 20.08.2010
(97) 2467465, 27.06.2012 en
(54) ALCOHOLIC COMPOSITIONS HAVING A LOWERED RISK OF ACETALDEHYDEMIA
(71) Protia LLC, 15025 Brioli Dr, Reno, Nevada 89511, US
(72) CZARNIK, Anthony, 15025 Brioli Dr, Reno Nevada 89511, US
MCKINNEY, Jeffrey, 851 Moraga Road, Lafayette California 94549, US

(51) MKP
C12Q 1/68 (2006.01) (97) **2425017 ***
C12Q 1/70 (2006.01)
C12N 15/11 (2006.01)
(86) NO2010000147 22.04.2010
(96) 10769997.7 07.03.2012
(87) WO2010126375, 22.04.2010
(97) 2425017, 07.03.2012 en
(54) A METHOD FOR DETECTION OF HUMAN PAPILLOMAVIRUS (HPV) TYPE
(71) Allum-Jenkins AS, Fjellaldsveien 300, 3721 Skien, NO
(72) JENKINS, Andrew, Fjellaldsveien 300, N-3721 Skien, NO
ALLUM, Anne-Gry, Storenga, N-3275 Svarstad, NO
STRAND, Linda, Øygardsvegen 62, N-3914 Porsgrunn, NO

(51) MKP
G06F 21/00 (2006.01) (97) **2309408**
(86) 10176518.8 13.04.2011
(97) 2309408, 13.04.2011 en
(54) Method and system for detection and prediction of computer virus-related epidemics
(71) Kaspersky Lab, ZAO, 10 Geroyev Panfilovtsev Street, Moscow 125363, RU
(72) Mashevsky, Yuri V., c/o KASPERSKY LAB ZAO 10/1 1st Volokolamsky Proezd, 123060, Moscow, RU
Namestnikov, Yuri V., c/o KASPERSKY LAB ZAO 10/1 1st Volokolamsky Proezd, 123060, Moscow, RU
Denishchenko, Nikolay V., c/o KASPERSKY LAB ZAO 10/1 1st Volokolamsky Proezd, 123060, Moscow, RU
Zelensky, Pavel A., c/o KASPERSKY LAB ZAO 10/1 1st Volokolamsky Proezd, 123060, Moscow, RU

(51) MKP
A61K 31/433 (2006.01) (97) **2419419 ***
A61P 3/10 (2006.01)
C07D 401/08 (2006.01)
A61P 29/00 (2006.01)
C07D 403/08 (2006.01)
C07D 205/04 (2006.01)
C07D 413/08 (2006.01)
C07D 403/10 (2006.01)
C07D 417/08 (2006.01)
C07D 405/08 (2006.01)
A61K 31/4427 (2006.01)
A61K 31/437 (2006.01)
(86) US2010031265 15.04.2010
(96) 10714804.1 22.02.2012
(87) WO2010121046, 15.04.2010
(97) 2419419, 22.02.2012 en
(54) 4-AZETIDINYL-1-PHENYL-CYCLOHEXANE ANTAGONISTS OF CCR2
(71) Janssen Pharmaceutica, N.V., Turnhoutseweg 30, 2340 Beerse, BE
(72) ZHANG, Xuqing, 1728 Osprey Drive, Audubon PA 19403, US
HUFNAGAL, Heather Rae, 64 Glen Manor Lane, Glenmoore PA 19343, US
HOU, Cuifen, Welsh&Mckean Roads, Spring House PA 19477, US
JOHNSON, Dana L., 1343 Lonely Cottage Road, Upper Black Eddy PA 18972, US
SUI, Zhihua, Welsh&Mckean Roads, Spring House PA 19477, US

(51) MKP
A61K 9/16 (2006.01) (97) **2413911 ***
C07D 215/18 (2006.01)
(86) EP2010002078 31.03.2010
(96) 10712359.8 08.02.2012
(87) WO2010112222, 31.03.2010
(97) 2413911, 08.02.2012 en
(54) PROGRESSIVE EMULSION CRYSTALLIZATION
(71) KRKA, D.D., Novo Mesto, Smarjeska cesta 6, 8501 Novo mesto, SI
(72) KLJAJIC, Alen, Smrekarjeva ulica 4, 3000 Celje, SI
ZUPEZ, Rok, Janeza Ro ica 6, 1000 Ljubljana, SI

(51) MKP
A61K 31/545 (2006.01) (97) **2480236 ***
(86) US2010049659 21.09.2010
(96) 10818022.5 01.08.2012
(87) WO2011035305, 21.09.2010
(97) 2480236, 01.08.2012 en
(54) COMPOSITIONS AND METHODS FOR TREATING BACTERIAL INFECTIONS USING CEFTAROLINE
(71) AstraZeneca AB, null, 151 85 Södertälje, SE
(72) THYE, Dirk, 826 Vallejo Street, San Francisco, CA 94133, US
TALBOT, George, 564 Maplewood Avenue, Wayne, PA 19087, US

(51) MKP
C07D 239/42 (2006.01) (97) **2448940 ***
C07D 487/04 (2006.01)
A61K 31/519 (2006.01)
C07D 239/06 (2006.01)
A61P 35/00 (2006.01)
(86) FR2010051374 01.07.2010
(96) 10742013.5 09.05.2012
(87) WO2011001113, 01.07.2010
(97) 2448940, 09.05.2012 fr
(54) NOVEL 1,2,3,4-TETRAHYDRO-PYRIMIDO(1,2-A)PYRIMIDIN-6-ONE DERIVATIVES, PREPARATION THEREOF, AND PHARMACEUTICAL USE THEREOF
(71) SANOFI, 54 rue La Boétie, 75008 Paris, FR
(72) KARLSSON, Karl Andreas, sanofi-aventis Département Brevets 174 avenue de France, F-75013 Paris, FR
EL AHMAD, Youssef, sanofi-aventis Département Brevets 174 avenue de France, F-75013 Paris, FR
VIVIANI, Fabrice, Sanofi-Aventis Département Brevets 174 avenue de France, F-75013 Paris, FR
BACQUE, Eric, sanofi-aventis Département Brevets 174 avenue de France, F-75013 Paris, FR
RONAN, Baptiste, sanofi-aventis Département Brevets 174 avenue de France, F-75013 Paris, FR
CLAUSS, Annie, sanofi-aventis Département Brevets 174 avenue de France, F-75013 Paris, FR
VIVET, Bertrand, Sanofi-Aventis Département Brevets 174 avenue de France, F-75013 Paris, FR
MARCINIAK, Gilbert, sanofi-aventis Département Brevets 174 avenue de France, F-75013 Paris, FR
FILOCHE-ROMMÉ, Bruno, sanofi-aventis Département Brevets 174 avenue de France, F-75013 Paris, FR
ZIMMERMANN, André, Sanofi-Aventis Département Brevets 174 avenue de France, F-75013 Paris, FR
HALLEY, Frank, sanofi-aventis Département Brevets 174 avenue de France, F-75013 Paris, FR
BROLLO, Maurice, sanofi-aventis Département Brevets 174 avenue de France, F-75013 Paris, FR
SCHIO, Laurent, sanofi-aventis Département Brevets 174 avenue de France, F-75013 Paris, FR

(51) MKP
F03D 7/02 (2006.01) (97) **2284390**
(86) 10168884.4 16.02.2011
(97) 2284390, 16.02.2011 en
(54) Hydraulic station and method for controlling pressure in a hydraulic system of a wind turbine
(71) Vestas Wind Systems A/S, Alsvej 21, 8940 Randers - SV, DK
(72) ROED, Carsten, Stendalen 119, DK-8850, Bjerringbro, DK

(51) MKP
A61M 15/00 (2006.01) (97) **2408497 ***
G06M 1/16 (2006.01)
(86) GB2010050404 10.03.2010
(96) 10710405.1 25.01.2012
(87) WO2010103315, 10.03.2010
(97) 2408497, 25.01.2012 en
(54) COUNTER
(71) Euro-Celtique S.A., 2, avenue Charles de Gaulle, 1653 Luxembourg, LU
(72) BACON, Raymond, Steep Farm Steep Petersfield, Hampshire GU32 2DB, GB
MCDERMENT, Iain, 7 Moat Lane Melbourn Royston, Hertfordshire SG8 6EH, GB

- (51) MKP
F02M 51/00 (2006.01) (97) **2409013 ***
F02M 51/06 (2006.01)
F02M 63/00 (2006.01)
F02M 47/02 (2006.01)
- (86) EP2010053573 18.03.2010
(96) 10710291.5 25.01.2012
(87) WO2010106150, 18.03.2010
(97) 2409013, 25.01.2012 en
(54) ACTUATOR ARRANGEMENT
(71) Delphi Technologies, Inc., P.O. Box 5052, Troy, Michigan 48007, US
(72) CANEPA-ANSON, Thomas, 18 Priory Court Wembley, London HA0 1XQ, GB
HARCOMBE, Anthony, 1 Warren Avenue Richmond, Surrey TW10 5DZ, GB
HARPER, Mark, 25 Worcester Close Hagley, Stourbridge Worcestershire DY9 0NP, GB
GRAHAM, Mark, 11A Druid Hill Stoke Bishop, Bristol BS9 1EW, GB
KHAN, Bashir, 82 Otley Drive Gantshill, London IG2 6QN, GB
BOWERS, Stephen, 22 Halsbury Road West Northolt, Middlesex UB5 4PN, GB
-
- (51) MKP
G07F 7/10 (2006.01) (97) **2462567 ***
G06Q 20/00 (2012.01)
- (86) IB2010051915 01.05.2010
(96) 10726578.7 13.06.2012
(87) WO2010128442, 01.05.2010
(97) 2462567, 13.06.2012 en
(54) A PAYMENT TERMINAL USING A MOBILE COMMUNICATION DEVICE, SUCH AS A MOBILE PHONE; A METHOD OF DIRECT DEBIT PAYMENT TRANSACTION
(71) Logomotion, s.r.o., Winterova 15, 921 01 Piestany, SK
(72) FLOREK, Miroslav, Sedmokraskova 4, 821 01 Bratislava, SK
MASARYK, Michal, Medzilaborecká 7, 821 01 Bratislava, SK
RIFFELMACHER, David, Alan, Chopinova 1472/ 14, 120 00 Praha 2, CZ
-
- (51) MKP
A61P 9/12 (2006.01) (97) **2498779 ***
A61P 3/10 (2006.01)
A61K 31/519 (2006.01)
A61P 29/00 (2006.01)
A61P 3/00 (2006.01)
- (86) GB2010002096 12.11.2010
(96) 10784564.6 19.09.2012
(87) WO2011058331, 12.11.2010
(97) 2498779, 19.09.2012 en
(54) PEMIROLAST FOR THE TREATMENT OF SYSTEMIC LOW GRADE INFLAMMATION
(71) Cardoz AB, P O Box 2077, 103 12 Stockholm, SE
(72) RAUD, Johan, Cardoz AB PO Box 2077, S-103 12 Stockholm, SE
DALSGAARD, Carl-Johan, Cardoz AB PO Box 2077, S-103 12 Stockholm, SE
-
- (51) MKP
A61K 38/48 (2006.01) (97) **2480249 ***
A61P 27/02 (2006.01)
- (86) EP2010062584 27.08.2010
(96) 10751599.1 01.08.2012
(87) WO2011023805, 27.08.2010
(97) 2480249, 01.08.2012 en
(54) USE OF PLASMIN FOR THE TREATMENT OF FILTRATION FAILURE AFTER TRABECULECTOMY
(71) ThromboGenics N.V., Gaston Geenslaan 1, 3001 Heverlee, BE
(72) STASSEN, Jean-Marie, Merellaan 31, B-3210 Lubbeek, BE
STALMANS, Ingeborg, Valkenpad 6, B-8300 Knokke, BE
-
- (51) MKP
H04W 92/02 (2009.01) (97) **2494750 ***
H04L 12/66 (2006.01)
- (86) CA2010001702 29.10.2010
(96) 10825897.1 05.09.2012
(87) WO2011050466, 29.10.2010
(97) 2494750, 05.09.2012 en
(54) ROUTING DEVICE AND METHOD OF CONFIGURATION FOR NETWORK NAME RESOLUTION OF SAME
(71) Sierra Wireless, Inc., 13811 Wireless Way, Richmond, British Columbia V6V 3A4, CA
(72) HACKBART, Randy, Wiffred, 5425 Kincaid Street, Burnaby British Columbia V5G 1W1, CA
LLOYD, Kevin, Russell, Coates, 13932 Dodder Court, Poway California 92064, US
KAVANAUGH, Richard, Thomas, 736 Birchview Drive, Encinitas California 92024, US
MITCHELL, Andrew, Hasley, Watson, 4807 Underwood Avenue, North Vancouver British Columbia V7K 3B2, CA
-
- (51) MKP
A61K 39/00 (2006.01) (97) **2494061 ***
C12P 21/06 (2006.01)
- (86) US2010053948 25.10.2010
(96) 10830418.9 05.09.2012
(87) WO2011059684, 25.10.2010
(97) 2494061, 05.09.2012 en
(54) ANTIBODY GLYCOSYLATION VARIANTS
(71) Janssen Biotech, Inc., 800/850 Ridgeview Drive, Horsham, PA 19044, US
(72) LUO, Jinqun, 145 King Of Prussia Road, Radnor PA 19087, US
MCCARTHY, Stephen, 145 King Of Prussia Road, Radnor PA 19087, US
RAJU, T., Shantha, 145 King Of Prussia Road, Radnor PA 19087, US
SCALLON, Bernard, 145 King Of Prussia Road, Radnor PA 19087, US
SPINKA-DOMS, Tracy, 145 King Of Prussia Road, Radnor PA 19087, US
-
- (51) MKP
C07K 14/62 (2006.01) (97) **2459228 ***
A61K 38/28 (2006.01)
A61K 47/48 (2006.01)
A61P 3/10 (2006.01)
- (86) EP2010061159 30.07.2010
(96) 10743076.1 06.06.2012
(87) WO2011012718, 30.07.2010
(97) 2459228, 06.06.2012 en
(54) PRODRUGS COMPRISING AN INSULIN LINKER CONJUGATE
(71) Sanofi-Aventis Deutschland GmbH, Industriepark Höchst, Geb. K 801, 65926 Frankfurt am Main, DE
(72) RAU, Harald, Schwarzwaldstr. 51/2, 69124 Heidelberg, DE
CLEEMANN, Felix, Turnerstraße 114, 69126 Heidelberg, DE
HERSEL, Ulrich, Fritz-Frey-Strasse 2, 69121 Heidelberg, DE
KADEN-VAGT, Silvia, Langgewann 79-81, 69121 Heidelberg, DE
LESSMANN, Torben, Schimperstrasse 2, 68167 Mannheim, DE
WEGGE, Thomas, Kurfürstenanlage 45, 69115 Heidelberg, DE
-
- (51) MKP
A61K 39/395 (2006.01) (97) **2467164 ***
- (86) US2010046364 23.08.2010
(96) 10810721.0 27.06.2012
(87) WO2011022727, 23.08.2010
(97) 2467164, 27.06.2012 en
(54) ANTIBODIES AGAINST THE ECTODOMAIN OF ERBB3 AND USES THEREOF
(71) Merrimack Pharmaceuticals, Inc., One Kendall Square Suite B7201, Cambridge, MA 02139, US
(72) SCHOEBERL, Birgit, 324 Windsor Street, Cambridge, MA 02141, US
NIELSEN, Ulrik, 18 Thomas Street, Quincy, MA 02169, US
FELDHAUS, Michael, P.O. Box 1888, Grantham, NH 03753, US

(51) MKP
C12P 21/08 (2006.01) (97) **2437780 ***
A61K 39/395 (2006.01)

(86) US2010037166 03.06.2010
(96) 10784057.1 11.04.2012
(87) WO2010141658, 03.06.2010
(97) 2437780, 11.04.2012 en

(54) THERAPEUTIC COMPOSITIONS AND METHODS FOR THE PREVENTION OF AUTOIMMUNE DISEASES

(71) The Regents of the University of Colorado, 1800 Grant Street, 8th Floor, Denver, CO 80203, US

(72) EISENBARTH, George, 2328 Holly Court, Golden, CO 80401, US
ZHANG, Li, 4855 South Lisbon Way, Aurora, CO 80015, US
KAPPLER, John, 4350 Montview Boulevard, Denver, CO 80207, US
STADINSKI, Brian, 1928 Denver West Court 2521, Lakewood, CO 80401, US

(51) MKP
A62B 23/02 (2006.01) (97) **2432562 ***

(86) EP2010001776 22.03.2010
(96) 10711147.8 28.03.2012
(87) WO2010133268, 22.03.2010
(97) 2432562, 28.03.2012 de

(54) PROTECTIVE MASK

(71) Blücher GmbH, Mettmanner Strasse 25, 40699 Erkrath, DE
SWENKER, Gerard, Martin, Hoogaarskade 8, NL - 2725 AN Zoetermeer, NL
VON BLÜCHER, Hasso, Parkstraße 10, 40699 Erkrath, DE

(51) MKP
G06F 19/00 (2011.01) (97) **2499589 ***

(86) US2011045869 29.07.2011
(96) 11751691.4 19.09.2012
(87) WO2012021307, 29.07.2011
(97) 2499589, 19.09.2012 en

(54) METHOD AND SYSTEM FOR PATIENT-SPECIFIC MODELING OF BLOOD FLOW

(71) Heartflow, Inc., 1700 Seaport Boulevard Suite 400, Redwood City, CA 94063, US

(72) TAYLOR, Charles, A., 3 Vasilakos Court, Menlo Park, CA 94025, US
FONTE, Timothy, A., 3587 17th Street Apt. 1, San Francisco, CA 94110, US
CHOI, Gilwoo, 3943 El Camino Real Apt. 2, Palo Alto, CA 94306, US
BAI, Ying, 1105 North Road, Belmont, CA 94002, US
ZARINS, Christopher, K., 199 Seminary Drive, Menlo Park, CA 94025, US

(51) MKP
C07D 405/14 (2006.01) (97) **2475428 ***
C07D 413/04 (2006.01)
C07D 417/14 (2006.01)
A61P 25/00 (2006.01)
A61K 31/437 (2006.01)
A61P 25/28 (2006.01)
A61K 31/4184 (2006.01)
C07D 403/14 (2006.01)
C07D 413/14 (2006.01)
C07D 471/04 (2006.01)

(86) EP2010063341 13.09.2010
(96) 10751952.2 18.07.2012
(87) WO2011029920, 13.09.2010
(97) 2475428, 18.07.2012 en

(54) HETEROCYCLIC DERIVATIVES AS INHIBITORS OF GLUTAMINYL CYCLASE

(71) Probiodrug AG, Weinbergweg 22, 06120 Halle/Saale, DE

(72) HEISER, Ulrich, Franz-Schubert-Strasse 5, 06108 Halle/Saale, DE
SOMMER, Robert, Herderstrasse 4, 06114 Halle/Saale, DE
RAMSBECK, Daniel, Laurentiusstrasse 17, 06108 Halle/Saale, DE
MEYER, Antje, Seebener Strasse 33, 06114 Halle/Saale, DE
HOFFMANN, Torsten, Koernerstrasse 8, 06114 Halle/Saale, DE
BOEHME, Livia, Falterweg 6a, 06126 Halle/Saale, DE
DEMUTH, Hans-Ulrich, Am Waldrand 13a, 06120 Halle/Saale, DE

(51) MKP
A61K 38/00 (2006.01) (97) **2486058 ***
C07K 16/28 (2006.01)

(86) EP2010065124 08.10.2010
(96) 10771381.0 15.08.2012
(87) WO2011042548, 08.10.2010
(97) 2486058, 15.08.2012 en

(54) POLYPEPTIDES FOR BINDING TO THE "RECEPTOR FOR ADVANCED GLYCATION ENDPRODUCTS" AS WELL AS COMPOSITIONS AND METHODS INVOLVING THE SAME

(71) SANOFI, 54, rue de la Boétie, 75008 Paris, FR

(72) HUBER, Jochen, c/o Sanofi-Aventis Deutschland GmbH, 65926 Frankfurt am Main, DE
BLANCHE, Francis, c/o Sanofi-Aventis Département Brevets 174 Avenue de France, F-75013 Paris, FR
DABDOUBI, Tarik, c/o Sanofi-Aventis Département Brevets 174 Avenue de France, F-75013 Paris, FR
SOUBRIER, Fabienne, c/o Sanofi-Aventis Département Brevets 174 Avenue de France, F-75013 Paris, FR
FOCKEN, Ingo, c/o Sanofi-Aventis Deutschland GmbH, 65926 Frankfurt am Main, DE
KRUIP, Jochen, c/o Sanofi-Aventis Deutschland GmbH, 65926 Frankfurt am Main, DE
HEERMEIER, Katherin, c/o Sanofi-Aventis Deutschland GmbH, 65926 Frankfurt am Main, DE
LANGE, Christian, c/o Sanofi-Aventis Deutschland GmbH, 65926 Frankfurt am Main, DE

(51) MKP
G06F 9/50 (2006.01) (97) **2388727**
G06F 21/00 (2006.01)

(96) 10193148.3 23.11.2011
(97) 2388727, 23.11.2011 en

(54) Team security for portable information devices

(71) Kaspersky Lab, ZAO, 10 Geroyev Panfilovtsev Street, Moscow 125363, RU

(72) Kalkuhl, Magnus, c/o Kaspersky Lab ZAO 10/1, 1st Volokolamsky Proezd, Moscow 123060, RU
Sobko, Andrey V., c/o Kaspersky Lab ZAO 10/1, 1st Volokolamsky Proezd, Moscow 123060, RU
Kashchenko, Nadezhda V., c/o Kaspersky Lab ZAO 10/1, 1st Volokolamsky Proezd, Moscow 123060, RU
Tikhomirov, Anton V., c/o Kaspersky Lab ZAO 10/1, 1st Volokolamsky Proezd, Moscow 123060, RU
Polyakov, Dmitry A., c/o Kaspersky Lab ZAO 10/1, 1st Volokolamsky Proezd, Moscow 123060, RU

(51) MKP
F02D 41/22 (2006.01) (97) **2295775**
F02D 41/38 (2006.01)

(96) 10168005.6 16.03.2011
(97) 2295775, 16.03.2011 en

(54) Control method for a common rail fuel pump and apparatus for performing the same

(71) Delphi Technologies Holding S.à.r.l., Avenue de Luxembourg, 4940 Bascharage, LU

(72) Sinclair, James, 244 Bilton Road, Perivale UB6 7HL, GB

(51) MKP
B41M 5/50 (2006.01) (97) **2402167**
D21H 19/82 (2006.01)

(96) 10168352.2 04.01.2012
(97) 2402167, 04.01.2012 en

(54) Paper for inkjet recording

(71) Omya Development AG, Baslerstrasse 42, 4665 Oftringen, CH
Gane, Patrick A.C., Studenweg 8, 4852, Rothrist, CH
Kukkamo, Vesa, Am Wettlingertobel 1 A, 8049, Zürich, CH
Ridgway, Catherine Jean, Wannenberg 12, 4812, Mühlethal, CH

- (51) MKP
A61K 9/14 (2006.01) (97) **2424506 ***
A61K 31/4184 (2006.01)
- (86) US2010029578 01.04.2010
(96) 10712267.3 07.03.2012
(87) WO2010126676, 01.04.2010
(97) 2424506, 07.03.2012 en
(54) ORAL FORMULATIONS OF BENDAMUSTINE
(71) Cephalon, Inc., 41 Moores Road P.O. Box 4011, Frazer, PA 19355, US
(72) LABELL, Rachel Y., 561 N. Sandy Hill Road, Coatesville Pennsylvania 19320, US
PATEL, Piyush R., 716 Scott Lane, Wallingford Pennsylvania 19086, US
-
- (51) MKP
A61K 31/497 (2006.01) (97) **2492269 ***
A61P 11/06 (2006.01)
A61K 31/496 (2006.01)
A61P 9/10 (2006.01)
A61P 35/00 (2006.01)
A61K 31/4439 (2006.01)
A61P 3/04 (2006.01)
A61P 27/02 (2006.01)
A61K 31/506 (2006.01)
A61P 17/00 (2006.01)
A61K 31/427 (2006.01)
A61P 1/16 (2006.01)
A61P 25/00 (2006.01)
C07D 417/04 (2006.01)
A61P 1/04 (2006.01)
A61P 19/02 (2006.01)
A61K 31/5377 (2006.01)
A61P 17/06 (2006.01)
A61K 31/454 (2006.01)
A61P 3/06 (2006.01)
A61P 29/00 (2006.01)
- (86) JP2010067383 04.10.2010
(96) 10824785.9 29.08.2012
(87) WO2011048936, 04.10.2010
(97) 2492269, 29.08.2012 en
(54) AMINOTHIAZOLE DERIVATIVE
(71) Taisho Pharmaceutical Co., Ltd., 24-1, Takada 3-chome Toshima-ku, Tokyo 170-8633, JP
(72) YABUUCHI Tetsuya, c/o TAISHO PHARMACEUTICAL CO. LTD. 24-1 Takada 3-chome Toshima-ku, Tokyo 170-8633, JP
OKA Yusuke, c/o TAISHO PHARMACEUTICAL CO. LTD. 24-1 Takada 3-chome Toshima-ku, Tokyo 170-8633, JP
KURODA Shoichi, c/o TAISHO PHARMACEUTICAL CO. LTD. 24-1 Takada 3-chome Toshima-ku, Tokyo 170-8633, JP
OI Takahiro, c/o TAISHO PHARMACEUTICAL CO. LTD. 24-1 Takada 3-chome Toshima-ku, Tokyo 170-8633, JP
SEKIGUCHI Yoshinori, c/o TAISHO PHARMACEUTICAL CO. LTD. 24-1 Takada 3-chome Toshima-ku, Tokyo 170-8633, JP
-
- (51) MKP
B65D 85/04 (2006.01) (97) **2230194**
B65D 5/60 (2006.01)
- (96) 10155331.1 22.09.2010
(97) 2230194, 22.09.2010 fr
(54) Packaging for a plurality of coils of feedwire
(71) L'AIR LIQUIDE, Société Anonyme pour l'Etude et l'Exploitation des Procédés Georges Claude, Direction de la Propriété Intellectuelle 75 quai d'Orsay, 75007 Paris, FR
AIR LIQUIDE WELDING FRANCE, 75, Quai d'Orsay, 75007 Paris, FR
(72) Leduey Bruno, 25, Chemin Depuis Vert, 95000, CERGY, FR
-
- (51) MKP
A61P 35/00 (2006.01) (97) **2471790 ***
A61P 43/00 (2006.01)
A61K 31/55 (2006.01)
A61K 31/5377 (2006.01)
C07D 471/04 (2006.01)
A61K 31/444 (2006.01)
A61K 31/4545 (2006.01)
A61K 31/437 (2006.01)
- (86) JP2010064413 25.08.2010
(96) 10811921.5 04.07.2012
(87) WO2011024872, 25.08.2010
(97) 2471790, 04.07.2012 en
(54) FUSED HETEROCYCLIC RING DERIVATIVE AND USE THEREOF
(71) Takeda Pharmaceutical Company Limited, 1-1 Doshomachi 4-chome Chuo-ku, Osaka-shi, Osaka 541-0045, JP
(72) SASAKI, Satoshi, c/o TAKEDA PHARMACEUTICAL COMPANY LIMITED 26-1, Muraoka-Higashi, 2-chome, Fujisawa Kanagawa 251-0012, JP
TANAKA, Yuta, c/o TAKEDA PHARMACEUTICAL COMPANY LIMITED 10 Wadai, 2-chome, Fujisawa Kanagawa 251-0012, JP
-
- (51) MKP
D21H 21/52 (2006.01) (97) **2480718 ***
C09C 1/02 (2006.01)
D21H 17/68 (2006.01)
D21H 19/38 (2006.01)
D21H 17/67 (2006.01)
C01F 11/18 (2006.01)
D21H 19/40 (2006.01)
- (86) EP2010063866 21.09.2010
(96) 10754527.9 01.08.2012
(87) WO2011033119, 21.09.2010
(97) 2480718, 01.08.2012 en
(54) AQUEOUS SLURRIES COMPRISING FINE CALCIUM CARBONATE PARTICLES FOR USE IN PAPER COATINGS
(71) Omya Development AG, Baslerstrasse 42, 4665 Oftringen, CH
BLUVOL, Guillermo, Sängetelmatten 6, CH-5014 Gretzenbach, CH
KÄSSBERGER, Michael, Schauensee 32, CH-6204 Sempach, CH
GANF, Patrick A.C., Studenweg 8, CH-4852 Rothrist, CH
-
- (51) MKP
C07D 335/02 (2006.01) (97) **2500342 ***
C07D 417/12 (2006.01)
A01N 43/10 (2006.01)
A01N 43/18 (2006.01)
C07D 333/36 (2006.01)
A01P 7/02 (2006.01)
A01P 7/04 (2006.01)
C07D 409/12 (2006.01)
- (86) JP2010069915 09.11.2010
(96) 10829922.3 19.09.2012
(87) WO2011058963, 09.11.2010
(97) 2500342, 19.09.2012 en
(54) 1-HETERODIENE DERIVATIVE AND NOXIOUS ORGANISM CONTROL AGENT
(71) Nippon Soda Co., Ltd., 2-1, Ohtemachi 2-chome Chiyoda-ku, Tokyo 100-8165, JP
(72) TAKAHASHI Jyun, c/o Odawara Research Center Nippon Soda Co. Ltd. 345 Takada, Odawara-shi Kanagawa 250-0280, JP
NAKAMURA Takehiko, c/o Odawara Research Center Nippon Soda Co. Ltd. 345 Takada, Odawara-shi Kanagawa 250-0280, JP
MIYAZAWA Masahiro, c/o Odawara Research Center Nippon Soda Co. Ltd. 345 Takada, Odawara-shi Kanagawa 250-0280, JP
HAMAMOTO Isami, c/o Odawara Research Center Nippon Soda Co. Ltd. 345 Takada, Odawara-shi Kanagawa 250-0280, JP
KANAZAWA Jyun, c/o Odawara Research Center Nippon Soda Co. Ltd. 345 Takada, Odawara-shi Kanagawa 250-0280, JP

- (51) MKP
C07D 401/12 (2006.01) (97) **2408763 ***
C07D 403/12 (2006.01)
C07D 409/12 (2006.01)
C07D 209/52 (2006.01)
C07D 333/38 (2006.01)
A61K 31/381 (2006.01)
A61K 31/403 (2006.01)
A61K 31/4439 (2006.01)
C07D 451/02 (2006.01)
C07D 213/81 (2006.01)
A61K 31/407 (2006.01)
A61P 25/00 (2006.01)
C07D 487/08 (2006.01)
C07D 333/16 (2006.01)
C07D 213/46 (2006.01)
C07D 209/12 (2006.01)
C07D 209/02 (2006.01)
A61K 31/44 (2006.01)
(86) FR2010050447 15.03.2010
(96) 10715932.9 25.01.2012
(87) WO2010106269, 15.03.2010
(97) 2408763, 25.01.2012 fr
(54) DERIVATIVES OF N-Y(2-AZA-BICYCLO[2.1.1]HEX-1-YL)-ARYL-METHYL-HETEROBENZAMIDE, PREPARATION THEREOF AND APPLICATION OF SAME IN THERAPEUTICS
(71) SANOFI, 174, Avenue de France, 75013 Paris, FR
(72) ESTENNE-BOUHTOU, Geneviève, C/o sanofi-aventis Département Brevets 174 Avenue de France, F-75013 Paris, FR
MAFROUD, Abdel-Kader, C/o sanofi-aventis Département Brevets 174 Avenue de France, F-75013 Paris, FR
-
- (51) MKP
B65B 69/00 (2006.01) (97) **2426056**
B65D 77/06 (2006.01)
(96) 11180087.6 07.03.2012
(97) 2426056, 07.03.2012 fr
(54) Packaging intended for transporting hazardous materials
(71) Manuco, Boulevard Charles Garaud, 24100 Bergerac, FR
(72) Guillaume, Claude, Hameau de phenix, 24560 Saint Aubin de Lanquais, FR
-
- (51) MKP
D21B 1/30 (2006.01) (97) **2414435 ***
D21C 9/00 (2006.01)
D01F 2/02 (2006.01)
C08J 5/00 (2006.01)
C08J 3/00 (2006.01)
C08J 3/075 (2006.01)
D21B 1/04 (2006.01)
(86) EP2010054233 30.03.2010
(96) 10711423.3 08.02.2012
(87) WO2010115785, 30.03.2010
(97) 2414435, 08.02.2012 en
(54) PROCESS FOR THE PRODUCTION OF NANO-FIBRILLAR CELLULOSE GELS
(71) Omya Development AG, Baslerstrasse 42, 4665 Oftringen, CH
(72) GANE, Patrick A.C., Studenweg 8, CH-4852 Rothrist, CH
SCHOELKOPF, Joachim, Buechbühlstrasse 3, CH-8956 Killwangen, CH
GANTENBEIN, Daniel, Vogesenstrasse 27, CH-4056 Basel, CH
SCHENKER, Michel, Baslerstrasse 9, CH-4665 Oftringen, CH
-
- (51) MKP
C07K 16/30 (2006.01) (97) **2440580 ***
(86) GB2010050969 09.06.2010
(96) 10724121.8 18.04.2012
(87) WO2010142990, 09.06.2010
(97) 2440580, 18.04.2012 en
(54) ANTI-EpCAM ANTIBODIES
(71) Affitech Research AS, Oslo Research Park Gaustadalléen 21, 0349 Oslo, NO
(72) CICORTAS GUNNARSSON, Lavinia Diana, Tingstuveien 17A, N-0281 Oslo, NO
PAUS, Didrik, Olav Aukrust vei 4b, N-0785 Oslo, NO
KARLSSON, Jenny Margareta, Ullevålsveien 56 C, N-0454 Oslo, NO
GRIEP, Remko Albert, Odalsveien 31B, N-3470 Slemmestad, NO
KIPRIJANOV, Sergej Michailovic, Hovseterveien 98, N-0768 Oslo, NO

- (51) MKP
A61P 1/00 (2006.01) (97) **2464373 ***
A61P 1/10 (2006.01)
A61K 47/00 (2006.01)
A61K 38/10 (2006.01)
A61K 9/00 (2006.01)
(86) US2010045518 13.08.2010
(96) 10747121.1 20.06.2012
(87) WO2011020054, 13.08.2010
(97) 2464373, 20.06.2012 en
(54) METHOD FOR MODULATING THE PHARMACODYNAMIC EFFECT OF ORALLY ADMINISTERED GUANYLATE CYCLASE RECEPTOR AGONISTS
(71) Ironwood Pharmaceuticals, Inc., 301 Binney Street, Cambridge, MA 02142, US
(72) JOHNSTON, Jeffrey, 26 Hanson Street Unit 2, Boston MA 02118, US
KURTZ, Caroline, 40 Stone Road, Sudbury MA 01776, US
-
- (51) MKP
A61K 47/48 (2006.01) (97) **2459227 ***
A61P 25/16 (2006.01)
(86) EP2010061163 30.07.2010
(96) 10742799.9 06.06.2012
(87) WO2011012722, 30.07.2010
(97) 2459227, 06.06.2012 en
(54) PRODRUGS CONTAINING AN AROMATIC AMINE CONNECTED BY AN AMIDO BOND TO A LINKER
(71) Ascendis Pharma A/S, Tuborg Boulevard 12, 2900 Hellerup, DK
(72) RAU, Harald, Talstrasse 41 i, 69221 Dossenheim, DE
BARON, Julia, pleikartsförster Strasse 2, 69124 Heidelberg, DE
HERSEL, Ulrich, Fritz-Frey-Strasse 8, 69121 Heidelberg, DE
KRUSCH, Mathias, Am Hungerberg 15, 69434 Hirschhorn, DE
-
- (51) MKP
E04B 1/10 (2006.01) (97) **2468970 ***
(86) RU2010000300 08.06.2010
(96) 10810242.7 27.06.2012
(87) WO2011021958, 08.06.2010
(97) 2468970, 27.06.2012 en
(54) METHOD FOR PRODUCING WOODEN HOUSES, STRUCTURES AND CONSTRUCTIONS
(71) Nenashev, Sergey Vladimirovich, Per. Karyakina 1-146, Samara 443023, RU
(72) BOYARINTSEV, Sergey Evgenevich, ul. Avtostroitelei 59-61, Togliatti 445056, RU
-
- (51) MKP
G06F 3/048 (2006.01) (97) **2406700 ***
G06F 3/041 (2006.01)
G06F 3/01 (2006.01)
(86) US2010026894 11.03.2010
(96) 10712198.0 18.01.2012
(87) WO2010105001, 11.03.2010
(97) 2406700, 18.01.2012 en
(54) SYSTEMS AND METHODS FOR PROVIDING FEATURES IN A FRICTION DISPLAY
(71) Immersion Corporation, 801 Fox Lane, San Jose, CA 95131, US
(72) CRUZ-HERNANDEZ, Juan, Manuel, 4840 Ste-Catherine West, Montreal Québec H3Z 1T1, CA
GRANT, Danny, A., 1784 De Lunebourg, Laval Québec H7M 2A1, CA
-
- (51) MKP
C07K 16/28 (2006.01) (97) **2414396 ***
A61K 39/395 (2006.01)
(86) IB2010051385 30.03.2010
(96) 10713013.0 08.02.2012
(87) WO2010113117, 30.03.2010
(97) 2414396, 08.02.2012 en
(54) PREPARATION OF ISOLATED AGONIST ANTI-EDAR MONOCLONAL ANTIBODIES
(71) Edimer Biotech S.a., Chemin de l'Eglise 7, 1066 Epalinges, CH
Université de Lausanne, Rue du Bugnon 21, 1015 Lausanne, CH
(72) SCHNEIDER, Pascal, Chemin des Ormeaux 10, CH-1066 Epalinges, CH
DUNKEL, Nathalie, Rue Ancienne 46, CH-1227 Carouge, CH
DEMOTZ, Stéphane, Chemin de l'Eglise 7, CH-1066 Epalinges, CH

- (51) MKP
B65H 19/18 (2006.01) (97) **2427398 ***
(86) IB2010051910 30.04.2010
(96) 10726218.0 14.03.2012
(87) WO2010128441, 30.04.2010
(97) 2427398, 14.03.2012 en
(54) A UNIT AND METHOD FOR FEEDING REELS OF A SHEET-LIKE MATERIAL, IN PARTICULAR BUT NOT EXCLUSIVELY A PRINTED PLASTIC FILM WITH PRINT- POSITION MARKS FOR AUTOMATIC PACKAGING MACHINES
(71) RENT S.r.l., Via Garibaldi, 5/c, 51010 Massa e Cozzile (Pistoia), IT
(72) TOMMASI, Renzo, Via Marconi 78, I-51016 Montecatini Terme (Pistoia), IT
-
- (51) MKP
C07C 255/54 (2006.01) (97) **2406206 ***
A61K 31/09 (2006.01)
C07C 43/225 (2006.01)
A61K 31/222 (2006.01)
C07C 39/17 (2006.01)
A61K 31/277 (2006.01)
C07C 43/21 (2006.01)
A61P 31/08 (2006.01)
C07C 43/23 (2006.01)
A61P 35/00 (2006.01)
C07C 69/157 (2006.01)
A61P 25/00 (2006.01)
C07C 255/55 (2006.01)
C07C 39/42 (2006.01)
A61K 31/055 (2006.01)
(86) EP2010053167 12.03.2010
(96) 10708535.9 18.01.2012
(87) WO2010103095, 12.03.2010
(97) 2406206, 18.01.2012 en
(54) TETRAHYDRONAPHTHALEN-2-OL DERIVATIVES
(71) MSD Oss B.V., Kloosterstraat 6, 5349 AB Oss, NL
(72) STOCK, Herman, Thijs, P.O. Box 20, NL-5340 BH Oss, NL
TEERHUIS, Neeltje, Miranda, P.O. Box 20, NL-5340 BH Oss, NL
VEENEMAN, Gerrit, Herman, P.O. Box 20, NL-5340 BH Oss, NL
-
- (51) MKP
A01N 45/00 (2006.01) (97) **2403341 ***
A61K 31/56 (2006.01)
(86) US2010000625 02.03.2010
(96) 10749041.9 11.01.2012
(87) WO2010101622, 02.03.2010
(97) 2403341, 11.01.2012 en
(54) LUNG CANCER TREATMENT
(71) Merck & Co., Inc., 126 East Lincoln Avenue, Rahway, NJ 07065-0907, US
ARIAD Pharmaceuticals, Inc, 26 Landsdowne Street, Cambridge, MA 02139, US
(72) EBBINGHAUS, Scot, 125 Kelsey Drive, Lansdale, PA 19446, US
-
- (51) MKP
C07K 14/605 (2006.01) (97) **2460825 ***
A61K 38/26 (2006.01)
(86) CN2010075548 29.07.2010
(96) 10803913.2 06.06.2012
(87) WO2011012080, 29.07.2010
(97) 2460825, 06.06.2012 en
(54) DERIVATIVE OF GLP-1 ANALOGUE OR ITS PHARMACEUTICAL SALTS AND THEIR USE
(71) Jiangsu Hansoh Pharmaceutical Group Co., Ltd., The 10th Industrial Sub-zone of Development Zone Lianyungang, Jiangsu 222047, CN
(72) WANG, Yali, The 10th Industrial Sub-zone of Development Zone, Lianyungang Jiangsu 222047, CN
LÜ, Aifeng, The 10th Industrial Sub-zone of Development Zone, Lianyungang Jiangsu 222047, CN
SUN, Changan, The 10th Industrial Sub-zone of Development Zone, Lianyungang Jiangsu 222047, CN
YUAN, Hengli, The 10th Industrial Sub-zone of Development Zone, Lianyungang Jiangsu 222047, CN
-
- (51) MKP
A61K 9/22 (2006.01) (97) **2480246 ***
A61K 31/185 (2006.01)
A61K 31/537 (2006.01)
A61P 3/10 (2006.01)
A61K 38/22 (2006.01)
(86) US2010049843 22.09.2010
(96) 10819399.6 01.08.2012
(87) WO2011038014, 22.09.2010
(97) 2480246, 01.08.2012 en
(54) COMPOSITION AND METHOD FOR TREATMENT OF DIABETES
(71) Biokier Inc., 105 Green Willow Ct., Chapel Hill, NC 27514, US
(72) SZEWCZYK, Jerzy, Ryszard, 105 Green Willow Court, Chapel Hill NC 27514, US
-
- (51) MKP
A61P 29/00 (2006.01) (97) **2435438 ***
A61P 25/00 (2006.01)
C07D 487/04 (2006.01)
C07D 491/04 (2006.01)
C07D 513/04 (2006.01)
A61P 35/00 (2006.01)
A61K 31/519 (2006.01)
A61P 9/00 (2006.01)
(86) US2010036199 26.05.2010
(96) 10720979.3 04.04.2012
(87) WO2010138589, 26.05.2010
(97) 2435438, 04.04.2012 en
(54) BICYCLIC PYRIMIDINE P13K INHIBITOR COMPOUNDS SELECTIVE FOR P110 DELTA, AND METHODS OF USE
(71) Genentech, Inc., 1 DNA Way, South San Francisco, CA 94080, US
F.Hoffmann-La Roche AG, Grenzacherstrasse 124, 4070 Basel, CH
(72) GOLDSTEIN, David Michael, 7045 Huntsfield Court, San Jose California 95120, US
SUTHERLIN, Daniel P., 1244 Cortez Avenue, Burlingame California 94010, US
KONDRU, Rama K., 33 Gatheringhill Court, Morris Plains New Jersey 07950, US
SWEENEY, Zachary Kevin, 143 King Street, Redwood City California 94062, US
LUCAS, Matthew C., 41 Wayland Drive, Verona New Jersey 07044, US
PALMER, Wylie Solang, 26 Normandy Heights Road, Morristown New Jersey 07960, US
PRICE, Stephen, 8/9 Spire Green Centre Flex Meadow, Harlow Essex CM19 5TR, GB
CHAN, Bryan, 2 Lilly Lane, San Carlos California 94070, US
SEWARD, Eileen Mary, 8/9 Spire Green Centre Flex Meadow, Harlow Essex CM19 5TR, GB
CASTANEDO, Georgette, 1320 Woodside Road, Redwood City California 94061, US
SAVY, Pascal Pierre Alexandre, 8/9 Spire Green Centre Flex Meadow, Harlow Essex CM19 5TR, GB
SAFINA, Brian, 1280 Woodside Road, Redwood City California 94061, US
-
- (51) MKP
C12P 21/06 (2006.01) (97) **2493923 ***
C07K 16/00 (2006.01)
C12P 21/02 (2006.01)
(86) US2010054475 28.10.2010
(96) 10773508.6 05.09.2012
(87) WO2011053699, 28.10.2010
(97) 2493923, 05.09.2012 en
(54) SORF CONSTRUCTS AND MULTIPLE GENE EXPRESSION
(71) Abbott Laboratories, 100 Abbott Park Rd., Abbott Park, IL 60064, US
(72) CARSON, Gerald R., 2 Kent Street, Belmont Massachusetts 02178, US
GION, Wendy R., 288 Partridge Hill Road, Charlton Massachusetts 01507, US
KUNES, Yune Z., 37 Amberwood Drive, Winchester Massachusetts 01890, US
LEISE III, Walter F., 184 Peregrine Lane, Hawthorn Woods Illinois 60047, US
DAVIS-TABER, Rachel A., 8 Old Brook Circle, Sturbridge Massachusetts 01566, US
FUNG, Emma, 31 Stratton Way, Northborough Massachusetts 01532, US

- (51) MKP
E04B 1/24 (2006.01) (97) **2228498**
E04B 1/74 (2006.01)
- (96) 10156382.3 15.09.2010
(97) 2228498, 15.09.2010 fr
- (54) A process of manufacture of an internally isolated building and building constructed according to that process, a method of producing a corresponding superstructural element and superstructural element produced according to that method
- (71) Innov Process Industrie, ZA de l'Espérance, 22120 Quessoy, FR
(72) Dore, Claude, Meudon, 22120, Quessoy, FR
-
- (51) MKP
A61K 38/22 (2006.01) (97) **2496248 ***
- (86) US2010055526 04.11.2010
(96) 10779603.9 12.09.2012
(87) WO2011057027, 04.11.2010
(97) 2496248, 12.09.2012 en
- (54) METHOD FOR TREATING HEART FAILURE WITH STRESSCOPIN-LIKE PEPTIDES
- (71) Janssen Pharmaceutica, N.V., Turnhoutseweg 30, 2340 Beerse, BE
(72) GENGO, Peter, J., 2334 Kyanite Place, Carlsbad, CA 92009, US
SABBAH, Hani, N., 1141 Meadowood, Waterford, MI 48327, US
SHANKLEY, Nigel, P., 449 Marview Lane, Solana Beach, CA 92075, US
-
- (51) MKP
B66B 11/04 (2006.01) (97) **2432725 ***
- (86) IB2011050777 24.02.2011
(96) 11713357.9 28.03.2012
(87) WO2011104683, 24.02.2011
(97) 2432725, 28.03.2012 en
- (54) DEVICE FOR SAVING ENERGY DURING VERTICAL AND HORIZONTAL MOTIONS WHEREIN THE RESISTING TORQUE CAN BE SPLIT INTO TWO TORQUES OPPOSING EACH OTHER
- (71) Jezek, Giorgio, Via Ponte Alto 45 A, 38050 Cognola di Trento, IT
(72) Jezek, Giorgio, Via Ponte Alto 45 A, 38050 Cognola di Trento, IT
-
- (51) MKP
C07D 513/04 (2006.01) (97) **2405973 ***
A61K 31/519 (2006.01)
A61P 29/00 (2006.01)
- (86) EP2010053318 15.03.2010
(96) 10711871.3 18.01.2012
(87) WO2010103130, 15.03.2010
(97) 2405973, 18.01.2012 en
- (54) THIAZOLOPYRIMIDINE MODULATORS AS IMMUNOSUPPRESSIVE AGENTS
- (71) Katholieke Universiteit Leuven, K.U. Leuven R&D, Minderbroedersstraat 8a, bus 5105, 3000 Leuven, BE
(72) HERDEWIJN, Piet, Olivierstraat 21, B-3111 Wezemaal, BE
DE JONGHE, Steven, Olmenstraat 23, B-3080 Tervuren, BE
GAO, Ling-Jie, Korbeek-Iosestraat 34, B-3360 Bierbeek, BE
JANG, Mi-Yeon, Tiensestraat 201, B-3000 Leuven, BE
VANDERHOYDONCK, Bart, Postbaan 49, B-3290 Diest, BE
WAER, Mark Jozef Albert, Waversebaan 263, B-3001 Heverlee, BE
LIN, Yuan, 101 Mass Avenue, Arlington MA 02474, US
HERMAN, Jean Ferdinand, Hoveniersdreef 100, B-3001 Heverlee, BE
LOUAT, Thierry André Michel, 35 square Henri Dunant, F-42400 Saint Chamond, FR
-
- (51) MKP
H04L 12/24 (2006.01) (97) **2486698 ***
- (86) IL2010000788 21.09.2010
(96) 10781531.8 15.08.2012
(87) WO2011036663, 21.09.2010
(97) 2486698, 15.08.2012 en
- (54) METHOD AND SYSTEM FOR RECONSTRUCTING TRANSACTIONS IN A COMMUNICATION NETWORK
- (71) Correlix Ltd., 4 Maskit Street P.O. Box 4162, 46733 Herzeliya, IL
(72) SHAQED, Ariel, 75 Einstein Street, Ramat-Aviv, IL
LEHAVI, David, 7 Heine Street, Haifa 34485, IL
-
- (51) MKP
G01N 33/569 (2006.01) (97) **2470907 ***
C07K 14/20 (2006.01)
- (86) FR2010051780 26.08.2010
(96) 10763756.3 04.07.2012
(87) WO2011023909, 26.08.2010
(97) 2470907, 04.07.2012 fr
- (54) PROTEINS USED FOR THE DIAGNOSIS OF LYME BORRELIOSIS
- (71) Biomérieux, Chemin de l'Orme, 69280 Marcy L'etoile, FR
(72) LEVET, Lionel, 32 rue de la Glacière Bâtiment B1, F-69600 Oullins, FR
MEJAN-LETOURNEUR, Odile, 70 avenue du Point du Jour, F-69005 Lyon, FR
-
- (51) MKP
C08G 63/66 (2006.01) (97) **2464678 ***
C08G 63/08 (2006.01)
C08G 63/60 (2006.01)
- (86) US2010044836 09.08.2010
(96) 10744791.4 20.06.2012
(87) WO2011019631, 09.08.2010
(97) 2464678, 20.06.2012 en
- (54) SEMI-CRYSTALLINE, FAST ABSORBING POLYMER FORMULATION
- (71) Ethicon, Inc, U.S. Route 22, Somerville, NJ 08876, US
(72) ANDJELIC, Sasa, 38 Oakland Place, Nanuet NY 10954, US
-
- (51) MKP
A01H 5/00 (2006.01) (97) **2473024 ***
C12Q 1/04 (2006.01)
C12N 15/82 (2006.01)
C12N 15/52 (2006.01)
- (86) US2010047575 01.09.2010
(96) 10814450.2 11.07.2012
(87) WO2011028836, 01.09.2010
(97) 2473024, 11.07.2012 en
- (54) HERBICIDE-TOLERANT PLANTS
- (71) BASF Agrochemical Products, B.V., Groningensingel 1, 6035 EA Arnhem, NL
(72) MANKIN, Scots, L., 4800 Deerwood Drive, Raleigh, NC 27612, US
WENCK, Allan, R., 4315 Etta Road, Durham, NC 27705, US
HONG, Haiping, 117 Melling Place, Cary, NC 27519, US
-
- (51) MKP
B65B 23/14 (2006.01) (97) **2364916**
B65B 35/44 (2006.01)
B65G 17/26 (2006.01)
B65G 47/82 (2006.01)
B65G 47/84 (2006.01)
- (96) 11156203.9 14.09.2011
(97) 2364916, 14.09.2011 en
- (54) Plant for forming and for continuous synchronised transferring of compact groups of products drawn near one another along the transfer path
- (71) Euroscima S.p.A., Via Arde 27, 20125 Milano, IT
(72) Redaelli, Marco, Via Gramsci, 16, 20060 Cassina De' Pecchi (MI), IT
-
- (51) MKP
C03B 9/16 (2006.01) (97) **2429960 ***
C03B 9/36 (2006.01)
F16B 7/20 (2006.01)
F16B 21/04 (2006.01)
F16D 1/112 (2006.01)
- (86) US2010031860 21.04.2010
(96) 10716189.5 21.03.2012
(87) WO2010132183, 21.04.2010
(97) 2429960, 21.03.2012 en
- (54) GLASSWARE FORMING MACHINE BAFFLE ARM ASSEMBLY
- (71) Owens-Brockway Glass Container INC., One Michael Owens Way, Perrysburg, OH 43551, US
(72) SHUE, Larry, N., 510 North Street, Woodville, OH 43469, US

- (51) MKP
B23Q 1/28 (2006.01) (97) **2440358 ***
B23F 17/00 (2006.01)
- (86) IB2010001381 09.06.2010
(96) 10740257.0 18.04.2012
(87) WO2010143047, 09.06.2010
(97) 2440358, 18.04.2012 en
(54) MACHINE FOR MAKING GEARS
(71) Samp S.p.a. Con Unico Socio, Via Saliceto 15, Bentivoglio, IT
(72) AFFATICATI, Artemio, Via Buonarroti 5, I-21052 Busto Arsizio, IT
FRANCESCHET, Marco, Via Cavin di Sala 152, I-30035 Mirano, IT
MANARA, Mauro, Via Gaiba Natale 42, I-44011 Argenta, IT
PERRONE, Vito, Via Cristoforo Colombo 2, I-26013 Crema, IT
-
- (51) MKP
B32B 21/02 (2006.01) (97) **2277692**
B32B 21/10 (2006.01)
B32B 19/06 (2006.01)
E04C 2/00 (2006.01)
E04F 13/00 (2006.01)
C04B 28/04 (2006.01)
B32B 5/26 (2006.01)
- (96) 10168962.8 26.01.2011
(97) 2277692, 26.01.2011 de
(54) Insulation board, adhesive mortar for attaching an insulation board to a wall or a ceiling of a building and assembly, comprising an insulation board and an adhesive mortar
(71) Fibrolith Dämmstoffe GmbH, An der L 83, 56746 Kempenich, DE
Quick-Mix Gruppe GmbH & Co. KG, Mühleneschweg 6, 49090 Osnabrück, DE
(72) Bühning, Volker, Am Mühlenfeld 2, 49163 Bohmte, DE
Kanig, Martin, Zur dünnen Hegge 13, 49565 Bramsche, DE
Rheindorf, Jürgen, Ochtendung Strasse 57, 56642 Krufft, DE
-
- (51) MKP
G01N 23/04 (2006.01) (97) **2443441 ***
- (86) CA2010000916 15.06.2010
(96) 10788557.6 25.04.2012
(87) WO2010145016, 15.06.2010
(97) 2443441, 25.04.2012 en
(54) METHOD AND APPARATUS FOR ASSESSING THE THREAT STATUS OF LUGGAGE
(71) Optosecurity Inc., 505 Blvd. du Parc Technologique, Québec, QC G1P 4S9, CA
(72) GUDMUNSON, Dan, 5 rue des Jadrins Mérici, Apt. 304,, Québec, Quebec G1S 4N7, CA
PERRON, Luc, 1127 de la Chatelaine, Charlesbourg, Quebec G2L 1A1, CA
-
- (51) MKP
A61P 27/02 (2006.01) (97) **2403937 ***
C12N 5/02 (2006.01)
C07K 14/54 (2006.01)
A61K 38/20 (2006.01)
- (86) US2010026112 03.03.2010
(96) 10749294.4 11.01.2012
(87) WO2010102052, 03.03.2010
(97) 2403937, 11.01.2012 en
(54) METHODS OF INHIBITING PHOTORECEPTOR APOPTOSIS
(71) The Regents of the University of Michigan, 1214 S. University Avenue, 2nd Floor, Ann Arbor, MI 48104-2592, US
(72) ZACKS, David Noam, 1000 Wall Street, Ann Arbor, Michigan 48105, US
-
- (51) MKP
A61F 13/02 (2006.01) (97) **2489339 ***
A61K 9/70 (2006.01)
A61L 15/58 (2006.01)
- (86) JP2010067129 30.09.2010
(96) 10823291.9 22.08.2012
(87) WO2011046023, 30.09.2010
(97) 2489339, 22.08.2012 en
(54) METHOD AND DEVICE FOR PRODUCING ADHESIVE PATCH
(71) Hisamitsu Pharmaceutical Co., Inc., 408, Tashirodaikan-machi, Tosu-shi, Saga 841-0017, JP
(72) TAKADA Kiyotaka, c/o HISAMITSU PHARMACEUTICAL CO. INC. 408 Tashirodaikan-machi, Tosu-shi Saga 841-0017, JP
-
- (51) MKP
H02G 3/08 (2006.01) (97) **2486635 ***
H02G 3/22 (2006.01)
H02G 15/013 (2006.01)
- (86) EP2010005897 28.09.2010
(96) 10760612.1 15.08.2012
(87) WO2011042128, 28.09.2010
(97) 2486635, 15.08.2012 en
(54) GASKET FOR ELECTRIC CABLES
(71) Palazzoli S.p.A., Via Palazzoli, 31, 25128 Brescia, IT
(72) LEVI, Bruno, Via Vittorio Emanuele II 1, I-25122 - Brescia (BS), IT
-
- (51) MKP
G08C 15/06 (2006.01) (97) **2406778 ***
- (86) US2010026956 11.03.2010
(96) 10751404.4 18.01.2012
(87) WO2010105038, 11.03.2010
(97) 2406778, 18.01.2012 en
(54) PROCESS, DEVICE AND SYSTEM FOR MAPPING TRANSFORMERS TO METERS AND LOCATING NON-TECHNICAL LINE LOSSES
(71) Trilliant Networks, Inc., 1300 Island Drive, Suite 103, Redwood City, CA 94065, US
(72) CONANT, Rob, 6006 Colton Blvd., Oakland CA 94611, US
PRINCE, Chris, 13813 Conner Knoll Parkway, Fishers IN 46038, US
-
- (51) MKP
C07D 417/12 (2006.01) (97) **2430019 ***
A61K 31/423 (2006.01)
C07D 417/14 (2006.01)
A61K 31/424 (2006.01)
C07D 493/04 (2006.01)
A61K 31/428 (2006.01)
C07D 495/04 (2006.01)
A61K 31/429 (2006.01)
C07D 498/04 (2006.01)
C07D 413/12 (2006.01)
C07D 519/00 (2006.01)
C07D 513/04 (2006.01)
C07D 413/14 (2006.01)
A61P 29/00 (2006.01)
- (86) US2010034597 12.05.2010
(96) 10726712.2 21.03.2012
(87) WO2010132599, 12.05.2010
(97) 2430019, 21.03.2012 en
(54) MOIETIES AS MODULATORS OF LEUKOTRIENE A4 HYDROLASE
(71) Janssen Pharmaceutica, N.V., Turnhoutseweg 30, 2340 Beerse, BE
(72) KEARNEY, Aaron, M., 11870 Walnut Road, Lakeside CA 92040, US
LANDRY-BAYLE, Adrienne, 7520 Gibraltar Street D, Carlsbad CA 92009, US
BACANI, Genesis, M., 13553 Longfellow Lane, San Diego CA 92129, US
LEE-DUTRA, Alice, 15561 Maturin Drive, San Diego CA 92127, US
CHROVIAN, Christa, C., 6262 Buisson Street, San Diego CA 92122, US
SANTILLAN, Alejandro, 5036 Savannah Street, San Diego CA 92110, US
ECCLES, Wendy, 4444 W. Point Loma Boulevard, 66, San Diego CA 92107, US
TANIS, Virginia, M., 1750 Oriole Court, Carlsbad CA 92011, US
GRICE, Cheryl, A., 3449 Camino Corte, Carlsbad CA 92009, US
GOMEZ, Laurent, 13270 Russet Leaf Lane, San Deigo CA 92129, US
FOURIE, Anne, M., 13060 Callcott Way, San Diego CA 92130, US
WIENER, John, J. M., 357 PlayaDel Sur 2, La Jolla CA 92037, US

- (51) MKP
A63K 3/04 (2006.01) (97) **2459290 ***
(86) CH2010000158 16.06.2010
(96) 10732255.4 06.06.2012
(87) WO2011011896, 16.06.2010
(97) 2459290, 06.06.2012 de
(54) HURDLE
(71) Dodic-Portner, Vojislav, Frauenfelderstrasse 4, 9542 Mönchwilten - TG, CH
(72) Dodic-Portner, Vojislav, Frauenfelderstrasse 4, 9542 Mönchwilten - TG, CH
-
- (51) MKP
H04W 28/26 (2009.01) (97) **2469921 ***
(86) CN2010076101 18.08.2010
(96) 10809566.2 27.06.2012
(87) WO2011020433, 18.08.2010
(97) 2469921, 27.06.2012 en
(54) METHOD, SYSTEM AND APPARATUS FOR ACK/NACK RESOURCE RESERVATION
(71) China Academy of Telecommunications Technology, 40, Xueyuan Road, Haidian District Beijing 100191, CN
(72) LIU, Tingting, No.40 Xueyuan Road Haidian District, Beijing 100083, CN
LIN, Yanan, No.40 Xueyuan Road Haidian District, Beijing 100083, CN
SHEN, Zukang, No.40 Xueyuan Road Haidian District, Beijing 100083, CN
-
- (51) MKP
A23L 1/00 (2006.01) (97) **2437624 ***
A23L 1/304 (2006.01)
A23L 1/03 (2006.01)
(86) IB2010001100 12.05.2010
(96) 10759968.0 11.04.2012
(87) WO2010140034, 12.05.2010
(97) 2437624, 11.04.2012 en
(54) FOOD PRODUCTS COMPRISING ZEOLITES
(71) HF Europe S.r.l., Via Daniele Manin, 60, 30174 Mestre (VE), IT
(72) BRUNELLO, Dario, c/o HF Europe S.r.l. Via Daniele Manin, 60, I- 30174 Mestre (VE), IT
TOMBOLAN, Luca, c/o HF Europe S.r.l. Via Daniele Manin, 60, I- 30174 Mestre (VE), IT
FARINATO, Alessandro, c/o HF Europe S.r.l. Via Daniele Manin, 60, I- 30174 Mestre (VE), IT
-
- (51) MKP
C07D 491/20 (2006.01) (97) **2488531 ***
(86) US2010052704 14.10.2010
(96) 10771606.0 22.08.2012
(87) WO2011047174, 14.10.2010
(97) 2488531, 22.08.2012 en
(54) SYNTHETIC METHODS FOR SPIRO-OXINDOLE COMPOUNDS
(71) Xenon Pharmaceuticals Inc., 3650 Gilmore Way, Burnaby, BC V5G 4W8, CA
(72) CADIEUX, Jean-Jacques, 7 5090 East Hastings Street, Burnaby, British Columbia V5B 1P6, CA
CHAFEEV, Mikhail, 8 Kudryavceva Street Apartment 58, Himki, Moscow Region 141401, RU
CHOWDHURY, Sultan, 7007 180th Street, Surrey, British Columbia V3S 7S3, CA
FU, Jianmin, 3170 Quintette Crescent, Coquitlam, British Columbia V3E 3B6, CA
JIA Qi, 7633 Buller Avenue, Burnaby, British Columbia V5J 5M6, CA
ABEL, Stefanie, Weidstrasse 20, CH-8800 Thalwil, CH
EL-SAYED, Emad, Kusnachterstrasse 27, CH-8126 Zumikon, CH
HUTHMANN, Elke, Rigistrasse 10, CH-5033 Buchs, CH
ISARNO, Thomas, 1 rue de Hombourg, F-68680 Niffer, FR
-
- (51) MKP
A61K 31/519 (2006.01) (97) **2470539 ***
A61P 35/00 (2006.01)
C07D 487/04 (2006.01)
(86) US2010046975 27.08.2010
(96) 10749741.4 04.07.2012
(87) WO2011025951, 27.08.2010
(97) 2470539, 04.07.2012 en
(54) RAF INHIBITOR COMPOUNDS AND METHODS OF USE THEREOF
(71) Genentech, Inc., 1 DNA Way, South San Francisco, CA 94080-4990, US
Array Biopharma, Inc., 3200 Walnut Street, Boulder, CO 80301, US
(72) GRADL, Stefan, 1 DNA Way, South San Francisco, California 94080-4990, US
RUDOLPH, Joachim, 1 DNA Way, South San Francisco, California 94080-4990, US
REN, Li, 3200 Walnut Street, Boulder, Colorado 80301, US
-
- (51) MKP
C03C 25/24 (2006.01) (97) **2438025 ***
(86) FR2010051073 02.06.2010
(96) 10734210.7 11.04.2012
(87) WO2010139897, 02.06.2010
(97) 2438025, 11.04.2012 fr
(54) MINERAL FIBER MAT CONTAINING A FORMALDEHYDE-TRAPPING AGENT, AND METHODS FOR MANUFACTURING SAME
(71) Saint-Gobain Adfors, 517, Avenue de la Boisse, 73000 Chambéry, FR
(72) BLANCHARD, Benjamin, 17 rue Auguste Méry, F-95150 Taverny, FR
CHUDA, Katarzyna, 21 rue de Boulainvilliers, F-75016 Paris, FR
JAFFRENNOU, Boris, 33 rue des Alouettes, F-75019 Paris, FR
-
- (51) MKP
A61K 8/11 (2006.01) (97) **2440193 ***
A61K 8/73 (2006.01)
A61K 9/51 (2006.01)
(86) EP2010057873 07.06.2010
(96) 10724783.5 18.04.2012
(87) WO2010142620, 07.06.2010
(97) 2440193, 18.04.2012 en
(54) PROCESS FOR THE PREPARATION OF COLLOIDAL SYSTEMS FOR THE DELIVERY OF ACTIVE COMPOUNDS
(71) Advancell Advanced in Vitro Cell Technologies, S.A., Barcelona Science Park C/ Baldiri Reixac, 10 - 1ª planta, 08028 Barcelona, ES
(72) CUESTA REGUEIRO, Ana Belén, Advancell Advanced In Vitro Cell Technologies S.A. Pabellón de Servicios Laboratorio FEDER Campus SUR, E-15782 Santiago de Compostela, ES
VILA PENA, Ana Isabel, Advancell Advanced In Vitro Cell Technologies, S.A. Pabellón de Servicios, Laboratorio FEDER Campus SUR, 15782 Santiago de Compostela, ES
-
- (51) MKP
A61M 5/24 (2006.01) (97) **2477682 ***
A61M 5/315 (2006.01)
(86) EP2010063506 15.09.2010
(96) 10752587.5 25.07.2012
(87) WO2011032952, 15.09.2010
(97) 2477682, 25.07.2012 en
(54) MEDICATION DELIVERY DEVICE AND METHOD FOR DISPENSING A MEDICATION
(71) Sanofi-Aventis Deutschland GmbH, Brüningstraße 50, 65929 Frankfurt, DE
(72) HEALD, Michael, c/o Sanofi-Aventis Deutschland GmbH, 65926 Frankfurt am Main, DE
-
- (51) MKP
F41B 3/02 (2006.01) (97) **2267395**
A01K 97/02 (2006.01)
(96) 10425197.0 29.12.2010
(97) 2267395, 29.12.2010 en
(54) Groundbait catapult
(71) Colmic Italia S.P.A., Loc. Ruota al Mando', 50066 Reggello (FI), IT
(72) Collini, Andrea, Loc. Bombone 17/C, 50067 Rignano sull'Arno, IT

- (51) MKP
C25B 1/46 (2006.01) (97) **2435605 ***
C25B 15/08 (2006.01)
C25B 1/26 (2006.01)
- (86) EP2010003253 28.05.2010
(96) 10724293.5 04.04.2012
(87) WO2010139425, 28.05.2010
(97) 2435605, 04.04.2012 de
- (54) PROCESS AND APPARATUS FOR THE ELECTROLYSIS OF AN AQUEOUS SOLUTION OF HYDROGEN CHLORIDE OR ALKALI CHLORIDE IN AN ELECTROLYTIC CELL
- (71) Messer Austria GmbH, Industriestrasse 5, 2352 Gumpoldskirchen, AT
Messer Group GmbH, Otto-Volger-Strasse 3c, 65843 Sulzbach, DE
Bayer Material Science AG, Kaiser-Wilhelm Allee, 51369 Leverkusen, DE
- (72) BACHLEITNER, Walter, Sandwirtstr. 12/5, A-4600 Wels, AT
ERDMANN, Christoph, Zaunkönigweg 35, 65719 Hofheim, DE
ROHOVEC, Joachim, Eichwaldgasse 42, A-2500 Baden bei Wien, AT
BULAN, Andreas, Alt Langenfeld 15, 40764 Langenfeld, DE
WEIS, Mathias, Am Knechtsgraben 39, 51379 Leverkusen, DE
-
- (51) MKP
F04B 17/04 (2006.01) (97) **2375054**
F01N 3/20 (2006.01)
F02M 69/02 (2006.01)
- (96) 10159128.7 12.10.2011
(97) 2375054, 12.10.2011 en
- (54) Reagent dosing system and pump
- (71) Delphi Technologies Holding S.à.r.l., Avenue de Luxembourg, 4940 Bascharage, LU
- (72) Cooke, Michael, 52 Burnt Oak Terrace, Gillingham, Kent ME7 1DR, GB
-
- (51) MKP
C09C 1/24 (2006.01) (97) **2261288**
C09C 1/34 (2006.01)
C09C 3/08 (2006.01)
F24J 2/48 (2006.01)
H01L 31/0216 (2006.01)
- (96) 10155595.1 15.12.2010
(97) 2261288, 15.12.2010 en
- (54) Aminosilane modified pigments for spectrally selective coatings, method for preparation and their use in coatings
- (71) Kemijski Institut, Hajdrihova 19, 1000 Ljubljana, SI
Color Industrija sintetičnih smol, barv in Lakov, Cesta Komandanta Staneta 4, 1215 Medvode, SI
- (72) Kozelj, Matjaz, Hocevoje 7, 1301, Krka, SI
Orel, Boris, Pod Kostanji 46, 1000, Ljubljana, SI
Steinbuecher, Miha, ?upanceva 5, 1241, Kamnik, SI
Jerman, Ivan, Locica 40, 3305, Vransko, SI
Vodlan, Marjanca, Va?e 2d, 1215, Medvode, SI
-
- (51) MKP
B03C 3/60 (2006.01) (97) **2411154 ***
B03C 3/16 (2006.01)
B03C 3/45 (2006.01)
- (86) CA2010000377 16.03.2010
(96) 10755346.3 01.02.2012
(87) WO2010108256, 16.03.2010
(97) 2411154, 01.02.2012 en
- (54) WET ELECTROSTATIC PRECIPITATOR SYSTEM COMPONENTS
- (71) Turbosonic Inc., 550 Parkside Drive Suite A-14, Waterloo, Ontario N2L 5V4, CA
- (72) ALLAN, Robert A., 126 Pinehurst Crescent, Kitchener Ontario N2N 1E4, CA
MCGRATH, Paul, 42-7284 Bellshire Gate, Mississauga Ontario L5N 8E4, CA
-
- (51) MKP
G06Q 30/00 (2012.01) (97) **2492863 ***
G06K 17/00 (2006.01)
- (86) JP2010068741 22.10.2010
(96) 10825058.0 29.08.2012
(87) WO2011049209, 22.10.2010
(97) 2492863, 29.08.2012 en
- (54) INFORMATION PROVISION DEVICE, INFORMATION PROVISION METHOD, INFORMATION PROVISION PROGRAM, AND COMPUTER-READABLE STORAGE MEDIUM FOR STORING SAID PROGRAM
- (71) Rakuten, Inc., 4-12-3, Higashishinagawa Shinagawa-ku, Tokyo 140-0002, JP
- (72) IWABUCHI Shigaku, c/o Rakuten Inc. 4-12-3 Higashishinagawa Shinagawa-ku, Tokyo 140-0002, JP
-
- (51) MKP
F03D 1/00 (2006.01) (97) **2499357 ***
- (86) FI2010050898 08.11.2010
(96) 10795029.7 19.09.2012
(87) WO2011055021, 08.11.2010
(97) 2499357, 19.09.2012 en
- (54) A METHOD AND AN APPARATUS FOR ASSEMBLING A WIND POWER PLANT
- (71) EASYWIND OY, Teollisuustie 2, 64700 Teuva, FI
- (72) LUHTALA, Pekka, Hahdonkuja 5, FIN-66300 Jurva, FI
-
- (51) MKP
C12Q 1/68 (2006.01) (97) **2435581 ***
- (86) EP2010003201 26.05.2010
(96) 10722005.5 04.04.2012
(87) WO2010136192, 26.05.2010
(97) 2435581, 04.04.2012 en
- (54) NOVEL TISSUE PROTECTIVE ERYTHROPOIETIN RECEPTOR (NEPOR) AND METHODS OF USE
- (71) MOLECULAR HEALTH GmbH, Belfortstr. 2, 69115 Heidelberg, DE
- (72) JACKSON, David B., Hauptstrasse 238, 69117 Heidelberg, DE
STEIN, Martin, Lissaer Weg 9, 68307 Mannheim, DE
VOSS, Hartmut, Madonnenbergweg 19, 69198 Schriesheim, DE
BROCK, Stephan, Lönsstrasse 12, 69469 Weinheim, DE
DANES, Christopher G., 4122 Glenshire Street, 77025 Houston, US
SOOD, Anil, 2719 Lakecrest Drive, Pearland TX 77584, US
-
- (51) MKP
C04B 20/10 (2006.01) (97) **2429969 ***
C04B 40/00 (2006.01)
C04B 28/02 (2006.01)
- (86) EP2010001626 15.03.2010
(96) 10710797.1 21.03.2012
(87) WO2010130314, 15.03.2010
(97) 2429969, 21.03.2012 de
- (54) NEW PIGMENT SYSTEM FOR COLORING CEMENT SYSTEMS, IN PARTICULAR CONCRETE
- (71) Harold Scholz&Co. GmbH, Ickerottweg 30, 45665 Recklinghausen, DE
- (72) WEBER, Peter, Rieslingweg 16, 55597 Wöllstein, DE
MATJASIC, Zlatko, Wichernstrasse 3, 51469 Bergisch Gladbach, DE
GADO, Klaus-Dieter, Schafheckenweg 46, 97846 Partenstein, DE
SIEBLIST, Christian, Schafheckenweg 1, 97846 Partenstein, DE
-
- (51) MKP
A01N 43/42 (2006.01) (97) **2458992 ***
A61K 31/42 (2006.01)
- (86) US2010002129 29.07.2010
(96) 10804826.5 06.06.2012
(87) WO2011014255, 29.07.2010
(97) 2458992, 06.06.2012 en
- (54) TREATMENT OF CROHN'S DISEASE WITH LAQUINIMOD
- (71) Teva Pharmaceutical Industries Ltd., 5 Basel Street P.O. Box 3190, 49131 Petah Tiqva, IL
- (72) TARCIC, Nora, Migdal David 29/1, Modlin, IL
HAVIV, Asi, 76802 Kvutsat Shiller, (Gan ScloMo), IL
BLAUGRUND, Eran, 94 Remez Street, 76449 Rehovot, IL
KAYE, Joel, 14/5 Hazamir Street, 42752 Netanya, IL

- (51) MKP
C07K 16/28 (2006.01) (97) **2493928 ***
 (86) EP2010066274 27.10.2010
 (96) 10771436.2 05.09.2012
 (87) WO2011051349, 27.10.2010
 (97) 2493928, 05.09.2012 en
 (54) ANTIBODIES TO ION CHANNELS
 (71) UCB Pharma, S.A., 60, allée de la Recherche, 1170 Brussels, BE
 (72) MILLER, Karen Margrete, Ucb Pharma S.a. 60 Allée de la Recherche, B-1070 Brussels, BE
 DE RYCK, Marc Roger, Ucb Pharma S.a. 60 Allée de la Recherche, B-1070 Brussels, BE
 WOLFF, Christian Gilbert J., Ucb Pharma S.a. 60 Allée de la Recherche, B-1070 Brussels, BE
 LAWSON, Alastair David Griffiths, UCB Celltech 208 Bath Road, Slough Berkshire SL1 3WE, GB
 FINNEY, Helene Margaret, UCB Celltech 208 Bath Road, Slough Berkshire SL1 3WE, GB
 BAKER, Terence Seward, UCB Celltech 208 Bath Road, Slough Berkshire SL1 3WE, GB
-
- (51) MKP
F01N 3/035 (2006.01) (97) **2464836 ***
B01D 53/92 (2006.01)
 (86) US2010002226 12.08.2010
 (96) 10808457.5 20.06.2012
 (87) WO2011019396, 12.08.2010
 (97) 2464836, 20.06.2012 en
 (54) MOUNTING MAT FOR EXHAUST GAS TREATMENT DEVICE
 (71) Unifrax I LLC, Unifrax Corporation 2351 Whirlpool Street Niagara Falls, NY 14305-2413, US
 (72) KUMAR, Amit, 20 Huntwood Court, Getzville New York 14068, US
-
- (51) MKP
B82B 1/00 (2006.01) (97) **2481088 ***
H01L 29/06 (2006.01)
 (86) US2010049988 23.09.2010
 (96) 10819454.9 01.08.2012
 (87) WO2011038111, 23.09.2010
 (97) 2481088, 01.08.2012 en
 (54) PASSIVATED NANOPARTICLES
 (71) Crystalplex Corporation, 2403 Sidney Street Suite 280, Pittsburgh, Pennsylvania 15203, US
 (72) QU, Lianhua, 1533 King Charles Drive, Pittsburgh Pennsylvania 15237, US
 MILLER, Gregory, 1245 Lakeside Drive, 1016, Sunnyvale California 94085, US
-
- (51) MKP
C08B 37/10 (2006.01) (97) **2427503 ***
A61K 31/727 (2006.01)
C08B 37/00 (2006.01)
 (86) IB2010051935 04.05.2010
 (96) 10719114.0 14.03.2012
 (87) WO2010128450, 04.05.2010
 (97) 2427503, 14.03.2012 en
 (54) NOVEL ACYLATED DECASACCHARIDES AND THEIR USE AS ANTITHROMBOTIC AGENTS
 (71) SANOFI, 174, Avenue de France, 75013 Paris, FR
 (72) MOURIER, Pierre, c/o sanofi-aventis Patent Department 174 avenue de France, F-75013 Paris, FR
 VISKOV, Christian, c/o sanofi-aventis Patent Department 174 avenue de France, F-75013 Paris, FR
-
- (51) MKP
C12P 7/10 (2006.01) (97) **2443245 ***
 (86) GB2010001120 08.06.2010
 (96) 10725247.0 25.04.2012
 (87) WO2010146331, 08.06.2010
 (97) 2443245, 25.04.2012 en
 (54) PROCESS FOR PRODUCTION OF SUGARS AND ALCOHOLS FROM A CELLULOSIC MATERIAL
 (71) Weyland AS, Lonningsflaten 22, 5258 Blomsterdalen, NO
 Cockbain, Julian, 42 Southmoor Road, Oxford OX2 6RD, GB
 (72) WEYDAHL, Karl, Ragnar, Weyland AS Espehaugen 25, N-5258 Blomsterdalen, NO

- (51) MKP
C07K 16/24 (2006.01) (97) **2424893 ***
A61K 39/395 (2006.01)
 (86) EP2010058788 22.06.2010
 (96) 10724534.2 07.03.2012
 (87) WO2010149641, 22.06.2010
 (97) 2424893, 07.03.2012 en
 (54) PHARMACEUTICAL AGENT
 (71) Peptcell Limited, 100 Fetter Lane, London EC4A 1BN, GB
 (72) STOLOFF, Gregory, 35 Royal Avenue, London SW3 4QE, GB
 WANDERLEY, Wilson, 3 Rixon Meadow Aylesbury, Buckinghamshire HP19 7FP, GB
-
- (51) MKP
A01N 35/00 (2006.01) (97) **2413693 ***
A61K 31/12 (2006.01)
 (86) US2010029172 30.03.2010
 (96) 10779665.8 08.02.2012
 (87) WO2010114824, 30.03.2010
 (97) 2413693, 08.02.2012 en
 (54) SUBSTITUTED AZOANTHRACENE DERIVATIVES, PHARMACEUTICAL COMPOSITIONS, AND METHODS OF USE THEREOF
 (71) TransTech Pharma, Inc, 4170 Mendenhall Oaks Parkway, High Point, North Carolina 27265, US
 (72) MJALLI, Adnan M.M., 6421 Ashton Park Drive, Oak Ridge North Carolina 27310, US
 YARRAGUNTA, Ravindra Reddy, 5001 Bass Chapel Rd. Apt. 1A, Greensboro North Carolina 27455, US
 QUADA, James, 3605 Nina Court, High Point North Carolina 27265, US
 YOKUM, Thomas Scott, 5108 Hartridge Way, Greensboro North Carolina 27407, US
 SANTHOSH, Kalpathy, 4132 Tutbury Drive, Jamestown North Carolina 27282, US
 FREEMAN, Jennifer, L.R., 154 Surtees Road, Winston-Salem, NC 27410, US
 BONDLELA, Muralidhar, 6527 Overland Park Drive, Greensboro North Carolina 27410, US
 GUZEL, Mustafa, 4058 Gunsmith Court, Jamestown North Carolina 27282, US
 BEHME, Christopher, 3392 Cherrybrook Drive, Jamestown North Carolina 27282, US
 GOHIMUKKULA, Devi Reddy, 4061 Cobbler Court, Jamestown North Carolina 27282, US
 CHRISTEN, Daniel P., 3345 Winter Brook Place, Jamestown North Carolina 27282, US
 ANDREWS, Robert Carl, 3312 Morris Farm Drive, Jamestown North Carolina 27282, US
 POLISETTI, Dharma Rao, 3741 Deerfield Street, High Point North Carolina 27265, US
 DAVIS, Stephen Thomas, 1 Wateroaks Court, Durham North Carolina 27703, US
-
- (51) MKP
C08L 17/00 (2006.01) (97) **2484720 ***
C08J 11/10 (2006.01)
 (86) CN2010001535 30.09.2010
 (96) 10819805.2 08.08.2012
 (87) WO2011038576, 30.09.2010
 (97) 2484720, 08.08.2012 en
 (54) THERMAL REGENERATION METHOD OF WASTE RUBBER
 (71) Chen, Huihong, Room 301 208 Huagong Ercun 300 Meilong Road, Shanghai 200237, CN
 Hu, Jiaqing, Room 1210 Hongcao Building 421 Hongcao Road, Shanghai 200233, CN
 (72) Chen, Huihong, Room 301 208 Huagong Ercun 300 Meilong Road, Shanghai 200237, CN
 Hu, Jiaqing, Room 1210 Hongcao Building 421 Hongcao Road, Shanghai 200233, CN

- (51) MKP
A01N 25/34 (2006.01) (97) **2490527 ***
A01N 25/10 (2006.01)
A01N 59/16 (2006.01)
A01N 59/20 (2006.01)
C09J 7/02 (2006.01)
(86) EP2010005256 27.08.2010
(96) 10752722.8 29.08.2012
(87) WO2011047747, 27.08.2010
(97) 2490527, 29.08.2012 de
(54) COATING FOR OBJECTS, IN PARTICULAR IN PUBLIC FACILITIES AND/OR MEANS OF TRANSPORTATION, FOR PREVENTING THE TRANSMISSION OF INFECTIONS
(71) Blücher GmbH, Mettmanner Strasse 25, 40699 Erkrath, DE
(72) VON BLÜCHER, Hasso, Parkstrasse 19, 40699 Erkrath, DE
-
- (51) MKP
A61P 37/00 (2006.01) (97) **2414341 ***
C07D 271/06 (2006.01)
A61K 31/4245 (2006.01)
(86) EP2010054100 29.03.2010
(96) 10711881.2 08.02.2012
(87) WO2010115751, 29.03.2010
(97) 2414341, 08.02.2012 en
(54) OXADIAZOLE DERIVATIVES
(71) Merck Serono SA, Centre Industriel, 1267 Coinsins, Vaud, CH
(72) QUATTROPANI, Anna, Route de Chêne 2, CH-1207 Genève, CH
MONTAGNE, Cyril, 1 rue de Lyon, F-01630 Saint Genis-Pouilly, FR
SAUER, Wolfgang, 71 chemin des Cornillons, CH-1292 Chambésy, CH
CROSIGNANI, Stefano, 2 chemin de Champs-Fusy, F-01630 St Genis-Pouilly, FR
BOMBRUN, Agnès, 71 chemin des Cornillons, CH-1292 Chambésy, CH
-
- (51) MKP
H04W 12/06 (2009.01) (97) **2481230 ***
H04W 4/12 (2009.01)
H04L 29/06 (2006.01)
(86) EP2010063979 22.09.2010
(96) 10767951.6 01.08.2012
(87) WO2011036179, 22.09.2010
(97) 2481230, 01.08.2012 en
(54) AUTHENTICATION METHOD, PAYMENT AUTHORISATION METHOD AND CORRESPONDING ELECTRONIC EQUIPMENTS
(71) 4Tech+ S.r.l., Via del Bollo 4, 20123 Milano, IT
(72) COLOMBO, Danilo, Via Valcomonica 36, 20059 Vilmercate, IT
BERGANTINI, Mario, Via V. Veneto 121/B, 20091 Bresso, IT
MINARDI, Alessandro, Via Vittorio Emanuele II, 20068 Peschiera Borromeo, IT
-
- (51) MKP
B29C 45/14 (2006.01) (97) **2496394 ***
(86) US2010002316 23.08.2010
(96) 10752647.7 12.09.2012
(87) WO2011028244, 23.08.2010
(97) 2496394, 12.09.2012 en
(54) METHOD OF MAKING A MOLDED TRIM ASSEMBLY
(71) Pilkington Group Limited, Prescott Road, St. Helens Merseyside WA10 3TT, GB
(72) ASH, Charles, E., 598 South Ridge, Perrysburg OH 43551, US
HERCZEG, Susan, M., 585 Hunter's Run, Perrysburg OH 43551, US
SITTERLET, Charles, 4100 Williston Road, Northwood OH 43619, US
-
- (51) MKP
A61P 35/00 (2006.01) (97) **2419177 ***
G01N 33/574 (2006.01)
(86) US2010031144 15.04.2010
(96) 10714422.2 22.02.2012
(87) WO2010120966, 15.04.2010
(97) 2419177, 22.02.2012 en
(54) BIOLOGICAL MARKERS PREDICTIVE OF ANTI-CANCER RESPONSE TO EPIDERMAL GROWTH FACTOR RECEPTOR KINASE INHIBITORS
(71) OSI Pharmaceuticals, LLC, 1 Bioscience Park Drive, Farmingdale, NY 11735, US
(72) RICHARDSON, Frank, C., 2860 Wilderness Place, Boulder CO 80301, US
YOUNG, G., David, 2860 Wilderness Place, Boulder CO 80301, US
WOLF, Julie, L., 2860 Wilderness Place, Boulder CO 80301, US
SENNELLO, Regina, M., 2860 Wilderness Place, Boulder CO 80301, US
-
- (51) MKP
A61K 9/70 (2006.01) (97) **2431028 ***
A61K 47/30 (2006.01)
A61K 31/14 (2006.01)
A61K 31/09 (2006.01)
A61P 43/00 (2006.01)
(86) KR2010004020 22.06.2010
(96) 10792302.1 21.03.2012
(87) WO2010151020, 22.06.2010
(97) 2431028, 21.03.2012 en
(54) FAST-DISSOLVING ORAL FILM FOR EFFECTIVELY CONCEALING UNPLEASANT TASTES
(71) Chabio & Diostech Co., Ltd., 151-21 Buk-ri Namsa-myeon Cheoin-gu Yongin-city, Kyunggi-do 449-884, KR
(72) PARK, Jin Kyu, 302-201 LG Village 3-cha Apartment 726 Seongbok-dong Suji-gu, Yongin-si Gyeonggi-do 448-140, KR
YANG, Won Suk, 113-301 Dongbu Centreville Apartment 613 Deokso-ri Wabu-eup, Namyangju-si Gyeonggi-do 472-918, KR
JUNG, Kyoung Tae, 501-606 Samik Green 2-cha Apartment Myoungil-dong Gandgong-gu, Seoul 134-782, KR
-
- (51) MKP
A23L 2/52 (2006.01) (97) **2442674 ***
C02F 1/68 (2006.01)
A23L 1/30 (2006.01)
C02F 1/70 (2006.01)
(86) US2010036748 28.05.2010
(96) 10789923.9 25.04.2012
(87) WO2010147751, 28.05.2010
(97) 2442674, 25.04.2012 en
(54) COMPOSITIONS AND METHODS FOR PRODUCING STABLE NEGATIVE OXIDATION REDUCTION POTENTIAL IN CONSUMABLE MATERIALS
(71) Miljkovic, Dusan, 4655 Ramsay Ave., San Diego, CA 92122, US
(72) Miljkovic, Dusan, 4655 Ramsay Ave., San Diego, CA 92122, US
-
- (51) MKP
A61F 13/15 (2006.01) (97) **2481383**
(86) 11196251.0 01.08.2012
(97) 2481383, 01.08.2012 en
(54) Method of creating a cross-machine direction fold line boundary
(71) Curt G. Joa, Inc., 100 Crocker Avenue, Sheboygan Falls, Wisconsin 53085, US
(72) Andrews, Robert E., N7488 Sunset Circle Drive, Sheboygan, WI Wisconsin 53083, US

- (51) MKP
A61P 19/10 (2006.01) (97) **2412697 ***
C07C 213/04 (2006.01)
C07C 213/08 (2006.01)
C07C 217/28 (2006.01)
C07D 303/22 (2006.01)
C07C 69/76 (2006.01)
A61K 31/235 (2006.01)
- (86) JP2010055160 25.03.2010
(96) 10756148.2 01.02.2012
(87) WO2010110352, 25.03.2010
(97) 2412697, 01.02.2012 en
(54) PROCESS FOR PRODUCING CARBOXYLIC ACID COMPOUND
- (71) Japan Tobacco, Inc., 2-1, Toranomom 2-chome Minato-ku, Tokyo 105-8422, JP
(72) MATSUMOTO, Katsuya, c/o Central Pharmaceutical Research Institute of Japan Tobacco Inc. 1-1, Murasaki-cho, Takatsuki-shi Osaka 569-1125, JP
YOKOTA, Katsuyuki, c/o Central Pharmaceutical Research Institute of Japan Tobacco Inc. 1-1, Murasaki-cho, Takatsuki-shi Osaka 569-1125, JP
SHINAGAWA, Yuko, c/o Central Pharmaceutical Research Institute of Japan Tobacco Inc. 1-1, Murasaki-cho, Takatsuki-shi Osaka 569-1125, JP
INOUE, Teruhiko, c/o Central Pharmaceutical Research Institute of Japan Tobacco Inc. 1-1, Murasaki-cho, Takatsuki-shi Osaka 569-1125, JP

- (51) MKP
A61K 31/496 (2006.01) (97) **2448579 ***
A61P 3/04 (2006.01)
- (86) EP2010003964 30.06.2010
(96) 10734674.4 09.05.2012
(87) WO2011000563, 30.06.2010
(97) 2448579, 09.05.2012 en
(54) ELTOPRAZINE FOR THE TREATMENT OF WEIGHT DISORDERS
- (71) Merz Pharma GmbH & Co. KGaA, Eckenheimer Landstrasse 100, 60318 Frankfurt am Main, DE
(72) FRANKE, Lutz, Bahnhofstrasse 2, 61118 Bad Vilbel, DE
VALASTRO, Barbara, Kettenhofweg 123, 60325 Frankfurt am Main, DE

- (51) MKP
C12Q 1/68 (2006.01) (97) **2486143 ***
A61P 1/00 (2006.01)
C12Q 1/04 (2006.01)
C12Q 1/10 (2006.01)
- (86) NL2010050645 05.10.2010
(96) 10763069.1 15.08.2012
(87) WO2011043654, 05.10.2010
(97) 2486143, 15.08.2012 en
(54) METHODS FOR DIAGNOSING IRRITABLE BOWEL SYNDROME
- (71) AAK Patent B.V., Singel 11, 4797 BJ Willemstad, NL
(72) TUK, Lambertus, Singel 11, NL-4797 BJ Willemstad, NL
DE VOS, Willem Meindert, Oude Bennekomseweg 77, NL-6717 LM Ede, NL
RAJILIC-STOJANOVIC, Mirjana, Danila Lekica Spanca 3/1, Beograd, RS

- (51) MKP
A61K 47/48 (2006.01) (97) **2427217 ***
A61P 37/04 (2006.01)
- (86) GB2010000915 07.05.2010
(96) 10718650.4 14.03.2012
(87) WO2010128303, 07.05.2010
(97) 2427217, 14.03.2012 en
(54) MULTI-VALENT ADJUVANT DISPLAY
- (71) Psioxus Therapeutics Limited, 5 New Street Square, London EC4A 3TW, GB
(72) SEYMOUR, Leonard, Charles, William, Rock Cottage Upper End Shipton Under Wychwood, Oxfordshire OX7 6DP, GB
FISHER, Kerry, 14 Grisedale Close Longlevens, Gloucester GL2 0EG, GB

- (51) MKP
A61K 9/107 (2006.01) (97) **2416759 ***
A61K 31/196 (2006.01)
A61K 9/00 (2006.01)
- (86) IN2010000167 22.03.2010
(96) 10740756.1 15.02.2012
(87) WO2010116382, 22.03.2010
(97) 2416759, 15.02.2012 en
(54) STABLE PHARMACEUTICAL COMPOSITIONS OF DICLOFENAC
- (71) Cadila Healthcare Limited, Sarkhej-Bavla N.H. No 8A Moraiya Tal Sanand, Dist. Ahmedabad 382 210, Gujarat, IN
(72) ROY, Sunilendu Bhushan, Sarkhej-Bavla N.H. No. 8A Moraiya Tal Sanand Dist. Ahmedabad 382 210, Gujarat, IN
SHEIKH, Shafiq, Sarkhej-Bavla N.H. No. 8A Moraiya Tal Sanand Dist. Ahmedabad 382 210, Gujarat, IN
KOTHARI, Jay, Sarkhej-Bavla N.H. No. 8A Moraiya Tal Sanand Dist. Ahmedabad 382 210, Gujarat, IN
PATEL, Jitendra, Sarkhej-Bavla N.H. No. 8A Moraiya Tal Sanand Dist. Ahmedabad 382 210, Gujarat, IN

- (51) MKP
A61K 31/535 (2006.01) (97) **2408767 ***
C07D 413/12 (2006.01)
C07D 413/10 (2006.01)
C07D 413/06 (2006.01)
A61P 25/28 (2006.01)
- (86) US2010027892 19.03.2010
(96) 10754142.7 25.01.2012
(87) WO2010108052, 19.03.2010
(97) 2408767, 25.01.2012 en
(54) AMIDE DERIVATIVES AS NEUROPEPTIDE Y5 RECEPTOR LIGANDS
- (71) H. Lundbeck A/S, 9 Ottiliavej, 2500 Valby-Copenhagen, DK
CHEN, Bin, 14 Oakmount Terrace, East Windsor NJ 08520, US
(72) BURNS, James, Ford, 103 Midland Avenue, Glen Ridge NJ 07028, US
DOLLER, Dario, 15 Quarterhorse Crossing, Sparta NJ 07871, US

- (51) MKP
A61P 11/06 (2006.01) (97) **2414375 ***
A61P 29/00 (2006.01)
C07J 71/00 (2006.01)
A61K 31/58 (2006.01)
A61P 11/00 (2006.01)
- (86) SE2010050354 31.03.2010
(96) 10759125.7 08.02.2012
(87) WO2010114471, 31.03.2010
(97) 2414375, 08.02.2012 en
(54) NOVEL AMIDE DERIVATIVES OF STEROIDAL γ 3,2-C'PYRAZOLE COMPOUNDS WITH GLUCOCORTICOID ACTIVITY
- (71) AstraZeneca AB, null, 151 85 Södertälje, SE
(72) BURKAMP, Frank, c/o AstraZeneca Intellectual Property AstraZeneca R&D Södertälje, S-151 85 Södertälje, SE
GABOS, Balint, AstraZeneca R&D Lund, S-221 87 Lund, SE
IVANOVA, Svetlana, AstraZeneca R&D Lund, S-221 87 Lund, SE
LISIUS, Alice Ingrid Annéa, AstraZeneca R&D Lund, S-221 87 Lund, SE

- (51) MKP
A61K 31/52 (2006.01) (97) **2456443 ***
A61P 1/16 (2006.01)
- (86) US2010042801 21.07.2010
(96) 10735414.4 30.05.2012
(87) WO2011011550, 21.07.2010
(97) 2456443, 30.05.2012 en
(54) TREATMENT OF LIVER DISORDERS WITH PI3K INHIBITORS
- (71) Gilead Calistoga LLC, 333 Lakeside Drive, Foster City, CA 94404, US
(72) ULRICH, Roger, G., 333 Lakeside Drive, Foster City, CA 94404, US

- (51) MKP
C12P 21/08 (2006.01) (97) **2459729 ***
(86) US2010043716 29.07.2010
(96) 10805046.9 06.06.2012
(87) WO2011014659, 29.07.2010
(97) 2459729, 06.06.2012 en
(54) DUAL VARIABLE DOMAIN IMMUNOGLOBULINS AND USES THEREOF
(71) Abbott Laboratories, 100 Abbott Park Rd., Abbott Park, IL 60064, US
(72) GHAYUR, Tariq, 1014 Washington Street, Holliston Massachusetts 01746, US
LIU, Junjian, 14 Crimson Drive, Shrewsbury Massachusetts 01545, US
IBRAGHIMOV, Alexander, 3 Blendon Woods Drive, Southborough Massachusetts 01772, US
-
- (51) MKP
A61K 45/06 (2006.01) (97) **2421515 ***
A61K 31/485 (2006.01)
A61K 9/50 (2006.01)
(86) DE2010000453 22.04.2010
(96) 10723484.1 29.02.2012
(87) WO2010121600, 22.04.2010
(97) 2421515, 29.02.2012 de
(54) PARTICULATE PHARMACEUTICAL COMPOSITION HAVING AN OPIOID AND AN OPIOID ANTAGONIST
(71) Hermann, Lars Holger, Paulistrasse 69, 8834 Schindellegi, CH
(72) Hermann, Lars Holger, Paulistrasse 69, 8834 Schindellegi, CH
-
- (51) MKP
A61P 3/06 (2006.01) (97) **2423203 ***
A61P 3/04 (2006.01)
A61P 9/00 (2006.01)
A61P 1/04 (2006.01)
A61P 3/10 (2006.01)
A61P 9/12 (2006.01)
A61K 31/536 (2006.01)
C07D 265/26 (2006.01)
(86) JP2010057110 22.04.2010
(96) 10767104.2 29.02.2012
(87) WO2010123047, 22.04.2010
(97) 2423203, 29.02.2012 en
(54) CRYSTAL OF BENZOXAZINONE COMPOUND
(71) Norgine BV, Hogehilweg 7, 1101 CA Amsterdam Zuid-Oost, NL
(72) ARET, Edwin, Zekeringstraat 29, 1014 BV Amsterdam, NL
-
- (51) MKP
C12N 15/13 (2006.01) (97) **2406286 ***
C07K 16/28 (2006.01)
C07K 14/725 (2006.01)
A61K 39/00 (2006.01)
C12N 15/63 (2006.01)
G01N 33/68 (2006.01)
(86) US2010026375 05.03.2010
(96) 10751218.8 18.01.2012
(87) WO2010104761, 05.03.2010
(97) 2406286, 18.01.2012 en
(54) ANTI-CD40 ANTIBODIES AND USES THEREOF
(71) Baylor Research Institute, 3310 Live Oak Street, Suite 501, Dallas, TX 75201, US
(72) BANCHEREAU, Jacques, F., 6730 Northaven Road, Dallas TX 75230, US
ZURAWSKI, Gerard, 7620 Jordan Lane, Midlothian TX 76065, US
ZURAWSKI, Sandra, 7620 Jordan Lane, Midlothian TX 76065, US
OH, Sangkon, 45 Caterham Court, Baltimore MD 21237, US
-
- (51) MKP
C07K 16/00 (2006.01) (97) **2419446 ***
(86) US2010031339 16.04.2010
(96) 10765230.7 22.02.2012
(87) WO2010121093, 16.04.2010
(97) 2419446, 22.02.2012 en
(54) HUMANIZED ANTIBODY COMPOSITIONS AND METHODS FOR BINDING LYSOPHOSPHATIDIC ACID
(71) Lpath, Inc., 6335 Ferris Square, Suite A, San Diego, CA 92121-3249, US
(72) SABBADINI, Roger A., 12509 Del Sol Road, Lakeside, CA 92040, US
GARLAND, William A., 310 Via Colibri, San Clemente, CA 92672, US
HANSEN, Genevieve, 6335 Ferris Square, Suite A, San Diego, CA 92121-3249, US
JONES, Steven Tarran, 1 Christchurch Crescent, Radlett Hertfordshire WD7 8AG, GB
WILLIAMS, David Gareth, 56 White Horse Drive, Epsom Surrey KT18 7LY, GB
-
- (51) MKP
H05B 37/02 (2006.01) (97) **2438800 ***
(86) US2010001600 02.06.2010
(96) 10727992.9 11.04.2012
(87) WO2010141076, 02.06.2010
(97) 2438800, 11.04.2012 en
(54) VIRTUAL ROOM-BASED LIGHT FIXTURE AND DEVICE CONTROL
(71) Savant Systems LLC., 886 Main Street, Osterville, MA 02655, US
(72) MADONNA, Robert, P., 32 Wianno Avenue, Osterville MA 02655, US
CIPOLLO, Nicholas, J., 32 Wianno Avenue, Osterville MA 02655, US
-
- (51) MKP
A61K 31/5386 (2006.01) (97) **2459572 ***
A61P 25/00 (2006.01)
A61P 11/00 (2006.01)
A61P 9/00 (2006.01)
A61P 37/00 (2006.01)
A61P 35/00 (2006.01)
A61P 19/00 (2006.01)
A61P 29/00 (2006.01)
C07D 519/00 (2006.01)
A61P 13/00 (2006.01)
A61P 17/00 (2006.01)
A61P 27/00 (2006.01)
C07D 498/10 (2006.01)
A61P 1/00 (2006.01)
(86) GB2010051242 29.07.2010
(96) 10752118.9 06.06.2012
(87) WO2011012896, 29.07.2010
(97) 2459572, 06.06.2012 en
(54) SPIROCYCLIC AMIDE DERIVATIVES
(71) AstraZeneca AB, null, 151 85 Södertälje, SE
Pulmagen Therapeutics (Synergy) Limited, The Coach House Greenville Court Britwell Road Burnham, Slough SL1 8DF, GB
(72) ALCARAZ, Lilian, c/o AstraZeneca Intellectual Property AstraZeneca R & D Alderley, Alderley Park, Macclesfield,, Cheshire SK10 4TG, GB
BAILEY, Andrew, AstraZeneca R & D Alderley, Alderley Park, Macclesfield,, Cheshire SK10 4TG, GB
KINDON, Nicholas, c/o AstraZeneca Intellectual Property AstraZeneca R & D Alderley, Alderley Park, Macclesfield,, Cheshire SK10 4TG, GB
-
- (51) MKP
A62B 17/04 (2006.01) (97) **2392384**
A42B 1/24 (2006.01)
A62B 17/00 (2006.01)
(96) 11003763.7 07.12.2011
(97) 2392384, 07.12.2011 de
(54) Protective suit with a lighting device
(71) Tesimax - Altinger GmbH, Leimenstrasse 2, 75242 Neuhausen-Steinegg, DE
(72) Altinger, Sven, Bunsenstrasse 30, 75173 Pforzheim, DE

- (51) MKP
A41C 3/12 (2006.01) (97) **2480102 ***
A41D 27/04 (2006.01)
A41D 27/06 (2006.01)
A44C 25/00 (2006.01)
(86) US2010049948 23.09.2010
(96) 10819436.6 01.08.2012
(87) WO2011038083, 23.09.2010
(97) 2480102, 01.08.2012 en
(54) CLEAVAGE ACCESSORY FOR A BRASSIERE
(71) De Sousa, Michelle Elizabeth, P.O. Box 111585, Naples, FL 34108, US
(72) De Sousa, Michelle Elizabeth, P.O. Box 111585, Naples, FL 34108, US
-
- (51) MKP
A01N 43/56 (2006.01) (97) **2434894 ***
(86) US2010036294 27.05.2010
(96) 10781176.2 04.04.2012
(87) WO2010138656, 27.05.2010
(97) 2434894, 04.04.2012 en
(54) METHODS OF ADMINISTRATION OF THROMBOPOIETIN AGONIST COMPOUNDS
(71) GlaxoSmithKline LLC, One Franklin Plaza 200 North 16th Street, Philadelphia, PA 19102, US
(72) ERICKSON-MILLER, Connie, L., 1250 South Collegeville Road, Collegeville PA 19426, US
JENKINS, Julian, 709 Swedeland Road, King of Prussia PA 19406, US
-
- (51) MKP
C07D 471/00 (2006.01) (97) **2477985 ***
(86) US2010048973 15.09.2010
(96) 10817784.1 25.07.2012
(87) WO2011034954, 15.09.2010
(97) 2477985, 25.07.2012 en
(54) TREATMENT OF CANCER
(71) Cerulean Pharma Inc., 840 Memorial Drive 5th Floor, Cambridge, MA 02139, US
(72) YEN, Yun, 1301 Oaklawn Road, Arcadia, CA 91006, US
SCHLUEP, Thomas, 3030 Hermosa Avenue, Las Crescenta, CA 91214, US
RYAN, John, 26 W. Bells Mill Road, Philadelphia, PA 19118, US
DAVIS, Mark, 575 Laguna Road, Pasadena, CA 91105, US
OLIVER, James, C., 4100 City of Oaks Wynd, Raleigh, NC 27612, US
-
- (51) MKP
A61K 39/395 (2006.01) (97) **2445528 ***
C07K 16/22 (2006.01)
(86) US2010039999 25.06.2010
(96) 10728555.3 02.05.2012
(87) WO2010151770, 25.06.2010
(97) 2445528, 02.05.2012 en
(54) METHOD OF TREATING CANCER WITH DLL4 ANTAGONIST AND CHEMOTHERAPEUTIC AGENT
(71) Regeneron Pharmaceuticals, Inc., 777 Old Saw Mill River Road, Tarrytown, NY 10591, US
(72) NOGUERA-TROISE, Irene, 33 Pilot Lane, Staten Island, NY 10309, US
THURSTON, Gavin, 15 Stewart Place Apt. 1m, White Plains, NY 10603, US
THIBAUT, Alain, 9607 Singleton Drive, Bethesda, MD 20817, US
-
- (51) MKP
C08L 31/04 (2006.01) (97) **2445964 ***
A23G 4/08 (2006.01)
(86) EP2010003750 22.06.2010
(96) 10730077.4 02.05.2012
(87) WO2010149334, 22.06.2010
(97) 2445964, 02.05.2012 en
(54) POLYMER COMPOSITIONS BASED ON POLYVINYL ALCOHOL FOR CHEWING GUM FORMULATIONS WITH A LOW ADHESIVE IMPACT
(71) Vinavil S.p.A., Viale Jenner4, 20159 Milano, IT
(72) PAFFUMI, Salvatore, Viale Jenner 4, I-20159 Milano, IT
FUSO NERINI, Ivan, Viale Jenner 4, I-20159 Milano, IT

- (51) MKP
C07D 413/14 (2006.01) (97) **2421850 ***
A61P 25/30 (2006.01)
C07D 403/14 (2006.01)
A61P 25/24 (2006.01)
A61K 31/44 (2006.01)
C07D 401/12 (2006.01)
A61P 25/22 (2006.01)
C07D 417/14 (2006.01)
A61P 3/04 (2006.01)
A61K 31/501 (2006.01)
A61K 31/506 (2006.01)
(86) EP2010055449 23.04.2010
(96) 10715239.9 29.02.2012
(87) WO2010122151, 23.04.2010
(97) 2421850, 29.02.2012 en
(54) 3 -AZABICYCLO [4.1.0]HEPTANES USED AS OREXIN ANTAGONISTS
(71) Glaxo Group Limited, Glaxo Wellcome House Berkeley Avenue Greenford, Middlesex UB6 0NN, GB
(72) AMANTINI, David, GlaxoSmithKline SpA Via Alessandro Fleming 2, I-37135 Verona, IT
FERRONI, Francesco, GlaxoSmithKline SpA Via Alessandro Fleming 2, I-37135 Verona, IT
GIANOTTI, Massimo, GlaxoSmithKline SpA Via Alessandro Fleming 2, I-37135 Verona, IT
PAVONE, Francesca, GlaxoSmithKline SpA Via Alessandro Fleming 2, I-37135 Verona, IT
DI FABIO, Romano, c/o GlaxoSmithKline SpA Via Alessandro Fleming 2, 37135 Verona, IT
-
- (51) MKP
C12N 15/10 (2006.01) (97) **2435568 ***
C07K 16/00 (2006.01)
C40B 30/02 (2006.01)
C40B 50/06 (2006.01)
C40B 40/08 (2006.01)
(86) EP2010057507 29.05.2010
(96) 10722101.2 04.04.2012
(87) WO2010136598, 29.05.2010
(97) 2435568, 04.04.2012 en
(54) A COLLECTION AND METHODS FOR ITS USE
(71) MorphoSys AG, Lena-Christ-Strasse 48, 82152 Planegg-Martinsried, DE
(72) ENZELBERGER, Markus, Pasteurstrasse 41, 82152 Planegg-Martinsried, DE
PRASSLER, Josef, Kriegerstrasse 8a, 82110 Germering, DE
URLINGER, Stefanie, Astenstrasse 12, 80689 München, DE
HERRMANN, Tanja, Georg-Hager-Str. 4, 81369 München, DE
TILLER, Thomas, Sauerbruchstraße 60, München 81377, DE
-
- (51) MKP
C12N 9/88 (2006.01) (97) **2411513 ***
(86) EP2010053795 23.03.2010
(96) 10713874.5 01.02.2012
(87) WO2010136231, 23.03.2010
(97) 2411513, 01.02.2012 en
(54) MUTANT CyaA POLYPEPTIDES AND POLYPEPTIDE DERIVATIVES SUITABLE FOR THE DELIVERY OF IMMUNOGENIC MOLECULES INTO A CELL
(71) Institut Pasteur, 25-28 rue du Docteur Roux, 75724 Paris Cédex 15, FR
Institute Of Physiology Of AS CR, V.V.I., Videnska 1083, 142 20 Praha 4, CZ
(72) SEBO, Peter, V Liskach 1781, 142 00 Prague 4, CZ
OSICKOVA, Adriana, Vyletni 363/8, 142 00 Prague 4, CZ
MASIN, Jiri, Polska 1646, 25082 Uvaly, CZ
FAYOLLE, Catherine, 20 sentier des ruelles, F-91360 Epinay sur Orge, FR
KRUSEK, Jan, Davidkova 95, 182 20 Prague 8, CZ
BASLER, Marek, Daskova 3075/12, 143 00 Prague 4, CZ
LECLERC, Claude, 13 rue de l'Amiral Roussin, F-75015 Paris, FR
OSICKA, Radim, Vyletni 363/8, 142 00 Praha 4, CZ

- (51) MKP
A61K 39/00 (2006.01) (97) **2413957 ***
C07K 14/47 (2006.01)
C07K 16/18 (2006.01)
G01N 33/53 (2006.01)
(86) EP2010054418 01.04.2010
(96) 10713172.4 08.02.2012
(87) WO2010115843, 01.04.2010
(97) 2413957, 08.02.2012 en
(54) PHARMACEUTICAL COMPOSITION
(71) AC Immune S.A., EPFL-PSE Building B, 1015 Lausanne, CH
K. U. Leuven Research & Development, Minderbroederstraat
8A Box 5051, 3000 Leuven, BE
(72) PFEIFER, Andrea, Route de Fenil 16A, CH-1806 St.-Légier, CH
MUHS, Andreas, Avenue des Cerisiers 39B, CH-1009 Pully, CH
VAN LEUVEN, Fred, Hertogenlaan 18, B-3210 Linden, BE
PHILGREN BOSCH, Maria, Chemin du Tessin 6B, CH-1052
Mont-sur-Lausanne, CH
-
- (51) MKP
C12N 9/10 (2006.01) (97) **2443234 ***
C12N 15/82 (2006.01)
(86) EP2010003749 10.06.2010
(96) 10731460.1 25.04.2012
(87) WO2010145846, 10.06.2010
(97) 2443234, 25.04.2012 en
(54) NICOTIANA BENTHAMIANA PLANTS DEFICIENT IN
XYLOSYLTRANSFERASE ACTIVITY
(71) Icon Genetics GmbH, Weinbergweg 22, 06120 Halle (Saale),
DE
(72) WETERINGS, Koen, 2805 Westwick Court, Raleigh, NC 27615,
US
VAN ELDIK, Gerben, Hekers 21, B-9052 Zwijnaarde, BE
-
- (51) MKP
C12Q 1/68 (2006.01) (97) **2476758 ***
A61K 31/7056 (2006.01)
G01N 33/53 (2006.01)
A61P 1/16 (2006.01)
A61K 38/21 (2006.01)
G01N 37/00 (2006.01)
(86) JP2010065306 07.09.2010
(96) 10813839.7 18.07.2012
(87) WO2011027893, 07.09.2010
(97) 2476758, 18.07.2012 en
(54) METHOD FOR PREDICTION OF THERAPEUTIC EFFECT ON
CHRONIC HEPATITIS C
(71) Murakami, Yoshiki, Center for Genomic Medicine Kyoto
University Graduate School of Medicine Konoe-cho Yoshida
Sakyo-ku, Kyoto-shi, Kyoto 606-8501, JP
(72) Murakami, Yoshiki, Center for Genomic Medicine Kyoto
University Graduate School of Medicine Konoe-cho Yoshida
Sakyo-ku, Kyoto-shi, Kyoto 606-8501, JP
-
- (51) MKP
A61K 9/16 (2006.01) (97) **2403481 ***
A61K 9/20 (2006.01)
A61K 31/195 (2006.01)
(86) US2010026427 05.03.2010
(96) 10708475.8 11.01.2012
(87) WO2010102252, 05.03.2010
(97) 2403481, 11.01.2012 en
(54) ORAL DOSAGE FORMS HAVING A HIGH LOADING OF A
GABAPENTIN PRODRUG
(71) XenoPort, Inc., 3410 Central Expressway, Santa Clara, CA
95051, US
(72) KARABORNI, Sami, 11753 Trinity Spring Court, Cupertino,
California 95014, US
KIDNEY, David J., 611 South 13th St., San Jose, California
95112, US
MAURER, Laura E., 860 East Evelyn Ave., Sunnyvale,
California 94086, US
-
- (51) MKP
C12N 15/866 (2006.01) (97) **2480678 ***
C12N 15/867 (2006.01)
C12N 7/02 (2006.01)
(86) EP2011065090 01.09.2011
(96) 11752530.3 01.08.2012
(87) WO2012028681, 01.09.2011
(97) 2480678, 01.08.2012 en
(54) STABLE PRODUCTION OF LENTIVIRAL VECTORS
(71) Molmed SpA, Via Olgettina 58, 20132 Milan, IT
BOVOLENTA, Chiara, MolMed SpA Via Olgettina 58, I-20132
Milan, IT
STORNAIUOLO, Anna, MolMed SpA Via Olgettina 58, I-20132
Milan, IT
RIZZARDI, Paolo, MolMed SpA Via Olgettina 58, I-20132 Milan,
IT
MAVILIO, Fulvio, Istituto Scientifico H. San Raffaele Via
Olgettina 58, I-20132 Milan, IT
-
- (51) MKP
A61K 31/395 (2006.01) (97) **2448929 ***
A61P 35/00 (2006.01)
C07D 273/08 (2006.01)
(86) FR2010050986 20.05.2010
(96) 10728799.7 09.05.2012
(87) WO2011001052, 20.05.2010
(97) 2448929, 09.05.2012 fr
(54) NOVEL CONJUGATES, PREPARATION THEREOF, AND
THERAPEUTIC USE THEREOF
(71) SANOFI, 54 rue La Boétie, 75008 Paris, FR
(72) BOUCHARD, Hervé, c/o Sanofi-aventis Département Brevets
174 avenue de France, F-75013 Paris, FR
BRUN, Marie-Priscille, c/o Sanofi-aventis Département Brevets
174 avenue de France, F-75013 Paris, FR
COMMERÇON, Alain, c/o Sanofi-aventis Département Brevets
174 avenue de France, F-75013 Paris, FR
ZHANG, Jidong, c/o Sanofi-aventis Département Brevets 174
avenue de France, F-75013 Paris, FR
-
- (51) MKP
B01J 20/24 (2006.01) (97) **2488294 ***
(86) IN2010000675 12.10.2010
(96) 10823140.8 22.08.2012
(87) WO2011045814, 12.10.2010
(97) 2488294, 22.08.2012 en
(54) HONEY COMB MATRIX COMPRISING MACRO POROUS
DESICCANT, PROCESS AND USE THEREOF
(71) Desiccant Rotors International Pvt. Ltd., 20 Rajpur Road, Delhi
110054, IN
(72) PAHWA, Deepak, 20 Rajpur Road, Delhi 110054, IN
CHOUDHARY, Anil Kumar, I-39 2nd Floor South City- II Sohna
Road Haryana, Gurgaon, IN
-
- (51) MKP
H02K 13/00 (2006.01) (97) **2465185 ***
(86) EP2010061569 10.08.2010
(96) 10744551.2 20.06.2012
(87) WO2011018438, 10.08.2010
(97) 2465185, 20.06.2012 de
(54) COLLECTOR RING ARRANGEMENT FOR A ROTATING
ELECTRIC MACHINE
(71) ALSTOM Hydro France, 3 Avenue André Malraux, 92300
Levallois Perret, FR
(72) SCHWERY, Alexander, Eichweg 24, CH-5024 Küttigen, CH
OKAI, Ricardo, Naoki, Mellingerstrasse 8, CH-5442 Fislisbach,
CH
BAUMEISTER, Stefan, Hofäckerweg 5, 79790 Rheinheim, DE
-
- (51) MKP
B60D 1/06 (2006.01) (97) **2269844**
(96) 10450113.5 05.01.2011
(97) 2269844, 05.01.2011 de
(54) Towing eye
(71) Scharmüller, Josef, Saxigen 14, 4892 Fornach, AT
Scharmüller, Josef, jun., Saxigen 14, 4892 Fornach, AT
Scharmüller, Josef Ing., Saxigen 14, 4892 Fornach, AT
Scharmüller, Josef, Saxigen 14, 4892 Fornach, AT
Scharmüller, Christine, Saxigen 14, 4892 Fornach, AT

- (51) MKP
G10K 5/00 (2006.01) (97) **2416312**
 (96) 10180479.7 08.02.2012
 (97) 2416312, 08.02.2012 en
 (54) Whistle with finger grip
 (71) Fox 40 International Inc., 560 Arvin Avenue, Stoney Creek, ON L8E 5P1, CA
 (72) Foxcroft, Ron, 1206 Appleford Lane, Burlington Ontario L7P 3M2, CA
-
- (51) MKP
E04C 3/08 (2006.01) (97) **2483492 ***
E04C 3/09 (2006.01)
 (86) EP2010005891 27.09.2010
 (96) 10766241.3 08.08.2012
 (87) WO2011038879, 27.09.2010
 (97) 2483492, 08.08.2012 de
 (54) THIN-WALLED, COLD-FORMED LIGHTWEIGHT STRUCTURAL PROFILE ELEMENT AND METHOD FOR PRODUCING SUCH A PROFILE ELEMENT
 (71) Protektorwerk Florenz Maisch GmbH & Co. KG, Viktoriastrasse 58, 76571 Gaggenau, DE
 (72) MAISCH, Christof, Baden-Badener Strasse 15, 76571 Gaggenau, DE
-
- (51) MKP
A61P 33/02 (2006.01) (97) **2413934 ***
A61P 37/02 (2006.01)
A61K 31/454 (2006.01)
A61K 45/06 (2006.01)
 (86) EP2010054177 30.03.2010
 (96) 10711405.0 08.02.2012
 (87) WO2010112497, 30.03.2010
 (97) 2413934, 08.02.2012 en
 (54) DOMPERIDONE AT A LOW DAILY DOSE FOR USE IN THE TREATMENT OR PREVENTION OF A DISEASE ASSOCIATED WITH AN ALTERATION OF THE IMMUNE RESPONSE
 (71) Laboratorios del. Dr. Esteve, S.A., Avda Mare de Deu de Montserrat 221, 08041 Barcelona, ES
 (72) SABATE ELIAS, David, Laboratorios Del Dr. Esteve S.a. Avda. Mare de Déu de Montserrat 221, E-08041 Barcelona, ES
 HOMEDES BEGUER, Josep M., Laboratorios Del Dr. Esteve S.a. Avda. Mare de Déu de Montserrat 221, E-08041 Barcelona, ES
 GÓMEZ OCHOA, Pablo, Universidad de Zaragoza Facultad de Veterinaria - Miguel Servet 177, E-50013 Zaragoza, ES
-
- (51) MKP
A61K 9/00 (2006.01) (97) **2440177 ***
A61K 31/5377 (2006.01)
A61K 9/14 (2006.01)
 (86) IB2010001659 08.06.2010
 (96) 10742875.7 18.04.2012
 (87) WO2010143074, 08.06.2010
 (97) 2440177, 18.04.2012 en
 (54) PHARMACEUTICAL DOSAGE FORM FOR ORAL ADMINISTRATION OF A BCL-2 FAMILY INHIBITOR
 (71) Abbott GmbH & Co. KG, Max-Planck-Ring 2, 65205 Wiesbaden, DE
 (72) PACKHAEUSER, Claudia, Burgstrasse 7, 68165 Mannheim, DE
 STEIGER, Norbert, Druslacherstrasse 1, 67360 Lingenfeld, DE
 LIEPOLD, Bernd, Birkenweg 44, 69221 Dossenheim, DE
 KOSTELAC, Drazen, R4 15, 68161 Mannheim, DE
 KNOBLOCH, Martin, Medenheimer Strasse 22a, 67141 Neuhofen, DE

- (51) MKP
A61P 3/10 (2006.01) (97) **2406256 ***
A61K 31/4245 (2006.01)
C07D 413/14 (2006.01)
 (86) GB2010050442 12.03.2010
 (96) 10709926.9 18.01.2012
 (87) WO2010103335, 12.03.2010
 (97) 2406256, 18.01.2012 en
 (54) COMPOUNDS FOR THE TREATMENT OF METABOLIC DISORDERS
 (71) Prosidion Limited, Windrush Court Watlington Road, Oxford, Oxfordshire OX4 6LT, GB
 (72) BARBA, Oscar, Prosidion Limited Windrush Court Watlington Road, Oxford Oxfordshire OX4 6LT, GB
 DAVIS, Susan, Helen, Prosidion Limited Windrush Court Watlington Road, Oxford Oxfordshire OX4 6LT, GB
 FYFE, Matthew, Colin, Thor, Prosidion Limited Windrush Court Watlington Road, Oxford Oxfordshire OX4 6LT, GB
 JEEVARATNAM, Revathy, Perpetua, Prosidion Limited Windrush Court Watlington Road, Oxford Oxfordshire OX4 6LT, GB
 SCHOFIELD, Karen, Lesley, Prosidion Limited Windrush Court Watlington Road, Oxford Oxfordshire OX4 6LT, GB
 STAROSKE, Thomas, Prosidion Limited Windrush Court Watlington Road, Oxford Oxfordshire OX4 6LT, GB
 STEWART, Alan, John, William, Prosidion Limited Windrush Court Watlington Road, Oxford Oxfordshire OX4 6LT, GB
 SWAIN, Simon, Andrew, Prosidion Limited Windrush Court Watlington Road, Oxford Oxfordshire OX4 6LT, GB
 WITHALL, David, Matthew, Prosidion Limited Windrush Court Watlington Road, Oxford Oxfordshire OX4 6LT, GB
-
- (51) MKP
A61K 48/00 (2006.01) (97) **2428229 ***
C12N 15/861 (2006.01)
 (86) ES2010000196 05.05.2010
 (96) 10772050.0 14.03.2012
 (87) WO2010128182, 05.05.2010
 (97) 2428229, 14.03.2012 en
 (54) ONCOLYTIC ADENOVIRUSES FOR TREATING CANCER
 (71) Fundació Privada Institut D'investigació Biomèdica, Gran Via s/n - km. 2 7, 08907 L'Hospitalet de Llobregat, ES
 Institut Català D'Oncologia, Gran Via s/n 199-203, 08907 L'Hospitalet de Llobregat, ES
 (72) GUEDAN CARRIÓ, Sònia, Sant Ramon 6 baixos, E-08242 Manresa, ES
 CASCALLO PIQUERAS, Manel Maria, Pg. Circumval.lació 54 2n, E-08790 Gelida, ES
 ALEMANY BONASTRE, Ramon, Passatge del Cim 19, E-08860 Castelldefels, ES
-
- (51) MKP
F23L 13/06 (2006.01) (97) **2430366 ***
F16K 15/02 (2006.01)
F23J 13/08 (2006.01)
F23L 11/00 (2006.01)
 (86) IT2010000202 06.05.2010
 (96) 10727980.4 21.03.2012
 (87) WO2010131282, 06.05.2010
 (97) 2430366, 21.03.2012 en
 (54) FUME-DISCHARGE DEVICE FOR BOILERS
 (71) LN 2 S.R.L. a socio unico, Via Deledda, 10-12, 62010 Montecassiano (MC), IT
 (72) FRATICELLI, Gabriele, Vie Piergili 2, I-62011 Cingoli (MC), IT
-
- (51) MKP
E03D 9/03 (2006.01) (97) **2270286**
E03D 9/02 (2006.01)
 (96) 10167413.3 05.01.2011
 (97) 2270286, 05.01.2011 en
 (54) Dispenser of active substances for WC bowls
 (71) RE.LE.VI. S.p.a., Via Postumia, 1, 46040 Rodigo (Mantova), IT
 (72) Pagani, Fabio, RE.LE.VI. - S.P.A. 1, Via Postumia, 46040, Rodigo (Mantova), IT

- (51) MKP
C07C 229/22 (2006.01) (97) **2445861 ***
A61P 9/08 (2006.01)
A61P 29/00 (2006.01)
C07C 229/12 (2006.01)
A61K 31/205 (2006.01)
C07C 69/157 (2006.01)
A61P 7/02 (2006.01)
A61K 31/616 (2006.01)
C07C 243/40 (2006.01)
(86) LV201000007 21.06.2010
(96) 10735094.4 02.05.2012
(87) WO2010151095, 21.06.2010
(97) 2445861, 02.05.2012 en
(54) NOVEL ACETYLSALICYLIC ACID SALTS
(71) Tetra, Sia, Aizkraukles iela 21, LV-1006 Riga, LV
(72) KALVINS, Ivars, Libieshu iela 25, LV-5052 Ikshkile, LV
BIRMANS, Anatolijs, Hospitalu 8-35, LV-1013 Riga, LV
VEVERIS, Maris, Vejas iela 10/2 Apt. 20, LV-1035 Riga, LV
LABEDEVIS, Antons, Kaivas iela 50/3-56b, LV-1021 Riga, LV
MISNOVS, Anatolijs, Vidzemes aleja 5-53, LV-1024 Riga, LV
-
- (51) MKP
A61K 47/10 (2006.01) (97) **2491931 ***
A61K 9/70 (2006.01)
A61K 31/445 (2006.01)
A61K 47/14 (2006.01)
A61P 25/28 (2006.01)
A61K 47/34 (2006.01)
A61K 47/22 (2006.01)
A61K 9/08 (2006.01)
(86) JP2010068260 18.10.2010
(96) 10824887.3 29.08.2012
(87) WO2011049038, 18.10.2010
(97) 2491931, 29.08.2012 en
(54) TRANSDERMALLY ABSORBABLE DONEPEZIL-CONTAINING
PREPARATION
(71) Teikoku Seiyaku Co., Ltd., 567 Sanbonmatsu, Higashikagawa-
shi, Kagawa 769-2695, JP
(72) KAWAKAMI, Satoshi, c/o TEIKOKU SEIYAKU CO. LTD. 567
Sanbonmatsu, Higashikagawa-shi Kagawa 769-2695, JP
YAMAJI, Masahiro, c/o TEIKOKU SEIYAKU CO. LTD. 567
Sanbonmatsu, Higashikagawa-shi Kagawa 769-2695, JP
-
- (51) MKP
A61K 51/00 (2006.01) (97) **2467170 ***
(86) US2010046245 20.08.2010
(96) 10810703.8 27.06.2012
(87) WO2011022707, 20.08.2010
(97) 2467170, 27.06.2012 en
(54) VESICULAR FORMULATIONS
(71) Targeted Delivery Technologies Limited, Palazzo Pietro Stiges
90, Strait Street, Valleta, MT
(72) HENRY, William, No. 1 Kemps Piece High Street, Haddenham,
Bucks HP17 8LA, GB
KROON, Henk-Andre, 89 Roseville Road, Westport,
Connecticut 06880, US
-
- (51) MKP
G01N 33/53 (2006.01) (97) **2475769 ***
A61K 38/45 (2006.01)
A61P 35/02 (2006.01)
C12N 9/10 (2006.01)
A61K 31/415 (2006.01)
(86) IB2010053998 06.09.2010
(96) 10813423.0 18.07.2012
(87) WO2011027330, 06.09.2010
(97) 2475769, 18.07.2012 en
(54) INHIBITION OF HISTONE ACETYLTRANSFERASES BY
CTK7A AND METHODS THEREOF
(71) Jawaharlal Nehru Centre for Advanced Scientific Research,
Jakkur, Bangalore 560 064, Karnataka, IN
(72) KUNDU, Tapas, Kumar, JJ-D1 Type Quarters Jawaharlal Nehru
Centre for Advanced Scientific Research Jakkur Bangalore,
Karnataka 560064, IN
ARIF, Mohammed, Quarter No. 1474 Sector: 12/A Bokaro Steel
City Bokaro, Jharkhand 827012, IN
MANTELINGU, Kempegowra, Makanahalli Bannur P.O. T.N. Pur
Taluk, Mysore District Karnataka 570001, IN
SRINIVASACHAR, Gopinath, Kodaganur, No. 20, Srinivasa
Behind Balaji Kalyana Mantapam 6th Main Road 5th Cross BSK
3rd Stage Bangalore, Karnataka 560085, IN
-
- (51) MKP
A61J 1/00 (2006.01) (97) **2451717 ***
B65D 30/00 (2006.01)
B65F 1/00 (2006.01)
(86) CA2010000806 27.05.2010
(96) 10796606.1 16.05.2012
(87) WO2011003174, 27.05.2010
(97) 2451717, 16.05.2012 en
(54) DISPOSAL SYSTEM AND METHOD FOR DISPOSABLE
ITEMS
(71) Jauvin, Michel, 209 rue St-Marcel App. 212, Drummondville,
Québec J2B 2E1, CA
(72) Jauvin, Michel, 209 rue St-Marcel App. 212, Drummondville,
Québec J2B 2E1, CA
-
- (51) MKP
C07D 309/32 (2006.01) (97) **2435415 ***
C07D 493/10 (2006.01)
(86) EP2010057121 25.05.2010
(96) 10720780.5 04.04.2012
(87) WO2010136431, 25.05.2010
(97) 2435415, 04.04.2012 en
(54) SPIRO EPOXIDES AS INTERMEDIATES
(71) Syngenta Limited, European Regional Centre Priestley Road
Surrey Research Park, Guildford, Surrey GU2 7YH, GB
(72) SCUTT, James Nicholas, Syngenta Limited Jealotts Hill
International Research Center, Bracknell Berkshire RG42 6EY,
GB
-
- (51) MKP
C07H 1/00 (2006.01) (97) **2480559 ***
C07H 19/23 (2006.01)
(86) US2010049508 20.09.2010
(96) 10757699.3 01.08.2012
(87) WO2011035250, 20.09.2010
(97) 2480559, 01.08.2012 en
(54) PROCESSES AND INTERMEDIATES FOR THE
PREPARATION OF 1'-SUBSTITUTED CARBA-NUCLEOSIDE
ANALOGS
(71) Gilead Sciences, Inc., 333 Lakeside Drive, Foster City, CA
94404, US
(72) BUTLER, Thomas, 601 Baltic Circle 605, Redwood City, CA
94065, US
CHO, Aesop, 1656 Notre Dame Drive, Mountain View, CA
94040, US
GRAETZ, Benjamin, R., 2925 Isabelle Avenue, San Mateo, CA
94403, US
KIM, Choung, U., 1750 Elizabeth Street, San Carlos, CA 94070,
US
METOBO, Samuel, E., 35329 Severn Drive, Newark, CA 94560,
US
SAUNDERS, Oliver, L., 615 Port Drive 202, San Mateo, CA
94404, US
WALTMAN, Andrew, W., 19a Noe Street, San Francisco, CA
94114, US
XU, Jie, 812 Rigel Lane, Foster City, CA 94404, US
ZHANG, Lijun, 12525 Minorca Ct., Los Altos Hills, CA 94022,
US
-
- (51) MKP
A61K 31/60 (2006.01) (97) **2470185 ***
A61K 31/573 (2006.01)
A61P 29/00 (2006.01)
(86) IB2010053812 25.08.2010
(96) 10754586.5 04.07.2012
(87) WO2011024122, 25.08.2010
(97) 2470185, 04.07.2012 en
(54) PHARMACEUTICAL COMPOSITIONS FOR TREATING IBD
(71) Disphar International B.V., Winkelskamp 6, 7255 PZ Hengelo,
NL
Nordic Pharma, 216, Boulevard Saint Germain, 75007 Paris, FR
SCHRAM, Hans, 38 rue des Vendangeurs, F-94440 Marolles
En Brie, FR
UGWOKE, Michael Ikechukwu, Juno 7, NL-1188ER
Amstelveen, NL
BUTTAFOCO, Laura, Eendstraat 17, NL-3582EZ Utrecht, NL

(51) MKP
F23K 3/02 (2006.01) (97) **2486326 ***
 (86) EP2010006149 08.10.2010
 (96) 10770996.6 15.08.2012
 (87) WO2011042193, 08.10.2010
 (97) 2486326, 15.08.2012 de
 (54) METERING SYSTEM, DENSE PHASE CONVEYING SYSTEM AND METHOD FOR SUPPLYING BULK MATERIAL IN POWDER FORM
 (71) Linde AG, Klosterhofstraße 1, 80331 München, DE
 (72) KRETSCHMER, Horst, Am Wäldchen 5, 09600 Weißenborn, DE
 KLEEBERG, Jörg, Hornstrasse 1, 09599 Freiberg, DE
 RÜGER, Dietmar, Carl-Bantzer-Strasse 7, 01728 Bannewitz-Goppeln, DE
 SCHULZE, Olaf, Lindenweg 16, 09633 Tuttendorf, DE
 EICHHORN, Christian, Schmiedestrasse 8, 09599 Freiberg, DE

(51) MKP
A61K 31/365 (2006.01) (97) **2419131 ***
A61K 39/15 (2006.01)
A61P 31/00 (2006.01)
A61K 39/215 (2006.01)
A61K 31/335 (2006.01)
 (86) NZ2010000067 14.04.2010
 (96) 10764714.1 22.02.2012
 (87) WO2010120195, 14.04.2010
 (97) 2419131, 22.02.2012 en
 (54) MACROCYCLIC LACTONE COMBINATION COMPOSITIONS, VACCINES AND METHODS FOR PRODUCING SAME
 (71) Merial Ltd., 3239 Satellite Blvd., Duluth, GA 30096-4640, US
 (72) HOLMES, Robert William Lachlan, 15 Calman Place Chatswood, North Shore City Auckland 0626, NZ
 RAZZAK, Majid Hameed Abdul, 59 Blue Bird Crescent, Albany Auckland 0632, NZ

(51) MKP
C13K 1/02 (2006.01) (97) **2430196 ***
C12P 7/10 (2006.01)
 (86) GB2010000791 20.04.2010
 (96) 10714946.0 21.03.2012
 (87) WO2010128272, 20.04.2010
 (97) 2430196, 21.03.2012 en
 (54) PROCESS FOR THE PRODUCTION OF ALCOHOLS
 (71) Weyland AS, Lonningsflaten 22, 5258 Blomsterdalen, NO
 Cockbain, Julian, 42 Southmoor Road, Oxford OX2 6RD, GB
 (72) WEYDAHL, Karl, Ragnar, Weyland AS Espehaugen 25, N-5258 Blomsterdalen, NO

(51) MKP
B01F 7/22 (2006.01) (97) **2405995 ***
B01F 7/04 (2006.01)
B01F 7/06 (2006.01)
B01F 7/00 (2006.01)
B01F 7/18 (2006.01)
 (86) FI2010050157 01.03.2010
 (96) 10750416.9 18.01.2012
 (87) WO2010103172, 01.03.2010
 (97) 2405995, 18.01.2012 en
 (54) IMPELLER FOR MIXING SLURRY IN METALLURGICAL PROCESSES
 (71) Outotec OYJ, Riihitontuntie 7, 02200 Espoo, FI
 (72) LILJA, Launo, Liisankatu 19 A 13, FI-28100 Pori, FI
 TIJHONEN, Jari, Päkintie 26, FI-28330 Pori, FI
 NYMAN, Bror, Ruispolku 1, FI-28450 Vanha-Ulvila, FI
 HIRSI, Tuomas, Hiomotie 46 a 24, FI-00380 Helsinki, FI
 VAARNO, Jussi, Omenatie 41, FI-02450 Sundsberg, FI
 PERÄÄHO, Jouko, Merimiehenkatu 18, 23500 Usikaupunki, FI

(51) MKP
D21H 17/67 (2006.01) (97) **2445710 ***
D21H 27/26 (2006.01)
E04C 2/04 (2006.01)
D21H 13/40 (2006.01)
D21H 21/18 (2006.01)
B32B 13/08 (2006.01)
D21H 23/22 (2006.01)
D21H 19/38 (2006.01)
 (86) US2010039296 21.06.2010
 (96) 10734593.6 02.05.2012
 (87) WO2010151499, 21.06.2010
 (97) 2445710, 02.05.2012 en
 (54) SEED CRYSTAL COATING FOR GYPSUM WALLBOARD FACING
 (71) Hercules Incorporated, Hercules Plaza 1313 N. Market Street, Wilmington, DE 19894-0001, US
 (72) HOHN, Wilfried, Adolf, Reinoldweg 12, 50374 Erftstadt, DE
 KINDLER, Alexander, Adolphe, Angermunder Weg 38, 40880 Ratingen, DE
 KRAUSE, Joachim, Remscheiderstr. 259, 42855, DE
 MORGENROTH, Christian, Loskenweg 45b, 45141 Essen, DE
 RENNERT, Brigitte, Breitestrasse 60, 41460 Neuss, DE

(51) MKP
A61K 47/48 (2006.01) (97) **2485767 ***
 (86) EP2010064874 06.10.2010
 (96) 10760719.4 15.08.2012
 (87) WO2011042450, 06.10.2010
 (97) 2485767, 15.08.2012 en
 (54) CARRIER LINKED PALIPERIDONE PRODRUGS
 (71) Ascendis Pharma A/S, Tuborg Boulevard 12, 2900 Hellerup, DK
 (72) HERSEL, Ulrich, Fritz-Frey-Strasse 8, 69121 Heidelberg, DE
 RAU, Harald, Talstrasse 41i, 69221 Dossenheim, DE
 MAITRO, Guillaume, Rheingoldstr. 157, 68199 Mannheim, DE
 WEGGE, Thomas, Kurfürstenanlage 45, 69115 Heidelberg, DE

(51) MKP
B60P 1/44 (2006.01) (97) **2384928**
 (96) 10004693.7 09.11.2011
 (97) 2384928, 09.11.2011 de
 (54) Loading platform
 (71) Sørensen Hydraulik, Zweigniederlassung, Ulfborg, Filial af Sørensen Hydraulik GmbH, Tyskland, Industriareale 54, 6990 Ulfborg, DK
 (72) Jensen, Jens, Herman, Industriareale 60, 6990 Ulfborg, DK

(51) MKP
C12Q 1/68 (2006.01) (97) **2467501 ***
 (86) US2010046004 19.08.2010
 (96) 10813092.3 27.06.2012
 (87) WO2011049669, 19.08.2010
 (97) 2467501, 27.06.2012 en
 (54) GENETIC FINGERPRINTING AND IDENTIFICATION METHOD
 (71) E. I. du Pont de Nemours and Company, 1007 N. Market Street, Wilmington, DE 19898, US
 (72) BURNS, Frank R., 2625 Sorrento Road, Philadelphia, Pennsylvania 19131, US
 PENG, Xuan, 106 Cardinal Circle, Hockessin, Delaware 19707, US

(51) MKP
A63H 27/00 (2006.01) (97) **2448645 ***
 (86) US2010055574 05.11.2010
 (96) 10829137.8 09.05.2012
 (87) WO2011057048, 05.11.2010
 (97) 2448645, 09.05.2012 en
 (54) FLYING SHARK
 (71) William Mark Corporation, 112 North Harvard Suite 229, Claremont, California 91711, US
 (72) FORTI, William Mark, 112 North Harvard 229, Claremont, California 91711, US
 ENGLISH, Blake, 112 North Harvard Suite 229, Claremont, California 91711, US

(51) MKP
B27B 25/04 (2006.01) (97) **2248643**
B27B 5/22 (2006.01)
 (96) 10447013.3 10.11.2010
 (97) 2248643, 10.11.2010 en
 (54) A sawing device for firewood trunks
 (71) Verschatsse, Pol, Hoogstraat 9, 8531 Bavikhove, BE
 (72) Verschatsse, Pol, Hoogstraat 9, 8531 Bavikhove, BE

- (51) MKP
A61K 9/20 (2006.01) (97) **2435029 ***
A61K 9/16 (2006.01)
- (86) EP2010003202 26.05.2010
(96) 10723926.1 04.04.2012
(87) WO2010136193, 26.05.2010
(97) 2435029, 04.04.2012 en
(54) PHARMACEUTICAL COMPOSITION COMPRISING TAMSULOSIN
(71) Krka Tovarna Zdravil, D.D., Novo Mesto, Smarjeska cesta 6, 8501 Novo Mesto, SI
(72) SEDMAK, Gregor, Palmejeva 30, SL-1000 Ljubljana, SI
STEFANIC, Marko, Tomsiceva ulica 14, SL-8340 Crnomelj, SI
-
- (51) MKP
A61H 3/00 (2006.01) (97) **2233120**
A61H 3/04 (2006.01)
- (96) 10157909.2 29.09.2010
(97) 2233120, 29.09.2010 de
(54) Walking aid
(71) Ruepp, Thomas, Stockertstrasse 2, 4132 Muttenz, CH
(72) Ruepp, Thomas, Stockertstrasse 2, 4132 Muttenz, CH
-
- (51) MKP
F02M 61/14 (2006.01) (97) **2422070 ***
F02M 55/00 (2006.01)
F02M 61/16 (2006.01)
- (86) EP2010055390 22.04.2010
(96) 10716329.7 29.02.2012
(87) WO2010122125, 22.04.2010
(97) 2422070, 29.02.2012 en
(54) FUEL INJECTOR
(71) Delphi Technologies Holding S.à.r.l., Avenue de Luxembourg, 4940 Bascharage, LU
(72) LECLUSE, Eric, 40 Rue De Vendome, F-41100 Pezou, FR
ENTERS, Richard, 12 Rue Francois Villon, F-41350 Vineuil, FR
BIMBENET, Bruno, 13 Bis Rue Du Bon Levraut, F-41350 Saint Claude De Diray, FR
-
- (51) MKP
A61P 9/10 (2006.01) (97) **2448933 ***
A61K 31/55 (2006.01)
C07D 403/12 (2006.01)
- (86) US2010040125 28.06.2010
(96) 10728558.7 09.05.2012
(87) WO2011002696, 28.06.2010
(97) 2448933, 09.05.2012 en
(54) TRANS-4-[[[(5S)-5-[[[3,5-BIS(TRIFLUOROMETHYL)PHENYL]METHYL](2-METHYL-2H-TETRAZOL-5-YL)AMINO]-2,3,4,5-TETRAHYDRO-7,9-DIMETHYL-1H-1-BENZAZEPIN-1-YL]METHYL]-CYCLOHEXANECARBOXYLIC ACID
(71) Eli Lilly and Company, Lilly Corporate Center, Indianapolis, IN 46285, US
(72) CHEN, Xinchao, Eli Lilly And Company Lilly Corporate Center, Indianapolis, Indiana 46285, US
FRANK, Scott, Alan, Eli Lilly And Company Lilly Corporate Center, Indianapolis, Indiana 46285, US
REMICK, David, Michael, Eli Lilly And Company Lilly Corporate Center, Indianapolis, Indiana 46285, US
PEDERSEN, Steven, Wayne, Eli Lilly And Company Lilly Corporate Center, Indianapolis, Indiana 46285, US
-
- (51) MKP
G01N 33/564 (2006.01) (97) **2425250 ***
- (86) US2010032572 27.04.2010
(96) 10716450.1 07.03.2012
(87) WO2010126890, 27.04.2010
(97) 2425250, 07.03.2012 en
(54) METHODS FOR MONITORING THE EFFICACY OF ANTI-IL-2R ANTIBODIES IN MULTIPLE SCLEROSIS PATIENTS
(71) Abbott Biotherapeutics Corp., 1500 Seaport Boulevard, Redwood City CA 94063, US
(72) SHERIDAN III, James Peter, 1058 Tulane Drive, Mountain View California 94040, US
-
- (51) MKP
E21B 43/10 (2006.01) (97) **2414626 ***
E21B 23/01 (2006.01)
E21B 33/04 (2006.01)
- (86) NO2010000124 31.03.2010
(96) 10759087.9 08.02.2012
(87) WO2010114389, 31.03.2010
(97) 2414626, 08.02.2012 en
(54) LINER HANGER
(71) I-TEC AS, Fabrikkeveien 28, 4033 Stavanger, NO
(72) BRÆKKE, Kristoffer, Kvernhusveien 1B, N-4025 Stavanger, NO
-
- (51) MKP
A61M 5/24 (2006.01) (97) **2437820 ***
A61M 5/315 (2006.01)
A61M 5/31 (2006.01)
- (86) EP2010057485 28.05.2010
(96) 10722097.2 11.04.2012
(87) WO2010139639, 28.05.2010
(97) 2437820, 11.04.2012 en
(54) DOSE SETTING MECHANISM FOR PRIMING A DRUG DELIVERY DEVICE
(71) Sanofi-Aventis Deutschland GmbH, Brüningstraße 50, 65929 Frankfurt, DE
(72) JONES, Christopher, 153 High Street, Broadway Worcestershire WR12 7AL, GB
-
- (51) MKP
E01F 8/00 (2006.01) (97) **2434055**
C08K 5/5419 (2006.01)
C08K 5/549 (2006.01)
C08J 5/04 (2006.01)
- (96) 11007521.5 28.03.2012
(97) 2434055, 28.03.2012 en
(54) The fibre-reinforced acrylic panel and the process for its manufacture
(71) Akripol proizvodnja in predelava polimerov, d.d., Prijateljeva 11, 8210 Trebnje, SI
(72) Japeli, Bostjan, Dr., Seidlova Cesta 34, 8000 Novo Mesto, SL
Brulc, Petra, Dr., Studljanska cesta 81, 1230 Domzale, SL
Popelar, Matjaz, Spodnji hotic 47, 1270 Litija, SL
Bundersek, Alenka, Podborst 22, 8297 Sentjanz, SL
Bitenc, Blaz, Jurckova cesta 5b, 1000 Ljubljana, SL
-
- (51) MKP
C07C 233/06 (2006.01) (97) **2448911 ***
C07C 209/62 (2006.01)
C07C 29/40 (2006.01)
C07C 211/35 (2006.01)
C07C 31/135 (2006.01)
C07C 231/06 (2006.01)
- (86) EP2010003920 28.06.2010
(96) 10734672.8 09.05.2012
(87) WO2011000537, 28.06.2010
(97) 2448911, 09.05.2012 en
(54) METHOD OF PREPARING 1-CHLOROACETAMIDO-1,3,3,5,5-PENTAMETHYLCYCLOHEXANE
(71) Merz Pharma GmbH & Co. KGaA, Eckenheimer Landstrasse 100, 60318 Frankfurt Main, DE
(72) KOLLER, Herbert, Quellenstrasse 155A/65, 1100 Wien, AT
PYERIN, Michael, Enzersdorferstrasse 3/2/8, 2345 Brunn am Gebirge, AT
-
- (51) MKP
A01N 43/00 (2006.01) (97) **2445343 ***
- (86) US2010039878 24.06.2010
(96) 10792691.7 02.05.2012
(87) WO2010151711, 24.06.2010
(97) 2445343, 02.05.2012 en
(54) PRODRUGS OF NH-ACIDIC COMPOUNDS
(71) Alkermes, Inc., 852 Winter Street, Waltham, MA 02451, US
(72) BLUMBERG, Laura, Cook, 37 Mill Street, Lincoln, MA 01773, US
REMENAR, Julius, F., 9 Eaton Road, Framingham, MA 01701, US
ALMARSSON, Örn, 22 Farmington Drive, Shrewsbury, MA 01545, US
ZEIDAN, Tarek, A., 296 Lexington Street, Watertown, MA 02472, US

(51) MKP
A61F 5/445 (2006.01) (97) **2289471**
A61L 24/00 (2006.01)
A61F 5/443 (2006.01)
(96) 10251523.6 02.03.2011
(97) 2289471, 02.03.2011 en
(54) Ostomy bag
(71) WELLAND MEDICAL LIMITED, 7/8 Brunel Centre, Newton Road, Crawley, West Sussex RH10 9TU, GB
(72) Smith, Rory James Maxwell, 7/8 Brunel Centre Newton Road, Crawley West Sussex RH10 9TU, GB
Bird, Paul, 7/8 Brunel Centre Newton Road, Crawley West Sussex RH10 9TU, GB

(51) MKP
C07C 69/28 (2006.01) (97) **2454223 ***
A01N 33/24 (2006.01)
C07C 251/44 (2006.01)
A01N 37/10 (2006.01)
C07C 69/24 (2006.01)
A01N 33/20 (2006.01)
C07C 255/56 (2006.01)
C07C 49/657 (2006.01)
C07C 317/24 (2006.01)
A01N 37/02 (2006.01)
C07C 49/683 (2006.01)
A01N 31/06 (2006.01)
C07C 65/36 (2006.01)
A01N 31/08 (2006.01)
C07C 205/45 (2006.01)
(86) GB2010001354 15.07.2010
(96) 10734799.9 23.05.2012
(87) WO2011007146, 15.07.2010
(97) 2454223, 23.05.2012 en
(54) HERBICIDALLY ACTIVE 2-(SUBSTITUTED-PHENYL)-CYCLOPENTANE-1,3-DIONE DERIVATIVES
(71) Syngenta Limited, European Regional Centre Priestley Road Surrey Research Park, Guildford Surrey GU2 7YH, GB
(72) FOLEY, Daniel Jason, Syngenta Limited Jealott's Hill International Research Centre Bracknell, Berkshire RG42 6EY, GB
JEANMART, Stephane André Marie, Syngenta Crop Protection AG Werk Stein Schaffhauserstrasse, CH-4332 Stein, CH
LONGSTAFF, Adrian, Syngenta Limited Jealott's Hill International Research Centre Bracknell, Berkshire RG42 6EY, GB
PARSONS, Robert William, Syngenta Limited Jealott's Hill International Research Centre Bracknell, Berkshire RG42 6EY, GB
RUSSELL, Claire Janet, Syngenta Limited Jealott's Hill International Research Centre Bracknell, Berkshire RG42 6EY, GB
TAYLOR, John Benjamin, Syngenta Limited Jealott's Hill International Research Centre Bracknell, Berkshire RG42 6EY, GB
WAILES, Jeffrey, Steven, Syngenta Limited Jealott's Hill International Research Centre Bracknell, Berkshire RG42 6EY, GB

(51) MKP
C07D 213/16 (2006.01) (97) **2477967 ***
C07D 213/18 (2006.01)
C07D 401/04 (2006.01)
C07D 487/04 (2006.01)
(86) EP2010005668 15.09.2010
(96) 10760917.4 25.07.2012
(87) WO2011032692, 15.09.2010
(97) 2477967, 25.07.2012 en
(54) PROCESS FOR PREPARING 3-[(4S)-8-BROMO-1-METHYL-6-(2-PYRIDINYL)-4H-IMIDAZOL[1,2-A][1,4]BENZODIAZEPINE-4-YL]PROPIONIC ACID METHYL ESTER OR THE BENZENE SULFONATE SALT THEREOF, AND COMPOUNDS USEFUL IN THAT PROCESS
(71) PAION UK Limited, Compass House Vision Park Chivers way, Cambridge Cambridgeshire CB4 9ZR, GB
(72) TILBROOK, Stuart, Gary, Hunney Cottage Short Lane Bluntisham Huntingdon Cambridgeshire, PE28 3NS, GB
SCHUMACHER, Andreas, Auf Der Hub 8, 79588 Efringen-Kirchen, DE
EMMENEGGER, René, Gotthardstrasse 81, CH-4054 Basel, CH

(51) MKP
A61P 1/00 (2006.01) (97) **2429566 ***
A61P 37/08 (2006.01)
A61P 37/00 (2006.01)
A61K 38/17 (2006.01)
A61K 38/18 (2006.01)
A61K 38/20 (2006.01)
(86) US2010034816 13.05.2010
(96) 10775575.3 21.03.2012
(87) WO2010132725, 13.05.2010
(97) 2429566, 21.03.2012 en
(54) CYCLIN DEPENDENT KINASE INHIBITORS AND METHODS OF USE
(71) The University of North Carolina At Chapel Hill, 308 Bynum Hall, Campus Box 4105, Chapel Hill, NC 27599-4105, US
(72) SHARPLESS, Norman, E., 8323 Loch Laven Lane, Chapel Hill NC 27516, US
ROBERTS, Patrick, J., 2508 West Club Blvd., Durham NC 27705, US
WONG, Kwok-Kin, C/o The University Of North Carolina at Chapel Hill 308 Bynum Hall Campus Box 4105, Chapel Hill, NC 27599-4105, US
LIU, Yan, C/o The University Of North Carolina at Chapel Hill 308 Bynum Hall Campus Box 4105, Chapel Hill, NC 27599-4105, US
JOHNSON, Soren, C/o The University Of North Carolina at Chapel Hill 308 Bynum Hall Campus Box 4105, Chapel Hill, NC 27599-4105, US

(51) MKP
C12N 7/02 (2006.01) (97) **2480677 ***
C12N 15/867 (2006.01)
C12N 15/866 (2006.01)
(86) EP2011065089 01.09.2011
(96) 11749849.3 01.08.2012
(87) WO2012028680, 01.09.2011
(97) 2480677, 01.08.2012 en
(54) SEMI-STABLE PRODUCTION OF LENTIVIRAL VECTORS
(71) Molmed SpA, Via Olgettina 58, 20132 Milan, IT
(72) BOVOLENTA, Chiara, MolMed SpA Via Olgettina 58, I-20132 Milan, IT
STORNAIUOLO, Anna, MolMed SpA Via Olgettina 58, I-20132 Milan, IT
RIZZARDI, Paolo, MolMed SpA Via Olgettina 58, I-20132 Milan, IT
MAVILIO, Fulvio, Istituto Scientifico H. San Raffaele Via Olgettina 55, I-20132 Milan, IT

(51) MKP
A61F 2/24 (2006.01) (97) **2498719 ***
(86) GR2010000050 09.11.2010
(96) 10790586.1 19.09.2012
(87) WO2011058385, 09.11.2010
(97) 2498719, 19.09.2012 en
(54) SUPPORT SYSTEM FOR BIOPROSTHETIC VALVES WITH COMMISURAL POSTS WITH HEART-SHAPED OPENINGS
(71) Agathos, Efstathios-Andreas, No. 10, October 28th str., 152 37 Filothei-Attikis, GR
(72) Agathos, Efstathios-Andreas, No. 10, October 28th str., 152 37 Filothei-Attikis, GR

- (51) MKP
C07D 265/30 (2006.01) (97) **2473490 ***
C07D 265/32 (2006.01)
C07D 413/12 (2006.01)
C07D 419/12 (2006.01)
C07D 471/04 (2006.01)
A61K 31/5377 (2006.01)
A61P 25/04 (2006.01)
A61P 25/06 (2006.01)
A61P 25/16 (2006.01)
A61P 25/18 (2006.01)
A61P 25/24 (2006.01)
A61P 25/28 (2006.01)
C07D 279/12 (2006.01)
C07D 417/12 (2006.01)
C07D 487/04 (2006.01)
(86) EP2010062552 27.08.2010
(96) 10745659.2 11.07.2012
(87) WO2011023795, 27.08.2010
(97) 2473490, 11.07.2012 en
(54) (THIO)MORPHOLINE DERIVATIVES AS S1P MODULATORS
(71) Abbott Healthcare Products B.V., C.J. van Houtenlaan 36, 1381 CP Weesp, NL
(72) IWEMA BAKKER, Wouter, I., c/o Abbott Healthcare Products B.V. C.J. van Houtenlaan 36, NL-1381 CP Weesp, NL
COOLEN, Hein K.A.C., c/o Abbott Healthcare Products B.V. C.J. van Houtenlaan 36, NL-1381 CP Weesp, NL
MONS, Harmen, c/o Abbott Healthcare Products B.V. C.J. van Houtenlaan 36, NL-1381 CP Weesp, NL
STOIT, Axel, c/o Abbott Healthcare Products B.V. C.J. van Houtenlaan 36, NL-1381 CP Weesp, NL
RONKEN, Eric, c/o Abbott Healthcare Products B.V. C.J. van Houtenlaan 36, NL-1381 CP Weesp, NL
KAM, VAN DER, Elizabeth, c/o Abbott Healthcare Products B.V. C.J. van Houtenlaan 36, NL-1381 CP Weesp, NL
FRANKENA, Jurjen, c/o Abbott Healthcare Products B.V. C.J. van Houtenlaan 36, NL-1381 CP Weesp, NL
-
- (51) MKP
C07D 471/04 (2006.01) (97) **2419428 ***
A61K 31/437 (2006.01)
A61P 35/00 (2006.01)
(86) GB2010050618 15.04.2010
(96) 10718660.3 22.02.2012
(87) WO2010119285, 15.04.2010
(97) 2419428, 22.02.2012 en
(54) IMIDAZO [1,2-A]PYRIDINE DERIVATIVES AS FGFR KINASE INHIBITORS FOR USE IN THERAPY
(71) Astex Therapeutics Ltd., 436 Cambridge Science Park Milton Road, Cambridge CB4 0QA, GB
(72) SAXTY, Gordon, Astex Therapeutics Limited 436 Cambridge Science Park Milton Road, Cambridge Cambridgeshire CB4 0QA, GB
BERDINI, Valerio, Astex Therapeutics Limited 436 Cambridge Science Park Milton Road, Cambridge Cambridgeshire CB4 0QA, GB
MURRAY, Christopher William, Astex Therapeutics Limited 436 Cambridge Science Park Milton Road, Cambridge Cambridgeshire CB4 0QA, GB
FREYNE, Eddy Jean Edgard, Jan Van Eycklei 8, B-2840 Rumst, BE
LIGNY, Yannick Aimé Eddy, 2 Rue Loucheur, F-76300 Sotteville-lés-Rouen, FR
BONNET, Pascal Ghislain André, Velodroomstraat 60, B-2600 Berchem, BE
WROBLOWSKI, Berthold, Osseven 3, B-2350 Vosselaar, BE
PAPANIKOS, Alexandra, Belgiëlei 138 bus 6, B-2018 Antwerpen, BE
-
- (51) MKP
C12M 1/00 (2006.01) (97) **2406366 ***
(86) AT2010000068 08.03.2010
(96) 10714553.4 18.01.2012
(87) WO2010102316, 08.03.2010
(97) 2406366, 18.01.2012 de
(54) DEVICE FOR A PHOTOCHEMICAL PROCESS
(71) ecoduna technologie GmbH, Fischamenderstrasse 12/3, 2460 Bruck an der Leitha, AT
(72) MOHR, Martin, Klosterplatz 7, 2410 Hainburg, AT
EMMINGER, Franz, Steinerweg 2, 2410 Hainburg, AT
-
- (51) MKP
A61K 9/14 (2006.01) (97) **2437738 ***
A61K 31/10 (2006.01)
A61K 9/16 (2006.01)
A61P 35/00 (2006.01)
(86) US2010037662 07.06.2010
(96) 10784237.9 11.04.2012
(87) WO2010141956, 07.06.2010
(97) 2437738, 11.04.2012 en
(54) METHODS AND COMPOSITIONS FOR THE TREATMENT OF CANCER
(71) Caron, Joan M., 9 Terrache Road, Thomaston, CT 06787, US
(72) Caron, Joan M., 9 Terrache Road, Thomaston, CT 06787, US
-
- (51) MKP
G01N 33/50 (2006.01) (97) **2435828 ***
(86) US2010036063 25.05.2010
(96) 10724617.5 04.04.2012
(87) WO2010138505, 25.05.2010
(97) 2435828, 04.04.2012 en
(54) METHOD OF MONITORING ERYTHROPOIESIS
(71) Vertex Pharmaceuticals Incorporated, 130 Waverly Street, Cambridge, MA 02139, US
(72) WOOD, Mark, 62 Pratt Road, Scituate Massachusetts 02066, US
-
- (51) MKP
E06B 3/667 (2006.01) (97) **2472048**
(96) 11195064.8 04.07.2012
(97) 2472048, 04.07.2012 de
(54) Connector
(71) CERA Handelsgesellschaft mbH, Gewerbepark - Fürgen 14., 87674 Ruderatshofen-Immenhofen, DE
(72) Rafeld-Cech, Karin, Frohnschwenden 77, D-87499 Wildpoldsried, DE
-
- (51) MKP
A61P 1/18 (2006.01) (97) **2481738 ***
A61P 17/00 (2006.01)
A61P 7/02 (2006.01)
A61P 17/06 (2006.01)
A61P 1/16 (2006.01)
A61P 15/06 (2006.01)
A61P 31/04 (2006.01)
C07D 413/14 (2006.01)
A61P 9/10 (2006.01)
A61P 19/02 (2006.01)
A61K 31/536 (2006.01)
A61P 11/00 (2006.01)
A61P 25/00 (2006.01)
A61P 1/04 (2006.01)
A61P 13/12 (2006.01)
A61P 29/00 (2006.01)
A61P 7/00 (2006.01)
A61P 17/02 (2006.01)
A61P 1/02 (2006.01)
A61P 11/06 (2006.01)
A61P 27/02 (2006.01)
(86) JP2010005786 27.09.2010
(96) 10818572.9 01.08.2012
(87) WO2011036895, 27.09.2010
(97) 2481738, 01.08.2012 en
(54) MALEIC ACID SALT AND CRYSTAL THEREOF
(71) Kyorin Pharmaceutical Co., Ltd., 5, Kanda Surugadai 2-chome Chiyoda-ku, Tokyo 101-8311, JP
(72) TSUBUKI, Takeshi, c/o Development Research Laboratories Kyorin Pharmaceutical Co. Ltd. 1848 Nogi Nogi-machi, Shimotsuga-gun Tochigi 329-0114, JP
SAGAWA, Tetsuya, c/o Development Research Laboratories Kyorin Pharmaceutical Co. Ltd. 1848 Nogi Nogi-machi, Shimotsuga-gun Tochigi 329-0114, JP
FUNADA, Keiko, c/o Development Research Laboratories Kyorin Pharmaceutical Co. Ltd. 1848 Nogi Nogi-machi, Shimotsuga-gun Tochigi 329-0114, JP
ARAYA, Ichiro, c/o Development Research Laboratories Kyorin Pharmaceutical Co. Ltd. 1848 Nogi Nogi-machi, Shimotsuga-gun Tochigi 329-0114, JP
-

- (51) MKP
C07D 471/10 (2006.01) (97) **2488500 ***
A61K 31/438 (2006.01)
A61P 3/10 (2006.01)
C07D 221/20 (2006.01)
(86) US2010052126 11.10.2010
(96) 10793349.1 22.08.2012
(87) WO2011046851, 11.10.2010
(97) 2488500, 22.08.2012 en
(54) SPIROPIPERIDINE COMPOUNDS AND PHARMACEUTICAL USE THEREOF FOR TREATING DIABETES
(71) Eli Lilly and Company, Lilly Corporate Center, Indianapolis, IN 46285, US
(72) HAMDOUCHI, Chafiq, Eli Lilly and Company Lilly Corporate Center, Indianapolis, Indiana 46285, US
LINESWALA, Jayana, Pankaj, Eli Lilly and Company Lilly Corporate Center, Indianapolis, Indiana 46285, US
MAITI, Pranab, 96 Industrial Suburb Second Phase Yeswantpur Bangalore, Karnataka 560022, IN

- (51) MKP
B26D 7/20 (2006.01) (97) **2497615**
B26D 5/02 (2006.01)
B26F 1/22 (2006.01)
(96) 12158666.3 12.09.2012
(97) 2497615, 12.09.2012 en
(54) Multi-profile die cutting assembly
(71) Curt G. Joa, Inc., 100 Crocker Avenue, Sheboygan Falls Wisconsin 53085, US
(72) Fritz, Jeffrey W, N4989 Country Aire Road, Plymouth, WI Wisconsin 53073, US
Andrews, Robert E, N7488 Sunset Circle Drive, Sheboygan Falls, WI Wisconsin 53083, US

- (51) MKP
A61K 31/565 (2006.01) (97) **2459199 ***
A61P 35/00 (2006.01)
(86) GB2010051228 26.07.2010
(96) 10752117.1 06.06.2012
(87) WO2011012885, 26.07.2010
(97) 2459199, 06.06.2012 en
(54) FULVESTRANT IN A DOSAGE OF 500MG FOR THE TREATMENT OF ADVANCED BREAST CANCER
(71) AstraZeneca UK Limited, 2 Kingdom Street, London W2 6BD, GB
(72) DIMERY, Isaiah, William, c/o AstraZeneca Intellectual Property AstraZeneca R&D Wilmington 1800 Concord Pike P.O. Box 15437 Wilmington, DE 19850-5437, US
WEBSTER, Alan, AstraZeneca R&D Alderley Alderley Park Macclesfield, Cheshire SK10 4TG, GB

- (51) MKP
F23H 17/12 (2006.01) (97) **2417392 ***
F23H 7/08 (2006.01)
(86) EP2010001981 29.03.2010
(96) 10712346.5 15.02.2012
(87) WO2010115541, 29.03.2010
(97) 2417392, 15.02.2012 de
(54) GRATE BAR FOR AN INCINERATOR AND METHOD FOR PRODUCING SUCH A GRATE BAR
(71) Baumgarte Boiler Systems GmbH, Senner Strasse 115, 33647 Bielefeld, DE
(72) SPLIETHOFF, Bernd, Meierfeld 29, 33611 Bielefeld, DE
MIMOR, Michael, Theodor-Fontane-Strasse 5, 32105 Bad Salzuflen, DE
GRÜNER, Gerald, Tribünenweg 39, 33649 Bielefeld, DE
PLAGGE, Nils, Im Westenwinkel 2, 32339 Espelkamp, DE

- (51) MKP
A61K 8/00 (2006.01) (97) **2437717 ***
(86) US2010001632 03.06.2010
(96) 10783716.3 11.04.2012
(87) WO2010141098, 03.06.2010
(97) 2437717, 11.04.2012 en
(54) COMPOSITION AND METHOD FOR HAIR STRAIGHTENING AND CURLING
(71) Zerran International Corporation, 12880 Pierce St., Pacoima, CA 91331, US
(72) SAUTE, Robert, 10236 Mossy Rock Circle, Los Angeles CA 90077, US
SAUTE, Steve, 3934 Robin Hill Road, La Canada Flintridge CA 91011, US

- (51) MKP
A01N 35/00 (2006.01) (97) **2418942 ***
(86) US2010031113 14.04.2010
(96) 10765133.3 22.02.2012
(87) WO2010120943, 14.04.2010
(97) 2418942, 22.02.2012 en
(54) NAPHTHALENE-BASED INHIBITORS OF ANTI-APOPTOTIC PROTEINS
(71) Sanford-Burnham Medical Research Institute, 10901 North Torrey Pines Road, La Jolla, CA 92037, US
(72) PELLECCCHIA, Maurizio, 10901 North Torrey Pines Road, La Jolla, CA 92037, US

- (51) MKP
C08B 37/10 (2006.01) (97) **2427500 ***
A61P 7/02 (2006.01)
A61K 31/727 (2006.01)
(86) IB2010051931 04.05.2010
(96) 10719110.8 14.03.2012
(87) WO2010128446, 04.05.2010
(97) 2427500, 14.03.2012 en
(54) NOVEL ACYLATED 1,6-ANHIDRO DECASACCHARIDE AND ITS USE AS ANTITHROMBOTIC AGENT
(71) SANOFI, 174, Avenue de France, 75013 Paris, FR
MOURIER, Pierre, c/o Sanofi-Aventis Patent Department 174 Avenue de France, F-75013 Paris, FR
VISKOV, Christian, c/o Sanofi-Aventis Patent Department 174 Avenue de France, F-75013 Paris, FR

- (51) MKP
A62D 3/02 (2007.01) (97) **2428254**
A62D 3/35 (2007.01)
A62D 3/36 (2007.01)
(96) 11175285.3 14.03.2012
(97) 2428254, 14.03.2012 en
(54) Process for treating an asbestos containing material
(71) Chemical Center S.r.l., Via Mattei 4, 40050 Castello d'Argile (BO), IT
(72) Balducci, Giulia, Via Vincini 7, 47921 RIMINI, IT
Foresti, Elisabetta, Via Capriglia, 55045 PIETRASANTA (LUCCA), IT
Lelli, Marco, Via San Michele 46, 40063 MONGHIDORO (BOLOGNA), IT
Lesci, Isidoro Giorgio, Viale Firenze 235, 48014 CASTEL BOLOGNESE (RAVENNA), IT
Marchetti, Marco, Via San Giovanni 19, 63062 MONTEFIORE DELL'ASO (ASCOLI PICENO), IT
Pierini, Filippo, Via Saragat 35, 61037 MONDOLFO (PESARO-URBINO), IT
Roveri, Norberto, Via Di Marzio 20, 40133 BOLOGNA, IT

- (51) MKP
B21J 13/10 (2006.01) (97) **2397244**
B21K 1/76 (2006.01)
B21J 9/12 (2006.01)
B21J 9/02 (2006.01)
B21J 9/20 (2006.01)
(96) 11002487.4 21.12.2011
(97) 2397244, 21.12.2011 de
(54) Charging device for a bush widening device for perforated socket blanks made out of steel, for example, and method of forging perforated socket blanks
(71) Brighton Equipment Corporation Limited, Unit 1108 Eastern Harbour Centre, Hoi Chak Street, Quarry Bay Hong Kong, CN
(72) Gröne, Siegfried, Wallstrasse 1, 40213 Düsseldorf, DE

- (51) MKP
A01D 41/127 (2006.01) (97) **2250871**
(96) 10159577.5 17.11.2010
(97) 2250871, 17.11.2010 en
(54) Scalable grain tank fill level display
(71) Deere & Company, One John Deere Place, Moline, IL 61265-8098, US
(72) Chervenka, Kirk, Jacob, 3627 Woodberry Ct., Bettendorf, IA 52722, US
Stevens, Barton J, 2952 Grandview Dr., Bettendorf, IA 52722, US
Wood, Joshua D, 17229 70th Street West, Reynolds, IL 61279, US
Schleicher, Tyler D, 537 NW Scott Street, Ankeny, IA 50023, US

- (51) MKP
A61M 1/16 (2006.01) (97) **2493525 ***
(86) FR2010052201 15.10.2010
(96) 10785127.1 05.09.2012
(87) WO2011051593, 15.10.2010
(97) 2493525, 05.09.2012 fr
(54) DEVICE AND METHOD FOR CHARACTERIZING AN EXTRACORPOREAL BLOOD TREATMENT, AND EXTRACORPOREAL TREATMENT APPARATUS IMPLEMENTING SUCH A DEVICE
(71) RD Nephrologie, 104 rue de la Galera, 34000 Montpellier, FR
(72) ARGILES CISCART, Angel, 31 allée des Mauves, F-34980 Saint Gely du Fesc, FR
FICHEUX, Alain, 18 rue Hilaire Bernigaud, F-34790 Grabels, FR
-
- (51) MKP
C03C 1/00 (2006.01) (97) **2361891**
G21F 9/30 (2006.01)
(96) 11152272.8 31.08.2011
(97) 2361891, 31.08.2011 en
(54) Method of disposal of radioactive waste in silica glass
(71) Instytut Chemii i Techniki Jadrowej, ul. Dorodna 16, 03-195 Warszawa, PL
(72) Chmielewski, Andrzej G., Director Instytut Chemii i Techniki Jadrowej ul. Zbojnegorska 11, 04-802, Warszawa, PL Deptula,, Andrzej, Instytut Chemii i Techniki Jadrowej, ul. Wilcza 33/2, 00-544, Warszawa, PL Milkowska, M Magdalena, Instytut Chemii i Techniki Jadrowej, ul. Bema 62, 05-074, Halinów, PL Lada, M Wiesława, Instytut Chemii i Techniki Jadrowej, ul. Dzika 9 / 240, 00-172, Warszawa, PL Olczak, M Tadeusz, Instytut Chemii i Techniki Jadrowej, ul. Kondratowicza 29 m. 21, 03-285, Warszawa, PL
-
- (51) MKP
C12N 15/63 (2006.01) (97) **2486134 ***
(86) US2010051646 06.10.2010
(96) 10822611.9 15.08.2012
(87) WO2011044246, 06.10.2010
(97) 2486134, 15.08.2012 en
(54) USE OF TOLL-LIKE RECEPTOR AND AGONIST FOR TREATING CANCER
(71) Panacela Labs, Inc., 73 High Street, Buffalo, NY 14203, US Roswell Park Cancer Institute, Elm and Carlton Streets, Buffalo, NY 14263, US
(72) GUDKOV, Andrei, V., 1933 Sweet Road, East Aurora, NY 14052, US
-
- (51) MKP
A61F 13/15 (2006.01) (97) **2491909**
(96) 12157191.3 29.08.2012
(97) 2491909, 29.08.2012 en
(54) Methods and apparatus for forming disposable products at high speeds with small machine footprint
(71) Curt G. Joa, Inc., 100 Crocker Avenue, Sheboygan Falls, Wisconsin 53085, US
(72) Fritz,, Jeffrey W., N4989 Country Aire Road, Plymouth,, WI Wisconsin 53073, US Schwartz,, Christopher J., 188 York Street, Sheboygan Falls,, WI Wisconsin 53085, US Hohm,, Gottfried Jason, 1012 Falls Parc Drive, Apt. 11, Sheboygan Falls,, WI Wisconsin 53085, US Andrews,, Robert E., N7488 Sunset Circle Drive, Sheboygan,, WI Wisconsin 53083, US Nelson,, Christopher J., W6244 Hill and Dale Road, Plymouth,, WI Wisconsin 53073, US Januski,, Brian G., W7762 Glen Road, Glenbeulah,, WI Wisconsin 53023, US Rabe,, Alan J., 331 Millersville Avenue, Howards Grove,, WI Wisconsin 53083, US Follen,, Sean P., 99 Highland Avenue, Sheboygan Falls,, WI Wisconsin 53085, US Horness,, Darren R., W2302 Playbird Road, Sheboygan,, WI Wisconsin 53083, US Pagel,, Tyler W., 2192 Willow Pond Way, Grafton,, WI Wisconsin 53024, US De Noble,, Adam D., 2020 Cottonwood Court, De Pere,, WI Wisconsin 54115, US
-
- (51) MKP
A61K 8/67 (2006.01) (97) **2429485 ***
A61K 8/34 (2006.01)
A61K 8/36 (2006.01)
A61K 8/49 (2006.01)
A61Q 19/02 (2006.01)
A61K 8/92 (2006.01)
(86) EP2010056533 12.05.2010
(96) 10721446.2 21.03.2012
(87) WO2010130776, 12.05.2010
(97) 2429485, 21.03.2012 en
(54) USE OF DELTA-TOCOPHERYL-CARBOHYDRATE AS A DEPIGMENTING AGENT
(71) Pierre Fabre Dermo-Cosmétique, 45, place Abel-Gance, 92100 Boulogne-Billancourt, FR
(72) POIGNY, Stéphane, 84 chemin des Roquettes, F-31600 Saubens, FR BELAUBRE, Françoise, 2ter impasse Bourrouil, F-31270 Villeneuve Tolosane, FR SAURAT, Jean-Hilaire, 2 place Reverdin, CH-1206 Genève, CH KASRAEE, Behrooz, route de Meyrin 20A, CH-1202 Genève, CH
SORQ, Olivier, 10 rue Micheli-du Crest, CH-1205 Genève, CH
-
- (51) MKP
C07D 291/08 (2006.01) (97) **2431360**
A61P 25/00 (2006.01)
A61K 31/551 (2006.01)
(96) 11290413.1 21.03.2012
(97) 2431360, 21.03.2012 fr
(54) Derivatives of dihydrobenzoxathiazepine, method of preparing same and pharmaceutical compositions containing them as well as their uses as modulators of AMPA receptors
(71) Les Laboratoires Servier, 35, rue de Verdun, 92284 Suresnes Cedex, FR
(72) Cordi, Alexis, 8 bis, rue Ledru-Rollin, 92150 Suresnes, FR Desos, Patrice, 49, rue des Bourguignons, 92270 Bois-Colombes, FR Lestage, Pierre, 9, allée de la Grande Terre, 78170 La Celle Saint Cloud, FR Danober, Laurence, 82 rue Henri Richaume, 78360 Montesson, FR
-
- (51) MKP
C25B 3/04 (2006.01) (97) **2494095 ***
C07D 213/803 (2006.01)
(86) US2010054082 26.10.2010
(96) 10776000.1 05.09.2012
(87) WO2011053582, 26.10.2010
(97) 2494095, 05.09.2012 en
(54) IMPROVED SILVER CATHODE ACTIVATION
(71) Dow AgroSciences, LLC, 9330 Zionsville Road, Indianapolis, Indiana 46268, US
(72) WANG, Chen, 5003 Amberwood Court, Midland, MI 48640, US HAYNES, Scott, 3207 Northwest Drive, Saginaw, MI 48603, US SCORTICHINI, Carey, 3609 Lawndale Drive, Midland, MI 48642, US
-
- (51) MKP
A61B 6/00 (2006.01) (97) **2435118 ***
G06F 19/00 (2011.01)
A61M 16/00 (2006.01)
A61B 5/08 (2006.01)
(86) EP2010057328 27.05.2010
(96) 10724363.6 04.04.2012
(87) WO2010136528, 27.05.2010
(97) 2435118, 04.04.2012 en
(54) METHOD FOR DETERMINING TREATMENTS USING PATIENT-SPECIFIC LUNG MODELS AND COMPUTER METHODS
(71) FluidDA Respi, Groeningenlei 132, 2550 Kontich, BE
(72) DE BACKER, Jan, Louizalaan 397/1, B-1050 Brussel, BE
-

- (51) MKP
A61K 35/74 (2006.01) (97) **2485743 ***
A61P 9/00 (2006.01)
 (86) EP2010064304 28.09.2010
 (96) 10757610.0 15.08.2012
 (87) WO2011042333, 28.09.2010
 (97) 2485743, 15.08.2012 en
 (54) LACTOBACILLUS PLANTARUM STRAINS AS HYPOCHOLESTEROLEMIC AGENTS.
 (71) AB-Biotics S.A., Masia Can Fatjó del Molí s/n, 08290 Cerdanyola Del Valles, ES
 (72) CUÑÉ CASTELLANA, Jordi, Edifici Eureka Campus UAB, E-08193 Bellaterra, ES

- (51) MKP
A61K 31/437 (2006.01) (97) **2455381 ***
A61P 7/06 (2006.01)
A61P 43/00 (2006.01)
C07D 471/04 (2006.01)
 (86) JP2010062037 16.07.2010
 (96) 10799914.6 23.05.2012
 (87) WO2011007856, 16.07.2010
 (97) 2455381, 23.05.2012 en
 (54) TRIAZOLOPYRIDINE COMPOUND, AND ACTION THEREOF AS PROLYL HYDROXYLASE INHIBITOR AND ERYTHROPOIETIN PRODUCTION INDUCER
 (71) Japan Tobacco, Inc., 2-1, Toranomom 2-chome Minato-ku, Tokyo 105-8422, JP
 (72) MATSUI, Takuya, c/o Central Pharmaceutical Research Institute of Japan Tobacco Inc. 1-1, Murasaki-cho, Takatsuki-shi Osaka 569-1125, JP
 ABE, Hiroyuki, c/o Central Pharmaceutical Research Institute of Japan Tobacco Inc. 1-1, Murasaki-cho, Takatsuki-shi Osaka 569-1125, JP
 TERASHITA, Masakazu, c/o Central Pharmaceutical Research Institute of Japan Tobacco Inc. 1-1, Murasaki-cho, Takatsuki-shi Osaka 569-1125, JP
 UEYAMA, Kazuhito, c/o Central Pharmaceutical Research Institute of Japan Tobacco Inc. 1-1, Murasaki-cho, Takatsuki-shi Osaka 569-1125, JP
 YOKOTA, Masahiro, c/o Central Pharmaceutical Research Institute of Japan Tobacco Inc. 1-1, Murasaki-cho, Takatsuki-shi Osaka 569-1125, JP
 MITANI, Ikuo, c/o Central Pharmaceutical Research Institute of Japan Tobacco Inc. 1-1, Murasaki-cho, Takatsuki-shi Osaka 569-1125, JP
 HOTTA, Takahiro, c/o Central Pharmaceutical Research Institute of Japan Tobacco Inc. 1-1, Murasaki-cho, Takatsuki-shi Osaka 569-1125, JP
 OGOSHI, Yosuke, c/o Central Pharmaceutical Research Institute of Japan Tobacco Inc. 1-1, Murasaki-cho, Takatsuki-shi Osaka 569-1125, JP
 ITO, Takashi, c/o Central Pharmaceutical Research Institute of Japan Tobacco Inc. 1-1, Murasaki-cho, Takatsuki-shi Osaka 569-1125, JP
 MOTODA, Dai, c/o Central Pharmaceutical Research Institute of Japan Tobacco Inc. 1-1, Murasaki-cho, Takatsuki-shi Osaka 569-1125, JP

- (51) MKP
C08K 3/34 (2006.01) (97) **2264092**
C08K 7/00 (2006.01)
C08L 95/00 (2006.01)
 (96) 10165657.7 22.12.2010
 (97) 2264092, 22.12.2010 en
 (54) Waterproofing membranes based on bitumen modified with polymers containing aluminium silicate cenospheres.
 (71) Polyglass S.p.A., Viale Edoardo Jenner, 4, 20159 Milano, IT
 (72) Drigo, Michele, c/o Polyglass S.p.A. Via dell' Artigianato, 34, 31047, PONTE DI PIAVE (TV), IT
 Pascon, Daniele, Vicolo del Grano, 5, 31040, SALGAREDA (TV), IT
 Zaffaroni, Pasquale, Viale Edoardo Jenner, 4, 20159, Milano, IT

- (51) MKP
A01N 31/08 (2006.01) (97) **2408299 ***
A61K 31/05 (2006.01)
 (86) US2010027905 19.03.2010
 (96) 10754148.4 25.01.2012
 (87) WO2010108060, 19.03.2010
 (97) 2408299, 25.01.2012 en
 (54) FATTY ACID MONOGLYCERIDE COMPOSITIONS
 (71) Stiefel Laboratories, Inc., 255 Alhambra Circle, Coral Gables, FL 22134, US
 Stiefel Research Australia Pty Ltd, 8 Macro Court, Rowville VIC 3178, AU
 (72) LENN, Jon, 3160 Porter Dr, Palo Alto CA 94304, US
 HUNT, Barry, 8 Macro Court, Rowville VIC 3178, AU
 HSIA, Edward, 3160 Porter Dr, Palo Alto CA 94304, US
 HOFLAND, Hans, 3160 Porter Dr, Palo Alto CA 94304, US

- (51) MKP
C12Q 1/68 (2006.01) (97) **2478116 ***
 (86) EP2010063751 17.09.2010
 (96) 10757757.9 25.07.2012
 (87) WO2011033095, 17.09.2010
 (97) 2478116, 25.07.2012 en
 (54) METHOD FOR IDENTIFYING WHETHER A PATIENT WILL BE RESPONDER OR NOT TO IMMUNOTHERAPY
 (71) GlaxoSmithKline Biologicals SA, Rue de l'Institut 89, 1330 Rixensart, BE
 (72) BRICHARD, Vincent, GlaxoSmithKline Biologicals s.a. Rue de l'Institut 89, B-1330 Rixensart, BE
 DIZIER, Benjamin, Georges, Elie, Lea, Ghislain, GlaxoSmithKline Biologicals s.a. Rue de l'Institut 89, B-1330 Rixensart, BE
 GRUSELLE, Olivier, GlaxoSmithKline Biologicals s.a. rue de l'Institut 89, B-1330 Rixensart, BE
 LOUAHED, Jamila, GlaxoSmithKline Biologicals s.a. Rue de l'Institut 89, B-1330 Rixensart, BE
 ULLOA-MONTOYA, Fernando, GlaxoSmithKline Biologicals s.a. Rue de l'Institut 89, B-1330 Rixensart, BE

- (51) MKP
C07K 1/113 (2006.01) (97) **2445923 ***
 (86) US2010039390 21.06.2010
 (96) 10747092.4 02.05.2012
 (87) WO2011005488, 21.06.2010
 (97) 2445923, 02.05.2012 en
 (54) REFOLDING PROTEINS USING A CHEMICALLY CONTROLLED REDOX STATE
 (71) Amgen, Inc, One Amgen Center Drive, Thousand Oaks, CA 91320-1799, US
 (72) SHULTZ, Joseph, Edward, 16675 Barranca Road, Santa Rosa Valley California 93012, US
 HART, Roger, 1279 Clayford Avenue, Loveland Colorado 80537, US
 KEENER III, Ronald, Nixon, 1893 Brush Oak Court, Newbury Park California 91320, US

- (51) MKP
C07D 471/08 (2006.01) (97) **2491034 ***
A61P 25/00 (2006.01)
A61K 31/439 (2006.01)
 (86) US2010053609 21.10.2010
 (96) 10774359.3 29.08.2012
 (87) WO2011050200, 21.10.2010
 (97) 2491034, 29.08.2012 en
 (54) FUSED HETEROCYCLIC COMPOUNDS AS OREXIN RECEPTOR MODULATORS
 (71) Janssen Pharmaceutica, N.V., Turnhoutseweg 30, 2340 Beerse, BE
 (72) BRANSTETTER, Bryan, James, 3504 Paseo De Los Americanos 67, Oceanside CA 92056, US
 LETAVIC, Michael, A., 4379 Mistral Place, San Diego CA 92130, US
 LY, Kiev, S., P.O. Box 927992, San Diego CA 92192, US
 RUDOLPH, Dale, A., 12721 Alondra Court, San Diego CA 92128, US
 SAVALL, Brad, M., 9512 Ronda Avenue, San Diego CA 92123, US
 SHAH, Chandravadan, R., 14213 Dalhousie Road, San Diego CA 92129, US
 SHIREMAN, Brock, T., 12625 Birchbrook Court, Poway CA 92064, US

- (51) MKP
C07D 401/12 (2006.01) (97) **2440544 ***
A61P 35/00 (2006.01)
C07D 403/12 (2006.01)
C07D 471/04 (2006.01)
A61K 31/4184 (2006.01)
(86) EP2010003441 09.06.2010
(96) 10724710.8 18.04.2012
(87) WO2010142426, 09.06.2010
(97) 2440544, 18.04.2012 en
(54) HEDGEHOG PATHWAY ANTAGONISTS AND THERAPEUTIC APPLICATIONS THEREOF
(71) Siena Biotech S.p.A., Via Banchi di Sotto, 34, 53100 Siena, IT
(72) THOMAS J. Russell, Strada del Petriccio e Belriguardo 35, 53100 Siena, IT
PERICOT MOHR Gal.Ja, Strada del Petriccio e Belriguardo 35, 53100 Siena, IT
CARAMELLI, Chiara, Strada del Petriccio e Belriguardo 35, 53100 Siena, IT
MINETTO, Giacomo, Strada del Petriccio e Belriguardo 35, 53100 Siena, IT
BELLINI, Marta, Strada del Petriccio e Belriguardo 35, 53100 Siena, IT

- (51) MKP
A61K 31/352 (2006.01) (97) **2480220 ***
A61P 31/18 (2006.01)
A61K 9/08 (2006.01)
A61K 9/51 (2006.01)
(86) EP2010063930 22.09.2010
(96) 10762626.9 01.08.2012
(87) WO2011036159, 22.09.2010
(97) 2480220, 01.08.2012 en
(54) TREATMENT AND PREVENTION OF HIV INFECTION
(71) Tibotec Pharmaceuticals, Eastgate Village Eastgate Little Island, Co Cork, IE
(72) BAERT, Lieven Elvire Colette, Jozef Van Wallegemstraat 11, B-8200 Brugge 2, BE
KRAUS, Guenter, De Billemontstraat 13, B-2860 Sint-Katelijne-Waver, BE

- (51) MKP
B60G 7/02 (2006.01) (97) **2380761**
B60G 13/00 (2006.01)
B62D 21/20 (2006.01)
B62D 21/00 (2006.01)
(96) 11003361.0 26.10.2011
(97) 2380761, 26.10.2011 en
(54) Fastening assembly for connecting a wheel suspension to a vehicle frame
(71) V.E.T.E.G. S.R.L., Via Del Castello 2, 24030 Mapello (BG), IT
(72) Gioffi, Igor, Via Roggia dei Mulini, 8, 28865 Crevoladossola (Verbania), IT

- (51) MKP
C07D 471/04 (2006.01) (97) **2493865 ***
C07D 403/12 (2006.01)
A61K 31/519 (2006.01)
A61P 35/00 (2006.01)
C07D 405/12 (2006.01)
A61K 31/517 (2006.01)
C07D 239/94 (2006.01)
(86) US2010046952 27.08.2010
(96) 10805862.9 05.09.2012
(87) WO2011025938, 27.08.2010
(97) 2493865, 05.09.2012 en
(54) RAF INHIBITOR COMPOUNDS AND METHODS OF USE THEREOF
(71) Array Biopharma, Inc., 3200 Walnut Street, Boulder, CO 80301, US
Genentech, Inc., 1 DNA Way, South San Francisco, CA 94080-4990, US
(72) MATHIEU, Simon, 1 DNA Way, South San Francisco, California 94080-4990, US
MORENO, David, 3200 Walnut Street, Boulder, Colorado 80301, US
RUDOLPH, Joachim, 1 DNA Way, South San Francisco, California 94080-4990, US
REN, Li, 3200 Walnut Street, Boulder, Colorado 80301, US
WEN, Zhaoyang, 1 DNA Way, South San Francisco, California 94080-4990, US
WENGLOWSKY, Steven Mark, 3200 Walnut Street, Boulder, Colorado 80301, US
ZHAO, Guiling, 1 DNA Way, South San Francisco, California 94080-4990, US
ALIAGAS, Ignacio, 1 DNA Way, South San Francisco, California 94080-4990, US
BUCKMELTER, Alexandre J., 3200 Walnut Street, Boulder, Colorado 80301, US
GRADL, Stefan, 1 DNA Way, South San Francisco, California 94080-4990, US
GRINA, Jonas, 3200 Walnut Street, Boulder, Colorado 80301, US
GUNZNER, Janet, 1 DNA Way, South San Francisco, California 94080-4990, US
HANSEN, Joshua D., 3200 Walnut Street, Boulder, Colorado 80301, US
LEE, Wendy, 1 DNA Way, South San Francisco, California 94080-4990, US
LAIRD, Ellen, 3200 Walnut Street, Boulder, Colorado 80301, US

- (51) MKP
C07K 16/22 (2006.01) (97) **2459592 ***
A61K 39/395 (2006.01)
A61P 35/00 (2006.01)
(86) US2010043295 27.07.2010
(96) 10737224.5 06.06.2012
(87) WO2011014469, 27.07.2010
(97) 2459592, 06.06.2012 en
(54) HIGH AFFINITY HUMAN ANTIBODIES TO HUMAN ANGIOPOIETIN-2
(71) Regeneron Pharmaceuticals, Inc., 777 Old Saw Mill River Road, Tarrytown, NY 10591, US
(72) THURSTON, Gavin, 15 Stewart Place Apt. 1M, White Plains NY 10603, US
DALY, Christopher, 315 East 72nd Street Apt. 7H, New York NY 10021, US

(51) MKP
A61P 9/00 (2006.01) (97) **2480547 ***
C07D 403/06 (2006.01)
A61P 11/00 (2006.01)
C07D 413/12 (2006.01)
C07D 417/12 (2006.01)
A61P 29/00 (2006.01)
C07D 471/04 (2006.01)
A61K 31/437 (2006.01)
(86) US2010049954 23.09.2010
(96) 10819439.0 01.08.2012
(87) WO2011038086, 23.09.2010
(97) 2480547, 01.08.2012 en
(54) INDOLIZINE INHIBITORS OF 5-LIPOXYGENASE
(71) Panmira Pharmaceuticals, LLC, 9535 Waples Street, Suite 100, San Diego, CA 92121, US
(72) STEARNS, Brian, Andrew, 157 Beechtree Drive, Encinitas CA 92024, US
ROPPE, Jeffrey, Roger, 32182 Camino Guarda, Temecula CA 92592, US
PARR, Timothy, Andrew, 8504 Lemon Avenue, La Mesa CA 91941, US
STOCK, Nicholas, Simon, 7087 Camino Degrazia 150, San Diego CA 92111, US
VOLKOTS, Deborah, 8212 Regents Rd. 204, San Diego CA 92122, US
HUTCHINSON, John, Howard, 3435 Richmond Street, San Diego CA 92103, US

(51) MKP
B29B 17/00 (2006.01) (97) **2445692 ***
(86) GB2010001241 23.06.2010
(96) 10784331.0 02.05.2012
(87) WO2010149973, 23.06.2010
(97) 2445692, 02.05.2012 en
(54) MATERIALS
(71) Sudscape Limited, Hints Road, Mile Oak Tamworth Staffordshire B78 3PQ, GB
(72) ORME, Chesney, Lapwing Farm Clayholes Lane, Kattleshulme High Peak SK23 7EJ, GB

(51) MKP
G06F 21/00 (2006.01) (97) **2388726**
(96) 10188163.9 23.11.2011
(97) 2388726, 23.11.2011 en
(54) Detection of hidden objects in a computer system
(71) Kaspersky Lab, ZAO, 10 Geroyev Panfilovtsev Street, Moscow 125363, RU
(72) Rusakov, Vyacheslav E., c/o KASPERSKY LAB ZAO 10/1 1st Volokolamsky Proezd, 123060, Moscow, RU

(51) MKP
A01N 25/04 (2006.01) (97) **2433987 ***
B27K 3/50 (2006.01)
C08K 5/10 (2006.01)
C08K 5/42 (2006.01)
C08L 71/02 (2006.01)
(86) JP2010003169 10.05.2010
(96) 10777519.9 28.03.2012
(87) WO2010134279, 10.05.2010
(97) 2433987, 28.03.2012 en
(54) COMPOSITION FOR PREPARING EMULSION OR MICROEMULSION FORMULATIONS
(71) Nippon Soda Co., Ltd., 2-1, Ohtemachi 2-chome Chiyoda-ku, Tokyo 100-8165, JP
(72) ARAI, Shigebumi, c/o Odawara Research Center Nippon Soda Co. Ltd. 345 Takada, Odawara-shi Kanagawa 250-0280, JP
KUBOTA, Tetsuo, c/o Odawara Research Center Nippon Soda Co. Ltd. 345 Takada, Odawara-shi Kanagawa 250-0280, JP

(51) MKP
C23C 16/505 (2006.01) (97) **2251453**
C23C 16/458 (2006.01)
G01N 15/08 (2006.01)
A61B 5/15 (2006.01)
(96) 10162757.8 17.11.2010
(97) 2251453, 17.11.2010 en
(54) Vessel holder
(71) CV Holdings, LLC., 1030 Riverfront Center, P.O.Box 710, Amsterdam, New York 12010, US
(72) Felts, John T., 2624 Calhoun Street, Alameda, CA 94501, US
Ferguson, John, 797 Greenwood Drive, Auburn, AL 36832, US
Freedman, Jonathan R., 2213 Brenton Lane, Auburn, AL 36830, US

(51) MKP
C12N 1/18 (2006.01) (97) **2456851 ***
C12N 9/02 (2006.01)
C12P 7/06 (2006.01)
C12P 7/10 (2006.01)
C12N 15/53 (2006.01)
(86) NL2010050475 23.07.2010
(96) 10740412.1 30.05.2012
(87) WO2011010923, 23.07.2010
(97) 2456851, 30.05.2012 en
(54) FERMENTATIVE GLYCEROL-FREE ETHANOL PRODUCTION
(71) Technische Universiteit Delft, Stevinweg 1, 2628 CN Delft, NL
PRONK, Jacobus Thomas, Bark 5, NL-2636 DD Schipluiden, NL
VAN MARIS, Antonius Jeroen Adriaan, Koornmarkt 42-13, NL-2611 EH Delft, NL
GUADALUPE MEDINA, Victor Gabriel, Oosteinde 129, NL-2611 VC Delft, NL

(51) MKP
E06B 7/02 (2006.01) (97) **2456944 ***
F23J 11/00 (2006.01)
E06B 7/26 (2006.01)
(86) IB2010001818 23.07.2010
(96) 10752159.3 30.05.2012
(87) WO2011010217, 23.07.2010
(97) 2456944, 30.05.2012 en
(54) DEFLECTOR BARRIER FOR SMOKE AND HEAT VENTS AND A SMOKE AND HEAT VENT PROVIDED WITH SAID DEFLECTOR BARRIER
(71) Caoduro, Paolo, Via Pigafetta, 23, 36100 Vicenza, IT
Caoduro, Carlo, Via Roma 26, 36010 Monticello Conte Otto, VI, IT
(72) Caoduro, Paolo, Via Pigafetta, 23, 36100 Vicenza, IT
Caoduro, Carlo, Via Roma 26, 36010 Monticello Conte Otto, VI, IT

(51) MKP
B32B 27/12 (2006.01) (97) **2452011 ***
B60N 3/04 (2006.01)
D06N 7/00 (2006.01)
B32B 27/32 (2006.01)
(86) US2010041167 07.07.2010
(96) 10734395.6 16.05.2012
(87) WO2011005828, 07.07.2010
(97) 2452011, 16.05.2012 en
(54) CARPET AND CARPET BACKING
(71) Dow Global Technologies LLC (formerly Known As Dow Global Technologies Inc.), 2040 Dow Center, Midland, MI 48674, US
(72) WEEKS, Ronald, 110 Indian Warrior Trail, Lake Jackson TX 77566, US
JIN, Yi, 110 Lake Road Apartment 320, Lake Jackson TX 77566, US

- (51) MKP
A61P 25/00 (2006.01) (97) **2485760 ***
C07K 16/22 (2006.01)
G01N 33/53 (2006.01)
C12N 15/68 (2006.01)
A61K 39/395 (2006.01)
A61P 29/02 (2006.01)
C12N 5/10 (2006.01)
A61P 19/02 (2006.01)
A61P 35/00 (2006.01)
(86) US2010051960 08.10.2010
(96) 10766193.6 15.08.2012
(87) WO2011049758, 08.10.2010
(97) 2485760, 15.08.2012 en
(54) HUMAN ANTI-NGF NEUTRALIZING ANTIBODIES AS SELECTIVE NGF PATHWAY INHIBITORS
(71) Amgen, Inc, One Amgen Center Drive, Thousand Oaks, CA 91320-1799, US
Medarex, Inc., Route 206 and Province Line Road, Princeton, NJ 08543-4000, US
(72) WILD, Kenneth, D., 1604 Meander Drive, Simi Valley, CA 93065, US
TREANOR, James, J.s., 454 Upper Lake Road, Sherwood, CA 91361, US
HUANG, Haichun, 4329 Crestwood Street, Fremont, CA 94538, US
INOUE, Heather, 6733 Limonite Court, Carlsbad, CA 92009, US
ZHANG, Tie, J., 5077 Via Camino, Thousand Oaks, CA 91320, US
MARTIN, Frank, 865 Fernhill Court, Newbury Park, CA 91320, US
-
- (51) MKP
A01K 13/00 (2006.01) (97) **2490524 ***
A61D 7/00 (2006.01)
(86) US2010053206 19.10.2010
(96) 10773463.4 29.08.2012
(87) WO2011049951, 19.10.2010
(97) 2490524, 29.08.2012 en
(54) TRANSDERMAL DISPENSING APPARATUS AND METHODS
(71) Aircom Manufacturing, Inc., 6205 E. 30th Street, Indianapolis, IN 46219, US
Eli Lilly And Company, 2500 Innovation Way, Greenfield, IN 46140, US
(72) TROMPEN, Mick, A., 1923 Emerald Pines Lane, Westfield IN 46074, US
LYON, Gregory, A., 8927 Serpent Circle, Indianapolis IN 46236, US
CLARK, Terrence, Patrick, 2690 Hope Road, Cottage Grove WI 53527, US
NEWBOUND, Garret, Conrad, 10379 Power Drive, Carmel IN 46033, US
-
- (51) MKP
D21H 19/52 (2006.01) (97) **2350387 ***
(86) GB2010000982 17.05.2010
(96) 10727476.3 03.08.2011
(87) WO2010131016, 17.05.2010
(97) 2350387, 03.08.2011 en
(54) PAPER FILLER COMPOSITION
(71) Imerys Minerals Limited, Par Moor Centre, Par Moor Road, Par, Cornwall PL24 2SQ, GB
(72) HUSBAND, John Claude, 34 Turnavean Road, St Austell Cornwall P25 5NX, GB
SVENDING, Per, Bokvagen 12, S-442 31 Kungälv, SE
SKUSE, David Robert, 2 Prospect Gardens, Truro Cornwall TR1 1BH, GB
MOTSI, Tafadzwa, Imerys Minerals Limited Par Moor Centre Par Moor Road, Par Cornwall PL24 2SQ, GB
LIKITALO, Mikko, 4 Clos de Differdange, B-140 Waterloo, BE
COLES, Alan, Bosilliac Mawnan Smith, Falmouth Cornwall TR11 5EN, GB
-
- (51) MKP
A61K 31/727 (2006.01) (97) **2408459 ***
A61K 31/765 (2006.01)
A61P 9/00 (2006.01)
A61P 7/02 (2006.01)
A61P 13/12 (2006.01)
A61P 41/00 (2006.01)
(86) IB2010051186 18.03.2010
(96) 10712548.6 25.01.2012
(87) WO2010106519, 18.03.2010
(97) 2408459, 25.01.2012 en
(54) A DOSE OF AVE5026 FOR THE TREATMENT OF VENOUS THROMBOEMBOLISM IN PATIENTS WITH SEVERE RENAL IMPAIRMENT
(71) SANOFI, 174, Avenue de France, 75013 Paris, FR
(72) CLOT, Pierre-François, c/o sanofi-aventis Département Brevets 174 Avenue de France, F-75013 Paris, FR
DUBRUC, Catherine, c/o sanofi-aventis Département Brevets 174 Avenue de France, F-75013 Paris, FR
-
- (51) MKP
A61K 9/107 (2006.01) (97) **2429521 ***
A61K 9/14 (2006.01)
A61P 35/00 (2006.01)
A61P 17/02 (2006.01)
A61P 3/00 (2006.01)
A61P 25/00 (2006.01)
A61K 31/415 (2006.01)
(86) US2010035136 17.05.2010
(96) 10775671.0 21.03.2012
(87) WO2010132882, 17.05.2010
(97) 2429521, 21.03.2012 en
(54) SUBLINGUAL DEXMEDETOMIDINE COMPOSITIONS AND METHODS OF USE THEREOF
(71) Recro Pharma, Inc., 55 Valley Stream Parkway Suite 100, Malvern, PA 19355, US
(72) HENWOOD, Geraldine Anne, 3 Jorrock Lane, Malvern PA 19355, US
MACK, Randall Jerome, 1633 Valley Greene Road, Paoli PA 19301, US
SHARR, Christopher Thomas, 907 Brookmont Circle, Malvern PA 19355, US
KOLENG, John Joseph, 11113 Alison Parke Trail, Austin TX 78750, US
-
- (51) MKP
A47L 13/10 (2006.01) (97) **2433545 ***
A47L 13/20 (2006.01)
(86) JP2010058621 21.05.2010
(96) 10777826.8 28.03.2012
(87) WO2010134594, 21.05.2010
(97) 2433545, 28.03.2012 en
(54) HANDY MOP
(71) Unicharm Corporation, 182 Shimobun Kinesei-cho Shikokuchuo-shi, Ehime 799-0111, JP
(72) TANAKA Yoshinori, c/o UNI-CHARM CORPORATION Technical Center 1531-7 Wadahama Toyohama-cho, Kanonji-shi Kagawa 769-1602, JP
FUKUZAWA Masumi, c/o UNI-CHARM CORPORATION Technical Center 1531-7 Wadahama Toyohama-cho, Kanonji-shi Kagawa 769-1602, JP
SUDA Tomokazu, 182 Shimobun Kinsei-cho, Shikokuchuo-shi Ehime 799-0111, JP
URAGAMI Jun, c/o DNP Nishinippon Co. Ltd. 2-16-36 Shimizu Minami-ku, Fukuoka-shi Fukuoka 815-0031, JP
UENISHI Toshihiko, c/o DNP Nishinippon Co. Ltd. 2-16-36 shimizu Minami-ku, Fukuoka-shi Fukuoka 815-0031, JP
-

- (51) MKP
A61P 3/10 (2006.01) (97) **2432880 ***
C12N 15/113 (2010.01)
A61K 31/712 (2006.01)
A61K 31/7125 (2006.01)
C07H 21/00 (2006.01)
C12Q 1/68 (2006.01)
A61P 3/06 (2006.01)
- (86) IB2010001384 19.05.2010
(96) 10724136.6 28.03.2012
(87) WO2010133970, 19.05.2010
(97) 2432880, 28.03.2012 en
(54) TARGETING MICRORNAS FOR METABOLIC DISORDERS
(71) ETH Zürich, Raemistrasse 101, 8092 Zürich, CH
(72) STOFFEL, Markus, Gartenstrasse 11, CH-8704 Herrliberg, CH
TRAJKOVSKI, Mirko, Nordstrasse 358, CH-8037 Zürich, CH
-

- (51) MKP
C07D 401/12 (2006.01) (97) **2445886 ***
A61K 31/4709 (2006.01)
C07D 401/14 (2006.01)
A61P 29/00 (2006.01)
C07D 215/44 (2006.01)
C07D 471/04 (2006.01)
C07D 401/04 (2006.01)
A61K 31/4706 (2006.01)
C07D 407/14 (2006.01)
C07D 409/12 (2006.01)
C07D 413/14 (2006.01)
C07D 417/14 (2006.01)
- (86) US2010040027 25.06.2010
(96) 10729753.3 02.05.2012
(87) WO2010151791, 25.06.2010
(97) 2445886, 02.05.2012 en
(54) HETEROCYCLIC COMPOUNDS AND THEIR USES
(71) Amgen, Inc, One Amgen Center Drive, Thousand Oaks, CA 91320-1799, US
(72) CUSHING, Timothy D., 1064 Glacier Avenue, Pacificia, California 94044, US
DRANSFIELD, Paul John, 178 Allison Street, San Francisco, California 94112, US
GONZALEZ LOPEZ DE TURISO, Felix, 10De Sabla Road 509, San Mateo, California 94402, US
JOHNSON, Michael G., 409 Clipper Street, San Francisco, California 94114, US
KOHN, Todd J., 818 North Delaware Street 412, San Mateo, California 94401, US
PATTAROPONG, Vatee, 1408 El Caminio Real, Unit 1, Burlingame, California 94010, US
SIMARD, Jillian L., 2584 Bush Street, San Francisco, California 94115, US
-

**INDEKS BROJEVA ZAHTJEVA ZA PROŠIRENJE EVROPSKIH PRIJAVA
PATENTA**
INDEX ON NUMBER OF REQUESTS FOR EXTENSION ON EUROPEAN PATENT
APPLICATIONS

Broj objave evropske prijave patenta (97)	MKP (51)	Broj objave evropske prijave patenta (97)	MKP (51)	Broj objave evropske prijave patenta (97)	MKP (51)
2451449 *	A61P 25/00 (2006.01) A61K 31/165 (2006.01) A61K 38/21 (2006.01)	2440034 *	A01H 5/10 (2006.01) C12N 15/82 (2006.01)	2230646	G07D 3/12 (2006.01)
2474593 *	C10G 2/00 (2006.01)	2475387 *	A61K 39/395 (2006.01) A61P 17/02 (2006.01) C07K 16/40 (2006.01) G01N 33/577 (2006.01) A61K 31/00 (2006.01) A61P 43/00 (2006.01)	2467366 *	A61K 31/443 (2006.01) C07D 249/06 (2006.01) A61K 31/4439 (2006.01) C07D 261/08 (2006.01) A61P 1/16 (2006.01) C07D 413/04 (2006.01) A61P 3/10 (2006.01) A61K 31/42 (2006.01) C07D 413/12 (2006.01) A61P 35/00 (2006.01) C07D 413/14 (2006.01) A61K 31/4192 (2006.01)
2461833 *	A61K 48/00 (2006.01) C12N 5/16 (2006.01)	2406243 *	C07D 405/14 (2006.01) A61K 31/5377 (2006.01) C07D 407/04 (2006.01) A61K 31/551 (2006.01) C07D 405/12 (2006.01) A61K 31/496 (2006.01) C07D 407/12 (2006.01) C07D 307/79 (2006.01) C07D 413/04 (2006.01) C07D 307/80 (2006.01) C07D 413/12 (2006.01) C07D 307/81 (2006.01) C07D 417/12 (2006.01) C07D 405/04 (2006.01) C07D 493/10 (2006.01)	2377537	A61K 31/4412 (2006.01) A61P 11/00 (2006.01)
2406703 *	G06F 3/041 (2006.01) G06F 3/01 (2006.01) G06F 3/048 (2006.01)	2419670 *	F16L 55/164 (2006.01)	2454364 *	A61K 39/13 (2006.01) C12N 7/02 (2006.01)
2406702 *	G06F 3/041 (2006.01) G06F 3/01 (2006.01) G06F 3/048 (2006.01)	2485532 *	H04W 40/20 (2009.01)	2462110 *	C07C 275/24 (2006.01) C07C 275/16 (2006.01) C07C 273/02 (2006.01) A61K 31/17 (2006.01) A61P 11/00 (2006.01)
2419670 *	F16L 55/164 (2006.01)	2371758	B67B 7/04 (2006.01)	2451823 *	C12N 15/11 (2006.01) C07H 21/04 (2006.01) C12N 5/07 (2010.01) C12N 5/00 (2006.01)
2485532 *	H04W 40/20 (2009.01)	2424859 *	C07D 401/14 (2006.01) C07D 473/00 (2006.01) A61P 35/00 (2006.01) A61K 31/52 (2006.01)	2478099 *	C12N 15/09 (2006.01)
2371758	B67B 7/04 (2006.01)	2475411 *	C07D 405/04 (2006.01) C07D 493/10 (2006.01)	2390965	H01R 13/533 (2006.01) E21B 17/20 (2006.01)
2424859 *	C07D 401/14 (2006.01) C07D 473/00 (2006.01) A61P 35/00 (2006.01) A61K 31/52 (2006.01)	2451631 *	F16K 11/074 (2006.01) B29C 73/16 (2006.01)		
2478099 *	C12N 15/09 (2006.01)				
2390965	H01R 13/533 (2006.01) E21B 17/20 (2006.01)				

Broj objave evropske prijava patenta (97)	MKP (51)	Broj objave evropske prijava patenta (97)	MKP (51)	Broj objave evropske prijava patenta (97)	MKP (51)
2404953	C08J 5/12 (2006.01) B29C 65/48 (2006.01) C08J 3/11 (2006.01) C09J 127/06 (2006.01) C09J 155/02 (2006.01)	2429518 *	A61K 45/06 (2006.01) A61P 25/00 (2006.01) A61P 25/28 (2006.01) A61K 31/27 (2006.01) A61K 31/439 (2006.01) A61K 31/473 (2006.01) A61K 31/445 (2006.01) A61K 31/55 (2006.01)	2440239 *	A61K 47/18 (2006.01) A61K 47/48 (2006.01) A61K 38/42 (2006.01)
2488658 *	C12P 21/08 (2006.01) C12Q 1/70 (2006.01)			2461812 *	A61K 31/557 (2006.01) A61K 31/5585 (2006.01) A61P 11/00 (2006.01)
2470078 *	A61B 17/06 (2006.01) A61B 17/00 (2006.01) A61B 7/04 (2006.01)	2414000 *	G09F 3/02 (2006.01) G09F 11/30 (2006.01) A61M 5/31 (2006.01) A61M 5/178 (2006.01) B65C 3/06 (2006.01)	2441128 *	H01R 9/24 (2006.01)
2496290 *	A61M 5/315 (2006.01)			2438045 *	C07D 213/16 (2006.01) A61K 31/4406 (2006.01)
2461960 *	B29C 35/14 (2006.01) B29B 15/10 (2006.01) B29C 47/02 (2006.01) B29C 70/50 (2006.01) B29C 70/20 (2006.01)	2454598 *	G01N 33/574 (2006.01)	2230223	C04B 2/10 (2006.01)
2481098 *	H01L 31/18 (2006.01)	2459553 *	C07D 413/04 (2006.01) A61K 31/4245 (2006.01) A61P 35/00 (2006.01)	2495313 *	A01H 5/08 (2006.01) A01H 5/10 (2006.01) A01H 5/00 (2006.01) C12N 15/09 (2006.01) C12N 5/10 (2006.01)
2442810 *	A61K 31/506 (2006.01) A61K 31/505 (2006.01) A61P 25/28 (2006.01) A61P 25/00 (2006.01)	2444334	B65D 41/46 (2006.01) B65D 41/62 (2006.01)	2462083 *	C22C 26/00 (2006.01) B22F 1/02 (2006.01) C04B 35/628 (2006.01) C22C 29/02 (2006.01)
2496943 *	G01N 33/68 (2006.01)	2480274 *	A61M 5/32 (2006.01)	2467539 *	E03C 1/232 (2006.01)
2404001 *	E03C 1/284 (2006.01) E03F 5/04 (2006.01)	2431643	F16L 11/04 (2006.01)	2435411 *	C07D 239/48 (2006.01) C07D 401/12 (2006.01) C07D 405/12 (2006.01) A61P 35/00 (2006.01) A61K 31/505 (2006.01)
		2279728	A61K 9/20 (2006.01) A61K 9/14 (2006.01) A61K 9/16 (2006.01)	2371940	C12M 1/00 (2006.01)

Broj objave evropske prijave patenta (97)	MKP (51)	Broj objave evropske prijave patenta (97)	MKP (51)	Broj objave evropske prijave patenta (97)	MKP (51)
2491183 *	F24J 3/08 (2006.01) E02D 5/30 (2006.01)	2496321 *	A63B 63/00 (2006.01)	2429964 *	C03C 17/28 (2006.01)
2408751 *	C07D 233/70 (2006.01) C07D 249/12 (2006.01) C07D 409/04 (2006.01) C07D 413/12 (2006.01) A61K 31/4166 (2006.01) A61K 31/4196 (2006.01) A61K 31/422 (2006.01) A61P 9/00 (2006.01)	2380943	C09K 5/10 (2006.01) G01M 3/22 (2006.01)	2453864 *	A61H 1/00 (2006.01)
2406253 *	A61K 31/506 (2006.01) A61P 3/04 (2006.01) A61K 31/497 (2006.01) A61P 3/10 (2006.01) C07D 405/14 (2006.01)	2395484	G07D 9/00 (2006.01) G07D 1/02 (2006.01)	2280263	G01L 5/13 (2006.01) G01G 19/12 (2006.01) B60D 1/58 (2006.01)
2417108 *	C07D 417/14 (2006.01) A61K 31/403 (2006.01) C07D 209/96 (2006.01) A61P 31/22 (2006.01) C07D 401/12 (2006.01) C07K 5/08 (2006.01) C07D 401/14 (2006.01) C07D 403/12 (2006.01) C07D 403/14 (2006.01) C07D 405/14 (2006.01)	2405908 *	A61K 31/4188 (2006.01) A61P 35/00 (2006.01) A61K 31/7064 (2006.01) A61K 31/18 (2006.01) A61K 31/185 (2006.01) A61K 31/436 (2006.01) A61K 31/517 (2006.01)	2427211 *	C12P 21/08 (2006.01) A61K 39/395 (2006.01)
2408538 *	B01D 53/02 (2006.01)	2459404 *	B60J 10/02 (2006.01) B29C 45/14 (2006.01) B60J 10/00 (2006.01)	2448408 *	A01N 43/42 (2006.01) A61K 31/44 (2006.01)
2412387 *	C12N 15/86 (2006.01) C12N 15/864 (2006.01) A61K 48/00 (2006.01) C07K 14/65 (2006.01)	2422023 *	E04B 9/16 (2006.01) E04B 1/38 (2006.01) E04B 9/06 (2006.01) E04B 9/00 (2006.01)	2445899 *	A61P 3/10 (2006.01) A61P 25/00 (2006.01) C07D 401/12 (2006.01) A61K 31/4725 (2006.01)
		2499746 *	G06K 17/00 (2006.01) H04B 5/00 (2006.01)	2357306	E06B 3/46 (2006.01)
		2464553 *	B61C 3/00 (2006.01)	2485751 *	A61K 38/10 (2006.01)
		2470569 *	C07K 16/28 (2006.01)	2398557 *	A61N 5/06 (2006.01) A61B 18/20 (2006.01) A61B 18/00 (2006.01)
		2410994 *	A61K 9/20 (2006.01) A61K 31/00 (2006.01)	2457576	A23L 1/30 (2006.01) C12R 1/225 (2006.01) A61P 19/06 (2006.01) A61K 35/74 (2006.01)
		2414842 *	G01N 33/573 (2006.01)	2411022 *	A61K 33/42 (2006.01)
				2478012 *	C07K 16/28 (2006.01) A61P 37/06 (2006.01)
				2491384 *	G01N 33/50 (2006.01)

Broj objave evropske prijava patenta (97)	MKP (51)	Broj objave evropske prijava patenta (97)	MKP (51)	Broj objave evropske prijava patenta (97)	MKP (51)
2392386	A62B 17/00 (2006.01) A62B 18/08 (2006.01)	2462258 *	H02K 7/18 (2006.01) C25B 1/04 (2006.01) F01D 1/00 (2006.01) F01D 7/02 (2006.01) H01M 8/08 (2006.01) H01M 8/22 (2006.01) F01D 17/06 (2006.01) C25B 1/02 (2006.01) F01D 25/30 (2006.01) F01D 15/10 (2006.01)	2467332 *	B01D 35/143 (2006.01) B01D 35/153 (2006.01) C02F 1/00 (2006.01)
2403569 *	A61M 5/32 (2006.01)			2406422 *	D06M 10/00 (2006.01)
2337133	H01M 8/24 (2006.01) H01M 8/02 (2006.01)			2454243 *	C07D 405/12 (2006.01) C07D 413/12 (2006.01) C07D 417/12 (2006.01) A61P 37/00 (2006.01) A61K 31/41 (2006.01) C07D 409/12 (2006.01) C07D 257/04 (2006.01)
2473190 *	A61K 39/15 (2006.01)				
2495645 *	G06T 11/60 (2006.01) G06F 3/048 (2006.01)	2474155 *	H04N 1/00 (2006.01)		
2485595 *	A01N 57/00 (2006.01)	2467038 *	A43B 23/24 (2006.01) A44C 25/00 (2006.01) A44C 27/00 (2006.01)	2338495	A61K 31/555 (2006.01) A61K 33/26 (2006.01) A61P 7/06 (2006.01)
2448927 *	C07D 239/47 (2006.01) C07D 413/12 (2006.01) A61K 31/513 (2006.01) A61K 31/5377 (2006.01) C07D 403/12 (2006.01) C07D 403/10 (2006.01) A61P 35/00 (2006.01) C07D 409/12 (2006.01) C07D 413/06 (2006.01) C07D 239/36 (2006.01) C07D 403/06 (2006.01)	2493878 *	A61K 31/506 (2006.01) C07D 403/14 (2006.01) A61K 31/497 (2006.01) A61P 25/04 (2006.01) C07D 401/14 (2006.01)	2436865	E06B 3/02 (2006.01) E06B 3/66 (2006.01)
		2421898 *	C07K 16/28 (2006.01) G01N 33/574 (2006.01)	2478070 *	F23G 5/027 (2006.01) C08J 11/00 (2006.01) C10G 1/10 (2006.01) B01D 11/04 (2006.01) C10L 1/02 (2006.01)
2414343 *	C07D 333/34 (2006.01) C07D 513/04 (2006.01)	2232972	A01B 33/08 (2006.01)	2413936 *	A61K 31/455 (2006.01) A61K 31/513 (2006.01) A61K 45/06 (2006.01) A61K 47/48 (2006.01) C07D 239/46 (2006.01)
2461621 *	H04W 24/10 (2009.01)				
		2290220	F02M 47/02 (2006.01) F02M 63/00 (2006.01)	2430047 *	C07K 16/10 (2006.01)
		2403788 *	B65G 47/82 (2006.01) B65G 17/26 (2006.01)		

Broj objave evropske prijava patenta (97)	MKP (51)	Broj objave evropske prijava patenta (97)	MKP (51)	Broj objave evropske prijava patenta (97)	MKP (51)
2470330 *	B24D 3/34 (2006.01) B24D 18/00 (2006.01) B24B 7/22 (2006.01) B24D 7/14 (2006.01)	2238955	A61F 13/15 (2006.01)	2470532 *	C07D 471/04 (2006.01) A61P 35/00 (2006.01) A61K 31/437 (2006.01) A61P 13/12 (2006.01)
2336459	E04H 17/14 (2006.01) E04F 11/18 (2006.01)	2443712 *	H02B 13/055 (2006.01)	2493473 *	A61K 31/519 (2006.01) A61P 25/18 (2006.01)
2260749	A47K 4/00 (2006.01)	2401543 *	F21Y 101/02 (2006.01) F21V 29/00 (2006.01) F21S 8/08 (2006.01) F21V 15/01 (2006.01)	2415826 *	B29K 25/00 (2006.01) C08J 9/18 (2006.01) B29C 44/00 (2006.01) C08K 3/36 (2006.01) C08K 5/02 (2006.01) C08L 25/04 (2006.01)
2406355 *	C10M 107/02 (2006.01) C10G 9/00 (2006.01) C08K 5/01 (2006.01) C10G 11/00 (2006.01) C10M 101/02 (2006.01) C09J 183/04 (2006.01) C08K 5/09 (2006.01) C10G 45/58 (2006.01) C08K 5/101 (2006.01) C10G 47/00 (2006.01) C08L 83/04 (2006.01) C09D 7/06 (2006.01) C09D 127/06 (2006.01)	2475427 *	A61K 38/17 (2006.01) A61P 21/00 (2006.01) A61P 19/08 (2006.01) A61K 38/18 (2006.01)	2345695	C08L 9/00 (2006.01) C08L 23/10 (2006.01)
		2405918 *	A61K 31/702 (2006.01) A61P 1/06 (2006.01) A61P 1/14 (2006.01)	2403959 *	C12Q 1/68 (2006.01)
		2486281 *	F04D 29/08 (2006.01) F04D 13/08 (2006.01) F04D 29/62 (2006.01)	2453889 *	A61K 36/185 (2006.01) A61K 36/45 (2006.01) A61K 31/353 (2006.01) A61K 31/04 (2006.01) A61K 31/02 (2006.01) A61K 36/70 (2006.01) A61P 1/02 (2006.01)
		2477962 *	C07C 279/22 (2006.01)	2453885 *	A61P 25/24 (2006.01) A61K 31/13 (2006.01)
		2480552 *	C07D 487/04 (2006.01)	2475591 *	B65D 75/30 (2006.01)
2425227 *	G01N 1/31 (2006.01)	2437813 *	A61M 5/24 (2006.01) F16F 1/02 (2006.01)	2478006 *	C07K 14/415 (2006.01) C12N 15/82 (2006.01)
2437822 *	A61M 5/315 (2006.01) A61M 5/00 (2006.01)	2416777 *	A61K 31/517 (2006.01) A61P 9/00 (2006.01) A61K 9/00 (2006.01)		
2480362 *	E03C 1/02 (2006.01) B23B 47/28 (2006.01)	2427192 *	A61K 31/4985 (2006.01) A61P 35/00 (2006.01)		
2424566 *	A61K 39/395 (2006.01) C12P 21/06 (2006.01)				
2421838 *	C07D 295/26 (2006.01)				

Broj objave evropske prijava patenta (97)	MKP (51)	Broj objave evropske prijava patenta (97)	MKP (51)	Broj objave evropske prijava patenta (97)	MKP (51)
2248615	B22C 9/06 (2006.01) B29C 33/38 (2006.01)	2429526 *	A61K 31/4965 (2006.01) A61P 25/06 (2006.01) A61P 25/08 (2006.01)	2467545 *	E04C 3/08 (2006.01) E04C 3/09 (2006.01)
2459191 *	A61K 31/404 (2006.01) A61K 31/53 (2006.01) A61K 39/395 (2006.01)	2449106 *	A61K 9/14 (2006.01) C07H 21/02 (2006.01) A61K 31/713 (2006.01) C07K 14/775 (2006.01) A61K 47/22 (2006.01) C12N 15/113 (2010.01)	2416790 *	A61K 35/16 (2006.01) G01N 33/50 (2006.01)
2403531 *	A61K 39/395 (2006.01)			2478323 *	F41A 23/24 (2006.01) F41A 27/28 (2006.01)
2419737 *	C12Q 1/68 (2006.01) G01N 33/15 (2006.01) A61P 35/00 (2006.01) G01N 33/574 (2006.01)	2496580 *	C07D 487/04 (2006.01) A61K 31/55 (2006.01) A61P 35/00 (2006.01) A61P 43/00 (2006.01)	2447185	B65D 83/00 (2006.01)
2460798 *	C07D 241/06 (2006.01) A61K 31/495 (2006.01)			2403535 *	A61K 47/00 (2006.01) C25D 5/00 (2006.01)
2470639 *	C12N 1/26 (2006.01) C12N 9/02 (2006.01) E21B 43/16 (2006.01) C09K 8/00 (2006.01)	2491037 *	A61P 11/06 (2006.01) A61P 11/00 (2006.01) C07D 487/04 (2006.01) A61P 17/00 (2006.01) A61P 35/00 (2006.01) A61P 19/02 (2006.01) A61K 31/519 (2006.01)	2451835 *	C12N 15/11 (2006.01) C12N 9/68 (2006.01) C07K 14/47 (2006.01) A61K 38/48 (2006.01)
2485593 *	A61K 31/425 (2006.01) A01N 43/78 (2006.01)			2403780 *	B65G 1/04 (2006.01)
2470029 *	A23G 3/02 (2006.01) A23G 3/00 (2006.01) A23G 9/22 (2006.01) F25C 1/22 (2006.01) A23G 9/08 (2006.01)	2449505 *	G06K 19/06 (2006.01) G06K 7/14 (2006.01)	2448593 *	C07K 19/00 (2006.01) A61K 39/00 (2006.01) A61K 39/395 (2006.01) C07K 16/10 (2006.01) A61K 38/16 (2006.01) A61K 39/42 (2006.01) A61K 39/21 (2006.01)
		2309160	F16K 15/06 (2006.01)		
		2443106 *	C07D 403/12 (2006.01) C07D 413/12 (2006.01) A61K 31/506 (2006.01) A61P 37/00 (2006.01) A61P 29/00 (2006.01)	2467660 *	F25D 31/00 (2006.01)
2473525 *	C07K 16/10 (2006.01) C12N 15/13 (2006.01) A61K 39/42 (2006.01) G01N 33/569 (2006.01)			2419409 *	C07D 211/46 (2006.01) C07C 233/33 (2006.01)
				2421695 *	B32B 3/12 (2006.01)
				2437694 *	A61F 5/56 (2006.01)

Broj objave evropske prijave patenta (97)	MKP (51)	Broj objave evropske prijave patenta (97)	MKP (51)	Broj objave evropske prijave patenta (97)	MKP (51)
2409016 *	F02M 63/00 (2006.01)	2421846 *	C07D 401/14 (2006.01) C07D 401/06 (2006.01) A61P 31/00 (2006.01) A61K 31/496 (2006.01) A61P 37/00 (2006.01) A61P 29/00 (2006.01) A61K 31/444 (2006.01) A61K 31/5377 (2006.01) A61P 35/00 (2006.01)	2464667 *	A61P 7/00 (2006.01) A61P 37/00 (2006.01) A61P 9/00 (2006.01) A61P 11/00 (2006.01) A61P 17/00 (2006.01) A61K 31/737 (2006.01) A61P 27/02 (2006.01) A61P 19/00 (2006.01) A61P 21/00 (2006.01) C08B 37/00 (2006.01) A61P 25/00 (2006.01)
2411424 *	C08F 10/00 (2006.01)				
2417120 *	A61K 31/454 (2006.01) A61P 31/00 (2006.01) C07D 401/04 (2006.01) A61P 35/00 (2006.01) C07D 401/14 (2006.01) A61P 37/00 (2006.01) C07D 413/04 (2006.01) C07D 413/14 (2006.01) C07D 417/14 (2006.01) A61K 31/4523 (2006.01)	2477655 *	A61K 39/395 (2006.01) A61K 38/16 (2006.01) A61K 38/17 (2006.01) A61P 35/00 (2006.01) A61P 25/00 (2006.01)	2494037 *	C07K 16/46 (2006.01) C07K 14/705 (2006.01) C07K 16/00 (2006.01) C12N 5/0781 (2010.01) C12N 15/62 (2006.01)
2482806 *	A61K 9/20 (2006.01) A61K 45/06 (2006.01) A61K 31/155 (2006.01)	2424841 *	C07D 213/02 (2006.01) C07D 401/12 (2006.01) A61K 31/4412 (2006.01) A61P 37/00 (2006.01)	2461824 *	A61K 39/085 (2006.01) A61K 39/116 (2006.01) C12N 15/62 (2006.01)
2431466 *	C12N 15/09 (2006.01) A61K 48/00 (2006.01) C12N 15/113 (2010.01) A61P 29/00 (2006.01)	2497558 *	B65B 31/06 (2006.01) B65D 1/02 (2006.01) C12H 1/07 (2006.01) B01D 35/00 (2006.01)	2478362 *	A61K 31/015 (2006.01) G01N 33/53 (2006.01)
2488201 *	A61K 39/395 (2006.01) G01N 33/53 (2006.01)			2498985 *	B32B 3/10 (2006.01)
2455786 *	H01L 51/50 (2006.01) H05B 33/02 (2006.01) G02B 5/18 (2006.01)	2483298 *	A61P 3/06 (2006.01) C12N 15/113 (2010.01) C07K 14/47 (2006.01)	2445900 *	A61P 19/02 (2006.01) C07D 471/04 (2006.01) C07D 487/04 (2006.01) A61K 31/444 (2006.01) C07D 401/12 (2006.01) A61K 31/4375 (2006.01) C07D 401/14 (2006.01)
2460046 *	G02C 3/00 (2006.01)			2410452	G06F 21/00 (2006.01)
2491039 *	C07D 487/04 (2006.01) A61K 31/505 (2006.01) A61P 37/00 (2006.01) A61P 35/00 (2006.01)				

Broj objave evropske prijava patenta (97)	MKP (51)	Broj objave evropske prijava patenta (97)	MKP (51)	Broj objave evropske prijava patenta (97)	MKP (51)
2378055	E21B 7/20 (2006.01) E21B 7/28 (2006.01) E21B 10/02 (2006.01)	2411368 *	C07D 401/12 (2006.01) C07D 401/14 (2006.01) C07D 401/02 (2006.01) A61K 31/444 (2006.01) A61P 35/00 (2006.01) C07D 213/79 (2006.01) C07D 213/82 (2006.01)	2433938 *	A61K 31/4709 (2006.01) C07D 495/04 (2006.01) A61K 31/506 (2006.01) C07D 417/14 (2006.01) A61K 31/5377 (2006.01) A61K 31/435 (2006.01) A61P 25/14 (2006.01) A61K 31/4355 (2006.01) A61P 25/16 (2006.01) A61K 31/4365 (2006.01) C07D 491/048 (2006.01) A61K 31/436 (2006.01) A61P 43/00 (2006.01) A61K 31/4439 (2006.01) C07D 491/052 (2006.01)
2429071 *	H02M 3/335 (2006.01)		A01N 57/00 (2006.01) C07C 403/00 (2006.01)		
2451794 *	C07D 417/12 (2006.01) C07D 417/10 (2006.01) C07D 285/08 (2006.01) A61K 31/433 (2006.01)	2473056 *			
2479241 *	C10G 2/00 (2006.01)	2474543 *	A61K 31/506 (2006.01) A61K 31/5377 (2006.01) A61K 31/4439 (2006.01) A61K 31/426 (2006.01) A61P 25/24 (2006.01) C07D 491/052 (2006.01) C07D 417/14 (2006.01)	2382146 *	B65G 47/84 (2006.01)
2475725 *	C09D 4/06 (2006.01) A61Q 3/02 (2006.01)		A61K 31/426 (2006.01) A61P 25/24 (2006.01) C07D 491/052 (2006.01) C07D 417/14 (2006.01)	2490998 *	C07C 205/02 (2006.01) C07C 201/08 (2006.01)
2429788 *	B28B 3/20 (2006.01) B28B 11/08 (2006.01)		A61P 25/24 (2006.01) C07D 491/052 (2006.01) C07D 417/14 (2006.01)	2480235 *	C07D 403/02 (2006.01) A61K 31/506 (2006.01)
2470538 *	A61K 31/38 (2006.01) C07D 487/04 (2006.01) C07D 495/04 (2006.01) C07D 513/04 (2006.01) A61P 35/00 (2006.01)		C07D 495/04 (2006.01) C07D 491/048 (2006.01)	2499256 *	C12P 21/08 (2006.01) C07K 16/28 (2006.01)
2438070 *	C07D 487/04 (2006.01) A61P 25/00 (2006.01) A61K 31/519 (2006.01)			2438664 *	H02G 3/14 (2006.01) H01H 3/12 (2006.01)
2437812 *	A61M 5/31 (2006.01) A61M 5/24 (2006.01) A61M 5/315 (2006.01) A61M 5/00 (2006.01)			2464634 *	C07D 239/34 (2006.01) C07D 239/47 (2006.01) C07D 401/12 (2006.01)
2349509 *	A63C 9/00 (2006.01)				

Broj objave evropske prijave patenta (97)	MKP (51)	Broj objave evropske prijave patenta (97)	MKP (51)	Broj objave evropske prijave patenta (97)	MKP (51)
2499139 *	A61K 31/438 (2006.01) A61P 1/16 (2006.01) A61P 3/10 (2006.01) C07D 471/10 (2006.01)	2424606 *	A61B 17/34 (2006.01) A61M 25/00 (2006.01)	2488581 *	C08K 9/02 (2006.01) C01G 9/02 (2006.01) C09C 1/02 (2006.01) C09C 1/28 (2006.01) C09C 1/30 (2006.01) C09C 1/40 (2006.01) C09C 1/56 (2006.01)
2403343 *	A01N 57/20 (2006.01) A01N 41/06 (2006.01) A01P 13/00 (2006.01)	2445924 *	C07K 1/18 (2006.01) C07K 1/22 (2006.01) C07K 1/32 (2006.01)	2464159 *	H04W 24/00 (2009.01)
2443253 *	C12Q 1/68 (2006.01)	2462111 *	C07C 309/82 (2006.01) C07C 309/85 (2006.01) C07C 311/28 (2006.01) C07C 303/40 (2006.01) C07C 303/38 (2006.01)	2424991 *	C12N 15/79 (2006.01) A61K 31/7088 (2006.01)
2300699 *	F02B 33/30 (2006.01)	2440775 *	F03B 13/12 (2006.01)	2445527 *	A61K 39/155 (2006.01)
2403880 *	C07K 16/40 (2006.01)	2421971 *	C12N 15/11 (2006.01) C12N 15/113 (2010.01)	2480676 *	C07K 16/46 (2006.01) C12N 15/85 (2006.01) C07K 16/00 (2006.01) A01K 67/027 (2006.01)
2419427 *	C07D 471/04 (2006.01) A61P 35/00 (2006.01) A61K 31/437 (2006.01)	2456884 *	C12Q 1/68 (2006.01)	2491119 *	C12N 9/02 (2006.01)
2490700 *	A61P 13/00 (2006.01) A61K 33/14 (2006.01) A61K 9/06 (2006.01) A61P 15/02 (2006.01) C11D 3/20 (2006.01)	2451812 *	C07D 487/04 (2006.01) C07D 519/00 (2006.01) A61K 31/519 (2006.01)	2410871 *	A23K 1/16 (2006.01) C11C 3/02 (2006.01)
2491006 *	C07C 231/24 (2006.01) C07C 231/12 (2006.01) C07C 233/87 (2006.01)	2428359	B41F 7/16 (2006.01) B41F 23/00 (2006.01) B41M 5/00 (2006.01)	2480276 *	A61M 5/50 (2006.01)
2457570 *	A61K 31/4468 (2006.01) A61K 9/70 (2006.01) A61K 47/06 (2006.01) A61K 47/14 (2006.01) A61K 47/32 (2006.01)	2488961 *	G06F 17/00 (2006.01)	2406701 *	G06F 3/048 (2006.01) G06F 3/041 (2006.01) G06F 3/01 (2006.01)
2470620 *	C10G 1/04 (2006.01) C10G 1/00 (2006.01)	2488067 *	A47C 27/00 (2006.01) A47G 9/00 (2006.01)	2451952 *	C12N 15/11 (2006.01)
				2481310 *	A41D 19/015 (2006.01)
				2417591 *	G08B 1/08 (2006.01)

Broj objave evropske prijava patenta (97)	MKP (51)	Broj objave evropske prijava patenta (97)	MKP (51)	Broj objave evropske prijava patenta (97)	MKP (51)
2432766 *	C07D 235/26 (2006.01) C07D 471/04 (2006.01) A61K 31/4745 (2006.01) A61P 35/00 (2006.01)	2433790 *	B29C 70/00 (2006.01) F41H 5/04 (2006.01) B32B 5/26 (2006.01)	2480577 *	C07K 16/18 (2006.01) C07K 16/24 (2006.01) C07K 16/46 (2006.01) C07K 16/28 (2006.01)
2454829 *	H04B 10/10 (2006.01)	2442651 *	A01N 43/42 (2006.01) A61K 31/47 (2006.01)	2485410 *	H04B 7/14 (2006.01)
2462108 *	C07D 231/14 (2006.01) C07C 45/62 (2006.01) C07C 45/64 (2006.01) C07C 45/66 (2006.01) C07C 251/44 (2006.01) C07C 45/69 (2006.01) C07C 49/693 (2006.01) C07C 49/743 (2006.01)	2480225 *	A61K 31/195 (2006.01) A61K 47/06 (2006.01) A61K 9/00 (2006.01) A61P 17/02 (2006.01) A61K 31/185 (2006.01) A61P 17/00 (2006.01)	2428290	B21D 24/14 (2006.01)
2495002 *	A61M 5/178 (2006.01) B65D 83/00 (2006.01) A61M 5/31 (2006.01) B05C 17/01 (2006.01)	2403564 *	A61M 5/31 (2006.01)	2456459 *	A61K 39/00 (2006.01) C07K 7/14 (2006.01)
2251454	C23C 16/505 (2006.01) C23C 16/52 (2006.01) C23C 16/54 (2006.01) G01N 15/08 (2006.01) A61B 5/15 (2006.01)	2427208 *	C07K 14/50 (2006.01) A61K 38/18 (2006.01)	2432623 *	B25B 5/06 (2006.01) B25B 5/10 (2006.01) B25B 5/16 (2006.01)
2412413 *	A63F 9/34 (2006.01) A63F 9/30 (2006.01) A63F 9/02 (2006.01)	2408498 *	A61M 15/00 (2006.01) G06M 1/24 (2006.01)	2437825 *	A61M 5/315 (2006.01)
2498173 *	G06F 3/048 (2006.01)	2409549 *	H05B 33/08 (2006.01)	2340726	F25D 23/00 (2006.01) A23L 3/36 (2006.01) F25D 3/00 (2006.01) F25D 13/00 (2006.01)
2403485 *	A61K 9/20 (2006.01) A61K 31/205 (2006.01) A61P 25/16 (2006.01)	2406251 *	A61P 3/10 (2006.01) C07D 403/12 (2006.01) A61K 31/506 (2006.01)	2496559 *	C07D 471/04 (2006.01) C07D 498/04 (2006.01) C07D 221/10 (2006.01) A61K 31/5377 (2006.01) C07D 401/12 (2006.01) C07D 401/14 (2006.01) A61K 31/498 (2006.01) C07D 401/06 (2006.01) A61P 3/00 (2006.01) C07D 417/06 (2006.01) C07D 405/14 (2006.01) A61K 31/473 (2006.01) A61K 31/497 (2006.01)
		2434895 *	A01N 43/90 (2006.01)		
		2414347 *	C07D 401/12 (2006.01) A61K 31/415 (2006.01) A61P 11/00 (2006.01) A61P 29/00 (2006.01)		

Broj objave evropske prijava patenta (97)	MKP (51)	Broj objave evropske prijava patenta (97)	MKP (51)	Broj objave evropske prijava patenta (97)	MKP (51)
2416899 *	B09B 3/00 (2006.01)	2464501 *	B29D 35/14 (2010.01) B29C 33/00 (2006.01) B29C 33/10 (2006.01) B29C 45/34 (2006.01) B29C 45/14 (2006.01) B29C 45/00 (2006.01)	2366687	C07D 209/40 (2006.01) C07D 209/88 (2006.01) C07D 409/12 (2006.01) A61P 35/00 (2006.01) C07D 209/08 (2006.01) A61K 31/404 (2006.01)
2461808 *	A61K 31/4178 (2006.01) A61P 25/00 (2006.01) A61P 25/28 (2006.01)	2476840	E05D 15/06 (2006.01)	2493858 *	C07D 417/12 (2006.01) A61K 31/44 (2006.01) C07D 405/12 (2006.01) A61K 31/5377 (2006.01) A61K 31/42 (2006.01) C07D 231/14 (2006.01) A61K 31/438 (2006.01) C07D 413/12 (2006.01) A61K 31/416 (2006.01) C07D 401/12 (2006.01) A61K 31/497 (2006.01) A61P 35/00 (2006.01) C07D 403/12 (2006.01) A61K 31/4523 (2006.01)
2461441	H02G 1/04 (2006.01)	2317158	F16B 13/14 (2006.01)	2475266 *	A23L 1/176 (2006.01) A23L 1/01 (2006.01)
2377900	C09C 1/02 (2006.01) C09C 1/42 (2006.01)	2483869 *	G01S 5/02 (2010.01) G08B 13/00 (2006.01) G07C 9/00 (2006.01) G07C 5/02 (2006.01) G07F 7/10 (2006.01)	2374353	A01N 59/08 (2006.01) A61K 8/19 (2006.01) A01N 59/06 (2006.01) C02F 1/50 (2006.01) D21H 21/36 (2006.01) A01N 55/02 (2006.01)
2403523 *	A61K 38/48 (2006.01) C07K 14/435 (2006.01)	2485724 *	A61P 3/10 (2006.01) A61K 31/185 (2006.01)		
2440056 *	A01N 43/66 (2006.01) A61K 31/53 (2006.01)	2445883 *	C07D 213/65 (2006.01) C07C 311/07 (2006.01) C07D 405/12 (2006.01) A61K 31/443 (2006.01) C07D 409/12 (2006.01) A61K 31/4453 (2006.01) C07D 295/096 (2006.01) C07D 307/42 (2006.01) A61K 31/381 (2006.01) C07D 409/14 (2006.01) A61K 31/4709 (2006.01) C07D 333/38 (2006.01) A61K 31/402 (2006.01) C07D 307/22 (2006.01) A61K 31/341 (2006.01)		
2435412 *	A61P 31/00 (2006.01) A61P 35/00 (2006.01) C07D 239/49 (2006.01) A61K 31/505 (2006.01) A61P 17/00 (2006.01) A61P 11/00 (2006.01) A61P 27/14 (2006.01)				
2410144	F01N 3/023 (2006.01) F01N 9/00 (2006.01) F01N 13/02 (2010.01)				
2371338	A61H 3/02 (2006.01)				
2462226 *	C12N 15/10 (2006.01)				

Broj objave evropske prijave patenta (97)	MKP (51)	Broj objave evropske prijave patenta (97)	MKP (51)	Broj objave evropske prijave patenta (97)	MKP (51)
2445852 *	C06B 23/00 (2006.01) C06B 45/10 (2006.01) C06B 21/00 (2006.01) F42B 33/06 (2006.01) A62D 3/02 (2007.01) A62D 3/30 (2007.01)	2429582 *	A61K 39/395 (2006.01)	2474558 *	C07K 19/00 (2006.01) C12N 15/62 (2006.01) A61P 31/04 (2006.01) C12N 15/63 (2006.01) A61K 38/16 (2006.01) A61K 47/48 (2006.01) C12P 21/02 (2006.01)
		2400070	E03D 9/08 (2006.01)		
		2421548 *	A61K 38/27 (2006.01) C07K 17/02 (2006.01) A61K 38/16 (2006.01) C07K 14/60 (2006.01) A61K 31/366 (2006.01)	2482670 *	A23J 1/14 (2006.01) A23J 3/16 (2006.01) A23L 2/02 (2006.01)
2467132 *	A61K 9/50 (2006.01) A61K 9/00 (2006.01) A61K 8/11 (2006.01)	2435577 *	C12P 19/02 (2006.01)		
2453693 *	H04W 24/04 (2009.01)	2340338 *	E04B 1/80 (2006.01)	2414605 *	E04H 15/32 (2006.01) E04H 15/64 (2006.01) E04B 1/343 (2006.01)
2499245 *	C12N 9/10 (2006.01) C12P 21/02 (2006.01) A61K 38/14 (2006.01) C12N 15/54 (2006.01) C12Q 1/68 (2006.01)	2460806 *	A61K 31/438 (2006.01) A61P 17/00 (2006.01) A61K 31/519 (2006.01) A61P 17/06 (2006.01) A61K 31/55 (2006.01) A61P 19/02 (2006.01) A61P 1/04 (2006.01) A61P 21/04 (2006.01) A61K 31/437 (2006.01) A61P 11/06 (2006.01) A61P 3/10 (2006.01) A61P 25/00 (2006.01) A61P 7/00 (2006.01) C07D 519/00 (2006.01) A61P 11/02 (2006.01)	2353366	A01G 3/037 (2006.01)
				2453855 *	A61F 11/00 (2006.01) A61B 17/34 (2006.01)
2427187 *	A61K 31/337 (2006.01) A61K 31/7068 (2006.01) A61P 35/00 (2006.01)			2446192 *	F23D 14/70 (2006.01) F23Q 3/00 (2006.01) F23C 3/00 (2006.01) F23D 14/10 (2006.01)
2377855	A61P 3/00 (2006.01) A61P 9/00 (2006.01) C07D 257/04 (2006.01) A61K 31/41 (2006.01)			2410844 *	A01N 37/18 (2006.01) A01K 31/16 (2006.01)
2442655 *	A61K 31/425 (2006.01) A01N 43/78 (2006.01)			2456433 *	A61K 31/205 (2006.01) A61P 25/12 (2006.01) A61P 25/00 (2006.01)
2451940 *	C12N 15/11 (2006.01) C12N 5/00 (2006.01)			2332505	A61F 13/15 (2006.01)
2443224 *	C12M 1/12 (2006.01)			2492288 *	C08F 2/18 (2006.01) C08F 20/14 (2006.01)
2478677 *	H04L 12/56 (2006.01)				

Broj objave evropske prijava patenta (97)	MKP (51)	Broj objave evropske prijava patenta (97)	MKP (51)	Broj objave evropske prijava patenta (97)	MKP (51)
2432649 *	B44C 1/10 (2006.01) B44C 1/16 (2006.01) B44C 1/18 (2006.01) B44C 5/04 (2006.01)	2432784 *	C07D 487/04 (2006.01) A61K 31/519 (2006.01) A61P 35/00 (2006.01) A61P 25/28 (2006.01) A61P 37/00 (2006.01)	2486363 *	F42B 8/00 (2006.01) F41A 33/04 (2006.01) F41A 33/02 (2006.01)
2419431 *	A61K 31/407 (2006.01) A61P 25/00 (2006.01) C07D 487/08 (2006.01) C07D 207/14 (2006.01) C07C 233/77 (2006.01)	2466923 *	H04W 4/06 (2009.01)	2416776 *	A61P 9/00 (2006.01) A61P 43/00 (2006.01) A61K 31/50 (2006.01) A61K 31/195 (2006.01) A61K 31/4985 (2006.01) A61P 3/00 (2006.01)
2292696	C08L 85/02 (2006.01) C08K 5/357 (2006.01) C08K 5/5399 (2006.01) C08L 79/04 (2006.01)	2483266 *	C07D 413/06 (2006.01) C07D 413/14 (2006.01) C07D 417/06 (2006.01) A61P 3/06 (2006.01) A61K 31/357 (2006.01) C07D 405/14 (2006.01) C07D 417/14 (2006.01) C07D 405/06 (2006.01)	2493863 *	A61P 25/04 (2006.01) C07D 417/12 (2006.01) C07D 239/34 (2006.01) C07D 401/12 (2006.01) A61K 31/506 (2006.01) C07D 403/12 (2006.01) C07D 239/28 (2006.01) C07D 413/12 (2006.01)
2456585 *	B23B 37/00 (2006.01)	2488458 *	C02F 3/34 (2006.01) C02F 103/02 (2006.01) C02F 1/00 (2006.01) C02F 1/46 (2006.01) C02F 1/44 (2006.01) C02F 1/32 (2006.01) C02F 5/02 (2006.01) C02F 1/48 (2006.01)	2380871	C07C 227/32 (2006.01)
2443080 *	C07C 17/16 (2006.01)			2491054 *	C07K 14/605 (2006.01)
2407146	A61K 8/49 (2006.01) A61Q 11/00 (2006.01)			2435117 *	A61M 16/00 (2006.01)
2454373 *	C12N 15/67 (2006.01)			2376334 *	B65D 85/10 (2006.01) B65D 5/66 (2006.01)
2441096 *	H01L 31/18 (2006.01)	2464249 *	A61F 3/00 (2006.01) A61K 36/82 (2006.01) A61P 25/00 (2006.01) A61P 25/28 (2006.01) A23L 2/52 (2006.01)	2385948 *	A61K 31/519 (2006.01) A61P 7/06 (2006.01) C07D 513/16 (2006.01) C07D 513/06 (2006.01)
2440048 *	A01N 43/42 (2006.01) A61K 31/47 (2006.01) A61K 31/517 (2006.01)				
2491024 *	C07D 401/04 (2006.01) A61K 31/4155 (2006.01) A61P 25/00 (2006.01)	2455415	C08G 63/80 (2006.01) C08G 63/90 (2006.01) C08G 63/08 (2006.01)	2414363 *	C07D 487/04 (2006.01) A61K 31/519 (2006.01)

Broj objave evropske prijava patenta (97)	MKP (51)	Broj objave evropske prijava patenta (97)	MKP (51)	Broj objave evropske prijava patenta (97)	MKP (51)
2456334 *	A45C 11/00 (2006.01)	2496649 *	C09D 7/12 (2006.01) C09D 5/02 (2006.01)	2482654 *	A01N 33/08 (2006.01) A01N 39/04 (2006.01) A01N 33/04 (2006.01) A01N 37/40 (2006.01) A01N 57/20 (2006.01)
2394923	B65D 21/02 (2006.01) B65D 71/50 (2006.01)	2487158	C07C 211/00 (2006.01) C07D 223/16 (2006.01)		
2475430 *	A61K 9/16 (2006.01) A61K 31/4184 (2006.01) A61K 31/425 (2006.01) A61P 33/00 (2006.01)	2419137 *	A61K 39/395 (2006.01)	2482830 *	A61K 8/97 (2006.01) A61Q 19/02 (2006.01) A61Q 19/08 (2006.01) A61K 36/47 (2006.01) A61P 29/00 (2006.01) A61P 17/00 (2006.01)
2478147 *	D06F 57/00 (2006.01) D06F 53/00 (2006.01)	2454239 *	A61P 25/28 (2006.01) C07D 401/14 (2006.01) C07D 471/04 (2006.01) A61K 31/4439 (2006.01) C07D 403/10 (2006.01) C07D 498/04 (2006.01) C07D 487/04 (2006.01) C07D 233/60 (2006.01) C07D 405/14 (2006.01) A61K 31/4178 (2006.01) A61K 31/4196 (2006.01)	2305085	A47K 3/34 (2006.01) E05D 15/06 (2006.01)
2490531 *	A01N 43/38 (2006.01) A61K 31/40 (2006.01)			2425042 *	C25C 3/26 (2006.01) C25C 3/00 (2006.01) C25B 1/00 (2006.01) C25C 1/00 (2006.01) C25C 3/34 (2006.01)
2467142 *	A61K 31/54 (2006.01)	2448909 *	C07C 211/35 (2006.01) C07C 209/62 (2006.01)	2473052 *	A01N 43/90 (2006.01) A61K 31/522 (2006.01)
2361840	B65D 25/50 (2006.01) B65D 51/16 (2006.01)	2477912 *	B65D 88/16 (2006.01) B65D 90/00 (2006.01) B65D 90/04 (2006.01)	2443233 *	C12N 7/02 (2006.01)
2448909 *	C07C 211/35 (2006.01) C07C 209/62 (2006.01)	2419176 *	A61K 31/047 (2006.01) A61K 45/06 (2006.01) A61K 9/00 (2006.01) A61Q 19/00 (2006.01) A61P 17/16 (2006.01) A61K 31/01 (2006.01)		
2473507 *	C07D 417/04 (2006.01) C07D 417/14 (2006.01)	2452277 *	G06F 17/30 (2006.01)		
2430021 *	C07D 471/04 (2006.01) A61K 31/437 (2006.01) A61K 31/444 (2006.01) A61K 31/445 (2006.01) A61P 25/00 (2006.01)				
2403482 *	A61K 31/437 (2006.01) A61K 31/4468 (2006.01) A61P 25/04 (2006.01) A61K 9/16 (2006.01)				

Broj objave evropske prijave patenta (97)	MKP (51)	Broj objave evropske prijave patenta (97)	MKP (51)	Broj objave evropske prijave patenta (97)	MKP (51)
2432556 *	A61P 35/00 (2006.01) C07C 257/18 (2006.01) A61K 31/47 (2006.01) C07C 235/62 (2006.01) A61K 31/44 (2006.01) C07D 211/26 (2006.01) A61K 31/445 (2006.01) C07D 211/58 (2006.01) C07C 311/20 (2006.01) C07D 215/08 (2006.01) C07D 401/06 (2006.01) C07D 213/61 (2006.01) C07D 213/75 (2006.01) C07D 217/06 (2006.01) C07C 259/18 (2006.01)	2483314 *	C07K 16/18 (2006.01) C07K 16/28 (2006.01) C07K 16/22 (2006.01) A61P 35/00 (2006.01)	2440576 *	C07K 14/705 (2006.01) A61P 3/00 (2006.01) A61K 38/18 (2006.01)
		2470849 *	F27D 13/00 (2006.01) F27D 3/12 (2006.01)	2486067 *	A61Q 3/02 (2006.01) A45D 31/00 (2006.01) C08F 251/02 (2006.01) C09D 4/06 (2006.01) A61K 8/91 (2006.01)
		2388695	G06F 21/00 (2006.01) G06F 9/445 (2006.01) G06F 11/34 (2006.01)	2419462 *	C08F 265/06 (2006.01) C08F 265/04 (2006.01) D21H 21/10 (2006.01) C08F 265/10 (2006.01) C08F 2/32 (2006.01)
		2251671	G01M 3/32 (2006.01) G01N 33/00 (2006.01) G01N 15/08 (2006.01)		
		2461683 *	A01N 43/42 (2006.01)	2467488 *	C12N 15/82 (2006.01) A01H 5/00 (2006.01)
2434889 *	A61K 31/40 (2006.01) A01N 43/36 (2006.01)	2445912 *	A61P 35/00 (2006.01) A61P 37/00 (2006.01) C07D 471/04 (2006.01) A61K 31/437 (2006.01) A61P 29/00 (2006.01)	2493926 *	C07K 16/28 (2006.01)
2467010 *	A01H 5/00 (2006.01)			2476677 *	C07D 401/12 (2006.01)
2464563 *	B63B 25/16 (2006.01) B63B 27/24 (2006.01) B63J 2/12 (2006.01) F17C 6/00 (2006.01) F17C 9/02 (2006.01) F17C 9/04 (2006.01)	2471902 *	C12N 5/071 (2010.01) A61L 27/38 (2006.01) A61K 35/12 (2006.01)	2482817 *	A61K 31/495 (2006.01) A61P 9/00 (2006.01)
		2450223	B60M 3/04 (2006.01) B65G 1/04 (2006.01)	2437504 *	H04N 13/04 (2006.01) G11B 20/10 (2006.01) G11B 20/12 (2006.01) G11B 27/00 (2006.01) H04N 5/93 (2006.01)
2445542 *	A61L 2/18 (2006.01) A61L 2/16 (2006.01) A61L 101/34 (2006.01) A61L 2/26 (2006.01)	2493342 *	A24F 47/00 (2006.01)	2405915 *	A61K 9/20 (2006.01) A61K 31/485 (2006.01) A61P 25/04 (2006.01) A61K 9/28 (2006.01)
2483637 *	G01D 4/00 (2006.01) H04B 1/713 (2011.01) H04W 4/06 (2009.01)	2414864 *	G01T 1/29 (2006.01) G01N 23/04 (2006.01) A61B 6/02 (2006.01) G21K 1/02 (2006.01)		

Broj objave evropske prijava patenta (97)	MKP (51)	Broj objave evropske prijava patenta (97)	MKP (51)	Broj objave evropske prijava patenta (97)	MKP (51)
2336473	E06B 3/46 (2006.01)	2426113 *	C07D 233/86 (2006.01) A61K 31/4164 (2006.01) A61K 31/496 (2006.01) A61K 31/551 (2006.01) A61P 3/06 (2006.01) A61P 3/10 (2006.01) A61P 9/10 (2006.01) A61P 17/00 (2006.01) A61P 25/28 (2006.01) A61P 29/00 (2006.01) A61P 43/00 (2006.01) C07D 401/04 (2006.01) C07D 401/12 (2006.01) C07D 401/14 (2006.01) C07D 403/06 (2006.01) C07D 405/04 (2006.01) C07D 405/14 (2006.01) C07D 491/048 (2006.01) C07D 491/056 (2006.01)	2406227 *	C07D 215/26 (2006.01) A61K 31/4704 (2006.01) A61P 11/00 (2006.01)
2448910 *	C07C 209/62 (2006.01) C07C 211/35 (2006.01) C07C 209/16 (2006.01)			2448970 *	C12N 5/10 (2006.01) A61K 39/395 (2006.01) A61P 25/00 (2006.01) C07K 16/22 (2006.01) C12N 15/13 (2006.01)
2491335 *	G01D 5/12 (2006.01) G01B 7/30 (2006.01) B62D 15/02 (2006.01)			2270382	F16L 57/04 (2006.01)
2430003 *	C07D 253/075 (2006.01) A61P 25/08 (2006.01) A61K 31/53 (2006.01)			2488596 *	D06M 13/10 (2006.01) C09J 103/02 (2006.01) E04B 1/74 (2006.01) C03C 25/14 (2006.01) C03C 25/24 (2006.01) C03C 25/26 (2006.01) C03C 25/32 (2006.01) D04H 1/58 (2012.01) D04H 1/64 (2012.01)
2494074 *	C12Q 1/68 (2006.01)			2459372 *	B32B 15/08 (2006.01) B32B 17/10 (2006.01) B29C 45/14 (2006.01)
2491342 *	G01C 21/00 (2006.01)			2406225 *	A61K 31/455 (2006.01) A61P 37/00 (2006.01) C07D 213/80 (2006.01)
2387391 *	A61K 9/12 (2006.01)			2427315 *	B29C 35/16 (2006.01) B29B 7/90 (2006.01) B29B 17/00 (2006.01)
2414850 *	G01R 31/00 (2006.01) G01R 29/08 (2006.01)	2458995 *	A01P 1/00 (2006.01) A61K 31/69 (2006.01) A61P 31/04 (2006.01) A01N 55/08 (2006.01) C07F 5/02 (2006.01) A62D 3/36 (2007.01)		
2292142	A61B 5/026 (2006.01)				
2485632 *	A61B 1/00 (2006.01) A61B 17/00 (2006.01)				
2478171 *	E04H 7/22 (2006.01) E04H 12/08 (2006.01) E04G 11/06 (2006.01) E04H 12/34 (2006.01)	2413899 *	A61K 9/00 (2006.01) A61K 31/245 (2006.01) A61K 31/4174 (2006.01) A61P 23/02 (2006.01)		
2493513 *	C07D 401/14 (2006.01) A61K 51/04 (2006.01)	2405750 *	A01N 37/18 (2006.01) A61K 31/16 (2006.01)	2496594 *	C07H 21/04 (2006.01) C12N 15/11 (2006.01)
2411517 *	C12N 15/113 (2010.01)				

Broj objave evropske prijava patenta (97)	MKP (51)	Broj objave evropske prijava patenta (97)	MKP (51)	Broj objave evropske prijava patenta (97)	MKP (51)
2475499 *	B24B 33/02 (2006.01) B23Q 17/22 (2006.01) B24B 5/40 (2006.01)	2442809 *	A61K 31/506 (2006.01) A61P 31/16 (2006.01)	2429998 *	A61P 29/00 (2006.01) C07D 231/12 (2006.01) C07D 261/10 (2006.01) C07D 277/22 (2006.01) C07D 401/14 (2006.01) A61K 31/439 (2006.01) C07D 413/14 (2006.01) A61P 25/00 (2006.01)
2477505 *	C07K 1/24 (2006.01) A23J 1/14 (2006.01) C07K 14/415 (2006.01)	2440057 *	A01N 43/66 (2006.01) A61K 31/53 (2006.01)	2371727	B65D 21/02 (2006.01) B65D 85/34 (2006.01) B65D 6/00 (2006.01)
2241507	B65B 39/00 (2006.01) B65B 39/04 (2006.01) B65B 31/04 (2006.01) B65B 55/02 (2006.01)	2438066 *	A61K 31/437 (2006.01) A61P 35/00 (2006.01) C07D 471/04 (2006.01) A61K 31/4196 (2006.01)	2491169 *	B22D 27/04 (2006.01) C30B 11/00 (2006.01) C30B 35/00 (2006.01) F27B 14/14 (2006.01) C30B 29/06 (2006.01) H05B 6/44 (2006.01) H05B 6/36 (2006.01)
2406247 *	A61K 31/4523 (2006.01) A61K 31/397 (2006.01) C07D 413/14 (2006.01) A61P 3/00 (2006.01) C07D 401/12 (2006.01) C07D 401/14 (2006.01) C07D 403/14 (2006.01)	2451241 *	H04W 88/00 (2009.01)	2493571 *	C07C 237/06 (2006.01) C07D 233/61 (2006.01) A61P 11/06 (2006.01) C07D 217/12 (2006.01) C07D 277/30 (2006.01) C07D 231/12 (2006.01) C07D 333/52 (2006.01) C07C 317/32 (2006.01) C07D 317/58 (2006.01) C07C 237/08 (2006.01) C07D 213/61 (2006.01) A61K 31/16 (2006.01) C07D 311/04 (2006.01) C07D 211/46 (2006.01) C07D 319/14 (2006.01) C07D 211/42 (2006.01) C07D 213/56 (2006.01)
2403563 *	A61M 5/28 (2006.01) A61M 5/32 (2006.01)	2449127 *	C12P 21/08 (2006.01)	2496572 *	C07D 403/14 (2006.01) A61P 31/12 (2006.01) A61K 31/4184 (2006.01)
2440551 *	A61K 31/375 (2006.01) A61P 29/00 (2006.01) C07D 407/04 (2006.01)	2263487	A43B 3/24 (2006.01) A43B 3/30 (2006.01) A43C 11/14 (2006.01)		
2491543 *	G08B 17/10 (2006.01)	2440249 *	A61K 47/48 (2006.01)		
2317179	F16H 48/12 (2006.01)	2493779 *	B65D 33/01 (2006.01) B65B 1/22 (2006.01) B65B 1/24 (2006.01)		
2406530 *	F16L 37/14 (2006.01) E04D 13/04 (2006.01)				
2485771 *	A61M 36/14 (2006.01) A61K 51/00 (2006.01)				

Broj objave evropske prijave patenta (97)	MKP (51)	Broj objave evropske prijave patenta (97)	MKP (51)	Broj objave evropske prijave patenta (97)	MKP (51)
2414144 *	B29C 45/14 (2006.01) B29C 45/16 (2006.01)	2449512 *	G06Q 20/00 (2012.01)	2493553 *	A61N 1/34 (2006.01) A61B 5/0408 (2006.01) A61N 1/36 (2006.01) A61N 1/04 (2006.01)
2482855 *	A61K 47/48 (2006.01)	2418177	C02F 1/68 (2006.01)		
2333889	H01M 8/24 (2006.01) H01M 8/02 (2006.01)	2387142 *	H02M 7/10 (2006.01)	2496154 *	A61B 1/005 (2006.01) A61B 17/128 (2006.01) A61B 18/14 (2006.01) A61M 25/10 (2006.01) A61B 17/32 (2006.01) A61B 17/34 (2006.01) A61B 17/29 (2006.01) A61B 17/00 (2006.01) A61B 17/04 (2006.01)
2427185 *	A61P 35/00 (2006.01) A61K 31/167 (2006.01) A61K 31/4412 (2006.01)	2412644 *	A47K 7/00 (2006.01) B65D 83/08 (2006.01)		
2461959 *	B29C 47/00 (2006.01)	2419588 *	E05C 1/10 (2006.01)		
2456439 *	A61K 31/4439 (2006.01) A61K 31/185 (2006.01) A61K 47/40 (2006.01) A61K 47/30 (2006.01) A61K 9/08 (2006.01) A61K 9/10 (2006.01)	2413935 *	A61K 31/4545 (2006.01) A61P 25/24 (2006.01)		
2403486 *	A61K 31/27 (2006.01) A61K 9/20 (2006.01) A61K 31/197 (2006.01)	2431034 *	A61P 25/16 (2006.01) A61K 31/4045 (2006.01) A61K 9/70 (2006.01) A61K 47/32 (2006.01) A61K 47/30 (2006.01) A61K 47/34 (2006.01)	2435432 *	C07D 471/04 (2006.01)
2378107	F02M 51/06 (2006.01) F02M 63/00 (2006.01) H01L 41/053 (2006.01)	2483656 *	G01M 3/24 (2006.01) F17D 5/06 (2006.01) G01S 11/14 (2006.01)	2420484 *	C05G 3/02 (2006.01) A01N 43/80 (2006.01) A01P 13/02 (2006.01) C05G 5/00 (2006.01)
2408816 *	C07K 16/28 (2006.01)	2236691	E04D 13/00 (2006.01) G01M 3/16 (2006.01)	2425286 *	G02B 6/35 (2006.01) G01N 21/64 (2006.01)
2432798 *	C07J 31/00 (2006.01) C07J 41/00 (2006.01) A61K 31/567 (2006.01) A61P 5/36 (2006.01)	2454264 *	A61K 31/4188 (2006.01) A61P 29/00 (2006.01) C07D 487/10 (2006.01) A61P 37/08 (2006.01)	2449109 *	C12N 15/82 (2006.01)
2488235 *	A61M 5/32 (2006.01)			2448563 *	A61K 9/20 (2006.01) A61K 31/4709 (2006.01)
				2429517 *	A61K 31/185 (2006.01) A01N 37/00 (2006.01) A61K 31/19 (2006.01) A61K 31/192 (2006.01) A61L 15/44 (2006.01) A61P 31/10 (2006.01)

Broj objave evropske prijave patenta (97)	MKP (51)	Broj objave evropske prijave patenta (97)	MKP (51)	Broj objave evropske prijave patenta (97)	MKP (51)
2386281	A61F 13/15 (2006.01) B65H 29/68 (2006.01)	2377640	B62D 33/02 (2006.01) B23K 26/26 (2006.01) B60P 1/28 (2006.01) B62D 27/02 (2006.01)	2403833 *	A61K 31/5377 (2006.01) A61K 31/497 (2006.01) C07D 401/14 (2006.01) A61P 5/50 (2006.01) A61K 31/4375 (2006.01) C07D 417/12 (2006.01) A61P 35/02 (2006.01) A61K 31/47 (2006.01) C07D 417/14 (2006.01) A61K 31/538 (2006.01) A61K 31/501 (2006.01) C07D 215/48 (2006.01) C07D 413/14 (2006.01) A61P 9/00 (2006.01) A61K 31/519 (2006.01) A61K 31/4709 (2006.01) C07D 487/04 (2006.01) C07D 401/12 (2006.01) A61P 3/00 (2006.01) A61K 31/506 (2006.01)
2473023 *	A01H 5/00 (2006.01) C12N 15/52 (2006.01) C12N 15/82 (2006.01)	2499144 *	A61P 37/00 (2006.01) A61K 31/522 (2006.01) A61P 25/00 (2006.01) A61P 31/00 (2006.01) C07D 487/04 (2006.01) A61P 3/00 (2006.01) A61P 9/02 (2006.01) A61P 29/00 (2006.01) A61P 27/02 (2006.01) A61P 25/28 (2006.01) C07D 495/04 (2006.01) A61P 35/00 (2006.01)	2473540 *	C08G 18/00 (2006.01)
2408496 *	A61M 15/00 (2006.01)			2419411 *	C07D 401/12 (2006.01) C07D 409/12 (2006.01) C07D 413/12 (2006.01) A61K 31/498 (2006.01) A61P 35/00 (2006.01) C07D 403/04 (2006.01) A61K 31/5377 (2006.01) C07D 241/44 (2006.01)
2432879 *	C12N 15/11 (2006.01) A61K 31/7088 (2006.01) A61P 3/04 (2006.01)			2414006 *	A61M 5/315 (2006.01)
2485592 *	A01N 43/64 (2006.01) A61K 31/41 (2006.01)	2425252 *	G01N 33/574 (2006.01)		
2314530	B65G 57/10 (2006.01) B65G 57/112 (2006.01) B65G 57/18 (2006.01)	2429993 *	C07D 401/00 (2006.01) C07D 405/00 (2006.01) C07D 213/55 (2006.01) C07D 413/00 (2006.01) A61K 31/44 (2006.01) C07D 417/00 (2006.01) A61K 31/5375 (2006.01) C07D 471/04 (2006.01) A61P 31/18 (2006.01) C07D 498/06 (2006.01) A61K 31/54 (2006.01) C07D 491/06 (2006.01) C07D 213/60 (2006.01)		
2383046	B05B 15/06 (2006.01) D21F 1/32 (2006.01) D21F 1/34 (2006.01)				
2467140 *	A61K 31/517 (2006.01)				
2371725	B65D 21/02 (2006.01) B65D 85/34 (2006.01) B65D 6/00 (2006.01)				
2464661 *	C07K 14/705 (2006.01)	2476841	E05D 15/06 (2006.01)		
2482799 *	A61K 31/167 (2006.01) A61K 9/00 (2006.01) A61K 31/573 (2006.01)				

Broj objave evropske prijave patenta (97)	MKP (51)	Broj objave evropske prijave patenta (97)	MKP (51)	Broj objave evropske prijave patenta (97)	MKP (51)
2470172 *	A61K 47/26 (2006.01) A61K 9/00 (2006.01) A61K 47/14 (2006.01) A61K 31/167 (2006.01)	2473479 *	C07D 237/24 (2006.01) A61K 31/235 (2006.01) C07D 213/81 (2006.01) C07D 213/80 (2006.01) C07C 233/75 (2006.01) A61K 31/192 (2006.01) C07C 237/42 (2006.01) A61K 31/44 (2006.01) C07D 213/30 (2006.01) A61P 25/28 (2006.01) C07C 235/56 (2006.01) A61K 31/166 (2006.01)	2439204 *	A61K 31/496 (2006.01) A61P 21/00 (2006.01) C07D 409/14 (2006.01) A61K 31/381 (2006.01) A61P 7/06 (2006.01) A61P 43/00 (2006.01) A61K 31/4436 (2006.01) A61P 9/10 (2006.01) C07D 409/12 (2006.01) A61P 3/10 (2006.01) A61P 37/04 (2006.01) C07D 333/38 (2006.01) A61P 7/00 (2006.01) A61P 37/06 (2006.01) A61K 31/5377 (2006.01) A61P 25/00 (2006.01) A61K 38/00 (2006.01) A61P 35/00 (2006.01) A61K 38/22 (2006.01) A61P 35/02 (2006.01)
2406197 *	C03C 17/36 (2006.01)	2421558 *	A61K 39/395 (2006.01)	2440506 *	C04B 35/63 (2006.01) C04B 35/44 (2006.01) C04B 35/626 (2006.01)
2429995 *	A61K 31/4418 (2006.01) C07D 213/76 (2006.01) A61P 9/00 (2006.01)	2427502 *	C08B 37/10 (2006.01)	2438255 *	E04G 23/00 (2006.01) B08B 3/02 (2006.01) E04G 1/20 (2006.01) E04G 23/08 (2006.01)
2406240 *	C07D 271/12 (2006.01) A61K 31/4245 (2006.01) C07D 235/02 (2006.01) A61K 31/4184 (2006.01) C07D 277/60 (2006.01) C07D 498/10 (2006.01) C07D 239/70 (2006.01) A61K 31/4188 (2006.01) C07D 491/10 (2006.01) A61K 31/517 (2006.01) C07D 487/10 (2006.01) A61K 31/519 (2006.01) C07D 403/06 (2006.01) A61K 31/428 (2006.01) C07D 405/12 (2006.01)	2449079 *	C11D 3/37 (2006.01) A61K 8/81 (2006.01) A61Q 5/02 (2006.01) A61K 8/73 (2006.01)	2383145	B60P 7/08 (2006.01)
2500034 *	A61P 17/00 (2006.01) A61P 37/08 (2006.01) A61K 39/395 (2006.01) A61P 17/04 (2006.01)	2456771 *	A61P 25/28 (2006.01) C07D 491/048 (2006.01) A61K 31/522 (2006.01)		
		2498519 *	H04W 4/02 (2009.01)		
		2438185 *	C12P 21/04 (2006.01)		
		2438487 *	G05B 13/04 (2006.01)		
		2411373 *	C07D 239/94 (2006.01)		
		2485772 *	A61L 2/06 (2006.01) B65B 55/06 (2006.01) A61L 2/24 (2006.01)		

Broj objave evropske prijave patenta (97)	MKP (51)	Broj objave evropske prijave patenta (97)	MKP (51)	Broj objave evropske prijave patenta (97)	MKP (51)
2496556 *	C07D 213/16 (2006.01) C07D 317/06 (2006.01) C07D 309/08 (2006.01) A61K 31/085 (2006.01) C07D 305/04 (2006.01) C07C 235/54 (2006.01) C07D 335/14 (2006.01)	2490544 *	A21B 1/46 (2006.01) A21B 3/07 (2006.01)	2471745	C02F 1/00 (2006.01) B01D 35/153 (2006.01) B01D 35/143 (2006.01)
		2443105 *	A61K 31/4353 (2006.01) A61K 31/4184 (2006.01) C07D 487/04 (2006.01) A61K 31/519 (2006.01) A61P 25/00 (2006.01) C07D 403/12 (2006.01)	2461820 *	A61P 5/50 (2006.01) A61K 38/17 (2006.01) A61K 38/28 (2006.01) A61K 31/195 (2006.01)
2461809 *	A61K 31/4418 (2006.01) A61K 31/4355 (2006.01) A61K 31/435 (2006.01) A61P 27/02 (2006.01)	2491385 *		2491385 *	G01N 33/50 (2006.01)
		2496086 *	A01N 43/90 (2006.01) A61K 31/519 (2006.01)	2421837 *	C07D 401/06 (2006.01) C07D 241/16 (2006.01)
2459531 *	C07D 207/16 (2006.01) A61K 31/4015 (2006.01) A61K 9/16 (2006.01)	2470722 *	E02B 11/00 (2006.01) E03F 1/00 (2006.01)	2445499 *	A61P 29/00 (2006.01) A61K 9/24 (2006.01) A61P 19/02 (2006.01) A61K 31/4439 (2006.01)
		2421422 *	A47K 10/36 (2006.01) A47K 5/12 (2006.01)		
2281836	A61K 39/36 (2006.01) C07K 14/415 (2006.01) C12N 15/62 (2006.01)	2448950 *	C07F 9/6561 (2006.01)	2476420 *	A61P 31/04 (2006.01) A61K 9/14 (2006.01) A61K 9/51 (2006.01) A61K 47/04 (2006.01) A61K 31/665 (2006.01)
2408364 *	A61B 5/053 (2006.01)	2451470 *	A61K 38/21 (2006.01) C12P 21/02 (2006.01)		
2278627	H01L 31/042 (2006.01)	2459213 *	A61K 38/57 (2006.01) C07K 14/81 (2006.01) C07K 16/38 (2006.01)	2411172 *	B22D 11/06 (2006.01)
2459171 *	A61K 9/06 (2006.01) A61K 47/48 (2006.01) A61K 9/00 (2006.01)	2488266 *	B01B 1/06 (2006.01) H01L 41/09 (2006.01)		
2412713 *	A61K 31/4439 (2006.01) A61P 1/04 (2006.01) C07D 401/04 (2006.01)	2464976 *	G01N 33/564 (2006.01) G01N 33/68 (2006.01)		
2375042	F02P 7/077 (2006.01) F02D 35/02 (2006.01) F02D 41/34 (2006.01)	2451797 *	C07D 309/10 (2006.01)		

Broj objave evropske prijava patenta (97)	MKP (51)	Broj objave evropske prijava patenta (97)	MKP (51)	Broj objave evropske prijava patenta (97)	MKP (51)
2417130 *	C07D 405/14 (2006.01) A61P 9/00 (2006.01) C07D 309/14 (2006.01) A61P 25/00 (2006.01) C07D 335/02 (2006.01) C07D 239/96 (2006.01) A61K 31/517 (2006.01) C07D 407/04 (2006.01) A61P 37/00 (2006.01) C07D 409/04 (2006.01) A61P 29/00 (2006.01) C07D 405/04 (2006.01) A61P 11/00 (2006.01)	2408967 *	E01B 31/13 (2006.01) B21B 1/085 (2006.01)	2470526 *	A61P 35/00 (2006.01) A61K 31/506 (2006.01) C07D 401/14 (2006.01) C07D 403/04 (2006.01)
		2419423 *	C07D 239/48 (2006.01) C07D 407/12 (2006.01) A61K 31/506 (2006.01) A61K 31/5377 (2006.01) A61P 35/00 (2006.01) C07D 403/12 (2006.01)	2475519 *	B32B 7/12 (2006.01) F16S 1/12 (2006.01) B32B 3/28 (2006.01) B32B 1/08 (2006.01) F16S 1/14 (2006.01)
		2264094	C08L 95/00 (2006.01) C08K 7/28 (2006.01) C08K 7/00 (2006.01)	2407537 *	C12N 15/09 (2006.01) A61K 39/395 (2006.01) A61P 31/04 (2006.01) C07K 16/12 (2006.01)
2486004 *	C07C 317/44 (2006.01) C07D 405/12 (2006.01) C07D 275/02 (2006.01) A61K 31/381 (2006.01) C07D 277/30 (2006.01) A61K 31/415 (2006.01) C07D 307/54 (2006.01) A61K 31/421 (2006.01) C07D 263/32 (2006.01) A61K 31/341 (2006.01) C07D 333/24 (2006.01) C07D 231/10 (2006.01) A61K 31/277 (2006.01) C07C 317/46 (2006.01) A61K 31/192 (2006.01)	2415381 *	A47L 13/20 (2006.01) A47L 13/10 (2006.01) A47L 13/17 (2006.01)	2427467 *	A61K 31/665 (2006.01) A61P 35/00 (2006.01) C07F 9/6561 (2006.01)
		2470210 *	A61K 39/395 (2006.01)	2406258 *	C07D 487/04 (2006.01) C07D 471/04 (2006.01) A61K 31/519 (2006.01) A61P 37/00 (2006.01)
		2408519 *	A61N 1/36 (2006.01) H04L 27/12 (2006.01) H04R 25/00 (2006.01)	2448964 *	C07K 14/71 (2006.01) A61K 31/4745 (2006.01)
		2411123 *	B01D 53/83 (2006.01) B01D 53/96 (2006.01) C01D 7/00 (2006.01) C01F 11/46 (2006.01) F23J 15/04 (2006.01) B01D 53/50 (2006.01) B01D 53/75 (2006.01) B01D 53/78 (2006.01)	2411792 *	G01N 25/48 (2006.01) G01B 7/012 (2006.01) G01N 35/00 (2006.01) G01N 35/04 (2006.01)
2499146 *	C07D 495/14 (2006.01) A61P 37/00 (2006.01) A61K 31/56 (2006.01) C07D 495/04 (2006.01)	2466085 *	F01N 3/037 (2006.01) F24F 3/16 (2006.01) F24F 5/00 (2006.01)	2427630 *	E21B 33/124 (2006.01) E21B 34/14 (2006.01)

Broj objave evropske prijave patenta (97)	MKP (51)	Broj objave evropske prijave patenta (97)	MKP (51)	Broj objave evropske prijave patenta (97)	MKP (51)
2427177 *	A61K 47/02 (2006.01) A61K 31/4468 (2006.01) A61K 9/16 (2006.01)	2459721 *	C12N 5/16 (2006.01) C12N 15/67 (2006.01) C12N 15/79 (2006.01)	2483271 *	C07D 403/04 (2006.01) A61P 9/00 (2006.01) C07D 413/04 (2006.01) A61P 5/00 (2006.01) A61K 31/551 (2006.01) C07D 471/14 (2006.01) A61P 35/00 (2006.01) A61K 31/554 (2006.01) C07D 513/14 (2006.01) A61P 11/00 (2006.01) A61K 31/553 (2006.01) C07D 498/14 (2006.01) A61P 25/00 (2006.01)
2425010 *	C12P 21/08 (2006.01) A61K 39/00 (2006.01)	2459681 *	C10J 3/46 (2006.01) C10B 53/00 (2006.01)		
2414386 *	C07K 14/11 (2006.01) C12N 15/86 (2006.01)	2473636 *	C12Q 1/68 (2006.01)		
2458981 *	A01N 37/46 (2006.01) A01N 43/653 (2006.01) A01N 47/24 (2006.01) A01N 25/04 (2006.01)	2443092 *	C07D 401/12 (2006.01) C07D 405/04 (2006.01) C07D 215/60 (2006.01) A61P 25/00 (2006.01) C07D 401/04 (2006.01) C07D 471/04 (2006.01)		
2459225 *	A61K 47/48 (2006.01) A61P 25/16 (2006.01)			2482892 *	A61M 5/315 (2006.01)
2338790	B64C 29/00 (2006.01)			2458251	F16J 15/02 (2006.01) F16L 13/14 (2006.01) F16L 37/092 (2006.01) F16L 41/08 (2006.01) F16L 23/16 (2006.01)
2424865 *	C07D 413/14 (2006.01) A61K 31/535 (2006.01) A61P 3/00 (2006.01) A61P 5/00 (2006.01)	2493524 *	A61L 31/10 (2006.01) A61L 27/30 (2006.01) A61L 27/34 (2006.01) A61L 31/08 (2006.01) A61L 17/00 (2006.01)	2424523 *	A61K 31/335 (2006.01) A61K 9/12 (2006.01)
2388700	G06F 9/50 (2006.01)			2445526 *	A61K 39/155 (2006.01) C07K 14/135 (2006.01)
2436767 *	C07D 207/08 (2006.01) C12N 15/113 (2010.01)			2454480 *	F03G 6/00 (2006.01)
2488202 *	A61K 39/395 (2006.01)			2476839	E05D 15/08 (2006.01) E05D 15/06 (2006.01)
2421871 *	A61K 31/4439 (2006.01) C07D 513/04 (2006.01) A61P 35/00 (2006.01)			2499036 *	B62D 1/06 (2006.01)

Broj objave evropske prijava patenta (97)	MKP (51)	Broj objave evropske prijava patenta (97)	MKP (51)	Broj objave evropske prijava patenta (97)	MKP (51)
2430013 *	A61K 31/437 (2006.01) C07D 401/14 (2006.01) A61K 31/52 (2006.01) C07D 403/04 (2006.01) A61K 31/53 (2006.01) C07D 403/14 (2006.01) A61P 35/00 (2006.01) C07D 471/04 (2006.01) C07D 519/00 (2006.01) C07D 487/04 (2006.01) A61K 31/506 (2006.01)	2480390 *	B29C 49/64 (2006.01) H05B 3/00 (2006.01) F21V 7/00 (2006.01) B29B 13/02 (2006.01) B29C 49/68 (2006.01)	2445908 *	C07D 417/14 (2006.01) A61K 31/4245 (2006.01) A61P 3/10 (2006.01) A61K 31/427 (2006.01) C07D 417/12 (2006.01)
		2267474	G01S 3/32 (2006.01) H04B 7/185 (2006.01)	2493888 *	A61K 31/437 (2006.01) A61K 31/553 (2006.01) A61K 31/4375 (2006.01) A61K 31/5365 (2006.01) C07D 487/04 (2006.01) A61K 31/55 (2006.01) A61K 31/4985 (2006.01) C07D 471/04 (2006.01) A61K 31/551 (2006.01) C07D 519/00 (2006.01) A61P 5/50 (2006.01)
		2493482 *	A61K 33/00 (2006.01) A61P 3/00 (2006.01)		
2483460 *	D01F 4/02 (2006.01) D01D 5/00 (2006.01)	2435481 *	C07K 16/24 (2006.01) A61P 11/06 (2006.01) C07K 16/46 (2006.01)		
2496188 *	A61F 2/60 (2006.01)	2464346 *	A61P 11/10 (2006.01) A61K 9/00 (2006.01) A61P 11/00 (2006.01) A61K 31/198 (2006.01) A61K 33/06 (2006.01) A61K 33/14 (2006.01)	2424546 *	A61K 31/7076 (2006.01) A61P 27/02 (2006.01) C07H 19/167 (2006.01)
2462142 *	C07D 471/04 (2006.01) C07D 487/04 (2006.01) C07D 498/04 (2006.01) C07D 513/04 (2006.01) A61K 31/33 (2006.01) A61P 25/00 (2006.01)	2273053	E06B 3/42 (2006.01) E05D 15/06 (2006.01)	2485712 *	A61K 47/48 (2006.01) A61K 31/519 (2006.01) A61K 9/00 (2006.01) A61K 9/06 (2006.01)
2494015 *	C11B 3/00 (2006.01) C12N 9/16 (2006.01)	2435431 *	C07D 417/14 (2006.01) A61K 31/541 (2006.01)	2475676 *	C07J 71/00 (2006.01) A61P 5/44 (2006.01) A61K 31/58 (2006.01)
2459674 *	C09K 11/07 (2006.01) F42B 12/36 (2006.01) F42B 12/40 (2006.01) F42B 12/46 (2006.01)	2482809 *	A61K 31/05 (2006.01) A61K 36/185 (2006.01) A61K 36/77 (2006.01) A61K 36/48 (2006.01) A61K 36/28 (2006.01)		

Broj objave evropske prijave patenta (97)	MKP (51)	Broj objave evropske prijave patenta (97)	MKP (51)	Broj objave evropske prijave patenta (97)	MKP (51)
2424847 *	C07D 265/32 (2006.01) A61K 31/5375 (2006.01) A61K 31/5377 (2006.01) A61P 7/02 (2006.01) C07D 413/12 (2006.01) C07D 413/14 (2006.01)	2459547 *	C07D 417/08 (2006.01) C07D 417/14 (2006.01) A01N 43/78 (2006.01) C07D 409/08 (2006.01) C07D 401/08 (2006.01) C07D 405/08 (2006.01)	2394905	B63B 3/28 (2006.01) B63B 9/06 (2006.01) E04B 9/06 (2006.01) E04F 11/00 (2006.01)
2461642 *	H04W 88/08 (2009.01) H04B 7/26 (2006.01) H04W 24/00 (2009.01)	2280105	D04B 21/16 (2006.01)	2277882	C07D 491/04 (2006.01) A61K 31/407 (2006.01)
2490694 *	A61K 31/56 (2006.01) A61P 9/00 (2006.01)	2435075 *	A61P 27/02 (2006.01) C07K 14/715 (2006.01) C07K 16/22 (2006.01) A61K 39/395 (2006.01) C07K 16/24 (2006.01)	2424501 *	A61K 9/00 (2006.01)
2403878 *	C07K 16/28 (2006.01)	2477983 *	C07D 409/14 (2006.01) C07D 451/02 (2006.01) C07D 451/06 (2006.01) A61K 31/4439 (2006.01) A61P 3/00 (2006.01)	2454256 *	A61P 25/18 (2006.01) C07D 471/04 (2006.01) A61K 31/42 (2006.01)
2241709	E05F 15/14 (2006.01) E05F 17/00 (2006.01)	2491028 *	A61K 31/4439 (2006.01) C07D 401/12 (2006.01) A61K 31/437 (2006.01) C07D 471/04 (2006.01)	2464799 *	E04C 2/38 (2006.01)
2451275 *	A01P 3/00 (2006.01) A01N 43/50 (2006.01) A01N 47/04 (2006.01)	2412869	D21G 9/00 (2006.01)	2480531 *	A61K 31/4025 (2006.01) C07D 209/52 (2006.01) C07D 405/04 (2006.01) C07D 209/46 (2006.01) A61P 29/00 (2006.01) C07D 403/06 (2006.01) C07D 493/04 (2006.01) C07D 207/416 (2006.01) C07D 401/06 (2006.01)
2451792 *	C07D 403/04 (2006.01) C07D 487/04 (2006.01) C07D 253/06 (2006.01)	2294925	A23L 1/216 (2006.01) A23L 1/217 (2006.01) A23B 7/02 (2006.01) A23B 7/03 (2006.01)	2464417 *	A61M 37/00 (2006.01) A61N 7/00 (2006.01) A61K 41/00 (2006.01)
2416796 *	A61K 38/00 (2006.01)	2459201 *	A61K 31/74 (2006.01)		
2459193 *	A61K 31/4418 (2006.01) A61P 7/02 (2006.01) A61P 9/10 (2006.01)				

Broj objave evropske prijave patenta (97)	MKP (51)	Broj objave evropske prijave patenta (97)	MKP (51)	Broj objave evropske prijave patenta (97)	MKP (51)
2464384 *	C12N 15/87 (2006.01) A61K 41/00 (2006.01) A61P 35/00 (2006.01) A61K 48/00 (2006.01) A61K 9/00 (2006.01) A61P 43/00 (2006.01)	2424625 *	A63B 23/02 (2006.01)	2454250 *	C07D 413/14 (2006.01) A61P 9/00 (2006.01) C07D 491/048 (2006.01) A61P 29/00 (2006.01) C07D 407/14 (2006.01) A61K 31/506 (2006.01) A61K 31/437 (2006.01) A61P 37/00 (2006.01) A61K 31/4439 (2006.01) C07D 401/12 (2006.01) A61K 31/444 (2006.01) C07D 401/14 (2006.01) A61K 31/497 (2006.01) C07D 471/04 (2006.01) A61P 25/28 (2006.01)
2478100 *	C12N 15/90 (2006.01) C12N 15/10 (2006.01)	2478182 *	E21B 43/25 (2006.01) E21B 43/26 (2006.01)	2459173 *	A61P 35/00 (2006.01) A61K 9/00 (2006.01) A61K 9/08 (2006.01) A61K 31/55 (2006.01)
2490689 *	A61P 35/00 (2006.01) A61K 31/404 (2006.01) A61K 31/40 (2006.01) A61K 31/4709 (2006.01) A61P 31/00 (2006.01) A61P 29/00 (2006.01) A61K 31/44 (2006.01)	2440126 *	G06K 9/00 (2006.01) A61B 5/0452 (2006.01) G06F 17/00 (2006.01)	2371357	A61K 31/485 (2006.01) A61K 9/20 (2006.01) C07D 489/08 (2006.01)
2345395	A61F 13/15 (2006.01)	2463258	C05D 3/02 (2006.01) C05G 3/00 (2006.01)	2493703 *	G09F 1/10 (2006.01) B43L 5/02 (2006.01) F16B 2/16 (2006.01) B42F 15/06 (2006.01) A47G 1/21 (2006.01)
2480668 *	C12N 15/113 (2010.01) A61K 31/713 (2006.01) C07H 21/02 (2006.01) A61P 35/00 (2006.01)	2475657 *	C07D 409/14 (2006.01) A61P 31/12 (2006.01) C07D 409/12 (2006.01) C07D 417/12 (2006.01) C07D 333/68 (2006.01) C07D 413/12 (2006.01) C07D 487/04 (2006.01) C07D 493/04 (2006.01) A61K 31/381 (2006.01)	2408505 *	A61M 25/00 (2006.01) A61M 25/06 (2006.01)
2388052	E01C 13/08 (2006.01) A63C 19/02 (2006.01)	2410991 *	A61K 9/127 (2006.01)	2408472 *	A61K 38/31 (2006.01)
2413943 *	A61K 31/785 (2006.01) A61K 31/795 (2006.01)	2451437 *	C07K 14/62 (2006.01) C12N 15/81 (2006.01) A61K 9/10 (2006.01) A61K 47/00 (2006.01)		
2470541 *	C07D 495/04 (2006.01) A61K 31/519 (2006.01) C07D 491/04 (2006.01) C07D 487/04 (2006.01) A61P 35/00 (2006.01)				

Broj objave evropske prijave patenta (97)	MKP (51)	Broj objave evropske prijave patenta (97)	MKP (51)	Broj objave evropske prijave patenta (97)	MKP (51)
2452939 *	C07D 403/04 (2006.01) C07D 403/06 (2006.01) C07D 207/273 (2006.01)	2483254 *	C07D 261/14 (2006.01) A61K 31/495 (2006.01) C07D 241/04 (2006.01) A61K 31/44 (2006.01) C07C 223/00 (2006.01) A61P 25/28 (2006.01) C07D 231/12 (2006.01) A61K 31/4155 (2006.01) C07D 265/30 (2006.01) A61K 31/4965 (2006.01) C07D 237/20 (2006.01) A61K 31/42 (2006.01) C07C 233/00 (2006.01) A61P 25/16 (2006.01) A61K 31/5375 (2006.01) A61P 25/00 (2006.01)	2448924 *	A61P 35/00 (2006.01) C07D 231/38 (2006.01) A61K 31/415 (2006.01) C07C 275/30 (2006.01)
2385029	C04B 28/00 (2006.01)			2370085 *	A61K 35/74 (2006.01)
2283963	B23K 26/08 (2006.01) B23Q 1/01 (2006.01) B23K 37/02 (2006.01) B23Q 1/54 (2006.01) B23Q 1/58 (2006.01) B25J 17/02 (2006.01) B23K 26/38 (2006.01)			2414325 *	C07C 307/06 (2006.01) C07D 417/12 (2006.01)
2493468 *	A61K 31/195 (2006.01) A61P 37/02 (2006.01)			2434890 *	A61K 31/40 (2006.01) A01N 43/36 (2006.01)
2406290 *	A61K 39/395 (2006.01) C07K 16/30 (2006.01) A61P 35/00 (2006.01) C07K 19/00 (2006.01) C12N 15/63 (2006.01) C12N 15/62 (2006.01)	2483233 *	A61P 9/00 (2006.01) A61P 11/00 (2006.01) A61K 31/201 (2006.01) C07C 205/50 (2006.01)	2403840 *	A61K 31/5415 (2006.01) C07D 275/06 (2006.01)
2430049 *	C07K 16/18 (2006.01) G01N 33/68 (2006.01) A61K 39/395 (2006.01) A61P 25/28 (2006.01)	2496221 *	A61K 31/00 (2006.01) A61K 9/00 (2006.01) A61K 9/20 (2006.01)	2414134 *	B24C 1/04 (2006.01) B24C 3/04 (2006.01)
2491018 *	C07D 487/08 (2006.01) C07D 215/56 (2006.01)	2459207 *	A61K 38/08 (2006.01)	2442870 *	A61P 43/00 (2006.01) A61P 3/00 (2006.01) A61P 15/00 (2006.01) A61P 13/02 (2006.01) C07D 498/04 (2006.01) A61P 21/00 (2006.01)
2477611 *	A61K 9/20 (2006.01) A61K 31/277 (2006.01)	2403571 *	A61M 5/32 (2006.01) A61M 5/50 (2006.01)	2456335 *	A45D 31/00 (2006.01) A61K 8/02 (2006.01) A61K 8/35 (2006.01) A61K 8/37 (2006.01) A61K 8/42 (2006.01) A61Q 3/02 (2006.01)
		2411171 *	B22D 11/06 (2006.01) B22D 11/12 (2006.01)		

Broj objave evropske prijave patenta (97)	MKP (51)	Broj objave evropske prijave patenta (97)	MKP (51)	Broj objave evropske prijave patenta (97)	MKP (51)
2325407	F16K 31/30 (2006.01) F16K 31/46 (2006.01) F15C 1/16 (2006.01) E03F 5/10 (2006.01) F15D 1/00 (2006.01)	2456175	H04M 1/02 (2006.01) G06F 1/16 (2006.01)	2424955 *	C10B 7/02 (2006.01) C10L 5/40 (2006.01) C10L 9/08 (2006.01) C10B 53/02 (2006.01) F26B 23/02 (2006.01) C10B 49/02 (2006.01) F27B 9/18 (2006.01) F26B 17/00 (2006.01)
2402012	A61K 31/4545 (2006.01) A61K 47/10 (2006.01) A61P 11/02 (2006.01) A61K 9/08 (2006.01) A61P 37/08 (2006.01) A61K 9/00 (2006.01) G01N 30/02 (2006.01) A61P 11/04 (2006.01)	2410935 *	A61B 17/94 (2006.01) A61B 17/34 (2006.01) A61B 19/00 (2006.01)	2496707 *	C12N 5/07 (2010.01) C12P 21/08 (2006.01)
2491655 *	H03K 5/22 (2006.01)	2453813 *	A61B 17/32 (2006.01) A61B 18/14 (2006.01) A61B 17/28 (2006.01)	2453959 *	A61M 5/315 (2006.01)
2448400 *	A01H 3/00 (2006.01)	2456431 *	A61K 31/19 (2006.01) A61K 31/195 (2006.01) A61K 31/198 (2006.01) A61K 31/4172 (2006.01) A61K 31/661 (2006.01) A61K 31/675 (2006.01) A61K 31/7004 (2006.01)	2424897 *	C07K 16/28 (2006.01) A61K 39/395 (2006.01) A61P 31/18 (2006.01)
2428214	A61P 31/04 (2006.01) A61K 35/74 (2006.01) A61P 15/02 (2006.01)		A61K 33/00 (2006.01) A61K 33/06 (2006.01) A61K 33/10 (2006.01) A61P 7/08 (2006.01) A61K 45/06 (2006.01)	2432781 *	C07D 451/10 (2006.01) A61K 31/46 (2006.01) A61P 11/00 (2006.01)
2464363 *	A23L 1/305 (2006.01) A61K 36/88 (2006.01) A61K 36/78 (2006.01) A61P 9/12 (2006.01)	2473057 *	A61K 36/00 (2006.01) A01N 65/00 (2009.01)	2437819 *	A61M 5/315 (2006.01)
2475648 *	C07D 403/12 (2006.01) A61K 31/505 (2006.01) A61P 37/00 (2006.01) C07D 239/48 (2006.01) A61K 31/506 (2006.01) A61P 35/00 (2006.01)	2464646 *	C07D 471/04 (2006.01)	2441459 *	A61P 25/00 (2006.01) A61K 31/7076 (2006.01) A61P 25/28 (2006.01)
2438194 *	C12Q 1/68 (2006.01)	2466939 *	H04W 16/00 (2009.01)	2450051 *	A61P 1/16 (2006.01) A61P 31/14 (2006.01) A61K 31/56 (2006.01) A61P 43/00 (2006.01) A61K 31/7056 (2006.01) A61K 38/21 (2006.01)

Broj objave evropske prijave patenta (97)	MKP (51)	Broj objave evropske prijave patenta (97)	MKP (51)	Broj objave evropske prijave patenta (97)	MKP (51)
2491038 *	C07D 487/04 (2006.01) A61K 31/407 (2006.01) A61P 25/00 (2006.01)	2491168 *	C30B 11/00 (2006.01) C30B 29/06 (2006.01) B22D 27/04 (2006.01) H05B 6/44 (2006.01) H05B 6/36 (2006.01) F27B 14/14 (2006.01) C30B 35/00 (2006.01)	2418349 *	E21B 47/00 (2012.01) E21B 43/00 (2006.01)
2421897 *	C07K 16/00 (2006.01)			2421535 *	A61P 25/02 (2006.01) A61P 1/06 (2006.01) A61K 31/496 (2006.01) A61P 29/00 (2006.01)
2411906 *	G06F 7/04 (2006.01)				
2427238 *	A61M 5/32 (2006.01)	2428140	A47C 23/06 (2006.01)	2489022 *	G07F 17/32 (2006.01)
2248429	A22C 21/00 (2006.01) A22C 21/06 (2006.01)	2454254 *	C07D 495/04 (2006.01) C07D 401/14 (2006.01) A61P 3/00 (2006.01) C07D 417/14 (2006.01) C07D 403/14 (2006.01) C07D 407/14 (2006.01) A61K 31/4184 (2006.01) C07D 409/14 (2006.01) C07D 413/14 (2006.01)	2397028	A01G 1/00 (2006.01) A01G 9/02 (2006.01)
2430006 *	C07D 277/64 (2006.01) C07D 285/06 (2006.01) C07D 403/12 (2006.01) C07D 413/14 (2006.01) C07D 417/12 (2006.01) A61K 31/403 (2006.01) C07D 417/14 (2006.01) A61P 29/00 (2006.01)			2486199 *	E04H 15/18 (2006.01) E04C 3/00 (2006.01) E04H 15/64 (2006.01) E04H 15/48 (2006.01)
		2411391 *	C07D 473/34 (2006.01) A61K 31/52 (2006.01) A61P 35/00 (2006.01)	2406262 *	A61K 31/4709 (2006.01) C07D 239/94 (2006.01) C07D 471/04 (2006.01) A61K 31/517 (2006.01) A61K 31/519 (2006.01) C07D 403/12 (2006.01) C07D 403/14 (2006.01) A61K 31/4178 (2006.01) A61P 35/00 (2006.01) C07D 405/14 (2006.01)
2386753	H02P 9/00 (2006.01) F03D 9/00 (2006.01) H02P 9/30 (2006.01) H02P 9/48 (2006.01)	2482970 *	B01D 53/64 (2006.01) B01J 20/02 (2006.01) B01J 20/28 (2006.01) B01D 53/02 (2006.01)		
2474544 *	A61K 31/506 (2006.01) A61K 31/5377 (2006.01) A61K 31/4439 (2006.01) A61K 31/426 (2006.01) A61P 25/22 (2006.01) C07D 491/052 (2006.01) C07D 417/14 (2006.01) C07D 495/04 (2006.01) C07D 491/048 (2006.01)	2470898 *	G01N 33/48 (2006.01)	2427449 *	C07D 401/14 (2006.01) A61K 31/4439 (2006.01)
		2337131	H01M 8/02 (2006.01) H01M 8/24 (2006.01)	2244353	H02J 9/00 (2006.01)
		2497830 *	C12N 15/86 (2006.01) C12N 15/63 (2006.01)	2470894 *	G01N 33/00 (2006.01)
				2464913 *	F24F 3/00 (2006.01)

Broj objave evropske prijava patenta (97)	MKP (51)	Broj objave evropske prijava patenta (97)	MKP (51)	Broj objave evropske prijava patenta (97)	MKP (51)
2406222 *	A61P 17/00 (2006.01) A61P 19/00 (2006.01) A61K 31/506 (2006.01) A61P 33/06 (2006.01) A61P 35/00 (2006.01) C07D 213/74 (2006.01) A61P 37/00 (2006.01) C07D 239/42 (2006.01) A61K 31/44 (2006.01)	2464224 *	A01N 37/18 (2006.01)	2488199 *	A61K 39/395 (2006.01) A61P 35/00 (2006.01) C07K 14/525 (2006.01) C07K 14/765 (2006.01) C07K 16/28 (2006.01) C07K 16/32 (2006.01) C07K 16/46 (2006.01) C07K 19/00 (2006.01)
2408762 *	C07D 401/04 (2006.01) C07D 401/14 (2006.01) C07D 403/04 (2006.01) C07D 407/14 (2006.01) C07D 493/08 (2006.01) A61K 31/4709 (2006.01) A61K 31/4184 (2006.01) A61P 35/00 (2006.01)	2496115 *	A47B 88/04 (2006.01)	2475368 *	A61K 31/502 (2006.01) A61P 35/00 (2006.01) A61P 35/02 (2006.01)
2440543 *	C07D 401/10 (2006.01) C07D 213/64 (2006.01) A61K 31/4412 (2006.01) A61P 9/00 (2006.01)	2448901 *	C07C 45/69 (2006.01) C07C 209/62 (2006.01) C07C 211/35 (2006.01) C07C 49/403 (2006.01)	2459919 *	F16L 11/00 (2006.01)
2456426 *	A61K 9/20 (2006.01) A61K 31/295 (2006.01)	2416651 *	A01N 43/04 (2006.01) A61K 31/70 (2006.01)	2442648 *	A01P 7/00 (2006.01) A01N 25/02 (2006.01) A01N 47/40 (2006.01) A01N 51/00 (2006.01) A01N 43/40 (2006.01) A01N 43/86 (2006.01)
2470545 *	C07D 498/04 (2006.01) A61K 31/4985 (2006.01) A61P 25/00 (2006.01)	2432555 *	A61K 31/519 (2006.01) C07D 487/04 (2006.01) A61P 35/00 (2006.01)	2482884 *	A61M 5/315 (2006.01)
2415802 *	A61Q 19/00 (2006.01) C08G 77/388 (2006.01) C08L 83/08 (2006.01) A61K 8/898 (2006.01)	2482883 *	A61M 5/315 (2006.01)	2485730 *	A61K 47/44 (2006.01) A61K 31/444 (2006.01) A61K 47/10 (2006.01) A61K 47/12 (2006.01) A61P 29/00 (2006.01) A61K 9/00 (2006.01)
		2474605	C12M 1/00 (2006.01)	2332910	C07D 209/52 (2006.01) A61K 31/403 (2006.01) A61P 25/00 (2006.01)

Broj objave evropske prijave patenta (97)	MKP (51)	Broj objave evropske prijave patenta (97)	MKP (51)	Broj objave evropske prijave patenta (97)	MKP (51)
2256275	E05D 11/10 (2006.01) E05F 1/00 (2006.01) E05F 3/22 (2006.01)	2473148 *	A61G 5/12 (2006.01)	2455372 *	C07D 277/56 (2006.01) A61P 19/06 (2006.01) C07D 277/20 (2006.01) A61K 31/426 (2006.01)
2414535 *	C12Q 1/00 (2006.01)	2435093 *	A61K 39/00 (2006.01) A61K 39/385 (2006.01) A61K 47/48 (2006.01) A61P 25/28 (2006.01)	2460067 *	G06F 7/00 (2006.01) G06F 17/00 (2006.01)
2485520 *	H04W 16/28 (2009.01) H04B 7/04 (2006.01)	2499154 *	C07K 7/08 (2006.01) C07K 14/47 (2006.01)	2421825 *	C07D 405/14 (2006.01) A61K 31/496 (2006.01) C07D 405/12 (2006.01) C07D 495/04 (2006.01) C07D 409/14 (2006.01) A61P 25/00 (2006.01) C07D 403/12 (2006.01) C07D 417/14 (2006.01) C07D 409/12 (2006.01) A61P 29/00 (2006.01) C07D 413/12 (2006.01) C07D 401/14 (2006.01) C07D 417/12 (2006.01) C07D 205/04 (2006.01) C07D 413/14 (2006.01)
2447328	C09C 1/02 (2006.01)	2459587 *	C07K 14/325 (2006.01) C12N 15/82 (2006.01)		
2295841	F16L 13/007 (2006.01) F16L 25/10 (2006.01) F16L 13/16 (2006.01)	2389806	A01N 37/02 (2006.01) A01N 65/00 (2009.01) A01N 37/04 (2006.01) A01N 65/22 (2009.01) A01P 7/00 (2006.01) A01N 3/00 (2006.01) A01P 21/00 (2006.01) A01N 65/38 (2009.01) A01N 65/42 (2009.01)		
2406388 *	C12P 21/04 (2006.01)				
2476701 *	A61P 31/10 (2006.01) C07K 14/805 (2006.01) C07F 15/02 (2006.01) A61K 38/42 (2006.01) A61P 31/04 (2006.01) C07D 487/22 (2006.01)	2428580 *	C12Q 1/04 (2006.01)		
2478109 *	C12P 7/52 (2006.01) C12N 15/52 (2006.01) C12N 9/10 (2006.01) C12N 9/88 (2006.01) C12N 1/21 (2006.01)	2427198 *	A61K 31/727 (2006.01) C08B 37/10 (2006.01) C08B 37/00 (2006.01)		
2408799 *	C07J 41/00 (2006.01) A61K 31/573 (2006.01) A61P 5/36 (2006.01)	2424499 *	A61K 47/14 (2006.01) A61K 47/02 (2006.01) A61K 9/48 (2006.01) A61K 47/00 (2006.01) A61K 47/20 (2006.01) A61K 31/5377 (2006.01) A61K 9/00 (2006.01)		
2383548	G01F 1/58 (2006.01) G01F 1/60 (2006.01)				

Broj objave evropske prijava patenta (97)	MKP (51)	Broj objave evropske prijava patenta (97)	MKP (51)	Broj objave evropske prijava patenta (97)	MKP (51)
2485728 *	A61K 31/517 (2006.01) C07D 239/22 (2006.01) A61K 31/4166 (2006.01) A61K 31/553 (2006.01) A61K 31/4184 (2006.01) A61K 31/554 (2006.01) A61K 31/437 (2006.01) C07D 217/14 (2006.01) A61K 31/5513 (2006.01) A61K 31/472 (2006.01) C07D 235/26 (2006.01) A61K 31/551 (2006.01) C07D 239/96 (2006.01) A61K 31/5377 (2006.01) C07D 239/80 (2006.01)	2359820	A61K 36/9066 (2006.01) A61K 31/12 (2006.01) A61P 25/28 (2006.01)	2499126 *	C07D 401/12 (2006.01) A61P 35/00 (2006.01) A61P 9/00 (2006.01) C07D 487/04 (2006.01) A61K 31/47 (2006.01) A61P 37/00 (2006.01) C07D 473/02 (2006.01) A61P 27/02 (2006.01) A61P 3/00 (2006.01) A61P 25/28 (2006.01)
		2411805 *	G01N 33/50 (2006.01) G01N 33/564 (2006.01) G01N 33/68 (2006.01)		
		2480268 *	A61M 5/145 (2006.01) A61M 5/315 (2006.01)		
		2406278 *	C12N 15/82 (2006.01) C07K 14/325 (2006.01) A01H 5/00 (2006.01)	2470243 *	A61M 5/24 (2006.01) A61M 5/28 (2006.01) A61M 5/315 (2006.01) A61M 5/31 (2006.01) A61M 5/34 (2006.01)
		2497731	B65H 26/00 (2006.01)		
2414830 *	G01N 33/50 (2006.01) C12Q 1/44 (2006.01) A61K 31/00 (2006.01)	2315322	H01R 31/06 (2006.01) H02J 7/00 (2006.01)	2330550	G06Q 30/00 (2006.01)
		2459990 *	G01N 23/00 (2006.01)	2421847 *	A61P 25/00 (2006.01) A61K 31/496 (2006.01) C07D 401/06 (2006.01) C07D 409/06 (2006.01) A61P 29/00 (2006.01) C07D 417/06 (2006.01) C07D 401/12 (2006.01) C07D 205/04 (2006.01)
2411380 *	C07D 401/04 (2006.01)	2479661 *	G06F 13/10 (2006.01) G06F 3/14 (2006.01)		
2454090 *	B32B 27/12 (2006.01)				
2478308 *	F24J 2/10 (2006.01) F24J 2/14 (2006.01)	2432976 *	F01N 13/18 (2010.01) F01N 3/20 (2006.01) F01N 3/36 (2006.01)		
2430620 *	G07F 7/10 (2006.01) G06Q 20/00 (2012.01) G07F 7/08 (2006.01)	2486041 *	A61P 35/00 (2006.01) C07D 487/04 (2006.01) A61K 31/519 (2006.01)	2369166	F02M 61/06 (2006.01) F02M 61/18 (2006.01)
2464715 *	C11C 3/10 (2006.01)				
2411246 *	B60R 19/34 (2006.01)	2499489 *	G01N 33/50 (2006.01)		
2499167 *	C08B 37/00 (2006.01)				

Broj objave evropske prijava patenta (97)	MKP (51)	Broj objave evropske prijava patenta (97)	MKP (51)	Broj objave evropske prijava patenta (97)	MKP (51)
2366708	A61K 39/12 (2006.01) C07K 14/005 (2006.01) C07K 16/10 (2006.01) C12Q 1/70 (2006.01) C07K 14/08 (2006.01) C12N 7/00 (2006.01) G01N 33/569 (2006.01) C12N 15/40 (2006.01)	2482657 *	A01N 43/40 (2006.01) A61K 31/44 (2006.01)	2485886 *	B32B 17/10 (2006.01) B32B 37/10 (2006.01) B30B 5/02 (2006.01)
		2406288 *	C07K 19/00 (2006.01) C07K 16/18 (2006.01) C12N 15/63 (2006.01) A61K 39/395 (2006.01)	2437784 *	A61K 47/36 (2006.01)
		2383047	B08B 3/02 (2006.01) B05B 15/06 (2006.01) D21F 1/34 (2006.01)	2484672 *	C07D 401/04 (2006.01) C07D 495/04 (2006.01) A01N 43/62 (2006.01) A01N 43/46 (2006.01) A01P 3/00 (2006.01) C07D 498/04 (2006.01)
2316312	A47J 31/40 (2006.01)				
2266826	B60J 7/08 (2006.01)	2467143 *	A61K 31/19 (2006.01) A61K 31/60 (2006.01)	2493304 *	A01N 43/38 (2006.01) A61K 31/40 (2006.01)
2274998	A45C 7/00 (2006.01) G06F 1/16 (2006.01) A45C 11/38 (2006.01) H04B 1/38 (2006.01) A45C 13/00 (2006.01) A45C 11/00 (2006.01) H04M 1/18 (2006.01)	2430026 *	C07D 487/04 (2006.01) A61P 35/00 (2006.01) A61K 31/52 (2006.01)	2421860 *	C07D 417/14 (2006.01) C07D 417/12 (2006.01) A61K 31/496 (2006.01) A61P 29/00 (2006.01) A61P 25/00 (2006.01)
		2477994 *	C07D 498/04 (2006.01) A61K 31/519 (2006.01) A61K 31/522 (2006.01) A61P 25/00 (2006.01)	2462137 *	C07D 405/12 (2006.01) A61P 9/00 (2006.01)
2407998	H01J 37/32 (2006.01)				
2493846 *	C07C 309/65 (2006.01) A61P 25/04 (2006.01) C07C 237/20 (2006.01) A61P 29/00 (2006.01) C07D 277/46 (2006.01) C07D 295/12 (2006.01) C07C 233/01 (2006.01) A61P 11/00 (2006.01) A61K 31/16 (2006.01) C07D 211/06 (2006.01) C07C 235/34 (2006.01) A61K 31/18 (2006.01)	2455414	C08G 63/08 (2006.01) C08G 63/90 (2006.01) C08G 63/80 (2006.01)	2416771 *	A61K 31/37 (2006.01) A61K 31/35 (2006.01) A61P 1/00 (2006.01) A61P 3/04 (2006.01) A61P 3/00 (2006.01)
		2491129 *	C12P 21/08 (2006.01)		
		2470732 *	E04F 13/04 (2006.01)		
		2494352 *	G01N 33/564 (2006.01) G01N 33/50 (2006.01)		
		2461766 *	A61F 2/06 (2006.01)		

Broj objave evropske prijava patenta (97)	MKP (51)	Broj objave evropske prijava patenta (97)	MKP (51)	Broj objave evropske prijava patenta (97)	MKP (51)
2406356 *	C10G 11/00 (2006.01) C10M 101/02 (2006.01) C10G 45/58 (2006.01) C10G 9/00 (2006.01) C10M 107/02 (2006.01) C10G 47/00 (2006.01) A01N 25/02 (2006.01) C10L 1/04 (2006.01) C08K 5/01 (2006.01) C10L 11/04 (2006.01) C09D 11/02 (2006.01) C09K 8/02 (2006.01)	2421823 *	C07D 409/14 (2006.01) C07D 405/12 (2006.01) C07D 205/04 (2006.01) A61P 25/00 (2006.01) C07D 403/14 (2006.01) C07D 491/048 (2006.01) A61K 31/496 (2006.01) C07D 403/12 (2006.01) C07D 417/14 (2006.01) C07D 401/10 (2006.01) C07D 417/12 (2006.01) C07D 401/12 (2006.01) A61P 29/00 (2006.01)	2371350	A61K 8/44 (2006.01) A61K 8/04 (2006.01) A61K 9/00 (2006.01) A61K 9/107 (2006.01) A61K 31/17 (2006.01) A61K 9/12 (2006.01)
2499161 *	C07K 14/705 (2006.01) C07K 16/28 (2006.01) A61P 35/00 (2006.01) A61K 39/395 (2006.01)	2479243 *	C10G 47/36 (2006.01)	2490999 *	C07C 205/02 (2006.01) C07C 201/08 (2006.01)
2488867 *	C40B 50/06 (2006.01) C40B 40/10 (2006.01) C40B 30/04 (2006.01) G01N 33/53 (2006.01)	2486068 *	C08F 251/02 (2006.01) A61Q 3/02 (2006.01) A45D 31/00 (2006.01) A61K 8/91 (2006.01) C09D 4/06 (2006.01)	2408773 *	C07D 471/04 (2006.01) A61P 35/00 (2006.01)
2480196 *	A61K 8/02 (2006.01) A61Q 1/02 (2006.01) A61K 8/64 (2006.01) A61K 8/72 (2006.01)	2406704 *	G06F 3/041 (2006.01) G06F 3/01 (2006.01) G06F 3/048 (2006.01)	2464645 *	C07D 471/04 (2006.01) A61K 31/437 (2006.01) A61P 9/00 (2006.01) A61K 31/519 (2006.01) A61K 31/4985 (2006.01) A61K 31/5025 (2006.01)
		2414390 *	C07K 14/47 (2006.01)	2490970 *	A47K 10/16 (2006.01) B65H 75/10 (2006.01)
		2493880 *	C07D 405/04 (2006.01) A01N 43/56 (2006.01)	2437823 *	A61M 5/315 (2006.01)
		2403561 *	A61M 5/20 (2006.01)	2408277	H01H 85/046 (2006.01) H05K 1/16 (2006.01) H01H 85/041 (2006.01) H05K 1/00 (2006.01)

Broj objave evropske prijava patenta (97)	MKP (51)	Broj objave evropske prijava patenta (97)	MKP (51)	Broj objave evropske prijava patenta (97)	MKP (51)
2493506 *	C07K 16/00 (2006.01) A61K 39/395 (2006.01)	2445937 *	C07K 16/18 (2006.01) A61K 39/00 (2006.01) C07K 16/46 (2006.01) A61P 31/00 (2006.01)	2421521 *	A61P 17/10 (2006.01) A61K 9/00 (2006.01) A61K 31/433 (2006.01) A61P 17/00 (2006.01) A61K 31/155 (2006.01)
2392455	B65D 65/40 (2006.01) B32B 27/32 (2006.01) B32B 15/08 (2006.01)	2475337 *	A61F 5/00 (2006.01)	2482895 *	A61M 5/315 (2006.01)
2251573	F16K 1/22 (2006.01)	2421828 *	A61P 13/12 (2006.01) A61P 11/00 (2006.01) C07D 405/12 (2006.01) A61P 9/10 (2006.01) C07D 211/60 (2006.01) A61K 31/4468 (2006.01) A61P 9/02 (2006.01) A61P 9/04 (2006.01)	2485729 *	A61K 31/4178 (2006.01) A61P 31/10 (2006.01) A61P 13/02 (2006.01) A61K 31/439 (2006.01) A61P 13/10 (2006.01) A61K 31/341 (2006.01) A61K 31/44 (2006.01) A61P 15/02 (2006.01) A61K 31/433 (2006.01)
2364058	H05B 7/144 (2006.01) H02M 5/257 (2006.01)	2361850	B65D 83/00 (2006.01)		
2459557 *	C07D 471/04 (2006.01) C07D 487/04 (2006.01) A61K 31/437 (2006.01) A61P 9/12 (2006.01)	2406440 *	E04D 13/04 (2006.01) F16L 37/14 (2006.01)	2448571 *	A61K 33/06 (2006.01) A61K 9/00 (2006.01) A61K 31/198 (2006.01) A61P 11/00 (2006.01) A61P 11/10 (2006.01) A61K 33/14 (2006.01)
2497753	C02F 1/68 (2006.01)	2435067 *	C12N 5/00 (2006.01) A61P 9/00 (2006.01) A61P 21/00 (2006.01) A61K 38/19 (2006.01) C07K 16/18 (2006.01) A61K 39/395 (2006.01) C07K 16/46 (2006.01)	2419445 *	C07K 16/00 (2006.01)
2308747	B62K 11/14 (2006.01) B62D 51/00 (2006.01)			2423241	C08G 61/10 (2006.01) C08G 61/12 (2006.01) C08J 9/00 (2006.01)
2416871 *	B01D 53/75 (2006.01) B01D 53/78 (2006.01) B01D 53/81 (2006.01) B01D 53/96 (2006.01) C21B 5/06 (2006.01) B01D 53/50 (2006.01)	2437824 *	A61M 5/315 (2006.01)		
2406188 *	C02F 1/68 (2006.01) C02F 1/00 (2006.01) C02F 1/76 (2006.01) C02F 103/42 (2006.01)	2491045 *	C07D 513/04 (2006.01) A61K 31/433 (2006.01) A61P 25/08 (2006.01)	2427235 *	A61M 5/158 (2006.01) F15C 5/00 (2006.01) G01L 9/00 (2006.01) A61M 5/142 (2006.01) F16K 99/00 (2006.01)
		2412272	A45D 20/12 (2006.01)		

Broj objave evropske prijava patenta (97)	MKP (51)	Broj objave evropske prijava patenta (97)	MKP (51)	Broj objave evropske prijava patenta (97)	MKP (51)
2440096 *	A47J 45/06 (2006.01)	2461968 *	A61F 13/26 (2006.01) B31C 3/00 (2006.01) D21H 17/28 (2006.01) D21H 27/00 (2006.01) D21H 17/29 (2006.01) D21H 19/54 (2006.01) D21H 25/04 (2006.01)	2470531 *	C07D 471/04 (2006.01) A61K 31/437 (2006.01)
2372139	F02M 63/00 (2006.01) F02M 51/06 (2006.01) F02M 61/16 (2006.01)			2464359 *	A61P 11/00 (2006.01) A61P 17/00 (2006.01) A61P 19/00 (2006.01) A61P 21/00 (2006.01) A61P 9/00 (2006.01) A61K 31/737 (2006.01) A61P 25/00 (2006.01) C08B 37/00 (2006.01) A61P 27/02 (2006.01) A61P 7/00 (2006.01) A61P 37/00 (2006.01)
2354074	B66C 1/02 (2006.01) B65G 47/00 (2006.01) B65G 61/00 (2006.01)	2467500 *	C12P 19/34 (2006.01) C12Q 1/68 (2006.01)		
2371766	C01F 11/18 (2006.01)	2429555 *	A61K 35/74 (2006.01)		
2445340 *	A61K 31/19 (2006.01) A61K 31/215 (2006.01) A01N 37/28 (2006.01)	2483308 *	C07K 14/605 (2006.01) A61K 39/395 (2006.01) A61P 3/08 (2006.01) C07K 14/575 (2006.01) A61K 47/48 (2006.01) C07K 16/18 (2006.01) A61P 5/48 (2006.01)	2485725 *	A61K 31/365 (2006.01) A61K 38/48 (2006.01) A61K 47/44 (2006.01) A61K 39/39 (2006.01) A61K 39/00 (2006.01)
2453962 *	A61M 11/00 (2006.01)				
2480152 *	A61B 18/14 (2006.01) G06F 3/00 (2006.01)				
2311424	A61H 1/02 (2006.01)	2421869 *	C07D 498/22 (2006.01) C07D 493/20 (2006.01) A61K 31/357 (2006.01) A61K 31/437 (2006.01) A61P 31/00 (2006.01)	2403476 *	A61K 9/08 (2006.01) A61K 31/137 (2006.01) A61K 31/5375 (2006.01) A61K 47/10 (2006.01) A61P 31/10 (2006.01)
2386699	F24F 13/08 (2006.01) F24F 7/02 (2006.01) E04D 13/00 (2006.01) E04D 13/17 (2006.01)				
2475410 *	A61M 5/315 (2006.01)	2435330 *	B65D 33/00 (2006.01)		
2477944 *	B01D 9/00 (2006.01) C01B 31/36 (2006.01)	2445902 *	C07D 401/14 (2006.01)		
		2419402 *	C07C 303/32 (2006.01) C07C 211/35 (2006.01) C07C 309/04 (2006.01) A61K 31/13 (2006.01)		
		2482885 *	A61M 5/315 (2006.01)		

Broj objave evropske prijave patenta (97)	MKP (51)	Broj objave evropske prijave patenta (97)	MKP (51)	Broj objave evropske prijave patenta (97)	MKP (51)
2493518 *	A61L 27/58 (2006.01) A61L 27/34 (2006.01) A61L 29/06 (2006.01) A61L 17/12 (2006.01) A61L 31/14 (2006.01) A61L 27/54 (2006.01) A61L 27/18 (2006.01) A61L 31/06 (2006.01) A61L 29/14 (2006.01) A61L 17/00 (2006.01) A61L 31/10 (2006.01) A61L 29/16 (2006.01) A61L 29/08 (2006.01) A61L 26/00 (2006.01) A61L 31/16 (2006.01)	2389906	A61F 2/90 (2006.01)	2480526 *	C07C 269/06 (2006.01) A61P 9/00 (2006.01) C07C 309/15 (2006.01) A61K 31/165 (2006.01) C07C 271/28 (2006.01) C07C 303/22 (2006.01)
		2486626 *	H01R 4/24 (2006.01)		
		2446088 *	E01F 15/08 (2006.01)		
		2451809 *	C07D 453/02 (2006.01)		
		2452300 *	G06Q 20/00 (2012.01)	2496582 *	A61K 31/55 (2006.01) C07D 487/04 (2006.01) A61P 43/00 (2006.01) A61P 35/00 (2006.01)
		2459218 *	A61K 47/02 (2006.01) A61K 47/10 (2006.01) A61K 9/00 (2006.01) A61P 1/10 (2006.01)	2437603 *	A01N 43/42 (2006.01)
		2435629 *	D21C 9/10 (2006.01) D21C 9/16 (2006.01)	2454190 *	C01B 7/09 (2006.01)
2317128	F03D 3/00 (2006.01) F03D 11/02 (2006.01)	2454080 *	B29C 67/00 (2006.01)	2441419	A61F 13/15 (2006.01)
		2461673 *	A61K 38/17 (2006.01) A01K 67/027 (2006.01)	2488182 *	A61K 31/513 (2006.01) A61P 35/00 (2006.01)
2460113 *	G06F 21/00 (2006.01) G06F 11/07 (2006.01)	2493347 *	B29D 35/12 (2010.01) A43B 17/08 (2006.01) A43B 7/08 (2006.01)	2459147 *	A61J 1/20 (2006.01)
2471896 *	C10M 107/24 (2006.01) C10N 40/30 (2006.01) C10M 107/34 (2006.01) C10M 105/18 (2006.01) C10N 30/10 (2006.01) C09K 5/04 (2006.01) C10N 30/08 (2006.01) C10M 129/18 (2006.01) C10M 137/08 (2006.01) C10M 169/04 (2006.01) C10N 30/06 (2006.01) C10M 133/04 (2006.01)	2437826 *	A61M 5/00 (2006.01) A61M 5/315 (2006.01)	2497004 *	G10L 15/22 (2006.01) G06F 3/01 (2006.01) G10L 21/06 (2006.01)
		2440194 *	A61P 43/00 (2006.01) A61K 31/395 (2006.01) A61P 25/00 (2006.01) A61K 31/045 (2006.01) A61K 31/167 (2006.01)	2399737	B32B 27/00 (2006.01)
				2482813 *	A61K 31/395 (2006.01) C07D 269/00 (2006.01) A61P 1/00 (2006.01) A61K 31/352 (2006.01)
2406919 *	H04L 12/28 (2006.01)				

Broj objave evropske prijava patenta (97)	MKP (51)	Broj objave evropske prijava patenta (97)	MKP (51)	Broj objave evropske prijava patenta (97)	MKP (51)
2438037 *	A61K 31/167 (2006.01) A61P 25/02 (2006.01) C07C 65/21 (2006.01) C07C 235/24 (2006.01) C07C 235/68 (2006.01) C07C 311/51 (2006.01)	2493306 *	A01N 43/40 (2006.01) A01N 43/18 (2006.01) A01P 13/00 (2006.01) A01N 43/76 (2006.01) A01N 39/02 (2006.01)	2454240 *	A61P 25/22 (2006.01) A61K 31/4164 (2006.01) A61P 25/28 (2006.01) A61P 25/20 (2006.01) A61K 31/4196 (2006.01) A61P 25/30 (2006.01) A61P 25/00 (2006.01) A61P 43/00 (2006.01) C07D 233/90 (2006.01) A61P 25/24 (2006.01) A61P 25/04 (2006.01) C07D 249/10 (2006.01) A61P 25/18 (2006.01)
2448620 *	A61M 5/315 (2006.01)	2410108	E04H 15/00 (2006.01) E04H 15/32 (2006.01) F22B 37/24 (2006.01)		
2443458 *	G01N 33/53 (2006.01) G01N 33/566 (2006.01)	2390280	C08J 5/18 (2006.01) C08K 9/04 (2006.01) C09C 1/02 (2006.01) C09C 3/08 (2006.01)		
2420332	B21D 39/04 (2006.01) B21J 7/14 (2006.01) B21J 13/08 (2006.01)			2473178 *	A61P 9/14 (2006.01) A61K 36/63 (2006.01) A61K 36/33 (2006.01)
2456981 *	F04B 53/00 (2006.01) F04B 53/16 (2006.01) F02M 59/48 (2006.01)	2488028 *	A01N 43/40 (2006.01) A61K 31/445 (2006.01)		
2475635 *	C07C 57/26 (2006.01) C07C 69/608 (2006.01) C07D 493/18 (2006.01) C07C 51/36 (2006.01) C07C 67/303 (2006.01)	2421829 *	C07D 211/96 (2006.01) A61P 25/28 (2006.01) A61K 31/445 (2006.01) C07D 243/08 (2006.01) C07D 295/26 (2006.01) C07C 311/29 (2006.01) C07D 241/04 (2006.01) A61P 11/06 (2006.01) C07D 403/04 (2006.01) C07D 487/04 (2006.01)	2477626 *	A61K 31/496 (2006.01) A61K 31/495 (2006.01) A61P 25/24 (2006.01) A61P 25/30 (2006.01) A61K 31/4965 (2006.01)
2444386 *	C07C 45/68 (2006.01) C07C 45/80 (2006.01) C07C 49/617 (2006.01) C07C 49/683 (2006.01) C07C 49/798 (2006.01)			2448424 *	A23L 2/02 (2006.01) A23J 3/16 (2006.01) A23J 1/14 (2006.01)
2409789	B08B 9/055 (2006.01) F16J 15/32 (2006.01) F16L 55/28 (2006.01)			2349531 *	B01J 37/04 (2006.01) B01J 37/08 (2006.01) B01J 37/03 (2006.01) B01D 53/00 (2006.01) B01J 21/06 (2006.01) B01J 23/00 (2006.01) B01J 23/847 (2006.01) B01J 35/04 (2006.01)

Broj objave evropske prijave patenta (97)	MKP (51)	Broj objave evropske prijave patenta (97)	MKP (51)	Broj objave evropske prijave patenta (97)	MKP (51)
2452119 *	F21S 11/00 (2006.01) F21S 19/00 (2006.01)	2488524 *	C07D 487/04 (2006.01) A61K 31/519 (2006.01) A61P 37/00 (2006.01)	2408311 *	A23C 7/04 (2006.01) A23C 9/14 (2006.01) A23C 9/142 (2006.01) A23C 21/00 (2006.01) A23J 1/20 (2006.01) A23L 1/29 (2006.01)
2473486 *	C07D 239/47 (2006.01) C07D 251/18 (2006.01) C07D 251/66 (2006.01) C07D 401/04 (2006.01) C07D 401/14 (2006.01) C07D 403/04 (2006.01) A61K 31/53 (2006.01) A61K 31/506 (2006.01) A61K 31/5377 (2006.01) A61P 7/06 (2006.01)	2399919	C07D 491/22 (2006.01)	2440924 *	G01N 33/50 (2006.01) G01N 33/68 (2006.01)
2485525 *	H04W 28/00 (2009.01) H04W 16/28 (2009.01)	2433125 *	G01N 33/50 (2006.01)	2453002	C11C 5/00 (2006.01) A61F 11/00 (2006.01)
2419097 *	A61P 43/00 (2006.01) A61K 31/155 (2006.01) A61P 13/12 (2006.01) A61K 31/4439 (2006.01) A61P 25/00 (2006.01) A61K 31/64 (2006.01) A61P 27/02 (2006.01) A61K 45/00 (2006.01) A61P 3/10 (2006.01) C07D 335/02 (2006.01) A61P 5/50 (2006.01) A61P 9/10 (2006.01) A61K 31/382 (2006.01) A61P 9/14 (2006.01)	2414380 *	C07K 1/18 (2006.01) C07K 1/20 (2006.01) C07K 14/59 (2006.01)	2470911 *	G01N 33/15 (2006.01) G01N 33/53 (2006.01) G01N 33/68 (2006.01)
2305761	C09D 11/00 (2006.01)	2475681 *	A61P 9/10 (2006.01) A61P 17/00 (2006.01) C07K 14/515 (2006.01) A61K 38/18 (2006.01)	2425008 *	C12P 21/06 (2006.01)
2482882 *	A61M 5/315 (2006.01)	2476717 *	C08G 69/26 (2006.01) C08L 77/06 (2006.01)	2415766 *	C07D 243/12 (2006.01) A61P 1/04 (2006.01) C07C 269/06 (2006.01) A61P 35/00 (2006.01) C07C 271/20 (2006.01) A61P 35/02 (2006.01) C07C 271/28 (2006.01) A61P 43/00 (2006.01) C07C 303/36 (2006.01) C07B 61/00 (2006.01) C07C 303/40 (2006.01) C07C 311/16 (2006.01) A61K 31/551 (2006.01)
		2411533 *	C12Q 1/68 (2006.01)	2305372	B01J 2/06 (2006.01)
		2426121 *	C07D 401/12 (2006.01) A61K 31/4709 (2006.01) A61P 11/00 (2006.01) A61P 11/06 (2006.01) A61P 43/00 (2006.01) C07D 491/18 (2006.01)	2493436 *	A61F 5/56 (2006.01)
		2289659	B23K 20/12 (2006.01) B29C 65/06 (2006.01) F16B 37/06 (2006.01)		

Broj objave evropske prijave patenta (97)	MKP (51)	Broj objave evropske prijave patenta (97)	MKP (51)	Broj objave evropske prijave patenta (97)	MKP (51)
2471496	A61F 2/64 (2006.01)	2412708 *	A61K 31/4412 (2006.01) A61K 31/497 (2006.01) C07D 401/04 (2006.01) A61K 31/443 (2006.01) A61K 31/506 (2006.01) C07D 401/06 (2006.01) A61K 31/4433 (2006.01) A61K 31/5377 (2006.01) C07D 401/10 (2006.01) A61K 31/4436 (2006.01) A61P 31/00 (2006.01) A61K 31/4439 (2006.01) A61P 31/16 (2006.01) A61K 31/444 (2006.01) A61P 31/18 (2006.01) A61K 31/4545 (2006.01) A61P 43/00 (2006.01) C07D 213/80 (2006.01) A61K 31/4709 (2006.01) C07D 213/89 (2006.01)	2470552 *	C07H 17/02 (2006.01)
2417131 *	C07D 413/04 (2006.01) A61K 31/4523 (2006.01) A61P 7/04 (2006.01)			2440188 *	A61K 47/14 (2006.01) A61K 31/197 (2006.01) A61K 9/20 (2006.01) A61K 9/48 (2006.01) A61K 9/02 (2006.01)
2423265	C09C 1/02 (2006.01) C04B 14/28 (2006.01) C04B 20/10 (2006.01) C04B 28/02 (2006.01)			2488497 *	C07D 213/803 (2006.01) C07C 211/45 (2006.01) C07C 211/64 (2006.01) C07D 213/80 (2006.01)
2430183 *	C12Q 1/68 (2006.01)				
2490766 *	A61P 29/00 (2006.01) A61P 35/00 (2006.01) C07K 5/00 (2006.01) A61K 38/00 (2006.01)			2485661 *	A61B 17/00 (2006.01) A61B 17/29 (2006.01) A61B 17/28 (2006.01) A61B 18/08 (2006.01) A61B 18/00 (2006.01)
2323095	G06Q 30/00 (2006.01)				
2440579 *	C07K 16/28 (2006.01)			2403874 *	C07K 16/18 (2006.01) C07K 16/00 (2006.01)
2493480 *	A61P 27/02 (2006.01) A61K 31/7076 (2006.01)	2451486 *	C12N 9/82 (2006.01) A61P 35/02 (2006.01) A61K 47/48 (2006.01)	2448423 *	A23J 1/14 (2006.01) A23J 3/16 (2006.01) A23L 2/02 (2006.01)
2464741 *	C12Q 1/00 (2006.01)				
2360683	H04S 3/00 (2006.01) G10L 19/00 (2006.01)	2354041	B65F 1/06 (2006.01)	2499494 *	G01N 33/577 (2006.01) G01N 33/50 (2006.01) G01N 33/68 (2006.01) G01N 33/53 (2006.01)
		2460523 *	A61K 9/20 (2006.01) A61K 47/04 (2006.01) A61K 47/38 (2006.01) A61K 31/506 (2006.01)	2451840 *	C12P 21/06 (2006.01) C07K 16/00 (2006.01)
		2403570 *	A61M 5/32 (2006.01)		
		2372726	H01F 41/02 (2006.01) H01F 1/057 (2006.01)	2445525 *	A61K 39/12 (2006.01) C07K 14/025 (2006.01)

Broj objave evropske prijava patenta (97)	MKP (51)	Broj objave evropske prijava patenta (97)	MKP (51)	Broj objave evropske prijava patenta (97)	MKP (51)
2405916 *	A61K 31/519 (2006.01) A61P 35/00 (2006.01)	2441752 *	C07C 327/48 (2006.01)	2488237 *	A61M 5/32 (2006.01)
2454417 *	E02B 3/20 (2006.01)	2414338 *	A61K 31/5377 (2006.01) A61P 11/00 (2006.01) A61P 35/00 (2006.01)	2486327 *	F23K 3/02 (2006.01)
2417580 *	G06T 17/00 (2006.01) G01S 13/95 (2006.01) G06F 3/14 (2006.01)	2459752 *	G01N 33/52 (2006.01) C12N 15/11 (2006.01) C12Q 1/68 (2006.01)	2419679 *	F24J 2/04 (2006.01) F24J 2/52 (2006.01) F24J 2/46 (2006.01) F24J 2/51 (2006.01)
2435024 *	A61K 9/12 (2006.01) A61P 11/00 (2006.01)	2451352 *	A61B 5/11 (2006.01)	2419108 *	A61K 31/56 (2006.01) A61K 31/57 (2006.01) A61K 9/20 (2006.01)
2430031 *	C07D 519/00 (2006.01) C07D 471/04 (2006.01) A61K 31/437 (2006.01) A61P 25/00 (2006.01)	2470540 *	A61K 31/407 (2006.01) A61P 25/28 (2006.01) C07D 487/04 (2006.01)	2443089 *	C07D 209/46 (2006.01) C07D 209/48 (2006.01) C07D 405/12 (2006.01) A61K 31/4035 (2006.01) A61P 17/06 (2006.01)
2470566 *	C12N 5/0783 (2010.01) A61K 39/395 (2006.01) C07K 16/24 (2006.01)	2473266 *	B01J 2/18 (2006.01) A61K 9/16 (2006.01) B01J 2/04 (2006.01)	2368535	A61G 12/00 (2006.01)
2478499 *	G07F 11/54 (2006.01)	2403859 *	A61K 31/663 (2006.01) A61P 25/00 (2006.01) A61K 31/661 (2006.01) C07F 9/12 (2006.01) C07F 9/40 (2006.01)	2482810 *	G06F 19/00 (2011.01) A61K 31/137 (2006.01) A61P 37/06 (2006.01) A61P 11/06 (2006.01)
2237378	H01R 13/24 (2006.01) H01R 13/33 (2006.01) H01R 43/16 (2006.01) H01R 12/04 (2006.01) H01R 12/22 (2006.01)	2338636	B23K 37/00 (2006.01) B23K 9/32 (2006.01) A42B 3/04 (2006.01) A42B 3/22 (2006.01) A61F 9/06 (2006.01) F16P 1/06 (2006.01) G10K 11/18 (2006.01)	2486047 *	C07K 14/34 (2006.01)
2371800	C07C 51/41 (2006.01) C07C 51/02 (2006.01) C07C 51/46 (2006.01) C07C 55/10 (2006.01) C07C 51/44 (2006.01)	2496663 *	C09K 17/32 (2006.01) C09K 17/14 (2006.01)	2322066	A47K 5/12 (2006.01)
2429522 *	A61K 31/4166 (2006.01)	2473512 *	C07D 493/22 (2006.01) C07C 69/96 (2006.01)	2411005 *	A61K 31/40 (2006.01) A61K 31/4985 (2006.01) A61P 9/00 (2006.01) A61P 3/00 (2006.01)

Broj objave evropske prijava patenta (97)	MKP (51)	Broj objave evropske prijava patenta (97)	MKP (51)	Broj objave evropske prijava patenta (97)	MKP (51)
2439202 *	A61K 31/472 (2006.01) C07D 295/104 (2006.01) A61K 31/4709 (2006.01)	2454607 *	G01S 15/96 (2006.01) G01S 15/89 (2006.01)	2483279 *	A61P 35/00 (2006.01) C07K 16/46 (2006.01) C07K 16/30 (2006.01) A61K 31/537 (2006.01) C12P 21/08 (2006.01) C07D 498/18 (2006.01)
2245150 *	C12N 9/64 (2006.01) C07K 16/40 (2006.01) A61K 38/43 (2006.01) C12N 15/62 (2006.01) C12N 5/10 (2006.01)	2498801 *	A61K 38/26 (2006.01) A61P 3/10 (2006.01) A61K 47/18 (2006.01)	2424598 *	A61M 5/32 (2006.01)
2459220 *	A61K 9/10 (2006.01) A61K 9/50 (2006.01) A61K 47/10 (2006.01) A61K 9/16 (2006.01) A61K 9/28 (2006.01)	2449492 *	G06F 19/00 (2011.01)	2437805 *	A61M 5/178 (2006.01) A61M 5/315 (2006.01)
2418966 *	A23L 1/16 (2006.01) A23L 1/39 (2006.01) A23L 1/162 (2006.01) A23L 1/00 (2006.01)	2371797	C07C 51/44 (2006.01) C07D 307/08 (2006.01) C07D 307/33 (2006.01) C07C 51/41 (2006.01) C07C 29/136 (2006.01) C07C 51/02 (2006.01)	2485791 *	A61M 5/315 (2006.01) A61M 5/24 (2006.01)
2403568 *	A61M 5/32 (2006.01)	2470536 *	A61P 11/00 (2006.01) C07D 487/04 (2006.01) A61K 31/519 (2006.01)	2419418 *	C07D 401/08 (2006.01) A61P 29/00 (2006.01) C07D 403/08 (2006.01) C07D 405/08 (2006.01) C07D 413/08 (2006.01) C07D 417/08 (2006.01) A61K 31/4427 (2006.01) A61K 31/437 (2006.01) A61K 31/433 (2006.01) A61P 3/10 (2006.01)
2493573 *	A61K 31/4706 (2006.01) A61K 33/26 (2006.01) A61P 33/06 (2006.01)	2496648 *	C09C 1/02 (2006.01) C01F 5/24 (2006.01)	2421851 *	C07D 417/12 (2006.01) C07D 409/12 (2006.01) C07D 495/04 (2006.01) C07D 403/14 (2006.01) C07D 417/14 (2006.01) A61K 31/496 (2006.01) C07D 403/12 (2006.01) A61P 29/00 (2006.01) C07D 401/12 (2006.01) A61P 25/00 (2006.01)
2388452	F01N 3/20 (2006.01)	2421851 *	C07D 417/12 (2006.01) C07D 409/12 (2006.01) C07D 495/04 (2006.01) C07D 403/14 (2006.01) C07D 417/14 (2006.01) A61K 31/496 (2006.01) C07D 403/12 (2006.01) A61P 29/00 (2006.01) C07D 401/12 (2006.01) A61P 25/00 (2006.01)	2442789 *	A61K 9/00 (2006.01) A61K 31/5377 (2006.01) A61K 47/02 (2006.01) A61K 9/10 (2006.01)
2421864 *	A61K 31/4745 (2006.01) C07D 471/04 (2006.01) A61P 35/00 (2006.01)	2400090	E05C 19/00 (2006.01)	2407487	C07K 16/30 (2006.01) C07K 16/32 (2006.01)
2424538 *	A61K 9/00 (2006.01) A61P 17/02 (2006.01) A61K 31/52 (2006.01) A61K 31/519 (2006.01)				

Broj objave evropske prijave patenta (97)	MKP (51)	Broj objave evropske prijave patenta (97)	MKP (51)	Broj objave evropske prijave patenta (97)	MKP (51)
2409105 *	F28D 21/00 (2006.01) F28F 1/40 (2006.01) F28F 21/08 (2006.01)	2461967 *	B31C 3/00 (2006.01) D21H 17/28 (2006.01) D21H 17/29 (2006.01) D21H 19/54 (2006.01) D21H 25/04 (2006.01) D21H 27/00 (2006.01)	2470644 *	C12N 5/0783 (2010.01)
2460937 *	G08B 21/00 (2006.01) E01F 9/017 (2006.01)			2481821	C14C 15/00 (2006.01) C14B 3/00 (2006.01)
2273715	H04L 5/00 (2006.01) H04N 7/24 (2011.01)	2432332 *	A23L 1/236 (2006.01) A23L 1/00 (2006.01) A23G 3/44 (2006.01) A23G 3/42 (2006.01)	2404600	A61K 45/06 (2006.01) A61P 9/04 (2006.01) A61K 31/55 (2006.01) A61K 31/4045 (2006.01)
2437828 *	A61M 5/315 (2006.01)			2407121	A61C 8/00 (2006.01)
2366532	B29C 67/20 (2006.01) B29C 44/56 (2006.01) B29C 44/30 (2006.01) B29C 44/34 (2006.01)	2498604 *	A01N 47/36 (2006.01) A01N 39/04 (2006.01) A01N 43/40 (2006.01)	2497816 *	C10G 45/72 (2006.01) C10G 45/02 (2006.01)
2470908 *	C07K 14/20 (2006.01) G01N 33/569 (2006.01)	2403537 *	A61K 47/48 (2006.01)	2462418 *	G01L 9/00 (2006.01) G01L 9/12 (2006.01) G01L 9/04 (2006.01) G01B 7/02 (2006.01)
2427445 *	A61K 31/351 (2006.01) A61P 11/00 (2006.01) C07D 309/14 (2006.01)	2445973 *	C09C 3/10 (2006.01) B29B 9/12 (2006.01) C09C 1/02 (2006.01) C08K 9/00 (2006.01)	2477603 *	A61K 9/00 (2006.01) A61K 47/36 (2006.01) A61K 47/42 (2006.01) A61K 39/00 (2006.01) A61K 39/395 (2006.01) C07K 16/00 (2006.01) C07K 16/06 (2006.01) C12N 9/24 (2006.01)
2430344 *	F16K 25/00 (2006.01)	2437811 *	A61M 5/24 (2006.01)		
2413649	H04W 72/00 (2009.01)	2405749 *	A01N 37/12 (2006.01) A01N 37/44 (2006.01) A61K 31/195 (2006.01)		
2457575	A61P 31/04 (2006.01) C12R 1/225 (2006.01) A61K 35/74 (2006.01) A23L 1/30 (2006.01)	2477633 *	A61K 31/722 (2006.01) A23L 1/30 (2006.01) A61K 36/185 (2006.01) A61K 36/06 (2006.01) A61K 36/234 (2006.01) A61P 15/10 (2006.01) A23L 1/29 (2006.01)	2419106 *	A61K 31/5517 (2006.01) A61P 35/02 (2006.01)
2424597 *	A61M 5/315 (2006.01)				
2456941 *	E05F 3/10 (2006.01)				

Broj objave evropske prijave patenta (97)	MKP (51)	Broj objave evropske prijave patenta (97)	MKP (51)	Broj objave evropske prijave patenta (97)	MKP (51)
2403834 *	C07D 401/12 (2006.01) C07D 401/14 (2006.01) C07D 401/04 (2006.01) C07D 403/12 (2006.01) C07D 407/12 (2006.01) C07D 231/12 (2006.01) C07D 409/04 (2006.01) C07D 231/20 (2006.01) C07D 417/12 (2006.01) C07D 231/38 (2006.01) A61K 31/4155 (2006.01)	2413297	G07F 17/32 (2006.01)	2415470 *	A61K 47/36 (2006.01) A61K 31/357 (2006.01) A61K 9/127 (2006.01) A61K 47/02 (2006.01) A61K 47/18 (2006.01) A61K 47/24 (2006.01) A61K 47/28 (2006.01) A61K 47/34 (2006.01)
		2488515 *	C07D 409/10 (2006.01) C07D 409/14 (2006.01) C07F 3/06 (2006.01)	2301488	A61F 5/01 (2006.01)
		2419732 *	G01N 33/53 (2006.01)	2421881 *	C07H 21/04 (2006.01) C12Q 1/68 (2006.01) C12N 9/24 (2006.01)
		2407120	A61C 8/00 (2006.01)	2325363	D05B 25/00 (2006.01) D05B 33/00 (2006.01)
		2493924 *	A61K 39/395 (2006.01) C07K 16/00 (2006.01)	2485736 *	A61K 31/54 (2006.01)
2336982	G07C 9/00 (2006.01) E05B 19/04 (2006.01) H01H 13/06 (2006.01) B60R 25/00 (2006.01) E05B 47/06 (2006.01)	2435055 *	A61K 35/56 (2006.01)	2488698 *	E01B 3/34 (2006.01) E01B 7/22 (2006.01)
		2483302 *	A61K 38/16 (2006.01) C07K 14/705 (2006.01) C12N 5/071 (2010.01)	2485856 *	B21F 27/10 (2006.01) B21F 27/20 (2006.01) E04C 5/04 (2006.01) B21F 23/00 (2006.01) B23K 11/00 (2006.01)
		2430008 *	C07D 295/135 (2006.01)	2477970 *	C07C 309/73 (2006.01) C07D 223/16 (2006.01) C07C 309/66 (2006.01)
2417104 *	A61P 17/00 (2006.01) A01N 31/16 (2006.01) C07C 317/22 (2006.01) A01N 39/00 (2006.01) C07C 323/20 (2006.01) A01N 41/10 (2006.01) A61K 8/46 (2006.01) A01P 1/00 (2006.01) A61Q 5/08 (2006.01) A61Q 19/02 (2006.01) A61Q 19/08 (2006.01)	2493430 *	A61F 2/84 (2006.01) A61F 2/90 (2006.01) A61F 2/00 (2006.01)	2493870 *	A61K 31/558 (2006.01) A61K 31/5377 (2006.01) C07D 311/22 (2006.01)
		2390285	C09C 1/02 (2006.01)		
		2445560 *	A61M 15/08 (2006.01)		
		2470511 *	C07D 413/12 (2006.01) A61K 31/53 (2006.01) A61P 35/00 (2006.01) C07D 239/48 (2006.01)		
2446050 *	C12Q 1/48 (2006.01) C12N 9/10 (2006.01)	2456786 *	C07K 14/18 (2006.01) C12N 15/867 (2006.01)		
2473855 *	C12Q 1/37 (2006.01) G01N 33/573 (2006.01) G01N 33/68 (2006.01)				

Broj objave evropske prijave patenta (97)	MKP (51)	Broj objave evropske prijave patenta (97)	MKP (51)	Broj objave evropske prijave patenta (97)	MKP (51)
2441455	A61K 31/4412 (2006.01) A61P 11/00 (2006.01) A61K 31/135 (2006.01) A61K 31/15 (2006.01) A61K 31/44 (2006.01)	2275358	B29C 65/02 (2006.01) B29C 65/48 (2006.01) B65D 43/16 (2006.01) B29C 65/58 (2006.01) B29C 65/78 (2006.01) B29L 31/22 (2006.01) B29C 65/08 (2006.01) B29C 65/16 (2006.01)	2408794 *	C07H 19/00 (2006.01) C12P 19/26 (2006.01) A23C 9/146 (2006.01)
2456863 *	C12N 5/074 (2010.01) C12N 5/077 (2010.01)			2454422 *	E04B 2/74 (2006.01)
2483046 *	H05B 3/00 (2006.01) B29C 49/64 (2006.01) F21V 7/00 (2006.01) B29B 13/02 (2006.01) B29C 49/68 (2006.01)	2411021 *	A61K 33/14 (2006.01) A61P 41/00 (2006.01) A61K 33/40 (2006.01) A61K 33/20 (2006.01)	2488552 *	A61P 35/00 (2006.01) C07K 16/28 (2006.01) A61K 39/395 (2006.01)
2412709 *	C07D 213/80 (2006.01) C07D 309/32 (2006.01) C07D 405/06 (2006.01)	2411017 *	A61K 31/702 (2006.01) A61K 48/00 (2006.01) A61K 9/00 (2006.01) C12N 15/88 (2006.01)	2408043 *	H01M 2/16 (2006.01) B32B 27/32 (2006.01)
2446162 *	F02B 67/06 (2006.01) B60K 25/02 (2006.01) F16D 13/42 (2006.01) F16D 27/112 (2006.01) F16D 15/00 (2006.01) F04B 17/00 (2006.01)	2414584 *	D21C 9/00 (2006.01) D21D 1/00 (2006.01) D21H 11/00 (2006.01) D21H 11/18 (2006.01) D21B 1/16 (2006.01)	2469020	E21B 43/267 (2006.01)
2480661 *	C12N 9/50 (2006.01) C12P 21/00 (2006.01)	2483274 *	C07D 487/04 (2006.01) A61K 31/519 (2006.01) A61P 33/06 (2006.01)	2392467	B41M 5/50 (2006.01) B41M 5/00 (2006.01) B41M 5/52 (2006.01)
2404611 *	A61K 38/10 (2006.01) A61P 17/00 (2006.01)	2429304 *	A23L 1/307 (2006.01) A23C 9/12 (2006.01) A23C 9/156 (2006.01) A23C 9/127 (2006.01) A23L 1/29 (2006.01)	2493311 *	A01P 13/02 (2006.01) A01N 43/54 (2006.01) A01N 43/40 (2006.01)
		2475375 *	A61K 38/00 (2006.01)		

Broj objave evropske prijave patenta (97)	MKP (51)	Broj objave evropske prijave patenta (97)	MKP (51)	Broj objave evropske prijave patenta (97)	MKP (51)
2451813 *	A61K 31/519 (2006.01) C07D 487/08 (2006.01) A61P 25/00 (2006.01) C07D 471/04 (2006.01) A61P 35/00 (2006.01) A61K 31/499 (2006.01) A61P 17/00 (2006.01) A61K 31/437 (2006.01) A61P 37/00 (2006.01) C07D 487/04 (2006.01) A61P 27/00 (2006.01) A61P 3/00 (2006.01)	2480316 *	C04B 14/30 (2006.01) D04H 1/42 (2012.01) F01N 3/28 (2006.01) B01D 53/94 (2006.01)	2480710 *	D04H 13/00 (2006.01) B32B 3/26 (2006.01)
		2435023 *	A61K 9/12 (2006.01) A61P 11/00 (2006.01) A61K 31/40 (2006.01) A61K 9/00 (2006.01)	2290488	G05B 23/02 (2006.01)
		2480490 *	A47J 31/36 (2006.01) B67D 1/00 (2006.01)	2475442 *	C02F 1/04 (2006.01) B01D 1/28 (2006.01) B01D 1/26 (2006.01) B01D 1/30 (2006.01) B01D 3/06 (2006.01) B01D 1/16 (2006.01)
		2301825	B62D 25/08 (2006.01)	2453777 *	A47J 31/18 (2006.01)
2448908 *	C07C 209/16 (2006.01) C07C 211/35 (2006.01) C07C 209/62 (2006.01)	2467153 *	A61K 38/17 (2006.01) A61K 39/00 (2006.01) C07K 7/06 (2006.01) A61P 25/16 (2006.01) A61P 25/28 (2006.01)	2421824 *	C07D 401/10 (2006.01) A61K 31/496 (2006.01) C07D 401/06 (2006.01) C07D 417/14 (2006.01) C07D 403/10 (2006.01) A61P 29/00 (2006.01) C07D 401/04 (2006.01) C07D 417/06 (2006.01) C07D 403/06 (2006.01) A61P 25/00 (2006.01) C07D 205/04 (2006.01) C07D 409/06 (2006.01) C07D 403/12 (2006.01) C07D 405/12 (2006.01)
2400369	G06F 1/32 (2006.01)				
2403852 *	C07D 471/04 (2006.01) A61K 31/4188 (2006.01) A61P 11/00 (2006.01) A61P 29/00 (2006.01)	2454251 *	A61P 3/10 (2006.01) A61K 31/4427 (2006.01) C07D 401/12 (2006.01) C07D 401/14 (2006.01)	2459096 *	A61B 18/18 (2006.01) A61B 18/02 (2006.01) A61N 5/02 (2006.01)
2332413	A21C 9/04 (2006.01) A21C 9/08 (2006.01)	2477931 *	B66F 9/12 (2006.01)		
2476991	F41B 11/02 (2006.01) F41B 11/22 (2006.01)	2482850 *	A61P 29/00 (2006.01) A61K 47/16 (2006.01) A61K 31/444 (2006.01) A61K 47/10 (2006.01) A61K 47/38 (2006.01)		
2417311 *	E04F 15/18 (2006.01)				
2480643 *	C10M 169/04 (2006.01)				
		2473851 *	G01N 33/564 (2006.01)	2405939 *	A61K 39/285 (2006.01) C07K 14/07 (2006.01) C12N 15/863 (2006.01)

Broj objave evropske prijave patenta (97)	MKP (51)	Broj objave evropske prijave patenta (97)	MKP (51)	Broj objave evropske prijave patenta (97)	MKP (51)
2482819 *	A61K 31/505 (2006.01)	2427322 *	B29C 67/24 (2006.01) B29B 7/90 (2006.01) C04B 26/00 (2006.01) B29B 7/00 (2006.01) B29B 17/00 (2006.01)	2436209 *	H04W 36/00 (2009.01)
2496555 *	C07D 207/263 (2006.01) A61K 31/4015 (2006.01) A61P 25/28 (2006.01) A61P 25/00 (2006.01)			2253735	G01N 15/08 (2006.01) A61B 5/15 (2006.01) C23C 16/54 (2006.01) C23C 16/04 (2006.01) C23C 16/52 (2006.01) C23C 16/505 (2006.01)
2493704 *	B43K 21/16 (2006.01)	2412409	A62C 2/12 (2006.01)		
2448941 *	A61K 31/437 (2006.01) C07D 403/12 (2006.01) C07D 487/04 (2006.01) A61P 35/00 (2006.01)	2480675 *	A01K 67/027 (2006.01) C07K 16/46 (2006.01) C12N 15/85 (2006.01) C07K 16/00 (2006.01)	2319789	B65H 75/08 (2006.01) B65H 75/18 (2006.01)
2457132 *	G05D 23/19 (2006.01) H02J 3/14 (2006.01)	2477607 *	A61K 9/14 (2006.01)	2421865 *	C07D 471/10 (2006.01) A01N 43/90 (2006.01)
2421556 *	A61K 39/02 (2006.01)	2494062 *	C12P 21/08 (2006.01) C07H 21/04 (2006.01)	2416795 *	A61K 36/906 (2006.01) A61K 31/40 (2006.01) C07D 207/04 (2006.01)
2467445 *	C09K 11/06 (2006.01) F21K 2/06 (2006.01) F21L 17/00 (2006.01) G08B 5/00 (2006.01) F21L 26/00 (2006.01)	2443857 *	H04W 16/12 (2009.01)	2443120 *	A61K 31/519 (2006.01) A61P 29/00 (2006.01) C07D 471/04 (2006.01) A61K 45/06 (2006.01)
2461868 *	A61N 5/06 (2006.01)	2335704	A61K 31/593 (2006.01) A61K 47/40 (2006.01) A61K 45/06 (2006.01) A61K 33/24 (2006.01) A61P 19/00 (2006.01)	2440242 *	A61K 39/00 (2006.01)
2421470 *	A61F 2/06 (2006.01)	2407162 *	A61K 9/16 (2006.01) A61P 1/00 (2006.01) A61P 1/04 (2006.01) A61K 31/198 (2006.01)	2459871 *	F03D 3/06 (2006.01) F03D 3/04 (2006.01) F03D 3/00 (2006.01)
2456869 *	C12N 15/09 (2006.01)			2491042 *	A61K 31/407 (2006.01) C07D 487/08 (2006.01) A61P 11/00 (2006.01)
2462154 *	C07J 41/00 (2006.01) A61K 31/573 (2006.01) A61P 5/36 (2006.01)	2427058 *	A01N 43/50 (2006.01) A61K 31/415 (2006.01)		
2490922 *	B60R 25/10 (2006.01)	2460076 *	G06F 11/07 (2006.01) G06F 21/00 (2006.01)	2480085 *	A01N 43/54 (2006.01) A61K 31/415 (2006.01) A61K 31/505 (2006.01)

Broj objave evropske prijava patenta (97)	MKP (51)	Broj objave evropske prijava patenta (97)	MKP (51)	Broj objave evropske prijava patenta (97)	MKP (51)
2483111 *	B60R 21/2165 (2011.01)	2430012 *	C07D 417/12 (2006.01) A61K 31/4523 (2006.01) A61P 29/00 (2006.01) A61P 25/00 (2006.01) C07D 401/12 (2006.01) C07D 413/12 (2006.01)	2457264 *	H01L 31/18 (2006.01) H01L 31/042 (2006.01)
2424357 *	A01N 37/12 (2006.01) A01N 37/44 (2006.01) A61K 31/195 (2006.01)			2493504 *	A61K 39/395 (2006.01) C07K 16/46 (2006.01) C07K 16/28 (2006.01) C07K 16/18 (2006.01)
2494127 *	E04H 1/02 (2006.01)				
2449108 *	C12N 15/82 (2006.01)	2368693	B29C 57/02 (2006.01) F16L 47/08 (2006.01)	2430002 *	C07D 233/64 (2006.01) C07D 233/84 (2006.01) C07D 401/06 (2006.01)
2464368 *	A61K 38/00 (2006.01)	2261542	F16L 11/08 (2006.01)		
2498842 *	A61M 5/32 (2006.01)	2454282 *	C07K 14/605 (2006.01) A61P 5/48 (2006.01) A61K 38/26 (2006.01)	2412787 *	C10G 2/00 (2006.01) C10G 45/10 (2006.01) C10G 47/18 (2006.01) C10G 65/02 (2006.01) C10G 65/04 (2006.01) B01J 23/42 (2006.01) B01J 23/46 (2006.01)
2435409 *	C07D 261/18 (2006.01) C07C 233/47 (2006.01) A61K 31/21 (2006.01) A61K 31/435 (2006.01) C07D 213/82 (2006.01) C07D 239/36 (2006.01) C07D 271/06 (2006.01)	2305903	E03D 9/08 (2006.01)		
		2461690 *	A01N 43/90 (2006.01) A61K 31/52 (2006.01) A61K 31/522 (2006.01)	2429583 *	A61K 39/395 (2006.01) A61K 38/18 (2006.01)
2329983	B60K 17/04 (2006.01) B60K 7/00 (2006.01)	2432469 *	A61K 31/4439 (2006.01) C07D 401/06 (2006.01) A61P 25/00 (2006.01)	2435469 *	C07K 14/47 (2006.01) A61K 39/00 (2006.01) A61P 35/00 (2006.01)
2427453 *	C07D 403/12 (2006.01) C07D 403/14 (2006.01) C07D 413/12 (2006.01) C07D 413/14 (2006.01) C07D 417/12 (2006.01) A61K 31/416 (2006.01) C07D 471/04 (2006.01) A61P 25/28 (2006.01)	2438051 *	A61K 31/454 (2006.01) C07D 401/04 (2006.01) C07D 401/14 (2006.01) A61K 31/4545 (2006.01) A61P 3/10 (2006.01)	2493437 *	A61F 5/56 (2006.01)
		2449049 *	B65H 75/00 (2006.01) C09J 7/02 (2006.01)	2450438 *	C12N 15/09 (2006.01) C12N 9/42 (2006.01) C12P 19/00 (2006.01)
		2456174	H04M 1/02 (2006.01)	2435398 *	C07C 205/43 (2006.01) A61K 31/343 (2006.01) C07D 307/80 (2006.01) A61P 9/06 (2006.01)

Broj objave evropske prijave patenta (97)	MKP (51)	Broj objave evropske prijave patenta (97)	MKP (51)	Broj objave evropske prijave patenta (97)	MKP (51)
2464211 *	A01P 21/00 (2006.01) A01N 63/00 (2006.01) A01G 7/06 (2006.01) A01N 43/38 (2006.01) A01N 31/02 (2006.01)	2405157	F16H 3/72 (2006.01) B30B 1/26 (2006.01) B30B 15/14 (2006.01) F16H 57/02 (2012.01)	2406272 *	A61P 37/02 (2006.01) C07J 63/00 (2006.01) A61K 31/575 (2006.01) A61P 29/00 (2006.01) A61P 35/00 (2006.01)
2404351 *	H01R 33/945 (2006.01)	2497493 *	A61K 39/00 (2006.01) A61K 48/00 (2006.01) C12N 15/09 (2006.01) A61K 39/04 (2006.01) A61P 31/06 (2006.01) A61K 35/76 (2006.01)	2440045 *	A01N 25/34 (2006.01) D21H 19/00 (2006.01)
2494146 *	E21B 43/14 (2006.01) E21B 43/25 (2006.01) E21B 34/14 (2006.01)	2363815	G06F 17/30 (2006.01)	2493515 *	B08B 9/00 (2006.01) B65B 55/00 (2006.01) A61L 2/10 (2006.01)
2421504 *	A61K 9/00 (2006.01) A61K 9/08 (2006.01) A61K 31/13 (2006.01)	2408479 *	A61K 45/00 (2006.01) A61K 31/395 (2006.01) A61K 31/4985 (2006.01) A61P 35/00 (2006.01)	2403353 *	A23K 1/00 (2006.01)
2459073 *	A61B 5/107 (2006.01) A61B 8/08 (2006.01)	2423324 *	C12N 15/09 (2006.01) C12Q 1/68 (2006.01)	2485723 *	A61P 37/06 (2006.01) A61K 31/18 (2006.01)
2483286 *	C07H 15/203 (2006.01) A61K 31/7048 (2006.01)	2470547 *	C07D 519/00 (2006.01) A61K 31/551 (2006.01) A61P 35/00 (2006.01)	2403849 *	A61P 29/00 (2006.01) C07D 413/04 (2006.01) C07D 413/14 (2006.01) A61K 31/4245 (2006.01) A61P 37/00 (2006.01)
2438056 *	A61K 31/497 (2006.01) C07D 403/14 (2006.01) A61P 35/00 (2006.01) C07D 401/12 (2006.01) C07D 403/12 (2006.01)	2295021	A47B 43/00 (2006.01) A61G 1/013 (2006.01) A61G 21/00 (2006.01)	2421861 *	C07D 417/14 (2006.01) A01N 43/80 (2006.01)
2277750	B60R 25/02 (2006.01)	2482832 *	A61K 36/80 (2006.01)	2498534 *	H04W 28/00 (2009.01) H04W 52/00 (2009.01)
2443256 *	B01L 3/00 (2006.01) C12Q 1/68 (2006.01) G01N 27/447 (2006.01) G01N 21/64 (2006.01)	2255617	A01K 15/02 (2006.01)	2491005 *	A61K 31/14 (2006.01) C07C 229/12 (2006.01) A61P 9/10 (2006.01)
2414063 *	B01D 35/18 (2006.01)			2454606 *	G01S 15/89 (2006.01) G01S 15/87 (2006.01)

Broj objave evropske prijave patenta (97)	MKP (51)	Broj objave evropske prijave patenta (97)	MKP (51)	Broj objave evropske prijave patenta (97)	MKP (51)
2413916 *	A61K 9/19 (2006.01) A61K 47/40 (2006.01) A61K 47/26 (2006.01) A61K 31/69 (2006.01) A61P 35/00 (2006.01) A61K 47/48 (2006.01)	2243696	B63B 15/00 (2006.01)	2409976 *	C07D 405/12 (2006.01) A61K 31/4178 (2006.01) A61K 31/4196 (2006.01) A61K 31/437 (2006.01) A61K 31/4439 (2006.01) A61P 25/08 (2006.01) A61P 25/14 (2006.01) A61P 25/18 (2006.01) C07D 409/12 (2006.01) A61P 25/20 (2006.01) C07D 471/04 (2006.01) A61P 25/22 (2006.01) A61P 25/24 (2006.01) A61P 25/28 (2006.01) A61P 25/30 (2006.01) A61P 43/00 (2006.01) C07D 405/14 (2006.01)
2388102	B23K 26/26 (2006.01) B21B 15/00 (2006.01) B23K 26/38 (2006.01)	2408970 *	E01F 15/02 (2006.01) E01F 15/04 (2006.01)	2470368 *	B32B 27/12 (2006.01) B32B 33/00 (2006.01)
2322901	G01B 11/03 (2006.01) G01C 15/00 (2006.01) G01S 17/89 (2006.01) G01B 11/00 (2006.01) G01S 17/48 (2006.01)	2444112 *	A61M 11/00 (2006.01)	2403847 *	C07D 401/14 (2006.01) A61K 31/47 (2006.01) A61P 9/00 (2006.01)
2249141	G01N 11/04 (2006.01)	2374979	E06B 3/667 (2006.01)	2464981 *	G01P 15/09 (2006.01)
2440569 *	C07K 7/06 (2006.01) A61K 38/08 (2006.01) A61P 3/04 (2006.01)	2383232	C02F 11/12 (2006.01) C02F 1/469 (2006.01) B01D 57/02 (2006.01)	2473049 *	A01N 43/54 (2006.01) C07D 471/04 (2006.01) C07D 471/22 (2006.01)
2399874	C03B 33/10 (2006.01)	2488184 *	A61K 31/54 (2006.01)	2498825 *	C12N 15/86 (2006.01) C12N 15/864 (2006.01) A61K 48/00 (2006.01)
2483234 *	C07C 209/62 (2006.01) C07C 211/35 (2006.01)	2451789 *	C07D 241/04 (2006.01)	2405907 *	A61K 31/4412 (2006.01) A61P 35/04 (2006.01) A61K 31/18 (2006.01)
2459555 *	C07D 413/14 (2006.01) A61K 31/42 (2006.01) A61P 7/00 (2006.01)	2296214	H01M 10/48 (2006.01)	2419478 *	C09B 23/00 (2006.01) G01N 33/58 (2006.01) C09B 23/01 (2006.01) C09B 23/08 (2006.01)
2296214	H01M 10/48 (2006.01)	2442659 *	A01P 3/00 (2006.01) A01N 43/40 (2006.01)		

Broj objave evropske prijave patenta (97)	MKP (51)	Broj objave evropske prijave patenta (97)	MKP (51)	Broj objave evropske prijave patenta (97)	MKP (51)
2401448 *	E04D 1/30 (2006.01) F24J 2/04 (2006.01) H01L 31/048 (2006.01)	2468399	B01J 23/50 (2006.01) B01D 53/86 (2006.01) B01D 53/94 (2006.01)	2459595 *	C07K 16/30 (2006.01)
2416852 *	A63B 23/02 (2006.01)	2488060 *	A43B 7/06 (2006.01) A43B 7/08 (2006.01) A43B 7/12 (2006.01)	2435025 *	A61K 9/12 (2006.01) A61P 11/00 (2006.01)
2322900	G01C 9/28 (2006.01)			2452944 *	C07F 9/09 (2006.01) C07F 9/38 (2006.01) A61P 31/04 (2006.01) A61P 43/00 (2006.01) A61K 31/662 (2006.01)
2444400 *	A61K 31/5377 (2006.01) A61K 31/5383 (2006.01) A61K 31/4985 (2006.01) C07D 498/14 (2006.01) A61K 31/53 (2006.01) A61K 31/553 (2006.01) A61P 31/16 (2006.01) A61P 43/00 (2006.01) C07D 471/04 (2006.01) C07D 471/14 (2006.01)	2437827 *	A61M 5/315 (2006.01) A61M 5/50 (2006.01)	2437746 *	C07J 3/00 (2006.01) A61K 31/56 (2006.01)
		2461691 *	A01N 45/00 (2006.01) A61K 31/59 (2006.01)	2482876 *	A61M 5/315 (2006.01) A61M 5/24 (2006.01)
		2485732 *	A61K 31/505 (2006.01)	2473053 *	A01N 43/90 (2006.01) A61K 31/522 (2006.01)
		2425510 *	H02J 13/00 (2006.01) H02H 3/04 (2006.01)		
2371740	B65D 85/34 (2006.01) B65D 6/00 (2006.01) B65D 21/02 (2006.01)	2411162 *	B05D 7/24 (2006.01) C04B 41/52 (2006.01)	2464688 *	C08K 5/053 (2006.01) C09J 167/00 (2006.01) C08L 67/02 (2006.01) G02B 6/02 (2006.01) B24B 13/005 (2006.01) C08L 63/00 (2006.01)
		2410160	F02D 41/24 (2006.01)		
2477243 *	F21V 7/22 (2006.01) F21Y 101/02 (2006.01) C08G 69/26 (2006.01) C08K 5/00 (2006.01) C08K 9/00 (2006.01) C08L 77/06 (2006.01) H01L 33/60 (2010.01) C08K 3/22 (2006.01)	2427940 *	H02J 3/14 (2006.01) H02H 3/04 (2006.01)		
		2413922 *	A61K 9/06 (2006.01) A61K 9/08 (2006.01) A61K 8/27 (2006.01) A61K 8/34 (2006.01) A61K 31/05 (2006.01) A61K 33/30 (2006.01) A61K 45/06 (2006.01) A61K 9/00 (2006.01)	2448469 *	G01N 33/487 (2006.01) A61B 5/00 (2006.01)
2453873 *	A61K 9/00 (2006.01) A61K 47/10 (2006.01)			2430024 *	C07D 487/04 (2006.01) A61K 31/5025 (2006.01) A61P 35/00 (2006.01)
		2462670 *	H02H 1/00 (2006.01)	2445517 *	A61K 38/48 (2006.01)

Broj objave evropske prijava patenta (97)	MKP (51)	Broj objave evropske prijava patenta (97)	MKP (51)	Broj objave evropske prijava patenta (97)	MKP (51)
2394994	C07D 213/74 (2006.01) A61K 31/44 (2006.01)	2377435	G09F 7/04 (2006.01) A47G 1/06 (2006.01) A47G 1/17 (2006.01)	2496571 *	C07D 403/14 (2006.01)
2459212 *	A61K 38/47 (2006.01) A61K 38/46 (2006.01)	2427207 *	A61K 38/18 (2006.01) C07K 14/50 (2006.01)	2405932 *	A61K 38/17 (2006.01)
2499041 *	B63J 3/02 (2006.01) B63J 3/04 (2006.01) B63H 21/20 (2006.01)	2483189 *	B65G 67/20 (2006.01)	2445553 *	A61M 5/315 (2006.01)
2415001 *	G06K 19/077 (2006.01) B32B 37/00 (2006.01)	2436683 *	A61P 1/04 (2006.01) C07D 405/14 (2006.01) A61P 3/10 (2006.01) A61K 31/4184 (2006.01) A61P 7/02 (2006.01) A61K 31/423 (2006.01) A61P 7/04 (2006.01) A61K 31/428 (2006.01) A61P 9/08 (2006.01) A61K 31/454 (2006.01) A61P 13/12 (2006.01) A61K 31/4439 (2006.01) A61P 9/10 (2006.01) A61P 1/02 (2006.01)	2419417 *	A61K 31/4427 (2006.01) A61K 31/437 (2006.01) A61K 31/433 (2006.01) C07D 401/08 (2006.01) A61P 3/10 (2006.01) C07D 403/08 (2006.01) A61P 29/00 (2006.01) C07D 413/08 (2006.01) C07D 417/08 (2006.01) C07D 471/04 (2006.01)
2468859 *	C12N 1/15 (2006.01) D21H 17/22 (2006.01) C12N 1/19 (2006.01) C12N 1/21 (2006.01) C12N 5/10 (2006.01) A23K 1/16 (2006.01) D21C 5/02 (2006.01) C12N 9/42 (2006.01) C12P 19/14 (2006.01) C12N 15/09 (2006.01) C12P 21/02 (2006.01)	2424661 *	B01J 29/08 (2006.01) B01J 37/00 (2006.01)	2485789 *	A61M 5/315 (2006.01) A61M 5/00 (2006.01) A61M 5/24 (2006.01)
2476828	E05B 17/20 (2006.01) E05B 15/00 (2006.01) E05B 65/08 (2006.01) E05D 15/06 (2006.01) E05B 63/00 (2006.01)	2430032 *	C07H 19/19 (2006.01) C07H 1/00 (2006.01)	2409572	A22B 5/20 (2006.01)
2436088 *	H01R 9/05 (2006.01) H01R 13/648 (2006.01)	2490688 *	A61K 45/06 (2006.01) A61K 31/337 (2006.01) A61P 35/00 (2006.01) A61K 31/4196 (2006.01)	2442799 *	A61K 9/20 (2006.01) A61K 31/5377 (2006.01)
2499170 *	C08F 8/00 (2006.01)	2485163 *	G06F 17/30 (2006.01)	2453988 *	A62B 1/14 (2006.01)
		2488021 *	A01N 33/00 (2006.01) A01N 43/90 (2006.01)	2490690 *	A61P 35/00 (2006.01) A61K 31/506 (2006.01)

Broj objave evropske prijave patenta (97)	MKP (51)	Broj objave evropske prijave patenta (97)	MKP (51)	Broj objave evropske prijave patenta (97)	MKP (51)
2466979 *	H04W 72/04 (2009.01)	2475429 *	A61P 25/00 (2006.01) C07D 489/02 (2006.01) A61K 31/485 (2006.01)	2440091 *	A47G 27/02 (2006.01) A47G 27/04 (2006.01) D06N 7/00 (2006.01) D05C 17/02 (2006.01)
2440053 *	A01N 43/66 (2006.01) A61K 31/53 (2006.01)	2445903 *	C07D 417/14 (2006.01) A61K 31/4178 (2006.01) C07D 407/14 (2006.01) C07D 409/14 (2006.01) A61P 35/00 (2006.01) C07D 403/04 (2006.01) C07D 403/14 (2006.01)	2421830 *	A61P 11/02 (2006.01) A61K 31/18 (2006.01) C07D 211/96 (2006.01) A61P 29/00 (2006.01) C07D 295/26 (2006.01) A01N 43/62 (2006.01) A61P 25/28 (2006.01) C07D 241/04 (2006.01) C07D 241/08 (2006.01)
2411364 *	C07D 401/12 (2006.01) A61K 31/444 (2006.01) A61P 35/00 (2006.01) C07D 213/56 (2006.01)	2470508 *	A61K 31/4439 (2006.01) A61K 31/497 (2006.01) A61K 31/416 (2006.01) C07D 401/14 (2006.01) A61P 29/00 (2006.01) C07D 403/04 (2006.01) A61P 19/02 (2006.01) C07D 405/14 (2006.01) C07D 401/04 (2006.01) C07F 9/09 (2006.01) C07D 231/54 (2006.01) A61K 31/661 (2006.01)	2275086	A61K 9/00 (2006.01) A61K 38/16 (2006.01)
2458983 *	A61K 31/045 (2006.01) A01N 31/00 (2006.01)	2499148 *	A61P 25/24 (2006.01) A61K 31/4745 (2006.01) C07D 498/04 (2006.01) C07D 498/18 (2006.01) C07F 7/08 (2006.01) A61K 31/695 (2006.01) A61P 1/06 (2006.01)	2305778	C10G 3/00 (2006.01) C10L 1/02 (2006.01)
2431355 *	A61P 25/20 (2006.01) A61P 25/22 (2006.01) A61P 25/24 (2006.01) C07C 233/18 (2006.01) A61P 9/00 (2006.01) A61K 31/165 (2006.01) A61P 1/00 (2006.01) A61P 25/00 (2006.01) A61P 5/00 (2006.01) A61P 25/18 (2006.01)	2498802 *	A61K 47/20 (2006.01) A61K 38/28 (2006.01) A61P 3/10 (2006.01) A61K 38/26 (2006.01)	2446098 *	E04H 4/14 (2006.01) E04H 4/12 (2006.01) F04D 15/00 (2006.01) A63B 69/12 (2006.01)
2435413 *	C07D 307/80 (2006.01)	2403856 *	A61P 35/02 (2006.01) A61P 35/00 (2006.01) C07D 491/04 (2006.01) A61K 31/4355 (2006.01)	2464385 *	A61K 41/00 (2006.01) A61K 9/00 (2006.01) A61K 48/00 (2006.01) C12N 15/87 (2006.01) A61P 35/00 (2006.01) A61P 43/00 (2006.01)
2479278	C12N 15/10 (2006.01) C12N 15/79 (2006.01)	2490496 *	H04W 72/04 (2009.01)	2482875 *	A61M 5/315 (2006.01) A61M 5/24 (2006.01)

Broj objave evropske prijave patenta (97)	MKP (51)	Broj objave evropske prijave patenta (97)	MKP (51)	Broj objave evropske prijave patenta (97)	MKP (51)
2440577 *	C07K 14/705 (2006.01) A61K 38/17 (2006.01) A61P 3/00 (2006.01)	2357305	E05D 15/06 (2006.01)	2408426 *	A61K 9/00 (2006.01) A61K 9/06 (2006.01) A61K 47/32 (2006.01) A61K 31/20 (2006.01) A61K 31/201 (2006.01) A61K 31/202 (2006.01)
2493852 *	C07D 405/12 (2006.01) A61K 31/444 (2006.01) C07D 211/56 (2006.01) A61K 31/397 (2006.01) C07D 413/12 (2006.01) A61K 31/4025 (2006.01) C07D 451/04 (2006.01) C07D 401/12 (2006.01) A61K 31/40 (2006.01) C07D 205/04 (2006.01) C07D 453/02 (2006.01) C07D 409/12 (2006.01) A61K 31/4245 (2006.01) C07D 207/09 (2006.01) C07C 217/90 (2006.01)	2462499 *	G06F 3/044 (2006.01)	2448566 *	A61K 9/28 (2006.01) A61K 9/48 (2006.01) A61K 9/50 (2006.01)
2451476 *	A61K 39/00 (2006.01) C07H 21/02 (2006.01) C12N 15/11 (2006.01)	2272826	C07C 323/61 (2006.01) C07C 327/34 (2006.01) C07D 205/04 (2006.01) C07D 211/34 (2006.01) C07D 213/55 (2006.01) C07D 213/73 (2006.01) A61P 9/00 (2006.01) A61K 31/095 (2006.01) A61P 7/02 (2006.01)	2460040 *	G02B 6/255 (2006.01)
2474164 *	H04N 7/24 (2011.01) H04L 29/06 (2006.01) H04N 7/16 (2011.01) H04N 7/173 (2011.01) H04N 5/265 (2006.01) G06F 17/30 (2006.01)	2411050 *	A61K 39/395 (2006.01)	2400812	H04W 84/20 (2009.01)
2427201 *	A61K 35/76 (2006.01) A61P 33/06 (2006.01)	2485862 *	B23K 26/24 (2006.01) B23K 26/03 (2006.01) B23K 26/067 (2006.01) B23K 26/42 (2006.01) B23K 26/04 (2006.01)	2467372 *	C07D 401/00 (2006.01)
2493128 *	H04L 12/56 (2006.01)	2493460 *	A61K 31/55 (2006.01) A61K 31/535 (2006.01) A61K 31/00 (2006.01)	2425251 *	G01N 33/569 (2006.01)
		2414145 *	B29C 45/14 (2006.01) B29C 33/18 (2006.01) B29C 33/38 (2006.01)	2493862 *	C07D 401/12 (2006.01) A61P 35/00 (2006.01) A61K 31/4164 (2006.01) C07D 407/12 (2006.01) A61P 31/00 (2006.01) C07D 409/12 (2006.01) C07D 233/64 (2006.01) A61K 31/4178 (2006.01) C07D 413/12 (2006.01) C07D 403/12 (2006.01) A61P 37/00 (2006.01) C07D 417/12 (2006.01)
		2437790 *	A61K 39/395 (2006.01) A61K 51/00 (2006.01) A61K 47/48 (2006.01)	2470510 *	C07D 233/60 (2006.01) A61K 31/4164 (2006.01) A61P 25/28 (2006.01)
				2490720 *	A61K 39/395 (2006.01)

Broj objave evropske prijava patenta (97)	MKP (51)	Broj objave evropske prijava patenta (97)	MKP (51)	Broj objave evropske prijava patenta (97)	MKP (51)
2421547 *	C07K 14/60 (2006.01) A61K 31/427 (2006.01) A61K 38/27 (2006.01) A61K 38/16 (2006.01) C07K 17/02 (2006.01)	2451790 *	C07C 247/06 (2006.01) C07D 249/06 (2006.01) A61P 35/04 (2006.01) C07D 403/10 (2006.01) A61K 31/4192 (2006.01) C07D 413/10 (2006.01) C07C 259/10 (2006.01) C07D 403/04 (2006.01) A61K 35/00 (2006.01) A61P 35/02 (2006.01) C07C 209/10 (2006.01)	2483249 *	C07D 239/47 (2006.01) A61K 31/506 (2006.01) C07D 417/12 (2006.01) A61P 35/00 (2006.01) C07D 403/12 (2006.01)
2299292	G01S 15/89 (2006.01) G01F 23/296 (2006.01)			2277863	C07D 211/42 (2006.01) A61K 31/445 (2006.01) A61K 31/4462 (2006.01) A61P 25/00 (2006.01)
2473850 *	G01N 33/50 (2006.01) G01N 33/74 (2006.01) C12Q 1/68 (2006.01) A61K 38/27 (2006.01)			2451786 *	C07D 239/34 (2006.01)
2480232 *	A61K 31/454 (2006.01) C07D 401/06 (2006.01) A61P 11/00 (2006.01) A61P 29/00 (2006.01) A61P 19/02 (2006.01) A61P 1/00 (2006.01)	2465169 *	H01R 13/658 (2011.01) H01B 11/06 (2006.01) H01R 13/646 (2011.01)	2470901 *	G01N 33/50 (2006.01) G01N 33/564 (2006.01)
		2443100 *	C07D 261/14 (2006.01) C07D 413/12 (2006.01) C07D 413/14 (2006.01) C07D 417/06 (2006.01) C07D 417/12 (2006.01) C07D 417/14 (2006.01) A61K 31/42 (2006.01) A61P 29/00 (2006.01)	2406152 *	B65G 5/00 (2006.01) E21F 17/16 (2006.01)
2491499 *	G06F 17/00 (2006.01) G06Q 50/00 (2012.01)			2416581 *	H04N 13/04 (2006.01) G11B 20/12 (2006.01) H04N 5/92 (2006.01)
2416770 *	A61K 31/198 (2006.01) A61P 13/12 (2006.01)	2311353	A47J 31/40 (2006.01) A47J 31/60 (2006.01)	2438237 *	D21H 17/56 (2006.01) D21H 17/46 (2006.01) D21H 17/52 (2006.01) D21H 19/80 (2006.01) D21H 19/82 (2006.01) D21H 19/36 (2006.01) D21H 21/20 (2006.01) D21H 19/40 (2006.01) D21H 27/10 (2006.01) D21H 19/62 (2006.01)
		2429310 *	A23J 1/14 (2006.01) A23J 3/16 (2006.01)		
		2375038	F02D 41/22 (2006.01)		
				2435406 *	C07D 211/34 (2006.01) A61K 31/451 (2006.01)

Broj objave evropske prijave patenta (97)	MKP (51)	Broj objave evropske prijave patenta (97)	MKP (51)	Broj objave evropske prijave patenta (97)	MKP (51)
2392385	A62B 18/08 (2006.01) A62B 17/04 (2006.01)	2456460 *	A61K 39/00 (2006.01)	2449101 *	A61K 31/713 (2006.01) C12N 15/63 (2006.01) C07K 14/33 (2006.01) A61K 38/48 (2006.01) C12N 9/52 (2006.01) C07K 16/12 (2006.01) C12N 1/21 (2006.01) C12P 21/02 (2006.01)
2440050 *	A01N 43/66 (2006.01) A61K 31/53 (2006.01)	2459716 *	C12N 15/00 (2006.01) A61K 31/70 (2006.01)		
2325228	C08G 63/21 (2006.01) C08G 63/47 (2006.01)	2483243 *	C07D 213/16 (2006.01) C07D 211/18 (2006.01) C07F 5/02 (2006.01)		
2494425 *	G06F 3/01 (2006.01) G06F 3/16 (2006.01)	2496237 *	C07D 239/95 (2006.01) A61K 31/517 (2006.01) A61P 35/00 (2006.01)	2475357 *	A61K 47/14 (2006.01) A61K 47/26 (2006.01) A61K 9/10 (2006.01) A61K 31/55 (2006.01) A61K 47/36 (2006.01)
2410927 *	A61B 17/29 (2006.01) A61B 17/00 (2006.01)	2410358	G02B 27/00 (2006.01) G02B 6/08 (2006.01) G02B 6/42 (2006.01)		
2440243 *	A61K 39/00 (2006.01)			2421503 *	A61K 9/12 (2006.01) A61K 9/00 (2006.01) A61K 31/335 (2006.01)
2424533 *	A61K 31/47 (2006.01)	2422314 *	G06Q 50/00 (2012.01)		
2427203 *	A61K 38/00 (2006.01) C07K 14/54 (2006.01) C07K 16/24 (2006.01)	2496481 *	B65B 35/54 (2006.01)	2459012 *	A23P 1/12 (2006.01) A23P 1/02 (2006.01) A23L 1/10 (2006.01)
2427425 *	C07C 275/24 (2006.01) C07D 221/20 (2006.01) C07C 311/06 (2006.01) C07D 295/03 (2006.01) C07C 311/19 (2006.01) C07D 223/04 (2006.01) C07D 205/04 (2006.01) C07D 223/32 (2006.01) C07D 207/06 (2006.01) C07D 209/04 (2006.01) C07D 207/08 (2006.01) C07C 237/26 (2006.01) C07D 211/34 (2006.01)	2422376 *	H01L 31/048 (2006.01) F16B 5/02 (2006.01) E04D 3/365 (2006.01) E04D 13/18 (2006.01) H01L 31/042 (2006.01)	2462566 *	G07D 9/00 (2006.01) G07F 1/04 (2006.01)
		2406414 *	C30B 33/02 (2006.01) H01L 29/32 (2006.01)	2424864 *	C07D 413/14 (2006.01) A61K 31/4439 (2006.01) A61P 31/12 (2006.01) A61K 31/422 (2006.01) A61P 35/00 (2006.01) A61P 11/00 (2006.01) A61P 37/00 (2006.01)
		2440762 *	F02B 39/02 (2006.01) B60K 11/02 (2006.01) B60R 16/08 (2006.01) B60R 17/00 (2006.01) F02B 39/16 (2006.01)	2414597 *	E04B 1/32 (2006.01)

Broj objave evropske prijave patenta (97)	MKP (51)	Broj objave evropske prijave patenta (97)	MKP (51)	Broj objave evropske prijave patenta (97)	MKP (51)
2493292 *	A01N 43/653 (2006.01) A01N 25/32 (2006.01) A01N 43/42 (2006.01) A01P 13/00 (2006.01) A01N 43/54 (2006.01) A01N 43/56 (2006.01)	2477653 *	A61K 39/395 (2006.01) A61P 35/00 (2006.01) C07K 16/28 (2006.01) C07K 16/30 (2006.01) C07K 16/46 (2006.01)	2435402 *	A61K 31/165 (2006.01) C07C 233/45 (2006.01) C07C 233/64 (2006.01) C07C 233/57 (2006.01) A61K 31/166 (2006.01)
2437783 *	A61K 47/36 (2006.01)	2342164 *	C02F 1/66 (2006.01) C02F 1/72 (2006.01) C02F 9/00 (2006.01) C02F 11/06 (2006.01) C02F 101/20 (2006.01) C02F 101/30 (2006.01)	2406283 *	C07K 16/46 (2006.01) C12N 15/13 (2006.01) A61P 11/06 (2006.01) C07K 16/24 (2006.01) A61K 39/395 (2006.01)
2445999 *	C10J 3/56 (2006.01) C10J 3/84 (2006.01) C10J 3/48 (2006.01) C10J 3/86 (2006.01)	2339253	F24F 5/00 (2006.01) F24F 12/00 (2006.01)	2279792	B05B 1/30 (2006.01)
2451793 *	C07D 498/04 (2006.01) C07D 513/02 (2006.01) C07D 279/08 (2006.01)	2484701 *	C08F 36/04 (2006.01) C08K 3/36 (2006.01) C08L 15/00 (2006.01) C08C 19/25 (2006.01)	2430443 *	G01N 33/543 (2006.01) G01N 33/574 (2006.01) G01N 33/50 (2006.01) G01N 33/533 (2006.01) G01N 33/532 (2006.01) G01N 33/535 (2006.01)
2456588 *	B23F 5/22 (2006.01) B23Q 1/28 (2006.01)	2263657	A61K 9/20 (2006.01)	2430103 *	C09K 11/06 (2006.01) C09D 11/10 (2006.01) C09D 11/00 (2006.01) B41M 3/14 (2006.01)
2444384 *	A24B 3/18 (2006.01) A24B 15/00 (2006.01) A24B 3/12 (2006.01) A24B 15/32 (2006.01) A24B 3/14 (2006.01) A24B 15/10 (2006.01) C07C 11/12 (2006.01) A24B 15/18 (2006.01) C07C 11/00 (2006.01) A24B 15/28 (2006.01) A24B 3/00 (2006.01) A24B 15/30 (2006.01)	2435558 *	C12N 15/12 (2006.01) C12N 5/074 (2010.01) C12N 5/10 (2006.01)	2411383 *	C07D 409/12 (2006.01) A61K 31/4535 (2006.01) A61P 25/00 (2006.01) C07D 409/06 (2006.01)
2445293 *		2448501 *	H04W 72/12 (2009.01)		
2448501 *		2386651 *	A61B 17/32 (2006.01)		
2424590 *	A61M 3/02 (2006.01) A61M 1/00 (2006.01)		C12Q 1/02 (2006.01) C12N 15/09 (2006.01)		

Broj objave evropske prijava patenta (97)	MKP (51)	Broj objave evropske prijava patenta (97)	MKP (51)	Broj objave evropske prijava patenta (97)	MKP (51)
2464651 *	A61P 35/00 (2006.01) A61P 29/00 (2006.01) C07H 17/08 (2006.01) A61P 11/06 (2006.01) C07D 498/04 (2006.01) A61K 31/4433 (2006.01)	2491364 *	G01L 9/00 (2006.01)	2448407 *	A61K 31/44 (2006.01) A01N 43/42 (2006.01)
		2429297 *	A01N 45/00 (2006.01)	2449114 *	C12N 15/88 (2006.01) C07H 21/00 (2006.01) C07H 21/02 (2006.01) C12N 15/87 (2006.01) A61K 9/14 (2006.01) C12N 15/113 (2010.01) A61P 35/00 (2006.01) A61K 31/713 (2006.01)
		2319568	A61M 16/00 (2006.01) A61M 16/16 (2006.01)		
2403948 *	C12N 15/82 (2006.01) C07K 14/325 (2006.01)	2341046	C07D 211/58 (2006.01) C07D 491/22 (2006.01) A61P 35/00 (2006.01) A61K 31/4375 (2006.01)		
2400954 *	A61K 9/20 (2006.01)				
2406442 *	E05B 21/06 (2006.01)	2491031 *	A61P 25/00 (2006.01) C07D 487/04 (2006.01) C07D 471/04 (2006.01) A61K 31/4353 (2006.01)	2403783 *	B65G 17/26 (2006.01)
2472817	H04L 29/06 (2006.01)			2427473 *	C07J 41/00 (2006.01) C07J 9/00 (2006.01)
2425183 *	F24C 11/00 (2006.01)	2493927 *	C07K 16/28 (2006.01)	2403519 *	A61K 38/19 (2006.01)
2476419 *	A61K 31/665 (2006.01) A61K 47/04 (2006.01) A61P 31/04 (2006.01) A61K 9/51 (2006.01)	2364972	A61P 9/00 (2006.01) C07D 223/16 (2006.01) A61K 31/55 (2006.01)	2499020 *	B60N 2/28 (2006.01) B60N 2/26 (2006.01)
2324831	A61K 31/4412 (2006.01) A61P 11/00 (2006.01)	2427154 *	A61K 9/00 (2006.01) A61F 6/14 (2006.01)	2493312 *	A61K 31/425 (2006.01) A01N 43/78 (2006.01)
2429959 *	C03B 7/06 (2006.01) F23N 5/02 (2006.01)	2435068 *	A61P 35/00 (2006.01) A61P 35/02 (2006.01) G01N 33/574 (2006.01) A61K 38/20 (2006.01) A61K 39/395 (2006.01)	2445911 *	A61K 31/437 (2006.01) A61P 19/02 (2006.01) C07D 471/04 (2006.01)
2487149 *	C07C 45/34 (2006.01) C07C 255/17 (2006.01) C07B 61/00 (2006.01) C07C 253/30 (2006.01) C07C 49/17 (2006.01) C07C 49/175 (2006.01)	2459203 *	A61K 35/74 (2006.01) A61P 5/50 (2006.01) A61P 29/00 (2006.01)	2470019 *	A01N 43/62 (2006.01) A61K 31/55 (2006.01)
2454227 *	C07C 69/76 (2006.01)			2459593 *	C07K 16/28 (2006.01) C07K 16/40 (2006.01) A61P 27/02 (2006.01) A61P 43/00 (2006.01)

Broj objave evropske prijave patenta (97)	MKP (51)	Broj objave evropske prijave patenta (97)	MKP (51)	Broj objave evropske prijave patenta (97)	MKP (51)
2483057 *	B29C 65/08 (2006.01) B29C 65/64 (2006.01) B60J 10/02 (2006.01) B29C 65/60 (2006.01) B60R 13/06 (2006.01) B60R 13/04 (2006.01)	2402609	F01N 3/20 (2006.01) F04B 53/16 (2006.01) F04B 39/12 (2006.01)	2451771 *	C07C 53/126 (2006.01) A61P 25/16 (2006.01) C07C 53/122 (2006.01) A61K 31/19 (2006.01) C07C 211/42 (2006.01) A61K 31/13 (2006.01) C07C 57/12 (2006.01)
2357622	G07F 17/32 (2006.01) G07F 17/34 (2006.01)	2499129 *	A61K 31/517 (2006.01) C07D 487/04 (2006.01) A61P 35/00 (2006.01) A61P 29/00 (2006.01) C07D 403/04 (2006.01) A61P 25/28 (2006.01) A61P 9/00 (2006.01)	2408814 *	C07K 16/00 (2006.01) C12P 21/08 (2006.01)
2495886 *	H04B 7/26 (2006.01)	2452321 *	G07F 19/00 (2006.01)	2440534 *	C07D 405/12 (2006.01) C07D 239/48 (2006.01) A61K 31/505 (2006.01) C07D 401/12 (2006.01)
2440208 *	A61K 9/00 (2006.01) A61K 31/5377 (2006.01) A61K 9/14 (2006.01)	2454011 *	B01J 2/22 (2006.01)	2443095 *	A61K 31/506 (2006.01) A61P 37/00 (2006.01) C07D 239/48 (2006.01) C07D 403/12 (2006.01) C07D 403/14 (2006.01)
2443095 *	A61K 31/506 (2006.01) A61P 37/00 (2006.01) C07D 239/48 (2006.01) C07D 403/12 (2006.01) C07D 403/14 (2006.01)	2497774	A61K 31/551 (2006.01) C07D 498/04 (2006.01)	2474594 *	C10G 45/00 (2006.01) C10G 2/00 (2006.01)
2459084 *	A61B 17/34 (2006.01) A61B 19/00 (2006.01)	2473022 *	A01H 5/00 (2006.01) C12N 15/52 (2006.01) C12N 15/82 (2006.01)	2406383 *	C12P 7/06 (2006.01)
2470216 *	A61K 47/48 (2006.01) C07K 5/02 (2006.01)	2465781	B65B 9/067 (2012.01) B65B 9/087 (2012.01) B29C 65/18 (2006.01) B65B 43/04 (2006.01)	2486008 *	C07D 207/16 (2006.01) A61P 3/10 (2006.01) A61K 31/401 (2006.01)
2437726 *	A61K 9/127 (2006.01)	2435427 *	A61K 31/4535 (2006.01) C07D 413/04 (2006.01) A61K 31/4525 (2006.01) C07D 413/14 (2006.01) A61K 31/4545 (2006.01)	2485811 *	A62C 35/02 (2006.01) A62C 99/00 (2010.01) A62D 1/02 (2006.01) A62D 1/06 (2006.01)
2298328	A61P 25/18 (2006.01) A61P 25/28 (2006.01) A61P 25/16 (2006.01) A61K 35/44 (2006.01)	2411388 *	C07D 471/04 (2006.01) A61K 31/437 (2006.01)	2413397	H01M 2/10 (2006.01) H01M 10/50 (2006.01)
				2427190 *	A61K 31/435 (2006.01) A61P 31/04 (2006.01) C07D 221/18 (2006.01)

Broj objave evropske prijava patenta (97)	MKP (51)	Broj objave evropske prijava patenta (97)	MKP (51)	Broj objave evropske prijava patenta (97)	MKP (51)
2490912 *	B60K 37/02 (2006.01) B60K 11/08 (2006.01) G01P 1/08 (2006.01) G01D 13/26 (2006.01) G01D 11/28 (2006.01)	2491190 *	E03D 11/12 (2006.01)	2459567 *	C07D 487/22 (2006.01) A61K 31/555 (2006.01) A61P 31/00 (2006.01) A61P 35/00 (2006.01)
		2364864	B44C 1/26 (2006.01) B44C 1/28 (2006.01) B44C 5/04 (2006.01)	2496009 *	H04W 28/04 (2009.01)
2338446	A61F 9/06 (2006.01)	2454235 *	C07D 209/42 (2006.01)	2440051 *	A01N 43/66 (2006.01) A61K 31/53 (2006.01)
2448938 *	C07D 513/04 (2006.01) A61K 31/52 (2006.01) A61P 37/00 (2006.01) A61P 29/00 (2006.01) C07D 473/34 (2006.01)	2419529 *	C12Q 1/68 (2006.01) G01N 33/564 (2006.01) G01N 33/68 (2006.01)	2406559 *	F24J 3/08 (2006.01)
		2350863 *	H04W 40/02 (2009.01) G06F 15/16 (2006.01) G06F 15/177 (2006.01)	2424348 *	A01N 59/10 (2006.01) A01N 41/10 (2006.01) A01P 1/00 (2006.01) A01N 25/06 (2006.01) A01N 59/16 (2006.01)
2486029 *	C07D 309/10 (2006.01)	2411054 *	A61K 47/48 (2006.01) C07K 16/18 (2006.01) A61P 3/10 (2006.01)	2462098 *	C07C 51/09 (2006.01) C07C 253/14 (2006.01) C07C 61/40 (2006.01) C07C 253/30 (2006.01) C07C 255/35 (2006.01) C07C 255/46 (2006.01)
2417859 *	A23J 1/00 (2006.01) A23J 3/00 (2006.01)				
2432884 *	C12N 15/68 (2006.01) C12N 15/73 (2006.01) C12N 15/63 (2006.01)	2421852 *	C07D 403/14 (2006.01) A61P 25/00 (2006.01) C07D 403/12 (2006.01) A61P 29/00 (2006.01) C07D 409/12 (2006.01) C07D 401/14 (2006.01) A61K 31/496 (2006.01) C07D 405/14 (2006.01) C07D 409/14 (2006.01) C07D 401/12 (2006.01) C07D 417/12 (2006.01) C07D 413/12 (2006.01)	2392548	B01J 21/00 (2006.01) C01B 33/12 (2006.01)
2474592 *	C10G 2/00 (2006.01)			2448922 *	A61P 11/00 (2006.01) A61P 13/12 (2006.01) A61P 35/00 (2006.01) C07D 213/69 (2006.01) A61P 25/28 (2006.01) A61K 31/4422 (2006.01)
2500400 *	C10G 2/00 (2006.01) C10G 47/36 (2006.01)				
2486146 *	C12Q 1/68 (2006.01)			2284750	G06F 21/00 (2006.01)
2432482 *	A61K 35/34 (2006.01)				
2486198 *	E04B 2/02 (2006.01) B32B 27/04 (2006.01) B32B 7/04 (2006.01) E04C 2/24 (2006.01) E04C 1/40 (2006.01)	2366430	A61N 7/00 (2006.01)		

Broj objave evropske prijave patenta (97)	MKP (51)	Broj objave evropske prijave patenta (97)	MKP (51)	Broj objave evropske prijave patenta (97)	MKP (51)
2419605 *	E21B 47/12 (2012.01) E21B 17/00 (2006.01)	2406289 *	A61K 39/395 (2006.01) C07K 19/00 (2006.01) C07K 16/08 (2006.01) C12N 15/63 (2006.01) C12N 15/62 (2006.01) A61K 39/12 (2006.01)	2424874 *	C07H 19/20 (2006.01) A61K 31/708 (2006.01)
2461700 *	A01N 31/00 (2006.01) A23K 1/18 (2006.01) A23K 1/17 (2006.01) A23K 1/16 (2006.01)	2477625 *	A61P 29/00 (2006.01) A61K 31/433 (2006.01) A61P 35/00 (2006.01)	2406218 *	A61K 31/4422 (2006.01) C07D 211/90 (2006.01)
2449493 *	G06F 19/00 (2011.01)	2488033 *	A01N 43/90 (2006.01) A61K 31/519 (2006.01)	2419044 *	A61C 8/00 (2006.01)
2415438	A61F 13/15 (2006.01)	248516 *	A61N 1/36 (2006.01) A61N 1/34 (2006.01)	2256066	B65G 7/04 (2006.01) B65D 90/18 (2006.01)
2440554 *	A61P 37/06 (2006.01) C07D 471/04 (2006.01) A61K 31/4245 (2006.01) C07D 413/04 (2006.01) C07D 413/14 (2006.01)	2270305	E06B 3/54 (2006.01)	2469445	G06F 21/00 (2006.01)
2444460	C09C 1/00 (2006.01) C09D 7/12 (2006.01) C22B 34/14 (2006.01)	2440052 *	A01N 43/66 (2006.01) A61K 31/53 (2006.01)	2424866 *	C07D 471/04 (2006.01) C07D 487/04 (2006.01) A61K 31/437 (2006.01) A61P 25/28 (2006.01)
2424177	H04L 29/06 (2006.01) H04L 12/56 (2006.01)	2468281 *	A61P 35/00 (2006.01) A61P 35/04 (2006.01) A61P 43/00 (2006.01) C07D 215/48 (2006.01) A61K 47/38 (2006.01) A61K 31/47 (2006.01) A61K 47/32 (2006.01) A61K 47/36 (2006.01)	2427501 *	C08B 37/00 (2006.01) C08B 37/10 (2006.01)
2397318	B31D 1/06 (2006.01) B31B 19/86 (2006.01)	2454163 *	A61P 35/00 (2006.01) A61P 35/04 (2006.01) A61P 43/00 (2006.01) C07D 215/48 (2006.01) A61K 47/38 (2006.01) A61K 31/47 (2006.01) A61K 47/32 (2006.01) A61K 47/36 (2006.01)	2482768 *	A61K 9/00 (2006.01) A61F 6/14 (2006.01)
2454163 *	B65D 33/28 (2006.01) B31B 19/90 (2006.01)	2380935	A61F 13/15 (2006.01) B07C 5/342 (2006.01)	2366725	C08G 63/00 (2006.01) C08L 67/00 (2006.01) C08K 7/22 (2006.01) C08K 7/00 (2006.01)
2380935	C09D 195/00 (2006.01) E01C 7/35 (2006.01) C08L 95/00 (2006.01)	2412348	A61F 13/15 (2006.01) B07C 5/342 (2006.01)	2493877 *	C07D 413/14 (2006.01) C07D 403/12 (2006.01) A61P 25/04 (2006.01) C07D 403/14 (2006.01) A61K 31/506 (2006.01) C07D 401/14 (2006.01)
		2448896 *	C07C 209/62 (2006.01) C07C 29/40 (2006.01) C07C 211/35 (2006.01)	2421893 *	C07K 14/635 (2006.01)

Broj objave evropske prijava patenta (97)	MKP (51)	Broj objave evropske prijava patenta (97)	MKP (51)	Broj objave evropske prijava patenta (97)	MKP (51)
2464909 *	F16L 55/38 (2006.01)	2322451	B65D 85/76 (2006.01) B65D 25/10 (2006.01)	2470551 *	C07H 1/00 (2006.01) C07H 17/02 (2006.01)
2333168	E03D 11/13 (2006.01) E03D 11/12 (2006.01)	2443109 *	A01N 43/653 (2006.01) C07D 405/06 (2006.01)	2286919	A61B 10/00 (2006.01) G01N 1/40 (2006.01) B01L 3/00 (2006.01) B01L 3/14 (2006.01)
2366847	E04F 13/00 (2006.01) E04B 1/74 (2006.01)	2445904 *	C07D 411/12 (2006.01) A61K 31/4535 (2006.01) A61K 31/454 (2006.01) C07D 413/14 (2006.01) A61K 31/506 (2006.01) C07D 417/14 (2006.01) C07D 411/14 (2006.01)	2452318 *	G07F 17/00 (2006.01) G07F 19/00 (2006.01)
2419976 *	H01T 4/08 (2006.01) H02H 9/02 (2006.01)	2448943 *	A61P 29/00 (2006.01) A61K 31/404 (2006.01) C07D 491/22 (2006.01)	2477708 *	B01D 21/24 (2006.01) B01D 21/01 (2006.01)
2448943 *	A61P 29/00 (2006.01) A61K 31/404 (2006.01) C07D 491/22 (2006.01)	2493848 *	C07C 253/30 (2006.01) C07D 257/04 (2006.01)	2403661 *	B08B 7/00 (2006.01) B08B 1/00 (2006.01)
2459529 *	C07D 207/10 (2006.01) C07D 215/06 (2006.01) C07D 209/44 (2006.01) C07D 217/04 (2006.01) C07D 211/14 (2006.01) C07D 241/08 (2006.01) C07D 211/38 (2006.01) C07D 401/12 (2006.01) C07D 207/06 (2006.01) A61P 25/00 (2006.01) C07D 211/46 (2006.01) C07D 403/12 (2006.01) A61K 31/496 (2006.01) C07D 407/12 (2006.01) A61K 31/5377 (2006.01)	2456901 *	C22C 38/46 (2006.01) C22C 38/54 (2006.01) C22C 38/00 (2006.01)	2414342 *	C07D 271/06 (2006.01) A61K 31/4245 (2006.01) A61P 37/00 (2006.01)
2453748 *	A61K 31/415 (2006.01) A01N 43/56 (2006.01)	2489340 *	A61K 9/70 (2006.01) A61L 15/58 (2006.01) A61F 13/02 (2006.01)	2475374 *	A61K 36/00 (2006.01)
2468319	A61L 29/08 (2006.01) A61L 29/16 (2006.01)	2435562 *	C12N 9/14 (2006.01) C12N 9/68 (2006.01) C12N 15/82 (2006.01) A61K 38/16 (2006.01) C12N 5/04 (2006.01)	2483257 *	A61P 25/00 (2006.01) C07D 285/36 (2006.01) A61K 31/554 (2006.01) C07D 285/06 (2006.01) C07D 309/24 (2006.01)
2453748 *	A61K 31/415 (2006.01) A01N 43/56 (2006.01)	2308491	A61K 31/4412 (2006.01) A61P 11/00 (2006.01)	2495288 *	C09B 67/20 (2006.01) C09B 67/02 (2006.01) C09B 67/46 (2006.01) G02B 5/22 (2006.01) G02B 5/20 (2006.01)
2468319	A61L 29/08 (2006.01) A61L 29/16 (2006.01)	2389903	A61F 2/44 (2006.01)	2417671 *	H01R 9/05 (2006.01) H01R 13/646 (2011.01)

Broj objave evropske prijave patenta (97)	MKP (51)	Broj objave evropske prijave patenta (97)	MKP (51)	Broj objave evropske prijave patenta (97)	MKP (51)
2498598 *	A01N 25/24 (2006.01) A01N 25/26 (2006.01)	2437831 *	A61M 5/315 (2006.01) A61M 5/00 (2006.01)	2419400 *	A61K 31/137 (2006.01) A61K 31/135 (2006.01) A61P 25/00 (2006.01) C07C 211/27 (2006.01) C07C 211/29 (2006.01) C07C 211/35 (2006.01) C07C 225/16 (2006.01) C07C 225/18 (2006.01)
2483300 *	C07K 14/435 (2006.01) C07K 7/06 (2006.01) A61K 38/10 (2006.01) A61P 19/10 (2006.01) C07K 14/475 (2006.01) C07K 17/08 (2006.01) A61P 3/10 (2006.01) A61K 38/18 (2006.01) C07K 7/08 (2006.01) A61P 21/06 (2006.01) A61P 17/00 (2006.01) A61P 3/04 (2006.01) A61K 38/08 (2006.01) C12N 15/12 (2006.01)	2451830 *	C12N 15/82 (2006.01) C07K 14/415 (2006.01)	2392816	F02M 61/16 (2006.01) C21D 7/10 (2006.01)
		2437821 *	A61M 5/315 (2006.01)	2416800 *	A61K 38/48 (2006.01) A61P 31/04 (2006.01)
		2470173 *	A61K 31/337 (2006.01) A61K 9/20 (2006.01)	2475745 *	C10G 1/04 (2006.01)
		2485905 *	C08L 27/00 (2006.01) B60C 19/00 (2006.01) G01M 1/36 (2006.01) C08L 71/02 (2006.01)	2425389 *	G06Q 20/00 (2012.01)
		2477608 *	A61K 9/14 (2006.01)	2430022 *	A61P 25/28 (2006.01) C07D 519/00 (2006.01) C07D 471/04 (2006.01) A61K 31/437 (2006.01)
		2418562	G06F 3/01 (2006.01)	2456587 *	B23F 5/22 (2006.01) B23Q 39/02 (2006.01)
2453746 *	A01N 43/06 (2006.01) A01N 43/12 (2006.01) A61K 31/38 (2006.01)	2341119	F28D 7/00 (2006.01) C10L 9/08 (2006.01) C10B 53/02 (2006.01) C10L 9/00 (2006.01) C10B 49/14 (2006.01)	2419735 *	G01N 33/573 (2006.01)
2486024 *	C07D 413/14 (2006.01) C07D 271/06 (2006.01) A61K 31/506 (2006.01) A61P 5/00 (2006.01) A61P 37/00 (2006.01)	2440402 *	B32B 9/00 (2006.01) B32B 33/00 (2006.01)	2411615 *	E06C 1/383 (2006.01) E06C 7/08 (2006.01) E06C 9/06 (2006.01)
2416675 *	B29D 35/00 (2010.01) B29D 35/08 (2010.01) A43B 7/06 (2006.01) A43B 7/12 (2006.01) B29C 44/12 (2006.01)	2491541 *	G08B 1/08 (2006.01)	2414673 *	F03D 11/00 (2006.01)
2406628 *	G01N 33/50 (2006.01)				

Broj objave evropske prijava patenta (97)	MKP (51)	Broj objave evropske prijava patenta (97)	MKP (51)	Broj objave evropske prijava patenta (97)	MKP (51)
2369064	E02F 3/815 (2006.01) E02F 9/28 (2006.01) E01H 5/06 (2006.01) A01B 31/00 (2006.01)	2494135 *	E21B 4/18 (2006.01) E21B 23/14 (2006.01) E21B 47/12 (2012.01)	2493930 *	C12N 1/21 (2006.01) C07K 16/28 (2006.01) C07K 16/46 (2006.01) C12N 5/10 (2006.01) C12N 1/19 (2006.01) A61K 39/395 (2006.01) C12N 15/09 (2006.01) A61P 37/06 (2006.01) C12N 1/15 (2006.01) A61P 1/04 (2006.01) C12P 21/08 (2006.01)
2456919 *	D21H 21/16 (2006.01)	2419135 *	A61K 31/517 (2006.01) A61K 39/395 (2006.01)	2454285 *	C07K 16/18 (2006.01)
2476440 *	A61P 31/12 (2006.01) A61P 35/00 (2006.01) A61K 47/48 (2006.01) A61K 38/39 (2006.01) C07K 14/025 (2006.01) C07K 14/78 (2006.01) A61K 38/16 (2006.01)	2459145 *	A61H 33/02 (2006.01)	2480562 *	A61K 39/00 (2006.01) C07K 7/00 (2006.01)
2263852	B29C 45/26 (2006.01) B29C 33/30 (2006.01) B29C 45/36 (2006.01) B29C 33/76 (2006.01)	2464664 *	C12N 5/10 (2006.01) C07K 16/10 (2006.01) C12N 15/13 (2006.01) A61K 39/42 (2006.01) C12N 15/63 (2006.01) A61P 31/14 (2006.01) A61K 47/48 (2006.01) G01N 33/53 (2006.01) A61K 38/00 (2006.01) A61K 31/00 (2006.01)	2477989 *	A61P 3/04 (2006.01) A61P 19/02 (2006.01) C07D 471/04 (2006.01) A61P 35/00 (2006.01) A61K 31/4745 (2006.01) A61P 13/12 (2006.01) A61P 11/16 (2006.01) A61P 9/10 (2006.01) A61P 11/00 (2006.01) A61P 43/00 (2006.01) A61P 7/02 (2006.01) A61P 31/04 (2006.01) A61P 1/04 (2006.01)
2459535 *	C07D 213/74 (2006.01) C07D 401/04 (2006.01) C07D 401/12 (2006.01) A61K 31/506 (2006.01) A61P 29/00 (2006.01) A61P 35/00 (2006.01)	2281756	E03D 9/02 (2006.01) B65D 83/00 (2006.01)		
2462237 *	C12P 21/06 (2006.01) C07H 21/04 (2006.01)	2494125 *	F16B 13/00 (2006.01) F16B 13/04 (2006.01) F16B 13/12 (2006.01) E04B 1/76 (2006.01) F16B 5/06 (2006.01) E04F 13/04 (2006.01) E04F 13/08 (2006.01)		
2493282 *	A01G 1/00 (2006.01)	2473524 *	C07K 16/00 (2006.01) C07H 21/00 (2006.01)	2371737	B65D 75/58 (2006.01)
2406705 *	G06F 3/041 (2006.01) G06F 3/01 (2006.01) G06F 3/048 (2006.01)	2494255 *	F16L 37/091 (2006.01)		
2417158 *	C07K 16/18 (2006.01)				

Broj objave evropske prijava patenta (97)	MKP (51)	Broj objave evropske prijava patenta (97)	MKP (51)	Broj objave evropske prijava patenta (97)	MKP (51)
2427444 *	C07D 295/155 (2006.01) C07D 307/88 (2006.01) A61K 31/495 (2006.01) C07D 405/08 (2006.01) A61K 31/529 (2006.01) C07D 407/08 (2006.01) A61P 7/10 (2006.01) C07D 413/08 (2006.01) C07D 493/04 (2006.01) C07D 487/08 (2006.01) C07D 295/135 (2006.01)	2292321	B01F 5/10 (2006.01) B01F 3/04 (2006.01) B01F 5/04 (2006.01) B01F 5/06 (2006.01)	2368419	A01F 15/08 (2006.01)
		2371798	C07C 51/46 (2006.01) C07D 307/08 (2006.01) C07C 51/41 (2006.01) C07C 51/44 (2006.01) C07D 307/33 (2006.01) C07C 55/10 (2006.01) C07C 29/136 (2006.01)	2405900 *	A61K 9/20 (2006.01) A61K 31/4453 (2006.01)
			C07C 31/20 (2006.01) C07C 51/02 (2006.01)	2498775 *	C07D 471/04 (2006.01) A61P 19/00 (2006.01) A61K 31/4375 (2006.01)
2438917 *	A61K 45/00 (2006.01) A61K 9/70 (2006.01) A61K 31/404 (2006.01) A61K 31/4045 (2006.01) A61K 47/22 (2006.01) A61P 25/16 (2006.01) A61P 43/00 (2006.01)			2399907	C07D 211/58 (2006.01)
		2456499 *	A61M 25/01 (2006.01)	2462498 *	G06F 3/044 (2006.01)
		2435443 *	C07D 513/04 (2006.01) A61P 35/00 (2006.01) A61K 31/47 (2006.01)	2427718 *	F41H 5/04 (2006.01)
2462124 *	C07D 239/54 (2006.01)			2443145 *	C07K 14/50 (2006.01)
2368845	C01B 31/22 (2006.01)	2390246	C07C 227/06 (2006.01) C07C 229/60 (2006.01)	2333172	E03F 5/04 (2006.01)
2478363 *	G01N 33/53 (2006.01)	2433349 *	H02K 21/14 (2006.01)	2450421	F26B 17/10 (2006.01) C10L 5/46 (2006.01)
2485586 *	A01N 25/32 (2006.01) A01N 25/04 (2006.01)	2430035 *	C07H 19/10 (2006.01) C07H 19/06 (2006.01) A61K 31/7072 (2006.01)	2386585	C08J 9/14 (2006.01) C08G 18/09 (2006.01) C08G 18/50 (2006.01) C08G 18/76 (2006.01) B29C 44/34 (2006.01) F25D 23/06 (2006.01)
2421975 *	C12N 9/10 (2006.01) C12N 15/82 (2006.01) C12P 21/00 (2006.01)	2480260 *	A61L 15/16 (2006.01) A61L 27/00 (2006.01) A61L 15/64 (2006.01)	2489738 *	A01H 1/00 (2006.01) A01H 5/00 (2006.01) C12N 5/10 (2006.01) C12N 15/29 (2006.01)
2435031 *	A61K 9/51 (2006.01)	2421588 *	A61M 11/06 (2006.01) A61M 15/00 (2006.01) A61M 11/02 (2006.01)	2496849 *	F16B 39/22 (2006.01)
2427723 *	G01B 11/02 (2006.01)			2312187	F16K 31/02 (2006.01) G05D 23/19 (2006.01)

Broj objave evropske prijava patenta (97)	MKP (51)	Broj objave evropske prijava patenta (97)	MKP (51)	Broj objave evropske prijava patenta (97)	MKP (51)
2419916 *	H01H 85/02 (2006.01) H01H 85/25 (2006.01) H01H 85/22 (2006.01)	2419736 *	G01N 33/574 (2006.01) A61K 31/715 (2006.01) G01N 33/50 (2006.01)	2421848 *	C07D 401/10 (2006.01) C07D 417/06 (2006.01) C07D 413/06 (2006.01) C07D 403/06 (2006.01)
2417111 *	C07D 237/28 (2006.01) A61K 31/502 (2006.01) A61P 29/00 (2006.01)	2443094 *	C07D 235/20 (2006.01) A61P 9/12 (2006.01) A61K 31/4184 (2006.01)		C07D 403/06 (2006.01) A61P 29/00 (2006.01) C07D 409/10 (2006.01) C07D 403/04 (2006.01) A61K 31/496 (2006.01)
2451965 *	G01N 33/00 (2006.01) C12Q 1/00 (2006.01)	2376335 *	B65D 5/66 (2006.01) B65D 85/10 (2006.01)		C07D 403/10 (2006.01) A61P 25/00 (2006.01) C07D 409/06 (2006.01)
2366838	E03D 11/14 (2006.01)	2493454 *	A61K 9/16 (2006.01)		C07D 405/06 (2006.01)
2460792 *	A61P 43/00 (2006.01) C07D 409/06 (2006.01) C07D 401/04 (2006.01) C07D 409/14 (2006.01) C07D 209/18 (2006.01) C07D 401/06 (2006.01) C07D 413/14 (2006.01) A61K 31/404 (2006.01) C07D 401/14 (2006.01) C07D 417/06 (2006.01) A61P 13/02 (2006.01) C07D 409/04 (2006.01) A61K 31/422 (2006.01) C07D 405/04 (2006.01) C07D 417/14 (2006.01) A61K 31/427 (2006.01) C07D 405/06 (2006.01) A61K 31/4439 (2006.01) C07D 405/14 (2006.01)	2253778	E04G 5/14 (2006.01)	2445346 *	A01N 43/54 (2006.01)
		2445933 *	C07K 14/54 (2006.01) C07K 14/53 (2006.01) A61K 38/20 (2006.01) A61K 38/19 (2006.01)	2493503 *	G01N 33/574 (2006.01) C07K 16/46 (2006.01) A61K 39/395 (2006.01)
		2482896 *	A61M 5/315 (2006.01)	2421531 *	A61K 31/422 (2006.01) A61K 9/20 (2006.01) A61P 31/04 (2006.01) A61K 9/06 (2006.01) A61P 15/02 (2006.01) A61P 13/02 (2006.01) A61K 9/00 (2006.01) A61P 15/00 (2006.01)
		2410892 *	A47C 27/08 (2006.01)		
		2414722 *	F16T 1/34 (2006.01)	2437829 *	A61M 5/315 (2006.01)
		2456774 *	C07D 498/04 (2006.01) A61K 31/5365 (2006.01) A61P 25/28 (2006.01)	2302308	F24J 2/51 (2006.01)
		2460075 *	G06F 21/00 (2006.01) G06F 11/07 (2006.01)		
		2440054 *	A01N 43/66 (2006.01) A61K 31/53 (2006.01)		
2486138 *	A61K 39/21 (2006.01) C12N 15/863 (2006.01)				

Broj objave evropske prijave patenta (97)	MKP (51)	Broj objave evropske prijave patenta (97)	MKP (51)	Broj objave evropske prijave patenta (97)	MKP (51)
2445898 *	C07D 473/34 (2006.01) C07D 473/38 (2006.01) C07D 401/12 (2006.01) A61P 29/00 (2006.01) C07D 471/04 (2006.01) C07D 487/04 (2006.01) A61K 31/52 (2006.01) A61K 31/517 (2006.01) A61K 31/506 (2006.01)	2411941 *	G06K 9/00 (2006.01) G01H 17/00 (2006.01)	2431365 *	A61P 13/12 (2006.01) A61P 37/08 (2006.01) A61P 17/06 (2006.01) A61P 43/00 (2006.01) C07D 401/06 (2006.01) A61P 19/02 (2006.01) C07D 401/14 (2006.01) A61K 31/4427 (2006.01) A61P 19/08 (2006.01) C07D 405/14 (2006.01) A61K 31/4439 (2006.01) A61P 19/10 (2006.01) C07D 409/14 (2006.01) A61K 31/497 (2006.01) A61P 35/00 (2006.01) A61K 31/4545 (2006.01) A61P 29/00 (2006.01) C07D 413/14 (2006.01) A61K 31/551 (2006.01) A61P 35/02 (2006.01)
		2443679 *	H01L 41/22 (2006.01) H04R 17/00 (2006.01)		
		2406221 *	C07D 213/74 (2006.01) C07D 239/42 (2006.01) A61P 17/06 (2006.01) A61P 19/00 (2006.01) A61P 37/00 (2006.01)		
2475380 *	A61K 38/20 (2006.01) C12N 15/00 (2006.01)	2499206 *	C09C 3/12 (2006.01) C09D 7/12 (2006.01) B82Y 30/00 (2011.01) C09D 5/08 (2006.01) C09C 1/00 (2006.01)		
2488015 *	A01N 25/00 (2006.01) A01C 1/06 (2006.01)				
2493889 *	A61P 3/00 (2006.01) A61K 31/5025 (2006.01) A61P 25/00 (2006.01) C07D 487/04 (2006.01)	2483312 *	A61P 35/00 (2006.01) A61K 39/395 (2006.01) A61K 47/48 (2006.01) C07K 16/28 (2006.01)		
2480252 *	A61K 39/00 (2006.01)			2456434 *	A61K 31/33 (2006.01) A61P 25/28 (2006.01)
2406236 *	C07D 239/72 (2006.01)	2478420 *	G05B 9/02 (2006.01) H04L 12/40 (2006.01) H04L 12/413 (2006.01) H04L 12/46 (2006.01) H04L 12/66 (2006.01)	2281822	C07D 401/12 (2006.01) C07D 401/14 (2006.01) C07D 403/12 (2006.01) C07D 403/14 (2006.01) C07D 413/14 (2006.01) C07D 417/14 (2006.01) A61K 31/404 (2006.01) A61P 35/00 (2006.01)
2464600 *	C01B 31/20 (2006.01) C07C 275/00 (2006.01)				
2480548 *	C07D 413/12 (2006.01) A61K 31/437 (2006.01) C07D 403/06 (2006.01) A61P 29/00 (2006.01) A61P 11/00 (2006.01) C07D 471/04 (2006.01) C07D 401/14 (2006.01) A61P 9/00 (2006.01)	2290955	H04N 5/44 (2011.01)		
		2416773 *	A61K 45/06 (2006.01) A61P 35/00 (2006.01) A61K 31/437 (2006.01) A61K 31/4745 (2006.01) A61K 31/7068 (2006.01)		

Broj objave evropske prijava patenta (97)	MKP (51)	Broj objave evropske prijava patenta (97)	MKP (51)	Broj objave evropske prijava patenta (97)	MKP (51)
2384800	B01J 41/04 (2006.01) B01J 47/02 (2006.01) B01D 15/36 (2006.01) C25D 3/56 (2006.01) C25D 21/22 (2006.01)	2368547	A61P 31/20 (2006.01) A61P 31/22 (2006.01) A61P 31/18 (2006.01) A61K 31/045 (2006.01) A61K 31/122 (2006.01) A61P 31/12 (2006.01) A61P 31/14 (2006.01) A61P 31/16 (2006.01)	2403875 *	C07K 16/18 (2006.01) C07K 16/30 (2006.01) G01N 33/577 (2006.01)
2424594 *	A61M 5/20 (2006.01)			2414377 *	A61P 29/00 (2006.01) C07J 71/00 (2006.01) A61K 31/58 (2006.01) A61P 11/00 (2006.01) A61P 11/06 (2006.01)
2490383	H04L 12/58 (2006.01)				
2498690 *	A61B 17/06 (2006.01)	2315580 *	A61K 9/00 (2006.01) A61K 47/02 (2006.01) A61K 47/12 (2006.01)	2461685 *	A01N 43/54 (2006.01)
2498597 *	A01K 27/00 (2006.01)			2485594 *	A01N 43/78 (2006.01) A61K 31/425 (2006.01)
2496262 *	A61K 47/48 (2006.01) A61K 47/10 (2006.01) A61K 9/08 (2006.01) A61K 38/00 (2006.01) A61K 9/00 (2006.01) A61K 38/23 (2006.01)	2251452	C23C 16/505 (2006.01) G01N 15/08 (2006.01) A61B 5/15 (2006.01)	2410105	E04G 3/30 (2006.01) F22B 37/24 (2006.01) E04G 3/00 (2006.01)
		2435033 *	A61K 31/00 (2006.01) A61K 31/155 (2006.01) A61K 31/4439 (2006.01) A61K 31/70 (2006.01) A61P 3/10 (2006.01)	2490547 *	A23C 9/14 (2006.01) A23C 9/20 (2006.01)
2437729 *	A61K 31/485 (2006.01) A61K 45/06 (2006.01) A61K 9/20 (2006.01) A61K 9/16 (2006.01)			2440178 *	A61K 9/02 (2006.01)
		2434225 *	F24D 19/10 (2006.01) F24D 17/00 (2006.01) E03B 1/00 (2006.01) F24H 1/48 (2006.01)	2480084 *	A01N 43/54 (2006.01) A61K 31/415 (2006.01) A61K 31/505 (2006.01)
2448932 *	A61K 31/513 (2006.01) C07D 413/06 (2006.01) A61K 31/5377 (2006.01) C07D 403/06 (2006.01) A61P 35/00 (2006.01)			2432777 *	C07D 405/14 (2006.01)
		2475634 *	C07C 47/277 (2006.01)	2432768 *	A61K 31/505 (2006.01) A61K 31/5377 (2006.01) A61P 35/00 (2006.01) C07D 239/49 (2006.01) C07D 403/12 (2006.01) C07D 401/12 (2006.01) C07D 413/12 (2006.01)
2418596	G06F 19/00 (2011.01)	2366456	B03D 1/01 (2006.01) C22B 26/00 (2006.01) C22B 26/20 (2006.01) B03D 101/02 (2006.01)		
		2425388 *	G06Q 20/00 (2012.01)		

Broj objave evropske prijave patenta (97)	MKP (51)	Broj objave evropske prijave patenta (97)	MKP (51)	Broj objave evropske prijave patenta (97)	MKP (51)
2433544 *	A47L 13/20 (2006.01) A47L 13/10 (2006.01) A46B 5/00 (2006.01) A47L 13/24 (2006.01)	2446868	A61F 13/15 (2006.01)	2486039 *	C07D 473/34 (2006.01) A61P 25/00 (2006.01) A61P 25/28 (2006.01) A61K 31/52 (2006.01) A61K 31/538 (2006.01) A61P 35/00 (2006.01)
2445842 *	A01N 47/28 (2006.01) C07C 273/18 (2006.01) C02F 1/76 (2006.01) A01N 25/02 (2006.01)	2445502 *	A61K 31/497 (2006.01)	2432488 *	A61K 38/16 (2006.01)
2446016 *	C12M 1/00 (2006.01)	2427243 *	A61M 31/00 (2006.01)	2249302	G06Q 30/00 (2006.01) G07F 17/40 (2006.01) G07F 7/00 (2006.01)
2485589 *	A01N 43/42 (2006.01)	2305346	A61N 2/02 (2006.01)	2275313	B60R 25/02 (2006.01)
2386296	A61K 9/16 (2006.01) A61K 31/352 (2006.01) A61K 9/48 (2006.01) A61K 9/50 (2006.01)	2414986 *	C09D 11/10 (2006.01) B41M 3/14 (2006.01) C09K 19/02 (2006.01) G06K 1/12 (2006.01) G07D 7/12 (2006.01) G06Q 10/00 (2012.01)	2415359 *	A23L 1/228 (2006.01)
2471374 *	A23C 11/10 (2006.01)	2362161	F24J 2/52 (2006.01)	2238818	A01B 3/46 (2006.01) A01B 3/42 (2006.01)
2459221 *	A61K 47/14 (2006.01) A61K 9/00 (2006.01) A61K 31/519 (2006.01)	2496583 *	C07D 493/08 (2006.01) C07H 7/04 (2006.01) A61P 3/10 (2006.01) A61K 31/35 (2006.01) A61P 3/04 (2006.01)	2279652	A01B 49/02 (2006.01)
2432456 *	A61K 9/16 (2006.01) A61K 9/20 (2006.01) A61K 31/55 (2006.01) A61K 9/28 (2006.01)	2432472 *	A61K 31/519 (2006.01) C07D 487/04 (2006.01) A61P 35/00 (2006.01) A61P 17/00 (2006.01) A61P 27/02 (2006.01) A61P 29/00 (2006.01)	2408452 *	A61K 31/4439 (2006.01) A61K 45/06 (2006.01) A61P 31/06 (2006.01)
2427226 *	C08F 26/10 (2006.01) A61L 27/14 (2006.01) A61F 2/12 (2006.01)	2419734 *	G01N 33/569 (2006.01) G01N 33/58 (2006.01)	2444815 *	G01N 33/68 (2006.01) C07D 405/12 (2006.01) G01N 33/533 (2006.01) A61K 8/64 (2006.01)
2453900 *	A61P 25/04 (2006.01) A61K 31/55 (2006.01) C07D 223/04 (2006.01)	2411449 *	C08G 77/00 (2006.01)	2364949	B66C 23/36 (2006.01) B66C 13/08 (2006.01)
		2430178 *	C12Q 1/00 (2006.01)		

Broj objave evropske prijave patenta (97)	MKP (51)	Broj objave evropske prijave patenta (97)	MKP (51)	Broj objave evropske prijave patenta (97)	MKP (51)
2421856 *	A61P 25/00 (2006.01) A61K 31/496 (2006.01) C07D 205/06 (2006.01) A61P 29/00 (2006.01) C07D 409/06 (2006.01) C07D 405/06 (2006.01)	2478102 *	C12N 15/113 (2010.01)	2470568 *	C07K 16/28 (2006.01)
2430383 *	F27D 3/16 (2006.01) F27D 3/12 (2006.01) B01J 4/00 (2006.01)	2389936	A61K 31/245 (2006.01) A61P 25/06 (2006.01)	2413929 *	A61K 31/4188 (2006.01) A61K 31/4164 (2006.01) A61P 25/28 (2006.01)
2419406 *	C07D 209/12 (2006.01)	2435081 *	A61K 45/06 (2006.01) A61P 11/00 (2006.01)	2449107 *	C12N 15/52 (2006.01) G01N 33/53 (2006.01) C12N 15/29 (2006.01) C12N 15/11 (2006.01) C12N 15/63 (2006.01) C07K 14/415 (2006.01)
2430046 *	C07K 16/10 (2006.01) A61K 39/42 (2006.01)	2445496 *	A61P 25/16 (2006.01) A61K 31/381 (2006.01) A61K 9/00 (2006.01) A61K 9/70 (2006.01) C07D 333/20 (2006.01)	2449223 *	F02B 1/12 (2006.01) F02B 19/10 (2006.01) F02B 41/04 (2006.01) F02B 75/02 (2006.01) F02B 41/06 (2006.01) F02B 19/02 (2006.01)
2480025 *	H04W 36/34 (2009.01) H04W 88/02 (2009.01)	2452950 *	A61P 35/00 (2006.01) C07K 16/30 (2006.01) A61K 39/00 (2006.01) A61P 1/00 (2006.01) C12N 15/09 (2006.01) A61K 39/395 (2006.01) C12N 5/10 (2006.01)	2470083 *	A61B 17/06 (2006.01) D04C 3/42 (2006.01) A61B 17/00 (2006.01)
2446032 *	C12N 15/10 (2006.01)	2361462 *	H04L 9/08 (2006.01)	2452028 *	E04F 11/16 (2006.01)
2476044 *	G06F 3/023 (2006.01) G06F 3/01 (2006.01)	2417415 *	F41H 7/02 (2006.01)	2494045 *	C12P 21/00 (2006.01) C12N 15/70 (2006.01) C12N 15/00 (2006.01)
2353841	B29C 49/04 (2006.01) B29C 49/48 (2006.01)	2353841	B29C 49/04 (2006.01) B29C 49/48 (2006.01) E06B 3/88 (2006.01)	2440055 *	A01N 43/66 (2006.01) A61K 31/53 (2006.01)
2419917 *	H01H 85/32 (2006.01)	2462068 *	C03C 13/06 (2006.01) C08J 5/08 (2006.01) C03C 13/00 (2006.01) C03C 3/087 (2006.01)	2465080 *	G06Q 20/00 (2012.01)
2419487 *	C09K 8/32 (2006.01) C09K 8/34 (2006.01)	2491134 *	C12Q 1/68 (2006.01)		
		2475470 *	B09B 3/00 (2006.01)		

Broj objave evropske prijave patenta (97)	MKP (51)	Broj objave evropske prijave patenta (97)	MKP (51)	Broj objave evropske prijave patenta (97)	MKP (51)
2493514 *	A61K 47/48 (2006.01) A61K 41/00 (2006.01) A61L 2/00 (2006.01) C08G 65/329 (2006.01) A61K 9/16 (2006.01) A61P 43/00 (2006.01)	2309408	G06F 21/00 (2006.01)	2462567 *	G07F 7/10 (2006.01) G06Q 20/00 (2012.01)
2493466 *	A61P 35/00 (2006.01) A61K 31/56 (2006.01) A61K 45/06 (2006.01) A61K 31/164 (2006.01)	2419419 *	A61K 31/433 (2006.01) A61P 3/10 (2006.01) C07D 401/08 (2006.01) A61P 29/00 (2006.01) C07D 403/08 (2006.01) C07D 205/04 (2006.01) C07D 413/08 (2006.01) C07D 403/10 (2006.01) C07D 417/08 (2006.01) C07D 405/08 (2006.01) A61K 31/4427 (2006.01) A61K 31/437 (2006.01)	2498779 *	A61P 9/12 (2006.01) A61P 3/10 (2006.01) A61K 31/519 (2006.01) A61P 29/00 (2006.01) A61P 3/00 (2006.01)
2448920 *	A61K 31/4965 (2006.01) C07D 215/14 (2006.01) C07D 261/20 (2006.01) C07D 295/26 (2006.01) C07D 209/10 (2006.01) A61P 25/00 (2006.01) C07D 471/04 (2006.01) C07D 213/30 (2006.01) A61P 29/00 (2006.01) A61P 35/00 (2006.01)	2413911 *	A61K 9/16 (2006.01) C07D 215/18 (2006.01)	2480249 *	A61K 38/48 (2006.01) A61P 27/02 (2006.01)
2451482 *	A61K 31/155 (2006.01) A61K 45/06 (2006.01) A61P 3/04 (2006.01) A61P 3/10 (2006.01) A61K 31/7034 (2006.01)	2480236 *	A61K 31/545 (2006.01)	2494750 *	H04W 92/02 (2009.01) H04L 12/66 (2006.01)
2449350 *	G01F 19/00 (2006.01)	2448940 *	C07D 239/42 (2006.01) C07D 487/04 (2006.01) A61K 31/519 (2006.01) C07D 239/06 (2006.01) A61P 35/00 (2006.01)	2494061 *	A61K 39/00 (2006.01) C12P 21/06 (2006.01)
2467465 *	C12C 11/00 (2006.01)	2284390	F03D 7/02 (2006.01)	2459228 *	C07K 14/62 (2006.01) A61K 38/28 (2006.01) A61K 47/48 (2006.01) A61P 3/10 (2006.01)
2425017 *	C12Q 1/68 (2006.01) C12Q 1/70 (2006.01) C12N 15/11 (2006.01)	2408497 *	A61M 15/00 (2006.01) G06M 1/16 (2006.01)	2467164 *	A61K 39/395 (2006.01)
		2409013 *	F02M 51/00 (2006.01) F02M 51/06 (2006.01) F02M 63/00 (2006.01) F02M 47/02 (2006.01)	2437780 *	C12P 21/08 (2006.01) A61K 39/395 (2006.01)
				2432562 *	A62B 23/02 (2006.01)
				2499589 *	G06F 19/00 (2011.01)

Broj objave evropske prijava patenta (97)	MKP (51)	Broj objave evropske prijava patenta (97)	MKP (51)	Broj objave evropske prijava patenta (97)	MKP (51)
2475428 *	C07D 405/14 (2006.01) C07D 413/04 (2006.01) C07D 417/14 (2006.01) A61P 25/00 (2006.01) A61K 31/437 (2006.01) A61P 25/28 (2006.01) A61K 31/4184 (2006.01) C07D 403/14 (2006.01) C07D 413/14 (2006.01) C07D 471/04 (2006.01)	2492269 *	A61K 31/497 (2006.01) A61P 11/06 (2006.01) A61K 31/496 (2006.01) A61P 9/10 (2006.01) A61P 35/00 (2006.01) A61K 31/4439 (2006.01) A61P 3/04 (2006.01) A61P 27/02 (2006.01) A61K 31/506 (2006.01) A61P 17/00 (2006.01) A61K 31/427 (2006.01) A61P 1/16 (2006.01) A61P 25/00 (2006.01) C07D 417/04 (2006.01) A61P 1/04 (2006.01) A61P 19/02 (2006.01) A61K 31/5377 (2006.01) A61P 17/06 (2006.01) A61K 31/454 (2006.01) A61P 3/06 (2006.01) A61P 29/00 (2006.01)	2480718 *	D21H 21/52 (2006.01) C09C 1/02 (2006.01) D21H 17/68 (2006.01) D21H 19/38 (2006.01) D21H 17/67 (2006.01) C01F 11/18 (2006.01) D21H 19/40 (2006.01)
2486058 *	A61K 38/00 (2006.01) C07K 16/28 (2006.01)			2500342 *	C07D 335/02 (2006.01) C07D 417/12 (2006.01) A01N 43/10 (2006.01) A01N 43/18 (2006.01) C07D 333/36 (2006.01) A01P 7/02 (2006.01) A01P 7/04 (2006.01) C07D 409/12 (2006.01)
2388727	G06F 9/50 (2006.01) G06F 21/00 (2006.01)			2408763 *	C07D 401/12 (2006.01) C07D 403/12 (2006.01) C07D 409/12 (2006.01) C07D 209/52 (2006.01) C07D 333/38 (2006.01) A61K 31/381 (2006.01) A61K 31/403 (2006.01) A61K 31/4439 (2006.01) C07D 451/02 (2006.01) C07D 213/81 (2006.01) A61K 31/407 (2006.01) A61P 25/00 (2006.01) C07D 487/08 (2006.01) C07D 333/16 (2006.01) C07D 213/46 (2006.01) C07D 209/12 (2006.01) C07D 209/02 (2006.01) A61K 31/44 (2006.01)
2295775	F02D 41/22 (2006.01) F02D 41/38 (2006.01)				
2402167	B41M 5/50 (2006.01) D21H 19/82 (2006.01)				
2424506 *	A61K 9/14 (2006.01) A61K 31/4184 (2006.01)	2230194	B65D 85/04 (2006.01) B65D 5/60 (2006.01)		
		2471790 *	A61P 35/00 (2006.01) A61P 43/00 (2006.01) A61K 31/55 (2006.01) A61K 31/5377 (2006.01) C07D 471/04 (2006.01) A61K 31/444 (2006.01) A61K 31/4545 (2006.01) A61K 31/437 (2006.01)		

Broj objave evropske prijave patenta (97)	MKP (51)	Broj objave evropske prijave patenta (97)	MKP (51)	Broj objave evropske prijave patenta (97)	MKP (51)
2426056	B65B 69/00 (2006.01) B65D 77/06 (2006.01)	2406206 *	C07C 255/54 (2006.01) A61K 31/09 (2006.01) C07C 43/225 (2006.01) A61K 31/222 (2006.01) C07C 39/17 (2006.01) A61K 31/277 (2006.01) C07C 43/21 (2006.01) A61P 31/08 (2006.01) C07C 43/23 (2006.01) A61P 35/00 (2006.01) C07C 69/157 (2006.01) A61P 25/00 (2006.01) C07C 255/55 (2006.01) C07C 39/42 (2006.01) A61K 31/055 (2006.01)	2493923 *	C12P 21/06 (2006.01) C07K 16/00 (2006.01) C12P 21/02 (2006.01)
2414435 *	D21B 1/30 (2006.01) D21C 9/00 (2006.01) D01F 2/02 (2006.01) C08J 5/00 (2006.01) C08J 3/00 (2006.01) C08J 3/075 (2006.01) D21B 1/04 (2006.01)	2403341 *	A01N 45/00 (2006.01) A61K 31/56 (2006.01)	2228498	E04B 1/24 (2006.01) E04B 1/74 (2006.01)
2440580 *	C07K 16/30 (2006.01)	2460825 *	C07K 14/605 (2006.01) A61K 38/26 (2006.01)	2496248 *	A61K 38/22 (2006.01)
2464373 *	A61P 1/00 (2006.01) A61P 1/10 (2006.01) A61K 47/00 (2006.01) A61K 38/10 (2006.01) A61K 9/00 (2006.01)	2480246 *	A61K 9/22 (2006.01) A61K 31/185 (2006.01) A61K 31/537 (2006.01) A61P 3/10 (2006.01) A61K 38/22 (2006.01)	2432725 *	B66B 11/04 (2006.01)
2459227 *	A61K 47/48 (2006.01) A61P 25/16 (2006.01)	2435438 *	A61P 29/00 (2006.01) A61P 25/00 (2006.01) C07D 487/04 (2006.01) C07D 491/04 (2006.01) C07D 513/04 (2006.01) A61P 35/00 (2006.01) A61K 31/519 (2006.01) A61P 9/00 (2006.01)	2405973 *	C07D 513/04 (2006.01) A61K 31/519 (2006.01) A61P 29/00 (2006.01)
2468970 *	E04B 1/10 (2006.01)	2364916		2486698 *	H04L 12/24 (2006.01)
2406700 *	G06F 3/048 (2006.01) G06F 3/041 (2006.01) G06F 3/01 (2006.01)			2470907 *	G01N 33/569 (2006.01) C07K 14/20 (2006.01)
2414396 *	C07K 16/28 (2006.01) A61K 39/395 (2006.01)			2464678 *	C08G 63/66 (2006.01) C08G 63/08 (2006.01) C08G 63/60 (2006.01)
2427398 *	B65H 19/18 (2006.01)			2473024 *	A01H 5/00 (2006.01) C12Q 1/04 (2006.01) C12N 15/82 (2006.01) C12N 15/52 (2006.01)

Broj objave evropske prijava patenta (97)	MKP (51)	Broj objave evropske prijava patenta (97)	MKP (51)	Broj objave evropske prijava patenta (97)	MKP (51)
2429960 *	C03B 9/16 (2006.01) C03B 9/36 (2006.01) F16B 7/20 (2006.01) F16B 21/04 (2006.01) F16D 1/112 (2006.01)	2430019 *	C07D 417/12 (2006.01) A61K 31/423 (2006.01) C07D 417/14 (2006.01) A61K 31/424 (2006.01) C07D 493/04 (2006.01) A61K 31/428 (2006.01) C07D 495/04 (2006.01) A61K 31/429 (2006.01) C07D 498/04 (2006.01) C07D 413/12 (2006.01) C07D 519/00 (2006.01) C07D 513/04 (2006.01) C07D 413/14 (2006.01) A61P 29/00 (2006.01)	2267395	F41B 3/02 (2006.01) A01K 97/02 (2006.01)
2440358 *	B23Q 1/28 (2006.01) B23F 17/00 (2006.01)	2459290 *	A63K 3/04 (2006.01)	2435605 *	C25B 1/46 (2006.01) C25B 15/08 (2006.01) C25B 1/26 (2006.01)
2277692	B32B 21/02 (2006.01) B32B 21/10 (2006.01) B32B 19/06 (2006.01) E04C 2/00 (2006.01) E04F 13/00 (2006.01) C04B 28/04 (2006.01) B32B 5/26 (2006.01)	2469921 *	H04W 28/26 (2009.01)	2375054	F04B 17/04 (2006.01) F01N 3/20 (2006.01) F02M 69/02 (2006.01)
2443441 *	G01N 23/04 (2006.01)	2437624 *	A23L 1/00 (2006.01) A23L 1/304 (2006.01) A23L 1/03 (2006.01)	2261288	C09C 1/24 (2006.01) C09C 1/34 (2006.01) C09C 3/08 (2006.01) F24J 2/48 (2006.01) H01L 31/0216 (2006.01)
2403937 *	A61P 27/02 (2006.01) C12N 5/02 (2006.01) C07K 14/54 (2006.01) A61K 38/20 (2006.01)	2488531 *	C07D 491/20 (2006.01)	2411154 *	B03C 3/60 (2006.01) B03C 3/16 (2006.01) B03C 3/45 (2006.01)
2489339 *	A61F 13/02 (2006.01) A61K 9/70 (2006.01) A61L 15/58 (2006.01)	2470539 *	A61K 31/519 (2006.01) A61P 35/00 (2006.01) C07D 487/04 (2006.01)	2492863 *	G06Q 30/00 (2012.01) G06K 17/00 (2006.01)
2486635 *	H02G 3/08 (2006.01) H02G 3/22 (2006.01) H02G 15/013 (2006.01)	2488531 *	C07D 491/20 (2006.01)	2499357 *	F03D 1/00 (2006.01)
2406778 *	G08C 15/06 (2006.01)	2438025 *	C03C 25/24 (2006.01)	2435581 *	C12Q 1/68 (2006.01)
		2440193 *	A61K 8/11 (2006.01) A61K 8/73 (2006.01) A61K 9/51 (2006.01)	2429969 *	C04B 20/10 (2006.01) C04B 40/00 (2006.01) C04B 28/02 (2006.01)
		2477682 *	A61M 5/24 (2006.01) A61M 5/315 (2006.01)	2458992 *	A01N 43/42 (2006.01) A61K 31/42 (2006.01)
				2493928 *	C07K 16/28 (2006.01)

Broj objave evropske prijave patenta (97)	MKP (51)	Broj objave evropske prijave patenta (97)	MKP (51)	Broj objave evropske prijave patenta (97)	MKP (51)
2464836 *	F01N 3/035 (2006.01) B01D 53/92 (2006.01)	2419177 *	A61P 35/00 (2006.01) G01N 33/574 (2006.01)	2416759 *	A61K 9/107 (2006.01) A61K 31/196 (2006.01) A61K 9/00 (2006.01)
2481088 *	B82B 1/00 (2006.01) H01L 29/06 (2006.01)	2431028 *	A61K 9/70 (2006.01) A61K 47/30 (2006.01) A61K 31/14 (2006.01) A61K 31/09 (2006.01) A61P 43/00 (2006.01)	2408767 *	A61K 31/535 (2006.01) C07D 413/12 (2006.01) C07D 413/10 (2006.01) C07D 413/06 (2006.01) A61P 25/28 (2006.01)
2427503 *	C08B 37/10 (2006.01) A61K 31/727 (2006.01) C08B 37/00 (2006.01)	2442674 *	A23L 2/52 (2006.01) C02F 1/68 (2006.01) A23L 1/30 (2006.01) C02F 1/70 (2006.01)	2414375 *	A61P 11/06 (2006.01) A61P 29/00 (2006.01) C07J 71/00 (2006.01) A61K 31/58 (2006.01) A61P 11/00 (2006.01)
2443245 *	C12P 7/10 (2006.01)	2481383	A61F 13/15 (2006.01)	2456443 *	A61K 31/52 (2006.01) A61P 1/16 (2006.01)
2424893 *	C07K 16/24 (2006.01) A61K 39/395 (2006.01)	2412697 *	A61P 19/10 (2006.01) C07C 213/04 (2006.01) C07C 213/08 (2006.01) C07C 217/28 (2006.01) C07D 303/22 (2006.01) C07C 69/76 (2006.01) A61K 31/235 (2006.01)	2459729 *	C12P 21/08 (2006.01)
2413693 *	A01N 35/00 (2006.01) A61K 31/12 (2006.01)	2448579 *	A61K 31/496 (2006.01) A61P 3/04 (2006.01)	2421515 *	A61K 45/06 (2006.01) A61K 31/485 (2006.01) A61K 9/50 (2006.01)
2484720 *	C08L 17/00 (2006.01) C08J 11/10 (2006.01)	2414341 *	A61P 37/00 (2006.01) C07D 271/06 (2006.01) A61K 31/4245 (2006.01)	2423203 *	A61P 3/06 (2006.01) A61P 3/04 (2006.01) A61P 9/00 (2006.01) A61P 1/04 (2006.01) A61P 3/10 (2006.01) A61P 9/12 (2006.01) A61K 31/536 (2006.01) C07D 265/26 (2006.01)
2490527 *	A01N 25/34 (2006.01) A01N 25/10 (2006.01) A01N 59/16 (2006.01) A01N 59/20 (2006.01) C09J 7/02 (2006.01)	2486143 *	C12Q 1/68 (2006.01) A61P 1/00 (2006.01) C12Q 1/04 (2006.01) C12Q 1/10 (2006.01)	2481230 *	H04W 12/06 (2009.01) H04W 4/12 (2009.01) H04L 29/06 (2006.01)
2496394 *	B29C 45/14 (2006.01)	2427217 *	A61K 47/48 (2006.01) A61P 37/04 (2006.01)		

Broj objave evropske prijava patenta (97)	MKP (51)	Broj objave evropske prijava patenta (97)	MKP (51)	Broj objave evropske prijava patenta (97)	MKP (51)
2406286 *	C12N 15/13 (2006.01) C07K 16/28 (2006.01) C07K 14/725 (2006.01) A61K 39/00 (2006.01) C12N 15/63 (2006.01) G01N 33/68 (2006.01)	2477985 *	C07D 471/00 (2006.01)	2476758 *	C12Q 1/68 (2006.01) A61K 31/7056 (2006.01) G01N 33/53 (2006.01) A61P 1/16 (2006.01) A61K 38/21 (2006.01) G01N 37/00 (2006.01)
2419446 *	C07K 16/00 (2006.01)	2445528 *	A61K 39/395 (2006.01) C07K 16/22 (2006.01)	2403481 *	A61K 9/16 (2006.01) A61K 9/20 (2006.01) A61K 31/195 (2006.01)
2438800 *	H05B 37/02 (2006.01)	2421850 *	C07D 413/14 (2006.01) A61P 25/30 (2006.01) C07D 403/14 (2006.01)	2480678 *	C12N 15/866 (2006.01) C12N 15/867 (2006.01) C12N 7/02 (2006.01)
2459572 *	A61K 31/5386 (2006.01) A61P 25/00 (2006.01) A61P 11/00 (2006.01) A61P 9/00 (2006.01) A61P 37/00 (2006.01) A61P 35/00 (2006.01) A61P 19/00 (2006.01) A61P 29/00 (2006.01) C07D 519/00 (2006.01) A61P 13/00 (2006.01) A61P 17/00 (2006.01) A61P 27/00 (2006.01) C07D 498/10 (2006.01) A61P 1/00 (2006.01)	2435568 *	C12N 15/10 (2006.01) C07K 16/00 (2006.01) C40B 30/02 (2006.01) C40B 50/06 (2006.01) C40B 40/08 (2006.01)	2448929 *	A61K 31/395 (2006.01) A61P 35/00 (2006.01) C07D 273/08 (2006.01)
2392384	A62B 17/04 (2006.01) A42B 1/24 (2006.01) A62B 17/00 (2006.01)	2411513 *	C12N 9/88 (2006.01)	2488294 *	B01J 20/24 (2006.01)
2480102 *	A41C 3/12 (2006.01) A41D 27/04 (2006.01) A41D 27/06 (2006.01) A44C 25/00 (2006.01)	2413957 *	A61K 39/00 (2006.01) C07K 14/47 (2006.01) C07K 16/18 (2006.01) G01N 33/53 (2006.01)	2465185 *	H02K 13/00 (2006.01)
2434894 *	A01N 43/56 (2006.01)	2443234 *	C12N 9/10 (2006.01) C12N 15/82 (2006.01)	2269844	B60D 1/06 (2006.01)
				2416312	G10K 5/00 (2006.01)
				2483492 *	E04C 3/08 (2006.01) E04C 3/09 (2006.01)
				2413934 *	A61P 33/02 (2006.01) A61P 37/02 (2006.01) A61K 31/454 (2006.01) A61K 45/06 (2006.01)

Broj objave evropske prijave patenta (97)	MKP (51)	Broj objave evropske prijave patenta (97)	MKP (51)	Broj objave evropske prijave patenta (97)	MKP (51)
2440177 *	A61K 9/00 (2006.01) A61K 31/5377 (2006.01) A61K 9/14 (2006.01)	2491931 *	A61K 47/10 (2006.01) A61K 9/70 (2006.01) A61K 31/445 (2006.01) A61K 47/14 (2006.01) A61P 25/28 (2006.01) A61K 47/34 (2006.01) A61K 47/22 (2006.01) A61K 9/08 (2006.01)	2419131 *	A61K 31/365 (2006.01) A61K 39/15 (2006.01) A61P 31/00 (2006.01) A61K 39/215 (2006.01) A61K 31/335 (2006.01)
2406256 *	A61P 3/10 (2006.01) A61K 31/4245 (2006.01) C07D 413/14 (2006.01)	2467170 *	A61K 51/00 (2006.01)	2430196 *	C13K 1/02 (2006.01) C12P 7/10 (2006.01)
2428229 *	A61K 48/00 (2006.01) C12N 15/861 (2006.01)	2475769 *	G01N 33/53 (2006.01) A61K 38/45 (2006.01) A61P 35/02 (2006.01) C12N 9/10 (2006.01) A61K 31/415 (2006.01)	2405995 *	B01F 7/22 (2006.01) B01F 7/04 (2006.01) B01F 7/06 (2006.01) B01F 7/00 (2006.01) B01F 7/18 (2006.01)
2430366 *	F23L 13/06 (2006.01) F16K 15/02 (2006.01) F23J 13/08 (2006.01) F23L 11/00 (2006.01)	2451717 *	A61J 1/00 (2006.01) B65D 30/00 (2006.01) B65F 1/00 (2006.01)	2445710 *	D21H 17/67 (2006.01) D21H 27/26 (2006.01) E04C 2/04 (2006.01) D21H 13/40 (2006.01) D21H 21/18 (2006.01) B32B 13/08 (2006.01) D21H 23/22 (2006.01) D21H 19/38 (2006.01)
2270286	E03D 9/03 (2006.01) E03D 9/02 (2006.01)	2435415 *	C07D 309/32 (2006.01) C07D 493/10 (2006.01)	2485767 *	A61K 47/48 (2006.01)
2445861 *	C07C 229/22 (2006.01) A61P 9/08 (2006.01) A61P 29/00 (2006.01) C07C 229/12 (2006.01) A61K 31/205 (2006.01) C07C 69/157 (2006.01) A61P 7/02 (2006.01) A61K 31/616 (2006.01) C07C 243/40 (2006.01)	2480559 *	C07H 1/00 (2006.01) C07H 19/23 (2006.01)	2384928	B60P 1/44 (2006.01)
		2470185 *	A61K 31/60 (2006.01) A61K 31/573 (2006.01) A61P 29/00 (2006.01)	2467501 *	C12Q 1/68 (2006.01)
		2486326 *	F23K 3/02 (2006.01)	2448645 *	A63H 27/00 (2006.01)
				2248643	B27B 25/04 (2006.01) B27B 5/22 (2006.01)
				2435029 *	A61K 9/20 (2006.01) A61K 9/16 (2006.01)

Broj objave evropske prijava patenta (97)	MKP (51)	Broj objave evropske prijava patenta (97)	MKP (51)	Broj objave evropske prijava patenta (97)	MKP (51)
2233120	A61H 3/00 (2006.01) A61H 3/04 (2006.01)	2289471	A61F 5/445 (2006.01) A61L 24/00 (2006.01) A61F 5/443 (2006.01)	2498719 *	A61F 2/24 (2006.01)
2422070 *	F02M 61/14 (2006.01) F02M 55/00 (2006.01) F02M 61/16 (2006.01)	2454223 *	C07C 69/28 (2006.01) A01N 33/24 (2006.01) C07C 251/44 (2006.01) A01N 37/10 (2006.01) C07C 69/24 (2006.01) A01N 33/20 (2006.01) C07C 255/56 (2006.01) C07C 49/657 (2006.01) C07C 317/24 (2006.01) A01N 37/02 (2006.01) C07C 49/683 (2006.01) A01N 31/06 (2006.01) C07C 65/36 (2006.01) A01N 31/08 (2006.01) C07C 205/45 (2006.01)	2473490 *	C07D 265/30 (2006.01) C07D 265/32 (2006.01) C07D 413/12 (2006.01) C07D 419/12 (2006.01) C07D 471/04 (2006.01) A61K 31/5377 (2006.01) A61P 25/04 (2006.01) A61P 25/06 (2006.01) A61P 25/16 (2006.01) A61P 25/18 (2006.01) A61P 25/24 (2006.01) A61P 25/28 (2006.01) C07D 279/12 (2006.01) C07D 417/12 (2006.01) C07D 487/04 (2006.01)
2448933 *	A61P 9/10 (2006.01) A61K 31/55 (2006.01) C07D 403/12 (2006.01)			2419428 *	C07D 471/04 (2006.01) A61K 31/437 (2006.01) A61P 35/00 (2006.01)
2425250 *	G01N 33/564 (2006.01)			2406366 *	C12M 1/00 (2006.01)
2414626 *	E21B 43/10 (2006.01) E21B 23/01 (2006.01) E21B 33/04 (2006.01)			2437738 *	A61K 9/14 (2006.01) A61K 31/10 (2006.01) A61K 9/16 (2006.01) A61P 35/00 (2006.01)
2437820 *	A61M 5/24 (2006.01) A61M 5/315 (2006.01) A61M 5/31 (2006.01)			2435828 *	G01N 33/50 (2006.01)
2434055	E01F 8/00 (2006.01) C08K 5/5419 (2006.01) C08K 5/549 (2006.01) C08J 5/04 (2006.01)	2477967 *	C07D 213/16 (2006.01) C07D 213/18 (2006.01) C07D 401/04 (2006.01) C07D 487/04 (2006.01)	2472048	E06B 3/667 (2006.01)
2448911 *	C07C 233/06 (2006.01) C07C 209/62 (2006.01) C07C 29/40 (2006.01) C07C 211/35 (2006.01) C07C 31/135 (2006.01) C07C 231/06 (2006.01)	2429566 *	A61P 1/00 (2006.01) A61P 37/08 (2006.01) A61P 37/00 (2006.01) A61K 38/17 (2006.01) A61K 38/18 (2006.01) A61K 38/20 (2006.01)		
2445343 *	A01N 43/00 (2006.01)	2480677 *	C12N 7/02 (2006.01) C12N 15/867 (2006.01) C12N 15/866 (2006.01)		

Broj objave evropske prijave patenta (97)	MKP (51)	Broj objave evropske prijave patenta (97)	MKP (51)	Broj objave evropske prijave patenta (97)	MKP (51)
2481738 *	A61P 1/18 (2006.01) A61P 17/00 (2006.01) A61P 7/02 (2006.01) A61P 17/06 (2006.01) A61P 1/16 (2006.01) A61P 15/06 (2006.01) A61P 31/04 (2006.01) C07D 413/14 (2006.01) A61P 9/10 (2006.01) A61P 19/02 (2006.01) A61K 31/536 (2006.01) A61P 11/00 (2006.01) A61P 25/00 (2006.01) A61P 1/04 (2006.01) A61P 13/12 (2006.01) A61P 29/00 (2006.01) A61P 7/00 (2006.01) A61P 17/02 (2006.01) A61P 1/02 (2006.01) A61P 11/06 (2006.01) A61P 27/02 (2006.01)	2437717 *	A61K 8/00 (2006.01)	2431360	C07D 291/08 (2006.01) A61P 25/00 (2006.01) A61K 31/551 (2006.01)
		2418942 *	A01N 35/00 (2006.01)		
		2427500 *	C08B 37/10 (2006.01) A61P 7/02 (2006.01) A61K 31/727 (2006.01)	2494095 *	C25B 3/04 (2006.01) C07D 213/803 (2006.01)
		2428254	A62D 3/02 (2007.01) A62D 3/35 (2007.01) A62D 3/36 (2007.01)	2435118 *	A61B 6/00 (2006.01) G06F 19/00 (2011.01) A61M 16/00 (2006.01) A61B 5/08 (2006.01)
		2397244	B21J 13/10 (2006.01) B21K 1/76 (2006.01) B21J 9/12 (2006.01) B21J 9/02 (2006.01) B21J 9/20 (2006.01)	2485743 *	A61K 35/74 (2006.01) A61P 9/00 (2006.01)
		2250871	A01D 41/127 (2006.01)	2455381 *	A61K 31/437 (2006.01) A61P 7/06 (2006.01) A61P 43/00 (2006.01) C07D 471/04 (2006.01)
		2493525 *	A61M 1/16 (2006.01)	2264092	C08K 3/34 (2006.01) C08K 7/00 (2006.01) C08L 95/00 (2006.01)
		2361891	C03C 1/00 (2006.01) G21F 9/30 (2006.01)		
2488500 *	C07D 471/10 (2006.01) A61K 31/438 (2006.01) A61P 3/10 (2006.01) C07D 221/20 (2006.01)	2486134 *	C12N 15/63 (2006.01)	2408299 *	A01N 31/08 (2006.01) A61K 31/05 (2006.01)
		2491909	A61F 13/15 (2006.01)	2478116 *	C12Q 1/68 (2006.01)
2497615	B26D 7/20 (2006.01) B26D 5/02 (2006.01) B26F 1/22 (2006.01)	2429485 *	A61K 8/67 (2006.01) A61K 8/34 (2006.01) A61K 8/36 (2006.01) A61K 8/49 (2006.01) A61Q 19/02 (2006.01) A61K 8/92 (2006.01)	2445923 *	C07K 1/113 (2006.01)
2459199 *	A61K 31/565 (2006.01) A61P 35/00 (2006.01)			2491034 *	C07D 471/08 (2006.01) A61P 25/00 (2006.01) A61K 31/439 (2006.01)
2417392 *	F23H 17/12 (2006.01) F23H 7/08 (2006.01)				

Broj objave evropske prijava patenta (97)	MKP (51)	Broj objave evropske prijava patenta (97)	MKP (51)	Broj objave evropske prijava patenta (97)	MKP (51)
2440544 *	C07D 401/12 (2006.01) A61P 35/00 (2006.01) C07D 403/12 (2006.01) C07D 471/04 (2006.01) A61K 31/4184 (2006.01)	2445692 *	B29B 17/00 (2006.01)	2485760 *	A61P 25/00 (2006.01) C07K 16/22 (2006.01) G01N 33/53 (2006.01) C12N 15/68 (2006.01) A61K 39/395 (2006.01) A61P 29/02 (2006.01) C12N 5/10 (2006.01) A61P 19/02 (2006.01) A61P 35/00 (2006.01)
		2388726	G06F 21/00 (2006.01)		
2480220 *	A61K 31/352 (2006.01) A61P 31/18 (2006.01) A61K 9/08 (2006.01) A61K 9/51 (2006.01)	2433987 *	A01N 25/04 (2006.01) B27K 3/50 (2006.01) C08K 5/10 (2006.01) C08K 5/42 (2006.01) C08L 71/02 (2006.01)		
		2251453	C23C 16/505 (2006.01) C23C 16/458 (2006.01) G01N 15/08 (2006.01) A61B 5/15 (2006.01)	2490524 *	A01K 13/00 (2006.01) A61D 7/00 (2006.01)
2380761	B60G 7/02 (2006.01) B60G 13/00 (2006.01) B62D 21/20 (2006.01) B62D 21/00 (2006.01)			2350387 *	D21H 19/52 (2006.01)
		2456851 *	C12N 1/18 (2006.01) C12N 9/02 (2006.01) C12P 7/06 (2006.01) C12P 7/10 (2006.01) C12N 15/53 (2006.01)	2408459 *	A61K 31/727 (2006.01) A61K 31/765 (2006.01) A61P 9/00 (2006.01) A61P 7/02 (2006.01) A61P 13/12 (2006.01) A61P 41/00 (2006.01)
2493865 *	C07D 471/04 (2006.01) C07D 403/12 (2006.01) A61K 31/519 (2006.01) A61P 35/00 (2006.01) C07D 405/12 (2006.01) A61K 31/517 (2006.01) C07D 239/94 (2006.01)	2456944 *	E06B 7/02 (2006.01) F23J 11/00 (2006.01) E06B 7/26 (2006.01)	2429521 *	A61K 9/107 (2006.01) A61K 9/14 (2006.01) A61P 35/00 (2006.01) A61P 17/02 (2006.01) A61P 3/00 (2006.01) A61P 25/00 (2006.01) A61K 31/415 (2006.01)
2459592 *	C07K 16/22 (2006.01) A61K 39/395 (2006.01) A61P 35/00 (2006.01)	2452011 *	B32B 27/12 (2006.01) B60N 3/04 (2006.01) D06N 7/00 (2006.01) B32B 27/32 (2006.01)		
				2433545 *	A47L 13/10 (2006.01) A47L 13/20 (2006.01)
2480547 *	A61P 9/00 (2006.01) C07D 403/06 (2006.01) A61P 11/00 (2006.01) C07D 413/12 (2006.01) C07D 417/12 (2006.01) A61P 29/00 (2006.01) C07D 471/04 (2006.01) A61K 31/437 (2006.01)				

Broj objave evropske prijave patenta (97)	MKP (51)
2432880 *	A61P 3/10 (2006.01) C12N 15/113 (2010.01) A61K 31/712 (2006.01) A61K 31/7125 (2006.01) C07H 21/00 (2006.01) C12Q 1/68 (2006.01) A61P 3/06 (2006.01)
2445886 *	C07D 401/12 (2006.01) A61K 31/4709 (2006.01) C07D 401/14 (2006.01) A61P 29/00 (2006.01) C07D 215/44 (2006.01) C07D 471/04 (2006.01) C07D 401/04 (2006.01) A61K 31/4706 (2006.01) C07D 407/14 (2006.01) C07D 409/12 (2006.01) C07D 413/14 (2006.01) C07D 417/14 (2006.01)

**INDEKS KLASIFIKACIJSKIH OZNAKA BROJEVA ZAHTJEVA ZA PROŠIRENJE
EVROPSKIH PRIJAVA PATENTA PREMA MKP
INDEX ON CLASSIFICATION MARKS ON REQUESTS FOR EXTENSION
OF EUROPEAN PATENT APPLICATION IN ACCORDANCE WITH THE
INTERNATIONAL PATENT CLASSIFICATION**

MKP (51)	Broj objave evropske prijava patenta (97)	Naziv pronalaska (54)
A61P 25/00 (2006.01)	2451449 *	USE OF THE COMBINATION OF TERIFLUNOMIDE AND INTERFERON BETA FOR TREATING MULTIPLE SCLEROSIS
A61K 31/165 (2006.01)	2451449 *	USE OF THE COMBINATION OF TERIFLUNOMIDE AND INTERFERON BETA FOR TREATING MULTIPLE SCLEROSIS
A61K 38/21 (2006.01)	2451449 *	USE OF THE COMBINATION OF TERIFLUNOMIDE AND INTERFERON BETA FOR TREATING MULTIPLE SCLEROSIS
C10G 2/00 (2006.01)	2474593 *	SLURRY PREPARATION METHOD, SLURRY PREPARATION APPARATUS, HYDROCARBON SYNTHESIS REACTION APPARATUS, AND HYDROCARBON SYNTHESIS REACTION SYSTEM
A61K 48/00 (2006.01)	2461833 *	VACCINE COMPOSITION COMPRISING 5'-CAP MODIFIED RNA
C12N 5/16 (2006.01)	2461833 *	VACCINE COMPOSITION COMPRISING 5'-CAP MODIFIED RNA
G06F 3/041 (2006.01)	2406703 *	SYSTEMS AND METHODS FOR FRICTION DISPLAYS AND ADDITIONAL HAPTIC EFFECTS
G06F 3/01 (2006.01)	2406703 *	SYSTEMS AND METHODS FOR FRICTION DISPLAYS AND ADDITIONAL HAPTIC EFFECTS
G06F 3/048 (2006.01)	2406703 *	SYSTEMS AND METHODS FOR FRICTION DISPLAYS AND ADDITIONAL HAPTIC EFFECTS
G06F 3/041 (2006.01)	2406702 *	SYSTEMS AND METHODS FOR INTERFACES FEATURING SURFACE-BASED HAPTIC EFFECTS
G06F 3/01 (2006.01)	2406702 *	SYSTEMS AND METHODS FOR INTERFACES FEATURING SURFACE-BASED HAPTIC EFFECTS
G06F 3/048 (2006.01)	2406702 *	SYSTEMS AND METHODS FOR INTERFACES FEATURING SURFACE-BASED HAPTIC EFFECTS
F16L 55/164 (2006.01)	2419670 *	DELIVERY METHOD AND COMPOSITIONS
H04W 40/20 (2009.01)	2485532 *	METHOD, SYSTEM AND APPARATUS FOR ACQUIRING CELL LOCATION INFORMATION
B67B 7/04 (2006.01)	2371758	Perforating tip for a corkscrew
C07D 401/14 (2006.01)	2424859 *	INHIBITORS OF PI3 KINASE AND / OR MTOR
C07D 473/00 (2006.01)	2424859 *	INHIBITORS OF PI3 KINASE AND / OR MTOR
A61P 35/00 (2006.01)	2424859 *	INHIBITORS OF PI3 KINASE AND / OR MTOR
A61K 31/52 (2006.01)	2424859 *	INHIBITORS OF PI3 KINASE AND / OR MTOR
C12N 15/09 (2006.01)	2478099 *	METHOD AND COMPOSITION FOR TREATING ALZHEIMER-TYPE DEMENTIA
H01R 13/533 (2006.01)	2390965	An electrical connector, particularly for a drill string
E21B 17/20 (2006.01)	2390965	An electrical connector, particularly for a drill string
A01H 5/10 (2006.01)	2440034 *	HIGH OIL CONTENT PLANTS
C12N 15/82 (2006.01)	2440034 *	HIGH OIL CONTENT PLANTS
A61K 39/395 (2006.01)	2475387 *	USE OF VAP-1 INHIBITORS FOR TREATING FIBROTIC CONDITIONS
A61P 17/02 (2006.01)	2475387 *	USE OF VAP-1 INHIBITORS FOR TREATING FIBROTIC CONDITIONS
C07K 16/40 (2006.01)	2475387 *	USE OF VAP-1 INHIBITORS FOR TREATING FIBROTIC CONDITIONS
G01N 33/577 (2006.01)	2475387 *	USE OF VAP-1 INHIBITORS FOR TREATING FIBROTIC CONDITIONS
A61K 31/00 (2006.01)	2475387 *	USE OF VAP-1 INHIBITORS FOR TREATING FIBROTIC CONDITIONS
A61P 43/00 (2006.01)	2475387 *	USE OF VAP-1 INHIBITORS FOR TREATING FIBROTIC CONDITIONS
C07D 405/14 (2006.01)	2406243 *	BENZOFURAN DERIVATIVES
A61K 31/5377 (2006.01)	2406243 *	BENZOFURAN DERIVATIVES

MKP (51)	Broj objave evropske prijava patenta (97)	Naziv pronalaska (54)
C07D 407/04 (2006.01)	2406243 *	BENZOFURAN DERIVATIVES
A61K 31/551 (2006.01)	2406243 *	BENZOFURAN DERIVATIVES
C07D 405/12 (2006.01)	2406243 *	BENZOFURAN DERIVATIVES
A61K 31/496 (2006.01)	2406243 *	BENZOFURAN DERIVATIVES
C07D 407/12 (2006.01)	2406243 *	BENZOFURAN DERIVATIVES
C07D 307/79 (2006.01)	2406243 *	BENZOFURAN DERIVATIVES
C07D 413/04 (2006.01)	2406243 *	BENZOFURAN DERIVATIVES
C07D 307/80 (2006.01)	2406243 *	BENZOFURAN DERIVATIVES
C07D 413/12 (2006.01)	2406243 *	BENZOFURAN DERIVATIVES
C07D 307/81 (2006.01)	2406243 *	BENZOFURAN DERIVATIVES
C07D 417/12 (2006.01)	2406243 *	BENZOFURAN DERIVATIVES
C07D 405/04 (2006.01)	2406243 *	BENZOFURAN DERIVATIVES
C07D 493/10 (2006.01)	2406243 *	BENZOFURAN DERIVATIVES
C08K 5/15 (2006.01)	2464690 *	FORMULATIONS COMPRISING ISOSORBIDE-MODIFIED UNSATURATED POLYESTER RESINS AND LOW PROFILE ADDITIVES WHICH PRODUCE LOW SHRINKAGE MATRICES
A61M 5/315 (2006.01)	2475411 *	DRIVE MECHANISM FOR DRUG DELIVERY DEVICE
F16K 11/074 (2006.01)	2451631 *	VALVE FOR TYRE REPAIR KIT
B29C 73/16 (2006.01)	2451631 *	VALVE FOR TYRE REPAIR KIT
G07D 3/12 (2006.01)	2230646	Coin dispenser device
A61K 31/443 (2006.01)	2467366 *	NOVEL FXR (NR1H4) BINDING AND ACTIVITY MODULATING COMPOUNDS
C07D 249/06 (2006.01)	2467366 *	NOVEL FXR (NR1H4) BINDING AND ACTIVITY MODULATING COMPOUNDS
A61K 31/4439 (2006.01)	2467366 *	NOVEL FXR (NR1H4) BINDING AND ACTIVITY MODULATING COMPOUNDS
C07D 261/08 (2006.01)	2467366 *	NOVEL FXR (NR1H4) BINDING AND ACTIVITY MODULATING COMPOUNDS
A61P 1/16 (2006.01)	2467366 *	NOVEL FXR (NR1H4) BINDING AND ACTIVITY MODULATING COMPOUNDS
C07D 413/04 (2006.01)	2467366 *	NOVEL FXR (NR1H4) BINDING AND ACTIVITY MODULATING COMPOUNDS
A61P 3/10 (2006.01)	2467366 *	NOVEL FXR (NR1H4) BINDING AND ACTIVITY MODULATING COMPOUNDS
A61K 31/42 (2006.01)	2467366 *	NOVEL FXR (NR1H4) BINDING AND ACTIVITY MODULATING COMPOUNDS
C07D 413/12 (2006.01)	2467366 *	NOVEL FXR (NR1H4) BINDING AND ACTIVITY MODULATING COMPOUNDS
A61P 35/00 (2006.01)	2467366 *	NOVEL FXR (NR1H4) BINDING AND ACTIVITY MODULATING COMPOUNDS
C07D 413/14 (2006.01)	2467366 *	NOVEL FXR (NR1H4) BINDING AND ACTIVITY MODULATING COMPOUNDS
A61K 31/4192 (2006.01)	2467366 *	NOVEL FXR (NR1H4) BINDING AND ACTIVITY MODULATING COMPOUNDS
A61K 31/4412 (2006.01)	2377537	Pirfenidone therapy and inducers of cytochrome P450
A61P 11/00 (2006.01)	2377537	Pirfenidone therapy and inducers of cytochrome P450
A61K 39/13 (2006.01)	2454364 *	PRODUCTION OF POLIO VIRUS AT HIGH TITERS FOR VACCINE PRODUCTION
C12N 7/02 (2006.01)	2454364 *	PRODUCTION OF POLIO VIRUS AT HIGH TITERS FOR VACCINE PRODUCTION
C07C 275/24 (2006.01)	2462110 *	DP2 ANTAGONIST AND USES THEREOF
C07C 275/16 (2006.01)	2462110 *	DP2 ANTAGONIST AND USES THEREOF
C07C 273/02 (2006.01)	2462110 *	DP2 ANTAGONIST AND USES THEREOF
A61K 31/17 (2006.01)	2462110 *	DP2 ANTAGONIST AND USES THEREOF

MKP (51)	Broj objave evropske prijava patenta (97)	Naziv pronalaska (54)
A61P 11/00 (2006.01)	2462110 *	DP2 ANTAGONIST AND USES THEREOF
C12N 15/11 (2006.01)	2451823 *	COMPOSITIONS AND METHODS FOR ENHANCING PRODUCTION OF A BIOLOGICAL PRODUCT
C07H 21/04 (2006.01)	2451823 *	COMPOSITIONS AND METHODS FOR ENHANCING PRODUCTION OF A BIOLOGICAL PRODUCT
C12N 5/07 (2010.01)	2451823 *	COMPOSITIONS AND METHODS FOR ENHANCING PRODUCTION OF A BIOLOGICAL PRODUCT
C12N 5/00 (2006.01)	2451823 *	COMPOSITIONS AND METHODS FOR ENHANCING PRODUCTION OF A BIOLOGICAL PRODUCT
C08J 5/12 (2006.01)	2404953	Solvent based glue composition
B29C 65/48 (2006.01)	2404953	Solvent based glue composition
C08J 3/11 (2006.01)	2404953	Solvent based glue composition
C09J 127/06 (2006.01)	2404953	Solvent based glue composition
C09J 155/02 (2006.01)	2404953	Solvent based glue composition
C12P 21/08 (2006.01)	2488658 *	DUAL VARIABLE DOMAIN IMMUNOGLOBULINS AND USES THEREOF
C12Q 1/70 (2006.01)	2488658 *	DUAL VARIABLE DOMAIN IMMUNOGLOBULINS AND USES THEREOF
A61B 17/06 (2006.01)	2470078 *	BARBED SUTURES HAVING PLEDGET STOPPERS AND METHODS THEREFOR
A61B 17/00 (2006.01)	2470078 *	BARBED SUTURES HAVING PLEDGET STOPPERS AND METHODS THEREFOR
A61B 7/04 (2006.01)	2470078 *	BARBED SUTURES HAVING PLEDGET STOPPERS AND METHODS THEREFOR
A61M 5/315 (2006.01)	2496290 *	ASSEMBLY FOR A DRUG DELIVERY DEVICE AND DRUG DELIVERY DEVICE
B29C 35/14 (2006.01)	2461960 *	MANUFACTURE AND USE OF A REINFORCED PROFILE
B29B 15/10 (2006.01)	2461960 *	MANUFACTURE AND USE OF A REINFORCED PROFILE
B29C 47/02 (2006.01)	2461960 *	MANUFACTURE AND USE OF A REINFORCED PROFILE
B29C 70/50 (2006.01)	2461960 *	MANUFACTURE AND USE OF A REINFORCED PROFILE
B29C 70/20 (2006.01)	2461960 *	MANUFACTURE AND USE OF A REINFORCED PROFILE
H01L 31/18 (2006.01)	2481098 *	METHOD AND DEVICE FOR CHARGING PHOTOVOLTAIC MODULES
A61K 31/506 (2006.01)	2442810 *	REVERSAL OF L-DOPA-INDUCED DYSKINESIA BY NEURONAL NICOTINIC RECEPTOR LIGANDS
A61K 31/505 (2006.01)	2442810 *	REVERSAL OF L-DOPA-INDUCED DYSKINESIA BY NEURONAL NICOTINIC RECEPTOR LIGANDS
A61P 25/28 (2006.01)	2442810 *	REVERSAL OF L-DOPA-INDUCED DYSKINESIA BY NEURONAL NICOTINIC RECEPTOR LIGANDS
A61P 25/00 (2006.01)	2442810 *	REVERSAL OF L-DOPA-INDUCED DYSKINESIA BY NEURONAL NICOTINIC RECEPTOR LIGANDS
G01N 33/68 (2006.01)	2496943 *	METHODS AND USES RELATING TO THE IDENTIFICATION OF COMPOUND INVOLVED IN PAIN AS WELL AS METHODS OF DIAGNOSING ALGESIA
E03C 1/284 (2006.01)	2404001 *	WATER DRAIN SIPHON DEVICE, IN PARTICULAR FOR FLOOR SHOWERS AND SHOWER TRAYS
E03F 5/04 (2006.01)	2404001 *	WATER DRAIN SIPHON DEVICE, IN PARTICULAR FOR FLOOR SHOWERS AND SHOWER TRAYS
A61K 45/06 (2006.01)	2429518 *	TREATMENT OF COGNITIVE DISORDERS WITH CERTAIN ALPHA-7 NICOTINIC ACID RECEPTORS IN COMBINATION WITH ACETYLCHOLINESTERASE INHIBITORS
A61P 25/00 (2006.01)	2429518 *	TREATMENT OF COGNITIVE DISORDERS WITH CERTAIN ALPHA-7 NICOTINIC ACID RECEPTORS IN COMBINATION WITH ACETYLCHOLINESTERASE INHIBITORS
A61P 25/28 (2006.01)	2429518 *	TREATMENT OF COGNITIVE DISORDERS WITH CERTAIN ALPHA-7 NICOTINIC ACID RECEPTORS IN COMBINATION WITH ACETYLCHOLINESTERASE INHIBITORS

MKP (51)	Broj objave evropske prijava patenta (97)	Naziv pronalaska (54)
A61K 31/27 (2006.01)	2429518 *	TREATMENT OF COGNITIVE DISORDERS WITH CERTAIN ALPHA-7 NICOTINIC ACID RECEPTORS IN COMBINATION WITH ACETYLCHOLINESTERASE INHIBITORS
A61K 31/439 (2006.01)	2429518 *	TREATMENT OF COGNITIVE DISORDERS WITH CERTAIN ALPHA-7 NICOTINIC ACID RECEPTORS IN COMBINATION WITH ACETYLCHOLINESTERASE INHIBITORS
A61K 31/473 (2006.01)	2429518 *	TREATMENT OF COGNITIVE DISORDERS WITH CERTAIN ALPHA-7 NICOTINIC ACID RECEPTORS IN COMBINATION WITH ACETYLCHOLINESTERASE INHIBITORS
A61K 31/445 (2006.01)	2429518 *	TREATMENT OF COGNITIVE DISORDERS WITH CERTAIN ALPHA-7 NICOTINIC ACID RECEPTORS IN COMBINATION WITH ACETYLCHOLINESTERASE INHIBITORS
A61K 31/55 (2006.01)	2429518 *	TREATMENT OF COGNITIVE DISORDERS WITH CERTAIN ALPHA-7 NICOTINIC ACID RECEPTORS IN COMBINATION WITH ACETYLCHOLINESTERASE INHIBITORS
G09F 3/02 (2006.01)	2414000 *	DRUG DELIVERY DEVICE WITH INTEGRATED EXTENDABLE / RETRACTABLE INFORMATION DISPLAY ELEMENT
G09F 11/30 (2006.01)	2414000 *	DRUG DELIVERY DEVICE WITH INTEGRATED EXTENDABLE / RETRACTABLE INFORMATION DISPLAY ELEMENT
A61M 5/31 (2006.01)	2414000 *	DRUG DELIVERY DEVICE WITH INTEGRATED EXTENDABLE / RETRACTABLE INFORMATION DISPLAY ELEMENT
A61M 5/178 (2006.01)	2414000 *	DRUG DELIVERY DEVICE WITH INTEGRATED EXTENDABLE / RETRACTABLE INFORMATION DISPLAY ELEMENT
B65C 3/06 (2006.01)	2414000 *	DRUG DELIVERY DEVICE WITH INTEGRATED EXTENDABLE / RETRACTABLE INFORMATION DISPLAY ELEMENT
G01N 33/574 (2006.01)	2454598 *	DRUG SELECTION FOR GASTRIC CANCER THERAPY USING ANTIBODY-BASED ARRAYS
C07D 413/04 (2006.01)	2459553 *	FURAZANOBENZIMIDAZOLES AS PRODRUGS TO TREAT NEOPLASTIC OR AUTOIMMUNE DISEASES
A61K 31/4245 (2006.01)	2459553 *	FURAZANOBENZIMIDAZOLES AS PRODRUGS TO TREAT NEOPLASTIC OR AUTOIMMUNE DISEASES
A61P 35/00 (2006.01)	2459553 *	FURAZANOBENZIMIDAZOLES AS PRODRUGS TO TREAT NEOPLASTIC OR AUTOIMMUNE DISEASES
B65D 41/46 (2006.01)	2444334	Safety bottle cap
B65D 41/62 (2006.01)	2444334	Safety bottle cap
A61M 5/32 (2006.01)	2480274 *	ACTUATOR FOR SAFETY DEVICES FOR NEEDLES AND DISPOSABLE MEDICAL INSTRUMENTS
F16L 11/04 (2006.01)	2431643	Method and apparatus for the surface treatment of collapsible tubular sub-layers intended for the production of multi-layer tubes
G09G 5/00 (2006.01)	2407922 *	HORSE BODY INFORMATION PROVISION SYSTEM, HORSE BODY STILL IMAGE DATA EXTRACTION METHOD, HORSE BODY STILL IMAGE DATA EXTRACTION PROGRAM, AND COMPUTER-READABLE RECORDING MEDIUM
G09G 5/36 (2006.01)	2407922 *	HORSE BODY INFORMATION PROVISION SYSTEM, HORSE BODY STILL IMAGE DATA EXTRACTION METHOD, HORSE BODY STILL IMAGE DATA EXTRACTION PROGRAM, AND COMPUTER-READABLE RECORDING MEDIUM
G06Q 50/00 (2012.01)	2407922 *	HORSE BODY INFORMATION PROVISION SYSTEM, HORSE BODY STILL IMAGE DATA EXTRACTION METHOD, HORSE BODY STILL IMAGE DATA EXTRACTION PROGRAM, AND COMPUTER-READABLE RECORDING MEDIUM
G06Q 10/00 (2012.01)	2407922 *	HORSE BODY INFORMATION PROVISION SYSTEM, HORSE BODY STILL IMAGE DATA EXTRACTION METHOD, HORSE BODY STILL IMAGE DATA EXTRACTION PROGRAM, AND COMPUTER-READABLE RECORDING MEDIUM
A61K 9/20 (2006.01)	2279728	Solid dosage forms of HIV protease inhibitors
A61K 9/14 (2006.01)	2279728	Solid dosage forms of HIV protease inhibitors
A61K 9/16 (2006.01)	2279728	Solid dosage forms of HIV protease inhibitors
A61K 47/18 (2006.01)	2440239 *	HEMOGLOBIN COMPOSITIONS

MKP (51)	Broj objave evropske prijava patenta (97)	Naziv pronalaska (54)
A61K 47/48 (2006.01)	2440239 *	HEMOGLOBIN COMPOSITIONS
A61K 38/42 (2006.01)	2440239 *	HEMOGLOBIN COMPOSITIONS
A61K 31/557 (2006.01)	2461812 *	COMPOSITION FOR THE TREATMENT OF CYSTIC FIBROSIS
A61K 31/5585 (2006.01)	2461812 *	COMPOSITION FOR THE TREATMENT OF CYSTIC FIBROSIS
A61P 11/00 (2006.01)	2461812 *	COMPOSITION FOR THE TREATMENT OF CYSTIC FIBROSIS
C11D 1/44 (2006.01)	2316914	Adhesive detergent composition
H01R 9/24 (2006.01)	2441128 *	TERMINAL STRIP
C07D 213/16 (2006.01)	2438045 *	CRYSTALLINE PHASES OF 2'-{[2-(4-METHOXY-PHENYL)-ACETYLAMINO]-METHYL}-BIPHENYL-2-CARBOXYLIC ACID (2-PYRIDIN-3-YL-ETHYL)-AMIDE
A61K 31/4406 (2006.01)	2438045 *	CRYSTALLINE PHASES OF 2'-{[2-(4-METHOXY-PHENYL)-ACETYLAMINO]-METHYL}-BIPHENYL-2-CARBOXYLIC ACID (2-PYRIDIN-3-YL-ETHYL)-AMIDE
C04B 2/10 (2006.01)	2230223	Method and device for producing calcium
A01H 5/08 (2006.01)	2495313 *	PRODUCTION METHOD FOR GENETICALLY MODIFIED PLANT CELLS
A01H 5/10 (2006.01)	2495313 *	PRODUCTION METHOD FOR GENETICALLY MODIFIED PLANT CELLS
A01H 5/00 (2006.01)	2495313 *	PRODUCTION METHOD FOR GENETICALLY MODIFIED PLANT CELLS
C12N 15/09 (2006.01)	2495313 *	PRODUCTION METHOD FOR GENETICALLY MODIFIED PLANT CELLS
C12N 5/10 (2006.01)	2495313 *	PRODUCTION METHOD FOR GENETICALLY MODIFIED PLANT CELLS
C22C 26/00 (2006.01)	2462083 *	TOUGH COATED HARD PARTICLES CONSOLIDATED IN A TOUGH MATRIX MATERIAL
B22F 1/02 (2006.01)	2462083 *	TOUGH COATED HARD PARTICLES CONSOLIDATED IN A TOUGH MATRIX MATERIAL
C04B 35/628 (2006.01)	2462083 *	TOUGH COATED HARD PARTICLES CONSOLIDATED IN A TOUGH MATRIX MATERIAL
C22C 29/02 (2006.01)	2462083 *	TOUGH COATED HARD PARTICLES CONSOLIDATED IN A TOUGH MATRIX MATERIAL
E03C 1/232 (2006.01)	2467539 *	CABLE ACTUATED DRAIN
C07D 239/48 (2006.01)	2435411 *	2, 4 -DIAMINOPYRIMIDINES FOR THE TREATMENT OF DISEASES CHARACTERISED BY EXCESSIVE OR ABNORMAL CELL PROLIFERATION
C07D 401/12 (2006.01)	2435411 *	2, 4 -DIAMINOPYRIMIDINES FOR THE TREATMENT OF DISEASES CHARACTERISED BY EXCESSIVE OR ABNORMAL CELL PROLIFERATION
C07D 405/12 (2006.01)	2435411 *	2, 4 -DIAMINOPYRIMIDINES FOR THE TREATMENT OF DISEASES CHARACTERISED BY EXCESSIVE OR ABNORMAL CELL PROLIFERATION
A61P 35/00 (2006.01)	2435411 *	2, 4 -DIAMINOPYRIMIDINES FOR THE TREATMENT OF DISEASES CHARACTERISED BY EXCESSIVE OR ABNORMAL CELL PROLIFERATION
A61K 31/505 (2006.01)	2435411 *	2, 4 -DIAMINOPYRIMIDINES FOR THE TREATMENT OF DISEASES CHARACTERISED BY EXCESSIVE OR ABNORMAL CELL PROLIFERATION
C12M 1/00 (2006.01)	2371940	Process for bio-oil production involving the use of CO ₂
F24J 3/08 (2006.01)	2491183 *	PILE WITH INTEGRAL GEOTHERMAL CONDUIT LOOP RETAINING MEANS
E02D 5/30 (2006.01)	2491183 *	PILE WITH INTEGRAL GEOTHERMAL CONDUIT LOOP RETAINING MEANS
C07D 233/70 (2006.01)	2408751 *	Substituted 2-acetamido-5-aryl-1,2,4-triazolones and use thereof
C07D 249/12 (2006.01)	2408751 *	Substituted 2-acetamido-5-aryl-1,2,4-triazolones and use thereof
C07D 409/04 (2006.01)	2408751 *	Substituted 2-acetamido-5-aryl-1,2,4-triazolones and use thereof
C07D 413/12 (2006.01)	2408751 *	Substituted 2-acetamido-5-aryl-1,2,4-triazolones and use thereof
A61K 31/4166 (2006.01)	2408751 *	Substituted 2-acetamido-5-aryl-1,2,4-triazolones and use thereof
A61K 31/4196 (2006.01)	2408751 *	Substituted 2-acetamido-5-aryl-1,2,4-triazolones and use thereof
A61K 31/422 (2006.01)	2408751 *	Substituted 2-acetamido-5-aryl-1,2,4-triazolones and use thereof
A61P 9/00 (2006.01)	2408751 *	Substituted 2-acetamido-5-aryl-1,2,4-triazolones and use thereof
A61K 31/506 (2006.01)	2406253 *	BENZOFURANYL DERIVATIVES USED AS GLUCOKINASE INHIBITORS
A61P 3/04 (2006.01)	2406253 *	BENZOFURANYL DERIVATIVES USED AS GLUCOKINASE INHIBITORS
A61K 31/497 (2006.01)	2406253 *	BENZOFURANYL DERIVATIVES USED AS GLUCOKINASE INHIBITORS
A61P 3/10 (2006.01)	2406253 *	BENZOFURANYL DERIVATIVES USED AS GLUCOKINASE INHIBITORS

MKP (51)	Broj objave evropske prijave patenta (97)	Naziv pronalaska (54)
C07D 405/14 (2006.01)	2406253 *	BENZOFURANYL DERIVATIVES USED AS GLUCOKINASE INHIBITORS
C07D 417/14 (2006.01)	2417108 *	ORGANIC COMPOUNDS AND THEIR USES
A61K 31/403 (2006.01)	2417108 *	ORGANIC COMPOUNDS AND THEIR USES
C07D 209/96 (2006.01)	2417108 *	ORGANIC COMPOUNDS AND THEIR USES
A61P 31/22 (2006.01)	2417108 *	ORGANIC COMPOUNDS AND THEIR USES
C07D 401/12 (2006.01)	2417108 *	ORGANIC COMPOUNDS AND THEIR USES
C07K 5/08 (2006.01)	2417108 *	ORGANIC COMPOUNDS AND THEIR USES
C07D 401/14 (2006.01)	2417108 *	ORGANIC COMPOUNDS AND THEIR USES
C07D 403/12 (2006.01)	2417108 *	ORGANIC COMPOUNDS AND THEIR USES
C07D 403/14 (2006.01)	2417108 *	ORGANIC COMPOUNDS AND THEIR USES
C07D 405/14 (2006.01)	2417108 *	ORGANIC COMPOUNDS AND THEIR USES
B01D 53/02 (2006.01)	2408538 *	CARBON DIOXIDE CAPTURE/REGENERATION STRUCTURES AND TECHNIQUES
C12N 15/86 (2006.01)	2412387 *	METHODS AND COMPOSITIONS FOR THE TREATMENT OF CIRRHOSIS AND LIVER FIBROSIS
C12N 15/864 (2006.01)	2412387 *	METHODS AND COMPOSITIONS FOR THE TREATMENT OF CIRRHOSIS AND LIVER FIBROSIS
A61K 48/00 (2006.01)	2412387 *	METHODS AND COMPOSITIONS FOR THE TREATMENT OF CIRRHOSIS AND LIVER FIBROSIS
C07K 14/65 (2006.01)	2412387 *	METHODS AND COMPOSITIONS FOR THE TREATMENT OF CIRRHOSIS AND LIVER FIBROSIS
A63B 63/00 (2006.01)	2496321 *	COLLAPSIBLE GOAL DEVICE FOR BALL GAMES
C09K 5/10 (2006.01)	2380943	Fluorescent detector
G01M 3/22 (2006.01)	2380943	Fluorescent detector
G07D 9/00 (2006.01)	2395484	Adapter for coin dispensing device
G07D 1/02 (2006.01)	2395484	Adapter for coin dispensing device
A61K 31/4188 (2006.01)	2405908 *	PHARMACEUTICAL COMBINATIONS COMPRISING RDEA119/BAY 869766 FOR THE TREATMENT OF SPECIFIC CANCERS
A61P 35/00 (2006.01)	2405908 *	PHARMACEUTICAL COMBINATIONS COMPRISING RDEA119/BAY 869766 FOR THE TREATMENT OF SPECIFIC CANCERS
A61K 31/7064 (2006.01)	2405908 *	PHARMACEUTICAL COMBINATIONS COMPRISING RDEA119/BAY 869766 FOR THE TREATMENT OF SPECIFIC CANCERS
A61K 31/18 (2006.01)	2405908 *	PHARMACEUTICAL COMBINATIONS COMPRISING RDEA119/BAY 869766 FOR THE TREATMENT OF SPECIFIC CANCERS
A61K 31/185 (2006.01)	2405908 *	PHARMACEUTICAL COMBINATIONS COMPRISING RDEA119/BAY 869766 FOR THE TREATMENT OF SPECIFIC CANCERS
A61K 31/436 (2006.01)	2405908 *	PHARMACEUTICAL COMBINATIONS COMPRISING RDEA119/BAY 869766 FOR THE TREATMENT OF SPECIFIC CANCERS
A61K 31/517 (2006.01)	2405908 *	PHARMACEUTICAL COMBINATIONS COMPRISING RDEA119/BAY 869766 FOR THE TREATMENT OF SPECIFIC CANCERS
B60J 10/02 (2006.01)	2459404 *	JOINTED GLASS PANEL COMPRISING COMB-SHAPED INSERT, AND METHOD FOR MANUFACTURING SAID GLASS PANEL
B29C 45/14 (2006.01)	2459404 *	JOINTED GLASS PANEL COMPRISING COMB-SHAPED INSERT, AND METHOD FOR MANUFACTURING SAID GLASS PANEL
B60J 10/00 (2006.01)	2459404 *	JOINTED GLASS PANEL COMPRISING COMB-SHAPED INSERT, AND METHOD FOR MANUFACTURING SAID GLASS PANEL
E04B 9/16 (2006.01)	2422023 *	METHOD AND APPARATUS FOR ATTACHING OBJECTS ON AND ABOVE A CEILING WITH UNATTACHED CEILING PANELS AND CEILING BEAMS
E04B 1/38 (2006.01)	2422023 *	METHOD AND APPARATUS FOR ATTACHING OBJECTS ON AND ABOVE A CEILING WITH UNATTACHED CEILING PANELS AND CEILING BEAMS
E04B 9/06 (2006.01)	2422023 *	METHOD AND APPARATUS FOR ATTACHING OBJECTS ON AND ABOVE A CEILING WITH UNATTACHED CEILING PANELS AND CEILING BEAMS
E04B 9/00 (2006.01)	2422023 *	METHOD AND APPARATUS FOR ATTACHING OBJECTS ON AND ABOVE A CEILING WITH UNATTACHED CEILING PANELS AND CEILING BEAMS

MKP (51)	Broj objave evropske prijave patenta (97)	Naziv pronalaska (54)
G06K 17/00 (2006.01)	2499746 *	THE METHOD AND SOLUTION OF DATA TRANSMISSION FROM THE TRANSPONDER TO THE READER, ESPECIALLY IN PAYMENT SOLUTIONS WITH A MOBILE COMMUNICATION DEVICE
H04B 5/00 (2006.01)	2499746 *	THE METHOD AND SOLUTION OF DATA TRANSMISSION FROM THE TRANSPONDER TO THE READER, ESPECIALLY IN PAYMENT SOLUTIONS WITH A MOBILE COMMUNICATION DEVICE
B61C 3/00 (2006.01)	2464553 *	UTILITY SCALE ELECTRIC ENERGY STORAGE SYSTEM
C07K 16/28 (2006.01)	2470569 *	ANTIBODIES AGAINST EPHA10
A61K 9/20 (2006.01)	2410994 *	PHARMACEUTICAL COMPOSITION CONTAINING LEVODOPA, ENTACAPONE AND CARBIDOPA
A61K 31/00 (2006.01)	2410994 *	PHARMACEUTICAL COMPOSITION CONTAINING LEVODOPA, ENTACAPONE AND CARBIDOPA
G01N 33/573 (2006.01)	2414842 *	DIAGNOSIS OF AND TREATMENT GLUTEN-INDUCED AUTOIMMUNE DISEASES
C03C 17/28 (2006.01)	2429964 *	PREPARATION FOR CHEMICAL TREATMENT OF GLASS, CERAMIC AND STONE SURFACES
A61H 1/00 (2006.01)	2453864 *	SYSTEMS AND METHODS FOR DRIVING SEALED NEBULIZERS
G01L 5/13 (2006.01)	2280263	Supporting load measuring device and retrofitting method for a vehicle trailer device
G01G 19/12 (2006.01)	2280263	Supporting load measuring device and retrofitting method for a vehicle trailer device
B60D 1/58 (2006.01)	2280263	Supporting load measuring device and retrofitting method for a vehicle trailer device
C12P 21/08 (2006.01)	2427211 *	STABLE HIGH PROTEIN CONCENTRATION FORMULATIONS OF HUMAN ANTI-TNF-ALPHA-ANTIBODIES
A61K 39/395 (2006.01)	2427211 *	STABLE HIGH PROTEIN CONCENTRATION FORMULATIONS OF HUMAN ANTI-TNF-ALPHA-ANTIBODIES
A01N 43/42 (2006.01)	2448408 *	PHENYLETHANOIC ACID, PHENYLPROPANOIC ACID AND PHENYLPROPENOIC ACID CONJUGATES AND PRODRUGS OF HYDROCODONE, METHODS OF MAKING AND USE THEREOF
A61K 31/44 (2006.01)	2448408 *	PHENYLETHANOIC ACID, PHENYLPROPANOIC ACID AND PHENYLPROPENOIC ACID CONJUGATES AND PRODRUGS OF HYDROCODONE, METHODS OF MAKING AND USE THEREOF
A61P 3/10 (2006.01)	2445899 *	NOVEL FUMARATE SALTS OF A HISTAMINE H3 RECEPTOR ANTAGONIST
A61P 25/00 (2006.01)	2445899 *	NOVEL FUMARATE SALTS OF A HISTAMINE H3 RECEPTOR ANTAGONIST
C07D 401/12 (2006.01)	2445899 *	NOVEL FUMARATE SALTS OF A HISTAMINE H3 RECEPTOR ANTAGONIST
A61K 31/4725 (2006.01)	2445899 *	NOVEL FUMARATE SALTS OF A HISTAMINE H3 RECEPTOR ANTAGONIST
E06B 3/46 (2006.01)	2357306	Universal counterframe for retractable sliding door panel
A61K 38/10 (2006.01)	2485751 *	METHODS OF TREATING DEPRESSION AND OTHER RELATED DISEASES
A61N 5/06 (2006.01)	2398557 *	POWER SUPPLY FOR LIGHT-BASED DERMATOLOGIC TREATMENT DEVICE
A61B 18/20 (2006.01)	2398557 *	POWER SUPPLY FOR LIGHT-BASED DERMATOLOGIC TREATMENT DEVICE
A61B 18/00 (2006.01)	2398557 *	POWER SUPPLY FOR LIGHT-BASED DERMATOLOGIC TREATMENT DEVICE
A23L 1/30 (2006.01)	2457576	New Lactobacillus reuteri strain useful in medical and veterinary prophylaxis and treatment
C12R 1/225 (2006.01)	2457576	New Lactobacillus reuteri strain useful in medical and veterinary prophylaxis and treatment
A61P 19/06 (2006.01)	2457576	New Lactobacillus reuteri strain useful in medical and veterinary prophylaxis and treatment
A61K 35/74 (2006.01)	2457576	New Lactobacillus reuteri strain useful in medical and veterinary prophylaxis and treatment
A61K 33/42 (2006.01)	2411022 *	COMPOSITIONS FOR BOWEL PREPARATION AND METHODS OF USE THEREOF
C07K 16/28 (2006.01)	2478012 *	TREATMENT OF AUTOIMMUNE AND INFLAMMATORY DISEASES WITH EPRATUZUMAB

MKP (51)	Broj objave evropske prijava patenta (97)	Naziv pronalaska (54)
A61P 37/06 (2006.01)	2478012 *	TREATMENT OF AUTOIMMUNE AND INFLAMMATORY DISEASES WITH EPRATUZUMAB
G01N 33/50 (2006.01)	2491384 *	SYSTEM FOR DETERMINING UNPROCESSED AND PARTIALLY PROCESSED NEUROTOXIN TYPE A
A62B 17/00 (2006.01)	2392386	View pane of a protective suit
A62B 18/08 (2006.01)	2392386	View pane of a protective suit
A61M 5/32 (2006.01)	2403569 *	DRUG DELIVERY DEVICE WITH RETRACTABLE NEEDLE
H01M 8/24 (2006.01)	2337133	Fluid flow plate assemblies
H01M 8/02 (2006.01)	2337133	Fluid flow plate assemblies
A61K 39/15 (2006.01)	2473190 *	HETEROLOGOUS PRIME-BOOST IMMUNIZATION REGIMEN AGAINST BLUETONGUE VIRUS
G06T 11/60 (2006.01)	2495645 *	OBJECT CONTROL METHOD FOR DISPLAYING OBJECTS IN FRONT OF LINK ELEMENTS
G06F 3/048 (2006.01)	2495645 *	OBJECT CONTROL METHOD FOR DISPLAYING OBJECTS IN FRONT OF LINK ELEMENTS
A01N 57/00 (2006.01)	2485595 *	COMBINATION THERAPY USING A BETA 3 ADRENERGIC RECEPTOR AGONIST AND AN ANTIMUSCARINIC AGENT
C07D 239/47 (2006.01)	2448927 *	NOVEL (6-OXO-1, 6-DIHYDRO-PYRIMIDIN-2-YL)-AMIDE DERIVATIVES, PREPARATION THEREOF, AND PHARMACEUTICAL USE THEREOF AS AKT(PKB) PHOSPHORYLATION INHIBITORS
C07D 413/12 (2006.01)	2448927 *	NOVEL (6-OXO-1, 6-DIHYDRO-PYRIMIDIN-2-YL)-AMIDE DERIVATIVES, PREPARATION THEREOF, AND PHARMACEUTICAL USE THEREOF AS AKT(PKB) PHOSPHORYLATION INHIBITORS
A61K 31/513 (2006.01)	2448927 *	NOVEL (6-OXO-1, 6-DIHYDRO-PYRIMIDIN-2-YL)-AMIDE DERIVATIVES, PREPARATION THEREOF, AND PHARMACEUTICAL USE THEREOF AS AKT(PKB) PHOSPHORYLATION INHIBITORS
A61K 31/5377 (2006.01)	2448927 *	NOVEL (6-OXO-1, 6-DIHYDRO-PYRIMIDIN-2-YL)-AMIDE DERIVATIVES, PREPARATION THEREOF, AND PHARMACEUTICAL USE THEREOF AS AKT(PKB) PHOSPHORYLATION INHIBITORS
C07D 403/12 (2006.01)	2448927 *	NOVEL (6-OXO-1, 6-DIHYDRO-PYRIMIDIN-2-YL)-AMIDE DERIVATIVES, PREPARATION THEREOF, AND PHARMACEUTICAL USE THEREOF AS AKT(PKB) PHOSPHORYLATION INHIBITORS
C07D 403/10 (2006.01)	2448927 *	NOVEL (6-OXO-1, 6-DIHYDRO-PYRIMIDIN-2-YL)-AMIDE DERIVATIVES, PREPARATION THEREOF, AND PHARMACEUTICAL USE THEREOF AS AKT(PKB) PHOSPHORYLATION INHIBITORS
A61P 35/00 (2006.01)	2448927 *	NOVEL (6-OXO-1, 6-DIHYDRO-PYRIMIDIN-2-YL)-AMIDE DERIVATIVES, PREPARATION THEREOF, AND PHARMACEUTICAL USE THEREOF AS AKT(PKB) PHOSPHORYLATION INHIBITORS
C07D 409/12 (2006.01)	2448927 *	NOVEL (6-OXO-1, 6-DIHYDRO-PYRIMIDIN-2-YL)-AMIDE DERIVATIVES, PREPARATION THEREOF, AND PHARMACEUTICAL USE THEREOF AS AKT(PKB) PHOSPHORYLATION INHIBITORS
C07D 413/06 (2006.01)	2448927 *	NOVEL (6-OXO-1, 6-DIHYDRO-PYRIMIDIN-2-YL)-AMIDE DERIVATIVES, PREPARATION THEREOF, AND PHARMACEUTICAL USE THEREOF AS AKT(PKB) PHOSPHORYLATION INHIBITORS
C07D 239/36 (2006.01)	2448927 *	NOVEL (6-OXO-1, 6-DIHYDRO-PYRIMIDIN-2-YL)-AMIDE DERIVATIVES, PREPARATION THEREOF, AND PHARMACEUTICAL USE THEREOF AS AKT(PKB) PHOSPHORYLATION INHIBITORS
C07D 403/06 (2006.01)	2448927 *	NOVEL (6-OXO-1, 6-DIHYDRO-PYRIMIDIN-2-YL)-AMIDE DERIVATIVES, PREPARATION THEREOF, AND PHARMACEUTICAL USE THEREOF AS AKT(PKB) PHOSPHORYLATION INHIBITORS
C07D 333/34 (2006.01)	2414343 *	PROCESS FOR PREPARING BRINZOLAMIDE
C07D 513/04 (2006.01)	2414343 *	PROCESS FOR PREPARING BRINZOLAMIDE
H04W 24/10 (2009.01)	2461621 *	MEASUREMENT METHOD AND DEVICE FOR WIRELESS NETWORK COMMUNICATION SYSTEM
H02K 7/18 (2006.01)	2462258 *	ELECTROLYSIS CELL AND ELECTRICAL POWER UNIT INCORPORATING SAME
C25B 1/04 (2006.01)	2462258 *	ELECTROLYSIS CELL AND ELECTRICAL POWER UNIT INCORPORATING SAME

MKP (51)	Broj objave evropske prijava patenta (97)	Naziv pronalaska (54)
F01D 1/00 (2006.01)	2462258 *	ELECTROLYSIS CELL AND ELECTRICAL POWER UNIT INCORPORATING SAME
F01D 7/02 (2006.01)	2462258 *	ELECTROLYSIS CELL AND ELECTRICAL POWER UNIT INCORPORATING SAME
H01M 8/08 (2006.01)	2462258 *	ELECTROLYSIS CELL AND ELECTRICAL POWER UNIT INCORPORATING SAME
H01M 8/22 (2006.01)	2462258 *	ELECTROLYSIS CELL AND ELECTRICAL POWER UNIT INCORPORATING SAME
F01D 17/06 (2006.01)	2462258 *	ELECTROLYSIS CELL AND ELECTRICAL POWER UNIT INCORPORATING SAME
C25B 1/02 (2006.01)	2462258 *	ELECTROLYSIS CELL AND ELECTRICAL POWER UNIT INCORPORATING SAME
F01D 25/30 (2006.01)	2462258 *	ELECTROLYSIS CELL AND ELECTRICAL POWER UNIT INCORPORATING SAME
F01D 15/10 (2006.01)	2462258 *	ELECTROLYSIS CELL AND ELECTRICAL POWER UNIT INCORPORATING SAME
H04N 1/00 (2006.01)	2474155 *	METHOD AND SYSTEM FOR DISPLAYING, MANAGING AND SELLING DIGITAL IMAGES
A43B 23/24 (2006.01)	2467038 *	RECONFIGURABLE SHOES AND APPAREL AND DOCKING ASSEMBLY THEREFOR
A44C 25/00 (2006.01)	2467038 *	RECONFIGURABLE SHOES AND APPAREL AND DOCKING ASSEMBLY THEREFOR
A44C 27/00 (2006.01)	2467038 *	RECONFIGURABLE SHOES AND APPAREL AND DOCKING ASSEMBLY THEREFOR
A61K 31/506 (2006.01)	2493878 *	PYRAZINES AS DELTA OPIOID RECEPTOR MODULATORS
C07D 403/14 (2006.01)	2493878 *	PYRAZINES AS DELTA OPIOID RECEPTOR MODULATORS
A61K 31/497 (2006.01)	2493878 *	PYRAZINES AS DELTA OPIOID RECEPTOR MODULATORS
A61P 25/04 (2006.01)	2493878 *	PYRAZINES AS DELTA OPIOID RECEPTOR MODULATORS
C07D 401/14 (2006.01)	2493878 *	PYRAZINES AS DELTA OPIOID RECEPTOR MODULATORS
C07K 16/28 (2006.01)	2421898 *	ANTIBODIES SPECIFIC TO CADHERIN-17
G01N 33/574 (2006.01)	2421898 *	ANTIBODIES SPECIFIC TO CADHERIN-17
A01B 33/08 (2006.01)	2232972	Rotary harrow
A61K 9/28 (2006.01)	2410997 *	COMPOSITION FOR THE ADMINISTRATION OF POLYMERIC DRUGS
A61K 9/16 (2006.01)	2410997 *	COMPOSITION FOR THE ADMINISTRATION OF POLYMERIC DRUGS
A61K 9/00 (2006.01)	2410997 *	COMPOSITION FOR THE ADMINISTRATION OF POLYMERIC DRUGS
F02M 47/02 (2006.01)	2290220	Fuel injector
F02M 63/00 (2006.01)	2290220	Fuel injector
B65G 47/82 (2006.01)	2403788 *	PLANT WITH A TRANSFERRING SHUTTLE FOR FEEDING PRODUCTS TO A PACKAGING MACHINE
B65G 17/26 (2006.01)	2403788 *	PLANT WITH A TRANSFERRING SHUTTLE FOR FEEDING PRODUCTS TO A PACKAGING MACHINE
B01D 35/143 (2006.01)	2467332 *	LIQUID FILTER DEVICE
B01D 35/153 (2006.01)	2467332 *	LIQUID FILTER DEVICE
C02F 1/00 (2006.01)	2467332 *	LIQUID FILTER DEVICE
D06M 10/00 (2006.01)	2406422 *	ELECTRON BEAM WEB IRRADIATION APPARATUS AND PROCESS
C07D 405/12 (2006.01)	2454243 *	TETRAZOLE DERIVATIVES
C07D 413/12 (2006.01)	2454243 *	TETRAZOLE DERIVATIVES
C07D 417/12 (2006.01)	2454243 *	TETRAZOLE DERIVATIVES
A61P 37/00 (2006.01)	2454243 *	TETRAZOLE DERIVATIVES
A61K 31/41 (2006.01)	2454243 *	TETRAZOLE DERIVATIVES
C07D 409/12 (2006.01)	2454243 *	TETRAZOLE DERIVATIVES
C07D 257/04 (2006.01)	2454243 *	TETRAZOLE DERIVATIVES
A61K 31/555 (2006.01)	2338495	Iron bis-glycinate chelate for use in the oral treatment of anemia in patients with celiac disease

MKP (51)	Broj objave evropske prijava patenta (97)	Naziv pronalaska (54)
A61K 33/26 (2006.01)	2338495	Iron bis-glycinate chelate for use in the oral treatment of anemia in patients with celiac disease
A61P 7/06 (2006.01)	2338495	Iron bis-glycinate chelate for use in the oral treatment of anemia in patients with celiac disease
E06B 3/02 (2006.01)	2436865	Window
E06B 3/66 (2006.01)	2436865	Window
F23G 5/027 (2006.01)	2478070 *	DECOMPOSITION OF WASTE PLASTICS
C08J 11/00 (2006.01)	2478070 *	DECOMPOSITION OF WASTE PLASTICS
C10G 1/10 (2006.01)	2478070 *	DECOMPOSITION OF WASTE PLASTICS
B01D 11/04 (2006.01)	2478070 *	DECOMPOSITION OF WASTE PLASTICS
C10L 1/02 (2006.01)	2478070 *	DECOMPOSITION OF WASTE PLASTICS
A61K 31/455 (2006.01)	2413936 *	CO-CRYSTAL OF ETRAVIRINE AND NICOTINAMIDE
A61K 31/513 (2006.01)	2413936 *	CO-CRYSTAL OF ETRAVIRINE AND NICOTINAMIDE
A61K 45/06 (2006.01)	2413936 *	CO-CRYSTAL OF ETRAVIRINE AND NICOTINAMIDE
A61K 47/48 (2006.01)	2413936 *	CO-CRYSTAL OF ETRAVIRINE AND NICOTINAMIDE
C07D 239/46 (2006.01)	2413936 *	CO-CRYSTAL OF ETRAVIRINE AND NICOTINAMIDE
C07K 16/10 (2006.01)	2430047 *	NEUTRALIZING MOLECULES TO INFLUENZA VIRUSES
B24D 3/34 (2006.01)	2470330 *	METHOD OF OBTAINING A TOOL FOR WORKING STONE MATERIALS
B24D 18/00 (2006.01)	2470330 *	METHOD OF OBTAINING A TOOL FOR WORKING STONE MATERIALS
B24B 7/22 (2006.01)	2470330 *	METHOD OF OBTAINING A TOOL FOR WORKING STONE MATERIALS
B24D 7/14 (2006.01)	2470330 *	METHOD OF OBTAINING A TOOL FOR WORKING STONE MATERIALS
E04H 17/14 (2006.01)	2336459	Orientable pickets fence assembly
E04F 11/18 (2006.01)	2336459	Orientable pickets fence assembly
A47K 4/00 (2006.01)	2260749	Modular toilet.
C10M 107/02 (2006.01)	2406355 *	LOW VOC HYDROCARBON DILUENT FOR CONSTRUCTION MATERIALS
C10G 9/00 (2006.01)	2406355 *	LOW VOC HYDROCARBON DILUENT FOR CONSTRUCTION MATERIALS
C08K 5/01 (2006.01)	2406355 *	LOW VOC HYDROCARBON DILUENT FOR CONSTRUCTION MATERIALS
C10G 11/00 (2006.01)	2406355 *	LOW VOC HYDROCARBON DILUENT FOR CONSTRUCTION MATERIALS
C10M 101/02 (2006.01)	2406355 *	LOW VOC HYDROCARBON DILUENT FOR CONSTRUCTION MATERIALS
C09J 183/04 (2006.01)	2406355 *	LOW VOC HYDROCARBON DILUENT FOR CONSTRUCTION MATERIALS
C08K 5/09 (2006.01)	2406355 *	LOW VOC HYDROCARBON DILUENT FOR CONSTRUCTION MATERIALS
C10G 45/58 (2006.01)	2406355 *	LOW VOC HYDROCARBON DILUENT FOR CONSTRUCTION MATERIALS
C08K 5/101 (2006.01)	2406355 *	LOW VOC HYDROCARBON DILUENT FOR CONSTRUCTION MATERIALS
C10G 47/00 (2006.01)	2406355 *	LOW VOC HYDROCARBON DILUENT FOR CONSTRUCTION MATERIALS
C08L 83/04 (2006.01)	2406355 *	LOW VOC HYDROCARBON DILUENT FOR CONSTRUCTION MATERIALS
C09D 7/06 (2006.01)	2406355 *	LOW VOC HYDROCARBON DILUENT FOR CONSTRUCTION MATERIALS
C09D 127/06 (2006.01)	2406355 *	LOW VOC HYDROCARBON DILUENT FOR CONSTRUCTION MATERIALS
G01N 1/31 (2006.01)	2425227 *	SAMPLE PREPARATION DEVICE AND ASSOCIATED METHOD
A61M 5/315 (2006.01)	2437822 *	MEDICAMENT IDENTIFICATION SYSTEM FOR MULTI-DOSE INJECTION DEVICES
A61M 5/00 (2006.01)	2437822 *	MEDICAMENT IDENTIFICATION SYSTEM FOR MULTI-DOSE INJECTION DEVICES
E03C 1/02 (2006.01)	2480362 *	METHOD AND TEMPLATE FOR PRODUCING A TENSILE TEST COUPON
B23B 47/28 (2006.01)	2480362 *	METHOD AND TEMPLATE FOR PRODUCING A TENSILE TEST COUPON
A61K 39/395 (2006.01)	2424566 *	DUAL VARIABLE DOMAIN IMMUNOGLOBULINS AND USES THEREOF
C12P 21/06 (2006.01)	2424566 *	DUAL VARIABLE DOMAIN IMMUNOGLOBULINS AND USES THEREOF
C07D 295/26 (2006.01)	2421838 *	ARYLSULFONAMIDE CCR3 ANTAGONISTS
A61F 13/15 (2006.01)	2238955	Methods and apparatus for application of nested zero waste ear to traveling web
H02B 13/055 (2006.01)	2443712 *	FLUORINATED KETONES AS A HIGH-VOLTAGE INSULATING MEDIUM
F21Y 101/02 (2006.01)	2401543 *	OUTDOOR LIGHTING UNIT

MKP (51)	Broj objave evropske prijava patenta (97)	Naziv pronalaska (54)
F21V 29/00 (2006.01)	2401543 *	OUTDOOR LIGHTING UNIT
F21S 8/08 (2006.01)	2401543 *	OUTDOOR LIGHTING UNIT
F21V 15/01 (2006.01)	2401543 *	OUTDOOR LIGHTING UNIT
A61K 38/17 (2006.01)	2475427 *	ACTRIIB ANTAGONISTS AND DOSING AND USES THEREOF
A61P 21/00 (2006.01)	2475427 *	ACTRIIB ANTAGONISTS AND DOSING AND USES THEREOF
A61P 19/08 (2006.01)	2475427 *	ACTRIIB ANTAGONISTS AND DOSING AND USES THEREOF
A61K 38/18 (2006.01)	2475427 *	ACTRIIB ANTAGONISTS AND DOSING AND USES THEREOF
A61K 31/702 (2006.01)	2405918 *	PREBIOTIC OLIGOSACCHARIDES
A61P 1/06 (2006.01)	2405918 *	PREBIOTIC OLIGOSACCHARIDES
A61P 1/14 (2006.01)	2405918 *	PREBIOTIC OLIGOSACCHARIDES
F04D 29/08 (2006.01)	2486281 *	SUBMERGED CENTRIFUGAL ELECTRIC PUMP
F04D 13/08 (2006.01)	2486281 *	SUBMERGED CENTRIFUGAL ELECTRIC PUMP
F04D 29/62 (2006.01)	2486281 *	SUBMERGED CENTRIFUGAL ELECTRIC PUMP
C07C 279/22 (2006.01)	2477962 *	PRODRUGS OF GUANFACINE
C07D 487/04 (2006.01)	2480552 *	2'-FLUORO SUBSTITUTED CARBA-NUCLEOSIDE ANALOGS FOR ANTIVIRAL TREATMENT
A61M 5/24 (2006.01)	2437813 *	BIASING MECHANISM FOR A CARTRIDGE OF A DRUG DELIVERY SERVICE
F16F 1/02 (2006.01)	2437813 *	BIASING MECHANISM FOR A CARTRIDGE OF A DRUG DELIVERY SERVICE
A61K 31/517 (2006.01)	2416777 *	THERAPEUTIC APPLICATIONS IN THE CARDIOVASCULAR FIELD OF QUINAZOLINEDIONE DERIVATIVES
A61P 9/00 (2006.01)	2416777 *	THERAPEUTIC APPLICATIONS IN THE CARDIOVASCULAR FIELD OF QUINAZOLINEDIONE DERIVATIVES
A61K 9/00 (2006.01)	2416777 *	THERAPEUTIC APPLICATIONS IN THE CARDIOVASCULAR FIELD OF QUINAZOLINEDIONE DERIVATIVES
A61K 31/4985 (2006.01)	2427192 *	USE OF OSI-906 FOR TREATING ADRENOCORTICAL CARCINOMA
A61P 35/00 (2006.01)	2427192 *	USE OF OSI-906 FOR TREATING ADRENOCORTICAL CARCINOMA
C07D 471/04 (2006.01)	2470532 *	1H-PYRAZOLO [3, 4-B]PYRIDINE COMPOUNDS FOR INHIBITING RAF KINASE
A61P 35/00 (2006.01)	2470532 *	1H-PYRAZOLO [3, 4-B]PYRIDINE COMPOUNDS FOR INHIBITING RAF KINASE
A61K 31/437 (2006.01)	2470532 *	1H-PYRAZOLO [3, 4-B]PYRIDINE COMPOUNDS FOR INHIBITING RAF KINASE
A61P 13/12 (2006.01)	2470532 *	1H-PYRAZOLO [3, 4-B]PYRIDINE COMPOUNDS FOR INHIBITING RAF KINASE
A61K 31/519 (2006.01)	2493473 *	DOSING REGIMEN ASSOCIATED WITH LONG-ACTING INJECTABLE PALIPERIDONE ESTERS
A61P 25/18 (2006.01)	2493473 *	DOSING REGIMEN ASSOCIATED WITH LONG-ACTING INJECTABLE PALIPERIDONE ESTERS
B29K 25/00 (2006.01)	2415826 *	EXPANDABLE POLYSTYRENE RESIN PARTICLES AND PROCESS FOR PRODUCING SAME
C08J 9/18 (2006.01)	2415826 *	EXPANDABLE POLYSTYRENE RESIN PARTICLES AND PROCESS FOR PRODUCING SAME
B29C 44/00 (2006.01)	2415826 *	EXPANDABLE POLYSTYRENE RESIN PARTICLES AND PROCESS FOR PRODUCING SAME
C08K 3/36 (2006.01)	2415826 *	EXPANDABLE POLYSTYRENE RESIN PARTICLES AND PROCESS FOR PRODUCING SAME
C08K 5/02 (2006.01)	2415826 *	EXPANDABLE POLYSTYRENE RESIN PARTICLES AND PROCESS FOR PRODUCING SAME
C08L 25/04 (2006.01)	2415826 *	EXPANDABLE POLYSTYRENE RESIN PARTICLES AND PROCESS FOR PRODUCING SAME
C08L 9/00 (2006.01)	2345695	Elastomer-modified thermoplastic compound
C08L 23/10 (2006.01)	2345695	Elastomer-modified thermoplastic compound

MKP (51)	Broj objave evropske prijava patenta (97)	Naziv pronalaska (54)
C12Q 1/68 (2006.01)	2403959 *	BANK1 RELATED SNPS AND SLE AND/OR MS SUSCEPTIBILITY
A61K 36/185 (2006.01)	2453889 *	USE OF PROANTHOCYANIDINS FOR PRODUCTION OF AN ANTIADHESIVE PREPARATION
A61K 36/45 (2006.01)	2453889 *	USE OF PROANTHOCYANIDINS FOR PRODUCTION OF AN ANTIADHESIVE PREPARATION
A61K 31/353 (2006.01)	2453889 *	USE OF PROANTHOCYANIDINS FOR PRODUCTION OF AN ANTIADHESIVE PREPARATION
A61K 31/04 (2006.01)	2453889 *	USE OF PROANTHOCYANIDINS FOR PRODUCTION OF AN ANTIADHESIVE PREPARATION
A61K 31/02 (2006.01)	2453889 *	USE OF PROANTHOCYANIDINS FOR PRODUCTION OF AN ANTIADHESIVE PREPARATION
A61K 36/70 (2006.01)	2453889 *	USE OF PROANTHOCYANIDINS FOR PRODUCTION OF AN ANTIADHESIVE PREPARATION
A61P 1/02 (2006.01)	2453889 *	USE OF PROANTHOCYANIDINS FOR PRODUCTION OF AN ANTIADHESIVE PREPARATION
A61P 25/24 (2006.01)	2453885 *	EXO-S-MECAMYLAMINE METHOD, USE, AND COMPOUND FOR TREATMENT
A61K 31/13 (2006.01)	2453885 *	EXO-S-MECAMYLAMINE METHOD, USE, AND COMPOUND FOR TREATMENT
B65D 75/30 (2006.01)	2475591 *	SOFT-SIDED FLEXIBLE BLISTER PACKAGE
C07K 14/415 (2006.01)	2478006 *	CLONING AND EXPLOITATION OF A FUNCTIONAL R-GENE FROM SOLANUM CHACOENSE
C12N 15/82 (2006.01)	2478006 *	CLONING AND EXPLOITATION OF A FUNCTIONAL R-GENE FROM SOLANUM CHACOENSE
B22C 9/06 (2006.01)	2248615	Temperable tool and method for producing the same, tool holder frame for holding same
B29C 33/38 (2006.01)	2248615	Temperable tool and method for producing the same, tool holder frame for holding same
A61K 31/404 (2006.01)	2459191 *	MTOR INHIBITOR AND ANGIOGENESIS INHIBITOR COMBINATION THERAPY
A61K 31/53 (2006.01)	2459191 *	MTOR INHIBITOR AND ANGIOGENESIS INHIBITOR COMBINATION THERAPY
A61K 39/395 (2006.01)	2459191 *	MTOR INHIBITOR AND ANGIOGENESIS INHIBITOR COMBINATION THERAPY
A61K 39/395 (2006.01)	2403531 *	IL-17 BINDING PROTEINS
C12Q 1/68 (2006.01)	2419737 *	HISTONE MODIFICATION PATTERNS FOR CLINICAL DIAGNOSIS AND PROGNOSIS OF CANCER
G01N 33/15 (2006.01)	2419737 *	HISTONE MODIFICATION PATTERNS FOR CLINICAL DIAGNOSIS AND PROGNOSIS OF CANCER
A61P 35/00 (2006.01)	2419737 *	HISTONE MODIFICATION PATTERNS FOR CLINICAL DIAGNOSIS AND PROGNOSIS OF CANCER
G01N 33/574 (2006.01)	2419737 *	HISTONE MODIFICATION PATTERNS FOR CLINICAL DIAGNOSIS AND PROGNOSIS OF CANCER
C07D 241/06 (2006.01)	2460798 *	APAF-1 INHIBITOR COMPOUNDS
A61K 31/495 (2006.01)	2460798 *	APAF-1 INHIBITOR COMPOUNDS
C12N 1/26 (2006.01)	2470639 *	MICROBIAL ENHANCED OIL RECOVERY METHODS
C12N 9/02 (2006.01)	2470639 *	MICROBIAL ENHANCED OIL RECOVERY METHODS
E21B 43/16 (2006.01)	2470639 *	MICROBIAL ENHANCED OIL RECOVERY METHODS
C09K 8/00 (2006.01)	2470639 *	MICROBIAL ENHANCED OIL RECOVERY METHODS
A61K 31/425 (2006.01)	2485593 *	COMBINATION
A01N 43/78 (2006.01)	2485593 *	COMBINATION
A23G 3/02 (2006.01)	2470029 *	METHOD FOR THE INDUSTRIAL PRODUCTION OF SINGLE SERVING PORTIONS OF ICE CREAM
A23G 3/00 (2006.01)	2470029 *	METHOD FOR THE INDUSTRIAL PRODUCTION OF SINGLE SERVING PORTIONS OF ICE CREAM

MKP (51)	Broj objave evropske prijava patenta (97)	Naziv pronalaska (54)
A23G 9/22 (2006.01)	2470029 *	METHOD FOR THE INDUSTRIAL PRODUCTION OF SINGLE SERVING PORTIONS OF ICE CREAM
F25C 1/22 (2006.01)	2470029 *	METHOD FOR THE INDUSTRIAL PRODUCTION OF SINGLE SERVING PORTIONS OF ICE CREAM
A23G 9/08 (2006.01)	2470029 *	METHOD FOR THE INDUSTRIAL PRODUCTION OF SINGLE SERVING PORTIONS OF ICE CREAM
C07K 16/10 (2006.01)	2473525 *	MONOCLONAL ANTIBODIES AGAINST GLYCOPROTEIN OF EBOLA SUDAN BONIFACE VIRUS
C12N 15/13 (2006.01)	2473525 *	MONOCLONAL ANTIBODIES AGAINST GLYCOPROTEIN OF EBOLA SUDAN BONIFACE VIRUS
A61K 39/42 (2006.01)	2473525 *	MONOCLONAL ANTIBODIES AGAINST GLYCOPROTEIN OF EBOLA SUDAN BONIFACE VIRUS
G01N 33/569 (2006.01)	2473525 *	MONOCLONAL ANTIBODIES AGAINST GLYCOPROTEIN OF EBOLA SUDAN BONIFACE VIRUS
A61K 31/4965 (2006.01)	2429526 *	RANOLAZINE FOR THE TREATMENT OF CNS DISORDERS
A61P 25/06 (2006.01)	2429526 *	RANOLAZINE FOR THE TREATMENT OF CNS DISORDERS
A61P 25/08 (2006.01)	2429526 *	RANOLAZINE FOR THE TREATMENT OF CNS DISORDERS
A61K 9/14 (2006.01)	2449106 *	COMPOSITIONS AND METHODS FOR SILENCING APOLIPOPROTEIN B
C07H 21/02 (2006.01)	2449106 *	COMPOSITIONS AND METHODS FOR SILENCING APOLIPOPROTEIN B
A61K 31/713 (2006.01)	2449106 *	COMPOSITIONS AND METHODS FOR SILENCING APOLIPOPROTEIN B
C07K 14/775 (2006.01)	2449106 *	COMPOSITIONS AND METHODS FOR SILENCING APOLIPOPROTEIN B
A61K 47/22 (2006.01)	2449106 *	COMPOSITIONS AND METHODS FOR SILENCING APOLIPOPROTEIN B
C12N 15/113 (2010.01)	2449106 *	COMPOSITIONS AND METHODS FOR SILENCING APOLIPOPROTEIN B
C07D 487/04 (2006.01)	2496580 *	BENZODIAZEPINE BROMODOMAIN INHIBITOR
A61K 31/55 (2006.01)	2496580 *	BENZODIAZEPINE BROMODOMAIN INHIBITOR
A61P 35/00 (2006.01)	2496580 *	BENZODIAZEPINE BROMODOMAIN INHIBITOR
A61P 43/00 (2006.01)	2496580 *	BENZODIAZEPINE BROMODOMAIN INHIBITOR
A61P 11/06 (2006.01)	2491037 *	COMPOUNDS
A61P 11/00 (2006.01)	2491037 *	COMPOUNDS
C07D 487/04 (2006.01)	2491037 *	COMPOUNDS
A61P 17/00 (2006.01)	2491037 *	COMPOUNDS
A61P 35/00 (2006.01)	2491037 *	COMPOUNDS
A61P 19/02 (2006.01)	2491037 *	COMPOUNDS
A61K 31/519 (2006.01)	2491037 *	COMPOUNDS
G06K 19/06 (2006.01)	2449505 *	CIRCULAR BAR-CODE FOR DRUG CONTAINER
G06K 7/14 (2006.01)	2449505 *	CIRCULAR BAR-CODE FOR DRUG CONTAINER
F16K 15/06 (2006.01)	2309160	Device for metering a cryogenic medium
C07D 403/12 (2006.01)	2443106 *	HETEROCYCLYLAMINOPYRIMIDINES AS KINASE INHIBITORS
C07D 413/12 (2006.01)	2443106 *	HETEROCYCLYLAMINOPYRIMIDINES AS KINASE INHIBITORS
A61K 31/506 (2006.01)	2443106 *	HETEROCYCLYLAMINOPYRIMIDINES AS KINASE INHIBITORS
A61P 37/00 (2006.01)	2443106 *	HETEROCYCLYLAMINOPYRIMIDINES AS KINASE INHIBITORS
A61P 29/00 (2006.01)	2443106 *	HETEROCYCLYLAMINOPYRIMIDINES AS KINASE INHIBITORS
E04C 3/08 (2006.01)	2467545 *	PROFILE ELEMENT AND METHOD FOR MANUFACTURING A PROFILE ELEMENT
E04C 3/09 (2006.01)	2467545 *	PROFILE ELEMENT AND METHOD FOR MANUFACTURING A PROFILE ELEMENT
A61K 35/16 (2006.01)	2416790 *	SPRAY-DRIED BLOOD PRODUCTS AND METHODS OF MAKING SAME
G01N 33/50 (2006.01)	2416790 *	SPRAY-DRIED BLOOD PRODUCTS AND METHODS OF MAKING SAME
F41A 23/24 (2006.01)	2478323 *	MULTI-WEAPONS SYSTEM
F41A 27/28 (2006.01)	2478323 *	MULTI-WEAPONS SYSTEM
B65D 83/00 (2006.01)	2447185	Cylindrical packaging for pasty materials
A61K 47/00 (2006.01)	2403535 *	COMPATIBILIZED ELECTROLYTE FORMULATIONS

MKP (51)	Broj objave evropske prijava patenta (97)	Naziv pronalaska (54)
C25D 5/00 (2006.01)	2403535 *	COMPATIBILIZED ELECTROLYTE FORMULATIONS
C12N 15/11 (2006.01)	2451835 *	VARIANTS OF PLASMINOGEN AND PLASMIN
C12N 9/68 (2006.01)	2451835 *	VARIANTS OF PLASMINOGEN AND PLASMIN
C07K 14/47 (2006.01)	2451835 *	VARIANTS OF PLASMINOGEN AND PLASMIN
A61K 38/48 (2006.01)	2451835 *	VARIANTS OF PLASMINOGEN AND PLASMIN
B65G 1/04 (2006.01)	2403780 *	ARRANGEMENT FOR STORAGE, WAREHOUSE RACK AND HANDLING MACHINE PARTICULARLY FOR SUCH ARRANGEMENT
C07K 19/00 (2006.01)	2448593 *	HIV RELATED PEPTIDES COMBINATION OR FUSION FOR USE IN HIV VACCINE COMPOSITION OR AS DIAGNOSTIC MEANS
A61K 39/00 (2006.01)	2448593 *	HIV RELATED PEPTIDES COMBINATION OR FUSION FOR USE IN HIV VACCINE COMPOSITION OR AS DIAGNOSTIC MEANS
A61K 39/395 (2006.01)	2448593 *	HIV RELATED PEPTIDES COMBINATION OR FUSION FOR USE IN HIV VACCINE COMPOSITION OR AS DIAGNOSTIC MEANS
C07K 16/10 (2006.01)	2448593 *	HIV RELATED PEPTIDES COMBINATION OR FUSION FOR USE IN HIV VACCINE COMPOSITION OR AS DIAGNOSTIC MEANS
A61K 38/16 (2006.01)	2448593 *	HIV RELATED PEPTIDES COMBINATION OR FUSION FOR USE IN HIV VACCINE COMPOSITION OR AS DIAGNOSTIC MEANS
A61K 39/42 (2006.01)	2448593 *	HIV RELATED PEPTIDES COMBINATION OR FUSION FOR USE IN HIV VACCINE COMPOSITION OR AS DIAGNOSTIC MEANS
A61K 39/21 (2006.01)	2448593 *	HIV RELATED PEPTIDES COMBINATION OR FUSION FOR USE IN HIV VACCINE COMPOSITION OR AS DIAGNOSTIC MEANS
F25D 31/00 (2006.01)	2467660 *	TEMPERATURE CONTROL SYSTEM FOR A LIQUID
C07D 211/46 (2006.01)	2419409 *	PROCESS FOR THE PREPARATION OF A BIPHENYL-2-YLCARBAMIC ACID ESTER
C07C 233/33 (2006.01)	2419409 *	PROCESS FOR THE PREPARATION OF A BIPHENYL-2-YLCARBAMIC ACID ESTER
B32B 3/12 (2006.01)	2421695 *	SMART ENZYME-CONTAINING CATALYTIC PEELABLE COATINGS
A61F 5/56 (2006.01)	2437694 *	APPARATUSES AND METHODS FOR MANDIBULAR PROTRUSION
F02M 63/00 (2006.01)	2409016 *	ACTUATOR ARRANGEMENT
C08F 10/00 (2006.01)	2411424 *	CATALYSTS, PROCESSES FOR MAKING CATALYSTS, PROCESSES FOR MAKING POLYOLEFIN COMPOSITIONS AND POLYOLEFIN COMPOSITIONS
A61K 31/454 (2006.01)	2417120 *	SUBSTITUTED PIPERIDINES AS CCR3 ANTAGONISTS
A61P 31/00 (2006.01)	2417120 *	SUBSTITUTED PIPERIDINES AS CCR3 ANTAGONISTS
C07D 401/04 (2006.01)	2417120 *	SUBSTITUTED PIPERIDINES AS CCR3 ANTAGONISTS
A61P 35/00 (2006.01)	2417120 *	SUBSTITUTED PIPERIDINES AS CCR3 ANTAGONISTS
C07D 401/14 (2006.01)	2417120 *	SUBSTITUTED PIPERIDINES AS CCR3 ANTAGONISTS
A61P 37/00 (2006.01)	2417120 *	SUBSTITUTED PIPERIDINES AS CCR3 ANTAGONISTS
C07D 413/04 (2006.01)	2417120 *	SUBSTITUTED PIPERIDINES AS CCR3 ANTAGONISTS
C07D 413/14 (2006.01)	2417120 *	SUBSTITUTED PIPERIDINES AS CCR3 ANTAGONISTS
C07D 417/14 (2006.01)	2417120 *	SUBSTITUTED PIPERIDINES AS CCR3 ANTAGONISTS
A61K 31/4523 (2006.01)	2417120 *	SUBSTITUTED PIPERIDINES AS CCR3 ANTAGONISTS
A61K 9/20 (2006.01)	2482806 *	PHARMACEUTICAL COMPOSITION, PHARMACEUTICAL DOSAGE FORM, PROCESS FOR THEIR PREPARATION, METHODS FOR TREATING AND USES THEREOF
A61K 45/06 (2006.01)	2482806 *	PHARMACEUTICAL COMPOSITION, PHARMACEUTICAL DOSAGE FORM, PROCESS FOR THEIR PREPARATION, METHODS FOR TREATING AND USES THEREOF
A61K 31/155 (2006.01)	2482806 *	PHARMACEUTICAL COMPOSITION, PHARMACEUTICAL DOSAGE FORM, PROCESS FOR THEIR PREPARATION, METHODS FOR TREATING AND USES THEREOF
C12N 15/09 (2006.01)	2431466 *	SINGLE-STRAND NUCLEIC ACID MOLECULE FOR CONTROLLING GENE EXPRESSION
A61K 48/00 (2006.01)	2431466 *	SINGLE-STRAND NUCLEIC ACID MOLECULE FOR CONTROLLING GENE EXPRESSION

MKP (51)	Broj objave evropske prijave patenta (97)	Naziv pronalaska (54)
C12N 15/113 (2010.01)	2431466 *	SINGLE-STRAND NUCLEIC ACID MOLECULE FOR CONTROLLING GENE EXPRESSION
A61P 29/00 (2006.01)	2431466 *	SINGLE-STRAND NUCLEIC ACID MOLECULE FOR CONTROLLING GENE EXPRESSION
A61K 39/395 (2006.01)	2488201 *	IL-1 BINDING PROTEINS
G01N 33/53 (2006.01)	2488201 *	IL-1 BINDING PROTEINS
H01L 51/50 (2006.01)	2455786 *	DIFFRACTION GRATING, ORGANIC EL ELEMENT USING SAME, AND METHOD FOR MANUFACTURING SAID DIFFRACTION GRATING AND ORGANIC EL ELEMENT
H05B 33/02 (2006.01)	2455786 *	DIFFRACTION GRATING, ORGANIC EL ELEMENT USING SAME, AND METHOD FOR MANUFACTURING SAID DIFFRACTION GRATING AND ORGANIC EL ELEMENT
G02B 5/18 (2006.01)	2455786 *	DIFFRACTION GRATING, ORGANIC EL ELEMENT USING SAME, AND METHOD FOR MANUFACTURING SAID DIFFRACTION GRATING AND ORGANIC EL ELEMENT
G02C 3/00 (2006.01)	2460046 *	EXPANDABLE EYEWEAR WITH SNAP-TOGETHER BRIDGE
C07D 487/04 (2006.01)	2491039 *	HETEROCYCLYL PYRAZOLOPYRIMIDINE ANALOGUES AS JAK INHIBITORS
A61K 31/505 (2006.01)	2491039 *	HETEROCYCLYL PYRAZOLOPYRIMIDINE ANALOGUES AS JAK INHIBITORS
A61P 37/00 (2006.01)	2491039 *	HETEROCYCLYL PYRAZOLOPYRIMIDINE ANALOGUES AS JAK INHIBITORS
A61P 35/00 (2006.01)	2491039 *	HETEROCYCLYL PYRAZOLOPYRIMIDINE ANALOGUES AS JAK INHIBITORS
C07D 401/14 (2006.01)	2421846 *	5-ALKYNYL-PYRIDINES
C07D 401/06 (2006.01)	2421846 *	5-ALKYNYL-PYRIDINES
A61P 31/00 (2006.01)	2421846 *	5-ALKYNYL-PYRIDINES
A61K 31/496 (2006.01)	2421846 *	5-ALKYNYL-PYRIDINES
A61P 37/00 (2006.01)	2421846 *	5-ALKYNYL-PYRIDINES
A61P 29/00 (2006.01)	2421846 *	5-ALKYNYL-PYRIDINES
A61K 31/444 (2006.01)	2421846 *	5-ALKYNYL-PYRIDINES
A61K 31/5377 (2006.01)	2421846 *	5-ALKYNYL-PYRIDINES
A61P 35/00 (2006.01)	2421846 *	5-ALKYNYL-PYRIDINES
A61K 39/395 (2006.01)	2477655 *	VACCINES DIRECTED TO LANGERHANS CELLS
A61K 38/16 (2006.01)	2477655 *	VACCINES DIRECTED TO LANGERHANS CELLS
A61K 38/17 (2006.01)	2477655 *	VACCINES DIRECTED TO LANGERHANS CELLS
A61P 35/00 (2006.01)	2477655 *	VACCINES DIRECTED TO LANGERHANS CELLS
A61P 25/00 (2006.01)	2477655 *	VACCINES DIRECTED TO LANGERHANS CELLS
C07D 213/02 (2006.01)	2424841 *	PYRIDINONE ANTAGONISTS OF ALPHA-4 INTEGRINS
C07D 401/12 (2006.01)	2424841 *	PYRIDINONE ANTAGONISTS OF ALPHA-4 INTEGRINS
A61K 31/4412 (2006.01)	2424841 *	PYRIDINONE ANTAGONISTS OF ALPHA-4 INTEGRINS
A61P 37/00 (2006.01)	2424841 *	PYRIDINONE ANTAGONISTS OF ALPHA-4 INTEGRINS
B65B 31/06 (2006.01)	2497558 *	UNIVERSAL DEVICE FOR TREATING AND PURIFYING A LIQUID PRODUCT CONTAINED IN A RESILIENT DEFORMABLE CONTAINER AND FOR PREPARING A NEW PRODUCT THAT DIFFERS FROM THE ORIGINAL
B65D 1/02 (2006.01)	2497558 *	UNIVERSAL DEVICE FOR TREATING AND PURIFYING A LIQUID PRODUCT CONTAINED IN A RESILIENT DEFORMABLE CONTAINER AND FOR PREPARING A NEW PRODUCT THAT DIFFERS FROM THE ORIGINAL
C12H 1/07 (2006.01)	2497558 *	UNIVERSAL DEVICE FOR TREATING AND PURIFYING A LIQUID PRODUCT CONTAINED IN A RESILIENT DEFORMABLE CONTAINER AND FOR PREPARING A NEW PRODUCT THAT DIFFERS FROM THE ORIGINAL
B01D 35/00 (2006.01)	2497558 *	UNIVERSAL DEVICE FOR TREATING AND PURIFYING A LIQUID PRODUCT CONTAINED IN A RESILIENT DEFORMABLE CONTAINER AND FOR PREPARING A NEW PRODUCT THAT DIFFERS FROM THE ORIGINAL

MKP (51)	Broj objave evropske prijava patenta (97)	Naziv pronalaska (54)
A61P 3/06 (2006.01)	2483298 *	USE OF SIRNA TARGETTING SIPA1L1 FOR THE REDUCTION OF ADIPOGENESIS
C12N 15/113 (2010.01)	2483298 *	USE OF SIRNA TARGETTING SIPA1L1 FOR THE REDUCTION OF ADIPOGENESIS
C07K 14/47 (2006.01)	2483298 *	USE OF SIRNA TARGETTING SIPA1L1 FOR THE REDUCTION OF ADIPOGENESIS
A61P 7/00 (2006.01)	2464667 *	N-ACYLATED OCTASACCHARIDES ACTIVATING FGFS RECEPTORS, THEIR SYNTHESIS AND THEIR THERAPEUTICAL APPLICATION
A61P 37/00 (2006.01)	2464667 *	N-ACYLATED OCTASACCHARIDES ACTIVATING FGFS RECEPTORS, THEIR SYNTHESIS AND THEIR THERAPEUTICAL APPLICATION
A61P 9/00 (2006.01)	2464667 *	N-ACYLATED OCTASACCHARIDES ACTIVATING FGFS RECEPTORS, THEIR SYNTHESIS AND THEIR THERAPEUTICAL APPLICATION
A61P 11/00 (2006.01)	2464667 *	N-ACYLATED OCTASACCHARIDES ACTIVATING FGFS RECEPTORS, THEIR SYNTHESIS AND THEIR THERAPEUTICAL APPLICATION
A61P 17/00 (2006.01)	2464667 *	N-ACYLATED OCTASACCHARIDES ACTIVATING FGFS RECEPTORS, THEIR SYNTHESIS AND THEIR THERAPEUTICAL APPLICATION
A61K 31/737 (2006.01)	2464667 *	N-ACYLATED OCTASACCHARIDES ACTIVATING FGFS RECEPTORS, THEIR SYNTHESIS AND THEIR THERAPEUTICAL APPLICATION
A61P 27/02 (2006.01)	2464667 *	N-ACYLATED OCTASACCHARIDES ACTIVATING FGFS RECEPTORS, THEIR SYNTHESIS AND THEIR THERAPEUTICAL APPLICATION
A61P 19/00 (2006.01)	2464667 *	N-ACYLATED OCTASACCHARIDES ACTIVATING FGFS RECEPTORS, THEIR SYNTHESIS AND THEIR THERAPEUTICAL APPLICATION
A61P 21/00 (2006.01)	2464667 *	N-ACYLATED OCTASACCHARIDES ACTIVATING FGFS RECEPTORS, THEIR SYNTHESIS AND THEIR THERAPEUTICAL APPLICATION
C08B 37/00 (2006.01)	2464667 *	N-ACYLATED OCTASACCHARIDES ACTIVATING FGFS RECEPTORS, THEIR SYNTHESIS AND THEIR THERAPEUTICAL APPLICATION
A61P 25/00 (2006.01)	2464667 *	N-ACYLATED OCTASACCHARIDES ACTIVATING FGFS RECEPTORS, THEIR SYNTHESIS AND THEIR THERAPEUTICAL APPLICATION
C07K 16/46 (2006.01)	2494037 *	CLONAL EXPANSION OF B CELLS
C07K 14/705 (2006.01)	2494037 *	CLONAL EXPANSION OF B CELLS
C07K 16/00 (2006.01)	2494037 *	CLONAL EXPANSION OF B CELLS
C12N 5/0781 (2010.01)	2494037 *	CLONAL EXPANSION OF B CELLS
C12N 15/62 (2006.01)	2494037 *	CLONAL EXPANSION OF B CELLS
A61K 39/085 (2006.01)	2461824 *	IMMUNOGENIC COMPOSITION COMPRISING ANTIGENIC S. AUREUS PROTEINS
A61K 39/116 (2006.01)	2461824 *	IMMUNOGENIC COMPOSITION COMPRISING ANTIGENIC S. AUREUS PROTEINS
C12N 15/62 (2006.01)	2461824 *	IMMUNOGENIC COMPOSITION COMPRISING ANTIGENIC S. AUREUS PROTEINS
A61K 31/015 (2006.01)	2478362 *	USE OF THE SPARC MICROENVIRONMENT SIGNATURE IN THE TREATMENT OF CANCER
G01N 33/53 (2006.01)	2478362 *	USE OF THE SPARC MICROENVIRONMENT SIGNATURE IN THE TREATMENT OF CANCER
B32B 3/10 (2006.01)	2498985 *	A PACKAGE FOR PAPER SHEETS
A61P 19/02 (2006.01)	2445900 *	POLYCYCLIC DERIVATIVES OF PYRIDINE AND THEIR USE IN THE TREATMENT OF (INTER ALIA) RHEUMATOID ARTHRITIS AND SIMILAR DISEASES
C07D 471/04 (2006.01)	2445900 *	POLYCYCLIC DERIVATIVES OF PYRIDINE AND THEIR USE IN THE TREATMENT OF (INTER ALIA) RHEUMATOID ARTHRITIS AND SIMILAR DISEASES
C07D 487/04 (2006.01)	2445900 *	POLYCYCLIC DERIVATIVES OF PYRIDINE AND THEIR USE IN THE TREATMENT OF (INTER ALIA) RHEUMATOID ARTHRITIS AND SIMILAR DISEASES
A61K 31/444 (2006.01)	2445900 *	POLYCYCLIC DERIVATIVES OF PYRIDINE AND THEIR USE IN THE TREATMENT OF (INTER ALIA) RHEUMATOID ARTHRITIS AND SIMILAR DISEASES

MKP (51)	Broj objave evropske prijava patenta (97)	Naziv pronalaska (54)
C07D 401/12 (2006.01)	2445900 *	POLYCYCLIC DERIVATIVES OF PYRIDINE AND THEIR USE IN THE TREATMENT OF (INTER ALIA) RHEUMATOID ARTHRITIS AND SIMILAR DISEASES
A61K 31/4375 (2006.01)	2445900 *	POLYCYCLIC DERIVATIVES OF PYRIDINE AND THEIR USE IN THE TREATMENT OF (INTER ALIA) RHEUMATOID ARTHRITIS AND SIMILAR DISEASES
C07D 401/14 (2006.01)	2445900 *	POLYCYCLIC DERIVATIVES OF PYRIDINE AND THEIR USE IN THE TREATMENT OF (INTER ALIA) RHEUMATOID ARTHRITIS AND SIMILAR DISEASES
G06F 21/00 (2006.01)	2410452	Protection against malware on web resources
E21B 7/20 (2006.01)	2378055	A method for the reconstruction of wells through the removal of the old casing by using a single reverse-circulation perforation and relative device
E21B 7/28 (2006.01)	2378055	A method for the reconstruction of wells through the removal of the old casing by using a single reverse-circulation perforation and relative device
E21B 10/02 (2006.01)	2378055	A method for the reconstruction of wells through the removal of the old casing by using a single reverse-circulation perforation and relative device
H02M 3/335 (2006.01)	2429071 *	AUTONOMOUS ELECTRICAL POWER SUPPLY SOURCE WITH A RECHARGING FUNCTION USING ONE RECHARGEABLE BATTERY
C07D 417/12 (2006.01)	2451794 *	1,2,4-THIAZOLIDIN-3-ONE DERIVATIVES AND THEIR USE IN THE TREATMENT OF CANCER
C07D 417/10 (2006.01)	2451794 *	1,2,4-THIAZOLIDIN-3-ONE DERIVATIVES AND THEIR USE IN THE TREATMENT OF CANCER
C07D 285/08 (2006.01)	2451794 *	1,2,4-THIAZOLIDIN-3-ONE DERIVATIVES AND THEIR USE IN THE TREATMENT OF CANCER
A61K 31/433 (2006.01)	2451794 *	1,2,4-THIAZOLIDIN-3-ONE DERIVATIVES AND THEIR USE IN THE TREATMENT OF CANCER
C10G 2/00 (2006.01)	2479241 *	METHOD FOR PRODUCING HYDROCARBON OIL AND SYNTHETIC REACTION SYSTEM
C09D 4/06 (2006.01)	2475725 *	REMOVABLE COLOR GEL BASECOAT FOR ARTIFICIAL NAIL COATINGS AND METHODS THEREFORE
A61Q 3/02 (2006.01)	2475725 *	REMOVABLE COLOR GEL BASECOAT FOR ARTIFICIAL NAIL COATINGS AND METHODS THEREFORE
B28B 3/20 (2006.01)	2429788 *	METHOD AND PLANT FOR PRODUCING A CONCRETE BODY
B28B 11/08 (2006.01)	2429788 *	METHOD AND PLANT FOR PRODUCING A CONCRETE BODY
A61K 31/38 (2006.01)	2470538 *	RAF INHIBITOR COMPOUNDS AND METHODS OF USE THEREOF
C07D 487/04 (2006.01)	2470538 *	RAF INHIBITOR COMPOUNDS AND METHODS OF USE THEREOF
C07D 495/04 (2006.01)	2470538 *	RAF INHIBITOR COMPOUNDS AND METHODS OF USE THEREOF
C07D 513/04 (2006.01)	2470538 *	RAF INHIBITOR COMPOUNDS AND METHODS OF USE THEREOF
A61P 35/00 (2006.01)	2470538 *	RAF INHIBITOR COMPOUNDS AND METHODS OF USE THEREOF
C07D 487/04 (2006.01)	2438070 *	GLYCINE B ANTAGONISTS
A61P 25/00 (2006.01)	2438070 *	GLYCINE B ANTAGONISTS
A61K 31/519 (2006.01)	2438070 *	GLYCINE B ANTAGONISTS
A61M 5/31 (2006.01)	2437812 *	DOSE SETTING MECHANISM FOR PRIMING A DRUG DELIVERY DEVICE
A61M 5/24 (2006.01)	2437812 *	DOSE SETTING MECHANISM FOR PRIMING A DRUG DELIVERY DEVICE
A61M 5/315 (2006.01)	2437812 *	DOSE SETTING MECHANISM FOR PRIMING A DRUG DELIVERY DEVICE
A61M 5/00 (2006.01)	2437812 *	DOSE SETTING MECHANISM FOR PRIMING A DRUG DELIVERY DEVICE
A63C 9/00 (2006.01)	2349509 *	BINDING FOR SNOWBOARD AND OTHER BOARD SPORTS
C07D 401/12 (2006.01)	2411368 *	NICOTINAMIDE DERIVATIVES, PREPARATION THEREOF, AND THERAPEUTIC USE THEREOF AS ANTICANCER DRUGS
C07D 401/14 (2006.01)	2411368 *	NICOTINAMIDE DERIVATIVES, PREPARATION THEREOF, AND THERAPEUTIC USE THEREOF AS ANTICANCER DRUGS
C07D 401/02 (2006.01)	2411368 *	NICOTINAMIDE DERIVATIVES, PREPARATION THEREOF, AND THERAPEUTIC USE THEREOF AS ANTICANCER DRUGS
A61K 31/444 (2006.01)	2411368 *	NICOTINAMIDE DERIVATIVES, PREPARATION THEREOF, AND THERAPEUTIC USE THEREOF AS ANTICANCER DRUGS

MKP (51)	Broj objave evropske prijave patenta (97)	Naziv pronalaska (54)
A61P 35/00 (2006.01)	2411368 *	NICOTINAMIDE DERIVATIVES, PREPARATION THEREOF, AND THERAPEUTIC USE THEREOF AS ANTICANCER DRUGS
C07D 213/79 (2006.01)	2411368 *	NICOTINAMIDE DERIVATIVES, PREPARATION THEREOF, AND THERAPEUTIC USE THEREOF AS ANTICANCER DRUGS
C07D 213/82 (2006.01)	2411368 *	NICOTINAMIDE DERIVATIVES, PREPARATION THEREOF, AND THERAPEUTIC USE THEREOF AS ANTICANCER DRUGS
A01N 57/00 (2006.01)	2473056 *	CHEMICAL COMPOUNDS
C07C 403/00 (2006.01)	2473056 *	CHEMICAL COMPOUNDS
A61K 31/506 (2006.01)	2474543 *	THERAPEUTIC AGENT FOR MOOD DISORDERS
A61K 31/5377 (2006.01)	2474543 *	THERAPEUTIC AGENT FOR MOOD DISORDERS
A61K 31/4439 (2006.01)	2474543 *	THERAPEUTIC AGENT FOR MOOD DISORDERS
A61K 31/426 (2006.01)	2474543 *	THERAPEUTIC AGENT FOR MOOD DISORDERS
A61P 25/24 (2006.01)	2474543 *	THERAPEUTIC AGENT FOR MOOD DISORDERS
C07D 491/052 (2006.01)	2474543 *	THERAPEUTIC AGENT FOR MOOD DISORDERS
C07D 417/14 (2006.01)	2474543 *	THERAPEUTIC AGENT FOR MOOD DISORDERS
C07D 495/04 (2006.01)	2474543 *	THERAPEUTIC AGENT FOR MOOD DISORDERS
C07D 491/048 (2006.01)	2474543 *	THERAPEUTIC AGENT FOR MOOD DISORDERS
A61K 31/4709 (2006.01)	2433938 *	THERAPEUTIC AGENT FOR MOTOR DISORDERS
C07D 495/04 (2006.01)	2433938 *	THERAPEUTIC AGENT FOR MOTOR DISORDERS
A61K 31/506 (2006.01)	2433938 *	THERAPEUTIC AGENT FOR MOTOR DISORDERS
C07D 417/14 (2006.01)	2433938 *	THERAPEUTIC AGENT FOR MOTOR DISORDERS
A61K 31/5377 (2006.01)	2433938 *	THERAPEUTIC AGENT FOR MOTOR DISORDERS
A61K 31/435 (2006.01)	2433938 *	THERAPEUTIC AGENT FOR MOTOR DISORDERS
A61P 25/14 (2006.01)	2433938 *	THERAPEUTIC AGENT FOR MOTOR DISORDERS
A61K 31/4355 (2006.01)	2433938 *	THERAPEUTIC AGENT FOR MOTOR DISORDERS
A61P 25/16 (2006.01)	2433938 *	THERAPEUTIC AGENT FOR MOTOR DISORDERS
A61K 31/4365 (2006.01)	2433938 *	THERAPEUTIC AGENT FOR MOTOR DISORDERS
C07D 491/048 (2006.01)	2433938 *	THERAPEUTIC AGENT FOR MOTOR DISORDERS
A61K 31/436 (2006.01)	2433938 *	THERAPEUTIC AGENT FOR MOTOR DISORDERS
A61P 43/00 (2006.01)	2433938 *	THERAPEUTIC AGENT FOR MOTOR DISORDERS
A61K 31/4439 (2006.01)	2433938 *	THERAPEUTIC AGENT FOR MOTOR DISORDERS
C07D 491/052 (2006.01)	2433938 *	THERAPEUTIC AGENT FOR MOTOR DISORDERS
B65G 47/84 (2006.01)	2382146 *	A CONVEYOR FOR CONTAINERS, SUCH AS BOTTLES, TO BE PROCESSED AND FOR PROCESSED CONTAINERS FOR OPERATING MACHINES OF THE TYPE WITH A ROTARY CARROUSEL
C07C 205/02 (2006.01)	2490998 *	PROCESS FOR DOWNSTREAM RECOVERY OF NITROALKANE USING DIVIDING WALL COLUMN
C07C 201/08 (2006.01)	2490998 *	PROCESS FOR DOWNSTREAM RECOVERY OF NITROALKANE USING DIVIDING WALL COLUMN
C07D 403/02 (2006.01)	2480235 *	NOVEL IODO PYRIMIDINE DERIVATIVES USEFUL FOR THE TREATMENT OF MACROPHAGE MIGRATION INHIBITORY FACTOR (MIF)-IMPLICATED DISEASES AND CONDITIONS
A61K 31/506 (2006.01)	2480235 *	NOVEL IODO PYRIMIDINE DERIVATIVES USEFUL FOR THE TREATMENT OF MACROPHAGE MIGRATION INHIBITORY FACTOR (MIF)-IMPLICATED DISEASES AND CONDITIONS
C12P 21/08 (2006.01)	2499256 *	ANTI-C-MPL ANTIBODIES
C07K 16/28 (2006.01)	2499256 *	ANTI-C-MPL ANTIBODIES
H02G 3/14 (2006.01)	2438664 *	ELECTRICAL INSTALLATION UNIT
H01H 3/12 (2006.01)	2438664 *	ELECTRICAL INSTALLATION UNIT
C07D 239/34 (2006.01)	2464634 *	REGIOSELECTIVE PREPARATION OF 2 -AMINO-5-TRIFLUOROMETHYLPYRIMIDINE DERIVATIVES
C07D 239/47 (2006.01)	2464634 *	REGIOSELECTIVE PREPARATION OF 2 -AMINO-5-TRIFLUOROMETHYLPYRIMIDINE DERIVATIVES

MKP (51)	Broj objave evropske prijava patenta (97)	Naziv pronalaska (54)
C07D 401/12 (2006.01)	2464634 *	REGIOSELECTIVE PREPARATION OF 2 -AMINO-5-TRIFLUOROMETHYLPYRIMIDINE DERIVATIVES
A61K 31/438 (2006.01)	2499139 *	N1-PYRAZOLOSPIROKETONE ACETYL-COA CARBOXYLASE INHIBITORS
A61P 1/16 (2006.01)	2499139 *	N1-PYRAZOLOSPIROKETONE ACETYL-COA CARBOXYLASE INHIBITORS
A61P 3/10 (2006.01)	2499139 *	N1-PYRAZOLOSPIROKETONE ACETYL-COA CARBOXYLASE INHIBITORS
C07D 471/10 (2006.01)	2499139 *	N1-PYRAZOLOSPIROKETONE ACETYL-COA CARBOXYLASE INHIBITORS
A01N 57/20 (2006.01)	2403343 *	HERBICIDAL FORMULATIONS
A01N 41/06 (2006.01)	2403343 *	HERBICIDAL FORMULATIONS
A01P 13/00 (2006.01)	2403343 *	HERBICIDAL FORMULATIONS
C12Q 1/68 (2006.01)	2443253 *	STEM ACCELERATED ISOTHERMAL NUCLEIC ACID AMPLIFICATION TECHNOLOGY
F02B 33/30 (2006.01)	2300699 *	PART-LOAD CONTROL IN A SPLIT-CYCLE ENGINE
C07K 16/40 (2006.01)	2403880 *	MATRIX METALLOPROTEINASE-7 (MMP-7) MONOCLONAL ANTIBODIES AND METHODS FOR THEIR USE IN THE DETECTION OF OVARIAN CANCER
C07D 471/04 (2006.01)	2419427 *	BICYCLIC HETEROCYCLYL DERIVATIVES AS FGFR KINASE INHIBITORS FOR THERAPEUTIC USE
A61P 35/00 (2006.01)	2419427 *	BICYCLIC HETEROCYCLYL DERIVATIVES AS FGFR KINASE INHIBITORS FOR THERAPEUTIC USE
A61K 31/437 (2006.01)	2419427 *	BICYCLIC HETEROCYCLYL DERIVATIVES AS FGFR KINASE INHIBITORS FOR THERAPEUTIC USE
A61P 13/00 (2006.01)	2490700 *	A SKIN EXTERNAL COMPOSITION COMPRISING A SALT AND SUGAR AS ACTIVE INGREDIENTS FOR PREVENTING AND TREATING VAGINOSIS AND THE USE THEREOF
A61K 33/14 (2006.01)	2490700 *	A SKIN EXTERNAL COMPOSITION COMPRISING A SALT AND SUGAR AS ACTIVE INGREDIENTS FOR PREVENTING AND TREATING VAGINOSIS AND THE USE THEREOF
A61K 9/06 (2006.01)	2490700 *	A SKIN EXTERNAL COMPOSITION COMPRISING A SALT AND SUGAR AS ACTIVE INGREDIENTS FOR PREVENTING AND TREATING VAGINOSIS AND THE USE THEREOF
A61P 15/02 (2006.01)	2490700 *	A SKIN EXTERNAL COMPOSITION COMPRISING A SALT AND SUGAR AS ACTIVE INGREDIENTS FOR PREVENTING AND TREATING VAGINOSIS AND THE USE THEREOF
C11D 3/20 (2006.01)	2490700 *	A SKIN EXTERNAL COMPOSITION COMPRISING A SALT AND SUGAR AS ACTIVE INGREDIENTS FOR PREVENTING AND TREATING VAGINOSIS AND THE USE THEREOF
C07C 231/24 (2006.01)	2491006 *	PROCESS FOR PREPARING A PHENYLALANINE DERIVATIVE
C07C 231/12 (2006.01)	2491006 *	PROCESS FOR PREPARING A PHENYLALANINE DERIVATIVE
C07C 233/87 (2006.01)	2491006 *	PROCESS FOR PREPARING A PHENYLALANINE DERIVATIVE
A61K 31/4468 (2006.01)	2457570 *	FENTANYL-CONTAINING ADHESIVE PREPARATION FOR EXTERNAL USE
A61K 9/70 (2006.01)	2457570 *	FENTANYL-CONTAINING ADHESIVE PREPARATION FOR EXTERNAL USE
A61K 47/06 (2006.01)	2457570 *	FENTANYL-CONTAINING ADHESIVE PREPARATION FOR EXTERNAL USE
A61K 47/14 (2006.01)	2457570 *	FENTANYL-CONTAINING ADHESIVE PREPARATION FOR EXTERNAL USE
A61K 47/32 (2006.01)	2457570 *	FENTANYL-CONTAINING ADHESIVE PREPARATION FOR EXTERNAL USE
C10G 1/04 (2006.01)	2470620 *	SYSTEMS, METHODS AND COMPOSITIONS FOR THE SEPARATION AND RECOVERY OF HYDROCARBONS FROM PARTICULATE MATTER
C10G 1/00 (2006.01)	2470620 *	SYSTEMS, METHODS AND COMPOSITIONS FOR THE SEPARATION AND RECOVERY OF HYDROCARBONS FROM PARTICULATE MATTER
A61B 17/34 (2006.01)	2424606 *	INJECTION CATHETER FOR DELIVERING A THERAPEUTIC AGENT INTO A SUBSTRATE
A61M 25/00 (2006.01)	2424606 *	INJECTION CATHETER FOR DELIVERING A THERAPEUTIC AGENT INTO A SUBSTRATE
C07K 1/18 (2006.01)	2445924 *	CAPTURE PURIFICATION PROCESSES FOR PROTEINS EXPRESSED IN A NON-MAMMALIAN SYSTEM
C07K 1/22 (2006.01)	2445924 *	CAPTURE PURIFICATION PROCESSES FOR PROTEINS EXPRESSED IN A NON-MAMMALIAN SYSTEM

MKP (51)	Broj objave evropske prijava patenta (97)	Naziv pronalaska (54)
C07K 1/32 (2006.01)	2445924 *	CAPTURE PURIFICATION PROCESSES FOR PROTEINS EXPRESSED IN A NON-MAMMALIAN SYSTEM
C07C 309/82 (2006.01)	2462111 *	PREPARATION OF (R)- AND (S)-N-(3, 4-DIFLUORO-2-(2-FLUORO-4-IODOPHENYLAMINO)--6-METHOXYPHENYL) -1- (2, 3-DIHYDROXYPROPYL)CYCLOPROPANE-1-SULFONAMIDE AND PROTECTED DERIVATIVES THEREOF
C07C 309/85 (2006.01)	2462111 *	PREPARATION OF (R)- AND (S)-N-(3, 4-DIFLUORO-2-(2-FLUORO-4-IODOPHENYLAMINO)--6-METHOXYPHENYL) -1- (2, 3-DIHYDROXYPROPYL)CYCLOPROPANE-1-SULFONAMIDE AND PROTECTED DERIVATIVES THEREOF
C07C 311/28 (2006.01)	2462111 *	PREPARATION OF (R)- AND (S)-N-(3, 4-DIFLUORO-2-(2-FLUORO-4-IODOPHENYLAMINO)--6-METHOXYPHENYL) -1- (2, 3-DIHYDROXYPROPYL)CYCLOPROPANE-1-SULFONAMIDE AND PROTECTED DERIVATIVES THEREOF
C07C 303/40 (2006.01)	2462111 *	PREPARATION OF (R)- AND (S)-N-(3, 4-DIFLUORO-2-(2-FLUORO-4-IODOPHENYLAMINO)--6-METHOXYPHENYL) -1- (2, 3-DIHYDROXYPROPYL)CYCLOPROPANE-1-SULFONAMIDE AND PROTECTED DERIVATIVES THEREOF
C07C 303/38 (2006.01)	2462111 *	PREPARATION OF (R)- AND (S)-N-(3, 4-DIFLUORO-2-(2-FLUORO-4-IODOPHENYLAMINO)--6-METHOXYPHENYL) -1- (2, 3-DIHYDROXYPROPYL)CYCLOPROPANE-1-SULFONAMIDE AND PROTECTED DERIVATIVES THEREOF
F03B 13/12 (2006.01)	2440775 *	WAVE ENERGY ELECTRICAL POWER GENERATION
C12N 15/11 (2006.01)	2421971 *	OLIGONUCLEOTIDE COMPRISING AN INOSINE FOR TREATING DMD
C12N 15/113 (2010.01)	2421971 *	OLIGONUCLEOTIDE COMPRISING AN INOSINE FOR TREATING DMD
C12Q 1/68 (2006.01)	2456884 *	SEQUENCES AND THEIR USE FOR DETECTION AND CHARACTERIZATION OF E. COLI O157:H7
C07D 487/04 (2006.01)	2451812 *	SUBSTITUTED PYRAZOLO[1,5-a]PYRIMIDINE COMPOUNDS AS TRK KINASE INHIBITORS
C07D 519/00 (2006.01)	2451812 *	SUBSTITUTED PYRAZOLO[1,5-a]PYRIMIDINE COMPOUNDS AS TRK KINASE INHIBITORS
A61K 31/519 (2006.01)	2451812 *	SUBSTITUTED PYRAZOLO[1,5-a]PYRIMIDINE COMPOUNDS AS TRK KINASE INHIBITORS
B41F 7/16 (2006.01)	2428359	Printer and method for printing on flat materials
B41F 23/00 (2006.01)	2428359	Printer and method for printing on flat materials
B41M 5/00 (2006.01)	2428359	Printer and method for printing on flat materials
G06F 17/00 (2006.01)	2488961 *	PROCESS FOR THE AUTOMATED CLASSIFICATION AND ANALYSIS OF RAW DATA AND ITS USE IN THE OPTIMIZATION OF PROCESSES
A47C 27/00 (2006.01)	2488067 *	MULTILAYERED PROTECTIVE AND STIMULATING PAD FOR MATTRESSES
A47G 9/00 (2006.01)	2488067 *	MULTILAYERED PROTECTIVE AND STIMULATING PAD FOR MATTRESSES
C08K 9/02 (2006.01)	2488581 *	CROSSLINKING INITIATOR
C01G 9/02 (2006.01)	2488581 *	CROSSLINKING INITIATOR
C09C 1/02 (2006.01)	2488581 *	CROSSLINKING INITIATOR
C09C 1/28 (2006.01)	2488581 *	CROSSLINKING INITIATOR
C09C 1/30 (2006.01)	2488581 *	CROSSLINKING INITIATOR
C09C 1/40 (2006.01)	2488581 *	CROSSLINKING INITIATOR
C09C 1/56 (2006.01)	2488581 *	CROSSLINKING INITIATOR
H04W 24/00 (2009.01)	2464159 *	METHOD, SYSTEM AND DEVICE FOR REPORTING UPLINK PILOT INTERFERENCE
C12N 15/79 (2006.01)	2424991 *	GENE THERAPY FOR NEURODEGENERATIVE DISORDERS
A61K 31/7088 (2006.01)	2424991 *	GENE THERAPY FOR NEURODEGENERATIVE DISORDERS
A61K 39/155 (2006.01)	2445527 *	VACCINE
C07K 16/46 (2006.01)	2480676 *	HYBRID LIGHT CHAIN MICE
C12N 15/85 (2006.01)	2480676 *	HYBRID LIGHT CHAIN MICE

MKP (51)	Broj objave evropske prijava patenta (97)	Naziv pronalaska (54)
C07K 16/00 (2006.01)	2480676 *	HYBRID LIGHT CHAIN MICE
A01K 67/027 (2006.01)	2480676 *	HYBRID LIGHT CHAIN MICE
C12N 9/02 (2006.01)	2491119 *	METHODS AND MEANS TO ALTER LIPID BIOSYNTHESIS BY TARGETING MULTIPLE ENZYMES TO SUBORGANELLE DOMAINS
A23K 1/16 (2006.01)	2410871 *	COMPOSITIONS CONTAINING C1 TO C7 ORGANIC ACID MONOGLYCERIDES AND GLYCEROL, THEIR PREPARATION AND USE AS ANTIBACTERIALS AND ANTI-MOULD AGENTS
C11C 3/02 (2006.01)	2410871 *	COMPOSITIONS CONTAINING C1 TO C7 ORGANIC ACID MONOGLYCERIDES AND GLYCEROL, THEIR PREPARATION AND USE AS ANTIBACTERIALS AND ANTI-MOULD AGENTS
A61M 5/50 (2006.01)	2480276 *	ASSEMBLY FOR A DRUG DELIVERY DEVICE AND DRUG DELIVERY DEVICE
G06F 3/048 (2006.01)	2406701 *	SYSTEMS AND METHODS FOR USING MULTIPLE ACTUATORS TO REALIZE TEXTURES
G06F 3/041 (2006.01)	2406701 *	SYSTEMS AND METHODS FOR USING MULTIPLE ACTUATORS TO REALIZE TEXTURES
G06F 3/01 (2006.01)	2406701 *	SYSTEMS AND METHODS FOR USING MULTIPLE ACTUATORS TO REALIZE TEXTURES
C12N 15/11 (2006.01)	2451952 *	SPARC ANTISENSE COMPOSITIONS AND USES THEREOF
A41D 19/015 (2006.01)	2481310 *	ASEPTIC/PROTECTIVE MITT
G08B 1/08 (2006.01)	2417591 *	REDUCING MEDICAL ERROR
C07D 235/26 (2006.01)	2432766 *	ANTICANCER COMPOUND AND PHARMACEUTICAL COMPOSITION CONTAINING THE SAME
C07D 471/04 (2006.01)	2432766 *	ANTICANCER COMPOUND AND PHARMACEUTICAL COMPOSITION CONTAINING THE SAME
A61K 31/4745 (2006.01)	2432766 *	ANTICANCER COMPOUND AND PHARMACEUTICAL COMPOSITION CONTAINING THE SAME
A61P 35/00 (2006.01)	2432766 *	ANTICANCER COMPOUND AND PHARMACEUTICAL COMPOSITION CONTAINING THE SAME
H04B 10/10 (2006.01)	2454829 *	APPARATUS FOR TRANSFERRING DATA IN WIRELESS MODE TO A PORTABLE ELECTRONIC DEVICE BY MEANS OF LIGHT PULSES EMITTED FROM AN LCD MONITOR
C07D 231/14 (2006.01)	2462108 *	PROCESS FOR THE PREPARATION OF PYRAZOLE CARBOXYLIC ACID AMIDES
C07C 45/62 (2006.01)	2462108 *	PROCESS FOR THE PREPARATION OF PYRAZOLE CARBOXYLIC ACID AMIDES
C07C 45/64 (2006.01)	2462108 *	PROCESS FOR THE PREPARATION OF PYRAZOLE CARBOXYLIC ACID AMIDES
C07C 45/66 (2006.01)	2462108 *	PROCESS FOR THE PREPARATION OF PYRAZOLE CARBOXYLIC ACID AMIDES
C07C 251/44 (2006.01)	2462108 *	PROCESS FOR THE PREPARATION OF PYRAZOLE CARBOXYLIC ACID AMIDES
C07C 45/69 (2006.01)	2462108 *	PROCESS FOR THE PREPARATION OF PYRAZOLE CARBOXYLIC ACID AMIDES
C07C 49/693 (2006.01)	2462108 *	PROCESS FOR THE PREPARATION OF PYRAZOLE CARBOXYLIC ACID AMIDES
C07C 49/743 (2006.01)	2462108 *	PROCESS FOR THE PREPARATION OF PYRAZOLE CARBOXYLIC ACID AMIDES
A61M 5/178 (2006.01)	2495002 *	SYRINGE, DEVICE FOR PRODUCING SYRINGE BODY, AND METHOD FOR PRODUCING SYRINGE BODY
B65D 83/00 (2006.01)	2495002 *	SYRINGE, DEVICE FOR PRODUCING SYRINGE BODY, AND METHOD FOR PRODUCING SYRINGE BODY
A61M 5/31 (2006.01)	2495002 *	SYRINGE, DEVICE FOR PRODUCING SYRINGE BODY, AND METHOD FOR PRODUCING SYRINGE BODY
B05C 17/01 (2006.01)	2495002 *	SYRINGE, DEVICE FOR PRODUCING SYRINGE BODY, AND METHOD FOR PRODUCING SYRINGE BODY
C23C 16/505 (2006.01)	2251454	Vessel coating and inspection

MKP (51)	Broj objave evropske prijava patenta (97)	Naziv pronalaska (54)
C23C 16/52 (2006.01)	2251454	Vessel coating and inspection
C23C 16/54 (2006.01)	2251454	Vessel coating and inspection
G01N 15/08 (2006.01)	2251454	Vessel coating and inspection
A61B 5/15 (2006.01)	2251454	Vessel coating and inspection
A63F 9/34 (2006.01)	2412413 *	MAGNETIC PICKUP GAME DEVICE
A63F 9/30 (2006.01)	2412413 *	MAGNETIC PICKUP GAME DEVICE
A63F 9/02 (2006.01)	2412413 *	MAGNETIC PICKUP GAME DEVICE
G06F 3/048 (2006.01)	2498173 *	OBJECT CONTROL METHOD, OBJECT CONTROL PROGRAM, AND Web SERVER
A61K 9/20 (2006.01)	2403485 *	PHARMACEUTICAL COMPOSITION CONTAINING RASAGILINE MESYLATE
A61K 31/205 (2006.01)	2403485 *	PHARMACEUTICAL COMPOSITION CONTAINING RASAGILINE MESYLATE
A61P 25/16 (2006.01)	2403485 *	PHARMACEUTICAL COMPOSITION CONTAINING RASAGILINE MESYLATE
B29C 70/00 (2006.01)	2433790 *	STAB-RESISTANT BALLISTIC-RESISTANT MATERIAL AND PRODUCTION PROCESS THEREOF
F41H 5/04 (2006.01)	2433790 *	STAB-RESISTANT BALLISTIC-RESISTANT MATERIAL AND PRODUCTION PROCESS THEREOF
B32B 5/26 (2006.01)	2433790 *	STAB-RESISTANT BALLISTIC-RESISTANT MATERIAL AND PRODUCTION PROCESS THEREOF
A01N 43/42 (2006.01)	2442651 *	TREATMENT OF MULTIPLE SCLEROSIS WITH LAQUINIMOD
A61K 31/47 (2006.01)	2442651 *	TREATMENT OF MULTIPLE SCLEROSIS WITH LAQUINIMOD
A61K 31/195 (2006.01)	2480225 *	DERMAL FORMULATIONS OF DP2 RECEPTOR ANTAGONISTS
A61K 47/06 (2006.01)	2480225 *	DERMAL FORMULATIONS OF DP2 RECEPTOR ANTAGONISTS
A61K 9/00 (2006.01)	2480225 *	DERMAL FORMULATIONS OF DP2 RECEPTOR ANTAGONISTS
A61P 17/02 (2006.01)	2480225 *	DERMAL FORMULATIONS OF DP2 RECEPTOR ANTAGONISTS
A61K 31/185 (2006.01)	2480225 *	DERMAL FORMULATIONS OF DP2 RECEPTOR ANTAGONISTS
A61P 17/00 (2006.01)	2480225 *	DERMAL FORMULATIONS OF DP2 RECEPTOR ANTAGONISTS
A61K 31/155 (2006.01)	2424516 *	PENTAMIDINE COMBINATIONS FOR TREATING CANCER
A61M 5/31 (2006.01)	2403564 *	MEDICATION DELIVERY DEVICE WITH FOLDABLE FINGER PAD
C07K 14/50 (2006.01)	2427208 *	FGF21 MUTANTS AND USES THEREOF
A61K 38/18 (2006.01)	2427208 *	FGF21 MUTANTS AND USES THEREOF
A61M 15/00 (2006.01)	2408498 *	COUNTER
G06M 1/24 (2006.01)	2408498 *	COUNTER
H05B 33/08 (2006.01)	2409549 *	CIRCUIT FOR A LIGHT-EMITTING DIODE ASSEMBLY AND LIGHT EMITTING DIODE MODULE
A61P 3/10 (2006.01)	2406251 *	COMPOUNDS FOR THE TREATMENT OF METABOLIC DISORDERS
C07D 403/12 (2006.01)	2406251 *	COMPOUNDS FOR THE TREATMENT OF METABOLIC DISORDERS
A61K 31/506 (2006.01)	2406251 *	COMPOUNDS FOR THE TREATMENT OF METABOLIC DISORDERS
A01N 43/90 (2006.01)	2434895 *	ORGANIC COMPOUNDS
C07D 401/12 (2006.01)	2414347 *	P38MAP KINASE INHIBITOR
A61K 31/415 (2006.01)	2414347 *	P38MAP KINASE INHIBITOR
A61P 11/00 (2006.01)	2414347 *	P38MAP KINASE INHIBITOR
A61P 29/00 (2006.01)	2414347 *	P38MAP KINASE INHIBITOR
C07K 16/18 (2006.01)	2480577 *	DISULFIDE STABILISED MULTIVALENT ANTIBODIES
C07K 16/24 (2006.01)	2480577 *	DISULFIDE STABILISED MULTIVALENT ANTIBODIES
C07K 16/46 (2006.01)	2480577 *	DISULFIDE STABILISED MULTIVALENT ANTIBODIES
C07K 16/28 (2006.01)	2480577 *	DISULFIDE STABILISED MULTIVALENT ANTIBODIES
H04B 7/14 (2006.01)	2485410 *	TRANSMISSION METHOD, DETECTION METHOD AND EQUIPMENT FOR CONTROL CHANNELS OF A RELAY SYSTEM
B21D 24/14 (2006.01)	2428290	A cushioning arrangement for presses
A61K 39/00 (2006.01)	2456459 *	VACCINE
C07K 7/14 (2006.01)	2456459 *	VACCINE

MKP (51)	Broj objave evropske prijave patenta (97)	Naziv pronalaska (54)
B25B 5/06 (2006.01)	2432623 *	VARIABLE CLAMPING TOOL
B25B 5/10 (2006.01)	2432623 *	VARIABLE CLAMPING TOOL
B25B 5/16 (2006.01)	2432623 *	VARIABLE CLAMPING TOOL
A61M 5/315 (2006.01)	2437825 *	RESETTING MECHANISM FOR A DRUG DELIVERY DEVICE
F25D 23/00 (2006.01)	2340726	Freezer system for rind formation of a food product
A23L 3/36 (2006.01)	2340726	Freezer system for rind formation of a food product
F25D 3/00 (2006.01)	2340726	Freezer system for rind formation of a food product
F25D 13/00 (2006.01)	2340726	Freezer system for rind formation of a food product
C07D 471/04 (2006.01)	2496559 *	ARYL- AND HETEROARYLCARBONYL DERIVATIVES OF HEXAHYDROINDENOPYRIDINE AND OCTAHYDROBENZOQUINOLINE
C07D 498/04 (2006.01)	2496559 *	ARYL- AND HETEROARYLCARBONYL DERIVATIVES OF HEXAHYDROINDENOPYRIDINE AND OCTAHYDROBENZOQUINOLINE
C07D 221/10 (2006.01)	2496559 *	ARYL- AND HETEROARYLCARBONYL DERIVATIVES OF HEXAHYDROINDENOPYRIDINE AND OCTAHYDROBENZOQUINOLINE
A61K 31/5377 (2006.01)	2496559 *	ARYL- AND HETEROARYLCARBONYL DERIVATIVES OF HEXAHYDROINDENOPYRIDINE AND OCTAHYDROBENZOQUINOLINE
C07D 401/12 (2006.01)	2496559 *	ARYL- AND HETEROARYLCARBONYL DERIVATIVES OF HEXAHYDROINDENOPYRIDINE AND OCTAHYDROBENZOQUINOLINE
C07D 401/14 (2006.01)	2496559 *	ARYL- AND HETEROARYLCARBONYL DERIVATIVES OF HEXAHYDROINDENOPYRIDINE AND OCTAHYDROBENZOQUINOLINE
A61K 31/498 (2006.01)	2496559 *	ARYL- AND HETEROARYLCARBONYL DERIVATIVES OF HEXAHYDROINDENOPYRIDINE AND OCTAHYDROBENZOQUINOLINE
C07D 401/06 (2006.01)	2496559 *	ARYL- AND HETEROARYLCARBONYL DERIVATIVES OF HEXAHYDROINDENOPYRIDINE AND OCTAHYDROBENZOQUINOLINE
A61P 3/00 (2006.01)	2496559 *	ARYL- AND HETEROARYLCARBONYL DERIVATIVES OF HEXAHYDROINDENOPYRIDINE AND OCTAHYDROBENZOQUINOLINE
C07D 417/06 (2006.01)	2496559 *	ARYL- AND HETEROARYLCARBONYL DERIVATIVES OF HEXAHYDROINDENOPYRIDINE AND OCTAHYDROBENZOQUINOLINE
C07D 405/14 (2006.01)	2496559 *	ARYL- AND HETEROARYLCARBONYL DERIVATIVES OF HEXAHYDROINDENOPYRIDINE AND OCTAHYDROBENZOQUINOLINE
A61K 31/473 (2006.01)	2496559 *	ARYL- AND HETEROARYLCARBONYL DERIVATIVES OF HEXAHYDROINDENOPYRIDINE AND OCTAHYDROBENZOQUINOLINE
A61K 31/497 (2006.01)	2496559 *	ARYL- AND HETEROARYLCARBONYL DERIVATIVES OF HEXAHYDROINDENOPYRIDINE AND OCTAHYDROBENZOQUINOLINE
B09B 3/00 (2006.01)	2416899 *	WASTE TREATMENT METHOD
A61K 31/4178 (2006.01)	2461808 *	METHODS FOR ENHANCING THE COGNITIVE FUNCTION
A61P 25/00 (2006.01)	2461808 *	METHODS FOR ENHANCING THE COGNITIVE FUNCTION
A61P 25/28 (2006.01)	2461808 *	METHODS FOR ENHANCING THE COGNITIVE FUNCTION
H02G 1/04 (2006.01)	2461441	wheel for installing cables
C09C 1/02 (2006.01)	2377900	Process to prepare surface-modified mineral material, resulting products and uses thereof
C09C 1/42 (2006.01)	2377900	Process to prepare surface-modified mineral material, resulting products and uses thereof
A61K 38/48 (2006.01)	2403523 *	TEMPERATURE SENSITIVE MUTANTS OF MATRIX METALLOPROTEASE 1 UND USES THEREOF
C07K 14/435 (2006.01)	2403523 *	TEMPERATURE SENSITIVE MUTANTS OF MATRIX METALLOPROTEASE 1 UND USES THEREOF
A01N 43/66 (2006.01)	2440056 *	UREIDOPHENYL SUBSTITUTED TRIAZINE DERIVATIVES AND THEIR THERAPEUTICAL APPLICATIONS
A61K 31/53 (2006.01)	2440056 *	UREIDOPHENYL SUBSTITUTED TRIAZINE DERIVATIVES AND THEIR THERAPEUTICAL APPLICATIONS
A61P 31/00 (2006.01)	2435412 *	DISACCHARIN, DIFUMARIC ACID, DI-L-HYDROXY-2-NAPHTHOIC ACID AND MONO-BENZOIC ACID SALTS OF 4- (DIMETHYLAMINO)BUTYL 2- (4- (2-AMINO-4-METHYL-6- (PENTYLAMINO) PYRIMIDIN- 5 -YL) METHYL) PHENYL)ACETATE

MKP (51)	Broj objave evropske prijava patenta (97)	Naziv pronalaska (54)
A61P 35/00 (2006.01)	2435412 *	DISACCHARIN, DIFUMARIC ACID, DI-L-HYDROXY-2-NAPHTHOIC ACID AND MONO-BENZOIC ACID SALTS OF 4- (DIMETHYLAMINO)BUTYL 2- (4- (2-AMINO-4-METHYL-6- (PENTYLAMINO) PYRIMIDIN- 5 -YL) METHYL) PHENYL)ACETATE
C07D 239/49 (2006.01)	2435412 *	DISACCHARIN, DIFUMARIC ACID, DI-L-HYDROXY-2-NAPHTHOIC ACID AND MONO-BENZOIC ACID SALTS OF 4- (DIMETHYLAMINO)BUTYL 2- (4- (2-AMINO-4-METHYL-6- (PENTYLAMINO) PYRIMIDIN- 5 -YL) METHYL) PHENYL)ACETATE
A61K 31/505 (2006.01)	2435412 *	DISACCHARIN, DIFUMARIC ACID, DI-L-HYDROXY-2-NAPHTHOIC ACID AND MONO-BENZOIC ACID SALTS OF 4- (DIMETHYLAMINO)BUTYL 2- (4- (2-AMINO-4-METHYL-6- (PENTYLAMINO) PYRIMIDIN- 5 -YL) METHYL) PHENYL)ACETATE
A61P 17/00 (2006.01)	2435412 *	DISACCHARIN, DIFUMARIC ACID, DI-L-HYDROXY-2-NAPHTHOIC ACID AND MONO-BENZOIC ACID SALTS OF 4- (DIMETHYLAMINO)BUTYL 2- (4- (2-AMINO-4-METHYL-6- (PENTYLAMINO) PYRIMIDIN- 5 -YL) METHYL) PHENYL)ACETATE
A61P 11/00 (2006.01)	2435412 *	DISACCHARIN, DIFUMARIC ACID, DI-L-HYDROXY-2-NAPHTHOIC ACID AND MONO-BENZOIC ACID SALTS OF 4- (DIMETHYLAMINO)BUTYL 2- (4- (2-AMINO-4-METHYL-6- (PENTYLAMINO) PYRIMIDIN- 5 -YL) METHYL) PHENYL)ACETATE
A61P 27/14 (2006.01)	2435412 *	DISACCHARIN, DIFUMARIC ACID, DI-L-HYDROXY-2-NAPHTHOIC ACID AND MONO-BENZOIC ACID SALTS OF 4- (DIMETHYLAMINO)BUTYL 2- (4- (2-AMINO-4-METHYL-6- (PENTYLAMINO) PYRIMIDIN- 5 -YL) METHYL) PHENYL)ACETATE
F01N 3/023 (2006.01)	2410144	Method of Controlling NOx Emissions in an Internal Combustion Engine
F01N 9/00 (2006.01)	2410144	Method of Controlling NOx Emissions in an Internal Combustion Engine
F01N 13/02 (2010.01)	2410144	Method of Controlling NOx Emissions in an Internal Combustion Engine
A61H 3/02 (2006.01)	2371338	A walking aid
C12N 15/10 (2006.01)	2462226 *	PROCESS AND DEVICE FOR COLLECTING NUCLEIC ACIDS OF MICROORGANISMS FROM A PARTICULATE SAMPLE
B29D 35/14 (2010.01)	2464501 *	INJECTION MOULD WITH COMPENSATION CHAMBER FOR MOULDING TPU AND OTHER THERMOPLASTIC MATERIALS ON RUBBER TREAD.
B29C 33/00 (2006.01)	2464501 *	INJECTION MOULD WITH COMPENSATION CHAMBER FOR MOULDING TPU AND OTHER THERMOPLASTIC MATERIALS ON RUBBER TREAD.
B29C 33/10 (2006.01)	2464501 *	INJECTION MOULD WITH COMPENSATION CHAMBER FOR MOULDING TPU AND OTHER THERMOPLASTIC MATERIALS ON RUBBER TREAD.
B29C 45/34 (2006.01)	2464501 *	INJECTION MOULD WITH COMPENSATION CHAMBER FOR MOULDING TPU AND OTHER THERMOPLASTIC MATERIALS ON RUBBER TREAD.
B29C 45/14 (2006.01)	2464501 *	INJECTION MOULD WITH COMPENSATION CHAMBER FOR MOULDING TPU AND OTHER THERMOPLASTIC MATERIALS ON RUBBER TREAD.
B29C 45/00 (2006.01)	2464501 *	INJECTION MOULD WITH COMPENSATION CHAMBER FOR MOULDING TPU AND OTHER THERMOPLASTIC MATERIALS ON RUBBER TREAD.
E05D 15/06 (2006.01)	2476840	Track roller device
F16B 13/14 (2006.01)	2317158	Wall plug for masonry walls provided with insulating layers of friable spongy materials
G01S 5/02 (2010.01)	2483869 *	KEY DEVICE FOR MONITORING SYSTEMS
G08B 13/00 (2006.01)	2483869 *	KEY DEVICE FOR MONITORING SYSTEMS
G07C 9/00 (2006.01)	2483869 *	KEY DEVICE FOR MONITORING SYSTEMS
G07C 5/02 (2006.01)	2483869 *	KEY DEVICE FOR MONITORING SYSTEMS
G07F 7/10 (2006.01)	2483869 *	KEY DEVICE FOR MONITORING SYSTEMS
A61P 3/10 (2006.01)	2485724 *	SULFONAMIDES FOR THE PREVENTION OF DIABETES
A61K 31/185 (2006.01)	2485724 *	SULFONAMIDES FOR THE PREVENTION OF DIABETES
C07D 213/65 (2006.01)	2445883 *	HETEROCYCLIC SULFONAMIDES, USES AND PHARMACEUTICAL COMPOSITIONS THEREOF
C07C 311/07 (2006.01)	2445883 *	HETEROCYCLIC SULFONAMIDES, USES AND PHARMACEUTICAL COMPOSITIONS THEREOF
C07D 405/12 (2006.01)	2445883 *	HETEROCYCLIC SULFONAMIDES, USES AND PHARMACEUTICAL COMPOSITIONS THEREOF

MKP (51)	Broj objave evropske prijava patenta (97)	Naziv pronalaska (54)
A61K 31/443 (2006.01)	2445883 *	HETEROCYCLIC SULFONAMIDES, USES AND PHARMACEUTICAL COMPOSITIONS THEREOF
C07D 409/12 (2006.01)	2445883 *	HETEROCYCLIC SULFONAMIDES, USES AND PHARMACEUTICAL COMPOSITIONS THEREOF
A61K 31/4453 (2006.01)	2445883 *	HETEROCYCLIC SULFONAMIDES, USES AND PHARMACEUTICAL COMPOSITIONS THEREOF
C07D 295/096 (2006.01)	2445883 *	HETEROCYCLIC SULFONAMIDES, USES AND PHARMACEUTICAL COMPOSITIONS THEREOF
C07D 307/42 (2006.01)	2445883 *	HETEROCYCLIC SULFONAMIDES, USES AND PHARMACEUTICAL COMPOSITIONS THEREOF
A61K 31/381 (2006.01)	2445883 *	HETEROCYCLIC SULFONAMIDES, USES AND PHARMACEUTICAL COMPOSITIONS THEREOF
C07D 409/14 (2006.01)	2445883 *	HETEROCYCLIC SULFONAMIDES, USES AND PHARMACEUTICAL COMPOSITIONS THEREOF
A61K 31/4709 (2006.01)	2445883 *	HETEROCYCLIC SULFONAMIDES, USES AND PHARMACEUTICAL COMPOSITIONS THEREOF
C07D 333/38 (2006.01)	2445883 *	HETEROCYCLIC SULFONAMIDES, USES AND PHARMACEUTICAL COMPOSITIONS THEREOF
A61K 31/402 (2006.01)	2445883 *	HETEROCYCLIC SULFONAMIDES, USES AND PHARMACEUTICAL COMPOSITIONS THEREOF
C07D 307/22 (2006.01)	2445883 *	HETEROCYCLIC SULFONAMIDES, USES AND PHARMACEUTICAL COMPOSITIONS THEREOF
A61K 31/341 (2006.01)	2445883 *	HETEROCYCLIC SULFONAMIDES, USES AND PHARMACEUTICAL COMPOSITIONS THEREOF
C07D 209/40 (2006.01)	2366687	Benzenesulfonamide derivatives and pharmaceutical composition thereof
C07D 209/88 (2006.01)	2366687	Benzenesulfonamide derivatives and pharmaceutical composition thereof
C07D 409/12 (2006.01)	2366687	Benzenesulfonamide derivatives and pharmaceutical composition thereof
A61P 35/00 (2006.01)	2366687	Benzenesulfonamide derivatives and pharmaceutical composition thereof
C07D 209/08 (2006.01)	2366687	Benzenesulfonamide derivatives and pharmaceutical composition thereof
A61K 31/404 (2006.01)	2366687	Benzenesulfonamide derivatives and pharmaceutical composition thereof
C07D 417/12 (2006.01)	2493858 *	ANDROGEN RECEPTOR MODULATING COMPOUNDS
A61K 31/44 (2006.01)	2493858 *	ANDROGEN RECEPTOR MODULATING COMPOUNDS
C07D 405/12 (2006.01)	2493858 *	ANDROGEN RECEPTOR MODULATING COMPOUNDS
A61K 31/5377 (2006.01)	2493858 *	ANDROGEN RECEPTOR MODULATING COMPOUNDS
A61K 31/42 (2006.01)	2493858 *	ANDROGEN RECEPTOR MODULATING COMPOUNDS
C07D 231/14 (2006.01)	2493858 *	ANDROGEN RECEPTOR MODULATING COMPOUNDS
A61K 31/438 (2006.01)	2493858 *	ANDROGEN RECEPTOR MODULATING COMPOUNDS
C07D 413/12 (2006.01)	2493858 *	ANDROGEN RECEPTOR MODULATING COMPOUNDS
A61K 31/416 (2006.01)	2493858 *	ANDROGEN RECEPTOR MODULATING COMPOUNDS
C07D 401/12 (2006.01)	2493858 *	ANDROGEN RECEPTOR MODULATING COMPOUNDS
A61K 31/497 (2006.01)	2493858 *	ANDROGEN RECEPTOR MODULATING COMPOUNDS
A61P 35/00 (2006.01)	2493858 *	ANDROGEN RECEPTOR MODULATING COMPOUNDS
C07D 403/12 (2006.01)	2493858 *	ANDROGEN RECEPTOR MODULATING COMPOUNDS
A61K 31/4523 (2006.01)	2493858 *	ANDROGEN RECEPTOR MODULATING COMPOUNDS
A23L 1/176 (2006.01)	2475266 *	EDIBLE SURFACE-MODIFYING PARTICLES AND METHODS FOR THEIR MANUFACTURE
A23L 1/01 (2006.01)	2475266 *	EDIBLE SURFACE-MODIFYING PARTICLES AND METHODS FOR THEIR MANUFACTURE
A01N 59/08 (2006.01)	2374353	Process to preserve aqueous preparations of mineral materials, preserved aqueous preparations of mineral materials and use of preservative compounds in aqueous preparations of mineral materials
A61K 8/19 (2006.01)	2374353	Process to preserve aqueous preparations of mineral materials, preserved aqueous preparations of mineral materials and use of preservative compounds in aqueous preparations of mineral materials

MKP (51)	Broj objave evropske prijava patenta (97)	Naziv pronalaska (54)
A01N 59/06 (2006.01)	2374353	Process to preserve aqueous preparations of mineral materials, preserved aqueous preparations of mineral materials and use of preservative compounds in aqueous preparations of mineral materials
C02F 1/50 (2006.01)	2374353	Process to preserve aqueous preparations of mineral materials, preserved aqueous preparations of mineral materials and use of preservative compounds in aqueous preparations of mineral materials
D21H 21/36 (2006.01)	2374353	Process to preserve aqueous preparations of mineral materials, preserved aqueous preparations of mineral materials and use of preservative compounds in aqueous preparations of mineral materials
A01N 55/02 (2006.01)	2374353	Process to preserve aqueous preparations of mineral materials, preserved aqueous preparations of mineral materials and use of preservative compounds in aqueous preparations of mineral materials
C06B 23/00 (2006.01)	2445852 *	SYSTEMS AND METHODS FOR CHEMICAL AND/OR MECHANICAL REMEDIATION OF NITRO COMPOUNDS AND NITRATE ESTERS
C06B 45/10 (2006.01)	2445852 *	SYSTEMS AND METHODS FOR CHEMICAL AND/OR MECHANICAL REMEDIATION OF NITRO COMPOUNDS AND NITRATE ESTERS
C06B 21/00 (2006.01)	2445852 *	SYSTEMS AND METHODS FOR CHEMICAL AND/OR MECHANICAL REMEDIATION OF NITRO COMPOUNDS AND NITRATE ESTERS
F42B 33/06 (2006.01)	2445852 *	SYSTEMS AND METHODS FOR CHEMICAL AND/OR MECHANICAL REMEDIATION OF NITRO COMPOUNDS AND NITRATE ESTERS
A62D 3/02 (2007.01)	2445852 *	SYSTEMS AND METHODS FOR CHEMICAL AND/OR MECHANICAL REMEDIATION OF NITRO COMPOUNDS AND NITRATE ESTERS
A62D 3/30 (2007.01)	2445852 *	SYSTEMS AND METHODS FOR CHEMICAL AND/OR MECHANICAL REMEDIATION OF NITRO COMPOUNDS AND NITRATE ESTERS
A61K 9/50 (2006.01)	2467132 *	CORE STABILIZED MICROCAPSULES, METHOD OF THEIR PREPARATION AND USES THEREOF
A61K 9/00 (2006.01)	2467132 *	CORE STABILIZED MICROCAPSULES, METHOD OF THEIR PREPARATION AND USES THEREOF
A61K 8/11 (2006.01)	2467132 *	CORE STABILIZED MICROCAPSULES, METHOD OF THEIR PREPARATION AND USES THEREOF
H04W 24/04 (2009.01)	2453693 *	METHOD AND DEVICE FOR MAINTAINING LONG TERM EVOLUTION BASE STATION
C12N 9/10 (2006.01)	2499245 *	GLYCOSYL TRANSFERASE FROM CHINESE HAMSTER AND RELATED METHODS
C12P 21/02 (2006.01)	2499245 *	GLYCOSYL TRANSFERASE FROM CHINESE HAMSTER AND RELATED METHODS
A61K 38/14 (2006.01)	2499245 *	GLYCOSYL TRANSFERASE FROM CHINESE HAMSTER AND RELATED METHODS
C12N 15/54 (2006.01)	2499245 *	GLYCOSYL TRANSFERASE FROM CHINESE HAMSTER AND RELATED METHODS
C12Q 1/68 (2006.01)	2499245 *	GLYCOSYL TRANSFERASE FROM CHINESE HAMSTER AND RELATED METHODS
A61K 31/337 (2006.01)	2427187 *	ANTITUMOR COMBINATION INCLUDING CABAZITAXEL AND CAPECITABINE
A61K 31/7068 (2006.01)	2427187 *	ANTITUMOR COMBINATION INCLUDING CABAZITAXEL AND CAPECITABINE
A61P 35/00 (2006.01)	2427187 *	ANTITUMOR COMBINATION INCLUDING CABAZITAXEL AND CAPECITABINE
A61P 3/00 (2006.01)	2377855	A valsartanamide dinitrate derivative for the treatment of vascular and metabolic diseases
A61P 9/00 (2006.01)	2377855	A valsartanamide dinitrate derivative for the treatment of vascular and metabolic diseases
C07D 257/04 (2006.01)	2377855	A valsartanamide dinitrate derivative for the treatment of vascular and metabolic diseases
A61K 31/41 (2006.01)	2377855	A valsartanamide dinitrate derivative for the treatment of vascular and metabolic diseases
A61K 31/425 (2006.01)	2442655 *	COMPOSITIONS AND METHODS FOR TREATING AMYOTROPHIC LATERAL SCLEROSIS

MKP (51)	Broj objave evropske prijava patenta (97)	Naziv pronalaska (54)
A01N 43/78 (2006.01)	2442655 *	COMPOSITIONS AND METHODS FOR TREATING AMYOTROPHIC LATERAL SCLEROSIS
C12N 15/11 (2006.01)	2451940 *	BIOPROCESSING
C12N 5/00 (2006.01)	2451940 *	BIOPROCESSING
C12M 1/12 (2006.01)	2443224 *	NON-INVASIVE SENSING OF BIOPROCESS PARAMETERS
H04L 12/56 (2006.01)	2478677 *	AN APPARATUS FOR ANALYZING A DATA PACKET, A DATA PACKET PROCESSING SYSTEM AND A METHOD
A61K 39/395 (2006.01)	2429582 *	ANTI-HUMAN CD52 IMMUNOGLOBULINS
E03D 9/08 (2006.01)	2400070	Sanitary washing apparatus for private body parts
A61K 38/27 (2006.01)	2421548 *	USE OF (HEXENOYL TRANS-3)HGRF(L-44)NH ₂ AND SIMVASTATIN IN COMBINATION THERAPY
C07K 17/02 (2006.01)	2421548 *	USE OF (HEXENOYL TRANS-3)HGRF(L-44)NH ₂ AND SIMVASTATIN IN COMBINATION THERAPY
A61K 38/16 (2006.01)	2421548 *	USE OF (HEXENOYL TRANS-3)HGRF(L-44)NH ₂ AND SIMVASTATIN IN COMBINATION THERAPY
C07K 14/60 (2006.01)	2421548 *	USE OF (HEXENOYL TRANS-3)HGRF(L-44)NH ₂ AND SIMVASTATIN IN COMBINATION THERAPY
A61K 31/366 (2006.01)	2421548 *	USE OF (HEXENOYL TRANS-3)HGRF(L-44)NH ₂ AND SIMVASTATIN IN COMBINATION THERAPY
C12P 19/02 (2006.01)	2435577 *	PRODUCTION OF GLYCOPROTEINS
E04B 1/80 (2006.01)	2340338 *	GAS FILLED INSULATION CONSTRUCTION PANEL
A61K 31/438 (2006.01)	2460806 *	NITROGEN-CONTAINING SPIRO-RING COMPOUND AND MEDICINAL USE OF SAME
A61P 17/00 (2006.01)	2460806 *	NITROGEN-CONTAINING SPIRO-RING COMPOUND AND MEDICINAL USE OF SAME
A61K 31/519 (2006.01)	2460806 *	NITROGEN-CONTAINING SPIRO-RING COMPOUND AND MEDICINAL USE OF SAME
A61P 17/06 (2006.01)	2460806 *	NITROGEN-CONTAINING SPIRO-RING COMPOUND AND MEDICINAL USE OF SAME
A61K 31/55 (2006.01)	2460806 *	NITROGEN-CONTAINING SPIRO-RING COMPOUND AND MEDICINAL USE OF SAME
A61P 19/02 (2006.01)	2460806 *	NITROGEN-CONTAINING SPIRO-RING COMPOUND AND MEDICINAL USE OF SAME
A61P 1/04 (2006.01)	2460806 *	NITROGEN-CONTAINING SPIRO-RING COMPOUND AND MEDICINAL USE OF SAME
A61P 21/04 (2006.01)	2460806 *	NITROGEN-CONTAINING SPIRO-RING COMPOUND AND MEDICINAL USE OF SAME
A61K 31/437 (2006.01)	2460806 *	NITROGEN-CONTAINING SPIRO-RING COMPOUND AND MEDICINAL USE OF SAME
A61P 11/06 (2006.01)	2460806 *	NITROGEN-CONTAINING SPIRO-RING COMPOUND AND MEDICINAL USE OF SAME
A61P 3/10 (2006.01)	2460806 *	NITROGEN-CONTAINING SPIRO-RING COMPOUND AND MEDICINAL USE OF SAME
A61P 25/00 (2006.01)	2460806 *	NITROGEN-CONTAINING SPIRO-RING COMPOUND AND MEDICINAL USE OF SAME
A61P 7/00 (2006.01)	2460806 *	NITROGEN-CONTAINING SPIRO-RING COMPOUND AND MEDICINAL USE OF SAME
C07D 519/00 (2006.01)	2460806 *	NITROGEN-CONTAINING SPIRO-RING COMPOUND AND MEDICINAL USE OF SAME
A61P 11/02 (2006.01)	2460806 *	NITROGEN-CONTAINING SPIRO-RING COMPOUND AND MEDICINAL USE OF SAME
C07K 19/00 (2006.01)	2474558 *	NEW ANTIBIOTIC CONTAINING SIMULACRUM ANTIBODY, PREPARATION METHOD AND APPLICATION THEREOF
C12N 15/62 (2006.01)	2474558 *	NEW ANTIBIOTIC CONTAINING SIMULACRUM ANTIBODY, PREPARATION METHOD AND APPLICATION THEREOF
A61P 31/04 (2006.01)	2474558 *	NEW ANTIBIOTIC CONTAINING SIMULACRUM ANTIBODY, PREPARATION METHOD AND APPLICATION THEREOF

MKP (51)	Broj objave evropske prijava patenta (97)	Naziv pronalaska (54)
C12N 15/63 (2006.01)	2474558 *	NEW ANTIBIOTIC CONTAINING SIMULACRUM ANTIBODY, PREPARATION METHOD AND APPLICATION THEREOF
A61K 38/16 (2006.01)	2474558 *	NEW ANTIBIOTIC CONTAINING SIMULACRUM ANTIBODY, PREPARATION METHOD AND APPLICATION THEREOF
A61K 47/48 (2006.01)	2474558 *	NEW ANTIBIOTIC CONTAINING SIMULACRUM ANTIBODY, PREPARATION METHOD AND APPLICATION THEREOF
C12P 21/02 (2006.01)	2474558 *	NEW ANTIBIOTIC CONTAINING SIMULACRUM ANTIBODY, PREPARATION METHOD AND APPLICATION THEREOF
A23J 1/14 (2006.01)	2482670 *	PREPARATION OF SOY PROTEIN ISOLATE USING CALCIUM CHLORIDE EXTRACTION ("S703")
A23J 3/16 (2006.01)	2482670 *	PREPARATION OF SOY PROTEIN ISOLATE USING CALCIUM CHLORIDE EXTRACTION ("S703")
A23L 2/02 (2006.01)	2482670 *	PREPARATION OF SOY PROTEIN ISOLATE USING CALCIUM CHLORIDE EXTRACTION ("S703")
E04H 15/32 (2006.01)	2414605 *	SUPPORT PROFILE
E04H 15/64 (2006.01)	2414605 *	SUPPORT PROFILE
E04B 1/343 (2006.01)	2414605 *	SUPPORT PROFILE
A01G 3/037 (2006.01)	2353366	Branche shear for cutting plants
A61F 11/00 (2006.01)	2453855 *	TYMPANIC MEMBRANE PRESSURE EQUALIZATION TUBE DELIVERY SYSTEM
A61B 17/34 (2006.01)	2453855 *	TYMPANIC MEMBRANE PRESSURE EQUALIZATION TUBE DELIVERY SYSTEM
F23D 14/70 (2006.01)	2446192 *	BURNER
F23Q 3/00 (2006.01)	2446192 *	BURNER
F23C 3/00 (2006.01)	2446192 *	BURNER
F23D 14/10 (2006.01)	2446192 *	BURNER
A01N 37/18 (2006.01)	2410844 *	INHIBITORS OF HEPATITIS C VIRUS REPLICATION
A01K 31/16 (2006.01)	2410844 *	INHIBITORS OF HEPATITIS C VIRUS REPLICATION
A61K 31/205 (2006.01)	2456433 *	METHODS FOR THE PREPARATION AND USE OF AQUEOUS SOLUTIONS OF MAGNESIUM VALPROATE HYDRATE AND L-CARNITINE
A61P 25/12 (2006.01)	2456433 *	METHODS FOR THE PREPARATION AND USE OF AQUEOUS SOLUTIONS OF MAGNESIUM VALPROATE HYDRATE AND L-CARNITINE
A61P 25/00 (2006.01)	2456433 *	METHODS FOR THE PREPARATION AND USE OF AQUEOUS SOLUTIONS OF MAGNESIUM VALPROATE HYDRATE AND L-CARNITINE
A61F 13/15 (2006.01)	2332505	Method and apparatus for stretching segmented stretchable film and application of the segmented film to a moving web
C08F 2/18 (2006.01)	2492288 *	METHACRYLIC RESIN, MOLDED BODY THEREOF, AND METHOD FOR PRODUCING METHACRYLIC RESIN
C08F 20/14 (2006.01)	2492288 *	METHACRYLIC RESIN, MOLDED BODY THEREOF, AND METHOD FOR PRODUCING METHACRYLIC RESIN
B44C 1/10 (2006.01)	2432649 *	DECORATIVE ELEMENT FOR DECORATION OF SURFACES, PREFERABLY WALL SURFACES
B44C 1/16 (2006.01)	2432649 *	DECORATIVE ELEMENT FOR DECORATION OF SURFACES, PREFERABLY WALL SURFACES
B44C 1/18 (2006.01)	2432649 *	DECORATIVE ELEMENT FOR DECORATION OF SURFACES, PREFERABLY WALL SURFACES
B44C 5/04 (2006.01)	2432649 *	DECORATIVE ELEMENT FOR DECORATION OF SURFACES, PREFERABLY WALL SURFACES
A61K 31/407 (2006.01)	2419431 *	DERIVATIVES OF N-[(7-AZA-BICYCLO[2.2.1]HEPT-1-YL)-ARYL-METHYL]-BENZAMIDE, PREPARATION THEREOF, AND THERAPEUTIC USE THEREOF
A61P 25/00 (2006.01)	2419431 *	DERIVATIVES OF N-[(7-AZA-BICYCLO[2.2.1]HEPT-1-YL)-ARYL-METHYL]-BENZAMIDE, PREPARATION THEREOF, AND THERAPEUTIC USE THEREOF
C07D 487/08 (2006.01)	2419431 *	DERIVATIVES OF N-[(7-AZA-BICYCLO[2.2.1]HEPT-1-YL)-ARYL-METHYL]-BENZAMIDE, PREPARATION THEREOF, AND THERAPEUTIC USE THEREOF

MKP (51)	Broj objave evropske prijava patenta (97)	Naziv pronalaska (54)
C07D 207/14 (2006.01)	2419431 *	DERIVATIVES OF N-[(7-AZA-BICYCLO[2.2.1]HEPT-1-YL)-ARYL-METHYL]-BENZAMIDE, PREPARATION THEREOF, AND THERAPEUTIC USE THEREOF
C07C 233/77 (2006.01)	2419431 *	DERIVATIVES OF N-[(7-AZA-BICYCLO[2.2.1]HEPT-1-YL)-ARYL-METHYL]-BENZAMIDE, PREPARATION THEREOF, AND THERAPEUTIC USE THEREOF
C08L 85/02 (2006.01)	2292696	Method for improving flame retardant efficiency of phenoxyphosphazene compound, and prepreg, laminate, and laminate for printed circuit made by the method
C08K 5/357 (2006.01)	2292696	Method for improving flame retardant efficiency of phenoxyphosphazene compound, and prepreg, laminate, and laminate for printed circuit made by the method
C08K 5/5399 (2006.01)	2292696	Method for improving flame retardant efficiency of phenoxyphosphazene compound, and prepreg, laminate, and laminate for printed circuit made by the method
C08L 79/04 (2006.01)	2292696	Method for improving flame retardant efficiency of phenoxyphosphazene compound, and prepreg, laminate, and laminate for printed circuit made by the method
B23B 37/00 (2006.01)	2456585 *	HIGH CELLULOSE CONTENT, LAMINIFEROUS NONWOVEN FABRIC
C07C 17/16 (2006.01)	2443080 *	PROCESS FOR THE PREPARATION OF 5-HT _{2C} RECEPTOR AGONISTS
A61K 8/49 (2006.01)	2407146	Use of acesulfame K as a flavour modulator
A61Q 11/00 (2006.01)	2407146	Use of acesulfame K as a flavour modulator
C12N 15/67 (2006.01)	2454373 *	ENHANCEMENT OF CELLULAR PRODUCTION THROUGH MECHANOTRANSDUCTION
H01L 31/18 (2006.01)	2441096 *	METHOD FOR PRODUCING A SOLAR PANEL
A01N 43/42 (2006.01)	2440048 *	ISOQUINOLINE, QUINOLINE, AND QUINAZOLINE DERIVATIVES AS INHIBITORS OF HEDGEHOG SIGNALING
A61K 31/47 (2006.01)	2440048 *	ISOQUINOLINE, QUINOLINE, AND QUINAZOLINE DERIVATIVES AS INHIBITORS OF HEDGEHOG SIGNALING
A61K 31/517 (2006.01)	2440048 *	ISOQUINOLINE, QUINOLINE, AND QUINAZOLINE DERIVATIVES AS INHIBITORS OF HEDGEHOG SIGNALING
C07D 401/04 (2006.01)	2491024 *	SUBSTITUTED N-PHENYL-1-(4-PYRIDINYL)-1H-PYRAZOL-3-AMINES
A61K 31/4155 (2006.01)	2491024 *	SUBSTITUTED N-PHENYL-1-(4-PYRIDINYL)-1H-PYRAZOL-3-AMINES
A61P 25/00 (2006.01)	2491024 *	SUBSTITUTED N-PHENYL-1-(4-PYRIDINYL)-1H-PYRAZOL-3-AMINES
C07D 487/04 (2006.01)	2432784 *	FUSED BICYCLIC PYRAZOLE DERIVATIVES AS KINASE INHIBITORS
A61K 31/519 (2006.01)	2432784 *	FUSED BICYCLIC PYRAZOLE DERIVATIVES AS KINASE INHIBITORS
A61P 35/00 (2006.01)	2432784 *	FUSED BICYCLIC PYRAZOLE DERIVATIVES AS KINASE INHIBITORS
A61P 25/28 (2006.01)	2432784 *	FUSED BICYCLIC PYRAZOLE DERIVATIVES AS KINASE INHIBITORS
A61P 37/00 (2006.01)	2432784 *	FUSED BICYCLIC PYRAZOLE DERIVATIVES AS KINASE INHIBITORS
H04W 4/06 (2009.01)	2466923 *	METHOD, APPARATUS AND SYSTEM FOR CONFIGURING MULTIMEDIA BROADCAST MULTICAST SERVICE (MBMS) CONTROL INFORMATION
C07D 413/06 (2006.01)	2483266 *	COMPOUNDS FOR THE TREATMENT OF DYSLIPIDEMIA AND RELATED DISEASES
C07D 413/14 (2006.01)	2483266 *	COMPOUNDS FOR THE TREATMENT OF DYSLIPIDEMIA AND RELATED DISEASES
C07D 417/06 (2006.01)	2483266 *	COMPOUNDS FOR THE TREATMENT OF DYSLIPIDEMIA AND RELATED DISEASES
A61P 3/06 (2006.01)	2483266 *	COMPOUNDS FOR THE TREATMENT OF DYSLIPIDEMIA AND RELATED DISEASES
A61K 31/357 (2006.01)	2483266 *	COMPOUNDS FOR THE TREATMENT OF DYSLIPIDEMIA AND RELATED DISEASES
C07D 405/14 (2006.01)	2483266 *	COMPOUNDS FOR THE TREATMENT OF DYSLIPIDEMIA AND RELATED DISEASES
C07D 417/14 (2006.01)	2483266 *	COMPOUNDS FOR THE TREATMENT OF DYSLIPIDEMIA AND RELATED DISEASES
C07D 405/06 (2006.01)	2483266 *	COMPOUNDS FOR THE TREATMENT OF DYSLIPIDEMIA AND RELATED DISEASES

MKP (51)	Broj objave evropske prijava patenta (97)	Naziv pronalaska (54)
C02F 3/34 (2006.01)	2488458 *	COOLING SYSTEM COMPRISING A BIO-FILTER AND METHOD FOR OPERATING SAID SYSTEM
C02F 103/02 (2006.01)	2488458 *	COOLING SYSTEM COMPRISING A BIO-FILTER AND METHOD FOR OPERATING SAID SYSTEM
C02F 1/00 (2006.01)	2488458 *	COOLING SYSTEM COMPRISING A BIO-FILTER AND METHOD FOR OPERATING SAID SYSTEM
C02F 1/46 (2006.01)	2488458 *	COOLING SYSTEM COMPRISING A BIO-FILTER AND METHOD FOR OPERATING SAID SYSTEM
C02F 1/44 (2006.01)	2488458 *	COOLING SYSTEM COMPRISING A BIO-FILTER AND METHOD FOR OPERATING SAID SYSTEM
C02F 1/32 (2006.01)	2488458 *	COOLING SYSTEM COMPRISING A BIO-FILTER AND METHOD FOR OPERATING SAID SYSTEM
C02F 5/02 (2006.01)	2488458 *	COOLING SYSTEM COMPRISING A BIO-FILTER AND METHOD FOR OPERATING SAID SYSTEM
C02F 1/48 (2006.01)	2488458 *	COOLING SYSTEM COMPRISING A BIO-FILTER AND METHOD FOR OPERATING SAID SYSTEM
A61F 3/00 (2006.01)	2464249 *	CONCENTRATION-ENHANCING DRINK
A61K 36/82 (2006.01)	2464249 *	CONCENTRATION-ENHANCING DRINK
A61P 25/00 (2006.01)	2464249 *	CONCENTRATION-ENHANCING DRINK
A61P 25/28 (2006.01)	2464249 *	CONCENTRATION-ENHANCING DRINK
A23L 2/52 (2006.01)	2464249 *	CONCENTRATION-ENHANCING DRINK
C08G 63/80 (2006.01)	2455415	Method for manufacturing low-molecular resorbable polyesters, low-molecular resorbable polyester manufactured according to the method and application of same
C08G 63/90 (2006.01)	2455415	Method for manufacturing low-molecular resorbable polyesters, low-molecular resorbable polyester manufactured according to the method and application of same
C08G 63/08 (2006.01)	2455415	Method for manufacturing low-molecular resorbable polyesters, low-molecular resorbable polyester manufactured according to the method and application of same
F42B 8/00 (2006.01)	2486363 *	ELECTRONIC BLANK AMMUNITION
F41A 33/04 (2006.01)	2486363 *	ELECTRONIC BLANK AMMUNITION
F41A 33/02 (2006.01)	2486363 *	ELECTRONIC BLANK AMMUNITION
A61P 9/00 (2006.01)	2416776 *	USE OF TETRAHYDROBIOPTERIN AS A MARKER AND A THERAPEUTIC AGENT FOR FABRY DISEASE
A61P 43/00 (2006.01)	2416776 *	USE OF TETRAHYDROBIOPTERIN AS A MARKER AND A THERAPEUTIC AGENT FOR FABRY DISEASE
A61K 31/50 (2006.01)	2416776 *	USE OF TETRAHYDROBIOPTERIN AS A MARKER AND A THERAPEUTIC AGENT FOR FABRY DISEASE
A61K 31/195 (2006.01)	2416776 *	USE OF TETRAHYDROBIOPTERIN AS A MARKER AND A THERAPEUTIC AGENT FOR FABRY DISEASE
A61K 31/4985 (2006.01)	2416776 *	USE OF TETRAHYDROBIOPTERIN AS A MARKER AND A THERAPEUTIC AGENT FOR FABRY DISEASE
A61P 3/00 (2006.01)	2416776 *	USE OF TETRAHYDROBIOPTERIN AS A MARKER AND A THERAPEUTIC AGENT FOR FABRY DISEASE
A61P 25/04 (2006.01)	2493863 *	PHENOXY-SUBSTITUTED PYRIMIDINES AS OPIOID RECEPTOR MODULATORS
C07D 417/12 (2006.01)	2493863 *	PHENOXY-SUBSTITUTED PYRIMIDINES AS OPIOID RECEPTOR MODULATORS
C07D 239/34 (2006.01)	2493863 *	PHENOXY-SUBSTITUTED PYRIMIDINES AS OPIOID RECEPTOR MODULATORS
C07D 401/12 (2006.01)	2493863 *	PHENOXY-SUBSTITUTED PYRIMIDINES AS OPIOID RECEPTOR MODULATORS
A61K 31/506 (2006.01)	2493863 *	PHENOXY-SUBSTITUTED PYRIMIDINES AS OPIOID RECEPTOR MODULATORS
C07D 403/12 (2006.01)	2493863 *	PHENOXY-SUBSTITUTED PYRIMIDINES AS OPIOID RECEPTOR MODULATORS

MKP (51)	Broj objave evropske prijava patenta (97)	Naziv pronalaska (54)
C07D 239/28 (2006.01)	2493863 *	PHENOXY-SUBSTITUTED PYRIMIDINES AS OPIOID RECEPTOR MODULATORS
C07D 413/12 (2006.01)	2493863 *	PHENOXY-SUBSTITUTED PYRIMIDINES AS OPIOID RECEPTOR MODULATORS
C07C 227/32 (2006.01)	2380871	A process for the preparation of isoserine derivatives
C07K 14/605 (2006.01)	2491054 *	SHORT CHAIN PEPTIDOMIMETICS BASED ORALLY ACTIVE GLP-1 AGONIST AND GLUCAGON RECEPTOR ANTAGONIST
A61M 16/00 (2006.01)	2435117 *	VENTILATOR AND ADJUSTMENT METHOD THEREFOR
B65D 85/10 (2006.01)	2376334 *	PACKAGE FOR TOBACCO-RELATED ARTICLES
B65D 5/66 (2006.01)	2376334 *	PACKAGE FOR TOBACCO-RELATED ARTICLES
A61K 31/519 (2006.01)	2385948 *	FUSED THIAZOLO AND OXAZOLO PYRIMIDINONES
A61P 7/06 (2006.01)	2385948 *	FUSED THIAZOLO AND OXAZOLO PYRIMIDINONES
C07D 513/16 (2006.01)	2385948 *	FUSED THIAZOLO AND OXAZOLO PYRIMIDINONES
C07D 513/06 (2006.01)	2385948 *	FUSED THIAZOLO AND OXAZOLO PYRIMIDINONES
C07D 487/04 (2006.01)	2414363 *	1-HETEROCYCLYL-1, 5-DIHYDRO-PYRAZOLO [3, 4-D]PYRIMIDIN-4-ONE DERIVATIVES AND THEIR USE AS PDE9A MODULATORS
A61K 31/519 (2006.01)	2414363 *	1-HETEROCYCLYL-1, 5-DIHYDRO-PYRAZOLO [3, 4-D]PYRIMIDIN-4-ONE DERIVATIVES AND THEIR USE AS PDE9A MODULATORS
A45C 11/00 (2006.01)	2456334 *	PORTIONED PACKAGES FOR MAINTENANCE SOLUTIONS AND OPHTHALMIC LENSES
B65D 21/02 (2006.01)	2394923	Handle device for a plurality of containers
B65D 71/50 (2006.01)	2394923	Handle device for a plurality of containers
A61K 9/16 (2006.01)	2475430 *	GRANULATED ANTHELMINTIC PREPARATIONS AND DELIVERY SYSTEMS
A61K 31/4184 (2006.01)	2475430 *	GRANULATED ANTHELMINTIC PREPARATIONS AND DELIVERY SYSTEMS
A61K 31/425 (2006.01)	2475430 *	GRANULATED ANTHELMINTIC PREPARATIONS AND DELIVERY SYSTEMS
A61P 33/00 (2006.01)	2475430 *	GRANULATED ANTHELMINTIC PREPARATIONS AND DELIVERY SYSTEMS
D06F 57/00 (2006.01)	2478147 *	AUXILIARY DEVICE
D06F 53/00 (2006.01)	2478147 *	AUXILIARY DEVICE
A01N 43/38 (2006.01)	2490531 *	METHOD FOR TREATING ANDROGEN RECEPTOR POSITIVE CANCERS
A61K 31/40 (2006.01)	2490531 *	METHOD FOR TREATING ANDROGEN RECEPTOR POSITIVE CANCERS
A61K 31/54 (2006.01)	2467142 *	HEAT SHOCK PROTEIN BINDING COMPOUNDS, COMPOSITIONS, AND METHODS FOR MAKING AND USING SAME
B65D 25/50 (2006.01)	2361840	Canister
B65D 51/16 (2006.01)	2361840	Canister
C07C 211/35 (2006.01)	2448909 *	METHOD OF PREPARING 1-AMINO-1,3,3,5,5-PENTAMETHYLCYCLOHEXANE
C07C 209/62 (2006.01)	2448909 *	METHOD OF PREPARING 1-AMINO-1,3,3,5,5-PENTAMETHYLCYCLOHEXANE
C07D 417/04 (2006.01)	2473507 *	STABLE SNS-595 COMPOSITIONS AND METHODS OF PREPARATION
C07D 417/14 (2006.01)	2473507 *	STABLE SNS-595 COMPOSITIONS AND METHODS OF PREPARATION
C07D 471/04 (2006.01)	2430021 *	7-ARYL-1,2,4-TRIAZOLO[4,3-A]PYRIDINE DERIVATIVES AND THEIR USE AS POSITIVE ALLOSTERIC MODULATORS OF MGLUR2 RECEPTORS
A61K 31/437 (2006.01)	2430021 *	7-ARYL-1,2,4-TRIAZOLO[4,3-A]PYRIDINE DERIVATIVES AND THEIR USE AS POSITIVE ALLOSTERIC MODULATORS OF MGLUR2 RECEPTORS
A61K 31/444 (2006.01)	2430021 *	7-ARYL-1,2,4-TRIAZOLO[4,3-A]PYRIDINE DERIVATIVES AND THEIR USE AS POSITIVE ALLOSTERIC MODULATORS OF MGLUR2 RECEPTORS
A61K 31/445 (2006.01)	2430021 *	7-ARYL-1,2,4-TRIAZOLO[4,3-A]PYRIDINE DERIVATIVES AND THEIR USE AS POSITIVE ALLOSTERIC MODULATORS OF MGLUR2 RECEPTORS
A61P 25/00 (2006.01)	2430021 *	7-ARYL-1,2,4-TRIAZOLO[4,3-A]PYRIDINE DERIVATIVES AND THEIR USE AS POSITIVE ALLOSTERIC MODULATORS OF MGLUR2 RECEPTORS
A61K 31/437 (2006.01)	2403482 *	ABUSE RESISTANT FORMULATION
A61K 31/4468 (2006.01)	2403482 *	ABUSE RESISTANT FORMULATION
A61P 25/04 (2006.01)	2403482 *	ABUSE RESISTANT FORMULATION

MKP (51)	Broj objave evropske prijave patenta (97)	Naziv pronalaska (54)
A61K 9/16 (2006.01)	2403482 *	ABUSE RESISTANT FORMULATION
C09D 7/12 (2006.01)	2496649 *	FILM-FORMING COMPOSITION CONTAINING AN AGENT CAPABLE OF TRAPPING FORMALDEHYDE
C09D 5/02 (2006.01)	2496649 *	FILM-FORMING COMPOSITION CONTAINING AN AGENT CAPABLE OF TRAPPING FORMALDEHYDE
C07C 211/00 (2006.01)	2487158	New method for synthesising ivabradine and its added salts with a pharmaceutically acceptable acid.
C07D 223/16 (2006.01)	2487158	New method for synthesising ivabradine and its added salts with a pharmaceutically acceptable acid.
A61K 39/395 (2006.01)	2419137 *	COMPOSITIONS AND METHODS TO TREAT ACUTE MYELOGENOUS LEUKEMIA
A61P 25/28 (2006.01)	2454239 *	SUBSTITUTED TRIAZOLE AND IMIDAZOLE DERIVATIVES AS GAMMA SECRETASE MODULATORS
C07D 401/14 (2006.01)	2454239 *	SUBSTITUTED TRIAZOLE AND IMIDAZOLE DERIVATIVES AS GAMMA SECRETASE MODULATORS
C07D 471/04 (2006.01)	2454239 *	SUBSTITUTED TRIAZOLE AND IMIDAZOLE DERIVATIVES AS GAMMA SECRETASE MODULATORS
A61K 31/4439 (2006.01)	2454239 *	SUBSTITUTED TRIAZOLE AND IMIDAZOLE DERIVATIVES AS GAMMA SECRETASE MODULATORS
C07D 403/10 (2006.01)	2454239 *	SUBSTITUTED TRIAZOLE AND IMIDAZOLE DERIVATIVES AS GAMMA SECRETASE MODULATORS
C07D 498/04 (2006.01)	2454239 *	SUBSTITUTED TRIAZOLE AND IMIDAZOLE DERIVATIVES AS GAMMA SECRETASE MODULATORS
C07D 487/04 (2006.01)	2454239 *	SUBSTITUTED TRIAZOLE AND IMIDAZOLE DERIVATIVES AS GAMMA SECRETASE MODULATORS
C07D 233/60 (2006.01)	2454239 *	SUBSTITUTED TRIAZOLE AND IMIDAZOLE DERIVATIVES AS GAMMA SECRETASE MODULATORS
C07D 405/14 (2006.01)	2454239 *	SUBSTITUTED TRIAZOLE AND IMIDAZOLE DERIVATIVES AS GAMMA SECRETASE MODULATORS
A61K 31/4178 (2006.01)	2454239 *	SUBSTITUTED TRIAZOLE AND IMIDAZOLE DERIVATIVES AS GAMMA SECRETASE MODULATORS
A61K 31/4196 (2006.01)	2454239 *	SUBSTITUTED TRIAZOLE AND IMIDAZOLE DERIVATIVES AS GAMMA SECRETASE MODULATORS
B65D 88/16 (2006.01)	2477912 *	PACKAGING CONTAINER FOR BITUMEN
B65D 90/00 (2006.01)	2477912 *	PACKAGING CONTAINER FOR BITUMEN
B65D 90/04 (2006.01)	2477912 *	PACKAGING CONTAINER FOR BITUMEN
A61K 31/047 (2006.01)	2419176 *	PHARMACEUTICAL COMPOSITION COMPRISING GLYCEROL, WHITE SOFT PARAFFIN AND LIQUID PARAFFIN FOR THE TREATMENT OF UREMIC XEROSIS AND/OR PRURITUS
A61K 45/06 (2006.01)	2419176 *	PHARMACEUTICAL COMPOSITION COMPRISING GLYCEROL, WHITE SOFT PARAFFIN AND LIQUID PARAFFIN FOR THE TREATMENT OF UREMIC XEROSIS AND/OR PRURITUS
A61K 9/00 (2006.01)	2419176 *	PHARMACEUTICAL COMPOSITION COMPRISING GLYCEROL, WHITE SOFT PARAFFIN AND LIQUID PARAFFIN FOR THE TREATMENT OF UREMIC XEROSIS AND/OR PRURITUS
A61Q 19/00 (2006.01)	2419176 *	PHARMACEUTICAL COMPOSITION COMPRISING GLYCEROL, WHITE SOFT PARAFFIN AND LIQUID PARAFFIN FOR THE TREATMENT OF UREMIC XEROSIS AND/OR PRURITUS
A61P 17/16 (2006.01)	2419176 *	PHARMACEUTICAL COMPOSITION COMPRISING GLYCEROL, WHITE SOFT PARAFFIN AND LIQUID PARAFFIN FOR THE TREATMENT OF UREMIC XEROSIS AND/OR PRURITUS
A61K 31/01 (2006.01)	2419176 *	PHARMACEUTICAL COMPOSITION COMPRISING GLYCEROL, WHITE SOFT PARAFFIN AND LIQUID PARAFFIN FOR THE TREATMENT OF UREMIC XEROSIS AND/OR PRURITUS
G06F 17/30 (2006.01)	2452277 *	METHODS, SYSTEMS AND DEVICES FOR PERFORMING INCREMENTAL UPDATES OF PARTIAL DATABASES
A01N 33/08 (2006.01)	2482654 *	LOW VOLATILE AMINE SALTS OF ANIONIC PESTICIDES
A01N 39/04 (2006.01)	2482654 *	LOW VOLATILE AMINE SALTS OF ANIONIC PESTICIDES

MKP (51)	Broj objave evropske prijave patenta (97)	Naziv pronalaska (54)
A01N 33/04 (2006.01)	2482654 *	LOW VOLATILE AMINE SALTS OF ANIONIC PESTICIDES
A01N 37/40 (2006.01)	2482654 *	LOW VOLATILE AMINE SALTS OF ANIONIC PESTICIDES
A01N 57/20 (2006.01)	2482654 *	LOW VOLATILE AMINE SALTS OF ANIONIC PESTICIDES
A61K 8/97 (2006.01)	2482830 *	EXTRACTS OF PHYLLANTHUS NIRURI
A61Q 19/02 (2006.01)	2482830 *	EXTRACTS OF PHYLLANTHUS NIRURI
A61Q 19/08 (2006.01)	2482830 *	EXTRACTS OF PHYLLANTHUS NIRURI
A61K 36/47 (2006.01)	2482830 *	EXTRACTS OF PHYLLANTHUS NIRURI
A61P 29/00 (2006.01)	2482830 *	EXTRACTS OF PHYLLANTHUS NIRURI
A61P 17/00 (2006.01)	2482830 *	EXTRACTS OF PHYLLANTHUS NIRURI
A47K 3/34 (2006.01)	2305085	Shower cabin with sliding door
E05D 15/06 (2006.01)	2305085	Shower cabin with sliding door
C25C 3/26 (2006.01)	2425042 *	PRIMARY PRODUCTION OF ELEMENTS
C25C 3/00 (2006.01)	2425042 *	PRIMARY PRODUCTION OF ELEMENTS
C25B 1/00 (2006.01)	2425042 *	PRIMARY PRODUCTION OF ELEMENTS
C25C 1/00 (2006.01)	2425042 *	PRIMARY PRODUCTION OF ELEMENTS
C25C 3/34 (2006.01)	2425042 *	PRIMARY PRODUCTION OF ELEMENTS
A01N 43/90 (2006.01)	2473052 *	SUBSTITUTED XANTHINE DERIVATIVES
A61K 31/522 (2006.01)	2473052 *	SUBSTITUTED XANTHINE DERIVATIVES
C12N 7/02 (2006.01)	2443233 *	IMPROVED METHODS FOR PURIFICATION OF RECOMBINANT AAV VECTORS
A61P 35/00 (2006.01)	2432556 *	PROTEASE INHIBITORS
C07C 257/18 (2006.01)	2432556 *	PROTEASE INHIBITORS
A61K 31/47 (2006.01)	2432556 *	PROTEASE INHIBITORS
C07C 235/62 (2006.01)	2432556 *	PROTEASE INHIBITORS
A61K 31/44 (2006.01)	2432556 *	PROTEASE INHIBITORS
C07D 211/26 (2006.01)	2432556 *	PROTEASE INHIBITORS
A61K 31/445 (2006.01)	2432556 *	PROTEASE INHIBITORS
C07D 211/58 (2006.01)	2432556 *	PROTEASE INHIBITORS
C07C 311/20 (2006.01)	2432556 *	PROTEASE INHIBITORS
C07D 215/08 (2006.01)	2432556 *	PROTEASE INHIBITORS
C07D 401/06 (2006.01)	2432556 *	PROTEASE INHIBITORS
C07D 213/61 (2006.01)	2432556 *	PROTEASE INHIBITORS
C07D 213/75 (2006.01)	2432556 *	PROTEASE INHIBITORS
C07D 217/06 (2006.01)	2432556 *	PROTEASE INHIBITORS
C07C 259/18 (2006.01)	2432556 *	PROTEASE INHIBITORS
A61K 31/40 (2006.01)	2434889 *	IAP INHIBITORS
A01N 43/36 (2006.01)	2434889 *	IAP INHIBITORS
A01H 5/00 (2006.01)	2467010 *	AAD-1 EVENT DAS-40278-9, RELATED TRANSGENIC CORN LINES, AND EVENT-SPECIFIC IDENTIFICATION THEREOF
B63B 25/16 (2006.01)	2464563 *	A PLANT COMPRISING A TANK FOR STORING OF LIQUID NATURAL GAS (LNG) AS MARINE FUEL
B63B 27/24 (2006.01)	2464563 *	A PLANT COMPRISING A TANK FOR STORING OF LIQUID NATURAL GAS (LNG) AS MARINE FUEL
B63J 2/12 (2006.01)	2464563 *	A PLANT COMPRISING A TANK FOR STORING OF LIQUID NATURAL GAS (LNG) AS MARINE FUEL
F17C 6/00 (2006.01)	2464563 *	A PLANT COMPRISING A TANK FOR STORING OF LIQUID NATURAL GAS (LNG) AS MARINE FUEL
F17C 9/02 (2006.01)	2464563 *	A PLANT COMPRISING A TANK FOR STORING OF LIQUID NATURAL GAS (LNG) AS MARINE FUEL
F17C 9/04 (2006.01)	2464563 *	A PLANT COMPRISING A TANK FOR STORING OF LIQUID NATURAL GAS (LNG) AS MARINE FUEL

MKP (51)	Broj objave evropske prijava patenta (97)	Naziv pronalaska (54)
A61L 2/18 (2006.01)	2445542 *	SANITIZATION APPARATUSES, KITS, AND METHODS
A61L 2/16 (2006.01)	2445542 *	SANITIZATION APPARATUSES, KITS, AND METHODS
A61L 101/34 (2006.01)	2445542 *	SANITIZATION APPARATUSES, KITS, AND METHODS
A61L 2/26 (2006.01)	2445542 *	SANITIZATION APPARATUSES, KITS, AND METHODS
G01D 4/00 (2006.01)	2483637 *	METHODS AND SYSTEMS FOR DISTRIBUTING BROADCAST MESSAGES ON VARIOUS NETWORKS
H04B 1/713 (2011.01)	2483637 *	METHODS AND SYSTEMS FOR DISTRIBUTING BROADCAST MESSAGES ON VARIOUS NETWORKS
H04W 4/06 (2009.01)	2483637 *	METHODS AND SYSTEMS FOR DISTRIBUTING BROADCAST MESSAGES ON VARIOUS NETWORKS
C07K 16/18 (2006.01)	2483314 *	BISPECIFIC BINDING MOLECULES FOR ANTI-ANGIOGENESIS THERAPY
C07K 16/28 (2006.01)	2483314 *	BISPECIFIC BINDING MOLECULES FOR ANTI-ANGIOGENESIS THERAPY
C07K 16/22 (2006.01)	2483314 *	BISPECIFIC BINDING MOLECULES FOR ANTI-ANGIOGENESIS THERAPY
A61P 35/00 (2006.01)	2483314 *	BISPECIFIC BINDING MOLECULES FOR ANTI-ANGIOGENESIS THERAPY
F27D 13/00 (2006.01)	2470849 *	MOVABLE SWEAT HEARTH FOR METAL MELTING FURNACE
F27D 3/12 (2006.01)	2470849 *	MOVABLE SWEAT HEARTH FOR METAL MELTING FURNACE
G06F 21/00 (2006.01)	2388695	Adaptive configuration of conflicting applications
G06F 9/445 (2006.01)	2388695	Adaptive configuration of conflicting applications
G06F 11/34 (2006.01)	2388695	Adaptive configuration of conflicting applications
G01M 3/32 (2006.01)	2251671	Outgassing method for inspecting a coated surface
G01N 33/00 (2006.01)	2251671	Outgassing method for inspecting a coated surface
G01N 15/08 (2006.01)	2251671	Outgassing method for inspecting a coated surface
A01N 43/42 (2006.01)	2461683 *	BICYCLIC ARYL SPHINGOSINE 1-PHOSPHATE ANALOGS
A61P 35/00 (2006.01)	2445912 *	NOVEL COMPOUND USEFUL FOR THE TREATMENT OF DEGENERATIVE AND INFLAMMATORY DISEASES
A61P 37/00 (2006.01)	2445912 *	NOVEL COMPOUND USEFUL FOR THE TREATMENT OF DEGENERATIVE AND INFLAMMATORY DISEASES
C07D 471/04 (2006.01)	2445912 *	NOVEL COMPOUND USEFUL FOR THE TREATMENT OF DEGENERATIVE AND INFLAMMATORY DISEASES
A61K 31/437 (2006.01)	2445912 *	NOVEL COMPOUND USEFUL FOR THE TREATMENT OF DEGENERATIVE AND INFLAMMATORY DISEASES
A61P 29/00 (2006.01)	2445912 *	NOVEL COMPOUND USEFUL FOR THE TREATMENT OF DEGENERATIVE AND INFLAMMATORY DISEASES
C12N 5/071 (2010.01)	2471902 *	PRODUCTION OF ARTIFICIAL TISSUES BY MEANS OF TISSUE ENGINEERING USING AGAROSE-FIBRIN BIOMATERIALS
A61L 27/38 (2006.01)	2471902 *	PRODUCTION OF ARTIFICIAL TISSUES BY MEANS OF TISSUE ENGINEERING USING AGAROSE-FIBRIN BIOMATERIALS
A61K 35/12 (2006.01)	2471902 *	PRODUCTION OF ARTIFICIAL TISSUES BY MEANS OF TISSUE ENGINEERING USING AGAROSE-FIBRIN BIOMATERIALS
B60M 3/04 (2006.01)	2450223	Automated storage systems including at least one track provided with a mechanism for halting a carriage.
B65G 1/04 (2006.01)	2450223	Automated storage systems including at least one track provided with a mechanism for halting a carriage.
A24F 47/00 (2006.01)	2493342 *	AN ELECTRICALLY HEATED SMOKING SYSTEM WITH IMPROVED HEATER
G01T 1/29 (2006.01)	2414864 *	INTERWOVEN MULTI-APERTURE COLLIMATOR FOR 3-DIMENSIONAL RADIATION IMAGING APPLICATIONS
G01N 23/04 (2006.01)	2414864 *	INTERWOVEN MULTI-APERTURE COLLIMATOR FOR 3-DIMENSIONAL RADIATION IMAGING APPLICATIONS
A61B 6/02 (2006.01)	2414864 *	INTERWOVEN MULTI-APERTURE COLLIMATOR FOR 3-DIMENSIONAL RADIATION IMAGING APPLICATIONS
G21K 1/02 (2006.01)	2414864 *	INTERWOVEN MULTI-APERTURE COLLIMATOR FOR 3-DIMENSIONAL RADIATION IMAGING APPLICATIONS
C07K 14/705 (2006.01)	2440576 *	METHODS FOR INCREASING THERMOGENIC ADIPOCYTES

MKP (51)	Broj objave evropske prijava patenta (97)	Naziv pronalaska (54)
A61P 3/00 (2006.01)	2440576 *	METHODS FOR INCREASING THERMOGENIC ADIPOCYTES
A61K 38/18 (2006.01)	2440576 *	METHODS FOR INCREASING THERMOGENIC ADIPOCYTES
A61Q 3/02 (2006.01)	2486067 *	REMOVABLE PROTECTIVE TOPCOAT FOR ARTIFICIAL NAIL COATINGS AND METHODS THEREFORE
A45D 31/00 (2006.01)	2486067 *	REMOVABLE PROTECTIVE TOPCOAT FOR ARTIFICIAL NAIL COATINGS AND METHODS THEREFORE
C08F 251/02 (2006.01)	2486067 *	REMOVABLE PROTECTIVE TOPCOAT FOR ARTIFICIAL NAIL COATINGS AND METHODS THEREFORE
C09D 4/06 (2006.01)	2486067 *	REMOVABLE PROTECTIVE TOPCOAT FOR ARTIFICIAL NAIL COATINGS AND METHODS THEREFORE
A61K 8/91 (2006.01)	2486067 *	REMOVABLE PROTECTIVE TOPCOAT FOR ARTIFICIAL NAIL COATINGS AND METHODS THEREFORE
C08F 265/06 (2006.01)	2419462 *	BIMOLECULAR INVERSE EMULSION POLYMER
C08F 265/04 (2006.01)	2419462 *	BIMOLECULAR INVERSE EMULSION POLYMER
D21H 21/10 (2006.01)	2419462 *	BIMOLECULAR INVERSE EMULSION POLYMER
C08F 265/10 (2006.01)	2419462 *	BIMOLECULAR INVERSE EMULSION POLYMER
C08F 2/32 (2006.01)	2419462 *	BIMOLECULAR INVERSE EMULSION POLYMER
C12N 15/82 (2006.01)	2467488 *	CONTROL OF AAD-1 MONOCOT VOLUNTEERS IN FIELDS OF DICOT CROPS
A01H 5/00 (2006.01)	2467488 *	CONTROL OF AAD-1 MONOCOT VOLUNTEERS IN FIELDS OF DICOT CROPS
C07K 16/28 (2006.01)	2493926 *	FUNCTION MODIFYING NAV 1.7 ANTIBODIES
C07D 401/12 (2006.01)	2476677 *	PROCESS FOR PRODUCTION OF 4-(5-METHYLPYRIDIN-2-YLAMINO) PIPERIDINE-1-CARBOXYLIC ACID DERIVATIVES
A61K 31/495 (2006.01)	2482817 *	METHODS OF TREATING ANEURYSMAL DILATATION, BLOOD VESSEL WALL WEAKNESS AND SPECIFICALLY ABDOMINAL AORTIC AND THORACIC ANEURYSM USING MATRIX METALLOPROTEASE-2 INHIBITORS
A61P 9/00 (2006.01)	2482817 *	METHODS OF TREATING ANEURYSMAL DILATATION, BLOOD VESSEL WALL WEAKNESS AND SPECIFICALLY ABDOMINAL AORTIC AND THORACIC ANEURYSM USING MATRIX METALLOPROTEASE-2 INHIBITORS
H04N 13/04 (2006.01)	2437504 *	RECORDING MEDIUM, REPRODUCTION DEVICE, INTEGRATED CIRCUIT, REPRODUCTION METHOD, AND PROGRAM
G11B 20/10 (2006.01)	2437504 *	RECORDING MEDIUM, REPRODUCTION DEVICE, INTEGRATED CIRCUIT, REPRODUCTION METHOD, AND PROGRAM
G11B 20/12 (2006.01)	2437504 *	RECORDING MEDIUM, REPRODUCTION DEVICE, INTEGRATED CIRCUIT, REPRODUCTION METHOD, AND PROGRAM
G11B 27/00 (2006.01)	2437504 *	RECORDING MEDIUM, REPRODUCTION DEVICE, INTEGRATED CIRCUIT, REPRODUCTION METHOD, AND PROGRAM
H04N 5/93 (2006.01)	2437504 *	RECORDING MEDIUM, REPRODUCTION DEVICE, INTEGRATED CIRCUIT, REPRODUCTION METHOD, AND PROGRAM
A61K 9/20 (2006.01)	2405915 *	IMMEDIATE RELEASE PHARMACEUTICAL COMPOSITIONS COMPRISING OXYCODONE AND NALOXONE
A61K 31/485 (2006.01)	2405915 *	IMMEDIATE RELEASE PHARMACEUTICAL COMPOSITIONS COMPRISING OXYCODONE AND NALOXONE
A61P 25/04 (2006.01)	2405915 *	IMMEDIATE RELEASE PHARMACEUTICAL COMPOSITIONS COMPRISING OXYCODONE AND NALOXONE
A61K 9/28 (2006.01)	2405915 *	IMMEDIATE RELEASE PHARMACEUTICAL COMPOSITIONS COMPRISING OXYCODONE AND NALOXONE
E06B 3/46 (2006.01)	2336473	Case for counterframe for disappearing sliding door and counterframe with case of the door panel provided with a side for supporting hanging objects
C07C 209/62 (2006.01)	2448910 *	METHOD OF PREPARING NERAMEXANE
C07C 211/35 (2006.01)	2448910 *	METHOD OF PREPARING NERAMEXANE
C07C 209/16 (2006.01)	2448910 *	METHOD OF PREPARING NERAMEXANE
G01D 5/12 (2006.01)	2491335 *	MULTI-TURN SENSOR

MKP (51)	Broj objave evropske prijava patenta (97)	Naziv pronalaska (54)
G01B 7/30 (2006.01)	2491335 *	MULTI-TURN SENSOR
B62D 15/02 (2006.01)	2491335 *	MULTI-TURN SENSOR
C07D 253/075 (2006.01)	2430003 *	OLIGOMER-CONTAINING SUBSTITUTED AROMATIC TRIAZINE COMPOUNDS
A61P 25/08 (2006.01)	2430003 *	OLIGOMER-CONTAINING SUBSTITUTED AROMATIC TRIAZINE COMPOUNDS
A61K 31/53 (2006.01)	2430003 *	OLIGOMER-CONTAINING SUBSTITUTED AROMATIC TRIAZINE COMPOUNDS
C12Q 1/68 (2006.01)	2494074 *	METHODS FOR DIAGNOSING IRRITABLE BOWEL SYNDROME
G01C 21/00 (2006.01)	2491342 *	POWER MANAGEMENT SYSTEM AND METHOD FOR VEHICLE LOCATING UNIT
A61K 9/12 (2006.01)	2387391 *	METHOD FOR DEVELOPING A LIQUID COMPOSITION TO BE APPLIED TO THE SKIN AS A FOAM AND A COMPOSITION THAT CAN BE APPLIED TOPICALLY
G01R 31/00 (2006.01)	2414850 *	METHOD OF CHECKING THE DIRECTIVITY AND POLARIZATION OF COHERENT FIELD DISTRIBUTIONS IN A REVERBERANT MEDIUM
G01R 29/08 (2006.01)	2414850 *	METHOD OF CHECKING THE DIRECTIVITY AND POLARIZATION OF COHERENT FIELD DISTRIBUTIONS IN A REVERBERANT MEDIUM
A61B 5/026 (2006.01)	2292142	Method and device for evaluation of blood fluidity
A61B 1/00 (2006.01)	2485632 *	LAPAROSCOPIC INSTRUMENT WITH ATTACHABLE END EFFECTOR
A61B 17/00 (2006.01)	2485632 *	LAPAROSCOPIC INSTRUMENT WITH ATTACHABLE END EFFECTOR
E04H 7/22 (2006.01)	2478171 *	TUBULAR BUILDING STRUCTURE WITH HINGEDLY CONNECTED PLATFORM SEGMENT
E04H 12/08 (2006.01)	2478171 *	TUBULAR BUILDING STRUCTURE WITH HINGEDLY CONNECTED PLATFORM SEGMENT
E04G 11/06 (2006.01)	2478171 *	TUBULAR BUILDING STRUCTURE WITH HINGEDLY CONNECTED PLATFORM SEGMENT
E04H 12/34 (2006.01)	2478171 *	TUBULAR BUILDING STRUCTURE WITH HINGEDLY CONNECTED PLATFORM SEGMENT
C07D 401/14 (2006.01)	2493513 *	RADIOLABELLED PDE10 LIGANDS
A61K 51/04 (2006.01)	2493513 *	RADIOLABELLED PDE10 LIGANDS
C12N 15/113 (2010.01)	2411517 *	RNA INTERFERENCE MEDIATED INHIBITION OF THE INTERCELLULAR ADHESION MOLECULE 1 (ICAM-1) GENE EXPRESSION USING SHORT INTERFERING NUCLEIC ACID (siNA)
C07D 233/86 (2006.01)	2426113 *	CARBINOL COMPOUND HAVING HETEROCYCLIC LINKER
A61K 31/4164 (2006.01)	2426113 *	CARBINOL COMPOUND HAVING HETEROCYCLIC LINKER
A61K 31/496 (2006.01)	2426113 *	CARBINOL COMPOUND HAVING HETEROCYCLIC LINKER
A61K 31/551 (2006.01)	2426113 *	CARBINOL COMPOUND HAVING HETEROCYCLIC LINKER
A61P 3/06 (2006.01)	2426113 *	CARBINOL COMPOUND HAVING HETEROCYCLIC LINKER
A61P 3/10 (2006.01)	2426113 *	CARBINOL COMPOUND HAVING HETEROCYCLIC LINKER
A61P 9/10 (2006.01)	2426113 *	CARBINOL COMPOUND HAVING HETEROCYCLIC LINKER
A61P 17/00 (2006.01)	2426113 *	CARBINOL COMPOUND HAVING HETEROCYCLIC LINKER
A61P 25/28 (2006.01)	2426113 *	CARBINOL COMPOUND HAVING HETEROCYCLIC LINKER
A61P 29/00 (2006.01)	2426113 *	CARBINOL COMPOUND HAVING HETEROCYCLIC LINKER
A61P 43/00 (2006.01)	2426113 *	CARBINOL COMPOUND HAVING HETEROCYCLIC LINKER
C07D 401/04 (2006.01)	2426113 *	CARBINOL COMPOUND HAVING HETEROCYCLIC LINKER
C07D 401/12 (2006.01)	2426113 *	CARBINOL COMPOUND HAVING HETEROCYCLIC LINKER
C07D 401/14 (2006.01)	2426113 *	CARBINOL COMPOUND HAVING HETEROCYCLIC LINKER
C07D 403/06 (2006.01)	2426113 *	CARBINOL COMPOUND HAVING HETEROCYCLIC LINKER
C07D 405/04 (2006.01)	2426113 *	CARBINOL COMPOUND HAVING HETEROCYCLIC LINKER
C07D 405/14 (2006.01)	2426113 *	CARBINOL COMPOUND HAVING HETEROCYCLIC LINKER
C07D 491/048 (2006.01)	2426113 *	CARBINOL COMPOUND HAVING HETEROCYCLIC LINKER
C07D 491/056 (2006.01)	2426113 *	CARBINOL COMPOUND HAVING HETEROCYCLIC LINKER

MKP (51)	Broj objave evropske prijave patenta (97)	Naziv pronalaska (54)
A01P 1/00 (2006.01)	2458995 *	TRISUBSTITUTED BORON-CONTAINING MOLECULES
A61K 31/69 (2006.01)	2458995 *	TRISUBSTITUTED BORON-CONTAINING MOLECULES
A61P 31/04 (2006.01)	2458995 *	TRISUBSTITUTED BORON-CONTAINING MOLECULES
A01N 55/08 (2006.01)	2458995 *	TRISUBSTITUTED BORON-CONTAINING MOLECULES
C07F 5/02 (2006.01)	2458995 *	TRISUBSTITUTED BORON-CONTAINING MOLECULES
A62D 3/36 (2007.01)	2458995 *	TRISUBSTITUTED BORON-CONTAINING MOLECULES
A61K 9/00 (2006.01)	2413899 *	DENTAL ANESTHETIC COMPRISING TETRACAINE AND A VASOCONSTRICTOR FOR INTRANASAL ADMINISTRATION
A61K 31/245 (2006.01)	2413899 *	DENTAL ANESTHETIC COMPRISING TETRACAINE AND A VASOCONSTRICTOR FOR INTRANASAL ADMINISTRATION
A61K 31/4174 (2006.01)	2413899 *	DENTAL ANESTHETIC COMPRISING TETRACAINE AND A VASOCONSTRICTOR FOR INTRANASAL ADMINISTRATION
A61P 23/02 (2006.01)	2413899 *	DENTAL ANESTHETIC COMPRISING TETRACAINE AND A VASOCONSTRICTOR FOR INTRANASAL ADMINISTRATION
A01N 37/18 (2006.01)	2405750 *	COMBINATION THERAPY WITH THIOCOLCHICINE DERIVATIVES
A61K 31/16 (2006.01)	2405750 *	COMBINATION THERAPY WITH THIOCOLCHICINE DERIVATIVES
C07D 215/26 (2006.01)	2406227 *	PROCESS FOR MANUFACTURING 5-(2-{{[6-(2,2-DIFLUORO-2-PHENYLETHOXY) HEXYL]AMINO}-1- HYDROXYETHYL)-8-HYDROXYQUINOLIN-2(1H)-ONE.
A61K 31/4704 (2006.01)	2406227 *	PROCESS FOR MANUFACTURING 5-(2-{{[6-(2,2-DIFLUORO-2-PHENYLETHOXY) HEXYL]AMINO}-1- HYDROXYETHYL)-8-HYDROXYQUINOLIN-2(1H)-ONE.
A61P 11/00 (2006.01)	2406227 *	PROCESS FOR MANUFACTURING 5-(2-{{[6-(2,2-DIFLUORO-2-PHENYLETHOXY) HEXYL]AMINO}-1- HYDROXYETHYL)-8-HYDROXYQUINOLIN-2(1H)-ONE.
C12N 5/10 (2006.01)	2448970 *	ANTIBODIES AGAINST NERVE GROWTH FACTOR (NGF) WITH ENHANCED IN VIVO STABILITY
A61K 39/395 (2006.01)	2448970 *	ANTIBODIES AGAINST NERVE GROWTH FACTOR (NGF) WITH ENHANCED IN VIVO STABILITY
A61P 25/00 (2006.01)	2448970 *	ANTIBODIES AGAINST NERVE GROWTH FACTOR (NGF) WITH ENHANCED IN VIVO STABILITY
C07K 16/22 (2006.01)	2448970 *	ANTIBODIES AGAINST NERVE GROWTH FACTOR (NGF) WITH ENHANCED IN VIVO STABILITY
C12N 15/13 (2006.01)	2448970 *	ANTIBODIES AGAINST NERVE GROWTH FACTOR (NGF) WITH ENHANCED IN VIVO STABILITY
F16L 57/04 (2006.01)	2270382	Thin layer strip for coating metal components and method for applying a coating which forms a thin layer
D06M 13/10 (2006.01)	2488596 *	ADHESIVE COMPOSITION FOR MINERAL WOOL INCLUDING A REDUCING SUGAR AND A METAL SALT OF AN INORGANIC ACID, AND INSULATING PRODUCTS THUS OBTAINED.
C09J 103/02 (2006.01)	2488596 *	ADHESIVE COMPOSITION FOR MINERAL WOOL INCLUDING A REDUCING SUGAR AND A METAL SALT OF AN INORGANIC ACID, AND INSULATING PRODUCTS THUS OBTAINED.
E04B 1/74 (2006.01)	2488596 *	ADHESIVE COMPOSITION FOR MINERAL WOOL INCLUDING A REDUCING SUGAR AND A METAL SALT OF AN INORGANIC ACID, AND INSULATING PRODUCTS THUS OBTAINED.
C03C 25/14 (2006.01)	2488596 *	ADHESIVE COMPOSITION FOR MINERAL WOOL INCLUDING A REDUCING SUGAR AND A METAL SALT OF AN INORGANIC ACID, AND INSULATING PRODUCTS THUS OBTAINED.
C03C 25/24 (2006.01)	2488596 *	ADHESIVE COMPOSITION FOR MINERAL WOOL INCLUDING A REDUCING SUGAR AND A METAL SALT OF AN INORGANIC ACID, AND INSULATING PRODUCTS THUS OBTAINED.
C03C 25/26 (2006.01)	2488596 *	ADHESIVE COMPOSITION FOR MINERAL WOOL INCLUDING A REDUCING SUGAR AND A METAL SALT OF AN INORGANIC ACID, AND INSULATING PRODUCTS THUS OBTAINED.
C03C 25/32 (2006.01)	2488596 *	ADHESIVE COMPOSITION FOR MINERAL WOOL INCLUDING A REDUCING SUGAR AND A METAL SALT OF AN INORGANIC ACID, AND INSULATING PRODUCTS THUS OBTAINED.

MKP (51)	Broj objave evropske prijave patenta (97)	Naziv pronalaska (54)
D04H 1/58 (2012.01)	2488596 *	ADHESIVE COMPOSITION FOR MINERAL WOOL INCLUDING A REDUCING SUGAR AND A METAL SALT OF AN INORGANIC ACID, AND INSULATING PRODUCTS THUS OBTAINED.
D04H 1/64 (2012.01)	2488596 *	ADHESIVE COMPOSITION FOR MINERAL WOOL INCLUDING A REDUCING SUGAR AND A METAL SALT OF AN INORGANIC ACID, AND INSULATING PRODUCTS THUS OBTAINED.
B32B 15/08 (2006.01)	2459372 *	THERMALLY RESPONSIVE COMPOSITE MATERIALS
B32B 17/10 (2006.01)	2459372 *	THERMALLY RESPONSIVE COMPOSITE MATERIALS
B29C 45/14 (2006.01)	2459372 *	THERMALLY RESPONSIVE COMPOSITE MATERIALS
A61K 31/455 (2006.01)	2406225 *	ADDITION SALTS OF AMINES CONTAINING HYDROXYL AND/OR CARBOXYLIC GROUPS WITH AMINO NICOTINIC ACID DERIVATIVES AS DHODH INHIBITORS
A61P 37/00 (2006.01)	2406225 *	ADDITION SALTS OF AMINES CONTAINING HYDROXYL AND/OR CARBOXYLIC GROUPS WITH AMINO NICOTINIC ACID DERIVATIVES AS DHODH INHIBITORS
C07D 213/80 (2006.01)	2406225 *	ADDITION SALTS OF AMINES CONTAINING HYDROXYL AND/OR CARBOXYLIC GROUPS WITH AMINO NICOTINIC ACID DERIVATIVES AS DHODH INHIBITORS
B29C 35/16 (2006.01)	2427315 *	PROCESS FOR MANUFACTURING A COMPOSITION COMPRISING RECYCLED PET BY CONTROLLED COOLING
B29B 7/90 (2006.01)	2427315 *	PROCESS FOR MANUFACTURING A COMPOSITION COMPRISING RECYCLED PET BY CONTROLLED COOLING
B29B 17/00 (2006.01)	2427315 *	PROCESS FOR MANUFACTURING A COMPOSITION COMPRISING RECYCLED PET BY CONTROLLED COOLING
C07H 21/04 (2006.01)	2496594 *	METHODS AND COMPOSITIONS FOR MODULATING TAU LEVELS
C12N 15/11 (2006.01)	2496594 *	METHODS AND COMPOSITIONS FOR MODULATING TAU LEVELS
B24B 33/02 (2006.01)	2475499 *	BORE MACHINING METHOD AND APPARATUS
B23Q 17/22 (2006.01)	2475499 *	BORE MACHINING METHOD AND APPARATUS
B24B 5/40 (2006.01)	2475499 *	BORE MACHINING METHOD AND APPARATUS
C07K 1/24 (2006.01)	2477505 *	CANOLA PROTEIN PRODUCT FROM SUPERNATANT
A23J 1/14 (2006.01)	2477505 *	CANOLA PROTEIN PRODUCT FROM SUPERNATANT
C07K 14/415 (2006.01)	2477505 *	CANOLA PROTEIN PRODUCT FROM SUPERNATANT
B65B 39/00 (2006.01)	2241507	Apparatus for filling flexible containers with a fluid, for example foodstuffs, such as cream, yoghurt, fruit juices and purées, vegetables and similar
B65B 39/04 (2006.01)	2241507	Apparatus for filling flexible containers with a fluid, for example foodstuffs, such as cream, yoghurt, fruit juices and purées, vegetables and similar
B65B 31/04 (2006.01)	2241507	Apparatus for filling flexible containers with a fluid, for example foodstuffs, such as cream, yoghurt, fruit juices and purées, vegetables and similar
B65B 55/02 (2006.01)	2241507	Apparatus for filling flexible containers with a fluid, for example foodstuffs, such as cream, yoghurt, fruit juices and purées, vegetables and similar
A61K 31/4523 (2006.01)	2406247 *	COMPOUNDS FOR THE TREATMENT OF METABOLIC DISORDERS
A61K 31/397 (2006.01)	2406247 *	COMPOUNDS FOR THE TREATMENT OF METABOLIC DISORDERS
C07D 413/14 (2006.01)	2406247 *	COMPOUNDS FOR THE TREATMENT OF METABOLIC DISORDERS
A61P 3/00 (2006.01)	2406247 *	COMPOUNDS FOR THE TREATMENT OF METABOLIC DISORDERS
C07D 401/12 (2006.01)	2406247 *	COMPOUNDS FOR THE TREATMENT OF METABOLIC DISORDERS
C07D 401/14 (2006.01)	2406247 *	COMPOUNDS FOR THE TREATMENT OF METABOLIC DISORDERS
C07D 403/14 (2006.01)	2406247 *	COMPOUNDS FOR THE TREATMENT OF METABOLIC DISORDERS
A61M 5/28 (2006.01)	2403563 *	SEAL MEMBER FOR SYRINGE WITH RETRACTABLE NEEDLE
A61M 5/32 (2006.01)	2403563 *	SEAL MEMBER FOR SYRINGE WITH RETRACTABLE NEEDLE
A61K 31/375 (2006.01)	2440551 *	UNSATURATED FATTY ACID MONOESTERS AND DIESTERS ON ASCORBIC ACID AND COSMETIC USES THEREOF
A61P 29/00 (2006.01)	2440551 *	UNSATURATED FATTY ACID MONOESTERS AND DIESTERS ON ASCORBIC ACID AND COSMETIC USES THEREOF
C07D 407/04 (2006.01)	2440551 *	UNSATURATED FATTY ACID MONOESTERS AND DIESTERS ON ASCORBIC ACID AND COSMETIC USES THEREOF

MKP (51)	Broj objave evropske prijava patenta (97)	Naziv pronalaska (54)
G08B 17/10 (2006.01)	2491543 *	MULTIFUNCTIONAL/MODULAR SMOKE ALARM DEVICE
F16H 48/12 (2006.01)	2317179	Differential of automatic alterations of folding rhomb
F16L 37/14 (2006.01)	2406530 *	WATER DRAIN ASSEMBLY, IN PARTICULAR FOR SIPHONIC ROOF DRAINAGE SYSTEMS
E04D 13/04 (2006.01)	2406530 *	WATER DRAIN ASSEMBLY, IN PARTICULAR FOR SIPHONIC ROOF DRAINAGE SYSTEMS
A61M 36/14 (2006.01)	2485771 *	PHOSPHODIESTERASE 1-TARGETING TRACERS AND METHODS
A61K 51/00 (2006.01)	2485771 *	PHOSPHODIESTERASE 1-TARGETING TRACERS AND METHODS
A61K 31/506 (2006.01)	2442809 *	INHIBITORS OF INFLUENZA VIRUSES REPLICATION
A61P 31/16 (2006.01)	2442809 *	INHIBITORS OF INFLUENZA VIRUSES REPLICATION
A01N 43/66 (2006.01)	2440057 *	TRIAZINE DERIVATIVES AND THEIR THERAPEUTICAL APPLICATIONS
A61K 31/53 (2006.01)	2440057 *	TRIAZINE DERIVATIVES AND THEIR THERAPEUTICAL APPLICATIONS
A61K 31/437 (2006.01)	2438066 *	PREPARATION AND USES OF 1,2,4-TRIAZOLO [1,5a]PYRIDINE DERIVATIVES
A61P 35/00 (2006.01)	2438066 *	PREPARATION AND USES OF 1,2,4-TRIAZOLO [1,5a]PYRIDINE DERIVATIVES
C07D 471/04 (2006.01)	2438066 *	PREPARATION AND USES OF 1,2,4-TRIAZOLO [1,5a]PYRIDINE DERIVATIVES
A61K 31/4196 (2006.01)	2438066 *	PREPARATION AND USES OF 1,2,4-TRIAZOLO [1,5a]PYRIDINE DERIVATIVES
B22D 27/04 (2006.01)	2491169 *	METHOD AND DEVICE FOR OBTAINING A MULTICRYSTALLINE SEMICONDUCTOR MATERIAL, IN PARTICULAR SILICON
C30B 11/00 (2006.01)	2491169 *	METHOD AND DEVICE FOR OBTAINING A MULTICRYSTALLINE SEMICONDUCTOR MATERIAL, IN PARTICULAR SILICON
C30B 35/00 (2006.01)	2491169 *	METHOD AND DEVICE FOR OBTAINING A MULTICRYSTALLINE SEMICONDUCTOR MATERIAL, IN PARTICULAR SILICON
F27B 14/14 (2006.01)	2491169 *	METHOD AND DEVICE FOR OBTAINING A MULTICRYSTALLINE SEMICONDUCTOR MATERIAL, IN PARTICULAR SILICON
C30B 29/06 (2006.01)	2491169 *	METHOD AND DEVICE FOR OBTAINING A MULTICRYSTALLINE SEMICONDUCTOR MATERIAL, IN PARTICULAR SILICON
H05B 6/44 (2006.01)	2491169 *	METHOD AND DEVICE FOR OBTAINING A MULTICRYSTALLINE SEMICONDUCTOR MATERIAL, IN PARTICULAR SILICON
H05B 6/36 (2006.01)	2491169 *	METHOD AND DEVICE FOR OBTAINING A MULTICRYSTALLINE SEMICONDUCTOR MATERIAL, IN PARTICULAR SILICON
H04W 88/00 (2009.01)	2451241 *	SYNCHRONIZATION SCHEDULE METHOD, APPARATUS AND SYSTEM
C12P 21/08 (2006.01)	2449127 *	POLYPEPTIDES AND METHOD OF TREATMENT
A43B 3/24 (2006.01)	2263487	Shoe with interchangeable strap
A43B 3/30 (2006.01)	2263487	Shoe with interchangeable strap
A43C 11/14 (2006.01)	2263487	Shoe with interchangeable strap
A61K 47/48 (2006.01)	2440249 *	COVALENT CONJUGATES COMPRISING A PROTEASE INHIBITOR, A WATER-SOLUBLE, NON-PEPTIDIC OLIGOMER AND A LIPOPHILIC MOIETY
B65D 33/01 (2006.01)	2493779 *	IMPROVED PACKAGING CONTAINER WITH OVERPRESSURE RELIEF, PACKING METHOD AND SYSTEM
B65B 1/22 (2006.01)	2493779 *	IMPROVED PACKAGING CONTAINER WITH OVERPRESSURE RELIEF, PACKING METHOD AND SYSTEM
B65B 1/24 (2006.01)	2493779 *	IMPROVED PACKAGING CONTAINER WITH OVERPRESSURE RELIEF, PACKING METHOD AND SYSTEM
A61P 29/00 (2006.01)	2429998 *	5-MEMBERED HETEROCYCLIC COMPOUND CYCLOPENTA[C] PYRROLYLALKYL CARBAMATE DERIVATIVES, PREPARATION THEREOF, AND THERAPEUTIC USE THEREOF
C07D 231/12 (2006.01)	2429998 *	5-MEMBERED HETEROCYCLIC COMPOUND CYCLOPENTA[C] PYRROLYLALKYL CARBAMATE DERIVATIVES, PREPARATION THEREOF, AND THERAPEUTIC USE THEREOF
C07D 261/10 (2006.01)	2429998 *	5-MEMBERED HETEROCYCLIC COMPOUND CYCLOPENTA[C] PYRROLYLALKYL CARBAMATE DERIVATIVES, PREPARATION THEREOF, AND THERAPEUTIC USE THEREOF

MKP (51)	Broj objave evropske prijave patenta (97)	Naziv pronalaska (54)
C07D 277/22 (2006.01)	2429998 *	5-MEMBERED HETEROCYCLIC COMPOUND CYCLOPENTA[C] PYRROLYLALKYL CARBAMATE DERIVATIVES, PREPARATION THEREOF, AND THERAPEUTIC USE THEREOF
C07D 401/14 (2006.01)	2429998 *	5-MEMBERED HETEROCYCLIC COMPOUND CYCLOPENTA[C] PYRROLYLALKYL CARBAMATE DERIVATIVES, PREPARATION THEREOF, AND THERAPEUTIC USE THEREOF
A61K 31/439 (2006.01)	2429998 *	5-MEMBERED HETEROCYCLIC COMPOUND CYCLOPENTA[C] PYRROLYLALKYL CARBAMATE DERIVATIVES, PREPARATION THEREOF, AND THERAPEUTIC USE THEREOF
C07D 413/14 (2006.01)	2429998 *	5-MEMBERED HETEROCYCLIC COMPOUND CYCLOPENTA[C] PYRROLYLALKYL CARBAMATE DERIVATIVES, PREPARATION THEREOF, AND THERAPEUTIC USE THEREOF
A61P 25/00 (2006.01)	2429998 *	5-MEMBERED HETEROCYCLIC COMPOUND CYCLOPENTA[C] PYRROLYLALKYL CARBAMATE DERIVATIVES, PREPARATION THEREOF, AND THERAPEUTIC USE THEREOF
B65D 21/02 (2006.01)	2371727	Crate
B65D 85/34 (2006.01)	2371727	Crate
B65D 6/00 (2006.01)	2371727	Crate
C07C 237/06 (2006.01)	2493571 *	ALKYNYL DERIVATIVES USEFUL AS DPP-1 INHIBITORS
C07D 233/61 (2006.01)	2493571 *	ALKYNYL DERIVATIVES USEFUL AS DPP-1 INHIBITORS
A61P 11/06 (2006.01)	2493571 *	ALKYNYL DERIVATIVES USEFUL AS DPP-1 INHIBITORS
C07D 217/12 (2006.01)	2493571 *	ALKYNYL DERIVATIVES USEFUL AS DPP-1 INHIBITORS
C07D 277/30 (2006.01)	2493571 *	ALKYNYL DERIVATIVES USEFUL AS DPP-1 INHIBITORS
C07D 231/12 (2006.01)	2493571 *	ALKYNYL DERIVATIVES USEFUL AS DPP-1 INHIBITORS
C07D 333/52 (2006.01)	2493571 *	ALKYNYL DERIVATIVES USEFUL AS DPP-1 INHIBITORS
C07C 317/32 (2006.01)	2493571 *	ALKYNYL DERIVATIVES USEFUL AS DPP-1 INHIBITORS
C07D 317/58 (2006.01)	2493571 *	ALKYNYL DERIVATIVES USEFUL AS DPP-1 INHIBITORS
C07C 237/08 (2006.01)	2493571 *	ALKYNYL DERIVATIVES USEFUL AS DPP-1 INHIBITORS
C07D 213/61 (2006.01)	2493571 *	ALKYNYL DERIVATIVES USEFUL AS DPP-1 INHIBITORS
A61K 31/16 (2006.01)	2493571 *	ALKYNYL DERIVATIVES USEFUL AS DPP-1 INHIBITORS
C07D 311/04 (2006.01)	2493571 *	ALKYNYL DERIVATIVES USEFUL AS DPP-1 INHIBITORS
C07D 211/46 (2006.01)	2493571 *	ALKYNYL DERIVATIVES USEFUL AS DPP-1 INHIBITORS
C07D 319/14 (2006.01)	2493571 *	ALKYNYL DERIVATIVES USEFUL AS DPP-1 INHIBITORS
C07D 211/42 (2006.01)	2493571 *	ALKYNYL DERIVATIVES USEFUL AS DPP-1 INHIBITORS
C07D 213/56 (2006.01)	2493571 *	ALKYNYL DERIVATIVES USEFUL AS DPP-1 INHIBITORS
C07D 403/14 (2006.01)	2496572 *	BENZIMIDAZOLE-IMIDAZOLE DERIVATIVES
A61P 31/12 (2006.01)	2496572 *	BENZIMIDAZOLE-IMIDAZOLE DERIVATIVES
A61K 31/4184 (2006.01)	2496572 *	BENZIMIDAZOLE-IMIDAZOLE DERIVATIVES
B29C 45/14 (2006.01)	2414144 *	METHOD FOR MOULDING A PLASTIC PART WITH A METAL INSERT HELD IN PLACE BY MAGNETISATION, MOULDING DEVICE AND USE OF A MAGNET FOR SECURING SAID INSERT
B29C 45/16 (2006.01)	2414144 *	METHOD FOR MOULDING A PLASTIC PART WITH A METAL INSERT HELD IN PLACE BY MAGNETISATION, MOULDING DEVICE AND USE OF A MAGNET FOR SECURING SAID INSERT
A61K 47/48 (2006.01)	2482855 *	OLIGOMER-CALCIMIMETIC CONJUGATES AND RELATED COMPOUNDS
H01M 8/24 (2006.01)	2333889	Fuel cell devices with biasing current collectors
H01M 8/02 (2006.01)	2333889	Fuel cell devices with biasing current collectors
A61P 35/00 (2006.01)	2427185 *	ANTITUMOR COMBINATION INCLUDING AVE8062 AND SORAFENIB
A61K 31/167 (2006.01)	2427185 *	ANTITUMOR COMBINATION INCLUDING AVE8062 AND SORAFENIB
A61K 31/4412 (2006.01)	2427185 *	ANTITUMOR COMBINATION INCLUDING AVE8062 AND SORAFENIB
B29C 47/00 (2006.01)	2461959 *	MULTILAYERED COMPOSITE
A61K 31/4439 (2006.01)	2456439 *	A STABLE PHARMACEUTICAL OMEPRAZOLE FORMULATION FOR ORAL ADMINISTRATION

MKP (51)	Broj objave evropske prijava patenta (97)	Naziv pronalaska (54)
A61K 31/185 (2006.01)	2456439 *	A STABLE PHARMACEUTICAL OMEPRAZOLE FORMULATION FOR ORAL ADMINISTRATION
A61K 47/40 (2006.01)	2456439 *	A STABLE PHARMACEUTICAL OMEPRAZOLE FORMULATION FOR ORAL ADMINISTRATION
A61K 47/30 (2006.01)	2456439 *	A STABLE PHARMACEUTICAL OMEPRAZOLE FORMULATION FOR ORAL ADMINISTRATION
A61K 9/08 (2006.01)	2456439 *	A STABLE PHARMACEUTICAL OMEPRAZOLE FORMULATION FOR ORAL ADMINISTRATION
A61K 9/10 (2006.01)	2456439 *	A STABLE PHARMACEUTICAL OMEPRAZOLE FORMULATION FOR ORAL ADMINISTRATION
A61K 31/27 (2006.01)	2403486 *	SUSTAINED RELEASE ORAL DOSAGE FORMS OF AN R-BACLOFEN PRODRUG
A61K 9/20 (2006.01)	2403486 *	SUSTAINED RELEASE ORAL DOSAGE FORMS OF AN R-BACLOFEN PRODRUG
A61K 31/197 (2006.01)	2403486 *	SUSTAINED RELEASE ORAL DOSAGE FORMS OF AN R-BACLOFEN PRODRUG
F02M 51/06 (2006.01)	2378107	Actuator arrangement for use in a fuel injector
F02M 63/00 (2006.01)	2378107	Actuator arrangement for use in a fuel injector
H01L 41/053 (2006.01)	2378107	Actuator arrangement for use in a fuel injector
C07K 16/28 (2006.01)	2408816 *	ALPHA-4-BETA-7 HETERODIMER SPECIFIC ANTAGONIST ANTIBODY
C07J 31/00 (2006.01)	2432798 *	17-HYDROXY-17-PENTAFLUORETHYL-ESTRA-4,9(10)-DIEN-11-ARYL DERIVATIVES, METHODS FOR THE PRODUCTION THEREOF AND USE THEREOF FOR TREATING DISEASES
C07J 41/00 (2006.01)	2432798 *	17-HYDROXY-17-PENTAFLUORETHYL-ESTRA-4,9(10)-DIEN-11-ARYL DERIVATIVES, METHODS FOR THE PRODUCTION THEREOF AND USE THEREOF FOR TREATING DISEASES
A61K 31/567 (2006.01)	2432798 *	17-HYDROXY-17-PENTAFLUORETHYL-ESTRA-4,9(10)-DIEN-11-ARYL DERIVATIVES, METHODS FOR THE PRODUCTION THEREOF AND USE THEREOF FOR TREATING DISEASES
A61P 5/36 (2006.01)	2432798 *	17-HYDROXY-17-PENTAFLUORETHYL-ESTRA-4,9(10)-DIEN-11-ARYL DERIVATIVES, METHODS FOR THE PRODUCTION THEREOF AND USE THEREOF FOR TREATING DISEASES
A61M 5/32 (2006.01)	2488235 *	CARTRIDGE HOLDER ASSEMBLY FOR A DRUG DELIVERY DEVICE
G06Q 20/00 (2012.01)	2449512 *	METHOD AND SYSTEM OF ELECTRONIC PAYMENT TRANSACTION, IN PARTICULAR BY USING CONTACTLESS PAYMENT MEANS
C02F 1/68 (2006.01)	2418177	Micronized CaCO ₃ slurry injection system for the remineralization of desalinated and fresh water
H02M 7/10 (2006.01)	2387142 *	COMBINED RECTIFIER
C07D 405/04 (2006.01)	2426124 *	PROCESS FOR PRODUCING PYRIPYROPENE DERIVATIVE
A47K 7/00 (2006.01)	2412644 *	PACKAGING BODY
B65D 83/08 (2006.01)	2412644 *	PACKAGING BODY
E05C 1/10 (2006.01)	2419588 *	SNAP-ACTING LOCKING DEVICE, PARTICULARLY FOR LIDS, DOORS AND THE LIKE
A61K 31/4545 (2006.01)	2413935 *	LOW DOSE PIPAMPERONE IN TREATING MOOD DISORDERS
A61P 25/24 (2006.01)	2413935 *	LOW DOSE PIPAMPERONE IN TREATING MOOD DISORDERS
A61P 25/16 (2006.01)	2431034 *	ADHESIVE PATCH-CONTAINING PACKAGE BAG AND METHOD FOR STORING ADHESIVE PATCH
A61K 31/4045 (2006.01)	2431034 *	ADHESIVE PATCH-CONTAINING PACKAGE BAG AND METHOD FOR STORING ADHESIVE PATCH
A61K 9/70 (2006.01)	2431034 *	ADHESIVE PATCH-CONTAINING PACKAGE BAG AND METHOD FOR STORING ADHESIVE PATCH
A61K 47/32 (2006.01)	2431034 *	ADHESIVE PATCH-CONTAINING PACKAGE BAG AND METHOD FOR STORING ADHESIVE PATCH
A61K 47/30 (2006.01)	2431034 *	ADHESIVE PATCH-CONTAINING PACKAGE BAG AND METHOD FOR STORING ADHESIVE PATCH
A61K 47/34 (2006.01)	2431034 *	ADHESIVE PATCH-CONTAINING PACKAGE BAG AND METHOD FOR STORING ADHESIVE PATCH

MKP (51)	Broj objave evropske prijava patenta (97)	Naziv pronalaska (54)
G01M 3/24 (2006.01)	2483656 *	SYSTEM AND METHOD FOR THE CONTINUOUS DETECTION OF IMPACTS ON PIPELINES FOR THE TRANSPORTATION OF FLUIDS, PARTICULARLY SUITABLE FOR UNDERWATER PIPELINES
F17D 5/06 (2006.01)	2483656 *	SYSTEM AND METHOD FOR THE CONTINUOUS DETECTION OF IMPACTS ON PIPELINES FOR THE TRANSPORTATION OF FLUIDS, PARTICULARLY SUITABLE FOR UNDERWATER PIPELINES
G01S 11/14 (2006.01)	2483656 *	SYSTEM AND METHOD FOR THE CONTINUOUS DETECTION OF IMPACTS ON PIPELINES FOR THE TRANSPORTATION OF FLUIDS, PARTICULARLY SUITABLE FOR UNDERWATER PIPELINES
E04D 13/00 (2006.01)	2236691	Assembly and method for checking roofs
G01M 3/16 (2006.01)	2236691	Assembly and method for checking roofs
A61K 31/4188 (2006.01)	2454264 *	TRICYCLIC INDOLE-DERIVED SPIRO DERIVATIVES AS CRTH2 MODULATORS
A61P 29/00 (2006.01)	2454264 *	TRICYCLIC INDOLE-DERIVED SPIRO DERIVATIVES AS CRTH2 MODULATORS
C07D 487/10 (2006.01)	2454264 *	TRICYCLIC INDOLE-DERIVED SPIRO DERIVATIVES AS CRTH2 MODULATORS
A61P 37/08 (2006.01)	2454264 *	TRICYCLIC INDOLE-DERIVED SPIRO DERIVATIVES AS CRTH2 MODULATORS
A61N 1/34 (2006.01)	2493553 *	OFFSET ELECTRODE
A61B 5/0408 (2006.01)	2493553 *	OFFSET ELECTRODE
A61N 1/36 (2006.01)	2493553 *	OFFSET ELECTRODE
A61N 1/04 (2006.01)	2493553 *	OFFSET ELECTRODE
A61B 1/005 (2006.01)	2496154 *	KITS AND PROCEDURES FOR NATURAL ORIFICE TRANSLUMENAL ENDOSCOPIC SURGERY
A61B 17/128 (2006.01)	2496154 *	KITS AND PROCEDURES FOR NATURAL ORIFICE TRANSLUMENAL ENDOSCOPIC SURGERY
A61B 18/14 (2006.01)	2496154 *	KITS AND PROCEDURES FOR NATURAL ORIFICE TRANSLUMENAL ENDOSCOPIC SURGERY
A61M 25/10 (2006.01)	2496154 *	KITS AND PROCEDURES FOR NATURAL ORIFICE TRANSLUMENAL ENDOSCOPIC SURGERY
A61B 17/32 (2006.01)	2496154 *	KITS AND PROCEDURES FOR NATURAL ORIFICE TRANSLUMENAL ENDOSCOPIC SURGERY
A61B 17/34 (2006.01)	2496154 *	KITS AND PROCEDURES FOR NATURAL ORIFICE TRANSLUMENAL ENDOSCOPIC SURGERY
A61B 17/29 (2006.01)	2496154 *	KITS AND PROCEDURES FOR NATURAL ORIFICE TRANSLUMENAL ENDOSCOPIC SURGERY
A61B 17/00 (2006.01)	2496154 *	KITS AND PROCEDURES FOR NATURAL ORIFICE TRANSLUMENAL ENDOSCOPIC SURGERY
A61B 17/04 (2006.01)	2496154 *	KITS AND PROCEDURES FOR NATURAL ORIFICE TRANSLUMENAL ENDOSCOPIC SURGERY
C07D 471/04 (2006.01)	2435432 *	APOPTOSIS-INDUCING AGENTS FOR THE TREATMENT OF CANCER AND IMMUNE AND AUTOIMMUNE DISEASES
C05G 3/02 (2006.01)	2420484 *	GRANULAR FERTILIZER CONTAINING HERBICIDAL AGROCHEMICAL
A01N 43/80 (2006.01)	2420484 *	GRANULAR FERTILIZER CONTAINING HERBICIDAL AGROCHEMICAL
A01P 13/02 (2006.01)	2420484 *	GRANULAR FERTILIZER CONTAINING HERBICIDAL AGROCHEMICAL
C05G 5/00 (2006.01)	2420484 *	GRANULAR FERTILIZER CONTAINING HERBICIDAL AGROCHEMICAL
G02B 6/35 (2006.01)	2425286 *	WAVEGUIDE-BASED DETECTION SYSTEM WITH SCANNING LIGHT SOURCE
G01N 21/64 (2006.01)	2425286 *	WAVEGUIDE-BASED DETECTION SYSTEM WITH SCANNING LIGHT SOURCE
C12N 15/82 (2006.01)	2449109 *	AXMI-205 PESTICIDAL GENE AND METHODS FOR ITS USE
A61K 9/20 (2006.01)	2448563 *	3-CYANOQUINOLINE TABLET FORMULATIONS AND USES THEREOF
A61K 31/4709 (2006.01)	2448563 *	3-CYANOQUINOLINE TABLET FORMULATIONS AND USES THEREOF
A61K 31/185 (2006.01)	2429517 *	COMPOSITIONS SUITABLE FOR THE TOPICAL TREATMENT OF FUNGAL INFECTIONS OF THE SKIN AND NAILS

MKP (51)	Broj objave evropske prijava patenta (97)	Naziv pronalaska (54)
A01N 37/00 (2006.01)	2429517 *	COMPOSITIONS SUITABLE FOR THE TOPICAL TREATMENT OF FUNGAL INFECTIONS OF THE SKIN AND NAILS
A61K 31/19 (2006.01)	2429517 *	COMPOSITIONS SUITABLE FOR THE TOPICAL TREATMENT OF FUNGAL INFECTIONS OF THE SKIN AND NAILS
A61K 31/192 (2006.01)	2429517 *	COMPOSITIONS SUITABLE FOR THE TOPICAL TREATMENT OF FUNGAL INFECTIONS OF THE SKIN AND NAILS
A61L 15/44 (2006.01)	2429517 *	COMPOSITIONS SUITABLE FOR THE TOPICAL TREATMENT OF FUNGAL INFECTIONS OF THE SKIN AND NAILS
A61P 31/10 (2006.01)	2429517 *	COMPOSITIONS SUITABLE FOR THE TOPICAL TREATMENT OF FUNGAL INFECTIONS OF THE SKIN AND NAILS
A61F 13/15 (2006.01)	2386281	Method and apparatus for changing speed or direction of an article
B65H 29/68 (2006.01)	2386281	Method and apparatus for changing speed or direction of an article
A01H 5/00 (2006.01)	2473023 *	HERBICIDE-TOLERANT PLANTS
C12N 15/52 (2006.01)	2473023 *	HERBICIDE-TOLERANT PLANTS
C12N 15/82 (2006.01)	2473023 *	HERBICIDE-TOLERANT PLANTS
A61M 15/00 (2006.01)	2408496 *	TRIGGER MECHANISM FOR A DRUG DELIVERY DEVICE
C12N 15/11 (2006.01)	2432879 *	USE OF INHIBITORS OF ZDHHC2 ACTIVITY FOR MODULATION OF ADIPOGENESIS
A61K 31/7088 (2006.01)	2432879 *	USE OF INHIBITORS OF ZDHHC2 ACTIVITY FOR MODULATION OF ADIPOGENESIS
A61P 3/04 (2006.01)	2432879 *	USE OF INHIBITORS OF ZDHHC2 ACTIVITY FOR MODULATION OF ADIPOGENESIS
A01N 43/64 (2006.01)	2485592 *	SYNERGISTIC FUNGICIDAL MIXTURES FOR FUNGAL CONTROL IN CEREALS
A61K 31/41 (2006.01)	2485592 *	SYNERGISTIC FUNGICIDAL MIXTURES FOR FUNGAL CONTROL IN CEREALS
B65G 57/10 (2006.01)	2314530	Mobile device for stacking wooden logs onto a pallet with raised sides
B65G 57/112 (2006.01)	2314530	Mobile device for stacking wooden logs onto a pallet with raised sides
B65G 57/18 (2006.01)	2314530	Mobile device for stacking wooden logs onto a pallet with raised sides
B05B 15/06 (2006.01)	2383046	Nozzle device
D21F 1/32 (2006.01)	2383046	Nozzle device
D21F 1/34 (2006.01)	2383046	Nozzle device
A61K 31/517 (2006.01)	2467140 *	METHOD OF THREATING CANCER
B65D 21/02 (2006.01)	2371725	Crate
B65D 85/34 (2006.01)	2371725	Crate
B65D 6/00 (2006.01)	2371725	Crate
C07K 14/705 (2006.01)	2464661 *	METHODS OF MODULATING IMMUNE FUNCTION
A61K 31/167 (2006.01)	2482799 *	PHARMACEUTICAL AEROSOL FORMULATIONS OF FORMOTEROL AND BECLOMETASONE DIPROPIONATE
A61K 9/00 (2006.01)	2482799 *	PHARMACEUTICAL AEROSOL FORMULATIONS OF FORMOTEROL AND BECLOMETASONE DIPROPIONATE
A61K 31/573 (2006.01)	2482799 *	PHARMACEUTICAL AEROSOL FORMULATIONS OF FORMOTEROL AND BECLOMETASONE DIPROPIONATE
B62D 33/02 (2006.01)	2377640	Method of producing a basin body, in particular a tipping trough for a transport vehicle using laser welding process ; corresponding basin body, in particular a tipping trough for a transport vehicle and basin body for a transport vehicle
B23K 26/26 (2006.01)	2377640	Method of producing a basin body, in particular a tipping trough for a transport vehicle using laser welding process ; corresponding basin body, in particular a tipping trough for a transport vehicle and basin body for a transport vehicle
B60P 1/28 (2006.01)	2377640	Method of producing a basin body, in particular a tipping trough for a transport vehicle using laser welding process ; corresponding basin body, in particular a tipping trough for a transport vehicle and basin body for a transport vehicle
B62D 27/02 (2006.01)	2377640	Method of producing a basin body, in particular a tipping trough for a transport vehicle using laser welding process ; corresponding basin body, in particular a tipping trough for a transport vehicle and basin body for a transport vehicle

MKP (51)	Broj objave evropske prijava patenta (97)	Naziv pronalaska (54)
A61P 37/00 (2006.01)	2499144 *	QUINOLINE AND QUINOXALINE DERIVATIVES AS KINASE INHIBITORS
A61K 31/522 (2006.01)	2499144 *	QUINOLINE AND QUINOXALINE DERIVATIVES AS KINASE INHIBITORS
A61P 25/00 (2006.01)	2499144 *	QUINOLINE AND QUINOXALINE DERIVATIVES AS KINASE INHIBITORS
A61P 31/00 (2006.01)	2499144 *	QUINOLINE AND QUINOXALINE DERIVATIVES AS KINASE INHIBITORS
C07D 487/04 (2006.01)	2499144 *	QUINOLINE AND QUINOXALINE DERIVATIVES AS KINASE INHIBITORS
A61P 3/00 (2006.01)	2499144 *	QUINOLINE AND QUINOXALINE DERIVATIVES AS KINASE INHIBITORS
A61P 9/02 (2006.01)	2499144 *	QUINOLINE AND QUINOXALINE DERIVATIVES AS KINASE INHIBITORS
A61P 29/00 (2006.01)	2499144 *	QUINOLINE AND QUINOXALINE DERIVATIVES AS KINASE INHIBITORS
A61P 27/02 (2006.01)	2499144 *	QUINOLINE AND QUINOXALINE DERIVATIVES AS KINASE INHIBITORS
A61P 25/28 (2006.01)	2499144 *	QUINOLINE AND QUINOXALINE DERIVATIVES AS KINASE INHIBITORS
C07D 495/04 (2006.01)	2499144 *	QUINOLINE AND QUINOXALINE DERIVATIVES AS KINASE INHIBITORS
A61P 35/00 (2006.01)	2499144 *	QUINOLINE AND QUINOXALINE DERIVATIVES AS KINASE INHIBITORS
G01N 33/574 (2006.01)	2425252 *	IDENTIFICATION OF TUMOR-ASSOCIATED MARKERS FOR DIAGNOSIS AND THERAPY
C07D 401/00 (2006.01)	2429993 *	INHIBITORS OF HUMAN IMMUNODEFICIENCY VIRUS REPLICATION
C07D 405/00 (2006.01)	2429993 *	INHIBITORS OF HUMAN IMMUNODEFICIENCY VIRUS REPLICATION
C07D 213/55 (2006.01)	2429993 *	INHIBITORS OF HUMAN IMMUNODEFICIENCY VIRUS REPLICATION
C07D 413/00 (2006.01)	2429993 *	INHIBITORS OF HUMAN IMMUNODEFICIENCY VIRUS REPLICATION
A61K 31/44 (2006.01)	2429993 *	INHIBITORS OF HUMAN IMMUNODEFICIENCY VIRUS REPLICATION
C07D 417/00 (2006.01)	2429993 *	INHIBITORS OF HUMAN IMMUNODEFICIENCY VIRUS REPLICATION
A61K 31/5375 (2006.01)	2429993 *	INHIBITORS OF HUMAN IMMUNODEFICIENCY VIRUS REPLICATION
C07D 471/04 (2006.01)	2429993 *	INHIBITORS OF HUMAN IMMUNODEFICIENCY VIRUS REPLICATION
A61P 31/18 (2006.01)	2429993 *	INHIBITORS OF HUMAN IMMUNODEFICIENCY VIRUS REPLICATION
C07D 498/06 (2006.01)	2429993 *	INHIBITORS OF HUMAN IMMUNODEFICIENCY VIRUS REPLICATION
A61K 31/54 (2006.01)	2429993 *	INHIBITORS OF HUMAN IMMUNODEFICIENCY VIRUS REPLICATION
C07D 491/06 (2006.01)	2429993 *	INHIBITORS OF HUMAN IMMUNODEFICIENCY VIRUS REPLICATION
C07D 213/60 (2006.01)	2429993 *	INHIBITORS OF HUMAN IMMUNODEFICIENCY VIRUS REPLICATION
E05D 15/06 (2006.01)	2476841	Device for securing a sliding wing of a sliding wing system
A61K 31/5377 (2006.01)	2403833 *	8-SUBSTITUTED QUINOLINES AND RELATED ANALOGS AS SIRTUIN MODULATORS
A61K 31/497 (2006.01)	2403833 *	8-SUBSTITUTED QUINOLINES AND RELATED ANALOGS AS SIRTUIN MODULATORS
C07D 401/14 (2006.01)	2403833 *	8-SUBSTITUTED QUINOLINES AND RELATED ANALOGS AS SIRTUIN MODULATORS
A61P 5/50 (2006.01)	2403833 *	8-SUBSTITUTED QUINOLINES AND RELATED ANALOGS AS SIRTUIN MODULATORS
A61K 31/4375 (2006.01)	2403833 *	8-SUBSTITUTED QUINOLINES AND RELATED ANALOGS AS SIRTUIN MODULATORS
C07D 417/12 (2006.01)	2403833 *	8-SUBSTITUTED QUINOLINES AND RELATED ANALOGS AS SIRTUIN MODULATORS
A61P 35/02 (2006.01)	2403833 *	8-SUBSTITUTED QUINOLINES AND RELATED ANALOGS AS SIRTUIN MODULATORS
A61K 31/47 (2006.01)	2403833 *	8-SUBSTITUTED QUINOLINES AND RELATED ANALOGS AS SIRTUIN MODULATORS
C07D 417/14 (2006.01)	2403833 *	8-SUBSTITUTED QUINOLINES AND RELATED ANALOGS AS SIRTUIN MODULATORS
A61K 31/538 (2006.01)	2403833 *	8-SUBSTITUTED QUINOLINES AND RELATED ANALOGS AS SIRTUIN MODULATORS
A61K 31/501 (2006.01)	2403833 *	8-SUBSTITUTED QUINOLINES AND RELATED ANALOGS AS SIRTUIN MODULATORS
C07D 215/48 (2006.01)	2403833 *	8-SUBSTITUTED QUINOLINES AND RELATED ANALOGS AS SIRTUIN MODULATORS

MKP (51)	Broj objave evropske prijava patenta (97)	Naziv pronalaska (54)
C07D 413/14 (2006.01)	2403833 *	8-SUBSTITUTED QUINOLINES AND RELATED ANALOGS AS SIRTUIN MODULATORS
A61P 9/00 (2006.01)	2403833 *	8-SUBSTITUTED QUINOLINES AND RELATED ANALOGS AS SIRTUIN MODULATORS
A61K 31/519 (2006.01)	2403833 *	8-SUBSTITUTED QUINOLINES AND RELATED ANALOGS AS SIRTUIN MODULATORS
A61K 31/4709 (2006.01)	2403833 *	8-SUBSTITUTED QUINOLINES AND RELATED ANALOGS AS SIRTUIN MODULATORS
C07D 487/04 (2006.01)	2403833 *	8-SUBSTITUTED QUINOLINES AND RELATED ANALOGS AS SIRTUIN MODULATORS
C07D 401/12 (2006.01)	2403833 *	8-SUBSTITUTED QUINOLINES AND RELATED ANALOGS AS SIRTUIN MODULATORS
A61P 3/00 (2006.01)	2403833 *	8-SUBSTITUTED QUINOLINES AND RELATED ANALOGS AS SIRTUIN MODULATORS
A61K 31/506 (2006.01)	2403833 *	8-SUBSTITUTED QUINOLINES AND RELATED ANALOGS AS SIRTUIN MODULATORS
C08G 18/00 (2006.01)	2473540 *	STRUCTURAL URETHANE ADHESIVES COMPRISING AMIDE POLYOLS
C07D 401/12 (2006.01)	2419411 *	QUINOXALINE DERIVATIVES AND THEIR USE FOR TREATING BENIGN AND MALIGNANT TUMOUR DISORDERS
C07D 409/12 (2006.01)	2419411 *	QUINOXALINE DERIVATIVES AND THEIR USE FOR TREATING BENIGN AND MALIGNANT TUMOUR DISORDERS
C07D 413/12 (2006.01)	2419411 *	QUINOXALINE DERIVATIVES AND THEIR USE FOR TREATING BENIGN AND MALIGNANT TUMOUR DISORDERS
A61K 31/498 (2006.01)	2419411 *	QUINOXALINE DERIVATIVES AND THEIR USE FOR TREATING BENIGN AND MALIGNANT TUMOUR DISORDERS
A61P 35/00 (2006.01)	2419411 *	QUINOXALINE DERIVATIVES AND THEIR USE FOR TREATING BENIGN AND MALIGNANT TUMOUR DISORDERS
C07D 403/04 (2006.01)	2419411 *	QUINOXALINE DERIVATIVES AND THEIR USE FOR TREATING BENIGN AND MALIGNANT TUMOUR DISORDERS
A61K 31/5377 (2006.01)	2419411 *	QUINOXALINE DERIVATIVES AND THEIR USE FOR TREATING BENIGN AND MALIGNANT TUMOUR DISORDERS
C07D 241/44 (2006.01)	2419411 *	QUINOXALINE DERIVATIVES AND THEIR USE FOR TREATING BENIGN AND MALIGNANT TUMOUR DISORDERS
A61M 5/315 (2006.01)	2414006 *	DRUG DELIVERY DEVICE WITH AN IMPROVED PISTON ROD
A61K 47/26 (2006.01)	2470172 *	PHARMACEUTICAL FORMULATIONS AND METHODS OF USE
A61K 9/00 (2006.01)	2470172 *	PHARMACEUTICAL FORMULATIONS AND METHODS OF USE
A61K 47/14 (2006.01)	2470172 *	PHARMACEUTICAL FORMULATIONS AND METHODS OF USE
A61K 31/167 (2006.01)	2470172 *	PHARMACEUTICAL FORMULATIONS AND METHODS OF USE
C03C 17/36 (2006.01)	2406197 *	SUBSTRATE PROVIDED WITH A STACK WITH THERMAL PROPERTIES AND COMPRISING HIGH REFRACTIVE INDEX LAYERS
A61K 31/4418 (2006.01)	2429995 *	ARYL PYRIDINE AS ALDOSTERONE SYNTHASE INHIBITORS
C07D 213/76 (2006.01)	2429995 *	ARYL PYRIDINE AS ALDOSTERONE SYNTHASE INHIBITORS
A61P 9/00 (2006.01)	2429995 *	ARYL PYRIDINE AS ALDOSTERONE SYNTHASE INHIBITORS
C07D 271/12 (2006.01)	2406240 *	INHIBITORS OF BETA-SECRETASE
A61K 31/4245 (2006.01)	2406240 *	INHIBITORS OF BETA-SECRETASE
C07D 235/02 (2006.01)	2406240 *	INHIBITORS OF BETA-SECRETASE
A61K 31/4184 (2006.01)	2406240 *	INHIBITORS OF BETA-SECRETASE
C07D 277/60 (2006.01)	2406240 *	INHIBITORS OF BETA-SECRETASE
C07D 498/10 (2006.01)	2406240 *	INHIBITORS OF BETA-SECRETASE
C07D 239/70 (2006.01)	2406240 *	INHIBITORS OF BETA-SECRETASE
A61K 31/4188 (2006.01)	2406240 *	INHIBITORS OF BETA-SECRETASE
C07D 491/10 (2006.01)	2406240 *	INHIBITORS OF BETA-SECRETASE
A61K 31/517 (2006.01)	2406240 *	INHIBITORS OF BETA-SECRETASE
C07D 487/10 (2006.01)	2406240 *	INHIBITORS OF BETA-SECRETASE

MKP (51)	Broj objave evropske prijave patenta (97)	Naziv pronalaska (54)
A61K 31/519 (2006.01)	2406240 *	INHIBITORS OF BETA-SECRETASE
C07D 403/06 (2006.01)	2406240 *	INHIBITORS OF BETA-SECRETASE
A61K 31/428 (2006.01)	2406240 *	INHIBITORS OF BETA-SECRETASE
C07D 405/12 (2006.01)	2406240 *	INHIBITORS OF BETA-SECRETASE
A61P 17/00 (2006.01)	2500034 *	THERAPEUTIC AGENT FOR PSORIASIS OR ATOPIC DERMATITIS
A61P 37/08 (2006.01)	2500034 *	THERAPEUTIC AGENT FOR PSORIASIS OR ATOPIC DERMATITIS
A61K 39/395 (2006.01)	2500034 *	THERAPEUTIC AGENT FOR PSORIASIS OR ATOPIC DERMATITIS
A61P 17/04 (2006.01)	2500034 *	THERAPEUTIC AGENT FOR PSORIASIS OR ATOPIC DERMATITIS
C07D 237/24 (2006.01)	2473479 *	THERAPEUTIC ARYL-AM I DO-ARYL COMPOUNDS AND THEIR USE
A61K 31/235 (2006.01)	2473479 *	THERAPEUTIC ARYL-AM I DO-ARYL COMPOUNDS AND THEIR USE
C07D 213/81 (2006.01)	2473479 *	THERAPEUTIC ARYL-AM I DO-ARYL COMPOUNDS AND THEIR USE
C07D 213/80 (2006.01)	2473479 *	THERAPEUTIC ARYL-AM I DO-ARYL COMPOUNDS AND THEIR USE
C07C 233/75 (2006.01)	2473479 *	THERAPEUTIC ARYL-AM I DO-ARYL COMPOUNDS AND THEIR USE
A61K 31/192 (2006.01)	2473479 *	THERAPEUTIC ARYL-AM I DO-ARYL COMPOUNDS AND THEIR USE
C07C 237/42 (2006.01)	2473479 *	THERAPEUTIC ARYL-AM I DO-ARYL COMPOUNDS AND THEIR USE
A61K 31/44 (2006.01)	2473479 *	THERAPEUTIC ARYL-AM I DO-ARYL COMPOUNDS AND THEIR USE
C07D 213/30 (2006.01)	2473479 *	THERAPEUTIC ARYL-AM I DO-ARYL COMPOUNDS AND THEIR USE
A61P 25/28 (2006.01)	2473479 *	THERAPEUTIC ARYL-AM I DO-ARYL COMPOUNDS AND THEIR USE
C07C 235/56 (2006.01)	2473479 *	THERAPEUTIC ARYL-AM I DO-ARYL COMPOUNDS AND THEIR USE
A61K 31/166 (2006.01)	2473479 *	THERAPEUTIC ARYL-AM I DO-ARYL COMPOUNDS AND THEIR USE
A61K 39/395 (2006.01)	2421558 *	ADJUVANT CANCER THERAPY
C08B 37/10 (2006.01)	2427502 *	NOVEL SULFATED OCTASACCHARIDE AND ITS USE AS ANTITHROMBOTIC
C11D 3/37 (2006.01)	2449079 *	CATIONIC SYNTHETIC POLYMERS WITH IMPROVED SOLUBILITY AND PERFORMANCE IN SURFACTANT-BASED SYSTEMS AND USE IN PERSONAL CARE AND HOUSEHOLD APPLICATIONS
A61K 8/81 (2006.01)	2449079 *	CATIONIC SYNTHETIC POLYMERS WITH IMPROVED SOLUBILITY AND PERFORMANCE IN SURFACTANT-BASED SYSTEMS AND USE IN PERSONAL CARE AND HOUSEHOLD APPLICATIONS
A61Q 5/02 (2006.01)	2449079 *	CATIONIC SYNTHETIC POLYMERS WITH IMPROVED SOLUBILITY AND PERFORMANCE IN SURFACTANT-BASED SYSTEMS AND USE IN PERSONAL CARE AND HOUSEHOLD APPLICATIONS
A61K 8/73 (2006.01)	2449079 *	CATIONIC SYNTHETIC POLYMERS WITH IMPROVED SOLUBILITY AND PERFORMANCE IN SURFACTANT-BASED SYSTEMS AND USE IN PERSONAL CARE AND HOUSEHOLD APPLICATIONS
A61P 25/28 (2006.01)	2456771 *	FUSED AMINODIHYDROPYRIMIDONE DERIVATIVES
C07D 491/048 (2006.01)	2456771 *	FUSED AMINODIHYDROPYRIMIDONE DERIVATIVES
A61K 31/522 (2006.01)	2456771 *	FUSED AMINODIHYDROPYRIMIDONE DERIVATIVES
H04W 4/02 (2009.01)	2498519 *	LOCATION METHOD, APPARATUS AND SYSTEM
C12P 21/04 (2006.01)	2438185 *	METHODS OF MODULATING FUCOSYLATION OF GLYCOPROTEINS
G05B 13/04 (2006.01)	2438487 *	AUTOMATED PID CONTROLLER DESIGN
C07D 239/94 (2006.01)	2411373 *	PROCESS FOR THE PREPARATION OF ERLOTINIB OR ITS PHARMACEUTICALLY ACCEPTABLE SALTS THEREOF
A61L 2/06 (2006.01)	2485772 *	STERILIZATION APPARATUS AND METHOD FOR CONTROLLING OF A STERILIZATION APPARATUS
B65B 55/06 (2006.01)	2485772 *	STERILIZATION APPARATUS AND METHOD FOR CONTROLLING OF A STERILIZATION APPARATUS
A61L 2/24 (2006.01)	2485772 *	STERILIZATION APPARATUS AND METHOD FOR CONTROLLING OF A STERILIZATION APPARATUS
A61K 31/496 (2006.01)	2439204 *	HETEROCYCLIC COMPOUND AND HEMATOPOIETIC STEM CELL AMPLIFIER
A61P 21/00 (2006.01)	2439204 *	HETEROCYCLIC COMPOUND AND HEMATOPOIETIC STEM CELL AMPLIFIER

MKP (51)	Broj objave evropske prijava patenta (97)	Naziv pronalaska (54)
C07D 409/14 (2006.01)	2439204 *	HETEROCYCLIC COMPOUND AND HEMATOPOIETIC STEM CELL AMPLIFIER
A61K 31/381 (2006.01)	2439204 *	HETEROCYCLIC COMPOUND AND HEMATOPOIETIC STEM CELL AMPLIFIER
A61P 7/06 (2006.01)	2439204 *	HETEROCYCLIC COMPOUND AND HEMATOPOIETIC STEM CELL AMPLIFIER
A61P 43/00 (2006.01)	2439204 *	HETEROCYCLIC COMPOUND AND HEMATOPOIETIC STEM CELL AMPLIFIER
A61K 31/4436 (2006.01)	2439204 *	HETEROCYCLIC COMPOUND AND HEMATOPOIETIC STEM CELL AMPLIFIER
A61P 9/10 (2006.01)	2439204 *	HETEROCYCLIC COMPOUND AND HEMATOPOIETIC STEM CELL AMPLIFIER
C07D 409/12 (2006.01)	2439204 *	HETEROCYCLIC COMPOUND AND HEMATOPOIETIC STEM CELL AMPLIFIER
A61P 3/10 (2006.01)	2439204 *	HETEROCYCLIC COMPOUND AND HEMATOPOIETIC STEM CELL AMPLIFIER
A61P 37/04 (2006.01)	2439204 *	HETEROCYCLIC COMPOUND AND HEMATOPOIETIC STEM CELL AMPLIFIER
C07D 333/38 (2006.01)	2439204 *	HETEROCYCLIC COMPOUND AND HEMATOPOIETIC STEM CELL AMPLIFIER
A61P 7/00 (2006.01)	2439204 *	HETEROCYCLIC COMPOUND AND HEMATOPOIETIC STEM CELL AMPLIFIER
A61P 37/06 (2006.01)	2439204 *	HETEROCYCLIC COMPOUND AND HEMATOPOIETIC STEM CELL AMPLIFIER
A61K 31/5377 (2006.01)	2439204 *	HETEROCYCLIC COMPOUND AND HEMATOPOIETIC STEM CELL AMPLIFIER
A61P 25/00 (2006.01)	2439204 *	HETEROCYCLIC COMPOUND AND HEMATOPOIETIC STEM CELL AMPLIFIER
A61K 38/00 (2006.01)	2439204 *	HETEROCYCLIC COMPOUND AND HEMATOPOIETIC STEM CELL AMPLIFIER
A61P 35/00 (2006.01)	2439204 *	HETEROCYCLIC COMPOUND AND HEMATOPOIETIC STEM CELL AMPLIFIER
A61K 38/22 (2006.01)	2439204 *	HETEROCYCLIC COMPOUND AND HEMATOPOIETIC STEM CELL AMPLIFIER
A61P 35/02 (2006.01)	2439204 *	HETEROCYCLIC COMPOUND AND HEMATOPOIETIC STEM CELL AMPLIFIER
C04B 35/63 (2006.01)	2440506 *	YTTRIA-BASED SLURRY COMPOSITION
C04B 35/44 (2006.01)	2440506 *	YTTRIA-BASED SLURRY COMPOSITION
C04B 35/626 (2006.01)	2440506 *	YTTRIA-BASED SLURRY COMPOSITION
E04G 23/00 (2006.01)	2438255 *	WATER JET EJECTING DEVICE
B08B 3/02 (2006.01)	2438255 *	WATER JET EJECTING DEVICE
E04G 1/20 (2006.01)	2438255 *	WATER JET EJECTING DEVICE
E04G 23/08 (2006.01)	2438255 *	WATER JET EJECTING DEVICE
B60P 7/08 (2006.01)	2383145	Tensioning system and cargo space and vehicle provided with such a tensioning system
C07D 213/16 (2006.01)	2496556 *	ACYLAMINO-SUBSTITUTED CYCLIC CARBOXYLIC ACID DERIVATIVES AND THEIR USE AS PHARMACEUTICALS
C07D 317/06 (2006.01)	2496556 *	ACYLAMINO-SUBSTITUTED CYCLIC CARBOXYLIC ACID DERIVATIVES AND THEIR USE AS PHARMACEUTICALS
C07D 309/08 (2006.01)	2496556 *	ACYLAMINO-SUBSTITUTED CYCLIC CARBOXYLIC ACID DERIVATIVES AND THEIR USE AS PHARMACEUTICALS
A61K 31/085 (2006.01)	2496556 *	ACYLAMINO-SUBSTITUTED CYCLIC CARBOXYLIC ACID DERIVATIVES AND THEIR USE AS PHARMACEUTICALS
C07D 305/04 (2006.01)	2496556 *	ACYLAMINO-SUBSTITUTED CYCLIC CARBOXYLIC ACID DERIVATIVES AND THEIR USE AS PHARMACEUTICALS
C07C 235/54 (2006.01)	2496556 *	ACYLAMINO-SUBSTITUTED CYCLIC CARBOXYLIC ACID DERIVATIVES AND THEIR USE AS PHARMACEUTICALS

MKP (51)	Broj objave evropske prijava patenta (97)	Naziv pronalaska (54)
C07D 335/14 (2006.01)	2496556 *	ACYLAMINO-SUBSTITUTED CYCLIC CARBOXYLIC ACID DERIVATIVES AND THEIR USE AS PHARMACEUTICALS
A61K 31/4418 (2006.01)	2461809 *	OPHTHALMIC PHARMACEUTICAL COMPOSITIONS OF DP2 RECEPTOR ANTAGONISTS
A61K 31/4355 (2006.01)	2461809 *	OPHTHALMIC PHARMACEUTICAL COMPOSITIONS OF DP2 RECEPTOR ANTAGONISTS
A61K 31/435 (2006.01)	2461809 *	OPHTHALMIC PHARMACEUTICAL COMPOSITIONS OF DP2 RECEPTOR ANTAGONISTS
A61P 27/02 (2006.01)	2461809 *	OPHTHALMIC PHARMACEUTICAL COMPOSITIONS OF DP2 RECEPTOR ANTAGONISTS
C07D 207/16 (2006.01)	2459531 *	SYNTHESIS AND USE OF VILDAGLIPTIN FOR THE PREPARATION OF PHARMACEUTICAL DOSAGE FORMS
A61K 31/4015 (2006.01)	2459531 *	SYNTHESIS AND USE OF VILDAGLIPTIN FOR THE PREPARATION OF PHARMACEUTICAL DOSAGE FORMS
A61K 9/16 (2006.01)	2459531 *	SYNTHESIS AND USE OF VILDAGLIPTIN FOR THE PREPARATION OF PHARMACEUTICAL DOSAGE FORMS
A61K 39/36 (2006.01)	2281836	Hybrid proteins from <i>Parietaria judaica</i> major allergens and uses thereof
C07K 14/415 (2006.01)	2281836	Hybrid proteins from <i>Parietaria judaica</i> major allergens and uses thereof
C12N 15/62 (2006.01)	2281836	Hybrid proteins from <i>Parietaria judaica</i> major allergens and uses thereof
A61B 5/053 (2006.01)	2408364 *	SYSTEMS AND METHOD FOR CHARACTERISTIC PARAMETER ESTIMATION OF GASTRIC IMPEDANCE SPECTRA IN HUMANS
H01L 31/042 (2006.01)	2278627	Automatic localisation of photovoltaic modules in a photovoltaic field
A61K 9/06 (2006.01)	2459171 *	LONG ACTING INSULIN COMPOSITION
A61K 47/48 (2006.01)	2459171 *	LONG ACTING INSULIN COMPOSITION
A61K 9/00 (2006.01)	2459171 *	LONG ACTING INSULIN COMPOSITION
A61K 31/4439 (2006.01)	2412713 *	PYRAZOLE COMPOUND
A61P 1/04 (2006.01)	2412713 *	PYRAZOLE COMPOUND
C07D 401/04 (2006.01)	2412713 *	PYRAZOLE COMPOUND
F02P 7/077 (2006.01)	2375042	Injection control method
F02D 35/02 (2006.01)	2375042	Injection control method
F02D 41/34 (2006.01)	2375042	Injection control method
A21B 1/46 (2006.01)	2490544 *	OVEN FOR FAST FOOD PREPARATION
A21B 3/07 (2006.01)	2490544 *	OVEN FOR FAST FOOD PREPARATION
A61K 31/4353 (2006.01)	2443105 *	NOVEL PHENYLIMIDAZOLE DERIVATIVE AS PDE10A ENZYME INHIBITOR
A61K 31/4184 (2006.01)	2443105 *	NOVEL PHENYLIMIDAZOLE DERIVATIVE AS PDE10A ENZYME INHIBITOR
C07D 487/04 (2006.01)	2443105 *	NOVEL PHENYLIMIDAZOLE DERIVATIVE AS PDE10A ENZYME INHIBITOR
A61K 31/519 (2006.01)	2443105 *	NOVEL PHENYLIMIDAZOLE DERIVATIVE AS PDE10A ENZYME INHIBITOR
A61P 25/00 (2006.01)	2443105 *	NOVEL PHENYLIMIDAZOLE DERIVATIVE AS PDE10A ENZYME INHIBITOR
C07D 403/12 (2006.01)	2443105 *	NOVEL PHENYLIMIDAZOLE DERIVATIVE AS PDE10A ENZYME INHIBITOR
A01N 43/90 (2006.01)	2496086 *	COMPOUNDS AND METHODS FOR KINASE MODULATION, AND INDICATIONS THEREFOR
A61K 31/519 (2006.01)	2496086 *	COMPOUNDS AND METHODS FOR KINASE MODULATION, AND INDICATIONS THEREFOR
E02B 11/00 (2006.01)	2470722 *	DRAINAGE BODY
E03F 1/00 (2006.01)	2470722 *	DRAINAGE BODY
A47K 10/36 (2006.01)	2421422 *	SANITARY DISPENSER HAVING CAPACITIVE SENSOR
A47K 5/12 (2006.01)	2421422 *	SANITARY DISPENSER HAVING CAPACITIVE SENSOR
C07F 9/6561 (2006.01)	2448950 *	SYNTHESIS OF N4- (2, 2-DIMETHYL-4- [(DIHYDROGEN PHOSPHONOXY)-3-OXO-5-PYRIDO [1, 4]OXAZIN-6-YL)-5-FLUORO-N2- (3, 4, 5,-TRIMETHOXYPHENYL) -2, 4- PYRIMIDINEDIAMINE DISODIUM SALT
A61K 38/21 (2006.01)	2451470 *	METHOD FOR THE PURIFICATION OF INTERFERON- β
C12P 21/02 (2006.01)	2451470 *	METHOD FOR THE PURIFICATION OF INTERFERON- β

MKP (51)	Broj objave evropske prijava patenta (97)	Naziv pronalaska (54)
A61K 38/57 (2006.01)	2459213 *	POLYPEPTIDES THAT BIND TISSUE INHIBITOR OF METALLOPROTEINASE TYPE THREE (TIMP-3), COMPOSITIONS AND METHODS
C07K 14/81 (2006.01)	2459213 *	POLYPEPTIDES THAT BIND TISSUE INHIBITOR OF METALLOPROTEINASE TYPE THREE (TIMP-3), COMPOSITIONS AND METHODS
C07K 16/38 (2006.01)	2459213 *	POLYPEPTIDES THAT BIND TISSUE INHIBITOR OF METALLOPROTEINASE TYPE THREE (TIMP-3), COMPOSITIONS AND METHODS
B01B 1/06 (2006.01)	2488266 *	SYSTEMS AND METHODS FOR PROVIDING HAPTIC FEEDBACK AT MULTIPLE RESONANCE FREQUENCIES
H01L 41/09 (2006.01)	2488266 *	SYSTEMS AND METHODS FOR PROVIDING HAPTIC FEEDBACK AT MULTIPLE RESONANCE FREQUENCIES
G01N 33/564 (2006.01)	2464976 *	METHODS OF DIAGNOSING AND TREATING AUTISM
G01N 33/68 (2006.01)	2464976 *	METHODS OF DIAGNOSING AND TREATING AUTISM
C07D 309/10 (2006.01)	2451797 *	CRYSTALLISATION PROCESS FOR 1-(β -D-GLUCOPYRANOSYL)-4-METHYL-3-[5-(4-FLUOROPHENYL)-2-THIENYLMETHYL]BENZENE
C02F 1/00 (2006.01)	2471745	Liquid filter device
B01D 35/153 (2006.01)	2471745	Liquid filter device
B01D 35/143 (2006.01)	2471745	Liquid filter device
A61P 5/50 (2006.01)	2461820 *	ORALLY ADMINISTERABLE PHARMACEUTICAL PREPARATION CONTAINING INSULIN
A61K 38/17 (2006.01)	2461820 *	ORALLY ADMINISTERABLE PHARMACEUTICAL PREPARATION CONTAINING INSULIN
A61K 38/28 (2006.01)	2461820 *	ORALLY ADMINISTERABLE PHARMACEUTICAL PREPARATION CONTAINING INSULIN
A61K 31/195 (2006.01)	2461820 *	ORALLY ADMINISTERABLE PHARMACEUTICAL PREPARATION CONTAINING INSULIN
G01N 33/50 (2006.01)	2491385 *	PROXIMITY-MEDIATED ASSAYS FOR DETECTING ONCOGENIC FUSION PROTEINS
C07D 401/06 (2006.01)	2421837 *	PREPARATION OF C-PYRAZINE-METHYLAMINES
C07D 241/16 (2006.01)	2421837 *	PREPARATION OF C-PYRAZINE-METHYLAMINES
A61P 29/00 (2006.01)	2445499 *	METHOD FOR TREATING A PATIENT AT RISK FOR DEVELOPING AN NSAID-ASSOCIATED ULCER
A61K 9/24 (2006.01)	2445499 *	METHOD FOR TREATING A PATIENT AT RISK FOR DEVELOPING AN NSAID-ASSOCIATED ULCER
A61P 19/02 (2006.01)	2445499 *	METHOD FOR TREATING A PATIENT AT RISK FOR DEVELOPING AN NSAID-ASSOCIATED ULCER
A61K 31/4439 (2006.01)	2445499 *	METHOD FOR TREATING A PATIENT AT RISK FOR DEVELOPING AN NSAID-ASSOCIATED ULCER
A61P 31/04 (2006.01)	2476420 *	PHARMACEUTICAL COMPOSITION HAVING ANTIMICROBIAL AND FAST-HEALING ACTIVITY FOR EXTERNAL ADMINISTRATION, PROCESS FOR PREPARING SAME
A61K 9/14 (2006.01)	2476420 *	PHARMACEUTICAL COMPOSITION HAVING ANTIMICROBIAL AND FAST-HEALING ACTIVITY FOR EXTERNAL ADMINISTRATION, PROCESS FOR PREPARING SAME
A61K 9/51 (2006.01)	2476420 *	PHARMACEUTICAL COMPOSITION HAVING ANTIMICROBIAL AND FAST-HEALING ACTIVITY FOR EXTERNAL ADMINISTRATION, PROCESS FOR PREPARING SAME
A61K 47/04 (2006.01)	2476420 *	PHARMACEUTICAL COMPOSITION HAVING ANTIMICROBIAL AND FAST-HEALING ACTIVITY FOR EXTERNAL ADMINISTRATION, PROCESS FOR PREPARING SAME
A61K 31/665 (2006.01)	2476420 *	PHARMACEUTICAL COMPOSITION HAVING ANTIMICROBIAL AND FAST-HEALING ACTIVITY FOR EXTERNAL ADMINISTRATION, PROCESS FOR PREPARING SAME
B22D 11/06 (2006.01)	2411172 *	CONTINUOUS CASTING APPARATUS FOR CASTING STRIP OF VARIABLE WIDTH

MKP (51)	Broj objave evropske prijava patenta (97)	Naziv pronalaska (54)
C07D 405/14 (2006.01)	2417130 *	QUINAZOLINEDIONE DERIVATIVES, PREPARATION THEREOF AND VARIOUS THERAPEUTIC USES THEREOF
A61P 9/00 (2006.01)	2417130 *	QUINAZOLINEDIONE DERIVATIVES, PREPARATION THEREOF AND VARIOUS THERAPEUTIC USES THEREOF
C07D 309/14 (2006.01)	2417130 *	QUINAZOLINEDIONE DERIVATIVES, PREPARATION THEREOF AND VARIOUS THERAPEUTIC USES THEREOF
A61P 25/00 (2006.01)	2417130 *	QUINAZOLINEDIONE DERIVATIVES, PREPARATION THEREOF AND VARIOUS THERAPEUTIC USES THEREOF
C07D 335/02 (2006.01)	2417130 *	QUINAZOLINEDIONE DERIVATIVES, PREPARATION THEREOF AND VARIOUS THERAPEUTIC USES THEREOF
C07D 239/96 (2006.01)	2417130 *	QUINAZOLINEDIONE DERIVATIVES, PREPARATION THEREOF AND VARIOUS THERAPEUTIC USES THEREOF
A61K 31/517 (2006.01)	2417130 *	QUINAZOLINEDIONE DERIVATIVES, PREPARATION THEREOF AND VARIOUS THERAPEUTIC USES THEREOF
C07D 407/04 (2006.01)	2417130 *	QUINAZOLINEDIONE DERIVATIVES, PREPARATION THEREOF AND VARIOUS THERAPEUTIC USES THEREOF
A61P 37/00 (2006.01)	2417130 *	QUINAZOLINEDIONE DERIVATIVES, PREPARATION THEREOF AND VARIOUS THERAPEUTIC USES THEREOF
C07D 409/04 (2006.01)	2417130 *	QUINAZOLINEDIONE DERIVATIVES, PREPARATION THEREOF AND VARIOUS THERAPEUTIC USES THEREOF
A61P 29/00 (2006.01)	2417130 *	QUINAZOLINEDIONE DERIVATIVES, PREPARATION THEREOF AND VARIOUS THERAPEUTIC USES THEREOF
C07D 405/04 (2006.01)	2417130 *	QUINAZOLINEDIONE DERIVATIVES, PREPARATION THEREOF AND VARIOUS THERAPEUTIC USES THEREOF
A61P 11/00 (2006.01)	2417130 *	QUINAZOLINEDIONE DERIVATIVES, PREPARATION THEREOF AND VARIOUS THERAPEUTIC USES THEREOF
C07C 317/44 (2006.01)	2486004 *	SULPHONE COMPOUNDS AND METHODS OF MAKING AND USING SAME
C07D 405/12 (2006.01)	2486004 *	SULPHONE COMPOUNDS AND METHODS OF MAKING AND USING SAME
C07D 275/02 (2006.01)	2486004 *	SULPHONE COMPOUNDS AND METHODS OF MAKING AND USING SAME
A61K 31/381 (2006.01)	2486004 *	SULPHONE COMPOUNDS AND METHODS OF MAKING AND USING SAME
C07D 277/30 (2006.01)	2486004 *	SULPHONE COMPOUNDS AND METHODS OF MAKING AND USING SAME
A61K 31/415 (2006.01)	2486004 *	SULPHONE COMPOUNDS AND METHODS OF MAKING AND USING SAME
C07D 307/54 (2006.01)	2486004 *	SULPHONE COMPOUNDS AND METHODS OF MAKING AND USING SAME
A61K 31/421 (2006.01)	2486004 *	SULPHONE COMPOUNDS AND METHODS OF MAKING AND USING SAME
C07D 263/32 (2006.01)	2486004 *	SULPHONE COMPOUNDS AND METHODS OF MAKING AND USING SAME
A61K 31/341 (2006.01)	2486004 *	SULPHONE COMPOUNDS AND METHODS OF MAKING AND USING SAME
C07D 333/24 (2006.01)	2486004 *	SULPHONE COMPOUNDS AND METHODS OF MAKING AND USING SAME
C07D 231/10 (2006.01)	2486004 *	SULPHONE COMPOUNDS AND METHODS OF MAKING AND USING SAME
A61K 31/277 (2006.01)	2486004 *	SULPHONE COMPOUNDS AND METHODS OF MAKING AND USING SAME
C07C 317/46 (2006.01)	2486004 *	SULPHONE COMPOUNDS AND METHODS OF MAKING AND USING SAME
A61K 31/192 (2006.01)	2486004 *	SULPHONE COMPOUNDS AND METHODS OF MAKING AND USING SAME
C07D 495/14 (2006.01)	2499146 *	TRICYCLIC PYRAZOL AMINE DERIVATIVES
A61P 37/00 (2006.01)	2499146 *	TRICYCLIC PYRAZOL AMINE DERIVATIVES
A61K 31/56 (2006.01)	2499146 *	TRICYCLIC PYRAZOL AMINE DERIVATIVES
C07D 495/04 (2006.01)	2499146 *	TRICYCLIC PYRAZOL AMINE DERIVATIVES
E01B 31/13 (2006.01)	2408967 *	A METHOD OF ROLLING RAILS, APPARATUS FOR ROLLING RAILS AND RAIL PRODUCED ACCORDING TO SAID METHOD
B21B 1/085 (2006.01)	2408967 *	A METHOD OF ROLLING RAILS, APPARATUS FOR ROLLING RAILS AND RAIL PRODUCED ACCORDING TO SAID METHOD
C07D 239/48 (2006.01)	2419423 *	FLUORO SUBSTITUTED PYRIMIDINE COMPOUNDS AS JAK3 INHIBITORS
C07D 407/12 (2006.01)	2419423 *	FLUORO SUBSTITUTED PYRIMIDINE COMPOUNDS AS JAK3 INHIBITORS
A61K 31/506 (2006.01)	2419423 *	FLUORO SUBSTITUTED PYRIMIDINE COMPOUNDS AS JAK3 INHIBITORS
A61K 31/5377 (2006.01)	2419423 *	FLUORO SUBSTITUTED PYRIMIDINE COMPOUNDS AS JAK3 INHIBITORS
A61P 35/00 (2006.01)	2419423 *	FLUORO SUBSTITUTED PYRIMIDINE COMPOUNDS AS JAK3 INHIBITORS

MKP (51)	Broj objave evropske prijave patenta (97)	Naziv pronalaska (54)
C07D 403/12 (2006.01)	2419423 *	FLUORO SUBSTITUTED PYRIMIDINE COMPOUNDS AS JAK3 INHIBITORS
C08L 95/00 (2006.01)	2264094	Waterproofing membrane based on bitumen modified with polymers containing hollow glass microspheres.
C08K 7/28 (2006.01)	2264094	Waterproofing membrane based on bitumen modified with polymers containing hollow glass microspheres.
C08K 7/00 (2006.01)	2264094	Waterproofing membrane based on bitumen modified with polymers containing hollow glass microspheres.
A47L 13/20 (2006.01)	2415381 *	CLEANING IMPLEMENT AND CLEANING BODY
A47L 13/10 (2006.01)	2415381 *	CLEANING IMPLEMENT AND CLEANING BODY
A47L 13/17 (2006.01)	2415381 *	CLEANING IMPLEMENT AND CLEANING BODY
A61K 39/395 (2006.01)	2470210 *	METHODS OF TREATMENT USING ANTI-OXIDIZED LDL ANTIBODIES
A61N 1/36 (2006.01)	2408519 *	TRANSCUTANEOUS MODULATED POWER LINK FOR A MEDICAL IMPLANT
H04L 27/12 (2006.01)	2408519 *	TRANSCUTANEOUS MODULATED POWER LINK FOR A MEDICAL IMPLANT
H04R 25/00 (2006.01)	2408519 *	TRANSCUTANEOUS MODULATED POWER LINK FOR A MEDICAL IMPLANT
B01D 53/83 (2006.01)	2411123 *	METHOD FOR TREATING EXHAUST GASES COMPRISING SULFUR OXIDES
B01D 53/96 (2006.01)	2411123 *	METHOD FOR TREATING EXHAUST GASES COMPRISING SULFUR OXIDES
C01D 7/00 (2006.01)	2411123 *	METHOD FOR TREATING EXHAUST GASES COMPRISING SULFUR OXIDES
C01F 11/46 (2006.01)	2411123 *	METHOD FOR TREATING EXHAUST GASES COMPRISING SULFUR OXIDES
F23J 15/04 (2006.01)	2411123 *	METHOD FOR TREATING EXHAUST GASES COMPRISING SULFUR OXIDES
B01D 53/50 (2006.01)	2411123 *	METHOD FOR TREATING EXHAUST GASES COMPRISING SULFUR OXIDES
B01D 53/75 (2006.01)	2411123 *	METHOD FOR TREATING EXHAUST GASES COMPRISING SULFUR OXIDES
B01D 53/78 (2006.01)	2411123 *	METHOD FOR TREATING EXHAUST GASES COMPRISING SULFUR OXIDES
F01N 3/037 (2006.01)	2466085 *	CENTRIFUGAL, WET-TYPE AIR CLEANER
F24F 3/16 (2006.01)	2466085 *	CENTRIFUGAL, WET-TYPE AIR CLEANER
F24F 5/00 (2006.01)	2466085 *	CENTRIFUGAL, WET-TYPE AIR CLEANER
A61P 35/00 (2006.01)	2470526 *	COMPOUNDS AND COMPOSITIONS AS PROTEIN KINASE INHIBITORS
A61K 31/506 (2006.01)	2470526 *	COMPOUNDS AND COMPOSITIONS AS PROTEIN KINASE INHIBITORS
C07D 401/14 (2006.01)	2470526 *	COMPOUNDS AND COMPOSITIONS AS PROTEIN KINASE INHIBITORS
C07D 403/04 (2006.01)	2470526 *	COMPOUNDS AND COMPOSITIONS AS PROTEIN KINASE INHIBITORS
B32B 7/12 (2006.01)	2475519 *	ASSEMBLY OF WET ELECTROSTATIC PRECIPITATOR
F16S 1/12 (2006.01)	2475519 *	ASSEMBLY OF WET ELECTROSTATIC PRECIPITATOR
B32B 3/28 (2006.01)	2475519 *	ASSEMBLY OF WET ELECTROSTATIC PRECIPITATOR
B32B 1/08 (2006.01)	2475519 *	ASSEMBLY OF WET ELECTROSTATIC PRECIPITATOR
F16S 1/14 (2006.01)	2475519 *	ASSEMBLY OF WET ELECTROSTATIC PRECIPITATOR
C12N 15/09 (2006.01)	2407537 *	HUMANIZED PCRV ANTIBODY HAVING ANTI-PSEUDOMONAL ACTIVITY
A61K 39/395 (2006.01)	2407537 *	HUMANIZED PCRV ANTIBODY HAVING ANTI-PSEUDOMONAL ACTIVITY
A61P 31/04 (2006.01)	2407537 *	HUMANIZED PCRV ANTIBODY HAVING ANTI-PSEUDOMONAL ACTIVITY
C07K 16/12 (2006.01)	2407537 *	HUMANIZED PCRV ANTIBODY HAVING ANTI-PSEUDOMONAL ACTIVITY
A61K 31/665 (2006.01)	2427467 *	TRIPTOLIDE PRODRUGS
A61P 35/00 (2006.01)	2427467 *	TRIPTOLIDE PRODRUGS
C07F 9/6561 (2006.01)	2427467 *	TRIPTOLIDE PRODRUGS
C07D 487/04 (2006.01)	2406258 *	PYRIMIDINE DERIVATIVES AS mTOR INHIBITORS

MKP (51)	Broj objave evropske prijava patenta (97)	Naziv pronalaska (54)
C07D 471/04 (2006.01)	2406258 *	PYRIMIDINE DERIVATIVES AS mTOR INHIBITORS
A61K 31/519 (2006.01)	2406258 *	PYRIMIDINE DERIVATIVES AS mTOR INHIBITORS
A61P 37/00 (2006.01)	2406258 *	PYRIMIDINE DERIVATIVES AS mTOR INHIBITORS
C07K 14/71 (2006.01)	2448964 *	EXTRACELLULAR ALLOSTERIC INHIBITOR BINDING DOMAIN FROM A TYROSINE KINASE RECEPTOR
A61K 31/4745 (2006.01)	2448964 *	EXTRACELLULAR ALLOSTERIC INHIBITOR BINDING DOMAIN FROM A TYROSINE KINASE RECEPTOR
G01N 25/48 (2006.01)	2411792 *	SYSTEM AND AUTO-ALIGNMENT METHOD FOR DETERMINING POSITION USING A DISCRETE CONTACT PROBE
G01B 7/012 (2006.01)	2411792 *	SYSTEM AND AUTO-ALIGNMENT METHOD FOR DETERMINING POSITION USING A DISCRETE CONTACT PROBE
G01N 35/00 (2006.01)	2411792 *	SYSTEM AND AUTO-ALIGNMENT METHOD FOR DETERMINING POSITION USING A DISCRETE CONTACT PROBE
G01N 35/04 (2006.01)	2411792 *	SYSTEM AND AUTO-ALIGNMENT METHOD FOR DETERMINING POSITION USING A DISCRETE CONTACT PROBE
E21B 33/124 (2006.01)	2427630 *	SLIDING SLEEVE SUB AND METHOD AND APPARATUS FOR WELLBORE FLUID TREATMENT
E21B 34/14 (2006.01)	2427630 *	SLIDING SLEEVE SUB AND METHOD AND APPARATUS FOR WELLBORE FLUID TREATMENT
A61K 47/02 (2006.01)	2427177 *	COMPOSITION FOR SUSTAINED DRUG DELIVERY COMPRISING GEOPOLYMERIC BINDER
A61K 31/4468 (2006.01)	2427177 *	COMPOSITION FOR SUSTAINED DRUG DELIVERY COMPRISING GEOPOLYMERIC BINDER
A61K 9/16 (2006.01)	2427177 *	COMPOSITION FOR SUSTAINED DRUG DELIVERY COMPRISING GEOPOLYMERIC BINDER
C12P 21/08 (2006.01)	2425010 *	DUAL VARIABLE DOMAIN IMMUNOGLOBULINS AND USES THEREOF
A61K 39/00 (2006.01)	2425010 *	DUAL VARIABLE DOMAIN IMMUNOGLOBULINS AND USES THEREOF
C07K 14/11 (2006.01)	2414386 *	NEWCASTLE DISEASE VIRUS VECTORED AVIAN VACCINES
C12N 15/86 (2006.01)	2414386 *	NEWCASTLE DISEASE VIRUS VECTORED AVIAN VACCINES
A01N 37/46 (2006.01)	2458981 *	PESTICIDAL SUSPO-EMULSION COMPOSITIONS
A01N 43/653 (2006.01)	2458981 *	PESTICIDAL SUSPO-EMULSION COMPOSITIONS
A01N 47/24 (2006.01)	2458981 *	PESTICIDAL SUSPO-EMULSION COMPOSITIONS
A01N 25/04 (2006.01)	2458981 *	PESTICIDAL SUSPO-EMULSION COMPOSITIONS
A61K 47/48 (2006.01)	2459225 *	CARRIER LINKED PRAMIPEXOLE PRODRUGS
A61P 25/16 (2006.01)	2459225 *	CARRIER LINKED PRAMIPEXOLE PRODRUGS
B64C 29/00 (2006.01)	2338790	VTOL aircraft with a thrust-to-weight ratio smaller than 1
C07D 413/14 (2006.01)	2424865 *	CYCLIC INHIBITORS OF 11BETA-HYDROXYSTEROID DEHYDROGENASE 1
A61K 31/535 (2006.01)	2424865 *	CYCLIC INHIBITORS OF 11BETA-HYDROXYSTEROID DEHYDROGENASE 1
A61P 3/00 (2006.01)	2424865 *	CYCLIC INHIBITORS OF 11BETA-HYDROXYSTEROID DEHYDROGENASE 1
A61P 5/00 (2006.01)	2424865 *	CYCLIC INHIBITORS OF 11BETA-HYDROXYSTEROID DEHYDROGENASE 1
G06F 9/50 (2006.01)	2388700	Systems and methods for policy-based program configuration
C07D 207/08 (2006.01)	2436767 *	SINGLE-STRANDED NUCLEIC ACID MOLECULE HAVING NITROGEN-CONTAINING ALICYCLIC SKELETON
C12N 15/113 (2010.01)	2436767 *	SINGLE-STRANDED NUCLEIC ACID MOLECULE HAVING NITROGEN-CONTAINING ALICYCLIC SKELETON
A61K 39/395 (2006.01)	2488202 *	ANTIBODY THERAPEUTICS WITH LOCAL ACTIVITY IN THE DIGESTIVE TRACT
A61K 31/4439 (2006.01)	2421871 *	THIA-TRIAZA-CYCLOPENTAZULENES AS PI3-KINASES INHIBITORS FOR THE TREATMENT OF CANCER
C07D 513/04 (2006.01)	2421871 *	THIA-TRIAZA-CYCLOPENTAZULENES AS PI3-KINASES INHIBITORS FOR THE TREATMENT OF CANCER

MKP (51)	Broj objave evropske prijava patenta (97)	Naziv pronalaska (54)
A61P 35/00 (2006.01)	2421871 *	THIA-TRIAZA-CYCLOPENTAZULENES AS PI3-KINASES INHIBITORS FOR THE TREATMENT OF CANCER
C12N 5/16 (2006.01)	2459721 *	IMPROVED HUMAN LONG PENTRAXIN 3 EXPRESSION SYSTEM AND USES THEREOF
C12N 15/67 (2006.01)	2459721 *	IMPROVED HUMAN LONG PENTRAXIN 3 EXPRESSION SYSTEM AND USES THEREOF
C12N 15/79 (2006.01)	2459721 *	IMPROVED HUMAN LONG PENTRAXIN 3 EXPRESSION SYSTEM AND USES THEREOF
C10J 3/46 (2006.01)	2459681 *	CARBON CONVERSION SYSTEM WITH INTEGRATED PROCESSING ZONES
C10B 53/00 (2006.01)	2459681 *	CARBON CONVERSION SYSTEM WITH INTEGRATED PROCESSING ZONES
C12Q 1/68 (2006.01)	2473636 *	TYPE 1 INTERFERON DIAGNOSTIC
C07D 401/12 (2006.01)	2443092 *	BICYCLIC AND TRICYCLIC COMPOUNDS AS KAT II INHIBITORS
C07D 405/04 (2006.01)	2443092 *	BICYCLIC AND TRICYCLIC COMPOUNDS AS KAT II INHIBITORS
C07D 215/60 (2006.01)	2443092 *	BICYCLIC AND TRICYCLIC COMPOUNDS AS KAT II INHIBITORS
A61P 25/00 (2006.01)	2443092 *	BICYCLIC AND TRICYCLIC COMPOUNDS AS KAT II INHIBITORS
C07D 401/04 (2006.01)	2443092 *	BICYCLIC AND TRICYCLIC COMPOUNDS AS KAT II INHIBITORS
C07D 471/04 (2006.01)	2443092 *	BICYCLIC AND TRICYCLIC COMPOUNDS AS KAT II INHIBITORS
C07D 491/04 (2006.01)	2443092 *	BICYCLIC AND TRICYCLIC COMPOUNDS AS KAT II INHIBITORS
A61K 31/4375 (2006.01)	2443092 *	BICYCLIC AND TRICYCLIC COMPOUNDS AS KAT II INHIBITORS
A61K 31/4704 (2006.01)	2443092 *	BICYCLIC AND TRICYCLIC COMPOUNDS AS KAT II INHIBITORS
A61L 31/10 (2006.01)	2493524 *	ANTIMICROBIAL COATINGS WITH PREFERRED MICROSTRUCTURE FOR MEDICAL DEVICES
A61L 27/30 (2006.01)	2493524 *	ANTIMICROBIAL COATINGS WITH PREFERRED MICROSTRUCTURE FOR MEDICAL DEVICES
A61L 27/34 (2006.01)	2493524 *	ANTIMICROBIAL COATINGS WITH PREFERRED MICROSTRUCTURE FOR MEDICAL DEVICES
A61L 31/08 (2006.01)	2493524 *	ANTIMICROBIAL COATINGS WITH PREFERRED MICROSTRUCTURE FOR MEDICAL DEVICES
A61L 17/00 (2006.01)	2493524 *	ANTIMICROBIAL COATINGS WITH PREFERRED MICROSTRUCTURE FOR MEDICAL DEVICES
C07D 403/04 (2006.01)	2483271 *	PYRAZOLINE DIONE DERIVATIVES AS NADPH OXIDASE INHIBITORS
A61P 9/00 (2006.01)	2483271 *	PYRAZOLINE DIONE DERIVATIVES AS NADPH OXIDASE INHIBITORS
C07D 413/04 (2006.01)	2483271 *	PYRAZOLINE DIONE DERIVATIVES AS NADPH OXIDASE INHIBITORS
A61P 5/00 (2006.01)	2483271 *	PYRAZOLINE DIONE DERIVATIVES AS NADPH OXIDASE INHIBITORS
A61K 31/551 (2006.01)	2483271 *	PYRAZOLINE DIONE DERIVATIVES AS NADPH OXIDASE INHIBITORS
C07D 471/14 (2006.01)	2483271 *	PYRAZOLINE DIONE DERIVATIVES AS NADPH OXIDASE INHIBITORS
A61P 35/00 (2006.01)	2483271 *	PYRAZOLINE DIONE DERIVATIVES AS NADPH OXIDASE INHIBITORS
A61K 31/554 (2006.01)	2483271 *	PYRAZOLINE DIONE DERIVATIVES AS NADPH OXIDASE INHIBITORS
C07D 513/14 (2006.01)	2483271 *	PYRAZOLINE DIONE DERIVATIVES AS NADPH OXIDASE INHIBITORS
A61P 11/00 (2006.01)	2483271 *	PYRAZOLINE DIONE DERIVATIVES AS NADPH OXIDASE INHIBITORS
A61K 31/553 (2006.01)	2483271 *	PYRAZOLINE DIONE DERIVATIVES AS NADPH OXIDASE INHIBITORS
C07D 498/14 (2006.01)	2483271 *	PYRAZOLINE DIONE DERIVATIVES AS NADPH OXIDASE INHIBITORS
A61P 25/00 (2006.01)	2483271 *	PYRAZOLINE DIONE DERIVATIVES AS NADPH OXIDASE INHIBITORS
A61M 5/315 (2006.01)	2482892 *	DRIVE MECHANISM FOR A DRUG DELIVERY DEVICE
F16J 15/02 (2006.01)	2458251	A composite sliding gasket for high-pressure joints
F16L 13/14 (2006.01)	2458251	A composite sliding gasket for high-pressure joints
F16L 37/092 (2006.01)	2458251	A composite sliding gasket for high-pressure joints
F16L 41/08 (2006.01)	2458251	A composite sliding gasket for high-pressure joints
F16L 23/16 (2006.01)	2458251	A composite sliding gasket for high-pressure joints
A61K 31/335 (2006.01)	2424523 *	SUBLINGUAL SPRAY FORMULATION COMPRISING DIHYDROARTEMESININ

MKP (51)	Broj objave evropske prijave patenta (97)	Naziv pronalaska (54)
A61K 9/12 (2006.01)	2424523 *	SUBLINGUAL SPRAY FORMULATION COMPRISING DIHYDROARTEMESININ
A61K 39/155 (2006.01)	2445526 *	RECOMBINANT RSV ANTIGENS
C07K 14/135 (2006.01)	2445526 *	RECOMBINANT RSV ANTIGENS
F03G 6/00 (2006.01)	2454480 *	POWER GENERATION SYSTEM
E05D 15/08 (2006.01)	2476839	Ground rail track for a sliding wing system
E05D 15/06 (2006.01)	2476839	Ground rail track for a sliding wing system
B62D 1/06 (2006.01)	2499036 *	METHOD FOR APPLYING LEATHER TO VEHICLE INTERIOR PARTS
A61K 31/437 (2006.01)	2430013 *	HETEROARYL COMPOUNDS AS PIKK INHIBITORS
C07D 401/14 (2006.01)	2430013 *	HETEROARYL COMPOUNDS AS PIKK INHIBITORS
A61K 31/52 (2006.01)	2430013 *	HETEROARYL COMPOUNDS AS PIKK INHIBITORS
C07D 403/04 (2006.01)	2430013 *	HETEROARYL COMPOUNDS AS PIKK INHIBITORS
A61K 31/53 (2006.01)	2430013 *	HETEROARYL COMPOUNDS AS PIKK INHIBITORS
C07D 403/14 (2006.01)	2430013 *	HETEROARYL COMPOUNDS AS PIKK INHIBITORS
A61P 35/00 (2006.01)	2430013 *	HETEROARYL COMPOUNDS AS PIKK INHIBITORS
C07D 471/04 (2006.01)	2430013 *	HETEROARYL COMPOUNDS AS PIKK INHIBITORS
C07D 519/00 (2006.01)	2430013 *	HETEROARYL COMPOUNDS AS PIKK INHIBITORS
C07D 487/04 (2006.01)	2430013 *	HETEROARYL COMPOUNDS AS PIKK INHIBITORS
A61K 31/506 (2006.01)	2430013 *	HETEROARYL COMPOUNDS AS PIKK INHIBITORS
D01F 4/02 (2006.01)	2483460 *	DRAWN SILK EGEL FIBERS AND METHODS OF MAKING SAME
D01D 5/00 (2006.01)	2483460 *	DRAWN SILK EGEL FIBERS AND METHODS OF MAKING SAME
A61F 2/60 (2006.01)	2496188 *	REPLACEABLE FAIRING FOR PROSTHETIC LIMB OR BRACE
C07D 471/04 (2006.01)	2462142 *	METABOTROPIC GLUTAMATE RECEPTOR MODULATORS
C07D 487/04 (2006.01)	2462142 *	METABOTROPIC GLUTAMATE RECEPTOR MODULATORS
C07D 498/04 (2006.01)	2462142 *	METABOTROPIC GLUTAMATE RECEPTOR MODULATORS
C07D 513/04 (2006.01)	2462142 *	METABOTROPIC GLUTAMATE RECEPTOR MODULATORS
A61K 31/33 (2006.01)	2462142 *	METABOTROPIC GLUTAMATE RECEPTOR MODULATORS
A61P 25/00 (2006.01)	2462142 *	METABOTROPIC GLUTAMATE RECEPTOR MODULATORS
C11B 3/00 (2006.01)	2494015 *	CLONING, EXPRESSION AND USE OF ACID PHOSPHOLIPASES
C12N 9/16 (2006.01)	2494015 *	CLONING, EXPRESSION AND USE OF ACID PHOSPHOLIPASES
C09K 11/07 (2006.01)	2459674 *	COMBINED THERMAL AND CHEMILUMINESCENT REACTION SYSTEM
F42B 12/36 (2006.01)	2459674 *	COMBINED THERMAL AND CHEMILUMINESCENT REACTION SYSTEM
F42B 12/40 (2006.01)	2459674 *	COMBINED THERMAL AND CHEMILUMINESCENT REACTION SYSTEM
F42B 12/46 (2006.01)	2459674 *	COMBINED THERMAL AND CHEMILUMINESCENT REACTION SYSTEM
B29C 49/64 (2006.01)	2480390 *	HEATING INSTALLATION AND REFLECTING DEVICE FOR A HEATING INSTALLATION.
H05B 3/00 (2006.01)	2480390 *	HEATING INSTALLATION AND REFLECTING DEVICE FOR A HEATING INSTALLATION.
F21V 7/00 (2006.01)	2480390 *	HEATING INSTALLATION AND REFLECTING DEVICE FOR A HEATING INSTALLATION.
B29B 13/02 (2006.01)	2480390 *	HEATING INSTALLATION AND REFLECTING DEVICE FOR A HEATING INSTALLATION.
B29C 49/68 (2006.01)	2480390 *	HEATING INSTALLATION AND REFLECTING DEVICE FOR A HEATING INSTALLATION.
G01S 3/32 (2006.01)	2267474	Monopulse receiver and method
H04B 7/185 (2006.01)	2267474	Monopulse receiver and method
A61K 33/00 (2006.01)	2493482 *	THERAPEUTIC GAS FOR THE TREATMENT OF MITOCHONDRIAL DISORDERS
A61P 3/00 (2006.01)	2493482 *	THERAPEUTIC GAS FOR THE TREATMENT OF MITOCHONDRIAL DISORDERS
C07K 16/24 (2006.01)	2435481 *	IL-13 BINDING PROTEIN

MKP (51)	Broj objave evropske prijava patenta (97)	Naziv pronalaska (54)
A61P 11/06 (2006.01)	2435481 *	IL-13 BINDING PROTEIN
C07K 16/46 (2006.01)	2435481 *	IL-13 BINDING PROTEIN
A61P 11/10 (2006.01)	2464346 *	TREATMENT OF CYSTIC FIBROSIS USING CALCIUM LACTATE, LEUCINE AND SODIUM CHLORIDE IN A RESPIRABLE DRY POWDER
A61K 9/00 (2006.01)	2464346 *	TREATMENT OF CYSTIC FIBROSIS USING CALCIUM LACTATE, LEUCINE AND SODIUM CHLORIDE IN A RESPIRABLE DRY POWDER
A61P 11/00 (2006.01)	2464346 *	TREATMENT OF CYSTIC FIBROSIS USING CALCIUM LACTATE, LEUCINE AND SODIUM CHLORIDE IN A RESPIRABLE DRY POWDER
A61K 31/198 (2006.01)	2464346 *	TREATMENT OF CYSTIC FIBROSIS USING CALCIUM LACTATE, LEUCINE AND SODIUM CHLORIDE IN A RESPIRABLE DRY POWDER
A61K 33/06 (2006.01)	2464346 *	TREATMENT OF CYSTIC FIBROSIS USING CALCIUM LACTATE, LEUCINE AND SODIUM CHLORIDE IN A RESPIRABLE DRY POWDER
A61K 33/14 (2006.01)	2464346 *	TREATMENT OF CYSTIC FIBROSIS USING CALCIUM LACTATE, LEUCINE AND SODIUM CHLORIDE IN A RESPIRABLE DRY POWDER
E06B 3/42 (2006.01)	2273053	Schiebetür mit Entgleisungsschutz
E05D 15/06 (2006.01)	2273053	Schiebetür mit Entgleisungsschutz
C07D 417/14 (2006.01)	2435431 *	SUBSTITUTED PIPERIDINES
A61K 31/541 (2006.01)	2435431 *	SUBSTITUTED PIPERIDINES
A61K 31/05 (2006.01)	2482809 *	COMPOSITIONS COMPRISING AN ANTI-INFLAMMATORY BLEND
A61K 36/185 (2006.01)	2482809 *	COMPOSITIONS COMPRISING AN ANTI-INFLAMMATORY BLEND
A61K 36/77 (2006.01)	2482809 *	COMPOSITIONS COMPRISING AN ANTI-INFLAMMATORY BLEND
A61K 36/48 (2006.01)	2482809 *	COMPOSITIONS COMPRISING AN ANTI-INFLAMMATORY BLEND
A61K 36/28 (2006.01)	2482809 *	COMPOSITIONS COMPRISING AN ANTI-INFLAMMATORY BLEND
C07D 417/14 (2006.01)	2445908 *	DISUBSTITUTED BENZAMIDE DERIVATIVES AS GLUCOKINASE (GK) ACTIVATORS
A61K 31/4245 (2006.01)	2445908 *	DISUBSTITUTED BENZAMIDE DERIVATIVES AS GLUCOKINASE (GK) ACTIVATORS
A61P 3/10 (2006.01)	2445908 *	DISUBSTITUTED BENZAMIDE DERIVATIVES AS GLUCOKINASE (GK) ACTIVATORS
A61K 31/427 (2006.01)	2445908 *	DISUBSTITUTED BENZAMIDE DERIVATIVES AS GLUCOKINASE (GK) ACTIVATORS
C07D 417/12 (2006.01)	2445908 *	DISUBSTITUTED BENZAMIDE DERIVATIVES AS GLUCOKINASE (GK) ACTIVATORS
A61K 31/437 (2006.01)	2493888 *	BICYCLIC PYRIDINES AND ANALOGS AS SIRTUIN MODULATORS
A61K 31/553 (2006.01)	2493888 *	BICYCLIC PYRIDINES AND ANALOGS AS SIRTUIN MODULATORS
A61K 31/4375 (2006.01)	2493888 *	BICYCLIC PYRIDINES AND ANALOGS AS SIRTUIN MODULATORS
A61K 31/5365 (2006.01)	2493888 *	BICYCLIC PYRIDINES AND ANALOGS AS SIRTUIN MODULATORS
C07D 487/04 (2006.01)	2493888 *	BICYCLIC PYRIDINES AND ANALOGS AS SIRTUIN MODULATORS
A61K 31/55 (2006.01)	2493888 *	BICYCLIC PYRIDINES AND ANALOGS AS SIRTUIN MODULATORS
A61K 31/4985 (2006.01)	2493888 *	BICYCLIC PYRIDINES AND ANALOGS AS SIRTUIN MODULATORS
C07D 471/04 (2006.01)	2493888 *	BICYCLIC PYRIDINES AND ANALOGS AS SIRTUIN MODULATORS
A61K 31/551 (2006.01)	2493888 *	BICYCLIC PYRIDINES AND ANALOGS AS SIRTUIN MODULATORS
C07D 519/00 (2006.01)	2493888 *	BICYCLIC PYRIDINES AND ANALOGS AS SIRTUIN MODULATORS
A61P 5/50 (2006.01)	2493888 *	BICYCLIC PYRIDINES AND ANALOGS AS SIRTUIN MODULATORS
A61K 31/7076 (2006.01)	2424546 *	METHOD OF REDUCING INTRAOCULAR PRESSURE IN HUMANS
A61P 27/02 (2006.01)	2424546 *	METHOD OF REDUCING INTRAOCULAR PRESSURE IN HUMANS
C07H 19/167 (2006.01)	2424546 *	METHOD OF REDUCING INTRAOCULAR PRESSURE IN HUMANS
A61K 47/48 (2006.01)	2485712 *	SUBCUTANEOUS PALIPERIDONE COMPOSITION
A61K 31/519 (2006.01)	2485712 *	SUBCUTANEOUS PALIPERIDONE COMPOSITION
A61K 9/00 (2006.01)	2485712 *	SUBCUTANEOUS PALIPERIDONE COMPOSITION
A61K 9/06 (2006.01)	2485712 *	SUBCUTANEOUS PALIPERIDONE COMPOSITION
C07J 71/00 (2006.01)	2475676 *	Pregnane derivatives condensed in the 16,17 position with an N-substituted isoxazolidine ring as anti-inflammatory agents

MKP (51)	Broj objave evropske prijava patenta (97)	Naziv pronalaska (54)
A61P 5/44 (2006.01)	2475676 *	Pregnane derivatives condensed in the 16,17 position with an N-substituted isoxazolidine ring as anti-inflammatory agents
A61K 31/58 (2006.01)	2475676 *	Pregnane derivatives condensed in the 16,17 position with an N-substituted isoxazolidine ring as anti-inflammatory agents
C07D 265/32 (2006.01)	2424847 *	PROCESSES FOR THE PREPARATION OF RIVAROXABAN AND INTERMEDIATES THEREOF
A61K 31/5375 (2006.01)	2424847 *	PROCESSES FOR THE PREPARATION OF RIVAROXABAN AND INTERMEDIATES THEREOF
A61K 31/5377 (2006.01)	2424847 *	PROCESSES FOR THE PREPARATION OF RIVAROXABAN AND INTERMEDIATES THEREOF
A61P 7/02 (2006.01)	2424847 *	PROCESSES FOR THE PREPARATION OF RIVAROXABAN AND INTERMEDIATES THEREOF
C07D 413/12 (2006.01)	2424847 *	PROCESSES FOR THE PREPARATION OF RIVAROXABAN AND INTERMEDIATES THEREOF
C07D 413/14 (2006.01)	2424847 *	PROCESSES FOR THE PREPARATION OF RIVAROXABAN AND INTERMEDIATES THEREOF
H04W 88/08 (2009.01)	2461642 *	METHOD, DEVICE AND SYSTEM FOR TRANSMITTING SOUNDING REFERENCE SIGNALS
H04B 7/26 (2006.01)	2461642 *	METHOD, DEVICE AND SYSTEM FOR TRANSMITTING SOUNDING REFERENCE SIGNALS
H04W 24/00 (2009.01)	2461642 *	METHOD, DEVICE AND SYSTEM FOR TRANSMITTING SOUNDING REFERENCE SIGNALS
A61K 31/56 (2006.01)	2490694 *	METHODS AND SYSTEMS FOR PHARMACOGENOMIC TREATMENT OF CARDIOVASCULAR CONDITIONS
A61P 9/00 (2006.01)	2490694 *	METHODS AND SYSTEMS FOR PHARMACOGENOMIC TREATMENT OF CARDIOVASCULAR CONDITIONS
C07K 16/28 (2006.01)	2403878 *	FULLY HUMAN ANTIBODIES SPECIFIC TO CADM1
E05F 15/14 (2006.01)	2241709	Simultaneous displacement device for sliding doors
E05F 17/00 (2006.01)	2241709	Simultaneous displacement device for sliding doors
A01P 3/00 (2006.01)	2451275 *	AGRICULTURAL OR HORTICULTURAL FUNGICIDE COMPOSITION AND ITS USE FOR CONTROLLING PLANT PATHOGENS
A01N 43/50 (2006.01)	2451275 *	AGRICULTURAL OR HORTICULTURAL FUNGICIDE COMPOSITION AND ITS USE FOR CONTROLLING PLANT PATHOGENS
A01N 47/04 (2006.01)	2451275 *	AGRICULTURAL OR HORTICULTURAL FUNGICIDE COMPOSITION AND ITS USE FOR CONTROLLING PLANT PATHOGENS
C07D 403/04 (2006.01)	2451792 *	PROCESS FOR SUBSTITUTED 3-AMINO-5-OXO-4,5-DIHYDRO-[1,2,4] TRIAZINES
C07D 487/04 (2006.01)	2451792 *	PROCESS FOR SUBSTITUTED 3-AMINO-5-OXO-4,5-DIHYDRO-[1,2,4] TRIAZINES
C07D 253/06 (2006.01)	2451792 *	PROCESS FOR SUBSTITUTED 3-AMINO-5-OXO-4,5-DIHYDRO-[1,2,4] TRIAZINES
A61K 38/00 (2006.01)	2416796 *	Modified dnase compositions and methods of use thereof
A61K 31/4418 (2006.01)	2459193 *	OTAMIXABAN FOR TREATMENT OF ELDERLY AND RENAL IMPAIRED NON-ST ELEVATION MYOCARDIAL INFARCTION PATIENTS
A61P 7/02 (2006.01)	2459193 *	OTAMIXABAN FOR TREATMENT OF ELDERLY AND RENAL IMPAIRED NON-ST ELEVATION MYOCARDIAL INFARCTION PATIENTS
A61P 9/10 (2006.01)	2459193 *	OTAMIXABAN FOR TREATMENT OF ELDERLY AND RENAL IMPAIRED NON-ST ELEVATION MYOCARDIAL INFARCTION PATIENTS
C07D 417/08 (2006.01)	2459547 *	HERBICIDALLY ACTIVE HETEROARYL-SUBSTITUTED CYCLIC DIONES OR DERIVATIVES THEREOF
C07D 417/14 (2006.01)	2459547 *	HERBICIDALLY ACTIVE HETEROARYL-SUBSTITUTED CYCLIC DIONES OR DERIVATIVES THEREOF
A01N 43/78 (2006.01)	2459547 *	HERBICIDALLY ACTIVE HETEROARYL-SUBSTITUTED CYCLIC DIONES OR DERIVATIVES THEREOF
C07D 409/08 (2006.01)	2459547 *	HERBICIDALLY ACTIVE HETEROARYL-SUBSTITUTED CYCLIC DIONES OR DERIVATIVES THEREOF

MKP (51)	Broj objave evropske prijave patenta (97)	Naziv pronalaska (54)
C07D 401/08 (2006.01)	2459547 *	HERBICIDALLY ACTIVE HETEROARYL-SUBSTITUTED CYCLIC DIONES OR DERIVATIVES THEREOF
C07D 405/08 (2006.01)	2459547 *	HERBICIDALLY ACTIVE HETEROARYL-SUBSTITUTED CYCLIC DIONES OR DERIVATIVES THEREOF
D04B 21/16 (2006.01)	2280105	Fabric for binding tape, and binding tape
A61P 27/02 (2006.01)	2435075 *	ANTIGEN-BINDING PROTEINS
C07K 14/715 (2006.01)	2435075 *	ANTIGEN-BINDING PROTEINS
C07K 16/22 (2006.01)	2435075 *	ANTIGEN-BINDING PROTEINS
A61K 39/395 (2006.01)	2435075 *	ANTIGEN-BINDING PROTEINS
C07K 16/24 (2006.01)	2435075 *	ANTIGEN-BINDING PROTEINS
C07D 409/14 (2006.01)	2477983 *	(4-PHENYL-PIPERIDIN-1-YL)-[5-1H-PYRAZOL-4YL]-THIOPHEN-3-YL]-METHANONE COMPOUNDS AND THEIR USE
C07D 451/02 (2006.01)	2477983 *	(4-PHENYL-PIPERIDIN-1-YL)-[5-1H-PYRAZOL-4YL]-THIOPHEN-3-YL]-METHANONE COMPOUNDS AND THEIR USE
C07D 451/06 (2006.01)	2477983 *	(4-PHENYL-PIPERIDIN-1-YL)-[5-1H-PYRAZOL-4YL]-THIOPHEN-3-YL]-METHANONE COMPOUNDS AND THEIR USE
A61K 31/4439 (2006.01)	2477983 *	(4-PHENYL-PIPERIDIN-1-YL)-[5-1H-PYRAZOL-4YL]-THIOPHEN-3-YL]-METHANONE COMPOUNDS AND THEIR USE
A61P 3/00 (2006.01)	2477983 *	(4-PHENYL-PIPERIDIN-1-YL)-[5-1H-PYRAZOL-4YL]-THIOPHEN-3-YL]-METHANONE COMPOUNDS AND THEIR USE
A61K 31/4439 (2006.01)	2491028 *	INDAZOLE AND PYRAZOLOPYRIDINE COMPOUNDS AS CCR1 RECEPTOR ANTAGONISTS
C07D 401/12 (2006.01)	2491028 *	INDAZOLE AND PYRAZOLOPYRIDINE COMPOUNDS AS CCR1 RECEPTOR ANTAGONISTS
A61K 31/437 (2006.01)	2491028 *	INDAZOLE AND PYRAZOLOPYRIDINE COMPOUNDS AS CCR1 RECEPTOR ANTAGONISTS
C07D 471/04 (2006.01)	2491028 *	INDAZOLE AND PYRAZOLOPYRIDINE COMPOUNDS AS CCR1 RECEPTOR ANTAGONISTS
D21G 9/00 (2006.01)	2412869	Method for producing sheet-like material
A23L 1/216 (2006.01)	2294925	Chip mixture
A23L 1/217 (2006.01)	2294925	Chip mixture
A23B 7/02 (2006.01)	2294925	Chip mixture
A23B 7/03 (2006.01)	2294925	Chip mixture
A61K 31/74 (2006.01)	2459201 *	HYDROGEL FORMULATION COMPRISING OXIDATIVE REDUCTIVE POTENTIAL WATER
B63B 3/28 (2006.01)	2394905	A unit comprising a frame proving shape and a support profile supporting a construction board
B63B 9/06 (2006.01)	2394905	A unit comprising a frame proving shape and a support profile supporting a construction board
E04B 9/06 (2006.01)	2394905	A unit comprising a frame proving shape and a support profile supporting a construction board
E04F 11/00 (2006.01)	2394905	A unit comprising a frame proving shape and a support profile supporting a construction board
C07K 16/26 (2006.01)	2488551 *	MONOCLONAL ANTIBODIES TO PROGASTRIN AND THEIR USES
C07D 491/04 (2006.01)	2277882	Pipéridinic compounds, process for their préparation and pharmaceutical compositions containing them
A61K 31/407 (2006.01)	2277882	Pipéridinic compounds, process for their préparation and pharmaceutical compositions containing them
A61K 9/00 (2006.01)	2424501 *	SOLID PREPARATION
A61P 25/18 (2006.01)	2454256 *	PROCESS FOR THE SYNTHESIS OF PALIPERIDONE
C07D 471/04 (2006.01)	2454256 *	PROCESS FOR THE SYNTHESIS OF PALIPERIDONE
A61K 31/42 (2006.01)	2454256 *	PROCESS FOR THE SYNTHESIS OF PALIPERIDONE
E04C 2/38 (2006.01)	2464799 *	BUILDING PANEL AS STRUCTURE OF EXTERNAL AND INNER PLATE WITH INTERMEDIATE INSULATION SPACE

MKP (51)	Broj objave evropske prijava patenta (97)	Naziv pronalaska (54)
A61K 31/4025 (2006.01)	2480531 *	PYRROLIDINONE CARBOXAMIDE DERIVATIVES AS CHEMERIN-R (CHEMR23) MODULATORS
C07D 209/52 (2006.01)	2480531 *	PYRROLIDINONE CARBOXAMIDE DERIVATIVES AS CHEMERIN-R (CHEMR23) MODULATORS
C07D 405/04 (2006.01)	2480531 *	PYRROLIDINONE CARBOXAMIDE DERIVATIVES AS CHEMERIN-R (CHEMR23) MODULATORS
C07D 209/46 (2006.01)	2480531 *	PYRROLIDINONE CARBOXAMIDE DERIVATIVES AS CHEMERIN-R (CHEMR23) MODULATORS
A61P 29/00 (2006.01)	2480531 *	PYRROLIDINONE CARBOXAMIDE DERIVATIVES AS CHEMERIN-R (CHEMR23) MODULATORS
C07D 403/06 (2006.01)	2480531 *	PYRROLIDINONE CARBOXAMIDE DERIVATIVES AS CHEMERIN-R (CHEMR23) MODULATORS
C07D 493/04 (2006.01)	2480531 *	PYRROLIDINONE CARBOXAMIDE DERIVATIVES AS CHEMERIN-R (CHEMR23) MODULATORS
C07D 207/416 (2006.01)	2480531 *	PYRROLIDINONE CARBOXAMIDE DERIVATIVES AS CHEMERIN-R (CHEMR23) MODULATORS
C07D 401/06 (2006.01)	2480531 *	PYRROLIDINONE CARBOXAMIDE DERIVATIVES AS CHEMERIN-R (CHEMR23) MODULATORS
A61M 37/00 (2006.01)	2464417 *	ULTRASONIC SURGICAL APPARATUS AND SILICON WAVEGUIDE AND METHODS FOR USE THEREOF
A61N 7/00 (2006.01)	2464417 *	ULTRASONIC SURGICAL APPARATUS AND SILICON WAVEGUIDE AND METHODS FOR USE THEREOF
A61K 41/00 (2006.01)	2464417 *	ULTRASONIC SURGICAL APPARATUS AND SILICON WAVEGUIDE AND METHODS FOR USE THEREOF
C12N 15/87 (2006.01)	2464384 *	PHOTOSENSITIZING COMPOSITIONS
A61K 41/00 (2006.01)	2464384 *	PHOTOSENSITIZING COMPOSITIONS
A61P 35/00 (2006.01)	2464384 *	PHOTOSENSITIZING COMPOSITIONS
A61K 48/00 (2006.01)	2464384 *	PHOTOSENSITIZING COMPOSITIONS
A61K 9/00 (2006.01)	2464384 *	PHOTOSENSITIZING COMPOSITIONS
A61P 43/00 (2006.01)	2464384 *	PHOTOSENSITIZING COMPOSITIONS
C12N 15/90 (2006.01)	2478100 *	METHOD OF GENERATING GENE MOSAICS
C12N 15/10 (2006.01)	2478100 *	METHOD OF GENERATING GENE MOSAICS
A61P 35/00 (2006.01)	2490689 *	INJECTABLE FORMULATIONS FOR INTRA- ARTICULAR OR PERI-ARTICULAR ADMINISTRATION
A61K 31/404 (2006.01)	2490689 *	INJECTABLE FORMULATIONS FOR INTRA- ARTICULAR OR PERI-ARTICULAR ADMINISTRATION
A61K 31/40 (2006.01)	2490689 *	INJECTABLE FORMULATIONS FOR INTRA- ARTICULAR OR PERI-ARTICULAR ADMINISTRATION
A61K 31/4709 (2006.01)	2490689 *	INJECTABLE FORMULATIONS FOR INTRA- ARTICULAR OR PERI-ARTICULAR ADMINISTRATION
A61P 31/00 (2006.01)	2490689 *	INJECTABLE FORMULATIONS FOR INTRA- ARTICULAR OR PERI-ARTICULAR ADMINISTRATION
A61P 29/00 (2006.01)	2490689 *	INJECTABLE FORMULATIONS FOR INTRA- ARTICULAR OR PERI-ARTICULAR ADMINISTRATION
A61K 31/44 (2006.01)	2490689 *	INJECTABLE FORMULATIONS FOR INTRA- ARTICULAR OR PERI-ARTICULAR ADMINISTRATION
A61F 13/15 (2006.01)	2345395	Apparatus and method for producing absorbent article with stretch film side panel and application of intermittent discrete components of an absorbent article
C12N 15/113 (2010.01)	2480668 *	COMPOSITIONS AND METHODS FOR SILENCING GENES EXPRESSED IN CANCER
A61K 31/713 (2006.01)	2480668 *	COMPOSITIONS AND METHODS FOR SILENCING GENES EXPRESSED IN CANCER
C07H 21/02 (2006.01)	2480668 *	COMPOSITIONS AND METHODS FOR SILENCING GENES EXPRESSED IN CANCER
A61P 35/00 (2006.01)	2480668 *	COMPOSITIONS AND METHODS FOR SILENCING GENES EXPRESSED IN CANCER

MKP (51)	Broj objave evropske prijava patenta (97)	Naziv pronalaska (54)
E01C 13/08 (2006.01)	2388052	Base for a playing field
A63C 19/02 (2006.01)	2388052	Base for a playing field
A61K 31/785 (2006.01)	2413943 *	CONTROLLED EXOTHERM OF CYANOACRYLATE FORMULATIONS
A61K 31/795 (2006.01)	2413943 *	CONTROLLED EXOTHERM OF CYANOACRYLATE FORMULATIONS
C07D 495/04 (2006.01)	2470541 *	RAF INHIBITOR COMPOUNDS AND METHODS OF USE THEREOF
A61K 31/519 (2006.01)	2470541 *	RAF INHIBITOR COMPOUNDS AND METHODS OF USE THEREOF
C07D 491/04 (2006.01)	2470541 *	RAF INHIBITOR COMPOUNDS AND METHODS OF USE THEREOF
C07D 487/04 (2006.01)	2470541 *	RAF INHIBITOR COMPOUNDS AND METHODS OF USE THEREOF
A61P 35/00 (2006.01)	2470541 *	RAF INHIBITOR COMPOUNDS AND METHODS OF USE THEREOF
A63B 23/02 (2006.01)	2424625 *	UPPER BODY EXERCISE DEVICE
E21B 43/25 (2006.01)	2478182 *	WATER HEATING APPARATUS FOR CONTINUOUS HEATED WATER FLOW AND METHOD FOR USE IN HYDRAULIC FRACTURING
E21B 43/26 (2006.01)	2478182 *	WATER HEATING APPARATUS FOR CONTINUOUS HEATED WATER FLOW AND METHOD FOR USE IN HYDRAULIC FRACTURING
G06K 9/00 (2006.01)	2440126 *	SYSTEMS AND METHODS FOR QUANTITATIVE ASSESSMENT OF CARDIAC ELECTRICAL EVENTS
A61B 5/0452 (2006.01)	2440126 *	SYSTEMS AND METHODS FOR QUANTITATIVE ASSESSMENT OF CARDIAC ELECTRICAL EVENTS
G06F 17/00 (2006.01)	2440126 *	SYSTEMS AND METHODS FOR QUANTITATIVE ASSESSMENT OF CARDIAC ELECTRICAL EVENTS
A61K 9/16 (2006.01)	2470166 *	NEW COMPOSITIONS OF 1-[2-(2,4-DIMETHYL-PHENYLSULFANYL)-PHENYL]PIPERAZINE
A61K 9/28 (2006.01)	2470166 *	NEW COMPOSITIONS OF 1-[2-(2,4-DIMETHYL-PHENYLSULFANYL)-PHENYL]PIPERAZINE
A61K 9/50 (2006.01)	2470166 *	NEW COMPOSITIONS OF 1-[2-(2,4-DIMETHYL-PHENYLSULFANYL)-PHENYL]PIPERAZINE
A61K 9/20 (2006.01)	2470166 *	NEW COMPOSITIONS OF 1-[2-(2,4-DIMETHYL-PHENYLSULFANYL)-PHENYL]PIPERAZINE
C05D 3/02 (2006.01)	2463258	Soil improvements and fertilizers by dynamic disintegration, their manufacturing method and their uses in agriculture
C05G 3/00 (2006.01)	2463258	Soil improvements and fertilizers by dynamic disintegration, their manufacturing method and their uses in agriculture
C07D 409/14 (2006.01)	2475657 *	INHIBITORS OF FLAVIVIRIDAE VIRUSES
A61P 31/12 (2006.01)	2475657 *	INHIBITORS OF FLAVIVIRIDAE VIRUSES
C07D 409/12 (2006.01)	2475657 *	INHIBITORS OF FLAVIVIRIDAE VIRUSES
C07D 417/12 (2006.01)	2475657 *	INHIBITORS OF FLAVIVIRIDAE VIRUSES
C07D 333/68 (2006.01)	2475657 *	INHIBITORS OF FLAVIVIRIDAE VIRUSES
C07D 413/12 (2006.01)	2475657 *	INHIBITORS OF FLAVIVIRIDAE VIRUSES
C07D 487/04 (2006.01)	2475657 *	INHIBITORS OF FLAVIVIRIDAE VIRUSES
C07D 493/04 (2006.01)	2475657 *	INHIBITORS OF FLAVIVIRIDAE VIRUSES
A61K 31/381 (2006.01)	2475657 *	INHIBITORS OF FLAVIVIRIDAE VIRUSES
A61K 9/127 (2006.01)	2410991 *	ORALLY BIOAVAILABLE LIPID-BASED CONSTRUCTS
C07K 14/62 (2006.01)	2451437 *	AQUEOUS PREPARATIONS COMPRISING METHIONINE
C12N 15/81 (2006.01)	2451437 *	AQUEOUS PREPARATIONS COMPRISING METHIONINE
A61K 9/10 (2006.01)	2451437 *	AQUEOUS PREPARATIONS COMPRISING METHIONINE
A61K 47/00 (2006.01)	2451437 *	AQUEOUS PREPARATIONS COMPRISING METHIONINE
A61K 38/31 (2006.01)	2408472 *	USE OF SOMATOSTATIN OR AN ANALOGUE THEREOF IN COMBINATION WITH EXTERNAL RADIATION THERAPY
C07D 413/14 (2006.01)	2454250 *	APOPTOSIS SIGNAL-REGULATING KINASE INHIBITORS
A61P 9/00 (2006.01)	2454250 *	APOPTOSIS SIGNAL-REGULATING KINASE INHIBITORS
C07D 491/048 (2006.01)	2454250 *	APOPTOSIS SIGNAL-REGULATING KINASE INHIBITORS
A61P 29/00 (2006.01)	2454250 *	APOPTOSIS SIGNAL-REGULATING KINASE INHIBITORS
C07D 407/14 (2006.01)	2454250 *	APOPTOSIS SIGNAL-REGULATING KINASE INHIBITORS

MKP (51)	Broj objave evropske prijava patenta (97)	Naziv pronalaska (54)
A61K 31/506 (2006.01)	2454250 *	APOPTOSIS SIGNAL-REGULATING KINASE INHIBITORS
A61K 31/437 (2006.01)	2454250 *	APOPTOSIS SIGNAL-REGULATING KINASE INHIBITORS
A61P 37/00 (2006.01)	2454250 *	APOPTOSIS SIGNAL-REGULATING KINASE INHIBITORS
A61K 31/4439 (2006.01)	2454250 *	APOPTOSIS SIGNAL-REGULATING KINASE INHIBITORS
C07D 401/12 (2006.01)	2454250 *	APOPTOSIS SIGNAL-REGULATING KINASE INHIBITORS
A61K 31/444 (2006.01)	2454250 *	APOPTOSIS SIGNAL-REGULATING KINASE INHIBITORS
C07D 401/14 (2006.01)	2454250 *	APOPTOSIS SIGNAL-REGULATING KINASE INHIBITORS
A61K 31/497 (2006.01)	2454250 *	APOPTOSIS SIGNAL-REGULATING KINASE INHIBITORS
C07D 471/04 (2006.01)	2454250 *	APOPTOSIS SIGNAL-REGULATING KINASE INHIBITORS
A61P 25/28 (2006.01)	2454250 *	APOPTOSIS SIGNAL-REGULATING KINASE INHIBITORS
A61P 35/00 (2006.01)	2459173 *	PHARMACEUTICAL COMPOSITIONS FOR THE TREATMENT OF CANCER AND OTHER DISEASES OR DISORDERS
A61K 9/00 (2006.01)	2459173 *	PHARMACEUTICAL COMPOSITIONS FOR THE TREATMENT OF CANCER AND OTHER DISEASES OR DISORDERS
A61K 9/08 (2006.01)	2459173 *	PHARMACEUTICAL COMPOSITIONS FOR THE TREATMENT OF CANCER AND OTHER DISEASES OR DISORDERS
A61K 31/55 (2006.01)	2459173 *	PHARMACEUTICAL COMPOSITIONS FOR THE TREATMENT OF CANCER AND OTHER DISEASES OR DISORDERS
A61K 31/485 (2006.01)	2371357	Oral formulations and lipophilic salts of methylnaltrexone
A61K 9/20 (2006.01)	2371357	Oral formulations and lipophilic salts of methylnaltrexone
C07D 489/08 (2006.01)	2371357	Oral formulations and lipophilic salts of methylnaltrexone
G09F 1/10 (2006.01)	2493703 *	DOCUMENTS-HANGING SHOWCASE WITHOUT THE UTILISATION OF CLIPS AND METHOD FOR ITS REALISATION
B43L 5/02 (2006.01)	2493703 *	DOCUMENTS-HANGING SHOWCASE WITHOUT THE UTILISATION OF CLIPS AND METHOD FOR ITS REALISATION
F16B 2/16 (2006.01)	2493703 *	DOCUMENTS-HANGING SHOWCASE WITHOUT THE UTILISATION OF CLIPS AND METHOD FOR ITS REALISATION
B42F 15/06 (2006.01)	2493703 *	DOCUMENTS-HANGING SHOWCASE WITHOUT THE UTILISATION OF CLIPS AND METHOD FOR ITS REALISATION
A47G 1/21 (2006.01)	2493703 *	DOCUMENTS-HANGING SHOWCASE WITHOUT THE UTILISATION OF CLIPS AND METHOD FOR ITS REALISATION
A61M 25/00 (2006.01)	2408505 *	GUIDE SYSTEM WITH SUCTION
A61M 25/06 (2006.01)	2408505 *	GUIDE SYSTEM WITH SUCTION
C07D 403/04 (2006.01)	2452939 *	PIPERAZINYL 3-AMINOPYRROLIDINE DERIVATIVES AS A CCR2 ANTAGONIST
C07D 403/06 (2006.01)	2452939 *	PIPERAZINYL 3-AMINOPYRROLIDINE DERIVATIVES AS A CCR2 ANTAGONIST
C07D 207/273 (2006.01)	2452939 *	PIPERAZINYL 3-AMINOPYRROLIDINE DERIVATIVES AS A CCR2 ANTAGONIST
C04B 28/00 (2006.01)	2385029	Compositions and method for well cementing
B23K 26/08 (2006.01)	2283963	Manipulator of low inertia for laser cutting machines for flat sheet metals
B23Q 1/01 (2006.01)	2283963	Manipulator of low inertia for laser cutting machines for flat sheet metals
B23K 37/02 (2006.01)	2283963	Manipulator of low inertia for laser cutting machines for flat sheet metals
B23Q 1/54 (2006.01)	2283963	Manipulator of low inertia for laser cutting machines for flat sheet metals
B23Q 1/58 (2006.01)	2283963	Manipulator of low inertia for laser cutting machines for flat sheet metals
B25J 17/02 (2006.01)	2283963	Manipulator of low inertia for laser cutting machines for flat sheet metals
B23K 26/38 (2006.01)	2283963	Manipulator of low inertia for laser cutting machines for flat sheet metals
A61K 31/195 (2006.01)	2493468 *	AMINO-BENZOIC ACID DERIVATIVES FOR USE IN THE TREATMENT OF DIHYDROGENASE-RELATED DISORDERS
A61P 37/02 (2006.01)	2493468 *	AMINO-BENZOIC ACID DERIVATIVES FOR USE IN THE TREATMENT OF DIHYDROGENASE-RELATED DISORDERS
A61K 39/395 (2006.01)	2406290 *	ANTIGEN PRESENTING CELL TARGETED CANCER VACCINES
C07K 16/30 (2006.01)	2406290 *	ANTIGEN PRESENTING CELL TARGETED CANCER VACCINES

MKP (51)	Broj objave evropske prijava patenta (97)	Naziv pronalaska (54)
A61P 35/00 (2006.01)	2406290 *	ANTIGEN PRESENTING CELL TARGETED CANCER VACCINES
C07K 19/00 (2006.01)	2406290 *	ANTIGEN PRESENTING CELL TARGETED CANCER VACCINES
C12N 15/63 (2006.01)	2406290 *	ANTIGEN PRESENTING CELL TARGETED CANCER VACCINES
C12N 15/62 (2006.01)	2406290 *	ANTIGEN PRESENTING CELL TARGETED CANCER VACCINES
C07K 16/18 (2006.01)	2430049 *	HUMANIZED ANTIBODIES SPECIFIC TO THE PROTOFIBRILLAR FORM OF THE BETA-AMYLOID PEPTIDE
G01N 33/68 (2006.01)	2430049 *	HUMANIZED ANTIBODIES SPECIFIC TO THE PROTOFIBRILLAR FORM OF THE BETA-AMYLOID PEPTIDE
A61K 39/395 (2006.01)	2430049 *	HUMANIZED ANTIBODIES SPECIFIC TO THE PROTOFIBRILLAR FORM OF THE BETA-AMYLOID PEPTIDE
A61P 25/28 (2006.01)	2430049 *	HUMANIZED ANTIBODIES SPECIFIC TO THE PROTOFIBRILLAR FORM OF THE BETA-AMYLOID PEPTIDE
C07D 487/08 (2006.01)	2491018 *	PROCESS FOR PREPARING MODULATORS OF CYSTIC FIBROSIS TRANSMEMBRANE CONDUCTANCE REGULATOR
C07D 215/56 (2006.01)	2491018 *	PROCESS FOR PREPARING MODULATORS OF CYSTIC FIBROSIS TRANSMEMBRANE CONDUCTANCE REGULATOR
A61K 9/20 (2006.01)	2477611 *	(Z)-2-CYANO-3-HYDROXY-BUT-2-ENOIC ACID-(4'-TRIFLUORMETHYLPHENYL)-AMIDE TABLET FORMULATIONS WITH IMPROVED STABILITY
A61K 31/277 (2006.01)	2477611 *	(Z)-2-CYANO-3-HYDROXY-BUT-2-ENOIC ACID-(4'-TRIFLUORMETHYLPHENYL)-AMIDE TABLET FORMULATIONS WITH IMPROVED STABILITY
C07D 261/14 (2006.01)	2483254 *	NOVEL COMPOUNDS
A61K 31/495 (2006.01)	2483254 *	NOVEL COMPOUNDS
C07D 241/04 (2006.01)	2483254 *	NOVEL COMPOUNDS
A61K 31/44 (2006.01)	2483254 *	NOVEL COMPOUNDS
C07C 223/00 (2006.01)	2483254 *	NOVEL COMPOUNDS
A61P 25/28 (2006.01)	2483254 *	NOVEL COMPOUNDS
C07D 231/12 (2006.01)	2483254 *	NOVEL COMPOUNDS
A61K 31/4155 (2006.01)	2483254 *	NOVEL COMPOUNDS
C07D 265/30 (2006.01)	2483254 *	NOVEL COMPOUNDS
A61K 31/4965 (2006.01)	2483254 *	NOVEL COMPOUNDS
C07D 237/20 (2006.01)	2483254 *	NOVEL COMPOUNDS
A61K 31/42 (2006.01)	2483254 *	NOVEL COMPOUNDS
C07C 233/00 (2006.01)	2483254 *	NOVEL COMPOUNDS
A61P 25/16 (2006.01)	2483254 *	NOVEL COMPOUNDS
A61K 31/5375 (2006.01)	2483254 *	NOVEL COMPOUNDS
A61P 25/00 (2006.01)	2483254 *	NOVEL COMPOUNDS
A61P 9/00 (2006.01)	2483233 *	HETEROATOM CONTAINING SUBSTITUTED FATTY ACIDS
A61P 11/00 (2006.01)	2483233 *	HETEROATOM CONTAINING SUBSTITUTED FATTY ACIDS
A61K 31/201 (2006.01)	2483233 *	HETEROATOM CONTAINING SUBSTITUTED FATTY ACIDS
C07C 205/50 (2006.01)	2483233 *	HETEROATOM CONTAINING SUBSTITUTED FATTY ACIDS
A61K 31/00 (2006.01)	2496221 *	MULTILAYER PHARMACEUTICAL COMPOSITION THAT CAN BE DISPERSED IN WATER AND WHICH CONTAINS A COMBINATION OF ANTIMALARIAL AGENTS
A61K 9/00 (2006.01)	2496221 *	MULTILAYER PHARMACEUTICAL COMPOSITION THAT CAN BE DISPERSED IN WATER AND WHICH CONTAINS A COMBINATION OF ANTIMALARIAL AGENTS
A61K 9/20 (2006.01)	2496221 *	MULTILAYER PHARMACEUTICAL COMPOSITION THAT CAN BE DISPERSED IN WATER AND WHICH CONTAINS A COMBINATION OF ANTIMALARIAL AGENTS
A61K 38/08 (2006.01)	2459207 *	PHARMACEUTICAL COMPOSITION FOR TREATING MEDICAL CONDITIONS AND A METHOD FOR TREATING ALIMENTARY DISORDERS AND RELATED DISEASES

MKP (51)	Broj objave evropske prijava patenta (97)	Naziv pronalaska (54)
A61M 5/32 (2006.01)	2403571 *	DRUG DELIVERY DEVICE WITH RETRACTABLE NEEDLE
A61M 5/50 (2006.01)	2403571 *	DRUG DELIVERY DEVICE WITH RETRACTABLE NEEDLE
B22D 11/06 (2006.01)	2411171 *	ADJUSTABLE SIDE DAM FOR CONTINUOUS CASTING APPARATUS
B22D 11/12 (2006.01)	2411171 *	ADJUSTABLE SIDE DAM FOR CONTINUOUS CASTING APPARATUS
A61P 35/00 (2006.01)	2448924 *	PYRAZOLE DERIVATIVES, PREPARATION THEREOF, AND THERAPEUTIC USE THEREOF
C07D 231/38 (2006.01)	2448924 *	PYRAZOLE DERIVATIVES, PREPARATION THEREOF, AND THERAPEUTIC USE THEREOF
A61K 31/415 (2006.01)	2448924 *	PYRAZOLE DERIVATIVES, PREPARATION THEREOF, AND THERAPEUTIC USE THEREOF
C07C 275/30 (2006.01)	2448924 *	PYRAZOLE DERIVATIVES, PREPARATION THEREOF, AND THERAPEUTIC USE THEREOF
A61K 35/74 (2006.01)	2370085 *	TREATMENT OF CANCER OR TUMOR INDUCED BY THE RELEASE OF HEAT GENERATED BY VARIOUS CHAINS OF MAGNETOSOMES EXTRACTED FROM MAGNETOTACTIC BACTERIA AND SUBMITTED TO AN ALTERNATIVE MAGNETIC FIELD
C07C 307/06 (2006.01)	2414325 *	METHOD OF PREPARING AN INHIBITOR OF CYTOCHROME P450 MONOOXYGENASE, AND INTERMEDIATES INVOLVED
C07D 417/12 (2006.01)	2414325 *	METHOD OF PREPARING AN INHIBITOR OF CYTOCHROME P450 MONOOXYGENASE, AND INTERMEDIATES INVOLVED
A61K 31/40 (2006.01)	2434890 *	IAP INHIBITORS
A01N 43/36 (2006.01)	2434890 *	IAP INHIBITORS
A61M 5/32 (2006.01)	2403567 *	NEEDLE ASSEMBLY
B21F 1/00 (2006.01)	2427135 *	APPARATUS AND METHOD FOR CUSTOMIZED SHAPING OF ORTHODONTIC ARCHWIRES AND OTHER MEDICAL DEVICES
A61C 7/02 (2006.01)	2427135 *	APPARATUS AND METHOD FOR CUSTOMIZED SHAPING OF ORTHODONTIC ARCHWIRES AND OTHER MEDICAL DEVICES
A61K 31/5415 (2006.01)	2403840 *	DERIVATIVES OF BENZOTHIAZINES, PREPARATION THEREOF AND APPLICATION THEREOF AS DRUGS
C07D 275/06 (2006.01)	2403840 *	DERIVATIVES OF BENZOTHIAZINES, PREPARATION THEREOF AND APPLICATION THEREOF AS DRUGS
B24C 1/04 (2006.01)	2414134 *	DEVICE AND METHOD FOR WATER-JET CUTTING
B24C 3/04 (2006.01)	2414134 *	DEVICE AND METHOD FOR WATER-JET CUTTING
A61P 43/00 (2006.01)	2442870 *	PYRAZINOOXAZEPINE DERIVATIVES
A61P 3/00 (2006.01)	2442870 *	PYRAZINOOXAZEPINE DERIVATIVES
A61P 15/00 (2006.01)	2442870 *	PYRAZINOOXAZEPINE DERIVATIVES
A61P 13/02 (2006.01)	2442870 *	PYRAZINOOXAZEPINE DERIVATIVES
C07D 498/04 (2006.01)	2442870 *	PYRAZINOOXAZEPINE DERIVATIVES
A61P 21/00 (2006.01)	2442870 *	PYRAZINOOXAZEPINE DERIVATIVES
A45D 31/00 (2006.01)	2456335 *	COMPOSITIONS FOR REMOVABLE GEL APPLICATIONS FOR NAILS AND METHODS OF THEIR USE
A61K 8/02 (2006.01)	2456335 *	COMPOSITIONS FOR REMOVABLE GEL APPLICATIONS FOR NAILS AND METHODS OF THEIR USE
A61K 8/35 (2006.01)	2456335 *	COMPOSITIONS FOR REMOVABLE GEL APPLICATIONS FOR NAILS AND METHODS OF THEIR USE
A61K 8/37 (2006.01)	2456335 *	COMPOSITIONS FOR REMOVABLE GEL APPLICATIONS FOR NAILS AND METHODS OF THEIR USE
A61K 8/42 (2006.01)	2456335 *	COMPOSITIONS FOR REMOVABLE GEL APPLICATIONS FOR NAILS AND METHODS OF THEIR USE
A61Q 3/02 (2006.01)	2456335 *	COMPOSITIONS FOR REMOVABLE GEL APPLICATIONS FOR NAILS AND METHODS OF THEIR USE
F16K 31/30 (2006.01)	2325407	Bypass valve
F16K 31/46 (2006.01)	2325407	Bypass valve
F15C 1/16 (2006.01)	2325407	Bypass valve
E03F 5/10 (2006.01)	2325407	Bypass valve

MKP (51)	Broj objave evropske prijava patenta (97)	Naziv pronalaska (54)
F15D 1/00 (2006.01)	2325407	Bypass valve
A61K 31/4545 (2006.01)	2402012	Liquid formulations of rupatadine fumarate
A61K 47/10 (2006.01)	2402012	Liquid formulations of rupatadine fumarate
A61P 11/02 (2006.01)	2402012	Liquid formulations of rupatadine fumarate
A61K 9/08 (2006.01)	2402012	Liquid formulations of rupatadine fumarate
A61P 37/08 (2006.01)	2402012	Liquid formulations of rupatadine fumarate
A61K 9/00 (2006.01)	2402012	Liquid formulations of rupatadine fumarate
G01N 30/02 (2006.01)	2402012	Liquid formulations of rupatadine fumarate
A61P 11/04 (2006.01)	2402012	Liquid formulations of rupatadine fumarate
H03K 5/22 (2006.01)	2491655 *	FAST SETTLING, BIT SLICING COMPARATOR CIRCUIT
A01H 3/00 (2006.01)	2448400 *	IMPROVEMENT OF YIELD IN CROP PLANTS THROUGH SELECTION OF EPIGENETICALLY MODIFIED POPULATIONS
A61P 31/04 (2006.01)	2428214	Compositions for the vaginal and oral administration of lactobacillus and uses thereof
A61K 35/74 (2006.01)	2428214	Compositions for the vaginal and oral administration of lactobacillus and uses thereof
A61P 15/02 (2006.01)	2428214	Compositions for the vaginal and oral administration of lactobacillus and uses thereof
A23L 1/305 (2006.01)	2464363 *	NATURAL EXTRACT FROM WHOLE BANANA FRUIT (MUSA SPP.)
A61K 36/88 (2006.01)	2464363 *	NATURAL EXTRACT FROM WHOLE BANANA FRUIT (MUSA SPP.)
A61K 36/78 (2006.01)	2464363 *	NATURAL EXTRACT FROM WHOLE BANANA FRUIT (MUSA SPP.)
A61P 9/12 (2006.01)	2464363 *	NATURAL EXTRACT FROM WHOLE BANANA FRUIT (MUSA SPP.)
C07D 403/12 (2006.01)	2475648 *	ORTHO SUBSTITUTED PYRIMIDINE COMPOUNDS AS JAK INHIBITORS
A61K 31/505 (2006.01)	2475648 *	ORTHO SUBSTITUTED PYRIMIDINE COMPOUNDS AS JAK INHIBITORS
A61P 37/00 (2006.01)	2475648 *	ORTHO SUBSTITUTED PYRIMIDINE COMPOUNDS AS JAK INHIBITORS
C07D 239/48 (2006.01)	2475648 *	ORTHO SUBSTITUTED PYRIMIDINE COMPOUNDS AS JAK INHIBITORS
A61K 31/506 (2006.01)	2475648 *	ORTHO SUBSTITUTED PYRIMIDINE COMPOUNDS AS JAK INHIBITORS
A61P 35/00 (2006.01)	2475648 *	ORTHO SUBSTITUTED PYRIMIDINE COMPOUNDS AS JAK INHIBITORS
C12Q 1/68 (2006.01)	2438194 *	METHODS FOR SCREENING AND IDENTIFYING COMPOUNDS
H04M 1/02 (2006.01)	2456175	Portable electronic device including flexible display
G06F 1/16 (2006.01)	2456175	Portable electronic device including flexible display
A61B 17/94 (2006.01)	2410935 *	CANNULA WITH INTEGRATED CAMERA AND ILLUMINATION
A61B 17/34 (2006.01)	2410935 *	CANNULA WITH INTEGRATED CAMERA AND ILLUMINATION
A61B 19/00 (2006.01)	2410935 *	CANNULA WITH INTEGRATED CAMERA AND ILLUMINATION
A61B 17/32 (2006.01)	2453813 *	ELECTROSURGERY GENERATOR FOR ULTRASONIC SURGICAL INSTRUMENTS
A61B 18/14 (2006.01)	2453813 *	ELECTROSURGERY GENERATOR FOR ULTRASONIC SURGICAL INSTRUMENTS
A61B 17/28 (2006.01)	2453813 *	ELECTROSURGERY GENERATOR FOR ULTRASONIC SURGICAL INSTRUMENTS
A61K 31/19 (2006.01)	2456431 *	CELL PROTECTION IN DIALYSIS PATIENTS BY ADMINISTRATION OF A CREATINE COMPOUND
A61K 31/195 (2006.01)	2456431 *	CELL PROTECTION IN DIALYSIS PATIENTS BY ADMINISTRATION OF A CREATINE COMPOUND
A61K 31/198 (2006.01)	2456431 *	CELL PROTECTION IN DIALYSIS PATIENTS BY ADMINISTRATION OF A CREATINE COMPOUND
A61K 31/4172 (2006.01)	2456431 *	CELL PROTECTION IN DIALYSIS PATIENTS BY ADMINISTRATION OF A CREATINE COMPOUND
A61K 31/661 (2006.01)	2456431 *	CELL PROTECTION IN DIALYSIS PATIENTS BY ADMINISTRATION OF A CREATINE COMPOUND
A61K 31/675 (2006.01)	2456431 *	CELL PROTECTION IN DIALYSIS PATIENTS BY ADMINISTRATION OF A CREATINE COMPOUND

MKP (51)	Broj objave evropske prijava patenta (97)	Naziv pronalaska (54)
A61K 31/7004 (2006.01)	2456431 *	CELL PROTECTION IN DIALYSIS PATIENTS BY ADMINISTRATION OF A CREATINE COMPOUND
A61K 33/00 (2006.01)	2456431 *	CELL PROTECTION IN DIALYSIS PATIENTS BY ADMINISTRATION OF A CREATINE COMPOUND
A61K 33/06 (2006.01)	2456431 *	CELL PROTECTION IN DIALYSIS PATIENTS BY ADMINISTRATION OF A CREATINE COMPOUND
A61K 33/10 (2006.01)	2456431 *	CELL PROTECTION IN DIALYSIS PATIENTS BY ADMINISTRATION OF A CREATINE COMPOUND
A61P 7/08 (2006.01)	2456431 *	CELL PROTECTION IN DIALYSIS PATIENTS BY ADMINISTRATION OF A CREATINE COMPOUND
A61K 45/06 (2006.01)	2456431 *	CELL PROTECTION IN DIALYSIS PATIENTS BY ADMINISTRATION OF A CREATINE COMPOUND
A61K 36/00 (2006.01)	2473057 *	PICRORHIZA KURROA EXTRACT FOR PREVENTION, ELIMINATION AND TREATMENT OF INFECTION DISEASES
A01N 65/00 (2009.01)	2473057 *	PICRORHIZA KURROA EXTRACT FOR PREVENTION, ELIMINATION AND TREATMENT OF INFECTION DISEASES
C07D 471/04 (2006.01)	2464646 *	PROCESS FOR THE PREPARATION OF CATHEPSIN S INHIBITORS
H04W 16/00 (2009.01)	2466939 *	METHOD, DEVICE AND SYSTEM FOR DETERMINING RESOURCE LOCATIONS
C10B 7/02 (2006.01)	2424955 *	DEVICE AND METHOD FOR DRYING AND TORREFYING AT LEAST ONE CARBON-CONTAINING SUBSTANCE STREAM IN A MULTIPLE-HEARTH FURNACE
C10L 5/40 (2006.01)	2424955 *	DEVICE AND METHOD FOR DRYING AND TORREFYING AT LEAST ONE CARBON-CONTAINING SUBSTANCE STREAM IN A MULTIPLE-HEARTH FURNACE
C10L 9/08 (2006.01)	2424955 *	DEVICE AND METHOD FOR DRYING AND TORREFYING AT LEAST ONE CARBON-CONTAINING SUBSTANCE STREAM IN A MULTIPLE-HEARTH FURNACE
C10B 53/02 (2006.01)	2424955 *	DEVICE AND METHOD FOR DRYING AND TORREFYING AT LEAST ONE CARBON-CONTAINING SUBSTANCE STREAM IN A MULTIPLE-HEARTH FURNACE
F26B 23/02 (2006.01)	2424955 *	DEVICE AND METHOD FOR DRYING AND TORREFYING AT LEAST ONE CARBON-CONTAINING SUBSTANCE STREAM IN A MULTIPLE-HEARTH FURNACE
C10B 49/02 (2006.01)	2424955 *	DEVICE AND METHOD FOR DRYING AND TORREFYING AT LEAST ONE CARBON-CONTAINING SUBSTANCE STREAM IN A MULTIPLE-HEARTH FURNACE
F27B 9/18 (2006.01)	2424955 *	DEVICE AND METHOD FOR DRYING AND TORREFYING AT LEAST ONE CARBON-CONTAINING SUBSTANCE STREAM IN A MULTIPLE-HEARTH FURNACE
F26B 17/00 (2006.01)	2424955 *	DEVICE AND METHOD FOR DRYING AND TORREFYING AT LEAST ONE CARBON-CONTAINING SUBSTANCE STREAM IN A MULTIPLE-HEARTH FURNACE
C12N 5/07 (2010.01)	2496707 *	ENGINEERED ANTI-TSLP ANTIBODY
C12P 21/08 (2006.01)	2496707 *	ENGINEERED ANTI-TSLP ANTIBODY
A61M 5/315 (2006.01)	2453959 *	DRUG DELIVERY DEVICE
C07K 16/28 (2006.01)	2424897 *	ANTI CXCR4 ANTIBODIES FOR THE TREATMENT OF HIV
A61K 39/395 (2006.01)	2424897 *	ANTI CXCR4 ANTIBODIES FOR THE TREATMENT OF HIV
A61P 31/18 (2006.01)	2424897 *	ANTI CXCR4 ANTIBODIES FOR THE TREATMENT OF HIV
C07D 451/10 (2006.01)	2432781 *	SALTS OF TIOTROPIUM WITH 10-CAMPHORSULFONIC ACID
A61K 31/46 (2006.01)	2432781 *	SALTS OF TIOTROPIUM WITH 10-CAMPHORSULFONIC ACID
A61P 11/00 (2006.01)	2432781 *	SALTS OF TIOTROPIUM WITH 10-CAMPHORSULFONIC ACID
A61M 5/315 (2006.01)	2437819 *	INNER HOUSING FOR A DRUG DELIVERY DEVICE
A61P 25/00 (2006.01)	2441459 *	5'-METHYLTHIOADENOSINE NEUROPROTECTIVE PROPERTIES
A61K 31/7076 (2006.01)	2441459 *	5'-METHYLTHIOADENOSINE NEUROPROTECTIVE PROPERTIES
A61P 25/28 (2006.01)	2441459 *	5'-METHYLTHIOADENOSINE NEUROPROTECTIVE PROPERTIES

MKP (51)	Broj objave evropske prijava patenta (97)	Naziv pronalaska (54)
A61P 1/16 (2006.01)	2450051 *	MEDICINAL AGENT AND METHOD FOR TREATMENT OF INTRACTABLE CHRONIC HEPATITIS C
A61P 31/14 (2006.01)	2450051 *	MEDICINAL AGENT AND METHOD FOR TREATMENT OF INTRACTABLE CHRONIC HEPATITIS C
A61K 31/56 (2006.01)	2450051 *	MEDICINAL AGENT AND METHOD FOR TREATMENT OF INTRACTABLE CHRONIC HEPATITIS C
A61P 43/00 (2006.01)	2450051 *	MEDICINAL AGENT AND METHOD FOR TREATMENT OF INTRACTABLE CHRONIC HEPATITIS C
A61K 31/7056 (2006.01)	2450051 *	MEDICINAL AGENT AND METHOD FOR TREATMENT OF INTRACTABLE CHRONIC HEPATITIS C
A61K 38/21 (2006.01)	2450051 *	MEDICINAL AGENT AND METHOD FOR TREATMENT OF INTRACTABLE CHRONIC HEPATITIS C
C07D 487/04 (2006.01)	2491038 *	DISUBSTITUTED OCTAHY - DROPYRROLO [3,4-C]PYRROLES AS OREXIN RECEPTOR MODULATORS
A61K 31/407 (2006.01)	2491038 *	DISUBSTITUTED OCTAHY - DROPYRROLO [3,4-C]PYRROLES AS OREXIN RECEPTOR MODULATORS
A61P 25/00 (2006.01)	2491038 *	DISUBSTITUTED OCTAHY - DROPYRROLO [3,4-C]PYRROLES AS OREXIN RECEPTOR MODULATORS
C07K 16/00 (2006.01)	2421897 *	FRAGMENTATION RESISTANT IgG1 Fc-CONJUGATES
G06F 7/04 (2006.01)	2411906 *	IMPROVED MULTIPLEXER FOR A PIEZO CERAMIC IDENTIFICATION DEVICE
A61M 5/32 (2006.01)	2427238 *	PIVOTABLE NEEDLE PROTECTOR
A22C 21/00 (2006.01)	2248429	Apparatus and method for conveying organ packages to a processing station
A22C 21/06 (2006.01)	2248429	Apparatus and method for conveying organ packages to a processing station
C07D 277/64 (2006.01)	2430006 *	CYCLOPENTA[C]PYRROLE-2-CARBOXYLATE DERIVATIVES, PREPARATION THEREOF, AND THERAPEUTIC USE THEREOF
C07D 285/06 (2006.01)	2430006 *	CYCLOPENTA[C]PYRROLE-2-CARBOXYLATE DERIVATIVES, PREPARATION THEREOF, AND THERAPEUTIC USE THEREOF
C07D 403/12 (2006.01)	2430006 *	CYCLOPENTA[C]PYRROLE-2-CARBOXYLATE DERIVATIVES, PREPARATION THEREOF, AND THERAPEUTIC USE THEREOF
C07D 413/14 (2006.01)	2430006 *	CYCLOPENTA[C]PYRROLE-2-CARBOXYLATE DERIVATIVES, PREPARATION THEREOF, AND THERAPEUTIC USE THEREOF
C07D 417/12 (2006.01)	2430006 *	CYCLOPENTA[C]PYRROLE-2-CARBOXYLATE DERIVATIVES, PREPARATION THEREOF, AND THERAPEUTIC USE THEREOF
A61K 31/403 (2006.01)	2430006 *	CYCLOPENTA[C]PYRROLE-2-CARBOXYLATE DERIVATIVES, PREPARATION THEREOF, AND THERAPEUTIC USE THEREOF
C07D 417/14 (2006.01)	2430006 *	CYCLOPENTA[C]PYRROLE-2-CARBOXYLATE DERIVATIVES, PREPARATION THEREOF, AND THERAPEUTIC USE THEREOF
A61P 29/00 (2006.01)	2430006 *	CYCLOPENTA[C]PYRROLE-2-CARBOXYLATE DERIVATIVES, PREPARATION THEREOF, AND THERAPEUTIC USE THEREOF
H02P 9/00 (2006.01)	2386753	Excitation circuit for an asynchronous generator and method for the excitation of an asynchronous generator
F03D 9/00 (2006.01)	2386753	Excitation circuit for an asynchronous generator and method for the excitation of an asynchronous generator
H02P 9/30 (2006.01)	2386753	Excitation circuit for an asynchronous generator and method for the excitation of an asynchronous generator
H02P 9/48 (2006.01)	2386753	Excitation circuit for an asynchronous generator and method for the excitation of an asynchronous generator
A61K 31/506 (2006.01)	2474544 *	THERAPEUTIC AGENT FOR ANXIETY DISORDERS
A61K 31/5377 (2006.01)	2474544 *	THERAPEUTIC AGENT FOR ANXIETY DISORDERS
A61K 31/4439 (2006.01)	2474544 *	THERAPEUTIC AGENT FOR ANXIETY DISORDERS
A61K 31/426 (2006.01)	2474544 *	THERAPEUTIC AGENT FOR ANXIETY DISORDERS
A61P 25/22 (2006.01)	2474544 *	THERAPEUTIC AGENT FOR ANXIETY DISORDERS
C07D 491/052 (2006.01)	2474544 *	THERAPEUTIC AGENT FOR ANXIETY DISORDERS
C07D 417/14 (2006.01)	2474544 *	THERAPEUTIC AGENT FOR ANXIETY DISORDERS
C07D 495/04 (2006.01)	2474544 *	THERAPEUTIC AGENT FOR ANXIETY DISORDERS

MKP (51)	Broj objave evropske prijava patenta (97)	Naziv pronalaska (54)
C07D 491/048 (2006.01)	2474544 *	THERAPEUTIC AGENT FOR ANXIETY DISORDERS
C30B 11/00 (2006.01)	2491168 *	DEVICE FOR OBTAINING A MULTICRYSTALLINE SEMICONDUCTOR MATERIAL, IN PARTICULAR SILICON, AND METHOD FOR CONTROLLING THE TEMPERATURE THEREIN
C30B 29/06 (2006.01)	2491168 *	DEVICE FOR OBTAINING A MULTICRYSTALLINE SEMICONDUCTOR MATERIAL, IN PARTICULAR SILICON, AND METHOD FOR CONTROLLING THE TEMPERATURE THEREIN
B22D 27/04 (2006.01)	2491168 *	DEVICE FOR OBTAINING A MULTICRYSTALLINE SEMICONDUCTOR MATERIAL, IN PARTICULAR SILICON, AND METHOD FOR CONTROLLING THE TEMPERATURE THEREIN
H05B 6/44 (2006.01)	2491168 *	DEVICE FOR OBTAINING A MULTICRYSTALLINE SEMICONDUCTOR MATERIAL, IN PARTICULAR SILICON, AND METHOD FOR CONTROLLING THE TEMPERATURE THEREIN
H05B 6/36 (2006.01)	2491168 *	DEVICE FOR OBTAINING A MULTICRYSTALLINE SEMICONDUCTOR MATERIAL, IN PARTICULAR SILICON, AND METHOD FOR CONTROLLING THE TEMPERATURE THEREIN
F27B 14/14 (2006.01)	2491168 *	DEVICE FOR OBTAINING A MULTICRYSTALLINE SEMICONDUCTOR MATERIAL, IN PARTICULAR SILICON, AND METHOD FOR CONTROLLING THE TEMPERATURE THEREIN
C30B 35/00 (2006.01)	2491168 *	DEVICE FOR OBTAINING A MULTICRYSTALLINE SEMICONDUCTOR MATERIAL, IN PARTICULAR SILICON, AND METHOD FOR CONTROLLING THE TEMPERATURE THEREIN
A47C 23/06 (2006.01)	2428140	Slatted frame
C07D 495/04 (2006.01)	2454254 *	BENZIMIDAZOLE ANALOGUES FOR THE TREATMENT OR PREVENTION OF FLAVIVIRUS INFECTIONS
C07D 401/14 (2006.01)	2454254 *	BENZIMIDAZOLE ANALOGUES FOR THE TREATMENT OR PREVENTION OF FLAVIVIRUS INFECTIONS
A61P 3/00 (2006.01)	2454254 *	BENZIMIDAZOLE ANALOGUES FOR THE TREATMENT OR PREVENTION OF FLAVIVIRUS INFECTIONS
C07D 417/14 (2006.01)	2454254 *	BENZIMIDAZOLE ANALOGUES FOR THE TREATMENT OR PREVENTION OF FLAVIVIRUS INFECTIONS
C07D 403/14 (2006.01)	2454254 *	BENZIMIDAZOLE ANALOGUES FOR THE TREATMENT OR PREVENTION OF FLAVIVIRUS INFECTIONS
C07D 407/14 (2006.01)	2454254 *	BENZIMIDAZOLE ANALOGUES FOR THE TREATMENT OR PREVENTION OF FLAVIVIRUS INFECTIONS
A61K 31/4184 (2006.01)	2454254 *	BENZIMIDAZOLE ANALOGUES FOR THE TREATMENT OR PREVENTION OF FLAVIVIRUS INFECTIONS
C07D 409/14 (2006.01)	2454254 *	BENZIMIDAZOLE ANALOGUES FOR THE TREATMENT OR PREVENTION OF FLAVIVIRUS INFECTIONS
C07D 413/14 (2006.01)	2454254 *	BENZIMIDAZOLE ANALOGUES FOR THE TREATMENT OR PREVENTION OF FLAVIVIRUS INFECTIONS
C07D 473/34 (2006.01)	2411391 *	ATROPISOMERS OF 2-PURINYL-3-TOLYL-QUINAZOLINONE DERIVATIVES AND METHODS OF USE
A61K 31/52 (2006.01)	2411391 *	ATROPISOMERS OF 2-PURINYL-3-TOLYL-QUINAZOLINONE DERIVATIVES AND METHODS OF USE
A61P 35/00 (2006.01)	2411391 *	ATROPISOMERS OF 2-PURINYL-3-TOLYL-QUINAZOLINONE DERIVATIVES AND METHODS OF USE
B01D 53/64 (2006.01)	2482970 *	SORBENT FORMULATION FOR REMOVAL OF MERCURY FROM FLUE GAS
B01J 20/02 (2006.01)	2482970 *	SORBENT FORMULATION FOR REMOVAL OF MERCURY FROM FLUE GAS
B01J 20/28 (2006.01)	2482970 *	SORBENT FORMULATION FOR REMOVAL OF MERCURY FROM FLUE GAS
B01D 53/02 (2006.01)	2482970 *	SORBENT FORMULATION FOR REMOVAL OF MERCURY FROM FLUE GAS
G01N 33/48 (2006.01)	2470898 *	DETERMINING SENSITIVITY OF CELLS TO B-RAF INHIBITOR TREATMENT BY DETECTING KRAS MUTATION AND RTK EXPRESSION LEVELS
H01M 8/02 (2006.01)	2337131	Two-sided fluid flow plate assembly having parallel flow channels

MKP (51)	Broj objave evropske prijava patenta (97)	Naziv pronalaska (54)
H01M 8/24 (2006.01)	2337131	Two-sided fluid flow plate assembly having parallel flow channels
C12N 15/86 (2006.01)	2497830 *	REGULATED EXPRESSION SYSTEMS
C12N 15/63 (2006.01)	2497830 *	REGULATED EXPRESSION SYSTEMS
E21B 47/00 (2012.01)	2418349 *	METHOD FOR MONITORING THE OIL-FIELD DEVELOPMENT
E21B 43/00 (2006.01)	2418349 *	METHOD FOR MONITORING THE OIL-FIELD DEVELOPMENT
A61P 25/02 (2006.01)	2421535 *	HETEROAROMATIC AND AROMATIC PIPERAZINYL AZETIDINYL AMIDES AS MONOACYLGLYCEROL LIPASE INHIBITORS
A61P 1/06 (2006.01)	2421535 *	HETEROAROMATIC AND AROMATIC PIPERAZINYL AZETIDINYL AMIDES AS MONOACYLGLYCEROL LIPASE INHIBITORS
A61K 31/496 (2006.01)	2421535 *	HETEROAROMATIC AND AROMATIC PIPERAZINYL AZETIDINYL AMIDES AS MONOACYLGLYCEROL LIPASE INHIBITORS
A61P 29/00 (2006.01)	2421535 *	HETEROAROMATIC AND AROMATIC PIPERAZINYL AZETIDINYL AMIDES AS MONOACYLGLYCEROL LIPASE INHIBITORS
G07F 17/32 (2006.01)	2489022 *	ENTERTAINMENT MACHINE HAVING A SYMBOL GAMING UNIT
A01G 1/00 (2006.01)	2397028	Plantable façade system
A01G 9/02 (2006.01)	2397028	Plantable façade system
E04H 15/18 (2006.01)	2486199 *	COLLAPSIBLE LATTICE BEAM, TRUSS AND CONSTRUCTION INCLUDING SUCH A BEAM
E04C 3/00 (2006.01)	2486199 *	COLLAPSIBLE LATTICE BEAM, TRUSS AND CONSTRUCTION INCLUDING SUCH A BEAM
E04H 15/64 (2006.01)	2486199 *	COLLAPSIBLE LATTICE BEAM, TRUSS AND CONSTRUCTION INCLUDING SUCH A BEAM
E04H 15/48 (2006.01)	2486199 *	COLLAPSIBLE LATTICE BEAM, TRUSS AND CONSTRUCTION INCLUDING SUCH A BEAM
A61K 31/4709 (2006.01)	2406262 *	PRODRUG FORMS OF KINASE INHIBITORS AND THEIR USE IN THERAPY
C07D 239/94 (2006.01)	2406262 *	PRODRUG FORMS OF KINASE INHIBITORS AND THEIR USE IN THERAPY
C07D 471/04 (2006.01)	2406262 *	PRODRUG FORMS OF KINASE INHIBITORS AND THEIR USE IN THERAPY
A61K 31/517 (2006.01)	2406262 *	PRODRUG FORMS OF KINASE INHIBITORS AND THEIR USE IN THERAPY
A61K 31/519 (2006.01)	2406262 *	PRODRUG FORMS OF KINASE INHIBITORS AND THEIR USE IN THERAPY
C07D 403/12 (2006.01)	2406262 *	PRODRUG FORMS OF KINASE INHIBITORS AND THEIR USE IN THERAPY
C07D 403/14 (2006.01)	2406262 *	PRODRUG FORMS OF KINASE INHIBITORS AND THEIR USE IN THERAPY
A61K 31/4178 (2006.01)	2406262 *	PRODRUG FORMS OF KINASE INHIBITORS AND THEIR USE IN THERAPY
A61P 35/00 (2006.01)	2406262 *	PRODRUG FORMS OF KINASE INHIBITORS AND THEIR USE IN THERAPY
C07D 405/14 (2006.01)	2406262 *	PRODRUG FORMS OF KINASE INHIBITORS AND THEIR USE IN THERAPY
C07D 401/14 (2006.01)	2427449 *	VINYL INDAZOLYL COMPOUNDS
A61K 31/4439 (2006.01)	2427449 *	VINYL INDAZOLYL COMPOUNDS
H02J 9/00 (2006.01)	2244353	Energy saving device
G01N 33/00 (2006.01)	2470894 *	SYNTHETIC MYCOTOXIN ADSORBENTS AND METHODS OF MAKING AND UTILIZING THE SAME
F24F 3/00 (2006.01)	2464913 *	MODULAR, SELF-CONTAINED, MOBILE CLEAN ROOM
A61P 17/00 (2006.01)	2406222 *	ADDITION SALTS OF TROMETHAMINE WITH AZABIPHENYLAMINO BENZOIC ACID DERIVATIVES AS DHODH INHIBITORS
A61P 19/00 (2006.01)	2406222 *	ADDITION SALTS OF TROMETHAMINE WITH AZABIPHENYLAMINO BENZOIC ACID DERIVATIVES AS DHODH INHIBITORS
A61K 31/506 (2006.01)	2406222 *	ADDITION SALTS OF TROMETHAMINE WITH AZABIPHENYLAMINO BENZOIC ACID DERIVATIVES AS DHODH INHIBITORS
A61P 33/06 (2006.01)	2406222 *	ADDITION SALTS OF TROMETHAMINE WITH AZABIPHENYLAMINO BENZOIC ACID DERIVATIVES AS DHODH INHIBITORS
A61P 35/00 (2006.01)	2406222 *	ADDITION SALTS OF TROMETHAMINE WITH AZABIPHENYLAMINO BENZOIC ACID DERIVATIVES AS DHODH INHIBITORS

MKP (51)	Broj objave evropske prijava patenta (97)	Naziv pronalaska (54)
C07D 213/74 (2006.01)	2406222 *	ADDITION SALTS OF TROMETHAMINE WITH AZABIPHENYLAMINO BENZOIC ACID DERIVATIVES AS DHODH INHIBITORS
A61P 37/00 (2006.01)	2406222 *	ADDITION SALTS OF TROMETHAMINE WITH AZABIPHENYLAMINO BENZOIC ACID DERIVATIVES AS DHODH INHIBITORS
C07D 239/42 (2006.01)	2406222 *	ADDITION SALTS OF TROMETHAMINE WITH AZABIPHENYLAMINO BENZOIC ACID DERIVATIVES AS DHODH INHIBITORS
A61K 31/44 (2006.01)	2406222 *	ADDITION SALTS OF TROMETHAMINE WITH AZABIPHENYLAMINO BENZOIC ACID DERIVATIVES AS DHODH INHIBITORS
C07D 401/04 (2006.01)	2408762 *	HSP90 INHIBITING INDAZOLE DERIVATIVES, COMPOSITIONS CONTAINING SAME AND USE THEREOF
C07D 401/14 (2006.01)	2408762 *	HSP90 INHIBITING INDAZOLE DERIVATIVES, COMPOSITIONS CONTAINING SAME AND USE THEREOF
C07D 403/04 (2006.01)	2408762 *	HSP90 INHIBITING INDAZOLE DERIVATIVES, COMPOSITIONS CONTAINING SAME AND USE THEREOF
C07D 407/14 (2006.01)	2408762 *	HSP90 INHIBITING INDAZOLE DERIVATIVES, COMPOSITIONS CONTAINING SAME AND USE THEREOF
C07D 493/08 (2006.01)	2408762 *	HSP90 INHIBITING INDAZOLE DERIVATIVES, COMPOSITIONS CONTAINING SAME AND USE THEREOF
A61K 31/4709 (2006.01)	2408762 *	HSP90 INHIBITING INDAZOLE DERIVATIVES, COMPOSITIONS CONTAINING SAME AND USE THEREOF
A61K 31/4184 (2006.01)	2408762 *	HSP90 INHIBITING INDAZOLE DERIVATIVES, COMPOSITIONS CONTAINING SAME AND USE THEREOF
A61P 35/00 (2006.01)	2408762 *	HSP90 INHIBITING INDAZOLE DERIVATIVES, COMPOSITIONS CONTAINING SAME AND USE THEREOF
C07D 401/10 (2006.01)	2440543 *	IMPROVED METHOD FOR SYNTHESIZING PIRFENIDONE
C07D 213/64 (2006.01)	2440543 *	IMPROVED METHOD FOR SYNTHESIZING PIRFENIDONE
A61K 31/4412 (2006.01)	2440543 *	IMPROVED METHOD FOR SYNTHESIZING PIRFENIDONE
A61P 9/00 (2006.01)	2440543 *	IMPROVED METHOD FOR SYNTHESIZING PIRFENIDONE
A61K 9/20 (2006.01)	2456426 *	FERRIC CITRATE DOSAGE FORMS
A61K 31/295 (2006.01)	2456426 *	FERRIC CITRATE DOSAGE FORMS
C07D 498/04 (2006.01)	2470545 *	ANHYDRATE FORMS OF A PYRIDINE DERIVATIVE
A61K 31/4985 (2006.01)	2470545 *	ANHYDRATE FORMS OF A PYRIDINE DERIVATIVE
A61P 25/00 (2006.01)	2470545 *	ANHYDRATE FORMS OF A PYRIDINE DERIVATIVE
A61Q 19/00 (2006.01)	2415802 *	NOVEL ACYL ACIDIC AMINO ACID ESTER
C08G 77/388 (2006.01)	2415802 *	NOVEL ACYL ACIDIC AMINO ACID ESTER
C08L 83/08 (2006.01)	2415802 *	NOVEL ACYL ACIDIC AMINO ACID ESTER
A61K 8/898 (2006.01)	2415802 *	NOVEL ACYL ACIDIC AMINO ACID ESTER
A01N 37/18 (2006.01)	2464224 *	METHODS FOR DRUG DELIVERY COMPRISING UNFOLDING AND FOLDING PROTEINS AND PEPTIDE NANOPARTICLES
A47B 88/04 (2006.01)	2496115 *	CLOSING DEVICE FOR DRAWERS
A47B 83/04 (2006.01)	2277410	Modular piece of furniture with extractable chairs and tables
C07K 16/40 (2006.01)	2481758	Human antibodies to PSCK9 for use in methods of treating particular groups of subjects (11566)
A01P 15/00 (2006.01)	2442646 *	ECTOPARASITICIDAL METHODS AND FORMULATIONS
A01N 43/22 (2006.01)	2442646 *	ECTOPARASITICIDAL METHODS AND FORMULATIONS
A61K 31/00 (2006.01)	2442646 *	ECTOPARASITICIDAL METHODS AND FORMULATIONS
C07C 45/69 (2006.01)	2448901 *	METHOD OF PREPARING 3,3,5,5-TETRAMETHYLCYCLOHEXANONE
C07C 209/62 (2006.01)	2448901 *	METHOD OF PREPARING 3,3,5,5-TETRAMETHYLCYCLOHEXANONE
C07C 211/35 (2006.01)	2448901 *	METHOD OF PREPARING 3,3,5,5-TETRAMETHYLCYCLOHEXANONE
C07C 49/403 (2006.01)	2448901 *	METHOD OF PREPARING 3,3,5,5-TETRAMETHYLCYCLOHEXANONE

MKP (51)	Broj objave evropske prijava patenta (97)	Naziv pronalaska (54)
A01N 43/04 (2006.01)	2416651 *	METHODS OF TREATING EDEMA RELATED TO ISCHEMIA-REPERFUSION
A61K 31/70 (2006.01)	2416651 *	METHODS OF TREATING EDEMA RELATED TO ISCHEMIA-REPERFUSION
A61K 31/519 (2006.01)	2432555 *	N-(HETERO)ARYL-PYRROLIDINE DERIVATIVES OF PYRAZOL-4-YL-PYRROLO[2,3-d]PYRIMIDINES AND PYRROL-3-YL-PYRROLO[2,3-d]PYRIMIDINES AS JANUS KINASE INHIBITORS
C07D 487/04 (2006.01)	2432555 *	N-(HETERO)ARYL-PYRROLIDINE DERIVATIVES OF PYRAZOL-4-YL-PYRROLO[2,3-d]PYRIMIDINES AND PYRROL-3-YL-PYRROLO[2,3-d]PYRIMIDINES AS JANUS KINASE INHIBITORS
A61P 35/00 (2006.01)	2432555 *	N-(HETERO)ARYL-PYRROLIDINE DERIVATIVES OF PYRAZOL-4-YL-PYRROLO[2,3-d]PYRIMIDINES AND PYRROL-3-YL-PYRROLO[2,3-d]PYRIMIDINES AS JANUS KINASE INHIBITORS
A61M 5/315 (2006.01)	2482883 *	DRUG DELIVERY DEVICE
A61K 47/48 (2006.01)	2456469 *	OLIGOMER-OPIOID AGONIST CONJUGATES
A61P 25/04 (2006.01)	2456469 *	OLIGOMER-OPIOID AGONIST CONJUGATES
A61P 25/36 (2006.01)	2456469 *	OLIGOMER-OPIOID AGONIST CONJUGATES
C12M 1/00 (2006.01)	2474605	Container fermentor
A61K 39/395 (2006.01)	2488199 *	BISPECIFIC BINDING AGENTS TARGETING IGF-1R AND ERBB3 SIGNALLING AND USES THEREOF
A61P 35/00 (2006.01)	2488199 *	BISPECIFIC BINDING AGENTS TARGETING IGF-1R AND ERBB3 SIGNALLING AND USES THEREOF
C07K 14/525 (2006.01)	2488199 *	BISPECIFIC BINDING AGENTS TARGETING IGF-1R AND ERBB3 SIGNALLING AND USES THEREOF
C07K 14/765 (2006.01)	2488199 *	BISPECIFIC BINDING AGENTS TARGETING IGF-1R AND ERBB3 SIGNALLING AND USES THEREOF
C07K 16/28 (2006.01)	2488199 *	BISPECIFIC BINDING AGENTS TARGETING IGF-1R AND ERBB3 SIGNALLING AND USES THEREOF
C07K 16/32 (2006.01)	2488199 *	BISPECIFIC BINDING AGENTS TARGETING IGF-1R AND ERBB3 SIGNALLING AND USES THEREOF
C07K 16/46 (2006.01)	2488199 *	BISPECIFIC BINDING AGENTS TARGETING IGF-1R AND ERBB3 SIGNALLING AND USES THEREOF
C07K 19/00 (2006.01)	2488199 *	BISPECIFIC BINDING AGENTS TARGETING IGF-1R AND ERBB3 SIGNALLING AND USES THEREOF
A61K 31/502 (2006.01)	2475368 *	N-4 - ((3- (2 -AMINO-4 PYRIMIDINYL) -2 -PYRIDINYL) OXY) PHENYL) -4- (4-METHYL-2-THIENYL) -1-PHTHALAZINAMINE FOR USE IN THE TREATMENT OF ANTIMITOTIC AGENT RESISTANT CANCER
A61P 35/00 (2006.01)	2475368 *	N-4 - ((3- (2 -AMINO-4 PYRIMIDINYL) -2 -PYRIDINYL) OXY) PHENYL) -4- (4-METHYL-2-THIENYL) -1-PHTHALAZINAMINE FOR USE IN THE TREATMENT OF ANTIMITOTIC AGENT RESISTANT CANCER
A61P 35/02 (2006.01)	2475368 *	N-4 - ((3- (2 -AMINO-4 PYRIMIDINYL) -2 -PYRIDINYL) OXY) PHENYL) -4- (4-METHYL-2-THIENYL) -1-PHTHALAZINAMINE FOR USE IN THE TREATMENT OF ANTIMITOTIC AGENT RESISTANT CANCER
F16L 11/00 (2006.01)	2459919 *	BREATHING HOSE
A01P 7/00 (2006.01)	2442648 *	NMP-FREE FORMULATIONS OF NEONICOTINOIDS
A01N 25/02 (2006.01)	2442648 *	NMP-FREE FORMULATIONS OF NEONICOTINOIDS
A01N 47/40 (2006.01)	2442648 *	NMP-FREE FORMULATIONS OF NEONICOTINOIDS
A01N 51/00 (2006.01)	2442648 *	NMP-FREE FORMULATIONS OF NEONICOTINOIDS
A01N 43/40 (2006.01)	2442648 *	NMP-FREE FORMULATIONS OF NEONICOTINOIDS
A01N 43/86 (2006.01)	2442648 *	NMP-FREE FORMULATIONS OF NEONICOTINOIDS
A61M 5/315 (2006.01)	2482884 *	DRUG DELIVERY DEVICE AND DRIVE MEMBER FOR A DRUG DELIVERY DEVICE
A61K 47/44 (2006.01)	2485730 *	TOPICAL FORMULATION COMPRISING ETORICOXIB AND A ZWITTERIONIC SURFACTANT
A61K 31/444 (2006.01)	2485730 *	TOPICAL FORMULATION COMPRISING ETORICOXIB AND A ZWITTERIONIC SURFACTANT
A61K 47/10 (2006.01)	2485730 *	TOPICAL FORMULATION COMPRISING ETORICOXIB AND A ZWITTERIONIC SURFACTANT

MKP (51)	Broj objave evropske prijava patenta (97)	Naziv pronalaska (54)
A61K 47/12 (2006.01)	2485730 *	TOPICAL FORMULATION COMPRISING ETORICOXIB AND A ZWITTERIONIC SURFACTANT
A61P 29/00 (2006.01)	2485730 *	TOPICAL FORMULATION COMPRISING ETORICOXIB AND A ZWITTERIONIC SURFACTANT
A61K 9/00 (2006.01)	2485730 *	TOPICAL FORMULATION COMPRISING ETORICOXIB AND A ZWITTERIONIC SURFACTANT
C07D 209/52 (2006.01)	2332910	New derivatives of azabicyclo[3.2.0]hept-3-yl, method for preparing same and pharmaceutical compositions containing them
A61K 31/403 (2006.01)	2332910	New derivatives of azabicyclo[3.2.0]hept-3-yl, method for preparing same and pharmaceutical compositions containing them
A61P 25/00 (2006.01)	2332910	New derivatives of azabicyclo[3.2.0]hept-3-yl, method for preparing same and pharmaceutical compositions containing them
E05D 11/10 (2006.01)	2256275	Rotation blocking device of a door and door equipped with such device
E05F 1/00 (2006.01)	2256275	Rotation blocking device of a door and door equipped with such device
E05F 3/22 (2006.01)	2256275	Rotation blocking device of a door and door equipped with such device
C12Q 1/00 (2006.01)	2414535 *	BIOMARKERS RELATED TO INSULIN RESISTANCE AND METHODS USING THE SAME
H04W 16/28 (2009.01)	2485520 *	METHOD AND DEVICE FOR COORDINATED SCHEDULING
H04B 7/04 (2006.01)	2485520 *	METHOD AND DEVICE FOR COORDINATED SCHEDULING
C09C 1/02 (2006.01)	2447328	Method for improving handleability of calcium carbonate containing materials
F16L 13/007 (2006.01)	2295841	Method for connecting tubes and tube connections
F16L 25/10 (2006.01)	2295841	Method for connecting tubes and tube connections
F16L 13/16 (2006.01)	2295841	Method for connecting tubes and tube connections
C12P 21/04 (2006.01)	2406388 *	OX40/TRAIL FUSION PROTEINS
A61P 31/10 (2006.01)	2476701 *	ANTIMICROBIAL AGENTS BASED ON HEMIN DERIVATIVES
C07K 14/805 (2006.01)	2476701 *	ANTIMICROBIAL AGENTS BASED ON HEMIN DERIVATIVES
C07F 15/02 (2006.01)	2476701 *	ANTIMICROBIAL AGENTS BASED ON HEMIN DERIVATIVES
A61K 38/42 (2006.01)	2476701 *	ANTIMICROBIAL AGENTS BASED ON HEMIN DERIVATIVES
A61P 31/04 (2006.01)	2476701 *	ANTIMICROBIAL AGENTS BASED ON HEMIN DERIVATIVES
C07D 487/22 (2006.01)	2476701 *	ANTIMICROBIAL AGENTS BASED ON HEMIN DERIVATIVES
C12P 7/52 (2006.01)	2478109 *	METHOD FOR THE ENZYMATIC PRODUCTION OF 3-HYDROXY-S-METHYLBUTYRIC ACID FROM ACETONE AND ACETYL-COA
C12N 15/52 (2006.01)	2478109 *	METHOD FOR THE ENZYMATIC PRODUCTION OF 3-HYDROXY-S-METHYLBUTYRIC ACID FROM ACETONE AND ACETYL-COA
C12N 9/10 (2006.01)	2478109 *	METHOD FOR THE ENZYMATIC PRODUCTION OF 3-HYDROXY-S-METHYLBUTYRIC ACID FROM ACETONE AND ACETYL-COA
C12N 9/88 (2006.01)	2478109 *	METHOD FOR THE ENZYMATIC PRODUCTION OF 3-HYDROXY-S-METHYLBUTYRIC ACID FROM ACETONE AND ACETYL-COA
C12N 1/21 (2006.01)	2478109 *	METHOD FOR THE ENZYMATIC PRODUCTION OF 3-HYDROXY-S-METHYLBUTYRIC ACID FROM ACETONE AND ACETYL-COA
C07J 41/00 (2006.01)	2408799 *	NOVEL CRYSTALLINE FORM OF ANTIPROGESTIN CDB-4124
A61K 31/573 (2006.01)	2408799 *	NOVEL CRYSTALLINE FORM OF ANTIPROGESTIN CDB-4124
A61P 5/36 (2006.01)	2408799 *	NOVEL CRYSTALLINE FORM OF ANTIPROGESTIN CDB-4124
G01F 1/58 (2006.01)	2383548	Measuring device and method for measuring the flow speed of a medium flowing through a measuring tube
G01F 1/60 (2006.01)	2383548	Measuring device and method for measuring the flow speed of a medium flowing through a measuring tube
A61G 5/12 (2006.01)	2473148 *	SUPPORT AND CONTAINMENT STRUCTURE FOR PERSONS
A61K 39/00 (2006.01)	2435093 *	ALBUMIN-AMYLOID PEPTIDE CONJUGATES AND USES THEREOF
A61K 39/385 (2006.01)	2435093 *	ALBUMIN-AMYLOID PEPTIDE CONJUGATES AND USES THEREOF
A61K 47/48 (2006.01)	2435093 *	ALBUMIN-AMYLOID PEPTIDE CONJUGATES AND USES THEREOF
A61P 25/28 (2006.01)	2435093 *	ALBUMIN-AMYLOID PEPTIDE CONJUGATES AND USES THEREOF
C07K 7/08 (2006.01)	2499154 *	TREATMENTS FOR GASTROINTESTINAL DISORDERS

MKP (51)	Broj objave evropske prijave patenta (97)	Naziv pronalaska (54)
C07K 14/47 (2006.01)	2499154 *	TREATMENTS FOR GASTROINTESTINAL DISORDERS
C07K 14/325 (2006.01)	2459587 *	AXMI-192 FAMILY OF PESTICIDAL GENES AND METHODS FOR THEIR USE
C12N 15/82 (2006.01)	2459587 *	AXMI-192 FAMILY OF PESTICIDAL GENES AND METHODS FOR THEIR USE
A01N 37/02 (2006.01)	2389806	A natural composition for the treatment of plants, preparation and uses thereof
A01N 65/00 (2009.01)	2389806	A natural composition for the treatment of plants, preparation and uses thereof
A01N 37/04 (2006.01)	2389806	A natural composition for the treatment of plants, preparation and uses thereof
A01N 65/22 (2009.01)	2389806	A natural composition for the treatment of plants, preparation and uses thereof
A01P 7/00 (2006.01)	2389806	A natural composition for the treatment of plants, preparation and uses thereof
A01N 3/00 (2006.01)	2389806	A natural composition for the treatment of plants, preparation and uses thereof
A01P 21/00 (2006.01)	2389806	A natural composition for the treatment of plants, preparation and uses thereof
A01N 65/38 (2009.01)	2389806	A natural composition for the treatment of plants, preparation and uses thereof
A01N 65/42 (2009.01)	2389806	A natural composition for the treatment of plants, preparation and uses thereof
C12Q 1/04 (2006.01)	2428580 *	SMART PACKAGING FOR DETECTING MICROORGANISMS
A61K 31/727 (2006.01)	2427198 *	USE OF AN ACYLATED OCTASACCHARIDE AS ANTITHROMBOTIC AGENT
C08B 37/10 (2006.01)	2427198 *	USE OF AN ACYLATED OCTASACCHARIDE AS ANTITHROMBOTIC AGENT
C08B 37/00 (2006.01)	2427198 *	USE OF AN ACYLATED OCTASACCHARIDE AS ANTITHROMBOTIC AGENT
A61K 47/14 (2006.01)	2424499 *	STABILIZED LIPID FORMULATION OF APOPTOSIS PROMOTER
A61K 47/02 (2006.01)	2424499 *	STABILIZED LIPID FORMULATION OF APOPTOSIS PROMOTER
A61K 9/48 (2006.01)	2424499 *	STABILIZED LIPID FORMULATION OF APOPTOSIS PROMOTER
A61K 47/00 (2006.01)	2424499 *	STABILIZED LIPID FORMULATION OF APOPTOSIS PROMOTER
A61K 47/20 (2006.01)	2424499 *	STABILIZED LIPID FORMULATION OF APOPTOSIS PROMOTER
A61K 31/5377 (2006.01)	2424499 *	STABILIZED LIPID FORMULATION OF APOPTOSIS PROMOTER
A61K 9/00 (2006.01)	2424499 *	STABILIZED LIPID FORMULATION OF APOPTOSIS PROMOTER
C07D 277/56 (2006.01)	2455372 *	PROCESS FOR PRODUCING CRYSTALS OF POLYMORPHIC 2-(3-CYANO-4-ISOBUTYLOXYPHENYL)-4-METHYL-5-THIAZOLECARBOXYLIC ACID BY POOR-SOLVENT ADDITION METHOD
A61P 19/06 (2006.01)	2455372 *	PROCESS FOR PRODUCING CRYSTALS OF POLYMORPHIC 2-(3-CYANO-4-ISOBUTYLOXYPHENYL)-4-METHYL-5-THIAZOLECARBOXYLIC ACID BY POOR-SOLVENT ADDITION METHOD
C07D 277/20 (2006.01)	2455372 *	PROCESS FOR PRODUCING CRYSTALS OF POLYMORPHIC 2-(3-CYANO-4-ISOBUTYLOXYPHENYL)-4-METHYL-5-THIAZOLECARBOXYLIC ACID BY POOR-SOLVENT ADDITION METHOD
A61K 31/426 (2006.01)	2455372 *	PROCESS FOR PRODUCING CRYSTALS OF POLYMORPHIC 2-(3-CYANO-4-ISOBUTYLOXYPHENYL)-4-METHYL-5-THIAZOLECARBOXYLIC ACID BY POOR-SOLVENT ADDITION METHOD
G06F 7/00 (2006.01)	2460067 *	SYSTEM AND METHOD FOR DETERMINING ROAD CONDITIONS
G06F 17/00 (2006.01)	2460067 *	SYSTEM AND METHOD FOR DETERMINING ROAD CONDITIONS
C07D 405/14 (2006.01)	2421825 *	AZETIDINYL DIAMIDES AS MONOACYLGLYCEROL LIPASE INHIBITORS
A61K 31/496 (2006.01)	2421825 *	AZETIDINYL DIAMIDES AS MONOACYLGLYCEROL LIPASE INHIBITORS
C07D 405/12 (2006.01)	2421825 *	AZETIDINYL DIAMIDES AS MONOACYLGLYCEROL LIPASE INHIBITORS
C07D 495/04 (2006.01)	2421825 *	AZETIDINYL DIAMIDES AS MONOACYLGLYCEROL LIPASE INHIBITORS
C07D 409/14 (2006.01)	2421825 *	AZETIDINYL DIAMIDES AS MONOACYLGLYCEROL LIPASE INHIBITORS
A61P 25/00 (2006.01)	2421825 *	AZETIDINYL DIAMIDES AS MONOACYLGLYCEROL LIPASE INHIBITORS
C07D 403/12 (2006.01)	2421825 *	AZETIDINYL DIAMIDES AS MONOACYLGLYCEROL LIPASE INHIBITORS
C07D 417/14 (2006.01)	2421825 *	AZETIDINYL DIAMIDES AS MONOACYLGLYCEROL LIPASE INHIBITORS
C07D 409/12 (2006.01)	2421825 *	AZETIDINYL DIAMIDES AS MONOACYLGLYCEROL LIPASE INHIBITORS
A61P 29/00 (2006.01)	2421825 *	AZETIDINYL DIAMIDES AS MONOACYLGLYCEROL LIPASE INHIBITORS
C07D 413/12 (2006.01)	2421825 *	AZETIDINYL DIAMIDES AS MONOACYLGLYCEROL LIPASE INHIBITORS
C07D 401/14 (2006.01)	2421825 *	AZETIDINYL DIAMIDES AS MONOACYLGLYCEROL LIPASE INHIBITORS
C07D 417/12 (2006.01)	2421825 *	AZETIDINYL DIAMIDES AS MONOACYLGLYCEROL LIPASE INHIBITORS

MKP (51)	Broj objave evropske prijave patenta (97)	Naziv pronalaska (54)
C07D 205/04 (2006.01)	2421825 *	AZETIDINYL DIAMIDES AS MONOACYLGLYCEROL LIPASE INHIBITORS
C07D 413/14 (2006.01)	2421825 *	AZETIDINYL DIAMIDES AS MONOACYLGLYCEROL LIPASE INHIBITORS
A61K 31/517 (2006.01)	2485728 *	WNT PATHWAY ANTAGONISTS
C07D 239/22 (2006.01)	2485728 *	WNT PATHWAY ANTAGONISTS
A61K 31/4166 (2006.01)	2485728 *	WNT PATHWAY ANTAGONISTS
A61K 31/553 (2006.01)	2485728 *	WNT PATHWAY ANTAGONISTS
A61K 31/4184 (2006.01)	2485728 *	WNT PATHWAY ANTAGONISTS
A61K 31/554 (2006.01)	2485728 *	WNT PATHWAY ANTAGONISTS
A61K 31/437 (2006.01)	2485728 *	WNT PATHWAY ANTAGONISTS
C07D 217/14 (2006.01)	2485728 *	WNT PATHWAY ANTAGONISTS
A61K 31/5513 (2006.01)	2485728 *	WNT PATHWAY ANTAGONISTS
A61K 31/472 (2006.01)	2485728 *	WNT PATHWAY ANTAGONISTS
C07D 235/26 (2006.01)	2485728 *	WNT PATHWAY ANTAGONISTS
A61K 31/551 (2006.01)	2485728 *	WNT PATHWAY ANTAGONISTS
C07D 239/96 (2006.01)	2485728 *	WNT PATHWAY ANTAGONISTS
A61K 31/5377 (2006.01)	2485728 *	WNT PATHWAY ANTAGONISTS
C07D 239/80 (2006.01)	2485728 *	WNT PATHWAY ANTAGONISTS
G01N 33/50 (2006.01)	2414830 *	MODULATION OF ADIPOSE TRIGLYCERIDE LIPASE FOR PREVENTION AND TREATMENT OF CACHEXIA, LOSS OF WEIGHT AND MUSCLE ATROPHY AND METHODS OF SCREENING THEREFOR
C12Q 1/44 (2006.01)	2414830 *	MODULATION OF ADIPOSE TRIGLYCERIDE LIPASE FOR PREVENTION AND TREATMENT OF CACHEXIA, LOSS OF WEIGHT AND MUSCLE ATROPHY AND METHODS OF SCREENING THEREFOR
A61K 31/00 (2006.01)	2414830 *	MODULATION OF ADIPOSE TRIGLYCERIDE LIPASE FOR PREVENTION AND TREATMENT OF CACHEXIA, LOSS OF WEIGHT AND MUSCLE ATROPHY AND METHODS OF SCREENING THEREFOR
C07D 401/04 (2006.01)	2411380 *	PROCESS FOR THE PREPARATION OF DESLORATADINE
B32B 27/12 (2006.01)	2454090 *	FIBER COMPOSITE AND PROCESS OF MANUFACTURE
F24J 2/10 (2006.01)	2478308 *	A REFLECTING- PANEL HAVING A THIN MIRROR AND A SUPPORT MADE OF COMPOSITE MATERIAL SMC (SHEET MOULDING COMPOUND) FOR LINEAR PARABOLIC SOLAR CONCENTRATORS
F24J 2/14 (2006.01)	2478308 *	A REFLECTING- PANEL HAVING A THIN MIRROR AND A SUPPORT MADE OF COMPOSITE MATERIAL SMC (SHEET MOULDING COMPOUND) FOR LINEAR PARABOLIC SOLAR CONCENTRATORS
G07F 7/10 (2006.01)	2430620 *	CONTACTLESS PAYMENT DEVICE, METHOD OF CONTACTLESS TOP-UP OF ELECTRONIC MONEY ON A PAYMENT DEVICE
G06Q 20/00 (2012.01)	2430620 *	CONTACTLESS PAYMENT DEVICE, METHOD OF CONTACTLESS TOP-UP OF ELECTRONIC MONEY ON A PAYMENT DEVICE
G07F 7/08 (2006.01)	2430620 *	CONTACTLESS PAYMENT DEVICE, METHOD OF CONTACTLESS TOP-UP OF ELECTRONIC MONEY ON A PAYMENT DEVICE
C11C 3/10 (2006.01)	2464715 *	METHOD FOR MANUFACTURING BIODIESEL BY ACID TRANSESTERIFICATION, AND USE OF SULPHONIC ACID AS A CATALYST IN THE MANUFACTURE OF BIODIESEL
B60R 19/34 (2006.01)	2411246 *	BUMPER STRUCTURE
C08B 37/00 (2006.01)	2499167 *	COMPOSITIONS AND METHODS FOR TREATING A DISORDER OR DEFECT IN SOFT TISSUE
A61K 36/9066 (2006.01)	2359820	Shunt delivery of curcumin for the treatment Alzheimer
A61K 31/12 (2006.01)	2359820	Shunt delivery of curcumin for the treatment Alzheimer
A61P 25/28 (2006.01)	2359820	Shunt delivery of curcumin for the treatment Alzheimer
G01N 33/50 (2006.01)	2411805 *	NEW MARKER FOR DIAGNOSIS OF ACTIVE MULTIPLE SCLEROSIS
G01N 33/564 (2006.01)	2411805 *	NEW MARKER FOR DIAGNOSIS OF ACTIVE MULTIPLE SCLEROSIS
G01N 33/68 (2006.01)	2411805 *	NEW MARKER FOR DIAGNOSIS OF ACTIVE MULTIPLE SCLEROSIS
A61M 5/145 (2006.01)	2480268 *	ASSEMBLY AND INDICATOR FOR A DRUG DELIVERY DEVICE
A61M 5/315 (2006.01)	2480268 *	ASSEMBLY AND INDICATOR FOR A DRUG DELIVERY DEVICE

MKP (51)	Broj objave evropske prijava patenta (97)	Naziv pronalaska (54)
C12N 15/82 (2006.01)	2406278 *	AXMI-001, AXMI-002, AXMI-030, AXMI-035, AND AXMI-045: INSECTICIDAL PROTEINS FROM BACILLUS THURINGIENSIS AND METHODS FOR THEIR USE
C07K 14/325 (2006.01)	2406278 *	AXMI-001, AXMI-002, AXMI-030, AXMI-035, AND AXMI-045: INSECTICIDAL PROTEINS FROM BACILLUS THURINGIENSIS AND METHODS FOR THEIR USE
A01H 5/00 (2006.01)	2406278 *	AXMI-001, AXMI-002, AXMI-030, AXMI-035, AND AXMI-045: INSECTICIDAL PROTEINS FROM BACILLUS THURINGIENSIS AND METHODS FOR THEIR USE
B65H 26/00 (2006.01)	2497731	Apparatus and method for minimizing waste and improving quality and production in narrow web processing operations by automatic twist defect correction
H01R 31/06 (2006.01)	2315322	Docking station and device for use in a docking station
H02J 7/00 (2006.01)	2315322	Docking station and device for use in a docking station
G01N 23/00 (2006.01)	2459990 *	METHOD AND SYSTEM FOR IDENTIFYING A LIQUID PRODUCT IN LUGGAGE OR OTHER RECEPTACLE
G06F 13/10 (2006.01)	2479661 *	TRIPLE DISPLAY DEVICE, AND COMPUTER EMPLOYING SAME
G06F 3/14 (2006.01)	2479661 *	TRIPLE DISPLAY DEVICE, AND COMPUTER EMPLOYING SAME
F01N 13/18 (2010.01)	2432976 *	FLUID DOSING DEVICE
F01N 3/20 (2006.01)	2432976 *	FLUID DOSING DEVICE
F01N 3/36 (2006.01)	2432976 *	FLUID DOSING DEVICE
A61P 35/00 (2006.01)	2486041 *	HYDROXYL, KETO, AND GLUCURONIDE DERIVATIVES OF 3-(4-(7H-PYRROLO[2,3-D]PYRIMIDIN-4-YL)-1H-PYRAZOL-1-YL)-3-CYCLOPENTYLPROPANENITRILE
C07D 487/04 (2006.01)	2486041 *	HYDROXYL, KETO, AND GLUCURONIDE DERIVATIVES OF 3-(4-(7H-PYRROLO[2,3-D]PYRIMIDIN-4-YL)-1H-PYRAZOL-1-YL)-3-CYCLOPENTYLPROPANENITRILE
A61K 31/519 (2006.01)	2486041 *	HYDROXYL, KETO, AND GLUCURONIDE DERIVATIVES OF 3-(4-(7H-PYRROLO[2,3-D]PYRIMIDIN-4-YL)-1H-PYRAZOL-1-YL)-3-CYCLOPENTYLPROPANENITRILE
G01N 33/50 (2006.01)	2499489 *	RISK FACTORS AND PREDICTION OF MYOCARDIAL INFARCTION
C07D 401/12 (2006.01)	2499126 *	FUSED BICYCLIC PYRIDINE AND PYRAZINE DERIVATIVES AS KINASE INHIBITORS
A61P 35/00 (2006.01)	2499126 *	FUSED BICYCLIC PYRIDINE AND PYRAZINE DERIVATIVES AS KINASE INHIBITORS
A61P 9/00 (2006.01)	2499126 *	FUSED BICYCLIC PYRIDINE AND PYRAZINE DERIVATIVES AS KINASE INHIBITORS
C07D 487/04 (2006.01)	2499126 *	FUSED BICYCLIC PYRIDINE AND PYRAZINE DERIVATIVES AS KINASE INHIBITORS
A61K 31/47 (2006.01)	2499126 *	FUSED BICYCLIC PYRIDINE AND PYRAZINE DERIVATIVES AS KINASE INHIBITORS
A61P 37/00 (2006.01)	2499126 *	FUSED BICYCLIC PYRIDINE AND PYRAZINE DERIVATIVES AS KINASE INHIBITORS
C07D 473/02 (2006.01)	2499126 *	FUSED BICYCLIC PYRIDINE AND PYRAZINE DERIVATIVES AS KINASE INHIBITORS
A61P 27/02 (2006.01)	2499126 *	FUSED BICYCLIC PYRIDINE AND PYRAZINE DERIVATIVES AS KINASE INHIBITORS
A61P 3/00 (2006.01)	2499126 *	FUSED BICYCLIC PYRIDINE AND PYRAZINE DERIVATIVES AS KINASE INHIBITORS
A61P 25/28 (2006.01)	2499126 *	FUSED BICYCLIC PYRIDINE AND PYRAZINE DERIVATIVES AS KINASE INHIBITORS
A61M 5/24 (2006.01)	2470243 *	ASSEMBLY KIT FOR PREPARING OF A PRE-FILLED SYRINGE
A61M 5/28 (2006.01)	2470243 *	ASSEMBLY KIT FOR PREPARING OF A PRE-FILLED SYRINGE
A61M 5/315 (2006.01)	2470243 *	ASSEMBLY KIT FOR PREPARING OF A PRE-FILLED SYRINGE
A61M 5/31 (2006.01)	2470243 *	ASSEMBLY KIT FOR PREPARING OF A PRE-FILLED SYRINGE
A61M 5/34 (2006.01)	2470243 *	ASSEMBLY KIT FOR PREPARING OF A PRE-FILLED SYRINGE
G06Q 30/00 (2006.01)	2330550	Mediation of online trading services

MKP (51)	Broj objave evropske prijave patenta (97)	Naziv pronalaska (54)
A61P 25/00 (2006.01)	2421847 *	AZETIDINYL DIAMIDES AS MONOACYLGLYCEROL LIPASE INHIBITORS
A61K 31/496 (2006.01)	2421847 *	AZETIDINYL DIAMIDES AS MONOACYLGLYCEROL LIPASE INHIBITORS
C07D 401/06 (2006.01)	2421847 *	AZETIDINYL DIAMIDES AS MONOACYLGLYCEROL LIPASE INHIBITORS
C07D 409/06 (2006.01)	2421847 *	AZETIDINYL DIAMIDES AS MONOACYLGLYCEROL LIPASE INHIBITORS
A61P 29/00 (2006.01)	2421847 *	AZETIDINYL DIAMIDES AS MONOACYLGLYCEROL LIPASE INHIBITORS
C07D 417/06 (2006.01)	2421847 *	AZETIDINYL DIAMIDES AS MONOACYLGLYCEROL LIPASE INHIBITORS
C07D 401/12 (2006.01)	2421847 *	AZETIDINYL DIAMIDES AS MONOACYLGLYCEROL LIPASE INHIBITORS
C07D 205/04 (2006.01)	2421847 *	AZETIDINYL DIAMIDES AS MONOACYLGLYCEROL LIPASE INHIBITORS
F02M 61/06 (2006.01)	2369166	Injection nozzle
F02M 61/18 (2006.01)	2369166	Injection nozzle
A61K 39/12 (2006.01)	2366708	Canine astrovirus AstV strain Bari/08 identified in dogs with gastro-enteritis
C07K 14/005 (2006.01)	2366708	Canine astrovirus AstV strain Bari/08 identified in dogs with gastro-enteritis
C07K 16/10 (2006.01)	2366708	Canine astrovirus AstV strain Bari/08 identified in dogs with gastro-enteritis
C12Q 1/70 (2006.01)	2366708	Canine astrovirus AstV strain Bari/08 identified in dogs with gastro-enteritis
C07K 14/08 (2006.01)	2366708	Canine astrovirus AstV strain Bari/08 identified in dogs with gastro-enteritis
C12N 7/00 (2006.01)	2366708	Canine astrovirus AstV strain Bari/08 identified in dogs with gastro-enteritis
G01N 33/569 (2006.01)	2366708	Canine astrovirus AstV strain Bari/08 identified in dogs with gastro-enteritis
C12N 15/40 (2006.01)	2366708	Canine astrovirus AstV strain Bari/08 identified in dogs with gastro-enteritis
A47J 31/40 (2006.01)	2316312	Coffee machine
B60J 7/08 (2006.01)	2266826	Automated covering device
A45C 7/00 (2006.01)	2274998	Protective cover
G06F 1/16 (2006.01)	2274998	Protective cover
A45C 11/38 (2006.01)	2274998	Protective cover
H04B 1/38 (2006.01)	2274998	Protective cover
A45C 13/00 (2006.01)	2274998	Protective cover
A45C 11/00 (2006.01)	2274998	Protective cover
H04M 1/18 (2006.01)	2274998	Protective cover
H01J 37/32 (2006.01)	2407998	Plasma processing in a capacitively-coupled reactor with trapezoidal-waveform excitation
C07C 309/65 (2006.01)	2493846 *	2-ARYL-PROPIONAMIDE DERIVATIVES USEFUL AS BRADYKININ RECEPTOR ANTAGONISTS AND PHARMACEUTICAL COMPOSITIONS CONTAINING THEM
A61P 25/04 (2006.01)	2493846 *	2-ARYL-PROPIONAMIDE DERIVATIVES USEFUL AS BRADYKININ RECEPTOR ANTAGONISTS AND PHARMACEUTICAL COMPOSITIONS CONTAINING THEM
C07C 237/20 (2006.01)	2493846 *	2-ARYL-PROPIONAMIDE DERIVATIVES USEFUL AS BRADYKININ RECEPTOR ANTAGONISTS AND PHARMACEUTICAL COMPOSITIONS CONTAINING THEM
A61P 29/00 (2006.01)	2493846 *	2-ARYL-PROPIONAMIDE DERIVATIVES USEFUL AS BRADYKININ RECEPTOR ANTAGONISTS AND PHARMACEUTICAL COMPOSITIONS CONTAINING THEM
C07D 277/46 (2006.01)	2493846 *	2-ARYL-PROPIONAMIDE DERIVATIVES USEFUL AS BRADYKININ RECEPTOR ANTAGONISTS AND PHARMACEUTICAL COMPOSITIONS CONTAINING THEM
C07D 295/12 (2006.01)	2493846 *	2-ARYL-PROPIONAMIDE DERIVATIVES USEFUL AS BRADYKININ RECEPTOR ANTAGONISTS AND PHARMACEUTICAL COMPOSITIONS CONTAINING THEM
C07C 233/01 (2006.01)	2493846 *	2-ARYL-PROPIONAMIDE DERIVATIVES USEFUL AS BRADYKININ RECEPTOR ANTAGONISTS AND PHARMACEUTICAL COMPOSITIONS CONTAINING THEM
A61P 11/00 (2006.01)	2493846 *	2-ARYL-PROPIONAMIDE DERIVATIVES USEFUL AS BRADYKININ RECEPTOR ANTAGONISTS AND PHARMACEUTICAL COMPOSITIONS CONTAINING THEM

MKP (51)	Broj objave evropske prijava patenta (97)	Naziv pronalaska (54)
A61K 31/16 (2006.01)	2493846 *	2-ARYL-PROPIONAMIDE DERIVATIVES USEFUL AS BRADYKININ RECEPTOR ANTAGONISTS AND PHARMACEUTICAL COMPOSITIONS CONTAINING THEM
C07D 211/06 (2006.01)	2493846 *	2-ARYL-PROPIONAMIDE DERIVATIVES USEFUL AS BRADYKININ RECEPTOR ANTAGONISTS AND PHARMACEUTICAL COMPOSITIONS CONTAINING THEM
C07C 235/34 (2006.01)	2493846 *	2-ARYL-PROPIONAMIDE DERIVATIVES USEFUL AS BRADYKININ RECEPTOR ANTAGONISTS AND PHARMACEUTICAL COMPOSITIONS CONTAINING THEM
A61K 31/18 (2006.01)	2493846 *	2-ARYL-PROPIONAMIDE DERIVATIVES USEFUL AS BRADYKININ RECEPTOR ANTAGONISTS AND PHARMACEUTICAL COMPOSITIONS CONTAINING THEM
A01N 43/40 (2006.01)	2482657 *	O-BENZYL NICOTINAMIDE ANALOGS AS MGLUR5 POSITIVE ALLOSTERIC MODULATORS
A61K 31/44 (2006.01)	2482657 *	O-BENZYL NICOTINAMIDE ANALOGS AS MGLUR5 POSITIVE ALLOSTERIC MODULATORS
C07K 19/00 (2006.01)	2406288 *	ANTIGEN PRESENTING CELL TARGETED VACCINES
C07K 16/18 (2006.01)	2406288 *	ANTIGEN PRESENTING CELL TARGETED VACCINES
C12N 15/63 (2006.01)	2406288 *	ANTIGEN PRESENTING CELL TARGETED VACCINES
A61K 39/395 (2006.01)	2406288 *	ANTIGEN PRESENTING CELL TARGETED VACCINES
B08B 3/02 (2006.01)	2383047	Nozzle device
B05B 15/06 (2006.01)	2383047	Nozzle device
D21F 1/34 (2006.01)	2383047	Nozzle device
A61K 31/19 (2006.01)	2467143 *	BROAD SPECTRUM PRESERVATION BLENDS
A61K 31/60 (2006.01)	2467143 *	BROAD SPECTRUM PRESERVATION BLENDS
C07D 487/04 (2006.01)	2430026 *	HYDROCHLORIDE SALT OF ((1S,2S,4R)-4-{4-[(1S)-2,3-DIHYDRO-1H-INDEN-1-YLAMINO]-7H-PYRROLO [2,3-D]PYRIMIDIN-7-YL}-2-HYDROXYCYCLOPENTYL)METHYL SULFAMATE
A61P 35/00 (2006.01)	2430026 *	HYDROCHLORIDE SALT OF ((1S,2S,4R)-4-{4-[(1S)-2,3-DIHYDRO-1H-INDEN-1-YLAMINO]-7H-PYRROLO [2,3-D]PYRIMIDIN-7-YL}-2-HYDROXYCYCLOPENTYL)METHYL SULFAMATE
A61K 31/52 (2006.01)	2430026 *	HYDROCHLORIDE SALT OF ((1S,2S,4R)-4-{4-[(1S)-2,3-DIHYDRO-1H-INDEN-1-YLAMINO]-7H-PYRROLO [2,3-D]PYRIMIDIN-7-YL}-2-HYDROXYCYCLOPENTYL)METHYL SULFAMATE
C07D 498/04 (2006.01)	2477994 *	SUBSTITUTED DIHYDRO BENZOCYCLOALKYLOXYMETHYL OXAZOLOPYRIMIDINONES, PREPARATION AND USE THEREOF
A61K 31/519 (2006.01)	2477994 *	SUBSTITUTED DIHYDRO BENZOCYCLOALKYLOXYMETHYL OXAZOLOPYRIMIDINONES, PREPARATION AND USE THEREOF
A61K 31/522 (2006.01)	2477994 *	SUBSTITUTED DIHYDRO BENZOCYCLOALKYLOXYMETHYL OXAZOLOPYRIMIDINONES, PREPARATION AND USE THEREOF
A61P 25/00 (2006.01)	2477994 *	SUBSTITUTED DIHYDRO BENZOCYCLOALKYLOXYMETHYL OXAZOLOPYRIMIDINONES, PREPARATION AND USE THEREOF
C08G 63/08 (2006.01)	2455414	Process for the production of resorbable polyesters
C08G 63/90 (2006.01)	2455414	Process for the production of resorbable polyesters
C08G 63/80 (2006.01)	2455414	Process for the production of resorbable polyesters
C12P 21/08 (2006.01)	2491129 *	DUAL VARIABLE DOMAIN IMMUNOGLOBULINS AND USES THEREOF
E04F 13/04 (2006.01)	2470732 *	REINFORCING MESH FOR A REINFORCED MORTAR LAYER OR SPRAYED MORTAR LAYER ON AN UNDERLAYMENT, AND METHOD FOR THE INSTALLATION THEREOF AND REINFORCED MORTAR COATING PRODUCED THEREWITH
G01N 33/564 (2006.01)	2494352 *	ASSAYS FOR THE DETECTION OF ANTI-TNF DRUGS AND AUTOANTIBODIES
G01N 33/50 (2006.01)	2494352 *	ASSAYS FOR THE DETECTION OF ANTI-TNF DRUGS AND AUTOANTIBODIES
A61F 2/06 (2006.01)	2461766 *	PROSTHETIC DEVICE INCLUDING ELECTROSTATICALLY SPUN FIBROUS LAYER AND METHOD FOR MAKING THE SAME
B32B 17/10 (2006.01)	2485886 *	DEVICE AND METHOD FOR PRODUCING LAMINATED SAFETY GLASS

MKP (51)	Broj objave evropske prijava patenta (97)	Naziv pronalaska (54)
B32B 37/10 (2006.01)	2485886 *	DEVICE AND METHOD FOR PRODUCING LAMINATED SAFETY GLASS
B30B 5/02 (2006.01)	2485886 *	DEVICE AND METHOD FOR PRODUCING LAMINATED SAFETY GLASS
A61K 47/36 (2006.01)	2437784 *	ALGINATE OLIGOMERS FOR USE IN OVERCOMING MULTIDRUG RESISTANCE IN BACTERIA
C07D 401/04 (2006.01)	2484672 *	NITROGEN-CONTAINING HETEROCYCLIC COMPOUND AND SALT THEREOF, AND BACTERICIDE FOR AGRICULTURAL AND HORTICULTURAL USE
C07D 495/04 (2006.01)	2484672 *	NITROGEN-CONTAINING HETEROCYCLIC COMPOUND AND SALT THEREOF, AND BACTERICIDE FOR AGRICULTURAL AND HORTICULTURAL USE
A01N 43/62 (2006.01)	2484672 *	NITROGEN-CONTAINING HETEROCYCLIC COMPOUND AND SALT THEREOF, AND BACTERICIDE FOR AGRICULTURAL AND HORTICULTURAL USE
A01N 43/46 (2006.01)	2484672 *	NITROGEN-CONTAINING HETEROCYCLIC COMPOUND AND SALT THEREOF, AND BACTERICIDE FOR AGRICULTURAL AND HORTICULTURAL USE
A01P 3/00 (2006.01)	2484672 *	NITROGEN-CONTAINING HETEROCYCLIC COMPOUND AND SALT THEREOF, AND BACTERICIDE FOR AGRICULTURAL AND HORTICULTURAL USE
C07D 498/04 (2006.01)	2484672 *	NITROGEN-CONTAINING HETEROCYCLIC COMPOUND AND SALT THEREOF, AND BACTERICIDE FOR AGRICULTURAL AND HORTICULTURAL USE
A01N 43/38 (2006.01)	2493304 *	SPIROLACTAM DERIVATIVES AND USES OF SAME
A61K 31/40 (2006.01)	2493304 *	SPIROLACTAM DERIVATIVES AND USES OF SAME
C07D 417/14 (2006.01)	2421860 *	AZETIDINYL DIAMIDES AS MONOACYLGLYCEROL LIPASE INHIBITORS
C07D 417/12 (2006.01)	2421860 *	AZETIDINYL DIAMIDES AS MONOACYLGLYCEROL LIPASE INHIBITORS
A61K 31/496 (2006.01)	2421860 *	AZETIDINYL DIAMIDES AS MONOACYLGLYCEROL LIPASE INHIBITORS
A61P 29/00 (2006.01)	2421860 *	AZETIDINYL DIAMIDES AS MONOACYLGLYCEROL LIPASE INHIBITORS
A61P 25/00 (2006.01)	2421860 *	AZETIDINYL DIAMIDES AS MONOACYLGLYCEROL LIPASE INHIBITORS
C07D 405/12 (2006.01)	2462137 *	CRYSTALLINE SALTS OF METHYL 2- ((R) - (3-CHLORO PHENYL)) ((R) -L- ((S) -2- (METHYLAMINO) -3- ((R) -TETRAHYDRO-2H-PYRAN-3-YL) PROPYL CARBAMOYL)
A61P 9/00 (2006.01)	2462137 *	CRYSTALLINE SALTS OF METHYL 2- ((R) - (3-CHLORO PHENYL)) ((R) -L- ((S) -2- (METHYLAMINO) -3- ((R) -TETRAHYDRO-2H-PYRAN-3-YL) PROPYL CARBAMOYL)
A61K 31/37 (2006.01)	2416771 *	METHODS AND COMPOSITIONS OF PI-3 KINASE INHIBITORS FOR TREATING FIBROSIS
A61K 31/35 (2006.01)	2416771 *	METHODS AND COMPOSITIONS OF PI-3 KINASE INHIBITORS FOR TREATING FIBROSIS
A61P 1/00 (2006.01)	2416771 *	METHODS AND COMPOSITIONS OF PI-3 KINASE INHIBITORS FOR TREATING FIBROSIS
A61P 3/04 (2006.01)	2416771 *	METHODS AND COMPOSITIONS OF PI-3 KINASE INHIBITORS FOR TREATING FIBROSIS
A61P 3/00 (2006.01)	2416771 *	METHODS AND COMPOSITIONS OF PI-3 KINASE INHIBITORS FOR TREATING FIBROSIS
C10G 11/00 (2006.01)	2406356 *	HYDRODEWAXED HYDROCARBON FLUID USED IN THE MANUFACTURE OF FLUIDS FOR INDUSTRIAL, AGRICULTURAL, OR DOMESTIC USE
C10M 101/02 (2006.01)	2406356 *	HYDRODEWAXED HYDROCARBON FLUID USED IN THE MANUFACTURE OF FLUIDS FOR INDUSTRIAL, AGRICULTURAL, OR DOMESTIC USE
C10G 45/58 (2006.01)	2406356 *	HYDRODEWAXED HYDROCARBON FLUID USED IN THE MANUFACTURE OF FLUIDS FOR INDUSTRIAL, AGRICULTURAL, OR DOMESTIC USE
C10G 9/00 (2006.01)	2406356 *	HYDRODEWAXED HYDROCARBON FLUID USED IN THE MANUFACTURE OF FLUIDS FOR INDUSTRIAL, AGRICULTURAL, OR DOMESTIC USE
C10M 107/02 (2006.01)	2406356 *	HYDRODEWAXED HYDROCARBON FLUID USED IN THE MANUFACTURE OF FLUIDS FOR INDUSTRIAL, AGRICULTURAL, OR DOMESTIC USE
C10G 47/00 (2006.01)	2406356 *	HYDRODEWAXED HYDROCARBON FLUID USED IN THE MANUFACTURE OF FLUIDS FOR INDUSTRIAL, AGRICULTURAL, OR DOMESTIC USE

MKP (51)	Broj objave evropske prijava patenta (97)	Naziv pronalaska (54)
A01N 25/02 (2006.01)	2406356 *	HYDRODEWAXED HYDROCARBON FLUID USED IN THE MANUFACTURE OF FLUIDS FOR INDUSTRIAL, AGRICULTURAL, OR DOMESTIC USE
C10L 1/04 (2006.01)	2406356 *	HYDRODEWAXED HYDROCARBON FLUID USED IN THE MANUFACTURE OF FLUIDS FOR INDUSTRIAL, AGRICULTURAL, OR DOMESTIC USE
C08K 5/01 (2006.01)	2406356 *	HYDRODEWAXED HYDROCARBON FLUID USED IN THE MANUFACTURE OF FLUIDS FOR INDUSTRIAL, AGRICULTURAL, OR DOMESTIC USE
C10L 11/04 (2006.01)	2406356 *	HYDRODEWAXED HYDROCARBON FLUID USED IN THE MANUFACTURE OF FLUIDS FOR INDUSTRIAL, AGRICULTURAL, OR DOMESTIC USE
C09D 11/02 (2006.01)	2406356 *	HYDRODEWAXED HYDROCARBON FLUID USED IN THE MANUFACTURE OF FLUIDS FOR INDUSTRIAL, AGRICULTURAL, OR DOMESTIC USE
C09K 8/02 (2006.01)	2406356 *	HYDRODEWAXED HYDROCARBON FLUID USED IN THE MANUFACTURE OF FLUIDS FOR INDUSTRIAL, AGRICULTURAL, OR DOMESTIC USE
C07K 14/705 (2006.01)	2499161 *	ANTIBODIES SPECIFIC FOR CLAUDIN 6 (CLDN6)
C07K 16/28 (2006.01)	2499161 *	ANTIBODIES SPECIFIC FOR CLAUDIN 6 (CLDN6)
A61P 35/00 (2006.01)	2499161 *	ANTIBODIES SPECIFIC FOR CLAUDIN 6 (CLDN6)
A61K 39/395 (2006.01)	2499161 *	ANTIBODIES SPECIFIC FOR CLAUDIN 6 (CLDN6)
C40B 50/06 (2006.01)	2488867 *	METHODS OF AFFINITY MATURING ANTIBODIES
C40B 40/10 (2006.01)	2488867 *	METHODS OF AFFINITY MATURING ANTIBODIES
C40B 30/04 (2006.01)	2488867 *	METHODS OF AFFINITY MATURING ANTIBODIES
G01N 33/53 (2006.01)	2488867 *	METHODS OF AFFINITY MATURING ANTIBODIES
A61K 8/02 (2006.01)	2480196 *	METHODS AND COMPOSITIONS FOR SELECTIVELY TREATING SKIN
A61Q 1/02 (2006.01)	2480196 *	METHODS AND COMPOSITIONS FOR SELECTIVELY TREATING SKIN
A61K 8/64 (2006.01)	2480196 *	METHODS AND COMPOSITIONS FOR SELECTIVELY TREATING SKIN
A61K 8/72 (2006.01)	2480196 *	METHODS AND COMPOSITIONS FOR SELECTIVELY TREATING SKIN
C07D 409/14 (2006.01)	2421823 *	AZETIDINYL DIAMIDES AS MONOACYLGLYCEROL LIPASE INHIBITORS
C07D 405/12 (2006.01)	2421823 *	AZETIDINYL DIAMIDES AS MONOACYLGLYCEROL LIPASE INHIBITORS
C07D 205/04 (2006.01)	2421823 *	AZETIDINYL DIAMIDES AS MONOACYLGLYCEROL LIPASE INHIBITORS
A61P 25/00 (2006.01)	2421823 *	AZETIDINYL DIAMIDES AS MONOACYLGLYCEROL LIPASE INHIBITORS
C07D 403/14 (2006.01)	2421823 *	AZETIDINYL DIAMIDES AS MONOACYLGLYCEROL LIPASE INHIBITORS
C07D 491/048 (2006.01)	2421823 *	AZETIDINYL DIAMIDES AS MONOACYLGLYCEROL LIPASE INHIBITORS
A61K 31/496 (2006.01)	2421823 *	AZETIDINYL DIAMIDES AS MONOACYLGLYCEROL LIPASE INHIBITORS
C07D 403/12 (2006.01)	2421823 *	AZETIDINYL DIAMIDES AS MONOACYLGLYCEROL LIPASE INHIBITORS
C07D 417/14 (2006.01)	2421823 *	AZETIDINYL DIAMIDES AS MONOACYLGLYCEROL LIPASE INHIBITORS
C07D 401/10 (2006.01)	2421823 *	AZETIDINYL DIAMIDES AS MONOACYLGLYCEROL LIPASE INHIBITORS
C07D 417/12 (2006.01)	2421823 *	AZETIDINYL DIAMIDES AS MONOACYLGLYCEROL LIPASE INHIBITORS
C07D 401/12 (2006.01)	2421823 *	AZETIDINYL DIAMIDES AS MONOACYLGLYCEROL LIPASE INHIBITORS
A61P 29/00 (2006.01)	2421823 *	AZETIDINYL DIAMIDES AS MONOACYLGLYCEROL LIPASE INHIBITORS
C10G 47/36 (2006.01)	2479243 *	METHOD OF HYDROCRACKING AND PROCESS FOR PRODUCING HYDROCARBON OIL
C08F 251/02 (2006.01)	2486068 *	REMOVABLE COLOR LAYER FOR ARTIFICIAL NAIL COATINGS AND METHODS THEREFORE
A61Q 3/02 (2006.01)	2486068 *	REMOVABLE COLOR LAYER FOR ARTIFICIAL NAIL COATINGS AND METHODS THEREFORE
A45D 31/00 (2006.01)	2486068 *	REMOVABLE COLOR LAYER FOR ARTIFICIAL NAIL COATINGS AND METHODS THEREFORE
A61K 8/91 (2006.01)	2486068 *	REMOVABLE COLOR LAYER FOR ARTIFICIAL NAIL COATINGS AND METHODS THEREFORE
C09D 4/06 (2006.01)	2486068 *	REMOVABLE COLOR LAYER FOR ARTIFICIAL NAIL COATINGS AND METHODS THEREFORE
G06F 3/041 (2006.01)	2406704 *	SYSTEMS AND METHODS FOR A TEXTURE ENGINE
G06F 3/01 (2006.01)	2406704 *	SYSTEMS AND METHODS FOR A TEXTURE ENGINE
G06F 3/048 (2006.01)	2406704 *	SYSTEMS AND METHODS FOR A TEXTURE ENGINE

MKP (51)	Broj objave evropske prijava patenta (97)	Naziv pronalaska (54)
C07K 14/47 (2006.01)	2414390 *	CITRULLINATED PEPTIDES FOR DIAGNOSING AND PROGNOSING RHEUMATOID ARTHRITIS
C07D 405/04 (2006.01)	2493880 *	HETEROBICYCLE-SUBSTITUTED AZOLYL BENZENE FUNGICIDES
A01N 43/56 (2006.01)	2493880 *	HETEROBICYCLE-SUBSTITUTED AZOLYL BENZENE FUNGICIDES
A61M 5/20 (2006.01)	2403561 *	SYRINGE, AUTO-INJECTOR DEVICE AND SET OF AUTO-INJECTOR DEVICES AND SYRINGES
A61K 8/44 (2006.01)	2371350	Foam formulas for treating animal skin illnesses
A61K 8/04 (2006.01)	2371350	Foam formulas for treating animal skin illnesses
A61K 9/00 (2006.01)	2371350	Foam formulas for treating animal skin illnesses
A61K 9/107 (2006.01)	2371350	Foam formulas for treating animal skin illnesses
A61K 31/17 (2006.01)	2371350	Foam formulas for treating animal skin illnesses
A61K 9/12 (2006.01)	2371350	Foam formulas for treating animal skin illnesses
C23C 14/02 (2006.01)	2491161 *	SURFACE COATINGS FOR MEDICAL IMPLANTS
A61L 31/08 (2006.01)	2491161 *	SURFACE COATINGS FOR MEDICAL IMPLANTS
C23C 14/32 (2006.01)	2491161 *	SURFACE COATINGS FOR MEDICAL IMPLANTS
C23C 14/06 (2006.01)	2491161 *	SURFACE COATINGS FOR MEDICAL IMPLANTS
C23C 14/35 (2006.01)	2491161 *	SURFACE COATINGS FOR MEDICAL IMPLANTS
A61L 27/30 (2006.01)	2491161 *	SURFACE COATINGS FOR MEDICAL IMPLANTS
C07C 205/02 (2006.01)	2490999 *	ISOTHERMAL REACTOR FOR HYDROCARBON NITRATION
C07C 201/08 (2006.01)	2490999 *	ISOTHERMAL REACTOR FOR HYDROCARBON NITRATION
C07D 471/04 (2006.01)	2408773 *	INHIBITORS OF PI3 KINASE
A61P 35/00 (2006.01)	2408773 *	INHIBITORS OF PI3 KINASE
C07D 471/04 (2006.01)	2464645 *	FUSED HETEROCYCLIC COMPOUNDS AS ION CHANNEL MODULATORS
A61K 31/437 (2006.01)	2464645 *	FUSED HETEROCYCLIC COMPOUNDS AS ION CHANNEL MODULATORS
A61P 9/00 (2006.01)	2464645 *	FUSED HETEROCYCLIC COMPOUNDS AS ION CHANNEL MODULATORS
A61K 31/519 (2006.01)	2464645 *	FUSED HETEROCYCLIC COMPOUNDS AS ION CHANNEL MODULATORS
A61K 31/4985 (2006.01)	2464645 *	FUSED HETEROCYCLIC COMPOUNDS AS ION CHANNEL MODULATORS
A61K 31/5025 (2006.01)	2464645 *	FUSED HETEROCYCLIC COMPOUNDS AS ION CHANNEL MODULATORS
A47K 10/16 (2006.01)	2490970 *	CORE FOR A PRODUCT IN SHEET FORM WOUND AROUND THIS CORE, AND ROLL FORMED WITH SUCH A CORE
B65H 75/10 (2006.01)	2490970 *	CORE FOR A PRODUCT IN SHEET FORM WOUND AROUND THIS CORE, AND ROLL FORMED WITH SUCH A CORE
A61M 5/315 (2006.01)	2437823 *	DRUG DELIVERY DOSE SETTING MECHANISM WITH VARIABLE MAXIMUM DOSE
H01H 85/046 (2006.01)	2408277	Fuse element
H05K 1/16 (2006.01)	2408277	Fuse element
H01H 85/041 (2006.01)	2408277	Fuse element
H05K 1/00 (2006.01)	2408277	Fuse element
C07K 16/00 (2006.01)	2493506 *	IL-17A ANTAGONISTS
A61K 39/395 (2006.01)	2493506 *	IL-17A ANTAGONISTS
B65D 65/40 (2006.01)	2392455	Multilayered wrapping film and use thereof
B32B 27/32 (2006.01)	2392455	Multilayered wrapping film and use thereof
B32B 15/08 (2006.01)	2392455	Multilayered wrapping film and use thereof
F16K 1/22 (2006.01)	2251573	Isolation or regulating fitting
H05B 7/144 (2006.01)	2364058	Power supply assembly
H02M 5/257 (2006.01)	2364058	Power supply assembly
C07D 471/04 (2006.01)	2459557 *	CYCLIC (AZA)INDOLIZINECARBOXAMIDES, THEIR PREPARATION AND THEIR USE AS PHARMACEUTICALS
C07D 487/04 (2006.01)	2459557 *	CYCLIC (AZA)INDOLIZINECARBOXAMIDES, THEIR PREPARATION AND THEIR USE AS PHARMACEUTICALS

MKP (51)	Broj objave evropske prijava patenta (97)	Naziv pronalaska (54)
A61K 31/437 (2006.01)	2459557 *	CYCLIC (AZA)INDOLIZINECARBOXAMIDES, THEIR PREPARATION AND THEIR USE AS PHARMACEUTICALS
A61P 9/12 (2006.01)	2459557 *	CYCLIC (AZA)INDOLIZINECARBOXAMIDES, THEIR PREPARATION AND THEIR USE AS PHARMACEUTICALS
C02F 1/68 (2006.01)	2497753	Device for producing and metering calcium hypochlorite and comparable solutions
B62K 11/14 (2006.01)	2308747	A drive control apparatus for two-wheeled vehicles
B62D 51/00 (2006.01)	2308747	A drive control apparatus for two-wheeled vehicles
B01D 53/75 (2006.01)	2416871 *	METHOD FOR TREATING WASTE GASES, ESPECIALLY RESULTING FROM STEEL PRODUCTION
B01D 53/78 (2006.01)	2416871 *	METHOD FOR TREATING WASTE GASES, ESPECIALLY RESULTING FROM STEEL PRODUCTION
B01D 53/81 (2006.01)	2416871 *	METHOD FOR TREATING WASTE GASES, ESPECIALLY RESULTING FROM STEEL PRODUCTION
B01D 53/96 (2006.01)	2416871 *	METHOD FOR TREATING WASTE GASES, ESPECIALLY RESULTING FROM STEEL PRODUCTION
C21B 5/06 (2006.01)	2416871 *	METHOD FOR TREATING WASTE GASES, ESPECIALLY RESULTING FROM STEEL PRODUCTION
B01D 53/50 (2006.01)	2416871 *	METHOD FOR TREATING WASTE GASES, ESPECIALLY RESULTING FROM STEEL PRODUCTION
C02F 1/68 (2006.01)	2406188 *	METHOD AND DEVICE FOR DISSOLVING SOLID SUBSTANCES IN WATER
C02F 1/00 (2006.01)	2406188 *	METHOD AND DEVICE FOR DISSOLVING SOLID SUBSTANCES IN WATER
C02F 1/76 (2006.01)	2406188 *	METHOD AND DEVICE FOR DISSOLVING SOLID SUBSTANCES IN WATER
C02F 103/42 (2006.01)	2406188 *	METHOD AND DEVICE FOR DISSOLVING SOLID SUBSTANCES IN WATER
C07K 16/18 (2006.01)	2445937 *	BISPECIFIC ANTIBODIES THAT BIND TO COMPLEMENT PROTEINS
A61K 39/00 (2006.01)	2445937 *	BISPECIFIC ANTIBODIES THAT BIND TO COMPLEMENT PROTEINS
C07K 16/46 (2006.01)	2445937 *	BISPECIFIC ANTIBODIES THAT BIND TO COMPLEMENT PROTEINS
A61P 31/00 (2006.01)	2445937 *	BISPECIFIC ANTIBODIES THAT BIND TO COMPLEMENT PROTEINS
A61F 5/00 (2006.01)	2475337 *	DETACHABLE ANTENNA FOR REMOTE BAND
A61P 13/12 (2006.01)	2421828 *	PIPERIDINE DERIVATIVES AS INHIBITORS OF RENIN
A61P 11/00 (2006.01)	2421828 *	PIPERIDINE DERIVATIVES AS INHIBITORS OF RENIN
C07D 405/12 (2006.01)	2421828 *	PIPERIDINE DERIVATIVES AS INHIBITORS OF RENIN
A61P 9/10 (2006.01)	2421828 *	PIPERIDINE DERIVATIVES AS INHIBITORS OF RENIN
C07D 211/60 (2006.01)	2421828 *	PIPERIDINE DERIVATIVES AS INHIBITORS OF RENIN
A61K 31/4468 (2006.01)	2421828 *	PIPERIDINE DERIVATIVES AS INHIBITORS OF RENIN
A61P 9/02 (2006.01)	2421828 *	PIPERIDINE DERIVATIVES AS INHIBITORS OF RENIN
A61P 9/04 (2006.01)	2421828 *	PIPERIDINE DERIVATIVES AS INHIBITORS OF RENIN
B65D 83/00 (2006.01)	2361850	Metering device
E04D 13/04 (2006.01)	2406440 *	WATER DRAIN ASSEMBLY, IN PARTICULAR FOR SIPHONIC ROOF DRAINAGE SYSTEMS
F16L 37/14 (2006.01)	2406440 *	WATER DRAIN ASSEMBLY, IN PARTICULAR FOR SIPHONIC ROOF DRAINAGE SYSTEMS
C12N 5/00 (2006.01)	2435067 *	STEM CELL TARGETING
A61P 9/00 (2006.01)	2435067 *	STEM CELL TARGETING
A61P 21/00 (2006.01)	2435067 *	STEM CELL TARGETING
A61K 38/19 (2006.01)	2435067 *	STEM CELL TARGETING
C07K 16/18 (2006.01)	2435067 *	STEM CELL TARGETING
A61K 39/395 (2006.01)	2435067 *	STEM CELL TARGETING
C07K 16/46 (2006.01)	2435067 *	STEM CELL TARGETING
A61M 5/315 (2006.01)	2437824 *	DOSE SETTING MECHANISM FOR PRIMING A DRUG DELIVERY DEVICE
C07D 513/04 (2006.01)	2491045 *	2-OXO-1-PYRROLIDINYL IMIDAZOTHIADIAZOLE DERIVATIVES
A61K 31/433 (2006.01)	2491045 *	2-OXO-1-PYRROLIDINYL IMIDAZOTHIADIAZOLE DERIVATIVES

MKP (51)	Broj objave evropske prijava patenta (97)	Naziv pronalaska (54)
A61P 25/08 (2006.01)	2491045 *	2-OXO-1-PYRROLIDINYL IMIDAZOTHIADIAZOLE DERIVATIVES
A45D 20/12 (2006.01)	2412272	A silencer device for a hair dryer
A61P 17/10 (2006.01)	2421521 *	STABLE TOPICAL COMPOSITIONS FOR 1,2,4-THIADIAZOLE DERIVATIVES
A61K 9/00 (2006.01)	2421521 *	STABLE TOPICAL COMPOSITIONS FOR 1,2,4-THIADIAZOLE DERIVATIVES
A61K 31/433 (2006.01)	2421521 *	STABLE TOPICAL COMPOSITIONS FOR 1,2,4-THIADIAZOLE DERIVATIVES
A61P 17/00 (2006.01)	2421521 *	STABLE TOPICAL COMPOSITIONS FOR 1,2,4-THIADIAZOLE DERIVATIVES
A61K 31/155 (2006.01)	2421521 *	STABLE TOPICAL COMPOSITIONS FOR 1,2,4-THIADIAZOLE DERIVATIVES
A61M 5/315 (2006.01)	2482895 *	ASSEMBLY FOR A DRUG DELIVERY DEVICE
A61K 31/4178 (2006.01)	2485729 *	TREATMENT WITH CHOLINERGIC AGONISTS
A61P 31/10 (2006.01)	2485729 *	TREATMENT WITH CHOLINERGIC AGONISTS
A61P 13/02 (2006.01)	2485729 *	TREATMENT WITH CHOLINERGIC AGONISTS
A61K 31/439 (2006.01)	2485729 *	TREATMENT WITH CHOLINERGIC AGONISTS
A61P 13/10 (2006.01)	2485729 *	TREATMENT WITH CHOLINERGIC AGONISTS
A61K 31/341 (2006.01)	2485729 *	TREATMENT WITH CHOLINERGIC AGONISTS
A61K 31/44 (2006.01)	2485729 *	TREATMENT WITH CHOLINERGIC AGONISTS
A61P 15/02 (2006.01)	2485729 *	TREATMENT WITH CHOLINERGIC AGONISTS
A61K 31/433 (2006.01)	2485729 *	TREATMENT WITH CHOLINERGIC AGONISTS
A61K 33/06 (2006.01)	2448571 *	RESPIRABLY DRY POWDER COMPRISING CALCIUM LACTATE, SODIUM CHLORIDE AND LEUCINE
A61K 9/00 (2006.01)	2448571 *	RESPIRABLY DRY POWDER COMPRISING CALCIUM LACTATE, SODIUM CHLORIDE AND LEUCINE
A61K 31/198 (2006.01)	2448571 *	RESPIRABLY DRY POWDER COMPRISING CALCIUM LACTATE, SODIUM CHLORIDE AND LEUCINE
A61P 11/00 (2006.01)	2448571 *	RESPIRABLY DRY POWDER COMPRISING CALCIUM LACTATE, SODIUM CHLORIDE AND LEUCINE
A61P 11/10 (2006.01)	2448571 *	RESPIRABLY DRY POWDER COMPRISING CALCIUM LACTATE, SODIUM CHLORIDE AND LEUCINE
A61K 33/14 (2006.01)	2448571 *	RESPIRABLY DRY POWDER COMPRISING CALCIUM LACTATE, SODIUM CHLORIDE AND LEUCINE
C07K 16/00 (2006.01)	2419445 *	NEW METHODS OF MAKING AN ANTIBODY AND COMPOSITIONS THEREOF
C08G 61/10 (2006.01)	2423241	Unit with porous organic polymers and use of same
C08G 61/12 (2006.01)	2423241	Unit with porous organic polymers and use of same
C08J 9/00 (2006.01)	2423241	Unit with porous organic polymers and use of same
A61M 5/158 (2006.01)	2427235 *	LOW-DEAD VOLUME MICROFLUIDIC CIRCUIT AND METHODS
F15C 5/00 (2006.01)	2427235 *	LOW-DEAD VOLUME MICROFLUIDIC CIRCUIT AND METHODS
G01L 9/00 (2006.01)	2427235 *	LOW-DEAD VOLUME MICROFLUIDIC CIRCUIT AND METHODS
A61M 5/142 (2006.01)	2427235 *	LOW-DEAD VOLUME MICROFLUIDIC CIRCUIT AND METHODS
F16K 99/00 (2006.01)	2427235 *	LOW-DEAD VOLUME MICROFLUIDIC CIRCUIT AND METHODS
A47J 45/06 (2006.01)	2440096 *	PAN WITH AN INVERTED CURVED HANDLE
F02M 63/00 (2006.01)	2372139	Actuator Arrangement for use in a Fuel Injector
F02M 51/06 (2006.01)	2372139	Actuator Arrangement for use in a Fuel Injector
F02M 61/16 (2006.01)	2372139	Actuator Arrangement for use in a Fuel Injector
B66C 1/02 (2006.01)	2354074	Method and apparatus for assembling building shell elements
B65G 47/00 (2006.01)	2354074	Method and apparatus for assembling building shell elements
B65G 61/00 (2006.01)	2354074	Method and apparatus for assembling building shell elements
C01F 11/18 (2006.01)	2371766	Process for obtaining precipitated calcium carbonate
A61K 31/19 (2006.01)	2445340 *	SUBSTITUTED HYDROXAMIC ACIDS AND USES THEREOF
A61K 31/215 (2006.01)	2445340 *	SUBSTITUTED HYDROXAMIC ACIDS AND USES THEREOF
A01N 37/28 (2006.01)	2445340 *	SUBSTITUTED HYDROXAMIC ACIDS AND USES THEREOF
A61M 11/00 (2006.01)	2453962 *	NEGATIVELY BIASED SEALED NEBULIZERS SYSTEMS AND METHODS

MKP (51)	Broj objave evropske prijave patenta (97)	Naziv pronalaska (54)
A61B 18/14 (2006.01)	2480152 *	SYSTEMS AND METHODS FOR CONTROLLING USE AND OPERATION OF A FAMILY OF DIFFERENT TREATMENT DEVICES
G06F 3/00 (2006.01)	2480152 *	SYSTEMS AND METHODS FOR CONTROLLING USE AND OPERATION OF A FAMILY OF DIFFERENT TREATMENT DEVICES
A61H 1/02 (2006.01)	2311424	Sling table for carrying out physiotherapy and rehabilitation and functional element for such a sling table
F24F 13/08 (2006.01)	2386699	Ventilated eaves closure
F24F 7/02 (2006.01)	2386699	Ventilated eaves closure
E04D 13/00 (2006.01)	2386699	Ventilated eaves closure
E04D 13/17 (2006.01)	2386699	Ventilated eaves closure
A61M 5/315 (2006.01)	2475410 *	DRIVE MECHANISM FOR A MEDICATION DELIVERY DEVICE AND MEDICATION DELIVERY DEVICE
B01D 9/00 (2006.01)	2477944 *	SUBLIMATION GROWTH OF SIC SINGLE CRYSTALS
C01B 31/36 (2006.01)	2477944 *	SUBLIMATION GROWTH OF SIC SINGLE CRYSTALS
A61F 13/26 (2006.01)	2461968 *	FIBROUS SHEET THAT DISINTEGRATES IN WATER, PROCESS FOR MANUFACTURING SAID FIBROUS SHEET, CORE CONSISTING OF STRIPS OF SAID FIBROUS SHEET
B31C 3/00 (2006.01)	2461968 *	FIBROUS SHEET THAT DISINTEGRATES IN WATER, PROCESS FOR MANUFACTURING SAID FIBROUS SHEET, CORE CONSISTING OF STRIPS OF SAID FIBROUS SHEET
D21H 17/28 (2006.01)	2461968 *	FIBROUS SHEET THAT DISINTEGRATES IN WATER, PROCESS FOR MANUFACTURING SAID FIBROUS SHEET, CORE CONSISTING OF STRIPS OF SAID FIBROUS SHEET
D21H 27/00 (2006.01)	2461968 *	FIBROUS SHEET THAT DISINTEGRATES IN WATER, PROCESS FOR MANUFACTURING SAID FIBROUS SHEET, CORE CONSISTING OF STRIPS OF SAID FIBROUS SHEET
D21H 17/29 (2006.01)	2461968 *	FIBROUS SHEET THAT DISINTEGRATES IN WATER, PROCESS FOR MANUFACTURING SAID FIBROUS SHEET, CORE CONSISTING OF STRIPS OF SAID FIBROUS SHEET
D21H 19/54 (2006.01)	2461968 *	FIBROUS SHEET THAT DISINTEGRATES IN WATER, PROCESS FOR MANUFACTURING SAID FIBROUS SHEET, CORE CONSISTING OF STRIPS OF SAID FIBROUS SHEET
D21H 25/04 (2006.01)	2461968 *	FIBROUS SHEET THAT DISINTEGRATES IN WATER, PROCESS FOR MANUFACTURING SAID FIBROUS SHEET, CORE CONSISTING OF STRIPS OF SAID FIBROUS SHEET
C12P 19/34 (2006.01)	2467500 *	DETECTION OF AAD-1 EVENT DAS-40278-9
C12Q 1/68 (2006.01)	2467500 *	DETECTION OF AAD-1 EVENT DAS-40278-9
A61K 35/74 (2006.01)	2429555 *	NOVEL USE OF PROBIOTICS
C07K 14/605 (2006.01)	2483308 *	DRUG FUSIONS AND CONJUGATES WITH EXTENDED HALF LIFE
A61K 39/395 (2006.01)	2483308 *	DRUG FUSIONS AND CONJUGATES WITH EXTENDED HALF LIFE
A61P 3/08 (2006.01)	2483308 *	DRUG FUSIONS AND CONJUGATES WITH EXTENDED HALF LIFE
C07K 14/575 (2006.01)	2483308 *	DRUG FUSIONS AND CONJUGATES WITH EXTENDED HALF LIFE
A61K 47/48 (2006.01)	2483308 *	DRUG FUSIONS AND CONJUGATES WITH EXTENDED HALF LIFE
C07K 16/18 (2006.01)	2483308 *	DRUG FUSIONS AND CONJUGATES WITH EXTENDED HALF LIFE
A61P 5/48 (2006.01)	2483308 *	DRUG FUSIONS AND CONJUGATES WITH EXTENDED HALF LIFE
C07D 498/22 (2006.01)	2421869 *	RIFAMYCIN DERIVATIVES
C07D 493/20 (2006.01)	2421869 *	RIFAMYCIN DERIVATIVES
A61K 31/357 (2006.01)	2421869 *	RIFAMYCIN DERIVATIVES
A61K 31/437 (2006.01)	2421869 *	RIFAMYCIN DERIVATIVES
A61P 31/00 (2006.01)	2421869 *	RIFAMYCIN DERIVATIVES
B65D 33/00 (2006.01)	2435330 *	PAPER BAG WITH DETACHABLE CARD
C07D 401/14 (2006.01)	2445902 *	HETEROCYCLIC COMPOUNDS AND THEIR USES AS INHIBITORS OF PI3K ACTIVITY
C07C 303/32 (2006.01)	2419402 *	SYNTHESIS OF 1-AMINO-1,3,3,5,5-PENTAMETHYLCYCLOHEXANE MESYLATE

MKP (51)	Broj objave evropske prijave patenta (97)	Naziv pronalaska (54)
C07C 211/35 (2006.01)	2419402 *	SYNTHESIS OF 1-AMINO-1,3,3,5,5-PENTAMETHYLCYCLOHEXANE MESYLATE
C07C 309/04 (2006.01)	2419402 *	SYNTHESIS OF 1-AMINO-1,3,3,5,5-PENTAMETHYLCYCLOHEXANE MESYLATE
A61K 31/13 (2006.01)	2419402 *	SYNTHESIS OF 1-AMINO-1,3,3,5,5-PENTAMETHYLCYCLOHEXANE MESYLATE
A61M 5/315 (2006.01)	2482885 *	DRIVE MECHANISM FOR A DRUG DELIVERY DEVICE
C07D 471/04 (2006.01)	2470531 *	METHYLPYRROLOPYRIDINECARBOXAMIDES
A61K 31/437 (2006.01)	2470531 *	METHYLPYRROLOPYRIDINECARBOXAMIDES
A61P 11/00 (2006.01)	2464359 *	N-SULFATED OLIGOSACCHARIDES ACTIVATING FGFS RECEPTORS, THEIR SYNTHESIS AND THEIR THERAPEUTICAL APPLICATION
A61P 17/00 (2006.01)	2464359 *	N-SULFATED OLIGOSACCHARIDES ACTIVATING FGFS RECEPTORS, THEIR SYNTHESIS AND THEIR THERAPEUTICAL APPLICATION
A61P 19/00 (2006.01)	2464359 *	N-SULFATED OLIGOSACCHARIDES ACTIVATING FGFS RECEPTORS, THEIR SYNTHESIS AND THEIR THERAPEUTICAL APPLICATION
A61P 21/00 (2006.01)	2464359 *	N-SULFATED OLIGOSACCHARIDES ACTIVATING FGFS RECEPTORS, THEIR SYNTHESIS AND THEIR THERAPEUTICAL APPLICATION
A61P 9/00 (2006.01)	2464359 *	N-SULFATED OLIGOSACCHARIDES ACTIVATING FGFS RECEPTORS, THEIR SYNTHESIS AND THEIR THERAPEUTICAL APPLICATION
A61K 31/737 (2006.01)	2464359 *	N-SULFATED OLIGOSACCHARIDES ACTIVATING FGFS RECEPTORS, THEIR SYNTHESIS AND THEIR THERAPEUTICAL APPLICATION
A61P 25/00 (2006.01)	2464359 *	N-SULFATED OLIGOSACCHARIDES ACTIVATING FGFS RECEPTORS, THEIR SYNTHESIS AND THEIR THERAPEUTICAL APPLICATION
C08B 37/00 (2006.01)	2464359 *	N-SULFATED OLIGOSACCHARIDES ACTIVATING FGFS RECEPTORS, THEIR SYNTHESIS AND THEIR THERAPEUTICAL APPLICATION
A61P 27/02 (2006.01)	2464359 *	N-SULFATED OLIGOSACCHARIDES ACTIVATING FGFS RECEPTORS, THEIR SYNTHESIS AND THEIR THERAPEUTICAL APPLICATION
A61P 7/00 (2006.01)	2464359 *	N-SULFATED OLIGOSACCHARIDES ACTIVATING FGFS RECEPTORS, THEIR SYNTHESIS AND THEIR THERAPEUTICAL APPLICATION
A61P 37/00 (2006.01)	2464359 *	N-SULFATED OLIGOSACCHARIDES ACTIVATING FGFS RECEPTORS, THEIR SYNTHESIS AND THEIR THERAPEUTICAL APPLICATION
A61K 31/365 (2006.01)	2485725 *	COMPOSITIONS COMPRISING ADJUVANT, MACROLIDE AND PROTEINACEOUS ANTIGEN AND METHODS OF USE THEREOF
A61K 38/48 (2006.01)	2485725 *	COMPOSITIONS COMPRISING ADJUVANT, MACROLIDE AND PROTEINACEOUS ANTIGEN AND METHODS OF USE THEREOF
A61K 47/44 (2006.01)	2485725 *	COMPOSITIONS COMPRISING ADJUVANT, MACROLIDE AND PROTEINACEOUS ANTIGEN AND METHODS OF USE THEREOF
A61K 39/39 (2006.01)	2485725 *	COMPOSITIONS COMPRISING ADJUVANT, MACROLIDE AND PROTEINACEOUS ANTIGEN AND METHODS OF USE THEREOF
A61K 39/00 (2006.01)	2485725 *	COMPOSITIONS COMPRISING ADJUVANT, MACROLIDE AND PROTEINACEOUS ANTIGEN AND METHODS OF USE THEREOF
A61K 9/08 (2006.01)	2403476 *	METHOD OF DISSOLVING ANTIFUNGAL AGENT, AND COMPOSITIONS WITH A HIGH CONCENTRATION OF ANTIFUNGAL AGENT, SUITABLE FOR APPLICATION TO THE NAIL
A61K 31/137 (2006.01)	2403476 *	METHOD OF DISSOLVING ANTIFUNGAL AGENT, AND COMPOSITIONS WITH A HIGH CONCENTRATION OF ANTIFUNGAL AGENT, SUITABLE FOR APPLICATION TO THE NAIL
A61K 31/5375 (2006.01)	2403476 *	METHOD OF DISSOLVING ANTIFUNGAL AGENT, AND COMPOSITIONS WITH A HIGH CONCENTRATION OF ANTIFUNGAL AGENT, SUITABLE FOR APPLICATION TO THE NAIL
A61K 47/10 (2006.01)	2403476 *	METHOD OF DISSOLVING ANTIFUNGAL AGENT, AND COMPOSITIONS WITH A HIGH CONCENTRATION OF ANTIFUNGAL AGENT, SUITABLE FOR APPLICATION TO THE NAIL
A61P 31/10 (2006.01)	2403476 *	METHOD OF DISSOLVING ANTIFUNGAL AGENT, AND COMPOSITIONS WITH A HIGH CONCENTRATION OF ANTIFUNGAL AGENT, SUITABLE FOR APPLICATION TO THE NAIL
A61L 27/58 (2006.01)	2493518 *	ABSORBABLE POLYETHYLENE DIGLYCOLATE COPOLYMERS TO REDUCE MICROBIAL ADHESION TO MEDICAL DEVICES AND IMPLANTS

MKP (51)	Broj objave evropske prijava patenta (97)	Naziv pronalaska (54)
A61L 27/34 (2006.01)	2493518 *	ABSORBABLE POLYETHYLENE DIGLYCOLATE COPOLYMERS TO REDUCE MICROBIAL ADHESION TO MEDICAL DEVICES AND IMPLANTS
A61L 29/06 (2006.01)	2493518 *	ABSORBABLE POLYETHYLENE DIGLYCOLATE COPOLYMERS TO REDUCE MICROBIAL ADHESION TO MEDICAL DEVICES AND IMPLANTS
A61L 17/12 (2006.01)	2493518 *	ABSORBABLE POLYETHYLENE DIGLYCOLATE COPOLYMERS TO REDUCE MICROBIAL ADHESION TO MEDICAL DEVICES AND IMPLANTS
A61L 31/14 (2006.01)	2493518 *	ABSORBABLE POLYETHYLENE DIGLYCOLATE COPOLYMERS TO REDUCE MICROBIAL ADHESION TO MEDICAL DEVICES AND IMPLANTS
A61L 27/54 (2006.01)	2493518 *	ABSORBABLE POLYETHYLENE DIGLYCOLATE COPOLYMERS TO REDUCE MICROBIAL ADHESION TO MEDICAL DEVICES AND IMPLANTS
A61L 27/18 (2006.01)	2493518 *	ABSORBABLE POLYETHYLENE DIGLYCOLATE COPOLYMERS TO REDUCE MICROBIAL ADHESION TO MEDICAL DEVICES AND IMPLANTS
A61L 31/06 (2006.01)	2493518 *	ABSORBABLE POLYETHYLENE DIGLYCOLATE COPOLYMERS TO REDUCE MICROBIAL ADHESION TO MEDICAL DEVICES AND IMPLANTS
A61L 29/14 (2006.01)	2493518 *	ABSORBABLE POLYETHYLENE DIGLYCOLATE COPOLYMERS TO REDUCE MICROBIAL ADHESION TO MEDICAL DEVICES AND IMPLANTS
A61L 17/00 (2006.01)	2493518 *	ABSORBABLE POLYETHYLENE DIGLYCOLATE COPOLYMERS TO REDUCE MICROBIAL ADHESION TO MEDICAL DEVICES AND IMPLANTS
A61L 31/10 (2006.01)	2493518 *	ABSORBABLE POLYETHYLENE DIGLYCOLATE COPOLYMERS TO REDUCE MICROBIAL ADHESION TO MEDICAL DEVICES AND IMPLANTS
A61L 29/16 (2006.01)	2493518 *	ABSORBABLE POLYETHYLENE DIGLYCOLATE COPOLYMERS TO REDUCE MICROBIAL ADHESION TO MEDICAL DEVICES AND IMPLANTS
A61L 29/08 (2006.01)	2493518 *	ABSORBABLE POLYETHYLENE DIGLYCOLATE COPOLYMERS TO REDUCE MICROBIAL ADHESION TO MEDICAL DEVICES AND IMPLANTS
A61L 26/00 (2006.01)	2493518 *	ABSORBABLE POLYETHYLENE DIGLYCOLATE COPOLYMERS TO REDUCE MICROBIAL ADHESION TO MEDICAL DEVICES AND IMPLANTS
A61L 31/16 (2006.01)	2493518 *	ABSORBABLE POLYETHYLENE DIGLYCOLATE COPOLYMERS TO REDUCE MICROBIAL ADHESION TO MEDICAL DEVICES AND IMPLANTS
F03D 3/00 (2006.01)	2317128	Vertical axis wind turbine
F03D 11/02 (2006.01)	2317128	Vertical axis wind turbine
G06F 21/00 (2006.01)	2460113 *	AUTOMATED UNPACKING OF PORTABLE EXECUTABLE FILES
G06F 11/07 (2006.01)	2460113 *	AUTOMATED UNPACKING OF PORTABLE EXECUTABLE FILES
C10M 107/24 (2006.01)	2471896 *	REFRIGERANT OIL FOR FREEZERS AND OPERATING FLUID COMPOSITION FOR FREEZERS
C10N 40/30 (2006.01)	2471896 *	REFRIGERANT OIL FOR FREEZERS AND OPERATING FLUID COMPOSITION FOR FREEZERS
C10M 107/34 (2006.01)	2471896 *	REFRIGERANT OIL FOR FREEZERS AND OPERATING FLUID COMPOSITION FOR FREEZERS
C10M 105/18 (2006.01)	2471896 *	REFRIGERANT OIL FOR FREEZERS AND OPERATING FLUID COMPOSITION FOR FREEZERS
C10N 30/10 (2006.01)	2471896 *	REFRIGERANT OIL FOR FREEZERS AND OPERATING FLUID COMPOSITION FOR FREEZERS
C09K 5/04 (2006.01)	2471896 *	REFRIGERANT OIL FOR FREEZERS AND OPERATING FLUID COMPOSITION FOR FREEZERS
C10N 30/08 (2006.01)	2471896 *	REFRIGERANT OIL FOR FREEZERS AND OPERATING FLUID COMPOSITION FOR FREEZERS
C10M 129/18 (2006.01)	2471896 *	REFRIGERANT OIL FOR FREEZERS AND OPERATING FLUID COMPOSITION FOR FREEZERS
C10M 137/08 (2006.01)	2471896 *	REFRIGERANT OIL FOR FREEZERS AND OPERATING FLUID COMPOSITION FOR FREEZERS
C10M 169/04 (2006.01)	2471896 *	REFRIGERANT OIL FOR FREEZERS AND OPERATING FLUID COMPOSITION FOR FREEZERS
C10N 30/06 (2006.01)	2471896 *	REFRIGERANT OIL FOR FREEZERS AND OPERATING FLUID COMPOSITION FOR FREEZERS
C10M 133/04 (2006.01)	2471896 *	REFRIGERANT OIL FOR FREEZERS AND OPERATING FLUID COMPOSITION FOR FREEZERS
H04L 12/28 (2006.01)	2406919 *	USE OF SNMP FOR MANAGEMENT OF SMALL FOOTPRINT DEVICES

MKP (51)	Broj objave evropske prijava patenta (97)	Naziv pronalaska (54)
A61F 2/90 (2006.01)	2389906	Stent
H01R 4/24 (2006.01)	2486626 *	JUNCTION BOX, PARTICULARLY FOR LIGHTING LINES FOR TUNNELS
E01F 15/08 (2006.01)	2446088 *	TERMINATING ELEMENT
C07D 453/02 (2006.01)	2451809 *	A PROCESS FOR THE PREPARATION AND PURIFICATION OF SOLIFENACIN SALTS
G06Q 20/00 (2012.01)	2452300 *	METHOD AND SYSTEM OF CONTACTLESS AUTHENTICATION, AND CARRIER OF PIN CODE
A61K 47/02 (2006.01)	2459218 *	SOLUTIONS COMPRISING POLYETHYLENE GLYCOL AND ELECTROLYTES
A61K 47/10 (2006.01)	2459218 *	SOLUTIONS COMPRISING POLYETHYLENE GLYCOL AND ELECTROLYTES
A61K 9/00 (2006.01)	2459218 *	SOLUTIONS COMPRISING POLYETHYLENE GLYCOL AND ELECTROLYTES
A61P 1/10 (2006.01)	2459218 *	SOLUTIONS COMPRISING POLYETHYLENE GLYCOL AND ELECTROLYTES
D21C 9/10 (2006.01)	2435629 *	MODIFIED CELLULOSE FROM CHEMICAL KRAFT FIBER AND METHODS OF MAKING AND USING THE SAME
D21C 9/16 (2006.01)	2435629 *	MODIFIED CELLULOSE FROM CHEMICAL KRAFT FIBER AND METHODS OF MAKING AND USING THE SAME
B29C 67/00 (2006.01)	2454080 *	IMPROVED STEREOLITHOGRAPHY MACHINE
A61K 38/17 (2006.01)	2461673 *	NOVEL REGULATORY PROTEINS AND INHIBITORS
A01K 67/027 (2006.01)	2461673 *	NOVEL REGULATORY PROTEINS AND INHIBITORS
B29D 35/12 (2010.01)	2493347 *	Shoe with ventilation system.
A43B 17/08 (2006.01)	2493347 *	Shoe with ventilation system.
A43B 7/08 (2006.01)	2493347 *	Shoe with ventilation system.
A61M 5/00 (2006.01)	2437826 *	DOSING MECHANISM FOR A DRUG DELIVERY DEVICE
A61M 5/315 (2006.01)	2437826 *	DOSING MECHANISM FOR A DRUG DELIVERY DEVICE
A61P 43/00 (2006.01)	2440194 *	METHODS AND COMPOSITIONS FOR THE INDUCTION OF HYPOTHERMIA
A61K 31/395 (2006.01)	2440194 *	METHODS AND COMPOSITIONS FOR THE INDUCTION OF HYPOTHERMIA
A61P 25/00 (2006.01)	2440194 *	METHODS AND COMPOSITIONS FOR THE INDUCTION OF HYPOTHERMIA
A61K 31/045 (2006.01)	2440194 *	METHODS AND COMPOSITIONS FOR THE INDUCTION OF HYPOTHERMIA
A61K 31/167 (2006.01)	2440194 *	METHODS AND COMPOSITIONS FOR THE INDUCTION OF HYPOTHERMIA
C07C 269/06 (2006.01)	2480526 *	CRYSTALLINE FORMS AND PROCESSES FOR THE PREPARATION OF PGI2 RECEPTOR AGONISTS
A61P 9/00 (2006.01)	2480526 *	CRYSTALLINE FORMS AND PROCESSES FOR THE PREPARATION OF PGI2 RECEPTOR AGONISTS
C07C 309/15 (2006.01)	2480526 *	CRYSTALLINE FORMS AND PROCESSES FOR THE PREPARATION OF PGI2 RECEPTOR AGONISTS
A61K 31/165 (2006.01)	2480526 *	CRYSTALLINE FORMS AND PROCESSES FOR THE PREPARATION OF PGI2 RECEPTOR AGONISTS
C07C 271/28 (2006.01)	2480526 *	CRYSTALLINE FORMS AND PROCESSES FOR THE PREPARATION OF PGI2 RECEPTOR AGONISTS
C07C 303/22 (2006.01)	2480526 *	CRYSTALLINE FORMS AND PROCESSES FOR THE PREPARATION OF PGI2 RECEPTOR AGONISTS
A61K 31/55 (2006.01)	2496582 *	BENZODIAZEPINE BROMODOMAIN INHIBITOR
C07D 487/04 (2006.01)	2496582 *	BENZODIAZEPINE BROMODOMAIN INHIBITOR
A61P 43/00 (2006.01)	2496582 *	BENZODIAZEPINE BROMODOMAIN INHIBITOR
A61P 35/00 (2006.01)	2496582 *	BENZODIAZEPINE BROMODOMAIN INHIBITOR
A01N 43/42 (2006.01)	2437603 *	METHODS OF TREATING HEPATIC ENCEPHALOPATHY
C01B 7/09 (2006.01)	2454190 *	CONVERSION OF HYDROGEN BROMIDE TO ELEMENTAL BROMINE

MKP (51)	Broj objave evropske prijava patenta (97)	Naziv pronalaska (54)
A61F 13/15 (2006.01)	2441419	Method of providing a diaper with a contoured leg opening
A61K 31/513 (2006.01)	2488182 *	TREATING NEUROTOXICITY ASSOCIATED WITH COMBINATIONS OF 5 - FU OR ITS PRODRUGS AND DPD INHIBITORS
A61P 35/00 (2006.01)	2488182 *	TREATING NEUROTOXICITY ASSOCIATED WITH COMBINATIONS OF 5 - FU OR ITS PRODRUGS AND DPD INHIBITORS
A61J 1/20 (2006.01)	2459147 *	DEVICE/SYSTEM FOR MIXING LIQUIDS, DRUGS AND SOLUTIONS BEFORE ADMINISTRATION INTO THE HUMAN BODY
G10L 15/22 (2006.01)	2497004 *	SYSTEMS AND METHODS FOR HAPTIC CONFIRMATION OF COMMANDS
G06F 3/01 (2006.01)	2497004 *	SYSTEMS AND METHODS FOR HAPTIC CONFIRMATION OF COMMANDS
G10L 21/06 (2006.01)	2497004 *	SYSTEMS AND METHODS FOR HAPTIC CONFIRMATION OF COMMANDS
B32B 27/00 (2006.01)	2399737	Styrene polymer foam compound body
A61K 31/395 (2006.01)	2482813 *	SALTS, SOLVATES, AND PHARMACEUTICAL COMPOSITIONS OF MACROCYCLIC GHRELIN RECEPTOR AGONISTS AND METHODS OF USING THE SAME
C07D 269/00 (2006.01)	2482813 *	SALTS, SOLVATES, AND PHARMACEUTICAL COMPOSITIONS OF MACROCYCLIC GHRELIN RECEPTOR AGONISTS AND METHODS OF USING THE SAME
A61P 1/00 (2006.01)	2482813 *	SALTS, SOLVATES, AND PHARMACEUTICAL COMPOSITIONS OF MACROCYCLIC GHRELIN RECEPTOR AGONISTS AND METHODS OF USING THE SAME
A61K 31/352 (2006.01)	2482813 *	SALTS, SOLVATES, AND PHARMACEUTICAL COMPOSITIONS OF MACROCYCLIC GHRELIN RECEPTOR AGONISTS AND METHODS OF USING THE SAME
A61K 31/167 (2006.01)	2438037 *	GLYCINE B ANTAGONISTS
A61P 25/02 (2006.01)	2438037 *	GLYCINE B ANTAGONISTS
C07C 65/21 (2006.01)	2438037 *	GLYCINE B ANTAGONISTS
C07C 235/24 (2006.01)	2438037 *	GLYCINE B ANTAGONISTS
C07C 235/68 (2006.01)	2438037 *	GLYCINE B ANTAGONISTS
C07C 311/51 (2006.01)	2438037 *	GLYCINE B ANTAGONISTS
A61M 5/315 (2006.01)	2448620 *	DRIVE MECHANISM AND DRUG DELIVERY DEVICE
G01N 33/53 (2006.01)	2443458 *	METHOD FOR MEASURING LIPOPROTEIN-SPECIFIC APOLIPOPROTEINS
G01N 33/566 (2006.01)	2443458 *	METHOD FOR MEASURING LIPOPROTEIN-SPECIFIC APOLIPOPROTEINS
B21D 39/04 (2006.01)	2420332	Gripper for holding the tools of a radial press
B21J 7/14 (2006.01)	2420332	Gripper for holding the tools of a radial press
B21J 13/08 (2006.01)	2420332	Gripper for holding the tools of a radial press
F04B 53/00 (2006.01)	2456981 *	PUMP ASSEMBLY
F04B 53/16 (2006.01)	2456981 *	PUMP ASSEMBLY
F02M 59/48 (2006.01)	2456981 *	PUMP ASSEMBLY
C07C 57/26 (2006.01)	2475635 *	PROCESS FOR THE PRODUCTION OF ARTEMISININ INTERMEDIATES
C07C 69/608 (2006.01)	2475635 *	PROCESS FOR THE PRODUCTION OF ARTEMISININ INTERMEDIATES
C07D 493/18 (2006.01)	2475635 *	PROCESS FOR THE PRODUCTION OF ARTEMISININ INTERMEDIATES
C07C 51/36 (2006.01)	2475635 *	PROCESS FOR THE PRODUCTION OF ARTEMISININ INTERMEDIATES
C07C 67/303 (2006.01)	2475635 *	PROCESS FOR THE PRODUCTION OF ARTEMISININ INTERMEDIATES
C07C 45/68 (2006.01)	2444386 *	PROCESS FOR PREPARATION OF NORBORNENE DERIVATIVES
C07C 45/80 (2006.01)	2444386 *	PROCESS FOR PREPARATION OF NORBORNENE DERIVATIVES
C07C 49/617 (2006.01)	2444386 *	PROCESS FOR PREPARATION OF NORBORNENE DERIVATIVES
C07C 49/683 (2006.01)	2444386 *	PROCESS FOR PREPARATION OF NORBORNENE DERIVATIVES
C07C 49/798 (2006.01)	2444386 *	PROCESS FOR PREPARATION OF NORBORNENE DERIVATIVES
B08B 9/055 (2006.01)	2409789	Pipeline debris shearing device
F16J 15/32 (2006.01)	2409789	Pipeline debris shearing device
F16L 55/28 (2006.01)	2409789	Pipeline debris shearing device
A01N 43/40 (2006.01)	2493306 *	SYNERGISTIC HERBICIDAL COMPOSITION CONTAINING FLUROXYPYR AND CYHALOFOP, METAMIFOP OR PROFOXYDIM

MKP (51)	Broj objave evropske prijava patenta (97)	Naziv pronalaska (54)
A01N 43/18 (2006.01)	2493306 *	SYNERGISTIC HERBICIDAL COMPOSITION CONTAINING FLUROXYPYR AND CYHALOFOP, METAMIFOP OR PROFOXYDIM
A01P 13/00 (2006.01)	2493306 *	SYNERGISTIC HERBICIDAL COMPOSITION CONTAINING FLUROXYPYR AND CYHALOFOP, METAMIFOP OR PROFOXYDIM
A01N 43/76 (2006.01)	2493306 *	SYNERGISTIC HERBICIDAL COMPOSITION CONTAINING FLUROXYPYR AND CYHALOFOP, METAMIFOP OR PROFOXYDIM
A01N 39/02 (2006.01)	2493306 *	SYNERGISTIC HERBICIDAL COMPOSITION CONTAINING FLUROXYPYR AND CYHALOFOP, METAMIFOP OR PROFOXYDIM
E04H 15/00 (2006.01)	2410108	Fixing system of a covering element
E04H 15/32 (2006.01)	2410108	Fixing system of a covering element
F22B 37/24 (2006.01)	2410108	Fixing system of a covering element
C08J 5/18 (2006.01)	2390280	Treated mineral filler products, process for the preparation thereof and uses of same
C08K 9/04 (2006.01)	2390280	Treated mineral filler products, process for the preparation thereof and uses of same
C09C 1/02 (2006.01)	2390280	Treated mineral filler products, process for the preparation thereof and uses of same
C09C 3/08 (2006.01)	2390280	Treated mineral filler products, process for the preparation thereof and uses of same
A01N 43/40 (2006.01)	2488028 *	SUBSTITUTED PIPERIDINES THAT INCREASE p53 ACTIVITY AND THE USES THEREOF
A61K 31/445 (2006.01)	2488028 *	SUBSTITUTED PIPERIDINES THAT INCREASE p53 ACTIVITY AND THE USES THEREOF
C07D 211/96 (2006.01)	2421829 *	2,5-DISUBSTITUTED ARYLSULFONAMIDE CCR3 ANTAGONISTS
A61P 25/28 (2006.01)	2421829 *	2,5-DISUBSTITUTED ARYLSULFONAMIDE CCR3 ANTAGONISTS
A61K 31/445 (2006.01)	2421829 *	2,5-DISUBSTITUTED ARYLSULFONAMIDE CCR3 ANTAGONISTS
C07D 243/08 (2006.01)	2421829 *	2,5-DISUBSTITUTED ARYLSULFONAMIDE CCR3 ANTAGONISTS
C07D 295/26 (2006.01)	2421829 *	2,5-DISUBSTITUTED ARYLSULFONAMIDE CCR3 ANTAGONISTS
C07C 311/29 (2006.01)	2421829 *	2,5-DISUBSTITUTED ARYLSULFONAMIDE CCR3 ANTAGONISTS
C07D 241/04 (2006.01)	2421829 *	2,5-DISUBSTITUTED ARYLSULFONAMIDE CCR3 ANTAGONISTS
A61P 11/06 (2006.01)	2421829 *	2,5-DISUBSTITUTED ARYLSULFONAMIDE CCR3 ANTAGONISTS
C07D 403/04 (2006.01)	2421829 *	2,5-DISUBSTITUTED ARYLSULFONAMIDE CCR3 ANTAGONISTS
C07D 487/04 (2006.01)	2421829 *	2,5-DISUBSTITUTED ARYLSULFONAMIDE CCR3 ANTAGONISTS
A61P 25/22 (2006.01)	2454240 *	GLYCINE TRANSPORTER INHIBITORS
A61K 31/4164 (2006.01)	2454240 *	GLYCINE TRANSPORTER INHIBITORS
A61P 25/28 (2006.01)	2454240 *	GLYCINE TRANSPORTER INHIBITORS
A61P 25/20 (2006.01)	2454240 *	GLYCINE TRANSPORTER INHIBITORS
A61K 31/4196 (2006.01)	2454240 *	GLYCINE TRANSPORTER INHIBITORS
A61P 25/30 (2006.01)	2454240 *	GLYCINE TRANSPORTER INHIBITORS
A61P 25/00 (2006.01)	2454240 *	GLYCINE TRANSPORTER INHIBITORS
A61P 43/00 (2006.01)	2454240 *	GLYCINE TRANSPORTER INHIBITORS
C07D 233/90 (2006.01)	2454240 *	GLYCINE TRANSPORTER INHIBITORS
A61P 25/24 (2006.01)	2454240 *	GLYCINE TRANSPORTER INHIBITORS
A61P 25/04 (2006.01)	2454240 *	GLYCINE TRANSPORTER INHIBITORS
C07D 249/10 (2006.01)	2454240 *	GLYCINE TRANSPORTER INHIBITORS
A61P 25/18 (2006.01)	2454240 *	GLYCINE TRANSPORTER INHIBITORS
A61P 9/14 (2006.01)	2473178 *	COMPOSITION FOR THE TREATMENT OF HEMORRHOIDS AND RELATED DISEASES
A61K 36/63 (2006.01)	2473178 *	COMPOSITION FOR THE TREATMENT OF HEMORRHOIDS AND RELATED DISEASES
A61K 36/33 (2006.01)	2473178 *	COMPOSITION FOR THE TREATMENT OF HEMORRHOIDS AND RELATED DISEASES

MKP (51)	Broj objave evropske prijava patenta (97)	Naziv pronalaska (54)
A61K 31/496 (2006.01)	2477626 *	ROLE OF N-2 HYDROXY-ETHYL-PIPERAZINE-N'-2-ETHANE SULFONIC ACID (HEPES) IN PAIN CONTROL AND REVERSAL OF DEMYELINIZATION INJURY
A61K 31/495 (2006.01)	2477626 *	ROLE OF N-2 HYDROXY-ETHYL-PIPERAZINE-N'-2-ETHANE SULFONIC ACID (HEPES) IN PAIN CONTROL AND REVERSAL OF DEMYELINIZATION INJURY
A61P 25/24 (2006.01)	2477626 *	ROLE OF N-2 HYDROXY-ETHYL-PIPERAZINE-N'-2-ETHANE SULFONIC ACID (HEPES) IN PAIN CONTROL AND REVERSAL OF DEMYELINIZATION INJURY
A61P 25/30 (2006.01)	2477626 *	ROLE OF N-2 HYDROXY-ETHYL-PIPERAZINE-N'-2-ETHANE SULFONIC ACID (HEPES) IN PAIN CONTROL AND REVERSAL OF DEMYELINIZATION INJURY
A61K 31/4965 (2006.01)	2477626 *	ROLE OF N-2 HYDROXY-ETHYL-PIPERAZINE-N'-2-ETHANE SULFONIC ACID (HEPES) IN PAIN CONTROL AND REVERSAL OF DEMYELINIZATION INJURY
A23L 2/02 (2006.01)	2448424 *	PRODUCTION OF ACID SOLUBLE SOY PROTEIN ISOLATES ("S800")
A23J 3/16 (2006.01)	2448424 *	PRODUCTION OF ACID SOLUBLE SOY PROTEIN ISOLATES ("S800")
A23J 1/14 (2006.01)	2448424 *	PRODUCTION OF ACID SOLUBLE SOY PROTEIN ISOLATES ("S800")
B01J 37/04 (2006.01)	2349531 *	TRANSITION-METAL VANADATE OR MIXED TRANSITION-METAL / RARE EARTH VANADATE BASED CATALYST COMPOSITION FOR SELECTIVE CATALYTIC REDUCTION OF EXHAUST GASES
B01J 37/08 (2006.01)	2349531 *	TRANSITION-METAL VANADATE OR MIXED TRANSITION-METAL / RARE EARTH VANADATE BASED CATALYST COMPOSITION FOR SELECTIVE CATALYTIC REDUCTION OF EXHAUST GASES
B01J 37/03 (2006.01)	2349531 *	TRANSITION-METAL VANADATE OR MIXED TRANSITION-METAL / RARE EARTH VANADATE BASED CATALYST COMPOSITION FOR SELECTIVE CATALYTIC REDUCTION OF EXHAUST GASES
B01D 53/00 (2006.01)	2349531 *	TRANSITION-METAL VANADATE OR MIXED TRANSITION-METAL / RARE EARTH VANADATE BASED CATALYST COMPOSITION FOR SELECTIVE CATALYTIC REDUCTION OF EXHAUST GASES
B01J 21/06 (2006.01)	2349531 *	TRANSITION-METAL VANADATE OR MIXED TRANSITION-METAL / RARE EARTH VANADATE BASED CATALYST COMPOSITION FOR SELECTIVE CATALYTIC REDUCTION OF EXHAUST GASES
B01J 23/00 (2006.01)	2349531 *	TRANSITION-METAL VANADATE OR MIXED TRANSITION-METAL / RARE EARTH VANADATE BASED CATALYST COMPOSITION FOR SELECTIVE CATALYTIC REDUCTION OF EXHAUST GASES
B01J 23/847 (2006.01)	2349531 *	TRANSITION-METAL VANADATE OR MIXED TRANSITION-METAL / RARE EARTH VANADATE BASED CATALYST COMPOSITION FOR SELECTIVE CATALYTIC REDUCTION OF EXHAUST GASES
B01J 35/04 (2006.01)	2349531 *	TRANSITION-METAL VANADATE OR MIXED TRANSITION-METAL / RARE EARTH VANADATE BASED CATALYST COMPOSITION FOR SELECTIVE CATALYTIC REDUCTION OF EXHAUST GASES
F21S 11/00 (2006.01)	2452119 *	TUBULAR SKYLIGHT
F21S 19/00 (2006.01)	2452119 *	TUBULAR SKYLIGHT
C07D 239/47 (2006.01)	2473486 *	NOVEL PYRIMIDINE AND TRIAZINE HEPICIDINE ANTAGONISTS
C07D 251/18 (2006.01)	2473486 *	NOVEL PYRIMIDINE AND TRIAZINE HEPICIDINE ANTAGONISTS
C07D 251/66 (2006.01)	2473486 *	NOVEL PYRIMIDINE AND TRIAZINE HEPICIDINE ANTAGONISTS
C07D 401/04 (2006.01)	2473486 *	NOVEL PYRIMIDINE AND TRIAZINE HEPICIDINE ANTAGONISTS
C07D 401/14 (2006.01)	2473486 *	NOVEL PYRIMIDINE AND TRIAZINE HEPICIDINE ANTAGONISTS
C07D 403/04 (2006.01)	2473486 *	NOVEL PYRIMIDINE AND TRIAZINE HEPICIDINE ANTAGONISTS
A61K 31/53 (2006.01)	2473486 *	NOVEL PYRIMIDINE AND TRIAZINE HEPICIDINE ANTAGONISTS
A61K 31/506 (2006.01)	2473486 *	NOVEL PYRIMIDINE AND TRIAZINE HEPICIDINE ANTAGONISTS
A61K 31/5377 (2006.01)	2473486 *	NOVEL PYRIMIDINE AND TRIAZINE HEPICIDINE ANTAGONISTS
A61P 7/06 (2006.01)	2473486 *	NOVEL PYRIMIDINE AND TRIAZINE HEPICIDINE ANTAGONISTS
H04W 28/00 (2009.01)	2485525 *	METHOD AND DEVICE FOR PERFORMING SPACE COORDINATION AMONG CELLS
H04W 16/28 (2009.01)	2485525 *	METHOD AND DEVICE FOR PERFORMING SPACE COORDINATION AMONG CELLS

MKP (51)	Broj objave evropske prijava patenta (97)	Naziv pronalaska (54)
A61P 43/00 (2006.01)	2419097 *	PHARMACEUTICAL COMPOSITIONS
A61K 31/155 (2006.01)	2419097 *	PHARMACEUTICAL COMPOSITIONS
A61P 13/12 (2006.01)	2419097 *	PHARMACEUTICAL COMPOSITIONS
A61K 31/4439 (2006.01)	2419097 *	PHARMACEUTICAL COMPOSITIONS
A61P 25/00 (2006.01)	2419097 *	PHARMACEUTICAL COMPOSITIONS
A61K 31/64 (2006.01)	2419097 *	PHARMACEUTICAL COMPOSITIONS
A61P 27/02 (2006.01)	2419097 *	PHARMACEUTICAL COMPOSITIONS
A61K 45/00 (2006.01)	2419097 *	PHARMACEUTICAL COMPOSITIONS
A61P 3/10 (2006.01)	2419097 *	PHARMACEUTICAL COMPOSITIONS
C07D 335/02 (2006.01)	2419097 *	PHARMACEUTICAL COMPOSITIONS
A61P 5/50 (2006.01)	2419097 *	PHARMACEUTICAL COMPOSITIONS
A61P 9/10 (2006.01)	2419097 *	PHARMACEUTICAL COMPOSITIONS
A61K 31/382 (2006.01)	2419097 *	PHARMACEUTICAL COMPOSITIONS
A61P 9/14 (2006.01)	2419097 *	PHARMACEUTICAL COMPOSITIONS
C09D 11/00 (2006.01)	2305761	Ink jet ink
A61M 5/315 (2006.01)	2482882 *	DRIVE MECHANISM FOR A DRUG DELIVERY DEVICE AND RESILIENT ELEMENT FOR A DRIVE MECHANISM
C07D 487/04 (2006.01)	2488524 *	PYRROLO[2,3-D]PYRIMIDINE COMPOUNDS
A61K 31/519 (2006.01)	2488524 *	PYRROLO[2,3-D]PYRIMIDINE COMPOUNDS
A61P 37/00 (2006.01)	2488524 *	PYRROLO[2,3-D]PYRIMIDINE COMPOUNDS
C07D 491/22 (2006.01)	2399919	(S)-4, 11-diethyl-3, 14-dioxo-3, 4, 12, 14-tetrahydro-1H-pyrano [3', 4':6, 7] indolizino [1.2-b]quinoline-4, 9-diyl bis([1, 4'-bipiperidine]-carboxylate and its use
G01N 33/50 (2006.01)	2433125 *	METHOD FOR DETERMINING THE CARDIO-GENERATIVE POTENTIAL OF MAMMALIAN CELLS
A61F 5/56 (2006.01)	2493435 *	FLUID FILLED IMPLANTS FOR TREATING OBSTRUCTIVE SLEEP APNEA
C07K 1/18 (2006.01)	2414380 *	METHOD FOR PURIFYING RECOMBINANT FSH
C07K 1/20 (2006.01)	2414380 *	METHOD FOR PURIFYING RECOMBINANT FSH
C07K 14/59 (2006.01)	2414380 *	METHOD FOR PURIFYING RECOMBINANT FSH
A61P 9/10 (2006.01)	2475681 *	PLGF-1 IN HOMODIMERIC FORM
A61P 17/00 (2006.01)	2475681 *	PLGF-1 IN HOMODIMERIC FORM
C07K 14/515 (2006.01)	2475681 *	PLGF-1 IN HOMODIMERIC FORM
A61K 38/18 (2006.01)	2475681 *	PLGF-1 IN HOMODIMERIC FORM
C08G 69/26 (2006.01)	2476717 *	POLYAMIDE AND POLYAMIDE COMPOSITION
C08L 77/06 (2006.01)	2476717 *	POLYAMIDE AND POLYAMIDE COMPOSITION
C12Q 1/68 (2006.01)	2411533 *	GENETIC SEVERITY MARKERS IN MULTIPLE SCLEROSIS
C07D 401/12 (2006.01)	2426121 *	QUATERNARY AMMONIUM SALT COMPOUND
A61K 31/4709 (2006.01)	2426121 *	QUATERNARY AMMONIUM SALT COMPOUND
A61P 11/00 (2006.01)	2426121 *	QUATERNARY AMMONIUM SALT COMPOUND
A61P 11/06 (2006.01)	2426121 *	QUATERNARY AMMONIUM SALT COMPOUND
A61P 43/00 (2006.01)	2426121 *	QUATERNARY AMMONIUM SALT COMPOUND
C07D 491/18 (2006.01)	2426121 *	QUATERNARY AMMONIUM SALT COMPOUND
B23K 20/12 (2006.01)	2289659	Apparatus for frictionally connecting at least two plates through a connecting element with a system for measuring the applied load and the advancing length during connection
B29C 65/06 (2006.01)	2289659	Apparatus for frictionally connecting at least two plates through a connecting element with a system for measuring the applied load and the advancing length during connection
F16B 37/06 (2006.01)	2289659	Apparatus for frictionally connecting at least two plates through a connecting element with a system for measuring the applied load and the advancing length during connection
A23C 7/04 (2006.01)	2408311 *	WHEY OR RAW MILK DEMINERALISATION AND FRACTIONATION.
A23C 9/14 (2006.01)	2408311 *	WHEY OR RAW MILK DEMINERALISATION AND FRACTIONATION.

MKP (51)	Broj objave evropske prijava patenta (97)	Naziv pronalaska (54)
A23C 9/142 (2006.01)	2408311 *	WHEY OR RAW MILK DEMINERALISATION AND FRACTIONATION.
A23C 21/00 (2006.01)	2408311 *	WHEY OR RAW MILK DEMINERALISATION AND FRACTIONATION.
A23J 1/20 (2006.01)	2408311 *	WHEY OR RAW MILK DEMINERALISATION AND FRACTIONATION.
A23L 1/29 (2006.01)	2408311 *	WHEY OR RAW MILK DEMINERALISATION AND FRACTIONATION.
G01N 33/50 (2006.01)	2440924 *	IN VITRO METHOD FOR DETECTING GP91PHOX AS A MARKER OF OXIDATIVE STRESS
G01N 33/68 (2006.01)	2440924 *	IN VITRO METHOD FOR DETECTING GP91PHOX AS A MARKER OF OXIDATIVE STRESS
C11C 5/00 (2006.01)	2453002	Ear candle
A61F 11/00 (2006.01)	2453002	Ear candle
G01N 33/15 (2006.01)	2470911 *	GALECTIN-3 AND CARDIAC RESYNCHRONIZATION THERAPY
G01N 33/53 (2006.01)	2470911 *	GALECTIN-3 AND CARDIAC RESYNCHRONIZATION THERAPY
G01N 33/68 (2006.01)	2470911 *	GALECTIN-3 AND CARDIAC RESYNCHRONIZATION THERAPY
C12P 21/06 (2006.01)	2425008 *	TOLL-LIKE RECEPTOR 3 ANTAGONISTS
C07D 243/12 (2006.01)	2415766 *	METHOD FOR MANUFACTURING BENZODIAZEPINE DERIVATIVE
A61P 1/04 (2006.01)	2415766 *	METHOD FOR MANUFACTURING BENZODIAZEPINE DERIVATIVE
C07C 269/06 (2006.01)	2415766 *	METHOD FOR MANUFACTURING BENZODIAZEPINE DERIVATIVE
A61P 35/00 (2006.01)	2415766 *	METHOD FOR MANUFACTURING BENZODIAZEPINE DERIVATIVE
C07C 271/20 (2006.01)	2415766 *	METHOD FOR MANUFACTURING BENZODIAZEPINE DERIVATIVE
A61P 35/02 (2006.01)	2415766 *	METHOD FOR MANUFACTURING BENZODIAZEPINE DERIVATIVE
C07C 271/28 (2006.01)	2415766 *	METHOD FOR MANUFACTURING BENZODIAZEPINE DERIVATIVE
A61P 43/00 (2006.01)	2415766 *	METHOD FOR MANUFACTURING BENZODIAZEPINE DERIVATIVE
C07C 303/36 (2006.01)	2415766 *	METHOD FOR MANUFACTURING BENZODIAZEPINE DERIVATIVE
C07B 61/00 (2006.01)	2415766 *	METHOD FOR MANUFACTURING BENZODIAZEPINE DERIVATIVE
C07C 303/40 (2006.01)	2415766 *	METHOD FOR MANUFACTURING BENZODIAZEPINE DERIVATIVE
C07C 311/16 (2006.01)	2415766 *	METHOD FOR MANUFACTURING BENZODIAZEPINE DERIVATIVE
A61K 31/551 (2006.01)	2415766 *	METHOD FOR MANUFACTURING BENZODIAZEPINE DERIVATIVE
B01J 2/06 (2006.01)	2305372	Device and method for pelletising or granulating a fluid or paste material
A61F 5/56 (2006.01)	2493436 *	FLEXIBLE IMPLANTS HAVING INTERNAL VOLUME SHIFTING CAPABILITIES FOR TREATING OBSTRUCTIVE SLEEP APNEA
A61F 2/64 (2006.01)	2471496	Prosthetic knee used preferably for sports
C07D 413/04 (2006.01)	2417131 *	ISOXAZOL-3(2H)-ONE ANALOGS AS THERAPEUTIC AGENTS
A61K 31/4523 (2006.01)	2417131 *	ISOXAZOL-3(2H)-ONE ANALOGS AS THERAPEUTIC AGENTS
A61P 7/04 (2006.01)	2417131 *	ISOXAZOL-3(2H)-ONE ANALOGS AS THERAPEUTIC AGENTS
C09C 1/02 (2006.01)	2423265	Process for the preparation of cement, mortars, concrete compositions containing a calcium carbonate-based filler (pre)-treated with a superplasticizer, compositions and cement products obtained and their applications
C04B 14/28 (2006.01)	2423265	Process for the preparation of cement, mortars, concrete compositions containing a calcium carbonate-based filler (pre)-treated with a superplasticizer, compositions and cement products obtained and their applications
C04B 20/10 (2006.01)	2423265	Process for the preparation of cement, mortars, concrete compositions containing a calcium carbonate-based filler (pre)-treated with a superplasticizer, compositions and cement products obtained and their applications
C04B 28/02 (2006.01)	2423265	Process for the preparation of cement, mortars, concrete compositions containing a calcium carbonate-based filler (pre)-treated with a superplasticizer, compositions and cement products obtained and their applications
C12Q 1/68 (2006.01)	2430183 *	ANTIPSYCHOTIC TREATMENT BASED ON DRD2 OR ANKK1 SNP GENOTYPE
A61P 29/00 (2006.01)	2490766 *	NON-NATURAL MACROCYCLIC AMIDE HDAC6 INHIBITOR COMPOUNDS AND THEIR USES AS THERAPEUTIC AGENTS

MKP (51)	Broj objave evropske prijava patenta (97)	Naziv pronalaska (54)
A61P 35/00 (2006.01)	2490766 *	NON-NATURAL MACROCYCLIC AMIDE HDAC6 INHIBITOR COMPOUNDS AND THEIR USES AS THERAPEUTIC AGENTS
C07K 5/00 (2006.01)	2490766 *	NON-NATURAL MACROCYCLIC AMIDE HDAC6 INHIBITOR COMPOUNDS AND THEIR USES AS THERAPEUTIC AGENTS
A61K 38/00 (2006.01)	2490766 *	NON-NATURAL MACROCYCLIC AMIDE HDAC6 INHIBITOR COMPOUNDS AND THEIR USES AS THERAPEUTIC AGENTS
G06Q 30/00 (2006.01)	2323095	Mediation of content-related services
C07K 16/28 (2006.01)	2440579 *	ANTIBODIES
A61P 27/02 (2006.01)	2493480 *	OPHTHALMIC FORMULATION AND METHOD OF MANUFACTURE THEREOF
A61K 31/7076 (2006.01)	2493480 *	OPHTHALMIC FORMULATION AND METHOD OF MANUFACTURE THEREOF
C12Q 1/00 (2006.01)	2464741 *	METHODS OF DETECTING RESPONSES TO THERAPIES USING PERFORIN LEVELS
H04S 3/00 (2006.01)	2360683	Audio decoder and decoding method using efficient downmixing
G10L 19/00 (2006.01)	2360683	Audio decoder and decoding method using efficient downmixing
A61K 31/4412 (2006.01)	2412708 *	SUBSTITUTED 3-HYDROXY-4-PYRIDONE DERIVATIVE
A61K 31/497 (2006.01)	2412708 *	SUBSTITUTED 3-HYDROXY-4-PYRIDONE DERIVATIVE
C07D 401/04 (2006.01)	2412708 *	SUBSTITUTED 3-HYDROXY-4-PYRIDONE DERIVATIVE
A61K 31/443 (2006.01)	2412708 *	SUBSTITUTED 3-HYDROXY-4-PYRIDONE DERIVATIVE
A61K 31/506 (2006.01)	2412708 *	SUBSTITUTED 3-HYDROXY-4-PYRIDONE DERIVATIVE
C07D 401/06 (2006.01)	2412708 *	SUBSTITUTED 3-HYDROXY-4-PYRIDONE DERIVATIVE
A61K 31/4433 (2006.01)	2412708 *	SUBSTITUTED 3-HYDROXY-4-PYRIDONE DERIVATIVE
A61K 31/5377 (2006.01)	2412708 *	SUBSTITUTED 3-HYDROXY-4-PYRIDONE DERIVATIVE
C07D 401/10 (2006.01)	2412708 *	SUBSTITUTED 3-HYDROXY-4-PYRIDONE DERIVATIVE
A61K 31/4436 (2006.01)	2412708 *	SUBSTITUTED 3-HYDROXY-4-PYRIDONE DERIVATIVE
A61P 31/00 (2006.01)	2412708 *	SUBSTITUTED 3-HYDROXY-4-PYRIDONE DERIVATIVE
A61K 31/4439 (2006.01)	2412708 *	SUBSTITUTED 3-HYDROXY-4-PYRIDONE DERIVATIVE
A61P 31/16 (2006.01)	2412708 *	SUBSTITUTED 3-HYDROXY-4-PYRIDONE DERIVATIVE
A61K 31/444 (2006.01)	2412708 *	SUBSTITUTED 3-HYDROXY-4-PYRIDONE DERIVATIVE
A61P 31/18 (2006.01)	2412708 *	SUBSTITUTED 3-HYDROXY-4-PYRIDONE DERIVATIVE
A61K 31/4545 (2006.01)	2412708 *	SUBSTITUTED 3-HYDROXY-4-PYRIDONE DERIVATIVE
A61P 43/00 (2006.01)	2412708 *	SUBSTITUTED 3-HYDROXY-4-PYRIDONE DERIVATIVE
C07D 213/80 (2006.01)	2412708 *	SUBSTITUTED 3-HYDROXY-4-PYRIDONE DERIVATIVE
A61K 31/4709 (2006.01)	2412708 *	SUBSTITUTED 3-HYDROXY-4-PYRIDONE DERIVATIVE
C07D 213/89 (2006.01)	2412708 *	SUBSTITUTED 3-HYDROXY-4-PYRIDONE DERIVATIVE
C12N 9/82 (2006.01)	2451486 *	PEGYLATED L-ASPARAGINASE
A61P 35/02 (2006.01)	2451486 *	PEGYLATED L-ASPARAGINASE
A61K 47/48 (2006.01)	2451486 *	PEGYLATED L-ASPARAGINASE
B65F 1/06 (2006.01)	2354041	Refuse receptacle with means for fixing a trash bag
A61K 9/20 (2006.01)	2460523 *	TABLET
A61K 47/04 (2006.01)	2460523 *	TABLET
A61K 47/38 (2006.01)	2460523 *	TABLET
A61K 31/506 (2006.01)	2460523 *	TABLET
A61M 5/32 (2006.01)	2403570 *	DRUG DELIVERY DEVICE
H01F 41/02 (2006.01)	2372726	Rare-earth magnet, method of manufacturing rare-earth magnet and rotator
H01F 1/057 (2006.01)	2372726	Rare-earth magnet, method of manufacturing rare-earth magnet and rotator
C07H 17/02 (2006.01)	2470552 *	NOVEL CRYSTALLINE HETEROAROMATIC FLUOROGLYCOSIDE HYDRATES, PHARMACEUTICALS COMPRISING THESE COMPOUNDS AND THEIR USE
A61K 47/14 (2006.01)	2440188 *	SOLID COMPOSITIONS COMPRISING 5-AMINOLEVULINIC ACID

MKP (51)	Broj objave evropske prijava patenta (97)	Naziv pronalaska (54)
A61K 31/197 (2006.01)	2440188 *	SOLID COMPOSITIONS COMPRISING 5-AMINOLEVULINIC ACID
A61K 9/20 (2006.01)	2440188 *	SOLID COMPOSITIONS COMPRISING 5-AMINOLEVULINIC ACID
A61K 9/48 (2006.01)	2440188 *	SOLID COMPOSITIONS COMPRISING 5-AMINOLEVULINIC ACID
A61K 9/02 (2006.01)	2440188 *	SOLID COMPOSITIONS COMPRISING 5-AMINOLEVULINIC ACID
C07D 213/803 (2006.01)	2488497 *	PROCESS FOR MANUFACTURING 2-[(3,5-DIFLUORO-3'-METHOXY-1,1'-BIPHENYL-4-YL)AMINO]NICOTINIC ACID
C07C 211/45 (2006.01)	2488497 *	PROCESS FOR MANUFACTURING 2-[(3,5-DIFLUORO-3'-METHOXY-1,1'-BIPHENYL-4-YL)AMINO]NICOTINIC ACID
C07C 211/64 (2006.01)	2488497 *	PROCESS FOR MANUFACTURING 2-[(3,5-DIFLUORO-3'-METHOXY-1,1'-BIPHENYL-4-YL)AMINO]NICOTINIC ACID
C07D 213/80 (2006.01)	2488497 *	PROCESS FOR MANUFACTURING 2-[(3,5-DIFLUORO-3'-METHOXY-1,1'-BIPHENYL-4-YL)AMINO]NICOTINIC ACID
A61B 17/00 (2006.01)	2485661 *	SURGICAL INSTRUMENT
A61B 17/29 (2006.01)	2485661 *	SURGICAL INSTRUMENT
A61B 17/28 (2006.01)	2485661 *	SURGICAL INSTRUMENT
A61B 18/08 (2006.01)	2485661 *	SURGICAL INSTRUMENT
A61B 18/00 (2006.01)	2485661 *	SURGICAL INSTRUMENT
C07K 16/18 (2006.01)	2403874 *	ANTIBODY FORMULATION
C07K 16/00 (2006.01)	2403874 *	ANTIBODY FORMULATION
A23J 1/14 (2006.01)	2448423 *	PRODUCTION OF ACID SOLUBLE SOY PROTEIN ISOLATES ("S700")
A23J 3/16 (2006.01)	2448423 *	PRODUCTION OF ACID SOLUBLE SOY PROTEIN ISOLATES ("S700")
A23L 2/02 (2006.01)	2448423 *	PRODUCTION OF ACID SOLUBLE SOY PROTEIN ISOLATES ("S700")
G01N 33/577 (2006.01)	2499494 *	REAGENTS AND METHODS FOR DETECTING PNH TYPE II WHITE BLOOD CELLS AND THEIR IDENTIFICATION AS RISK FACTORS FOR THROMBOTIC DISORDERS
G01N 33/50 (2006.01)	2499494 *	REAGENTS AND METHODS FOR DETECTING PNH TYPE II WHITE BLOOD CELLS AND THEIR IDENTIFICATION AS RISK FACTORS FOR THROMBOTIC DISORDERS
G01N 33/68 (2006.01)	2499494 *	REAGENTS AND METHODS FOR DETECTING PNH TYPE II WHITE BLOOD CELLS AND THEIR IDENTIFICATION AS RISK FACTORS FOR THROMBOTIC DISORDERS
G01N 33/53 (2006.01)	2499494 *	REAGENTS AND METHODS FOR DETECTING PNH TYPE II WHITE BLOOD CELLS AND THEIR IDENTIFICATION AS RISK FACTORS FOR THROMBOTIC DISORDERS
C12P 21/06 (2006.01)	2451840 *	DESIGN OF STABLE AND AGGREGATION FREE ANTIBODY FC MOLECULES THROUGH CH3 DOMAIN INTERFACE ENGINEERING
C07K 16/00 (2006.01)	2451840 *	DESIGN OF STABLE AND AGGREGATION FREE ANTIBODY FC MOLECULES THROUGH CH3 DOMAIN INTERFACE ENGINEERING
A61K 39/12 (2006.01)	2445525 *	NOVEL HUMAN PAPILLOMAVIRUS (HPV) PROTEIN CONSTRUCTS AND THEIR USE IN THE PREVENTION OF HPV DISEASE
C07K 14/025 (2006.01)	2445525 *	NOVEL HUMAN PAPILLOMAVIRUS (HPV) PROTEIN CONSTRUCTS AND THEIR USE IN THE PREVENTION OF HPV DISEASE
A61K 31/519 (2006.01)	2405916 *	COMBINATIONS OF PHOSPHOINOSITIDE 3-KINASE INHIBITOR COMPOUNDS AND CHEMOTHERAPEUTIC AGENTS FOR THE TREATMENT OF HEMATOPOIETIC MALIGNANCIES
A61P 35/00 (2006.01)	2405916 *	COMBINATIONS OF PHOSPHOINOSITIDE 3-KINASE INHIBITOR COMPOUNDS AND CHEMOTHERAPEUTIC AGENTS FOR THE TREATMENT OF HEMATOPOIETIC MALIGNANCIES
E02B 3/20 (2006.01)	2454417 *	DEVICE FOR PROTECTING A BERTHING PLACE
G06T 17/00 (2006.01)	2417580 *	SYSTEM FOR DRAPING METEOROLOGICAL DATA ON A THREE DIMENSIONAL TERRAIN IMAGE
G01S 13/95 (2006.01)	2417580 *	SYSTEM FOR DRAPING METEOROLOGICAL DATA ON A THREE DIMENSIONAL TERRAIN IMAGE
G06F 3/14 (2006.01)	2417580 *	SYSTEM FOR DRAPING METEOROLOGICAL DATA ON A THREE DIMENSIONAL TERRAIN IMAGE

MKP (51)	Broj objave evropske prijave patenta (97)	Naziv pronalaska (54)
A61K 9/12 (2006.01)	2435024 *	COMPOSITIONS FOR RESPIRATORY DELIVERY OF ACTIVE AGENTS AND ASSOCIATED METHODS AND SYSTEMS
A61P 11/00 (2006.01)	2435024 *	COMPOSITIONS FOR RESPIRATORY DELIVERY OF ACTIVE AGENTS AND ASSOCIATED METHODS AND SYSTEMS
C07D 519/00 (2006.01)	2430031 *	1,2,4-TRIAZOLO[4,3-A]PYRIDINE DERIVATIVES AND THEIR USE AS POSITIVE ALLOSTERIC MODULATORS OF MGLUR2 RECEPTORS
C07D 471/04 (2006.01)	2430031 *	1,2,4-TRIAZOLO[4,3-A]PYRIDINE DERIVATIVES AND THEIR USE AS POSITIVE ALLOSTERIC MODULATORS OF MGLUR2 RECEPTORS
A61K 31/437 (2006.01)	2430031 *	1,2,4-TRIAZOLO[4,3-A]PYRIDINE DERIVATIVES AND THEIR USE AS POSITIVE ALLOSTERIC MODULATORS OF MGLUR2 RECEPTORS
A61P 25/00 (2006.01)	2430031 *	1,2,4-TRIAZOLO[4,3-A]PYRIDINE DERIVATIVES AND THEIR USE AS POSITIVE ALLOSTERIC MODULATORS OF MGLUR2 RECEPTORS
C12N 5/0783 (2010.01)	2470566 *	COMPOSITIONS AND METHODS FOR POTENTIATING INTERLEUKIN-35
A61K 39/395 (2006.01)	2470566 *	COMPOSITIONS AND METHODS FOR POTENTIATING INTERLEUKIN-35
C07K 16/24 (2006.01)	2470566 *	COMPOSITIONS AND METHODS FOR POTENTIATING INTERLEUKIN-35
G07F 11/54 (2006.01)	2478499 *	METHOD AND SYSTEM OF DISPLAYING, MANAGING AND SELLING IMAGES IN AN EVENT PHOTOGRAPHY ENVIRONMENT
H01R 13/24 (2006.01)	2237378	Contact device
H01R 13/33 (2006.01)	2237378	Contact device
H01R 43/16 (2006.01)	2237378	Contact device
H01R 12/04 (2006.01)	2237378	Contact device
H01R 12/22 (2006.01)	2237378	Contact device
C07C 51/41 (2006.01)	2371800	Processes for producing monoammonium succinate from fermentation broths containing diammonium succinate, monoammonium succinate and/or succinic acid, and conversion of monoammonium succinate to succinic acid
C07C 51/02 (2006.01)	2371800	Processes for producing monoammonium succinate from fermentation broths containing diammonium succinate, monoammonium succinate and/or succinic acid, and conversion of monoammonium succinate to succinic acid
C07C 51/46 (2006.01)	2371800	Processes for producing monoammonium succinate from fermentation broths containing diammonium succinate, monoammonium succinate and/or succinic acid, and conversion of monoammonium succinate to succinic acid
C07C 55/10 (2006.01)	2371800	Processes for producing monoammonium succinate from fermentation broths containing diammonium succinate, monoammonium succinate and/or succinic acid, and conversion of monoammonium succinate to succinic acid
C07C 51/44 (2006.01)	2371800	Processes for producing monoammonium succinate from fermentation broths containing diammonium succinate, monoammonium succinate and/or succinic acid, and conversion of monoammonium succinate to succinic acid
A61K 31/4166 (2006.01)	2429522 *	METHOD OF DECREASING UBIQUITYLATED PROTEIN LEVELS
C07C 327/48 (2006.01)	2441752 *	METHOD FOR PRODUCING 4-SUBSTITUTED BENZOTHIOAMIDE DERIVATIVE
A61K 31/5377 (2006.01)	2414338 *	SALTS AND HYDRATES OF 4-[(3-CHLOR-4-FLUORO-PHENYL)AMINO]-6-(CIS-4-{N-[(MORPH-1-OLINO-4-YL)CARBONYL]-N-METHYL-AMINO}-CYCLOHEXANE-1-YLOXY)-7-METHOXY-QUINAZOLINE, THEIR USE AS DRUGS AND THEIR PRODUCTION
A61P 11/00 (2006.01)	2414338 *	SALTS AND HYDRATES OF 4-[(3-CHLOR-4-FLUORO-PHENYL)AMINO]-6-(CIS-4-{N-[(MORPH-1-OLINO-4-YL)CARBONYL]-N-METHYL-AMINO}-CYCLOHEXANE-1-YLOXY)-7-METHOXY-QUINAZOLINE, THEIR USE AS DRUGS AND THEIR PRODUCTION
A61P 35/00 (2006.01)	2414338 *	SALTS AND HYDRATES OF 4-[(3-CHLOR-4-FLUORO-PHENYL)AMINO]-6-(CIS-4-{N-[(MORPH-1-OLINO-4-YL)CARBONYL]-N-METHYL-AMINO}-CYCLOHEXANE-1-YLOXY)-7-METHOXY-QUINAZOLINE, THEIR USE AS DRUGS AND THEIR PRODUCTION
C07D 239/94 (2006.01)	2414338 *	SALTS AND HYDRATES OF 4-[(3-CHLOR-4-FLUORO-PHENYL)AMINO]-6-(CIS-4-{N-[(MORPH-1-OLINO-4-YL)CARBONYL]-N-METHYL-AMINO}-CYCLOHEXANE-1-YLOXY)-7-METHOXY-QUINAZOLINE, THEIR USE AS DRUGS AND THEIR PRODUCTION
G01N 33/52 (2006.01)	2459752 *	ENTEROCOCCUS AND FECAL BACTEROIDES FOR RAPID WATER QUALITY ASSESSMENT

MKP (51)	Broj objave evropske prijava patenta (97)	Naziv pronalaska (54)
C12N 15/11 (2006.01)	2459752 *	ENTEROCOCCUS AND FECAL BACTEROIDES FOR RAPID WATER QUALITY ASSESSMENT
C12Q 1/68 (2006.01)	2459752 *	ENTEROCOCCUS AND FECAL BACTEROIDES FOR RAPID WATER QUALITY ASSESSMENT
A61B 5/11 (2006.01)	2451352 *	METHOD FOR ACCURATE ASSESSMENT AND GRADED TRAINING OF SENSORIMOTOR FUNCTIONS
A61K 31/407 (2006.01)	2470540 *	NOVEL FORMS OF A MULTICYCLIC COMPOUND
A61P 25/28 (2006.01)	2470540 *	NOVEL FORMS OF A MULTICYCLIC COMPOUND
C07D 487/04 (2006.01)	2470540 *	NOVEL FORMS OF A MULTICYCLIC COMPOUND
B01J 2/18 (2006.01)	2473266 *	METHOD AND APPARATUS FOR PREPARING MICRO-PARTICLES OF POLYSACCHARIDES
A61K 9/16 (2006.01)	2473266 *	METHOD AND APPARATUS FOR PREPARING MICRO-PARTICLES OF POLYSACCHARIDES
B01J 2/04 (2006.01)	2473266 *	METHOD AND APPARATUS FOR PREPARING MICRO-PARTICLES OF POLYSACCHARIDES
A61K 31/663 (2006.01)	2403859 *	MOLECULAR TWEEZERS FOR THE TREATMENT OF AMYLOID-RELATED DISEASES
A61P 25/00 (2006.01)	2403859 *	MOLECULAR TWEEZERS FOR THE TREATMENT OF AMYLOID-RELATED DISEASES
A61K 31/661 (2006.01)	2403859 *	MOLECULAR TWEEZERS FOR THE TREATMENT OF AMYLOID-RELATED DISEASES
C07F 9/12 (2006.01)	2403859 *	MOLECULAR TWEEZERS FOR THE TREATMENT OF AMYLOID-RELATED DISEASES
C07F 9/40 (2006.01)	2403859 *	MOLECULAR TWEEZERS FOR THE TREATMENT OF AMYLOID-RELATED DISEASES
B23K 37/00 (2006.01)	2338636	Anti-blinding device having wireless communication function
B23K 9/32 (2006.01)	2338636	Anti-blinding device having wireless communication function
A42B 3/04 (2006.01)	2338636	Anti-blinding device having wireless communication function
A42B 3/22 (2006.01)	2338636	Anti-blinding device having wireless communication function
A61F 9/06 (2006.01)	2338636	Anti-blinding device having wireless communication function
F16P 1/06 (2006.01)	2338636	Anti-blinding device having wireless communication function
G10K 11/18 (2006.01)	2338636	Anti-blinding device having wireless communication function
C07D 493/22 (2006.01)	2473512 *	PHOTOCHEMICAL PROCESS FOR PRODUCING ARTEMISININ
C07C 69/96 (2006.01)	2473512 *	PHOTOCHEMICAL PROCESS FOR PRODUCING ARTEMISININ
A61M 5/32 (2006.01)	2488237 *	PALM ACTIVATED DRUG DELIVERY DEVICE
F23K 3/02 (2006.01)	2486327 *	METERING SYSTEM, DENSE PHASE CONVEYING SYSTEM AND METHOD FOR SUPPLYING BULK MATERIAL IN POWDER FORM
F24J 2/04 (2006.01)	2419679 *	Moulded insulating collector
F24J 2/52 (2006.01)	2419679 *	Moulded insulating collector
F24J 2/46 (2006.01)	2419679 *	Moulded insulating collector
F24J 2/51 (2006.01)	2419679 *	Moulded insulating collector
A61K 31/56 (2006.01)	2419108 *	METHOD FOR ON-DEMAND CONTRACEPTION
A61K 31/57 (2006.01)	2419108 *	METHOD FOR ON-DEMAND CONTRACEPTION
A61K 9/20 (2006.01)	2419108 *	METHOD FOR ON-DEMAND CONTRACEPTION
C07D 209/46 (2006.01)	2443089 *	DEUTERATED I SOINDOLINE- I, 3-DIONE DERIVATIVES AS PDE4 AND TNF-ALPHA INHIBITORS
C07D 209/48 (2006.01)	2443089 *	DEUTERATED I SOINDOLINE- I, 3-DIONE DERIVATIVES AS PDE4 AND TNF-ALPHA INHIBITORS
C07D 405/12 (2006.01)	2443089 *	DEUTERATED I SOINDOLINE- I, 3-DIONE DERIVATIVES AS PDE4 AND TNF-ALPHA INHIBITORS
A61K 31/4035 (2006.01)	2443089 *	DEUTERATED I SOINDOLINE- I, 3-DIONE DERIVATIVES AS PDE4 AND TNF-ALPHA INHIBITORS
A61P 17/06 (2006.01)	2443089 *	DEUTERATED I SOINDOLINE- I, 3-DIONE DERIVATIVES AS PDE4 AND TNF-ALPHA INHIBITORS

MKP (51)	Broj objave evropske prijava patenta (97)	Naziv pronalaska (54)
A61G 12/00 (2006.01)	2368535	People monitoring system
G06F 19/00 (2011.01)	2482810 *	DOSAGE REGIMEN OF AN S1P RECEPTOR MODULATOR
A61K 31/137 (2006.01)	2482810 *	DOSAGE REGIMEN OF AN S1P RECEPTOR MODULATOR
A61P 37/06 (2006.01)	2482810 *	DOSAGE REGIMEN OF AN S1P RECEPTOR MODULATOR
A61P 11/06 (2006.01)	2482810 *	DOSAGE REGIMEN OF AN S1P RECEPTOR MODULATOR
C07K 14/34 (2006.01)	2486047 *	EXPRESSION SYSTEM
C09K 17/32 (2006.01)	2496663 *	RESIN SYSTEM WITH CARBON ADDITIVE
C09K 17/14 (2006.01)	2496663 *	RESIN SYSTEM WITH CARBON ADDITIVE
A47K 5/12 (2006.01)	2322066	Method and dispenser for releasing portions of a fluid
A61K 31/40 (2006.01)	2411005 *	METHODS FOR PREVENTING MAJOR ADVERSE CARDIOVASCULAR EVENTS WITH DPP-IV INHIBITORS
A61K 31/4985 (2006.01)	2411005 *	METHODS FOR PREVENTING MAJOR ADVERSE CARDIOVASCULAR EVENTS WITH DPP-IV INHIBITORS
A61P 9/00 (2006.01)	2411005 *	METHODS FOR PREVENTING MAJOR ADVERSE CARDIOVASCULAR EVENTS WITH DPP-IV INHIBITORS
A61P 3/00 (2006.01)	2411005 *	METHODS FOR PREVENTING MAJOR ADVERSE CARDIOVASCULAR EVENTS WITH DPP-IV INHIBITORS
A61K 31/472 (2006.01)	2439202 *	INHIBITOR COMPOUNDS OF 11-BETA-HYDROXYSTEROID DEHYDROGENASE TYPE 1
C07D 295/104 (2006.01)	2439202 *	INHIBITOR COMPOUNDS OF 11-BETA-HYDROXYSTEROID DEHYDROGENASE TYPE 1
A61K 31/4709 (2006.01)	2439202 *	INHIBITOR COMPOUNDS OF 11-BETA-HYDROXYSTEROID DEHYDROGENASE TYPE 1
C12N 9/64 (2006.01)	2245150 *	PROTEASE FOR WOUND CONDITIONING AND SKIN CARE
C07K 16/40 (2006.01)	2245150 *	PROTEASE FOR WOUND CONDITIONING AND SKIN CARE
A61K 38/43 (2006.01)	2245150 *	PROTEASE FOR WOUND CONDITIONING AND SKIN CARE
C12N 15/62 (2006.01)	2245150 *	PROTEASE FOR WOUND CONDITIONING AND SKIN CARE
C12N 5/10 (2006.01)	2245150 *	PROTEASE FOR WOUND CONDITIONING AND SKIN CARE
A61K 9/10 (2006.01)	2459220 *	BIODEGRADABLE POLYETHYLENE GLYCOL BASED WATER-INSOLUBLE HYDROGELS
A61K 9/50 (2006.01)	2459220 *	BIODEGRADABLE POLYETHYLENE GLYCOL BASED WATER-INSOLUBLE HYDROGELS
A61K 47/10 (2006.01)	2459220 *	BIODEGRADABLE POLYETHYLENE GLYCOL BASED WATER-INSOLUBLE HYDROGELS
A61K 9/16 (2006.01)	2459220 *	BIODEGRADABLE POLYETHYLENE GLYCOL BASED WATER-INSOLUBLE HYDROGELS
A61K 9/28 (2006.01)	2459220 *	BIODEGRADABLE POLYETHYLENE GLYCOL BASED WATER-INSOLUBLE HYDROGELS
A23L 1/16 (2006.01)	2418966 *	WHOLEGRAIN INSTANT PASTA
A23L 1/39 (2006.01)	2418966 *	WHOLEGRAIN INSTANT PASTA
A23L 1/162 (2006.01)	2418966 *	WHOLEGRAIN INSTANT PASTA
A23L 1/00 (2006.01)	2418966 *	WHOLEGRAIN INSTANT PASTA
A61M 5/32 (2006.01)	2403568 *	NEEDLE UNIT
A61K 31/4706 (2006.01)	2493573 *	USE OF FERROQUINE IN THE TREATMENT OR PREVENTION OF MALARIA
A61K 33/26 (2006.01)	2493573 *	USE OF FERROQUINE IN THE TREATMENT OR PREVENTION OF MALARIA
A61P 33/06 (2006.01)	2493573 *	USE OF FERROQUINE IN THE TREATMENT OR PREVENTION OF MALARIA
F01N 3/20 (2006.01)	2388452	Reagent dosing device
A61K 31/4745 (2006.01)	2421864 *	1-PYRAZOLO[4,3-C]ISOQUINOLINE DERIVATIVES, PREPARATION THEREOF AND THERAPEUTIC USE THEREOF
C07D 471/04 (2006.01)	2421864 *	1-PYRAZOLO[4,3-C]ISOQUINOLINE DERIVATIVES, PREPARATION THEREOF AND THERAPEUTIC USE THEREOF

MKP (51)	Broj objave evropske prijava patenta (97)	Naziv pronalaska (54)
A61P 35/00 (2006.01)	2421864 *	1-PYRAZOLO[4,3-C]ISOQUINOLINE DERIVATIVES, PREPARATION THEREOF AND THERAPEUTIC USE THEREOF
A61K 9/00 (2006.01)	2424538 *	USE OF ALLOPURINOL FOR THE TREATMENT OF HAND FOOT SKIN REACTION
A61P 17/02 (2006.01)	2424538 *	USE OF ALLOPURINOL FOR THE TREATMENT OF HAND FOOT SKIN REACTION
A61K 31/52 (2006.01)	2424538 *	USE OF ALLOPURINOL FOR THE TREATMENT OF HAND FOOT SKIN REACTION
A61K 31/519 (2006.01)	2424538 *	USE OF ALLOPURINOL FOR THE TREATMENT OF HAND FOOT SKIN REACTION
G01S 15/96 (2006.01)	2454607 *	DOWNSCAN IMAGING SONAR
G01S 15/89 (2006.01)	2454607 *	DOWNSCAN IMAGING SONAR
A61K 38/26 (2006.01)	2498801 *	PHARMACEUTICAL COMPOSITION COMPRISING A GLP-1 AGONIST AND METHIONINE
A61P 3/10 (2006.01)	2498801 *	PHARMACEUTICAL COMPOSITION COMPRISING A GLP-1 AGONIST AND METHIONINE
A61K 47/18 (2006.01)	2498801 *	PHARMACEUTICAL COMPOSITION COMPRISING A GLP-1 AGONIST AND METHIONINE
G06F 19/00 (2011.01)	2449492 *	ANALYTE TESTING METHOD AND SYSTEM
C07C 51/44 (2006.01)	2371797	Processes for the production of tetrahydrofuran, gamma-butyrolactone and/or butanediol from salts of succinic acid
C07D 307/08 (2006.01)	2371797	Processes for the production of tetrahydrofuran, gamma-butyrolactone and/or butanediol from salts of succinic acid
C07D 307/33 (2006.01)	2371797	Processes for the production of tetrahydrofuran, gamma-butyrolactone and/or butanediol from salts of succinic acid
C07C 51/41 (2006.01)	2371797	Processes for the production of tetrahydrofuran, gamma-butyrolactone and/or butanediol from salts of succinic acid
C07C 29/136 (2006.01)	2371797	Processes for the production of tetrahydrofuran, gamma-butyrolactone and/or butanediol from salts of succinic acid
C07C 51/02 (2006.01)	2371797	Processes for the production of tetrahydrofuran, gamma-butyrolactone and/or butanediol from salts of succinic acid
A61P 11/00 (2006.01)	2470536 *	METHYLPYRROLOPYRIMIDINECARBOXAMIDES
C07D 487/04 (2006.01)	2470536 *	METHYLPYRROLOPYRIMIDINECARBOXAMIDES
A61K 31/519 (2006.01)	2470536 *	METHYLPYRROLOPYRIMIDINECARBOXAMIDES
C09C 1/02 (2006.01)	2496648 *	PRECIPITATED MAGNESIUM CARBONATE
C01F 5/24 (2006.01)	2496648 *	PRECIPITATED MAGNESIUM CARBONATE
C07D 417/12 (2006.01)	2421851 *	AZETIDINYL DIAMIDES AS MONOACYLGLYCEROL LIPASE INHIBITORS
C07D 409/12 (2006.01)	2421851 *	AZETIDINYL DIAMIDES AS MONOACYLGLYCEROL LIPASE INHIBITORS
C07D 495/04 (2006.01)	2421851 *	AZETIDINYL DIAMIDES AS MONOACYLGLYCEROL LIPASE INHIBITORS
C07D 403/14 (2006.01)	2421851 *	AZETIDINYL DIAMIDES AS MONOACYLGLYCEROL LIPASE INHIBITORS
C07D 417/14 (2006.01)	2421851 *	AZETIDINYL DIAMIDES AS MONOACYLGLYCEROL LIPASE INHIBITORS
A61K 31/496 (2006.01)	2421851 *	AZETIDINYL DIAMIDES AS MONOACYLGLYCEROL LIPASE INHIBITORS
C07D 403/12 (2006.01)	2421851 *	AZETIDINYL DIAMIDES AS MONOACYLGLYCEROL LIPASE INHIBITORS
A61P 29/00 (2006.01)	2421851 *	AZETIDINYL DIAMIDES AS MONOACYLGLYCEROL LIPASE INHIBITORS
C07D 401/12 (2006.01)	2421851 *	AZETIDINYL DIAMIDES AS MONOACYLGLYCEROL LIPASE INHIBITORS
A61P 25/00 (2006.01)	2421851 *	AZETIDINYL DIAMIDES AS MONOACYLGLYCEROL LIPASE INHIBITORS
A61P 35/00 (2006.01)	2483279 *	NEW MAYTANSINOIDS AND THE USE OF SAID MAYTANSINOIDS TO PREPARE CONJUGATES WITH AN ANTIBODY
C07K 16/46 (2006.01)	2483279 *	NEW MAYTANSINOIDS AND THE USE OF SAID MAYTANSINOIDS TO PREPARE CONJUGATES WITH AN ANTIBODY
C07K 16/30 (2006.01)	2483279 *	NEW MAYTANSINOIDS AND THE USE OF SAID MAYTANSINOIDS TO PREPARE CONJUGATES WITH AN ANTIBODY
A61K 31/537 (2006.01)	2483279 *	NEW MAYTANSINOIDS AND THE USE OF SAID MAYTANSINOIDS TO PREPARE CONJUGATES WITH AN ANTIBODY

MKP (51)	Broj objave evropske prijava patenta (97)	Naziv pronalaska (54)
C12P 21/08 (2006.01)	2483279 *	NEW MAYTANSINOIDS AND THE USE OF SAID MAYTANSINOIDS TO PREPARE CONJUGATES WITH AN ANTIBODY
C07D 498/18 (2006.01)	2483279 *	NEW MAYTANSINOIDS AND THE USE OF SAID MAYTANSINOIDS TO PREPARE CONJUGATES WITH AN ANTIBODY
A61M 5/32 (2006.01)	2424598 *	NEEDLE REMOVER AND METHOD FOR REMOVING A NEEDLE
A61M 5/178 (2006.01)	2437805 *	A DRIVE MECHANISM FOR A DRUG DELIVERY DEVICE
A61M 5/315 (2006.01)	2437805 *	A DRIVE MECHANISM FOR A DRUG DELIVERY DEVICE
A61M 5/315 (2006.01)	2485791 *	DRIVE MECHANISM FOR DRUG DELIVERY DEVICES
A61M 5/24 (2006.01)	2485791 *	DRIVE MECHANISM FOR DRUG DELIVERY DEVICES
C07D 401/08 (2006.01)	2419418 *	4-AZETIDINYL-1-HETEROATOM LINKED-CYCLOHEXANE ANTAGONISTS OF CCR2
A61P 29/00 (2006.01)	2419418 *	4-AZETIDINYL-1-HETEROATOM LINKED-CYCLOHEXANE ANTAGONISTS OF CCR2
C07D 403/08 (2006.01)	2419418 *	4-AZETIDINYL-1-HETEROATOM LINKED-CYCLOHEXANE ANTAGONISTS OF CCR2
C07D 405/08 (2006.01)	2419418 *	4-AZETIDINYL-1-HETEROATOM LINKED-CYCLOHEXANE ANTAGONISTS OF CCR2
C07D 413/08 (2006.01)	2419418 *	4-AZETIDINYL-1-HETEROATOM LINKED-CYCLOHEXANE ANTAGONISTS OF CCR2
C07D 417/08 (2006.01)	2419418 *	4-AZETIDINYL-1-HETEROATOM LINKED-CYCLOHEXANE ANTAGONISTS OF CCR2
A61K 31/4427 (2006.01)	2419418 *	4-AZETIDINYL-1-HETEROATOM LINKED-CYCLOHEXANE ANTAGONISTS OF CCR2
A61K 31/437 (2006.01)	2419418 *	4-AZETIDINYL-1-HETEROATOM LINKED-CYCLOHEXANE ANTAGONISTS OF CCR2
A61K 31/433 (2006.01)	2419418 *	4-AZETIDINYL-1-HETEROATOM LINKED-CYCLOHEXANE ANTAGONISTS OF CCR2
A61P 3/10 (2006.01)	2419418 *	4-AZETIDINYL-1-HETEROATOM LINKED-CYCLOHEXANE ANTAGONISTS OF CCR2
A61K 9/00 (2006.01)	2442789 *	STABLE NANOPARTICULATE DRUG SUSPENSION
A61K 31/5377 (2006.01)	2442789 *	STABLE NANOPARTICULATE DRUG SUSPENSION
A61K 47/02 (2006.01)	2442789 *	STABLE NANOPARTICULATE DRUG SUSPENSION
A61K 9/10 (2006.01)	2442789 *	STABLE NANOPARTICULATE DRUG SUSPENSION
E05C 19/00 (2006.01)	2400090	An anti-intrusion device for doors and windows in general
C07K 16/30 (2006.01)	2407487	Multispecific modular antibody
C07K 16/32 (2006.01)	2407487	Multispecific modular antibody
F28D 21/00 (2006.01)	2409105 *	TUBE FOR CONVEYING EXHAUST GASES IN HEAT EXCHANGE DEVICES, PARTICULARLY BOILERS FOR GENERATING HOT WATER OR STEAM
F28F 1/40 (2006.01)	2409105 *	TUBE FOR CONVEYING EXHAUST GASES IN HEAT EXCHANGE DEVICES, PARTICULARLY BOILERS FOR GENERATING HOT WATER OR STEAM
F28F 21/08 (2006.01)	2409105 *	TUBE FOR CONVEYING EXHAUST GASES IN HEAT EXCHANGE DEVICES, PARTICULARLY BOILERS FOR GENERATING HOT WATER OR STEAM
G08B 21/00 (2006.01)	2460937 *	Highway protection barrier
E01F 9/017 (2006.01)	2460937 *	Highway protection barrier
H04L 5/00 (2006.01)	2273715	Multipath data streaming over a wireless network
H04N 7/24 (2011.01)	2273715	Multipath data streaming over a wireless network
A61M 5/315 (2006.01)	2437828 *	DRUG DELIVERY DEVICE INNER HOUSING HAVING HELICAL SPLINE
B29C 67/20 (2006.01)	2366532	Apparatus and method for production of insulating and draining boards
B29C 44/56 (2006.01)	2366532	Apparatus and method for production of insulating and draining boards
B29C 44/30 (2006.01)	2366532	Apparatus and method for production of insulating and draining boards
B29C 44/34 (2006.01)	2366532	Apparatus and method for production of insulating and draining boards
C07K 14/20 (2006.01)	2470908 *	PROTEINS USED FOR THE DIAGNOSIS OF LYME BORRELIOSIS
G01N 33/569 (2006.01)	2470908 *	PROTEINS USED FOR THE DIAGNOSIS OF LYME BORRELIOSIS

MKP (51)	Broj objave evropske prijava patenta (97)	Naziv pronalaska (54)
A61K 31/351 (2006.01)	2427445 *	SUBSTITUTED 1-CYANOETHYLHETEROCYCLYL CARBOXAMIDE COMPOUNDS 750
A61P 11/00 (2006.01)	2427445 *	SUBSTITUTED 1-CYANOETHYLHETEROCYCLYL CARBOXAMIDE COMPOUNDS 750
C07D 309/14 (2006.01)	2427445 *	SUBSTITUTED 1-CYANOETHYLHETEROCYCLYL CARBOXAMIDE COMPOUNDS 750
F16K 25/00 (2006.01)	2430344 *	HIGH-PRESSURE HOMOGENISATION WITH A SILICON NITRIDE VALVE
H04W 72/00 (2009.01)	2413649	Wireless communication method and system with collision avoidance protocol
A61P 31/04 (2006.01)	2457575	New method for obtaining a Lactobacillus reuteri strain useful in medical and veterinary prophylaxis and treatment
C12R 1/225 (2006.01)	2457575	New method for obtaining a Lactobacillus reuteri strain useful in medical and veterinary prophylaxis and treatment
A61K 35/74 (2006.01)	2457575	New method for obtaining a Lactobacillus reuteri strain useful in medical and veterinary prophylaxis and treatment
A23L 1/30 (2006.01)	2457575	New method for obtaining a Lactobacillus reuteri strain useful in medical and veterinary prophylaxis and treatment
A61M 5/315 (2006.01)	2424597 *	AXIALLY ADJUSTABLE CONNECTION OF PISTON ROD TO PISTON FOR DRIVE MECHANISM OF A DRUG DELIVERY DEVICE
E05F 3/10 (2006.01)	2456941 *	DOOR CLOSER
B31C 3/00 (2006.01)	2461967 *	FIBROUS SHEET THAT DISINTEGRATES IN WATER, PROCESS FOR MANUFACTURING SAID FIBROUS SHEET, CORE CONSISTING OF STRIPS OF SAID FIBROUS SHEET
D21H 17/28 (2006.01)	2461967 *	FIBROUS SHEET THAT DISINTEGRATES IN WATER, PROCESS FOR MANUFACTURING SAID FIBROUS SHEET, CORE CONSISTING OF STRIPS OF SAID FIBROUS SHEET
D21H 17/29 (2006.01)	2461967 *	FIBROUS SHEET THAT DISINTEGRATES IN WATER, PROCESS FOR MANUFACTURING SAID FIBROUS SHEET, CORE CONSISTING OF STRIPS OF SAID FIBROUS SHEET
D21H 19/54 (2006.01)	2461967 *	FIBROUS SHEET THAT DISINTEGRATES IN WATER, PROCESS FOR MANUFACTURING SAID FIBROUS SHEET, CORE CONSISTING OF STRIPS OF SAID FIBROUS SHEET
D21H 25/04 (2006.01)	2461967 *	FIBROUS SHEET THAT DISINTEGRATES IN WATER, PROCESS FOR MANUFACTURING SAID FIBROUS SHEET, CORE CONSISTING OF STRIPS OF SAID FIBROUS SHEET
D21H 27/00 (2006.01)	2461967 *	FIBROUS SHEET THAT DISINTEGRATES IN WATER, PROCESS FOR MANUFACTURING SAID FIBROUS SHEET, CORE CONSISTING OF STRIPS OF SAID FIBROUS SHEET
A23L 1/236 (2006.01)	2432332 *	SUCRALOSE-CONTAINING ARTIFICIAL SWEETENER COMPOSITIONS
A23L 1/00 (2006.01)	2432332 *	SUCRALOSE-CONTAINING ARTIFICIAL SWEETENER COMPOSITIONS
A23G 3/44 (2006.01)	2432332 *	SUCRALOSE-CONTAINING ARTIFICIAL SWEETENER COMPOSITIONS
A23G 3/42 (2006.01)	2432332 *	SUCRALOSE-CONTAINING ARTIFICIAL SWEETENER COMPOSITIONS
A01N 47/36 (2006.01)	2498604 *	SYNERGISTIC HERBICIDAL COMPOSITION CONTAINING AMINOPYRALID AND SULFONYLUREAS
A01N 39/04 (2006.01)	2498604 *	SYNERGISTIC HERBICIDAL COMPOSITION CONTAINING AMINOPYRALID AND SULFONYLUREAS
A01N 43/40 (2006.01)	2498604 *	SYNERGISTIC HERBICIDAL COMPOSITION CONTAINING AMINOPYRALID AND SULFONYLUREAS
A61K 47/48 (2006.01)	2403537 *	INTERFERON ALPHA CARRIER PRODRUGS
C09C 3/10 (2006.01)	2445973 *	PROCESS FOR MANUFACTURING A SURFACE-TREATED COMPACTED MATERIAL PROCESSABLE ON A SINGLE SCREW PLASTICS CONVERSION EQUIPMENT
B29B 9/12 (2006.01)	2445973 *	PROCESS FOR MANUFACTURING A SURFACE-TREATED COMPACTED MATERIAL PROCESSABLE ON A SINGLE SCREW PLASTICS CONVERSION EQUIPMENT
C09C 1/02 (2006.01)	2445973 *	PROCESS FOR MANUFACTURING A SURFACE-TREATED COMPACTED MATERIAL PROCESSABLE ON A SINGLE SCREW PLASTICS CONVERSION EQUIPMENT

MKP (51)	Broj objave evropske prijava patenta (97)	Naziv pronalaska (54)
C08K 9/00 (2006.01)	2445973 *	PROCESS FOR MANUFACTURING A SURFACE-TREATED COMPACTED MATERIAL PROCESSABLE ON A SINGLE SCREW PLASTICS CONVERSION EQUIPMENT
A61M 5/24 (2006.01)	2437811 *	RESETTABLE DRUG DELIVERY DEVICE
A01N 37/12 (2006.01)	2405749 *	LOW FREQUENCY GLATIRAMER ACETATE THERAPY
A01N 37/44 (2006.01)	2405749 *	LOW FREQUENCY GLATIRAMER ACETATE THERAPY
A61K 31/195 (2006.01)	2405749 *	LOW FREQUENCY GLATIRAMER ACETATE THERAPY
A61K 31/722 (2006.01)	2477633 *	"DIETARY SUPPLEMENT STIMULATING THE MALE SEXUAL FUNCTION"
A23L 1/30 (2006.01)	2477633 *	"DIETARY SUPPLEMENT STIMULATING THE MALE SEXUAL FUNCTION"
A61K 36/185 (2006.01)	2477633 *	"DIETARY SUPPLEMENT STIMULATING THE MALE SEXUAL FUNCTION"
A61K 36/06 (2006.01)	2477633 *	"DIETARY SUPPLEMENT STIMULATING THE MALE SEXUAL FUNCTION"
A61K 36/234 (2006.01)	2477633 *	"DIETARY SUPPLEMENT STIMULATING THE MALE SEXUAL FUNCTION"
A61P 15/10 (2006.01)	2477633 *	"DIETARY SUPPLEMENT STIMULATING THE MALE SEXUAL FUNCTION"
A23L 1/29 (2006.01)	2477633 *	"DIETARY SUPPLEMENT STIMULATING THE MALE SEXUAL FUNCTION"
C12N 5/0783 (2010.01)	2470644 *	GENERATION OF CTL LINES WITH SPECIFICITY AGAINST MULTIPLE TUMOR ANTIGENS OR MULTIPLE VIRUSES
C14C 15/00 (2006.01)	2481821	Process and device for treating leather
C14B 3/00 (2006.01)	2481821	Process and device for treating leather
A61K 45/06 (2006.01)	2404600	Use of the combination of a sinus current If inhibitor and an inhibitor of the angiotensin conversion enzyme for treating cardiac insufficiency
A61P 9/04 (2006.01)	2404600	Use of the combination of a sinus current If inhibitor and an inhibitor of the angiotensin conversion enzyme for treating cardiac insufficiency
A61K 31/55 (2006.01)	2404600	Use of the combination of a sinus current If inhibitor and an inhibitor of the angiotensin conversion enzyme for treating cardiac insufficiency
A61K 31/4045 (2006.01)	2404600	Use of the combination of a sinus current If inhibitor and an inhibitor of the angiotensin conversion enzyme for treating cardiac insufficiency
A61C 8/00 (2006.01)	2407121	Abutment system
C10G 45/72 (2006.01)	2497816 *	METHOD FOR HYDROFINING NAPHTHA FRACTION AND PROCESS FOR PRODUCING HYDROCARBON OIL
C10G 45/02 (2006.01)	2497816 *	METHOD FOR HYDROFINING NAPHTHA FRACTION AND PROCESS FOR PRODUCING HYDROCARBON OIL
G01L 9/00 (2006.01)	2462418 *	CAPACITIVE PRESSURE SENSOR INCORPORATING A TEMPERATURE MEASUREMENT AND COMPATIBLE WITH HOT ENVIRONMENTS
G01L 9/12 (2006.01)	2462418 *	CAPACITIVE PRESSURE SENSOR INCORPORATING A TEMPERATURE MEASUREMENT AND COMPATIBLE WITH HOT ENVIRONMENTS
G01L 9/04 (2006.01)	2462418 *	CAPACITIVE PRESSURE SENSOR INCORPORATING A TEMPERATURE MEASUREMENT AND COMPATIBLE WITH HOT ENVIRONMENTS
G01B 7/02 (2006.01)	2462418 *	CAPACITIVE PRESSURE SENSOR INCORPORATING A TEMPERATURE MEASUREMENT AND COMPATIBLE WITH HOT ENVIRONMENTS
A61K 9/00 (2006.01)	2477603 *	STABLE CO-FORMULATION OF HYALURONIDASE AND IMMUNOGLOBULIN, AND METHODS OF USE THEREOF
A61K 47/36 (2006.01)	2477603 *	STABLE CO-FORMULATION OF HYALURONIDASE AND IMMUNOGLOBULIN, AND METHODS OF USE THEREOF
A61K 47/42 (2006.01)	2477603 *	STABLE CO-FORMULATION OF HYALURONIDASE AND IMMUNOGLOBULIN, AND METHODS OF USE THEREOF
A61K 39/00 (2006.01)	2477603 *	STABLE CO-FORMULATION OF HYALURONIDASE AND IMMUNOGLOBULIN, AND METHODS OF USE THEREOF
A61K 39/395 (2006.01)	2477603 *	STABLE CO-FORMULATION OF HYALURONIDASE AND IMMUNOGLOBULIN, AND METHODS OF USE THEREOF
C07K 16/00 (2006.01)	2477603 *	STABLE CO-FORMULATION OF HYALURONIDASE AND IMMUNOGLOBULIN, AND METHODS OF USE THEREOF
C07K 16/06 (2006.01)	2477603 *	STABLE CO-FORMULATION OF HYALURONIDASE AND IMMUNOGLOBULIN, AND METHODS OF USE THEREOF
C12N 9/24 (2006.01)	2477603 *	STABLE CO-FORMULATION OF HYALURONIDASE AND IMMUNOGLOBULIN, AND METHODS OF USE THEREOF

MKP (51)	Broj objave evropske prijava patenta (97)	Naziv pronalaska (54)
A61K 31/5517 (2006.01)	2419106 *	BENZODIAZEPINE DERIVATIVE FOR THE TREATMENT OF HEMATOPOIETIC NEOPLASM AND LEUKEMIA
A61P 35/02 (2006.01)	2419106 *	BENZODIAZEPINE DERIVATIVE FOR THE TREATMENT OF HEMATOPOIETIC NEOPLASM AND LEUKEMIA
C07D 401/12 (2006.01)	2403834 *	Fungicidal pyrazoles
C07D 401/14 (2006.01)	2403834 *	Fungicidal pyrazoles
C07D 401/04 (2006.01)	2403834 *	Fungicidal pyrazoles
C07D 403/12 (2006.01)	2403834 *	Fungicidal pyrazoles
C07D 407/12 (2006.01)	2403834 *	Fungicidal pyrazoles
C07D 231/12 (2006.01)	2403834 *	Fungicidal pyrazoles
C07D 409/04 (2006.01)	2403834 *	Fungicidal pyrazoles
C07D 231/20 (2006.01)	2403834 *	Fungicidal pyrazoles
C07D 417/12 (2006.01)	2403834 *	Fungicidal pyrazoles
C07D 231/38 (2006.01)	2403834 *	Fungicidal pyrazoles
A61K 31/4155 (2006.01)	2403834 *	Fungicidal pyrazoles
G07C 9/00 (2006.01)	2336982	Mobile device
E05B 19/04 (2006.01)	2336982	Mobile device
H01H 13/06 (2006.01)	2336982	Mobile device
B60R 25/00 (2006.01)	2336982	Mobile device
E05B 47/06 (2006.01)	2336982	Mobile device
A61P 17/00 (2006.01)	2417104 *	SULPHURATED DERIVATIVES OF RESORCINOL, PREPARATION OF SAME AND COSMETIC USES THEREOF
A01N 31/16 (2006.01)	2417104 *	SULPHURATED DERIVATIVES OF RESORCINOL, PREPARATION OF SAME AND COSMETIC USES THEREOF
C07C 317/22 (2006.01)	2417104 *	SULPHURATED DERIVATIVES OF RESORCINOL, PREPARATION OF SAME AND COSMETIC USES THEREOF
A01N 39/00 (2006.01)	2417104 *	SULPHURATED DERIVATIVES OF RESORCINOL, PREPARATION OF SAME AND COSMETIC USES THEREOF
C07C 323/20 (2006.01)	2417104 *	SULPHURATED DERIVATIVES OF RESORCINOL, PREPARATION OF SAME AND COSMETIC USES THEREOF
A01N 41/10 (2006.01)	2417104 *	SULPHURATED DERIVATIVES OF RESORCINOL, PREPARATION OF SAME AND COSMETIC USES THEREOF
A61K 8/46 (2006.01)	2417104 *	SULPHURATED DERIVATIVES OF RESORCINOL, PREPARATION OF SAME AND COSMETIC USES THEREOF
A01P 1/00 (2006.01)	2417104 *	SULPHURATED DERIVATIVES OF RESORCINOL, PREPARATION OF SAME AND COSMETIC USES THEREOF
A61Q 5/08 (2006.01)	2417104 *	SULPHURATED DERIVATIVES OF RESORCINOL, PREPARATION OF SAME AND COSMETIC USES THEREOF
A61Q 19/02 (2006.01)	2417104 *	SULPHURATED DERIVATIVES OF RESORCINOL, PREPARATION OF SAME AND COSMETIC USES THEREOF
A61Q 19/08 (2006.01)	2417104 *	SULPHURATED DERIVATIVES OF RESORCINOL, PREPARATION OF SAME AND COSMETIC USES THEREOF
C12Q 1/48 (2006.01)	2446050 *	TEST SYSTEM FOR MEASURING MEST ACTIVITY AS WELL AS METHODS AND USES INVOLVING THE SAME
C12N 9/10 (2006.01)	2446050 *	TEST SYSTEM FOR MEASURING MEST ACTIVITY AS WELL AS METHODS AND USES INVOLVING THE SAME
C12Q 1/37 (2006.01)	2473855 *	USE OF CATHEPSIN H
G01N 33/573 (2006.01)	2473855 *	USE OF CATHEPSIN H
G01N 33/68 (2006.01)	2473855 *	USE OF CATHEPSIN H
G07F 17/32 (2006.01)	2413297	Method for limiting the number of coin-operated entertainment machines a player can use.
C07D 409/10 (2006.01)	2488515 *	PROCESS FOR THE PREPARATION OF COMPOUNDS USEFUL AS INHIBITORS OF SGLT2

MKP (51)	Broj objave evropske prijava patenta (97)	Naziv pronalaska (54)
C07D 409/14 (2006.01)	2488515 *	PROCESS FOR THE PREPARATION OF COMPOUNDS USEFUL AS INHIBITORS OF SGLT2
C07F 3/06 (2006.01)	2488515 *	PROCESS FOR THE PREPARATION OF COMPOUNDS USEFUL AS INHIBITORS OF SGLT2
G01N 33/53 (2006.01)	2419732 *	PRION-FREE NANOPARTICLE COMPOSITIONS AND METHODS
A61C 8/00 (2006.01)	2407120	Implant system
A61K 39/395 (2006.01)	2493924 *	DUAL VARIABLE DOMAIN IMMUNOGLOBULINS AND USES THEREOF
C07K 16/00 (2006.01)	2493924 *	DUAL VARIABLE DOMAIN IMMUNOGLOBULINS AND USES THEREOF
A61K 35/56 (2006.01)	2435055 *	METHODS OF USING KRILL OIL TO TREAT RISK FACTORS FOR METABOLIC DISORDERS AND OBESITY
A61K 38/16 (2006.01)	2483302 *	PARSTATIN PEPTIDES
C07K 14/705 (2006.01)	2483302 *	PARSTATIN PEPTIDES
C12N 5/071 (2010.01)	2483302 *	PARSTATIN PEPTIDES
C07D 295/135 (2006.01)	2430008 *	STABLE FORMS OF N-(2,6-DIMETHYL-4-MORPHOLIN-4-YL-PHENYL)-3,3-DIMETHYL-BUTYRAMIDE
A61F 2/84 (2006.01)	2493430 *	INTRALUMINAL DEVICE WITH IMPROVED FLEXIBILITY AND DURABILITY
A61F 2/90 (2006.01)	2493430 *	INTRALUMINAL DEVICE WITH IMPROVED FLEXIBILITY AND DURABILITY
A61F 2/00 (2006.01)	2493430 *	INTRALUMINAL DEVICE WITH IMPROVED FLEXIBILITY AND DURABILITY
C09C 1/02 (2006.01)	2390285	Process for the preparation of surface treated mineral filler products and uses of same
A61M 15/08 (2006.01)	2445560 *	NASAL INTERFACE DEVICE
C07D 413/12 (2006.01)	2470511 *	RAF INHIBITOR COMPOUNDS AND METHODS OF USE THEREOF
A61K 31/53 (2006.01)	2470511 *	RAF INHIBITOR COMPOUNDS AND METHODS OF USE THEREOF
A61P 35/00 (2006.01)	2470511 *	RAF INHIBITOR COMPOUNDS AND METHODS OF USE THEREOF
C07D 239/48 (2006.01)	2470511 *	RAF INHIBITOR COMPOUNDS AND METHODS OF USE THEREOF
C07K 14/18 (2006.01)	2456786 *	LENTIVIRAL VECTORS PSEUDOTYPED WITH A SINDBIS VIRUS ENVELOPE GLYCOPROTEIN
C12N 15/867 (2006.01)	2456786 *	LENTIVIRAL VECTORS PSEUDOTYPED WITH A SINDBIS VIRUS ENVELOPE GLYCOPROTEIN
A61K 47/36 (2006.01)	2415470 *	LIPOSOME COMPOSITION
A61K 31/357 (2006.01)	2415470 *	LIPOSOME COMPOSITION
A61K 9/127 (2006.01)	2415470 *	LIPOSOME COMPOSITION
A61K 47/02 (2006.01)	2415470 *	LIPOSOME COMPOSITION
A61K 47/18 (2006.01)	2415470 *	LIPOSOME COMPOSITION
A61K 47/24 (2006.01)	2415470 *	LIPOSOME COMPOSITION
A61K 47/28 (2006.01)	2415470 *	LIPOSOME COMPOSITION
A61K 47/34 (2006.01)	2415470 *	LIPOSOME COMPOSITION
A61F 5/01 (2006.01)	2301488	Immobilizing rail
C07H 21/04 (2006.01)	2421881 *	ENGINEERED DEMETER 5-METHYLCYTOSINE DNA GLYCOSYLASE WITH IMPROVED YIELD, STABILITY AND SOLUBILITY
C12Q 1/68 (2006.01)	2421881 *	ENGINEERED DEMETER 5-METHYLCYTOSINE DNA GLYCOSYLASE WITH IMPROVED YIELD, STABILITY AND SOLUBILITY
C12N 9/24 (2006.01)	2421881 *	ENGINEERED DEMETER 5-METHYLCYTOSINE DNA GLYCOSYLASE WITH IMPROVED YIELD, STABILITY AND SOLUBILITY
D05B 25/00 (2006.01)	2325363	Conveying device and sewing machine comprising said device
D05B 33/00 (2006.01)	2325363	Conveying device and sewing machine comprising said device
A61K 31/54 (2006.01)	2485736 *	IMINOTHIADIAZINE DIOXIDE COMPOUNDS AS BACE INHIBITORS, COMPOSITIONS, AND THEIR USE
E01B 3/34 (2006.01)	2488698 *	PRESTRESSED CONCRETE SLEEPER AND METHOD FOR TRANSPORTING AND INSTALLING A SWITCH HAVING PRESTRESSED CONCRETE SLEEPERS
E01B 7/22 (2006.01)	2488698 *	PRESTRESSED CONCRETE SLEEPER AND METHOD FOR TRANSPORTING AND INSTALLING A SWITCH HAVING PRESTRESSED CONCRETE SLEEPERS

MKP (51)	Broj objave evropske prijave patenta (97)	Naziv pronalaska (54)
B21F 27/10 (2006.01)	2485856 *	METHOD AND DEVICE FOR PRODUCING WELDED CONNECTIONS
B21F 27/20 (2006.01)	2485856 *	METHOD AND DEVICE FOR PRODUCING WELDED CONNECTIONS
E04C 5/04 (2006.01)	2485856 *	METHOD AND DEVICE FOR PRODUCING WELDED CONNECTIONS
B21F 23/00 (2006.01)	2485856 *	METHOD AND DEVICE FOR PRODUCING WELDED CONNECTIONS
B23K 11/00 (2006.01)	2485856 *	METHOD AND DEVICE FOR PRODUCING WELDED CONNECTIONS
C07C 309/73 (2006.01)	2477970 *	NOVEL METHOD FOR SYNTHESIZING IVABRADINE AND THE ADDITION SALTS THEREOF WITH A PHARMACEUTICALLY ACCEPTABLE ACID
C07D 223/16 (2006.01)	2477970 *	NOVEL METHOD FOR SYNTHESIZING IVABRADINE AND THE ADDITION SALTS THEREOF WITH A PHARMACEUTICALLY ACCEPTABLE ACID
C07C 309/66 (2006.01)	2477970 *	NOVEL METHOD FOR SYNTHESIZING IVABRADINE AND THE ADDITION SALTS THEREOF WITH A PHARMACEUTICALLY ACCEPTABLE ACID
A61K 31/558 (2006.01)	2493870 *	CHROMENONE DERIVATIVES WITH ANTI-TUMOUR ACTIVITY
A61K 31/5377 (2006.01)	2493870 *	CHROMENONE DERIVATIVES WITH ANTI-TUMOUR ACTIVITY
C07D 311/22 (2006.01)	2493870 *	CHROMENONE DERIVATIVES WITH ANTI-TUMOUR ACTIVITY
A61K 31/4412 (2006.01)	2441455	Methods of administering pirfenidone therapy
A61P 11/00 (2006.01)	2441455	Methods of administering pirfenidone therapy
A61K 31/135 (2006.01)	2441455	Methods of administering pirfenidone therapy
A61K 31/15 (2006.01)	2441455	Methods of administering pirfenidone therapy
A61K 31/44 (2006.01)	2441455	Methods of administering pirfenidone therapy
C12N 5/074 (2010.01)	2456863 *	PLURIPOTENT STEM CELLS OBTAINED FROM DENTAL PULP
C12N 5/077 (2010.01)	2456863 *	PLURIPOTENT STEM CELLS OBTAINED FROM DENTAL PULP
H05B 3/00 (2006.01)	2483046 *	ARRANGEMENT OF A COUNTER REFLECTOR DEVICE FOR USE IN HEATING AN OBJECT, INSTALLATION AND METHOD OF HEATING
B29C 49/64 (2006.01)	2483046 *	ARRANGEMENT OF A COUNTER REFLECTOR DEVICE FOR USE IN HEATING AN OBJECT, INSTALLATION AND METHOD OF HEATING
F21V 7/00 (2006.01)	2483046 *	ARRANGEMENT OF A COUNTER REFLECTOR DEVICE FOR USE IN HEATING AN OBJECT, INSTALLATION AND METHOD OF HEATING
B29B 13/02 (2006.01)	2483046 *	ARRANGEMENT OF A COUNTER REFLECTOR DEVICE FOR USE IN HEATING AN OBJECT, INSTALLATION AND METHOD OF HEATING
B29C 49/68 (2006.01)	2483046 *	ARRANGEMENT OF A COUNTER REFLECTOR DEVICE FOR USE IN HEATING AN OBJECT, INSTALLATION AND METHOD OF HEATING
C07D 213/80 (2006.01)	2412709 *	PROCESS FOR PRODUCING PYRONE AND PYRIDONE DERIVATIVES
C07D 309/32 (2006.01)	2412709 *	PROCESS FOR PRODUCING PYRONE AND PYRIDONE DERIVATIVES
C07D 405/06 (2006.01)	2412709 *	PROCESS FOR PRODUCING PYRONE AND PYRIDONE DERIVATIVES
F02B 67/06 (2006.01)	2446162 *	BALL RAMP CLUTCH
B60K 25/02 (2006.01)	2446162 *	BALL RAMP CLUTCH
F16D 13/42 (2006.01)	2446162 *	BALL RAMP CLUTCH
F16D 27/112 (2006.01)	2446162 *	BALL RAMP CLUTCH
F16D 15/00 (2006.01)	2446162 *	BALL RAMP CLUTCH
F04B 17/00 (2006.01)	2446162 *	BALL RAMP CLUTCH
C12N 9/50 (2006.01)	2480661 *	BACTERIAL HOST STRAIN
C12P 21/00 (2006.01)	2480661 *	BACTERIAL HOST STRAIN
A61K 38/10 (2006.01)	2404611 *	Peptide for the prophylactic or therapeutic treatment of skin tumours in initial stages
A61P 17/00 (2006.01)	2404611 *	Peptide for the prophylactic or therapeutic treatment of skin tumours in initial stages
B29C 65/02 (2006.01)	2275358	A process and plant for obtaining a container body particularly suitable for packaging food products
B29C 65/48 (2006.01)	2275358	A process and plant for obtaining a container body particularly suitable for packaging food products
B65D 43/16 (2006.01)	2275358	A process and plant for obtaining a container body particularly suitable for packaging food products

MKP (51)	Broj objave evropske prijava patenta (97)	Naziv pronalaska (54)
B29C 65/58 (2006.01)	2275358	A process and plant for obtaining a container body particularly suitable for packaging food products
B29C 65/78 (2006.01)	2275358	A process and plant for obtaining a container body particularly suitable for packaging food products
B29L 31/22 (2006.01)	2275358	A process and plant for obtaining a container body particularly suitable for packaging food products
B29C 65/08 (2006.01)	2275358	A process and plant for obtaining a container body particularly suitable for packaging food products
B29C 65/16 (2006.01)	2275358	A process and plant for obtaining a container body particularly suitable for packaging food products
A61K 33/14 (2006.01)	2411021 *	METHOD FOR SUPPRESSING OR PREVENTING FIBROUS ADHESION FORMATION USING A MULTICOMPONENT AQUEOUS OXYCHLORINE COMPOSITION PREPARED ON-SITE
A61P 41/00 (2006.01)	2411021 *	METHOD FOR SUPPRESSING OR PREVENTING FIBROUS ADHESION FORMATION USING A MULTICOMPONENT AQUEOUS OXYCHLORINE COMPOSITION PREPARED ON-SITE
A61K 33/40 (2006.01)	2411021 *	METHOD FOR SUPPRESSING OR PREVENTING FIBROUS ADHESION FORMATION USING A MULTICOMPONENT AQUEOUS OXYCHLORINE COMPOSITION PREPARED ON-SITE
A61K 33/20 (2006.01)	2411021 *	METHOD FOR SUPPRESSING OR PREVENTING FIBROUS ADHESION FORMATION USING A MULTICOMPONENT AQUEOUS OXYCHLORINE COMPOSITION PREPARED ON-SITE
A61K 31/702 (2006.01)	2411017 *	PARENTERAL PHARMACEUTICAL COMPOSITION FOR USE IN GENE THERAPY
A61K 48/00 (2006.01)	2411017 *	PARENTERAL PHARMACEUTICAL COMPOSITION FOR USE IN GENE THERAPY
A61K 9/00 (2006.01)	2411017 *	PARENTERAL PHARMACEUTICAL COMPOSITION FOR USE IN GENE THERAPY
C12N 15/88 (2006.01)	2411017 *	PARENTERAL PHARMACEUTICAL COMPOSITION FOR USE IN GENE THERAPY
D21C 9/00 (2006.01)	2414584 *	PROCESS FOR THE PRODUCTION OF NANO-FIBRILLAR CELLULOSE SUSPENSIONS
D21D 1/00 (2006.01)	2414584 *	PROCESS FOR THE PRODUCTION OF NANO-FIBRILLAR CELLULOSE SUSPENSIONS
D21H 11/00 (2006.01)	2414584 *	PROCESS FOR THE PRODUCTION OF NANO-FIBRILLAR CELLULOSE SUSPENSIONS
D21H 11/18 (2006.01)	2414584 *	PROCESS FOR THE PRODUCTION OF NANO-FIBRILLAR CELLULOSE SUSPENSIONS
D21B 1/16 (2006.01)	2414584 *	PROCESS FOR THE PRODUCTION OF NANO-FIBRILLAR CELLULOSE SUSPENSIONS
C07D 487/04 (2006.01)	2483274 *	ANTIMALARIAL AGENTS THAT ARE INHIBITORS OF DIHYDROOROTATE DEHYDROGENASE
A61K 31/519 (2006.01)	2483274 *	ANTIMALARIAL AGENTS THAT ARE INHIBITORS OF DIHYDROOROTATE DEHYDROGENASE
A61P 33/06 (2006.01)	2483274 *	ANTIMALARIAL AGENTS THAT ARE INHIBITORS OF DIHYDROOROTATE DEHYDROGENASE
A23L 1/307 (2006.01)	2429304 *	PRODUCT AND PROCESS FOR ITS PREPARATION
A23C 9/12 (2006.01)	2429304 *	PRODUCT AND PROCESS FOR ITS PREPARATION
A23C 9/156 (2006.01)	2429304 *	PRODUCT AND PROCESS FOR ITS PREPARATION
A23C 9/127 (2006.01)	2429304 *	PRODUCT AND PROCESS FOR ITS PREPARATION
A23L 1/29 (2006.01)	2429304 *	PRODUCT AND PROCESS FOR ITS PREPARATION
A61K 38/00 (2006.01)	2475375 *	PI3 KINASE INHIBITORS AND USES THEREOF
C07H 19/00 (2006.01)	2408794 *	ISOLATION AND PURIFICATION OF COMPONENTS OF WHEY
C12P 19/26 (2006.01)	2408794 *	ISOLATION AND PURIFICATION OF COMPONENTS OF WHEY
A23C 9/146 (2006.01)	2408794 *	ISOLATION AND PURIFICATION OF COMPONENTS OF WHEY
E04B 2/74 (2006.01)	2454422 *	PROFILED ELEMENT AND METHOD FOR PRODUCING A PROFILED ELEMENT

MKP (51)	Broj objave evropske prijava patenta (97)	Naziv pronalaska (54)
B29C 70/38 (2006.01)	2314445	A method for manufacturing a composite body and a composite body manufacturing arrangement
B29B 11/16 (2006.01)	2314445	A method for manufacturing a composite body and a composite body manufacturing arrangement
A61P 35/00 (2006.01)	2488552 *	USE OF IL-17 RECEPTOR A ANTIGEN BINDING PROTEINS
C07K 16/28 (2006.01)	2488552 *	USE OF IL-17 RECEPTOR A ANTIGEN BINDING PROTEINS
A61K 39/395 (2006.01)	2488552 *	USE OF IL-17 RECEPTOR A ANTIGEN BINDING PROTEINS
H01M 2/16 (2006.01)	2408043 *	LAMINATED SEPARATOR, POLYOLEFIN MICROPOROUS MEMBRANE, AND SEPARATOR FOR ELECTRICITY STORAGE DEVICE
B32B 27/32 (2006.01)	2408043 *	LAMINATED SEPARATOR, POLYOLEFIN MICROPOROUS MEMBRANE, AND SEPARATOR FOR ELECTRICITY STORAGE DEVICE
E21B 43/267 (2006.01)	2469020	Process of hydraulic fracturing to create a layered proppant pack structure alongside the faces of the fracture to prevent formation fines to damage fracture conductivity
B41M 5/50 (2006.01)	2392467	Substrate for ink-jet printing
B41M 5/00 (2006.01)	2392467	Substrate for ink-jet printing
B41M 5/52 (2006.01)	2392467	Substrate for ink-jet printing
B65D 73/00 (2006.01)	2289816	Unitized package and method of making same
B65D 75/58 (2006.01)	2289816	Unitized package and method of making same
A01P 13/02 (2006.01)	2493311 *	SYNERGISTIC HERBICIDAL COMPOSITION CONTAINING FLUROXYPYR AND PENOXSULAM, HALOSULFURON-METHYL, IMAZAMOX OR IMAZETHAPYR
A01N 43/54 (2006.01)	2493311 *	SYNERGISTIC HERBICIDAL COMPOSITION CONTAINING FLUROXYPYR AND PENOXSULAM, HALOSULFURON-METHYL, IMAZAMOX OR IMAZETHAPYR
A01N 43/40 (2006.01)	2493311 *	SYNERGISTIC HERBICIDAL COMPOSITION CONTAINING FLUROXYPYR AND PENOXSULAM, HALOSULFURON-METHYL, IMAZAMOX OR IMAZETHAPYR
A61K 31/519 (2006.01)	2451813 *	HETEROCYCLIC COMPOUNDS AS JAK RECEPTOR AND PROTEIN TYROSINE KINASE INHIBITORS
C07D 487/08 (2006.01)	2451813 *	HETEROCYCLIC COMPOUNDS AS JAK RECEPTOR AND PROTEIN TYROSINE KINASE INHIBITORS
A61P 25/00 (2006.01)	2451813 *	HETEROCYCLIC COMPOUNDS AS JAK RECEPTOR AND PROTEIN TYROSINE KINASE INHIBITORS
C07D 471/04 (2006.01)	2451813 *	HETEROCYCLIC COMPOUNDS AS JAK RECEPTOR AND PROTEIN TYROSINE KINASE INHIBITORS
A61P 35/00 (2006.01)	2451813 *	HETEROCYCLIC COMPOUNDS AS JAK RECEPTOR AND PROTEIN TYROSINE KINASE INHIBITORS
A61K 31/499 (2006.01)	2451813 *	HETEROCYCLIC COMPOUNDS AS JAK RECEPTOR AND PROTEIN TYROSINE KINASE INHIBITORS
A61P 17/00 (2006.01)	2451813 *	HETEROCYCLIC COMPOUNDS AS JAK RECEPTOR AND PROTEIN TYROSINE KINASE INHIBITORS
A61K 31/437 (2006.01)	2451813 *	HETEROCYCLIC COMPOUNDS AS JAK RECEPTOR AND PROTEIN TYROSINE KINASE INHIBITORS
A61P 37/00 (2006.01)	2451813 *	HETEROCYCLIC COMPOUNDS AS JAK RECEPTOR AND PROTEIN TYROSINE KINASE INHIBITORS
C07D 487/04 (2006.01)	2451813 *	HETEROCYCLIC COMPOUNDS AS JAK RECEPTOR AND PROTEIN TYROSINE KINASE INHIBITORS
A61P 27/00 (2006.01)	2451813 *	HETEROCYCLIC COMPOUNDS AS JAK RECEPTOR AND PROTEIN TYROSINE KINASE INHIBITORS
A61P 3/00 (2006.01)	2451813 *	HETEROCYCLIC COMPOUNDS AS JAK RECEPTOR AND PROTEIN TYROSINE KINASE INHIBITORS
C07C 209/16 (2006.01)	2448908 *	METHOD OF PREPARING NERAMEXANE
C07C 211/35 (2006.01)	2448908 *	METHOD OF PREPARING NERAMEXANE
C07C 209/62 (2006.01)	2448908 *	METHOD OF PREPARING NERAMEXANE
G06F 1/32 (2006.01)	2400369	A method for polling a universal integrated circuit card and an integrated circuit having an independent polling circuit

MKP (51)	Broj objave evropske prijava patenta (97)	Naziv pronalaska (54)
C07D 471/04 (2006.01)	2403852 *	3H-IMIDAZO [4, 5 -C]PYRIDINE- 6 -CARBOXAMIDES AS ANTI-INFLAMMATORY AGENTS
A61K 31/4188 (2006.01)	2403852 *	3H-IMIDAZO [4, 5 -C]PYRIDINE- 6 -CARBOXAMIDES AS ANTI-INFLAMMATORY AGENTS
A61P 11/00 (2006.01)	2403852 *	3H-IMIDAZO [4, 5 -C]PYRIDINE- 6 -CARBOXAMIDES AS ANTI-INFLAMMATORY AGENTS
A61P 29/00 (2006.01)	2403852 *	3H-IMIDAZO [4, 5 -C]PYRIDINE- 6 -CARBOXAMIDES AS ANTI-INFLAMMATORY AGENTS
A21C 9/04 (2006.01)	2332413	An apparatus for portioning and positioning solid portions of food products and a process therefor
A21C 9/08 (2006.01)	2332413	An apparatus for portioning and positioning solid portions of food products and a process therefor
F41B 11/02 (2006.01)	2476991	Retrofit magazin for a break-barrel air gun
F41B 11/22 (2006.01)	2476991	Retrofit magazin for a break-barrel air gun
E04F 15/18 (2006.01)	2417311 *	SYSTEMS AND METHODS FOR MODULAR FLOOR INSTALLATION
C10M 169/04 (2006.01)	2480643 *	LUBRICANT COMPOSITIONS
C04B 14/30 (2006.01)	2480316 *	LOW SHEAR MOUNTING MAT FOR POLLUTION CONTROL DEVICES
D04H 1/42 (2012.01)	2480316 *	LOW SHEAR MOUNTING MAT FOR POLLUTION CONTROL DEVICES
F01N 3/28 (2006.01)	2480316 *	LOW SHEAR MOUNTING MAT FOR POLLUTION CONTROL DEVICES
B01D 53/94 (2006.01)	2480316 *	LOW SHEAR MOUNTING MAT FOR POLLUTION CONTROL DEVICES
A61K 9/12 (2006.01)	2435023 *	COMPOSITON FOR PLUMONARY DELIVERY OF LONG-AGTING MUSCARINIC ANTAGONISTS AND LONG LONG-ACTING BETA 2 ADRENERGIC RECEPTOR AGONISTS AND ASSOCIATED METHODS AND SYSTEMS
A61P 11/00 (2006.01)	2435023 *	COMPOSITON FOR PLUMONARY DELIVERY OF LONG-AGTING MUSCARINIC ANTAGONISTS AND LONG LONG-ACTING BETA 2 ADRENERGIC RECEPTOR AGONISTS AND ASSOCIATED METHODS AND SYSTEMS
A61K 31/40 (2006.01)	2435023 *	COMPOSITON FOR PLUMONARY DELIVERY OF LONG-AGTING MUSCARINIC ANTAGONISTS AND LONG LONG-ACTING BETA 2 ADRENERGIC RECEPTOR AGONISTS AND ASSOCIATED METHODS AND SYSTEMS
A61K 9/00 (2006.01)	2435023 *	COMPOSITON FOR PLUMONARY DELIVERY OF LONG-AGTING MUSCARINIC ANTAGONISTS AND LONG LONG-ACTING BETA 2 ADRENERGIC RECEPTOR AGONISTS AND ASSOCIATED METHODS AND SYSTEMS
A47J 31/36 (2006.01)	2480490 *	BEVERAGE CARTRIDGE
B67D 1/00 (2006.01)	2480490 *	BEVERAGE CARTRIDGE
B62D 25/08 (2006.01)	2301825	Front end module for a motor vehicle
A61K 38/17 (2006.01)	2467153 *	USE OF MIMOTOPES OF ALPHA-SYNUCLEIN EPITOPES FOR TREATING LEWY BODY DISEASES
A61K 39/00 (2006.01)	2467153 *	USE OF MIMOTOPES OF ALPHA-SYNUCLEIN EPITOPES FOR TREATING LEWY BODY DISEASES
C07K 7/06 (2006.01)	2467153 *	USE OF MIMOTOPES OF ALPHA-SYNUCLEIN EPITOPES FOR TREATING LEWY BODY DISEASES
A61P 25/16 (2006.01)	2467153 *	USE OF MIMOTOPES OF ALPHA-SYNUCLEIN EPITOPES FOR TREATING LEWY BODY DISEASES
A61P 25/28 (2006.01)	2467153 *	USE OF MIMOTOPES OF ALPHA-SYNUCLEIN EPITOPES FOR TREATING LEWY BODY DISEASES
A61P 3/10 (2006.01)	2454251 *	GPR119 AGONISTS
A61K 31/4427 (2006.01)	2454251 *	GPR119 AGONISTS
C07D 401/12 (2006.01)	2454251 *	GPR119 AGONISTS
C07D 401/14 (2006.01)	2454251 *	GPR119 AGONISTS
B66F 9/12 (2006.01)	2477931 *	A LINKAGE SYSTEM FOR A FORKLIFT TRUCK
A61P 29/00 (2006.01)	2482850 *	TOPICAL FORMULATIONS
A61K 47/16 (2006.01)	2482850 *	TOPICAL FORMULATIONS

MKP (51)	Broj objave evropske prijava patenta (97)	Naziv pronalaska (54)
A61K 31/444 (2006.01)	2482850 *	TOPICAL FORMULATIONS
A61K 47/10 (2006.01)	2482850 *	TOPICAL FORMULATIONS
A61K 47/38 (2006.01)	2482850 *	TOPICAL FORMULATIONS
G01N 33/564 (2006.01)	2473851 *	USE OF AN IMMUNOREGULATORY NK CELL POPULATION FOR MONITORING THE EFFICACY OF ANTI-IL-2R ANTIBODIES IN MULTIPLE SCLEROSIS PATIENTS
D04H 13/00 (2006.01)	2480710 *	MULTI-LAYER HIGH MOISTURE BARRIER POLYLACTIC ACID FILM
B32B 3/26 (2006.01)	2480710 *	MULTI-LAYER HIGH MOISTURE BARRIER POLYLACTIC ACID FILM
G05B 23/02 (2006.01)	2290488	A method and a system for adjusting alarm level of a component in a wind turbine
C02F 1/04 (2006.01)	2475442 *	MULTIPLE-EFFECT EVAPORATOR
B01D 1/28 (2006.01)	2475442 *	MULTIPLE-EFFECT EVAPORATOR
B01D 1/26 (2006.01)	2475442 *	MULTIPLE-EFFECT EVAPORATOR
B01D 1/30 (2006.01)	2475442 *	MULTIPLE-EFFECT EVAPORATOR
B01D 3/06 (2006.01)	2475442 *	MULTIPLE-EFFECT EVAPORATOR
B01D 1/16 (2006.01)	2475442 *	MULTIPLE-EFFECT EVAPORATOR
A47J 31/18 (2006.01)	2453777 *	TURKISH COFFEE MACHINE
C07D 401/10 (2006.01)	2421824 *	AZETIDINYL DIAMIDES AS MONOACYLGLYCEROL LIPASE INHIBITORS
A61K 31/496 (2006.01)	2421824 *	AZETIDINYL DIAMIDES AS MONOACYLGLYCEROL LIPASE INHIBITORS
C07D 401/06 (2006.01)	2421824 *	AZETIDINYL DIAMIDES AS MONOACYLGLYCEROL LIPASE INHIBITORS
C07D 417/14 (2006.01)	2421824 *	AZETIDINYL DIAMIDES AS MONOACYLGLYCEROL LIPASE INHIBITORS
C07D 403/10 (2006.01)	2421824 *	AZETIDINYL DIAMIDES AS MONOACYLGLYCEROL LIPASE INHIBITORS
A61P 29/00 (2006.01)	2421824 *	AZETIDINYL DIAMIDES AS MONOACYLGLYCEROL LIPASE INHIBITORS
C07D 401/04 (2006.01)	2421824 *	AZETIDINYL DIAMIDES AS MONOACYLGLYCEROL LIPASE INHIBITORS
C07D 417/06 (2006.01)	2421824 *	AZETIDINYL DIAMIDES AS MONOACYLGLYCEROL LIPASE INHIBITORS
C07D 403/06 (2006.01)	2421824 *	AZETIDINYL DIAMIDES AS MONOACYLGLYCEROL LIPASE INHIBITORS
A61P 25/00 (2006.01)	2421824 *	AZETIDINYL DIAMIDES AS MONOACYLGLYCEROL LIPASE INHIBITORS
C07D 205/04 (2006.01)	2421824 *	AZETIDINYL DIAMIDES AS MONOACYLGLYCEROL LIPASE INHIBITORS
C07D 409/06 (2006.01)	2421824 *	AZETIDINYL DIAMIDES AS MONOACYLGLYCEROL LIPASE INHIBITORS
C07D 403/12 (2006.01)	2421824 *	AZETIDINYL DIAMIDES AS MONOACYLGLYCEROL LIPASE INHIBITORS
C07D 405/12 (2006.01)	2421824 *	AZETIDINYL DIAMIDES AS MONOACYLGLYCEROL LIPASE INHIBITORS
A61B 18/18 (2006.01)	2459096 *	ENERGY DELIVERY SYSTEMS AND USES THEREOF
A61B 18/02 (2006.01)	2459096 *	ENERGY DELIVERY SYSTEMS AND USES THEREOF
A61N 5/02 (2006.01)	2459096 *	ENERGY DELIVERY SYSTEMS AND USES THEREOF
A61K 39/285 (2006.01)	2405939 *	OPTIMIZED EARLY-LATE PROMOTER COMBINED WITH REPEATED VACCINATION FAVORS CYTOTOXIC T CELL RESPONSE AGAINST ANTIGENS IN REPLICATION DEFICIENT RECOMBINANT VIRUS VACCINES
C07K 14/07 (2006.01)	2405939 *	OPTIMIZED EARLY-LATE PROMOTER COMBINED WITH REPEATED VACCINATION FAVORS CYTOTOXIC T CELL RESPONSE AGAINST ANTIGENS IN REPLICATION DEFICIENT RECOMBINANT VIRUS VACCINES
C12N 15/863 (2006.01)	2405939 *	OPTIMIZED EARLY-LATE PROMOTER COMBINED WITH REPEATED VACCINATION FAVORS CYTOTOXIC T CELL RESPONSE AGAINST ANTIGENS IN REPLICATION DEFICIENT RECOMBINANT VIRUS VACCINES
A61K 31/505 (2006.01)	2482819 *	COMBINATION
C07D 207/263 (2006.01)	2496555 *	4R,5S-ENANTIOMER OF 2-(5-METHYL-2-OXO-4-PHENYL-PYRROLIDIN-1-YL)-ACETAMIDE WITH NOOTROPIC ACTIVITY
A61K 31/4015 (2006.01)	2496555 *	4R,5S-ENANTIOMER OF 2-(5-METHYL-2-OXO-4-PHENYL-PYRROLIDIN-1-YL)-ACETAMIDE WITH NOOTROPIC ACTIVITY
A61P 25/28 (2006.01)	2496555 *	4R,5S-ENANTIOMER OF 2-(5-METHYL-2-OXO-4-PHENYL-PYRROLIDIN-1-YL)-ACETAMIDE WITH NOOTROPIC ACTIVITY

MKP (51)	Broj objave evropske prijava patenta (97)	Naziv pronalaska (54)
A61P 25/00 (2006.01)	2496555 *	4R,5S-ENANTIOMER OF 2-(5-METHYL-2-OXO-4-PHENYL-PYRROLIDIN-1-YL)-ACETAMIDE WITH NOOTROPIC ACTIVITY
B43K 21/16 (2006.01)	2493704 *	UNIVERSAL PENCIL MECHANISM
A61K 31/437 (2006.01)	2448941 *	PYRAZOLOPYRIMIDINE JAK INHIBITOR COMPOUNDS AND METHODS
C07D 403/12 (2006.01)	2448941 *	PYRAZOLOPYRIMIDINE JAK INHIBITOR COMPOUNDS AND METHODS
C07D 487/04 (2006.01)	2448941 *	PYRAZOLOPYRIMIDINE JAK INHIBITOR COMPOUNDS AND METHODS
A61P 35/00 (2006.01)	2448941 *	PYRAZOLOPYRIMIDINE JAK INHIBITOR COMPOUNDS AND METHODS
G05D 23/19 (2006.01)	2457132 *	ENERGY MANAGEMENT SYSTEM AND METHOD
H02J 3/14 (2006.01)	2457132 *	ENERGY MANAGEMENT SYSTEM AND METHOD
A61K 39/02 (2006.01)	2421556 *	VACCINES COMPRISING ATTENUATED MYCOPLASMA BOVIS STRAINS AND METHOD FOR THE ATTENUATION
C09K 11/06 (2006.01)	2467445 *	CHEMILUMINESCENT SIGNALING DEVICES
F21K 2/06 (2006.01)	2467445 *	CHEMILUMINESCENT SIGNALING DEVICES
F21L 17/00 (2006.01)	2467445 *	CHEMILUMINESCENT SIGNALING DEVICES
G08B 5/00 (2006.01)	2467445 *	CHEMILUMINESCENT SIGNALING DEVICES
F21L 26/00 (2006.01)	2467445 *	CHEMILUMINESCENT SIGNALING DEVICES
A61N 5/06 (2006.01)	2461868 *	HANDHELD LOW-LEVEL LASER THERAPY APPARATUS
A61F 2/06 (2006.01)	2421470 *	FLEXIBLE DEVICES
C12N 15/09 (2006.01)	2456869 *	INHIBITORS OF MTOR KINASE AS ANTI-VIRAL AGENTS
C07J 41/00 (2006.01)	2462154 *	NOVEL CRYSTAL FORM OF CDB-4124 AND PROCESS FOR THE PREPARATION THEREOF
A61K 31/573 (2006.01)	2462154 *	NOVEL CRYSTAL FORM OF CDB-4124 AND PROCESS FOR THE PREPARATION THEREOF
A61P 5/36 (2006.01)	2462154 *	NOVEL CRYSTAL FORM OF CDB-4124 AND PROCESS FOR THE PREPARATION THEREOF
B60R 25/10 (2006.01)	2490922 *	DUTY CYCLE ESTIMATION SYSTEM AND METHOD
B29C 67/24 (2006.01)	2427322 *	PROCESS FOR MANUFACTURING A SHAPED ARTICLE FROM A COMPOSITE MATERIAL COMPRISING A SOLID FILLER AND A THERMOPLASTIC BINDER
B29B 7/90 (2006.01)	2427322 *	PROCESS FOR MANUFACTURING A SHAPED ARTICLE FROM A COMPOSITE MATERIAL COMPRISING A SOLID FILLER AND A THERMOPLASTIC BINDER
C04B 26/00 (2006.01)	2427322 *	PROCESS FOR MANUFACTURING A SHAPED ARTICLE FROM A COMPOSITE MATERIAL COMPRISING A SOLID FILLER AND A THERMOPLASTIC BINDER
B29B 7/00 (2006.01)	2427322 *	PROCESS FOR MANUFACTURING A SHAPED ARTICLE FROM A COMPOSITE MATERIAL COMPRISING A SOLID FILLER AND A THERMOPLASTIC BINDER
B29B 17/00 (2006.01)	2427322 *	PROCESS FOR MANUFACTURING A SHAPED ARTICLE FROM A COMPOSITE MATERIAL COMPRISING A SOLID FILLER AND A THERMOPLASTIC BINDER
A62C 2/12 (2006.01)	2412409	Single-body intumescent gaskets for cold and hot smoke sealing, in particular for fire dampers
A01K 67/027 (2006.01)	2480675 *	MICE EXPRESSING ALIGHT CHAIN WITH HUMAN LAMBDA VARIABLE AND MOUSE CONSTANT REGIONS
C07K 16/46 (2006.01)	2480675 *	MICE EXPRESSING ALIGHT CHAIN WITH HUMAN LAMBDA VARIABLE AND MOUSE CONSTANT REGIONS
C12N 15/85 (2006.01)	2480675 *	MICE EXPRESSING ALIGHT CHAIN WITH HUMAN LAMBDA VARIABLE AND MOUSE CONSTANT REGIONS
C07K 16/00 (2006.01)	2480675 *	MICE EXPRESSING ALIGHT CHAIN WITH HUMAN LAMBDA VARIABLE AND MOUSE CONSTANT REGIONS
A61K 9/14 (2006.01)	2477607 *	IMPROVED DEVICE AND METHOD FOR DELIVERY OF A MEDICAMENT
C12P 21/08 (2006.01)	2494062 *	ANTI-GLP-1R ANTIBODIES AND THEIR USES
C07H 21/04 (2006.01)	2494062 *	ANTI-GLP-1R ANTIBODIES AND THEIR USES

MKP (51)	Broj objave evropske prijave patenta (97)	Naziv pronalaska (54)
H04W 16/12 (2009.01)	2443857 *	METHOD, SYSTEM AND BASE STATION FOR SHARING OR JOINTLY USING ONE OF A GERAN (GSM EDGE RADIO ACCESS NETWORK) MOBILE RADIO ACCESS NETWORK
A61K 31/593 (2006.01)	2335704	Pharmaceutical composition comprising a strontium salt, vitamine D and a cyclodextrine
A61K 47/40 (2006.01)	2335704	Pharmaceutical composition comprising a strontium salt, vitamine D and a cyclodextrine
A61K 45/06 (2006.01)	2335704	Pharmaceutical composition comprising a strontium salt, vitamine D and a cyclodextrine
A61K 33/24 (2006.01)	2335704	Pharmaceutical composition comprising a strontium salt, vitamine D and a cyclodextrine
A61P 19/00 (2006.01)	2335704	Pharmaceutical composition comprising a strontium salt, vitamine D and a cyclodextrine
A61K 9/16 (2006.01)	2407162 *	COMPOSITION FOR ORAL ADMINISTRATION
A61P 1/00 (2006.01)	2407162 *	COMPOSITION FOR ORAL ADMINISTRATION
A61P 1/04 (2006.01)	2407162 *	COMPOSITION FOR ORAL ADMINISTRATION
A61K 31/198 (2006.01)	2407162 *	COMPOSITION FOR ORAL ADMINISTRATION
A01N 43/50 (2006.01)	2427058 *	NEMATOCIDAL SULFONAMIDES
A61K 31/415 (2006.01)	2427058 *	NEMATOCIDAL SULFONAMIDES
G06F 11/07 (2006.01)	2460076 *	PORTABLE EXECUTABLE FILE ANALYSIS
G06F 21/00 (2006.01)	2460076 *	PORTABLE EXECUTABLE FILE ANALYSIS
H04W 36/00 (2009.01)	2436209 *	MECHANISM FOR APPLICATION MOBILITY IN A CELL SITE-BASED CONTENT DISTRIBUTION NETWORK
G01N 15/08 (2006.01)	2253735	Vessel processing
A61B 5/15 (2006.01)	2253735	Vessel processing
C23C 16/54 (2006.01)	2253735	Vessel processing
C23C 16/04 (2006.01)	2253735	Vessel processing
C23C 16/52 (2006.01)	2253735	Vessel processing
C23C 16/505 (2006.01)	2253735	Vessel processing
B65H 75/08 (2006.01)	2319789	Unwinding device
B65H 75/18 (2006.01)	2319789	Unwinding device
C07D 471/10 (2006.01)	2421865 *	SPIROHETEROCYCLIC PYRROLIDINE DIONE DERIVATIVES USED AS PESTICIDES
A01N 43/90 (2006.01)	2421865 *	SPIROHETEROCYCLIC PYRROLIDINE DIONE DERIVATIVES USED AS PESTICIDES
A61K 36/906 (2006.01)	2416795 *	Inhibitors of cognitive decline
A61K 31/40 (2006.01)	2416795 *	Inhibitors of cognitive decline
C07D 207/04 (2006.01)	2416795 *	Inhibitors of cognitive decline
A61K 31/519 (2006.01)	2443120 *	NEW CRYSTALLINE FORM OF PEMIROLAST
A61P 29/00 (2006.01)	2443120 *	NEW CRYSTALLINE FORM OF PEMIROLAST
C07D 471/04 (2006.01)	2443120 *	NEW CRYSTALLINE FORM OF PEMIROLAST
A61K 45/06 (2006.01)	2443120 *	NEW CRYSTALLINE FORM OF PEMIROLAST
A61K 39/00 (2006.01)	2440242 *	ADJUVANT COMPOSITIONS COMPRISING A NON-IONIC ISOTONICITY AGENT
F03D 3/06 (2006.01)	2459871 *	AEROGENERATOR WITH FREE INTERNAL FLOW ROTOR
F03D 3/04 (2006.01)	2459871 *	AEROGENERATOR WITH FREE INTERNAL FLOW ROTOR
F03D 3/00 (2006.01)	2459871 *	AEROGENERATOR WITH FREE INTERNAL FLOW ROTOR
A61K 31/407 (2006.01)	2491042 *	SOLID FORMS OF N-(4-(7-AZABICYCLO[2.2.1]HEPTAN-7-YL)-2-TRIFLUOROMETHYL)PHENYL)-4-OXO-5-(TRIFLUOROMETHYL)-1,4-DIHYDROQUINOLINE-3-CARBOXAMIDE
C07D 487/08 (2006.01)	2491042 *	SOLID FORMS OF N-(4-(7-AZABICYCLO[2.2.1]HEPTAN-7-YL)-2-TRIFLUOROMETHYL)PHENYL)-4-OXO-5-(TRIFLUOROMETHYL)-1,4-DIHYDROQUINOLINE-3-CARBOXAMIDE

MKP (51)	Broj objave evropske prijava patenta (97)	Naziv pronalaska (54)
A61P 11/00 (2006.01)	2491042 *	SOLID FORMS OF N-(4-(7-AZABICYCLO[2.2.1]HEPTAN-7-YL)-2-TRIFLUOROMETHYL)PHENYL)-4-OXO-5-(TRIFLUOROMETHYL)-1,4-DIHYDROQUINOLINE-3-CARBOXAMIDE
A01N 43/54 (2006.01)	2480085 *	COMBINATION
A61K 31/415 (2006.01)	2480085 *	COMBINATION
A61K 31/505 (2006.01)	2480085 *	COMBINATION
B60R 21/2165 (2011.01)	2483111 *	MOULDED TRIM COMPONENT FOR COVERING AN AIRBAG IN A MOTOR VEHICLE
A01N 37/12 (2006.01)	2424357 *	TREATMENT OF NEURODEGENERATION AND NEUROINFLAMMATION
A01N 37/44 (2006.01)	2424357 *	TREATMENT OF NEURODEGENERATION AND NEUROINFLAMMATION
A61K 31/195 (2006.01)	2424357 *	TREATMENT OF NEURODEGENERATION AND NEUROINFLAMMATION
E04H 1/02 (2006.01)	2494127 *	PREFABRICATED CONTAINER HOUSE
C12N 15/82 (2006.01)	2449108 *	METHODS AND MEANS FOR OBTAINING PLANTS WITH ENHANCED GLYPHOSATE TOLERANCE
A61K 38/00 (2006.01)	2464368 *	CATHEPSIN C INHIBITORS
A61M 5/32 (2006.01)	2498842 *	SURGICAL NEEDLE COATINGS AND METHODS
C07D 261/18 (2006.01)	2435409 *	SUBSTITUTED AMINOPROPIONIC DERIVATIVES AS NEPRILYSIN INHIBITORS
C07C 233/47 (2006.01)	2435409 *	SUBSTITUTED AMINOPROPIONIC DERIVATIVES AS NEPRILYSIN INHIBITORS
A61K 31/21 (2006.01)	2435409 *	SUBSTITUTED AMINOPROPIONIC DERIVATIVES AS NEPRILYSIN INHIBITORS
A61K 31/435 (2006.01)	2435409 *	SUBSTITUTED AMINOPROPIONIC DERIVATIVES AS NEPRILYSIN INHIBITORS
C07D 213/82 (2006.01)	2435409 *	SUBSTITUTED AMINOPROPIONIC DERIVATIVES AS NEPRILYSIN INHIBITORS
C07D 239/36 (2006.01)	2435409 *	SUBSTITUTED AMINOPROPIONIC DERIVATIVES AS NEPRILYSIN INHIBITORS
C07D 271/06 (2006.01)	2435409 *	SUBSTITUTED AMINOPROPIONIC DERIVATIVES AS NEPRILYSIN INHIBITORS
B60K 17/04 (2006.01)	2329983	Wheel drive assembly and a spindle carrier
B60K 7/00 (2006.01)	2329983	Wheel drive assembly and a spindle carrier
C07D 403/12 (2006.01)	2427453 *	NOVEL SUBSTITUTED INDAZOLE AND AZA-INDAZOLE DERIVATIVES AS GAMMA SECRETASE MODULATORS
C07D 403/14 (2006.01)	2427453 *	NOVEL SUBSTITUTED INDAZOLE AND AZA-INDAZOLE DERIVATIVES AS GAMMA SECRETASE MODULATORS
C07D 413/12 (2006.01)	2427453 *	NOVEL SUBSTITUTED INDAZOLE AND AZA-INDAZOLE DERIVATIVES AS GAMMA SECRETASE MODULATORS
C07D 413/14 (2006.01)	2427453 *	NOVEL SUBSTITUTED INDAZOLE AND AZA-INDAZOLE DERIVATIVES AS GAMMA SECRETASE MODULATORS
C07D 417/12 (2006.01)	2427453 *	NOVEL SUBSTITUTED INDAZOLE AND AZA-INDAZOLE DERIVATIVES AS GAMMA SECRETASE MODULATORS
A61K 31/416 (2006.01)	2427453 *	NOVEL SUBSTITUTED INDAZOLE AND AZA-INDAZOLE DERIVATIVES AS GAMMA SECRETASE MODULATORS
C07D 471/04 (2006.01)	2427453 *	NOVEL SUBSTITUTED INDAZOLE AND AZA-INDAZOLE DERIVATIVES AS GAMMA SECRETASE MODULATORS
A61P 25/28 (2006.01)	2427453 *	NOVEL SUBSTITUTED INDAZOLE AND AZA-INDAZOLE DERIVATIVES AS GAMMA SECRETASE MODULATORS
C07D 417/12 (2006.01)	2430012 *	7-AZA-SPIRO[3.5]NONANE-7-CARBOXYLATE DERIVATIVES, PREPARATION THEREOF, AND THERAPEUTIC USE THEREOF
A61K 31/4523 (2006.01)	2430012 *	7-AZA-SPIRO[3.5]NONANE-7-CARBOXYLATE DERIVATIVES, PREPARATION THEREOF, AND THERAPEUTIC USE THEREOF
A61P 29/00 (2006.01)	2430012 *	7-AZA-SPIRO[3.5]NONANE-7-CARBOXYLATE DERIVATIVES, PREPARATION THEREOF, AND THERAPEUTIC USE THEREOF
A61P 25/00 (2006.01)	2430012 *	7-AZA-SPIRO[3.5]NONANE-7-CARBOXYLATE DERIVATIVES, PREPARATION THEREOF, AND THERAPEUTIC USE THEREOF

MKP (51)	Broj objave evropske prijava patenta (97)	Naziv pronalaska (54)
C07D 401/12 (2006.01)	2430012 *	7-AZA-SPIRO[3.5]NONANE-7-CARBOXYLATE DERIVATIVES, PREPARATION THEREOF, AND THERAPEUTIC USE THEREOF
C07D 413/12 (2006.01)	2430012 *	7-AZA-SPIRO[3.5]NONANE-7-CARBOXYLATE DERIVATIVES, PREPARATION THEREOF, AND THERAPEUTIC USE THEREOF
B29C 57/02 (2006.01)	2368693	Belling machine for pipes made of thermoplastic material
F16L 47/08 (2006.01)	2368693	Belling machine for pipes made of thermoplastic material
F16L 11/08 (2006.01)	2261542	Pipe for water-supply systems
C07K 14/605 (2006.01)	2454282 *	ACYLATED GLUCAGON ANALOGUES
A61P 5/48 (2006.01)	2454282 *	ACYLATED GLUCAGON ANALOGUES
A61K 38/26 (2006.01)	2454282 *	ACYLATED GLUCAGON ANALOGUES
E03D 9/08 (2006.01)	2305903	Washing device for user's private parts
A01N 43/90 (2006.01)	2461690 *	LIPIDATED OXOADENINE DERIVATIVES
A61K 31/52 (2006.01)	2461690 *	LIPIDATED OXOADENINE DERIVATIVES
A61K 31/522 (2006.01)	2461690 *	LIPIDATED OXOADENINE DERIVATIVES
A61K 31/4439 (2006.01)	2432469 *	NOVEL PHARMACEUTICALLY ACCEPTABLE SALTS OF 4-(1H-IMIDAZOL-4-YLMETHYL)PYRIDINE AND THEIR THERAPEUTICAL USES
C07D 401/06 (2006.01)	2432469 *	NOVEL PHARMACEUTICALLY ACCEPTABLE SALTS OF 4-(1H-IMIDAZOL-4-YLMETHYL)PYRIDINE AND THEIR THERAPEUTICAL USES
A61P 25/00 (2006.01)	2432469 *	NOVEL PHARMACEUTICALLY ACCEPTABLE SALTS OF 4-(1H-IMIDAZOL-4-YLMETHYL)PYRIDINE AND THEIR THERAPEUTICAL USES
A61K 31/454 (2006.01)	2438051 *	L- (PIPERIDIN-4-YL) -PYRAZOLE DERIVATIVES AS GPR 119 MODULATORS
C07D 401/04 (2006.01)	2438051 *	L- (PIPERIDIN-4-YL) -PYRAZOLE DERIVATIVES AS GPR 119 MODULATORS
C07D 401/14 (2006.01)	2438051 *	L- (PIPERIDIN-4-YL) -PYRAZOLE DERIVATIVES AS GPR 119 MODULATORS
A61K 31/4545 (2006.01)	2438051 *	L- (PIPERIDIN-4-YL) -PYRAZOLE DERIVATIVES AS GPR 119 MODULATORS
A61P 3/10 (2006.01)	2438051 *	L- (PIPERIDIN-4-YL) -PYRAZOLE DERIVATIVES AS GPR 119 MODULATORS
B65H 75/00 (2006.01)	2449049 *	IMPROVED ADHESIVE SHEETED ROLL
C09J 7/02 (2006.01)	2449049 *	IMPROVED ADHESIVE SHEETED ROLL
H04M 1/02 (2006.01)	2456174	Segmented portable electronic device and method of display
H01L 31/18 (2006.01)	2457264 *	SYSTEM AND METHOD FOR MAKING A PHOTOVOLTAIC UNIT
H01L 31/042 (2006.01)	2457264 *	SYSTEM AND METHOD FOR MAKING A PHOTOVOLTAIC UNIT
A61K 39/395 (2006.01)	2493504 *	STABLE ANTI-TNFR1 POLYPEPTIDES, ANTIBODY VARIABLE DOMAINS&ANTAGONISTS
C07K 16/46 (2006.01)	2493504 *	STABLE ANTI-TNFR1 POLYPEPTIDES, ANTIBODY VARIABLE DOMAINS&ANTAGONISTS
C07K 16/28 (2006.01)	2493504 *	STABLE ANTI-TNFR1 POLYPEPTIDES, ANTIBODY VARIABLE DOMAINS&ANTAGONISTS
C07K 16/18 (2006.01)	2493504 *	STABLE ANTI-TNFR1 POLYPEPTIDES, ANTIBODY VARIABLE DOMAINS&ANTAGONISTS
C07D 233/64 (2006.01)	2430002 *	PROCESS FOR THE PREPARATION OF A COMPOUND USEFUL AS AN INHIBITOR OF TAFIA
C07D 233/84 (2006.01)	2430002 *	PROCESS FOR THE PREPARATION OF A COMPOUND USEFUL AS AN INHIBITOR OF TAFIA
C07D 401/06 (2006.01)	2430002 *	PROCESS FOR THE PREPARATION OF A COMPOUND USEFUL AS AN INHIBITOR OF TAFIA
C10G 2/00 (2006.01)	2412787 *	METHOD FOR PRODUCING LIQUID FUEL AND SYSTEM FOR PRODUCING LIQUID FUEL
C10G 45/10 (2006.01)	2412787 *	METHOD FOR PRODUCING LIQUID FUEL AND SYSTEM FOR PRODUCING LIQUID FUEL
C10G 47/18 (2006.01)	2412787 *	METHOD FOR PRODUCING LIQUID FUEL AND SYSTEM FOR PRODUCING LIQUID FUEL

MKP (51)	Broj objave evropske prijave patenta (97)	Naziv pronalaska (54)
C10G 65/02 (2006.01)	2412787 *	METHOD FOR PRODUCING LIQUID FUEL AND SYSTEM FOR PRODUCING LIQUID FUEL
C10G 65/04 (2006.01)	2412787 *	METHOD FOR PRODUCING LIQUID FUEL AND SYSTEM FOR PRODUCING LIQUID FUEL
B01J 23/42 (2006.01)	2412787 *	METHOD FOR PRODUCING LIQUID FUEL AND SYSTEM FOR PRODUCING LIQUID FUEL
B01J 23/46 (2006.01)	2412787 *	METHOD FOR PRODUCING LIQUID FUEL AND SYSTEM FOR PRODUCING LIQUID FUEL
A61K 39/395 (2006.01)	2429583 *	METHODS AND COMPOSITIONS FOR TREATING LUPUS
A61K 38/18 (2006.01)	2429583 *	METHODS AND COMPOSITIONS FOR TREATING LUPUS
C07K 14/47 (2006.01)	2435469 *	CASB7439 CONSTRUCTS
A61K 39/00 (2006.01)	2435469 *	CASB7439 CONSTRUCTS
A61P 35/00 (2006.01)	2435469 *	CASB7439 CONSTRUCTS
A61F 5/56 (2006.01)	2493437 *	TONGUE SUSPENSION SYSTEM WITH HYOID-EXTENDER FOR TREATING OBSTRUCTIVE SLEEP APNEA
C12N 15/09 (2006.01)	2450438 *	CELLULASE PREPARATION CONTAINING ENDOGLUCANASES DERIVED FROM TWO DIFFERENT TYPES OF MICROORGANISMS
C12N 9/42 (2006.01)	2450438 *	CELLULASE PREPARATION CONTAINING ENDOGLUCANASES DERIVED FROM TWO DIFFERENT TYPES OF MICROORGANISMS
C12P 19/00 (2006.01)	2450438 *	CELLULASE PREPARATION CONTAINING ENDOGLUCANASES DERIVED FROM TWO DIFFERENT TYPES OF MICROORGANISMS
C07C 205/43 (2006.01)	2435398 *	PROCESS FOR THE PRODUCTION OF BENZOFURANS
A61K 31/343 (2006.01)	2435398 *	PROCESS FOR THE PRODUCTION OF BENZOFURANS
C07D 307/80 (2006.01)	2435398 *	PROCESS FOR THE PRODUCTION OF BENZOFURANS
A61P 9/06 (2006.01)	2435398 *	PROCESS FOR THE PRODUCTION OF BENZOFURANS
A01P 21/00 (2006.01)	2464211 *	METHODS FOR VEGETATIVE PROPAGATION OF GRASS PLANTS
A01N 63/00 (2006.01)	2464211 *	METHODS FOR VEGETATIVE PROPAGATION OF GRASS PLANTS
A01G 7/06 (2006.01)	2464211 *	METHODS FOR VEGETATIVE PROPAGATION OF GRASS PLANTS
A01N 43/38 (2006.01)	2464211 *	METHODS FOR VEGETATIVE PROPAGATION OF GRASS PLANTS
A01N 31/02 (2006.01)	2464211 *	METHODS FOR VEGETATIVE PROPAGATION OF GRASS PLANTS
H01R 33/945 (2006.01)	2404351 *	OVERHEAD POWER CONNECTOR INTEGRITY ASSESSMENT BY APPLICATION OF THERMAL HISTORY DETECTORS
E21B 43/14 (2006.01)	2494146 *	PLUG RETAINER AND METHOD FOR WELLBORE FLUID TREATMENT
E21B 43/25 (2006.01)	2494146 *	PLUG RETAINER AND METHOD FOR WELLBORE FLUID TREATMENT
E21B 34/14 (2006.01)	2494146 *	PLUG RETAINER AND METHOD FOR WELLBORE FLUID TREATMENT
A61K 9/00 (2006.01)	2421504 *	PAEDIATRIC SOLUTIONS COMPRISING A BETA-BLOCKER
A61K 9/08 (2006.01)	2421504 *	PAEDIATRIC SOLUTIONS COMPRISING A BETA-BLOCKER
A61K 31/13 (2006.01)	2421504 *	PAEDIATRIC SOLUTIONS COMPRISING A BETA-BLOCKER
A61B 5/107 (2006.01)	2459073 *	THREE-DIMENSIONAL (3D) ULTRASOUND IMAGING SYSTEM FOR ASSESSING SCOLIOSIS
A61B 8/08 (2006.01)	2459073 *	THREE-DIMENSIONAL (3D) ULTRASOUND IMAGING SYSTEM FOR ASSESSING SCOLIOSIS
C07H 15/203 (2006.01)	2483286 *	METHOD FOR THE PREPARATION OF A CRYSTALLINE FORM OF 1-CHLORO-4- (BETA-D-GLUCOPYRANOS-1-YL)-2-(4-((S)-TETRAHYDROFURAN-3-YLOXY)BENZYL)BENZENE
A61K 31/7048 (2006.01)	2483286 *	METHOD FOR THE PREPARATION OF A CRYSTALLINE FORM OF 1-CHLORO-4- (BETA-D-GLUCOPYRANOS-1-YL)-2-(4-((S)-TETRAHYDROFURAN-3-YLOXY)BENZYL)BENZENE
A61K 31/497 (2006.01)	2438056 *	AMINO PYRIMIDINE ANTICANCER COMPOUNDS
C07D 403/14 (2006.01)	2438056 *	AMINO PYRIMIDINE ANTICANCER COMPOUNDS
A61P 35/00 (2006.01)	2438056 *	AMINO PYRIMIDINE ANTICANCER COMPOUNDS
C07D 401/12 (2006.01)	2438056 *	AMINO PYRIMIDINE ANTICANCER COMPOUNDS
C07D 403/12 (2006.01)	2438056 *	AMINO PYRIMIDINE ANTICANCER COMPOUNDS
B60R 25/02 (2006.01)	2277750	Armor-plated mechanical antitheft steering lock for automotive vehicles.

MKP (51)	Broj objave evropske prijava patenta (97)	Naziv pronalaska (54)
B01L 3/00 (2006.01)	2443256 *	NUCLEIC ACID DETECTION
C12Q 1/68 (2006.01)	2443256 *	NUCLEIC ACID DETECTION
G01N 27/447 (2006.01)	2443256 *	NUCLEIC ACID DETECTION
G01N 21/64 (2006.01)	2443256 *	NUCLEIC ACID DETECTION
B01D 35/18 (2006.01)	2414063 *	FILTER ASSEMBLY
F16H 3/72 (2006.01)	2405157	Planetary transmission with two inputs and one output
B30B 1/26 (2006.01)	2405157	Planetary transmission with two inputs and one output
B30B 15/14 (2006.01)	2405157	Planetary transmission with two inputs and one output
F16H 57/02 (2012.01)	2405157	Planetary transmission with two inputs and one output
A61K 39/00 (2006.01)	2497493 *	NEBULIZABLE TUBERCULOSIS VACCINE FOR TRANSNASAL ADMINISTRATION COMPRISING PARAMYXOVIRUS VECTOR
A61K 48/00 (2006.01)	2497493 *	NEBULIZABLE TUBERCULOSIS VACCINE FOR TRANSNASAL ADMINISTRATION COMPRISING PARAMYXOVIRUS VECTOR
C12N 15/09 (2006.01)	2497493 *	NEBULIZABLE TUBERCULOSIS VACCINE FOR TRANSNASAL ADMINISTRATION COMPRISING PARAMYXOVIRUS VECTOR
A61K 39/04 (2006.01)	2497493 *	NEBULIZABLE TUBERCULOSIS VACCINE FOR TRANSNASAL ADMINISTRATION COMPRISING PARAMYXOVIRUS VECTOR
A61P 31/06 (2006.01)	2497493 *	NEBULIZABLE TUBERCULOSIS VACCINE FOR TRANSNASAL ADMINISTRATION COMPRISING PARAMYXOVIRUS VECTOR
A61K 35/76 (2006.01)	2497493 *	NEBULIZABLE TUBERCULOSIS VACCINE FOR TRANSNASAL ADMINISTRATION COMPRISING PARAMYXOVIRUS VECTOR
G06F 17/30 (2006.01)	2363815	System for permanent file deletion
A61K 45/00 (2006.01)	2408479 *	COMBINATION CANCER THERAPY COMPRISING ADMINISTRATION OF AN EGFR INHIBITOR AND AN IGF-1R INHIBITOR
A61K 31/395 (2006.01)	2408479 *	COMBINATION CANCER THERAPY COMPRISING ADMINISTRATION OF AN EGFR INHIBITOR AND AN IGF-1R INHIBITOR
A61K 31/4985 (2006.01)	2408479 *	COMBINATION CANCER THERAPY COMPRISING ADMINISTRATION OF AN EGFR INHIBITOR AND AN IGF-1R INHIBITOR
A61P 35/00 (2006.01)	2408479 *	COMBINATION CANCER THERAPY COMPRISING ADMINISTRATION OF AN EGFR INHIBITOR AND AN IGF-1R INHIBITOR
C12N 15/09 (2006.01)	2423324 *	PROBE SET FOR IDENTIFICATION OF NUCLEOTIDE MUTATION, AND METHOD FOR IDENTIFICATION OF NUCLEOTIDE MUTATION
C12Q 1/68 (2006.01)	2423324 *	PROBE SET FOR IDENTIFICATION OF NUCLEOTIDE MUTATION, AND METHOD FOR IDENTIFICATION OF NUCLEOTIDE MUTATION
C07D 519/00 (2006.01)	2470547 *	CONJUGATES OF PYRROLO[1,4]BENZODIAZEPINE DIMERS AS ANTICANCER AGENTS
A61K 31/551 (2006.01)	2470547 *	CONJUGATES OF PYRROLO[1,4]BENZODIAZEPINE DIMERS AS ANTICANCER AGENTS
A61P 35/00 (2006.01)	2470547 *	CONJUGATES OF PYRROLO[1,4]BENZODIAZEPINE DIMERS AS ANTICANCER AGENTS
A47B 43/00 (2006.01)	2295021	Collapsible cadaver rack
A61G 1/013 (2006.01)	2295021	Collapsible cadaver rack
A61G 21/00 (2006.01)	2295021	Collapsible cadaver rack
A61K 36/80 (2006.01)	2482832 *	PICRORHIZA KURROA EXTRACT FOR PREVENTION, ELIMINATION AND TREATMENT OF DNA BASED VIRUSES IN HUMANS AND IN BIOTECH INDUSTRY
A01K 15/02 (2006.01)	2255617	Dog training device with chewable body
A61P 37/02 (2006.01)	2406272 *	N-HYDROXY C29-AMIDE DERIVATIVES OF OLEANDRANE
C07J 63/00 (2006.01)	2406272 *	N-HYDROXY C29-AMIDE DERIVATIVES OF OLEANDRANE
A61K 31/575 (2006.01)	2406272 *	N-HYDROXY C29-AMIDE DERIVATIVES OF OLEANDRANE
A61P 29/00 (2006.01)	2406272 *	N-HYDROXY C29-AMIDE DERIVATIVES OF OLEANDRANE
A61P 35/00 (2006.01)	2406272 *	N-HYDROXY C29-AMIDE DERIVATIVES OF OLEANDRANE
A01N 25/34 (2006.01)	2440045 *	NOVEL ARTICLE
D21H 19/00 (2006.01)	2440045 *	NOVEL ARTICLE

MKP (51)	Broj objave evropske prijava patenta (97)	Naziv pronalaska (54)
B08B 9/00 (2006.01)	2493515 *	COOLED PULSED LIGHT TREATMENT DEVICE
B65B 55/00 (2006.01)	2493515 *	COOLED PULSED LIGHT TREATMENT DEVICE
A61L 2/10 (2006.01)	2493515 *	COOLED PULSED LIGHT TREATMENT DEVICE
A23K 1/00 (2006.01)	2403353 *	COMPOSITION FOR CONTROLLING FISH
A61P 37/06 (2006.01)	2485723 *	INHIBITORS OF CXCR1/2 AS ADJUVANTS IN THE TRANSPLANT OF PANCREATIC ISLETS
A61K 31/18 (2006.01)	2485723 *	INHIBITORS OF CXCR1/2 AS ADJUVANTS IN THE TRANSPLANT OF PANCREATIC ISLETS
A61P 29/00 (2006.01)	2403849 *	OXAZOLE PYRIDINE DERIVATIVES USEFUL AS S1P1 RECEPTOR AGONISTS
C07D 413/04 (2006.01)	2403849 *	OXAZOLE PYRIDINE DERIVATIVES USEFUL AS S1P1 RECEPTOR AGONISTS
C07D 413/14 (2006.01)	2403849 *	OXAZOLE PYRIDINE DERIVATIVES USEFUL AS S1P1 RECEPTOR AGONISTS
A61K 31/4245 (2006.01)	2403849 *	OXAZOLE PYRIDINE DERIVATIVES USEFUL AS S1P1 RECEPTOR AGONISTS
A61P 37/00 (2006.01)	2403849 *	OXAZOLE PYRIDINE DERIVATIVES USEFUL AS S1P1 RECEPTOR AGONISTS
C07D 417/14 (2006.01)	2421861 *	SOLID FORMS OF AN AZOCYCLIC AMIDE
A01N 43/80 (2006.01)	2421861 *	SOLID FORMS OF AN AZOCYCLIC AMIDE
H04W 28/00 (2009.01)	2498534 *	CONFIGURATION METHOD, SYSTEM AND DEVICE FOR UPLINK CHANNEL
H04W 52/00 (2009.01)	2498534 *	CONFIGURATION METHOD, SYSTEM AND DEVICE FOR UPLINK CHANNEL
A61K 31/14 (2006.01)	2491005 *	USE OF 4-[ETHYL(DIMETHYL)AMMONIO]BUTANOATE IN THE TREATMENT OF CARDIOVASCULAR DISEASE
C07C 229/12 (2006.01)	2491005 *	USE OF 4-[ETHYL(DIMETHYL)AMMONIO]BUTANOATE IN THE TREATMENT OF CARDIOVASCULAR DISEASE
A61P 9/10 (2006.01)	2491005 *	USE OF 4-[ETHYL(DIMETHYL)AMMONIO]BUTANOATE IN THE TREATMENT OF CARDIOVASCULAR DISEASE
G01S 15/89 (2006.01)	2454606 *	LINEAR AND CIRCULAR DOWNSCAN IMAGING SONAR
G01S 15/87 (2006.01)	2454606 *	LINEAR AND CIRCULAR DOWNSCAN IMAGING SONAR
A61K 9/19 (2006.01)	2413916 *	LYOPHILIZATION CAKES OF PROTEASOME INHIBITORS
A61K 47/40 (2006.01)	2413916 *	LYOPHILIZATION CAKES OF PROTEASOME INHIBITORS
A61K 47/26 (2006.01)	2413916 *	LYOPHILIZATION CAKES OF PROTEASOME INHIBITORS
A61K 31/69 (2006.01)	2413916 *	LYOPHILIZATION CAKES OF PROTEASOME INHIBITORS
A61P 35/00 (2006.01)	2413916 *	LYOPHILIZATION CAKES OF PROTEASOME INHIBITORS
A61K 47/48 (2006.01)	2413916 *	LYOPHILIZATION CAKES OF PROTEASOME INHIBITORS
B23K 26/26 (2006.01)	2388102	Method and apparatus for laser strip slicing
B21B 15/00 (2006.01)	2388102	Method and apparatus for laser strip slicing
B23K 26/38 (2006.01)	2388102	Method and apparatus for laser strip slicing
G01B 11/03 (2006.01)	2322901	Method for improving position and orientation measurement data
G01C 15/00 (2006.01)	2322901	Method for improving position and orientation measurement data
G01S 17/89 (2006.01)	2322901	Method for improving position and orientation measurement data
G01B 11/00 (2006.01)	2322901	Method for improving position and orientation measurement data
G01S 17/48 (2006.01)	2322901	Method for improving position and orientation measurement data
G01N 11/04 (2006.01)	2249141	A viscometer and a method for operating the same
C07K 7/06 (2006.01)	2440569 *	MELANOCORTIN RECEPTOR-SPECIFIC PEPTIDES
A61K 38/08 (2006.01)	2440569 *	MELANOCORTIN RECEPTOR-SPECIFIC PEPTIDES
A61P 3/04 (2006.01)	2440569 *	MELANOCORTIN RECEPTOR-SPECIFIC PEPTIDES
C03B 33/10 (2006.01)	2399874	Glass cutter
C07C 209/62 (2006.01)	2483234 *	METHOD OF PREPARING NERAMEXANE OR A SALT THEREOF
C07C 211/35 (2006.01)	2483234 *	METHOD OF PREPARING NERAMEXANE OR A SALT THEREOF

MKP (51)	Broj objave evropske prijava patenta (97)	Naziv pronalaska (54)
C07D 413/14 (2006.01)	2459555 *	PROCESSES FOR CRYSTALLIZATION OF RIVAROXABAN
A61K 31/42 (2006.01)	2459555 *	PROCESSES FOR CRYSTALLIZATION OF RIVAROXABAN
A61P 7/00 (2006.01)	2459555 *	PROCESSES FOR CRYSTALLIZATION OF RIVAROXABAN
H01M 10/48 (2006.01)	2296214	Device for monitoring an energy storage device
A01P 3/00 (2006.01)	2442659 *	CONTROL AGENT FOR SOFT ROT AND CONTROL METHOD FOR THE SAME
A01N 43/40 (2006.01)	2442659 *	CONTROL AGENT FOR SOFT ROT AND CONTROL METHOD FOR THE SAME
B63B 15/00 (2006.01)	2243696	Sailing boat with variable lift.
E01F 15/02 (2006.01)	2408970 *	IMPROVED ROAD BARRIER
E01F 15/04 (2006.01)	2408970 *	IMPROVED ROAD BARRIER
A61M 11/00 (2006.01)	2444112 *	HIGH-FREQUENCY INDUCTION ATOMIZATION DEVICE
E06B 3/667 (2006.01)	2374979	Plug-connector
C02F 11/12 (2006.01)	2383232	System and Method for the Concentration of a Slurry
C02F 1/469 (2006.01)	2383232	System and Method for the Concentration of a Slurry
B01D 57/02 (2006.01)	2383232	System and Method for the Concentration of a Slurry
B32B 27/12 (2006.01)	2470368 *	MULTIPURPOSE LAMINATED STRETCH FABRIC
B32B 33/00 (2006.01)	2470368 *	MULTIPURPOSE LAMINATED STRETCH FABRIC
C07D 401/14 (2006.01)	2403847 *	TRIAZINE DERIVATIVES AS KINASE INHIBITORS
A61K 31/47 (2006.01)	2403847 *	TRIAZINE DERIVATIVES AS KINASE INHIBITORS
A61P 9/00 (2006.01)	2403847 *	TRIAZINE DERIVATIVES AS KINASE INHIBITORS
B23D 49/10 (2006.01)	2448706 *	SAW BLADE, KNIFE AND SAW
B26B 9/02 (2006.01)	2448706 *	SAW BLADE, KNIFE AND SAW
B23D 61/12 (2006.01)	2448706 *	SAW BLADE, KNIFE AND SAW
A61K 31/54 (2006.01)	2488184 *	COMBINATION
C07D 241/04 (2006.01)	2451789 *	MANUFACTURE OF 4-((1R,3S)-6-CHLORO-3-PHENYL-INDAN-1-YL)-1,2,2-TRIMETHYL-PIPERAZINE AND 1-((1R,3S)-6-CHLORO-3-PHENYL-INDAN-1-YL)-3,3-DIMETHYL-PIPERAZINE
C07D 405/12 (2006.01)	2409976 *	GLYCINE TRANSPORTER INHIBITOR
A61K 31/4178 (2006.01)	2409976 *	GLYCINE TRANSPORTER INHIBITOR
A61K 31/4196 (2006.01)	2409976 *	GLYCINE TRANSPORTER INHIBITOR
A61K 31/437 (2006.01)	2409976 *	GLYCINE TRANSPORTER INHIBITOR
A61K 31/4439 (2006.01)	2409976 *	GLYCINE TRANSPORTER INHIBITOR
A61P 25/08 (2006.01)	2409976 *	GLYCINE TRANSPORTER INHIBITOR
A61P 25/14 (2006.01)	2409976 *	GLYCINE TRANSPORTER INHIBITOR
A61P 25/18 (2006.01)	2409976 *	GLYCINE TRANSPORTER INHIBITOR
C07D 409/12 (2006.01)	2409976 *	GLYCINE TRANSPORTER INHIBITOR
A61P 25/20 (2006.01)	2409976 *	GLYCINE TRANSPORTER INHIBITOR
C07D 471/04 (2006.01)	2409976 *	GLYCINE TRANSPORTER INHIBITOR
A61P 25/22 (2006.01)	2409976 *	GLYCINE TRANSPORTER INHIBITOR
A61P 25/24 (2006.01)	2409976 *	GLYCINE TRANSPORTER INHIBITOR
A61P 25/28 (2006.01)	2409976 *	GLYCINE TRANSPORTER INHIBITOR
A61P 25/30 (2006.01)	2409976 *	GLYCINE TRANSPORTER INHIBITOR
A61P 43/00 (2006.01)	2409976 *	GLYCINE TRANSPORTER INHIBITOR
C07D 405/14 (2006.01)	2409976 *	GLYCINE TRANSPORTER INHIBITOR
G01P 15/09 (2006.01)	2464981 *	PROOF MASS FOR MAXIMIZED, BI-DIRECTIONAL AND SYMMETRIC DAMPING IN HIGH G-RANGE ACCELERATION SENSORS
A01N 43/54 (2006.01)	2473049 *	BRUTON'S TYROSINE KINASE INHIBITORS
C07D 471/04 (2006.01)	2473049 *	BRUTON'S TYROSINE KINASE INHIBITORS
C07D 471/22 (2006.01)	2473049 *	BRUTON'S TYROSINE KINASE INHIBITORS

MKP (51)	Broj objave evropske prijava patenta (97)	Naziv pronalaska (54)
C12N 15/86 (2006.01)	2498825 *	NOVEL VIRAL VECTOR CONSTRUCT FOR NEURON SPECIFIC CONTINUOUS DOPA SYNTHESIS IN VIVO
C12N 15/864 (2006.01)	2498825 *	NOVEL VIRAL VECTOR CONSTRUCT FOR NEURON SPECIFIC CONTINUOUS DOPA SYNTHESIS IN VIVO
A61K 48/00 (2006.01)	2498825 *	NOVEL VIRAL VECTOR CONSTRUCT FOR NEURON SPECIFIC CONTINUOUS DOPA SYNTHESIS IN VIVO
A61K 31/4412 (2006.01)	2405907 *	TREATMENT OF PANCREATIC CANCER
A61P 35/04 (2006.01)	2405907 *	TREATMENT OF PANCREATIC CANCER
A61K 31/18 (2006.01)	2405907 *	TREATMENT OF PANCREATIC CANCER
C09B 23/00 (2006.01)	2419478 *	FLUORESCENT IMAGING WITH SUBSTITUTED CYANINE DYES
G01N 33/58 (2006.01)	2419478 *	FLUORESCENT IMAGING WITH SUBSTITUTED CYANINE DYES
C09B 23/01 (2006.01)	2419478 *	FLUORESCENT IMAGING WITH SUBSTITUTED CYANINE DYES
C09B 23/08 (2006.01)	2419478 *	FLUORESCENT IMAGING WITH SUBSTITUTED CYANINE DYES
E04D 1/30 (2006.01)	2401448 *	BUILDING COVER ELEMENT WITH AN INTEGRATED ENERGY PRODUCTION DEVICE
F24J 2/04 (2006.01)	2401448 *	BUILDING COVER ELEMENT WITH AN INTEGRATED ENERGY PRODUCTION DEVICE
H01L 31/048 (2006.01)	2401448 *	BUILDING COVER ELEMENT WITH AN INTEGRATED ENERGY PRODUCTION DEVICE
A63B 23/02 (2006.01)	2416852 *	A SLIDING ABDOMINAL EXERCISE DEVICE
G01C 9/28 (2006.01)	2322900	Water level
A61K 31/5377 (2006.01)	2444400 *	SUBSTITUTED POLYCYCLIC CARBAMOYL PYRIDONE DERIVATIVE
A61K 31/5383 (2006.01)	2444400 *	SUBSTITUTED POLYCYCLIC CARBAMOYL PYRIDONE DERIVATIVE
A61K 31/4985 (2006.01)	2444400 *	SUBSTITUTED POLYCYCLIC CARBAMOYL PYRIDONE DERIVATIVE
C07D 498/14 (2006.01)	2444400 *	SUBSTITUTED POLYCYCLIC CARBAMOYL PYRIDONE DERIVATIVE
A61K 31/53 (2006.01)	2444400 *	SUBSTITUTED POLYCYCLIC CARBAMOYL PYRIDONE DERIVATIVE
A61K 31/553 (2006.01)	2444400 *	SUBSTITUTED POLYCYCLIC CARBAMOYL PYRIDONE DERIVATIVE
A61P 31/16 (2006.01)	2444400 *	SUBSTITUTED POLYCYCLIC CARBAMOYL PYRIDONE DERIVATIVE
A61P 43/00 (2006.01)	2444400 *	SUBSTITUTED POLYCYCLIC CARBAMOYL PYRIDONE DERIVATIVE
C07D 471/04 (2006.01)	2444400 *	SUBSTITUTED POLYCYCLIC CARBAMOYL PYRIDONE DERIVATIVE
C07D 471/14 (2006.01)	2444400 *	SUBSTITUTED POLYCYCLIC CARBAMOYL PYRIDONE DERIVATIVE
B65D 85/34 (2006.01)	2371740	Crate
B65D 6/00 (2006.01)	2371740	Crate
B65D 21/02 (2006.01)	2371740	Crate
F21V 7/22 (2006.01)	2477243 *	REFLECTOR FOR LIGHT-EMITTING DEVICE, AND LIGHT-EMITTING DEVICE
F21Y 101/02 (2006.01)	2477243 *	REFLECTOR FOR LIGHT-EMITTING DEVICE, AND LIGHT-EMITTING DEVICE
C08G 69/26 (2006.01)	2477243 *	REFLECTOR FOR LIGHT-EMITTING DEVICE, AND LIGHT-EMITTING DEVICE
C08K 5/00 (2006.01)	2477243 *	REFLECTOR FOR LIGHT-EMITTING DEVICE, AND LIGHT-EMITTING DEVICE
C08K 9/00 (2006.01)	2477243 *	REFLECTOR FOR LIGHT-EMITTING DEVICE, AND LIGHT-EMITTING DEVICE
C08L 77/06 (2006.01)	2477243 *	REFLECTOR FOR LIGHT-EMITTING DEVICE, AND LIGHT-EMITTING DEVICE
H01L 33/60 (2010.01)	2477243 *	REFLECTOR FOR LIGHT-EMITTING DEVICE, AND LIGHT-EMITTING DEVICE
C08K 3/22 (2006.01)	2477243 *	REFLECTOR FOR LIGHT-EMITTING DEVICE, AND LIGHT-EMITTING DEVICE
A61K 9/00 (2006.01)	2453873 *	IMPROVEMENTS IN AND RELATING TO COLON CLEANSING COMPOSITIONS
A61K 47/10 (2006.01)	2453873 *	IMPROVEMENTS IN AND RELATING TO COLON CLEANSING COMPOSITIONS

MKP (51)	Broj objave evropske prijava patenta (97)	Naziv pronalaska (54)
B01J 23/50 (2006.01)	2468399	Catalyst for the reduction of NO to N2 with ethanol or ethanol and hydrogen under lean DENOx conditions
B01D 53/86 (2006.01)	2468399	Catalyst for the reduction of NO to N2 with ethanol or ethanol and hydrogen under lean DENOx conditions
B01D 53/94 (2006.01)	2468399	Catalyst for the reduction of NO to N2 with ethanol or ethanol and hydrogen under lean DENOx conditions
A43B 7/06 (2006.01)	2488060 *	WATERPROOF AND VAPOR-PERMEABLE SOLE FOR SHOES AND SHOE PROVIDED WITH SAID SOLE
A43B 7/08 (2006.01)	2488060 *	WATERPROOF AND VAPOR-PERMEABLE SOLE FOR SHOES AND SHOE PROVIDED WITH SAID SOLE
A43B 7/12 (2006.01)	2488060 *	WATERPROOF AND VAPOR-PERMEABLE SOLE FOR SHOES AND SHOE PROVIDED WITH SAID SOLE
A61M 5/315 (2006.01)	2437827 *	SPINDLE AND BEARING COMBINATION AND DRUG DELIVERY DEVICE
A61M 5/50 (2006.01)	2437827 *	SPINDLE AND BEARING COMBINATION AND DRUG DELIVERY DEVICE
A01N 45/00 (2006.01)	2461691 *	THERAPEUTIC VITAMIN D SUN-PROTECTING FORMULATIONS AND METHODS FOR THEIR USE
A61K 31/59 (2006.01)	2461691 *	THERAPEUTIC VITAMIN D SUN-PROTECTING FORMULATIONS AND METHODS FOR THEIR USE
A61K 31/505 (2006.01)	2485732 *	SYNERGISTIC FUNGICIDAL COMPOSITION CONTAINING 5-FLUOROCYTOSINE FOR FUNGAL CONTROL IN CEREALS
H02J 13/00 (2006.01)	2425510 *	HIGH VOLTAGE POWER LINE COMMUNICATION SYSTEM USING AN ENERGY HARVESTING POWER SUPPLY
H02H 3/04 (2006.01)	2425510 *	HIGH VOLTAGE POWER LINE COMMUNICATION SYSTEM USING AN ENERGY HARVESTING POWER SUPPLY
B05D 7/24 (2006.01)	2411162 *	SELF-DISPERSIBLE COATED METAL OXIDE POWDER, AND PROCESS FOR PRODUCTION AND USE
C04B 41/52 (2006.01)	2411162 *	SELF-DISPERSIBLE COATED METAL OXIDE POWDER, AND PROCESS FOR PRODUCTION AND USE
F02D 41/24 (2006.01)	2410160	Method of providing trim data for a fuel injection device
H02J 3/14 (2006.01)	2427940 *	MONITORING APPARATUS
H02H 3/04 (2006.01)	2427940 *	MONITORING APPARATUS
A61K 9/06 (2006.01)	2413922 *	ANTIBACTERIAL COMPOSITION COMPRISING 4-ISOPROPYL-3-METHYLPHENO AND ZINC IONS
A61K 9/08 (2006.01)	2413922 *	ANTIBACTERIAL COMPOSITION COMPRISING 4-ISOPROPYL-3-METHYLPHENO AND ZINC IONS
A61K 8/27 (2006.01)	2413922 *	ANTIBACTERIAL COMPOSITION COMPRISING 4-ISOPROPYL-3-METHYLPHENO AND ZINC IONS
A61K 8/34 (2006.01)	2413922 *	ANTIBACTERIAL COMPOSITION COMPRISING 4-ISOPROPYL-3-METHYLPHENO AND ZINC IONS
A61K 31/05 (2006.01)	2413922 *	ANTIBACTERIAL COMPOSITION COMPRISING 4-ISOPROPYL-3-METHYLPHENO AND ZINC IONS
A61K 33/30 (2006.01)	2413922 *	ANTIBACTERIAL COMPOSITION COMPRISING 4-ISOPROPYL-3-METHYLPHENO AND ZINC IONS
A61K 45/06 (2006.01)	2413922 *	ANTIBACTERIAL COMPOSITION COMPRISING 4-ISOPROPYL-3-METHYLPHENO AND ZINC IONS
A61K 9/00 (2006.01)	2413922 *	ANTIBACTERIAL COMPOSITION COMPRISING 4-ISOPROPYL-3-METHYLPHENO AND ZINC IONS
H02H 1/00 (2006.01)	2462670 *	ELECTRICAL INSTALLATION ARRANGEMENT
C07K 16/30 (2006.01)	2459595 *	MUC1 ANTIBODIES
A61K 9/12 (2006.01)	2435025 *	RESPIRATORY DELIVERY OF ACTIVE AGENTS
A61P 11/00 (2006.01)	2435025 *	RESPIRATORY DELIVERY OF ACTIVE AGENTS
C07F 9/09 (2006.01)	2452944 *	DIPHENYL SULFIDE DERIVATIVES AND MEDICINES CONTAINING SAME AS ACTIVE INGREDIENT
C07F 9/38 (2006.01)	2452944 *	DIPHENYL SULFIDE DERIVATIVES AND MEDICINES CONTAINING SAME AS ACTIVE INGREDIENT

MKP (51)	Broj objave evropske prijava patenta (97)	Naziv pronalaska (54)
A61P 31/04 (2006.01)	2452944 *	DIPHENYL SULFIDE DERIVATIVES AND MEDICINES CONTAINING SAME AS ACTIVE INGREDIENT
A61P 43/00 (2006.01)	2452944 *	DIPHENYL SULFIDE DERIVATIVES AND MEDICINES CONTAINING SAME AS ACTIVE INGREDIENT
A61K 31/662 (2006.01)	2452944 *	DIPHENYL SULFIDE DERIVATIVES AND MEDICINES CONTAINING SAME AS ACTIVE INGREDIENT
C07J 3/00 (2006.01)	2437746 *	17 BETA-ALKYL-17 ALPHA-OXY-ESTRADIENES
A61K 31/56 (2006.01)	2437746 *	17 BETA-ALKYL-17 ALPHA-OXY-ESTRADIENES
A61M 5/315 (2006.01)	2482876 *	Drive assembly and use of a spring in a drug delivery device
A61M 5/24 (2006.01)	2482876 *	Drive assembly and use of a spring in a drug delivery device
A01N 43/90 (2006.01)	2473053 *	SUBSTITUTED XANTHINE DERIVATIVES
A61K 31/522 (2006.01)	2473053 *	SUBSTITUTED XANTHINE DERIVATIVES
C08K 5/053 (2006.01)	2464688 *	COMPOSITION, IN PARTICULAR A BLOCKING AGENT COMPOSITION FOR FIXING BLANKS TO OPHTHALMIC OR OPTICAL LENSES
C09J 167/00 (2006.01)	2464688 *	COMPOSITION, IN PARTICULAR A BLOCKING AGENT COMPOSITION FOR FIXING BLANKS TO OPHTHALMIC OR OPTICAL LENSES
C08L 67/02 (2006.01)	2464688 *	COMPOSITION, IN PARTICULAR A BLOCKING AGENT COMPOSITION FOR FIXING BLANKS TO OPHTHALMIC OR OPTICAL LENSES
G02B 6/02 (2006.01)	2464688 *	COMPOSITION, IN PARTICULAR A BLOCKING AGENT COMPOSITION FOR FIXING BLANKS TO OPHTHALMIC OR OPTICAL LENSES
B24B 13/005 (2006.01)	2464688 *	COMPOSITION, IN PARTICULAR A BLOCKING AGENT COMPOSITION FOR FIXING BLANKS TO OPHTHALMIC OR OPTICAL LENSES
C08L 63/00 (2006.01)	2464688 *	COMPOSITION, IN PARTICULAR A BLOCKING AGENT COMPOSITION FOR FIXING BLANKS TO OPHTHALMIC OR OPTICAL LENSES
G01N 33/487 (2006.01)	2448469 *	ANALYTE TESTING METHODS AND DEVICE FOR CALCULATING BASAL INSULIN THERAPY
A61B 5/00 (2006.01)	2448469 *	ANALYTE TESTING METHODS AND DEVICE FOR CALCULATING BASAL INSULIN THERAPY
C07D 487/04 (2006.01)	2430024 *	[1,2,4]TRIAZOLO [4,3-B]PYRIDAZINES AS LIGANDS OF THE ANDROGEN RECEPTOR
A61K 31/5025 (2006.01)	2430024 *	[1,2,4]TRIAZOLO [4,3-B]PYRIDAZINES AS LIGANDS OF THE ANDROGEN RECEPTOR
A61P 35/00 (2006.01)	2430024 *	[1,2,4]TRIAZOLO [4,3-B]PYRIDAZINES AS LIGANDS OF THE ANDROGEN RECEPTOR
A61K 38/48 (2006.01)	2445517 *	METHODS FOR DIAGNOSING IRRITABLE BOWEL SYNDROME
C07D 213/74 (2006.01)	2394994	One-pot process for the synthesis of dalfampridine
A61K 31/44 (2006.01)	2394994	One-pot process for the synthesis of dalfampridine
A61K 38/47 (2006.01)	2459212 *	COMPOSITIONS AND METHODS FOR TREATING GAUCHER DISEASE
A61K 38/46 (2006.01)	2459212 *	COMPOSITIONS AND METHODS FOR TREATING GAUCHER DISEASE
B63J 3/02 (2006.01)	2499041 *	HYBRID PROPULSION SYSTEM FOR A VESSEL
B63J 3/04 (2006.01)	2499041 *	HYBRID PROPULSION SYSTEM FOR A VESSEL
B63H 21/20 (2006.01)	2499041 *	HYBRID PROPULSION SYSTEM FOR A VESSEL
G06K 19/077 (2006.01)	2415001 *	INSERT FORMING AN ANTENNA AND SMART CARD COMPRISING SAME
B32B 37/00 (2006.01)	2415001 *	INSERT FORMING AN ANTENNA AND SMART CARD COMPRISING SAME
C12N 1/15 (2006.01)	2468859 *	NOVEL PROTEIN HAVING B-GLUCOSIDASE ACTIVITY, AND USE THEREOF
D21H 17/22 (2006.01)	2468859 *	NOVEL PROTEIN HAVING B-GLUCOSIDASE ACTIVITY, AND USE THEREOF
C12N 1/19 (2006.01)	2468859 *	NOVEL PROTEIN HAVING B-GLUCOSIDASE ACTIVITY, AND USE THEREOF
C12N 1/21 (2006.01)	2468859 *	NOVEL PROTEIN HAVING B-GLUCOSIDASE ACTIVITY, AND USE THEREOF
C12N 5/10 (2006.01)	2468859 *	NOVEL PROTEIN HAVING B-GLUCOSIDASE ACTIVITY, AND USE THEREOF

MKP (51)	Broj objave evropske prijave patenta (97)	Naziv pronalaska (54)
A23K 1/16 (2006.01)	2468859 *	NOVEL PROTEIN HAVING B-GLUCOSIDASE ACTIVITY, AND USE THEREOF
D21C 5/02 (2006.01)	2468859 *	NOVEL PROTEIN HAVING B-GLUCOSIDASE ACTIVITY, AND USE THEREOF
C12N 9/42 (2006.01)	2468859 *	NOVEL PROTEIN HAVING B-GLUCOSIDASE ACTIVITY, AND USE THEREOF
C12P 19/14 (2006.01)	2468859 *	NOVEL PROTEIN HAVING B-GLUCOSIDASE ACTIVITY, AND USE THEREOF
C12N 15/09 (2006.01)	2468859 *	NOVEL PROTEIN HAVING B-GLUCOSIDASE ACTIVITY, AND USE THEREOF
C12P 21/02 (2006.01)	2468859 *	NOVEL PROTEIN HAVING B-GLUCOSIDASE ACTIVITY, AND USE THEREOF
E05B 17/20 (2006.01)	2476828	Locking device
E05B 15/00 (2006.01)	2476828	Locking device
E05B 65/08 (2006.01)	2476828	Locking device
E05D 15/06 (2006.01)	2476828	Locking device
E05B 63/00 (2006.01)	2476828	Locking device
H01R 9/05 (2006.01)	2436088 *	COAXIAL CABLE CONNECTOR HAVING ELECTRICAL CONTINUITY MEMBER
H01R 13/648 (2006.01)	2436088 *	COAXIAL CABLE CONNECTOR HAVING ELECTRICAL CONTINUITY MEMBER
C08F 8/00 (2006.01)	2499170 *	SURGICAL NEEDLE COATING AND METHODS
G09F 7/04 (2006.01)	2377435	Assembly for reversible attachment of representative works
A47G 1/06 (2006.01)	2377435	Assembly for reversible attachment of representative works
A47G 1/17 (2006.01)	2377435	Assembly for reversible attachment of representative works
A61K 38/18 (2006.01)	2427207 *	FGF21 MUTANTS AND USES THEREOF
C07K 14/50 (2006.01)	2427207 *	FGF21 MUTANTS AND USES THEREOF
B65G 67/20 (2006.01)	2483189 *	METHOD AND DEVICE FOR FILLING A CONTAINER
A61P 1/04 (2006.01)	2436683 *	AGENT FOR TREATMENT OR PREVENTION OF DISEASES ASSOCIATED WITH ACTIVITY OF NEUROTROPHIC FACTORS
C07D 405/14 (2006.01)	2436683 *	AGENT FOR TREATMENT OR PREVENTION OF DISEASES ASSOCIATED WITH ACTIVITY OF NEUROTROPHIC FACTORS
A61P 3/10 (2006.01)	2436683 *	AGENT FOR TREATMENT OR PREVENTION OF DISEASES ASSOCIATED WITH ACTIVITY OF NEUROTROPHIC FACTORS
A61K 31/4184 (2006.01)	2436683 *	AGENT FOR TREATMENT OR PREVENTION OF DISEASES ASSOCIATED WITH ACTIVITY OF NEUROTROPHIC FACTORS
A61P 7/02 (2006.01)	2436683 *	AGENT FOR TREATMENT OR PREVENTION OF DISEASES ASSOCIATED WITH ACTIVITY OF NEUROTROPHIC FACTORS
A61K 31/423 (2006.01)	2436683 *	AGENT FOR TREATMENT OR PREVENTION OF DISEASES ASSOCIATED WITH ACTIVITY OF NEUROTROPHIC FACTORS
A61P 7/04 (2006.01)	2436683 *	AGENT FOR TREATMENT OR PREVENTION OF DISEASES ASSOCIATED WITH ACTIVITY OF NEUROTROPHIC FACTORS
A61K 31/428 (2006.01)	2436683 *	AGENT FOR TREATMENT OR PREVENTION OF DISEASES ASSOCIATED WITH ACTIVITY OF NEUROTROPHIC FACTORS
A61P 9/08 (2006.01)	2436683 *	AGENT FOR TREATMENT OR PREVENTION OF DISEASES ASSOCIATED WITH ACTIVITY OF NEUROTROPHIC FACTORS
A61K 31/454 (2006.01)	2436683 *	AGENT FOR TREATMENT OR PREVENTION OF DISEASES ASSOCIATED WITH ACTIVITY OF NEUROTROPHIC FACTORS
A61P 13/12 (2006.01)	2436683 *	AGENT FOR TREATMENT OR PREVENTION OF DISEASES ASSOCIATED WITH ACTIVITY OF NEUROTROPHIC FACTORS
A61K 31/4439 (2006.01)	2436683 *	AGENT FOR TREATMENT OR PREVENTION OF DISEASES ASSOCIATED WITH ACTIVITY OF NEUROTROPHIC FACTORS
A61P 9/10 (2006.01)	2436683 *	AGENT FOR TREATMENT OR PREVENTION OF DISEASES ASSOCIATED WITH ACTIVITY OF NEUROTROPHIC FACTORS
A61P 1/02 (2006.01)	2436683 *	AGENT FOR TREATMENT OR PREVENTION OF DISEASES ASSOCIATED WITH ACTIVITY OF NEUROTROPHIC FACTORS

MKP (51)	Broj objave evropske prijava patenta (97)	Naziv pronalaska (54)
C07H 19/19 (2006.01)	2430032 *	METHOD FOR THE MANUFACTURE OF 2-FLUORO-ARA-ADENINE
C07H 1/00 (2006.01)	2430032 *	METHOD FOR THE MANUFACTURE OF 2-FLUORO-ARA-ADENINE
A61K 45/06 (2006.01)	2490688 *	COMBINATION CANCER THERAPY WITH HSP90 INHIBITORY COMPOUNDS
A61K 31/337 (2006.01)	2490688 *	COMBINATION CANCER THERAPY WITH HSP90 INHIBITORY COMPOUNDS
A61P 35/00 (2006.01)	2490688 *	COMBINATION CANCER THERAPY WITH HSP90 INHIBITORY COMPOUNDS
A61K 31/4196 (2006.01)	2490688 *	COMBINATION CANCER THERAPY WITH HSP90 INHIBITORY COMPOUNDS
G06F 17/30 (2006.01)	2485163 *	SERVER, DICTIONARY-GENERATION METHOD, DICTIONARY-GENERATION PROGRAM, AND COMPUTER-READABLE RECORDING MEDIUM WITH SAID PROGRAM RECORDED THEREON
A01N 33/00 (2006.01)	2488021 *	COMPOSITIONS AND METHODS TO CONTROL OOMYCETE FUNGAL PATHOGENS
A01N 43/90 (2006.01)	2488021 *	COMPOSITIONS AND METHODS TO CONTROL OOMYCETE FUNGAL PATHOGENS
C07D 403/14 (2006.01)	2496571 *	PROCESSES FOR THE PREPARATION OF 5-LIPOXYGENASE ACTIVATING PROTEIN INHIBITORS AND THEIR INTERMEDIATES
A61K 38/17 (2006.01)	2405932 *	Sparc angiogenic domain and methods of use
A61M 5/315 (2006.01)	2445553 *	DRIVE MECHANISM FOR DRUG DELIVERY DEVICE
C07K 14/505 (2006.01)	2480569 *	PROCESS FOR THE PURIFICATION OF RECOMBINANT HUMAN ERYTHROPOIETIN (EPO), EPO THUS PURIFIED AND PHARMACEUTICAL COMPOSITIONS COMPRISING SAME
C07K 1/16 (2006.01)	2480569 *	PROCESS FOR THE PURIFICATION OF RECOMBINANT HUMAN ERYTHROPOIETIN (EPO), EPO THUS PURIFIED AND PHARMACEUTICAL COMPOSITIONS COMPRISING SAME
A61K 31/4427 (2006.01)	2419417 *	4-AZETIDINYL-1-HETEROARYL-CYCLOHEXANE ANTAGONISTS OF CCR2
A61K 31/437 (2006.01)	2419417 *	4-AZETIDINYL-1-HETEROARYL-CYCLOHEXANE ANTAGONISTS OF CCR2
A61K 31/433 (2006.01)	2419417 *	4-AZETIDINYL-1-HETEROARYL-CYCLOHEXANE ANTAGONISTS OF CCR2
C07D 401/08 (2006.01)	2419417 *	4-AZETIDINYL-1-HETEROARYL-CYCLOHEXANE ANTAGONISTS OF CCR2
A61P 3/10 (2006.01)	2419417 *	4-AZETIDINYL-1-HETEROARYL-CYCLOHEXANE ANTAGONISTS OF CCR2
C07D 403/08 (2006.01)	2419417 *	4-AZETIDINYL-1-HETEROARYL-CYCLOHEXANE ANTAGONISTS OF CCR2
A61P 29/00 (2006.01)	2419417 *	4-AZETIDINYL-1-HETEROARYL-CYCLOHEXANE ANTAGONISTS OF CCR2
C07D 413/08 (2006.01)	2419417 *	4-AZETIDINYL-1-HETEROARYL-CYCLOHEXANE ANTAGONISTS OF CCR2
C07D 417/08 (2006.01)	2419417 *	4-AZETIDINYL-1-HETEROARYL-CYCLOHEXANE ANTAGONISTS OF CCR2
C07D 471/04 (2006.01)	2419417 *	4-AZETIDINYL-1-HETEROARYL-CYCLOHEXANE ANTAGONISTS OF CCR2
B01J 29/08 (2006.01)	2424661 *	ZEOLITE Y
B01J 37/00 (2006.01)	2424661 *	ZEOLITE Y
A61M 5/315 (2006.01)	2485789 *	DRUG DELIVERY DEVICE WITH CLEARANCE COMPENSATION MEANS
A61M 5/00 (2006.01)	2485789 *	DRUG DELIVERY DEVICE WITH CLEARANCE COMPENSATION MEANS
A61M 5/24 (2006.01)	2485789 *	DRUG DELIVERY DEVICE WITH CLEARANCE COMPENSATION MEANS
A22B 5/20 (2006.01)	2409572	Machine for extracting material classified as hazardous from the medullary canal of sheep and goats
A61K 9/20 (2006.01)	2442799 *	SOLID PHARMACEUTICAL COMPOSITION COMPRISING RIVAROXABAN
A61K 31/5377 (2006.01)	2442799 *	SOLID PHARMACEUTICAL COMPOSITION COMPRISING RIVAROXABAN
A62B 1/14 (2006.01)	2453988 *	SAFETY DEVICE
A61P 35/00 (2006.01)	2490690 *	METHOD OF TREATING PROLIFERATIVE DISORDERS AND OTHER PATHOLOGICAL CONDITIONS MEDIATED BY BCR-ABL, C-KIT, DDR1, DDR2 OR PDGF-R KINASE ACTIVITY
A61K 31/506 (2006.01)	2490690 *	METHOD OF TREATING PROLIFERATIVE DISORDERS AND OTHER PATHOLOGICAL CONDITIONS MEDIATED BY BCR-ABL, C-KIT, DDR1, DDR2 OR PDGF-R KINASE ACTIVITY
H04W 72/04 (2009.01)	2466979 *	METHOD, SYSTEM AND DEVICE FOR USING TERMINAL IDENTIFIER

MKP (51)	Broj objave evropske prijava patenta (97)	Naziv pronalaska (54)
A01N 43/66 (2006.01)	2440053 *	BENZYL SUBSTITUTED TRIAZINE DERIVATIVES AND THEIR THERAPEUTICAL APPLICATIONS
A61K 31/53 (2006.01)	2440053 *	BENZYL SUBSTITUTED TRIAZINE DERIVATIVES AND THEIR THERAPEUTICAL APPLICATIONS
C07D 401/12 (2006.01)	2411364 *	ANTICANCER COMPOUNDS, PREPARATION THEREOF, AND THERAPEUTIC USE THEREOF
A61K 31/444 (2006.01)	2411364 *	ANTICANCER COMPOUNDS, PREPARATION THEREOF, AND THERAPEUTIC USE THEREOF
A61P 35/00 (2006.01)	2411364 *	ANTICANCER COMPOUNDS, PREPARATION THEREOF, AND THERAPEUTIC USE THEREOF
C07D 213/56 (2006.01)	2411364 *	ANTICANCER COMPOUNDS, PREPARATION THEREOF, AND THERAPEUTIC USE THEREOF
A61K 31/045 (2006.01)	2458983 *	INHIBITORS OF COGNITIVE DECLINE
A01N 31/00 (2006.01)	2458983 *	INHIBITORS OF COGNITIVE DECLINE
A61P 25/24 (2006.01)	2499148 *	CONFORMATIONALLY CONSTRAINED, FULLY SYNTHETIC MACROCYCLIC COMPOUNDS
A61K 31/4745 (2006.01)	2499148 *	CONFORMATIONALLY CONSTRAINED, FULLY SYNTHETIC MACROCYCLIC COMPOUNDS
C07D 498/04 (2006.01)	2499148 *	CONFORMATIONALLY CONSTRAINED, FULLY SYNTHETIC MACROCYCLIC COMPOUNDS
C07D 498/18 (2006.01)	2499148 *	CONFORMATIONALLY CONSTRAINED, FULLY SYNTHETIC MACROCYCLIC COMPOUNDS
C07F 7/08 (2006.01)	2499148 *	CONFORMATIONALLY CONSTRAINED, FULLY SYNTHETIC MACROCYCLIC COMPOUNDS
A61K 31/695 (2006.01)	2499148 *	CONFORMATIONALLY CONSTRAINED, FULLY SYNTHETIC MACROCYCLIC COMPOUNDS
A61P 1/06 (2006.01)	2499148 *	CONFORMATIONALLY CONSTRAINED, FULLY SYNTHETIC MACROCYCLIC COMPOUNDS
A61P 25/20 (2006.01)	2431355 *	NEW CRYSTALLINE FORM VI OF AGOMELATINE, PREPARATION METHOD AND APPLICATION THEREOF
A61P 25/22 (2006.01)	2431355 *	NEW CRYSTALLINE FORM VI OF AGOMELATINE, PREPARATION METHOD AND APPLICATION THEREOF
A61P 25/24 (2006.01)	2431355 *	NEW CRYSTALLINE FORM VI OF AGOMELATINE, PREPARATION METHOD AND APPLICATION THEREOF
C07C 233/18 (2006.01)	2431355 *	NEW CRYSTALLINE FORM VI OF AGOMELATINE, PREPARATION METHOD AND APPLICATION THEREOF
A61P 9/00 (2006.01)	2431355 *	NEW CRYSTALLINE FORM VI OF AGOMELATINE, PREPARATION METHOD AND APPLICATION THEREOF
A61K 31/165 (2006.01)	2431355 *	NEW CRYSTALLINE FORM VI OF AGOMELATINE, PREPARATION METHOD AND APPLICATION THEREOF
A61P 1/00 (2006.01)	2431355 *	NEW CRYSTALLINE FORM VI OF AGOMELATINE, PREPARATION METHOD AND APPLICATION THEREOF
A61P 25/00 (2006.01)	2431355 *	NEW CRYSTALLINE FORM VI OF AGOMELATINE, PREPARATION METHOD AND APPLICATION THEREOF
A61P 5/00 (2006.01)	2431355 *	NEW CRYSTALLINE FORM VI OF AGOMELATINE, PREPARATION METHOD AND APPLICATION THEREOF
A61P 25/18 (2006.01)	2431355 *	NEW CRYSTALLINE FORM VI OF AGOMELATINE, PREPARATION METHOD AND APPLICATION THEREOF
C07D 307/80 (2006.01)	2435413 *	PROCESS FOR THE PRODUCTION OF DRONEDARONE INTERMEDIATES
C12N 15/10 (2006.01)	2479278	Method for the construction of specific promoters
C12N 15/79 (2006.01)	2479278	Method for the construction of specific promoters
A61P 25/00 (2006.01)	2475429 *	COMPOSITIONS COMPRISING ENZYME-CLEAVABLE KETONE-MODIFIED OPIOID PRODRUGS AND OPTIONAL INHIBITORS THEREOF
C07D 489/02 (2006.01)	2475429 *	COMPOSITIONS COMPRISING ENZYME-CLEAVABLE KETONE-MODIFIED OPIOID PRODRUGS AND OPTIONAL INHIBITORS THEREOF
A61K 31/485 (2006.01)	2475429 *	COMPOSITIONS COMPRISING ENZYME-CLEAVABLE KETONE-MODIFIED OPIOID PRODRUGS AND OPTIONAL INHIBITORS THEREOF

MKP (51)	Broj objave evropske prijava patenta (97)	Naziv pronalaska (54)
C07D 417/14 (2006.01)	2445903 *	1, 3-DISUBSTITUTED IMIDAZOLIDIN-2-ONE DERIVATIVES AS INHIBITORS OF CYP 17
A61K 31/4178 (2006.01)	2445903 *	1, 3-DISUBSTITUTED IMIDAZOLIDIN-2-ONE DERIVATIVES AS INHIBITORS OF CYP 17
C07D 407/14 (2006.01)	2445903 *	1, 3-DISUBSTITUTED IMIDAZOLIDIN-2-ONE DERIVATIVES AS INHIBITORS OF CYP 17
C07D 409/14 (2006.01)	2445903 *	1, 3-DISUBSTITUTED IMIDAZOLIDIN-2-ONE DERIVATIVES AS INHIBITORS OF CYP 17
A61P 35/00 (2006.01)	2445903 *	1, 3-DISUBSTITUTED IMIDAZOLIDIN-2-ONE DERIVATIVES AS INHIBITORS OF CYP 17
C07D 403/04 (2006.01)	2445903 *	1, 3-DISUBSTITUTED IMIDAZOLIDIN-2-ONE DERIVATIVES AS INHIBITORS OF CYP 17
C07D 403/14 (2006.01)	2445903 *	1, 3-DISUBSTITUTED IMIDAZOLIDIN-2-ONE DERIVATIVES AS INHIBITORS OF CYP 17
A61K 31/4439 (2006.01)	2470508 *	CANNABINOID RECEPTOR MODULATORS
A61K 31/497 (2006.01)	2470508 *	CANNABINOID RECEPTOR MODULATORS
A61K 31/416 (2006.01)	2470508 *	CANNABINOID RECEPTOR MODULATORS
C07D 401/14 (2006.01)	2470508 *	CANNABINOID RECEPTOR MODULATORS
A61P 29/00 (2006.01)	2470508 *	CANNABINOID RECEPTOR MODULATORS
C07D 403/04 (2006.01)	2470508 *	CANNABINOID RECEPTOR MODULATORS
A61P 19/02 (2006.01)	2470508 *	CANNABINOID RECEPTOR MODULATORS
C07D 405/14 (2006.01)	2470508 *	CANNABINOID RECEPTOR MODULATORS
C07D 401/04 (2006.01)	2470508 *	CANNABINOID RECEPTOR MODULATORS
C07F 9/09 (2006.01)	2470508 *	CANNABINOID RECEPTOR MODULATORS
C07D 231/54 (2006.01)	2470508 *	CANNABINOID RECEPTOR MODULATORS
A61K 31/661 (2006.01)	2470508 *	CANNABINOID RECEPTOR MODULATORS
A61K 47/20 (2006.01)	2498802 *	PHARMACEUTICAL COMPOSITION COMPRISING A GLP-1 AGONIST, AN INSULIN, AND METHIONINE
A61K 38/28 (2006.01)	2498802 *	PHARMACEUTICAL COMPOSITION COMPRISING A GLP-1 AGONIST, AN INSULIN, AND METHIONINE
A61P 3/10 (2006.01)	2498802 *	PHARMACEUTICAL COMPOSITION COMPRISING A GLP-1 AGONIST, AN INSULIN, AND METHIONINE
A61K 38/26 (2006.01)	2498802 *	PHARMACEUTICAL COMPOSITION COMPRISING A GLP-1 AGONIST, AN INSULIN, AND METHIONINE
A61P 35/02 (2006.01)	2403856 *	METHYLENEDIOXYBENZO [I]PHENANTHRIDINE DERIVATIVES USED TO TREAT CANCER
A61P 35/00 (2006.01)	2403856 *	METHYLENEDIOXYBENZO [I]PHENANTHRIDINE DERIVATIVES USED TO TREAT CANCER
C07D 491/04 (2006.01)	2403856 *	METHYLENEDIOXYBENZO [I]PHENANTHRIDINE DERIVATIVES USED TO TREAT CANCER
A61K 31/4355 (2006.01)	2403856 *	METHYLENEDIOXYBENZO [I]PHENANTHRIDINE DERIVATIVES USED TO TREAT CANCER
H04W 72/04 (2009.01)	2490496 *	RESOURCE CONFIGURATION METHOD, EQUIPMENT AND SYSTEM FOR UPLINK CONTROL CHANNEL
A47G 27/02 (2006.01)	2440091 *	CARPET TILES AND METHODS OF PRODUCING CARPET TILES WITH DIVERSITY OF COLOR AND TEXTURE
A47G 27/04 (2006.01)	2440091 *	CARPET TILES AND METHODS OF PRODUCING CARPET TILES WITH DIVERSITY OF COLOR AND TEXTURE
D06N 7/00 (2006.01)	2440091 *	CARPET TILES AND METHODS OF PRODUCING CARPET TILES WITH DIVERSITY OF COLOR AND TEXTURE
D05C 17/02 (2006.01)	2440091 *	CARPET TILES AND METHODS OF PRODUCING CARPET TILES WITH DIVERSITY OF COLOR AND TEXTURE
A61P 11/02 (2006.01)	2421830 *	2,5-DISUBSTITUTED ARYLSULFONAMIDE CCR3 ANTAGONISTS
A61K 31/18 (2006.01)	2421830 *	2,5-DISUBSTITUTED ARYLSULFONAMIDE CCR3 ANTAGONISTS
C07D 211/96 (2006.01)	2421830 *	2,5-DISUBSTITUTED ARYLSULFONAMIDE CCR3 ANTAGONISTS

MKP (51)	Broj objave evropske prijava patenta (97)	Naziv pronalaska (54)
A61P 29/00 (2006.01)	2421830 *	2,5-DISUBSTITUTED ARYLSULFONAMIDE CCR3 ANTAGONISTS
C07D 295/26 (2006.01)	2421830 *	2,5-DISUBSTITUTED ARYLSULFONAMIDE CCR3 ANTAGONISTS
A01N 43/62 (2006.01)	2421830 *	2,5-DISUBSTITUTED ARYLSULFONAMIDE CCR3 ANTAGONISTS
A61P 25/28 (2006.01)	2421830 *	2,5-DISUBSTITUTED ARYLSULFONAMIDE CCR3 ANTAGONISTS
C07D 241/04 (2006.01)	2421830 *	2,5-DISUBSTITUTED ARYLSULFONAMIDE CCR3 ANTAGONISTS
C07D 241/08 (2006.01)	2421830 *	2,5-DISUBSTITUTED ARYLSULFONAMIDE CCR3 ANTAGONISTS
A61K 9/00 (2006.01)	2275086	Reduced volume formulation of glatiramer acetate and methods of administration
A61K 38/16 (2006.01)	2275086	Reduced volume formulation of glatiramer acetate and methods of administration
C10G 3/00 (2006.01)	2305778	Fuel and fuel additives capable for use for internal combustion engines and process for the production thereof
C10L 1/02 (2006.01)	2305778	Fuel and fuel additives capable for use for internal combustion engines and process for the production thereof
E04H 4/14 (2006.01)	2446098 *	WATER ATTRACTION DEVICE
E04H 4/12 (2006.01)	2446098 *	WATER ATTRACTION DEVICE
F04D 15/00 (2006.01)	2446098 *	WATER ATTRACTION DEVICE
A63B 69/12 (2006.01)	2446098 *	WATER ATTRACTION DEVICE
A61K 41/00 (2006.01)	2464385 *	PHOTOCHEMICAL INTERNALIZATION METHOD
A61K 9/00 (2006.01)	2464385 *	PHOTOCHEMICAL INTERNALIZATION METHOD
A61K 48/00 (2006.01)	2464385 *	PHOTOCHEMICAL INTERNALIZATION METHOD
C12N 15/87 (2006.01)	2464385 *	PHOTOCHEMICAL INTERNALIZATION METHOD
A61P 35/00 (2006.01)	2464385 *	PHOTOCHEMICAL INTERNALIZATION METHOD
A61P 43/00 (2006.01)	2464385 *	PHOTOCHEMICAL INTERNALIZATION METHOD
A61M 5/315 (2006.01)	2482875 *	DRIVE ASSEMBLY, PISTON ROD, DRUG DELIVERY DEVICE, AND USE OF A SPRING
A61M 5/24 (2006.01)	2482875 *	DRIVE ASSEMBLY, PISTON ROD, DRUG DELIVERY DEVICE, AND USE OF A SPRING
C07K 14/705 (2006.01)	2440577 *	TRUNCATED ACTRIIB-FC FUSION PROTEINS
A61K 38/17 (2006.01)	2440577 *	TRUNCATED ACTRIIB-FC FUSION PROTEINS
A61P 3/00 (2006.01)	2440577 *	TRUNCATED ACTRIIB-FC FUSION PROTEINS
C07D 405/12 (2006.01)	2493852 *	4-SUBSTITUTED-2-PHENOXY-PHENYLAMINE DELTA OPIOID RECEPTOR MODULATORS
A61K 31/444 (2006.01)	2493852 *	4-SUBSTITUTED-2-PHENOXY-PHENYLAMINE DELTA OPIOID RECEPTOR MODULATORS
C07D 211/56 (2006.01)	2493852 *	4-SUBSTITUTED-2-PHENOXY-PHENYLAMINE DELTA OPIOID RECEPTOR MODULATORS
A61K 31/397 (2006.01)	2493852 *	4-SUBSTITUTED-2-PHENOXY-PHENYLAMINE DELTA OPIOID RECEPTOR MODULATORS
C07D 413/12 (2006.01)	2493852 *	4-SUBSTITUTED-2-PHENOXY-PHENYLAMINE DELTA OPIOID RECEPTOR MODULATORS
A61K 31/4025 (2006.01)	2493852 *	4-SUBSTITUTED-2-PHENOXY-PHENYLAMINE DELTA OPIOID RECEPTOR MODULATORS
C07D 451/04 (2006.01)	2493852 *	4-SUBSTITUTED-2-PHENOXY-PHENYLAMINE DELTA OPIOID RECEPTOR MODULATORS
C07D 401/12 (2006.01)	2493852 *	4-SUBSTITUTED-2-PHENOXY-PHENYLAMINE DELTA OPIOID RECEPTOR MODULATORS
A61K 31/40 (2006.01)	2493852 *	4-SUBSTITUTED-2-PHENOXY-PHENYLAMINE DELTA OPIOID RECEPTOR MODULATORS
C07D 205/04 (2006.01)	2493852 *	4-SUBSTITUTED-2-PHENOXY-PHENYLAMINE DELTA OPIOID RECEPTOR MODULATORS
C07D 453/02 (2006.01)	2493852 *	4-SUBSTITUTED-2-PHENOXY-PHENYLAMINE DELTA OPIOID RECEPTOR MODULATORS

MKP (51)	Broj objave evropske prijave patenta (97)	Naziv pronalaska (54)
C07D 409/12 (2006.01)	2493852 *	4-SUBSTITUTED-2-PHENOXY-PHENYLAMINE DELTA OPIOID RECEPTOR MODULATORS
A61K 31/4245 (2006.01)	2493852 *	4-SUBSTITUTED-2-PHENOXY-PHENYLAMINE DELTA OPIOID RECEPTOR MODULATORS
C07D 207/09 (2006.01)	2493852 *	4-SUBSTITUTED-2-PHENOXY-PHENYLAMINE DELTA OPIOID RECEPTOR MODULATORS
C07C 217/90 (2006.01)	2493852 *	4-SUBSTITUTED-2-PHENOXY-PHENYLAMINE DELTA OPIOID RECEPTOR MODULATORS
A61K 39/00 (2006.01)	2451476 *	CELL-BASED BIOPROCESSING
C07H 21/02 (2006.01)	2451476 *	CELL-BASED BIOPROCESSING
C12N 15/11 (2006.01)	2451476 *	CELL-BASED BIOPROCESSING
H04N 7/24 (2011.01)	2474164 *	METHODS AND SYSTEMS TO PERSONALIZE CONTENT STREAMS
H04L 29/06 (2006.01)	2474164 *	METHODS AND SYSTEMS TO PERSONALIZE CONTENT STREAMS
H04N 7/16 (2011.01)	2474164 *	METHODS AND SYSTEMS TO PERSONALIZE CONTENT STREAMS
H04N 7/173 (2011.01)	2474164 *	METHODS AND SYSTEMS TO PERSONALIZE CONTENT STREAMS
H04N 5/265 (2006.01)	2474164 *	METHODS AND SYSTEMS TO PERSONALIZE CONTENT STREAMS
G06F 17/30 (2006.01)	2474164 *	METHODS AND SYSTEMS TO PERSONALIZE CONTENT STREAMS
A61K 35/76 (2006.01)	2427201 *	COMBINED MEASLES-MALARIA VACCINE
A61P 33/06 (2006.01)	2427201 *	COMBINED MEASLES-MALARIA VACCINE
H04L 12/56 (2006.01)	2493128 *	COMMUNICATION SYSTEM, FLOW CONTROL APPARATUS, FLOW TABLE UPDATING METHOD AND PROGRAM
E05D 15/06 (2006.01)	2357305	Device for supporting and anchoring in a having condition the door panel in a counter-frame for retractable sliding doors
G06F 3/044 (2006.01)	2462499 *	CAPACITIVE DETECTION DEVICE HAVING FUNCTION INTEGRATION
A61K 9/28 (2006.01)	2448566 *	STABLE SHELLAC ENTERIC COATING FORMULATION FOR NUTRACEUTICAL AND PHARMACEUTICAL DOSAGE FORMS
A61K 9/48 (2006.01)	2448566 *	STABLE SHELLAC ENTERIC COATING FORMULATION FOR NUTRACEUTICAL AND PHARMACEUTICAL DOSAGE FORMS
A61K 9/50 (2006.01)	2448566 *	STABLE SHELLAC ENTERIC COATING FORMULATION FOR NUTRACEUTICAL AND PHARMACEUTICAL DOSAGE FORMS
C07C 323/61 (2006.01)	2272826	2-mercaptopentancarboxylic acid derivatives, the method for preparing them and the pharmaceutical compositions containing them
C07C 327/34 (2006.01)	2272826	2-mercaptopentancarboxylic acid derivatives, the method for preparing them and the pharmaceutical compositions containing them
C07D 205/04 (2006.01)	2272826	2-mercaptopentancarboxylic acid derivatives, the method for preparing them and the pharmaceutical compositions containing them
C07D 211/34 (2006.01)	2272826	2-mercaptopentancarboxylic acid derivatives, the method for preparing them and the pharmaceutical compositions containing them
C07D 213/55 (2006.01)	2272826	2-mercaptopentancarboxylic acid derivatives, the method for preparing them and the pharmaceutical compositions containing them
C07D 213/73 (2006.01)	2272826	2-mercaptopentancarboxylic acid derivatives, the method for preparing them and the pharmaceutical compositions containing them
A61P 9/00 (2006.01)	2272826	2-mercaptopentancarboxylic acid derivatives, the method for preparing them and the pharmaceutical compositions containing them
A61K 31/095 (2006.01)	2272826	2-mercaptopentancarboxylic acid derivatives, the method for preparing them and the pharmaceutical compositions containing them
A61P 7/02 (2006.01)	2272826	2-mercaptopentancarboxylic acid derivatives, the method for preparing them and the pharmaceutical compositions containing them
A61K 39/395 (2006.01)	2411050 *	ANTIBODY CONSTANT DOMAIN REGIONS AND USES THEREOF
B23K 26/24 (2006.01)	2485862 *	JOINING DEVICE FOR NON-POSITIVE JOINING BY MEANS OF A FILLER MATERIAL USING SENSORS
B23K 26/03 (2006.01)	2485862 *	JOINING DEVICE FOR NON-POSITIVE JOINING BY MEANS OF A FILLER MATERIAL USING SENSORS
B23K 26/067 (2006.01)	2485862 *	JOINING DEVICE FOR NON-POSITIVE JOINING BY MEANS OF A FILLER MATERIAL USING SENSORS

MKP (51)	Broj objave evropske prijava patenta (97)	Naziv pronalaska (54)
B23K 26/42 (2006.01)	2485862 *	JOINING DEVICE FOR NON-POSITIVE JOINING BY MEANS OF A FILLER MATERIAL USING SENSORS
B23K 26/04 (2006.01)	2485862 *	JOINING DEVICE FOR NON-POSITIVE JOINING BY MEANS OF A FILLER MATERIAL USING SENSORS
A61K 31/55 (2006.01)	2493460 *	METHODS AND COMPOSITIONS FOR TREATING CANCER
A61K 31/535 (2006.01)	2493460 *	METHODS AND COMPOSITIONS FOR TREATING CANCER
A61K 31/00 (2006.01)	2493460 *	METHODS AND COMPOSITIONS FOR TREATING CANCER
B29C 45/14 (2006.01)	2414145 *	METHOD FOR MOULDING A PLASTIC PART WITH AN INSERT HELD IN PLACE BY MEANS OF SUCTION, MOULDING DEVICE AND USE
B29C 33/18 (2006.01)	2414145 *	METHOD FOR MOULDING A PLASTIC PART WITH AN INSERT HELD IN PLACE BY MEANS OF SUCTION, MOULDING DEVICE AND USE
B29C 33/38 (2006.01)	2414145 *	METHOD FOR MOULDING A PLASTIC PART WITH AN INSERT HELD IN PLACE BY MEANS OF SUCTION, MOULDING DEVICE AND USE
A61K 39/395 (2006.01)	2437790 *	CONJUGATION METHODS
A61K 51/00 (2006.01)	2437790 *	CONJUGATION METHODS
A61K 47/48 (2006.01)	2437790 *	CONJUGATION METHODS
A61K 9/00 (2006.01)	2408426 *	OPHTHALMIC COMPOSITIONS BASED ON POLYUNSATURATED OMEGA-3 AND OMEGA-6 FATTY ACIDS
A61K 9/06 (2006.01)	2408426 *	OPHTHALMIC COMPOSITIONS BASED ON POLYUNSATURATED OMEGA-3 AND OMEGA-6 FATTY ACIDS
A61K 47/32 (2006.01)	2408426 *	OPHTHALMIC COMPOSITIONS BASED ON POLYUNSATURATED OMEGA-3 AND OMEGA-6 FATTY ACIDS
A61K 31/20 (2006.01)	2408426 *	OPHTHALMIC COMPOSITIONS BASED ON POLYUNSATURATED OMEGA-3 AND OMEGA-6 FATTY ACIDS
A61K 31/201 (2006.01)	2408426 *	OPHTHALMIC COMPOSITIONS BASED ON POLYUNSATURATED OMEGA-3 AND OMEGA-6 FATTY ACIDS
A61K 31/202 (2006.01)	2408426 *	OPHTHALMIC COMPOSITIONS BASED ON POLYUNSATURATED OMEGA-3 AND OMEGA-6 FATTY ACIDS
G02B 6/255 (2006.01)	2460040 *	SPLICED FIBER GLASS ROVINGS AND METHODS AND SYSTEMS FOR SPLICING FIBER GLASS ROVINGS
H04W 84/20 (2009.01)	2400812	Bluetooth networking
C07D 401/00 (2006.01)	2467372 *	TREATMENT OF BDNF-RELATED DISORDERS USING LAQUINIMOD
G01N 33/569 (2006.01)	2425251 *	MEANS AND METHODS FOR THE DETERMINATION OF THE AMOUNT OF NEUROTOXIN POLYPEPTIDE AND OF ITS CATALYTIC AND PROTEOLYTIC ACTIVITIES
C07D 401/12 (2006.01)	2493862 *	IMIDAZOLE DERIVATIVES AS IDO INHIBITORS
A61P 35/00 (2006.01)	2493862 *	IMIDAZOLE DERIVATIVES AS IDO INHIBITORS
A61K 31/4164 (2006.01)	2493862 *	IMIDAZOLE DERIVATIVES AS IDO INHIBITORS
C07D 407/12 (2006.01)	2493862 *	IMIDAZOLE DERIVATIVES AS IDO INHIBITORS
A61P 31/00 (2006.01)	2493862 *	IMIDAZOLE DERIVATIVES AS IDO INHIBITORS
C07D 409/12 (2006.01)	2493862 *	IMIDAZOLE DERIVATIVES AS IDO INHIBITORS
C07D 233/64 (2006.01)	2493862 *	IMIDAZOLE DERIVATIVES AS IDO INHIBITORS
A61K 31/4178 (2006.01)	2493862 *	IMIDAZOLE DERIVATIVES AS IDO INHIBITORS
C07D 413/12 (2006.01)	2493862 *	IMIDAZOLE DERIVATIVES AS IDO INHIBITORS
C07D 403/12 (2006.01)	2493862 *	IMIDAZOLE DERIVATIVES AS IDO INHIBITORS
A61P 37/00 (2006.01)	2493862 *	IMIDAZOLE DERIVATIVES AS IDO INHIBITORS
C07D 417/12 (2006.01)	2493862 *	IMIDAZOLE DERIVATIVES AS IDO INHIBITORS
C07D 233/60 (2006.01)	2470510 *	SUBSTITUTED IMIDAZOLE DERIVATIVES FOR TREATMENT OF ALZHEIMERS DISEASE
A61K 31/4164 (2006.01)	2470510 *	SUBSTITUTED IMIDAZOLE DERIVATIVES FOR TREATMENT OF ALZHEIMERS DISEASE
A61P 25/28 (2006.01)	2470510 *	SUBSTITUTED IMIDAZOLE DERIVATIVES FOR TREATMENT OF ALZHEIMERS DISEASE

MKP (51)	Broj objave evropske prijava patenta (97)	Naziv pronalaska (54)
A61K 39/395 (2006.01)	2490720 *	ANTI-GCC ANTIBODY MOLECULES AND RELATED COMPOSITIONS AND METHODS
C07K 14/60 (2006.01)	2421547 *	USE OF (HEXENOYL TRANS-3)HGRF(1-44)NH ₂ AND RITONAVIR IN COMBINATION THERAPY
A61K 31/427 (2006.01)	2421547 *	USE OF (HEXENOYL TRANS-3)HGRF(1-44)NH ₂ AND RITONAVIR IN COMBINATION THERAPY
A61K 38/27 (2006.01)	2421547 *	USE OF (HEXENOYL TRANS-3)HGRF(1-44)NH ₂ AND RITONAVIR IN COMBINATION THERAPY
A61K 38/16 (2006.01)	2421547 *	USE OF (HEXENOYL TRANS-3)HGRF(1-44)NH ₂ AND RITONAVIR IN COMBINATION THERAPY
C07K 17/02 (2006.01)	2421547 *	USE OF (HEXENOYL TRANS-3)HGRF(1-44)NH ₂ AND RITONAVIR IN COMBINATION THERAPY
G01S 15/89 (2006.01)	2299292	Scanning apparatus and method
G01F 23/296 (2006.01)	2299292	Scanning apparatus and method
G01N 33/50 (2006.01)	2473850 *	COMPOSITIONS AND METHODS FOR TREATING GROWTH HORMONE DEFICIENCY
G01N 33/74 (2006.01)	2473850 *	COMPOSITIONS AND METHODS FOR TREATING GROWTH HORMONE DEFICIENCY
C12Q 1/68 (2006.01)	2473850 *	COMPOSITIONS AND METHODS FOR TREATING GROWTH HORMONE DEFICIENCY
A61K 38/27 (2006.01)	2473850 *	COMPOSITIONS AND METHODS FOR TREATING GROWTH HORMONE DEFICIENCY
A61K 31/454 (2006.01)	2480232 *	DISUBSTITUTED $\text{j}4$ -(5-AMINOMETHYL-PHENYL)-PIPERIDIN-1-YL]-1H-INDOL-3-YL]-METHANONES
C07D 401/06 (2006.01)	2480232 *	DISUBSTITUTED $\text{j}4$ -(5-AMINOMETHYL-PHENYL)-PIPERIDIN-1-YL]-1H-INDOL-3-YL]-METHANONES
A61P 11/00 (2006.01)	2480232 *	DISUBSTITUTED $\text{j}4$ -(5-AMINOMETHYL-PHENYL)-PIPERIDIN-1-YL]-1H-INDOL-3-YL]-METHANONES
A61P 29/00 (2006.01)	2480232 *	DISUBSTITUTED $\text{j}4$ -(5-AMINOMETHYL-PHENYL)-PIPERIDIN-1-YL]-1H-INDOL-3-YL]-METHANONES
A61P 19/02 (2006.01)	2480232 *	DISUBSTITUTED $\text{j}4$ -(5-AMINOMETHYL-PHENYL)-PIPERIDIN-1-YL]-1H-INDOL-3-YL]-METHANONES
A61P 1/00 (2006.01)	2480232 *	DISUBSTITUTED $\text{j}4$ -(5-AMINOMETHYL-PHENYL)-PIPERIDIN-1-YL]-1H-INDOL-3-YL]-METHANONES
G06F 17/00 (2006.01)	2491499 *	INTEGRATED HEALTH DATA CAPTURE AND ANALYSIS SYSTEM
G06Q 50/00 (2012.01)	2491499 *	INTEGRATED HEALTH DATA CAPTURE AND ANALYSIS SYSTEM
A61K 31/198 (2006.01)	2416770 *	HEMODIALYSIS AND PERITONEAL DIALYSIS SOLUTIONS COMPRISING ONE OR MORE CREATINE COMPOUNDS
A61P 13/12 (2006.01)	2416770 *	HEMODIALYSIS AND PERITONEAL DIALYSIS SOLUTIONS COMPRISING ONE OR MORE CREATINE COMPOUNDS
C07C 247/06 (2006.01)	2451790 *	HISTONE DEACETYLASE INHIBITORS
C07D 249/06 (2006.01)	2451790 *	HISTONE DEACETYLASE INHIBITORS
A61P 35/04 (2006.01)	2451790 *	HISTONE DEACETYLASE INHIBITORS
C07D 403/10 (2006.01)	2451790 *	HISTONE DEACETYLASE INHIBITORS
A61K 31/4192 (2006.01)	2451790 *	HISTONE DEACETYLASE INHIBITORS
C07D 413/10 (2006.01)	2451790 *	HISTONE DEACETYLASE INHIBITORS
C07C 259/10 (2006.01)	2451790 *	HISTONE DEACETYLASE INHIBITORS
C07D 403/04 (2006.01)	2451790 *	HISTONE DEACETYLASE INHIBITORS
A61K 35/00 (2006.01)	2451790 *	HISTONE DEACETYLASE INHIBITORS
A61P 35/02 (2006.01)	2451790 *	HISTONE DEACETYLASE INHIBITORS
C07C 209/10 (2006.01)	2451790 *	HISTONE DEACETYLASE INHIBITORS
H01R 13/658 (2011.01)	2465169 *	CONDUCTIVE ELASTOMER AND METHOD OF APPLYING A CONDUCTIVE COATING TO ELASTROMERIC SUBSTRATE
H01B 11/06 (2006.01)	2465169 *	CONDUCTIVE ELASTOMER AND METHOD OF APPLYING A CONDUCTIVE COATING TO ELASTROMERIC SUBSTRATE

MKP (51)	Broj objave evropske prijava patenta (97)	Naziv pronalaska (54)
H01R 13/646 (2011.01)	2465169 *	CONDUCTIVE ELASTOMER AND METHOD OF APPLYING A CONDUCTIVE COATING TO ELASTOMERIC SUBSTRATE
C07D 261/14 (2006.01)	2443100 *	COMPOUNDS WHICH SELECTIVELY MODULATE THE CB2 RECEPTOR
C07D 413/12 (2006.01)	2443100 *	COMPOUNDS WHICH SELECTIVELY MODULATE THE CB2 RECEPTOR
C07D 413/14 (2006.01)	2443100 *	COMPOUNDS WHICH SELECTIVELY MODULATE THE CB2 RECEPTOR
C07D 417/06 (2006.01)	2443100 *	COMPOUNDS WHICH SELECTIVELY MODULATE THE CB2 RECEPTOR
C07D 417/12 (2006.01)	2443100 *	COMPOUNDS WHICH SELECTIVELY MODULATE THE CB2 RECEPTOR
C07D 417/14 (2006.01)	2443100 *	COMPOUNDS WHICH SELECTIVELY MODULATE THE CB2 RECEPTOR
A61K 31/42 (2006.01)	2443100 *	COMPOUNDS WHICH SELECTIVELY MODULATE THE CB2 RECEPTOR
A61P 29/00 (2006.01)	2443100 *	COMPOUNDS WHICH SELECTIVELY MODULATE THE CB2 RECEPTOR
A47J 31/40 (2006.01)	2311353	Machine for the production of mixed beverages
A47J 31/60 (2006.01)	2311353	Machine for the production of mixed beverages
A23J 1/14 (2006.01)	2429310 *	PRODUCTION OF CANOLA PROTEIN PRODUCT WITHOUT HEAT TREATMENT ("C200CaC")
A23J 3/16 (2006.01)	2429310 *	PRODUCTION OF CANOLA PROTEIN PRODUCT WITHOUT HEAT TREATMENT ("C200CaC")
F02D 41/22 (2006.01)	2375038	Diagnosis device and method using an in-cylinder pressure sensor in an internal combustion engine
C07D 239/47 (2006.01)	2483249 *	PYRIMIDINE DERIVATIVES AS PROTEIN TYROSINE KINASE 2 INHIBITORS
A61K 31/506 (2006.01)	2483249 *	PYRIMIDINE DERIVATIVES AS PROTEIN TYROSINE KINASE 2 INHIBITORS
C07D 417/12 (2006.01)	2483249 *	PYRIMIDINE DERIVATIVES AS PROTEIN TYROSINE KINASE 2 INHIBITORS
A61P 35/00 (2006.01)	2483249 *	PYRIMIDINE DERIVATIVES AS PROTEIN TYROSINE KINASE 2 INHIBITORS
C07D 403/12 (2006.01)	2483249 *	PYRIMIDINE DERIVATIVES AS PROTEIN TYROSINE KINASE 2 INHIBITORS
C07D 211/42 (2006.01)	2277863	Piperidine derivatives, process for their preparation and pharmaceutical compositions containing them
A61K 31/445 (2006.01)	2277863	Piperidine derivatives, process for their preparation and pharmaceutical compositions containing them
A61K 31/4462 (2006.01)	2277863	Piperidine derivatives, process for their preparation and pharmaceutical compositions containing them
A61P 25/00 (2006.01)	2277863	Piperidine derivatives, process for their preparation and pharmaceutical compositions containing them
C07D 239/34 (2006.01)	2451786 *	IMPROVED PROCESS FOR THE PREPARATION OF AMBRISENTAN AND NOVEL INTERMEDIATES THEREOF
G01N 33/50 (2006.01)	2470901 *	USE OF IMMUNOREGULATORY NK CELL POPULATIONS FOR PREDICTING THE EFFICACY OF ANTI-IL-2R ANTIBODIES IN MULTIPLE SCLEROSIS PATIENTS
G01N 33/564 (2006.01)	2470901 *	USE OF IMMUNOREGULATORY NK CELL POPULATIONS FOR PREDICTING THE EFFICACY OF ANTI-IL-2R ANTIBODIES IN MULTIPLE SCLEROSIS PATIENTS
B65G 5/00 (2006.01)	2406152 *	PROCESS FOR SEQUESTRATION OF FLUIDS IN GEOLOGICAL FORMATIONS
E21F 17/16 (2006.01)	2406152 *	PROCESS FOR SEQUESTRATION OF FLUIDS IN GEOLOGICAL FORMATIONS
H04N 13/04 (2006.01)	2416581 *	RECORDING MEDIUM, REPRODUCING DEVICE, AND INTEGRATED CIRCUIT
G11B 20/12 (2006.01)	2416581 *	RECORDING MEDIUM, REPRODUCING DEVICE, AND INTEGRATED CIRCUIT
H04N 5/92 (2006.01)	2416581 *	RECORDING MEDIUM, REPRODUCING DEVICE, AND INTEGRATED CIRCUIT
D21H 17/56 (2006.01)	2438237 *	CATIONIC WET STRENGTH RESIN MODIFIED PIGMENTS IN WATER-BASED LATEX COATING APPLICATIONS
D21H 17/46 (2006.01)	2438237 *	CATIONIC WET STRENGTH RESIN MODIFIED PIGMENTS IN WATER-BASED LATEX COATING APPLICATIONS
D21H 17/52 (2006.01)	2438237 *	CATIONIC WET STRENGTH RESIN MODIFIED PIGMENTS IN WATER-BASED LATEX COATING APPLICATIONS

MKP (51)	Broj objave evropske prijava patenta (97)	Naziv pronalaska (54)
D21H 19/80 (2006.01)	2438237 *	CATIONIC WET STRENGTH RESIN MODIFIED PIGMENTS IN WATER-BASED LATEX COATING APPLICATIONS
D21H 19/82 (2006.01)	2438237 *	CATIONIC WET STRENGTH RESIN MODIFIED PIGMENTS IN WATER-BASED LATEX COATING APPLICATIONS
D21H 19/36 (2006.01)	2438237 *	CATIONIC WET STRENGTH RESIN MODIFIED PIGMENTS IN WATER-BASED LATEX COATING APPLICATIONS
D21H 21/20 (2006.01)	2438237 *	CATIONIC WET STRENGTH RESIN MODIFIED PIGMENTS IN WATER-BASED LATEX COATING APPLICATIONS
D21H 19/40 (2006.01)	2438237 *	CATIONIC WET STRENGTH RESIN MODIFIED PIGMENTS IN WATER-BASED LATEX COATING APPLICATIONS
D21H 27/10 (2006.01)	2438237 *	CATIONIC WET STRENGTH RESIN MODIFIED PIGMENTS IN WATER-BASED LATEX COATING APPLICATIONS
D21H 19/62 (2006.01)	2438237 *	CATIONIC WET STRENGTH RESIN MODIFIED PIGMENTS IN WATER-BASED LATEX COATING APPLICATIONS
C07D 211/34 (2006.01)	2435406 *	RESOLUTION OF (±)-METHYL PHENYL[4-[4'-[[[4'-(TRIFLUOROMETHYL)-2-BIPHENYLYL]CARBONYL]AMINO]PHENYL]-1-PIPERIDINYL]ACETATE
A61K 31/451 (2006.01)	2435406 *	RESOLUTION OF (±)-METHYL PHENYL[4-[4'-[[[4'-(TRIFLUOROMETHYL)-2-BIPHENYLYL]CARBONYL]AMINO]PHENYL]-1-PIPERIDINYL]ACETATE
A62B 18/08 (2006.01)	2392385	Viewing pane frame for a protective suit
A62B 17/04 (2006.01)	2392385	Viewing pane frame for a protective suit
A01N 43/66 (2006.01)	2440050 *	TRIAZINE DERIVATIVES AND THEIR THERAPEUTICAL APPLICATIONS
A61K 31/53 (2006.01)	2440050 *	TRIAZINE DERIVATIVES AND THEIR THERAPEUTICAL APPLICATIONS
C08G 63/21 (2006.01)	2325228	An aliphatic-aromatic copolyester, the preparation method and the use thereof
C08G 63/47 (2006.01)	2325228	An aliphatic-aromatic copolyester, the preparation method and the use thereof
G06F 3/01 (2006.01)	2494425 *	SYSTEMS AND METHODS FOR HAPTIC AUGMENTATION OF VOICE-TO-TEXT CONVERSION
G06F 3/16 (2006.01)	2494425 *	SYSTEMS AND METHODS FOR HAPTIC AUGMENTATION OF VOICE-TO-TEXT CONVERSION
A61B 17/29 (2006.01)	2410927 *	SURGICAL INSTRUMENTS FOR IN VIVO ASSEMBLY
A61B 17/00 (2006.01)	2410927 *	SURGICAL INSTRUMENTS FOR IN VIVO ASSEMBLY
A61K 39/00 (2006.01)	2440243 *	IMMUNOGENIC COMPOSITIONS HAVING LOW SODIUM CHLORIDE CONCENTRATION
A61K 31/47 (2006.01)	2424533 *	SUBSTITUTED ISOQUINOLINE DERIVATIVES, PHARMACEUTICAL COMPOSITIONS, AND METHODS OF USE AS -SECRETASE INHIBITORS
A61K 38/00 (2006.01)	2427203 *	ANTI-IL-17F ANTIBODIES AND METHODS OF USE THEREOF
C07K 14/54 (2006.01)	2427203 *	ANTI-IL-17F ANTIBODIES AND METHODS OF USE THEREOF
C07K 16/24 (2006.01)	2427203 *	ANTI-IL-17F ANTIBODIES AND METHODS OF USE THEREOF
C07C 275/24 (2006.01)	2427425 *	TETRACYCLINE COMPOUNDS
C07D 221/20 (2006.01)	2427425 *	TETRACYCLINE COMPOUNDS
C07C 311/06 (2006.01)	2427425 *	TETRACYCLINE COMPOUNDS
C07D 295/03 (2006.01)	2427425 *	TETRACYCLINE COMPOUNDS
C07C 311/19 (2006.01)	2427425 *	TETRACYCLINE COMPOUNDS
C07D 223/04 (2006.01)	2427425 *	TETRACYCLINE COMPOUNDS
C07D 205/04 (2006.01)	2427425 *	TETRACYCLINE COMPOUNDS
C07D 223/32 (2006.01)	2427425 *	TETRACYCLINE COMPOUNDS
C07D 207/06 (2006.01)	2427425 *	TETRACYCLINE COMPOUNDS
C07D 209/04 (2006.01)	2427425 *	TETRACYCLINE COMPOUNDS
C07D 207/08 (2006.01)	2427425 *	TETRACYCLINE COMPOUNDS
C07C 237/26 (2006.01)	2427425 *	TETRACYCLINE COMPOUNDS
C07D 211/34 (2006.01)	2427425 *	TETRACYCLINE COMPOUNDS
A61K 39/00 (2006.01)	2456460 *	METHODS AND COMPOSITIONS FOR TREATING AND PREVENTING DISEASE ASSOCIATED WITH AVB5 INTEGRIN
C12N 15/00 (2006.01)	2459716 *	ADENOVIRAL-BASED VECTORS

MKP (51)	Broj objave evropske prijave patenta (97)	Naziv pronalaska (54)
A61K 31/70 (2006.01)	2459716 *	ADENOVIRAL-BASED VECTORS
C07D 213/16 (2006.01)	2483243 *	SYNTHESIS OF (4-FLUORO-3-PIPERIDIN-4-YL-BENZYL)-CARBAMIC ACID TERT-BUTYL ESTER AND INTERMEDIATES THEREOF
C07D 211/18 (2006.01)	2483243 *	SYNTHESIS OF (4-FLUORO-3-PIPERIDIN-4-YL-BENZYL)-CARBAMIC ACID TERT-BUTYL ESTER AND INTERMEDIATES THEREOF
C07F 5/02 (2006.01)	2483243 *	SYNTHESIS OF (4-FLUORO-3-PIPERIDIN-4-YL-BENZYL)-CARBAMIC ACID TERT-BUTYL ESTER AND INTERMEDIATES THEREOF
C07D 239/95 (2006.01)	2496237 *	ENZYME INHIBITING COMPOUNDS
A61K 31/517 (2006.01)	2496237 *	ENZYME INHIBITING COMPOUNDS
A61P 35/00 (2006.01)	2496237 *	ENZYME INHIBITING COMPOUNDS
G02B 27/00 (2006.01)	2410358	Imaging optics and optical device for mapping a curved image field
G02B 6/08 (2006.01)	2410358	Imaging optics and optical device for mapping a curved image field
G02B 6/42 (2006.01)	2410358	Imaging optics and optical device for mapping a curved image field
G06Q 50/00 (2012.01)	2422314 *	SYSTEMS AND METHODS FOR MANAGING PATENT LICENSES
B65B 35/54 (2006.01)	2496481 *	MULTI-SPEED RESIN CARTRIDGE PRODUCTION SYSTEM
H01L 31/048 (2006.01)	2422376 *	ATTACHMENT PART FOR ASSEMBLING A MODULE, IN PARTICULAR A PHOTOVOLTAIC MODULE, ON A RIBBED METAL SHEET, ASSEMBLY AND USE THEREOF FOR MAKING A BUILDING COVER, AND RELATED METHOD OF PRODUCTION
F16B 5/02 (2006.01)	2422376 *	ATTACHMENT PART FOR ASSEMBLING A MODULE, IN PARTICULAR A PHOTOVOLTAIC MODULE, ON A RIBBED METAL SHEET, ASSEMBLY AND USE THEREOF FOR MAKING A BUILDING COVER, AND RELATED METHOD OF PRODUCTION
E04D 3/365 (2006.01)	2422376 *	ATTACHMENT PART FOR ASSEMBLING A MODULE, IN PARTICULAR A PHOTOVOLTAIC MODULE, ON A RIBBED METAL SHEET, ASSEMBLY AND USE THEREOF FOR MAKING A BUILDING COVER, AND RELATED METHOD OF PRODUCTION
E04D 13/18 (2006.01)	2422376 *	ATTACHMENT PART FOR ASSEMBLING A MODULE, IN PARTICULAR A PHOTOVOLTAIC MODULE, ON A RIBBED METAL SHEET, ASSEMBLY AND USE THEREOF FOR MAKING A BUILDING COVER, AND RELATED METHOD OF PRODUCTION
H01L 31/042 (2006.01)	2422376 *	ATTACHMENT PART FOR ASSEMBLING A MODULE, IN PARTICULAR A PHOTOVOLTAIC MODULE, ON A RIBBED METAL SHEET, ASSEMBLY AND USE THEREOF FOR MAKING A BUILDING COVER, AND RELATED METHOD OF PRODUCTION
C30B 33/02 (2006.01)	2406414 *	PREVENTION OF CRACK PROPAGATION IN BRITTLE MATERIALS
H01L 29/32 (2006.01)	2406414 *	PREVENTION OF CRACK PROPAGATION IN BRITTLE MATERIALS
F02B 39/02 (2006.01)	2440762 *	DUAL POWER INPUT FLUID PUMP
B60K 11/02 (2006.01)	2440762 *	DUAL POWER INPUT FLUID PUMP
B60R 16/08 (2006.01)	2440762 *	DUAL POWER INPUT FLUID PUMP
B60R 17/00 (2006.01)	2440762 *	DUAL POWER INPUT FLUID PUMP
F02B 39/16 (2006.01)	2440762 *	DUAL POWER INPUT FLUID PUMP
A61K 31/713 (2006.01)	2449101 *	NEUROTOXINS EXHIBITING SHORTENED BIOLOGICAL ACTIVITY
C12N 15/63 (2006.01)	2449101 *	NEUROTOXINS EXHIBITING SHORTENED BIOLOGICAL ACTIVITY
C07K 14/33 (2006.01)	2449101 *	NEUROTOXINS EXHIBITING SHORTENED BIOLOGICAL ACTIVITY
A61K 38/48 (2006.01)	2449101 *	NEUROTOXINS EXHIBITING SHORTENED BIOLOGICAL ACTIVITY
C12N 9/52 (2006.01)	2449101 *	NEUROTOXINS EXHIBITING SHORTENED BIOLOGICAL ACTIVITY
C07K 16/12 (2006.01)	2449101 *	NEUROTOXINS EXHIBITING SHORTENED BIOLOGICAL ACTIVITY
C12N 1/21 (2006.01)	2449101 *	NEUROTOXINS EXHIBITING SHORTENED BIOLOGICAL ACTIVITY
C12P 21/02 (2006.01)	2449101 *	NEUROTOXINS EXHIBITING SHORTENED BIOLOGICAL ACTIVITY
A61K 47/14 (2006.01)	2475357 *	ORAL SUSPENSION FORMULATIONS OF ESCLICARBAZEPINE ACETATE
A61K 47/26 (2006.01)	2475357 *	ORAL SUSPENSION FORMULATIONS OF ESCLICARBAZEPINE ACETATE
A61K 9/10 (2006.01)	2475357 *	ORAL SUSPENSION FORMULATIONS OF ESCLICARBAZEPINE ACETATE
A61K 31/55 (2006.01)	2475357 *	ORAL SUSPENSION FORMULATIONS OF ESCLICARBAZEPINE ACETATE

MKP (51)	Broj objave evropske prijava patenta (97)	Naziv pronalaska (54)
A61K 47/36 (2006.01)	2475357 *	ORAL SUSPENSION FORMULATIONS OF ESCLICARBAZEPINE ACETATE
A61K 9/12 (2006.01)	2421503 *	SUBLINGUAL PHARMACEUTICAL COMPOSITION COMPRISING A NEUTRAL OIL
A61K 9/00 (2006.01)	2421503 *	SUBLINGUAL PHARMACEUTICAL COMPOSITION COMPRISING A NEUTRAL OIL
A61K 31/335 (2006.01)	2421503 *	SUBLINGUAL PHARMACEUTICAL COMPOSITION COMPRISING A NEUTRAL OIL
A23P 1/12 (2006.01)	2459012 *	AGGLOMERATES AND PREPARATION THEREOF
A23P 1/02 (2006.01)	2459012 *	AGGLOMERATES AND PREPARATION THEREOF
A23L 1/10 (2006.01)	2459012 *	AGGLOMERATES AND PREPARATION THEREOF
G07D 9/00 (2006.01)	2462566 *	DEVICE FOR RECEIVING COINS
G07F 1/04 (2006.01)	2462566 *	DEVICE FOR RECEIVING COINS
C07D 413/14 (2006.01)	2424864 *	OXAZOLE SUBSTITUTED INDAZOLES AS PI3-KINASE INHIBITORS
A61K 31/4439 (2006.01)	2424864 *	OXAZOLE SUBSTITUTED INDAZOLES AS PI3-KINASE INHIBITORS
A61P 31/12 (2006.01)	2424864 *	OXAZOLE SUBSTITUTED INDAZOLES AS PI3-KINASE INHIBITORS
A61K 31/422 (2006.01)	2424864 *	OXAZOLE SUBSTITUTED INDAZOLES AS PI3-KINASE INHIBITORS
A61P 35/00 (2006.01)	2424864 *	OXAZOLE SUBSTITUTED INDAZOLES AS PI3-KINASE INHIBITORS
A61P 11/00 (2006.01)	2424864 *	OXAZOLE SUBSTITUTED INDAZOLES AS PI3-KINASE INHIBITORS
A61P 37/00 (2006.01)	2424864 *	OXAZOLE SUBSTITUTED INDAZOLES AS PI3-KINASE INHIBITORS
E04B 1/32 (2006.01)	2414597 *	PREFABRICATED CONSTRUCTION OBJECT WHICH IS BUILT FROM PREFABRICATED FEROCEMENT RIB ELEMENTS BY SANDWICH TYPE WHICH ARE EFFUSED IN MOULDS
A01N 43/653 (2006.01)	2493292 *	SAFENING 6-AMINO-2-(SUBSTITUTED PHENYL)-5-SUBSTITUTED-4-PYRIMIDINECARBOXYLATE HERBICIDE INJURY ON CEREAL CROPS
A01N 25/32 (2006.01)	2493292 *	SAFENING 6-AMINO-2-(SUBSTITUTED PHENYL)-5-SUBSTITUTED-4-PYRIMIDINECARBOXYLATE HERBICIDE INJURY ON CEREAL CROPS
A01N 43/42 (2006.01)	2493292 *	SAFENING 6-AMINO-2-(SUBSTITUTED PHENYL)-5-SUBSTITUTED-4-PYRIMIDINECARBOXYLATE HERBICIDE INJURY ON CEREAL CROPS
A01P 13/00 (2006.01)	2493292 *	SAFENING 6-AMINO-2-(SUBSTITUTED PHENYL)-5-SUBSTITUTED-4-PYRIMIDINECARBOXYLATE HERBICIDE INJURY ON CEREAL CROPS
A01N 43/54 (2006.01)	2493292 *	SAFENING 6-AMINO-2-(SUBSTITUTED PHENYL)-5-SUBSTITUTED-4-PYRIMIDINECARBOXYLATE HERBICIDE INJURY ON CEREAL CROPS
A01N 43/56 (2006.01)	2493292 *	SAFENING 6-AMINO-2-(SUBSTITUTED PHENYL)-5-SUBSTITUTED-4-PYRIMIDINECARBOXYLATE HERBICIDE INJURY ON CEREAL CROPS
A61K 47/36 (2006.01)	2437783 *	TREATMENT OF ACINETOBACTER WITH ALGINATE OLIGOMERS AND ANTIBIOTICS
C10J 3/56 (2006.01)	2445999 *	METHOD AND SYSTEM FOR CLEANING OF AND HEAT RECOVERY FROM HOT GASES
C10J 3/84 (2006.01)	2445999 *	METHOD AND SYSTEM FOR CLEANING OF AND HEAT RECOVERY FROM HOT GASES
C10J 3/48 (2006.01)	2445999 *	METHOD AND SYSTEM FOR CLEANING OF AND HEAT RECOVERY FROM HOT GASES
C10J 3/86 (2006.01)	2445999 *	METHOD AND SYSTEM FOR CLEANING OF AND HEAT RECOVERY FROM HOT GASES
C07D 498/04 (2006.01)	2451793 *	BACE INHIBITORS
C07D 513/02 (2006.01)	2451793 *	BACE INHIBITORS
C07D 279/08 (2006.01)	2451793 *	BACE INHIBITORS
B23F 5/22 (2006.01)	2456588 *	MACHINE FOR MAKING GEARS
B23Q 1/28 (2006.01)	2456588 *	MACHINE FOR MAKING GEARS
A24B 3/18 (2006.01)	2444384 *	USE OF NEOPHYTADIENE AS ADDITIVE FOR LIQUID CIGARETTE
A24B 15/00 (2006.01)	2444384 *	USE OF NEOPHYTADIENE AS ADDITIVE FOR LIQUID CIGARETTE
A24B 3/12 (2006.01)	2444384 *	USE OF NEOPHYTADIENE AS ADDITIVE FOR LIQUID CIGARETTE
A24B 15/32 (2006.01)	2444384 *	USE OF NEOPHYTADIENE AS ADDITIVE FOR LIQUID CIGARETTE
A24B 3/14 (2006.01)	2444384 *	USE OF NEOPHYTADIENE AS ADDITIVE FOR LIQUID CIGARETTE

MKP (51)	Broj objave evropske prijava patenta (97)	Naziv pronalaska (54)
A24B 15/10 (2006.01)	2444384 *	USE OF NEOPHYTADIENE AS ADDITIVE FOR LIQUID CIGARETTE
C07C 11/12 (2006.01)	2444384 *	USE OF NEOPHYTADIENE AS ADDITIVE FOR LIQUID CIGARETTE
A24B 15/18 (2006.01)	2444384 *	USE OF NEOPHYTADIENE AS ADDITIVE FOR LIQUID CIGARETTE
C07C 11/00 (2006.01)	2444384 *	USE OF NEOPHYTADIENE AS ADDITIVE FOR LIQUID CIGARETTE
A24B 15/28 (2006.01)	2444384 *	USE OF NEOPHYTADIENE AS ADDITIVE FOR LIQUID CIGARETTE
A24B 3/00 (2006.01)	2444384 *	USE OF NEOPHYTADIENE AS ADDITIVE FOR LIQUID CIGARETTE
A24B 15/30 (2006.01)	2444384 *	USE OF NEOPHYTADIENE AS ADDITIVE FOR LIQUID CIGARETTE
A61M 3/02 (2006.01)	2424590 *	IRRIGATION AND ASPIRATION DEVICES AND METHODS
A61M 1/00 (2006.01)	2424590 *	IRRIGATION AND ASPIRATION DEVICES AND METHODS
A61K 39/395 (2006.01)	2477653 *	DOSAGE REGIMEN FOR ADMINISTERING AN EPCAMXCD3 BISPECIFIC ANTIBODY
A61P 35/00 (2006.01)	2477653 *	DOSAGE REGIMEN FOR ADMINISTERING AN EPCAMXCD3 BISPECIFIC ANTIBODY
C07K 16/28 (2006.01)	2477653 *	DOSAGE REGIMEN FOR ADMINISTERING AN EPCAMXCD3 BISPECIFIC ANTIBODY
C07K 16/30 (2006.01)	2477653 *	DOSAGE REGIMEN FOR ADMINISTERING AN EPCAMXCD3 BISPECIFIC ANTIBODY
C07K 16/46 (2006.01)	2477653 *	DOSAGE REGIMEN FOR ADMINISTERING AN EPCAMXCD3 BISPECIFIC ANTIBODY
C02F 1/66 (2006.01)	2342164 *	PROCESS FOR THE DISPOSAL OF WASTES, PARTICULARLY OF SLUDGES DERIVING FROM WASTE WATER DEPURATION
C02F 1/72 (2006.01)	2342164 *	PROCESS FOR THE DISPOSAL OF WASTES, PARTICULARLY OF SLUDGES DERIVING FROM WASTE WATER DEPURATION
C02F 9/00 (2006.01)	2342164 *	PROCESS FOR THE DISPOSAL OF WASTES, PARTICULARLY OF SLUDGES DERIVING FROM WASTE WATER DEPURATION
C02F 11/06 (2006.01)	2342164 *	PROCESS FOR THE DISPOSAL OF WASTES, PARTICULARLY OF SLUDGES DERIVING FROM WASTE WATER DEPURATION
C02F 101/20 (2006.01)	2342164 *	PROCESS FOR THE DISPOSAL OF WASTES, PARTICULARLY OF SLUDGES DERIVING FROM WASTE WATER DEPURATION
C02F 101/30 (2006.01)	2342164 *	PROCESS FOR THE DISPOSAL OF WASTES, PARTICULARLY OF SLUDGES DERIVING FROM WASTE WATER DEPURATION
F24F 5/00 (2006.01)	2339253	Dwelling with passive air-conditioning system
F24F 12/00 (2006.01)	2339253	Dwelling with passive air-conditioning system
C08F 36/04 (2006.01)	2484701 *	PRODUCTION METHOD FOR MODIFIED CONJUGATED DIENE POLYMER, MODIFIED CONJUGATED DIENE POLYMER, AND MODIFIED CONJUGATED DIENE POLYMER COMPOSITION
C08K 3/36 (2006.01)	2484701 *	PRODUCTION METHOD FOR MODIFIED CONJUGATED DIENE POLYMER, MODIFIED CONJUGATED DIENE POLYMER, AND MODIFIED CONJUGATED DIENE POLYMER COMPOSITION
C08L 15/00 (2006.01)	2484701 *	PRODUCTION METHOD FOR MODIFIED CONJUGATED DIENE POLYMER, MODIFIED CONJUGATED DIENE POLYMER, AND MODIFIED CONJUGATED DIENE POLYMER COMPOSITION
C08C 19/25 (2006.01)	2484701 *	PRODUCTION METHOD FOR MODIFIED CONJUGATED DIENE POLYMER, MODIFIED CONJUGATED DIENE POLYMER, AND MODIFIED CONJUGATED DIENE POLYMER COMPOSITION
A61K 9/20 (2006.01)	2263657	Controlled release lamotrigine formulations
C12N 15/12 (2006.01)	2435558 *	GENERATION OF GENETICALLY CORRECTED DISEASE-FREE INDUCED PLURIPOTENT STEM CELLS
C12N 5/074 (2010.01)	2435558 *	GENERATION OF GENETICALLY CORRECTED DISEASE-FREE INDUCED PLURIPOTENT STEM CELLS
C12N 5/10 (2006.01)	2435558 *	GENERATION OF GENETICALLY CORRECTED DISEASE-FREE INDUCED PLURIPOTENT STEM CELLS
H04W 72/12 (2009.01)	2445293 *	METHOD, DEVICE AND SYSTEM FOR REPORTING POWER HEADROOM
A61B 17/32 (2006.01)	2448501 *	ULTRASONIC DEVICE FOR CUTTING AND COAGULATING
C12Q 1/02 (2006.01)	2386651 *	METHOD FOR SCREENING FOR SALTY TASTE CONTROL SUBSTANCE
C12N 15/09 (2006.01)	2386651 *	METHOD FOR SCREENING FOR SALTY TASTE CONTROL SUBSTANCE

MKP (51)	Broj objave evropske prijave patenta (97)	Naziv pronalaska (54)
A61K 31/165 (2006.01)	2435402 *	SUBSTITUTED AMINO BUTYRIC DERIVATIVES AS NEPRILYSIN INHIBITORS
C07C 233/45 (2006.01)	2435402 *	SUBSTITUTED AMINO BUTYRIC DERIVATIVES AS NEPRILYSIN INHIBITORS
C07C 233/64 (2006.01)	2435402 *	SUBSTITUTED AMINO BUTYRIC DERIVATIVES AS NEPRILYSIN INHIBITORS
C07C 233/57 (2006.01)	2435402 *	SUBSTITUTED AMINO BUTYRIC DERIVATIVES AS NEPRILYSIN INHIBITORS
A61K 31/166 (2006.01)	2435402 *	SUBSTITUTED AMINO BUTYRIC DERIVATIVES AS NEPRILYSIN INHIBITORS
C07K 16/46 (2006.01)	2406283 *	ANTIBODY MOLECULES HAVING BINDING SPECIFICITY FOR HUMAN IL-13
C12N 15/13 (2006.01)	2406283 *	ANTIBODY MOLECULES HAVING BINDING SPECIFICITY FOR HUMAN IL-13
A61P 11/06 (2006.01)	2406283 *	ANTIBODY MOLECULES HAVING BINDING SPECIFICITY FOR HUMAN IL-13
C07K 16/24 (2006.01)	2406283 *	ANTIBODY MOLECULES HAVING BINDING SPECIFICITY FOR HUMAN IL-13
A61K 39/395 (2006.01)	2406283 *	ANTIBODY MOLECULES HAVING BINDING SPECIFICITY FOR HUMAN IL-13
B05B 1/30 (2006.01)	2279792	Spray gun
G01N 33/543 (2006.01)	2430443 *	BIOMARKERS FOR DETERMINING SENSITIVITY OF BREAST CANCER CELLS TO HER2-TARGETED THERAPY
G01N 33/574 (2006.01)	2430443 *	BIOMARKERS FOR DETERMINING SENSITIVITY OF BREAST CANCER CELLS TO HER2-TARGETED THERAPY
G01N 33/50 (2006.01)	2430443 *	BIOMARKERS FOR DETERMINING SENSITIVITY OF BREAST CANCER CELLS TO HER2-TARGETED THERAPY
G01N 33/533 (2006.01)	2430443 *	BIOMARKERS FOR DETERMINING SENSITIVITY OF BREAST CANCER CELLS TO HER2-TARGETED THERAPY
G01N 33/532 (2006.01)	2430443 *	BIOMARKERS FOR DETERMINING SENSITIVITY OF BREAST CANCER CELLS TO HER2-TARGETED THERAPY
G01N 33/535 (2006.01)	2430443 *	BIOMARKERS FOR DETERMINING SENSITIVITY OF BREAST CANCER CELLS TO HER2-TARGETED THERAPY
C09K 11/06 (2006.01)	2430103 *	SECURE DOCUMENT COMPRISING LUMINESCENT CHELATES
C09D 11/10 (2006.01)	2430103 *	SECURE DOCUMENT COMPRISING LUMINESCENT CHELATES
C09D 11/00 (2006.01)	2430103 *	SECURE DOCUMENT COMPRISING LUMINESCENT CHELATES
B41M 3/14 (2006.01)	2430103 *	SECURE DOCUMENT COMPRISING LUMINESCENT CHELATES
C07D 409/12 (2006.01)	2411383 *	DERIVATIVES OF 3-ALKOXY-4,5-DIARYLTHIOPHENE-2-CARBOXAMIDE, PREPARATION THEREOF, AND THERAPEUTIC USE THEREOF
A61K 31/4535 (2006.01)	2411383 *	DERIVATIVES OF 3-ALKOXY-4,5-DIARYLTHIOPHENE-2-CARBOXAMIDE, PREPARATION THEREOF, AND THERAPEUTIC USE THEREOF
A61P 25/00 (2006.01)	2411383 *	DERIVATIVES OF 3-ALKOXY-4,5-DIARYLTHIOPHENE-2-CARBOXAMIDE, PREPARATION THEREOF, AND THERAPEUTIC USE THEREOF
C07D 409/06 (2006.01)	2411383 *	DERIVATIVES OF 3-ALKOXY-4,5-DIARYLTHIOPHENE-2-CARBOXAMIDE, PREPARATION THEREOF, AND THERAPEUTIC USE THEREOF
A61P 35/00 (2006.01)	2464651 *	NEW MACROLIDES AND THEIR USE
A61P 29/00 (2006.01)	2464651 *	NEW MACROLIDES AND THEIR USE
C07H 17/08 (2006.01)	2464651 *	NEW MACROLIDES AND THEIR USE
A61P 11/06 (2006.01)	2464651 *	NEW MACROLIDES AND THEIR USE
C07D 498/04 (2006.01)	2464651 *	NEW MACROLIDES AND THEIR USE
A61K 31/4433 (2006.01)	2464651 *	NEW MACROLIDES AND THEIR USE
C12N 15/82 (2006.01)	2403948 *	METHODS AND COMPOSITIONS FOR CONTROLLING PLANT PESTS
C07K 14/325 (2006.01)	2403948 *	METHODS AND COMPOSITIONS FOR CONTROLLING PLANT PESTS
A61K 9/20 (2006.01)	2400954 *	PROCESS FOR FORMING SOLID ORAL DOSAGE FORMS OF SOLIFENACIN AND ITS PHARMACEUTICALLY ACCEPTABLE SALTS

MKP (51)	Broj objave evropske prijava patenta (97)	Naziv pronalaska (54)
E05B 21/06 (2006.01)	2406442 *	DISC TUMBLER CYLINDER LOCK AND KEY COMBINATION
H04L 29/06 (2006.01)	2472817	System and method for optimization of execution of security tasks in local network
F24C 11/00 (2006.01)	2425183 *	HEATING DEVICE HAVING ELECTRIC AND FUEL POWERED HEAT SOURCES
A61K 31/665 (2006.01)	2476419 *	PHARMACEUTICAL COMPOSITION HAVING ANTIMICROBIAL AND ANTI-INFLAMMATORY ACTIVITY FOR PARENTERAL ADMINISTRATION, PROCESS FOR PREPARING SAME
A61K 47/04 (2006.01)	2476419 *	PHARMACEUTICAL COMPOSITION HAVING ANTIMICROBIAL AND ANTI-INFLAMMATORY ACTIVITY FOR PARENTERAL ADMINISTRATION, PROCESS FOR PREPARING SAME
A61P 31/04 (2006.01)	2476419 *	PHARMACEUTICAL COMPOSITION HAVING ANTIMICROBIAL AND ANTI-INFLAMMATORY ACTIVITY FOR PARENTERAL ADMINISTRATION, PROCESS FOR PREPARING SAME
A61K 9/51 (2006.01)	2476419 *	PHARMACEUTICAL COMPOSITION HAVING ANTIMICROBIAL AND ANTI-INFLAMMATORY ACTIVITY FOR PARENTERAL ADMINISTRATION, PROCESS FOR PREPARING SAME
A61K 31/4412 (2006.01)	2324831	Methods of administering pirfenidone therapy
A61P 11/00 (2006.01)	2324831	Methods of administering pirfenidone therapy
C03B 7/06 (2006.01)	2429959 *	SYSTEM AND METHOD FOR CONTROLLING TEMPERATURE IN A FOREHEARTH
F23N 5/02 (2006.01)	2429959 *	SYSTEM AND METHOD FOR CONTROLLING TEMPERATURE IN A FOREHEARTH
C07C 45/34 (2006.01)	2487149 *	METHOD FOR PRODUCING KETONE
C07C 255/17 (2006.01)	2487149 *	METHOD FOR PRODUCING KETONE
C07B 61/00 (2006.01)	2487149 *	METHOD FOR PRODUCING KETONE
C07C 253/30 (2006.01)	2487149 *	METHOD FOR PRODUCING KETONE
C07C 49/17 (2006.01)	2487149 *	METHOD FOR PRODUCING KETONE
C07C 49/175 (2006.01)	2487149 *	METHOD FOR PRODUCING KETONE
C07C 69/76 (2006.01)	2454227 *	SYNTHESIS OF PROSTANOIDS
G01L 9/00 (2006.01)	2491364 *	SEPARATING MEMBRANE FOR PRESSURE SENSOR
A01N 45/00 (2006.01)	2429297 *	METHOD OF ADMINISTERING DOSE-SPARING AMOUNTS OF FORMOTEROL FUMARATE-BUDESONIDE COMBINATION PARTICLES BY INHALATION
A61M 16/00 (2006.01)	2319568	Device for moistening breathed air for artificial respiration
A61M 16/16 (2006.01)	2319568	Device for moistening breathed air for artificial respiration
C07D 211/58 (2006.01)	2341046	Process for the preparation of 7-ethyl-10-[4-(1-piperidino)-1-piperidino] carbonyloxy-camptothecin hydrochloride trihydrate
C07D 491/22 (2006.01)	2341046	Process for the preparation of 7-ethyl-10-[4-(1-piperidino)-1-piperidino] carbonyloxy-camptothecin hydrochloride trihydrate
A61P 35/00 (2006.01)	2341046	Process for the preparation of 7-ethyl-10-[4-(1-piperidino)-1-piperidino] carbonyloxy-camptothecin hydrochloride trihydrate
A61K 31/4375 (2006.01)	2341046	Process for the preparation of 7-ethyl-10-[4-(1-piperidino)-1-piperidino] carbonyloxy-camptothecin hydrochloride trihydrate
A61P 25/00 (2006.01)	2491031 *	FUSED HETEROCYCLIC COMPOUNDS AS OREXIN RECEPTOR MODULATORS
C07D 487/04 (2006.01)	2491031 *	FUSED HETEROCYCLIC COMPOUNDS AS OREXIN RECEPTOR MODULATORS
C07D 471/04 (2006.01)	2491031 *	FUSED HETEROCYCLIC COMPOUNDS AS OREXIN RECEPTOR MODULATORS
A61K 31/4353 (2006.01)	2491031 *	FUSED HETEROCYCLIC COMPOUNDS AS OREXIN RECEPTOR MODULATORS
C07K 16/28 (2006.01)	2493927 *	METHOD TO GENERATE ANTIBODIES TO ION CHANNELS
A61P 9/00 (2006.01)	2364972	New method for synthesising ivabradine and its addition salts
C07D 223/16 (2006.01)	2364972	New method for synthesising ivabradine and its addition salts
A61K 31/55 (2006.01)	2364972	New method for synthesising ivabradine and its addition salts

MKP (51)	Broj objave evropske prijava patenta (97)	Naziv pronalaska (54)
A61K 9/00 (2006.01)	2427154 *	INTRAUTERINE SYSTEM FOR USE IN MEDICAL TREATMENT
A61F 6/14 (2006.01)	2427154 *	INTRAUTERINE SYSTEM FOR USE IN MEDICAL TREATMENT
A61P 35/00 (2006.01)	2435068 *	USE OF 2 ANTI-SPARC ANTIBODIES TO PREDICT RESPONSE TO CHEMOTHERAPY
A61P 35/02 (2006.01)	2435068 *	USE OF 2 ANTI-SPARC ANTIBODIES TO PREDICT RESPONSE TO CHEMOTHERAPY
G01N 33/574 (2006.01)	2435068 *	USE OF 2 ANTI-SPARC ANTIBODIES TO PREDICT RESPONSE TO CHEMOTHERAPY
A61K 38/20 (2006.01)	2435068 *	USE OF 2 ANTI-SPARC ANTIBODIES TO PREDICT RESPONSE TO CHEMOTHERAPY
A61K 39/395 (2006.01)	2435068 *	USE OF 2 ANTI-SPARC ANTIBODIES TO PREDICT RESPONSE TO CHEMOTHERAPY
A61K 35/74 (2006.01)	2459203 *	LACTIC ACID BACTERIA AND BIFIDOBACTERIA FOR TREATING ENDOTOXEMIA
A61P 5/50 (2006.01)	2459203 *	LACTIC ACID BACTERIA AND BIFIDOBACTERIA FOR TREATING ENDOTOXEMIA
A61P 29/00 (2006.01)	2459203 *	LACTIC ACID BACTERIA AND BIFIDOBACTERIA FOR TREATING ENDOTOXEMIA
A61K 31/44 (2006.01)	2448407 *	BENZOIC ACID, BENZOIC ACID DERIVATIVES AND HETEROARYL CARBOXYLIC ACID CONJUGATES OF HYDROCODONE, PRODRUGS, METHODS OF MAKING AND USE THEREOF
A01N 43/42 (2006.01)	2448407 *	BENZOIC ACID, BENZOIC ACID DERIVATIVES AND HETEROARYL CARBOXYLIC ACID CONJUGATES OF HYDROCODONE, PRODRUGS, METHODS OF MAKING AND USE THEREOF
C12N 15/88 (2006.01)	2449114 *	NOVEL LIPID FORMULATIONS FOR DELIVERY OF THERAPEUTIC AGENTS TO SOLID TUMORS
C07H 21/00 (2006.01)	2449114 *	NOVEL LIPID FORMULATIONS FOR DELIVERY OF THERAPEUTIC AGENTS TO SOLID TUMORS
C07H 21/02 (2006.01)	2449114 *	NOVEL LIPID FORMULATIONS FOR DELIVERY OF THERAPEUTIC AGENTS TO SOLID TUMORS
C12N 15/87 (2006.01)	2449114 *	NOVEL LIPID FORMULATIONS FOR DELIVERY OF THERAPEUTIC AGENTS TO SOLID TUMORS
A61K 9/14 (2006.01)	2449114 *	NOVEL LIPID FORMULATIONS FOR DELIVERY OF THERAPEUTIC AGENTS TO SOLID TUMORS
C12N 15/113 (2010.01)	2449114 *	NOVEL LIPID FORMULATIONS FOR DELIVERY OF THERAPEUTIC AGENTS TO SOLID TUMORS
A61P 35/00 (2006.01)	2449114 *	NOVEL LIPID FORMULATIONS FOR DELIVERY OF THERAPEUTIC AGENTS TO SOLID TUMORS
A61K 31/713 (2006.01)	2449114 *	NOVEL LIPID FORMULATIONS FOR DELIVERY OF THERAPEUTIC AGENTS TO SOLID TUMORS
B65G 17/26 (2006.01)	2403783 *	PLANT FOR FEEDING GROUPS OF PRODUCTS TO A PACKAGING MACHINE
C07J 41/00 (2006.01)	2427473 *	METHOD FOR THE SYNTHESIS OF GLYCOCHOLIC ACID
C07J 9/00 (2006.01)	2427473 *	METHOD FOR THE SYNTHESIS OF GLYCOCHOLIC ACID
A61K 38/19 (2006.01)	2403519 *	METHOD FOR PREVENTING AND TREATING HYPERPERMEABILITY
B60N 2/28 (2006.01)	2499020 *	CHILD SEAT WITH IMPACT PROTECTION
B60N 2/26 (2006.01)	2499020 *	CHILD SEAT WITH IMPACT PROTECTION
A61K 31/425 (2006.01)	2493312 *	SOLID PHARMACEUTICAL COMPOSITIONS CONTAINING AN INTEGRASE INHIBITOR
A01N 43/78 (2006.01)	2493312 *	SOLID PHARMACEUTICAL COMPOSITIONS CONTAINING AN INTEGRASE INHIBITOR
A61K 31/437 (2006.01)	2445911 *	5-PHENYL-[1,2,4]TRIAZOLO[1,5-A]PYRIDIN-2-YL CARBOXAMIDES AS JAK INHIBITORS
A61P 19/02 (2006.01)	2445911 *	5-PHENYL-[1,2,4]TRIAZOLO[1,5-A]PYRIDIN-2-YL CARBOXAMIDES AS JAK INHIBITORS
C07D 471/04 (2006.01)	2445911 *	5-PHENYL-[1,2,4]TRIAZOLO[1,5-A]PYRIDIN-2-YL CARBOXAMIDES AS JAK INHIBITORS

MKP (51)	Broj objave evropske prijave patenta (97)	Naziv pronalaska (54)
A01N 43/62 (2006.01)	2470019 *	COMPOSITIONS FOR DELIVERY OF INSOLUBLE AGENTS
A61K 31/55 (2006.01)	2470019 *	COMPOSITIONS FOR DELIVERY OF INSOLUBLE AGENTS
C07K 16/28 (2006.01)	2459593 *	ANTI-TGF-BETA RECEPTOR TYPE II SINGLE DOMAIN ANTIBODIES
C07K 16/40 (2006.01)	2459593 *	ANTI-TGF-BETA RECEPTOR TYPE II SINGLE DOMAIN ANTIBODIES
A61P 27/02 (2006.01)	2459593 *	ANTI-TGF-BETA RECEPTOR TYPE II SINGLE DOMAIN ANTIBODIES
A61P 43/00 (2006.01)	2459593 *	ANTI-TGF-BETA RECEPTOR TYPE II SINGLE DOMAIN ANTIBODIES
B29C 65/08 (2006.01)	2483057 *	METHOD FOR FIXING AN ADDITIONAL PART TO A GLAZING OR A PROFILED RIM, FIXING DEVICE FOR FIXING SAID PART, AND GLAZING OBTAINED BY SAID METHOD
B29C 65/64 (2006.01)	2483057 *	METHOD FOR FIXING AN ADDITIONAL PART TO A GLAZING OR A PROFILED RIM, FIXING DEVICE FOR FIXING SAID PART, AND GLAZING OBTAINED BY SAID METHOD
B60J 10/02 (2006.01)	2483057 *	METHOD FOR FIXING AN ADDITIONAL PART TO A GLAZING OR A PROFILED RIM, FIXING DEVICE FOR FIXING SAID PART, AND GLAZING OBTAINED BY SAID METHOD
B29C 65/60 (2006.01)	2483057 *	METHOD FOR FIXING AN ADDITIONAL PART TO A GLAZING OR A PROFILED RIM, FIXING DEVICE FOR FIXING SAID PART, AND GLAZING OBTAINED BY SAID METHOD
B60R 13/06 (2006.01)	2483057 *	METHOD FOR FIXING AN ADDITIONAL PART TO A GLAZING OR A PROFILED RIM, FIXING DEVICE FOR FIXING SAID PART, AND GLAZING OBTAINED BY SAID METHOD
B60R 13/04 (2006.01)	2483057 *	METHOD FOR FIXING AN ADDITIONAL PART TO A GLAZING OR A PROFILED RIM, FIXING DEVICE FOR FIXING SAID PART, AND GLAZING OBTAINED BY SAID METHOD
G07F 17/32 (2006.01)	2357622	Method for operating a gaming device of an entertainment device
G07F 17/34 (2006.01)	2357622	Method for operating a gaming device of an entertainment device
H04B 7/26 (2006.01)	2495886 *	METHOD, APPARATUS AND SYSTEM FOR UPLINK SYNCHRONIZATION
A61K 9/00 (2006.01)	2440208 *	SOLID DISPERSIONS CONTAINING AN APOPTOSIS-PROMOTING AGENT
A61K 31/5377 (2006.01)	2440208 *	SOLID DISPERSIONS CONTAINING AN APOPTOSIS-PROMOTING AGENT
A61K 9/14 (2006.01)	2440208 *	SOLID DISPERSIONS CONTAINING AN APOPTOSIS-PROMOTING AGENT
A61K 31/506 (2006.01)	2443095 *	SULFONAMIDES AND SULFAMIDES AS ZAP-70 INHIBITORS
A61P 37/00 (2006.01)	2443095 *	SULFONAMIDES AND SULFAMIDES AS ZAP-70 INHIBITORS
C07D 239/48 (2006.01)	2443095 *	SULFONAMIDES AND SULFAMIDES AS ZAP-70 INHIBITORS
C07D 403/12 (2006.01)	2443095 *	SULFONAMIDES AND SULFAMIDES AS ZAP-70 INHIBITORS
C07D 403/14 (2006.01)	2443095 *	SULFONAMIDES AND SULFAMIDES AS ZAP-70 INHIBITORS
A61B 17/34 (2006.01)	2459084 *	SURGICAL ACCESS DEVICES WITH SORBENTS
A61B 19/00 (2006.01)	2459084 *	SURGICAL ACCESS DEVICES WITH SORBENTS
A61K 47/48 (2006.01)	2470216 *	PEPTIDE CLEARING AGENTS
C07K 5/02 (2006.01)	2470216 *	PEPTIDE CLEARING AGENTS
A61K 9/127 (2006.01)	2437726 *	FORMULATIONS FOR THE TREATMENT OF DEEP TISSUE PAIN
A61P 25/18 (2006.01)	2298328	Use of umbilical cord blood cells for the treatment of neurological disorders
A61P 25/28 (2006.01)	2298328	Use of umbilical cord blood cells for the treatment of neurological disorders
A61P 25/16 (2006.01)	2298328	Use of umbilical cord blood cells for the treatment of neurological disorders
A61K 35/44 (2006.01)	2298328	Use of umbilical cord blood cells for the treatment of neurological disorders
F01N 3/20 (2006.01)	2402609	Pump for dosing fluids
F04B 53/16 (2006.01)	2402609	Pump for dosing fluids
F04B 39/12 (2006.01)	2402609	Pump for dosing fluids
A61K 31/517 (2006.01)	2499129 *	QUINOLINE AND QUINOXALINE DERIVATIVES AS KINASE INHIBITORS
C07D 487/04 (2006.01)	2499129 *	QUINOLINE AND QUINOXALINE DERIVATIVES AS KINASE INHIBITORS
A61P 35/00 (2006.01)	2499129 *	QUINOLINE AND QUINOXALINE DERIVATIVES AS KINASE INHIBITORS
A61P 29/00 (2006.01)	2499129 *	QUINOLINE AND QUINOXALINE DERIVATIVES AS KINASE INHIBITORS
C07D 403/04 (2006.01)	2499129 *	QUINOLINE AND QUINOXALINE DERIVATIVES AS KINASE INHIBITORS
A61P 25/28 (2006.01)	2499129 *	QUINOLINE AND QUINOXALINE DERIVATIVES AS KINASE INHIBITORS

MKP (51)	Broj objave evropske prijava patenta (97)	Naziv pronalaska (54)
A61P 9/00 (2006.01)	2499129 *	QUINOLINE AND QUINOXALINE DERIVATIVES AS KINASE INHIBITORS
G07F 19/00 (2006.01)	2452321 *	DEVICE FOR MANAGING, RECEIVING, AND/OR DISPENSING OBJECTS OF VALUE
B01J 2/22 (2006.01)	2454011 *	ENGINEERED AEROSOL PARTICLES, AND ASSOCIATED METHODS
A61K 31/551 (2006.01)	2497774	Dihydro-oxazolobenzodiazepinone derivatives, processes for their preparation and pharmaceutical compositions comprising these compounds
C07D 498/04 (2006.01)	2497774	Dihydro-oxazolobenzodiazepinone derivatives, processes for their preparation and pharmaceutical compositions comprising these compounds
A01H 5/00 (2006.01)	2473022 *	HERBICIDE-TOLERANT PLANTS
C12N 15/52 (2006.01)	2473022 *	HERBICIDE-TOLERANT PLANTS
C12N 15/82 (2006.01)	2473022 *	HERBICIDE-TOLERANT PLANTS
B65B 9/067 (2012.01)	2465781	Horizontal packaging machine
B65B 9/087 (2012.01)	2465781	Horizontal packaging machine
B29C 65/18 (2006.01)	2465781	Horizontal packaging machine
B65B 43/04 (2006.01)	2465781	Horizontal packaging machine
A61K 31/4535 (2006.01)	2435427 *	SUBSTITUTED PIPERIDINES
C07D 413/04 (2006.01)	2435427 *	SUBSTITUTED PIPERIDINES
A61K 31/4525 (2006.01)	2435427 *	SUBSTITUTED PIPERIDINES
C07D 413/14 (2006.01)	2435427 *	SUBSTITUTED PIPERIDINES
A61K 31/4545 (2006.01)	2435427 *	SUBSTITUTED PIPERIDINES
C07D 471/04 (2006.01)	2411388 *	PROCESS FOR THE PRODUCTION OF FUSED, TRICYCLIC SULFONAMIDES
A61K 31/437 (2006.01)	2411388 *	PROCESS FOR THE PRODUCTION OF FUSED, TRICYCLIC SULFONAMIDES
C07C 53/126 (2006.01)	2451771 *	SALTS OF RASAGILINE AND PHARMACEUTICAL PREPARATIONS THEREOF
A61P 25/16 (2006.01)	2451771 *	SALTS OF RASAGILINE AND PHARMACEUTICAL PREPARATIONS THEREOF
C07C 53/122 (2006.01)	2451771 *	SALTS OF RASAGILINE AND PHARMACEUTICAL PREPARATIONS THEREOF
A61K 31/19 (2006.01)	2451771 *	SALTS OF RASAGILINE AND PHARMACEUTICAL PREPARATIONS THEREOF
C07C 211/42 (2006.01)	2451771 *	SALTS OF RASAGILINE AND PHARMACEUTICAL PREPARATIONS THEREOF
A61K 31/13 (2006.01)	2451771 *	SALTS OF RASAGILINE AND PHARMACEUTICAL PREPARATIONS THEREOF
C07C 57/12 (2006.01)	2451771 *	SALTS OF RASAGILINE AND PHARMACEUTICAL PREPARATIONS THEREOF
C07K 16/00 (2006.01)	2408814 *	CARRIER IMMUNOGLOBULINS AND USES THEREOF
C12P 21/08 (2006.01)	2408814 *	CARRIER IMMUNOGLOBULINS AND USES THEREOF
C07D 405/12 (2006.01)	2440534 *	PYRIMIDINE DERIVATIVES AS ZAP-70 INHIBITORS
C07D 239/48 (2006.01)	2440534 *	PYRIMIDINE DERIVATIVES AS ZAP-70 INHIBITORS
A61K 31/505 (2006.01)	2440534 *	PYRIMIDINE DERIVATIVES AS ZAP-70 INHIBITORS
C07D 401/12 (2006.01)	2440534 *	PYRIMIDINE DERIVATIVES AS ZAP-70 INHIBITORS
C10G 45/00 (2006.01)	2474594 *	HYDROCARBON SYNTHESIS REACTION APPARATUS, HYDROCARBON SYNTHESIS REACTION SYSTEM, AND HYDROCARBON SYNTHESIS REACTION METHOD
C10G 2/00 (2006.01)	2474594 *	HYDROCARBON SYNTHESIS REACTION APPARATUS, HYDROCARBON SYNTHESIS REACTION SYSTEM, AND HYDROCARBON SYNTHESIS REACTION METHOD
C12P 7/06 (2006.01)	2406383 *	REDUCING CARBON DIOXIDE PRODUCTION AND INCREASING ETHANOL YIELD DURING MICROBIAL ETHANOL FERMENTATION
C07D 207/16 (2006.01)	2486008 *	INORGANIC SALT COMPLEXES OF VILDAGLIPTIN
A61P 3/10 (2006.01)	2486008 *	INORGANIC SALT COMPLEXES OF VILDAGLIPTIN

MKP (51)	Broj objave evropske prijava patenta (97)	Naziv pronalaska (54)
A61K 31/401 (2006.01)	2486008 *	INORGANIC SALT COMPLEXES OF VILDAGLIPTIN
A62C 35/02 (2006.01)	2485811 *	SYSTEM AND METHOD FOR SODIUM AZIDE BASED SUPPRESSION OF FIRES
A62C 99/00 (2010.01)	2485811 *	SYSTEM AND METHOD FOR SODIUM AZIDE BASED SUPPRESSION OF FIRES
A62D 1/02 (2006.01)	2485811 *	SYSTEM AND METHOD FOR SODIUM AZIDE BASED SUPPRESSION OF FIRES
A62D 1/06 (2006.01)	2485811 *	SYSTEM AND METHOD FOR SODIUM AZIDE BASED SUPPRESSION OF FIRES
H01M 2/10 (2006.01)	2413397	Device for holding a galvanic element, energy storage unit and energy storage stack
H01M 10/50 (2006.01)	2413397	Device for holding a galvanic element, energy storage unit and energy storage stack
A61K 31/435 (2006.01)	2427190 *	8-AZA TETRACYCLINE COMPOUNDS
A61P 31/04 (2006.01)	2427190 *	8-AZA TETRACYCLINE COMPOUNDS
C07D 221/18 (2006.01)	2427190 *	8-AZA TETRACYCLINE COMPOUNDS
B60K 37/02 (2006.01)	2490912 *	DISPLAY INSTRUMENT HAVING A POINTER
B60K 11/08 (2006.01)	2490912 *	DISPLAY INSTRUMENT HAVING A POINTER
G01P 1/08 (2006.01)	2490912 *	DISPLAY INSTRUMENT HAVING A POINTER
G01D 13/26 (2006.01)	2490912 *	DISPLAY INSTRUMENT HAVING A POINTER
G01D 11/28 (2006.01)	2490912 *	DISPLAY INSTRUMENT HAVING A POINTER
A61F 9/06 (2006.01)	2338446	Method for controlling cartridge of welding helmet having display function of welding operation time
C07D 513/04 (2006.01)	2448938 *	PYRIMIDINONES AS PI3K INHIBITORS
A61K 31/52 (2006.01)	2448938 *	PYRIMIDINONES AS PI3K INHIBITORS
A61P 37/00 (2006.01)	2448938 *	PYRIMIDINONES AS PI3K INHIBITORS
A61P 29/00 (2006.01)	2448938 *	PYRIMIDINONES AS PI3K INHIBITORS
C07D 473/34 (2006.01)	2448938 *	PYRIMIDINONES AS PI3K INHIBITORS
C07D 309/10 (2006.01)	2486029 *	PROCESSES FOR PREPARING OF GLUCOPYRANOSYL-SUBSTITUTED BENZYL-BENZENE DERIVATIVES
A23J 1/00 (2006.01)	2417859 *	CONCENTRATED PROTEIN PRODUCTS AND METHODS FOR PRODUCING SAME
A23J 3/00 (2006.01)	2417859 *	CONCENTRATED PROTEIN PRODUCTS AND METHODS FOR PRODUCING SAME
C12N 15/68 (2006.01)	2432884 *	ANTIBIOTIC-FREE PLASMID
C12N 15/73 (2006.01)	2432884 *	ANTIBIOTIC-FREE PLASMID
C12N 15/63 (2006.01)	2432884 *	ANTIBIOTIC-FREE PLASMID
C10G 2/00 (2006.01)	2474592 *	HYDROCARBON SYNTHESIS REACTION APPARATUS, HYDROCARBON SYNTHESIS REACTION SYSTEM, AND METHOD FOR COLLECTION OF LIQUID HYDROCARBON
C10G 2/00 (2006.01)	2500400 *	METHOD OF HYDROCRACKING AND PROCESS FOR PRODUCING HYDROCARBON OIL
C10G 47/36 (2006.01)	2500400 *	METHOD OF HYDROCRACKING AND PROCESS FOR PRODUCING HYDROCARBON OIL
C12Q 1/68 (2006.01)	2486146 *	METHOD FOR DETECTING GENE MODIFICATIONS BY MEANS OF ASYMMETRICAL PCR AND BLOCKING AGENTS
A61K 35/34 (2006.01)	2432482 *	PHARMACEUTICAL COMPOSITION FOR THE TREATMENT OF HEART DISEASES.
E04B 2/02 (2006.01)	2486198 *	A BUILDING PANEL, BUILDING SYSTEM AND METHOD OF CONSTRUCTING A BUILDING
B32B 27/04 (2006.01)	2486198 *	A BUILDING PANEL, BUILDING SYSTEM AND METHOD OF CONSTRUCTING A BUILDING
B32B 7/04 (2006.01)	2486198 *	A BUILDING PANEL, BUILDING SYSTEM AND METHOD OF CONSTRUCTING A BUILDING

MKP (51)	Broj objave evropske prijava patenta (97)	Naziv pronalaska (54)
E04C 2/24 (2006.01)	2486198 *	A BUILDING PANEL, BUILDING SYSTEM AND METHOD OF CONSTRUCTING A BUILDING
E04C 1/40 (2006.01)	2486198 *	A BUILDING PANEL, BUILDING SYSTEM AND METHOD OF CONSTRUCTING A BUILDING
E03D 11/12 (2006.01)	2491190 *	BELLOWS-LIKE FOLDABLE TOILET BOWL
B44C 1/26 (2006.01)	2364864	System of ornamental stone floors and ornamental friezes and manufacturing process of ornamental stone floors and ornamental friezes
B44C 1/28 (2006.01)	2364864	System of ornamental stone floors and ornamental friezes and manufacturing process of ornamental stone floors and ornamental friezes
B44C 5/04 (2006.01)	2364864	System of ornamental stone floors and ornamental friezes and manufacturing process of ornamental stone floors and ornamental friezes
C07D 209/42 (2006.01)	2454235 *	PROCESSES FOR THE SYNTHESIS OF (2S, 3AR, 7AS)-OCTAHYDRO-1H-INDOLE CARBOXYLIC ACID AS AN INTERMEDIATE FOR TRANDOLAPRIL
C12Q 1/68 (2006.01)	2419529 *	INFLAMMATORY BOWEL DISEASE PROGNOSTICS
G01N 33/564 (2006.01)	2419529 *	INFLAMMATORY BOWEL DISEASE PROGNOSTICS
G01N 33/68 (2006.01)	2419529 *	INFLAMMATORY BOWEL DISEASE PROGNOSTICS
H04W 40/02 (2009.01)	2350863 *	ESTABLISHING A MESH NETWORK WITH WIRED AND WIRELESS LINKS
G06F 15/16 (2006.01)	2350863 *	ESTABLISHING A MESH NETWORK WITH WIRED AND WIRELESS LINKS
G06F 15/177 (2006.01)	2350863 *	ESTABLISHING A MESH NETWORK WITH WIRED AND WIRELESS LINKS
A61K 47/48 (2006.01)	2411054 *	DRUG FUSIONS AND CONJUGATES
C07K 16/18 (2006.01)	2411054 *	DRUG FUSIONS AND CONJUGATES
A61P 3/10 (2006.01)	2411054 *	DRUG FUSIONS AND CONJUGATES
C07D 403/14 (2006.01)	2421852 *	HETEROAROMATIC AND AROMATIC PIPERAZINYL AZETIDINYL AMIDES AS MONOACYLGLYCEROL LIPASE INHIBITOR
A61P 25/00 (2006.01)	2421852 *	HETEROAROMATIC AND AROMATIC PIPERAZINYL AZETIDINYL AMIDES AS MONOACYLGLYCEROL LIPASE INHIBITOR
C07D 403/12 (2006.01)	2421852 *	HETEROAROMATIC AND AROMATIC PIPERAZINYL AZETIDINYL AMIDES AS MONOACYLGLYCEROL LIPASE INHIBITOR
A61P 29/00 (2006.01)	2421852 *	HETEROAROMATIC AND AROMATIC PIPERAZINYL AZETIDINYL AMIDES AS MONOACYLGLYCEROL LIPASE INHIBITOR
C07D 409/12 (2006.01)	2421852 *	HETEROAROMATIC AND AROMATIC PIPERAZINYL AZETIDINYL AMIDES AS MONOACYLGLYCEROL LIPASE INHIBITOR
C07D 401/14 (2006.01)	2421852 *	HETEROAROMATIC AND AROMATIC PIPERAZINYL AZETIDINYL AMIDES AS MONOACYLGLYCEROL LIPASE INHIBITOR
A61K 31/496 (2006.01)	2421852 *	HETEROAROMATIC AND AROMATIC PIPERAZINYL AZETIDINYL AMIDES AS MONOACYLGLYCEROL LIPASE INHIBITOR
C07D 405/14 (2006.01)	2421852 *	HETEROAROMATIC AND AROMATIC PIPERAZINYL AZETIDINYL AMIDES AS MONOACYLGLYCEROL LIPASE INHIBITOR
C07D 409/14 (2006.01)	2421852 *	HETEROAROMATIC AND AROMATIC PIPERAZINYL AZETIDINYL AMIDES AS MONOACYLGLYCEROL LIPASE INHIBITOR
C07D 401/12 (2006.01)	2421852 *	HETEROAROMATIC AND AROMATIC PIPERAZINYL AZETIDINYL AMIDES AS MONOACYLGLYCEROL LIPASE INHIBITOR
C07D 417/12 (2006.01)	2421852 *	HETEROAROMATIC AND AROMATIC PIPERAZINYL AZETIDINYL AMIDES AS MONOACYLGLYCEROL LIPASE INHIBITOR
C07D 413/12 (2006.01)	2421852 *	HETEROAROMATIC AND AROMATIC PIPERAZINYL AZETIDINYL AMIDES AS MONOACYLGLYCEROL LIPASE INHIBITOR
A61N 7/00 (2006.01)	2366430	Ultrasound application device
C07D 487/22 (2006.01)	2459567 *	PHTHALOCYANINE DERIVATIVE CONSISTING OF A MIXTURE OF 4 ISOMERS
A61K 31/555 (2006.01)	2459567 *	PHTHALOCYANINE DERIVATIVE CONSISTING OF A MIXTURE OF 4 ISOMERS
A61P 31/00 (2006.01)	2459567 *	PHTHALOCYANINE DERIVATIVE CONSISTING OF A MIXTURE OF 4 ISOMERS
A61P 35/00 (2006.01)	2459567 *	PHTHALOCYANINE DERIVATIVE CONSISTING OF A MIXTURE OF 4 ISOMERS
H04W 28/04 (2009.01)	2496009 *	METHOD, DEVICE AND SYSTEM FOR SYNCHRONIZING MBMS

MKP (51)	Broj objave evropske prijava patenta (97)	Naziv pronalaska (54)
A01N 43/66 (2006.01)	2440051 *	TRIAZINE DERIVATIVES AND THEIR THERAPEUTICAL APPLICATIONS
A61K 31/53 (2006.01)	2440051 *	TRIAZINE DERIVATIVES AND THEIR THERAPEUTICAL APPLICATIONS
F24J 3/08 (2006.01)	2406559 *	PERCUSSION MOLE
A01N 59/10 (2006.01)	2424348 *	COMPOSITION FOR STERILIZING SURFACES
A01N 41/10 (2006.01)	2424348 *	COMPOSITION FOR STERILIZING SURFACES
A01P 1/00 (2006.01)	2424348 *	COMPOSITION FOR STERILIZING SURFACES
A01N 25/06 (2006.01)	2424348 *	COMPOSITION FOR STERILIZING SURFACES
A01N 59/16 (2006.01)	2424348 *	COMPOSITION FOR STERILIZING SURFACES
C07C 51/09 (2006.01)	2462098 *	PROCESS FOR THE PREPARATION OF DERIVATIVES OF 1-(2-HALOBIPHENYL-4-YL)-CYCLOPROPANECARBOXYLIC ACID
C07C 253/14 (2006.01)	2462098 *	PROCESS FOR THE PREPARATION OF DERIVATIVES OF 1-(2-HALOBIPHENYL-4-YL)-CYCLOPROPANECARBOXYLIC ACID
C07C 61/40 (2006.01)	2462098 *	PROCESS FOR THE PREPARATION OF DERIVATIVES OF 1-(2-HALOBIPHENYL-4-YL)-CYCLOPROPANECARBOXYLIC ACID
C07C 253/30 (2006.01)	2462098 *	PROCESS FOR THE PREPARATION OF DERIVATIVES OF 1-(2-HALOBIPHENYL-4-YL)-CYCLOPROPANECARBOXYLIC ACID
C07C 255/35 (2006.01)	2462098 *	PROCESS FOR THE PREPARATION OF DERIVATIVES OF 1-(2-HALOBIPHENYL-4-YL)-CYCLOPROPANECARBOXYLIC ACID
C07C 255/46 (2006.01)	2462098 *	PROCESS FOR THE PREPARATION OF DERIVATIVES OF 1-(2-HALOBIPHENYL-4-YL)-CYCLOPROPANECARBOXYLIC ACID
B01J 21/00 (2006.01)	2392548	Process for preparing an amorphous silica-alumina composition and relative amorphous silica-alumina composition
C01B 33/12 (2006.01)	2392548	Process for preparing an amorphous silica-alumina composition and relative amorphous silica-alumina composition
A61P 11/00 (2006.01)	2448922 *	FLUORINATED DERIVATIVES OF 3-HYDROXYPYRIDIN-4-ONES
A61P 13/12 (2006.01)	2448922 *	FLUORINATED DERIVATIVES OF 3-HYDROXYPYRIDIN-4-ONES
A61P 35/00 (2006.01)	2448922 *	FLUORINATED DERIVATIVES OF 3-HYDROXYPYRIDIN-4-ONES
C07D 213/69 (2006.01)	2448922 *	FLUORINATED DERIVATIVES OF 3-HYDROXYPYRIDIN-4-ONES
A61P 25/28 (2006.01)	2448922 *	FLUORINATED DERIVATIVES OF 3-HYDROXYPYRIDIN-4-ONES
A61K 31/4422 (2006.01)	2448922 *	FLUORINATED DERIVATIVES OF 3-HYDROXYPYRIDIN-4-ONES
G06F 21/00 (2006.01)	2284750	System and method for detecting obfuscated malware using code normalization
E21B 47/12 (2012.01)	2419605 *	A COMMUNICATION ARRANGEMENT FOR TRANSMISSION OF COMMUNICATION SIGNALS ALONG A PIPE LINE
E21B 17/00 (2006.01)	2419605 *	A COMMUNICATION ARRANGEMENT FOR TRANSMISSION OF COMMUNICATION SIGNALS ALONG A PIPE LINE
A01N 31/00 (2006.01)	2461700 *	WATER AND FEED PRESERVATIVE
A23K 1/18 (2006.01)	2461700 *	WATER AND FEED PRESERVATIVE
A23K 1/17 (2006.01)	2461700 *	WATER AND FEED PRESERVATIVE
A23K 1/16 (2006.01)	2461700 *	WATER AND FEED PRESERVATIVE
G06F 19/00 (2011.01)	2449493 *	SYSTEMS FOR DIABETES MANAGEMENT AND METHODS
A61F 13/15 (2006.01)	2415438	Apparatus and method for minimizing waste and improving quality and production in web processing operations by automatic cuff defect correction
A61P 37/06 (2006.01)	2440554 *	PYRAZOLE OXADIAZOLE DERIVATIVES AS S1P1 AGONISTS
C07D 471/04 (2006.01)	2440554 *	PYRAZOLE OXADIAZOLE DERIVATIVES AS S1P1 AGONISTS
A61K 31/4245 (2006.01)	2440554 *	PYRAZOLE OXADIAZOLE DERIVATIVES AS S1P1 AGONISTS
C07D 413/04 (2006.01)	2440554 *	PYRAZOLE OXADIAZOLE DERIVATIVES AS S1P1 AGONISTS
C07D 413/14 (2006.01)	2440554 *	PYRAZOLE OXADIAZOLE DERIVATIVES AS S1P1 AGONISTS
C09C 1/00 (2006.01)	2444460	Milled expanded volcanic glass as lamellar filler
C09D 7/12 (2006.01)	2444460	Milled expanded volcanic glass as lamellar filler
C22B 34/14 (2006.01)	2444460	Milled expanded volcanic glass as lamellar filler
H04L 29/06 (2006.01)	2424177	Method and system for network data flow management
H04L 12/56 (2006.01)	2424177	Method and system for network data flow management

MKP (51)	Broj objave evropske prijava patenta (97)	Naziv pronalaska (54)
B31D 1/06 (2006.01)	2397318	Handle-forming machine
B31B 19/86 (2006.01)	2397318	Handle-forming machine
B65D 33/28 (2006.01)	2454163 *	METHOD FOR MANUFACTURING DRAW STRING BAGS
B31B 19/90 (2006.01)	2454163 *	METHOD FOR MANUFACTURING DRAW STRING BAGS
C09D 195/00 (2006.01)	2380935	Bituminous compositions
E01C 7/35 (2006.01)	2380935	Bituminous compositions
C08L 95/00 (2006.01)	2380935	Bituminous compositions
A61K 39/395 (2006.01)	2406289 *	ANTIGEN PRESENTING CELL TARGETED ANTI-VIRAL VACCINES
C07K 19/00 (2006.01)	2406289 *	ANTIGEN PRESENTING CELL TARGETED ANTI-VIRAL VACCINES
C07K 16/08 (2006.01)	2406289 *	ANTIGEN PRESENTING CELL TARGETED ANTI-VIRAL VACCINES
C12N 15/63 (2006.01)	2406289 *	ANTIGEN PRESENTING CELL TARGETED ANTI-VIRAL VACCINES
C12N 15/62 (2006.01)	2406289 *	ANTIGEN PRESENTING CELL TARGETED ANTI-VIRAL VACCINES
A61K 39/12 (2006.01)	2406289 *	ANTIGEN PRESENTING CELL TARGETED ANTI-VIRAL VACCINES
A61P 29/00 (2006.01)	2477625 *	PHARMACEUTICAL COMPOSITIONS AND FORMULATIONS INCLUDING INHIBITORS OF THE PLECKSTRIN HOMOLOGY DOMAIN AND METHODS FOR USING SAME
A61K 31/433 (2006.01)	2477625 *	PHARMACEUTICAL COMPOSITIONS AND FORMULATIONS INCLUDING INHIBITORS OF THE PLECKSTRIN HOMOLOGY DOMAIN AND METHODS FOR USING SAME
A61P 35/00 (2006.01)	2477625 *	PHARMACEUTICAL COMPOSITIONS AND FORMULATIONS INCLUDING INHIBITORS OF THE PLECKSTRIN HOMOLOGY DOMAIN AND METHODS FOR USING SAME
A01N 43/90 (2006.01)	2488033 *	COMBINATION
A61K 31/519 (2006.01)	2488033 *	COMBINATION
A61N 1/36 (2006.01)	2408516 *	ELECTRICAL STIMULATION DEVICE WITH ADDITIONAL SENSORY MODALITIES
A61N 1/34 (2006.01)	2408516 *	ELECTRICAL STIMULATION DEVICE WITH ADDITIONAL SENSORY MODALITIES
E06B 3/54 (2006.01)	2270305	Adjusting device for the inclination of window frames and window frame
A01N 43/66 (2006.01)	2440052 *	TRIAZINE DERIVATIVES AND THEIR THERAPEUTICAL APPLICATIONS
A61K 31/53 (2006.01)	2440052 *	TRIAZINE DERIVATIVES AND THEIR THERAPEUTICAL APPLICATIONS
A61P 35/00 (2006.01)	2468281 *	QUINOLINE DERIVATIVE-CONTAINING PHARMACEUTICAL COMPOSITION
A61P 35/04 (2006.01)	2468281 *	QUINOLINE DERIVATIVE-CONTAINING PHARMACEUTICAL COMPOSITION
A61P 43/00 (2006.01)	2468281 *	QUINOLINE DERIVATIVE-CONTAINING PHARMACEUTICAL COMPOSITION
C07D 215/48 (2006.01)	2468281 *	QUINOLINE DERIVATIVE-CONTAINING PHARMACEUTICAL COMPOSITION
A61K 47/38 (2006.01)	2468281 *	QUINOLINE DERIVATIVE-CONTAINING PHARMACEUTICAL COMPOSITION
A61K 31/47 (2006.01)	2468281 *	QUINOLINE DERIVATIVE-CONTAINING PHARMACEUTICAL COMPOSITION
A61K 47/32 (2006.01)	2468281 *	QUINOLINE DERIVATIVE-CONTAINING PHARMACEUTICAL COMPOSITION
A61K 47/36 (2006.01)	2468281 *	QUINOLINE DERIVATIVE-CONTAINING PHARMACEUTICAL COMPOSITION
A61F 13/15 (2006.01)	2412348	Apparatus and method for minimizing waste and improving quality and production in web processing operations by automated threading and re-threading of web materials
B07C 5/342 (2006.01)	2412348	Apparatus and method for minimizing waste and improving quality and production in web processing operations by automated threading and re-threading of web materials
C07C 209/62 (2006.01)	2448896 *	METHOD OF PREPARING 1-HYDROXY-1,3,3,5,5-PENTAMETHYLCYCLOHEXANE
C07C 29/40 (2006.01)	2448896 *	METHOD OF PREPARING 1-HYDROXY-1,3,3,5,5-PENTAMETHYLCYCLOHEXANE
C07C 211/35 (2006.01)	2448896 *	METHOD OF PREPARING 1-HYDROXY-1,3,3,5,5-PENTAMETHYLCYCLOHEXANE
C07H 19/20 (2006.01)	2424874 *	NOVEL PHOSPHATE MODIFIED NUCLEOSIDES USEFUL AS SUBSTRATES FOR POLYMERASES AND AS ANTIVIRAL AGENTS

MKP (51)	Broj objave evropske prijava patenta (97)	Naziv pronalaska (54)
A61K 31/708 (2006.01)	2424874 *	NOVEL PHOSPHATE MODIFIED NUCLEOSIDES USEFUL AS SUBSTRATES FOR POLYMERASES AND AS ANTIVIRAL AGENTS
A61K 31/4422 (2006.01)	2406218 *	Pharmaceutical combination of 5-fluorouracil and derivate of 1,4-dihydropyridine and its use in the treatment of cancer
C07D 211/90 (2006.01)	2406218 *	Pharmaceutical combination of 5-fluorouracil and derivate of 1,4-dihydropyridine and its use in the treatment of cancer
A61C 8/00 (2006.01)	2419044 *	DENTAL IMPLANT ASSEMBLY COMPRISING A MAGNETIC TEMPORARY SCREW
B65G 7/04 (2006.01)	2256066	Method for attaching a transport wheel arrangement to a container and a transport wheel arrangement of a container
B65D 90/18 (2006.01)	2256066	Method for attaching a transport wheel arrangement to a container and a transport wheel arrangement of a container
G06F 21/00 (2006.01)	2469445	Optimization of anti-malware processing by automated correction of detection rules
C07D 471/04 (2006.01)	2424866 *	SUBSTITUTED IMIDAZO[1,2-A]PYRIDINE DERIVATIVES, PHARMACEUTICAL COMPOSITIONS, AND METHODS OF USE AS -SECRETASE INHIBITORS
C07D 487/04 (2006.01)	2424866 *	SUBSTITUTED IMIDAZO[1,2-A]PYRIDINE DERIVATIVES, PHARMACEUTICAL COMPOSITIONS, AND METHODS OF USE AS -SECRETASE INHIBITORS
A61K 31/437 (2006.01)	2424866 *	SUBSTITUTED IMIDAZO[1,2-A]PYRIDINE DERIVATIVES, PHARMACEUTICAL COMPOSITIONS, AND METHODS OF USE AS -SECRETASE INHIBITORS
A61P 25/28 (2006.01)	2424866 *	SUBSTITUTED IMIDAZO[1,2-A]PYRIDINE DERIVATIVES, PHARMACEUTICAL COMPOSITIONS, AND METHODS OF USE AS -SECRETASE INHIBITORS
C08B 37/00 (2006.01)	2427501 *	NOVEL SULFATED HEPTASACCHARIDE AND ITS USE AS ANTITHROMBOTIC AGENT
C08B 37/10 (2006.01)	2427501 *	NOVEL SULFATED HEPTASACCHARIDE AND ITS USE AS ANTITHROMBOTIC AGENT
A61K 9/00 (2006.01)	2482768 *	AN INTRAUTERINE SYSTEM
A61F 6/14 (2006.01)	2482768 *	AN INTRAUTERINE SYSTEM
C08G 63/00 (2006.01)	2366725	Composite material
C08L 67/00 (2006.01)	2366725	Composite material
C08K 7/22 (2006.01)	2366725	Composite material
C08K 7/00 (2006.01)	2366725	Composite material
C07D 413/14 (2006.01)	2493877 *	PYRIMIDINE COMPOUNDS AS DELTA OPIOID RECEPTOR MODULATORS
C07D 403/12 (2006.01)	2493877 *	PYRIMIDINE COMPOUNDS AS DELTA OPIOID RECEPTOR MODULATORS
A61P 25/04 (2006.01)	2493877 *	PYRIMIDINE COMPOUNDS AS DELTA OPIOID RECEPTOR MODULATORS
C07D 403/14 (2006.01)	2493877 *	PYRIMIDINE COMPOUNDS AS DELTA OPIOID RECEPTOR MODULATORS
A61K 31/506 (2006.01)	2493877 *	PYRIMIDINE COMPOUNDS AS DELTA OPIOID RECEPTOR MODULATORS
C07D 401/14 (2006.01)	2493877 *	PYRIMIDINE COMPOUNDS AS DELTA OPIOID RECEPTOR MODULATORS
C07K 14/635 (2006.01)	2421893 *	SHORT-CHAIN PEPTIDES AS PARATHYROID HORMONE (PTH) RECEPTOR AGONIST
F16L 55/38 (2006.01)	2464909 *	SPEED CONTROL DRIVE SECTION WITH FAILSAFE VALVE
E03D 11/13 (2006.01)	2333168	Bellows-like foldable bidet
E03D 11/12 (2006.01)	2333168	Bellows-like foldable bidet
E04F 13/00 (2006.01)	2366847	Insulating and draining board
E04B 1/74 (2006.01)	2366847	Insulating and draining board
H01T 4/08 (2006.01)	2419976 *	COAXIAL BROADBAND SURGE PROTECTOR
H02H 9/02 (2006.01)	2419976 *	COAXIAL BROADBAND SURGE PROTECTOR
A61P 29/00 (2006.01)	2448943 *	ENANTIOMERS OF SPIRO-OXINDOLE COMPOUNDS AND THEIR USES AS THERAPEUTIC AGENTS
A61K 31/404 (2006.01)	2448943 *	ENANTIOMERS OF SPIRO-OXINDOLE COMPOUNDS AND THEIR USES AS THERAPEUTIC AGENTS

MKP (51)	Broj objave evropske prijava patenta (97)	Naziv pronalaska (54)
C07D 491/22 (2006.01)	2448943 *	ENANTIOMERS OF SPIRO-OXINDOLE COMPOUNDS AND THEIR USES AS THERAPEUTIC AGENTS
C07D 207/10 (2006.01)	2459529 *	SUBSTITUTED PHENOXYPROPYLCYCLOAMINE DERIVATIVES AS HISTAMINE-3 (H3) RECEPTOR LIGANDS
C07D 215/06 (2006.01)	2459529 *	SUBSTITUTED PHENOXYPROPYLCYCLOAMINE DERIVATIVES AS HISTAMINE-3 (H3) RECEPTOR LIGANDS
C07D 209/44 (2006.01)	2459529 *	SUBSTITUTED PHENOXYPROPYLCYCLOAMINE DERIVATIVES AS HISTAMINE-3 (H3) RECEPTOR LIGANDS
C07D 217/04 (2006.01)	2459529 *	SUBSTITUTED PHENOXYPROPYLCYCLOAMINE DERIVATIVES AS HISTAMINE-3 (H3) RECEPTOR LIGANDS
C07D 211/14 (2006.01)	2459529 *	SUBSTITUTED PHENOXYPROPYLCYCLOAMINE DERIVATIVES AS HISTAMINE-3 (H3) RECEPTOR LIGANDS
C07D 241/08 (2006.01)	2459529 *	SUBSTITUTED PHENOXYPROPYLCYCLOAMINE DERIVATIVES AS HISTAMINE-3 (H3) RECEPTOR LIGANDS
C07D 211/38 (2006.01)	2459529 *	SUBSTITUTED PHENOXYPROPYLCYCLOAMINE DERIVATIVES AS HISTAMINE-3 (H3) RECEPTOR LIGANDS
C07D 401/12 (2006.01)	2459529 *	SUBSTITUTED PHENOXYPROPYLCYCLOAMINE DERIVATIVES AS HISTAMINE-3 (H3) RECEPTOR LIGANDS
C07D 207/06 (2006.01)	2459529 *	SUBSTITUTED PHENOXYPROPYLCYCLOAMINE DERIVATIVES AS HISTAMINE-3 (H3) RECEPTOR LIGANDS
A61P 25/00 (2006.01)	2459529 *	SUBSTITUTED PHENOXYPROPYLCYCLOAMINE DERIVATIVES AS HISTAMINE-3 (H3) RECEPTOR LIGANDS
C07D 211/46 (2006.01)	2459529 *	SUBSTITUTED PHENOXYPROPYLCYCLOAMINE DERIVATIVES AS HISTAMINE-3 (H3) RECEPTOR LIGANDS
C07D 403/12 (2006.01)	2459529 *	SUBSTITUTED PHENOXYPROPYLCYCLOAMINE DERIVATIVES AS HISTAMINE-3 (H3) RECEPTOR LIGANDS
A61K 31/496 (2006.01)	2459529 *	SUBSTITUTED PHENOXYPROPYLCYCLOAMINE DERIVATIVES AS HISTAMINE-3 (H3) RECEPTOR LIGANDS
C07D 407/12 (2006.01)	2459529 *	SUBSTITUTED PHENOXYPROPYLCYCLOAMINE DERIVATIVES AS HISTAMINE-3 (H3) RECEPTOR LIGANDS
A61K 31/5377 (2006.01)	2459529 *	SUBSTITUTED PHENOXYPROPYLCYCLOAMINE DERIVATIVES AS HISTAMINE-3 (H3) RECEPTOR LIGANDS
A61K 31/415 (2006.01)	2453748 *	TREATMENT METHOD
A01N 43/56 (2006.01)	2453748 *	TREATMENT METHOD
A61L 29/08 (2006.01)	2468319	New nanoparticle useful in prophylaxis, diagnostics and medical and veterinary treatment
A61L 29/16 (2006.01)	2468319	New nanoparticle useful in prophylaxis, diagnostics and medical and veterinary treatment
B65D 85/76 (2006.01)	2322451	Packaging of a food product in portions
B65D 25/10 (2006.01)	2322451	Packaging of a food product in portions
A01N 43/653 (2006.01)	2443109 *	TRIAZOLE COMPOUNDS CARRYING A SULFUR SUBSTITUENT
C07D 405/06 (2006.01)	2443109 *	TRIAZOLE COMPOUNDS CARRYING A SULFUR SUBSTITUENT
C07D 411/12 (2006.01)	2445904 *	NOVEL GPR 119 AGONISTS
A61K 31/4535 (2006.01)	2445904 *	NOVEL GPR 119 AGONISTS
A61K 31/454 (2006.01)	2445904 *	NOVEL GPR 119 AGONISTS
C07D 413/14 (2006.01)	2445904 *	NOVEL GPR 119 AGONISTS
A61K 31/506 (2006.01)	2445904 *	NOVEL GPR 119 AGONISTS
C07D 417/14 (2006.01)	2445904 *	NOVEL GPR 119 AGONISTS
C07D 411/14 (2006.01)	2445904 *	NOVEL GPR 119 AGONISTS
C07C 253/30 (2006.01)	2493848 *	PROCESS FOR THE MANUFACTURE OF ORGANIC COMPOUNDS
C07D 257/04 (2006.01)	2493848 *	PROCESS FOR THE MANUFACTURE OF ORGANIC COMPOUNDS
C22C 38/46 (2006.01)	2456901 *	HEAT-RESISTANT AUSTENITIC STEEL HAVING HIGH RESISTANCE TO STRESS RELAXATION CRACKING
C22C 38/54 (2006.01)	2456901 *	HEAT-RESISTANT AUSTENITIC STEEL HAVING HIGH RESISTANCE TO STRESS RELAXATION CRACKING

MKP (51)	Broj objave evropske prijava patenta (97)	Naziv pronalaska (54)
C22C 38/00 (2006.01)	2456901 *	HEAT-RESISTANT AUSTENITIC STEEL HAVING HIGH RESISTANCE TO STRESS RELAXATION CRACKING
A61K 9/70 (2006.01)	2489340 *	ADHESIVE PATCH
A61L 15/58 (2006.01)	2489340 *	ADHESIVE PATCH
A61F 13/02 (2006.01)	2489340 *	ADHESIVE PATCH
C12N 9/14 (2006.01)	2435562 *	COMPOSITIONS AND METHODS FOR PRODUCTION OF AGLYCOSYLATED PLASMINOGEN
C12N 9/68 (2006.01)	2435562 *	COMPOSITIONS AND METHODS FOR PRODUCTION OF AGLYCOSYLATED PLASMINOGEN
C12N 15/82 (2006.01)	2435562 *	COMPOSITIONS AND METHODS FOR PRODUCTION OF AGLYCOSYLATED PLASMINOGEN
A61K 38/16 (2006.01)	2435562 *	COMPOSITIONS AND METHODS FOR PRODUCTION OF AGLYCOSYLATED PLASMINOGEN
C12N 5/04 (2006.01)	2435562 *	COMPOSITIONS AND METHODS FOR PRODUCTION OF AGLYCOSYLATED PLASMINOGEN
A61K 31/4412 (2006.01)	2308491	Pirfenidone therapy and inducers of cytochrome P450
A61P 11/00 (2006.01)	2308491	Pirfenidone therapy and inducers of cytochrome P450
A61F 2/44 (2006.01)	2389903	System for performing arthrodesis between two vertebrae and installation accessories
C07H 1/00 (2006.01)	2470551 *	METHOD FOR PRODUCING PYRAZOLE GLYCOSIDE DERIVATIVES
C07H 17/02 (2006.01)	2470551 *	METHOD FOR PRODUCING PYRAZOLE GLYCOSIDE DERIVATIVES
A61B 10/00 (2006.01)	2286919	Filtration device for analyses
G01N 1/40 (2006.01)	2286919	Filtration device for analyses
B01L 3/00 (2006.01)	2286919	Filtration device for analyses
B01L 3/14 (2006.01)	2286919	Filtration device for analyses
G07F 17/00 (2006.01)	2452318 *	DEVICE FOR CONDUCTING MONETARY TRANSACTIONS
G07F 19/00 (2006.01)	2452318 *	DEVICE FOR CONDUCTING MONETARY TRANSACTIONS
B01D 21/24 (2006.01)	2477708 *	PROCESS FOR FLOCCULATING AND DEWATERING OIL SAND MATURE FINE TAILINGS
B01D 21/01 (2006.01)	2477708 *	PROCESS FOR FLOCCULATING AND DEWATERING OIL SAND MATURE FINE TAILINGS
B08B 7/00 (2006.01)	2403661 *	CLEANING CONTACT CLEANING ROLLERS
B08B 1/00 (2006.01)	2403661 *	CLEANING CONTACT CLEANING ROLLERS
C07D 271/06 (2006.01)	2414342 *	OXADIAZOLE DERIVATIVES
A61K 31/4245 (2006.01)	2414342 *	OXADIAZOLE DERIVATIVES
A61P 37/00 (2006.01)	2414342 *	OXADIAZOLE DERIVATIVES
A61K 36/00 (2006.01)	2475374 *	METHODS FOR ISOLATING ALKALOIDS FROM PLANTS
A61P 25/00 (2006.01)	2483257 *	2,3,4-BENZOTHIADIAZEPINE-2,2-DIOXIDE DERIVATIVES
C07D 285/36 (2006.01)	2483257 *	2,3,4-BENZOTHIADIAZEPINE-2,2-DIOXIDE DERIVATIVES
A61K 31/554 (2006.01)	2483257 *	2,3,4-BENZOTHIADIAZEPINE-2,2-DIOXIDE DERIVATIVES
C07D 285/06 (2006.01)	2483257 *	2,3,4-BENZOTHIADIAZEPINE-2,2-DIOXIDE DERIVATIVES
C07D 309/24 (2006.01)	2483257 *	2,3,4-BENZOTHIADIAZEPINE-2,2-DIOXIDE DERIVATIVES
C09B 67/20 (2006.01)	2495288 *	DIKETOPYRROLOPYRROLE PIGMENT DISPERSING AGENT, PIGMENT COMPOSITION USING SAME, COLORED COMPOSITION, AND COLOR FILTER
C09B 67/02 (2006.01)	2495288 *	DIKETOPYRROLOPYRROLE PIGMENT DISPERSING AGENT, PIGMENT COMPOSITION USING SAME, COLORED COMPOSITION, AND COLOR FILTER
C09B 67/46 (2006.01)	2495288 *	DIKETOPYRROLOPYRROLE PIGMENT DISPERSING AGENT, PIGMENT COMPOSITION USING SAME, COLORED COMPOSITION, AND COLOR FILTER
G02B 5/22 (2006.01)	2495288 *	DIKETOPYRROLOPYRROLE PIGMENT DISPERSING AGENT, PIGMENT COMPOSITION USING SAME, COLORED COMPOSITION, AND COLOR FILTER

MKP (51)	Broj objave evropske prijava patenta (97)	Naziv pronalaska (54)
G02B 5/20 (2006.01)	2495288 *	DIKETOPYRROLOPYRROLE PIGMENT DISPERSING AGENT, PIGMENT COMPOSITION USING SAME, COLORED COMPOSITION, AND COLOR FILTER
H01R 9/05 (2006.01)	2417671 *	COMPRESSION CONNECTOR FOR COAXIAL CABLE WITH STAGGERED SEIZURE OF OUTER AND CENTER CONDUCTOR AND CENTER CONDUCTOR SEIZING MECHANISM
H01R 13/646 (2011.01)	2417671 *	COMPRESSION CONNECTOR FOR COAXIAL CABLE WITH STAGGERED SEIZURE OF OUTER AND CENTER CONDUCTOR AND CENTER CONDUCTOR SEIZING MECHANISM
A01N 25/24 (2006.01)	2498598 *	METHODS FOR GENERATING HIGH ASPECT RATIO POLYMERIC PARTICLES COMPRISING AN ACTIVE INGREDIENT
A01N 25/26 (2006.01)	2498598 *	METHODS FOR GENERATING HIGH ASPECT RATIO POLYMERIC PARTICLES COMPRISING AN ACTIVE INGREDIENT
C07K 14/435 (2006.01)	2483300 *	SYNTHETIC MYOSTATIN PEPTIDE ANTAGONISTS
C07K 7/06 (2006.01)	2483300 *	SYNTHETIC MYOSTATIN PEPTIDE ANTAGONISTS
A61K 38/10 (2006.01)	2483300 *	SYNTHETIC MYOSTATIN PEPTIDE ANTAGONISTS
A61P 19/10 (2006.01)	2483300 *	SYNTHETIC MYOSTATIN PEPTIDE ANTAGONISTS
C07K 14/475 (2006.01)	2483300 *	SYNTHETIC MYOSTATIN PEPTIDE ANTAGONISTS
C07K 17/08 (2006.01)	2483300 *	SYNTHETIC MYOSTATIN PEPTIDE ANTAGONISTS
A61P 3/10 (2006.01)	2483300 *	SYNTHETIC MYOSTATIN PEPTIDE ANTAGONISTS
A61K 38/18 (2006.01)	2483300 *	SYNTHETIC MYOSTATIN PEPTIDE ANTAGONISTS
C07K 7/08 (2006.01)	2483300 *	SYNTHETIC MYOSTATIN PEPTIDE ANTAGONISTS
A61P 21/06 (2006.01)	2483300 *	SYNTHETIC MYOSTATIN PEPTIDE ANTAGONISTS
A61P 17/00 (2006.01)	2483300 *	SYNTHETIC MYOSTATIN PEPTIDE ANTAGONISTS
A61P 3/04 (2006.01)	2483300 *	SYNTHETIC MYOSTATIN PEPTIDE ANTAGONISTS
A61K 38/08 (2006.01)	2483300 *	SYNTHETIC MYOSTATIN PEPTIDE ANTAGONISTS
C12N 15/12 (2006.01)	2483300 *	SYNTHETIC MYOSTATIN PEPTIDE ANTAGONISTS
A01N 43/06 (2006.01)	2453746 *	TAZAROTENE DERIVATIVES
A01N 43/12 (2006.01)	2453746 *	TAZAROTENE DERIVATIVES
A61K 31/38 (2006.01)	2453746 *	TAZAROTENE DERIVATIVES
C07D 413/14 (2006.01)	2486024 *	PHENYLOXADIAZOLE DERIVATIVES AS PGDS INHIBITORS
C07D 271/06 (2006.01)	2486024 *	PHENYLOXADIAZOLE DERIVATIVES AS PGDS INHIBITORS
A61K 31/506 (2006.01)	2486024 *	PHENYLOXADIAZOLE DERIVATIVES AS PGDS INHIBITORS
A61P 5/00 (2006.01)	2486024 *	PHENYLOXADIAZOLE DERIVATIVES AS PGDS INHIBITORS
A61P 37/00 (2006.01)	2486024 *	PHENYLOXADIAZOLE DERIVATIVES AS PGDS INHIBITORS
B29D 35/00 (2010.01)	2416675 *	SHOE WITH VENTILATION SYSTEM OBTAINED BY DIRECT INJECTION METHOD ON UPPER AND MOULD THEREFOR
B29D 35/08 (2010.01)	2416675 *	SHOE WITH VENTILATION SYSTEM OBTAINED BY DIRECT INJECTION METHOD ON UPPER AND MOULD THEREFOR
A43B 7/06 (2006.01)	2416675 *	SHOE WITH VENTILATION SYSTEM OBTAINED BY DIRECT INJECTION METHOD ON UPPER AND MOULD THEREFOR
A43B 7/12 (2006.01)	2416675 *	SHOE WITH VENTILATION SYSTEM OBTAINED BY DIRECT INJECTION METHOD ON UPPER AND MOULD THEREFOR
B29C 44/12 (2006.01)	2416675 *	SHOE WITH VENTILATION SYSTEM OBTAINED BY DIRECT INJECTION METHOD ON UPPER AND MOULD THEREFOR
G01N 33/50 (2006.01)	2406628 *	METHOD OR SYSTEM USING BIOMARKERS FOR THE MONITORING OF A TREATMENT
A61M 5/315 (2006.01)	2437831 *	DOSE SETTING MECHANISM FOR A DRUG DELIVERY DEVICE
A61M 5/00 (2006.01)	2437831 *	DOSE SETTING MECHANISM FOR A DRUG DELIVERY DEVICE
C12N 15/82 (2006.01)	2451830 *	METHOD FOR INCREASING THE RESISTANCE OF A PLANT OR A PART THEREOF TO A PATHOGEN, METHOD FOR SCREENING THE RESISTANCE OF A PLANT OR PART THEREOF TO A PATHOGEN, AND USE THEREOF

MKP (51)	Broj objave evropske prijava patenta (97)	Naziv pronalaska (54)
C07K 14/415 (2006.01)	2451830 *	METHOD FOR INCREASING THE RESISTANCE OF A PLANT OR A PART THEREOF TO A PATHOGEN, METHOD FOR SCREENING THE RESISTANCE OF A PLANT OR PART THEREOF TO A PATHOGEN, AND USE THEREOF
A61M 5/315 (2006.01)	2437821 *	SPINDLE FOR A DRUG DELIVERY DEVICE
A61K 31/337 (2006.01)	2470173 *	COMBINATION THERAPY WITH NANOPARTICLE COMPOSITIONS OF TAXANE AND HEDGEHOG INHIBITORS
A61K 9/20 (2006.01)	2470173 *	COMBINATION THERAPY WITH NANOPARTICLE COMPOSITIONS OF TAXANE AND HEDGEHOG INHIBITORS
C08L 27/00 (2006.01)	2485905 *	COMPOSITION, METHOD AND SYSTEM FOR BALANCING A ROTARY SYSTEM
B60C 19/00 (2006.01)	2485905 *	COMPOSITION, METHOD AND SYSTEM FOR BALANCING A ROTARY SYSTEM
G01M 1/36 (2006.01)	2485905 *	COMPOSITION, METHOD AND SYSTEM FOR BALANCING A ROTARY SYSTEM
C08L 71/02 (2006.01)	2485905 *	COMPOSITION, METHOD AND SYSTEM FOR BALANCING A ROTARY SYSTEM
A61K 9/14 (2006.01)	2477608 *	ORAL SOLID DOSAGE FORM CONTAINING NANOPARTICLES AND PROCESS OF FORMULATING THE SAME USING FISH GELATIN
G06F 3/01 (2006.01)	2418562	Modelling of hand and arm position and orientation
F28D 7/00 (2006.01)	2341119	Method and device for tempering an exothermic reaction
C10L 9/08 (2006.01)	2341119	Method and device for tempering an exothermic reaction
C10B 53/02 (2006.01)	2341119	Method and device for tempering an exothermic reaction
C10L 9/00 (2006.01)	2341119	Method and device for tempering an exothermic reaction
C10B 49/14 (2006.01)	2341119	Method and device for tempering an exothermic reaction
B32B 9/00 (2006.01)	2440402 *	HYDROPHOBIC MATERIALS MADE BY VAPOR DEPOSITION COATING AND APPLICATIONS THEREOF
B32B 33/00 (2006.01)	2440402 *	HYDROPHOBIC MATERIALS MADE BY VAPOR DEPOSITION COATING AND APPLICATIONS THEREOF
G08B 1/08 (2006.01)	2491541 *	SYNCHRONIZATION SYSTEM AND METHOD FOR ACHIEVING LOW POWER BATTERY OPERATION OF A VEHICLE LOCATING UNIT
A61K 31/137 (2006.01)	2419400 *	MONOAMINE REUPTAKE INHIBITORS
A61K 31/135 (2006.01)	2419400 *	MONOAMINE REUPTAKE INHIBITORS
A61P 25/00 (2006.01)	2419400 *	MONOAMINE REUPTAKE INHIBITORS
C07C 211/27 (2006.01)	2419400 *	MONOAMINE REUPTAKE INHIBITORS
C07C 211/29 (2006.01)	2419400 *	MONOAMINE REUPTAKE INHIBITORS
C07C 211/35 (2006.01)	2419400 *	MONOAMINE REUPTAKE INHIBITORS
C07C 225/16 (2006.01)	2419400 *	MONOAMINE REUPTAKE INHIBITORS
C07C 225/18 (2006.01)	2419400 *	MONOAMINE REUPTAKE INHIBITORS
F02M 61/16 (2006.01)	2392816	Stress Relief in Pressurized Fluid Flow System
C21D 7/10 (2006.01)	2392816	Stress Relief in Pressurized Fluid Flow System
A61K 38/48 (2006.01)	2416800 *	ORAL LACTOFERRIN IN THE TREATMENT OF SEVERE SEPSIS
A61P 31/04 (2006.01)	2416800 *	ORAL LACTOFERRIN IN THE TREATMENT OF SEVERE SEPSIS
C10G 1/04 (2006.01)	2475745 *	BITUMEN SEPARATION COMPOSITIONS AND PROCESSES
G06Q 20/00 (2012.01)	2425389 *	METHOD FOR SUSPENDING AND ACTIVATING A SERVICE IN A MOBILE NETWORK
A61P 25/28 (2006.01)	2430022 *	1,2,3-TRIAZOLO 4,3-A-PYRIDINE DERIVATIVES AND THEIR USE FOR THE TREATMENT OR PREVENTION OF NEUROLOGICAL AND PSYCHIATRIC DISORDERS
C07D 519/00 (2006.01)	2430022 *	1,2,3-TRIAZOLO 4,3-A-PYRIDINE DERIVATIVES AND THEIR USE FOR THE TREATMENT OR PREVENTION OF NEUROLOGICAL AND PSYCHIATRIC DISORDERS
C07D 471/04 (2006.01)	2430022 *	1,2,3-TRIAZOLO 4,3-A-PYRIDINE DERIVATIVES AND THEIR USE FOR THE TREATMENT OR PREVENTION OF NEUROLOGICAL AND PSYCHIATRIC DISORDERS

MKP (51)	Broj objave evropske prijava patenta (97)	Naziv pronalaska (54)
A61K 31/437 (2006.01)	2430022 *	1,2,3-TRIAZOLO 4,3-A-PYRIDINE DERIVATIVES AND THEIR USE FOR THE TREATMENT OR PREVENTION OF NEUROLOGICAL AND PSYCHIATRIC DISORDERS
B23F 5/22 (2006.01)	2456587 *	A WORKING MACHINE FOR MAKING GEARS
B23Q 39/02 (2006.01)	2456587 *	A WORKING MACHINE FOR MAKING GEARS
G01N 33/573 (2006.01)	2419735 *	METHOD FOR DETERMINING THE CBL-B EXPRESSION
E06C 1/383 (2006.01)	2411615 *	EMERGENCY ESCAPE LADDER
E06C 7/08 (2006.01)	2411615 *	EMERGENCY ESCAPE LADDER
E06C 9/06 (2006.01)	2411615 *	EMERGENCY ESCAPE LADDER
F03D 11/00 (2006.01)	2414673 *	SEGMENTED WIND TURBINE
E02F 3/815 (2006.01)	2369064	Blade segment and blade assembly for a surface working vehicle
E02F 9/28 (2006.01)	2369064	Blade segment and blade assembly for a surface working vehicle
E01H 5/06 (2006.01)	2369064	Blade segment and blade assembly for a surface working vehicle
A01B 31/00 (2006.01)	2369064	Blade segment and blade assembly for a surface working vehicle
D21H 21/16 (2006.01)	2456919 *	SIZING COMPOSITION FOR HOT PENETRANT RESISTANCE
A61P 31/12 (2006.01)	2476440 *	THERAPEUTIC COMPOSITIONS FOR THE TREATMENT OF HPV-INDUCED DISEASES
A61P 35/00 (2006.01)	2476440 *	THERAPEUTIC COMPOSITIONS FOR THE TREATMENT OF HPV-INDUCED DISEASES
A61K 47/48 (2006.01)	2476440 *	THERAPEUTIC COMPOSITIONS FOR THE TREATMENT OF HPV-INDUCED DISEASES
A61K 38/39 (2006.01)	2476440 *	THERAPEUTIC COMPOSITIONS FOR THE TREATMENT OF HPV-INDUCED DISEASES
C07K 14/025 (2006.01)	2476440 *	THERAPEUTIC COMPOSITIONS FOR THE TREATMENT OF HPV-INDUCED DISEASES
C07K 14/78 (2006.01)	2476440 *	THERAPEUTIC COMPOSITIONS FOR THE TREATMENT OF HPV-INDUCED DISEASES
A61K 38/16 (2006.01)	2476440 *	THERAPEUTIC COMPOSITIONS FOR THE TREATMENT OF HPV-INDUCED DISEASES
B29C 45/26 (2006.01)	2263852	Mold for plastics, particularly of the type of a mold for providing preforms of plastic bottles and the like
B29C 33/30 (2006.01)	2263852	Mold for plastics, particularly of the type of a mold for providing preforms of plastic bottles and the like
B29C 45/36 (2006.01)	2263852	Mold for plastics, particularly of the type of a mold for providing preforms of plastic bottles and the like
B29C 33/76 (2006.01)	2263852	Mold for plastics, particularly of the type of a mold for providing preforms of plastic bottles and the like
C07D 213/74 (2006.01)	2459535 *	PYRIDINE AND PYRAZINE DERIVATIVES AS PROTEIN KINASE MODULATORS
C07D 401/04 (2006.01)	2459535 *	PYRIDINE AND PYRAZINE DERIVATIVES AS PROTEIN KINASE MODULATORS
C07D 401/12 (2006.01)	2459535 *	PYRIDINE AND PYRAZINE DERIVATIVES AS PROTEIN KINASE MODULATORS
A61K 31/506 (2006.01)	2459535 *	PYRIDINE AND PYRAZINE DERIVATIVES AS PROTEIN KINASE MODULATORS
A61P 29/00 (2006.01)	2459535 *	PYRIDINE AND PYRAZINE DERIVATIVES AS PROTEIN KINASE MODULATORS
A61P 35/00 (2006.01)	2459535 *	PYRIDINE AND PYRAZINE DERIVATIVES AS PROTEIN KINASE MODULATORS
C12P 21/06 (2006.01)	2462237 *	METHODS FOR IMPROVING RECOMBINANT PROTEIN EXPRESSION
C07H 21/04 (2006.01)	2462237 *	METHODS FOR IMPROVING RECOMBINANT PROTEIN EXPRESSION
A01G 1/00 (2006.01)	2493282 *	DEVICE FOR A VERTICAL OR ANGLED ARRANGEMENT OF THE HYDROPONIC CULTIVATION OF PLANTS
G06F 3/041 (2006.01)	2406705 *	SYSTEMS AND METHODS FOR USING TEXTURES IN GRAPHICAL USER INTERFACE WIDGETS

MKP (51)	Broj objave evropske prijava patenta (97)	Naziv pronalaska (54)
G06F 3/01 (2006.01)	2406705 *	SYSTEMS AND METHODS FOR USING TEXTURES IN GRAPHICAL USER INTERFACE WIDGETS
G06F 3/048 (2006.01)	2406705 *	SYSTEMS AND METHODS FOR USING TEXTURES IN GRAPHICAL USER INTERFACE WIDGETS
C07K 16/18 (2006.01)	2417158 *	DKK-1 ANTIBODIES
E21B 4/18 (2006.01)	2494135 *	DOWNHOLE APPARATUS
E21B 23/14 (2006.01)	2494135 *	DOWNHOLE APPARATUS
E21B 47/12 (2012.01)	2494135 *	DOWNHOLE APPARATUS
A61K 31/517 (2006.01)	2419135 *	COMBINATION THERAPY USING AN ANTI-EGFR AGENT(S) AND IGF-1R SPECIFIC INHIBITORS
A61K 39/395 (2006.01)	2419135 *	COMBINATION THERAPY USING AN ANTI-EGFR AGENT(S) AND IGF-1R SPECIFIC INHIBITORS
A61H 33/02 (2006.01)	2459145 *	BABY BATH, NAMELY FOR TODDLERS AND INFANTS
C12N 5/10 (2006.01)	2464664 *	ANTIBODIES AGAINST HUMAN RESPIRATORY SYNCYTIAL VIRUS (RSV) AND METHODS OF USE
C07K 16/10 (2006.01)	2464664 *	ANTIBODIES AGAINST HUMAN RESPIRATORY SYNCYTIAL VIRUS (RSV) AND METHODS OF USE
C12N 15/13 (2006.01)	2464664 *	ANTIBODIES AGAINST HUMAN RESPIRATORY SYNCYTIAL VIRUS (RSV) AND METHODS OF USE
A61K 39/42 (2006.01)	2464664 *	ANTIBODIES AGAINST HUMAN RESPIRATORY SYNCYTIAL VIRUS (RSV) AND METHODS OF USE
C12N 15/63 (2006.01)	2464664 *	ANTIBODIES AGAINST HUMAN RESPIRATORY SYNCYTIAL VIRUS (RSV) AND METHODS OF USE
A61P 31/14 (2006.01)	2464664 *	ANTIBODIES AGAINST HUMAN RESPIRATORY SYNCYTIAL VIRUS (RSV) AND METHODS OF USE
A61K 47/48 (2006.01)	2464664 *	ANTIBODIES AGAINST HUMAN RESPIRATORY SYNCYTIAL VIRUS (RSV) AND METHODS OF USE
G01N 33/53 (2006.01)	2464664 *	ANTIBODIES AGAINST HUMAN RESPIRATORY SYNCYTIAL VIRUS (RSV) AND METHODS OF USE
A61K 38/00 (2006.01)	2464664 *	ANTIBODIES AGAINST HUMAN RESPIRATORY SYNCYTIAL VIRUS (RSV) AND METHODS OF USE
A61K 31/00 (2006.01)	2464664 *	ANTIBODIES AGAINST HUMAN RESPIRATORY SYNCYTIAL VIRUS (RSV) AND METHODS OF USE
E03D 9/02 (2006.01)	2281756	Application device of sanitary hygiene products
B65D 83/00 (2006.01)	2281756	Application device of sanitary hygiene products
F16B 13/00 (2006.01)	2494125 *	PLASTERING SYSTEM AND PLASTIC ANCHOR/METAL SCREW ASSEMBLY FOR SAME
F16B 13/04 (2006.01)	2494125 *	PLASTERING SYSTEM AND PLASTIC ANCHOR/METAL SCREW ASSEMBLY FOR SAME
F16B 13/12 (2006.01)	2494125 *	PLASTERING SYSTEM AND PLASTIC ANCHOR/METAL SCREW ASSEMBLY FOR SAME
E04B 1/76 (2006.01)	2494125 *	PLASTERING SYSTEM AND PLASTIC ANCHOR/METAL SCREW ASSEMBLY FOR SAME
F16B 5/06 (2006.01)	2494125 *	PLASTERING SYSTEM AND PLASTIC ANCHOR/METAL SCREW ASSEMBLY FOR SAME
E04F 13/04 (2006.01)	2494125 *	PLASTERING SYSTEM AND PLASTIC ANCHOR/METAL SCREW ASSEMBLY FOR SAME
E04F 13/08 (2006.01)	2494125 *	PLASTERING SYSTEM AND PLASTIC ANCHOR/METAL SCREW ASSEMBLY FOR SAME
C07K 16/00 (2006.01)	2473524 *	DUAL VARIABLE DOMAIN IMMUNOGLOBULINS AND USES THEREOF
C07H 21/00 (2006.01)	2473524 *	DUAL VARIABLE DOMAIN IMMUNOGLOBULINS AND USES THEREOF
F16L 37/091 (2006.01)	2494255 *	QUICK- FIT CONNECTION
C12N 1/21 (2006.01)	2493930 *	COMPOSITIONS AND METHODS FOR TREATING INFLAMMATORY DISORDERS
C07K 16/28 (2006.01)	2493930 *	COMPOSITIONS AND METHODS FOR TREATING INFLAMMATORY DISORDERS

MKP (51)	Broj objave evropske prijava patenta (97)	Naziv pronalaska (54)
C07K 16/46 (2006.01)	2493930 *	COMPOSITIONS AND METHODS FOR TREATING INFLAMMATORY DISORDERS
C12N 5/10 (2006.01)	2493930 *	COMPOSITIONS AND METHODS FOR TREATING INFLAMMATORY DISORDERS
C12N 1/19 (2006.01)	2493930 *	COMPOSITIONS AND METHODS FOR TREATING INFLAMMATORY DISORDERS
A61K 39/395 (2006.01)	2493930 *	COMPOSITIONS AND METHODS FOR TREATING INFLAMMATORY DISORDERS
C12N 15/09 (2006.01)	2493930 *	COMPOSITIONS AND METHODS FOR TREATING INFLAMMATORY DISORDERS
A61P 37/06 (2006.01)	2493930 *	COMPOSITIONS AND METHODS FOR TREATING INFLAMMATORY DISORDERS
C12N 1/15 (2006.01)	2493930 *	COMPOSITIONS AND METHODS FOR TREATING INFLAMMATORY DISORDERS
A61P 1/04 (2006.01)	2493930 *	COMPOSITIONS AND METHODS FOR TREATING INFLAMMATORY DISORDERS
C12P 21/08 (2006.01)	2493930 *	COMPOSITIONS AND METHODS FOR TREATING INFLAMMATORY DISORDERS
C07K 16/18 (2006.01)	2454285 *	IMPROVED ANTI-SERUM ALBUMIN BINDING SINGLE VARIABLE DOMAINS
A61K 39/00 (2006.01)	2480562 *	IDENTIFICATION OF ANTIGENIC PEPTIDES FROM MULTIPLE MYELOMA CELLS
C07K 7/00 (2006.01)	2480562 *	IDENTIFICATION OF ANTIGENIC PEPTIDES FROM MULTIPLE MYELOMA CELLS
A61P 3/04 (2006.01)	2477989 *	COMPOUNDS HAVING TAFIa INHIBITORY ACTIVITY
A61P 19/02 (2006.01)	2477989 *	COMPOUNDS HAVING TAFIa INHIBITORY ACTIVITY
C07D 471/04 (2006.01)	2477989 *	COMPOUNDS HAVING TAFIa INHIBITORY ACTIVITY
A61P 35/00 (2006.01)	2477989 *	COMPOUNDS HAVING TAFIa INHIBITORY ACTIVITY
A61K 31/4745 (2006.01)	2477989 *	COMPOUNDS HAVING TAFIa INHIBITORY ACTIVITY
A61P 13/12 (2006.01)	2477989 *	COMPOUNDS HAVING TAFIa INHIBITORY ACTIVITY
A61P 11/16 (2006.01)	2477989 *	COMPOUNDS HAVING TAFIa INHIBITORY ACTIVITY
A61P 9/10 (2006.01)	2477989 *	COMPOUNDS HAVING TAFIa INHIBITORY ACTIVITY
A61P 11/00 (2006.01)	2477989 *	COMPOUNDS HAVING TAFIa INHIBITORY ACTIVITY
A61P 43/00 (2006.01)	2477989 *	COMPOUNDS HAVING TAFIa INHIBITORY ACTIVITY
A61P 7/02 (2006.01)	2477989 *	COMPOUNDS HAVING TAFIa INHIBITORY ACTIVITY
A61P 31/04 (2006.01)	2477989 *	COMPOUNDS HAVING TAFIa INHIBITORY ACTIVITY
A61P 1/04 (2006.01)	2477989 *	COMPOUNDS HAVING TAFIa INHIBITORY ACTIVITY
B65D 75/58 (2006.01)	2371737	Packaging with tear strip
C07D 295/155 (2006.01)	2427444 *	INHIBITORS OF THE RENAL OUTER MEDULLARY POTASSIUM CHANNEL
C07D 307/88 (2006.01)	2427444 *	INHIBITORS OF THE RENAL OUTER MEDULLARY POTASSIUM CHANNEL
A61K 31/495 (2006.01)	2427444 *	INHIBITORS OF THE RENAL OUTER MEDULLARY POTASSIUM CHANNEL
C07D 405/08 (2006.01)	2427444 *	INHIBITORS OF THE RENAL OUTER MEDULLARY POTASSIUM CHANNEL
A61K 31/529 (2006.01)	2427444 *	INHIBITORS OF THE RENAL OUTER MEDULLARY POTASSIUM CHANNEL
C07D 407/08 (2006.01)	2427444 *	INHIBITORS OF THE RENAL OUTER MEDULLARY POTASSIUM CHANNEL
A61P 7/10 (2006.01)	2427444 *	INHIBITORS OF THE RENAL OUTER MEDULLARY POTASSIUM CHANNEL
C07D 413/08 (2006.01)	2427444 *	INHIBITORS OF THE RENAL OUTER MEDULLARY POTASSIUM CHANNEL
C07D 493/04 (2006.01)	2427444 *	INHIBITORS OF THE RENAL OUTER MEDULLARY POTASSIUM CHANNEL
C07D 487/08 (2006.01)	2427444 *	INHIBITORS OF THE RENAL OUTER MEDULLARY POTASSIUM CHANNEL
C07D 295/135 (2006.01)	2427444 *	INHIBITORS OF THE RENAL OUTER MEDULLARY POTASSIUM CHANNEL
A61K 45/00 (2006.01)	2438917 *	TRANSDERMAL PREPARATION
A61K 9/70 (2006.01)	2438917 *	TRANSDERMAL PREPARATION
A61K 31/404 (2006.01)	2438917 *	TRANSDERMAL PREPARATION
A61K 31/4045 (2006.01)	2438917 *	TRANSDERMAL PREPARATION

MKP (51)	Broj objave evropske prijava patenta (97)	Naziv pronalaska (54)
A61K 47/22 (2006.01)	2438917 *	TRANSDERMAL PREPARATION
A61P 25/16 (2006.01)	2438917 *	TRANSDERMAL PREPARATION
A61P 43/00 (2006.01)	2438917 *	TRANSDERMAL PREPARATION
C07D 239/54 (2006.01)	2462124 *	MESOIONIC PESTICIDES
C01B 31/22 (2006.01)	2368845	Device and method for creating carbon dioxide snow
G01N 33/53 (2006.01)	2478363 *	IDENTIFICATION OF DISCRIMINANT PROTEINS THROUGH ANTIBODY PROFILING, METHODS AND APPARATUS FOR IDENTIFYING AN INDIVIDUAL
A01N 25/32 (2006.01)	2485586 *	STABLE OIL-IN-WATER EMULSIONS
A01N 25/04 (2006.01)	2485586 *	STABLE OIL-IN-WATER EMULSIONS
C12N 9/10 (2006.01)	2421975 *	PRODUCTION OF MULTI-ANTENNARY N-GLYCAN STRUCTURES IN PLANTS
C12N 15/82 (2006.01)	2421975 *	PRODUCTION OF MULTI-ANTENNARY N-GLYCAN STRUCTURES IN PLANTS
C12P 21/00 (2006.01)	2421975 *	PRODUCTION OF MULTI-ANTENNARY N-GLYCAN STRUCTURES IN PLANTS
A61K 9/51 (2006.01)	2435031 *	FUNCTIONAL AMPHIPHILIC MOLECULE OR MACROMOLECULE FORMULATIONS WITH MULTIPLE COMPARTMENTS
G01B 11/02 (2006.01)	2427723 *	METHODS AND COMPUTER PROGRAM PRODUCTS FOR QUANTITATIVE THREE-DIMENSIONAL IMAGE CORRECTION AND CLINICAL PARAMETER COMPUTATION IN OPTICAL COHERENCE TOMOGRAPHY
B01F 5/10 (2006.01)	2292321	Facility for producing a homogeneous gas mixture using liquid and gaseous ingredients
B01F 3/04 (2006.01)	2292321	Facility for producing a homogeneous gas mixture using liquid and gaseous ingredients
B01F 5/04 (2006.01)	2292321	Facility for producing a homogeneous gas mixture using liquid and gaseous ingredients
B01F 5/06 (2006.01)	2292321	Facility for producing a homogeneous gas mixture using liquid and gaseous ingredients
C07C 51/46 (2006.01)	2371798	Processes for the production of tetrahydrofuran, gamma-butyrolactone and/or butanediol from salts of succinic acid
C07D 307/08 (2006.01)	2371798	Processes for the production of tetrahydrofuran, gamma-butyrolactone and/or butanediol from salts of succinic acid
C07C 51/41 (2006.01)	2371798	Processes for the production of tetrahydrofuran, gamma-butyrolactone and/or butanediol from salts of succinic acid
C07C 51/44 (2006.01)	2371798	Processes for the production of tetrahydrofuran, gamma-butyrolactone and/or butanediol from salts of succinic acid
C07D 307/33 (2006.01)	2371798	Processes for the production of tetrahydrofuran, gamma-butyrolactone and/or butanediol from salts of succinic acid
C07C 55/10 (2006.01)	2371798	Processes for the production of tetrahydrofuran, gamma-butyrolactone and/or butanediol from salts of succinic acid
C07C 29/136 (2006.01)	2371798	Processes for the production of tetrahydrofuran, gamma-butyrolactone and/or butanediol from salts of succinic acid
C07C 31/20 (2006.01)	2371798	Processes for the production of tetrahydrofuran, gamma-butyrolactone and/or butanediol from salts of succinic acid
C07C 51/02 (2006.01)	2371798	Processes for the production of tetrahydrofuran, gamma-butyrolactone and/or butanediol from salts of succinic acid
A61M 25/01 (2006.01)	2456499 *	DEVICES AND METHODS FOR MINIMALLY INVASIVE ACCESS TO SINUSES AND TREATMENT OF SINUSITIS
C07D 513/04 (2006.01)	2435443 *	AMINOPYRAZOLE TRIAZOLOTHIADIAZOLE INHIBITORS OF C-MET PROTIEN KINASE
A61P 35/00 (2006.01)	2435443 *	AMINOPYRAZOLE TRIAZOLOTHIADIAZOLE INHIBITORS OF C-MET PROTIEN KINASE
A61K 31/47 (2006.01)	2435443 *	AMINOPYRAZOLE TRIAZOLOTHIADIAZOLE INHIBITORS OF C-MET PROTIEN KINASE
C07C 227/06 (2006.01)	2390246	Process for the preparation of aminaphtone
C07C 229/60 (2006.01)	2390246	Process for the preparation of aminaphtone

MKP (51)	Broj objave evropske prijava patenta (97)	Naziv pronalaska (54)
H02K 21/14 (2006.01)	2433349 *	VERNIER MACHINE WITH INSERTED MAGNETS
C07H 19/10 (2006.01)	2430035 *	URACYL SPIROOXETANE NUCLEOSIDES
C07H 19/06 (2006.01)	2430035 *	URACYL SPIROOXETANE NUCLEOSIDES
A61K 31/7072 (2006.01)	2430035 *	URACYL SPIROOXETANE NUCLEOSIDES
A61L 15/16 (2006.01)	2480260 *	COMPOSITE LAYERED HEMOSTASIS DEVICE
A61L 27/00 (2006.01)	2480260 *	COMPOSITE LAYERED HEMOSTASIS DEVICE
A61L 15/64 (2006.01)	2480260 *	COMPOSITE LAYERED HEMOSTASIS DEVICE
A61M 11/06 (2006.01)	2421588 *	IMPROVED APPARATUS FOR THE AEROSOLIZATION OF LARGE VOLUMES OF DRY POWDER
A61M 15/00 (2006.01)	2421588 *	IMPROVED APPARATUS FOR THE AEROSOLIZATION OF LARGE VOLUMES OF DRY POWDER
A61M 11/02 (2006.01)	2421588 *	IMPROVED APPARATUS FOR THE AEROSOLIZATION OF LARGE VOLUMES OF DRY POWDER
A01F 15/08 (2006.01)	2368419	A method of detecting a structure in a field, a method of steering an agricultural vehicle and an agricultural vehicle
A61K 9/20 (2006.01)	2405900 *	A NOVEL SUSTAINED RELEASE COMPOSITION OF COMPOUNDS SELECTED FROM THE CLASS OF CENTRALLY ACTING MUSCLE RELAXANTS
A61K 31/4453 (2006.01)	2405900 *	A NOVEL SUSTAINED RELEASE COMPOSITION OF COMPOUNDS SELECTED FROM THE CLASS OF CENTRALLY ACTING MUSCLE RELAXANTS
C07D 471/04 (2006.01)	2498775 *	NEW 7-PHENYL-[1,2,4]TRIAZOLO[4,3-A]PYRIDIN-3(2H)-ONE DERIVATIVES
A61P 19/00 (2006.01)	2498775 *	NEW 7-PHENYL-[1,2,4]TRIAZOLO[4,3-A]PYRIDIN-3(2H)-ONE DERIVATIVES
A61K 31/4375 (2006.01)	2498775 *	NEW 7-PHENYL-[1,2,4]TRIAZOLO[4,3-A]PYRIDIN-3(2H)-ONE DERIVATIVES
C07D 211/58 (2006.01)	2399907	Solid Form of [1,4']-Bipiperidiny-1'-Carbonyl Chloride
G06F 3/044 (2006.01)	2462498 *	DEVICE AND METHOD FOR CONTROL INTERFACE SENSITIVE TO A MOVEMENT OF A BODY OR OF AN OBJECT AND CONTROL EQUIPMENT INTEGRATING THIS DEVICE
F41H 5/04 (2006.01)	2427718 *	COMPOSITE MATERIALS AND APPLICATIONS THEREOF
C07K 14/50 (2006.01)	2443145 *	CHIMERIC FGF19 POLYPEPTIDES AND USES THEREOF
E03F 5/04 (2006.01)	2333172	Drainage device
F26B 17/10 (2006.01)	2450421	Method for the production of a fuel from waste
C10L 5/46 (2006.01)	2450421	Method for the production of a fuel from waste
C08J 9/14 (2006.01)	2386585	Foam insulation unit
C08G 18/09 (2006.01)	2386585	Foam insulation unit
C08G 18/50 (2006.01)	2386585	Foam insulation unit
C08G 18/76 (2006.01)	2386585	Foam insulation unit
B29C 44/34 (2006.01)	2386585	Foam insulation unit
F25D 23/06 (2006.01)	2386585	Foam insulation unit
A01H 1/00 (2006.01)	2489738 *	GENE CONTROLLING FLOWERING HABIT/CLEISTOGAMY IN PLANTS, AND USE THEREOF
A01H 5/00 (2006.01)	2489738 *	GENE CONTROLLING FLOWERING HABIT/CLEISTOGAMY IN PLANTS, AND USE THEREOF
C12N 5/10 (2006.01)	2489738 *	GENE CONTROLLING FLOWERING HABIT/CLEISTOGAMY IN PLANTS, AND USE THEREOF
C12N 15/29 (2006.01)	2489738 *	GENE CONTROLLING FLOWERING HABIT/CLEISTOGAMY IN PLANTS, AND USE THEREOF
F16B 39/22 (2006.01)	2496849 *	SELF-LOCKING SCREWING ATTACHMENT DEVICE AND ASSEMBLY PROVIDED WITH SAME
F16K 31/02 (2006.01)	2312187	Device with a linearly adjustable lifting part
G05D 23/19 (2006.01)	2312187	Device with a linearly adjustable lifting part
H01H 85/02 (2006.01)	2419916 *	FUSE HOLDER, PARTICULARLY FOR INTERLOCKED SOCKETS AND ELECTRICAL APPARATUSES IN GENERAL

MKP (51)	Broj objave evropske prijava patenta (97)	Naziv pronalaska (54)
H01H 85/25 (2006.01)	2419916 *	FUSE HOLDER, PARTICULARLY FOR INTERLOCKED SOCKETS AND ELECTRICAL APPARATUSES IN GENERAL
H01H 85/22 (2006.01)	2419916 *	FUSE HOLDER, PARTICULARLY FOR INTERLOCKED SOCKETS AND ELECTRICAL APPARATUSES IN GENERAL
C07D 237/28 (2006.01)	2417111 *	SUBSTITUTED 1-ALCYLCINNOLIN-4(1H)-ONE DERIVATIVES, PREPARATION THEREOF AND THERAPEUTIC APPLICATION OF SAME
A61K 31/502 (2006.01)	2417111 *	SUBSTITUTED 1-ALCYLCINNOLIN-4(1H)-ONE DERIVATIVES, PREPARATION THEREOF AND THERAPEUTIC APPLICATION OF SAME
A61P 29/00 (2006.01)	2417111 *	SUBSTITUTED 1-ALCYLCINNOLIN-4(1H)-ONE DERIVATIVES, PREPARATION THEREOF AND THERAPEUTIC APPLICATION OF SAME
G01N 33/00 (2006.01)	2451965 *	BACTERIAL ADHERENCE AND ANTI-ADHERENCE TO MUCUS, EPITHELIAL CELLS AND OTHER CELLS
C12Q 1/00 (2006.01)	2451965 *	BACTERIAL ADHERENCE AND ANTI-ADHERENCE TO MUCUS, EPITHELIAL CELLS AND OTHER CELLS
E03D 11/14 (2006.01)	2366838	Frame for fixing sanitary fixtures to a wall
A61P 43/00 (2006.01)	2460792 *	INDOLE DERIVATIVE AND PHARMACOLOGICALLY ACCEPTABLE SALT THEREOF
C07D 409/06 (2006.01)	2460792 *	INDOLE DERIVATIVE AND PHARMACOLOGICALLY ACCEPTABLE SALT THEREOF
C07D 401/04 (2006.01)	2460792 *	INDOLE DERIVATIVE AND PHARMACOLOGICALLY ACCEPTABLE SALT THEREOF
C07D 409/14 (2006.01)	2460792 *	INDOLE DERIVATIVE AND PHARMACOLOGICALLY ACCEPTABLE SALT THEREOF
C07D 209/18 (2006.01)	2460792 *	INDOLE DERIVATIVE AND PHARMACOLOGICALLY ACCEPTABLE SALT THEREOF
C07D 401/06 (2006.01)	2460792 *	INDOLE DERIVATIVE AND PHARMACOLOGICALLY ACCEPTABLE SALT THEREOF
C07D 413/14 (2006.01)	2460792 *	INDOLE DERIVATIVE AND PHARMACOLOGICALLY ACCEPTABLE SALT THEREOF
A61K 31/404 (2006.01)	2460792 *	INDOLE DERIVATIVE AND PHARMACOLOGICALLY ACCEPTABLE SALT THEREOF
C07D 401/14 (2006.01)	2460792 *	INDOLE DERIVATIVE AND PHARMACOLOGICALLY ACCEPTABLE SALT THEREOF
C07D 417/06 (2006.01)	2460792 *	INDOLE DERIVATIVE AND PHARMACOLOGICALLY ACCEPTABLE SALT THEREOF
A61P 13/02 (2006.01)	2460792 *	INDOLE DERIVATIVE AND PHARMACOLOGICALLY ACCEPTABLE SALT THEREOF
C07D 409/04 (2006.01)	2460792 *	INDOLE DERIVATIVE AND PHARMACOLOGICALLY ACCEPTABLE SALT THEREOF
A61K 31/422 (2006.01)	2460792 *	INDOLE DERIVATIVE AND PHARMACOLOGICALLY ACCEPTABLE SALT THEREOF
C07D 405/04 (2006.01)	2460792 *	INDOLE DERIVATIVE AND PHARMACOLOGICALLY ACCEPTABLE SALT THEREOF
C07D 417/14 (2006.01)	2460792 *	INDOLE DERIVATIVE AND PHARMACOLOGICALLY ACCEPTABLE SALT THEREOF
A61K 31/427 (2006.01)	2460792 *	INDOLE DERIVATIVE AND PHARMACOLOGICALLY ACCEPTABLE SALT THEREOF
C07D 405/06 (2006.01)	2460792 *	INDOLE DERIVATIVE AND PHARMACOLOGICALLY ACCEPTABLE SALT THEREOF
A61K 31/4439 (2006.01)	2460792 *	INDOLE DERIVATIVE AND PHARMACOLOGICALLY ACCEPTABLE SALT THEREOF
C07D 405/14 (2006.01)	2460792 *	INDOLE DERIVATIVE AND PHARMACOLOGICALLY ACCEPTABLE SALT THEREOF
A61K 39/21 (2006.01)	2486138 *	GENERATION OF A BROAD T-CELL RESPONSE IN HUMANS AGAINST HIV
C12N 15/863 (2006.01)	2486138 *	GENERATION OF A BROAD T-CELL RESPONSE IN HUMANS AGAINST HIV
G01N 33/574 (2006.01)	2419736 *	METHODS OF ASSESSING ACTIVITY OF A POLYSACCHARIDE COMPOSITION

MKP (51)	Broj objave evropske prijava patenta (97)	Naziv pronalaska (54)
A61K 31/715 (2006.01)	2419736 *	METHODS OF ASSESSING ACTIVITY OF A POLYSACCHARIDE COMPOSITION
G01N 33/50 (2006.01)	2419736 *	METHODS OF ASSESSING ACTIVITY OF A POLYSACCHARIDE COMPOSITION
C07D 235/20 (2006.01)	2443094 *	PROCESS FOR THE PREPARATION OF TELMISARTAN
A61P 9/12 (2006.01)	2443094 *	PROCESS FOR THE PREPARATION OF TELMISARTAN
A61K 31/4184 (2006.01)	2443094 *	PROCESS FOR THE PREPARATION OF TELMISARTAN
B65D 5/66 (2006.01)	2376335 *	PACKAGE FOR TOBACCO-RELATED ARTICLES
B65D 85/10 (2006.01)	2376335 *	PACKAGE FOR TOBACCO-RELATED ARTICLES
A61K 9/16 (2006.01)	2493454 *	FAST DISSOLVING/DISINTEGRATING COATING COMPOSITIONS
E04G 5/14 (2006.01)	2253778	An advance guard rail
C07K 14/54 (2006.01)	2445933 *	AVIAN COLONY STIMULATING FACTOR 1 RECEPTOR BINDING PROTEINS
C07K 14/53 (2006.01)	2445933 *	AVIAN COLONY STIMULATING FACTOR 1 RECEPTOR BINDING PROTEINS
A61K 38/20 (2006.01)	2445933 *	AVIAN COLONY STIMULATING FACTOR 1 RECEPTOR BINDING PROTEINS
A61K 38/19 (2006.01)	2445933 *	AVIAN COLONY STIMULATING FACTOR 1 RECEPTOR BINDING PROTEINS
A61M 5/315 (2006.01)	2482896 *	DRIVE MECHANISM FOR A DRUG DELIVERY DEVICE AND RESET MEMBER FOR A DRIVE MECHANISM
A47C 27/08 (2006.01)	2410892 *	UNIVERSAL BED INSERT, BUILT BY AIR MATTRESS, COMBINED WITH AIRTIGHT VALVES, AND METHOD FOR PRODUCING THEREOF
F16T 1/34 (2006.01)	2414722 *	PROGRAMMABLE STEAM TRAP APPARATUS
C07D 498/04 (2006.01)	2456774 *	FUSED AMINODIHYDRO-OXAZINE DERIVATIVES
A61K 31/5365 (2006.01)	2456774 *	FUSED AMINODIHYDRO-OXAZINE DERIVATIVES
A61P 25/28 (2006.01)	2456774 *	FUSED AMINODIHYDRO-OXAZINE DERIVATIVES
G06F 21/00 (2006.01)	2460075 *	REPAIRING PORTABLE EXECUTABLE FILES
G06F 11/07 (2006.01)	2460075 *	REPAIRING PORTABLE EXECUTABLE FILES
A01N 43/66 (2006.01)	2440054 *	PYRIDIL-TRIAZINE INHIBITORS OF HEDGEHOG SIGNALING
A61K 31/53 (2006.01)	2440054 *	PYRIDIL-TRIAZINE INHIBITORS OF HEDGEHOG SIGNALING
C07D 401/10 (2006.01)	2421848 *	AZETIDINYL DIAMIDES AS MONOACYLGLYCEROL LIPASE INHIBITORS
C07D 417/06 (2006.01)	2421848 *	AZETIDINYL DIAMIDES AS MONOACYLGLYCEROL LIPASE INHIBITORS
C07D 413/06 (2006.01)	2421848 *	AZETIDINYL DIAMIDES AS MONOACYLGLYCEROL LIPASE INHIBITORS
C07D 403/06 (2006.01)	2421848 *	AZETIDINYL DIAMIDES AS MONOACYLGLYCEROL LIPASE INHIBITORS
A61P 29/00 (2006.01)	2421848 *	AZETIDINYL DIAMIDES AS MONOACYLGLYCEROL LIPASE INHIBITORS
C07D 409/10 (2006.01)	2421848 *	AZETIDINYL DIAMIDES AS MONOACYLGLYCEROL LIPASE INHIBITORS
C07D 403/04 (2006.01)	2421848 *	AZETIDINYL DIAMIDES AS MONOACYLGLYCEROL LIPASE INHIBITORS
A61K 31/496 (2006.01)	2421848 *	AZETIDINYL DIAMIDES AS MONOACYLGLYCEROL LIPASE INHIBITORS
C07D 403/10 (2006.01)	2421848 *	AZETIDINYL DIAMIDES AS MONOACYLGLYCEROL LIPASE INHIBITORS
A61P 25/00 (2006.01)	2421848 *	AZETIDINYL DIAMIDES AS MONOACYLGLYCEROL LIPASE INHIBITORS
C07D 409/06 (2006.01)	2421848 *	AZETIDINYL DIAMIDES AS MONOACYLGLYCEROL LIPASE INHIBITORS
C07D 405/06 (2006.01)	2421848 *	AZETIDINYL DIAMIDES AS MONOACYLGLYCEROL LIPASE INHIBITORS
A01N 43/54 (2006.01)	2445346 *	OXO-HETEROCYCLE FUSED PYRIMIDINE COMPOUNDS, COMPOSITIONS AND METHODS OF USE
G01N 33/574 (2006.01)	2493503 *	DOSAGE REGIMEN FOR ADMINISTERING A CD19XCD3 BISPECIFIC ANTIBODY
C07K 16/46 (2006.01)	2493503 *	DOSAGE REGIMEN FOR ADMINISTERING A CD19XCD3 BISPECIFIC ANTIBODY
A61K 39/395 (2006.01)	2493503 *	DOSAGE REGIMEN FOR ADMINISTERING A CD19XCD3 BISPECIFIC ANTIBODY
A61K 31/422 (2006.01)	2421531 *	USE OF NIFURATEL TO TREAT INFECTIONS CAUSED BY ATOPOBIUM SPECIES

MKP (51)	Broj objave evropske prijava patenta (97)	Naziv pronalaska (54)
A61K 9/20 (2006.01)	2421531 *	USE OF NIFURATEL TO TREAT INFECTIONS CAUSED BY ATOPOBIUM SPECIES
A61P 31/04 (2006.01)	2421531 *	USE OF NIFURATEL TO TREAT INFECTIONS CAUSED BY ATOPOBIUM SPECIES
A61K 9/06 (2006.01)	2421531 *	USE OF NIFURATEL TO TREAT INFECTIONS CAUSED BY ATOPOBIUM SPECIES
A61P 15/02 (2006.01)	2421531 *	USE OF NIFURATEL TO TREAT INFECTIONS CAUSED BY ATOPOBIUM SPECIES
A61P 13/02 (2006.01)	2421531 *	USE OF NIFURATEL TO TREAT INFECTIONS CAUSED BY ATOPOBIUM SPECIES
A61K 9/00 (2006.01)	2421531 *	USE OF NIFURATEL TO TREAT INFECTIONS CAUSED BY ATOPOBIUM SPECIES
A61P 15/00 (2006.01)	2421531 *	USE OF NIFURATEL TO TREAT INFECTIONS CAUSED BY ATOPOBIUM SPECIES
A61M 5/315 (2006.01)	2437829 *	DOSE SETTING MECHANISM FOR A DRUG DELIVERY DEVICE
F24J 2/51 (2006.01)	2302308	Colored mineral wool
C07D 473/34 (2006.01)	2445898 *	4H-PYRIDO[1,2-A]PYRIMIDIN-4-ONE DERIVATIVES AS PI3K INHIBITORS
C07D 473/38 (2006.01)	2445898 *	4H-PYRIDO[1,2-A]PYRIMIDIN-4-ONE DERIVATIVES AS PI3K INHIBITORS
C07D 401/12 (2006.01)	2445898 *	4H-PYRIDO[1,2-A]PYRIMIDIN-4-ONE DERIVATIVES AS PI3K INHIBITORS
A61P 29/00 (2006.01)	2445898 *	4H-PYRIDO[1,2-A]PYRIMIDIN-4-ONE DERIVATIVES AS PI3K INHIBITORS
C07D 471/04 (2006.01)	2445898 *	4H-PYRIDO[1,2-A]PYRIMIDIN-4-ONE DERIVATIVES AS PI3K INHIBITORS
C07D 487/04 (2006.01)	2445898 *	4H-PYRIDO[1,2-A]PYRIMIDIN-4-ONE DERIVATIVES AS PI3K INHIBITORS
A61K 31/52 (2006.01)	2445898 *	4H-PYRIDO[1,2-A]PYRIMIDIN-4-ONE DERIVATIVES AS PI3K INHIBITORS
A61K 31/517 (2006.01)	2445898 *	4H-PYRIDO[1,2-A]PYRIMIDIN-4-ONE DERIVATIVES AS PI3K INHIBITORS
A61K 31/506 (2006.01)	2445898 *	4H-PYRIDO[1,2-A]PYRIMIDIN-4-ONE DERIVATIVES AS PI3K INHIBITORS
A61K 38/20 (2006.01)	2475380 *	COMPOSITION FOR TREATMENT OF CXCL8-MEDIATED LUNG INFLAMMATION
C12N 15/00 (2006.01)	2475380 *	COMPOSITION FOR TREATMENT OF CXCL8-MEDIATED LUNG INFLAMMATION
A01N 25/00 (2006.01)	2488015 *	FUZZY COTTON SEEDS COMPRISING AN AQUEOUS POLYURETHANE COATING
A01C 1/06 (2006.01)	2488015 *	FUZZY COTTON SEEDS COMPRISING AN AQUEOUS POLYURETHANE COATING
A61P 3/00 (2006.01)	2493889 *	IMIDAZO[1,2-b]PYRIDAZINE DERIVATIVES AND THEIR USE AS PDE10 INHIBITORS
A61K 31/5025 (2006.01)	2493889 *	IMIDAZO[1,2-b]PYRIDAZINE DERIVATIVES AND THEIR USE AS PDE10 INHIBITORS
A61P 25/00 (2006.01)	2493889 *	IMIDAZO[1,2-b]PYRIDAZINE DERIVATIVES AND THEIR USE AS PDE10 INHIBITORS
C07D 487/04 (2006.01)	2493889 *	IMIDAZO[1,2-b]PYRIDAZINE DERIVATIVES AND THEIR USE AS PDE10 INHIBITORS
A61K 39/00 (2006.01)	2480252 *	METHODS, COMPOSITIONS, AND KITS FOR REDUCING ANTI-ANTIBODY RESPONSES
C07D 239/72 (2006.01)	2406236 *	RHO KINASE INHIBITORS
C01B 31/20 (2006.01)	2464600 *	MODULARIZED SYSTEM AND METHOD FOR UREA PRODUCTION USING STRANDED NATURAL GAS
C07C 275/00 (2006.01)	2464600 *	MODULARIZED SYSTEM AND METHOD FOR UREA PRODUCTION USING STRANDED NATURAL GAS
C07D 413/12 (2006.01)	2480548 *	INDOLIZINE INHIBITORS OF 5-LIPOXYGENASE
A61K 31/437 (2006.01)	2480548 *	INDOLIZINE INHIBITORS OF 5-LIPOXYGENASE
C07D 403/06 (2006.01)	2480548 *	INDOLIZINE INHIBITORS OF 5-LIPOXYGENASE
A61P 29/00 (2006.01)	2480548 *	INDOLIZINE INHIBITORS OF 5-LIPOXYGENASE
A61P 11/00 (2006.01)	2480548 *	INDOLIZINE INHIBITORS OF 5-LIPOXYGENASE
C07D 471/04 (2006.01)	2480548 *	INDOLIZINE INHIBITORS OF 5-LIPOXYGENASE

MKP (51)	Broj objave evropske prijava patenta (97)	Naziv pronalaska (54)
C07D 401/14 (2006.01)	2480548 *	INDOLIZINE INHIBITORS OF 5-LIPOXYGENASE
A61P 9/00 (2006.01)	2480548 *	INDOLIZINE INHIBITORS OF 5-LIPOXYGENASE
G06K 9/00 (2006.01)	2411941 *	IMPROVED PIEZOELECTRIC IDENTIFICATION DEVICE AND APPLICATIONS THEREOF
G01H 17/00 (2006.01)	2411941 *	IMPROVED PIEZOELECTRIC IDENTIFICATION DEVICE AND APPLICATIONS THEREOF
H01L 41/22 (2006.01)	2443679 *	METHOD FOR MANUFACTURING A PIEZOELECTRIC CERAMIC BODY
H04R 17/00 (2006.01)	2443679 *	METHOD FOR MANUFACTURING A PIEZOELECTRIC CERAMIC BODY
C07D 213/74 (2006.01)	2406221 *	SODIUM SALT OF 5-CYCLOPROPYL-2- $\{$ 2,6-DIFLUOROPHENYL $\}$ PYRIMIDIN-5-YL $\}^{\sim}$ AMINO $\}$ BENZOIC ACID AS DHODH INHIBITOR
C07D 239/42 (2006.01)	2406221 *	SODIUM SALT OF 5-CYCLOPROPYL-2- $\{$ 2,6-DIFLUOROPHENYL $\}$ PYRIMIDIN-5-YL $\}^{\sim}$ AMINO $\}$ BENZOIC ACID AS DHODH INHIBITOR
A61P 17/06 (2006.01)	2406221 *	SODIUM SALT OF 5-CYCLOPROPYL-2- $\{$ 2,6-DIFLUOROPHENYL $\}$ PYRIMIDIN-5-YL $\}^{\sim}$ AMINO $\}$ BENZOIC ACID AS DHODH INHIBITOR
A61P 19/00 (2006.01)	2406221 *	SODIUM SALT OF 5-CYCLOPROPYL-2- $\{$ 2,6-DIFLUOROPHENYL $\}$ PYRIMIDIN-5-YL $\}^{\sim}$ AMINO $\}$ BENZOIC ACID AS DHODH INHIBITOR
A61P 37/00 (2006.01)	2406221 *	SODIUM SALT OF 5-CYCLOPROPYL-2- $\{$ 2,6-DIFLUOROPHENYL $\}$ PYRIMIDIN-5-YL $\}^{\sim}$ AMINO $\}$ BENZOIC ACID AS DHODH INHIBITOR
C09C 3/12 (2006.01)	2499206 *	COATING COMPOSITION
C09D 7/12 (2006.01)	2499206 *	COATING COMPOSITION
B82Y 30/00 (2011.01)	2499206 *	COATING COMPOSITION
C09D 5/08 (2006.01)	2499206 *	COATING COMPOSITION
C09C 1/00 (2006.01)	2499206 *	COATING COMPOSITION
A61P 35/00 (2006.01)	2483312 *	ANTIBODIES THAT SPECIFICALLY BIND TO THE EPHA2 RECEPTOR
A61K 39/395 (2006.01)	2483312 *	ANTIBODIES THAT SPECIFICALLY BIND TO THE EPHA2 RECEPTOR
A61K 47/48 (2006.01)	2483312 *	ANTIBODIES THAT SPECIFICALLY BIND TO THE EPHA2 RECEPTOR
C07K 16/28 (2006.01)	2483312 *	ANTIBODIES THAT SPECIFICALLY BIND TO THE EPHA2 RECEPTOR
G05B 9/02 (2006.01)	2478420 *	CIRCUIT ASSEMBLY HAVING A CONVERTER PART COMPRISING A CENTRAL CONTROL UNIT
H04L 12/40 (2006.01)	2478420 *	CIRCUIT ASSEMBLY HAVING A CONVERTER PART COMPRISING A CENTRAL CONTROL UNIT
H04L 12/413 (2006.01)	2478420 *	CIRCUIT ASSEMBLY HAVING A CONVERTER PART COMPRISING A CENTRAL CONTROL UNIT
H04L 12/46 (2006.01)	2478420 *	CIRCUIT ASSEMBLY HAVING A CONVERTER PART COMPRISING A CENTRAL CONTROL UNIT
H04L 12/66 (2006.01)	2478420 *	CIRCUIT ASSEMBLY HAVING A CONVERTER PART COMPRISING A CENTRAL CONTROL UNIT
H04N 5/44 (2011.01)	2290955	Method for distributing digital data
A61K 45/06 (2006.01)	2416773 *	CHECKPOINT KINASE 1 INHIBITORS FOR POTENTIATING DNA DAMAGING AGENTS
A61P 35/00 (2006.01)	2416773 *	CHECKPOINT KINASE 1 INHIBITORS FOR POTENTIATING DNA DAMAGING AGENTS
A61K 31/437 (2006.01)	2416773 *	CHECKPOINT KINASE 1 INHIBITORS FOR POTENTIATING DNA DAMAGING AGENTS
A61K 31/4745 (2006.01)	2416773 *	CHECKPOINT KINASE 1 INHIBITORS FOR POTENTIATING DNA DAMAGING AGENTS
A61K 31/7068 (2006.01)	2416773 *	CHECKPOINT KINASE 1 INHIBITORS FOR POTENTIATING DNA DAMAGING AGENTS
A61P 13/12 (2006.01)	2431365 *	AZETIDINE COMPOUND AND MEDICINAL USE THEREOF
A61P 37/08 (2006.01)	2431365 *	AZETIDINE COMPOUND AND MEDICINAL USE THEREOF
A61P 17/06 (2006.01)	2431365 *	AZETIDINE COMPOUND AND MEDICINAL USE THEREOF
A61P 43/00 (2006.01)	2431365 *	AZETIDINE COMPOUND AND MEDICINAL USE THEREOF
C07D 401/06 (2006.01)	2431365 *	AZETIDINE COMPOUND AND MEDICINAL USE THEREOF
A61P 19/02 (2006.01)	2431365 *	AZETIDINE COMPOUND AND MEDICINAL USE THEREOF

MKP (51)	Broj objave evropske prijava patenta (97)	Naziv pronalaska (54)
C07D 401/14 (2006.01)	2431365 *	AZETIDINE COMPOUND AND MEDICINAL USE THEREOF
A61K 31/4427 (2006.01)	2431365 *	AZETIDINE COMPOUND AND MEDICINAL USE THEREOF
A61P 19/08 (2006.01)	2431365 *	AZETIDINE COMPOUND AND MEDICINAL USE THEREOF
C07D 405/14 (2006.01)	2431365 *	AZETIDINE COMPOUND AND MEDICINAL USE THEREOF
A61K 31/4439 (2006.01)	2431365 *	AZETIDINE COMPOUND AND MEDICINAL USE THEREOF
A61P 19/10 (2006.01)	2431365 *	AZETIDINE COMPOUND AND MEDICINAL USE THEREOF
C07D 409/14 (2006.01)	2431365 *	AZETIDINE COMPOUND AND MEDICINAL USE THEREOF
A61K 31/497 (2006.01)	2431365 *	AZETIDINE COMPOUND AND MEDICINAL USE THEREOF
A61P 35/00 (2006.01)	2431365 *	AZETIDINE COMPOUND AND MEDICINAL USE THEREOF
A61K 31/4545 (2006.01)	2431365 *	AZETIDINE COMPOUND AND MEDICINAL USE THEREOF
A61P 29/00 (2006.01)	2431365 *	AZETIDINE COMPOUND AND MEDICINAL USE THEREOF
C07D 413/14 (2006.01)	2431365 *	AZETIDINE COMPOUND AND MEDICINAL USE THEREOF
A61K 31/551 (2006.01)	2431365 *	AZETIDINE COMPOUND AND MEDICINAL USE THEREOF
A61P 35/02 (2006.01)	2431365 *	AZETIDINE COMPOUND AND MEDICINAL USE THEREOF
A61K 31/33 (2006.01)	2456434 *	GALANTAMINE AMINO ACID AND PEPTIDE PRODRUGS AND USES THEREOF
A61P 25/28 (2006.01)	2456434 *	GALANTAMINE AMINO ACID AND PEPTIDE PRODRUGS AND USES THEREOF
C07D 401/12 (2006.01)	2281822	New dihydroindolone derivatives, method of preparing same and pharmaceutical compositions containing them
C07D 401/14 (2006.01)	2281822	New dihydroindolone derivatives, method of preparing same and pharmaceutical compositions containing them
C07D 403/12 (2006.01)	2281822	New dihydroindolone derivatives, method of preparing same and pharmaceutical compositions containing them
C07D 403/14 (2006.01)	2281822	New dihydroindolone derivatives, method of preparing same and pharmaceutical compositions containing them
C07D 413/14 (2006.01)	2281822	New dihydroindolone derivatives, method of preparing same and pharmaceutical compositions containing them
C07D 417/14 (2006.01)	2281822	New dihydroindolone derivatives, method of preparing same and pharmaceutical compositions containing them
A61K 31/404 (2006.01)	2281822	New dihydroindolone derivatives, method of preparing same and pharmaceutical compositions containing them
A61P 35/00 (2006.01)	2281822	New dihydroindolone derivatives, method of preparing same and pharmaceutical compositions containing them
B01J 41/04 (2006.01)	2384800	Regeneration of alkaline zinc electrolytes by removing cyanidiones
B01J 47/02 (2006.01)	2384800	Regeneration of alkaline zinc electrolytes by removing cyanidiones
B01D 15/36 (2006.01)	2384800	Regeneration of alkaline zinc electrolytes by removing cyanidiones
C25D 3/56 (2006.01)	2384800	Regeneration of alkaline zinc electrolytes by removing cyanidiones
C25D 21/22 (2006.01)	2384800	Regeneration of alkaline zinc electrolytes by removing cyanidiones
A61M 5/20 (2006.01)	2424594 *	AUTOMATIC INJECTION DEVICE
H04L 12/58 (2006.01)	2490383	Systems and methods of probing data transmissions for detecting spam bots
A61B 17/06 (2006.01)	2498690 *	SURGICAL NEEDLE COATINGS AND METHODS
A01K 27/00 (2006.01)	2498597 *	LEASH FOR DOGS OR OTHER DOMESTIC ANIMALS
A61K 47/48 (2006.01)	2496262 *	STABILIZED PROTEIN FORMULATIONS AND USE THEREOF
A61K 47/10 (2006.01)	2496262 *	STABILIZED PROTEIN FORMULATIONS AND USE THEREOF
A61K 9/08 (2006.01)	2496262 *	STABILIZED PROTEIN FORMULATIONS AND USE THEREOF
A61K 38/00 (2006.01)	2496262 *	STABILIZED PROTEIN FORMULATIONS AND USE THEREOF
A61K 9/00 (2006.01)	2496262 *	STABILIZED PROTEIN FORMULATIONS AND USE THEREOF
A61K 38/23 (2006.01)	2496262 *	STABILIZED PROTEIN FORMULATIONS AND USE THEREOF
A61K 31/485 (2006.01)	2437729 *	TAMPER RESISTANT DOSAGE FORM COMPRISING A MATRIX AND MELT-EXTRUDED PARTICULATES COMPRISING A DRUG
A61K 45/06 (2006.01)	2437729 *	TAMPER RESISTANT DOSAGE FORM COMPRISING A MATRIX AND MELT-EXTRUDED PARTICULATES COMPRISING A DRUG

MKP (51)	Broj objave evropske prijava patenta (97)	Naziv pronalaska (54)
A61K 9/20 (2006.01)	2437729 *	TAMPER RESISTANT DOSAGE FORM COMPRISING A MATRIX AND MELT-EXTRUDED PARTICULATES COMPRISING A DRUG
A61K 9/16 (2006.01)	2437729 *	TAMPER RESISTANT DOSAGE FORM COMPRISING A MATRIX AND MELT-EXTRUDED PARTICULATES COMPRISING A DRUG
A61K 31/513 (2006.01)	2448932 *	NOVEL 6-MORPHOLIN-4-YL-PYRIMIDIN-4-(3H)-ONE DERIVATIVES, AND THE PHARMACEUTICAL PREPARATION THEREOF AS AKT(PKB) PHOSPHORYLATION INHIBITORS
C07D 413/06 (2006.01)	2448932 *	NOVEL 6-MORPHOLIN-4-YL-PYRIMIDIN-4-(3H)-ONE DERIVATIVES, AND THE PHARMACEUTICAL PREPARATION THEREOF AS AKT(PKB) PHOSPHORYLATION INHIBITORS
A61K 31/5377 (2006.01)	2448932 *	NOVEL 6-MORPHOLIN-4-YL-PYRIMIDIN-4-(3H)-ONE DERIVATIVES, AND THE PHARMACEUTICAL PREPARATION THEREOF AS AKT(PKB) PHOSPHORYLATION INHIBITORS
C07D 403/06 (2006.01)	2448932 *	NOVEL 6-MORPHOLIN-4-YL-PYRIMIDIN-4-(3H)-ONE DERIVATIVES, AND THE PHARMACEUTICAL PREPARATION THEREOF AS AKT(PKB) PHOSPHORYLATION INHIBITORS
A61P 35/00 (2006.01)	2448932 *	NOVEL 6-MORPHOLIN-4-YL-PYRIMIDIN-4-(3H)-ONE DERIVATIVES, AND THE PHARMACEUTICAL PREPARATION THEREOF AS AKT(PKB) PHOSPHORYLATION INHIBITORS
G06F 19/00 (2011.01)	2418596	A system for monitoring patients that perform a medical self-check and relative method
A61P 31/20 (2006.01)	2368547	Antiviral compositions comprising geraniol and carvone
A61P 31/22 (2006.01)	2368547	Antiviral compositions comprising geraniol and carvone
A61P 31/18 (2006.01)	2368547	Antiviral compositions comprising geraniol and carvone
A61K 31/045 (2006.01)	2368547	Antiviral compositions comprising geraniol and carvone
A61K 31/122 (2006.01)	2368547	Antiviral compositions comprising geraniol and carvone
A61P 31/12 (2006.01)	2368547	Antiviral compositions comprising geraniol and carvone
A61P 31/14 (2006.01)	2368547	Antiviral compositions comprising geraniol and carvone
A61P 31/16 (2006.01)	2368547	Antiviral compositions comprising geraniol and carvone
A61K 9/00 (2006.01)	2315580 *	PHARMACEUTICAL FORMULATIONS AND METHODS FOR TREATING RESPIRATORY TRACT INFECTIONS
A61K 47/02 (2006.01)	2315580 *	PHARMACEUTICAL FORMULATIONS AND METHODS FOR TREATING RESPIRATORY TRACT INFECTIONS
A61K 47/12 (2006.01)	2315580 *	PHARMACEUTICAL FORMULATIONS AND METHODS FOR TREATING RESPIRATORY TRACT INFECTIONS
C23C 16/505 (2006.01)	2251452	Vessel processing
G01N 15/08 (2006.01)	2251452	Vessel processing
A61B 5/15 (2006.01)	2251452	Vessel processing
A61K 31/00 (2006.01)	2435033 *	METHODS FOR TREATING TYPE 2 DIABETES IN PATIENTS RESISTANT TO PREVIOUS TREATMENT WITH OTHER ANTI-DIABETIC DRUGS EMPLOYING AN SGLT2 INHIBITOR AND COMPOSITIONS THEREOF
A61K 31/155 (2006.01)	2435033 *	METHODS FOR TREATING TYPE 2 DIABETES IN PATIENTS RESISTANT TO PREVIOUS TREATMENT WITH OTHER ANTI-DIABETIC DRUGS EMPLOYING AN SGLT2 INHIBITOR AND COMPOSITIONS THEREOF
A61K 31/4439 (2006.01)	2435033 *	METHODS FOR TREATING TYPE 2 DIABETES IN PATIENTS RESISTANT TO PREVIOUS TREATMENT WITH OTHER ANTI-DIABETIC DRUGS EMPLOYING AN SGLT2 INHIBITOR AND COMPOSITIONS THEREOF
A61K 31/70 (2006.01)	2435033 *	METHODS FOR TREATING TYPE 2 DIABETES IN PATIENTS RESISTANT TO PREVIOUS TREATMENT WITH OTHER ANTI-DIABETIC DRUGS EMPLOYING AN SGLT2 INHIBITOR AND COMPOSITIONS THEREOF
A61P 3/10 (2006.01)	2435033 *	METHODS FOR TREATING TYPE 2 DIABETES IN PATIENTS RESISTANT TO PREVIOUS TREATMENT WITH OTHER ANTI-DIABETIC DRUGS EMPLOYING AN SGLT2 INHIBITOR AND COMPOSITIONS THEREOF
F24D 19/10 (2006.01)	2434225 *	COLD/HOT WATER SUPPLY SYSTEM WITH AN IMPROVED CONTROL UNIT
F24D 17/00 (2006.01)	2434225 *	COLD/HOT WATER SUPPLY SYSTEM WITH AN IMPROVED CONTROL UNIT

MKP (51)	Broj objave evropske prijava patenta (97)	Naziv pronalaska (54)
E03B 1/00 (2006.01)	2434225 *	COLD/HOT WATER SUPPLY SYSTEM WITH AN IMPROVED CONTROL UNIT
F24H 1/48 (2006.01)	2434225 *	COLD/HOT WATER SUPPLY SYSTEM WITH AN IMPROVED CONTROL UNIT
C07C 47/277 (2006.01)	2475634 *	PROCESS FOR THE PREPARATION OF INDOLINE DERIVATIVES AND THEIR INTERMEDIATES THEREOF
B03D 1/01 (2006.01)	2366456	Froth flotation process for the separation of silicates and alkaline earth metal carbonates using a collector comprising at least one hydrophobically modified polyalkyleneimine
C22B 26/00 (2006.01)	2366456	Froth flotation process for the separation of silicates and alkaline earth metal carbonates using a collector comprising at least one hydrophobically modified polyalkyleneimine
C22B 26/20 (2006.01)	2366456	Froth flotation process for the separation of silicates and alkaline earth metal carbonates using a collector comprising at least one hydrophobically modified polyalkyleneimine
B03D 101/02 (2006.01)	2366456	Froth flotation process for the separation of silicates and alkaline earth metal carbonates using a collector comprising at least one hydrophobically modified polyalkyleneimine
G06Q 20/00 (2012.01)	2425388 *	METHOD FOR CHARGING FOR AND PROVIDING ACCESS TO A SERVICE FROM A MOBILE COMMUNICATION TERMINAL
C07K 16/18 (2006.01)	2403875 *	GLYCODELIN MONOCLONAL ANTIBODIES AND METHODS FOR THEIR USE IN THE DETECTION OF OVARIAN CANCER
C07K 16/30 (2006.01)	2403875 *	GLYCODELIN MONOCLONAL ANTIBODIES AND METHODS FOR THEIR USE IN THE DETECTION OF OVARIAN CANCER
G01N 33/577 (2006.01)	2403875 *	GLYCODELIN MONOCLONAL ANTIBODIES AND METHODS FOR THEIR USE IN THE DETECTION OF OVARIAN CANCER
A61P 29/00 (2006.01)	2414377 *	NOVEL DERIVATIVES OF STEROIDAL 3,2-C''PYRAZOLE COMPOUNDS WITH GLUCOCORTICOID ACTIVITY
C07J 71/00 (2006.01)	2414377 *	NOVEL DERIVATIVES OF STEROIDAL 3,2-C''PYRAZOLE COMPOUNDS WITH GLUCOCORTICOID ACTIVITY
A61K 31/58 (2006.01)	2414377 *	NOVEL DERIVATIVES OF STEROIDAL 3,2-C''PYRAZOLE COMPOUNDS WITH GLUCOCORTICOID ACTIVITY
A61P 11/00 (2006.01)	2414377 *	NOVEL DERIVATIVES OF STEROIDAL 3,2-C''PYRAZOLE COMPOUNDS WITH GLUCOCORTICOID ACTIVITY
A61P 11/06 (2006.01)	2414377 *	NOVEL DERIVATIVES OF STEROIDAL 3,2-C''PYRAZOLE COMPOUNDS WITH GLUCOCORTICOID ACTIVITY
A01N 43/54 (2006.01)	2461685 *	MIXTURES OF MESOIONIC PESTICIDES
A01N 43/78 (2006.01)	2485594 *	COMBINATION
A61K 31/425 (2006.01)	2485594 *	COMBINATION
E04G 3/30 (2006.01)	2410105	Assembly of a covering element and an access facility or raised platform within a work room
F22B 37/24 (2006.01)	2410105	Assembly of a covering element and an access facility or raised platform within a work room
E04G 3/00 (2006.01)	2410105	Assembly of a covering element and an access facility or raised platform within a work room
A23C 9/14 (2006.01)	2490547 *	COMPOSITE DIETETIC MILK DRAUGHT AND METHOD FOR PRODUCTION OF COMPOSITE DIETETIC MILK DRAUGHT WITH REDUCED LEVEL OF URIC ACID AND PURINE COMPOUNDS
A23C 9/20 (2006.01)	2490547 *	COMPOSITE DIETETIC MILK DRAUGHT AND METHOD FOR PRODUCTION OF COMPOSITE DIETETIC MILK DRAUGHT WITH REDUCED LEVEL OF URIC ACID AND PURINE COMPOUNDS
A61K 9/02 (2006.01)	2440178 *	GLYCEROL-FREE OSMOTIC LAXATIVE SUPPOSITORY
A01N 43/54 (2006.01)	2480084 *	COMBINATION
A61K 31/415 (2006.01)	2480084 *	COMBINATION
A61K 31/505 (2006.01)	2480084 *	COMBINATION
C07D 405/14 (2006.01)	2432777 *	PROCESS FOR THE PREPARATION OF OLMESARTAN MEDOXOMIL
A61K 31/505 (2006.01)	2432768 *	NOVEL PYRIMIDINE DERIVATIVES AND THEIR USE IN THE TREATMENT OF CANCER AND FURTHER DISEASES

MKP (51)	Broj objave evropske prijava patenta (97)	Naziv pronalaska (54)
A61K 31/5377 (2006.01)	2432768 *	NOVEL PYRIMIDINE DERIVATIVES AND THEIR USE IN THE TREATMENT OF CANCER AND FURTHER DISEASES
A61P 35/00 (2006.01)	2432768 *	NOVEL PYRIMIDINE DERIVATIVES AND THEIR USE IN THE TREATMENT OF CANCER AND FURTHER DISEASES
C07D 239/49 (2006.01)	2432768 *	NOVEL PYRIMIDINE DERIVATIVES AND THEIR USE IN THE TREATMENT OF CANCER AND FURTHER DISEASES
C07D 403/12 (2006.01)	2432768 *	NOVEL PYRIMIDINE DERIVATIVES AND THEIR USE IN THE TREATMENT OF CANCER AND FURTHER DISEASES
C07D 401/12 (2006.01)	2432768 *	NOVEL PYRIMIDINE DERIVATIVES AND THEIR USE IN THE TREATMENT OF CANCER AND FURTHER DISEASES
C07D 413/12 (2006.01)	2432768 *	NOVEL PYRIMIDINE DERIVATIVES AND THEIR USE IN THE TREATMENT OF CANCER AND FURTHER DISEASES
A47L 13/20 (2006.01)	2433544 *	CLEANER HOLDER AND CLEANING TOOL
A47L 13/10 (2006.01)	2433544 *	CLEANER HOLDER AND CLEANING TOOL
A46B 5/00 (2006.01)	2433544 *	CLEANER HOLDER AND CLEANING TOOL
A47L 13/24 (2006.01)	2433544 *	CLEANER HOLDER AND CLEANING TOOL
A01N 47/28 (2006.01)	2445842 *	USE OF MONOCHLOROUREA TO TREAT INDUSTRIAL WATERS
C07C 273/18 (2006.01)	2445842 *	USE OF MONOCHLOROUREA TO TREAT INDUSTRIAL WATERS
C02F 1/76 (2006.01)	2445842 *	USE OF MONOCHLOROUREA TO TREAT INDUSTRIAL WATERS
A01N 25/02 (2006.01)	2445842 *	USE OF MONOCHLOROUREA TO TREAT INDUSTRIAL WATERS
C12M 1/00 (2006.01)	2446016 *	METHOD FOR PRODUCING BIOMASS AND PHOTOBIOREACTOR FOR CULTIVATING PHOTOTROPHIC OR MIXOTROPHIC ORGANISMS OR CELLS
A01N 43/42 (2006.01)	2485589 *	HETEROARYL BTK INHIBITORS
A61K 9/16 (2006.01)	2386296	New application forms for cineol
A61K 31/352 (2006.01)	2386296	New application forms for cineol
A61K 9/48 (2006.01)	2386296	New application forms for cineol
A61K 9/50 (2006.01)	2386296	New application forms for cineol
A23C 11/10 (2006.01)	2471374 *	METHOD AND SYSTEM FOR MANUFACTURING WHOLE SOY MILK
A61K 47/14 (2006.01)	2459221 *	PHARMACEUTICAL FORMULATION
A61K 9/00 (2006.01)	2459221 *	PHARMACEUTICAL FORMULATION
A61K 31/519 (2006.01)	2459221 *	PHARMACEUTICAL FORMULATION
A61K 9/16 (2006.01)	2432456 *	SOLID PHARMACEUTICAL COMPOSITIONS AND PROCESSES FOR THEIR PRODUCTION
A61K 9/20 (2006.01)	2432456 *	SOLID PHARMACEUTICAL COMPOSITIONS AND PROCESSES FOR THEIR PRODUCTION
A61K 31/55 (2006.01)	2432456 *	SOLID PHARMACEUTICAL COMPOSITIONS AND PROCESSES FOR THEIR PRODUCTION
A61K 9/28 (2006.01)	2432456 *	SOLID PHARMACEUTICAL COMPOSITIONS AND PROCESSES FOR THEIR PRODUCTION
C08F 26/10 (2006.01)	2427226 *	IMPLANT FILLING MATERIAL AND METHOD
A61L 27/14 (2006.01)	2427226 *	IMPLANT FILLING MATERIAL AND METHOD
A61F 2/12 (2006.01)	2427226 *	IMPLANT FILLING MATERIAL AND METHOD
A61P 25/04 (2006.01)	2453900 *	NOVEL CARBAMATE AMINO ACID AND PEPTIDE PRODRUGS OF OPIOIDS AND USES THEREOF
A61K 31/55 (2006.01)	2453900 *	NOVEL CARBAMATE AMINO ACID AND PEPTIDE PRODRUGS OF OPIOIDS AND USES THEREOF
C07D 223/04 (2006.01)	2453900 *	NOVEL CARBAMATE AMINO ACID AND PEPTIDE PRODRUGS OF OPIOIDS AND USES THEREOF
A61F 13/15 (2006.01)	2446868	APPARATUS AND METHOD FOR THE APPLICATION OF A CURVED RIBBON TO A TRAVELING WEB
A61K 31/497 (2006.01)	2445502 *	HETEROCYCLIC COMPOUNDS FOR THE TREATMENT OF NEUROLOGICAL AND PSYCHOLOGICAL DISORDERS

MKP (51)	Broj objave evropske prijava patenta (97)	Naziv pronalaska (54)
A61M 31/00 (2006.01)	2427243 *	NOVEL FORMULATIONS OF VOLATILE ANESTHETICS AND METHODS OF USE FOR REDUCING INFLAMMATION
A61N 2/02 (2006.01)	2305346	Method for treating obesity
C09D 11/10 (2006.01)	2414986 *	IDENTIFICATION AND AUTHENTICATION USING POLYMERIC LIQUID CRYSTAL MATERIAL MARKINGS
B41M 3/14 (2006.01)	2414986 *	IDENTIFICATION AND AUTHENTICATION USING POLYMERIC LIQUID CRYSTAL MATERIAL MARKINGS
C09K 19/02 (2006.01)	2414986 *	IDENTIFICATION AND AUTHENTICATION USING POLYMERIC LIQUID CRYSTAL MATERIAL MARKINGS
G06K 1/12 (2006.01)	2414986 *	IDENTIFICATION AND AUTHENTICATION USING POLYMERIC LIQUID CRYSTAL MATERIAL MARKINGS
G07D 7/12 (2006.01)	2414986 *	IDENTIFICATION AND AUTHENTICATION USING POLYMERIC LIQUID CRYSTAL MATERIAL MARKINGS
G06Q 10/00 (2012.01)	2414986 *	IDENTIFICATION AND AUTHENTICATION USING POLYMERIC LIQUID CRYSTAL MATERIAL MARKINGS
F24J 2/52 (2006.01)	2362161	Panel mounting system
C07D 493/08 (2006.01)	2496583 *	DIOXA-BICYCLO[3.2.1]OCTANE-2,3,4-TRIOL DERIVATIVES
C07H 7/04 (2006.01)	2496583 *	DIOXA-BICYCLO[3.2.1]OCTANE-2,3,4-TRIOL DERIVATIVES
A61P 3/10 (2006.01)	2496583 *	DIOXA-BICYCLO[3.2.1]OCTANE-2,3,4-TRIOL DERIVATIVES
A61K 31/35 (2006.01)	2496583 *	DIOXA-BICYCLO[3.2.1]OCTANE-2,3,4-TRIOL DERIVATIVES
A61P 3/04 (2006.01)	2496583 *	DIOXA-BICYCLO[3.2.1]OCTANE-2,3,4-TRIOL DERIVATIVES
A61K 31/519 (2006.01)	2432472 *	3-[4-(7H-PYRROLO[2,3-D]PYRIMIDIN-4-YL)-1H-PYRAZOL-1-YL]OCTANE-OR HEPTANE-NITRILE AS JAK INHIBITORS
C07D 487/04 (2006.01)	2432472 *	3-[4-(7H-PYRROLO[2,3-D]PYRIMIDIN-4-YL)-1H-PYRAZOL-1-YL]OCTANE-OR HEPTANE-NITRILE AS JAK INHIBITORS
A61P 35/00 (2006.01)	2432472 *	3-[4-(7H-PYRROLO[2,3-D]PYRIMIDIN-4-YL)-1H-PYRAZOL-1-YL]OCTANE-OR HEPTANE-NITRILE AS JAK INHIBITORS
A61P 17/00 (2006.01)	2432472 *	3-[4-(7H-PYRROLO[2,3-D]PYRIMIDIN-4-YL)-1H-PYRAZOL-1-YL]OCTANE-OR HEPTANE-NITRILE AS JAK INHIBITORS
A61P 27/02 (2006.01)	2432472 *	3-[4-(7H-PYRROLO[2,3-D]PYRIMIDIN-4-YL)-1H-PYRAZOL-1-YL]OCTANE-OR HEPTANE-NITRILE AS JAK INHIBITORS
A61P 29/00 (2006.01)	2432472 *	3-[4-(7H-PYRROLO[2,3-D]PYRIMIDIN-4-YL)-1H-PYRAZOL-1-YL]OCTANE-OR HEPTANE-NITRILE AS JAK INHIBITORS
G01N 33/569 (2006.01)	2419734 *	DIRECT FLUORESCENCE IMMUNOASSAY FOR VIRAL ANTIGENS
G01N 33/58 (2006.01)	2419734 *	DIRECT FLUORESCENCE IMMUNOASSAY FOR VIRAL ANTIGENS
C08G 77/00 (2006.01)	2411449 *	IMPRINTED BIOMIMETIC CATALYSTS FOR CELLULOSE HYDROLYSIS
C12Q 1/00 (2006.01)	2430178 *	METHODS AND KITS FOR MEASURING TOXICITY AND OXIDATIVE STRESS IN LIVE CELLS
C07D 473/34 (2006.01)	2486039 *	PURINE DERIVATIVES USEFUL AS HSP90 INHIBITORS
A61P 25/00 (2006.01)	2486039 *	PURINE DERIVATIVES USEFUL AS HSP90 INHIBITORS
A61P 25/28 (2006.01)	2486039 *	PURINE DERIVATIVES USEFUL AS HSP90 INHIBITORS
A61K 31/52 (2006.01)	2486039 *	PURINE DERIVATIVES USEFUL AS HSP90 INHIBITORS
A61K 31/538 (2006.01)	2486039 *	PURINE DERIVATIVES USEFUL AS HSP90 INHIBITORS
A61P 35/00 (2006.01)	2486039 *	PURINE DERIVATIVES USEFUL AS HSP90 INHIBITORS
A61K 38/16 (2006.01)	2432488 *	SELECTIVE AND POTENT PEPTIDE INHIBITORS OF KV1.3
G06Q 30/00 (2006.01)	2249302	Device for ordering and/or booking and/or purchasing goods or services and ordering, booking or purchasing device
G07F 17/40 (2006.01)	2249302	Device for ordering and/or booking and/or purchasing goods or services and ordering, booking or purchasing device
G07F 7/00 (2006.01)	2249302	Device for ordering and/or booking and/or purchasing goods or services and ordering, booking or purchasing device
B60R 25/02 (2006.01)	2275313	Blocking device for blocking an essential component of a motor vehicle, particularly for blocking a steering column of a motor vehicle
A23L 1/228 (2006.01)	2415359 *	USE OF PEPTIDE FOR IMPARTING BODY TASTE

MKP (51)	Broj objave evropske prijava patenta (97)	Naziv pronalaska (54)
A01B 3/46 (2006.01)	2238818	Reversible plough with a device for reducing the pressure
A01B 3/42 (2006.01)	2238818	Reversible plough with a device for reducing the pressure
A01B 49/02 (2006.01)	2279652	Grubber
A61K 31/4439 (2006.01)	2408452 *	COMPOUND FOR THE TREATMENT OF TUBERCULOSIS
A61K 45/06 (2006.01)	2408452 *	COMPOUND FOR THE TREATMENT OF TUBERCULOSIS
A61P 31/06 (2006.01)	2408452 *	COMPOUND FOR THE TREATMENT OF TUBERCULOSIS
G01N 33/68 (2006.01)	2444815 *	METHOD FOR SCREENING FOR SUBSTANCE WHICH INHIBITS INTERACTION BETWEEN BETA AMYLOID PEPTIDE AND VEGF AND INHIBITOR SEARCHED BY SAME
C07D 405/12 (2006.01)	2444815 *	METHOD FOR SCREENING FOR SUBSTANCE WHICH INHIBITS INTERACTION BETWEEN BETA AMYLOID PEPTIDE AND VEGF AND INHIBITOR SEARCHED BY SAME
G01N 33/533 (2006.01)	2444815 *	METHOD FOR SCREENING FOR SUBSTANCE WHICH INHIBITS INTERACTION BETWEEN BETA AMYLOID PEPTIDE AND VEGF AND INHIBITOR SEARCHED BY SAME
A61K 8/64 (2006.01)	2444815 *	METHOD FOR SCREENING FOR SUBSTANCE WHICH INHIBITS INTERACTION BETWEEN BETA AMYLOID PEPTIDE AND VEGF AND INHIBITOR SEARCHED BY SAME
B66C 23/36 (2006.01)	2364949	Methods and apparatus for handling a tower section of a wind turbine with a crane
B66C 13/08 (2006.01)	2364949	Methods and apparatus for handling a tower section of a wind turbine with a crane
A61P 25/00 (2006.01)	2421856 *	AZETIDINYL DIAMIDES AS MONOACYLGLYCEROL LIPASE INHIBITORS
A61K 31/496 (2006.01)	2421856 *	AZETIDINYL DIAMIDES AS MONOACYLGLYCEROL LIPASE INHIBITORS
C07D 205/06 (2006.01)	2421856 *	AZETIDINYL DIAMIDES AS MONOACYLGLYCEROL LIPASE INHIBITORS
A61P 29/00 (2006.01)	2421856 *	AZETIDINYL DIAMIDES AS MONOACYLGLYCEROL LIPASE INHIBITORS
C07D 409/06 (2006.01)	2421856 *	AZETIDINYL DIAMIDES AS MONOACYLGLYCEROL LIPASE INHIBITORS
C07D 405/06 (2006.01)	2421856 *	AZETIDINYL DIAMIDES AS MONOACYLGLYCEROL LIPASE INHIBITORS
F27D 3/16 (2006.01)	2430383 *	A LATERAL TRANSFER SYSTEM
F27D 3/12 (2006.01)	2430383 *	A LATERAL TRANSFER SYSTEM
B01J 4/00 (2006.01)	2430383 *	A LATERAL TRANSFER SYSTEM
C07D 209/12 (2006.01)	2419406 *	PROCESSES FOR THE SYNTHESIS OF BAZEDOXIFENE ACETATE AND INTERMEDIATES THEREOF
C07K 16/10 (2006.01)	2430046 *	HUMAN BINDING MOLECULES CAPABLE OF NEUTRALIZING INFLUENZA VIRUS H3N2 AND USES THEREOF
A61K 39/42 (2006.01)	2430046 *	HUMAN BINDING MOLECULES CAPABLE OF NEUTRALIZING INFLUENZA VIRUS H3N2 AND USES THEREOF
H04W 36/34 (2009.01)	2480025 *	METHOD, DEVICE AND SYSTEM FOR RECONFIGURING AGGREGATION CELL
H04W 88/02 (2009.01)	2480025 *	METHOD, DEVICE AND SYSTEM FOR RECONFIGURING AGGREGATION CELL
C12N 15/10 (2006.01)	2446032 *	EXPRESSION OF SURROGATE LIGHT CHAINS
G06F 3/023 (2006.01)	2476044 *	SYSTEMS AND METHODS FOR HAPTICALLY-ENHANCED TEXT INTERFACES
G06F 3/01 (2006.01)	2476044 *	SYSTEMS AND METHODS FOR HAPTICALLY-ENHANCED TEXT INTERFACES
H04L 9/08 (2006.01)	2361462 *	METHOD FOR GENERATING AN ENCRYPTION/DECRYPTION KEY
F41H 7/02 (2006.01)	2417415 *	MINE RESISTANT ARMORED VEHICLE
B29C 49/04 (2006.01)	2353841	Container for liquid and manufacturing method thereof
B29C 49/48 (2006.01)	2353841	Container for liquid and manufacturing method thereof
H01H 85/32 (2006.01)	2419917 *	FAULT SIGNALING DEVICE, PARTICULARLY FOR ELECTRICAL APPARATUS SUCH AS INTERLOCKED SOCKETS
C09K 8/32 (2006.01)	2419487 *	FLUID FOR DEEP OFFSHORE DRILLING
C09K 8/34 (2006.01)	2419487 *	FLUID FOR DEEP OFFSHORE DRILLING

MKP (51)	Broj objave evropske prijava patenta (97)	Naziv pronalaska (54)
C12Q 1/68 (2006.01)	2491134 *	GENETIC POLYMORPHISMS IN AGE-RELATED MACULAR DEGENERATION
C12N 15/113 (2010.01)	2478102 *	A METHOD OF MODIFYING THE CARBOHYDRATE CONTENT OF A PLANT
A61K 31/245 (2006.01)	2389936	Aminaphtone for use in the treatment and/or prevention of migraine
A61P 25/06 (2006.01)	2389936	Aminaphtone for use in the treatment and/or prevention of migraine
A61K 45/06 (2006.01)	2435081 *	A THERAPEUTIC COMBINATION COMPRISING A PULMONARY SURFACTANT AND A STEROID
A61P 11/00 (2006.01)	2435081 *	A THERAPEUTIC COMBINATION COMPRISING A PULMONARY SURFACTANT AND A STEROID
A61K 31/136 (2006.01)	2485722 *	USE OF RASAGILINE FOR THE TREATMENT OF PROGRESSIVE SUPRANUCLEAR PALSY
A61P 25/28 (2006.01)	2485722 *	USE OF RASAGILINE FOR THE TREATMENT OF PROGRESSIVE SUPRANUCLEAR PALSY
A61P 25/16 (2006.01)	2445496 *	Pharmaceutical composition comprising rotigotine salts (acid or Na), especially for iontophoresis
A61K 31/381 (2006.01)	2445496 *	Pharmaceutical composition comprising rotigotine salts (acid or Na), especially for iontophoresis
A61K 9/00 (2006.01)	2445496 *	Pharmaceutical composition comprising rotigotine salts (acid or Na), especially for iontophoresis
A61K 9/70 (2006.01)	2445496 *	Pharmaceutical composition comprising rotigotine salts (acid or Na), especially for iontophoresis
C07D 333/20 (2006.01)	2445496 *	Pharmaceutical composition comprising rotigotine salts (acid or Na), especially for iontophoresis
A61P 35/00 (2006.01)	2452950 *	ANTIBODY HAVING ANTI-CANCER ACTIVITY
C07K 16/30 (2006.01)	2452950 *	ANTIBODY HAVING ANTI-CANCER ACTIVITY
A61K 39/00 (2006.01)	2452950 *	ANTIBODY HAVING ANTI-CANCER ACTIVITY
A61P 1/00 (2006.01)	2452950 *	ANTIBODY HAVING ANTI-CANCER ACTIVITY
C12N 15/09 (2006.01)	2452950 *	ANTIBODY HAVING ANTI-CANCER ACTIVITY
A61K 39/395 (2006.01)	2452950 *	ANTIBODY HAVING ANTI-CANCER ACTIVITY
C12N 5/10 (2006.01)	2452950 *	ANTIBODY HAVING ANTI-CANCER ACTIVITY
E06B 1/02 (2006.01)	2275637	Door leaf
E06B 3/964 (2006.01)	2275637	Door leaf
E06B 3/06 (2006.01)	2275637	Door leaf
B29C 70/76 (2006.01)	2275637	Door leaf
E06B 3/88 (2006.01)	2275637	Door leaf
C03C 13/06 (2006.01)	2462068 *	GLASS COMPOSITIONS AND FIBERS MADE THEREFROM
C08J 5/08 (2006.01)	2462068 *	GLASS COMPOSITIONS AND FIBERS MADE THEREFROM
C03C 13/00 (2006.01)	2462068 *	GLASS COMPOSITIONS AND FIBERS MADE THEREFROM
C03C 3/087 (2006.01)	2462068 *	GLASS COMPOSITIONS AND FIBERS MADE THEREFROM
B09B 3/00 (2006.01)	2475470 *	APPARATUS FOR PROCESSING WASTE MATERIAL WITH INWARDLY DIRECTED OPENING
C07K 16/28 (2006.01)	2470568 *	THERAPEUTIC DLL4 BINDING PROTEINS
A61K 31/4188 (2006.01)	2413929 *	METHOD OF TREATING COGNITIVE IMPAIRMENT
A61K 31/4164 (2006.01)	2413929 *	METHOD OF TREATING COGNITIVE IMPAIRMENT
A61P 25/28 (2006.01)	2413929 *	METHOD OF TREATING COGNITIVE IMPAIRMENT
C12N 15/52 (2006.01)	2449107 *	TERPENE SYNTHASES FROM SANTALUM
G01N 33/53 (2006.01)	2449107 *	TERPENE SYNTHASES FROM SANTALUM
C12N 15/29 (2006.01)	2449107 *	TERPENE SYNTHASES FROM SANTALUM
C12N 15/11 (2006.01)	2449107 *	TERPENE SYNTHASES FROM SANTALUM
C12N 15/63 (2006.01)	2449107 *	TERPENE SYNTHASES FROM SANTALUM
C07K 14/415 (2006.01)	2449107 *	TERPENE SYNTHASES FROM SANTALUM

MKP (51)	Broj objave evropske prijava patenta (97)	Naziv pronalaska (54)
F02B 1/12 (2006.01)	2449223 *	INTERNAL COMBUSTION ENGINE WITH SEPARATE COMBUSTION CHAMBER AND A METHOD TO ACHIEVE MODIFIED AND CONTROLLED AUTOIGNITION IN SAID CHAMBER
F02B 19/10 (2006.01)	2449223 *	INTERNAL COMBUSTION ENGINE WITH SEPARATE COMBUSTION CHAMBER AND A METHOD TO ACHIEVE MODIFIED AND CONTROLLED AUTOIGNITION IN SAID CHAMBER
F02B 41/04 (2006.01)	2449223 *	INTERNAL COMBUSTION ENGINE WITH SEPARATE COMBUSTION CHAMBER AND A METHOD TO ACHIEVE MODIFIED AND CONTROLLED AUTOIGNITION IN SAID CHAMBER
F02B 75/02 (2006.01)	2449223 *	INTERNAL COMBUSTION ENGINE WITH SEPARATE COMBUSTION CHAMBER AND A METHOD TO ACHIEVE MODIFIED AND CONTROLLED AUTOIGNITION IN SAID CHAMBER
F02B 41/06 (2006.01)	2449223 *	INTERNAL COMBUSTION ENGINE WITH SEPARATE COMBUSTION CHAMBER AND A METHOD TO ACHIEVE MODIFIED AND CONTROLLED AUTOIGNITION IN SAID CHAMBER
F02B 19/02 (2006.01)	2449223 *	INTERNAL COMBUSTION ENGINE WITH SEPARATE COMBUSTION CHAMBER AND A METHOD TO ACHIEVE MODIFIED AND CONTROLLED AUTOIGNITION IN SAID CHAMBER
A61B 17/06 (2006.01)	2470083 *	AUTOMATED SYSTEMS AND METHODS FOR MAKING BRAIDED BARBED SUTURES
D04C 3/42 (2006.01)	2470083 *	AUTOMATED SYSTEMS AND METHODS FOR MAKING BRAIDED BARBED SUTURES
A61B 17/00 (2006.01)	2470083 *	AUTOMATED SYSTEMS AND METHODS FOR MAKING BRAIDED BARBED SUTURES
E04F 11/16 (2006.01)	2452028 *	DEVICE FOR FIXING THE EDGE OF A FLOOR COVERING TO A PROFILED STRUCTURE
C12P 21/00 (2006.01)	2494045 *	SOLUTION ASSAY AND HIGH THROUGH-PUT SCREEN TO PROBE INTERACTION BETWEEN HUMAN CULLIN-RING LIGASE COMPLEX AND HIV-VIF PROTEIN
C12N 15/70 (2006.01)	2494045 *	SOLUTION ASSAY AND HIGH THROUGH-PUT SCREEN TO PROBE INTERACTION BETWEEN HUMAN CULLIN-RING LIGASE COMPLEX AND HIV-VIF PROTEIN
C12N 15/00 (2006.01)	2494045 *	SOLUTION ASSAY AND HIGH THROUGH-PUT SCREEN TO PROBE INTERACTION BETWEEN HUMAN CULLIN-RING LIGASE COMPLEX AND HIV-VIF PROTEIN
A01N 43/66 (2006.01)	2440055 *	STYRYL-TRIAZINE DERIVATIVES AND THEIR THERAPEUTICAL APPLICATIONS
A61K 31/53 (2006.01)	2440055 *	STYRYL-TRIAZINE DERIVATIVES AND THEIR THERAPEUTICAL APPLICATIONS
G06Q 20/00 (2012.01)	2465080 *	SYSTEM AND METHOD FOR TRANSFERRING MONEY FROM A MOBILE PHONE ACCOUNT
A61K 47/48 (2006.01)	2493514 *	STERILIZATION OF BIODEGRADABLE HYDROGELS
A61K 41/00 (2006.01)	2493514 *	STERILIZATION OF BIODEGRADABLE HYDROGELS
A61L 2/00 (2006.01)	2493514 *	STERILIZATION OF BIODEGRADABLE HYDROGELS
C08G 65/329 (2006.01)	2493514 *	STERILIZATION OF BIODEGRADABLE HYDROGELS
A61K 9/16 (2006.01)	2493514 *	STERILIZATION OF BIODEGRADABLE HYDROGELS
A61P 43/00 (2006.01)	2493514 *	STERILIZATION OF BIODEGRADABLE HYDROGELS
A61P 35/00 (2006.01)	2493466 *	NOVEL ANTITUMORAL USE OF CABAZITAXEL
A61K 31/56 (2006.01)	2493466 *	NOVEL ANTITUMORAL USE OF CABAZITAXEL
A61K 45/06 (2006.01)	2493466 *	NOVEL ANTITUMORAL USE OF CABAZITAXEL
A61K 31/164 (2006.01)	2493466 *	NOVEL ANTITUMORAL USE OF CABAZITAXEL
A61K 31/4965 (2006.01)	2448920 *	NOVEL BENZENESULFONAMIDE COMPOUNDS, METHOD FOR SYNTHESIZING SAME, AND USE THEREOF IN MEDICINE AS WELL AS IN COSMETICS
C07D 215/14 (2006.01)	2448920 *	NOVEL BENZENESULFONAMIDE COMPOUNDS, METHOD FOR SYNTHESIZING SAME, AND USE THEREOF IN MEDICINE AS WELL AS IN COSMETICS

MKP (51)	Broj objave evropske prijava patenta (97)	Naziv pronalaska (54)
C07D 261/20 (2006.01)	2448920 *	NOVEL BENZENESULFONAMIDE COMPOUNDS, METHOD FOR SYNTHESIZING SAME, AND USE THEREOF IN MEDICINE AS WELL AS IN COSMETICS
C07D 295/26 (2006.01)	2448920 *	NOVEL BENZENESULFONAMIDE COMPOUNDS, METHOD FOR SYNTHESIZING SAME, AND USE THEREOF IN MEDICINE AS WELL AS IN COSMETICS
C07D 209/10 (2006.01)	2448920 *	NOVEL BENZENESULFONAMIDE COMPOUNDS, METHOD FOR SYNTHESIZING SAME, AND USE THEREOF IN MEDICINE AS WELL AS IN COSMETICS
A61P 25/00 (2006.01)	2448920 *	NOVEL BENZENESULFONAMIDE COMPOUNDS, METHOD FOR SYNTHESIZING SAME, AND USE THEREOF IN MEDICINE AS WELL AS IN COSMETICS
C07D 471/04 (2006.01)	2448920 *	NOVEL BENZENESULFONAMIDE COMPOUNDS, METHOD FOR SYNTHESIZING SAME, AND USE THEREOF IN MEDICINE AS WELL AS IN COSMETICS
C07D 213/30 (2006.01)	2448920 *	NOVEL BENZENESULFONAMIDE COMPOUNDS, METHOD FOR SYNTHESIZING SAME, AND USE THEREOF IN MEDICINE AS WELL AS IN COSMETICS
A61P 29/00 (2006.01)	2448920 *	NOVEL BENZENESULFONAMIDE COMPOUNDS, METHOD FOR SYNTHESIZING SAME, AND USE THEREOF IN MEDICINE AS WELL AS IN COSMETICS
A61P 35/00 (2006.01)	2448920 *	NOVEL BENZENESULFONAMIDE COMPOUNDS, METHOD FOR SYNTHESIZING SAME, AND USE THEREOF IN MEDICINE AS WELL AS IN COSMETICS
A61K 31/155 (2006.01)	2451482 *	COMBINATION THERAPY FOR THE TREATMENT OF DIABETES
A61K 45/06 (2006.01)	2451482 *	COMBINATION THERAPY FOR THE TREATMENT OF DIABETES
A61P 3/04 (2006.01)	2451482 *	COMBINATION THERAPY FOR THE TREATMENT OF DIABETES
A61P 3/10 (2006.01)	2451482 *	COMBINATION THERAPY FOR THE TREATMENT OF DIABETES
A61K 31/7034 (2006.01)	2451482 *	COMBINATION THERAPY FOR THE TREATMENT OF DIABETES
G01F 19/00 (2006.01)	2449350 *	A MEASURING DEVICE
C12C 11/00 (2006.01)	2467465 *	ALCOHOLIC COMPOSITIONS HAVING A LOWERED RISK OF ACETALDEHYDEMIAS
C12Q 1/68 (2006.01)	2425017 *	A METHOD FOR DETECTION OF HUMAN PAPILLOMAVIRUS (HPV) TYPE
C12Q 1/70 (2006.01)	2425017 *	A METHOD FOR DETECTION OF HUMAN PAPILLOMAVIRUS (HPV) TYPE
C12N 15/11 (2006.01)	2425017 *	A METHOD FOR DETECTION OF HUMAN PAPILLOMAVIRUS (HPV) TYPE
G06F 21/00 (2006.01)	2309408	Method and system for detection and prediction of computer virus-related epidemics
A61K 31/433 (2006.01)	2419419 *	4-AZETIDINYL-1-PHENYL-CYCLOHEXANE ANTAGONISTS OF CCR2
A61P 3/10 (2006.01)	2419419 *	4-AZETIDINYL-1-PHENYL-CYCLOHEXANE ANTAGONISTS OF CCR2
C07D 401/08 (2006.01)	2419419 *	4-AZETIDINYL-1-PHENYL-CYCLOHEXANE ANTAGONISTS OF CCR2
A61P 29/00 (2006.01)	2419419 *	4-AZETIDINYL-1-PHENYL-CYCLOHEXANE ANTAGONISTS OF CCR2
C07D 403/08 (2006.01)	2419419 *	4-AZETIDINYL-1-PHENYL-CYCLOHEXANE ANTAGONISTS OF CCR2
C07D 205/04 (2006.01)	2419419 *	4-AZETIDINYL-1-PHENYL-CYCLOHEXANE ANTAGONISTS OF CCR2
C07D 413/08 (2006.01)	2419419 *	4-AZETIDINYL-1-PHENYL-CYCLOHEXANE ANTAGONISTS OF CCR2
C07D 403/10 (2006.01)	2419419 *	4-AZETIDINYL-1-PHENYL-CYCLOHEXANE ANTAGONISTS OF CCR2
C07D 417/08 (2006.01)	2419419 *	4-AZETIDINYL-1-PHENYL-CYCLOHEXANE ANTAGONISTS OF CCR2
C07D 405/08 (2006.01)	2419419 *	4-AZETIDINYL-1-PHENYL-CYCLOHEXANE ANTAGONISTS OF CCR2
A61K 31/4427 (2006.01)	2419419 *	4-AZETIDINYL-1-PHENYL-CYCLOHEXANE ANTAGONISTS OF CCR2
A61K 31/437 (2006.01)	2419419 *	4-AZETIDINYL-1-PHENYL-CYCLOHEXANE ANTAGONISTS OF CCR2
A61K 9/16 (2006.01)	2413911 *	PROGRESSIVE EMULSION CRYSTALLIZATION
C07D 215/18 (2006.01)	2413911 *	PROGRESSIVE EMULSION CRYSTALLIZATION
A61K 31/545 (2006.01)	2480236 *	COMPOSITIONS AND METHODS FOR TREATING BACTERIAL INFECTIONS USING CEFTAROLINE

MKP (51)	Broj objave evropske prijava patenta (97)	Naziv pronalaska (54)
C07D 239/42 (2006.01)	2448940 *	NOVEL 1,2,3,4-TETRAHYDRO-PYRIMIDO(1,2-A)PYRIMIDIN-6-ONE DERIVATIVES, PREPARATION THEREOF, AND PHARMACEUTICAL USE THEREOF
C07D 487/04 (2006.01)	2448940 *	NOVEL 1,2,3,4-TETRAHYDRO-PYRIMIDO(1,2-A)PYRIMIDIN-6-ONE DERIVATIVES, PREPARATION THEREOF, AND PHARMACEUTICAL USE THEREOF
A61K 31/519 (2006.01)	2448940 *	NOVEL 1,2,3,4-TETRAHYDRO-PYRIMIDO(1,2-A)PYRIMIDIN-6-ONE DERIVATIVES, PREPARATION THEREOF, AND PHARMACEUTICAL USE THEREOF
C07D 239/06 (2006.01)	2448940 *	NOVEL 1,2,3,4-TETRAHYDRO-PYRIMIDO(1,2-A)PYRIMIDIN-6-ONE DERIVATIVES, PREPARATION THEREOF, AND PHARMACEUTICAL USE THEREOF
A61P 35/00 (2006.01)	2448940 *	NOVEL 1,2,3,4-TETRAHYDRO-PYRIMIDO(1,2-A)PYRIMIDIN-6-ONE DERIVATIVES, PREPARATION THEREOF, AND PHARMACEUTICAL USE THEREOF
F03D 7/02 (2006.01)	2284390	Hydraulic station and method for controlling pressure in a hydraulic system of a wind turbine
A61M 15/00 (2006.01)	2408497 *	COUNTER
G06M 1/16 (2006.01)	2408497 *	COUNTER
F02M 51/00 (2006.01)	2409013 *	ACTUATOR ARRANGEMENT
F02M 51/06 (2006.01)	2409013 *	ACTUATOR ARRANGEMENT
F02M 63/00 (2006.01)	2409013 *	ACTUATOR ARRANGEMENT
F02M 47/02 (2006.01)	2409013 *	ACTUATOR ARRANGEMENT
G07F 7/10 (2006.01)	2462567 *	A PAYMENT TERMINAL USING A MOBILE COMMUNICATION DEVICE, SUCH AS A MOBILE PHONE; A METHOD OF DIRECT DEBIT PAYMENT TRANSACTION
G06Q 20/00 (2012.01)	2462567 *	A PAYMENT TERMINAL USING A MOBILE COMMUNICATION DEVICE, SUCH AS A MOBILE PHONE; A METHOD OF DIRECT DEBIT PAYMENT TRANSACTION
A61P 9/12 (2006.01)	2498779 *	PEMIROLAST FOR THE TREATMENT OF SYSTEMIC LOW GRADE INFLAMMATION
A61P 3/10 (2006.01)	2498779 *	PEMIROLAST FOR THE TREATMENT OF SYSTEMIC LOW GRADE INFLAMMATION
A61K 31/519 (2006.01)	2498779 *	PEMIROLAST FOR THE TREATMENT OF SYSTEMIC LOW GRADE INFLAMMATION
A61P 29/00 (2006.01)	2498779 *	PEMIROLAST FOR THE TREATMENT OF SYSTEMIC LOW GRADE INFLAMMATION
A61P 3/00 (2006.01)	2498779 *	PEMIROLAST FOR THE TREATMENT OF SYSTEMIC LOW GRADE INFLAMMATION
A61K 38/48 (2006.01)	2480249 *	USE OF PLASMIN FOR THE TREATMENT OF FILTRATION FAILURE AFTER TRABECULECTOMY
A61P 27/02 (2006.01)	2480249 *	USE OF PLASMIN FOR THE TREATMENT OF FILTRATION FAILURE AFTER TRABECULECTOMY
H04W 92/02 (2009.01)	2494750 *	ROUTING DEVICE AND METHOD OF CONFIGURATION FOR NETWORK NAME RESOLUTION OF SAME
H04L 12/66 (2006.01)	2494750 *	ROUTING DEVICE AND METHOD OF CONFIGURATION FOR NETWORK NAME RESOLUTION OF SAME
A61K 39/00 (2006.01)	2494061 *	ANTIBODY GLYCOSYLATION VARIANTS
C12P 21/06 (2006.01)	2494061 *	ANTIBODY GLYCOSYLATION VARIANTS
C07K 14/62 (2006.01)	2459228 *	PRODRUGS COMPRISING AN INSULIN LINKER CONJUGATE
A61K 38/28 (2006.01)	2459228 *	PRODRUGS COMPRISING AN INSULIN LINKER CONJUGATE
A61K 47/48 (2006.01)	2459228 *	PRODRUGS COMPRISING AN INSULIN LINKER CONJUGATE
A61P 3/10 (2006.01)	2459228 *	PRODRUGS COMPRISING AN INSULIN LINKER CONJUGATE
A61K 39/395 (2006.01)	2467164 *	ANTIBODIES AGAINST THE ECTODOMAIN OF ERBB3 AND USES THEREOF
C12P 21/08 (2006.01)	2437780 *	THERAPEUTIC COMPOSITIONS AND METHODS FOR THE PREVENTION OF AUTOIMMUNE DISEASES

MKP (51)	Broj objave evropske prijava patenta (97)	Naziv pronalaska (54)
A61K 39/395 (2006.01)	2437780 *	THERAPEUTIC COMPOSITIONS AND METHODS FOR THE PREVENTION OF AUTOIMMUNE DISEASES
A62B 23/02 (2006.01)	2432562 *	PROTECTIVE MASK
G06F 19/00 (2011.01)	2499589 *	METHOD AND SYSTEM FOR PATIENT-SPECIFIC MODELING OF BLOOD FLOW
C07D 405/14 (2006.01)	2475428 *	HETEROCYCLIC DERIVATIVES AS INHIBITORS OF GLUTAMINYL CYCLASE
C07D 413/04 (2006.01)	2475428 *	HETEROCYCLIC DERIVATIVES AS INHIBITORS OF GLUTAMINYL CYCLASE
C07D 417/14 (2006.01)	2475428 *	HETEROCYCLIC DERIVATIVES AS INHIBITORS OF GLUTAMINYL CYCLASE
A61P 25/00 (2006.01)	2475428 *	HETEROCYCLIC DERIVATIVES AS INHIBITORS OF GLUTAMINYL CYCLASE
A61K 31/437 (2006.01)	2475428 *	HETEROCYCLIC DERIVATIVES AS INHIBITORS OF GLUTAMINYL CYCLASE
A61P 25/28 (2006.01)	2475428 *	HETEROCYCLIC DERIVATIVES AS INHIBITORS OF GLUTAMINYL CYCLASE
A61K 31/4184 (2006.01)	2475428 *	HETEROCYCLIC DERIVATIVES AS INHIBITORS OF GLUTAMINYL CYCLASE
C07D 403/14 (2006.01)	2475428 *	HETEROCYCLIC DERIVATIVES AS INHIBITORS OF GLUTAMINYL CYCLASE
C07D 413/14 (2006.01)	2475428 *	HETEROCYCLIC DERIVATIVES AS INHIBITORS OF GLUTAMINYL CYCLASE
C07D 471/04 (2006.01)	2475428 *	HETEROCYCLIC DERIVATIVES AS INHIBITORS OF GLUTAMINYL CYCLASE
A61K 38/00 (2006.01)	2486058 *	POLYPEPTIDES FOR BINDING TO THE "RECEPTOR FOR ADVANCED GLYCATION ENDPRODUCTS" AS WELL AS COMPOSITIONS AND METHODS INVOLVING THE SAME
C07K 16/28 (2006.01)	2486058 *	POLYPEPTIDES FOR BINDING TO THE "RECEPTOR FOR ADVANCED GLYCATION ENDPRODUCTS" AS WELL AS COMPOSITIONS AND METHODS INVOLVING THE SAME
G06F 9/50 (2006.01)	2388727	Team security for portable information devices
G06F 21/00 (2006.01)	2388727	Team security for portable information devices
F02D 41/22 (2006.01)	2295775	Control method for a common rail fuel pump and apparatus for performing the same
F02D 41/38 (2006.01)	2295775	Control method for a common rail fuel pump and apparatus for performing the same
B41M 5/50 (2006.01)	2402167	Paper for inkjet recording
D21H 19/82 (2006.01)	2402167	Paper for inkjet recording
A61K 9/14 (2006.01)	2424506 *	ORAL FORMULATIONS OF BENDAMUSTINE
A61K 31/4184 (2006.01)	2424506 *	ORAL FORMULATIONS OF BENDAMUSTINE
A61K 31/497 (2006.01)	2492269 *	AMINOTHIAZOLE DERIVATIVE
A61P 11/06 (2006.01)	2492269 *	AMINOTHIAZOLE DERIVATIVE
A61K 31/496 (2006.01)	2492269 *	AMINOTHIAZOLE DERIVATIVE
A61P 9/10 (2006.01)	2492269 *	AMINOTHIAZOLE DERIVATIVE
A61P 35/00 (2006.01)	2492269 *	AMINOTHIAZOLE DERIVATIVE
A61K 31/4439 (2006.01)	2492269 *	AMINOTHIAZOLE DERIVATIVE
A61P 3/04 (2006.01)	2492269 *	AMINOTHIAZOLE DERIVATIVE
A61P 27/02 (2006.01)	2492269 *	AMINOTHIAZOLE DERIVATIVE
A61K 31/506 (2006.01)	2492269 *	AMINOTHIAZOLE DERIVATIVE
A61P 17/00 (2006.01)	2492269 *	AMINOTHIAZOLE DERIVATIVE
A61K 31/427 (2006.01)	2492269 *	AMINOTHIAZOLE DERIVATIVE
A61P 1/16 (2006.01)	2492269 *	AMINOTHIAZOLE DERIVATIVE
A61P 25/00 (2006.01)	2492269 *	AMINOTHIAZOLE DERIVATIVE

MKP (51)	Broj objave evropske prijave patenta (97)	Naziv pronalaska (54)
C07D 417/04 (2006.01)	2492269 *	AMINOTHIAZOLE DERIVATIVE
A61P 1/04 (2006.01)	2492269 *	AMINOTHIAZOLE DERIVATIVE
A61P 19/02 (2006.01)	2492269 *	AMINOTHIAZOLE DERIVATIVE
A61K 31/5377 (2006.01)	2492269 *	AMINOTHIAZOLE DERIVATIVE
A61P 17/06 (2006.01)	2492269 *	AMINOTHIAZOLE DERIVATIVE
A61K 31/454 (2006.01)	2492269 *	AMINOTHIAZOLE DERIVATIVE
A61P 3/06 (2006.01)	2492269 *	AMINOTHIAZOLE DERIVATIVE
A61P 29/00 (2006.01)	2492269 *	AMINOTHIAZOLE DERIVATIVE
B65D 85/04 (2006.01)	2230194	Packaging for a plurality of coils of feedwire
B65D 5/60 (2006.01)	2230194	Packaging for a plurality of coils of feedwire
A61P 35/00 (2006.01)	2471790 *	FUSED HETEROCYCLIC RING DERIVATIVE AND USE THEREOF
A61P 43/00 (2006.01)	2471790 *	FUSED HETEROCYCLIC RING DERIVATIVE AND USE THEREOF
A61K 31/55 (2006.01)	2471790 *	FUSED HETEROCYCLIC RING DERIVATIVE AND USE THEREOF
A61K 31/5377 (2006.01)	2471790 *	FUSED HETEROCYCLIC RING DERIVATIVE AND USE THEREOF
C07D 471/04 (2006.01)	2471790 *	FUSED HETEROCYCLIC RING DERIVATIVE AND USE THEREOF
A61K 31/444 (2006.01)	2471790 *	FUSED HETEROCYCLIC RING DERIVATIVE AND USE THEREOF
A61K 31/4545 (2006.01)	2471790 *	FUSED HETEROCYCLIC RING DERIVATIVE AND USE THEREOF
A61K 31/437 (2006.01)	2471790 *	FUSED HETEROCYCLIC RING DERIVATIVE AND USE THEREOF
D21H 21/52 (2006.01)	2480718 *	AQUEOUS SLURRIES COMPRISING FINE CALCIUM CARBONATE PARTICLES FOR USE IN PAPER COATINGS
C09C 1/02 (2006.01)	2480718 *	AQUEOUS SLURRIES COMPRISING FINE CALCIUM CARBONATE PARTICLES FOR USE IN PAPER COATINGS
D21H 17/68 (2006.01)	2480718 *	AQUEOUS SLURRIES COMPRISING FINE CALCIUM CARBONATE PARTICLES FOR USE IN PAPER COATINGS
D21H 19/38 (2006.01)	2480718 *	AQUEOUS SLURRIES COMPRISING FINE CALCIUM CARBONATE PARTICLES FOR USE IN PAPER COATINGS
D21H 17/67 (2006.01)	2480718 *	AQUEOUS SLURRIES COMPRISING FINE CALCIUM CARBONATE PARTICLES FOR USE IN PAPER COATINGS
C01F 11/18 (2006.01)	2480718 *	AQUEOUS SLURRIES COMPRISING FINE CALCIUM CARBONATE PARTICLES FOR USE IN PAPER COATINGS
D21H 19/40 (2006.01)	2480718 *	AQUEOUS SLURRIES COMPRISING FINE CALCIUM CARBONATE PARTICLES FOR USE IN PAPER COATINGS
C07D 335/02 (2006.01)	2500342 *	1-HETERODIENE DERIVATIVE AND NOXIOUS ORGANISM CONTROL AGENT
C07D 417/12 (2006.01)	2500342 *	1-HETERODIENE DERIVATIVE AND NOXIOUS ORGANISM CONTROL AGENT
A01N 43/10 (2006.01)	2500342 *	1-HETERODIENE DERIVATIVE AND NOXIOUS ORGANISM CONTROL AGENT
A01N 43/18 (2006.01)	2500342 *	1-HETERODIENE DERIVATIVE AND NOXIOUS ORGANISM CONTROL AGENT
C07D 333/36 (2006.01)	2500342 *	1-HETERODIENE DERIVATIVE AND NOXIOUS ORGANISM CONTROL AGENT
A01P 7/02 (2006.01)	2500342 *	1-HETERODIENE DERIVATIVE AND NOXIOUS ORGANISM CONTROL AGENT
A01P 7/04 (2006.01)	2500342 *	1-HETERODIENE DERIVATIVE AND NOXIOUS ORGANISM CONTROL AGENT
C07D 409/12 (2006.01)	2500342 *	1-HETERODIENE DERIVATIVE AND NOXIOUS ORGANISM CONTROL AGENT
C07D 401/12 (2006.01)	2408763 *	DERIVATIVES OF N-Ų(2-AZA-BICYCLOŲ2.1.1"HEX-1-YL)-ARYL-METHYL"-HETEROBENZAMIDE, PREPARATION THEREOF AND APPLICATION OF SAME IN THERAPEUTICS
C07D 403/12 (2006.01)	2408763 *	DERIVATIVES OF N-Ų(2-AZA-BICYCLOŲ2.1.1"HEX-1-YL)-ARYL-METHYL"-HETEROBENZAMIDE, PREPARATION THEREOF AND APPLICATION OF SAME IN THERAPEUTICS

MKP (51)	Broj objave evropske prijava patenta (97)	Naziv pronalaska (54)
C07D 409/12 (2006.01)	2408763 *	DERIVATIVES OF N-Ý(2-AZA-BICYCLOÝ2.1.1"HEX-1-YL)-ARYL-METHYL"-HETEROBENZAMIDE, PREPARATION THEREOF AND APPLICATION OF SAME IN THERAPEUTICS
C07D 209/52 (2006.01)	2408763 *	DERIVATIVES OF N-Ý(2-AZA-BICYCLOÝ2.1.1"HEX-1-YL)-ARYL-METHYL"-HETEROBENZAMIDE, PREPARATION THEREOF AND APPLICATION OF SAME IN THERAPEUTICS
C07D 333/38 (2006.01)	2408763 *	DERIVATIVES OF N-Ý(2-AZA-BICYCLOÝ2.1.1"HEX-1-YL)-ARYL-METHYL"-HETEROBENZAMIDE, PREPARATION THEREOF AND APPLICATION OF SAME IN THERAPEUTICS
A61K 31/381 (2006.01)	2408763 *	DERIVATIVES OF N-Ý(2-AZA-BICYCLOÝ2.1.1"HEX-1-YL)-ARYL-METHYL"-HETEROBENZAMIDE, PREPARATION THEREOF AND APPLICATION OF SAME IN THERAPEUTICS
A61K 31/403 (2006.01)	2408763 *	DERIVATIVES OF N-Ý(2-AZA-BICYCLOÝ2.1.1"HEX-1-YL)-ARYL-METHYL"-HETEROBENZAMIDE, PREPARATION THEREOF AND APPLICATION OF SAME IN THERAPEUTICS
A61K 31/4439 (2006.01)	2408763 *	DERIVATIVES OF N-Ý(2-AZA-BICYCLOÝ2.1.1"HEX-1-YL)-ARYL-METHYL"-HETEROBENZAMIDE, PREPARATION THEREOF AND APPLICATION OF SAME IN THERAPEUTICS
C07D 451/02 (2006.01)	2408763 *	DERIVATIVES OF N-Ý(2-AZA-BICYCLOÝ2.1.1"HEX-1-YL)-ARYL-METHYL"-HETEROBENZAMIDE, PREPARATION THEREOF AND APPLICATION OF SAME IN THERAPEUTICS
C07D 213/81 (2006.01)	2408763 *	DERIVATIVES OF N-Ý(2-AZA-BICYCLOÝ2.1.1"HEX-1-YL)-ARYL-METHYL"-HETEROBENZAMIDE, PREPARATION THEREOF AND APPLICATION OF SAME IN THERAPEUTICS
A61K 31/407 (2006.01)	2408763 *	DERIVATIVES OF N-Ý(2-AZA-BICYCLOÝ2.1.1"HEX-1-YL)-ARYL-METHYL"-HETEROBENZAMIDE, PREPARATION THEREOF AND APPLICATION OF SAME IN THERAPEUTICS
A61P 25/00 (2006.01)	2408763 *	DERIVATIVES OF N-Ý(2-AZA-BICYCLOÝ2.1.1"HEX-1-YL)-ARYL-METHYL"-HETEROBENZAMIDE, PREPARATION THEREOF AND APPLICATION OF SAME IN THERAPEUTICS
C07D 487/08 (2006.01)	2408763 *	DERIVATIVES OF N-Ý(2-AZA-BICYCLOÝ2.1.1"HEX-1-YL)-ARYL-METHYL"-HETEROBENZAMIDE, PREPARATION THEREOF AND APPLICATION OF SAME IN THERAPEUTICS
C07D 333/16 (2006.01)	2408763 *	DERIVATIVES OF N-Ý(2-AZA-BICYCLOÝ2.1.1"HEX-1-YL)-ARYL-METHYL"-HETEROBENZAMIDE, PREPARATION THEREOF AND APPLICATION OF SAME IN THERAPEUTICS
C07D 213/46 (2006.01)	2408763 *	DERIVATIVES OF N-Ý(2-AZA-BICYCLOÝ2.1.1"HEX-1-YL)-ARYL-METHYL"-HETEROBENZAMIDE, PREPARATION THEREOF AND APPLICATION OF SAME IN THERAPEUTICS
C07D 209/12 (2006.01)	2408763 *	DERIVATIVES OF N-Ý(2-AZA-BICYCLOÝ2.1.1"HEX-1-YL)-ARYL-METHYL"-HETEROBENZAMIDE, PREPARATION THEREOF AND APPLICATION OF SAME IN THERAPEUTICS
C07D 209/02 (2006.01)	2408763 *	DERIVATIVES OF N-Ý(2-AZA-BICYCLOÝ2.1.1"HEX-1-YL)-ARYL-METHYL"-HETEROBENZAMIDE, PREPARATION THEREOF AND APPLICATION OF SAME IN THERAPEUTICS
A61K 31/44 (2006.01)	2408763 *	DERIVATIVES OF N-Ý(2-AZA-BICYCLOÝ2.1.1"HEX-1-YL)-ARYL-METHYL"-HETEROBENZAMIDE, PREPARATION THEREOF AND APPLICATION OF SAME IN THERAPEUTICS
B65B 69/00 (2006.01)	2426056	Packaging intended for transporting hazardous materials
B65D 77/06 (2006.01)	2426056	Packaging intended for transporting hazardous materials
D21B 1/30 (2006.01)	2414435 *	PROCESS FOR THE PRODUCTION OF NANO-FIBRILLAR CELLULOSE GELS
D21C 9/00 (2006.01)	2414435 *	PROCESS FOR THE PRODUCTION OF NANO-FIBRILLAR CELLULOSE GELS
D01F 2/02 (2006.01)	2414435 *	PROCESS FOR THE PRODUCTION OF NANO-FIBRILLAR CELLULOSE GELS
C08J 5/00 (2006.01)	2414435 *	PROCESS FOR THE PRODUCTION OF NANO-FIBRILLAR CELLULOSE GELS
C08J 3/00 (2006.01)	2414435 *	PROCESS FOR THE PRODUCTION OF NANO-FIBRILLAR CELLULOSE GELS

MKP (51)	Broj objave evropske prijava patenta (97)	Naziv pronalaska (54)
C08J 3/075 (2006.01)	2414435 *	PROCESS FOR THE PRODUCTION OF NANO-FIBRILLAR CELLULOSE GELS
D21B 1/04 (2006.01)	2414435 *	PROCESS FOR THE PRODUCTION OF NANO-FIBRILLAR CELLULOSE GELS
C07K 16/30 (2006.01)	2440580 *	ANTI-EpCAM ANTIBODIES
A61P 1/00 (2006.01)	2464373 *	METHOD FOR MODULATING THE PHARMACODYNAMIC EFFECT OF ORALLY ADMINISTERED GUANYLATE CYCLASE RECEPTOR AGONISTS
A61P 1/10 (2006.01)	2464373 *	METHOD FOR MODULATING THE PHARMACODYNAMIC EFFECT OF ORALLY ADMINISTERED GUANYLATE CYCLASE RECEPTOR AGONISTS
A61K 47/00 (2006.01)	2464373 *	METHOD FOR MODULATING THE PHARMACODYNAMIC EFFECT OF ORALLY ADMINISTERED GUANYLATE CYCLASE RECEPTOR AGONISTS
A61K 38/10 (2006.01)	2464373 *	METHOD FOR MODULATING THE PHARMACODYNAMIC EFFECT OF ORALLY ADMINISTERED GUANYLATE CYCLASE RECEPTOR AGONISTS
A61K 9/00 (2006.01)	2464373 *	METHOD FOR MODULATING THE PHARMACODYNAMIC EFFECT OF ORALLY ADMINISTERED GUANYLATE CYCLASE RECEPTOR AGONISTS
A61K 47/48 (2006.01)	2459227 *	PRODRUGS CONTAINING AN AROMATIC AMINE CONNECTED BY AN AMIDO BOND TO A LINKER
A61P 25/16 (2006.01)	2459227 *	PRODRUGS CONTAINING AN AROMATIC AMINE CONNECTED BY AN AMIDO BOND TO A LINKER
E04B 1/10 (2006.01)	2468970 *	METHOD FOR PRODUCING WOODEN HOUSES, STRUCTURES AND CONSTRUCTIONS
G06F 3/048 (2006.01)	2406700 *	SYSTEMS AND METHODS FOR PROVIDING FEATURES IN A FRICTION DISPLAY
G06F 3/041 (2006.01)	2406700 *	SYSTEMS AND METHODS FOR PROVIDING FEATURES IN A FRICTION DISPLAY
G06F 3/01 (2006.01)	2406700 *	SYSTEMS AND METHODS FOR PROVIDING FEATURES IN A FRICTION DISPLAY
C07K 16/28 (2006.01)	2414396 *	PREPARATION OF ISOLATED AGONIST ANTI-EDAR MONOCLONAL ANTIBODIES
A61K 39/395 (2006.01)	2414396 *	PREPARATION OF ISOLATED AGONIST ANTI-EDAR MONOCLONAL ANTIBODIES
B65H 19/18 (2006.01)	2427398 *	A UNIT AND METHOD FOR FEEDING REELS OF A SHEET-LIKE MATERIAL, IN PARTICULAR BUT NOT EXCLUSIVELY A PRINTED PLASTIC FILM WITH PRINT- POSITION MARKS FOR AUTOMATIC PACKAGING MACHINES
C07C 255/54 (2006.01)	2406206 *	TETRAHYDRONAPHTHALEN-2-OL DERIVATIVES
A61K 31/09 (2006.01)	2406206 *	TETRAHYDRONAPHTHALEN-2-OL DERIVATIVES
C07C 43/225 (2006.01)	2406206 *	TETRAHYDRONAPHTHALEN-2-OL DERIVATIVES
A61K 31/222 (2006.01)	2406206 *	TETRAHYDRONAPHTHALEN-2-OL DERIVATIVES
C07C 39/17 (2006.01)	2406206 *	TETRAHYDRONAPHTHALEN-2-OL DERIVATIVES
A61K 31/277 (2006.01)	2406206 *	TETRAHYDRONAPHTHALEN-2-OL DERIVATIVES
C07C 43/21 (2006.01)	2406206 *	TETRAHYDRONAPHTHALEN-2-OL DERIVATIVES
A61P 31/08 (2006.01)	2406206 *	TETRAHYDRONAPHTHALEN-2-OL DERIVATIVES
C07C 43/23 (2006.01)	2406206 *	TETRAHYDRONAPHTHALEN-2-OL DERIVATIVES
A61P 35/00 (2006.01)	2406206 *	TETRAHYDRONAPHTHALEN-2-OL DERIVATIVES
C07C 69/157 (2006.01)	2406206 *	TETRAHYDRONAPHTHALEN-2-OL DERIVATIVES
A61P 25/00 (2006.01)	2406206 *	TETRAHYDRONAPHTHALEN-2-OL DERIVATIVES
C07C 255/55 (2006.01)	2406206 *	TETRAHYDRONAPHTHALEN-2-OL DERIVATIVES
C07C 39/42 (2006.01)	2406206 *	TETRAHYDRONAPHTHALEN-2-OL DERIVATIVES
A61K 31/055 (2006.01)	2406206 *	TETRAHYDRONAPHTHALEN-2-OL DERIVATIVES
A01N 45/00 (2006.01)	2403341 *	LUNG CANCER TREATMENT
A61K 31/56 (2006.01)	2403341 *	LUNG CANCER TREATMENT
C07K 14/605 (2006.01)	2460825 *	DERIVATIVE OF GLP-1 ANALOGUE OR ITS PHARMACEUTICAL SALTS AND THEIR USE
A61K 38/26 (2006.01)	2460825 *	DERIVATIVE OF GLP-1 ANALOGUE OR ITS PHARMACEUTICAL SALTS AND THEIR USE

MKP (51)	Broj objave evropske prijava patenta (97)	Naziv pronalaska (54)
A61K 9/22 (2006.01)	2480246 *	COMPOSITION AND METHOD FOR TREATMENT OF DIABETES
A61K 31/185 (2006.01)	2480246 *	COMPOSITION AND METHOD FOR TREATMENT OF DIABETES
A61K 31/537 (2006.01)	2480246 *	COMPOSITION AND METHOD FOR TREATMENT OF DIABETES
A61P 3/10 (2006.01)	2480246 *	COMPOSITION AND METHOD FOR TREATMENT OF DIABETES
A61K 38/22 (2006.01)	2480246 *	COMPOSITION AND METHOD FOR TREATMENT OF DIABETES
A61P 29/00 (2006.01)	2435438 *	BICYCLIC PYRIMIDINE PI3K INHIBITOR COMPOUNDS SELECTIVE FOR P110 DELTA, AND METHODS OF USE
A61P 25/00 (2006.01)	2435438 *	BICYCLIC PYRIMIDINE PI3K INHIBITOR COMPOUNDS SELECTIVE FOR P110 DELTA, AND METHODS OF USE
C07D 487/04 (2006.01)	2435438 *	BICYCLIC PYRIMIDINE PI3K INHIBITOR COMPOUNDS SELECTIVE FOR P110 DELTA, AND METHODS OF USE
C07D 491/04 (2006.01)	2435438 *	BICYCLIC PYRIMIDINE PI3K INHIBITOR COMPOUNDS SELECTIVE FOR P110 DELTA, AND METHODS OF USE
C07D 513/04 (2006.01)	2435438 *	BICYCLIC PYRIMIDINE PI3K INHIBITOR COMPOUNDS SELECTIVE FOR P110 DELTA, AND METHODS OF USE
A61P 35/00 (2006.01)	2435438 *	BICYCLIC PYRIMIDINE PI3K INHIBITOR COMPOUNDS SELECTIVE FOR P110 DELTA, AND METHODS OF USE
A61K 31/519 (2006.01)	2435438 *	BICYCLIC PYRIMIDINE PI3K INHIBITOR COMPOUNDS SELECTIVE FOR P110 DELTA, AND METHODS OF USE
A61P 9/00 (2006.01)	2435438 *	BICYCLIC PYRIMIDINE PI3K INHIBITOR COMPOUNDS SELECTIVE FOR P110 DELTA, AND METHODS OF USE
C12P 21/06 (2006.01)	2493923 *	SORF CONSTRUCTS AND MULTIPLE GENE EXPRESSION
C07K 16/00 (2006.01)	2493923 *	SORF CONSTRUCTS AND MULTIPLE GENE EXPRESSION
C12P 21/02 (2006.01)	2493923 *	SORF CONSTRUCTS AND MULTIPLE GENE EXPRESSION
E04B 1/24 (2006.01)	2228498	A process of manufacture of an internally isolated building and building constructed according to that process, a method of producing a corresponding superstructural element and superstructural element produced according to that method
E04B 1/74 (2006.01)	2228498	A process of manufacture of an internally isolated building and building constructed according to that process, a method of producing a corresponding superstructural element and superstructural element produced according to that method
A61K 38/22 (2006.01)	2496248 *	METHOD FOR TREATING HEART FAILURE WITH STRESSCOPIN-LIKE PEPTIDES
B66B 11/04 (2006.01)	2432725 *	DEVICE FOR SAVING ENERGY DURING VERTICAL AND HORIZONTAL MOTIONS WHEREIN THE RESISTING TORQUE CAN BE SPLIT INTO TWO TORQUES OPPOSING EACH OTHER
C07D 513/04 (2006.01)	2405973 *	THIAZOLOPYRIMIDINE MODULATORS AS IMMUNOSUPPRESSIVE AGENTS
A61K 31/519 (2006.01)	2405973 *	THIAZOLOPYRIMIDINE MODULATORS AS IMMUNOSUPPRESSIVE AGENTS
A61P 29/00 (2006.01)	2405973 *	THIAZOLOPYRIMIDINE MODULATORS AS IMMUNOSUPPRESSIVE AGENTS
H04L 12/24 (2006.01)	2486698 *	METHOD AND SYSTEM FOR RECONSTRUCTING TRANSACTIONS IN A COMMUNICATION NETWORK
G01N 33/569 (2006.01)	2470907 *	PROTEINS USED FOR THE DIAGNOSIS OF LYME BORRELIOSIS
C07K 14/20 (2006.01)	2470907 *	PROTEINS USED FOR THE DIAGNOSIS OF LYME BORRELIOSIS
C08G 63/66 (2006.01)	2464678 *	SEMI-CRYSTALLINE, FAST ABSORBING POLYMER FORMULATION
C08G 63/08 (2006.01)	2464678 *	SEMI-CRYSTALLINE, FAST ABSORBING POLYMER FORMULATION
C08G 63/60 (2006.01)	2464678 *	SEMI-CRYSTALLINE, FAST ABSORBING POLYMER FORMULATION
A01H 5/00 (2006.01)	2473024 *	HERBICIDE-TOLERANT PLANTS
C12Q 1/04 (2006.01)	2473024 *	HERBICIDE-TOLERANT PLANTS
C12N 15/82 (2006.01)	2473024 *	HERBICIDE-TOLERANT PLANTS
C12N 15/52 (2006.01)	2473024 *	HERBICIDE-TOLERANT PLANTS
B65B 23/14 (2006.01)	2364916	Plant for forming and for continuous synchronised transferring of compact groups of products drawn near one another along the transfer path

MKP (51)	Broj objave evropske prijave patenta (97)	Naziv pronalaska (54)
B65B 35/44 (2006.01)	2364916	Plant for forming and for continuous synchronised transferring of compact groups of products drawn near one another along the transfer path
B65G 17/26 (2006.01)	2364916	Plant for forming and for continuous synchronised transferring of compact groups of products drawn near one another along the transfer path
B65G 47/82 (2006.01)	2364916	Plant for forming and for continuous synchronised transferring of compact groups of products drawn near one another along the transfer path
B65G 47/84 (2006.01)	2364916	Plant for forming and for continuous synchronised transferring of compact groups of products drawn near one another along the transfer path
C03B 9/16 (2006.01)	2429960 *	GLASSWARE FORMING MACHINE BAFFLE ARM ASSEMBLY
C03B 9/36 (2006.01)	2429960 *	GLASSWARE FORMING MACHINE BAFFLE ARM ASSEMBLY
F16B 7/20 (2006.01)	2429960 *	GLASSWARE FORMING MACHINE BAFFLE ARM ASSEMBLY
F16B 21/04 (2006.01)	2429960 *	GLASSWARE FORMING MACHINE BAFFLE ARM ASSEMBLY
F16D 1/112 (2006.01)	2429960 *	GLASSWARE FORMING MACHINE BAFFLE ARM ASSEMBLY
B23Q 1/28 (2006.01)	2440358 *	MACHINE FOR MAKING GEARS
B23F 17/00 (2006.01)	2440358 *	MACHINE FOR MAKING GEARS
B32B 21/02 (2006.01)	2277692	Insulation board, adhesive mortar for attaching an insulation board to a wall or a ceiling of a building and assembly, comprising an insulation board and an adhesive mortar
B32B 21/10 (2006.01)	2277692	Insulation board, adhesive mortar for attaching an insulation board to a wall or a ceiling of a building and assembly, comprising an insulation board and an adhesive mortar
B32B 19/06 (2006.01)	2277692	Insulation board, adhesive mortar for attaching an insulation board to a wall or a ceiling of a building and assembly, comprising an insulation board and an adhesive mortar
E04C 2/00 (2006.01)	2277692	Insulation board, adhesive mortar for attaching an insulation board to a wall or a ceiling of a building and assembly, comprising an insulation board and an adhesive mortar
E04F 13/00 (2006.01)	2277692	Insulation board, adhesive mortar for attaching an insulation board to a wall or a ceiling of a building and assembly, comprising an insulation board and an adhesive mortar
C04B 28/04 (2006.01)	2277692	Insulation board, adhesive mortar for attaching an insulation board to a wall or a ceiling of a building and assembly, comprising an insulation board and an adhesive mortar
B32B 5/26 (2006.01)	2277692	Insulation board, adhesive mortar for attaching an insulation board to a wall or a ceiling of a building and assembly, comprising an insulation board and an adhesive mortar
G01N 23/04 (2006.01)	2443441 *	METHOD AND APPARATUS FOR ASSESSING THE THREAT STATUS OF LUGGAGE
A61P 27/02 (2006.01)	2403937 *	METHODS OF INHIBITING PHOTORECEPTOR APOPTOSIS
C12N 5/02 (2006.01)	2403937 *	METHODS OF INHIBITING PHOTORECEPTOR APOPTOSIS
C07K 14/54 (2006.01)	2403937 *	METHODS OF INHIBITING PHOTORECEPTOR APOPTOSIS
A61K 38/20 (2006.01)	2403937 *	METHODS OF INHIBITING PHOTORECEPTOR APOPTOSIS
A61F 13/02 (2006.01)	2489339 *	METHOD AND DEVICE FOR PRODUCING ADHESIVE PATCH
A61K 9/70 (2006.01)	2489339 *	METHOD AND DEVICE FOR PRODUCING ADHESIVE PATCH
A61L 15/58 (2006.01)	2489339 *	METHOD AND DEVICE FOR PRODUCING ADHESIVE PATCH
H02G 3/08 (2006.01)	2486635 *	GASKET FOR ELECTRIC CABLES
H02G 3/22 (2006.01)	2486635 *	GASKET FOR ELECTRIC CABLES
H02G 15/013 (2006.01)	2486635 *	GASKET FOR ELECTRIC CABLES
G08C 15/06 (2006.01)	2406778 *	PROCESS, DEVICE AND SYSTEM FOR MAPPING TRANSFORMERS TO METERS AND LOCATING NON-TECHNICAL LINE LOSSES
C07D 417/12 (2006.01)	2430019 *	COMPOUNDS WITH TWO FUSED BICYCLIC HETEROARYL MOIETIES AS MODULATORS OF LEUKOTRIENE A4 HYDROLASE
A61K 31/423 (2006.01)	2430019 *	COMPOUNDS WITH TWO FUSED BICYCLIC HETEROARYL MOIETIES AS MODULATORS OF LEUKOTRIENE A4 HYDROLASE
C07D 417/14 (2006.01)	2430019 *	COMPOUNDS WITH TWO FUSED BICYCLIC HETEROARYL MOIETIES AS MODULATORS OF LEUKOTRIENE A4 HYDROLASE

MKP (51)	Broj objave evropske prijava patenta (97)	Naziv pronalaska (54)
A61K 31/424 (2006.01)	2430019 *	COMPOUNDS WITH TWO FUSED BICYCLIC HETEROARYL MOIETIES AS MODULATORS OF LEUKOTRIENE A4 HYDROLASE
C07D 493/04 (2006.01)	2430019 *	COMPOUNDS WITH TWO FUSED BICYCLIC HETEROARYL MOIETIES AS MODULATORS OF LEUKOTRIENE A4 HYDROLASE
A61K 31/428 (2006.01)	2430019 *	COMPOUNDS WITH TWO FUSED BICYCLIC HETEROARYL MOIETIES AS MODULATORS OF LEUKOTRIENE A4 HYDROLASE
C07D 495/04 (2006.01)	2430019 *	COMPOUNDS WITH TWO FUSED BICYCLIC HETEROARYL MOIETIES AS MODULATORS OF LEUKOTRIENE A4 HYDROLASE
A61K 31/429 (2006.01)	2430019 *	COMPOUNDS WITH TWO FUSED BICYCLIC HETEROARYL MOIETIES AS MODULATORS OF LEUKOTRIENE A4 HYDROLASE
C07D 498/04 (2006.01)	2430019 *	COMPOUNDS WITH TWO FUSED BICYCLIC HETEROARYL MOIETIES AS MODULATORS OF LEUKOTRIENE A4 HYDROLASE
C07D 413/12 (2006.01)	2430019 *	COMPOUNDS WITH TWO FUSED BICYCLIC HETEROARYL MOIETIES AS MODULATORS OF LEUKOTRIENE A4 HYDROLASE
C07D 519/00 (2006.01)	2430019 *	COMPOUNDS WITH TWO FUSED BICYCLIC HETEROARYL MOIETIES AS MODULATORS OF LEUKOTRIENE A4 HYDROLASE
C07D 513/04 (2006.01)	2430019 *	COMPOUNDS WITH TWO FUSED BICYCLIC HETEROARYL MOIETIES AS MODULATORS OF LEUKOTRIENE A4 HYDROLASE
C07D 413/14 (2006.01)	2430019 *	COMPOUNDS WITH TWO FUSED BICYCLIC HETEROARYL MOIETIES AS MODULATORS OF LEUKOTRIENE A4 HYDROLASE
A61P 29/00 (2006.01)	2430019 *	COMPOUNDS WITH TWO FUSED BICYCLIC HETEROARYL MOIETIES AS MODULATORS OF LEUKOTRIENE A4 HYDROLASE
A63K 3/04 (2006.01)	2459290 *	HURDLE
H04W 28/26 (2009.01)	2469921 *	METHOD, SYSTEM AND APPARATUS FOR ACK/NACK RESOURCE RESERVATION
A23L 1/00 (2006.01)	2437624 *	FOOD PRODUCTS COMPRISING ZEOLITES
A23L 1/304 (2006.01)	2437624 *	FOOD PRODUCTS COMPRISING ZEOLITES
A23L 1/03 (2006.01)	2437624 *	FOOD PRODUCTS COMPRISING ZEOLITES
C07D 491/20 (2006.01)	2488531 *	SYNTHETIC METHODS FOR SPIRO-OXINDOLE COMPOUNDS
A61K 31/519 (2006.01)	2470539 *	RAF INHIBITOR COMPOUNDS AND METHODS OF USE THEREOF
A61P 35/00 (2006.01)	2470539 *	RAF INHIBITOR COMPOUNDS AND METHODS OF USE THEREOF
C07D 487/04 (2006.01)	2470539 *	RAF INHIBITOR COMPOUNDS AND METHODS OF USE THEREOF
C03C 25/24 (2006.01)	2438025 *	MINERAL FIBER MAT CONTAINING A FORMALDEHYDE-TRAPPING AGENT, AND METHODS FOR MANUFACTURING SAME
A61K 8/11 (2006.01)	2440193 *	PROCESS FOR THE PREPARATION OF COLLOIDAL SYSTEMS FOR THE DELIVERY OF ACTIVE COMPOUNDS
A61K 8/73 (2006.01)	2440193 *	PROCESS FOR THE PREPARATION OF COLLOIDAL SYSTEMS FOR THE DELIVERY OF ACTIVE COMPOUNDS
A61K 9/51 (2006.01)	2440193 *	PROCESS FOR THE PREPARATION OF COLLOIDAL SYSTEMS FOR THE DELIVERY OF ACTIVE COMPOUNDS
A61M 5/24 (2006.01)	2477682 *	MEDICATION DELIVERY DEVICE AND METHOD FOR DISPENSING A MEDICATION
A61M 5/315 (2006.01)	2477682 *	MEDICATION DELIVERY DEVICE AND METHOD FOR DISPENSING A MEDICATION
F41B 3/02 (2006.01)	2267395	Groundbait catapult
A01K 97/02 (2006.01)	2267395	Groundbait catapult
C25B 1/46 (2006.01)	2435605 *	PROCESS AND APPARATUS FOR THE ELECTROLYSIS OF AN AQUEOUS SOLUTION OF HYDROGEN CHLORIDE OR ALKALI CHLORIDE IN AN ELECTROLYTIC CELL
C25B 15/08 (2006.01)	2435605 *	PROCESS AND APPARATUS FOR THE ELECTROLYSIS OF AN AQUEOUS SOLUTION OF HYDROGEN CHLORIDE OR ALKALI CHLORIDE IN AN ELECTROLYTIC CELL
C25B 1/26 (2006.01)	2435605 *	PROCESS AND APPARATUS FOR THE ELECTROLYSIS OF AN AQUEOUS SOLUTION OF HYDROGEN CHLORIDE OR ALKALI CHLORIDE IN AN ELECTROLYTIC CELL
F04B 17/04 (2006.01)	2375054	Reagent dosing system and pump

MKP (51)	Broj objave evropske prijava patenta (97)	Naziv pronalaska (54)
F01N 3/20 (2006.01)	2375054	Reagent dosing system and pump
F02M 69/02 (2006.01)	2375054	Reagent dosing system and pump
C09C 1/24 (2006.01)	2261288	Aminosilane modified pigments for spectrally selective coatings, method for preparation and their use in coatings
C09C 1/34 (2006.01)	2261288	Aminosilane modified pigments for spectrally selective coatings, method for preparation and their use in coatings
C09C 3/08 (2006.01)	2261288	Aminosilane modified pigments for spectrally selective coatings, method for preparation and their use in coatings
F24J 2/48 (2006.01)	2261288	Aminosilane modified pigments for spectrally selective coatings, method for preparation and their use in coatings
H01L 31/0216 (2006.01)	2261288	Aminosilane modified pigments for spectrally selective coatings, method for preparation and their use in coatings
B03C 3/60 (2006.01)	2411154 *	WET ELECTROSTATIC PRECIPITATOR SYSTEM COMPONENTS
B03C 3/16 (2006.01)	2411154 *	WET ELECTROSTATIC PRECIPITATOR SYSTEM COMPONENTS
B03C 3/45 (2006.01)	2411154 *	WET ELECTROSTATIC PRECIPITATOR SYSTEM COMPONENTS
G06Q 30/00 (2012.01)	2492863 *	INFORMATION PROVISION DEVICE, INFORMATION PROVISION METHOD, INFORMATION PROVISION PROGRAM, AND COMPUTER-READABLE STORAGE MEDIUM FOR STORING SAID PROGRAM
G06K 17/00 (2006.01)	2492863 *	INFORMATION PROVISION DEVICE, INFORMATION PROVISION METHOD, INFORMATION PROVISION PROGRAM, AND COMPUTER-READABLE STORAGE MEDIUM FOR STORING SAID PROGRAM
F03D 1/00 (2006.01)	2499357 *	A METHOD AND AN APPARATUS FOR ASSEMBLING A WIND POWER PLANT
C12Q 1/68 (2006.01)	2435581 *	NOVEL TISSUE PROTECTIVE ERYTHROPOIETIN RECEPTOR (NEPOR) AND METHODS OF USE
C04B 20/10 (2006.01)	2429969 *	NEW PIGMENT SYSTEM FOR COLORING CEMENT SYSTEMS, IN PARTICULAR CONCRETE
C04B 40/00 (2006.01)	2429969 *	NEW PIGMENT SYSTEM FOR COLORING CEMENT SYSTEMS, IN PARTICULAR CONCRETE
C04B 28/02 (2006.01)	2429969 *	NEW PIGMENT SYSTEM FOR COLORING CEMENT SYSTEMS, IN PARTICULAR CONCRETE
A01N 43/42 (2006.01)	2458992 *	TREATMENT OF CROHN'S DISEASE WITH LAQUINIMOD
A61K 31/42 (2006.01)	2458992 *	TREATMENT OF CROHN'S DISEASE WITH LAQUINIMOD
C07K 16/28 (2006.01)	2493928 *	ANTIBODIES TO ION CHANNELS
F01N 3/035 (2006.01)	2464836 *	MOUNTING MAT FOR EXHAUST GAS TREATMENT DEVICE
B01D 53/92 (2006.01)	2464836 *	MOUNTING MAT FOR EXHAUST GAS TREATMENT DEVICE
B82B 1/00 (2006.01)	2481088 *	PASSIVATED NANOPARTICLES
H01L 29/06 (2006.01)	2481088 *	PASSIVATED NANOPARTICLES
C08B 37/10 (2006.01)	2427503 *	NOVEL ACYLATED DECASACCHARIDES AND THEIR USE AS ANTITHROMBOTIC AGENTS
A61K 31/727 (2006.01)	2427503 *	NOVEL ACYLATED DECASACCHARIDES AND THEIR USE AS ANTITHROMBOTIC AGENTS
C08B 37/00 (2006.01)	2427503 *	NOVEL ACYLATED DECASACCHARIDES AND THEIR USE AS ANTITHROMBOTIC AGENTS
C12P 7/10 (2006.01)	2443245 *	PROCESS FOR PRODUCTION OF SUGARS AND ALCOHOLS FROM A CELLULOSIC MATERIAL
C07K 16/24 (2006.01)	2424893 *	PHARMACEUTICAL AGENT
A61K 39/395 (2006.01)	2424893 *	PHARMACEUTICAL AGENT
A01N 35/00 (2006.01)	2413693 *	SUBSTITUTED AZOANTHRACENE DERIVATIVES, PHARMACEUTICAL COMPOSITIONS, AND METHODS OF USE THEREOF
A61K 31/12 (2006.01)	2413693 *	SUBSTITUTED AZOANTHRACENE DERIVATIVES, PHARMACEUTICAL COMPOSITIONS, AND METHODS OF USE THEREOF
C08L 17/00 (2006.01)	2484720 *	THERMAL REGENERATION METHOD OF WASTE RUBBER
C08J 11/10 (2006.01)	2484720 *	THERMAL REGENERATION METHOD OF WASTE RUBBER

MKP (51)	Broj objave evropske prijava patenta (97)	Naziv pronalaska (54)
A01N 25/34 (2006.01)	2490527 *	COATING FOR OBJECTS, IN PARTICULAR IN PUBLIC FACILITIES AND/OR MEANS OF TRANSPORTATION, FOR PREVENTING THE TRANSMISSION OF INFECTIONS
A01N 25/10 (2006.01)	2490527 *	COATING FOR OBJECTS, IN PARTICULAR IN PUBLIC FACILITIES AND/OR MEANS OF TRANSPORTATION, FOR PREVENTING THE TRANSMISSION OF INFECTIONS
A01N 59/16 (2006.01)	2490527 *	COATING FOR OBJECTS, IN PARTICULAR IN PUBLIC FACILITIES AND/OR MEANS OF TRANSPORTATION, FOR PREVENTING THE TRANSMISSION OF INFECTIONS
A01N 59/20 (2006.01)	2490527 *	COATING FOR OBJECTS, IN PARTICULAR IN PUBLIC FACILITIES AND/OR MEANS OF TRANSPORTATION, FOR PREVENTING THE TRANSMISSION OF INFECTIONS
C09J 7/02 (2006.01)	2490527 *	COATING FOR OBJECTS, IN PARTICULAR IN PUBLIC FACILITIES AND/OR MEANS OF TRANSPORTATION, FOR PREVENTING THE TRANSMISSION OF INFECTIONS
A61P 37/00 (2006.01)	2414341 *	OXADIAZOLE DERIVATIVES
C07D 271/06 (2006.01)	2414341 *	OXADIAZOLE DERIVATIVES
A61K 31/4245 (2006.01)	2414341 *	OXADIAZOLE DERIVATIVES
H04W 12/06 (2009.01)	2481230 *	AUTHENTICATION METHOD, PAYMENT AUTHORISATION METHOD AND CORRESPONDING ELECTRONIC EQUIPMENTS
H04W 4/12 (2009.01)	2481230 *	AUTHENTICATION METHOD, PAYMENT AUTHORISATION METHOD AND CORRESPONDING ELECTRONIC EQUIPMENTS
H04L 29/06 (2006.01)	2481230 *	AUTHENTICATION METHOD, PAYMENT AUTHORISATION METHOD AND CORRESPONDING ELECTRONIC EQUIPMENTS
B29C 45/14 (2006.01)	2496394 *	METHOD OF MAKING A MOLDED TRIM ASSEMBLY
A61P 35/00 (2006.01)	2419177 *	BIOLOGICAL MARKERS PREDICTIVE OF ANTI-CANCER RESPONSE TO EPIDERMAL GROWTH FACTOR RECEPTOR KINASE INHIBITORS
G01N 33/574 (2006.01)	2419177 *	BIOLOGICAL MARKERS PREDICTIVE OF ANTI-CANCER RESPONSE TO EPIDERMAL GROWTH FACTOR RECEPTOR KINASE INHIBITORS
A61K 9/70 (2006.01)	2431028 *	FAST-DISSOLVING ORAL FILM FOR EFFECTIVELY CONCEALING UNPLEASANT TASTES
A61K 47/30 (2006.01)	2431028 *	FAST-DISSOLVING ORAL FILM FOR EFFECTIVELY CONCEALING UNPLEASANT TASTES
A61K 31/14 (2006.01)	2431028 *	FAST-DISSOLVING ORAL FILM FOR EFFECTIVELY CONCEALING UNPLEASANT TASTES
A61K 31/09 (2006.01)	2431028 *	FAST-DISSOLVING ORAL FILM FOR EFFECTIVELY CONCEALING UNPLEASANT TASTES
A61P 43/00 (2006.01)	2431028 *	FAST-DISSOLVING ORAL FILM FOR EFFECTIVELY CONCEALING UNPLEASANT TASTES
A23L 2/52 (2006.01)	2442674 *	COMPOSITIONS AND METHODS FOR PRODUCING STABLE NEGATIVE OXIDATION REDUCTION POTENTIAL IN CONSUMABLE MATERIALS
C02F 1/68 (2006.01)	2442674 *	COMPOSITIONS AND METHODS FOR PRODUCING STABLE NEGATIVE OXIDATION REDUCTION POTENTIAL IN CONSUMABLE MATERIALS
A23L 1/30 (2006.01)	2442674 *	COMPOSITIONS AND METHODS FOR PRODUCING STABLE NEGATIVE OXIDATION REDUCTION POTENTIAL IN CONSUMABLE MATERIALS
C02F 1/70 (2006.01)	2442674 *	COMPOSITIONS AND METHODS FOR PRODUCING STABLE NEGATIVE OXIDATION REDUCTION POTENTIAL IN CONSUMABLE MATERIALS
A61F 13/15 (2006.01)	2481383	Method of creating a cross-machine direction fold line boundary
A61P 19/10 (2006.01)	2412697 *	PROCESS FOR PRODUCING CARBOXYLIC ACID COMPOUND
C07C 213/04 (2006.01)	2412697 *	PROCESS FOR PRODUCING CARBOXYLIC ACID COMPOUND
C07C 213/08 (2006.01)	2412697 *	PROCESS FOR PRODUCING CARBOXYLIC ACID COMPOUND
C07C 217/28 (2006.01)	2412697 *	PROCESS FOR PRODUCING CARBOXYLIC ACID COMPOUND
C07D 303/22 (2006.01)	2412697 *	PROCESS FOR PRODUCING CARBOXYLIC ACID COMPOUND
C07C 69/76 (2006.01)	2412697 *	PROCESS FOR PRODUCING CARBOXYLIC ACID COMPOUND
A61K 31/235 (2006.01)	2412697 *	PROCESS FOR PRODUCING CARBOXYLIC ACID COMPOUND
A61K 31/496 (2006.01)	2448579 *	ELTOPRAZINE FOR THE TREATMENT OF WEIGHT DISORDERS

MKP (51)	Broj objave evropske prijava patenta (97)	Naziv pronalaska (54)
A61P 3/04 (2006.01)	2448579 *	ELTOPRAZINE FOR THE TREATMENT OF WEIGHT DISORDERS
C12Q 1/68 (2006.01)	2486143 *	METHODS FOR DIAGNOSING IRRITABLE BOWEL SYNDROME
A61P 1/00 (2006.01)	2486143 *	METHODS FOR DIAGNOSING IRRITABLE BOWEL SYNDROME
C12Q 1/04 (2006.01)	2486143 *	METHODS FOR DIAGNOSING IRRITABLE BOWEL SYNDROME
C12Q 1/10 (2006.01)	2486143 *	METHODS FOR DIAGNOSING IRRITABLE BOWEL SYNDROME
A61K 47/48 (2006.01)	2427217 *	MULTI- VALENT ADJUVANT DISPLAY
A61P 37/04 (2006.01)	2427217 *	MULTI- VALENT ADJUVANT DISPLAY
A61K 9/107 (2006.01)	2416759 *	STABLE PHARMACEUTICAL COMPOSITIONS OF DICLOFENAC
A61K 31/196 (2006.01)	2416759 *	STABLE PHARMACEUTICAL COMPOSITIONS OF DICLOFENAC
A61K 9/00 (2006.01)	2416759 *	STABLE PHARMACEUTICAL COMPOSITIONS OF DICLOFENAC
A61K 31/535 (2006.01)	2408767 *	AMIDE DERIVATIVES AS NEUROPEPTIDE Y5 RECEPTOR LIGANDS
C07D 413/12 (2006.01)	2408767 *	AMIDE DERIVATIVES AS NEUROPEPTIDE Y5 RECEPTOR LIGANDS
C07D 413/10 (2006.01)	2408767 *	AMIDE DERIVATIVES AS NEUROPEPTIDE Y5 RECEPTOR LIGANDS
C07D 413/06 (2006.01)	2408767 *	AMIDE DERIVATIVES AS NEUROPEPTIDE Y5 RECEPTOR LIGANDS
A61P 25/28 (2006.01)	2408767 *	AMIDE DERIVATIVES AS NEUROPEPTIDE Y5 RECEPTOR LIGANDS
A61P 11/06 (2006.01)	2414375 *	NOVEL AMIDE DERIVATIVES OF STEROIDAL 3,2-C'PYRAZOLE COMPOUNDS WITH GLUCOCORTICOID ACTIVITY
A61P 29/00 (2006.01)	2414375 *	NOVEL AMIDE DERIVATIVES OF STEROIDAL 3,2-C'PYRAZOLE COMPOUNDS WITH GLUCOCORTICOID ACTIVITY
C07J 71/00 (2006.01)	2414375 *	NOVEL AMIDE DERIVATIVES OF STEROIDAL 3,2-C'PYRAZOLE COMPOUNDS WITH GLUCOCORTICOID ACTIVITY
A61K 31/58 (2006.01)	2414375 *	NOVEL AMIDE DERIVATIVES OF STEROIDAL 3,2-C'PYRAZOLE COMPOUNDS WITH GLUCOCORTICOID ACTIVITY
A61P 11/00 (2006.01)	2414375 *	NOVEL AMIDE DERIVATIVES OF STEROIDAL 3,2-C'PYRAZOLE COMPOUNDS WITH GLUCOCORTICOID ACTIVITY
A61K 31/52 (2006.01)	2456443 *	TREATMENT OF LIVER DISORDERS WITH PI3K INHIBITORS
A61P 1/16 (2006.01)	2456443 *	TREATMENT OF LIVER DISORDERS WITH PI3K INHIBITORS
C12P 21/08 (2006.01)	2459729 *	DUAL VARIABLE DOMAIN IMMUNOGLOBULINS AND USES THEREOF
A61K 45/06 (2006.01)	2421515 *	PARTICULATE PHARMACEUTICAL COMPOSITION HAVING AN OPIOID AND AN OPIOID ANTAGONIST
A61K 31/485 (2006.01)	2421515 *	PARTICULATE PHARMACEUTICAL COMPOSITION HAVING AN OPIOID AND AN OPIOID ANTAGONIST
A61K 9/50 (2006.01)	2421515 *	PARTICULATE PHARMACEUTICAL COMPOSITION HAVING AN OPIOID AND AN OPIOID ANTAGONIST
A61P 3/06 (2006.01)	2423203 *	CRYSTAL OF BENZOAZINONE COMPOUND
A61P 3/04 (2006.01)	2423203 *	CRYSTAL OF BENZOAZINONE COMPOUND
A61P 9/00 (2006.01)	2423203 *	CRYSTAL OF BENZOAZINONE COMPOUND
A61P 1/04 (2006.01)	2423203 *	CRYSTAL OF BENZOAZINONE COMPOUND
A61P 3/10 (2006.01)	2423203 *	CRYSTAL OF BENZOAZINONE COMPOUND
A61P 9/12 (2006.01)	2423203 *	CRYSTAL OF BENZOAZINONE COMPOUND
A61K 31/536 (2006.01)	2423203 *	CRYSTAL OF BENZOAZINONE COMPOUND
C07D 265/26 (2006.01)	2423203 *	CRYSTAL OF BENZOAZINONE COMPOUND
C12N 15/13 (2006.01)	2406286 *	ANTI-CD40 ANTIBODIES AND USES THEREOF
C07K 16/28 (2006.01)	2406286 *	ANTI-CD40 ANTIBODIES AND USES THEREOF
C07K 14/725 (2006.01)	2406286 *	ANTI-CD40 ANTIBODIES AND USES THEREOF
A61K 39/00 (2006.01)	2406286 *	ANTI-CD40 ANTIBODIES AND USES THEREOF
C12N 15/63 (2006.01)	2406286 *	ANTI-CD40 ANTIBODIES AND USES THEREOF
G01N 33/68 (2006.01)	2406286 *	ANTI-CD40 ANTIBODIES AND USES THEREOF
C07K 16/00 (2006.01)	2419446 *	HUMANIZED ANTIBODY COMPOSITIONS AND METHODS FOR BINDING LYSOPHOSPHATIDIC ACID
H05B 37/02 (2006.01)	2438800 *	VIRTUAL ROOM-BASED LIGHT FIXTURE AND DEVICE CONTROL
A61K 31/5386 (2006.01)	2459572 *	SPIROCYCLIC AMIDE DERIVATIVES

MKP (51)	Broj objave evropske prijave patenta (97)	Naziv pronalaska (54)
A61P 25/00 (2006.01)	2459572 *	SPIROCYCLIC AMIDE DERIVATIVES
A61P 11/00 (2006.01)	2459572 *	SPIROCYCLIC AMIDE DERIVATIVES
A61P 9/00 (2006.01)	2459572 *	SPIROCYCLIC AMIDE DERIVATIVES
A61P 37/00 (2006.01)	2459572 *	SPIROCYCLIC AMIDE DERIVATIVES
A61P 35/00 (2006.01)	2459572 *	SPIROCYCLIC AMIDE DERIVATIVES
A61P 19/00 (2006.01)	2459572 *	SPIROCYCLIC AMIDE DERIVATIVES
A61P 29/00 (2006.01)	2459572 *	SPIROCYCLIC AMIDE DERIVATIVES
C07D 519/00 (2006.01)	2459572 *	SPIROCYCLIC AMIDE DERIVATIVES
A61P 13/00 (2006.01)	2459572 *	SPIROCYCLIC AMIDE DERIVATIVES
A61P 17/00 (2006.01)	2459572 *	SPIROCYCLIC AMIDE DERIVATIVES
A61P 27/00 (2006.01)	2459572 *	SPIROCYCLIC AMIDE DERIVATIVES
C07D 498/10 (2006.01)	2459572 *	SPIROCYCLIC AMIDE DERIVATIVES
A61P 1/00 (2006.01)	2459572 *	SPIROCYCLIC AMIDE DERIVATIVES
A62B 17/04 (2006.01)	2392384	Protective suit with a lighting device
A42B 1/24 (2006.01)	2392384	Protective suit with a lighting device
A62B 17/00 (2006.01)	2392384	Protective suit with a lighting device
A41C 3/12 (2006.01)	2480102 *	CLEAVAGE ACCESSORY FOR A BRASSIERE
A41D 27/04 (2006.01)	2480102 *	CLEAVAGE ACCESSORY FOR A BRASSIERE
A41D 27/06 (2006.01)	2480102 *	CLEAVAGE ACCESSORY FOR A BRASSIERE
A44C 25/00 (2006.01)	2480102 *	CLEAVAGE ACCESSORY FOR A BRASSIERE
A01N 43/56 (2006.01)	2434894 *	METHODS OF ADMINISTRATION OF THROMBOPOIETIN AGONIST COMPOUNDS
C07D 471/00 (2006.01)	2477985 *	TREATMENT OF CANCER
A61K 39/395 (2006.01)	2445528 *	METHOD OF TREATING CANCER WITH DLL4 ANTAGONIST AND CHEMOTHERAPEUTIC AGENT
C07K 16/22 (2006.01)	2445528 *	METHOD OF TREATING CANCER WITH DLL4 ANTAGONIST AND CHEMOTHERAPEUTIC AGENT
C08L 31/04 (2006.01)	2445964 *	POLYMER COMPOSITIONS BASED ON POLYVINYL ALCOHOL FOR CHEWING GUM FORMULATIONS WITH A LOW ADHESIVE IMPACT
A23G 4/08 (2006.01)	2445964 *	POLYMER COMPOSITIONS BASED ON POLYVINYL ALCOHOL FOR CHEWING GUM FORMULATIONS WITH A LOW ADHESIVE IMPACT
C07D 413/14 (2006.01)	2421850 *	3-AZABICYCLO [4.1.0]HEPTANES USED AS OREXIN ANTAGONISTS
A61P 25/30 (2006.01)	2421850 *	3-AZABICYCLO [4.1.0]HEPTANES USED AS OREXIN ANTAGONISTS
C07D 403/14 (2006.01)	2421850 *	3-AZABICYCLO [4.1.0]HEPTANES USED AS OREXIN ANTAGONISTS
A61P 25/24 (2006.01)	2421850 *	3-AZABICYCLO [4.1.0]HEPTANES USED AS OREXIN ANTAGONISTS
A61K 31/44 (2006.01)	2421850 *	3-AZABICYCLO [4.1.0]HEPTANES USED AS OREXIN ANTAGONISTS
C07D 401/12 (2006.01)	2421850 *	3-AZABICYCLO [4.1.0]HEPTANES USED AS OREXIN ANTAGONISTS
A61P 25/22 (2006.01)	2421850 *	3-AZABICYCLO [4.1.0]HEPTANES USED AS OREXIN ANTAGONISTS
C07D 417/14 (2006.01)	2421850 *	3-AZABICYCLO [4.1.0]HEPTANES USED AS OREXIN ANTAGONISTS
A61P 3/04 (2006.01)	2421850 *	3-AZABICYCLO [4.1.0]HEPTANES USED AS OREXIN ANTAGONISTS
A61K 31/501 (2006.01)	2421850 *	3-AZABICYCLO [4.1.0]HEPTANES USED AS OREXIN ANTAGONISTS
A61K 31/506 (2006.01)	2421850 *	3-AZABICYCLO [4.1.0]HEPTANES USED AS OREXIN ANTAGONISTS
C12N 15/10 (2006.01)	2435568 *	A COLLECTION AND METHODS FOR ITS USE
C07K 16/00 (2006.01)	2435568 *	A COLLECTION AND METHODS FOR ITS USE
C40B 30/02 (2006.01)	2435568 *	A COLLECTION AND METHODS FOR ITS USE
C40B 50/06 (2006.01)	2435568 *	A COLLECTION AND METHODS FOR ITS USE
C40B 40/08 (2006.01)	2435568 *	A COLLECTION AND METHODS FOR ITS USE
C12N 9/88 (2006.01)	2411513 *	MUTANT CyaA POLYPEPTIDES AND POLYPEPTIDE DERIVATIVES SUITABLE FOR THE DELIVERY OF IMMUNOGENIC MOLECULES INTO A CELL
A61K 39/00 (2006.01)	2413957 *	PHARMACEUTICAL COMPOSITION

MKP (51)	Broj objave evropske prijava patenta (97)	Naziv pronalaska (54)
C07K 14/47 (2006.01)	2413957 *	PHARMACEUTICAL COMPOSITION
C07K 16/18 (2006.01)	2413957 *	PHARMACEUTICAL COMPOSITION
G01N 33/53 (2006.01)	2413957 *	PHARMACEUTICAL COMPOSITION
C12N 9/10 (2006.01)	2443234 *	NICOTIANA BENTHAMIANA PLANTS DEFICIENT IN XYLOSYLTRANSFERASE ACTIVITY
C12N 15/82 (2006.01)	2443234 *	NICOTIANA BENTHAMIANA PLANTS DEFICIENT IN XYLOSYLTRANSFERASE ACTIVITY
C12Q 1/68 (2006.01)	2476758 *	METHOD FOR PREDICTION OF THERAPEUTIC EFFECT ON CHRONIC HEPATITIS C
A61K 31/7056 (2006.01)	2476758 *	METHOD FOR PREDICTION OF THERAPEUTIC EFFECT ON CHRONIC HEPATITIS C
G01N 33/53 (2006.01)	2476758 *	METHOD FOR PREDICTION OF THERAPEUTIC EFFECT ON CHRONIC HEPATITIS C
A61P 1/16 (2006.01)	2476758 *	METHOD FOR PREDICTION OF THERAPEUTIC EFFECT ON CHRONIC HEPATITIS C
A61K 38/21 (2006.01)	2476758 *	METHOD FOR PREDICTION OF THERAPEUTIC EFFECT ON CHRONIC HEPATITIS C
G01N 37/00 (2006.01)	2476758 *	METHOD FOR PREDICTION OF THERAPEUTIC EFFECT ON CHRONIC HEPATITIS C
A61K 9/16 (2006.01)	2403481 *	ORAL DOSAGE FORMS HAVING A HIGH LOADING OF A GABAPENTIN PRODRUG
A61K 9/20 (2006.01)	2403481 *	ORAL DOSAGE FORMS HAVING A HIGH LOADING OF A GABAPENTIN PRODRUG
A61K 31/195 (2006.01)	2403481 *	ORAL DOSAGE FORMS HAVING A HIGH LOADING OF A GABAPENTIN PRODRUG
C12N 15/866 (2006.01)	2480678 *	STABLE PRODUCTION OF LENTIVIRAL VECTORS
C12N 15/867 (2006.01)	2480678 *	STABLE PRODUCTION OF LENTIVIRAL VECTORS
C12N 7/02 (2006.01)	2480678 *	STABLE PRODUCTION OF LENTIVIRAL VECTORS
A61K 31/395 (2006.01)	2448929 *	NOVEL CONJUGATES, PREPARATION THEREOF, AND THERAPEUTIC USE THEREOF
A61P 35/00 (2006.01)	2448929 *	NOVEL CONJUGATES, PREPARATION THEREOF, AND THERAPEUTIC USE THEREOF
C07D 273/08 (2006.01)	2448929 *	NOVEL CONJUGATES, PREPARATION THEREOF, AND THERAPEUTIC USE THEREOF
B01J 20/24 (2006.01)	2488294 *	HONEY COMB MATRIX COMPRISING MACRO POROUS DESICCANT, PROCESS AND USE THEREOF
H02K 13/00 (2006.01)	2465185 *	COLLECTOR RING ARRANGEMENT FOR A ROTATING ELECTRIC MACHINE
B60D 1/06 (2006.01)	2269844	Towing eye
G10K 5/00 (2006.01)	2416312	Whistle with finger grip
E04C 3/08 (2006.01)	2483492 *	THIN-WALLED, COLD-FORMED LIGHTWEIGHT STRUCTURAL PROFILE ELEMENT AND METHOD FOR PRODUCING SUCH A PROFILE ELEMENT
E04C 3/09 (2006.01)	2483492 *	THIN-WALLED, COLD-FORMED LIGHTWEIGHT STRUCTURAL PROFILE ELEMENT AND METHOD FOR PRODUCING SUCH A PROFILE ELEMENT
A61P 33/02 (2006.01)	2413934 *	DOMPERIDONE AT A LOW DAILY DOSE FOR USE IN THE TREATMENT OR PREVENTION OF A DISEASE ASSOCIATED WITH AN ALTERATION OF THE IMMUNE RESPONSE
A61P 37/02 (2006.01)	2413934 *	DOMPERIDONE AT A LOW DAILY DOSE FOR USE IN THE TREATMENT OR PREVENTION OF A DISEASE ASSOCIATED WITH AN ALTERATION OF THE IMMUNE RESPONSE
A61K 31/454 (2006.01)	2413934 *	DOMPERIDONE AT A LOW DAILY DOSE FOR USE IN THE TREATMENT OR PREVENTION OF A DISEASE ASSOCIATED WITH AN ALTERATION OF THE IMMUNE RESPONSE
A61K 45/06 (2006.01)	2413934 *	DOMPERIDONE AT A LOW DAILY DOSE FOR USE IN THE TREATMENT OR PREVENTION OF A DISEASE ASSOCIATED WITH AN ALTERATION OF THE IMMUNE RESPONSE

MKP (51)	Broj objave evropske prijava patenta (97)	Naziv pronalaska (54)
A61K 9/00 (2006.01)	2440177 *	PHARMACEUTICAL DOSAGE FORM FOR ORAL ADMINISTRATION OF A BCL-2 FAMILY INHIBITOR
A61K 31/5377 (2006.01)	2440177 *	PHARMACEUTICAL DOSAGE FORM FOR ORAL ADMINISTRATION OF A BCL-2 FAMILY INHIBITOR
A61K 9/14 (2006.01)	2440177 *	PHARMACEUTICAL DOSAGE FORM FOR ORAL ADMINISTRATION OF A BCL-2 FAMILY INHIBITOR
A61P 3/10 (2006.01)	2406256 *	COMPOUNDS FOR THE TREATMENT OF METABOLIC DISORDERS
A61K 31/4245 (2006.01)	2406256 *	COMPOUNDS FOR THE TREATMENT OF METABOLIC DISORDERS
C07D 413/14 (2006.01)	2406256 *	COMPOUNDS FOR THE TREATMENT OF METABOLIC DISORDERS
A61K 48/00 (2006.01)	2428229 *	ONCOLYTIC ADENOVIRUSES FOR TREATING CANCER
C12N 15/861 (2006.01)	2428229 *	ONCOLYTIC ADENOVIRUSES FOR TREATING CANCER
F23L 13/06 (2006.01)	2430366 *	FUME-DISCHARGE DEVICE FOR BOILERS
F16K 15/02 (2006.01)	2430366 *	FUME-DISCHARGE DEVICE FOR BOILERS
F23J 13/08 (2006.01)	2430366 *	FUME-DISCHARGE DEVICE FOR BOILERS
F23L 11/00 (2006.01)	2430366 *	FUME-DISCHARGE DEVICE FOR BOILERS
E03D 9/03 (2006.01)	2270286	Dispenser of active substances for WC bowls
E03D 9/02 (2006.01)	2270286	Dispenser of active substances for WC bowls
C07C 229/22 (2006.01)	2445861 *	NOVEL ACETYLSALICYLIC ACID SALTS
A61P 9/08 (2006.01)	2445861 *	NOVEL ACETYLSALICYLIC ACID SALTS
A61P 29/00 (2006.01)	2445861 *	NOVEL ACETYLSALICYLIC ACID SALTS
C07C 229/12 (2006.01)	2445861 *	NOVEL ACETYLSALICYLIC ACID SALTS
A61K 31/205 (2006.01)	2445861 *	NOVEL ACETYLSALICYLIC ACID SALTS
C07C 69/157 (2006.01)	2445861 *	NOVEL ACETYLSALICYLIC ACID SALTS
A61P 7/02 (2006.01)	2445861 *	NOVEL ACETYLSALICYLIC ACID SALTS
A61K 31/616 (2006.01)	2445861 *	NOVEL ACETYLSALICYLIC ACID SALTS
C07C 243/40 (2006.01)	2445861 *	NOVEL ACETYLSALICYLIC ACID SALTS
A61K 47/10 (2006.01)	2491931 *	TRANSDERMALLY ABSORBABLE DONEPEZIL-CONTAINING PREPARATION
A61K 9/70 (2006.01)	2491931 *	TRANSDERMALLY ABSORBABLE DONEPEZIL-CONTAINING PREPARATION
A61K 31/445 (2006.01)	2491931 *	TRANSDERMALLY ABSORBABLE DONEPEZIL-CONTAINING PREPARATION
A61K 47/14 (2006.01)	2491931 *	TRANSDERMALLY ABSORBABLE DONEPEZIL-CONTAINING PREPARATION
A61P 25/28 (2006.01)	2491931 *	TRANSDERMALLY ABSORBABLE DONEPEZIL-CONTAINING PREPARATION
A61K 47/34 (2006.01)	2491931 *	TRANSDERMALLY ABSORBABLE DONEPEZIL-CONTAINING PREPARATION
A61K 47/22 (2006.01)	2491931 *	TRANSDERMALLY ABSORBABLE DONEPEZIL-CONTAINING PREPARATION
A61K 9/08 (2006.01)	2491931 *	TRANSDERMALLY ABSORBABLE DONEPEZIL-CONTAINING PREPARATION
A61K 51/00 (2006.01)	2467170 *	VESICULAR FORMULATIONS
G01N 33/53 (2006.01)	2475769 *	INHIBITION OF HISTONE ACETYLTRANSFERASES BY CTK7A AND METHODS THEREOF
A61K 38/45 (2006.01)	2475769 *	INHIBITION OF HISTONE ACETYLTRANSFERASES BY CTK7A AND METHODS THEREOF
A61P 35/02 (2006.01)	2475769 *	INHIBITION OF HISTONE ACETYLTRANSFERASES BY CTK7A AND METHODS THEREOF
C12N 9/10 (2006.01)	2475769 *	INHIBITION OF HISTONE ACETYLTRANSFERASES BY CTK7A AND METHODS THEREOF
A61K 31/415 (2006.01)	2475769 *	INHIBITION OF HISTONE ACETYLTRANSFERASES BY CTK7A AND METHODS THEREOF
A61J 1/00 (2006.01)	2451717 *	DISPOSAL SYSTEM AND METHOD FOR DISPOSABLE ITEMS

MKP (51)	Broj objave evropske prijava patenta (97)	Naziv pronalaska (54)
B65D 30/00 (2006.01)	2451717 *	DISPOSAL SYSTEM AND METHOD FOR DISPOSABLE ITEMS
B65F 1/00 (2006.01)	2451717 *	DISPOSAL SYSTEM AND METHOD FOR DISPOSABLE ITEMS
C07D 309/32 (2006.01)	2435415 *	SPIRO EPOXIDES AS INTERMEDIATES
C07D 493/10 (2006.01)	2435415 *	SPIRO EPOXIDES AS INTERMEDIATES
C07H 1/00 (2006.01)	2480559 *	PROCESSES AND INTERMEDIATES FOR THE PREPARATION OF 1'-SUBSTITUTED CARBA-NUCLEOSIDE ANALOGS
C07H 19/23 (2006.01)	2480559 *	PROCESSES AND INTERMEDIATES FOR THE PREPARATION OF 1'-SUBSTITUTED CARBA-NUCLEOSIDE ANALOGS
A61K 31/60 (2006.01)	2470185 *	PHARMACEUTICAL COMPOSITIONS FOR TREATING IBD
A61K 31/573 (2006.01)	2470185 *	PHARMACEUTICAL COMPOSITIONS FOR TREATING IBD
A61P 29/00 (2006.01)	2470185 *	PHARMACEUTICAL COMPOSITIONS FOR TREATING IBD
F23K 3/02 (2006.01)	2486326 *	METERING SYSTEM, DENSE PHASE CONVEYING SYSTEM AND METHOD FOR SUPPLYING BULK MATERIAL IN POWDER FORM
A61K 31/365 (2006.01)	2419131 *	MACROCYCLIC LACTONE COMBINATION COMPOSITIONS, VACCINES AND METHODS FOR PRODUCING SAME
A61K 39/15 (2006.01)	2419131 *	MACROCYCLIC LACTONE COMBINATION COMPOSITIONS, VACCINES AND METHODS FOR PRODUCING SAME
A61P 31/00 (2006.01)	2419131 *	MACROCYCLIC LACTONE COMBINATION COMPOSITIONS, VACCINES AND METHODS FOR PRODUCING SAME
A61K 39/215 (2006.01)	2419131 *	MACROCYCLIC LACTONE COMBINATION COMPOSITIONS, VACCINES AND METHODS FOR PRODUCING SAME
A61K 31/335 (2006.01)	2419131 *	MACROCYCLIC LACTONE COMBINATION COMPOSITIONS, VACCINES AND METHODS FOR PRODUCING SAME
C13K 1/02 (2006.01)	2430196 *	PROCESS FOR THE PRODUCTION OF ALCOHOLS
C12P 7/10 (2006.01)	2430196 *	PROCESS FOR THE PRODUCTION OF ALCOHOLS
B01F 7/22 (2006.01)	2405995 *	IMPELLER FOR MIXING SLURRY IN METALLURGICAL PROCESSES
B01F 7/04 (2006.01)	2405995 *	IMPELLER FOR MIXING SLURRY IN METALLURGICAL PROCESSES
B01F 7/06 (2006.01)	2405995 *	IMPELLER FOR MIXING SLURRY IN METALLURGICAL PROCESSES
B01F 7/00 (2006.01)	2405995 *	IMPELLER FOR MIXING SLURRY IN METALLURGICAL PROCESSES
B01F 7/18 (2006.01)	2405995 *	IMPELLER FOR MIXING SLURRY IN METALLURGICAL PROCESSES
D21H 17/67 (2006.01)	2445710 *	SEED CRYSTAL COATING FOR GYPSUM WALLBOARD FACING
D21H 27/26 (2006.01)	2445710 *	SEED CRYSTAL COATING FOR GYPSUM WALLBOARD FACING
E04C 2/04 (2006.01)	2445710 *	SEED CRYSTAL COATING FOR GYPSUM WALLBOARD FACING
D21H 13/40 (2006.01)	2445710 *	SEED CRYSTAL COATING FOR GYPSUM WALLBOARD FACING
D21H 21/18 (2006.01)	2445710 *	SEED CRYSTAL COATING FOR GYPSUM WALLBOARD FACING
B32B 13/08 (2006.01)	2445710 *	SEED CRYSTAL COATING FOR GYPSUM WALLBOARD FACING
D21H 23/22 (2006.01)	2445710 *	SEED CRYSTAL COATING FOR GYPSUM WALLBOARD FACING
D21H 19/38 (2006.01)	2445710 *	SEED CRYSTAL COATING FOR GYPSUM WALLBOARD FACING
A61K 47/48 (2006.01)	2485767 *	CARRIER LINKED PALIPERIDONE PRODRUGS
B60P 1/44 (2006.01)	2384928	Loading platform
C12Q 1/68 (2006.01)	2467501 *	GENETIC FINGERPRINTING AND IDENTIFICATION METHOD
A63H 27/00 (2006.01)	2448645 *	FLYING SHARK
B27B 25/04 (2006.01)	2248643	A sawing device for firewood trunks
B27B 5/22 (2006.01)	2248643	A sawing device for firewood trunks
A61K 9/20 (2006.01)	2435029 *	PHARMACEUTICAL COMPOSITION COMPRISING TAMSULOSIN
A61K 9/16 (2006.01)	2435029 *	PHARMACEUTICAL COMPOSITION COMPRISING TAMSULOSIN
A61H 3/00 (2006.01)	2233120	Walking aid
A61H 3/04 (2006.01)	2233120	Walking aid
F02M 61/14 (2006.01)	2422070 *	FUEL INJECTOR
F02M 55/00 (2006.01)	2422070 *	FUEL INJECTOR
F02M 61/16 (2006.01)	2422070 *	FUEL INJECTOR

MKP (51)	Broj objave evropske prijave patenta (97)	Naziv pronalaska (54)
A61P 9/10 (2006.01)	2448933 *	TRANS-4-[[[(5S)-5-[[[3,5-BIS(TRIFLUOROMETHYL)PHENYL]METHYL](2-METHYL-2H-TETRAZOL-5-YL)AMINO]-2,3,4,5-TETRAHYDRO-7,9-DIMETHYL-1H-1-BENZAZEPIN-1-YL]METHYL]-CYCLOHEXANECARBOXYLIC ACID
A61K 31/55 (2006.01)	2448933 *	TRANS-4-[[[(5S)-5-[[[3,5-BIS(TRIFLUOROMETHYL)PHENYL]METHYL](2-METHYL-2H-TETRAZOL-5-YL)AMINO]-2,3,4,5-TETRAHYDRO-7,9-DIMETHYL-1H-1-BENZAZEPIN-1-YL]METHYL]-CYCLOHEXANECARBOXYLIC ACID
C07D 403/12 (2006.01)	2448933 *	TRANS-4-[[[(5S)-5-[[[3,5-BIS(TRIFLUOROMETHYL)PHENYL]METHYL](2-METHYL-2H-TETRAZOL-5-YL)AMINO]-2,3,4,5-TETRAHYDRO-7,9-DIMETHYL-1H-1-BENZAZEPIN-1-YL]METHYL]-CYCLOHEXANECARBOXYLIC ACID
G01N 33/564 (2006.01)	2425250 *	METHODS FOR MONITORING THE EFFICACY OF ANTI-IL-2R ANTIBODIES IN MULTIPLE SCLEROSIS PATIENTS
E21B 43/10 (2006.01)	2414626 *	LINER HANGER
E21B 23/01 (2006.01)	2414626 *	LINER HANGER
E21B 33/04 (2006.01)	2414626 *	LINER HANGER
A61M 5/24 (2006.01)	2437820 *	DOSE SETTING MECHANISM FOR PRIMING A DRUG DELIVERY DEVICE
A61M 5/315 (2006.01)	2437820 *	DOSE SETTING MECHANISM FOR PRIMING A DRUG DELIVERY DEVICE
A61M 5/31 (2006.01)	2437820 *	DOSE SETTING MECHANISM FOR PRIMING A DRUG DELIVERY DEVICE
E01F 8/00 (2006.01)	2434055	The fibre-reinforced acrylic panel and the process for its manufacture
C08K 5/5419 (2006.01)	2434055	The fibre-reinforced acrylic panel and the process for its manufacture
C08K 5/549 (2006.01)	2434055	The fibre-reinforced acrylic panel and the process for its manufacture
C08J 5/04 (2006.01)	2434055	The fibre-reinforced acrylic panel and the process for its manufacture
C07C 233/06 (2006.01)	2448911 *	METHOD OF PREPARING 1-CHLOROACETAMIDO-1,3,3,5,5-PENTAMETHYLCYCLOHEXANE
C07C 209/62 (2006.01)	2448911 *	METHOD OF PREPARING 1-CHLOROACETAMIDO-1,3,3,5,5-PENTAMETHYLCYCLOHEXANE
C07C 29/40 (2006.01)	2448911 *	METHOD OF PREPARING 1-CHLOROACETAMIDO-1,3,3,5,5-PENTAMETHYLCYCLOHEXANE
C07C 211/35 (2006.01)	2448911 *	METHOD OF PREPARING 1-CHLOROACETAMIDO-1,3,3,5,5-PENTAMETHYLCYCLOHEXANE
C07C 31/135 (2006.01)	2448911 *	METHOD OF PREPARING 1-CHLOROACETAMIDO-1,3,3,5,5-PENTAMETHYLCYCLOHEXANE
C07C 231/06 (2006.01)	2448911 *	METHOD OF PREPARING 1-CHLOROACETAMIDO-1,3,3,5,5-PENTAMETHYLCYCLOHEXANE
A01N 43/00 (2006.01)	2445343 *	PRODRUGS OF NH-ACIDIC COMPOUNDS
A61F 5/445 (2006.01)	2289471	Ostomy bag
A61L 24/00 (2006.01)	2289471	Ostomy bag
A61F 5/443 (2006.01)	2289471	Ostomy bag
C07C 69/28 (2006.01)	2454223 *	HERBICIDALLY ACTIVE 2-(SUBSTITUTED-PHENYL)-CYCLOPENTANE-1,3-DIONE DERIVATIVES
A01N 33/24 (2006.01)	2454223 *	HERBICIDALLY ACTIVE 2-(SUBSTITUTED-PHENYL)-CYCLOPENTANE-1,3-DIONE DERIVATIVES
C07C 251/44 (2006.01)	2454223 *	HERBICIDALLY ACTIVE 2-(SUBSTITUTED-PHENYL)-CYCLOPENTANE-1,3-DIONE DERIVATIVES
A01N 37/10 (2006.01)	2454223 *	HERBICIDALLY ACTIVE 2-(SUBSTITUTED-PHENYL)-CYCLOPENTANE-1,3-DIONE DERIVATIVES
C07C 69/24 (2006.01)	2454223 *	HERBICIDALLY ACTIVE 2-(SUBSTITUTED-PHENYL)-CYCLOPENTANE-1,3-DIONE DERIVATIVES
A01N 33/20 (2006.01)	2454223 *	HERBICIDALLY ACTIVE 2-(SUBSTITUTED-PHENYL)-CYCLOPENTANE-1,3-DIONE DERIVATIVES
C07C 255/56 (2006.01)	2454223 *	HERBICIDALLY ACTIVE 2-(SUBSTITUTED-PHENYL)-CYCLOPENTANE-1,3-DIONE DERIVATIVES
C07C 49/657 (2006.01)	2454223 *	HERBICIDALLY ACTIVE 2-(SUBSTITUTED-PHENYL)-CYCLOPENTANE-1,3-DIONE DERIVATIVES

MKP (51)	Broj objave evropske prijava patenta (97)	Naziv pronalaska (54)
C07C 317/24 (2006.01)	2454223 *	HERBICIDALLY ACTIVE 2-(SUBSTITUTED-PHENYL)-CYCLOPENTANE-1,3-DIONE DERIVATIVES
A01N 37/02 (2006.01)	2454223 *	HERBICIDALLY ACTIVE 2-(SUBSTITUTED-PHENYL)-CYCLOPENTANE-1,3-DIONE DERIVATIVES
C07C 49/683 (2006.01)	2454223 *	HERBICIDALLY ACTIVE 2-(SUBSTITUTED-PHENYL)-CYCLOPENTANE-1,3-DIONE DERIVATIVES
A01N 31/06 (2006.01)	2454223 *	HERBICIDALLY ACTIVE 2-(SUBSTITUTED-PHENYL)-CYCLOPENTANE-1,3-DIONE DERIVATIVES
C07C 65/36 (2006.01)	2454223 *	HERBICIDALLY ACTIVE 2-(SUBSTITUTED-PHENYL)-CYCLOPENTANE-1,3-DIONE DERIVATIVES
A01N 31/08 (2006.01)	2454223 *	HERBICIDALLY ACTIVE 2-(SUBSTITUTED-PHENYL)-CYCLOPENTANE-1,3-DIONE DERIVATIVES
C07C 205/45 (2006.01)	2454223 *	HERBICIDALLY ACTIVE 2-(SUBSTITUTED-PHENYL)-CYCLOPENTANE-1,3-DIONE DERIVATIVES
C07D 213/16 (2006.01)	2477967 *	PROCESS FOR PREPARING 3-[(4S)-8-BROMO-1-METHYL-6-(2-PYRIDINYL)-4H-IMIDAZOL[1,2-A][1,4]BENZODIAZEPINE-4-YL]PROPIONIC ACID METHYL ESTER OR THE BENZENE SULFONATE SALT THEREOF, AND COMPOUNDS USEFUL IN THAT PROCESS
C07D 213/18 (2006.01)	2477967 *	PROCESS FOR PREPARING 3-[(4S)-8-BROMO-1-METHYL-6-(2-PYRIDINYL)-4H-IMIDAZOL[1,2-A][1,4]BENZODIAZEPINE-4-YL]PROPIONIC ACID METHYL ESTER OR THE BENZENE SULFONATE SALT THEREOF, AND COMPOUNDS USEFUL IN THAT PROCESS
C07D 401/04 (2006.01)	2477967 *	PROCESS FOR PREPARING 3-[(4S)-8-BROMO-1-METHYL-6-(2-PYRIDINYL)-4H-IMIDAZOL[1,2-A][1,4]BENZODIAZEPINE-4-YL]PROPIONIC ACID METHYL ESTER OR THE BENZENE SULFONATE SALT THEREOF, AND COMPOUNDS USEFUL IN THAT PROCESS
C07D 487/04 (2006.01)	2477967 *	PROCESS FOR PREPARING 3-[(4S)-8-BROMO-1-METHYL-6-(2-PYRIDINYL)-4H-IMIDAZOL[1,2-A][1,4]BENZODIAZEPINE-4-YL]PROPIONIC ACID METHYL ESTER OR THE BENZENE SULFONATE SALT THEREOF, AND COMPOUNDS USEFUL IN THAT PROCESS
A61P 1/00 (2006.01)	2429566 *	CYCLIN DEPENDENT KINASE INHIBITORS AND METHODS OF USE
A61P 37/08 (2006.01)	2429566 *	CYCLIN DEPENDENT KINASE INHIBITORS AND METHODS OF USE
A61P 37/00 (2006.01)	2429566 *	CYCLIN DEPENDENT KINASE INHIBITORS AND METHODS OF USE
A61K 38/17 (2006.01)	2429566 *	CYCLIN DEPENDENT KINASE INHIBITORS AND METHODS OF USE
A61K 38/18 (2006.01)	2429566 *	CYCLIN DEPENDENT KINASE INHIBITORS AND METHODS OF USE
A61K 38/20 (2006.01)	2429566 *	CYCLIN DEPENDENT KINASE INHIBITORS AND METHODS OF USE
C12N 7/02 (2006.01)	2480677 *	SEMI-STABLE PRODUCTION OF LENTIVIRAL VECTORS
C12N 15/867 (2006.01)	2480677 *	SEMI-STABLE PRODUCTION OF LENTIVIRAL VECTORS
C12N 15/866 (2006.01)	2480677 *	SEMI-STABLE PRODUCTION OF LENTIVIRAL VECTORS
A61F 2/24 (2006.01)	2498719 *	SUPPORT SYSTEM FOR BIOPROSTHETIC VALVES WITH COMMISURAL POSTS WITH HEART-SHAPED OPENINGS
C07D 265/30 (2006.01)	2473490 *	(THIO)MORPHOLINE DERIVATIVES AS S1P MODULATORS
C07D 265/32 (2006.01)	2473490 *	(THIO)MORPHOLINE DERIVATIVES AS S1P MODULATORS
C07D 413/12 (2006.01)	2473490 *	(THIO)MORPHOLINE DERIVATIVES AS S1P MODULATORS
C07D 419/12 (2006.01)	2473490 *	(THIO)MORPHOLINE DERIVATIVES AS S1P MODULATORS
C07D 471/04 (2006.01)	2473490 *	(THIO)MORPHOLINE DERIVATIVES AS S1P MODULATORS
A61K 31/5377 (2006.01)	2473490 *	(THIO)MORPHOLINE DERIVATIVES AS S1P MODULATORS
A61P 25/04 (2006.01)	2473490 *	(THIO)MORPHOLINE DERIVATIVES AS S1P MODULATORS
A61P 25/06 (2006.01)	2473490 *	(THIO)MORPHOLINE DERIVATIVES AS S1P MODULATORS
A61P 25/16 (2006.01)	2473490 *	(THIO)MORPHOLINE DERIVATIVES AS S1P MODULATORS
A61P 25/18 (2006.01)	2473490 *	(THIO)MORPHOLINE DERIVATIVES AS S1P MODULATORS
A61P 25/24 (2006.01)	2473490 *	(THIO)MORPHOLINE DERIVATIVES AS S1P MODULATORS
A61P 25/28 (2006.01)	2473490 *	(THIO)MORPHOLINE DERIVATIVES AS S1P MODULATORS
C07D 279/12 (2006.01)	2473490 *	(THIO)MORPHOLINE DERIVATIVES AS S1P MODULATORS
C07D 417/12 (2006.01)	2473490 *	(THIO)MORPHOLINE DERIVATIVES AS S1P MODULATORS

MKP (51)	Broj objave evropske prijava patenta (97)	Naziv pronalaska (54)
C07D 487/04 (2006.01)	2473490 *	(THIO)MORPHOLINE DERIVATIVES AS S1P MODULATORS
C07D 471/04 (2006.01)	2419428 *	IMIDAZO [1,2-A]PYRIDINE DERIVATIVES AS FGFR KINASE INHIBITORS FOR USE IN THERAPY
A61K 31/437 (2006.01)	2419428 *	IMIDAZO [1,2-A]PYRIDINE DERIVATIVES AS FGFR KINASE INHIBITORS FOR USE IN THERAPY
A61P 35/00 (2006.01)	2419428 *	IMIDAZO [1,2-A]PYRIDINE DERIVATIVES AS FGFR KINASE INHIBITORS FOR USE IN THERAPY
C12M 1/00 (2006.01)	2406366 *	DEVICE FOR A PHOTOCHEMICAL PROCESS
A61K 9/14 (2006.01)	2437738 *	METHODS AND COMPOSITIONS FOR THE TREATMENT OF CANCER
A61K 31/10 (2006.01)	2437738 *	METHODS AND COMPOSITIONS FOR THE TREATMENT OF CANCER
A61K 9/16 (2006.01)	2437738 *	METHODS AND COMPOSITIONS FOR THE TREATMENT OF CANCER
A61P 35/00 (2006.01)	2437738 *	METHODS AND COMPOSITIONS FOR THE TREATMENT OF CANCER
G01N 33/50 (2006.01)	2435828 *	METHOD OF MONITORING ERYTHROPOIESIS
E06B 3/667 (2006.01)	2472048	Connector
A61P 1/18 (2006.01)	2481738 *	MALEIC ACID SALT AND CRYSTAL THEREOF
A61P 17/00 (2006.01)	2481738 *	MALEIC ACID SALT AND CRYSTAL THEREOF
A61P 7/02 (2006.01)	2481738 *	MALEIC ACID SALT AND CRYSTAL THEREOF
A61P 17/06 (2006.01)	2481738 *	MALEIC ACID SALT AND CRYSTAL THEREOF
A61P 1/16 (2006.01)	2481738 *	MALEIC ACID SALT AND CRYSTAL THEREOF
A61P 15/06 (2006.01)	2481738 *	MALEIC ACID SALT AND CRYSTAL THEREOF
A61P 31/04 (2006.01)	2481738 *	MALEIC ACID SALT AND CRYSTAL THEREOF
C07D 413/14 (2006.01)	2481738 *	MALEIC ACID SALT AND CRYSTAL THEREOF
A61P 9/10 (2006.01)	2481738 *	MALEIC ACID SALT AND CRYSTAL THEREOF
A61P 19/02 (2006.01)	2481738 *	MALEIC ACID SALT AND CRYSTAL THEREOF
A61K 31/536 (2006.01)	2481738 *	MALEIC ACID SALT AND CRYSTAL THEREOF
A61P 11/00 (2006.01)	2481738 *	MALEIC ACID SALT AND CRYSTAL THEREOF
A61P 25/00 (2006.01)	2481738 *	MALEIC ACID SALT AND CRYSTAL THEREOF
A61P 1/04 (2006.01)	2481738 *	MALEIC ACID SALT AND CRYSTAL THEREOF
A61P 13/12 (2006.01)	2481738 *	MALEIC ACID SALT AND CRYSTAL THEREOF
A61P 29/00 (2006.01)	2481738 *	MALEIC ACID SALT AND CRYSTAL THEREOF
A61P 7/00 (2006.01)	2481738 *	MALEIC ACID SALT AND CRYSTAL THEREOF
A61P 17/02 (2006.01)	2481738 *	MALEIC ACID SALT AND CRYSTAL THEREOF
A61P 1/02 (2006.01)	2481738 *	MALEIC ACID SALT AND CRYSTAL THEREOF
A61P 11/06 (2006.01)	2481738 *	MALEIC ACID SALT AND CRYSTAL THEREOF
A61P 27/02 (2006.01)	2481738 *	MALEIC ACID SALT AND CRYSTAL THEREOF
C07D 471/10 (2006.01)	2488500 *	SPIROPIPERIDINE COMPOUNDS AND PHARMACEUTICAL USE THEREOF FOR TREATING DIABETES
A61K 31/438 (2006.01)	2488500 *	SPIROPIPERIDINE COMPOUNDS AND PHARMACEUTICAL USE THEREOF FOR TREATING DIABETES
A61P 3/10 (2006.01)	2488500 *	SPIROPIPERIDINE COMPOUNDS AND PHARMACEUTICAL USE THEREOF FOR TREATING DIABETES
C07D 221/20 (2006.01)	2488500 *	SPIROPIPERIDINE COMPOUNDS AND PHARMACEUTICAL USE THEREOF FOR TREATING DIABETES
B26D 7/20 (2006.01)	2497615	Multi-profile die cutting assembly
B26D 5/02 (2006.01)	2497615	Multi-profile die cutting assembly
B26F 1/22 (2006.01)	2497615	Multi-profile die cutting assembly
A61K 31/565 (2006.01)	2459199 *	FULVESTRANT IN A DOSAGE OF 500MG FOR THE TREATMENT OF ADVANCED BREAST CANCER
A61P 35/00 (2006.01)	2459199 *	FULVESTRANT IN A DOSAGE OF 500MG FOR THE TREATMENT OF ADVANCED BREAST CANCER
F23H 17/12 (2006.01)	2417392 *	GRATE BAR FOR AN INCINERATOR AND METHOD FOR PRODUCING SUCH A GRATE BAR

MKP (51)	Broj objave evropske prijava patenta (97)	Naziv pronalaska (54)
F23H 7/08 (2006.01)	2417392 *	GRATE BAR FOR AN INCINERATOR AND METHOD FOR PRODUCING SUCH A GRATE BAR
A61K 8/00 (2006.01)	2437717 *	COMPOSTION AND METHOD FOR HAIR STRAIGHTENING AND CURLING
A01N 35/00 (2006.01)	2418942 *	NAPHTHALENE-BASED INHIBITORS OF ANTI-APOPTOTIC PROTEINS
C08B 37/10 (2006.01)	2427500 *	NOVEL ACYLATED 1,6-ANHYDRO DECASACCHARIDE AND ITS USE AS ANTITHROMBOTIC AGENT
A61P 7/02 (2006.01)	2427500 *	NOVEL ACYLATED 1,6-ANHYDRO DECASACCHARIDE AND ITS USE AS ANTITHROMBOTIC AGENT
A61K 31/727 (2006.01)	2427500 *	NOVEL ACYLATED 1,6-ANHYDRO DECASACCHARIDE AND ITS USE AS ANTITHROMBOTIC AGENT
A62D 3/02 (2007.01)	2428254	Process for treating an asbestos containing material
A62D 3/35 (2007.01)	2428254	Process for treating an asbestos containing material
A62D 3/36 (2007.01)	2428254	Process for treating an asbestos containing material
B21J 13/10 (2006.01)	2397244	Charging device for a bush widening device for perforated socket blanks made out of steel, for example, and method of forging perforated socket blanks
B21K 1/76 (2006.01)	2397244	Charging device for a bush widening device for perforated socket blanks made out of steel, for example, and method of forging perforated socket blanks
B21J 9/12 (2006.01)	2397244	Charging device for a bush widening device for perforated socket blanks made out of steel, for example, and method of forging perforated socket blanks
B21J 9/02 (2006.01)	2397244	Charging device for a bush widening device for perforated socket blanks made out of steel, for example, and method of forging perforated socket blanks
B21J 9/20 (2006.01)	2397244	Charging device for a bush widening device for perforated socket blanks made out of steel, for example, and method of forging perforated socket blanks
A01D 41/127 (2006.01)	2250871	Scalable grain tank fill level display
A61M 1/16 (2006.01)	2493525 *	DEVICE AND METHOD FOR CHARACTERIZING AN EXTRACORPOREAL BLOOD TREATMENT, AND EXTRACORPOREAL TREATMENT APPARATUS IMPLEMENTING SUCH A DEVICE
C03C 1/00 (2006.01)	2361891	Method of disposal of radioactive waste in silica glass
G21F 9/30 (2006.01)	2361891	Method of disposal of radioactive waste in silica glass
C12N 15/63 (2006.01)	2486134 *	USE OF TOLL-LIKE RECEPTOR AND AGONIST FOR TREATING CANCER
A61F 13/15 (2006.01)	2491909	Methods and apparatus for forming disposable products at high speeds with small machine footprint
A61K 8/67 (2006.01)	2429485 *	USE OF DELTA-TOCOPHERYL-CARBOHYDRATE AS A DEPIGMENTING AGENT
A61K 8/34 (2006.01)	2429485 *	USE OF DELTA-TOCOPHERYL-CARBOHYDRATE AS A DEPIGMENTING AGENT
A61K 8/36 (2006.01)	2429485 *	USE OF DELTA-TOCOPHERYL-CARBOHYDRATE AS A DEPIGMENTING AGENT
A61K 8/49 (2006.01)	2429485 *	USE OF DELTA-TOCOPHERYL-CARBOHYDRATE AS A DEPIGMENTING AGENT
A61Q 19/02 (2006.01)	2429485 *	USE OF DELTA-TOCOPHERYL-CARBOHYDRATE AS A DEPIGMENTING AGENT
A61K 8/92 (2006.01)	2429485 *	USE OF DELTA-TOCOPHERYL-CARBOHYDRATE AS A DEPIGMENTING AGENT
C07D 291/08 (2006.01)	2431360	Derivatives of dihydrobenzoxathiazepine, method of preparing same and pharmaceutical compositions containing them as well as their uses as modulators of AMPA receptors
A61P 25/00 (2006.01)	2431360	Derivatives of dihydrobenzoxathiazepine, method of preparing same and pharmaceutical compositions containing them as well as their uses as modulators of AMPA receptors
A61K 31/551 (2006.01)	2431360	Derivatives of dihydrobenzoxathiazepine, method of preparing same and pharmaceutical compositions containing them as well as their uses as modulators of AMPA receptors
C25B 3/04 (2006.01)	2494095 *	IMPROVED SILVER CATHODE ACTIVATION
C07D 213/803 (2006.01)	2494095 *	IMPROVED SILVER CATHODE ACTIVATION
A61B 6/00 (2006.01)	2435118 *	METHOD FOR DETERMINING TREATMENTS USING PATIENT-SPECIFIC LUNG MODELS AND COMPUTER METHODS

MKP (51)	Broj objave evropske prijava patenta (97)	Naziv pronalaska (54)
G06F 19/00 (2011.01)	2435118 *	METHOD FOR DETERMINING TREATMENTS USING PATIENT-SPECIFIC LUNG MODELS AND COMPUTER METHODS
A61M 16/00 (2006.01)	2435118 *	METHOD FOR DETERMINING TREATMENTS USING PATIENT-SPECIFIC LUNG MODELS AND COMPUTER METHODS
A61B 5/08 (2006.01)	2435118 *	METHOD FOR DETERMINING TREATMENTS USING PATIENT-SPECIFIC LUNG MODELS AND COMPUTER METHODS
A61K 35/74 (2006.01)	2485743 *	LACTOBACILLUS PLANTARUM STRAINS AS HYPOCHOLESTEROLEMIC AGENTS.
A61P 9/00 (2006.01)	2485743 *	LACTOBACILLUS PLANTARUM STRAINS AS HYPOCHOLESTEROLEMIC AGENTS.
A61K 31/437 (2006.01)	2455381 *	TRIAZOLOPYRIDINE COMPOUND, AND ACTION THEREOF AS PROLYL HYDROXYLASE INHIBITOR AND ERYTHROPOIETIN PRODUCTION INDUCER
A61P 7/06 (2006.01)	2455381 *	TRIAZOLOPYRIDINE COMPOUND, AND ACTION THEREOF AS PROLYL HYDROXYLASE INHIBITOR AND ERYTHROPOIETIN PRODUCTION INDUCER
A61P 43/00 (2006.01)	2455381 *	TRIAZOLOPYRIDINE COMPOUND, AND ACTION THEREOF AS PROLYL HYDROXYLASE INHIBITOR AND ERYTHROPOIETIN PRODUCTION INDUCER
C07D 471/04 (2006.01)	2455381 *	TRIAZOLOPYRIDINE COMPOUND, AND ACTION THEREOF AS PROLYL HYDROXYLASE INHIBITOR AND ERYTHROPOIETIN PRODUCTION INDUCER
C08K 3/34 (2006.01)	2264092	Waterproofing membranes based on bitumen modified with polymers containing aluminium silicate cenospheres.
C08K 7/00 (2006.01)	2264092	Waterproofing membranes based on bitumen modified with polymers containing aluminium silicate cenospheres.
C08L 95/00 (2006.01)	2264092	Waterproofing membranes based on bitumen modified with polymers containing aluminium silicate cenospheres.
A01N 31/08 (2006.01)	2408299 *	FATTY ACID MONOGLYCERIDE COMPOSITIONS
A61K 31/05 (2006.01)	2408299 *	FATTY ACID MONOGLYCERIDE COMPOSITIONS
C12Q 1/68 (2006.01)	2478116 *	METHOD FOR IDENTIFYING WHETHER A PATIENT WILL BE RESPONDER OR NOT TO IMMUNOTHERAPY
C07K 1/113 (2006.01)	2445923 *	REFOLDING PROTEINS USING A CHEMICALLY CONTROLLED REDOX STATE
C07D 471/08 (2006.01)	2491034 *	FUSED HETEROCYCLIC COMPOUNDS AS OREXIN RECEPTOR MODULATORS
A61P 25/00 (2006.01)	2491034 *	FUSED HETEROCYCLIC COMPOUNDS AS OREXIN RECEPTOR MODULATORS
A61K 31/439 (2006.01)	2491034 *	FUSED HETEROCYCLIC COMPOUNDS AS OREXIN RECEPTOR MODULATORS
C07D 401/12 (2006.01)	2440544 *	HEDGEHOG PATHWAY ANTAGONISTS AND THERAPEUTIC APPLICATIONS THEREOF
A61P 35/00 (2006.01)	2440544 *	HEDGEHOG PATHWAY ANTAGONISTS AND THERAPEUTIC APPLICATIONS THEREOF
C07D 403/12 (2006.01)	2440544 *	HEDGEHOG PATHWAY ANTAGONISTS AND THERAPEUTIC APPLICATIONS THEREOF
C07D 471/04 (2006.01)	2440544 *	HEDGEHOG PATHWAY ANTAGONISTS AND THERAPEUTIC APPLICATIONS THEREOF
A61K 31/4184 (2006.01)	2440544 *	HEDGEHOG PATHWAY ANTAGONISTS AND THERAPEUTIC APPLICATIONS THEREOF
A61K 31/352 (2006.01)	2480220 *	TREATMENT AND PREVENTION OF HIV INFECTION
A61P 31/18 (2006.01)	2480220 *	TREATMENT AND PREVENTION OF HIV INFECTION
A61K 9/08 (2006.01)	2480220 *	TREATMENT AND PREVENTION OF HIV INFECTION
A61K 9/51 (2006.01)	2480220 *	TREATMENT AND PREVENTION OF HIV INFECTION
B60G 7/02 (2006.01)	2380761	Fastening assembly for connecting a wheel suspension to a vehicle frame
B60G 13/00 (2006.01)	2380761	Fastening assembly for connecting a wheel suspension to a vehicle frame
B62D 21/20 (2006.01)	2380761	Fastening assembly for connecting a wheel suspension to a vehicle frame

MKP (51)	Broj objave evropske prijave patenta (97)	Naziv pronalaska (54)
B62D 21/00 (2006.01)	2380761	Fastening assembly for connecting a wheel suspension to a vehicle frame
C07D 471/04 (2006.01)	2493865 *	RAF INHIBITOR COMPOUNDS AND METHODS OF USE THEREOF
C07D 403/12 (2006.01)	2493865 *	RAF INHIBITOR COMPOUNDS AND METHODS OF USE THEREOF
A61K 31/519 (2006.01)	2493865 *	RAF INHIBITOR COMPOUNDS AND METHODS OF USE THEREOF
A61P 35/00 (2006.01)	2493865 *	RAF INHIBITOR COMPOUNDS AND METHODS OF USE THEREOF
C07D 405/12 (2006.01)	2493865 *	RAF INHIBITOR COMPOUNDS AND METHODS OF USE THEREOF
A61K 31/517 (2006.01)	2493865 *	RAF INHIBITOR COMPOUNDS AND METHODS OF USE THEREOF
C07D 239/94 (2006.01)	2493865 *	RAF INHIBITOR COMPOUNDS AND METHODS OF USE THEREOF
C07K 16/22 (2006.01)	2459592 *	HIGH AFFINITY HUMAN ANTIBODIES TO HUMAN ANGIOPOIETIN-2
A61K 39/395 (2006.01)	2459592 *	HIGH AFFINITY HUMAN ANTIBODIES TO HUMAN ANGIOPOIETIN-2
A61P 35/00 (2006.01)	2459592 *	HIGH AFFINITY HUMAN ANTIBODIES TO HUMAN ANGIOPOIETIN-2
A61P 9/00 (2006.01)	2480547 *	INDOLIZINE INHIBITORS OF 5-LIPOXYGENASE
C07D 403/06 (2006.01)	2480547 *	INDOLIZINE INHIBITORS OF 5-LIPOXYGENASE
A61P 11/00 (2006.01)	2480547 *	INDOLIZINE INHIBITORS OF 5-LIPOXYGENASE
C07D 413/12 (2006.01)	2480547 *	INDOLIZINE INHIBITORS OF 5-LIPOXYGENASE
C07D 417/12 (2006.01)	2480547 *	INDOLIZINE INHIBITORS OF 5-LIPOXYGENASE
A61P 29/00 (2006.01)	2480547 *	INDOLIZINE INHIBITORS OF 5-LIPOXYGENASE
C07D 471/04 (2006.01)	2480547 *	INDOLIZINE INHIBITORS OF 5-LIPOXYGENASE
A61K 31/437 (2006.01)	2480547 *	INDOLIZINE INHIBITORS OF 5-LIPOXYGENASE
B29B 17/00 (2006.01)	2445692 *	MATERIALS
G06F 21/00 (2006.01)	2388726	Detection of hidden objects in a computer system
A01N 25/04 (2006.01)	2433987 *	COMPOSITION FOR PREPARING EMULSION OR MICROEMULSION FORMULATIONS
B27K 3/50 (2006.01)	2433987 *	COMPOSITION FOR PREPARING EMULSION OR MICROEMULSION FORMULATIONS
C08K 5/10 (2006.01)	2433987 *	COMPOSITION FOR PREPARING EMULSION OR MICROEMULSION FORMULATIONS
C08K 5/42 (2006.01)	2433987 *	COMPOSITION FOR PREPARING EMULSION OR MICROEMULSION FORMULATIONS
C08L 71/02 (2006.01)	2433987 *	COMPOSITION FOR PREPARING EMULSION OR MICROEMULSION FORMULATIONS
C23C 16/505 (2006.01)	2251453	Vessel holder
C23C 16/458 (2006.01)	2251453	Vessel holder
G01N 15/08 (2006.01)	2251453	Vessel holder
A61B 5/15 (2006.01)	2251453	Vessel holder
C12N 1/18 (2006.01)	2456851 *	FERMENTATIVE GLYCEROL-FREE ETHANOL PRODUCTION
C12N 9/02 (2006.01)	2456851 *	FERMENTATIVE GLYCEROL-FREE ETHANOL PRODUCTION
C12P 7/06 (2006.01)	2456851 *	FERMENTATIVE GLYCEROL-FREE ETHANOL PRODUCTION
C12P 7/10 (2006.01)	2456851 *	FERMENTATIVE GLYCEROL-FREE ETHANOL PRODUCTION
C12N 15/53 (2006.01)	2456851 *	FERMENTATIVE GLYCEROL-FREE ETHANOL PRODUCTION
E06B 7/02 (2006.01)	2456944 *	DEFLECTOR BARRIER FOR SMOKE AND HEAT VENTS AND A SMOKE AND HEAT VENT PROVIDED WITH SAID DEFLECTOR BARRIER
F23J 11/00 (2006.01)	2456944 *	DEFLECTOR BARRIER FOR SMOKE AND HEAT VENTS AND A SMOKE AND HEAT VENT PROVIDED WITH SAID DEFLECTOR BARRIER
E06B 7/26 (2006.01)	2456944 *	DEFLECTOR BARRIER FOR SMOKE AND HEAT VENTS AND A SMOKE AND HEAT VENT PROVIDED WITH SAID DEFLECTOR BARRIER
B32B 27/12 (2006.01)	2452011 *	CARPET AND CARPET BACKING
B60N 3/04 (2006.01)	2452011 *	CARPET AND CARPET BACKING
D06N 7/00 (2006.01)	2452011 *	CARPET AND CARPET BACKING
B32B 27/32 (2006.01)	2452011 *	CARPET AND CARPET BACKING
A61P 25/00 (2006.01)	2485760 *	HUMAN ANTI-NGF NEUTRALIZING ANTIBODIES AS SELECTIVE NGF PATHWAY INHIBITORS

MKP (51)	Broj objave evropske prijava patenta (97)	Naziv pronalaska (54)
C07K 16/22 (2006.01)	2485760 *	HUMAN ANTI-NGF NEUTRALIZING ANTIBODIES AS SELECTIVE NGF PATHWAY INHIBITORS
G01N 33/53 (2006.01)	2485760 *	HUMAN ANTI-NGF NEUTRALIZING ANTIBODIES AS SELECTIVE NGF PATHWAY INHIBITORS
C12N 15/68 (2006.01)	2485760 *	HUMAN ANTI-NGF NEUTRALIZING ANTIBODIES AS SELECTIVE NGF PATHWAY INHIBITORS
A61K 39/395 (2006.01)	2485760 *	HUMAN ANTI-NGF NEUTRALIZING ANTIBODIES AS SELECTIVE NGF PATHWAY INHIBITORS
A61P 29/02 (2006.01)	2485760 *	HUMAN ANTI-NGF NEUTRALIZING ANTIBODIES AS SELECTIVE NGF PATHWAY INHIBITORS
C12N 5/10 (2006.01)	2485760 *	HUMAN ANTI-NGF NEUTRALIZING ANTIBODIES AS SELECTIVE NGF PATHWAY INHIBITORS
A61P 19/02 (2006.01)	2485760 *	HUMAN ANTI-NGF NEUTRALIZING ANTIBODIES AS SELECTIVE NGF PATHWAY INHIBITORS
A61P 35/00 (2006.01)	2485760 *	HUMAN ANTI-NGF NEUTRALIZING ANTIBODIES AS SELECTIVE NGF PATHWAY INHIBITORS
A01K 13/00 (2006.01)	2490524 *	TRANSDERMAL DISPENSING APPARATUS AND METHODS
A61D 7/00 (2006.01)	2490524 *	TRANSDERMAL DISPENSING APPARATUS AND METHODS
D21H 19/52 (2006.01)	2350387 *	PAPER FILLER COMPOSITION
A61K 31/727 (2006.01)	2408459 *	A DOSE OF AVE5026 FOR THE TREATMENT OF VENOUS THROMBOEMBOLISM IN PATIENTS WITH SEVERE RENAL IMPAIRMENT
A61K 31/765 (2006.01)	2408459 *	A DOSE OF AVE5026 FOR THE TREATMENT OF VENOUS THROMBOEMBOLISM IN PATIENTS WITH SEVERE RENAL IMPAIRMENT
A61P 9/00 (2006.01)	2408459 *	A DOSE OF AVE5026 FOR THE TREATMENT OF VENOUS THROMBOEMBOLISM IN PATIENTS WITH SEVERE RENAL IMPAIRMENT
A61P 7/02 (2006.01)	2408459 *	A DOSE OF AVE5026 FOR THE TREATMENT OF VENOUS THROMBOEMBOLISM IN PATIENTS WITH SEVERE RENAL IMPAIRMENT
A61P 13/12 (2006.01)	2408459 *	A DOSE OF AVE5026 FOR THE TREATMENT OF VENOUS THROMBOEMBOLISM IN PATIENTS WITH SEVERE RENAL IMPAIRMENT
A61P 41/00 (2006.01)	2408459 *	A DOSE OF AVE5026 FOR THE TREATMENT OF VENOUS THROMBOEMBOLISM IN PATIENTS WITH SEVERE RENAL IMPAIRMENT
A61K 9/107 (2006.01)	2429521 *	SUBLINGUAL DEXMEDETOMIDINE COMPOSITIONS AND METHODS OF USE THEREOF
A61K 9/14 (2006.01)	2429521 *	SUBLINGUAL DEXMEDETOMIDINE COMPOSITIONS AND METHODS OF USE THEREOF
A61P 35/00 (2006.01)	2429521 *	SUBLINGUAL DEXMEDETOMIDINE COMPOSITIONS AND METHODS OF USE THEREOF
A61P 17/02 (2006.01)	2429521 *	SUBLINGUAL DEXMEDETOMIDINE COMPOSITIONS AND METHODS OF USE THEREOF
A61P 3/00 (2006.01)	2429521 *	SUBLINGUAL DEXMEDETOMIDINE COMPOSITIONS AND METHODS OF USE THEREOF
A61P 25/00 (2006.01)	2429521 *	SUBLINGUAL DEXMEDETOMIDINE COMPOSITIONS AND METHODS OF USE THEREOF
A61K 31/415 (2006.01)	2429521 *	SUBLINGUAL DEXMEDETOMIDINE COMPOSITIONS AND METHODS OF USE THEREOF
A47L 13/10 (2006.01)	2433545 *	HANDY MOP
A47L 13/20 (2006.01)	2433545 *	HANDY MOP
A61P 3/10 (2006.01)	2432880 *	TARGETING MICRORNAS FOR METABOLIC DISORDERS
C12N 15/113 (2010.01)	2432880 *	TARGETING MICRORNAS FOR METABOLIC DISORDERS
A61K 31/712 (2006.01)	2432880 *	TARGETING MICRORNAS FOR METABOLIC DISORDERS
A61K 31/7125 (2006.01)	2432880 *	TARGETING MICRORNAS FOR METABOLIC DISORDERS
C07H 21/00 (2006.01)	2432880 *	TARGETING MICRORNAS FOR METABOLIC DISORDERS
C12Q 1/68 (2006.01)	2432880 *	TARGETING MICRORNAS FOR METABOLIC DISORDERS
A61P 3/06 (2006.01)	2432880 *	TARGETING MICRORNAS FOR METABOLIC DISORDERS
C07D 401/12 (2006.01)	2445886 *	HETEROCYCLIC COMPOUNDS AND THEIR USES

MKP (51)	Broj objave evropske prijava patenta (97)	Naziv pronalaska (54)
A61K 31/4709 (2006.01)	2445886 *	HETEROCYCLIC COMPOUNDS AND THEIR USES
C07D 401/14 (2006.01)	2445886 *	HETEROCYCLIC COMPOUNDS AND THEIR USES
A61P 29/00 (2006.01)	2445886 *	HETEROCYCLIC COMPOUNDS AND THEIR USES
C07D 215/44 (2006.01)	2445886 *	HETEROCYCLIC COMPOUNDS AND THEIR USES
C07D 471/04 (2006.01)	2445886 *	HETEROCYCLIC COMPOUNDS AND THEIR USES
C07D 401/04 (2006.01)	2445886 *	HETEROCYCLIC COMPOUNDS AND THEIR USES
A61K 31/4706 (2006.01)	2445886 *	HETEROCYCLIC COMPOUNDS AND THEIR USES
C07D 407/14 (2006.01)	2445886 *	HETEROCYCLIC COMPOUNDS AND THEIR USES
C07D 409/12 (2006.01)	2445886 *	HETEROCYCLIC COMPOUNDS AND THEIR USES
C07D 413/14 (2006.01)	2445886 *	HETEROCYCLIC COMPOUNDS AND THEIR USES
C07D 417/14 (2006.01)	2445886 *	HETEROCYCLIC COMPOUNDS AND THEIR USES

INDEKS PODNOSITELJA ZAHTEVA ZA PROŠIRENJE EVROPSKIH PRIJAVA PATENTA

INDEX ON NUMBER OF APPLICATIONS FOR EXTENSION OF EUROPEAN PATENT APPLICATION

Podnosilac evropske prijave patenta (71)	MKP (51)	Broj objave evropske prijave patenta (97)	Naziv pronalaska (54)
Sanofi-Aventis U.S. LLC	A61P 25/00 (2006.01) A61K 31/165 (2006.01) A61K 38/21 (2006.01)	2451449 *	USE OF THE COMBINATION OF TERIFLUNOMIDE AND INTERFERON BETA FOR TREATING MULTIPLE SCLEROSIS
Nippon Steel Engineering Co., Ltd	C10G 2/00 (2006.01)	2474593 *	SLURRY PREPARATION METHOD, SLURRY PREPARATION APPARATUS, HYDROCARBON SYNTHESIS REACTION APPARATUS, AND HYDROCARBON SYNTHESIS REACTION SYSTEM
Japan Oil, Gas and Metals National Corporation	C10G 2/00 (2006.01)	2474593 *	SLURRY PREPARATION METHOD, SLURRY PREPARATION APPARATUS, HYDROCARBON SYNTHESIS REACTION APPARATUS, AND HYDROCARBON SYNTHESIS REACTION SYSTEM
Japan Petroleum Exploration Co., Ltd.	C10G 2/00 (2006.01)	2474593 *	SLURRY PREPARATION METHOD, SLURRY PREPARATION APPARATUS, HYDROCARBON SYNTHESIS REACTION APPARATUS, AND HYDROCARBON SYNTHESIS REACTION SYSTEM
JX Nippon Oil & Energy Corporation	C10G 2/00 (2006.01)	2474593 *	SLURRY PREPARATION METHOD, SLURRY PREPARATION APPARATUS, HYDROCARBON SYNTHESIS REACTION APPARATUS, AND HYDROCARBON SYNTHESIS REACTION SYSTEM
Cosmo Oil Co., Ltd.	C10G 2/00 (2006.01)	2474593 *	SLURRY PREPARATION METHOD, SLURRY PREPARATION APPARATUS, HYDROCARBON SYNTHESIS REACTION APPARATUS, AND HYDROCARBON SYNTHESIS REACTION SYSTEM
INPEX Corporation	C10G 2/00 (2006.01)	2474593 *	SLURRY PREPARATION METHOD, SLURRY PREPARATION APPARATUS, HYDROCARBON SYNTHESIS REACTION APPARATUS, AND HYDROCARBON SYNTHESIS REACTION SYSTEM
Johannes- Gutenberg-Universität Mainz	A61K 48/00 (2006.01) C12N 5/16 (2006.01)	2461833 *	VACCINE COMPOSITION COMPRISING 5'-CAP MODIFIED RNA
Biontech AG	A61K 48/00 (2006.01) C12N 5/16 (2006.01)	2461833 *	VACCINE COMPOSITION COMPRISING 5'-CAP MODIFIED RNA
Uniwersytet Warszawski	A61K 48/00 (2006.01) C12N 5/16 (2006.01)	2461833 *	VACCINE COMPOSITION COMPRISING 5'-CAP MODIFIED RNA
Immersion Corporation	G06F 3/041 (2006.01) G06F 3/01 (2006.01) G06F 3/048 (2006.01)	2406703 *	SYSTEMS AND METHODS FOR FRICTION DISPLAYS AND ADDITIONAL HAPTIC EFFECTS
Immersion Corporation	G06F 3/041 (2006.01) G06F 3/01 (2006.01) G06F 3/048 (2006.01)	2406702 *	SYSTEMS AND METHODS FOR INTERFACES FEATURING SURFACE-BASED HAPTIC EFFECTS
Brinker Technology Limited	F16L 55/164 (2006.01)	2419670 *	DELIVERY METHOD AND COMPOSITIONS
China Academy of Telecommunications Technology	H04W 40/20 (2009.01)	2485532 *	METHOD, SYSTEM AND APPARATUS FOR ACQUIRING CELL LOCATION INFORMATION
Zanatta S.r.l.	B67B 7/04 (2006.01)	2371758	Perforating tip for a corkscrew
Amgen, Inc	C07D 401/14 (2006.01) C07D 473/00 (2006.01) A61P 35/00 (2006.01) A61K 31/52 (2006.01)	2424859 *	INHIBITORS OF PI3 KINASE AND / OR MTOR
Chase Pharmaceuticals Corporation	C12N 15/09 (2006.01)	2478099 *	METHOD AND COMPOSITION FOR TREATING ALZHEIMER-TYPE DEMENTIA
PE.GAS.US. S.r.l.	H01R 13/533 (2006.01) E21B 17/20 (2006.01)	2390965	An electrical connector, particularly for a drill string
Bayer BioScience N.V.	A01H 5/10 (2006.01) C12N 15/82 (2006.01)	2440034 *	HIGH OIL CONTENT PLANTS

Podnosilac evropske prijave patenta (71)	MKP (51)	Broj objave evropske prijave patenta (97)	Naziv pronalaska (54)
Biotie Therapies Corp.	A61K 39/395 (2006.01) A61P 17/02 (2006.01) C07K 16/40 (2006.01) G01N 33/577 (2006.01) A61K 31/00 (2006.01) A61P 43/00 (2006.01)	2475387 *	USE OF VAP-1 INHIBITORS FOR TREATING FIBROTIC CONDITIONS
The University of Birmingham	A61K 39/395 (2006.01) A61P 17/02 (2006.01) C07K 16/40 (2006.01) G01N 33/577 (2006.01) A61K 31/00 (2006.01) A61P 43/00 (2006.01)	2475387 *	USE OF VAP-1 INHIBITORS FOR TREATING FIBROTIC CONDITIONS
Takeda Pharmaceutical Company Limited	C07D 405/14 (2006.01) A61K 31/5377 (2006.01) C07D 407/04 (2006.01) A61K 31/551 (2006.01) C07D 405/12 (2006.01) A61K 31/496 (2006.01) C07D 407/12 (2006.01) C07D 307/79 (2006.01) C07D 413/04 (2006.01) C07D 307/80 (2006.01) C07D 413/12 (2006.01) C07D 307/81 (2006.01) C07D 417/12 (2006.01) C07D 405/04 (2006.01) C07D 493/10 (2006.01)	2406243 *	BENZOFURAN DERIVATIVES
Ashland Licensing And Intellectual Property, LLC	C08K 5/15 (2006.01)	2464690 *	FORMULATIONS COMPRISING ISOSORBIDE-MODIFIED UNSATURATED POLYESTER RESINS AND LOW PROFILE ADDITIVES WHICH PRODUCE LOW SHRINKAGE MATRICES
Sanofi-Aventis Deutschland GmbH	A61M 5/315 (2006.01)	2475411 *	DRIVE MECHANISM FOR DRUG DELIVERY DEVICE
Active Tools International (HK) Ltd.	F16K 11/074 (2006.01) B29C 73/16 (2006.01)	2451631 *	VALVE FOR TYRE REPAIR KIT
Alberici S.p.A.	G07D 3/12 (2006.01)	2230646	Coin dispenser device
Phenex Pharmaceuticals AG	A61K 31/443 (2006.01) C07D 249/06 (2006.01) A61K 31/4439 (2006.01) C07D 261/08 (2006.01) A61P 1/16 (2006.01) C07D 413/04 (2006.01) A61P 3/10 (2006.01) A61K 31/42 (2006.01) C07D 413/12 (2006.01) A61P 35/00 (2006.01) C07D 413/14 (2006.01) A61K 31/4192 (2006.01)	2467366 *	NOVEL FXR (NR1H4) BINDING AND ACTIVITY MODULATING COMPOUNDS
Intermune, Inc.	A61K 31/4412 (2006.01) A61P 11/00 (2006.01)	2377537	Pirfenidone therapy and inducers of cytochrome P450
Crucell Holland B.V.	A61K 39/13 (2006.01) C12N 7/02 (2006.01)	2454364 *	PRODUCTION OF POLIO VIRUS AT HIGH TITERS FOR VACCINE PRODUCTION
Panmira Pharmaceuticals, LLC	C07C 275/24 (2006.01) C07C 275/16 (2006.01) C07C 273/02 (2006.01) A61K 31/17 (2006.01) A61P 11/00 (2006.01)	2462110 *	DP2 ANTAGONIST AND USES THEREOF
Alnylam Pharmaceuticals, Inc.	C12N 15/11 (2006.01) C07H 21/04 (2006.01) C12N 5/07 (2010.01) C12N 5/00 (2006.01)	2451823 *	COMPOSITIONS AND METHODS FOR ENHANCING PRODUCTION OF A BIOLOGICAL PRODUCT

Podnosilac evropske prijave patenta (71)	MKP (51)	Broj objave evropske prijave patenta (97)	Naziv pronalaska (54)
Nordcoll A/S	C08J 5/12 (2006.01) B29C 65/48 (2006.01) C08J 3/11 (2006.01) C09J 127/06 (2006.01) C09J 155/02 (2006.01)	2404953	Solvent based glue composition
Abbott Laboratories	C12P 21/08 (2006.01) C12Q 1/70 (2006.01)	2488658 *	DUAL VARIABLE DOMAIN IMMUNOGLOBULINS AND USES THEREOF
Ethicon, Inc	A61B 17/06 (2006.01) A61B 17/00 (2006.01) A61B 7/04 (2006.01)	2470078 *	BARBED SUTURES HAVING PLEDGET STOPPERS AND METHODS THEREFOR
Sanofi-Aventis Deutschland GmbH	A61M 5/315 (2006.01)	2496290 *	ASSEMBLY FOR A DRUG DELIVERY DEVICE AND DRUG DELIVERY DEVICE
SOLVAY SA	B29C 35/14 (2006.01) B29B 15/10 (2006.01) B29C 47/02 (2006.01) B29C 70/50 (2006.01) B29C 70/20 (2006.01)	2461960 *	MANUFACTURE AND USE OF A REINFORCED PROFILE
Deutsche Landwirtschafts-Gesellschaft E.V.	H01L 31/18 (2006.01)	2481098 *	METHOD AND DEVICE FOR CHARGING PHOTOVOLTAIC MODULES
Targacept Inc.	A61K 31/506 (2006.01) A61K 31/505 (2006.01) A61P 25/28 (2006.01) A61P 25/00 (2006.01)	2442810 *	REVERSAL OF L-DOPA-INDUCED DYSKINESIA BY NEURONAL NICOTINIC RECEPTOR LIGANDS
SANOFI	G01N 33/68 (2006.01)	2496943 *	METHODS AND USES RELATING TO THE IDENTIFICATION OF COMPOUND INVOLVED IN PAIN AS WELL AS METHODS OF DIAGNOSING ALGESIA
VALSIR S.p.A.	E03C 1/284 (2006.01) E03F 5/04 (2006.01)	2404001 *	WATER DRAIN SIPHON DEVICE, IN PARTICULAR FOR FLOOR SHOWERS AND SHOWER TRAYS
Envivo Pharmaceuticals, Inc.	A61K 45/06 (2006.01) A61P 25/00 (2006.01) A61P 25/28 (2006.01) A61K 31/27 (2006.01) A61K 31/439 (2006.01) A61K 31/473 (2006.01) A61K 31/445 (2006.01) A61K 31/55 (2006.01)	2429518 *	TREATMENT OF COGNITIVE DISORDERS WITH CERTAIN ALPHA-7 NICOTINIC ACID RECEPTORS IN COMBINATION WITH ACETYLCHOLINESTERASE INHIBITORS
Sanofi-Aventis Deutschland GmbH	G09F 3/02 (2006.01) G09F 11/30 (2006.01) A61M 5/31 (2006.01) A61M 5/178 (2006.01) B65C 3/06 (2006.01)	2414000 *	DRUG DELIVERY DEVICE WITH INTEGRATED EXTENDABLE /RETRACTABLE INFORMATION DISPLAY ELEMENT
Prometheus Laboratories Inc.	G01N 33/574 (2006.01)	2454598 *	DRUG SELECTION FOR GASTRIC CANCER THERAPY USING ANTIBODY-BASED ARRAYS
Basilea Pharmaceutica AG	C07D 413/04 (2006.01) A61K 31/4245 (2006.01) A61P 35/00 (2006.01)	2459553 *	FURAZANOBENZIMIDAZOLES AS PRODRUGS TO TREAT NEOPLASTIC OR AUTOIMMUNE DISEASES
CEDC International sp. z.o.o.	B65D 41/46 (2006.01) B65D 41/62 (2006.01)	2444334	Safety bottle cap
Gargani, Mario	A61M 5/32 (2006.01)	2480274 *	ACTUATOR FOR SAFETY DEVICES FOR NEEDLES AND DISPOSABLE MEDICAL INSTRUMENTS
MANIFATTURA TUBI GOMMA S.p.A.	F16L 11/04 (2006.01)	2431643	Method and apparatus for the surface treatment of collapsible tubular sub-layers intended for the production of multi-layer tubes
Rakuten, Inc.	G09G 5/00 (2006.01) G09G 5/36 (2006.01) G06Q 50/00 (2012.01) G06Q 10/00 (2012.01)	2407922 *	HORSE BODY INFORMATION PROVISION SYSTEM, HORSE BODY STILL IMAGE DATA EXTRACTION METHOD, HORSE BODY STILL IMAGE DATA EXTRACTION PROGRAM, AND COMPUTER-READABLE RECORDING MEDIUM
Ranbaxy Laboratories Limited	A61K 9/20 (2006.01) A61K 9/14 (2006.01) A61K 9/16 (2006.01)	2279728	Solid dosage forms of HIV protease inhibitors

Podnosilac evropske prijave patenta (71)	MKP (51)	Broj objave evropske prijave patenta (97)	Naziv pronalaska (54)
Prolong Pharmaceuticals, LLC	A61K 47/18 (2006.01) A61K 47/48 (2006.01) A61K 38/42 (2006.01)	2440239 *	HEMOGLOBIN COMPOSITIONS
SciPharm SàRL	A61K 31/557 (2006.01) A61K 31/5585 (2006.01) A61P 11/00 (2006.01)	2461812 *	COMPOSITION FOR THE TREATMENT OF CYSTIC FIBROSIS
Bolton Manitoba SpA	C11D 1/44 (2006.01)	2316914	Adhesive detergent composition
ADC GmbH	H01R 9/24 (2006.01)	2441128 *	TERMINAL STRIP
Sanofi-Aventis Deutschland GmbH	C07D 213/16 (2006.01) A61K 31/4406 (2006.01)	2438045 *	CRYSTALLINE PHASES OF 2'-[2-(4-METHOXY-PHENYL)-ACETYLAMINO]-METHYL-BIPHENYL-2-CARBOXYLIC ACID (2-PYRIDIN-3-YL-ETHYL)-AMIDE
Messer Group GmbH	C04B 2/10 (2006.01)	2230223	Method and device for producing calcium
National Institute Of Agrobiological Sciences	A01H 5/08 (2006.01) A01H 5/10 (2006.01) A01H 5/00 (2006.01) C12N 15/09 (2006.01) C12N 5/10 (2006.01)	2495313 *	PRODUCTION METHOD FOR GENETICALLY MODIFIED PLANT CELLS
Allomet Corporation	C22C 26/00 (2006.01) B22F 1/02 (2006.01) C04B 35/628 (2006.01) C22C 29/02 (2006.01)	2462083 *	TOUGH COATED HARD PARTICLES CONSOLIDATED IN A TOUGH MATRIX MATERIAL
WCM Industries, Inc.	E03C 1/232 (2006.01)	2467539 *	CABLE ACTUATED DRAIN
Boehringer Ingelheim International GmbH	C07D 239/48 (2006.01) C07D 401/12 (2006.01) C07D 405/12 (2006.01) A61P 35/00 (2006.01) A61K 31/505 (2006.01)	2435411 *	2, 4 -DIAMINOPYRIMIDINES FOR THE TREATMENT OF DISEASES CHARACTERISED BY EXCESSIVE OR ABNORMAL CELL PROLIFERATION
B.T.Biochemical Tissues S.R.L.	C12M 1/00 (2006.01)	2371940	Process for bio-oil production involving the use of CO2
Desmeules, Alain	F24J 3/08 (2006.01) E02D 5/30 (2006.01)	2491183 *	PILE WITH INTEGRAL GEOTHERMAL CONDUIT LOOP RETAINING MEANS
Bayer Pharma Aktiengesellschaft	C07D 233/70 (2006.01) C07D 249/12 (2006.01) C07D 409/04 (2006.01) C07D 413/12 (2006.01) A61K 31/4166 (2006.01) A61K 31/4196 (2006.01) A61K 31/422 (2006.01) A61P 9/00 (2006.01)	2408751 *	Substituted 2-acetamido-5-aryl-1,2,4-triazolones and use thereof
Pfizer Inc.	A61K 31/506 (2006.01) A61P 3/04 (2006.01) A61K 31/497 (2006.01) A61P 3/10 (2006.01) C07D 405/14 (2006.01)	2406253 *	BENZOFURANYL DERIVATIVES USED AS GLUCOKINASE INHIBITORS
Novartis AG	C07D 417/14 (2006.01) A61K 31/403 (2006.01) C07D 209/96 (2006.01) A61P 31/22 (2006.01) C07D 401/12 (2006.01) C07K 5/08 (2006.01) C07D 401/14 (2006.01) C07D 403/12 (2006.01) C07D 403/14 (2006.01) C07D 405/14 (2006.01)	2417108 *	ORGANIC COMPOUNDS AND THEIR USES
Eisenberger, Peter	B01D 53/02 (2006.01)	2408538 *	CARBON DIOXIDE CAPTURE/REGENERATION STRUCTURES AND TECHNIQUES
Chichilnisky, Graciela	B01D 53/02 (2006.01)	2408538 *	CARBON DIOXIDE CAPTURE/REGENERATION STRUCTURES AND TECHNIQUES
Proyecto de Biomedicina Cima, S.L.	C12N 15/86 (2006.01) C12N 15/864 (2006.01) A61K 48/00 (2006.01) C07K 14/65 (2006.01)	2412387 *	METHODS AND COMPOSITIONS FOR THE TREATMENT OF CIRRHOSIS AND LIVER FIBROSIS

Podnosilac evropske prijave patenta (71)	MKP (51)	Broj objave evropske prijave patenta (97)	Naziv pronalaska (54)
Parklife Innovations Ltd.	A63B 63/00 (2006.01)	2496321 *	COLLAPSIBLE GOAL DEVICE FOR BALL GAMES
Berton, Gabriele	C09K 5/10 (2006.01) G01M 3/22 (2006.01)	2380943	Fluorescent detector
Alberici S.p.A.	G07D 9/00 (2006.01) G07D 1/02 (2006.01)	2395484	Adapter for coin dispensing device
Ardea Biosciences, Inc.	A61K 31/4188 (2006.01) A61P 35/00 (2006.01) A61K 31/7064 (2006.01) A61K 31/18 (2006.01) A61K 31/185 (2006.01) A61K 31/436 (2006.01) A61K 31/517 (2006.01)	2405908 *	PHARMACEUTICAL COMBINATIONS COMPRISING RDEA119/BAY 869766 FOR THE TREATMENT OF SPECIFIC CANCERS
Saint-Gobain Glass France	B60J 10/02 (2006.01) B29C 45/14 (2006.01) B60J 10/00 (2006.01)	2459404 *	JOINTED GLASS PANEL COMPRISING COMB-SHAPED INSERT, AND METHOD FOR MANUFACTURING SAID GLASS PANEL
Roman Empire AS	E04B 9/16 (2006.01) E04B 1/38 (2006.01) E04B 9/06 (2006.01) E04B 9/00 (2006.01)	2422023 *	METHOD AND APPARATUS FOR ATTACHING OBJECTS ON AND ABOVE A CEILING WITH UNATTACHED CEILING PANELS AND CEILING BEAMS
Logomotion, S.r.O.	G06K 17/00 (2006.01) H04B 5/00 (2006.01)	2499746 *	THE METHOD AND SOLUTION OF DATA TRANSMISSION FROM THE TRANSPONDER TO THE READER, ESPECIALLY IN PAYMENT SOLUTIONS WITH A MOBILE COMMUNICATION DEVICE
Advanced Rail Energy Storage, LLC	B61C 3/00 (2006.01)	2464553 *	UTILITY SCALE ELECTRIC ENERGY STORAGE SYSTEM
Oxford Biotherapeutics Ltd.	C07K 16/28 (2006.01)	2470569 *	ANTIBODIES AGAINST EPHA10
Laboratorios Lesvi, S.L.	A61K 9/20 (2006.01) A61K 31/00 (2006.01)	2410994 *	PHARMACEUTICAL COMPOSITION CONTAINING LEVODOPA, ENTACAPONE AND CARBIDOPA
University of Debrecen	G01N 33/573 (2006.01)	2414842 *	DIAGNOSIS OF AND TREATMENT GLUTEN-INDUCED AUTOIMMUNE DISEASES
RUDJER BOSKOVIC INSTITUTE	C03C 17/28 (2006.01)	2429964 *	PREPARATION FOR CHEMICAL TREATMENT OF GLASS, CERAMIC AND STONE SURFACES
Nektar Therapeutics	A61H 1/00 (2006.01)	2453864 *	SYSTEMS AND METHODS FOR DRIVING SEALED NEBULIZERS
Hein, Herr Thomas	G01L 5/13 (2006.01) G01G 19/12 (2006.01) B60D 1/58 (2006.01)	2280263	Supporting load measuring device and retrofitting method for a vehicle trailer device
Diemer, Herr Andreas	G01L 5/13 (2006.01) G01G 19/12 (2006.01) B60D 1/58 (2006.01)	2280263	Supporting load measuring device and retrofitting method for a vehicle trailer device
Abbott Biotechnology Ltd.	C12P 21/08 (2006.01) A61K 39/395 (2006.01)	2427211 *	STABLE HIGH PROTEIN CONCENTRATION FORMULATIONS OF HUMAN ANTI-TNF-ALPHA-ANTIBODIES
Kempharm, Inc.	A01N 43/42 (2006.01) A61K 31/44 (2006.01)	2448408 *	PHENYLETHANOIC ACID, PHENYLPROPANOIC ACID AND PHENYLPROPENOIC ACID CONJUGATES AND PRODRUGS OF HYDROCODONE, METHODS OF MAKING AND USE THEREOF
SANOFI	A61P 3/10 (2006.01) A61P 25/00 (2006.01) C07D 401/12 (2006.01) A61K 31/4725 (2006.01)	2445899 *	NOVEL FUMARATE SALTS OF A HISTAMINE H3 RECEPTOR ANTAGONIST
ECLISSE SRL	E06B 3/46 (2006.01)	2357306	Universal counterframe for retractable sliding door panel
Northwestern University	A61K 38/10 (2006.01)	2485751 *	METHODS OF TREATING DEPRESSION AND OTHER RELATED DISEASES
Shaser, Inc.	A61N 5/06 (2006.01) A61B 18/20 (2006.01) A61B 18/00 (2006.01)	2398557 *	POWER SUPPLY FOR LIGHT-BASED DERMATOLOGIC TREATMENT DEVICE

Podnosilac evropske prijave patenta (71)	MKP (51)	Broj objave evropske prijave patenta (97)	Naziv pronalaska (54)
Eurochit Danuta Kruszezwska	A23L 1/30 (2006.01) C12R 1/225 (2006.01) A61P 19/06 (2006.01) A61K 35/74 (2006.01)	2457576	New Lactobacillus reuteri strain useful in medical and veterinary prophylaxis and treatment
Salix Pharmaceuticals, Ltd.	A61K 33/42 (2006.01)	2411022 *	COMPOSITIONS FOR BOWEL PREPARATION AND METHODS OF USE THEREOF
UCB Pharma S.A.	C07K 16/28 (2006.01) A61P 37/06 (2006.01)	2478012 *	TREATMENT OF AUTOIMMUNE AND INFLAMMATORY DISEASES WITH EPRATUZUMAB
Merz Pharma GmbH & Co. KGaA	G01N 33/50 (2006.01)	2491384 *	SYSTEM FOR DETERMINING UNPROCESSED AND PARTIALLY PROCESSED NEUROTOXIN TYPE A
Tesimax - Altinger GmbH	A62B 17/00 (2006.01) A62B 18/08 (2006.01)	2392386	View pane of a protective suit
Sanofi-Aventis Deutschland GmbH	A61M 5/32 (2006.01)	2403569 *	DRUG DELIVERY DEVICE WITH RETRACTABLE NEEDLE
Industrial Technology Research Institute	H01M 8/24 (2006.01) H01M 8/02 (2006.01)	2337133	Fluid flow plate assemblies
Wyeth LLC	A61K 39/15 (2006.01)	2473190 *	HETEROLOGOUS PRIME-BOOST IMMUNIZATION REGIMEN AGAINST BLUETONGUE VIRUS
Rakuten, Inc.	G06T 11/60 (2006.01) G06F 3/048 (2006.01)	2495645 *	OBJECT CONTROL METHOD FOR DISPLAYING OBJECTS IN FRONT OF LINK ELEMENTS
Merck Sharp & Dohme Corp.	A01N 57/00 (2006.01)	2485595 *	COMBINATION THERAPY USING A BETA 3 ADRENERGIC RECEPTOR AGONIST AND AN ANTIMUSCARINIC AGENT
SANOFI	C07D 239/47 (2006.01) C07D 413/12 (2006.01) A61K 31/513 (2006.01) A61K 31/5377 (2006.01) C07D 403/12 (2006.01) C07D 403/10 (2006.01) A61P 35/00 (2006.01) C07D 409/12 (2006.01) C07D 413/06 (2006.01) C07D 239/36 (2006.01) C07D 403/06 (2006.01)	2448927 *	NOVEL (6-OXO-1, 6-DIHYDRO-PYRIMIDIN-2-YL)-AMIDE DERIVATIVES, PREPARATION THEREOF, AND PHARMACEUTICAL USE THEREOF AS AKT(PKB) PHOSPHORYLATION INHIBITORS
Azad Pharmaceutical Ingredients AG	C07D 333/34 (2006.01) C07D 513/04 (2006.01)	2414343 *	PROCESS FOR PREPARING BRINZOLAMIDE
China Academy of Telecommunications Technology	H04W 24/10 (2009.01)	2461621 *	MEASUREMENT METHOD AND DEVICE FOR WIRELESS NETWORK COMMUNICATION SYSTEM
Craft Holdings Wa Pty Ltd	H02K 7/18 (2006.01) C25B 1/04 (2006.01) F01D 1/00 (2006.01) F01D 7/02 (2006.01) H01M 8/08 (2006.01) H01M 8/22 (2006.01) F01D 17/06 (2006.01) C25B 1/02 (2006.01) F01D 25/30 (2006.01) F01D 15/10 (2006.01)	2462258 *	ELECTROLYSIS CELL AND ELECTRICAL POWER UNIT INCORPORATING SAME
Image Holdings	H04N 1/00 (2006.01)	2474155 *	METHOD AND SYSTEM FOR DISPLAYING, MANAGING AND SELLING DIGITAL IMAGES
Code Footwear, LLC	A43B 23/24 (2006.01) A44C 25/00 (2006.01) A44C 27/00 (2006.01)	2467038 *	RECONFIGURABLE SHOES AND APPAREL AND DOCKING ASSEMBLY THEREFOR
Janssen Pharmaceutica NV	A61K 31/506 (2006.01) C07D 403/14 (2006.01) A61K 31/497 (2006.01) A61P 25/04 (2006.01) C07D 401/14 (2006.01)	2493878 *	PYRAZINES AS DELTA OPIOID RECEPTOR MODULATORS
Oxford Biotherapeutics Ltd.	C07K 16/28 (2006.01) G01N 33/574 (2006.01)	2421898 *	ANTIBODIES SPECIFIC TO CADHERIN-17

Podnosilac evropske prijave patenta (71)	MKP (51)	Broj objave evropske prijave patenta (97)	Naziv pronalaska (54)
Maschio Gaspardo S.p.A.	A01B 33/08 (2006.01)	2232972	Rotary harrow
NTNU Technology Transfer AS	A61K 9/28 (2006.01) A61K 9/16 (2006.01) A61K 9/00 (2006.01)	2410997 *	COMPOSITION FOR THE ADMINISTRATION OF POLYMERIC DRUGS
Delphi Technologies Holding S.à.r.l.	F02M 47/02 (2006.01) F02M 63/00 (2006.01)	2290220	Fuel injector
Eurosicma S.p.A.	B65G 47/82 (2006.01) B65G 17/26 (2006.01)	2403788 *	PLANT WITH A TRANSFERRING SHUTTLE FOR FEEDING PRODUCTS TO A PACKAGING MACHINE
Strauss Water Ltd	B01D 35/143 (2006.01) B01D 35/153 (2006.01) C02F 1/00 (2006.01)	2467332 *	LIQUID FILTER DEVICE
PCT Engineered Systems, LLC	D06M 10/00 (2006.01)	2406422 *	ELECTRON BEAM WEB IRRADIATION APPARATUS AND PROCESS
Merck Serono SA	C07D 405/12 (2006.01) C07D 413/12 (2006.01) C07D 417/12 (2006.01) A61P 37/00 (2006.01) A61K 31/41 (2006.01) C07D 409/12 (2006.01) C07D 257/04 (2006.01)	2454243 *	TETRAZOLE DERIVATIVES
Laboratori Baldacci S.P.A.	A61K 31/555 (2006.01) A61K 33/26 (2006.01) A61P 7/06 (2006.01)	2338495	Iron bis-glycinate chelate for use in the oral treatment of anemia in patients with celiac disease
Inles d.d.	E06B 3/02 (2006.01) E06B 3/66 (2006.01)	2436865	Window
Envion Inc.	F23G 5/027 (2006.01) C08J 11/00 (2006.01) C10G 1/10 (2006.01) B01D 11/04 (2006.01) C10L 1/02 (2006.01)	2478070 *	DECOMPOSITION OF WASTE PLASTICS
Tibotec Pharmaceuticals	A61K 31/455 (2006.01) A61K 31/513 (2006.01) A61K 45/06 (2006.01) A61K 47/48 (2006.01) C07D 239/46 (2006.01)	2413936 *	CO-CRYSTAL OF ETRAVIRINE AND NICOTINAMIDE
Sea Lane Biotechnologies, llc.	C07K 16/10 (2006.01)	2430047 *	NEUTRALIZING MOLECULES TO INFLUENZA VIRUSES
Aros S.r.l.	B24D 3/34 (2006.01) B24D 18/00 (2006.01) B24B 7/22 (2006.01) B24D 7/14 (2006.01)	2470330 *	METHOD OF OBTAINING A TOOL FOR WORKING STONE MATERIALS
Ceccato, Nicola	E04H 17/14 (2006.01) E04F 11/18 (2006.01)	2336459	Orientable pickets fence assembly
Trolese, Igor	E04H 17/14 (2006.01) E04F 11/18 (2006.01)	2336459	Orientable pickets fence assembly
Vaccari, Albano	A47K 4/00 (2006.01)	2260749	Modular toilet.
Total Raffinage Marketing	C10M 107/02 (2006.01) C10G 9/00 (2006.01) C08K 5/01 (2006.01) C10G 11/00 (2006.01) C10M 101/02 (2006.01) C09J 183/04 (2006.01) C08K 5/09 (2006.01) C10G 45/58 (2006.01) C08K 5/101 (2006.01) C10G 47/00 (2006.01) C08L 83/04 (2006.01) C09D 7/06 (2006.01) C09D 127/06 (2006.01)	2406355 *	LOW VOC HYDROCARBON DILUENT FOR CONSTRUCTION MATERIALS
Becton, Dickinson and Company	G01N 1/31 (2006.01)	2425227 *	SAMPLE PREPARATION DEVICE AND ASSOCIATED METHOD

Podnositelj evropske prijave patenta (71)	MKP (51)	Broj objave evropske prijave patenta (97)	Naziv pronalaska (54)
Sanofi-Aventis Deutschland GmbH	A61M 5/315 (2006.01) A61M 5/00 (2006.01)	2437822 *	MEDICAMENT IDENTIFICATION SYSTEM FOR MULTI-DOSE INJECTION DEVICES
McElroy Manufacturing, Inc.	E03C 1/02 (2006.01) B23B 47/28 (2006.01)	2480362 *	METHOD AND TEMPLATE FOR PRODUCING A TENSILE TEST COUPON
Abbott Laboratories	A61K 39/395 (2006.01) C12P 21/06 (2006.01)	2424566 *	DUAL VARIABLE DOMAIN IMMUNOGLOBULINS AND USES THEREOF
Axikin Pharmaceuticals, Inc.	C07D 295/26 (2006.01)	2421838 *	ARYLSULFONAMIDE CCR3 ANTAGONISTS
Curt G. Joa, Inc.	A61F 13/15 (2006.01)	2238955	Methods and apparatus for application of nested zero waste ear to traveling web
Ormazabal Anlagentechnik GmbH	H02B 13/055 (2006.01)	2443712 *	FLUORINATED KETONES AS A HIGH-VOLTAGE INSULATING MEDIUM
Vishay Electronic GmbH	F21Y 101/02 (2006.01) F21V 29/00 (2006.01) F21S 8/08 (2006.01) F21V 15/01 (2006.01)	2401543 *	OUTDOOR LIGHTING UNIT
Acceleron Pharma, Inc.	A61K 38/17 (2006.01) A61P 21/00 (2006.01) A61P 19/08 (2006.01) A61K 38/18 (2006.01)	2475427 *	ACTRIIB ANTAGONISTS AND DOSING AND USES THEREOF
DSM Food Specialties USA Inc.	A61K 31/702 (2006.01) A61P 1/06 (2006.01) A61P 1/14 (2006.01)	2405918 *	PREBIOTIC OLIGOSACCHARIDES
The Regents of the University of California	A61K 31/702 (2006.01) A61P 1/06 (2006.01) A61P 1/14 (2006.01)	2405918 *	PREBIOTIC OLIGOSACCHARIDES
Pedrollo S.p.a.	F04D 29/08 (2006.01) F04D 13/08 (2006.01) F04D 29/62 (2006.01)	2486281 *	SUBMERGED CENTRIFUGAL ELECTRIC PUMP
Shire LLC	C07C 279/22 (2006.01)	2477962 *	PRODRUGS OF GUANFACINE
Gilead Sciences, Inc.	C07D 487/04 (2006.01)	2480552 *	2' -FLUORO SUBSTITUTED CARBA-NUCLEOSIDE ANALOGS FOR ANTIVIRAL TREATMENT
Sanofi-Aventis Deutschland GmbH	A61M 5/24 (2006.01) F16F 1/02 (2006.01)	2437813 *	BIASING MECHANISM FOR A CARTRIDGE OF A DRUG DELIVERY SERVICE
SANOFI	A61K 31/517 (2006.01) A61P 9/00 (2006.01) A61K 9/00 (2006.01)	2416777 *	THERAPEUTIC APPLICATIONS IN THE CARDIOVASCULAR FIELD OF QUINAZOLINEDIONE DERIVATIVES
OSI Pharmaceuticals, LLC	A61K 31/4985 (2006.01) A61P 35/00 (2006.01)	2427192 *	USE OF OSI-906 FOR TREATING ADRENOCORTICAL CARCINOMA
Genentech, Inc.	C07D 471/04 (2006.01) A61P 35/00 (2006.01) A61K 31/437 (2006.01) A61P 13/12 (2006.01)	2470532 *	1H-PYRAZOLO [3, 4-B]PYRIDINE COMPOUNDS FOR INHIBITING RAF KINASE
Array Biopharma, Inc.	C07D 471/04 (2006.01) A61P 35/00 (2006.01) A61K 31/437 (2006.01) A61P 13/12 (2006.01)	2470532 *	1H-PYRAZOLO [3, 4-B]PYRIDINE COMPOUNDS FOR INHIBITING RAF KINASE
Janssen Pharmaceutica NV	A61K 31/519 (2006.01) A61P 25/18 (2006.01)	2493473 *	DOSING REGIMEN ASSOCIATED WITH LONG-ACTING INJECTABLE PALIPERIDONE ESTERS
Sekisui Plastics Co., Ltd.	B29K 25/00 (2006.01) C08J 9/18 (2006.01) B29C 44/00 (2006.01) C08K 3/36 (2006.01) C08K 5/02 (2006.01) C08L 25/04 (2006.01)	2415826 *	EXPANDABLE POLYSTYRENE RESIN PARTICLES AND PROCESS FOR PRODUCING SAME
Fraunhofer-Gesellschaft zur Förderung der angewandten Forschung e.V.	C08L 9/00 (2006.01) C08L 23/10 (2006.01)	2345695	Elastomer-modified thermoplastic compound
Merck Serono S.A.	C12Q 1/68 (2006.01)	2403959 *	BANK1 RELATED SNPS AND SLE AND/OR MS SUSCEPTIBILITY

Podnosilac evropske prijave patenta (71)	MKP (51)	Broj objave evropske prijave patenta (97)	Naziv pronalaska (54)
Westfälische Wilhelms-Universität Münster	A61K 36/185 (2006.01) A61K 36/45 (2006.01) A61K 31/353 (2006.01) A61K 31/04 (2006.01) A61K 31/02 (2006.01) A61K 36/70 (2006.01) A61P 1/02 (2006.01)	2453889 *	USE OF PROANTHOCYANIDINS FOR PRODUCTION OF AN ANTIADHESIVE PREPARATION
Targacept, Inc.	A61P 25/24 (2006.01) A61K 31/13 (2006.01)	2453885 *	EXO-S-MECAMYLAMINE METHOD, USE, AND COMPOUND FOR TREATMENT
Kraft Foods Global Brands LLC	B65D 75/30 (2006.01)	2475591 *	SOFT-SIDED FLEXIBLE BLISTER PACKAGE
Wageningen Universiteit	C07K 14/415 (2006.01) C12N 15/82 (2006.01)	2478006 *	CLONING AND EXPLOITATION OF A FUNCTIONAL R-GENE FROM SOLANUM CHACOENSE
Meissner Formenttechnologie GmbH	B22C 9/06 (2006.01) B29C 33/38 (2006.01)	2248615	Temperable tool and method for producing the same, tool holder frame for holding same
OSI Pharmaceuticals, LLC	A61K 31/404 (2006.01) A61K 31/53 (2006.01) A61K 39/395 (2006.01)	2459191 *	MTOR INHIBITOR AND ANGIOGENESIS INHIBITOR COMBINATION THERAPY
Abbott Laboratories	A61K 39/395 (2006.01)	2403531 *	IL-17 BINDING PROTEINS
The Regents of the University of California	C12Q 1/68 (2006.01) G01N 33/15 (2006.01) A61P 35/00 (2006.01) G01N 33/574 (2006.01)	2419737 *	HISTONE MODIFICATION PATTERNS FOR CLINICAL DIAGNOSIS AND PROGNOSIS OF CANCER
Laboratorios SALVAT, S.A.	C07D 241/06 (2006.01) A61K 31/495 (2006.01)	2460798 *	APAF-1 INHIBITOR COMPOUNDS
Geo Fossil Fuels, LLC	C12N 1/26 (2006.01) C12N 9/02 (2006.01) E21B 43/16 (2006.01) C09K 8/00 (2006.01)	2470639 *	MICROBIAL ENHANCED OIL RECOVERY METHODS
GlaxoSmithKline LLC	A61K 31/425 (2006.01) A01N 43/78 (2006.01)	2485593 *	COMBINATION
Mazzuto, Vincenzo	A23G 3/02 (2006.01) A23G 3/00 (2006.01) A23G 9/22 (2006.01) F25C 1/22 (2006.01) A23G 9/08 (2006.01)	2470029 *	METHOD FOR THE INDUSTRIAL PRODUCTION OF SINGLE SERVING PORTIONS OF ICE CREAM
United States Department of The Army, as represented by the Secretary of the Army	C07K 16/10 (2006.01) C12N 15/13 (2006.01) A61K 39/42 (2006.01) G01N 33/569 (2006.01)	2473525 *	MONOCLONAL ANTIBODIES AGAINST GLYCOPROTEIN OF EBOLA SUDAN BONIFACE VIRUS
Gilead Sciences, Inc.	A61K 31/4965 (2006.01) A61P 25/06 (2006.01) A61P 25/08 (2006.01)	2429526 *	RANOLAZINE FOR THE TREATMENT OF CNS DISORDERS
Protiva Biotherapeutics Inc.	A61K 9/14 (2006.01) C07H 21/02 (2006.01) A61K 31/713 (2006.01) C07K 14/775 (2006.01) A61K 47/22 (2006.01) C12N 15/113 (2010.01)	2449106 *	COMPOSITIONS AND METHODS FOR SILENCING APOLIPOPROTEIN B
GlaxoSmithKline LLC	C07D 487/04 (2006.01) A61K 31/55 (2006.01) A61P 35/00 (2006.01) A61P 43/00 (2006.01)	2496580 *	BENZODIAZEPINE BROMODOMAIN INHIBITOR
Respivert Limited	A61P 11/06 (2006.01) A61P 11/00 (2006.01) C07D 487/04 (2006.01) A61P 17/00 (2006.01) A61P 35/00 (2006.01) A61P 19/02 (2006.01) A61K 31/519 (2006.01)	2491037 *	COMPOUNDS
Sanofi-Aventis Deutschland GmbH	G06K 19/06 (2006.01) G06K 7/14 (2006.01)	2449505 *	CIRCULAR BAR-CODE FOR DRUG CONTAINER

Podnosilac evropske prijave patenta (71)	MKP (51)	Broj objave evropske prijave patenta (97)	Naziv pronalaska (54)
Messer Group GmbH	F16K 15/06 (2006.01)	2309160	Device for metering a cryogenic medium
Messer France S.A.S.	F16K 15/06 (2006.01)	2309160	Device for metering a cryogenic medium
Cellzome Limited	C07D 403/12 (2006.01) C07D 413/12 (2006.01) A61K 31/506 (2006.01) A61P 37/00 (2006.01) A61P 29/00 (2006.01)	2443106 *	HETEROCYCLYLAMINOPYRIMIDINES AS KINASE INHIBITORS
Protektorwerk Florenz Maisch GmbH & Co. KG	E04C 3/08 (2006.01) E04C 3/09 (2006.01)	2467545 *	PROFILE ELEMENT AND METHOD FOR MANUFACTURING A PROFILE ELEMENT
Entegriion, Inc.	A61K 35/16 (2006.01) G01N 33/50 (2006.01)	2416790 *	SPRAY-DRIED BLOOD PRODUCTS AND METHODS OF MAKING SAME
Israel Military Industries Ltd.	F41A 23/24 (2006.01) F41A 27/28 (2006.01)	2478323 *	MULTI-WEAPONS SYSTEM
VG Nicolaus GmbH	B65D 83/00 (2006.01)	2447185	Cylindrical packaging for pasty materials
Syngenta Participations AG	A61K 47/00 (2006.01) C25D 5/00 (2006.01)	2403535 *	COMPATIBILIZED ELECTROLYTE FORMULATIONS
Jones III, Charles A.	A61K 47/00 (2006.01) C25D 5/00 (2006.01)	2403535 *	COMPATIBILIZED ELECTROLYTE FORMULATIONS
Syngenta Limited	A61K 47/00 (2006.01) C25D 5/00 (2006.01)	2403535 *	COMPATIBILIZED ELECTROLYTE FORMULATIONS
ThromboGenics N.V.	C12N 15/11 (2006.01) C12N 9/68 (2006.01) C07K 14/47 (2006.01) A61K 38/48 (2006.01)	2451835 *	VARIANTS OF PLASMINOGEN AND PLASMIN
Zombori, Antal	B65G 1/04 (2006.01)	2403780 *	ARRANGEMENT FOR STORAGE, WAREHOUSE RACK AND HANDLING MACHINE PARTICULARLY FOR SUCH ARRANGEMENT
Bionor Immuno AS	C07K 19/00 (2006.01) A61K 39/00 (2006.01) A61K 39/395 (2006.01) C07K 16/10 (2006.01) A61K 38/16 (2006.01) A61K 39/42 (2006.01) A61K 39/21 (2006.01)	2448593 *	HIV RELATED PEPTIDES COMBINATION OR FUSION FOR USE IN HIV VACCINE COMPOSITION OR AS DIAGNOSTIC MEANS
Strauss Water Ltd	F25D 31/00 (2006.01)	2467660 *	TEMPERATURE CONTROL SYSTEM FOR A LIQUID
Glaxo Group Limited	C07D 211/46 (2006.01) C07C 233/33 (2006.01)	2419409 *	PROCESS FOR THE PREPARATION OF A BIPHENYL-2-YLCARBAMIC ACID ESTER
ICX-Agentase	B32B 3/12 (2006.01)	2421695 *	SMART ENZYME-CONTAINING CATALYTIC PEELABLE COATINGS
ZST Holdings, Inc.	A61F 5/56 (2006.01)	2437694 *	APPARATUSES AND METHODS FOR MANDIBULAR PROTRUSION
Delphi Technologies, Inc.	F02M 63/00 (2006.01)	2409016 *	ACTUATOR ARRANGEMENT
Dow Global Technologies LLC	C08F 10/00 (2006.01)	2411424 *	CATALYSTS, PROCESSES FOR MAKING CATALYSTS, PROCESSES FOR MAKING POLYOLEFIN COMPOSITIONS AND POLYOLEFIN COMPOSITIONS
Boehringer Ingelheim International GmbH	A61K 31/454 (2006.01) A61P 31/00 (2006.01) C07D 401/04 (2006.01) A61P 35/00 (2006.01) C07D 401/14 (2006.01) A61P 37/00 (2006.01) C07D 413/04 (2006.01) C07D 413/14 (2006.01) C07D 417/14 (2006.01) A61K 31/4523 (2006.01)	2417120 *	SUBSTITUTED PIPERIDINES AS CCR3 ANTAGONISTS
Boehringer Ingelheim International GmbH	A61K 9/20 (2006.01) A61K 45/06 (2006.01) A61K 31/155 (2006.01)	2482806 *	PHARMACEUTICAL COMPOSITION, PHARMACEUTICAL DOSAGE FORM, PROCESS FOR THEIR PREPARATION, METHODS FOR TREATING AND USES THEREOF

Podnosilac evropske prijave patenta (71)	MKP (51)	Broj objave evropske prijave patenta (97)	Naziv pronalaska (54)
Bonac Corporation	C12N 15/09 (2006.01) A61K 48/00 (2006.01) C12N 15/113 (2010.01) A61P 29/00 (2006.01)	2431466 *	SINGLE-STRAND NUCLEIC ACID MOLECULE FOR CONTROLLING GENE EXPRESSION
Abbott Laboratories	A61K 39/395 (2006.01) G01N 33/53 (2006.01)	2488201 *	IL-1 BINDING PROTEINS
JX Nippon Oil & Energy Corporation	H01L 51/50 (2006.01) H05B 33/02 (2006.01) G02B 5/18 (2006.01)	2455786 *	DIFFRACTION GRATING, ORGANIC EL ELEMENT USING SAME, AND METHOD FOR MANUFACTURING SAID DIFFRACTION GRATING AND ORGANIC EL ELEMENT
Tokyo Institute of Technology	H01L 51/50 (2006.01) H05B 33/02 (2006.01) G02B 5/18 (2006.01)	2455786 *	DIFFRACTION GRATING, ORGANIC EL ELEMENT USING SAME, AND METHOD FOR MANUFACTURING SAID DIFFRACTION GRATING AND ORGANIC EL ELEMENT
Lando, Ron	G02C 3/00 (2006.01)	2460046 *	EXPANDABLE EYEWEAR WITH SNAP-TOGETHER BRIDGE
Cellzome Limited	C07D 487/04 (2006.01) A61K 31/505 (2006.01) A61P 37/00 (2006.01) A61P 35/00 (2006.01)	2491039 *	HETEROCYCLYL PYRAZOLOPYRIMIDINE ANALOGUES AS JAK INHIBITORS
Boehringer Ingelheim International GmbH	C07D 401/14 (2006.01) C07D 401/06 (2006.01) A61P 31/00 (2006.01) A61K 31/496 (2006.01) A61P 37/00 (2006.01) A61P 29/00 (2006.01) A61K 31/444 (2006.01) A61K 31/5377 (2006.01) A61P 35/00 (2006.01)	2421846 *	5-ALKYNYL-PYRIDINES
Baylor Research Institute	A61K 39/395 (2006.01) A61K 38/16 (2006.01) A61K 38/17 (2006.01) A61P 35/00 (2006.01) A61P 25/00 (2006.01)	2477655 *	VACCINES DIRECTED TO LANGERHANS CELLS
Elan Pharmaceuticals Inc.	C07D 213/02 (2006.01) C07D 401/12 (2006.01) A61K 31/4412 (2006.01) A61P 37/00 (2006.01)	2424841 *	PYRIDINONE ANTAGONISTS OF ALPHA-4 INTEGRINS
Obschestvo S Ogranichennoi Otvetstvennostiyu "Eurostandart"	B65B 31/06 (2006.01) B65D 1/02 (2006.01) C12H 1/07 (2006.01) B01D 35/00 (2006.01)	2497558 *	UNIVERSAL DEVICE FOR TREATING AND PURIFYING A LIQUID PRODUCT CONTAINED IN A RESILIENT DEFORMABLE CONTAINER AND FOR PREPARING A NEW PRODUCT THAT DIFFERS FROM THE ORIGINAL
SANOFI	A61P 3/06 (2006.01) C12N 15/113 (2010.01) C07K 14/47 (2006.01)	2483298 *	USE OF SIRNA TARGETTING SIPA1L1 FOR THE REDUCTION OF ADIPOGENESIS
SANOFI	A61P 7/00 (2006.01) A61P 37/00 (2006.01) A61P 9/00 (2006.01) A61P 11/00 (2006.01) A61P 17/00 (2006.01) A61K 31/737 (2006.01) A61P 27/02 (2006.01) A61P 19/00 (2006.01) A61P 21/00 (2006.01) C08B 37/00 (2006.01) A61P 25/00 (2006.01)	2464667 *	N-ACYLATED OCTASACCHARIDES ACTIVATING FGFS RECEPTORS, THEIR SYNTHESIS AND THEIR THERAPEUTICAL APPLICATION
Biontech AG	C07K 16/46 (2006.01) C07K 14/705 (2006.01) C07K 16/00 (2006.01) C12N 5/0781 (2010.01) C12N 15/62 (2006.01)	2494037 *	CLONAL EXPANSION OF B CELLS

Podnosilac evropske prijave patenta (71)	MKP (51)	Broj objave evropske prijave patenta (97)	Naziv pronalaska (54)
Universitätsmedizin der Johannes Gutenberg-Universität Mainz	C07K 16/46 (2006.01) C07K 14/705 (2006.01) C07K 16/00 (2006.01) C12N 5/0781 (2010.01) C12N 15/62 (2006.01)	2494037 *	CLONAL EXPANSION OF B CELLS
GlaxoSmithKline Biologicals SA	A61K 39/085 (2006.01) A61K 39/116 (2006.01) C12N 15/62 (2006.01)	2461824 *	IMMUNOGENIC COMPOSITION COMPRISING ANTIGENIC S. AUREUS PROTEINS
Abraxis BioScience, LLC	A61K 31/015 (2006.01) G01N 33/53 (2006.01)	2478362 *	USE OF THE SPARC MICROENVIRONMENT SIGNATURE IN THE TREATMENT OF CANCER
Papéis Amália Ltda	B32B 3/10 (2006.01)	2498985 *	A PACKAGE FOR PAPER SHEETS
Amgen, Inc	A61P 19/02 (2006.01) C07D 471/04 (2006.01) C07D 487/04 (2006.01) A61K 31/444 (2006.01) C07D 401/12 (2006.01) A61K 31/4375 (2006.01) C07D 401/14 (2006.01)	2445900 *	POLYCYCLIC DERIVATIVES OF PYRIDINE AND THEIR USE IN THE TREATMENT OF (INTER ALIA) RHEUMATOID ARTHRITIS AND SIMILAR DISEASES
Kaspersky Lab, ZAO	G06F 21/00 (2006.01)	2410452	Protection against malware on web resources
Landi di Stefano Chiarugi & C. S.a.s.	E21B 7/20 (2006.01) E21B 7/28 (2006.01) E21B 10/02 (2006.01)	2378055	A method for the reconstruction of wells through the removal of the old casing by using a single reverse-circulation perforation and relative device
Acque Ingegneria S.r.l.	E21B 7/20 (2006.01) E21B 7/28 (2006.01) E21B 10/02 (2006.01)	2378055	A method for the reconstruction of wells through the removal of the old casing by using a single reverse-circulation perforation and relative device
Stepanov, Arkady Anatolievich	H02M 3/335 (2006.01)	2429071 *	AUTONOMOUS ELECTRICAL POWER SUPPLY SOURCE WITH A RECHARGING FUNCTION USING ONE RECHARGEABLE BATTERY
Khoryakov, Vladimir Vladimirovich	H02M 3/335 (2006.01)	2429071 *	AUTONOMOUS ELECTRICAL POWER SUPPLY SOURCE WITH A RECHARGING FUNCTION USING ONE RECHARGEABLE BATTERY
BALTIC BIO AB	C07D 417/12 (2006.01) C07D 417/10 (2006.01) C07D 285/08 (2006.01) A61K 31/433 (2006.01)	2451794 *	1,2,4-THIAZOLIDIN-3-ONE DERIVATIVES AND THEIR USE IN THE TREATMENT OF CANCER
Japan Oil, Gas and Metals National Corporation	C10G 2/00 (2006.01)	2479241 *	METHOD FOR PRODUCING HYDROCARBON OIL AND SYNTHETIC REACTION SYSTEM
INPEX Corporation	C10G 2/00 (2006.01)	2479241 *	METHOD FOR PRODUCING HYDROCARBON OIL AND SYNTHETIC REACTION SYSTEM
JX Nippon Oil & Energy Corporation	C10G 2/00 (2006.01)	2479241 *	METHOD FOR PRODUCING HYDROCARBON OIL AND SYNTHETIC REACTION SYSTEM
Japan Petroleum Exploration Co., Ltd.	C10G 2/00 (2006.01)	2479241 *	METHOD FOR PRODUCING HYDROCARBON OIL AND SYNTHETIC REACTION SYSTEM
Cosmo Oil Co., Ltd.	C10G 2/00 (2006.01)	2479241 *	METHOD FOR PRODUCING HYDROCARBON OIL AND SYNTHETIC REACTION SYSTEM
Nippon Steel Engineering Co., Ltd	C10G 2/00 (2006.01)	2479241 *	METHOD FOR PRODUCING HYDROCARBON OIL AND SYNTHETIC REACTION SYSTEM
Creative Nail Design, Inc.	C09D 4/06 (2006.01) A61Q 3/02 (2006.01)	2475725 *	REMOVABLE COLOR GEL BASECOAT FOR ARTIFICIAL NAIL COATINGS AND METHODS THEREFORE
Monier Technical Centre GmbH	B28B 3/20 (2006.01) B28B 11/08 (2006.01)	2429788 *	METHOD AND PLANT FOR PRODUCING A CONCRETE BODY
Genentech, Inc.	A61K 31/38 (2006.01) C07D 487/04 (2006.01) C07D 495/04 (2006.01) C07D 513/04 (2006.01) A61P 35/00 (2006.01)	2470538 *	RAF INHIBITOR COMPOUNDS AND METHODS OF USE THEREOF

Podnosilac evropske prijave patenta (71)	MKP (51)	Broj objave evropske prijave patenta (97)	Naziv pronalaska (54)
Array Biopharma, Inc.	A61K 31/38 (2006.01) C07D 487/04 (2006.01) C07D 495/04 (2006.01) C07D 513/04 (2006.01) A61P 35/00 (2006.01)	2470538 *	RAF INHIBITOR COMPOUNDS AND METHODS OF USE THEREOF
Merz Pharma GmbH & Co. KGaA	C07D 487/04 (2006.01) A61P 25/00 (2006.01) A61K 31/519 (2006.01)	2438070 *	GLYCINE B ANTAGONISTS
Sanofi-Aventis Deutschland GmbH	A61M 5/31 (2006.01) A61M 5/24 (2006.01) A61M 5/315 (2006.01) A61M 5/00 (2006.01)	2437812 *	DOSE SETTING MECHANISM FOR PRIMING A DRUG DELIVERY DEVICE
Walker, Brendan	A63C 9/00 (2006.01)	2349509 *	BINDING FOR SNOWBOARD AND OTHER BOARD SPORTS
SANOFI	C07D 401/12 (2006.01) C07D 401/14 (2006.01) C07D 401/02 (2006.01) A61K 31/444 (2006.01) A61P 35/00 (2006.01) C07D 213/79 (2006.01) C07D 213/82 (2006.01)	2411368 *	NICOTINAMIDE DERIVATIVES, PREPARATION THEREOF, AND THERAPEUTIC USE THEREOF AS ANTICANCER DRUGS
GlaxoSmithKline LLC	A01N 57/00 (2006.01) C07C 403/00 (2006.01)	2473056 *	CHEMICAL COMPOUNDS
Kyowa Hakko Kirin Co., Ltd.	A61K 31/506 (2006.01) A61K 31/5377 (2006.01) A61K 31/4439 (2006.01) A61K 31/426 (2006.01) A61P 25/24 (2006.01) C07D 491/052 (2006.01) C07D 417/14 (2006.01) C07D 495/04 (2006.01) C07D 491/048 (2006.01)	2474543 *	THERAPEUTIC AGENT FOR MOOD DISORDERS
Kyowa Hakko Kirin Co., Ltd.	A61K 31/4709 (2006.01) C07D 495/04 (2006.01) A61K 31/506 (2006.01) C07D 417/14 (2006.01) A61K 31/5377 (2006.01) A61K 31/435 (2006.01) A61P 25/14 (2006.01) A61K 31/4355 (2006.01) A61P 25/16 (2006.01) A61K 31/4365 (2006.01) C07D 491/048 (2006.01) A61K 31/436 (2006.01) A61P 43/00 (2006.01) A61K 31/4439 (2006.01) C07D 491/052 (2006.01)	2433938 *	THERAPEUTIC AGENT FOR MOTOR DISORDERS
Makro Labelling S.r.l.	B65G 47/84 (2006.01)	2382146 *	A CONVEYOR FOR CONTAINERS, SUCH AS BOTTLES, TO BE PROCESSED AND FOR PROCESSED CONTAINERS FOR OPERATING MACHINES OF THE TYPE WITH A ROTARY CARROUSEL
Dow Global Technologies LLC	C07C 205/02 (2006.01) C07C 201/08 (2006.01)	2490998 *	PROCESS FOR DOWNSTREAM RECOVERY OF NITROALKANE USING DIVIDING WALL COLUMN
ANGUS Chemical Company	C07C 205/02 (2006.01) C07C 201/08 (2006.01)	2490998 *	PROCESS FOR DOWNSTREAM RECOVERY OF NITROALKANE USING DIVIDING WALL COLUMN
University Of Louisville Research Foundation, Inc.	C07D 403/02 (2006.01) A61K 31/506 (2006.01)	2480235 *	NOVEL IODO PYRIMIDINE DERIVATIVES USEFUL FOR THE TREATMENT OF MACROPHAGE MIGRATION INHIBITORY FACTOR (MIF)-IMPLICATED DISEASES AND CONDITIONS
Advanced Cancer Therapeutics, LLC	C07D 403/02 (2006.01) A61K 31/506 (2006.01)	2480235 *	NOVEL IODO PYRIMIDINE DERIVATIVES USEFUL FOR THE TREATMENT OF MACROPHAGE MIGRATION INHIBITORY FACTOR (MIF)-IMPLICATED DISEASES AND CONDITIONS

Podnosilac evropske prijave patenta (71)	MKP (51)	Broj objave evropske prijave patenta (97)	Naziv pronalaska (54)
Amgen, Inc	C12P 21/08 (2006.01) C07K 16/28 (2006.01)	2499256 *	ANTI-C-MPL ANTIBODIES
Eaton GmbH	H02G 3/14 (2006.01) H01H 3/12 (2006.01)	2438664 *	ELECTRICAL INSTALLATION UNIT
Boehringer Ingelheim International GmbH	C07D 239/34 (2006.01) C07D 239/47 (2006.01) C07D 401/12 (2006.01)	2464634 *	REGIOSELECTIVE PREPARATION OF 2-AMINO-5-TRIFLUOROMETHYLPYRIMIDINE DERIVATIVES
Pfizer Inc	A61K 31/438 (2006.01) A61P 1/16 (2006.01) A61P 3/10 (2006.01) C07D 471/10 (2006.01)	2499139 *	N1-PYRAZOLOSPIROKETONE ACETYL-COA CARBOXYLASE INHIBITORS
Syngenta Limited	A01N 57/20 (2006.01) A01N 41/06 (2006.01) A01P 13/00 (2006.01)	2403343 *	HERBICIDAL FORMULATIONS
Lumora Ltd	C12Q 1/68 (2006.01)	2443253 *	STEM ACCELERATED ISOTHERMAL NUCLEIC ACID AMPLIFICATION TECHNOLOGY
Scuderi Group, Llc	F02B 33/30 (2006.01)	2300699 *	PART-LOAD CONTROL IN A SPLIT-CYCLE ENGINE
Tripath Imaging, Inc.	C07K 16/40 (2006.01)	2403880 *	MATRIX METALLOPROTEINASE-7 (MMP-7) MONOCLONAL ANTIBODIES AND METHODS FOR THEIR USE IN THE DETECTION OF OVARIAN CANCER
Astex Therapeutics Ltd.	C07D 471/04 (2006.01) A61P 35/00 (2006.01) A61K 31/437 (2006.01)	2419427 *	BICYCLIC HETEROCYCLYL DERIVATIVES AS FGFR KINASE INHIBITORS FOR THERAPEUTIC USE
Choi, Won Seog	A61P 13/00 (2006.01) A61K 33/14 (2006.01) A61K 9/06 (2006.01) A61P 15/02 (2006.01) C11D 3/20 (2006.01)	2490700 *	A SKIN EXTERNAL COMPOSITION COMPRISING A SALT AND SUGAR AS ACTIVE INGREDIENTS FOR PREVENTING AND TREATING VAGINOSIS AND THE USE THEREOF
Glaxo Group Limited	C07C 231/24 (2006.01) C07C 231/12 (2006.01) C07C 233/87 (2006.01)	2491006 *	PROCESS FOR PREPARING A PHENYLALANINE DERIVATIVE
Mitsubishi Tanabe Pharma Corporation	C07C 231/24 (2006.01) C07C 231/12 (2006.01) C07C 233/87 (2006.01)	2491006 *	PROCESS FOR PREPARING A PHENYLALANINE DERIVATIVE
Teikoku Seiyaku Co., Ltd.	A61K 31/4468 (2006.01) A61K 9/70 (2006.01) A61K 47/06 (2006.01) A61K 47/14 (2006.01) A61K 47/32 (2006.01)	2457570 *	FENTANYL-CONTAINING ADHESIVE PREPARATION FOR EXTERNAL USE
The Penn State Research Foundation	C10G 1/04 (2006.01) C10G 1/00 (2006.01)	2470620 *	SYSTEMS, METHODS AND COMPOSITIONS FOR THE SEPARATION AND RECOVERY OF HYDROCARBONS FROM PARTICULATE MATTER
Cardio3 Biosciences S.A.	A61B 17/34 (2006.01) A61M 25/00 (2006.01)	2424606 *	INJECTION CATHETER FOR DELIVERING A THERAPEUTIC AGENT INTO A SUBSTRATE
Amgen, Inc	C07K 1/18 (2006.01) C07K 1/22 (2006.01) C07K 1/32 (2006.01)	2445924 *	CAPTURE PURIFICATION PROCESSES FOR PROTEINS EXPRESSED IN A NON-MAMMALIAN SYSTEM
Ardea Biosciences, Inc.	C07C 309/82 (2006.01) C07C 309/85 (2006.01) C07C 311/28 (2006.01) C07C 303/40 (2006.01) C07C 303/38 (2006.01)	2462111 *	PREPARATION OF (R)- AND (S)-N-(3, 4-DIFLUORO-2-(2-FLUORO-4-IODOPHENYLAMINO)--6-METHOXYPHENYL)-1-(2, 3-DIHYDROXYPROPYL) CYCLOPROPANE-1-SULFONAMIDE AND PROTECTED DERIVATIVES THEREOF
Healy, James W.	F03B 13/12 (2006.01)	2440775 *	WAVE ENERGY ELECTRICAL POWER GENERATION
Prosensa Technologies B.V.	C12N 15/11 (2006.01) C12N 15/113 (2010.01)	2421971 *	OLIGONUCLEOTIDE COMPRISING AN INOSINE FOR TREATING DMD
E. I. Du Pont De Nemours And Company	C12Q 1/68 (2006.01)	2456884 *	SEQUENCES AND THEIR USE FOR DETECTION AND CHARACTERIZATION OF E. COLI O157:H7
Array Biopharma, Inc.	C07D 487/04 (2006.01) C07D 519/00 (2006.01) A61K 31/519 (2006.01)	2451812 *	SUBSTITUTED PYRAZOLO[1,5-a]PYRIMIDINE COMPOUNDS AS TRK KINASE INHIBITORS

Podnosilac evropske prijave patenta (71)	MKP (51)	Broj objave evropske prijave patenta (97)	Naziv pronalaska (54)
Hoffmann Neopac AG	B41F 7/16 (2006.01) B41F 23/00 (2006.01) B41M 5/00 (2006.01)	2428359	Printer and method for printing on flat materials
KRKA, tovarna zdravil, d.d., Novo mesto	G06F 17/00 (2006.01)	2488961 *	PROCESS FOR THE AUTOMATED CLASSIFICATION AND ANALYSIS OF RAW DATA AND ITS USE IN THE OPTIMIZATION OF PROCESSES
Pavletic D.O.O.	A47C 27/00 (2006.01) A47G 9/00 (2006.01)	2488067 *	MULTILAYERED PROTECTIVE AND STIMULATING PAD FOR MATTRESSES
Societe Industrielle Liegeoise des Oxydes SA	C08K 9/02 (2006.01) C01G 9/02 (2006.01) C09C 1/02 (2006.01) C09C 1/28 (2006.01) C09C 1/30 (2006.01) C09C 1/40 (2006.01) C09C 1/56 (2006.01)	2488581 *	CROSSLINKING INITIATOR
China Academy of Telecommunications Technology	H04W 24/00 (2009.01)	2464159 *	METHOD, SYSTEM AND DEVICE FOR REPORTING UPLINK PILOT INTERFERENCE
Genzyme Corporation	C12N 15/79 (2006.01) A61K 31/7088 (2006.01)	2424991 *	GENE THERAPY FOR NEURODEGENERATIVE DISORDERS
ID Biomedical Corporation of Quebec	A61K 39/155 (2006.01)	2445527 *	VACCINE
GlaxoSmithKline Biologicals S.A.	A61K 39/155 (2006.01)	2445527 *	VACCINE
Regeneron Pharmaceuticals, Inc.	C07K 16/46 (2006.01) C12N 15/85 (2006.01) C07K 16/00 (2006.01) A01K 67/027 (2006.01)	2480676 *	HYBRID LIGHT CHAIN MICE
Bayer CropScience NV	C12N 9/02 (2006.01)	2491119 *	METHODS AND MEANS TO ALTER LIPID BIOSYNTHESIS BY TARGETING MULTIPLE ENZYMES TO SUBORGANELLE DOMAINS
Cantini, Fernando	A23K 1/16 (2006.01) C11C 3/02 (2006.01)	2410871 *	COMPOSITIONS CONTAINING C1 TO C7 ORGANIC ACID MONOGLYCERIDES AND GLYCEROL, THEIR PREPARATION AND USE AS ANTIBACTERIALS AND ANTI-MOULD AGENTS
Sanofi-Aventis Deutschland GmbH	A61M 5/50 (2006.01)	2480276 *	ASSEMBLY FOR A DRUG DELIVERY DEVICE AND DRUG DELIVERY DEVICE
Immersion Corporation	G06F 3/048 (2006.01) G06F 3/041 (2006.01) G06F 3/01 (2006.01)	2406701 *	SYSTEMS AND METHODS FOR USING MULTIPLE ACTUATORS TO REALIZE TEXTURES
Abraxis BioScience, LLC	C12N 15/11 (2006.01)	2451952 *	SPARC ANTISENSE COMPOSITIONS AND USES THEREOF
Pujal Laborda, Joan	A41D 19/015 (2006.01)	2481310 *	ASEPTIC/PROTECTIVE MITT
Snif Labs, Inc.	G08B 1/08 (2006.01)	2417591 *	REDUCING MEDICAL ERROR
SANOFI	C07D 235/26 (2006.01) C07D 471/04 (2006.01) A61K 31/4745 (2006.01) A61P 35/00 (2006.01)	2432766 *	ANTICANCER COMPOUND AND PHARMACEUTICAL COMPOSITION CONTAINING THE SAME
Agostini, Roberto	H04B 10/10 (2006.01)	2454829 *	APPARATUS FOR TRANSFERRING DATA IN WIRELESS MODE TO A PORTABLE ELECTRONIC DEVICE BY MEANS OF LIGHT PULSES EMITTED FROM AN LCD MONITOR
Syngenta Participations AG	C07D 231/14 (2006.01) C07C 45/62 (2006.01) C07C 45/64 (2006.01) C07C 45/66 (2006.01) C07C 251/44 (2006.01) C07C 45/69 (2006.01) C07C 49/693 (2006.01) C07C 49/743 (2006.01)	2462108 *	PROCESS FOR THE PREPARATION OF PYRAZOLE CARBOXYLIC ACID AMIDES

Podnosilac evropske prijave patenta (71)	MKP (51)	Broj objave evropske prijave patenta (97)	Naziv pronalaska (54)
Ajinomoto Co., Inc.	A61M 5/178 (2006.01) B65D 83/00 (2006.01) A61M 5/31 (2006.01) B05C 17/01 (2006.01)	2495002 *	SYRINGE, DEVICE FOR PRODUCING SYRINGE BODY, AND METHOD FOR PRODUCING SYRINGE BODY
CV Holdings, LLC.	C23C 16/505 (2006.01) C23C 16/52 (2006.01) C23C 16/54 (2006.01) G01N 15/08 (2006.01) A61B 5/15 (2006.01)	2251454	Vessel coating and inspection
Basic Concepts International Ltd.	A63F 9/34 (2006.01) A63F 9/30 (2006.01) A63F 9/02 (2006.01)	2412413 *	MAGNETIC PICKUP GAME DEVICE
Rakuten, Inc.	G06F 3/048 (2006.01)	2498173 *	OBJECT CONTROL METHOD, OBJECT CONTROL PROGRAM, AND WEB SERVER
Sandoz AG	A61K 9/20 (2006.01) A61K 31/205 (2006.01) A61P 25/16 (2006.01)	2403485 *	PHARMACEUTICAL COMPOSITION CONTAINING RASAGILINE MESYLATE
Hunan Zhongtai Special Equipment Co., Ltd.	B29C 70/00 (2006.01) F41H 5/04 (2006.01) B32B 5/26 (2006.01)	2433790 *	STAB-RESISTANT BALLISTIC-RESISTANT MATERIAL AND PRODUCTION PROCESS THEREOF
Teva Pharmaceutical Industries Ltd.	A01N 43/42 (2006.01) A61K 31/47 (2006.01)	2442651 *	TREATMENT OF MULTIPLE SCLEROSIS WITH LAQUINIMOD
Panmira Pharmaceuticals, LLC	A61K 31/195 (2006.01) A61K 47/06 (2006.01) A61K 9/00 (2006.01) A61P 17/02 (2006.01) A61K 31/185 (2006.01) A61P 17/00 (2006.01)	2480225 *	DERMAL FORMULATIONS OF DP2 RECEPTOR ANTAGONISTS
Oncozyme Pharma Inc.	A61K 31/155 (2006.01)	2424516 *	PENTAMIDINE COMBINATIONS FOR TREATING CANCER
Sanofi-Aventis Deutschland GmbH	A61M 5/31 (2006.01)	2403564 *	MEDICATION DELIVERY DEVICE WITH FOLDABLE FINGER PAD
Amgen, Inc	C07K 14/50 (2006.01) A61K 38/18 (2006.01)	2427208 *	FGF21 MUTANTS AND USES THEREOF
Euro-Celtique S.A.	A61M 15/00 (2006.01) G06M 1/24 (2006.01)	2408498 *	COUNTER
Vishay Electronic GmbH	H05B 33/08 (2006.01)	2409549 *	CIRCUIT FOR A LIGHT-EMITTING DIODE ASSEMBLY AND LIGHT EMITTING DIODE MODULE
Prosidion Limited	A61P 3/10 (2006.01) C07D 403/12 (2006.01) A61K 31/506 (2006.01)	2406251 *	COMPOUNDS FOR THE TREATMENT OF METABOLIC DISORDERS
Intra-Cellular Therapies, Inc.	A01N 43/90 (2006.01)	2434895 *	ORGANIC COMPOUNDS
Respivert Limited	C07D 401/12 (2006.01) A61K 31/415 (2006.01) A61P 11/00 (2006.01) A61P 29/00 (2006.01)	2414347 *	P38MAP KINASE INHIBITOR
UCB Pharma, S.A.	C07K 16/18 (2006.01) C07K 16/24 (2006.01) C07K 16/46 (2006.01) C07K 16/28 (2006.01)	2480577 *	DISULFIDE STABILISED MULTIVALENT ANTIBODIES
China Academy of Telecommunications Technology	H04B 7/14 (2006.01)	2485410 *	TRANSMISSION METHOD, DETECTION METHOD AND EQUIPMENT FOR CONTROL CHANNELS OF A RELAY SYSTEM
Coskunöz Metal Form Makina Endüstriye Tic. A.S.	B21D 24/14 (2006.01)	2428290	A cushioning arrangement for presses
Affiris AG	A61K 39/00 (2006.01) C07K 7/14 (2006.01)	2456459 *	VACCINE

Podnosilac evropske prijave patenta (71)	MKP (51)	Broj objave evropske prijave patenta (97)	Naziv pronalaska (54)
Siegmund, Bernd	B25B 5/06 (2006.01) B25B 5/10 (2006.01) B25B 5/16 (2006.01)	2432623 *	VARIABLE CLAMPING TOOL
Sanofi-Aventis Deutschland GmbH	A61M 5/315 (2006.01)	2437825 *	RESETTING MECHANISM FOR A DRUG DELIVERY DEVICE
CEMMI-Construction-Etude de Matériel-Maintenance Industrielle	F25D 23/00 (2006.01) A23L 3/36 (2006.01) F25D 3/00 (2006.01) F25D 13/00 (2006.01)	2340726	Freezer system for rind formation of a food product
Vitae Pharmaceuticals, Inc.	C07D 471/04 (2006.01) C07D 498/04 (2006.01) C07D 221/10 (2006.01) A61K 31/5377 (2006.01) C07D 401/12 (2006.01) C07D 401/14 (2006.01) A61K 31/498 (2006.01) C07D 401/06 (2006.01) A61P 3/00 (2006.01) C07D 417/06 (2006.01) C07D 405/14 (2006.01) A61K 31/473 (2006.01) A61K 31/497 (2006.01)	2496559 *	ARYL- AND HETEROARYLCARBONYL DERIVATIVES OF HEXAHYDROINDENOPYRIDINE AND OCTAHYDROBENZOQUINOLINE
Boehringer Ingelheim International GmbH	C07D 471/04 (2006.01) C07D 498/04 (2006.01) C07D 221/10 (2006.01) A61K 31/5377 (2006.01) C07D 401/12 (2006.01) C07D 401/14 (2006.01) A61K 31/498 (2006.01) C07D 401/06 (2006.01) A61P 3/00 (2006.01) C07D 417/06 (2006.01) C07D 405/14 (2006.01) A61K 31/473 (2006.01) A61K 31/497 (2006.01)	2496559 *	ARYL- AND HETEROARYLCARBONYL DERIVATIVES OF HEXAHYDROINDENOPYRIDINE AND OCTAHYDROBENZOQUINOLINE
AS & Partners S.R.L.	B09B 3/00 (2006.01)	2416899 *	WASTE TREATMENT METHOD
UCB Pharma S.A.	A61K 31/4178 (2006.01) A61P 25/00 (2006.01) A61P 25/28 (2006.01)	2461808 *	METHODS FOR ENHANCING THE COGNITIVE FUNCTION
Linjeservice AS	H02G 1/04 (2006.01)	2461441	wheel for installing cables
Omya Development AG	C09C 1/02 (2006.01) C09C 1/42 (2006.01)	2377900	Process to prepare surface-modified mineral material, resulting products and uses thereof
Halozyme, Inc.	A61K 38/48 (2006.01) C07K 14/435 (2006.01)	2403523 *	TEMPERATURE SENSITIVE MUTANTS OF MATRIX METALLOPROTEASE 1 UND USES THEREOF
Abraxis BioScience, LLC	A01N 43/66 (2006.01) A61K 31/53 (2006.01)	2440056 *	UREIDOPHENYL SUBSTITUTED TRIAZINE DERIVATIVES AND THEIR THERAPEUTICAL APPLICATIONS
AstraZeneca AB	A61P 31/00 (2006.01) A61P 35/00 (2006.01) C07D 239/49 (2006.01) A61K 31/505 (2006.01) A61P 17/00 (2006.01) A61P 11/00 (2006.01) A61P 27/14 (2006.01)	2435412 *	DISACCHARIN, DIFUMARIC ACID, DI-L-HYDROXY-2-NAPHTHOIC ACID AND MONO-BENZOIC ACID SALTS OF 4- (DIMETHYLAMINO)BUTYL 2- (4- ((2-AMINO-4-METHYL-6- (PENTYLAMINO) PYRIMIDIN- 5 -YL) METHYL) PHENYL)ACETATE
Dainippon Sumitomo Pharma Co., Ltd.	A61P 31/00 (2006.01) A61P 35/00 (2006.01) C07D 239/49 (2006.01) A61K 31/505 (2006.01) A61P 17/00 (2006.01) A61P 11/00 (2006.01) A61P 27/14 (2006.01)	2435412 *	DISACCHARIN, DIFUMARIC ACID, DI-L-HYDROXY-2-NAPHTHOIC ACID AND MONO-BENZOIC ACID SALTS OF 4- (DIMETHYLAMINO)BUTYL 2- (4- ((2-AMINO-4-METHYL-6- (PENTYLAMINO) PYRIMIDIN- 5 -YL) METHYL) PHENYL)ACETATE
Delphi Technologies Holding S.à.r.l.	F01N 3/023 (2006.01) F01N 9/00 (2006.01) F01N 13/02 (2010.01)	2410144	Method of Controlling NOx Emissions in an Internal Combustion Engine

Podnosilac evropske prijave patenta (71)	MKP (51)	Broj objave evropske prijave patenta (97)	Naziv pronalaska (54)
Hateley, Brian Peter	A61H 3/02 (2006.01)	2371338	A walking aid
E. I. Du Pont De Nemours And Company	C12N 15/10 (2006.01)	2462226 *	PROCESS AND DEVICE FOR COLLECTING NUCLEIC ACIDS OF MICROORGANISMS FROM A PARTICULATE SAMPLE
EUROSUOLE S.P.A.	B29D 35/14 (2010.01) B29C 33/00 (2006.01) B29C 33/10 (2006.01) B29C 45/34 (2006.01) B29C 45/14 (2006.01) B29C 45/00 (2006.01)	2464501 *	INJECTION MOULD WITH COMPENSATION CHAMBER FOR MOULDING TPU AND OTHER THERMOPLASTIC MATERIALS ON RUBBER TREAD.
Sunflex Aluminiumsysteme GmbH	E05D 15/06 (2006.01)	2476840	Track roller device
Cirilli, Alessandro	F16B 13/14 (2006.01)	2317158	Wall plug for masonry walls provided with insulating layers of friable spongy materials
Checkpoint Systems, Inc.	G01S 5/02 (2010.01) G08B 13/00 (2006.01) G07C 9/00 (2006.01) G07C 5/02 (2006.01) G07F 7/10 (2006.01)	2483869 *	KEY DEVICE FOR MONITORING SYSTEMS
Dompé S.p.A.	A61P 3/10 (2006.01) A61K 31/185 (2006.01)	2485724 *	SULFONAMIDES FOR THE PREVENTION OF DIABETES
Pfizer Inc.	C07D 213/65 (2006.01) C07C 311/07 (2006.01) C07D 405/12 (2006.01) A61K 31/443 (2006.01) C07D 409/12 (2006.01) A61K 31/4453 (2006.01) C07D 295/096 (2006.01) C07D 307/42 (2006.01) A61K 31/381 (2006.01) C07D 409/14 (2006.01) A61K 31/4709 (2006.01) C07D 333/38 (2006.01) A61K 31/402 (2006.01) C07D 307/22 (2006.01) A61K 31/341 (2006.01)	2445883 *	HETEROCYCLIC SULFONAMIDES, USES AND PHARMACEUTICAL COMPOSITIONS THEREOF
Purzer Pharmaceutical Co., Ltd.	C07D 209/40 (2006.01) C07D 209/88 (2006.01) C07D 409/12 (2006.01) A61P 35/00 (2006.01) C07D 209/08 (2006.01) A61K 31/404 (2006.01)	2366687	Benzenesulfonamide derivatives and pharmaceutical composition thereof
Orion Corporation	C07D 417/12 (2006.01) A61K 31/44 (2006.01) C07D 405/12 (2006.01) A61K 31/5377 (2006.01) A61K 31/42 (2006.01) C07D 231/14 (2006.01) A61K 31/438 (2006.01) C07D 413/12 (2006.01) A61K 31/416 (2006.01) C07D 401/12 (2006.01) A61K 31/497 (2006.01) A61P 35/00 (2006.01) C07D 403/12 (2006.01) A61K 31/4523 (2006.01)	2493858 *	ANDROGEN RECEPTOR MODULATING COMPOUNDS
Durafizz, LLC	A23L 1/176 (2006.01) A23L 1/01 (2006.01)	2475266 *	EDIBLE SURFACE-MODIFYING PARTICLES AND METHODS FOR THEIR MANUFACTURE
Omya Development AG	A01N 59/08 (2006.01) A61K 8/19 (2006.01) A01N 59/06 (2006.01) C02F 1/50 (2006.01) D21H 21/36 (2006.01) A01N 55/02 (2006.01)	2374353	Process to preserve aqueous preparations of mineral materials, preserved aqueous preparations of mineral materials and use of preservative compounds in aqueous preparations of mineral materials

Podnosilac evropske prijave patenta (71)	MKP (51)	Broj objave evropske prijave patenta (97)	Naziv pronalaska (54)
Maxamcorp Holding, S.L.	C06B 23/00 (2006.01) C06B 45/10 (2006.01) C06B 21/00 (2006.01) F42B 33/06 (2006.01) A62D 3/02 (2007.01) A62D 3/30 (2007.01)	2445852 *	SYSTEMS AND METHODS FOR CHEMICAL AND/OR MECHANICAL REMEDIATION OF NITRO COMPOUNDS AND NITRATE ESTERS
Sol-Gel Technologies Ltd.	A61K 9/50 (2006.01) A61K 9/00 (2006.01) A61K 8/11 (2006.01)	2467132 *	CORE STABILIZED MICROCAPSULES, METHOD OF THEIR PREPARATION AND USES THEREOF
China Academy of Telecommunications Technology	H04W 24/04 (2009.01)	2453693 *	METHOD AND DEVICE FOR MAINTAINING LONG TERM EVOLUTION BASE STATION
Momenta Pharmaceuticals, Inc.	C12N 9/10 (2006.01) C12P 21/02 (2006.01) A61K 38/14 (2006.01) C12N 15/54 (2006.01) C12Q 1/68 (2006.01)	2499245 *	GLYCOSYL TRANSFERASE FROM CHINESE HAMSTER AND RELATED METHODS
SANOFI	A61K 31/337 (2006.01) A61K 31/7068 (2006.01) A61P 35/00 (2006.01)	2427187 *	ANTITUMOR COMBINATION INCLUDING CABAZITAXEL AND CAPECITABINE
Cardiolynx AG	A61P 3/00 (2006.01) A61P 9/00 (2006.01) C07D 257/04 (2006.01) A61K 31/41 (2006.01)	2377855	A valsartanamide dinitrate derivative for the treatment of vascular and metabolic diseases
Knopp Neurosciences, Inc.	A61K 31/425 (2006.01) A01N 43/78 (2006.01)	2442655 *	COMPOSITIONS AND METHODS FOR TREATING AMYOTROPHIC LATERAL SCLEROSIS
Alnylam Pharmaceuticals, Inc.	C12N 15/11 (2006.01) C12N 5/00 (2006.01)	2451940 *	BIOPROCESSING
University of Maryland, Baltimore County	C12M 1/12 (2006.01)	2443224 *	NON-INVASIVE SENSING OF BIOPROCESS PARAMETERS
Napatech A/S	H04L 12/56 (2006.01)	2478677 *	AN APPARATUS FOR ANALYZING A DATA PACKET, A DATA PACKET PROCESSING SYSTEM AND A METHOD
Genzyme Corporation	A61K 39/395 (2006.01)	2429582 *	ANTI-HUMAN CD52 IMMUNOGLOBULINS
Toto Ltd.	E03D 9/08 (2006.01)	2400070	Sanitary washing apparatus for private body parts
Theratechnologies Inc.	A61K 38/27 (2006.01) C07K 17/02 (2006.01) A61K 38/16 (2006.01) C07K 14/60 (2006.01) A61K 31/366 (2006.01)	2421548 *	USE OF (HEXENOYL TRANS-3)HGRF(L-44)NH ₂ AND SIMVASTATIN IN COMBINATION THERAPY
Momenta Pharmaceuticals, Inc.	C12P 19/02 (2006.01)	2435577 *	PRODUCTION OF GLYCOPROTEINS
CBS Institut Celovite Gradbene Resitve, d.o.o.	E04B 1/80 (2006.01)	2340338 *	GAS FILLED INSULATION CONSTRUCTION PANEL
Reflex d.o.o.	E04B 1/80 (2006.01)	2340338 *	GAS FILLED INSULATION CONSTRUCTION PANEL
Japan Tobacco, Inc.	A61K 31/438 (2006.01) A61P 17/00 (2006.01) A61K 31/519 (2006.01) A61P 17/06 (2006.01) A61K 31/55 (2006.01) A61P 19/02 (2006.01) A61P 1/04 (2006.01) A61P 21/04 (2006.01) A61K 31/437 (2006.01) A61P 11/06 (2006.01) A61P 3/10 (2006.01) A61P 25/00 (2006.01) A61P 7/00 (2006.01) C07D 519/00 (2006.01) A61P 11/02 (2006.01)	2460806 *	NITROGEN-CONTAINING SPIRO-RING COMPOUND AND MEDICINAL USE OF SAME

Podnosilac evropske prijave patenta (71)	MKP (51)	Broj objave evropske prijave patenta (97)	Naziv pronalaska (54)
Protein Design Lab, Ltd.	C07K 19/00 (2006.01) C12N 15/62 (2006.01) A61P 31/04 (2006.01) C12N 15/63 (2006.01) A61K 38/16 (2006.01) A61K 47/48 (2006.01) C12P 21/02 (2006.01)	2474558 *	NEW ANTIBIOTIC CONTAINING SIMULACRUM ANTIBODY, PREPARATION METHOD AND APPLICATION THEREOF
Burcon Nutrascience (MB) Corp.	A23J 1/14 (2006.01) A23J 3/16 (2006.01) A23L 2/02 (2006.01)	2482670 *	PREPARATION OF SOY PROTEIN ISOLATE USING CALCIUM CHLORIDE EXTRACTION ("S703")
Delta Systems AS	E04H 15/32 (2006.01) E04H 15/64 (2006.01) E04B 1/343 (2006.01)	2414605 *	SUPPORT PROFILE
Infaco S.A.S	A01G 3/037 (2006.01)	2353366	Branche shear for cutting plants
Acclarent, Inc.	A61F 11/00 (2006.01) A61B 17/34 (2006.01)	2453855 *	TYMPANIC MEMBRANE PRESSURE EQUALIZATION TUBE DELIVERY SYSTEM
Ergo Design S.R.L.	F23D 14/70 (2006.01) F23Q 3/00 (2006.01) F23C 3/00 (2006.01) F23D 14/10 (2006.01)	2446192 *	BURNER
Lualdi, Ambrogio	F23D 14/70 (2006.01) F23Q 3/00 (2006.01) F23C 3/00 (2006.01) F23D 14/10 (2006.01)	2446192 *	BURNER
Merck Sharp & Dohme Corp.	A01N 37/18 (2006.01) A01K 31/16 (2006.01)	2410844 *	INHIBITORS OF HEPATITIS C VIRUS REPLICATION
Biolink Life Sciences, Inc.	A61K 31/205 (2006.01) A61P 25/12 (2006.01) A61P 25/00 (2006.01)	2456433 *	METHODS FOR THE PREPARATION AND USE OF AQUEOUS SOLUTIONS OF MAGNESIUM VALPROATE HYDRATE AND L-CARNITINE
Curt G. Joa, Inc.	A61F 13/15 (2006.01)	2332505	Method and apparatus for stretching segmented stretchable film and application of the segmented film to a moving web
Asahi Kasei Chemicals Corporation	C08F 2/18 (2006.01) C08F 20/14 (2006.01)	2492288 *	METHACRYLIC RESIN, MOLDED BODY THEREOF, AND METHOD FOR PRODUCING METHACRYLIC RESIN
Bindics, Elek	B44C 1/10 (2006.01) B44C 1/16 (2006.01) B44C 1/18 (2006.01) B44C 5/04 (2006.01)	2432649 *	DECORATIVE ELEMENT FOR DECORATION OF SURFACES, PREFERABLY WALL SURFACES
SANOFI	A61K 31/407 (2006.01) A61P 25/00 (2006.01) C07D 487/08 (2006.01) C07D 207/14 (2006.01) C07C 233/77 (2006.01)	2419431 *	DERIVATIVES OF N-[(7-AZA-BICYCLO[2.2.1]HEPT-1-YL)-ARYL-METHYL]-BENZAMIDE, PREPARATION THEREOF, AND THERAPEUTIC USE THEREOF
Guangdong Shengyi Sci. Tech Co., Ltd.	C08L 85/02 (2006.01) C08K 5/357 (2006.01) C08K 5/5399 (2006.01) C08L 79/04 (2006.01)	2292696	Method for improving flame retardant efficiency of phenoxyphosphazene compound, and prepreg, laminate, and laminate for printed circuit made by the method
Suominen Corporation	B23B 37/00 (2006.01)	2456585 *	HIGH CELLULOSE CONTENT, LAMINIFEROUS NONWOVEN FABRIC
Arena Pharmaceuticals, Inc.	C07C 17/16 (2006.01)	2443080 *	PROCESS FOR THE PREPARATION OF 5-HT _{2C} RECEPTOR AGONISTS
Nutrinova Nutrition Specialties & Food Ingredients GmbH	A61K 8/49 (2006.01) A61Q 11/00 (2006.01)	2407146	Use of acesulfame K as a flavour modulator
Abbott Laboratories	C12N 15/67 (2006.01)	2454373 *	ENHANCEMENT OF CELLULAR PRODUCTION THROUGH MECHANOTRANSDUCTION
3S Swiss Solar Systems AG	H01L 31/18 (2006.01)	2441096 *	METHOD FOR PRODUCING A SOLAR PANEL
Abraxis BioScience, LLC	A01N 43/42 (2006.01) A61K 31/47 (2006.01) A61K 31/517 (2006.01)	2440048 *	ISOQUINOLINE, QUINOLINE, AND QUINAZOLINE DERIVATIVES AS INHIBITORS OF HEDGEHOG SIGNALING

Podnosilac evropske prijave patenta (71)	MKP (51)	Broj objave evropske prijave patenta (97)	Naziv pronalaska (54)
Janssen Pharmaceutica N.V.	C07D 401/04 (2006.01) A61K 31/4155 (2006.01) A61P 25/00 (2006.01)	2491024 *	SUBSTITUTED N-PHENYL-1-(4-PYRIDINYL)-1H-PYRAZOL-3-AMINES
UCB Pharma, S.A.	C07D 487/04 (2006.01) A61K 31/519 (2006.01) A61P 35/00 (2006.01) A61P 25/28 (2006.01) A61P 37/00 (2006.01)	2432784 *	FUSED BICYCLIC PYRAZOLE DERIVATIVES AS KINASE INHIBITORS
China Academy of Telecommunications Technology	H04W 4/06 (2009.01)	2466923 *	METHOD, APPARATUS AND SYSTEM FOR CONFIGURING MULTIMEDIA BROADCAST MULTICAST SERVICE (MBMS) CONTROL INFORMATION
Cadila Healthcare Limited	C07D 413/06 (2006.01) C07D 413/14 (2006.01) C07D 417/06 (2006.01) A61P 3/06 (2006.01) A61K 31/357 (2006.01) C07D 405/14 (2006.01) C07D 417/14 (2006.01) C07D 405/06 (2006.01)	2483266 *	COMPOUNDS FOR THE TREATMENT OF DYSLIPIDEMIA AND RELATED DISEASES
Dat Dynamic Aquabion Tower GmbH	C02F 3/34 (2006.01) C02F 103/02 (2006.01) C02F 1/00 (2006.01) C02F 1/46 (2006.01) C02F 1/44 (2006.01) C02F 1/32 (2006.01) C02F 5/02 (2006.01) C02F 1/48 (2006.01)	2488458 *	COOLING SYSTEM COMPRISING A BIO-FILTER AND METHOD FOR OPERATING SAID SYSTEM
Huber, Johannes	A61F 3/00 (2006.01) A61K 36/82 (2006.01) A61P 25/00 (2006.01) A61P 25/28 (2006.01) A23L 2/52 (2006.01)	2464249 *	CONCENTRATION-ENHANCING DRINK
Evonik Röhm GmbH	C08G 63/80 (2006.01) C08G 63/90 (2006.01) C08G 63/08 (2006.01)	2455415	Method for manufacturing low-molecular resorbable polyesters, low-molecular resorbable polyester manufactured according to the method and application of same
Nimtec AS	F42B 8/00 (2006.01) F41A 33/04 (2006.01) F41A 33/02 (2006.01)	2486363 *	ELECTRONIC BLANK AMMUNITION
Baylor Research Institute	A61P 9/00 (2006.01) A61P 43/00 (2006.01) A61K 31/50 (2006.01) A61K 31/195 (2006.01) A61K 31/4985 (2006.01) A61P 3/00 (2006.01)	2416776 *	USE OF TETRAHYDROBIOPTERIN AS A MARKER AND A THERAPEUTIC AGENT FOR FABRY DISEASE
Janssen Pharmaceutica NV	A61P 25/04 (2006.01) C07D 417/12 (2006.01) C07D 239/34 (2006.01) C07D 401/12 (2006.01) A61K 31/506 (2006.01) C07D 403/12 (2006.01) C07D 239/28 (2006.01) C07D 413/12 (2006.01)	2493863 *	PHENOXY-SUBSTITUTED PYRIMIDINES AS OPIOID RECEPTOR MODULATORS
Indena S.p.A.	C07C 227/32 (2006.01)	2380871	A process for the preparation of isoserine derivatives
Cadila Healthcare Limited	C07K 14/605 (2006.01)	2491054 *	SHORT CHAIN PEPTIDOMIMETICS BASED ORALLY ACTIVE GLP-1 AGONIST AND GLUCAGON RECEPTOR ANTAGONIST
IMT Information-Management-Technology Ag	A61M 16/00 (2006.01)	2435117 *	VENTILATOR AND ADJUSTMENT METHOD THEREFOR
Imperial Tobacco Limited	B65D 85/10 (2006.01) B65D 5/66 (2006.01)	2376334 *	PACKAGE FOR TOBACCO-RELATED ARTICLES

Podnosilac evropske prijave patenta (71)	MKP (51)	Broj objave evropske prijave patenta (97)	Naziv pronalaska (54)
Torrent Pharmaceuticals Limited	A61K 31/519 (2006.01) A61P 7/06 (2006.01) C07D 513/16 (2006.01) C07D 513/06 (2006.01)	2385948 *	FUSED THIAZOLO AND OXAZOLO PYRIMIDINONES
Boehringer Ingelheim International GmbH	C07D 487/04 (2006.01) A61K 31/519 (2006.01)	2414363 *	1-HETEROCYCLYL-1, 5-DIHYDRO-PYRAZOLO [3, 4-D]PYRIMIDIN-4-ONE DERIVATIVES AND THEIR USE AS PDE9A MODULATORS
Johnson & Johnson Vision Care Inc.	A45C 11/00 (2006.01)	2456334 *	PORTIONED PACKAGES FOR MAINTENANCE SOLUTIONS AND OPHTHALMIC LENSES
Unsöld, Manfred	B65D 21/02 (2006.01) B65D 71/50 (2006.01)	2394923	Handle device for a plurality of containers
Cleverly, Douglas Robert	A61K 9/16 (2006.01) A61K 31/4184 (2006.01) A61K 31/425 (2006.01) A61P 33/00 (2006.01)	2475430 *	GRANULATED ANTHELMINTIC PREPARATIONS AND DELIVERY SYSTEMS
Mukhopadhyay, Debashis	A61K 9/16 (2006.01) A61K 31/4184 (2006.01) A61K 31/425 (2006.01) A61P 33/00 (2006.01)	2475430 *	GRANULATED ANTHELMINTIC PREPARATIONS AND DELIVERY SYSTEMS
Machács, Márton	D06F 57/00 (2006.01) D06F 53/00 (2006.01)	2478147 *	AUXILIARY DEVICE
Panacela Labs, Inc.	A01N 43/38 (2006.01) A61K 31/40 (2006.01)	2490531 *	METHOD FOR TREATING ANDROGEN RECEPTOR POSITIVE CANCERS
Memorial Sloan-Kettering Cancer Center	A61K 31/54 (2006.01)	2467142 *	HEAT SHOCK PROTEIN BINDING COMPOUNDS, COMPOSITIONS, AND METHODS FOR MAKING AND USING SAME
TBG Technische Beteiligungsgesellschaft AG	B65D 25/50 (2006.01) B65D 51/16 (2006.01)	2361840	Canister
Merz Pharma GmbH & Co. KGaA	C07C 211/35 (2006.01) C07C 209/62 (2006.01)	2448909 *	METHOD OF PREPARING 1-AMINO-1,3,3,5,5-PENTAMETHYLCYCLOHEXANE
Sunesis Pharmaceuticals, Inc.	C07D 417/04 (2006.01) C07D 417/14 (2006.01)	2473507 *	STABLE SNS-595 COMPOSITIONS AND METHODS OF PREPARATION
Janssen Pharmaceuticals Inc.	C07D 471/04 (2006.01) A61K 31/437 (2006.01) A61K 31/444 (2006.01) A61K 31/445 (2006.01) A61P 25/00 (2006.01)	2430021 *	7-ARYL-1,2,4-TRIAZOLO[4,3-A]PYRIDINE DERIVATIVES AND THEIR USE AS POSITIVE ALLOSTERIC MODULATORS OF MGLUR2 RECEPTORS
Addex Pharma SA	C07D 471/04 (2006.01) A61K 31/437 (2006.01) A61K 31/444 (2006.01) A61K 31/445 (2006.01) A61P 25/00 (2006.01)	2430021 *	7-ARYL-1,2,4-TRIAZOLO[4,3-A]PYRIDINE DERIVATIVES AND THEIR USE AS POSITIVE ALLOSTERIC MODULATORS OF MGLUR2 RECEPTORS
Orexo AB	A61K 31/437 (2006.01) A61K 31/4468 (2006.01) A61P 25/04 (2006.01) A61K 9/16 (2006.01)	2403482 *	ABUSE RESISTANT FORMULATION
Saint-Gobain Adfors	C09D 7/12 (2006.01) C09D 5/02 (2006.01)	2496649 *	FILM-FORMING COMPOSITION CONTAINING AN AGENT CAPABLE OF TRAPPING FORMALDEHYDE
Les Laboratoires Servier	C07C 211/00 (2006.01) C07D 223/16 (2006.01)	2487158	New method for synthesising ivabradine and its added salts with a pharmaceutically acceptable acid.
Biogen Idec MA Inc.	A61K 39/395 (2006.01)	2419137 *	COMPOSITIONS AND METHODS TO TREAT ACUTE MYELOGENOUS LEUKEMIA

Podnosilac evropske prijave patenta (71)	MKP (51)	Broj objave evropske prijave patenta (97)	Naziv pronalaska (54)
Janssen Pharmaceuticals Inc.	A61P 25/28 (2006.01) C07D 401/14 (2006.01) C07D 471/04 (2006.01) A61K 31/4439 (2006.01) C07D 403/10 (2006.01) C07D 498/04 (2006.01) C07D 487/04 (2006.01) C07D 233/60 (2006.01) C07D 405/14 (2006.01) A61K 31/4178 (2006.01) A61K 31/4196 (2006.01)	2454239 *	SUBSTITUTED TRIAZOLE AND IMIDAZOLE DERIVATIVES AS GAMMA SECRETASE MODULATORS
Polycube Systems GmbH	B65D 88/16 (2006.01) B65D 90/00 (2006.01) B65D 90/04 (2006.01)	2477912 *	PACKAGING CONTAINER FOR BITUMEN
Orfagen	A61K 31/047 (2006.01) A61K 45/06 (2006.01) A61K 9/00 (2006.01) A61Q 19/00 (2006.01) A61P 17/16 (2006.01) A61K 31/01 (2006.01)	2419176 *	PHARMACEUTICAL COMPOSITION COMPRISING GLYCEROL, WHITE SOFT PARAFFIN AND LIQUID PARAFFIN FOR THE TREATMENT OF UREMIC XEROSIS AND/OR PRURITUS
Norsync Technology AS	G06F 17/30 (2006.01)	2452277 *	METHODS, SYSTEMS AND DEVICES FOR PERFORMING INCREMENTAL UPDATES OF PARTIAL DATABASES
BASF SE	A01N 33/08 (2006.01) A01N 39/04 (2006.01) A01N 33/04 (2006.01) A01N 37/40 (2006.01) A01N 57/20 (2006.01)	2482654 *	LOW VOLATILE AMINE SALTS OF ANIONIC PESTICIDES
Johnson & Johnson Consumer Companies, Inc.	A61K 8/97 (2006.01) A61Q 19/02 (2006.01) A61Q 19/08 (2006.01) A61K 36/47 (2006.01) A61P 29/00 (2006.01) A61P 17/00 (2006.01)	2482830 *	EXTRACTS OF PHYLLANTHUS NIRURI
Antonio Lupi Desing S.P.A. ,	A47K 3/34 (2006.01) E05D 15/06 (2006.01)	2305085	Shower cabin with sliding door
Metal Oxygen Separation Technologies, Inc.	C25C 3/26 (2006.01) C25C 3/00 (2006.01) C25B 1/00 (2006.01) C25C 1/00 (2006.01) C25C 3/34 (2006.01)	2425042 *	PRIMARY PRODUCTION OF ELEMENTS
Concert Pharmaceuticals Inc.	A01N 43/90 (2006.01) A61K 31/522 (2006.01)	2473052 *	SUBSTITUTED XANTHINE DERIVATIVES
Genzyme Corporation	C12N 7/02 (2006.01)	2443233 *	IMPROVED METHODS FOR PURIFICATION OF RECOMBINANT AAV VECTORS
Orion Corporation	A61P 35/00 (2006.01) C07C 257/18 (2006.01) A61K 31/47 (2006.01) C07C 235/62 (2006.01) A61K 31/44 (2006.01) C07D 211/26 (2006.01) A61K 31/445 (2006.01) C07D 211/58 (2006.01) C07C 311/20 (2006.01) C07D 215/08 (2006.01) C07D 401/06 (2006.01) C07D 213/61 (2006.01) C07D 213/75 (2006.01) C07D 217/06 (2006.01) C07C 259/18 (2006.01)	2432556 *	PROTEASE INHIBITORS
Tetralogic Pharmaceuticals Corp.	A61K 31/40 (2006.01) A01N 43/36 (2006.01)	2434889 *	IAP INHIBITORS
Dow AgroSciences, LLC	A01H 5/00 (2006.01)	2467010 *	AAD-1 EVENT DAS-40278-9, RELATED TRANSGENIC CORN LINES, AND EVENT-SPECIFIC IDENTIFICATION THEREOF

Podnositelj evropske prijave patenta (71)	MKP (51)	Broj objave evropske prijave patenta (97)	Naziv pronalaska (54)
Rondane Teknologji AS	B63B 25/16 (2006.01) B63B 27/24 (2006.01) B63J 2/12 (2006.01) F17C 6/00 (2006.01) F17C 9/02 (2006.01) F17C 9/04 (2006.01)	2464563 *	A PLANT COMPRISING A TANK FOR STORING OF LIQUID NATURAL GAS (LNG) AS MARINE FUEL
Cleanint, Llc	A61L 2/18 (2006.01) A61L 2/16 (2006.01) A61L 101/34 (2006.01) A61L 2/26 (2006.01)	2445542 *	SANITIZATION APPARATUSES, KITS, AND METHODS
Cellnet Innovations, Inc.	G01D 4/00 (2006.01) H04B 1/713 (2011.01) H04W 4/06 (2009.01)	2483637 *	METHODS AND SYSTEMS FOR DISTRIBUTING BROADCAST MESSAGES ON VARIOUS NETWORKS
Boehringer Ingelheim International GmbH	C07K 16/18 (2006.01) C07K 16/28 (2006.01) C07K 16/22 (2006.01) A61P 35/00 (2006.01)	2483314 *	BISPECIFIC BINDING MOLECULES FOR ANTI-ANGIOGENESIS THERAPY
Novelis, Inc.	F27D 13/00 (2006.01) F27D 3/12 (2006.01)	2470849 *	MOVABLE SWEAT HEARTH FOR METAL MELTING FURNACE
Kaspersky Lab, ZAO	G06F 21/00 (2006.01) G06F 9/445 (2006.01) G06F 11/34 (2006.01)	2388695	Adaptive configuration of conflicting applications
CV Holdings, LLC.	G01M 3/32 (2006.01) G01N 33/00 (2006.01) G01N 15/08 (2006.01)	2251671	Outgassing method for inspecting a coated surface
Biogen Idec MA Inc.	A01N 43/42 (2006.01)	2461683 *	BICYCLIC ARYL SPHINGOSINE 1-PHOSPHATE ANALOGS
Galapagos N.V.	A61P 35/00 (2006.01) A61P 37/00 (2006.01) C07D 471/04 (2006.01) A61K 31/437 (2006.01) A61P 29/00 (2006.01)	2445912 *	NOVEL COMPOUND USEFUL FOR THE TREATMENT OF DEGENERATIVE AND INFLAMMATORY DISEASES
Servicio Andaluz De Salud	C12N 5/071 (2010.01) A61L 27/38 (2006.01) A61K 35/12 (2006.01)	2471902 *	PRODUCTION OF ARTIFICIAL TISSUES BY MEANS OF TISSUE ENGINEERING USING AGAROSE-FIBRIN BIOMATERIALS
Universidad de Granada	C12N 5/071 (2010.01) A61L 27/38 (2006.01) A61K 35/12 (2006.01)	2471902 *	PRODUCTION OF ARTIFICIAL TISSUES BY MEANS OF TISSUE ENGINEERING USING AGAROSE-FIBRIN BIOMATERIALS
Savoye	B60M 3/04 (2006.01) B65G 1/04 (2006.01)	2450223	Automated storage systems including at least one track provided with a mechanism for halting a carriage.
Philip Morris Products S.A.	A24F 47/00 (2006.01)	2493342 *	AN ELECTRICALLY HEATED SMOKING SYSTEM WITH IMPROVED HEATER
Brookhaven Science Associates	G01T 1/29 (2006.01) G01N 23/04 (2006.01) A61B 6/02 (2006.01) G21K 1/02 (2006.01)	2414864 *	INTERWOVEN MULTI-APERTURE COLLIMATOR FOR 3-DIMENSIONAL RADIATION IMAGING APPLICATIONS
Acceleron Pharma, Inc.	C07K 14/705 (2006.01) A61P 3/00 (2006.01) A61K 38/18 (2006.01)	2440576 *	METHODS FOR INCREASING THERMOGENIC ADIPOCYTES
Creative Nail Design, Inc.	A61Q 3/02 (2006.01) A45D 31/00 (2006.01) C08F 251/02 (2006.01) C09D 4/06 (2006.01) A61K 8/91 (2006.01)	2486067 *	REMOVABLE PROTECTIVE TOPCOAT FOR ARTIFICIAL NAIL COATINGS AND METHODS THEREFORE
Ashland Licensing and Intellectual Property LLC	C08F 265/06 (2006.01) C08F 265/04 (2006.01) D21H 21/10 (2006.01) C08F 265/10 (2006.01) C08F 2/32 (2006.01)	2419462 *	BIMOLECULAR INVERSE EMULSION POLYMER
Dow AgroSciences, LLC	C12N 15/82 (2006.01) A01H 5/00 (2006.01)	2467488 *	CONTROL OF AAD-1 MONOCOT VOLUNTEERS IN FIELDS OF DICOT CROPS
UCB Pharma, S.A.	C07K 16/28 (2006.01)	2493926 *	FUNCTION MODIFYING NAV 1.7 ANTIBODIES

Podnosilac evropske prijave patenta (71)	MKP (51)	Broj objave evropske prijave patenta (97)	Naziv pronalaska (54)
Kyorin Pharmaceutical Co., Ltd.	C07D 401/12 (2006.01)	2476677 *	PROCESS FOR PRODUCTION OF 4-(5-METHYLPYRIDIN-2-YLAMINO)PIPERIDINE-1-CARBOXYLIC ACID DERIVATIVES
Symphony Evolution, Inc.	A61K 31/495 (2006.01) A61P 9/00 (2006.01)	2482817 *	METHODS OF TREATING ANEURYSMAL DILATATION, BLOOD VESSEL WALL WEAKNESS AND SPECIFICALLY ABDOMINAL AORTIC AND THORACIC ANEURYSM USING MATRIX METALLOPROTEASE-2 INHIBITORS
Panasonic Corporation	H04N 13/04 (2006.01) G11B 20/10 (2006.01) G11B 20/12 (2006.01) G11B 27/00 (2006.01) H04N 5/93 (2006.01)	2437504 *	RECORDING MEDIUM, REPRODUCTION DEVICE, INTEGRATED CIRCUIT, REPRODUCTION METHOD, AND PROGRAM
Euro-Celtique S.A.	A61K 9/20 (2006.01) A61K 31/485 (2006.01) A61P 25/04 (2006.01) A61K 9/28 (2006.01)	2405915 *	IMMEDIATE RELEASE PHARMACEUTICAL COMPOSITIONS COMPRISING OXYCODONE AND NALOXONE
ECLISSE SRL	E06B 3/46 (2006.01)	2336473	Case for counterframe for disappearing sliding door and counterframe with case of the door panel provided with a side for supporting hanging objects
Merz Pharma GmbH & Co. KGaA	C07C 209/62 (2006.01) C07C 211/35 (2006.01) C07C 209/16 (2006.01)	2448910 *	METHOD OF PREPARING NERAMEXANE
Bei Duncan Electronics	G01D 5/12 (2006.01) G01B 7/30 (2006.01) B62D 15/02 (2006.01)	2491335 *	MULTI-TURN SENSOR
Nektar Therapeutics	C07D 253/075 (2006.01) A61P 25/08 (2006.01) A61K 31/53 (2006.01)	2430003 *	OLIGOMER-CONTAINING SUBSTITUTED AROMATIC TRIAZINE COMPOUNDS
Prometheus Laboratories Inc.	C12Q 1/68 (2006.01)	2494074 *	METHODS FOR DIAGNOSING IRRITABLE BOWEL SYNDROME
Lojack Operating Company, Lp	G01C 21/00 (2006.01)	2491342 *	POWER MANAGEMENT SYSTEM AND METHOD FOR VEHICLE LOCATING UNIT
MIKA Pharma Gesellschaft für die Entwicklung und Vermarktung pharmazeutischer Produkte mbH	A61K 9/12 (2006.01)	2387391 *	METHOD FOR DEVELOPING A LIQUID COMPOSITION TO BE APPLIED TO THE SKIN AS A FOAM AND A COMPOSITION THAT CAN BE APPLIED TOPICALLY
Supelec	G01R 31/00 (2006.01) G01R 29/08 (2006.01)	2414850 *	METHOD OF CHECKING THE DIRECTIVITY AND POLARIZATION OF COHERENT FIELD DISTRIBUTIONS IN A REVERBERANT MEDIUM
Adtex Inc.	A61B 5/026 (2006.01)	2292142	Method and device for evaluation of blood fluidity
Ethicon Endo-Surgery, Inc.	A61B 1/00 (2006.01) A61B 17/00 (2006.01)	2485632 *	LAPAROSCOPIC INSTRUMENT WITH ATTACHABLE END EFFECTOR
Andresen Towers A/S	E04H 7/22 (2006.01) E04H 12/08 (2006.01) E04G 11/06 (2006.01) E04H 12/34 (2006.01)	2478171 *	TUBULAR BUILDING STRUCTURE WITH HINGEDLY CONNECTED PLATFORM SEGMENT
Janssen Pharmaceutica, N.V.	C07D 401/14 (2006.01) A61K 51/04 (2006.01)	2493513 *	RADIOLABELLED PDE10 LIGANDS
Merck Sharp&Dohme Corp.	C12N 15/113 (2010.01)	2411517 *	RNA INTERFERENCE MEDIATED INHIBITION OF THE INTERCELLULAR ADHESION MOLECULE 1 (ICAM-1) GENE EXPRESSION USING SHORT INTERFERING NUCLEIC ACID (siNA)

Podnosilac evropske prijave patenta (71)	MKP (51)	Broj objave evropske prijave patenta (97)	Naziv pronalaska (54)
Kowa Company, Ltd.	C07D 233/86 (2006.01) A61K 31/4164 (2006.01) A61K 31/496 (2006.01) A61K 31/551 (2006.01) A61P 3/06 (2006.01) A61P 3/10 (2006.01) A61P 9/10 (2006.01) A61P 17/00 (2006.01) A61P 25/28 (2006.01) A61P 29/00 (2006.01) A61P 43/00 (2006.01) C07D 401/04 (2006.01) C07D 401/12 (2006.01) C07D 401/14 (2006.01) C07D 403/06 (2006.01) C07D 405/04 (2006.01) C07D 405/14 (2006.01) C07D 491/048 (2006.01) C07D 491/056 (2006.01)	2426113 *	CARBINOL COMPOUND HAVING HETEROCYCLIC LINKER
Anacor Pharmaceuticals, Inc.	A01P 1/00 (2006.01) A61K 31/69 (2006.01) A61P 31/04 (2006.01) A01N 55/08 (2006.01) C07F 5/02 (2006.01) A62D 3/36 (2007.01)	2458995 *	TRISUBSTITUTED BORON-CONTAINING MOLECULES
St. Renatus, LLC	A61K 9/00 (2006.01) A61K 31/245 (2006.01) A61K 31/4174 (2006.01) A61P 23/02 (2006.01)	2413899 *	DENTAL ANESTHETIC COMPRISING TETRACAINE AND A VASOCONSTRICTOR FOR INTRANASAL ADMINISTRATION
Abraxis BioScience, LLC	A01N 37/18 (2006.01) A61K 31/16 (2006.01)	2405750 *	COMBINATION THERAPY WITH THIOCOLCHICINE DERIVATIVES
Almirall S.A.	C07D 215/26 (2006.01) A61K 31/4704 (2006.01) A61P 11/00 (2006.01)	2406227 *	PROCESS FOR MANUFACTURING 5-(2-{{6-(2,2-DIFLUORO-2-PHENYLETHOXY) HEXYL}AMINO}-1- HYDROXYETHYL)-8- HYDROXYQUINOLIN-2(1H)-ONE.
Abbott Research B.V.	C12N 5/10 (2006.01) A61K 39/395 (2006.01) A61P 25/00 (2006.01) C07K 16/22 (2006.01) C12N 15/13 (2006.01)	2448970 *	ANTIBODIES AGAINST NERVE GROWTH FACTOR (NGF) WITH ENHANCED IN VIVO STABILITY
Rütgers Organics GmbH	F16L 57/04 (2006.01)	2270382	Thin layer strip for coating metal components and method for applying a coating which forms a thin layer
Saint-Gobain Isover	D06M 13/10 (2006.01) C09J 103/02 (2006.01) E04B 1/74 (2006.01) C03C 25/14 (2006.01) C03C 25/24 (2006.01) C03C 25/26 (2006.01) C03C 25/32 (2006.01) D04H 1/58 (2012.01) D04H 1/64 (2012.01)	2488596 *	ADHESIVE COMPOSITION FOR MINERAL WOOL INCLUDING A REDUCING SUGAR AND A METAL SALT OF AN INORGANIC ACID, AND INSULATING PRODUCTS THUS OBTAINED.
North Carolina State University	B32B 15/08 (2006.01) B32B 17/10 (2006.01) B29C 45/14 (2006.01)	2459372 *	THERMALLY RESPONSIVE COMPOSITE MATERIALS
Almirall S.A.	A61K 31/455 (2006.01) A61P 37/00 (2006.01) C07D 213/80 (2006.01)	2406225 *	ADDITION SALTS OF AMINES CONTAINING HYDROXYL AND/OR CARBOXYLIC GROUPS WITH AMINO NICOTINIC ACID DERIVATIVES AS DHODH INHIBITORS
Echotect B.V.	B29C 35/16 (2006.01) B29B 7/90 (2006.01) B29B 17/00 (2006.01)	2427315 *	PROCESS FOR MANUFACTURING A COMPOSITION COMPRISING RECYCLED PET BY CONTROLLED COOLING
The J. David Gladstone Institutes	C07H 21/04 (2006.01) C12N 15/11 (2006.01)	2496594 *	METHODS AND COMPOSITIONS FOR MODULATING TAU LEVELS

Podnosilac evropske prijave patenta (71)	MKP (51)	Broj objave evropske prijave patenta (97)	Naziv pronalaska (54)
Pipeline Technique Limited	B24B 33/02 (2006.01) B23Q 17/22 (2006.01) B24B 5/40 (2006.01)	2475499 *	BORE MACHINING METHOD AND APPARATUS
Burcon Nutrascience (MB) Corp.	C07K 1/24 (2006.01) A23J 1/14 (2006.01) C07K 14/415 (2006.01)	2477505 *	CANOLA PROTEIN PRODUCT FROM SUPERNATANT
Flextech S.r.l.	B65B 39/00 (2006.01) B65B 39/04 (2006.01) B65B 31/04 (2006.01) B65B 55/02 (2006.01)	2241507	Apparatus for filling flexible containers with a fluid, for example foodstuffs, such as cream, yoghurt, fruit juices and purées, vegetables and similar
Prosidion Limited	A61K 31/4523 (2006.01) A61K 31/397 (2006.01) C07D 413/14 (2006.01) A61P 3/00 (2006.01) C07D 401/12 (2006.01) C07D 401/14 (2006.01) C07D 403/14 (2006.01)	2406247 *	COMPOUNDS FOR THE TREATMENT OF METABOLIC DISORDERS
Sanofi-Aventis Deutschland GmbH	A61M 5/28 (2006.01) A61M 5/32 (2006.01)	2403563 *	SEAL MEMBER FOR SYRINGE WITH RETRACTABLE NEEDLE
Pierre Fabre Dermo-Cosmétique	A61K 31/375 (2006.01) A61P 29/00 (2006.01) C07D 407/04 (2006.01)	2440551 *	UNSATURATED FATTY ACID MONOESTERS AND DIESTERS ON ASCORBIC ACID AND COSMETIC USES THEREOF
Casey, Daniel P.	G08B 17/10 (2006.01)	2491543 *	MULTIFUNCTIONAL/MODULAR SMOKE ALARM DEVICE
Stefanou, Loizos	F16H 48/12 (2006.01)	2317179	Differential of automatic alterations of folding rhomb
VALSIR S.p.A.	F16L 37/14 (2006.01) E04D 13/04 (2006.01)	2406530 *	WATER DRAIN ASSEMBLY, IN PARTICULAR FOR SIPHONIC ROOF DRAINAGE SYSTEMS
Intra-Cellular Therapies, Inc.	A61M 36/14 (2006.01) A61K 51/00 (2006.01)	2485771 *	PHOSPHODIESTERASE 1-TARGETING TRACERS AND METHODS
Vertex Pharmaceuticals Incorporated	A61K 31/506 (2006.01) A61P 31/16 (2006.01)	2442809 *	INHIBITORS OF INFLUENZA VIRUSES REPLICATION
Abraxis BioScience, LLC	A01N 43/66 (2006.01) A61K 31/53 (2006.01)	2440057 *	TRIAZINE DERIVATIVES AND THEIR THERAPEUTICAL APPLICATIONS
Cephalon, Inc.	A61K 31/437 (2006.01) A61P 35/00 (2006.01) C07D 471/04 (2006.01) A61K 31/4196 (2006.01)	2438066 *	PREPARATION AND USES OF 1,2,4-TRIAZOLO [1,5a] PYRIDINE DERIVATIVES
Saet S.p.A.	B22D 27/04 (2006.01) C30B 11/00 (2006.01) C30B 35/00 (2006.01) F27B 14/14 (2006.01) C30B 29/06 (2006.01) H05B 6/44 (2006.01) H05B 6/36 (2006.01)	2491169 *	METHOD AND DEVICE FOR OBTAINING A MULTICRYSTALLINE SEMICONDUCTOR MATERIAL, IN PARTICULAR SILICON
China Academy of Telecommunications Technology	H04W 88/00 (2009.01)	2451241 *	SYNCHRONIZATION SCHEDULE METHOD, APPARATUS AND SYSTEM
Glaxo Group Limited	C12P 21/08 (2006.01)	2449127 *	POLYPEPTIDES AND METHOD OF TREATMENT
LELLI KELLY S.p.A.	A43B 3/24 (2006.01) A43B 3/30 (2006.01) A43C 11/14 (2006.01)	2263487	Shoe with interchangeable strap
Nektar Therapeutics	A61K 47/48 (2006.01)	2440249 *	COVALENT CONJUGATES COMPRISING A PROTEASE INHIBITOR, A WATER-SOLUBLE, NON-PEPTIDIC OLIGOMER AND A LIPOPHILIC MOIETY
Mandzsu, Zoltan	B65D 33/01 (2006.01) B65B 1/22 (2006.01) B65B 1/24 (2006.01)	2493779 *	IMPROVED PACKAGING CONTAINER WITH OVERPRESSURE RELIEF, PACKING METHOD AND SYSTEM
IFJ. Mandzsu, József	B65D 33/01 (2006.01) B65B 1/22 (2006.01) B65B 1/24 (2006.01)	2493779 *	IMPROVED PACKAGING CONTAINER WITH OVERPRESSURE RELIEF, PACKING METHOD AND SYSTEM

Podnosilac evropske prijave patenta (71)	MKP (51)	Broj objave evropske prijave patenta (97)	Naziv pronalaska (54)
Mandzsu, Jozsef, Id.	B65D 33/01 (2006.01) B65B 1/22 (2006.01) B65B 1/24 (2006.01)	2493779 *	IMPROVED PACKAGING CONTAINER WITH OVERPRESSURE RELIEF, PACKING METHOD AND SYSTEM
SANOFI	A61P 29/00 (2006.01) C07D 231/12 (2006.01) C07D 261/10 (2006.01) C07D 277/22 (2006.01) C07D 401/14 (2006.01) A61K 31/439 (2006.01) C07D 413/14 (2006.01) A61P 25/00 (2006.01)	2429998 *	5-MEMBERED HETEROCYCLIC COMPOUND CYCLOPENTA[C]PYRROLYLALKYL CARBAMATE DERIVATIVES, PREPARATION THEREOF, AND THERAPEUTIC USE THEREOF
IFCO Systems GmbH	B65D 21/02 (2006.01) B65D 85/34 (2006.01) B65D 6/00 (2006.01)	2371727	Crate
Janssen Pharmaceutica, N.V.	C07C 237/06 (2006.01) C07D 233/61 (2006.01) A61P 11/06 (2006.01) C07D 217/12 (2006.01) C07D 277/30 (2006.01) C07D 231/12 (2006.01) C07D 333/52 (2006.01) C07C 317/32 (2006.01) C07D 317/58 (2006.01) C07C 237/08 (2006.01) C07D 213/61 (2006.01) A61K 31/16 (2006.01) C07D 311/04 (2006.01) C07D 211/46 (2006.01) C07D 319/14 (2006.01) C07D 211/42 (2006.01) C07D 213/56 (2006.01)	2493571 *	ALKYNYL DERIVATIVES USEFUL AS DPP-1 INHIBITORS
Janssen R&D Ireland	C07D 403/14 (2006.01) A61P 31/12 (2006.01) A61K 31/4184 (2006.01)	2496572 *	BENZIMIDAZOLE-IMIDAZOLE DERIVATIVES
Saint-Gobain Glass France	B29C 45/14 (2006.01) B29C 45/16 (2006.01)	2414144 *	METHOD FOR MOULDING A PLASTIC PART WITH A METAL INSERT HELD IN PLACE BY MAGNETISATION, MOULDING DEVICE AND USE OF A MAGNET FOR SECURING SAID INSERT
Nektar Therapeutics	A61K 47/48 (2006.01)	2482855 *	OLIGOMER-CALCIMIMETIC CONJUGATES AND RELATED COMPOUNDS
Industrial Technology Research Institute	H01M 8/24 (2006.01) H01M 8/02 (2006.01)	2333889	Fuel cell devices with biasing current collectors
SANOFI	A61P 35/00 (2006.01) A61K 31/167 (2006.01) A61K 31/4412 (2006.01)	2427185 *	ANTITUMOR COMBINATION INCLUDING AVE8062 AND SORAFENIB
Zeus Industrial Products, Inc.	B29C 47/00 (2006.01)	2461959 *	MULTILAYERED COMPOSITE
Vetegen, LLC	A61K 31/4439 (2006.01) A61K 31/185 (2006.01) A61K 47/40 (2006.01) A61K 47/30 (2006.01) A61K 9/08 (2006.01) A61K 9/10 (2006.01)	2456439 *	A STABLE PHARMACEUTICAL OMEPRAZOLE FORMULATION FOR ORAL ADMINISTRATION
XenoPort, Inc.	A61K 31/27 (2006.01) A61K 9/20 (2006.01) A61K 31/197 (2006.01)	2403486 *	SUSTAINED RELEASE ORAL DOSAGE FORMS OF AN R-BACLOFEN PRODRUG
Delphi Technologies Holding S.à.r.l.	F02M 51/06 (2006.01) F02M 63/00 (2006.01) H01L 41/053 (2006.01)	2378107	Actuator arrangement for use in a fuel injector
Amgen Inc.	C07K 16/28 (2006.01)	2408816 *	ALPHA-4-BETA-7 HETERODIMER SPECIFIC ANTAGONIST ANTIBODY

Podnosilac evropske prijave patenta (71)	MKP (51)	Broj objave evropske prijave patenta (97)	Naziv pronalaska (54)
Bayer Pharma Aktiengesellschaft	C07J 31/00 (2006.01) C07J 41/00 (2006.01) A61K 31/567 (2006.01) A61P 5/36 (2006.01)	2432798 *	17-HYDROXY-17-PENTAFLUORETHYL-ESTRA-4,9(10)-DIEN-11-ARYL DERIVATIVES, METHODS FOR THE PRODUCTION THEREOF AND USE THEREOF FOR TREATING DISEASES
Sanofi-Aventis Deutschland GmbH	A61M 5/32 (2006.01)	2488235 *	CARTRIDGE HOLDER ASSEMBLY FOR A DRUG DELIVERY DEVICE
Logomotion, s.r.o.	G06Q 20/00 (2012.01)	2449512 *	METHOD AND SYSTEM OF ELECTRONIC PAYMENT TRANSACTION, IN PARTICULAR BY USING CONTACTLESS PAYMENT MEANS
Omya Development AG	C02F 1/68 (2006.01)	2418177	Micronized CaCO ₃ slurry injection system for the remineralization of desalinated and fresh water
Stepanov, Arkady Anatolievich	H02M 7/10 (2006.01)	2387142 *	COMBINED RECTIFIER
Khoryakov, Vladimir Vladimirovich	H02M 7/10 (2006.01)	2387142 *	COMBINED RECTIFIER
Savin, Vladimir Valerievich	H02M 7/10 (2006.01)	2387142 *	COMBINED RECTIFIER
Berezhnoi, Viktor Yurievich	H02M 7/10 (2006.01)	2387142 *	COMBINED RECTIFIER
Kozhemyakin, Yury Alexandrovich	H02M 7/10 (2006.01)	2387142 *	COMBINED RECTIFIER
Gorozhanov, Maxim Alexandrovich	H02M 7/10 (2006.01)	2387142 *	COMBINED RECTIFIER
Zuev, Alexandr Vladimirovich	H02M 7/10 (2006.01)	2387142 *	COMBINED RECTIFIER
Meiji Seika Pharma Co., Ltd.	C07D 405/04 (2006.01)	2426124 *	PROCESS FOR PRODUCING PYRIPYROPENE DERIVATIVE
Unicharm Corporation	A47K 7/00 (2006.01) B65D 83/08 (2006.01)	2412644 *	PACKAGING BODY
Palazzoli S.p.A.	E05C 1/10 (2006.01)	2419588 *	SNAP-ACTING LOCKING DEVICE, PARTICULARLY FOR LIDS, DOORS AND THE LIKE
PharmaNeuroBoost N.V.	A61K 31/4545 (2006.01) A61P 25/24 (2006.01)	2413935 *	LOW DOSE PIPAMPERONE IN TREATING MOOD DISORDERS
Hisamitsu Pharmaceutical Co., Inc.	A61P 25/16 (2006.01) A61K 31/4045 (2006.01) A61K 9/70 (2006.01) A61K 47/32 (2006.01) A61K 47/30 (2006.01) A61K 47/34 (2006.01)	2431034 *	ADHESIVE PATCH-CONTAINING PACKAGE BAG AND METHOD FOR STORING ADHESIVE PATCH
ENI S.p.A.	G01M 3/24 (2006.01) F17D 5/06 (2006.01) G01S 11/14 (2006.01)	2483656 *	SYSTEM AND METHOD FOR THE CONTINUOUS DETECTION OF IMPACTS ON PIPELINES FOR THE TRANSPORTATION OF FLUIDS, PARTICULARLY SUITABLE FOR UNDERWATER PIPELINES
Fleischmann & Petschnig Dachdeckungs-Gesellschaft m.b.H.	E04D 13/00 (2006.01) G01M 3/16 (2006.01)	2236691	Assembly and method for checking roofs
Merck Serono S.A.	A61K 31/4188 (2006.01) A61P 29/00 (2006.01) C07D 487/10 (2006.01) A61P 37/08 (2006.01)	2454264 *	TRICYCLIC INDOLE-DERIVED SPIRO DERIVATIVES AS CRTH2 MODULATORS
Ethicon, Inc	A61N 1/34 (2006.01) A61B 5/0408 (2006.01) A61N 1/36 (2006.01) A61N 1/04 (2006.01)	2493553 *	OFFSET ELECTRODE

Podnosilac evropske prijave patenta (71)	MKP (51)	Broj objave evropske prijave patenta (97)	Naziv pronalaska (54)
Ethicon Endo-Surgery, Inc.	A61B 1/005 (2006.01) A61B 17/128 (2006.01) A61B 18/14 (2006.01) A61M 25/10 (2006.01) A61B 17/32 (2006.01) A61B 17/34 (2006.01) A61B 17/29 (2006.01) A61B 17/00 (2006.01) A61B 17/04 (2006.01)	2496154 *	KITS AND PROCEDURES FOR NATURAL ORIFICE TRANSLUMENAL ENDOSCOPIC SURGERY
Abbott Laboratories	C07D 471/04 (2006.01)	2435432 *	APOPTOSIS-INDUCING AGENTS FOR THE TREATMENT OF CANCER AND IMMUNE AND AUTOIMMUNE DISEASES
Kumiai Chemical Industry CO., LTD.	C05G 3/02 (2006.01) A01N 43/80 (2006.01) A01P 13/02 (2006.01) C05G 5/00 (2006.01)	2420484 *	GRANULAR FERTILIZER CONTAINING HERBICIDAL AGROCHEMICAL
Plc Diagnostics Inc.	G02B 6/35 (2006.01) G01N 21/64 (2006.01)	2425286 *	WAVEGUIDE-BASED DETECTION SYSTEM WITH SCANNING LIGHT SOURCE
Athenix Corporation	C12N 15/82 (2006.01)	2449109 *	AXMI-205 PESTICIDAL GENE AND METHODS FOR ITS USE
Wyeth LLC	A61K 9/20 (2006.01) A61K 31/4709 (2006.01)	2448563 *	3-CYANOQUINOLINE TABLET FORMULATIONS AND USES THEREOF
Biocepta Corporation	A61K 31/185 (2006.01) A01N 37/00 (2006.01) A61K 31/19 (2006.01) A61K 31/192 (2006.01) A61L 15/44 (2006.01) A61P 31/10 (2006.01)	2429517 *	COMPOSITIONS SUITABLE FOR THE TOPICAL TREATMENT OF FUNGAL INFECTIONS OF THE SKIN AND NAILS
Curt G. Joa, Inc.	A61F 13/15 (2006.01) B65H 29/68 (2006.01)	2386281	Method and apparatus for changing speed or direction of an article
BASF Agrochemical Products, B.V.	A01H 5/00 (2006.01) C12N 15/52 (2006.01) C12N 15/82 (2006.01)	2473023 *	HERBICIDE-TOLERANT PLANTS
Sanofi-Aventis Deutschland GmbH	A61M 15/00 (2006.01)	2408496 *	TRIGGER MECHANISM FOR A DRUG DELIVERY DEVICE
SANOFI	C12N 15/11 (2006.01) A61K 31/7088 (2006.01) A61P 3/04 (2006.01)	2432879 *	USE OF INHIBITORS OF ZDHHC2 ACTIVITY FOR MODULATION OF ADIPOGENESIS
Dow AgroSciences, LLC	A01N 43/64 (2006.01) A61K 31/41 (2006.01)	2485592 *	SYNERGISTIC FUNGICIDAL MIXTURES FOR FUNGAL CONTROL IN CEREALS
Winkl, Peter	B65G 57/10 (2006.01) B65G 57/112 (2006.01) B65G 57/18 (2006.01)	2314530	Mobile device for stacking wooden logs onto a pallet with raised sides
Papiermaschinen-Systemtechnik GmbH	B05B 15/06 (2006.01) D21F 1/32 (2006.01) D21F 1/34 (2006.01)	2383046	Nozzle device
Smithkline Beecham (Cork) Ltd.	A61K 31/517 (2006.01)	2467140 *	METHOD OF THREATING CANCER
IFCO Systems GmbH	B65D 21/02 (2006.01) B65D 85/34 (2006.01) B65D 6/00 (2006.01)	2371725	Crate
The Johns Hopkins University	C07K 14/705 (2006.01)	2464661 *	METHODS OF MODULATING IMMUNE FUNCTION
Chiesi Farmaceutici S.p.A.	A61K 31/167 (2006.01) A61K 9/00 (2006.01) A61K 31/573 (2006.01)	2482799 *	PHARMACEUTICAL AEROSOL FORMULATIONS OF FORMOTEROL AND BECLOMETASONE DIPROPIONATE
Ferro Umformtechnik GmbH & Co. KG	B62D 33/02 (2006.01) B23K 26/26 (2006.01) B60P 1/28 (2006.01) B62D 27/02 (2006.01)	2377640	Method of producing a basin body, in particular a tipping trough for a transport vehicle using laser welding process ; corresponding basin body, in particular a tipping trough for a transport vehicle and basin body for a transport vehicle

Podnosilac evropske prijave patenta (71)	MKP (51)	Broj objave evropske prijave patenta (97)	Naziv pronalaska (54)
UCB Pharma, S.A.	A61P 37/00 (2006.01) A61K 31/522 (2006.01) A61P 25/00 (2006.01) A61P 31/00 (2006.01) C07D 487/04 (2006.01) A61P 3/00 (2006.01) A61P 9/02 (2006.01) A61P 29/00 (2006.01) A61P 27/02 (2006.01) A61P 25/28 (2006.01) C07D 495/04 (2006.01) A61P 35/00 (2006.01)	2499144 *	QUINOLINE AND QUINOXALINE DERIVATIVES AS KINASE INHIBITORS
Johannes- Gutenberg- Universität Mainz	G01N 33/574 (2006.01)	2425252 *	IDENTIFICATION OF TUMOR-ASSOCIATED MARKERS FOR DIAGNOSIS AND THERAPY
GANYMED Pharmaceuticals AG	G01N 33/574 (2006.01)	2425252 *	IDENTIFICATION OF TUMOR-ASSOCIATED MARKERS FOR DIAGNOSIS AND THERAPY
Gilead Sciences, Inc.	C07D 401/00 (2006.01) C07D 405/00 (2006.01) C07D 213/55 (2006.01) C07D 413/00 (2006.01) A61K 31/44 (2006.01) C07D 417/00 (2006.01) A61K 31/5375 (2006.01) C07D 471/04 (2006.01) A61P 31/18 (2006.01) C07D 498/06 (2006.01) A61K 31/54 (2006.01) C07D 491/06 (2006.01) C07D 213/60 (2006.01)	2429993 *	INHIBITORS OF HUMAN IMMUNODEFICIENCY VIRUS REPLICATION
Sunflex Aluminiumsysteme GmbH	E05D 15/06 (2006.01)	2476841	Device for securing a sliding wing of a sliding wing system
Sirtris Pharmaceuticals, Inc.	A61K 31/5377 (2006.01) A61K 31/497 (2006.01) C07D 401/14 (2006.01) A61P 5/50 (2006.01) A61K 31/4375 (2006.01) C07D 417/12 (2006.01) A61P 35/02 (2006.01) A61K 31/47 (2006.01) C07D 417/14 (2006.01) A61K 31/538 (2006.01) A61K 31/501 (2006.01) C07D 215/48 (2006.01) C07D 413/14 (2006.01) A61P 9/00 (2006.01) A61K 31/519 (2006.01) A61K 31/4709 (2006.01) C07D 487/04 (2006.01) C07D 401/12 (2006.01) A61P 3/00 (2006.01) A61K 31/506 (2006.01)	2403833 *	8-SUBSTITUTED QUINOLINES AND RELATED ANALOGS AS SIRTUIN MODULATORS
Ashland Licensing And Intellectual Property LLC	C08G 18/00 (2006.01)	2473540 *	STRUCTURAL URETHANE ADHESIVES COMPRISING AMIDE POLYOLS
Æterna Zentaris GmbH	C07D 401/12 (2006.01) C07D 409/12 (2006.01) C07D 413/12 (2006.01) A61K 31/498 (2006.01) A61P 35/00 (2006.01) C07D 403/04 (2006.01) A61K 31/5377 (2006.01) C07D 241/44 (2006.01)	2419411 *	QUINOXALINE DERIVATIVES AND THEIR USE FOR TREATING BENIGN AND MALIGNANT TUMOUR DISORDERS
Sanofi-Aventis Deutschland GmbH	A61M 5/315 (2006.01)	2414006 *	DRUG DELIVERY DEVICE WITH AN IMPROVED PISTON ROD

Podnosilac evropske prijave patenta (71)	MKP (51)	Broj objave evropske prijave patenta (97)	Naziv pronalaska (54)
Nuvo Research Inc.	A61K 47/26 (2006.01) A61K 9/00 (2006.01) A61K 47/14 (2006.01) A61K 31/167 (2006.01)	2470172 *	PHARMACEUTICAL FORMULATIONS AND METHODS OF USE
Saint-Gobain Glass France	C03C 17/36 (2006.01)	2406197 *	SUBSTRATE PROVIDED WITH A STACK WITH THERMAL PROPERTIES AND COMPRISING HIGH REFRACTIVE INDEX LAYERS
Novartis AG	A61K 31/4418 (2006.01) C07D 213/76 (2006.01) A61P 9/00 (2006.01)	2429995 *	ARYL PYRIDINE AS ALDOSTERONE SYNTHASE INHIBITORS
Boehringer Ingelheim International GmbH	C07D 271/12 (2006.01) A61K 31/4245 (2006.01) C07D 235/02 (2006.01) A61K 31/4184 (2006.01) C07D 277/60 (2006.01) C07D 498/10 (2006.01) C07D 239/70 (2006.01) A61K 31/4188 (2006.01) C07D 491/10 (2006.01) A61K 31/517 (2006.01) C07D 487/10 (2006.01) A61K 31/519 (2006.01) C07D 403/06 (2006.01) A61K 31/428 (2006.01) C07D 405/12 (2006.01)	2406240 *	INHIBITORS OF BETA-SECRETASE
Vitae Pharmaceuticals, Inc.	C07D 271/12 (2006.01) A61K 31/4245 (2006.01) C07D 235/02 (2006.01) A61K 31/4184 (2006.01) C07D 277/60 (2006.01) C07D 498/10 (2006.01) C07D 239/70 (2006.01) A61K 31/4188 (2006.01) C07D 491/10 (2006.01) A61K 31/517 (2006.01) C07D 487/10 (2006.01) A61K 31/519 (2006.01) C07D 403/06 (2006.01) A61K 31/428 (2006.01) C07D 405/12 (2006.01)	2406240 *	INHIBITORS OF BETA-SECRETASE
Kabushiki Kaisha Saiwai Medix	A61P 17/00 (2006.01) A61P 37/08 (2006.01) A61K 39/395 (2006.01) A61P 17/04 (2006.01)	2500034 *	THERAPEUTIC AGENT FOR PSORIASIS OR ATOPIC DERMATITIS
King's College London	C07D 237/24 (2006.01) A61K 31/235 (2006.01) C07D 213/81 (2006.01) C07D 213/80 (2006.01) C07C 233/75 (2006.01) A61K 31/192 (2006.01) C07C 237/42 (2006.01) A61K 31/44 (2006.01) C07D 213/30 (2006.01) A61P 25/28 (2006.01) C07C 235/56 (2006.01) A61K 31/166 (2006.01)	2473479 *	THERAPEUTIC ARYL-AM I DO-ARYL COMPOUNDS AND THEIR USE
Genentech, Inc.	A61K 39/395 (2006.01)	2421558 *	ADJUVANT CANCER THERAPY
NSABP Foundation, Inc.	A61K 39/395 (2006.01)	2421558 *	ADJUVANT CANCER THERAPY
SANOFI	C08B 37/10 (2006.01)	2427502 *	NOVEL SULFATED OCTASACCHARIDE AND ITS USE AS ANTITHROMBOTIC
Hercules Incorporated	C11D 3/37 (2006.01) A61K 8/81 (2006.01) A61Q 5/02 (2006.01) A61K 8/73 (2006.01)	2449079 *	CATIONIC SYNTHETIC POLYMERS WITH IMPROVED SOLUBILITY AND PERFORMANCE IN SURFACTANT-BASED SYSTEMS AND USE IN PERSONAL CARE AND HOUSEHOLD APPLICATIONS

Podnosilac evropske prijave patenta (71)	MKP (51)	Broj objave evropske prijave patenta (97)	Naziv pronalaska (54)
Eisai R&D Management Co., Ltd.	A61P 25/28 (2006.01) C07D 491/048 (2006.01) A61K 31/522 (2006.01)	2456771 *	FUSED AMINODIHYDOPYRIMIDONE DERIVATIVES
Datang Mobile Communications Equipment Co., Ltd	H04W 4/02 (2009.01)	2498519 *	LOCATION METHOD, APPARATUS AND SYSTEM
Momenta Pharmaceuticals, Inc.	C12P 21/04 (2006.01)	2438185 *	METHODS OF MODULATING FUCOSYLATION OF GLYCOPROTEINS
The Mathworks, Inc.	G05B 13/04 (2006.01)	2438487 *	AUTOMATED PID CONTROLLER DESIGN
Ranbaxy Laboratories Limited	C07D 239/94 (2006.01)	2411373 *	PROCESS FOR THE PREPARATION OF ERLOTINIB OR ITS PHARMACEUTICALLY ACCEPTABLE SALTS THEREOF
Sanofi-Aventis Deutschland GmbH	A61L 2/06 (2006.01) B65B 55/06 (2006.01) A61L 2/24 (2006.01)	2485772 *	STERILIZATION APPARATUS AND METHOD FOR CONTROLLING OF A STERILIZATION APPARATUS
Nissan Chemical Industries, Ltd.	A61K 31/496 (2006.01) A61P 21/00 (2006.01) C07D 409/14 (2006.01) A61K 31/381 (2006.01) A61P 7/06 (2006.01) A61P 43/00 (2006.01) A61K 31/4436 (2006.01) A61P 9/10 (2006.01) C07D 409/12 (2006.01) A61P 3/10 (2006.01) A61P 37/04 (2006.01) C07D 333/38 (2006.01) A61P 7/00 (2006.01) A61P 37/06 (2006.01) A61K 31/5377 (2006.01) A61P 25/00 (2006.01) A61K 38/00 (2006.01) A61P 35/00 (2006.01) A61K 38/22 (2006.01) A61P 35/02 (2006.01)	2439204 *	HETEROCYCLIC COMPOUND AND HEMATOPOIETIC STEM CELL AMPLIFIER
Treibacher Industrie AG	C04B 35/63 (2006.01) C04B 35/44 (2006.01) C04B 35/626 (2006.01)	2440506 *	YTTRIA-BASED SLURRY COMPOSITION
Conjet AB	E04G 23/00 (2006.01) B08B 3/02 (2006.01) E04G 1/20 (2006.01) E04G 23/08 (2006.01)	2438255 *	WATER JET EJECTING DEVICE
Bosmans, Rutger Lucien Maria	B60P 7/08 (2006.01)	2383145	Tensioning system and cargo space and vehicle provided with such a tensioning system
SANOFI	C07D 213/16 (2006.01) C07D 317/06 (2006.01) C07D 309/08 (2006.01) A61K 31/085 (2006.01) C07D 305/04 (2006.01) C07C 235/54 (2006.01) C07D 335/14 (2006.01)	2496556 *	ACYLAMINO-SUBSTITUTED CYCLIC CARBOXYLIC ACID DERIVATIVES AND THEIR USE AS PHARMACEUTICALS
Panmira Pharmaceuticals, LLC	A61K 31/4418 (2006.01) A61K 31/4355 (2006.01) A61K 31/435 (2006.01) A61P 27/02 (2006.01)	2461809 *	OPHTHALMIC PHARMACEUTICAL COMPOSITIONS OF DP2 RECEPTOR ANTAGONISTS
KRKA, D.D., Novo Mesto	C07D 207/16 (2006.01) A61K 31/4015 (2006.01) A61K 9/16 (2006.01)	2459531 *	SYNTHESIS AND USE OF VILDAGLIPTIN FOR THE PREPARATION OF PHARMACEUTICAL DOSAGE FORMS
LOFARMA S.p.A.	A61K 39/36 (2006.01) C07K 14/415 (2006.01) C12N 15/62 (2006.01)	2281836	Hybrid proteins from Parietaria judaica major allergens and uses thereof
Critical Perfusion, Inc.	A61B 5/053 (2006.01)	2408364 *	SYSTEMS AND METHOD FOR CHARACTERISTIC PARAMETER ESTIMATION OF GASTRIC IMPEDANCE SPECTRA IN HUMANS

Podnosilac evropske prijave patenta (71)	MKP (51)	Broj objave evropske prijave patenta (97)	Naziv pronalaska (54)
Photowatt International S.A.	H01L 31/042 (2006.01)	2278627	Automatic localisation of photovoltaic modules in a photovoltaic field
Sanofi-Aventis Deutschland GmbH	A61K 9/06 (2006.01) A61K 47/48 (2006.01) A61K 9/00 (2006.01)	2459171 *	LONG ACTING INSULIN COMPOSITION
Takeda Pharmaceutical Company Limited	A61K 31/4439 (2006.01) A61P 1/04 (2006.01) C07D 401/04 (2006.01)	2412713 *	PYRAZOLE COMPOUND
Delphi Technologies Holding S.à.r.l.	F02P 7/077 (2006.01) F02D 35/02 (2006.01) F02D 41/34 (2006.01)	2375042	Injection control method
Kalliardos, Stergios	A21B 1/46 (2006.01) A21B 3/07 (2006.01)	2490544 *	OVEN FOR FAST FOOD PREPARATION
Tsikopoulos, Ioannis	A21B 1/46 (2006.01) A21B 3/07 (2006.01)	2490544 *	OVEN FOR FAST FOOD PREPARATION
H. Lundbeck A/S	A61K 31/4353 (2006.01) A61K 31/4184 (2006.01) C07D 487/04 (2006.01) A61K 31/519 (2006.01) A61P 25/00 (2006.01) C07D 403/12 (2006.01)	2443105 *	NOVEL PHENYLIMIDAZOLE DERIVATIVE AS PDE10A ENZYME INHIBITOR
Plexxikon, Inc.	A01N 43/90 (2006.01) A61K 31/519 (2006.01)	2496086 *	COMPOUNDS AND METHODS FOR KINASE MODULATION, AND INDICATIONS THEREFOR
ACO Severin Ahlmann GmbH & Co. KG	E02B 11/00 (2006.01) E03F 1/00 (2006.01)	2470722 *	DRAINAGE BODY
Hagleitner, Hans Georg	A47K 10/36 (2006.01) A47K 5/12 (2006.01)	2421422 *	SANITARY DISPENSER HAVING CAPACITIVE SENSOR
Rigel Pharmaceuticals, Inc.	C07F 9/6561 (2006.01)	2448950 *	SYNTHESIS OF N4- (2, 2-DIMETHYL-4- [(DIHYDROGEN PHOSPHONOXY)-3-OXO-5-PYRIDO [1, 4]OXAZIN-6-YL)-5-FLUORO-N2-(3, 4, 5,-TRIMETHOXYPHENYL) -2, 4-PYRIMIDINEDIAMINE DISODIUM SALT
BioGeneriX AG	A61K 38/21 (2006.01) C12P 21/02 (2006.01)	2451470 *	METHOD FOR THE PURIFICATION OF INTERFERON-β
Amgen Inc.	A61K 38/57 (2006.01) C07K 14/81 (2006.01) C07K 16/38 (2006.01)	2459213 *	POLYPEPTIDES THAT BIND TISSUE INHIBITOR OF METALLOPROTEINASE TYPE THREE (TIMP-3), COMPOSITIONS AND METHODS
Immersion Corporation	B01B 1/06 (2006.01) H01L 41/09 (2006.01)	2488266 *	SYSTEMS AND METHODS FOR PROVIDING HAPTIC FEEDBACK AT MULTIPLE RESONANCE FREQUENCIES
The Regents of the University of California	G01N 33/564 (2006.01) G01N 33/68 (2006.01)	2464976 *	METHODS OF DIAGNOSING AND TREATING AUTISM
Janssen Pharmaceutica, N.V.	C07D 309/10 (2006.01)	2451797 *	CRYSTALLISATION PROCESS FOR 1-(β-D-GLUCOPYRANOSYL)-4-METHYL-3-[5-(4-FLUOROPHENYL)-2-THIENYLMETHYL]BENZENE
Strauss Water Ltd	C02F 1/00 (2006.01) B01D 35/153 (2006.01) B01D 35/143 (2006.01)	2471745	Liquid filter device
Cera-Med Kft.	A61P 5/50 (2006.01) A61K 38/17 (2006.01) A61K 38/28 (2006.01) A61K 31/195 (2006.01)	2461820 *	ORALLY ADMINISTERABLE PHARMACEUTICAL PREPARATION CONTAINING INSULIN
Prometheus Laboratories Inc.	G01N 33/50 (2006.01)	2491385 *	PROXIMITY-MEDIATED ASSAYS FOR DETECTING ONCOGENIC FUSION PROTEINS
OSI Pharmaceuticals, LLC	C07D 401/06 (2006.01) C07D 241/16 (2006.01)	2421837 *	PREPARATION OF C-PYRAZINE-METHYLAMINES
AstraZeneca AB	A61P 29/00 (2006.01) A61K 9/24 (2006.01) A61P 19/02 (2006.01) A61K 31/4439 (2006.01)	2445499 *	METHOD FOR TREATING A PATIENT AT RISK FOR DEVELOPING AN NSAID-ASSOCIATED ULCER

Podnosilac evropske prijave patenta (71)	MKP (51)	Broj objave evropske prijave patenta (97)	Naziv pronalaska (54)
Pozen, Inc.	A61P 29/00 (2006.01) A61K 9/24 (2006.01) A61P 19/02 (2006.01) A61K 31/4439 (2006.01)	2445499 *	METHOD FOR TREATING A PATIENT AT RISK FOR DEVELOPING AN NSAID-ASSOCIATED ULCER
Limonov, Viktor Lvovich	A61P 31/04 (2006.01) A61K 9/14 (2006.01) A61K 9/51 (2006.01) A61K 47/04 (2006.01) A61K 31/665 (2006.01)	2476420 *	PHARMACEUTICAL COMPOSITION HAVING ANTIMICROBIAL AND FAST-HEALING ACTIVITY FOR EXTERNAL ADMINISTRATION, PROCESS FOR PREPARING SAME
Novelis, Inc.	B22D 11/06 (2006.01)	2411172 *	CONTINUOUS CASTING APPARATUS FOR CASTING STRIP OF VARIABLE WIDTH
SANOFI	C07D 405/14 (2006.01) A61P 9/00 (2006.01) C07D 309/14 (2006.01) A61P 25/00 (2006.01) C07D 335/02 (2006.01) C07D 239/96 (2006.01) A61K 31/517 (2006.01) C07D 407/04 (2006.01) A61P 37/00 (2006.01) C07D 409/04 (2006.01) A61P 29/00 (2006.01) C07D 405/04 (2006.01) A61P 11/00 (2006.01)	2417130 *	QUINAZOLINEDIONE DERIVATIVES, PREPARATION THEREOF AND VARIOUS THERAPEUTIC USES THEREOF
Zafgen Corporation	C07C 317/44 (2006.01) C07D 405/12 (2006.01) C07D 275/02 (2006.01) A61K 31/381 (2006.01) C07D 277/30 (2006.01) A61K 31/415 (2006.01) C07D 307/54 (2006.01) A61K 31/421 (2006.01) C07D 263/32 (2006.01) A61K 31/341 (2006.01) C07D 333/24 (2006.01) C07D 231/10 (2006.01) A61K 31/277 (2006.01) C07C 317/46 (2006.01) A61K 31/192 (2006.01)	2486004 *	SULPHONE COMPOUNDS AND METHODS OF MAKING AND USING SAME
Merck Serono S.A.	C07D 495/14 (2006.01) A61P 37/00 (2006.01) A61K 31/56 (2006.01) C07D 495/04 (2006.01)	2499146 *	TRICYCLIC PYRAZOL AMINE DERIVATIVES
Tata Steel UK Ltd	E01B 31/13 (2006.01) B21B 1/085 (2006.01)	2408967 *	A METHOD OF ROLLING RAILS, APPARATUS FOR ROLLING RAILS AND RAIL PRODUCED ACCORDING TO SAID METHOD
Cellzome Limited	C07D 239/48 (2006.01) C07D 407/12 (2006.01) A61K 31/506 (2006.01) A61K 31/5377 (2006.01) A61P 35/00 (2006.01) C07D 403/12 (2006.01)	2419423 *	FLUORO SUBSTITUTED PYRIMIDINE COMPOUNDS AS JAK3 INHIBITORS
Polyglass S.p.A.	C08L 95/00 (2006.01) C08K 7/28 (2006.01) C08K 7/00 (2006.01)	2264094	Waterproofing membrane based on bitumen modified with polymers containing hollow glass microspheres.
Uni-charm Corporation	A47L 13/20 (2006.01) A47L 13/10 (2006.01) A47L 13/17 (2006.01)	2415381 *	CLEANING IMPLEMENT AND CLEANING BODY
Genentech, Inc.	A61K 39/395 (2006.01)	2470210 *	METHODS OF TREATMENT USING ANTI-OXIDIZED LDL ANTIBODIES
BioInvent International AB	A61K 39/395 (2006.01)	2470210 *	METHODS OF TREATMENT USING ANTI-OXIDIZED LDL ANTIBODIES
Oregon Health and Science University	A61K 39/395 (2006.01)	2470210 *	METHODS OF TREATMENT USING ANTI-OXIDIZED LDL ANTIBODIES

Podnosilac evropske prijave patenta (71)	MKP (51)	Broj objave evropske prijave patenta (97)	Naziv pronalaska (54)
Cochlear Limited	A61N 1/36 (2006.01) H04L 27/12 (2006.01) H04R 25/00 (2006.01)	2408519 *	TRANSCUTANEOUS MODULATED POWER LINK FOR A MEDICAL IMPLANT
DrySo Tec GmbH	B01D 53/83 (2006.01) B01D 53/96 (2006.01) C01D 7/00 (2006.01) C01F 11/46 (2006.01) F23J 15/04 (2006.01) B01D 53/50 (2006.01) B01D 53/75 (2006.01) B01D 53/78 (2006.01)	2411123 *	METHOD FOR TREATING EXHAUST GASES COMPRISING SULFUR OXIDES
Yun, Jang-Shik	F01N 3/037 (2006.01) F24F 3/16 (2006.01) F24F 5/00 (2006.01)	2466085 *	CENTRIFUGAL, WET-TYPE AIR CLEANER
IRM LLC	A61P 35/00 (2006.01) A61K 31/506 (2006.01) C07D 401/14 (2006.01) C07D 403/04 (2006.01)	2470526 *	COMPOUNDS AND COMPOSITIONS AS PROTEIN KINASE INHIBITORS
Novartis AG	A61P 35/00 (2006.01) A61K 31/506 (2006.01) C07D 401/14 (2006.01) C07D 403/04 (2006.01)	2470526 *	COMPOUNDS AND COMPOSITIONS AS PROTEIN KINASE INHIBITORS
Turbosonic Inc.	B32B 7/12 (2006.01) F16S 1/12 (2006.01) B32B 3/28 (2006.01) B32B 1/08 (2006.01) F16S 1/14 (2006.01)	2475519 *	ASSEMBLY OF WET ELECTROSTATIC PRECIPITATOR
Shionogi & Co., Ltd.	C12N 15/09 (2006.01) A61K 39/395 (2006.01) A61P 31/04 (2006.01) C07K 16/12 (2006.01)	2407537 *	HUMANIZED PCR V ANTIBODY HAVING ANTI-PSEUDOMONAL ACTIVITY
Regents of the University of Minnesota	A61K 31/665 (2006.01) A61P 35/00 (2006.01) C07F 9/6561 (2006.01)	2427467 *	TRIPITOLIDE PRODRUGS
Cellzome Limited	C07D 487/04 (2006.01) C07D 471/04 (2006.01) A61K 31/519 (2006.01) A61P 37/00 (2006.01)	2406258 *	PYRIMIDINE DERIVATIVES AS mTOR INHIBITORS
VIB VZW	C07K 14/71 (2006.01) A61K 31/4745 (2006.01)	2448964 *	EXTRACELLULAR ALLOSTERIC INHIBITOR BINDING DOMAIN FROM A TYROSINE KINASE RECEPTOR
Vrije Universiteit Brussel	C07K 14/71 (2006.01) A61K 31/4745 (2006.01)	2448964 *	EXTRACELLULAR ALLOSTERIC INHIBITOR BINDING DOMAIN FROM A TYROSINE KINASE RECEPTOR
SANOFI	C07K 14/71 (2006.01) A61K 31/4745 (2006.01)	2448964 *	EXTRACELLULAR ALLOSTERIC INHIBITOR BINDING DOMAIN FROM A TYROSINE KINASE RECEPTOR
Life Sciences Research Partners VZW	C07K 14/71 (2006.01) A61K 31/4745 (2006.01)	2448964 *	EXTRACELLULAR ALLOSTERIC INHIBITOR BINDING DOMAIN FROM A TYROSINE KINASE RECEPTOR
PerkinElmer Health Sciences, Inc.	G01N 25/48 (2006.01) G01B 7/012 (2006.01) G01N 35/00 (2006.01) G01N 35/04 (2006.01)	2411792 *	SYSTEM AND AUTO-ALIGNMENT METHOD FOR DETERMINING POSITION USING A DISCRETE CONTACT PROBE
Packers Plus Energy Services Inc.	E21B 33/124 (2006.01) E21B 34/14 (2006.01)	2427630 *	SLIDING SLEEVE SUB AND METHOD AND APPARATUS FOR WELLBORE FLUID TREATMENT
Orexo AB	A61K 47/02 (2006.01) A61K 31/4468 (2006.01) A61K 9/16 (2006.01)	2427177 *	COMPOSITION FOR SUSTAINED DRUG DELIVERY COMPRISING GEOPOLYMERIC BINDER
Abbott Laboratories	C12P 21/08 (2006.01) A61K 39/00 (2006.01)	2425010 *	DUAL VARIABLE DOMAIN IMMUNOGLOBULINS AND USES THEREOF
Meril Limited	C07K 14/11 (2006.01) C12N 15/86 (2006.01)	2414386 *	NEWCASTLE DISEASE VIRUS VECTORED AVIAN VACCINES

Podnosilac evropske prijave patenta (71)	MKP (51)	Broj objave evropske prijave patenta (97)	Naziv pronalaska (54)
BASF SE	A01N 37/46 (2006.01) A01N 43/653 (2006.01) A01N 47/24 (2006.01) A01N 25/04 (2006.01)	2458981 *	PESTICIDAL SUSPO-EMULSION COMPOSITIONS
Ascendis Pharma A/S	A61K 47/48 (2006.01) A61P 25/16 (2006.01)	2459225 *	CARRIER LINKED PRAMIPEXOLE PRODRUGS
Chen, Li Jing	B64C 29/00 (2006.01)	2338790	VTOL aircraft with a thrust-to-weight ratio smaller than 1
Boehringer Ingelheim International GmbH	C07D 413/14 (2006.01) A61K 31/535 (2006.01) A61P 3/00 (2006.01) A61P 5/00 (2006.01)	2424865 *	CYCLIC INHIBITORS OF 11BETA-HYDROXYSTEROID DEHYDROGENASE 1
Vitae Pharmaceuticals, Inc.	C07D 413/14 (2006.01) A61K 31/535 (2006.01) A61P 3/00 (2006.01) A61P 5/00 (2006.01)	2424865 *	CYCLIC INHIBITORS OF 11BETA-HYDROXYSTEROID DEHYDROGENASE 1
Kaspersky Lab, ZAO	G06F 9/50 (2006.01)	2388700	Systems and methods for policy-based program configuration
Bonac Corporation	C07D 207/08 (2006.01) C12N 15/113 (2010.01)	2436767 *	SINGLE-STRANDED NUCLEIC ACID MOLECULE HAVING NITROGEN-CONTAINING ALICYCLIC SKELETON
Avaxia Biologics, Inc.	A61K 39/395 (2006.01)	2488202 *	ANTIBODY THERAPEUTICS WITH LOCAL ACTIVITY IN THE DIGESTIVE TRACT
Boehringer Ingelheim International GmbH	A61K 31/4439 (2006.01) C07D 513/04 (2006.01) A61P 35/00 (2006.01)	2421871 *	THIA-TRIAZA-CYCLOPENTAZULENES AS PI3-KINASES INHIBITORS FOR THE TREATMENT OF CANCER
Tecnogen S.p.A.	C12N 5/16 (2006.01) C12N 15/67 (2006.01) C12N 15/79 (2006.01)	2459721 *	IMPROVED HUMAN LONG PENTRAXIN 3 EXPRESSION SYSTEM AND USES THEREOF
Plasco Energy Group Inc.	C10J 3/46 (2006.01) C10B 53/00 (2006.01)	2459681 *	CARBON CONVERSION SYSTEM WITH INTEGRATED PROCESSING ZONES
MedImmune, LLC	C12Q 1/68 (2006.01)	2473636 *	TYPE 1 INTERFERON DIAGNOSTIC
Pfizer Inc.	C07D 401/12 (2006.01) C07D 405/04 (2006.01) C07D 215/60 (2006.01) A61P 25/00 (2006.01) C07D 401/04 (2006.01) C07D 471/04 (2006.01) C07D 491/04 (2006.01) A61K 31/4375 (2006.01) A61K 31/4704 (2006.01)	2443092 *	BICYCLIC AND TRICYCLIC COMPOUNDS AS KAT II INHIBITORS
Ethicon, Inc	A61L 31/10 (2006.01) A61L 27/30 (2006.01) A61L 27/34 (2006.01) A61L 31/08 (2006.01) A61L 17/00 (2006.01)	2493524 *	ANTIMICROBIAL COATINGS WITH PREFERRED MICROSTRUCTURE FOR MEDICAL DEVICES
GenKyoTex SA	C07D 403/04 (2006.01) A61P 9/00 (2006.01) C07D 413/04 (2006.01) A61P 5/00 (2006.01) A61K 31/551 (2006.01) C07D 471/14 (2006.01) A61P 35/00 (2006.01) A61K 31/554 (2006.01) C07D 513/14 (2006.01) A61P 11/00 (2006.01) A61K 31/553 (2006.01) C07D 498/14 (2006.01) A61P 25/00 (2006.01)	2483271 *	PYRAZOLINE DIONE DERIVATIVES AS NADPH OXIDASE INHIBITORS
Sanofi-Aventis Deutschland GmbH	A61M 5/315 (2006.01)	2482892 *	DRIVE MECHANISM FOR A DRUG DELIVERY DEVICE

Podnosilac evropske prijave patenta (71)	MKP (51)	Broj objave evropske prijave patenta (97)	Naziv pronalaska (54)
Coes Company Srl	F16J 15/02 (2006.01) F16L 13/14 (2006.01) F16L 37/092 (2006.01) F16L 41/08 (2006.01) F16L 23/16 (2006.01)	2458251	A composite sliding gasket for high-pressure joints
Londonpharma Ltd.	A61K 31/335 (2006.01) A61K 9/12 (2006.01)	2424523 *	SUBLINGUAL SPRAY FORMULATION COMPRISING DIHYDROARTEMESININ
GlaxoSmithKline Biologicals S.A.	A61K 39/155 (2006.01) C07K 14/135 (2006.01)	2445526 *	RECOMBINANT RSV ANTIGENS
ID Biomedical Corporation of Quebec	A61K 39/155 (2006.01) C07K 14/135 (2006.01)	2445526 *	RECOMBINANT RSV ANTIGENS
Global Power Enterprises, LLC	F03G 6/00 (2006.01)	2454480 *	POWER GENERATION SYSTEM
Sunflex Aluminiumsysteme GmbH	E05D 15/08 (2006.01) E05D 15/06 (2006.01)	2476839	Ground rail track for a sliding wing system
Wollsdorf Leder Schmidt & Co. Ges.m.b.H.	B26D 1/06 (2006.01)	2499036 *	METHOD FOR APPLYING LEATHER TO VEHICLE INTERIOR PARTS
Amgen, Inc	A61K 31/437 (2006.01) C07D 401/14 (2006.01) A61K 31/52 (2006.01) C07D 403/04 (2006.01) A61K 31/53 (2006.01) C07D 403/14 (2006.01) A61P 35/00 (2006.01) C07D 471/04 (2006.01) C07D 519/00 (2006.01) C07D 487/04 (2006.01) A61K 31/506 (2006.01)	2430013 *	HETEROARYL COMPOUNDS AS PIKK INHIBITORS
Trustees Of Tufts College	D01F 4/02 (2006.01) D01D 5/00 (2006.01)	2483460 *	DRAWN SILK EGEL FIBERS AND METHODS OF MAKING SAME
Bespoke Innovations, Inc.	A61F 2/60 (2006.01)	2496188 *	REPLACEABLE FAIRING FOR PROSTHETIC LIMB OR BRACE
Merz Pharma GmbH & Co. KGaA	C07D 471/04 (2006.01) C07D 487/04 (2006.01) C07D 498/04 (2006.01) C07D 513/04 (2006.01) A61K 31/33 (2006.01) A61P 25/00 (2006.01)	2462142 *	METABOTROPIC GLUTAMATE RECEPTOR MODULATORS
AB Enzymes GmbH	C11B 3/00 (2006.01) C12N 9/16 (2006.01)	2494015 *	CLONING, EXPRESSION AND USE OF ACID PHOSPHOLIPASES
Cyalume Technologies, Inc	C09K 11/07 (2006.01) F42B 12/36 (2006.01) F42B 12/40 (2006.01) F42B 12/46 (2006.01)	2459674 *	COMBINED THERMAL AND CHEMILUMINESCENT REACTION SYSTEM
Speziallampenfabrik Dr. Fischer GmbH	B29C 49/64 (2006.01) H05B 3/00 (2006.01) F21V 7/00 (2006.01) B29B 13/02 (2006.01) B29C 49/68 (2006.01)	2480390 *	HEATING INSTALLATION AND REFLECTING DEVICE FOR A HEATING INSTALLATION.
Thrane & Thrane A/s	G01S 3/32 (2006.01) H04B 7/185 (2006.01)	2267474	Monopulse receiver and method
Cellgym Technologies GmbH	A61K 33/00 (2006.01) A61P 3/00 (2006.01)	2493482 *	THERAPEUTIC GAS FOR THE TREATMENT OF MITOCHONDRIAL DISORDERS
Glaxo Group Limited	C07K 16/24 (2006.01) A61P 11/06 (2006.01) C07K 16/46 (2006.01)	2435481 *	IL-13 BINDING PROTEIN
Pulmatrix, Inc.	A61P 11/10 (2006.01) A61K 9/00 (2006.01) A61P 11/00 (2006.01) A61K 31/198 (2006.01) A61K 33/06 (2006.01) A61K 33/14 (2006.01)	2464346 *	TREATMENT OF CYSTIC FIBROSIS USING CALCIUM LACTATE, LEUCINE AND SODIUM CHLORIDE IN A RESPIRABLE DRY POWDER

Podnosilac evropske prijave patenta (71)	MKP (51)	Broj objave evropske prijave patenta (97)	Naziv pronalaska (54)
Saint-Gobain Seva	E06B 3/42 (2006.01) E05D 15/06 (2006.01)	2273053	Schiebetür mit Entgleisungsschutz
Bayer Pharma Aktiengesellschaft	C07D 417/14 (2006.01) A61K 31/541 (2006.01)	2435431 *	SUBSTITUTED PIPERIDINES
Johnson & Johnson Consumer Companies, Inc.	A61K 31/05 (2006.01) A61K 36/185 (2006.01) A61K 36/77 (2006.01) A61K 36/48 (2006.01) A61K 36/28 (2006.01)	2482809 *	COMPOSITIONS COMPRISING AN ANTI-INFLAMMATORY BLEND
Cadila Healthcare Limited	C07D 417/14 (2006.01) A61K 31/4245 (2006.01) A61P 3/10 (2006.01) A61K 31/427 (2006.01) C07D 417/12 (2006.01)	2445908 *	DISUBSTITUTED BENZAMIDE DERIVATIVES AS GLUCOKINASE (GK) ACTIVATORS
Sirtris Pharmaceuticals, Inc.	A61K 31/437 (2006.01) A61K 31/553 (2006.01) A61K 31/4375 (2006.01) A61K 31/5365 (2006.01) C07D 487/04 (2006.01) A61K 31/55 (2006.01) A61K 31/4985 (2006.01) C07D 471/04 (2006.01) A61K 31/551 (2006.01) C07D 519/00 (2006.01) A61P 5/50 (2006.01)	2493888 *	BICYCLIC PYRIDINES AND ANALOGS AS SIRTUIN MODULATORS
Inotek Pharmaceuticals Corporation	A61K 31/7076 (2006.01) A61P 27/02 (2006.01) C07H 19/167 (2006.01)	2424546 *	METHOD OF REDUCING INTRAOCULAR PRESSURE IN HUMANS
Ascendis Pharma A/S	A61K 47/48 (2006.01) A61K 31/519 (2006.01) A61K 9/00 (2006.01) A61K 9/06 (2006.01)	2485712 *	SUBCUTANEOUS PALIPERIDONE COMPOSITION
Chiesi Farmaceutici S.p.A.	C07J 71/00 (2006.01) A61P 5/44 (2006.01) A61K 31/58 (2006.01)	2475676 *	Pregnane derivatives condensed in the 16,17 position with an N-substituted isoxazolidine ring as anti-inflammatory agents
Apotex Pharmachem Inc.	C07D 265/32 (2006.01) A61K 31/5375 (2006.01) A61K 31/5377 (2006.01) A61P 7/02 (2006.01) C07D 413/12 (2006.01) C07D 413/14 (2006.01)	2424847 *	PROCESSES FOR THE PREPARATION OF RIVAROXABAN AND INTERMEDIATES THEREOF
China Academy of Telecommunications Technology	H04W 88/08 (2009.01) H04B 7/26 (2006.01) H04W 24/00 (2009.01)	2461642 *	METHOD, DEVICE AND SYSTEM FOR TRANSMITTING SOUNDING REFERENCE SIGNALS
Rostaquo S.p.A.	A61K 31/56 (2006.01) A61P 9/00 (2006.01)	2490694 *	METHODS AND SYSTEMS FOR PHARMACOGENOMIC TREATMENT OF CARDIOVASCULAR CONDITIONS
Oxford Biotherapeutics Ltd.	C07K 16/28 (2006.01)	2403878 *	FULLY HUMAN ANTIBODIES SPECIFIC TO CADM1
Medarex, Inc.	C07K 16/28 (2006.01)	2403878 *	FULLY HUMAN ANTIBODIES SPECIFIC TO CADM1
KLEIN IBÉRICA, S.A.	E05F 15/14 (2006.01) E05F 17/00 (2006.01)	2241709	Simultaneous displacement device for sliding doors
Ishihara Sangyo Kaisha, Ltd.	A01P 3/00 (2006.01) A01N 43/50 (2006.01) A01N 47/04 (2006.01)	2451275 *	AGRICULTURAL OR HORTICULTURAL FUNGICIDE COMPOSITION AND ITS USE FOR CONTROLLING PLANT PATHOGENS
OSI Pharmaceuticals, LLC	C07D 403/04 (2006.01) C07D 487/04 (2006.01) C07D 253/06 (2006.01)	2451792 *	PROCESS FOR SUBSTITUTED 3-AMINO-5-OXO-4,5-DIHYDRO-[1,2,4]TRIAZINES
Bio-Rad Laboratories, Inc.	A61K 38/00 (2006.01)	2416796 *	Modified dnase compositions and methods of use thereof
SANOFI	A61K 31/4418 (2006.01) A61P 7/02 (2006.01) A61P 9/10 (2006.01)	2459193 *	OTAMIXABAN FOR TREATMENT OF ELDERLY AND RENAL IMPAIRED NON-ST ELEVATION MYOCARDIAL INFARCTION PATIENTS

Podnosilac evropske prijave patenta (71)	MKP (51)	Broj objave evropske prijave patenta (97)	Naziv pronalaska (54)
Syngenta Limited	C07D 417/08 (2006.01) C07D 417/14 (2006.01) A01N 43/78 (2006.01) C07D 409/08 (2006.01) C07D 401/08 (2006.01) C07D 405/08 (2006.01)	2459547 *	HERBICIDALLY ACTIVE HETEROARYL-SUBSTITUTED CYCLIC DIONES OR DERIVATIVES THEREOF
Sumitomo Wiring Systems, Ltd.	D04B 21/16 (2006.01)	2280105	Fabric for binding tape, and binding tape
Glaxo Group Limited	A61P 27/02 (2006.01) C07K 14/715 (2006.01) C07K 16/22 (2006.01) A61K 39/395 (2006.01) C07K 16/24 (2006.01)	2435075 *	ANTIGEN-BINDING PROTEINS
THE UNIVERSITY OF EDINBURGH	C07D 409/14 (2006.01) C07D 451/02 (2006.01) C07D 451/06 (2006.01) A61K 31/4439 (2006.01) A61P 3/00 (2006.01)	2477983 *	(4-PHENYL-PIPERIDIN-1-YL)-[5-1H-PYRAZOL-4YL]-THIOPHEN-3-YL]-METHANONE COMPOUNDS AND THEIR USE
Boehringer Ingelheim International GmbH	A61K 31/4439 (2006.01) C07D 401/12 (2006.01) A61K 31/437 (2006.01) C07D 471/04 (2006.01)	2491028 *	INDAZOLE AND PYRAZOLOPYRIDINE COMPOUNDS AS CCR1 RECEPTOR ANTAGONISTS
Mitsubishi HiTec Paper Europe GmbH	D21G 9/00 (2006.01)	2412869	Method for producing sheet-like material
Zweifel Pomy-Chips AG	A23L 1/216 (2006.01) A23L 1/217 (2006.01) A23B 7/02 (2006.01) A23B 7/03 (2006.01)	2294925	Chip mixture
Oculus Innovative Sciences, Inc.	A61K 31/74 (2006.01)	2459201 *	HYDROGEL FORMULATION COMPRISING OXIDATIVE REDUCTIVE POTENTIAL WATER
Knauf Gips KG	B63B 3/28 (2006.01) B63B 9/06 (2006.01) E04B 9/06 (2006.01) E04F 11/00 (2006.01)	2394905	A unit comprising a frame proving shape and a support profile supporting a construction board
Biorealites S.A.S.	C07K 16/26 (2006.01)	2488551 *	MONOCLONAL ANTIBODIES TO PROGASTRIN AND THEIR USES
Institut National de la Santé et de la Recherche Médicale (INSERM)	C07K 16/26 (2006.01)	2488551 *	MONOCLONAL ANTIBODIES TO PROGASTRIN AND THEIR USES
Centre National de la Recherche Scientifique CNRS	C07K 16/26 (2006.01)	2488551 *	MONOCLONAL ANTIBODIES TO PROGASTRIN AND THEIR USES
Les Laboratoires Servier	C07D 491/04 (2006.01) A61K 31/407 (2006.01)	2277882	Pipéridinic compounds, process for their préparation and pharmaceutical compositions containing them
Takeda Pharmaceutical Company Limited	A61K 9/00 (2006.01)	2424501 *	SOLID PREPARATION
KRKA, D.D., Novo Mesto	A61P 25/18 (2006.01) C07D 471/04 (2006.01) A61K 31/42 (2006.01)	2454256 *	PROCESS FOR THE SYNTHESIS OF PALIPERIDONE
CBS Institut Celovite Gradbene Resitve, d.o.o.	E04C 2/38 (2006.01)	2464799 *	BUILDING PANEL AS STRUCTURE OF EXTERNAL AND INNER PLATE WITH INTERMEDIATE INSULATION SPACE
ChemoCentryx, Inc.	A61K 31/4025 (2006.01) C07D 209/52 (2006.01) C07D 405/04 (2006.01) C07D 209/46 (2006.01) A61P 29/00 (2006.01) C07D 403/06 (2006.01) C07D 493/04 (2006.01) C07D 207/416 (2006.01) C07D 401/06 (2006.01)	2480531 *	PYRROLIDINONE CARBOXAMIDE DERIVATIVES AS CHEMERIN-R (CHEMR23) MODULATORS

Podnosilac evropske prijave patenta (71)	MKP (51)	Broj objave evropske prijave patenta (97)	Naziv pronalaska (54)
Ethicon Endo-Surgery, Inc.	A61M 37/00 (2006.01) A61N 7/00 (2006.01) A61K 41/00 (2006.01)	2464417 *	ULTRASONIC SURGICAL APPARATUS AND SILICON WAVEGUIDE AND METHODS FOR USE THEREOF
PCI Biotech AS	C12N 15/87 (2006.01) A61K 41/00 (2006.01) A61P 35/00 (2006.01) A61K 48/00 (2006.01) A61K 9/00 (2006.01) A61P 43/00 (2006.01)	2464384 *	PHOTOSENSITIZING COMPOSITIONS
Eviagenics S.A.	C12N 15/90 (2006.01) C12N 15/10 (2006.01)	2478100 *	METHOD OF GENERATING GENE MOSAICS
Panmira Pharmaceuticals, LLC	A61P 35/00 (2006.01) A61K 31/404 (2006.01) A61K 31/40 (2006.01) A61K 31/4709 (2006.01) A61P 31/00 (2006.01) A61P 29/00 (2006.01) A61K 31/44 (2006.01)	2490689 *	INJECTABLE FORMULATIONS FOR INTRA-ARTICULAR OR PERI-ARTICULAR ADMINISTRATION
Curt C. Joa. Inc.	A61F 13/15 (2006.01)	2345395	Apparatus and method for producing absorbent article with stretch film side panel and application of intermittent discrete components of an absorbent article
Protiva Biotherapeutics Inc.	C12N 15/113 (2010.01) A61K 31/713 (2006.01) C07H 21/02 (2006.01) A61P 35/00 (2006.01)	2480668 *	COMPOSITIONS AND METHODS FOR SILENCING GENES EXPRESSED IN CANCER
The Government of the United States of America, as represented by the Secretary of the Department of Health and Human Services	C12N 15/113 (2010.01) A61K 31/713 (2006.01) C07H 21/02 (2006.01) A61P 35/00 (2006.01)	2480668 *	COMPOSITIONS AND METHODS FOR SILENCING GENES EXPRESSED IN CANCER
New Tennis System S.r.l.	E01C 13/08 (2006.01) A63C 19/02 (2006.01)	2388052	Base for a playing field
Ethicon, Inc	A61K 31/785 (2006.01) A61K 31/795 (2006.01)	2413943 *	CONTROLLED EXOTHERM OF CYANOACRYLATE FORMULATIONS
Array Biopharma, Inc.	C07D 495/04 (2006.01) A61K 31/519 (2006.01) C07D 491/04 (2006.01) C07D 487/04 (2006.01) A61P 35/00 (2006.01)	2470541 *	RAF INHIBITOR COMPOUNDS AND METHODS OF USE THEREOF
Genentech, Inc.	C07D 495/04 (2006.01) A61K 31/519 (2006.01) C07D 491/04 (2006.01) C07D 487/04 (2006.01) A61P 35/00 (2006.01)	2470541 *	RAF INHIBITOR COMPOUNDS AND METHODS OF USE THEREOF
Sutton, Calvin Emanuel	A63B 23/02 (2006.01)	2424625 *	UPPER BODY EXERCISE DEVICE
HEAT ON-THE-FLY, LLC	E21B 43/25 (2006.01) E21B 43/26 (2006.01)	2478182 *	WATER HEATING APPARATUS FOR CONTINUOUS HEATED WATER FLOW AND METHOD FOR USE IN HYDRAULIC FRACTURING
Newcardio, Inc.	G06K 9/00 (2006.01) A61B 5/0452 (2006.01) G06F 17/00 (2006.01)	2440126 *	SYSTEMS AND METHODS FOR QUANTITATIVE ASSESSMENT OF CARDIAC ELECTRICAL EVENTS
H. Lundbeck A/S	A61K 9/16 (2006.01) A61K 9/28 (2006.01) A61K 9/50 (2006.01) A61K 9/20 (2006.01)	2470166 *	NEW COMPOSITIONS OF 1-[2-(2,4-DIMETHYL-PHENYLSULFANYL)-PHENYL]PIPERAZINE
Omya Development AG	C05D 3/02 (2006.01) C05G 3/00 (2006.01)	2463258	Soil improvements and fertilizers by dynamic disintegration, their manufacturing method and their uses in agriculture

Podnosilac evropske prijave patenta (71)	MKP (51)	Broj objave evropske prijave patenta (97)	Naziv pronalaska (54)
Gilead Sciences, Inc.	C07D 409/14 (2006.01) A61P 31/12 (2006.01) C07D 409/12 (2006.01) C07D 417/12 (2006.01) C07D 333/68 (2006.01) C07D 413/12 (2006.01) C07D 487/04 (2006.01) C07D 493/04 (2006.01) A61K 31/381 (2006.01)	2475657 *	INHIBITORS OF FLAVIVIRIDAE VIRUSES
SDG, INC. (an Ohio Corporation)	A61K 9/127 (2006.01)	2410991 *	ORALLY BIOAVAILABLE LIPID-BASED CONSTRUCTS
Sanofi-Aventis Deutschland GmbH	C07K 14/62 (2006.01) C12N 15/81 (2006.01) A61K 9/10 (2006.01) A61K 47/00 (2006.01)	2451437 *	AQUEOUS PREPARATIONS COMPRISING METHIONINE
THE BOARD OF TRUSTEES OF THE LELAND STANFORD JUNIOR UNIVERSITY	A61K 38/31 (2006.01)	2408472 *	USE OF SOMATOSTATIN OR AN ANALOGUE THEREOF IN COMBINATION WITH EXTERNAL RADIATION THERAPY
Gilead Sciences, Inc.	C07D 413/14 (2006.01) A61P 9/00 (2006.01) C07D 491/048 (2006.01) A61P 29/00 (2006.01) C07D 407/14 (2006.01) A61K 31/506 (2006.01) A61K 31/437 (2006.01) A61P 37/00 (2006.01) A61K 31/4439 (2006.01) C07D 401/12 (2006.01) A61K 31/444 (2006.01) C07D 401/14 (2006.01) A61K 31/497 (2006.01) C07D 471/04 (2006.01) A61P 25/28 (2006.01)	2454250 *	APOPTOSIS SIGNAL-REGULATING KINASE INHIBITORS
Millennium Pharmaceuticals, Inc.	A61P 35/00 (2006.01) A61K 9/00 (2006.01) A61K 9/08 (2006.01) A61K 31/55 (2006.01)	2459173 *	PHARMACEUTICAL COMPOSITIONS FOR THE TREATMENT OF CANCER AND OTHER DISEASES OR DISORDERS
Wyeth LLC	A61K 31/485 (2006.01) A61K 9/20 (2006.01) C07D 489/08 (2006.01)	2371357	Oral formulations and lipophilic salts of methylnaltrexone
Bertaso, Luigi	G09F 1/10 (2006.01) B43L 5/02 (2006.01) F16B 2/16 (2006.01) B42F 15/06 (2006.01) A47G 1/21 (2006.01)	2493703 *	DOCUMENTS-HANGING SHOWCASE WITHOUT THE UTILISATION OF CLIPS AND METHOD FOR ITS REALISATION
Acclarent, Inc.	A61M 25/00 (2006.01) A61M 25/06 (2006.01)	2408505 *	GUIDE SYSTEM WITH SUCTION
Yang Ji Chemical Co., Ltd.	C07D 403/04 (2006.01) C07D 403/06 (2006.01) C07D 207/273 (2006.01)	2452939 *	PIPERAZINYL 3-AMINOPYRROLIDINE DERIVATIVES AS A CCR2 ANTAGONIST
Schlumberger Technology B.V.	C04B 28/00 (2006.01)	2385029	Compositions and method for well cementing
Prad Research And Development Limited	C04B 28/00 (2006.01)	2385029	Compositions and method for well cementing
Services Pétroliers Schlumberger	C04B 28/00 (2006.01)	2385029	Compositions and method for well cementing
Schlumberger Holdings Limited	C04B 28/00 (2006.01)	2385029	Compositions and method for well cementing

Podnosilac evropske prijave patenta (71)	MKP (51)	Broj objave evropske prijave patenta (97)	Naziv pronalaska (54)
SALVAGNINI ITALIA S.p.A.	B23K 26/08 (2006.01) B23Q 1/01 (2006.01) B23K 37/02 (2006.01) B23Q 1/54 (2006.01) B23Q 1/58 (2006.01) B25J 17/02 (2006.01) B23K 26/38 (2006.01)	2283963	Manipulator of low inertia for laser cutting machines for flat sheet metals
SANOFI	A61K 31/195 (2006.01) A61P 37/02 (2006.01)	2493468 *	AMINO-BENZOIC ACID DERIVATIVES FOR USE IN THE TREATMENT OF DIHYDROGENASE-RELATED DISORDERS
Baylor Research Institute	A61K 39/395 (2006.01) C07K 16/30 (2006.01) A61P 35/00 (2006.01) C07K 19/00 (2006.01) C12N 15/63 (2006.01) C12N 15/62 (2006.01)	2406290 *	ANTIGEN PRESENTING CELL TARGETED CANCER VACCINES
SANOFI	C07K 16/18 (2006.01) G01N 33/68 (2006.01) A61K 39/395 (2006.01) A61P 25/28 (2006.01)	2430049 *	HUMANIZED ANTIBODIES SPECIFIC TO THE PROTOFIBRILLAR FORM OF THE BETA-AMYLOID PEPTIDE
Vertex Pharmaceuticals Incorporated	C07D 487/08 (2006.01) C07D 215/56 (2006.01)	2491018 *	PROCESS FOR PREPARING MODULATORS OF CYSTIC FIBROSIS TRANSMEMBRANE CONDUCTANCE REGULATOR
SANOFI	A61K 9/20 (2006.01) A61K 31/277 (2006.01)	2477611 *	(Z)-2-CYANO-3-HYDROXY-BUT-2-ENOIC ACID-(4'-TRIFLUORMETHYLPHENYL)-AMIDE TABLET FORMULATIONS WITH IMPROVED STABILITY
Glaxo Group Limited	C07D 261/14 (2006.01) A61K 31/495 (2006.01) C07D 241/04 (2006.01) A61K 31/44 (2006.01) C07C 223/00 (2006.01) A61P 25/28 (2006.01) C07D 231/12 (2006.01) A61K 31/4155 (2006.01) C07D 265/30 (2006.01) A61K 31/4965 (2006.01) C07D 237/20 (2006.01) A61K 31/42 (2006.01) C07C 233/00 (2006.01) A61P 25/16 (2006.01) A61K 31/5375 (2006.01) A61P 25/00 (2006.01)	2483254 *	NOVEL COMPOUNDS
Miller, Raymond A.	A61P 9/00 (2006.01) A61P 11/00 (2006.01) A61K 31/201 (2006.01) C07C 205/50 (2006.01)	2483233 *	HETEROATOM CONTAINING SUBSTITUTED FATTY ACIDS
SANOFI	A61K 31/00 (2006.01) A61K 9/00 (2006.01) A61K 9/20 (2006.01)	2496221 *	MULTILAYER PHARMACEUTICAL COMPOSITION THAT CAN BE DISPERSED IN WATER AND WHICH CONTAINS A COMBINATION OF ANTIMALARIAL AGENTS
SOCIEDADE BENEFICENTE DE SENHORAS HOSPITAL SÍRIO E LIBANÊS	A61K 38/08 (2006.01)	2459207 *	PHARMACEUTICAL COMPOSITION FOR TREATING MEDICAL CONDITIONS AND A METHOD FOR TREATING ALIMENTARY DISORDERS AND RELATED DISEASES
Sanofi-Aventis Deutschland GmbH	A61M 5/32 (2006.01) A61M 5/50 (2006.01)	2403571 *	DRUG DELIVERY DEVICE WITH RETRACTABLE NEEDLE
Novelis, Inc.	B22D 11/06 (2006.01) B22D 11/12 (2006.01)	2411171 *	ADJUSTABLE SIDE DAM FOR CONTINUOUS CASTING APPARATUS
SANOFI	A61P 35/00 (2006.01) C07D 231/38 (2006.01) A61K 31/415 (2006.01) C07C 275/30 (2006.01)	2448924 *	PYRAZOLE DERIVATIVES, PREPARATION THEREOF, AND THERAPEUTIC USE THEREOF

Podnosilac evropske prijave patenta (71)	MKP (51)	Broj objave evropske prijave patenta (97)	Naziv pronalaska (54)
Nanobacterie	A61K 35/74 (2006.01)	2370085 *	TREATMENT OF CANCER OR TUMOR INDUCED BY THE RELEASE OF HEAT GENERATED BY VARIOUS CHAINS OF MAGNETOSOMES EXTRACTED FROM MAGNETOTACTIC BACTERIA AND SUBMITTED TO AN ALTERNATIVE MAGNETIC FIELD
Gilead Sciences, Inc.	C07C 307/06 (2006.01) C07D 417/12 (2006.01)	2414325 *	METHOD OF PREPARING AN INHIBITOR OF CYTOCHROME P450 MONOOXYGENASE, AND INTERMEDIATES INVOLVED
Tetralogic Pharmaceuticals Corp.	A61K 31/40 (2006.01) A01N 43/36 (2006.01)	2434890 *	IAP INHIBITORS
Sanofi-Aventis Deutschland GmbH	A61M 5/32 (2006.01)	2403567 *	NEEDLE ASSEMBLY
OraMetrix, Inc.	B21F 1/00 (2006.01) A61C 7/02 (2006.01)	2427135 *	APPARATUS AND METHOD FOR CUSTOMIZED SHAPING OF ORTHODONTIC ARCHWIRES AND OTHER MEDICAL DEVICES
Pierre Fabre Medicament	A61K 31/5415 (2006.01) C07D 275/06 (2006.01)	2403840 *	DERIVATIVES OF BENZOTHIAZINES, PREPARATION THEREOF AND APPLICATION THEREOF AS DRUGS
Bystronic Laser AG	B24C 1/04 (2006.01) B24C 3/04 (2006.01)	2414134 *	DEVICE AND METHOD FOR WATER-JET CUTTING
Takeda Pharmaceutical Company Limited	A61P 43/00 (2006.01) A61P 3/00 (2006.01) A61P 15/00 (2006.01) A61P 13/02 (2006.01) C07D 498/04 (2006.01) A61P 21/00 (2006.01)	2442870 *	PYRAZINOOXAZEPINE DERIVATIVES
Haile, Danny Lee	A45D 31/00 (2006.01) A61K 8/02 (2006.01) A61K 8/35 (2006.01) A61K 8/37 (2006.01) A61K 8/42 (2006.01) A61Q 3/02 (2006.01)	2456335 *	COMPOSITIONS FOR REMOVABLE GEL APPLICATIONS FOR NAILS AND METHODS OF THEIR USE
ACO Technologies plc	F16K 31/30 (2006.01) F16K 31/46 (2006.01) F15C 1/16 (2006.01) E03F 5/10 (2006.01) F15D 1/00 (2006.01)	2325407	Bypass valve
J. Uriach y Compania S.A.	A61K 31/4545 (2006.01) A61K 47/10 (2006.01) A61P 11/02 (2006.01) A61K 9/08 (2006.01) A61P 37/08 (2006.01) A61K 9/00 (2006.01) G01N 30/02 (2006.01) A61P 11/04 (2006.01)	2402012	Liquid formulations of rupatadine fumarate
Lojack Operating Company, Lp	H03K 5/22 (2006.01)	2491655 *	FAST SETTLING, BIT SLICING COMPARATOR CIRCUIT
Bayer CropScience N.V.	A01H 3/00 (2006.01)	2448400 *	IMPROVEMENT OF YIELD IN CROP PLANTS THROUGH SELECTION OF EPIGENETICALLY MODIFIED POPULATIONS
HSO Health Care GmbH	A61P 31/04 (2006.01) A61K 35/74 (2006.01) A61P 15/02 (2006.01)	2428214	Compositions for the vaginal and oral administration of lactobacillus and uses thereof
Medasani, Munisekhar	A23L 1/305 (2006.01) A61K 36/88 (2006.01) A61K 36/78 (2006.01) A61P 9/12 (2006.01)	2464363 *	NATURAL EXTRACT FROM WHOLE BANANA FRUIT (MUSA SPP.)
Cellzome Limited	C07D 403/12 (2006.01) A61K 31/505 (2006.01) A61P 37/00 (2006.01) C07D 239/48 (2006.01) A61K 31/506 (2006.01) A61P 35/00 (2006.01)	2475648 *	ORTHO SUBSTITUTED PYRIMIDINE COMPOUNDS AS JAK INHIBITORS

Podnosilac evropske prijave patenta (71)	MKP (51)	Broj objave evropske prijave patenta (97)	Naziv pronalaska (54)
BioRelix, Inc.	C12Q 1/68 (2006.01)	2438194 *	METHODS FOR SCREENING AND IDENTIFYING COMPOUNDS
Research In Motion Limited	H04M 1/02 (2006.01) G06F 1/16 (2006.01)	2456175	Portable electronic device including flexible display
Endosphere Surgical, Inc.	A61B 17/94 (2006.01) A61B 17/34 (2006.01) A61B 19/00 (2006.01)	2410935 *	CANNULA WITH INTEGRATED CAMERA AND ILLUMINATION
Ethicon Endo-Surgery, Inc.	A61B 17/32 (2006.01) A61B 18/14 (2006.01) A61B 17/28 (2006.01)	2453813 *	ELECTROSURGERY GENERATOR FOR ULTRASONIC SURGICAL INSTRUMENTS
Crearene Ltd.	A61K 31/19 (2006.01) A61K 31/195 (2006.01) A61K 31/198 (2006.01) A61K 31/4172 (2006.01) A61K 31/661 (2006.01) A61K 31/675 (2006.01) A61K 31/7004 (2006.01) A61K 33/00 (2006.01) A61K 33/06 (2006.01) A61K 33/10 (2006.01) A61P 7/08 (2006.01) A61K 45/06 (2006.01)	2456431 *	CELL PROTECTION IN DIALYSIS PATIENTS BY ADMINISTRATION OF A CREATINE COMPOUND
Medasani, Munisekhar	A61K 36/00 (2006.01) A01N 65/00 (2009.01)	2473057 *	PICRORHIZA KURROA EXTRACT FOR PREVENTION, ELIMINATION AND TREATMENT OF INFECTION DISEASES
Janssen Pharmaceutica, N.V.	C07D 471/04 (2006.01)	2464646 *	PROCESS FOR THE PREPARATION OF CATHEPSIN S INHIBITORS
China Academy of Telecommunications Technology	H04W 16/00 (2009.01)	2466939 *	METHOD, DEVICE AND SYSTEM FOR DETERMINING RESOURCE LOCATIONS
ThyssenKrupp Polysius AG	C10B 7/02 (2006.01) C10L 5/40 (2006.01) C10L 9/08 (2006.01) C10B 53/02 (2006.01) F26B 23/02 (2006.01) C10B 49/02 (2006.01) F27B 9/18 (2006.01) F26B 17/00 (2006.01)	2424955 *	DEVICE AND METHOD FOR DRYING AND TORREFYING AT LEAST ONE CARBON-CONTAINING SUBSTANCE STREAM IN A MULTIPLE-HEARTH FURNACE
Merck Sharp & Dohme Corp.	C12N 5/07 (2010.01) C12P 21/08 (2006.01)	2496707 *	ENGINEERED ANTI-TSLP ANTIBODY
Sanofi-Aventis Deutschland GmbH	A61M 5/315 (2006.01)	2453959 *	DRUG DELIVERY DEVICE
Pierre Fabre Medicament	C07K 16/28 (2006.01) A61K 39/395 (2006.01) A61P 31/18 (2006.01)	2424897 *	ANTI CXCR4 ANTIBODIES FOR THE TREATMENT OF HIV
Adamed SP. Z O.O.	C07D 451/10 (2006.01) A61K 31/46 (2006.01) A61P 11/00 (2006.01)	2432781 *	SALTS OF TIOTROPIUM WITH 10-CAMPHORSULFONIC ACID
Sanofi-Aventis Deutschland GmbH	A61M 5/315 (2006.01)	2437819 *	INNER HOUSING FOR A DRUG DELIVERY DEVICE
Proyecto de Biomedicina Cima, S.L.	A61P 25/00 (2006.01) A61K 31/7076 (2006.01) A61P 25/28 (2006.01)	2441459 *	5'-METHYLTHIOADENOSINE NEUROPROTECTIVE PROPERTIES
Meiji Seika Pharma Co., Ltd.	A61P 1/16 (2006.01) A61P 31/14 (2006.01) A61K 31/56 (2006.01) A61P 43/00 (2006.01) A61K 31/7056 (2006.01) A61K 38/21 (2006.01)	2450051 *	MEDICINAL AGENT AND METHOD FOR TREATMENT OF INTRACTABLE CHRONIC HEPATITIS C
Janssen Pharmaceutica N.V.	C07D 487/04 (2006.01) A61K 31/407 (2006.01) A61P 25/00 (2006.01)	2491038 *	DISUBSTITUTED OCTAHY - DROPYRROLO [3,4-C] PYRROLES AS OREXIN RECEPTOR MODULATORS

Podnosilac evropske prijave patenta (71)	MKP (51)	Broj objave evropske prijave patenta (97)	Naziv pronalaska (54)
Amgen Inc.	C07K 16/00 (2006.01)	2421897 *	FRAGMENTATION RESISTANT IgG1 Fc-CONJUGATES
Sonavation, Inc.	G06F 7/04 (2006.01)	2411906 *	IMPROVED MULTIPLEXER FOR A PIEZO CERAMIC IDENTIFICATION DEVICE
Dispomedicor ZRT.	A61M 5/32 (2006.01)	2427238 *	PIVOTABLE NEEDLE PROTECTOR
Meijn Food Processing Technology B.V.	A22C 21/00 (2006.01) A22C 21/06 (2006.01)	2248429	Apparatus and method for conveying organ packages to a processing station
SANOFI	C07D 277/64 (2006.01) C07D 285/06 (2006.01) C07D 403/12 (2006.01) C07D 413/14 (2006.01) C07D 417/12 (2006.01) A61K 31/403 (2006.01) C07D 417/14 (2006.01) A61P 29/00 (2006.01)	2430006 *	CYCLOPENTA[C]PYRROLE-2-CARBOXYLATE DERIVATIVES, PREPARATION THEREOF, AND THERAPEUTIC USE THEREOF
Wind To Power System, S.I.	H02P 9/00 (2006.01) F03D 9/00 (2006.01) H02P 9/30 (2006.01) H02P 9/48 (2006.01)	2386753	Excitation circuit for an asynchronous generator and method for the excitation of an asynchronous generator
Kyowa Hakko Kirin Co., Ltd.	A61K 31/506 (2006.01) A61K 31/5377 (2006.01) A61K 31/4439 (2006.01) A61K 31/426 (2006.01) A61P 25/22 (2006.01) C07D 491/052 (2006.01) C07D 417/14 (2006.01) C07D 495/04 (2006.01) C07D 491/048 (2006.01)	2474544 *	THERAPEUTIC AGENT FOR ANXIETY DISORDERS
Saet S.p.A.	C30B 11/00 (2006.01) C30B 29/06 (2006.01) B22D 27/04 (2006.01) H05B 6/44 (2006.01) H05B 6/36 (2006.01) F27B 14/14 (2006.01) C30B 35/00 (2006.01)	2491168 *	DEVICE FOR OBTAINING A MULTICRYSTALLINE SEMICONDUCTOR MATERIAL, IN PARTICULAR SILICON, AND METHOD FOR CONTROLLING THE TEMPERATURE THEREIN
Fleischmann Alois & Co. KG	A47C 23/06 (2006.01)	2428140	Slatted frame
Vertex Pharmaceuticals Incorporated	C07D 495/04 (2006.01) C07D 401/14 (2006.01) A61P 3/00 (2006.01) C07D 417/14 (2006.01) C07D 403/14 (2006.01) C07D 407/14 (2006.01) A61K 31/4184 (2006.01) C07D 409/14 (2006.01) C07D 413/14 (2006.01)	2454254 *	BENZIMIDAZOLE ANALOGUES FOR THE TREATMENT OR PREVENTION OF FLAVIVIRUS INFECTIONS
Gilead Calistoga LLC	C07D 473/34 (2006.01) A61K 31/52 (2006.01) A61P 35/00 (2006.01)	2411391 *	ATROPISOMERS OF 2-PURINYL-3-TOLYL-QUINAZOLINONE DERIVATIVES AND METHODS OF USE
CALGON CARBON CORPORATION	B01D 53/64 (2006.01) B01J 20/02 (2006.01) B01J 20/28 (2006.01) B01D 53/02 (2006.01)	2482970 *	SORBENT FORMULATION FOR REMOVAL OF MERCURY FROM FLUE GAS
Genentech, Inc.	G01N 33/48 (2006.01)	2470898 *	DETERMINING SENSITIVITY OF CELLS TO B-RAF INHIBITOR TREATMENT BY DETECTING KRAS MUTATION AND RTK EXPRESSION LEVELS
Industrial Technology Research Institute	H01M 8/02 (2006.01) H01M 8/24 (2006.01)	2337131	Two-sided fluid flow plate assembly having parallel flow channels
Proyecto de Biomedicina Cima, S.L.	C12N 15/86 (2006.01) C12N 15/63 (2006.01)	2497830 *	REGULATED EXPRESSION SYSTEMS
Mirsaetov, Oleg Marsimovich	E21B 47/00 (2012.01) E21B 43/00 (2006.01)	2418349 *	METHOD FOR MONITORING THE OIL-FIELD DEVELOPMENT

Podnosilac evropske prijave patenta (71)	MKP (51)	Broj objave evropske prijave patenta (97)	Naziv pronalaska (54)
Fedorov, Yury Viktorovich	E21B 47/00 (2012.01) E21B 43/00 (2006.01)	2418349 *	METHOD FOR MONITORING THE OIL-FIELD DEVELOPMENT
Janssen Pharmaceutica N.V.	A61P 25/02 (2006.01) A61P 1/06 (2006.01) A61K 31/496 (2006.01) A61P 29/00 (2006.01)	2421535 *	HETEROAROMATIC AND AROMATIC PIPERAZINYL AZETIDINYL AMIDES AS MONOACYLGLYCEROL LIPASE INHIBITORS
Novomatic AG	G07F 17/32 (2006.01)	2489022 *	ENTERTAINMENT MACHINE HAVING A SYMBOL GAMING UNIT
Lichtblau, Andreas	A01G 1/00 (2006.01) A01G 9/02 (2006.01)	2397028	Plantable façade system
Glanz, Markus	A01G 1/00 (2006.01) A01G 9/02 (2006.01)	2397028	Plantable façade system
Zecha, Jörg	A01G 1/00 (2006.01) A01G 9/02 (2006.01)	2397028	Plantable façade system
Spantech France (Societe A Responsabilite Limitee)	E04H 15/18 (2006.01) E04C 3/00 (2006.01) E04H 15/64 (2006.01) E04H 15/48 (2006.01)	2486199 *	COLLAPSIBLE LATTICE BEAM, TRUSS AND CONSTRUCTION INCLUDING SUCH A BEAM
Auckland UniServices Limited	A61K 31/4709 (2006.01) C07D 239/94 (2006.01) C07D 471/04 (2006.01) A61K 31/517 (2006.01) A61K 31/519 (2006.01) C07D 403/12 (2006.01) C07D 403/14 (2006.01) A61K 31/4178 (2006.01) A61P 35/00 (2006.01) C07D 405/14 (2006.01)	2406262 *	PRODRUG FORMS OF KINASE INHIBITORS AND THEIR USE IN THERAPY
Eli Lilly and Company	C07D 401/14 (2006.01) A61K 31/4439 (2006.01)	2427449 *	VINYL INDIAZOLYL COMPOUNDS
Alfa Electric Ltd.	H02J 9/00 (2006.01)	2244353	Energy saving device
Alltech, Inc.	G01N 33/00 (2006.01)	2470894 *	SYNTHETIC MYCOTOXIN ADSORBENTS AND METHODS OF MAKING AND UTILIZING THE SAME
G-Con, LLC	F24F 3/00 (2006.01)	2464913 *	MODULAR, SELF-CONTAINED, MOBILE CLEAN ROOM
Almirall S.A.	A61P 17/00 (2006.01) A61P 19/00 (2006.01) A61K 31/506 (2006.01) A61P 33/06 (2006.01) A61P 35/00 (2006.01) C07D 213/74 (2006.01) A61P 37/00 (2006.01) C07D 239/42 (2006.01) A61K 31/44 (2006.01)	2406222 *	ADDITION SALTS OF TROMETHAMINE WITH AZABIPHENYLAMINO BENZOIC ACID DERIVATIVES AS DHODH INHIBITORS
SANOFI	C07D 401/04 (2006.01) C07D 401/14 (2006.01) C07D 403/04 (2006.01) C07D 407/14 (2006.01) C07D 493/08 (2006.01) A61K 31/4709 (2006.01) A61K 31/4184 (2006.01) A61P 35/00 (2006.01)	2408762 *	HSP90 INHIBITING INDIAZOLE DERIVATIVES, COMPOSITIONS CONTAINING SAME AND USE THEREOF
Intermune, Inc.	C07D 401/10 (2006.01) C07D 213/64 (2006.01) A61K 31/4412 (2006.01) A61P 9/00 (2006.01)	2440543 *	IMPROVED METHOD FOR SYNTHESIZING PIRFENIDONE
Keryx Biopharmaceuticals, Inc.	A61K 9/20 (2006.01) A61K 31/295 (2006.01)	2456426 *	FERRIC CITRATE DOSAGE FORMS
GlaxoSmithKline LLC	C07D 498/04 (2006.01) A61K 31/4985 (2006.01) A61P 25/00 (2006.01)	2470545 *	ANHYDRATE FORMS OF A PYRIDINE DERIVATIVE

Podnosilac evropske prijave patenta (71)	MKP (51)	Broj objave evropske prijave patenta (97)	Naziv pronalaska (54)
Ajinomoto Co., Inc.	A61Q 19/00 (2006.01) C08G 77/388 (2006.01) C08L 83/08 (2006.01) A61K 8/898 (2006.01)	2415802 *	NOVEL ACYL ACIDIC AMINO ACID ESTER
Nanopax Pharma, LLC	A01N 37/18 (2006.01)	2464224 *	METHODS FOR DRUG DELIVERY COMPRISING UNFOLDING AND FOLDING PROTEINS AND PEPTIDE NANOPARTICLES
Knape & Vogt Manufacturing Company	A47B 88/04 (2006.01)	2496115 *	CLOSING DEVICE FOR DRAWERS
Adamo, Gabriele	A47B 83/04 (2006.01)	2277410	Modular piece of furniture with extractable chairs and tables
SANOFI	C07K 16/40 (2006.01)	2481758	Human antibodies to PSCK9 for use in methods of treating particular groups of subjects (11566)
Eli Lilly and Company	A01P 15/00 (2006.01) A01N 43/22 (2006.01) A61K 31/00 (2006.01)	2442646 *	ECTOPARASITICIDAL METHODS AND FORMULATIONS
Merz Pharma GmbH & Co. KGaA	C07C 45/69 (2006.01) C07C 209/62 (2006.01) C07C 211/35 (2006.01) C07C 49/403 (2006.01)	2448901 *	METHOD OF PREPARING 3,3,5,5-TETRAMETHYLCYCLOHEXANONE
The University of North Carolina At Chapel Hill	A01N 43/04 (2006.01) A61K 31/70 (2006.01)	2416651 *	METHODS OF TREATING EDEMA RELATED TO ISCHEMIA-REPERFUSION
Incyte Corporation	A61K 31/519 (2006.01) C07D 487/04 (2006.01) A61P 35/00 (2006.01)	2432555 *	N-(HETERO)ARYL-PYRROLIDINE DERIVATIVES OF PYRAZOL-4-YL-PYRROLO[2,3-d]PYRIMIDINES AND PYRROL-3-YL-PYRROLO[2,3-d]PYRIMIDINES AS JANUS KINASE INHIBITORS
Sanofi-Aventis Deutschland GmbH	A61M 5/315 (2006.01)	2482883 *	DRUG DELIVERY DEVICE
Nektar Therapeutics	A61K 47/48 (2006.01) A61P 25/04 (2006.01) A61P 25/36 (2006.01)	2456469 *	OLIGOMER-OPIOID AGONIST CONJUGATES
KHT s.r.o.	C12M 1/00 (2006.01)	2474605	Container fermentor
Merrimack Pharmaceuticals, Inc.	A61K 39/395 (2006.01) A61P 35/00 (2006.01) C07K 14/525 (2006.01) C07K 14/765 (2006.01) C07K 16/28 (2006.01) C07K 16/32 (2006.01) C07K 16/46 (2006.01) C07K 19/00 (2006.01)	2488199 *	BISPECIFIC BINDING AGENTS TARGETING IGF-1R AND ERBB3 SIGNALLING AND USES THEREOF
Dyx Corp.	A61K 39/395 (2006.01) A61P 35/00 (2006.01) C07K 14/525 (2006.01) C07K 14/765 (2006.01) C07K 16/28 (2006.01) C07K 16/32 (2006.01) C07K 16/46 (2006.01) C07K 19/00 (2006.01)	2488199 *	BISPECIFIC BINDING AGENTS TARGETING IGF-1R AND ERBB3 SIGNALLING AND USES THEREOF
Amgen, Inc	A61K 31/502 (2006.01) A61P 35/00 (2006.01) A61P 35/02 (2006.01)	2475368 *	N-4 (- ((3- (2 -AMINO-4 PYRIMIDINYL) -2 -PYRIDINYL) OXY) PHENYL) -4- (4-METHYL-2-THIENYL) -1-PHTHALAZINAMINE FOR USE IN THE TREATMENT OF ANTIMITOTIC AGENT RESISTANT CANCER
Kast Silicone Ltd.	F16L 11/00 (2006.01)	2459919 *	BREATHING HOSE
NUFARM	A01P 7/00 (2006.01) A01N 25/02 (2006.01) A01N 47/40 (2006.01) A01N 51/00 (2006.01) A01N 43/40 (2006.01) A01N 43/86 (2006.01)	2442648 *	NMP-FREE FORMULATIONS OF NEONICOTINOIDS
Sanofi-Aventis Deutschland GmbH	A61M 5/315 (2006.01)	2482884 *	DRUG DELIVERY DEVICE AND DRIVE MEMBER FOR A DRUG DELIVERY DEVICE

Podnosilac evropske prijave patenta (71)	MKP (51)	Broj objave evropske prijave patenta (97)	Naziv pronalaska (54)
Nuvo Research Inc.	A61K 47/44 (2006.01) A61K 31/444 (2006.01) A61K 47/10 (2006.01) A61K 47/12 (2006.01) A61P 29/00 (2006.01) A61K 9/00 (2006.01)	2485730 *	TOPICAL FORMULATION COMPRISING ETORICOXIB AND A ZWITTERIONIC SURFACTANT
Les Laboratoires Servier	C07D 209/52 (2006.01) A61K 31/403 (2006.01) A61P 25/00 (2006.01)	2332910	New derivatives of azabicyclo[3.2.0]hept-3-yl, method for preparing same and pharmaceutical compositions containing them
SAINT-GOBAIN SEVA	E05D 11/10 (2006.01) E05F 1/00 (2006.01) E05F 3/22 (2006.01)	2256275	Rotation blocking device of a door and door equipped with such device
Metabolon Inc.	C12Q 1/00 (2006.01)	2414535 *	BIOMARKERS RELATED TO INSULIN RESISTANCE AND METHODS USING THE SAME
China Academy of Telecommunications Technology	H04W 16/28 (2009.01) H04B 7/04 (2006.01)	2485520 *	METHOD AND DEVICE FOR COORDINATED SCHEDULING
Omya Development AG	C09C 1/02 (2006.01)	2447328	Method for improving handleability of calcium carbonate containing materials
ELB-Form GmbH	F16L 13/007 (2006.01) F16L 25/10 (2006.01) F16L 13/16 (2006.01)	2295841	Method for connecting tubes and tube connections
The Trustees Of The University Of Pennsylvania	C12P 21/04 (2006.01)	2406388 *	OX40/TRAIL FUSION PROTEINS
Obschestvo S Ogranichennoi Otvetstvennostiyu "Pharmenterprises"	A61P 31/10 (2006.01) C07K 14/805 (2006.01) C07F 15/02 (2006.01) A61K 38/42 (2006.01) A61P 31/04 (2006.01) C07D 487/22 (2006.01)	2476701 *	ANTIMICROBIAL AGENTS BASED ON HEMIN DERIVATIVES
Marlière, Philippe	C12P 7/52 (2006.01) C12N 15/52 (2006.01) C12N 9/10 (2006.01) C12N 9/88 (2006.01) C12N 1/21 (2006.01)	2478109 *	METHOD FOR THE ENZYMATIC PRODUCTION OF 3-HYDROXY-S-METHYLBUTYRIC ACID FROM ACETONE AND ACETYL-COA
Richter Gedeon Nyrt.	C07J 41/00 (2006.01) A61K 31/573 (2006.01) A61P 5/36 (2006.01)	2408799 *	NOVEL CRYSTALLINE FORM OF ANTIPROGESTIN CDB-4124
Zylum Beteiligungsgesellschaft mbH & Co. Patente II KG	G01F 1/58 (2006.01) G01F 1/60 (2006.01)	2383548	Measuring device and method for measuring the flow speed of a medium flowing through a measuring tube
Galante, Marco	A61G 5/12 (2006.01)	2473148 *	SUPPORT AND CONTAINMENT STRUCTURE FOR PERSONS
Araclón Biotech, S. L.	A61K 39/00 (2006.01) A61K 39/385 (2006.01) A61K 47/48 (2006.01) A61P 25/28 (2006.01)	2435093 *	ALBUMIN-AMYLOID PEPTIDE CONJUGATES AND USES THEREOF
Ironwood Pharmaceuticals, Inc.	C07K 7/08 (2006.01) C07K 14/47 (2006.01)	2499154 *	TREATMENTS FOR GASTROINTESTINAL DISORDERS
Athenix Corporation	C07K 14/325 (2006.01) C12N 15/82 (2006.01)	2459587 *	AXMI-192 FAMILY OF PESTICIDAL GENES AND METHODS FOR THEIR USE
Rao, Sebastiano	A01N 37/02 (2006.01) A01N 65/00 (2009.01) A01N 37/04 (2006.01) A01N 65/22 (2009.01) A01P 7/00 (2006.01) A01N 3/00 (2006.01) A01P 21/00 (2006.01) A01N 65/38 (2009.01) A01N 65/42 (2009.01)	2389806	A natural composition for the treatment of plants, preparation and uses thereof

Podnosilac evropske prijave patenta (71)	MKP (51)	Broj objave evropske prijave patenta (97)	Naziv pronalaska (54)
Universidad De Zaragoza	C12Q 1/04 (2006.01)	2428580 *	SMART PACKAGING FOR DETECTING MICROORGANISMS
SANOFI	A61K 31/727 (2006.01) C08B 37/10 (2006.01) C08B 37/00 (2006.01)	2427198 *	USE OF AN ACYLATED OCTASACCHARIDE AS ANTITHROMBOTIC AGENT
Abbott Laboratories	A61K 47/14 (2006.01) A61K 47/02 (2006.01) A61K 9/48 (2006.01) A61K 47/00 (2006.01) A61K 47/20 (2006.01) A61K 31/5377 (2006.01) A61K 9/00 (2006.01)	2424499 *	STABILIZED LIPID FORMULATION OF APOPTOSIS PROMOTER
Teijin Pharma Limited	C07D 277/56 (2006.01) A61P 19/06 (2006.01) C07D 277/20 (2006.01) A61K 31/426 (2006.01)	2455372 *	PROCESS FOR PRODUCING CRYSTALS OF POLYMORPHIC 2-(3-CYANO-4-ISOBUTYLOXYPHENYL)-4-METHYL-5-THIAZOLECARBOXYLIC ACID BY POOR-SOLVENT ADDITION METHOD
Baron Services, Inc.	G06F 7/00 (2006.01) G06F 17/00 (2006.01)	2460067 *	SYSTEM AND METHOD FOR DETERMINING ROAD CONDITIONS
Janssen Pharmaceutica N.V.	C07D 405/14 (2006.01) A61K 31/496 (2006.01) C07D 405/12 (2006.01) C07D 495/04 (2006.01) C07D 409/14 (2006.01) A61P 25/00 (2006.01) C07D 403/12 (2006.01) C07D 417/14 (2006.01) C07D 409/12 (2006.01) A61P 29/00 (2006.01) C07D 413/12 (2006.01) C07D 401/14 (2006.01) C07D 417/12 (2006.01) C07D 205/04 (2006.01) C07D 413/14 (2006.01)	2421825 *	AZETIDINYL DIAMIDES AS MONOACYLGLYCEROL LIPASE INHIBITORS
Siena Biotech S.p.a.	A61K 31/517 (2006.01) C07D 239/22 (2006.01) A61K 31/4166 (2006.01) A61K 31/553 (2006.01) A61K 31/4184 (2006.01) A61K 31/554 (2006.01) A61K 31/437 (2006.01) C07D 217/14 (2006.01) A61K 31/5513 (2006.01) A61K 31/472 (2006.01) C07D 235/26 (2006.01) A61K 31/551 (2006.01) C07D 239/96 (2006.01) A61K 31/5377 (2006.01) C07D 239/80 (2006.01)	2485728 *	WNT PATHWAY ANTAGONISTS
Zechner, Rudolf	G01N 33/50 (2006.01) C12Q 1/44 (2006.01) A61K 31/00 (2006.01)	2414830 *	MODULATION OF ADIPOSE TRIGLYCERIDE LIPASE FOR PREVENTION AND TREATMENT OF CACHEXIA, LOSS OF WEIGHT AND MUSCLE ATROPHY AND METHODS OF SCREENING THEREFOR
Höfler, Gerald	G01N 33/50 (2006.01) C12Q 1/44 (2006.01) A61K 31/00 (2006.01)	2414830 *	MODULATION OF ADIPOSE TRIGLYCERIDE LIPASE FOR PREVENTION AND TREATMENT OF CACHEXIA, LOSS OF WEIGHT AND MUSCLE ATROPHY AND METHODS OF SCREENING THEREFOR
Lass, Achim	G01N 33/50 (2006.01) C12Q 1/44 (2006.01) A61K 31/00 (2006.01)	2414830 *	MODULATION OF ADIPOSE TRIGLYCERIDE LIPASE FOR PREVENTION AND TREATMENT OF CACHEXIA, LOSS OF WEIGHT AND MUSCLE ATROPHY AND METHODS OF SCREENING THEREFOR
Zimmermann, Robert	G01N 33/50 (2006.01) C12Q 1/44 (2006.01) A61K 31/00 (2006.01)	2414830 *	MODULATION OF ADIPOSE TRIGLYCERIDE LIPASE FOR PREVENTION AND TREATMENT OF CACHEXIA, LOSS OF WEIGHT AND MUSCLE ATROPHY AND METHODS OF SCREENING THEREFOR

Podnosilac evropske prijave patenta (71)	MKP (51)	Broj objave evropske prijave patenta (97)	Naziv pronalaska (54)
Haemmerle, Günther	G01N 33/50 (2006.01) C12Q 1/44 (2006.01) A61K 31/00 (2006.01)	2414830 *	MODULATION OF ADIPOSE TRIGLYCERIDE LIPASE FOR PREVENTION AND TREATMENT OF CACHEXIA, LOSS OF WEIGHT AND MUSCLE ATROPHY AND METHODS OF SCREENING THEREFOR
Das, Suman	G01N 33/50 (2006.01) C12Q 1/44 (2006.01) A61K 31/00 (2006.01)	2414830 *	MODULATION OF ADIPOSE TRIGLYCERIDE LIPASE FOR PREVENTION AND TREATMENT OF CACHEXIA, LOSS OF WEIGHT AND MUSCLE ATROPHY AND METHODS OF SCREENING THEREFOR
Ranbaxy Laboratories Limited	C07D 401/04 (2006.01)	2411380 *	PROCESS FOR THE PREPARATION OF DESLORATADINE
Xene Corporation	B32B 27/12 (2006.01)	2454090 *	FIBER COMPOSITE AND PROCESS OF MANUFACTURE
ENEA - Agenzia Nazionale Per Le Nuove Tecnologie, L'Energia e Lo Sviluppo Economico Sostenibile	F24J 2/10 (2006.01) F24J 2/14 (2006.01)	2478308 *	A REFLECTING- PANEL HAVING A THIN MIRROR AND A SUPPORT MADE OF COMPOSITE MATERIAL SMC (SHEET MOULDING COMPOUND) FOR LINEAR PARABOLIC SOLAR CONCENTRATORS
Logomotion, s.r.o.	G07F 7/10 (2006.01) G06Q 20/00 (2012.01) G07F 7/08 (2006.01)	2430620 *	CONTACTLESS PAYMENT DEVICE, METHOD OF CONTACTLESS TOP-UP OF ELECTRONIC MONEY ON A PAYMENT DEVICE
Ingendoh, Axel	C11C 3/10 (2006.01)	2464715 *	METHOD FOR MANUFACTURING BIODIESEL BY ACID TRANSESTERIFICATION, AND USE OF SULPHONIC ACID AS A CATALYST IN THE MANUFACTURE OF BIODIESEL
Svimar S.R.L. Societa' per Lo Sviluppo Del Marketing e Della Ricerca	B60R 19/34 (2006.01)	2411246 *	BUMPER STRUCTURE
Drexel University	C08B 37/00 (2006.01)	2499167 *	COMPOSITIONS AND METHODS FOR TREATING A DISORDER OR DEFECT IN SOFT TISSUE
Codman & Shurtleff, Inc.	A61K 36/9066 (2006.01) A61K 31/12 (2006.01) A61P 25/28 (2006.01)	2359820	Shunt delivery of curcumin for the treatment Alzheimer
Université Libre de Bruxelles	G01N 33/50 (2006.01) G01N 33/564 (2006.01) G01N 33/68 (2006.01)	2411805 *	NEW MARKER FOR DIAGNOSIS OF ACTIVE MULTIPLE SCLEROSIS
Sanofi-Aventis Deutschland GmbH	A61M 5/145 (2006.01) A61M 5/315 (2006.01)	2480268 *	ASSEMBLY AND INDICATOR FOR A DRUG DELIVERY DEVICE
Athenix Corp.	C12N 15/82 (2006.01) C07K 14/325 (2006.01) A01H 5/00 (2006.01)	2406278 *	AXMI-001, AXMI-002, AXMI-030, AXMI-035, AND AXMI-045: INSECTICIDAL PROTEINS FROM BACILLUS THURINGIENSIS AND METHODS FOR THEIR USE
Curt G. Joa, Inc.	B65H 26/00 (2006.01)	2497731	Apparatus and method for minimizing waste and improving quality and production in narrow web processing operations by automatic twist defect correction
SA Shuang	H01R 31/06 (2006.01) H02J 7/00 (2006.01)	2315322	Docking station and device for use in a docking station
Optosecurity Inc.	G01N 23/00 (2006.01)	2459990 *	METHOD AND SYSTEM FOR IDENTIFYING A LIQUID PRODUCT IN LUGGAGE OR OTHER RECEPTACLE
Lee, Eun Suk	G06F 13/10 (2006.01) G06F 3/14 (2006.01)	2479661 *	TRIPLE DISPLAY DEVICE, AND COMPUTER EMPLOYING SAME
Delphi Technologies Holding S.à.r.l.	F01N 13/18 (2010.01) F01N 3/20 (2006.01) F01N 3/36 (2006.01)	2432976 *	FLUID DOSING DEVICE
Incyte Corporation	A61P 35/00 (2006.01) C07D 487/04 (2006.01) A61K 31/519 (2006.01)	2486041 *	HYDROXYL, KETO, AND GLUCURONIDE DERIVATIVES OF 3-(4-(7H-PYRROLO[2,3-D]PYRIMIDIN-4-YL)-1H-PYRAZOL-1-YL)-3-CYCLOPENTYLPROPANENITRILE
BG Medicine, Inc.	G01N 33/50 (2006.01)	2499489 *	RISK FACTORS AND PREDICTION OF MYOCARDIAL INFARCTION

Podnosilac evropske prijave patenta (71)	MKP (51)	Broj objave evropske prijave patenta (97)	Naziv pronalaska (54)
UCB Pharma, S.A.	C07D 401/12 (2006.01) A61P 35/00 (2006.01) A61P 9/00 (2006.01) C07D 487/04 (2006.01) A61K 31/47 (2006.01) A61P 37/00 (2006.01) C07D 473/02 (2006.01) A61P 27/02 (2006.01) A61P 3/00 (2006.01) A61P 25/28 (2006.01)	2499126 *	FUSED BICYCLIC PYRIDINE AND PYRAZINE DERIVATIVES AS KINASE INHIBITORS
Sanofi-Aventis Deutschland GmbH	A61M 5/24 (2006.01) A61M 5/28 (2006.01) A61M 5/315 (2006.01) A61M 5/31 (2006.01) A61M 5/34 (2006.01)	2470243 *	ASSEMBLY KIT FOR PREPARING OF A PRE-FILLED SYRINGE
Sony Computer Entertainment Inc.	G06Q 30/00 (2006.01)	2330550	Mediation of online trading services
Janssen Pharmaceutica N.V.	A61P 25/00 (2006.01) A61K 31/496 (2006.01) C07D 401/06 (2006.01) C07D 409/06 (2006.01) A61P 29/00 (2006.01) C07D 417/06 (2006.01) C07D 401/12 (2006.01) C07D 205/04 (2006.01)	2421847 *	AZETIDINYL DIAMIDES AS MONOACYLGLYCEROL LIPASE INHIBITORS
Delphi Technologies Holding S.à.r.l.	F02M 61/06 (2006.01) F02M 61/18 (2006.01)	2369166	Injection nozzle
Martella, Vito	A61K 39/12 (2006.01) C07K 14/005 (2006.01) C07K 16/10 (2006.01) C12Q 1/70 (2006.01) C07K 14/08 (2006.01) C12N 7/00 (2006.01) G01N 33/569 (2006.01) C12N 15/40 (2006.01)	2366708	Canine astrovirus AstV strain Bari/08 identified in dogs with gastro-enteritis
Research, Investment & Development S.A.L. (Holding)	A47J 31/40 (2006.01)	2316312	Coffee machine
Ets JOSKIN S.A.	B60J 7/08 (2006.01)	2266826	Automated covering device
SA Shuang	A45C 7/00 (2006.01) G06F 1/16 (2006.01) A45C 11/38 (2006.01) H04B 1/38 (2006.01) A45C 13/00 (2006.01) A45C 11/00 (2006.01) H04M 1/18 (2006.01)	2274998	Protective cover
Ecole Polytechnique	H01J 37/32 (2006.01)	2407998	Plasma processing in a capacitively-coupled reactor with trapezoidal-waveform excitation
Centre National de la Recherche Scientifique	H01J 37/32 (2006.01)	2407998	Plasma processing in a capacitively-coupled reactor with trapezoidal-waveform excitation
Dompé S.p.A.	C07C 309/65 (2006.01) A61P 25/04 (2006.01) C07C 237/20 (2006.01) A61P 29/00 (2006.01) C07D 277/46 (2006.01) C07D 295/12 (2006.01) C07C 233/01 (2006.01) A61P 11/00 (2006.01) A61K 31/16 (2006.01) C07D 211/06 (2006.01) C07C 235/34 (2006.01) A61K 31/18 (2006.01)	2493846 *	2-ARYL-PROPIONAMIDE DERIVATIVES USEFUL AS BRADYKININ RECEPTOR ANTAGONISTS AND PHARMACEUTICAL COMPOSITIONS CONTAINING THEM
Vanderbilt University	A01N 43/40 (2006.01) A61K 31/44 (2006.01)	2482657 *	O-BENZYL NICOTINAMIDE ANALOGS AS MGLUR5 POSITIVE ALLOSTERIC MODULATORS

Podnosilac evropske prijave patenta (71)	MKP (51)	Broj objave evropske prijave patenta (97)	Naziv pronalaska (54)
Johnson & Johnson	A01N 43/40 (2006.01) A61K 31/44 (2006.01)	2482657 *	O-BENZYL NICOTINAMIDE ANALOGS AS MGLUR5 POSITIVE ALLOSTERIC MODULATORS
Baylor Research Institute	C07K 19/00 (2006.01) C07K 16/18 (2006.01) C12N 15/63 (2006.01) A61K 39/395 (2006.01)	2406288 *	ANTIGEN PRESENTING CELL TARGETED VACCINES
Papiermaschinen-Systemtechnik GmbH	B08B 3/02 (2006.01) B05B 15/06 (2006.01) D21F 1/34 (2006.01)	2383047	Nozzle device
Arch Personal Care Products, L.P.	A61K 31/19 (2006.01) A61K 31/60 (2006.01)	2467143 *	BROAD SPECTRUM PRESERVATION BLENDS
Millennium Pharmaceuticals, Inc.	C07D 487/04 (2006.01) A61P 35/00 (2006.01) A61K 31/52 (2006.01)	2430026 *	HYDROCHLORIDE SALT OF ((1S,2S,4R)-4-{4-[(1S)-2,3-DIHYDRO-1H-INDEN-1-YLAMINO]-7H-PYRROLO [2,3-D]PYRIMIDIN-7-YL}-2-HYDROXYCYCLOPENTYL) METHYL SULFAMATE
SANOFI	C07D 498/04 (2006.01) A61K 31/519 (2006.01) A61K 31/522 (2006.01) A61P 25/00 (2006.01)	2477994 *	SUBSTITUTED DIHYDRO BENZOCYCLOALKYLOXYMETHYL OXAZOLOPYRIMIDINONES, PREPARATION AND USE THEREOF
Evonik Röhm GmbH	C08G 63/08 (2006.01) C08G 63/90 (2006.01) C08G 63/80 (2006.01)	2455414	Process for the production of resorbable polyesters
Abbott Laboratories	C12P 21/08 (2006.01)	2491129 *	DUAL VARIABLE DOMAIN IMMUNOGLOBULINS AND USES THEREOF
S & P Clever Reinforcement Company AG	E04F 13/04 (2006.01)	2470732 *	REINFORCING MESH FOR A REINFORCED MORTAR LAYER OR SPRAYED MORTAR LAYER ON AN UNDERLAYMENT, AND METHOD FOR THE INSTALLATION THEREOF AND REINFORCED MORTAR COATING PRODUCED THEREWITH
Prometheus Laboratories Inc.	G01N 33/564 (2006.01) G01N 33/50 (2006.01)	2494352 *	ASSAYS FOR THE DETECTION OF ANTI-TNF DRUGS AND AUTOANTIBODIES
Zeus Industrial Products, Inc.	A61F 2/06 (2006.01)	2461766 *	PROSTHETIC DEVICE INCLUDING ELECTROSTATICALLY SPUN FIBROUS LAYER AND METHOD FOR MAKING THE SAME
Fotoverbundglas Marl GmbH	B32B 17/10 (2006.01) B32B 37/10 (2006.01) B30B 5/02 (2006.01)	2485886 *	DEVICE AND METHOD FOR PRODUCING LAMINATED SAFETY GLASS
ALGIPHARMAAS	A61K 47/36 (2006.01)	2437784 *	ALGINATE OLIGOMERS FOR USE IN OVERCOMING MULTIDRUG RESISTANCE IN BACTERIA
Nippon Soda Co., Ltd.	C07D 401/04 (2006.01) C07D 495/04 (2006.01) A01N 43/62 (2006.01) A01N 43/46 (2006.01) A01P 3/00 (2006.01) C07D 498/04 (2006.01)	2484672 *	NITROGEN-CONTAINING HETEROCYCLIC COMPOUND AND SALT THEREOF, AND BACTERICIDE FOR AGRICULTURAL AND HORTICULTURAL USE
H. Lundbeck A/S	A01N 43/38 (2006.01) A61K 31/40 (2006.01)	2493304 *	SPIROLACTAM DERIVATIVES AND USES OF SAME
Janssen Pharmaceutica N.V.	C07D 417/14 (2006.01) C07D 417/12 (2006.01) A61K 31/496 (2006.01) A61P 29/00 (2006.01) A61P 25/00 (2006.01)	2421860 *	AZETIDINYL DIAMIDES AS MONOACYLGLYCEROL LIPASE INHIBITORS
Vitae Pharmaceuticals, Inc.	C07D 405/12 (2006.01) A61P 9/00 (2006.01)	2462137 *	CRYSTALLINE SALTS OF METHYL 2- ((R) - (3-CHLORO PHENYL)) ((R) -L- ((S) -2-(METHYLAMINO) -3- ((R) -TETRAHYDRO-2H-PYRAN-3-YL) PROPYL CARBAMOYL)
Oncothyreon Inc.	A61K 31/37 (2006.01) A61K 31/35 (2006.01) A61P 1/00 (2006.01) A61P 3/04 (2006.01) A61P 3/00 (2006.01)	2416771 *	METHODS AND COMPOSITIONS OF PI-3 KINASE INHIBITORS FOR TREATING FIBROSIS

Podnosilac evropske prijave patenta (71)	MKP (51)	Broj objave evropske prijave patenta (97)	Naziv pronalaska (54)
Total Raffinage Marketing	C10G 11/00 (2006.01) C10M 101/02 (2006.01) C10G 45/58 (2006.01) C10G 9/00 (2006.01) C10M 107/02 (2006.01) C10G 47/00 (2006.01) A01N 25/02 (2006.01) C10L 1/04 (2006.01) C08K 5/01 (2006.01) C10L 11/04 (2006.01) C09D 11/02 (2006.01) C09K 8/02 (2006.01)	2406356 *	HYDRODEWAXED HYDROCARBON FLUID USED IN THE MANUFACTURE OF FLUIDS FOR INDUSTRIAL, AGRICULTURAL, OR DOMESTIC USE
GANYMED Pharmaceuticals AG	C07K 14/705 (2006.01) C07K 16/28 (2006.01) A61P 35/00 (2006.01) A61K 39/395 (2006.01)	2499161 *	ANTIBODIES SPECIFIC FOR CLAUDIN 6 (CLDN6)
Johannes Gutenberg-Universität Mainz	C07K 14/705 (2006.01) C07K 16/28 (2006.01) A61P 35/00 (2006.01) A61K 39/395 (2006.01)	2499161 *	ANTIBODIES SPECIFIC FOR CLAUDIN 6 (CLDN6)
Janssen Biotech, Inc.	C40B 50/06 (2006.01) C40B 40/10 (2006.01) C40B 30/04 (2006.01) G01N 33/53 (2006.01)	2488867 *	METHODS OF AFFINITY MATURING ANTIBODIES
Johnson & Johnson Consumer Companies, Inc.	A61K 8/02 (2006.01) A61Q 1/02 (2006.01) A61K 8/64 (2006.01) A61K 8/72 (2006.01)	2480196 *	METHODS AND COMPOSITIONS FOR SELECTIVELY TREATING SKIN
Janssen Pharmaceutica N.V.	C07D 409/14 (2006.01) C07D 405/12 (2006.01) C07D 205/04 (2006.01) A61P 25/00 (2006.01) C07D 403/14 (2006.01) C07D 491/048 (2006.01) A61K 31/496 (2006.01) C07D 403/12 (2006.01) C07D 417/14 (2006.01) C07D 401/10 (2006.01) C07D 417/12 (2006.01) C07D 401/12 (2006.01) A61P 29/00 (2006.01)	2421823 *	AZETIDINYL DIAMIDES AS MONOACYLGLYCEROL LIPASE INHIBITORS
Japan Oil, Gas and Metals National Corporation	C10G 47/36 (2006.01)	2479243 *	METHOD OF HYDROCRACKING AND PROCESS FOR PRODUCING HYDROCARBON OIL
INPEX Corporation	C10G 47/36 (2006.01)	2479243 *	METHOD OF HYDROCRACKING AND PROCESS FOR PRODUCING HYDROCARBON OIL
JX Nippon Oil & Energy Corporation	C10G 47/36 (2006.01)	2479243 *	METHOD OF HYDROCRACKING AND PROCESS FOR PRODUCING HYDROCARBON OIL
Japan Petroleum Exploration Co., Ltd.	C10G 47/36 (2006.01)	2479243 *	METHOD OF HYDROCRACKING AND PROCESS FOR PRODUCING HYDROCARBON OIL
Cosmo Oil Co., Ltd.	C10G 47/36 (2006.01)	2479243 *	METHOD OF HYDROCRACKING AND PROCESS FOR PRODUCING HYDROCARBON OIL
Nippon Steel Engineering Co., Ltd	C10G 47/36 (2006.01)	2479243 *	METHOD OF HYDROCRACKING AND PROCESS FOR PRODUCING HYDROCARBON OIL
Creative Nail Design, Inc.	C08F 251/02 (2006.01) A61Q 3/02 (2006.01) A45D 31/00 (2006.01) A61K 8/91 (2006.01) C09D 4/06 (2006.01)	2486068 *	REMOVABLE COLOR LAYER FOR ARTIFICIAL NAIL COATINGS AND METHODS THEREFORE
Immersion Corporation	G06F 3/041 (2006.01) G06F 3/01 (2006.01) G06F 3/048 (2006.01)	2406704 *	SYSTEMS AND METHODS FOR A TEXTURE ENGINE
Prometheus Laboratories Inc.	C07K 14/47 (2006.01)	2414390 *	CITRULLINATED PEPTIDES FOR DIAGNOSING AND PROGNOSED RHEUMATOID ARTHRITIS

Podnosilac evropske prijave patenta (71)	MKP (51)	Broj objave evropske prijave patenta (97)	Naziv pronalaska (54)
E. I. du Pont de Nemours and Company	C07D 405/04 (2006.01) A01N 43/56 (2006.01)	2493880 *	HETEROBICYCLE-SUBSTITUTED AZOLYL BENZENE FUNGICIDES
Sanofi-Aventis Deutschland GmbH	A61M 5/20 (2006.01)	2403561 *	SYRINGE, AUTO-INJECTOR DEVICE AND SET OF AUTO-INJECTOR DEVICES AND SYRINGES
Neubourg Skin Care GmbH & Co. KG	A61K 8/44 (2006.01) A61K 8/04 (2006.01) A61K 9/00 (2006.01) A61K 9/107 (2006.01) A61K 31/17 (2006.01) A61K 9/12 (2006.01)	2371350	Foam formulas for treating animal skin illnesses
IMC Infomusic Consultants GmbH	C23C 14/02 (2006.01) A61L 31/08 (2006.01) C23C 14/32 (2006.01) C23C 14/06 (2006.01) C23C 14/35 (2006.01) A61L 27/30 (2006.01)	2491161 *	SURFACE COATINGS FOR MEDICAL IMPLANTS
ANGUS Chemical Company	C07C 205/02 (2006.01) C07C 201/08 (2006.01)	2490999 *	ISOTHERMAL REACTOR FOR HYDROCARBON NITRATION
Amgen, Inc	C07D 471/04 (2006.01) A61P 35/00 (2006.01)	2408773 *	INHIBITORS OF PI3 KINASE
Gilead Palo Alto, Inc.	C07D 471/04 (2006.01) A61K 31/437 (2006.01) A61P 9/00 (2006.01) A61K 31/519 (2006.01) A61K 31/4985 (2006.01) A61K 31/5025 (2006.01)	2464645 *	FUSED HETEROCYCLIC COMPOUNDS AS ION CHANNEL MODULATORS
Georgia-Pacific France	A47K 10/16 (2006.01) B65H 75/10 (2006.01)	2490970 *	CORE FOR A PRODUCT IN SHEET FORM WOUND AROUND THIS CORE, AND ROLL FORMED WITH SUCH A CORE
Sanofi-Aventis Deutschland GmbH	A61M 5/315 (2006.01)	2437823 *	DRUG DELIVERY DOSE SETTING MECHANISM WITH VARIABLE MAXIMUM DOSE
Schurter AG	H01H 85/046 (2006.01) H05K 1/16 (2006.01) H01H 85/041 (2006.01) H05K 1/00 (2006.01)	2408277	Fuse element
Janssen Biotech, Inc.	C07K 16/00 (2006.01) A61K 39/395 (2006.01)	2493506 *	IL-17A ANTAGONISTS
Danapak Flexibles A/S	B65D 65/40 (2006.01) B32B 27/32 (2006.01) B32B 15/08 (2006.01)	2392455	Multilayered wrapping film and use thereof
CTV-Armaturen GmbH	F16K 1/22 (2006.01)	2251573	Isolation or regulating fitting
AEG Power Solutions B.V.	H05B 7/144 (2006.01) H02M 5/257 (2006.01)	2364058	Power supply assembly
SANOFI	C07D 471/04 (2006.01) C07D 487/04 (2006.01) A61K 31/437 (2006.01) A61P 9/12 (2006.01)	2459557 *	CYCLIC (AZA)INDOLIZINECARBOXAMIDES, THEIR PREPARATION AND THEIR USE AS PHARMACEUTICALS
INKA Holding und Immobilien GmbH & Co. KG	C02F 1/68 (2006.01)	2497753	Device for producing and metering calcium hypochlorite and comparable solutions
Tecnomobility SRL	B62K 11/14 (2006.01) B62D 51/00 (2006.01)	2308747	A drive control apparatus for two-wheeled vehicles
DrySo Tec GmbH	B01D 53/75 (2006.01) B01D 53/78 (2006.01) B01D 53/81 (2006.01) B01D 53/96 (2006.01) C21B 5/06 (2006.01) B01D 53/50 (2006.01)	2416871 *	METHOD FOR TREATING WASTE GASES, ESPECIALLY RESULTING FROM STEEL PRODUCTION
Marchi&Brevetti Interprise S.R.L. Con Unico Socio	C02F 1/68 (2006.01) C02F 1/00 (2006.01) C02F 1/76 (2006.01) C02F 103/42 (2006.01)	2406188 *	METHOD AND DEVICE FOR DISSOLVING SOLID SUBSTANCES IN WATER

Podnosilac evropske prijave patenta (71)	MKP (51)	Broj objave evropske prijave patenta (97)	Naziv pronalaska (54)
ALEXION PHARMACEUTICALS, INC.	C07K 16/18 (2006.01) A61K 39/00 (2006.01) C07K 16/46 (2006.01) A61P 31/00 (2006.01)	2445937 *	BISPECIFIC ANTIBODIES THAT BIND TO COMPLEMENT PROTEINS
Ethicon Endo-Surgery, Inc.	A61F 5/00 (2006.01)	2475337 *	DETACHABLE ANTENNA FOR REMOTE BAND
Cadila Healthcare Limited	A61P 13/12 (2006.01) A61P 11/00 (2006.01) C07D 405/12 (2006.01) A61P 9/10 (2006.01) C07D 211/60 (2006.01) A61K 31/4468 (2006.01) A61P 9/02 (2006.01) A61P 9/04 (2006.01)	2421828 *	PIPERIDINE DERIVATIVES AS INHIBITORS OF RENIN
Tomil s.r.o.	B65D 83/00 (2006.01)	2361850	Metering device
VALSIR S.p.A.	E04D 13/04 (2006.01) F16L 37/14 (2006.01)	2406440 *	WATER DRAIN ASSEMBLY, IN PARTICULAR FOR SIPHONIC ROOF DRAINAGE SYSTEMS
Glaxo Group Limited	C12N 5/00 (2006.01) A61P 9/00 (2006.01) A61P 21/00 (2006.01) A61K 38/19 (2006.01) C07K 16/18 (2006.01) A61K 39/395 (2006.01) C07K 16/46 (2006.01)	2435067 *	STEM CELL TARGETING
Sanofi-Aventis Deutschland GmbH	A61M 5/315 (2006.01)	2437824 *	DOSE SETTING MECHANISM FOR PRIMING A DRUG DELIVERY DEVICE
UCB Pharma S.A.	C07D 513/04 (2006.01) A61K 31/433 (2006.01) A61P 25/08 (2006.01)	2491045 *	2-OXO-1-PYRROLIDINYL IMIDAZOTHIADIAZOLE DERIVATIVES
Parlux S.P.A.	A45D 20/12 (2006.01)	2412272	A silencer device for a hair dryer
Janssen Pharmaceuticals, Inc.	A61P 17/10 (2006.01) A61K 9/00 (2006.01) A61K 31/433 (2006.01) A61P 17/00 (2006.01) A61K 31/155 (2006.01)	2421521 *	STABLE TOPICAL COMPOSITIONS FOR 1,2,4-THIADIAZOLE DERIVATIVES
Sanofi-Aventis Deutschland GmbH	A61M 5/315 (2006.01)	2482895 *	ASSEMBLY FOR A DRUG DELIVERY DEVICE
Vivus, Inc.	A61K 31/4178 (2006.01) A61P 31/10 (2006.01) A61P 13/02 (2006.01) A61K 31/439 (2006.01) A61P 13/10 (2006.01) A61K 31/341 (2006.01) A61K 31/44 (2006.01) A61P 15/02 (2006.01) A61K 31/433 (2006.01)	2485729 *	TREATMENT WITH CHOLINERGIC AGONISTS
Pulmatrix, Inc.	A61K 33/06 (2006.01) A61K 9/00 (2006.01) A61K 31/198 (2006.01) A61P 11/00 (2006.01) A61P 11/10 (2006.01) A61K 33/14 (2006.01)	2448571 *	RESPIRABLY DRY POWDER COMPRISING CALCIUM LACTATE, SODIUM CHLORIDE AND LEUCINE
Forsyth Dental Infirmary for Children	C07K 16/00 (2006.01)	2419445 *	NEW METHODS OF MAKING AN ANTIBODY AND COMPOSITIONS THEREOF
Blücher GmbH	C08G 61/10 (2006.01) C08G 61/12 (2006.01) C08J 9/00 (2006.01)	2423241	Unit with porous organic polymers and use of same
Cequr SA	A61M 5/158 (2006.01) F15C 5/00 (2006.01) G01L 9/00 (2006.01) A61M 5/142 (2006.01) F16K 99/00 (2006.01)	2427235 *	LOW-DEAD VOLUME MICROFLUIDIC CIRCUIT AND METHODS
Sanmiro S.R.L.	A47J 45/06 (2006.01)	2440096 *	PAN WITH AN INVERTED CURVED HANDLE

Podnosilac evropske prijave patenta (71)	MKP (51)	Broj objave evropske prijave patenta (97)	Naziv pronalaska (54)
Delphi Technologies Holding S.à.r.l.	F02M 63/00 (2006.01) F02M 51/06 (2006.01) F02M 61/16 (2006.01)	2372139	Actuator Arrangement for use in a Fuel Injector
Trimo d.d.	B66C 1/02 (2006.01) B65G 47/00 (2006.01) B65G 61/00 (2006.01)	2354074	Method and apparatus for assembling building shell elements
OMYA DEVELOPMENT AG	C01F 11/18 (2006.01)	2371766	Process for obtaining precipitated calcium carbonate
Millennium Pharmaceuticals, Inc.	A61K 31/19 (2006.01) A61K 31/215 (2006.01) A01N 37/28 (2006.01)	2445340 *	SUBSTITUTED HYDROXAMIC ACIDS AND USES THEREOF
Nektar Therapeutics	A61M 11/00 (2006.01)	2453962 *	NEGATIVELY BIASED SEALED NEBULIZERS SYSTEMS AND METHODS
Mederi Therapeutics Inc.	A61B 18/14 (2006.01) G06F 3/00 (2006.01)	2480152 *	SYSTEMS AND METHODS FOR CONTROLLING USE AND OPERATION OF A FAMILY OF DIFFERENT TREATMENT DEVICES
Powersling GmbH & Co. KG	A61H 1/02 (2006.01)	2311424	Sling table for carrying out physiotherapy and rehabilitation and functional element for such a sling table
Expo-Net Danmark A/S	F24F 13/08 (2006.01) F24F 7/02 (2006.01) E04D 13/00 (2006.01) E04D 13/17 (2006.01)	2386699	Ventilated eaves closure
Sanofi-Aventis Deutschland GmbH	A61M 5/315 (2006.01)	2475410 *	DRIVE MECHANISM FOR A MEDICATION DELIVERY DEVICE AND MEDICATION DELIVERY DEVICE
II-VI Incorporated	B01D 9/00 (2006.01) C01B 31/36 (2006.01)	2477944 *	SUBLIMATION GROWTH OF SIC SINGLE CRYSTALS
Georgia-Pacific France	A61F 13/26 (2006.01) B31C 3/00 (2006.01) D21H 17/28 (2006.01) D21H 27/00 (2006.01) D21H 17/29 (2006.01) D21H 19/54 (2006.01) D21H 25/04 (2006.01)	2461968 *	FIBROUS SHEET THAT DISINTEGRATES IN WATER, PROCESS FOR MANUFACTURING SAID FIBROUS SHEET, CORE CONSISTING OF STRIPS OF SAID FIBROUS SHEET
Dow AgroSciences, LLC	C12P 19/34 (2006.01) C12Q 1/68 (2006.01)	2467500 *	DETECTION OF AAD-1 EVENT DAS-40278-9
Valio Ltd.	A61K 35/74 (2006.01)	2429555 *	NOVEL USE OF PROBIOTICS
Glaxo Group Limited	C07K 14/605 (2006.01) A61K 39/395 (2006.01) A61P 3/08 (2006.01) C07K 14/575 (2006.01) A61K 47/48 (2006.01) C07K 16/18 (2006.01) A61P 5/48 (2006.01)	2483308 *	DRUG FUSIONS AND CONJUGATES WITH EXTENDED HALF LIFE
ALFA WASSERMANN S.p.A.	C07D 498/22 (2006.01) C07D 493/20 (2006.01) A61K 31/357 (2006.01) A61K 31/437 (2006.01) A61P 31/00 (2006.01)	2421869 *	RIFAMYCIN DERIVATIVES
Guccini, Francesco	B65D 33/00 (2006.01)	2435330 *	PAPER BAG WITH DETACHABLE CARD
Amgen, Inc	C07D 401/14 (2006.01)	2445902 *	HETEROCYCLIC COMPOUNDS AND THEIR USES AS INHIBITORS OF PI3K ACTIVITY
Merz Pharma GmbH & Co. KGaA	C07C 303/32 (2006.01) C07C 211/35 (2006.01) C07C 309/04 (2006.01) A61K 31/13 (2006.01)	2419402 *	SYNTHESIS OF 1-AMINO-1,3,3,5,5-PENTAMETHYLCYCLOHEXANE MESYLATE
Sanofi-Aventis Deutschland GmbH	A61M 5/315 (2006.01)	2482885 *	DRIVE MECHANISM FOR A DRUG DELIVERY DEVICE
Nycomed GmbH	C07D 471/04 (2006.01) A61K 31/437 (2006.01)	2470531 *	METHYLPYRROLOPYRIDINECARBOXAMIDES

Podnosilac evropske prijave patenta (71)	MKP (51)	Broj objave evropske prijave patenta (97)	Naziv pronalaska (54)
SANOFI	A61P 11/00 (2006.01) A61P 17/00 (2006.01) A61P 19/00 (2006.01) A61P 21/00 (2006.01) A61P 9/00 (2006.01) A61K 31/737 (2006.01) A61P 25/00 (2006.01) C08B 37/00 (2006.01) A61P 27/02 (2006.01) A61P 7/00 (2006.01) A61P 37/00 (2006.01)	2464359 *	N-SULFATED OLIGOSACCHARIDES ACTIVATING FGFS RECEPTORS, THEIR SYNTHESIS AND THEIR THERAPEUTICAL APPLICATION
Wyeth LLC	A61K 31/365 (2006.01) A61K 38/48 (2006.01) A61K 47/44 (2006.01) A61K 39/39 (2006.01) A61K 39/00 (2006.01)	2485725 *	COMPOSITIONS COMPRISING ADJUVANT, MACROLIDE AND PROTEINACEOUS ANTIGEN AND METHODS OF USE THEREOF
Galderma Research & Development	A61K 9/08 (2006.01) A61K 31/137 (2006.01) A61K 31/5375 (2006.01) A61K 47/10 (2006.01) A61P 31/10 (2006.01)	2403476 *	METHOD OF DISSOLVING ANTIFUNGAL AGENT, AND COMPOSITIONS WITH A HIGH CONCENTRATION OF ANTIFUNGAL AGENT, SUITABLE FOR APPLICATION TO THE NAIL
Ethicon, Inc	A61L 27/58 (2006.01) A61L 27/34 (2006.01) A61L 29/06 (2006.01) A61L 17/12 (2006.01) A61L 31/14 (2006.01) A61L 27/54 (2006.01) A61L 27/18 (2006.01) A61L 31/06 (2006.01) A61L 29/14 (2006.01) A61L 17/00 (2006.01) A61L 31/10 (2006.01) A61L 29/16 (2006.01) A61L 29/08 (2006.01) A61L 26/00 (2006.01) A61L 31/16 (2006.01)	2493518 *	ABSORBABLE POLYETHYLENE DIGLYCOLATE COPOLYMERS TO REDUCE MICROBIAL ADHESION TO MEDICAL DEVICES AND IMPLANTS
Hopewell Wind Power Limited	F03D 3/00 (2006.01) F03D 11/02 (2006.01)	2317128	Vertical axis wind turbine
Reversinglabs Corporation	G06F 21/00 (2006.01) G06F 11/07 (2006.01)	2460113 *	AUTOMATED UNPACKING OF PORTABLE EXECUTABLE FILES
JX Nippon Oil & Energy Corporation	C10M 107/24 (2006.01) C10N 40/30 (2006.01) C10M 107/34 (2006.01) C10M 105/18 (2006.01) C10N 30/10 (2006.01) C09K 5/04 (2006.01) C10N 30/08 (2006.01) C10M 129/18 (2006.01) C10M 137/08 (2006.01) C10M 169/04 (2006.01) C10N 30/06 (2006.01) C10M 133/04 (2006.01)	2471896 *	REFRIGERANT OIL FOR FREEZERS AND OPERATING FLUID COMPOSITION FOR FREEZERS
Assa Abloy AB	H04L 12/28 (2006.01)	2406919 *	USE OF SNMP FOR MANAGEMENT OF SMALL FOOTPRINT DEVICES
Terumo Kabushiki Kaisha	A61F 2/90 (2006.01)	2389906	Stent
Palazzoli S.p.A.	H01R 4/24 (2006.01)	2486626 *	JUNCTION BOX, PARTICULARLY FOR LIGHTING LINES FOR TUNNELS
Kirchdorfer Fertigteilverwaltung GmbH	E01F 15/08 (2006.01)	2446088 *	TERMINATING ELEMENT
KRKA, D.D., Novo Mesto	C07D 453/02 (2006.01)	2451809 *	A PROCESS FOR THE PREPARATION AND PURIFICATION OF SOLIFENACIN SALTS
Logomotion, s.r.o.	G06Q 20/00 (2012.01)	2452300 *	METHOD AND SYSTEM OF CONTACTLESS AUTHENTICATION, AND CARRIER OF PIN CODE

Podnosilac evropske prijave patenta (71)	MKP (51)	Broj objave evropske prijave patenta (97)	Naziv pronalaska (54)
Norgine BV	A61K 47/02 (2006.01) A61K 47/10 (2006.01) A61K 9/00 (2006.01) A61P 1/10 (2006.01)	2459218 *	SOLUTIONS COMPRISING POLYETHYLENE GLYCOL AND ELECTROLYTES
GP Cellulose GmbH	D21C 9/10 (2006.01) D21C 9/16 (2006.01)	2435629 *	MODIFIED CELLULOSE FROM CHEMICAL KRAFT FIBER AND METHODS OF MAKING AND USING THE SAME
Dws S.R.L.	B29C 67/00 (2006.01)	2454080 *	IMPROVED STEREO LITHOGRAPHY MACHINE
Intra-Cellular Therapies, Inc.	A61K 38/17 (2006.01) A01K 67/027 (2006.01)	2461673 *	NOVEL REGULATORY PROTEINS AND INHIBITORS
Gruppo Meccaniche Luciani S.r.l.	B29D 35/12 (2010.01) A43B 17/08 (2006.01) A43B 7/08 (2006.01)	2493347 *	Shoe with ventilation system.
Sanofi-Aventis Deutschland GmbH	A61M 5/00 (2006.01) A61M 5/315 (2006.01)	2437826 *	DOSING MECHANISM FOR A DRUG DELIVERY DEVICE
The University of North Carolina At Chapel Hill	A61P 43/00 (2006.01) A61K 31/395 (2006.01) A61P 25/00 (2006.01) A61K 31/045 (2006.01) A61K 31/167 (2006.01)	2440194 *	METHODS AND COMPOSITIONS FOR THE INDUCTION OF HYPOTHERMIA
Arena Pharmaceuticals, Inc.	C07C 269/06 (2006.01) A61P 9/00 (2006.01) C07C 309/15 (2006.01) A61K 31/165 (2006.01) C07C 271/28 (2006.01) C07C 303/22 (2006.01)	2480526 *	CRYSTALLINE FORMS AND PROCESSES FOR THE PREPARATION OF PGI2 RECEPTOR AGONISTS
GlaxoSmithKline LLC	A61K 31/55 (2006.01) C07D 487/04 (2006.01) A61P 43/00 (2006.01) A61P 35/00 (2006.01)	2496582 *	BENZODIAZEPINE BROMODOMAIN INHIBITOR
Salix Pharmaceuticals, Ltd.	A01N 43/42 (2006.01)	2437603 *	METHODS OF TREATING HEPATIC ENCEPHALOPATHY
Marathon GTF Technology, Ltd.	C01B 7/09 (2006.01)	2454190 *	CONVERSION OF HYDROGEN BROMIDE TO ELEMENTAL BROMINE
Curt G. Joa, Inc.	A61F 13/15 (2006.01)	2441419	Method of providing a diaper with a contoured leg opening
Adherex Technologies, Inc.	A61K 31/513 (2006.01) A61P 35/00 (2006.01)	2488182 *	TREATING NEUROTOXICITY ASSOCIATED WITH COMBINATIONS OF 5 - FU OR ITS PRODRUGS AND DPD INHIBITORS
Life Medical Division SRL	A61J 1/20 (2006.01)	2459147 *	DEVICE/SYSTEM FOR MIXING LIQUIDS, DRUGS AND SOLUTIONS BEFORE ADMINISTRATION INTO THE HUMAN BODY
Immersion Corporation	G10L 15/22 (2006.01) G06F 3/01 (2006.01) G10L 21/06 (2006.01)	2497004 *	SYSTEMS AND METHODS FOR HAPTIC CONFIRMATION OF COMMANDS
Alporit AG	B32B 27/00 (2006.01)	2399737	Styrene polymer foam compound body
Tranzyme Pharma Inc.	A61K 31/395 (2006.01) C07D 269/00 (2006.01) A61P 1/00 (2006.01) A61K 31/352 (2006.01)	2482813 *	SALTS, SOLVATES, AND PHARMACEUTICAL COMPOSITIONS OF MACROCYCLIC GHRELIN RECEPTOR AGONISTS AND METHODS OF USING THE SAME
Merz Pharma GmbH & Co. KGaA	A61K 31/167 (2006.01) A61P 25/02 (2006.01) C07C 65/21 (2006.01) C07C 235/24 (2006.01) C07C 235/68 (2006.01) C07C 311/51 (2006.01)	2438037 *	GLYCINE B ANTAGONISTS
Sanofi-Aventis Deutschland GmbH	A61M 5/315 (2006.01)	2448620 *	DRIVE MECHANISM AND DRUG DELIVERY DEVICE
Maine Standards Company, LLC	G01N 33/53 (2006.01) G01N 33/566 (2006.01)	2443458 *	METHOD FOR MEASURING LIPOPROTEIN-SPECIFIC APOLIPOPROTEINS

Podnosilac evropske prijave patenta (71)	MKP (51)	Broj objave evropske prijave patenta (97)	Naziv pronalaska (54)
OP S.r.l.	B21D 39/04 (2006.01) B21J 7/14 (2006.01) B21J 13/08 (2006.01)	2420332	Gripper for holding the tools of a radial press
Delphi Technologies Holding S.à.r.l.	F04B 53/00 (2006.01) F04B 53/16 (2006.01) F02M 59/48 (2006.01)	2456981 *	PUMP ASSEMBLY
SANOFI	C07C 57/26 (2006.01) C07C 69/608 (2006.01) C07D 493/18 (2006.01) C07C 51/36 (2006.01) C07C 67/303 (2006.01)	2475635 *	PROCESS FOR THE PRODUCTION OF ARTEMISININ INTERMEDIATES
JX Nippon Oil & Energy Corporation	C07C 45/68 (2006.01) C07C 45/80 (2006.01) C07C 49/617 (2006.01) C07C 49/683 (2006.01) C07C 49/798 (2006.01)	2444386 *	PROCESS FOR PREPARATION OF NORBORNENE DERIVATIVES
TDW Delaware, Inc.	B08B 9/055 (2006.01) F16J 15/32 (2006.01) F16L 55/28 (2006.01)	2409789	Pipeline debris shearing device
Dow AgroSciences LLC	A01N 43/40 (2006.01) A01N 43/18 (2006.01) A01P 13/00 (2006.01) A01N 43/76 (2006.01) A01N 39/02 (2006.01)	2493306 *	SYNERGISTIC HERBICIDAL COMPOSITION CONTAINING FLUROXYPYR AND CYHALOFOP, METAMIFOP OR PROFOXYDIM
Hitachi Power Europe GmbH	E04H 15/00 (2006.01) E04H 15/32 (2006.01) F22B 37/24 (2006.01)	2410108	Fixing system of a covering element
Omya Development AG	C08J 5/18 (2006.01) C08K 9/04 (2006.01) C09C 1/02 (2006.01) C09C 3/08 (2006.01)	2390280	Treated mineral filler products, process for the preparation thereof and uses of same
Merck Sharp & Dohme Corp.	A01N 43/40 (2006.01) A61K 31/445 (2006.01)	2488028 *	SUBSTITUTED PIPERIDINES THAT INCREASE p53 ACTIVITY AND THE USES THEREOF
Axikin Pharmaceuticals, Inc.	C07D 211/96 (2006.01) A61P 25/28 (2006.01) A61K 31/445 (2006.01) C07D 243/08 (2006.01) C07D 295/26 (2006.01) C07C 311/29 (2006.01) C07D 241/04 (2006.01) A61P 11/06 (2006.01) C07D 403/04 (2006.01) C07D 487/04 (2006.01)	2421829 *	2,5-DISUBSTITUTED ARYLSULFONAMIDE CCR3 ANTAGONISTS
Taisho Pharmaceutical Co., Ltd.	A61P 25/22 (2006.01) A61K 31/4164 (2006.01) A61P 25/28 (2006.01) A61P 25/20 (2006.01) A61K 31/4196 (2006.01) A61P 25/30 (2006.01) A61P 25/00 (2006.01) A61P 43/00 (2006.01) C07D 233/90 (2006.01) A61P 25/24 (2006.01) A61P 25/04 (2006.01) C07D 249/10 (2006.01) A61P 25/18 (2006.01)	2454240 *	GLYCINE TRANSPORTER INHIBITORS
Bionap S.r.L.	A61P 9/14 (2006.01) A61K 36/63 (2006.01) A61K 36/33 (2006.01)	2473178 *	COMPOSITION FOR THE TREATMENT OF HEMORRHOIDS AND RELATED DISEASES
North Texas Medical Associates	A61K 31/496 (2006.01) A61K 31/495 (2006.01) A61P 25/24 (2006.01) A61P 25/30 (2006.01) A61K 31/4965 (2006.01)	2477626 *	ROLE OF N-2 HYDROXY-ETHYL-PIPERAZINE-N'-2-ETHANE SULFONIC ACID (HEPES) IN PAIN CONTROL AND REVERSAL OF DEMYELINIZATION INJURY

Podnosilac evropske prijave patenta (71)	MKP (51)	Broj objave evropske prijave patenta (97)	Naziv pronalaska (54)
Burcon Nutrascience (MB) Corp.	A23L 2/02 (2006.01) A23J 3/16 (2006.01) A23J 1/14 (2006.01)	2448424 *	PRODUCTION OF ACID SOLUBLE SOY PROTEIN ISOLATES ("S800")
Treibacher Industrie AG	B01J 37/04 (2006.01) B01J 37/08 (2006.01) B01J 37/03 (2006.01) B01D 53/00 (2006.01) B01J 21/06 (2006.01) B01J 23/00 (2006.01) B01J 23/847 (2006.01) B01J 35/04 (2006.01)	2349531 *	TRANSITION-METAL VANADATE OR MIXED TRANSITION-METAL / RARE EARTH VANADATE BASED CATALYST COMPOSITION FOR SELECTIVE CATALYTIC REDUCTION OF EXHAUST GASES
Bracale, Gennaro	F21S 11/00 (2006.01) F21S 19/00 (2006.01)	2452119 *	TUBULAR SKYLIGHT
VIFOR (INTERNATIONAL) AG	C07D 239/47 (2006.01) C07D 251/18 (2006.01) C07D 251/66 (2006.01) C07D 401/04 (2006.01) C07D 401/14 (2006.01) C07D 403/04 (2006.01) A61K 31/53 (2006.01) A61K 31/506 (2006.01) A61K 31/5377 (2006.01) A61P 7/06 (2006.01)	2473486 *	NOVEL PYRIMIDINE AND TRIAZINE HEPICIDINE ANTAGONISTS
China Academy of Telecommunications Technology	H04W 28/00 (2009.01) H04W 16/28 (2009.01)	2485525 *	METHOD AND DEVICE FOR PERFORMING SPACE COORDINATION AMONG CELLS
Taisho Pharmaceutical Co., Ltd.	A61P 43/00 (2006.01) A61K 31/155 (2006.01) A61P 13/12 (2006.01) A61K 31/4439 (2006.01) A61P 25/00 (2006.01) A61K 31/64 (2006.01) A61P 27/02 (2006.01) A61K 45/00 (2006.01) A61P 3/10 (2006.01) C07D 335/02 (2006.01) A61P 5/50 (2006.01) A61P 9/10 (2006.01) A61K 31/382 (2006.01) A61P 9/14 (2006.01)	2419097 *	PHARMACEUTICAL COMPOSITIONS
Österreichische Staatsdruckerei GmbH	C09D 11/00 (2006.01)	2305761	Ink jet ink
Aerospace & Advanced Composites GmbH	C09D 11/00 (2006.01)	2305761	Ink jet ink
Sanofi-Aventis Deutschland GmbH	A61M 5/315 (2006.01)	2482882 *	DRIVE MECHANISM FOR A DRUG DELIVERY DEVICE AND RESILIENT ELEMENT FOR A DRIVE MECHANISM
Pfizer Inc.	C07D 487/04 (2006.01) A61K 31/519 (2006.01) A61P 37/00 (2006.01)	2488524 *	PYRROLO[2,3-D]PYRIMIDINE COMPOUNDS
Cadila Healthcare Limited	C07D 491/22 (2006.01)	2399919	(S)-4,11-diethyl-3,14-dioxo-3,4,12,14-tetrahydro-1H-pyran [3',4':6,7] indolizino [1.2-b]quinoline-4,9-diyl bis([1,4'-bipiperidine]-carboxylate and its use
Mayo Foundation for Medical Education and Research	G01N 33/50 (2006.01)	2433125 *	METHOD FOR DETERMINING THE CARDIO-GENERATIVE POTENTIAL OF MAMMALIAN CELLS
Cardio3 Biosciences S.A.	G01N 33/50 (2006.01)	2433125 *	METHOD FOR DETERMINING THE CARDIO-GENERATIVE POTENTIAL OF MAMMALIAN CELLS
Ethicon. Inc.	A61F 5/56 (2006.01)	2493435 *	FLUID FILLED IMPLANTS FOR TREATING OBSTRUCTIVE SLEEP APNEA
BioGeneriX AG	C07K 1/18 (2006.01) C07K 1/20 (2006.01) C07K 14/59 (2006.01)	2414380 *	METHOD FOR PURIFYING RECOMBINANT FSH

Podnosilac evropske prijave patenta (71)	MKP (51)	Broj objave evropske prijave patenta (97)	Naziv pronalaska (54)
Dompé S.p.A.	A61P 9/10 (2006.01) A61P 17/00 (2006.01) C07K 14/515 (2006.01) A61K 38/18 (2006.01)	2475681 *	PLGF-1 IN HOMODIMERIC FORM
Geymonat S.p.A.	A61P 9/10 (2006.01) A61P 17/00 (2006.01) C07K 14/515 (2006.01) A61K 38/18 (2006.01)	2475681 *	PLGF-1 IN HOMODIMERIC FORM
Asahi Kasei Chemicals Corporation	C08G 69/26 (2006.01) C08L 77/06 (2006.01)	2476717 *	POLYAMIDE AND POLYAMIDE COMPOSITION
Merck Serono S.A.	C12Q 1/68 (2006.01)	2411533 *	GENETIC SEVERITY MARKERS IN MULTIPLE SCLEROSIS
Teijin Pharma Limited	C07D 401/12 (2006.01) A61K 31/4709 (2006.01) A61P 11/00 (2006.01) A61P 11/06 (2006.01) A61P 43/00 (2006.01) C07D 491/18 (2006.01)	2426121 *	QUATERNARY AMMONIUM SALT COMPOUND
EJOT GmbH & Co. KG	B23K 20/12 (2006.01) B29C 65/06 (2006.01) F16B 37/06 (2006.01)	2289659	Apparatus for frictionally connecting at least two plates through a connecting element with a system for measuring the applied load and the advancing length during connection
Separation Technologies Investments Limited	A23C 7/04 (2006.01) A23C 9/14 (2006.01) A23C 9/142 (2006.01) A23C 21/00 (2006.01) A23J 1/20 (2006.01) A23L 1/29 (2006.01)	2408311 *	WHEY OR RAW MILK DEMINERALISATION AND FRACTIONATION.
Bios International S.r.l.	G01N 33/50 (2006.01) G01N 33/68 (2006.01)	2440924 *	IN VITRO METHOD FOR DETECTING GP91PHOX AS A MARKER OF OXIDATIVE STRESS
Leschik, Udo	C11C 5/00 (2006.01) A61F 11/00 (2006.01)	2453002	Ear candle
BG Medicine, Inc.	G01N 33/15 (2006.01) G01N 33/53 (2006.01) G01N 33/68 (2006.01)	2470911 *	GALECTIN-3 AND CARDIAC RESYNCHRONIZATION THERAPY
Janssen Biotech, Inc.	C12P 21/06 (2006.01)	2425008 *	TOLL-LIKE RECEPTOR 3 ANTAGONISTS
Zeria Pharmaceutical Co., Ltd.	C07D 243/12 (2006.01) A61P 1/04 (2006.01) C07C 269/06 (2006.01) A61P 35/00 (2006.01) C07C 271/20 (2006.01) A61P 35/02 (2006.01) C07C 271/28 (2006.01) A61P 43/00 (2006.01) C07C 303/36 (2006.01) C07B 61/00 (2006.01) C07C 303/40 (2006.01) C07C 311/16 (2006.01) A61K 31/551 (2006.01)	2415766 *	METHOD FOR MANUFACTURING BENZODIAZEPINE DERIVATIVE
Messer Group GmbH	B01J 2/06 (2006.01)	2305372	Device and method for pelletising or granulating a fluid or paste material
Messer Austria GmbH	B01J 2/06 (2006.01)	2305372	Device and method for pelletising or granulating a fluid or paste material
Ethicon. Inc.	A61F 5/56 (2006.01)	2493436 *	FLEXIBLE IMPLANTS HAVING INTERNAL VOLUME SHIFTING CAPABILITIES FOR TREATING OBSTRUCTIVE SLEEP APNEA
ART-LEG-d.o.o.	A61F 2/64 (2006.01)	2471496	Prosthetic knee used preferably for sports
AstraZeneca AB	C07D 413/04 (2006.01) A61K 31/4523 (2006.01) A61P 7/04 (2006.01)	2417131 *	ISOXAZOL-3(2H)-ONE ANALOGS AS THERAPEUTIC AGENTS

Podnosilac evropske prijave patenta (71)	MKP (51)	Broj objave evropske prijave patenta (97)	Naziv pronalaska (54)
Omya Development AG	C09C 1/02 (2006.01) C04B 14/28 (2006.01) C04B 20/10 (2006.01) C04B 28/02 (2006.01)	2423265	Process for the preparation of cement, mortars, concrete compositions containing a calcium carbonate-based filler (pre)-treated with a superplasticizer, compositions and cement products obtained and their applications
Vanda Pharmaceuticals Inc.	C12Q 1/68 (2006.01)	2430183 *	ANTIPSYCHOTIC TREATMENT BASED ON DRD2 OR ANKK1 SNP GENOTYPE
SIGMA-TAU Industrie Farmaceutiche Riunite S.p.A.	A61P 29/00 (2006.01) A61P 35/00 (2006.01) C07K 5/00 (2006.01) A61K 38/00 (2006.01)	2490766 *	NON-NATURAL MACROCYCLIC AMIDE HDAC6 INHIBITOR COMPOUNDS AND THEIR USES AS THERAPEUTIC AGENTS
Sony Computer Entertainment Inc.	G06Q 30/00 (2006.01)	2323095	Mediation of content-related services
Affitech Research AS	C07K 16/28 (2006.01)	2440579 *	ANTIBODIES
Inotek Pharmaceuticals Corporation	A61P 27/02 (2006.01) A61K 31/7076 (2006.01)	2493480 *	OPHTHALMIC FORMULATION AND METHOD OF MANUFACTURE THEREOF
Nayak, Ramesh C.	C12Q 1/00 (2006.01)	2464741 *	METHODS OF DETECTING RESPONSES TO THERAPIES USING PERFORIN LEVELS
Dolby Laboratories Licensing Corporation	H04S 3/00 (2006.01) G10L 19/00 (2006.01)	2360683	Audio decoder and decoding method using efficient downmixing
Dolby International AB	H04S 3/00 (2006.01) G10L 19/00 (2006.01)	2360683	Audio decoder and decoding method using efficient downmixing
Shionogi & Co., Ltd.	A61K 31/4412 (2006.01) A61K 31/497 (2006.01) C07D 401/04 (2006.01) A61K 31/443 (2006.01) A61K 31/506 (2006.01) C07D 401/06 (2006.01) A61K 31/4433 (2006.01) A61K 31/5377 (2006.01) C07D 401/10 (2006.01) A61K 31/4436 (2006.01) A61P 31/00 (2006.01) A61K 31/4439 (2006.01) A61P 31/16 (2006.01) A61K 31/444 (2006.01) A61P 31/18 (2006.01) A61K 31/4545 (2006.01) A61P 43/00 (2006.01) C07D 213/80 (2006.01) A61K 31/4709 (2006.01) C07D 213/89 (2006.01)	2412708 *	SUBSTITUTED 3-HYDROXY-4-PYRIDONE DERIVATIVE
Alize Pharma II	C12N 9/82 (2006.01) A61P 35/02 (2006.01) A61K 47/48 (2006.01)	2451486 *	PEGYLATED L-ASPARAGINASE
Hailo-Werk Rudolf Loh GmbH & Co. KG	B65F 1/06 (2006.01)	2354041	Refuse receptacle with means for fixing a trash bag
Takeda Pharmaceutical Company Limited	A61K 9/20 (2006.01) A61K 47/04 (2006.01) A61K 47/38 (2006.01) A61K 31/506 (2006.01)	2460523 *	TABLET
Sanofi-Aventis Deutschland GmbH	A61M 5/32 (2006.01)	2403570 *	DRUG DELIVERY DEVICE
TDK Corporation	H01F 41/02 (2006.01) H01F 1/057 (2006.01)	2372726	Rare-earth magnet, method of manufacturing rare-earth magnet and rotator
SANOFI	C07H 17/02 (2006.01)	2470552 *	NOVEL CRYSTALLINE HETEROAROMATIC FLUOROGLYCOSIDE HYDRATES, PHARMACEUTICALS COMPRISING THESE COMPOUNDS AND THEIR USE
Photocure ASA	A61K 47/14 (2006.01) A61K 31/197 (2006.01) A61K 9/20 (2006.01) A61K 9/48 (2006.01) A61K 9/02 (2006.01)	2440188 *	SOLID COMPOSITIONS COMPRISING 5-AMINOLEVULINIC ACID

Podnosilac evropske prijave patenta (71)	MKP (51)	Broj objave evropske prijave patenta (97)	Naziv pronalaska (54)
Almirall S.A.	C07D 213/803 (2006.01) C07C 211/45 (2006.01) C07C 211/64 (2006.01) C07D 213/80 (2006.01)	2488497 *	PROCESS FOR MANUFACTURING 2-[(3,5-DIFLUORO-3'-METHOXY-1,1'-BIPHENYL-4-YL) AMINO]NICOTINIC ACID
Ethicon Endo-Surgery, Inc.	A61B 17/00 (2006.01) A61B 17/29 (2006.01) A61B 17/28 (2006.01) A61B 18/08 (2006.01) A61B 18/00 (2006.01)	2485661 *	SURGICAL INSTRUMENT
Genentech, Inc.	C07K 16/18 (2006.01) C07K 16/00 (2006.01)	2403874 *	ANTIBODY FORMULATION
Burcon Nutrascience (MB) Corp.	A23J 1/14 (2006.01) A23J 3/16 (2006.01) A23L 2/02 (2006.01)	2448423 *	PRODUCTION OF ACID SOLUBLE SOY PROTEIN ISOLATES ("S700")
ALEXION PHARMACEUTICALS, INC.	G01N 33/577 (2006.01) G01N 33/50 (2006.01) G01N 33/68 (2006.01) G01N 33/53 (2006.01)	2499494 *	REAGENTS AND METHODS FOR DETECTING PNH TYPE II WHITE BLOOD CELLS AND THEIR IDENTIFICATION AS RISK FACTORS FOR THROMBOTIC DISORDERS
Amgen Inc.	C12P 21/06 (2006.01) C07K 16/00 (2006.01)	2451840 *	DESIGN OF STABLE AND AGGREGATION FREE ANTIBODY FC MOLECULES THROUGH CH3 DOMAIN INTERFACE ENGINEERING
GlaxoSmithKline Biologicals S.A.	A61K 39/12 (2006.01) C07K 14/025 (2006.01)	2445525 *	NOVEL HUMAN PAPILOMAVIRUS (HPV) PROTEIN CONSTRUCTS AND THEIR USE IN THE PREVENTION OF HPV DISEASE
Genentech, Inc.	A61K 31/519 (2006.01) A61P 35/00 (2006.01)	2405916 *	COMBINATIONS OF PHOSPHOINOSITIDE 3-KINASE INHIBITOR COMPOUNDS AND CHEMOTHERAPEUTIC AGENTS FOR THE TREATMENT OF HEMATOPOIETIC MALIGNANCIES
Arco S.R.L.	E02B 3/20 (2006.01)	2454417 *	DEVICE FOR PROTECTING A BERTHING PLACE
Baron Services, Inc.	G06T 17/00 (2006.01) G01S 13/95 (2006.01) G06F 3/14 (2006.01)	2417580 *	SYSTEM FOR DRAPING METEOROLOGICAL DATA ON A THREE DIMENSIONAL TERRAIN IMAGE
Pearl Therapeutics, Inc.	A61K 9/12 (2006.01) A61P 11/00 (2006.01)	2435024 *	COMPOSITIONS FOR RESPIRATORY DELIVERY OF ACTIVE AGENTS AND ASSOCIATED METHODS AND SYSTEMS
Janssen Pharmaceuticals Inc.	C07D 519/00 (2006.01) C07D 471/04 (2006.01) A61K 31/437 (2006.01) A61P 25/00 (2006.01)	2430031 *	1,2,4-TRIAZOLO[4,3-A]PYRIDINE DERIVATIVES AND THEIR USE AS POSITIVE ALLOSTERIC MODULATORS OF MGLUR2 RECEPTORS
Addex Pharma SA	C07D 519/00 (2006.01) C07D 471/04 (2006.01) A61K 31/437 (2006.01) A61P 25/00 (2006.01)	2430031 *	1,2,4-TRIAZOLO[4,3-A]PYRIDINE DERIVATIVES AND THEIR USE AS POSITIVE ALLOSTERIC MODULATORS OF MGLUR2 RECEPTORS
St. Jude Children's Research Hospital	C12N 5/0783 (2010.01) A61K 39/395 (2006.01) C07K 16/24 (2006.01)	2470566 *	COMPOSITIONS AND METHODS FOR POTENTIATING INTERLEUKIN-35
Image Holdings	G07F 11/54 (2006.01)	2478499 *	METHOD AND SYSTEM OF DISPLAYING, MANAGING AND SELLING IMAGES IN AN EVENT PHOTOGRAPHY ENVIRONMENT
Amphenol-Tuchel Electronics GmbH	H01R 13/24 (2006.01) H01R 13/33 (2006.01) H01R 43/16 (2006.01) H01R 12/04 (2006.01) H01R 12/22 (2006.01)	2237378	Contact device
BioAmber S.A.S.	C07C 51/41 (2006.01) C07C 51/02 (2006.01) C07C 51/46 (2006.01) C07C 55/10 (2006.01) C07C 51/44 (2006.01)	2371800	Processes for producing monoammonium succinate from fermentation broths containing diammonium succinate, monoammonium succinate and/or succinic acid, and conversion of monoammonium succinate to succinic acid
The Regents of the University of California Office of Technology Transfer	A61K 31/4166 (2006.01)	2429522 *	METHOD OF DECREASING UBIQUITYLATED PROTEIN LEVELS

Podnosilac evropske prijave patenta (71)	MKP (51)	Broj objave evropske prijave patenta (97)	Naziv pronalaska (54)
ZENYAKU KOGYO KABUSHIKKAISHA	A61K 31/4166 (2006.01)	2429522 *	METHOD OF DECREASING UBIQUITYLATED PROTEIN LEVELS
Teijin Pharma Limited	C07C 327/48 (2006.01)	2441752 *	METHOD FOR PRODUCING 4-SUBSTITUTED BENZOTHIOAMIDE DERIVATIVE
Boehringer Ingelheim International GmbH	A61K 31/5377 (2006.01) A61P 11/00 (2006.01) A61P 35/00 (2006.01) C07D 239/94 (2006.01)	2414338 *	SALTS AND HYDRATES OF 4-[(3-CHLOR-4-FLUORO-PHENYL)AMINO]-6-(CIS-4-[N-[(MORPH-1-OLINO-4-YL)CARBONYL]-N-METHYL-AMINO]-CYCLOHEXANE-1-YLOXY)-7-METHOXY-QUINAZOLINE, THEIR USE AS DRUGS AND THEIR PRODUCTION
The University of North Carolina at Chapel Hill	G01N 33/52 (2006.01) C12N 15/11 (2006.01) C12Q 1/68 (2006.01)	2459752 *	ENTEROCOCCUS AND FECAL BACTEROIDES FOR RAPID WATER QUALITY ASSESSMENT
Kristjansson, Eythor	A61B 5/11 (2006.01)	2451352 *	METHOD FOR ACCURATE ASSESSMENT AND GRADED TRAINING OF SENSORIMOTOR FUNCTIONS
Cephalon, Inc.	A61K 31/407 (2006.01) A61P 25/28 (2006.01) C07D 487/04 (2006.01)	2470540 *	NOVEL FORMS OF A MULTICYCLIC COMPOUND
INNOVATION FACTORY S.R.L.	B01J 2/18 (2006.01) A61K 9/16 (2006.01) B01J 2/04 (2006.01)	2473266 *	METHOD AND APPARATUS FOR PREPARING MICRO-PARTICLES OF POLYSACCHARIDES
Fondazione Carlo e Dirce Callerio Onlus	B01J 2/18 (2006.01) A61K 9/16 (2006.01) B01J 2/04 (2006.01)	2473266 *	METHOD AND APPARATUS FOR PREPARING MICRO-PARTICLES OF POLYSACCHARIDES
Universität Duisburg- Essen	A61K 31/663 (2006.01) A61P 25/00 (2006.01) A61K 31/661 (2006.01) C07F 9/12 (2006.01) C07F 9/40 (2006.01)	2403859 *	MOLECULAR TWEEZERS FOR THE TREATMENT OF AMYLOID-RELATED DISEASES
Department of Veterans Affairs	A61K 31/663 (2006.01) A61P 25/00 (2006.01) A61K 31/661 (2006.01) C07F 9/12 (2006.01) C07F 9/40 (2006.01)	2403859 *	MOLECULAR TWEEZERS FOR THE TREATMENT OF AMYLOID-RELATED DISEASES
The Regents of the University of California	A61K 31/663 (2006.01) A61P 25/00 (2006.01) A61K 31/661 (2006.01) C07F 9/12 (2006.01) C07F 9/40 (2006.01)	2403859 *	MOLECULAR TWEEZERS FOR THE TREATMENT OF AMYLOID-RELATED DISEASES
Massachusetts Institute of Technology	A61K 31/663 (2006.01) A61P 25/00 (2006.01) A61K 31/661 (2006.01) C07F 9/12 (2006.01) C07F 9/40 (2006.01)	2403859 *	MOLECULAR TWEEZERS FOR THE TREATMENT OF AMYLOID-RELATED DISEASES
Otos Wing Co., Ltd.	B23K 37/00 (2006.01) B23K 9/32 (2006.01) A42B 3/04 (2006.01) A42B 3/22 (2006.01) A61F 9/06 (2006.01) F16P 1/06 (2006.01) G10K 11/18 (2006.01)	2338636	Anti-blinding device having wireless communication function
SANOFI	C07D 493/22 (2006.01) C07C 69/96 (2006.01)	2473512 *	PHOTOCHEMICAL PROCESS FOR PRODUCING ARTEMISININ
Janssen Biotech, Inc.	A61M 5/32 (2006.01)	2488237 *	PALM ACTIVATED DRUG DELIVERY DEVICE
Linde AG	F23K 3/02 (2006.01)	2486327 *	METERING SYSTEM, DENSE PHASE CONVEYING SYSTEM AND METHOD FOR SUPPLYING BULK MATERIAL IN POWDER FORM
Sumika Polymer Compounds (France) SA	F24J 2/04 (2006.01) F24J 2/52 (2006.01) F24J 2/46 (2006.01) F24J 2/51 (2006.01)	2419679 *	Moulded insulating collector

Podnosilac evropske prijave patenta (71)	MKP (51)	Broj objave evropske prijave patenta (97)	Naziv pronalaska (54)
Laboratoire HRA Pharma	A61K 31/56 (2006.01) A61K 31/57 (2006.01) A61K 9/20 (2006.01)	2419108 *	METHOD FOR ON-DEMAND CONTRACEPTION
Concert Pharmaceuticals Inc.	C07D 209/46 (2006.01) C07D 209/48 (2006.01) C07D 405/12 (2006.01) A61K 31/4035 (2006.01) A61P 17/06 (2006.01)	2443089 *	DEUTERATED I SOINDOLINE- I, 3-DIONE DERIVATIVES AS PDE4 AND TNF-ALPHA INHIBITORS
Polat, Candemir	A61G 12/00 (2006.01)	2368535	People monitoring system
Novartis AG	G06F 19/00 (2011.01) A61K 31/137 (2006.01) A61P 37/06 (2006.01) A61P 11/06 (2006.01)	2482810 *	DOSAGE REGIMEN OF AN S1P RECEPTOR MODULATOR
GlaxoSmithKline Biologicals S.A.	C07K 14/34 (2006.01)	2486047 *	EXPRESSION SYSTEM
J-Lok Co.	C09K 17/32 (2006.01) C09K 17/14 (2006.01)	2496663 *	RESIN SYSTEM WITH CARBON ADDITIVE
Hagleitner, Hans Georg	A47K 5/12 (2006.01)	2322066	Method and dispenser for releasing portions of a fluid
Bristol-Myers Squibb Company	A61K 31/40 (2006.01) A61K 31/4985 (2006.01) A61P 9/00 (2006.01) A61P 3/00 (2006.01)	2411005 *	METHODS FOR PREVENTING MAJOR ADVERSE CARDIOVASCULAR EVENTS WITH DPP-IV INHIBITORS
AstraZeneca UK Limited	A61K 31/40 (2006.01) A61K 31/4985 (2006.01) A61P 9/00 (2006.01) A61P 3/00 (2006.01)	2411005 *	METHODS FOR PREVENTING MAJOR ADVERSE CARDIOVASCULAR EVENTS WITH DPP-IV INHIBITORS
Laboratorios SALVAT, S.A.	A61K 31/472 (2006.01) C07D 295/104 (2006.01) A61K 31/4709 (2006.01)	2439202 *	INHIBITOR COMPOUNDS OF 11-BETA-HYDROXYSTEROID DEHYDROGENASE TYPE 1
B.R.A.I.N. Biotechnology Research And Information Network AG	C12N 9/64 (2006.01) C07K 16/40 (2006.01) A61K 38/43 (2006.01) C12N 15/62 (2006.01) C12N 5/10 (2006.01)	2245150 *	PROTEASE FOR WOUND CONDITIONING AND SKIN CARE
Ascendis Pharma A/S	A61K 9/10 (2006.01) A61K 9/50 (2006.01) A61K 47/10 (2006.01) A61K 9/16 (2006.01) A61K 9/28 (2006.01)	2459220 *	BIODEGRADABLE POLYETHYLENE GLYCOL BASED WATER-INSOLUBLE HYDROGELS
Nestec S.A.	A23L 1/16 (2006.01) A23L 1/39 (2006.01) A23L 1/162 (2006.01) A23L 1/00 (2006.01)	2418966 *	WHOLEGRAIN INSTANT PASTA
Sanofi-Aventis Deutschland GmbH	A61M 5/32 (2006.01)	2403568 *	NEEDLE UNIT
SANOFI	A61K 31/4706 (2006.01) A61K 33/26 (2006.01) A61P 33/06 (2006.01)	2493573 *	USE OF FERROQUINE IN THE TREATMENT OR PREVENTION OF MALARIA
Delphi Technologies Holding S.à.r.l.	F01N 3/20 (2006.01)	2388452	Reagent dosing device
SANOFI	A61K 31/4745 (2006.01) C07D 471/04 (2006.01) A61P 35/00 (2006.01)	2421864 *	1-PYRAZOLO[4,3-C]ISOQUINOLINE DERIVATIVES, PREPARATION THEREOF AND THERAPEUTIC USE THEREOF
Advancell Advanced in Vitro Cell Technologies, S.A.	A61K 9/00 (2006.01) A61P 17/02 (2006.01) A61K 31/52 (2006.01) A61K 31/519 (2006.01)	2424538 *	USE OF ALLOPURINOL FOR THE TREATMENT OF HAND FOOT SKIN REACTION
Nobera Pharma, S.L.	A61K 9/00 (2006.01) A61P 17/02 (2006.01) A61K 31/52 (2006.01) A61K 31/519 (2006.01)	2424538 *	USE OF ALLOPURINOL FOR THE TREATMENT OF HAND FOOT SKIN REACTION

Podnosilac evropske prijave patenta (71)	MKP (51)	Broj objave evropske prijave patenta (97)	Naziv pronalaska (54)
Navico, Inc.	G01S 15/96 (2006.01) G01S 15/89 (2006.01)	2454607 *	DOWNSCAN IMAGING SONAR
Sanofi-Aventis Deutschland GmbH	A61K 38/26 (2006.01) A61P 3/10 (2006.01) A61K 47/18 (2006.01)	2498801 *	PHARMACEUTICAL COMPOSITION COMPRISING A GLP-1 AGONIST AND METHIONINE
Lifescan, Inc.	G06F 19/00 (2011.01)	2449492 *	ANALYTE TESTING METHOD AND SYSTEM
BioAmber International S.A.R.L.	C07C 51/44 (2006.01) C07D 307/08 (2006.01) C07D 307/33 (2006.01) C07C 51/41 (2006.01) C07C 29/136 (2006.01) C07C 51/02 (2006.01)	2371797	Processes for the production of tetrahydrofuran, gamma-butyrolactone and/or butanediol from salts of succinic acid
Nycomed GmbH	A61P 11/00 (2006.01) C07D 487/04 (2006.01) A61K 31/519 (2006.01)	2470536 *	METHYLPYRROLOPYRIMIDINECARBOXAMIDES
Omya Development AG	C09C 1/02 (2006.01) C01F 5/24 (2006.01)	2496648 *	PRECIPITATED MAGNESIUM CARBONATE
Janssen Pharmaceutica, N.V.	C07D 417/12 (2006.01) C07D 409/12 (2006.01) C07D 495/04 (2006.01) C07D 403/14 (2006.01) C07D 417/14 (2006.01) A61K 31/496 (2006.01) C07D 403/12 (2006.01) A61P 29/00 (2006.01) C07D 401/12 (2006.01) A61P 25/00 (2006.01)	2421851 *	AZETIDINYL DIAMIDES AS MONOACYLGLYCEROL LIPASE INHIBITORS
SANOFI	A61P 35/00 (2006.01) C07K 16/46 (2006.01) C07K 16/30 (2006.01) A61K 31/537 (2006.01) C12P 21/08 (2006.01) C07D 498/18 (2006.01)	2483279 *	NEW MAYTANSINOIDS AND THE USE OF SAID MAYTANSINOIDS TO PREPARE CONJUGATES WITH AN ANTIBODY
Sanofi-Aventis Deutschland GmbH	A61M 5/32 (2006.01)	2424598 *	NEEDLE REMOVER AND METHOD FOR REMOVING A NEEDLE
Sanofi-Aventis Deutschland GmbH	A61M 5/178 (2006.01) A61M 5/315 (2006.01)	2437805 *	A DRIVE MECHANISM FOR A DRUG DELIVERY DEVICE
Sanofi-Aventis Deutschland GmbH	A61M 5/315 (2006.01) A61M 5/24 (2006.01)	2485791 *	DRIVE MECHANISM FOR DRUG DELIVERY DEVICES
Janssen Pharmaceutica, N.V.	C07D 401/08 (2006.01) A61P 29/00 (2006.01) C07D 403/08 (2006.01) C07D 405/08 (2006.01) C07D 413/08 (2006.01) C07D 417/08 (2006.01) A61K 31/4427 (2006.01) A61K 31/437 (2006.01) A61K 31/433 (2006.01) A61P 3/10 (2006.01)	2419418 *	4-AZETIDINYL-1-HETEROATOM LINKED-CYCLOHEXANE ANTAGONISTS OF CCR2
Abbott Laboratories	A61K 9/00 (2006.01) A61K 31/5377 (2006.01) A61K 47/02 (2006.01) A61K 9/10 (2006.01)	2442789 *	STABLE NANOPARTICULATE DRUG SUSPENSION
De Gennaro, Roberto	E05C 19/00 (2006.01)	2400090	An anti-intrusion device for doors and windows in general
F-Star Biotechnologische Forschungs- und Entwicklungsges. M.B.H.	C07K 16/30 (2006.01) C07K 16/32 (2006.01)	2407487	Multispecific modular antibody
UNICAL AG S.p.A.	F28D 21/00 (2006.01) F28F 1/40 (2006.01) F28F 21/08 (2006.01)	2409105 *	TUBE FOR CONVEYING EXHAUST GASES IN HEAT EXCHANGE DEVICES, PARTICULARLY BOILERS FOR GENERATING HOT WATER OR STEAM
Sanchez De La Cruz, Jose Manuel	G08B 21/00 (2006.01) E01F 9/017 (2006.01)	2460937 *	Highway protection barrier

Podnosilac evropske prijave patenta (71)	MKP (51)	Broj objave evropske prijave patenta (97)	Naziv pronalaska (54)
Dejero Labs Inc.	H04L 5/00 (2006.01) H04N 7/24 (2011.01)	2273715	Multipath data streaming over a wireless network
Sanofi-Aventis Deutschland GmbH	A61M 5/315 (2006.01)	2437828 *	DRUG DELIVERY DEVICE INNER HOUSING HAVING HELICAL SPLINE
Ignucell AB	B29C 67/20 (2006.01) B29C 44/56 (2006.01) B29C 44/30 (2006.01) B29C 44/34 (2006.01)	2366532	Apparatus and method for production of insulating and draining boards
Biomérieux	C07K 14/20 (2006.01) G01N 33/569 (2006.01)	2470908 *	PROTEINS USED FOR THE DIAGNOSIS OF LYME BORRELIOSIS
AstraZeneca AB	A61K 31/351 (2006.01) A61P 11/00 (2006.01) C07D 309/14 (2006.01)	2427445 *	SUBSTITUTED 1-CYANOETHYLHETEROCYCLYL CARBOXAMIDE COMPOUNDS 750
SANOFI	F16K 25/00 (2006.01)	2430344 *	HIGH-PRESSURE HOMOGENISATION WITH A SILICON NITRIDE VALVE
ABB Research Ltd.	H04W 72/00 (2009.01)	2413649	Wireless communication method and system with collision avoidance protocol
Eurochit Danuta Kruszezwska	A61P 31/04 (2006.01) C12R 1/225 (2006.01) A61K 35/74 (2006.01) A23L 1/30 (2006.01)	2457575	New method for obtaining a <i>Lactobacillus reuteri</i> strain useful in medical and veterinary prophylaxis and treatment
Sanofi-Aventis Deutschland GmbH	A61M 5/315 (2006.01)	2424597 *	AXIALLY ADJUSTABLE CONNECTION OF PISTON ROD TO PISTON FOR DRIVE MECHANISM OF A DRUG DELIVERY DEVICE
Dorma GmbH + Co. KG	E05F 3/10 (2006.01)	2456941 *	DOOR CLOSER
Georgia-Pacific France	B31C 3/00 (2006.01) D21H 17/28 (2006.01) D21H 17/29 (2006.01) D21H 19/54 (2006.01) D21H 25/04 (2006.01) D21H 27/00 (2006.01)	2461967 *	FIBROUS SHEET THAT DISINTEGRATES IN WATER, PROCESS FOR MANUFACTURING SAID FIBROUS SHEET, CORE CONSISTING OF STRIPS OF SAID FIBROUS SHEET
Krüger GmbH & Co. KG	A23L 1/236 (2006.01) A23L 1/00 (2006.01) A23G 3/44 (2006.01) A23G 3/42 (2006.01)	2432332 *	SUCRALOSE-CONTAINING ARTIFICIAL SWEETENER COMPOSITIONS
Dow AgroSciences, LLC	A01N 47/36 (2006.01) A01N 39/04 (2006.01) A01N 43/40 (2006.01)	2498604 *	SYNERGISTIC HERBICIDAL COMPOSITION CONTAINING AMINOPYRALID AND SULFONYLUREAS
Ascendis Pharma A/S	A61K 47/48 (2006.01)	2403537 *	INTERFERON ALPHA CARRIER PRODRUGS
Omya Development AG	C09C 3/10 (2006.01) B29B 9/12 (2006.01) C09C 1/02 (2006.01) C08K 9/00 (2006.01)	2445973 *	PROCESS FOR MANUFACTURING A SURFACE-TREATED COMPACTED MATERIAL PROCESSABLE ON A SINGLE SCREW PLASTICS CONVERSION EQUIPMENT
Sanofi-Aventis Deutschland GmbH	A61M 5/24 (2006.01)	2437811 *	RESETTABLE DRUG DELIVERY DEVICE
Yeda Research and Development Co., Ltd.	A01N 37/12 (2006.01) A01N 37/44 (2006.01) A61K 31/195 (2006.01)	2405749 *	LOW FREQUENCY GLATIRAMER ACETATE THERAPY
Tradapharma SAGL	A61K 31/722 (2006.01) A23L 1/30 (2006.01) A61K 36/185 (2006.01) A61K 36/06 (2006.01) A61K 36/234 (2006.01) A61P 15/10 (2006.01) A23L 1/29 (2006.01)	2477633 *	"DIETARY SUPPLEMENT STIMULATING THE MALE SEXUAL FUNCTION"
Baylor College Of Medicine	C12N 5/0783 (2010.01)	2470644 *	GENERATION OF CTL LINES WITH SPECIFICITY AGAINST MULTIPLE TUMOR ANTIGENS OR MULTIPLE VIRUSES
Wilson Wolf Manufacturing	C12N 5/0783 (2010.01)	2470644 *	GENERATION OF CTL LINES WITH SPECIFICITY AGAINST MULTIPLE TUMOR ANTIGENS OR MULTIPLE VIRUSES

Podnosilac evropske prijave patenta (71)	MKP (51)	Broj objave evropske prijave patenta (97)	Naziv pronalaska (54)
Boxmark Leather proizvodnja in trgovina d.o.o.	C14C 15/00 (2006.01) C14B 3/00 (2006.01)	2481821	Process and device for treating leather
Les Laboratoires Servier	A61K 45/06 (2006.01) A61P 9/04 (2006.01) A61K 31/55 (2006.01) A61K 31/4045 (2006.01)	2404600	Use of the combination of a sinus current If inhibitor and an inhibitor of the angiotensin conversion enzyme for treating cardiac insufficiency
Nobel Biocare Services AG	A61C 8/00 (2006.01)	2407121	Abutment system
Japan Oil, Gas and Metals National Corporation	C10G 45/72 (2006.01) C10G 45/02 (2006.01)	2497816 *	METHOD FOR HYDROFINING NAPHTHA FRACTION AND PROCESS FOR PRODUCING HYDROCARBON OIL
INPEX Corporation	C10G 45/72 (2006.01) C10G 45/02 (2006.01)	2497816 *	METHOD FOR HYDROFINING NAPHTHA FRACTION AND PROCESS FOR PRODUCING HYDROCARBON OIL
JX Nippon Oil & Energy Corporation	C10G 45/72 (2006.01) C10G 45/02 (2006.01)	2497816 *	METHOD FOR HYDROFINING NAPHTHA FRACTION AND PROCESS FOR PRODUCING HYDROCARBON OIL
Japan Petroleum Exploration Co., Ltd.	C10G 45/72 (2006.01) C10G 45/02 (2006.01)	2497816 *	METHOD FOR HYDROFINING NAPHTHA FRACTION AND PROCESS FOR PRODUCING HYDROCARBON OIL
Cosmo Oil Co., Ltd.	C10G 45/72 (2006.01) C10G 45/02 (2006.01)	2497816 *	METHOD FOR HYDROFINING NAPHTHA FRACTION AND PROCESS FOR PRODUCING HYDROCARBON OIL
Nippon Steel Engineering Co., Ltd	C10G 45/72 (2006.01) C10G 45/02 (2006.01)	2497816 *	METHOD FOR HYDROFINING NAPHTHA FRACTION AND PROCESS FOR PRODUCING HYDROCARBON OIL
Nanotec Solution	G01L 9/00 (2006.01) G01L 9/12 (2006.01) G01L 9/04 (2006.01) G01B 7/02 (2006.01)	2462418 *	CAPACITIVE PRESSURE SENSOR INCORPORATING A TEMPERATURE MEASUREMENT AND COMPATIBLE WITH HOT ENVIRONMENTS
Baxter Healthcare SA	A61K 9/00 (2006.01) A61K 47/36 (2006.01) A61K 47/42 (2006.01) A61K 39/00 (2006.01) A61K 39/395 (2006.01) C07K 16/00 (2006.01) C07K 16/06 (2006.01) C12N 9/24 (2006.01)	2477603 *	STABLE CO-FORMULATION OF HYALURONIDASE AND IMMUNOGLOBULIN, AND METHODS OF USE THEREOF
Baxter International Inc	A61K 9/00 (2006.01) A61K 47/36 (2006.01) A61K 47/42 (2006.01) A61K 39/00 (2006.01) A61K 39/395 (2006.01) C07K 16/00 (2006.01) C07K 16/06 (2006.01) C12N 9/24 (2006.01)	2477603 *	STABLE CO-FORMULATION OF HYALURONIDASE AND IMMUNOGLOBULIN, AND METHODS OF USE THEREOF
Eli Lilly and Company	A61K 31/5517 (2006.01) A61P 35/02 (2006.01)	2419106 *	BENZODIAZEPINE DERIVATIVE FOR THE TREATMENT OF HEMATOPOIETIC NEOPLASM AND LEUKEMIA
E. I. du Pont de Nemours and Company	C07D 401/12 (2006.01) C07D 401/14 (2006.01) C07D 401/04 (2006.01) C07D 403/12 (2006.01) C07D 407/12 (2006.01) C07D 231/12 (2006.01) C07D 409/04 (2006.01) C07D 231/20 (2006.01) C07D 417/12 (2006.01) C07D 231/38 (2006.01) A61K 31/4155 (2006.01)	2403834 *	Fungicidal pyrazoles

Podnosilac evropske prijave patenta (71)	MKP (51)	Broj objave evropske prijave patenta (97)	Naziv pronalaska (54)
Huf Hülsbeck & Fürst GmbH & Co. KG	G07C 9/00 (2006.01) E05B 19/04 (2006.01) H01H 13/06 (2006.01) B60R 25/00 (2006.01) E05B 47/06 (2006.01)	2336982	Mobile device
Pierre Fabre Dermo-Cosmétique	A61P 17/00 (2006.01) A01N 31/16 (2006.01) C07C 317/22 (2006.01) A01N 39/00 (2006.01) C07C 323/20 (2006.01) A01N 41/10 (2006.01) A61K 8/46 (2006.01) A01P 1/00 (2006.01) A61Q 5/08 (2006.01) A61Q 19/02 (2006.01) A61Q 19/08 (2006.01)	2417104 *	SULPHURATED DERIVATIVES OF RESORCINOL, PREPARATION OF SAME AND COSMETIC USES THEREOF
SANOFI	C12Q 1/48 (2006.01) C12N 9/10 (2006.01)	2446050 *	TEST SYSTEM FOR MEASURING MEST ACTIVITY AS WELL AS METHODS AND USES INVOLVING THE SAME
SANOFI	C12Q 1/37 (2006.01) G01N 33/573 (2006.01) G01N 33/68 (2006.01)	2473855 *	USE OF CATHEPSIN H
adp Gauselmann GmbH	G07F 17/32 (2006.01)	2413297	Method for limiting the number of coin-operated entertainment machines a player can use.
Janssen Pharmaceutica, N.V.	C07D 409/10 (2006.01) C07D 409/14 (2006.01) C07F 3/06 (2006.01)	2488515 *	PROCESS FOR THE PREPARATION OF COMPOUNDS USEFUL AS INHIBITORS OF SGLT2
Abraxis BioScience, LLC	G01N 33/53 (2006.01)	2419732 *	PRION-FREE NANOPARTICLE COMPOSITIONS AND METHODS
Nobel Biocare Services AG	A61C 8/00 (2006.01)	2407120	Implant system
Abbott Laboratories	A61K 39/395 (2006.01) C07K 16/00 (2006.01)	2493924 *	DUAL VARIABLE DOMAIN IMMUNOGLOBULINS AND USES THEREOF
Aker Biomarine ASA	A61K 35/56 (2006.01)	2435055 *	METHODS OF USING KRILL OIL TO TREAT RISK FACTORS FOR METABOLIC DISORDERS AND OBESITY
Tsopanoglou, Nikos	A61K 38/16 (2006.01) C07K 14/705 (2006.01) C12N 5/071 (2010.01)	2483302 *	PARSTATIN PEPTIDES
Maragoudakis, Michael	A61K 38/16 (2006.01) C07K 14/705 (2006.01) C12N 5/071 (2010.01)	2483302 *	PARSTATIN PEPTIDES
Vinores, Stanley	A61K 38/16 (2006.01) C07K 14/705 (2006.01) C12N 5/071 (2010.01)	2483302 *	PARSTATIN PEPTIDES
Strande, Jennifer	A61K 38/16 (2006.01) C07K 14/705 (2006.01) C12N 5/071 (2010.01)	2483302 *	PARSTATIN PEPTIDES
Gartaganis, Sotirios	A61K 38/16 (2006.01) C07K 14/705 (2006.01) C12N 5/071 (2010.01)	2483302 *	PARSTATIN PEPTIDES
Siablis, Dimitrios	A61K 38/16 (2006.01) C07K 14/705 (2006.01) C12N 5/071 (2010.01)	2483302 *	PARSTATIN PEPTIDES
H. Lundbeck A/S	C07D 295/135 (2006.01)	2430008 *	STABLE FORMS OF N-(2,6-DIMETHYL-4-MORPHOLIN-4-YL-PHENYL)-3,3-DIMETHYL-BUTYRAMIDE
Cordis Corporation	A61F 2/84 (2006.01) A61F 2/90 (2006.01) A61F 2/00 (2006.01)	2493430 *	INTRALUMINAL DEVICE WITH IMPROVED FLEXIBILITY AND DURABILITY
Omya Development AG	C09C 1/02 (2006.01)	2390285	Process for the preparation of surface treated mineral filler products and uses of same

Podnosilac evropske prijave patenta (71)	MKP (51)	Broj objave evropske prijave patenta (97)	Naziv pronalaska (54)
Kast Silicone Ltd.	A61M 15/08 (2006.01)	2445560 *	NASAL INTERFACE DEVICE
Genentech, Inc.	C07D 413/12 (2006.01) A61K 31/53 (2006.01) A61P 35/00 (2006.01) C07D 239/48 (2006.01)	2470511 *	RAF INHIBITOR COMPOUNDS AND METHODS OF USE THEREOF
Immune Design Corp	C07K 14/18 (2006.01) C12N 15/867 (2006.01)	2456786 *	LENTIVIRAL VECTORS PSEUDOTYPED WITH A SINDBIS VIRUS ENVELOPE GLYCOPROTEIN
Eisai R&D Management Co., Ltd.	A61K 47/36 (2006.01) A61K 31/357 (2006.01) A61K 9/127 (2006.01) A61K 47/02 (2006.01) A61K 47/18 (2006.01) A61K 47/24 (2006.01) A61K 47/28 (2006.01) A61K 47/34 (2006.01)	2415470 *	LIPOSOME COMPOSITION
MIC & Partners GmbH	A61F 5/01 (2006.01)	2301488	Immobilizing rail
The Regents of the University of California	C07H 21/04 (2006.01) C12Q 1/68 (2006.01) C12N 9/24 (2006.01)	2421881 *	ENGINEERED DEMETER 5-METHYLCYTOSINE DNA GLYCOSYLASE WITH IMPROVED YIELD, STABILITY AND SOLUBILITY
VI.BE.MAC. S.p.A.	D05B 25/00 (2006.01) D05B 33/00 (2006.01)	2325363	Conveying device and sewing machine comprising said device
Merck Sharp & Dohme Corp.	A61K 31/54 (2006.01)	2485736 *	IMINOTHIADIAZINE DIOXIDE COMPOUNDS AS BACE INHIBITORS, COMPOSITIONS, AND THEIR USE
DB Netz AG	E01B 3/34 (2006.01) E01B 7/22 (2006.01)	2488698 *	PRESTRESSED CONCRETE SLEEPER AND METHOD FOR TRANSPORTING AND INSTALLING A SWITCH HAVING PRESTRESSED CONCRETE SLEEPERS
RAIL.ONE GmbH	E01B 3/34 (2006.01) E01B 7/22 (2006.01)	2488698 *	PRESTRESSED CONCRETE SLEEPER AND METHOD FOR TRANSPORTING AND INSTALLING A SWITCH HAVING PRESTRESSED CONCRETE SLEEPERS
Häussler Innovation GmbH	B21F 27/10 (2006.01) B21F 27/20 (2006.01) E04C 5/04 (2006.01) B21F 23/00 (2006.01) B23K 11/00 (2006.01)	2485856 *	METHOD AND DEVICE FOR PRODUCING WELDED CONNECTIONS
Les Laboratoires Servier	C07C 309/73 (2006.01) C07D 223/16 (2006.01) C07C 309/66 (2006.01)	2477970 *	NOVEL METHOD FOR SYNTHESIZING IVABRADINE AND THE ADDITION SALTS THEREOF WITH A PHARMACEUTICALLY ACCEPTABLE ACID
AstraZeneca AB	A61K 31/558 (2006.01) A61K 31/5377 (2006.01) C07D 311/22 (2006.01)	2493870 *	CHROMENONE DERIVATIVES WITH ANTI-TUMOUR ACTIVITY
Intermune, Inc.	A61K 31/4412 (2006.01) A61P 11/00 (2006.01) A61K 31/135 (2006.01) A61K 31/15 (2006.01) A61K 31/44 (2006.01)	2441455	Methods of administering pirfenidone therapy
Universitat Internacional De Catalunya	C12N 5/074 (2010.01) C12N 5/077 (2010.01)	2456863 *	PLURIPOTENT STEM CELLS OBTAINED FROM DENTAL PULP
Speziallampenfabrik Dr. Fischer GmbH	H05B 3/00 (2006.01) B29C 49/64 (2006.01) F21V 7/00 (2006.01) B29B 13/02 (2006.01) B29C 49/68 (2006.01)	2483046 *	ARRANGEMENT OF A COUNTER REFLECTOR DEVICE FOR USE IN HEATING AN OBJECT, INSTALLATION AND METHOD OF HEATING
Shionogi & Co., Ltd.	C07D 213/80 (2006.01) C07D 309/32 (2006.01) C07D 405/06 (2006.01)	2412709 *	PROCESS FOR PRODUCING PYRONE AND PYRIDONE DERIVATIVES

Podnosilac evropske prijave patenta (71)	MKP (51)	Broj objave evropske prijave patenta (97)	Naziv pronalaska (54)
Magna Powertrain Inc.	F02B 67/06 (2006.01) B60K 25/02 (2006.01) F16D 13/42 (2006.01) F16D 27/112 (2006.01) F16D 15/00 (2006.01) F04B 17/00 (2006.01)	2446162 *	BALL RAMP CLUTCH
UCB Pharma, S.A.	C12N 9/50 (2006.01) C12P 21/00 (2006.01)	2480661 *	BACTERIAL HOST STRAIN
ISDIN S.A.	A61K 38/10 (2006.01) A61P 17/00 (2006.01)	2404611 *	Peptide for the prophylactic or therapeutic treatment of skin tumours in initial stages
ISAP Packaging S.P.A.	B29C 65/02 (2006.01) B29C 65/48 (2006.01) B65D 43/16 (2006.01) B29C 65/58 (2006.01) B29C 65/78 (2006.01) B29L 31/22 (2006.01) B29C 65/08 (2006.01) B29C 65/16 (2006.01)	2275358	A process and plant for obtaining a container body particularly suitable for packaging food products
Kross-Link Laboratories, Inc.	A61K 33/14 (2006.01) A61P 41/00 (2006.01) A61K 33/40 (2006.01) A61K 33/20 (2006.01)	2411021 *	METHOD FOR SUPPRESSING OR PREVENTING FIBROUS ADHESION FORMATION USING A MULTICOMPONENT AQUEOUS OXYCHLORINE COMPOSITION PREPARED ON-SITE
NTNU Technology Transfer AS	A61K 31/702 (2006.01) A61K 48/00 (2006.01) A61K 9/00 (2006.01) C12N 15/88 (2006.01)	2411017 *	PARENTERAL PHARMACEUTICAL COMPOSITION FOR USE IN GENE THERAPY
Omya Development AG	D21C 9/00 (2006.01) D21D 1/00 (2006.01) D21H 11/00 (2006.01) D21H 11/18 (2006.01) D21B 1/16 (2006.01)	2414584 *	PROCESS FOR THE PRODUCTION OF NANO-FIBRILLAR CELLULOSE SUSPENSIONS
Board of Regents, The University of Texas System	C07D 487/04 (2006.01) A61K 31/519 (2006.01) A61P 33/06 (2006.01)	2483274 *	ANTIMALARIAL AGENTS THAT ARE INHIBITORS OF DIHYDROOROTATE DEHYDROGENASE
Monash University	C07D 487/04 (2006.01) A61K 31/519 (2006.01) A61P 33/06 (2006.01)	2483274 *	ANTIMALARIAL AGENTS THAT ARE INHIBITORS OF DIHYDROOROTATE DEHYDROGENASE
Medicines For Malaria Venture	C07D 487/04 (2006.01) A61K 31/519 (2006.01) A61P 33/06 (2006.01)	2483274 *	ANTIMALARIAL AGENTS THAT ARE INHIBITORS OF DIHYDROOROTATE DEHYDROGENASE
University of Washington	C07D 487/04 (2006.01) A61K 31/519 (2006.01) A61P 33/06 (2006.01)	2483274 *	ANTIMALARIAL AGENTS THAT ARE INHIBITORS OF DIHYDROOROTATE DEHYDROGENASE
Glaxosmithkline Investigacion y Desarrollo, S.L.	C07D 487/04 (2006.01) A61K 31/519 (2006.01) A61P 33/06 (2006.01)	2483274 *	ANTIMALARIAL AGENTS THAT ARE INHIBITORS OF DIHYDROOROTATE DEHYDROGENASE
Valio Ltd.	A23L 1/307 (2006.01) A23C 9/12 (2006.01) A23C 9/156 (2006.01) A23C 9/127 (2006.01) A23L 1/29 (2006.01)	2429304 *	PRODUCT AND PROCESS FOR ITS PREPARATION
Avila Therapeutics, Inc.	A61K 38/00 (2006.01)	2475375 *	PI3 KINASE INHIBITORS AND USES THEREOF
Separation Technologies Investments Limited	C07H 19/00 (2006.01) C12P 19/26 (2006.01) A23C 9/146 (2006.01)	2408794 *	ISOLATION AND PURIFICATION OF COMPONENTS OF WHEY
Protektorwerk Florenz Maisch GmbH & Co. KG	E04B 2/74 (2006.01)	2454422 *	PROFILED ELEMENT AND METHOD FOR PRODUCING A PROFILED ELEMENT
Vestas Wind Systems A/S	B29C 70/38 (2006.01) B29B 11/16 (2006.01)	2314445	A method for manufacturing a composite body and a composite body manufacturing arrangement
Amgen Inc.	A61P 35/00 (2006.01) C07K 16/28 (2006.01) A61K 39/395 (2006.01)	2488552 *	USE OF IL-17 RECEPTOR A ANTIGEN BINDING PROTEINS

Podnosilac evropske prijave patenta (71)	MKP (51)	Broj objave evropske prijave patenta (97)	Naziv pronalaska (54)
Asahi Kasei E-Materials Corporation	H01M 21/16 (2006.01) B32B 27/32 (2006.01)	2408043 *	LAMINATED SEPARATOR, POLYOLEFIN MICROPOROUS MEMBRANE, AND SEPARATOR FOR ELECTRICITY STORAGE DEVICE
Vercaemer, Claude	E21B 43/267 (2006.01)	2469020	Process of hydraulic fracturing to create a layered proppant pack structure alongside the faces of the fracture to prevent formation fines to damage fracture conductivity
SAPPI Netherlands Services B.V.	B41M 5/50 (2006.01) B41M 5/00 (2006.01) B41M 5/52 (2006.01)	2392467	Substrate for ink-jet printing
AKI, Inc.	B65D 73/00 (2006.01) B65D 75/58 (2006.01)	2289816	Unitized package and method of making same
Dow AgroSciences LLC	A01P 13/02 (2006.01) A01N 43/54 (2006.01) A01N 43/40 (2006.01)	2493311 *	SYNERGISTIC HERBICIDAL COMPOSITION CONTAINING FLUROXYPYR AND PENOXSULAM, HALOSULFURON-METHYL, IMAZAMOX OR IMAZETHAPYR
Leo Pharma A/S	A61K 31/519 (2006.01) C07D 487/08 (2006.01) A61P 25/00 (2006.01) C07D 471/04 (2006.01) A61P 35/00 (2006.01) A61K 31/499 (2006.01) A61P 17/00 (2006.01) A61K 31/437 (2006.01) A61P 37/00 (2006.01) C07D 487/04 (2006.01) A61P 27/00 (2006.01) A61P 3/00 (2006.01)	2451813 *	HETEROCYCLIC COMPOUNDS AS JAK RECEPTOR AND PROTEIN TYROSINE KINASE INHIBITORS
Merz Pharma GmbH & Co. KGaA	C07C 209/16 (2006.01) C07C 211/35 (2006.01) C07C 209/62 (2006.01)	2448908 *	METHOD OF PREPARING NERAMEXANE
Motorola Mobility, Inc.	G06F 1/32 (2006.01)	2400369	A method for polling a universal integrated circuit card and an integrated circuit having an independent polling circuit
Boehringer Ingelheim International GmbH	C07D 471/04 (2006.01) A61K 31/4188 (2006.01) A61P 11/00 (2006.01) A61P 29/00 (2006.01)	2403852 *	3H-IMIDAZO [4, 5 -C]PYRIDINE- 6 -CARBOXAMIDES AS ANTI- INFLAMMATORY AGENTS
Zenatti, Sandro	A21C 9/04 (2006.01) A21C 9/08 (2006.01)	2332413	An apparatus for portioning and positioning solid portions of food products and a process therefor
Koch, Günter	F41B 11/02 (2006.01) F41B 11/22 (2006.01)	2476991	Retrofit magazin for a break-barrel air gun
Interface, Inc.	E04F 15/18 (2006.01)	2417311 *	SYSTEMS AND METHODS FOR MODULAR FLOOR INSTALLATION
Cognis IP Management GmbH	C10M 169/04 (2006.01)	2480643 *	LUBRICANT COMPOSITIONS
Unifrax I LLC	C04B 14/30 (2006.01) D04H 1/42 (2012.01) F01N 3/28 (2006.01) B01D 53/94 (2006.01)	2480316 *	LOW SHEAR MOUNTING MAT FOR POLLUTION CONTROL DEVICES
Pearl Therapeutics, Inc.	A61K 9/12 (2006.01) A61P 11/00 (2006.01) A61K 31/40 (2006.01) A61K 9/00 (2006.01)	2435023 *	COMPOSITON FOR PLUMONARY DELIVERY OF LONG-AGTING MUSCARINIC ANTAGONISTS AND LONG LONG-ACTING BETA 2 ADRENERGIC RECEPTOR AGONISTS AND ASSOCIATED METHODS AND SYSTEMS
Koninklijke Douwe Egberts B.V.	A47J 31/36 (2006.01) B67D 1/00 (2006.01)	2480490 *	BEVERAGE CARTRIDGE
HBPO GmbH	B62D 25/08 (2006.01)	2301825	Front end module for a motor vehicle
Affiris AG	A61K 38/17 (2006.01) A61K 39/00 (2006.01) C07K 7/06 (2006.01) A61P 25/16 (2006.01) A61P 25/28 (2006.01)	2467153 *	USE OF MIMOTOPES OF ALPHA-SYNUCLEIN EPITOPES FOR TREATING LEWY BODY DISEASES

Podnosilac evropske prijave patenta (71)	MKP (51)	Broj objave evropske prijave patenta (97)	Naziv pronalaska (54)
Eli Lilly and Company	A61P 31/10 (2006.01) A61K 31/4427 (2006.01) C07D 401/12 (2006.01) C07D 401/14 (2006.01)	2454251 *	GPR119 AGONISTS
Terberg Kinglifter B.V.	B66F 9/12 (2006.01)	2477931 *	A LINKAGE SYSTEM FOR A FORKLIFT TRUCK
Nuvo Research Inc.	A61P 29/00 (2006.01) A61K 47/16 (2006.01) A61K 31/444 (2006.01) A61K 47/10 (2006.01) A61K 47/38 (2006.01)	2482850 *	TOPICAL FORMULATIONS
Abbott Biotherapeutics Corp.	G01N 33/564 (2006.01)	2473851 *	USE OF AN IMMUNOREGULATORY NK CELL POPULATION FOR MONITORING THE EFFICACY OF ANTI-IL-2R ANTIBODIES IN MULTIPLE SCLEROSIS PATIENTS
Toray Plastics (America) , Inc.	D04H 13/00 (2006.01) B32B 3/26 (2006.01)	2480710 *	MULTI-LAYER HIGH MOISTURE BARRIER POLYLACTIC ACID FILM
Vestas Wind Systems A/S	G05B 23/02 (2006.01)	2290488	A method and a system for adjusting alarm level of a component in a wind turbine
Isproma S.r.l.	C02F 1/04 (2006.01) B01D 1/28 (2006.01) B01D 1/26 (2006.01) B01D 1/30 (2006.01) B01D 3/06 (2006.01) B01D 1/16 (2006.01)	2475442 *	MULTIPLE-EFFECT EVAPORATOR
Lovalvo, Sally Ann	A47J 31/18 (2006.01)	2453777 *	TURKISH COFFEE MACHINE
Haremlik Gida, Dekorasyon Ve Ekipmanlari Ticaret Sirketi	A47J 31/18 (2006.01)	2453777 *	TURKISH COFFEE MACHINE
Janssen Pharmaceutica N.V.	C07D 401/10 (2006.01) A61K 31/496 (2006.01) C07D 401/06 (2006.01) C07D 417/14 (2006.01) C07D 403/10 (2006.01) A61P 29/00 (2006.01) C07D 401/04 (2006.01) C07D 417/06 (2006.01) C07D 403/06 (2006.01) A61P 25/00 (2006.01) C07D 205/04 (2006.01) C07D 409/06 (2006.01) C07D 403/12 (2006.01) C07D 405/12 (2006.01)	2421824 *	AZETIDINYL DIAMIDES AS MONOACYLGLYCEROL LIPASE INHIBITORS
Neuwave Medical, Inc.	A61B 18/18 (2006.01) A61B 18/02 (2006.01) A61N 5/02 (2006.01)	2459096 *	ENERGY DELIVERY SYSTEMS AND USES THEREOF
Bavarian Nordic A/S	A61K 39/285 (2006.01) C07K 14/07 (2006.01) C12N 15/863 (2006.01)	2405939 *	OPTIMIZED EARLY-LATE PROMOTER COMBINED WITH REPEATED VACCINATION FAVORS CYTOTOXIC T CELL RESPONSE AGAINST ANTIGENS IN REPLICATION DEFICIENT RECOMBINANT VIRUS VACCINES
GlaxoSmithKline LLC	A61K 31/505 (2006.01)	2482819 *	COMBINATION
Grindeks, A Joint Stock Company	C07D 207/263 (2006.01) A61K 31/4015 (2006.01) A61P 25/28 (2006.01) A61P 25/00 (2006.01)	2496555 *	4R,5S-ENANTIOMER OF 2-(5-METHYL-2-OXO-4-PHENYL-PYRROLIDIN-1-YL)-ACETAMIDE WITH NOOTROPIC ACTIVITY
A.T.X. International, Inc.	B43K 21/16 (2006.01)	2493704 *	UNIVERSAL PENCIL MECHANISM
Genentech, Inc.	A61K 31/437 (2006.01) C07D 403/12 (2006.01) C07D 487/04 (2006.01) A61P 35/00 (2006.01)	2448941 *	PYRAZOLOPYRIMIDINE JAK INHIBITOR COMPOUNDS AND METHODS
Allure Energy, Inc.	G05D 23/19 (2006.01) H02J 3/14 (2006.01)	2457132 *	ENERGY MANAGEMENT SYSTEM AND METHOD

Podnosilac evropske prijave patenta (71)	MKP (51)	Broj objave evropske prijave patenta (97)	Naziv pronalaska (54)
Boehringer Ingelheim Vetmedica, Inc.	A61K 39/02 (2006.01)	2421556 *	VACCINES COMPRISING ATTENUATED MYCOPLASMA BOVIS STRAINS AND METHOD FOR THE ATTENUATION
Cyalume Technologies, Inc	C09K 11/06 (2006.01) F21K 2/06 (2006.01) F21L 17/00 (2006.01) G08B 5/00 (2006.01) F21L 26/00 (2006.01)	2467445 *	CHEMILUMINESCENT SIGNALING DEVICES
Schlosser, Michael	A61N 5/06 (2006.01)	2461868 *	HANDHELD LOW-LEVEL LASER THERAPY APPARATUS
Flexible Stenting Solutions, Inc.	A61F 2/06 (2006.01)	2421470 *	FLEXIBLE DEVICES
The Trustees of the University of Princeton	C12N 15/09 (2006.01)	2456869 *	INHIBITORS OF MTOR KINASE AS ANTI-VIRAL AGENTS
Richter Gedeon Nyrt.	C07J 41/00 (2006.01) A61K 31/573 (2006.01) A61P 5/36 (2006.01)	2462154 *	NOVEL CRYSTAL FORM OF CDB-4124 AND PROCESS FOR THE PREPARATION THEREOF
Lojack Operating Company, Lp	B60R 25/10 (2006.01)	2490922 *	DUTY CYCLE ESTIMATION SYSTEM AND METHOD
Echotect B.V.	B29C 67/24 (2006.01) B29B 7/90 (2006.01) C04B 26/00 (2006.01) B29B 7/00 (2006.01) B29B 17/00 (2006.01)	2427322 *	PROCESS FOR MANUFACTURING A SHAPED ARTICLE FROM A COMPOSITE MATERIAL COMPRISING A SOLID FILLER AND A THERMOPLASTIC BINDER
Posa S.P.A.	A62C 2/12 (2006.01)	2412409	Single-body intumescent gaskets for cold and hot smoke sealing, in particular for fire dampers
JT Finance	A62C 2/12 (2006.01)	2412409	Single-body intumescent gaskets for cold and hot smoke sealing, in particular for fire dampers
Regeneron Pharmaceuticals, Inc.	A01K 67/027 (2006.01) C07K 16/46 (2006.01) C12N 15/85 (2006.01) C07K 16/00 (2006.01)	2480675 *	MICE EXPRESSING ALIGHT CHAIN WITH HUMAN LAMBDA VARIABLE AND MOUSE CONSTANT REGIONS
Philip Morris Products S.A.	A61K 9/14 (2006.01)	2477607 *	IMPROVED DEVICE AND METHOD FOR DELIVERY OF A MEDICAMENT
Janssen Biotech, Inc.	C12P 21/08 (2006.01) C07H 21/04 (2006.01)	2494062 *	ANTI-GLP-1R ANTIBODIES AND THEIR USES
Deutsche Telekom AG	H04W 16/12 (2009.01)	2443857 *	METHOD, SYSTEM AND BASE STATION FOR SHARING OR JOINTLY USING ONE OF A GERAN (GSM EDGE RADIO ACCESS NETWORK) MOBILE RADIO ACCESS NETWORK
Les Laboratoires Servier	A61K 31/593 (2006.01) A61K 47/40 (2006.01) A61K 45/06 (2006.01) A61K 33/24 (2006.01) A61P 19/00 (2006.01)	2335704	Pharmaceutical composition comprising a strontium salt, vitamine D and a cyclodextrine
Ajinomoto Co., Inc.	A61K 9/16 (2006.01) A61P 1/00 (2006.01) A61P 1/04 (2006.01) A61K 31/198 (2006.01)	2407162 *	COMPOSITION FOR ORAL ADMINISTRATION
National University Corporation Gunma University	A61K 9/16 (2006.01) A61P 1/00 (2006.01) A61P 1/04 (2006.01) A61K 31/198 (2006.01)	2407162 *	COMPOSITION FOR ORAL ADMINISTRATION
E. I. du Pont de Nemours and Company	A01N 43/50 (2006.01) A61K 31/415 (2006.01)	2427058 *	NEMATOCIDAL SULFONAMIDES
Reversinglabs Corporation	G06F 11/07 (2006.01) G06F 21/00 (2006.01)	2460076 *	PORTABLE EXECUTABLE FILE ANALYSIS
Sycamore Networks, Inc.	H04W 36/00 (2009.01)	2436209 *	MECHANISM FOR APPLICATION MOBILITY IN A CELL SITE-BASED CONTENT DISTRIBUTION NETWORK

Podnosilac evropske prijave patenta (71)	MKP (51)	Broj objave evropske prijave patenta (97)	Naziv pronalaska (54)
CV Holdings, LLC.	G01N 15/08 (2006.01) A61B 5/15 (2006.01) C23C 16/54 (2006.01) C23C 16/04 (2006.01) C23C 16/52 (2006.01) C23C 16/505 (2006.01)	2253735	Vessel processing
Crocco S.P.A.	B65H 75/08 (2006.01) B65H 75/18 (2006.01)	2319789	Unwinding device
Syngenta Participations AG	C07D 471/10 (2006.01) A01N 43/90 (2006.01)	2421865 *	SPIROHETEROCYCLIC PYRROLIDINE DIONE DERIVATIVES USED AS PESTICIDES
Cognition Therapeutics, Inc.	A61K 36/906 (2006.01) A61K 31/40 (2006.01) C07D 207/04 (2006.01)	2416795 *	Inhibitors of cognitive decline
Cardoz AB	A61K 31/519 (2006.01) A61P 29/00 (2006.01) C07D 471/04 (2006.01) A61K 45/06 (2006.01)	2443120 *	NEW CRYSTALLINE FORM OF PEMIROLAST
GlaxoSmithKline Biologicals S.A.	A61K 39/00 (2006.01)	2440242 *	ADJUVANT COMPOSITIONS COMPRISING A NON-IONIC ISOTONICITY AGENT
Chiarelli, Mario Rosario	F03D 3/06 (2006.01) F03D 3/04 (2006.01) F03D 3/00 (2006.01)	2459871 *	AEROGENERATOR WITH FREE INTERNAL FLOW ROTOR
Massai, Andrea	F03D 3/06 (2006.01) F03D 3/04 (2006.01) F03D 3/00 (2006.01)	2459871 *	AEROGENERATOR WITH FREE INTERNAL FLOW ROTOR
Bolognesi, Paolo	F03D 3/06 (2006.01) F03D 3/04 (2006.01) F03D 3/00 (2006.01)	2459871 *	AEROGENERATOR WITH FREE INTERNAL FLOW ROTOR
Russo, Giovanni	F03D 3/06 (2006.01) F03D 3/04 (2006.01) F03D 3/00 (2006.01)	2459871 *	AEROGENERATOR WITH FREE INTERNAL FLOW ROTOR
Atzeni, Davide	F03D 3/06 (2006.01) F03D 3/04 (2006.01) F03D 3/00 (2006.01)	2459871 *	AEROGENERATOR WITH FREE INTERNAL FLOW ROTOR
Vertex Pharmaceuticals Inc.	A61K 31/407 (2006.01) C07D 487/08 (2006.01) A61P 11/00 (2006.01)	2491042 *	SOLID FORMS OF N-(4-(7-AZABICYCLO[2.2.1]HEPTAN-7-YL)-2-TRIFLUOROMETHYL)PHENYL)-4-OXO-5-(TRIFLUOROMETHYL)-1,4-DIHYDROQUINOLINE-3-CARBOXAMIDE
GlaxoSmithKline LLC	A01N 43/54 (2006.01) A61K 31/415 (2006.01) A61K 31/505 (2006.01)	2480085 *	COMBINATION
Johnson Controls Interiors GmbH & Co. KG	B60R 21/2165 (2011.01)	2483111 *	MOULDED TRIM COMPONENT FOR COVERING AN AIRBAG IN A MOTOR VEHICLE
Biogen Idec MA Inc.	A01N 37/12 (2006.01) A01N 37/44 (2006.01) A61K 31/195 (2006.01)	2424357 *	TREATMENT OF NEURODEGENERATION AND NEUROINFLAMMATION
Shen, Kangna Nelson	E04H 1/02 (2006.01)	2494127 *	PREFABRICATED CONTAINER HOUSE
Bayer BioScience N.V.	C12N 15/82 (2006.01)	2449108 *	METHODS AND MEANS FOR OBTAINING PLANTS WITH ENHANCED GLYPHOSATE TOLERANCE
Glaxo Group Limited	A61K 38/00 (2006.01)	2464368 *	CATHEPSIN C INHIBITORS
Ethicon, Inc.	A61M 5/32 (2006.01)	2498842 *	SURGICAL NEEDLE COATINGS AND METHODS
Novartis AG	C07D 261/18 (2006.01) C07C 233/47 (2006.01) A61K 31/21 (2006.01) A61K 31/435 (2006.01) C07D 213/82 (2006.01) C07D 239/36 (2006.01) C07D 271/06 (2006.01)	2435409 *	SUBSTITUTED AMINOPROPIONIC DERIVATIVES AS NEPRILYSIN INHIBITORS
Fairfield Manufacturing Company, Inc.	B60K 17/04 (2006.01) B60K 7/00 (2006.01)	2329983	Wheel drive assembly and a spindle carrier

Podnosilac evropske prijave patenta (71)	MKP (51)	Broj objave evropske prijave patenta (97)	Naziv pronalaska (54)
Janssen Pharmaceuticals, Inc.	C07D 403/12 (2006.01) C07D 403/14 (2006.01) C07D 413/12 (2006.01) C07D 413/14 (2006.01) C07D 417/12 (2006.01) A61K 31/416 (2006.01) C07D 471/04 (2006.01) A61P 25/28 (2006.01)	2427453 *	NOVEL SUBSTITUTED INDAZOLE AND AZA-INDAZOLE DERIVATIVES AS GAMMA SECRETASE MODULATORS
SANOFI	C07D 417/12 (2006.01) A61K 31/4523 (2006.01) A61P 29/00 (2006.01) A61P 25/00 (2006.01) C07D 401/12 (2006.01) C07D 413/12 (2006.01)	2430012 *	7-AZA-SPIRO[3.5]NONANE-7-CARBOXYLATE DERIVATIVES, PREPARATION THEREOF, AND THERAPEUTIC USE THEREOF
SICA S.P.A.	B29C 57/02 (2006.01) F16L 47/08 (2006.01)	2368693	Belling machine for pipes made of thermoplastic material
ABN Pipe Systems, S.L.U.	F16L 11/08 (2006.01)	2261542	Pipe for water-supply systems
Zealand Pharma A/S	C07K 14/605 (2006.01) A61P 5/48 (2006.01) A61K 38/26 (2006.01)	2454282 *	ACYLATED GLUCAGON ANALOGUES
Toto Ltd.	E03D 9/08 (2006.01)	2305903	Washing device for user's private parts
GlaxoSmithKline Biologicals S.A.	A01N 43/90 (2006.01) A61K 31/52 (2006.01) A61K 31/522 (2006.01)	2461690 *	LIPIDATED OXOADENINE DERIVATIVES
BIOPROJET	A61K 31/4439 (2006.01) C07D 401/06 (2006.01) A61P 25/00 (2006.01)	2432469 *	NOVEL PHARMACEUTICALLY ACCEPTABLE SALTS OF 4-(1H-IMIDAZOL-4-YLMETHYL)PYRIDINE AND THEIR THERAPEUTICAL USES
Pfizer Inc.	A61K 31/454 (2006.01) C07D 401/04 (2006.01) C07D 401/14 (2006.01) A61K 31/4545 (2006.01) A61P 3/10 (2006.01)	2438051 *	L- (PIPERIDIN-4-YL) -PYRAZOLE DERIVATIVES AS GPR 119 MODULATORS
ITW CS (UK) Limited	B65H 75/00 (2006.01) C09J 7/02 (2006.01)	2449049 *	IMPROVED ADHESIVE SHEETED ROLL
Research In Motion Limited	H04M 1/02 (2006.01)	2456174	Segmented portable electronic device and method of display
Sears, James B.	H01L 31/18 (2006.01) H01L 31/042 (2006.01)	2457264 *	SYSTEM AND METHOD FOR MAKING A PHOTOVOLTAIC UNIT
Glaxo Group Limited	A61K 39/395 (2006.01) C07K 16/46 (2006.01) C07K 16/28 (2006.01) C07K 16/18 (2006.01)	2493504 *	STABLE ANTI-TNFR1 POLYPEPTIDES, ANTIBODY VARIABLE DOMAINS&ANTAGONISTS
SANOFI	C07D 233/64 (2006.01) C07D 233/84 (2006.01) C07D 401/06 (2006.01)	2430002 *	PROCESS FOR THE PREPARATION OF A COMPOUND USEFUL AS AN INHIBITOR OF TAFIA
Japan Oil, Gas and Metals National Corporation	C10G 2/00 (2006.01) C10G 45/10 (2006.01) C10G 47/18 (2006.01) C10G 65/02 (2006.01) C10G 65/04 (2006.01) B01J 23/42 (2006.01) B01J 23/46 (2006.01)	2412787 *	METHOD FOR PRODUCING LIQUID FUEL AND SYSTEM FOR PRODUCING LIQUID FUEL
INPEX Corporation	C10G 2/00 (2006.01) C10G 45/10 (2006.01) C10G 47/18 (2006.01) C10G 65/02 (2006.01) C10G 65/04 (2006.01) B01J 23/42 (2006.01) B01J 23/46 (2006.01)	2412787 *	METHOD FOR PRODUCING LIQUID FUEL AND SYSTEM FOR PRODUCING LIQUID FUEL

Podnosilac evropske prijave patenta (71)	MKP (51)	Broj objave evropske prijave patenta (97)	Naziv pronalaska (54)
JX Nippon Oil & Energy Corporation	C10G 2/00 (2006.01) C10G 45/10 (2006.01) C10G 47/18 (2006.01) C10G 65/02 (2006.01) C10G 65/04 (2006.01) B01J 23/42 (2006.01) B01J 23/46 (2006.01)	2412787 *	METHOD FOR PRODUCING LIQUID FUEL AND SYSTEM FOR PRODUCING LIQUID FUEL
Japan Petroleum Exploration Co., Ltd.	C10G 2/00 (2006.01) C10G 45/10 (2006.01) C10G 47/18 (2006.01) C10G 65/02 (2006.01) C10G 65/04 (2006.01) B01J 23/42 (2006.01) B01J 23/46 (2006.01)	2412787 *	METHOD FOR PRODUCING LIQUID FUEL AND SYSTEM FOR PRODUCING LIQUID FUEL
Cosmo Oil Co., Ltd.	C10G 2/00 (2006.01) C10G 45/10 (2006.01) C10G 47/18 (2006.01) C10G 65/02 (2006.01) C10G 65/04 (2006.01) B01J 23/42 (2006.01) B01J 23/46 (2006.01)	2412787 *	METHOD FOR PRODUCING LIQUID FUEL AND SYSTEM FOR PRODUCING LIQUID FUEL
Nippon Steel Engineering Co., Ltd	C10G 2/00 (2006.01) C10G 45/10 (2006.01) C10G 47/18 (2006.01) C10G 65/02 (2006.01) C10G 65/04 (2006.01) B01J 23/42 (2006.01) B01J 23/46 (2006.01)	2412787 *	METHOD FOR PRODUCING LIQUID FUEL AND SYSTEM FOR PRODUCING LIQUID FUEL
Genzyme Corporation	A61K 39/395 (2006.01) A61K 38/18 (2006.01)	2429583 *	METHODS AND COMPOSITIONS FOR TREATING LUPUS
GlaxoSmithKline Biologicals S.A.	C07K 14/47 (2006.01) A61K 39/00 (2006.01) A61P 35/00 (2006.01)	2435469 *	CASB7439 CONSTRUCTS
Ethicon. Inc.	A61F 5/56 (2006.01)	2493437 *	TONGUE SUSPENSION SYSTEM WITH HYOID-EXTENDER FOR TREATING OBSTRUCTIVE SLEEP APNEA
Meiji Seika Pharma Co., Ltd.	C12N 15/09 (2006.01) C12N 9/42 (2006.01) C12P 19/00 (2006.01)	2450438 *	CELLULASE PREPARATION CONTAINING ENDOGLUCANASES DERIVED FROM TWO DIFFERENT TYPES OF MICROORGANISMS
SANOFI	C07C 205/43 (2006.01) A61K 31/343 (2006.01) C07D 307/80 (2006.01) A61P 9/06 (2006.01)	2435398 *	PROCESS FOR THE PRODUCTION OF BENZOFURANS
Treefree Biomass Solutions, Inc.	A01P 21/00 (2006.01) A01N 63/00 (2006.01) A01G 7/06 (2006.01) A01N 43/38 (2006.01) A01N 31/02 (2006.01)	2464211 *	METHODS FOR VEGETATIVE PROPAGATION OF GRASS PLANTS
Georgia Tech Research Corporation	H01R 33/945 (2006.01)	2404351 *	OVERHEAD POWER CONNECTOR INTEGRITY ASSESSMENT BY APPLICATION OF THERMAL HISTORY DETECTORS
Packers Plus Energy Services Inc.	E21B 43/14 (2006.01) E21B 43/25 (2006.01) E21B 34/14 (2006.01)	2494146 *	PLUG RETAINER AND METHOD FOR WELLBORE FLUID TREATMENT
Pierre Fabre Dermo-Cosmétique	A61K 9/00 (2006.01) A61K 9/08 (2006.01) A61K 31/13 (2006.01)	2421504 *	PAEDIATRIC SOLUTIONS COMPRISING A BETA-BLOCKER
The Hong Kong Polytechnic University	A61B 5/107 (2006.01) A61B 8/08 (2006.01)	2459073 *	THREE-DIMENSIONAL (3D) ULTRASOUND IMAGING SYSTEM FOR ASSESSING SCOLIOSIS
Boehringer Ingelheim International GmbH	C07H 15/203 (2006.01) A61K 31/7048 (2006.01)	2483286 *	METHOD FOR THE PREPARATION OF A CRYSTALLINE FORM OF 1-CHLORO-4-(BETA-D-GLUCOPYRANOS-1-YL)-2-(4-((S)-TETRAHYDROFURAN-3-YLOXY)BENZYL)BENZENE

Podnosilac evropske prijave patenta (71)	MKP (51)	Broj objave evropske prijave patenta (97)	Naziv pronalaska (54)
OSI Pharmaceuticals, LLC	A61K 31/497 (2006.01) C07D 403/14 (2006.01) A61P 35/00 (2006.01) C07D 401/12 (2006.01) C07D 403/12 (2006.01)	2438056 *	AMINO PYRIMIDINE ANTICANCER COMPOUNDS
Zammito, Roberto	B60R 25/02 (2006.01)	2277750	Armor-plated mechanical antitheft steering lock for automotive vehicles.
BG Research Ltd	B01L 3/00 (2006.01) C12Q 1/68 (2006.01) G01N 27/447 (2006.01) G01N 21/64 (2006.01)	2443256 *	NUCLEIC ACID DETECTION
Delphi Technologies Holding S.à.r.l.	B01D 35/18 (2006.01)	2414063 *	FILTER ASSEMBLY
Coskunoz Metal Form Makina Endüstriveç Tic A.S.	F16H 3/72 (2006.01) B30B 1/26 (2006.01) B30B 15/14 (2006.01) F16H 57/02 (2012.01)	2405157	Planetary transmission with two inputs and one output
Mie University	A61K 39/00 (2006.01) A61K 48/00 (2006.01) C12N 15/09 (2006.01) A61K 39/04 (2006.01) A61P 31/06 (2006.01) A61K 35/76 (2006.01)	2497493 *	NEBULIZABLE TUBERCULOSIS VACCINE FOR TRANSNASAL ADMINISTRATION COMPRISING PARAMYXOVIRUS VECTOR
Biocomo Co., Ltd.	A61K 39/00 (2006.01) A61K 48/00 (2006.01) C12N 15/09 (2006.01) A61K 39/04 (2006.01) A61P 31/06 (2006.01) A61K 35/76 (2006.01)	2497493 *	NEBULIZABLE TUBERCULOSIS VACCINE FOR TRANSNASAL ADMINISTRATION COMPRISING PARAMYXOVIRUS VECTOR
National Institute of Biomedical Innovation	A61K 39/00 (2006.01) A61K 48/00 (2006.01) C12N 15/09 (2006.01) A61K 39/04 (2006.01) A61P 31/06 (2006.01) A61K 35/76 (2006.01)	2497493 *	NEBULIZABLE TUBERCULOSIS VACCINE FOR TRANSNASAL ADMINISTRATION COMPRISING PARAMYXOVIRUS VECTOR
Kaspersky Lab, ZAO	G06F 17/30 (2006.01)	2363815	System for permanent file deletion
OSI Pharmaceuticals, LLC	A61K 45/00 (2006.01) A61K 31/395 (2006.01) A61K 31/4985 (2006.01) A61P 35/00 (2006.01)	2408479 *	COMBINATION CANCER THERAPY COMPRISING ADMINISTRATION OF AN EGFR INHIBITOR AND AN IGF-1R INHIBITOR
Vertex Pharmaceuticals Incorporated	C12N 15/09 (2006.01) C12Q 1/68 (2006.01)	2423324 *	PROBE SET FOR IDENTIFICATION OF NUCLEOTIDE MUTATION, AND METHOD FOR IDENTIFICATION OF NUCLEOTIDE MUTATION
SANOFI	C07D 519/00 (2006.01) A61K 31/551 (2006.01) A61P 35/00 (2006.01)	2470547 *	CONJUGATES OF PYRROLO[1,4]BENZODIAZEPINE DIMERS AS ANTICANCER AGENTS
TrailerLogic, LLC d.b.a. Mortuary Response Solutions	A47B 43/00 (2006.01) A61G 1/013 (2006.01) A61G 21/00 (2006.01)	2295021	Collapsible cadaver rack
Medasani, Munisekhar	A61K 36/80 (2006.01)	2482832 *	PICRORHIZA KURROA EXTRACT FOR PREVENTION, ELIMINATION AND TREATMENT OF DNA BASED VIRUSES IN HUMANS AND IN BIOTECH INDUSTRY
Schwendinger, Markus	A01K 15/02 (2006.01)	2255617	Dog training device with chewable body
onopharm Research & Development GmbH	A61P 37/02 (2006.01) C07J 63/00 (2006.01) A61K 31/575 (2006.01) A61P 29/00 (2006.01) A61P 35/00 (2006.01)	2406272 *	N-HYDROXY C29-AMIDE DERIVATIVES OF OLEANDRANE
GlaxoSmithKline LLC	A01N 25/34 (2006.01) D21H 19/00 (2006.01)	2440045 *	NOVEL ARTICLE

Podnosilac evropske prijave patenta (71)	MKP (51)	Broj objave evropske prijave patenta (97)	Naziv pronalaska (54)
Claranor	B08B 9/00 (2006.01) B65B 55/00 (2006.01) A61L 2/10 (2006.01)	2493515 *	COOLED PULSED LIGHT TREATMENT DEVICE
Gregg, Kenneth William	A23K 1/00 (2006.01)	2403353 *	COMPOSITION FOR CONTROLLING FISH
Dompé S.p.A.	A61P 37/06 (2006.01) A61K 31/18 (2006.01)	2485723 *	INHIBITORS OF CXCR1/2 AS ADJUVANTS IN THE TRANSPLANT OF PANCREATIC ISLETS
Merck Serono S.A.	A61P 29/00 (2006.01) C07D 413/04 (2006.01) C07D 413/14 (2006.01) A61K 31/4245 (2006.01) A61P 37/00 (2006.01)	2403849 *	OXAZOLE PYRIDINE DERIVATIVES USEFUL AS S1P1 RECEPTOR AGONISTS
E. I. du Pont de Nemours and Company	C07D 417/14 (2006.01) A01N 43/80 (2006.01)	2421861 *	SOLID FORMS OF AN AZOCYCLIC AMIDE
China Academy of Telecommunications Technology	H04W 28/00 (2009.01) H04W 52/00 (2009.01)	2498534 *	CONFIGURATION METHOD, SYSTEM AND DEVICE FOR UPLINK CHANNEL
Grindeks, A Joint Stock Company	A61K 31/14 (2006.01) C07C 229/12 (2006.01) A61P 9/10 (2006.01)	2491005 *	USE OF 4-[ETHYL(DIMETHYL)AMMONIO] BUTANOATE IN THE TREATMENT OF CARDIOVASCULAR DISEASE
Navico, Inc.	G01S 15/89 (2006.01) G01S 15/87 (2006.01)	2454606 *	LINEAR AND CIRCULAR DOWNSCAN IMAGING SONAR
Cephalon, Inc.	A61K 9/19 (2006.01) A61K 47/40 (2006.01) A61K 47/26 (2006.01) A61K 31/69 (2006.01) A61P 35/00 (2006.01) A61K 47/48 (2006.01)	2413916 *	LYOPHILIZATION CAKES OF PROTEASOME INHIBITORS
Cephalon France	A61K 9/19 (2006.01) A61K 47/40 (2006.01) A61K 47/26 (2006.01) A61K 31/69 (2006.01) A61P 35/00 (2006.01) A61K 47/48 (2006.01)	2413916 *	LYOPHILIZATION CAKES OF PROTEASOME INHIBITORS
Joining Technologies, Inc.	B23K 26/26 (2006.01) B21B 15/00 (2006.01) B23K 26/38 (2006.01)	2388102	Method and apparatus for laser strip slicing
Riegl Laser Measurement Systems GmbH	G01B 11/03 (2006.01) G01C 15/00 (2006.01) G01S 17/89 (2006.01) G01B 11/00 (2006.01) G01S 17/48 (2006.01)	2322901	Method for improving position and orientation measurement data
Poulsen Selfe & Lee Ltd.	G01N 11/04 (2006.01)	2249141	A viscometer and a method for operating the same
AstraZeneca AB	C07K 7/06 (2006.01) A61K 38/08 (2006.01) A61P 3/04 (2006.01)	2440569 *	MELANOCORTIN RECEPTOR-SPECIFIC PEPTIDES
Hitachi Displays, Ltd.	C03B 33/10 (2006.01)	2399874	Glass cutter
Panasonic Liquid Crystal Display Co., Ltd.	C03B 33/10 (2006.01)	2399874	Glass cutter
Merz Pharma GmbH & Co. KGaA	C07C 209/62 (2006.01) C07C 211/35 (2006.01)	2483234 *	METHOD OF PREPARING NERAMEXANE OR A SALT THEREOF
KRKA, D.D., Novo Mesto	C07D 413/14 (2006.01) A61K 31/42 (2006.01) A61P 7/00 (2006.01)	2459555 *	PROCESSES FOR CRYSTALLIZATION OF RIVAROXABAN
Hoppecke Advanced Battery Technology GmbH	H01M 10/48 (2006.01)	2296214	Device for monitoring an energy storage device
Ishihara Sangyo Kaisha, Ltd.	A01P 3/00 (2006.01) A01N 43/40 (2006.01)	2442659 *	CONTROL AGENT FOR SOFT ROT AND CONTROL METHOD FOR THE SAME
Corbinelli, Giovanni	B63B 15/00 (2006.01)	2243696	Sailing boat with variable lift.
Industrial Galvanizers Corporation PTY, Ltd.	E01F 15/02 (2006.01) E01F 15/04 (2006.01)	2408970 *	IMPROVED ROAD BARRIER

Podnosilac evropske prijave patenta (71)	MKP (51)	Broj objave evropske prijave patenta (97)	Naziv pronalaska (54)
Li, Wenbo	A61M 11/00 (2006.01)	2444112 *	HIGH-FREQUENCY INDUCTION ATOMIZATION DEVICE
CERA Handelsgesellschaft mbH	E06B 3/667 (2006.01)	2374979	Plug-connector
Omya Development AG	C02F 11/12 (2006.01) C02F 1/469 (2006.01) B01D 57/02 (2006.01)	2383232	System and Method for the Concentration of a Slurry
Kulkarni, Sachin Hanmant	B32B 27/12 (2006.01) B32B 33/00 (2006.01)	2470368 *	MULTIPURPOSE LAMINATED STRETCH FABRIC
UCB Pharma, S.A.	C07D 401/14 (2006.01) A61K 31/47 (2006.01) A61P 9/00 (2006.01)	2403847 *	TRIAZINE DERIVATIVES AS KINASE INHIBITORS
Kapman AB	B23D 49/10 (2006.01) B26B 9/02 (2006.01) B23D 61/12 (2006.01)	2448706 *	SAW BLADE, KNIFE AND SAW
GlaxoSmithKline LLC	A61K 31/54 (2006.01)	2488184 *	COMBINATION
H. Lundbeck A/S	C07D 241/04 (2006.01)	2451789 *	MANUFACTURE OF 4-((1R,3S)-6-CHLORO-3-PHENYL-INDAN-1-YL)-1,2,2-TRIMETHYL-PIPERAZINE AND 1-((1R,3S)-6-CHLORO-3-PHENYL-INDAN-1-YL)-3,3-DIMETHYL-PIPERAZINE
Taisho Pharmaceutical Co., Ltd.	C07D 405/12 (2006.01) A61K 31/4178 (2006.01) A61K 31/4196 (2006.01) A61K 31/437 (2006.01) A61K 31/4439 (2006.01) A61P 25/08 (2006.01) A61P 25/14 (2006.01) A61P 25/18 (2006.01) C07D 409/12 (2006.01) A61P 25/20 (2006.01) C07D 471/04 (2006.01) A61P 25/22 (2006.01) A61P 25/24 (2006.01) A61P 25/28 (2006.01) A61P 25/30 (2006.01) A61P 43/00 (2006.01) C07D 405/14 (2006.01)	2409976 *	GLYCINE TRANSPORTER INHIBITOR
Meggitt (San Juan Capistrano), Inc.	G01P 15/09 (2006.01)	2464981 *	PROOF MASS FOR MAXIMIZED, BI-DIRECTIONAL AND SYMMETRIC DAMPING IN HIGH G-RANGE ACCELERATION SENSORS
Biogen Idec MA Inc.	A01N 43/54 (2006.01) C07D 471/04 (2006.01) C07D 471/22 (2006.01)	2473049 *	BRUTON'S TYROSINE KINASE INHIBITORS
Sunesis Pharmaceuticals, Inc.	A01N 43/54 (2006.01) C07D 471/04 (2006.01) C07D 471/22 (2006.01)	2473049 *	BRUTON'S TYROSINE KINASE INHIBITORS
Genepod Therapeutics Ab	C12N 15/86 (2006.01) C12N 15/864 (2006.01) A61K 48/00 (2006.01)	2498825 *	NOVEL VIRAL VECTOR CONSTRUCT FOR NEURON SPECIFIC CONTINUOUS DOPA SYNTHESIS IN VIVO
Ardea Biosciences, Inc.	A61K 31/4412 (2006.01) A61P 35/04 (2006.01) A61K 31/18 (2006.01)	2405907 *	TREATMENT OF PANCREATIC CANCER
LI-COR, INC.	C09B 23/00 (2006.01) G01N 33/58 (2006.01) C09B 23/01 (2006.01) C09B 23/08 (2006.01)	2419478 *	FLUORESCENT IMAGING WITH SUBSTITUTED CYANINE DYES
Istituto Ricerche Per Lo Sviluppo Economico E Sociale S.R.L.	E04D 1/30 (2006.01) F24J 2/04 (2006.01) H01L 31/048 (2006.01)	2401448 *	BUILDING COVER ELEMENT WITH AN INTEGRATED ENERGY PRODUCTION DEVICE
Fitworx, LLC	A63B 23/02 (2006.01)	2416852 *	A SLIDING ABDOMINAL EXERCISE DEVICE
SOLA-Messwerkzeuge GmbH	G01C 9/28 (2006.01)	2322900	Water level

Podnosilac evropske prijave patenta (71)	MKP (51)	Broj objave evropske prijave patenta (97)	Naziv pronalaska (54)
Shionogi & Co., Ltd.	A61K 31/5377 (2006.01) A61K 31/5383 (2006.01) A61K 31/4985 (2006.01) C07D 498/14 (2006.01) A61K 31/53 (2006.01) A61K 31/553 (2006.01) A61P 31/16 (2006.01) A61P 43/00 (2006.01) C07D 471/04 (2006.01) C07D 471/14 (2006.01)	2444400 *	SUBSTITUTED POLYCYCLIC CARBAMOYLPIRIDONE DERIVATIVE
IFCO Systems GmbH	B65D 85/34 (2006.01) B65D 6/00 (2006.01) B65D 21/02 (2006.01)	2371740	Crate
Asahi Kasei Chemicals Corporation	F21V 7/22 (2006.01) F21Y 101/02 (2006.01) C08G 69/26 (2006.01) C08K 5/00 (2006.01) C08K 9/00 (2006.01) C08L 77/06 (2006.01) H01L 33/60 (2010.01) C08K 3/22 (2006.01)	2477243 *	REFLECTOR FOR LIGHT-EMITTING DEVICE, AND LIGHT-EMITTING DEVICE
Norgine BV	A61K 9/00 (2006.01) A61K 47/10 (2006.01)	2453873 *	IMPROVEMENTS IN AND RELATING TO COLON CLEANSING COMPOSITIONS
Cyprus University of Technology	B01J 23/50 (2006.01) B01D 53/86 (2006.01) B01D 53/94 (2006.01)	2468399	Catalyst for the reduction of NO to N2 with ethanol or ethanol and hydrogen under lean DENOx conditions
Geox S.p.A.	A43B 7/06 (2006.01) A43B 7/08 (2006.01) A43B 7/12 (2006.01)	2488060 *	WATERPROOF AND VAPOR-PERMEABLE SOLE FOR SHOES AND SHOE PROVIDED WITH SAID SOLE
Sanofi-Aventis Deutschland GmbH	A61M 5/315 (2006.01) A61M 5/50 (2006.01)	2437827 *	SPINDLE AND BEARING COMBINATION AND DRUG DELIVERY DEVICE
Avidas Pharmaceuticals LLC	A01N 45/00 (2006.01) A61K 31/59 (2006.01)	2461691 *	THERAPEUTIC VITAMIN D SUN-PROTECTING FORMULATIONS AND METHODS FOR THEIR USE
Dow AgroSciences LLC	A61K 31/505 (2006.01)	2485732 *	SYNERGISTIC FUNGICIDAL COMPOSITION CONTAINING 5-FLUOROCYTOSINE FOR FUNGAL CONTROL IN CEREALS
SSI Power LLC	H02J 13/00 (2006.01) H02H 3/04 (2006.01)	2425510 *	HIGH VOLTAGE POWER LINE COMMUNICATION SYSTEM USING AN ENERGY HARVESTING POWER SUPPLY
Kobo Products Inc.	B05D 7/24 (2006.01) C04B 41/52 (2006.01)	2411162 *	SELF-DISPERSIBLE COATED METAL OXIDE POWDER, AND PROCESS FOR PRODUCTION AND USE
Delphi Technologies Holding S.à.r.l.	F02D 41/24 (2006.01)	2410160	Method of providing trim data for a fuel injection device
Eaton GmbH	H02J 3/14 (2006.01) H02H 3/04 (2006.01)	2427940 *	MONITORING APPARATUS
Glaxo Group Limited	A61K 9/06 (2006.01) A61K 9/08 (2006.01) A61K 8/27 (2006.01) A61K 8/34 (2006.01) A61K 31/05 (2006.01) A61K 33/30 (2006.01) A61K 45/06 (2006.01) A61K 9/00 (2006.01)	2413922 *	ANTIBACTERIAL COMPOSITION COMPRISING 4-ISOPROPYL-3-METHYLPHENO AND ZINC IONS
Eaton Industries (Austria) GmbH	H02H 1/00 (2006.01)	2462670 *	ELECTRICAL INSTALLATION ARRANGEMENT
Glycotope GmbH	C07K 16/30 (2006.01)	2459595 *	MUC1 ANTIBODIES
Pearl Therapeutics, Inc.	A61K 9/12 (2006.01) A61P 11/00 (2006.01)	2435025 *	RESPIRATORY DELIVERY OF ACTIVE AGENTS

Podnosilac evropske prijave patenta (71)	MKP (51)	Broj objave evropske prijave patenta (97)	Naziv pronalaska (54)
Kyorin Pharmaceutical Co., Ltd.	C07F 9/09 (2006.01) C07F 9/38 (2006.01) A61P 31/04 (2006.01) A61P 43/00 (2006.01) A61K 31/662 (2006.01)	2452944 *	DIPHENYL SULFIDE DERIVATIVES AND MEDICINES CONTAINING SAME AS ACTIVE INGREDIENT
Bayer Pharma Aktiengesellschaft	C07J 3/00 (2006.01) A61K 31/56 (2006.01)	2437746 *	17 BETA-ALKYL-17 ALPHA-OXY-ESTRADIENES
Sanofi-Aventis Deutschland GmbH	A61M 5/315 (2006.01) A61M 5/24 (2006.01)	2482876 *	Drive assembly and use of a spring in a drug delivery device
Concert Pharmaceuticals Inc.	A01N 43/90 (2006.01) A61K 31/522 (2006.01)	2473053 *	SUBSTITUTED XANTHINE DERIVATIVES
Schneider GmbH & Co. KG	C08K 5/053 (2006.01) C09J 167/00 (2006.01) C08L 67/02 (2006.01) G02B 6/02 (2006.01) B24B 13/005 (2006.01) C08L 63/00 (2006.01)	2464688 *	COMPOSITION, IN PARTICULAR A BLOCKING AGENT COMPOSITION FOR FIXING BLANKS TO OPHTHALMIC OR OPTICAL LENSES
Lifescan, Inc.	G01N 33/487 (2006.01) A61B 5/00 (2006.01)	2448469 *	ANALYTE TESTING METHODS AND DEVICE FOR CALCULATING BASAL INSULIN THERAPY
AstraZeneca AB	C07D 487/04 (2006.01) A61K 31/5025 (2006.01) A61P 35/00 (2006.01)	2430024 *	[1,2,4]TRIAZOLO [4,3-B]PYRIDAZINES AS LIGANDS OF THE ANDROGEN RECEPTOR
Prometheus Laboratories Inc.	A61K 38/48 (2006.01)	2445517 *	METHODS FOR DIAGNOSING IRRITABLE BOWEL SYNDROME
Procos S.p.A.	C07D 213/74 (2006.01) A61K 31/44 (2006.01)	2394994	One-pot process for the synthesis of dalfampridine
Shire Human Genetic Therapies	A61K 38/47 (2006.01) A61K 38/46 (2006.01)	2459212 *	COMPOSITIONS AND METHODS FOR TREATING GAUCHER DISEASE
Rolls-Royce Marine AS	B63J 3/02 (2006.01) B63J 3/04 (2006.01) B63H 21/20 (2006.01)	2499041 *	HYBRID PROPULSION SYSTEM FOR A VESSEL
Imprimerie Nationale	G06K 19/077 (2006.01) B32B 37/00 (2006.01)	2415001 *	INSERT FORMING AN ANTENNA AND SMART CARD COMPRISING SAME
Meiji Seika Pharma Co., Ltd.	C12N 1/15 (2006.01) D21H 17/22 (2006.01) C12N 1/19 (2006.01) C12N 1/21 (2006.01) C12N 5/10 (2006.01) A23K 1/16 (2006.01) D21C 5/02 (2006.01) C12N 9/42 (2006.01) C12P 19/14 (2006.01) C12N 15/09 (2006.01) C12P 21/02 (2006.01)	2468859 *	NOVEL PROTEIN HAVING B-GLUCOSIDASE ACTIVITY, AND USE THEREOF
Sunflex Aluminiumsysteme GmbH	E05B 17/20 (2006.01) E05B 15/00 (2006.01) E05B 65/08 (2006.01) E05D 15/06 (2006.01) E05B 63/00 (2006.01)	2476828	Locking device
John Mezzalingua Associates, Inc.	H01R 9/05 (2006.01) H01R 13/648 (2006.01)	2436088 *	COAXIAL CABLE CONNECTOR HAVING ELECTRICAL CONTINUITY MEMBER
Ethicon, Inc.	C08F 8/00 (2006.01)	2499170 *	SURGICAL NEEDLE COATING AND METHODS
Schlink, Marcus	G09F 7/04 (2006.01) A47G 1/06 (2006.01) A47G 1/17 (2006.01)	2377435	Assembly for reversible attachment of representative works
Amgen, Inc	A61K 38/18 (2006.01) C07K 14/50 (2006.01)	2427207 *	FGF21 MUTANTS AND USES THEREOF
Järvensivu, Jouni	B65G 67/20 (2006.01)	2483189 *	METHOD AND DEVICE FOR FILLING A CONTAINER

Podnosilac evropske prijave patenta (71)	MKP (51)	Broj objave evropske prijave patenta (97)	Naziv pronalaska (54)
Sumitomo Chemical Company, Limited	A61P 1/04 (2006.01) C07D 405/14 (2006.01) A61P 3/10 (2006.01) A61K 31/4184 (2006.01) A61P 7/02 (2006.01) A61K 31/423 (2006.01) A61P 7/04 (2006.01) A61K 31/428 (2006.01) A61P 9/08 (2006.01) A61K 31/454 (2006.01) A61P 13/12 (2006.01) A61K 31/4439 (2006.01) A61P 9/10 (2006.01) A61P 1/02 (2006.01)	2436683 *	AGENT FOR TREATMENT OR PREVENTION OF DISEASES ASSOCIATED WITH ACTIVITY OF NEUROTROPHIC FACTORS
Alcafleu Management GmbH & Co. KG	C07H 19/19 (2006.01) C07H 1/00 (2006.01)	2430032 *	METHOD FOR THE MANUFACTURE OF 2-FLUORO-ARA-ADENINE
Synta Pharmaceuticals Corp.	A61K 45/06 (2006.01) A61K 31/337 (2006.01) A61P 35/00 (2006.01) A61K 31/4196 (2006.01)	2490688 *	COMBINATION CANCER THERAPY WITH HSP90 INHIBITORY COMPOUNDS
Rakuten, Inc.	G06F 17/30 (2006.01)	2485163 *	SERVER, DICTIONARY-GENERATION METHOD, DICTIONARY-GENERATION PROGRAM, AND COMPUTER-READABLE RECORDING MEDIUM WITH SAID PROGRAM RECORDED THEREON
Dow AgroSciences, LLC	A01N 33/00 (2006.01) A01N 43/90 (2006.01)	2488021 *	COMPOSITIONS AND METHODS TO CONTROL OOMYCETE FUNGAL PATHOGENS
Glaxo Group Limited	C07D 403/14 (2006.01)	2496571 *	PROCESSES FOR THE PREPARATION OF 5-LIPOXYGENASE ACTIVATING PROTEIN INHIBITORS AND THEIR INTERMEDIATES
Panmira Pharmaceuticals, LLC	C07D 403/14 (2006.01)	2496571 *	PROCESSES FOR THE PREPARATION OF 5-LIPOXYGENASE ACTIVATING PROTEIN INHIBITORS AND THEIR INTERMEDIATES
Abraxis BioScience, LLC	A61K 38/17 (2006.01)	2405932 *	Sparc angiogenic domain and methods of use
Sanofi-Aventis Deutschland GmbH	A61M 5/315 (2006.01)	2445553 *	DRIVE MECHANISM FOR DRUG DELIVERY DEVICE
BioGeneriX AG	C07K 14/505 (2006.01) C07K 1/16 (2006.01)	2480569 *	PROCESS FOR THE PURIFICATION OF RECOMBINANT HUMAN ERYTHROPOIETIN (EPO), EPO THUS PURIFIED AND PHARMACEUTICAL COMPOSITIONS COMPRISING SAME
Janssen Pharmaceutica, N.V.	A61K 31/4427 (2006.01) A61K 31/437 (2006.01) A61K 31/433 (2006.01) C07D 401/08 (2006.01) A61P 3/10 (2006.01) C07D 403/08 (2006.01) A61P 29/00 (2006.01) C07D 413/08 (2006.01) C07D 417/08 (2006.01) C07D 471/04 (2006.01)	2419417 *	4-AZETIDINYL-1-HETEROARYL-CYCLOHEXANE ANTAGONISTS OF CCR2
PQ Corporation	B01J 29/08 (2006.01) B01J 37/00 (2006.01)	2424661 *	ZEOLITE Y
Sanofi-Aventis Deutschland GmbH	A61M 5/315 (2006.01) A61M 5/00 (2006.01) A61M 5/24 (2006.01)	2485789 *	DRUG DELIVERY DEVICE WITH CLEARANCE COMPENSATION MEANS
Extracción de Médulas y Complementos, S.L.	A22B 5/20 (2006.01)	2409572	Machine for extracting material classified as hazardous from the medullary canal of sheep and goats
Krka Tovarna Zdravil, D.D., Novo Mesto	A61K 9/20 (2006.01) A61K 31/5377 (2006.01)	2442799 *	SOLID PHARMACEUTICAL COMPOSITION COMPRISING RIVAROXABAN
ALUDESIGN S.p.A.	A62B 1/14 (2006.01)	2453988 *	SAFETY DEVICE
Novartis AG	A61P 35/00 (2006.01) A61K 31/506 (2006.01)	2490690 *	METHOD OF TREATING PROLIFERATIVE DISORDERS AND OTHER PATHOLOGICAL CONDITIONS MEDIATED BY BCR-ABL, C-KIT, DDR1, DDR2 OR PDGF-R KINASE ACTIVITY

Podnosilac evropske prijave patenta (71)	MKP (51)	Broj objave evropske prijave patenta (97)	Naziv pronalaska (54)
China Academy of Telecommunications Technology	H04W 72/04 (2009.01)	2466979 *	METHOD, SYSTEM AND DEVICE FOR USING TERMINAL IDENTIFIER
Abraxis BioScience, LLC	A01N 43/66 (2006.01) A61K 31/53 (2006.01)	2440053 *	BENZYL SUBSTITUTED TRIAZINE DERIVATIVES AND THEIR THERAPEUTICAL APPLICATIONS
SANOFI	C07D 401/12 (2006.01) A61K 31/444 (2006.01) A61P 35/00 (2006.01) C07D 213/56 (2006.01)	2411364 *	ANTICANCER COMPOUNDS, PREPARATION THEREOF, AND THERAPEUTIC USE THEREOF
Cognition Therapeutics, Inc.	A61K 31/045 (2006.01) A01N 31/00 (2006.01)	2458983 *	INHIBITORS OF COGNITIVE DECLINE
Polyphor Ag	A61P 25/24 (2006.01) A61K 31/4745 (2006.01) C07D 498/04 (2006.01) C07D 498/18 (2006.01) C07F 7/08 (2006.01) A61K 31/695 (2006.01) A61P 1/06 (2006.01)	2499148 *	CONFORMATIONALLY CONSTRAINED, FULLY SYNTHETIC MACROCYCLIC COMPOUNDS
Les Laboratoires Servier	A61P 25/20 (2006.01) A61P 25/22 (2006.01) A61P 25/24 (2006.01) C07C 233/18 (2006.01) A61P 9/00 (2006.01) A61K 31/165 (2006.01) A61P 1/00 (2006.01) A61P 25/00 (2006.01) A61P 5/00 (2006.01) A61P 25/18 (2006.01)	2431355 *	NEW CRYSTALLINE FORM VI OF AGOMELATINE, PREPARATION METHOD AND APPLICATION THEREOF
SANOFI	C07D 307/80 (2006.01)	2435413 *	PROCESS FOR THE PRODUCTION OF DRONEDARONE INTERMEDIATES
Synpromics Ltd.	C12N 15/10 (2006.01) C12N 15/79 (2006.01)	2479278	Method for the construction of specific promoters
Signature Therapeutics, Inc.	A61P 25/00 (2006.01) C07D 489/02 (2006.01) A61K 31/485 (2006.01)	2475429 *	COMPOSITIONS COMPRISING ENZYME-CLEAVABLE KETONE-MODIFIED OPIOID PRODRUGS AND OPTIONAL INHIBITORS THEREOF
Novartis AG	C07D 417/14 (2006.01) A61K 31/4178 (2006.01) C07D 407/14 (2006.01) C07D 409/14 (2006.01) A61P 35/00 (2006.01) C07D 403/04 (2006.01) C07D 403/14 (2006.01)	2445903 *	1, 3-DISUBSTITUTED IMIDAZOLIDIN-2-ONE DERIVATIVES AS INHIBITORS OF CYP 17
Arena Pharmaceuticals, Inc.	A61K 31/4439 (2006.01) A61K 31/497 (2006.01) A61K 31/416 (2006.01) C07D 401/14 (2006.01) A61P 29/00 (2006.01) C07D 403/04 (2006.01) A61P 19/02 (2006.01) C07D 405/14 (2006.01) C07D 401/04 (2006.01) C07F 9/09 (2006.01) C07D 231/54 (2006.01) A61K 31/661 (2006.01)	2470508 *	CANNABINOID RECEPTOR MODULATORS
Sanofi-Aventis Deutschland GmbH	A61K 47/20 (2006.01) A61K 38/28 (2006.01) A61P 3/10 (2006.01) A61K 38/26 (2006.01)	2498802 *	PHARMACEUTICAL COMPOSITION COMPRISING A GLP-1 AGONIST, AN INSULIN, AND METHIONINE
University Of Medicine And Dentistry Of New Jersey	A61P 35/02 (2006.01) A61P 35/00 (2006.01) C07D 491/04 (2006.01) A61K 31/4355 (2006.01)	2403856 *	METHYLENEDIOXYBENZO [I]PHENANTHRIDINE DERIVATIVES USED TO TREAT CANCER

Podnosilac evropske prijave patenta (71)	MKP (51)	Broj objave evropske prijave patenta (97)	Naziv pronalaska (54)
Rutgers, The State University of New Jersey	A61P 35/02 (2006.01) A61P 35/00 (2006.01) C07D 491/04 (2006.01) A61K 31/4355 (2006.01)	2403856 *	METHYLENEDIOXYBENZO [I]PHENANTHRIDINE DERIVATIVES USED TO TREAT CANCER
China Academy of Telecommunications Technology	H04W 72/04 (2009.01)	2490496 *	RESOURCE CONFIGURATION METHOD, EQUIPMENT AND SYSTEM FOR UPLINK CONTROL CHANNEL
Interface, Inc.	A47G 27/02 (2006.01) A47G 27/04 (2006.01) D06N 7/00 (2006.01) D05C 17/02 (2006.01)	2440091 *	CARPET TILES AND METHODS OF PRODUCING CARPET TILES WITH DIVERSITY OF COLOR AND TEXTURE
Axikin Pharmaceuticals, Inc.	A61P 11/02 (2006.01) A61K 31/18 (2006.01) C07D 211/96 (2006.01) A61P 29/00 (2006.01) C07D 295/26 (2006.01) A01N 43/62 (2006.01) A61P 25/28 (2006.01) C07D 241/04 (2006.01) C07D 241/08 (2006.01)	2421830 *	2,5-DISUBSTITUTED ARYLSULFONAMIDE CCR3 ANTAGONISTS
TEVA PHARMACEUTICAL INDUSTRIES, LTD.	A61K 9/00 (2006.01) A61K 38/16 (2006.01)	2275086	Reduced volume formulation of glatiramer acetate and methods of administration
MOL Magyar Olaj- és Gázipari Nyrt.	C10G 3/00 (2006.01) C10L 1/02 (2006.01)	2305778	Fuel and fuel additives capable for use for internal combustion engines and process for the production thereof
OLAJTERV FÉVÁLLAKOZÓ ÉS TERVEZŐ ZRT.	C10G 3/00 (2006.01) C10L 1/02 (2006.01)	2305778	Fuel and fuel additives capable for use for internal combustion engines and process for the production thereof
Pannon Egyetem	C10G 3/00 (2006.01) C10L 1/02 (2006.01)	2305778	Fuel and fuel additives capable for use for internal combustion engines and process for the production thereof
Magyar Tudományos Akadémia Kémiai Kutatóközpont	C10G 3/00 (2006.01) C10L 1/02 (2006.01)	2305778	Fuel and fuel additives capable for use for internal combustion engines and process for the production thereof
WTS Kereskedelmi és Szolgáltató Kft.	E04H 4/14 (2006.01) E04H 4/12 (2006.01) F04D 15/00 (2006.01) A63B 69/12 (2006.01)	2446098 *	WATER ATTRACTION DEVICE
PCI Biotech AS	A61K 41/00 (2006.01) A61K 9/00 (2006.01) A61K 48/00 (2006.01) C12N 15/87 (2006.01) A61P 35/00 (2006.01) A61P 43/00 (2006.01)	2464385 *	PHOTOCHEMICAL INTERNALIZATION METHOD
Sanofi-Aventis Deutschland GmbH	A61M 5/315 (2006.01) A61M 5/24 (2006.01)	2482875 *	DRIVE ASSEMBLY, PISTON ROD, DRUG DELIVERY DEVICE, AND USE OF A SPRING
Acceleron Pharma, Inc.	C07K 14/705 (2006.01) A61K 38/17 (2006.01) A61P 3/00 (2006.01)	2440577 *	TRUNCATED ACTRIIB-FC FUSION PROTEINS
Janssen Pharmaceutica NV	C07D 405/12 (2006.01) A61K 31/444 (2006.01) C07D 211/56 (2006.01) A61K 31/397 (2006.01) C07D 413/12 (2006.01) A61K 31/4025 (2006.01) C07D 451/04 (2006.01) C07D 401/12 (2006.01) A61K 31/40 (2006.01) C07D 205/04 (2006.01) C07D 453/02 (2006.01) C07D 409/12 (2006.01) A61K 31/4245 (2006.01) C07D 207/09 (2006.01) C07C 217/90 (2006.01)	2493852 *	4-SUBSTITUTED-2-PHENOXY-PHENYLAMINE DELTA OPIOID RECEPTOR MODULATORS

Podnosilac evropske prijave patenta (71)	MKP (51)	Broj objave evropske prijave patenta (97)	Naziv pronalaska (54)
Alylam Pharmaceuticals, Inc.	A61K 39/00 (2006.01) C07H 21/02 (2006.01) C12N 15/11 (2006.01)	2451476 *	CELL-BASED BIOPROCESSING
Nieuwenhuys, Bruno	H04N 7/24 (2011.01) H04L 29/06 (2006.01) H04N 7/16 (2011.01) H04N 7/173 (2011.01) H04N 5/265 (2006.01) G06F 17/30 (2006.01)	2474164 *	METHODS AND SYSTEMS TO PERSONALIZE CONTENT STREAMS
Cadila Healthcare Limited	A61K 35/76 (2006.01) A61P 33/06 (2006.01)	2427201 *	COMBINED MEASLES-MALARIA VACCINE
NEC Corporation	H04L 12/56 (2006.01)	2493128 *	COMMUNICATION SYSTEM, FLOW CONTROL APPARATUS, FLOW TABLE UPDATING METHOD AND PROGRAM
ECLISSE SRL	E05D 15/06 (2006.01)	2357305	Device for supporting and anchoring in a having condition the door panel in a counter-frame for retractable sliding doors
Nanotec Solution	G06F 3/044 (2006.01)	2462499 *	CAPACITIVE DETECTION DEVICE HAVING FUNCTION INTEGRATION
Hercules Incorporated	A61K 9/28 (2006.01) A61K 9/48 (2006.01) A61K 9/50 (2006.01)	2448566 *	STABLE SHELLAC ENTERIC COATING FORMULATION FOR NUTRACEUTICAL AND PHARMACEUTICAL DOSAGE FORMS
Les Laboratoires Servier	C07C 323/61 (2006.01) C07C 327/34 (2006.01) C07D 205/04 (2006.01) C07D 211/34 (2006.01) C07D 213/55 (2006.01) C07D 213/73 (2006.01) A61P 9/00 (2006.01) A61K 31/095 (2006.01) A61P 7/02 (2006.01)	2272826	2-mercaptopentancarboxylic acid derivatives, the method for preparing them and the pharmaceutical compositions containing them
Institut National des Sciences Appliquées de Rouen (INSA)	C07C 323/61 (2006.01) C07C 327/34 (2006.01) C07D 205/04 (2006.01) C07D 211/34 (2006.01) C07D 213/55 (2006.01) C07D 213/73 (2006.01) A61P 9/00 (2006.01) A61K 31/095 (2006.01) A61P 7/02 (2006.01)	2272826	2-mercaptopentancarboxylic acid derivatives, the method for preparing them and the pharmaceutical compositions containing them
Centre National de la Recherche Scientifique (C.N.R.S.)	C07C 323/61 (2006.01) C07C 327/34 (2006.01) C07D 205/04 (2006.01) C07D 211/34 (2006.01) C07D 213/55 (2006.01) C07D 213/73 (2006.01) A61P 9/00 (2006.01) A61K 31/095 (2006.01) A61P 7/02 (2006.01)	2272826	2-mercaptopentancarboxylic acid derivatives, the method for preparing them and the pharmaceutical compositions containing them
Universite de Rouen	C07C 323/61 (2006.01) C07C 327/34 (2006.01) C07D 205/04 (2006.01) C07D 211/34 (2006.01) C07D 213/55 (2006.01) C07D 213/73 (2006.01) A61P 9/00 (2006.01) A61K 31/095 (2006.01) A61P 7/02 (2006.01)	2272826	2-mercaptopentancarboxylic acid derivatives, the method for preparing them and the pharmaceutical compositions containing them
Vet Therapeutics, Inc.	A61K 39/395 (2006.01)	2411050 *	ANTIBODY CONSTANT DOMAIN REGIONS AND USES THEREOF
Scansonic MI GmbH	B23K 26/24 (2006.01) B23K 26/03 (2006.01) B23K 26/067 (2006.01) B23K 26/42 (2006.01) B23K 26/04 (2006.01)	2485862 *	JOINING DEVICE FOR NON-POSITIVE JOINING BY MEANS OF A FILLER MATERIAL USING SENSORS

Podnosilac evropske prijave patenta (71)	MKP (51)	Broj objave evropske prijave patenta (97)	Naziv pronalaska (54)
Bayerische Motoren Werke AG	B23K 26/24 (2006.01) B23K 26/03 (2006.01) B23K 26/067 (2006.01) B23K 26/42 (2006.01) B23K 26/04 (2006.01)	2485862 *	JOINING DEVICE FOR NON-POSITIVE JOINING BY MEANS OF A FILLER MATERIAL USING SENSORS
ARIAD Pharmaceuticals, Inc	A61K 31/55 (2006.01) A61K 31/535 (2006.01) A61K 31/00 (2006.01)	2493460 *	METHODS AND COMPOSITIONS FOR TREATING CANCER
Saint-Gobain Glass France	B29C 45/14 (2006.01) B29C 33/18 (2006.01) B29C 33/38 (2006.01)	2414145 *	METHOD FOR MOULDING A PLASTIC PART WITH AN INSERT HELD IN PLACE BY MEANS OF SUCTION, MOULDING DEVICE AND USE
Immunogen, Inc.	A61K 39/395 (2006.01) A61K 51/00 (2006.01) A61K 47/48 (2006.01)	2437790 *	CONJUGATION METHODS
TRB Chemedica International S.A.	A61K 9/00 (2006.01) A61K 9/06 (2006.01) A61K 47/32 (2006.01) A61K 31/20 (2006.01) A61K 31/201 (2006.01) A61K 31/202 (2006.01)	2408426 *	OPHTHALMIC COMPOSITIONS BASED ON POLYUNSATURATED OMEGA-3 AND OMEGA-6 FATTY ACIDS
PPG Industries Ohio, Inc.	G02B 6/255 (2006.01)	2460040 *	SPLICED FIBER GLASS ROVINGS AND METHODS AND SYSTEMS FOR SPLICING FIBER GLASS ROVINGS
9Solutions Oy	H04W 84/20 (2009.01)	2400812	Bluetooth networking
Teva Pharmaceutical Industries Ltd.	C07D 401/00 (2006.01)	2467372 *	TREATMENT OF BDNF-RELATED DISORDERS USING LAQUINIMOD
Merz Pharma GmbH & Co. KGaA	G01N 33/569 (2006.01)	2425251 *	MEANS AND METHODS FOR THE DETERMINATION OF THE AMOUNT OF NEUROTOXIN POLYPEPTIDE AND OF ITS CATALYTIC AND PROTEOLYTIC ACTIVITIES
Newlink Genetics Corporation	C07D 401/12 (2006.01) A61P 35/00 (2006.01) A61K 31/4164 (2006.01) C07D 407/12 (2006.01) A61P 31/00 (2006.01) C07D 409/12 (2006.01) C07D 233/64 (2006.01) A61K 31/4178 (2006.01) C07D 413/12 (2006.01) C07D 403/12 (2006.01) A61P 37/00 (2006.01) C07D 417/12 (2006.01)	2493862 *	IMIDAZOLE DERIVATIVES AS IDO INHIBITORS
TransTech Pharma, Inc.	C07D 233/60 (2006.01) A61K 31/4164 (2006.01) A61P 25/28 (2006.01)	2470510 *	SUBSTITUTED IMIDAZOLE DERIVATIVES FOR TREATMENT OF ALZHEIMERS DISEASE
Millennium Pharmaceuticals, Inc.	A61K 39/395 (2006.01)	2490720 *	ANTI-GCC ANTIBODY MOLECULES AND RELATED COMPOSITIONS AND METHODS
Amgen British Columbia	A61K 39/395 (2006.01)	2490720 *	ANTI-GCC ANTIBODY MOLECULES AND RELATED COMPOSITIONS AND METHODS
Theratechnologies Inc.	C07K 14/60 (2006.01) A61K 31/427 (2006.01) A61K 38/27 (2006.01) A61K 38/16 (2006.01) C07K 17/02 (2006.01)	2421547 *	USE OF (HEXENOYL TRANS-3)HGRF(1-44)NH2 AND RITONAVIR IN COMBINATION THERAPY
Oceanscan Limited	G01S 15/89 (2006.01) G01F 23/296 (2006.01)	2299292	Scanning apparatus and method
Merck Serono S.A.	G01N 33/50 (2006.01) G01N 33/74 (2006.01) C12Q 1/68 (2006.01) A61K 38/27 (2006.01)	2473850 *	COMPOSITIONS AND METHODS FOR TREATING GROWTH HORMONE DEFICIENCY

Podnosilac evropske prijave patenta (71)	MKP (51)	Broj objave evropske prijave patenta (97)	Naziv pronalaska (54)
SANOFI	A61K 31/454 (2006.01) C07D 401/06 (2006.01) A61P 11/00 (2006.01) A61P 29/00 (2006.01) A61P 19/02 (2006.01) A61P 1/00 (2006.01)	2480232 *	DISUBSTITUTED]4-(5-AMINOMETHYL-PHENYL)-PIPERIDIN-1-YL]-1H-INDOL-3-YL]-METHANONES
Theranos, Inc.	G06F 17/00 (2006.01) G06Q 50/00 (2012.01)	2491499 *	INTEGRATED HEALTH DATA CAPTURE AND ANALYSIS SYSTEM
Crearene Ltd.	A61K 31/198 (2006.01) A61P 13/12 (2006.01)	2416770 *	HEMODIALYSIS AND PERITONEAL DIALYSIS SOLUTIONS COMPRISING ONE OR MORE CREATINE COMPOUNDS
Anthem Biosciences Private Limited	C07C 247/06 (2006.01) C07D 249/06 (2006.01) A61P 35/04 (2006.01) C07D 403/10 (2006.01) A61K 31/4192 (2006.01) C07D 413/10 (2006.01) C07C 259/10 (2006.01) C07D 403/04 (2006.01) A61K 35/00 (2006.01) A61P 35/02 (2006.01) C07C 209/10 (2006.01)	2451790 *	HISTONE DEACETYLASE INHIBITORS
John Mezzalingua Assoc., Inc.	H01R 13/658 (2011.01) H01B 11/06 (2006.01) H01R 13/646 (2011.01)	2465169 *	CONDUCTIVE ELASTOMER AND METHOD OF APPLYING A CONDUCTIVE COATING TO ELASTROMERIC SUBSTRATE
Boehringer Ingelheim International GmbH	C07D 261/14 (2006.01) C07D 413/12 (2006.01) C07D 413/14 (2006.01) C07D 417/06 (2006.01) C07D 417/12 (2006.01) C07D 417/14 (2006.01) A61K 31/42 (2006.01) A61P 29/00 (2006.01)	2443100 *	COMPOUNDS WHICH SELECTIVELY MODULATE THE CB2 RECEPTOR
Cafés Folliet	A47J 31/40 (2006.01) A47J 31/60 (2006.01)	2311353	Machine for the production of mixed beverages
Burcon Nutrascience (MB) Corp.	A23J 1/14 (2006.01) A23J 3/16 (2006.01)	2429310 *	PRODUCTION OF CANOLA PROTEIN PRODUCT WITHOUT HEAT TREATMENT ("C200CaC")
Delphi Technologies Holding S.à.r.l.	F02D 41/22 (2006.01)	2375038	Diagnosis device and method using an in-cylinder pressure sensor in an internal combustion engine
Boehringer Ingelheim International GmbH	C07D 239/47 (2006.01) A61K 31/506 (2006.01) C07D 417/12 (2006.01) A61P 35/00 (2006.01) C07D 403/12 (2006.01)	2483249 *	PYRIMIDINE DERIVATIVES AS PROTEIN TYROSINE KINASE 2 INHIBITORS
Les Laboratoires Servier	C07D 211/42 (2006.01) A61K 31/445 (2006.01) A61K 31/4462 (2006.01) A61P 25/00 (2006.01)	2277863	Piperidine derivatives, process for their preparation and pharmaceutical compositions containing them
Universite De Nantes I	C07D 211/42 (2006.01) A61K 31/445 (2006.01) A61K 31/4462 (2006.01) A61P 25/00 (2006.01)	2277863	Piperidine derivatives, process for their preparation and pharmaceutical compositions containing them
Cadila Healthcare Limited	C07D 239/34 (2006.01)	2451786 *	IMPROVED PROCESS FOR THE PREPARATION OF AMBRISENTAN AND NOVEL INTERMEDIATES THEREOF
Abbott Biotherapeutics Corp.	G01N 33/50 (2006.01) G01N 33/564 (2006.01)	2470901 *	USE OF IMMUNOREGULATORY NK CELL POPULATIONS FOR PREDICTING THE EFFICACY OF ANTI-IL-2R ANTIBODIES IN MULTIPLE SCLEROSIS PATIENTS
Dusseault, Maurice B.	B65G 5/00 (2006.01) E21F 17/16 (2006.01)	2406152 *	PROCESS FOR SEQUESTRATION OF FLUIDS IN GEOLOGICAL FORMATIONS
Bilak, Roman	B65G 5/00 (2006.01) E21F 17/16 (2006.01)	2406152 *	PROCESS FOR SEQUESTRATION OF FLUIDS IN GEOLOGICAL FORMATIONS

Podnosilac evropske prijave patenta (71)	MKP (51)	Broj objave evropske prijave patenta (97)	Naziv pronalaska (54)
Panasonic Corporation	H04N 13/04 (2006.01) G11B 20/12 (2006.01) H04N 5/92 (2006.01)	2416581 *	RECORDING MEDIUM, REPRODUCING DEVICE, AND INTEGRATED CIRCUIT
Hercules Incorporated	D21H 17/56 (2006.01) D21H 17/46 (2006.01) D21H 17/52 (2006.01) D21H 19/80 (2006.01) D21H 19/82 (2006.01) D21H 19/36 (2006.01) D21H 21/20 (2006.01) D21H 19/40 (2006.01) D21H 27/10 (2006.01) D21H 19/62 (2006.01)	2438237 *	CATIONIC WET STRENGTH RESIN MODIFIED PIGMENTS IN WATER-BASED LATEX COATING APPLICATIONS
Janssen Pharmaceutica, N.V.	C07D 211/34 (2006.01) A61K 31/451 (2006.01)	2435406 *	RESOLUTION OF (±)-METHYL PHENYL[4-[4-[[[4'-(TRIFLUOROMETHYL)-2-BIPHENYLYL]CARBONYL]AMINO]PHENYL]-1-PIPERIDINYL]ACETATE
Tesimax - Altinger GmbH	A62B 18/08 (2006.01) A62B 17/04 (2006.01)	2392385	Viewing pane frame for a protective suit
Abraxis BioScience, LLC	A01N 43/66 (2006.01) A61K 31/53 (2006.01)	2440050 *	TRIAZINE DERIVATIVES AND THEIR THERAPEUTICAL APPLICATIONS
Zhejiang Hangzhou Xinfu Pharmaceutical Co. Ltd	C08G 63/21 (2006.01) C08G 63/47 (2006.01)	2325228	An aliphatic-aromatic copolymer, the preparation method and the use thereof
Immersion Corporation	G06F 3/01 (2006.01) G06F 3/16 (2006.01)	2494425 *	SYSTEMS AND METHODS FOR HAPTIC AUGMENTATION OF VOICE-TO-TEXT CONVERSION
Ethicon Endo-Surgery, Inc.	A61B 17/29 (2006.01) A61B 17/00 (2006.01)	2410927 *	SURGICAL INSTRUMENTS FOR IN VIVO ASSEMBLY
GlaxoSmithKline Biologicals S.A.	A61K 39/00 (2006.01)	2440243 *	IMMUNOGENIC COMPOSITIONS HAVING LOW SODIUM CHLORIDE CONCENTRATION
High Point Pharmaceuticals, LLC	A61K 31/47 (2006.01)	2424533 *	SUBSTITUTED ISOQUINOLINE DERIVATIVES, PHARMACEUTICAL COMPOSITIONS, AND METHODS OF USE AS -SECRETASE INHIBITORS
Novimmune S.A.	A61K 38/00 (2006.01) C07K 14/54 (2006.01) C07K 16/24 (2006.01)	2427203 *	ANTI-IL-17F ANTIBODIES AND METHODS OF USE THEREOF
Tetraphase Pharmaceuticals, Inc.	C07C 275/24 (2006.01) C07D 221/20 (2006.01) C07C 311/06 (2006.01) C07D 295/03 (2006.01) C07C 311/19 (2006.01) C07D 223/04 (2006.01) C07D 205/04 (2006.01) C07D 223/32 (2006.01) C07D 207/06 (2006.01) C07D 209/04 (2006.01) C07D 207/08 (2006.01) C07C 237/26 (2006.01) C07D 211/34 (2006.01)	2427425 *	TETRACYCLINE COMPOUNDS
The Regents of the University of California	A61K 39/00 (2006.01)	2456460 *	METHODS AND COMPOSITIONS FOR TREATING AND PREVENTING DISEASE ASSOCIATED WITH AVB5 INTEGRIN
Paxvax, Inc.	C12N 15/00 (2006.01) A61K 31/70 (2006.01)	2459716 *	ADENOVIRAL-BASED VECTORS
Sanofi-Aventis U.S. LLC	C07D 213/16 (2006.01) C07D 211/18 (2006.01) C07F 5/02 (2006.01)	2483243 *	SYNTHESIS OF (4-FLUORO-3-PIPERIDIN-4-YL-BENZYL)-CARBAMIC ACID TERT-BUTYL ESTER AND INTERMEDIATES THEREOF
Chelsea Therapeutics, Inc.	C07D 239/95 (2006.01) A61K 31/517 (2006.01) A61P 35/00 (2006.01)	2496237 *	ENZYME INHIBITING COMPOUNDS
EUROPEAN SPACE AGENCY	G02B 27/00 (2006.01) G02B 6/08 (2006.01) G02B 6/42 (2006.01)	2410358	Imaging optics and optical device for mapping a curved image field

Podnosilac evropske prijave patenta (71)	MKP (51)	Broj objave evropske prijave patenta (97)	Naziv pronalaska (54)
Mpeg LA, L.I.c.	G06Q 50/00 (2012.01)	2422314 *	SYSTEMS AND METHODS FOR MANAGING PATENT LICENSES
J-Lok Co.	B65B 35/54 (2006.01)	2496481 *	MULTI-SPEED RESIN CARTRIDGE PRODUCTION SYSTEM
ArcelorMittal Construction France	H01L 31/048 (2006.01) F16B 5/02 (2006.01) E04D 3/365 (2006.01) E04D 13/18 (2006.01) H01L 31/042 (2006.01)	2422376 *	ATTACHMENT PART FOR ASSEMBLING A MODULE, IN PARTICULAR A PHOTOVOLTAIC MODULE, ON A RIBBED METAL SHEET, ASSEMBLY AND USE THEREOF FOR MAKING A BUILDING COVER, AND RELATED METHOD OF PRODUCTION
Innotech Solar ASA	C30B 33/02 (2006.01) H01L 29/32 (2006.01)	2406414 *	PREVENTION OF CRACK PROPAGATION IN BRITTLE MATERIALS
Magna Powertrain Inc.	F02B 39/02 (2006.01) B60K 11/02 (2006.01) B60R 16/08 (2006.01) B60R 17/00 (2006.01) F02B 39/16 (2006.01)	2440762 *	DUAL POWER INPUT FLUID PUMP
Merz Pharma GmbH & Co. KGaA	A61K 31/713 (2006.01) C12N 15/63 (2006.01) C07K 14/33 (2006.01) A61K 38/48 (2006.01) C12N 9/52 (2006.01) C07K 16/12 (2006.01) C12N 1/21 (2006.01) C12P 21/02 (2006.01)	2449101 *	NEUROTOXINS EXHIBITING SHORTENED BIOLOGICAL ACTIVITY
Bial-Portela & CA, S.A.	A61K 47/14 (2006.01) A61K 47/26 (2006.01) A61K 9/10 (2006.01) A61K 31/55 (2006.01) A61K 47/36 (2006.01)	2475357 *	ORAL SUSPENSION FORMULATIONS OF ESCLICARBAZEPINE ACETATE
Londonpharma Ltd.	A61K 9/12 (2006.01) A61K 9/00 (2006.01) A61K 31/335 (2006.01)	2421503 *	SUBLINGUAL PHARMACEUTICAL COMPOSITION COMPRISING A NEUTRAL OIL
Griffith Laboratories International, Inc.	A23P 1/12 (2006.01) A23P 1/02 (2006.01) A23L 1/10 (2006.01)	2459012 *	AGGLOMERATES AND PREPARATION THEREOF
Novomatic AG	G07D 9/00 (2006.01) G07F 1/04 (2006.01)	2462566 *	DEVICE FOR RECEIVING COINS
Glaxo Group Limited	C07D 413/14 (2006.01) A61K 31/4439 (2006.01) A61P 31/12 (2006.01) A61K 31/422 (2006.01) A61P 35/00 (2006.01) A61P 11/00 (2006.01) A61P 37/00 (2006.01)	2424864 *	OXAZOLE SUBSTITUTED INDAZOLES AS PI3-KINASE INHIBITORS
Milinkovic, Mladen	E04B 1/32 (2006.01)	2414597 *	PREFABRICATED CONSTRUCTION OBJECT WHICH IS BUILT FROM PREFABRICATED FEROCEMENT RIB ELEMENTS BY SANDWICH TYPE WHICH ARE EFFUSED IN MOULDS
Milinkovic, Milenko	E04B 1/32 (2006.01)	2414597 *	PREFABRICATED CONSTRUCTION OBJECT WHICH IS BUILT FROM PREFABRICATED FEROCEMENT RIB ELEMENTS BY SANDWICH TYPE WHICH ARE EFFUSED IN MOULDS
Dow AgroSciences, LLC	A01N 43/653 (2006.01) A01N 25/32 (2006.01) A01N 43/42 (2006.01) A01P 13/00 (2006.01) A01N 43/54 (2006.01) A01N 43/56 (2006.01)	2493292 *	SAFENING 6-AMINO-2-(SUBSTITUTED PHENYL)-5-SUBSTITUTED-4-PYRIMIDINECARBOXYLATE HERBICIDE INJURY ON CEREAL CROPS
ALGIPHARMA AS	A61K 47/36 (2006.01)	2437783 *	TREATMENT OF ACINETOBACTER WITH ALGINATE OLIGOMERS AND ANTIBIOTICS
Dall Energy Holding ApS	C10J 3/56 (2006.01) C10J 3/84 (2006.01) C10J 3/48 (2006.01) C10J 3/86 (2006.01)	2445999 *	METHOD AND SYSTEM FOR CLEANING OF AND HEAT RECOVERY FROM HOT GASES

Podnosilac evropske prijave patenta (71)	MKP (51)	Broj objave evropske prijave patenta (97)	Naziv pronalaska (54)
Eli Lilly and Company	C07D 498/04 (2006.01) C07D 513/02 (2006.01) C07D 279/08 (2006.01)	2451793 *	BACE INHIBITORS
Samp S.p.a. Con Unico Socio	B23F 5/22 (2006.01) B23Q 1/28 (2006.01)	2456588 *	MACHINE FOR MAKING GEARS
Li, Wenbo	A24B 3/18 (2006.01) A24B 15/00 (2006.01) A24B 3/12 (2006.01) A24B 15/32 (2006.01) A24B 3/14 (2006.01) A24B 15/10 (2006.01) C07C 11/12 (2006.01) A24B 15/18 (2006.01) C07C 11/00 (2006.01) A24B 15/28 (2006.01) A24B 3/00 (2006.01) A24B 15/30 (2006.01)	2444384 *	USE OF NEOPHYTADIENE AS ADDITIVE FOR LIQUID CIGARETTE
Aardvark Medical, Llc	A61M 3/02 (2006.01) A61M 1/00 (2006.01)	2424590 *	IRRIGATION AND ASPIRATION DEVICES AND METHODS
Micromet AG	A61K 39/395 (2006.01) A61P 35/00 (2006.01) C07K 16/28 (2006.01) C07K 16/30 (2006.01) C07K 16/46 (2006.01)	2477653 *	DOSAGE REGIMEN FOR ADMINISTERING AN EPCAMXCD3 BISPECIFIC ANTIBODY
Biolase S.p.A.	C02F 1/66 (2006.01) C02F 1/72 (2006.01) C02F 9/00 (2006.01) C02F 11/06 (2006.01) C02F 101/20 (2006.01) C02F 101/30 (2006.01)	2342164 *	PROCESS FOR THE DISPOSAL OF WASTES, PARTICULARLY OF SLUDGES DERIVING FROM WASTE WATER DEPURATION
Garoni, M. Régis	F24F 5/00 (2006.01) F24F 12/00 (2006.01)	2339253	Dwelling with passive air-conditioning system
Asahi Kasei Chemicals Corporation	C08F 36/04 (2006.01) C08K 3/36 (2006.01) C08L 15/00 (2006.01) C08C 19/25 (2006.01)	2484701 *	PRODUCTION METHOD FOR MODIFIED CONJUGATED DIENE POLYMER, MODIFIED CONJUGATED DIENE POLYMER, AND MODIFIED CONJUGATED DIENE POLYMER COMPOSITION
Ranbaxy Laboratories Limited	A61K 9/20 (2006.01)	2263657	Controlled release lamotrigine formulations
The Salk Institute for Biological Studies	C12N 15/12 (2006.01) C12N 5/074 (2010.01) C12N 5/10 (2006.01)	2435558 *	GENERATION OF GENETICALLY CORRECTED DISEASE-FREE INDUCED PLURIPOTENT STEM CELLS
Center Of Regenerative Medicine Of Barcelona, Spain	C12N 15/12 (2006.01) C12N 5/074 (2010.01) C12N 5/10 (2006.01)	2435558 *	GENERATION OF GENETICALLY CORRECTED DISEASE-FREE INDUCED PLURIPOTENT STEM CELLS
China Academy of Telecommunications Technology	H04W 72/12 (2009.01)	2445293 *	METHOD, DEVICE AND SYSTEM FOR REPORTING POWER HEADROOM
Ethicon Endo-Surgery, Inc.	A61B 17/32 (2006.01)	2448501 *	ULTRASONIC DEVICE FOR CUTTING AND COAGULATING
Ajinomoto Co., Inc.	C12Q 1/02 (2006.01) C12N 15/09 (2006.01)	2386651 *	METHOD FOR SCREENING FOR SALTY TASTE CONTROL SUBSTANCE
Novartis AG	A61K 31/165 (2006.01) C07C 233/45 (2006.01) C07C 233/64 (2006.01) C07C 233/57 (2006.01) A61K 31/166 (2006.01)	2435402 *	SUBSTITUTED AMINO BUTYRIC DERIVATIVES AS NEPRILYSIN INHIBITORS
UCB Pharma, S.A.	C07K 16/46 (2006.01) C12N 15/13 (2006.01) A61P 11/06 (2006.01) C07K 16/24 (2006.01) A61K 39/395 (2006.01)	2406283 *	ANTIBODY MOLECULES HAVING BINDING SPECIFICITY FOR HUMAN IL-13
Walther Spritz- und Lackiersysteme GmbH	B05B 1/30 (2006.01)	2279792	Spray gun

Podnosilac evropske prijave patenta (71)	MKP (51)	Broj objave evropske prijave patenta (97)	Naziv pronalaska (54)
Prometheus Laboratories Inc.	G01N 33/543 (2006.01) G01N 33/574 (2006.01) G01N 33/50 (2006.01) G01N 33/533 (2006.01) G01N 33/532 (2006.01) G01N 33/535 (2006.01)	2430443 *	BIOMARKERS FOR DETERMINING SENSITIVITY OF BREAST CANCER CELLS TO HER2-TARGETED THERAPY
SICPA HOLDING SA	C09K 11/06 (2006.01) C09D 11/10 (2006.01) C09D 11/00 (2006.01) B41M 3/14 (2006.01)	2430103 *	SECURE DOCUMENT COMPRISING LUMINESCENT CHELATES
SANOFI	C07D 409/12 (2006.01) A61K 31/4535 (2006.01) A61P 25/00 (2006.01) C07D 409/06 (2006.01)	2411383 *	DERIVATIVES OF 3-ALKOXY-4,5-DIARYLTHIOPHENE-2-CARBOXAMIDE, PREPARATION THEREOF, AND THERAPEUTIC USE THEREOF
Basilea Pharmaceutica AG	A61P 35/00 (2006.01) A61P 29/00 (2006.01) C07H 17/08 (2006.01) A61P 11/06 (2006.01) C07D 498/04 (2006.01) A61K 31/4433 (2006.01)	2464651 *	NEW MACROLIDES AND THEIR USE
Athenix Corporation	C12N 15/82 (2006.01) C07K 14/325 (2006.01)	2403948 *	METHODS AND COMPOSITIONS FOR CONTROLLING PLANT PESTS
Krka, D.D., Novo Mesto	A61K 9/20 (2006.01)	2400954 *	PROCESS FOR FORMING SOLID ORAL DOSAGE FORMS OF SOLIFENACIN AND ITS PHARMACEUTICALLY ACCEPTABLE SALTS
Abloy Oy	E05B 21/06 (2006.01)	2406442 *	DISC TUMBLER CYLINDER LOCK AND KEY COMBINATION
Kaspersky Lab, ZAO	H04L 29/06 (2006.01)	2472817	System and method for optimization of execution of security tasks in local network
The Schawbel Corporation	F24C 11/00 (2006.01)	2425183 *	HEATING DEVICE HAVING ELECTRIC AND FUEL POWERED HEAT SOURCES
Limonov, Viktor Lvovich	A61K 31/665 (2006.01) A61K 47/04 (2006.01) A61P 31/04 (2006.01) A61K 9/51 (2006.01)	2476419 *	PHARMACEUTICAL COMPOSITION HAVING ANTIMICROBIAL AND ANTI-INFLAMMATORY ACTIVITY FOR PARENTERAL ADMINISTRATION, PROCESS FOR PREPARING SAME
Intermune, Inc.	A61K 31/4412 (2006.01) A61P 11/00 (2006.01)	2324831	Methods of administering pirfenidone therapy
Owens-Brockway Glass Container INC.	C03B 7/06 (2006.01) F23N 5/02 (2006.01)	2429959 *	SYSTEM AND METHOD FOR CONTROLLING TEMPERATURE IN A FOREHEARTH
JX Nippon Oil & Energy Corporation	C07C 45/34 (2006.01) C07C 255/17 (2006.01) C07B 61/00 (2006.01) C07C 253/30 (2006.01) C07C 49/17 (2006.01) C07C 49/175 (2006.01)	2487149 *	METHOD FOR PRODUCING KETONE
Osaka University	C07C 45/34 (2006.01) C07C 255/17 (2006.01) C07B 61/00 (2006.01) C07C 253/30 (2006.01) C07C 49/17 (2006.01) C07C 49/175 (2006.01)	2487149 *	METHOD FOR PRODUCING KETONE
Irix Pharmaceuticals	C07C 69/76 (2006.01)	2454227 *	SYNTHESIS OF PROSTANOIDS
Presens AS	G01L 9/00 (2006.01)	2491364 *	SEPARATING MEMBRANE FOR PRESSURE SENSOR
MAP Pharmaceuticals Inc	A01N 45/00 (2006.01)	2429297 *	METHOD OF ADMINISTERING DOSE-SPARING AMOUNTS OF FORMOTEROL FUMARATE-BUDESONIDE COMBINATION PARTICLES BY INHALATION
ARTA PLAST AB	A61M 16/00 (2006.01) A61M 16/16 (2006.01)	2319568	Device for moistening breathed air for artificial respiration

Podnosilac evropske prijave patenta (71)	MKP (51)	Broj objave evropske prijave patenta (97)	Naziv pronalaska (54)
CADILA HEALTHCARE LIMITED	C07D 211/58 (2006.01) C07D 491/22 (2006.01) A61P 35/00 (2006.01) A61K 31/4375 (2006.01)	2341046	Process for the preparation of 7-ethyl-10-[4-(1-piperidino)-1-piperidino] carbonyloxy-camptothecin hydrochloride trihydrate
Janssen Pharmaceutica N.V.	A61P 25/00 (2006.01) C07D 487/04 (2006.01) C07D 471/04 (2006.01) A61K 31/4353 (2006.01)	2491031 *	FUSED HETEROCYCLIC COMPOUNDS AS OREXIN RECEPTOR MODULATORS
UCB Pharma, S.A.	C07K 16/28 (2006.01)	2493927 *	METHOD TO GENERATE ANTIBODIES TO ION CHANNELS
Les Laboratoires Servier	A61P 9/00 (2006.01) C07D 223/16 (2006.01) A61K 31/55 (2006.01)	2364972	New method for synthesising ivabradine and its addition salts
N.V. Organon	A61K 9/00 (2006.01) A61F 6/14 (2006.01)	2427154 *	INTRAUTERINE SYSTEM FOR USE IN MEDICAL TREATMENT
Abraxis BioScience, LLC	A61P 35/00 (2006.01) A61P 35/02 (2006.01) G01N 33/574 (2006.01) A61K 38/20 (2006.01) A61K 39/395 (2006.01)	2435068 *	USE OF 2 ANTI-SPARC ANTIBODIES TO PREDICT RESPONSE TO CHEMOTHERAPY
Danisco A/S	A61K 35/74 (2006.01) A61P 5/50 (2006.01) A61P 29/00 (2006.01)	2459203 *	LACTIC ACID BACTERIA AND BIFIDOBACTERIA FOR TREATING ENDOTOXEMIA
Kempharm, Inc.	A61K 31/44 (2006.01) A01N 43/42 (2006.01)	2448407 *	BENZOIC ACID, BENZOIC ACID DERIVATIVES AND HETEROARYL CARBOXYLIC ACID CONJUGATES OF HYDROCODONE, PRODRUGS, METHODS OF MAKING AND USE THEREOF
Protiva Biotherapeutics Inc.	C12N 15/88 (2006.01) C07H 21/00 (2006.01) C07H 21/02 (2006.01) C12N 15/87 (2006.01) A61K 9/14 (2006.01) C12N 15/113 (2010.01) A61P 35/00 (2006.01) A61K 31/713 (2006.01)	2449114 *	NOVEL LIPID FORMULATIONS FOR DELIVERY OF THERAPEUTIC AGENTS TO SOLID TUMORS
Eurosicma S.p.A.	B65G 17/26 (2006.01)	2403783 *	PLANT FOR FEEDING GROUPS OF PRODUCTS TO A PACKAGING MACHINE
PRODOTTI CHIMICI E ALIMENTARI SPA	C07J 41/00 (2006.01) C07J 9/00 (2006.01)	2427473 *	METHOD FOR THE SYNTHESIS OF GLYCOCHOLIC ACID
Apeptico Forschung Und Entwicklung GmbH	A61K 38/19 (2006.01)	2403519 *	METHOD FOR PREVENTING AND TREATING HYPERPERMEABILITY
Britax Childcare Pty Ltd.	B60N 2/28 (2006.01) B60N 2/26 (2006.01)	2499020 *	CHILD SEAT WITH IMPACT PROTECTION
Merck Sharp & Dohme Corp.	A61K 31/425 (2006.01) A01N 43/78 (2006.01)	2493312 *	SOLID PHARMACEUTICAL COMPOSITIONS CONTAINING AN INTEGRASE INHIBITOR
Galapagos N.V.	A61K 31/437 (2006.01) A61P 19/02 (2006.01) C07D 471/04 (2006.01)	2445911 *	5-PHENYL-[1,2,4]TRIAZOLO[1,5-A]PYRIDIN-2-YL CARBOXAMIDES AS JAK INHIBITORS
Cardiokine Biopharma, LLC	A01N 43/62 (2006.01) A61K 31/55 (2006.01)	2470019 *	COMPOSITIONS FOR DELIVERY OF INSOLUBLE AGENTS
Glaxo Group Limited	C07K 16/28 (2006.01) C07K 16/40 (2006.01) A61P 27/02 (2006.01) A61P 43/00 (2006.01)	2459593 *	ANTI-TGF-BETA RECEPTOR TYPE II SINGLE DOMAIN ANTIBODIES
Saint-Gobain Glass France	B29C 65/08 (2006.01) B29C 65/64 (2006.01) B60J 10/02 (2006.01) B29C 65/60 (2006.01) B60R 13/06 (2006.01) B60R 13/04 (2006.01)	2483057 *	METHOD FOR FIXING AN ADDITIONAL PART TO A GLAZING OR A PROFILED RIM, FIXING DEVICE FOR FIXING SAID PART, AND GLAZING OBTAINED BY SAID METHOD
adp Gauselmann GmbH	G07F 17/32 (2006.01) G07F 17/34 (2006.01)	2357622	Method for operating a gaming device of an entertainment device

Podnosilac evropske prijave patenta (71)	MKP (51)	Broj objave evropske prijave patenta (97)	Naziv pronalaska (54)
China Academy of Telecommunications Technology	H04B 7/26 (2006.01)	2495886 *	METHOD, APPARATUS AND SYSTEM FOR UPLINK SYNCHRONIZATION
Abbott Laboratories	A61K 9/00 (2006.01) A61K 31/5377 (2006.01) A61K 9/14 (2006.01)	2440208 *	SOLID DISPERSIONS CONTAINING AN APOPTOSIS-PROMOTING AGENT
Cellzome Limited	A61K 31/506 (2006.01) A61P 37/00 (2006.01) C07D 239/48 (2006.01) C07D 403/12 (2006.01) C07D 403/14 (2006.01)	2443095 *	SULFONAMIDES AND SULFAMIDES AS ZAP-70 INHIBITORS
Ethicon Endo-Surgery, Inc.	A61B 17/34 (2006.01) A61B 19/00 (2006.01)	2459084 *	SURGICAL ACCESS DEVICES WITH SORBENTS
Mologic Ltd	A61K 47/48 (2006.01) C07K 5/02 (2006.01)	2470216 *	PEPTIDE CLEARING AGENTS
Mayo, John Charles	A61K 9/127 (2006.01)	2437726 *	FORMULATIONS FOR THE TREATMENT OF DEEP TISSUE PAIN
Vierl, Ulrich	A61K 9/127 (2006.01)	2437726 *	FORMULATIONS FOR THE TREATMENT OF DEEP TISSUE PAIN
Iliffe, George Langton	A61K 9/127 (2006.01)	2437726 *	FORMULATIONS FOR THE TREATMENT OF DEEP TISSUE PAIN
Rother, Matthias	A61K 9/127 (2006.01)	2437726 *	FORMULATIONS FOR THE TREATMENT OF DEEP TISSUE PAIN
Cryocenter, Ltd.	A61P 25/18 (2006.01) A61P 25/28 (2006.01) A61P 25/16 (2006.01) A61K 35/44 (2006.01)	2298328	Use of umbilical cord blood cells for the treatment of neurological disorders
Delphi Technologies Holding S.à.r.l.	F01N 3/20 (2006.01) F04B 53/16 (2006.01) F04B 39/12 (2006.01)	2402609	Pump for dosing fluids
UCB Pharma, S.A.	A61K 31/517 (2006.01) C07D 487/04 (2006.01) A61P 35/00 (2006.01) A61P 29/00 (2006.01) C07D 403/04 (2006.01) A61P 25/28 (2006.01) A61P 9/00 (2006.01)	2499129 *	QUINOLINE AND QUINOXALINE DERIVATIVES AS KINASE INHIBITORS
Novomatic AG	G07F 19/00 (2006.01)	2452321 *	DEVICE FOR MANAGING, RECEIVING, AND/OR DISPENSING OBJECTS OF VALUE
The University of North Carolina At Chapel Hill	B01J 2/22 (2006.01)	2454011 *	ENGINEERED AEROSOL PARTICLES, AND ASSOCIATED METHODS
Liquidia Technologies, Inc.	B01J 2/22 (2006.01)	2454011 *	ENGINEERED AEROSOL PARTICLES, AND ASSOCIATED METHODS
Les Laboratoires Servier	A61K 31/551 (2006.01) C07D 498/04 (2006.01)	2497774	Dihydro-oxazolobenzodiazepinone derivatives, processes for their preparation and pharmaceutical compositions comprising these compounds
EGIS Gyógyszergyár Nyrt	A61K 31/551 (2006.01) C07D 498/04 (2006.01)	2497774	Dihydro-oxazolobenzodiazepinone derivatives, processes for their preparation and pharmaceutical compositions comprising these compounds
BASF Agrochemical Products, B.V.	A01H 5/00 (2006.01) C12N 15/52 (2006.01) C12N 15/82 (2006.01)	2473022 *	HERBICIDE-TOLERANT PLANTS
Eficiencia y Tecnologia, S.A.	B65B 9/067 (2012.01) B65B 9/087 (2012.01) B29C 65/18 (2006.01) B65B 43/04 (2006.01)	2465781	Horizontal packaging machine
Bayer Pharma Aktiengesellschaft	A61K 31/4535 (2006.01) C07D 413/04 (2006.01) A61K 31/4525 (2006.01) C07D 413/14 (2006.01) A61K 31/4545 (2006.01)	2435427 *	SUBSTITUTED PIPERIDINES

Podnosilac evropske prijave patenta (71)	MKP (51)	Broj objave evropske prijave patenta (97)	Naziv pronalaska (54)
Elan Pharmaceuticals Inc.	C07D 471/04 (2006.01) A61K 31/437 (2006.01)	2411388 *	PROCESS FOR THE PRODUCTION OF FUSED, TRICYCLIC SULFONAMIDES
Ratiopharm GmbH	C07C 53/126 (2006.01) A61P 25/16 (2006.01) C07C 53/122 (2006.01) A61K 31/19 (2006.01) C07C 211/42 (2006.01) A61K 31/13 (2006.01) C07C 57/12 (2006.01)	2451771 *	SALTS OF RASAGILINE AND PHARMACEUTICAL PREPARATIONS THEREOF
Amgen, Inc	C07K 16/00 (2006.01) C12P 21/08 (2006.01)	2408814 *	CARRIER IMMUNOGLOBULINS AND USES THEREOF
Cellzome Limited	C07D 405/12 (2006.01) C07D 239/48 (2006.01) A61K 31/505 (2006.01) C07D 401/12 (2006.01)	2440534 *	PYRIMIDINE DERIVATIVES AS ZAP-70 INHIBITORS
INPEX Corporation	C10G 45/00 (2006.01) C10G 2/00 (2006.01)	2474594 *	HYDROCARBON SYNTHESIS REACTION APPARATUS, HYDROCARBON SYNTHESIS REACTION SYSTEM, AND HYDROCARBON SYNTHESIS REACTION METHOD
Japan Oil, Gas and Metals National Corporation	C10G 45/00 (2006.01) C10G 2/00 (2006.01)	2474594 *	HYDROCARBON SYNTHESIS REACTION APPARATUS, HYDROCARBON SYNTHESIS REACTION SYSTEM, AND HYDROCARBON SYNTHESIS REACTION METHOD
Nippon Steel Engineering Co., Ltd	C10G 45/00 (2006.01) C10G 2/00 (2006.01)	2474594 *	HYDROCARBON SYNTHESIS REACTION APPARATUS, HYDROCARBON SYNTHESIS REACTION SYSTEM, AND HYDROCARBON SYNTHESIS REACTION METHOD
Japan Petroleum Exploration Co., Ltd.	C10G 45/00 (2006.01) C10G 2/00 (2006.01)	2474594 *	HYDROCARBON SYNTHESIS REACTION APPARATUS, HYDROCARBON SYNTHESIS REACTION SYSTEM, AND HYDROCARBON SYNTHESIS REACTION METHOD
Cosmo Oil Co., Ltd.	C10G 45/00 (2006.01) C10G 2/00 (2006.01)	2474594 *	HYDROCARBON SYNTHESIS REACTION APPARATUS, HYDROCARBON SYNTHESIS REACTION SYSTEM, AND HYDROCARBON SYNTHESIS REACTION METHOD
JX Nippon Oil & Energy Corporation	C10G 45/00 (2006.01) C10G 2/00 (2006.01)	2474594 *	HYDROCARBON SYNTHESIS REACTION APPARATUS, HYDROCARBON SYNTHESIS REACTION SYSTEM, AND HYDROCARBON SYNTHESIS REACTION METHOD
Athena Biotechnologies, Inc.	C12P 7/06 (2006.01)	2406383 *	REDUCING CARBON DIOXIDE PRODUCTION AND INCREASING ETHANOL YIELD DURING MICROBIAL ETHANOL FERMENTATION
Egis Gyógyszergyár Nyilvánosan Működő Részvény-Társaság	C07D 207/16 (2006.01) A61P 3/10 (2006.01) A61K 31/401 (2006.01)	2486008 *	INORGANIC SALT COMPLEXES OF VILDAGLIPTIN
N2 Towers Inc.	A62C 35/02 (2006.01) A62C 99/00 (2010.01) A62D 1/02 (2006.01) A62D 1/06 (2006.01)	2485811 *	SYSTEM AND METHOD FOR SODIUM AZIDE BASED SUPPRESSION OF FIRES
Hoppecke Abt	H01M 2/10 (2006.01) H01M 10/50 (2006.01)	2413397	Device for holding a galvanic element, energy storage unit and energy storage stack
Tetraphase Pharmaceuticals, Inc.	A61K 31/435 (2006.01) A61P 31/04 (2006.01) C07D 221/18 (2006.01)	2427190 *	8-AZA TETRACYCLINE COMPOUNDS
Johnson Controls Automotive Electronics GmbH	B60K 37/02 (2006.01) B60K 11/08 (2006.01) G01P 1/08 (2006.01) G01D 13/26 (2006.01) G01D 11/28 (2006.01)	2490912 *	DISPLAY INSTRUMENT HAVING A POINTER
Otos Wing Co., Ltd.	A61F 9/06 (2006.01)	2338446	Method for controlling cartridge of welding helmet having display function of welding operation time

Podnosilac evropske prijave patenta (71)	MKP (51)	Broj objave evropske prijave patenta (97)	Naziv pronalaska (54)
Incyte Corporation	C07D 513/04 (2006.01) A61K 31/52 (2006.01) A61P 37/00 (2006.01) A61P 29/00 (2006.01) C07D 473/34 (2006.01)	2448938 *	PYRIMIDINONES AS PI3K INHIBITORS
Boehringer Ingelheim International GmbH	C07D 309/10 (2006.01)	2486029 *	PROCESSES FOR PREPARING OF GLUCOPYRANOSYL-SUBSTITUTED BENZYL-BENZENE DERIVATIVES
Ponomarev, Vasily Vasilievich	A23J 1/00 (2006.01) A23J 3/00 (2006.01)	2417859 *	CONCENTRATED PROTEIN PRODUCTS AND METHODS FOR PRODUCING SAME
Bikbov, Takhir Mukhammedovich	A23J 1/00 (2006.01) A23J 3/00 (2006.01)	2417859 *	CONCENTRATED PROTEIN PRODUCTS AND METHODS FOR PRODUCING SAME
Merial Ltd.	C12N 15/68 (2006.01) C12N 15/73 (2006.01) C12N 15/63 (2006.01)	2432884 *	ANTIBIOTIC-FREE PLASMID
INPEX Corporation	C10G 2/00 (2006.01)	2474592 *	HYDROCARBON SYNTHESIS REACTION APPARATUS, HYDROCARBON SYNTHESIS REACTION SYSTEM, AND METHOD FOR COLLECTION OF LIQUID HYDROCARBON
Japan Petroleum Exploration Co., Ltd.	C10G 2/00 (2006.01)	2474592 *	HYDROCARBON SYNTHESIS REACTION APPARATUS, HYDROCARBON SYNTHESIS REACTION SYSTEM, AND METHOD FOR COLLECTION OF LIQUID HYDROCARBON
Cosmo Oil Co., Ltd.	C10G 2/00 (2006.01)	2474592 *	HYDROCARBON SYNTHESIS REACTION APPARATUS, HYDROCARBON SYNTHESIS REACTION SYSTEM, AND METHOD FOR COLLECTION OF LIQUID HYDROCARBON
Japan Oil, Gas and Metals National Corporation	C10G 2/00 (2006.01)	2474592 *	HYDROCARBON SYNTHESIS REACTION APPARATUS, HYDROCARBON SYNTHESIS REACTION SYSTEM, AND METHOD FOR COLLECTION OF LIQUID HYDROCARBON
Nippon Steel Engineering Co., Ltd	C10G 2/00 (2006.01)	2474592 *	HYDROCARBON SYNTHESIS REACTION APPARATUS, HYDROCARBON SYNTHESIS REACTION SYSTEM, AND METHOD FOR COLLECTION OF LIQUID HYDROCARBON
JX Nippon Oil & Energy Corporation	C10G 2/00 (2006.01)	2474592 *	HYDROCARBON SYNTHESIS REACTION APPARATUS, HYDROCARBON SYNTHESIS REACTION SYSTEM, AND METHOD FOR COLLECTION OF LIQUID HYDROCARBON
Japan Oil, Gas and Metals National Corporation	C10G 2/00 (2006.01) C10G 47/36 (2006.01)	2500400 *	METHOD OF HYDROCRACKING AND PROCESS FOR PRODUCING HYDROCARBON OIL
INPEX Corporation	C10G 2/00 (2006.01) C10G 47/36 (2006.01)	2500400 *	METHOD OF HYDROCRACKING AND PROCESS FOR PRODUCING HYDROCARBON OIL
JX Nippon Oil & Energy Corporation	C10G 2/00 (2006.01) C10G 47/36 (2006.01)	2500400 *	METHOD OF HYDROCRACKING AND PROCESS FOR PRODUCING HYDROCARBON OIL
Japan Petroleum Exploration Co., Ltd.	C10G 2/00 (2006.01) C10G 47/36 (2006.01)	2500400 *	METHOD OF HYDROCRACKING AND PROCESS FOR PRODUCING HYDROCARBON OIL
Cosmo Oil Co., Ltd.	C10G 2/00 (2006.01) C10G 47/36 (2006.01)	2500400 *	METHOD OF HYDROCRACKING AND PROCESS FOR PRODUCING HYDROCARBON OIL
Nippon Steel Engineering Co., Ltd	C10G 2/00 (2006.01) C10G 47/36 (2006.01)	2500400 *	METHOD OF HYDROCRACKING AND PROCESS FOR PRODUCING HYDROCARBON OIL
Universität Duisburg-Essen	C12Q 1/68 (2006.01)	2486146 *	METHOD FOR DETECTING GENE MODIFICATIONS BY MEANS OF ASYMMETRICAL PCR AND BLOCKING AGENTS
Cardio3 Biosciences S.A.	A61K 35/34 (2006.01)	2432482 *	PHARMACEUTICAL COMPOSITION FOR THE TREATMENT OF HEART DISEASES.
FBM Corporation Pty Ltd	E04B 2/02 (2006.01) B32B 27/04 (2006.01) B32B 7/04 (2006.01) E04C 2/24 (2006.01) E04C 1/40 (2006.01)	2486198 *	A BUILDING PANEL, BUILDING SYSTEM AND METHOD OF CONSTRUCTING A BUILDING

Podnosilac evropske prijave patenta (71)	MKP (51)	Broj objave evropske prijave patenta (97)	Naziv pronalaska (54)
NON SOLO YACHTING s.a.s. di Salzano Alessandro e Grimaldi Orfeo Paolo	E03D 11/12 (2006.01)	2491190 *	BELLOWS-LIKE FOLDABLE TOILET BOWL
Golay, Kevin	B44C 1/26 (2006.01) B44C 1/28 (2006.01) B44C 5/04 (2006.01)	2364864	System of ornamental stone floors and ornamental friezes and manufacturing process of ornamental stone floors and ornamental friezes
Abbott Laboratories	C07D 209/42 (2006.01)	2454235 *	PROCESSES FOR THE SYNTHESIS OF (2S, 3AR, 7AS)-OCTAHYDRO-1H-INDOLE CARBOXYLIC ACID AS AN INTERMEDIATE FOR TRANDOLAPRIL
Prometheus Laboratories Inc.	C12Q 1/68 (2006.01) G01N 33/564 (2006.01) G01N 33/68 (2006.01)	2419529 *	INFLAMMATORY BOWEL DISEASE PROGNOSTICS
Ruckus Wireless, Inc.	H04W 40/02 (2009.01) G06F 15/16 (2006.01) G06F 15/177 (2006.01)	2350863 *	ESTABLISHING A MESH NETWORK WITH WIRED AND WIRELESS LINKS
Glaxo Group Limited	A61K 47/48 (2006.01) C07K 16/18 (2006.01) A61P 3/10 (2006.01)	2411054 *	DRUG FUSIONS AND CONJUGATES
Janssen Pharmaceutica N.V.	C07D 403/14 (2006.01) A61P 25/00 (2006.01) C07D 403/12 (2006.01) A61P 29/00 (2006.01) C07D 409/12 (2006.01) C07D 401/14 (2006.01) A61K 31/496 (2006.01) C07D 405/14 (2006.01) C07D 409/14 (2006.01) C07D 401/12 (2006.01) C07D 417/12 (2006.01) C07D 413/12 (2006.01)	2421852 *	HETEROAROMATIC AND AROMATIC PIPERAZINYL AZETIDINYL AMIDES AS MONOACYLGLYCEROL LIPASE INHIBITOR
Enraf Nonius B.V.	A61N 7/00 (2006.01)	2366430	Ultrasound application device
Molteni L. E C. Dei Fratelli Alitti Societa' Di Esercizio S.P.A.	C07D 487/22 (2006.01) A61K 31/555 (2006.01) A61P 31/00 (2006.01) A61P 35/00 (2006.01)	2459567 *	PHTHALOCYANINE DERIVATIVE CONSISTING OF A MIXTURE OF 4 ISOMERS
Datang Mobile Communications Equipment Co., Ltd	H04W 28/04 (2009.01)	2496009 *	METHOD, DEVICE AND SYSTEM FOR SYNCHRONIZING MBMS
Abraxis BioScience, LLC	A01N 43/66 (2006.01) A61K 31/53 (2006.01)	2440051 *	TRIAZINE DERIVATIVES AND THEIR THERAPEUTICAL APPLICATIONS
Geo-Mole Limited	F24J 3/08 (2006.01)	2406559 *	PERCUSSION MOLE
Bakteriefritt AS	A01N 59/10 (2006.01) A01N 41/10 (2006.01) A01P 1/00 (2006.01) A01N 25/06 (2006.01) A01N 59/16 (2006.01)	2424348 *	COMPOSITION FOR STERILIZING SURFACES
Chiesi Farmaceutici S.p.A.	C07C 51/09 (2006.01) C07C 253/14 (2006.01) C07C 61/40 (2006.01) C07C 253/30 (2006.01) C07C 255/35 (2006.01) C07C 255/46 (2006.01)	2462098 *	PROCESS FOR THE PREPARATION OF DERIVATIVES OF 1-(2-HALOBIHENYL-4-YL)-CYCLOPROPANECARBOXYLIC ACID
SASOL ITALY S.p.A.	B01J 21/00 (2006.01) C01B 33/12 (2006.01)	2392548	Process for preparing an amorphous silica-alumina composition and relative amorphous silica-alumina composition
Apotex Technologies Inc.	A61P 11/00 (2006.01) A61P 13/12 (2006.01) A61P 35/00 (2006.01) C07D 213/69 (2006.01) A61P 25/28 (2006.01) A61K 31/4422 (2006.01)	2448922 *	FLUORINATED DERIVATIVES OF 3-HYDROXYPYRIDIN-4-ONES

Podnosilac evropske prijave patenta (71)	MKP (51)	Broj objave evropske prijave patenta (97)	Naziv pronalaska (54)
Kaspersky Lab, ZAO	G06F 21/00 (2006.01)	2284750	System and method for detecting obfuscated malware using code normalization
Sinvent AS	E21B 47/12 (2012.01) E21B 17/00 (2006.01)	2419605 *	A COMMUNICATION ARRANGEMENT FOR TRANSMISSION OF COMMUNICATION SIGNALS ALONG A PIPE LINE
ANITOX CORPORATION	A01N 31/00 (2006.01) A23K 1/18 (2006.01) A23K 1/17 (2006.01) A23K 1/16 (2006.01)	2461700 *	WATER AND FEED PRESERVATIVE
Lifescan Scotland Limited	G06F 19/00 (2011.01)	2449493 *	SYSTEMS FOR DIABETES MANAGEMENT AND METHODS
Curt C. Joa. Inc.	A61F 13/15 (2006.01)	2415438	Apparatus and method for minimizing waste and improving quality and production in web processing operations by automatic cuff defect correction
Merck Serono S.A.	A61P 37/06 (2006.01) C07D 471/04 (2006.01) A61K 31/4245 (2006.01) C07D 413/04 (2006.01) C07D 413/14 (2006.01)	2440554 *	PYRAZOLE OXADIAZOLE DERIVATIVES AS S1P1 AGONISTS
S&B Industrial Minerals S.A.	C09C 1/00 (2006.01) C09D 7/12 (2006.01) C22B 34/14 (2006.01)	2444460	Milled expanded volcanic glass as lamellar filler
Sandvine Incorporated ULC	H04L 29/06 (2006.01) H04L 12/56 (2006.01)	2424177	Method and system for network data flow management
Flat System S.r.l.	B31D 1/06 (2006.01) B31B 19/86 (2006.01)	2397318	Handle-forming machine
Ulfoss Company Group A/S	B65D 33/28 (2006.01) B31B 19/90 (2006.01)	2454163 *	METHOD FOR MANUFACTURING DRAW STRING BAGS
Lafarge	C09D 195/00 (2006.01) E01C 7/35 (2006.01) C08L 95/00 (2006.01)	2380935	Bituminous compositions
Baylor Research Institute	A61K 39/395 (2006.01) C07K 19/00 (2006.01) C07K 16/08 (2006.01) C12N 15/63 (2006.01) C12N 15/62 (2006.01) A61K 39/12 (2006.01)	2406289 *	ANTIGEN PRESENTING CELL TARGETED ANTI-VIRAL VACCINES
Phusis Therapeutics Inc.	A61P 29/00 (2006.01) A61K 31/433 (2006.01) A61P 35/00 (2006.01)	2477625 *	PHARMACEUTICAL COMPOSITIONS AND FORMULATIONS INCLUDING INHIBITORS OF THE PLECKSTRIN HOMOLOGY DOMAIN AND METHODS FOR USING SAME
GlaxoSmithKline LLC	A01N 43/90 (2006.01) A61K 31/519 (2006.01)	2488033 *	COMBINATION
McNeil-PPC, Inc.	A61N 1/36 (2006.01) A61N 1/34 (2006.01)	2408516 *	ELECTRICAL STIMULATION DEVICE WITH ADDITIONAL SENSORY MODALITIES
Cirilli, Alessandro	E06B 3/54 (2006.01)	2270305	Adjusting device for the inclination of window frames and window frame
Abraxis BioScience, LLC	A01N 43/66 (2006.01) A61K 31/53 (2006.01)	2440052 *	TRIAZINE DERIVATIVES AND THEIR THERAPEUTICAL APPLICATIONS
Eisai R&D Management Co., Ltd.	A61P 35/00 (2006.01) A61P 35/04 (2006.01) A61P 43/00 (2006.01) C07D 215/48 (2006.01) A61K 47/38 (2006.01) A61K 31/47 (2006.01) A61K 47/32 (2006.01) A61K 47/36 (2006.01)	2468281 *	QUINOLINE DERIVATIVE-CONTAINING PHARMACEUTICAL COMPOSITION
CURT G. JOA, INC.	A61F 13/15 (2006.01) B07C 5/342 (2006.01)	2412348	Apparatus and method for minimizing waste and improving quality and production in web processing operations by automated threading and re-threading of web materials

Podnosilac evropske prijave patenta (71)	MKP (51)	Broj objave evropske prijave patenta (97)	Naziv pronalaska (54)
Merz Pharma GmbH & Co. KGaA	C07C 209/62 (2006.01) C07C 29/40 (2006.01) C07C 211/35 (2006.01)	2448896 *	METHOD OF PREPARING 1-HYDROXY-1,3,3,5,5-PENTAMETHYLCYCLOHEXANE
Katholieke Universiteit Leuven, K.U. Leuven R&D	C07H 19/20 (2006.01) A61K 31/708 (2006.01)	2424874 *	NOVEL PHOSPHATE MODIFIED NUCLEOSIDES USEFUL AS SUBSTRATES FOR POLYMERASES AND AS ANTIVIRAL AGENTS
Grindeks, A Joint Stock Company	A61K 31/4422 (2006.01) C07D 211/90 (2006.01)	2406218 *	Pharmaceutical combination of 5-fluorouracil and derivate of 1,4-dihydropyridine and its use in the treatment of cancer
SUPERCHARGED PRODUCTION S.R.L.	A61C 8/00 (2006.01)	2419044 *	DENTAL IMPLANT ASSEMBLY COMPRISING A MAGNETIC TEMPORARY SCREW
Yski, Pasi	B65G 7/04 (2006.01) B65D 90/18 (2006.01)	2256066	Method for attaching a transport wheel arrangement to a container and a transport wheel arrangement of a container
Kaspersky Lab, ZAO	G06F 21/00 (2006.01)	2469445	Optimization of anti-malware processing by automated correction of detection rules
High Point Pharmaceuticals, LLC	C07D 471/04 (2006.01) C07D 487/04 (2006.01) A61K 31/437 (2006.01) A61P 25/28 (2006.01)	2424866 *	SUBSTITUTED IMIDAZO[1,2-A]PYRIDINE DERIVATIVES, PHARMACEUTICAL COMPOSITIONS, AND METHODS OF USE AS -SECRETASE INHIBITORS
SANOFI	C08B 37/00 (2006.01) C08B 37/10 (2006.01)	2427501 *	NOVEL SULFATED HEPTASACCHARIDE AND ITS USE AS ANTITHROMBOTIC AGENT
Bayer Oy	A61K 9/00 (2006.01) A61F 6/14 (2006.01)	2482768 *	AN INTRAUTERINE SYSTEM
Temi S.r.l.	C08G 63/00 (2006.01) C08L 67/00 (2006.01) C08K 7/22 (2006.01) C08K 7/00 (2006.01)	2366725	Composite material
Janssen Pharmaceutica NV	C07D 413/14 (2006.01) C07D 403/12 (2006.01) A61P 25/04 (2006.01) C07D 403/14 (2006.01) A61K 31/506 (2006.01) C07D 401/14 (2006.01)	2493877 *	PYRIMIDINE COMPOUNDS AS DELTA OPIOID RECEPTOR MODULATORS
Cadila Healthcare Limited	C07K 14/635 (2006.01)	2421893 *	SHORT-CHAIN PEPTIDES AS PARATHYROID HORMONE (PTH) RECEPTOR AGONIST
TDW Delaware, Inc.	F16L 55/38 (2006.01)	2464909 *	SPEED CONTROL DRIVE SECTION WITH FAILSAFE VALVE
NON SOLO YACHTING s.a.s. di Salzano Alessandro e Grimaldi Orfeo Paolo	E03D 11/13 (2006.01) E03D 11/12 (2006.01)	2333168	Bellows-like foldable bidet
Ignucell AB	E04F 13/00 (2006.01) E04B 1/74 (2006.01)	2366847	Insulating and draining board
John Mezzalingua Assoc., Inc.	H01T 4/08 (2006.01) H02H 9/02 (2006.01)	2419976 *	COAXIAL BROADBAND SURGE PROTECTOR
Xenon Pharmaceuticals Inc.	A61P 29/00 (2006.01) A61K 31/404 (2006.01) C07D 491/22 (2006.01)	2448943 *	ENANTIOMERS OF SPIRO-OXINDOLE COMPOUNDS AND THEIR USES AS THERAPEUTIC AGENTS

Podnosilac evropske prijave patenta (71)	MKP (51)	Broj objave evropske prijave patenta (97)	Naziv pronalaska (54)
Cephalon, Inc.	C07D 207/10 (2006.01) C07D 215/06 (2006.01) C07D 209/44 (2006.01) C07D 217/04 (2006.01) C07D 211/14 (2006.01) C07D 241/08 (2006.01) C07D 211/38 (2006.01) C07D 401/12 (2006.01) C07D 207/06 (2006.01) A61P 25/00 (2006.01) C07D 211/46 (2006.01) C07D 403/12 (2006.01) A61K 31/496 (2006.01) C07D 407/12 (2006.01) A61K 31/5377 (2006.01)	2459529 *	SUBSTITUTED PHENOXYPROPYLCYCLOAMINE DERIVATIVES AS HISTAMINE-3 (H3) RECEPTOR LIGANDS
Cephalon France	C07D 207/10 (2006.01) C07D 215/06 (2006.01) C07D 209/44 (2006.01) C07D 217/04 (2006.01) C07D 211/14 (2006.01) C07D 241/08 (2006.01) C07D 211/38 (2006.01) C07D 401/12 (2006.01) C07D 207/06 (2006.01) A61P 25/00 (2006.01) C07D 211/46 (2006.01) C07D 403/12 (2006.01) A61K 31/496 (2006.01) C07D 407/12 (2006.01) A61K 31/5377 (2006.01)	2459529 *	SUBSTITUTED PHENOXYPROPYLCYCLOAMINE DERIVATIVES AS HISTAMINE-3 (H3) RECEPTOR LIGANDS
Glaxo Wellcome Manufacturing Pte Ltd	A61K 31/415 (2006.01) A01N 43/56 (2006.01)	2453748 *	TREATMENT METHOD
Eurochit Danuta Kruszevska	A61L 29/08 (2006.01) A61L 29/16 (2006.01)	2468319	New nanoproduct useful in prophylaxis, diagnostics and medical and veterinary treatment
BONGRAIN S.A.	B65D 85/76 (2006.01) B65D 25/10 (2006.01)	2322451	Packaging of a food product in portions
BASF SE	A01N 43/653 (2006.01) C07D 405/06 (2006.01)	2443109 *	TRIAZOLE COMPOUNDS CARRYING A SULFUR SUBSTITUENT
Cadila Healthcare Limited	C07D 411/12 (2006.01) A61K 31/4535 (2006.01) A61K 31/454 (2006.01) C07D 413/14 (2006.01) A61K 31/506 (2006.01) C07D 417/14 (2006.01) C07D 411/14 (2006.01)	2445904 *	NOVEL GPR 119 AGONISTS
Novartis AG	C07C 253/30 (2006.01) C07D 257/04 (2006.01)	2493848 *	PROCESS FOR THE MANUFACTURE OF ORGANIC COMPOUNDS
Arcelormittal Investigación y Desarrollo SL	C22C 38/46 (2006.01) C22C 38/54 (2006.01) C22C 38/00 (2006.01)	2456901 *	HEAT-RESISTANT AUSTENITIC STEEL HAVING HIGH RESISTANCE TO STRESS RELAXATION CRACKING
CENTRO SVILUPPO MATERIALI S.p.A.	C22C 38/46 (2006.01) C22C 38/54 (2006.01) C22C 38/00 (2006.01)	2456901 *	HEAT-RESISTANT AUSTENITIC STEEL HAVING HIGH RESISTANCE TO STRESS RELAXATION CRACKING
Netherlands Organization For Applied Scientific Research (TNO)	C22C 38/46 (2006.01) C22C 38/54 (2006.01) C22C 38/00 (2006.01)	2456901 *	HEAT-RESISTANT AUSTENITIC STEEL HAVING HIGH RESISTANCE TO STRESS RELAXATION CRACKING
Hisamitsu Pharmaceutical Co., Inc.	A61K 9/70 (2006.01) A61L 15/58 (2006.01) A61F 13/02 (2006.01)	2489340 *	ADHESIVE PATCH
Biolex Therapeutics, Inc.	C12N 9/14 (2006.01) C12N 9/68 (2006.01) C12N 15/82 (2006.01) A61K 38/16 (2006.01) C12N 5/04 (2006.01)	2435562 *	COMPOSITIONS AND METHODS FOR PRODUCTION OF AGLYCOSYLATED PLASMINOGEN

Podnosilac evropske prijave patenta (71)	MKP (51)	Broj objave evropske prijave patenta (97)	Naziv pronalaska (54)
Intermune, Inc.	A61K 31/4412 (2006.01) A61P 11/00 (2006.01)	2308491	Pirfenidone therapy and inducers of cytochrome P450
Prosteel	A61F 2/44 (2006.01)	2389903	System for performing arthrodesis between two vertebrae and installation accessories
Minelli, Nadia	A61F 2/44 (2006.01)	2389903	System for performing arthrodesis between two vertebrae and installation accessories
Gille, Olivier	A61F 2/44 (2006.01)	2389903	System for performing arthrodesis between two vertebrae and installation accessories
Renaud, Christian	A61F 2/44 (2006.01)	2389903	System for performing arthrodesis between two vertebrae and installation accessories
Limito, Jean-François	A61F 2/44 (2006.01)	2389903	System for performing arthrodesis between two vertebrae and installation accessories
SANOFI	C07H 1/00 (2006.01) C07H 17/02 (2006.01)	2470551 *	METHOD FOR PRODUCING PYRAZOLE GLYCOSIDE DERIVATIVES
Advance Invest	A61B 10/00 (2006.01) G01N 1/40 (2006.01) B01L 3/00 (2006.01) B01L 3/14 (2006.01)	2286919	Filtration device for analyses
Novomatic AG	G07F 17/00 (2006.01) G07F 19/00 (2006.01)	2452318 *	DEVICE FOR CONDUCTING MONETARY TRANSACTIONS
Suncor Energy Inc.	B01D 21/24 (2006.01) B01D 21/01 (2006.01)	2477708 *	PROCESS FOR FLOCCULATING AND DEWATERING OIL SAND MATURE FINE TAILINGS
T H Group Limited	B08B 7/00 (2006.01) B08B 1/00 (2006.01)	2403661 *	CLEANING CONTACT CLEANING ROLLERS
Merck Serono S.A.	C07D 271/06 (2006.01) A61K 31/4245 (2006.01) A61P 37/00 (2006.01)	2414342 *	OXADIAZOLE DERIVATIVES
Kallimopoulos, Thomas, Dr.	A61K 36/00 (2006.01)	2475374 *	METHODS FOR ISOLATING ALKALOIDS FROM PLANTS
EGIS GYÓGYSZERGYÁR Nyilvánosan Működő Részvénytársaság	A61P 25/00 (2006.01) C07D 285/36 (2006.01) A61K 31/554 (2006.01) C07D 285/06 (2006.01) C07D 309/24 (2006.01)	2483257 *	2,3,4-BENZOTHIADIAZEPINE-2,2-DIOXIDE DERIVATIVES
Toyo Ink SC Holdings Co., Ltd.	C09B 67/20 (2006.01) C09B 67/02 (2006.01) C09B 67/46 (2006.01) G02B 5/22 (2006.01) G02B 5/20 (2006.01)	2495288 *	DIKETOPYRROLOPYRROLE PIGMENT DISPERSING AGENT, PIGMENT COMPOSITION USING SAME, COLORED COMPOSITION, AND COLOR FILTER
Toyocolor Co., Ltd.	C09B 67/20 (2006.01) C09B 67/02 (2006.01) C09B 67/46 (2006.01) G02B 5/22 (2006.01) G02B 5/20 (2006.01)	2495288 *	DIKETOPYRROLOPYRROLE PIGMENT DISPERSING AGENT, PIGMENT COMPOSITION USING SAME, COLORED COMPOSITION, AND COLOR FILTER
John Mezzalingua Associates, Inc.	H01R 9/05 (2006.01) H01R 13/646 (2011.01)	2417671 *	COMPRESSION CONNECTOR FOR COAXIAL CABLE WITH STAGGERED SEIZURE OF OUTER AND CENTER CONDUCTOR AND CENTER CONDUCTOR SEIZING MECHANISM
Syngenta Participations AG	A01N 25/24 (2006.01) A01N 25/26 (2006.01)	2498598 *	METHODS FOR GENERATING HIGH ASPECT RATIO POLYMERIC PARTICLES COMPRISING AN ACTIVE INGREDIENT

Podnositelj evropske prijave patenta (71)	MKP (51)	Broj objave evropske prijave patenta (97)	Naziv pronalaska (54)
Covita Limited	C07K 14/435 (2006.01) C07K 7/06 (2006.01) A61K 38/10 (2006.01) A61P 19/10 (2006.01) C07K 14/475 (2006.01) C07K 17/08 (2006.01) A61P 3/10 (2006.01) A61K 38/18 (2006.01) C07K 7/08 (2006.01) A61P 21/06 (2006.01) A61P 17/00 (2006.01) A61P 3/04 (2006.01) A61K 38/08 (2006.01) C12N 15/12 (2006.01)	2483300 *	SYNTHETIC MYOSTATIN PEPTIDE ANTAGONISTS
Stiefel Laboratories, Inc.	A01N 43/06 (2006.01) A01N 43/12 (2006.01) A61K 31/38 (2006.01)	2453746 *	TAZAROTENE DERIVATIVES
SANOFI	C07D 413/14 (2006.01) C07D 271/06 (2006.01) A61K 31/506 (2006.01) A61P 5/00 (2006.01) A61P 37/00 (2006.01)	2486024 *	PHENYLOXADIAZOLE DERIVATIVES AS PGDS INHIBITORS
Gruppo Meccaniche Luciani S.R.L.	B29D 35/00 (2010.01) B29D 35/08 (2010.01) A43B 7/06 (2006.01) A43B 7/12 (2006.01) B29C 44/12 (2006.01)	2416675 *	SHOE WITH VENTILATION SYSTEM OBTAINED BY DIRECT INJECTION METHOD ON UPPER AND MOULD THEREFOR
Boehringer Ingelheim International GmbH	G01N 33/50 (2006.01)	2406628 *	METHOD OR SYSTEM USING BIOMARKERS FOR THE MONITORING OF A TREATMENT
Sanofi-Aventis Deutschland GmbH	A61M 5/315 (2006.01) A61M 5/00 (2006.01)	2437831 *	DOSE SETTING MECHANISM FOR A DRUG DELIVERY DEVICE
Wageningen Universiteit	C12N 15/82 (2006.01) C07K 14/415 (2006.01)	2451830 *	METHOD FOR INCREASING THE RESISTANCE OF A PLANT OR A PART THEREOF TO A PATHOGEN, METHOD FOR SCREENING THE RESISTANCE OF A PLANT OR PART THEREOF TO A PATHOGEN, AND USE THEREOF
Sanofi-Aventis Deutschland GmbH	A61M 5/315 (2006.01)	2437821 *	SPINDLE FOR A DRUG DELIVERY DEVICE
Abraxis BioScience, LLC	A61K 31/337 (2006.01) A61K 9/20 (2006.01)	2470173 *	COMBINATION THERAPY WITH NANOPARTICLE COMPOSITIONS OF TAXANE AND HEDGEHOG INHIBITORS
Carnehammar, Lars Bertil	C08L 27/00 (2006.01) B60C 19/00 (2006.01) G01M 1/36 (2006.01) C08L 71/02 (2006.01)	2485905 *	COMPOSITION, METHOD AND SYSTEM FOR BALANCING A ROTARY SYSTEM
R.P. Scherer Technologies, LLC	A61K 9/14 (2006.01)	2477608 *	ORAL SOLID DOSAGE FORM CONTAINING NANOPARTICLES AND PROCESS OF FORMULATING THE SAME USING FISH GELATIN
Deutsches Primatenzentrum GmbH	G06F 3/01 (2006.01)	2418562	Modelling of hand and arm position and orientation
Heete, Lars Christian	F28D 7/00 (2006.01) C10L 9/08 (2006.01) C10B 53/02 (2006.01) C10L 9/00 (2006.01) C10B 49/14 (2006.01)	2341119	Method and device for tempering an exothermic reaction
Innovanano, Inc.	B32B 9/00 (2006.01) B32B 33/00 (2006.01)	2440402 *	HYDROPHOBIC MATERIALS MADE BY VAPOR DEPOSITION COATING AND APPLICATIONS THEREOF
Lojack Operating Company, L.P.	G08B 1/08 (2006.01)	2491541 *	SYNCHRONIZATION SYSTEM AND METHOD FOR ACHIEVING LOW POWER BATTERY OPERATION OF A VEHICLE LOCATING UNIT

Podnosilac evropske prijave patenta (71)	MKP (51)	Broj objave evropske prijave patenta (97)	Naziv pronalaska (54)
RESEARCH TRIANGLE INSTITUTE	A61K 31/137 (2006.01) A61K 31/135 (2006.01) A61P 25/00 (2006.01) C07C 211/27 (2006.01) C07C 211/29 (2006.01) C07C 211/35 (2006.01) C07C 225/16 (2006.01) C07C 225/18 (2006.01)	2419400 *	MONOAMINE REUPTAKE INHIBITORS
Delphi Technologies Holding S.à.r.l.	F02M 61/16 (2006.01) C21D 7/10 (2006.01)	2392816	Stress Relief in Pressurized Fluid Flow System
Agennix AG	A61K 38/48 (2006.01) A61P 31/04 (2006.01)	2416800 *	ORAL LACTOFERRIN IN THE TREATMENT OF SEVERE SEPSIS
Vary Petrochem, LLC	C10G 1/04 (2006.01)	2475745 *	BITUMEN SEPARATION COMPOSITIONS AND PROCESSES
Dhatim SARL	G06Q 20/00 (2012.01)	2425389 *	METHOD FOR SUSPENDING AND ACTIVATING A SERVICE IN A MOBILE NETWORK
Janssen Pharmaceuticals, Inc.	A61P 25/28 (2006.01) C07D 519/00 (2006.01) C07D 471/04 (2006.01) A61K 31/437 (2006.01)	2430022 *	1,2,3-TRIAZOLO Ý4,3-A"PYRIDINE DERIVATIVES AND THEIR USE FOR THE TREATMENT OR PREVENTION OF NEUROLOGICAL AND PSYCHIATRIC DISORDERS
Addex Pharma SA	A61P 25/28 (2006.01) C07D 519/00 (2006.01) C07D 471/04 (2006.01) A61K 31/437 (2006.01)	2430022 *	1,2,3-TRIAZOLO Ý4,3-A"PYRIDINE DERIVATIVES AND THEIR USE FOR THE TREATMENT OR PREVENTION OF NEUROLOGICAL AND PSYCHIATRIC DISORDERS
Samp S.p.a. Con Unico Socio	B23F 5/22 (2006.01) B23Q 39/02 (2006.01)	2456587 *	A WORKING MACHINE FOR MAKING GEARS
Medizinische Universität Innsbruck	G01N 33/573 (2006.01)	2419735 *	METHOD FOR DETERMINING THE CBL-B EXPRESSION
Apeiron Biologics AG	G01N 33/573 (2006.01)	2419735 *	METHOD FOR DETERMINING THE CBL-B EXPRESSION
Murphy, Russell Edward	E06C 1/383 (2006.01) E06C 7/08 (2006.01) E06C 9/06 (2006.01)	2411615 *	EMERGENCY ESCAPE LADDER
Flodesign Wind Turbine Corporation	F03D 11/00 (2006.01)	2414673 *	SEGMENTED WIND TURBINE
Boundary Equipment Co. Ltd.	E02F 3/815 (2006.01) E02F 9/28 (2006.01) E01H 5/06 (2006.01) A01B 31/00 (2006.01)	2369064	Blade segment and blade assembly for a surface working vehicle
Hercules Incorporated	D21H 21/16 (2006.01)	2456919 *	SIZING COMPOSITION FOR HOT PENETRANT RESISTANCE
Proyecto de Biomedicina Cima, S.L.	A61P 31/12 (2006.01) A61P 35/00 (2006.01) A61K 47/48 (2006.01) A61K 38/39 (2006.01) C07K 14/025 (2006.01) C07K 14/78 (2006.01) A61K 38/16 (2006.01)	2476440 *	THERAPEUTIC COMPOSITIONS FOR THE TREATMENT OF HPV-INDUCED DISEASES
Acqua Minerale San Benedetto S.P.A.	B29C 45/26 (2006.01) B29C 33/30 (2006.01) B29C 45/36 (2006.01) B29C 33/76 (2006.01)	2263852	Mold for plastics, particularly of the type of a mold for providing preforms of plastic bottles and the like
Novartis AG	C07D 213/74 (2006.01) C07D 401/04 (2006.01) C07D 401/12 (2006.01) A61K 31/506 (2006.01) A61P 29/00 (2006.01) A61P 35/00 (2006.01)	2459535 *	PYRIDINE AND PYRAZINE DERIVATIVES AS PROTEIN KINASE MODULATORS
Cmc Icos Biologics, Inc.	C12P 21/06 (2006.01) C07H 21/04 (2006.01)	2462237 *	METHODS FOR IMPROVING RECOMBINANT PROTEIN EXPRESSION

Podnosilac evropske prijave patenta (71)	MKP (51)	Broj objave evropske prijave patenta (97)	Naziv pronalaska (54)
Modulogreen Vertical Solutions	A01G 1/00 (2006.01)	2493282 *	DEVICE FOR A VERTICAL OR ANGLED ARRANGEMENT OF THE HYDROPONIC CULTIVATION OF PLANTS
Immersion Corporation	G06F 3/041 (2006.01) G06F 3/01 (2006.01) G06F 3/048 (2006.01)	2406705 *	SYSTEMS AND METHODS FOR USING TEXTURES IN GRAPHICAL USER INTERFACE WIDGETS
Eli Lilly and Company	C07K 16/18 (2006.01)	2417158 *	DKK-1 ANTIBODIES
Maersk Oil Qatar A/S	E21B 4/18 (2006.01) E21B 23/14 (2006.01) E21B 47/12 (2012.01)	2494135 *	DOWNHOLE APPARATUS
Merck Sharp & Dohme Corp.	A61K 31/517 (2006.01) A61K 39/395 (2006.01)	2419135 *	COMBINATION THERAPY USING AN ANTI-EGFR AGENT(S) AND IGF-1R SPECIFIC INHIBITORS
Koller, Rudolf	A61H 33/02 (2006.01)	2459145 *	BABY BATH, NAMELY FOR TODDLERS AND INFANTS
Crucell Holland B.V.	C12N 5/10 (2006.01) C07K 16/10 (2006.01) C12N 15/13 (2006.01) A61K 39/42 (2006.01) C12N 15/63 (2006.01) A61P 31/14 (2006.01) A61K 47/48 (2006.01) G01N 33/53 (2006.01) A61K 38/00 (2006.01) A61K 31/00 (2006.01)	2464664 *	ANTIBODIES AGAINST HUMAN RESPIRATORY SYNCYTIAL VIRUS (RSV) AND METHODS OF USE
Bolton Manitoba SpA	E03D 9/02 (2006.01) B65D 83/00 (2006.01)	2281756	Application device of sanitary hygiene products
SFS Intec Holding AG	F16B 13/00 (2006.01) F16B 13/04 (2006.01) F16B 13/12 (2006.01) E04B 1/76 (2006.01) F16B 5/06 (2006.01) E04F 13/04 (2006.01) E04F 13/08 (2006.01)	2494125 *	PLASTERING SYSTEM AND PLASTIC ANCHOR/ METAL SCREW ASSEMBLY FOR SAME
Abbott Laboratories	C07K 16/00 (2006.01) C07H 21/00 (2006.01)	2473524 *	DUAL VARIABLE DOMAIN IMMUNOGLOBULINS AND USES THEREOF
Giordano, Vincenza	F16L 37/091 (2006.01)	2494255 *	QUICK- FIT CONNECTION
Eisai R&D Management Co., Ltd.	C12N 1/21 (2006.01) C07K 16/28 (2006.01) C07K 16/46 (2006.01) C12N 5/10 (2006.01) C12N 1/19 (2006.01) A61K 39/395 (2006.01) C12N 15/09 (2006.01) A61P 37/06 (2006.01) C12N 1/15 (2006.01) A61P 1/04 (2006.01) C12P 21/08 (2006.01)	2493930 *	COMPOSITIONS AND METHODS FOR TREATING INFLAMMATORY DISORDERS
Glaxo Group Limited	C07K 16/18 (2006.01)	2454285 *	IMPROVED ANTI-SERUM ALBUMIN BINDING SINGLE VARIABLE DOMAINS
Janssen Pharmaceutica N.V.	A61K 39/00 (2006.01) C07K 7/00 (2006.01)	2480562 *	IDENTIFICATION OF ANTIGENIC PEPTIDES FROM MULTIPLE MYELOMA CELLS
Taisho Pharmaceutical Co., Ltd.	A61P 3/04 (2006.01) A61P 19/02 (2006.01) C07D 471/04 (2006.01) A61P 35/00 (2006.01) A61K 31/4745 (2006.01) A61P 13/12 (2006.01) A61P 11/16 (2006.01) A61P 9/10 (2006.01) A61P 11/00 (2006.01) A61P 43/00 (2006.01) A61P 7/02 (2006.01) A61P 31/04 (2006.01) A61P 1/04 (2006.01)	2477989 *	COMPOUNDS HAVING TAFIa INHIBITORY ACTIVITY

Podnosilac evropske prijave patenta (71)	MKP (51)	Broj objave evropske prijave patenta (97)	Naziv pronalaska (54)
Constantia Patz Ges. m.b.H.	B65D 75/58 (2006.01)	2371737	Packaging with tear strip
Merck Sharp & Dohme Corp.	C07D 295/155 (2006.01) C07D 307/88 (2006.01) A61K 31/495 (2006.01) C07D 405/08 (2006.01) A61K 31/529 (2006.01) C07D 407/08 (2006.01) A61P 7/10 (2006.01) C07D 413/08 (2006.01) C07D 493/04 (2006.01) C07D 487/08 (2006.01) C07D 295/135 (2006.01)	2427444 *	INHIBITORS OF THE RENAL OUTER MEDULLARY POTASSIUM CHANNEL
Hisamitsu Pharmaceutical Co., Inc.	A61K 45/00 (2006.01) A61K 9/70 (2006.01) A61K 31/404 (2006.01) A61K 31/4045 (2006.01) A61K 47/22 (2006.01) A61P 25/16 (2006.01) A61P 43/00 (2006.01)	2438917 *	TRANSDERMAL PREPARATION
E. I. du Pont de Nemours and Company	C07D 239/54 (2006.01)	2462124 *	MESOIIONIC PESTICIDES
Messer France S.A.S.	C01B 31/22 (2006.01)	2368845	Device and method for creating carbon dioxide snow
Battelle Energy Alliance, LLC	G01N 33/53 (2006.01)	2478363 *	IDENTIFICATION OF DISCRIMINANT PROTEINS THROUGH ANTIBODY PROFILING, METHODS AND APPARATUS FOR IDENTIFYING AN INDIVIDUAL
Dow AgroSciences LLC	A01N 25/32 (2006.01) A01N 25/04 (2006.01)	2485586 *	STABLE OIL-IN-WATER EMULSIONS
Bayer BioScience N.V.	C12N 9/10 (2006.01) C12N 15/82 (2006.01) C12P 21/00 (2006.01)	2421975 *	PRODUCTION OF MULTI-ANTENNARY N-GLYCAN STRUCTURES IN PLANTS
Universiteit Gent	C12N 9/10 (2006.01) C12N 15/82 (2006.01) C12P 21/00 (2006.01)	2421975 *	PRODUCTION OF MULTI-ANTENNARY N-GLYCAN STRUCTURES IN PLANTS
Université Bordeaux Segalen	A61K 9/51 (2006.01)	2435031 *	FUNCTIONAL AMPHIPHILIC MOLECULE OR MACROMOLECULE FORMULATIONS WITH MULTIPLE COMPARTMENTS
Université de la Méditerranée	A61K 9/51 (2006.01)	2435031 *	FUNCTIONAL AMPHIPHILIC MOLECULE OR MACROMOLECULE FORMULATIONS WITH MULTIPLE COMPARTMENTS
Duke University	G01B 11/02 (2006.01)	2427723 *	METHODS AND COMPUTER PROGRAM PRODUCTS FOR QUANTITATIVE THREE-DIMENSIONAL IMAGE CORRECTION AND CLINICAL PARAMETER COMPUTATION IN OPTICAL COHERENCE TOMOGRAPHY
SDEL Alsace	B01F 5/10 (2006.01) B01F 3/04 (2006.01) B01F 5/04 (2006.01) B01F 5/06 (2006.01)	2292321	Facility for producing a homogeneous gas mixture using liquid and gaseous ingredients
BioAmber International S.A.R.L.	C07C 51/46 (2006.01) C07D 307/08 (2006.01) C07C 51/41 (2006.01) C07C 51/44 (2006.01) C07D 307/33 (2006.01) C07C 55/10 (2006.01) C07C 29/136 (2006.01) C07C 31/20 (2006.01) C07C 51/02 (2006.01)	2371798	Processes for the production of tetrahydrofuran, gamma-butyrolactone and/or butanediol from salts of succinic acid
Covello, Leonard V.	A61M 25/01 (2006.01)	2456499 *	DEVICES AND METHODS FOR MINIMALLY INVASIVE ACCESS TO SINUSES AND TREATMENT OF SINUSITIS
Vertex Pharmaceuticals Incorporated	C07D 513/04 (2006.01) A61P 35/00 (2006.01) A61K 31/47 (2006.01)	2435443 *	AMINOPYRAZOLE TRIAZOLOTHIADIAZOLE INHIBITORS OF C-MET PROTIEN KINASE

Podnosilac evropske prijave patenta (71)	MKP (51)	Broj objave evropske prijave patenta (97)	Naziv pronalaska (54)
Laboratori Baldacci S.P.A.	C07C 227/06 (2006.01) C07C 229/60 (2006.01)	2390246	Process for the preparation of aminaphnone
Erneo	H02K 21/14 (2006.01)	2433349 *	VERNIER MACHINE WITH INSERTED MAGNETS
Janssen Products, L.P.	C07H 19/10 (2006.01) C07H 19/06 (2006.01) A61K 31/7072 (2006.01)	2430035 *	URACYL SPIROOXETANE NUCLEOSIDES
Medivir AB	C07H 19/10 (2006.01) C07H 19/06 (2006.01) A61K 31/7072 (2006.01)	2430035 *	URACYL SPIROOXETANE NUCLEOSIDES
Ethicon, Inc	A61L 15/16 (2006.01) A61L 27/00 (2006.01) A61L 15/64 (2006.01)	2480260 *	COMPOSITE LAYERED HEMOSTASIS DEVICE
Nycomed GmbH	A61M 11/06 (2006.01) A61M 15/00 (2006.01) A61M 11/02 (2006.01)	2421588 *	IMPROVED APPARATUS FOR THE AEROSOLIZATION OF LARGE VOLUMES OF DRY POWDER
CLAAS Agrosystems GmbH & Co. KG	A01F 15/08 (2006.01)	2368419	A method of detecting a structure in a field, a method of steering an agricultural vehicle and an agricultural vehicle
Patel, Dinesh Shantilal	A61K 9/20 (2006.01) A61K 31/4453 (2006.01)	2405900 *	A NOVEL SUSTAINED RELEASE COMPOSITION OF COMPOUNDS SELECTED FROM THE CLASS OF CENTRALLY ACTING MUSCLE RELAXANTS
Kurani, Shashikant Prabhudas	A61K 9/20 (2006.01) A61K 31/4453 (2006.01)	2405900 *	A NOVEL SUSTAINED RELEASE COMPOSITION OF COMPOUNDS SELECTED FROM THE CLASS OF CENTRALLY ACTING MUSCLE RELAXANTS
Patel, Sachin Dinesh	A61K 9/20 (2006.01) A61K 31/4453 (2006.01)	2405900 *	A NOVEL SUSTAINED RELEASE COMPOSITION OF COMPOUNDS SELECTED FROM THE CLASS OF CENTRALLY ACTING MUSCLE RELAXANTS
Almirall S.A.	C07D 471/04 (2006.01) A61P 19/00 (2006.01) A61K 31/4375 (2006.01)	2498775 *	NEW 7-PHENYL-[1,2,4]TRIAZOLO[4,3-A]PYRIDIN-3(2H)-ONE DERIVATIVES
Cadila Healthcare Limited	C07D 211/58 (2006.01)	2399907	Solid Form of [1,4']-Bipiperidiny-1'-Carbonyl Chloride
Nanotec Solution	G06F 3/044 (2006.01)	2462498 *	DEVICE AND METHOD FOR CONTROL INTERFACE SENSITIVE TO A MOVEMENT OF A BODY OR OF AN OBJECT AND CONTROL EQUIPMENT INTEGRATING THIS DEVICE
PPG Industries Ohio, Inc.	F41H 5/04 (2006.01)	2427718 *	COMPOSITE MATERIALS AND APPLICATIONS THEREOF
Amgen, Inc	C07K 14/50 (2006.01)	2443145 *	CHIMERIC FGF19 POLYPEPTIDES AND USES THEREOF
Dallmer GmbH & Co. KG	E03F 5/04 (2006.01)	2333172	Drainage device
DFD Green Technology SRL	F26B 17/10 (2006.01) C10L 5/46 (2006.01)	2450421	Method for the production of a fuel from waste
Dow Global Technologies LLC	C08J 9/14 (2006.01) C08G 18/09 (2006.01) C08G 18/50 (2006.01) C08G 18/76 (2006.01) B29C 44/34 (2006.01) F25D 23/06 (2006.01)	2386585	Foam insulation unit
National Institute Of Agrobiological Sciences	A01H 1/00 (2006.01) A01H 5/00 (2006.01) C12N 5/10 (2006.01) C12N 15/29 (2006.01)	2489738 *	GENE CONTROLLING FLOWERING HABIT/ CLEISTOGAMY IN PLANTS, AND USE THEREOF
JPB Systeme	F16B 39/22 (2006.01)	2496849 *	SELF-LOCKING SCREWING ATTACHMENT DEVICE AND ASSEMBLY PROVIDED WITH SAME
Unovatis GmbH	F16K 31/02 (2006.01) G05D 23/19 (2006.01)	2312187	Device with a linearly adjustable lifting part
Palazzoli S.p.A.	H01H 85/02 (2006.01) H01H 85/25 (2006.01) H01H 85/22 (2006.01)	2419916 *	FUSE HOLDER, PARTICULARLY FOR INTERLOCKED SOCKETS AND ELECTRICAL APPARATUSES IN GENERAL

Podnosilac evropske prijave patenta (71)	MKP (51)	Broj objave evropske prijave patenta (97)	Naziv pronalaska (54)
SANOFI	C07D 237/28 (2006.01) A61K 31/502 (2006.01) A61P 29/00 (2006.01)	2417111 *	SUBSTITUTED 1-ALKYL CINNOLIN-4(1H)-ONE DERIVATIVES, PREPARATION THEREOF AND THERAPEUTIC APPLICATION OF SAME
Alltech, Inc.	G01N 33/00 (2006.01) C12Q 1/00 (2006.01)	2451965 *	BACTERIAL ADHERENCE AND ANTI-ADHERENCE TO MUCUS, EPITHELIAL CELLS AND OTHER CELLS
Raccorderie Metalliche S.p.A.	E03D 11/14 (2006.01)	2366838	Frame for fixing sanitary fixtures to a wall
Kissei Pharmaceutical Co., Ltd.	A61P 43/00 (2006.01) C07D 409/06 (2006.01) C07D 401/04 (2006.01) C07D 409/14 (2006.01) C07D 209/18 (2006.01) C07D 401/06 (2006.01) C07D 413/14 (2006.01) A61K 31/404 (2006.01) C07D 401/14 (2006.01) C07D 417/06 (2006.01) A61P 13/02 (2006.01) C07D 409/04 (2006.01) A61K 31/422 (2006.01) C07D 405/04 (2006.01) C07D 417/14 (2006.01) A61K 31/427 (2006.01) C07D 405/06 (2006.01) A61K 31/4439 (2006.01) C07D 405/14 (2006.01)	2460792 *	INDOLE DERIVATIVE AND PHARMACOLOGICALLY ACCEPTABLE SALT THEREOF
Bavarian Nordic A/S	A61K 39/21 (2006.01) C12N 15/863 (2006.01)	2486138 *	GENERATION OF A BROAD T-CELL RESPONSE IN HUMANS AGAINST HIV
Momenta Pharmaceuticals, Inc.	G01N 33/574 (2006.01) A61K 31/715 (2006.01) G01N 33/50 (2006.01)	2419736 *	METHODS OF ASSESSING ACTIVITY OF A POLYSACCHARIDE COMPOSITION
Krka Tovarna Zdravil, D.D., Novo Mesto	C07D 235/20 (2006.01) A61P 9/12 (2006.01) A61K 31/4184 (2006.01)	2443094 *	PROCESS FOR THE PREPARATION OF TELMISARTAN
Imperial Tobacco Limited	B65D 5/66 (2006.01) B65D 85/10 (2006.01)	2376335 *	PACKAGE FOR TOBACCO-RELATED ARTICLES
McNeil-PPC, Inc.	A61K 9/16 (2006.01)	2493454 *	FAST DISSOLVING/DISINTEGRATING COATING COMPOSITIONS
Ui Property Limited	E04G 5/14 (2006.01)	2253778	An advance guard rail
University Court of the University of Edinburgh	C07K 14/54 (2006.01) C07K 14/53 (2006.01) A61K 38/20 (2006.01) A61K 38/19 (2006.01)	2445933 *	AVIAN COLONY STIMULATING FACTOR 1 RECEPTOR BINDING PROTEINS
Sanofi-Aventis Deutschland GmbH	A61M 5/315 (2006.01)	2482896 *	DRIVE MECHANISM FOR A DRUG DELIVERY DEVICE AND RESET MEMBER FOR A DRIVE MECHANISM
Kovács, Attila	A47C 27/08 (2006.01)	2410892 *	UNIVERSAL BED INSERT, BUILT BY AIR MATTRESS, COMBINED WITH AIRTIGHT VALVES, AND METHOD FOR PRODUCING THEREOF
Kovács, Krisztián	A47C 27/08 (2006.01)	2410892 *	UNIVERSAL BED INSERT, BUILT BY AIR MATTRESS, COMBINED WITH AIRTIGHT VALVES, AND METHOD FOR PRODUCING THEREOF
Teva Pharmaceutical Industries Ltd.	F16T 1/34 (2006.01)	2414722 *	PROGRAMMABLE STEAM TRAP APPARATUS
Eisai R&D Management Co., Ltd.	C07D 498/04 (2006.01) A61K 31/5365 (2006.01) A61P 25/28 (2006.01)	2456774 *	FUSED AMINODIHYDRO-OXAZINE DERIVATIVES
Reversinglabs Corporation	G06F 21/00 (2006.01) G06F 11/07 (2006.01)	2460075 *	REPAIRING PORTABLE EXECUTABLE FILES
Abraxis BioScience, LLC	A01N 43/66 (2006.01) A61K 31/53 (2006.01)	2440054 *	PYRIDIL-TRIAZINE INHIBITORS OF HEDGEHOG SIGNALING

Podnosilac evropske prijave patenta (71)	MKP (51)	Broj objave evropske prijave patenta (97)	Naziv pronalaska (54)
Janssen Pharmaceutica N.V.	C07D 401/10 (2006.01) C07D 417/06 (2006.01) C07D 413/06 (2006.01) C07D 403/06 (2006.01) A61P 29/00 (2006.01) C07D 409/10 (2006.01) C07D 403/04 (2006.01) A61K 31/496 (2006.01) C07D 403/10 (2006.01) A61P 25/00 (2006.01) C07D 409/06 (2006.01) C07D 405/06 (2006.01)	2421848 *	AZETIDINYL DIAMIDES AS MONOACYLGLYCEROL LIPASE INHIBITORS
Genentech, Inc.	A01N 43/54 (2006.01)	2445346 *	OXO-HETEROCYCLE FUSED PYRIMIDINE COMPOUNDS, COMPOSITIONS AND METHODS OF USE
Amgen Research (Munich) GmbH	G01N 33/574 (2006.01) C07K 16/46 (2006.01) A61K 39/395 (2006.01)	2493503 *	DOSAGE REGIMEN FOR ADMINISTERING A CD19XCD3 BISPECIFIC ANTIBODY
POLICHEM S.A.	A61K 31/422 (2006.01) A61K 9/20 (2006.01) A61P 31/04 (2006.01) A61K 9/06 (2006.01) A61P 15/02 (2006.01) A61P 13/02 (2006.01) A61K 9/00 (2006.01) A61P 15/00 (2006.01)	2421531 *	USE OF NIFURATEL TO TREAT INFECTIONS CAUSED BY ATOPOBIUM SPECIES
Sanofi-Aventis Deutschland GmbH	A61M 5/315 (2006.01)	2437829 *	DOSE SETTING MECHANISM FOR A DRUG DELIVERY DEVICE
Knauf Insulation Technology GmbH	F24J 2/51 (2006.01)	2302308	Colored mineral wool
Amgen, Inc	C07D 473/34 (2006.01) C07D 473/38 (2006.01) C07D 401/12 (2006.01) A61P 29/00 (2006.01) C07D 471/04 (2006.01) C07D 487/04 (2006.01) A61K 31/52 (2006.01) A61K 31/517 (2006.01) A61K 31/506 (2006.01)	2445898 *	4H-PYRIDO[1,2-A]PYRIMIDIN-4-ONE DERIVATIVES AS PI3K INHIBITORS
Protaffin Biotechnologie AG	A61K 38/20 (2006.01) C12N 15/00 (2006.01)	2475380 *	COMPOSITION FOR TREATMENT OF CXCL8-MEDIATED LUNG INFLAMMATION
Bayer Material Science AG	A01N 25/00 (2006.01) A01C 1/06 (2006.01)	2488015 *	FUZZY COTTON SEEDS COMPRISING AN AQUEOUS POLYURETHANE COATING
Bayer Cropscience LP	A01N 25/00 (2006.01) A01C 1/06 (2006.01)	2488015 *	FUZZY COTTON SEEDS COMPRISING AN AQUEOUS POLYURETHANE COATING
Janssen Pharmaceutica, N.V.	A61P 3/00 (2006.01) A61K 31/5025 (2006.01) A61P 25/00 (2006.01) C07D 487/04 (2006.01)	2493889 *	IMIDAZO[1,2-b]PYRIDAZINE DERIVATIVES AND THEIR USE AS PDE10 INHIBITORS
XBioTech, Inc	A61K 39/00 (2006.01)	2480252 *	METHODS, COMPOSITIONS, AND KITS FOR REDUCING ANTI-ANTIBODY RESPONSES
Surface Logix, Inc.	C07D 239/72 (2006.01)	2406236 *	RHO KINASE INHIBITORS
4A Technologies, LLC	C01B 31/20 (2006.01) C07C 275/00 (2006.01)	2464600 *	MODULARIZED SYSTEM AND METHOD FOR UREA PRODUCTION USING STRANDED NATURAL GAS
Panmira Pharmaceuticals, LLC	C07D 413/12 (2006.01) A61K 31/437 (2006.01) C07D 403/06 (2006.01) A61P 29/00 (2006.01) A61P 11/00 (2006.01) C07D 471/04 (2006.01) C07D 401/14 (2006.01) A61P 9/00 (2006.01)	2480548 *	INDOLIZINE INHIBITORS OF 5-LIPOXYGENASE
Sonavation, Inc.	G06K 9/00 (2006.01) G01H 17/00 (2006.01)	2411941 *	IMPROVED PIEZOELECTRIC IDENTIFICATION DEVICE AND APPLICATIONS THEREOF

Podnosilac evropske prijave patenta (71)	MKP (51)	Broj objave evropske prijave patenta (97)	Naziv pronalaska (54)
Sonavation, Inc.	H01L 41/22 (2006.01) H04R 17/00 (2006.01)	2443679 *	METHOD FOR MANUFACTURING A PIEZOELECTRIC CERAMIC BODY
Almirall S.A.	C07D 213/74 (2006.01) C07D 239/42 (2006.01) A61P 17/06 (2006.01) A61P 19/00 (2006.01) A61P 37/00 (2006.01)	2406221 *	SODIUM SALT OF 5-CYCLOPROPYL-2-((2,6-DIFLUOROPHENYL)PYRIMIDIN-5-YL)AMINO} BENZOIC ACID AS DHODH INHIBITOR
BYK-Chemie GmbH	C09C 3/12 (2006.01) C09D 7/12 (2006.01) B82Y 30/00 (2011.01) C09D 5/08 (2006.01) C09C 1/00 (2006.01)	2499206 *	COATING COMPOSITION
SANOFI	A61P 35/00 (2006.01) A61K 39/395 (2006.01) A61K 47/48 (2006.01) C07K 16/28 (2006.01)	2483312 *	ANTIBODIES THAT SPECIFICALLY BIND TO THE EPHA2 RECEPTOR
AEG Power Solutions B.V.	G05B 9/02 (2006.01) H04L 12/40 (2006.01) H04L 12/413 (2006.01) H04L 12/46 (2006.01) H04L 12/66 (2006.01)	2478420 *	CIRCUIT ASSEMBLY HAVING A CONVERTER PART COMPRISING A CENTRAL CONTROL UNIT
Quadrille Ingénierie	H04N 5/44 (2011.01)	2290955	Method for distributing digital data
Array Biopharma, Inc.	A61K 45/06 (2006.01) A61P 35/00 (2006.01) A61K 31/437 (2006.01) A61K 31/4745 (2006.01) A61K 31/7068 (2006.01)	2416773 *	CHECKPOINT KINASE 1 INHIBITORS FOR POTENTIATING DNA DAMAGING AGENTS
Japan Tobacco, Inc.	A61P 13/12 (2006.01) A61P 37/08 (2006.01) A61P 17/06 (2006.01) A61P 43/00 (2006.01) C07D 401/06 (2006.01) A61P 19/02 (2006.01) C07D 401/14 (2006.01) A61K 31/4427 (2006.01) A61P 19/08 (2006.01) C07D 405/14 (2006.01) A61K 31/4439 (2006.01) A61P 19/10 (2006.01) C07D 409/14 (2006.01) A61K 31/497 (2006.01) A61P 35/00 (2006.01) A61K 31/4545 (2006.01) A61P 29/00 (2006.01) C07D 413/14 (2006.01) A61K 31/551 (2006.01) A61P 35/02 (2006.01)	2431365 *	AZETIDINE COMPOUND AND MEDICINAL USE THEREOF
Shire LLC	A61K 31/33 (2006.01) A61P 25/28 (2006.01)	2456434 *	GALANTAMINE AMINO ACID AND PEPTIDE PRODRUGS AND USES THEREOF
Les Laboratoires Servier	C07D 401/12 (2006.01) C07D 401/14 (2006.01) C07D 403/12 (2006.01) C07D 403/14 (2006.01) C07D 413/14 (2006.01) C07D 417/14 (2006.01) A61K 31/404 (2006.01) A61P 35/00 (2006.01)	2281822	New dihydroindolone derivatives, method of preparing same and pharmaceutical compositions containing them
Dr.Ing. Max Schlötter GmbH & Co. KG	B01J 41/04 (2006.01) B01J 47/02 (2006.01) B01D 15/36 (2006.01) C25D 3/56 (2006.01) C25D 21/22 (2006.01)	2384800	Regeneration of alkaline zinc electrolytes by removing cyanidones
Abbott Biotechnology Ltd	A61M 5/20 (2006.01)	2424594 *	AUTOMATIC INJECTION DEVICE
Kaspersky Lab, ZAO	H04L 12/58 (2006.01)	2490383	Systems and methods of probing data transmissions for detecting spam bots

Podnosilac evropske prijave patenta (71)	MKP (51)	Broj objave evropske prijave patenta (97)	Naziv pronalaska (54)
Ethicon, Inc.	A61B 17/06 (2006.01)	2498690 *	SURGICAL NEEDLE COATINGS AND METHODS
Primenove S.r.l.	A01K 27/00 (2006.01)	2498597 *	LEASH FOR DOGS OR OTHER DOMESTIC ANIMALS
Université de Genève	A61K 47/48 (2006.01)	2496262 *	STABILIZED PROTEIN FORMULATIONS AND USE THEREOF
	A61K 47/10 (2006.01)		
	A61K 9/08 (2006.01)		
	A61K 38/00 (2006.01)		
	A61K 9/00 (2006.01)		
Therapeomic AG	A61K 47/48 (2006.01)	2496262 *	STABILIZED PROTEIN FORMULATIONS AND USE THEREOF
	A61K 47/10 (2006.01)		
	A61K 9/08 (2006.01)		
	A61K 38/00 (2006.01)		
	A61K 9/00 (2006.01)		
Euro-Celtique S.A.	A61K 31/485 (2006.01)	2437729 *	TAMPER RESISTANT DOSAGE FORM COMPRISING A MATRIX AND MELT-EXTRUDED PARTICULATES COMPRISING A DRUG
	A61K 45/06 (2006.01)		
	A61K 9/20 (2006.01)		
	A61K 9/16 (2006.01)		
SANOFI	A61K 31/513 (2006.01)	2448932 *	NOVEL 6-MORPHOLIN-4-YL-PYRIMIDIN-4-(3H)-ONE DERIVATIVES, AND THE PHARMACEUTICAL PREPARATION THEREOF AS AKT(PKB) PHOSPHORYLATION INHIBITORS
	C07D 413/06 (2006.01)		
	A61K 31/5377 (2006.01)		
	C07D 403/06 (2006.01)		
Akern S.r.L.	G06F 19/00 (2011.01)	2418596	A system for monitoring patients that perform a medical self-check and relative method
	G06F 19/00 (2011.01)		
Marris, Jörg	G06F 19/00 (2011.01)	2418596	A system for monitoring patients that perform a medical self-check and relative method
Cesa Alliance S.A.	A61P 31/20 (2006.01)	2368547	Antiviral compositions comprising geraniol and carvone
	A61P 31/22 (2006.01)		
	A61P 31/18 (2006.01)		
	A61K 31/045 (2006.01)		
	A61K 31/122 (2006.01)		
	A61P 31/12 (2006.01)		
	A61P 31/14 (2006.01)		
A61P 31/16 (2006.01)			
Pulmatrix, Inc.	A61K 9/00 (2006.01)	2315580 *	PHARMACEUTICAL FORMULATIONS AND METHODS FOR TREATING RESPIRATORY TRACT INFECTIONS
	A61K 47/02 (2006.01)		
	A61K 47/12 (2006.01)		
CV Holdings, LLC.	C23C 16/505 (2006.01)	2251452	Vessel processing
	G01N 15/08 (2006.01)		
	A61B 5/15 (2006.01)		
Bristol-Myers Squibb Company	A61K 31/00 (2006.01)	2435033 *	METHODS FOR TREATING TYPE 2 DIABETES IN PATIENTS RESISTANT TO PREVIOUS TREATMENT WITH OTHER ANTI-DIABETIC DRUGS EMPLOYING AN SGLT2 INHIBITOR AND COMPOSITIONS THEREOF
	A61K 31/155 (2006.01)		
	A61K 31/4439 (2006.01)		
	A61K 31/70 (2006.01)		
	A61P 3/10 (2006.01)		
AstraZeneca UK Limited	A61K 31/00 (2006.01)	2435033 *	METHODS FOR TREATING TYPE 2 DIABETES IN PATIENTS RESISTANT TO PREVIOUS TREATMENT WITH OTHER ANTI-DIABETIC DRUGS EMPLOYING AN SGLT2 INHIBITOR AND COMPOSITIONS THEREOF
	A61K 31/155 (2006.01)		
	A61K 31/4439 (2006.01)		
	A61P 3/10 (2006.01)		
PIP Co., Ltd	F24D 19/10 (2006.01)	2434225 *	COLD/HOT WATER SUPPLY SYSTEM WITH AN IMPROVED CONTROL UNIT
	F24D 17/00 (2006.01)		
	E03B 1/00 (2006.01)		
	F24H 1/48 (2006.01)		
Kiseung Metal Co., Ltd.	F24D 19/10 (2006.01)	2434225 *	COLD/HOT WATER SUPPLY SYSTEM WITH AN IMPROVED CONTROL UNIT
	F24D 17/00 (2006.01)		
	E03B 1/00 (2006.01)		
	F24H 1/48 (2006.01)		
Sandoz AG	C07C 47/277 (2006.01)	2475634 *	PROCESS FOR THE PREPARATION OF INDOLINE DERIVATIVES AND THEIR INTERMEDIATES THEREOF

Podnosilac evropske prijave patenta (71)	MKP (51)	Broj objave evropske prijave patenta (97)	Naziv pronalaska (54)
Omya Development AG	B03D 1/01 (2006.01) C22B 26/00 (2006.01) C22B 26/20 (2006.01) B03D 101/02 (2006.01)	2366456	Froth flotation process for the separation of silicates and alkaline earth metal carbonates using a collector comprising at least one hydrophobically modified polyalkyleneimine
Dhatim SARL	G06Q 20/00 (2012.01)	2425388 *	METHOD FOR CHARGING FOR AND PROVIDING ACCESS TO A SERVICE FROM A MOBILE COMMUNICATION TERMINAL
Tripath Imaging, Inc.	C07K 16/18 (2006.01) C07K 16/30 (2006.01) G01N 33/577 (2006.01)	2403875 *	GLYCODELIN MONOCLONAL ANTIBODIES AND METHODS FOR THEIR USE IN THE DETECTION OF OVARIAN CANCER
AstraZeneca AB	A61P 29/00 (2006.01) C07J 71/00 (2006.01) A61K 31/58 (2006.01) A61P 11/00 (2006.01) A61P 11/06 (2006.01)	2414377 *	NOVEL DERIVATIVES OF STEROIDAL 3,2-C'PYRAZOLE COMPOUNDS WITH GLUCOCORTICOID ACTIVITY
E. I. du Pont de Nemours and Company	A01N 43/54 (2006.01)	2461685 *	MIXTURES OF MESOIONIC PESTICIDES
GlaxoSmithKline LLC	A01N 43/78 (2006.01) A61K 31/425 (2006.01)	2485594 *	COMBINATION
Hitachi Power Europe GmbH	E04G 3/30 (2006.01) F22B 37/24 (2006.01) E04G 3/00 (2006.01)	2410105	Assembly of a covering element and an access facility or raised platform within a work room
Cencic, Avrelija	A23C 9/14 (2006.01) A23C 9/20 (2006.01)	2490547 *	COMPOSITE DIETETIC MILK DRAUGHT AND METHOD FOR PRODUCTION OF COMPOSITE DIETETIC MILK DRAUGHT WITH REDUCED LEVEL OF URIC ACID AND PURINE COMPOUNDS
Egis Gyógyszergyár Nyilvánosan M Kód Részvénytársaság	A61K 9/02 (2006.01)	2440178 *	GLYCEROL-FREE OSMOTIC LAXATIVE SUPPOSITORY
GlaxoSmithKline LLC	A01N 43/54 (2006.01) A61K 31/415 (2006.01) A61K 31/505 (2006.01)	2480084 *	COMBINATION
Ranbaxy Laboratories Limited	C07D 405/14 (2006.01)	2432777 *	PROCESS FOR THE PREPARATION OF OLMESARTAN MEDOXOMIL
Dainippon Sumitomo Pharma Co., Ltd.	A61K 31/505 (2006.01) A61K 31/5377 (2006.01) A61P 35/00 (2006.01) C07D 239/49 (2006.01) C07D 403/12 (2006.01) C07D 401/12 (2006.01) C07D 413/12 (2006.01)	2432768 *	NOVEL PYRIMIDINE DERIVATIVES AND THEIR USE IN THE TREATMENT OF CANCER AND FURTHER DISEASES
AstraZeneca AB	A61K 31/505 (2006.01) A61K 31/5377 (2006.01) A61P 35/00 (2006.01) C07D 239/49 (2006.01) C07D 403/12 (2006.01) C07D 401/12 (2006.01) C07D 413/12 (2006.01)	2432768 *	NOVEL PYRIMIDINE DERIVATIVES AND THEIR USE IN THE TREATMENT OF CANCER AND FURTHER DISEASES
Unicharm Corporation	A47L 13/20 (2006.01) A47L 13/10 (2006.01) A46B 5/00 (2006.01) A47L 13/24 (2006.01)	2433544 *	CLEANER HOLDER AND CLEANING TOOL
Hercules Incorporated	A01N 47/28 (2006.01) C07C 273/18 (2006.01) C02F 1/76 (2006.01) A01N 25/02 (2006.01)	2445842 *	USE OF MONOCHLOROUREA TO TREAT INDUSTRIAL WATERS
IGV Institut für Getreideverarbeitung GmbH	C12M 1/00 (2006.01)	2446016 *	METHOD FOR PRODUCING BIOMASS AND PHOTOBIOREACTOR FOR CULTIVATING PHOTOTROPHIC OR MIXOTROPHIC ORGANISMS OR CELLS
Biogen Idec MA Inc.	A01N 43/42 (2006.01)	2485589 *	HETEROARYL BTK INHIBITORS
Sunesis Pharmaceuticals, Inc.	A01N 43/42 (2006.01)	2485589 *	HETEROARYL BTK INHIBITORS

Podnosilac evropske prijave patenta (71)	MKP (51)	Broj objave evropske prijave patenta (97)	Naziv pronalaska (54)
Maria Clementine	A61K 9/16 (2006.01)	2386296	New application forms for cineol
Martin Klosterfrau	A61K 31/352 (2006.01)		
Vertriebsgesellschaft mbH	A61K 9/48 (2006.01) A61K 9/50 (2006.01)		
Kim, JongHae	A23C 11/10 (2006.01)	2471374 *	METHOD AND SYSTEM FOR MANUFACTURING WHOLE SOY MILK
Kim, Michael J.	A23C 11/10 (2006.01)	2471374 *	METHOD AND SYSTEM FOR MANUFACTURING WHOLE SOY MILK
SANOFI	A61K 47/14 (2006.01) A61K 9/00 (2006.01) A61K 31/519 (2006.01)	2459221 *	PHARMACEUTICAL FORMULATION
Millennium Pharmaceuticals, Inc.	A61K 9/16 (2006.01) A61K 9/20 (2006.01) A61K 31/55 (2006.01) A61K 9/28 (2006.01)	2432456 *	SOLID PHARMACEUTICAL COMPOSITIONS AND PROCESSES FOR THEIR PRODUCTION
Beisang, Arthur A.	C08F 26/10 (2006.01) A61L 27/14 (2006.01) A61F 2/12 (2006.01)	2427226 *	IMPLANT FILLING MATERIAL AND METHOD
Ersek, Robert A.	C08F 26/10 (2006.01) A61L 27/14 (2006.01) A61F 2/12 (2006.01)	2427226 *	IMPLANT FILLING MATERIAL AND METHOD
Beisang Iii, Arthur A.	C08F 26/10 (2006.01) A61L 27/14 (2006.01) A61F 2/12 (2006.01)	2427226 *	IMPLANT FILLING MATERIAL AND METHOD
Beisang, Daniel J.	C08F 26/10 (2006.01) A61L 27/14 (2006.01) A61F 2/12 (2006.01)	2427226 *	IMPLANT FILLING MATERIAL AND METHOD
Shire LLC	A61P 25/04 (2006.01) A61K 31/55 (2006.01) C07D 223/04 (2006.01)	2453900 *	NOVEL CARBAMATE AMINO ACID AND PEPTIDE PRODRUGS OF OPIOIDS AND USES THEREOF
Curt G. Joa, Inc.	A61F 13/15 (2006.01)	2446868	APPARATUS AND METHOD FOR THE APPLICATION OF A CURVED RIBBON TO A TRAVELING WEB
Alkermes, Inc.	A61K 31/497 (2006.01)	2445502 *	HETEROCYCLIC COMPOUNDS FOR THE TREATMENT OF NEUROLOGICAL AND PSYCHOLOGICAL DISORDERS
Vapogenix, Inc.	A61M 31/00 (2006.01)	2427243 *	NOVEL FORMULATIONS OF VOLATILE ANESTHETICS AND METHODS OF USE FOR REDUCING INFLAMMATION
Hesse, Albert	A61N 2/02 (2006.01)	2305346	Method for treating obesity
SICPA HOLDING SA	C09D 11/10 (2006.01) B41M 3/14 (2006.01) C09K 19/02 (2006.01) G06K 1/12 (2006.01) G07D 7/12 (2006.01) G06Q 10/00 (2012.01)	2414986 *	IDENTIFICATION AND AUTHENTICATION USING POLYMERIC LIQUID CRYSTAL MATERIAL MARKINGS
B&L	F24J 2/52 (2006.01)	2362161	Panel mounting system
Pfizer Inc	C07D 493/08 (2006.01) C07H 7/04 (2006.01) A61P 3/10 (2006.01) A61K 31/35 (2006.01) A61P 3/04 (2006.01)	2496583 *	DIOXA-BICYCLO[3.2.1]OCTANE-2,3,4-TRIOL DERIVATIVES
Incyte Corporation	A61K 31/519 (2006.01) C07D 487/04 (2006.01) A61P 35/00 (2006.01) A61P 17/00 (2006.01) A61P 27/02 (2006.01) A61P 29/00 (2006.01)	2432472 *	3-[4-(7H-PYRROLO[2,3-D]PYRIMIDIN-4-YL)-1H-PYRAZOL-1-YL]OCTANE- OR HEPTANE-NITRILE AS JAK INHIBITORS
Diagnostic Hybrids, Inc.	G01N 33/569 (2006.01) G01N 33/58 (2006.01)	2419734 *	DIRECT FLUORESCENCE IMMUNOASSAY FOR VIRAL ANTIGENS
The Trustees Of The University Of Pennsylvania	C08G 77/00 (2006.01)	2411449 *	IMPRINTED BIOMIMETIC CATALYSTS FOR CELLULOSE HYDROLYSIS

Podnosilac evropske prijave patenta (71)	MKP (51)	Broj objave evropske prijave patenta (97)	Naziv pronalaska (54)
Roth, Stephen	C08G 77/00 (2006.01)	2411449 *	IMPRINTED BIOMIMETIC CATALYSTS FOR CELLULOSE HYDROLYSIS
Lankenau Institute for Medical Research	C12Q 1/00 (2006.01)	2430178 *	METHODS AND KITS FOR MEASURING TOXICITY AND OXIDATIVE STRESS IN LIVE CELLS
Sloan Kettering Institute For Cancer Research	C07D 473/34 (2006.01) A61P 25/00 (2006.01) A61P 25/28 (2006.01) A61K 31/52 (2006.01) A61K 31/538 (2006.01) A61P 35/00 (2006.01)	2486039 *	PURINE DERIVATIVES USEFUL AS HSP90 INHIBITORS
Amgen, Inc	A61K 38/16 (2006.01)	2432488 *	SELECTIVE AND POTENT PEPTIDE INHIBITORS OF KV1.3
CoBox AG	G06Q 30/00 (2006.01) G07F 17/40 (2006.01) G07F 7/00 (2006.01)	2249302	Device for ordering and/or booking and/or purchasing goods or services and ordering, booking or purchasing device
Huf Hülbeck & Fürst GmbH & Co. KG	B60R 25/02 (2006.01)	2275313	Blocking device for blocking an essential component of a motor vehicle, particularly for blocking a steering column of a motor vehicle
Ajinomoto Co., Inc.	A23L 1/228 (2006.01)	2415359 *	USE OF PEPTIDE FOR IMPARTING BODY TASTE
Kuhn-Huard S.A.	A01B 3/46 (2006.01) A01B 3/42 (2006.01)	2238818	Reversible plough with a device for reducing the pressure
Treffler, Paul	A01B 49/02 (2006.01)	2279652	Grubber
AstraZeneca AB	A61K 31/4439 (2006.01) A61K 45/06 (2006.01) A61P 31/06 (2006.01)	2408452 *	COMPOUND FOR THE TREATMENT OF TUBERCULOSIS
Innopharmascreeen Inc.	G01N 33/68 (2006.01) C07D 405/12 (2006.01) G01N 33/533 (2006.01) A61K 8/64 (2006.01)	2444815 *	METHOD FOR SCREENING FOR SUBSTANCE WHICH INHIBITS INTERACTION BETWEEN BETA AMYLOID PEPTIDE AND VEGF AND INHIBITOR SEARCHED BY SAME
Vestas Wind Systems A/S	B66C 23/36 (2006.01) B66C 13/08 (2006.01)	2364949	Methods and apparatus for handling a tower section of a wind turbine with a crane
Janssen Pharmaceutica N.V.	A61P 25/00 (2006.01) A61K 31/496 (2006.01) C07D 205/06 (2006.01) A61P 29/00 (2006.01) C07D 409/06 (2006.01) C07D 405/06 (2006.01)	2421856 *	AZETIDINYL DIAMIDES AS MONOACYLGLYCEROL LIPASE INHIBITORS
Plasco Energy Group Inc.	F27D 3/16 (2006.01) F27D 3/12 (2006.01) B01J 4/00 (2006.01)	2430383 *	A LATERAL TRANSFER SYSTEM
PlascoEnergy IP Holdings, S.L., Bilbao, Schaffhausen Branch	F27D 3/16 (2006.01) F27D 3/12 (2006.01) B01J 4/00 (2006.01)	2430383 *	A LATERAL TRANSFER SYSTEM
Sandoz AG	C07D 209/12 (2006.01)	2419406 *	PROCESSES FOR THE SYNTHESIS OF BAZEDOXIFENE ACETATE AND INTERMEDIATES THEREOF
Crucell Holland B.V.	C07K 16/10 (2006.01) A61K 39/42 (2006.01)	2430046 *	HUMAN BINDING MOLECULES CAPABLE OF NEUTRALIZING INFLUENZA VIRUS H3N2 AND USES THEREOF
China Academy of Telecommunications Technology	H04W 36/34 (2009.01) H04W 88/02 (2009.01)	2480025 *	METHOD, DEVICE AND SYSTEM FOR RECONFIGURING AGGREGATION CELL
Sea Lane Biotechnologies, llc.	C12N 15/10 (2006.01)	2446032 *	EXPRESSION OF SURROGATE LIGHT CHAINS
Immersion Corporation	G06F 3/023 (2006.01) G06F 3/01 (2006.01)	2476044 *	SYSTEMS AND METHODS FOR HAPTICALLY-ENHANCED TEXT INTERFACES
Kelisec AB	H04L 9/08 (2006.01)	2361462 *	METHOD FOR GENERATING AN ENCRYPTION/DECRYPTION KEY
Force Protection Technologies, Inc.	F41H 7/02 (2006.01)	2417415 *	MINE RESISTANT ARMORED VEHICLE

Podnosilac evropske prijave patenta (71)	MKP (51)	Broj objave evropske prijave patenta (97)	Naziv pronalaska (54)
Guenuchet, Claude	B29C 49/04 (2006.01) B29C 49/48 (2006.01)	2353841	Container for liquid and manufacturing method thereof
Palazzoli S.p.A.	H01H 85/32 (2006.01)	2419917 *	FAULT SIGNALING DEVICE, PARTICULARLY FOR ELECTRICAL APPARATUS SUCH AS INTERLOCKED SOCKETS
Total Raffinage Marketing	C09K 8/32 (2006.01) C09K 8/34 (2006.01)	2419487 *	FLUID FOR DEEP OFFSHORE DRILLING
Genentech, Inc.	C12Q 1/68 (2006.01)	2491134 *	GENETIC POLYMORPHISMS IN AGE-RELATED MACULAR DEGENERATION
Stellenbosch University	C12N 15/113 (2010.01)	2478102 *	A METHOD OF MODIFYING THE CARBOHYDRATE CONTENT OF A PLANT
South African Sugarcane Research Institute	C12N 15/113 (2010.01)	2478102 *	A METHOD OF MODIFYING THE CARBOHYDRATE CONTENT OF A PLANT
Laboratori Baldacci S.P.A.	A61K 31/245 (2006.01) A61P 25/06 (2006.01)	2389936	Aminaphtone for use in the treatment and/or prevention of migraine
Chiesi Farmaceutici S.p.A.	A61K 45/06 (2006.01) A61P 11/00 (2006.01)	2435081 *	A THERAPEUTIC COMBINATION COMPRISING A PULMONARY SURFACTANT AND A STEROID
TEVA PHARMACEUTICAL INDUSTRIES, LTD.	A61K 31/136 (2006.01) A61P 25/28 (2006.01)	2485722 *	USE OF RASAGILINE FOR THE TREATMENT OF PROGRESSIVE SUPRANUCLEAR PALSY
UCB Pharma GmbH	A61P 25/16 (2006.01) A61K 31/381 (2006.01) A61K 9/00 (2006.01) A61K 9/70 (2006.01) C07D 333/20 (2006.01)	2445496 *	Pharmaceutical composition comprising rotigotine salts (acid or Na), especially for iontophoresis
ACTGen, Inc.	A61P 35/00 (2006.01) C07K 16/30 (2006.01) A61K 39/00 (2006.01) A61P 1/00 (2006.01) C12N 15/09 (2006.01) A61K 39/395 (2006.01) C12N 5/10 (2006.01)	2452950 *	ANTIBODY HAVING ANTI-CANCER ACTIVITY
Noblesse Türfüllungen GmbH & Co. KG	E06B 1/02 (2006.01) E06B 3/964 (2006.01) E06B 3/06 (2006.01) B29C 70/76 (2006.01) E06B 3/88 (2006.01)	2275637	Door leaf
PPG Industries Ohio, Inc.	C03C 13/06 (2006.01) C08J 5/08 (2006.01) C03C 13/00 (2006.01) C03C 3/087 (2006.01)	2462068 *	GLASS COMPOSITIONS AND FIBERS MADE THEREFROM
Chalabi, Rifat Al	B09B 3/00 (2006.01)	2475470 *	APPARATUS FOR PROCESSING WASTE MATERIAL WITH INWARDLY DIRECTED OPENING
Perry, Ophneil Henry	B09B 3/00 (2006.01)	2475470 *	APPARATUS FOR PROCESSING WASTE MATERIAL WITH INWARDLY DIRECTED OPENING
Abbott Laboratories	C07K 16/28 (2006.01)	2470568 *	THERAPEUTIC DLL4 BINDING PROTEINS
Zenyaku Kogyo Co., Ltd	A61K 31/4188 (2006.01) A61K 31/4164 (2006.01) A61P 25/28 (2006.01)	2413929 *	METHOD OF TREATING COGNITIVE IMPAIRMENT
The University Of Western Australia	C12N 15/52 (2006.01) G01N 33/53 (2006.01) C12N 15/29 (2006.01) C12N 15/11 (2006.01) C12N 15/63 (2006.01) C07K 14/415 (2006.01)	2449107 *	TERPENE SYNTHASES FROM SANTALUM
University Of British Columbia	C12N 15/52 (2006.01) G01N 33/53 (2006.01) C12N 15/29 (2006.01) C12N 15/11 (2006.01) C12N 15/63 (2006.01) C07K 14/415 (2006.01)	2449107 *	TERPENE SYNTHASES FROM SANTALUM

Podnosilac evropske prijave patenta (71)	MKP (51)	Broj objave evropske prijave patenta (97)	Naziv pronalaska (54)
Forest Products Commission	C12N 15/52 (2006.01) G01N 33/53 (2006.01) C12N 15/29 (2006.01) C12N 15/11 (2006.01) C12N 15/63 (2006.01) C07K 14/415 (2006.01)	2449107 *	TERPENE SYNTHASES FROM SANTALUM
Polgár, Jenó	F02B 1/12 (2006.01) F02B 19/10 (2006.01) F02B 41/04 (2006.01) F02B 75/02 (2006.01) F02B 41/06 (2006.01) F02B 19/02 (2006.01)	2449223 *	INTERNAL COMBUSTION ENGINE WITH SEPARATE COMBUSTION CHAMBER AND A METHOD TO ACHIEVE MODIFIED AND CONTROLLED AUTOIGNITION IN SAID CHAMBER
Ethicon, Inc	A61B 17/06 (2006.01) D04C 3/42 (2006.01) A61B 17/00 (2006.01)	2470083 *	AUTOMATED SYSTEMS AND METHODS FOR MAKING BRAIDED BARBED SUTURES
Küberit Profile Systems GmbH & Co. KG	E04F 11/16 (2006.01)	2452028 *	DEVICE FOR FIXING THE EDGE OF A FLOOR COVERING TO A PROFILED STRUCTURE
University Of Rochester	C12P 21/00 (2006.01) C12N 15/70 (2006.01) C12N 15/00 (2006.01)	2494045 *	SOLUTION ASSAY AND HIGH THROUGH-PUT SCREEN TO PROBE INTERACTION BETWEEN HUMAN CULLIN-RING LIGASE COMPLEX AND HIV-1 PROTEIN
Abraxis BioScience, LLC	A01N 43/66 (2006.01) A61K 31/53 (2006.01)	2440055 *	STYRYL-TRIAZINE DERIVATIVES AND THEIR THERAPEUTICAL APPLICATIONS
Onebip S.r.l.	G06Q 20/00 (2012.01)	2465080 *	SYSTEM AND METHOD FOR TRANSFERRING MONEY FROM A MOBILE PHONE ACCOUNT
Ascendis Pharma A/S	A61K 47/48 (2006.01) A61K 41/00 (2006.01) A61L 2/00 (2006.01) C08G 65/329 (2006.01) A61K 9/16 (2006.01) A61P 43/00 (2006.01)	2493514 *	STERILIZATION OF BIODEGRADABLE HYDROGELS
Aventis Pharma S.A.	A61P 35/00 (2006.01) A61K 31/56 (2006.01) A61K 45/06 (2006.01) A61K 31/164 (2006.01)	2493466 *	NOVEL ANTITUMORAL USE OF CABAZITAXEL
Galderma Research & Development	A61K 31/4965 (2006.01) C07D 215/14 (2006.01) C07D 261/20 (2006.01) C07D 295/26 (2006.01) C07D 209/10 (2006.01) A61P 25/00 (2006.01) C07D 471/04 (2006.01) C07D 213/30 (2006.01) A61P 29/00 (2006.01) A61P 35/00 (2006.01)	2448920 *	NOVEL BENZENESULFONAMIDE COMPOUNDS, METHOD FOR SYNTHESIZING SAME, AND USE THEREOF IN MEDICINE AS WELL AS IN COSMETICS
Janssen Pharmaceutica, N.V.	A61K 31/155 (2006.01) A61K 45/06 (2006.01) A61P 3/04 (2006.01) A61P 3/10 (2006.01) A61K 31/7034 (2006.01)	2451482 *	COMBINATION THERAPY FOR THE TREATMENT OF DIABETES
Handy Baby Products Ltd	G01F 19/00 (2006.01)	2449350 *	A MEASURING DEVICE
Protia LLC	C12C 11/00 (2006.01)	2467465 *	ALCOHOLIC COMPOSITIONS HAVING A LOWERED RISK OF ACETALDEHYDEMIAS
Allum-Jenkins AS	C12Q 1/68 (2006.01) C12Q 1/70 (2006.01) C12N 15/11 (2006.01)	2425017 *	A METHOD FOR DETECTION OF HUMAN PAPILLOMAVIRUS (HPV) TYPE
Kaspersky Lab, ZAO	G06F 21/00 (2006.01)	2309408	Method and system for detection and prediction of computer virus-related epidemics

Podnosilac evropske prijave patenta (71)	MKP (51)	Broj objave evropske prijave patenta (97)	Naziv pronalaska (54)
Janssen Pharmaceutica, N.V.	A61K 31/433 (2006.01) A61P 3/10 (2006.01) C07D 401/08 (2006.01) A61P 29/00 (2006.01) C07D 403/08 (2006.01) C07D 205/04 (2006.01) C07D 413/08 (2006.01) C07D 403/10 (2006.01) C07D 417/08 (2006.01) C07D 405/08 (2006.01) A61K 31/4427 (2006.01) A61K 31/437 (2006.01)	2419419 *	4-AZETIDINYL-1-PHENYL-CYCLOHEXANE ANTAGONISTS OF CCR2
KRKA, D.D., Novo Mesto	A61K 9/16 (2006.01) C07D 215/18 (2006.01)	2413911 *	PROGRESSIVE EMULSION CRYSTALLIZATION
AstraZeneca AB	A61K 31/545 (2006.01)	2480236 *	COMPOSITIONS AND METHODS FOR TREATING BACTERIAL INFECTIONS USING CEFTAROLINE
SANOFI	C07D 239/42 (2006.01) C07D 487/04 (2006.01) A61K 31/519 (2006.01) C07D 239/06 (2006.01) A61P 35/00 (2006.01)	2448940 *	NOVEL 1,2,3,4-TETRAHYDRO-PYRIMIDO(1,2-A) PYRIMIDIN-6-ONE DERIVATIVES, PREPARATION THEREOF, AND PHARMACEUTICAL USE THEREOF
Vestas Wind Systems A/S	F03D 7/02 (2006.01)	2284390	Hydraulic station and method for controlling pressure in a hydraulic system of a wind turbine
Euro-Celtique S.A.	A61M 15/00 (2006.01) G06M 1/16 (2006.01)	2408497 *	COUNTER
Delphi Technologies, Inc.	F02M 51/00 (2006.01) F02M 51/06 (2006.01) F02M 63/00 (2006.01) F02M 47/02 (2006.01)	2409013 *	ACTUATOR ARRANGEMENT
Logomotion, s.r.o.	G07F 7/10 (2006.01) G06Q 20/00 (2012.01)	2462567 *	A PAYMENT TERMINAL USING A MOBILE COMMUNICATION DEVICE, SUCH AS A MOBILE PHONE; A METHOD OF DIRECT DEBIT PAYMENT TRANSACTION
Cardoz AB	A61P 9/12 (2006.01) A61P 3/10 (2006.01) A61K 31/519 (2006.01) A61P 29/00 (2006.01) A61P 3/00 (2006.01)	2498779 *	PEMIROLAST FOR THE TREATMENT OF SYSTEMIC LOW GRADE INFLAMMATION
ThromboGenics N.V.	A61K 38/48 (2006.01) A61P 27/02 (2006.01)	2480249 *	USE OF PLASMIN FOR THE TREATMENT OF FILTRATION FAILURE AFTER TRABECULECTOMY
Sierra Wireless, Inc.	H04W 92/02 (2009.01) H04L 12/66 (2006.01)	2494750 *	ROUTING DEVICE AND METHOD OF CONFIGURATION FOR NETWORK NAME RESOLUTION OF SAME
Janssen Biotech, Inc.	A61K 39/00 (2006.01) C12P 21/06 (2006.01)	2494061 *	ANTIBODY GLYCOSYLATION VARIANTS
Sanofi-Aventis Deutschland GmbH	C07K 14/62 (2006.01) A61K 38/28 (2006.01) A61K 47/48 (2006.01) A61P 3/10 (2006.01)	2459228 *	PRODRUGS COMPRISING AN INSULIN LINKER CONJUGATE
Merrimack Pharmaceuticals, Inc.	A61K 39/395 (2006.01)	2467164 *	ANTIBODIES AGAINST THE ECTODOMAIN OF ERBB3 AND USES THEREOF
The Regents of the University of Colorado	C12P 21/08 (2006.01) A61K 39/395 (2006.01)	2437780 *	THERAPEUTIC COMPOSITIONS AND METHODS FOR THE PREVENTION OF AUTOIMMUNE DISEASES
Blücher GmbH	A62B 23/02 (2006.01)	2432562 *	PROTECTIVE MASK
Heartflow, Inc.	G06F 19/00 (2011.01)	2499589 *	METHOD AND SYSTEM FOR PATIENT-SPECIFIC MODELING OF BLOOD FLOW

Podnosilac evropske prijave patenta (71)	MKP (51)	Broj objave evropske prijave patenta (97)	Naziv pronalaska (54)
Probiodrug AG	C07D 405/14 (2006.01) C07D 413/04 (2006.01) C07D 417/14 (2006.01) A61P 25/00 (2006.01) A61K 31/437 (2006.01) A61P 25/28 (2006.01) A61K 31/4184 (2006.01) C07D 403/14 (2006.01) C07D 413/14 (2006.01) C07D 471/04 (2006.01)	2475428 *	HETEROCYCLIC DERIVATIVES AS INHIBITORS OF GLUTAMINYL CYCLASE
SANOFI	A61K 38/00 (2006.01) C07K 16/28 (2006.01)	2486058 *	POLYPEPTIDES FOR BINDING TO THE "RECEPTOR FOR ADVANCED GLYCATION ENDPRODUCTS" AS WELL AS COMPOSITIONS AND METHODS INVOLVING THE SAME
Kaspersky Lab, ZAO	G06F 9/50 (2006.01) G06F 21/00 (2006.01)	2388727	Team security for portable information devices
Delphi Technologies Holding S.à.r.l.	F02D 41/22 (2006.01) F02D 41/38 (2006.01)	2295775	Control method for a common rail fuel pump and apparatus for performing the same
Omya Development AG	B41M 5/50 (2006.01) D21H 19/82 (2006.01)	2402167	Paper for inkjet recording
Cephalon, Inc.	A61K 9/14 (2006.01) A61K 31/4184 (2006.01)	2424506 *	ORAL FORMULATIONS OF BENDAMUSTINE
Taisho Pharmaceutical Co., Ltd.	A61K 31/497 (2006.01) A61P 11/06 (2006.01) A61K 31/496 (2006.01) A61P 9/10 (2006.01) A61P 35/00 (2006.01) A61K 31/4439 (2006.01) A61P 3/04 (2006.01) A61P 27/02 (2006.01) A61K 31/506 (2006.01) A61P 17/00 (2006.01) A61K 31/427 (2006.01) A61P 1/16 (2006.01) A61P 25/00 (2006.01) C07D 417/04 (2006.01) A61P 1/04 (2006.01) A61P 19/02 (2006.01) A61K 31/5377 (2006.01) A61P 17/06 (2006.01) A61K 31/454 (2006.01) A61P 3/06 (2006.01) A61P 29/00 (2006.01)	2492269 *	AMINOTHIAZOLE DERIVATIVE
L'AIR LIQUIDE, Société Anonyme pour l'Etude et l'Exploitation des Procédés Georges Claude	B65D 85/04 (2006.01) B65D 5/60 (2006.01)	2230194	Packaging for a plurality of coils of feedwire
AIR LIQUIDE WELDING FRANCE	B65D 85/04 (2006.01) B65D 5/60 (2006.01)	2230194	Packaging for a plurality of coils of feedwire
Takeda Pharmaceutical Company Limited	A61P 35/00 (2006.01) A61P 43/00 (2006.01) A61K 31/55 (2006.01) A61K 31/5377 (2006.01) C07D 471/04 (2006.01) A61K 31/444 (2006.01) A61K 31/4545 (2006.01) A61K 31/437 (2006.01)	2471790 *	FUSED HETEROCYCLIC RING DERIVATIVE AND USE THEREOF
Omya Development AG	D21H 21/52 (2006.01) C09C 1/02 (2006.01) D21H 17/68 (2006.01) D21H 19/38 (2006.01) D21H 17/67 (2006.01) C01F 11/18 (2006.01) D21H 19/40 (2006.01)	2480718 *	AQUEOUS SLURRIES COMPRISING FINE CALCIUM CARBONATE PARTICLES FOR USE IN PAPER COATINGS

Podnosilac evropske prijave patenta (71)	MKP (51)	Broj objave evropske prijave patenta (97)	Naziv pronalaska (54)
Nippon Soda Co., Ltd.	C07D 335/02 (2006.01) C07D 417/12 (2006.01) A01N 43/10 (2006.01) A01N 43/18 (2006.01) C07D 333/36 (2006.01) A01P 7/02 (2006.01) A01P 7/04 (2006.01) C07D 409/12 (2006.01)	2500342 *	1-HETERODIENE DERIVATIVE AND NOXIOUS ORGANISM CONTROL AGENT
SANOFI	C07D 401/12 (2006.01) C07D 403/12 (2006.01) C07D 409/12 (2006.01) C07D 209/52 (2006.01) C07D 333/38 (2006.01) A61K 31/381 (2006.01) A61K 31/403 (2006.01) A61K 31/4439 (2006.01) C07D 451/02 (2006.01) C07D 213/81 (2006.01) A61K 31/407 (2006.01) A61P 25/00 (2006.01) C07D 487/08 (2006.01) C07D 333/16 (2006.01) C07D 213/46 (2006.01) C07D 209/12 (2006.01) C07D 209/02 (2006.01) A61K 31/44 (2006.01)	2408763 *	DERIVATIVES OF N-(2-AZA-BICYCLO[2.1.1]HEX-1-YL)-ARYL-METHYL-HETEROBENZAMIDE, PREPARATION THEREOF AND APPLICATION OF SAME IN THERAPEUTICS
Manuco	B65B 69/00 (2006.01) B65D 77/06 (2006.01)	2426056	Packaging intended for transporting hazardous materials
Omya Development AG	D21B 1/30 (2006.01) D21C 9/00 (2006.01) D01F 2/02 (2006.01) C08J 5/00 (2006.01) C08J 3/00 (2006.01) C08J 3/075 (2006.01) D21B 1/04 (2006.01)	2414435 *	PROCESS FOR THE PRODUCTION OF NANO-FIBRILLAR CELLULOSE GELS
Affitech Research AS	C07K 16/30 (2006.01)	2440580 *	ANTI-EpCAM ANTIBODIES
Ironwood Pharmaceuticals, Inc.	A61P 1/00 (2006.01) A61P 1/10 (2006.01) A61K 47/00 (2006.01) A61K 38/10 (2006.01) A61K 9/00 (2006.01)	2464373 *	METHOD FOR MODULATING THE PHARMACODYNAMIC EFFECT OF ORALLY ADMINISTERED GUANYLATE CYCLASE RECEPTOR AGONISTS
Ascendis Pharma A/S	A61K 47/48 (2006.01) A61P 25/16 (2006.01)	2459227 *	PRODRUGS CONTAINING AN AROMATIC AMINE CONNECTED BY AN AMIDO BOND TO A LINKER
Nenashev, Sergey Vladimirovich	E04B 1/10 (2006.01)	2468970 *	METHOD FOR PRODUCING WOODEN HOUSES, STRUCTURES AND CONSTRUCTIONS
Immersion Corporation	G06F 3/048 (2006.01) G06F 3/041 (2006.01) G06F 3/01 (2006.01)	2406700 *	SYSTEMS AND METHODS FOR PROVIDING FEATURES IN A FRICTION DISPLAY
Edimer Biotech S.a.	C07K 16/28 (2006.01) A61K 39/395 (2006.01)	2414396 *	PREPARATION OF ISOLATED AGONIST ANTI-EDAR MONOCLONAL ANTIBODIES
Université de Lausanne	C07K 16/28 (2006.01) A61K 39/395 (2006.01)	2414396 *	PREPARATION OF ISOLATED AGONIST ANTI-EDAR MONOCLONAL ANTIBODIES
RENT S.r.l.	B65H 19/18 (2006.01)	2427398 *	A UNIT AND METHOD FOR FEEDING REELS OF A SHEET-LIKE MATERIAL, IN PARTICULAR BUT NOT EXCLUSIVELY A PRINTED PLASTIC FILM WITH PRINT- POSITION MARKS FOR AUTOMATIC PACKAGING MACHINES

Podnosilac evropske prijave patenta (71)	MKP (51)	Broj objave evropske prijave patenta (97)	Naziv pronalaska (54)
MSD Oss B.V.	C07C 255/54 (2006.01) A61K 31/09 (2006.01) C07C 43/225 (2006.01) A61K 31/222 (2006.01) C07C 39/17 (2006.01) A61K 31/277 (2006.01) C07C 43/21 (2006.01) A61P 31/08 (2006.01) C07C 43/23 (2006.01) A61P 35/00 (2006.01) C07C 69/157 (2006.01) A61P 25/00 (2006.01) C07C 255/55 (2006.01) C07C 39/42 (2006.01) A61K 31/055 (2006.01)	2406206 *	TETRAHYDRONAPHTHALEN-2-OL DERIVATIVES
Merck & Co., Inc.	A01N 45/00 (2006.01) A61K 31/56 (2006.01)	2403341 *	LUNG CANCER TREATMENT
ARIAD Pharmaceuticals, Inc	A01N 45/00 (2006.01) A61K 31/56 (2006.01)	2403341 *	LUNG CANCER TREATMENT
Jiangsu Hansoh Pharmaceutical Group Co., Ltd.	C07K 14/605 (2006.01) A61K 38/26 (2006.01)	2460825 *	DERIVATIVE OF GLP-1 ANALOGUE OR ITS PHARMACEUTICAL SALTS AND THEIR USE
Biokier Inc.	A61K 9/22 (2006.01) A61K 31/185 (2006.01) A61K 31/537 (2006.01) A61P 3/10 (2006.01) A61K 38/22 (2006.01)	2480246 *	COMPOSITION AND METHOD FOR TREATMENT OF DIABETES
Genentech, Inc.	A61P 29/00 (2006.01) A61P 25/00 (2006.01) C07D 487/04 (2006.01) C07D 491/04 (2006.01) C07D 513/04 (2006.01) A61P 35/00 (2006.01) A61K 31/519 (2006.01) A61P 9/00 (2006.01)	2435438 *	BICYCLIC PYRIMIDINE PI3K INHIBITOR COMPOUNDS SELECTIVE FOR P110 DELTA, AND METHODS OF USE
F.Hoffmann-La Roche AG	A61P 29/00 (2006.01) A61P 25/00 (2006.01) C07D 487/04 (2006.01) C07D 491/04 (2006.01) C07D 513/04 (2006.01) A61P 35/00 (2006.01) A61K 31/519 (2006.01) A61P 9/00 (2006.01)	2435438 *	BICYCLIC PYRIMIDINE PI3K INHIBITOR COMPOUNDS SELECTIVE FOR P110 DELTA, AND METHODS OF USE
Abbott Laboratories	C12P 21/06 (2006.01) C07K 16/00 (2006.01) C12P 21/02 (2006.01)	2493923 *	SORF CONSTRUCTS AND MULTIPLE GENE EXPRESSION
Innov Process Industrie	E04B 1/24 (2006.01) E04B 1/74 (2006.01)	2228498	A process of manufacture of an internally isolated building and building constructed according to that process, a method of producing a corresponding superstructural element and superstructural element produced according to that method
Janssen Pharmaceutica, N.V.	A61K 38/22 (2006.01)	2496248 *	METHOD FOR TREATING HEART FAILURE WITH STRESSCOPIN-LIKE PEPTIDES
Jezek, Giorgio	B66B 11/04 (2006.01)	2432725 *	DEVICE FOR SAVING ENERGY DURING VERTICAL AND HORIZONTAL MOTIONS WHEREIN THE RESISTING TORQUE CAN BE SPLIT INTO TWO TORQUES OPPOSING EACH OTHER
Katholieke Universiteit Leuven, K.U. Leuven R&D	C07D 513/04 (2006.01) A61K 31/519 (2006.01) A61P 29/00 (2006.01)	2405973 *	THIAZOLOPYRIMIDINE MODULATORS AS IMMUNOSUPPRESSIVE AGENTS
Correlix Ltd.	H04L 12/24 (2006.01)	2486698 *	METHOD AND SYSTEM FOR RECONSTRUCTING TRANSACTIONS IN A COMMUNICATION NETWORK
Biomérieux	G01N 33/569 (2006.01) C07K 14/20 (2006.01)	2470907 *	PROTEINS USED FOR THE DIAGNOSIS OF LYME BORRELIOSIS

Podnosilac evropske prijave patenta (71)	MKP (51)	Broj objave evropske prijave patenta (97)	Naziv pronalaska (54)
Ethicon, Inc	C08G 63/66 (2006.01) C08G 63/08 (2006.01) C08G 63/60 (2006.01)	2464678 *	SEMI-CRYSTALLINE, FAST ABSORBING POLYMER FORMULATION
BASF Agrochemical Products, B.V.	A01H 5/00 (2006.01) C12Q 1/04 (2006.01) C12N 15/82 (2006.01) C12N 15/52 (2006.01)	2473024 *	HERBICIDE-TOLERANT PLANTS
Eurosicma S.p.A.	B65B 23/14 (2006.01) B65B 35/44 (2006.01) B65G 17/26 (2006.01) B65G 47/82 (2006.01) B65G 47/84 (2006.01)	2364916	Plant for forming and for continuous synchronised transferring of compact groups of products drawn near one another along the transfer path
Owens-Brockway Glass Container INC.	C03B 9/16 (2006.01) C03B 9/36 (2006.01) F16B 7/20 (2006.01) F16B 21/04 (2006.01) F16D 1/112 (2006.01)	2429960 *	GLASSWARE FORMING MACHINE BAFFLE ARM ASSEMBLY
Samp S.p.a. Con Unico Socio	B23Q 1/28 (2006.01) B23F 17/00 (2006.01)	2440358 *	MACHINE FOR MAKING GEARS
Fibrolith Dämmstoffe GmbH	B32B 21/02 (2006.01) B32B 21/10 (2006.01) B32B 19/06 (2006.01) E04C 2/00 (2006.01) E04F 13/00 (2006.01) C04B 28/04 (2006.01) B32B 5/26 (2006.01)	2277692	Insulation board, adhesive mortar for attaching an insulation board to a wall or a ceiling of a building and assembly, comprising an insulation board and an adhesive mortar
Quick-Mix Gruppe GmbH & Co. KG	B32B 21/02 (2006.01) B32B 21/10 (2006.01) B32B 19/06 (2006.01) E04C 2/00 (2006.01) E04F 13/00 (2006.01) C04B 28/04 (2006.01) B32B 5/26 (2006.01)	2277692	Insulation board, adhesive mortar for attaching an insulation board to a wall or a ceiling of a building and assembly, comprising an insulation board and an adhesive mortar
Optosecurity Inc.	G01N 23/04 (2006.01)	2443441 *	METHOD AND APPARATUS FOR ASSESSING THE THREAT STATUS OF LUGGAGE
The Regents of the University of Michigan	A61P 27/02 (2006.01) C12N 5/02 (2006.01) C07K 14/54 (2006.01) A61K 38/20 (2006.01)	2403937 *	METHODS OF INHIBITING PHOTORECEPTOR APOPTOSIS
Hisamitsu Pharmaceutical Co., Inc.	A61F 13/02 (2006.01) A61K 9/70 (2006.01) A61L 15/58 (2006.01)	2489339 *	METHOD AND DEVICE FOR PRODUCING ADHESIVE PATCH
Palazzoli S.p.A.	H02G 3/08 (2006.01) H02G 3/22 (2006.01) H02G 15/013 (2006.01)	2486635 *	GASKET FOR ELECTRIC CABLES
Trilliant Networks, Inc.	G08C 15/06 (2006.01)	2406778 *	PROCESS, DEVICE AND SYSTEM FOR MAPPING TRANSFORMERS TO METERS AND LOCATING NON-TECHNICAL LINE LOSSES
Janssen Pharmaceutica, N.V.	C07D 417/12 (2006.01) A61K 31/423 (2006.01) C07D 417/14 (2006.01) A61K 31/424 (2006.01) C07D 493/04 (2006.01) A61K 31/428 (2006.01) C07D 495/04 (2006.01) A61K 31/429 (2006.01) C07D 498/04 (2006.01) C07D 413/12 (2006.01) C07D 519/00 (2006.01) C07D 513/04 (2006.01) C07D 413/14 (2006.01) A61P 29/00 (2006.01)	2430019 *	COMPOUNDS WITH TWO FUSED BICYCLIC HETEROARYL MOIETIES AS MODULATORS OF LEUKOTRIENE A4 HYDROLASE
Dodic-Portner, Vojislav	A63K 3/04 (2006.01)	2459290 *	HURDLE

Podnosilac evropske prijave patenta (71)	MKP (51)	Broj objave evropske prijave patenta (97)	Naziv pronalaska (54)
China Academy of Telecommunications Technology	H04W 28/26 (2009.01)	2469921 *	METHOD, SYSTEM AND APPARATUS FOR ACK/NACK RESOURCE RESERVATION
HF Europe S.r.l.	A23L 1/00 (2006.01) A23L 1/304 (2006.01) A23L 1/03 (2006.01)	2437624 *	FOOD PRODUCTS COMPRISING ZEOLITES
Xenon Pharmaceuticals Inc.	C07D 491/20 (2006.01)	2488531 *	SYNTHETIC METHODS FOR SPIRO-OXINDOLE COMPOUNDS
Genentech, Inc.	A61K 31/519 (2006.01) A61P 35/00 (2006.01) C07D 487/04 (2006.01)	2470539 *	RAF INHIBITOR COMPOUNDS AND METHODS OF USE THEREOF
Array Biopharma, Inc.	A61K 31/519 (2006.01) A61P 35/00 (2006.01) C07D 487/04 (2006.01)	2470539 *	RAF INHIBITOR COMPOUNDS AND METHODS OF USE THEREOF
Saint-Gobain Adfors	C03C 25/24 (2006.01)	2438025 *	MINERAL FIBER MAT CONTAINING A FORMALDEHYDE-TRAPPING AGENT, AND METHODS FOR MANUFACTURING SAME
Advancell Advanced in Vitro Cell Technologies, S.A.	A61K 8/11 (2006.01) A61K 8/73 (2006.01) A61K 9/51 (2006.01)	2440193 *	PROCESS FOR THE PREPARATION OF COLLOIDAL SYSTEMS FOR THE DELIVERY OF ACTIVE COMPOUNDS
Sanofi-Aventis Deutschland GmbH	A61M 5/24 (2006.01) A61M 5/315 (2006.01)	2477682 *	MEDICATION DELIVERY DEVICE AND METHOD FOR DISPENSING A MEDICATION
Colmic Italia S.P.A.	F41B 3/02 (2006.01) A01K 97/02 (2006.01)	2267395	Groundbait catapult
Messer Austria GmbH	C25B 1/46 (2006.01) C25B 15/08 (2006.01) C25B 1/26 (2006.01)	2435605 *	PROCESS AND APPARATUS FOR THE ELECTROLYSIS OF AN AQUEOUS SOLUTION OF HYDROGEN CHLORIDE OR ALKALI CHLORIDE IN AN ELECTROLYTIC CELL
Messer Group GmbH	C25B 1/46 (2006.01) C25B 15/08 (2006.01) C25B 1/26 (2006.01)	2435605 *	PROCESS AND APPARATUS FOR THE ELECTROLYSIS OF AN AQUEOUS SOLUTION OF HYDROGEN CHLORIDE OR ALKALI CHLORIDE IN AN ELECTROLYTIC CELL
Bayer Material Science AG	C25B 1/46 (2006.01) C25B 15/08 (2006.01) C25B 1/26 (2006.01)	2435605 *	PROCESS AND APPARATUS FOR THE ELECTROLYSIS OF AN AQUEOUS SOLUTION OF HYDROGEN CHLORIDE OR ALKALI CHLORIDE IN AN ELECTROLYTIC CELL
Delphi Technologies Holding S.à.r.l.	F04B 17/04 (2006.01) F01N 3/20 (2006.01) F02M 69/02 (2006.01)	2375054	Reagent dosing system and pump
Kemijski Institut	C09C 1/24 (2006.01) C09C 1/34 (2006.01) C09C 3/08 (2006.01) F24J 2/48 (2006.01) H01L 31/0216 (2006.01)	2261288	Aminosilane modified pigments for spectrally selective coatings, method for preparation and their use in coatings
Color Industrija sintetičkih smol, barv in Lakov	C09C 1/24 (2006.01) C09C 1/34 (2006.01) C09C 3/08 (2006.01) F24J 2/48 (2006.01) H01L 31/0216 (2006.01)	2261288	Aminosilane modified pigments for spectrally selective coatings, method for preparation and their use in coatings
Turbosonic Inc.	B03C 3/60 (2006.01) B03C 3/16 (2006.01) B03C 3/45 (2006.01)	2411154 *	WET ELECTROSTATIC PRECIPITATOR SYSTEM COMPONENTS
Rakuten, Inc.	G06Q 30/00 (2012.01) G06K 17/00 (2006.01)	2492863 *	INFORMATION PROVISION DEVICE, INFORMATION PROVISION METHOD, INFORMATION PROVISION PROGRAM, AND COMPUTER-READABLE STORAGE MEDIUM FOR STORING SAID PROGRAM
EASYWIND OY	F03D 1/00 (2006.01)	2499357 *	A METHOD AND AN APPARATUS FOR ASSEMBLING A WIND POWER PLANT
MOLECULAR HEALTH GmbH	C12Q 1/68 (2006.01)	2435581 *	NOVEL TISSUE PROTECTIVE ERYTHROPOIETIN RECEPTOR (NEPOR) AND METHODS OF USE

Podnosilac evropske prijave patenta (71)	MKP (51)	Broj objave evropske prijave patenta (97)	Naziv pronalaska (54)
Harold Scholz&Co. GmbH	C04B 20/10 (2006.01) C04B 40/00 (2006.01) C04B 28/02 (2006.01)	2429969 *	NEW PIGMENT SYSTEM FOR COLORING CEMENT SYSTEMS, IN PARTICULAR CONCRETE
Teva Pharmaceutical Industries Ltd.	A01N 43/42 (2006.01) A61K 31/42 (2006.01)	2458992 *	TREATMENT OF CROHN'S DISEASE WITH LAQUINIMOD
UCB Pharma, S.A.	C07K 16/28 (2006.01)	2493928 *	ANTIBODIES TO ION CHANNELS
Unifrax I LLC	F01N 3/035 (2006.01) B01D 53/92 (2006.01)	2464836 *	MOUNTING MAT FOR EXHAUST GAS TREATMENT DEVICE
Crystalplex Corporation	B82B 1/00 (2006.01) H01L 29/06 (2006.01)	2481088 *	PASSIVATED NANOPARTICLES
SANOFI	C08B 37/10 (2006.01) A61K 31/727 (2006.01) C08B 37/00 (2006.01)	2427503 *	NOVEL ACYLATED DECASACCHARIDES AND THEIR USE AS ANTITHROMBOTIC AGENTS
Weyland AS	C12P 7/10 (2006.01)	2443245 *	PROCESS FOR PRODUCTION OF SUGARS AND ALCOHOLS FROM A CELLULOSIC MATERIAL
Cockbain, Julian	C12P 7/10 (2006.01)	2443245 *	PROCESS FOR PRODUCTION OF SUGARS AND ALCOHOLS FROM A CELLULOSIC MATERIAL
Peptcell Limited	C07K 16/24 (2006.01) A61K 39/395 (2006.01)	2424893 *	PHARMACEUTICAL AGENT
TransTech Pharma, Inc	A01N 35/00 (2006.01) A61K 31/12 (2006.01)	2413693 *	SUBSTITUTED AZOANTHRACENE DERIVATIVES, PHARMACEUTICAL COMPOSITIONS, AND METHODS OF USE THEREOF
Chen, Huihong	C08L 17/00 (2006.01) C08J 11/10 (2006.01)	2484720 *	THERMAL REGENERATION METHOD OF WASTE RUBBER
Hu, Jiaqing	C08L 17/00 (2006.01) C08J 11/10 (2006.01)	2484720 *	THERMAL REGENERATION METHOD OF WASTE RUBBER
Blücher GmbH	A01N 25/34 (2006.01) A01N 25/10 (2006.01) A01N 59/16 (2006.01) A01N 59/20 (2006.01) C09J 7/02 (2006.01)	2490527 *	COATING FOR OBJECTS, IN PARTICULAR IN PUBLIC FACILITIES AND/OR MEANS OF TRANSPORTATION, FOR PREVENTING THE TRANSMISSION OF INFECTIONS
Merck Serono SA	A61P 37/00 (2006.01) C07D 271/06 (2006.01) A61K 31/4245 (2006.01)	2414341 *	OXADIAZOLE DERIVATIVES
4Tech+ S.r.l.	H04W 12/06 (2009.01) H04W 4/12 (2009.01) H04L 29/06 (2006.01)	2481230 *	AUTHENTICATION METHOD, PAYMENT AUTHORISATION METHOD AND CORRESPONDING ELECTRONIC EQUIPMENTS
Pilkington Group Limited	B29C 45/14 (2006.01)	2496394 *	METHOD OF MAKING A MOLDED TRIM ASSEMBLY
OSI Pharmaceuticals, LLC	A61P 35/00 (2006.01) G01N 33/574 (2006.01)	2419177 *	BIOLOGICAL MARKERS PREDICTIVE OF ANTI-CANCER RESPONSE TO EPIDERMAL GROWTH FACTOR RECEPTOR KINASE INHIBITORS
Chabio & Diostech Co., Ltd.	A61K 9/70 (2006.01) A61K 47/30 (2006.01) A61K 31/14 (2006.01) A61K 31/09 (2006.01) A61P 43/00 (2006.01)	2431028 *	FAST-DISSOLVING ORAL FILM FOR EFFECTIVELY CONCEALING UNPLEASANT TASTES
Miljkovic, Dusan	A23L 2/52 (2006.01) C02F 1/68 (2006.01) A23L 1/30 (2006.01) C02F 1/70 (2006.01)	2442674 *	COMPOSITIONS AND METHODS FOR PRODUCING STABLE NEGATIVE OXIDATION REDUCTION POTENTIAL IN CONSUMABLE MATERIALS
Curt G. Joa, Inc.	A61F 13/15 (2006.01)	2481383	Method of creating a cross-machine direction fold line boundary
Japan Tobacco, Inc.	A61P 19/10 (2006.01) C07C 213/04 (2006.01) C07C 213/08 (2006.01) C07C 217/28 (2006.01) C07D 303/22 (2006.01) C07C 69/76 (2006.01) A61K 31/235 (2006.01)	2412697 *	PROCESS FOR PRODUCING CARBOXYLIC ACID COMPOUND
Merz Pharma GmbH & Co. KGaA	A61K 31/496 (2006.01) A61P 3/04 (2006.01)	2448579 *	ELTOPRAZINE FOR THE TREATMENT OF WEIGHT DISORDERS

Podnosilac evropske prijave patenta (71)	MKP (51)	Broj objave evropske prijave patenta (97)	Naziv pronalaska (54)
AAK Patent B.V.	C12Q 1/68 (2006.01) A61P 1/00 (2006.01) C12Q 1/04 (2006.01) C12Q 1/10 (2006.01)	2486143 *	METHODS FOR DIAGNOSING IRRITABLE BOWEL SYNDROME
Psioxus Therapeutics Limited	A61K 47/48 (2006.01) A61P 37/04 (2006.01)	2427217 *	MULTI- VALENT ADJUVANT DISPLAY
Cadila Healthcare Limited	A61K 9/107 (2006.01) A61K 31/196 (2006.01) A61K 9/00 (2006.01)	2416759 *	STABLE PHARMACEUTICAL COMPOSITIONS OF DICLOFENAC
H. Lundbeck A/S	A61K 31/535 (2006.01) C07D 413/12 (2006.01) C07D 413/10 (2006.01) C07D 413/06 (2006.01) A61P 25/28 (2006.01)	2408767 *	AMIDE DERIVATIVES AS NEUROPEPTIDE Y5 RECEPTOR LIGANDS
AstraZeneca AB	A61P 11/06 (2006.01) A61P 29/00 (2006.01) C07J 71/00 (2006.01) A61K 31/58 (2006.01) A61P 11/00 (2006.01)	2414375 *	NOVEL AMIDE DERIVATIVES OF STEROIDAL 3,2-C'PYRAZOLE COMPOUNDS WITH GLUCOCORTICOID ACTIVITY
Gilead Calistoga LLC	A61K 31/52 (2006.01) A61P 1/16 (2006.01)	2456443 *	TREATMENT OF LIVER DISORDERS WITH PI3K INHIBITORS
Abbott Laboratories	C12P 21/08 (2006.01)	2459729 *	DUAL VARIABLE DOMAIN IMMUNOGLOBULINS AND USES THEREOF
Hermann, Lars Holger	A61K 45/06 (2006.01) A61K 31/485 (2006.01) A61K 9/50 (2006.01)	2421515 *	PARTICULATE PHARMACEUTICAL COMPOSITION HAVING AN OPIOID AND AN OPIOID ANTAGONIST
Norgine BV	A61P 3/06 (2006.01) A61P 3/04 (2006.01) A61P 9/00 (2006.01) A61P 1/04 (2006.01) A61P 3/10 (2006.01) A61P 9/12 (2006.01) A61K 31/536 (2006.01) C07D 265/26 (2006.01)	2423203 *	CRYSTAL OF BENZOXAZINONE COMPOUND
Baylor Research Institute	C12N 15/13 (2006.01) C07K 16/28 (2006.01) C07K 14/725 (2006.01) A61K 39/00 (2006.01) C12N 15/63 (2006.01) G01N 33/68 (2006.01)	2406286 *	ANTI-CD40 ANTIBODIES AND USES THEREOF
Lpath, Inc.	C07K 16/00 (2006.01)	2419446 *	HUMANIZED ANTIBODY COMPOSITIONS AND METHODS FOR BINDING LYSOPHOSPHATIDIC ACID
Savant Systems LLC.	H05B 37/02 (2006.01)	2438800 *	VIRTUAL ROOM-BASED LIGHT FIXTURE AND DEVICE CONTROL
AstraZeneca AB	A61K 31/5386 (2006.01) A61P 25/00 (2006.01) A61P 11/00 (2006.01) A61P 9/00 (2006.01) A61P 37/00 (2006.01) A61P 35/00 (2006.01) A61P 19/00 (2006.01) A61P 29/00 (2006.01) C07D 519/00 (2006.01) A61P 13/00 (2006.01) A61P 17/00 (2006.01) A61P 27/00 (2006.01) C07D 498/10 (2006.01) A61P 1/00 (2006.01)	2459572 *	SPIROCYCLIC AMIDE DERIVATIVES

Podnosilac evropske prijave patenta (71)	MKP (51)	Broj objave evropske prijave patenta (97)	Naziv pronalaska (54)
Pulmagen Therapeutics (Synergy) Limited	A61K 31/5386 (2006.01) A61P 25/00 (2006.01) A61P 11/00 (2006.01) A61P 9/00 (2006.01) A61P 37/00 (2006.01) A61P 35/00 (2006.01) A61P 19/00 (2006.01) A61P 29/00 (2006.01) C07D 519/00 (2006.01) A61P 13/00 (2006.01) A61P 17/00 (2006.01) A61P 27/00 (2006.01) C07D 498/10 (2006.01) A61P 1/00 (2006.01)	2459572 *	SPIROCYCLIC AMIDE DERIVATIVES
Tesimax - Altinger GmbH	A62B 17/04 (2006.01) A42B 1/24 (2006.01) A62B 17/00 (2006.01)	2392384	Protective suit with a lighting device
De Sousa, Michelle Elizabeth	A41C 3/12 (2006.01) A41D 27/04 (2006.01) A41D 27/06 (2006.01) A44C 25/00 (2006.01)	2480102 *	CLEAVAGE ACCESSORY FOR A BRASSIERE
GlaxoSmithKline LLC	A01N 43/56 (2006.01)	2434894 *	METHODS OF ADMINISTRATION OF THROMBOPOIETIN AGONIST COMPOUNDS
Cerulean Pharma Inc.	C07D 471/00 (2006.01)	2477985 *	TREATMENT OF CANCER
Regeneron Pharmaceuticals, Inc.	A61K 39/395 (2006.01) C07K 16/22 (2006.01)	2445528 *	METHOD OF TREATING CANCER WITH DLL4 ANTAGONIST AND CHEMOTHERAPEUTIC AGENT
Vinavil S.p.A.	C08L 31/04 (2006.01) A23G 4/08 (2006.01)	2445964 *	POLYMER COMPOSITIONS BASED ON POLYVINYL ALCOHOL FOR CHEWING GUM FORMULATIONS WITH A LOW ADHESIVE IMPACT
Glaxo Group Limited	C07D 413/14 (2006.01) A61P 25/30 (2006.01) C07D 403/14 (2006.01) A61P 25/24 (2006.01) A61K 31/44 (2006.01) C07D 401/12 (2006.01) A61P 25/22 (2006.01) C07D 417/14 (2006.01) A61P 3/04 (2006.01) A61K 31/501 (2006.01) A61K 31/506 (2006.01)	2421850 *	3 -AZABICYCLO [4.1.0]HEPTANES USED AS OREXIN ANTAGONISTS
MorphoSys AG	C12N 15/10 (2006.01) C07K 16/00 (2006.01) C40B 30/02 (2006.01) C40B 50/06 (2006.01) C40B 40/08 (2006.01)	2435568 *	A COLLECTION AND METHODS FOR ITS USE
Institut Pasteur	C12N 9/88 (2006.01)	2411513 *	MUTANT CyaA POLYPEPTIDES AND POLYPEPTIDE DERIVATIVES SUITABLE FOR THE DELIVERY OF IMMUNOGENIC MOLECULES INTO A CELL
Institute Of Physiology Of AS CR, V.V.I.	C12N 9/88 (2006.01)	2411513 *	MUTANT CyaA POLYPEPTIDES AND POLYPEPTIDE DERIVATIVES SUITABLE FOR THE DELIVERY OF IMMUNOGENIC MOLECULES INTO A CELL
AC Immune S.A.	A61K 39/00 (2006.01) C07K 14/47 (2006.01) C07K 16/18 (2006.01) G01N 33/53 (2006.01)	2413957 *	PHARMACEUTICAL COMPOSITION
K. U. Leuven Research & Development	A61K 39/00 (2006.01) C07K 14/47 (2006.01) C07K 16/18 (2006.01) G01N 33/53 (2006.01)	2413957 *	PHARMACEUTICAL COMPOSITION
Icon Genetics GmbH	C12N 9/10 (2006.01) C12N 15/82 (2006.01)	2443234 *	NICOTIANA BENTHAMIANA PLANTS DEFICIENT IN XYLOSYLTRANSFERASE ACTIVITY

Podnosilac evropske prijave patenta (71)	MKP (51)	Broj objave evropske prijave patenta (97)	Naziv pronalaska (54)
Murakami, Yoshiki	C12Q 1/68 (2006.01) A61K 31/7056 (2006.01) G01N 33/53 (2006.01) A61P 1/16 (2006.01) A61K 38/21 (2006.01) G01N 37/00 (2006.01)	2476758 *	METHOD FOR PREDICTION OF THERAPEUTIC EFFECT ON CHRONIC HEPATITIS C
XenoPort, Inc.	A61K 9/16 (2006.01) A61K 9/20 (2006.01) A61K 31/195 (2006.01)	2403481 *	ORAL DOSAGE FORMS HAVING A HIGH LOADING OF A GABAPENTIN PRODRUG
Molmed SpA	C12N 15/866 (2006.01) C12N 15/867 (2006.01) C12N 7/02 (2006.01)	2480678 *	STABLE PRODUCTION OF LENTIVIRAL VECTORS
SANOFI	A61K 31/395 (2006.01) A61P 35/00 (2006.01) C07D 273/08 (2006.01)	2448929 *	NOVEL CONJUGATES, PREPARATION THEREOF, AND THERAPEUTIC USE THEREOF
Desiccant Rotors International Pvt. Ltd.	B01J 20/24 (2006.01)	2488294 *	HONEY COMB MATRIX COMPRISING MACRO POROUS DESICCANT, PROCESS AND USE THEREOF
ALSTOM Hydro France	H02K 13/00 (2006.01)	2465185 *	COLLECTOR RING ARRANGEMENT FOR A ROTATING ELECTRIC MACHINE
Scharmüller, Josef	B60D 1/06 (2006.01)	2269844	Towing eye
Scharmüller, Josef, jun.	B60D 1/06 (2006.01)	2269844	Towing eye
Fox 40 International Inc.	G10K 5/00 (2006.01)	2416312	Whistle with finger grip
Protektorwerk Florenz Maisch GmbH & Co. KG	E04C 3/08 (2006.01) E04C 3/09 (2006.01)	2483492 *	THIN-WALLED, COLD-FORMED LIGHTWEIGHT STRUCTURAL PROFILE ELEMENT AND METHOD FOR PRODUCING SUCH A PROFILE ELEMENT
Laboratorios del. Dr. Esteve, S.A.	A61P 33/02 (2006.01) A61P 37/02 (2006.01) A61K 31/454 (2006.01) A61K 45/06 (2006.01)	2413934 *	DOMPERIDONE AT A LOW DAILY DOSE FOR USE IN THE TREATMENT OR PREVENTION OF A DISEASE ASSOCIATED WITH AN ALTERATION OF THE IMMUNE RESPONSE
Abbott GmbH & Co. KG	A61K 9/00 (2006.01) A61K 31/5377 (2006.01) A61K 9/14 (2006.01)	2440177 *	PHARMACEUTICAL DOSAGE FORM FOR ORAL ADMINISTRATION OF A BCL-2 FAMILY INHIBITOR
Prosidion Limited	A61P 3/10 (2006.01) A61K 31/4245 (2006.01) C07D 413/14 (2006.01)	2406256 *	COMPOUNDS FOR THE TREATMENT OF METABOLIC DISORDERS
Fundació Privada Institut D'investigació Biomèdica	A61K 48/00 (2006.01) C12N 15/861 (2006.01)	2428229 *	ONCOLYTIC ADENOVIRUSES FOR TREATING CANCER
Institut Català D'Oncologia	A61K 48/00 (2006.01) C12N 15/861 (2006.01)	2428229 *	ONCOLYTIC ADENOVIRUSES FOR TREATING CANCER
LN 2 S.R.L. a socio unico	F23L 13/06 (2006.01) F16K 15/02 (2006.01) F23J 13/08 (2006.01) F23L 11/00 (2006.01)	2430366 *	FUME-DISCHARGE DEVICE FOR BOILERS
RE.LE.VI. S.p.a.	E03D 9/03 (2006.01) E03D 9/02 (2006.01)	2270286	Dispenser of active substances for WC bowls
Tetra, Sia	C07C 229/22 (2006.01) A61P 9/08 (2006.01) A61P 29/00 (2006.01) C07C 229/12 (2006.01) A61K 31/205 (2006.01) C07C 69/157 (2006.01) A61P 7/02 (2006.01) A61K 31/616 (2006.01) C07C 243/40 (2006.01)	2445861 *	NOVEL ACETYLSALICYLIC ACID SALTS

Podnosilac evropske prijave patenta (71)	MKP (51)	Broj objave evropske prijave patenta (97)	Naziv pronalaska (54)
Teikoku Seiyaku Co., Ltd.	A61K 47/10 (2006.01) A61K 9/70 (2006.01) A61K 31/445 (2006.01) A61K 47/14 (2006.01) A61P 25/28 (2006.01) A61K 47/34 (2006.01) A61K 47/22 (2006.01) A61K 9/08 (2006.01)	2491931 *	TRANSDERMALLY ABSORBABLE DONEPEZIL-CONTAINING PREPARATION
Targeted Delivery Technologies Limited	A61K 51/00 (2006.01)	2467170 *	VESICULAR FORMULATIONS
Jawaharlal Nehru Centre for Advanced Scientific Research	G01N 33/53 (2006.01) A61K 38/45 (2006.01) A61P 35/02 (2006.01) C12N 9/10 (2006.01) A61K 31/415 (2006.01)	2475769 *	INHIBITION OF HISTONE ACETYLTRANSFERASES BY CTK7A AND METHODS THEREOF
Jauvin, Michel	A61J 1/00 (2006.01) B65D 30/00 (2006.01) B65F 1/00 (2006.01)	2451717 *	DISPOSAL SYSTEM AND METHOD FOR DISPOSABLE ITEMS
Syngenta Limited	C07D 309/32 (2006.01) C07D 493/10 (2006.01)	2435415 *	SPIRO EPOXIDES AS INTERMEDIATES
Gilead Sciences, Inc.	C07H 1/00 (2006.01) C07H 19/23 (2006.01)	2480559 *	PROCESSES AND INTERMEDIATES FOR THE PREPARATION OF 1'-SUBSTITUTED CARBA-NUCLEOSIDE ANALOGS
Disphar International B.V.	A61K 31/60 (2006.01) A61K 31/573 (2006.01) A61P 29/00 (2006.01)	2470185 *	PHARMACEUTICAL COMPOSITIONS FOR TREATING IBD
Nordic Pharma	A61K 31/60 (2006.01) A61K 31/573 (2006.01) A61P 29/00 (2006.01)	2470185 *	PHARMACEUTICAL COMPOSITIONS FOR TREATING IBD
Linde AG	F23K 3/02 (2006.01)	2486326 *	METERING SYSTEM, DENSE PHASE CONVEYING SYSTEM AND METHOD FOR SUPPLYING BULK MATERIAL IN POWDER FORM
Meril Ltd.	A61K 31/365 (2006.01) A61K 39/15 (2006.01) A61P 31/00 (2006.01) A61K 39/215 (2006.01) A61K 31/335 (2006.01)	2419131 *	MACROCYCLIC LACTONE COMBINATION COMPOSITIONS, VACCINES AND METHODS FOR PRODUCING SAME
Weyland AS	C13K 1/02 (2006.01) C12P 7/10 (2006.01)	2430196 *	PROCESS FOR THE PRODUCTION OF ALCOHOLS
Cockbain, Julian	C13K 1/02 (2006.01) C12P 7/10 (2006.01)	2430196 *	PROCESS FOR THE PRODUCTION OF ALCOHOLS
Outotec OYJ	B01F 7/22 (2006.01) B01F 7/04 (2006.01) B01F 7/06 (2006.01) B01F 7/00 (2006.01) B01F 7/18 (2006.01)	2405995 *	IMPELLER FOR MIXING SLURRY IN METALLURGICAL PROCESSES
Hercules Incorporated	D21H 17/67 (2006.01) D21H 27/26 (2006.01) E04C 2/04 (2006.01) D21H 13/40 (2006.01) D21H 21/18 (2006.01) B32B 13/08 (2006.01) D21H 23/22 (2006.01) D21H 19/38 (2006.01)	2445710 *	SEED CRYSTAL COATING FOR GYPSUM WALLBOARD FACING
Ascendis Pharma A/S	A61K 47/48 (2006.01)	2485767 *	CARRIER LINKED PALIPERIDONE PRODRUGS
Sörensen Hydraulik, Zweigniederlassung, Ulfborg, Filial af Sörensen Hydraulik GmbH, Tyskland	B60P 1/44 (2006.01)	2384928	Loading platform
E. I. du Pont de Nemours and Company	C12Q 1/68 (2006.01)	2467501 *	GENETIC FINGERPRINTING AND IDENTIFICATION METHOD

Podnosilac evropske prijave patenta (71)	MKP (51)	Broj objave evropske prijave patenta (97)	Naziv pronalaska (54)
William Mark Corporation	A63H 27/00 (2006.01)	2448645 *	FLYING SHARK
Verschatse, Pol	B27B 25/04 (2006.01) B27B 5/22 (2006.01)	2248643	A sawing device for firewood trunks
Krka Tovarna Zdravil, D.D., Novo Mesto	A61K 9/20 (2006.01) A61K 9/16 (2006.01)	2435029 *	PHARMACEUTICAL COMPOSITION COMPRISING TAMSULOSIN
Ruepp, Thomas	A61H 3/00 (2006.01) A61H 3/04 (2006.01)	2233120	Walking aid
Delphi Technologies Holding S.à.r.l.	F02M 61/14 (2006.01) F02M 55/00 (2006.01) F02M 61/16 (2006.01)	2422070 *	FUEL INJECTOR
Eli Lilly and Company	A61P 9/10 (2006.01) A61K 31/55 (2006.01) C07D 403/12 (2006.01)	2448933 *	TRANS-4-[[[(5S)-5-[[[3,5-BIS(TRIFLUOROMETHYL)PHENYL]METHYL](2-METHYL-2H-TETRAZOL-5-YL)AMINO]-2,3,4,5-TETRAHYDRO-7,9-DIMETHYL-1H-1-BENZAZEPIN-1-YL]METHYL]-CYCLOHEXANECARBOXYLIC ACID
Abbott Biotherapeutics Corp.	G01N 33/564 (2006.01)	2425250 *	METHODS FOR MONITORING THE EFFICACY OF ANTI-IL-2R ANTIBODIES IN MULTIPLE SCLEROSIS PATIENTS
I-TEC AS	E21B 43/10 (2006.01) E21B 23/01 (2006.01) E21B 33/04 (2006.01)	2414626 *	LINER HANGER
Sanofi-Aventis Deutschland GmbH	A61M 5/24 (2006.01) A61M 5/315 (2006.01) A61M 5/31 (2006.01)	2437820 *	DOSE SETTING MECHANISM FOR PRIMING A DRUG DELIVERY DEVICE
Akripol proizvodnja in predelava polimerov, d.d.	E01F 8/00 (2006.01) C08K 5/5419 (2006.01) C08K 5/549 (2006.01) C08J 5/04 (2006.01)	2434055	The fibre-reinforced acrylic panel and the process for its manufacture
Merz Pharma GmbH & Co. KGaA	C07C 233/06 (2006.01) C07C 209/62 (2006.01) C07C 29/40 (2006.01) C07C 211/35 (2006.01) C07C 31/135 (2006.01) C07C 231/06 (2006.01)	2448911 *	METHOD OF PREPARING 1-CHLOROACETAMIDO-1,3,3,5,5-PENTAMETHYLCYCLOHEXANE
Alkermes, Inc.	A01N 43/00 (2006.01)	2445343 *	PRODRUGS OF NH-ACIDIC COMPOUNDS
WELLAND MEDICAL LIMITED	A61F 5/445 (2006.01) A61L 24/00 (2006.01) A61F 5/443 (2006.01)	2289471	Ostomy bag
Syngenta Limited	C07C 69/28 (2006.01) A01N 33/24 (2006.01) C07C 251/44 (2006.01) A01N 37/10 (2006.01) C07C 69/24 (2006.01) A01N 33/20 (2006.01) C07C 255/56 (2006.01) C07C 49/657 (2006.01) C07C 317/24 (2006.01) A01N 37/02 (2006.01) C07C 49/683 (2006.01) A01N 31/06 (2006.01) C07C 65/36 (2006.01) A01N 31/08 (2006.01) C07C 205/45 (2006.01)	2454223 *	HERBICIDALLY ACTIVE 2-(SUBSTITUTED-PHENYL)-CYCLOPENTANE-1,3-DIONE DERIVATIVES
PAION UK Limited	C07D 213/16 (2006.01) C07D 213/18 (2006.01) C07D 401/04 (2006.01) C07D 487/04 (2006.01)	2477967 *	PROCESS FOR PREPARING 3-[(4S)-8-BROMO-1-METHYL-6-(2-PYRIDINYL)-4H-IMIDAZOL[1,2-A][1,4]BENZODIAZEPINE-4-YL]PROPIONIC ACID METHYL ESTER OR THE BENZENE SULFONATE SALT THEREOF, AND COMPOUNDS USEFUL IN THAT PROCESS

Podnosilac evropske prijave patenta (71)	MKP (51)	Broj objave evropske prijave patenta (97)	Naziv pronalaska (54)
The University of North Carolina At Chapel Hill	A61P 1/00 (2006.01) A61P 37/08 (2006.01) A61P 37/00 (2006.01) A61K 38/17 (2006.01) A61K 38/18 (2006.01) A61K 38/20 (2006.01)	2429566 *	CYCLIN DEPENDENT KINASE INHIBITORS AND METHODS OF USE
Molmed SpA	C12N 7/02 (2006.01) C12N 15/867 (2006.01) C12N 15/866 (2006.01)	2480677 *	SEMI-STABLE PRODUCTION OF LENTIVIRAL VECTORS
Agathos, Efsthios-Andreas	A61F 2/24 (2006.01)	2498719 *	SUPPORT SYSTEM FOR BIOPROSTHETIC VALVES WITH COMMISURAL POSTS WITH HEART-SHAPED OPENINGS
Abbott Healthcare Products B.V.	C07D 265/30 (2006.01) C07D 265/32 (2006.01) C07D 413/12 (2006.01) C07D 419/12 (2006.01) C07D 471/04 (2006.01) A61K 31/5377 (2006.01) A61P 25/04 (2006.01) A61P 25/06 (2006.01) A61P 25/16 (2006.01) A61P 25/18 (2006.01) A61P 25/24 (2006.01) A61P 25/28 (2006.01) C07D 279/12 (2006.01) C07D 417/12 (2006.01) C07D 487/04 (2006.01)	2473490 *	(THIO)MORPHOLINE DERIVATIVES AS S1P MODULATORS
Astex Therapeutics Ltd.	C07D 471/04 (2006.01) A61K 31/437 (2006.01) A61P 35/00 (2006.01)	2419428 *	IMIDAZO [1,2-A]PYRIDINE DERIVATIVES AS FGFR KINASE INHIBITORS FOR USE IN THERAPY
ecoduna technologie GmbH	C12M 1/00 (2006.01)	2406366 *	DEVICE FOR A PHOTOCHEMICAL PROCESS
Caron, Joan M.	A61K 9/14 (2006.01) A61K 31/10 (2006.01) A61K 9/16 (2006.01) A61P 35/00 (2006.01)	2437738 *	METHODS AND COMPOSITIONS FOR THE TREATMENT OF CANCER
Vertex Pharmaceuticals Incorporated	G01N 33/50 (2006.01)	2435828 *	METHOD OF MONITORING ERYTHROPOIESIS
CERA Handelsgesellschaft mbH	E06B 3/667 (2006.01)	2472048	Connector
Kyorin Pharmaceutical Co., Ltd.	A61P 1/18 (2006.01) A61P 17/00 (2006.01) A61P 7/02 (2006.01) A61P 17/06 (2006.01) A61P 1/16 (2006.01) A61P 15/06 (2006.01) A61P 31/04 (2006.01) C07D 413/14 (2006.01) A61P 9/10 (2006.01) A61P 19/02 (2006.01) A61K 31/536 (2006.01) A61P 11/00 (2006.01) A61P 25/00 (2006.01) A61P 1/04 (2006.01) A61P 13/12 (2006.01) A61P 29/00 (2006.01) A61P 7/00 (2006.01) A61P 17/02 (2006.01) A61P 1/02 (2006.01) A61P 11/06 (2006.01) A61P 27/02 (2006.01)	2481738 *	MALEIC ACID SALT AND CRYSTAL THEREOF
Eli Lilly and Company	C07D 471/10 (2006.01) A61K 31/438 (2006.01) A61P 3/10 (2006.01) C07D 221/20 (2006.01)	2488500 *	SPIROPIPERIDINE COMPOUNDS AND PHARMACEUTICAL USE THEREOF FOR TREATING DIABETES

Podnosilac evropske prijave patenta (71)	MKP (51)	Broj objave evropske prijave patenta (97)	Naziv pronalaska (54)
Curt G. Joa, Inc.	B26D 7/20 (2006.01) B26D 5/02 (2006.01) B26F 1/22 (2006.01)	2497615	Multi-profile die cutting assembly
AstraZeneca UK Limited	A61K 31/565 (2006.01) A61P 35/00 (2006.01)	2459199 *	FULVESTRANT IN A DOSAGE OF 500MG FOR THE TREATMENT OF ADVANCED BREAST CANCER
Baumgarte Boiler Systems GmbH	F23H 17/12 (2006.01) F23H 7/08 (2006.01)	2417392 *	GRATE BAR FOR AN INCINERATOR AND METHOD FOR PRODUCING SUCH A GRATE BAR
Zerran International Corporation	A61K 8/00 (2006.01)	2437717 *	COMPOSTION AND METHOD FOR HAIR STRAIGHTENING AND CURLING
Sanford-Burnham Medical Research Institute	A01N 35/00 (2006.01)	2418942 *	NAPHTHALENE-BASED INHIBITORS OF ANTI-APOPTOTIC PROTEINS
SANOFI	C08B 37/10 (2006.01) A61P 7/02 (2006.01) A61K 31/727 (2006.01)	2427500 *	NOVEL ACYLATED 1,6-ANHYDRO DECASACCHARIDE AND ITS USE AS ANTITHROMBOTIC AGENT
Chemical Center S.r.l.	A62D 3/02 (2007.01) A62D 3/35 (2007.01) A62D 3/36 (2007.01)	2428254	Process for treating an asbestos containing material
Brighton Equipment Corporation Limited	B21J 13/10 (2006.01) B21K 1/76 (2006.01) B21J 9/12 (2006.01) B21J 9/02 (2006.01) B21J 9/20 (2006.01)	2397244	Charging device for a bush widening device for perforated socket blanks made out of steel, for example, and method of forging perforated socket blanks
Deere & Company	A01D 41/127 (2006.01)	2250871	Scalable grain tank fill level display
RD Nephrologie	A61M 1/16 (2006.01)	2493525 *	DEVICE AND METHOD FOR CHARACTERIZING AN EXTRACORPOREAL BLOOD TREATMENT, AND EXTRACORPOREAL TREATMENT APPARATUS IMPLEMENTING SUCH A DEVICE
Instytut Chemii i Techniki Jadrowej	C03C 1/00 (2006.01) G21F 9/30 (2006.01)	2361891	Method of disposal of radioactive waste in silica glass
Panacela Labs, Inc.	C12N 15/63 (2006.01)	2486134 *	USE OF TOLL-LIKE RECEPTOR AND AGONIST FOR TREATING CANCER
Roswell Park Cancer Institute	C12N 15/63 (2006.01)	2486134 *	USE OF TOLL-LIKE RECEPTOR AND AGONIST FOR TREATING CANCER
Curt G. Joa, Inc.	A61F 13/15 (2006.01)	2491909	Methods and apparatus for forming disposable products at high speeds with small machine footprint
Pierre Fabre Dermo-Cosmétique	A61K 8/67 (2006.01) A61K 8/34 (2006.01) A61K 8/36 (2006.01) A61K 8/49 (2006.01) A61Q 19/02 (2006.01) A61K 8/92 (2006.01)	2429485 *	USE OF DELTA-TOCOPHERYL-CARBOHYDRATE AS A DEPIGMENTING AGENT
Les Laboratoires Servier	C07D 291/08 (2006.01) A61P 25/00 (2006.01) A61K 31/551 (2006.01)	2431360	Derivatives of dihydrobenzoxathiazepine, method of preparing same and pharmaceutical compositions containing them as well as their uses as modulators of AMPA receptors
Dow AgroSciences, LLC	C25B 3/04 (2006.01) C07D 213/803 (2006.01)	2494095 *	IMPROVED SILVER CATHODE ACTIVATION
FluidDA Respi	A61B 6/00 (2006.01) G06F 19/00 (2011.01) A61M 16/00 (2006.01) A61B 5/08 (2006.01)	2435118 *	METHOD FOR DETERMINING TREATMENTS USING PATIENT-SPECIFIC LUNG MODELS AND COMPUTER METHODS
AB-Biotics S.A.	A61K 35/74 (2006.01) A61P 9/00 (2006.01)	2485743 *	LACTOBACILLUS PLANTARUM STRAINS AS HYPOCHOLESTEROLEMIC AGENTS.
Japan Tobacco, Inc.	A61K 31/437 (2006.01) A61P 7/06 (2006.01) A61P 43/00 (2006.01) C07D 471/04 (2006.01)	2455381 *	TRIAZOLOPYRIDINE COMPOUND, AND ACTION THEREOF AS PROLYL HYDROXYLASE INHIBITOR AND ERYTHROPOIETIN PRODUCTION INDUCER
Polyglass S.p.A.	C08K 3/34 (2006.01) C08K 7/00 (2006.01) C08L 95/00 (2006.01)	2264092	Waterproofing membranes based on bitumen modified with polymers containing aluminium silicate cenospheres.

Podnosilac evropske prijave patenta (71)	MKP (51)	Broj objave evropske prijave patenta (97)	Naziv pronalaska (54)
Stiefel Laboratories, Inc.	A01N 31/08 (2006.01) A61K 31/05 (2006.01)	2408299 *	FATTY ACID MONOGLYCERIDE COMPOSITIONS
Stiefel Research Australia Pty Ltd	A01N 31/08 (2006.01) A61K 31/05 (2006.01)	2408299 *	FATTY ACID MONOGLYCERIDE COMPOSITIONS
GlaxoSmithKline Biologicals SA	C12Q 1/68 (2006.01)	2478116 *	METHOD FOR IDENTIFYING WHETHER A PATIENT WILL BE RESPONDER OR NOT TO IMMUNOTHERAPY
Amgen, Inc	C07K 1/113 (2006.01)	2445923 *	REFOLDING PROTEINS USING A CHEMICALLY CONTROLLED REDOX STATE
Janssen Pharmaceutica, N.V.	C07D 471/08 (2006.01) A61P 25/00 (2006.01) A61K 31/439 (2006.01)	2491034 *	FUSED HETEROCYCLIC COMPOUNDS AS OREXIN RECEPTOR MODULATORS
Siena Biotech S.p.A.	C07D 401/12 (2006.01) A61P 35/00 (2006.01) C07D 403/12 (2006.01) C07D 471/04 (2006.01) A61K 31/4184 (2006.01)	2440544 *	HEDGEHOG PATHWAY ANTAGONISTS AND THERAPEUTIC APPLICATIONS THEREOF
Tibotec Pharmaceuticals	A61K 31/352 (2006.01) A61P 31/18 (2006.01) A61K 9/08 (2006.01) A61K 9/51 (2006.01)	2480220 *	TREATMENT AND PREVENTION OF HIV INFECTION
V.E.T.E.G. S.R.L.	B60G 7/02 (2006.01) B60G 13/00 (2006.01) B62D 21/20 (2006.01) B62D 21/00 (2006.01)	2380761	Fastening assembly for connecting a wheel suspension to a vehicle frame
Array Biopharma, Inc.	C07D 471/04 (2006.01) C07D 403/12 (2006.01) A61K 31/519 (2006.01) A61P 35/00 (2006.01) C07D 405/12 (2006.01) A61K 31/517 (2006.01) C07D 239/94 (2006.01)	2493865 *	RAF INHIBITOR COMPOUNDS AND METHODS OF USE THEREOF
Genentech, Inc.	C07D 471/04 (2006.01) C07D 403/12 (2006.01) A61K 31/519 (2006.01) A61P 35/00 (2006.01) C07D 405/12 (2006.01) A61K 31/517 (2006.01) C07D 239/94 (2006.01)	2493865 *	RAF INHIBITOR COMPOUNDS AND METHODS OF USE THEREOF
Regeneron Pharmaceuticals, Inc.	C07K 16/22 (2006.01) A61K 39/395 (2006.01) A61P 35/00 (2006.01)	2459592 *	HIGH AFFINITY HUMAN ANTIBODIES TO HUMAN ANGIOPOIETIN-2
Panmira Pharmaceuticals, LLC	A61P 9/00 (2006.01) C07D 403/06 (2006.01) A61P 11/00 (2006.01) C07D 413/12 (2006.01) C07D 417/12 (2006.01) A61P 29/00 (2006.01) C07D 471/04 (2006.01) A61K 31/437 (2006.01)	2480547 *	INDOLIZINE INHIBITORS OF 5-LIPOXYGENASE
Sudscape Limited	B29B 17/00 (2006.01)	2445692 *	MATERIALS
Kaspersky Lab, ZAO	G06F 21/00 (2006.01)	2388726	Detection of hidden objects in a computer system
Nippon Soda Co., Ltd.	A01N 25/04 (2006.01) B27K 3/50 (2006.01) C08K 5/10 (2006.01) C08K 5/42 (2006.01) C08L 71/02 (2006.01)	2433987 *	COMPOSITION FOR PREPARING EMULSION OR MICROEMULSION FORMULATIONS
CV Holdings, LLC.	C23C 16/505 (2006.01) C23C 16/458 (2006.01) G01N 15/08 (2006.01) A61B 5/15 (2006.01)	2251453	Vessel holder

Podnosilac evropske prijave patenta (71)	MKP (51)	Broj objave evropske prijave patenta (97)	Naziv pronalaska (54)
Technische Universiteit Delft	C12N 1/18 (2006.01) C12N 9/02 (2006.01) C12P 7/06 (2006.01) C12P 7/10 (2006.01) C12N 15/53 (2006.01)	2456851 *	FERMENTATIVE GLYCEROL-FREE ETHANOL PRODUCTION
Caoduro, Paolo	E06B 7/02 (2006.01) F23J 11/00 (2006.01) E06B 7/26 (2006.01)	2456944 *	DEFLECTOR BARRIER FOR SMOKE AND HEAT VENTS AND A SMOKE AND HEAT VENT PROVIDED WITH SAID DEFLECTOR BARRIER
Caoduro, Carlo	E06B 7/02 (2006.01) F23J 11/00 (2006.01) E06B 7/26 (2006.01)	2456944 *	DEFLECTOR BARRIER FOR SMOKE AND HEAT VENTS AND A SMOKE AND HEAT VENT PROVIDED WITH SAID DEFLECTOR BARRIER
Dow Global Technologies LLC (formerly Known As Dow Global Technologies Inc.)	B32B 27/12 (2006.01) B60N 3/04 (2006.01) D06N 7/00 (2006.01) B32B 27/32 (2006.01)	2452011 *	CARPET AND CARPET BACKING
Amgen, Inc	A61P 25/00 (2006.01) C07K 16/22 (2006.01) G01N 33/53 (2006.01) C12N 15/68 (2006.01) A61K 39/395 (2006.01) A61P 29/02 (2006.01) C12N 5/10 (2006.01) A61P 19/02 (2006.01) A61P 35/00 (2006.01)	2485760 *	HUMAN ANTI-NGF NEUTRALIZING ANTIBODIES AS SELECTIVE NGF PATHWAY INHIBITORS
Medarex, Inc.	A61P 25/00 (2006.01) C07K 16/22 (2006.01) G01N 33/53 (2006.01) C12N 15/68 (2006.01) A61K 39/395 (2006.01) A61P 29/02 (2006.01) C12N 5/10 (2006.01) A61P 19/02 (2006.01) A61P 35/00 (2006.01)	2485760 *	HUMAN ANTI-NGF NEUTRALIZING ANTIBODIES AS SELECTIVE NGF PATHWAY INHIBITORS
Aircom Manufacturing, Inc.	A01K 13/00 (2006.01) A61D 7/00 (2006.01)	2490524 *	TRANSDERMAL DISPENSING APPARATUS AND METHODS
Eli Lilly And Company	A01K 13/00 (2006.01) A61D 7/00 (2006.01)	2490524 *	TRANSDERMAL DISPENSING APPARATUS AND METHODS
Imerys Minerals Limited	D21H 19/52 (2006.01)	2350387 *	PAPER FILLER COMPOSITION
SANOFI	A61K 31/727 (2006.01) A61K 31/765 (2006.01) A61P 9/00 (2006.01) A61P 7/02 (2006.01) A61P 13/12 (2006.01) A61P 41/00 (2006.01)	2408459 *	A DOSE OF AVE5026 FOR THE TREATMENT OF VENOUS THROMBOEMBOLISM IN PATIENTS WITH SEVERE RENAL IMPAIRMENT
Recro Pharma, Inc.	A61K 9/107 (2006.01) A61K 9/14 (2006.01) A61P 35/00 (2006.01) A61P 17/02 (2006.01) A61P 3/00 (2006.01) A61P 25/00 (2006.01) A61K 31/415 (2006.01)	2429521 *	SUBLINGUAL DEXMEDETOMIDINE COMPOSITIONS AND METHODS OF USE THEREOF
Unicharm Corporation	A47L 13/10 (2006.01) A47L 13/20 (2006.01)	2433545 *	HANDY MOP
ETH Zürich	A61P 3/10 (2006.01) C12N 15/113 (2010.01) A61K 31/712 (2006.01) A61K 31/7125 (2006.01) C07H 21/00 (2006.01) C12Q 1/68 (2006.01) A61P 3/06 (2006.01)	2432880 *	TARGETING MICRORNAs FOR METABOLIC DISORDERS

Podnosilac evropske prijave patenta (71)	MKP (51)	Broj objave evropske prijave patenta (97)	Naziv pronalaska (54)
Amgen, Inc	C07D 401/12 (2006.01) A61K 31/4709 (2006.01) C07D 401/14 (2006.01) A61P 29/00 (2006.01) C07D 215/44 (2006.01) C07D 471/04 (2006.01) C07D 401/04 (2006.01) A61K 31/4706 (2006.01) C07D 407/14 (2006.01) C07D 409/12 (2006.01) C07D 413/14 (2006.01) C07D 417/14 (2006.01)	2445886 *	HETEROCYCLIC COMPOUNDS AND THEIR USES

**OBJAVA POVUČENIH ZAHTJEVA ZA PROŠIRENJE EVROPSKIH PRIJAVA
PATENTA**
**PUBLICATION OF WITHDRAWN REQUESTS FOR EXTENSION OF EUROPEAN
PATENT APPLICATION**

Broj objave evropske prijave patenta (97)	MKP (51)	Datum kada je zahtev za proširenje evropske prijave patenta povučen	Zahtev objavljen u CGIS-u broj	Naziv pronalaska (54)	Podnosilac evropske prijave patenta (71)
2232972	A01B 33/08	15.11.2011	4/2012	Rotary harrow	Maschio Gaspardo S.p.A.
2421838 *	C07D 295/26	06.06.2012	4/2012	ARYLSULFONAMIDE CCR3 ANTAGONISTS	Axikin Pharmaceuticals, Inc.
2292696	C08L 85/02 C08K 5/357 C08K 5/5399 C08L 79/04	16.12.2011	4/2012	Method for improving flame retardant efficiency of phenoxyphosphazene compound, and prepreg, laminate, and laminate for printed circuit made by the method	Guangdong Shengyi Sci. Tech Co., Ltd.
2454480 *	F03G 6/00	27.04.2012	4/2012	POWER GENERATION SYSTEM	Global Power Enterprises, LLC
2354074	B66C 1/02 B65G 47/00 B65G 61/00	11.02.2012	4/2012	Method and apparatus for assembling building shell elements	Trimo d.d.
2317128	F03D 3/00 F03D 11/02	05.11.2011	4/2012	Vertical axis wind turbine	Hopewell Wind Power Limited
2243696	B63B 15/00	22.11.2011	4/2012	Sailing boat with variable lift.	Corbinelli, Giovanni
2277863	C07D 211/42 A61K 31/445 A61K 31/4462 A61P 25/00	24.11.2011	4/2012	Piperidine derivatives, process for their preparation and pharmaceutical compositions containing them	Les Laboratoires Servier Universite De Nantes I
2364864	B44C 1/26 B44C 1/28 B44C 5/04	15.03.2012	4/2012	System of ornamental stone floors and ornamental friezes and manufacturing process of ornamental stone floors and ornamental friezes	Golay, Kevin
2270305	E06B 3/54	20.01.2012	4/2012	Adjusting device for the inclination of window frames and window frame	Cirilli, Alessandro
2371737	B65D 75/58	25.07.2012	4/2012	Packaging with tear strip	Constantia Patz Ges. m.b.H.
2453900 *	A61P 25/04 A61K 31/55 C07D 223/04	29.06.2012	4/2012	NOVEL CARBAMATE AMINO ACID AND PEPTIDE PRODRUGS OF OPIOIDS AND USES THEREOF	Shire LLC
2249302	G06Q 30/00 G07F 17/40 G07F 7/00	30.05.2011	4/2012	Device for ordering and/or booking and/or purchasing goods or services and ordering, booking or purchasing device	CoBox AG
2412697 *	A61P 19/10 C07C 213/04 C07C 213/08 C07C 217/28 C07D 303/22 C07C 69/76 A61K 31/235	30.05.2012	4/2012	PROCESS FOR PRODUCING CARBOXYLIC ACID COMPOUND	Japan Tobacco, Inc.
2270286	E03D 9/03 E03D 9/02	02.08.2011	4/2012	Dispenser of active substances for WC bowls	RE.IE.VI. S.p.a.

- (51) **C07D 209/30**
C07D 401/12
A61K 31/404
A61P 29/00

- (11) **01040**
(21) **P-66/08**

- (30) 200301923P 23.12.2003. DK
532593P 23.12.2003. US

(86) PCT/DK2004/000894 21.12.2004.

(87) WO 2005/061455 07.07.2005.

(96) 04803045.6 21.12.2004.

(97) EP 1701940 28.05.2008. 2008/22 En

(54) (ME) **2-(1H-INDOLILSULFANIL)-BENZIL AMIN DERIVATI KAO SSRI**
(EN) **2-(1H-INDOLYLSULFANYL)-BENZYL AMINE DERIVATIVES AS SSRI**

(73) H. Lundbeck A/S; Ottliavej 9, DK-2500 Valby-Copenhagen (DK)

(72) KEHLER, Jan; Nymollevej 28, DK-2800 Lyngby (DK)

JUHL, Karsten ; Brydeholm 56, DK-2670 Greve (DK)

SEJBERG, Jimmy; Overdrevet 4, DK-4623 Lille Skensved (DK)

NORGAARD, Morten, Bang; Buddingevej 130A, DK-2800 Lyngby (DK)

(74) Popović Miladin, Đoka Miraševića 21/III, Podgorica (ME)

(57) Jedinjenje opšte formule I:

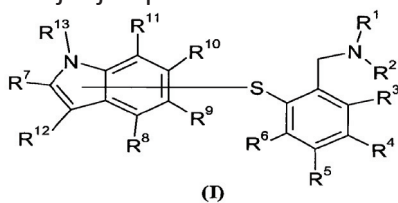

naznačeno time, što je atom sumpora zakačen za indol putem bilo kog ugljenika u prstenu indola i gdje R^1 - R^2 su nezavisno odabrani od vodonika, C_{1-6} -alk(en/in)il, C_{3-8} -cikloalk(en)il i C_{3-8} -cikloalk(en)il- C_{1-6} -alk(en/in)il ili R^1 i R^2 zajedno sa azotom formiraju 4-7 člani prsten koji sadrži nijednu ili jednu dvogubu vezu, opciono navedeni prsten dodatno navedenom azotu sadrži još jedan heteroatom odabran od azota, kiseonika i sumpora; R^3 - R^{12} su nezavisno odabrani od vodonika, halogena, cijano, nitro, C_{1-6} -alk(en/in)il, C_{3-8} -cikloalk(en)il, C_{3-8} -cikloalk(en)il- C_{1-6} -alk(en/in)il, amino, C_{1-6} -alk(en/in)ilamino, di- $(C_{1-6}$ -alk(en/in)il)amino, C_{1-6} -alk(en/in)ilkarbonil, aminokarbonil, C_{1-6} -alk(en/in)ilaminokarbonil, di- $(C_{1-6}$ -alk(en/in)il)aminokarbonil, hidroksi, C_{1-6} -alk(en/in)iloksi, C_{1-6} -alk(en/in)iltio, halo- C_{1-6} -alk(en/in)il i C_{1-6} -alk(en/in)ilsulfonil; Pod uslovom da je R^{10} odabran od halogena, cijano, C_{1-6} -alk(en/in)il, hidroksil, C_{1-6} -alk(en/in)iloksi i halo- C_{1-6} -alk(en/in)il; i R^{13} je odabran od vodonika i C_{1-6} -alkila; kao slobodna baza ili njena so; pod uslovima da:

- kada je atom sumpora zakačen putem atoma br. 2 indola onda R^7 ne postoji;
- kada je atom sumpora zakačen putem atoma br. 3 indola onda R^{12} ne postoji;
- kada je atom sumpora zakačen putem atoma br. 4 indola onda R^8 ne postoji;
- kada je atom sumpora zakačen putem atoma br. 5 indola onda R^9 ne postoji;
- kada je atom sumpora zakačen putem atoma br. 7 indola onda R^{11} ne postoji.

Patent sadrži još 16 patentnih zahtjeva.

- (51) **A61K 8/49**
A61K 31/4425
A61Q 11/00
A61K 9/00
- (11) **01041**
(21) **P-77/08**
- (30) 10 2004 049 798.2 12.10.2004. DE
10 2004 052 308.8 28.10.2004. DE
- (86) PCT/EP2005/008973 19.08.2005.
(87) WO 2006/039961 20.04.2006.
(96) 05777078.6 19.08.2005.
(97) EP 1799186 18.06.2008. 2008/25 DE
- (54) (ME) **OKTENIDINSKE PASTILE PROTIV BOLESTI ZAPALJENJA USTA I ŽDRIJELA**
(EN) OCTENIDINE-CONTAINING LOZENGES USED AGAINST INFLAMMATORY ORAL AND PHARYNGEAL DISEASES
- (73) Divapharma GmbH; Motzener Strasse 41, 12277 Berlin (DE)
(72) MIETHING, Holger; Hochfeilerweg 8, 12107 Berlin (DE)
(74) Popović Miladin, Đoka Miraševića 21/III, Podgorica (ME)
- (57) Farmaceutska kompozicija, naznačena time, da je u formi čvrstih tableta za rastvaranje u ustima, posebno pastila, za lokalno uspješno liječenje bolesti zapaljenja usne šupljine i ždrijela, gdje kompozicija uključuje terapijski efikasnu količinu oktenidina.
Patent sadrži još 23 patentna zahtjeva.

- (51) **C07D 401/06**
A61K 31/4184
C07D 413/14
A61P 11/00
A61P 31/12
- (11) **01042**
(21) **P-207/08**
- (30) 03104810 18.12.2003. EP
567182 30.04.2004. US
04105312 26.10.2004. EP
- (86) PCT/EP2004/053620 20.12.2004.
(87) WO 2005/055571 30.06.2005.
(96) 04817576.4 20.12.2004.
(97) EP 1697345 12.03.2008. 2008/11 En
- (54) (ME) **MORFOLINIL KOJI SADRŽI BENZIMIDAZOLE KAO INHIBITORE REPLIKACIJE SINCICIJONOG RESPIRATORNOG VIRUSA**
(EN) MORPHOLINYL CONTAINING BENZIMIDAZOLES AS INHIBITORS OF RESPIRATORY SYNCYTIAL VIRUS REPLICATION
- (73) TIBOTEC PHARMACEUTICALS LTD.; Eastgate Village Eastgate Little Island, Co Cork (IE)
- (72) BONFANTI, Jean-François; 11 Impasse des Lauriers F-27430 Andé (FR)
ANDRIES, Koenraad, Jozef, Lodewijk; Oosteneinde 9, B-2340 Beerse (BE)
FORTIN, Jérôme, Michel, Claude; 22, rue des acacias, F-27460 Igoville (FR)
MULLER, Philippe; 17 Route d'Herqueville, F-27430 Andé (FR)
DOUBLET, Frédéric, Marc, Maurice; 1646, Route de Neufchatel, F-76230 Isneauville (FR)
MEYER, Christophe; 428 rue de Gouy, F-76520 Les Authieux s/l, Port St Ouen (FR)
WILLEBRORDS, Rudy, Edmond; Vaartstraat 70, B-2330 Merksplas (BE)
GEVERS, Tom, Valerius, Josepha; Burgemeester Bossaertlaan 17, B-2350 Vosselaar (BE)
TIMMERMAN, Philip, Maria, Martha, Bern Vijversstraat 211, B-3550 Hasselt (BE)
- (74) Radulović Božidar, Jovana Tomaševića 9/III-1, Podgorica (ME)
- (57) Jedinjenje, naznačeno time, da je predstavljeno formulom

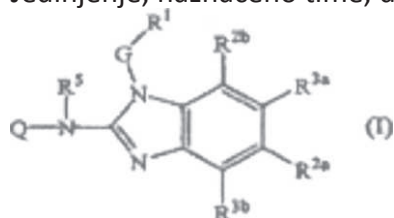

N-oksidom, adicijom soli, kvaternim aminom, metalnim kompleksom i stereohemiski izomernom formom gdje G je direktna veza ili C1-10alkandiil ponekad supstituisan sa jednim ili više supstituenata pojedinačno izabranih između grupe supstituenata koja obuhvata hidroksi, C1-6alkiloksi, Ar1C1-6alkiloksi, C1-6alkiltio, Ar1C1-6alkiltio, HO(-CH₂-CH₂-O)_n, C1-6alkiloksi(-CH₂-CH₂-O)_n ili Ar1C1-6alkiloksi(-CH₂-CH₂-O)_n; R¹ i Ar¹ su monociklički ili biciklički heterocikal koji je izabran između piperidina, piperazina, piridina, pirazina, piridazina, pirimidina, furana, tetrahidrofurana, tienila, pirolila, tiazolila, oksazolila, imidazolila, izotiazolila, pirazolila, oksazolila, oksadiazolila, kinolinila, kinoksalinila, benzo furanila, benzotienila, benzimidazolila, benzoksazolila, benzotiazolila, piridopiridila, naftiridina, 1H-imidazo[4,5-b]piridina, 3H-imidazo[4,5-b]piridina, imidazo[1,2-a]piridina, 2,3-dihidro-1,4-deoksino[2,3-b]piridila ili radikala sa formulom

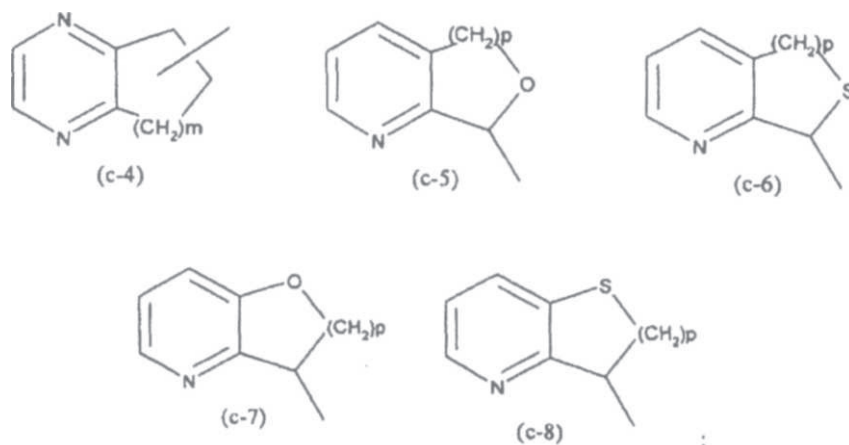

gdje svaki od spomenutih monocikličkih ili bicikličkih heterocikala može ponekad da bude supstituisan sa 1 ili kada je moguće više, kao 2, 3, 4 ili 5, supstituenata pojedinačno izabranih iz grupe supstituenata koja se sastoji od halo, hidroksi, amino, cijano, karboksil, C1-6alkila, C1-6alkiloksi, C1-6alkiltio, C1-6alkiloksi C1-6alkil, Ar1, Ar1C1-6alkila, Ar1C1-6alkiloksi, hidroksiC1-6alkila, mono- ili di(C1-6alkil)amino, mono- ili di(C1-6alkil)aminoC1-6alkila, polihalo C1-6alkila, C1-6alkilkarbonilamino, C1-6alkil-SO₂-NR_{5c}-, Ar1-SO₂-NR_{5c}-, C1-6alkiloksikarbonila, -C(=O)-NR_{5c}R_{5d}, HO(-CH₂-CH₂-O)_n-, halo(-CH₂-CH₂-O)_n-, C1-6alkiloksi(-CH₂-CH₂-O)_n-, Ar1C1-6alkiloksi(-CH₂-CH₂-O)_n- i mono- ili di(C1-6alkil)amino(-CH₂-CH₂-O)_n-;

svaki n nezavisno je 1, 2, 3 ili 4; svaki m nezavisno je 1 ili 2; svaki p nezavisno je 1 ili 2; svaki t nezavisno je 0, 1 ili 2; Q je R₇, pirolidinil supstituisan sa R₇, piperidinil supstituisan sa R₇ ili homopiperidinil supstituisan sa R₇ gde R₇ je C1-6alkil supstituisan sa heterociklom ili R₇ je C1-6alkil supstituisan sa radikalom -OR₈ ili heterociklom, gde spomenuti heterocikl je izabran iz grupe koja obuhvata oksazolidin, tiazolidin, 1-okso-tiazolidin, 1,1-deoksotiazolidin, morfolinil, tiomorfolinil, 1-okso-tiomorfolinil, 1-deoksotiomorfolinil, heksahidrooksazepin, heksahidrotiazepin, 1-okso-heksahidrotiazepin, 1,1-deokso-heksahidrotiazepin; gde svaki od spomenutih heterocikala može ponekad da bude supstituisan sa jednim ili dva supstituenata izabrana iz grupe koja obuhvata C1-6alkil, hidroksi, aminokarbonilC1-6alkil, hidroksi, karboksil, C1-4alkiloksikarbonil, aminokarbonil, mono- ili di(C1-4alkil)aminokarbonil, C1-4alkilkarbonilamino, aminosulfonil i mono- ili di(C1-4alkil)aminosulfonil; R₈ je vodonik, C1-6alkil ili Ar1C1-6alkil; jedan od R_{2a} i R_{3a} je izabran iz halo, ponekad mono- ili polisupstituirani C1-6alkil, ponekad mono- ili polisupstituirani C2-6alkenil nitro, hidroksi, Ar₂, N(R_{4a}R_{4b}), N(R_{4a}R_{4b})sulfonil, N(R_{4a}R_{4b})karbonil, C1-6alkiloksi, Ar₂oksi, Ar₂C1-6alkiloksi, karboksil, C1-6alkiloksikarbonil, ili -C(=Z)Ar₂; a ostali R_{2a} i R_{3a} su vodonik; gdje =Z je =O, =CH-C(=O)-NR_{5a}R_{5b}, =CH₂, =CH-C1-6alkil, =N-OH ili =N-O-C1-6alkil; i neobavezni supstituenti na C1-6alkil i C2-6alkenil mogu da budu isti ili mogu da budu različiti jedni od drugog, a svaki je nezavisno izabran iz grupe supstituenata koja obuhvata hidroksi, cijano, halo, nitro, N(R_{4a}R_{4b}), N(R_{4a}R_{4b})sulfonil, Het, Ar₂, C1-6alkiloksi, C1-6alkil-S(=O), Ar₂oksi, Ar₂-S(=O)-, Ar₂C1-6alkiloksi, Ar₂C1-6alkil-S(=O)t, Het-oksi, Het-S(=O)t, HetC1-6alkiloksi, HetC1-6alkil-S(=O)t, karboksil, C1-6alkiloksikarbonil i -C(=Z)Ar₂; u slučaju kada R_{2a} je različit od vodonika tada R_{2b} je vodonik, C1-6alkil ili halogen, a R_{3b} je vodonik; u slučaju kada R_{3a} je različit od vodonika tada R_{3b} je vodonik, C1-6alkil ili halogen, a R_{2b} je vodonik; R_{4a} i R_{4b} mogu da budu isti ili različiti jedan na drugoga, a svaki je nezavisno izabran iz grupe koja obuhvata vodonik, C1-6alkil, Ar₂C1-6alkil, (Ar₂)(hidroksi)C1-6alkil, Het-C1-6alkil, hidroksiC1-6alkil, mono- i di-(C1-6alkiloksi)C1-6alkil, (hidroksiC1-6alkil)oksiC1-6alkil, Ar1C1-6alkiloksi-C1-6alkil, dihidroksiC1-6alkil, (C1-6alkiloksi)(hidroksi)C1-6alkil, (Ar1C1-6alkiloksi)(hidroksi)C1-6alkil, Ar1oksi-C1-6alkil, (Ar1oksi)(hidroksi)-C1-6alkil, aminoC1-

6alkil, mono- i di(C1- 6alkil)amino-C1-6alkil, karboksil-C1- 6alkil, C1-6 alkiloksikarbonilC1-6alkil, aminokarbonilC1-6alkil, mono- i di(C1-6alkil)aminokarbonil C1-6alkil, C1-6alkilkarbonilC1-6alkil, (C 1-4alkiloksi)2P(=O)-C1-6alkil, (C1-4alkiloksi)2P(-O)-O-C>alkil, aminosulfonil-C1-6alkil, mono- i di(C1-6alkil)aminosulfonil-C1-6alkil, C1-6alkilkarbonil, A2karbonil, Het-karbonil, Ar2C1-6alkilkarbonil, Het-C1-6 alkilkarbonil, C1-6alkilsulfonil, aminosulfonil, mono- i di(C1-6alkil)aminosulfonil, Ar2sulfonil, Ar2C1-6alkilsulfonil, Ar2, Het, Het-sulfonil, HetC1-6alkilsulfonil; R5 je vodonik ili C1-6alkil; R5a i R5b mogu da budu isti ili različiti jedan od drugog, a svaki je nezavisno vodonik ili C 1-6alkil; ili R5a i R5b zajedno mogu da formiraju dvovalentan radikal sa formulom $-(CH_2)_5-$ gde s je 4 ili 5; R5c i R5d mogu da budu isti ili različiti jedan od drugog, a svaki je nezavisno vodonik ili C1-6 alkil; ili R5c i R5d uzeti zajedno mogu da formiraju dvovalentni radikal sa formulom $-(CH_2)_5-$ gde s je 4 ili 5; Ar1 je fenil ili fenil supstituisan sa 1 ili više, kao 2, 3 ili 4, supstituenata izabrana između halo, hidroksi, C1-6alkil, hidroksiC1-6alkil, polihaloC1-6alkil i C1-6alkiloksi; Ar2 je fenil, fenil spojen sa C5-7cikloalkilom, ili fenil supstituisan sa 1 ili više, kao 2, 3, 4 ili 5, supstituenata izabranih između halo, cijano, C1-6alkila, Het-C1-6alkila, Ar1C1-6 alkila, cijano C1-6 alkila, C2-6 alkenila, cijanoC2-6alkenila, R6b-O-C3.6alkenila, C2-6 alkinila, cijanoC2-6alkinila, R6b-O-C3-6alkinila, Ar1, Het, R6b-O-, R6b-S-, R6c-SO-, R6c-SO2-, R6b-O-C1-6alkil-SO2-, -N(R6aR6b), polihalo-C1-6alkila, polihaloC1-6alkiloksi, polihaloC1-6alkiltio, R6c-C(=O)-, R6b-O-C(=O)-, N(R6aR6b)-C(=O)-, R6b-O-C1-10alkila, R6b-S-C1-6alkila, R6c-S(=O)2-C1-6alkila, N(R6aR6b-C1-6alkila, R6c-C(=O)-C1-6alkila, R6b-O-C(=O)-C1-6alkila, N(R6aR6b)-C(=O)-C1-6alkila, R6c-C(=O)-NR6b-, R6c-C(=O)-O-, R6c-C(=O)-NR6b-C1-6alkila R6c-C(=O)-O-C1-6alkila, N(R6aR6b-S(=O)2-, H2N-C(=NH)-; R68 je vodonik, C1-6alkil, Ar1, Ar'1C1-6alkil, C1-6alkilkarbonil, Ar1karbonil, Ar1C 1-6 alkilkarbonil, C1-6alkilsulfonil, Ar1sulfonil, Ar1C 1-6alkilsulfonil, C 1-6 alkiloksiC1-6 alkil, aminoC 1-6alkil, mono- ili di(C1-6alkil)aminoC1-6alkil, hidroksiC1-6 alkil, (karboksil)-C1-6,alkil, (C1-6alkiloksikarbonil)-C1-6alkil, aminokarbonilC1-6alkil, mono- i di (C1-6 alkil)aminokarbonilC1-6alkil, aminosulfonil-C1-6alkil, mono- i di(C1-6 alkil) aminosulfonil-C 1-6alkil, Het, Het-C1-6alkil, Het-karbonil, Het-sulfonil, Het-C1-6 alkilkarbonil; R6b je vodonik, C1-6alkil, Ar1 ili Ar'1C1-6alkil; R6c je C1-6alkil, Ar1 ili Ar1C 1-6alkil; Het je heterocikal koji je izabran iz tetrahidrofuranila, tetrahidrotienila, pirolidinila, pirolidinonila, furanila, tienila, pirolila, tiazolila, oksazolila, imidazolila, izotiazolila, pirazolila, izoksazolila, oksadiazolila, tiadiazolila, piperidinila, homopiperidinila, piperazinila, morfolinila, piridila, pirazinila, piridazinila, pirimidinila, tetrahidrokinolinila, kinolinila, izokinolinila, benzodeoksanila, benzodeoksolila, indolinila, indolila, a svaki od spomenutih heterocikala može ponekad da bude supstituisan sa okso, amino, Ar1, C1-4alkilom, aminoC1-4alkilom, Ar1C1-4alkilom, mono- ili di(C1-6 alkil)amino C1-6alkilom, mono- ili di (C1-6alkilamino, (hidroksiC1-6alkilamino, a ponekad i sa jednim ili dva C1-4alkil radikala.

Patent sadrži još 30 patentnih zahtjeva.

- (51) **C07K 14/59**
A61K 38/04
- (30) 04105639 09.11.2004. EP
628717P 17.11.2004. US
- (86) PCT/EP2005/055815 08.11.2005.
(87) WO 2006/051070 18.05.2006.
(96) 05815953.4 08.11.2005
(97) EP 1809663 17.09.2008. 2008/38 En
- (54) (ME) **METODE ZA PREČIŠĆAVANJE FSH-A**
(EN) METHOD FOR PURIFYING FSH
- (73) ARES TRADING S.A.; Zone Industrielle de l'Ourietta, 1170 Aubonne (CH)
(72) VALAX, Pascal, Route de Fontanivent 34, CH-1822 Chernex (CH)
WENGER, Pierre, 144, Ch. de Bellevue, F-01220 Grilly (FR)
STANLEY, Anne; P.O. Box 12193, NZ-Rotorua (NZ)
DELEGRANGE, Lydia; 17 route de la Petite Corniche Apt12, CH-1095 Lutry (CH)
CAPPONI, Luciano; Chemin de Crey -Derrey 117, CH-1618 Chatel Saint Denis (CH)
- (74) Radulović Božidar, Jovana Tomaševića 9/III-1, Podgorica (ME)
- (57) Metoda za purifikaciju rekombinantnog FSH ili neke varijante FSH koja podrazumeva podvrgavanje tečnosti koja sadrži FSH: afinitetnoj hromatografiji sa prebojavanjem;
(1) hromatografiji sa hidrofobnom reakcijom; i
(2) hromatografiji obmune fazekoje se mogu primeniti po bilo kom redosljedu.
Patent sadrži još 23 patentna zahtjeva.

(51) **C07D 401/04**
C07D 401/12
C07D 401/14
A61K 31/506
A61P 3/10
A61P 35/00

(11) **01048**
(21) **P-294/08**

(30) 553571 P 15.03.2004. US
629524 P 18.11.2004. US

(96) 04258153.8 21.12.2004.

(97) EP 1586571 16.07.2008. 2008/29 En

(54) (ME) **INHIBITORI DIPEPTIDIL PEPTIDAZE**
(EN) **DIPEPTIDYL PEPTIDASE INHIBITORS**

(73) Takeda Pharmaceutical Company Limited; Osaka-shi, Osaka 541-0045 (JP)

(72) FENG, Jun; 3536 Corte Yolanda, Carlsbad, CA 92009 (US)

GWALTNEY, II, Stephen, L; Escondido, CA 92025 (US)

STAFFORD, Jeffrey A.; San Diego, CA 92130 (US)

ZHANG, Zhiyuan; San Diego, CA 92130 (US)

ELDER, Bruce J.; c/o Albany Molecular Research Inc. Albany, New York 12212 (US)

ISBESTER, Paul K.; c/o Albany Molecular Research Inc. Albany, New York 12212 (US)

PALMER, Grant J.; c/o Albany Molecular Research Inc. Albany, New York 12212 (US)

SALSBURY, Jonathon S.; c/o Albany Molecular Research Inc. Albany, New York 12212 (US)

ULYSEE, Luckner G. c/o Albany Molecular Research Inc. Albany, New York 12212 (US)

(74) Popović Miladin, Đoka Miraševića 21/III, Podgorica (ME)

(57) Jedinjenje naznačeno time što sadrži:

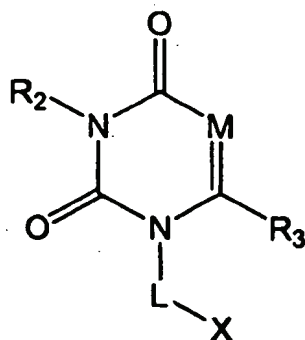

gdje

M je CR₄;

R₂ je vodonik ili je izabran iz grupe koju čine (C₁₋₁₀)alkil, (C₃₋₁₂)cikloalkil, (C₃₋₁₂)cikloalkil(C₁₋₅)alkil, hetero(C₃₋₁₂)cikloalkil(C₁₋₅)alkil, hetero(C₃₋₁₂)cikloalkil, aril(C₁₋₁₀)alkil, heteroaril(C₁₋₅)alkil, (C₉₋₁₂)bicikloaril, hetero(C₄₋₁₂)bicikloaril, hetero(C₄₋₁₂)bicikloaril(C₁₋₅)alkil, karbonil(C₁₋₃)alkil, tiokarbonil(C₁₋₃)alkil, sulfonil(C₁₋₃)alkil, sulfinil(C₁₋₃)alkil, imino(C₁₋₃)alkil, amino, aril, heteroaril, hidroksi, alkoksi, ariloksi, heteroariloksi, karbonil grupa, imino grupa, sulfonil grupa i sulfinil grupa, svaka od njih supstituisana ili nesupstituisana;

R₃ sadrži formulu

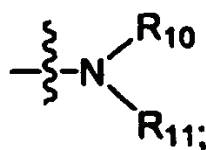

gde su svako R₁₀ i R₁₁ nezavisno izabrani iz grupe koju čine vodonik, perhalo(C1-10)

alkil, amino, (C1-10)alkil, (C3-12)cikloalkil, hetero(C3-12)cikloalkil, aril(C1-10)alkil, heteroaril(C1-5)alkil, (C9-12)bicikloaril, hetero(C4-12)bicikloaril, karbonil(C1-3)alkil, tiokarbonil (C1-3)alkil, aril, heteroaril, hidroksi, alkoksi, ariloksi, heteroariloksi, karbonil grupa, sulfonil grupa i sulfinil grupa, gde je svaka od njih supstituisana ili nesupstituisana, ili R10 i R11 su uzeti zajedno tako da formiraju 4, 5, 6 ili 7 člani prsten, gde je svaki od njih supstituisan ili nesupstituisan; R4 je vodonik ili je izabran iz grupe koju čine halo, perhalo(C1-10)alkil, amino, cijano, tio, (C1-10)alkil, cikloalkil, heterocikloalkil, arilalkil, heteroarilalkil, aril, heteroaril, karbonil (C1-3)alkil, tiokarbonil(C1-3)alkil, sulfonil(C1-3)alkil, sulfinil (C1-3)alkil, imino(C1-3)alkil, hidroksi, alkoksi, ariloksi, heteroariloksi, karbonil grupa, imino grupa, sulfonil grupa i sulfinil grupa, svaka supstituisana ili nesupstituisana; i-L-X uzeto zajedno je izabrano iz grupe koju čine -(CH₂)-(2-cijano)fenil; -(CH₂)-(3-cijano)fenil; -(CH₂)-(2-hidroksi)fenil; -(CH₂)-(3-hidroksi)fenil; -(CH₂)-(2-alkenil)fenil; -(CH₂)-(3-alkenil)fenil; -(CH₂)-(2-alkinil)fenil; -(CH₂)-(3-alkinil)fenil; -(CH₂)-(2-metoksi)fenil; -(CH₂)-(3-metoksi)fenil; -(CH₂)-(2-nitro)fenil; -(CH₂)-(3-nitro)fenil; -(CH₂)-(2-karboksi)fenil; -(CH₂)-(3-karboksi)fenil; -(CH₂)-(2-karboksamido)fenil; -(CH₂)-(3-karboksamido)fenil; -(CH₂)-(2-sulfonamido)fenil; -(CH₂)-(3-sulfonamido)fenil; -(CH₂)-(2-tetrazolil)fenil; -(CH₂)-(3-tetrazolil)fenil; -(CH₂)-(2-aminometil)fenil; -(CH₂)-(3-aminometil)fenil; -(CH₂)-(2-hidroksimetil)fenil; -(CH₂)-(3-hidroksimetil)fenil; -(CH₂)-(2-fenil)fenil; -(CH₂)-(3-fenil)fenil; -(CH₂)-(2-halo)fenil; -(CH₂)-(3-halo)fenil; -(CH₂)-(2-CONH₂)fenil; -(CH₂)-(3-CONH₂)fenil; -(CH₂)-(2-CONH(C1-7)alkil)fenil; -(CH₂)-(3-CONHC1-7)alkil)fenil; -(CH₂)-(2-CO₂(C1-7)alkil)fenil; -(CH₂)-(3-CO₂(C1-7)alkil)fenil; -(CH₂)-(2-NH₂)fenil; -(CH₂)-(3-NH₂)fenil; -(CH₂)-(2-(C3-7)alkil)fenil; -(CH₂)-(3-(C3-7)alkil)fenil; -(CH₂)-(2-(C3-7)cikloalkil)fenil; -(CH₂)-(3-(C3-7)cikloalkil)fenil; -(CH₂)-(2-aril)fenil; -(CH₂)-(3-aril)fenil; -(CH₂)-(2-heteroaril)fenil; -(CH₂)-(3-heteroaril)fenil; -(CH₂)-2-bromo-5-fluoro fenil; -(CH₂)-2-hloro-5-fluoro fenil; -(CH₂)-2-cijano-5-fluoro fenil; -(CH₂)-2,5-dihloro fenil; -(CH₂)-2,5-difluoro fenil; -(CH₂)-2,5-dibromo fenil; -(CH₂)-2-bromo-3,5-difluoro fenil; -(CH₂)-2-hloro-3,5-difluoro fenil; -(CH₂)-2,3,5-trifluoro fenil; -(CH₂)-2,3,5,6-tetrafluorofenil; -(CH₂)-2-bromo-3,5,6-trifluoro fenil; -(CH₂)-2-hloro-3,5,6-trifluoro fenil; -(CH₂)-2-cijano-3,5-difluoro fenil; -(CH₂)-2-cijano-3,5,6-trifluoro fenil; -(CH₂)-(2-heterocikloalkil)fenil; i -(CH₂)-(3-heterocikloalkil)fenil, svaki supstituisan ili nesupstituisan.

Patent sadrži još 77 patentnih zahtjeva.

(51) **C07D 489/02**
C07F 7/08

(11) **01049**
(21) **P-746/08**

(30) 542711P 06.02.2004. US

(86) PCT/US2005/003390 04.02.2005.

(87) WO 2005/077957 25.08.2005.

(96) 05712726.8 04.02.2005.

(97) EP 1711502 27.08.2008. 2008/35 En

(54) (ME) **POSTUPCI ZA DOBIJANJE 3-O-ZAŠTIĆENIH MORFINONA I 3-O-ZAŠTIĆENIH MORFINON DIENOL KARBOKSILATA**

(EN) **METHODS FOR MAKING 3-O-PROTECTED MORPHINONES AND 3-O-PROTECTED MORPHINONE DIENOL CARBOXYLATES**

(73) EURO-CELTIQUE S.A.; 2, avenue Charles de Gaulle, L-1653 Luxembourg (LU)

(72) STUMPF, Andreas; 5504 Aspen Street Dublin, CA 94568-7678 (US)

(74) Lutovac Branislav, Bulevar Crnojevića 93, Podgorica (ME)

(57) Kompozicija koja se dobija kombinovanjem smješe jedinjenja formule R_1SR_2 , trihloroizocijanurske kiseline i baze sa sekundarnim alkoholom formule (I):

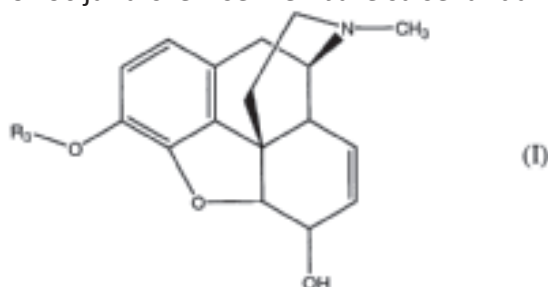

Gdje je R_3 zaštitna grupa, ili se dobija dodavanjem sekundarnog alkohola formule (I) u smješu koja sadrži jedinjenje formule R_1SR_2 i trihloroizocijanursku kiselinu, a zatim se dodaje baza, gdje su R_1 i R_2 svaki nezavisno $-(C_1-C_{20})$ alkil, $-(C_3-C_8)$ cikloalkil ili -fenil.
Patent sadrži još 20 patentnih zahtjeva.

(51) **A61K 31/44**
A61K 9/00
A61K 9/08
A61K 47/14

(11) **01050**
(21) **P-797/08**

(30) 102004046235 22.09.2004. DE

(86) PCT/EP2005/054723 21.09.2005.

(87) WO 2006/032675 30.03.2006.

(96) 05794694.9 21.09.2005.

(97) EP 1796668 17.09.2008. 2008/38 En

(54) (ME) **VODENI FARMACEUTSKI PREPARATI KOJI SADRŽE ROFLUMILAST**
(EN) **AQUEOUS PHARMACEUTICAL PREPARATION COMPRISING ROFLUMILAST**

(73) Nycomed GmbH; Byk-Gulden-Strasse 2, 78467 Konstanz (DE)

(72) LINDER, Rudolf; Lindauer Str. 40, 78464 Konstanz (DE)

(74) Radulović Božidar, Jovana Tomaševića 9/III-1, Podgorica (ME)

(57) Vodeni farmaceutski preparat sadrži aktivni sastojak u terapijskoj efikasnoj i farmakološki prihvatljivoj količini i alkoksilatnu mast, gde je aktivni sastojak izabran iz grupe koja se sastoji od roflumilasta, soli roflumilasta, N-oksida piridinskog ostatka roflumilasta ili njegove soli.

Patent sadrži još 18 patentnih zahtjeva.

(51) **A01N 43/50**

(11) **01051**

(21) **P-841/08**

(30) 20040558131P 01.04.2004 US

(86) PCT/EP2005/003302 30.03.2005.

(87) WO 2005/096814 20.10.2005.

(96) 05731882.6 30.03.2005

(97) EP 1734823 15.10.2008. 2008/42 En

(54) (ME) **HERBICIDNA SMJEŠA SA SINERGISTIČKIM DJELOVANJEM**
(EN) SYNERGISTICALLY ACTING HERBICIDAL MIXTURES

(73) BASF; 67056 Ludwigshafen (DE)

(72) SIEVERNICH, Bernd; 67454 Hassloch (DE)

BRIX, Horst, Dieter; 76829 Landau (DE)

MALEFYT, Tim; Stroudsburg, PA 18360 (US)

(74) Popović Miladin, Đoka Miraševića 21/III, Podgorica (ME)

(57) 1. Sinergistička herbicidna smješa, naznačena time što sadrži

A) imazamoks, uključujući njegove odgovarajuće izomere, kao i njegove odgovarajuće sa životnom sredinom kompatibilne soli, estre, amide ili druge derivate; i

B) najmanje jedno herbicidno jedinjenje iz grupe hlороacetamida i prema potrebi,

C) najmanje jedno herbicidno jedinjenje izabrano iz grupe koju čine klomazon, atrazin, dihlormid, benoksakor, LAB-145138, MG-191, MON-13900, ciometrinil, oksabetrinil, fluksofenim, flurazol, anhidrid naftalne kiseline, fenhlорim, fenhlорazol, mefenpir, klohintocet (uključujući njegov hidrat (hidrate)), l-etil-4-hidroksi-3-(1H-tetrazol-5-il)-1H-hinolin-2-on, 4-karboksimetil-hroman-4-karbonska kiselina, N-(2-metoksi-benzoil)-4-(3-metil-ureido)-benzolsulfonamid, metil estar (3-okso-izotiohroman-4-ilidenmetoksi)-sircetne kiseline uključujući njihove odgovarajuće izomere, kao i njihove odgovarajuće kompatibilne sa životnom sredinom soli, estre, amide ili druge derivate.

Patent sadrži još 7 patentnih zahtjeva.

(51) **G06K 19/077**

(11) **01052**

(21) **P-40/09**

(30) 05100694 01.02.2005. EP

05109094 30.09.2005. EP

(86) PCT/EP2006/050585 01.02.2006.

(87) WO 2006/082199 10.08.2006.

(96) 06707949.1 01.02.2006.

(97) EP 1846874 05.11.2008. 2008/45 FR

(54) (ME) **POSTUPAK POSTAVLJANJA ELEKTRONSKOG SKLOPA NA SUPSTRAT I UREĐAJ ZA POSTAVLJANJE TAKVOG SKLOPA**

(EN) METHOD FOR APPLYING AN ELECTRONIC ASSEMBLY TO A SUBSTRATE AND A DEVICE FOR APPLYING SAID ASSEMBLY

(73) NAGRAID SA; Crêt-du-Loche, 10; 2322 Crêt-du-Loche (CH)

(72) DROZ, François; Rue Des Pins 20, CH-2035 Corcelles (CH)

(74) Ćupić Branislav, Dalmatinska 10, Podgorica (ME)

(57) Postupak raspoređivanja u supstrat (7) bar jednog elektronskog sklopa koji sadrži čip (4), sa bar jednim električnim kontaktom (5,5`) na jednoj od svojih strana i bar jednog segmenta (3,3`) provodnog traga, koji je priključen na bar jedan pomenuti električni kontakt (5,5`), karakterisan time što sadrži sledeće etape:

-formiranje bar jednog pomenutog segmenta (3,3`) provodnog traga sa unaprijed određenim obodom;

-obuhvatanje bar jednog pomenutog segmenta (3,3`) traga sa uređajem (6),

-obuhvatanje čipa (4) sa uređajem (6) koji nosi segmente (3,3`) traga, tako da se kraj pomenutog segmenta (3,3`) postavi paralelno uz kontakt (5,5`) čipa (4) ili se stavi uz pomenuti kontakt (5,5`);

-postavljanje pomenutog elektronskog sklopa koju drži uređaj (6) u određenom položaju u odnosu na pomenutu podlogu (7); i

-pritiskanje pomenutog elektronskog sklopa u pomenutu podlogu (7).

Patent sadrži još 37 patentnih zahtjeva.

- (51) **C07F 9/6561**
A61P 31/18
A61K 31/675

- (11) **01053**
(21) **P-50/09**

- (30) 611061 P 17.09.2004. US
711445 P 25.08.2005. US
711565 P 26.08.2005. US

(86) PCT/IB2005/004063 16.09.2005.

(87) WO 2006/054182 26.05.2006.

(96) 05850774.0 16.09.2005.

(97) EP 1799696 12.11.2008. 2008/46 En

(54) (ME) **FOSFOINDOLI KAO HIV INHIBITORI**
(EN) PHOSPHOINDOLES AS HIV INHIBITORS

(73) IDENIX Pharmaceuticals, Inc., One Kendall Square, Building 1400, Cambridge, MA 02139 (US)

(72) -STORER, Richard, Sandgate Point, The Leas Folkestone, Kent CT20 2JE (GB)

-DOUSSON, Cyril; Las Rebes, 126 Allée Beranger, F-34080 Montpellier (FR)

-ALEXANDRE, François-René; Résidence Occitanie, 200 avenue du, F-34090 Montpellier (FR)

-ROLAND, Arlène; Clair Matin, Bâtiment C1, 200 avenue St. Maur F-34000 Montpellier (FR)

(74) Lutovac Branislav, Bulevar Crnojevića 93, Podgorica (ME)

(57) Jedinjenje Formule (A):

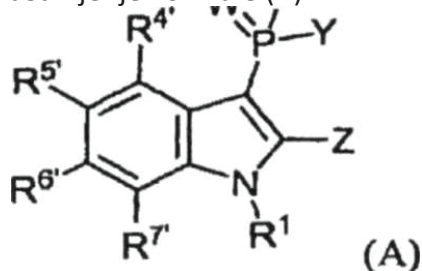

ili njegova farmaceutski prihvatljiva so, N-oksid, kvaternerni amin, stereohemijski izomer ili tautomer, gde:

X je supstituisani ili nesupstituisani fenil;

Y je O-alkil;

W je O; S; NH; N-N(R²)(R²); -N(R²); N-OH ili N-O-alkil;

R² svaki nezavisno, je H, OH; halogen; opciono supstituisani račvasti ili neračvasti alkil; opciono supstituisani račvasti ili neračvasti alkenil; opciono supstituisani račvasti ili neračvasti alkinil; 3-14-to člani karbocikl; alkilheterocikl; acil; karboksamido; karbamoil; alkoksi; opciono supstituisani aril, opciono supstituisani aralkil; opciono supstituisani alkilaril; O-alkil; O-alkenil; O-alkinil; O-alkaril; O-aralkil; O-karbocikl; O-heterocikl; O-aril; CF₃; CN; S(O)_n-R³; N(R³)(R³); NH-S(O)_n-R³; NHC(=W)aril; NHC(=W)-alkil; NHC(=W)-heterocikl; CH₂-S(O)_nR³; C(=W)R³; C(=W)NR³R³; C(alkil)₂-S(O)_nR³; CH(alkil)-S(O)_nR³; C(alkil)₂-NH₂; CH(alkil)-N(alkil)R³; CR³R²-NR³R³; CH₂N(alkil)R³; CH(alkil)-NHR³; C(alkil)₂-NHR³; C(alkil)₂-N(alkil)R³; CH₂-C(=W)H; CH₂-C(=W)alkil; CR³R³-C(=W)R³; A-R³; C(R³)₂-C(=W)R³; CH₂-C(=W)H; CH₂-C(=W)alkenil; CH(alkenil)-C(=W)H; A-S(O)R³; CH(NH)-S(O)_nR³; ili A-N(NH)R³, pri čemu se pomenuta opciona supstitucija sastoji od jednog ili više: supstituisanog ili neusptituisanog heterocikla; C(=W)O-aril; C(=W)O-alkil; C(=W)NH₂; C(=W)NH-alkil; C(=W)NH-aril; C(=W)N-di-alkil; C(=W)N(alkil)-aril; α-aminokiselina; α-aminoestar; α-aminkarboksamid; β-aminokiselina; β-aminoestar ili β-amino-karboksamid; R³ svaki nezavisno, je H; OH; C₁₋₆ alkil; C₂₋₆ alkenil; C₂₋₆ alkinil; alkoksi; CF₃; CN; amino; NR²R²; O-alkil; O-alkenil; O-alkinil; C(R²)(R²)-S(O)_nNH₂; C(R²)(R²)-S(O)_nCF₃; C(R²)(R²)-NH₂; A-heterocikl; C(R²)(R²)-NR²R²; C(R²)(R²)-C(=W)R²; aril; karbocikl; heterocikl; cikloalkil; alkaril; alkilheterocikl; aralkil; ili heterocikl-

alkil; od kojih svaki može biti nesupstituisan ili supstituisan sa jednim ili više od sledećih, uzetih u bilo kojoj kombinaciji: halo; OH; OR²; SR²; COOH; estar karboksilne kiseline; C(=W)R²; C(=W)OR²; C(=W)OR³; C(=W)SR²; A-C(=W)NH₂; C(=W)NR²R³; NR²R²; NR²R³; NR²-S(O)_nR³; NR²-C(=W)-C₁₋₆alkil; S(O)_nR³; C₁₋₆alkoksi; C₁₋₆tioetar; ostatak aminokiseline; NH-A-(ostatak aminokiseline), C(=W)NH-A-(ostatak aminokiseline); a kada pomenuta, opciona supstitucija sadrži supstituisani heterocikl, tada se supstitucija bira iz grupe koju čine: C(=W)O-aril; C(=W)O-alkil; C(=W)NH₂; C(=W)NH-aril; C(=W)NH-alkil; C(=W)N-di-alkil; C(=W)N(alkil)-aril; α-aminokiselina; α-aminoestar; α-amino-karboksamid; β-aminokiselina; β-aminoestar; β-amino-karboksamid; halo; ili cijano, uzeti sami ili u bilo kojoj kombinaciji; n svaki nezavisno, je 0, 1 ili 2; A je disupstituisani distancer, koji se bira iz grupe koju čine: C₁₋₆alkilen, račvast ili neračvast, koji opciono ima jedan ili više heteroatoma, aril, cikloalkil ili heterociklil funkcije, u ili pripojene lancu; C₂₋₁₂alkenilen, račvast ili neračvast, koji opciono ima jedan ili više heteroatoma, aril, cikloalkil ili heterociklil funkcije, u ili pripojene lancu; C₂₋₁₂alkinilen, račvast ili neračvast, koji opciono ima jedan ili više heteroatoma, aril, cikloalkil ili heterociklil funkcije, u ili pripojene lancu; opciono supstituisani arilen; O-alkilen, račvast ili neračvast, koji opciono ima jedan ili više heteroatoma, aril, cikloalkil ili heterociklil funkcije, u ili pripojene lancu; aralkilen, račvast ili neračvast, koji opciono ima jedan ili više heteroatoma, aril, cikloalkil ili heterociklil funkcije, u ili pripojene lancu; opciono supstituisani cikloalkil; i opciono supstituisani heterocikl; pri čemu "A" može da se pripoji bilo kojoj željenoj vezi ili bilo kojoj kombinaciji željenih veza; R¹, R^{4'}, R^{6'} i R^{7'} svaki nezavisno je H; R^{5'} je halogen; i Z je karboksamid.

Patent sadrži još 17 patentnih zahtjeva.

- (51) **C21D 8/02** (11) **01054**
C21D 8/12 (21) **P-51/09**
- (96) 04425877.0 24.11.2004.
- (97) EP 1662010 07.01.2009. 2009/02 En
- (54) (ME) **TOPLO VALJANE MAGNETNE ČELIČNE TRAKE POSEBNO POGODNE ZA PROIZVODNJU ELEKTROMAGNETNIH SLOJEVITIH PAKETA**
(EN) MAGNETIC HOT ROLLED STEEL STRIP PARTICULARLY SUITED FOR THE PRODUCTION OF ELECTROMAGNETIC LAMINATION PACKS
- (73) ARVEDI, Giovanni; I-26100 Cremona (IT)
- (72) ARVEDI, Giovanni; I-26100 Cremona (IT)
- (74) Popović Miladin, Đoka Miraševića 21/III, Podgorica (ME)
- (57) Toplo valjana magnetna traka pogodna za proizvodnju električnih čeličnih limova, debljine između 0.65 i 1.0 mm i fine zrnaste strukture, naznačena time što ima udio silicijuma <0.03%, stepen paralelnosti <0.02 mm i 70% feritnih zrnaca između 9. i 12. stepena ASTM E 112 standarda, a ta se svojstva dobijaju bez dodatnih koraka žarenja i hladnog valjanja sa sledećim sastavom: C<0.06%, Mn 0.10±0.20%, Si< 0.03%, P<0.010%, S<0.005%, Cr<0.10%, Ni<0.12%, Mo<0.03%, Al 0.030±0.050%, glavni je sastojak Fe i neizbježna zagađenja. Patent sadrži još 6 patentnih zahtjeva.

- (51) **C07D 213/74**
A61K 31/435
A61K 31/495
A61P 1/00
A61P 17/00
A61P 25/00
A61P 29/00
- (30) 533037P 30.12.2003. US
(86) PCT/US2004/042732 17.12.2004.
(87) WO 2005/066130 21.07.2005.
(96) 04814866.2 17.12.2004.
(97) EP 1727801 18.02.2009. 2009/08 En
- (54) (ME) **PIPERAZINI KORISNI ZA LIJEČENJE BOLA**
(EN) PIPERAZINES USEFUL FOR TREATING PAIN
- (73) EURO-CELTIQUE S.A.; 2, avenue Charles de Gaulle;1653 Luxembourg (LU)
(72) SUN, Qun; 19 Aldgate Court, Princeton, NJ 08540 (US)
TAFESSE, Laykea; 11 Abbington Lane, Robbinsville, NJ 08691 (US)
(74) Lutovac Branislav, Bulevar Crnojevića 93, Podgorica (ME)
(57)

Dos.20387

PATENTNI ZAHTEVI

5

1. Jedinjenje formule (1):

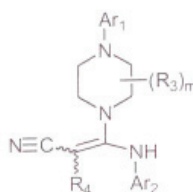

10

(1)

ili njegova farmaceutske prihvatljiva so, u kome:

Ar₁ je

15

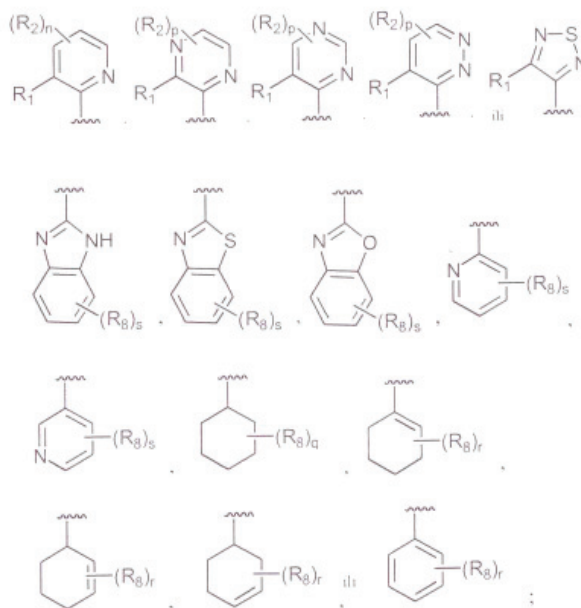

- 198 -

R₁ je -H, -halo, -CH₃, -CN, -NO₂, -OCH₃, -NH₂, -C(halo)₃, -CH(halo)₂ ili -CH₂(halo); svaki R₂ je nezavisno:

(a) –halo, –OH, –NH₂, –CN ili –NO₂;

(b) –(C₁–C₁₀)alkil, –(C₂–C₁₀)alkenil, –(C₂–C₁₀)alkinil, –(C₃–C₁₀)cikloalkil, –(C₈–C₁₄)bicikloalkil, –(C₈–C₁₄)trcikloalkil, –(C₅–C₈)cikloalkenil, –(C₈–C₁₄)bicikloalkenil, –(C₈–C₁₄)trcikloalkenil, –(3-to 7-člani)heterocikl. ili –(7- do 10-člani)bicikloheterocikl, od kojih je svaki nesupstituisan ili supstituisan sa jednom ili više R₅ grupa: ili

(c) –fenil, –naftil, –(C₁₄)aril ili –(5- do 10-člani)heteroaril, od kojih je svaki nesupstituisan ili supstituisan sa jednom ili više R₆ grupa; svaki R₃ je nezavisno:

(a) –halo, –OH, –NH₂, –CN ili –NO₂;

(b) –(C₁–C₁₀)alkil, –(C₂–C₁₀)alkenil, –(C₂–C₁₀)alkinil, –(C₃–C₁₀)cikloalkil, –(C₈–C₁₄)bicikloalkil, –(C₈–C₁₄)trcikloalkil, –(C₅–C₁₀)cikloalkenil, –(C₈–C₁₄)bicikloalkenil, –(C₈–C₁₄)trcikloalkenil, –(3- do 7-člani)heterocikl ili –(7- do 10-člani)bicikloheterocikl. od kojih je svaki nesupstituisan ili supstituisan sa jednom ili više R₅ grupa; ili

(c) –fenil, –naftil, –(C₁₄)aril ili –(5- do 10-člani)heteroaril, od kojih je svaki nesupstituisan ili supstituisan sa jednom ili više R₆ grupa;

R₄ je –H, –CN, –C(O)O(C₁–C₄)alkil, ili –C(O)NH((C₁–C₄)alkil); svaki R₅ je nezavisno –CN, –OH, –(C₁–C₆)alkil, –(C₂–C₆)alkenil, –(C₂–C₆)alkinil, –halo, –N₃, –NO₂, –N(R₇)₂, –CH=NR₇, –NR₇OH, –OR₇, –COR₇, –C(O)OR₇, –OC(O)R₇, –OC(O)OR₇, –SR₇, –S(O)R₇, ili –S(O)₂R₇; svaki R₆ je nezavisno –(C₁–C₆)alkil, –(C₂–C₆)alkenil, –(C₂–C₆)alkinil, –(C₃–C₈)cikloalkil, –(C₅–C₈)cikloalkenil, –fenil, –(3- do 5-člani)heterocikl, –C(halo)₃, –CH(halo)₂, –CH₂(halo), –CN, –OH, –halo, –N₃, –NO₂, –N(R₇)₂, –CH=NR₇, –NR₇OH, –OR₇, –COR₇, –C(O)OR₇, –OC(O)R₇, –OC(O)OR₇, –SR₇, –S(O)R₇, ili –S(O)₂R₇; svaki R-je nezavisno –H, –(C₁–C₆)alkil, –(C₂–C₆)alkenil, –(C₂–C₆)alkinil, –(C₃–C₈)cikloalkil, –(C₅–C₈)cikloalkenil, –fenil, –(3- do 5-člani)heterocikl, –C(halo)₃, –CH(halo)₂, ili –CH₂(halo); svaki R₈ je nezavisno –(C₁–C₆)alkyl, –(C₂–C₆)alkenil, –(C₂–C₆)alkinil, –(C₃–C₈)cikloalkil, –(C₅–C₈)cikloalkenil, –fenil, –(3- do 5-člani)heterocikl, –C(halo)₃, –CH(halo)₂, –CH₂(halo), –CN, –OH, –halo, –N₃, –NO₂, –N(R₇)₂, –CH=NR₇, –NR₇OH, –OR₇, –COR₇, –C(O)OR₇, –OC(O)R₇, –OC(O)OR₇, –SR₇, –S(O)R₇, ili –S(O)₂R₇; svaki halo je nezavisno –F, –Cl, –Br, ili –I:

m je cijeli broj u opsegu od 0 do 2:

n je cijeli broj u opsegu od 0 do 3:

p je cijeli broj u opsegu od 0 do 2;

q je cijeli broj u opsegu od 0 do 6;

r je cijeli broj u opsegu od 0 do 5; i

s je cijeli broj u opsegu od 0 do 4.

Patent sadrži još 10 patentnih zahtjeva.

(51) **A61K 31/565**
A61P 15/00
A61K 31/57
A61P 15/18

(11) **01056**
(21) **P-171/09**

(30) 05022324.7 13.10.2005

(96) 05022324.7 13.10.2005

(97) EP 1787649 11.03.2009. 2009/11 DE

(54) (ME) **UPOTREBA ESTRADIOLVALERATA I DIENOGESTA ZA ORALNO LIJEČENJE DISFUNKCIONALNOG UTERINOG KRVARENJA U KONTRACENCIJSKOM METODU**

(EN) USE OF ESTRADIOLVALERATE AND DIENOGEST FOR ORAL TREATMENT OF DYSFUNCTIONAL UTERINE BLEEDING IN A CONTRACEPTIVE METHOD

(73) BAYER PHARMA AKTIENGESELLSCHAFT; Müllerstrasse 178, 13353 Berlin (DE)

(72) Zeun, Susan; Tunnelstr. 36b, 10245 Berlin (DE)

Boudes, Pol; 10 Setting Sun Drive, Hackettstown, NJ 07840 (US)

Endrikat, Jan; 2 Chianti, Kirkland, H9H 5B5 Québec (CA)

Secci, Angelo; 12 Kearny Court, Parsippany, NJ 07054 (US)

Zimmermann, Holger; Lessingallee 3a, 14612 Falkensee (DE)

(74) Radulović Božidar, Jovana Tomaševića 9/III-1, Podgorica (ME)

(57) Primjena estradiolvalerata u kombinaciji sa 17 α -cijanometil-17- β -hidroksiestra-4,9-dien-3-on (dienogest), naznačena time da sadržava prvu fazu sa 2 jedinice dnevne doze estradiolvalerata do 3 mg, drugu fazu sa 2 grupe jedinice dnevne doze, pri čemu prva grupa sadržava 5 jedinica dnevne doze kombinacije 2 mg estradiolvalerata i 2 mg dienogesta, i druga grupa sadržava 17 jedinica dnevne doze kombinacije 2 mg estradiolvalerata i 3 mg dienogesta, trecu fazu sa 2 jedinice dnevne doze sa 1 mg estradiolvalerata i jednu dodatnu fazu sa 2 jedinice dnevne doze farmaceutski neškodljivog placeba za izradu višefaznog kombinovanog preparata sa ukupnim brojem od 28 jedinica dnevne doze za oralnu terapiju disfunkcionalnog uterinog krvarenja, gdje se podrazumjeva menstrualno krvarenje duže od 7 dana, zajedno sa oralnom kontracepcijom.

(51) **H02G 3/04**

(11) **01057**

(21) **P-205/09**

(30) 202004018974 U 08.12.2004 DE

(96) 05025849.0 26.11.2005.

(97) EP 1670110 10.12.2008. 2008/50 DE

(54) (ME) **KRAJNJA PLOČA ZA KANALE ZA VOĐENJE VODOVA**

(EN) END PLATE FOR CABLE CONDUITS

(73) Tehalit GmbH; Seebergstrasse 37, 67716 Heltersberg (DE)

(72) Eberle, Patrick; Turnerstrasse 19, 66292 Riegelsberg (DE)

(74) Lutovac Branislav, Bulevar Crnojevića 93, Podgorica (ME)

(57) Krajnja ploča za bočno zatvaranje kanala za vođenje vodova različitih širina i/ili visina, naznačena time, što ima pet pojedinačnih elemenata (10, 20, 30, 40, 50) sa po jednom ravnom pločom (11, 21, 31, 41, 51) je jedna od ploča osnovna ploča (10) sa jednom klem-lajsnom (17), koja odgovara kanalu za vođenje vodova i dva-para od po četiri otvora (15), -su dve ploče ugaone ploče (30, 50) sa uglastom ivicom (33,53) i po jednim parom čepova (32, 52) koji odgovaraju otvorima (15) u osnovnoj ploči (10), su dve ploče međuploče (20, 40) sa -jednom čeonom ivicom (23, 43)-i jednim čepom (22, 42) koji odgovara otvorima (15) u osnovnoj ploči (10), po jedna među ploča (40) i jedna ugaona ploča (50) imaju produžetak (41', 51') ravne ploče (41, 51), produžetak (41') međuploče (40) nosi jedan čep (44) koji odgovara otvorima (15) u osnovnoj ploči (10), i jedan otvor (45) koji odgovara čepu (45) druge međuploče (20), - produžetak (51') ugaone ploče (50) nosi -jedan par čepova (54) koji odgovaraju otvorima (15) u osnovnoj ploči (10), i jedan par otvora (55) koji odgovaraju čepovima (32) druge ugaone ploče (30),

Patent sadrži još 4 patentna zahtjeva.

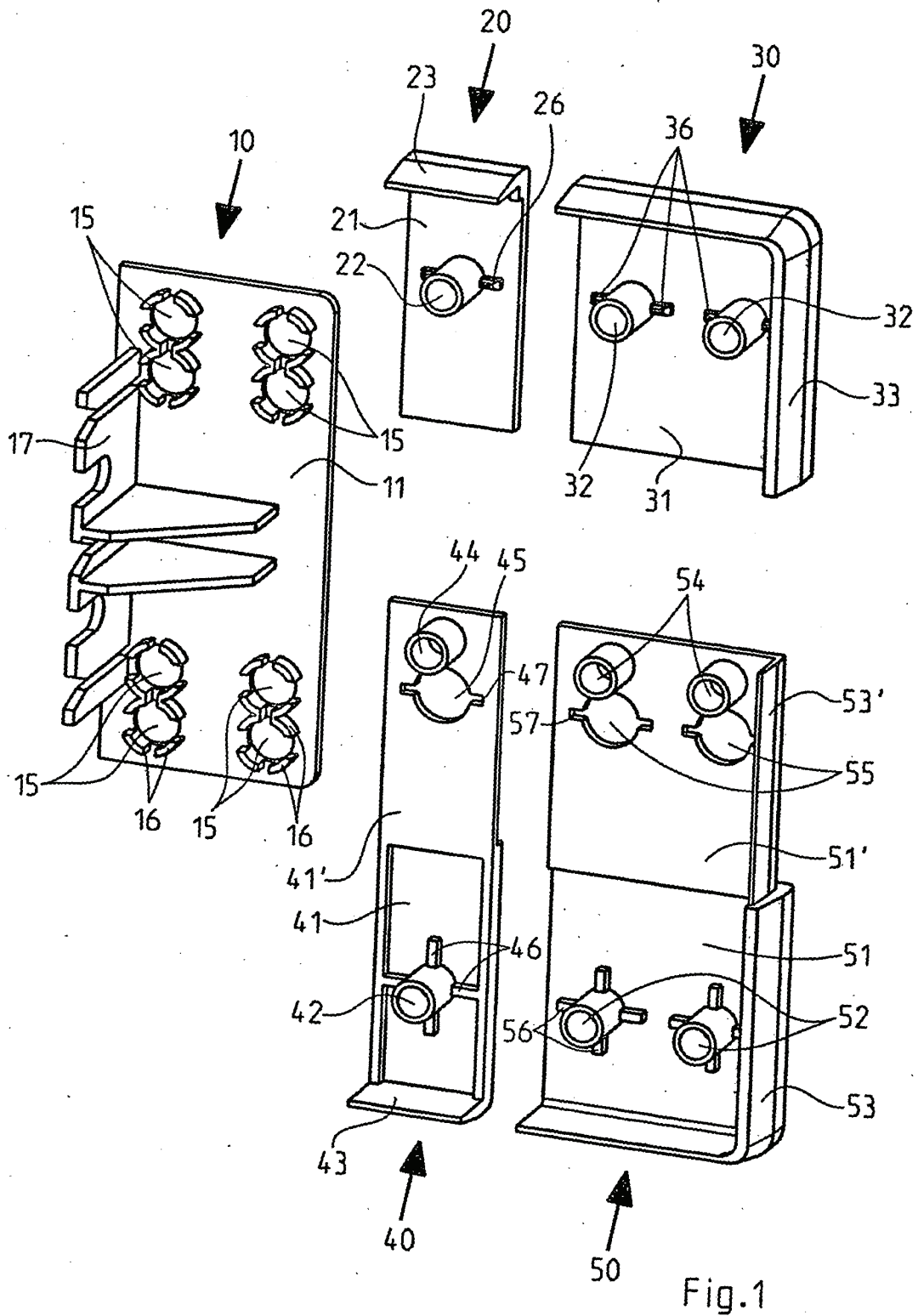
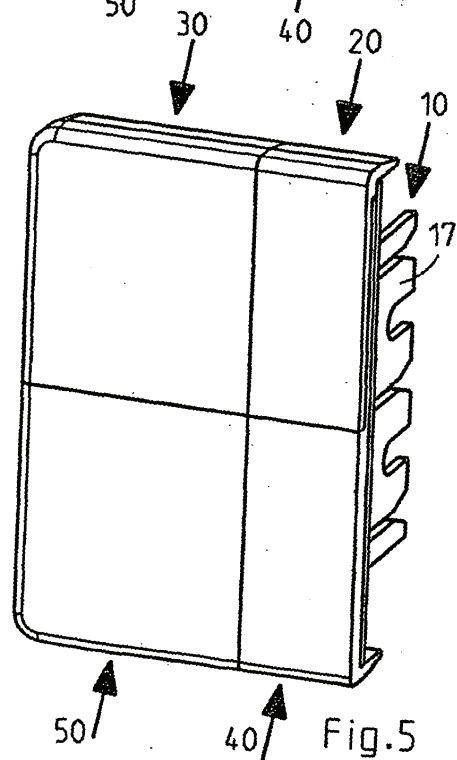
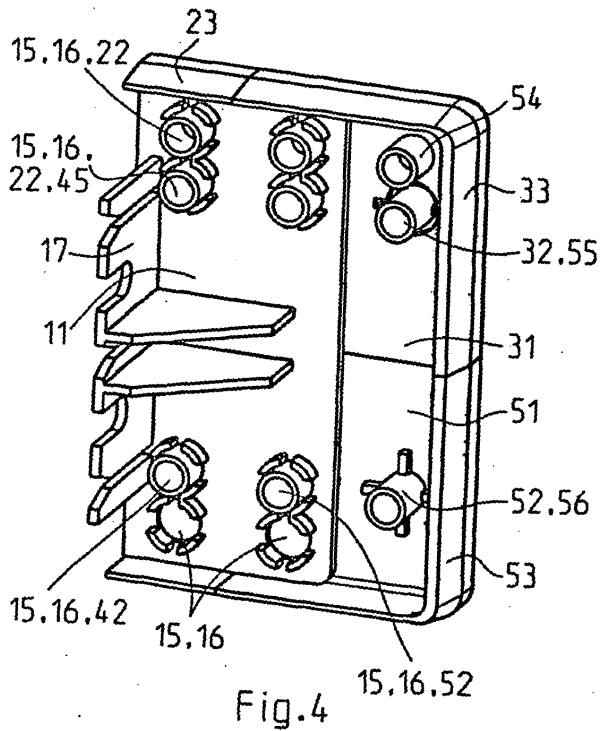
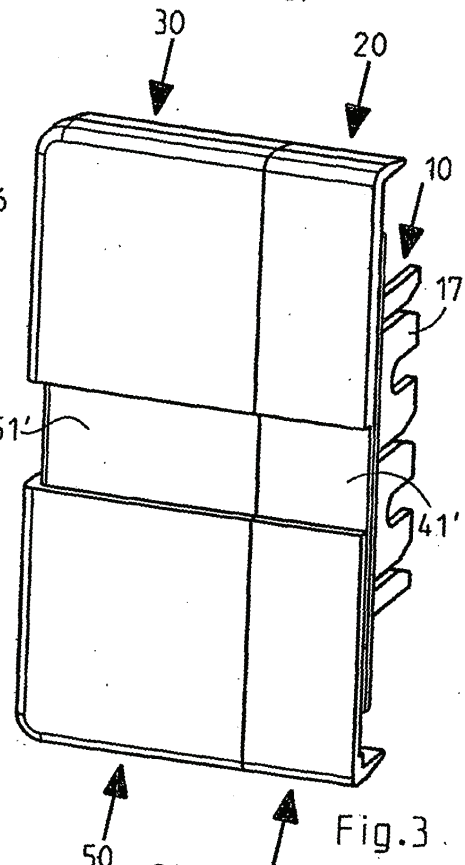
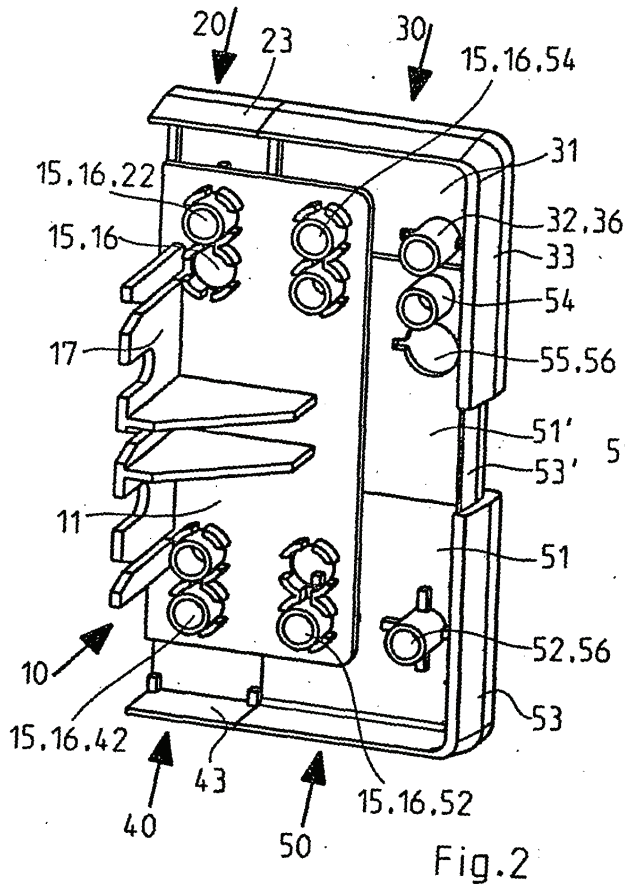

Fig.1



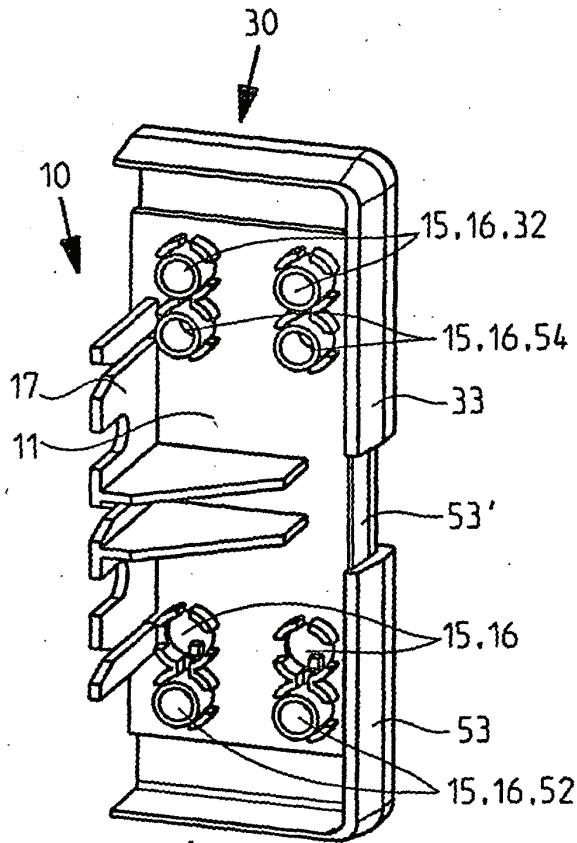

Fig. 6

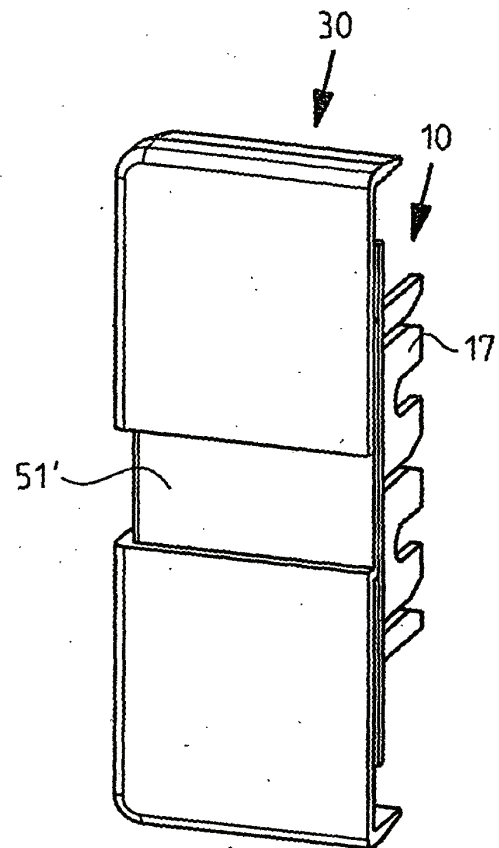

Fig. 7

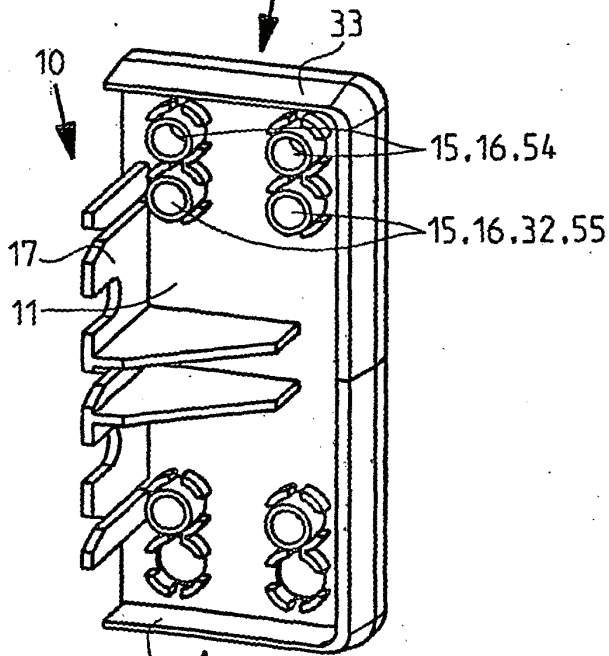

Fig. 8

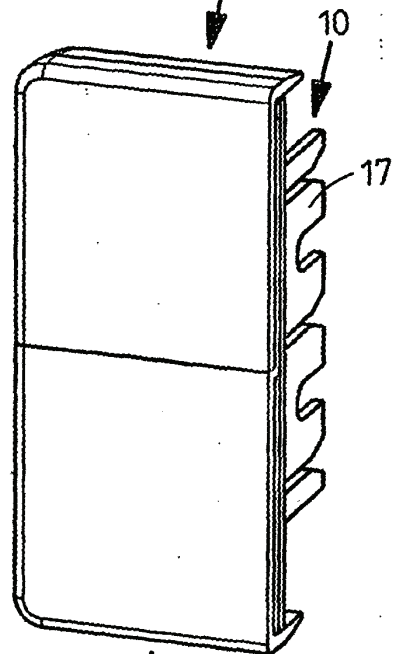

Fig. 9

(51) C07D 403/12

(11) 01058

(21) P-264/09

(30) 04077171 28.07.2004. EP
592357 29.07.2004. US

(86) PCT/EP2005/053611 25.07.2005.

(87) WO 2005/010749 02.02.2006.

(96) 05777776.5 25.07.2005.

(97) EP 1776358 27.05.2009. 2009/22 En

(54) (ME) **SUPSTITUISANI DERIVATI PROPENIL PIPERAZINA KAO NOVI INHIBITORI HISTONSKE DEACETILAZE**

(EN) SUBSTITUTED PROPENYL PIPERAZINE DERIVATIVES AS NOVEL INHIBITORS OF HISTONE DEACETYLASE

(73) Janssen Pharmaceutica NV; Turnhoutseweg 30, 2340 Beerse (BE)

(72) VAN BRANDT, Sven F. A., Janssen Pharmaceutica N.V. Turnhoutseweg 30, B-2340 Beerse (BE)

VAN EMELLEN, Kristof, Janssen Pharmaceutica N.V. Turnhoutseweg 30, B-2340 Beerse (BE)

ANGIBAUD, Patrick R, Janssen-Cilag, Campus de Maigremont BP 615, F-27106 Val De Reuil Cedex (FR)

MARCONNET-DECRANE, Laurence, F. B., Janssen-Cilag Campus de Maigremont BP 615, F-27106 Val de Reuil Cedex (FR)

ARTS, Janine, Janssen Pharmaceutica N.V.; Turnhoutseweg 30, B-2340 Beerse (BE)

(74) Radulović Božidar, Jovana Tomaševića 9/III-1, Podgorica (ME)

(57) Jedinjenje sa formulom (I).

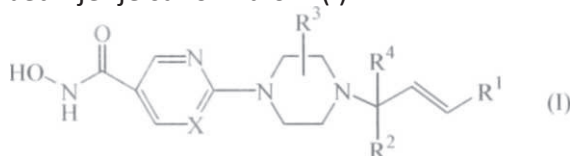

N'-oksidne forme, njegove farmaceutski prihvatljive adicijske soli i stereohemijske izomerne forme, naznačeno time, da svaki X je nezavisno N ili CH; R^1 je fenil, naftalenil ili heterociklil; gdje svaki od pomenutih fenila ili naftalenila ponekad je supstituisan sa jednim ili dva supstituenta svaki nezavisno izabran među halo, C_{1-6} alkila, C_{1-6} alkiloksi, polihalo C_{1-6} alkila, arila, hidroksi, cijano, amino, C_{1-6} alkilkarbonilamino, C_{1-6} alkilsulfonilamino, hidroksikarbonila, C_{1-6} alkiloksikarbonila, hidroksi C_{1-6} alkila, C_{1-6} alkiloksimetila, aminometila, C_{1-6} alkilaminometila, C_{1-6} alkilkarbonilaminometila, C_{1-6} alkilsulfonilaminometila, aminosulfonila, C_{1-6} alkilaminosulfonila ili heterociklila; R^2 je vodonik, $-CH_2-R^5$, triflorometil, $-C(=O)-R^6$ ili $-CH_2-NR^7R^8$; gde svaki R^5 je nezavisno izabran iz vodonika, hidroksi, C_{1-6} alkoksi, C_{1-6} alkiloksi C_{1-6} alkiloksi, C_{1-6} alkilkarboniloksi, piperazinila, N-metilpiperazinila, morfolinila, tiomorfolinila, imidazolila ili triazolila; svaki R^6 je nezavisno izabran među hidroksi, C_{1-6} alkiloksi, amino ili mono- ili di(C_{1-6} alkil)amino, C_{1-6} cikloalkilamino, hidroksi C_{1-6} alkilamino, piperazinila, mono- ili di(C_{1-6} alkil)amino C_{1-6} alkilamino N-metilpiperazinila, morfolinila ili tiomorfolinila: svaki R^7 i R^8 su nezavisno izabrani među vodonika, C_{1-6} alkila, C_{1-6} alkilkarbonila, C_{1-6} alkilsulfonila ili mono- ili di (C_{1-4} alkil)aminosulfonila; R^3 je vodonik, hidroksimetil, aminometil ili mono- ili di(C_{1-6} alkil) aminometil; R^4 je vodonik ili C_{1-6} alkil; aril u gornjem fenilu ili naftalenilu; gdje svaki pomenuti fenil ili naftalenil je ponekad supstituisan sa jednim ili dva supstituenta svaki neovisno izabran među halo, C_{1-6} alkila, C_{1-6} alkoksi, trifluorometila, cijano ili hidroksikarbonila; i gore pomenuti heterociklil je furanil, tienil, pirolil, pirolinil, pirolidinil, dioksolil, oksazolil, tiazolil, imidazolil, imidazolidinil, pirazolil, pirazolinil, pirazolidinil, izoksazolil, izotiazolil, oksadiazolil, triazolil, tiadiazolil, piranil, piridinil, piperidinil, dioksanil, morfolinil, ditanil, tiomorfolinil, piradizinil,

pirimidinil, pirazinil, piperazinil, triazinil, tritianil, indolizinil, indolil, indolinil, benzofuranil, benzotifenil, indazolil, benzimidazolil, bentatiazolil, purinil, kinolizinil, kinolinil, cinolinil, ftlazilil, kinazolinil, kinoksalinil ili naftiridinil: gdje svaki pomenuti heterocikal je ponekad supstituisan sa jednim ili više supstituenata svaki nezavisno izabran među halo, C₁₋₆ alkila, C₁₋₆ alkoksi, C₁₋₆ alkiloksi, cijano, amino, mono- ili di(C₁₋₄ alkil)amino. Patent sadrži još 11 patentnih zahtjeva.

(51) **C07D 493/04**(11) **01059**(21) **P-274/09**

(30) 03104949 23.12.2003. EP

568183 04.05.2004. US

(86) PCT/EP2004/053692 23.12.2004.

(87) WO 2005/063770 14.07.2005.

(96) 04805020.7 23.12.2004

(97) EP 1725566 17.06.2009. 2009/25 En

(54) (ME) **PROCES ZA PRIPREMANJE (3R,3AS,6AR)-HEKSAHIDROFURO [2,3-B] FURAN-3-IL (1S,2R)-3-[[(4-AMINOFENIL) SULFONIL] (IZOBUTIL) AMINO]-1-BENZIL-2-IDROKSIPROPILKARBAMATA**

(EN) **PROCESS FOR THE PREPARATION OF (3R,3AS,6AR)-HEXAHYDROFURO [2,3-B] FURAN-3-YL (1S,2R)-3-[[(4-AMINOPHENYL) SULFONYL] (ISOBUTYL) AMINO]-1-BENZYL-2-HYDROXYPROPYLCARBAMATE**

(73) Tibotec Pharmaceuticals; Eastgate Village Eastgate Little Island, Co Cork (IE)

(72) GOYVAERTS, Nicolaas, Martha, Felix; Welvaartstraat 69 B-2590 Berlaar (BE)

WIGERINCK, Piet, Tom, Bert, Paul; Kardinaal Cardijnstraat 29 B-2840 Terhagen (BE)

ZINSER, Hartmut, Burghard; J.J. Wepferstrasse 5, CH-8200 Schaffhausen (CH)

EBERT, Birgit, M.; Hochstrasse 311; CH-8200 Schaffhausen (CH)

(74) Radulović Božidar, Jovana Tomaševića 9/III-1, Podgorica (ME)

(57) Proces za pripremanje jedinjenja sa formulom (6)

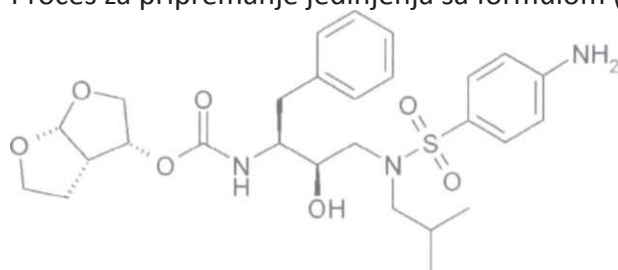

njegovih adicijskih soli, polimornih i/ili pseudopolimornih formi, naznačen time, da pomenuti proces obuhvata korake:

(i) uvođenja izobutilamino grupe u jedinjenje sa formulom (1');

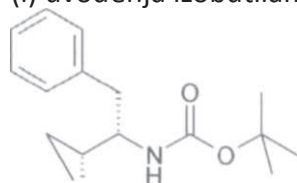

sa ciljem dobijanja jedinjenja formulom

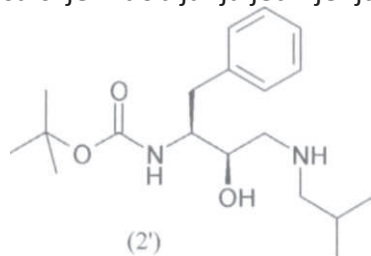

(ii) uvođenja p-nitrofenilsulfonilne grupe u jedinjenje sa formulom (2') sa ciljem da se dobije jedinjenje sa formulom (3');

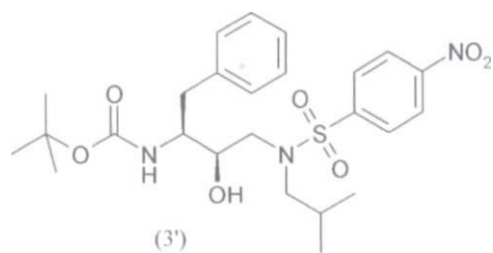

(iii) reduciranja nitro ostatka iz jedinjenja sa formulom (3') sa ciljem da se dobije jedinjenje sa formulom (4');

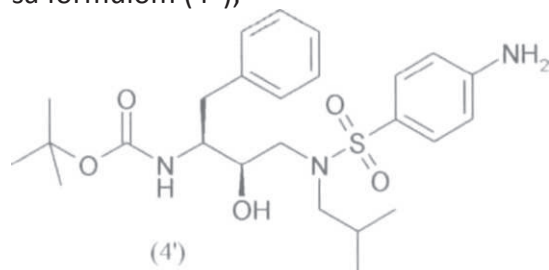

(iv) otklanjanja zaštite sa jedinjenja sa formulom (4') sa ciljem da se dobije jedinjenje sa formulom (5);

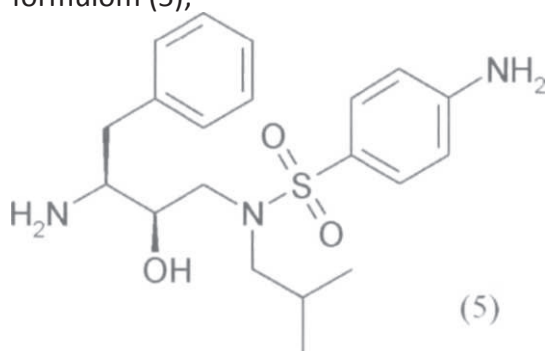

spajanja jedinjenja sa formulom (5) sa derivatom (3R,3aS,6aR)-heksahidrofuro [2,3-b] furan-3-il, koji je dobiven aktivisanjem (3R,3aS,6aR)heksahidrofuro [2,3-b] furan-3-ol ili njegovih prekursora uz pomoc karbamoilcije uz korišćenje agensa za spajanje sa ciljem dobivanja jedinjenja sa formulom (6) gde pomenuti prekursor (3R, 3aS, 6aR)heksahidrofuro [2, 3-b] furan-3-ol obuhvata jedinjenja gde kiseonik iz alkoholne funkcije je zašćen sa O-zastitnim grupama, izabranima iz t-butil etera, acetata, benzilnih grupa, benzilnih etera, allila, silil zaštitnih grupa, alkoksialkilnih grupa tetrahidropiranila.

Patent sadži još 13 patentnih zahtjeva.

- (51) **C07D 401/14**
C07D 405/14
C07D 409/14
A61K 31/4439
A61K 31/506
A61P 17/06
A61P 35/00

- (11) **01060**
(21) **P-276/09**

- (30) 06100584 19.01.2006.
(86) PCT/EP2007/050376 16.01.2007
(87) WO 2007/082878 26.07.2007
(96) 07703891.7 16.01.2007
(97) EP 1981874 27.05.2009 2009/22 En
(54) (ME) **DERIVATI AMINOFENILA KAO NOVI INHIBITORI HISTON DEACETILAZE**
(EN) AMINOPHENYL DERIVATIVES AS NOVEL INHIBITORS OF HISTONE DEACETYLASE
(73) Janssen Pharmaceutica N.V.; Turnhoutseweg 30, 2340 Beerse (BE)
(72) 01/ ANGIBAUD, Patrick, René Johnson & Johnson Pharmaceutical Research and Development; Division of Janssen-Cilag Campus De Maigremont BP 615 F-27106 Val de Reuil Cedex (FR)
02/ PILATTE, Isabelle, Noëlle, Constance Johnson & Johnson Pharmaceutical Research and Development; Division of Janssen-Cilag Campus De Maigremont BP 615 F-27106 Val de Reuil Cedex (FR)
03/ ROUX, Bruno Johnson & Johnson Pharmaceutical Research and Development; Division of Janssen-Cilag Campus De Maigremont BP 615 F-27106 Val de Reuil Cedex (FR)
04/ ARTS, Janine Janssen Pharmaceutica N.V. Turnhoutseweg 30 B-2340 Beerse (BE)
(74) Radulović Božidar, Jovana Tomaševića 9/III-1, Podgorica (ME)
(57) Jedinjenje sa formulom (I),

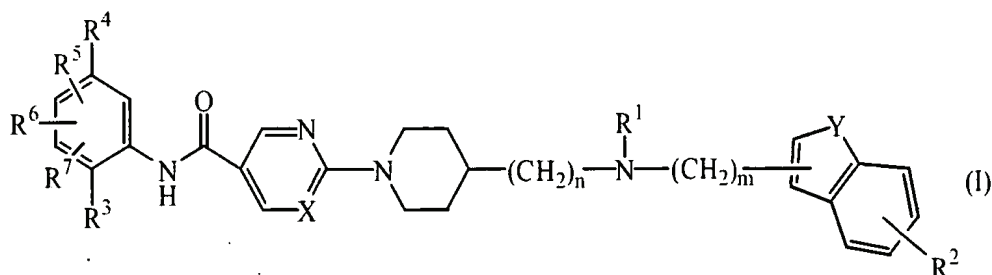

N-oksidne forme, njegove farmaceutski prihvatljive adicijske soli i stereohemijske izomerne forme, naznačeno time, da n je cijeli broj sa vrijednošću 0, 1 ili 2 i kada je n jednak 0 naznačena je direktna veza; m je cijeli broj sa vrednošću 1 ili 2; X je N ili CH; Y je O, S ili NR⁸; u čemu R⁸ je vodonik, C₁₋₆alkil, C₁₋₆alkiloksiC₁₋₆alkil, C₃₋₆cikloalkil, C₃₋₆cikloalkilmetil, fenil C₁₋₆alkil, -C(=O)-CHR⁹R¹⁰ ili -S(=O)₂-N(CH₃)₂; u čemu svaki je R⁹ i R¹⁰ nezavisno vodonik, amino, C₁₋₆alkil ili amino C₁₋₆alkil; i kada je Y jest NR⁸ i R² na poziciji 7- ili je indolil, tada R² i R⁸ mogu zajedno da formiraju bivalentni radikal

-(CH₂)₂- (a-1), ili

-(CH₂)₃- (a-2);

R¹ je vodonik, C₁₋₆alkil, hidroksi C₁₋₆alkil, cijanoC₁₋₆alkil, C₁₋₆alkilsulfonyl, C₁₋₆alkilkarbonil ili mono- ili di(C₁₋₆alkil)aminosulfonyl; R² je vodonik, hidroksi, amino, halo, C₁₋₆alkil, cijano, C₂₋₆alkenil, polihaloC₁₋₆alkil, nitro, fenil, C₁₋₆alkilkarbonil, hidroksikarbonil, C₁₋₆alkilkarbonilamino, C₁₋₆alkiloksi ili mono-ili di(C₁₋₆alkil)amino; R³ je hidroksi ili amino; R⁴ je vodonik, tienil, furanil ili fenil i svaki tienil, furanil ili fenil može po izboru da se supstituiše

sa halo, amino, nitro, cijano, hidroksi, fenil, C₁₋₆ alkil, (di C₁₋₆ alkil)amino, C₁₋₆ alkiloksi, fenilC₁₋₆ alkiloksi, hidroksi C₁₋₆ alkil, C₁₋₆ alkiloksikarbonil, hidroksikarbonil, C₁₋₆ alkilkarbonil, polihaloC₁₋₆ alkiloksi, polihaloC₁₋₆ alkil, C₁₋₆ alkilsulfonil, hidroksikarbonilC₁₋₆ alkil, C₁₋₆ alkilkarbonilamino, aminosulfonil, aminosulfonil C₁₋₆ alkil, izoksazolil, aminokarbonil, fenilC₂₋₆ alkenil, fenilC₃₋₆ alkinil ili piridinilC₆ alkinil; R, R⁶ i R⁷ su svaki nezavisno vodonik, amino, nitro, furanil, halo, C₁₋₆ alkil, C₁₋₆ alkiloksi, trifluorometil, tienil, fenil, C₁₋₆ alkilkarbonilamino, aminokarbonil C₁₋₆ alkil ili -C=C-CH₂-R¹¹.

Patent sadrži još 9 patentnih zahtjeva.

(51) **C07D 403/14**

(11) **01061**

(21) **P-289/09**

(30) 570300 P 12.05.2004 US

664305 P 21.03.2005 US

(86) PCT/IB2005/001194 29.04.2005.

(87) WO 2005/116014 08.12.2005.

(96) 05733750.3 29.04.2005

(97) EP 1753748 29.07.2009. 2009/31 En

(54) (ME) **DERIVATI PROLINA I NJIHOVA UPOTREBA KAO INHIBITORA DIPEPTIDIL PEPTIDAZE IV**

(EN) PROLINE DERIVATIVES AND THEIR USE AS DIPEPTIDYL PEPTIDASE IV INHIBITORS

(73) Pfizer Products Inc.; Eastern Point Road, Groton, CT 06340 (US)

(72) HULIN, Bernard; Pfizer Global Research & Dev. Eastern Point Road, Groton, CT 06340 (US)

PIOTROWSKI, David, Walter; Pfizer Global Research & Dev. Eastern Point Road, Groton, CT 06340 (US)

(74) Ćupić Branislav, Dalmatinska 10, Podgorica (ME)

(57) Jedinjenje koje predstavlja (3,3-difluoropirolidin-1-il)-((2S,4S)-4-(4-(pirimidin-2-il) piperazin-1-il)pirolidin-2-il)metanon, ili njegova farmaceutski prihvatljiva so.

Patent sadrži još 6 patentnih zahtjeva.

- (51) **C22C 38/18**
C22C 38/20
C22C 38/24
C22C 38/28
C22C 38/40
C21D 9/02
- (11) **01062**
(21) **P-344/09**
- (30) 0512775 15.12.2005. DE
(86) PCT/FR2006/002700 11.12.2003.
(87) WO 2007/080256 19.07.2007.
(96) 06841905.0 11.12.2006.
(97) EP 1966407 07.10.2009. 2009/41 Fr
- (54) **ME) ČELIK ZA OPRUGE, POSTUPAK PROIZVODNJE ČELIKA ZA PROIZVODNJU OPRUGA, I OPRUGE NAPRAVLJENE OD OVOG ČELIKA**
(EN) SPRING STEEL, METHOD FOR PRODUCING A SPRING USING SAID STEEL AND A SPRING MADE FROM SUCH STEEL
- (73) ASCOMETAL; 8 Avenue De L'arche Faubourg De L'arche, 92400 Courbevoie (FR)
(72) YOSHIHARA, Nao; 7-3-1 Takamari Tarumi-ku Kobe- Hyogo, 655- 0016 (JP)
KAWATA, Kazuhisa; 9-10 Mondo-Okada-Cho - Nishinomiya-Hyogo, 662-0826 (JP)
MOUGIN, Julie; 13 les Jardins du Grésivaudan 566 Avenue Du Granier F-38530 Pontcharra (FR)
LANGUILLAUME, Jacques; 807 Bis Le Pré Raz F-73110 Arvillard (FR)
- (74) Lutovac Branislav, Bulevar Crnojevića 93, Podgorica (ME)
- (57) Čelik za opruge postojan na veće zamore na vazduhu i koroziione zamore i sa visokom otpornošću na ciklično omekšavanje, ima sastav u težinskim procentima:
C=0,45-0,70%
Si=1,65 - 2,50%
Mn = 0,20 - 0,75%
Cr = 0,60 - 2%
Ni = 0,15 - 1%
Mo = u tragovima - 1%
V = 0,003 - 0,8%
Cu = 0,10 - 1%
Ti = 0,020 -0,2%
Nb = u tragovima - 0,2%
Al = 0,002 - 0,050%
P = u tragovima - 0,015%
S = u tragovima - 0,015%
O = u tragovima - 0,0020%
N = 0,0020 - 0,0110%
ostatak su gvožđe i nečistoće nastale pri dobijanju i čiji je sadržaj ugljeničnog ekvivalenta Ceq , izracunat po formuli
 $Ceq\% = [C\%] + 0,12 [Si\%] + 0,17 [Mn\%] - 0,1 [Ni\%] + 0,13[Cr\%] - 0,24[V\%]$
i zmeđu je 0,80 i 1,00%, čija tvrdoća, posle kaljenja i opuštanja je veća ili ravna 55HRC, maksimalna veličina Ti nitrida i karbonitrida posmatrana na $1,5 \pm 0,5$ mm površine šipke, ili žice, komada metala ili opruge na 100 mm² površine preseka manja ili ravna 20pm, a ta veličina je kvadratni korijen površine inkluzija posmatranih kao kvadrati.
Patent sadrži još 4 patentna zahtjeva.

- (51) **C22C 38/18**
C22C 38/20
C22C 38/24
C22C 38/28
C22C 38/40
C21D 9/02
- (11) **01063**
(21) **P-347/09**
- (30) 0560453 P 08.04.2004. US
(86) PCT/US2005/011873 08.04.2005.
(87) WO 2005/100381 27.10.2005.
(96) 05735068.8 08.04.2005.
(97) EP 1735345 17.06.2009. 2009/25 En
- (54) (ME) **POSTUPAK ZA DOBIJANJE EPTIFIBATIDA I ODGOVARAJUĆIH INTERMEDIJERNIH JEDINJENJA**
(EN) PROCESSES FOR PREPARING EPTIFIBATIDE AND PERTINENT INTERMEDIATE COMPOUNDS
- (73) MILLENNIUM PHARMACEUTICALS, INC.; 40 Landsdowne Street Cambridge, MA 02139 (US)
- (72) HO,Guojie; 33 Grindstone Lane Sudury, MA 01776 /(US)
AONE, Antoinette, D.; 9 Apollo Circle Lexington, MA 02421 (US)
FORNI, Luciano; Chemin du Foriest B-1420 Braine-l'Alleud (BE)
DETOLLENAERE, Catherine, Chemin du Foriest B-1420 Braine-l'Alleud (BE)
- (74) Lutovac Branislav, Bulevar Crnojevića 93, Podgorica (ME)
- (57) Postupak koji obuhvata:
• dobijanje jedinjenja formule II

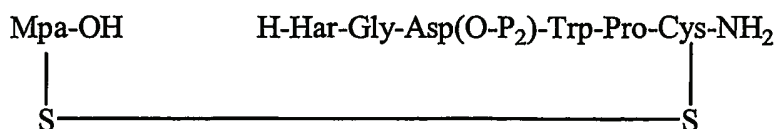

(II)

u kojoj Har je homoarginil; Gly je glicil; Asp je asparagil; Trp je triptofanil; Pro je prolil; Cys-NH₂ je cisteinamid; Mpa je merkaptopropionska kiselina; i P₂ je karboksilna zaštitna grupa i kuplovanje Har i Mpa ostataka da bi se dobilo jedinjenje formule III

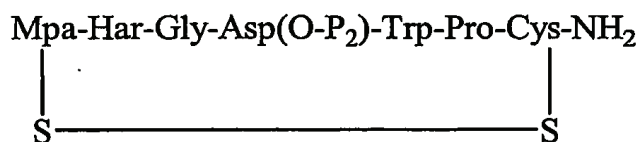

(III)

Patent sadrži još 32 patentna zahtjeva.

- (51) **A61K 31/485**
A61K 9/32
A61K 9/22
- (30) 840244 P 25.08.2006. US
(96) 07114982.7 24.08.2007.
(97) EP 1897545 30.09.2009. 2009/40 En
- (54) (ME) **FARMACEUTSKI DOZNI OBLICI REZISTENTNI NA ZLOUPOTREBU KOJI SADRŽE OPIOIDNI ANALGETIK**
(EN) TAMPER RESISTANT ORAL PHARMACEUTICAL DOSAGE FORMS COMPRISING AN OPIOID ANALGESIC
- (73) PURDUE PHARMA LP; One Stamford Forum 201 Tresser Boulevard, Stamford, CT 06901 (US)
- (72) Mannion, Richard Owen; 3860 Green Ridge Road, Furlong, PA 18925 (US)
O'Donnell, Edward Patrick; 38 Chestnut Court, Basking Ridge, NJ 07920 (US)
McKenna, William Henry; 10 Longmeadow Road, Yonkers, NY 10704 (US)
Huang, Haiyong Hugh; 33 Ketley Place, Princeton, NJ 08540 (US)
- (74) Lutovac Branislav, Bulevar Crnojevića 93, Podgorica (ME)
- (57) Proces za dobijanje čvrstog oralnog farmaceutskog oblika za doziranje sa produženim oslobađanjem, naznačen time, što se sastoji najmanje od koraka:
(a) kombinovanja bar
(1) najmanje jednog polietilen-oksida, koji na osnovu reoloških merenja ima morarnu masu od najmanje 1,000,000, i
(2) najmanje jednog aktivnog agensa, formirajući kompoziciju; oblikovanja ove kompozicije, formiranjem formulacije matrice za produženo oslobađanje; i očvršćavanja pomenute formulacije matrice za produženo oslobađanje, koje se sastoji najmanje od koraka očvršćavanja, podvrgavanjem formulacije matrice za produženo oslobađanje temperaturi koja je najmanje jednaka temperaturi omekšavanja pomenutog polietilen-oksida, tokom perioda vremena od najmanje oko 1 min.
Patent sadrži još 58 patentnih zahtjeva.

- (51) **A61K 31/47**
A61K 31/4709
C07D 215/14
C07D 215/22
C07D 215/38
C07D 401/04
C07D 401/06
C07D 401/12
C07D 401/14
C07D 405/04
C07D 405/06
C07D 405/12
C07D 405/14
C07D 409/04
C07D 409/14

- (11) **01065**
(21) **P-351/09**

- (30) 38907 P 23.01.2004. US
(86) PCT/EP2005/050271 21.01.2005
(87) WO 2005/070430 04.08.2005
(96) 05701589.3 21.01.2005
(97) EP 1711181 30.09.2009 2009/40 En

- (54) (ME) **DERIVATI KVINOLINA I NJIHOVA UPOTREBA KAO MIKOBAKTERIJSKIH INHIBITORA**

(EN) QUINOLINE DERIVATIVES AND USE THEREOF AS MYCOBACTERIAL INHIBITORS

- (73) Janssen Pharmaceutica N.V.; Turnhoutseweg 30, 2340 Beerse (BE)
(72) GUILLEMONT, J. E. G.; Johnson & Johnson R & D; Campus de Maigremon, BP 615, 27106 Val-de-Reuil Cedex (FR)
PASQUIER, E. T. J. Johnson & Johnson R & D; Campus de Maigremon, BP 615, 27106 Val-de-Reuil Cedex (FR)
LANCOIS, D. F. A.; Johnson & Johnson R & D; Campus de Maigremon, BP 615, 27106 Val-de-Reuil Cedex (FR)
(74) Radulović Božidar, Jovana Tomaševića 9/III-1, Podgorica (ME)
(57) Jedinjenje prema opštoj Formuli (Ia) ili opštoj Formuli (Ib)

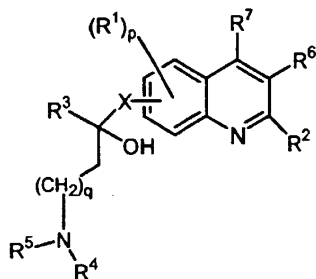

(Ia)

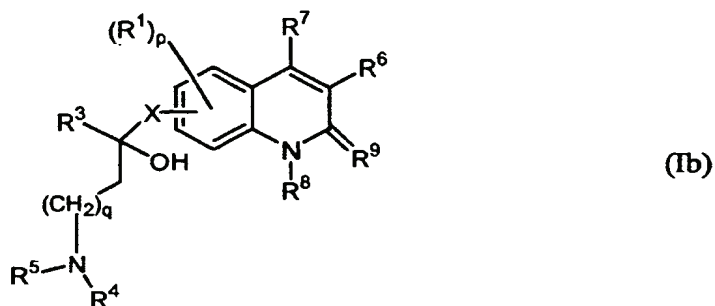

farmaceutski prihvatljive kisjele ili bazične adicione soli od toga, kvaterne amine od toga, stereoemijski izomerne forme od toga, tautomerne forme od toga i N-oksidne forme od toga, naznačeni time da:

R¹ je vodonik, halo, haloalkil, cijano, hidroksi, Ar, Het, alkil, alkiloksi, Alkiltio, alkiloksialkil, alkiltioalkil. Ar-alkil ili di(Ar)alkyl; p je cijeli broj jednak 1, 2 ili 3;

R² je vodonik; alkil; hidroksi; tio; alkiloksi po izboru supstituisan sa amino ili

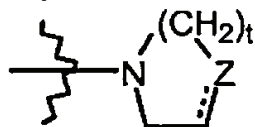

mono ili di(alkil)amino ili radikalom formule u čemu Z jest

CH₂, CH-R¹⁰, O, S, N-R¹⁰ i t je cijeli broj jednak 1 ili 2, i istačkana linija predstavlja vezu po izboru; alkiloksialkiloksi; alkiltio; mono ili di(alkil)amino u

čemu alkil može po izboru da bude supstituisan sa jednim ili dva supstituenta od kojih je svaki nezavisno izabran između alkiloksi ili Ar ili Het

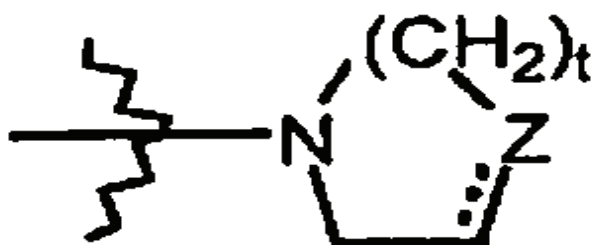

ili morfolinil ili 2-oksopirolidinil; Ar, Het ili radikal formule u čemu Z jest CH₂, CH-R¹⁰, O, S, N-R¹⁰; t je cijeli broj jednak 1 ili 2; i istačkana linija predstavlja vezu po izboru; R³ je alkil, Ar, Ar-alkil, Het ili Het-alkil; q je cijeli broj jednak nuli, 1, 2, 3 ili 4; X je direktna veza ili CH₂; R⁴ i R⁵ svaki nezavisno su vodonik, alkil ili benzil; ili R⁴ i R⁵ zajedno i uključujući N na kojeg su vezani mogu da čine radikal izabran iz grupe koja sadržava pirolidinil, 2H-pirolil, 2-pirolinil, 3-pirolinil, pirolil, imidazolidinil, pirazolidinil, 2-imidazolinil, 2-pirazolinil, imidazolil, pirazolil, triazolil, piperidinil, piridinil, piperazinil, imidazolidinil, piridazinil, pirimidinil, pirazinil, triazinil, morfolinil i tiomorfolinil, svaki od pomenutih prstena po izboru supstituisan sa alkil, halo, haloalkil, hidroksi, alkiloksi, amino, mono-ili dialkilamino, alkiltio, alkiloksi, alkiltioalkil i pirimidinil;

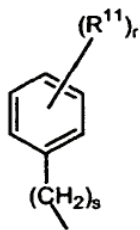

R^6 je vodonik ili radikal formule u čemu s jest celi broj jednak nuli, 1, 3 ili 4; r je cijeli broj jednak 1, 2, 3, 4 ili 5; i R^{11} je vodonik, halo, haloalkil, Hidroksi, Ar, alkyl, alkiloksi, alkiltio, alkiloksialkil, alkiltioalkil, Ar-alkil ili di(Ar)alkil; ili dva susedna R^{11} radikala mogu da se zajedno uzmu da sa fenilnim prstenom na kojeg su vezani čine naftil; R^7 je vodonik, alkil, Ar ili Het; R^8 je vodonik ili alkil; R^9 je okso; R^{10} je vodonik, alkil, hidroksil, aminokarbonil, mono- ili di(alkil)aminokarbonil, Ar, Het, alkil supstituisan sa jednim ili dva Het, alkil supstituisan sa jednim ili dva Ar, Het-C(=O)-, Ar-C(=O)-; alkil je ravan ili račvast zasićeni radikal ugljovodonika koji ima od 1 do 6 atoma ugljenika; ili je ciklički zasićeni radikal ugljovodonika koji ima od 3 do 6 atoma ugljenika; ili je ciklički zasićeni radikal ugljovodonika koji ima od 3 do 6 atoma ugljenika vezan na ravan ili račvasti zasićeni radikal ugljovodonika koji ima od 1 do 6 atoma ugljenika; u čemu svaki atom ugljenika može po izboru da bude supstituisan sa halo, hidroksi, alkiloksi ili okso; Ar je homoprsten izabran iz grupe koja sadržava fenil, naftil, acenaftil, Tetrahidronaftil, svaki po izboru supstituisan sa 1, 2 ili 3 supstituenta, svaki supstituent nezavisno izabran iz grupe koja sadržava hidroksi, halo, cijano, nitro, amino, mono- ili dialkilamino, alkil, haloalkil, alkiloksi, haloalkiloksi, karboksil, alkiloksidikarbonil, alkilkarbonil, aminokarbonil, morfolinil i mono-ili dialkilaminokarbonil; Het je monociklički heteroprsten izabran iz grupe koja sadržava N- fenoksipiperidinil, pirolil, pirazolil, imidazolil, furanil, tienil, oksazolil, izoksazolil, tiazolil, izotiazolil, triazolil, piridinil, pirimidinil, pirazinil i piridazinil; ili bieklični heteroprsten izabran iz grupe koja sadržava kvinolinil, izokvinolinil, 1,2,3,4-tetrahidroizokvinolinil, kvinoksalinil, indolil, indazolil, benzimidazolil, benzoksazolil, benzizoksazolil, benzotiazolil, benzizotiazolil, benzofuranil, benzotienil, 2,3-dihidrobenzo[1,4] dioksinil ili benzol 1,3]dioksolil; svaki monociklički ili biciklički heteroprsten može po izboru da bude supstituisan na atomu ugljenika sa 1, 2 ili 3 supstituenta izabrana iz grupe koja sadržava halo, hidroksi, alkil ili alkiloksi; halo je supstituent izabran iz grupe koja sadržava fluoro, hloro, bromo i jodo i haloalkil je ravan ili račvasti zasićeni radikal ugljovodonika koji ima od 1 do 6 atoma ugljenika ili ciklički zasićeni radikal ugljovodonika koji ima od 3 do 6 atoma ugljenika, u čemu su jedan ili više atoma ugljenika supstituisani sa jednim ili više halo atoma; uz uslov da kada je R^7 vodonik tada pomenuti vodonik može takođe da se zamijeni sa

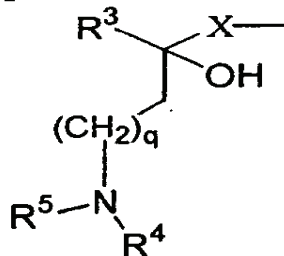

radikalom.

Patent sadrži još 16 patentnih zahtjeva.

- (51) **A61K 31/485**
A61K 9/20
A61P 25/04
- (11) **01066**
(21) **P-352/09**
- (30) 645490 P 18.01.2005. US
(86) PCT/EP2006/050252 17.01.2006.
(87) WO 2006/077212 27.07.2006.
(96) 06700652.8 17.01.2006
(97) EP 1838318 21.10.2009. 2009/43 En
- (54) (ME) **UPOTREBA OKSIKODONA ZA TRETIRANJE VISCERALNOG BOLA**
(EN) USE OF OXYCODONE FOR TREATING VISCERAL PAIN
- (73) EURO-CELTIQUE S.A.; 2, avenue Charles de Gaulle, 1653 Luxembourg (LU)
(72) DREWES, Asbjorn Mohr; Himmelbjergvej 1, Laven , DK-8600 Silkeborg (DK)
NIELSEN, Lars Arendt; M A Schultz Vej 7, DK-9000 Aalborg (DK)
(74) Lutovac Branislav, Bulevar Crnojevića 93, Podgorica (ME)
- (57) Upotreba oksikodona ili neke njegove farmaceutske prihvatljive soli za proizvodnju lijeka za tretiranje visceralnog bola.
Patent sadrži još 19 patentna zahtjeva.

(51) **C07D 403/14**(11) **01067**(21) **P-2010/50**

(30) 581671 P 21.06.2004. US

629034 P 18.11.2004. US

(86) PCT/IB2005/001924 09.06.2005.

(87) WO 2006/000904 05.01.2006.

(96) 05753107.1 09.06.2005

(97) EP 1831154 13.01.2010. 2010/02 En

(54) (ME) **DOBJANJE PREGABALINA I SRODNIH JEDINJENJA**

(ME) PREPARATION OF PREGABALIN AND RELATED COMPOUNDS

(73) Warner-Lambert Company LLC; 235 East 42nd Street, New York, NY 10017 (US)

(72) HU, Shanghai Agouron Pharma., Inc.; A Pfizer Company, 10777 Science Center Drive, CA 92121 (US)

MARTINEZ, Carlos A. Agouron Pharma., Inc.; A Pfizer Company, 10777 Science Center Drive CA 92121 (US)

TAO, Junhua Agouron Pharma., Inc.; A Pfizer Company, 10777 Science Center Drive CA 92121 (US)

TULLY, William E. Pfizer Loughbeg API, Pfizer Loughbeg API, Loughbeg Ringaskiddy, County Cork (IE)

KELLEHER, Patrick G.T. Pfizer Loughbeg API; Pfizer Loughbeg API, Loughbeg Ringaskiddy, County Cork (IE)

DUMOND, Yves R. Pfizer Loughbeg API; Pfizer Loughbeg API, Loughbeg Ringaskiddy, County Cork (IE)

(74) Ćupić Branislav, Dalmatinska 10, Podgorica (ME)

(57) Postupak za dobijanje jedinjenja Formule 1,

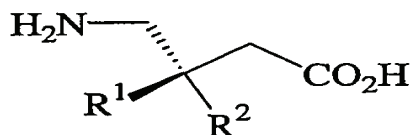

1

ili njegovog farmaceutski prihvatljivog kompleksa, soli, solvata ili hidrata, u kojima R^1 i R^2 su različiti i nezavisno jedan od drugog odabrani od atoma vodonika, C_{1-2} alkila, C_{3-12} cikloalkila i supstituisanog C_{3-12} cikloalkila, postupak se sastoji od:

(a) reakcije jedinjenja Formule 2,

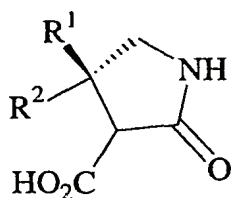

2

ili njegove soli, sa kiselinom i vodom da bi se dobilo jedinjenje Formule 1 ili njegova so; i

(b) po izboru konverzije jedinjenja Formule 1 ili njegove soli u farmaceutski prihvatljiv kompleks, so, solvat ili hidrat, u kojem je R^1 i R^2 u Formuli 2 kao što je definisano za Formulu 1.

Patent sadrži još 12 patentnih zahtjeva.

(51) **C07C323/60**
C07C235/42
C07D213/62
A61P3/10
A61K31/197

(11) **01068**
(21) **P-2010/57**

(30) 579362 P 14.06.2004. US
(86) PCT/US2005/019901 08.06.2005.
(87) WO 2005/123668 29.12.2005.
(96) 05757998.9 08.06.2005.
(97) EP 1758853 20.01.2010. 2010/03 En

(54) (ME) **ANTAGONISTI RECEPTORA ZA GLUKAGON, DOBIJANJE I TERAPEUTSKE UPOTREBE**

(EN) **GLUCAGON RECEPTOR ANTAGONISTS, PREPARATION AND THERAPEUTIC USES**

(73) ELI LILLY & COMPANY; Indianapolis, Indiana 46285 (US)
(72) 01/ CONNER, Scott, Eugene; 8426 Carefree Circle, Indianapolis, IN 46236 (US)
02/ ZHU, Guoxin, 21F, 1 Corporate Avenue, nr. 222, Hu Bin Road, Shanghai, 200021 (CN)
03/ LI, Jianke; 7838 Red Clover Drive Indianapolis, IN 46227 (US)
(74) Čupić Branislav, Dalmatinska 10, Podgorica (ME)
(57) Jedinjenje koje strukturalno predstavlja formula I

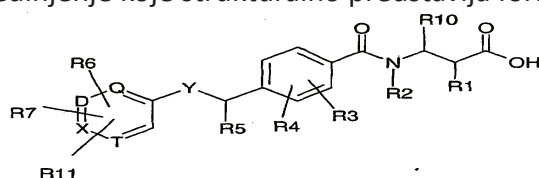

(I)

ili njegova farmaceutski prihvatljiva so, naznačena time, što:

Yje -O- ili -S-; Q, D, X, i T nezavisno predstavljaju ugljenik (supstituisan sa vodonikom ili opcionalnim supstituentima kako je ovde navedeno), ili azot (opcionalno supstituisan sa kiseonikom), pod uslovom da ne više od dva od Q, D, X, i T jesu azot; R1 je -H, -OH, ili -halogen; R2 je -H ili -(C₁-C₃) alkil (opcionalno supstituisan sa 1 do 3 halogena); R3 i R4 su nezavisno -H, -halogen, -CN, -OH, -(C₁-C₇) alkoksi, -(C₁-C₇) alkil (opcionalno supstituisan sa 1 do 3 halogena), ili -(C₂-C₇) alkenil; R5 se bira između -H, -(C₁-C₁₂) alkil (opcionalno supstituisan sa 1 do 3 halogena), -(C₃-C₁₂) cikloalkil, -fenil, -fenil-fenil-(C₁-C₁₂) alkil, -aril, -aril-(C₁-C₁₂) alkil, -heteroaril, -heteroaril-(C₁-C₁₂) alkil, -(C₂-C₁₂) alkenil, -(C₃-C₁₂) cikloalkenil, -heterocikloalkil, -aril-(C₂-C₁₀) alkenil, -heteroaril-(C₂-C₁₀) alkenil, -(C₂-C₁₂) alkinil, -(C₃-C₁₂) cikloalkinil, -aril-(C₂-C₁₂) alkinil, i -heteroaril-(C₂-C₁₂) alkinil, i gde su -(C₁-C₁₂) alkil, -(C₃-C₁₂) cikloalkil, -fenil, -fenil-fenil-(C₁-C₁₂) alkil, -aril, -aril-(C₁-C₁₂) alkil, -heteroaril, -heteroaril-(C₁-C₁₂) alkil, -heterocikloalkil, -(C₂-C₁₂) alkenil, -(C₃-C₁₂) cikloalkenil, -aril-(C₂-C₁₀) alkenil, -heteroaril-(C₂-C₁₀) alkenil, -(C₂-C₁₂) alkinil, -(C₃-C₁₂) cikloalkinil, -aril-(C₂-C₁₂) alkinil, -heteroaril-(C₂-C₁₂) alkinil, su svaki opcionalno supstituisani sa od jednog do tri supstituenta koji se svaki nezavisno bira između -vodonika, -hidroksi, -cijano, -nitro, -halo, -okso, -(C₁-C₇) alkil (opcionalno supstituisan sa 1 do 3 halogena), -(C₁-C₇) alkil-C(O) OR₁₂, -(C₁-C₇) alkoksi, -(C₃-C₇) cikloalkil, -C(O)R₁₂, -C(O)OR₁₂, -OC(O)R₁₂, -OS(O)₂R₁₂, -N(R₁₂)₂, -NR₁₂C(O)R₁₂, -NR₁₂SO₂R₁₂, -SR₁₂, =S(O)R₁₂, -S(O)₂R₁₂, i -S(O)₂N(R₁₂)₂; R6 i R7 se nezavisno kod svakog pojavljivanja biraju između -H, -halogena, -hidroksi, -CN, -(C₁-C₇) alkoksi, -(C₂-C₇) alkenil, -(C₁-C₁₀) alkil (opcionalno supstituisan sa 1 do 3 halogena), -(C₃-C₁₂) cikloalkil, terc-butoksiiminometil, 1,3-dioksan-2-il, hidroksimetil, formil, hidroksiiminometil, morfilino-4-il-metil, 4-metilpentiloksi, and pentiloksi; pod uslovom da kada D jeste azot, tada R6 ili R7 nisu vezani za D, i pod uslovom da kada T jeste azot, tada R6 ili R7 nisu vezani za T, i pod uslovom da kada Q jeste azot, tada

R6 ili R7 nisu vezani za Q, i pod uslovom da kada X jeste azot, tada R6 ili R7 nisu vezani za X; gde R6 i R7 mogu opcionalno sačinjavati šestoclani prsten sa atomima za koje su vezani, a tako formiran prsten može opcionalno sadržati do dva kiseonika, i dalje tako formiran prsten može biti opcionalno supstituisan sa do četiri halogena; R8 i R9 se nezavisno kod svakog pojavljivanja biraju između -vodonika, -hidroksi, -CN, -nitro, -halo, $-(C_1-C_7)$ alkil (opcionalno supstituisan sa 1 do 3 halogena), $-(C_1-C_7)$ alkoksi, $-(C_3-C_7)$ cikloalkil, aril, -aril- (C_1-C_7) alkil, -heteroaril, -heteroaril- $(C-C_7)$ alkil, -ariloksi, $-C(O)R_{12}$, $-COOR_{12}$, $-OC(O)R_{12}$, $-OS(O)_2R_{12}$, $-N(R_{12})_2$, $-NR_{12}C(O)R_{12}$, $-NR_{12}SO_2R_{12}$, $-SR_{12}$, $-S(O)R_{12}$, $-S(O)_2R_{12}$, $-O(C_2-C_7)$ alkenil, i $-S(O)_2N(R_{12})_2$; i gde su $-(C_1-C_7)$ alkil, $-(C_1-C_7)$ alkoksi, $-(C_3-C_7)$ cikloalkil, -aril, -aril- (C_1-C_7) alkil, -heteroaril, -heteroaril- (C_1-C_7) alkil, -ariloksi, i $-O(C_2-C_7)$ alkenil svaki opcionalno supstituisani sa jednim do tri supstituenta koji se nezavisno biraju između -vodonika, -hidroksi, -cijano, -nitro, -halo, -okso, $-(C_1-C_7)$ alkil, $-(C_1-C_7)$ alkil- $C(O)OR_{12}$, $-(C_1-C_7)$ alkoksil, $-(C_3-C_7)$ cikloalkil, -heterocikloalkil, $-C(O)R_{12}$, $-COOR_{12}$, $-OC(O)R_{12}$, $OS(O)_2R_{12}$, $-N(R_{12})_2$, $-NR_{12}C(O)R_{12}$, $-NR_{12}SO_2R_{12}$, $-SR_{12}$, $-S(O)R_{12}$, $-S(O)_2R_{12}$, i $-S(O)_2N(R_{12})_2$; R10 se bira između -H, halogena, $-(C_1-C_{12})$ alkil (opcionalno supstituisan sa 1 do 3 halogena), -cikloalkil, -aril, -aril- (C_1-C_7) alkil, -heteroaril, $-(C_1-C_7)$ alkil, $-(C_2-C_{12})$ alkenil, $-(C_3-C_{12})$ cikloalkenil, -aril- (C_2-C_{10}) alkenil, -heteroaril- (C_2-C_{10}) alkenil, $-(C_2-C_{10})$ alkinil, $-(C_3-C_{12})$ cikloalkinil, -aril- (C_2-C_{12}) alkinil, i -heteroaril- (C_2-C_{12}) alkinil; R11 se nezavisno kod svakog pojavljivanja bira između -H, -halogena,

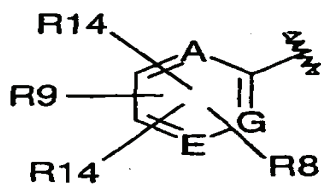

gdje cik-cak oznaka pokazuje tačku vezivanja roditeljskog molekula, gde A, G, i E nezavisno predstavljaju ugljenik (supstituisan sa vodonikom ili opcionalno supstituentima koji su ovde navedeni) ili azot, pod uslovom da ne više od dva od A, G, i E jesu azot; pod uslovom da kada A jeste azot, tada R8, R9, i R14 nisu vezani za A, i pod uslovima da kada G jeste azot, tada R8, R9, i R14 nisu vezani za G, i pod uslovom da kada E jeste azot, tada R8, R9, i R14 nisu vezani za E,

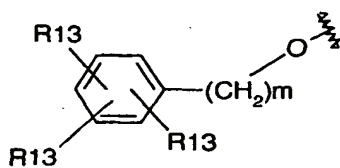

gdje cik-cak oznaka pokazuje tačku vezivanja roditeljskog molekula, gde je m cio broj od 0, 1, 2, ili 3, i kada m jeste 0 tada $(CH_2)_m$ jeste veza, i

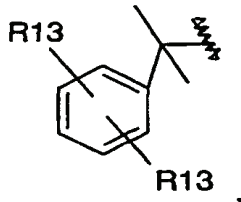

gdje cik-cak oznaka pokazuje tačku vezivanja roditeljskog molekula, pod uslovom da kada D jeste azot, tada R11 nije vezan za D, i pod uslovom da kada T jeste azot, tada R11 nije vezan za T, i pod uslovom da kada Q jeste azot, tada R11 nije vezan za Q, i pod uslovom da kada X jeste azot, tada R11 nije vezan za X; R12 se nezavisno kod svakog pojavljivanja bira između -vodonika, $-(C_1-C_7)$ alkil (opcionalno supstituisan sa 1 do 3 halogena), i -aril; R13 se

nezavisno kod svakog pojavljivanja bira između -vodonika, -halogena, $-(C_1-C_7)$ alkil (opcionalno supstituisan sa 1 do 3 halogena), fenil, i $-(C_2-C_7)$ alkenil; i R14 je nezavisno kod svakog pojavljivanja -H, -halogen, ili $-(C_1-C_7)$ alkil (opcionalno supstituisan sa 1 do 3 halogena). Patent sadrži još 18 patentnih zahtjeva.

- (51) **A61K 9/70** (11) **01069**
A61K 31/565 (21) **P-2010/79**
- (30) 03078881 12.12.2003. EP
(96) 04078365.6 10.12.2004.
(97) EP 1541137 10.02.2010. 2010/06 En
- (54) (ME) **TRANSDERMALNI SISTEM ZA DOSTAVU GESTODENA**
(EN) TRANSDERMAL DELIVERY SYSTEM OF GESTODENE
- (73) Bayer Schering Pharma Aktiengesellschaft, Müllerstrasse 178, 13353 Berlin (DE)
- (72) 01/ Langguth, Thomas; Am Goethepark 2 B, 07751 Jena (DE)
02/ Bracht, Stefan, Dr. ; Meisenweg 16, 07751Jena (DE)
03/ Dittgen, Michael, Prof. Dr.; Heidenberg 35, 99510 Apolda (DE)
04/ Huber, Petra; Lindwurmstrasse 72, 80337 München (DE)
05/ Schenk, Drik; Ostenerfeldweg 5a, 83623 Dietramszell (DE)
- (74) Radulović Božidar, Jovana Tomaševića 9/III-1, Podgorica (ME)
- (57) Kompozicija za transdermalnu dostavu, naznačena time da obuhvata sloj koji sadrži lijek, a koji obuhvata Gestoden ili neki njegov ester i kerijer koji je izabran iz grupe koja se sastoji od poliiizobutilena, polibutena, poliiizoprena, polistirena, stiren izoprem stiren blok polimera, stiren budadien stiren blok polimera i njihovih mješavina, a gdje sloj koji sadrži lijek posjeduje rastvorivost za pomenuti Gestoden od ne više od 3 % težine samoga sloja koji sadrži lijek i gdje Gestoden ili neki njegov ester je prisutan u količini koja sekreće u rasponu između 0.5 i 3 % težine samoga sloja koji sadrži lijek
Patent sadrži još 21 patentna zahtjeva.

- (51) **A61K31/435**
A61P1/08
A61K9/08
A61K9/14
A61K47/36
- (11) **01070**
(21) **P-2010/80**
- (30) 0328186 05.12.2003. GB
(86) PCT/GB2004/005043 30.11.2004.
(87) WO 2005/056008 23.06.2005.
(96) 04798713.6 30.11.2004
(97) EP 1696911 17.03.2010. 2010/11 En
- (54) (ME) **INTRANAZALNE KOMPOZICIJE**
(EN) INTRANASAL COMPOSITIONS
- (73) Archimedes Development Limited; Albert Einstein Centre, Nottingham Science & Technology Park, University Boulevard, Nottingham NG7 2TN (GB)
- (72) 01/ SMITH, Alan; West Pharmaceutical Services, Drug Delivery & Clinical Research Centre Ltd., University Boulevard Nottingham NG7 2TN (GB)
02/ WATTS, Peter, James; West Pharmaceutical Services, Drug Delivery & Clinical Research Centre Ltd., University Boulevard Nottingham NG7 2TN (GB)
03/ CASTILE, Jonathan; West Pharmaceutical Services, Drug Delivery & Clinical Research Centre Ltd., University Boulevard Nottingham NG7 2TN (GB)
- (74) Lutovac Branislav, Bulevar Crnojevića 93, Podgorica (ME)
- (57) Kompozicija za nazalno davanje koja se sastoji od granisetrona ili njegove farmaceutski prihvatljive soli i hitosana, njegove soli, derivata ili soli njegovog derivata.
Patent sadrži još 20 patentnih zahtjeva.

(51) **A61K31/505**
C07D 405/06
C07D 309/10
C07D 309/30

(11) **01071**
(21) **P-2010/82**

(30) 0406757 26.03.2004. GB

(86) PCT/GB2005/001099 23.03.2005.

(87) WO 2005/092867 06.10.2005.

(96) 05731809.9 30.11.2004

(97) EP 1729775 24.02.2010. 2010/08 En

(54) (ME) **POSTUPAK I INTERMEDIJERNA JEDINJENJA KORISNA ZA DOBIJANJE STATINA, NAROČITO ROSUVASTATINA**

(EN) **PROCESS AND INTERMEDIATE COMPOUNDS USEFUL IN THE PREPARATION OF STATINS, PARTICULARLY ROSUVASTATIN**

(73) REDX PHARMA LIMITED; Floor 9, Lowry House, 17 Marble Street, Manchester M2 3AW (UK)

(72) 01/ MOODY, David, John Wellbrae House Wellbrae, Falkland, Fife KY15 7AY (GB)

02/ WIFFEN, Jonathan, William 62 Springhill Manor, Magheralin, Craigavon, County Down BT67 0OB (GB)

(74) Lutovac Branislav, Bulevar Crnojevića 93, Podgorica (ME)

1. Postupak za dobijanje jedinjenja formule (7):

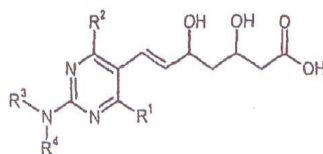

gde

R^1 predstavlja alkil grupu, kao što je C_{1-6} alkil grupa, a poželjno izopropil grupu;

R^2 predstavlja aril grupu, poželjno 4-fluorofenil grupu;

R^3 predstavlja vodonik, zaštitnu grupu ili alkil grupu, kao što je C_{1-6} alkil grupa, a poželjno metil grupa; i

R^4 predstavlja vodonik, zaštitnu grupu ili SO_2R^5 grupu, gde je R^5 alkil grupa, kao što je C_{1-6} alkil grupa, a poželjno metil grupa,

koji obuhvata

a) hidroksilaciju jedinjenja formule (1):

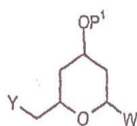

gde Y predstavlja halo grupu, poželjno Cl ili Br; P^1 predstavlja vodonik ili zaštitnu grupu i W predstavlja $-OP^2$, gde P^2 predstavlja vodonik ili zaštitnu grupu,

da bi se dobilo jedinjenje formule (2):

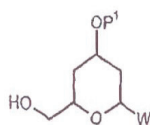

(57) b) oksidaciju jedinjenja formule (2) da bi se dobilo jedinjenje formule (3):

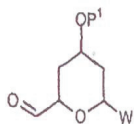

c) kuplovanje jedinjenja formule (3) sa jedinjenjem formule (4):

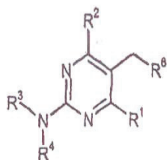

gde R³ predstavlja zaštitnu grupu ili alkil grupu, kao što je C₁₋₆ alkil grupa, a poželjno metil grupa; R⁴ predstavlja zaštitnu grupu ili SO₂R⁵ grupu, gde je R⁵ alkil grupa, kao što je C₁₋₆ alkil grupa, a poželjno metil grupa; i R⁶ predstavlja (PR⁷R⁸)⁺X⁻ ili P(=O)R⁷R⁸ u kojoj je X anjon i R⁷ i R⁸ su svaki nezavisno alkil, aril, alkoksi ili ariloksi grupa, a poželjno fenil grupa,

da bi se dobilo jedinjenje formule (5)

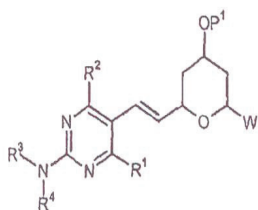

gde R³ predstavlja zaštitnu grupu ili alkil grupu, kao što je C₁₋₆ alkil grupa i poželjno metil grupa; i R⁴ predstavlja zaštitnu grupu ili SO₂R⁵ grupu, gde je R⁵ alkil grupa, kao što je C₁₋₆ alkil grupa, a poželjno metil grupa,

d) uklanjanje bilo koje P² zaštitne grupe i oksidacija jedinjenja formule (5) da bi se dobilo jedinjenje formule (6):

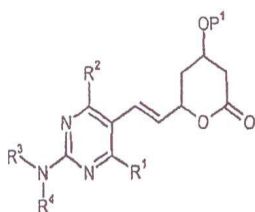

i

e) podvrgavanje jedinjenja formule (6) otvaranja prstena, uklanjanja bilo koje zaštitne grupe p¹ i opciono uklanjanje bilo kojih dodatnih zaštitnih grupa da bi se dobilo jedinjenje formule (7).

Patent sadrži još 2 patentna zahtjeva.

- (51) **C07D 473/34**
C07H 11/00
C07H 11/02
C07H 13/12
C07H 19/167
A61K 31/70
A61K 31/52
A61K 31/7004
A61K 31/7024
A61K 31/7076
A61P 1/18
A61P 3/04
A61P 3/10
A61P 9/06
A61P 9/08
A61P 9/10
A61P 25/02
A61P 25/06
A61P 25/08
A61P 25/16
A61P 25/18
A61P 25/22
A61P 25/24
A61P 25/28
A61P 43/00
- (30) 574805 P 26.05.2004 US
588263 P 15.07.2004 US
- (86) PCT/US2005/018381 25.05.2005.
(87) WO 2005/117910 15.12.2005.
(96) 05757108.5 25.05.2005.
(97) EP 1758596 31.03.2010. 2010/13 En
- (54) (ME) **DERIVATI PURINA KAO AGONISTI RECEPTORA ADENOZINA A1 I
POSTUPCI ZA NJIHOVU UPOTREBU**
(EN)PURINE DERIVATIVES AS ADENOSINE A1 RECEPTOR AGONISTS AND METHODS OF USE
THEREOF
- (73) Inotek Pharmaceuticals Corporation; 33 Hayden Avenue, Second Floor, Lexington, MA
02421 (US)
- (72) 01/ JAGTAP, Prakash; 486 Sharpners Pond Road, North Andover, Massachusetts 01845
(US)
02/ SZABO, Csaba; 30 Starknaught Heights Gloucester, MA 01930 (US)
03/ SALZMAN, Andrew, L.; 483 Pleasant Street, Unit 1 Belmont, MA 02478 (US)
- (74) Lutovac Branislav, Bulevar Crnojevića 93, Podgorica (ME)
- (11) **01072**
(21) **P-2010/87**

1. Jedinjenje koje ima formulu

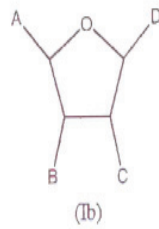

ili njegova farmaceutski prihvatljiva so,

gde:

A je $-\text{CH}_2\text{ONO}_2$;

B i C su $-\text{OH}$;

D je

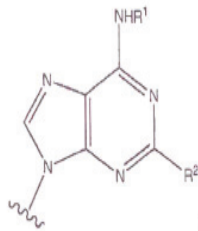

A i B su u *trans* konfiguraciji u odnosu jedan prema drugom;

B i C su u *cis* konfiguraciji u odnosu jedan prema drugom;

C i D su u *cis* ili *trans* konfiguraciji u odnosu jedan prema drugom;

R^1 je pentil, izopentil, neopentil, heksil, izoheksil, neoheksil, heptil, izoheptil, neoheptil, oktil, izooktil, neooktil, nonil, izononil, neononil, decil, izodecil, neodecil, -aril,

(57)

-3 - 7-člani monociklični heterocikl, -8 - 12-člani biciklični heterocikl, $-C_3-C_8$ monociklični cikloalkil, $-C_3-C_8$ monociklični cikloalkenil, $-C_8-C_{12}$ biciklični cikloalkil, $-C_8-C_{12}$ biciklični cikloalkenil, $-(CH_2)_n-(C_3-C_8$ monociklični cikloalkil), $-(CH_2)_n-(C_3-C_8$ monociklični cikloalkenil), $-(CH_2)_n-(C_8-C_{12}$ biciklični cikloalkil), $-(CH_2)_n-(C_8-C_{12}$ biciklični cikloalkenil), ili $-(CH_2)_n$ -aril;

R^2 je $-CN$, $-NHR^4$, $-NHC(O)R^4$, $-NHC(O)OR^4$, $-NHC(O)NHR^4$, $-NHNHC(O)R^4$, $-NHNHC(O)OR^4$, $-NHNHC(O)NHR^4$, ili $-NH-N=C(R^6)R^7$;

R^4 je $-C_1-C_{15}$ alkil, -aril, $-(CH_2)_n$ -aril, $-(CH_2)_n$ -(3-7-člani monociklični heterocikl), $-(CH_2)_n$ -(8-12-člani biciklični heterocikl), $-(CH_2)_n-(C_3-C_8$ monociklični cikloalkil), $-(CH_2)_n-(C_3-C_8$ monociklični cikloalkenil), $-(CH_2)_n-(C_8-C_{12}$ biciklični cikloalkil), $-(CH_2)_n-(C_8-C_{12}$ biciklični cikloalkenil), $-C\equiv C-(C_1-C_{10}$ alkil) ili $-C\equiv C$ -aril;

R^6 je $-C_1-C_{10}$ alkil, -aril, $-(CH_2)_n$ -aril, $-(CH_2)_n$ -(3-7-člani monociklični heterocikl), $-(CH_2)_n$ -(8-12-člani biciklični heterocikl), $-(CH_2)_n-(C_3-C_8$ monociklični cikloalkil), $-(CH_2)_n-(C_3-C_8$ monociklični cikloalkenil), $-(CH_2)_n-(C_8-C_{12}$ biciklični cikloalkil), $-(CH_2)_n-(C_8-C_{12}$ biciklični cikloalkenil), -fenilen- $(CH_2)_nCOOH$ ili -fenilen- $(CH_2)_nCOO-(C_1-C_{10}$ alkil);

R^7 je $-H$, $-C_1-C_{10}$ alkil, -aril, $-(CH_2)_n$ -aril, $-(CH_2)_n$ -(3-7-člani monociklični heterocikl), $-(CH_2)_n$ -(8-12-člani biciklični heterocikl), $-(CH_2)_n-(C_3-C_8$ monociklični cikloalkil), $-(CH_2)_n-(C_3-C_8$ monociklični cikloalkenil), $-(CH_2)_n-(C_8-C_{12}$ biciklični cikloalkenil), ili $-(CH_2)_n-(C_8-C_{12}$ biciklični cikloalkil); i

n svaki nezavisno, je ceo broj u opsegu od 1 do 5.

Patent sadrži još 56 patentnih zahtjeva.

- (51) **C07D215/22** (11) **01073**
A61K31/465 (21) **P-2010/111**
A61P31/06

- (30) 06125521 06.12.2006. EP
 (86) PCT/EP2007/063315 04.12.2007.
 (87) WO 2008/068269 12.06.2008.
 (96) 07847813.8 04.12.2007.
 (97) EP 2086941 28.04.2010. 2010/17 En

(54) (ME) **ANTIBAKTERIJSKI DERIVATI KVINOLINA**
 (EN) **ANTIBACTERIAL QUINOLINE DERIVATIVES**

- (73) Janssen Pharmaceutica NV; Turnhoutseweg 30, 2340 Beerse (BE)
 (72) 01/ GUILLEMONT, Jérôme Emile Georges, 27106 Val de Reuil Cedex (FR)
 02/ MOTTE, Magali Madeleine Simone; 27106 Val de Reuil Cedex (FR)
 03/ ANDRIES, Koenraad Jozef Lodewijk Marcel 2340 Beerse (BE)
 04/ KOUL, Anil; 2340 Beerse (BE)
 (74) Radulović Božidar, Jovana Tomaševića 9/III-1, Podgorica (ME)
 (57) Jedinjenje formule (I_a),

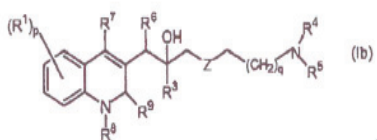
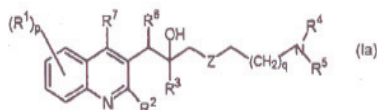

uključujući sve stereohemijske izomerske oblike, naznačeno time da je

p ceo broj koji iznosi 1, 2, 3 ili 4;

q ceo broj koji iznosi nula, 1, 2, 3 ili 4;

R¹ je vodonik, cijano, formil, karboksil, halo, alkil, C₂₋₆alkenil, C₂₋₆alkinil, haloalkil, hidroksi, alkiloksi, alkiltio, alkiltioalkil, -C=N-OR¹¹, amino, mono ili di(alkil)amino, aminoalkil, mono ili di(alkil)aminoalkil, alkilkarbonilaminoalkil, aminokarbonil, mono ili di(alkil)aminokarbonil, arilalkil, arilkarbonil, R^{5a}R^{4a}Nalkil, di(aril)alkil, aril, R^{5a}R^{4a}N-, R^{5a}R^{4a}N-C(=O)-, ili Het;

R² je vodonik, alkiloksi, aril, ariloksi, hidroksi, merkpto, alkiloksialkiloksi, alkiltio, mono ili di(alkil)amino, piroolidin ili radikal formule



gde je Y CH₂, O, S, NH ili N-alkil;

R³

je alkil, arilalkil, aril-O-alkil, aril-alkil-O-alkil, aril, aril-aril, Het, Het-alkil, Het-O-alkil, Het-alkil-O-alkil ili

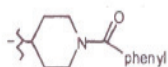

R⁴ i R⁵

su - svaki nezavisno - vodonik; alkil; alkiloksialkil; arilalkil; Het-alkil.; mono- ili dialkilaminoalkil; biciclo[2.2.1]heptil; Het; aril; ili -C(=Nm)-NH₂; ili

R^4 i R^5 zajedno sa atomom azota za koji su vezani obrazuju radikal izabran između sledećih: piroolidin, piperidin, piperazin, morfolin, 4-tiomorfolin, 1,1-dioksid-tiomorfolinil, azetidil, 2,3-dihidroizoindol-1-il, tiazolidin-3-il, 1,2,3,6- tetrahidropiridil, heksahidro-1*H*-azepinil, heksahidro-1*H*-1,4- diazepinil, heksahidro-1,4-oksazepinil, 1,2,3,4-tetrahidroizokvinolin-2- il, 2,5-diazabicyklo[2.2.1]heptil, pirolinil, pirolil, imidazolidinil, pirazolidinil, 2-imidazolinil, 2-pirazolinil, imidazolil, pirazolil, triazolil, piridinil, piridazinil, pirimidinil, pirazinil i triazinil, gde je svaki radikal opciono supstituisan sa 1, 2, 3 ili 4 supstituenta, svaki supstituent je nezavisno izabran između: alkil, haloalkil, alkilkarbonil, halo, arilalkil, hidroksi, alkiloksi, amino, mono- ili dialkilamino, aminoalkil, mono- ili dialkilaminoalkil, alkiltio, alkiltioalkil, aril, piridil, pirimidinil, piperidinil opciono supstituisani sa alkilom ili pirolidinil opciono supstituisan arilalkilom;

R^{4a} i R^{5a} zajedno sa atomom azota za koji su vezani obrazuju radikal između sledećih: piroolidin, piperidin, piperazin, morfolin, 4-tiomorfolin, 2,3-dihidroizoindol-1-il, tiazolidin-3-il, 1,2,3,6-tetrahidropiridil, heksahidro-1*H*-azepinil, heksahidro-1*H*-1,4-diazepinil, heksahidro-1,4-oksazepinil, 1,2,3,4- tetrahidroizokvinolin-2-il, pirolinil, pirolil, imidazolidinil, pirazolidinil, 2-imidazolinil, 2-pirazolinil, imidazolil, pirazolil, triazolil, piridinil, piridazinil, pirimidinil, pirazinil i triazinil, a gde je svaki radikal opciono supstituisan sa 1, 2, 3 ili 4 supstituenta, svaki supstituent je nezavisno izabran između: alkil, haloalkil, halo, arilalkil, hidroksi, alkiloksi, amino, mono- ili dialkilamino, alkiltio, alkiltioalkil, aril, piridil ili pirimidinil;

R^6 je aril¹ ili Het;

R^7 je vodonik, halo, alkil, aril ili Het;

R^8 je vodonik ili alkil;

R^9 je okso; ili

R^8 i R^9 zajedno obrazuju radikal $-\text{CH}=\text{CH}-\text{N}=\text{}$;

R^{10} je vodonik, C_{1-6} alkil ili aril C_{1-6} alkil;

R^{11} je vodonik ili alkil;

Z je S ili NR^{10} ;

aril je homociklično jedinjenje izabrano između: fenil, naftil, acenaftil ili tetrahidronaftil, gde je svaki opciono supstituisan sa 1, 2 ili 3 supstituenta, svaki supstituent je nezavisno izabran između: hidroksi, halo, cijano, nitro, amino, mono- ili dialkilamino, alkil, C_{2-6} alkenil opciono supstituisan sa: fenil, haloalkil, alkiloksi, haloalkiloksi, karboksil, alkiloksikarbonil, aminokarbonil, morfolinil ili mono- ili dialkilaminokarbonil;

aril¹ je homociklično jedinjenje izabrano između: fenil, naftil, acenaftil ili tetrahidronaftil, gde je svaki opciono supstituisan sa 1, 2 ili 3 supstituenta, svaki supstituent je nezavisno izabran između: hidroksi, halo, cijano, nitro, amino, mono- ili dialkilamino, alkil, haloalkil, alkiloksi, alkiltio, haloalkiloksi, karboksil, alkiloksikarbonil, aminokarbonil, morfolinil, Het ili mono- ili dialkilaminokarbonil;

Het je monociklično heterociklično jedinjenje izabrano između: *N*-fenoksipiperidinil, piperidinil, pirolil, pirazolil, imidazolil, furanil, tienil, oksazolil, izoksazolil, tiazolil, izotiazolil, piridinil, pirimidinil, pirazinil ili piridazinil; odnosno biciklično heterociklično jedinjenje izabrano između: kvinolinil, kvinoksalinil, indolil, benzimidazolil, benzoksazolil, benzizoksazolil, benzotiazolil, benzotiazolil, benzotiazolil, benzofuranil, benzotienil, 2,3-dihidrobenzo[1,4]dioksinil ili benzo[1,3]dioksolil; gde je svako monociklično i biciklično heterociklično jedinjenje opciono supstituisano sa 1, 2 ili 3 supstituenta, svaki supstituent je nezavisno selektovan između: halo, hidroksi, alkil ili alkiloksi;

a njihovi *N*-oksidi, farmaceutski prihvatljive soli ili solvati.

Patent sadrži još 23 patentna zahtjeva.

- (51) **C07J 1/00**
C07J 21/00
C07J 51/00
A61K 31/567
A61P 5/36
- (11) **01074**
(21) **P-2010/112**
- (30) 200610054535 15.11.2006 DE
(86) PCT/EP2007/009997 04.11.2007.
(87) WO 2008/058767 22.05.2008.
(96) 07819866.0 14.11.2007.
(97) EP 2081951 21.04.2010. 2010/16 EN
- (54) (ME) **ANTAGONISTI RECEPTORA PROGESTERONA**
(EN) **PROGESTERONE RECEPTOR ANTAGONISTS**
- (73) Bayer Schering Pharma Aktiengesellschaft, Müllerstrasse 178, 13353 Berlin (DE)
(72) 01/ FUHRMANN, Ulrike ; Charlottenburger Ufer 4, 10587 Berlin (DE)
02/ SCHMIDT, Anja; 659 Berkeley Avenue, Orange, NJ 07050 (US)
03/ CLEVE, Arwed; Konstanzer Strasse 8, 10707 Berlin (DE)
04/ PETROV, Orlin; Pücklerstr. 8, 14195 Berlin (DE)
05/ GARKE, Gunnar; Wiesengrundstrasse 4, 42781 Haan (DE)
06/ PRUEHS, Stefan; Schwannstrasse 30, 41460 Neuss (DE)
07/ BRUDNY-KLOEPEL, Margarete; Kreuzbergstrasse 29, 10965 Berlin (DE)
08/ ROTTMANN, Antje; Choriner Strasse 52, 10435 Berlin (DE)
09/ HASSELMANN, Rainer; Sagemühler Steig 72, 13503 Berlin (DE)
10/ SCHULTZE-MOSGAU, Marcus; Wachsmuthstrasse 23, 13467 Berlin (DE)
11/ MOELLER, Carsten; Pflugstrasse 9a, 10115 Berlin (DE)
- (74) Radulović Božidar, Jovana Tomaševića 9/III-1, Podgorica (ME)
- (57) (1) Antagonist receptora progesterona naznačen time da je opšte formule I:

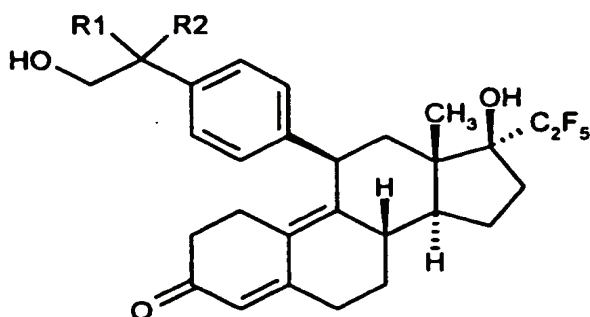

formula I

U čemu R_1 može da bude atom vodonika a R_2 hidroksilna grupa, ili R_1 i R_2 zajedno mogu da budu okso grupa.

Patent sadrži još 23 patentna zahtjeva.



ŽIGOVI

TRADEMARKS

Službeni glasnik Zavoda za intelektualnu svojinu Crne Gore
Official Gazette of the Montenegrin Intellectual Property Office

10/2012



Zavod za intelektualnu svojinu Crne Gore
ul. Rimski trg br. 46,
81000 Podgorica,
Crna Gora



**MEĐUNARODNI KODOVI ZA IDENTIFIKACIJU BIBLIOGRAFSKIH
PODATAKA O ŽIGOVIMA PREMA WIPO ST 60**
RECOMMENDATION CONCERNING BIBLIOGRAFIC DATA RELATING TO
TRADEMARKS- WIPO-ST. 60

CRNOGORSKI	MDK	ENGLESKI
REGISTRARSKI BROJ	111	NUMBER OF THE REGISTRATION
DATUM REGISTRACIJE	151	DATE OF THE REGISTRATION
OČEKIVANI DATUM PRESTANKA VAŽENJA ŽIGA	181	EXPECTED EXPIRATION DATE OF THE REGISTRATION
BROJ PRIJAVE	210	NUMBER OF THE APPLICATION
DATUM PODNOŠENJA PRIJAVE	220	DATE OF FILING OF THE APPLICATION
PODACI O IZLOŽBENOM PRAVU PRVENSTVA	230	DATA CONCERNING EXHIBITIONS
PODACI O PRAVU PRVENSTVA NA OSNOVU PARISKE KONVENCIJE	300	DATA RELATING TO PRIORITU UNDER THE PARIS CONVENTION
DATUM OBJAVLJIVANJA PRIJAVE	442	DATA OF PUBLICATION OF APPLICATION
SPISAK ROBA I USLUGA PREMA NIČANSKOJ KLASIFIKACIJI ROBA I USLUGA	511	LIST OF GOODS AND SERVICES ACCORDING THE NICE CLASSIFICATION OF GOODS AND SERVICE
IZJAVA PODNOSIOCA PRIJAVE DA NE TRAŽE EKSKLUZIVNO PRAVO ZA POJEDINE NEDINSTIKTIVNE ELEMENTE ZNAKA	526	DISCLAIMER
IZGLED ZNAKA	540	REPRODUCTION OF THE MARK
NAZNAKA O PRIRODI ILI VRSTI ZNAKA	550	INDICATION RELATING TO THE NATURE OR KIND OF MARK
INFORMACIJA O ZATRAŽENIM BOJAMA NA ZNAKU	591	INFORMATION CONCERNING THE COLORS CLAIMED
PODACI O PODNOSIOCU PRIJAVE	731	NAME AND ADRESS OF THE APPLICANT
IME I ADRESA NOSIOCA ŽIGA	732	NAME AND ADDRESS OF THE HOLDER OF THE REGISTRATION
INFORMACIJA O ZATRAŽENIM BOJAMA NA ZNAKU	591	INFORMATION CONCERNING THE COLORS CLAIMED
PODACI O PODNOSIOCU PRIJAVE	731	NAME AND ADRESS OF THE APPLICANT
IME I ADRESA NOSIOCA ŽIGA	732	NAME AND ADDRESS OF THE HOLDER OF THE REGISTRATION
IME I ADRESA PUNOMOĆNIKA	740	NAME AND ADDRESS OF THE REPRESENTATIVE



OBAVJEŠTENJE NOTICE

Obavještavamo korisnike da se od 7-og broja Crnogorskog glasnika za intelektualnu svojinu koji se objavljuje na web stranici Zavoda za intelektualnu svojinu Crne Gore, u elektronskoj formi, odnosno od 20.12.2011 godine (Glasnik broj 7/2011) uvodi objava prijave za registraciju žiga. Stupanjem na snagu Pravilnika o postupku za priznanje, promjenama, obnovi i međunarodnoj registraciji žiga ("Sl. list CG" broj 55/11) stekli su se uslovi da Zavod postupa u skladu sa odredbom člana 29 stav 1 Zakona o žigu i uredne prijave, za koje nije utvrđen razlog za odbijanje registracije iz člana 28 ovog zakona, objavi u Službenom glasilu.

Od dana objavljivanja prijave u Službenom glasilu, shodno odredbi člana 30 stav 1 Zakona o žigu, pravna i fizička lica ili udruženja proizvođača roba ili usluga, pružaoci usluga, trgovci i potrošači mogu, u roku od 90 dana od datuma objavljivanja prijave, dostaviti Zavodu obrazloženo mišljenje u pisanoj formi o apsolutnim razlozima za odbijanje registracije iz člana 6 Zakona o žigu.

U roku od 90 dana od dana objavljivanja prijave u Službenom glasilu, nosilac ranijeg žiga ili sticalac licence, na osnovu ovlašćenja nosioca žiga, mogu zbog razloga iz čl. 7 i 8 Zakona o žigu, u roku od 90 dana od dana objavljivanja prijave, shodno odredbi člana 31 stav 1 i 2 Zakona o žigu podnijeti Zavodu Prigovor za odbijanje registracije žiga.



(210) **2009-255**

(442) **20.10.2012**

(220) 20.05.2009

(300) RS Z-1613/2005 28.11.2005

(731) **WIX-FILTRON SP ZOO**, WROCLAWSKA 145, 63-800 GOSTYN PL

FILTRON

(540)

(550) I

(740) Čejović Vladimir, 13. jula 21, Podgorica (ME)

(511) **Klasa 7:** Filteri, filteri (dijelovi mašina ili motora), ulošci filtera, aparati za filtriranje i materijali, posebno za motore sa unutrašnjim sagorijevanjem.

Klasa 12: Vozila: aparati za kretanje po zemlji, vazduhu ili vodi, sve vrste filtera i uložaka za filtere za vozila i aparate za kretanje po zemlji, vazduhu i vodi, uređaji protiv zagađenja za motore i mašine koje njima pripadaju.

(210) **2009-515**

(442) **20.10.2012**

(220) 17.08.2009

(731) **THE PROCTER GAMBLE COMPANY**, ONE PROCTER GAMBLE PLAZA, CINCINNATI, OHIO 45202 US

COLOUR BLEND TECHNOLOGY

(540)

(550) I

(740) Lutovac Branislav, Bulevar Crnojevića 93, Podgorica (ME)

(511) **Klasa 03:** sapuni, parfimerija, esencijalna ulja, kozmetički preparati, losioni za kosu, preparati za čišćenje, njegu i uljepšavanje kože, vlasišta i kose, proizvodi za oblikovanje frizure, preparati za nijansiranje, blajhanje, farbanje i bojenje kose.

(210) **2010-141**

(442) **20.10.2012**

(220) 28.4.2010

(731) **CRNOGORSKI TELEKOM**, MOSKOVSKA 29. PODGORICA ME



(540)

(550) I

(511) **Klasa 09:** Aparati i instrumenti naučni, pomorski, geodetski, fotografski kinematografski, optički, za vaganje, mjerenje, signalizaciju, kontrolu (inspekciju), spašavanje i nastavu, Aparati i instrumenti za provodjenje, prekid, transformaciju, akumulaciju, regulisanje ili kontrolu električne energije, aparati za snimanje, prenos i reprodukovanje zvuka ili slike, aagnetni nosioci podataka, diskovi za snimanje, automatske mašine i mehanizmi koji se pokreću novcem ili žetonom, registar kase , računске mašine, oprema za obradu podataka i kompjuteri, aparati za gašenje požara

Klasa 16: Štampane stvari, fotografije, kancelarijski rekviziti (izuzev namještaja), materijali za obuku i nastavu (izuzev aparata)

Klasa 35: Oglašavanje, poslovno upravljanje, sistematizacija informacija u kompjuterske baze podataka, usluge prodaje (takodje preko Interneta i ostalih sredstava komunikacije)

Klasa 36: Osiguranje, finansijski poslovi, novčani poslovi, poslovi vezani za nepokretnosti

Klasa 37: Gradjevinsko konstruisanje, usluge instalacije, popravljanje i održavanje kompjutera i telekomunikacionih hardvera

Klasa 38: Telekomunikacije informacije o telekomunikacijama, usluge koje omogućavaju najmanje jednom licu da komunicira sa drugim koristeći čula i to: 1) dozvoljavanje jednom licu da komunicira sa drugim, 2) prenos poruka od jedne osobe do druge, 3) stavljanje lica u položaj vizuelne ili govorne komunikacije sa drugim (radio i televizija), komunikacija mobilnim telefonom, usluge koje sadrže difuziju radio ili televizijskih programa, emitovanje putem kablovske televizije, usluge prenosa podataka, slanje poruka, usluge telekonferencije, usluge govorne pošte, slanje poruka i slika uz pomoć kompjutera, komunikacija preko optičke mreže, elektronska pošta, pristup globalnoj kompjuterskoj mreži, izdavanje i održavanje telekomunikacione opreme, izdavanje modema, izdavanje telefona

Klasa 41: Obrazovne usluge, pripremanje obuke, razonoda, sportske i kulturne aktivnosti.

Klasa 42: Naučne i tehnološke usluge i istraživanje i projektovanje u vezi navedenih usluga, usluge industrijske analize i istraživanja, razvoj i projektovanje kompjuterskih hardvera i softvera, održavanje kompjuterskog softvera, tehničke konsultacije, dizajn kompjuterskog sistema, analize kompjuterskog sistema, usluge zaštite od kompjuterskog virusa, kreiranje i održavanje web stranica za druge.

(210) **2010-291**

(442) **20.10.2012**

(220) 11.08.2010

(731) **NOVARTIS AG**, 4002 BASEL CH

HEXAL

(540)

(550) I

(740) Popović Miladin, Đoka Miraševića 21/III, Podgorica (ME)

(511) **Klasa 05:** Farmaceutski i veterinarski preparati, sanitarni preparati za medicinsku upotrebu, dijetetske supstance prilagođene za upotrebu u medicini, hrana za bebe, flasteri, materijali za zavijanje, materijali za plombiranje zuba, zubarska smola, dezinfekciona sredstva, preparati za uništavanje štetočina, fungicidi, herbicidi

(210) **2010-310**

(442) **20.10.2012**

(220) 01.09.2010

(731) **MISS SELFRIDGE RETAIL LIMITED**, COLEGRAVE HOUSE, 70 BERNERS STREET, LONDON W1P 3AE GB

MISS SELFRIDGE

(540)

(550) I

(740) Kojić Ivana, Serdara Jola Piletica bb, Podgorica (ME)

(511) **Klasa 25:** Odjeća, obuća i pokrivala za glavu.

(210) **2010-312**

(442) **20.10.2012**

(220) 03.09.2010

(731) **PWC BUSINESS TRUST STATE OF DELAWARE USA**, 300 MADISON AVENUE, NEW YORK, NY 10017 US

PWC

(540)

(550) I

(740) Čupić Branislav, Dalmatinska 10, Podgorica (ME)

(511) **Klasa 09:** Kompjuterski softver, elektronske publikacije, ne-štampane publikacije, publikacije koje se mogu preuzeti elektronskim putem (downloadable), aparati, instrumenti i mediji za snimanje, skladištenje, prenošenje, manipulaciju, emitovanje, reprodukciju i očitavanje podataka, signala, informacija, koda, slika, teksta, video, zvučnih i audio zapisa, CD-ROM-ovi, DVD-i, audio, vizuelni i audiovizuelni materijali koji se mogu preuzeti elektronskim putem (downloadable), interaktivni kompjuterski softver, aparati i instrumenti za nastavu, kodirane kartice i identifikacione kartice, kompjuterski softver za prikupljanje i upravljanje podacima, vršenje analiza, sprovođenje studija i pravljenje i generisanje izvještaja u oblasti računovodstva, revizije, menadžmenta, biznisa i poreza, djelovi i oprema za svu navedenu robu.

Klasa 35: Poslovni menadžment, poslovna administracija, kancelarijski poslovi, računovodstvene usluge, usluge poslovne revizije, usluge konsaltinga i savjetodavne usluge u vezi sa porezom, usluge konsaltinga i savjetodavne usluge u vezi sa spajanjem, akvizicijom i devastacijom privrednih subjekata, usluge konsaltinga i savjetodavne usluge u vezi sa poslovnim menadžmentom i biznisom, savjetodavne usluge u vezi sa korporativnim upravljanjem, usluge istraživanja tržišta, savjetodavne uloge u vezi sa upravljanjem ljudskim resursima, savjetodavne usluge u vezi sa poslovnim informacijama i istraživanjem, knjigovodstvo, revizija, usluge pripreme poreskih prijava i konsaltinga u vezi sa porezom, konsalting usluge u vezi sa poslovnim menadžmentom u oblasti informacionih tehnologija, usluge davanja savjeta i istraživanja u vezi sa porezom, informacione, savjetodavne i konsultantske usluge u vezi sa svim uslugama navedenim u ovoj klasi, usluge selekcije i regrutovanja osoblja, usluge poslovnog informisanja i istraživanja, pružanje informacija kao i savjetodavnih i konsultantskih usluga u vezi sa svim uslugama navedenim u ovoj klasi onlajn putem, u štampanoj i elektronskoj formi.

Klasa 36: Finansijski poslovi, monetarni poslovi, finansijski menadžment, usluge pružanja pomoći, savjetodavne, konsultantske, informacijske i istraživačke usluge u oblasti finansija, konsul-

tantske usluge u vezi poreza i dažbina, usluge vezane za stečaj, usluge u vezi investicija, usluge procjene, konsultantske i savjetodavne usluge u vezi sa investicionim bankarstvom, konsultantske i savjetodavne usluge u vezi sa finansijama, konsultantske usluge u vezi sa procjenom rizika, konsultantske usluge u vezi sa beneficijama za zaposlene, usluge finansijske procjene u oblastima privrednih preduzeća, zaliha, imovine, opreme, licenciranja, nekretnina i intelektualne svojine, usluge procjene nekretnina, usluge upravljanja rizicima, konsultantske usluge u oblasti programa za beneficije za zaposlene, usluge agencija za imovinu i menadžmenta imovine, usluge u vezi sa nekretninama, pružanje finansijskih informacija, pružanje informacija onlajn putem, u štampanoj i elektronskoj formi, savjetodavne i konsultantske usluge u vezi sa svim uslugama navedenim u ovoj klasi.

(210) **2010-343**

(442) **20.10.2012**

(220) 28.9.2010

(731) **INVEST BANKA MONTENEGRO AD PODGORICA**, BULEVAR SVETOG PETRA CETINJSKOG BROJ 115 ME



(540)

(550) I

(511) **Klasa 36:** bankarski poslovi, kreditno-garantni poslovi, izdavanje garancija i preuzimanje drugih vanbilansnih obaveza, kupovinu, prodaju i naplatu potraživanja (faktoring, forfeting i dr.), izdavanje, obradu i evidentiranje platnih instrumenata: platni promet u zemlji i sa inostranstvom, u skladu sa propisima kojima se uređuje platni promet, finansijski lizing, poslove sa hartijama od vrijednosti, u skladu sa zakonom kojim se uređuju hartije od vrijednosti, trgovanje u svoje ime i za svoj račun ili za račun klijenta: stranim sredstvima plaćanja, uključujući mjenjačke poslove, finansijskim derivatima, depo poslove, izradu analiza i davanje informacija i savjeta o kreditnoj sposobnosti privrednih društava i preduzetnika i drugim pitanjima u vezi poslovanja, iznajmljivanje sefova, poslove koji su dio bankarskih poslova, pomoćne poslove u odnosu na poslove banke i poslove neposredno povezane sa poslovima te banke, u skladu sa statutom banke, usluge koje pružaju sve vrste bankarskih institucija ili mjenjačke, brokerske i klirinške usluge, kreditne usluge svih vrsta, investicione usluge holding kompanija, usluge koje se odnose na berze, akcije i svojinu, davanje garancija dužnicima u monetarnim poslovima, izdavanje putničkih čekova i kreditnih

(210) **2010-394**

(442) **20.10.2012**

(220) 26.10.2010

(731) **PAVLE JURLINA**, SELJANOVO 12 TIVAT ME

DUZBALT MAST

(540)

(550) I

(740) Jurlina Pavle, Seljanovo 12, Tivat (ME)

(511) **Klasa 05:** Farmaceutski i veterinarski preparati.

(210) **2010-412**(442) **20.10.2012**

(220) 09.11.2010

(731) **MR. JAMAL ABDUL NASSER MAHMOOD AL MAHAMID**, P.O. BOX 81450, DUBAI AE

(540)

(550) I

(740) Čosović Dejan, 13. jula 1/5, Budva (ME)

(511) **Klasa 34:** Cigaretete, cigare, duvan.(210) **2010-474**(442) **20.10.2012**

(220) 23.12.2010

(731) **STADION DOO**, PODGORICA ME

(540)

(550) I

(511) **Klasa 29:** Meso, riba, perad i divljač, mesni ekstrakti, konzervirano, sušeno i kuvano voće i povrće, želei, džemovi, kompoti, jaja, mlijeko i mliječni proizvodi, jestiva ulja i masti**Klasa 30:** Kafa, čaj, kakao, šećer, pirinač, tapioka, sago, zamjena kafe, brašno i proizvodi od žitarica, hljeb, kolači, poslastice, bomboni, sladoled, med, sirup od melase, kvasac, prašak za pecivo, so, senf, sirće, sosevi (začini), mirođije, led za hlađenje(210) **2010-77**(442) **20.10.2012**

(220) 25.3.2010

(731) **DOO. VERY IMPORTANT PERSONS**, KRALJEVAČKA 21, PODGORICA ME



(540)

(550) I

(511) **Klasa 18:** Koža i imitacija kože, proizvodi izrađeni od ovih materijala koji nisu uključeni u druge klase, životinjska koža, krzno, koferi i putne torbe, kišobrani, suncobrani i štapovi za hodanje, bičevi, saračka i sjedlarska oprema.

Klasa 25: Odjeća, obuća, pokrivala za glavu.

(111) **03411**
 (210) **2009-504**

(181) **11.08.2019.**
 (220) 11.08.2009.
 (151) 07.06.2012.
 (300) 11.08.2009

(732) **MONTEORGANICA DOO, UL. VASA RAIČKOVIĆA 18, 20000 PODGORICA ME**



(540)
 (550) I

(740) Nikolić Jovan, Velimira Terzića br 3, Podgorica, (ME)

(511) **Klasa 42:** Utvrđivanje ispunjenosti uslova za zasnivanje organske poljoprivrede; kontrola primjene metoda organske poljoprivrede; izdavanje sertifikata za proizvode dobijene metodama organske poljoprivrede.

(111) **03853**
 (210) **2009-420**

(181) **17.06.2019.**
 (220) 17.06.2009.
 (151) 27.07.2012.
 (300) 17.06.2009.

(732) **SUMITOMO CHEMICAL CO., LTD. 27-1, SHINKAWA 2-CHOME CHUO-KU TOKYO 104-8260, JP**

SUMIPEX

(540)
 (550) I

(740) Stanković Mugoša Ana, Trg Republike 13, Podgorica (ME)

(511) **Klasa 01:** Neprerađene plastične materije, neprerađene vještačke smole.

(111) **03293**
 (210) **2008-886**

(181) **23.10.2018.**
 (220) 23.10.2008.
 (151) 31.05.2012.
 (300) 23.10.2008.

(732) **N.V. SUMATRA TOBACCO TRADING COMPANY JALAN PATTIMURA NO. 3, PEMATANG SIANTAR, SUMATERA UTARA ID**

UNITED

(540)
 (550) I

(740) Popović Miladin, Đoka Miraševića 21/III, Podgorica, (ME)

(511) **Klasa 34:** Duvan, cigarete, cigare, artikli za pušače, upaljači i šibice.

(111) **03482** (151) **14.06.2012**

(210) **2009-179** (442) **20.12.2011**

(220) 26.03.2009

(300) 05.02.2008 Ž-204-08 RS

(732) **ELAN PHARMA INTERNATIONAL LIMITED; MONKSLAND ATHOLONE, COUNTRY WESTMEATH, IE**

TYSABRI

(540)

(550) I

(740) Čejović Vladimir, 13 Jul br. 21, Podgorica, (ME)

(511) **Klasa 05:** farmaceutske preparati za prevenciju, liječenje i dijagnostiku upalnih poremećaja, bolesti i stanja, i za prevenciju, liječenje i dijagnostiku fizioloških stanja u vezi sa adhezijom, signaliziranjem i migracijom ćelija.

(111) **03483** (151) **19.07.2012**

(210) **2009-180** (442) **20.12.2011**

(220) 26.03.2009

(300) 09.05.2008. Ž-1185/08 RS

(732) **ELAN PHARMA INTERNATIONAL LIMITED; MONKSLAND, ATHLONE, COUNTRY WESTMEATH IE**



(540)

(550) I

(740) Čejović Vladimir, 13 Jul br. 21, Podgorica, (ME)

(511) **Klasa 05:** farmaceutske preparati za prevenciju, liječenje i dijagnostiku upalnih poremećaja, bolesti i stanja, i za prevenciju, liječenje i dijagnostiku fizioloških stanja u vezi sa adhezijom, signaliziranjem i migracijom ćelija.

(111) **03651** (151) **25.07.2012**

(210) **2008-845** (442) **20.12.2011**

(220) 20.10.2008

(732) **DRUŠTVO ZA PROMET, TRGOVINU I USLUGE KOMO DOO NIKŠIĆ ME**



(540)

(550) I

(740) Mijanović Vera, VI Crnogorske T-6, Nikšić (ME)

(511) **Klasa 16:** Papir, karton i proizvodi koji nijesu obuhvaćeni drugim klasama, štampani proizvodi, proizvodi za uvezivanje knjiga, fotografije, -pribor za pisanje, ljepila, slikarski pribor -četkice, pisaće mašine i kancelarijski materijal oprema za nastavu i obuku, plastični materijali za ambalažu, štamparska slova -kliše

Klasa 25: Odjeća, obuća, kape

Klasa 35: oglašavanje i reklamiranje, vođenje komercijalnih poslova, komercijalna administracija, kancelarijski proslovi

Klasa 40: obrada materijala

(111) **03652**(151) **25.07.2012**(210) **2009-173**(442) **20.12.2011**

(220) 20.03.2009

(732) **HUAWEI TECHNOLOGIES CO; ADMINISTRATION BUILDING HUAWEI TECHNOLOGIES CO, BANATIAN, LONGGANG DISTRICT, SHENZEHEN P R CN**

ETS

(540)

(550) I

(740) Čejović Vladimir, 13 Jul br. 21, Podgorica, (ME)

(511) **Klasa 09:** Kompjuterski periferni uređaji; periferni uređaji (kompjuterski); kompjuterski softver (snimljeni); kartice sa integrisanim kolima (pametne kartice); pametne kartice (kartice sa integrisanim kolima); antene; predajnici (telekomunikacioni); prenosivi telefoni; optički telekomunikacioni aparati; komutacioni aparati kontrolisani uskladištenim programom; mrežni aparati za telekomunikacije; štampana kola; integrisana kola; čipovi (integrisana kola); komutacioni aparati; telekomunikacioni aparati; optički telekomunikacioni aparati; aparati za pristupne mreže; radio-frekventni aparati za telekomunikacije; mobilni telefoni; bežični telefoni; telefoni; predajni aparati za komunikacije; video i audio oprema; video i audio prijemnici i predajnici; aparati za obradu podataka; kompjuterski programi; kompjuteri.

(111) **03653**(151) **26.07.2012**(210) **2009-331**(442) **20.03.2012**

(220) 27.05.2009

(300) 18.07.2008 Z-2008-1840 RS

(732) **INTERTEK GROUP PLC; 25 SAVILE ROW, LONDON, W1S 2ES GB**

INTERTEK

(540)

(550) I

(740) Ćupić Branislav, Dalmatinska 10, Podgorica (ME)

(511) **Klasa 42:** usluge testiranja; usluge inspekcije; usluge procjene; usluge analize; testiranje, inspekcija, analiza i procjena robe, materijala, robe široke potrošnje, vozila, artikla, minerala, hrane, napitaka, medicinskih i farmaceutskih proizvoda; usluge za elektronsko, električno, fizičko, hemijsko, metalurško, mehaničko i optičko testiranje, inspekciju, analizu procjenu; usluge inspekcije pre i poslije otpremanja; usluge skeniranja kontejnera; sve u saglasnosti sa standardima nadzora, kvaliteta, kvantiteta, konzistencije, izvođenja ili bezbjednosti; usluge kontrole i procjene kvaliteta i bezbjednosti; usluge kalibriranja; usluge laboratorije; medicinsko laboratorijske usluge; usluge medicinskog testiranja; usluge analize krvi; usluge analize tjelesne tečnosti; usluge industrijske analize; usluge industrijskog i naučnog istraživanja; usluge davanja sertifikata/ovjere; usluge dizajna; usluge projektovanja bezbjednosnih postavki; usluge projektovanja rasporeda prostora; usluge premjeravanja; inženjerske usluge; priprema inženjerske analize i izvještavanje; kompjutersko programiranje; usluge testiranja, inspekcije, procjene i davanje sertifikata za poslovne sisteme, sisteme menadžmenta, sisteme kvaliteta menadžmenta, sisteme menadžmenta za životnu sredinu; sisteme proizvodnje, metoda i postupaka, sve u saglasnosti sa standardima regulative, kvaliteta, kvaiteta, konzistencije, izvršenja i bezbjednosti; usluge savjetovanja i konsultacije i u vezi sa svim gore navedenim uslugama.

Klasa 45: pružanje informacije i savjetovanje o bezbjednosti.

(111) **03654**(151) **26.07.2012**(210) **2009-334**(442) **20.03.2012**

(220) 28.05.2009

(300) 19.05.2008 Z-1254/08 RS

(732) **WRANGLER APPAREL CORP; 3411 SILVESIDE ROAD WILMINGTON, DELAWARE 19810 US**



(540)

(550) I

(740) Radulović Božidar, Jovana Tomaševića 9/III, Podgorica, (ME)

(511) **Klasa 25:** Odjeća, obuća, pokrivala za glavu i donji veš.

(111) **03655**(151) **26.07.2012**(210) **2009-520**(442) **20.03.2012**

(220) 25.08.2009

(732) **GENZYME CORPORATION MASSACHUSETTS CORPORATION; 500 KEN-**

DALL STREET CAMBRIDGE, MASSACHUSETTS 02142 US

GOLTUNI

(540)

(550) I

(740) Radulović Božidar, Jovana Tomaševića 9/III, Podgorica (ME)

(511) **Klasa 05:** Farmaceutski i veterinarski preparati; sanitarni preparati za medicinske svrhe; dijetetske supstance za upotrebu u medicini, hrana za bebe; flasteri, materijal za zavijanje; materijali za plombiranje zuba, zubarska smola; dezinfekciona sredstva; preparati za uništavanje štetočina; fungicidi, herbicidi; farmaceutski preparati za tretiranje Gošerove bolesti

(111) **03656**

(151) **26.07.2012**

(210) **2009-552**

(442) **20.03.2012**

(220) 09.09.2009

(300) 20.11.2007 947320 IR

(732) **ATLAS SPOLKA Z O O; UL SWIETEJ TERESY OD DZIECIATKA JEZUS 105, PL-91-222 LODZ PL**



(540)

(550) I

(740) Čejović Vladimir, 13. jul 21, Podgorica (ME)

(511) **Klasa 01:** Hemijski proizvodi koji se upotrebljavaju u industriji, nauci i fotografiji, kao i u poljoprivredi, hortikulturi i šumarstvu; neprerađene vještačke smole; neprerađene plastične materije; đubriva; smješe za gašenje vatre; preparati za kaljenje i zavarivanje; hemijske supstance za očuvanje namirnica; materije za štavljenje; adhezivi koji se upotrebljavaju u industriji.

Klasa 02: Boje, firnajzi, lakovi; sredstva za zaštitu drveta od rđe i truljenja; materije za bojenje; sredstva za nagrizanje; sirove prirodne smole; metali u obliku listova i praha za slikare, dekoratere, štampare i umjetnike.

Klasa 17: Guma, gutaperka, kaučuk, azbest, liskun i proizvodi napravljeni od ovih materijala koji nijesu uključeni u druge klase; poluprerađeni plastični proizvodi; materijali za podbijanje, zaptivanje i izolovanje; savitljive nemetalne cevi.

Klasa 19: Građevinski materijali (nemetalni); čvrste nemetalne cijevi za građevine; asfalt; crna smola i bitumen, nemetalne prenosne građevine; spomenici koji nijesu od metala.

(111) **03657**
 (210) **2009-525**

(151) **26.07.2012**
 (442) **20.03.2012**
 (220) 25.08.2009

(732) **GENZUME CORPORATION MASSACHUSETTS CORPORATION; 500 KENDALL STREET CAMBRIDGE, MASSACHUSETTS 02142 US**

MACI

(540)
 (550) I

(740) Radulović Božidar, Jovana Tomaševića 9/III, Podgorica (ME)

(511) **Klasa 10:** Hirurški, medicinski, zubarski i veterinarski aparati i instrumenti; vještački udovi, oči i zubi; ortopedski artikli; hirurški materijal za zašivanje; hirurški implantanti (živa tkiva), naročito ljudske hondrocite na supstratu na osnovi kolagena za medicinsku i terapeutsku upotrebu.

(111) **03658**
 (210) **2009-527**

(151) **26.07.2012**
 (442) **20.03.2012**
 (220) 25.08.2009

(732) **GENZUME CORPORATION MASSACHUSETTS CORPORATION; 500 KENDALL STREET CAMBRIDGE, MASSACHUSETTS 02142 US**

RENVELA

(540)
 (550) I

(740) Radulović Božidar, Jovana Tomaševića 9/III, Podgorica (ME)

(511) **Klasa 05:** Farmaceutski i veterinarski preparati; sanitarni preparati za medicinske svrhe; dijetetske supstance za upotrebu u medicini, hrana za bebe; flasteri, materijal za zavijanje; materijali za plombiranje zuba, zubarska smola; dezinfekciona sredstva; preparati za uništavanje štetočina; fungicidi, herbicidi; sredstva za vezivanje forsfata za tretiranje hiperfosfate-mije.

(111) **03659**
 (210) **2009-528**

(151) **26.07.2012**
 (442) **20.03.2012**
 (220) 25.08.2009

(732) **GENZYME CORPORATION MASSACHUSETTS CORPORATION; 500 KENDALL STREET CAMBRIDGE, MASSACHUSETTS 02142 US**

SEPRAFILM

(540)
 (550) I

(740) Radulović Božidar, Jovana Tomaševića 9/III, Podgorica (ME)

(511) **Klasa 05:** Farmaceutski i veterinarski preparati; sanitarni preparati za medicinske svrhe; dijetetske supstance za upotrebu u medicini, hrana za bebe; flasteri, materijal za zavijanje; materijali za plombiranje zuba, zubarska smola; dezinfekciona sredstva; preparati za uništavanje štetočina; fungicidi, herbicidi; biopolimeri u obliku filma koji se koriste u hirurgiji za smanjivanje ili sprečavanje adhezije.

Klasa 10: Hirurški, medicinski, zubarski i veterinarski aparati i instrumenti; vještački udovi, oči i zubi; ortopedski artikli; hirurški materijal za zašivanje; medicinski uređaji, naročito biopolimeri u obliku filma koji se koriste kao uređaji u hirurgiji za smanjivanje ili sprečavanje adhezije.

(111) **03660** (151) **26.07.2012**

(210) **2009-529** (442) **20.03.2012**

(220) 25.08.2009

(732) **GENZUME CORPORATION MASSACHUSETTS CORPORATION; 500 KENDALL STREET CAMBRIDGE, MASSACHUSETTS 02142 US**

SEPRASPRAY

(540)

(550) I

(740) Radulović Božidar, Jovana Tomaševića 9/III, Podgorica (ME)

(511) **Klasa 05:** Farmaceutski i veterinarski preparati; sanitarni preparati za medicinske svrhe; dijetetske supstance za upotrebu u medicini, hrana za bebe; flasteri, materijal za zavijanje; materijali za plombiranje zuba, zubarska smola; dezinfekciona sredstva; preparati za uništavanje štetočina; fungicidi, herbicidi; farmaceutski i medicinski preparati, naročito obloge koje se koriste na ljudskom tijelu, ljudskom tkivu i ljudskim organima u hirurgiji za smanjivanje ili sprečavanje adhezije.

Klasa 10: Hirurški, medicinski, zubarski i veterinarski aparati i instrumenti; vještački udovi, oči i zubi; ortopedski artikli; hirurški materijal za zašivanje; medicinski uređaji, medicinski preparati koji sadrže tubuse spakovani u hermetički zatvorene vrećice koji se koriste kao prepreke za adheziju površine tkiva tokom ili poslije hirurškog zahvata.

(111) **03661** (151) **26.07.2012**

(210) **2009-543** (442) **20.03.2012**

(220) 01.09.2009

(732) **PATRON SPIRITS INTERNATIONAL AG; SPITALSTRASSE 5 8200 SCHAFFHAUSEN CH**

GRAN PATRON BURDEOS

(540)

(550) I

(740) Lutovac Branislav, ul. Bulevar Crnojevića 93, Podgorica (ME)

(511) **Klasa 33:** Alkoholna pića (osim piva); žestoka pića; rum; tekila; vina; likeri.

- (111) **03662** (151) **26.07.2012**
 (210) **2009-544** (442) **20.03.2012**
 (220) 01.09.2009
 (732) **PATRON SPIRITS INTERNATIONAL AG; SPITALSTRASSE 5 8200 SCHAFFHAUSEN CH**

SURVANTA

- (540)
 (550) I
 (740) Lutovac Branislav, ul. Bulevar Crnojevića 93, Podgorica (ME)
 (511) **Klasa 33:** Alkoholna pića (osim piva); žestoka pića; rum; tekila; vina; likeri.

-
- (111) **03663** (151) **26.07.2012**
 (210) **2009-551** (442) **20.03.2012**
 (220) 30.07.2009
 (300) 30 01 2009 93625981 FR
 (732) **FUZE BEVERAGE LLC; ONE COCA-COLA PLAZA, ATLANTA, GEORGIA 30313 US**

FUZE

- (540)
 (550) I
 (740) Popović Miladin, Đoka Miraševića 21/III Podgorica (ME)
 (511) **Klasa 30:** Kafa, čaj, kakao, šećer, pirinač, tapioka, sago, zamjena kafe; brašno i proizvodi od žitarica, hleb, kolači i poslastice, sladoledi; med, melasa, kvasac, prašak za pecivo; so, senf; sirće, sosovi (kao dodaci); začini; led
Klasa 32: Piva; mineralne i sodne vode i ostala bezalkoholna pića; voćna pića i voćni sokovi; sirupi i drugi preparati za proizvodnju pića.

-
- (111) **03664** (151) **26.07.2012**
 (210) **2009-553** (442) **20.03.2012**
 (220) 10.09.2009
 (732) **LABORATORIE GARNIER CIE, SOCIETE EN NOM COLLECTIF; 281, RUE SAINT HONORE, 75008 PARIS FR**

GARNIER
Color Intensity

(540)

(550) I

(740) Ćupić Branislav, Dalmatinska 10, Podgorica (ME)

(511) **Klasa 03:** Šamponi; gelovi; sprejovi; pjene i balzami za stiliziranje kose i njegu kose; lakovi za kosu; preparati za farbanje i izbjeljivanje kose; preparati za trajnu i mini val; eterična ulja za ličnu upotrebu.(111) **03665**(151) **26.07.2012**(210) **2009-554**(442) **20.03.2012**

(220) 10.09.2009

(732) **ABBOTT LABORATORIES; ABBOTT PARK, ILLIONS 60064 US**

SURVANTA

(540)

(550) I

(740) Popović Miladin, Đoka Miraševića 21/III Podgorica (ME)

(511) **Klasa 05:** Farmaceutski preparati.(111) **03666**(151) **26.07.2012**(210) **2009-559**(442) **20.03.2012**

(220) 15.09.2009

(732) **LINING SPORTS SHANGAI COMPANY LIMITED; SUITE 3201, CHINA MERCHANTSTOWER, NO.161 LUJIZUI E ROAD, PUDONG, SHANGHAI 200120 PRC CN**

(540)

(550) I

(740) Čejović Vladimir, 13. jul 21, Podgorica (ME)

(511) **Klasa 18:** Rančevi; kožne torbe za pakovanje; sportske torbe; torbe za kampere; planinarske torbe; torbe za putovanja; akten tašne; futrole za kartice; kovačezi od kože ili kože i ploča; ručne tašne; pretenjače; futrole za ključeve (kožne); štapovi za planinarenje; džepni novčanici; tašne; ruksaci; torbe za kupovinu; školske torbe; koferi; putne torbe; putni kovačezi; putni kompleti (kožni); kovačezi za prtljag; kišobrani.

Klasa 25: Bade mantili; papuče za kupanje; kape za kupanje; gaće za kupanje; odjela za kupanje; odjeća za plažu; obuća za plažu; opasači; beretke; čizme; sportske čizme; kape; kape (za tuširanje); odjeća; odjeća za gimnastičare; kožna odjeća; odjeća za džudo; kaputi; zaštitne navlake za odjeću; naušnice; čizme za ragbi; obuća za ragbi; obuća; pojasevi; rukavice; gimnastička obuća; poluduboke čizme; šeširi; trake za glavu; pokrivala za glavu; pletena odjeća; jakne; džemperi; trikotaža; koža (-odjeća od); koža (-odjeća od imitacije); kamašne; rukavice bez prstiju sa palcem; kravate; gornji kaputi; ogrtači; pantalone; puloveri; sandale; šalovi; košulje; cipele; čizme za skijanje; haljine; papuče; čarape; sport (-čizme za); sportski trikoi; sportska obuća; ženske čarape; odjela; trenerke; plivačka odjela; majce; čakšire; prsluci; trake za zglobove; perjane jakne; odjeća za džoging; kožne cipele; fudbalska obuća.

Klasa 28: Lopte za igru; lopte (za košarku); lopte (za fudbal); lopte (za odbojku); lopte (za golf); lopte (za tenis); palice za igru; bicikli (stacionarni, za vježbu); trenažni aparati; štitnici za laktove; rukavice za igru; torbe za golf, sa i bez točkića; štapovi za golf; rukavice za golf; gimnastičke sprave; štitnici za koljena; mreže za sportove; štitnici (kao sportska oprema); lopte kao igračke; reketi za igre; rošule; štitnici za kožu; loptice za badminton; žice za rekete; stolovi za stoni tenis; trake za zglobove; torbe za rekete.

(111) **03667** (151) **26.07.2012**

(210) **2009-560** (442) **20.03.2012**

(220) 17.09.2009

(732) **NOVARTIS AG; 4002 BASEL CH**

ANGAL

(540)

(550) I

(740) Popović Miladin, Đoka Miraševića 21/III Podgorica (ME)

(511) **Klasa 05:** Farmaceutski preparati.

(111) **03668** (151) **26.07.2012**

(210) **2009-580** (442) **20.03.2012**

(220) 28.09.2009

(732) **THE GOODYEAR TIRE I RUBBER COMPANY; 1144 EAST MARKET STREET, AKRON, OHIO 44316-0001 US**

KELLY

(540)

(550) I

(740) Čejović Vladimir, 13. jul 21, Podgorica (ME)

(511) **Klasa 12:** Autogume (svaka druga guma za točkove).

- (111) **03669** (151) **26.07.2012**
 (210) **2009-583** (442) **20.03.2012**
 (220) 29.09.2009
 (300) 02.06.2009 77-750248 US
 (732) **MOTOROLA INC A DELAWARE CORPORATION; 1303 E ALGONGUIN ROAD, SCHAUMBURG, IL 60196 US**

MILESTONE

- (540)
 (550) I
 (740) Čejović Vladimir, 13. jul 21, Podgorica (ME)
 (511) **Klasa 09:** Mobilni telefoni; mobilni telefoni sa mogućnošću slanja i primanja elektronskih poruka; mobilni telefoni sa digitalnim fotoaparatom i video kamerom; mobilni telefoni sa MP3, audio i video plejerom; mobilni telefoni sa elektronskim igricama; mobilni telefoni sa mogućnošću GPS-a i navigacije; uređaji za bezicnu komunikaciju sa mogućnošću prenosa glasa, podataka i slike; baterije za mobilne telefone; punjači za baterije i adapteri za struju.

- (111) **03773** (151) **26.07.2012**
 (210) **2009-312** (442) **20.03.2012**
 (220) 27.05.2009
 (732) **OTSUKA PHARMACEUTICAL CO LTD; 2-9 KANADA -TSUKASAMACHI, CHIYODA, TOKYO JP**



- (540)
 (550) I
 (740) Popović Miladin, Đoka Miraševića 21/III Podgorica (ME)
 (511) **Klasa 05:** Farmaceutski preparati.

- (111) **03774** (151) **26.07.2012**
 (210) **2009-521** (442) **20.03.2012**
 (220) 25.08.2009
 (732) **GENZUME CORPORATION MASSACHUSETTS CORPORATION; 500 KENDALL STREET CAMBRIDGE, MASSACHUSETTS 02142 US**

CELSIOR

(540)

(550) I

(740) Radulović Božidar, Jovana Tomaševića 9/III, Podgorica (ME)

(511) **Klasa 05:** Farmaceutski i veterinarski preparati; sanitarni preparati za medicinske svrhe; dijetetske supstance za upotrebu u medicini, hrana za bebe; flasteri, materijal za zavijanje; materijali za plombiranje zuba, zubarska smola; dezinfekciona sredstva; preparati za uništavanje štetočina; fungicidi, herbicidi; tečni preparati za perfuziju, reperfuziju i očuvanje organa.

(111) **03775**(151) **26.07.2012**(210) **2009-523**(442) **20.03.2012**

(220) 25.08.2009

(732) GENZUME CORPORATION MASSACHUSETTS CORPORATION; 500 KENDALL STREET CAMBRIDGE, MASSACHUSETTS 02142 US

CLOLAR

(540)

(550) I

(740) Radulović Božidar, Jovana Tomaševića 9/III, Podgorica (ME)

(511) **Klasa 05:** Farmaceutski i veterinarski preparati; sanitarni preparati za medicinske svrhe; dijetetske supstance za upotrebu u medicini, hrana za bebe; flasteri, materijal za zavijanje; materijali za plombiranje zuba, zubarska smola; dezinfekciona sredstva; preparati za uništavanje štetočina; fungicidi, herbicidi; farmaceutski preparati za tretiranje raka i autoimunih bolesti u oblasti onkologije.

(111) **03776**(151) **26.07.2012**(210) **2009-524**(442) **20.03.2012**

(220) 25.08.2009

(732) GENZUME CORPORATION MASSACHUSETTS CORPORATION; 500 KENDALL STREET CAMBRIDGE, MASSACHUSETTS 02142 US

EVOLTRA

(540)

(550) I

(740) Radulović Božidar, Jovana Tomaševića 9/III, Podgorica (ME)

(511) **Klasa 05:** Farmaceutski i veterinarski preparati; sanitarni preparati za medicinske svrhe; dijetetske supstance za upotrebu u medicini, hrana za bebe; flasteri, materijal za zavijanje; materijali za plombiranje zuba, zubarska smola; dezinfekciona sredstva; preparati za uništavanje štetočina; fungicidi, herbicidi; farmaceutski preparati, naročito terapijski lijekovi koji se daju pri tretiranju raka i autoimunih bolesti.

(111) 03777

(151) 26.07.2012

(210) 2009-526

(442) 20.03.2012

(220) 25.08.2009

(732) GENZUME CORPORATION MASSACHUSETTS CORPORATION; 500 KENDALL STREET CAMBRIDGE, MASSACHUSETTS 02142 US

MOZOBIL

(540)

(550) I

(740) Radulović Božidar, Jovana Tomaševića 9/III, Podgorica (ME)

(511) **Klasa 05:** Farmaceutski i veterinarski preparati; sanitarni preparati za medicinske svrhe; dijetetske supstance za upotrebu u medicini, hrana za bebe; flasteri, materijal za zavijanje; materijali za plombiranje zuba, zubarska smola; dezinfekciona sredstva; preparati za uništavanje štetočina; fungicidi, herbicidi; farmaceutski i medicinski preparati za tretiranje HIV-a, upala, artritisa, astme, raka, transplantacije ćelija, i odbacivanja transplantiranih ćelija, transplantacije organa, i odbacivanja transplantiranih organa, angiogeneza, multiple skleroze, bakterijskih upala, mobilizacije matičnih ćelija iz periferne krvi, kardiovaskularnih bolesti, limfoma, regeneracije tkiva, zarastanja tkiva, leukemije, anemije izazvane lijekovima, retrovirusa, hematopojetskog deficita koji je posljedica hemoterapije ili radio terapije, podizanje broja bijelih krvnih zrnaca, i očnih bolesti, uključujući starosnu makularnu degeneraciju i dijabetičku retinopatiju.

(111) 03778

(151) 26.07.2012

(210) 2009-574

(442) 20.03.2012

(220) 30.06.2009

(732) KRAFT FOODS GLOBAL BRANDS LLC A STATE OF DELAWARE LIMITED LIABILITY COMPANY; THREE LAKES DRIVE, NORTFIELD, IL 60093 US



(540)

(550) I

(740) Čupić Branislav, Dalmatinska 10, Podgorica (ME)

(511) **Klasa 29:** Rendani sir; prerađeni sir; prehrambeni proizvodi od prerađenog sira; beli sir; pavlaka; krem sir; želei; džemovi; prerađeno meso, naročito ćuretina, piletina, govedina i šunka; slanina; turšije; prerađeno koštunjavo voće; pripremljeni obroci koji sadrže meso i sir; prerađeni umaci i namazi od sira; sosevi od sira; umaci i namazi na bazi povrća, mješavine grickalica koje se sastoje uglavnom od prerađenog voća i koštunjavog voća; proteinske štanglice.

Klasa 30: Kafa; brašno i proizvodi od žitarica i hleb; senf; ren; reliš; kečap; prelive za salatu;

sosevi za roštilj; majonez; slatkiši uključujući karamele, čokolade i maršmelou; grickalice od zrnevlja; začini; keksi; krekeri; pudinzi; aromatizovani i zaslađeni želatini; pica; mješavina za nadev koja sadrži hleb; pasta; pripremljena jela koja se sastoje prvenstveno od paste i soseva.

Klasa 32: Mineralne i sodne vode i ostala bezalkoholna pića, voćni napitci i voćni sokovi; preparati za proizvodnju pića.

(111) **03824** (151) **26.07.2012**

(210) **2009-537** (442) **20.03.2012**

(220) 27.08.2009

(732) BRITISH AMERICAN TOBACCO BRANDS INC; 2711 CENTERVILLE ROAD, SUITE 300, WILMINGTON, DELAWARE 19808 US



(540)

(550) I

(740) Popović Miladin, Đoka Miraševića 21/III Podgorica (ME)

(511) **Klasa 34:** Cigarete; proizvodi od duvana; upaljači; šibice; artikli za pušače.

(111) **03825** (151) **26.07.2012**

(210) **2009-538** (442) **20.03.2012**

(220) 27.08.2009

(732) BRITISH AMERICAN TOBACCO BRANDS INC; 2711 CENTERVILLE ROAD, SUITE 300, WILMINGTON, DELAWARE 19808 US



(540)

(550) I

(740) Popović Miladin, Đoka Miraševića 21/III Podgorica (ME)

(511) **Klasa 34:** Cigarete; proizvodi od duvana; upaljači; šibice; artikli za pušače.

(111) **03826**(151) **26.07.2012**(210) **2009-594**(442) **20.03.2012**

(220) 10.05.2009

(732) AMERICAN-CIGARETTE COMPANY-OVERSEAS-LIMITED; ZAEHLERWEG 4 ZUG 6300 CH



(540)

(550) I

(740) Popović Miladin, Đoka Miraševića 21/III Podgorica (ME)

(511) **Klasa 34:** Cigarette; duvan; proizvodi od duvana; upaljači; šibice; artikli za pušače.(111) **03827**(151) **26.07.2012**(210) **2009-595**(442) **20.03.2012**

(220) 10.05.2009

(732) AMERICAN-CIGARETTE COMPANY-OVERSEAS-LIMITED; ZAEHLERWEG 4 ZUG 6300 CH



(540)

(550) I

(740) Popović Miladin, Đoka Miraševića 21/III Podgorica (ME)

(511) **Klasa 34:** Cigarette; duvan; proizvodi od duvana; upaljači; šibice; artikli za pušače.(111) **03828**(151) **26.07.2012**(210) **2009-596**(442) **20.03.2012**

(220) 10.05.2009

(732) AMERICAN-CIGARETTE COMPANY-OVERSEAS-LIMITED; ZAEHLERWEG 4 ZUG 6300 CH



(540)

(550) I

(740) Popović Miladin, Đoka Miraševića 21/III Podgorica (ME)

(511) **Klasa 34:** Cigarette; duvan; proizvodi od duvana; upaljači; šibice; artikli za pušače.(111) **03839**(151) **26.07.2012**(210) **2009-539**(442) **20.03.2012**

(220) 27.08.2009

(732) BRITISH AMERICAN TOBACCO BRANDS INC; 2711 CENTERVILLE ROAD, SUITE 300, WILMINGTON, DELAWARE 19808 US



(540)

(550) I

(740) Popović Miladin, Đoka Miraševića 21/III Podgorica (ME)

(511) **Klasa 34:** Cigarette; proizvodi od duvana; upaljači; šibice; artikli za pušače.(111) **03840**(151) **30.07.2012**(210) **2009-155**(442) **20.03.2012**

(220) 06.03.2009

(300) 16.03.2007 Z-554-07 ZISS

(732) GOOGLE INC; 1600 AMPHITHEATRE PARKWAY MOUNTAINVIEW, CALIFORNIJA 94043 US



(540)

(550) I

(740) Radulović Božidar, Jovana Tomaševića 9/III, Podgorica (ME)

(511) **Klasa 38:** Telekomunikacije; naročito usluge emitovanja programa, usluge emitovanja putem mreže; obezbjeđivanje portala za zajedničko korišćenje video zapisa; usluge emitovanja koje uključuju snimanje na mrežu, postavljanje, prikazivanje, izlaganje, označavanje, usluge bloga, usluge zajedničkog korišćenja i obezbjeđivanje na druge načine elektronskih medija ili informacija preko Interneta ili drugih komunikacionih mreža; usluge elektronske komunikacije; prenošenje poruka, podataka i sadržaja preko Interneta i komunikacionih mreža; obezbjeđivanje onlajn foruma, prostora za razgovor, žurnala, blogova i lista servera za prenos poruka, komentara i multimedijalnih sadržaja između korisnika; prenos elektronskih medija, multimedijalnih sadržaja, video zapisa, filmova, slika, grafičkih prikaza, teksta, fotografija, igara, sadržaja koje stvaraju korisnici, audio sadržaja, i informacija preko Interneta i drugih kompjuterskih i komunikacionih mreža; obezbjeđivanje onlajn foruma za korisnike kako bi postavljali, pretraživali, gledali, zajednički koristili, kritikovali, ocjenjivali i komentarisali video zapise i drugi multimedijalni sadržaj; obezbjeđivanje digitalne distribucije audio i video emitovanja programa preko globalne kompjuterske mreže.

Klasa 41: Obrazovne usluge; pripremanje obuke; razonoda; sportske i kulturne aktivnosti; naročito usluge zabave; usluge obrazovanja; obezbjeđivanje portala za zajedničko korišćenje video zapisa za svrhe obrazovanja i razonode; usluge razonode i obrazovanja koje podrazumijevaju elektronske medije, multimedijalne sadržaje, video zapise, filmove, slike, grafičke prikaze, tekst, fotografije, igre, sadržaje koje stvaraju korisnici audio sadržaje, i odnosne informacije preko kompjuterskih i komunikacionih mreža; usluge razonode i obrazovanja, naročito snimanje na mrežu, preuzimanje sa mreže, učitavanje, postavljanje, prikazivanje, obrada, puštanje, reprodukovanje u realnom vremenu, gledanje, pred-prikazivanje, izlaganje, označavanje, usluge bloga, zajedničko korišćenje, manipulisanje, distribuisanje, objavljivanje, reprodukovanje, ili obezbjeđivanje na druge načine elektronskih medija, multimedijalnih sadržaja, video zapisa, filmova, slika, grafičkih prikaza, teksta, fotografija, igara, sadržaja koje stvaraju korisnici, audio sadržaja, i informacija preko Interneta i drugih kompjuterskih i komunikacionih mreža; usluge promocije za druge; promotivne usluge u obliku onlajn zabave i obrazovanja; usluge objavljivanja digitalne video, audio i multimedijalne razonode; usluge obezbjeđivanja prostora na mreži za multimedijalne obrazovne i zabavne sadržaje za druge.

(111) **03841**

(151) **30.07.2012**

(210) **2009-178**

(442) **20.03.2012**

(220) 25.03.2009

(732) **INTEL CORPORATION; 2200 MISSION COLLEGE BOULEVARD, SANTA CLARA, CALIFORNIA 95052-8119 US**



(540)

(550) I

(740) Čejović Vladimir, 13. jul 21, Podgorica (ME)

(511) **Klasa 09:** Računarski softver; 3D animacioni softver; 3D animaciona obrada tehnološkog softvera za stvaranje, proizvodnju, snimanje, prenošenje ili reprodukciju zvuka, snimka, filma, animiranog sadržaja, softverskog programa, grafike i slike; računarski softver za upotrebu digitalnih animacija i specijalnih efekata za slike; softver za izradu slika, grafika i teksta; softver za kontrolu i poboljšanje računara i audio opreme zvučnog kvaliteta; softver za igre na računaru; grafički softver računara; softver za elektronske igre; softver za igre; softver za video igre; softver za virtuelne video igre; interaktivne video igre sadržane u hardveru i softveru računara; računari; served; radne stanice; računarski hardver, matične ploče, ujedinjena strujna kola, poluprovodnici i procesori; ketridži za video igre; računarski softver za igranje video igara i računarske igre za igranje putem globalnih računara i komunikacionih mreža; računarski softver za kompresovanje i dekompresovanje podataka i video slika; prenosni i laptop računari; portabl računari; ručni računari; tablet računari; ultra mobilni računari; računarski softver koji obezbjeđuje pristup većem broju korisnika na globalnu računarsku informacionu mrežu; računarski upravljački softver, naime, računarski operacioni sistem softvera, računarski korisnički softver i drugi računarski softver; portabl video plejeri; lični uređaji za igre; visoko određeni disk plejeri; DVD plejeri.

Klasa 41: Servisi za zabavu, naime, produkcija igranih filmova, snimaka i filmova; nabavka televizije, snimaka i specijalnih efekata filmske produkcije; razvoj softvera za upotrebu u filmskoj produkciji, snimcima i filmovima; servisi animirane produkcije; servisi za produkciju multimedialnih softvera.

(111) **03842**

(151) **30.07.2012**

(210) **2009-185**

(442) **20.03.2012**

(220) 01.04.2009

(300) 25.02.2005 Z-203/2005 RS

(732) GALLUP INC; 1001 GALLUP DRIVE, OMAHA, NEBRASKA 68102 US

GALLUP

(540)

(550) I

(740) Čejović Vladimir, 13. jul 21, Podgorica (ME)

(511) **Klasa 09:** Aparati i instrumenti naučni, pomorski, geodetski, fotografski, kinematografski, optički, za vaganje, mjerenje, signalizaciju, kontrolu, inspekciju, spasavanje i nastavu; aparati i instrumenti za provođenje, prekidanje, transformaciju, akumuliranje, regulisanje ili kontrolu elektriciteta; aparati za snimanje, prenos i reprodukovanje zvuka ili slike; magnetni nosioci podataka, diskovi za snimanje; automatske mašine i mehanizmi za aparate koji se pokreću novcem ili žetonom; registar kase, računске mašine, oprema za obradu podataka i kompjuteri, aparati za gašenje požara.

Klasa 35: Oglašavanje, vođenje poslova; poslovno upravljanje; kancelarijski poslovi.

Klasa 38: Telekomunikacije.

Klasa 41: Obrazovne usluge; pripremanje obuke; razonoda; sportske i kulturne aktivnosti.

(111) **03843**

(151) **30.07.2012**

(210) **2011-369**

(442) **20.03.2012**

(220) 20.07.2011

(732) **ZDRAVLJE AD; VLAJKOVA 199, 16000 LESKOVAC RS****VIVACE PLUS L**

(540)

(550) I

(740) Popović Miladin, Đoka Miraševića 21/III Podgorica, (ME)

(511) **Klasa 05:** Farmaceutski preparati i supstance.(111) **03844**(151) **30.07.2012**(210) **2011-370**(442) **20.03.2012**

(220) 20.07.2011

(732) **ZDRAVLJE AD; VLAJKOVA 199, 16000 LESKOVAC RS****VIVACE PLUS**

(540)

(550) I

(740) Popović Miladin, Đoka Miraševića 21/III Podgorica (ME)

(511) **Klasa 05:** Farmaceutski preparati i supstance.(111) **03845**(151) **30.07.2012**(210) **2009-380**(442) **20.03.2012**

(220) 28.05.2009

(732) GLAXO GROUP LIMITED; GLAXO WELLCOME HOUSE, BERKELEY AVENUE, GREENFORD, MIDDLESEX, UB6 ONN GB

ALLI

(540)

(550) I

(740) Popović Miladin, Đoka Miraševića 21/III Podgorica (ME)

(511) **Klasa 05:** Farmaceutski preparati i supstance za gubitak težine, kontrolu težine, vođenje dijete, ishranu i fitnes; dijetetska hrana i supstance prilagođene za medicinsku upotrebu; vitamini, minerali i dodaci ishrani.(111) **03846**(151) **30.07.2012**(210) **2009-398**(442) **20.03.2012**

(220) 28.05.2009

(300) 06.07.2007 Z-2007-1334 RS

(732) CATERPILLAR INC; A CORPORATION OF DELAWARE 100 NE ADAMS STREET, PEORIA, ILLINOIS 61629 US



(540)

(550) I

(740) Čupić Branislav, Dalmatinska 10, Podgorica (ME)

(511) **Klasa 09:** Aparati i instrumenti naučni, nautički, geodetski, optički, za vaganje, mjerenje, signalizaciju, kontrolu (inspekciju), pomoć (spasavanje), i nastavu; aparati i instrumenti za provođenje, prekidanje, transformisanje, akumuliranje, regulisanje ili kontrolu električne energije; aparati za snimanje, prenos ili reprodukciju zvuka ili slike; nosači magnetskih podataka, diskovi za snimanje; računске mašine, uređaji za obradu podataka i računari; električni i elektronski aparati i instrumenti; aparati i instrumenti za mjerenje i testiranje; aparati za nadgledanje i prikazivanje; dijagnostički aparati i instrumenti; indikatori za pritisak i temperaturu, podesivi merači i satovi za pritisak i temperaturu; kompjuterski hardver i softver; kontrolne jedinice; operatorski interfejs; sigurnosna oprema; oprema za GPS (sistem za globalno pozicioniranje); oprema za daljinsko rukovanje, kontrolu i nadgledanje vozila za prenos zemlje, obradu zemljišta, rukovanje materijalima, građevinarstvo, rudarstvo, popločavanje, poljoprivredu i šumarstvo, opreme, i mašinerije, pogonskih mašina, opreme za proizvodnju električne energije, i kamiona za kretanje van glavnih puteva; baterije (akumulatori), punjači baterija; kablovi, kablovski vodovi, prekidači; radio uređaji; telekomunikacijska oprema; naočari za sunce; CD-ROM igrice; djelovi i oprema za svu navedenu robu u klasi 9.

Klasa 35: Oглаšavanje; poslovni menadžment; poslovna administracija; kancelarijski poslovi; poslovni menadžment i konsalting; obezbjeđivanje poslovnih informacija; usluge menadžmenta u oblasti distribucije proizvoda; logističke konsalting usluge, uključujući dizajniranje i menadžment lanca nabavke; usluge marketinga; kompiliranje i sistematizacija podataka u kompjuterske baze podataka; menadžment i sistematizacija kompjuterskih baza podataka, usluge iznajmljivanja robe; usluge on-lajn prodaje robe na malo; usluge prodaje robe na malo; obezbjeđivanje pretraživih kompjuterskih baza podataka, veb-sajtova i on-lajn informativnih usluga u vezi sa kupovinom, iznajmljivanjem, finansiranjem, popravkom i održavanjem vozila za prenos zemlje, obradu zemljišta, rukovanje materijalima, građevinarstvo, rudarstvo, popločavanje, poljoprivredu i šumarstvo, opreme, i mašinerije, pogonskih mašina i opreme za proizvodnju struje.

Klasa 36: Osiguranje; finansijski poslovi; monetarni poslovi; poslovi u vezi nekretnina; finansijske usluge; usluge finansijskog menadžmenta; davanje obezbeđenja za dug; usluge investiranja; usluge osiguranja; usluge kreditiranja; usluge davanja garancija.

(111) **03847**(151) **30.07.2012**(210) **2009-399**(442) **20.03.2012**

(220) 28.05.2009

(300) 06.07.2007 Z-2007-1335 RS

(732) **CATERPILLAR INC; A CORPORATION OF DELAWARE 100 NE ADAMS STREET, PEORIA, ILLINOIS 61629 US**



(540)

(550) I

(740) Ćupić Branislav, Dalmatinska 10, Podgorica (ME)

(511) **Klasa 04:** Industrijska ulja i masti, sredstva za podmazivanje; smese za upijanje, vlaženje i vezivanje prašine; goriva (uključujući tečna goriva za motore) i materije za osvjetljavanje; sveće i fitilji za osvjetljavanje; masti, sredstva za podmazivanje i ulja za suvozemna vozila; masti, sredstva za podmazivanje i ulja za motore; industrijske masti, sredstva za podmazivanje i ulja; hidraulična ulja; masti, sredstva za podmazivanje i ulja za industrijske mašine; ne-hemijska sredstva za tretiranje motora i ne-hemijski aditivi za motorna ulja, benzin i dizel-gorivo, za tečnosti za mjenjače, i za tečnosti za hlađenje.

Klasa 09: Aparati i instrumenti naučni, nautički, geodetski, optički, za vaganje, mjerenje, signalizaciju, kontrolu (inspekciju), pomoć (spasavanje), i nastavu; aparati i instrumenti za provođenje, prekidanje, transformisanje, akumuliranje, regulisanje ili kontrolu električne energije; aparati za snimanje, prenos ili reprodukciju zvuka ili slike; nosači magnetskih podataka, diskovi za snimanje; računске mašine, uređaji za obradu podataka i računari; električni i elektronski aparati i instrumenti; aparati i instrumenti za mjerenje i testiranje; aparati za nadgledanje i prikazivanje; dijagnostički aparati i instrumenti; indikatori za pritisak i temperaturu, podesivi merači i satovi za pritisak i temperaturu; kompjuterski hardver i softver; kontrolne jedinice; operatorski interfejs; sigurnosna oprema; oprema za GPS (sistem za globalno pozicioniranje); oprema za daljinsko rukovanje, kontrolu i nadgledanje vozila za prenos zemlje, obradu zemljišta, rukovanje materijalima, građevinarstvo, rudarstvo, popločavanje, poljoprivredu i šumarstvo, opreme, i mašinerije, pogonskih mašina, opreme za proizvodnju električne energije, i kamiona za kretanje van glavnih puteva; baterije (akumulatori), punjači baterija; kablovi, kablovski vodovi, prekidači; radio uređaji; telekomunikacijska oprema; naočari za sunce; CD-ROM igrice; djelovi i oprema za svu navedenu robu u klasi 9.

Klasa 36: Osiguranje; finansijski poslovi; monetarni poslovi; poslovi u vezi nekretnina; finansijske usluge; usluge finansijskog menadžmenta; davanje obezbeđenja za dug; usluge investiranja; usluge osiguranja; usluge kreditiranja; usluge davanja garancija.

(111) **03848**(151) **30.07.2012**(210) **2009-410**(442) **20.03.2012**

(220) 02.06.2009

(732) **ALKALOID AD SKOPLJE; BULEVAR ALEKSANDAR MAKEDONSKI 12, 1000 SKOPLJE MK**

CAFFETIN cold

(540)

(550) I

(740) Popović Miladin, Đoka Miraševića 21/III Podgorica (ME)

(511) **Klasa 05:** Farmaceutski preparati.

(111) **03849** (151) **30.07.2012**

(210) **2009-411** (442) **20.03.2012**

(220) 03.06.2009

(732) **ALKALOID AD SKOPLJE; BULEVAR ALEKSANDAR MAKEDONSKI 12, 1000 SKOPLJE MK**

PROCULIN

(540)

(550) I

(740) Popović Miladin, Đoka Miraševića 21/III Podgorica (ME)

(511) **Klasa 05:** Farmaceutski preparati.

(111) **03850** (151) **30.07.2012**

(210) **2009-413** (442) **20.03.2012**

(220) 03.06.2009

(732) **ALKALOID AD SKOPLJE; BULEVAR ALEKSANDAR MAKEDONSKI 12, 1000 SKOPLJE MK**

CAFFETIN MENSTRUAL

(540)

(550) I

(740) Popović Miladin, Đoka Miraševića 21/III Podgorica (ME)

(511) **Klasa 05:** Farmaceutski preparati.

(111) **03851** (151) **30.07.2012**

(210) **2009-415** (442) **20.03.2012**

(220) 05.06.2009

(732) **KIA MOTORS CORPORATION; 231, YANGJIE-DONG, SEOCHO-GU, SEUL KR**



(540)

(550) I

(740) Popović Miladin, Đoka Miraševića 21/III Podgorica (ME)

(511) **Klasa 12:** Putnički automobili, kamioni, autobusi, minibusi, automobili sa pogonom na četiri točka, kombi, minikombi.

(111) **03852** (151) **30.07.2012**

(210) **2009-417** (442) **20.03.2012**

(220) 12.06.2009

(732) **REEMTSAMA CIGARETTENFABRIKEN GMBH A COMPANY; MAX-BORN-STRASSE4, 22761 HAMBURG DE****GOLDEN GATE**

(540)

(550) I

(740) Ćupić Branislav, Dalmatinska 10, Podgorica (ME)

(511) **Klasa 34:** Duvan, bilo prerađen ili neprerađen; proizvodi od duvana; cigarete; cigare; zamjene za duvan, koje nisu za medicinske ili terapijske svrhe; šibice i proizvodi za pušače.(111) **03853**(151) **30.07.2012**(210) **2009-420**(442) **20.03.2012**

(220) 17.06.2009

(732) **SUMITOMO CHEMICAL CO LTD; 27-1 SHINKAWA 2-CHOME CHUO-KU TOKYO 104-8260 JP****SUMIPEX**

(540)

(550) I

(740) Stanković Mugoša Ana, Trg Republike br.13 81000 Podgorica (ME)

(511) **Klasa 01:** Neprerađene plastične materije, neprerađene vještačke smole.(111) **03854**(151) **30.07.2012**(210) **2009-423**(442) **20.03.2012**

(220) 22.06.2009

(732) **BOSNA LIJEK DD; JUKIĆEVA 53, 71000 SARAJEVO BA**

(540)

(550) I

(740) Radulović Božidar, Jovana Tomaševića 9/III, Podgorica (ME)

(511) **Klasa 05:** Farmaceutski proizvodi.(111) **03855**(151) **30.07.2012**(210) **2009-424**(442) **20.03.2012**

(220) 22.06.2009

(732) **BOSNA LIJEK DD; JUKIĆEVA 53, 71000 SARAJEVO BA**

BOSNYL

(540)

(550) I

(740) Radulović Božidar, Jovana Tomaševića 9/III, Podgorica (ME)

(511) **Klasa 05:** Farmaceutski proizvodi.

(111) **03856**

(151) **30.07.2012**

(210) **2009-425**

(442) **20.03.2012**

(220) 24.06.2009

(732) **NBA PROPERTIES INC; OLYMPIC TOWER BLDG. 645 FIFTH AVENUE, NEW YORK, NY 10022 US**



(540)

(550) I

(740) Popović Miladin, Đoka Miraševića 21/III Podgorica (ME)

(511) **Klasa 25:** Odjeća, naime čarape, obuća, cipele za košarku, patike za košarku, majice, košulje, polo majice, dukserice, donji djelovi trenerke, pantalone, majice na bretele, džemper, kratke pantalone, pidžame, sportske majice, ragbi majice, vunene majice, kaiševi, kravate, spavačice, šeširi, kape, štيتnici na kačketima, trenerke, donji djelovi trenerki, dresovi, jakne, vetrovke, kišne krznene jakne, kaputi, portikle za bebe ne od papira, trake za glavu, narukvice, kecelje, donje rublje, bokserice, široke pantalone, štيتnici za uši, rukavice, bokserske rukavice, šalovi, pletene i štrikane majice, trikotažne haljine, haljine, dresovi i uniforme za navijačice, odjeća za plivanje, odela za kupanje, kupaci kostimi, bikini, tamkini kupaći kostimi, gaćice za plivanje, gaćice za kupanje, šorcevi za surfovanje, šorcevi za kupanje, marame za plažu, pokrivala za kupaći kostim, ogrtači za kupaći kostim, sandale, sandale za plažu, šeširi za plažu, štيتnici za sunce, kape za plivanje, kape za kupanje, nova pokrivala za glavu sa prikacnim umecima.

Klasa 28: Igračke, igre i sportske stvari, naime košarkaške lopte, loptice za golf, lopte za igralište, sportske lopte, gumene lopte i penaste lopte, plišane lopte za igru, plastične lopte za igru, mrežice za košarku, table za košarku, minijaturne table za košarku, pumpe i igle za naduvavanje košarkaških lopti; golf klubovi, golf torbe, štapovi za golf, oprema za golf, naime, alat za popravku golf terena, kupice na koje se stavlja lopta, markeri lopti, torbe za golf opremu, pokrivala za glave golf štapova, rukavice za golf, kutije za golf lopte, elektronske table za košarkaške igrice na tabli, table za košarkaške igrice, košarkaške igrice, akcione igrice, društvene igrice za odrasle i decu, mašine za jednostavne informacione igrice i elektronske

video arkada igrice, košarkaška torbica koja se sastoji od mrežice i zviždaljke, lutke, dekorativne lutke, lutke za kolekciju, akcione figure za igru, akcione figure karikature, punjene igračke, nove plišane igračke sa umecima, puzzle, montažni blokovi za igre, ukrasi za Božićnu jelku i Božićne čarape; vozila igračke u oblika automobila, kamiona, vozova i kombija, svi sa temom košarke, nove penaste igračke u obliku prsta ili trofeja, igrački trofeji, karte za igru, igrice sa kartama, igračke koje prave zvuk, igračke za kućne ljubimce; igračke za plažu, naime lopte za plažu, nepotopljive lopte, kantice za igru, lopatice za igru, igračke za pesak, kutijice za pesak, gumene igračke za vodu; oprema za bazen, naime plivačka oprema za plutanje, oprema za plutanje u bazenu, igračke za splavarenje na vodi, penasta oprema za plutanje, gume za plivanje, gume za plivanje u bazenu, penaste gume, daske za plivanje, daske za surfovanje, peraja za plivanje, peraja za surfovanje, mišići za plutanje i krila za pomoć pri plivanju u rekreativne svrhe; odbojkaške torbice za igru koje se sastoje od lopte, mrežice, sporednih stvari i zviždaljke, i vaterpolo torbice za igru koje se sastoje od lopte, mrežice i zviždaljke; dekorativne igračke koje se puštaju da lete na vetru.

Klasa 41: Usluge razonode i obrazovne usluge u vidu televizijskih događaja i radio programa u polju košarke i prikazanih košarkaških igara i košarkaških priredbi; usluge produkcije i distribucije radio i televizijskih programa o košarkaškim igrama, košarkaškim događajima i programima iz oblasti košarke; usluge vođenja i organizovanja košarkaških klinika i kampova, klinika i kampova za trenere, klinika i kampova za plesne timove i košarkaške igre; usluge razonode u vidu ličnog pojavljivanja u kostimiziranim maskotama ili u plesnim timovima na košarkaškim igrama i priredbama, klinikama, kampovima, promocijama i drugim događajima, specijalnim događajima i žurkama vezanim za košarku; usluge klubova obožavalaca; usluge razonode, naime one koje pružaju vebsajt predstavljanje multimedijalnih sadržaja u vidu najvažnijih televizijskih događaja, interaktivnih najvažnijih televizijskih događaja, video snimaka, video strim snimaka, interaktivnih video izbora najvažnijih događaja, radio programa, najvažnijih radijskih događaja i audio snimaka u polju košarke; usluge obezbeđivanja vesti i informacija u vidu statistika i osnovnih podataka u polju košarke; onlajn igrice koje se ne mogu preuzimati, naime kompjuterske igrice, video igrice, interaktivne video igrice, akcione igrice, arkadne igrice, društvene igrice za odrasle i decu, igre na tabli, puzzle, jednostavne igrice; usluge elektronskog izdavanja, naime, izdavanje magazina, vodiča, biltena, knjiga u boji i igrice kod kojih se igrači određuju putem interneta, sve u vezi sa košarkom; usluge obezbeđivanja onlajn kompjuterske baze podataka u polju košarke.

(111) **06373**

(151) **25.09.2012**

(210) **2009-333**

(442) **20.03.2012**

(220) 28.05.2009

(732) **VITALIA NIKOLA I DR. DOO EHPORT-IMPORT; UL 516 BB 1000 SKOPLJE MK**



(540) Heart of the Health

(550) I

(740) Radulović Božidar, Jovana Tomaševića 9/III, Podgorica (ME)

(511) **Klasa 05:** Farmaceutski i veterinarski preparati; sanitarni preparati za medicinsku upotrebu; dijetetske supstance prilagođene za upotrebu u medicini, hrana za bebe; flasteri, materijali za zavijanje; materijali za plombiranje zuba, zubarska smola; dezinfekciona sredstva; preparati za uništavanje štetočina.

Klasa 29: Meso, riba, živina i divljač; mesne preradevine; konzervisano, zamrznuto, sušeno i kuvano voće i povrće; želei, dzemovi, kompoti; jaja, mlijeko, i mliječni proizvodi; jestiva ulja i masti.

Klasa 30: Kafa, čaj, kakao, šećer, pirinac, tapioka, sago, zamjena kafe; brašno i proizvodi od žitarica, hljeb, kolači i poslastice, sladoledi; med, mjelasa; kvasac, prašak za pecivo; so, senf; sirće, sosovi (kao dodaci); začini; led.

Klasa 31: Poljoprivredni, vrtlarski i šumarski proizvodi i zrnevlje koji nisu uključeni u druge klase; žive životinje; svježe voće i povrće; sjeme, prirodne biljke i cvijeće; hrana za životinje, slad.

Klasa 32: Mineralne i sodne vode i druga bezalkoholna pića; pića od voća i voćni sokovi; sirupi i drugi preparati za proizvodnju pića.

Klasa 39: Transportne usluge; pakovanje i skladištenje robe; organizovanje putovanja.

(111) **06374**(151) **25.09.2012**(210) **2009-512**(442) **20.03.2012**

(220) 17.08.2009

(732) **BARBERTON-CONSULTORES E SERVICOS LDA; ZONA FRANCA DE MADERIA, AVENIDA DO INFANTE NO. 50. FUNCHAL-MADERIA PT**

DIPLOMATICO

(540)

(550) I

(740) Popović Miladin, Đoka Miraševića 21/III Podgorica (ME)

(511) **Klasa 33:** Rum i liker od ruma.(111) **06375**(151) **25.09.2012**(210) **2009-513**(442) **20.03.2012**

(220) 17.08.2009

(732) **BARBERTON-CONSULTORES E SERVICOS LDA; ZONA FRANCA DE MADERIA, AVENIDA DO INFANTE NO. 50. FUNCHAL-MADERIA PT**

HACIENDA SARURO

(540)

(550) I

(740) Popović Miladin, Đoka Miraševića 21/III Podgorica (ME)

(511) **Klasa 33:** Rum i liker od ruma.(111) **06376**(151) **25.09.2012**

(210) **2009-516**(442) **20.03.2012**

(220) 20.08.2009

(732) **BEOHEMIJA-INHEM DOO; PANČEVAČKA BB ZRENJANIN RS****DIEL**

(540)

(550) I

(740) Božović Vesko, Rimski trg, 50/11, Podgorica (ME)

(511) **Klasa 01:** hemijski proizvodi koji se upotrebljavaju u industriji, nauci, fotografiji, poljoprivredi, hortikulturi i šumarstvu; neprerađene veštačke smole, neprerađene plastične materije; đubriva; smješe za gašenje vatre; preparati za kaljenje i zavarivanje; hemijske spustance za očuvanje namirnica; materije za štavljenje; lepljive spustance koje se upotrebljavaju u industriji.

Klasa 02: boje, firnajzi, lakovi, sredstva za zaštitu od rđe i truljenja drveta; materije za bojenje; sredstva za nagrizanje; sirove prirodne smole; metali u obliku listova i praha za slikare, dekoratere, štampare i umjetnike.

Klasa 03: sredstva za beljenje i druge spustance za upotrebu u perionicama; preparati za čišćenje, poliranje, ribanje i nagrizanje; sapuni; parfimerija, eterična ulja, kozmetika, losioni za kosu; paste za zube.

(111) **06377**(151) **25.09.2012**(210) **2009-517**(442) **20.03.2012**

(220) 20.08.2009

(732) **PODRAVKA PREHRAMBRENA INDUSTRIJA DD KOPRIVNICA; A STARČEVICA 32 KOPRIVNICA HR**

(540)

(550) I

(740) Božović Vesko, Rimski trg, 50/11, Podgorica (ME)

(511) **Klasa 32:** Pivo, mineralne sodne vode i druga bezalkoholna pića; pića od voća voćni sokovi; sirupi i drugi preparati za proizvodnju pića.

(111) **06378**(151) **25.09.2012**

(210) **2009-532**(442) **20.03.2012**

(220) 25.08.2009

(732) **NIPPON YUSOKI CO LTD; NO.1-1, HIGASHI-KOTARI 2-CHOME, NAGAO-KAKYO-SHI, KYOTO JP****NICHIYU**

(540)

(550) I

(740) Popović Miladin, Đoka Miraševića 21/III Podgorica, (ME)

(511) **Klasa 07:** Mašine i instrumenti za utovar i istovar; mašine i instrumenti koje pokreću vetar/voda; mašine i instrumenti za namotavanje plastičnog filma/tabaka; mašine i instrumenti za namotavanje netkanog materijala; mašine i instrumenti za namotavanje materijala; mašine i instrumenti za namotavanje platnene lepljive trake; mašine i instrumenti za namotavanje plastične lepljive trake; mašine i instrumenti za namotavanje plastičnih samolepljivih traka za zaštitu dekorativnog laminata; mašine i instrumenti za namotavanje papirnih samolepljivih traka za zaštitu dekorativnog laminata; mašine za namotavanje slikarskih plastičnih samolepljivih traka; mašine i instrumenti za namotavanje slikarskih papirnih samolepljivih traka; mašine i instrumenti za kožne proizvode; mašine i instrumenti za namotavanje metalnih folija; mašine i instrumenti za namotavanje papirnih lepljivih traka; mašine i instrumenti za pravljenje celuloze i papira; glavni pokretači, osim za suvozemna vozila; started za motore i mašine; motori na naizmjeničnu i motori na jednosmernu struju; generatori (alternatori) na naizmjeničnu struju; generatori na jednosmernu struju; djelovi za mašine, osim za suvozemna vozila; mehanički aparati za parkiranje vozila.

Klasa 12: Šinska vozila i oprema i djelovi za ista; automobili i oprema i djelovi za njih; ručna kolica; kolica; uređaji za prenošenje broskog tereta i tovara; uređaji za istovar kosih željezničkih tovarnih vagona; gurači rudarskih kolica; tegljači rudarskih kolica; traktori; mašinski elementi za suvozemna vozila; motori na naizmjeničnu i motori na jednosmernu struju za suvozemna vozila (neuključujući njihove djelove); glavni pokretači za suvozemna vozila (neuključujući njihove djelove).

Klasa 37: Usluge vezane za radove na visokogradnji; usluge vezane za radove na niskogradnji; usluge vezane za rad na čeličnim konstrukcijama; stolarske usluge; vodoinstalaterske usluge; usluge instalacije aparata; usluge vezane za električne radove; usluge spajanja telekomunikacijskih žica; usluge popravke ili održavanja automobila; usluge popravke ili održavanja šinskih vozila; usluge popravke ili održavanja električnih motora; usluge popravke ili održavanja mašina i aparata za distribuciju i kontrolu struje; usluge popravke ili održavanja telekomunikacijskih mašina i aparata; usluge popravke ili održavanja automatskih sistema za skladištenje; usluge restauracije nameštaja; usluge popravke ili održavanja aparata za parkiranje automobila.

(111) **06379**(151) **25.09.2012**(210) **2009-533**(442) **20.03.2012**

(220) 25.08.2009

(732) **DIAGEO NORTH AMERICA, INC; 801 MAIN AVENUE, NORWALK, CONNECTICUT 06851 US**



(540)

(550) I

(740) Čejović Vladimir, 13. jul 21, Podgorica (ME)

(511) **Klasa 33:** Alkoholna pića.(111) **06380**(151) **25.09.2012**(210) **2009-534**(442) **20.03.2012**

(220) 25.08.2009

(732) **SURF CO LTDA; RUA GUAIANAZES, 1448, SAO PAULO-SP BR****HANG LOOSE**

(540)

(550) I

(740) Lutovac Branislav, Bulevar Crnojevića 93, Podgorica (ME)

(511) **Klasa 25:** Odjeća, a naročito majice, jakne, košulje, pantalone i kape.(111) **06381**(151) **25.09.2012**(210) **2009-535**(442) **20.03.2012**

(220) 26.08.2009

(732) **PT INDOFOOD SUKSES MAKMUR TBK; SUDIRMAN PLAZA, INDOFOOD TOWER, 27 FLOOR, JI JEND. SUDIRMAN KAV. 76-78, JAKARTA SELATAN ID**



(540)

(550) I

(740) Čejović Vladimir, 13. jul 21, Podgorica (ME)

(511) **Klasa 30:** Kafa, čaj, kakao, šećer, pirinač, tapioka, sago, zamjena kafe; brašno i proizvodi od žitarica, hljeb, kolači i poslastice, sladoledi; med, melasa; kvasac, prašak za pecivo; so, senf; sirće, sosovi (kao začini); začini; led; makaroni, rezanci, tjestenina, tanki rezanci za supu, pšenično brašno.

(111) **06382**(151) **25.09.2012**(210) **2009-536**(442) **20.03.2012**

(220) 26.08.2009

(732) **PT INDOFOOD SUKSES MAKMUR TBK; SUDIRMAN PLAZA, INDOFOOD TOWER, 27 FLOOR, JI JEND. SUDIRMAN KAV. 76-78, JAKARTA SELATAN ID**



(540)

(550) I

(740) Čejović Vladimir, 13. jul 21, Podgorica (ME)

(511) **Klasa 30:** Kafa, čaj, kakao, šećer, pirinač, tapioka, sago, zamjena kafe; brašno i proizvodi od žitarica, hljeb, kolači i poslastice, sladoledi; med, melasa; kvasac, prašak za pecivo; so, senf; sirće, sosovi (kao začini); začini; led; makaroni, rezanci, tjestenina, tanki rezanci za supu, pšenično brašno.

(111) **06383**(151) **25.09.2012**(210) **2009-540**(442) **20.03.2012**

(220) 28.08.2009

(732) **GENZYME CORPORATION; 500 KENDALL STREET CAMBRIGE, MASSACHUSETTS 02142 US**

TRANSLARNA

(540)

(550) I

(740) Radulović Božidar, Jovana Tomaševića 9/III, Podgorica (ME)

(511) **Klasa 05:** Farmaceutski i veterinarski preparati; sanitarni preparati za medicinske svrhe;

dijetetske supstance za upotrebu u medicini, hrana za bebe; flasteri, materijal za zavijanje; materijali za plombiranje zuba, zubarska smola; dezinfekciona sredstva; preparati za uništavanje štetočina; fungicidi, herbicidi: naročito farmaceutski proizvodi za tretiranje genetskih poremećaja.

(111) **06384**

(151) **25.09.2012**

(210) **2009-541**

(442) **20.03.2012**

(220) 28.08.2009

(732) **GENZYME CORPORATION; 500 KENDALL STREET CAMBRIGE, MASSACHUSETTS 02142 US**

ILUMERNA

(540)

(550) I

(740) Radulović Božidar, Jovana Tomaševića 9/III, Podgorica (ME)

(511) **Klasa 05:** Farmaceutski i veterinarski preparati; sanitarni preparati za medicinske svrhe; dijetetske supstance za upotrebu u medicini, hrana za bebe; flasteri, materijal za zavijanje; materijali za plombiranje zuba, zubarska smola; dezinfekciona sredstva; preparati za uništavanje štetočina; fungicidi, herbicidi: naročito farmaceutski proizvodi za tretiranje genetskih poremećaja.

(111) **06385**

(151) **25.09.2012**

(210) **2009-542**

(442) **20.03.2012**

(220) 28.08.2009

(732) **GENZYME CORPORATION; 500 KENDALL STREET CAMBRIGE, MASSACHUSETTS 02142 US**

APERLURI

(540)

(550) I

(740) Radulović Božidar, Jovana Tomaševića 9/III, Podgorica (ME)

(511) **Klasa 05:** Farmaceutski i veterinarski preparati; sanitarni preparati za medicinske svrhe; dijetetske supstance za upotrebu u medicini, hrana za bebe; flasteri, materijal za zavijanje; materijali za plombiranje zuba, zubarska smola; dezinfekciona sredstva; preparati za uništavanje štetočina; fungicidi, herbicidi: naročito farmaceutski proizvodi za tretiranje genetskih poremećaja.

(111) **06386**

(151) **25.09.2012**

(210) **2009-548**

(442) **20.03.2012**

(220) 04.09.2009

(732) **VOTORANTIM CELULOSE E PAPEL SA; ALAMEDA SANTOS, 1.357-6 ANDAR, 01419-001- SAO PAULO, SP BR**

FIBRIA

(540)

(550) I

(740) Radulović Božidar, Jovana Tomaševića 9/III, Podgorica (ME)

(511) **Klasa 01:** Celuloza; hemijske supstance celuloze; drvena masa; plutani čepovi; mineralne supstance i proizvodi (uključeni u ovu klasu); krečni minerali (uključeni u ovu klasu); dubri-
va.

Klasa 16: Papir, karton; knjige; proizvodi od celuloze (uključeni u ovu klasu); papirni blokovi; bilježnice; knjižice; štamparski proizvodi (uključeni u ovu klasu); štampani obrasci; pribor za pisanje i kancelarijski pribor; kutije od kartona i papira; ambalaža; notesi; karte; karte za igru; koverta; papirnati ubrusi; toaletni papir; papirnat maramice.

Klasa 31: Sjeme; sadnice; prirodne biljke i cvijeće; sirovo drvo; žito; hrana za ptice i životinje.

Klasa 40: Usluge restauriranja, obrade i oplemenjivanja drveta; štamparske usluge, usluge uvezivanja knjiga; fotografsko štampanje, finiširanje papira, obrada papira.

Klasa 42: Usluge za građevinske projekte, geofizička i geološka istraživanja; profesionalne savjetodavne usluge u odnosu s navedenim radnjama.

Klasa 44: Poljoprivredne, povrtlarske i šumarske usluge, usluge pošumljavanja; usluge sadnje šuma; arboretumske usluge; uništavanja korova; prskanje odnosno vazdušno i površinsko širenje đubriva i ostale poljoprivredne hemikalije; uništavanje životinjskih štetočina (u poljoprivredi, povrtlarstvu i šumarstvu).

(111) **06387**

(151) **25.09.2012**

(210) **2009-549**

(442) **20.03.2012**

(220) 04.09.2009

(732) **VOTORANTIM CELULOSE E PAPEL SA; ALAMEDA SANTOS, 1.357-6 AN-
DAR, 01419-001- SAO PAULO, SP BR**



(540)

(550) I

(740) Radulović Božidar, Jovana Tomaševića 9/III, Podgorica (ME)

(511) **Klasa 01:** Celuloza; hemijske supstance celuloze; drvena masa; plutani čepovi; mineralne supstance i proizvodi (uključeni u ovu klasu); krečni minerali (uključeni u ovu klasu); dubri-
va.

Klasa 16: Papir, karton; knjige; proizvodi od celuloze (uključeni u ovu klasu); papirni blokovi; bilježnice; knjižice; štamparski proizvodi (uključeni u ovu klasu); štampani obrasci; pribor za pisanje i kancelarijski pribor; kutije od kartona i papira; ambalaža; notesi; karte; karte za igru; koverta; papirnati ubrusi; toaletni papir; papirnat maramice.

Klasa 31: Sjeme; sadnice; prirodne biljke i cvijeće; sirovo drvo; žito; hrana za ptice i životinje.

Klasa 40: Usluge restauriranja, obrade i oplemenjivanja drveta; štamparske usluge, usluge uvezivanja knjiga; fotografsko štampanje, finiširanje papira, obrada papira.

Klasa 42: Usluge za građevinske projekte, geofizička i geološka istraživanja; profesionalne savjetodavne usluge u odnosu s navedenim radnjama.

Klasa 44: Poljoprivredne, povrtlarske i šumarske usluge, usluge pošumljavanja; usluge sadnje šuma; arboretumske usluge; uništavanja korova; prskanje odnosno vazdušno i površinsko širenje đubriva i ostale poljoprivredne hemikalije; uništavanje životinjskih štetočina (u poljoprivredi, povrtlarstvu i šumarstvu).

(111) **06388** (151) **25.09.2012**

(210) **2009-556** (442) **20.03.2012**

(220) 15.09.2009

(732) **WM WRIGLEY JR COMPANY; 410 NORTH MICHIGAN AVENUE, CHICAGO IL 60611 US**

ORBIT ESSENTIALS

(540)

(550) I

(740) Čejović Vladimir, 13. jul 21, Podgorica (ME)

(511) **Klasa 30:** Slatkiši, žvakaće gume, žvakaće gume od kojih mogu da se prave veliki baloni, bombone, dražeje peperminta, mali okrugli bomboni (drops) i pastile.

(111) **06389** (151) **25.09.2012**

(210) **2009-557** (442) **20.03.2012**

(220) 15.09.2009

(732) **WM WRIGLEY JR COMPANY; 410 NORTH MICHIGAN AVENUE, CHICAGO IL 60611 US**

RELAXING MOMENT

(540)

(550) I

(740) Čejović Vladimir, 13. jul 21, Podgorica (ME)

(511) **Klasa 30:** Slatkiši, žvakaće gume, žvakaće gume od kojih mogu da se prave veliki baloni, bombone, dražeje peperminta, mali okrugli bomboni (drops) i pastile.

(111) **06390** (151) **25.09.2012**

(210) **2009-558** (442) **20.03.2012**

(220) 15.09.2009

(732) **WM. WRIGLEY JR COMPANY; 410 NORTH MICHIGAN AVENUE, CHICAGO IL 60611 US**

SUPPORT YOUR DEFENSES

(540)

(550) I

(740) Čejović Vladimir, 13. jul 21, Podgorica (ME)

(511) **Klasa 30:** Slatkiši, žvakaće gume, žvakaće gume od kojih mogu da se prave veliki baloni, bombone, dražeje peperminta, mali okrugli bomboni (drops) i pastile.(111) **06391**(151) **25.09.2012**(210) **2009-565**(442) **20.03.2012**

(220) 18.09.2009

(732) **OTKRYTOE AKTSIONORE OBSHESTVO GAZOPROM; UL NAMETKINA
16 117997 MOSCOW RU**

(540)

(550) I

(740) Čejović Vladimir, 13. jul 21, Podgorica (ME)

(511) **Klasa 01:** Hemijski proizvodi koji se upotrebljavaju u industriji, nauci i fotografiji, kao i u poljoprivredi, hortikulturi i šumarstvu; neprerađene vještačke smole, neprerađene plastične materije; đubriva.**Klasa 04:** Industrijska ulja i masti; maziva; goriva i materije za osvjtljavanje; ulje, gas, uljni gas, gas za loženje (gorivni gas), tečni gas, komprimovani gas, električna energija.**Klasa 16:** Papir, karton i proizvodi dobijeni od ovih materijala, koji nijesu uključeni u druge klase; štampane stvari; knjigovezački materijal; fotografije; kancelarijski materijal; Ljepila za kancelarijske i kućne potrebe; umjetnički materijali; kičice; pisaće mašine i kancelarijski rekviziti (izuzev namještaja); materijali za obuku i nastavu (izuzev aparata); plastični materijali za pakovanje (koji nijesu uključeni u druge klase); štamparska slova; klišei.**Klasa 35:** Oglašavanje; vođenje poslova; poslovno upravljanje; kancelarijski poslovi.**Klasa 37:** Rekonstrukcija zgrada; popravke; usluge instaliranja.**Klasa 39:** Transport; pakovanje i skladištenje robe.**Klasa 40:** Obrađivanje materijala.**Klasa 42:** Analize za eksploataciju naftnih polja, testiranje naftnih i gasnih bušotina, usluge istraživanja nafte, gasa i minerala, geološka ispitivanja, hemijske analize i naučna istraživanja, inženjerske usluge.(111) **06392**(151) **25.09.2012**(210) **2009-566**(442) **20.03.2012**

(220) 18.09.2009

(732) **OTKRTOE AKTISIONERNOE OBSHESTVO GAZOPROM; UL NAMETKI-
NA 16 117997 MOSCOW RU**



(540)

(550) I

(740) Čejović Vladimir, 13. jul 21, Podgorica (ME)

(511) **Klasa 01:** Hemijski proizvodi koji se upotrebljavaju u industriji, nauci i fotografiji, kao i u poljoprivredi, hortikulturi i šumarstvu; neprerađene vještačke smole, neprerađene plastične materije; đubriva.

Klasa 04: Industrijska ulja i masti; maziva; goriva i materije za osvjetljavanje; ulje, gas, uljni gas, gas za loženje (gorivni gas), tečni gas, komprimovani gas, električna energija.

Klasa 16: Papir, karton i proizvodi dobijeni od ovih materijala, koji nijesu uključeni u druge klase; štampane stvari; knjigovezački materijal; fotografije; kancelarijski materijal; Ljepila za kancelarijske i kućne potrebe; umjetnički materijali; kičice; pisaće mašine i kancelarijski rekviziti (izuzev namještaja); materijali za obuku i nastavu (izuzev aparata); plastični materijali za pakovanje (koji nijesu uključeni u druge klase); štamparska slova; klišeji.

Klasa 35: Oglašavanje; vođenje poslova; poslovno upravljanje; kancelarijski poslovi.

Klasa 37: Rekonstrukcija zgrada; popravke; usluge instaliranja.

Klasa 39: Transport; pakovanje i skladištenje robe.

Klasa 40: Obradivanje materijala.

Klasa 42: Analize za eksploataciju naftnih polja, testiranje naftnih i gasnih bušotina, usluge istraživanja nafte, gasa i minerala, geološka ispitivanja, hemijske analize i naučna istraživanja, inženjerske usluge.

(111) **06393**(151) **25.09.2012**(210) **2009-567**(442) **20.03.2012**

(220) 18.09.2009

(732) **OTKRYTOE AKTSIONERNOE OBSHESTVO GAZOPROM; UL NAMETKI-NA 16 117997 MOSCOW RU**



(540)

(550) I

(740) Čejović Vladimir, 13. jul 21, Podgorica (ME)

(511) **Klasa 01:** Hemijski proizvodi koji se upotrebljavaju u industriji, nauci i fotografiji, kao i u poljoprivredi, hortikulturi i šumarstvu; neprerađene vještačke smole, neprerađene plastične materije; đubriva.

Klasa 04: Industrijska ulja i masti; maziva; goriva i materije za osvjetljavanje; ulje, gas, uljni gas, gas za loženje (gorivni gas), tečni gas, komprimovani gas, električna energija.

Klasa 16: Papir, karton i proizvodi dobijeni od ovih materijala, koji nijesu uključeni u druge klase; štampane stvari; knjigovezački materijal; fotografije; kancelarijski materijal; ljepila za kancelarijske i kućne potrebe; umjetnički materijali; kičice; pisaće mašine i kancelarijski rekviziti (izuzev namještaja); materijali za obuku i nastavu (izuzev aparata); plastični materijali za pakovanje (koji nijesu uključeni u druge klase); štamparska slova; klišei.

Klasa 35: Oglašavanje; vođenje poslova; poslovno upravljanje; kancelarijski poslovi.

Klasa 37: Rekonstrukcija zgrada; popravke; usluge instaliranja.

Klasa 39: Transport; pakovanje i skladištenje robe.

Klasa 40: Obrađivanje materijala.

Klasa 42: Analize za eksploataciju naftnih polja, testiranje naftnih i gasnih bušotina, usluge istraživanja nafte, gasa i minerala, geološka ispitivanja, hemijske analize i naučna istraživanja, inženjerske usluge.

(111) **06394** (151) **25.09.2012**

(210) **2009-568** (442) **20.03.2012**

(220) 18.09.2009

(732) **OTKRYTOE AKTSIONERNOE OBSHESTVO GAZPROM; UL NAMETKI-
NA 16 117997 MOSCOW RU**



(540)

(550) I

(740) Čejović Vladimir, 13. jul 21, Podgorica (ME)

(511) **Klasa 01:** Hemijski proizvodi koji se upotrebljavaju u industriji, nauci i fotografiji, kao i u poljoprivredi, hortikulturi i šumarstvu; neprerađene vještačke smole, neprerađene plastične materije; đubriva.

Klasa 04: Industrijska ulja i masti; maziva; goriva i materije za osvjetljavanje; ulje, gas, uljni gas, gas za loženje (gorivni gas), tečni gas, komprimovani gas, električna energija.

Klasa 16: Papir, karton i proizvodi dobijeni od ovih materijala, koji nijesu uključeni u druge klase; štampane stvari; knjigovezački materijal; fotografije; kancelarijski materijal; ljepila za kancelarijske i kućne potrebe; umjetnički materijali; kičice; pisaće mašine i kancelarijski rekviziti (izuzev namještaja); materijali za obuku i nastavu (izuzev aparata); plastični materijali za pakovanje (koji nijesu uključeni u druge klase); štamparska slova; klišei.

Klasa 35: Oglašavanje; vođenje poslova; poslovno upravljanje; kancelarijski poslovi.

Klasa 37: Rekonstrukcija zgrada; popravke; usluge instaliranja.

Klasa 39: Transport; pakovanje i skladištenje robe.

Klasa 40: Obradivanje materijala.

Klasa 42: Analize za eksploataciju naftnih polja, testiranje naftnih i gasnih bušotina, usluge istraživanja nafte, gasa i minerala, geološka ispitivanja, hemijske analize i naučna istraživanja, inženjerske usluge.

(111) **06395**

(151) **25.09.2012**

(210) **2009-569**

(442) **20.03.2012**

(220) 18.09.2009

(300) 21.04.2009 2009708557 RU

(732) **OTKRYTOE AKTSIONERNOE OBSHESTVO GAZOPROM; UL NAMETKI-NA 16 117997 MOSCOW RU**



(540)

(550) I

(740) Čejović Vladimir, 13. jul 21, Podgorica (ME)

(511) **Klasa 01:** Hemijski proizvodi koji se upotrebljavaju u industriji, nauci i fotografiji, kao i u poljoprivredi, hortikulturi i šumarstvu; neprerađene vještačke smole, neprerađene plastične materije; đubriva; smješe za gašenje vatre; preparati za kaljenje i zavarivanje; hemijske supstance za očuvanje namirnica; materije za štavljenje; Ljepljive supstance koje se upotrebljavaju u industriji.

Klasa 02: Boje, firnajzi, lakovi, sredstva za zaštitu od rđe i truljenja drveta; materije za bojenje; sredstva za nagrizanje; sirove prirodne smole; metali u obliku listova i praha za slikare, dekoratere, štampe i umjetnike.

Klasa 03: Sredstva za bijeljenje i druge supstance za upotrebu u perionicama; preparati za čišćenje, poliranje, ribanje i nagrizanje; sapuni; parfimerija, eterična ulja, kozmetika, losioni za kosu; paste za zube.

Klasa 04: Industrijska ulja i masti; maziva; jedinjenja za skupljanje prašine vlaženjem i vezivanjem; goriva (uključujući motorna tečna goriva) i materije za osvjetljavanje; svijeće i fitilji za osvjetljavanje.

Klasa 05: Farmaceutski i veterinarski preparati; sanitarni preparati za medicinsku upotrebu; dijetetske supstance prilagođene za upotrebu u medicini, hrana za bebe; flasteri, materijali za zavijanje; materijali za plombiranje zuba, zubarska smola; dezinfekciona sredstva; preparati za uništavanje štetočina; fungicidi, herbicidi.

Klasa 06: Obični metali i njihove legure; metalni građevinski materijali; metalne prenosne građevine; materijali od metala za željezničke sine; neelektrični kablovi i žice od običnog metala; bravarski proizvodi; mali metalni gvoždarski proizvodi; cjevčice i cijevi od metala; sefovi; proizvodi od običnih metala koji nijesu uključeni u druge klase; rude.

Klasa 07: Mašine i mašinski alati; motori i pogonske mašine (osim za suvozemna vozila); mašinske spojnice i transmisioni elementi (osim za suvozemna vozila); poljoprivredne sprave koje su drugačije od onih za ručno upravljanje; inkubatori za jaja.

Klasa 08: Ručni alati i sprave (kojima se ručno upravlja); pribor za jelo; hladno oružje; žileti.

Klasa 09: Aparati i instrumenti naučni, pomorski, geodetski, fotografski, kinematografski, optički, za vaganje, mjerenje, signalizaciju, kontrolu (inspekciju), spasavanje i nastavu; aparati i instrumenti za provođenje, prekid, transformaciju, akumulaciju, regulisanje i kontrolu elektriciteta; aparati za snimanje, prenos i reprodukovanje zvuka ili slike; magnetni nosioci podataka; diskovi za snimanje; automatske mašine i mehanizmi za aparate koji se pokreću novcem ili žetonom; registar kase, računске mašine, oprema za obradu podataka i kompjuteri; aparati za gašenje požara.

Klasa 10: Hirurški, medicinski, zubarski i veterinarski aparati i instrumenti; vještački udovi, oči i zubi; ortopedski artikli; hirurški materijali za zašivanje.

Klasa 11: Aparati za osvjetljavanje, grijanje, proizvodnju pare, kuvanje, hlađenje, sušenje, ventilaciju, snabdijevanje vodom i za sanitarne svrhe.

Klasa 12: Vozila; aparati za kretanje po zemlji, vazduhu ili vodi.

Klasa 13: Vatreno oružje; municija i projektili; eksplozivi; sredstva za vatromet.

Klasa 14: Dragocjeni metali i njihove legure i proizvodi od dragocjenih metala ili sa prevlakom od njih, koji nijesu uključeni u druge klase; nakit, bižuterija; časovničarski i hronometrijski instrumenti.

Klasa 15: Muzički instrumenti.

Klasa 16: Hartija, karton i proizvodi od njih, koji nijesu uključeni u druge klase; štampane stvari; knjigovezački materijal; fotografije; kancelarijski materijal; Ljepila za kancelarijske i kućne potrebe; umjetnički materijali; kičice; pisaće mašine i kancelarijski rekviziti (izuzev nameštaja); materijali za obuku i nastavu (izuzev aparata); plastični materijali za pakovanje (koji nijesu uključeni u druge klase); štamparska slova; klišei.

Klasa 17: Guma, gutaperka, kaučuk, azbest, liskun i proizvodi napravljeni od ovih materijala koji nijesu obuhvaćeni drugim klasama; presovani plastični proizvodi za upotrebu u proizvodnji; materijali za podbijanje (podloške), zaptivanje i izolovanje; savitljive nemetalne cijevi.

Klasa 18: Koža i imitacija kože, proizvodi izrađeni od ovih materijala koji nijesu uključeni u druge klase; životinjska koža, krzna; koferi i putne torbe; kišobrani, suncobrani i štapovi za hodanje; bičevi, saračka i sedlarska roba.

Klasa 19: Građevinski materijali (nemetalni); čvrste nemetalne cijevi za gradevine; asfalt, crna smola i bitumen, nemetalne prenosne gradevine; spomenici, koji nijesu od metala.

Klasa 20: Nameštaj, ogledala, okviri za slike; proizvodi (koji nijesu obuhvaćeni drugim klasama) od drveta, plute, trske, rogoza, vrbovog pruća, roga, kosti, slonovače, kitove kosti, školjki, ćilibara, sedefa, morske pjene i zamjene svih ovih materijala, ili od plastike.

Klasa 21: Kućne ili kuhinjske sprave i posuđe (koje nijesu od dragocjenih metala ili sa prevlakom od njih); češljevi i sunđereri; četke (izuzev kičica); materijali za pravljenje četki; artikli koji se koriste pri čišćenju; čelična vuna; nepreradeno ili polupreradeno staklo (osim stakla koje se koristi u građevinarstvu); staklarija, porcelan i grnčarija koja nije uključena u druge klase.

Klasa 22: Užad, kanapi, mreže, šatori, nadstrešnice od cirade, cirade, jedra, vreće (džakovi) i torbe (koje nijesu uključene u druge klase); materijali za punjenje madraca (osim od gume ili plastike); sirove vlaknaste tekstilne materije.

Klasa 23: Pređa i konac, za tekstilnu upotrebu.

Klasa 24: Tekstil i tekstilni proizvodi koji nijesu obuhvaćeni drugim klasama; prekrivači za kre-

vete i stolove.

Klasa 25: Odjeća, obuća, pokrivala za glavu.

Klasa 26: Čipka i vez, trake (pantljičke) i gajtani; dugmad, kopče i petlje, špenadle i igle; vještačko cvijeće.

Klasa 27: Tepisi, asure, prostirke i otirači, linoleum i drugi materijali za pokrivanje podova; prekrivači za zidove (netekstilni).

Klasa 28: Igre i igračke; gimnastički i sportski artikli koji nijesu obuhvaćeni drugim klasama; ukrasi za jelke.

Klasa 29: Meso, riba, živina i divljač; mesne prerađevine; konzervisano, sušeno i kuvano voće i povrće; želei, džemovi, kompoti; jaja, mlijeko i mliječni proizvodi; jestiva ulja i masti.

Klasa 30: Kafa, čaj, kakao, šećer, pirinač, tapioka, sago, zamjena kafe; brašno i proizvodi od žitarica, hljeb, kolači i poslastice, sladoledi; med, melasa, kvasac, prašak za pecivo; so, senf; sirće; sosovi (kao začini); začini; led.

Klasa 31: Poljoprivredni, vrtlarski i šumarski proizvodi i zrnavlje koji nijesu uključeni u druge klase; žive životinje; svježe voće i povrće; sjeme, prirodne biljke i cvijeće; hrana za životinje, slad.

Klasa 32: Pivo, mineralne i sodne vode i druga bezalkoholna pića; pića od voća i voćni sokovi; sirupi i drugi preparati za proizvodnju pića.

Klasa 33: Alkoholna pića (izuzev piva).

Klasa 34: Duvan; artikli za pušače; šibice.

Klasa 35: Oglašavanje; vođenje poslova; poslovno upravljanje; kancelarijski poslovi.

Klasa 36: Osiguranje; finansijski poslovi; novčani poslovi; poslovi vezani za nepokretnosti.

Klasa 37: Građevinsko konstruisanje; popravlanje; usluge instaliranja (instalacione usluge).

Klasa 38: Telekomunikacije.

Klasa 39: Transportne usluge; pakovanje i skladištenje robe; organizovanje putovanja.

Klasa 40: Obradivanje materijala.

Klasa 41: Obrazovne usluge; usavršavanje; razonoda; organizovanje sportskih i kulturnih aktivnosti.

Klasa 42: Naučne i tehnološke usluge i istraživanje i projektovanje u vezi navedenih usluga; usluge industrijske analize i istraživanja; projektovanje i razvoj kompjuterskog hardvera i softvera.

Klasa 43: Usluge obezbjeđivanja hrane i pića; privremeni smještaj.

Klasa 44: Medicinske usluge; veterinarske usluge; higijenska zaštita i njega Ljepote za ljude ili životinje; poljoprivredne, hortikulture i šumarske usluge.

Klasa 45: Pravne usluge; usluge obezbjeđenja radi zaštite imovine i lica; individualne i društvene usluge koje pružaju drugi, radi zadovoljavanja potreba pojedinaca.

(111) **06396**

(151) **25.09.2012**

(210) **2009-570**

(442) **20.03.2012**

(220) 18.09.2009

(300) 21.04.2009

2009708559 RU

(732) **OTKRYTOE AKTSIONERNOE OBSHESTVO GAZPROM; UL NAMETKI-NA 16 117997 MOSCOW RU**



(540)

(550) I

(740) Čejović Vladimir, 13. jul 21, Podgorica (ME)

(511) **Klasa 01:** Hemijski proizvodi koji se upotrebljavaju u industriji, nauci i fotografiji, kao i u poljoprivredi, hortikulturi i šumarstvu; neprerađene vještačke smole, neprerađene plastične materije; đubriva; smješe za gašenje vatre; preparati za kaljenje i zavarivanje; hemijske supstance za očuvanje namirnica; materije za štavljenje; ljepljive supstance koje se upotrebljavaju u industriji.

Klasa 02: Boje, firnajzi, lakovi, sredstva za zaštitu od rđe i truljenja drveta; materije za bojenje; sredstva za nagrizanje; sirove prirodne smole; metali u obliku listova i praha za slikare, dekoratere, štampe i umjetnike.

Klasa 03: Sredstva za bijeljenje i druge supstance za upotrebu u perionicama; preparati za čišćenje, poliranje, ribanje i nagrizanje; sapuni; parfimerija, eterična ulja, kozmetika, losioni za kosu; paste za zube.

Klasa 04: Industrijska ulja i masti; maziva; jedinjenja za skupljanje prašine vlaženjem i vezivanjem; goriva (uključujući motorna tečna goriva) i materije za osvjetljavanje; svijeće i fitilji za osvjetljavanje.

Klasa 05: Farmaceutski i veterinarski preparati; sanitarni preparati za medicinsku upotrebu; djetetske supstance prilagođene za upotrebu u medicini, hrana za bebe; flasteri, materijali za zavijanje; materijali za plombiranje zuba, zubarska smola; dezinfekciona sredstva; preparati za uništavanje štetočina; fungicidi, herbicidi.

Klasa 06: Obični metali i njihove legure; metalni građevinski materijali; metalne prenosne građevine; materijali od metala za željezničke sine; neelektrični kablovi i žice od običnog metala; bravarski proizvodi; mali metalni gvoždarski proizvodi; cjevčice i cijevi od metala; sefovi; proizvodi od običnih metala koji nijesu uključeni u druge klase; rude.

Klasa 07: Mašine i mašinski alati; motori i pogonske mašine (osim za suvozemna vozila); mašinske spojnice i transmisioni elementi (osim za suvozemna vozila); poljoprivredne sprave koje su drugačije od onih za ručno upravljanje; inkubatori za jaja.

Klasa 08: Ručni alati i sprave (kojima se ručno upravlja); pribor za jelo; hladno oružje; žileti.

Klasa 09: Aparati i instrumenti naučni, pomorski, geodetski, fotografski, kinematografski, optički, za vaganje, mjerenje, signalizaciju, kontrolu (inspekciju), spasavanje i nastavu; aparati i instrumenti za provođenje, prekid, transformaciju, akumulaciju, regulisanje i kontrolu elektriciteta; aparati za snimanje, prenos i reprodukovanje zvuka ili slike; magnetni nosioci podataka; diskovi za snimanje; automatske mašine i mehanizmi za aparate koji se pokreću novcem ili žetonom; registar kase, računске mašine, oprema za obradu podataka i kompjuteri; aparati za gašenje požara.

Klasa 10: Hirurški, medicinski, zubarski i veterinarski aparati i instrumenti; vještački udovi, oči i zubi; ortopedski artikli; hirurški materijali za zašivanje.

Klasa 11: Aparati za osvjetljavanje, grijanje, proizvodnju pare, kuvanje, hlađenje, sušenje, ven-

tilaciju, snabdijevanje vodom i za sanitarne svrhe.

Klasa 12: Vozila; aparati za kretanje po zemlji, vazduhu ili vodi.

Klasa 13: Vatreno oružje; municija i projektili; eksplozivi; sredstva za vatromet.

Klasa 14: Dragocjeni metali i njihove legure i proizvodi od dragocjenih metala ili sa prevlakom od njih, koji nijesu uključeni u druge klase; nakit, bižuterija; časovničarski i hronometrijski instrumenti.

Klasa 15: Muzički instrumenti.

Klasa 16: Hartija, karton i proizvodi od njih, koji nijesu uključeni u druge klase; štampane stvari; knjigovezački materijal; fotografije; kancelarijski materijal; Ljepila za kancelarijske i kućne potrebe; umjetnički materijali; kičice; pisaće mašine i kancelarijski rekviziti (izuzev nameštaja); materijali za obuku i nastavu (izuzev aparata); plastični materijali za pakovanje (koji nijesu uključeni u druge klase); štamparska slova; klišeji.

Klasa 17: Guma, gutaperka, kaučuk, azbest, liskun i proizvodi napravljeni od ovih materijala koji nijesu obuhvaćeni drugim klasama; presovani plastični proizvodi za upotrebu u proizvodnji; materijali za podbijanje (podloške), zaptivanje i izolovanje; savitljive nemetalne cijevi.

Klasa 18: Koža i imitacija kože, proizvodi izrađeni od ovih materijala koji nijesu uključeni u druge klase; životinjska koža, krzna; koferi i putne torbe; kišobrani, suncobrani i štapovi za hodanje; bičevi, saračka i sedlarska roba.

Klasa 19: Građevinski materijali (nemetalni); čvrste nemetalne cijevi za gradevine; asfalt, crna smola i bitumen, nemetalne prenosne gradevine; spomenici, koji nijesu od metala.

Klasa 20: Nameštaj, ogledala, okviri za slike; proizvodi (koji nijesu obuhvaćeni drugim klasama) od drveta, plute, trske, rogoza, vrbovog pruća, roga, kosti, slonovače, kitove kosti, školjki, ćilibara, sedefa, morske pjene i zamjene svih ovih materijala, ili od plastike.

Klasa 21: Kućne ili kuhinjske sprave i posuđe (koje nijesu od dragocjenih metala ili sa prevlakama od njih); češljevi i sunđereri; četke (izuzev kičica); materijali za pravljenje četki; artikli koji se koriste pri čišćenju; čelična vuna; nepreradeno ili polupreradeno staklo (osim stakla koje se koristi u građevinarstvu); staklarija, porcelan i grnčarija koja nije uključena u druge klase.

Klasa 22: Užad, kanapi, mreže, šatori, nadstrešnice od cirade, cirade, jedra, vreće (džakovi) i torbe (koje nijesu uključene u druge klase); materijali za punjenje madraca (osim od gume ili plastike); sirove vlaknaste tekstilne materije.

Klasa 23: Pređa i konac, za tekstilnu upotrebu.

Klasa 24: Tekstil i tekstilni proizvodi koji nijesu obuhvaćeni drugim klasama; prekrivači za krevete i stolove.

Klasa 25: Odjeća, obuća, pokrivala za glavu.

Klasa 26: Čipka i vez, trake (pantljike) i gajtani; dugmad, kopče i petlje, špenadle i igle; vještačko cvijeće.

Klasa 27: Tepisi, asure, prostirke i otirači, linoleum i drugi materijali za pokrivanje podova; prekrivači za zidove (netekstilni).

Klasa 28: Igre i igračke; gimnastički i sportski artikli koji nijesu obuhvaćeni drugim klasama; ukrasi za jelke.

Klasa 29: Meso, riba, živina i divljač; mesne prerađevine; konzervisano, sušeno i kuvano voće i povrće; želei, džemovi, kompoti; jaja, mlijeko i mliječni proizvodi; jestiva ulja i masti.

Klasa 30: Kafa, čaj, kakao, šećer, pirinač, tapioka, sago, zamjena kafe; brašno i proizvodi od žitarica, hljeb, kolači i poslastice, sladoledi; med, melasa, kvasac, prašak za pecivo; so, senf; sirće; sosovi (kao začini); začini; led.

Klasa 31: Poljoprivredni, vrtlarski i šumarski proizvodi i zrnevlje koji nijesu uključeni u druge

klase; žive životinje; svježe voće i povrće; sjeme, prirodne biljke i cvijeće; hrana za životinje, slad.

Klasa 32: Pivo, mineralne i sodne vode i druga bezalkoholna pića; pića od voća i voćni sokovi; sirupi i drugi preparati za proizvodnju pića.

Klasa 33: Alkoholna pića (izuzev piva).

Klasa 34: Duvan; artikli za pušače; šibice.

Klasa 35: Oglašavanje; vođenje poslova; poslovno upravljanje; kancelarijski poslovi.

Klasa 36: Osiguranje; finansijski poslovi; novčani poslovi; poslovi vezani za nepokretnosti.

Klasa 37: Građevinsko konstruisanje; popravljavanje; usluge instaliranja (instalacione usluge).

Klasa 38: Telekomunikacije.

Klasa 39: Transportne usluge; pakovanje i skladištenje robe; organizovanje putovanja.

Klasa 40: Obrađivanje materijala.

Klasa 41: Obrazovne usluge; usavršavanje; razonoda; organizovanje sportskih i kulturnih aktivnosti.

Klasa 42: Naučne i tehnološke usluge i istraživanje i projektovanje u vezi navedenih usluga; usluge industrijske analize i istraživanja; projektovanje i razvoj kompjuterskog hardvera i softvera.

Klasa 43: Usluge obezbjeđivanja hrane i pića; privremeni smještaj.

Klasa 44: Medicinske usluge; veterinarske usluge; higijenska zaštita i njega ljepote za ljude ili životinje; poljoprivredne, hortikulture i šumarske usluge.

Klasa 45: Pravne usluge; usluge obezbjeđenja radi zaštite imovine i lica; individualne i društvene usluge koje pružaju drugi, radi zadovoljavanja potreba pojedinaca.

(111) **06397**

(151) **25.09.2012**

(210) **2009-586**

(442) **20.03.2012**

(220) 30.09.2009

(732) **ARTCAFE SRL; VIALE FRATTI 31-C, 43121 PHARMA PR ITALY PR IT**



Artcafé

(540) _____

(550) I

(740) Čejović Vladimir, 13. jul 21, Podgorica (ME)

(511) **Klasa 30:** Kafa; čaj; kakao; šećer; sladoledi; peciva i slatkiši; napici na bazi kafe; čokolada.

(111) **06451**

(151) **25.09.2012**

(210) **2009-87**(442) **20.03.2012**

(220) 03.02.2009

(300) 07.05.2008 Z-1138-08 RS

(732) **MEGGLE AG; MEGGLESTRABE 6-12, 83512 WASSERBURG DE****Vita DRINK**

(540)

(550) I

(740) Radulović Božidar, Jovana Tomaševića 9/III, Podgorica (ME)

(511) **Klasa 29:** Mlijeko i mliječni proizvodi.**Klasa 32:** Napitci od surutke i napitci od surutke sa dodatkom voća.(111) **06452**(151) **25.09.2012**(210) **2009-88**(442) **20.03.2012**

(220) 04.02.2009

(300) 14.02.2008 Z-286-2008 RS

(732) **MEGGLE AG; MEGGLESTRABE 6-12, 83512 WASSERBURG DE****SALATISSIMA**

(540)

(550) I

(740) Radulović Božidar, Jovana Tomaševića 9/III, Podgorica (ME)

(511) **Klasa 29:** Mlijeko i mliječni proizvodi; sve vrste jogurta; proizvodi od mrvljenog sira.(111) **06453**(151) **25.09.2012**(210) **2009-174**(442) **20.03.2012**

(220) 20.03.2009

(732) **PHILLIP MORRIS PRODUCTS SA SWISS CORPORATION; QUAIN JEAN-RENAUD 3 2000 NEUCHATEL CH**

(540)

(550) I

(740) Čolović Branko, Mediteranska 2, Budva (ME)

(511) **Klasa 34:** Duvan (sirov i prerađen), proizvodi od duvana, naročito: cigare, cigarete, ciga-

rilosi/male cigarete, duvan za uvijanje cigareta, duvan za lule, duvan za žvakanje, duvan za šmrkanje, kretek, zamjena za duvan (za nemedicinsku upotrebu), artikli za pušače, naročito: papir za cigarete i lule, filteri za cigarete, kutije za duvan (od neplemenitih metala), kutije za cigarete i pepeljare (od neplemenitih metala), lule, ručni aparati/spravice za uvijanje cigareta, upaljači, šibice.

(111) **06454**

(151) **25.09.2012**

(210) **2009-382**

(442) **20.03.2012**

(220) 28.05.2009

(300) 12.11.2007 Z-2681/2007 RS

(732) **STARBUCKS CORPORATION D/B/A STARBUCKS COFFEE COMPANY;
2401 UTAH AVENUE SOUTH, SEATTLE, WASHINGTON 98134 US**

FRAPPUCCINO

(540)

(550) I

(740) Čejović Vladimir, 13. jul 21, Podgorica (ME)

(511) **Klasa 18:** Novčanici, lisnice, velike ručne torbe, ženske tašne, akten tašne, tašna za knjige, tašna za spise, putne torbe za ručni prtljag i kišobrani, sve od tkanine, plastike ili kože, kožni privjesci.

(111) **06455**

(151) **25.09.2012**

(210) **2009-387**

(442) **20.03.2012**

(220) 28.05.2009

(300) 12.11.2007 Z-2687/2007 RS

(732) **STARBUCKS CORPORATION D/B/A STARBUCKS COFFEE COMPANY;
2401 UTAH AVENUE SOUTH, SEATTLE, WASHINGTON 98134 US**

LIGHTNOTE BLEND

(540)

(550) I

(740) Čejović Vladimir, 13. jul 21, Podgorica (ME)

(511) **Klasa 30:** Mljevena kafa i kafa u zrnu, kakao, čaj (biljni i ne-biljni), kafa, čaj, kakao i espresso napici, napici na bazi kafe i/ili espresa, napici na bazi čaja, čokolad u prahu i vaniie; so-sovi; čokoladni sirupi, aromatizovani sirupi za napitke, pečeni proizvodi uključujući rafine, pšenične pogačice, biskvite, kolačiće, poslastice i hleb, sendviče, desert od žitarica, unapred spremljena kafa, unapred spremljert čaj, sladoled i smrznuti slatkiši; čokolada, bombone i slatkiši.

(111) **06456**

(151) **25.09.2012**

(210) **2009-388**

(442) **20.03.2012**

(220) 28.05.2009

(300) 12.11.2007 Z-2686/2007 RS

(732) **STARBUCKS CORPORATION D/B/A STARBUCKS COFFEE COMPANY;**

2401 UTAH AVENUE SOUTH, SEATTLE, WASHINGTON 98134 US

GOLD COAST BLEND

(540)

(550) I

(740) Čejović Vladimir, 13. jul 21, Podgorica (ME)

(511) **Klasa 30:** Mljevena kafa i kafa u zrnu, kakao, čaj (biljni i ne-biljni), kafa, čaj, kakao i espre-so napici, napici na bazi kafe i/ili espresa, napici na bazi čaja, čokoladc u prahu i vaniie; so-sovi; čokoladni sirupi, aromatizovani sirupi za napitke, pečeni proizvodi uključujući rnafine, pšenične pogačice, biskvite, kolačiće, poslastice i hleb, sendviče, desert od žitarica, unapred spremljena kafa, unaprijed spremljen čaj, sladoled i smrznuti slatkiši; čokolada, bombone i slatkiši.

(111) **06457**

(151) **25.09.2012**

(210) **2009-389**

(442) **20.03.2012**

(220) 28.05.2009

(300) 12.11.2007 Z-2685/2007 RS

(732) **STARBUCKS CORPORATION D/B/A STARBUCKS COFFEE COMPANY;
2401 UTAH AVENUE SOUTH, SEATTLE, WASHINGTON 98134 US**

GAZEBO BLEND

(540)

(550) I

(740) Čejović Vladimir, 13. jul 21, Podgorica (ME)

(511) **Klasa 30:** Mljevena kafa i kafa u zrnu, kakao, čaj (biljni i ne-biljni), kafa, čaj, kakao i espre-so napici, napici na bazi kafe i/ili espresa, napici na bazi čaja, čokolade u prahu i vaniie; so-sovi; čokoladni sirupi, aromatizovani sirupi za napitke, pečeni proizvodi uključujući rnafine, pšenične pogačice, biskvite, kolačiće, poslastice i hleb, sendviče, desert od žitarica, unapred spremljena kafa, unapred spremljen čaj, sladoled i smrznuti slatkiši; čokolada, bombone i slatkiši.

(111) **06458**

(151) **25.09.2012**

(210) **2009-390**

(442) **20.03.2012**

(220) 28.05.2009

(300) 12.11.2007 Z-2683/2007 RS

(732) **STARBUCKS CORPORATION D/B/A STARBUCKS COFFEE COMPANY;
2401 UTAH AVENUE SOUTH, SEATTLE, WASHINGTON 98134 US**

CAFFE VERONA

(540)

(550) I

(740) Čejović Vladimir, 13. jul 21, Podgorica (ME)

(511) **Klasa 30:** Mljevena kafa i kafa u zrnu, kakao, čaj (biljni i ne-biljni), kafa, čaj, kakao i espreso napici, napici na bazi kafe i/ili espresa, napici na bazi čaja, čokolade u prahu i vanile; sosovi; čokoladni sirupi, aromatizovani sirupi za napitke, pečeni proizvodi uključujući mafine, pšenične pogačice, biskvite, kolačiće, poslastice i hljeb, sendviče, desert od žitarica, unaprijed spremljena kafa, unaprijed spremljen čaj, sladoled i smrznuti slatkiši; čokolada, bomboni i slatkiši.

(111) **06459** (151) **25.09.2012**

(210) **2009-391** (442) **20.03.2012**

(220) 28.05.2009

(300) 12.11.2007 Z-2682/2007 RS

(732) **STARBUCKS CORPORATION D/B/A STARBUCKS COFFEE COMPANY;
2401 UTAH AVENUE SOUTH, SEATTLE, WASHINGTON 98134 US**

CAFE ESTIMA BLEND

(540)

(550) I

(740) Čejović Vladimir, 13. jul 21, Podgorica (ME)

(511) **Klasa 30:** Mljevena kafa i kafa u zrnu, kakao, čaj (biljni i ne-biljni), kafa, čaj, kakao i espreso napici, napici na bazi kafe i/ili espresa, napici na bazi čaja, čokolade u prahu i vanile; sosovi; čokoladni sirupi, aromatizovani sirupi za napitke, pečeni proizvodi uključujući mafine, pšenične pogačice, biskvite, kolačiće, poslastice i hljeb, sendviče, desert od žitarica, unapred spremljena kafa, unapred spremljen čaj, sladoled i smrznuti slatkiši; čokolada, bombone i slatkiši.

(111) **06460** (151) **25.09.2012**

(210) **2009-392** (442) **20.03.2012**

(220) 28.05.2009

(300) 12.11.2007 Z-2677/2007 RS

(732) **STARBUCKS CORPORATION D/B/A STARBUCKS COFFEE COMPANY;
2401 UTAH AVENUE SOUTH, SEATTLE, WASHINGTON 98134 US**

STARBUCKS

(540)

(550) I

(740) Čejović Vladimir, 13. jul 21, Podgorica (ME)

(511) **Klasa 43:** Usluge restorana, kafea, kafeterija, snek barova, kafe barova i kafe kuća, usluge restorana sa hranom za ponijeti (usluge «carry out» i «take out» restorana), usluge keteringa; usluge snabdijevanja kancelarija sa kafom; usluge ugovaranja pripreme hrane; usluge pripremanja hrane; usluge pripremanja i prodaje hrane i pića za ponijeti.

(111) **06461** (151) **25.09.2012**

(210) **2009-393** (442) **20.03.2012**

(220) 28.05.2009

(300) 12.11.2007 Z-2676/2007 RS

(732) **STARBUCKS CORPORATION D/B/A STARBUCKS COFFEE COMPANY;
2401 UTAH AVENUE SOUTH, SEATTLE, WASHINGTON 98134 US**

STARBUCKS

(540)

(550) I

(740) Čejović Vladimir, 13. jul 21, Podgorica (ME)

(511) **Klasa 09:** Kompjuterski softveri koji se primjenjuju kod pravljenja, skidanja, prenosa, prijema, montiranja, ekstrakovanja, kodiranja, dekodiranja, puštanja, čuvanja i organizovanja audio podataka; audio snimci koji predstavljaju klasičnu, jazz, savremenu, pop, sezonsku, R'n'B, soul, svjetsku, zydeco, rege, rock, folk i pozorišnu muziku; digitalni audio plejeri, muzika koja se preuzima preko globalne računarske mreže i bežičnih uređaja; aparati koji rade pomoću žetona.

Klasa 14: Časovnici, budilnici, džepni časovnici, ručni časovnici, kuhinjski tajmeri, štoperice; nakit.

Klasa 18: Novčanici, lisnice, velike ručne torbe, ženske tašne, akten tašne, tašna za knjige, tašna za spise, putne torbe za ručni prtljag i kišobrani, sve od tkanine, plastike ili kože, kožni privjesci.

Klasa 28: Igračke, naime, mede-igračke, punjene igračke, plišane igračke, lutke i njihova prateća oprema, božićni ukrasi, jo-joi.

Klasa 33: Žestoka alkoholna pića i likeri.

Klasa 41: Usluge zabave, odnosno, obezbjeđivanje i/ili organizovanje zabave, obrazovnih, rekreativnih i/ili muzičkih događaja; organizovanje, produkcija, ugošćavanje i/ili predstavljanje priredbi, nastupa uživo, koncerata i drugih događanja i aktivnosti; priređivanje i vođenje ličnih nastupa u svrhu zabave; usluge izdavanja i produkcije muzičkih i zvučnih snimaka; obezbjeđivanje pristupa interaktivnoj računarskoj bazi podataka koja predstavlja sveobuhvatan kratak prikaz muzičkih snimaka; obezbjeđivanje baze podataka i direktorijuma u oblasti muzike, video, radio, televizije, vijesti, sporta, igara, kulturnih dešavanja, zabave, i umjetnosti i slobodnog vremena preko komunikacijske mreže; snabdijevanje informacija, audio, video, grafike, teksta i drugih multimedijских sadržaja u oblasti muzike, video, radio, televizijske, vijesti, sporta, igara, kulturnih dešavanja, zabave, umjetnosti i slobodnog vremena preko komunikacijske mreže; usluge muzičkog izdavaštva; objavljivanje tekstova, grafike, audio i video djela preko komunikacione mreže; usluge snabdijevanja prodavnica i on-line prodavnica koje omogućavaju korisnicima da programiraju audio, video, tekstualne i druge multimedijске sadržaje, uključujući muziku, koncerte, video, radio, televiziju, vijesti, sport, igre, kulturne događaje i zabavno-orijentisane programe; usluge proizvodnje i distribucije radio programa; usluge muzičke produkcije; usluge zabave, naime obezbjeđivanje prikaza o muzici i komentara i članaka o muzici.

(111) **06462**

(151) **25.09.2012**

(210) **2009-394**

(442) **20.03.2012**

(220) 28.05.2009

(300) 12.11.2007 Z-2690/2007 RS

(732) **STARBUCKS CORPORATION D/B/A STARBUCKS COFFEE COMPANY;
2401 UTAH AVENUE SOUTH, SEATTLE, WASHINGTON 98134 US**

CREAMICE

(540)

(550) I

(740) Čejović Vladimir, 13. jul 21, Podgorica (ME)

(511) **Klasa 29:** Mlijeko, aromatizovatio mlijeko, milkšejkovi i napici na bazi mlijeka; voćiii džemovi, sosovi, želei, namazi, ugrušano mlijeko i ukuvano voće.**Klasa 30:** Mlevena kafa i kafa u zrnu, kakao, čaj (biljni i ne-biljni), kafa, čaj, kakao i espresso napici, napici na bazi kafe i/ili espresa, napici na bazi fiaja, čokolade u prahu i vanile; sosovi; čokoladni sirapi, aromatizovani sirupi za napitke, pečeni proizvodi uključujući mafine, pšenične pogačice, biskvite, kolačiće, poslastice i hleb, sendviče, desert od žitarica, unapred spremljena kafa, unapred spremljen čaj, sladoled i smrznuti slatkiši; čokolada, bombone i slatkiši.**Klasa 32:** Voda, mineralna voda, gazirana voda i draga bezalkoholna pića, sokovi, voćni napici i voćni sokovi, voćni napici i bezalkoholna pića koja sadrže voćne sokove, mješavine za napitke tečne ili u prahu; sosovi; aiomatizovani sirupi za spravljanje napitaka; aromatizovane ili liearomatizovane flaširane vode, gazirane vode, mineralne vode, voćni sokovi, gazirani napici na bazi voća ili soka i soda napici; zamiznuti voćni napici i zamrznuti napici na bazi voća.(111) **06463**(151) **25.09.2012**(210) **2009-395**(442) **20.03.2012**

(220) 28.05.2009

(300) 12.11.2007 Z-2692/2007 RS

(732) **STARBUCKS CORPORATION D/B/A STARBUCKS COFFEE COMPANY;
2401 UTAH AVENUE SOUTH, SEATTLE, WASHINGTON 98134 US**

BEARISTA

(540)

(550) I

(740) Čejović Vladimir, 13. jul 21, Podgorica (ME)

(511) **Klasa 28:** Igračke, naime, mede-igračke, punjene igračke, plišane igračke, lutke i njihova prateća oprema, božićni ukrasi, jo-joi.(111) **06464**(151) **25.09.2012**(210) **2009-396**(442) **20.03.2012**

(220) 28.05.2009

(300) 12.11.2007 Z-2679/2007 RS

(732) **STARBUCKS CORPORATION D/B/A STARBUCKS COFFEE COMPANY;
2401 UTAH AVENUE SOUTH, SEATTLE, WASHINGTON 98134 US**

STARBUCKS COFFEE

(540)

(550) I

(740) Čejović Vladimir, 13. jul 21, Podgorica (ME)

(511) **Klasa 35:** Poslovna administracija, upravljanje poslovanjem; franšizing, naime, obezbjeđivanje tehničke pomoći u osnivanju i/ili radu restorana, kafea, kafe kuća i snek barova; usluge maloprodaje u sljedećim oblastima: kafa, čaj, kakao, upakovana i pripremljena hrana, električni aparati, neelektrični aparati, kućni aparati, kuhinjski aparati, satovi, ručni satovi, kuhinjski tajmeri, štoperice, nakit, knjige, muzički snimci, podmetači za kompjuterskog miša, novčanici, lisnice, velike ručne torbe, ženske tašne, aktne tašne, tašne za knjige, putne torbe za ručni prtljag i kišobrani, sve napravljeno od tkanine, plastike ili kože, pločasti kožni privjesci, odjeća, kape i šeširi, igračke, uključujući mede-igračke, punjene igračke, plišane igračke, lutke i njihova prateća oprema, božićni ukrasi; usluge distributivnih centara za veleprodaju, radnji za veleprodaju i usluge naručivanja na veliko, sve u oblasti: kafa, čaj, kakao, upakovana i pripremljena hrana, električni aparati, neelektrični aparati, kućni aparati, kuhinjski aparati, satovi, ručni satovi, kuhinjski tajmeri, štoperice, nakit, knjige, muzički snimci, podmetači za miša, novčanici, lisnice, velike ručne torbe, ženske tašne, aktne tašne, tašne za knjige, putne torbe za ručni prtljag i kišobrani, napravljene od tkanine, plastike ili kože, pločasti privjesci od kože, odjeća, kape i šeširi, igračke, uključujući mede, punjene igračke, plišane igračke, lutke i njihova prateća oprema, božićni ukrasi; usluge naručivanja poštom i usluge naručivanja poštom preko kataloga, kompjuterizovane on-lajn usluge naručivanja, kompjuterizovane on-lajn usluge maloprodaje, on-lajn usluge naručivanja i on-lajn usluge maloprodaje, sve u oblasti: kafa, čaj, kakao, upakovana i pripremljena hrana, električni aparati, neelektrični aparati, kućni aparati, kuhinjski aparati, satovi, ručni satovi, kuhinjski tajmeri, štoperice, nakit, knjige, muzički snimci, podmetači za miša, novčanici, lisnice, velike ručne torbe, ženske tašne, aktne tašne, tašne za knjige, putne torbe za ručni prtljag i kišobrani, napravljene od tkanine, plastike ili kože, pločasti privjesci od kože, odjeća, kape i šeširi, igračke, uključujući mede-igračke, punjene igračke, plišane igračke, lutke i njihova prateća oprema, božićni ukrasi; usluge kompjuterizovanih on-lajn registara poklona i usluge naručivanja.

Klasa 43: Usluge restorana, kafea, kafeterija, snek barova, kafe barova i kafe kuća, usluge restorana sa hranom za ponijeti (usluge «carry out» i «take out» restorana), usluge kateringa; usluge snabdijevanja kancelarija sa kafom; usluge ugovaranja pripreme hrane; usluge pripremanja hrane; usluge pripremanja i prodaje hrane i pića za ponijeti.

(111) **06488**

(151) **25.09.2012**

(210) **2009-587**

(442) **20.03.2012**

(220) 10.01.2009

(732) **ALOKOZAY FZE, P. O. BOH 18165, JEBEL ALI FREE ZONE, DUBAI AE**



(540)

(550) I

(740) Kojić Ivana, Serdara Jola Piletića bb, Podgorica (ME)

(511) **Klasa 29:** Meso, riba, živina i divljač; mesne prerađevine; konzervisano, zamrznuto, sušeno i kuvano voće i povrće, naročito zamrznuto voće, kriške voća, voćni želei, kora od voća, konzervisano voće, voće konzervisano u alkoholu, voćna kaša (putpa), voćne salate, kuvano voće, grickalice na bazi voća (zakuske, odnosno mali obroci od voća pripremljeni na brzinu), ušećereno voće; želei; džemovi; jaja; mlijeko i mliječni proizvodi; jogurt; jestiva ulja i masti.

Klasa 30: Kafa, čaj, kakao, šećer, tapioka, sago, zamjena kafe; brašno i proizvodi od žitarica, hleb, kolači i poslastice; led; med, melasa; kvasac, prašak za pecivo; so, sent; sirće, sosovi (kao začini); začini; sladoledi; čokolade i kečap.

Klasa 32: Mineralne i sodne vode i druga bezalkoholna pića; pića od voća i voćni sokovi; sirupi i drugi pre pa rati za proizvodnju pića..

(111) **06489**

(151) **25.09.2012**

(210) **2009-588**

(442) **20.03.2012**

(220) 10.01.2009

(732) **ALOKOZAY FZE, P. O. BOH 18165, JEBEL ALI FREE ZONE, DUBAI AE**



(540)

(550) I

(740) Kojić Ivana, Serdara Jola Piletića bb, Podgorica (ME)

(511) **Klasa 35:** Oglašavanje; vođenje poslova; poslovno upravljanje; kancelarijski poslovi; uvoz-izvoz (agencije za uvoz-izvoz).

(111) **06505**

(151) **25.09.2012**

(210) **2008-1144**

(442) **20.03.2012**

(220) 28.11.2008

(300) 23.01.2007 Z-106/07 RS

(732) **ISHIHARA SANGYO KAISHA, LTD., 3-15 EDOBORI, 1-CHOME, NISHI-KU, OSAKA JP**

NEMATHORIN

(540)

(550) I

(740) Ćosović Dejan, 13. jul 1/5, Budva (ME)

(511) **Klasa 05:** Herbicidi, insekticidi i fungicidi.

(111) **06506**

(151) **25.09.2012**

(210) **2008-1145**

(442) **20.03.2012**

(220) 28.11.2008

(300) 18.03.2008 Z-589/08 RS

(732) ISHIHARA SANGYO KAISHA, LTD.; 3-15 EDOBORI, 1-CHOME, NISHI-KU, OSAKA JP

SAMSON

(540)

(550) I

(740) Ćosović Dejan, 13. jul 1/5, Budva (ME)

(511) **Klasa 05:** Poljoprivredni, hortikulturni i baštenski preparati, pesticidi za herbicide, fungicide i insekticide.

(111) **06507**

(151) **25.09.2012**

(210) **2008-1147**

(442) **20.03.2012**

(220) 28.11.2008

(300) 18.03.2008 Z-592/08 RS

(732) ISHIHARA SANGYO KAISHA, LTD.; 3-15 EDOBORI, 1-CHOME, NISHI-KU, OSAKA JP

TEPPEKI

(540)

(550) I

(740) Ćosović Dejan, 13. jul 1/5, Budva (ME)

(511) **Klasa 05:** Poljoprivredni, hortikulturni i baštenski preparati, pesticidi za herbicide, fungicide i insekticide.

(111) **06508**

(151) **25.09.2012**

(210) **2008-1148**

(442) **20.03.2012**

(220) 28.11.2008

(300) 18.03.2008 Z-591/08 RS

(732) ISHIHARA SANGYO KAISHA, LTD.; 3-15 EDOBORI, 1-CHOME, NISHI-KU, OSAKA JP

RANMAN

(540)

(550) I

(740) Ćosović Dejan, 13. jul 1/5, Budva (ME)

(511) **Klasa 05:** Poljoprivredni, hortikulturni i baštenski preparati, pesticidi za herbicide, fungicide i insekticide.

(111) **06509**

(151) **25.09.2012**

(210) **2008-1149**

(442) **20.03.2012**

(220) 28.11.2008

(300) 18.03.2008 Z-590/08 RS

(732) ISHIHARA SANGYO KAISHA, LTD.; 3-15 EDOBORI, 1-CHOME, NISHI-KU, OSAKA JP

MILDICUT

(540)

(550) I

(740) Ćosović Dejan, 13. jul 1/5, Budva (ME)

(511) **Klasa 05:** Poljoprivredni, hortikulturni i baštenski preparati, pesticidi za herbicide, fungicide i insekticide.(111) **06510**(151) **25.09.2012**(210) **2009-371**(442) **20.03.2012**

(220) 28.05.2009

(300) 07.04.2008 Z-848/08

(732) **GREE ELECTRIC APPLIANCES INC.; OF ZHUHAI JINI WEST ROAD, QIANSHAN ZHUHAI GUANGDONG CN**

(540)

(550) I

(740) Ćosović Dejan, 13. jul 1/5, Budva (ME)

(511) **Klasa 11:** Klima uređaji, ventilatori i instalacije i aparati za klimatizaciju; sve vrste uređaja za grijanje; električni toplotni radijatori; toplotni akumulatori i akumulacione peći; električni uređaji za sušenje veša; električni ventilatori; električni sušači vazduha za kućnu upotrebu; perčistači vazduha; električni uređaji i aparati za kuvanje; aspiratori za kuhinjsku upotrebu; grijači za vodu (ketleri) na gas; grijači za vodu (ketleri) na struju; elektromagnetne pećnice; električni šporet; električni automati i slični uređaji za pijaću vodu; električni čajnici (ketleri); ovlaživač vazduha; električne posude i uređaji za kuvanje pod pritiskom, klima uređaji za vuila; ventilatori kao djelovi klima instalacija; filteri za klima uređaje; grijači za vozila; sterilizatori vazduha; električni fenovi za kosu; kondenzatori; sterilizatori; ormarići za sterilizaciju posuđa; izmjenjivači toplote (ne kao djelovi mašine); izduvni ventilatori; grijači za vodu na solarnu energiju; električno čelično posuđe; grijači za kupatila; gasni gorionici; osveživači vazduha; frižideri; mikrotalasne pećnice (aparati za kuvanje); instalacije za prečišćavanje vode; uređaji i mašine za pranje sudova; aparati za kuvanje jaja; električni uređaji za pravljenje jogurta; aparati za parenje lica (saune); tosteri za hleb; električne mašine za kafu; električni aparati za pranje nogu; pekarske pećnice; električni uređaji za sporo spremanje hrane.

Klasa 35: Usluge oglašavanja za druge a naročito priprema i postavljanje oglasa u različitim medijima (od novina, radija do interneta i ostalih mogućih mjesta za oglašavanje); izvozno-uvozne agencije; promocija prodaje električnih uređaja za druge različitim sredstvima (od nagrade za prikupljanje bodova u kupovini do distribucije štampanog materijala do raspodjele poklona u cilju održavanja prodajnih pogodnosti, kao na primjer kupiti jedan, dobiti četiri ili bilo koje druge mogućnosti) i rukovođenje direktnom prodajom za druge; sistematizacija podataka u kompjuterskim bazama podataka; priprema i koordinacija ponuda za račun drugih u postupcima tendera; profesionalne savjetodavne usluge u trgovini; profesionalne poslovne konsultacije; poslovne i savjetodavne usluge u vezi sa menadžmentom; marken-

tiške analize za druge; konsalting u oblasti menadžmenta ljudskim resursima; usluge u vezi sa računovodstvom; pomoć u komercijalnom ili industrijskom menadžmentu; usluge revizije i tzv. "oditinga".

Klasa 37: Instalacije aparata za klima uređaje i njihova popravka; tapaciranje instalacije grejnih aparata i popravka; instaliranje mašina, održavanje i popravljanje; instalacija i popravka električnih uređaja i aparata; usluge instaliranja i popravljanja rashladne opreme; instalacija kompjuterskog hardvera, kao i održavanje i popravka; instalacija kancelarijskih mašina i opreme, kao i održavanje i popravka; usluge u vezi sa uklanjanjem rizika vezanih za elektronsku opremu; usluge čišćenja odjeće.

(111) **03789**

(151) **27.07.2012**

(210) **2008-307**

(442) **20.03.2012.**

(220) 22.07.2008.

(300) 20.07.2008.

(732) **TEKNOXGROUP CRNA GORA, D.O.O., LIJEŠNJE B.B. PODGORICA ME**

TEKMONT

(540)

(550) I

(740) Dobrijević Bralić Rada, Stari Grad, Kotor (ME)

(511) **Klasa 12:** Vozila; aparati za kretanje po zemlji, vazduhu ili vodi.

Klasa 35: Oglašavanje; vođenje poslova; poslovno upravljanje; kancelarijski poslovi.

Klasa 37: Građevinsko konstruisanje; popravljanje; usluge instaliranja (instalacione usluge).

(111) **03790**

(151) **27.07.2012**

(210) **2008-464**

(442) **20.03.2012**

(220) 02.09.2008

(300) 0.01.2006 Z-39/06 1

(732) **MIP METRO GROUP INTELLECTUAL PROPERTY GMBH CO; 40235 DUSSELDORF DE**

RELENTLESS

(540)

(550) I

(740) Perović Periša, Karađorđeva 4, Podgorica (ME)

(511) **Klasa 01:** Hemijski proizvodi koji se upotrebljavaju u industriji, nauci, fotografiji, poljoprivredi, hortikulturi i šumarstvu; neprerađene veštačke smole, neprerađene plastične materije; đubriva; smješe za gašenje vatre; preparati za kaljenje i zavarivanje; hemijske supstance za očuvanje namirnica; materije za štavljenje; lepljive supstance koje se upotrebljavaju u industriji.

Klasa 02: Boje, firnajzi, lakovi, sredstva za zaštitu od rđe i truljenja drveta; materije za bojenje; sredstva za nagrizanje; sirove prirodne smole; metali u obliku listova i praha za slikare, dekoratere, štampare i umjetnike.

Klasa 03: Sredstva za bijeljenje i druge supstance za upotrebu u perionicama; preparati za čišćenje, poliranje, ribanje i nagrizanje; sapuni; parfimerija, eterična ulja, kozmetika, losioni za kosu; paste za zube.

Klasa 04: Industrijska ulja i masti; maziva; jedinjenja za skupljanje prašine vlaženjem i veziva-

njem; goriva (uključujući motorna tečna goriva) i materije za osvjetljavanje; svijeće i fitilji za osvjetljavanje.

Klasa 05: Farmaceutski i veterinarski preparati; sanitarni preparati za medicinsku upotrebu; dijetetske supstance prilagođene za upotrebu u medicini, hrana za bebe; flasteri, materijali za zavijanje; materijali za plombiranje zuba, zubarska smola; dezinfekciona sredstva; preparati za uništavanje štetočina; fungicidi, herbicidi, i posebno, hrana za bebe, dijetetske namirnice za njegu zdravlja na bazi vitamina, mineralnih hranljivih sastojaka i mikroelemenata, pojedinačno ili kombinovano, dopune ishrani na bazi amino kiselina, mineralnih hranljivih sastojaka i mikroelemenata i za medicinsku upotrebu; flasteri, materijali za previjanje, higijenski artikli za žene, naime menstrualni ulošci, gaćice, ulošci za svakodnevnu upotrebu, tamponi.

Klasa 06: Obični metali i njihove legure; metalni građevinski materijali; metalne prenosne građevine; materijali od metala za željezničke sine; neelektrične žice i kablovi od običnog metala; bravarski proizvodi; mali metalni gvoždarski proizvodi; cjevčice i cjevi od metala; sefovi; proizvodi od običnih metala koji nijesu uključeni u druge klase; rude.

Klasa 07: Mašine i mašinski alati; motori i pogonske mašine (osim za suvozemna vozila); mašinske spojnice i transmisioni elementi (osim za suvozemna vozila); poljoprivredne sprave; inkubatori za jaja.

Klasa 08: Ručni alati i sprave (kojima se ručno upravlja); pribor za jelo; hladno oružje; žileti.

Klasa 09: Aparati i instrumenti naučni, pomorski, geodetski, fotografski, kinematografski, optički, za vaganje, mjerenje, signalizaciju, kontrolu (inspekciju), spasavanje i nastavu; aparati i instrumenti za provođenje, prekid, transformaciju, akumulaciju, regulisanje i kontrolu elektriciteta; aparati za snimanje, prenos i reprodukovanje zvuka ili slike; magnetni nosioci podataka, diskovi za snimanje; automatske mašine i mehanizmi za aparate koji se pokreću novcem ili žetonom; registar kase, računске mašine, oprema za obradu podataka i kompjuteri; aparati za gašenje požara.

Klasa 10: Hirurški, medicinski, zubarski i veterinarski aparati i instrumenti; veštački udovi, oči i zubi; ortopedski artikli; hirurški materijali za zašivanje.

Klasa 11: Aparati za osvjetljavanje, grejanje, proizvodnju pare, kuvanje, hladenje, sušenje, ventilaciju, snabdevanje vodom i za sanitarne svrhe.

Klasa 12: Vozila; aparati za kretanje po zemli, vazduhu ili void.

Klasa 13: Vatreno oružje; municija i projektili; eksplozivi; sredstva za vatromet.

Klasa 14: Dragoceni metali i njihove legure i proizvodi od dragocenih metala ili sa prevlakom od njih, koji nisu uključeni u druge klase; nakit, bižuterija, drago kamenje; časovničarski i hronometrijski instrumenti.

Klasa 15: Muzički instrumenti.

Klasa 16: Hartija, karton i proizvodi od njih, koji nisu uključeni u druge klase; štampane stvari, knjigovezački materijal; fotografije; kancelarijski materijal; ljepila za kancelarijske i kućne potrebe; umjetnički materijali; kičice; pisalice mašine i kancelarijski rekviziti (izuzev namještaja); materijali za obuku i nastavu (izuzev aparata); plastični materijal za pakovanje (koji nije uključen u druge klase); štamparska slova; klišei, a posebno, filter papir, papir za filter kafu, toaletni papir, papirne ili plastične korpe za otpatke, papir za uvijanje, papirne ili plastične vreće za pakovanje (koverte, kese), materijal za pakovanje od kartona, pelene i gaćice za bebe od papira ili celuloze; torbe (omotnice, vreće) od papira, gume ili plastike.

Klasa 17: Guma, gutaperka, kaučuk, azbest, liskun i proizvodi napravljeni od ovih materijala koji nisu uključeni u druge klase; polupreradeni plastični proizvodi; materijali za podbijanje (podloške), zaptivanje i izolovanje; savitljive nemetalne cijevi.

Klasa 18: Koža i imitacija kože, proizvodi izrađeni od ovih materijala koji nisu uključeni u druge

klase; životinjska koža; koferi i putne torbe; kišobrani, suncobrani i štapovi za hodanje; bičevi, saračka i sedlarska roba.

Klasa 19: Građevinski materijali (nemetalni); čvrste nemetalne cijevi za građevine; asfalt, crna smola i bitumen, nemetalne prenosne građevine; spomenici, koji nijesu od metala.

Klasa 20: Namještaj, ogledala, okviri za slike; proizvodi (koji nisu obuhvaćeni drugim klasama) od drveta, plute, trske, rogoza, vrbovog pruća, roga, kosti, slonovače, kitove kosti, školjki, ćilibara, sedefa, morske pjene i zamjene svih ovih materijala, ili od plastike.

Klasa 21: Kućne ili kuhinjske sprave i posude (koje nisu od dragocjenih metala ili sa prevlakama od njih); češljevi i sunđeri; četke (izuzev kičica); materijali za pravljenje četki; artikli koji se koriste pri čišćenju; čelična vuna; neprerađeno ili poluprerađeno staklo (osim stakla koje se koristi u građevinarstvu); staklarija, porcelan, fajans, grnčarija i lončarija koja nije uključena u druge klase.

Klasa 22: Užad, kanapi, mreže, šatori, nadstrešnice od cirade, cirade, jedra, vreće (džakovi) i torbe (koje nisu uključene u druge klase); materijali za punjenje madraca (osim od gume ili plastike); sirove vlaknaste tekstilne materije; a posebno, torbe od tekstila (omotnice, torbice) za pakovanje.

Klasa 23: Pređa i konac, za tekstilnu upotrebu.

Klasa 24: Tekstil i tekstilni proizvodi koji nisu obuhvaćeni drugim klasama; prekrivači za krevete i stolove.

Klasa 25: Odjeća, obuća, pokrivala za glavu.

Klasa 26: Čipka i vez, trake (pantljike) i gajtani; dugmad, kopče i petlje, špenadle i igle; veštačko cveće.

Klasa 27: Tepisi, asure, prostirke i otirači, linoleum i drugi materijali za pokrivanje podova; prekrivači za zidove (netekstilni).

Klasa 28: Igre i igračke; gimnastički i sportski artikli koji nisu obuhvaćeni drugim klasama; ukrasi za jelke.

Klasa 29: Meso, riba, živina i divljač; mesne prerađevine; konzervisano, sušeno i kuvano voće i povrće; želei, džemovi, kompoti; jaja, mlijeko i mliječni proizvodi; jestiva ulja i masti; a posebno, mesni želei, mješavine načinjene od povrća i mesa, sve navedeno takođe i u konzervi ili duboko zamrznutom obliku; kuvana, sušena, dugotrajna ili zamrznuta jela i poluspremljena jela kao i salate spremne za posluživanje, uglavnom načinjene od mesa i/ili ribe i/ili živine i/ili kobasice i/ili divljači; supe, mješavine za supu, bujoni; mješano kisjelo povrće, sušena, dugotrajna ili zamrznuta jela i poluspremljena jela kao i salate spremne za posluživanje, uglavnom načinjene od voća i/ili povrća, konzervisano zeleno bilje, proizvodi od pripremljenog krompira, uključeni u klasu 29, knedle od krompira, prženi krompir pire, krompir pire, kroketi, pomfrit, prženi rendani krompir; želei, džemovi, voćni kompoti, voćni želei, pirei od voća, napici od mlijeka (najvećim dijelom od mlijeka), buter, pavlaka, surutka, jogurt, punomasna slatka pavlaka, kisjela pavlaka, kiselo mlijeko, sir, proizvodi od sira; margarin, masni namazi i namazi na vegeterijanskoj osnovi, jela od soje kao zamjena za meso, tofu, zalogajčići, uključeni u klasu 29, proizvodi na bazi krompira za prehrambenu upotrebu, sačinjeni istiskivanjem kroz kalupe, uključeni u klasu 29, čips od krompira, štapići od krompira, kolutovi od krompira sa ukusom luka, sušeno voće, suvo grožđe, očišćeni orasi, lešnici, kikiriki, australijski orasi, indijski orasi, pistaći i bademi u ljusci, sušeni, prženi, zasoljeni, pečeni i/ili začinjani; dietetska hrana ili dopune ishrani za nemedicinsku upotrebu na bazi belanca, masnoća, masnih kiselina, uz dodatak vitamina, mineralnih hranljivih sastojaka, mikroelemenata, pojedinačno ili kombinovano, uključeno u klasu 29.

Klasa 30: Kafa, čaj, kakao, šećer, pirinač, tapioka, sago, zamjena kafe; brašno i proizvodi od

žitarica, hleb, kolači, poslastice, sladoledi; med, melasa, kvasac, prašak za pecivo; so, sent, sirće, sosovi (kao začini); začini; led; a posebno, zamjene za kafu, napici na bazi kafe, napici na bazi čaja, kakao, napici na bazi kaka; prirodni zaslađivači, pirinač, kuvana, sušena, konzervisana ili zamrznuta jela i polupripremljena jela, uglavnom sačinjena od pirinča, nasi goreng, suši, tapioka, sago; obroci na bazi cerealija; kukuruzne pahuljice, muzli; kolači; slatkiši i deserti; testa, rezanci bilo koje vrste; voćni sosovi, prelive za salatu, sosovi spremni za upotrebu, sos od paradajza, kečap, majonez, remulada, začini, mješavine začina, dietetske namirnice ili dopune ishrani za nemedicinsku upotrebu na bazi ugljenih hidrata, vlakana, uz dodatak vitamina, mineralnih hranljivih sastojaka, mikroelemenata, pojedinično ili kombinovano, uključeno u klasu 30.

Klasa 31: Poljoprivredni, vrtlarski i šumarski proizvodi i zrnevlje koji nisu uključeni u druge klase; žive životinje; sveže voće i povrće; sjeme, prirodne biljke i cvijeće; hrana za životinje, slad; a posebno, pijesak za ptice, prostirke za životinje.

Klasa 32: Pivo, mineralne i sodne vode i druga bezalkoholna pića; pića od voća i voćni sokovi; sirupi i drugi preparati za proizvodnju pića, sokovi od povrća (napici).

Klasa 33: Alkoholna pića (izuzev piva).

Klasa 34: Duvan; artikli za pušaće; šibice; a posebno, cigarete, cigare, male cigare; papir za cigarete, filteri za cigarete, muštikle za cigarete, pepeljare (ne od dragocenih metala), rezači cigara, lule, čistači lula, kremeni, šibice, upaljači za pušaće, plinska punjenja za upaljače.

Klasa 35: Oglašavanje; vođenje poslova; poslovno upravljanje; kancelarijski poslovi; a posebno, marketing, savjetovanje u vezi marketinga i kupoprodaje, istraživanje tržišta i analiza tržišta, odnosi sa javnošću, savjetovanje o poslovnoj, organizacionoj, kadrovskoj i kompanijskoj ekonomiji, kancelarijski rad; prezentovanje roba i usluga u hipermarketima, supermarketima, maloprodajama prehrambene robe i robnim kućama; poslovanje hipermarketa/supermarketa, naime, pregovaranje i zaključivanje ugovora u vezi sa kupovinom i prodajom robe i korišćenjem usluga; usluge maloprodaje prehrambenih i neprehrambenih artikala u supermarketima/hipermarketima.

Klasa 36: Osiguranje; finansijski poslovi; novčani (monetarni) poslovi; poslovi vezani za nepokretnosti.

Klasa 37: Građevinsko konstruisanje; popravlanje; usluge instaliranja (instalacione usluge).

Klasa 38: Telekomunikacije.

Klasa 39: Transportne usluge; pakovanje i skladištenje robe; organizovanje putovanja.

Klasa 40: Obradivanje materijala.

Klasa 41: Obrazovne usluge; pripremanje obuke; razonoda; sportske i kulturne aktivnosti.

Klasa 42: Naučne i tehnološke usluge i istraživanje i projektovanje u vezi navedenih usluga; usluge industrijske analize i istraživanja; projektovanje i razvoj kompjuterskog hardvera i softvera; pravne usluge.

Klasa 43: Usluge obezbeđivanja hrane i pića; privremeni smještaj.

Klasa 44: Medicinske usluge; veterinarske usluge; higijenska zaštita i nega lepote za ljude i životinje; agrikulturne, hortikulturne i šumarske usluge.

Klasa 45: Individualne i društvene usluge koje pružaju drugi, radi zadovoljavanja potreba pojedinaca; usluge obezbeđenja radi zaštite imovine i lica.

(111) **03791**

(151) **27.07.2012**

(210) **2008-767**

(442) **20.03.2012**

(220) 29.09.2008

(300) 27.04.2005 851969

(732) **INTERMAR SIMANTO NAHMIAŞ; FERHTPASA MAH M18 K II-B CATALCA ISTANBUL-TRAKYA SERBEST BOLGEESI IT SB TR**

(540)

(550) I

(740) Popović Miladin, Đoka Miraševića 21/III Podgorica, (ME)

(511) **Klasa 25:** Cipele papuče.(111) **03792**(151) **27.07.2012**(210) **2008-967**(442) **20.12.2011**

(220) 05.11.2008

(732) **PIK VRBOVEC-MESNA INDUSTRIJA DD; ZAGREBAČKA 148 10340 VRBOVEC HR**

(540)

(550) I

(740) Radulović Božidar, Jovana Tomaševića 9/III, Podgorica, (ME)

(511) **Klasa 29:** meso, riba, perad i divljač; sve vrste konzervisanih i nekonzervisanih proizvoda od istih; prehrambene namirnice životinjskog porijekla; mesni ekstrakti; konzervisano, sušeno i kuvano voće I povrće; želei, džemovi, kompoti; jaja, mlijeko i mliječni proizvodi; jestiva ulja i masti.**Klasa 31:** žive životinje, hrana za životinje**Klasa 35:** oglašavanje i reklamiranje; vođenje komercijalnih poslova; komercijalna administracija; uredski poslovi; usluge agencija za uvoz i izvoz; trgovina na malo i veliko, trgovina na malo i veliko prehrambenim i neprehrambenim proizvodima.**Klasa 40:** obrada i prerada mesa i mesnih prerađevina te ostalih namirnica u prehrambenoj industriji, konzerviranje, dimljenje i sušenje mesa i namirnica, klanje životinja.(111) **03793**(151) **27.07.2012**(210) **2008-1168**(442) **20.12.2011**

(220) 01.12.2008

(300) 23.10.2008. Ž-2008-2560 ZISS

(732) **NEKTAR DOO; NOVOSADSKI PUT BB 21000 BAČKA PALANKA SR**



(540)

(550) I

(740) Otašević Đuro, Serdara Jola Piletića bb., Podgorica (ME)

(511) **Klasa 16:** Harija, karton i proizvodi od njih koji nisu uključeni u druge klase; štampane stvari; knjigovezački materijal; fotografije; kancelarijski materijal; ljepila za kancelarijske i kućne potrebe; umjetnički materijali; kičice; pisace mašine i kancelarijski rekviziti (izuzev namještaja); materijali za obuku i nastavu (izuzev aparata); plastični materijal za pakovanje (koji nisu uključeni u druge klase); štamparska slova; klišei.

Klasa 29: Meso, riba, živina i divljač; mesne prerađevine, konzervisano, sušeno i kuvano voće i povrće; želei, džemovi, kompoti; jaja, mleko i mlečni proizvodi; jestiva ulja i masti.

Klasa 30: Kafa, čaj, kakao, šećer, pirinač, tapioka, sago, zamena kafe; brašno i proizvodi od žitarica, hleb, kolači, poslastice, sladoledi, med, melasa, kvasac, prašak za pecivo, so, senf; sirće, sosovi (kao začini); začini; led.

Klasa 31: Poljoprivredni, vrtlarski i šumarski proizvodi i zrnevlje koji nisu uključeni u druge klase, žive životinje; sveže voće i povrće; seme, prirodne biljke i cveće; hrana za životinje, slad.

Klasa 32: Pivo, mineralne i sodne vode i druga bezalkoholna pica; pića od voća i voćni sokovi; sirupi i drugi preparati za proizvodnju pića.

Klasa 33: Alkoholna pića (izuzev piva).

Klasa 35: Oglašavanje, vođenje poslova, poslovno upravljanje; kancelarijski poslovi.

Klasa 41: Obrazovne usluge; pripremanje obuke; razonoda; sportske i kulturne.

(111) **03794**(151) **27.07.2012**(210) **2008-1215**(442) **20.03.2012**

(220) 16.12.2008

(732) **MERZ PHARMA GMBH & CO KGAA; ECKENHEIMER LANDSTRASSE 100 D-60318 FRANKFURT/MAIN DE**

MERZ

(540)

(550) I

(740) Lutovac Branislav, ul. Bulevar Crnojevića 93, Podgorica (ME)

(511) **Klasa 03:** Kozmetički preparati.**Klasa 05:** Farmaceutski preparati.(111) **03795**(151) **27.07.2012**(210) **2008-1236**(442) **20.12.2011**

(220) 30.12.2008

(300) 30 2008 042 289.0 /38 01 07 2008 DE

(732) **DEUCTCHE TELECOM AG; FRIEDRICH EBERT ALLEE 140 53113 BONN DE**

Family

(540)

(550) I

(740) Popović Miladin, Đoka Miraševića 21/III Podgorica, (ME)

(511) **Klasa 09:** Aparati i instrumenti naučni, pomorski, geodetski, fotografski, kinematografski, optički, za vaganje, merenje, signalizaciju, kontrolu (inspekciju), spasavanje i nastavu; aparati i instrumenti za provođenje, prekid, transformaciju, akumulaciju, regulisanje ili kontrolu električne energije; aparati za snimanje, prenos, obradu i reprodukovanje zvuka, slike ili podataka; magnetni nosioci podataka, automatske mašine i mehanizmi za aparate koji se pokreću novcem ili žetonom; računске mašine, oprema za obradu podataka i kompjuteri; snimljeni i nesnimljeni diskovi svih vrsta (koji su uključeni u klasu 09); kompjuterski programi (snimljeni); elektronski sačuvani podaci (koji se mogu preuzeti); elektronske publikacije (koje se mogu preuzeti).

Klasa 38: Telekomunikacije; usluge novinskih agencija; iznajmljivanje telekomunikacione opreme; usluge informisanja o telekomunikacijama;

Klasa 42: Naučne i tehnološke usluge i istraživanje i projektovanje u vezi sa navedenim uslugama; usluge industrijske analize i istraživanja; razvoj i projektovanje kompjuterskog hardvera, softvera i baza podataka; održavanje softvera, tehničke konsultacije; usluge elektronskog čuvanja podataka; iznajmljivanje kompjutera; dizajniranje veb-sajtova za druge.

(111) **03796**(151) **27.07.2012**(210) **2009-3**(442) **20.12.2011**

(220) 14.01.2009

(300) 17.10.2007. Ž-2444/2007 RS

(732) **DIEGO IRELAND; ST. JAMES S GATE DUBLIN 8 IE**

(540)

(550) I

(740) Čejović Vladimir, 13 Jul br. 21, Podgorica, (ME)

(511) **Klasa 32:** Piva; ale, stout i porter; pića sa niskim procentom alkohola; mineralne i gazirane vode i ostala negazirana pića; voćni napici i voćni sokovi; sirupi i ostali preparati za spravljanje pića.

(111) **03797**(151) **27.07.2012**

(210) **2009-4**(442) **20.12.2011**

(220) 14.01.2009

(300) 17.10.2007. Ž-2447/2007 RS

(732) **DIAGEO IRELAND; ST. JAMES S GATE DUBLIN 8 IE**

(540)

(550) I

(740) Čejović Vladimir, 13 Jul br. 21, Podgorica, (ME)

(511) **Klasa 32:** Piva; ale, stout i porter; pića sa niskim procentom alkohola; mineralne i gazirane vode i ostala negazirana pića; voćni napici i voćni sokovi; sirupi i ostali preparati za spravljanje pića.(111) **03798**(151) **27.07.2012**(210) **2009-7**(442) **20.12.2011**

(220) 14.01.2009

(300) 17.10.2007. Ž-2446/2007 RS

(732) **DIAGEO IRELAND; ST. JAMES S GATE DUBLIN 8 IE**

(540)

(550) I

(740) Čejović Vladimir, 13 Jul br. 21, Podgorica, (ME)

(511) **Klasa 32:** Piva; ale, stout i porter; pića sa niskim procentom alkohola; mineralne i gazirane vode i ostala negazirana pića; voćni napici i voćni sokovi; sirupi i ostali preparati za spravljanje pića.(111) **03799**(151) **27.07.2012**(210) **2009-8**(442) **20.12.2011**

(220) 14.01.2009

(300) 17.10.2007 Ž-2448/2007 RS

(732) **DIAGEO IRELAND; ST. JAMES S GATE DUBLIN 8 IE**

SURGER

(540)

(550) I

(740) Čejović Vladimir, 13 Jul br. 21, Podgorica, (ME)

(511) **Klasa 09:** elektronski instrumenti za pravljenje ultrasoničnih talasa; naprave za pravljenje pивske pjene pomoću ultrasoničnih talasa (za upotrebu u industriji); naprave za pravljenje pивske pjene pomoću ultrasoničnih talasa (za upotrebu u domaćinstvu).**Klasa 32:** Piva; ale, stout i porter; pića sa niskim procentom alkohola; mineralne i gazirane vode i ostala negazirana pića; voćni napici i voćni sokovi; sirupi i ostali preparati za spravljanje pića.(111) **03800**(151) **27.07.2012**(210) **2009-6**(442) **20.12.2011**

(220) 14.01.2009

(300) 17.10.2007. Z-2445/2007 RS

(732) **DIAGEO IRELAND; ST. JAMES S GATE DUBLIN 8 IE**

HARP

(540)

(550) I

(740) Čejović Vladimir, 13 Jul br. 21, Podgorica, (ME)

(511) **Klasa 32:** Piva; ale, stout i porter; pića sa niskim procentom alkohola; mineralne i gazirane vode i ostala negazirana pića; voćni napici i voćni sokovi; sirupi i ostali preparati za spravljanje pića.(111) **03801**(151) **27.07.2012**(210) **2009-9**(442) **20.12.2011**

(220) 14.01.2009

(300) 17.10.2007. Ž-2443/2007 RS

(732) **DIAGEO IRELAND; ST. JAMES S GATE DUBLIN 8 IE**

KILKENNY

(540)

(550) I

(740) Čejović Vladimir, 13 Jul br. 21, Podgorica, (ME)

(511) **Klasa 32:** Piva; ale, stout i porter; pića sa niskim procentom alkohola; mineralne i gazirane vode i ostala negazirana pića; voćni napici i voćni sokovi; sirupi i ostali preparati za spravljanje pića.

(111) **03802** (151) **27.07.2012**

(210) **2009-30** (442) **20.03.2012**

(220) 26.01.2009

(732) **ANADOLU EFES BIRACILIK VE MALTSANAYIANONIM SIRKETI; ESKI LONDRA ASFALITI HAZNEDERCIFTLIGI MEVKII NO 22 BAHCELIEVER ISTANBUL TR**



(540)

(550) I

(740) Popović Miladin, Đoka Miraševića 21/III Podgorica (ME)

(511) **Klasa 32:** Piva; preparati za pravljenje piva, bezalkoholna pića, pića od slada, izotona pića, mineralne vode, stonog vode, vode (pića), sokovi od voća i povrća; njihovi koncentraci i nektari.

(111) **03803** (151) **27.07.2012**

(210) **2009-46** (442) **20.03.2012**

(220) 27.01.2009

(300) 15.11.2006 Z-2006/2617 RS

(732) **JT INTERNATIONAL S.A, 1 RUE DE LA GABELLE, 1211 GENEVA 26 CH**

AMBER LEAF

(540)

(550) I

(740) Čejović Vladimir, 13. jul 21, Podgorica (ME)

(511) **Klasa 34:** Duvan, duvan za ručno uvijanje, cigarete, artikli za pušaće uključeni u klasu 34.

(111) **03804** (151) **27.07.2012**

(210) **2009-244** (442) **20.12.2011**

(220) 18.05.2009

(300) 13.06.2007. Ž-2007-1380 55768 ZIS RS

(732) **E.R.SQUIBB SONS L.L.C; A DELAWARE LIMITED LIABILITY COMPANY LAWRENCEVILLE-PRINCETON ROAD, PRINCETON, NEW JERSEY 08540 US**

CONVATEC REBOUNDING MEMORY TECHNOLOGY

(540)

(550) I

(740) Čupić Branislav, Dalmatinska 10, Podgorica, (ME)

(511) **Klasa 10:** uređaji i naprave za ostomiju, naročito kese, prirubnice, obujmice, obloge, lijepljivi prstenovi, filteri, zaštitne podloge za kožu i djelovi i oprema za njih; kolektori za inkontinentne pacijente, naročito posude za drenažu, cijevni sistem, kontrolni adapteri za drenažu i djelovi i oprema za njih; naprave za urinarnu i fekalnu inkontinenciju, naročito posude za drenažu, kese, cijevni sistem, kontrolni adapteri za drenažu i dijelovi i oprema za njih.

(111) **03805**(151) **27.07.2012**(210) **2009-245**(442) **20.12.2011**

(220) 18.05.2009

(300) 28.03.2007. 77/142719 US

(732) **E.R.SQUIBB SONS L.L.C; A DELAWARE LIMITED LIABILITY COMPANY
LAWRENCEVILLE-PRINCETON ROAD, PRINCETON, NEW JERSEY
08540 US**



(540)

(550) I

(740) Čupić Branislav, Dalmatinska 10, Podgorica, (ME)

(511) **Klasa 10:** uređaji i naprave za ostomiju, naročito kese, prirubnice, obujmice, obloge, lijepljivi prstenovi, filteri, zaštitne podloge za kožu i delovi i oprema za njih; kolektori za inkontinentne pacijente, naročito posude za drenažu, cevni sistem, kontrolni adapteri za drenažu i delovi i oprema za njih; naprave za urinarnu i fekalnu inkontinenciju, naročito posude za drenažu, kese, cevni sistem, kontrolni adapteri za drenažu i delovi i oprema za njih.

(111) **03806**(151) **27.07.2012**(210) **2009-439**(442) **20.03.2012**

(220) 02.07.2009

(732) **SANOFI PASTEUR LIMITED/ SANOFI PASTEUR LIMITEE; 1755 STEELES AVENUE WEST, TORONTO, ONTARIO M2R 3T4 CA**



(540)

(550) I

(740) Lutovac Branislav, ul. Bulevar Crnojevića 93, Podgorica (ME)

(511) **Klasa 05:** Farmaceutski proizvodi, vakcine za ljudsku upotrebu.

(111) **03807**

(151) **27.07.2012**

(210) **2009-440**

(442) **20.03.2012**

(220) 02.07.2009

(732) **S. C. JOHNSON I SON INC; 1525 HOWE STREET, RACINE, WISCONSIN US**



(540)

(550) I

(740) Čejović Vladimir, 13. jul 21, Podgorica (ME)

(511) **Klasa 03:** Preparati za čišćenje, poliranje, ribanje i nagrizanje, voskovi, sapuni, deterdženti.

(111) **03808**

(151) **27.07.2012**

(210) **2009-441**

(442) **20.03.2012**

(220) 03.07.2009

(732) **YKK CORPORATION A JAPANESE CORPORATION; 1, KANADA IZUMI-CHO, CHIYODA-KU, TOKIO JP**



(540)

(550) I

(740) Ćupić Branislav, Dalmatinska 10, Podgorica (ME)

(511) **Klasa 26:** Patent zatvarači (rajsferšlusi), zatvarači na kukicu i petlju (zatvarači na pritisak), šnale za kaiš, dugmad, kopče, drikeri, kukica i petlja za odjeću i veš, dekorativna okca za fiksiranje džepova, držači bratela za grudnjake, kukice koje se otvaraju na pritisak, kukice, klizne bravice za tašne, trake, pritiskači, elastične trake, čipka i vez, trake i pletenice od traka, čiode i igle.

- (111) **03809** (151) **27.07.2012**
 (210) **2009-442** (442) **20.03.2012**
 (220) 03.07.2009
 (732) **KIA MOTORS CORPORATION; 231 YANGJAE-DOMG, SEOCHO-GU, SEUL 137-938 RK**

CERATO KOUP

- (540)
 (550) I
 (740) Čupić Branislav, Dalmatinska 10, Podgorica (ME)
 (511) **Klasa 12:** Putnička vozila, kamioni, autobusi, minibusevi, kamioneti, kombiji, omnlbusevi, vozila sa pogonom na četiri točka, vozila na dva točka.

- (111) **03810** (151) **27.07.2012**
 (210) **2009-456** (442) **20.03.2012**
 (220) 15.07.2009
 (732) **THE COCA COLA COMPANY; ONE COCA COLA PLAZA, ATLANTA, GEORGIA 30313 US**

TUMULT

- (540)
 (550) I
 (740) Popović Miladin, Đoka Miraševića 21/III Podgorica (ME)
 (511) **Klasa 30:** Kafa, čaj, kakao, šećer, pirinač, tapioka, sago, zamjena kafe; brašno i proizvodi od žitarica, hleb, kolači i poslastice, sladoledi; med, melasa, kvasac, prašak za pecivo; so, senf; sirće, sosovi (kao dodaci); začini; led.
Klasa 32: Piva; mineralne i sodne vode i ostala bezalkoholna pića; voćna pića i voćni sokovi; sirupi i drugi preparati za proizvodnju pića.
Klasa 33: Alkoholna pića, izuzev piva.

- (111) **03811** (151) **27.07.2012**
 (210) **2009-457** (442) **20.03.2012**
 (220) 16.07.2009
 (732) **BRIGESTONE LICENSING SERVICES INC; 536 MARRIOT DRIVE, NASHVILLE, TENNESSEE 37214 US**

FIRESTONE

- (540)
 (550) I
 (740) Popović Miladin, Đoka Miraševića 21/III Podgorica (ME)
 (511) **Klasa 01:** Lepkovi i prajmeri podloga.
Klasa 17: Zaptivne smješe koje se koriste u gradevinarstvu i montaži i izolacija koja se koristi u

gradevinarstvu i montaži.

Klasa 19: Nemetalni građevinski materijal; nemetalni materijali za krovove; membrane za krovove i vodootporne membrane.

Klasa 37: Usluge vezane za postavljanje krovnih konstrukcija.

-
- (111) **03812** (151) **27.07.2012**
 (210) **2009-462** (442) **20.03.2012**
 (220) 20.07.2009
 (732) **OBC AG; BAARESTRASE 53, CH-6304 ZUG CH**



(540)

(550) I

(740) Popović Miladin, Đoka Miraševića 21/III Podgorica (ME)

(511) **Klasa 35:** Usluge poslovanja, usluge koje se odnose na reklamiranje robe i usluga, usluge poslovne komunikacije kao i druge usluge poslovnog predstavljanja, usluge poslovanja vezane za finansijsko posredovanje i novac i posredovanje, profesionalni konsalting u poslovanju, usluge poslovne medijacije za treća lica, pružanje informacija u poslovanju, savetovanje i pomoć u vođenju poslovanja, konsultantske usluge u oblasti informisanja, komunikacija i odnosa sa javnošću, konsultantske usluge u oblasti organizacije i vođenja poslovanja, usluge istraživanja javnog mnjenja, usluge kompjuterske obrade podataka (poslovna administracija) za organizaciju i vođenje izlaganja (izložbi) i takmičenja, u komercijalne svrhe i/ili svrhe reklamiranja (oglašavanja); objavljivanje i rasturanje raznih vrsta publikacija, uključujući i rasturanje reklama i reklamnih tekstova, rasturanje promotivnog materijala, reklamiranje, reklamiranje putem slanja promotivnog materijala poštom, objavljivanje reklamnih tekstova, kreiranje reklamnih tekstova, reklamiranje putem kopjuterske mreže, usluge slanja putem pošte javnih reklama, oglašavanje na radio stanicama, promotivno oglašavanje na televiziji, umnožavanje dokumenata, usluge poslovnog informisanja, sprovođenje anketa, usluge agencija za uvoz-izvoz.

Klasa 36: Usluge osiguranja, finansijske transakcije, transakcije vezane za nekretnine, informacije u oblasti osiguranja, usluge konsaltinga u osiguranju, brokerski poslovi osiguranja, finansijska procena osiguranja, posredovanje i predstavljanje u osiguranju, sve gore navedene usluge online putem kompjuterske mreže i/ili Interneta, popis, finansijske i posredničke usluge i posredništvo u osiguranju u oblasti pokretne imovine i usluge vezane za nepokretnosti u oblasti trgovanja hartijama od vrednosti, finansijske usluge, kao i usluge finansijskog menadžmenta u oblasti bankarskih pozajmica, poslova štednje i usluga razmene, savetovanje u finansijskom poslovanju i finansijska analiza, konsalting u finansijskom inženjeringu u oblasti osiguranja i bankarstva.

Klasa 41: Edukacija i obuka u oblasti osiguranja, bankarstva, finansijskih i novčanih transakcija; objavljivanje tekstova u nereklamne svrhe, organizacija i vođenje seminara za obuku, konferencija, kongresa, simpozijuma, radionica za obuku i konsultacija, organizacija sajmovi i

izložbi u edukativne i kulturne svrhe, organizacija, vođenje i sprovođenje edukacije sa ispiti-
ma, praktična obuka, izdavanje štampanih tekstova (u nereklamne svrhe).

-
- (111) **03813** (151) **27.07.2012**
 (210) **2009-463** (442) **20.03.2012**
 (220) 21.07.2009
 (732) **SANOFI PASTEUR LIMITED; 1755 STEELES AVENUE WEST, TORONTO,
 ONTARIO M2R 3T4 CA**

IMMUCYST

- (540)
 (550) I
 (740) Lutovac Branislav, Bulevar Crnojevića 93, Podgorica (ME)
 (511) **Klasa 05:** Farmaceutski proizvodi, vakcine za ljudsku upotrebu.

-
- (111) **03814** (151) **27.07.2012**
 (210) **2009-246** (442) **20.12.2011**
 (220) 18.05.2009
 (300) 29.03.2007. 77/143445 US
 (732) **E.R SQUIBB SONS L.L.C; A DELAWARE LIMITED LIABILITY COMPANY
 LAWRENCEVILLE-PRINCETON ROAD, PRINCETON, NEW JERSEY
 08540 US**

AVELLE

- (540)
 (550) I
 (740) Ćupić Branislav, Dalmatinska 10, Podgorica, (ME)
 (511) **Klasa 10:** Medicinski uređaji, naročito pneumatski uređaji za tretman venske insuficijencije.

-
- (111) **03815** (151) **27.07.2012**
 (210) **2009-467** (442) **20.03.2012**
 (220) 24.07.2009
 (732) **NOVARTIS AG; 4002 BASEL CH**

LOPEDIUM

- (540)
 (550) I
 (740) Popović Miladin, Đoka Miraševića 21/III Podgorica (ME)

(511) **Klasa 05:** Farmaceutski preparati.

(111) **03816** (151) **27.07.2012**

(210) **2009-468** (442) **20.03.2012**

(220) 24.07.2009

(732) **NOVARTIS AG; 4002 BASEL CH**

SIMVAHEXAL

(540)

(550) I

(740) Popović Miladin, Đoka Miraševića 21/III Podgorica (ME)

(511) **Klasa 05:** Farmaceutski preparati.

(111) **03817** (151) **27.07.2012**

(210) **2009-469** (442) **20.03.2012**

(220) 24.07.2009

(732) **NOVARTIS AG; 4002 BASEL CH**

ENAHEXAL

(540)

(550) I

(740) Popović Miladin, Đoka Miraševića 21/III Podgorica (ME)

(511) **Klasa 05:** Farmaceutski preparati.

(111) **03818** (151) **27.07.2012**

(210) **2009-470** (442) **20.03.2012**

(220) 24.07.2009

(732) **NOVARTIS AG; 4002 BASEL CH**

DOXACOR

(540)

(550) I

(740) Popović Miladin, Đoka Miraševića 21/III Podgorica (ME)

(511) **Klasa 05:** Farmaceutski preparati.

(111) **03819** (151) **27.07.2012**

(210) **2009-471** (442) **20.03.2012**

(220) 27.07.2009

(732) **NOVARTIS AG; 4002 BASEL CH**

CARDOGREL

(540)

(550) I

(740) Popović Miladin, Đoka Miraševića 21/III Podgorica (ME)

(511) **Klasa 05:** Farmaceutski preparati.

(111) **03820**

(151) **27.07.2012**

(210) **2009-473**

(442) **20.03.2012**

(220) 27.07.2009

(732) **NOVARTIS AG; 4002 BASEL CH**

TACROCEL

(540)

(550) I

(740) Popović Miladin, Đoka Miraševića 21/III Podgorica (ME)

(511) **Klasa 05:** Farmaceutski preparati.

(111) **03821**

(151) **27.07.2012**

(210) **2009-474**

(442) **20.03.2012**

(220) 27.07.2009

(732) **NOVARTIS AG; 4002 BASEL CH**

PRENAPRIL

(540)

(550) I

(740) Popović Miladin, Đoka Miraševića 21/III Podgorica (ME)

(511) **Klasa 05:** Farmaceutski preparati.

(111) **03822**

(151) **27.07.2012**

(210) **2009-475**

(442) **20.03.2012**

(220) 27.07.2009

(732) **NOVARTIS AG; 4002 BASEL CH**

ILLINA

(540)

(550) I

(740) Popović Miladin, Đoka Miraševića 21/III Podgorica (ME)

(511) **Klasa 05:** Farmaceutski preparati.

(111) **03823**

(151) **27.07.2012**

(210) **2009-476**

(442) **20.03.2012**

(220) 27.07.2009

(732) **NOVARTIS AG; 4002 BASEL CH****PRAMIPEKS**

(540)

(550) I

(740) Popović Miladin, Đoka Miraševića 21/III Podgorica (ME)

(511) **Klasa 05:** Farmaceutski preparati.(111) **03873**(151) **30.07.2012**(210) **2008-412**(442) **20.03.2012**

(220) 22.08.2008

(732) **EHTRA PLANN BOŽOVIĆ DOO; UL. NJEGOŠEVA125 IGALO ME**

(540)

(550) I

(740) Božović Radisav, 5 Crnogorske brigade 21, Igalo, Herceg Novi (ME)

(511) **Klasa 29:** Meso, riba, živina, divljač; mesni ekstrakti; konzervirano, sušeno i kuvano voće i povrće; želej, mlijeko i mliječni proizvodi; jestiva ulja i masti.**Klasa 30:** Kafa, čaj, kakao, šećer, pirinac, tapioka, sago, zamjene kafe; brašno i proizvodi od žitarica, hleb, kolači, poslastice, bombone, sladoled; med, sirup od melase; kvasac, prašak za pecivo; sol, senf; sirće, umaci, začini; mirođije; led za hlađenje.**Klasa 43:** Usluge ishrane i prehrane; privremeno primanje na stan.(111) **03874**(151) **30.07.2012**(210) **2009-234**(442) **20.03.2012**

(220) 12.05.2009

(300) 13.05.2008

Z-2008-1195 57907

(732) **INTERTEK GROUP PLC; 25 SAVILE ROW, LONDON, W1S 2ES GB**

(540)

(550) I

(740) Ćupić Branislav, Dalmatinska 10, Podgorica (ME)

(511) **Klasa 42:** usluge testiranja; usluge inspekcije; usluge procjene; usluge analize; testiranje, inspekcija, analiza i procena robe, materijala, robe široke potrošnje, vozila, artikala, minerala, hrane, napitaka, medicinskih i farmaceutskih proizvoda; usluge za elektronsko, električno, fizičko, hemijsko, metalurško, mehaničko i optičko testiranje, inspekciju, analizu procjenu; usluge inspekcije prije i poslije otpremanja; usluge skeniranja kontejnera; sve u saglasnosti sa standardima nadzora, kvaliteta, kvantiteta, konzistencije, izvođenja ili bezbjednosti; usluge kontrole i procene kvaliteta i bezbjednosti; usluge kalibrisanja; usluge laboratorije; medicinsko laboratorijske usluge; usluge medicinskog testiranja; usluge analize krvi; usluge analize tjelesne tečnosti; usluge industrijske analize; usluge industrijskog i naučnog istraživanja; usluge davanja sertifikata/ovjere; usluge dizajna; usluge projektovanja bezbjednosnih postavki; usluge projektovanja rasporeda prostora; usluge premjeravanja, inženjerske usluge; priprema inženjerske analize i izvještavanje; kompjutersko programiranje; pružanje informacije i savjetovanje o bezbjednosti; usluge testiranja, inspekcije, procjene i davanje sertifikata za poslovne sisteme, sisteme menadžmenta, sisteme kvaliteta menadžmenta, sisteme menadžmenta za životnu sredinu; sisteme proizvodnje metoda i postupaka, sve u saglasnosti sa standardima regulative, kvaliteta, kvantiteta, konzistencije, izvršenja i bezbjednosti; usluge savjetovanja i konsultacije i u vezi sa svim gore navedenim uslugama.

(111) **06359**

(151) **25.09.2012**

(210) **2009-466**

(442) **20.03.2012**

(220) 24.07.2009

(732) **WARNER BROS. ENTERTAINMENT INC; 4000 WARNER BOULEVARD, BURBANK, CA 91522 US**

POTTERMORE

(540)

(550) I

(740) Popović Miladin, Đoka Miraševića 21/III Podgorica (ME)

(511) **Klasa 09:** Unapred snimljene trake, audio-video trake, audio video kasete, audio video diskovi, i digitalni višenamenski diskovi koji prikazuju komediju, dramu, akciju i avanturu; audio snimanja koja se mogu preuzimati koja prikazuju komediju, dramu, akciju i avanturu; audio-video snimanja koja se mogu preuzimati koja prikazuju komediju, dramu, akciju i avanturu; ručni digitroni; CD ROM diskovi za kompjuterske igrice; interaktivni programi za video igre; interaktivni multimedijalni programi za igre; kertridži za video igre i kasete; elektronski dnevnic; podloge za miša; kompjuterski programi, naime, softversko povezivanje digitalizovanih video i audio medija sa globalnom kompjuterskom informacionom mrežom putem opreme mobilnih telefona, naime hands free oprema, pozadine za mobilne telefone i pozadine za ekran mobilnih telefona; kodirane magnetske kartice, naime, kartice za telefon, kreditne kartice, platne kartice, debitne kartice i magnetska ključ kartica; telefonske melodije za bežične telefone; čuvari ekrana za kompjutere koje se mogu preuzimati.

Klasa 16: Štampane stvari i robe od papira - naime, knjige koje prikazuju akciju, avanturu i komediju, magazini koji prikazuju akaciju, avanturu i komediju, bojanke, dečje radne knjige; sveske, dnevnic, beležnice, kancelarijski materijal, papir za pisanje, kovert, razglednice, penkale, olovke i futrule za njih, gumice, krede, markeri, olovke u boji, kompleti za bojenje, krede i daske za kredu; poster; omoti za knjige, knjižne oznake, kalendari.

Klasa 28: Igračke i sportske robe, uključujući igre i igračke-naime, figure sa mehanizmom i oprema za njih; plišane igračke; baloni; igracke za jahanje; oprema koje se prodaje kao jedinica za igranje igara sa kartama, igracke vozila; lutke; jedinice za elektronske ručne igre; oprema za igre koje se prodaju kao jedinice za igranje igara na tabli, igre sa kartama, društvene igre i igre sa metom akcionog tipa; samostalne video mašine za igru sa izlazom; slagalice i slagalice koje se ručno izrađuju; lopte-naime, lopte za igralište, fudbalske lopte, košarkaške lopte; splavovi za plivanje za rekreativnu upotrebu; igračke za pečenje i kuvanje, igracke banke, snežni globusi igračke; ukrasi za Božićno drvo

Klasa 35: Onlajn usluge iznajmljivanja u radnjama koje sadrže unapred snimljene audio knjige; elektronske knjige; potrošačke robe, naime, knjige koje sadrže akciju, avanturu i komediju; magazini koji sadrže akciju, avanturu i komediju; bojanke, dečje radne knjige; sveske, dnevници, beležnice, kancelarijski materijal, papir za pisanje, kovertе, razglednice, penkale, olovke i futrule za njih, gumice, krede, markeri, olovke u boji, kompleti za bojenje, posterі; omoti za knjige, knjižne oznake i kalendari; usluge oglašavanja i promovisanja i usluge pružanja informacija u vezi sa njima; usluge poslovnih informacija; prikupljanje reklama.

Klasa 38: Obezbeđivanje višekorisničkog pristupa globalnoj kompjuterskoj informacionoj mreži; obezbeđivanje onlajn pričaonica i elektronskih oglasnih tabli za prenos (odašiljanje) poruka između korisnika u oblasti od opšteg interesa; obezbeđivanje onlajn komunikacionih veza koje prebacuju websajt korisnika na druge lokalne i globalne web strane; obezbeđivanje onlajn olakšica u interaktivnom režimu rada sa drugim kompjuterskim korisnicima u pogledu tema od opšteg interesa.

Klasa 41: Usluge zabave, naime, snabdevanje web sajtova koji prikazuju filmske isečke, fotografije i druge multimedijalne materijale; snabdevanje onlajn kompjuterskih igara; snabdevanje kompjuterskih igara kojima se može pristupiti putem telekomunikacione mreže; usluge obrazovanja, naime, pružanje informacija kojima se može pristupiti putem telekomunikacione mreže posebno u vezi sa dečjim knjigama, obrazovnim programima koji uključuju programe za čitanje i pisanje, programe za učenje čitanja i pisanja, materijali i programi za olakšavanje čitanja i pisanja za pojedince sa nervnim bolestima koje ometaju učenje, govor i pisanje; obezbeđivanje onlajn izdanja u svojstvu elektronskih knjiga; usluge elektronskog izdavaštva, naime, izdavanje tekstova i grafičkih knjiga za druge.

(111) **06360**

(151) **25.09.2012**

(210) **2009-464**

(442) **20.03.2012**

(220) 21.07.2009

(732) **THE COCA COLA COMPANY; ONE COCA COLA PLAZA, ATLANTA, GEORGIA 30313 US**

RELENTLESS

(540)

(550) I

(740) Popović Miladin, Đoka Miraševića 21/III Podgorica (ME)

(511) **Klasa 32:** Piva; mineralne i sodne vode i ostala bezalkoholna pića; voćna pića i voćni sokovi; sirupi i dragi preparati za proizvodnju pića.

Klasa 41: Obrazovne usluge; pripremanje obuke; razonoda; sportske i kultume aktivnosti.

(111) **03370**(151) **11.06.2012**(210) **2008-1226**(442) **20.12.2011**

(220) 23.12.2008

(300) RS 12 04 2007 Z-804/07

(732) **HYATT INTERNATIONAL CORPORATION; 71 SOUTH WACKER DRIVE, CHIKAGO ILLINOIS 60606 US****ANDAZ**

(540)

(550) I

(740) Lutovac Branislav, Bulevar Ivana Crnojevića 93, Podgorica (ME)

(511) **Klasa 43:** Usluge biroa za smještaj (hoteli, pansioni); hotelske usluge, usluge hotelske rezervacije; catering; usluge restorana, menzi, kafana i snek barova; iznajmljivanje privremenog smještaja; iznajmljivanje sala za sastanke**Klasa 44:** Banjske usluge(111) **03368**(151) **11.06.2012**(210) **2009-34**(442) **20.12.2011**

(220) 27.01.2009

(300) 22. 08. 2008. Ž-2008-2113 ZIS RS

(732) **SAVA TERZIĆ, ALEKSE NENADOVIĆA 24; 11 000 BEOGRAD RS****CertusAutoTrack**

(540)

(550) I

(740) Radulović Božidar, Jovana Tomaševića 9/III, Podgorica, (ME)

(511) **Klasa 09:** Aparati i instrumenti naučni, pomorski, geodetski, fotografski, kinematografski, optički, za vaganje, mjerenje, signalizaciju, kontrolu (inspekciju), spasavanje i nastavu; aparati i instrumenti za provođenje, prekid, transformaciju, akumulaciju, regulisanje ili kontrolu električne energije; aparati za snimanje, prenos i reprodukovanje zvuka ili slike; magnetni nosioci podataka, diskovi za snimanje; automatske mašine i mehanizmi za aparate koji se pokreću novcem ili žetonom, registar kase, računске mašine, oprema za obradu podataka i kompjuteri; aparati za gašenje požara; aparati za davanje podataka o položaju putem radio talasa.**Klasa 38:** Telekomunikacije.**Klasa 42:** Naučne i tehnološke usluge i istraživanje i projektovanje u vezi sa navedenim uslugama; usluge industrijske analize i istraživanja; projektovanje i razvoj kompjuterskog hardvera, softvera i baza podataka.**Klasa 45:** Usluge elektronske prismotre i praćenja stvari i ljudi; usluge traženja i lociranja stvari i ljudi; usluge obezbjeđenja stvari i ljudi; usluge obavještanja korisnika prethodno navedenih usluga o kretanju stvari i ljudi.(111) **03369**(151) **11.06.2012**

210) **2009-35**(442) **20.12.2011**

(220) 27.01.2009

(300) 22.08.2008. Ž-2008-2114 ZIS SRS

(732) **SAVA TERZIĆ, ALEKSE NENADOVIĆA 24; 11 000 BEOGRAD RS****CERTUS AUTOTRACK**

(540)

(550) I

(740) Radulović Božidar, Jovana Tomaševića 9/III, Podgorica, (ME)

(511) **Klasa 09:** Aparati i instrumenti naučni, pomorski, geodetski, fotografski, kinematografski, optički, za vaganje, mjerenje, signalizaciju, kontrolu (inspekciju), spasavanje i nastavu; aparati i instrumenti za provođenje, prekid, transformaciju, akumulaciju, regulisanje ili kontrolu električne energije; aparati za snimanje, prenos i reprodukovanje zvuka ili slike; magnetni nosioci podataka, diskovi za snimanje; automatske mašine i mehanizmi za aparate koji se pokreću novcem ili žetonom, registar kase, računске mašine, oprema za obradu podataka i kompjuteri; aparati za gašenje požara; aparati za davanje podataka o položaju putem radio talasa.

Klasa 38: Telekomunikacije.

Klasa 42: Naučne i tehnološke usluge i istraživanje i projektovanje u vezi sa navedenim uslugama; usluge industrijske analize i istraživanja; projektovanje i razvoj kompjuterskog hardvera, softvera i baza podataka.

Klasa 45: Usluge elektronske prismothe i praćenja stvari i ljudi; usluge traženja i lociranja stvari i ljudi; usluge obezbjeđenja stvari i ljudi; usluge obavještanja korisnika prethodno navedenih usluga o kretanju stvari i ljudi.

(111) **03481**(151) **14.06.2012**(210) **2009-213**(442) **20.12.2011**

(220) 27.04.2009

(732) **AD BJELASICA RADA; BIJELO POLJE ME**

„RADA”

(540)

(550) I

(511) **Klasa 32:** Mineralna gazirana voda.(111) **06362**(151) **25.09.2012**(210) **2009-459**(442) **20.03.2012**

(220) 17.07.2009

(732) **MARS, INCORPORATED; 6885 ELM STREET, MCLEAN, VA22101-3883 US**



(540)

(550) I

(740) Čejović Vladimir, 13. jul 21, Podgorica (ME)

(511) **Klasa 29:** Meso, riba, živina i divljač; mesne prerađevine; konzervisano, sušeno i kuvano voće i povrće; bilje; jaja; mlječni proizvodi; želei, džemovi, kompoti; mlijeko i mlječni napitci; proizvodi pripremljeni za konzumiranje i koji se sastoje uglavnom od gore navedenih proizvoda.

Klasa 30: Kafa i zamjena kafe; čaj, kakao, čokolada za piće; šećer, pirinač, tapioka, sago; brašno i proizvodi od žitarica; hljeb, biskviti, kolači, pecivo, čokolada i slatkiši; sladoled; led, led sa dodatkom voćnog soka i šećera u vidu dezerta; med, melasa; so, senf; sirće, sosevi; pesto; dodaci jelima; bilje; začini; proizvodi pripremljeni za konzumiranje i koji se sastoje uglavnom od gore navedenih proizvoda.

(111) **06363**(151) **25.09.2012**(210) **2009-455**(442) **20.03.2012**

(220) 15.07.2009

(732) **MARS, INCORPORATED; 6885 ELM STREET, MCLEAN, VA 22101-3883 US**



(540)

(550) I

(740) Čejović Vladimir, 13. jul 21, Podgorica (ME)

(511) **Klasa 29:** Meso, riba, živina i divljač; mesne prerađevine; konzervisano, sušeno i kuvano voće i povrće; bilje; jaja; mlječni proizvodi; želei, džemovi, kompoti; mlijeko i mlječni napitci; proizvodi pripremljeni za konzumiranje i koji se sastoje uglavnom od gore navedenih proizvoda.

Klasa 30: Kafa i zamjena kafe; čaj, kakao, čokolada za piće; šećer, pirinač, tapioka, sago; brašno i proizvodi od žitarica; hljeb, biskviti, kolači, pecivo, čokolada i slatkiši; sladoled; led, led sa dodatkom voćnog soka i šećera u vidu dezerta; med, melasa; so, senf; sirće, sosevi; pesto; dodaci jelima; bilje; začini; proizvodi pripremljeni za konzumiranje i koji se sastoje uglavnom od gore navedenih proizvoda.

(111) **06364**(151) **25.09.2012**

(210) **2009-453**(442) **20.03.2012**

(220) 15.07.2009

(732) **IEI TECHNOLOGY CORP.; 5F. NO.29, CHUNG-HSING RD. SHI-CHI CITY, TAIPEI HSIEN 221 CN****IEI**

(540)

(550) I

(740) Popović Miladin, Đoka Miraševića 21/III Podgorica (ME)

(511) **Klasa 09:** Aparati za daljinsko upravljanje industrijskim radnjama, računarska ploče na koju se mogu dodavati komponente, kompjuterska postolja, štampane ploče za kompjutere, kompjuterske matične i pomoćne ploče, kompjuterske interfejs kartice, kompjuterski hardver i kompjuterski periferni uređaji, hladnjaci za kompjutere, kompjuterske tastature, kompjuterski monitori, kompjuterski serveri, uređaji osetljivi na dodir za kompjutere, kompjuterske radne stanice, mašine za skladištenje podataka, električne instalacije za daljinsko upravljanje industrijskim radnjama, integrisana štampana kola, industrijski kompjuteri, industrijski kompjuterski softveri, LCD monitori, uređaji za napajanje.(111) **06365**(151) **25.09.2012**(210) **2009-449**(442) **20.03.2012**

(220) 10.07.2009

(732) **THE H. D. LEE COMPANY INC; 3411 SILVERSIDE ROAD WILMINGTON, DE 19810 US****LEE**

(540)

(550) I

(740) Radulović Božidar, Jovana Tomaševića 9/III, Podgorica (ME)

(511) **Klasa 25:** Odjeća, obuća, pokrivala za glavu, uključujući cipele, čizme, obuću za svaki dan, sportsku obuću, sandale, papuče, zaštitnu obuću.(111) **06366**(151) **25.09.2012**(210) **2009-443**(442) **20.03.2012**

(220) 07.07.2009

(732) **TOYOTA JIDOSHA KABUSHIKI KAISHA-ALSO TRADING AS TOYOTA MOTOR CORPORATION; 1-TOYOTA-CHO, TOYOTA-SHI, AICHI-KEN JP****CT200h**

(540)

(550) I

(740) Čejović Vladimir, 13. jul 21, Podgorica (ME)

(511) **Klasa 12:** Automobili i njihovi strukturni dijelovi.(111) **06367**(151) **25.09.2012**

(210) **2009-429**(442) **20.03.2012**

(220) 25.06.2009

(732) DIAGEO NORTH AMERICA INC; 801 MAIN AVENUE, NORWALK, CONNECTICUT 06851 US



(540)

(550) I

(740) Čejović Vladimir, 13. jul 21, Podgorica (ME)

(511) **Klasa 33:** Alkoholna pića.(111) **06361**(151) **25.09.2012**(210) **2009-465**(442) **20.03.2012**

(220) 21.07.2009

(300) 22.01.2009 2009700832 RU

(732) **COLGATE-PALMOLIVE COMPANY, A DELAWARE CORPORATION; 300 PARK AVENUE NEW YORK N.Y. 10022 US****XANLEIN**

(540)

(550) I

(740) Stanković Mugoša Ana, Trg Republike br.13 81000 Podgorica (ME)

(511) **Klasa 03:** Dezodoransi, antiperspiranti.(111) **06368**(151) **25.09.2012**(210) **2009-231**(442) **20.12.2011**

(220) 07.05.2009

(732) **ESCALADE LLC; 2120 CAREY AVENUE, CHEYENNE 82001 US**

(540)

(550) I

(740) Pejović Jovan, Podgorica (ME)

(511) **Klasa 29:** mlijeko i mliječni proizvodi**Klasa 30:** pića od kakaoa, kafe ili na bazi čokolade**Klasa 32:** mineralne i sodne vode i druga bezalkoholna pića**Klasa 35:** oglašavanje

Klasa 39: pakovanje i skladištenje robe, transportne usluge

- (111) **06369** (151) **25.09.2012**
 (210) **2009-189** (442) **20.03.2012**
 (220) 03.04.2009
 (732) **LIR DOO; VOJVOĐANSKA 22 P FAH 1 BUDVA ME**



- (540)
 (550) I
 (740)
 (511) **Klasa 41:** Obrazovne usluge; pripremanje obuke; razonoda; sportske i kulturne aktivnosti.

Klasa 43: Usluge obezbjeđivanja hrane i pića; privremeni smještaj

- (111) **06370** (151) **25.09.2012**
 (210) **2009-86** (442) **20.03.2012**
 (220) 03.02.2009
 (300) 21.03.2008 Z-647-2008 RS
 (732) **MEGGLE AG; MEGGLESTRABE 6-12, 83512 WASSERBURG DE**

Vitalitè

- (540)
 (550) I
 (740) Radulović Božidar, Jovana Tomaševića 9/III, Podgorica (ME)
 (511) **Klasa 29:** Mlijeko i mliječni proizvodi; buter i proizvodi od butera; sir i proizvodi od sira; namazi ili paštete; proizvodi na bazi mlijeka i jogurta, naročito napici od jogurta sa ili bez voćnih sastojaka; mliječni napici (u kojima preovladava mlijeko) mliječni napici na bazi surutke sa ili bez dodatka voća ili sirupa; voćni napici koji sadrže mlijeko; jestiva ulja i masti; proizvodi od soje (koji su uključeni u klasu 29) jogurt sa ili bez voćnih sastojaka; dezerti i drugi proizvodi na bazi mlijeka; supe; surutka; laktoza; voćni proteinski koncentraci za prehrambenu industriju; džemovi, kompoti; konzervirano, sušeno i kuvano voće; želei.

Klasa 32: Bezalkoholni napici sa malim sadržajem mlijeka i mliječnih sastojaka; napici od surutke sa ili bez dodatka voća ili sirupa; voćni napici.

- (111) **06371** (151) **25.09.2012**
 (210) **2009-2** (442) **20.03.2012**
 (220) 14.01.2009
 (300) 23.08.2006 Z-1873/2006 RS
 (732) **DIAGEO BRANDS B V; MOLENWERF 10 12 1014 BG AMSTERDAM NL**

ROMANA SAMBUCA

- (540)
 (550) I
 (740) Čejović Vladimir, 13. jul 21, Podgorica (ME)
 (511) **Klasa 33:** Alkoholna pića.

- (111) **06372** (151) **25.09.2012**
 (210) **2009-444** (442) **20.03.2012**
 (220) 08.07.2009
 (732) **NTP LABERION; STR. /LIAPI/ 32, 11000-PODUJEVE KOSOVO**



- (540)
 (550) I
 (740) Radulović Božidar, Jovana Tomaševića 9/III, Podgorica (ME)
 (511) **Klasa 29:** Konzervirano, zamrznuto, sušeno i kuvano voće i povrće; džemovi, marmelade, kompoti: voćna kaša.
Klasa 32: Voćni napici i voćni sokovi; sirupi i ostali preparati za pripremanje napitaka; koncentri od voća bez alkohola.

- (111) **06421** (151) **25.09.2012**
 (210) **2009-436** (442) **20.03.2012**
 (220) 26.06.2009
 (732) **AKITA INC; 2711 CENTRVILLE ROAD, SUITE 400, WILMINGTON, DE-LAWARE 19808 US**

CHARTIS

(540)

(550) I

(740) Čejović Vladimir, 13. jul 21, Podgorica (ME)

(511) **Klasa 36:** Usluge osiguranja i finansijske usluge.(111) **06422**(151) **25.09.2012**(210) **2009-460**(442) **20.03.2012**

(220) 20.07.2009

(732) **AKITA, INC; 2711 CENTERVILLE ROAD, SUITE 400, WILMINGTON, DELAWARE 19808 US**

(540)

(550) I

(740) Čejović Vladimir, 13. jul 21, Podgorica (ME)

(511) **Klasa 36:** Usluge osiguranja i finansijske usluge.(111) **06423**(151) **25.09.2012**(210) **2009-461**(442) **20.03.2012**

(220) 20.07.2009

(732) **AKITA INC; 2711 CENTERVILLE ROAD, SUITE 400, WILMINGTON, DELAWARE 19808 US**

(540)

(550) I

(740) Čejović Vladimir, 13. jul 21, Podgorica (ME)

(511) **Klasa 36:** Usluge osiguranja i finansijske usluge.(111) **06436**(151) **25.09.2012**(210) **2008-1186**(442) **20.03.2012**

(220) 09.12.2008

(300) 09.12.2008

(732) **INTERCONTINENTAL HOTELS GROUP PLC; 67 ALMA ROAD WINDSOR
BREKSHIRE SL4 3HD GB**

IHG

(540)

(550) I

(740) Dedić Tomislav, Bulevar Ivana Crnojevića 139, Podgorica (ME)

(511) **Klasa 43:** hotelske usluge, motelske usluge, obezbjeđenje smještaja; usluge privremenog smještaja; usluge rezervacije hotelskog smještaja i za druge smještaje; usluge informacije za odmor i planiranje u odnosu za smještaj; usluge barova, koktel salona i noćnih klubova; usluge kafea, restorana i snek-barova; usluge kateringa za obezbjeđivanje hranom i pićem; usluge za obezbjeđenja prostorija konferencije, sastanke i izložbe; hotelske usluge prihvata i otpreme; usluge elektronskog informisanja u vezi sa hotelima; savjetovanje i konsalting usluge koje se odnose na gornje.

(111) **06437**(151) **25.09.2012**210) **2009-422**(442) **20.03.2012**

(220) 22.06.2009

(300) 05.09.2006

Z-1968/06 55225RS

(732) **JAFFA, FABRIKA BISKVITA, CRVENKA, MARŠALA TITA 245, 25220 CR-
VENKA RS**



(540)

(550) I

(740) Lutovac Branislav, Bulevar Crnojevića 93, Podgorica (ME)

(511) **Klasa 30:** Kolač.(111) **06438**(151) **25.09.2012**(210) **2009-421**(442) **20.03.2012**

(220) 18.06.2009

(732) **HB BODY S.A.; 570 22 INDUSTRIAL AREA SINDOS, THESALONIKI GR**



(540)

(550) I

(740) Otašević Ivan, Moskovska br 3, Podgorica (ME)

(511)

Klasa 01: Hemijski proizvodi koji se upotrebljavaju u industriji, nauci, fotografiji, poljoprivredi, hortikulturi i šumarstvu; neprerađene veštačke smole, neprerađene plastične materije; đubriva; smješe za gašenje vatre; preparati za kaljenje i zavarivanje; hemijske supstance za očuvanje namirnica; maternje za štavljenje; lepljive supstance koje se upotrebljavaju u industriji.

Klasa 02: Boje, firnajzi, lakovi; sredstva za zaštitu od rđe i truljenja drveta; materije za bojenje; sredstva za nagrizanje; sirove prirodne smole; megali u obliku listova i praha za slikare, dekoratere, štampare i umjetnike.

Klasa 03: Sredstva za beljenje i druge sggustance za upotrebu u perionicama; preparati za čišćenje, poliranje, ribanje i nagrizanje: sapuni; parfimerija, eterična ulja, kozmetika, losioni za kosu; paste za zube.

Klasa 17: Guma, gutaperka, kaučuk, azbest, liskun i proizvodi napravljeni od ovih materijala koji nisu uključeni u druge klase; poluprerađeni plastični proizvodi koji se koriste u proizvodnji; materijali za podbijanje (podloške), zaptivanje i izolovanje; savitljive nemetalne cevi.

(111) **06439**(151) **25.09.2012**(210) **2009-418**(442) **20.03.2012**

(220) 12.06.2009

(732) **KIA MOTORS CORPORATION; 231YANGJAE-DONG, SEOCHO-GU, SEOUL137-938 KR**

(540)

(550) I

(740) Ćupić Branislav, Dalmatinska 10, Podgorica (ME)

(511) **Klasa 12:** Putnička vozila, kamioni, autobusi, minibusevi, kamioneti, kombiji, omnibusevi, vozila sa pogonom na četiri točka, vozila na dva točka.

(111) **06440**(151) **25.09.2012**(210) **2009-416**(442) **20.03.2012**

(220) 11.06.2009

(732) **NIKE INTERNATIONAL LTD A BERMUDA CORPORATION; ONE BOWERMAN DRIVE, BEAVERTON, OR 97005-6453 US**

AIR MAX

(540)

(550) I

(740) Čejović Vladimir, 13. jul 21, Podgorica (ME)

(511) **Klasa 25:** Obuća, odjeća, pokrivala za glavu.(111) **06441**(151) **25.09.2012**(210) **2009-414**(442) **20.03.2012**

(220) 03.06.2009

(732) **PODRAVKA; A. STARČEVICA 32, KOPRIVNICA, HR**

(540)

(550) I

(740) Božović Vesko, Rimski trg 50/11, Podgorica (ME)

(511) **Klasa 29:** Konzervirano, sušeno i kuvano povrće.**Klasa 30:** Sosovi (kao začini); začini.(111) **06442**(151) **25.09.2012**(210) **2009-409**(442) **20.03.2012**

(220) 02.06.2009

(300) 08.05.2007 Z 2007-995 RS

(732) **BAHTER INTERNATIONAL INC; ONE BAHTER PARKWAY, DEERFIELD, ILLINOIS 60015 US**

RECOMBINATE

(540)

(550) I

(740) Čejović Vladimir, 13. jul 21, Podgorica (ME)

(511) **Klasa 05:** Antihemofilički faktor, odnosno koncentrovani preparati faktora VIII, faktora VIII: C i AHF za primjenu na ljudima.(111) **06443**(151) **25.09.2012**

(210) **2009-408**(442) **20.03.2012**

(220) 02.06.2009

(732) **TOYOTA JIDOSHA KABUSHIKI KAISHA; ALSO TRADING AS TOYOTA MOTOR CORPORATION1, TOYOTA-CHO, TOYOTA SHI, AICHI-KEN JP****IS200d**

(540)

(550) I

(740) Čejović Vladimir, 13. jul 21, Podgorica (ME)

(511) **Klasa 12:** Automobili i njihovi strukturni djelovi.(111) **06445**(151) **25.09.2012**(210) **2009-397**(442) **20.03.2012**

(220) 28.05.2009

(300) 12.11.2007 Z-2691/2007 RS

(732) **STARBUCKS CORPORATION D/B/A STARBUCKS COFFEE COMPANY; 2401 UTAH AVENUE SOUTH, SEATTLE, WASHINGTON 98134 US****STARBUCKS
DOUBLESHOT**

(540)

(550) I

(740) Čejović Vladimir, 13. jul 21, Podgorica (ME)

(511) **Klasa 29:** Mlijeko, aromatizovano mlijeko, milk šejkovi i napici na bazi mlijeka; voćni džemovi, sosovi, želei, namazi, ugrušano mlijeko i ukuvano voće.**Klasa 30:** Mljevena kafa i kafa u zrnu, kako, čaj (biljni i ne-biljni), kafa, čaj, kakao i espresso napici, napici na bazi kafe, i/ili espresa, napici na bazi čaja, čokolade u prahu i vanile; sosovi; čokoladni sirupi, aromatizovani sirupi za napitke, pečeni proizvodi uključujući mafine, pšenične pogačice, biskvite, kolačiće, poslastice i hljeb, sendviče, desert od žitarica, unaprijed spremljena kafa, unaprijed spremljen čaj, sladoled i smrznuti slatkiši; čokolada, bombone i slatkiši.**Klasa 32:** Voda, mineralna voda, gazirana voda i druga bezalkoholna pića, sokovi, voćni napici i voćni sokovi, voćni napici i bezalkoholna pića koja sadrže voćne sokove, mješavina za naptke tečne ili u prahu; sosovi; aromatizovani sirupi za spravljanje napitaka; aromatizovane ili ne-aromatizovane flaširane vode, gazirane vode, mineralne vode, voćni sokovi, gazirani napici na bazi voća ili soka i soda napici; zamrznuti voćni napici i zamrznuti napici na bazi voća.(111) **06446**(151) **25.09.2012**(210) **2009-386**(442) **20.03.2012**

(220) 28.05.2009

(300) 12.11.2007 Z-2688/2007 RS

(732) **STARBUCKS CORPORATION D/BA STARBUCKS COFFEE COMPANY;
2401 UTAH AVENUE SOUTH, SEATTLE, WASHINGTON 98134 US****YUKON BLEND**

(540)

(550) I

(740) Čejović Vladimir, 13. jul 21, Podgorica (ME)

(511) **Klasa 30:** Mljevena kafa i kafa u zrnu, kakao, čaj (biljni i ne-biljni), kafa, čaj, kakao i espre-so napici, napici na bazi kafe i/ili espresa, napici na bazi čaja, čokoladc u prahu i vaniie; so-sovi; čokoladni sirupi, aromatizovani sirupi za napitke, pečeni proizvodi uključujući rnafine, pšenične pogačice, biskvite, kolačiće, poslastice i hleb, sendviče, desert od žitarica, unapred spremljena kafa, unapred sprernljert čaj, sladoled i smrznuti slatkiši; čokolada, bombone i slatkiši.(111) **06447**(151) **25.09.2012**(210) **2009-385**(442) **20.03.2012**

(220) 28.05.2009

(300) 12.11.2007 Z-2693/2007 RS

(732) **STARBUCKS CORPORATION D/B/A STARBUCKS COFFEE COMPANY;
2401 UTAH AVENUE SOUTH, SEATTLE, WASHINGTON 98134 US****AFRICA KITAMU**

(540)

(550) I

(740) Čejović Vladimir, 13. jul 21, Podgorica (ME)

(511) **Klasa 30:** Mljevena kafa i kafa u zrnu, kakao, čaj (biljni i ne-biljni), kafa, čaj, kakao i espre-so napici, napici na bazi kafe i/ili espresa, napici na bazi čaja, čokoladc u prahu i vaniie; so-sovi; čokoladni sirupi, aromatizovani sirupi za napitke, pečeni proizvodi uključujući rnafine, pšenične pogačice, biskvite, kolačiće, poslastice i hleb, sendviče, desert od žitarica, unapred spremljena kafa, unapred sprernljert čaj, sladoled i smrznuti slatkiši; čokolada, bombone i slatkiši.(111) **06448**(151) **25.09.2012**(210) **2009-384**(442) **20.03.2012**

(220) 28.05.2009

(300) 12.11.2007 Z-2678/2007 RS

(732) **STARBUCKS CORPORATION D/BA STARBUCKS COFFEE COMPANY;
2401 UTAH AVENUE SOUTH, SEATTLE, WASHINGTON 98134 US**



(540)

(550) I

(740) Čejović Vladimir, 13. jul 21, Podgorica (ME)

(511) **Klasa 09:** Kompjuterski softveri koji se primjenjuju kod pravljenja, skidanja, prenosa, prijema, montiranja, ekstrakovanja, kodiranja, dekodiranja, puštanja, čuvanja i organizovanja audio podataka; audio snimci koji predstavljaju klasičnu, jazz, savremenu, pop, sezonsku, R'n'B, soul, svjetsku, zydeco, rege, rock, folk i pozorišnu muziku; digitalni audio plejeri, muzika koja se preuzima preko globalne računarske mreže i bežičnih uređaja; aparati koji rade pomoću žetona.

Klasa 14: Časovnici, budilnici, džepni časovnici, ručni časovnici, kuhinjski tajmeri, štoperice; nakit.

Klasa 18: Novčanici, lisnice, velike ručne torbe, ženske tašne, akten tašne, tašna za knjige, tašna za spise, putne torbe za ručni prtljag i kišobrani, sve od tkanine, plastike ili kože, kožni privjesci.

Klasa 28: Igračke, naime, mede-igračke, punjene igračke, plišane igračke, lutke i njihova prateća oprema, božićni ukrasi, jo-joi.

Klasa 33: Žestoka alkoholna pića i likeri.

Klasa 41: Usluge zabave, odnosno, obezbjeđivanje i/ili organizovanje zabave, obrazovnih, rekreativnih i/ili muzičkih događaja; organizovanje, produkcija, ugošćavanje i/ili predstavljanje priredbi, nastupa uživo, koncerata i drugih događanja i aktivnosti; priređivanje i vođenje ličnih nastupa u svrhu zabave; usluge izdavanja i produkcije muzičkih i zvučnih snimaka; obezbjeđivanje pristupa interaktivnoj računarskoj bazi podataka koja predstavlja sveobuhvatan kratak prikaz muzičkih snimaka; obezbjeđivanje baze podataka i direktorijuma u oblasti muzike, video, radio, televizije, vijesti, sporta, igara, kulturnih dešavanja, zabave, i umjetnosti i slobodnog vremena preko komunikacijske mreže; snabdijevanje informacija, audio, video, grafike, teksta i drugih multimedijских sadržaja u oblasti muzike, video, radio, televizijske, vijesti, sporta, igara, kulturnih dešavanja, zabave, umjetnosti i slobodnog vremena preko komunikacijske mreže; usluge muzičkog izdavaštva; objavljivanje tekstova, grafike, audio i video djela preko komunikacione mreže; usluge snabdijevanja prodavnica i on-line prodavnica koje omogućavaju korisnicima da programiraju audio, video, tekstualne i druge multimedijске sadržaje, uključujući muziku, koncerte, video, radio, televiziju, vijesti, sport, igre, kulturne događaje i zabavno-orijentisane programe; usluge proizvodnje i distribucije radio programa; usluge muzičke produkcije; usluge zabave, naime obezbjeđivanje prikaza o muzici i komentara i članaka o muzici.

Klasa 43: Usluge restorana, kafea, kafeterija, snek barova, kafe barova i kafe kuća, usluge restorana sa hranom za ponijeti (usluge «carry out» i «take out» restorana), usluge kateringa; usluge snabdijevanja kancelarija sa kafom; usluge ugovaranja pripreme hrane; usluge pripremanja hrane; usluge pripremanja i prodaje hrane i pića za ponijeti.

(111) **06449**

(151) **25.09.2012**

(210) **2009-383**

(442) **20.03.2012**

(220) 28.05.2009

(300) 12.11.2007 Z-2680/2007 RS

(732) **STARBUCKS CORPORATION D/B/A STARBUCKS COFFEE COMPANY;
2401 UTAH AVENUE SOUTH, SEATTLE, WASHINGTON 98134 US**

STARBUCKS COFFEE

(540)

(550) I

(740) Čejović Vladimir, 13. jul 21, Podgorica (ME)

(511) **Klasa 35:** Poslovna administracija, upravljanje poslovanjem; franšizing, naime, obezbjeđivanje tehničke pomoći u osnivanju i/ili radu restorana, kafea, kafe kuća i snek barova; usluge maloprodaje u sljedećim oblastima: kafa, čaj, kakao, upakovana i pripremljena hrana, električni aparati, neelektrični aparati, kućni aparati, kuhinjski aparati, satovi, ručni satovi, kuhinjski tajmeri, štoperice, nakit, knjige, muzički snimci, podmetači za kompjuterskog miša, novčanici, lisnice, velike ručne torbe, ženske tašne, aktne tašne, tašne za knjige, putne torbe za ručni prtljag i kišobrani, sve napravljeno od tkanine, plastike ili kože, pločasti kožni privjerci, odjeća, kape i šeširi, igračke, uključujući mede-igračke, punjene igračke, plišane igračke, lutke i njihova prateća oprema, božićni ukrasi; usluge distributivnih centara za veleprodaju, radnji za veleprodaju i usluge naručivanja na veliko, sve u oblasti: kafa, čaj, kakao, upakovana i pripremljena hrana, električni aparati, neelektrični aparati, kućni aparati, kuhinjski aparati, satovi, ručni satovi, kuhinjski tajmeri, štoperice, nakit, knjige, muzički snimci, podmetači za miša, novčanici, lisnice, velike ručne torbe, ženske tašne, aktne tašne, tašne za knjige, putne torbe za ručni prtljag i kišobrani, napravljene od tkanine, plastike ili kože, pločasti privjerci od kože, odjeća, kape i šeširi, igračke, uključujući mede, punjene igračke, plišane igračke, lutke i njihova prateća oprema, božićni ukrasi; usluge naručivanja poštom i usluge naručivanja poštom preko kataloga, kompjuterizovane on-lajn usluge naručivanja, kompjuterizovane on-lajn usluge maloprodaje, on-lajn usluge naručivanja i on-lajn usluge maloprodaje, sve u oblasti: kafa, čaj, kakao, upakovana i pripremljena hrana, električni aparati, neelektrični aparati, kućni aparati, kuhinjski aparati, satovi, ručni satovi, kuhinjski tajmeri, štoperice, nakit, knjige, muzički snimci, podmetači za miša, novčanici, lisnice, velike ručne torbe, ženske tašne, aktne tašne, tašne za knjige, putne torbe za ručni prtljag i kišobrani, napravljene od tkanine, plastike ili kože, pločasti privjerci od kože, odjeća, kape i šeširi, igračke, uključujući mede-igračke, punjene igračke, plišane igračke, lutke i njihova prateća oprema, božićni ukrasi; usluge kompjuterizovanih on-lajn registara poklona i usluge naručivanja.

(111) **06450**

(151) **25.09.2012**

(210) **2009-381**

(442) **20.03.2012**

(220) 28.05.2009

(300) 12.11.2007 Z-2689 RS

(732) **STARBUCKS CORPORATION D/B/A STARBUCKS COFFEE COMPANY;
2401 UTAH AVENUE SOUTH, SEATTLE, WASHINGTON 98134 US****STARBUCKS BARISTA**

(540)

(550) I

(740) Čejović Vladimir, 13. jul 21, Podgorica (ME)

(511) **Klasa 07:** Električni mlinovi za kafu za kućne ili komercijalne upotrebe.**Klasa 11:** Električni aparati, naime aparati za espresso i aparati za kafu za kućnu ili komercijalnu upotrebu.(111) **06476**(151) **25.09.2012**(210) **2009-445**(442) **20.03.2012**

(220) 08.07.2009

(732) **PARK AG DOO; BOŽE JANKOVIĆA 33, BEOGRAD RS**

(540)

(550) I

(740) Stanković Mugoša Ana, Trg Republike 13, Podgorica (ME)

(511) **Klasa 03:** Kozmetički proizvodi, a naročito kreme, mlijeka, losioni, ulja, suva ulja za negu tijela na bazi lekovitog bilja (arnike, sjemena grožđa, lavande, kamilice, krastavca, aloje i masline odn. maslinovog ulja).(111) **06477**(151) **25.09.2012**(210) **2009-446**(442) **20.03.2012**

(220) 08.07.2009

(732) **PARK AG DOO; BOŽE JANKOVIĆA 33, BEOGRAD RS****Calmasol**

(540)

(550) I

(740) Stanković Mugoša Ana, Trg Republike 13, Podgorica (ME)

(511) **Klasa 03:** Kozmetički proizvodi, a naročito melemi za opekotine nastale prekomernim izlaganjem sunčevim zracima u obliku krema, mlijeka losiona i kompresa.(111) **06546**(151) **25.09.2012**(210) **2009-477**(442) **20.03.2012**

(220) 28.07.2009

(732) **WATSON PHARMACEUTICALS, INC; 311 BONNIE CICLE 92880 CORONA, CALIFORNIA US**

(540)

(550) I

(740) Ćosović Dejan, 13. jul 1/5, Budva (ME)

(511) **Klasa 05:** Farmaceutski proizvodi.(111) **06547**(151) **25.09.2012**(210) **2009-479**(442) **20.03.2012**

(220) 28.07.2009

(732) **WATSON PHARMACEUTICALS, INC; 311 BONNIE CICLE 92880 CORONA, CALIFORNIA US****WATSON**

(540)

(550) I

(740) Ćosović Dejan, 13. jul 1/5, Budva (ME)

(511) **Klasa 05:** Farmaceutski proizvodi.(111) **03584**(151) **03.07.2012**(210) **2010-179**(442) **20.03.2012**

(220) 31.05.2010

(732) **VICTOR DEVELOPMENT, DOO; GORELAC 252 BAR ME****MONTEDEN**

(540)

(550) I

(511) **Klasa 35:** Usluge oglašavanja, putem reklamne agencije i distribucija reklamnog materijala; Usluga vođenja poslova putem poslovnog savjetovanja i pomoći pri radu; Usluge iz poslovnog upravljanja putem „menadžment” organizacije poslova; Usluge u oblasti kancelarijskog poslovanja;

Klasa 36: Usluge osiguranja imovine, lica, roba; Usluge iz finansijskog poslovanja u vezi finansijskog menadžmenta; Usluge iz oblasti prometa nepokretnosti u dijelu upravljanja, iznajmljivanja i prodaje;

Klasa 37: Usluge iz građevinskog konstruisanja niskogradnje i visokogradnje; Usluge popravljivanja objekata sa popravkama manjeg obima i cijele rekonstrukcije; Usluge instaliranja svih vrsta instalacija u građevinarstvu;

Klasa 43: Usluge obezbeđivanja hrane i pića u turistističkim objektima; Usluge pružanja privremenog smještaja u turistističkim objektima; Usluge higijenske zaštite i nege lepote za ljude u salonima ljepote; Usluge agrikulture, hortikulturalne usluge i šumarske usluge planiranje i uređenje zelenih površina i vrtlarstva;

Klasa 44: Usluge medicinskih postupaka u dijelu laboratorijskih analiza; Usluge iz oblasti veterinarstva u dijelu laboratorijskih analiza i liječenja životinja

(111) **03631**

(151) **31.07.2012**

(210) **2009-676**

(442) **20.03.2012**

(220) 17.12.2009

(732) **JANSPORT APPAREL CORP. -DELAWARE CORPORATION; 3411 SILVER-SIDE ROAD, WILMINGTON, DELAWARE 19810 US**



(540)

(550) I

(740) Radulović Božidar, Jovana Tomaševića 9/III, Podgorica (ME)

(511) **Klasa 18:** Koža i imitacije kože, proizvodi izradeni od ovih materijala koji nisu uključeni u druge klase; životinjska koža, krzno; koferi i putne torbe; kišobrani, suncobrani i štapovi za hodanje; bičevi, saračka i sedlarska roba.

Klasa 25: Odjeća, obuća, pokrivala za glavu.

(111) **03632**

(151) **31.07.2012**

(210) **2009-686**

(442) **20.03.2012**

(220) 29.12.2009

(732) **ABBOTT MEDICAL OPTICS INC; 1700 EAST ST ANDREW PLACE, SANTA ANA, CALIFORNIA 92705-4933 US**

AMINAR

(540)

(550) I

(740) Popović Miladin, Đoka Miraševića 21/III Podgorica (ME)

(511) **Klasa 10:** Oftalmičke hiruške igle i vrhovi koji se koriste pri operaciji katarakte.(111) **03633**(151) **31.07.2012**(210) **2009-675**(442) **20.03.2012**

(220) 17.12.2009

(732) **JANSPORT APPAREL CORP. -DELAWARE CORPORATION; 3411 SILVER-SIDE ROAD, WILMINGTON, DELAWARE 19810 US****BUILT TO RESIST**

(540)

(550) I

(740) Radulović Božidar, Jovana Tomaševića 9/III, Podgorica (ME)

(511) **Klasa 18:** Koža i imitacije kože, proizvodi izradeni od ovih materijala koji nisu uključeni u druge klase; životinjska koža, krzno; koferi i putne torbe; kišobrani, suncobrani i štapovi za hodanje; bičevi, saračka i sedlarska roba.**Klasa 25:** Odjeća, obuća, pokrivala za glavu.(111) **03634**(151) **06.09.2012**(210) **2009-280**(442) **20.03.2012**

(220) 26.05.2009

(300) 16.02.2007 5.693.858 CTM

(732) **LOREAL SA; 14 RUE ROYALE 75008 PARIS FR****DERMAGENESE**

(540)

(550) I

(740) Čupić Branislav, Dalmatinska 10, Podgorica (ME)

(511) **Klasa 03:** Parfemi, toaletne vode, gelovi, soli za kupanje i tuširanje koje nisu za medicinsku upotrebu, toaletni sapuni, dezodoransi za tijelo, kozmetički proizvodi, naročito kreme, mijleko, losioni, gelovi i puderi za lice, tijelo i ruke; preparati za zaštitu od sunca (kozmetički proizvodi); proizvodi za šminkanje; šamponi; gelovi, sprejovi, pene i balzami za stiliziranje kose i njegu kose; lakovi za kosu; preparati za farbanje i izbjeljivanje kose; preparati za trajnu i mini-val; eterična ulja za ličnu upotrebu.(111) **03635**(151) **31.07.2012**(210) **2009-297**(442) **20.03.2012**

(220) 27.05.2009

(300) 19.10.2007 Z-2007-2469 56402 RS

(732) **MOTOROLA INC A DELAWARE CORPORATION; 1303 E ALGONGUIN ROAD, SCHAMBURG IL 60196 US****SONGID**

(540)

(550) I

(740) Ćupić Branislav, Dalmatinska 10, Podgorica (ME)

(511) **Klasa 09:** Mobilni telefoni; softver, naročito kompjuterski programi snimljeni ili u fiksnim memorijskim kolima za upotrebu u telekomunikacijskim uređajima i kompjuterima za prenos, reprodukovanje, pristup, pretraživanje, označavanje i traženje muzike, posebno, elektronska funkcija koja olakšava prepoznavanje muzike sa mobilnih telefona i drugih eksternih izvora koja muzika se nalazi u ili je generisana kompjuterskim softverom u mobilnim telefonima ili kompjuterima, a koja funkcija prikazuje informacije u vezi sa tom muzikom na mobilnim telefonima i kompjuterskim monitorima.

Klasa 38: Usluge telekomunikacija i prenosa podataka; savjetodavne i konsultantske usluge u vezi sa uslugama u oblasti telekomunikacija, Interneta, intranet i ekstranet mreža; daljinsko ucitavanje muzike, video igara, digitalnih podataka i kompjuterskog softvera; obezbjeđivanje pristupa kompjuterskim mrežama.

(111) **03636**

(151) **31.07.2012**

(210) **03636**

(442) 20.03.2012

(220) 26.05.2009

(732) **SHERATON INTERNATIONAL INC; 1111 WESTCHESTER AVENUE, WHITE PLAINS, N. Y.10604 US**

THE LUXURY COLLECTION

(540)

(550) I

(740) Lutovac Branislav, Bulevar Crnojevića 93, Podgorica (ME)

(511) **Klasa 43:** Usluge obezbjeđivanja hrane i pića; privremeni smještaj.

(111) **03637**

(151) **31.07.2012**

(210) **2009-278**

(442) **20.03.2012**

(220) 26.05.2009

(300) 09.04.2008 Z-2008-880 RS

(732) **THE POLO/LAUREN COMPANY L. P.; 650 MADISON AVENUE NEW YORK N. Y. 10022, US**

MODERN RESERVE

(540)

(550) I

(740) Ćupić Branislav, Dalmatinska 10, Podgorica (ME)

(511) **Klasa 03:** Parfemi, kolonjska voda, toaletna voda, laki parfemi, sredstva za poslije brijanja (aftershave), gelovi za brijanje, kreme za brijanje, kreme za poslije brijanja, gelovi za poslije brijanja, losioni za poslije brijanje, balzami za poslije brijanja, sredstva protiv znojenja, dezodoransi za ličnu upotrebu, talk u prahu, puder za tijelo, kozmetički proizvodi i proizvodi za negu lepote, naročito hidratantni preparati za tijelo, kreme i losioni za lice i tijelo, preparati za piling (eksfolijatori), preparati za pranje tijela, kreme i losioni za sunčanje i dobijanje preplanule boje, kreme i losioni za zaštitu od sunca, proizvodi za negu kose, naročito šamponi, balzami, sredstva za pranje kose, sredstva za ispiranje kose, kreme i losioni za kosu, briljantin i preparati za stimulaciju tjemena, proizvodi za kupanje i tuširanje, naročito toaletni sa-

puni, šamponi za tijelo, preparati za piling kože tijela, preparati za omekšavanje kože tijela, so za kupanje, gel za kupanje i tuširanje, ulje za kupanje i tuširanje, esencijalna ulja.

-
- (111) **03638** (151) **31.07.2012**
 (210) **2009-277** (442) **20.03.2012**
 (220) 26.05.2009
 (300) 04.10.2007 Z-2007-2234 57171 RS
 (732) **THE POLO/LAUREN COMPANY L. P.; 650 MADISON AVENUE NEW YORK N. Y. 10022, US**

POLO SPORT

- (540)
 (550) I
 (740) Čupić Branislav, Dalmatinska 10, Podgorica (ME)
 (511) **Klasa 03:** Parfemi, kolonjska voda, toaletna voda, laki parfemi, sredstva za posijle brijanja (aftershave), gelovi za brijanje, kreme za brijanje, kreme za poslije brijanja, gelovi za poslije brijanja, losioni za poslije brijanje, balzami za poslije brijanja, sredstva protiv znojenja, dezodoransi za ličnu upotrebu, talk u prahu, puder za tijelo, kozmetički proizvodi i proizvodi za negu lepote, naročito hidratantni preparati za tijelo, kreme i losioni za lice i tijelo, preparati za piling (eksfolijatori), preparati za pranje tijela, kreme i losioni za sunčanje i dobijanje preplanule boje, kreme i losioni za zaštitu od sunca, proizvodi za njegu kose, naročito šamponi, balzami, sredstva za pranje kose, sredstva za ispiranje kose, kreme i losioni za kosu, briljantin i preparati za stimulaciju tjemena, proizvodi za kupanje i tuširanje, naročito toaletni sapuni, šamponi za tijelo, preparati za piling kože tijela, preparati za omekšavanje kože tijela, so za kupanje, gel za kupanje i tuširanje, ulje za kupanje i tuširanje, esencijalna ulja.

-
- (111) **03639** (151) **31.07.2012**
 (210) **2009-283** (442) **20.03.2012**
 (220) 26.05.2009
 (732) **SHERATON INTERNATIONAL INC; 1111 WESTCHESTER AVENUE, WHITE PLAINS, N. Y.10604 US**

ST. REGIS

- (540)
 (550) I
 (740) Lutovac Branislav, Bulevar Crnojevića 93, Podgorica (ME)
 (511) **Klasa 43:** Usluge obezbjeđivanja hrane i pića; privremeni smještaj.

-
- (111) **03681** (151) **31.07.2012**
 (210) **2010-159** (442) **20.03.2012**
 (220) 14.05.2010
 (732) **DRAGAN MARKOVIĆ; DALMATINSKA 33, 81000 PODGORICA ME**



(540)

(550) I

(511) **Klasa 30:** Kafa, čaj kakao, šećer, pirinač tapioka, zamjena kafebrašno i proizvodi odžitarica, hleb, kolači i poslastice, sladoledi med, melasa kvasac, prašak za pecivo so, senf, sirce sosovi(kao dodaci) začini.

(111) **03682**(151) **31.07.2012**(210) **2009-684**(442) **20.03.2012**

(220) 24.12.2009

(732) **CILAG GMBH INTERNATIONAL; LANDIS+GUR-STRASSE 1 CH 6300 ZUG CH**



(540)

(550) I

(740) Radulović Božidar, Jovana Tomaševića 9/III, Podgorica (ME)

(511) **Klasa 03:** Toaletni i kozmetički proizvodi za njegu i čišćenje kože i kose.

Klasa 05: Medicinski preparati za spoljnu upotrebu za tretiranje stanja kože i kose.

(111) 03683

(151) 31.07.2012

(210) 2009-302

(442) 20.03.2012

(220) 27.05.2009

(300) 27.03.2008 Z-2008-728 RS

(732) FAIRMONT SPAS INC A CANADIAN CORPORATION; 100 WELLINGTON STREET, T D CENTRE PO BOH 40, SUITE 1600, TORONTO ONTARIO M5K 1 B7 CA

WILLOW STREAM

(540)

(550) I

(740) Ćupić Branislav, Dalmatinska 10, Podgorica (ME)

(511) **Klasa 03:** sapuni, parfimerijski proizvodi, esencijalna ulja, kozmetika i losioni za kosu; ne-medicinski toaletni preparati; puderi, kreme, losioni i maske, sve za lice, ruke i tijelo; maske za čišćenje lica; kozmetički preparati za negu kože; hidrantni preparati za lice, hidrantni preparati za kožu, hidrantni preparati za tijelo; sredstva za čišćenje lica, sredstva za čišćenje kože, sredstva za čišćenje tijela; losioni za lice, losioni za kožu, losioni za tijelo; kreme za lice, kreme za kožu, kreme za tijelo; ne-medicinski preparati za negu i tretman tijela, kože i kose; preparati za depilaciju; veštački nokti; veštačke trepavice; lak za nokte; sredstva za skidanje laka za nokte; šminka; preparati za tuširanje i kupanje; preparati za kosu; šamponi i regeneratori za kosu; proizvodi za brijanje i za poslije brijanja; kolonjske vode, toaletne vode, blagi parfemi; dezodoransi i anti perspiranti za ličnu upotrebu; ulja za masažu; proizvodi za aromaterapiju; sredstva za čišćenje zuba; sredstva za bijeljenje i za pranje; sredstva za čišćenje, poliranje i odmašćivanje i abrazivna sredstva.

Klasa 04: sveće, kandila i fitilji; industrijska ulja i masti; sredstva za podmazivanje; smješe za vezivanje prašine; goriva (uključujući tečna goriva za motore) i materije za osvjetljavanje.

Klasa 18: torbe; ranci; koferi i torbe; novčanici; kaiševi; ruksaci; kišobrani; torbe za igre; futrole za ključeve, koferčići i torbice za kozmetiku; koža i imitacija kože, proizvodi od ovih materijala koji nisu obuhvaćeni drugim klasama.

Klasa 24: peškiri, posteljina, stolnjaci i čaršavi, vreće za spavanje, zavjese, tkanine tekstilni proizvodi koji nisu obuhvaćeni drugim klasama; prekrivači za krevete i stolove.

Klasa 25: odjeća, obuća i pokrivala glave, odjevni predmeti za sport, pidžame, veš, spavaćice, kućne haljine, papuče, kupaći kostimi, sve obuhvaćeno klasom 25.

Klasa 30: kafa, čaj, kakao, šećer, pirinač, tapioka, sago, zamjena kafe; brašno i proizvodi od žitarica, hljeb, peciva, kolači, poslastice, bombone, sladoled; med, sirup od melase; kvasac, prašak za pecivo; so, senf; sirće, sosovi (kao začini); začini; led.

Klasa 32: piva; vode; mineralne i sodne vode i druga bezalkoholna pića; voćni napitci i voćni sokovi; sirupi i drugi preparati za proizvodnju pića.

Klasa 35: usluge oglašavanja i reklamiranja; poslovni menadžment i administrativne usluge; poslovni menadžment hotela, spa centara, apartmana sa pratećim uslugama, objekata za prodaju obroka hrane, objekata za prodaju pića, kancelarija, poslovnih centara, robnih kuća, šoping centara, maloprodajnih i veleprodajnih objekata; konsultantske usluge u vezi sa poslovnim menadžmentom, konsultantske usluge u vezi sa hotelskim menadžmentom, konsultantske usluge u vezi spa centara, konsultantske usluge u poslovnom menadžmentu u oblasti hrane i pića; poslovne savetodavne usluge u vezi sa franšizingom; poslovna admi-

nistracija; kancelarijski poslovi; organizovanje kongresa i izložbi u poslovne i komercijalne svrhe; usluge prodaje; usluge prometa robe na malo; usluge katalogske prodaje robe; usluge prodaje putem interneta; prikupljanje za treća lica razne robe radi omogućavanja potrošačima olakšanog razgledanja i kupovine te robe u hotelima, objektima za prodaju obroka hrane, objektima za prodaju pića, kancelarijskim zgradama, kongresnim centrima, robnim kućama, ili prodavnicama robe na veliko, putem kataloga za naručivanje preko pošte ili sredstvima telekomunikacija, ili putem veb sajta globalne komunikacione mreže za prodaju razne robe; pravljenje mailing lista; usluge omogućavanja naručivanja putem pošte, telefona, i svih drugih vidova komunikacije i telekomunikacije; usluge prodaje po narudžbenicama putem pošte, telefona i svih drugih vidova komunikacije i telekomunikacija; direktno oglašavanje; savetodavne poslovne usluge i usluge poslovnog menadžmenta; usluge izlaganja robe; reklamne usluge; marketinške i promotivne usluge, analiza i istraživanje tržišta; podsticajni nagradni programi, uključujući i one za goste hotela i odmarališta; podsticajni nagradni programi za mušterije u spa centrima; podsticajni nagradni programi za korisnike kreditnih kartica; vođenje programa za uspostavljanje i održavanje lojalnosti kupaca; usluge privatnih rezidencijalnih klubova, uključujući obezbjeđivanje kancelarijskih prostorija i opreme za članove i rezidente; usluge agencije za uvoz i izvoz, nabavljanje i kupovina robe za poslovne potrebe; aranžiranje izloga; uključujući i pružanje svih prethodno navedenih usluga elektronskim putem ili online iz kompjuterske baze podataka ili putem interneta; usluge pružanja informacija, savetodavne usluge i usluge konsaltinga u vezi sa prethodno navedenim uslugama; sve obuhvaćeno klasom 35.

Klasa 41: obrazovanje; obezbjeđivanje obuke; zabava; sportske i kulturne aktivnosti; pružanje usluga masaže i fizičkog vežbanja; držanje fitnes i velnes seminara, aerobik seminara; obezbjeđivanje prostora za klubove zdravlja, fitnes klubove, teretane, terena za golf i rekreaciju i pružanje odgovarajućih usluga; pružanje usluga kazina i igara na sreću; obuka i obrazovanje u vezi sa ishranom, zdravljem i fitnesom; organizovanje i vođenje konferencija; planiranje proslava; fotografske usluge; produkcija show predstava; organizovanje i vođenje takmičenja; usluge sportskih kampova; prikazivanje nastupa uživo; usluge zabavnih parkova; usluge igraonica za zabavu; usluge izdavaštva; usluge filmske produkcije; usluge radijske i televizijske produkcije; usluge pozorišta; pružanje usluga bioskopskih sala; obezbjeđivanje prostora za izlaganje muzejskih eksponata; usluge u vezi sa zoološkim vrtovima; uključujući sve navedene usluge elektronskim ili onlajn putem iz kompjuterske baze podataka ili putem interneta; informacijske, savetodavne i konsultantske usluge u vezi sa navedenim uslugama, sve obuhvaćeno klasom 41.

Klasa 43: obezbjeđivanje hrane i pića; privremeni smještaj; usluge hotela i odmarališta, usluge smještaja u hotelima; usluge rezervacije za hotelski smještaj; usluge iznajmljivanja soba; pravljenje rezervacija i bukiranje privremenog smještaja; pravljenje rezervacija za duži i kraći boravak u apartmanima i kondominijumima; usluge privatnih rezidencijalnih i društvenih klubova, uključujući usluge čuvanja djece, rezervacija mjesta u restoranima, rezervacija obroka, organizovanje banketa i društvenih događaja u posebnim prilikama; obezbjeđivanje usluga konferencijskih prostora, banketskih usluga; usluge barova, kafea, restorana, koktel barova i kafeterija; spravljanja hrane; usluge kateringa; obezbjeđivanje usluga objekata za konvencije i izložbe; uključujući sve navedene usluge elektronskim ili onlajn putem iz kompjuterske baze podataka ili putem interneta; informacijske, savetodavne i konsultantske usluge u vezi sa navedenim uslugama; sve obuhvaćeno klasom 43.

Klasa 44: medicinske usluge; veterinarske usluge; higijenske usluge i usluge nege lepote za ljude i životinje; usluge u oblasti poljoprivrede, hortikulture i šumarstva; obezbjeđivanje usluga zdravstvenih spa centara, sauna, hamama, i salona za masažu; pružanje usluga masaže; turska kupatila; saloni za lepotu i usluge nege lepote; frizerske i berberske usluge; usluge

aromaterapije; usluge fizioterapije; usluge elektrolize i depilacije; manikirske i pedikirske usluge; zdravstvene usluge, usluge nege lepote, nege tijela, kože i kose; domovi za zbrinjavanje; starački domovi; domovi za oporavak; uključujući sve navedene usluge elektronskim ili onlajn putem iz kompjuterske baze podataka ili putem interneta; informacijske, savetodavne i konsultantske usluge u vezi sa navedenim uslugama; sve obuhvaćeno klasom 44.

(111) **03684**

(151) **31.07.2012**

(210) **2009-683**

(442) **20.03.2012**

(220) 24.12.2009

(732) **CILAG GMBH INTERNATIONAL; LANDIS+GUR-STRASSE 1 CH 6300 ZUG CH**

RECETTES MEDITERRANEENNES

(540)

(550) I

(740) Radulović Božidar, Jovana Tomaševića 9/III, Podgorica (ME)

(511) **Klasa 03:** Toaletni i kozmetički proizvodi za njegu i čišćenje kože i kose.

Klasa 05: Medicinski preparati za spoljnu upotrebu za tretiranje stanja kože i kose.

(111) **03685**

(151) **31.07.2012**

(210) **2010-165**

(442) **20.03.2012**

(220) 19.05.2010

(732) **THE GILLETTE COMPANY; ONE GILLETE PARK, BOSTON, MA 02127 US**

COOL WHITE

(540)

(550) I

(740) Lutovac Branislav, Bulevar Crnojevića 93, Podgorica (ME)

(511) **Klasa 08:** Brijači i nožići za brijače, pribor za brijanje, kutije, kasete i kartridži, koji svi sadrže nožice; djelovi i oprema za napred navedenu robu.

(111) **03686**

(151) **31.07.2012**

(210) **2010-167**

(442) **20.03.2012**

(220) 20.05.2010

(732) **THE GILLETTE COMPANY; ONE GILLETTE PARK, BOSTON, MA 02127 US**

VENUS RIVIERA

(540)

(550) I

(740) Lutovac Branislav, Bulevar Crnojevića 93, Podgorica (ME)

(511) **Klasa 08:** Brijači i nožići za brijanje; pribor za brijanje, kuti kasete, držači i kartridži, koji svi sadrže nožiče; del i oprema za napred navedenu robu.

(111) **03869** (151) **30.07.2012**

(210) **2009-651** (442) **20.03.2012**

(220) 26.11.2009

(732) **WM. WRIGLEY JR. COMPANY; 410 NORTH MICHINGAN AVENUE, CHICAGO IL 60611 US**

WRIGLEY'S 5

(540)

(550) I

(740) Čejović Vladimir, 13. jul 21, Podgorica (ME)

(511) **Klasa 30:** Slatkiši, žvakaće gume, žvakaće gume od kojih mogu da se prave veliki baloni, bombone, dražeje peperminta, mali okrugli bomboni (drops) i pastile.

(111) **03870** (151) **30.07.2012**

(210) **2009-652** (442) **20.03.2012**

(220) 26.11.2009

(732) **WM. WRIGLEY JR. COMPANY; 410 NORTH MICHINGAN AVENUE, CHICAGO IL 60611 US**

A TINGLING SPEARMINT

(540)

(550) I

(740) Čejović Vladimir, 13. jul 21, Podgorica (ME)

(511) **Klasa 30:** Slatkiši, žvakaće gume, žvakaće gume od kojih mogu da se prave veliki baloni, bombone, dražeje peperminta, mali okrugli bomboni (drops) i pastile.

(111) **03871** (151) **30.07.2012**

(210) **2009-654** (442) **20.03.2012**

(220) 26.11.2009

(732) **WM. WRIGLEY JR. COMPANY; 410 NORTH MICHINGAN AVENUE, CHICAGO IL 60611 US**

COBALT

(540)

(550) I

(740) Čejović Vladimir, 13. jul 21, Podgorica (ME)

(511) **Klasa 30:** Slatkiši, žvakaće gume, žvakaće gume od kojih mogu da se prave veliki baloni, bombone, dražeje peperminta, mali okrugli bomboni (drops) i pastile.

(111) **03872**(151) **30.07.2012**(210) **2009-656**(442) **20.03.2012**

(220) 27.11.2009

(732) **AEGEAN AIRLINES SA; 31, VILTANIOTI STR. KIFISSIA 14564 GR**

(540)

(550) I

(740) Čejović Vladimir, 13. jul 21, Podgorica (ME)

(511) **Klasa 16:** Brošure, publikacije, magazini, pribor za pisanje, naljepnice za označavanje prtljaga, bording karte, karte (ulaznice).**Klasa 39:** Usluge transporta za putnike i robu, uslužne informacije za transport i putovanja, usluge organizacije putovanja, usluge rezervacije sjedišta na avio letovima, usluge putnih i transportnih rezervacija, zakup aviona (aerotaksi), kurirske usluge, transport i isporuka robe.(111) **03867**(151) **30.07.2012**(210) **2009-625**(442) **20.03.2012**

(220) 27.10.2009

(732) **JAPAN TOBACCO INC; 2-2-1 TORANOMON, MINATO-KU, TOKYO JP**

(540)

(550) I

(740) Čejović Vladimir, 13. jul 21, Podgorica (ME)

(511) **Klasa 34:** Cigarete, neprerađeni i industrijski prerađeni duvan, artikli za pušače i šibice.(111) **03868**(151) **30.07.2012**(210) **2009-650**(442) **20.03.2012**

(220) 26.11.2009

(732) **WM. WRIGLEY JR COMPANY; 410 NORTH MICHINGAN AVENUE, CHICAGO IL 60611 US****ELECTRO**

(540)

(550) I

(740) Čejović Vladimir, 13. jul 21, Podgorica (ME)

(511) **Klasa 30:** Slatkiši, žvakaće gume, žvakaće gume od kojih mogu da se prave veliki baloni, bombone, dražeje pepermint, mali okrugli bomboni (drops) i pastile.

(111) **03741**

(151) **31.07.2012**

(210) **2009-667**

(442) **20.03.2012**

(220) 12.04.2009

(300) 15.09.2009

77/827132-KLASE 2. 7. 9.16 US

15.09.2009

77/827148 KLASE 35. 36. 37. 38. 39.

40. 41. 42.

US

(732) **HEWLETT-PACKED DEVELOPMENT COMPANY L. P.; 11445 COMPAG CENTER DRIVE WEST, HOUSTON, TEXAS 77070. US**



(540)

(550) I

(740) Popović Miladin, Đoka Miraševića 21/III Podgorica (ME)

(511) **Klasa 02:** Toner kertridži; kertridži sa brizgajućim mastilom; štamparske boje; toneri.

Klasa 07: Prese za štampanje i djelovi za njih.

Klasa 09: Kućne oznake za kompjutere, kompjuterski hardver, kompjuterski softver, periferni uređaji za kompjutere, kompjuter i komunikacioni mrežni hardver i softver, sistemi za obradu podataka i čuvanje podataka, štampači, faksimil mašine, hardveri i softveri za reprodukciju slika, skeneri, aparati za fotokopiranje, projektori, kalkulatori, telefoni i djelovi i oprema za gore pomenuto; optički mediji za snimanje i presnimavanje; kompakt diskovi (CD) i digitalni video diskovi (DVD) za snimanje i presnimavanje i pogonski elementi i pisači za njih.

Klasa 16: Papir; glave za štampanje za štampače i plotere; brošure; priručnici; tehnički bilteni; tehnički podaci; katalogi proizvoda; priručnici za rukovanje i korišćenje proizvoda.

Klasa 35: Pružanje usluga savetovanja u poslovanju; usluge savetovanja u poslovnom upravljanju; usluge strateškog planiranja; usluge onlajn maloprodaje i poručivanja; usluge u oblasti udruživanja, partnerstva i rešenja razvoja programa; usluge reklamiranja; usluge marketinga i promocije; usluge menadžmenta u oblasti ljudskih resursa i ljudskog kapitala; usluge administriranja platnih spiskova za druge; usluge savetovanja u oblasti ljudskih resursa; usluge premeštaja poslova i zaposljenih i usluge informisanja; usluge prikupljanja podataka za poslodavce; usluge upravljanja bazama podataka; usluge praćenja poslovanja; usluge vođenja odnosa sa korisnicima.

Klasa 36: Usluge kupovine i zakupa u oblasti finansija; usluge razvoja, upravljanja i administriranja u oblasti zdravstvene i socijalne zaštite zaposlenih; usluge obezbjeđivanja transakcija putem kreditnih kartica za druge; usluge podnošenja zahtjeva za osiguranje za druge; pružanje usluga finansijske analize i konsultantske usluge za organizaciju i upravljanje bankar-

skim i finansijskim poslovanjem.

Klasa 37: Usluge instaliranja, održavanja i popravke kompjuterskog hardvera i telekomunikacijske opreme.

Klasa 38: Telekomunikacije; usluge „teleprisustva” (telepresence); usluge obezbjeđivanja onlajn soba za „četovanje” (razgovor), oglasnih tabli i foruma za razmenu poruka između korisnika; onlajn usluge servisnih provajdera; usluge video striminga; VOIP usluge; usluge elektronske trgovine; usluge elektronske razmene podataka i informacija.

Klasa 39: Usluge elektronskog čuvanja digitalnog sadržaja; usluge obezbjeđivanja veb sajta za čuvanje digitalnih slika i fotografija.

Klasa 40: Fotografске usluge i usluge digitalne obrade slika, usluge razvijanja i štampanja; usluge prilagođenog štampanja digitalnih i fotografskih slika na fotografskom papiru i trgovačkoj robi; usluge obezbjeđivanja veb sajta za elektronsko projektovanje, uređivanje, obradu, organizovanje i izmenu digitalnih slika; usluge štampanja; usluge štampanja na zahtev; prilagodena izrada kompjutera za druge; usluge recikliranja kompjuterskog hardvera, perifernih uređaja i elektronike.

Klasa 41: Obrazovne usluge i usluge obuke, naime, vođenje časova, radionica, seminara i konferencija u oblasti kompjutera, elektronske trgovine i informacione tehnologije; usluge obezbjeđivanja veb sajta za učitavanje, djeljenje, gledanje i postavljanje fotografija i digitalnih slika putem Interneta; usluge digitalnog projektovanja; usluge elektronskog izdavanja; onlajn časopisi, naime, blogovi koji sadrže informacije iz oblasti kompjutera, elektronske trgovine i informacione tehnologije; usluge obezbjeđivanja veb sajta sa video prikazima napravljenim od strane potrošača.

Klasa 42: Kompjuterske usluge, naime, usluge analiziranja kompjuterskih sistema, planiranja, integracije, dizajna i tehničke podrške; usluge internet konsaltinga, naime, obezbjeđivanje pomoći drugima u razvoju internet portala i stvaranja poslovnih procesa za upotrebu u oblasti elektronske trgovine; usluge konsaltinga u oblasti bezbednosti interneta i interne mreže; usluge kompjuterskog infrastrukturnog održavanja, naime, usluge obezbjeđivanja kompjuterskog hardvera, kompjuterskog softvera, kompjuterskih perifernih uređaja i srodnih operativnih i usluga podrške drugima na osnovu pretplate ili usluge „plati pa koristi” (pay-per-use); usluge davanja u zakup pristupnog vremena softverskim aplikacijama putem interneta; usluge upravljanja informacionim tehnologijama i usluge konsaltinga; usluge dizajna, instalacije, održavanja i popravke kompjuterskog softvera; usluge integracije kompjuterskih sistema i mreža; usluge upravljanja kompjuterskim sistemom i mrežom; usluge razvoja baze podataka; usluge kompjuterskog programiranja; usluge razvoja, održavanja i povezivanja veb sajtova za druge putem interneta; usluge konsaltinga za druge u izboru, implementaciji i korišćenju kompjuterskog softvera za kontrolu i upravljanje transakcijama i aktivnostima na kritičnim mestima; usluge tehničke podrške; usluge pretraživanja podataka; usluge razvrstavanja (taxonomy); usluge upravljanja informacijama; usluge prilagođenog dizajna kompjutera za druge; usluge deljenja datoteka; usluge pravljenja rezervnih kopija podataka i vraćanja izgubljenih podataka; usluge premeštanja podataka; usluge dešifrovanja podataka; kompjuterske usluge; veb sajt usluge; usluge iznajmljivanja i lizinga; usluge obezbjeđivanja grafičkog umjetničkog dizajna putem komunikacionih mreža; usluge naučnih i industrijskih istraživanja.

(111) **03742**

(151) **31.07.2012**

(210) **2009-621**

(442) **20.03.2012**

(220) 23.10.2009

(732) **RECKITT BENCKISER-SWITZERLAND-AG; RICHTISTRASSE 5, PO-**

STFACH, CH-8304 WALLISELLEN-ZURICH CH

AQUA MIST

(540)

(550) I

(740) Popović Miladin, Đoka Miraševića 21/III Podgorica (ME)

(511) **Klasa 03:** Parfimisani preparati za vazduh; potpuri, eterična ulja, parfimisani sprejevi za prostorije; preparati za parfimisanje ili aromatizaciju vazduha.

Klasa 05: Preparati za osvežavanje vazduha; preparati za pročišćavanje vazduha; osveživači za prostorije; dezodoransi; preparati za neutralizovanje neprijatnih mirisa.

Klasa 11: Aparati i instrumenti, svi za parfimisanje, pročišćavanje ili osvežavanje vazduha; delovi i oprema za sve gorepomenute robe.

(111) **03743**

(151) **31.07.2012**

(210) **2009-633**

(442) **20.03.2012**

(220) 11.05.2009

(732) **GENERAL MOTORS LLC; 300 RENAISSANCE CENTER, CITY OF DETROIT, STATE OF MICHINGEN 48265-3000 US**

CADILLAC ATS

(540)

(550) I

(740) Popović Miladin, oka Miraševića 21/III Podgorica (ME)

(511) **Klasa 12:** Motorna kopnena vozila.

(111) **03744**

(151) **31.07.2012**

(210) **2009-629**

(442) **20.03.2012**

(220) 30.10.2009

(732) **COLGATE-PALMOLIVE COMPANY; 300 PARK AVENUE, NEW YORK, N.Y.10022 US**



(540)

(550) I

(740) Lutovac Branislav, Bulevar Crnojevića 93, Podgorica (ME)

(511) **Klasa 03:** Preparati za oralnu njegu, a naročito paste za zube, zubni gelovi, tečni preparati za njegu zuba, zubne pene, gelovi za izbjeljivanje zuba, paste za izbjeljivanje zuba, osvježiva-

či daha i tečnosti za ispiranje usta, koji se ne koriste u medicinske svrhe.

Klasa 21: Četkice za zube, zubni konac.

(111) **03745** (151) **31.07.2012**

(210) **2009-631** (442) **20.03.2012**

(220) 11.03.2009

(732) **PROCTER&GAMBLE PHARMACEUTICALS, INC; ONE PROCTER& GAMBLE PLAZA, CINCINNATI, OHIO 45202 US**

OPTINATE

(540)

(550) I

(740) Lutovac Branislav, Bulevar Crnojevića 93, Podgorica (ME)

(511) **Klasa 05:** Farmaceutski i higijenski preparati i supstance.

(111) **03746** (151) **31.07.2012**

(210) **2009-604** (442) **20.03.2012**

(220) 10.09.2009

(732) **BONGARIN SA; 42 RUE RIEUSSEC, 78220 VIROFLAY FR**

TURIST

(540)

(550) I

(740) Lutovac Branislav, Bulevar Crnojevića 93, Podgorica (ME)

(511) **Klasa 29:** Mlijeko, sir i mliječni proizvodi; jestiva ulja i masti.

(111) **03747** (151) **31.07.2012**

(210) **2009-643** (442) **20.03.2012**

(220) 18.11.2009

(732) **COLGATE-PALMOLIVE COMPANY; A DELAWARE CORPORATION, 300 PARK AVENUE, NEW YORK, N.Y. 10022 US**

MAX WHITE ONE

(540)

(550) I

(740) Lutovac Branislav, Bulevar Crnojevića 93, Podgorica (ME)

(511) **Klasa 03:** Preparati za oralnu negu, a naročito paste za zube, zubni gelovi, tečni preparati za njegu zuba, zubne pene, gelovi za izbeljivanje zuba, paste za izbeljivanje zuba, osvježivači

daha i tečnosti za ispiranje usta, koji se ne koriste u medicinske svrhe.

Klasa 21: Četkice za zube, zubni konac.

-
- (111) **03748** (151) **31.07.2012**
 (210) **2009-668** (442) **20.03.2012**
 (220) 12.07.2009
 (732) **PATRON SPIRITS INTERNATIONAL AG; SPITALSTRASSE 5, 8200 SCHAFFHAUSEN CH**

XO CAFE

- (540)
 (550) I
 (740) Lutovac Branislav, Bulevar Crnojevića 93, Podgorica (ME)
 (511) **Klasa 33:** Alkoholna pića (izuzev piva); likeri.

-
- (111) **03749** (151) **31.07.2012**
 (210) **2009-282** (442) **20.03.2012**
 (220) 26.05.2009
 (732) **SHERATON INTERNATIONAL INC; 1111 WESTCHESTER AVENUE, WHITE PLAINS N.Y. 10604 US**



Sheraton

- (540)
 (550) I
 (740) Lutovac Branislav, Bulevar Crnojevića 93, Podgorica (ME)
 (511) **Klasa 36:** Osiguranje, finansijski poslovi; novčani; (monetarni) poslovi; poslovi vezani za nepokretnosti.

Klasa 43: Usluge obezbjeđivanje hrane i pića, privremeni smještaj.

-
- (111) **03750** (151) **31.07.2012**
 (210) **2009-276** (442) **20.03.2012**
 (220) 26.05.2009
 (300) 04.10.2007 Z-2007-2233 57 168 RS
 (732) **THE POLO/LAUREN COMPANY L. P.; 650 MADISON AVENUE NEW YORK N.Y. 10022 US**

POLO BLACK

(540)

(550) I

(740) Ćupić Branislav, Dalmatinska 10, Podgorica (ME)

(511) **Klasa 03:** Parfemi, kolonjska voda, toaletna voda, laki parfemi, sredstva za poslije brijanja (aftershave), gelovi za brijanje, kreme za brijanje, kreme za poslije brijanja, gelovi za poslije brijanja, losioni za poslije brijanje, balzami za poslije brijanja, sredstva protiv znojenja, dezodoransi za ličnu upotrebu, talk u prahu, puder za tijelo, kozmetički proizvodi i proizvodi za negu lepote, naročito hidratantni preparati za tijelo, kreme i losioni za lice i tijelo, preparati za piling (eksfoliatori), preparati za pranje tijela, kreme i losioni za sunčanje i dobijanje preplanule boje, kreme i losioni za zaštitu od sunca, proizvodi za negu kose, naročito šamponi, balzami, sredstva za pranje kose, sredstva za ispiranje kose, kreme i losioni za kosu, briljantin i preparati za stimulaciju temena, proizvodi za kupanje i tuširanje, naročito toaletni sapuni, šamponi za tijelo, preparati za piling kože tijela, preparati za omekšavanje kože tijela, so za kupanje, gel za kupanje i tuširanje, ulje za kupanje i tuširanje, esencijalna ulja.

(111) **03751**

(151) **31.07.2012**

(210) **2009-649**

(442) **20.03.2012**

(220) 26.11.2009

(732) **E.R. SQUIB SONSL. L.C.A DELAWARE LIMITED LIABILITY COMPANY; LAWRENCEVILLE-PRINCETON ROAD, PRINCETON, NEW JERESY 08540 Us**

MONOPRIL PLUS

(540)

(550) I

(740) Ćupić Branislav, Dalmatinska 10, Podgorica (ME)

(511) **Klasa 05:** Farmaceutski preparati za ljudsku upotrebu.

(111) **03752**

(151) **31.07.2012**

(210) **2009-639**

(442) **20.03.2012**

(220) 16.11.2009

(732) **GOOGLE INC; 1600 AMPHITHEATRE PARKWAY, MOUNTAIN VIEW, CA 94043. US**

ANDROID

(540)

(550) I

(740) Ćupić Branislav, Dalmatinska 10, Podgorica (ME)

(511) **Klasa 09:** Aparati i instrumenti naučni, pomorski, geodetski, fotografski, kinematografski, optički za vaganje, mjerenje, signalizaciju, kontrolu (inspekciju), pomoć (spasavanje) i nastavu; elektronski aparati i uređaji obuhvaćeni klasom 9; aparati i instrumenti za provođenje, prekidanje, transformisanje, akumuliranje, regulisanje ili kontrolu električne energije, aparati za snimanje, prenos ili reproduktovanje zvuka ili slike; magnetski nosioci po-

dataka, diskovi za snimanje; automatske prodajne mašine i mehanizmi za aparate koji se pokreću novcem ili žetonom; registar-kase, računске mašine, oprema za obradu podataka i kompjuteri; aparati za gašenje požara; softver, uključujući softver za upotrebu u vezi sa elektronskim aparatima i uređajima.

(111) **03756**

(151) **06.09.2012**

(210) **2009-662**

(442) **20.03.2012**

(220) 12.03.2009

(732) **ALKALOID AD SKOPLJE; BULEVAR ALEKSANDAR MAKEDONSKI 12, 1000 SKOPLJE MK**

TORVEX

(540)

(550) I

(740) Božović Vesko, Rimski trg 50/11, Podgorica (ME)

(511) **Klasa 05:** Farmaceutski preparati.

(111) **03753**

(151) **06.09.2012**

(210) **2009-665**

(442) **20.03.2012**

(220) 12.03.2009

(732) **ALKALOID AD SKOPLJE; BULEVAR ALEKSANDAR MAKEDONSKI 12, 1000 SKOPLJE MK**

CEFAZ

(540)

(550) I

(740) Božović Vesko, Rimski trg 50/11, Podgorica (ME)

(511) **Klasa 05:** Farmaceutski preparati.

(111) **03754**

(151) **06.09.2012**

(210) **2009-664**

(442) **20.03.2012**

(220) 12.03.2009

(732) **ALKALOID AD SKOPLJE; BULEVAR ALEKSANDAR MAKEDONSKI 12, 1000 SKOPLJE MK**

FUREXA

(540)

(550) I

(740) Božović Vesko, Rimski trg 50/11, Podgorica (ME)

(511) **Klasa 05:** Farmaceutski preparati.

(111) **03755**

(151) **06.09.2012**

(210) **2009-663**

(442) **20.03.2012**

(220) 12.03.2009

(732) **ALKALOID AD SKOPLJE; BULEVAR ALEKSANDAR MAKEDONSKI 12, 1000 SKOPLJE MK**

ALMACIN

(540)

(550) I

(740) Božović Vesko, Rimski trg 50/11, Podgorica (ME)

(511) **Klasa 05:** Farmaceutski preparati.

(111) **03757**

(151) **06.09.2012**

(210) **2009-661**

(442) **20.03.2012**

(220) 12.03.2009

(732) **ALKALOID AD SKOPLJE; BULEVAR ALEKSANDAR MAKEDONSKI 12, 1000 SKOPLJE MK**

ULCODIN

(540)

(550) I

(740) Božović Vesko, Rimski trg 50/11, Podgorica (ME)

(511) **Klasa 05:** Farmaceutski preparati.

(111) **03758**

(151) **06.09.2012**

(210) **2009-660**

(442) **20.03.2012**

(220) 12.02.2009

(732) **CHIGUITA BRANDS LLC; 255 EAST FIFTH STREET, CINCINNATI, OHIO, 45202 US**



(540)

(550) I

(740) Popović Miladin, Đoka Miraševića 21/III, Podgorica (ME)

(511) **Klasa 31:** Svježe banane(111) **03759**(151) **06.09.2012**(210) **2009-672**(442) **20.03.2012**

(220) 12.11.2009

(732) **CHIGUITA BRANDS LLC; 250 EAST FIFTH STREET, CINCINNATI, OHIO 45202 US****CHIQUITA**

(540)

(550) I

(740) Popović Miladin, Đoka Miraševića 21/III, Podgorica (ME)

(511) **Klasa 32:** voćni napitci; voćni sokovi.(111) **03760**(151) **06.09.2012**(210) **2009-673**(442) **20.03.2012**

(220) 12.11.2009

(732) **CHIGUITA BRANDS LLC; 250 EAST FIFTH STREET, CINCINNATI, OHIO 45202 US**

(540)

(550) I

(740) Popović Miladin, Đoka Miraševića 21/III, Podgorica (ME)

(511) **Klasa 32:** voćni napitci; voćni sokovi.(111) **03973**(151) **06.09.2012**(210) **2009-288**(442) **20.03.2012**

(220) 26.05.2009

(300) 05.10.2007 Z-2265/07 RS

(732) **WM WRIGLEY JR COMPANY; 410 NORTH MICHIGAN AVENUE, CHICAGO, IL 60611 US**

KICK UP A GEAR

(540)

(550) I

(740) Čejović Vladimir, 13. jul 21, Podgorica (ME)

(511) **Klasa 30:** Slatkiši, naime žvakaće gume i žvakaće gume od kojih mogu da se prave veliki baloni, bombone i dražeje peperminta.(111) **03983**(151) **06.09.2012**(210) **2010-163**(442) **20.03.2012**

(220) 18.05.2010

(732) **DISCOVERY COMMUNICATIONS LLC-DELAWARE LIMITED LIABILITY COMPANY; ONE DISCOVERY PLACE, SILVER SPRING, MARYLAND 20910 US**

TLC

(540)

(550) I

(740) Radulović Božidar, Jovana Tomaševića 9/III, Podgorica (ME)

(511) **Klasa 09:** Nasnimljeni video diskovi, audio-vizuelni zapisi, video trake, kompakt diskovi, DVD-ovi i CD-ROM-ovi.**Klasa 38:** Komunikacione usluge, naročito kontinuirani prenos (streamed) zvuka i audio-vizuelnih zapisa putem interneta, kablovskih mreža, bežičnih mreža, satelita ili interaktivnih multimedijalnih mreža; usluge audio i video emitovanja putem interneta; prenos informacija u okviru audio-vizuelne oblasti; usluge televizijskog emitovanja; usluge emitovanja kablovske televizije; usluge emitovanja satelitske televizije; usluge mobilnih medija u obliku elektronskog prenosa zabavnih medijskih sadržaja; usluge podkastinga; usluge emitovanja putem mreže; usluge prenosa video zapisa "na zahtev"; obezbjeđivanje onlajn soba za četovanje i elektronskih oglasnih tabli za prenos poruka iz oblasti opšteg interesovanja.**Klasa 41:** Usluge rasonode, naročito multimedijalni programi iz oblasti opšteg interesovanja, distribuirani putem raznih platformi kroz niz oblika medija za prenos; obezbjeđivanje informacija iz oblasti rasonode koji se odnose na tekuće televizijske programe putem globalne kompjuterske mreže; proizvodnja televizijskih programa; proizvodnja multimedijalnih programa.(111) **03980**(151) **06.09.2012**(210) **2009-599**(442) **20.03.2012**

(220) 10.06.2009

(732) **UNIVERSAL CITY STUDIOS LLLP-DELAWARE LIMITED LIABILITY LI-**

**MITED PARTNERSHIP; 100 UNIVERSAL CITY PLAZA UNIVERSAL CITY,
CALIFORNIA 91608 US**

STUDIO UNIVERSAL

(540)

(550) I

(740) Radulović Božidar, Jovana Tomaševića 9/III, Podgorica (ME)

(511) **Klasa 38:** Telekomunikacije.

Klasa 41: Obrazovne usluge; pripremanje obuke; razonoda; sportske i kulturne aktivnosti.

(111) **03969**

(151) **06.09.2012**

(210) **2009-600**

(442) **20.03.2012**

(220) 10.06.2009

(732) **JONHSON DIVERSEY, INC; 8310 16 TH STREET, STURTEVANT, WISCONSIN 53177 US**

DIVERSEY

(540)

(550) I

(740) Čejović Vladimir, 13. jul 21, Podgorica (ME)

(511) **Klasa 01:** Hemijske supstance koje se upotrebljavaju u industrijskim ili proizvodnim procesima, uključujući deterdžente za procese u industriji ili proizvodnji, odmašćivači za industriju, jedinjenja za omekšavanje vode, helatne agense, sredstva za uklanjanje kisjelina, sredstva za uklanjanje kamenca, kompozicije za pomoć prilikom ispiranja, sredstva protiv pjenušanja, rashladni koncentrovani rastvori soli, aditivi za hlađenje koncentrovanog rastvora soli, inhibitori korozije i za obrađivanje kamenca u rashlađenoj vodi, sredstva za tretman taloga vode u bojleru, sredstva za uklanjanje kiseonika i sredstva za dispergovanje.

Klasa 03: Univerzalni preparati za čišćenje, odmašćivanje, glačanje i poliranje kao i preparati za čišćenje sa dezinfekcionim svojstvima za upotrebu na površinama predmeta; odnosno preparati za čišćenje podova, preparati za glačanje podova, preparati za poliranje podova, preparati za uklanjanje voskova na podu i preparati za glačanje; glačanje namještaja; preparati za glačanje i čišćenje stakla; preparati za čišćenje nerđajućeg čelika; preparati za čišćenje za upotrebu kod unutrašnjeg ili spoljašnjeg čišćenja i održavanja svih vrsta vozila; prečišćivači odvodnih kanala, toaleta, tuševa i cijevi; preparati za čišćenje keramike; losioni i sapuni za ruke; šamponi; rastvori za čišćenje tepiha i sredstva za uklanjanje mrlja; preparati za čišćenje za upotrebu kod tkanina, namještaja i tepiha, sa ili bez uklanjanja mirisa; proizvodi za pranje za komercijalnu upotrebu, odnosno deterdženti, sredstva za bijeljenje, omekšivači tkanina, sredstva za neutralizaciju kiseline kod pranja, sredstva za uklanjanje štirka i mrlja; germicidni deterdženti za komercijalno pranje; proizvodi za pranje, odnosno, deterdženti za pranje sudova u mašini i aditivi za ispiranje, deterdženti za ručno pranje sudova, deterdženti za prethodno natapanje pribora za jelo, preparati za uklanjanje mrlja kod sudova, sredstva za čišćenje na bazi kiseline za upotrebu u mašini za pranje sudova; pomoćna sredstva za ispiranje, sredstva za čišćenje rezervoara za predpranje; preparati za pranje flaša; preparati za čišćenje peći, preparati za čišćenje cijevi i kanala; preparati za čišćenje rezervoara, cjevovoda, podova, zidova i plafona; sredstva za odmašćivanje; voskovi.

Klasa 05: Univerzalni preparati za čišćenje, germicidni preparati i dezodoransi za upotrebu na površinama predmeta; germicidni deterdženti za komercijalno pranje; univerzalna dezinfekciona sredstva i sredstva za čišćenje; osvježivači vazduha i dezodorizatori vazduha u sobama; sredstva za uklanjanje mirisa kod tepiha, tkanina i namještaja; fungicidi, herbicidi, insekticidi, rodenticidi (preparati za uništavanje štetočina), sredstvo za čišćenje cucli, algacidi, materijali za sterilisanje, biocidi za obrađivanje rashlađene vode.

Klasa 07: Mašine za čišćenje i poliranje, instrumenti i aparati kao i njihovi dijelovi i pribori koji nijesu obuhvaćeni drugim klasama, uključujući mašine za čišćenje podova i mašine za poliranje; usisivače i mašine za čišćenje tepiha i prostirki kao i njihovih dijelova i pribori koji nijesu obuhvaćeni drugim klasama, tresači tepiha i prostirki (mašine); mašine za suvo čišćenje tepiha i prostirki; električni uređaji za čišćenje podova; mašine za poliranje podova pomoću pjene koju proizvode.

Klasa 21: Dispenseri za preparate za čišćenje i dezinfekciju; instrumenti za čišćenje, odnosno četke za čišćenje, krpe, sunđer i tkanine za brisanje.

Klasa 37: Nastojničke usluge; usluge održavanja higijene, čišćenja, glancanja, deodorisanja, dezinfekcije i sanitarne usluge; usluge održavanja podova; održavanje kuhinjske higijene; usluge čišćenja i pranja; usluge održavanja higijene i čišćenja toaleta i umivaonica; usluge pranja i peglanja tkanina; instalacija, opravka i održavanje mašina za pranje i sušenje sudova i staklenih predmeta; instalacija, opravka i održavanje dispnzera; opravka i održavanje aparata i mašina za čišćenje, glačanje i prečišćavanje; iznajmljivanje opreme za čišćenje; usluge čišćenja vozila; usluge uništavanja štetočina.

Klasa 41: Edukacione i konsultantske usluge, naime, obezbjeđivanje obuke, seminara i radnih sastanaka i objavljivanje informacionog materijala koji se odnosi na higijenu, čišćenje, održavanje podova i pranje i peglanje veša kao i na postupke pravilnog i sigurnog rukovanja hranom i postupke čišćenja kuhinja i opreme za rukovanje hranom, na pravilno održavanje podova i tepiha, pravilne higijenske postupke za osobe koje pružaju usluge u vezi sa hranom i pravilno čišćenje i dezinfekciju uređaja za obradu hrane kao i prostora u kojima se ti uređaji nalaze.

(111) **03962**

(151) **06.09.2012**

(210) **2010-162**

(442) **20.03.2012**

(220) 17.05.2010

(732) **DIAGEO SCOTLAND LIMITED; EDINBURGH PARK, 5 LOCHSIDE WAY, EDINBURGH, EH12 9 DT UK**



(540)

(550) I
 (740) Čejović Vladimir, 13. jul 21, Podgorica (ME)
 (511) **Klasa 33:** Alkoholna pića (izuzev piva).

(111) **03963** (151) **06.09.2012**
 (210) **2010-160** (442) **20.03.2012**
 (220) 17.05.2010
 (732) **DIAGEO SCOTLAND LIMITED; EDINBURGH PARK, 5 LOCHSIDE WAY, EDINBURGH, EH12 9 DT UK**



(540)
 (550) I
 (740) Čejović Vladimir, 13. jul 21, Podgorica (ME)
 (511) **Klasa 33:** Alkoholna pića (izuzev piva).

(111) **03964** (151) **06.09.2012**
 (210) **2010-164** (442) **20.03.2012**
 (220) 18.05.2010
 (732) **BELUPO; DANICA 5 48000 KOPRIVNICA HR**

BELODERM

(540)
 (550) I
 (740) Božović Vesko, Rimski trg 50/11, Podgorica (ME)
 (511) **Klasa 05:** Farmaceutski proizvodi.

(111) **03965** (151) **06.09.2012**
 (210) **2009-622** (442) **20.03.2012**
 (220) 23.10.2009
 (300) 08.06.2009 56271-2009
 02.10.2009 591821 CH
 (732) **PMPI LLC; 9711 FARRAR COURT, RICHMOND 23236 VIRGINIA US**

MARLBORO CLASSICS

(540)

(550) I

(511) **Klasa 14:** Dragocjeni metali i njihove legure i proizvodi od dragocjenih metala ili sa prevlakom od njih, koji nisu uključeni u druge klase; nakit, drago kamenje; časovničarski i hronometrijski instrumenti.

Klasa 16: Hartija, karton i proizvodi od njih, koji nisu uključeni u druge klase; štampane stvari; knjigovezački materijal; fotografije; kancelarijski materijal; lepila za kancelarijske i kućne potrebe; umjetnički materijali; kičice; pisaće mašine i kancelarijski rekviziti (izuzev nameštaja); materijali za obuku i nastavu (izuzev aparata); plastični materijal za pakovanje (koji nije uključen u druge klase); štamparska slova; klišeji.

Klasa 18: Koža i imitacija kože, i proizvodi izrađeni od ovih materijala koji nisu uključeni u druge klase; životinjska koža, krzno; koferi i putne torbe; kišobrani, suncobrani i štapovi za hodanje; bičevi, saračka i sedlarska oprema.

Klasa 25: Odjeća, obuća, pokrivala za glavu.

Klasa 28: Igre i igračke; gimnastičarski i sportski artikli koji nisu obuhvaćeni drugim klasama; ukrasi za jelke.

Klasa 35: Oglašavanje; vođenje poslova; poslovno upravljanje; kancelarijski poslovi.

(111) 03966

(151) 06.09.2012

(210) 2009-655

(442) 20.03.2012

(220) 27.11.2009

(300) 02.05.2008 006886303 CTM

(732) CAFCO INTERNATIONAL SA, 42 RUE I AVENIR, 1147 LUXEMBOURG LU

FENDOLITE

(540)

(550) I

(740) Lutovac Branislav, Bulevar Crnojevića 93, Podgorica (ME)

(511) **Klasa 17:** Izolacioni materijali; materijali koji obezbjeđuju otpornost na vatru; materijali za oblaganje, zapušavanje ili zaptivanje.

Klasa 19: Nemetalni građevinski materijali koji imaju svojstvo izolacije zvuka, toplote ili vatre i za oblaganje površina.

(111) 03968

(151) 06.09.2012

(210) 2009-685

(442) 20.03.2012

(220) 24.12.2009

(732) SHIMANO INC; 77 OIMATSUCHO, SAKAI-KU, SAKAI CITY, OSAKA JP

DYNA.SYS

(540)

(550) I

(740) Popović Miladin, Đoka Miraševića 21/III, Podgorica (ME)

(511) **Klasa 12:** Bicikle, djelovi i oprema za bicikle, naime: prednji lančanici za točak, obrtaljke, komplet obrtaljka, sedišta, lanci za kočenje, klipovi za kočenje, lanci, deflektori za lance, sajle, ručice upravljača, točkovi, glavčine, unutrašnje glavčine mjenjača, glavčine dinamama za bicikle, glavčine za brzo otpuštanje poluge mjenjača, otpusne poluge mjenjača, poluge za mjenjanje brzina, vodice lanca, zupčanici, upravljači, drške upravljača, krajevi drške upravljača, uporišta sjedišta, pomoćni zupčanici za mjenjanje brzina (skretači lanaca), pedale za bicikle, klipseri (korpice za stopala), prednje viljuške, glavni djelovi za sklapanje rama viljuški, obruči, donje spone, nosači za sjedište, mehanizmi za brzo otpuštanje nosača sedišta, prenosni mehanizmi kojima upravlja kompjuter, pokazivači pozicije brzine bicikle, vreće za točkove bicikla; mašinski elementi za bicikle, naime dizalice za bicikle, prednji prenosni mehanizmi, zadnji prenosni mehanizmi, oprema za mjenjanje brzina, prenosnici snage i osvine, amortizeri, poluge kočnica, prednje kočnice, zadnje kočnice, sajle za kočnice, kočne papuče, kočnice, sve za bicikle.

(111) **03970**(151) **06.09.2012**(210) **2009-611**(442) **20.03.2012**

(220) 10.12.2009

(732) **KIMBERLY-CLARK WORLDWIDE, INC; NEENAH, WISCONSIN 54956 US**

(540)

(550) I

(740) Lutovac Branislav, Bulevar Crnojevića 93, Podgorica (ME)

(511) **Klasa 16:** Papirne maramice, toaletni papir, papirni ubrusi, papirne salvete.(111) **03971**(151) **06.09.2012**(210) **2009-612**(442) **20.03.2012**

(220) 10.12.2009

(732) **KIMBERLY-CLARK WORLDWIDE, INC; NEENAH, WISCONSIN 54956 US**

TERESITA

(540)

(550) I

(740) Lutovac Branislav, Bulevar Crnojevića 93, Podgorica (ME)

(511) **Klasa 16:** Papirni ubrusi, papirne maramice za lice, toaletni papir, papirne salvete.

Klasa 35: Oglašavanje; vođenje poslova; poslovno upravljanje; kancelarijski poslovi.

(111) **03974**

(151) **06.09.2012**

(210) **2009-287**

(442) **20.03.2012**

(220) 26.05.2009

(300) 15.08.2007 Z-1845/07 RS

(732) **WM WRIGLEY COMPANY; 410 NORTH MICHIGAN AVENUE, CHICAGO, IL 60611 US**

SWEETMINT TROPICAL

(540)

(550) I

(740) Čejović Vladimir, 13. jul 21, Podgorica (ME)

(511) **Klasa 30:** Slatkiši, naime žvakaće gume i žvakaće gume od kojih mogu da se prave veliki baloni, bombone i dražeje pepermint.

(111) **03975**

(151) **06.09.2012**

(210) **2009-285**

(442) **20.03.2012**

(220) 26.05.2009

(300) 13.08.2007 Z-1827/07 RS

(732) **WRIGLEY JR COMPANY; 410 NORTH MICHIGAN AVENUE, CHICAGO, IL 60611 US**

COOL EXOTIC

(540)

(550) I

(740) Čejović Vladimir, 13. jul 21, Podgorica (ME)

(511) **Klasa 30:** Slatkiši, naime žvakaće gume i žvakaće gume od kojih mogu da se prave veliki baloni, bombone i dražeje pepermint.

(111) **03977**

(151) **06.09.2012**

(210) **2009-630**

(442) **20.03.2012**

(220) 30.10.2009

(732) **STARBEV S. A. R. L.; 20 AVENUE MONTEREY, 2163 LU**



StarBev

(540)

(550) I

(740) Lutovac Branislav, Bulevar Crnojevića 93, Podgorica (ME)

(511) **Klasa 32:** Pivo; alkoholna pića na bazi slada; mineralne i sodne vode i druga bezalkoholna pića; pića od voća i voćni sokovi; sirupi i drugi preparati za proizvodnju pića.

Klasa 33: Alkoholna pića; aromatizovana i začinjena alkoholna pića; unapred pripremljene mješavine alkoholnih pića.

Klasa 35: Oglašavanje; savetodavne usluge u vezi sa organizacijom poslovanja i pomoć u vođenju poslova iz oblasti ugostiteljstva i hotelskih i restoranskih usluga i usluga kafića; savetodavne usluge u vezi sa organizacijom poslovanja i pomoć u vođenju poslova iz oblasti proizvodnje piva, koje se pružaju pivarama; iznajmljivanje automata; organizacija takmičenja i izložbi u komercijalne ili reklamne svrhe; nabavka za račun trećih lica; pomoć prodaje.

Klasa 36: Finansijsko pokroviteljstvo u vezi sa promocijom prodaje piva i alkoholnih i bezalkoholnih pića.

Klasa 39: Transportne usluge; pakovanje i skladištenje robe; isporuka robe.

Klasa 41: Obrazovne usluge; usluge obrazovanja iz oblasti pivarstva i piva; razonoda; sportske i kulturne aktivnosti; organizovanje takmičenja iz oblasti obrazovanja ili razonode; usluge nastavljanja profesionalne obuke iz oblasti ugostiteljstva i hotelskih i restoranskih usluga i usluga kafića.

Klasa 43: Usluge obezbeđivanja hrane i pića; usluge u vezi sa barovima, kafićima, menzama, kantinama, ugostiteljske usluge (uključujući usluge pripremanja i dostavljanja hrane).

(111) **03979**

(151) **06.09.2012**

(210) **2009-273**

(442) **20.03.2012**

(220) 25.05.2009

(300) 20.01.2007 RS

(732) **MAGINUS DOO; KNEZA VISESLAVA 3/11 BEOGRAD-CUKARICA RS**

LOVAC NA BOJE

(540)

(550) I

(740) Stanković Mugoša Ana, Trg Republike br. 13, Podgorica (ME)

(511) **Klasa 03:** Sredstva za beljenje i druge supstance za upotrebu u perionicama; preparati za čišćenje, poliranje, ribanje i nagrivanje; sapuni; a naročito netkani tekstil, hartija i čvrste i tečne supstance za upotrebu u mašinama za pranje veša.

(111) 03982

(151) 06.09.2012

(210) 2009-632

(442) 20.03.2012

(220) 11.03.2009

(732) **MAY CHEONG TOY PRODUCTS FACTORY LIMITED; 7/F., EAST WING, TSIM SHA TSUI CENTRE, 66 MODY ROAD, TSIMSHATSUI EAST, KOWLOON HK**



The logo for 'Maisto' features the word in a bold, sans-serif font. The letter 'i' is stylized with a thick, black brushstroke that extends upwards and to the right, ending in a sharp point.

(540)

(550) I

(740) Čejović Vladimir, 13. jul 21, Podgorica (ME)

(511) **Klasa 16:** Hartija, karton i proizvodi od ovih materijala, koji nisu uključeni u druge klase; štampane stvari; knjigovezački materijal; fotografije; kancelarijski materijal; lepila za kancelarijske i kućne potrebe; umjetnički materijali; kičice; pisaće mašine i kancelarijski rekviziti (izuzev nameštaja); materijali za obuku i nastavu (izuzev aparata); plastični materijali za pakovanje (koji nisu uključeni u druge klase); štamparska slova; klišei.

Klasa 28: Igračke, igre, igrice i društvene igre; automobili igračke; vozila igračke; umanjeni modeli (minijature) automobila, umanjeni modeli (minijature) vozila; kompleti za sklapanje umanjenih modela (minijatura) automobila i vozila; Božićne igračke; obrazovne igračke; predškolske igračke; elektronske igračke.

Klasa 35: Oglašavanje; vođenje poslova; poslovno upravljanje; kancelarijski poslovi; maloprodaja, veleprodaja i "onlajn" maloprodaja igračaka, igara, igrice i društvenih igara.

(111) 03984

(151) 06.09.2012

(210) 2009-619

(442) 20.03.2012

(220) 18.10.2009

(732) **TATA MOTORS LIMITED AN INDIAN COMPANY MANUFACTURER & MERCHANTS; BOMBAY HOUSE, 24 HOMI MODY STREET, HUTATINA CHOWK, MUMBAI 400001, MAHARSHTRA IN**

INDIGO MANZA

(540)

(550) I

(740) Popović Miladin, Đoka Miraševića 21/III, Podgorica (ME)

(511) **Klasa 12:** Kopnena vozila i djelovi za njih koji su uključeni u klasu 12.

(111) **03985**(151) **06.09.2012**(210) **2009-657**(442) **20.03.2012**

(220) 27.11.2009

(732) **AEGEAN AIRLINES SA; 31, VILTANIOTI STR. KIFISSIA 14564 GR**

(540)

(550) I

(740) Čejović Vladimir, 13. jul 21, Podgorica (ME)

(511) **Klasa 16:** Brošure, publikacije, magazini, pribor za pisanje, naljepnice za označavanje prtljaga, boarding karte, karte (ulaznice).**Klasa 39:** Usluge transporta za putnike i robu, uslužne informacije za transport i putovanja, usluge organizacije putovanja, usluge rezervacije sjedišta na avio letovima, usluge putnih i transportnih rezervacija, zakup aviona (aerotaksi), kurirske usluge, transport i isporuka robe.(111) **06411**(151) **12.09.2012**(210) **2009-617**(442) **20.03.2012**

(220) 18.10.2009

(732) **HANSEN BEVERAGE COMPANY; HAVING A PLACE OF BUSINESS AT 550 MONICA CIRCLE, SUITE 201 CORONA, CALIFORNIA 92880 US**

(540)

(550) I

(740) Ćosović Dejan, 13. jul 1/5, Budva (ME)

(511) **Klasa 05:** Nutricioni dodaci.**Klasa 32:** Bezalkoholna pića.(111) **06416**(151) **12.09.2012**(210) **2009-646**(442) **20.03.2012**

(220) 19.11.2009

(732) **PLAYBOY ENTERPRISES INTERNATIONAL INC; 680 NORTH LAKE SHO-**

RE DRIVE, CHIGAO, ILINOIS 60611 US

PLAYMATE

(540)

(550) I

(740) Ćupić Branislav, Dalmatinska 10, Podgorica (ME)

(511) **Klasa 22:** Užad, kanapi, šatori, nadstrešnice od cirade, cirade, jedra, vreće (đžakovi) i torbe (koje nisu uključene u druge klase; materijali za punjenje madraca (osim od gume ili plastike); sirove vlaknaste tekstilne materije; a naročito, kaiševi za sve namene; dlaka alpake; užad za usidravanje; kozija angora dlaka; životinjska dlaka; torbe za čuvanje dragocenosti; vreće za pranje čarapa; mrežaste vreće za igračke za kadu sa kačenjem na sistem vakuma; užad za bandži (bungee); omotači od jute za biljke; mreže za leptire; vreće od platna za pranje veša; vreće od tkanine za pranje veša; vreće od tkanine za odlaganje; uzice; paperje; nepromočiva platna za prekrivanje; mreže od tkanine ili poliestera koje se koriste za odlaganje igračaka i drugih artikala u domaćinstvu; šatorsko platno; vrećice od tkanine za poštansko slanje; punjenje; mreže za ribarenje; runska vuna; torbe za odlaganje odjeće; mreža za ljuljanje; viseće mreže za skladištenje lopti; kudeljia; torbe vreće koje se koriste u horiticulturi, naime, torbe i vreće od tkane sintetike ili prirodnih vlakana ili plastičnih materijala; sve za gajenje bilo kojih biljaka, žbunja ili drveća; juta; uzice za držanje naočara, znački, ključeve i drugih artikala; torbe za držanje veša; torbe za pranje veša; poštanske torbe; mrežaste vreće za odlaganje predmeta; mrežaste vreće za pranje donjeg rublja; užad za planinarenje; vreće od tkanine za višestruku namenu; mreža; vlakna od najlona koja se koriste za izradu tekstila; tekstilne torbe za pakovanje; materijali koji se koriste kao punjenje a nisu od gume, papira ili plastike; kanap za kačenje biljaka; plastične kese za odlaganje koje se koriste u industriji hemijskog čišćenja; plastične kesice za led; plastične karike za kućnu i baštensku upotrebu; vlakna od poliestera; pokretne torbe za odlaganje igračaka; zaštitne vreće od tkanine za čuvanje novčanike kada se ne koriste; zaštitne obloge od vinila za kade, bazene, ribnjake, banje (spa) i industrijske rezervoare; sirov pamuk; sirovi vlaknasti tekstilni materijali; sirov lan; sirova svila; sirova tekstilna vlakna; sirova vuna; užad koja se koriste kao igračke za kućne ljubimce; užetne lestve; polusintetička vlakna; vreće za odlaganje cipela; svilena vlakna; svilena mreža; torbe od platna i najlona za odlaganje dodataka usisivača; mreže za skidanje skrme iz bazena; sintetička vlakna; nakatranisana platna; šatori; šatori za planinarenje i kampovanje; vreće od tekstila za pakovanje trgovačke robe; tekstilna vlakna; kaiševi za vezivanje; neprilagođeni prekrivači za čamce ili morska vozila; neprilagođeni spa prekrivači; neprilagođeni prekrivači za bazene; neprilagođeni prekrivači za vozila; podni vinil prekrivači; vuna; vlaknasta prediva.

(111) **06419**

(151) **12.09.2012**

(210) **2009-609**

(442) **20.03.2012**

(220) 10.09.2009

(732) **TIKKURILA OY; KUNINKA ALANTIE 1, 01300 VANTAA FI**

VIVACOLOR

(540)

(550) I

(740) Ćupić Branislav, Dalmatinska 10, Podgorica (ME)

(511) **Klasa 02:** Boje, firnajzi, lakovi, sredstva za zaštitu od rđe i truljenja drveta, materije za bojenje, sredstva za nagrizanje, sirove prirodne smole, metali u obliku listova i praha za slikare, dekoratere, štampare i umjetnike.(111) **06418**(151) **12.09.2012**(210) **2009-644**(442) **20.03.2012**

(220) 19.11.2009

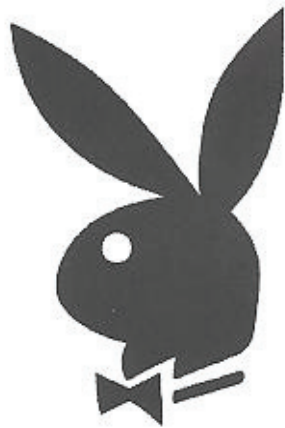
(732) **PLAYBOY ENTERPRISES INTERNATIONAL, INC; 680 NORTH LAKE SHORE DRIVE, CHIGAO, ILINOIS 60611 US**

(540)

(550) I

(740) Ćupić Branislav, Dalmatinska 10, Podgorica (ME)

(511) **Klasa 22:** Užad, kanapi, šatori, nadstrešnice od cirade, cirade, jedra, vreće (džakovi) i torbe (koje nisu uključene u druge klase; materijali za punjenje madraca (osim od gume ili plastike); sirove vlaknaste tekstilne materije; a naročito, kaiševi za sve namene; dlaka alpake; užad za usidranje; kozija angora dlaka; životinjska dlaka; torbe za čuvanje dragocjenosti; vreće za pranje čarapa; mrežaste vreće za igračke za kadu sa kačenjem na sistem vakuma; užad za bandži (bungee); omotači od jute za biljke; mreže za leptire; vreće od platna za pranje veša; vreće od tkanine za pranje veša; vreće od tkanine za odlaganje; uzice; paperje; nepromočiva platna za prekrivanje; mreže od tkanine ili poliestera koje se koriste za odlaganje igračaka i drugih artikala u domaćinstvu; šatorsko platno; vrećice od tkanine za poštansko slanje; punjenje; mreže za ribarenje; runska vuna; torbe za odlaganje odjeće; mreža za ljuljanje; viseće mreže za skladištenje lopti; kudeljia; torbe vreće koje se koriste u horitikulturi, naime, torbe i vreće od tkane sintetike ili prirodnih vlakana ili plastičnih materijala; sve za gajenje bilo kojih biljaka, žbunja ili drveća; juta; uzice za držanje naočara, znački, ključeve i drugih artikala; torbe za držanje veša; torbe za pranje veša; poštanske torbe; mrežaste vreće za odlaganje predmeta; mrežaste vreće za pranje donjeg rublja; užad za planinarenje; vreće od tkanine za višestruku namenu; mreža; vlakna od najlona koja se

koriste za izradu tekstila; tekstilne torbe za pakovanje; materijali koji se koriste kao punjenje a nisu od gume, papira ili plastike; kanap za kačenje biljaka; plastične kese za odlaganje koje se koriste u industriji hemijskog čišćenja; plastične kesice za led; plastične karike za kućnu i baštensku upotrebu; vlakna od poliestera; pokretne torbe za odlaganje igračkaka; zaštitne vreće od tkanine za čuvanje novčanike kada se ne koriste; zaštitne obloge od vinila za kade, bazene, ribnjake, banje (spa) i industrijske rezervoare; sirov pamuk; sirovi vlaknasti tekstilni materijali; sirov lan; sirova svila; sirova tekstilna vlakna; sirova vuna; užad koja se koriste kao igračke za kućne ljubimce; užetne lestve; polusintetička vlakna; vreće za odlaganje cipela; svilena vlakna; svilena mreža; torbe od platna i najlona za odlaganje dodataka usisivača; mreže za skidanje skrame iz bazena; sintetička vlakna; nakatranisana platna; šatori; šatori za planinarenje i kampovanje; vreće od tekstila za pakovanje trgovačke robe; tekstilna vlakna; kaiševi za vezivanje; neprilagođeni prekrivači za čamce ili morska vozila; neprilagođeni spa prekrivači; neprilagođeni prekrivači za bazene; neprilagođeni prekrivači za vozila; podni vinil prekrivači; vuna; vlaknasta prediva.

(111) **06435**

(151) **12.09.2012**

(210) **2009-640**

(442) **20.03.2012**

(220) 16.11.2009

(732) **DEUTCHE TELEKOM AG; FRIEDRICH-EBERT-ALLEE 140 53113 BON DE**

WebMeeting

(540)

(550) I

(740) Popović Miladin, Đoka Miraševića 21/III, Podgorica (ME)

(511) **Klasa 09:** Aparati i instrumenti naučni, pomorski, geodetski, fotografski, kinematografski, optički, za vaganje, mjerenje, signalizaciju, kontrolu (inspekciju), spasavanje i nastavu; aparati i instrumenti za provođenje, prekid, transformaciju, akumulaciju, regulisanje i kontrolu elektriciteta; aparati za snimanje, prenos, obradu i reprodukovanje zvuka, slika ili podataka; magnetni nosioci podataka; automatske mašine i mehanizmi za aparate koji se pokreću novcem ili žetonom; računске mašine, oprema za obradu podataka i kompjuteri; snimljeni i prazni nosioci podataka svih vrsta (uključeni u klasu 9); kompjuterski programi (snimljeni); elektronskim putem snimljeni podaci (koji se mogu daunlodovati); elektronska izdanja (koja se mogu daunlodovati).

Klasa 38: Telekomunikacije; usluge novinskih agencija; iznajmljivanje telekomunikacione opreme; informacije o telekomunikacijama.

Klasa 42: Naučne i tehnološke usluge i usluge istraživanja i dizajna s tim u vezi; usluge industrijske analize i istraživanja; dizajn i razvoj kompjuterskog hardvera, softvera i baza podataka; održavanje kompjuterskog softvera; tehničke konsultacije; kompjuterske usluge u vezi sa elektronskim čuvanjem podataka; iznajmljivanje kompjutera; usluge dizajniranja web strana za druge.

(111) **06415**

(151) **12.09.2012**

(210) **2009-637**

(442) **20.03.2012**

(220) 11.09.2009

(732) **BRITISH AMERICAN TOBACCO -BRANDS-INC; 2711 CENTERVILLE ROAD, SUITE 300, WILMINGTON, DELAWARE 19808 US****NANOKINGS**

(540)

(550) I

(740) Popović Miladin, Đoka Miraševića 21/III, Podgorica (ME)

(511) **Klasa 34:** Cigarete; duvan; proizvodi od duvana; upaljači; šibice; artikli za pušače.(111) **06414**(151) **12.09.2012**(210) **2009-627**(442) **20.03.2012**

(220) 30.10.2009

(732) **AMERICAN-CIGARETTE COMPANY-OVERSEAS-LIMITED; ZAEHLERWEG 4 ZUG 6300 CH**(540) *ni klasifikaciji*

(550) I

(740) Popović Miladin, Đoka Miraševića 21/III, Podgorica (ME)

(511) **Klasa 34:** Cigarete; duvan; proizvodi od duvana; artikli za pušače, upaljači; šibice.(111) **06413**(151) **12.09.2012**(210) **2009-628**(442) **20.03.2012**

(220) 30.10.2009

(732) **BRITISH AMERICAN TOBACCO -BRANDS-INC; 2711 CENTERVILLE ROAD, SUITE 300, WILMINGTON, DELAWARE 19808 US**



- (540) _____
 (550) I
 (740) Popović Miladin, Đoka Miraševića 21/III, Podgorica (ME)
 (511) **Klasa 34:** Cigarete; duvan; proizvodi od duvana; filteri za cigarete, artikli za pušače, upaljači; šibice.

-
- (111) **06351** (151) **12.09.2012**
 (210) **2009-669** (442) **20.03.2012**
 (220) 12.10.2009
 (300) 11 06 2009 77-756951 US
 (732) **GENERAL MOTORS LLC; 300 RENAISSANCE CENTER, CITY OF DETROIT, STATE OF MICHINGAN 48265-3000 US**

TRAX

- (540) _____
 (550) I
 (740) Popović Miladin, Đoka Miraševića 21/III, Podgorica (ME)
 (511) **Klasa 12:** Suvozemna motorna vozila, naime, automobili, sportska vozila, kamioni i kombi vozila, u klasi 12.

-
- (111) **06358** (151) **06.09.2012**
 (210) **2009-289** (442) **20.03.2012**
 (220) 26.05.2009
 (300) 16.11.2007 Z-2752/07 RS
 (732) **WM WRIGLEY JR COMPANY; 410 NORTH MICHIGAN AVENUE, CHICAGO, IL 60611 US**

FRESH & FUSION

- (540) _____
 (550) I

(740) Čejović Vladimir, 13. jul 21, Podgorica (ME)

(511) **Klasa 30:** Slatkiši, naime žvakaće gume i žvakaće gume od kojih mogu da se prave veliki baloni, bombone i dražeje peperminta.

(111) **06355**

(151) **12.09.2012**

(210) **2009-293**

(442) **20.03.2012**

(220) 26.05.2009

(300) 03.03.2008 Z-446/08 RS

(732) **WM WRIGLEY JR COMPANY; 410 NORTH MICHIGAN AVENUE, CHICAGO, IL 60611 US**

FUNKY FRUIT

(540)

(550) I

(740) Čejović Vladimir, 13. jul 21, Podgorica (ME)

(511) **Klasa 30:** Slatkiši, naime žvakaće gume i žvakaće gume od kojih mogu da se prave veliki baloni, bombone i dražeje peperminta.

(111) **06412**

(151) **12.09.2012**

(210) **2009-618**

(442) **20.03.2012**

(220) 18.10.2009

(732) **MONSTER ENERGY COMPANY (A DELAWARE CORPORATION) AT 550 MONICA CIRCLE, SUITE 201 CORONA, CALIFORNIA 92880 US**

MONSTER ENERGY

(540)

(550) I

(740) Čosović Dejan, 13. jul 1/5, Budva (ME)

(511) **Klasa 05:** Nutricioni dodaci.

Klasa 32: Bezalkoholna pića.

(111) **03976**

(151) **06.09.2012**

(210) **2009-666**

(442) **20.03.2012**

(220) 04.12.2009

(300) 04.12.2009

(732) **BASF SE CARL-BOSCH-STASSE LUDWIGSHAFEN AM RHEIN DE**

CORRIOLIS

(540)

(550) I

(740) Stanković Mugoša Ana, Trg Republike 13, Podgorica (ME)

(511) **Klasa 01:** Hemikalije koje se koriste u poljoprivredi, hortikulturi i šumarstvu, naročito preparati za jačanje biljaka, preparati za regulisanje rasta biljaka, hemijski preparati za tretiranje semena, površinski-aktivna sredstva, prirodne ili veštačke hemikalije koje se koriste kao seksualni mamci ili agensi za zbunjivanje insekata.

Klasa 05: Preparati za uništavanje i suzbijanje štetočina, fungicidi, herbicidi, pesticidi.

Klasa 31: Poljoprivredni proizvodi, proizvodi hortikulture i proizvodi šumarstva kao i žitarice koje nisu obuhvaćene drugim klasama, semenje, prehrambeni artikli za životinje.

(111) **03981**(151) **06.09.2012**(210) **2009-636**(442) **20.03.2012**

(220) 11.09.2009

(732) **GOODWILL TRADEMARKS PTE LTD; 3 ANSON ROAD,-27-01 SPRINGLEAF TOWER SINGAPORE 079909 SG**



(540)

(550) I

(740) Ćupić Branislav, Dalmatinska 10, Podgorica (ME)

(511) **Klasa 16:** Hartija, karton i proizvodi od ovih materijala, koji nisu uključeni u druge klase; štampane stvari; knjigovezački materijal; fotografije; kancelarijski materijal; lepila za kancelarijske i kućne potrebe; umjetnički materijali; kičice; pisaće mašine i kancelarijski rekviziti (izuzev nameštaja); materijali za obuku i nastavu (izuzev aparata); plastični materijali za pakovanje (koji nisu uključeni u druge klase); štamparska slova; klišeji.

Klasa 28: Igračke, igre, igrice i društvene igre; automobili igračke; vozila igračke; umanjeni modeli (minijature) automobila, umanjeni modeli (minijature) vozila; kompleti za sklapanje umanjenih modela (minijatura) automobila i vozila; Božićne igračke; obrazovne igračke; predškolske igračke; elektronske igračke.

Klasa 35: Oglašavanje; vođenje poslova; poslovno upravljanje; kancelarijski poslovi; maloprodaja, veleprodaja i "onlajn" maloprodaja igračaka, igara, igrica i društvenih igara.

(111) **06475**(151) **17.09.2012**(210) **2009-648**(442) **20.03.2012**

(220) 20.11.2009

(300) 24.06.2009 1642-2009 IS

(732) **BANK OF AMERICA CORPORATION; 680 NORTH LAKE SHORE DRIVE, CHICAGO, ILLINOIS 60611 US**

BOFAML

(540)

(550) I

(740) Čejović Vladimir, 13. jul 21, Podgorica (ME)

(511) **Klasa 36:** Osiguranje; finansijski poslovi; novčani (monetarni) poslovi poslovi u vezi sa nepokretnostima; bankarske usluge; finansijske usluge; finansijske analize; upravljanje i konsalting; usluge u vezi sa kapitalnim investicijama; brokerske usluge; transakcija i trgovi-na finansijskim instrumentima; pružanje informacija u vezi sa finansijama; usluge razmjene finansija, hartija od vrijednosti i dobara; finansijske usluge u smislu investicionih usluga; usluge u vezi sa kreditnim i debitnim karticama; finansijska istraživanja; i pružanja ovih usluga putem onlajn globalne kompjuterske mreže.

Klasa 42: Naučne i tehnološke usluge i istraživanje i projektovanje u vezi navedenih usluga; usluge industrijskih analiza i istraživanja: projektovanje i razvoj kompjuterskog hardvera i softvera; kompjutersko programiranje; savjetovanje u vezi sa kompjuterskim softverom; analize kompjuterskih sistema; nabavka onlajn kompjuterskih softvera; nabavka onlajn kompjuterskih softvera za pristup finansijskim informacijama i uslugama preko onlajn globalne kompjuterske mreže.

(111) **06354**(151) **12.09.2012**(210) **2009-290**(442) **20.03.2012**

(220) 26.05.2009

(300) 03.03.2008 Z-445/08 RS

(732) **WM WRIGLEY JR COMPANY; 410 NORTH MICHIGAN AVENUE, CHICAGO, IL 60611 US**

BUBBLE TAPE

(540)

(550) I

(740) Čejović Vladimir, 13. jul 21, Podgorica (ME)

(511) **Klasa 30:** Slatkiši, naime žvakaće gume i žvakaće gume od kojih mogu da se prave veliki baloni, bombone i dražeje pepermint.

(111) **06353**(151) **12.09.2012**(210) **2009-291**(442) **20.03.2012**

(220) 26.05.2009

(300) 20.03.2008 Z-637/08 RS

(732) **WM WRIGLEY COMPANY; 410 NORTH MICHIGAN AVENUE, CHICAGO, IL 60611 US**

LEMON ICE

(540)

(550) I

(740) Čejović Vladimir, 13. jul 21, Podgorica (ME)

(511) **Klasa 30:** Slatkiši, naime žvakaće gume i žvakaće gume od kojih mogu da se prave veliki baloni, bombone i dražeje pepermint.

(111) **06357** (151) **12.09.2012**
 (210) **2009-271** (442) **20.03.2012**
 (220) 25.05.2009
 (300) 27.02.2006 Z-491/06 RS

(732) **WM WRIGLEY JR COMPANY; 410 NORTH MICHIGAN AVENUE, CHICAGO, IL 60611 US**

HUBBA BUBBA BUBBLE TAPE COLORFUL CITRUS

(540)
 (550) I
 (740) Čejović Vladimir, 13. jul 21, Podgorica (ME)
 (511) **Klasa 30:** Slatkiši, naime žvakaće gume i žvakaće gume od kojih mogu da se prave veliki baloni, bombone i dražeje peperminta.

(111) **06356** (151) **12.09.2012**
 (210) **2009-295** (442) **20.03.2012**
 (220) 26.05.2009
 (300) 03.03.2008 Z-448/08 RS

(732) **WM WRIGLEY JR COMPANY; 410 NORTH MICHIGAN AVENUE, CHICAGO, IL 60611 US**

COLOURFUL CITRUS

(540)
 (550) I
 (740) Čejović Vladimir, 13. jul 21, Podgorica (ME)
 (511) **Klasa 30:** Slatkiši, naime žvakaće gume i žvakaće gume od kojih mogu da se prave veliki baloni, bombone i dražeje peperminta.

(111) **06417** (151) **12.09.2012**
 (210) **2009-645** (442) **20.03.2012**
 (220) 19.11.2009

(732) **PLAYBOY ENTERPRISES INTERNATIONAL, INC; 680 NORTH LAKE SHORE DRIVE, CHICAGO, ILLINOIS 60611 US**

PLAYBOY

(540)
 (550) I
 (740) Ćupić Branislav, Dalmatinska 10, Podgorica (ME)
 (511) **Klasa 22:** Užad, kanapi, šatori, nadstrešnice od cirade, cirade, jedra, vreće (džakovi) i

torbe (koje nisu uključene u druge klase; materijali za punjenje madraca (osim od gume ili plastike); sirove vlaknaste tekstilne materije; a naročito, kaiševi za sve namene; dlaka alpake; užad za usidranje; kozija angora dlaka; životinjska dlaka; torbe za čuvanje dragocenosti; vreće za pranje čarapa; mrežaste vreće za igračke za kadu sa kačenjem na sistem vakuma; užad za bandži (bungee); omotači od jute za biljke; mreže za leptire; vreće od platna za pranje veša; vreće od tkanine za pranje veša; vreće od tkanine za odlaganje; uzice; paperje; nepromoćiva platna za prekrivanje; mreže od tkanine ili poliestera koje se koriste za odlaganje igračaka i drugih artikala u domaćinstvu; šatorsko platno; vrećice od tkanine za poštansko slanje; punjenje; mreže za ribarenje; runska vuna; torbe za odlaganje odjeće; mreža za ljuljanje; viseće mreže za skladištenje lopti; kudeljia; torbe vreće koje se koriste u horitkulturi, naime, torbe i vreće od tkane sintetike ili prirodnih vlakana ili plastičnih materijala; sve za gajenje bilo kojih biljaka žbunja ili drveća; juta; uzice za držanje naočara, znački, ključeve i drugih artikala; torbe za držanje veša; torbe za pranje veša; poštanske torbe; mrežaste vreće za odlaganje predmeta; mrežaste vreće za pranje donjeg rublja; užad za planinarenje; vreće od tkanine za višestruku namenu; mreža; vlakna od najlona koja se koriste za izradu tekstila; tekstilne torbe za pakovanje; materijali koji se koriste kao punjenje a nisu od gume, papira ili plastike; kanap za kačenje biljaka; plastične kese za odlaganje koje se koriste u industriji hemijskog čišćenja; plastične kesice za led; plastične karike za kućnu i baštensku upotrebu; vlakna od poliestera; pokretne torbe za odlaganje igračaka; zaštitne vreće od tkanine za čuvanje novčanike kada se ne koriste; zaštitne obloge od vinila za kade, bazene, ribnjake, banje (spa) i industrijske rezervoare; sirov pamuk; sirovi vlaknasti tekstilni materijali; sirov lan; sirova svila; sirova tekstilna vlakna; sirova vuna; užad koja se koriste kao igračke za kućne ljubimce; užetne lestve; polusintetička vlakna; vreće za odlaganje cipela; svilena vlakna; svilena mreža; torbe od platna i najlona za odlaganje dodataka usisivača; mreže za skidanje skrame iz bazena; sintetička vlakna; nakatranisana platna; šatori; šatori za planinarenje i kampovanje; vreće od tekstila za pakovanje trgovačke robe; tekstilna vlakna; kaiševi za vezivanje; neprilagođeni prekrivači za čamce ili morska vozila; neprilagođeni spa prekrivači; neprilagođeni prekrivači za bazene; neprilagođeni prekrivači za vozila; podni vinil prekrivači; vuna; vlaknasta prediva.

(111) **06434**

(151) **12.09.2012**

(210) **2009-658**

(442) **20.03.2012**

(220) 30.11.2009

(732) **MONTENEGRO ADVERTISING AND PRODUCTION AGENCY, DOO UL.19 DECEMBRA BR 13 PODGORICA ME**



(540)

(550) I

(511) **Klasa 35:** Oglašavanje; vođenje poslova; poslovno upravljanje; kancelarijski poslovi.

Klasa 41: Obrazovne usluge; pripremanje obuke; razonoda; sportske i kulturne aktivnosti.

(111) **06469**
 (210) **2009-606**

(151) **17.09.2012**
 (442) **20.03.2012**
 (220) 10.09.2009

(732) **SINCLAIR PHARMACEUTICALS LIMITED; UNIT 4, GODALMING BUSINESS CENTRE, WOOLSACK WAY, GODALMING, SURREY GU7 1 XW UK**

HERPCLAIR

(540)

(550) I

(740) Čejović Vladimir, 13. jul 21, Podgorica (ME)

(511) **Klasa 03:** Kozmetički preparati za liječenje herpesa i groznice; balzam za usne za liječenje herpesa i groznice; masti za liječenje herpesa i groznice; kreme za liječenje herpesa i groznice.

Klasa 05: Medicinski preparati za liječenje herpesa i groznice; farmaceutski preparati za liječenje herpesa i groznice; medicinski balzami za usne za liječenje herpesa i groznice; medicinske masti za liječenje herpesa i groznice; medicinske kreme za liječenje herpesa i groznice.

(111) **03978**
 (210) **2009-301**

(151) **06.09.2012**
 (442) **20.03.2012**
 (220) 27.05.2009
 (300) 20.03.2009 Z-2009-507 RS

(732) **LABORATORIE GARNIER I CIE; SOCIETE EN NOM COLLECTIF 281 RUE SAINT-HONORE, 75008 PARIS FR**

INVISICLEAR

(540)

(550) I

(740) Čupić Branislav, Dalmatinska 10, Podgorica (ME)

(511) **Klasa 03:** Dezodoransi za tijelo; kozmetički proizvodi; naročito kreme, mlijeko, losioni, gelovi i puderi za lice, tijelo i ruke.

(111) **03967**
 (210) **2009-275**

(151) **06.09.2012**
 (442) **20.03.2012**
 (220) 26.05.2009
 (300) 20.03.2007 Z-2007-605 55447 RS

(732) **THE POLO LAUREN COMPANY L P; 650 MADISON AVENUE NEW YORK N. Y. 10022 US**

NOTOURIOUS

(540)

(550) I

(740) Čupić Branislav, Dalmatinska 10, Podgorica (ME)

(511) **Klasa 03:** Parfemi, kolonjska voda, toaletna voda, laki parfemi, sredstva za poslije brijanja (aftershave), gelovi za brijanje, kreme za brijanje, kreme za posijle brijanja, gelovi za poslije brijanja, losioni za poslije brijanje, balzami za poslije brijanja, sredstva protiv znojenja, dezodoransi za ličnu upotrebu, talk u prahu, puder za tijelo, kozmetički proizvodi i proizvodi za njegu ljepote, naročito hidratantni preparati za tijelo, kreme i losioni za lice i tijelo, preparati za piling (eksfolijatori), preparati za pranje tijela, kreme i losioni za sunčanje i dobijanje preplanule boje, kreme i losioni za zaštitu od sunca, proizvodi za njegu kose, naročito šamponi, balzami, sredstva za pranje kose, sredstva za ispiranje kose, kreme i losioni za kosu, briljantin i preparati za stimulaciju tjemena, proizvodi za kupanje i tuširanje, naročito toaletni sapuni, šamponi za tijelo, preparati za piling kože tijela, preparati za omekšavanje kože tijela, so za kupanje, gel za kupanje i tuširanje, ulje za kupanje i tuširanje, esencijalna ulja.

(111) **06465**

(151) **17.09.2012**

(210) **2009-613**

(442) **20.03.2012**

(220) 10.12.2009

(732) **THE GOODYEAR TIRE&RUBBER COMPANY; 1144 EAST MARKET STREET, AKRON, OHIO 44316-0001 US**

EAGLE

(540)

(550) I

(740) Čejović Vladimir, 13. jul 21, Podgorica (ME)

(511) **Klasa 12:** Autogume (svaka druga guma za točkove).

(111) **06466**

(151) **17.09.2012**

(210) **2009-642**

(442) **20.03.2012**

(220) 16.11.2009

(732) **ZAO TEHNONICOL; KRYMSKY VAL, D. 8.119049 MOSKOW RU**

**TECHNO
NICOL**

(540)

(550) I

(740) Čejović Vladimir, 13. jul 21, Podgorica (ME)

(511) **Klasa 01:** Hemijski proizvodi koji se upotrebljavaju u industriji, nauci i fotografiji, kao i u poljoprivredi, hortikulturi i šumarstvu; neprerađene vještačke smole, neprerađene plastične materije; đubriva; smješe za gašenje vatre; preparati za kaljenje i zavarivanje; hemijske supstance za konzervisanje namirnica; materije za štavljenje; ljepljive supstance koje se upotrebljavaju u industriji.

Klasa 02: Boje, firnajzi, lakovi, sredstva za zaštitu od rđe i truljenja drveta; materije za bojenje; sredstva za nagrizanje; sirove prirodne smole; metali u obliku listova i praha za slikare; de-

koratere, štampare i umjetnike.

Klasa 06: Obični metali i njihove legure; metalni građevinski materijali; metalne prenosne građevine; materijali od metala za željezničke šine; neelektrične žice i kablovi od običnog metala; bravarski proizvodi; mali metalni gvožđarski proizvodi; cjevčice i cijevi od metala; sefovi; proizvodi od običnih metala koji nijesu uključeni u druge klase; rude; ni jedna od ovih roba ne odnosi se na vodovodne cijevi i njihove spojeve, kanale i sifone za snabdijevanje vodom, ili za odvod otpadnih voda i kišnu kanalizaciju, ni rešetke za odvode otpadnih voda i kišnu kanalizaciju.

Klasa 16: Hartija, karton i proizvodi od njih, koji nijesu uključeni u druge klase; štampane stvari; knjigovezački materijal; fotografije; kancelarijski materijal; Ljepila za kancelarijske i kućne potrebe; umjetnički materijali; kičice; pisaće mašine i kancelarijski rekviziti (izuzev nameštaja); materijali za obuku i nastavu (izuzev aparata); plastični materijali za pakovanje (koji nije uključen u druge klase); štamparska slova; klišei.

Klasa 22: Užad, kanapi, mreže, šatori, nadstrešnice od cerade, cerade, jedra, vreće (džakovi) i torbe (koje nijesu uključene u druge klase); materijali za punjenje madraca (osim od gume ili plastike); sirove vlaknaste tekstilne materije.

Klasa 27: Tepisi, asure, prostirke i otirači, linoleum i drugi materijali za pokrivanje podova; prekrivači za zidove (netekstilni).

Klasa 35: Oglašavanje; vođenje poslova; poslovno upravljanje; kancelarijski poslovi; usluge uvozno-izvoznih agencija; marketinške studije; usluge unaprijeđenja prodaje; usluge nabavke (kupovine robe) za druge; usluge upravljanja maloprodajnim i veleprodajnim radnjama; usluge prodaje robe uključene u klase proizvoda koje su pokrivene ovim žigom.

Klasa 39: Transportne usluge; pakovanje i skladištenje robe; organizovanje putovanja.

Klasa 42: Naučne i tehnološke usluge i istraživanje i projektovanje u vezi navedenih usluga; usluge industrijske analize i istraživanja; projektovanje i razvoj kompjuterskog hardvera i softvera.

Klasa 45: Pravne usluge, individualne i društvene usluge koje pružaju drugi, radi zadovoljavanja potreba pojedinaca; usluge obezbjeđenja radi zaštite imovine i lica.

(111) **06467** (151) **17.09.2012**

(210) **2009-641** (442) **20.03.2012**

(220) 16.11.2009

(732) **ZAO TECHNOMICOL; KRYMSKY VAL, D. 8.119049 MOSKOW RU**

ТехноНИКОЛЬ/TechnoNICOL

(540)

(550) I

(740) Čejović Vladimir, 13. jul 21, Podgorica (ME)

(511) **Klasa 01:** Hemijski proizvodi koji se upotrebljavaju u industriji, nauci i fotografiji, kao i u poljoprivredi, hortikulturi i šumarstvu; neprerađene vještačke smole, neprerađene plastične materije; đubriva; smješe za gašenje vatre; preparati za kaljenje i zavarivanje; hemijske supstance za konzervisanje namirnica; materije za štavljenje; Ljepljive supstance koje se upotrebljavaju u industriji.

Klasa 02: Boje, firnajzi, lakovi, sredstva za zaštitu od rđe i truljenja drveta; materije za bojenje; sredstva za nagrizanje; sirove prirodne smole; metali u obliku listova i praha za slikare; dekoratere, štampare i umjetnike.

Klasa 06: Obični metali i njihove legure; metalni građevinski materijali; metalne prenosne građevine; materijali od metala za železničke šine; neelektrične žice i kablovi od običnog metala; bravarski proizvodi; mali metalni gvoždarski proizvodi; cjevčice i cijevi od metala; sefovi; proizvodi od običnih metala koji nijesu uključeni u druge klase; rude; ni jedna od ovih roba ne odnosi se na vodovodne cijevi i njihove spojeve, kanale i sifone za snabdijevanje vodom, ili za odvod otpadnih voda i kišnu kanalizaciju, ni rešetke za odvode otpadnih voda i kišnu kanalizaciju.

Klasa 16: Hartija, karton i proizvodi od njih, koji nijesu uključeni u druge klase; štampane stvari; knjigovezački materijal; fotografije; kancelarijski materijal; ljepila za kancelarijske i kućne potrebe; umjetnički materijali; kičice; pisaće mašine i kancelarijski rekviziti (izuzev nameštaja); materijali za obuku i nastavu (izuzev aparata); plastični materijali za pakovanje (koji nije uključen u druge klase); štamparska slova; klišeji.

Klasa 22: Užad, kanapi, mreže, šatori, nadstrešnice od cerade, cerade, jedra, vreće (džakovi) i torbe (koje nijesu uključene u druge klase); materijali za punjenje madraca (osim od gume ili plastike); sirove vlaknaste tekstilne materije.

Klasa 27: Tepisi, asure, prostirke i otirači, linoleum i drugi materijali za pokrivanje podova; prekrivači za zidove (netekstilni).

Klasa 35: Oglašavanje; vođenje poslova; poslovno upravljanje; kancelarijski poslovi; usluge uvožno-izvoznih agencija; marketinške studije; usluge unaprijeđenja prodaje; usluge nabavke (kupovine robe) za druge; usluge upravljanja maloprodajnim i veleprodajnim radnjama; usluge prodaje robe uključene u klase proizvoda koje su pokrivene ovim žigom.

Klasa 39: Transportne usluge; pakovanje i skladištenje robe; organizovanje putovanja.

Klasa 42: Naučne i tehnološke usluge i istraživanje i projektovanje u vezi navedenih usluga; usluge industrijske analize i istraživanja; projektovanje i razvoj kompjuterskog hardvera i softvera.

Klasa 45: Pravne usluge, individualne i društvene usluge koje pružaju drugi, radi zadovoljavanja potreba pojedinaca; usluge obezbjeđenja radi zaštite imovine i lica.

(111) **03972**

(151) **17.09.2012**

(210) **2009-294**

(442) **20.03.2012**

(220) 26.05.2009

(300) 03.03.2008 Z-447/08 RS

(732) **WM WRIGLEY JR COMPANY; 410 NORTH MICHIGAN AVENUE, CHICAGO, IL 60611 US**

ORBIT CLEAN

(540)

(550) I

(740) Čejović Vladimir, 13. jul 21, Podgorica (ME)

(511) **Klasa 30:** Slatkiši, naime žvakaće gume i žvakaće gume od kojih mogu da se prave veliki baloni, bombone i dražeje pepermint.

(111) **06474**

(151) **17.09.2012**

(210) **2009-608**

(442) **20.03.2012**

(220) 10.09.2009

(732) **SINCLAIR PHARMACEUTICALS LIMITED; UNIT 4, GODALMING BUSINESS CENTRE, WOOLSACK WAY, GODALMING, SURREY GU7 1 XW UK**

ATOPICLAIR

(540)

(550) I

(740) Čejović Vladimir, 13. jul 21, Podgorica (ME)

(511) **Klasa 05:** Farmaceutski i veterinarski proizvodi; sanitarni preparati za medicinsku upotrebu; dijetetske supstance prilagođene za upotrebu u medicini, hrana za bebe; flasteri, materijali za previjanje; materijali za plombiranje zuba, zubarska smola; sredstva za dezinfekciju; proizvodi za uništavanje životinjskih štetočina; fungicidi, herbicidi; farmaceutski proizvodi i supstance za liječenje kožnih bolesti kod ljudi; farmaceutski proizvodi i supstance za liječenje alergijskog dermatitisa; atopijskog dermatitisa i/ili kontaktnog dermatitisa kod ljudi.

(111) **06473** (151) **17.09.2012**

(210) **2009-607** (442) **20.03.2012**

(220) 10.09.2009

(732) **SINCLAIR PHARMACEUTICALS LIMITED; UNIT 4, GODALMING BUSINESS CENTRE, WOOLSACK WAY, GODALMING, SURREY GU7 1 XW UK**

SINLICE

(540)

(550) I

(740) Čejović Vladimir, 13. jul 21, Podgorica (ME)

(511) **Klasa 03:** Preparati za bijeljenje i ostale supstance za pranje rublja; preparati za čišćenje, poliranje, odmaščivanje i struganje; sapuni; parfimerijski proizvodi, eterična ulja, kozmetički proizvodi, losioni za kosu; proizvodi za njegu zuba; medicinski šamponi.

Klasa 05: Farmaceutski i veterinarski proizvodi; higijenski proizvodi za upotrebu u medicini; dijetetske supstance prilagođene za upotrebu u medicini, hrana za bebe; flasteri, materijali za previjanje; materijali za plombiranje zuba, zubarska smola; sredstva za dezinfekciju; proizvodi za uništavanje životinjskih štetočina; fungicidi, herbicidi; insekticidi; medicinski tretmani za uši; proizvodi za uništavanje uši; tretmani za uši.

(111) **06472** (151) **17.09.2012**

(210) **2009-634** (442) **20.03.2012**

(220) 11.06.2009

(732) **BANK OF AMERICA CORPORATION; 100 NORTH TRYON STREET, CHARLOTTE, NORTH CAROLINA 28255 US**



(540)

(550) I

(740) Čejović Vladimir, 13. jul 21, Podgorica (ME)

(511) **Klasa 36:** Osiguranje; finansijski poslovi; novčani (monetarni) poslovi; poslovi u vezi sa nepokretnostima; bankarske usluge; finansijske usluge; finansijske analize; upravljanje i konsalting; usluge u vezi sa kapitalnim investicijama; brokerske usluge; transakcija i trgovi-na finansijskim instrumentima; pružanje informacija u vezi sa finansijama; usluge razmjene finansija, hartija od vrijednosti i dobara; finansijske usluge u smislu investicionih usluga; us-luge u vezi sa kreditnim i debitnim karticama; finansijska istraživanja; i pružanje ovih usluga putem onlajn globalne kompjuterske mreže.

(111) **06471**(151) **17.09.2012**(210) **2009-635**(442) **20.03.2012**

(220) 11.06.2009

(732) **BANK OF AMERICA CORPORATION; 100 NORTH TRYON STREET, CHARLOTTE, NORTH CAROLINA 28255 US**

MERRILL

(540)

(550) I

(740) Čejović Vladimir, 13. jul 21, Podgorica (ME)

(511) **Klasa 36:** Osiguranje; finansijski poslovi; novčani (monetarni) poslovi; poslovi u vezi sa nepokretnostima; bankarske usluge; finansijske usluge; finansijske analize; upravljanje i konsalting; usluge u vezi sa kapitalnim investicijama; brokerske usluge; transakcija i trgovi-na finansijskim instrumentima; pružanje informacija u vezi sa finansijama; usluge razmjene finansija, hartija od vrijednosti i dobara; finansijske usluge u smislu investicionih usluga; us-luge u vezi sa kreditnim i debitnim karticama; finansijska istraživanja; i pružanje ovih usluga putem onlajn globalne kompjuterske mreže.

(111) **06470**(151) **17.09.2012**(210) **2009-638**(442) **20.03.2012**

(220) 11.10.2009

(732) **BUNGE ZRT; VACI UT 33 1134 BUDAPEST HU**



(540)

(550) I

(740) Čejović Vladimir, 13. jul 21, Podgorica (ME)

(511) **Klasa 29:** Jestiva ulja.(111) **06352**(151) **12.09.2012**(210) **2009-292**(442) **20.03.2012**

(220) 26.05.2009

(300) 08.05.2008 Z-1167/08 RS

(732) **WM WRIGLEY JR COMPANY; 410 NORTH MICHIGAN AVENUE, CHICAGO, IL 60611 US****WINTERFRESH ARCTIC ICE**

(540)

(550) I

(740) Čejović Vladimir, 13. jul 21, Podgorica (ME)

(511) **Klasa 30:** Slatkiši, naime žvakaće gume i žvakaće gume od kojih mogu da se prave veliki baloni, bombone i dražeje peperminta.(111) **03761**(151) **06.09.2012**(210) **2009-659**(442) **20.03.2012**

(220) 12.02.2009

(732) **CHIQUITA BRANDS LLC; 255 EAST FIFTH STREET, CINCINNATI, OHIO, 45202 US****CHIQUITA**

(540)

(550) I

(740) Popović Miladin, Đoka Miraševića 21/III, Podgorica (ME)

(511) **Klasa 31:** Svježe banane.(111) **03929**(151) **02.10.2012**

(210) **2009-272**(442) **20.03.2012**

(220) 25.05.2009

(300) 05.12.2006 RS

(732) **TELEFONAKTIBOLAGET L M ERICSSON; SE -164 83 STOCKHOLM SE**

(540)

(550) I

(740) Stanković Mugoša Ana, Trg Republike 13, Podgorica (ME)

(511) **Klasa 37:** Usluge održavanja.

Klasa 41: Obezbjedivanje baza podataka i knjiga uputstava u oblasti muzike, videa, radija, televizije, vijesti, sporta, igara, kulturnih događaja, zabave i umjetnosti i slobodnog vremena preko komunikacionih mreža; obezbjeđivanje informacija, audio, video, grafičkog, tekstualnog i drugog multimedijalnog sadržaja u oblasti muzike, videa, radija, televizije, vijesti, sporta, igara, kulturnih događaja, zabave i umjetnosti i slobodnog vremena preko komunikacionih mreža;

Klasa 42: Korisničke usluge, naime tehnička analiza i konsultacije, usluge kompjuterskog dijagnostičiranja, daljinsko i/ili na licu mjesta praćenje kompjuterskih sistema, sve na polju oblasti prenosa podataka, satelitske komunikacije i telekomunikacije; licenciranje kompjuterskog softvera kao i proizvoda i usluga za zabavu.

(111) **03769**(151) **06.09.2012**(210) **2009-659**(442) **20.03.2012**

(220) 12.02.2009

(732) **CHIQUITA BRANDS LLC; 255 EAST FIFTH STREET, CINCINNATI, OHIO, 45202 US**

CHIQUITA

(540)

(550) I

(740) Popović Miladin, Đoka Miraševića 21/III, Podgorica (ME)

(511) **Klasa 31:** Svježe banane.(111) **03762**(151) **03.09.2012**(210) **2010-174**(442) **20.03.2012**

(220) 24.05.2010

(732) **INVESTICIONO RAZVOJNI FOND CRNE GORE A. D.; PODGORICA ME**



Investiciono-razvojni fond
Crne Gore A.D.

(540)

(550) I

(511) **Klasa 34:** Odobravanje kredita i izdavanje garancija kojima se: podstiče osnivanje i razvoj malih i srednjih preduzeća i preduzetnika; pruža podrška i realizuju programi saradnje na: infrastrukturnim projektima, projektima vodosnabdijevanja, tretmana otpadnih voda kao i projektima unapređenja zaštite životne sredine; finansiraju projekti od lokalnog, regionalnog i državnog značaja; podstiče izvoz; podstiče zapošljavanje; poslovi vezani za prodaju kapitala u portfelju fonda; ostali poslovi kojima se obezbjeđuje podrška ekonomskom razvoju u skladu sa zakonom;



INDEKS NOSILACA ŽIGOVA
INDEX OF THE HOLDER OF THE REGISTRATION

(732)	(111)	(210)
ABBOTT LABORATORIES	03665	2009-554
ABBOTT MEDICAL OPTICS INC	03632	2009-686
AD BJELASICA RADA	03481	2009-213
AEGEAN AIRLINES SA	03872	2009-656
AEGEAN AIRLINES SA	03985	2009-657
AKITA INC	06423	2009-461
AKITA INC	06421	2009-436
AKITA, INC	06422	2009-460
ALKALOID AD SKOPLJE	03848	2009-410
ALKALOID AD SKOPLJE	03849	2009-411
ALKALOID AD SKOPLJE	03850	2009-413
ALKALOID AD SKOPLJE	03756	2009-662
ALKALOID AD SKOPLJE	03753	2009-665
ALKALOID AD SKOPLJE	03754	2009-664
ALKALOID AD SKOPLJE	03755	2009-663
ALKALOID AD SKOPLJE	03757	2009-661
ALOKOZAY FZE	06488	2009-587
ALOKOZAY FZE	06489	2009-588
AMERICAN-CIGARETTE COMPANY-OVERSEAS-LIMITED	03826	2009-594
AMERICAN-CIGARETTE COMPANY-OVERSEAS-LIMITED	03827	2009-595
AMERICAN-CIGARETTE COMPANY-OVERSEAS-LIMITED	03828	2009-596
AMERICAN-CIGARETTE COMPANY-OVERSEAS-LIMITED	06414	2009-627
ANADOLU EFES BIRACILIK VE MALTSANAYIANONIM SIRKETI	03802	2009-30
ANSPORT APPAREL CORP. -DELAWARE CORPORATION	03631	2009-676
ARK AG DOO	06476	2009-445
ARTCAFE SRL	06397	2009-586
ATLAS SPOLKA Z O O	03656	2009-552
BAHTER INTERNATIONAL INC	06442	2009-409
BANK OF AMERICA CORPORATION	06472	2009-634
BANK OF AMERICA CORPORATION	06471	2009-635
BANK OF AMERICA CORPORATION	06475	2009-648
BARBERTON-CONSULTORES E SERVICOS LDA	06374	2009-512
BARBERTON-CONSULTORES E SERVICOS LDA	06375	2009-513
BASF SE CARL-BOSCH-STASSE LUDWIGSHAFEN AM RHEIN DE	03976	2009-666

BELUPO	03964	2010-164
BEOHEMIJA-INHEM DOO	06376	2009-516
BONGARIN SA	03746	2009-604
BOSNA LIJEK DD	03854	2009-423
BOSNA LIJEK DD	03855	2009-424
BRIGESTONE LICENSING SERVICES INC	03811	2009-457
BRITISH AMERICAN TOBACCO BRANDS INC	03824	2009-537
BRITISH AMERICAN TOBACCO BRANDS INC	03825	2009-538
BRITISH AMERICAN TOBACCO BRANDS INC	03839	2009-539
BRITISH AMERICAN TOBACCO -BRANDS-INC	06415	2009-637
BRITISH AMERICAN TOBACCO -BRANDS-INC	06413	2009-628
BUNGE ZRT	06470	009-638
CAFCO INTERNATIONAL SA	03966	2009-655
CATERPILLAR INC	03846	2009-398
CATERPILLAR INC	03847	2009-399
CHIGUITA BRANDS LLC	03759	2009-672
CHIGUITA BRANDS LLC	03760	2009-673
CHIGUITA BRANDS LLC	03758	2009-660
CHIQUITA BRANDS LLC	03761	2009-659
CHIQUITA BRANDS LLC	03769	2009-659
CILAG GMBH INTERNATIONAL	03682	2009-684
CILAG GMBH INTERNATIONAL	03684	2009-683
COLGATE-PALMOLIVE COMPANY, A DELAWARE CORPORATION	06361	2009-465
COLGATE-PALMOLIVE COMPANY	03744	2009-629
COLGATE-PALMOLIVE COMPANY	03747	2009-643
DEUCTCHE TELECOM AG	03795	2008-1236
DEUTCHE TELEKOM AG	06435	2009-640
DIAGEO BRANDS B V	06371	2009-2
DIAGEO IRELAND	03797	2009-4
DIAGEO IRELAND	03798	2009-7
DIAGEO IRELAND	03799	2009-8
DIAGEO IRELAND	03800	2009-6
DIAGEO IRELAND	03801	2009-9
DIAGEO NORTH AMERICA INC	06367	2009-429
DIAGEO NORTH AMERICA, INC	06379	2009-533
DIAGEO SCOTLAND LIMITED	03962	2010-162
DIAGEO SCOTLAND LIMITED	03963	2010-160
DIEGO IRELAND	03796	2009-3
DISCOVERY COMMUNICATIONS LLC-DELAWARE LIMITED LIABILITY COMPANY	03983	2010-163
DRAGAN MARKOVIĆ	03681	2010-159

DRUŠTVO ZA PROMET, TRGOVINU I USLUGE KOMO DOO	03651	2008-845
E.R SQUIBB SONS L.L.C	03814	2009-246
E.R. SQUIB SONSL. L.C.A DELAWARE LIMITED LIABILITY COMPANY	03751	2009-649
E.R.SQUIBB SONS L.L.C	03804	2009-244
E.R.SQUIBB SONS L.L.C	03805	2009-245
EHTRA PLANN BOŽOVIĆ DOO	03873	2008-412
ELAN PHARMA INTERNATIONAL LIMITED	03482	2009-179
ELAN PHARMA INTERNATIONAL LIMITED	03483	2009-180
ESCALADE LLC	06368	2009-231
FAIRMONT SPAS INC A CANADIAN CORPORATION	03683	2009-302
FUZE BEVERAGE LLC	03663	2009-551
GALLAHER LIMITED	03803	2009-46
GALLUP INC	03842	2009-185
GENERAL MOTORS LLC	03743	2009-633
GENERAL MOTORS LLC	06351	2009-669
GENZUME CORPORATION MASSACHUSETTS CORPORATION	03657	2009-525
GENZUME CORPORATION MASSACHUSETTS CORPORATION	03658	2009-527
GENZUME CORPORATION MASSACHUSETTS CORPORATION	03660	2009-529
GENZUME CORPORATION MASSACHUSETTS CORPORATION	03774	2009-521
GENZUME CORPORATION MASSACHUSETTS CORPORATION	03775	2009-523
GENZUME CORPORATION MASSACHUSETTS CORPORATION	03776	2009-524
GENZUME CORPORATION MASSACHUSETTS CORPORATION	03777	2009-526
GENZYME CORPORATION MASSACHUSETTS CORPORATION	03655	2009-520
GENZYME CORPORATION MASSACHUSETTS CORPORATION	03659	2009-528
GENZYME CORPORATION	06383	2009-540
GENZYME CORPORATION	06384	2009-541
GENZYME CORPORATION	06385	2009-542
GLAXO GROUP LIMITED	03845	2009-380
GOODWILL TRADEMARKS PTE LTD	03981	2009-636
GOOGLE INC	03840	2009-155
GOOGLE INC	03752	2009-639
GREE ELECTRIC APPLIANCES INC.	06510	2009-371
HANSEN BEVERAGE COMPANY	06411	2009-617

HB BODY S. A.	06438	2009-421
HEWLETT-PACKED DEVELOPMENT COMPANY L. P.	03741	2009-667
HUAWEI TECHNOLOGIES CO	03652	2009-173
HYATT INTERNATIONAL CORPORATION	03370	2008-1226
IEI TECHNOLOGY CORP.	06364	2009-453
INTEL CORPORATION	03841	2009-178
INTERCONTINENTAL HOTELS GROUP PLC	06436	2008-1186
INTERMAR SIMANTO NAHMIA S	03791	2008-767
INTERTEK GROUP PLC	03653	2009-331
INTERTEK GROUP PLC	03874	2009-234
INVESTICIONO RAZVOJNI FOND CRNE GORE A. D.	03762	2010-174
ISHIHARA SANGYO KAISHA, LTD.	06505	2008-1144
ISHIHARA SANGYO KAISHA, LTD.	06506	2008-1145
ISHIHARA SANGYO KAISHA, LTD.	06507	2008-1147
ISHIHARA SANGYO KAISHA, LTD.	06508	2008-1148
ISHIHARA SANGYO KAISHA, LTD.	06509	2008-1149
JAFFA, FABRIKA BISKVITA	06437	2009-422
JANSPORT APPAREL CORP. -DELAWARE CORPORATION	03633	2009-675
JAPAN TOBACCO INC	03867	2009-625
JONHSON DIVERSEY, INC	03969	2009-600
KIA MOTORS CORPORATION	03809	2009-442
KIA MOTORS CORPORATION	03851	2009-415
KIA MOTORS CORPORATION	06439	2009-418
KIMBERLY-CLARK WORLDWIDE, INC	03970	2009-611
KIMBERLY-CLARK WORLDWIDE, INC	03971	2009-612
KRAFT FOODS GLOBAL BRANDS LLC A STATE OF DELAWARE LIMITED LIABILITY COMPANY	03778	2009-574
LABORATORIE GARNIER CIE, SOCIETE EN NOM COLLECTIF	03664	2009-553
LABORATORIE GARNIER I CIE	03978	2009-301
LINING SPORTS SHANGAI COMPANY LIMITED	03666	2009-559
LIR DOO	06369	2009-189
LOREAL SA	03634	2009-280
MAGINUS DOO	03979	2009-273
MARS, INCORPORATED	06363	2009-455
MARS, INCORPORATED	06362	2009-459
MAY CHEONG TOY PRODUCTS FACTORY LIMITED	03982	2009-632
MEGGLE AG	06451	2009-87
MEGGLE AG	06452	2009-88
MEGGLE AG	06370	2009-86
MERZ PHARMA GMBH & CO KGAA	03794	2008-1215
MIP METRO GROUP INTELLECTUAL PROPERTY GMBH CO	03790	2008-464

MONSTER ENERGY COMPANY (A DELAWARE CORPORATION)	06412	2009-618
MONTENEGRO ADVERTISING AND PRODUCTION AGENCY	06434	2009-658
MONTEORGANICA DOO	03411	2009-504
MOTOROLA INC A DELAWARE CORPORATION	03669	2009-583
MOTOROLA INC A DELAWARE CORPORATION	03635	2009-297
N.V. SUMATRA TOBACCO TRADING COMPANY JALAN PATTIMURA NO. 3	03293	2008-886
NBA PROPERTIES INC	03856	2009-425
NEKTAR DOO	03793	2008-1168
NIKE INTERNATIONAL LTD A BERMUDA CORPORATION	06440	2009-416
NIPPON YUSOKI CO LTD	06378	2009-532
NOVARTIS AG	03667	2009-560
NOVARTIS AG	03815	2009-467
NOVARTIS AG	03816	2009-468
NOVARTIS AG	03817	2009-469
NOVARTIS AG	03818	2009-470
NOVARTIS AG	03819	2009-471
NOVARTIS AG	03820	2009-473
NOVARTIS AG	03821	2009-474
NOVARTIS AG	03822	2009-475
NOVARTIS AG	03823	2009-476
NTP LABERION	06372	2009-444
OBC AG	03812	2009-462
OTKRTOE AKTISIONERNOE OBSHESTVO GAZOPROM	06392	2009-566
OTKRYTOE AKTISIONERNOE OBSHESTVO GAZOPROM	06393	2009-567
OTKRYTOE AKTISIONERNOE OBSHESTVO GAZOPROM	06395	2009-569
OTKRYTOE AKTISIONERNOE OBSHESTVO GAZOPROM	06394	2009-568
OTKRYTOE AKTISIONERNOE OBSHESTVO GAZOPROM	06396	2009-570
OTKRYTOE AKTISIONORE OBSHESTVO GAZOPROM	06391	2009-565
OTSUKA PHARMACEUTICAL CO LTD	03773	2009-312
PARK AG DOO	06477	2009-446
PATRON SPIRITS INTERNATIONAL AG	03661	2009-543
PATRON SPIRITS INTERNATIONAL AG	03662	2009-544
PATRON SPIRITS INTERNATIONAL AG	03748	2009-668
PHILLIP MORRIS PRODUCTS SA SWISS CORPORATION	06453	2009-174
PIK VRBOVEC-MESNA INDUSTRIJA DD	03792	2008-967
PLAYBOY ENTERPRISES INTERNATIONAL INC	06416	2009-646
PLAYBOY ENTERPRISES INTERNATIONAL, INC	06418	009-644
PLAYBOY ENTERPRISES INTERNATIONAL, INC	06417	2009-645
PMPI LLC	03965	2009-622
PODRAVKA PREHRAMBRENA INDUSTRIJA DD		

KOPRIVNICA	06377	2009-517
PODRAVKA	06441	2009-414
PROCTER&GAMBLE PHARMACEUTICALS, INC	03745	2009-631
PT INDOFOOD SUKSES MAKMUR TBK	06381	2009-535
PT INDOFOOD SUKSES MAKMUR TBK	06382	2009-536
RECKITT BENCKISER-SWITZERLAND-AG	03742	2009-621
REEMTSAMA CIGARETTENFABRIKEN GMBH A COMPANY	03852	2009-417
S. C. JONHSON I SON INC	03807	2009-440
SANOFI PASTEUR LIMITED/ SANOFI PASTEUR LIMITEE	03806	2009-439
SANOFI PASTEUR LIMITED	03813	2009-463
SAVA TERZIĆ	03368	2009-34
SAVA TERZIĆ	03369	2009-35
SHERATON INTERNATIONAL INC	03636	03636
SHERATON INTERNATIONAL INC	03639	2009-283
SHERATON INTERNATIONAL INC	03749	2009-282
SHIMANO INC	03968	2009-685
SINCLAIR PHARMACEUTICALS LIMITED	06469	2009-606
SINCLAIR PHARMACEUTICALS LIMITED	06474	2009-608
SINCLAIR PHARMACEUTICALS LIMITED	06473	2009-607
STARBEV S. A. R. L.	03977	2009-630
STARBUCKS CORPORATION D/B/A STARBUCKS COFFEE COMPANY	06454	2009-382
STARBUCKS CORPORATION D/B/A STARBUCKS COFFEE COMPANY	06455	2009-387
STARBUCKS CORPORATION D/B/A STARBUCKS COFFEE COMPANY	06457	2009-389
STARBUCKS CORPORATION D/B/A STARBUCKS COFFEE COMPANY	06458	2009-390
STARBUCKS CORPORATION D/B/A STARBUCKS COFFEE COMPANY	06445	2009-397
STARBUCKS CORPORATION D/B/A STARBUCKS COFFEE COMPANY	06447	2009-385
STARBUCKS CORPORATION D/B/A STARBUCKS COFFEE COMPANY	06449	2009-383
STARBUCKS CORPORATION D/B/A STARBUCKS COFFEE COMPANY	06450	2009-381
STARBUCKS CORPORATION D/B/A STARBUCKS COFFEE COMPANY	06456	2009-388
STARBUCKS CORPORATION D/BA STARBUCKS COFFEE COMPANY	06446	2009-386
STARBUCKS CORPORATION D/BA STARBUCKS COFFEE COMPANY	06448	2009-384
STARBUCKS CORPORATION D/B/A STARBUCKS COFFEE		

COMPANY	06459	2009-391
STARBUCKS CORPORATION D/B/A STARBUCKS COFFEE COMPANY	06460	2009-392
STARBUCKS CORPORATION D/B/A STARBUCKS COFFEE COMPANY	06461	2009-393
STARBUCKS CORPORATION D/B/A STARBUCKS COFFEE COMPANY	06462	2009-394
STARBUCKS CORPORATION D/B/A STARBUCKS COFFEE COMPANY	06463	2009-395
STARBUCKS CORPORATION D/B/A STARBUCKS COFFEE COMPANY	06464	2009-396
SUMITOMO CHEMICAL CO LTD	03853	2009-420
SUMITOMO CHEMICAL CO.	03853	2009-420
SURF CO LTDA	06380	2009-534
TATA MOTORS LIMITED AN INDIAN COMPANY MANUFACTURER & MERCHANTS	03984	2009-619
TEKNOXGROUP CRNA GORA, D.O.O.	03789	2008-307
TELEFONAKTIBOLAGET L M ERICSSON	03929	2009-272
THE COCA COLA COMPANY	03810	2009-456
THE COCA COLA COMPANY	06360	2009-464
THE GILLETTE COMPANY	03685	2010-165
THE GILLETTE COMPANY	03686	2010-167
THE GOODYEAR TIRE I RUBBER COMPANY	03668	2009-580
THE GOODYEAR TIRE&RUBBER COMPANY	06465	2009-613
THE H. D. LEE COMPANY INC	06365	2009-449
THE POLO LAUREN COMPANY L P	03967	2009-275
THE POLO/LAUREN COMPANY L. P.	03637	2009-278
THE POLO/LAUREN COMPANY L. P.	03638	2009-277
THE POLO/LAUREN COMPANY L. P.	03750	2009-276
TIKKURILA OY	06419	2009-609
TOYOTA JIDOSHA KABUSHIKI KAISHA	06443	2009-408
TOYOTA JIDOSHA KABUSHIKI KAISHA-ALSO TRADING AS TOYOTA MOTOR CORPORATION	06366	2009-443
UNIVERSAL CITY STUDIOS LLLP-DELAWARE LIMITED LIABILITY LIMITED PARTNERSHIP	03980	2009-599
VICTOR DEVELOPMENT, DOO	03584	2010-179
VITALIA NIKOLA I DR. DOO EHPORT-IMPORT	06373	2009-333
VOTORANTIM CELULOSE E PAPEL SA	06386	2009-548
VOTORANTIM CELULOSE E PAPEL SA	06387	2009-549
WARNER BROS. ENTERTAINMENT INC	06359	2009-466
WATSON PHARMACEUTICALS, INC	06546	2009-477
WATSON PHARMACEUTICALS, INC	06546	2009-479
WM WRIGLEY COMPANY	03974	2009-287

WM WRIGLEY COMPANY	06353	2009-291
WM WRIGLEY JR COMPANY	06388	2009-556
WM WRIGLEY JR COMPANY	06389	2009-557
WM WRIGLEY JR COMPANY	03973	2009-288
WM WRIGLEY JR COMPANY	06358	2009-289
WM WRIGLEY JR COMPANY	06355	2009-293
WM WRIGLEY JR COMPANY	06354	2009-290
WM WRIGLEY JR COMPANY	06357	2009-271
WM WRIGLEY JR COMPANY	06356	2009-295
WM WRIGLEY JR COMPANY	03972	2009-294
WM WRIGLEY JR COMPANY	06352	2009-292
WM. WRIGLEY JR COMPANY	06390	2009-558
WM. WRIGLEY JR COMPANY	03868	2009-650
WM. WRIGLEY JR. COMPANY	03869	2009-651
WM. WRIGLEY JR. COMPANY	03870	2009-652
WM. WRIGLEY JR. COMPANY	03871	2009-654
WRANGLER APPAREL CORP	03654	2009-334
WRIGLEY JR COMPANY	03975	2009-285
YKK CORPORATION A JAPANESE CORPORATION	03808	2009-441
ZAO TECHNOMICOL	06467	2009-641
ZAO TEHNONICOL	06466	2009-642
ZDRAVLJE AD	03844	2011-37
ZDRAVLJE AD	03843	2011-369

INDEKS BROJEVA ŽIGOVA
INDEX OF THE TRADEMARK NUMBERS

(210)	(111)	(210)	(111)	(210)	(111)
2008-1144	06505	2009-288	03973	2009-411	03849
2008-1145	06506	2009-289	06358	2009-413	03850
2008-1147	06507	2009-290	06354	2009-414	06441
2008-1148	06508	2009-291	06353	2009-415	03851
2008-1149	06509	2009-292	06352	2009-416	06440
2008-1168	03793	2009-293	06355	2009-417	03852
2008-1186	06436	2009-294	03972	2009-418	06439
2008-1215	03794	2009-295	06356	2009-420	03853
2008-1226	03370	2009-297	03635	2009-420	03853
2008-1236	03795	2009-3	03796	2009-421	06438
2008-307	03789	2009-30	03802	2009-422	06437
2008-412	03873	2009-301	03978	2009-423	03854
2008-464	03790	2009-302	03683	2009-424	03855
2008-767	03791	2009-312	03773	2009-425	03856
2008-845	03651	2009-331	03653	2009-429	06367
2008-886	03293	2009-333	06373	2009-436	06421
2008-967	03792	2009-334	03654	2009-439	03806
2009-155	03840	2009-34	03368	2009-440	03807
2009-173	03652	2009-35	03369	2009-441	03808
2009-174	06453	2009-371	06510	2009-442	03809
2009-178	03841	2009-380	03845	2009-443	06366
2009-179	03482	2009-381	06450	2009-444	06372
2009-180	03483	2009-382	06454	2009-445	06476
2009-185	03842	2009-383	06449	2009-446	06477
2009-189	06369	2009-384	06448	2009-449	06365
2009-2	06371	2009-385	06447	2009-453	06364
2009-213	03481	2009-386	06446	2009-455	06363
2009-231	06368	2009-387	06455	2009-456	03810
2009-234	03874	2009-388	06456	2009-457	03811
2009-244	03804	2009-389	06457	2009-459	06362
2009-245	03805	2009-390	06458	2009-46	03803
2009-246	03814	2009-391	06459	2009-460	06422
2009-271	06357	2009-392	06460	2009-461	06423
2009-272	03929	2009-393	06461	2009-462	03812
2009-273	03979	2009-394	06462	2009-463	03813
2009-275	03967	2009-395	06463	2009-464	06360
2009-276	03750	2009-396	06464	2009-465	06361
2009-277	03638	2009-397	06445	2009-466	06359
2009-278	03637	2009-398	03846	2009-467	03815
2009-280	03634	2009-399	03847	2009-468	03816
2009-282	03749	2009-4	03797	2009-469	03817
2009-283	03639	2009-408	06443	2009-470	03818
2009-285	03975	2009-409	06442	2009-471	03819
2009-287	03974	2009-410	03848	2009-473	03820

(210)	(111)	(210)	(111)	(210)	(111)
2009-474	03821	2009-569	06395	2009-646	06416
2009-475	03822	2009-570	06396	2009-648	06475
2009-476	03823	2009-574	03778	2009-649	03751
2009-477	06546	2009-580	03668	2009-650	03868
2009-479	06546	2009-583	03669	2009-651	03869
2009-504	03411	2009-586	06397	2009-652	03870
2009-512	06374	2009-587	06488	2009-654	03871
2009-513	06375	2009-588	06489	2009-655	03966
2009-516	06376	2009-594	03826	2009-656	03872
2009-517	06377	2009-595	03827	2009-657	03985
2009-520	03655	2009-596	03828	2009-658	06434
2009-521	03774	2009-599	03980	2009-659	03761
2009-523	03775	2009-6	03800	2009-659	03769
2009-524	03776	2009-600	03969	2009-660	03758
2009-525	03657	2009-604	03746	2009-661	03757
2009-526	03777	2009-606	06469	2009-662	03756
2009-527	03658	2009-607	06473	2009-663	03755
2009-528	03659	2009-608	06474	2009-664	03754
2009-529	03660	2009-609	06419	2009-665	03753
2009-532	06378	2009-611	03970	2009-666	03976
2009-533	06379	2009-612	03971	2009-667	03741
2009-534	06380	2009-613	06465	2009-668	03748
2009-535	06381	2009-617	06411	2009-669	06351
2009-536	06382	2009-618	06412	2009-672	03759
2009-537	03824	2009-619	03984	2009-673	03760
2009-538	03825	2009-621	03742	2009-675	03633
2009-539	03839	2009-622	03965	2009-676	03631
2009-540	06383	2009-625	03867	2009-683	03684
2009-541	06384	2009-627	06414	2009-684	03682
2009-542	06385	2009-628	06413	2009-685	03968
2009-543	03661	2009-629	03744	2009-686	03632
2009-544	03662	2009-630	03977	2009-7	03798
2009-548	06386	2009-631	03745	2009-8	03799
2009-549	06387	2009-632	03982	2009-86	06370
2009-551	03663	2009-633	03743	2009-87	06451
2009-552	03656	2009-634	06472	2009-88	06452
2009-553	03664	2009-635	06471	2009-9	03801
2009-554	03665	2009-636	03981	2010-159	03681
2009-556	06388	2009-637	06415	2010-160	03963
2009-557	06389	2009-638	06470	2010-162	03962
2009-558	06390	2009-639	03752	2010-163	03983
2009-559	03666	2009-640	06435	2010-164	03964
2009-560	03667	2009-641	06467	2010-165	03685
2009-565	06391	2009-642	06466	2010-167	03686
2009-566	06392	2009-643	03747	2010-174	03762
2009-567	06393	2009-644	06418	2010-179	03584
2009-568	06394	2009-645	06417	2011-369	03843
				2011-37	03844

INDEKS PO KLASAMA NIČANSKE KLASIFIKACIJE ROBA I USLUGA
INDEX ACCORDING TO THE NICE CLASSIFICATION OF GOODS AND SERVICES

Klasa 01	03790	03756	06507	06359
03656	03794	03757	06508	06364
03790	03807	03773	06509	06395
03811	03967	03774	06546	06396
03853	03969	03775	06546	06435
03853	03978	03776		06448
03969	03979	03777	Klasa 06	06461
03976	06361	03790	03790	
06376	06376	03794	06395	Klasa 10
06386	06395	03806	06396	03632
06387	06396	03813	06466	03657
06391	06438	03815	06467	03659
06392	06469	03816		03660
06393	06473	03817	Klasa 07	03790
06394	06476	03818	03741	03804
06395	06477	03819	03790	03805
06396		03820	03969	03814
06438	Klasa 04	03821	06378	06395
06466	03683	03822	06395	06396
06467	03790	03823	06396	
	03847	03843	06450	Klasa 11
Klasa 02	06391	03844		03742
03656	06392	03845	Klasa 08	03790
03741	06393	03848	03685	06395
03790	06394	03849	03686	06396
06376	06395	03850	03790	06450
06395	06396	03854	06395	06510
06396		03855	06396	
06419	Klasa 05	03964		Klasa 12
06438	03482	03969	Klasa 09	03668
06466	03483	03976	03368	03743
06467	03655	06373	03369	03789
	03658	06383	03635	03790
Klasa 03	03659	06384	03652	03809
03634	03660	06385	03669	03851
03637	03665	06395	03741	03968
03638	03667	06396	03752	03984
03664	03682	06411	03790	06351
03682	03684	06412	03795	06366
03683	03742	06442	03799	06378
03684	03745	06469	03841	06395
03742	03751	06473	03842	06396
03744	03753	06474	03846	06439
03747	03754	06505	03847	06443
03750	03755	06506	03983	06465

	06396	06395	06448	06356
Klasa 13	06438	06396	06461	06357
03790			06463	06358
06395	Klasa 18	Klasa 24		06362
06396	03631	03683	Klasa 29	06363
	03633	03790	03746	06368
Klasa 14	03666	06395	03778	06373
03790	03683	06396	03790	06381
03965	03790		03792	06382
06395	03965	Klasa 25	03792	06388
06396	06395	03631	03793	06389
06448	06396	03633	03873	06390
06461	06448	03651	06362	06395
	06454	03654	06363	06396
Klasa 15	06461	03666	06368	06397
03790		03683	06370	06437
06395	Klasa 19	03790	06372	06441
06396	03656	03791	06373	06445
	03790	03856	06395	06446
Klasa 16	03811	03965	06396	06447
03651	03966	06365	06441	06455
03741	06395	06380	06445	06456
03790	06396	06395	06451	06457
03793		06396	06452	06458
03872	Klasa 20	06440	06462	06459
03965	03790		06470	06462
03970	06395	Klasa 26	06488	06488
03971	06396	03790		
03981		03808	Klasa 30	Klasa 31
03982	Klasa 21	06395	03663	03758
03985	03744	06396	03681	03761
06359	03747		03683	03769
06386	03790	Klasa 27	03778	03790
06387	03969	03790	03790	03792
06391	06395	06395	03793	03793
06392	06396	06396	03810	03976
06393		06466	03868	06373
06394	Klasa 22	06467	03869	06386
06395	03790		03870	06387
06396	06395	Klasa 28	03871	06395
06466	06396	03666	03873	06396
06467	06416	03790	03972	06461
	06417	03856	03973	
Klasa 17	06418	03965	03974	Klasa 32
03656	06466	03981	03975	03481
03790	06467	03982	06352	03663
03811		06359	06353	03683
03966	Klasa 23	06395	06354	03759
06395	03790	06396	06355	03760

03778	03790	Klasa 36	06435	06360
03790	03803	03584		06369
03793	03824	03741	Klasa 39	06395
03796	03825	03749	03741	06396
03797	03826	03790	03790	06434
03798	03827	03812	03872	06448
03799	03828	03846	03977	06461
03800	03839	03847	03985	
03801	03852	03977	06368	Klasa 42
03802	03867	06395	06373	03368
03810	06395	06396	06391	03369
03977	06396	06421	06392	03411
06360	06413	06422	06393	03653
06368	06414	06423	06394	03741
06370	06415	06471	06395	03790
06372	06453	06472	06396	03795
06373		06475	06466	03874
06377	Klasa 35		06467	03929
06395	03584	Klasa 37		06386
06396	03651	03584	Klasa 40	06387
06411	03683	03741	03651	06391
06412	03741	03789	03741	06392
06445	03789	03790	03790	06393
06451	03790	03811	03792	06394
06462	03793	03929	06386	06395
06488	03812	03969	06387	06396
	03842	06378	06391	06435
Klasa 33	03846	06391	06392	06466
03661	03965	06392	06393	06467
03662	03971	06393	06394	06475
03748	03977	06394	06395	
03790	03981	06395	06396	Klasa 43
03793	03982	06396		03370
03810	06359	06510	Klasa 41	03584
03962	06368		03683	03636
03963	06391	Klasa 38	03741	03639
03977	06392	03368	03790	03683
06367	06393	03369	03793	03749
06371	06394	03635	03812	03790
06374	06395	03741	03840	03873
06375	06396	03790	03841	03977
06379	06434	03795	03842	06369
06395	06449	03840	03856	06395
06396	06464	03842	03929	06396
06448	06466	03980	03969	06436
	06467	03983	03977	06448
Klasa 34	06489	06359	03980	06460
03293	06510	06395	03983	06464
03762		06396	06359	

Klasa 44

03370
03584
03683
03790
06386
06387
06395
06396

Klasa 45

03368
03369
03653
03790
06395
06396
06466
06467

**OBJAVA ISPRAVKI
CORRECTIONS**

U „Crnogorskom glasniku intelektualne svojine“ broj **8. od 20.03.2012.** godine objavljeni su pogrešni podaci o datumu podnošenja prijave i imenu i adresi punomoćnika za žig **2009-632**

Pogrešni podaci

(220) 11.03.2009

Ispravni podaci

(220) 03.11.2009

Pogrešni podaci

(740) Čejović Vladimir, advokat, 13. jul 21, Podgorica (ME)

Ispravni podaci

(220) Čupić Branislav, Dalmatinska 10, Podgorica (ME)

U „Crnogorskom glasniku intelektualne svojine“ broj **8. od 20.03.2012.** godine objavljeni su pogrešni podaci o podnosiocu prijave i imenu i adresi punomoćnika prijave za žig **2009-677**

Pogrešni podaci

(731) JANSPOUT APPAREL CORP. -DELAWARE CORPORATION; 3411 SILVERSIDE ROAD, WILMINGTON, DELAWARE 19810 US

Ispravni podaci

(731) QUALCOMM INC. 5775 MOREHOUSE DRIVE, 92121-1714 SAN DIEGO, CA

Pogrešni podaci

(740) Radulović Božidar, advokat, Jovana Tomaševića 9/III, Podgorica (ME)

Ispravni podaci

(740) Čejović Vladimir, 13. jul 21, Podgorica (ME)

U „Crnogorskom glasniku intelektualne svojine“ broj **9. od 20.06.2012.** godine objavljeni su pogrešni podaci o podnosiocu prijave za žig **2010-374**

Pogrešni podaci

(731) FRES & CO DOO, IVANA GORANA KOVAČIĆA 3, 24000 SUBOTICA RS

Ispravni podaci

(731) FRESH & CO D.O.O., IVANA GORANA KOVAČIĆA 3, 24000 SUBOTICA RS

U „Crnogorskom glasniku intelektualne svojine“ broj **9. od 20.06.2012.** godine objavljeni su pogrešni podaci o podnosiocu prijave za žig **2008-256**

Pogrešni podaci

(731) T-MOBILE CRNA GORA DOO, PODGORICA, MOSKOVSKA 29, PODGORICA ME

Ispravni podaci

(731) DEUTSCHE TELEKOM AG, FRIEDRICH-EBERT-ALLEE 140, 53113 BONN DE

U „Crnogorskom glasniku intelektualne svojine“ broj **9. od 20.06.2012.** godine objavljeni su pogrešni podaci o podnosiocu prijave za žig **2008-167**

Pogrešni podaci

(731) T-MOBILE CRNA GORA DOO, PODGORICA, MOSKOVSKA 29, PODGORICA ME

Ispravni podaci

(731) DEUTSCHE TELEKOM AG, FRIEDRICH-EBERT-ALLEE 140, 53113 BONN DE

U „Crnogorskom glasniku intelektualne svojine“ broj **9. od 20.06.2012.** godine objavljeni su pogrešni podaci o podnosiocu prijave za žig **2008-168**

Pogrešni podaci

(731) T-MOBILE CRNA GORA DOO, PODGORICA, MOSKOVSKA 29, PODGORICA ME

Ispravni podaci

(731) DEUTSCHE TELEKOM AG, FRIEDRICH-EBERT-ALLEE 140, 53113 BONN DE

U „Crnogorskom glasniku intelektualne svojine“ broj **9. od 20.06.2012.** godine objavljeni su pogrešni podaci o podnosiocu prijave za žig **2008-169**

Pogrešni podaci

(731) T-MOBILE CRNA GORA DOO, PODGORICA, MOSKOVSKA 29, PODGORICA ME

Ispravni podaci

(731) DEUTSCHE TELEKOM AG, FRIEDRICH-EBERT-ALLEE 140, 53113 BONN DE

U „Crnogorskom glasniku intelektualne svojine“ broj **9. od 20.06.2012.** godine objavljeni su pogrešni podaci o podnosiocu prijave i izgledu znaka za žig **2009-458**

Pogrešni podaci

(731) DANHILL TOBACCO OF LONDON LIMITED, 1A ST JAMES STREET, LONDON, SW1A IEF GB

Ispravni podaci

(731) TOBACCO OF LONDON LIMITED, GLOBE HOUSE, 4 TEMPLE PLACE, LONDON WC2R 2PG GB

U „Crnogorskom glasniku intelektualne svojine“ broj **9. od 20.06.2012.** godine objavljenisu pogrešni podaci o podnosiocu prijave za žig **2010-2**, kao i pogrešni podaci o datumu podnošenja prijave i spisku roba i usluga prema ničanskoj klasifikaciji

Pogrešni podaci

(731) DEUTSCHE TELEKOM AG, FRIEDRICH-EBERT-ALLEE 140 53113 BON DE

Ispravni podaci

(731) DEUTSCHE TELEKOM AG, FRIEDRICH-EBERT-ALLEE 140, 53113 BONN DE

Pogrešni podaci

(220) 01.05.2010

Ispravni podaci

(220) 05.01.2010

Pogrešni podaci

(511) Klasa 35, 38, 38, 42

Ispravni podaci

(511) Klasa 35, 38, 41, 42

U „Crnogorskom glasniku intelektualne svojine“ broj **9. od 20.06.2012.** godine objavljeni su pogrešni podaci o podnosiocu prijave za žig **2010-3**

Pogrešni podaci

(731) UNILEVER N.V, WENNA 455,3013 AL, ROTTERDAM NL

Ispravni podaci

(731) UNILEVER N.V. WEENA 455, 3013 AL, ROTTERDAM NL

U „Crnogorskom glasniku intelektualne svojine“ broj **9. od 20.06.2012.** godine objavljeni su pogrešni podaci o podnosiocu prijave za žig **2010-20**

Pogrešni podaci

(731) CHIGUITA BRANDS LLC, 250 EAST FIFTH STREET, CINCINNATI, OHIO 45202 US

Ispravni podaci

(731) CHIQUITA BRANDS LLC. 250 EAST FIFTH STREET, CINCINNATI, OHIO 45202 US

U „Crnogorskom glasniku intelektualne svojine“ broj **9. od 20.06.2012.** godine objavljeni su pogrešni podaci o podnosiocu prijave za žig **2010-100**

Pogrešni podaci

(731) ABBOT MEDICAL OPTICS INC, 1700 EAST ST.ANDREW PLACE P.O.BOX 25162 SANTA ANA.CALIFORNIA 92705-4933 US

Ispravni podaci

(731) ABBOTT MEDICAL OPTICS INC. 1700 EAST ST.ANDREW PLACE P.O.BOX 25162 SANTA ANA CALIFORNIA 92705-4933 US

U „Crnogorskom glasniku intelektualne svojine“ broj **9. od 20.06.2012.** godine objavljeni su pogrešni podaci o podnosiocu prijave za žig **2010-238**

Pogrešni podaci

(731) CROWN BRAND LIMITED, CROWN HOUSE, HOLLINS ROAD, DARWEN, LANCASHIRE BB3 0BG GB

Ispravni podaci

(731) CROWN BRANDS LIMITED, CROWN HOUSE, HOLLINS ROAD, DARWEN, LANCASHIRE BB3 0BG GB

U „Crnogorskom glasniku intelektualne svojine“ broj **9. od 20.06.2012.** godine objavljeni su pogrešni podaci o podnosiocu prijave za žig **2010-418** kao i pogrešni podaci o spisku roba i usluga prema ničanskoj klasifikaciji

Pogrešni podaci

(731) JADRAN DD, PULAC BB, RIJEKA HR

Ispravni podaci

(731) JADRAN GALENISKI LABORATORIJ D.D. PULAC B.B. RIJEKA HR

Pogrešni podaci

(511) Klasa 03, 05, 36

Ispravni podaci

(511) Klasa 03, 05, 35

U „Crnogorskom glasniku intelektualne svojine“ broj **9. od 20.06.2012.** godine objavljeni su pogrešni podaci o podnosiocu prijave za žig **2010-419** kao i pogrešni podaci o spisku roba i usluga prema ničanskoj klasifikaciji

Pogrešni podaci

(731) JADRAN DD, PULAC BB, RIJEKA HR

Ispravni podaci

(731) JADRAN GALENISKI LABORATORIJ D.D. PULAC B.B. RIJEKA HR

Pogrešni podaci

(511) Klasa 03, 05, 36

Ispravni podaci

(511) Klasa 03, 05, 35

U „Crnogorskom glasniku intelektualne svojine“ broj **9. od 20.06.2012.** godine objavljeni su pogrešni podaci o podnosiocu prijave za žig **2010-420**

Pogrešni podaci

(731) JADRAN DD, RIJEKA PULAC BB HR

Ispravni podaci

(731) JADRAN GALENISKI LABORATORIJ D.D. PULAC B.B. RIJEKA HR

OBAVJEŠTENJE NOTICE

Objava upisa u Registar žigova CG priznatih žigova, registrovanih u Zavodu SCG, odnosno Zavodu Srbije, prije otvaranja Zavoda CG

Članom 65 stav 1 Zakona o žigu ("Sl.list CG", br. 72/10) priznata su prava na žigovima koji su registrovani i upisani u Registar žigova u Zavodu za intelektualnu svojinu Srbije i Crne Gore, odnosno Zavodu za intelektualnu svojinu Srbije do 28. maja 2008. godine (do dana otvaranja Zavoda za intelektualnu svojinu Crne Gore) do isteka njihovog trajanja.

Zavod je implementirao odredbu člana 65 stav 2 Zakona o žigu i izvršio upis u Registar, po službenoj dužnosti žigove za koje je izdao uvjerenja o važenju žiga u formi zabilješke u 2008. godini.

Zavod je implementirao odredbu stava 4 istog člana i donio rješenja o upisu u Registar žigova za koje su podnijeti zahtjevi u 2008. godini za obnovu važnosti žiga, prenos prava i promjenu imena i adrese shodno koja propisuje da se ti zahtjevi smatraju kao zahtjevi za upis u registar.

MEĐUNARODNI KODOVI ZA IDENTIFIKACIJU BIBLIOGRAFSKIH PODATAKA O ŽIGOVIMA PREMA WIPO ST 60 RECOMMENDATION CONCERNING BIBLIOGRAFIC DATA RELATING TO TRADEMARKS- WIPO-ST. 60

CRNOGORSKI	MDK	ENGLESKI
REGISTARSKI BROJ CG	111	NUMBER OF THE REGISTRATION CG
REGISTARSKI BROJ SCG	111	NUMBER OF THE REGISTRATION SCG
BROJ PRIJAVE	210	NUMBER OF THE APPLICATION
IME I ADRESA NOSIOCA ŽIGA	732	NAME AND ADDRESS OF THE HOLDER OF THE REGISTRATION



(111) CG	(210) Ž	(732)	(111) SCG
05444 PP	1989-606	PIVOVARNA UNION D.D. ; LJUBLJANA, PIVOVARNIŠKA 2, SI	34545
05448 PP	1988-736	SHELL BRANDS INTERNATIONAL AG ; Baarermaße, 6340 Baar, Switzerland, CH	33473
05440 PP	1977-789	LEK, TOVARNA FARMACEVTSKIH IN KEMIČNIH IZDELKOV, D.D. ; LJUBLJANA, VEROVŠKOVA 57, SI	23017
05438 PP	1976-293	AstraZeneca AB ; 151 85 SODERTALJE, SE	24306
05428 PP	1979-193	LEK, TOVARNA FARMACEVTSKIH IN KEMIČNIH IZDELKOV, D.D. ; LJUBLJANA, VEROVŠKOVA 57, SI	23855
05442 PP	1999-829	REEMTSMA CIGARETTENFABRIKEN G.m.b.H. ; Parkstrasse 51, 22605 Hamburg, DE	46969
05443 PP	1999-828	REEMTSMA CIGARETTENFABRIKEN G.m.b.H. ; Parkstrasse 51, 22605 Hamburg, DE	46970
05456 PP	1949-51	Diageo Brands B.V. and GUINNESS UNITED DISTILLERS & VINTNERS B. V. ; Molenwerf 10-12, 1014 BG Amsterdam, The Netherlands, NL and MOLENWERF 10-12, 1014 BG AMSTERDAM, THE NETHERLANDS, NL	11891
05451 PP	2006-2808	CHRYSLER LLC ; 1000 Chrysler Drive, Auburn Hills, Michigan 48326, US	54588
05445 PP	1999-439	ConAgra Foods, Inc. ; One ConAgra Drive, Omaha, Nebraska 68102, US	45579
05453 PP	1991-1499	DOLLAR RENT A CAR SYSTEMS, INC. (OKLAHOMA CORPORATION) ; 5330 E. 31st STREET, TULSA, OKLAHOMA 74135, US	38228
05446 PP	1999-707	KABUSHIKI KAISHA YAKULT HONSHA ; 1-19, Higashi Shinbashi 1-Chome, Minato-ku, Tokyo 105, JP	45062
05449 PP	1987-432	SHELL BRANDS INTERNATIONAL AG ; Baarermaße, 6340 Baar Switzerland, CH	33563
05452 PP	2006-2599	CHRYSLER LLC ; 1000 Chrysler Drive, Auburn Hills, Michigan 48326, US	54471
05447 pp	1968-753	SHELL BRANDS INTERNATIONAL AG ; Baarermaße, 6340 Baar Switzerland, CH	18425
05450 PP	1968-833	SHELL BRANDS INTERNATIONAL AG ; Baarermaße, 6340 Baar Switzerland, CH	18460
05441 pp	1961-281	LEK, TOVARNA FARMACEVTSKIH IN KEMIČNIH IZDELKOV, D.D. ; LJUBLJANA, VEROVŠKOVA 57, SI	15410
04696 PP	1998-962	Viacom International Inc. ; 1515 Broadway, New York, NY 10036, US	44411
04700 pp	1998-961	Viacom International Inc. ; 1515 Broadway, New York, NY 10036, US	44410
05433 pp	1998-317	AVENTIS INC. (Pennsylvania corporation) ; 3711 Kennett Pike, Suite 200, Greenville, Delaware 19807, US	43994
05432 PP	1991-100	AVENTIS INC. ; 3711 Kennett Pike, Suite 200, Greenville, Delaware 19807, US	36618
04702 PP	1998-958	Viacom International Inc. ; 1515 Broadway, New York, NY 10036, US	44456
04697 pp	1979-366	CBS Studios Inc. ; 51 West 52nd Street New York, NY 10019, US	32242
04699 PP	1998-956	Viacom International Inc. ; 1515 Broadway, New York, NY 10036, US	44407
05431 PP	1995-912	MERRELL PHARMACEUTICALS INC. (Delaware corporation); MERRELL PHARMACEUTICALS INC. (Delaware corporation); MERRELL PHARMACEUTICALS and MERRELL PHARMACEUTICALS INC. (Delaware corporation) ; 399 Interpace Parkwaz Parsippany, New Jersey, US; 3711 Kennett Pike, Suite 200, Greenville, Delaware, US; 2110 EAST GALBRAITH ROAD, CINCINNATI, OHIO, US and 300 Somerset Corporate BLVD., Bridgewater, New Jersey, US	41121
05434 PP	1967-426	AVENTIS INC. ; 3711 Kennett Pike, Suite 200, Greenville, Delaware 19807, US	17761
05439 PP	2005-248	KRAFT FOODS HOLDINGS, Inc., a Delaware corporation ; Three Lakes Drive, Northfield, Illinois 60093, US	52845
04701 PP	1998-963	Viacom International Inc. ; 1515 Broadway, New York, NY 10036, US	44897
05436 PP	1996-1444	MERRELL PHARMACEUTICALS INC. (DELAWARE CORPORATION) ; 2110 EAST GALBRAITH ROAD, CINCINNATI, OHIO, US	42095
04695 PP	1998-959	Viacom International Inc. ; 1515 Broadway, New York, NY 10036, US	44408
05427 PP	1979-246	LEK, TOVARNA FARMACEVTSKIH IN KEMIČNIH IZDELKOV, D.D. ; LJUBLJANA, VEROVŠKOVA 57, SI	23857
05429 PP	1999-349	LEK PHARMACEUTICAL AND CHEMICAL COMPANY D.D. ; Verovškova 57, 1526 Ljubljana, SI	45198

05430 PP	1988-1168	MERCK & CO., INC.; ONE MERCK DRIVE, P.O.BOX 100, WHITEHOUSE STATION, NJ 08889-0100,, US	33876
05437 PP	1997-679	AVENTIS INC.; 3711 Kennett Pike, Suite 200, Greenville, Delaware 19807, US	43410
04698 pp	1979-367	CBS Studios Inc.; 51 West 52nd Street, New York, NY 10019, SAD, US	32243
05761 PP	1989-1399	WARNER BROS. ENTERTAINMENT INC; 4000 WARNER BOULEVARD,BURBANK,CALIFORNIA 91522, US	34630
05757 PP	1990-250	MOEN INCORPORATED; 25300 AL MOEN DRIVE, NORTH OLMSTED, OHIO 44070-8022, US	35480
05742 PP	2000-228	THE GILLETTE COMPANY; Prudential Tower Building, Boston, Massachusetts 02199, US	46763
05762 PP	1989-901	WARNER BROS ENTERTAINMENT INC.; 4000 WARNER BOULEVARD,BURBANK,CALIFORNIA 91522, US	34368
05741 PP	2000-308	THE GILLETTE COMPANY; One Gillette Park,Boston,MA02127,USA	45631
05672 PP	2005-845	GENERAL MOTORS CORPORATION, Proizvodno i trgovinsko preduzeće organizovano po propisima države Delaware,; 300 Renaissance Center, Detroit, Michigan 48265-3000, US	51431
05664 PP	1973-332	CHIVAS BROTHERS PERNOD RICARD LIMITED; 111/113 RENFREW ROAD, PAISLEY PA 3 4DY, ŠKOTSKA, GB	21501
05666 PP	1974-491	CHIVAS BROTHERS PERNOD RICARD LIMITED; 111/113 RENFREW ROAD, PAISLEY PA3 4DY , ŠKOTSKA, GB	22915
05856 pp	1990-1526	PLIVA HRVATSKA d.o.o.; Prilaz baruna Filipovica 25,10000 Zagreb,HR	35404
05877 PP	1990-2020	ADVANCE MAGAZINE PUBLISHERS, INC.; FOUR TIMES SQUARE, NEW YORK 10036, US	37028
05855 pp	1990-880	COSTAN, S.p.A.; VIA DEGLI ALPINI 14, LIMANA, IT	36182
05882 PP	1997-1028	MERCK & CO., INC.; ONE MERCK DRIVE, P.O. BOX 100, WHITEHOUSE STATION, NEW JERSEY, US	43341
05859 pp	1976-136	NEC CORPORATION; 7-1, SHIBA 5-CHOME, MINATO-KU, TOKYO, JP	24500
05876 PP	1990-859	ADVANCE MAGAZINE PUBLISHERS, INC.; FOUR TIMES SQUARE, NEW YORK 10036, US	35623
05860 PP	1990-679	K.H.S MUSICAL INSTRUMENT CO.,LTD; 10 Fl.No.162,Zhongshan 2nd Rd.Luzhou City,Taipei County 247,Taiwan,TW	35592
06063 PP	1995-570	MERCK & CO., INC. A NEW JERSEY CORPORATION,; ONE MERCK DRIVE, P.O. BOX 100, WHITEHOUSE STATION, NEW JERSEY, US	40992
05881 PP	1991-1248	MERCK & CO., INC.; One Merck Drive, P.O. Box 100, Whitehouse Station, NJ 08889-0100, US	38170
06052 PP	1973-669	THE YOKOHAMA RUBBER CO. LTD.; 36-11, SHINBASHI 5-CHOME, MINATO-KU, TOKYO, JP	24650
05875 PP	1990-865	ADVANCE MAGAZINE PUBLISHERS, INC.; FOUR TIMES SQUARE, NEW YORK 10036, US	35886
05880 PP	2006-621	MERCK & CO., INC. a New Jersey corporation; One Merck Drive, P.O.Box 100, Whitehouse Station, New Jersey, US	50570
05861 pp	1990-658	KARELIA TOBACCO COMPANY, INC.; ATHINON AVE., 24100 KALAMATA, GR	35490
05884 PP	2002-1398	Merck & Co., Inc. a New Jersey Corporation; One Merck Drive, P.O.Box 100, Whitehouse Station, New Jersey,, US	48419
05879 pp	1966-167	TOBAČNA LJUBLJANA, PROIZVODNO IN TRGOVSKO PODJETJE ZA TOBAČNE IZDELKE, D.O.O.; LJUBLJANA, TOBAČNA ULICA 5, SI	16918
06054 PP	2000-423	EASTMAN KODAK COMPANY; 343 State Street, Rochester, New York, US,	46854
05883 PP	2002-1399	Merck Charp & Dohme Corp. a New Jersey Corporation; One Merck Drive, Whitehouse Station, New Jersey, 08889-01000,US	48418
06051 PP	2007-2375	Farmaceutsko hemijska industrija “ZDRAVLJE”, akcionarsko društvo; Vljakova 199, 16000 Leskovac, RS	53453
05846 pp	1989-16	PHILIP MORRIS PRODUCTS INC.; 3601 COMMERCE ROAD, RICHMOND, VIRGINIA 23234, US	33931
06060 PP	1976-924	THE PROCTER & GAMBLE COMPANY (OHIO CORPORATION); ONE PROCTER & GAMBLE PLAZA CINCINNATI,OHIO, US	24613
06065 PP	2006-2177	MERCK & CO., INC. a New Jersey corporation; One Merck Drive, P.O.Box 100, Whitehouse Station, New Jersey, US	54104

06053 PP	1990-452	FIRST INTERNATIONAL COMPUTER, INC.; 6F, NO. 201-24, TUNG HWA N. ROAD, TAIPEI, TW	37798
05878 pp	2006-2680	ĐORIĆ VELIBOR; Beograd, Gornjačka 22, RS	54563
05832 PP	1989-829	ATP TOUR, INC.; 200 ATP TOUR BOULEVARD, PONTE VEDRA BEACH, FLORIDA 32082, US	34438
05829 PP	1989-179	PHILIP MORRIS PRODUCTS S.A.; QUAI JEANRENAUD 3, CH-2000 NEUCHATEL, CH	33924
05826 pp	1986-677	JOHNSON & JOHNSON (NEW JERSEY CORPRATION); One Johnson & Johnson Plaza, New Brunswick, NJ 08933-7001 US	31455
06044 PP	2000-357	THE PROCTER & GAMBLE COMPANY; One Procter & Gamble Plaza, Cincinnati, Ohio, US	45744
05838 PP	1989-1432	AVIREX LTD.; 33-00 47th AVENUE, LONG ISLAND CITY, NY 11101, US	35550
05885 PP	1996-885	MERCK & CO., INC.; ONE MERCK DRIVE, P.O. BOX 100, WHITEHOUSE STATION, NEW JERSEY, US	41987
05836 pp	1980-25	“JUGOREMEDIJA” FABRIKA LEKOVA A.D. ZRENJANIN; Pančevačka bb, Zrenjanin, RS	24424
05837 PP	2000-438	INFINEUM INTERNATIONAL LIMITED; 1220 Parkview, Arlington Business Park, Theale, Reading RG7 4SA, Engleska, GB	45642
05852 pp	2000-645	LG LIFE SCIENCES, LTD.; 20, YOIDO-DONG, YOUNGDUNGPO-GU, SEOUL, KR	45897
05833 PP	1989-1232	ASHLAND INC.; 1000 ASHLAND DRIVE, RUSSELL, KENTUCKY 41169, US	35165
06043 PP	2000-360	THE PROCTER & GAMBLE COMPANY; One Procter & Gamble Plaza, Cincinnati, Ohio, US	45762
05835 pp	1980-280	Ashland Inc.; 50. E. RiverCenter Boulevard Covington, Kentucky 41012-0391, US	27494
05841 PP	2000-137	PHILIP MORRIS PRODUCTS S.A.; Quai Jeanrenaud 3, 2000 Neuchatel, CH	45972
05851 PP	1960-234	KELLOGG COMPANY; One Kellogg Square, P.O. Box 3599, Battle Creek, MI 49016-3599, US	15051
05886 PP	1997-1032	MERCK & CO., INC.; ONE MERCK DRIVE, P.O. BOX 100, WHITEHOUSE STATION, NEW JERSEY, US	42718
05827 PP	1989-861	LEK, TOVARNA FARMACEVTSKIH IN KEMIČNIH IZDELKOV, D.D.; LJUBLJANA, VEROVŠKOVA 57, SI	34223
05828 pp	1960-1	PHILIP MORRIS PRODUCTS S.A.; Quai Jeanrenaud 3, CH-2000 Neuchatel, CH	14850
05834 pp	2000-975	ASHLAND INC.; 50E. RiverCenter Boulevard, Covington, Kentucky 41012-0391, US	46153
05773 PP	2000-501	KABUSHIKI KAISHA SONY COMPUTER ENTERTAINMENT (SONY COMPUTER ENTERTAINMENT INC.); 1-1, Akasaka 7-chome, Minato-ku, Tokyo, JP	45720
05853 PP	1990-774	HERCULES INCORPORATED; HERCULES PLAZA, 1313 NORTH MARKET STREET, WILMINGTON, DELAWARE 19894-0001, US	35511
05854 PP	2000-415	INTERVET INTERNATIONAL B.V.; Wim de Korverstraat 35, 5831 AN Boxmeer, NL	45638
06046 PP	2004-1312	THE PRUDENTIAL INSURANCE COMPANY OF AMERICA (New Jersey Corporation); 751 Broad Street, Newark, New Jersey 07102, US	50427
06121 PP	1968-691	UNIROYAL CHEMICAL COMPANY, INC.; CHEMTURA CORPORATION and CHEMTURA USA CORPORATION; Benson Road, Middlebury, Connecticut 06749, US; Benson Road, Middlebury, Connecticut 06749, US and Benson Road, Middlebury, Connecticut 06749, US	18570
05870 PP	1990-863	ADVANCE MAGAZINE PUBLISHERS, INC.; FOUR TIMES SQUARE, NEW YORK 10036, US	35885
06105 pp	1976-370	BINNEY & SMITH INC.; 1100 CHURCH LANE, EASTON, PENNSYLVANIA 18042, US	24699
06050 PP	1990-460	FRUCTAL ŽIVILSKA INDUSTRIJA D.D.; TOVARNIŠKA 7, AJDOVŠČINA, SI	35421
06113 PP	1990-626	UNITED PARCEL SERVICE OF AMERICA, INC.; a Delaware Corporation, 55 Glenlake Parkway, NE, Atlanta, Georgia 30328, US	35546
06041 PP	1990-653	LEVI STRAUSS & CO.; 1155 BATTERY STREET, SAN FRANCISCO, CALIFORNIA, US	35690

06040 PP	2004-1313	THE PRUDENTIAL INSURANCE COMPANY OF AMERICA (New Jersey Corporation); 751 Broad Street, Newark, New Jersey 07102, US	51436
05867 pp	2000-392	ZHONGXING TELECOM LIMITED; Zhongxing Telecom, Couth Science Road, High & New Technology Zone, Shenzhen 518057, P.R., CN	45865
06116 PP	1990-736	NBA PROPERTIES, INC.; 645 FIFTH AVENUE, NEW YORK, N.Y. 10022, US	35507
06106 PP	2000-362	LRC PRODUCTS LIMITED; 103-105 Bath Road, Slough, SL, 3 UH, Engleska	45773
06129 PP	1988-495	JANSSEN PHARMACEUTICA N.V.; TURNHOUTSEWEG 30, B-2340 BEERSE, BE	31996
06102 PP	1988-1230	TOBAČNA LJUBLJANA Proizvodno in trgovsko podjetje za tobačne izdelke doo; TOBAČNA ULICA 5, LJUBLJANA, SI	34409
06125 PP	1989-906	ROYAL BANK OF CANADA; 1 PLACE VILLE MARIE, MONTREAL, PROVINCE OF QUEBEC H3C 3A9, CA	34422
06131 PP	2000-69	NET2PHONE, INC.; 171 Main Street, Hackensack, New Jersey 07601, US	46146
05866 pp	2000-393	ZHONGXING TELECOM LIMITED; Zhongxing Telecom, Couth Science Road, High & New Technology Zone, Shenzhen 518057, P.R., CN	45784
06122 PP	1990-891	Avenue Jean-Jacques Rousseau 7; 2000 Neuchatel, Švajcarska	35631
06108 PP	1975-471	PHILIP MORRIS PRODUCTS S.A.; Quai Jeanrenaud 3, CH-2000 Neuchatel, CH	24665
06107 PP	2000-831	ALPS ELECTRIC CO., LTD. (Japan corporation); 1-7, Yukigaya, Ohtsuka-cho, Ohta-ku, Tokyo, JP	46345
06123 PP	1990-890	MERISANT COMPANY 2 SARL; Avenue Jean-Jacques Rousseau 7, 2000 Neuchatel, Švajcarska	35630
05863 PP	1990-661	KARELIA TOBACCO COMPANY, INC.; PO BOX 22, ATHINON AVENUE, GR-24100 KALAMATA, GR	35491
06134 PP	1990-986	BELUPO LIJEKOVI I KOZMETIKA D.O.O.; Danica 5, 48000 Koprivnica HR	36139
06128 PP	1990-492	SANDGATE LTD.; PO.BOX 1179, CEDAR HOUSE, 41 CEDAR AVENUE, HAMILTON HM 12, BM	35599
06103 PP	1996-542	QNX SOFTWARE SYSTEMS GmbH & Co.; Am Listholze 76, D-30177, Hanover, Germany	41475
06136 PP	1969-379	YKK CORPORATION; KANDA IZUMI-CHO, CHIYODA-KU, NO. 1, TOKYO, JP	18640
06109 PP	1990-1738	S.C. JOHNSON & SON, INC.; 1525 HOWE STREET, RACINE, WISCONSIN 53403, US	36756
06132 pp	1989-520	BELUPO - Lijekovi i kozmetika, d.d.; Danica 5, 48000 Koprivnica, HR	34596
06045 PP	1990-488	KIMBERLY-CLARK WORLDWIDE, INC.; NEENAH, WISCONSIN 54956,, US	37862
06049 PP	1989-1391	ŽITO GORENJKA. PROIZVODNJA PEKARSKIH IN KONDITORSKIH IZDELKOV, D.D.; LESCE, ROŽNA DOLINA 8, SI	34821
06114 PP	1970-265	Candy Hoover Group S.r.l. Via Comolli 16; 20047 Brugherio, Monza e Brianza, Italy	19489
05871 PP	1990-862	ADVANCE MAGAZINE PUBLISHERS, INC.; FOUR TIMES SQUARE, NEW YORK 10036, US	35884
06110 PP	1990-598	SONY CORPRATION ; 1-7-1 Konan, Minato-ku, Tokio, JP	37864
06104 PP	1996-541	QNX SOFTWARE SYSTEMS GmbH & Co.; Am Listholze 76, D-30177, Hanover, Germany	41474
06115 PP	1950-125	Candy Elettrodomestici S.r.l. Via Comolli ; 20047 Brugherio, Monza e Brianzy, Italy	12156
05862 PP	1990-660	KARELIA TOBACCO COMPANY, INC.; PO BOX 22, ATHINON AVENUE, GR-24100 KALAMATA, GR	35808
06130 PP	1953-68	KOLINSKA, prehrambena industrija, d.d. and DROGA KOLINSKA, Živilska industrija d.d.; Kolinska ul. Br. 1, 1544 Ljubljana, SI and Kolinska br.1, 1544 LJubljana, SI	12661
06133 PP	1996-543	QNX SOFTWARE SYSTEMS; Am Listholze 76, D-30177, Hanover, Germany	41476
06137 PP	1990-38	Asahi Kasei Kabushiki Kaisha; 2-6, Dojima-hama 1-chome, Kita-ku, Osaka, JP	34993
05873 PP	1990-858	ADVANCE MAGAZINE PUBLISHERS, INC.; FOUR TIMES SQUARE, NEW YORK 10036, US	35622
05865 PP	1990-670	BAYER AG; 5090 LEVERKUSEN, BAYERWERK, DE	35590

06119 PP	1990-504	ATLANTIC RICHFIELD COMPANY; 515 FLOWER STREET, LOS ANGELES, CALIFORNIA 90071, US	35859
06135 PP	1976-181	FLEXSYS AMERICA, L.P.; 260 SPRINGSIDE DRIVE, AKRON, OHIO, US	24896
05864 PP	1990-664	KARELIA TOBACCO COMPANY, INC.; PO BOX 22, ATHINON AVENUE, GR-24100 KALAMATA, GR	35493
05525 PP	1978-164	MERIMA, HEMIJSKA INDUSTRIJA; KRUŠEVAC, ŽELEZNIČKA 24, YU	26376
06111 PP	1990-616	WM. WRIGLEY JR. COMPANY; WRIGLEY BUILDING, 410 N. MICHIGAN AVENUE, CHICAGO, ILLINOIS 60611, US	35658
06112 PP	1990-624	UNITED PARCEL SERVICE OF AMERICA, INC.; GREENWICH OFFICE PARK 5, GREENWICH, CONNECTICUT 06831, US	35565
06048 PP	1990-833	TIME INC.; 1271 AVENUE OF THE AMERICAS, NEW YORK, N.Y. 10020, US	36442
06124 PP	1968-719	FANUC LTD.; 3580 SHIBOKUSA AZA-KOMANBA, OSHINO-MURA, MINAMITSURU-GUN, YAMANASHI, JP	18625
05872 PP	1990-861	ADVANCE MAGAZINE PUBLISHERS, INC.; FOUR TIMES SQUARE, NEW YORK 10036, US	35883
05869 PP	1990-987	“BELUPO”, LIJEKOVI I KOZMETIKA, D.D.; Danica 5,4800 koprivnica,Hrvatska ,HR	35903
03414 PP	1968-893	E. I. du Pont de Nemours and Company; 1007 Market Street, Wilmington, DE 19898, US	18603
03415 PP	1989-743	DuPONT TEIJIN FILMS U.S., LIMITED PARTNERSHIP; RT. 141 AND LANCASTER PIKE, BARLEY MILL PLAZA, BUILDING 27, WILMINGTON, DELAWARE 19805,, US	34687
05903 PP	1989-612	SCHERING CORPORATION; GALLOPING HILL ROAD, KENILWORTH, NEW JERSEY 07033, US	34463
03451 PP	2001-101	Berlin-Chemie AG; Glienicke Weg 125, D-12489 Berlin, Deutschland, DE	46370
03450 PP	2001-104	BERLIN CHEMIE AG; Glienicke Weg 125/127, D-12489 Berlin, DE	46573
06212 PP	1990-1956	GEOFFREY, LLC; ONE GEOFFREY WAY,WAYNE,NEW JERSEY 07470,US	37405
06211 pp	1997-1114	BRISTOL-MYERS SQUIBB SARL,A FRENCH COMPANY; 3,RUE JOSEPH MONIER,92500 RUEIL MALMAISON, FR	43636
03876 PP	2001-962	MEDELA, AD Konditorska industrija,; Kulski put bb, VRBAS, YU	44414
03878 PP	2003-607	AD”MEDELA” KONDITORSKA INDUSTRIJA; Kulski put bb, Vrbas, YU	46071
03877 PP	2003-1309	AD”Medela” Konditorska industrija; Kulski put bb, Vrbas, YU	46597
03875 PP	2001-1033	MEDELA, AD, konditorska industrija; Kulski put bb, VRBAS, YU	43914
05210 PP	1977-149	LEK farmaceutska družba d.d.; 1526 Ljubljana, Verovškova 57,Slovenija	22269
05989 PP	1990-596	CNA HOLDINGS, INC.; 1601 West LBJ Freeway Dallas,Texas 75234,USA	35423
06126 PP	1967-316	DANFOSS A/S; DK-6430 NORDBORG, DK	18234
05991 PP	2005-702	FARMACEUTSKO-HEMIJSKA INDUSTRIJA “ZDRAVLJE”, Akcionarsko društvo; 16000 Leskovac, Vljakova 199, YU	48841
05992 pp	2007-702	Farmaceutsko hemijska industrija “ZDRAVLJE”, akcionarsko društvo; 16000 Leskovac, Vljakova 199, RS	52637
05990 pp	1982-165	Farmaceutsko-hemijska industrija “ZDRAVLJE”, akcionarsko društvo; Vljakova 199, 16000 Leskovac, YU	26292
04941 pp	1997-1166	Mitsumi Electric Co., Ltd. (Japanese Corporation); 2-11-2, Tsurumaki, Tama-Shi, Tokyo, JP	42884
06127 PP	1967-315	DANFOSS A/S; DK-6430 NORDBORG, DK	18176
04943 pp	1988-188	WBR/SIRE VENTURES INC.; 3300 Warner Boulevard Burbank California,SAD	33207
03372 PP	1991-623	BEST WESTERN INTERNATIONAL, INC. društvo organizovano po zakonima države Arizona; 6201 North 24th Parkway, Phoenix, Arizona 85016, SAD, US	37649
03244 PP	2004-1576	BELMONT BRANDS LIMITED; DSQUARED2 TM S.A. 18,rue de l Eau L-1449 Luxembourg	50380
03248 PP	1950-198	L’ OREAL S.A.; 14 RUE ROYALE, F-75008 PARIS, FR	12246
03373 pp	1990-2189	MARS U.K. LIMITED and MEI, Inc.; 3D DUNDEE ROAD, SLOUGH, BERKSHIRE SL1 4LG, ENGLESKA, GB and 1301 Wilson Drive, West Chester, Pennsylvania 19380, US	37056
03374 pp	2000-974	HYOSUNG CORPORATION; 450 Kongduk-dong, Mapo-gu, Seoul, KR	46173

03245 PP	2000-950	GE HEALTHCARE LIMITED; Amersham Place, Little Chalfont, Buckinghamshire, HP7 9NA England, GB	46426
03247 pp	1990-2123	OTIS ELEVATOR COMPANY; 10 FARM SPRINGS, FARMINGTON, CONNECTICUT 06032, US	37044
03243 PP	1982-662	ExxonMobil Corporation; 5959 Las Colinas Boulevard, Irving, TX 75039-2298, US	30638
03371 PP	1997-1155	PRUDENTIAL IP SERVICES LIMITED; LAURENCE POUNTNEY HILL, LONDON, EC4R 0HH, UK	43014
03249 pp	2000-925	FUJITSU SIEMENS COMPUTERS GmbH; Otto-Hahn-Ring 6, 81739 Munchen, DE	46004
06140 PP	1999-649	ALKALOID AD, FARMACEUTSKO HEMIJSKA KOZMETIČKA INDUSTRIJA; Bul. Aleksandar Makedonski 12, 91000 Skopje, MK	46052
06283 PP	1988-591	ALKALOID AD SKOPJE C.O., FARMACEUTSKO HEMISKA KOZMETIČKA INDUSTRIJA; SKOPJE, BULEVAR ALEKSANDAR MAKEDONSKI 12, MK	33589
06141 PP	1999-854	Preduzeće za eksploataciju mineralne vode i proizvodnju pića “KNJAZ MILOŠ” AD; Arandjelovac, Južna industrijska zona bb, RS	45106
06284 PP	1979-413	ALKALOID AD SKOPJE C.O., FARMACEUTSKO HEMISKA KOZMETIČKA INDUSTRIJA; SKOPJE, BULEVAR ALEKSANDAR MAKEDONSKI 12, MK	23968
02480 PP	1977-1224	Glaxo Group Limited, a British company; Glaxo Wellcome House, Berkeley Avenue, Greenford, Middlesex UB6 0NN, GB	26018
03149 PP	1990-1592	BELUPO LIJEKOVI I KOZMETIKA D.D.; Danica 5,4800 Koprivnica, Hrvatska, HR	36024
03958 PP	1966-170	THE COCA-COLA COMPANY; ONE COCA-COLA PLAZA, ATLANTA, GEORGIA 30313, US	17053
03957 PP	1985-948	THE COCA-COLA COMPANY; ONE COCA-COLA PLAZA, ATLANTA, GEORGIA 30313, US	30731
03953 PP	2004-521	The Coca-Cola Company; One Coca-Cola Plaza, Atlanta, Georgia 30313, US	49944
03956 PP	2003-52	THE COCA-COLA COMPANY; One Coca-Cola Plaza, Atlanta, Georgia 30313, US	48549
03952 PP	2005-1417	THE COCA-COLA COMPANY; One Coca-Cola Plaza, Atlanta, Georgia 30313, US	51689
03951 PP	1948-108	THE COCA-COLA COMPANY; ONE COCA-COLA PLAZA, ATLANTA, GEORGIA 30313, US	11733
03955 PP	2003-200	THE COCA-COLA COMPANY,; ONE COCA COLA PLAZA, ATLANTA, GA 30313, US	48723
03954 PP	2004-519	The Coca-Cola Company; One Coca-Cola Plaza, Atlanta, Georgia 30313, US	49942
03304 PP	1961-358	United Phosphorus Limited; Uniphos House, Madhu Park, 11th Road, Khar (W), Mumbai 400052, Indija	15451
03311 PP	2000-1280	MAKHTESHIM CHEMICAL WORKS LTD.; P.O.Box 60, Beer Sheva, Izrael, IL	46526
03316 PP	2001-275	SHELL BRANDS INTERNATIONAL AG; Baarermatte, 6340 Baar Switzerland, CH	46443
03298 PP	1961-19	SHELL BRANDS INTERNATIONAL AG; Baarermatte, 6340 Baar Switzerland, CH	15061
03317 PP	2001-340	SHELL BRANDS INTERNATIONAL AG; Baarermatte, 6340 Baar, Switzerland, CH	46520
03321 PP	2000-1233	CARGLASS LUXEMBOURG S.a.r.l. - Zug Branch; Gotthardstr. 20 CH - 6304 Zug, CH	47376
03326 pp	1990-2185	ALTICOR INC.; 7575 FULTON STREET EAST, ADA, MICHIGAN 49355, US	36583
03301 pp	2001-295	DIAGEO NORTH AMERICA, INC.; 801 Main Avenue, Norwalk CT 06851-1127, US	46497
03313 PP	1969-194	SHELL BRANDS INTERNATIONAL AG; Baarermatte, 6340 Baar Switzerland, CH	18752
03322 PP	2000-1226	CARGLASS LUXEMBOURG S.a.r.l. - Zug Branch; Gotthardstr. 20 CH - 6304 Zug, CH	47377
03323 PP	2000-1224	CARGLASS LUXEMBOURG S.a.r.l. - Zug Branch; Gotthardstr. 20 CH-6304 Zug, CH	46329

03300 pp	2001-414	DIAGEO NORTH AMERICA, INC. ; 801 Main Avenue, Norwalk CT 06851-1127, US	46786
03320 PP	2000-1223	CARGLASS LUXEMBOURG S.a.r.l. - Zug Branch ; Gotthardstr. 20 CH-6304 Zug, CH	46330
03299 PP	1961-17	SHELL BRANDS INTERNATIONAL AG ; Baarermaße, 6340 Baar Switzerland, CH	15060
03328 PP	1990-2186	ALTICOR INC. ; 7575 FULTON STREET EAST, ADA, MICHIGAN 49355, US	36584
03325 pp	1990-2246	ALTICOR INC. ; 7575 FULTON STREET EAST, ADA, MICHIGAN 49355, US	37769
03310 PP	1990-2299	PLYMOVENT AKTIEBOLAG ; SAGVAGEN 19, S-921 00 LYCKSELE, SE	37070
03314 PP	1969-193	SHELL BRANDS INTERNATIONAL AG ; Baarermaße, 6340 Baar Switzerland, CH	18751
03315 PP	1969-197	SHELL BRANDS INTERNATIONAL AG ; Baarermaße, 6340 Baar, Switzerland, CH	18753
03327 pp	1990-2183	ALTICOR INC. ; 7575 FULTON STREET EAST, ADA, MICHIGAN 49355, US	36794
03312 PP	1969-190	SHELL BRANDS INTERNATIONAL AG ; Baarermaße, 6340 Baar Switzerland, CH	18771
03335 pp	1973-713	Motorola Trademark Holdings, LLC ; 600 North US Highway 45 Libertyville, IL 60048, USA	24877
03324 PP	2000-1225	CARGLASS LUXEMBOURG S.a.r.l. - Zug Branch ; GOTTHARDSTR. 20, P.O. BOX 4123 CH - 6304 ZUG, CH	46348
03902 PP	1961-139	THE COCA-COLA COMPANY ; ONE COCA-COLA PLAZA, ATLANTA, GEORGIA 30313, US	15274
03716 PP	1991-2320	MERCK & CO., INC. ; ONE MERCK DRIVE, P.O. Box 100, Whitehouse Station, NJ 08889-0100, US	38755
03901 PP	1951-77	ATLANTIC INDUSTRIES and ATLANTIC INDUSTRIES ; P.O.Box 309 GT, Grand Cayman, Cayman Islands, KY and P.O.BOX 309 GT, UGLAND HOUSE, SOUTH CHURCH STREET, GEORGE TOWN, GRAND CAYMAN, CAYMAN ISLANDS (KAJMANSKA OSTRVA), KY	12328
03136 pp	2000-865	OHAUS CORPORATION ; 19A CHAPIN ROAD, P.O.BOX 2033, PINE BROOK, NEW JERSEY 07058-2033, US	46235
03134 PP	2006-46	Great Wall Motor Company Limited ; 2266 Chaoyang South Street, Baoding, Hebei 071000 China	52228
03900 pp	1992-386	ATLANTIC INDUSTRIES and ATLANTIC INDUSTRIES ; P.O.Box 309 GT, Grand Cayman, Cayman Islands, KY and P.O.BOX 309 GT, SOUTH CHURCH STREET, GRAND CAYMAN, GEORGE TOWN, KAYMAN ISLANDS (KAJMANSKA OSTRVA), KY	39057
03116 PP	1982-708	JANSSEN PHARMACEUTICA N.V. ; TURNHOUTSEWEG 30, B-2340 BEERSE, BE	26877
03118 PP	2003-1373	JOHNSON & JOHNSON (New Jersey corporation) ; One Johnson & Johnson Plaza New Brunswick, New Jersey, US	50506
03126 pp	2002-1330	Alza Corporation ; 1900 Charleston Road Mountain View, California, US	48445
03138 PP	1991-333	CASIO KEISANKI KABUSHIKI KAISHA (CASIO COMPUTER CO., LTD.) ; 6-2, HON-MACHI 1-CHOME, SHIBUYA TOKYO, JP	37581
03121 pp	1990-1697	SAN MIGUEL FABRICAS DE CERVEZA Y MALTA S.A. ; PO IMPERIAL, 32, E - 28005, MADRID, ES	36073
03127 pp	1992-361	ALZA CORPORATION (a Delaware corporation) ; 1900 Charleston Road, Mountain View, California, (US)	39048
03139 pp	1991-341	CASIO KEISANKI KABUSHIKI KAISHA (CASIO COMPUTER CO., LTD.) ; 6-2, HON-MACHI 1-CHOME, SHIBUYA TOKYO, JP	37587
03119 PP	1996-855	JOHNSON & JOHNSON ; ONE JOHNSON & JOHNSON PLAZA, NEW BRUNSWICK, NEW JERSEY 08933-7001, US	42317
03120 PP	2005-129	JOHNSON & JOHNSON (New Jersey corporation) ; One Johnson & Johnson Plaza, New Brunswick, New Jersey, US	53406
03115 PP	1977-631	JANSSEN PHARMACEUTICA N.V. ; TURNHOUTSEWEG 30, B-2340 BEERSE, BE	22805
03117 PP	2006-709	Johnson & Johnson (New Jersey corporation) ; One Johnson & Johnson Plaza, New Brunswick, New Jersey, US	53594

03140 pp	1991-337	CASIO KEISANKI KABUSHIKI KAISHA (CASIO COMPUTER CO., LTD.); 6-2, HON-MACHI 1-CHOME, SHIBUYA TOKYO, JP	37584
03114 pp	1978-246	JANSSEN PHARMACEUTICA N.V.; TURNHOUTSEWEG 30, B-2340 BEERSE, BE	23009
03128 pp	2002-853	Cilag GmbH International; Landis + Gyr-Strasse 1, CH 6300 Zug, CH	45041
03194 pp	2001-241	Y K K CORPORATION A JAPANESE CORPORATION,; 1, Kanda Izumi-cho, Chiyoda-ku, TOKYO,, JP	46686
03182 pp	1950-191	BIC U.K. LIMITED; SWAN HOUSE, WHITNY AVENUE, PARK ROYAL, LONDON N.W. 10, ENGLESKA, GB	12258
03172 PP	2001-246	PIVOVARNA UNION d.d.; Pivovarniška uluca 2, 1000 LJUBLJANA, SL	47468
03175 PP	2001-138	ROYAL BANK OF CANADA; 1, Place Ville Marie, Montreal, Quebec, Canada, H3C 3A9, CA	46479
03169 pp	1977-78	YAMAHA CORPORATION; 10-1, NAKAZAWA-CHO, HAMAMATSU-SHI, SHIZUOKA-KEN, JP	25236
03191 pp	2000-1287	SYSTEMAIR AB; Industrivagen 3,739 30 Skinnskatteberg,SE	46529
03297 PP	2004-1074	“Bosnalijek” farmaceutska i hemijska industrija, dioničko društvo; Jukićeva 55, 71000 Sarajevo, BA	47595
03170 PP	2001-249	PIVOVARNA UNION d.d.; Pivovarniška ulica 2, 1000 LJUBLJANA, SLOVENIJA, SL	47467
03177 pp	2001-472	FURUKAWA DENKI KOGYO KABUSHIKI KAISHA, The Furukawa Electric Co., Ltd (Japanese joint-stock company); 6-1, Marunouchi 2-chome, JP	46843
03195 PP	2001-267	SAPONIA-KEMIJSKA, PREHRAMBENA I FARMACEUTSKA INDUSTRIJA D.D. OSIJEK,; Matije Gupca 2, OSIJEK, HRVATSKA, HR	48113
03180 pp	1991-1212	COMERCIALIZADORA ELORO,S.A.; RESIDING AT KM.12.5, ANTIGUA CARRETERA MEXICO-PACHUCA,COL.INDUSTRIAL RUSTICA XALOSTOC,ESCATEPEC,ESTADO DE MEXICO,C.P.55340	38162
03173 PP	1991-1210	COMERCIALIZADORA ELORO,S.A.; RESIDING AT KM.12.5, ANTIGUA CARRETERA MEXICO-PACHUCA,COL.INDUSTRIAL RUSTICA XALOSTOC,ESCATEPEC,ESTADO DE MEXICO,C.P.55340	38160
03184 PP	1991-27	E.I. DU PONT DE NEMOURS & COMPANY; 1007 Market Street, Wilmington, Delaware 19898, US	37445
03174 pp	1991-1211	COMERCIALIZADORA ELORO,S.A.; RESIDING AT KM.12.5, ANTIGUA CARRETERA MEXICO-PACHUCA,COL.INDUSTRIAL RUSTICA XALOSTOC,ESCATEPEC,ESTADO DE MEXICO,C.P.55340	38161
03183 pp	1990-1016	ATLANTIC RECORDING CORPORATION; 75 ROCKEFELLER PLAZA, NEW YORK, NEW YORK 10019, US	36483
03185 PP	1991-294	E.I. DU PONT DE NEMOURS AND COMPANY; 1007 Market Street, Wilmington, Delaware 19898, US	38119
03199 PP	2002-885	“Bosnalijek”d.d. Farmaceutska i hemijska industrija,; Jukićeva 55, Sarajevo, BA	44954
03188 pp	2001-97	UNILEVER N.V.; Weena 455, 3013 AL Rotterdam, NL	46435
03179 pp	2001-327	NGK SPARK PLUG CO., LTD; 14-18 Takatsuji-cho, Mizuho-ku, Nagoya City, JAPAN, JP	46505
03168 PP	2001-253	PIVOVARNA UNION D.D.; Pivovarniška ulica 2, 1000 LJUBLJANA, SI	47055
03187 pp	2001-96	UNILEVER N.V.; Weena 455, 3013 AL Rotterdam, NL	46436
03181 pp	1991-1209	COMERCIALIZADORA ELORO,S.A.; RESIDING AT KM.12.5, ANTIGUA CARRETERA MEXICO-PACHUCA,COL.INDUSTRIAL RUSTICA XALOSTOC,ESCATEPEC,ESTADO DE MEXICO,C.P.55340	38159
06077 PP	1991-1398	CHEVRON GLOBAL ENERGY, INC.(Delaware Corporation); 6001 BOLLINGER CANYON ROAD SAN RAMON, CALIFORNIA 94583, US	38283
03689 PP	2001-963	RECKITT & COLMAN (OVERSEAS) LIMITED; Dansom Lane, Hull , HU8 7DS, England, GB	46929
06519 PP	1972-7	PROCTER & GAMBLE BUSINES CANADA COMPANY; Suite 800,1959 Upper Water Street,P.O.Box 997,Halifax,Nova Scotia B3J 2x2,CA	20900
05045 pp	1999-694	BELUPO - Lijekovi i kozmetika, d.d.; D.D. Danica 5,Koprivnica,Hrvatska	45214
03692 PP	1983-310	NIPPON SODA CO., LTD.; NO. 2-1, OHTEMACHI 2-CHOME, CHIYODA-KU, TOKYO, JP	29383

03694 PP	1991-509	BASKIN-ROBBINS INTERNATIONAL COMPANY; BASKIN-ROBBINS INTERNATIONAL LLC and BR IP Holder LLC, A Delaware limited liability company; 31 BASKIN-ROBBINS PLACE, GLENDALE, CALIFORNIA 91201, US; 130 Royall Street, Canton, Massachusetts 02021, US and 130 Royall Street, Canton, Massachusetts 02021, US	37619
03691 pp	2002-817	CANON KABUSHIKI KAISHA,; 30-2, Shimomaruko 3-chome, Ohta-ku, Tokyo, Japan, JP	48138
06078 pp	2000-1212	SUN MICROSYSTEMS, Inc. (Delaware corporation); 4150 Network Circle Santa Clara, California 95054 (US)	46865
05044 PP	1989-821	“BELUPO Ljekovi i kozmetika”; D.D. Danica 5, Koprivnica, Hrvatska	35029
03695 PP	1991-510	BASKIN-ROBBINS INTERNATIONAL COMPANY; BASKIN-ROBBINS INTERNATIONAL LLC and BR IP Holder LLC, A Delaware limited liability company; 31 BASKIN-ROBBINS PLACE, GLENDALE, CALIFORNIA 91201, US; 130 Royall Street, Canton, Massachusetts 02021, US and 130 Royall Street, Canton, Massachusetts 02021, US	37620
05043 pp	1989-791	“BELUPO Ljekovi i kozmetika”; D.D. Danica 5, Koprivnica, Hrvatska	35027
03416 PP	1984-762	THE PROCTER & GAMBLE COMPANY (OHIO CORPORATION); ONE PROCTER & GAMBLE PLAZA CINCINNATI, OHIO, US	29768
03696 PP	1991-508	BASKIN-ROBBINS INTERNATIONAL COMPANY; BASKIN-ROBBINS INTERNATIONAL LLC and BR IP Holder LLC, A Delaware limited liability company; 31 BASKIN-ROBBINS PLACE, GLENDALE, CALIFORNIA 91201, US; 130 Royall Street, Canton, Massachusetts 02021, US and 130 Royall Street, Canton, Massachusetts 02021, US	37664
03690 PP	1977-189	Reckitt Benckiser Healthcare (UK) Limited; Dansom Lane, Hull, HU8 7DS England, GB	25308
03688 PP	2005-330	HYATT INTERNATIONAL CORPORATION; 71 S. Wacker Drive, Chicago, Illinois 60606, US	51226
06214 pp	1990-1115	LIN PAC GROUP LIMITED; CHARLES STREET, LOUTH, LINCOLNSHIRE LN11 0LA, GB	36309
05908 PP	1990-1289	BLACKSTONE TM LLC; 345 PARK AVENUE, NEW YORK, N.Y. 10154, US	36504
06215 pp	1990-1116	LIN PAC GROUP LIMITED; CHARLES STREET, LOUTH, LINKOLNSHIRE LN11 0LA, GB	36310
06213 pp	2000-761	LAZARD STRATEGIC COORDINATION COMPANY LLC; 30 Rockefeller Plaza, New York, NY 10020, US	46139
05900 PP	2000-910	ATCO LTD.; 1500, 909-11th Avenue S.W., Calgary, Alberta T2R 1N6, Canada, CA	46010
05905 pp	2000-915	BLACKSTONE TM LLC; 345 Park Avenue, New York, New York 10154, US	46001
03390 pp	1990-2272	Macy’s West Stories, Inc., Ohio corporation; 50 O’Farrell Street, San Francisco, California 94102, US	36592
03388 pp	1975-28	ROWENTA-WERKE, GMBH; POSTFACH 24/25, 6050 OFFENBACH/MAIN, DE	24980
03385 pp	1975-855	AEROVIAS NACIONALES DE COLOMBIA S.A. AVIANCA; CARRERA 45 NO. 34-01 BARRANQUILLA, CO	25034
06491 PP	2006-1531	Grenki List Licenciranje, d.o.o.; Brodarjev trg 013, 1000 Ljubljana, SI	53772
06490 PP	2006-1530	Grenki List Licenciranje, d.o.o.; Brodarjev trg 013, 1000 Ljubljana, SI	53144
06271 pp	1976-899	THE PROCTER & GAMBLE COMPANY (OHIO CORPORATION); ONE PROCTER & GAMBLE PLAZA, CINCINNATI, OHIO, US	24607
03211 pp	1990-2173	Mitsubishi Jidosha Kogyo Kabushiki Kaisha; 33-8, Shiba 5-Chome, Minato-ku, Tokyo, JP	37629
03214 pp	1990-2172	Mitsubishi Jidosha Kogyo Kabushiki Kaisha; 33-8, Shiba 5-Chome, Minato-ku, Tokyo, JP	37286
06269 pp	1976-901	THE PROCTER & GAMBLE COMPANY (OHIO CORPORATION); ONE PROCTER & GAMBLE PLAZA, CINCINNATI, OHIO, US	24609
06268 pp	1969-136	TAKEDA PHARMACEUTICAL COMPANY LIMITED; 1-1, DOSHOMACHI 4-CHOME CHUO-KU, OSAKA, JP	18590
06270 pp	1976-900	THE PROCTER & GAMBLE COMPANY (OHIO CORPORATION); ONE PROCTER & GAMBLE PLAZA, CINCINNATI, OHIO, US	24608
06265 pp	1968-443	FUJITSU LIMITED; 1-1, KAMIKODANAKA 4-CHOME, NAKAHARA-KU, KAWASAKI-SHI, KANAGAWA-KEN, JP	18656

06264 pp	2000-1006	RECKITT & COLMAN (OVERSEAS) LIMITED; DANSOM LANE HULL, HU8 7DS, GB	47218
06272 pp	1976-902	THE PROCTER & GAMBLE COMPANY (OHIO CORPORATION); ONE PROCTER & GAMBLE PLAZA CINCINNATI, OHIO, US	24610
03215 pp	1990-2168	Mitsubishi Jidosha Kogyo Kabushiki Kaisha; 33-8, Shiba 5-Chome, Minato-ku, Tokyo, JP	37052
03212 pp	1990-2169	MITSUBISHI JIDOSHA KOGYO KABUSHIKI KAISHA; 33-8, Shiba 5-Chome, Minato-ku, Tokyo, JP	37053
03210 pp	2000-1023	HONDA GIKEN KOGYO KABUSHIKI KAISHA (HONDA MOTOR CO., LTD.); No. 1-1, 2-chome, Minami-aoyama, Minato-ku, Tokyo, JP	46211
06070 pp	2000-557	Farmaceutsko-hemijska industrija “Zdravlje” akcionarsko društvo; Vlajkova 199, Leskovac, RS	43405
06071 pp	2000-555	FARMACEUTSKO-HEMIJSKA INDUSTRIJA “ZDRAVLJE”, AKCIONARSKO DRUŠTVO; Vlajkova 199, Leskovac, YU	43460
03213 pp	1990-2170	Mitsubishi Jidosha Kogyo Kabushiki Kaisha; 33-8, Shiba 5-Chome, Minato-ku, Tokyo, JP	37054
06075 pp	1990-868	THE CLOROX COMPANY; 1221 BROADWAY, OAKLAND, CA 94612, US	35625
06072 pp	2000-552	FARMACEUTSKO-HEMIJSKA INDUSTRIJA “ZDRAVLJE” AKCIONARSKO DRUŠTVO; Leskovac, Vlajkova 199, YU	43402
06266 pp	2000-1005	RECKITT & COLMAN (OVERSEAS) LIMITED; DANSOM LANE HULL, HU8 7DS, VELIKA BRITANIJA, GB	46195



DIZAJN

DESIGNS

Službeni glasnik Zavoda za intelektualnu svojinu Crne Gore
Official Gazette of the Montenegrin Intellectual Property Office

10/2012



Zavod za intelektualnu svojinu Crne Gore
ul. Rimski trg br. 46,
81000 Podgorica,
Crna Gora

**MEĐUNARODNI KODOVI ZA IDENTIFIKACIJU BIBLIOGRAFSKIH
PODATAKA O DIZAJNU PREMA WIPO CT.80**
RECOMMENDATION CONCERNING BIBLIOGRAPHIC DATA RELATING TO
INDUSTRIAL DESIGNS WIPO CT.80

CRNOGORSKI	MDK	ENGLESKI
Registarski broj	11	Number of registration
Datum registracije	15	Date of the registration
Očekivani datum isteka registracije	18	Expected expiration date of the registration
Broj prijave	21	Number of the application
Datum podnošenja prijave	22	Date of filing of the application
Podaci o izložbenom pravu prvenstva	23	Exhibition priority data
Broj prijavljenih dizajna	28	Number of industrial designs included in the application
Podaci o pravu prvenstva na osnovu Pariske konvencije	30	Data relating to priority under the Paris Convention
Klasa i podklasa Lokarnske klasifikacije	51	Class and subclass of the Locarno Classification
Naziv dizajna	54	Title of the industrial design
Prikaz	55	Reproduction of the industrial design (e.g., drawing, photograph) and explanations relating to the reproduction
Ime autora dizajna	72	Name of the creator
Ime i adresa nosioca prava	73	Name and address of the owner
Ime i adresa punomoćnika	74	Name and address of the representative

- (11) **00066**
 (21) **D-2009/18**
 (22) 04.09. 2009.
 (28) 3
 (30) 04.03.2009. 1099550 EU

- (51) **14-04**
 (15) **25.09.2012.**
 (18) **04.09.2014.**

(54) **GRAFIČKO KORISNIČKI INTERFEJS MOBILNOG TELEFONA I IKONE**

- (72) Dominic Flic, Friedrich-Ebert-Allee 140, 53113 Bonn DE
 Peter Respondek, Friedrich-Ebert-Allee 140, 53113 Bonn DE
 (73) Deutsche Telekom AG, Friedrich-Ebert-Allee 140 53113 Bonn DE
 (74) Popović Miladin, Đoka Miraševića 21/III, Podgorica (ME)



2.1



2.2

(55)



18.1



18.2

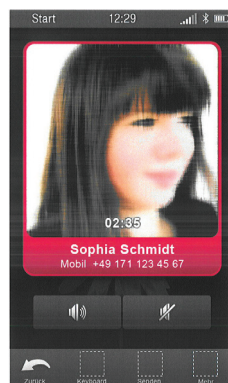

18.3

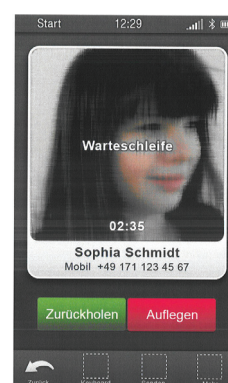

18.4



18.5



18.6



18.7

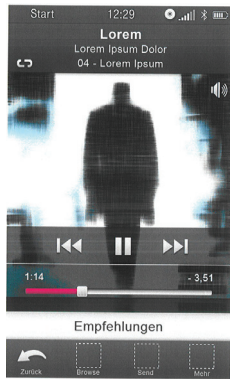

34.1

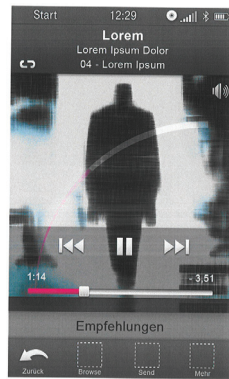

34.2

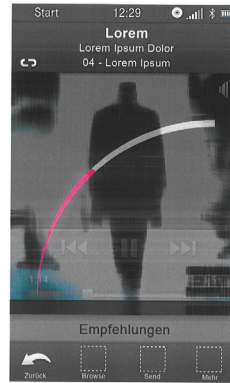

34.3

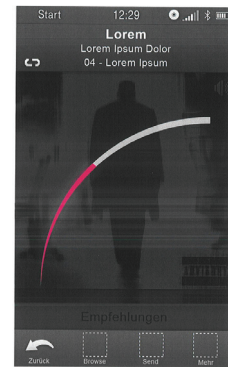

34.4



34.5

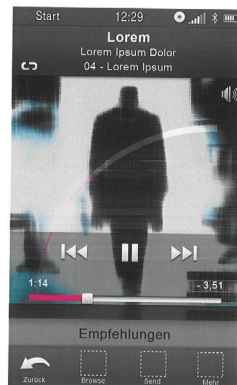

34.6

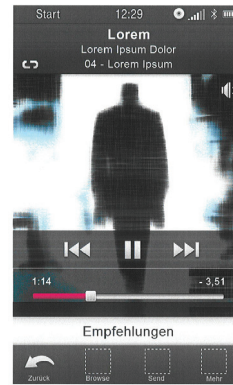

34.7



INFORMATOR

INFORMATION

Službeni glasnik Zavoda za intelektualnu svojinu Crne Gore
Official Gazette of the Montenegrin Intellectual Property Office

10/2012



Zavod za intelektualnu svojinu Crne Gore
ul. Rimski trg br. 46,
81000 Podgorica,
Crna Gora

INTELEKTUALNA SVOJINA

AUTORSKO PRAVO I SRODNA PRAVA

INDUSTRIJSKA SVOJINA

- * Patenti
- * Žigovi
- * Industrijski dizajn
- * Oznake geografskog porijekla roba i usluga
- * Topografija integriranih kola

AUTORSKO PRAVO

(Koje se odnosi na duhovne tvorevine)

- Kao što su naročito:
- * Književna djela
(pisana, govorna, kompjuterski programi)
 - * Muzička djela
 - * Dramska i dramsko-muzička djela
 - * Koreografska i pantomimska djela
 - * Djela likovnih umjetnosti iz područja slikarstva, vajarstva i arhitekture
 - * Djela primjenjenih umjetnosti
 - * Fotografiska djela
 - * Kinematografska djela
 - * Prevodi, obrade i druge prerade djela
 - * Zbirke autorskih djela, podataka ili druge građe

SRODNA PRAVA

- Koja se odnose:
- * Izvođenja umjetnika izvođača
 - * Fonograme
 - * Emitovanja radija I televizije

CIP - Каталогizacija u publikaciji
Централна народна библиотека Црне Горе, Цетиње

347.77/78(497.16)

CRNOGORSKI glasnik intelektualne svojine : Službeni glasnik
Zavoda za Intelektualnu svojinu Crne Gore = Journal of intel-
lectual properti in Montenegro = Official Gazete of the Intellec-
tual Property Office of Montenegro / glavni i odgovorni urednik
Novak Adžić - 2011, br.7 - 322. - Podgorica (Bulevar Revolucije
9) : Zavod za intelektualnu svojinu Crne Gore, 2010. - 30 cm

Tromjesečno.

ISSN 1800-8003 = Crnogorski glasnik intelektualne svojine
(Podgorica)

COBISS.CG-ID 15168784

