

2019-291ISSN 1800-8003

**CRNOGORSKI
GLASNIK
INTELEKTUALNE
SVOJINE**

INTELLECTUAL PROPERTY GAZETTE OF MONTENEGRO

35/2020

Službeni glasnik intelektualne svojine Crne Gore
Official Gazette of the Montenegrin Intellectual Property

MINISTARSTVO EKONOMIJE
Direktorat za unutrašnje tržište i konkurenciju
Direkcija za intelektualnu svojinu
Bulevar Mihaila Lalića br. 1,
Podgorica, Crna Gora

CRNOGORSKI GLASNIK INTELEKTUALNE SVOJINE

Godina XI

Datum objavljivanja 20.07.2020.

Izdavač:

MINISTARSTVO EKONOMIJE

Direktorat za unutrašnje tržište i konkurenciju

Direkcija za intelektualnu svojinu

Bulevar Mihaila Lalića br. 1,

Podgorica, Crna Gora

Za izdavača:

Dragica Sekulić

Glavni i odgovorni urednik:

Biljana Jakić

Urednički odbor:

Anica Zindović

Vesna Nikčević

Lidija Martić

Tehnički urednik:

Vladimir Mugoša

Crnogorski glasnik intelektualne svojine službeno je glasilo za intelektualnu svojinu Crne Gore. U Glasniku se objavljuju sve relevantnim zakonima i pravilnicima propisane informacije iz postupka dodjele prava industrijskog vlasništva, informacije o dodijeljenim pravima te o kasnijim promjenama u vezi s tim pravima, kao i ostale službene informacije.

The Montenegrin intellectual property gazette is the official gazette of the Intellectual Property of the Montenegro. The Gazette publishes all the information, prescribed by the relevant laws and regulations, relating to the industrial property granting procedure concerning granted rights and subsequent changes made in connection with such right, as well as other official information.

SADRŽAJ

DVOSLOVNE OZNAKE ZEMALJA, TERITORIJA I MEĐUNARODNIH ORGANIZACIJA / TWO LETTER CODE COUNTRIES, TERRITORIES AND INTERNATIONAL ORGANIZATIONS

PATENTI / PATENTS

MEĐUNARODNI KODOVI ZA IDENTIFIKACIJU BIBLIOGRAFSKIH PODATAKA O PATENTIMA PREMA WIPO STANDARDU ST. 9 / RECOMMENDATION CONCERNING BIBLIOGRAFIC DATA ON AND RELATING TO PATENTS- WIPO-ST. 9

OBJAVE PRIJAVA PATENATA / PUBLICATION OF PATENT APPLICATIONS

OBJAVA PROŠIRENIH EVROPSKIH PATENATA / PUBLICATION OF EXTENDED EUROPEAN PATENTS

OBJAVE ZAHTJEVA ZA PROŠIRENJE EVROPSKIH PRIJAVA PATENATA / PUBLICATION OF REQUEST FOR THE EXTENSION OF THE EFFECTS OF EUROPEAN PATENT APPLICATIONS

INDEKS BROJEVA ZAHTJEVA ZA PROŠIRENJE EVROPSKIH PRIJAVA PATENTA / INDEX ON NUMBER OF REQUESTS FOR EXTENSION ON EUROPEAN PATENT APPLICATION.

INDEKS KLASIFIKACIJSKIH OZNAKA BROJEVA ZAHTJEVA ZA PROŠIRENJE EVROPSKIH PRIJAVA PATENTA PREMA MKP / INDEX ON CLASSIFICATION MARKS ON REQUESTS FOR EXTENSION OF EUROPEAN PATENT APPLICATION IN ACCORDANCE WITH THE INTERNATIONAL PATENT CLASSIFICATION

INDEKS PODNOSITELJA ZAHTJEVA ZA PROŠIRENJE EVROPSKIH PRIJAVA PATENTA / INDEX ON NUMBER OF APPLICATIONS FOR EXTENSION OF EUROPEAN PATENT APPLICATION

OBJAVA UPISA PROMJENA U REGISTAR PATENATA / PUBLICATION OF RECORD OF CHANGES TO THE PATENT REGISTER

ŽIGOVI / TRADEMARKS

MEĐUNARODNI KODOVI ZA IDENTIFIKACIJU BIBLIOGRAFSKIH PODATAKA O ŽIGOVIMA PREMA WIPO ST 60/ RECOMMENDATION CONCERNING BIBLIOGRAFIC DATA RELATING TO TRADEMARKS- WIPO-ST. 60

OBJAVA PRIJAVA ŽIGOVA / PUBLICATION OF TRADEMARK APPLICATIONS

OBJAVA ŽIGOVA / PUBLICATION OF TRADEMARKS

OBJAVA UPISA PROMJENA U REGISTAR ŽIGOVA / PUBLICATION OF RECORD OF CHANGES TO THE TRADEMARK REGISTER

DIZAJN/DESIGN.....

MEĐUNARODNI KODOVI ZA IDENTIFIKACIJU BIBLIOGRAFSKIH PODATAKA O DIZAJNU PREMA WIPO ST 80/ RECOMMENDATION CONCERNING BIBLIOGRAFIC DATA RELATING TO INDUSTRIAL DESIGN- WIPO-ST. 80

OBJAVA UPISA PROMJENA U REGISTAR INDUSTRIJSKOG DIZAJNA / PUBLICATION OF RECORD OF CHANGES TO THE INDUSTRIAL DESIGN

DVOSLOVNE OZNAKE ZEMALJA, TERITORIJA I MEĐUNARODNIH ORGANIZACIJA (prema WIPO standardu ST. 3)

AD Andora	CG Kongo	Zaliva (GCC)
AE Ujedinjeni Arapski Emirati	CH Švajcarska	GD Grenada
AF Afganistan	CI Obala Bjelokosti	GE Gruzija
AG Antigva i Barbuda	CK Kukova ostrva	GG Guernsey
AI Angvila	CL Čile	GH Gana
AL Albanija	CM Kamerun	GI Gibraltar
AM Armenija	CN Kina	GL Grenland
AN Holandski Antili	CO Kolumbija	GM Gambija
AO Angola	CR Kostarika	GN Gvineja
AP Afrička regionalna organizacija za industrijsko vlasništvo (ARIPO)	CU Kuba	GQ Ekvatorska Gvineja
AR Argentina	CV Kabo Verde	GR Grčka
AT Austrija	CY Kipar	GS Južna Džordžija i Ostrva Južni Sendvič
AU Australija	CZ Češka Republika	GT Gvatemala
AW Aruba	DE Njemačka	GW Gvineja-Bisao
AZ Azerbejdžan	DJ Džibuti	GY Gvajana
BA Bosna i Hercegovina	DK Danska	HK Hongkong – Posebna administrativna regija
BB Barbados	DM Dominika	NR Kine
BD Bangladeš	DO Dominikanska Republika	HN Honduras
BE Belgija	DZ Alžir	HR Hrvatska
BF Burkina Faso	EA Evroazijska patentna organizacija (EAPO)	HT Haiti
BG Bugarska	EC Ekvador	HU Mađarska
BH Bahrein	EE Estonija	IB Međunarodna kancelarija Svjetske organizacije za intelektualno vlasništvo (WIPO)
BI Burundi	EG Egipat	ID Indonezija
BJ Benin	EH Zapadna Sahara	IE Irska
BM Bermudi	EM Kancelarija za harmonizaciju Unutrašnjeg tržišta (žigovi i dizajn) (OHIM)	IL Izrael
BN Brunej Darussalam	EP Evropska patentna kancelarija (EPO)	IM Ostrvo Man
BO Bolivija	ER Eritreja	IN Indija
BR Brazil	ES Španija	IQ Irak
BS Bahami	ET Etiopija	IR Iran (Islamska Republika)
BT Butan	FI Finska	IS Island
BV Ostrvo Buve	FJ Fidži	IT Italija
BW Bocvana	FK Foklandska ostrva (Malvini)	JE Džersi
BX Kancelarija za intelektualno vlasništvo Beneluksa (BOIP)	FO Farska Ostrva	JM Jamajka
BY Bjelorusija	FR Francuska	JO Jordan
BZ Belize	GA Gabon	JP Japan
CA Kanada	GB Velika Britanija	KE Kenija
CD Demokratska Republika Kongo	GC Patentna kancelarija Savjeta za saradnju država Arapskog	KG Kirgistan
CF Centralna Afrička Republika		KH Kambodža
		KI Kiribati
		KM Komori

KN Sveti Kristofor i Nevis
KP Demokratska Narodna
Republika Koreja
KR Republika Koreja
KW Kuvajt
KY Kajmanska Ostrva
KZ Kazahstan
LA Narodna Demokratska
Republika Laos
LB Libanon
LC Sveta Lucija
LI Lihtenštajn
LK Šri Lanka
LR Liberija
LS Lesoto
LT Litva
LU Luksemburg
LV Latvija
LY Libijska Arapska
Džamahirija
MA Maroko
MC Monako
MD Republika Moldavija
ME Crna Gora
MG Madagaskar
MK Sjeverna Makedonija
ML Mali
MM Mianmar
MN Mongolija
MO Makao
MP Sjeverna Marijanska
Ostrva
MR Mauritanija
MS Montserrat
MT Malta
MU Mauricijus
MV Maldivi
MW Malavi
MX Meksiko
MY Malezija
MZ Mozambik
NA Namibija
NE Niger
NG Nigerija
NI Nikaragva
NL Holandija
NO Norveška
NP Nepal
NR Nauru
NZ Novi Zeland
OA Afrička organizacija
za intelektualno
vlasništvo (OAPI)

OM Oman
PA Panama
PE Peru
PG Papuanska Nova
Gvineja
PH Filipini
PK Pakistan
PL Poljska
PT Portugal
PW Palau
PY Paragvaj
QA Katar
QZ Kancelarija Zajednice
za biljne sorte
(Evropska Unija)
(CPVO)
RO Rumunija
RS Srbija
RU Ruska Federacija
RW Ruanda
SA Saudijska Arabija
SB Solomonska Ostrva
SC Sejšeli
SD Sudan
SE Švedska
SG Singapur
SH Sveta Jelena
SI Slovenija
SK Slovačka
SL Sijera Leone
SM San Marino
SN Senegal
SO Somalija
SR Surinam
ST Sveti Toma i Princip
SV Salvador
SY Sirijska Arapska
Republika
SZ Svazi
TC Turska i Kajkoska
Ostrva
TD Čad
TG Togo
TH Tajland
TJ Tadžikistan
TL Istočni Timor
TM Turkmenistan
TN Tunis
TO Tonga
TR Turska
TT Trinidad i Tobago
TV Tuvalu
TW Tajvan, Kineska

Pokrajina
TZ Ujedinjena Republika
Tanzanija
UA Ukrajina
UG Uganda
US Sjedinjene Američke
Države
UY Urugvaj
UZ Uzbekistan
VA Sveta Stolica (Vatikan)
VC Sveti Vincent i
Grenadini
VE Venecuela
VG Britanska Djevičanska
Ostrva
VN Vijetnam
VU Vanuatu
WO Svjetska organizacije
za intelektualno
vlasništvo (WIPO)
(Međunarodna
kancelarija)
WS Samoa
XN Nordijski institut za
patente (NPI)
YE Jemen
ZA Južnoafrička
Republika
ZM Zambija
ZW Zimbabve

PATENTI
PATENTS

MEĐUNARODNI KODOVI ZA IDENTIFIKACIJU BIBLIOGRAFSKIH PODATAKA O PATENTIMA PREMA
WIPO STANDARDU ST. 9 / RECOMMENDATION CONCERNING BIBLIOGRAFIC DATA ON AND
RELATING TO PATENTS- WIPO-ST. 9

CRNOGORSKI	MDK	ENGLESKI
IDENTIFIKATOR DOKUMENTA	10	IDENTIFICATION OF THE PATENT
BROJ DOKUMENTA	11	NUMBER OF THE PATENT
VRSTA DOKUMENTA	13	KIND-OF-DOCUMENT CODE ACCORDING TO WIPO STANDARD
BROJ PRIJAVE	21	NUMBER(S) ASSIGNED TO THE APPLICATION(S)
DATUM PODNOŠENJA PRIJAVE	22	DATE(S) OF FILING THE APPLICATION(S)
DATUM IZLAGANJA NA MEĐUNARODNOJ IZLOŽBI	23	DATE OF EXHIBITING AT THE INTERNATIONAL EXHIBITION
PODACI O PRAVU PRVJENSTVA	30	PRIORITY DATA
DATUM OBJAVLJIVANJA PRIJAVE	43	PUBLICATION DATE OF THE UNEXAMINED APPLICATION
DATUM OBJAVLJIVANJA PATENTA	45	PUBLICATION DATE OF REGISTERED PATENT
MEĐUNARODNA KLASIFIKACIJA PATENATA	51	INTERNATIONAL PATENT CLASSIFICATION CODE
NAZIV PRONALASKA	54	TITLE OF THE INVENTION
APSTRAKT ILI PATENTNI ZAHTJEV	57	ABSTRACT OR CLAIM
BROJ OSNOVNE PRIJAVE (ILI PATENTA) ZA KOJI SE PODNOSI DOPUNSKA PRIJAVA	61	NUMBER OF THE EARLIER APPLICATION (OR PATENT) TO WHICH THE PRESENT DOCUMENT IS AN ADDITION
BROJ PRVOBITNE PRIJAVE IZ KOJE JE PRIJAVA IZDVOJENA	62	NUMBER OF THE EARLIER APPLICATION FROM WHICH THE PRESENT DOCUMENT HAS BEEN DIVIDED UP
IME PODNOSIOCA PRIJAVE	71	NAME OF THE APPLICANT
IME PRONALAZAČA	72	NAME OF THE INVENTOR
IME NOSIOCA PATENTA	73	NAME OF THE OWNER OF PATENT
IME PUNOMOĆNIKA	74	NAME OF THE REPRESENTATIVE
BROJ I DATUM PODNOŠENJA MEĐUNARODNE PRIJAVE	86	NUMBER AND FILING DATE OF THE INTERNATIONAL APPLICATION
BROJ I DATUM MEĐUNARODNE OBJAVE	87	NUMBER AND DATE OF THE PUBLICATION OF THE INTERNATIONAL APPLICATION

OBJAVE PRIJAVA PATENATA
PUBLICATION OF PATENT APPLICATIONS

PATENTI

(11) **03637** (13) **B**

..

(51) **G01D 1/06**^(2006.01)

G01D 5/58^(2006.01)

..

(21) P-2019-198

(22) 05.07.2019

(54) me **KASA ZA ŠTEDNJU KOVANOG NOVCA KOJA SE AUTOMATSKI OTVARA KADA SE DOSTIGNE ZADATI IZNOS**
en **CASH REGISTER FOR SAVING COINS WHICH OPENS AUTOMATICALLY WHEN IT REACHES DETERMINED AMOUNT**

(73) LATINOVIĆ, Damjan
Josipa Broza Tita, Lamela C, Podgorica, 81000/ ME

(72) LATINOVIĆ, Damjan
Josipa Broza Tita, Lamela C, Podgorica, 81000/ ME

(57) Uređaj koji se štiti patentom je kasa koja se automatski otvara kada se dostigne zadati iznos novca. Korisnik može koristiti uređaj na više načina u zavisnosti od potreba. Korisnik može putem smartfona unijeti iznos za štednju i zaključati kasu da ne može da se otvori. Kasa se otvara automatski kada se dostigne zadati iznos za štednju. Korisnik može koristiti kasu kao kutiju za donacije gdje se svaki ubačeni novčić može pratiti putem interneta, video bima ili slično. Na (slici 1) je u perspektivi prikazan izgled uređaja koji se sastoji od procesorske jedinice(1), otvor za ubacivanje novčića(2), poluge (3), mehanizma za razvrstavanje i detektovanja novčića (7), ekrana(4) i elektromotora(5) koji pokreće polugu(6) koja otvara ili zatvara vrata. Kada se novčić ubaci kroz otvor (2), pokreće polugu (3) koja budi procesor iz stanja spavanja. Novčić putem gravitacije klizi niz iskošeni dio i kada propadne kroz odgovarajući otvor presijeca ir zrak što detektuje procesor.

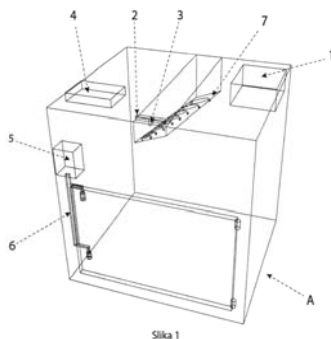

(11) 03644 (13) B

..

(51) G09B 21/04^(2006.01)

..

(21) P-2019-209

(22) 23.07.2019

(54) me **TAKTILNI, TRODIMENZIONALNI, MULTIMEDIJSKI SISTEM ZA PODUČAVANJE SLIJEPIH, SLABOVIDIH I OSOBA SA OŠTEĆENIM VIDOM: DODIRNI, SLUŠAJ, UČI**
en **TACTILE, THREE-DIMENSIONAL, MULTIMEDIA TEACHING SYSTEM FOR THE BLIND, THEVISION - IMPAIRED AND SIGHTED LEARNES: TOUCH, LISTEN, LEARN**

(72) ĐURKOVIĆ, Zoran
Maršala Tita 24/33, Bar, 85000/ ME

(57) Cjllj ovog izuma je da ponudi sjstem za podučavanje sljjepeih, slabovidih i osoba sa ostećenim vidom kroz nezavisno istrazivanje i razumijevanje obijka, strukture, karakteristika i istorjje bilo kog predmeta,putem taktalnog istraživanja i zvučnih informacija.

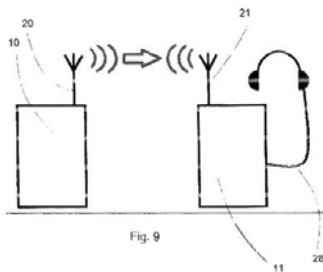

(11) **03645** (13) **B**

..

(51) **F24H 1/00**^(2006.01)

..

(21) P-2019-291

(22) 16.10.2019

(54) me **ELEKTRIČNI BOJLER ZA ZAGRIJAVANJE VODE U DOMAĆINSTVU I ETAŽNOM GRIJANJU**
en **ELECTRIC BOILER FOR WATER HEATING IN THE HOUSEHOLD AND FLOOR HEATING**

(73) BOJOVIĆ, Milan
Njegoševa 4 , Žabljak, 84220 / ME

(72) BOJOVIĆ, Milan
Njegoševa 4 , Žabljak, 84220 / ME
PETROV, Vojislav
Bate Brkića 10A, Novi Sad, 21 000 / RS

ĐURAŠEVIĆ, Željko
Vukice Mitrović bb, Sveti Stefan, 85315/ ME
ČABARKAPA, Obrad
Vojvode Stepe 135/H, Beograd , 11000 / RS

(57) Predmet našeg pronalaska Električni bojler za zagrijavanje tople vode u domaćinstvu etažnom grijanju je novo konstruktivno rešenje koje momentalno može pružiti željenu toplu vodu u roku od nekoliko sekundi. Pronalazak je velike snage i brzine zagrijavanja vode. Uređaj se javlja kao uređaj velike uštede električne energije, vremena i potrošnje vode i trostruke zaštite između vode i struje.

Smatra se intelektualnim uređajem. Ima induktor električne energije, temperature i senzor uključenja i isključenja. Pouzdan u radu, jednostavan za proizvodnju, upotrebu i održavanje.

Konstrukcija se sastoji u tome što se u kućište Fi 100mm, visine 65mm tačka 1 postavi glava motora sa silverredmikalit grijačima tačka 2 induktor električne energije tačka 3 induktor temperature tačka 4 i senzori uključeno isključeno tačka 5 povežu sa tačkom 2 i postave na tačku 1 cijev sa otvorom za vodu tačka 6 poveže sa tačkom 1 vezni nastavak priključka etažnog grijanja tačka 7 priključi na tačku 1 vezni nastavak za tuš tačka 8 poveže na tačku 1 savijena cijev tačka 9, sigurnosni prsten tačka 10 i gumeni prsten tačka 11 priključe na tačku 1 ako se koristi u kuhinji ručica za regulaciju tri zone: hladna voda, zaustavna zona i topla voda tačka 12 poveže na tačku 1 magnetni prsten, filter i fiksirajući prsten tačka 13, 14 i 15 povežu na tačku 1 elektro kabal naizmjenične struje napona 220 volti tačka 16 poveže na tačku 2 preko tačke 1 sve povezano cini funkcionalnu cjeljnu.

(11) (13) B

..

(51) **G21J 5/00**^(2006.01)

..

(21) P-2020-6

(22) 17.01.2020

(54) me **Taktički sistem za otkrivanje nuklearnog i radioaktivnog materijala**
en **Tactical system for detection nuclear and radioactive material**

(73) Dragan, PAVLIĆEVIĆ
Pera Četkovića 49, st.A1, PODGORICA, 81000

(72) PAVLIĆEVIĆ, Dragan
Petra Četkovića 49, st.A1, Podgorica, 81000/ ME

(57) Medijator je uređaj koji povezuje RDI sa mrežom mobilne telefonije i na taj način, prenosi stanje alarma na daljinu. Takođe sa određenom vrstom kamere, koja prima komande putem kodira i ih SMS poruka, omogućava se identifikacija uzročnika alarma. Slika se šalje odgovornjima putem e-maila i MMS poruka. Ovaj sistem stavlja u funkciju nedovoljno korisne detekcije instrumente. Radi u neprekidnom režimu, tako da povećava vjerovatnoću detekcije radioaktivnog materijala i ne zahtijeva angazman ljudi. Kod prekograničnih prelaza, slanjem upozorenja omogućava zajedničku saradnju vjese država. Sa obzirom da radi u prikrivenim režimima, omogućava ne samo sprečavanje, već i nadziranje prometa radioaktivnog materijala, pa na taj način i otkrivanje lanca krijumčara.

**INDEKS PREMA RASTUĆEM BROJU PRIJAVE PATENATA / INDEKS PREMA RASTUĆEM BROJU
PRIJAVE PATENATA / ИНДЕКС ПРЕМА РАСТУЋЕМ БРОЈУ ПРИЈАВЕ ПАТЕНАТА**

REGISTARSKI BROJ PRIJAVE PATENATA

REGISTRACIJSKI BROJ PRIJAVE PATENATA

РЕГИСТАРСКИ БРОЈ ПРИЈАВЕ ПАТЕНАТА

P-2019-198A

P-2019-209A

P-2019-291A

P-2020-6A

**INDEKS PREMA NOSIOCIMA PRIJAVE PATENTA / INDEKS PREMA NOSITELJIMA PRIJAVE
PATENTA / ИНДЕКС ПРЕМА НОСИОЦИМА ПРИЈАВЕ ПАТЕНТА**

BOJOVIĆ, Milan

P-2019-291A

Dragan, PAVLICEVIC

P-2020-6A

LATINOVIĆ, Damjan

P-2019-198A

OBJAVA PROŠIRENIH EVROPSKIH PATENATA
PUBLICATION OF EXTENDED EUROPEAN PATENTS

OBJAVA PROŠIRENIH EUROPSKIH PATENATA PUBLICATION OF EXTENDED EUROPEAN PATENTS

(11) **03638** (13) **B**

..

(51) **A61K 31/485**^(2006.01)

A61P 25/24^(2006.01)

A61P 25/04^(2006.01)

..

(21) P-2018-307

(22) 14.12.2012

(30) 201161576233P 15.12.2011 US

(96) 16201359.3/14.12.2012

(97) EP 3153171/12.04.2017/2017/15
EP 3153171/19.09.2018/19.09.2018

(54) me **SAMIDORFAN (ALKS 33) U KOMBINACIJI SA BUPRENORFINOM ZA LIJEČENJE
DEPRESIVNIH POREMEĆAJA**
en **SAMIDORPHAN (ALKS 33) IN COMBINATION WITH BUPRENORPHINE FOR THE
TREATMENT OF DEPRESSIVE DISORDERS**

(73) Alkermes Pharma Ireland Limited
Connaught House 1, Burlington Road, Dublin 4/ IE

(72) DEEVER, Daniel
4 Maple Brook Lane, Franklin, Massachusetts 02038/ US
EHRICH, Elliott
288 Marlborough St. Unit 2, Boston, Massachusetts 02116/ US

(74) AOD "Tripković & Raičević"
Cetinjski put 40, L 5-1, STAN 10, Podgorica, 81000/ ME

1. Supstanca koja obuhvata 1:1 maseni odnos buprenorfina prema Jedinjenju 1, pri čemu Jedinjenje 1 ima strukturu:

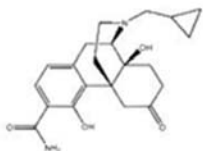

(57) Patent sadrži još 11 patentnih zahtjeva

(11) **03598** (13) **B**

..

(51) **A61M 15/00**^(2006.01)

..

(21) P-2018-341

(22) 10.03.2014

(30) 20130004784 15.03.2013 GB

(96) 14708558.3/10.03.2014

(86) EP PCT/EP2014/054523/10.03.2014

(87) WO 2014/139912/18.09.2014/2014/38

(97) EP 2968728/20.01.2016/2016/03
EP 2968728/03.10.2018/2018/40

(54) me **DISPENZER**
en **DISPENSER**

(73) EURO-CELTIQUE S.A.
1, rue Jean Piret, 2350 Luxembourg / LU

(72) DUIGNAN, Cathal
, Leitrim/ IE
McDERMENT, Iain
7 Moat Lane, Melbourn Royston, Hertfordshire SG8 6EH/ GB
PRIOR, Peter
No.8 Cuilmore Cove Cootehall Boyle Co., Roscommon/ IE

(74) MSA IP-MILOJEVIĆ, SEKULIĆ ADVOKATI
Karađorđeva 65, Beograd , 11000/ RS

(57) 1. Dispenzer za dispenzovanje doza gasovite, prenosive gasom ili u obliku kapljica supstance iz izvora (C) supstance, pri čemu dispenzer sadrži:

telo (1) za prijem izvora supstance, pri čemu telo ima pisak (2);

član za povezivanje (41) koji je klizno razmešten u telu za kretanje u pravcu longitudinalne ose tela da bi otpustio dozu supstance iz izvora supstance, pri čemu član za povezivanje sadrži čašicu (43) za prijempipka (S) iz izvora supstance;

pokretač dispenzera za kretanje člana za povezivanje u pravcu longitudinalne ose tela da bi se otpustila doza supstance iz izvora supstance, pri čemu pokretač dispenzera sadrži šipku (21) za okretanje i breg (23, 231, 232) koji je razmešten na šipci, pri čemu je pokretač dispenzera razmešten unutar tela tako da rotacija šipke za okretanje uzrokuje da se bregrotira i primenjuje silu na člana za povezivanje u pravcu longitudinalne ose;

pratioca (16) brega koji je klizno razmešten unutar tela, pri čemu pratioc brega sadrži osnovu (17) i suštinski rigidno ispučenje (18a, 18b) koje se proteže od osnove, pri čemu je ispučenje razmešteno između pokretača dispenzera i člana za povezivanje tako da sila koja je primenjena od strane brega pokretača dispenzera na ispučenje uzrokuje da se pratioc brega klizno pomera u pravcu longitudinalne ose tela i primenjuje silu na člana za povezivanje tako da se otpusti doza supstance iz izvora supstance;

poklopac (91) dispenzera koji sadrži šuplje telo koje imadonji otvoreni kraj koji može da se angažuje sa telom, i gornji otvoren kraj zaprijem uređaja za zatvaranje poklopca za zatvaranje gornjeg otvorenog kraja, pri čemu gornji otvoreni kraj sadrži deo koji se može angažovati; i

uređaj (120) za zatvaranje poklopca, koji sadrži:

gornji deo (121) za zatvaranje poklopca za angažovanje sagornjim otvorenim krajem dispenzera da bi se zatvorio gornji otvoreni kraj poklopca dispenzera;

niži deo (122) za zatvaranje poklopca za angažovanje sadelom koji se može angažovati da bi se osigurao uređaj za zatvaranje poklopca za poklopac dispenzera;

i bistabilni deo (130, 131, 132, 133) koji povezuje gornji deo za zatvaranje poklopca i donji deo za zatvaranje poklopca, pri čemu se bistabilni deo može prebaciti između prvog stabilnog oblika u kojem je bistabilni deo izdužen, i drugog bistabilnog oblika u kojem je bistabilni deo sklopljen,

gde se, kada je bistabilni deo u drugom stabilnom obliku, gornji deo za zatvaranje poklopca angažuje sa gornjim otvorenim krajem poklopca dispenzera da bi zatvorio poklopac dispenzera.

Patent sadrži još 30 patentnih zahtjeva

(11) **03641** (13) **B**

..

(51) A61K 9/00 ^(2006.01)	A61K 9/28 ^(2006.01)
A61K 31/606 ^(2006.01)	A61K 47/32 ^(2006.01)
A61K 47/36 ^(2006.01)	A61K 9/20 ^(2006.01)
A61K 31/196 ^(2006.01)	A61K 31/616 ^(2006.01)

..

(21) P-2019-111

(22) 29.04.2013

(30) 20120166110 30.04.2012 EP
201261640217P 30.04.2012 US

(96) 17188821.7/29.04.2013

(97) EP 3278792/07.02.2018/2018/06
EP 3278792/20.02.2019/2019/08

(54) me **FORMULACIJA LIJEKA SA ODLOŽENIM OTPUŠTANJEM**
en **A DELAYED RELEASE DRUG FORMULATION**

(73) TILLOTTS PHARMA AG
Baslerstrasse 15, Rheinfelden, 4310/ CH

(72) BRAVO GONZÁLEZ, Roberto Carlos
Im Klosteracker 57, Binningen, CH-4102 / CH
BUSER, Thomas
Gempenstrasse 19, Nuglar, CH-4412/ CH
GOUTTE, Frédéric Jean-Claude
4 rue du Ried, Schwoben, F-68130/ FR
BASIT, Abdul, Waseh
55 Alicia Gardens, Harrow, Middlesex HA3 8JB/ GB
VARUM, Felipe, José, Oliveria
Efringerstrasse 86, Basel, CH-4057/ CH
FREIRE, Ana, Cristina
92 West Cotton Close, Riverside Wharf, Northampton NN4 8BY/ GB

(57) Formulacija leka za odloženo oslobađanje za oralnu primenu da bi se lek isporučio kolonu subjekta, pri čemu navedena formulacija sadrži:

Jezgro i premaz za jezgro, jezgro koje sadrži lek i obloga koja sadrži spoljašnji sloj i najmanje jedan sloj između jezgra i spoljašnjeg sloja izabranog iz grupe koja se sastoji od izolacionog sloja i unutrašnjeg sloja, pomenuti spoljašnji sloj koji sadrži smešu prvog polimernog materijala koji je podložan napadu bakterija kolona i drugog polimernog materijala koji ima prag pH pri pH 6 ili više, pri čemu navedeni unutrašnji sloj sadrži treći polimerni materijal koji je nejonski polimer koji je rastvorljiv u crevnoj tečnosti ili gastrointestinalnoj tečnosti, i najmanje jedan aditivizabran iz pufera i baze,

Pomenuti izolacioni sloj koji sadrži ne-jonski polimer koji je rastvorljiv u crevnoj tečnosti ili gastrointestinalnoj tečnosti, pri čemu se spoljašnji sloj nanosi direktno na unutrašnji sloj ili izolacioni sloj upotrebom preparata za oblaganje formiranog kombinovanjem navedenog prvog polimernog materijala u vodenoj sredini sa navedenim drugim polimernim materijalom u organskoj sredini.

Patent sadrži još 18 patentnih zahtjeva

(11) **03642** (13) **B**

..

(51) **C07K 16/28**^(2006.01)

C07K 16/30^(2006.01)

A61K 39/395^(2006.01)

C07K 16/22^(2006.01)

A61P 35/00^(2006.01)

A61K 39/00^(2006.01)

A61K 45/06^(2006.01)

..

(21) P-2019-112

(22) 23.01.2015

(30) 201461930582P 23.01.2014 US

201462089549P 09.12.2014 US

(96) 15703380.4/23.01.2015

(86) US PCT/US2015/012595/23.01.2015

(87) WO 2015/112805/30.07.2015/2015/30

(97) EP 3097120/30.11.2016/2016/48

EP 3097120/23.01.2019/2019/04

(54) me **HUMANA ANTITIJELA ZA PD-L1**
en **HUMAN ANTIBODIES TO PD-L1**

(73) Regeneron Pharmaceuticals, Inc.

777 Old Saw Mill River Road, Tarrytown, NY 10591-6707/ US

(72) PAPADOPOULOS, Nicholas, J.

777 Old Saw Mill River Road, Tarrytown, NY 10591 / US

MURPHY, Andrew, J.

777 Old Saw Mill River Road, Tarrytown, NY 10591 / US

THURSTON, Gavin

777 Old Saw Mill River Road, Tarrytown, NY 10591 / US

IOFFE, Ella

777 Old Saw Mill River Road, Tarrytown, NY 10591 / US

BUROVA, Elena

777 Old Saw Mill River Road, Tarrytown, NY 10591 / US

(57) Izolovano antitijelo ili njegov fragment koji vezuje antjgen koji se vezuju za humani protein ligand programirane smrti 1 (PD-L1), pri čemu se izolovano antitijelo ili njegov fragment koji vezuje antigen sadrži tri regiona koji određuju komplementarnost (CDR-a) varijabilnog regiona teškog lanca (HCVR) koji imaju aminokisjelinsku sekvencu SEQ 10 NO: 82, i tri CDR-a varijabilnog regiona lakog lanca (LCVR) koji imaju aminokisjelinsku sekvencu SEQ 10 NO: 90.

Patent sadrži još 17 patentnih zahtjeva

(11) **03599** (13) **B**

..

(51) C07D 207/26 ^(2006.01)	C07D 207/273 ^(2006.01)
C07D 209/52 ^(2006.01)	C07D 215/48 ^(2006.01)
C07D 217/02 ^(2006.01)	C07D 217/22 ^(2006.01)
C07D 217/24 ^(2006.01)	C07D 239/86 ^(2006.01)
C07D 239/88 ^(2006.01)	C07D 263/24 ^(2006.01)
C07D 401/12 ^(2006.01)	C07D 401/14 ^(2006.01)
C07D 403/12 ^(2006.01)	C07D 405/12 ^(2006.01)
C07D 405/14 ^(2006.01)	C07D 413/12 ^(2006.01)

..

(21) P-2019-113

(22) 26.03.2015

(30) 201461975473P 04.04.2014 US

(96) 15717250.3/26.03.2015

(86) IB PCT/IB2015/052251/26.03.2015

(87) WO 2015/150995/08.10.2015/2015/40

(97) EP 3126330/08.02.2017/2017/06
EP 3126330/27.02.2019/2019/09

(54) me **BICIKLIČKI KONDENZIRANI HETEROARILNI ILI ARILNI SPOJEVI I NJIHOVA UPOTREBA
KAO INHIBITORA IRAK4**
en **BICYCLIC-FUSED HETEROARYL OR ARYL COMPOUNDS AND THEIR USE AS IRAK4
INHIBITORS**

(73) Pfizer Inc.
235 East 42nd Street, New York 10017/ US

(72) ANDERSON, David Randolph
32 Fawn Run, Salem, Connecticut 06420/ US
BUNNAGE, Mark Edward
39 Southfield Circle, Concord, Massachusetts 01742/ US
CURRAN, Kevin Joseph
18 Grouser Road, Somerset, New Jersey 08873 / US
DEHNHARDT, Christoph Martin
1803-4400 Buchanan Street, Burnaby, British Columbia V5C 0E3/ CA
GAVRIN, Lori Krim
306 Clairemont Road, Villanova, Pennsylvania 19085/ US
GOLDBERG, Joel Adam
2116 Short Street, New Orleans, Louisiana 70118/ US
HAN, Seungil
286 Deerfield Ridge Drive, Mystic, Connecticut 06355 / US

HEPWORTH, David
282 Sudbury Road, Concord, Massachusetts 01742/ US
HUANG, Horng-Chih
1126 Nooning Tree Drive, Chesterfield, Missouri 63017 / US
LEE, Arthur
7400 Damascus Road, Gaithersburg, Maryland 20882 / US
LEE, Katherine Lin
167 Adams Avenue, West Newton, Massachusetts 02465/ US
LOVERING, Frank Eldridge
2 Sutton Place, Acton, Massachusetts 01720/ US
LOWE, Michael Dennis
4 Martine Avenue 118, White Plains, New York 10606/ US
MATHIAS, John Paul
1338 Main Street, Concord, Massachusetts 01742/ US
PAPAIOANNOU, Nikolaos
743 East 4th Street, Boston, Massachusetts 02127/ US
PATNY, Akshay
600 Trapelo Road Unit 11, Waltham, Massachusetts 02452/ US
PIERCE, Betsy
237 Grassy Hill Road, East Lyme, Connecticut 06333/ US
SAIAH, Eddine
19 Kenwood Street, Brookline, Massachusetts 02446/ US
STROHBACH, Joseph Walter
114 Crockett Creek, Wentzville, Missouri 63385 / US
TRZUPEK, John David
55 Station Landing 515, Medford, Massachusetts 02155/ US
VARGAS, Richard
12 Jonathan Lane, Bedford, Massachusetts 01730 / US
WANG, Xiaolun
13572 Golden Cypress Place, San Diego, California 92130/ US
WRIGHT, Stephen Wayne
1 Whitman Lane, Old Lyme, Connecticut 06371/ US
ZAPF, Christoph Wolfgang
48 Kinder Circle, Marlborough, Massachusetts 01752/ US

(74) AOD "ĆUPIĆ"
Bulevar Džordža Vašigtona 79, Podgorica, 81000/ ME

(57)

1. Spoj, **naznačen time** što je 1- $\{[(2S,3S,4S)-3\text{-etil-4-fluor-5-oksopirolidin-2-il]metoksi}\}$ -7-metoksiizokininolin-6-karboksamid; ili farmaceutski prihvatljiva sol navedenog spoja ili tautomer navedenog spoja ili soli.

Patent sadrži još 14 patentnih zahtjeva

(11) **03643** (13) **B**

..

(51) **A61J1/10**^(2006.01)

A61J1/20^(2006.01)

F26B5/06^(2006.01)

..

(21) P-2019-114

(22) 12.07.2017

(30) 201715609870 31.05.2017 US

(96) 17181049.2/12.07.2017

(97) EP 3409259/05.12.2018/2018/49

EP 3409259/17.04.2019/2019/16

(54) me **FLEKSIBILNA KESA SA VIŠE ODJELJAKA I POSTUPCI ZA NJENO KORIŠĆENJE**
en **MULTI CHAMBER FLEXIBLE BAG AND METHODS OF USING SAME**

(73) ADIENNE Pharma & Biotech SA

Via Zurigo 46, Lugano, 6900/ CH

(72) DI NARO, Antonio Francesco

7 Via San Bartolomee, Morcote, CH 6922 / CH

(57) Postupak za pripremu farmaceutskog proizvoda u fleksibilnoj kesi (100) sa više odeljaka, naznačen time, što postupak obuhvata:

uvođenje farmaceutskog proizvoda u tečnom stanju u prvi odeljak (110) fleksibilne kese (100) kroz prvi priključak (112); i

liofilizovanje farmaceutskog proizvoda u prvom odeljku (110) fleksibilne kese (100) za dobijanje liofilizovanog farmaceutskog proizvoda,

pri čemu fleksibilna kesa (100) ima drugi odeljak (120), i prvi odeljak (110) i drugi odeljak (120) su razdvojeni zaptivnim spojem (130) koji može da se prekine,

gde je farmaceutski proizvod citotoksični lek.

Patent sadrži još 9 patentnih zahtjeva

(11) **03601** (13) **B**

..

(51) **C07K 16/28**^(2006.01)

C07K 14/72^(2006.01)

..

(21) P-2019-240

(22) 18.12.2009

(30) 20080203569P 23.12.2008 US

20090264622P 25.11.2009 US

(96) 16199717.6/18.12.2009

(97) EP 3184546/28.06.2017/2017/26

EP 3184546/17.07.2019/2019/29

(54) me **ANTITIJELA KOJA SE VEZUJU ZA HUMANI CGRP RECEPTOR**
en **HUMAN CGRP RECEPTOR BINDING ANTIBODIES**

(73) AMGEN INC.

One Amgen Center Drive, Thousand Oaks, California 91320-1799/ US

(72) BOONE, Thomas Charles

2715 Kelly Knoll Lane, Newbury Park CA 91320 / US

BRANKOW, David W.

18800 Tribune Street, Northridge CA 91326 / US

GEGG, Colin V., Jr.

31121 Village 31, Camarillo, CA 93012 / US

HU, Shaw-Fen Sylvia

986 Lynnmere Drive, Thousand Oaks, CA 91360 / US

KING, Chadwick T.

1325 Moody Avenue, Noreth Vancouver, BC V7L 3T5 / CA

LU, Hsieng Sen

2758 Rainfield Avenue, Thousand Oaks, CA 91362 / US

SHI, Licheng

5243 Via Capote, Newbury Park, CA 91320 / US

XU, Cen

5221 Via Jacinto, Newbury Park, CA 91320 / US

(74) Advokat RADULOVIĆ, Božidar S.

Studentska bb, Lamela 3/18 , Podgorica, 81000 / ME

(57) Monoklonsko antitelo ili njegov antigen-vezujući fragment koji vezuje humani CGRP receptor, navedeni humani CGRP receptor sadrži humani CRLR polipeptid i humani RAMP1 polipeptid, naznačeno time što se monoklonsko antitelo ili njegov antigen-vezujući fragment vezuje na epitop formiran od aminokiselinskih ostataka oba CRLR i RAMP1 polipeptida, i gde se monoklonsko antitelo ili njegov antigen-vezujući fragment takmiči se za vezivanje za humani CGRP receptor sa referentnim antitelom, pomenuto referentno antitelo obuhvata (i) varijabilnu regiju teškog lanca koji sadrži sekvencu izabranu iz grupe koju čine SEQ ID NOs: 161, 163, 164, 166, i 168; i (ii) varijabilnu regiju lakog lanca koji obuhvata sekvencu izabranu iz grupe koju čine SEQ ID NOs: 140, 143, 146, 148, i 150.

Patent sadrži još 10 patentnih zahtjeva

(11) **03606** (13) **B**

..

(51) E04H 5/02 ^(2006.01)	E04H 9/02 ^(2006.01)
E04B 1/348 ^(2006.01)	E04B 1/98 ^(2006.01)
E04B 1/343 ^(2006.01)	E04C 3/34 ^(2006.01)
E04B 1/35 ^(2006.01)	F16F 15/04 ^(2006.01)
E04B 1/41 ^(2006.01)	

..

(21) P-2019-242

(22) 23.12.2015

(30) 14200301 24.12.2014 EP

(96) 15817390.6/23.12.2015

(86) EP PCT/EP2015/081223/23.12.2015

(87) WO 2016/102703/30.06.2016/2016/26

(97) EP 3237707/01.11.2017/2017/44
EP 3237707/19.06.2019/2019/25

(54) me **MODULARNI GRAĐEVINSKI OBJEKAT I MONTAŽNI PRIBOR ZA PODIZANJE
MODULARNOG GRAĐEVINSKOG OBJEKTA**
en **MODULAR INSTALLATION AND ASSEMBLY SET FOR A MODULAR INSTALLATION**

(73) RV Lizenz AG
Alte Steinhauserstrasse 1, 6330 Cham/ CH

(72) RÜDLINGER, Mikael
RV Lizenz AG Alte Steinhauserstrasse 1, 6330 Cham/ CH

(57) Modularni građevinski objekat (1), naročito modularni industrijski građevinski objekat, sa više kvadarski oblikovanih modula (20, 20a, 40, 40a, 40b, 40c) objekta, koji su raspoređeni u dve ili više etaža naslaganih jedna iznad druge; pri čemu ti moduli obuhvataju noseću strukturu (78) sa pričvrstnim tačkama (24, 24', 44, 44');

te pričvrstne tačke predviđene su za povezivanje jednog modula sa odgovarajućim pričvrstnim tačkama susednih modula iznad i/ili ispod ležeće etaže;

moduli (20, 40) jedne etaže su funkcionalno izmenjivo povezani sa susednim modulima (40, 20) iznad i/ili ispod ležeće etaže u horizontalnoj ravni (x-y) (24, 24', 64, 44, 44');

predviđen je najmanje jedan uređaj (62, 70, 80) za obezbeđivanje zatezne sile sa zateznim elementom (62), na koji se može delovati sa silom zatezanja duž vertikale (z) najdonjom etažom modula (40a) odn. temeljnim blokom (6) naspram najgornje etaže modula (40c), tako da su moduli između pomenute najdonje etaže i pomenute najgornje etaže sa susednim modulima (40, 20) iznad i/ili ispod ležeće etaže duž vertikale (z) na pričvrstnim tačkama prisilno spojeni pritisnuti jedan na drugi i tako fiksirani;

na gornjoj strani (22, 42) noseće strukture (78) modula (20, 20a, 40) raspoređeno je tri ili više oslonih elemenata (24',44'), koji definišu prvu ravan,i na gornjoj strani naspramnoj donjoj strani (21, 41) noseće strukture, raspoređeno je tri ili više oslonih elemenata (24, 44), koji definišu drugu ravan paralelnu prvoj ravni;

pri čemu osloni elementi služe kao pričvrsne tačke tih modula;

ponekad jedan osloni element na gornjoj strani i jedan osloni element na donjoj strani čine par i raspoređeni su u liniji jedan sa drugim duž prave linije paralelne sa normalama na ravni; I dva jedan drugom okrenuta oslona elementa (24, 24', 44, 44') dva jedan drugom granična modula (20, 20a, 40) susednih etaža, povezani su veznim elementom (64);

naznačen time,što pomenuti osloni elementi (24, 24', 44, 44') obuhvataju koničnu površinu (25, 25' 45, 45'); I vezni element (64) obuhvata oblik dvostruke kupe ili dvostruke zarubljene kupe,i ponekad kupa odn. zarubljena kupa veznog elementa je smeštena u koničnom prihvat u jednog od dva oslona elementa i naleže direktno poravnato na njega.

Patent sadrži još 12 patentnih zahtjeva

(11) **03612** (13) **B**

..

(51) **A61K31/235**^(2006.01)

A61K31/192^(2006.01)

G01N33/68^(2006.01)

G01N33/50^(2006.01)

..

(21) P-2019-244

(22) 14.10.2014

(30) 201361890827P 14.10.2013 US

201462044168P 29.08.2014 US

(96) 14854074.3/14.10.2014

(86) US PCT/US2014/060543/14.10.2014

(87) WO 2015/057747/23.04.2015/2015/16

(97) EP 2986325/24.02.2016/2016/08

EP 2986325/26.06.2019/2019/26

(54) me **POSTUPCI TRETMANA POREMEĆAJA CIKLUSA UREE**
en **METHODS OF TREATING UREA CYCLE DISORDERS**

(73) Immedica Pharma AB

Norrtullsgatan 15, Stockholm, 113 29 / SE

(72) MOKHTARANI, Masoud

725 Castle Rock Road, Walnut Creek, CA 94598/ US

SCHARSCHMIDT, Bruce

45 St. Francis Boulevard, San Francisco, CA 941 27/ US

(57) Postupak za određivanje efikasne doze gliceril tri-[4-fenilbutirata] za tretman poremećaja ciklusa uree kod pacijenta uzrasta od 6 do 17 godina koji ima potrebu za tim, i obuhvata: izračunavanje telesne površine (BSA) pacijenta; i upoređivanje BSA sa unapred određenom graničnom vrednosti koja je 1,3 m², gde je efikasna doza prva doza od 7,3 do 8,79 g/m²/dan ako je BSA na ili iznad zadate granične vrednosti ili druge doze od 9 do 9,9 g/m²/dan ako je BSA ispod unapred određene granične vrednosti.

Patent sadrži još 6 patentnih zahtjeva

(11) **03559** (13) **B**

..

(51) **A61K 47/60**^(2017.01)

C07K 14/47^(2006.01)

A61K 38/00^(2006.01)

A61P 27/02^(2006.01)

A61P 35/00^(2006.01)

..

(21) P-2019-251

(22) 29.04.2011

(30) 20100161685 30.04.2010 EP

(96) 11716429.3/29.04.2011

(86) US PCT/EP2011/056824/29.04.2011

(87) WO 2011/135067/03.11.2011/2011/44

(97) EP 2563400/06.03.2013/2013/10

EP 2563400/10.07.2019/2019/28

(54) me **MODIFIKOVANI VEZIVNI PROTEINI KOJI INHIBIRAJU INTERAKCIJU RECEPTORA VEGF-A**
en **MODIFIED BINDING PROTEINS INHIBITING THE VEGF-A RECEPTOR INTERACTION**

(73) Molecular Partners AG
Wagistrasse 14, 8952 Schlieren/ CH

(72) BINZ, Hans Kaspar
Bachstrasse 27, 8903 Birmensdorf/ CH
FORRER, Patrik
Rainackerstrasse 17, 8953 Dietikon/ CH
STUMPP, Michael Tobias
Chratzstrasse 6, 8954 Geroldswil/ CH

(57) Rekombinantni vezivni protein koji sadrži ankirinski ponovljeni domen i polietilenglikol ni ostatak molekulske težine od najmanje 5 kDa, naznačen time, da navedeni ponovljeni domen ankirina vezuje VEGF-A165 sa Kd ispod 10^{-9} M i inhibira vezivanje VEGF-A165 za VEGFR-2, i gde pomenuti ankirinski ponovljeni domen odgovara aminokiselinama I do 126 iz SEK ID BR: 3.

Patent sadrži još 14 patentnih zahtjeva

(11) **03585** (13) **B**

..

(51) **C08G 73/06**^(2006.01)

C08L 79/06^(2006.01)

A61P 41/00^(2006.01)

C07D 401/04^(2006.01)

..

(21) P-2019-256

(22) 17.05.2012

(30) 2011119848 U 17.05.2011 RU

2011053043 U 26.12.2011 RU

(96) 12785811.6/17.05.2012

(86) IB PCT/IB2012/052483/17.05.2012

(87) WO 2012/156938/22.11.2012/2012/47

(97) EP 2716684/09.04.2014/2014/15

EP 2716684/26.06.2019/2019/26

(54) me **JEDINJENJA ZA PROFILAKSU I TRETMAN ADHEZIONOG PROCESA**
en **COMPOUNDS, PHARMACEUTICAL COMPOSITIONS AND A METHOD FOR THE**
PROPHYLAXIS AND TREATMENT OF THE ADHESION PROCESS

(73) Joint Stock Company "Pharmasyntez"

Office 3 Dom 23 ul. Krasnogvardeyskaya, Irkutsk 664007/ RU

(72) SHURYGIN, Mikhail Gennadievich

Marshal Zhukov Avenue 1-26, Irkutsk 664057/ RU

SHURYGINA, Irina Aleksandrovna

Marshal Zhukov Avenue 1-26, Irkutsk 664057/ RU

(57) I. Jedinjenje za primenu u metodi inhibiranja p38 MAP kinaze, koje je tipa (I):

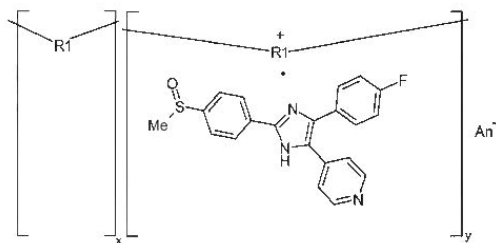

iii (II):

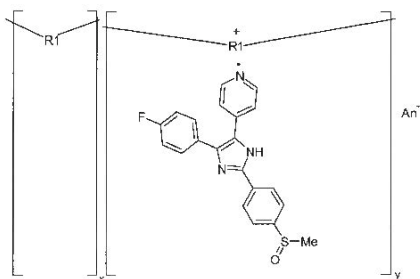

iii (III):

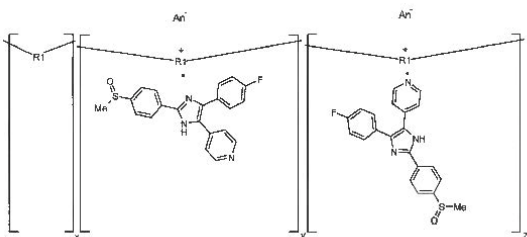

iii (IV):

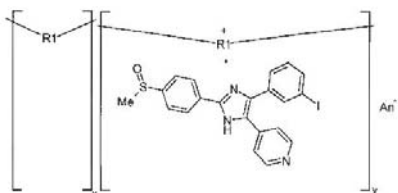

iii (V):

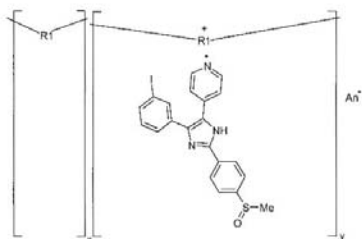

iii (VI):

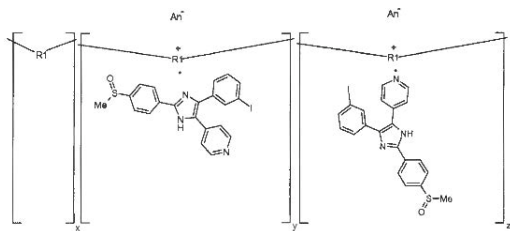

ili (VII):

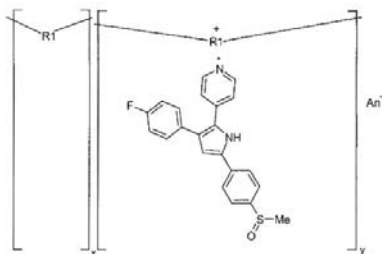

gde R₁ je strukturalna jedinica prirodnih ili sintetičkih u vodi rastvornih polimera odabrana od hitosana ili njegovih derivata, poliviniltetrazola ili njegovih kopolimera, soli karboksimetilceluloze, polivinilimidazola ili njegovih kopolimera, polietilenimina ili njegovih kopolimera, polivinilpiridina ili njihovih kopolimera, poliviniltriazola ili njihovih kopolimera, soli poliakrilne kiseline ili njenih kopolimera ili soli polimetakrilne kiseline ili njenih kopolimera; An⁻ - ostatak kiseline; x, y i z su celi brojevi, sem toga x#) i y#).

Patent sadrži još 0 patentnih zahtjeva

(11) **03560** (13) **B**

..

(51) **C07K16/40**^(2006.01)

G01N33/574^(2006.01)

..

(21) P-2019-257

(22) 27.04.2013

(30) 201261639376P 27.04.2012 US

(96) 13782061.9/27.04.2013

(86) US PCT/US2013/038542/27.04.2013

(87) WO 2013/163633/31.10.2013/2013/44

(97) EP 2841575/04.03.2015/2015/10
EP 2841575/26.06.2019/2019/26

(54) me **MOLEKULI ANTI-GCC ANTITELA I NJIHOVA UPOTREBA U ISPITIVANJU OSETLJIVOSTI NA GCC-CILJANU TERAPIJU**
en **ANTI-GCC ANTIBODY MOLECULES AND USE OF SAME TO TEST FOR SUSCEPTIBILITY TO GCC-TARGETED THERAPY**

(73) MILLENNIUM PHARMACEUTICALS, INC.
40 Landsdowne Street, Cambridge MA 02139/ US

(72) FRANK, Helen, Alison
7 Queens Circle, Sharon, MA 02067 / US
MCDONALD, Alice, A.
25 Swampscott Avenue, Swampscott, MA 01907/ US
O'KEEFE, Theresa, L.
20 Richgrain Avenue, Waltham, MA 02453 / US

(57) I. Molekuli anti-GCC antitela koji sadrži tri regiona koji određuju komplementarnost teškog lanca (HCDRI, HCDR2 i HCDR3) koji sadrže aminokiselinske sekvence SEQ ID NO: 21, 22 i 23, redom; i tri regiona koji određuju komplementarnost lakog lanca (LCDRI, LCDR2, i LCDR3) koji sadrže aminokiselinske sekvence SEQ ID NO: 27, 28 i 29, redom.

Patent sadrži još 16 patentnih zahtjeva

(11) **03565** (13) **B**

..

(51) C07K 14/47 ^(2006.01)	C07K 14/705 ^(2006.01)
C12N 5/0783 ^(2010.01)	C12N 9/90 ^(2006.01)
G01N 33/50 ^(2006.01)	C12Q 1/68 ^(2018.01)
C07K 7/08 ^(2006.01)	C07K 7/06 ^(2006.01)
C07K 7/02 ^(2006.01)	C07K 14/725 ^(2006.01)
A61K 35/17 ^(2015.01)	A61K 39/00 ^(2006.01)
C12Q 1/6886 ^(2018.01)	

..

(21) P-2019-258

(22) 08.05.2015

(30) 201461990980 P 09.05.2014 US

201408255 09.05.2014 GB

(96) 15732544.0/08.05.2015

(86) EP PCT/EP2015/060168/08.05.2015

(87) WO 2015/169945/12.11.2015/2015/45

(97) EP 3140319/15.03.2017/2017/11

EP 3140319/10.07.2019/2019/28

(54) me **NOVA IMUNOTERAPIJA ZA LEČENJE NEKOLIKO TUMORA KRVI, KAO ŠTO JE AKUTNA MIJELOIDNA LEUKEMIJA (AML)**
en **NOVEL IMMUNOTHERAPY AGAINST SEVERAL TUMORS OF THE BLOOD, SUCH AS ACUTE MYELOID LEUKEMIA (AML)**

(73) Immatix Biotechnologies GmbH
Paul-Ehrlich-Strasse 15, 72076 Tübingen/ DE

(72) WALZ, Juliane
Gartenstrasse 71, 72076 Tübingen/ DE
KOWALEWSKI, Daniel
Denzenbergstrasse 29, 72074 Tübingen/ DE
BERLIN, Claudia
Innere Wiener Strasse 5, 81667 München/ DE
RAMMENSEE, Hans-Georg
Sommerhalde 3, 72070 Tübingen/ DE
STEVANOVIC, Stefan
Auf der Burg 3, 72074 Tübingen/ DE

(74) Advokat POPOVIĆ, Miladin
Đoka Miraševića 21/III, Podgorica, 81000 / ME

(57)Peptid dužine između 9 i 30 aminokiselina, koji sadrži aminokiselinsku sekvencu KLQEQLA QL u skladu sa ID BR. SEKV: 266, ili njenu farmaceutski prihvatljivu so.

Patent sadrži još 14 patentnih zahtjeva

(11) **03562** (13) **B**

..

(51) A61K 35/74 ^(2015.01)	C12N 1/20 ^(2006.01)
A61P 1/00 ^(2006.01)	A61P 11/06 ^(2006.01)
A61P 29/00 ^(2006.01)	A61P 19/02 ^(2006.01)
A61P 25/28 ^(2006.01)	A61P 35/00 ^(2006.01)
A61K 35/745 ^(2015.01)	

..

(21) P-2019-259

(22) 15.06.2016

(30) 201510470 15.06.2015 GB

201520510 20.11.2015 GB

201603786 04.03.2016 GB

(96) 16731639.7/15.06.2016

(86) GB PCT/GB2016/051768/15.06.2016

(87) WO 2016/203217/22.12.2016/2016/51

(97) EP 3204024/16.08.2017/2017/33

EP 3204024/24.07.2019/2019/30

(54) me **KOMPOZICIJE KOJE SADRŽE BAKTERIJSKE SOJEVE**
en **COMPOSITIONS COMPRISING BACTERIAL STRAINS**

(73) 4D PHARMA RESEARCH LIMITED

Life Sciences Innovation Building, Cornhill Road, Aberdeen, Aberdeenshire AB25 2ZS/ GB

(72) GRANT, George

Life Sciences Innovation Building, Cornhill Road, Aberdeen Aberdeenshire AB25 2ZS/ GB

PATTERSON, Angela Margaret

Norwich Medical School, Faculty of Medicine and Health Sciences, University of East Anglia, Norwich

Norfolk NR4 7JT/ GB

MULDER, Imke

Life Sciences Innovation Building, Cornhill Road, Aberdeen Aberdeenshire AB25 2ZS/ GB

MCCLUSKEY, Seanin

3rd Floor 9 Bond Court, Leeds Yorkshire LS1 2JZ/ GB

RAFTIS, Emma

3rd Floor 9 Bond Court, Leeds Yorkshire LS1 2JZ/ GB

(57) Kompozicija koja sadrži bakterijski soj roda Bacteroides koji ima 16s rRNK sekvencu koja je bar 98% identična sa SEQ ID N0:4 , za upotrebu u postupku lečenja ili prevencije inflamatorne ili autoimune bolesti.

Patent sadrži još 14 patentnih zahtjeva

(11) **03563** (13) **B**

..

(51) **A61K 35/74**^(2015.01)

A61P 1/00^(2006.01)

A61P 11/06^(2006.01)

A61P 29/00^(2006.01)

A61P 19/02^(2006.01)

A61P 25/28^(2006.01)

C12N 1/20^(2006.01)

..

(21) P-2019-260

(22) 15.06.2016

(30) 201510468 15.06.2015 GB

201606807 19.04.2016 GB

(96) 16731642.1/15.06.2016

(86) GB PCT/GB2016/051774/15.06.2016

(87) WO 2016/203221/22.12.2016/2016/51

(97) EP 3307288/18.04.2018/2018/16

EP 3307288/24.07.2019/2019/30

(54) me **KOMPOZICIJE KOJE SADRŽE BAKTERIJSKE SOJEVE**
en **COMPOSITIONS COMPRISING BACTERIAL STRAINS**

(73) 4D PHARMA RESEARCH LIMITED

Life Sciences Innovation Building, Cornhill Road, Aberdeen Aberdeenshire AB25 2ZS/ GB

(72) STEVENSON, Alex

3rd Floor 9 Bond Court, Leeds Yorkshire LS1 2JZ/ GB

(57) Kompozicija koja obuhvata bakterijski soj vrste *Roseburia hominis*, za upotrebu u postupku lečenja ili prevenciji astme.

Patent sadrži još 11 patentnih zahtjeva

(11) **03570** (13) **B**

..

(51) C07D 233/56 ^(2006.01)	A61K 31/427 ^(2006.01)
A61K 31/4427 ^(2006.01)	A61K 31/443 ^(2006.01)
A61K 31/4436 ^(2006.01)	A61K 31/444 ^(2006.01)
C07D 417/12 ^(2006.01)	C07D 417/14 ^(2006.01)

..

(21) P-2019-265

(22) 22.01.2016

(30) 20150030085 22.01.2015 ES

(96) 16704680.4/22.01.2016

(86) ES PCT/ES2016/070032/22.01.2016

(87) WO 2016/116652/28.07.2016/2016/30

(97) EP 3248964/29.11.2017/2017/48
EP 3248964/17.07.2019/2019/29

(54) me **THIAZOLNI MODULATORI A3 ADENOZINSKIH RECEPTORA**
en **THIAZOLE MODULATORS OF A3 ADENOSINE RECEPTORS**

(73) PALOBIOFARMA S.L.

Tecnocampus Mataró, 2, Avenida Ernest Lluch, 32 - planta 2, oficina 7, Mataró, Barcelona, 08302 / ES

(72) CASTRO-PALOMINO LÁRIA, Julio

Tecnocampus Mataró 2 Avenida Ernest LLuch 32 - Planta 2 oficina 7, Mataro Barcelona, 08302 / ES

CAMACHO GÓMEZ, Juan

Tecnocampus Mataró 2 Avenida Ernest LLuch 32 - Planta 2 oficina 7, Mataro Barcelona, 08302 / ES

(74) Advokat ÓSOVIĆ, Dejan L.

ul.13 Jula br. 9, Budva, 85310/ ME

(57) Jedinjenje formule (I)

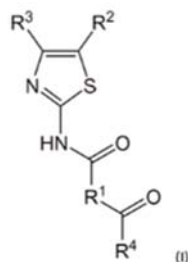

pri čemu:

- R1 predstavlja petočlanu ili šestočlanu arilnu ili heteroarilnu grupu, opciono supstituisanu jednim ili više supstituenata odabranih iz grupe koja se sastoji od atoma halogena, C1-C6 alkila pravolinijskog ili razgranatog, C3-C12 cikloalkila, hidroksila, C1-C6 alkoksi pravolinijski ili razgranat i cijano grupu,

- R2 je odabran iz grupe koju čine atom halogena i cijano grupa,

- R3 predstavlja petočlanu ili šestočlanu arilnu ili heteroarilnu grupu opciono supstituisanu jednim ili više supstituenata odabranih iz grupe koju čine atom halogena, cijano grupa, C3-C12 cikloalkil, hidroksil, C1-C6 alkoksi pravolinijski ili razgranat, opciono supstituisani jednim, dva ili tri atoma halogena, C1-C6 alkilom, amino, mono ili dialkilamino, C1-C6 alkoksialkilom, hidroksikarbonilom i C2-C6 alkoksikarbonilom i

- R4 predstavlja nezavisno:

a) hidroksilnu grupu,

b) -N(R5)(R6) grupa, pri čemu:

i) R5 i R6 nezavisno predstavljaju C3-C12 cikloalkilnu grupu ili C3-C4 alkil pravolinijski ili razgranat, supstituisane karboksilnom grupom (-COOH); ili

ii) R5 i R6 zajedno sa atomom azota za koji su vezani formiraju petočlani ili šestočlani zasićeni ciklus koji sadrži opciono heteroatom odabran od N i O, koji je supstituisan sa karboksilnom grupom (-COOH).

i njihove farmaceutski prihvatljive soli.

1. Jedinjenje prema patentnom zahtjevu 1, pri čemu R3 predstavlja fenilnu grupu koja je opciono supstituisana jednim, dva ili tri atoma halogena ili C1-C6 alkoksi grupom opciono supstituisanu sa jednim, dva ili tri atoma halogena.

Patent sadrži još 12 patentnih zahtjeva

(11) **03538** (13) **B**

..

(51) **A61K 31/7088**^(2006.01)

A61K 31/7125^(2006.01)

A61P 35/00^(2006.01)

A61P 35/02^(2006.01)

A61P 7/00^(2006.01)

A61P 7/06^(2006.01)

..

(21) P-2019-273

(22) 15.11.2013

(30) 201261734941 P 07.12.2012 US

201361799069 P 15.03.2013 US

201313841711 15.03.2013 US

201361900347 P 05.11.2013 US

(96) 13861008.4/15.11.2013

(86) US PCT /US2013/070437/15.11.2013

(87) WO 2014/088785/12.06.2014/2014/24

(97) EP 2928477/14.10.2015/2015/42

EP 2928477/24.07.2019/2019/30

(54) me **UPOTREBA INHIBITORA TELOMERAZE IMETELSTATA ZA LEČENJE MIJELOFIBROZE**
en **USE OF THE TELOMERASE INHIBITOR IMETELSTAT FOR THE TREATMENT OF**
MYELOFIBROSIS

(73) Geron Corporation

149 Commuweallh Drive, Menlo Park,, CA 94025/ US

(72) STUART, Monic J.

2828 Churchill Drive, Hillsborough, CA 94010/ US

KELSEY, Stephen

1468 Hamilton Avenue, Palo Alto, CA 94301/ US

(57) Inhibitor telomeraze za upotrebu u ublažavanju najmanje jednog simptoma koji je rezultat mijelofibroze (MF) kod individue, pri čemu, inhibitor telomeraze je imetelstat ili njegova farmaceutski prihvatljiva so.

Patent sadrži još 24 patentnih zahtjeva

(11) **03539** (13) **B**

..

(51) **C07K 16/46**^(2006.01)

..

(21) P-2019-274

(22) 25.06.2015

(30) 201411320 25.06.2014 GB

(96) 15732228.0/25.06.2015

(86) EP PCT/EP2015/064409/25.06.2015

(87) WO 2015/197772/30.12.2015/2015/52

(97) EP 3161007/03.05.2017/2017/18
EP 3161007/07.08.2019/2019/32

(54) me **MULTISPECIFIČNI KONSTRUKTI ANTITELA**
en **MULTISPECIFIC ANTIBODY CONSTRUCTS**

(73) UCB Biopharma SPRL
60,Allée de la Recherche , Brussels, 1070 / BE

(72) BHATTA, Pallavi
IPD UCB Celltech 208 Bath Road, Slough Berkshire SL1 3WE/ GB
DAVE, Emma
IPD UCB Celltech 208 Bath Road, Slough Berkshire SL1 3WE/ GB
HEYWOOD, Sam Philip
IPD UCB Celltech 208 Bath Road, Slough Berkshire SL1 3WE/ GB
HUMPHREYS, David Paul
IPD UCB Celltech 208 Bath Road, Slough Berkshire SL1 3WE/ GB

(57) Multispecifični molekul antitela obuhvatajući ili sastojeći se od:

a) polipeptidnog lanca formule (I):



i

b) polipeptidnog lanca formule (II):

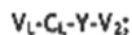

pri čemu:

V_H predstavlja varijabilni domen teškog lanca;

CH₁ predstavlja domen konstantnog regiona teškog lanca, na primer, domen 1 istog;

X predstavlja vezu ili veznik;

Y predstavlja vezu ili veznik;

V_1 predstavlja dsFv ili dsscFv;

V_L predstavlja varijabilni domen lakog lanca;

C_L predstavlja domen iz konstantnog regiona lakog lanca, kao što je Ckappa;

V_2 predstavlja dsFv ili dsscFv.

Patent sadrži još 23 patentnih zahtjeva

(11) **03540** (13) **B**

..

(51) A61K 9/06 ^(2006.01)	A61K 47/10 ^(2006.01)
A61K 47/14 ^(2006.01)	A61K 47/32 ^(2006.01)
A61K 47/38 ^(2006.01)	A61K 31/192 ^(2006.01)
A61P 29/00 ^(2006.01)	

..

(21) P-2019-275

(22) 03.05.2012

(30) 201161482058 P 03.05.2011 US

(96) 12779275.2/03.05.2012

(86) US PCT /US2012/036366/03.05.2012

(87) WO 2012/151427/08.11.2012/2012/45

(97) EP 2704703/12.03.2014/2014/11
EP 2704703/24.07.2019/2019/30

(54) me **TRANSDERMALNE KOMPOZICIJE IBUPROFENA I POSTUPCI ZA NJIHOVU UPOTREBU**
en **TRANSDERMAL COMPOSITIONS OF IBUPROFEN AND METHODS OF USE THEREOF**

(73) Aponia Laboratories, Inc.
67 Orchard Place, Greenwich, CT 06830/ US

(72) CHEN, Haigang
5250 Annapolis Lane North Apt. 2310, Plymouth, MN 55446/ US
WINCKLE, Gareth
1300 Sunset Drive, Petaluma, CA 94952/ US
RILEY, Christopher
1055 Forest Avenue, Maryville, MO 64468/ US

(57) Kompozicija za transdermalnu primenu ibuprofena, gde kompozicija sadrži:

ibuprofen u količini od 5 težinskih % kompozicije; sredstvo za geliranje, pri čemu je sredstvo za geliranje odabrano iz grupe koja se sastoji od karboksivinilnih polimera, metil celuloze, etil celuloze, hidroksiceluloze, hidroksietil celuloze i hidroksipropil celuloze; niži alkil alkohol; vodu; neisparljivi rastvarač, pri čemu je neisparljivi rastvarač odabran od propilen glikola, heksilen glikola i benzil alkohola;

pri čemu kompozicija ima prividni pH od 4.0 do 7.0; i pri čemu kompozicija dodatno sadrži pojačavač prodiranja kroz kožu odabran od izopropil miristata, izopropil palmitata i etil oleata.

Patent sadrži još 12 patentnih zahtjeva

(11) **03579** (13) **B**

..

(51) A61K 31/416 ^(2006.01)	C07D 231/56 ^(2006.01)
C07D 471/04 ^(2006.01)	C07D 403/06 ^(2006.01)
C07D 401/06 ^(2006.01)	A61K 31/496 ^(2006.01)
A61K 31/5377 ^(2006.01)	A61K 31/454 ^(2006.01)
A61P 29/00 ^(2006.01)	A61P 37/00 ^(2006.01)
C07D 209/26 ^(2006.01)	

..

(21) P-2019-276

(22) 14.08.2013

(30) PCT/CN2012/080133 15.08.2012 WO

(96) 13829099.4/14.08.2013

(86) US PCT/US2013/054902/14.08.2013

(87) WO 2014/028597/20.02.2014/2014/08

(97) EP /24.06.2015/2015/26

EP /24.07.2019/2019/30

(54) me **JEDJNJENJA JNDOLA I INDAZOLA SUPSTITUISANA 3-CJKLOHEKSENILOM I
CIKLOHEKSILOM KAO INHIBITORI RORgammaT i NJIHOVE UPOTREBE**
en **3-CYCLOHEXENYL AND CYCLOHEXYL SUBSTITUTED INDOLE AND INDAZOLE
COMPOUNDS AS RORgammaT INHIBITORS AND USES THEREOF**

(73) Merck Sharp & Dohme Corp.
126 East Lincoln Avenue, Rahway, NJ 07065/ US

(72) , BARR, Kenneth Jay
261 Commonwealth Avenue No. 7, Boston, Massachusetts 02116/ US
, MACLEAN, John
431 Washington Street Unit 4, Brookline, Massachusetts 02446/ US
, ZHANG, Hongjun
8 Town House Drive, Newton, Massachusetts 02460/ US
, BERESIS, Richard Thomas
Apartment 2504 Building 1 2504 Shimen 2 Road, Shanghai 200040/ CN
, ZHANG, Dongshan
Shanghai ChemPartner Co. Ltd. No. 10 Building 965 Halei Road Zhangjiang Hi-tech Park Pudong New
Area, Shanghai 201203/ CN
, ANDRESEN, Brian
33 Avenue Louis Pasteur, Boston, Massachusetts 02115/ US
, ANTHONY, Neville
52 Lawrence Street, Northborough, Massachusetts 01532/ US
, LAPOINTE, Blair
33 Avenue Louis Pasteur, Boston, Massachusetts 02115/ US

, SCIAMMETTA, Nunzio
33 Avenue Louis Pasteur, Boston, Massachusetts 02115/ US

(57) Jedinjenje prema formuli Ix

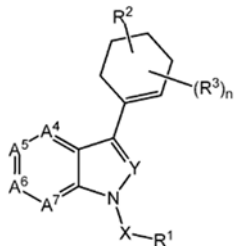

Ix

ili njegova farmaceutske prihvatljiva so ili solvat, naznačeno time što:

X je C(O);

Y je N, CH ili CRa;

n = 0, 1, 2, 3 ili 4;

A4 je CR4 ili N,

A5 je CR5 ili N,

A6 je CR6 ili N,

A7 je CR7 ili N,

uz uslov da ne više od dva od A4-A7 mogu biti N;

Ra je (C1-4)alkil;

R1 je

(i) (C3-12)karbociklil; ili

(ii) 4- do 12-člani heterociklil,

oba (i) i (ii) izborno supstituisani sa jednim, dva, tri, četiri ili pet R8;

R2 je hidroksikarbonil, hidroksikarbonil(C1-10)alkil, ili karbamoil;

R3 je vodonik, halogen, cijano, nitro, hidroksi, (C1-3)alkilC(O)O-, (C1-4)alkil, ili (C1-4)alkoksi, pri čemu su (C1-4)alkil i (C1-4)alkoksi izborno supstituisani sa jednim ili više halogena;

R4-R7 nezavisno su H, halogen, amino, cijano, hidroksi, (C1-3)alkoksi, (C1-4)alkil, (C0-10)alkilaminokarbonil, (di)(C1-6)alkilaminokarbonil ili amino(C1-4)alkil, pri čemu (C1-3)alkoksi, (C1-4)alkil, (C0-10)alkilaminokarbonil, (di)(C1-6)alkilaminokarbonil i amino(C1-4)alkil su izborno supstituisani sa jednim ili više halogena, hidroksila ili (C1-3)alkoksi; ili grupa koja ima formulu

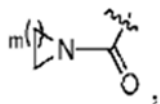

izborno supstituisana sa jednim ili više od sledećih: (C1-10)alkil, halogen, amino, cijano, hidroksi, (C1-3)alkoksi, i pri čemu m je 1, 2, 3 ili 4;

R8 je halogen, cijano, amino, nitro, hidroksi, H₂NC(O)-, (C1-3)alkoksikarbonil, (di)(C1-6)alkilaminokarbonil, (C1-4)alkil, (C3-7)cikloalkil, (C3-5)heterocikloalkil, (C1-3)alkoksiaminokarbonil, 4- do 8-člani heterociklilkarbonil, (C3-6)cikloalkilaminokarbonil, amino(C1-4)alkiloksikarbonil ili (C1-3)alkoksi, pri čemu su (C1-3)alkoksikarbonil, (di)(C1-6)alkilaminokarbonil, (C1-4)alkil, (C1-3)alkoksiaminokarbonil, 4- do 8-člani heterociklilkarbonil, (C3-6)cikloalkilaminokarbonil, amino(C1-4)alkiloksikarbonil i (C1-3)alkoksi izborno supstituisani sa okso, (C1-4)alkil, hidroksi(C1-3)alkil, ili jednim, dva ili tri halogena.

Patent sadrži još 25 patentnih zahtjeva

(11) **03576** (13) **B**

..

(51) **C07K 16/28**^(2006.01)

..

(21) P-2019-278

(22) 08.01.2016

(30) PCT/EP2015/050255 08.01.2015 WO

(96) 16700136.1/08.01.2016

(86) EP PCT/EP2016/050308/08.01.2016

(87) WO 2016/110584/14.07.2016/2016/28

(97) EP 3242890/15.11.2017/2017/746
EP 3242890/04.09.2019/2019/36

(54) me **AGONISTIČKA SREDSTVA ZA VEZIVANJE TNF RECEPTORA**
en **AGONISTIC TNF RECEPTOR BINDING AGENTS**

(73) BioNTech SE

An der Goldgrube 12, Mainz, 55131 / DE

Genmab A/S

Kalvebod Brygge 43, Copenhagen V, 1560/ DK

(72) SAHIN, Ugur

Philipp-von-Zabern-Platz 1, 55116 Mainz/ DE

GIESEKE, Friederike

Am Römertor 5, 55116 Mainz/ DE

ALTINTAS, Isil

Genmab B.V. Yalelaan 60, 3584 CM Utrecht/ NL

SATIJN, David

Genmab B.V. Yalelaan 60, 3584 CM Utrecht/ NL

PARREN, Paul

Genmab B.V. Yalelaan 60, 3584 CM Utrecht/ NL

(57) Vezivno sredstvo koje sadrži najmanje dva vezivna domena, pri čemu se prvi vezivni domen vezuje za prvi receptor superfamilije faktora nekroze tumora (TNF), a drugi vezivni domen se vezuje za drugi receptor superfamilije TNF-a, pri čemu se prvi vezivni domen vezuje za CD40 i drugi vezivni domen se vezuje za 4-1BB (CD137), naznačeno time što je vezivno sredstvo bispecifično antitelo, gde je vezivno sredstvo agonističko vezivno sredstvo, pri čemu je prvi domen vezivanja koji se vezuje za CD40 izabran iz prve grupe koja se sastoji od:

(a) HCDR1 regiona za određivanje komplementarnosti teškog lanca koji ima aminokiselinsku sekvencu od SEK ID BR: 2323, HCDR2 koji ima aminokiselinsku sekvencu od SEK ID BR: 2324 i HCDR3 koji ima aminokiselinsku sekvencu od SEK ID BR: 2325 i

LCDR1 regiona za određivanje komplementarnosti lakog lanca koji ima aminokiselinsku sekvencu od SEK ID BR: 2326, LCDR2 koji ima aminokiselinsku sekvencu od SEK ID BR: 2327 i LCDR3 koji ima aminokiselinsku sekvencu od SEK ID BR: 2328; i

(b)varijabilnog domena teškog lanca (VH) koji ima aminokiselinsku sekvencu od SEK ID BR: 2321 i varijabilnog domena lakog lanca (VL) koji ima aminokiselinsku sekvencu SEK ID BR: 2322; i naznačeno time, daje drugi vezivni domen koji se vezuje za 4-IBB (CD137) izabran iz druge grupe koja se sastoji od:

(a) HCDRI regiona za određivanje komplementarnosti teškog lanca koji ima aminokiselinsku sekvencu od SEK ID BR: 2297, HCDR2 koji ima aminokiselinsku sekvencu od SEK ID BR: 2298 i HCDR3 koji ima aminokiselinsku sekvencu od SEK ID BR: 2299 i

LCDRI regiona za određivanje komplementarnosti lakog lanca koji ima aminokiselinsku sekvencu od SEK ID BR: 2300, LCDR2 koji ima aminokiselinsku sekvencu od SEK ID BR: 2301 i LCDR3 koji ima aminokiselinsku sekvencu od SEK ID BR: 2302; i

(b)varijabilnog domena teškog lanca (VH) koji ima aminokiselinsku sekvencu od SEK ID BR: 2241 i varijabilnog domena lakog lanca (VL) koji ima aminokiselinsku sekvencu od SEK ID BR: 2242;

(e) HCDR1 regiona za određivanje komplementarnosti teškog lanca koji ima aminokiselinsku sekvencu od SEK ID BR: 2255, HCDR2 koji ima aminokiselinsku sekvencu od SEK ID BR: 2256 i HCDR3 koji ima aminokiselinsku sekvencu od SEK ID BR: 2257 i

LCDR1 regiona za određivanje komplementarnosti lakog lanca koji ima aminokiselinsku sekvencu od SEK ID BR: 2258, LCDR2 koji ima aminokiselinsku sekvencu od SEK ID BR: 2259 i LCDR3 koji ima aminokiselinsku sekvencu od SEK ID BR: 2260; i

(d)varijabilnog domena teškog lanca (VH) koji ima aminokiselinsku sekvencu od SEK ID BR: 2227 i varijabilnog domena lakog lanca (VL) koji ima aminokiselinsku sekvencu od SEK ID BR: 2228;

(e) HCDR1 regiona za određivanje komplementarnosti teškog lanca koji ima aminokiselinsku sekvencu od SEK ID BR: 2315, HCDR2 koji ima aminokiselinsku sekvencu od SEK ID BR: 2316 i HCDR3 koji ima aminokiselinsku sekvencu od SEK ID BR: 2317 i

LCDRI regiona za određivanje komplementarnosti lakog lanca koji ima aminokiselinsku sekvencu od SEK ID BR: 2318, LCDR2 koji ima aminokiselinsku sekvencu od SEK ID BR: 2319 i LCDR3 koji ima aminokiselinsku sekvencu od SEK ID BR: 2320; i

(t) varijabilnog domena teškog lanca (VH) koji ima aminokiselinsku sekvencu od SEK ID BR: 2247 i varijabilnog domena lakog lanca (VL) koji ima aminokiselinsku sekvencu od SEK ID BR: 2248;

gde roditeljska monospecifična antitela koja sadrže pomenute vezivne domene ne pokazuju agonističku aktivnost.

Patent sadrži još 8 patentnih zahtjeva

(11) **03541** (13) **B**

..

(51) **C07K 16/22**^(2006.01)

A61K 38/17^(2006.01)

A61K 31/519^(2006.01)

C07K 16/28^(2006.01)

A61P 19/00^(2006.01)

..

(21) P-2019-279

(22) 14.09.2015

(30) 201462049869 P 12.09.2014 US

201562141775 P 01.04.2015 US

(96) 15775835.0/14.09.2015

(86) US PCT/US2015/000100/14.09.2015

(87) WO 2016/039796/17.03.2016/2016/11

(97) EP 3191512/19.07.2017/2017/29

EP 3191512/24.07.2019/2019/30

(54) me **LIJEČENJE FIBRODISPLAZIJE OSSIFICANS PROGRESSIVA**
en **TREATMENT OF FIBRODYSPLASIA OSSIFICANS PROGRESSIVA**

(73) REGENERON PHARMACEUTICALS, INC.
777 Old Saw Mill River Road, Tarrytown NY 10591/ US

(72) HATSELL, Sarah J.
c/o Regeneron Pharmaceuticals Inc. 777 Old Saw Mill River Road, Tarrytown, NY 10591/ US
ECONOMIDES, Aris N.
c/o Regeneron Pharmaceuticals Inc. 777 Old Saw Mill River Road, Tarrytown, NY 10591/ US
IDONE, Vincent J.
c/o Regeneron Pharmaceuticals Inc. 777 Old Saw Mill River Road, Tarrytown, NY 10591/ US

(57) Antitijela protiv aktivina A za upotrebu u postupku liječenja fibrodisplazije ossificans progres'ssiva (FOP), taj postupak obuhvata isporuku pacijentu koji boluje od fibrodisplazije ossificans progressiva (FOP) djelotvornog režima antitijela protiv aktivina A.

Patent sadrži još 9 patentnih zahtjeva

(11) **03542** (13) **B**

..

(51) **C07D 401/14**^(2006.01) **A61K 31/4439**^(2006.01)

A61P 9/00^(2006.01) **A61P 13/00**^(2006.01)

A61P 25/00^(2006.01) **A61P 3/00**^(2006.01)

..

(21) P-2019-280

(22) 03.09.2013

(30) 201261697899 P 07.09.2012 US

(96) 13762666.9/03.09.2013

(86) US PCT/US2013/057826/03.09.2013

(87) WO 2014/039434/13.03.2014/2014/11

(97) EP 2892891/15.07.2015/2015/29

EP 2892891/31.07.2019/2019/31

(54) me **ALKOKSI PIRAZOLI KAO RASTVORUIVI AKTIVATORI GUANILAT CIKLAZE**
en **ALKOXY PYRAZOLES AS SOLUBLE GUANYLATE CYCLASE ACTIVATORS**

(73) Boehringer Ingelheim International GmbH

Binger Strasse 173, Ingelheim am Rhein, 55216/ DE

(72) , BRENNEMAN, Jehrod Burnett

c/o VP IP Legal Boehringer Ingelheim USA Corp. 900 Ridgebury Rd. P.O. Box 368, Ridgefield,
Connecticut 06877-0368/ US

, GINN, John David

c/o VP IP Legal Boehringer Ingelheim USA Corp. 900 Ridgebury Rd. P.O. Box 368, Ridgefield,
Connecticut 06877-0368/ US

, LOWE, Michael D.

c/o VP IP Legal Boehringer Ingelheim USA Corp. 900 Ridgebury Rd. P.O. Box 368, Ridgefield,
Connecticut 06877-0368/ US

, SARKO, Christopher Ronald

c/o VP IP Legal Boehringer Ingelheim USA Corp. 900 Ridgebury Rd. P.O. Box 368, Ridgefield,
Connecticut 06877-0368/ US

, TASBER, Edward S.

c/o VP IP Legal Boehringer Ingelheim USA Corp. 900 Ridgebury Rd. P.O. Box 368, Ridgefield,
Connecticut 06877-0368/ US

, ZHANG, Zhonghua

c/o VP IP Legal Boehringer Ingelheim USA Corp. 900 Ridgebury Rd. P.O. Box 368, Ridgefield,
Connecticut 06877-0368/ US

(57) Jedinjenje formule I

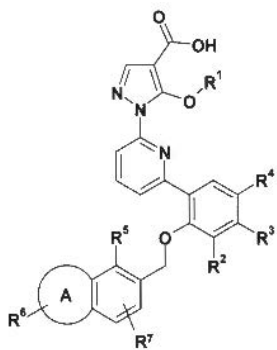

I

I

gdje:

A je 5-7 člani zasićeni heterocikličnagrupa koja sadrži jedan azot i opciono jedan kiseonik, pri čemu jedan zgljeniknavedene heterociklične grupe je opciono supstituisan sa jednom ili dvije grupeodabrane između C₁₋₃ alkil i okso ;

R¹ je C₁₋₄alkil opciono supstituisan sa metoksi grupom;

R² je odabranizmeđu H, F, Cl, C₁₋₃ alkil, -CN, -OMe i -CF₃;

R³ je odabranizmeđu H i -CH₃;

R⁴ je odabranizmeđu H F, -CH₃ i -OMe;

R⁵ je odabranizmeđu H, Cl -CH₃, -CH₂CH₃, -CF₃,F, i -OMe;

R⁶ je vezan za azotna A i odabran je između H, C₁₋₆ alkil, -(CH₂)_nC₃₋₆cikloalkil, -C(O)C₁₋₆ alkil, -(CH₂)_n heterociklil, -(CH₂)_n aril, -(CH₂)_n heteroaril, -SO₂ aril, SO₂C₁₋₆alkil pri čemu navedeni C₁₋₆ alkil, -(CH₂)_nheterociklil, -(CH₂)_n cikloalkil, -(CH₂)_n aril i -(CH₂)_n heteroaril su opciono supstituisani sajednom do četiri grupe nezavisno odabrane između C₁₋₃ alkil,halogen, C₁₋₃ alkoksi, -CF₃, -OH, okso, -(CH₂)₁₋₃O(CH₂)₂₋₃-OH,i -SO₂CH₃;

R⁷ je odabranizmeđu H, -CH₃, -CH₂CH₃, -CF₃, F, i-CN;

n je0, 1 ili 2

ilinjegova so.

Patent sadrži još 18 patentnih zahtjeva

(11) **03561** (13) **B**

..

(51) **C07K 16/24**^(2006.01)

C12N 9/48^(2006.01)

C12N 15/70^(2006.01)

C12P 21/02^(2006.01)

..

(21) P-2019-281

(22) 13.01.2011

(30) 20100000590 14.01.2010 GB

(96) 11700144.6/13.01.2011

(86) EP PCT/EP2011/050415/13.01.2011

(87) WO 2011/086138/21.07.2011/2011/29

(97) EP 2523975/21.11.2012/2012/47
EP 2523975/17.07.2019/2019/29

(54) me **SOJ BAKTERIJA DOMAĆINA KOJI SADRŽI MUTIRANI SPR GEN I DIVLJI TIP Tsp
GENA**
en **BACTERIAL HOST STRAIN COMPRISING A MUTANT SPR GENE AND A WILD-TYPE TSP
GENE**

(73) UCB BIOPHARMA SPRL
Allée de la Recherche 60, Brussels, 1070/ BE

(72) ELLIS, Mark
208 Bath Road, Slough Berkshire SL1 3WE/ GB
HUMPHREYS, David Paul
208 Bath Road, Slough Berkshire SL1 3WE/ GB

(57) Postupak za proizvodnju rekombinantnog proteina od interesa koji obuhvata kultivaciju rekombinantne gram-negativne bakterijske ćelije u medijumu kulture pod uslovima koji su efikasni za ekspresiju rekombinantnog proteina od interesa i izdvajanje rekombinantnog proteina od interesa iz periplazme rekombinantne gram-negativne bakterijske ćelije i/ili medijuma kulture, naznačen time što rekombinantna gram-negativna bakterijska ćelija sadrži

(a) mutirani spr gen koji kodira mutirani spr protein koji može da suzbije fenotip ćelije koji sadrži mutirani Tsp gen, naznačen time što mutirani spr gen kodira spr protein koji ima mutaciju u aminokiselini H145 prema aminokiselinskoj sekvenci SEK ID NO: 21, i

(b) nerekombinantni divlji tip hromozomskog Tsp gena, naznačen time što je ćelija izogenična sa divljim tipom ćelije E. coli, osim za mutirani spr gen.

Patent sadrži još 12 patentnih zahtjeva

(11) **03564** (13) **B**

..

(51) **C07D 295/192**^(2006.01)

A61K 31/496^(2006.01)

A61P 35/00^(2006.01)

..

(21) P-2019-282

(22) 11.03.2014

(30) 201361779962 P 13.03.2013 US

201361779908 P 13.03.2013 US

(96) 14779048.9/11.03.2014

(86) US PCT/US2014/023388/11.03.2014

(87) WO 2014/164749/09.10.2014/2014/41

(97) EP 2968316/20.01.2016/2016/03

EP 2968316/07.08.2019/2019/32

(54) me **DERIVATI 2-HIDROKSI-1-{4-[(4-FENILFENIL)KARBONIL]PIPERAZIN-1-IL}ETAN-1-ONA I SRODNA JEDINJENJA KAO INHIBITORI SINTAZE MASNIH KISELINA (FASN) ZA LEČENJE KANCERA**
en **2-HYDROXY-1-{4-[(4-PHENYLPHENYL)CARBONYL]PIPERAZIN-1-YL}ETHAN-1-ONE DERIVATIVES AND RELATED COMPOUNDS AS FATTY ACID SYNTHASE (FASN) INHIBITORS FOR THE TREATMENT OF CANCER**

(73) Forma Therapeutics, Inc.

500 Arsenal St., Suite 100, Watertown, MA 02472/ US

(72) BAIR, Kenneth W.

500 Arsenal St., Suite 100, Watertown, MA 02472/ US

LANCIA, David R.

500 Arsenal St., Suite 100, Watertown, MA 02472/ US

LI, Hongbin

500 Arsenal St., Suite 100, Watertown, MA 02472/ US

LOCH, James

500 Arsenal St., Suite 100, Watertown, MA 02472/ US

LU, Wei

500 Arsenal St., Suite 100, Watertown, MA 02472/ US

MARTIN, Matthew W.

500 Arsenal St., Suite 100, Watertown, MA 02472/ US

MILLAN, David S.

500 Arsenal St., Suite 100, Watertown, MA 02472/ US

SCHILLER, Shawn E.r.

500 Arsenal St., Suite 100, Watertown, MA 02472/ US

TEBBE, Mark J.

282 Renfrew Street, Arlington, MA 02476/ US

Jedinjenje formule I:

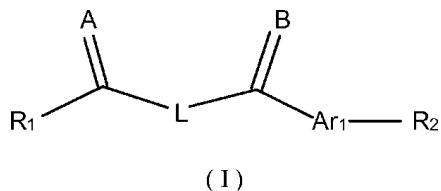

Gde

R₁ je

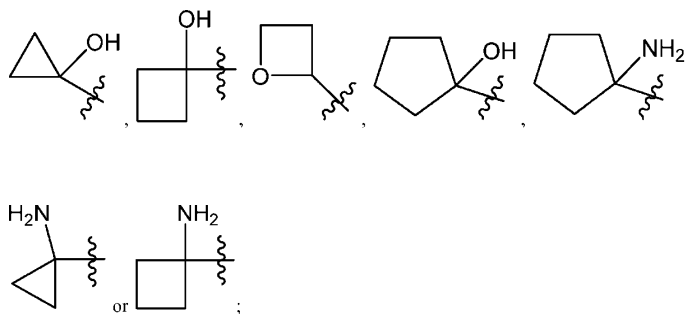

L je 5-10 člani monociklični ili biciklični alkil ili heteroalkil gde (i) heteroatomi kao članovi prstena 5-10 članog monocikličnog ili bicikličnog heteroalkila su nezavisno izabrani između O, S, ili N, i (ii) svaki od 5-10 članog monocikličnog ili bicikličnog alkila ili heteroalkila je ili nesupstituisan ili opciono supstituisan sa supstituentima izabranim iz grupe koju čine deuterijum i -Rb;

A i B su nezavisno O ili S;

An je

4-10 člani monociklični ili biciklični aril, heteroaril ili heterocikloalkil, gde (i) pomenuti 4-10 člani monociklični ili biciklični heteroaril ili heterocikloalkil imaju 1, 2, 3, ili 4 heteroatoma koji su nezavisno izabrani između N, S ili O, i (ii) svaki od pomenutih 4-10 članih monocikličnih ili bicikličnih arila, heteroarila, ili heterocikloalkila je ili nesupstituisan ili opciono nezavisno supstituisan sa 1 ili više supstituenata koji mogu biti isti ili različiti i nezavisno su izabrani iz grupe koju čine deuterijum, halo, alkil, -CHzF3-z, cijano, hidroksil, hidroksilalkil, amino, aminoalkil-, (amino)alkoksi-, -CONH₂, -C(O)NH(alkil), -C(O)N(alkil)₂, -C(O)NH(aril), -C(O)N(aril)₂, -OCHzF3-z, -alkil, -alkenil, -alkinil, -alkoksi ili (alkoksialkil)amino-, -N(Rc)-C(O)-alkil, -N(Rc)-C(O)-aril, -cikloalkil, -heterocikloalkil, -aril, i -heteroaril, uz uslov da dva susedna heteroatoma nisu oba S ili oba O;

R₂ je H ili 4-15 člani monociklični, biciklični ili triciklični aril, heteroaril, cikloalkil, ili heterocikloalkil, (i) 4-15 člani monociklični, biciklični ili triciklični heteroaril ili heterocikloalkil koji ima 1, 2, 3, 4, 5, 6, 7, ili 8 heteroatoma koji su nezavisno izabrani između N, S ili O, i (ii) gde bilo koji od pomenutih aril, heteroaril, cikloalkil, i heterocikloalkil je ili nesupstituisan ili opciono supstituisan sa 1 ili više supstituenata koji mogu biti isti ili različiti i nezavisno su izabrani iz grupe koju čine deuterijum, halo, cijano, hidroksil, hidroksil-alkil-, hidroksilcikloalkil-, hidroksil-heterocikloalkil-, hidroksil-aril-, hidroksil- heteroaril-, amino, aminoalkil, (amino)alkoksi-, -CONH₂, -C(O)NH(alkil), -C(O)N(alkil)₂, -C(O)NH(aril), -C(O)N(aril)₂, -CHzF3-z, -OCHzF3-z, -alkil, alkoksi-, -alkenil, -alkinil, ariloksi-, (alkoksialkil)amino-, -cikloalkil, -heterocikloalkil, (heterocikloalkil)alkil-, -aril, -heteroaril, -O(alkil), -O(cikloalkil), -O(heterocikloalkil), -O(aril), -O(heteroaril),

ONH₂, -C(O)NH(alkil), -C(O)N(aril)₂, -C(O)NH(cikloalkil), -NH(CO)cikloalkil, -NH(SO₂), -NH(SO₂)alkil, -NH(SO₂)aril, -NH(SO₂)heteroaril, -N(SO₂)cikloalkil, -C(O)N(alkil)₂, (aril)alkil-, -heteroaril, (heteroaril)alkil-, -S(O)₂-alkil, -S(O)₂-aril, -S(O)₂-cikloalkil, -C(O)N(alkil)₂, -C(O)alkil, -NH- C(O)-alkil, -NH-C(O)-cikloalkil, NH-C(O)-heterocikloalkil, NH-C(O)-heterocikloalkil-Rd, -NH- C(O)-Rd-(O)alkil, -NH-C(O)-aril, -NH-C(O)-NH-alkil, NH-C(O)-NH-cikloalkil, NH₂(CO)cikloalkil-, NH- C(O)-NH-aril, -NH-C(O)-O-alkil, NH-C(O)-NH-cikloalkil, , -NH-C(O)-O-cikloalkil, -NH(Rd)-C(O)-alkil, -NH(Rd)-C(O)-aril, -NH(Rd)-S(O₂)cikloalkil, -S(O₂)NH₂, -S(O₂)NH(alkil), S(O₂)N(Rd)cikloalkil, -S(O₂)N(alkil)₂, -C(O)N(H)(alkil), -C(O)N(Rd)(cikloalkil), metilendioksi, -CHzF₃-z, -OCHzF₃-z, i-alkoksi;

Rb je H, halo, C1-C4 alkil, C1-C3 hidroksil-alkil, ili C3-C4 cikloalkil;

Rc je H, halo, C1-C4 alkil, ili C3-C4 cikloalkil;

Rd je H, halo, C1-C4 alkil, ili C3-C4 cikloalkil;

i z je 0, 1 ili 2;

i njihove farmaceutski prihvatljive soli.

dalje gde:

R2 nije supstituisani ili nesupstituisani oblik

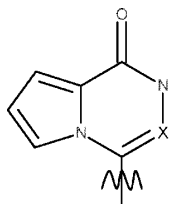

gde X je N ili CH;

kada Ar1 je

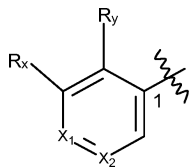

povezan sa

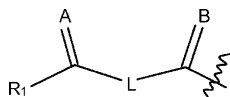

u položaju 1, i X1 i X2 su nezavisno N ili C-Rz, i Ry i Rz su bilo koji supstituent, tada Rx ne obuhvata alkinil, alkenil, aril, 5-14 člani heterociklik, 5-14 člani heteroaromatik, ili 4-9 člani karbosiklik;

gde Ar1 je supstituisani ili nesupstituisani oblik 5 članog heteroarila, Ar1 je supstituisani ili nesupstituisani oblik

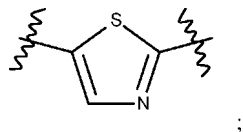

i gde R2 je

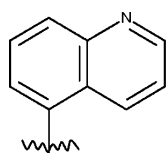

Ar1 nije supstituisani ili nesupstituisani oblik

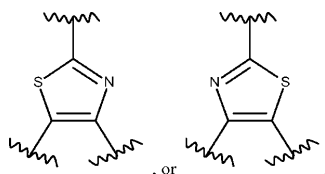

Patent sadrži još 45 patentnih zahtjeva

(11) **03566** (13) **B**

..

(51) **C07D 213/75**^(2006.01)

A61K 31/444^(2006.01)

A61P 9/00^(2006.01)

..

(21) P-2019-283

(22) 14.03.2014

(30) 201361785763 P 14.03.2013 US

(96) 14720369.9/14.03.2014

(86) US PCT/US2014/027146/14.03.2014

(87) WO 2014/152270/25.09.2014/2014/39

(97) EP 2970123/20.01.2016/2016//03

EP 2970123/14.08.2019/2019/33

(54) me **SO OMEKAMTIV MEKARBILA I PROCES ZA PRIPREMANJE SOLI**
en **SALT OF OMECAMTIV MECARBIL AND PROCESS FOR PREPARING SALT**

(73) AMGEN INC.

One Amgen Center Drive, Thousand Oaks, California 91320-1799/ US

CYTOKINETICS, INC.

280 East Grand Avenue, South San Francisco, CA 94080/ US

(72) CUI, Sheng

391 Lincoln Street, Lexington, MA 02421/ US

MORRISON, Henry

10789 Inspiration Cir., Dublin, CA 94568-5556/ US

NAGAPUDI, Karthik

594 Yarrow Drive, Simi Valley, CA 93065/ US

WALKER, Shawn

6710 Eton Avenue Unit 135, Woodland Hills, CA 91303/ US

BERNARD, Charles

14466 Laurel Lane, Moorpark, CA 93021/ US

HANSEN, Karl Bennett

35 Pond Street, Cohasset, MA 02025/ US

LANGILLE, Neil Fred

9 Willard Grant Road, Sudbury, MA 01776/ US

ALLGEIER, Alan Martin

1407 N. Grant Avenue, Wilmington, DE 19806/ US

MENNEN, Steven

167 Warren Avenue Apt.4, Boston, MA 02116/ US

WOO, Jacqueline

211 Ascott Crescent, Sherwood Park, Alberta T8H 0A6/ CA

MORGAN, Bradley Paul

1206 Rimer Drive, Moraga, CA 94556/ US

MUCI, Alex

2025 Stockton Street 3, San Francisco, CA 94133/ US

(57) Dihidrohlorid hidratna so omekamtiv mekarbila.

Patent sadrži još 14 patentnih zahtjeva

(11) **03575** (13) **B**

..

(51) **A23J 3/14**^(2006.01)

A23L 7/117^(2016.01)

A23L 33/185^(2016.01)

A23L 33/21^(2016.01)

A23L 7/17^(2016.01)

..

(21) P-2019-284

(22) 13.10.2016

(30) 20150190251 16.10.2015 EP

201615229290 05.08.2016 US

(96) 16790282.4/13.10.2016

(86) US PCT/EP2016/074556/13.10.2016

(87) WO 2017/064172/20.04.2017/2017/16

(97) EP 3361880/22.08.2018/2018/34

EP 3361880/14.08.2019/2019/33

(54) me **POSTUPAK PROIZVODNJE TEKSTURIRANOG PREHRAMBENOG PROIZVODA I
TEKSTURIRANI PREHRAMBENI PROIZVOD**
en **A METHOD OF MANUFACTURING A TEXTURED FOOD PRODUCT AND A TEXTURED
FOOD PRODUCT**

(73) Gold&Green Foods Oy
Hämeentie 157, 00560 Helsinki/ FI

(72) KIVELÄ, Reetta
Stenbäckinkatu 18 B, 00250 Helsinki/ FI
HÄKÄMIES, Anna
Vattuniemenkatu 10 A 14, 00210 Helsinki/ FI
JIANG, Zhongqing
Oltermannintie 31 B 5, 00620 Helsinki/ FI

(57) Postupak za proizvodnju teksturiranog prehrambenog proizvoda, kojisadrži korake:

- priprema mešavine koja sadrži suhu materiju ivodu,

1) pri čemu suva materija sadrži:

1. najmanje 35% mase proteina mahunarki,

2. od 10% do 45% mase mekinja ili brašna ilimešavine odabrane od:

i) ovsene mekinje,integralnog ovsenog brašna ilimešavine ovsene mekinje 1
integralnog ovsenog brašna,

ii) ječmene mekinje, ječmenog brašna ili mešavine ječmene mekinje 1 integralnog ječmenog brašna,

iii) ražene mekinje, integralnog ražanog brašna ili mešavine raženih mekinja i integralnog ražanog brašna, i

iv) mešavinu najmanje dve ilitri od navedenih od i) do 111), i

3. od 2% do 35% mase suve materije ovsnfn proteina,

od kojih komponenta 2.1 komponenta 3. uvek moraju da sadrže do 65 % mase;

i

ii) pri čemu mešavina dalje sadrži vodu od 20 % do 80 % mase suve materije; i

- kuvanje mešavine u ekstruderu; i

· ekstrudiranje kuvane kaše da bise dobio navedeniteksturiraniprehrambeniproizvod.

Patent sadrži još 46 patentnih zahtjeva

(11) **03567** (13) **B**

..

(51) **A61K 31/4188**^(2006.01)

A61P 25/28^(2006.01)

..

(21) P-2019-285

(22) 25.03.2016

(30) 20150305437 26.03.2015 EP

(96) 16713833.8/25.03.2016

(86) EP PCT/EP2016/056696/25.03.2016

(87) WO 2016/151132/29.09.2016/2016/39

(97) EP 3273957/31.01.2018/2018/05
EP 3273957/14.08.2019/2019/33

(54) me **BIOTIN ZA LEČENJE DEMIJELINIZACIONIH NEUROPATIJA**
en **BIOTIN FOR TREATING DEMYELINATING NEUROPATHIES**

(73) Medday Pharmaceuticals
24/26 rue de la Pépinière, 75008 Paris/ FR

(72) SEDEL, Frédéric
24/26 rue de la Pépinière, 7508 Paris/ FR

(57) Biotin za upotrebu u lečenju demijelinizacione neuropatije, pri čemu je navedena demijelinizaciona neuropatija izabrana iz grupe koja se sastoji iz demijelinizacione neuropatije povezane sa imunoglobulinom M (IgM) monoklonske gamapatije i antitela protiv glikoproteina povezanog sa mijelinom (MAG), tipične hronične inflamatorne demijelinizacione poliradikuloneuropatije, atipične hronične inflamatorne demijelinizacione poliradikuloneuropatije, bolesti Charcot Marie Tooth i Giljan Barovog sindroma.

Patent sadrži još 16 patentnih zahtjeva

(11) **03568** (13) **B**

..

(51) **C07D 487/04**^(2006.01)

A61K 31/519^(2006.01)

A61P 9/10^(2006.01)

..

(21) P-2019-286

(22) 30.11.2015

(30) 201462085722 P 01.12.2014 US

201562166808 P 27.05.2015 US

(96) 15802075.0/30.11.2015

(86) EP PCT/EP2015/077998/30.11.2015

(87) WO 2016/087338/09.06.2016/2016/23

(97) EP 3227294/11.10.2017/2017/41

EP 3227294/14.08.2019/2019/33

(54) me **1-[2-(AMINOMETIL)BENZIL]-2-TIOKS0-1,2,3,5-TETRAHIDRO-4H-PIROLO[3,2-D]PIRIMIDIN-4-ONI KAO INHIBITORI MIJELOPEROKSIDAZE**
en **1-[2-(AMINOMETHYL)BENZYL]-2-THIOXO-1,2,3,5-TETRAHYDRO-4H-PYRROLO[3,2-D]PYRIMIDIN-4-ONES AS INHIBITORS OF MYELOPEROXIDASE**

(73) ASTRAZENECA AB

, Södertälje, 151 85 / SE

(72) INGHARDT, Tord Bertil

, S-431 83 Mölndal/ SE

TOMKINSON, Nicholas

, Macclesfield Cheshire SK10 4TG/ GB

GAN, Li-Ming

, S-431 83 Mölndal/ SE

STONEHOUSE, Jeffrey Paul

35 Gatehouse Drive Waltham, MA 02451/ US

JOHANNESON, Petra

, S-431 83 Mölndal/ SE

JURVA, Ulrik

, S-431 83 Mölndal/ SE

MICHAËLSSON, Erik

, S-431 83 Mölndal/ SE

LINDSTEDT-ALSTERMARK, Eva-Lotte

, S-431 83 Mölndal/ SE

(57) Jedinjenje formule (1)

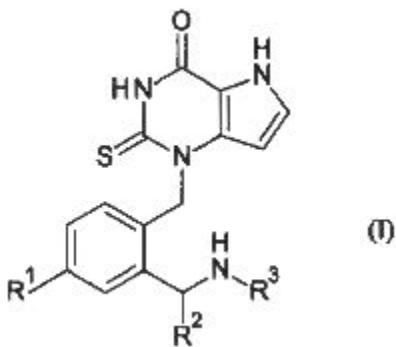

gde

R¹ je H, F, Cl ili CF₃;

R² je H, CH₃ ili C₂H₅; i

R³ je H, CH₃, C₂H₅, n-propil, izopropil, n-butil, izobutil, sek-butil, terc-butil, ciklopropil, ciklopropilmetil, ciklobutil, ciklobutilmetil ili ciklopentil;

ili njihova farmaceutske prihvatljiva so.

Patent sadrži još 15 patentnih zahtjeva

(11) **03569** (13) **B**

..

(51) **A61K 38/17**^(2006.01)

A61K 39/00^(2006.01)

C07K 7/06^(2006.01)

C07K 7/08^(2006.01)

G01N 33/50^(2006.01)

A61P 35/00^(2006.01)

..

(21) P-2019-287

(22) 15.03.2011

(30) 315704 P 19.03.2010 US

201004551 19.03.2010 GB

(96) 17157398.3/15.03.2011

(97) EP 3195873/26.07.2017/2017/30

EP 3195873/24.07.2019/2019/30

(54) me **NOVA IMUNOTERAPIJA PROTIV NEKOLIKO TUMORA UKLJUČUJUĆI
GASTROINTESTINALNI KARCINOM I KARCINOM ŽELUCA**
en **NOVEL IMMUNOTHERAPY AGAINST SEVERAL TUMORS INCLUDING
GASTROINTESTINAL AND GASTRIC CANCER**

(73) Immatrics biotechnologies GmbH
Paul-Ehrlich-Strasse 15, 72076 Tübingen/ DE

(72) Weinschenk, Toni
Im Morgenrain 15, 73773 Aichwald/ DE
Fritsche, Jens
Lärchenweg 11, 72144 Dusslingen/ DE
Walter, Steffen
2901 Wroxtton Road, Houston, TX 77005/ US
Lewandrowski, Peter
Grabenstrasse 11, 72070 Tübingen-Hirschau/ DE
Harpreet, Singh
Heckscherstrasse 25a, 80804 Munich/ DE

(57) Peptid koji se sastoji od aminokiselinske sekvence u skladu s ID BR. SEKV 58.

Patent sadrži još 14 patentnih zahtjeva

(11) **03571** (13) **B**

..

(51) C07D 401/14 ^(2006.01)	C07D 401/06 ^(2006.01)
C07D 401/12 ^(2006.01)	C07D 403/06 ^(2006.01)
C07D 403/14 ^(2006.01)	C07D 417/06 ^(2006.01)
C07D 417/14 ^(2006.01)	A61K 31/4155 ^(2006.01)
A61K 31/4439 ^(2006.01)	A61K 31/416 ^(2006.01)
A61K 31/427 ^(2006.01)	A61K 31/428 ^(2006.01)
A61K 31/4545 ^(2006.01)	A61P 25/00 ^(2006.01)

..

(21) P-2019-288

(22) 19.07.2016

(30) 4809CH2015 10.09.2015 IN

(96) 16750259.0/19.07.2016

(86) IN PCT/IB2016/054290/19.07.2016

(87) WO 2017/042643/16.03.2017/2017/11

(97) EP 3347349/18.07.2018/2018/29

EP 3347349/18.09.2019/2019/38

(54) me **FLUOROINDOL DERIVATI KAO POZITIVNI ALOSTERIČKI MODULATORI MUSKARINSKOG M1 RECEPTORA**
en **FLUOROINDOLE DERIVATIVES AS MUSCARINIC M1 RECEPTOR POSITIVE ALLOSTERIC MODULATORS**

(73) Suven Life Sciences Limited

Serene Chambers, Road - 5 Avenue - 7, Banjara Hills, Hyderabad, Telangana 500034/ IN

(72) NIROGI, Ramakrishna

Serene Chambers, Road-5, Avenue 7, Banjara Hills, Hyderabad Telangana 500034/ IN

SHINDE, Anil Karbhari

Serene Chambers, Road-5, Avenue 7, Banjara Hills, Hyderabad Telangana 500034/ IN

MOHAMMED, Abdul Rasheed

Serene Chambers, Road-5, Avenue 7, Banjara Hills, Hyderabad Telangana 500034/ IN

SUBRAMANIAN, Ramkumar

Serene Chambers, Road-5, Avenue 7, Banjara Hills, Hyderabad Telangana 500034/ IN

BENADE, Vijay Sidram

Serene Chambers, Road-5, Avenue 7, Banjara Hills, Hyderabad Telangana 500034/ IN

BHYRAPUNENI, Gopinadh

Serene Chambers, Road-5, Avenue 7, Banjara Hills, Hyderabad Telangana 500034/ IN

JASTI, Venkateswarlu

Serene Chambers, Road-5, Avenue 7, Banjara Hills, Hyderabad Telangana 500034/ IN

(57)

1. Fluoroindol jedinjenje formule (I),

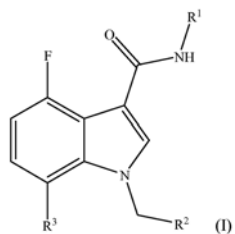

naznačeno time da:

R1 je

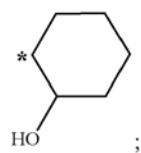

R2 je

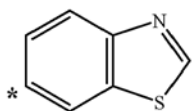
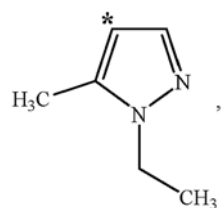
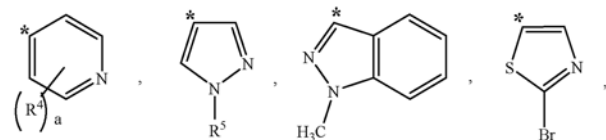

ili
;

naznačeno time da * predstavlja tačku vezivanja;

R3 je fluor ili vodonik;

R4 je halogen, S-CH3 ili vodonik;

R5 je CH3, -CH2CH2F ili vodonik;

a je 1 ili 2;

ili izotopski oblik, stereoizomer ili njegova farmaceutska prihvatljiva so.

Patent sadrži još 8 patentnih zahtjeva

(11) **03610** (13) **B**

..

(51) **C07D 519/00**^(2006.01)

A61K 31/439^(2006.01)

A61P 1/04^(2006.01)

..

(21) P-2019-289

(22) 26.05.2016

(30) 201562167694 P 28.05.2015 US

201662312273 P 23.03.2016 US

(96) 16728495.9/26.05.2016

(86) US PCT/US2016/034243/26.05.2016

(87) WO 2016/191524/01.12.2016/2016/48

(97) EP 3303348/11.04.2018/2018/15

EP 3303348/07.08.2019/2019/32

(54) me **NAFTIRIDINSKA JEDINJENJA KAO INHIBITORI JAK KINAZE**
en **NAPHTHYRIDINE COMPOUNDS AS JAK KINASE INHIBITORS**

(73) THERAVANCE BIOPHARMA R&D IP, LLC

901 Gateway Boulevard, South San Francisco, CA 94080/ US

(72) HUDSON, Ryan

1454 Walbrook Drive, San Jose, California 95129/ US

KOZAK, Jennifer

771 Prairie Creek Drive, Pacifica, California 94044/ US

FATHEREE, Paul R.

921 Minnesota Street, San Francisco, California 94107/ US

PODESTO, Dante D.

1122 Trinity Avenue, Modesto, California 95350/ US

BRANDT, Gary E.L.

2160 Buena Vista Avenue, Alameda, California 94501/ US

FLEURY, Melissa

47D Joy Avenue, Brisbane, California 94005/ US

BEAUSOLEIL, Anne-Marie

600 Brewster Avenue, Apt. 306, Redwood City, California 94063/ US

HUANG, Xiaojun

5978 Bollinger Road, San Jose, CA 95129 / US

THALLADI, Venkat R.

888 Foster City Boulevard Apt. E3, Foster City, California 94404/ US

(57) Jedinjenje formule (1):

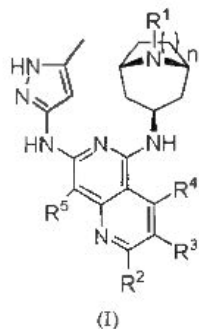

gde je

R¹ izabran od:

(a) C₁₋₄alkil radikala, pri čemu je C₁₋₄alkil po izboru supstituisan sa jednom, dve ili tri fluoro grupe ili sa supstituentom izabranim od:

- CN,

- OC₁₋₃alkil,

- C(O)OC₁₋₄alkil,

fenil radikala, pri čemu je fenil po izboru supstituisan sa -OH, piridinilom, pri čemu je piridinil po izboru supstituisan sa -CN, tetrahidropiraniom,

- C(O)NR^aR^b, gde su R^a i R^b nezavisno vodonik ili C₁₋₃alkil ili je R^a vodonik, a R^b je

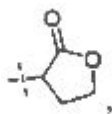

i grupa izabrana od

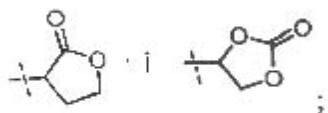

(b) grupe izabrane od

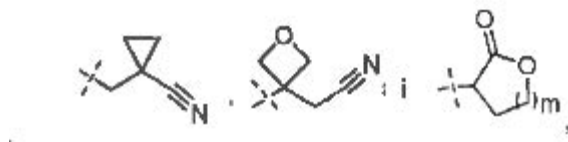

gde je m 1 ili 2;

(c) $-C(O)R^6$, gde je R^6 izabran od radikala:

C_{1-4} alkila, pri čemu je C_{1-4} alkil po izboru supstituisan sa jednom, dve ili tri fluora grupe ili sa supstituentom izabranim od $-OH$, $-CN$, $-OC_{1-4}$ alkil, fenil radikala i $-NR^eR^f$, gde su R^e i R^f nezavisno vodonik ili C_{1-3} alkil;

C_{3-6} cikloalkila, pri čemu je C_{3-6} cikloalkil po izboru supstituisan sa C_{1-3} alkil grupom;

piridinila, pri čemu je piridinil po izboru supstituisan sa $-CN$; i

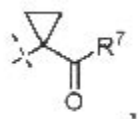

gde je R^7 $-CN$, $-CF_3$ ili $-OCH_3$;

(d) $-C(O)OR^8$ gde je R^8 izabran od radikala

C_{1-4} alkila, pri čemu je C_{1-4} alkil po izboru supstituisan sa $-CN$, C_{3-6} cikloalkil, tetrahidrofuranil grupom ili $-OR^m$, pri čemu je R^m vodonik ili C_{1-3} alkil; i

C_{1-4} alkenila; i

(e) $-S(O)_2R^9$ gde je R^9 izabran od radikala

C_{1-4} alkila, pri čemu je C_{1-4} alkil po izboru supstituisan sa $-CN$, $-OC_{1-3}$ alkil, fenil, piridinil ili C_{3-6} cikloalkil grupom,

C_{1-4} alkenila,

C_{3-6} cikloalkila, pri čemu je C_{3-6} cikloalkil po izboru supstituisan sa C_{1-3} alkil grupom,

fenila,

piridinila, pri čemu je piridinil po izboru supstituisan sa fluora grupom,

heterociklina koji sadrži 4 do 6 atoma u prstenu, uključujući jedan atom azota, pri čemu je heterociklin po izboru supstituisan sa -CN ili C₁₋₃alkil grupom, pri čemu je C₁₋₃alkil po izboru supstituisan sa -CN ili -OC₁₋₃alkil grupom; i

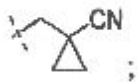

R² je izabran između vodonika, -OC₁₋₃alkil i -CH₂-R¹⁰ gde je R¹⁰ izabran od radikala -OH, morfolinila, piperidinila, pri čemu je piperidinil po izboru supstituisan sa 2 fluora, kao i piperazinila, pri čemu je piperazinil po izboru supstituisan sa metil grupom;

R³ je izabran između vodonika, C₁₋₃alkil, -OC₁₋₃alkil, -C(O)OC₁₋₃alkil, -S(O)₂C₁₋₃alkil i -CH₂S(O)₂C₁₋₃alkil radikala;

R⁴ je vodonik ili -OC₁₋₃ alkil;

R⁵ je vodonik ili fluoro grupa; i

n je 1 ili 2;

pod uslovom da

kada je R³ -OC₁₋₃alkil i svaki od R², R⁴ i R⁵ je vodonik, R⁹ nije fenil;

kada je R⁵ fluoro grupa, n je 1 i svaki od R², R³ i R⁴ je vodonik, R⁹ nije fenil; i

kada je R⁵ je fluoro grupa, R³ je metil i svaki od R² i R⁴ je vodonik, R¹ nije -C(O)OR⁸

ili njegova farmaceutski prihvatljiva so ili stereoizomer.

Patent sadrži još 30 patentnih zahtjeva

(11) **03632** (13) **B**

..

(51) **E05B 27/00**^(2006.01)

E05B 29/00^(2006.01)

..

(21) P-2019-290

(22) 31.08.2015

(30) 6922014 11.09.2014 AT

(96) 17165193.8/31.08.2015

(97) EP 3219884/20.09.2017/2017/38
EP 3219884/17.07.2019/2019/29

(54) me **KLJUČ, ODGOVARAJUĆA BRAVA I SISTEM KOJI SADRŽI KLJUČ I BRAVE**
en **KEY, CORRESPONDING LOCK AND SYSTEM COMPRISING KEY AND LOCKS**

(73) EVVA Sicherheitstechnologie GmbH
Wienerbergstrasse 59-65, 1120 Wien/ AT

(72) Baumhauer, Walter
Gablenzgasse 32/24-26, 1160 Wien/ AT

(57) Ključ (I) za zaključavanje brave, koji sadrži:

- a. najmanje jednu prvu površinu (2) i najmanje jednu drugu površinu (2'),
- b. sa najmanje jednim senzorskim položajem (4) obezbeđenim duž uzdužnog prostiranja ključa (I),
- c. na kojem najmanje jedan prvi kod (3) za čitanje u bravi je obezbeđen na prvoj površini (2) i najmanje jedan drugi kod (3') za čitanje u bravi je obezbeđen na drugoj površini (2'),
- d. kodove (3, 3') koje formiraju kontrolne tačke (6, 6', 7, 7') koje su obezbeđene poprečno na dužinu ključa (I) i postavljene na određenim kontrolnim visinama (5), i kontrolne tačke koje su povezane jedna sa drugom kontrolnim žlebovima (8, 8', 9, 9'),
- e. najmanje jedan kontrolni žleb (8, 9) sa kontrolnim tačkama (6, 7) koje su obezbeđene na prvoj površini (2), i najmanje jedana kontrolni žleb (8', 9') sa kontrolnim tačkama (6', 7') koje su slično obezbeđene na drugoj površini (2'), i kontrolne tačke svakog kontrolnog žleba u svakom slučaju su obezbeđene na definisanim senzorskim položajima (4),
- f. pri čemu se tu nalaze najmanje tri kontrolna žleba, od kojih najmanje jedan je konstruisan kao duboki kontrolni žleb (8, 8') sa dubokim kontrolnim tačkama (6, 6'), a preostali su konstruisani kao plitki kontrolni žlebovi (9, 9') sa plitkim kontrolnim tačkama (7, 7'), pri čemu duboki kontrolni žlebovi (8, 8') imaju veću dubinu žleba nego plitki kontrolni žlebovi (9, 9'), i plitki kontrolni žlebovi (9, 9') koji se prostiru suštinski paralelno jedan drugom, **naznačen time što** najmanje jedan kod (3) prve površine (2) se razlikuje na najmanje jednom senzorskom položaju (4) od drugog koda (3') na istom senzorskom položaju (4) u tome da najmanje jedna kontrolna tačka najmanje jednog kontrolnog žleba na najmanje jednom senzorskom položaju na prvoj površini (2) ima kontrolnu visinu različitu od one od kontrolne tačke odgovarajućeg kontrolnog žleba na istom senzorskom položaju na drugoj površini (2').

Patent sadrži još 16 patentnih zahtjeva

(11) **03646** (13) **B**

..

(51) H04L 5/14 ^(2006.01)	H04L 5/00 ^(2006.01)
H04B 7/0452 ^(2017.01)	H04B 7/08 ^(2006.01)
H04W 72/12 ^(2009.01)	H04W 74/02 ^(2009.01)
H04W 74/08 ^(2009.01)	

..

(21) P-2019-292

(22) 12.05.2017

(30) 15/154,212 13.05.2016 US

(96) 17727742.3/12.05.2017

(86) SE PCT/SE2017/050487/12.05.2017

(87) WO 2017/196246/16.11.2017/2017/46

(97) EP 3443704/20.02.2019/2019/08
EP 3443704/31.07.2019/2019/31

(54) me **MULTIPLEKSIRANJE PODOKVIRA SA RAZLIČITIM RASTOJANJIMA IZMEĐU
PODNOŠIOCA**
en **MULTIPLEXING OF SUBFRAMES WITH DIFFERENT SUBCARRIER SPACINGS**

(73) Telefonaktiebolaget LM Ericsson (PUBL)
, Stockholm, 164 83 / SE

(72) BALDEMAIR, Robert
Honnörsgatan 16, Solna, 170 69/ SE
ABRAHAMSSON, Richard
Åsgatan 45, Kvinsta, 741 45/ SE
AKTAS, Ismet
Kölner Strasse 205, Neuss, 41468/ DE
ALRIKSSON, Peter
Fridagatan 10, Hörnby , 242 31/ SE
ANSARI, Junaid
Paul-Keller-Str. 17, Fürth, 90768/ DE
ASHRAF, Shehzad Ali
Hubertusstrasse 42, Aachen, 52064/ DE
ASPLUND, Henrik
Borgargatan 16, Stockholm, 117 34/ SE
ATHLEY, Fredrik
Banvallen 65A, Kullavik, 429 30/ SE
AXELSSON, Håkan
Wernersgatan 27 A, Linköping, 582 46/ SE
AXMON, Joakim
Hattsnäcksgränd 1, apt 1301, Limhamn , 216 31/ SE

SEIFI, Nima
Våtmarksvägen 62, Solna, 170 62/ SE
SELÉN, Yngve
Lästmakargatan 8A, Uppsala , 754 34/ SE
SEMAAN, Eliane
Ursviks Allé 49, Sundbyberg, 174 66/ SE
SHARMA, Sachin
Röntgenvägen 1 lgh 1604, Huddinge, 141 52/ SE
SHI, Cong
No. 5 Lize East Street, Chaoyang District/ CN
SKÖLD, Johan
Gustav III:s Boulevard 17, Solna, 169 72/ SE
STATTIN, Magnus
Wäckareslingan 17, Upplands Väsby, 194 44/ SE
STJERNMAN, Anders
Björnåsvägen 3, Lindome , 437 41/ SE
SUNDMAN, Dennis
Råundavägen 146, Solna, 169 36/ SE
SUNDSTRÖM, Lars
Hardeberga 381, Södra Sandby, 247 91/ SE
AXNÅS, Johan
Johan Enbergs väg 15, Solna , 171 62/ SE
TERCERO VARGAS, Miurel Isabel
Polhemsvägen 30, Sollentuna , 191 33/ SE
TIDESTAV, Claes
Lillsjövägen 7, Båista, 746 31/ SE
TOMBAZ, Sibel
Storgatan 72A, 1102, Stockholm , 171 52/ SE
TORSNER, Johan
Bergtrollsvägen 2, Kyrkslätta, 02400/ FI
TULLBERG, HUGO
Långbergsvägen 6, Nyköping, 611 37/ SE
VIKBERG, Jari
Svalsättersvägen 12, Jäma, 153 38/ SE
VON WRYCZA, Peter
Strandvägen 29, Stockholm, 114 56/ SE
WAGER, Stefan
Övergårdsvägen 41 D, Espoo, 02360/ FI
WALLDEEN, Thomas
Liljegatan 8B, Linköping, 587 31/ SE
WALLENTIN, Pontus
Trastgatan 3, Linköping, 582 39/ SE
BALACHANDRAN, Kumar
5783 San Antonio Street, Pleasanton California 94566/ US
WANG, Hai
No.5 Lize East Street, Chaoyang District/ CN
WANG HELMERSSON, Ke
Spångerumsgatan 33, Linköping, 587 25/ SE
WANG, Jianfeng
No.5 Lize East Street, Chaoyang District/ CN
WANG, Yi-Pin Eric
1357 Grosventres Ct., Fremont California 94539/ US

KARLA, Karl
Järpstigen 5, Segeltorp, 141 72/ SE
WIBERG, Niclas
Sofielundsvägen 8, Linköping, 585 97/ SE
WITTENMARK, Emma
Norra Spolegatan 1R, Lund, 222 40/ SE
YILMAZ, Osman Nuri Can
Puolarkuja 3 D 8, Epsoo, 02280/ FI
ZAIDI, Ali
Vasavägen 75 LGH 1203, Järfälla, 177 32/ SE
ZHANG, Zhang
No.5 Lize East Street, Chaoyang District/ CN
BARK, Gunnar
Mariedalsgatan 104, Linköping, 586 65/ SE

(74) Advokat ČOSOVIĆ, Dejan L.
ul.13 Jula br. 9, Budva, 85310/ ME

(57) Metod za bežični uređaj, za rad u bežičnoj komunikacionoj mreži i operativan za komunikaciju sa opremom za radio mreže u bežičnoj komunikacionoj mreži, koji metod obuhvata:

prijem prvog downlink signala koji sadrži informacije koje označavaju postojanje mnoštva uplink pristupnih konfiguracija, svaku uplink pristupnu konfiguraciju uključujući i konfiguraciju za nasumični pristup;

prijem drugog downlink signala koji sadrži indeks uplink pristupnih konfiguracija, korišćenje indeksa uplink pristupnih konfiguracija za identifikaciju pojedinačne uplink pristupne konfiguracije iz označenog mnoštva uplink pristupnih konfiguracija i slanje transmisije za nasumični pristup bežičnoj komunikacionoj mreži u skladu sa konfiguracijom za nasumični pristup uključenom u identifikovanu uplink pristupnu konfiguraciju;

naznačeno time što metod dalje obuhvata:

prijem, kao odgovora, u prvom downlink podokviru, prve transmisije Ortogonalnim Frekvencijski-lzdvojenim Multipleksiranjem, OFDM, transmisije formatirane prema prvoj numerologiji i prijem, u drugom downlink podokviru, druge OFDM transmisije formatirane prema drugoj numerologiji, pri čemu je druga numerologija različita od prve numerologije po tome što prva numerologija ima prvo rastojanje među podnosiocima a druga numerologija ima drugo rastojanje među podnosiocima, pri čemu je prvo rastojanje među podnosiocima različito od drugog rastojanja među podnosiocima.

Patent sadrži još 92 patentnih zahtjeva

(11) **03600** (13) **B**

..

(51) **C07D 471/10**^(2006.01)

C07D 491/10^(2006.01)

A61K 31/439^(2006.01)

A61P 11/00^(2006.01)

..

(21) P-2019-293

(22) 08.09.2015

(30) 20140184613 12.09.2014 EP

(96) 15757523.4/08.09.2015

(86) EP PCT/EP2015/070449/08.09.2015

(87) WO 2016/038007/17.03.2016/2016/11

(97) EP 3191487/19.07.2017/2017/29

EP 3191487/07.08.2019/2019/32

(54) me **SPIROCIKLIČNI INHIBITORI KATEPSINA C**
en **SPIROCYCLIC INHIBITORS OF CATHEPSIN C**

(73) Boehringer Ingelheim International GmbH
Binger Strasse 173, Ingelheim am Rhein, 55216/ DE

(72) VINTONYAK, Viktor
Corporate Patents Binger Str. 173, Ingelheim Am Rhein , 55216 / DE
GRAUERT, Matthias
Corporate Patents Binger Str. 173, Ingelheim Am Rhein , 55216 / DE
GRUNDL, Marc
Corporate Patents Binger Str. 173, Ingelheim Am Rhein , 55216 / DE
PAUTSCH, Alexander
Corporate Patents Binger Str. 173, Ingelheim Am Rhein , 55216 / DE

(74) Advokat RADULOVIĆ, Božidar S.
Studentska bb, Lamela 3/18 , Podgorica, 81000 / ME

(57) Jedinjenje sa formulom I ili njegove farmaceutski prihvatljive soli ili solvati,

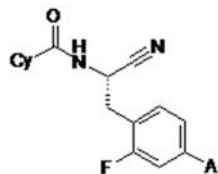

gdje

Cy je



A je

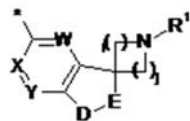

gdje

W je izabran iz grupe koju čine CH i N;

X je izabran iz grupe koju čine CH i N;

Y je izabran iz grupe koju čine CH i N;

pod uslovom da najviše jedan od W, X i Y može biti N;

D-E je izabran iz grupe koju čine N(R₂)-C(O), CH₂CH₂, C(O)-O i CH₂-O;

R₂ je izabran iz grupe koju čine H i C₁-3-alkil;

R₁ je izabran iz grupe koju čine H, C₁-3-alkil, CH₃OCH₂CH₂-, oksetanil, tetrahidrofuranil, 4-tetrahidropiranil i 3-tetrahidropiranil;

i je 1, 2 ili 3;

j je 1, 2 ili 3;

pod uslovom da suma od i+j je 2, 3 ili 4.

Patent sadrži još 27 patentnih zahtjeva

(11) **03605** (13) **B**

..

(51) C07D 209/14 ^(2006.01)	C07D 401/08 ^(2006.01)
C07D 401/12 ^(2006.01)	C07D 401/14 ^(2006.01)
C07D 403/08 ^(2006.01)	C07D 403/10 ^(2006.01)
C07D 403/12 ^(2006.01)	C07D 405/12 ^(2006.01)
C07D 409/08 ^(2006.01)	C07D 409/12 ^(2006.01)
C07D 413/08 ^(2006.01)	C07D 413/12 ^(2006.01)
C07D 417/14 ^(2006.01)	C07D 471/04 ^(2006.01)
C07D 487/04 ⁰	

..

(21) P-2019-294

(22) 26.09.2012

(30) 20110016559 26.09.2011 GB

201161626410P 26.09.2011 US

(96) 12775463.8/26.09.2012

(86) EP PCT/EP2012/069007/26.09.2012

(87) WO 2013/045516/04.04.2013/2013/14

(97) EP 2760831/06.08.2014/2014/32

EP 2760831/07.08.2019/2019/32

(54) me **INHIBITORI VIRUSNE REPLIKACIJE**
en **VIRAL REPLICATION INHIBITORS**

(73) Katholieke Universiteit Leuven

K.U. Leuven R&D Waaistraat 6 Box 5105 , Leuven , 3000 / BE

(72) BARDIOT, Dorothée

c/o Waaistraat 6, B-3000 Leuven / BE

CARLENS, Gunter

c/o Waaistraat 6, B-3000 Leuven / BE

DALLMEIER, Kai

c/o Waaistraat 6, B-3000 Leuven / BE

KAPTEIN, Suzanne

c/o Waaistraat 6, B-3000 Leuven/ BE

McNAUGHTON, Michael

c/o Waaistraat 6, B-3000 Leuven / BE

MARCHAND, Arnaud

c/o Waaistraat 6, B-3000 Leuven/ BE

NEYTS, Johan

c/o Waaistraat 6, B-3000 Leuven / BE

SMETS, Wim

c/o Waaistraat 6, B-3000 Leuven / BE

KOUKNI, Mohamed

c/o Waaistraat 6, B-3000 Leuven / BE

(74) Advokat JUSIĆ, Jasna

Dalmatinska 2, Podgorica, 81000 / ME

(57) Jedinjenje formule (B);

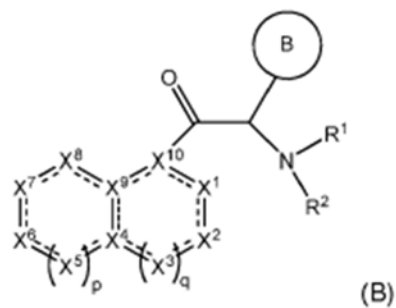

gde je

- deo

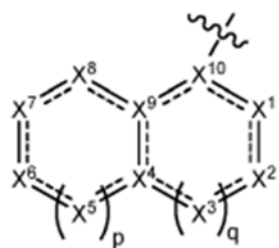

izabran iz

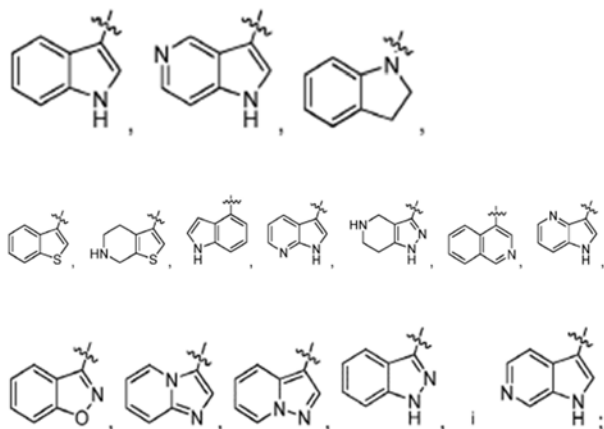

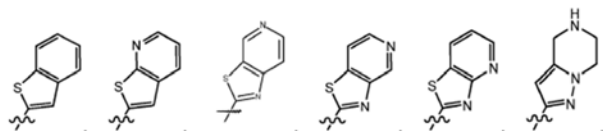
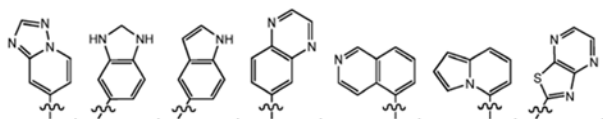
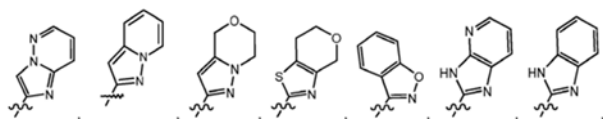
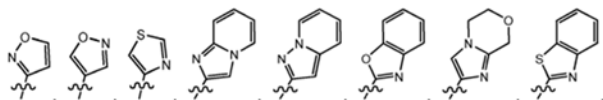
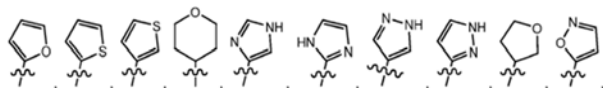
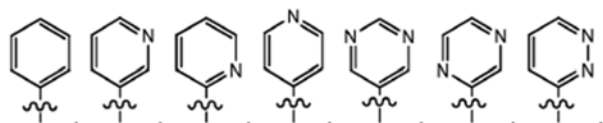

gde talasasta linija (~~~~) ukazuje mesto vezivanja za karbonil glavne formule (B); gde je navedeni deo zamenjen sa jednim ili dva Z1;

- cikl B je izabran iz

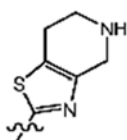

i



gde talasasta linija () ukazuje mesto vezivanja za atom ugljenika glavne formule (B), i gde su prikazani cikli zamenjeni sa jednim, dva ili tri Z1a;

- R1 je izabran iz C3-7 cikloalkila, arila, heterocikla;

i gde su C3-7 cikloalkil, aril i heterocikl zamenjeni sa jednim, dva ili tri Z1b;

- R2 je vodonik;

- svaki Z1, Z1a i Z1b je nezavisno izabran iz grupe koju cine halogen, hidroksil, -OZ2, -O-C(=O)Z3, =O, -S(=O)2Z3, -S(=O)2NZ4Z5, trifluorometil, trifluorometoksi, -NZ4Z5, -NZ4C(=O)Z2, -NZ4C(=O)-OZ2, - cijano, -C(=O)Z3, -C(=O)OZ2, -C(=O)NZ4Z5, C1-6 alkil, hetero C1-6 alkil, aril, heterocikl i heterocikl-C1-6 alkil; i gde su navedeni C1-6 alkil, hetero C1-6 alkil, aril, heterocikl i heterocikl-C1-6 alkil opciono zamenjeni sa jednim, dva ili tri supstituenta koji su izabrani iz hidroksila, =O, halogena, trifluorometila, -OCF3, -O-C(O)Me,

cijano, nitro, $-C(O)OH$, $-C(O)OC_{1-6}$ alkila, $-NH_2$, $-NHCH_3$, $-N(CH_3)_2$, $-NH-C(=O)O-C_{1-4}$ alkila, $-S(O)_2C_{1-4}$ alkila i $-O-C_{1-6}$ alkila;

- svaki Z2 je nezavisno izabran iz C_{1-6} alkila, arila, heterocikla i heterocikl- C_{1-6} alkila; gde su navedeni C_{1-6} alkil, aril, heterocikl i heterocikl- C_{1-6} alkil opciono zamenjeni sa jednim, dva ili tri supstituenta koji su izabrani iz hidroksila, $=O$, halogena, trifluorometila, difluorometila, $-O-C_{1-6}$ alkila, $-OCF_3$, $-S(=O)_2C_{1-4}$ alkila, cijano, $-C(=O)OH$, $-C(=O)O-C_{1-4}$ alkila, $-NH_2$, $-N(CH_3)_2$, pirolidinila, piperidinila i piperazinila;

- svaki Z3 je nezavisno izabran iz hidroksila, C_{1-6} alkila, arila i heterocikla;

gde su navedeni C_{1-6} alkil, aril i heterocikl opciono zamenjeni sa jednim, dva ili tri supstituenta koji su izabrani iz C_{1-6} alkila i $-N(CH_3)_2$;

- svaki Z4 i Z5 je nezavisno izabran iz vodonika, C_{1-6} alkila, arila, C_{3-7} cikloalkila i heterocikla;

i stereo-izomera ili tautomera, solvata, soli, naročito njihovih farmaceutski prihvatljivih soli;

gde termin „heterocikl“ označava zasićeni, nezasićeni ili aromatični prstenasti sistem sa 3 do 18 atoma uključujući bar jedan od N, O, S ili P.

Patent sadrži još 16 patentnih zahtjeva

(11) **03602** (13) **B**

..

(51) **C12N 15/67**^(2006.01)

..

(21) P-2019-295

(22) 05.10.2016

(30) 2015EP73180 07.10.2015 WO

(96) 16778784.5/05.10.2016

(86) EP PCT/EP2016/073814/05.10.2016

(87) WO 2017/060314/13.04.2017/2017/15

(97) EP 3337902/27.06.2018/2018/26
EP 3337902/25.09.2019/2019/39

(54) me **3' UTR SEKVENCE ZA STABILIZACIJU RNK**
en **3' UTR SEQUENCES FOR STABILIZATION OF RNA**

(73) BioNTech RNA Pharmaceuticals GmbH
An der Goldgrube 12, Mainz, 55131/ DE
TRON - Translationale Onkologie an der Universitätsmedizin der Johannes Gutenberg- Universität Mainz
gemeinnützige GmbH
Freiligrathstrasse 12, Mainz, 55131/ DE

(72) ORLANDINI VON NIESSEN, Alexandra
An der Goldgrube 12, Mainz , 55131/ DE
FESSER, Stephanie
An der Goldgrube 12, Mainz , 55131/ DE
VALLAZZA, Britta
An der Goldgrube 12, Mainz , 55131/ DE
BEISSERT, Tim
An der Goldgrube 12, Mainz , 55131/ DE
KUHN, Andreas
An der Goldgrube 12, Mainz , 55131/ DE
SAHIN, Ugur
An der Goldgrube 12, Mainz , 55131/ DE
POLEGANOV, Marco Alexander
An der Goldgrube 12, Mainz , 55131/ DE

(74) Advokat POPOVIĆ, Miladin
Đoka Miraševića 21/III , Podgorica , 81000 / ME

(57) Molekul nukleinske kiseline koji sadrži u 5' → 3' smeru transkripcije:

(a) promotor;

(b) transkriptabilnu sekvencu nukleinske kiseline ili sekvencu nukleinske kiseline za uvođenje transkriptabilne sekvence nukleinske kiseline; i

(c) sekvencu nukleinske kiseline koja, kada se transkribuje pod kontrolom promotora (a), kodira 3'-netranslatirajući region u transkriptu koji nije prirodno povezan sa sekvencom nukleinske kiseline (b), navedeni 3'-netranslatirajući region sadrži

(i) (c-4) sekvencu nukleinske kiseline 3'-netranslatirajućeg regiona amino-terminalnog pojačivača razdvajanja (AES) koja sadrži ili se sastoji od sekvence nukleinske kiseline odabrane iz grupe koja se sastoji od SEQ ID NO: 86 do 89, poželjno SEQ ID NO: 86, njenog fragmenta, ili varijante navedene sekvence nukleinske kiseline ili fragmenta koja je najmanje 90% identična navedenoj sekvenci nukleinske kiseline ili fragmentu; ili

(ii) (c-8) bilo koju kombinaciju (c-4) i jedne ili više sekvenci nukleinske kiseline odabranih iz grupe koja se sastoji od:

(c-1) sekvence nukleinske kiseline 3'-netranslatirajućeg regiona Fc fragmenta IgG, receptora, transportera, alfa (FCGRT) koja sadrži ili se sastoji od sekvence nukleinske kiseline odabrane iz grupe koja se sastoji od SEQ ID NO: 1 do 50, poželjno SEQ ID NO: 27, njenog fragmenta, ili varijante navedene sekvence nukleinske kiseline ili fragmenta koja je najmanje 90% identična navedenoj sekvenci nukleinske kiseline ili fragmentu,

(c-2) sekvence nukleinske kiseline 3'-netranslatirajućeg regiona limfocitnog specifičnog proteina 1 (LSP1) koja sadrži ili se sastoji od sekvence nukleinske kiseline odabrane iz grupe koja se sastoji od SEQ ID NO: 51 do 72, poželjno SEQ ID NO: 52, njenog fragmenta, ili varijante navedene sekvence nukleinske kiseline ili fragmenta koja je najmanje 90% identična navedenoj sekvenci nukleinske kiseline ili fragmentu,

(c-3) sekvence nukleinske kiseline 3'-netranslatirajućeg regiona hemokinskog liganda 22 (CCL22) koja sadrži ili se sastoji od sekvence nukleinske kiseline odabrane iz grupe koja se sastoji od SEQ ID NO: 73 do 85, poželjno SEQ ID NO: 79, njenog fragmenta, ili varijante navedene sekvence nukleinske kiseline ili fragmenta koja je najmanje 90% identična navedenoj sekvenci nukleinske kiseline ili fragmentu,

(c-4) sekvence nukleinske kiseline 3'-netranslatirajućeg regiona amino-terminalnog pojačivača razdvajanja (AES) koja sadrži ili se sastoji od sekvence nukleinske kiseline odabrane iz grupe koja se sastoji od SEQ ID NO: 86 do 89, poželjno SEQ ID NO: 86, njenog fragmenta, ili varijante navedene sekvence nukleinske kiseline ili fragmenta koja je najmanje 90% identična navedenoj sekvenci nukleinske kiseline ili fragmentu,

(c-5) sekvence nukleinske kiseline 3'-netranslatirajućeg regiona člana 3 porodice fosfolipaze D (PLD3) koja sadrži ili se sastoji od sekvence nukleinske kiseline odabrane iz grupe koja se sastoji od SEQ ID NO: 90 do 104, poželjno SEQ ID NO: 96, njenog fragmenta, ili varijante navedene sekvence nukleinske kiseline ili fragmenta koja je najmanje 90% identična navedenoj sekvenci nukleinske kiseline ili fragmentu,

(c-6) sekvence nukleinske kiseline nekodirajuće RNK mitohondrijalno kodirane 12S RNK (MT-RNR1) koja sadrži ili se sastoji od sekvence nukleinske kiseline odabrane iz grupe koja se sastoji od SEQ ID NO: 105 do 121, poželjno SEQ ID NO: 115, njenog fragmenta, ili varijante navedene sekvence nukleinske kiseline ili fragmenta koja je najmanje 90% identična navedenoj sekvenci nukleinske kiseline ili fragmentu, i

(c-7) nukleinske sekvence 3'-netranslatirajućeg regiona glavnog kompleksa histokompatibilnosti klase II DR Beta 4 (HLA-DRB4) koja sadrži ili se sastoji od sekvence nukleinske kiseline odabrane iz grupe koji se sastoji od SEQ ID NO: 122 do 143, poželjno SEQ ID NO: 126, njenog fragmenta, ili varijante navedene sekvence nukleinske kiseline ili fragmenta koja je najmanje 90% identična navedenoj sekvenci nukleinske kiseline ili fragmentu,

pri čemu se sekvence nukleinske kiseline (b) i (c) pod kontrolom promotora (a) mogu transkribovati da daju zajednički transkript u kojem je sekvenca nukleinske kiseline transkribovana sa sekvence nukleinske kiseline (c) aktivna tako da povećava efikasnost translacije i/ili stabilnost sekvence nukleinske kiseline transkribovane sa transkriptabilne sekvence nukleinske kiseline (b).

Patent sadrži još 22 patentnih zahtjeva

(11) **03647** (13) **B**

..

(51) **A61K 38/47**^(2006.01)

A61P 25/00^(2006.01)

A61P 25/28^(2006.01)

A61K 9/19^(2006.01)

A61K 38/46^(2006.01)

..

(21) P-2019-298

(22) 25.06.2011

(30) 201161435710P 24.01.2011 US

201161495268P 09.06.2011 US

201161476210P 15.04.2011 US

20100358857P 25.06.2010 US

201161442115P 11.02.2011 US

20100387862P 29.09.2010 US

20100360786P 01.07.2010 US

(96) 11799037.4/25.06.2011

(86) US PCT/US2011/041926/25.06.2011

(87) WO 2011/163650/29.12.2011/2011/52

(97) EP 2585104/01.05.2013/2013/18

EP 2585104/21.08.2019/2019/34

(54) me **POSTUPCI I KOMPOZICIJE ZA ISPORUKU ARILSULFATAZE A U CNS**
en **METHODS AND COMPOSITIONS FOR CNS DELIVERY OF ARYLSULFATASE A**

(73) Shire Human Genetic Therapies, Inc.
300 Shire Way, Lexington, MA 02421/ US

(72) SALAMAT-MILLER, Nazila
80 College Avenue, Arlington MA 02474 / US
TAYLOR, Katherine
472 Appleton Street, Arlington MA 02476 / US
CAMPOLIETO, Paul
3595 Red Hill Road, Charlottesville VA 22903 / US
SHAHROKH, Zahra
5 Terrace Road, Weston MA 02493/ US
PAN, Jing
868 Depot Road, Boxborough MA 01719/ US
CHARNAS, Lawrence
49 Mill Street, Natick MA 01760 / US
WRIGHT, Teresa Leah

39 Earl Street, Lexington MA 02142 / US
CALIAS, Pericles
39 Swains Pond Road, Melrose MA 02176 / US

(74) Advokat LUTOVAC, Branislav
Bulevar Ivana Crnojevića 93 , Podgorica, 81000 / ME

(57) Stabilna vodenaformulacija za intratekalnu primenu koja sadrži protein arilsulfatazu A (ASA) ukoncentraciji većoj od 10 mg/ml, so, polisorbitni surfaktant i puferski agens,pri čemu je so NaCl.

Patent sadrži još 15 patentnih zahtjeva

(11) **03648** (13) **B**

..

(51) **A61K 35/74**^(2015.01)

C12N 1/20^(2006.01)

A61P 1/00^(2006.01)

A61P 11/06^(2006.01)

A61P 29/00^(2006.01)

A61P 19/02^(2006.01)

A61P 25/28^(2006.01)

A61K 35/745^(2015.01)

..

(21) P-2019-299

(22) 15.06.2016

(30) 20150010466 15.06.2015 GB

20150020508 20.11.2015 GB

20160006810 19.04.2016 GB

(96) 16731640.5/15.06.2016

(86) GB PCT/GB2016/051770/15.06.2016

(87) WO 2016/203218/22.12.2016/2016/51

(97) EP 3240554/08.11.2017/2017/45

EP 3240554/31.07.2019/2019/31

(54) me **BLAUTIA STERCOSIS I WEXLERAE ZA UPOTREBU U LIJEČENJU INFLAMATORNIH I AUTOIMUNSKIH BOLESTI**
en **BLAUTIA STERCOSIS AND WEXLERAE FOR USE IN TREATING INFLAMMATORY AND AUTOIMMUNE DISEASES**

(73) 4D Pharma Research Limited

Life Sciences Innovation Building, Cornhill Road, Aberdeen AB25 2ZS/ GB

(72) GRANT, George

Life Sciences Innovation Building, Cornhill Road, Aberdeen Aberdeenshire , AB25 2ZS / GB

PATTERSON, Angela Margaret

, Norwich East Anglia , NR4 7JT / GB

MULDER, Imke

Life Sciences Innovation Building, Cornhill Road Aberdeen Aberdeenshire, AB25 2ZS/ GB

MCCLUSKEY, Seanin

3rd Floor 9 Bond Court , Leeds West Yorkshire , LS1 2JZ / GB

RAFTIS, Emma

3rd Floor 9 Bond Court, Leeds West Yorkshire , LS1 2JZ / GB

(74) Advokat LUTOVAC, Branislav

Bulevar Ivana Crnojevića 93 , Podgorica , 81000 / ME

(57) Kompozicijakoja obuhvata bakterijski soj vrsta *Blautia stercoris* ili *Blautia wexlerae*, za upotrebu u postupku lečenja ili prevencije inflamatorne ili autoimunske bolesti.

Patent sadrži još 14 patentnih zahtjeva

(11) **03649** (13) **B**

..

(51) **A61K 38/47**^(2006.01)

A61P 25/00^(2006.01)

A61P 25/28^(2006.01)

A61K 9/19^(2006.01)

A61K 9/00^(2006.01)

A61K 38/46^(2006.01)

..

(21) P-2019-300

(22) 25.06.2011

(30) 201161442115P 11.02.2011 US

20100360786P 01.07.2010 US

20100387862P 29.09.2010 US

201161435710P 24.01.2011 US

20100358857P 25.06.2010 US

201161495268P 09.06.2011 US

201161476210P 15.04.2011 US

(96) 11799036.6/25.06.2011

(86) US PCT/US2011/041925/25.06.2011

(87) WO 2011/163649/29.12.2011/2011/52

(97) EP 2593131/22.05.2013/2013/21

EP 2593131/21.08.2019/2019/34

(54) me **POSTUPCI I KOMPOZICIJE ZA ISPORUKU IDURONAT-2-SULFATAZE U CNS**
en **METHODS AND COMPOSITIONS FOR CNS DELIVERY OF IDURONATE-2-SULFATASE**

(73) Shire Human Genetic Therapies, Inc.
300 Shire Way, Lexington, MA 02421/ US

(72) ZHU, Gaozhong
680 South Avenue, Unit 15, Weston MA 02493/ US
LOWE, Kris
16 Sachem Street, Boston MA 02120 / US
SHAHROKH, Zahra
5 Terrace Road, Weston MA 02493/ US
CHRISTIAN, James
36 Gordon Circle, Grafton MA 01519/ US
FAHRNER, Rick
6 Beechwood Circle, Boxford MA 01921 / US
PAN, Jing
868 Depot Road, Boxborough MA 01719/ US
WRIGHT, Teresa, Leah
39 Earl Street, Lexington MA 02142 / US

CALIAS, Pericles
39 Swains Pond Avenue, Melrose MA 02176 / US

(74) Advokat LUTOVAC, Branislav
Bulevar Ivana Crnojevića 93 , Podgorica , 81000 / ME

(57) Stabilna vodenaformulacija za intratekalnu primenu koja sadrži protein iduronat-2-sulfatazu(I2S) u koncentraciji od 10 mg/ml ili više, so i polisorbitni surfaktant, pri čemuformulacija ima pH između 5,5 i 7,0 i sadrži fosfat u koncentraciji ne većoj od5mM i pri čemu je so NaCl.

Patent sadrži još 13 patentnih zahtjeva

(11) **03543** (13) **B**

..

(51) A23L 5/30 ^(2006.01)	A21D 13/06 ^(2006.01)
C12C 1/02 ^(2006.01)	A23L 5/20 ^(2006.01)
A23L 7/10 ^(2006.01)	A23L 7/196 ^(2006.01)
A21D 13/066 ^(2006.01)	A23L 3/3463 ^(2006.01)
A23L 3/3472 ^(2006.01)	A23B 9/04 ^(2006.01)
A23L 33/00 ^(2006.01)	

..

(21) P-2019-301

(22) 16.12.2016

(30) UB20159442 17.12.2015 IT

(96) 16823236.1/16.12.2016

(86) EP PCT/EP2016/081589/16.12.2016

(87) WO 2017/103214/22.06.2017/2017/25

(97) EP 3389400/24.10.2018/2018/43
EP 3389400/14.08.2019/2019/33

(54) me **METODA ZA DETOKSIFIKACIJU GLUTENSKIH PROTEINA IZ ZRNA ŽITARICA I NJENA PRIMENA U MEDICINSKOJ OBLASTI**
en **METHOD FOR THE DETOXIFICATION OF GLUTEN PROTEINS FROM CEREAL GRAINS AND USES THEREOF IN MEDICAL FIELD**

(73) New Gluten World S.r.l.
Viale Michelangelo 177, Foggia, 71121 / IT

(72) LAMACCHIA, Carmela
Via Paolo Telesforo 33, Foggia, 71122 / IT

(57) Metoda za detoksifikaciju glutena iz zrna žitarica, koja obuhvata sledeće korake:

a) hidriranje zrna žitarica vodom do stepena vlažnosti zrna sadržanom između 15 i 18%; b) tretiranje hidriranih zrna elektromagnetnim talasima tokom vremena i sa snagom potrebnim da se dostigne temperatura zrna sadržana između 60 i 70°C;

e) suspendovanje zračenja dok se ne dostigne temperatura sadržana između 50 i 60°C i simultano isparavanje vode sa gubitkom vlage zrna sadržanim između 14 i 16% u poređenju sa korakom a);

d) tretiranje hidriranih zrna elektromagnetnim talasima tokom vremena i sa snagom potrebnim da se dostigne temperatura zrna sadržana između 80 i 90°C;

e) suspendovanje zračenja do temperature sadržane između 70 i 80°C i simultano isparavanje vode sa gubitkom vlage zrna sadržanim između 40 i 44% u poređenju sa korakom a);

f) tretiranje hidriranih zrna elektromagnetnim talasima tokom vremena sa snagom potrebnim da se dostigne temperatura zrna sadržana između 110 i 120°C;

g) suspendovanje zračenja do temperature sadržane između 80 i 90°C i simultano isparavanje vode sa gubitkom vlage zrna sadržanim između 50 i 60% u poređenju sa korakom a);

h) sporo hlađenje detoksifikovanih zrna na sobnoj temperaturi.

Patent sadrži još 15 patentnih zahtjeva

(11) **03608** (13) **B**

..

(51) C07K16/30 ^(2006.01)	A61K39/395 ^(2006.01)
A61P35/00 ^(2006.01)	C12N5/12 ^(2006.01)
A61K51/10 ^(2006.01)	A61K45/06 ^(2006.01)
C07K16/18 ^(2006.01)	C07K16/28 ^(2006.01)
A61K39/00 ^(2006.01)	A61K47/68 ^(2006.01)

..

(21) P-2019-302

(22) 24.11.2006

(30) 20050025657 24.11.2005 EP

(96) 17192466.5/24.11.2006

(97) EP 3312197/25.04.2018/2018/17
EP 3312197/16.10.2018/2019/42

(54) me **MONOKLONSKA ANTITIJELA PROTIV KLAUDINA-18 ZA LIJEČENJE KANCERA**
en **MONOCLONAL ANTIBODIES AGAINST CLAUDIN-18 FOR TREATMENT OF CANCER**

(73) Astellas Pharma Inc.

5-1, Nihonbashi-Honcho 2-chome, Chuo-ku Tokyo 103-8411/ JP

TRON - Translationale Onkologie an der Universitätsmedizin der Johannes Gutenberg- Universität Mainz
gemeinnützige GmbH

Freiligrathstrasse 12, Mainz, 55131/ DE

(72) SAHIN, Ugur

Philipp-von-Zabern-Platz 1, 55116 Mainz/ DE

TÜRECI, Özlem

Philipp-von-Zabern-Platz 1, 55116 Mainz/ DE

USENER, Dirk

Richard-Wagner-Strasse 87b, Wiesbaden, 65193/ DE

FRITZ, Stefan

Geisterweg 35, Flonheim, 55237/ DE

UHEREK, Christoph

Lachenwörthsweg 6, Seligenstadt, 63500/ DE

Brandenburg, Gunda

Leharstrasse 89, Hamburg , 22145 / DE

GEPPERT, Harald-Gerhard

Grünstrasse 46, Solingen, 42697/ DE

SCHRÖDER, Anja Kristina

Jakob-Nickolaus-Weg 8, Mainz, 55122 / DE

Thiel, Philippe

Erfurter Ring 14, Ludwigschafen, 67071/ DE

(57) *In vitro* postupak za proizvodnju antitela koja imaju sposobnost vezivanja za CLD18A2 ali ne za CLD18A1 i povezivanju za CLD18A2 posreduju u ubijanju ćelija sa T ćelijama, pri čemu postupak sadrži korake:

(a) transformacije humanih ćelija domaćina sa ekspresionim vektorom koji eksprimira težak lanac antitela i ekspresionim vektorom koji eksprimira laki lanac antitela ili sa ekspresionim vektorom koji eksprimira oba lanca; i

(b) izolacije i prečišćavanja antitela eksprimiranog u humanoj ćeliji domaćinu:

Naznačeno time da transformisana humana ćelija domaćina sadrži:

sekvencu nukleinske kiseline koja kodira polipeptid koji sadrži varijabilni region teškog lanca antitela (VH) koji sadrži CDR1, CDR2, i CDR3 regione koji imaju aminokiselinske sekvence položaja 45-52, položaja 70-77, i položaja 116-124 od SEQ ID NO: 117, respektivno; i sekvencu nukleinske kiseline koja kodira polipeptid koji sadrži varijabilni region lakog lanca antitela (VL) koji sadrži CDR1, CDR2, i CDR3 regione koji imaju aminokiselinske sekvence položaja 47-52, položaja 70-72, i položaja 109-117 od SEQ ID NO:

123, respektivno: ili

(ii) sekvencu nukleinske kiseline koja kodira polipeptid koji sadrži varijabilni region teškog lanca antitela (VH) koji s drži CDR1, CDR2, i CDR3 regione koji imaju aminokiselinsku sekvencu položaja 45-52, položaja 70-77, i položaja 116-126 od SEQ ID NO: 116, respektivno; i sekvencu nukleinske kiseline koja kodira polipeptid koji sadrži varijabilni region lakog lanca antitela (VL) koji sadrži CDR1, CDR2, i CDR3 regione koji imaju aminokiselinske sekvence položaja 47-58, položaja 76-78, i položaja 115-123 od SEQ ID NO:

121, respektivno; ili

(iii) sekvencu nukleinske kiseline koja kodira polipeptid koji sadrži varijabilni region teškog lanca antitela (VH) koji sadrži CDR1, CDR2, i CDR3 regione koji imaju aminokiselinsku sekvencu položaja 45-52, položaja 70-77, i položaja 116-126 od SEQ ID NO: 118, respektivno; i sekvencu nukleinske kiseline koja kodira polipeptid koji sadrži varijabilni region lakog lanca antitela (VL) koji sadrži CDR1, CDR2, i CDR3 regione koji imaju aminokiselinske sekvence položaja 47-58, položaja 76-78, i položaja 115-123 od SEQ ID NO:

125, respektivno.

Patent sadrži još 11 patentnih zahtjeva

(11) **03544** (13) **B**

..

(51) **C07K 16/28**^(2006.01)

A61K 39/395^(2006.01)

A61P 35/02^(2006.01)

..

(21) P-2019-303

(22) 18.03.2015

(30) 201461955663 P 19.03.2014 US

201461981641 P 18.04.2014 US

201462007385 P 03.06.2014 US

201462033460 P 05.08.2014 US

(96) 15714116.9/18.03.2015

(86) US PCT/US2015/021322/18.03.2015

(87) WO 2015/143079/24.09.2015/2015/38

(97) EP 3119808/25.01.2017/2017/04

EP 3119808/04.09.2019/2019/36

(54) me **SUPSTANCE ANTITIJELA ZA LIJEČENJE TUMORA**
en **ANTIBODY COMPOSITIONS FOR TUMOR TREATMENT**

(73) REGENERON PHARMACEUTICALS, INC.

777 Old Saw Mill River Road, Tarrytown NY 10591/ US

(72) DAVIS, Samuel

c/o Regeneron Pharmaceuticals Inc. 777 Old Saw Mill River Road, Tarrytown, New York 10591/ US

SMITH, Eric

c/o Regeneron Pharmaceuticals Inc. 777 Old Saw Mill River Road, Tarrytown, New York 10591/ US

VARGHESE, Bindu

c/o Regeneron Pharmaceuticals Inc. 777 Old Saw Mill River Road, Tarrytown, New York 10591/ US

KIRSHNER, Jessica R.

c/o Regeneron Pharmaceuticals Inc. 777 Old Saw Mill River Road, Tarrytown, New York 10591/ US

THURSTON, Gavin

c/o Regeneron Pharmaceuticals Inc. 777 Old Saw Mill River Road, Tarrytown, New York 10591/ US

(57) Bispecifično antitelo za upotrebu za lečenje ili poboljšanje kancera B ćelije kod subjekta, pri čemu to bispecifično antitelo obuhvata prvi domen koji vezuje antigen koji veže humani CD3, drugi domen koji vezuje antigen koji veže humani CD20, i himerni Fc domen je privezan na svaki od prvih i drugih domena koji vezuju antigen, pri čemu taj himerni Fc domen obuhvata:

(a) sekvence aminokiseline gornjeg zgloba humanog IgG1 ili humanog IgG4 iz pozicija 216 do 227 (EU numeracija);

(b) sekvenca aminokiseline donjeg zgloba humanog IgG2 obuhvata PCPAPPVA (SEK ID BR: 52) od pozicija 228 do 236 (EU numeracija); (e) CH1 domen humanog IgG1 i CH3 domen humanog IgG1, ili CHI domen humanog IgG4 i CH3 domen humanog IgG4; i

(d) sekvencu aminokiseline CH2 domena humanog IgG4 od pozicija 237 do 340 (EU numeracija);

pri čemu bispecifično antitelo ispoljava viši afinitet vezivanja za humani FcγRIIA u odnosu na humani FcγRIIB, i ispoljava mali ili nedektibilan afinitet vezivanja na humani FcγRI i humani FcγRIII, kako je izmereno u ogledu rezonance površinskog plazmona.

Patent sadrži još 13 patentnih zahtjeva

(11) **03545** (13) **B**

..

(51) **C07K 14/16**^(2006.01)

..

(21) P-2019-304

(22) 15.12.2016

(30) 15200138 15.12.2015 EP

16194124 17.10.2016 EP

(96) 16822410.3/15.12.2016

(86) EP PCT/EP2016/081159/15.12.2016

(87) WO 2017/102929/22.06.2017/2017/25

(97) EP 3390430/24.10.2018/2018/43

EP 3390430/28.08.2019/2019/35

(54) me **ANTIGENI, VEKTORI I SASTAVI VIRUSA HUMANE IMUNODEFICIJENCIJE, I POSTUPCI NJIHOVE PRIMENE**
en **HUMAN IMMUNODEFICIENCY VIRUS ANTIGENS, VECTORS, COMPOSITIONS, AND METHODS OF USE THEREOF**

(73) Janssen Vaccines & Prevention B.V.
Archimedesweg 4, Leiden, 2333 CN / NL

(72) LANGEDIJK, Johannes Petrus Maria
Archimedesweg 4-6, 2333 CN Leiden/ NL
CALLENDRET, Benoit Christophe Stephan
Archimedesweg 4-6, 2333 CN Leiden/ NL
VAN MANEN, Danielle
Archimedesweg 4-6, 2333 CN Leiden/ NL
KRARUP, Anders
Archimedesweg 4-6, 2333 CN Leiden/ NL
STITZ, Jörn
Archimedesweg 4-6, 2333 CN Leiden/ NL
WEGMANN, Frank
Archimedesweg 4-6, 2333 CN Leiden/ NL
VELLINGA, Jort
Archimedesweg 4-6, 2333 CN Leiden/ NL

(57) Nukleinska kiselina koja kodira sintetički protein HIV omotača koji sadrži aminokiselinsku sekvencu SEQ ID NO: 8 ili SEQ ID NO: 8 koja ima jednu ili više mutacija izabranih iz grupe koju čine (i) I529P, (ii) K480E i (iii) kombinacije EK479- 480RRRR, I529P, A471C i T575C.

Patent sadrži još 14 patentnih zahtjeva

(11) **03546** (13) **B**

..

(51) **C07D 413/06**^(2006.01)

A61K 31/42^(2006.01)

C07D 413/12^(2006.01)

C07D 261/08^(2006.01)

..

(21) P-2019-305

(22) 15.12.2015

(30) 201462092402 P 16.12.2014 US

(96) 15816893.0/15.12.2015

(86) IB PCT/IB2015/059631/15.12.2015

(87) WO 2016/097995/23.06.2016/2016/25

(97) EP 3233843/25.10.2017/2017/43

EP 3233843/16.10.2019/2019/42

(54) me **JEDINJENJA IZOKSAZOL HIDROKSAMSKE KISELINE KAO INHIBITORI LPXC**
en **ISOXAZOLE HYDROXAMIC ACID COMPOUNDS AS LPXC INHIBITORS**

(73) NOVARTIS AG

Lichtstrasse 35, Basel, 4056/ CH

(72) FU, Jiping

Novartis Institutes for BioMedical Research Inc. 5300 Chiron Way, Emeryville, California 94608/ US
JIN, Xianming

Novartis Institutes for BioMedical Research Inc. 5300 Chiron Way, Emeryville, California 94608/ US
KARUR, Subramanian

Novartis Institutes for BioMedical Research Inc. 5300 Chiron Way, Emeryville, California 94608/ US
LAPOINTE, Guillaume

Novartis Institutes for BioMedical Research Inc. 5300 Chiron Way, Emeryville, California 94608/ US
MADERA, Ann Marie

Novartis Institutes for BioMedical Research Inc. 5300 Chiron Way, Emeryville, California 94608/ US
SWEENEY, Zachary Kevin

Novartis Institutes for BioMedical Research Inc. 5300 Chiron Way, Emeryville, California 94608/ US

(57) Jedinjenje prema formuli (1):

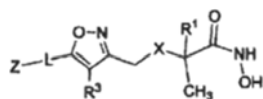

(1)

ili njegova farmaceutski prihvatljiva so, u kojoj:

X predstavlja -NH-, a R 1 predstavlja -CH(OH)-Y;

ili

X predstavlja -CH₂, a R 1 predstavlja -CH(OH)-Y ili -S₀₂R₂ gde R₂ predstavlja Cs<.:. alkil; R₃ predstavlja H ili halo;

Y je odabrano od 5-članog prstena heteroarila koji sadrži 1-3 heteroatoma odabranih od N, O i S kao članova prstena, fenil, i C_w alkil, a svako Y je opciono supstituisano sa jednim do tri R⁴;

svako R⁴ je nezavisno odabrano od halo, C₁ alkila, i C_u cikloalkila, pri čemu su C_{1.1} alkil i

6 cikloalkil svaki opciono supstituisani sa do tri grupe odabrane od halo, CN i -QH;

L predstavlja -C≡C-ili -CR⁵-;

R⁵ je nezavisno odabrano pri svakom javljanju od H, halo i metila;

i

Z je odabrano od C₁₋₆ alkila, C₃₋₆ cikloalkila, piridinila, i fenila, od kojih je svaki opciono supstituisan sa do tri grupe odabrane od halogena, hidroksi, CN, i C₁₋₄ alkoksi, C₁₋₄ haloalkoksi, CN, i C₁₋₄ alkila koji je opciono supstituisan sa jednom do tri grupe odabrane od halogena, hidroksi, amino, CN, i C₁₋₃ alkoksi;

ili, kada L predstavlja -CR⁵=CR⁵., Z zajedno sa jednom od R⁵ grupa i bjlo kojim od atoma koji povezuju Z sa R⁵ grupom moze da formira 3-7-članu grupu cikloalkila ili cikloalkenila koja je opciono

supstituisana sa do tri grupe odabrane od halogena, hidroksi, C₁₋₄ alkoksi, C₁₋₄ haloalkoksi, CN, i C₁₋₄ alkila koji je opciono supstituisan sa jednom do tri grupe odabrane od halogena, hidroksi, amino,

CN, i C₁₋₃ alkoksil.

Patent sadrži još 14 patentnih zahtjeva

(11) **03547** (13) **B**

..

(51) **C07D 471/04**^(2006.01) **A61K 31/4738**^(2006.01)

A61K 31/497^(2006.01) **A61P 35/00**^(2006.01)

..

(21) P-2019-306

(22) 13.10.2017

(30) 201662411799 P 24.10.2016 US

201662435159 P 16.12.2016 US

(96) 17783857.0/13.10.2017

(86) EP PCT/EP2017/076191/13.10.2017

(87) WO 2018/077630/03.05.2018/2018/18

(97) EP 3433256/30.01.2019/2019/05

EP 3433256/07.08.2019/2019/32

(54) me **DERIVAT 6,7,8,9-TETRAHIDRO-3H-PIRAZOLO[4,3-F]IZOHINOLINA KORISTAN U TRETMANU RAKA**
en **6,7,8,9-TETRAHYDRO-3H-PYRAZOLO[4,3-F]ISOQUINOLINE DERIVATIVE USEFUL IN THE TREATMENT OF CANCER**

(73) Astrazeneca AB
, 151 85 Södertälje/ SE

(72) SCOTT, James Stewart
AstraZeneca Darwin Building Cambridge Science Park Milton Road, Cambridge Cambridgeshire CB4 0WG/ GB
BARLAAM, Bernard Christophe
AstraZeneca Darwin Building Cambridge Science Park Milton Road, Cambridge Cambridgeshire CB4 0WG/ GB
YANG, Bin
AstraZeneca 35 Gatehouse Drive, Waltham, MA 02451/ US
MOSS, Thomas Andrew
AstraZeneca Darwin Building Darwin Building Cambridge Science Park Milton Road, Cambridge Cambridgeshire CB4 0WG/ GB
HUGHES, Samantha Jayne
AstraZeneca Darwin Building Cambridge Science Park Milton Road, Cambridge Cambridgeshire CB4 0WG/ GB
NISSINK, Johannes Wilhelmus Maria
AstraZeneca Darwin Building Cambridge Science Park Milton Road, Cambridge Canbridgeshire CB4 0WG/ GB
O'DONOVAN, Daniel Hillebrand
AstraZeneca Darwin Building Cambridge Science Park Milton Road, Cambridge Cambridgeshire CB4 0WG/ GB

(57) *N*-(1-(3-fluoropropil)azetidin-3-il)-6-((6*S*,8*R*)-8-metil-7-(2,2,2-trifluoroetil)-6,7,8,9-tetrahidro-3H-pirazolo[4,3-*f*]izohinolin-6-il)piridin-3-amin,

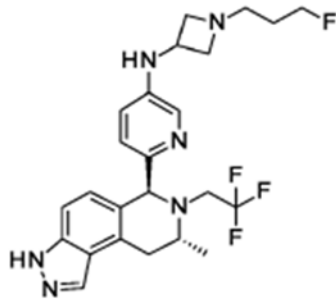

ili njegova farmaceutski prihvatljiva so.

Patent sadrži još 5 patentnih zahtjeva

(11) **03548** (13) **B**

..

(51) **A01K 1/01**^(2006.01)

..

(21) P-2019-307

(22) 14.05.2016

(30) 2015108503 27.05.2015 PT

(96) 16732007.6/14.05.2016

(86) PT PCT/PT2016/050009/14.05.2016

(87) WO 2016/190765/01.12.2016/2016/48

(97) EP 3302041/11.04.2018/2018/15
EP 3302041/31.07.2019/2019/31

(54) me **Cilindrični sistem za uklanjanje životinjskih izlučevina s pokretnom posudom za posip**
en **CYLINDRICAL SYSTEM FOR ANIMAL EXCREMENT REMOVAL WITH REMOVABLE LITTER TRAY**

(73) Couto, Dúnio

Ladeira Branca, nº6 - 1º Dt, Santa Luzia, 9700 - 241 Angra do Heroísmo Angra do Heroísmo/ PT

(72) Couto, Dúnio

Ladeira Branca, nº6 - 1º Dt, Santa Luzia, 9700 - 241 Angra do Heroísmo Angra do Heroísmo/ PT

(57) Cilindrični sistem za uklanjanje životinjskih izlučevina uključujući osnovnu strukturu (1) koja nosi rotirajući cilindar (2), rotirajući cilindar (2) koji ima unutrašnju komoru (2.1) s rešetkom za filtraciju (2.2) unutar rotirajućeg cilindra (2), otvor duž njegove strane (2.3) za istovar izlučevina i jedan otvor za ulazak i izlazak životinje (2.5), odlikuje se time što obuhvata:

- pokretnu posudu za posip (3) ubačenu u rotirajući cilindar (2);
- otvor (2.4) za stavljanje i vađenje pokretne posude za posip (3) u rotirajući cilindar (2);
- noseću bazu (6) u pokretnoj posudi za posip (3);
- rešetku u nosećoj bazi (7); i
- fioku za sakupljanje izlučevina (4), u osnovnoj strukturi (1).

Patent sadrži još 6 patentnih zahtjeva

(11) **03549** (13) **B**

..

(51) **C10J 3/66**^(2006.01)

C07C 29/151^(2006.01)

C10G 2/00^(2006.01)

F01K 23/06^(2006.01)

F02C 3/28^(2006.01)

F23J 15/06^(2006.01)

..

(21) P-2019-308

(22) 19.11.2010

(30) 09176684 20.11.2009 EP

10151481 22.01.2010 EP

10151473 22.01.2010 EP

10154449 23.02.2010 EP

(96) 10777041.4/19.11.2010

(86) EP PCT/EP2010/067847/19.11.2010

(87) WO 2011/061299/26.05.2011/2011/21

(97) EP 2501786/26.09.2012/2012/39

EP 2501786/07.08.2019/2019/32

(54) me **TOPLOTNO I HEMIJSKO ISKORIŠĆAVANJE UGLJENIČNIH MATERIJALA, NAROČITO ZA BEZEMISIONU PROIZVODNJU ENERGIJE**
en **THERMAL-CHEMICAL UTILIZATION OF CARBON-CONTAINING MATERIALS, IN PARTICULAR FOR THE EMISSION-FREE GENERATION OF ENERGY**

(73) RV Lizenz AG

Alte Steinhäuserstrasse 1, 6330 Cham/ CH

(72) RÜDLINGER, Mikael

c/o RV Lizenz AG, Alte Steinhäuserstrasse 1, 6330 Cham/ CH

(57) Postupak za proizvodnju energije (E1,E2,E4) i/ili ugljovodonika i metanola (M60, M61) iskorištavanjem ugljeničnih materijala (M10,M11) bez emisije ugljen dioksida u atmosferu, u kojem se u prvoj fazi postupka (P1) ugljenični materijali (M10, M11) dovode i pirolizuju, pri čemu se obrazuju pirolizni koks (M21) i pirolizni gas (M22); u drugoj fazi postupka (P2), pirolizni koks (M21), iz prve faze postupka postupka (P1) se gasifikuje, pri čemu se obrazuje sintezni gas (M24), a troska i drugi ostaci (M91,M92) se uklanjaju; i .:u treću fazu postupka (P3), sintezni gas (M24) iz druge faze postupka (P2) konvertuje se Fischer-Tropsch: sintezom ili si tezom metanola u tečnoj fazi u ugljovodonike i/ili metanol (M60,M61), koji se uklanjaju; naznačen tim, što te tri fae postupka (P1,P1,P3) obrazuju zatvoreni ciklus,

pri čemu se pirolizni gas (M22) prve faze postupka (P) sprovodi u drugu fazu postupka (P2), gde se u drugj fazi postupka uduviiVaju kiseonik (M31) i, ako je poželjno, procesna para (MSO) u užarenom sloju formiran od piroliznog koksa (M21),

gde pirolizni gas (M22) uduvava prostorno razdvojeno od tačke ula ka kiseoniku gasnu fazu iznad užarenog sloja, gde se višeatomski molekuli sadržani u piroliznom gasu krekuju i razgrađuju, pri čemu je temperatura u drugoj fazi postupka 850°C ili viša, pri čemu pirolizni koks i pirolizni gas ostaju u drugoj fazi postupka najmanje 2 sekunde,

gde se sintezni gas (M24) iz druge faze postupka (P2) sprovodi u treću fazu postupka (P3), a višak gasa (M5) iz treće faze postupka (P3) sprovodi se kao reciklujući gas u prvu fazu postupka (P1).

Patent sadrži još 30 patentnih zahtjeva

(11) **03550** (13) **B**

..

(51) C07K 19/00 ^(2006.01)	A61K 38/16 ^(2006.01)
A61K 38/45 ^(2006.01)	A61P 35/02 ^(2006.01)
C07K 14/705 ^(2006.01)	C07K 16/00 ^(2006.01)
C12N 15/62 ^(2006.01)	A61K 38/00 ^(2006.01)

..

(21) P-2019-310

(22) 17.12.2013

(30) 201261738008 P 17.12.2012 US

(96) 13865442.1/17.12.2013

(86) CA PCT/CA2013/001046/17.12.2013

(87) WO 2014/094122/26.06.2014/2014/26

(97) EP 2931752/21.10.2015/2015/43
EP 2931752/14.08.2019/2019/33

(54) me **LEČENJE CD47+ OBOLELIH ĆELIJA SA SIRP ALFA-FC FUZIJAMA**
en **TREATMENT OF CD47+ DISEASE CELLS WITH SIRP ALPHA-FC FUSIONS**

(73) Trillium Therapeutics Inc.
2488 Dunwin Drive Mississauga, Ontario, L5L 1J9/ CA

(72) UGER, Robert Adam
20 Reditt Court, Richmond Hill, ON L4C 7S4/ CA
SLAVOVA-PETROVA, Penka Slavtcheva
1207-2261 Lake Shore Blvd West, Toronto, ON M8V 3X1/ CA
PANG, Xinli
190 Mountainash Road, Brampton, ON L6R 3H1/ CA

(57) Humani SIRPa fuzioni protein koristan da inhibira rast i/ili proliferaciju CD47+ obolele ćelije, gde humani SIRPa fuzioni protein sadrži SEQ ID No. 25.

Patent sadrži još 19 patentnih zahtjeva

(11) **03625** (13) **B**

..

(51) **C07H 15/203**^(2006.01)

A61P 25/02^(2006.01)

A61P 25/28^(2006.01)

..

(21) P-2019-311

(22) 08.02.2013

(30) 201261597004 P 09.02.2012 US

(96) 13706822.7/08.02.2013

(86) US PCT/US2013/025387/08.02.2013

(87) WO 2013/119985/15.08.2013/2013/33

(97) EP 2812341/17.12.2014/2014/51
EP 2812341/28.08.2019/2019/35

(54) me **C-TERMINALNI NHIBITORI HSP90**
en **C-TERMINAL HSP90 INHIBITORS**

(73) The University of Kansas
245 Strong Hall, 1450 Jayhawk Boulevard, Lawrence, KS 66045/ US

(72) BLAGG, Brian S. J.
4705 Woodland Drive, Lawrence, KS 66049/ US
KUSUMA, Bhaskar, Reddy
100 Ronkonkoma Ave., Apt. 12G, Lake Ronkonkoma, NY 11779 / US
SUNDSTROM, Teather
205 N. 10th St., Canton, MO 63435/ US

(57) Jedinjenje prema Formuli I:

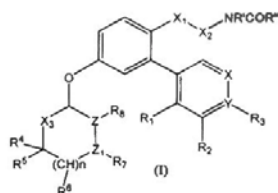

pri čemu

R₁ je vodonik, hidroksi, halo, trifluoroalkil, alkil, alkenil, alkinil, karbociklični, heterociklični, aril, aralkil, karboksil, amida, amino, alkoksi, sulfanil, sulfenil, sulfonil, ili etar;

R₂ je vodonik, halo, hidroksi, trifluorometil, alkoksi, alkil, alkenil, alkinil, karbociklični, alkilkarbociklični, alkil-heterociklični, heterociklični ili -R⁹-OR¹⁰pri čemu

R⁹ je kovalentna veza, ili alkilen, i

R¹⁰ je vodonik, alkil, e-amida ili acil; ili

R₂ zajedno sa R₃ i atomima na koje su vezani formiraju karbociklički prsten sa od 5 do 7 članova prstena ili heterociklički prsten sa od 4 do 8 članova prstena sa najmanje jednim heteroatomom odabranim od kiseonika ili azota;

R₃ je vodonik, hidroksi, halo, trifluoroalkil, alkil, alkoksi, sulfanil ili -R¹¹-OR¹² pri čemu

R¹¹ je kovalentna veza ili alkilen, i

R¹² je alkil, e-amida ili acil; ili

R₃ zajedno sa R₂ i atomima na koje su vezani formiraju karbociklički prsten sa od 5 do 7 članova prstena ili heterociklički prsten koji ima od 4 do 8 članova prstena sa najmanje jednim heteroatomom odabranim od kiseonika ili azota; ili

R₃ je odsutan kada je Y = N-;

R⁴ je vodonik, hidroksi, alkil, arilalkoksi, karboksi!, -R¹³-O-R¹⁴ ili -R¹³-R¹⁵; pri čemu

R¹³ je kovalentna veza ili alkilen, i

R¹⁴ je vodonik, e-amida, ili acil, ili

R¹⁵ je N-amida, -POR¹⁶R¹⁷-SO₂R¹⁸ ili sulfonamid, pri čemu

R₁₆, R₁₇, R₁₈ su nezavisno alkoksi;

R⁵ je vodonik, hidroksi, alkil, arilalkoksi, alkenil, alkinil, aril ili aralkil;

R⁶ je vodonik, hidroksi, sulfanil, alkil, alkenil, alkinil, aril, arilalkil, alkoksi, ariloksi, arilalkoksi ili heterociklički prsten sa od 4 do 8 članova prstena sa najmanje jednim heteroatomom odabranim od kiseonika ili azota;

R₇ je vodonik, hidroksi, arilalkoksi, alkil, acil, karboksi! ili je odsutan;

R₈ je vodonik, hidroksi ili arilalkoksi;

X_1 je $-\text{CHR}^{19}$ - ili $-\text{CR}^{19} =$, pri čemu

R^{19} je odabran od vodonika, halo, alkila, alkenila ili alkinila; ili

X_1 zajedno sa X_2 formira karbociklički prsten sa od 3 do 7 članova prstena; pri čemu X_1-X_2 jeste $-\text{C}\equiv\text{C}-$;

X_2 je $-\text{CHR}^{20}$ - ili $=\text{CR}^{20}$ -, pri čemu

R^{20} je odabran od vodonika, halo, alkila, alkenila ili alkinila; ili

X_2 zajedno sa X_1 formira karbociklički prsten sa od 3 do 7 članova prstena; pri čemu X_1-X_2 jeste $-\text{C}\equiv\text{C}-$;

X_3 je o ili CH_2 ;

Patent sadrži još 16 patentnih zahtjeva

(11) **03574** (13) **B**

..

(51) A61K 31/44 ^(2006.01)	A61K 31/506 ^(2006.01)
C07D 239/24 ^(2006.01)	C07F 9/535 ^(2006.01)
A61K 31/34 ^(2006.01)	A61K 31/505 ^(2006.01)
C07F 9/54 ^(2006.01)	C07F 9/655 ^(2006.01)
C07F 9/6558 ^(2006.01)	C07D 405/06 ^(2006.01)
C07D 409/06 ^(2006.01)	C07D 409/14 ^(2006.01)
C07D 471/04 ^(2006.01)	C07D 487/04 ^(2006.01)
C07D 491/052 ^(2006.01)	C07D 493/04 ^(2006.01)
C07D 495/04 ^(2006.01)	C07D 498/04 ^(2006.01)
C07D 513/04 ^(2006.01)	

..

(21) P-2019-312

(22) 30.06.2015

(30) 201462019756 P 01.07.2014 US

201562185678 P 28.06.2015 US

(96) 15815330.4/30.06.2015

(86) US PCT/US2015/038712/30.06.2015

(87) WO 2016/004136/07.01.2016/2016/01

(97) EP 3164130/10.05.2017/2017/19

EP 3164130/07.08.2019/2019/32

(54) me **HETEROARILNA JEDINJENJA KOJA SU KORISNA KAO INHIBITORI
SUMOAKTIVIRAJUĆEG ENZIMA**

en **HETEROARYL COMPOUNDS USEFUL AS INHIBITORS OF SUMO ACTIVATING ENZYME**

(73) Millennium Pharmaceuticals, Inc.

40 Landsdowne Street, Cambridge, MA 02139/ US

(72) DUFFEY, Matthew O.

5050 S. Lake Shore Dr. 2717, Chicago, IL 60615/ US

ENGLAND, Dylan

9 Wayne Road, Milford, MA 01757/ US

FREEZE, Scott

67 Gates St, Unit 1, Boston, MA 02127/ US

HU, Zhigen

64B Marshall Street, Somerville, MA 02145/ US

LANGSTON, Steven P.

164 Mill Road, Andover, MA 01845/ US

MCINTYRE, Charles

230 Brookline Street, Apt. 1, Cambridge, MA 02139/ US

MIZUTANI, Hirotake

264 Massachussets Ave., 209, Arlington, MA 02474/ US

ONO, Koji

26-1, Muraoka-Higashi 2-chome, Fujisawa Kanagawa 251-0012/ JP

XU, He

12 Louart Drive, Needham HGTS, MA 02494-1449/ US

(57) Hemijski entitet odabran od:

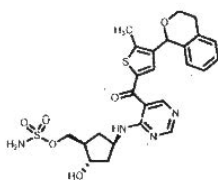

I-256;

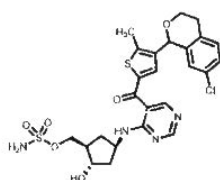

I-257;

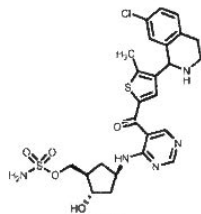

I-263;

i njihovih farmaceutski prilivatlji vih soli.

Patent sadrži još 14 patentnih zahtjeva

(11) **03573** (13) **B**

..

(51) **A61K 31/4162**^(2006.01)

C07D 471/04^(2006.01)

..

(21) P-2019-313

(22) 03.05.2013

(30) 201261642915 P 04.05.2012 US

(96) 13784942.8/03.05.2013

(86) US PCT/US2013/039484/03.05.2013

(87) WO 2013/166396/07.11.2013/2013/45

(97) EP 2770994/03.09.2014/2014/36
EP 2770994/21.08.2019/2019/34

(54) me **1H-PIRAZOLO[3,4-B]PIRIDINI I NJIHOVA TERAPEUTSKA UPOTREBA**
en **1H-PYRAZOLO[3,4-B]PYRIDINES AND THERAPEUTIC USES THEREOF**

(73) Samumed, LLC
9381 Judicial Drive, Suite 160, San Diego, California 92121/ US

(72) HOOD, John
10831 Vereda Sol del Dios, San Diego, California 92130/ US
KC, Sunil Kumar
10504 Clasico Court, San Diego, California 92127/ US
WALLACE, David Mark
6448 Peinado Way, San Diego, California 92121/ US

(57) Jedinjenje ili njegova farmaceutske prihvatljiva so koja ima strukturu Formule I:

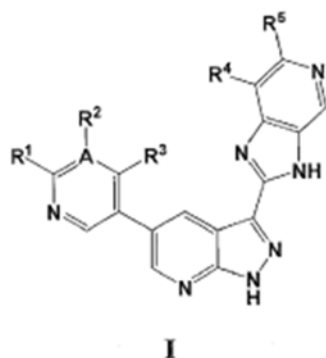

gde:

R2 je -CH₂N(R₉)₂ ili -N(R₉)₂;

R1 i R3 su H;

R4 je -fenil(R13)q, ili -heteroaril(R15)q;

R5 je H;

svako R6 je supstituent vezan na arilnom prstenu i nezavisno izabran iz grupe koju čine H, -C1-9 alkil, halid, CF₃ i CN;

svako R8 je supstituent vezan na heterociklični prsten i nezavisno izabran iz grupe koju čine H, halid, -(C1-3 alkil)naril(R6)q, i -C1-4 alkil;

svako R9 je nezavisno izabran iz grupe koju čine H, -C1-9 alkil, -(C1-3 alkil)naril(R6)q, -(C1-3 alkil)nkarbociklični i -(C1-9 alkil)N(R16)₂;

alternativno, dva susedna R9 mogu se uzeti zajedno sa atomima na koja su vezani da bi formirali heterociklični(R17)q;

svako R13 je supstituent vezan na arilnom prstenu i nezavisno izabran iz grupe koju čine H, halid, -CF₃, CN, -(C1-3 alkil)nheterociklični(R8)q, -(C1-9 alkil)nN(R9)₂ i -(C1-9 alkil)nNHSO₂R18;

svako R15 je supstituent vezan na heteroarilni prsten i nezavisno izabran iz grupe koju čine H, C1-3 alkil, halid, -CF₃, CN, -C(=O)(C1-3 alkil), -(C1-9 alkil)nN(R9)₂ i -(C1-9 alkil)nNHSO₂R18;

svako R16 je nezavisno odabrano iz grupe koju čine H i -(C1-3 alkil);

svako R17 je supstituent vezan na heterociklični prsten i nezavisno izabran iz grupe koju čine H, -(C1-9 alkil)naril(R6)q, i -C1-9 alkil;

svako R18 je C1-3 alkil;

A je N ili C;

pod uslovom da ako A je N onda R2 je ništa;

svako q je ceo broj od 1 do 5; i

svako n je ceo broj od 0 do 1.

Patent sadrži još 14 patentnih zahtjeva

(11) **03572** (13) **B**

..

(51) **A61K 31/506**^(2006.01)

A61P 25/00^(2006.01)

..

(21) P-2019-314

(22) 12.03.2014

(30) 201361780378 P 13.03.2013 US

(96) 17206491.7/12.03.2014

(97) EP 3363438/22.08.2018/2018/34
EP 3363438/18.09.2019/2019/38

(54) me **SUPSTITUISANI 2-AZABICIKLI I NJIHOVA UPOTREBA KAO MODULATORA RECEPTORA OREKSINA**
en **SUBSTITUTED 2-AZABICYCLES AND THEIR USE AS OREXIN RECEPTOR MODULATORS**

(73) Janssen Pharmaceutica NV
Turnhoutseweg 30, 2340 Beerse/ BE

(72) GELIN, Christine F.
5035 Sterling Grove Lane, San Diego, CA 92130/ US
LEBOLD, Terry P.
11296 Del Diablo Way, San Diego, CA 92129/ US
SHIREMAN, Brock T.
12625 Birchbrook Court, Poway, CA 92064/ US
ZIFF, Jeannie M.
3611 Florida Street 4, San Diego, CA 92104/ US

(57) (3-fluoro-2-(pirimidin-2-il)fenil)((1S,4R,6R)-6-((5-(trifluorometil)piridin-2-il)oksi)-2-azabiciklo[2.2.1]heptan-2-il)metanon ili njegova farmaceutski prihvatljiva so ili solvat za upotrebu u terapiji.

Patent sadrži još 18 patentnih zahtjeva

(11) **03580** (13) **B**

..

(51) C07D 401/14 ^(2006.01)	C07D 405/14 ^(2006.01)
C07D 401/04 ^(2006.01)	C07D 405/12 ^(2006.01)
C07D 413/06 ^(2006.01)	C07D 417/14 ^(2006.01)
C07D 211/98 ^(2006.01)	A61K 31/445 ^(2006.01)

..

(21) P-2019-315

(22) 12.02.2015

(30) 201461939458 P 13.02.2014 US

201462061258 P 08.10.2014 US

(96) 15707007.9/12.02.2015

(86) US PCT/US2015/015635/12.02.2015

(87) WO 2015/123424/20.08.2015/2015/33

(97) EP 3105226/21.12.2016/2016/51

EP 3105226/04.09.2019/2019/36

(54) me **CIKLOPROPILAMINI KAO LSD1 INHIBITORI**
en **CYCLOPROPYLAMINES AS LSD1 INHIBITORS**

(73) INCYTE CORPORATION

1801 Augustine Cut-Off, Wilmington, DE 19803/ US

(72) ZHANG, Fenglei

309 Daniel Drive, Ambler, Pennsylvania 19002/ US

COURTER, Joel R.

13308 Elam Drive, Glen Mills, Pennsylvania 19342/ US

WU, Liangxing

108 Sassafrass Court, Wilmington, Delaware 19088/ US

HE, Chunhong

40 Magnolia Way, Chadds Ford, Pennsylvania 19317/ US

KONKOL, Leah C.

1710 Gilpin Avenue, Wilmington, Delaware 19806/ US

QIAN, Ding-Quan

10 Donald Preston Drive, Newark, Delaware 19702/ US

SHEN, Bo

15 Martins Court, Garnet Valley, Pennsylvania 19060/ US

YAO, Wenqing

45 Magnolia Way, Chadds Ford, Pennsylvania 19317/ US

(57) Jedinjenje Formule II:

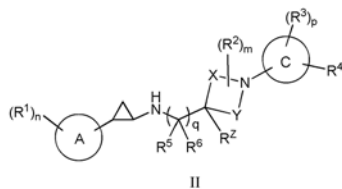

ili njegova farmaceutski prihvatljiva so, pri čemu:

prsten A je C6-10 aril ili 5-10 člani heteroaril koji sadrži ugljenik i 1, 2, 3 ili 4 heteroatoma izabranih između N, O, i S;

X je -CH2- ili -CH2-CH2-;

Y je -CH2- ili -CH2-CH2-;

pri čemu svaka R2 je supstituisana na bilo kom ugljenikovom atomu koji obrazuje prsten u prstenu Formule II koji sadrži X i Y izuzev ugljenikovog atoma koji obrazuje prsten sa kojim je vezana RZ;

prsten C je monociklični 4-7 člani heterocikloalkil koji sadrži ugljenik i 1, 2, 3 ili 4 heteroatoma izabranih između N, O, i S;

svaka R1 je nezavisno izabrana između halo, C1-6 alkil, C2-6 alkenil, C2-6 alkinil, C1-6 haloalkil, C6-10 aril,

C3-10 cikloalkil, 5-10 članog heteroarila, 4-10 članog heterocikloalkila, C6-10 aril-C1-4 alkil-, C3-10 cikloalkil-C1-4 alkil-, (5-10 člani heteroaril)-C1-4 alkil-, (4-10 člani heterocikloalkil)-C1-4 alkil-, CN, NO₂, ORa, SRa, C(O)Rb, C(O)NRcRd, C(O)ORa, OC(O)Rb, OC(O)NRcRd, NRcRd, NRcC(O)Rb, NRcC(O)ORa, NRcC(O)NRcRd, C(=NRe)Rb, C(=NRe)NRcRd, NRcC(=NRe)NRcRd, NRcS(O)Rb, NRcS(O)2Rb, NRcS(O)2NRcRd, S(O)Rb, S(O)NRcRd, S(O)2Rb, i S(O)2NRcRd, pri čemu pomenuti C1-6 alkil, C2-6 alkenil, C2-6 alkinil, C6-10 aril, C3-10 cikloalkil, 5-10 člani heteroaril, 4-10 člani heterocikloalkil, C6-10 aril-C1-4 alkil-, C3-10 cikloalkil-C1-4 alkil-, (5-10 člani heteroaril)-C1-4 alkil-, i (4-10 člani heterocikloalkil)-C1-4 alkil- su svaki opciono supstituisani sa 1, 2, 3, ili 4 supstituenata nezavisno izabranih između halo, C1-4 alkil, C1-4 haloalkil, C1-4 cijanoalkil, CN, NO₂, ORa, SRa, C(O)Rb, C(O)NRcRd, C(O)ORa, OC(O)Rb, OC(O)NRcRd, C(=NRe)NRcRd, NRcC(=NRe)NRcRd, NRcRd, NRcC(O)Rb, NRcC(O)ORa, NRcC(O)NRcRd, NRcS(O)Rb, NRcS(O)2Rb, NRcS(O)2NRcRd, S(O)Rb, S(O)NRcRd, NRc1S(O)Rb1, NRc1S(O)2Rb1, NRc1S(O)2NRc1Rd1, S(O)Rb1, S(O)NRc1Rd1, NRc1S(O)NRc1Rd1, S(O)2Rb1, i S(O)2NRc1Rd1;

svaka R2 je nezavisno izabrana između halo, C1-6 alkil, CN, ORa1, C(O)Rb1, C(O)NRc1Rd1, C(O)ORa1, NRc1Rd1, S(O)Rb1, S(O)NRc1Rd1, S(O)2Rb1, i S(O)2NRc1Rd1, pri čemu pomenuti C1-6 alkil je opciono supstituisan sa 1, 2, ili 3 supstituenata nezavisno izabranih između halo, CN, ORa1, SRa1, C(O)Rb1, C(O)NRc1Rd1, C(O)ORa1, OC(O)Rb1, OC(O)NRc1Rd1, C(=NRe1)NRc1Rd1, NRc1C(=NRe1)NRc1Rd1, NRc1Rd1, NRc1C(O)Rb1, NRc1C(O)ORa1, NRc1C(O)NRc1Rd1, NRc1S(O)Rb1, NRc1S(O)2Rb1, NRc1S(O)2NRc1Rd1, S(O)Rb1,

S(O)NRc1Rd1, S(O)2Rb1, i S(O)2NRc1Rd1;

svaka R3 je nezavisno izabrana između halo, C1-6 alkil, C2-6 alkenil, C2-6 alkinil, C1-6 haloalkil, C6-10 aril,

C3-10 cikloalkil, 5-10 člani heteroaril, 4-10 člani heterocikloalkil, C6-10 aril-C1-4 alkil-, C3-10 cikloalkil-

C1-4 alkil-, (5-10 člani heteroaril)-C1-4 alkil-, (4-10 člani heterocikloalkil)-C1-4 alkil-, CN, NO₂, ORa2, SRa2, C(O)Rb2, C(O)NRc2Rd2, C(O)ORa2, OC(O)Rb2, OC(O)NRc2Rd2, NRc2Rd2, NRc2C(O)Rb2, NRc2C(O)ORa2, NRc2C(O)NRc2Rd2, C(=NRe2)Rb2, C(=NRe2)NRc2Rd2, NRc2C(=NRe2)NRc2Rd2, NRc2S(O)Rb2, NRc2S(O)2Rb2, NRc2S(O)2NRc2Rd2, S(O)Rb2, S(O)NRc2Rd2, S(O)2Rb2, i S(O)2NRc2Rd2, pri čemu pomenuti C1-6 alkil, C2-6 alkenil, C2-6 alkinil, C6-10 aril, C3-10 cikloalkil, 5-10

člani heteroaril, 4-10 člani heterocikloalkil, C6-10 aril-C1-4 alkil-, C3-10 cikloalkil-C1-4 alkil-, (5-10 člani heteroaril)-C1-4 alkil-, 8 (4-10 člani heterocikloalkil)-C1-4 alkil- su svaki opciono supstituisani sa 1, 2, 3, ili 4 supstituenata nezavisno izabranih između halo, C1-4 alkil, C1-4 haloalkil, C1-4 cijanoalkil, CN, NO₂, ORa₂, SRa₂, C(O)Rb₂, C(O)NRc₂Rd₂, C(O)ORa₂, OC(O)Rb₂, OC(O)NRc₂Rd₂, C(=NRe₂)NRc₂Rd₂, NRc₂C(=NRe₂)NRc₂Rd₂, NRc₂Rd₂, NRc₂C(O)Rb₂, NRc₂C(O)ORa₂, NRc₂C(O)NRc₂Rd₂, NRc₂S(O)Rb₂, NRc₂S(O)2Rb₂, NRc₂S(O)2NRc₂Rd₂, S(O)Rb₂, S(O)NRc₂Rd₂, S(O)2Rb₂, i S(O)2NRc₂Rd₂;

R4 je halo, C1-6 alkil, C2-6 alkenil, C2-6 alkinil, C1-6 haloalkil, C6-10 aril, C3-10 cikloalkil, 5-10 člani heteroaril, 4-10 člani heterocikloalkil, C6-10 aril-C1-4 alkil-, C3-10 cikloalkil-C1-4 alkil-, (5-10 člani heteroaril)-C1-4 alkil-, (4-10 člani heterocikloalkil)-C1-4 alkil-, CN, NO₂, ORa₃, SRa₃, C(O)Rb₃, C(O)NRc₃Rd₃, C(O)ORa₃, OC(O)Rb₃, OC(O)NRc₃Rd₃, NRc₃Rd₃, NRc₃C(O)Rb₃, NRc₃C(O)ORa₃, NRc₃C(O)NRc₃Rd₃, C(=NRe₃)Rb₃, C(=NRe₃)NRc₃Rd₃, NRc₃C(=NRe₃)NRc₃Rd₃, NRc₃S(O)Rb₃, NRc₃S(O)2Rb₃, NRc₃S(O)2NRc₃Rd₃, S(O)Rb₃, S(O)NRc₃Rd₃, S(O)2Rb₃, ili S(O)2NRc₃Rd₃, pri čemu pomenuti C1-6 alkil, C2-6 alkenil, C2-6 alkinil, C6-10 aril, C3-10 cikloalkil, 5-10 člani heteroaril, 4-10 člani heterocikloalkil, C6-10 aril-C1-4 alkil-, C3-10 cikloalkil-C1-4 alkil-, (5-10 člani heteroaril)-C1-4 alkil-, i (4-10 člani heterocikloalkil)-C1-4 alkil- su svaki opciono supstituisani sa 1, 2, 3, ili 4 supstituenata nezavisno izabranih između halo, C1-4 alkil, C1-4 haloalkil, C1-4 cijanoalkil, CN, NO₂, ORa₃, SRa₃, C(O)Rb₃, C(O)NRc₃Rd₃, C(O)ORa₃, OC(O)Rb₃, OC(O)NRc₃Rd₃, C(=NRe₃)NRc₃Rd₃, NRc₃C(=NRe₃)NRc₃Rd₃, NRc₃Rd₃, NRc₃C(O)Rb₃, NRc₃C(O)ORa₃, NRc₃C(O)NRc₃Rd₃, NRc₃S(O)Rb₃, NRc₃S(O)2Rb₃, NRc₃S(O)2NRc₃Rd₃, S(O)Rb₃, S(O)NRc₃Rd₃, S(O)2Rb₃, i S(O)2NRc₃Rd₃;

R5 i R6 su svaki nezavisno izabrani između H, halo, CN, C1-4 alkil, C1-4 cijanoalkil, C1-4 haloalkil, i -(C1-4 alkil)-ORa₅;

RZ je H, halo, C1-6 alkil, C2-6 alkenil, C2-6 alkinil, C1-6 haloalkil, C6-10 aril, C3-10 cikloalkil, 5-10 člani heteroaril, 4-10 člani heterocikloalkil, C6-10 aril-C1-4 alkil-, C3-10 cikloalkil-C1-4 alkil-, (5-10 člani heteroaril)-C1-4 alkil-, (4-10 člani heterocikloalkil)-C1-4 alkil-, CN, NO₂, ORa₄, SRa₄, C(O)Rb₄, C(O)NRc₄Rd₄, C(O)ORa₄, OC(O)Rb₄, OC(O)NRc₄Rd₄, NRc₄Rd₄, NRc₄C(O)Rb₄, NRc₄C(O)ORa₄, NRc₄C(O)NRc₄Rd₄, C(=NRe₄)Rb₄, C(=NRe₄)NRc₄Rd₄, NRc₄C(=NRe₄)NRc₄Rd₄, NRc₄S(O)Rb₄, NRc₄S(O)2Rb₄, NRc₄S(O)2NRc₄Rd₄, S(O)Rb₄, S(O)NRc₄Rd₄, S(O)2Rb₄, i S(O)2NRc₄Rd₄, pri čemu pomenuti C1-6 alkil, C2-6 alkenil, C2-6 alkinil, C6-10 aril, C3-10 cikloalkil, 5-10 člani heteroaril, 4-10 člani heterocikloalkil, C6-10 aril-C1-4 alkil-, C3-10 cikloalkil-C1-4 alkil-, (5-10 člani heteroaril)-C1-4 alkil-, i (4-10 člani heterocikloalkil)-C1-4 alkil- su svaki opciono supstituisani sa 1, 2, 3, ili 4 supstituenata nezavisno izabranih između halo, C1-4 alkil, C1-4 haloalkil, C1-4 cijanoalkil, CN, NO₂, ORa₄, SRa₄, C(O)Rb₄, C(O)NRc₄Rd₄, C(O)ORa₄, OC(O)Rb₄, OC(O)NRc₄Rd₄, C(=NRe₄)NRc₄Rd₄, NRc₄C(=NRe₄)NRc₄Rd₄, NRc₄Rd₄, NRc₄C(O)Rb₄, NRc₄C(O)ORa₄, NRc₄C(O)NRc₄Rd₄, NRc₄S(O)Rb₄, NRc₄S(O)2Rb₄, NRc₄S(O)2NRc₄Rd₄, S(O)Rb₄, S(O)NRc₄Rd₄, S(O)2Rb₄, i S(O)2NRc₄Rd₄;

svaka Ra, Rb, Rc, Rd, Ra₂, Rb₂, Rc₂, Rd₂, Ra₃, Rb₃, Rc₃, Rd₃, Ra₄, Rb₄, Rc₄, i Rd₄ je nezavisno izabrana između H, C1-6 alkil, C1-4 haloalkil, C2-6 alkenil, C2-6 alkinil, C6-10 aril, C3-10 cikloalkil, 5-10 člani heteroaril, 4-10 člani heterocikloalkil, C6-10 aril-C1-4 alkil-, C3-10 cikloalkil-C1-4 alkil-, (5-10 člani heteroaril)-C1-4 alkil-, i (4-10 člani heterocikloalkil)-C1-4 alkil-, pri čemu pomenuti C1-6 alkil, C2-6 alkenil, C2-6 alkinil, C6-10 aril, C3-10 cikloalkil, 5-10 člani heteroaril, 4-10 člani heterocikloalkil, C6-10 aril-C1-4 alkil-, C3-10 cikloalkil-C1-4 alkil-, (5-10 člani heteroaril)-C1-4 alkil-, i (4-10 člani heterocikloalkil)-C1-4 alkil- je opciono supstituisan sa 1, 2, 3, 4, ili 5 supstituenata nezavisno izabranih između C1-4 alkil, C1-4 haloalkil, C1-4 cijanoalkil, halo, CN, ORa₅, SRa₅, C(O)Rb₅, C(O)NRc₅Rd₅, C(O)ORa₅, OC(O)Rb₅, OC(O)NRc₅Rd₅, NRc₅Rd₅, NRc₅C(O)Rb₅, NRc₅C(O)NRc₅Rd₅, NRc₅C(O)ORa₅, C(=NRe₅)NRc₅Rd₅, NRc₅C(=NRe₅)NRc₅Rd₅, S(O)Rb₅, S(O)NRc₅Rd₅, S(O)2Rb₅, NRc₅S(O)2Rb₅, NRc₅S(O)2NRc₅Rd₅, i S(O)2NRc₅Rd₅;

ili bilo koja Rc i Rd zajedno sa N atomom za koga su vezane obrazuju 4-, 5-, 6-, ili 7-članu heterocikloalkilnu grupu opciono supstituisanu sa 1, 2, ili 3 supstituenata nezavisno izabranih između C1-6 alkil, C3-7

cikloalkil, 4-7 člani heterocikloalkil, C6-10 aril, 5-6 člani heteroaril, C1-6 haloalkil, halo, CN, ORa5, SRa5, C(O)Rb5, C(O)NRc5Rd5, C(O)ORa5, OC(O)Rb5, OC(O)NRc5Rd5, NRc5Rd5, NRc5C(O)Rb5,

NRc5C(O)NRc5Rd5, NRc5C(O)ORa5, C(=NRe5)NRc5Rd5, NRc5C(=NRe5)NRc5Rd5, S(O)Rb5, S(O)NRc5Rd5, S(O)2Rb5, NRc5S(O)2Rb5, NRc5S(O)2NRc5Rd5, i S(O)2NRc5Rd5, pri čemu pomenuti C1-6 alkil, C3-7 cikloalkil, 4-7 člani heterocikloalkil, C6-10 aril, i 5-6 člani heteroaril su opciono supstituisani sa 1, 2, ili 3 supstituenata nezavisno izabranih između halo, C1-4 alkil, C1-4 haloalkil, C1-4 cijanoalkil, CN, ORa5, SRa5,

C(O)Rb5, C(O)NRc5Rd5, C(O)ORa5, OC(O)Rb5, OC(O)NRc5Rd5, NRc5Rd5, NRc5C(O)Rb5, NRc5C(O)NRc5Rd5,

NRc5C(O)ORa5, C(=NRe5)NRc5Rd5, NRc5C(=NRe5)NRc5Rd5, S(O)Rb5, S(O)NRc5Rd5, S(O)2Rb5, NRc5S(O)2Rb5, NRc5S(O)2NRc5Rd5, i S(O)2NRc5Rd5;

ili bilo koja Rc2 i Rd2 zajedno sa N atomom za koga su vezane obrazuju 4-, 5-, 6-, ili 7-članu heterocikloalkilnu grupu opciono supstituisanu sa 1, 2, ili 3 supstituenata nezavisno izabranih između C1-6 alkil, C3-7 cikloalkil, 4-7 članog heterocikloalkila, C6-10 aril, i 5-6 člani heteroaril, C1-6 haloalkil, halo, CN, ORa5, SRa5, C(O)Rb5, C(O)NRc5Rd5, C(O)ORa5, OC(O)Rb5, OC(O)NRc5Rd5, NRc5Rd5, NRc5C(O)Rb5, NRc5C(O)NRc5Rd5, NRc5C(O)ORa5, C(=NRe5)NRc5Rd5, NRc5C(=NRe5)NRc5Rd5, S(O)Rb5, S(O)NRc5Rd5, S(O)2Rb5, NRc5S(O)2Rb5, NRc5S(O)2NRc5Rd5, i S(O)2NRc5Rd5, pri čemu pomenuti C1-6 alkil, C3-7 cikloalkil, 4-7 člani heterocikloalkil, C6-10 aril, i 5-6 člani heteroaril su opciono supstituisani sa 1, 2, ili 3 supstituenata nezavisno izabranih između halo, C1-4 alkil, C1-4 haloalkil, C1-4 cijanoalkil, CN, ORa5, SRa5, C(O)Rb5, C(O)NRc5Rd5, C(O)ORa5, OC(O)Rb5, OC(O)NRc5Rd5, NRc5Rd5, NRc5C(O)Rb5, NRc5C(O)NRc5Rd5, NRc5C(O)ORa5, C(=NRe5)NRc5Rd5, NRc5C(=NRe5)NRc5Rd5, S(O)Rb5, S(O)NRc5Rd5, S(O)2Rb5, NRc5S(O)2Rb5, NRc5S(O)2NRc5Rd5, i S(O)2NRc5Rd5;

ili bilo koja Rc3 i Rd3 zajedno sa N atomom za koga su vezane obrazuju 4-, 5-, 6-, ili 7-članu heterocikloalkilnu grupu opciono supstituisanu sa 1, 2, ili 3 supstituenata nezavisno izabranih između C1-6 alkil, C3-7 cikloalkil, 4-7 člani heterocikloalkil, C6-10 aril, 5-6 člani heteroaril, C1-6 haloalkil, halo, CN, ORa5, SRa5, C(O)Rb5, C(O)NRc5Rd5, C(O)ORa5, OC(O)Rb5, OC(O)NRc5Rd5, NRc5Rd5, NRc5C(O)Rb5, NRc5C(O)NRc5Rd5, NRc5C(O)ORa5, C(=NRe5)NRc5Rd5, NRc5C(=NRe5)NRc5Rd5, S(O)Rb5, S(O)NRc5Rd5, S(O)2Rb5, NRc5S(O)2Rb5, NRc5S(O)2NRc5Rd5, i S(O)2NRc5Rd5, pri čemu pomenuti C1-6 alkil, C3-7 cikloalkil, 4-7 člani heterocikloalkil, C6-10 aril, i 5-6 člani heteroaril su opciono supstituisani sa 1, 2, ili 3 supstituenata nezavisno izabranih između halo, C1-4 alkil, C1-4 haloalkil, C1-4 cijanoalkil, CN, ORa5, SRa5, C(O)Rb5, C(O)NRc5Rd5, C(O)ORa5, OC(O)Rb5, OC(O)NRc5Rd5, NRc5Rd5, NRc5C(O)Rb5, NRc5C(O)NRc5Rd5, NRc5C(O)ORa5, C(=NRe5)NRc5Rd5, NRc5C(=NRe5)NRc5Rd5, S(O)Rb5, S(O)NRc5Rd5, S(O)2Rb5, NRc5S(O)2Rb5, NRc5S(O)2NRc5Rd5, i S(O)2NRc5Rd5;

ili bilo koja Rc4 i Rd4 zajedno sa N atomom za koga su vezane obrazuju 4-, 5-, 6-, ili 7-članu heterocikloalkilnu grupu opciono supstituisanu sa 1, 2, ili 3 supstituenata nezavisno izabranih između C1-6 alkil, C3-7 cikloalkil, 4-7 člani heterocikloalkil, C6-10 aril, 5-6 člani heteroaril, C1-6 haloalkil, halo, CN, ORa5, SRa5, C(O)Rb5, C(O)NRc5Rd5, C(O)ORa5, OC(O)Rb5, OC(O)NRc5Rd5, NRc5Rd5, NRc5C(O)Rb5,

NRc5C(O)NRc5Rd5, NRc5C(O)ORa5, C(=NRe5)NRc5Rd5, NRc5C(=NRe5)NRc5Rd5, S(O)Rb5, S(O)NRc5Rd5, S(O)2Rb5, NRc5S(O)2Rb5, NRc5S(O)2NRc5Rd5, i S(O)2NRc5Rd5, pri čemu pomenuti C1-6 alkil, C3-7 cikloalkil, 4-7 člani heterocikloalkil, C6-10 aril, i 5-6 člani heteroaril su opciono supstituisani sa 1, 2, ili 3 supstituenata nezavisno izabranih između halo, C1-4 alkil, C1-4 haloalkil, C1-4 cijanoalkil, CN, ORa5, SRa5,

C(O)Rb5, C(O)NRc5Rd5, C(O)ORa5, OC(O)Rb5, OC(O)NRc5Rd5, NRc5Rd5, NRc5C(O)Rb5, NRc5C(O)NRc5Rd5,

NRc5C(O)ORa5, C(=NRe5)NRc5Rd5, NRc5C(=NRe5)NRc5Rd5, S(O)Rb5, S(O)NRc5Rd5, S(O)2Rb5, NRc5S(O)2Rb5, NRc5S(O)2NRc5Rd5, i S(O)2NRc5Rd5;

svaka Ra1, Rb1, Rc1, Rd1 je nezavisno izabrana između H i C1-6 alkila opciono supstituisanog sa 1, 2, 3, 4, ili 5 supstituenata nezavisno izabranih između halo, CN, ORa5, SRa5, C(O)Rb5, C(O)NRc5Rd5, C(O)ORa5, OC(O)Rb5, OC(O)NRc5Rd5, NRc5Rd5, NRc5C(O)Rb5, NRc5C(O)NRc5Rd5, NRc5C(O)ORa5, C(=NRe5)NRc5Rd5, NRc5C(=NRe5)NRc5Rd5, S(O)Rb5, S(O)NRc5Rd5, S(O)2Rb5, NRc5S(O)2Rb5, NRc5S(O)2NRc5Rd5, i S(O)2NRc5Rd5;

svaka Ra5, Rb5, Rc5, i Rd5 je nezavisno izabrana između H, C1-4 alkil, C1-4 haloalkil, C2-4 alkenil, i C2-4 alkinil, pri čemu pomenuti C1-4 alkil, C2-4 alkenil, i C2-4 alkinil, je opciono supstituisan sa 1, 2, ili 3 supstituenata nezavisno izabranih između OH, CN, amino, halo, C1-4 alkil, C1-4 alkoksi, C1-4 alkiltio, C1-4 alkilamino, di(C1-4 alkil)amino, C1-4 haloalkil, i C1-4 haloalkoksi; i

svaka Re, Re1, Re2, Re3, Re4, i Re5 je nezavisno izabrana između H, C1-4 alkil, i CN;

m je 0, 1, ili 2;

n je 0, 1, 2, ili 3;

p je 0, 1, 2, 3; i

q je 0, 1, ili 2.

Patent sadrži još 28 patentnih zahtjeva

(11) **03582** (13) **B**

..

(51) **A61P 25/28**^(2006.01)

A61K 39/00^(2006.01)

C07K 16/18^(2006.01)

..

(21) P-2019-317

(22) 18.02.2016

(30) 201562121116 P 26.02.2015 US

(96) 16706741.2/18.02.2016

(86) US PCT/US2016/018419/18.02.2016

(87) WO 2016/137811/01.09.2016/2016/35

(97) EP 3261720/03.01.2018/2018/01

EP 3261720/18.09.2019/2019/38

(54) me **PROTUTIJELA PROTIV TAU I NJIHOVA UPOTREBA**
en **ANTIBODIES TO TAU AND USES THEREOF**

(73) ELI LILLY AND COMPANY

Lilly Corporate Center, Indianapolis, IN 46285/ US

(72) ALVARADO, Alberto

P.O. Box 6288, Indianapolis, Indiana 46206-6288/ US

DRIVER, David

P.O. Box 6288, Indianapolis, Indiana 46206-6288/ US

HAYASHI, Mansuo Lu

P.O. Box 6288, Indianapolis, Indiana 46206-6288/ US

LU, Jirong

P.O. Box 6288, Indianapolis, Indiana 46206-6288/ US

(57) Monoklonsko protutijelo koje se veže na ljudski tau, **naznačeno time** što sadrži varijabilno područje lakog lanca (LCVR) i varijabilno područje teškog lanca (HCVR), gdje aminokiselinski slijed LCVR je dan sa SEQ ID NO: 9, a aminokiselinski slijed HCVR je dan sa SEQ ID NO: 10.

Patent sadrži još 8 patentnih zahtjeva

(11) **03586** (13) **B**

..

(51) **C07H 21/02**^(2006.01)

A61K 31/7084^(2006.01)

A61P 37/02^(2006.01)

..

(21) P-2019-318

(22) 18.05.2014

(30) 201361825005 P 18.05.2013 US

201361902125 P 08.11.2013 US

(96) 14800848.5/18.05.2014

(86) US PCT/US2014/038525/18.05.2014

(87) WO 2014/189805/27.11.2014/2014/48

(97) EP 2996473/23.03.2016/2016/12

EP 2996473/21.08.2019/2019/34

(54) me **SASTAVI I METODE ZA AKTIVIRANJE SIGNALIZIRANJA KOJE JE ZAVISNO OD
„STIMULATORA GENA ZA INTERFERON“**
en **COMPOSITIONS AND METHODS FOR ACTIVATING "STIMULATOR OF INTERFERON
GENE"-DEPENDENT SIGNALLING**

(73) Aduro Biotech, Inc.

740 Heinz Avenue, Berkeley, CA 94710/ US

The Regents of the University of California

1111 Franklin Street, 12th Floor, , Oakland, CA 94607/ US

(72) DUBENSKY, Thomas W. Jr.

25 Tanglewood Road, Berkeley, California 94705/ US

KANNE, David B.

5 Flying Cloud Course, Corte Madera, CA 94925/ US

LEONG, Meredith Lai Ling

6615 Saroni Drive, Oakland, CA 94611/ US

GLICKMAN, Laura Hix

36 Rydal Court, Oakland, California 94611/ US

VANCE, Russell E.

1010 Peralta Avenue, Albany, CA 94706/ US

LEMMENS, Edward Emile

34 Iron Horse Lane, Walnut Creek, California 94597/ US

(57) Jedinjenje formule

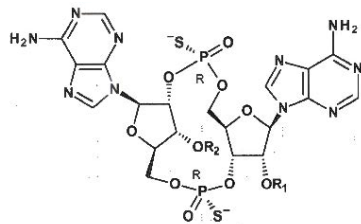

gde su R₁ i R₂ svaki H ili njegova farmaceutski prihvatljiva so.

Patent sadrži još 14 patentnih zahtjeva

(11) **03583** (13) **B**

..

(51) A61K 31/4745 ^(2006.01)	A61K 39/395 ^(2006.01)
A61K 31/573 ^(2006.01)	A61K 31/65 ^(2006.01)
A61K 31/675 ^(2006.01)	A61P 35/00 ^(2006.01)
A61P 35/02 ^(2006.01)	

..

(21) P-2019-319

(22) 25.02.2015

(30) 201461946002 P 28.02.2014 US

201462006386 P 02.06.2014 US

(96) 15755187.0/25.02.2015

(86) US PCT/US2015/017420/25.02.2015

(87) WO 2015/130728/03.09.2015/2015/35

(97) EP 3110843/04.01.2017/2017/01

EP 3110843/11.09.2019/2019/37

(54) me **KOMBINOVANE TERAPIJE SA ANTI-CD38 ANTITELIMA**
en **COMBINATION THERAPIES WITH ANTI-CD38 ANTIBODIES**

(73) Janssen Biotech, Inc.

800/850 Ridgeview Drive, Horsham, PA 19044/ US

(72) DOSHI, Parul

1400 McKean Road, Spring House, Pennsylvania 19477/ US

(57) Anti-CD38 antitelo, za upotrebu u lečenju subjekta koji ima CD38-pozitivni hematološkimalignitet, pri čemu se anti-CD38 antitelo ordinira kombinovano sa ciklofosamidom, doksorubicinom, vinkristinom i prednizonom (CHOP), pričemu anti-CD38 antitelo:

i. indukuje in vitro ubijanje ćelija koje ekspimiraju CD38 pomoću citotoksičnosti posredovane ćelijama koja zavisi od antitela (ADCC), ćelijske fagocitoze koja zavisi od antitela (ADCP), citotoksičnosti koja zavisi od komplementa (CDC), apoptoze, ili in vitro modulacije CD38 enzimske aktivnosti;

ii. obuhvata regione koji određuju komplementarnost teškog lanca (HCDR) I (HCDRI), 2 (HCDR2) i 3 (HCDR3) sekvenci SEQ ID NOs, 6, 7 i 8, redom; i

iii. obuhvata regione koji određuju komplementarnost lakog lanca (LCDR) I (LCDRI), 2 (LCDR2) i 3 (LCDR3) sekvenci SEQ ID NOs, 9, 10, i 11, redom.

Patent sadrži još 12 patentnih zahtjeva

(11) **03584** (13) **B**

..

(51) **A61K 35/74**^(2015.01)

C12N 1/20^(2006.01)

A61P 1/00^(2006.01)

A61P 11/06^(2006.01)

A61P 29/00^(2006.01)

A61P 19/02^(2006.01)

A61P 25/28^(2006.01)

A61P 35/00^(2006.01)

A61P 27/02^(2006.01)

..

(21) P-2019-320

(22) 15.06.2016

(30) 20150010469 15.06.2015 GB

20150020628 23.11.2015 GB

20160004566 17.03.2016 GB

(96) 16731641.3/15.06.2016

(86) GB PCT/GB2016/051773/15.06.2016

(87) WO 2016/203220/22.12.2016/2016/51

(97) EP 3204025/16.08.2017/2017/33

EP 3204025/11.09.2019/2019/37

(54) me **KOMPOZICIJE KOJE SADRŽE SOJEVE BAKTERIJA**
en **COMPOSITIONS COMPRISING BACTERIAL STRAINS**

(73) 4D PHARMA RESEARCH LIMITED

Life Sciences Innovation Building, Cornhill Road, Aberdeen, Aberdeenshire AB25 2ZS/ GB

(72) GRANT, George

Life Sciences Innovation Building, Cornhill Road, Aberdeen Aberdeenshire AB25 2ZS/ GB

PATTERSON, Angela Margaret

Norwich Medical School, Faculty of Medicine and Health Sciences, University of East Anglia, Norwich

Norfolk NR4 7JT/ GB

MULDER, Imke

Life Sciences Innovation Building, Cornhill Road, Aberdeen Aberdeenshire AB25 2ZS/ GB

MCCLUSKEY, Seanin

3rd Floor 9 Bond Court, Leeds Yorkshire LS1 2JZ/ GB

RAFTIS, Emma

3rd Floor 9 Bond Court, Leeds Yorkshire LS1 2JZ/ GB

(57) Kompozicija koja sadrži bakterijski soj vrste *Parabacteroides distasonis*, za upotrebu u postupku lečenja ili prevencije inflamatornog ili autoimunog oboljenja izabranog od multiple skleroze, astme ili reumatoidnog artritisa.

Patent sadrži još 11 patentnih zahtjeva

(11) **03603** (13) **B**

..

(51) **C07D 257/02**^(2006.01)

C07C 229/16^(2006.01)

A61K 49/10^(2006.01)

..

(21) P-2019-321

(22) 30.05.2016

(30) 20150170658 04.06.2015 EP

(96) 16726531.3/30.05.2016

(86) EP PCT/EP2016/062105/30.05.2016

(87) WO 2016/193190/08.12.2016/2016/49

(97) EP 3303307/11.04.2018/2018/15

EP 3303307/04.09.2019/2019/36

(54) me **NOVA JEDINJENJA GADOLINIJUM HELATA ZA PRIMJENU PRI SNIMANJU MAGNETNOM REZONANCOM**
en **NEW GADOLINIUM CHELATE COMPOUNDS FOR USE IN MAGNETIC RESONANCE IMAGING**

(73) Bayer Pharma Aktiengesellschaft
Müllerstrasse 178, Berlin, 13353 / DE

(72) BERGER, Markus
Albrechtstraße 83, Berlin , 12167 / DE
LOHRKE, Jessica
Rotschwanzweg 13, Berlin , 12351 / DE
HILGER, Christoph-Stephan
Langenauer Weg 24, Berlin , 13503 / DE
JOST, Gregor
Sadowastraße 16, Berlin , 10318 / DE
FRENZEL, Thomas
Paul-Schneider-Straße 41, Berlin , 12247 / DE
SÜLZLE, Detlev
Otternweg 15, Berlin , 13465 / DE
PLATZEK, Johannes
Grottkauer Strasse 55, Berlin, 12621/ DE
PANKNIN, Olaf
Parkstraße 36, Berlin , 13187 / DE
PIETSCH, Hubertus
Märkische Heide 71, Kleinmachnow, 14532 / DE

(74) Advokat RADULOVIĆ, Božidar S.
Studentska bb, Lamela 3/18 , Podgorica, 81000 / ME

(57) Jedinjenje opšte formule (I),

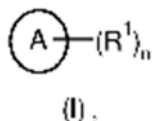

gde :



predstavlja

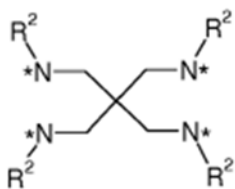

grupu,

u kojoj * ukazuje na tačku vezivanja navedene grupe sa R1;

R1 predstavlja grupu R3;

n predstavlja ceo broj 4;

R2 predstavlja atom vodonika;

R3 predstavlja grupu izabranu od:

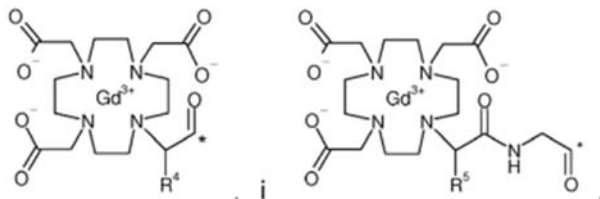

u kojima * ukazuje na tačku vezivanja navedene grupe sa ostatkom molekula;

R4 predstavlja atom vodonika;

R5 predstavlja atom vodonika ili metil grupu;

ili njihov stereoizomer, tautomer, hidrat, ili solvat, ili njihova smeša.

Patent sadrži još 14 patentnih zahtjeva

(11) **03650** (13) **B**

..

(51) **C07D 495/04**^(2006.01)

A61K 31/4365^(2006.01)

A61P 35/00^(2006.01)

..

(21) P-2019-322

(22) 22.08.2016

(30) 20150382433 27.08.2015 EP

20150382615 11.12.2015 EP

(96) 16757513.3/22.08.2016

(86) US PCT/US2016/047989/22.08.2016

(87) WO 2017/035060/02.03.2017/2017/09

(97) EP 3341379/04.07.2018/2018/27

EP 3341379/09.10.2019/2019/41

(54) me **INHIBITORI EZH2**
en **INHIBITORS OF EZH2**

(73) Eli Lilly and Company
Lilly Corporate Center, Indianapolis, IN 46285/ US

(72) DOMINGUEZ, Esteban
, Indianapolis, Indiana 46206-6288, P.O. Box 6288 / US
GUO, Deqi
, Indianapolis, Indiana 46206-6288, P.O. Box 6288 / US
MADER, Mary Margaret
, Indianapolis, Indiana 46206-6288, P.O. Box 6288 / US
NGUYEN, Anh-Quan Hannah
, Indianapolis, Indiana 46206-6288, P.O. Box 6288 / US
DEL PRADO, Miriam Filadelfa
, Indianapolis, Indiana 46206-6288, P.O. Box 6288 / US
RICHETT, Michael Enrico
, Indianapolis, Indiana 46206-6288, P.O. Box 6288 / US
RODRIGUEZ, Michael John
, Indianapolis, Indiana 46206-6288, P.O. Box 6288 / US
YIP, Yvonne Yee Mai
, Indianapolis, Indiana 46206-6288, P.O. Box 6288 / US
YU, Kuo-Long
, Indianapolis, Indiana 46206-6288, P.O. Box 6288 / US

(74) Advokat ČUPIĆ, Branislav
Dalmatinska 10 , Podgorica , 81000/ ME

(57) Spoj formule:

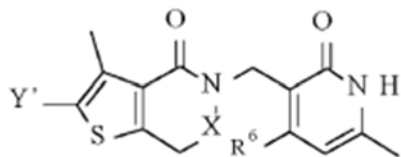

naznačen time što:

X je -CH₂-ili-CH₂-CH₂-;

Y' je -NR₄R₅, -CH(CH₃)-cikloheksil-4-il-*N*-metil-*N*-metoksietil ili -CH(CH₃)-cikloheks-4-il-azetidin-1-il, gdje azetidin-1-il može biti supstituiran s metoksi, 2-propoksi, metoksimetilom, metoksietoksi, ciklopropiloksi, ciklopropilmetoksi, pirazolilom, metilpirazolilom, triazolilom, piroldinilom, tetrahidrofuraniloksi ili morfolinilom;

R₄ je cikloheks-4-il, supstituiran s *N*-metil-*N*-metoksietilamino, *N*-metil-*N*-ciklopropilamino ili azetidin-1-ilom, gdje je azetidin-1-il supstituiran s metoksi, etoksi, metoksietoksi, ciklopropiloksi ili pirazolilom;

R₅ je metil ili etil; i

R₆ je metil ili klor;

ili njegova farmaceutske prihvatljiva sol.

Patent sadrži još 23 patentnih zahtjeva

(11) **03604** (13) **B**

..

(51) A61K 31/519 ^(2006.01)	A61P 35/00 ^(2006.01)
A61K 31/277 ^(2006.01)	A61K 31/4166 ^(2006.01)
A61K 31/58 ^(2006.01)	A61K 31/5025 ^(2006.01)
A61P 13/08 ^(2006.01)	

..

(21) P-2019-323

(22) 30.11.2012

(30) 201161564975P 30.11.2011 US

(96) 12795842.9/30.11.2012

(86) GB PCT/GB2012/052969/30.11.2012

(87) WO 2013/079964/06.06.2013/2013/23

(97) EP 2785349/08.10.2014/2014/41
EP 2785349/16.10.2019/2019/42

(54) me **KOMBINACIONI TRETMAN RAKA**
en **COMBINATION TREATMENT OF CANCER**

(73) AstraZeneca AB
151 85 Södertälje/ SE

(72) DAVIES, Barry, Robert
Alderley Park , Alderley Park Macclesfield Cheshire SK10 4TG / GB

(74) Advokat RADULOVIĆ, Božidar S.
Studentska bb, Lamela 3/18 , Podgorica, 81000 / ME

(57) Kombinacija koja sadrži:

(S)-4-amino-N-(1-(4-hlorofenil)-3-hidroksipropil)-1-(7H-pirol[2,3-d]pirimidin-4-il)piperidin-4-karboksamid (AZD5363), ili njegovu farmaceutski prihvatljiva so;

sa modulatorom za signalizaciju androgenog receptora, izabranim iz grupe koju čine:

4-{3-[4-cijano-3-(trifluorometil)-fenil]-5,5-dimetil-4-okso-2-tioksoimidazolidin-1-il}-2-fluoro-N-metilbenzamid (MDV-3100) ; i

N-[4-cijano-3-(trifluorometil)-fenil]-3-[(4-fluorofenil)-sulfonil]-2-hidroksi-2-metilpropanamid (bicalutamid);

ili njegova farmaceutski prihvatljiva so.

Patent sadrži još 12 patentnih zahtjeva

(11) **03651** (13) **B**

..

(51) **C02F 11/14**^(2018.01)

C02F 11/00^(2006.01)

C02F 1/36^(2006.01)

C02F 103/06^(2006.01)

C02F 1/68^(2006.01)

..

(21) P-2019-324

(22) 12.07.2010

(30) 20090000425 03.08.2009 HR

(96) 10749901.4/12.07.2010

(86) HR PCT/HR2010/000021/12.07.2010

(87) WO 2011/015889/10.02.2011/2011/06

(97) EP 2504286/03.10.2012/2012/40

EP 2504286/21.08.2019/2019/34

(54) me **PROCES ZA OBRADU KONCENTROVANIH RASTVORA KOJI POTIČU IZ PROCEDNIH VODA DEPONIJA**
en **PROCESS FOR TREATMENT OF CONCENTRATED SOLUTIONS ORIGINATING FROM LANDFILL LEACHATE**

(73) ECOGLOBAL SERVICES Limited

Craigmuir Chambers, P.O. Box 71 Road Town, Tortola, VG 1110, BVI / VG

(72) SPANOVIC, Milli

Hrnjanec, Cvjetna St. 27, Donja Zelina , 10382 / HR

(74) MSA IP-MILOJEVIĆ, SEKULIĆ ADVOKATI

Karađorđeva 65, Beograd , 11000/ RS

(57) Proces za obradu koncentrovanih rastvora koji potiču od dreniranih otpadnih voda iz komunalnog i industrijskog otpada, koji obuhvata korake dodavanja kalcijum oksida i ponovno upotrijebljenog solidifikata koncentrovanom rastvoru time stvarajući solidifikat;

ponovnog uvođenja u proces dela (8) stvorenog solidifikata; i odvođenja preostalog dela (9) stvorenog solidifikata dizalom (L) u uređaj (N) za sušenje i hlađenje i za isparavanje vode sadržane u preostalom dijelu (9) uz sušenje istog (9), stvarajući time neutralan i stabilan solidifikat (11) kao konačni proizvod.

Patent sadrži još 0 patentnih zahtjeva

(11) **03652** (13) **B**

..

(51) **C07D 215/56**^(2006.01)

C07B 59/00^(2006.01)

A61K 31/47^(2006.01)

A61P 11/12^(2006.01)

..

(21) P-2019-325

(22) 17.05.2012

(30) 201161487497P 18.05.2011 US

(96) 17160386.3/17.05.2012

(97) EP 3235812/25.10.2017/2017/43
EP 3235812/04.09.2019/2019/36

(54) me **DEUTERISANI DERIVATI IVAKAFTORA**
en **DEUTERATED DERIVATIVES OF IVACAFTOR**

(73) Vertex Pharmaceuticals (Europe) Limited
2 Kingdom Street, London W2 6BD/ GB

(72) Morgan, Adam J
14 Oak Ridge Lane, Ashland, MA Massachusetts 01721 / US

(74) Advokat LUTOVAC, Branislav
Bulevar Ivana Crnojevića 93, Podgorica, 81000 / ME

(57) Farmaceutska kompozicija pogodna za oralno davanje koja sadrži jedinjenje formule I:

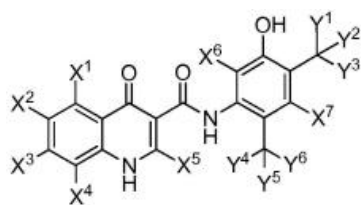

Formula I

ili njegovu farmaceutski prihvatljivu so, gde

svaki od X1, X2, X3, X4, X5, X6, i X7 je nezavisno vodonik ili deuterijum;

Y1, Y2, i Y3 su CD3;

svaki od Y4, Y5, i Y6 je nezavisno CH3 ili CD3; gde je faktor izotopskog obogaćenja za svaki obeleženi atom deuterijuma bar 6000; i gde bilo koji atom koji nije obeležen kao deuterijum je prisutan u svojoj prirodnoj izotopskoj rasprostranjenosti, uz uslov da jedinjenje formule I nije jedinjenje 100:

Jedinjenje 100

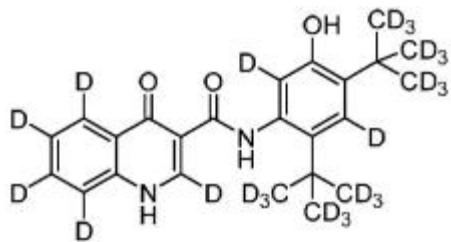

Compound 100

i farmaceutski prihvatljiv nosač.

Patent sadrži još 13 patentnih zahtjeva

(11) **03653** (13) **B**

..

(51) C07D 413/14 ^(2006.01)	A61K 31/422 ^(2006.01)
A61K 31/4439 ^(2006.01)	A61P 11/00 ^(2006.01)
A61P 31/12 ^(2006.01)	A61P 35/00 ^(2006.01)
A61P 37/00 ^(2006.01)	

..

(21) P-2019-326

(22) 31.05.2016

(30) 20150009492 02.06.2015 GB

(96) 16726309.4/31.05.2016

(86) EP PCT/EP2016/062250/31.05.2016

(87) WO 2016/193255/08.12.2016/2016/49

(97) EP 3303329/11.04.2018/2018/15
EP 3303329/18.09.2019/2019/38

(54) me **POSTUPCI ZA DOBIJANJE INDAZOL DERIVATA**
en **PROCESSES TO MAKE INDAZOLE DERIVATIVES**

(73) GlaxoSmithKline Intellectual Property Development Limited
980 Great West Road, Brentford, Middlesex TW8 9GS/ GB

(72) BREAM, Robert Nicholas
Gunnels Wood Road , Gunnels Wood Road Stevenage Hertfordshire SG1 2NY/ GB
HAYLER, John David
Gunnels Wood Road , Gunnels Wood Road Stevenage Hertfordshire SG1 2NY/ GB
IRONMONGER, Alan Geoffrey
Gunnels Wood Road , Gunnels Wood Road Stevenage Hertfordshire SG1 2NY/ GB
SZETO, Peter
Gunnels Wood Road , Gunnels Wood Road Stevenage Hertfordshire SG1 2NY/ GB
WEBB, Michael Robert
Gunnels Wood Road , Gunnels Wood Road Stevenage Hertfordshire SG1 2NY/ GB
WHEELHOUSE, Katherine Marie Penelope
Gunnels Wood Road , Gunnels Wood Road Stevenage Hertfordshire SG1 2NY/ GB
WILLACY, Robert David
Gunnels Wood Road , Gunnels Wood Road Stevenage Hertfordshire SG1 2NY/ GB

(74) Advokat LUTOVAC, Branislav
Bulevar Ivana Crnojevića 93 , Podgorica , 81000 / ME

(57) Postupak za dobijanje jedinjenja formule (IV) ili njegove soli

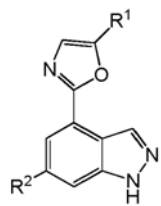

(IV)

pri čemu

R1 je

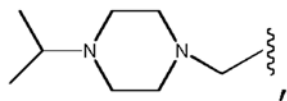

i

R2 je

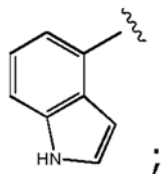

ili

R1 je

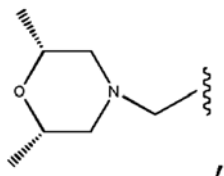

i

R2 je

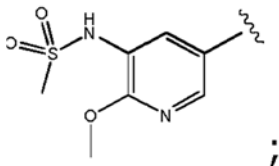

gde postupak obuhvata:

(a) reagovanje jedinjenja formule (VII) ili njegove soli

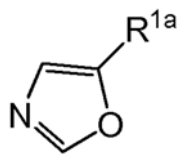

(VII)

gde R^{1a} je

ili

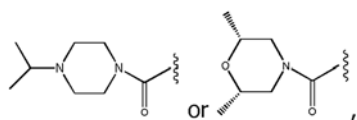

sa jedinjenjem formule (X) ili njegovom soli

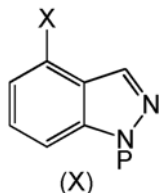

(X)

gde X je halogen i P je zaštitna grupa, u prisustvu paladijumovog katalizatora da se dobije jedinjenje formule (XI) ili njegova so

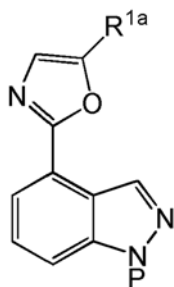

(XI)

gde R^{1a} i P su kao što je gore definisano,

(b) reagovanje jedinjenja formule (XI) ili njegove soli sa sredstvom za borilaciju u prisustvu sistema katalizatora da se dobije jedinjenje formule (XII) ili njegova so

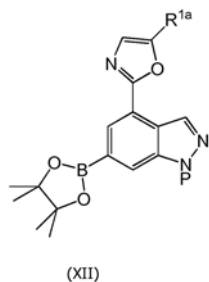

gde R1a i P su kao što je definisano gore u tekstu,

(c) reagovanje jedinjenja formule (XII) ili njegove soli sa jedinjenjem formule (XIV) ili njegovom soli



gde R2 je kao što je definisano u gore u tekstu i X1 je halogen, u prisustvu paladijumovog katalizatora da se dobije jedinjenje formule (XIII) ili njegova so

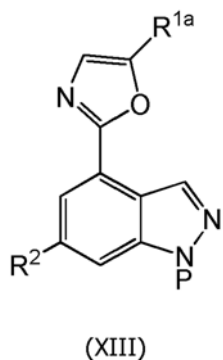

gde R1a, R2 i P su kao što je definisano gore u tekstu, i

(d) reagovanje jedinjenja formule (XIII) ili njegove soli sa redukujućim sredstvom nakon čega sledi uklanjanje zaštite.

Patent sadrži još 10 patentnih zahtjeva

(11) **03654** (13) **B**

..

(51) C07D 401/06 ^(2006.01)	A61K 31/397 ^(2006.01)
A61K 31/438 ^(2006.01)	A61K 31/4427 ^(2006.01)
A61K 31/4439 ^(2006.01)	A61K 31/445 ^(2006.01)
A61K 31/4468 ^(2006.01)	A61K 31/454 ^(2006.01)
A61K 31/4545 ^(2006.01)	A61K 31/496 ^(2006.01)
A61K 31/501 ^(2006.01)	A61K 31/506 ^(2006.01)
C07D 401/12 ^(2006.01)	C07D 471/10 ^(2006.01)
C07D 205/04 ^(2006.01)	

..

(21) P-2019-327

(22) 12.02.2015

(30) 201461939488P 13.02.2014 US

201462061283P 08.10.2014 US

(96) 15706634.1/12.02.2015

(86) US PCT/US2015/015706/12.02.2015

(87) WO 2015/123465/20.08.2015/2015/33

(97) EP 3105218/21.12.2016/2016/51

EP 3105218/25.09.2019/2019/39

(54) me **CIKLOPROPILAMINI KAO LSD1 INHIBITORI**
en **CYCLOPROPYLAMINES AS LSD1 INHIBITORS**

(73) Incyte Corporation

1801 Augustine Cut-Off, Wilmington DE 19803/ US

(72) WU, Liangxing

108 Sassafrass Court, Wilmington, Delaware 19808/ US

HE, Chunhong

40 Magnolia Way, Chadds Ford, PA 19317/ US

QIAN, Ding-Quan

10 Donald Preston Drive, Newark, DE 19702/ US

SHEN, Bo

15 Martins Court, Garnet Valley, Pennsylvania 19060/ US

WANG, Xiaozhao

2303 Larchmont Place, Mt. Laurel, NJ 08054 / US

YAO, Wenqing

45 Magnolia Way, Chadds Ford, Pennsylvania 19317/ US

ZHANG, Fenglei

309 Daniel Drive, Ambler, Pennsylvania 19002/ US

COURTER, Joel R.

13308 Elam Drvie, Glen Mills, Pennsylvania 19342 / US

(74) Advokat LUTOVAC, Branislav

Bulevar Ivana Crnojevića 93, Podgorica, 81000 / ME

(57) Jedinjenje formule II:

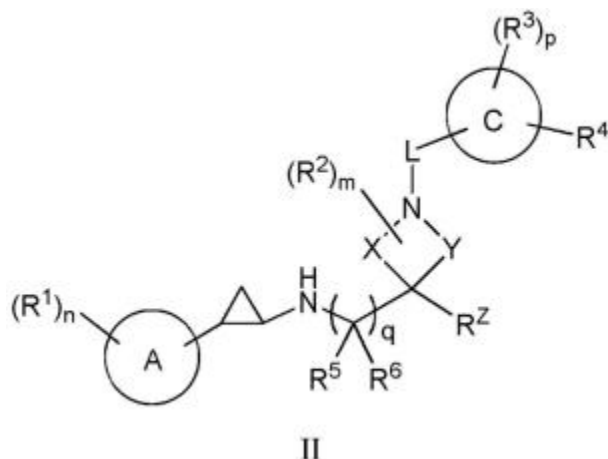

ili njegova farmaceutski prihvatljiva so, gde:

X je -CH₂- ili -CH₂-CH₂-;

Y je -CH₂- ili -CH₂-CH₂-;

svaki R₂ je supstituisan na bilo kom ugljenikovom atomu koji obrazuje prsten u prstenu formule II koji sadrži X i Y osim ugljenikovog atoma koji obrazuje prsten za koji je vezan R_Z ;

prsten A je C₆-10 aril ili 5-10 člani heteroaril koji sadrži ugljenik i 1, 2, 3 ili 4 heteroatoma izabranih između N, O, i S;

prsten C je C₃-7 cikloalkil;

L je C₁-4 alkilen, -C(=O)-, -C(=O)O-, -C(=O)NR₇-, O, NR₇, -S(O)₂-, -S(O)-, ili -S(O)₂NR₇-;

svaki R₁ je nezavisno izabran između halo, C₁-6 alkil, C₂-6 alkenil, C₂-6 alkinil, C₁-6 haloalkil, C₆-10 aril, C₃-10 cikloalkil, 5-10 člani heteroaril, 4-10 člani heterocikloalkil, C₆-10 aril-C₁-4 alkil-, C₃-10 cikloalkil-C₁-4 alkil-, (5-10 člani heteroaril)-C₁-4 alkil-, (4-10 člani heterocikloalkil)-C₁-4 alkil-, CN, NO₂, OR_a, SR_a, C(O)R_b, C(O)NR_cR_d, C(O)OR_a, OC(O)R_b, OC(O)NR_cR_d, NR_cR_d, NR_cC(O)R_b, NR_cC(O)OR_a, NR_cC(O)NR_cR_d, C(=NR_e)R_b, C(=NR_e)NR_cR_d, NR_cC(=NR_e)NR_cR_d, NR_cS(O)R_b, NR_cS(O)₂R_b, NR_cS(O)₂NR_cR_d, S(O)R_b, S(O)NR_cR_d, S(O)₂R_b, i S(O)₂NR_cR_d, gde pomenuti C₁-6 alkil, C₂-6 alkenil, C₂-6 alkinil, C₆-10 aril, C₃-10 cikloalkil, 5-10 člani heteroaril, 4-10 člani heterocikloalkil, C₆-10 aril-C₁-4 alkil-, C₃-10 cikloalkil-C₁-4 alkil-, (5-10 člani heteroaril)-C₁-4 alkil-, i (4-10 člani hetero-cikloalkil)-C₁-4 alkil- je svaki opciono supstituisan sa 1, 2, 3, ili 4 supstituenta nezavisno izabranih između halo, C₁-4 alkil, C₁-4 haloalkil, C₁-4 cijanoalkil, CN, NO₂, OR_a, SR_a, C(O)R_b, C(O)NR_cR_d, C(O)OR_a, OC(O)R_b, OC(O)NR_cR_d, C(=NR_e)NR_cR_d, NR_cC(=NR_e)NR_cR_d, NR_cR_d, NR_cC(O)R_b, NR_cC(O)OR_a, NR_cC(O)NR_cR_d, NR_cS(O)R_b, NR_cS(O)₂R_b, NR_cS(O)₂NR_cR_d, S(O)R_b, S(O)NR_cR_d, S(O)₂R_b, i S(O)₂NR_cR_d;

R_Z je halo, C₁-6 alkil, C₂-6 alkenil, C₂-6 alkinil, C₁-6 haloalkil, C₆-10 aril, C₃-10 cikloalkil, 5-10 člani heteroaril, 4-10 člani heterocikloalkil, C₆-10 aril-C₁-4 alkil-, C₃-10 cikloalkil-C₁-4 alkil-, (5-10 člani

heteroaril)-C1-4 alkil-, (4-10 člani heterocikloalkil)-C1-4 alkil-, CN, NO₂, ORa₁, SRa₁, C(O)Rb₁, C(O)NRc₁Rd₁, OC(O)Rb₁, OC(O)NRc₁Rd₁, NRc₁Rd₁, NRc₁C(O)Rb₁, NRc₁C(O)ORa₁, NRc₁C(O)NRc₁Rd₁, C(=NRe₁)Rb₁, C(=NRe₁)NRc₁Rd₁, NRc₁C(=NRe₁)NRc₁Rd₁, NRc₁S(O)Rb₁, NRc₁S(O)2Rb₁, NRc₁S(O)2NRc₁Rd₁, S(O)Rb₁, S(O)NRc₁Rd₁, S(O)2Rb₁, ili S(O)2NRc₁Rd₁, gde pomenuti C1-6 alkil, C2-6 alkenil, C2-6 alkinil, C6-10 aril, C3-10 cikloalkil, 5-10 člani heteroaril, 4-10 člani heterocikloalkil, C6-10 aril-C1-4 alkil-, C3-10 cikloalkil-C1-4 alkil-, (5-10 člani heteroaril)-C1-4 alkil-, i (4-10 člani heterocikloalkil)-C1-4 alkil je svaki opciono supstituisan sa 1, 2, 3, ili 4 supstituenta nezavisno izabranih između halo, C1-4 alkil, C1-4 haloalkil, C1-4 cijanoalkil, CN, NO₂, ORa₁, SRa₁, C(O)Rb₁, C(O)NRc₁Rd₁, C(O)ORa₁, OC(O)Rb₁, OC(O)NRc₁Rd₁, C(=NRe₁)NRc₁Rd₁, NRc₁C(=NRe₁)NRc₁Rd₁, NRc₁Rd₁, NRc₁C(O)Rb₁, NRc₁C(O)ORa₁, NRc₁C(O)NRc₁Rd₁, NRc₁S(O)Rb₁, NRc₁S(O)2Rb₁, NRc₁S(O)2NRc₁Rd₁, S(O)Rb₁, S(O)NRc₁Rd₁, S(O)2Rb₁, i S(O)2NRc₁Rd₁;

svaki R2 je nezavisno izabran između halo, C1-6 alkil, CN, ORa₅, C(O)Rb₅, C(O)NRc₅Rd₅, C(O)ORa₅, NRc₅Rd₅, S(O)Rb₅, S(O)NRc₅Rd₅, S(O)2Rb₅, i S(O)2NRc₅Rd₅, gde pomenuti C1-6 alkil je opciono supstituisan sa 1, 2, ili 3 supstituenta nezavisno izabranih između halo, CN, ORa₅, SRa₅, C(O)Rb₅, C(O)NRc₅Rd₅, C(O)ORa₅, OC(O)Rb₅, OC(O)NRc₅Rd₅, C(=NRe₅)NRc₅Rd₅, NRc₅C(=NRe₅)NRc₅Rd₅, NRc₅Rd₅, NRc₅C(O)Rb₅, NRc₅C(O)ORa₅, NRc₅C(O)NRc₅Rd₅, NRc₅S(O)Rb₅, NRc₅S(O)2Rb₅, NRc₅S(O)2NRc₅Rd₅, S(O)Rb₅, S(O)NRc₅Rd₅, S(O)2Rb₅, i S(O)2NRc₅Rd₅;

svaki R3 je nezavisno izabran između halo, C1-6 alkil, C2-6 alkenil, C2-6 alkinil, C1-6 haloalkil, C6-10 aril, C3-10 cikloalkil, 5-10 člani heteroaril, 4-10 člani heterocikloalkil, C6-10 aril-C1-4 alkil-, C3-10 cikloalkil-C1-4 alkil-, (5-10 člani heteroaril)-C1-4 alkil-, (4-10 člani heterocikloalkil)-C1-4 alkil-, CN, NO₂, ORa₂, SRa₂, C(O)Rb₂, C(O)NRc₂Rd₂, C(O)ORa₂, OC(O)Rb₂, OC(O)NRc₂Rd₂, NRc₂Rd₂, NRc₂C(O)Rb₂, NRc₂C(O)ORa₂, NRc₂C(O)NRc₂Rd₂, C(=NRe₂)Rb₂, C(=NRe₂)NRc₂Rd₂, NRc₂C(=NRe₂)NRc₂Rd₂, NRc₂S(O)Rb₂, NRc₂S(O)2Rb₂, NRc₂S(O)2NRc₂Rd₂, S(O)Rb₂, S(O)NRc₂Rd₂, S(O)2Rb₂, i S(O)2NRc₂Ra₂, gde pomenuti C1-6 alkil, C2-6 alkenil, C2-6 alkinil, C6-10 aril, C3-10 cikloalkil, 5-10 člani heteroaril, 4-10 člani heterocikloalkil, C6-10 aril-C1-4 alkil-, C3-10 cikloalkil-C1-4 alkil-, (5-10 člani heteroaril)-C1-4 alkil-, i (4-10 člani heterocikloalkil)-C1-4 alkil-je svaki opciono supstituisan sa 1, 2, 3, ili 4 supstituenta nezavisno izabranih između halo, C1-4 alkil, C1-4 haloalkil, C1-4 cijanoalkil, CN, NO₂, ORa₂, SRa₂, C(O)Rb₂, C(O)NRc₂Rd₂, C(O)ORa₂, OC(O)Rb₂, OC(O)NRc₂Rd₂, C(=NRe₂)NRc₂Rd₂, NRc₂C(=NRe₂)NRc₂Rd₂, NRc₂Rd₂, NRc₂C(O)Rb₂, NRc₂C(O)ORa₂, NRc₂C(O)NRc₂Rd₂, NRc₂S(O)Rb₂, NRc₂S(O)2Rb₂, NRc₂S(O)2NRc₂Rd₂, S(O)Rb₂, S(O)NRc₂Rd₂, S(O)2Rb₂, i S(O)2NRc₂Rd₂;

R4 je halo, C1-6 alkil, C2-6 alkenil, C2-6 alkinil, C1-6 haloalkil, C6-10 aril, C3-10 cikloalkil, 5-10 člani heteroaril, 4-10 člani heterocikloalkil, C6-10 aril-C1-4 alkil-, C3-10 cikloalkil-C1-4 alkil-, (5-10 člani heteroaril)-C1-4 alkil-, (4-10 člani heterocikloalkil)-C1-4 alkil-, CN, NO₂, ORa₃, SRa₃, C(O)Rb₃, C(O)NRc₃Rd₃, C(O)ORa₃, OC(O)Rb₃, OC(O)NRc₃Rd₃, NRc₃Rd₃, NRc₃C(O)Rb₃, NRc₃C(O)ORa₃, NRc₃C(O)NRc₃Rd₃, C(=NRe₃)Rb₃, C(=NRe₃)NRc₃Rd₃, NRc₃C(=NRe₃)NRc₃Rd₃, NRc₃S(O)Rb₃, NRc₃S(O)2Rb₃, NRc₃S(O)2NRc₃Rd₃, S(O)Rb₃, S(O)NRc₃Rd₃, S(O)2Rb₃, i S(O)2NRc₃Rd₃, gde pomenuti C1-6 alkil, C2-6 alkenil, C2-6 alkinil, C6-10 aril, C3-10 cikloalkil, 5-10 člani heteroaril, 4-10 člani heterocikloalkil, C6-10 aril-C1-4 alkil-, C3-10 cikloalkil-C1-4 alkil-, (5-10 člani heteroaril)-C1-4 alkil-, i (4-10 člani heterocikloalkil)-C1-4 alkil-je svaki opciono supstituisan sa 1, 2, 3, ili 4 supstituenta nezavisno izabranih između halo, C1-4 alkil, C1-4 haloalkil, C1-4 cijanoalkil, CN, NO₂, ORa₃, SRa₃, C(O)Rb₃, C(O)NRc₃Rd₃, C(O)ORa₃, OC(O)Rb₃, OC(O)NRc₃Rd₃, C(=NRe₃)NRc₃Rd₃, NRc₃C(=NRe₃)NRc₃Rd₃, NRc₃Rd₃, NRc₃C(O)Rb₃, NRc₃C(O)ORa₃, NRc₃C(O)NRc₃Rd₃, NRc₃S(O)Rb₃, NRc₃S(O)2Rb₃, NRc₃S(O)2NRc₃Rd₃, S(O)Rb₃, S(O)NRc₃Rd₃, S(O)2Rb₃, i S(O)2NRc₃Rd₃;

R5 i R6 su svaki nezavisno izabran između H, halo, CN, C1-4 alkil, C1-4 haloalkil, C1-4 cijanoalkil, i -(C1-4 alkil)-ORa₄;

R7 je H, C1-4 alkil ili C1-4 haloalkil;

svaki Ra, Rb, Rc, Rd, Ra1, Rb1, Rc1, Rd1, Ra2, Rb2, Rc2, Rd2, Ra3, Rb3, Rc3, i Rd3 je nezavisno izabran između H, C1-6 alkil, C1-4 haloalkil, C2-6 alkenil, C2-6 alkinil, C6-10 aril, C3-10 cikloalkil, 5-10 člani heteroaril, 4-10 člani heterocikloalkil, C6-10 aril-C1-4 alkil-, C3-10 cikloalkil-C1-4 alkil-, (5-10 člani heteroaril)-C1-4 alkil-, i (4-10 člani heterocikloalkil)-C1-4 alkil-, gde pomenuti C1-6 alkil, C2-6 alkenil, C2-6 alkinil, C6-10 aril, C3-10 cikloalkil, 5-10 člani heteroaril, 4-10 člani heterocikloalkil, C6-10 aril-C1-4 alkil-, C3-10 cikloalkil-C1-4 alkil-, (5-10 člani heteroaril)-C1-4 alkil-, i (4-10 člani heterocikloalkil)-C1-4 alkil-je opciono supstituisan sa 1, 2, 3, 4, ili 5 supstituenata nezavisno izabranih između C1-4 alkil, C1-4 haloalkil, C1-4 cijanoalkil, halo, CN, ORa4, SRa4, C(O)Rb4, C(O)NRc4Rd4, C(O)ORa4, OC(O)Rb4, OC(O)NRc4Rd4, NRc4Rd4, NRc4C(O)Rb4, NRc4C(O)NRc4Rd4, NRc4C(O)ORa4, C(=NRe4)NRc4Rd4, NRc4C(=NRe4)NRc4Rd4, S(O)Rb4, S(O)NRc4Rd4, S(O)2Rb4, NRc4S(O)2Rb4, NRc4S(O)2NRc4Rd4, i S(O)2NRc4Rd4;

ili bilo koji Rc i Rd zajedno sa N atom za koji su vezani obrazuju 4-, 5-, 6-, ili 7-članu heterocikloalkil grupu opciono supstituisanu sa 1, 2, ili 3 supstituenta nezavisno izabranih između C1-6 alkil, C3-7 cikloalkil, 4-7 člani heterocikloalkil, C6-10 aril, 5-6 člani heteroaril, C1-6 haloalkil, halo, CN, ORa4, SRa4, C(O)Rb4, C(O)NRc4Rd4, C(O)ORa4, OC(O)Rb4, OC(O)NRc4Rd4, NRc4Rd4, NRc4C(O)Rb4, NRc4C(O)NRc4Rd4, NRc4C(O)ORa4, C(=NRe4)NRc4Rd4, NRc4C(=NRe4)NRc4Rd4, S(O)Rb4, S(O)NRc4Rd4, S(O)2Rb4, NRc4S(O)2Rb4, NRc4S(O)2NRc4Rd4, i S(O)2NRc4Rd4, gde pomenuti C1-6 alkil, C3-7 cikloalkil, 4-7 člani heterocikloalkil, C6-10 aril, i 5-6 člani heteroaril su opciono supstituisani sa 1, 2, ili 3 supstituenta nezavisno izabranih između halo, C1-4 alkil, C1-4 haloalkil, C1-4 cijanoalkil, CN, ORa4, SRa4, C(O)Rb4, C(O)NRc4Rd4, C(O)ORa4, OC(O)Rb4, OC(O)NRc4Rd4, NRc4Rd4, NRc4C(O)Rb4, NRc4C(O)NRc4Rd4, NRc4C(O)ORa4, C(=NRe4)NRc4Rd4, NRc4C(=NRe4)NRc4Rd4, S(O)Rb4, S(O)NRc4Rd4, S(O)2Rb4, NRc4S(O)2Rb4, NRc4S(O)2NRc4Rd4, i S(O)2NRc4Rd4;

ili bilo koji Rc1 i Rd1 zajedno sa N atom za koji su vezani obrazuju 4-, 5-, 6-, ili 7-članu heterocikloalkil grupu opciono supstituisanu sa 1, 2, ili 3 supstituenta nezavisno izabranih između C1-6 alkil, C3-7 cikloalkil, 3-7 člani heterocikloalkil, C6-10 aril, 5-6 člani heteroaril, C1-6 haloalkil, halo, CN, ORa4, SRa4, C(O)Rb4, C(O)NRc4Rd4, C(O)ORa4, OC(O)Rb4, OC(O)NRc4Rd4, NRc4Rd4, NRc4C(O)Rb4, NRc4C(O)NRc4Rd4, NRc4C(O)ORa4, C(=NRe4)NRc4Rd4, NRc4C(=NRe4)NRc4Rd4, S(O)Rb4, S(O)NRc4Rd4, S(O)2Rb4, NRc4S(O)2Rb4, NRc4S(O)2NRc4Rd4, i S(O)2NRc4Rd4, gde pomenuti C1-6 alkil, C3-7 cikloalkil, 4-7 člani heterocikloalkil, C6-10 aril, i 5-6 člani heteroaril su opciono supstituisani sa 1, 2, ili 3 supstituenta nezavisno izabranih između halo, C1-4 alkil, C1-4 haloalkil, C1-4 cijanoalkil, CN, ORa4, SRa4, C(O)Rb4, C(O)NRc4Rd4, C(O)ORa4, OC(O)Rb4, OC(O)NRc4Rd4, NRc4Rd4, NRc4C(O)Rb4, NRc4C(O)NRc4Rd4, NRc4C(O)ORa4, C(=NRe4)NRc4Rd4, NRc4C(=NRe4)NRc4Rd4, S(O)Rb4, S(O)NRc4Rd4, S(O)2Rb4, NRc4S(O)2Rb4, NRc4S(O)2NRc4Rd4, i S(O)2NRc4Rd4;

ili bilo koji Rc2 i Rd2 zajedno sa N atom za koji su vezani obrazuju 4-, 5-, 6-, ili 7-članu heterocikloalkil grupu opciono supstituisanu sa 1, 2, ili 3 supstituenta nezavisno izabranih između C1-6 alkil, C3-7 cikloalkil, 4-7 člani heterocikloalkil, C6-10 aril, i 5-6 člani heteroaril, C1-6 haloalkil, halo, CN, ORa4, SRa4, C(O)Rb4, C(O)NRc4Rd4, C(O)ORa4, OC(O)Rb4, OC(O)NRc4Rd4, NRc4Rd4, NRc4C(O)Rb4, NRc4C(O)NRc4Rd4, NRc4C(O)ORa4, C(=NRe4)NRc4Rd4, NRc4C(=NRe4)NRc4Rd4, S(O)Rb4, S(O)NRc4Rd4, S(O)2Rb4, NRc4S(O)2Rb4, NRc4S(O)2NRc4Rd4, i S(O)2NRc4Rd4, gde pomenuti C1-6 alkil, C3-7 cikloalkil, 4-7 člani heterocikloalkil, C6-10 aril, i 5-6 člani heteroaril su opciono supstituisani sa 1, 2, ili 3 supstituenta nezavisno izabranih između halo, C1-4 alkil, C1-4 haloalkil, C1-4 cijanoalkil, CN, ORa4, SRa4, C(O)Rb4, C(O)NRc4Rd4, C(O)ORa4, OC(O)Rb4, OC(O)NRc4Rd4, NRc4Rd4, NRc4C(O)R14, NRc4C(O)NRc4Rd4, NRc4C(O)ORa4, C(=NRe4)NRc4Rd4, NRc4C(=NRe4)NRc4Rd4, S(O)Rb4, S(O)NRc4Rd4, S(O)2Rb4, NRc4S(O)2Rb4, NRc4S(O)2NRc4Rd4, i S(O)2NRc4Rd4;

ili bilo koji Rc3 i Rd3 zajedno sa N atom za koji su vezani obrazuju 4-, 5-, 6-, ili 7-članu heterocikloalkil grupu opciono supstituisanu sa 1, 2, ili 3 supstituenta nezavisno izabranih između C1-6 alkil, C3-7 cikloalkil, 4-7 člani heterocikloalkil, C6-10 aril, 5-6 člani heteroaril, C1-6 haloalkil, halo, CN, ORa4, SRa4, C(O)Rb4, C(O)NRc4Rd4, C(O)ORa4, OC(O)Rb4, OC(O)NRc4Rd4, NRc4Rd4, NRc4C(O)Rb4, NRc4C(O)NRc4Rd4, NRc4C(O)ORa4, C(=NRe4)NRc4Rd4, NRc4C(=NRe4)NRc4Rd4, S(O)Rb4, S(O)NRc4Rd4, S(O)2Rb4,

NRc4S(O)2Rb4, NRc4S(O)2NRc4Rd4, i S(O)2NRc4Rd4, gde pomenuti C1-6 alkil, C3-7 cikloalkil, 4-7 člani heterocikloalkil, C6-10 aril, i 5-6 člani heteroaril su opciono supstituisani sa 1, 2, ili 3 supstituenta nezavisno izabranih između halo, C1-4 alkil, C1-4 haloalkil, C1-4 cijanoalkil, CN, ORa4, SRa4, C(O)Rb4, C(O)NRc4Rd4, C(O)ORa4, OC(O)Rb4, OC(O)NRc4Rd4, NRc4Rd4, NRc4C(O)Rb4, NRc4C(O)NRc4Rd4, NRc4C(O)ORa4, C(=NRe4)NRc4Rd4, NRc4C(=NRe4)NRc4Rd4, S(O)Rb4, S(O)NRc4Rd4, S(O)2Rb4, NRc4S(O)2Rb4, NRc4S(O)2NRc4Rd4, i S(O)2NRc4Rd4;

svaki Ra4, Rb4, Rc4, i Rd4 je nezavisno izabran između H, C1-4 alkil, C1-4 haloalkil, C2-4 alkenil, i C2-4 alkinil, gde pomenuti C1-4 alkil, C2-4 alkenil, i C2-4 alkinil, je opciono supstituisan sa 1, 2, ili 3 supstituenta nezavisno izabranih između OH, CN, amino, halo, C1-4 alkil, C1-4 alkoksi, C1-4 alkiltio, C1-4 alkilamino, di(C1-4 alkil)amino, C1-4 haloalkil, i C1-4 haloalkoksi;

ili bilo koji Rc4 i Rd4 zajedno sa N atom za koji su vezani obrazuju 3-, 4-, 5-, 6-, ili 7-članu heterocikloalkil grupu opciono supstituisanu sa 1, 2, ili 3 supstituenta nezavisno izabranih između OH, CN, amino, halo, C1-6 alkil, C1-4 alkoksi, C1-4 alkiltio, C1-4 alkilamino, di(C1-4 alkil)amino, C1-4 haloalkil, i C1-4 haloalkoksi;

svaki Re, Re1, Re2, Re3, Re4, i Re5 je nezavisno izabran između H, C1-4 alkil, i CN;

svaki Ra5, Rb5, Rc5, i Rd5 je nezavisno izabran između H i C1-6 alkil opciono supstituisanu sa 1, 2, 3, 4, ili 5 supstituenata nezavisno izabranih između halo, CN, ORa6, SRa6, C(O)Rb6, C(O)NRc6Rd6, C(O)ORa6, OC(O)Rb6, OC(O)NRc6Rd6, NRc6Rd6, NRC6C(O)Rb6, NRc6C(O)NRc6Rd6, NRc6C(O)ORa6, C(=NRe6)NRc6Rd6, NRc6C(=NRe6)NRc6Rd6, S(O)Rb6, S(O)NRc6Rd6, S(O)2Rb6, NRc6S(O)2Rb6, NRc6S(O)2NRc6Rd6, i S(O)2NRc6Rd6;

svakiRa6, Rb6, Rc6, i Rd6 je nezavisno izabran između H, C1-4 alkil, C1-4 haloalkil, C2-4 alkenil, i C2-4 alkinil, gde pomenuti C1-4 alkil, C2-4 alkenil, i C2-4 alkinil, je opciono supstituisan sa 1, 2, ili 3 supstituenta nezavisno izabranih između OH, CN, amino, halo, C1-4 alkil, C1-4 alkoksi, C1-4 alkiltio, C1-4 alkilamino, di(C1-4 alkil)amino, C1-4 haloalkil, i C1-4 haloalkoksi;

svaki Re6 je nezavisno izabran između H, C1-4 alkil, i CN;

m je 0,1, ili 2;

n je 0, 1, 2, ili 3;

p je 0, 1, 2, ili 3; i

q je 0, 1, ili 2;

gde se cikloalkil odnosi na nearomatične ciklične ugljovodonične delove koji imaju brojne ugljenikove atome koji obrazuju prsten kao što je navedeno ispred pomenutog izraza koji mogu opciono sadržati jednu ili više alkenilen grupa kao deo prstenaste strukture; i

heterocikloalkil odnosi se na nearomatični heterociklični sistem prstenova, koji može opciono sadržati jedno ili više nezasićenja kao deo prstenaste strukture i koji ima bar jedan heteroatom kao član prstena nezavisno izabran između azota, sumpora i kiseonika .

Patent sadrži još 35 patentnih zahtjeva

(11) **03655** (13) **B**

..

(51) **C07K 16/34**^(2006.01)

G01N 33/68^(2006.01)

C07K 16/28^(2006.01)

..

(21) P-2019-328

(22) 31.03.2015

(30) 20140005775 31.03.2014 GB

20140017614 06.10.2014 GB

(96) 15713749.8/31.03.2015

(86) EP PCT/EP2015/057102/31.03.2015

(87) WO 2015/150417/08.10.2015/2015/40

(97) EP 3126391/08.02.2017/2017/06

EP 3126391/21.08.2019/2019/34

(54) me **ANTITIJELA PROTIV HPA-1A**
en **ANTIBODIES AGAINST HPA-1A**

(73) Rallybio IPA, LLC

400 Farmington Avenue, Suite R2818 , Farmington, CT 06032/ US

(72) MICHAELSEN, Terje

Postveien 5, N-1481 Hagan / NO

IHLE, Øistein

Odnaveien 7, N-1406 Ski / NO

STUGE, Tor Brynjar

Blårevsvingen 11, Apt. 307, N-9013 Tromsø / NO

HUSEBEKK, Anne

Hansmarkveien 2, N-9013 Tromsø / NO

TILLER, Heidi

Krognessvegen 5B, N-9006 Tromsø/ NO

EKSTEEN, Mariana

Tuftebakken 3B, N-9016 Tromsø / NO

SKOGEN, Bjørn Ragnar

Holtveien 21 A, N-9012 Tromsø / NO

(74) Advokat POPOVIĆ, Miladin

Đoka Miraševića 21/III , Podgorica , 81000 / ME

(57) Izolovano antitelo koje ima sposobnost da se veže za aloantigen HPA-1a i koje se ne vezuje značajno za aloantigen HPA-1b, i koje sadrži najmanje jedan varijabilni region teškog lanca koji sadrži tri CDR regiona i najmanje jedan varijabilni region lakog lanca koji sadrži tri CDR regiona, naznačen time, što navedeni varijabilni region lakog lanca sadrži:

(a) CDR1 varijabilnog lakog lanca (VL) koji ima aminokiselinsku sekvencu SEQ ID NO:8,

(b) CDR2 VL koji ima aminokiselinsku sekvencu SEQ ID NO:9, i

(c) CDR3 VL koji ima aminokiselinsku sekvencu SEQ ID NO:10; i gde navedeni varijabilni region teškog lanca sadrži:

(d) CDR1 varijabilnog teškog lanca (VH) koji ima aminokiselinsku sekvencu SEQ ID NO:5,

(e) CDR2 VH koji ima aminokiselinsku sekvencu SEQ ID NO:6, i

(f) CDR3 VH koji ima aminokiselinsku sekvencu SEQ ID NO:7.

Patent sadrži još 14 patentnih zahtjeva

(11) **03656** (13) **B**

..

(51) **A61K 9/20**^(2006.01)

A61K 9/28^(2006.01)

A61K 33/04^(2006.01)

A61P 1/10^(2006.01)

..

(21) P-2019-329

(22) 14.03.2014

(30) 201361798759P 15.03.2013 US

(96) 14722461.2/14.03.2014

(86) US PCT/US2014/028805/14.03.2014

(87) WO 2014/144407/18.09.2014/2014/38

(97) EP 2968174/20.01.2016/2016/03

EP 2968174/16.10.2019/2019/42

(54) me **ORALNA FARMACEUTSKA KOMPOZICIJA SULFATNIH SOLI U OBLIKU TABLETA
DVOSTRUKE PRIMJENE I POSTUPCI NJIHOVE UPOTREBE**
en **DUAL USE ORAL PHARMACEUTICAL COMPOSITION TABLETS OF SULFATE SALTES
AND METHODS OF USE THEREOF**

(73) Braintree Laboratories, Inc.
60 Columbian Street West, Braintree, MA 02184 / US

(72) DENNETT, Edmund V. Jr.
12 Butch Songin Circle, Walpole, MA 02071 / US
WELLS, David S.
44 Ireta Road, Shrewsbury, MA 01545 / US

(74) Advokat RADULOVIĆ, Božidar S.
Studentska bb, Lamela 3/18 , Podgorica, 81000 / ME

(57) Oralna farmaceutska kompozicija u obliku tablete koja obuhvata natrijumsulfat, pri čemu se ta kompozicija može davati direktno gutanjem i dezintegracijom u vodi pre gutanja, i pri čemu najmanje 95 mas.% natrijumsulfata u kompoziciji obuhvata čestice natrijumsulfata veličine od 150 µm do 1000 µm.

Patent sadrži još 14 patentnih zahtjeva

(11) **03657** (13) **B**

..

(51) C07D 513/04 ^(2006.01)	C07D 515/04 ^(2006.01)
C07D 291/08 ^(2006.01)	C07D 515/20 ^(2006.01)
C07D 513/20 ^(2006.01)	A61K 31/407 ^(2006.01)
A61P 31/20 ^(2006.01)	

..

(21) P-2019-330

(22) 01.07.2016

(30) 20150175021 02.07.2015 EP

20150189903 15.10.2015 EP

20150201332 18.12.2015 EP

20160157726 26.02.2016 EP

(96) 16733102.4/01.07.2016

(86) WO PCT/EP2016/065488/01.07.2016

(87) WO 2017/001655/05.01.2017/2017/01

(97) EP 3317286/09.05.2018/2018/19

EP 3317286/11.09.2019/2019/37

(54) me **CIKLIZOVANI DERIVATI SULFAMOLARILAMIDA I NJIHOVA UPOTREBA KAO LJEKOVA ZA LIJEČENJE HEPATITISA B**
en **CYCLIZED SULFAMOYLARYLAMIDE DERIVATIVES AND THE USE THEREOF AS MEDICAMENTS FOR THE TREATMENT OF HEPATITIS B**

(73) Janssen Sciences Ireland Unlimited Company
Barnahely, Ringaskiddy , Co Cork / IE

(72) VENDEVILLE, Sandrine, Marie, Helene

Turnhoutseweg 30 , 2340 Beerse / BE

LAST, Stefaan, Julien

Turnhoutseweg 30 , 2340 Beerse / BE

DEMIN, Samuël, Dominique

Turnhoutseweg 30 , 2340 Beerse / BE

GROSSE, Sandrine, Céline

Turnhoutseweg 30 , 2340 Beerse / BE

HACHÉ, Geerwin, Yvonne, Paul

Turnhoutseweg 30 , 2340 Beerse / BE

HU, Lili

Turnhoutseweg 30, 2340 Beerse / BE

PIETERS, Serge, Maria, Aloysius

Turnhoutseweg 30 , 2340 Beerse / BE

ROMBOUTS, Geert

Turnhoutseweg 30 , 2340 Beerse / BE

VANDYCK, Koen

Turnhoutseweg 30 , 2340 Beerse / BE

VERSCHUEREN, Wim, Gaston

Turnhoutseweg 30 , 2340 Beerse / BE

RABOISSON, Pierre, Jean-Marie, Bernard

Turnhoutseweg 30 , 2340 Beerse / BE

(74) Advokat RADULOVIĆ, Božidar S.

Studentska bb, Lamela 3/18 , Podgorica, 81000 / ME

(57) Jedinjenje Formule (I-A)

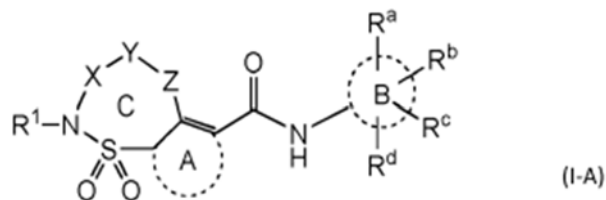

ili njegov stereoisomerni ili tautomerni oblik, naznačeno time što

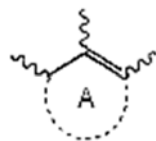

predstavlja monociklični 5 ili 6 člani aril koji opciono sadrži jedan ili dva heteroatoma, takav aril opciono je supstituisan sa jednim ili više supstituenata od kojih je svaki nezavisno izabran iz grupe koju čine C1-C3alkil, C3-C4cikloalkil, -CN i halogen;



predstavlja fenil ili piridil;

X predstavlja -CR₂R₃-;

Y predstavlja C1-C7alkandiil ili C2-C7alkendiil, svaki opciono supstituisani sa jednim ili više supstituenata od kojih je svaki nezavisno izabran iz grupe koju čine C1-C4alkil, fluoro, i -OH;

Z predstavlja heteroatom ili jednostruku vezu;

R_a, R_b, R_c i R_d su svaki nezavisno izabrani iz grupe koju čine vodonik, halogen, -CHF₂, -CF₂-metil, -CH₂F, -CF₃, -OCF₃, -CN, C3-C4cikloalkil i -C1-C4alkil;

R₁ je vodonik ili C1-C10alkil opciono supstituisan sa jednim ili više supstituenata od kojih je svaki nezavisno izabran iz grupe koju čine -OH, fluoro, i okso;

R₂ je izabran iz grupe koja sadrži vodonik; C1-C10alkil opciono supstituisan sa jednim ili više supstituenata od kojih je svaki nezavisno izabran iz grupe koju čine -OH, fluoro, metoksi, okso, i -C(=O)OC₁-C₄alkil; C1-C₃alkil-R₇; C₂-C₄alkinil; 3-7 člani zasićeni prsten koji opciono sadrži jedan ili više heteroatoma od kojih je svaki nezavisno izabran iz grupe koju čine O, S i N; i monociklični aril koji

opciono sadrži jedan ili dva heteroatoma; pri čemu su C1-C3alkil-R7, 3-7 člani zasićeni prsten ili monociklični aril svaki opciono supstituisani sa jednim ili više R8 supstituenata;

R3 je vodonik ili C1-6alkil opciono supstituisan sa -OH;

ili R2 i R3 uzeti zajedno sa atomom ugljenika na koji su vezani grade 3-7 člani zasićeni prsten koji opciono sadrži jedan ili više heteroatoma od kojih je svaki nezavisno izabran iz grupe koju čine O, S i N, i opciono je supstituisan sa jednim ili više supstituenata od kojih je svaki nezavisno izabran iz grupe koju čine -OH, fluoro, metoksi, okso, -C(=O)OC1-C4alkil, benzil, i C1-C4alkil opciono supstituisan sa jednim ili više supstituenata od kojih je svaki nezavisno izabran od fluoro i/ili -OH;

R7 predstavlja monociklični aril koji opciono sadrži jedan ili dva heteroatoma, i opciono je supstituisan sa jednim ili dva supstituenta od kojih je svaki nezavisno izabran iz grupe koju čine halo i C1-3alkil; 3-7 člani zasićeni prsten koji opciono sadrži jedan ili više heteroatoma od kojih je svaki nezavisno izabran iz grupe koju čine O, S i N; ili -NR9R10;

pri čemu R9 i R10 su svaki nezavisno izabrani iz niza koji čine vodonik i C1-C3alkil opciono supstituisan sa jednim ili više fluoro supstituenata;

svaki R8 je nezavisno izabran iz grupe koju čine -OH, fluoro, metoksi, okso, -C(=O)OC1-C4alkil, C1-C4alkiloksiC1-C4alkiloksi, i C1-C4alkil opciono supstituisan sa jednim ili više supstituenata od kojih je svaki nezavisno izabran od fluoro i/ili -OH;

ili njegova farmaceutski prihvatljiva so ili solvat.

Patent sadrži još 21 patentnih zahtjeva

(11) **03552** (13) **B**

..

(51) **C07D 239/52**^(2006.01)

A01N 47/36^(2006.01)

A01P 13/00^(2006.01)

A01P 21/00^(2006.01)

..

(21) P-2019-331

(22) 10.12.2015

(30) 14198010 15.12.2014 EP

(96) 15817115.7/10.12.2015

(86) EP PCT/EP2015/079283/10.12.2015

(87) WO 2016/096613/23.06.2016/2016/25

(97) EP 3233810/25.10.2017/2017/43

EP 3233810/11.09.2019/2019/37

(54) me **NOVI KRISTALNI OBLICI MONONATRIJUMOVE SOLI FORAMSULFURONA**
en **NOVEL CRYSTAL FORMS OF THE MONOSODIUM SALT OF FORAMSULFURON**

(73) Bayer CropScience Aktiengesellschaft
Alfred-Nobel-Strasse 50, 40789 Monheim am Rhein/ DE

(72) ANTONS, Stefan
Schwalbenweg 3, 51373 Leverkusen/ DE
OLENIK, Britta
Birkenstrasse 30, 46242 Bottrop/ DE
KRÜGER, Martin
Siedlungsstraße 47, 35325 Mücke/ DE

(57) Mononatrijurnova so foramsulfurona u kristalnom obliku, okarakterisana time što rendgenski difraktogram praha ove soli pri primeni Cu Ka zračenja na 25°C ima najmanje 3 od sledećih vrednosti 2θ (2 teta):

Vrednosti 2θ (2 teta), stepeni °
6,2
6,4
14,4
14,6
14,7
18,4
19,2
20,1
23,2
24,7

Patent sadrži još 14 patentnih zahtjeva

(11) **03551** (13) **B**

..

(51) **A01K 67/027**^(2006.01)

C07K 16/28^(2006.01)

C07K 16/40^(2006.01)

C07K 16/46^(2006.01)

..

(21) P-2019-332

(22) 07.03.2013

(30) 201261658466 P 12.06.2012 US

201261663131 P 22.06.2012 US

(96) 13710268.7/07.03.2013

(86) US PCT/US2013/029624/07.03.2013

(87) WO 2013/187953/19.12.2013/2013/51

(97) EP 2858487/15.04.2015/2015/16

EP 2858487/23.10.2019/2019/43

(54) me **HUMANIZOVANE NEHUMANE ŽIVOTINJE SA OGRANIČENIM LOKUSIMA
IMUNOGLOBULINSKOG TEŠKOG LANCA**
en **HUMANIZED NON-HUMAN ANIMALS WITH RESTRICTED IMMUNOGLOBULIN HEAVY
CHAIN LOCI**

(73) REGENERON PHARMACEUTICALS, INC.

777 Old Saw Mill River Road, Tarrytown NY 10591/ US

(72) MACDONALD, Lynn

16 Gedney Way, White Plains, NY 10605/ US

MCWHIRTHEER, John

2152 Crescent Drive, Tarrytown, NY 10591/ US

TU, Naxin

514 Washington Avenue, Pleasantville, NY 10570/ US

STEVENS, Sean

355 Berry Street 413, San Francisco, CA 94158/ US

MURPHY, Andrew, J.

10 Newton Court, Croton-on-Hudson, NY 10520/ US

(57) Miš koji ima u svom genomu:

(a) nereumaransiranoj humanoj genomskoj sekvenci koja sadrži samo jedan humani VH genski segment, jedan ili više humanih DH genskih segmenata, i jedan ili više humanih JH genskih segmenata, pri čemu su samo jedan humani VH genski segment, jedan ili više humanih DH genskih segmenata, i jedan ili više humanih JH genskih segmenata operativno povezani sa genom konstantnog regiona mišjeg imunoglobulinskog teškog lanca, i pri čemu je samo jedan humani VH genski segment VH1-2, VH1-S9, VH2-2S, VH2-70, ili njihova polimorfna varijanta; i

(b) sekvencu koja kodira mišji ADAMSA protein ili njegov funkcionalni fragment i sekvencu koja kodira mišji ADAMSB protein ili njegov funkcionalni fragment, pri čemu su mišji ADAMSA protein ili njegov funkcionalni

fragment i mišji ADAMSB protein ili njegov funkcionalni fragment funkcionalni kod mužjaka miša, pri čemu su pomenute kodirajuće sekvence smeštene u poziciji koja je različita od ADAMS lokusa miša divljeg tipa tako da kao reakcija na izlaganje antigenu, B ćelije miša izražavaju varijabilne domene humanog teškog lanca izražene od sekvence varijabilnog regiona humanog teškog lanca koja sadrži VH genski segment koji je identičan ili je somatski hipermutirana verzija VH1-2, VH1-S9, VH2-2S, VH2-70, ili njihove polimorfne varijante; pri čemu pomenutoj mišu nedostaje funkcionalni endogeni ADAMS gen.

Patent sadrži još 13 patentnih zahtjeva

(11) **03613** (13) **B**

..

(51) **C12N 15/85**^(2006.01)

A01K 67/027^(2006.01)

C12N 9/64^(2006.01)

C07K 16/46^(2006.01)

..

(21) P-2019-333

(22) 03.08.2012

(30) 201161515374 P 05.08.2011 US

(96) 12746246.3/03.08.2012

(86) US PCT/US2012/049600/03.08.2012

(87) WO 2013/022782/14.02.2013/2013/07

(97) EP 2739740/11.06.2014/2014/24

EP 2739740/02.10.2019/2019/40

(54) me **HUMANIZOVANI MIŠEVI UNIVERZALNOG LAKOG LANCA**
en **HUMANIZED UNIVERSAL LIGHT CHAIN MICE**

(73) REGENERON PHARMACEUTICALS, INC.

777 Old Saw Mill River Road, Tarrytown NY 10591/ US

(72) , MCWHIRTER, John

2035 Crescent Drive, Tarrytown, NY 10591/ US

, MACDONALD, Lynn

16 Gedney Way, White Plains, NY 10591/ US

, STEVENS, Sean

355 Berry Street 413, San Francisco, CA 94158/ US

, DAVIS, Samuel

332 West 88th Street Apt. B2, New York, NY 10024/ US

, BUCKLER, David, R.

6 Erick Court, Chester, NJ 07930/ US

, HOSIAWA, Karolina, A.

14 Church Street 2nd Floor, Tarrytown, NY 10591/ US

, MURPHY, Andrew, J.

10 Newton Court, Croton-on-hudson, NY 10520/ US

(57) Miš čiji genom sadrži:

(a) humanizovani imunoglobulinski varijabilni lokus teškog lanca koji sadrži najmanje jedan neuređeni humani V 11, najmanje jedan neuređeni humani DH i najmanje jedan neuređeni humani JH segment operativno povezan sa endogenim genom konstantnog regiona teškog lanca;

(b) humanizovani imunoglobulinski varijabilni lokus lakog lanca koji sadrži ne više odjedne. ili ne više od dve, preuređene V/J sekvence humanog lakog lanca, operativno povezane sa endogenim genom konstantnog regiona lakog lanca; i

(e) ektopičnu sekvencu nukleinske kiseline koja izražava funkcionalni mišji protein ADAM6a ili njegov funkcionalni ortolog, ili njegov funkcionalni homolog ili njegov funkcionalni fragment i sekvencu ektopične nukleinske kiseline koja izražava funkcionalni mišji protein ADAM6b ili njegov funkcionalni ortolog, ili njegov funkcionalni homolog ili njegov funkcionalni fragment, budući da su proteini ADAM6. ortolozi, homolozi ili fragmenti funkcionalni kod mužjaka miševa, pri čemu je pomenuta funkcija povezana sa plodnošću mužjaka, pomenuti miš koji ima eliminisanu ili smanjenu endogenu funkciju ADAM6 I dalje karakterisan time da njegovoj germinativnoj liniji nedostaje neuređeni endogeni imunoglobulinski VK genski segment i neuređeni endogeni imunoglobulinski J1e genski segment.

Patent sadrži još 6 patentnih zahtjeva

(11) **03553** (13) **B**

..

(51) **C12N 15/85**^(2006.01) **A01K 67/027**^(2006.01)

C12N 9/64^(2006.01) **C07K 16/46**^(2006.01)

C07K 16/28^(2006.01) **C07K 16/40**^(2006.01)

..

(21) P-2019-334

(22) 24.02.2012

(30) 201161446895 P 25.02.2011 US

201161497650 P 16.06.2011 US

201261595200 P 06.02.2012 US

(96) 14154918.8/24.02.2012

(97) EP 2738258/04.06.2014/2014/23

EP 2738258/25.09.2019/2019/39

(54) me **ADAM6 miševi**

en **ADAM6 mice**

(73) REGENERON PHARMACEUTICALS, INC.

777 Old Saw Mill River Road, Tarrytown NY 10591/ US

(72) Macdonald, Lynn

16 Gedney Way, White Plains, NY 10605/ US

Stevens, Sean

355 Berry Street, No. 413, San Francisco, CA 94158/ US

Murphy, Andrew J.

10 Newton Court, Croton-on-Hudson, NY 10520/ US

(57) Genetski modificirani miš, **naznačen time**, da njegov genom sadržava:

(a) ektopičnu sekvencu nukleinske kiseline koja sadržava sekvencu koja kodira mišji protein ADAM6a ili njegov ortolog ili njegov homolog ili njegov fragment koji je funkcionalan u muškom mišu, i mišji protein ADAM6b ili njegov ortolog, ili njegov homolog ili njegov fragment koji je funkcionalan

u muškom mišu, pri čemu su mišji protein ADAM6a ili njegov ortolog ili njegov homolog ili njegov fragment i mišji ADAM6b protein ili njegov ortolog ili njegov homolog ili njegov fragment eksprimirani iz ektopične sekvence nukleinske kiseline; i

(b) humanizirani lokus varijabilne regije teškog lanca imunoglobulina koji sadržava modifikaciju koja smanjuje ili eliminira endogenu funkciju ADAM6 u muškom mišu, pri čemu je ektopična nukleinska kiselina prisutna unutar humaniziranog lokusa varijabilne regije teškog lanca.

Patent sadrži još 14 patentnih zahtjeva

(11) **03554** (13) **B**

..

(51) **E04B 5/32**^(2006.01)

E04C 5/06^(2006.01)

E04C 5/065^(2006.01)

E04C 5/20^(2006.01)

..

(21) P-2019-335

(22) 14.01.2016

(30) 15405004 16.01.2015 EP

(96) 16700593.3/14.01.2016

(86) EP PCT/EP2016/050611/14.01.2016

(87) WO 2016/113326/21.07.2016/2016/29

(97) EP 3245346/22.11.2017/2017/47

EP 3245346/28.08.2019/2019/35

(54) me **BETONSKA PLOČA**
en **CONCRETE SLAB**

(73) Heinze Gruppe Verwaltungs GmbH
Eupener Str. 35, 32051 Herford/ DE

(72) MIEDZIK, Georg
Haselstrasse 54, 8335 Hittnau/ CH
MEIER, Hugo
Schützenstrasse 59, 8212 Neuhausen am Rheinfall/ CH

(57) Betonski plafon, koji sadrži najmanje jedan modul (1a) koji sadrži red (2) od više tela (100) za premeštanje, koja su smeštena jedno opred drugog u horizontalnom uzdužnom smeru (L), koja su zatvorena u rešetkanj strukturi izrađenoj od najmanje dve pojedinačne rešetke (10, 20) koje se prostiru u uzdužnom smeru (L), pri čemu svaka od rešetki (10, 20) obuhvata najmanje prvu i drugu uzdužnu šipku (11, 12 ili 21, 22), raspoređene na udaljenosti paralelno jedna s drugom i prostiru se u uzdužnom pravcu (L), a veći broj poprečnih šipki (13, 23) postavljenih na udaljenosti jedna od druge, koje su međusobno povezane uzdužnim šipkama (11, 12 ili 21, 22), pri čemu najmanje jedno telo (100) za premeštanje za svaku rešetku (10, 20) obuhvata najmanje jedan prvi držač (311 ili 321) i najmanje jedan drugi držač (412 ili 422) sa spoljašnje strane, navedeni držači se formiraju i postavljaju jedan u odnosu na drugi na takav način da su obe odgovarajuće rešetke (10, 20) barem međusobno međusobno zaključane i zatvoreno pričvršćene između prvog i drugog etencionog uređaja smeštanjem prve uzdužne šipke (11 ili 21) u prvom držaču (311 ili 321) i smeštajući drugu uzdužnu šipku (12 ili 22) u drugi držač (412 ili 422) i na taj način drži zajedno sva tela(100) za premeštanje, naznačen time, što su površine rešetki rešetki (10, 20) orijentisane poprečno ili nagnuto u odnosu na horizontalne, pri čemu svaka rešetka (10, 20) sadrži više poprečnih šipki (13, 23) orijentisanih poprečno ili nagnuto u odnosu na horizontalne, koje su međusobno povezane uzdužnim šipkama (11, 12 ili 21, 22).

Patent sadrži još 14 patentnih zahtjeva

(11) **03555** (13) **B**

..

(51) **C07F 9/6561**^(2006.01)

A61P 35/00^(2006.01)

A61K 31/661^(2006.01)

A61K 31/519^(2006.01)

C07D 495/04^(2006.01)

..

(21) P-2019-336

(22) 19.12.2016

(30) 1650411 19.01.2016 FR

(96) 16816667.6/19.12.2016

(86) EP PCT/EP2016/081688/19.12.2016

(87) WO 2017/125224/27.07.2017/2017/30

(97) EP 3405471/28.11.2018/2018/48

EP 3405471/30.10.2019/2019/44

(54) me **NOVI DERIVATI AMONIJA, POSTUPAK ZA NJIHOVU PRIPRAVU TE FARMACEUTSKI PRIPRAVCI KOJI IH SADRŽE**
en **NEW AMMONIUM DERIVATIVES, A PROCESS FOR THEIR PREPARATION AND PHARMACEUTICAL COMPOSITIONS CONTAINING THEM**

(73) Les Laboratoires Servier

35, Rue de Verdun, 92284 Suresnes/ FR

Vernalis (R&D) Limited

100 Berkshire Place Wharfedale Road, Winnersh Berkshire RG41 5RD/ GB

(72) PACZAL, Attila

Orjárat utca 95., 1158 Budapest/ HU

SZLÁVIK, Zoltán

Költő utca 2-4 D/2, 1121 Budapest/ HU

KOTSCHY, András

Álmos Vezér u.4, 2045 Törökbálint/ HU

CHANRION, Maïa

14 rue de la Galiote Apt D441, 92130 Issy Les Moulineaux/ FR

MARAGNO, Ana Leticia

4, Allée Anastasi, 78290 Croissy-sur-Seine/ FR

GENESTE, Olivier

Bâtiment A 17, rue Crevel Duval, 92500 Rueil Malmaison/ FR

DEMARLES, Didier

21 rue du Lièvre, 45430 Checy/ FR

BÁLINT, Balázs

Lehel utca 18, 2151 Fót/ HU

SIPOS, Szabolcs

Röppentyű utca 21-23. A épület 3/10, 1139 Budapest/ HU

(57) Spoj formule (I):

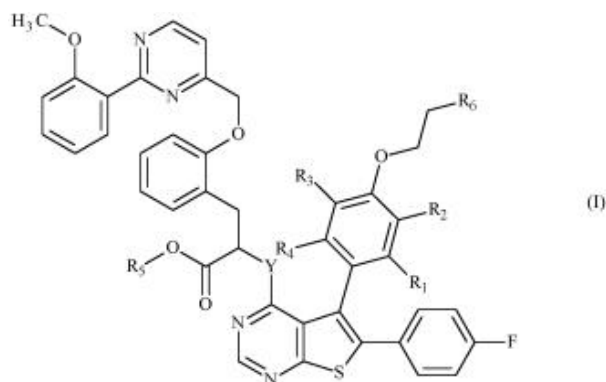

naznačen time, da

- Y predstavlja -NH- skupinu ili atom kisika,
- R1 predstavlja ravnu ili razgrananu (C1-C6)alkilnu skupinu, ravnu ili razgrananu (C2-C6)alkenilnu skupinu, ravnu ili razgrananu (C2-C6)alkinilnu skupinu, ravnu ili razgrananu (C1-C6)alkoksi skupinu, -S-(C1-C6)alkilnu skupinu, ravnu ili razgrananu (C1-C6)polihaloalkilnu skupinu, hidroksi skupinu, hidroksi(C1-C6)alkilnu skupinu, cijano skupinu, -NR9R9', -Cy1 ili atom halogena,
- R2, R3 i R4 neovisno jedan o drugome predstavljaju atom vodika, atom halogena, ravnu ili razgrananu (C1-C6)alkilnu skupinu, ravnu ili razgrananu (C2-C6)alkenilnu skupinu, ravnu ili razgrananu (C2-C6)alkinilnu skupinu, ravnu ili razgrananu (C1-C6)polihaloalkil, hidroksi skupinu, hidroksi(C1-C6)alkilnu skupinu, ravnu ili razgrananu (C1-C6)alkoksi skupinu, -S-(C1-C6)alkilnu skupinu, cijano skupinu, nitro skupinu, -alkil(C0-C6)-NR9R9', -O-alkil(C1-C6)-NR9R9', -C(O)-OR9, -O-C(O)-R9, -C(O)-NR9R9', -NR9-C(O)-R9', -NR9-C(O)-OR9', -alkil(C1-C6)-NR9-C(O)-R9', -SO2-NR9R9', -SO2-alkil(C1-C6),
- R5 predstavlja vodikov atom,
- R6 predstavlja skupinu

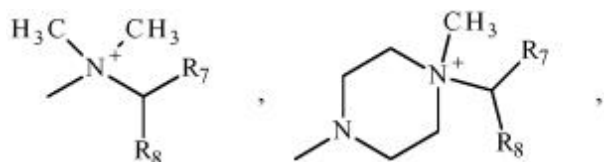

iii

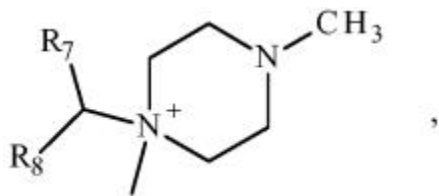

- R7 predstavlja vodikov atom ili ravnu ili razgrananu (C1-C6)alkilnu skupinu,
- R8 predstavlja -O-P(O)(O⁻)(O⁻) skupinu, -O-P(O)(O⁻)(OR10) skupinu, -O-P(O)(OR10)(OR10') skupinu, -O-SO₂-O⁻ skupinu, -O-SO₂-OR10 skupinu, -Cy2, -O-C(O)-R9 skupinu, -O-C(O)-OR9 skupinu ili -O-C(O)-NR9R9' skupinu;
- R9 i R9' neovisno jedan o drugom predstavljaju atom vodika, ravnu ili razgrananu (C1-C6)alkilnu skupinu ili ravnu ili razgrananu amino(C1-C6)alkilnu skupinu,
- R10 i R10' neovisno jedan o drugom predstavljaju atom vodika, ravnu ili razgrananu (C1-C6)alkilnu skupinu ili arilalkil(C1-C6) skupinu,
- Cy1 i Cy2 neovisno jedan o drugom, predstavljaju cikloalkilnu skupinu, heterocikloalkilnu skupinu, arilnu skupinu ili heteroarilnu skupinu,

kada je moguće da tako definiran amonij postoji kao zwitterionski oblik ili da ima jednovalentni anionski oblik protu-iona,

pri čemu se podrazumijeva da:

- "aril" znači fenil ili naftilnu skupinu,

- "heteroaril" znači bilo koju mono- ili bicikličku skupinu sastavljenu od 5 do 10 članova prstena, koji imaju najmanje jednu aromatsku polovicu koja sadrži 1 do 3 heteroatoma odabrana između kisika, sumpora i dušika,

- "cikloalkil" znači bilo koju mono- ili bicikličku nearomatsku karbocikličku skupinu koja sadrži 3 do 10 članova prstena,

- "heterocikloalkil" znači bilo koju mono- ili bicikličku nearomatsku karbocikličku skupinu koja sadrži 3 do 10 članova prstena, a sadrže od 1 do 3 heteroatoma odabranih između kisika, sumpora i dušika, koji mogu uključiti spojene, premoštene ili spiro prstenaste sustave,

Pri čemu su moguće tako definirane arilne, heteroarilne, cikloalkilne i heterocikloalkilne skupine te alkil, alkenil, alkinil, alkoksi skupine koje treba supstituirati s 1 do 4 skupine odabrane od ravnog ili razgrananog (C1-C6) alkila, ravne ili razgranane (C2-C6)alkenilne skupine, ravne ili razgranane (C2-C6) alkinilne skupine, ravnog ili razgrananog (C1-C6) alkoksi, (C1-C6) alkil-S-, hidroksi, okso (ili N-oksid prema potrebi), nitro, cijano, -C(O)-OR', -O-C(O)-R', -C(O)-NR'R'', -NR'R'', -(C=NR')-OR'', ravnog ili razgrananog (C1-C6) polihaloalkila, trifluorometoksi ili halogena, podrazumijeva se da R' i R'' međusobno neovisno predstavljaju atom vodika ili ravnu ili razgrananu (C1-C6) alkilnu skupinu i podrazumijeva se da jedan ili više ugljikovih atoma prethodnih mogućih supstituenata mogu biti deuterirani, njihovi enantiomeri, diastereoizomeri i atropisomeri i njihove adicijske soli s farmaceutski prihvatljivom kiselinom ili lužinom.

Patent sadrži još 30 patentnih zahtjeva

(11) **03556** (13) **B**

..

(51) **A61K 31/519**^(2006.01)

C07D 487/04^(2006.01)

A61P 35/00^(2006.01)

A61P 17/00^(2006.01)

A61P 27/02^(2006.01)

A61P 29/00^(2006.01)

..

(21) P-2019-337

(22) 21.05.2010

(30) 180582 P 22.05.2009 US

(96) 10721227.6/21.05.2010

(86) US PCT/US2010/035728/21.05.2010

(87) WO 2010/135621/25.11.2010/2010/47

(97) EP 2432472/28.03.2012/201/13

EP 2432472/02.10.2019/2019/40

(54) me **3-[4-(7H-PIROLO[2,3-D]PIRIMIDIN-4-IL)-1 H-PIRAZOL-1-IL]OKTAN- ILI HEPTAN - NITRIL KAO JAK INHIBITORI**
en **3-[4-(7H-PYRROLO[2,3-D]PYRIMIDIN-4-YL)-1H-PYRAZOL-1-YL]OCTANE- OR HEPTANE-NITRILE AS JAK INHIBITORS**

(73) INCYTE HOLDINGS CORPORATION
1801 Augustine Cut-Off, Wilmington, DE 19803/ US

(72) LI, Yun-Long
1 Pin Oak Drive, Chadds Ford, Pennsylvania 19317/ US
RODGERS, James D.
2 Hillside Lane, Landenberg, Pennsylvania 19350/ US

(57) Jedinjenje, koje je izabrano između:

3-[4-(7H-pirololo[2,3-d]pirimidin-4-ii)-1H-pirazol-1-il]oktannitrila;i

3-[4-(7H-pirololo[2,3-d]pirimidin-4-ii)-1H-pirazol-1-il]heptannitrila;

ili njegove farmaceutski prihvatljive soli.

Patent sadrži još 19 patentnih zahtjeva

(11) **03557** (13) **B**

..

(51) **A61K 31/44**^(2006.01)

C07D 491/14^(2006.01)

A61K 31/527^(2006.01)

A61P 35/00^(2006.01)

..

(21) P-2019-338

(22) 14.03.2014

(30) 201361798772 P 15.03.2013 US

201361861374 P 01.08.2013 US

201361911354 P 03.12.2013 US

201461949786 P 07.03.2014 US

(96) 14762438.1/14.03.2014

(86) US PCT/US2014/028685/14.03.2014

(87) WO 2014/144326/18.09.2014/2014/38

(97) EP 2968290/20.01.2016/2016/03

EP 2968290/25.09.2019/2019/39

(54) me **PRIVREMENA ZAŠTITA NORMALNIH ĆELIJA TOKOM HEMOTERAPIJE**
en **TRANSIENT PROTECTION OF NORMAL CELLS DURING CHEMOTHERAPY**

(73) G1 Therapeutics, Inc.

79 T.W. Alexander Drive 4501 Research Commons, Suite 100, Research Triangle Park, NC 27709/ US

(72) STRUM, Jay Copeland

c/o G1 Therapeutics Inc. 450 West Drive CB 7295, Chapel Hill, NC 27599-72995/ US

BISI, John Emerson

c/o G1 Therapeutics Inc. 450 West Drive CB 7295, Chapel Hill, NC 27599-72995/ US

ROBERTS, Patrick Joseph

c/o G1 Therapeutics Inc. 450 West Drive CB 7295, Chapel Hill, NC 27599-72995/ US

TAVARES, Francis Xavier

c/o G1 Therapeutics Inc. 450 West Drive CB 7295, Chapel Hill, NC 27599-72995/ US

(57) Jedinjenje formule:

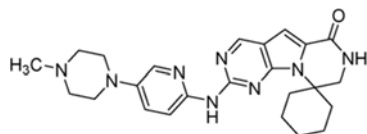

ili njegova farmaceutska prihvatljiva so, za upotrebu u postupku smanjenja efekta hemoterapije na zdravim ćelijama kod subjekta koji se leči od ciklin-zavisne kinaze 4/6 (CDK4/6) replikacije nezavisnog kancera ili abnormalne proliferacije ćelija, gde pomenute zdrave ćelije su hematopoetske stem ćelije, hematopoetske progenitorske ćelije, ili epitelne ćelije bubrega, postupak obuhvata ordiniranje subjektu efektivne količine jedinjenja.

Patent sadrži još 22 patentnih zahtjeva

(11) **03594** (13) **B**

..

(51) **A61K31/137**^(2006.01)

A61P37/00^(2006.01)

A61P37/06^(2006.01)

A61K31/135^(2006.01)

A61K31/138^(2006.01)

A61K31/661^(2006.01)

..

(21) P-2019-339

(22) 21.12.2009

(30) 20080139672P 22.12.2008 US

20090218530P 19.06.2009 US

20090246715P 29.09.2009 US

(96) 18179301.9/21.12.2009

(97) EP 3409274/05.12.2018/2018/49

EP 3409274/20.11.2019/2019/47

(54) me **REŽIM DOZIRANJA AGONISTA S1P RECEPTORA**
en **DOSAGE REGIMEN FOR A S1P RECEPTOR AGONIST**

(73) Novartis AG

Lichtstrasse 35, Basel, 4056/ CH

(72) Schmouder, Robert

One Health Plaza, East Hanover, New Jersey 07936 / US

Dumortier, Thomas

Novartis Pharma AG, Postfach 4002 Basel / CH

David, Olivier

Novartis Pharma AG, Postfach 4002 Basel / CH

Looby, Michael

Novartis Pharma AG, Postfach 4002 Basel / CH

(57) Upotreba modulatora ili agonista S I P receptora u izradi leka za lečenje autoimunskog oboljenja odabranog sa spiska koji se sastoji od multiple skleroze, polimiozitisa, lupusnog nefritisa, reumatoidnog artritisa, zapaljenske bolesti creva i psorijaze, naznačena time, što se pre otpočinjanja primene modulatora ili agonista S I P receptora u standardnoj dnevnoj terapijskoj dozi, pomenuti modulator ili agonist S I P receptora tokom početnog perioda lečenja primenjuje u dnevnoj dozi nižoj od standardne dnevne terapijske doze, pri čemu početni period lečenja iznosi 7 dana, i pri čemu je dnevna doza tokom početnog perioda lečenja do 10 puta niža od standardne dnevne doze.

Patent sadrži još 7 patentnih zahtjeva

(11) **03614** (13) **B**

..

(51) **A61K 47/68⁰**

C07K 16/28^(2006.01)

A61P 35/00^(2006.01)

..

(21) P-2019-340

(22) 08.10.2014

(30) 201361888337 P 08.10.2013 US

201361888365 P 08.10.2013 US

201461948363 P 05.03.2014 US

201462004815 P 29.05.2014 US

(96) 14852834.2/08.10.2014

(86) IB PCT /U 52014/059716/08.10.2014

(87) WO 2015/054400/16.04.2015/2015/15

(97) EP 3055332/17.08.2016/201633

EP 3055332/25.09.2019/201939

(54) me **REZIMI DOZJРАНJA IMUNOKONJUGATA ANTI-FOLR1**
en **ANTI-FOLR1 IMMUNOCONJUGATE DOSING REGIMENS**

(73) ImmunoGen, Inc.

830 Winter Street, Waltham, MA 02451-1477/ US

(72) LUTZ, Robert J.

218 Old Connecticut Path, Wayland, Massachusetts 01778/ US

PONTE, Jose

83 Cottage Lane, Weymouth, Massachusetts 02188/ US

(57) Imunokonjugat koji se vezuje za polipeptid FOLRI za upotrebu u lečenju kancera koji eksprimira FOLRI, naznačen time, što imunokonjugat sadrži majtanzinoid i antitelo ili njegov antigen-vezujući fragment koji sadrži region koji određuje komplementarnost (CDR)-1 varijabilnog lakog lanca (VL) prema SEQ ID NO: 6, CDR-2 VL prema SEQ ID NO: 7, CDR-3 VL prema SEQ ID NO: 8, CDR-1 varijabilnog teškog lanca (VH) prema SEQ ID NO: 9, CDR-2 VH prema SEQ ID NO: 11 i CDR-3 VH prema SEQ ID NO: 12, pri čemu kancer predstavlja kancer jajnika, kancer peritoneuma, kancer endometrijuma, ili kancer materice, poželjno, gde kancer predstavlja kancer jajnika koji eksprimira FOLRI, i pri čemu se imunokonjugat primenjuje u dozi od 6 miligrama (mg) po kilogramu (kg) prilagođene idealne telesne težine (AIBW).

Patent sadrži još 14 patentnih zahtjeva

(11) **03587** (13) **B**

..

(51) **A61K 39/395**^(2006.01) **A61P 25/28**^(2006.01)

C07K 16/18^(2006.01) **C12N 15/02**^(2006.01)

C12P 21/08^(2006.01) **C07K 16/46**^(2006.01)

..

(21) P-2019-341

(22) 30.05.2013

(30) 20120124336 31.05.2012 JP

(96) 13797290.7/30.05.2013

(86) JP PCT/JP2013/065090/30.05.2013

(87) WO 2013/180238/05.12.2013/2013/49

(97) EP 2857039/08.04.2015/2015/15

EP 2857039/20.11.2019/2019/47

(54) me **TERAPEUTSKI AGENSI ILI PROFILAKTIČKI AGENSI ZA DEMENCIJU**
en **THERAPEUTIC AGENT OR PROPHYLACTIC AGENT FOR DEMENTIA**

(73) OSAKA CITY UNIVERSITY

3-3-138 Sugimoto Sumiyoshi-ku, Osaka-shi, Osaka 558-8585/ JP

TEIJIN PHARMA LIMITED

2-1, Kasumigaseki 3-chome Chiyoda-ku, Tokyo 100-0013/ JP

(72) MORI, Hiroshi

4-3 Asahimachi 1-chome, Abeno-ku, Osaka-shi Osaka 545-8585/ JP

TOMIYAMA, Takami

4-3 Asahimachi 1-chome, Abeno-ku, Osaka-shi Osaka 545-8585/ JP

MATSUMOTO, Yoichi

Tokyo Research Center, 3-2 Asahigaoka 4-chome, Hino-shi Tokyo 191-0065/ JP

EGUCHI, Hiroshi

2-1 Kasumigaseki 3-chome, Chiyoda-ku Tokyo 100-0013/ JP

KUNORI, Yuichi

Tokyo Research Center, 3-2 Asahigaoka 4-chome, Hino-shi Tokyo 191-0065/ JP

(57) Terapeutski agens ili profilaktički agens za upotrebu u postupku lečenja ili prevencije tauopatije, pri čemu taj terapeutski agens ili profilaktički agens obuhvata, kao aktivni sastojak, monoklonalno antitelo koje se specifično vezuje za tau protein fosforilisan na aminokiselinskom ostatku koji odgovara Ser413 iz SEQ ID NO:1,

pri čemu je to vezivanje definisano afinitetom predstavljenim ravnotežnom konstantom disocijacije (KD) od najviše 1×10^{-6} M, i pri čemu je pomenuto vezivanje za fosforilisan tau protein najmanje 10 puta jače od vezivanja za tau protein koji nije fosforilisan na pomenutom Ser413.

Patent sadrži još 11 patentnih zahtjeva

(11) **03588** (13) **B**

..

(51) **B24C 1/00**^(2006.01)

..

(21) P-2019-342

(22) 06.05.2013

(96) 13750749.7/06.05.2013

(86) SK PCT/SK2013/050001/06.05.2013

(87) WO 2014/182253/13.11.2014/2014/46

(97) EP 2994269/16.03.2016/2016/11

EP 2994269/04.09.2019/2019/36

(54) me **UREĐAJ ZA MEŠANJE ČVRSTIH ČESTICA SUVOG LEDA SA PROTOKOM GASOVITOG MEDIJUMA**
en **DEVICE FOR MIXING SOLID PARTICLES OF DRY ICE WITH FLOW OF GASEOUS MEDIUM**

(73) ICS Ice Cleaning Systems S.r.o.
Robotnícka 2192, 017 01 Povazská Bystrica/ SK

(72) KUBIS, Ivan
Rozkvet 2038/76, 017 01 Povazská Bystrica/ SK
BAKALA, L'udovít
M. R. Stefánika 149/31, 017 01 Povazská Bystrica/ SK
GABRIS, Peter
Hliny 1235/58, 017 01 Povazská Bystrica/ SK

(57) Uređaj za mešanje čvrstih čestica suvog leda i protoka gasovitog medijuma, koji sadrži dovodni element (2) rotaciono smešten u fiksnom kućištu (1) koji ima otvore (12, 13) za protok gasovitog medijuma i/ili protok gasovitog medijuma sa čvrstim česticama, zaptivni element (3) između fiksnog kućišta (1) i rotaciono postavljenog dovodnog elementa (2), naznačeno time što je zaptivni element (3) nepokretna elastična membrana (3), pri čemu je fiksno kućište (1) na strani elastične membrane (3) sa obezbeđenom najmanje jednom zaptivenom komorom (14) pod pritiskom, povezanom sa otvorom (13) za protok gasovitog medijuma i/ili otvora (12) za protok gasovitog medijuma sa čvrstim česticama.

Patent sadrži još 1 patentnih zahtjeva

(11) **03592** (13) **B**

..

(51) **E02D 29/14**^(2006.01)

E05C 3/12^(2006.01)

E05B 35/00^(2006.01)

..

(21) P-2019-343

(22) 29.12.2015

(30) 20150000408 18.06.2015 CZ

20150031222 U 18.06.2015 CZ

(96) 15003681.2/29.12.2015

(97) EP 3106569/21.12.2016/2016/51

EP 3106569/04.09.2019/2019/36

(54) me **POKLOPAC, POSEBNO ZA ZATVARANJE GRAĐEVINSKIH I TEHNOLOŠKIH OTVORA**
en **CLOSURE, PARTICULARLY FOR CLOSING CONSTRUCTION AND TECHNOLOGICAL**
APERTURES

(73) BERNDORF BÄDERBAU, s.r.o.

Bystrice 1312, 739 95 Bystrice Nad Olsi/ CZ

(72) Cieslar, Rudolf

Milíkov 132, 739 81 Milíkov u Jablunkova/ CZ

(57) Poklopac, naročito za zatvaranje građevinskih i tehnoloških otvora u vertikalnoj i horizontalnoj ravni, **naznačen time** što je na donjoj strani poklopca (10) otvora (I) koji se zatvara, rotirajuće montiranaklackalica (2), koja je snabdevenasa ručicom (6), koja se u otvorenom položaju naslanja na donji zid poklopca (10), kao i sa ušicom (7), čiji se funkcionalni deo (8) u zatvorenom položajupoklopca (10) naslanjana naspramni element (5) koji je pričvršćen za otvor (I) koji se zatvara, i time što je poklopac (10) snabdeven sa rupom (12) za zatvaranje, iznad ručice (6) klackalice (2), za zatvaranjepoklopca i rupom (II) za otvaranje, iznad poluge (9) klackalice (2) za otvaranjepoklopca.

Patent sadrži još 5 patentnih zahtjeva

(11) **03589** (13) **B**

..

(51) **A61K 31/337**^(2006.01)

A61K 31/519^(2006.01)

A61P 35/00^(2006.01)

..

(21) P-2019-344

(22) 02.04.2012

(30) 201161470668 P 01.04.2011 US

(96) 12715421.9/02.04.2012

(86) US PCT/GB2012/050736/02.04.2012

(87) WO 2012/131399/04.10.2012/2012/40

(97) EP 2694056/12.02.2014/2014/07

EP 2694056/16.10.2019/2019/42

(54) me **TERAPEUTSKI TRETMAN**
en **THERAPEUTIC TREATMENT**

(73) ASTRAZENECA AB
, 151 85 Södertälje/ SE

(72) DAVIES, Barry Robert
AstraZeneca R&D Alderley Alderley Park, Macclesfield, Cheshire SK10 4TG/ GB

(57)

I. Kombinacija, **naznačena time**, što sadrži (S)-4-amino-N-(1-(4-hlorofenil)-3-hidroksipropil)-1-(7H-pirololo[2,3-d]pirimidin-4-il)piperidin-4-karboksamid, ili neku njegovu farmaceutski prihvatljivu so, i docetaxsel namenjena za primenu u tretmanu raka dojke.

Patent sadrži još 7 patentnih zahtjeva

(11) **03590** (13) **B**

..

(51) **A61K 47/69**^(2017.01)

A61K 39/00^(2006.01)

..

(21) P-2019-345

(22) 13.08.2014

(30) 201361865389 P 13.08.2013 US

201361869279 P 23.08.2013 US

201361887112 P 04.10.2013 US

(96) 14836306.2/13.08.2014

(86) US PCT/US2014/050962/13.08.2014

(87) WO 2015/023796/19.02.2015/2015/07

(97) EP 3033102/22.06.2016/2016/25

EP 3033102/23.10.2019/2019/43

(54) me **ČESTICE KONJUGOVANE PEPTIDOM**
en **PEPTIDE CONJUGATED PARTICLES**

(73) Northwestern University
633 Clark Street, Evanston, IL 60208/ US

(72) SHEA, Lonnie D
in care of Northwestern University, 633 Clark Street, Evanston Illinois 60208/ US
MILLER, Stephen D.
633 Clark Street, Evanston Illinois 60208/ US
YAP, Jonathan Woon Teck
in care of Northwestern University, 633 Clark Street, Evanston Illinois 60208/ US
GETTS, Daniel R.
3303 20th Street N.E., Washington District of Columbia 20018/ US
MCCARTHY, Derrick
in care of Northwestern University, 633 Clark Street, Evanston Illinois 60208/ US

(57) Kompozicija koja obuhvata površinski funkcionalizovane biorazgradive čestice koje obuhvataju inkapsulirani gliadin ili jedan ili više antigenskih epitopa gliadina, pri čemu čestica poseduje negativni zeta potencijal i pri čemu navedena čestica poseduje prečnik između 0,1 μm i 10 μm, pri čemu čestice poseduju zeta potencijal od -100 mV do -40 mV.

Patent sadrži još 8 patentnih zahtjeva

(11) **03591** (13) **B**

..

(51) **C07D 495/04**^(2006.01)

A61K 31/407^(2006.01)

A61P 25/16^(2006.01)

..

(21) P-2019-346

(22) 26.08.2016

(30) 2015EP69601 27.08.2015 WO

20150188368 05.10.2015 EP

(96) 16769872.9/26.08.2016

(86) EP PCT/EP2016/070175/26.08.2016

(87) WO 2017/032874/02.03.2017/2017/09

(97) EP 3341380/04.07.2018/2018/27

EP 3341380/13.11.2019/2019/46

(54) me **DERIVAT HROMONOKSIMA KOJI PRODIRE U MOZAK U SVRHU TERAPIJE DISKINEZIJE UZROKOVANE LEVODOPOM**
en **BRAIN-PENETRANT CHROMONE OXIME DERIVATIVE FOR THE THERAPY OF LEVODOPA-INDUCED DYSKINESIA**

(73) Prexton Therapeutics SA

14 Chemin des Aulx, 1228 Plan les Ouates, Geneva/ CH

(72) CHARVIN, Delphine

487, rue des vertes campagnes, 01170 Gex/ FR

CONQUET, François

86, route des Pitons, 74160 Beaumont/ FR

(57) Jedinjenje formule (1):

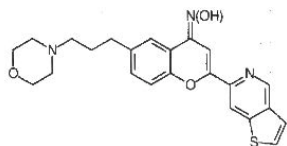

(1)

ili njegova farmaceutski prihvatljiva so ili solvat, za upotrebu u lečenju ili sprečavanju diskinezije uzrokovane levodopom.

Patent sadrži još 15 patentnih zahtjeva

(11) **03581** (13) **B**

..

(51) **C07D 513/04**^(2006.01)

A61K 31/542^(2006.01)

A61P 25/28^(2006.01)

..

(21) P-2019-347

(22) 22.01.2016

(30) 201562109733 P 30.01.2015 US

(96) 16702654.1/22.01.2016

(86) US PCT/US2016/014423/22.01.2016

(87) WO 2016/122968/04.08.2016/2016/31

(97) EP 3250575/06.12.2017/2017/49

EP 3250575/20.11.2019/2019/47

(54) me **TOSILATNA SOL N-[3-[(4AR,7 AS)-2-AMINO-6-(5-FLUOROPYRIMIDIN -2-IL)-4,4A,5,7-TETRAHIDROPIROLO [3,4-D] [1 ,3]THIAZIN-7 A-IL] -4- FLUOROFENIL]-5-METOKSIPIRAZIN-2-KARBOKSAMIDA**

en **TOSYLATE SALT OF N-[3-[(4AR,7AS)-2-AMINO-6-(5-FLUOROPYRIMIDIN-2-YL)-4,4A,5,7-TETRAHYDROPYRROLO[3,4-D][1,3]THIAZIN-7A-YL]-4-FLUORO-PHENYL]-5-METHOXY-PYRAZINE-2-CARBOXAMIDE.**

(73) ELI LILLY AND COMPANY

Lilly Corporate Center, Indianapolis, IN 46285/ US

(72) COATES, David Andrew

P.O. Box 6288, Indianapolis, Indiana 46206-6288/ US

WOLFANGEL, Craig Daniel

P.O. Box 6288, Indianapolis, Indiana 46206-6288/ US

(57) Spoj, **naznačen time** što je tosilatna sol *N*-[3-[(4aR,7aS)-2-amino-6-(5-fluorpirimidin-2-il)-4,4a,5,7- tetrahidropirol[3,4-d][l ,3]tiazin-7a-il]-4-fluorfenil]-5-metoksipirazin-2-karboksamida.

Patent sadrži još 6 patentnih zahtjeva

(11) **03611** (13) **B**

..

(51) **A01K 67/027**^(2006.01)

C07K 16/46^(2006.01)

C12N 9/64^(2006.01)

..

(21) P-2019-348

(22) 01.02.2013

(30) 201261593463 P 01.02.2012 US

201261677538 P 31.07.2012 US

(96) 13704329.5/01.02.2013

(86) US PCT/US2013/024295/01.02.2013

(87) WO 2013/116609/08.08.2013/2013/32

(97) EP 2809150/10.12.2014/2014/50

EP 2809150/18.09.2019/2019/38

(54) me **HUMANIZOVANI MIŠEVI KOJI EKSPRIMIRAJU TEŠKE LANCE KOJI SADRŽE VL DOMENE**
en **HUMANIZED MICE THAT EXPRESS HEAVY CHAINS CONTAINING VL DOMAINS**

(73) REGENERON PHARMACEUTICALS, INC.

777 Old Saw Mill River Road, Tarrytown NY 10591/ US

(72) MACDONALD, Lynn

16 Gedney Way, White Plains, NY 10605/ US

GURER, Cagan

8 Pamela Lane, Valhalla, NY 10595/ US

MEAGHER, Karolina A.

14 Church Street, 2nd Floor, Tarrytown, NY 10591/ US

STEVENS, Sean

355 Berry Street, 413, San Francisco, CA 94158/ US

MURPHY, Andrew J.

10 Newton Court, Corton-on-Hudson, NY 10520/ US

(57) Miš čiji genom sadrži:

(a) inserciju jednog ili više humanih V_L genskih segmenata i jednog ili više humanih J_L genskih segmenata ushodno of gena mišjeg imunoglobulinskog konstantnog regiona lakog lanca, naznačeno time da jedan ili više humanih V_L genskih segmenata i jedan ili više humanih J_L genskih segmenata su operativno vezani za gen mišjeg imunoglobulinskog konstantnog regiona lakog lanca;

(b) inserciju jednog ili više humanih V_L genskih segmenata i jednog ili više humanih J_L genskih segmenata ushodno of gena mišjeg imunoglobulinskog konstantnog regiona teškog lanca, naznačeno time da jedan ili više humanih V_L genskih segmenata i jedan ili više humanih J_L genskih segmenata su operativno vezani za gen mišjeg imunoglobulinskog konstantnog regiona teškog lanca; i

(e) ektopičnu sekvencu nukleinske kiseline koja kodira mišji ADAM6a protein ili njegov funkcionalni fragment i ektopičnu sekvencu nukleinske kiseline koja kodira mišji ADAM6b protein ili njegov funkcionalni fragment, naznačeno time da mišji ADAM6a i ADAM6b proteini ili njihovi funkcionalni fragmenti su eksprimirani od strane ektopične sekvence nukleinske kiseline,

naznačeno time da miš eksprimira antitelo koje sadrži (i) polipeptid koji sadrži varijabilni domen humanog lakog lanca povezan sa konstantnim domenom mišjeg teškog lanca; i (ii) polipeptid koji sadrži varijabilni domen humanog lakog lanca povezan sa mišjim konstantnim regionom lakog lanca.

Patent sadrži još 13 patentnih zahtjeva

(11) **03633** (13) **B**

..

(51) **F03D 1/04**^(2006.01)

..

(21) P-2019-349

(22) 24.08.2016

(30) 41366415 25.08.2015 PL

(96) 16770101.0/24.08.2016

(86) PL PCT/PL2016/000090/24.08.2016

(87) WO 2017/034426/02.03.2017/2017/09

(97) EP 3341608/04.07.2018/201827
EP 3341608/04.09.2019/201936

(54) me **TUNELSKA VAZDUŠNA TURBINA SA HORIZONTALNOM OSOM ROTACIJE ROTORA**
en **TUNNEL WIND TURBINE WITH A HORIZONTAL AXIS OF THE ROTOR ROTATION**

(73) Staszór, Roman
Ul. Jednosci Narodowej 8, 97-300 Piotrków Trybunalski/ PL

(72) Staszór, Roman
Ul. Jednosci Narodowej 8, 97-300 Piotrków Trybunalski/ PL

(57) Tunelska vazdušna turbina sa horizontalnom osom rotacije rotora koji obuhvata:

- prigušivač (1) u obliku rotacionog tela, čiji zid ima u svom aksijalnom delu oblik konveksno-konkavnog aeronautičkog profila sa nosom (17), projektovan da bude usmeren ka ulaznom vazduhu i koji je podržan setom (6) ležajeva usmerivača vetra vertikalne ose rotacije na jarbolu turbine i

- rotor (2) sa lopaticama (7) koji se okreću u ravni vrata (Rt) difuzera (I), a donji krajevi su povezani sa ležištem glavčine (3) postavljen koaksijalno sa difuzerom (I) i oblika koji je konzistentan sa aerodi namičnim profilom trupa {4} koji je rebrom (5) povezan sa difuzerom (1), **naznačena time**, što su donji krajevi lopatica (7)

postavljeni od površine glavčine (3) za dimenziju donjeg zazora (z2), dimenzija je određena visinom konektora (8) pričvršćenim na donje krajeve lopatica (7) i glavčine (3), dimenzije gornjeg zazora (z1) između gornjih krajeva lopatica (7) i površine vrata (Rt) i donjeg zazora (z2) kreću se od 0,5 do 15% poluprečnika vrata (Rt)

poželjno od 3 do 8 %.

Patent sadrži još 14 patentnih zahtjeva

(11) **03624** (13) **B**

..

(51) **C07D 495/20**^(2006.01)

A61K 31/438^(2006.01)

A61P 37/00^(2006.01)

A61P 17/06^(2006.01)

..

(21) P-2019-350

(22) 06.09.2016

(30) 201562215929 P 09.09.2015 US

(96) 16766765.8/06.09.2016

(86) US PCT/US2016/050374/06.09.2016

(87) WO 2017/044410/16.03.2017/2017/11

(97) EP 3347360/18.07.2018/2018/29

EP 3347360/23.10.2019/2019/43

(54) me **SPOJEVI KORISNI ZA INHIBITIRANJE ROR- γ -T**
en **COMPOUNDS USEFUL FOR INHIBITING ROR-GAMMA-T**

(73) ELI LILLY AND COMPANY

Lilly Corporate Center, Indianapolis, IN 46285/ US

(72) MORPHY, John Richard

P.O. Box 6288, Indianapolis, Indiana 46206-6288/ US

(57) Spoj, **naznačen time** što je spoj formule

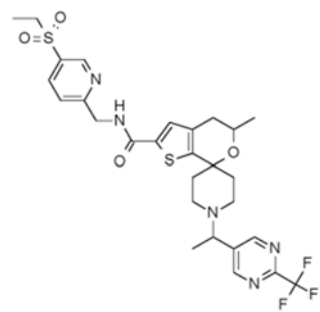

ili njegova farmaceutski prihvatljiva sol.

Patent sadrži još 8 patentnih zahtjeva

(11) **03659** (13) **B**

..

(51) **C07D 211/90**^(2006.01)

A61K 31/435^(2006.01)

A61P 9/12^(2006.01)

..

(21) P-2019-352

(22) 24.02.2006

(30) 20050656836P 25.02.2005 US

(96) 06723128.2/24.02.2006

(86) EP PCT/EP2006/001782/24.02.2006

(87) WO 2006/089787/31.08.2006/2006/35

(97) EP 1856051/21.11.2007/2007/41

EP 1856051/13.11.2019/2019/46

(54) me **AMORFNI LERKANIDIPIN HIDROHLORID**
en **AMORPHOUS LERCANIDIPINE HYDROCHLORIDE**

(73) Recordati Ireland Limited
Raheens East, Ringaskiddy, County Cork/ IE
RECORDATI INDUSTRIA CHIMICA E FARMACEUTICA S.p.a.
Via Matteo Civitali, 1, 20148 Milano/ IT

(72) LEONARDI, Amedeo
Via Poliziano 16, I-20154 Milano/ IT
MOTTA, Gianni
Via Ungaretti, 10, I-20030 Barlassina / IT
BERLATI, Fabio
Via Aldo Moro 9, I-20017 Rho / IT

(74) Advokat RADULOVIĆ, Božidar S.
Studentska bb, Lamela 3/18 , Podgorica, 81000 / ME

(57) Amorfni lerkanidipin hidrohlorid čistoće od najmanje 99.5% određene HPLC analizom i koji sadrži manje od 0.5% kristalnog lerkanidipin hidrohlorida.

Patent sadrži još 2 patentnih zahtjeva

(11) **03660** (13) **B**

..

(51) **C07D 513/04**^(2006.01)

A61K 31/542^(2006.01)

A61P 25/28^(2006.01)

..

(21) P-2019-353

(22) 22.04.2016

(30) 201562154242P 29.04.2015 US

(96) 16719728.4/22.04.2016

(86) US PCT/US2016/028896/22.04.2016

(87) WO 2016/176118/03.11.2016/2016/44

(97) EP 3288949/07.03.2018/2018/10

EP 3288949/06.11.2019/2019/45

(54) me **DERIVATI AMINOHIDROZIAZINA KONDENZIRANI S TETRAHIDROFURANOM, KORISNI U LIJEČENJU ALZHEIMEROVE BOLESTI**
en **TETRAHYDROFURANE-FUSED AMINOHYDROTHIAZINE DERIVATIVES WHICH ARE USEFUL IN THE TREATMENT OF ALZHEIMER'S DISEASE**

(73) Eli Lilly and Company

Lilly Corporate Center, Indianapolis, IN 46285/ US

(72) REMICK, David Michael

P.O. Box 6288 , Indianapolis, IN 46206-6288/ US

RICHARDS, Simon James

P.O. Box 6288 , Indianapolis, IN 46206-6288 / US

SANDERSON, Adam Jan

P.O. Box 6288 , Indianapolis, IN 46206-6288/ US

(74) AOD "ĆUPIĆ"

Bulevar Džordža Vašingtona 79, Podgorica, 81000/ ME

(57) Spoj, **naznačen time** što je spoj formule:

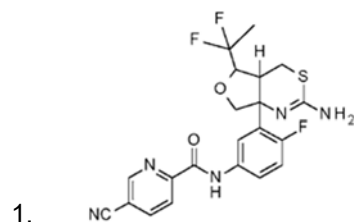

ili njegova farmaceutska prihvatljiva sol.

Patent sadrži još 16 patentnih zahtjeva

(11) **03661** (13) **B**

..

(51) **C07K 16/18**^(2006.01)

G01N 33/577^(2006.01)

A61K39/395^(2006.01)

A61P25/28^(2006.01)

..

(21) P-2019-356

(22) 09.08.2011

(30) 20100373026P 12.08.2010 US

(96) 18150424.2/09.08.2011

(97) EP 3339323/27.06.2018/2018/26

EP 3339323/13.11.2019/2019/46

(54) me **PROTUTIJELA PROTIV AMILOIDNOG BETA PEPTIDA N3PGLU I NJIHOVA UPOTREBA**
en **ANTI-N3PGLU AMYLOID BETA PEPTIDE ANTIBODIES AND USES THEREOF**

(73) Eli Lilly and Company

Lilly Corporate Center, Indianapolis, IN 46285/ US

(72) Demattos, Ronald Bradley

P.O. Box 6288 , Indianapolis, Indiana 46206-6288/ US

LU, Jirong

P.O. Box 6288, Indianapolis, Indiana 46206-6288/ US

Tang, Ying

P.O. Box 6288, Indianapolis, Indiana 46206-6288 / US

(74) Advokat ČUPIĆ, Branislav

Dalmatinska 10 , Podgorica , 81000/ ME

(57) Protutijelo protiv N3pGlu A β , koje sadrži varijabilno područje lakog lanca (LCVR) i varijabilno područje teškog lanca (HCVR), gdje je LCDRI KSX1X2SLLYSRX3KTYLN (SEQ ID NO: 51), LCDR2 je AVSKLX4S (SEQ ID NO:52), LCDR3 je VQGTHYPFT (SEQ ID NO: 5), te HCDRI je GYX5FTX6YYIN (SEQ ID NO: 53), HCDR2 je WINPGSGNTKYNEKFKG (SEQ ID NO: 8), a HCDR3 je EGX7TVY (SEQ ID NO: 54), gdje je XI S ili T; X2 je Q ili R, X3 je G ili S, X4 je D ili G, X5 je D ili T, X6 je R ili D, a X7 je I, T, E, ili V, **naznačeno time** što je namijenjeno upotrebi u sprječavanju Alzheimerove bolesti.

Patent sadrži još 2 patentnih zahtjeva

(11) **03662** (13) **B**

..

(51) **C07K 16/28**^(2006.01)

C07K 16/30^(2006.01)

A61K 47/68^(2017.01)

A61K 39/395^(2006.01)

A61P 35/00^(2006.01)

C07K 16/46^(2006.01)

..

(21) P-2019-357

(22) 27.01.2014

(30) 201361756991P 25.01.2013 US

201361785147P 14.03.2013 US

(96) 14705293.0/27.01.2014

(86) EP PCT/EP2014/051550/27.01.2014

(87) WO 2014/114800/31.07.2014/2014/31

(97) EP 2948477/02.12.2015/2015/49

EP 2948477/16.10.2019/2019/42

(54) me **KONSTRUKTI ANTITIJELA ZA CDH19 I CD3**
en **ANTIBODY CONSTRUCTS FOR CDH19 AND CD3**

(73) Amgen Research (Munich) GmbH
Staffelseestrasse 2, München, 81477 / DE
Amgen Inc.

One Amgen Center Drive, Thousand Oaks, California 91320-1799/ US

(72) XIAO, Shouhua

719 Coronado Lane , Foster City California 94404 / US

PAN, Zheng

4315 Mockingbird Way, Fremont California 94555 / US

WICKRAMASINGHE, Dineli

342 Liberty Street, San Francisco California 94114 / US

JEFFRIES, M., Shawn

6006 Sunset Lane, Indianapolis Indiana 46228 / US

KING, Chadwick Terence

1325 Moody Avenue, North Vancouver British Columbia V7L 3T5 / CA

CHAN, Brian Mingtung

2458 Kensington Crescent, Port Coquitlam British Columbia V3C 5N8/ CA

KUFER, Peter

Staffelseestr. 2, Munich , 81477/ DE

LUTTERBUESE, Ralf

Staffelseestr. 2, Munich , 81477/ DE

RAUM, Tobias

Staffelseestr. 2 , Munich, 81477/ DE

HOFFMANN, Patrick

Staffelseestr. 2 , Munich, 81477/ DE

RAU, Doris

Staffelseestr. 2 , Munich, 81477/ DE

KISCHEL, Roman

Staffelseestr. 2 , Munich, 81477/ DE

LEMON, Bryan

2493 Dell Avenue, Mountain View California 94043 / US

WESCHE, Holger

1080 Jamestown Avenue, San Francisco California 94124/ US

(74) Advokat RADULOVIĆ, Božidar S.

Studentska bb, Lamela 3/18 , Podgorica, 81000 / ME

(57)

1. Kozmetički postupak za poboljšanje estetskog izgleda kože ispitanika, pri čemu postupak uključuje davanje ispitaniku efikasne količine jedinjenja Formule I ili njegova dermatološki prihvatljive soli:

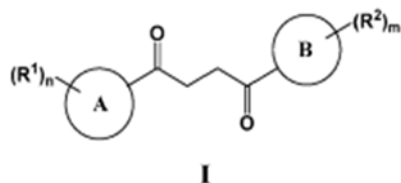

gde:

Prsten A je 7-12-člani heteroaril, pod uslovom da je ugljenikov atom na prstenu vezan za karbonil ugljenika;

Prsten B je izabran iz grupe koju čine fenil i 5-6-člani heteroaril, pod uslovom da je atom

ugljenika na prstenu vezan za karbonil ugljenika;

R1 je supstituent vezan za prsten A i nezavisno je izabran iz svake pojave iz grupe koja se sastoji od nesupstituisanog -C1-6 alkila, -C1-3 haloalkila, halogenida, -OR3 i CN;

R2 je supstituent vezan za prsten B i nezavisno je izabran iz svake pojave iz grupe koja se sastoji od nesupstituisanog -C1-6 alkila, -CH2OH, -CH2N(R3b)2, -Cl-3 haloalkila, halogenida, -OR3 i CN;

svako R3 je nezavisno odabrano iz grupe koju čine H, nesupstituisani C1-6 alkil i -C1-3

haloalkil;

svako R3b je nezavisno odabrano iz grupe koju čine H i nesupstituisani -C1-3 alkil; svako n je 0 do 10; i svako m je 0 do 5.

Patent sadrži još 14 patentnih zahtjeva

(11) **03663** (13) **B**

..

(51) C07D 231/40 ^(2006.01)	C07D 231/44 ^(2006.01)
C07D 231/50 ^(2006.01)	C07D 413/12 ^(2006.01)
C07D 417/12 ^(2006.01)	C07D 487/04 ^(2006.01)
C07D 498/04 ^(2006.01)	A61K 31/4155 ^(2006.01)
A61P 9/00 ^(2006.01)	

..

(21) P-2019-358

(22) 03.05.2016

(30) 201562156424P 04.05.2015 US

(96) 16720116.9/03.05.2016

(86) EP PCT/EP2016/059848/03.05.2016

(87) WO 2016/177703/10.11.2016/2016/45

(97) EP 3292105/14.03.2018/2018/11
EP 3292105/02.10.2019/2019/40

(54) me **DERIVATI RIRAZOLA KORISNI KAO INHIBITORI PROTEINA KOJI AKTIVIRA 5-LIPOKSIGENAZU (FLAP)**
en **PYRAZOLE DERIVATIVES USEFUL AS 5-LIPOXYGENASE ACTIVATING PROTEIN (FLAP) INHIBITORS**

(73) AstraZeneca AB
151 85 Södertälje/ SE

(72) BRODDEFALK, Johan, Olof
, SE-431 83 Mölndal / SE
EMTENÄS, Hans, Fredrik
, SE-431 83 Mölndal / SE
GRANBERG, Kenneth, Lars
, SE-431 83 Mölndal / SE
LEMURELL, Malin, Anita
, SE-431 83 Mölndal / SE
PETTERSEN, Daniel, Tor
, SE-431 83 Mölndal / SE
PLOWRIGHT, Alleyn, Thomas
, SE-431 83 Mölndal / SE
ULANDER, Lars, Johan, Andreas
, SE-431 83 Mölndal / SE

(74) Advokat RADULOVIĆ, Božidar S.
Studentska bb, Lamela 3/18 , Podgorica, 81000 / ME

(57)

1. Jedinjenje formule (IV):

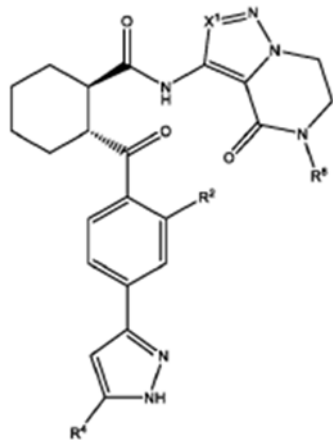

ili njihova farmaceutske prihvatljiva so, gde:

X¹ je CH ili CCH₃;

R² je -H ili -F;

R⁴ je -H ili -CH₃; i

R⁸ je -H ili CH₃.

Patent sadrži još 11 patentnih zahtjeva

(11) **03577** (13) **B**

..

(51) **F01N 9/00**^(2006.01)

F01N 13/04^(2010.01)

F01N 13/08^(2010.01)

F01N 1/16^(2006.01)

F01N 3/00^(2006.01)

..

(21) P-2019-361

(22) 10.08.2016

(30) 15002654 10.09.2015 EP

(96) 16750823.3/10.08.2016

(86) EP PCT/EP2016/069039/10.08.2016

(87) WO 2017/041980/16.03.2017/2017/11

(97) EP 3347579/18.07.2018/2018/29

EP 3347579/25.09.2019/2019/39

(54) me **REŽIM DOZIRANJA AGONISTA S1P RECEPTORA**
en **EXHAUST SYSTEM FOR AN INTERNAL COMBUSTION AUTOMOTIVE ENGINE**

(73) Akrapovic d.d.

Malo Hudo 8a, 1295 Ivancna Gorica/ SI

(72) AKRAPOVIC, Igor

Rozna dolina Cesta VIII 10/A, 1000 Ljubljana/ SI

KLEMENC, Jaka

Skrabceva 21, 1000 Ljubljana/ SI

SEDEJ, Gasper

Jelicni Vrh 7, 5280 Idrija/ SI

VIPAVEC, Simon

Gubceva 7, 8340 Crnomelj/ SI

(57) Izduvni sistem (1) za automobilski motor sa unutrašnjim sagorevanjem (3), kao što je na primer V-motor ili bokser motor, koji sadrži:

levi izduvni trakt (5) koji se može povezati sa levom grupom cilindara (35) automobilskog motora sa unutrašnjim sagorevanjem (3); i

desni izduvni trakt (7) koji se može povezati s desnom grupom cilindara (37) automobilskog motora sa unutrašnjim sagorevanjem (3);

gde svaki i-zduvni trakt (5, 7) sadrži strukturu trakta koju definišu

- dovod (51, 71) u trakt namenjen prihvatanju izduvnih gasova izbačenih iz grupe cilindara sa kojima se izduvni trakt (5, 7) može povezati,
- najmanje jedan izduvni otvor (53, 73) koji se otvara u atmosferu, i
- priključna cev (55, 75) koja se pruža između dovoda u trakt i izduvnog otvora (53, 73), koja sadrži ulazni otvor (55i, 75i) namenjen prihvatanju izduvnog gasa iz dovoda u trakt (51, 71) i izlaznog otvora. (55o, 75o) za prenos izduvnih gasova prema izduvnom otvoru (53, 73);

naznačen time

što su leva priključna cev (55) i desna priključna cev (75) spojene tako da formiraju spoj (9) cevi kojim priključne cevi obrazuju zajednički priključni otvor (91) za prenos izduvnih gasova između dva trakta (5, 7);

i ***time*** što izduvni sistem (1) sadrži najmanje jedan element (93, 93b, 95, 97) sa funkcijom ventila radi otvaranja i/ili zatvaranja zajedničkog priključnog otvora (91),

i ***time*** što izduvni sistem (1) sadrži uređaj (13, 52, 72) sa funkcijom ventila radi DELIMIČNE I/ili

potpune inhibicije putanje protoka izduvnih gasova unutar levog izduvnog trakta (5) i/ili unutar desnog izduvnog trakta (7) na odgovarajućem otvoru izduvnog trakta između ulaznog otvora (55i, 75i) i najmanje jednog

izlaznog otvora (55o, 75o), i pomoću kontrolne jedinice (11) prilagođene za kontrolu elementa (93, 93b; 95, 97) sa funkcijom ventila, kao i uređaja (13, 52, 72) sa funkcijom ventila, a prema najmanje jednom od sledećih podešavanja:

- a) zajednički priključni otvor (91) je zatvoren a otvori desnog i levog izduvnog trakta su otvoreni; i/ili
- b) zajednički priključni otvor (91) je otvoren a otvori desnog i levog izduvnog trakta su otvoreni;

i ***time*** što je kontrolna jedinica (11) prilagođena za kontrolu elementa (93, 93b,

95, 97) sa funkcijom ventila kao i uređaja (13) sa funkcijom ventila u skladu sa najmanje jednim od sledećih podešavanja:

- c) zajednički priključni otvor (91) je otvoren a desni i/ili otvor izduvnog trakta je delimično zatvoren i/ili
- d) zajednički priključni otvor (91) je otvoren i jedan otvor izduvnog trakta je otvoren dok je drugi otvor izduvnog trakta u potpunosti zatvoren.

Patent sadrži još 11 patentnih zahtjeva

(11) **03595** (13) **B**

..

(51) **A61K 35/74**^(2006.01)

A61P 11/06^(2006.01)

A61P 35/00^(2006.01)

A61K 35/745^(2006.01)

..

(21) P-2019-362

(22) 15.06.2016

(30) 201510467 15.06.2015 GB

201520501 20.11.2015 GB

(96) 18165143.1/15.06.2016

(97) EP 3360559/15.08.2018/2018/33

EP 3360559/23.10.2019/2019/43

(54) me **KOMPOZICIJE KOJE SADRŽE BAKTERIJSKE SOJEVE**
en **COMPOSITIONS COMPRISING BACTERIAL STRAINS**

(73) 4D PHARMA RESEARCH LIMITED

Life Sciences Innovation Building, Cornhill Road, Aberdeen, Aberdeenshire AB25 2ZS/ GB

(72) GRANT, George

Life Sciences Innovation Building Cornhill Road, Aberdeen, Aberdeenshire AB25 2ZS/ GB

PATTERSON, Angela Margaret

Norwich Medical School Faculty of Medicine and Health Sciences University of East Anglia, Norwich,

Norfolk NR4 7JT/ GB

MULDER, Imke

Life Sciences Innovation Building Cornhill Road, Aberdeen, Aberdeenshire AB25 2ZS/ GB

MCCLUSKEY, Seanin

c/o 4D PHARMA PLC 3rd Floor 9 Bond Court, Leeds, Yorkshire LS1 2JZ/ GB

RAFTIS, Emma

c/o 4D PHARMA PLC 3rd Floor 9 Bond Court, Leeds, Yorkshire LS1 2JZ/ GB

(57) Kompozicija koja sadrži bakteriju deponovanu pod pristupnim brojem NCIMB 42380 ili bakteriju koja ima 16s rRNK sekvencu koja je bar 98% identična sa SEQ ID N0:1, za upotrebu u postupku lečenja ili prevencije neutrofilne astme.

Patent sadrži još 11 patentnih zahtjeva

(11) **03596** (13) **B**

..

(51) **A61K 9/51**^(2006.01)

G01N 33/53^(2006.01)

A61K 9/16^(2006.01)

A61K 47/42^(2006.01)

A61K 31/337^(2006.01)

B82Y 5/00^(2011.01)

G01N 33/68^(2006.01)

..

(21) P-2019-364

(22) 15.04.2010

(30) 238052 P 28.08.2009 US

169665 P 15.04.2009 US

(96) 10765167.1/15.04.2010

(86) US PCT/US2010/031197/15.04.2010

(87) WO 2010/121000/21.10.2010/2010/42

(97) EP 2419732/22.02.2012/2012/08

EP 2419732/30.10.2019/2019/44

(54) me **KOMPOZICIJE NANOČESTICA BEZ PRIONA I POSTUPCI POVEZANI SA NJIMA**
en **PRION-FREE NANOPARTICLE COMPOSITIONS AND METHODS**

(73) Abraxis BioScience, LLC

86 Morris Avenue, Summit, NJ 07901/ US

(72) DESAI, Neil P.

1343 Luna Vista Drive , Pacific Palisades, CA 90272 / US

PEYKOV, Viktor

11830 Wilmington Road, San Diego, CA 92128/ US

SOON-SHIONG, Patrick

9922 Jefferson, Boulevard, Culver City, CA 90232/ US

(57) Postupak za proizvodnju kompozicije koja sadrži nanočestice koje sadrže albuniin t farmakološki aktivni agens suštinski nerastvorljiv u vodi, koji obuhvata: a) podvrgavanje smeše oja sadrži organsku fazu koja sadrži navedeni farmakološki aktivni agens suštinski . nerastvorljiv u vodi i rastvor albumina uslovima visokog smicanja, b) uklanjanje priroškog proteina iz na edene smeše, pri čemu navedeno uklanjanje obuhvata: 1) dovodepje u kontakt smee sa ligandom koji ima sposobnost da se veže za prionski protein; i 2) uklanjanje liganda i proteina vezanih za njega iz navedene smeše; i gde farmakološki vni agens suštinski nerastvorljiv u vodi predstavlja taksan, epotilon, kamptotecin, kolhicin, geladanamicin, amiodaro, tiroi ni hormon, amfotericin, kortikosteroid, propofol, melatonin, ciklosporin, rapamicin, takrolimus, mikofenolnu kiselinu, ifosfamid, vinorelbin, vankomicin, gemcitabin, SU5416, tiote'pu, bleomi in, ili dijagnostički radiokontrastni agens

a) podvrgavanje smeše oja sadrži organsku fazu koja sadrži navedeni farmakološki aktivni agens suštinski nerastvorljiv u vodi i rastvor albumina uslovima visokog smicanja,

b) uklanjanje priorskog proteina iz na edene smeše, pri čemu navedeno uklanjanje obuhvata:

1) dovođenje u kontakt smee sa ligandom koji ima sposobnost da se veže za prionski protein; i

2) uklanjanje liganda i proteina vezanih za njega iz navedene smeše;

i gde farmakološki vni agens suštinski nerastvorljiv u vodi predstavlja taksan, epotilon, kamptotecin, kolhicin, geladanamicin, amiodaro, tiroi ni hormon, amfotericin, kortikosteroid, propofol, melatonin, ciklosporin, rapamicin, takrolimus, mikofenolnu kiselinu, ifosfamid, vinorelbin, vankomicin, gemcitabin, SU5416, tiote'pu, bleomi in, ili dijagnostički radiokontrastni agens

Patent sadrži još 10 patentnih zahtjeva

(11) **03620** (13) **B**

..

(51) **C12Q 1/68**^(2006.01)

A61K 31/00^(2006.01)

C07K 16/28^(2006.01)

C12Q 1/6886^(2006.01)

C07K 14/72^(2006.01)

..

(21) P-2019-365

(22) 26.07.2013

(30) 201261676842 P 27.07.2012 US

201361783763 P 14.03.2013 US

201361829123 P 30.05.2013 US

(96) 13745973.1/26.07.2013

(86) IB PCT/US2013/052395/26.07.2013

(87) WO 2014/018926/30.01.2014/2014/05

(97) EP 2877599/03.06.2015/2015/23

EP 2877599/23.10.2019/2019/43

(54) me **POSTUPCI I KOMPOZICIJE ZA ODREĐIVANJE REZISTENCIJE NA TERAPIJU
POSREDOVANU ANDROGENIM RECEPTOROM**
en **METHODS AND COMPOSITIONS FOR DETERMINING RESISTANCE TO ANDROGEN
RECEPTOR THERAPY**

(73) ARAGON PHARMACEUTICALS, INC

10990 Wilshire Blvd. Suite 300, Los Angeles CA 90024 United States/ US

(72) , JOSEPH, James, David

10242 Lone Bluff Drive, San Diego, CA 92127/ US

, HAGER, Jeffrey H.

13381 Benchley Road, San Diego, CA 92130/ US

, SENSINTAFFAR, John, Lee

12777 Casa Avenida, Poway, CA 92064/ US

, LU, Nhin

3635 Ash Street Unit 4, San Diego, CA 92126/ US

, QIAN, Jing

9456 Compass Point Drive South 8, San Diego, CA 92126/ US

, SMITH, Nicholas, D.

1204 Beryl Street, San Diego, CA 92109/ US

(57) Postupak za utvrđivanje da li subjekat ispoljava ili će ispoljiti slabiji odgovor na terapiju sa antagonistom androgenog receptora (AR) prve ili druge generacije, koji obuhvata:

(a) ispitivanje uzorka koji sadrži molekulu nukleinske kiseline koji kodira AR polipeptid iz subjekta, da bi se utvrdilo da li je kodirani AR polipeptid modifikovan na poziciji aminokiseline koja odgovara poziciji aminokiseline 876 u aminokiselinskoj sekvencinavedenoj u SEQ ID NO:1;i

(b) karakterizaciju subjekta kao rezistentnog ili onog koji će postati rezistentan na terapiju sa AR antagonistom prve ili druge generacije ukoliko subjekat poseduje modifikaciju.

Patent sadrži još 55 patentnih zahtjeva

(11) **035578** (13) **B**

..

(51) **A61K 39/00**^(2006.01)

C07K 16/38^(2006.01)

A61P 7/04^(2006.01)

..

(21) P-2019-366

(22) 01.03.2011

(30) 309290 P 01.03.2010 US

(96) 17172199.6/01.03.2011

(97) EP 3345615/11.07.2018/2018/28

EP 3345615/16.10.2019/2019/42

(54) me **OPTIMIZOVANA MONOKLONSKA ANTITELA PROTIV INHIBITORA PUTA FAKTORA TKIVA (TFPI)**
en **OPTIMIZED MONOCLONAL ANTIBODIES AGAINST TISSUE FACTOR PATHWAY INHIBITOR (TFPI)**

(73) Bayer Healthcare LLC

100 Bayer Boulevard P.O. Box 915, Whippany, NJ 07981-0915/ US

(72) Scholz, Peter

Biesenkamp 10, 47533 Kleve/ DE

Wang, Zhuozhi

1388 Broadway Unit 383, Millbrae, California 94030/ US

PAN, Junliang

7 Ketelsen Court, Moraga, California 94556/ US

Grudzinska, Joanna

An den Eldenaer Höfen 37, 10247 Berlin/ DE

Votsmeier, Christian

Pellenzstrasse 25, 50823 Köln/ DE

Tebbe, Jan

Am Alten Stellwerk 16, 50733 Köln/ DE

Birkenfeld, Jörg

Kurfürstenstrasse 3, 60486 Frankfurt am Main/ DE

Wobst, Nina

Hummelsbergstrasse 7, 50939 Köln/ DE

Brückner, Simone

Nußallee 2, 50354 Hürth/ DE

Steinig, Susanne

Unere Dorfstrasse 41a, 50829 Köln/ DE

(57) Ljudsko monoklonsko IgG antitelo koje se specifično vezuje za ljudski inhibitor putanje faktora tkiva, gde a) ljudski teski lanac obuhvata SEQ ID NO: 1 O i

b) ljudski laki lanac obuhvata SEQ ID NO: 17.

Patent sadrži još 2 patentnih zahtjeva

(11) **03615** (13) **B**

..

(51) **C07D 487/04**^(2006.01)

..

(21) P-2019-368

(22) 21.07.2016

(30) 201562195023 P 21.07.2015 US

201662327973 P 26.04.2016 US

(96) 16745961.9/21.07.2016

(86) US PCT/US2016/043406/21.07.2016

(87) WO 2017/015496/26.01.2017/2017/04

(97) EP 3325483/30.05.2018/2018/22

EP 3325483/02.10.2019/2019/40

(54) me **POSTUPCI ZA PRIPREMU CITOTOKSICNIH BENZODIAZEPINSKIH DERIVATA**
en **METHODS OF PREPARING CYTOTOXIC BENZODIAZEPINE DERIVATIVES**

(73) ImmunoGen, Inc.

830 Winter Street, Waltham, MA 02451/ US

(72) GÉRARD, Baudouin

69 Dartmouth Street, Belmont, MA 02478/ US

SHIZUKA, Manami

253 Payson Road, Belmont, MA 02478/ US

MILLER, Michael Louis

4 Maymont Drive, Framingham, MA 01701/ US

SILVA, Richard A.

587 Greendale Avenue, Needham, MA 02492/ US

(57) Postupak za pripremu jedinjenja formule (17d):

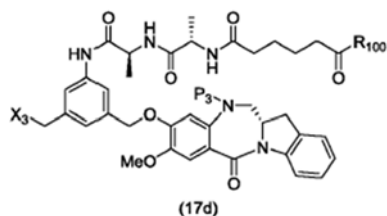

ili njegove soli, pri čemu navedeni postupak sadrži reakciju jedinjenja formule (14d)

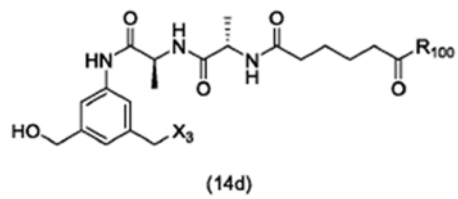

sa monomernim jedinjenjem formule (d1),

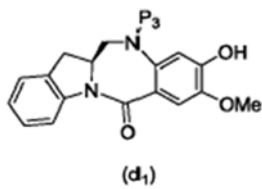

gde X3 predstavlja -Cl; P3 je H ili zaštitna grupa amina; i R100 je (C1-C3)alkoksi.

Patent sadrži još 15 patentnih zahtjeva

(11) **03616** (13) **B**

..

(51) **E04B 9/12**^(2006.01)

E04B 9/30^(2006.01)

..

(21) P-2019-369

(22) 10.03.2020

(96) 14755637.7/19.08.2014

(97) EP 3183396/28.06.2017/2017/26

EP 3183396/09.10.2019/2019/41

(54) me **IVICNI PROFILNI ELEMENT ZA POTKONSTRUKCIJU PLAFONA**
en **EDGE PROFILE ELEMENT FOR A CEILING SUBSTRUCTURE**

(73) Knauf Gips KG

Am Bahnhof 7, 97346 Iphofen/ DE

(72) SIMONIC, Boris

Senjskih uskoka 3, 51000 Rijeka/ HR

NYC, Miroslav

Lhotská 2202, 19300 Praha 9/ CZ

VIEBAHN, Michael

Ludwigstrasse 5, 97346 Iphofen/ DE

(57) Potkonstrukcija plafona, koja sadrži barem jedan ivični profilni element (15), pri čemu potkonstrukcija plafona sadrži više osnovnih profilnih elemenata (12) i više nosećih profilnih elemenata (14), pričvršćenih za osnovne profilne elemente (12), za pričvršćivanje više građevinskih ploča (24), naročito gipsanih građevinskih ploča, pri čemu je barem jedan ivični profilni element (15) profilni element u obliku slova L, sa prvim krakom (16) za montažu u zid i drugim krakom (17), naznačena time, što je zakrivljeni odeljak (19) drugog kraka (17), koji je usmeren ka unutra, izrađen tako da je distalni kraj zakrivljenog odeljka (19) bliži vertikali koja stoji uspravno u odnosu na prvi krak (16) i čiji distalni kraj seče, nego što je to proksimalni kraj zakrivljenog odeljka (19) i pri čemu je distalni odeljak (20) drugog kraka (17), koji se graniči sa zakrivljenim odeljkom (19), zakrivljen ka spolja u odnosu na zakrivljeni odeljak (19) za postavljanje barem jednog osnovnog profilnog elementa (12), a pruža se naročito uspravno u odnosu na prvi krak (16), pri čemu osnovni profilni elementi (12) naležu na odgovarajući distalni odeljak barem jednog ivičnog profilnog elementa.

Patent sadrži još 12 patentnih zahtjeva

(11) **03617** (13) **B**

..

(51) **A61K 38/17**^(2006.01)

A61K 39/00^(2006.01)

C07K 7/06^(2006.01)

C12N 5/0783^(2010.01)

C07K 7/08^(2006.01)

..

(21) P-2019-371

(22) 04.08.2014

(30) 201313987 05.08.2013 GB

201361862213 P 05.08.2013 US

201403297 25.02.2014 GB

(96) 14750175.3/04.08.2014

(86) EP PCT/EP2014/066755/04.08.2014

(87) WO 2015/018805/12.02.2015/2015/06

(97) EP 3030255/15.06.2016/2016/24

EP 3030255/09.10.2019/2019/41

(54) me **NOVA IMUNOTERAPIJA PROTIV NEKOLIKO TUMORA KAO ŠTO SU KARCINOM PLUĆA, UKLJUČUJUĆI NSCLC**
en **NOVEL IMMUNOTHERAPY AGAINST SEVERAL TUMORS, SUCH AS LUNG CANCER, INCLUDING NSCLC**

(73) Immatix biotechnologies GmbH
Paul-Ehrlich-Strasse 15, 72076 Tübingen/ DE

(72) WEINSCHENK, Toni
Im Morgenrain 15, 73773 Aichwald/ DE
WALTER, Steffen
Steinenbergstrasse 2, 72764 Reutlingen/ DE
FRITSCHÉ, Jens
Lärchenweg 11, 72144 Dusslingen/ DE
SONG, Colette
Willi Baumeisterweg 21, 73760 Ostfildern/ DE
SINGH, Harpreet
Possartstrasse 16, 81679 München/ DE

(57) Peptid koji se sastoji od aminokiselinske sekvence prema sekvencionom identifikacionom broju 5 (MXRA5-001), pri čemu pomenuti peptid ima sposobnost da se veže za molekulu ljudskog glavnog kompleksa histokompatibilnosti (MHC) klase I.

Patent sadrži još 14 patentnih zahtjeva

(11) **03597** (13) **B**

..

(51) **A61K 31/454**^(2006.01)

A61P 35/00^(2006.01)

..

(21) P-2019-372

(22) 28.08.2015

(30) 201462045976 P 04.09.2014 US

(96) 15838548.4/28.08.2015

(86) US PCT/US2015/047435/28.08.2015

(87) WO 2016/036598/10.03.2016/2016/10

(97) EP 3188599/12.07.2017/2017/28
EP 3188599/02.10.2019/2019/40

(54) me **MEDICINSKI TRETMANI NA BAZI ANAMORELINA**
en **MEDICAL TREATMENTS BASED ON ANAMORELIN**

(73) HELSINN HEALTHCARE S.A.
Via Pian Scairolo 9, Lugano-Pazzallo, 6912 / CH

(72) MANN, William
2 12th Street PH 13, Hoboken, NJ 07030/ US
FRIEND, John
26 Orchard Lane, Colts Neck, NJ 07722/ US
POLVINO, William
10 Churchill Downs Drive, Tinton Falls, NJ 07724/ US
ALLEN, Suzan
4620 Sonora Trace, Georgetown, TX 76833/ US
LU, Ming
5 Knight Drive East, Plainsboro, NJ 08536/ US
DUUS, Elizabeth
2543 SW 39th Street, Cape Coral, Florida 33914/ US
GIORGINO, Ruben
Oberwilerstrasse 51c, 4123 Allschwil/ CH
BARONI, Enrico
Via Cinque Giornate, 2Q, 22012 Cernobbio/ IT

(57) Anamorelin za upotrebu u postupku za tretman zamora koji nastaje usled kancerske kaheksije kod ljudskog pacijenta sa rakom, pri čemu je pomenuta kaheksija definisana kao indeks telesne mase manji od 20 Kg/m², pri čemu postupak sadrži svakodnevnu primenu anamorelina kod pomenutog pacijenta tokom terapeutski efikasnog vremenskog perioda.

Patent sadrži još 14 patentnih zahtjeva

(11) **03558** (13) **B**

..

(51) **C07K 16/28**^(2006.01)

A61P 35/00^(2006.01)

..

(21) P-2019-373

(22) 13.03.2015

(30) 201461953536 P 14.03.2014 US

201462059690 P 03.10.2014 US

201462094889 P 19.12.2014 US

(96) 15713290.3/13.03.2015

(86) US PCT/US2015/020474/13.03.2015

(87) WO 2015/138920/17.09.2015/2015/37

(97) EP 3116909/18.01.2017/2017/03

EP 3116909/13.11.2019/2019/46

(54) me **MOLEKULI ANTI-LAG-3 ANTITELA I NJIHOVE UPOTREBE**
en **ANTIBODY MOLECULES TO LAG-3 AND USES THEREOF**

(73) NOVARTIS AG

Lichtstrasse 35, 4056 Basel/ CH

Immutep S.A.S.

Parc Club Orsay 2 Rue Jean Rostand, 91893 Orsay/ FR

(72) TRIEBEL, Frederic

10 Rue Saint Louis, F-78000 Versailles/ FR

BRIGNONE, Chrystelle

4D rue Leon Martine Batiment D Appartement 02, F-92290 Chatenay-Malabry/ FR

BLATTLER, Walter A.

197 Mason Terrace, Brookline, MA 02446-2768/ US

MATARAZA, Jennifer Marie

250 Massachusetts Avenue, Cambridge, MA 02139/ US

SABATOS-PEYTON, Catherine Anne

250 Massachusetts Avenue, Cambridge, MA 02139/ US

CHANG, Hwai Wen

1318 Shadow Hills Drive, San Marcos, CA 92069/ US

FREY, Gerhard Johann

13768 Via Cima Bella, San Diego, CA 92129/ US

(57) Molekul humanizovanog antitela sposoban da se veže za humani limfocitni aktivacioni gen-3 (LAG-3) sa konstantom disocijacije (K_o) manjom od 0.2 nM određeno Biacore metodom, koji sadrži:

(a) varijabilni region teškog lanca (VH) koji sadrži aminokiselinsku sekvencu VHCDRI sekvence SEQ ID NO: 4, aminokiselinsku sekvencu VHCDR2 sekvence SEQ ID NO: 5, i aminokiselinsku sekvencu VHCDR3 sekvence SEQ ID NO: 3; i varijabilni region lakog lanca (VL) koji sadrži aminokiselinsku

sekvencu VLCDRI sekvence SEQ ID NO: 13, aminokiselinsku sekvencu VLCDR2 sekvence SEQ ID NO: 14, i aminokiselinsku sekvencu VLCDR3 sekvence SEQ ID NO: 15;

(b) VH koji sadrži aminokiselinsku sekvencu VHCDRI sekvence SEQ ID NO: 1; aminokiselinsku sekvencu VHCDR2 sekvence SEQ ID NO: 2; i aminokiselinsku sekvencu VHCDR3 sekvence SEQ ID NO: 3; i VL koji sadrži aminokiselinsku sekvencu VLCDRI sekvence SEQ ID NO: 10, aminokiselinsku sekvencu VLCDR2 sekvence SEQ ID NO: 11, i aminokiselinsku sekvencu VLCDR3 sekvence SEQ ID NO: 12;

(e) VH koji sadrži aminokiselinsku sekvencu VHCDRI sekvence SEQ ID NO: 286, aminokiselinsku sekvencu VHCDR2 sekvence SEQ ID NO: 5, i aminokiselinsku sekvencu VHCDR3 sekvence SEQ ID NO: 3; i VL koji sadrži aminokiselinsku sekvencu VLCDRI sekvence SEQ ID NO: 13, aminokiselinsku sekvencu VLCDR2 sekvence SEQ ID NO: 14, i aminokiselinsku sekvencu VLCDR3 sekvence SEQ ID NO: 15; ili

(d) VH koji sadrži aminokiselinsku sekvencu VHCDRI sekvence SEQ ID NO: 286; aminokiselinsku sekvencu VHCDR2 sekvence SEQ ID NO: 2; i aminokiselinsku sekvencu VHCDR3 sekvence SEQ ID NO: 3; i VL koji sadrži aminokiselinsku sekvencu VLCDRI sekvence SEQ ID NO: 10, aminokiselinsku sekvencu VLCDR2 sekvence SEQ ID NO: 11, i aminokiselinsku sekvencu VLCDR3 sekvence SEQ ID NO: 12;

gde VH sadrži četiri okvirna regiona (FW): VHF1 koji sadrži aminokiselinsku sekvencu SEQ ID NO: 187, 190, 194 ili 196, VHF2 koji sadrži aminokiselinsku sekvencu SEQ ID NO: 198,

202, 206 ili 208, VHF3 koji sadrži aminokiselinsku sekvencu SEQ ID NO: 210, 212, 217 ili

219, i VHF4 koji sadrži aminokiselinsku sekvencu SEQ ID NO: 221; i

VL sadrži četiri okvirna regiona (FW): VLF1 koji sadrži aminokiselinsku sekvencu SEQ ID NO: 226, 230, 232, 234, 236 ili 238, VLF2 koji sadrži aminokiselinsku sekvencu SEQ ID NO:

240, 244, 246 ili 248, VLF3 koji sadrži aminokiselinsku sekvencu SEQ ID NO: 252, 255, 259,

261, 265, 267 ili 269, i VLF4 koji sadrži aminokiselinsku sekvencu SEQ ID NO: 271.

Patent sadrži još 18 patentnih zahtjeva

(11) **03618** (13) **B**

..

(51) **C07K 16/30**^(2006.01)

..

(21) P-2019-374

(22) 06.05.2013

(30) PCT/EP2012/001991 09.05.2012 WO

(96) 13721596.8/06.05.2013

(86) EP PCT/EP2013/001331/06.05.2013

(87) WO 2013/167259/14.11.2013/2013/46

(97) EP 2847225/18.03.2015/2015/12
EP 2847225/27.11.2019/2019/48

(54) me **ANTITELA PREMA KLAUDINU 18.2 KOJA SU KORISNA U DIJAGNOZI KANCERA**
en **ANTIBODIES AGAINST CLAUDIN 18.2 USEFUL IN CANCER DIAGNOSIS**

(73) Astellas Pharma Inc.

5-1, Nihonbashi-Honcho 2-Chome, Chuo-ku Tokyo 103-8411/ JP

TRON - Translationale Onkologie an der Universitätsmedizin der Johannes Gutenberg- Universität Mainz
gemeinnützige GmbH

Freiligrathstrasse 12, Mainz, 55131/ DE

(72) SAHIN, Ugur

Philipp-von-Zabern-Platz 1, 55116 Mainz/ DE

TÜRECI, Özlem

Philipp-von-Zabern-Platz 1, 55116 Mainz/ DE

MITNACHT-KRAUS, Rita

Taunusstrasse 45, 61169 Friedberg/ DE

WÖLL, Stefan

Pommardstrasse 22a, 55299 Nackenheim/ DE

(57) Antitelo ili njegov antigen-vezujući fragment koje

(i) se vezuje za peptid koji ima amino-kiselinsku sekvencu TEDE-VQSYPKHDYV (SEQ ID NO: 5) ili EVQSYPKHDYV (SEQ ID NO: 6) i/ili

(ii) se vezuje za kladin 18.2 (CLDN18.2), naznačeno time što se navedeno antitelo

ili njegov antigen-vezujući fragment vezuje za CLDN18.2 vezivanjem najmanje za epitop unutar CLDN18.2 koji ima amino-kiselinsku sekvencu TEDEVQSYPKHDYV (SEQ ID NO: 5) ili EVQSYPKHDYV (SEQ ID NO: 6).

Patent sadrži još 19 patentnih zahtjeva

(11) **03640** (13) **B**

..

(51) **C07K 14/00**^(2006.01)

A61K 38/00^(2006.01)

A61K 38/16^(2006.01)

C07K 14/195^(2006.01)

C07K 14/315^(2006.01)

C07K 14/47^(2006.01)

..

(21) P-2019-84

(22) 19.02.2013

(30) 20120050145 20.02.2012 SE

(96) 13752233.0/19.02.2013

(86) SE PCT/SE2013/050139/19.02.2013

(87) WO 2013/126006/29.08.2013/2013/35

(97) EP 2817329/31.12.2014/2015/01

EP 2817329/02.01.2019/2019/01

(54) me **POLIPEPTIDI KOJI SE VEZUJU ZA HUMANI KOMPLEMENT C5**
en **POLYPEPTIDES BINDING TO HUMAN COMPLEMENT C5**

(73) Swedish Orphan Biovitrum AB (Publ)
112 76 Stockholm/ SE

(72) BERGHARD, Charlotta
Tomtebogatan 10, S-113 39 Stockholm/ SE
BERGLUND, Magnus
Törnvägen 23, S-136 72 Vendelsö/ SE
STRÖMBERG, Patrik
Kanalvägen 28 B, S-191 34 Sollentuna/ SE
LINDBORG, Malin
Hindvägen 5, S-132 48 Saltsjö-Boo/ SE
GUNNERIUSSON, Elin
Älgövägen 21, S-133 36 Saltsjöbaden/ SE
FELDWISCH, Joachim
Korallvägen 16, S-135 42 Tyresö / SE

(74) Advokat RAIČEVIĆ, Dejan
Vojvode Boža br.1 , Cetinje , 81250 / ME

(57) Polipeptid koji vezuje C5, koji sadrži motiv za vezivanje C5, *BM*, pri čemu se taj motiv sastoji od aminokiselinske sekvence izabrane između

i)

EX2X3X4A X6X7EID X11LPNL X16X17X18QW X21AFIX25 X26LX28D,

pri čemu je, nezavisno jedan od drugog,

X2 izabran između H, Q, S, T i V;

X3 izabran između I, L, M i V;

X4 izabran između A, D, E, H, K, L, N, Q, R, S, T i Y;

X6 izabran između N i W;

X7 izabran između A, D, E, H, N, Q, R, S i T;

X11 izabran između A, E, G, H, K, L, Q, R, S, T i Y;

X16 izabran između N i T;

X17 izabran između I, L i V;

X18 izabran između A, D, E, H, K, N, Q, R, S i T;

X21 izabran između I, L i V;

X25 izabran između D, E, G, H, N, S i T;

X26 izabran između K i S;

X28 izabran između A, D, E, H, N, Q, S, T i Y;

i

ii) aminokiselinske sekvence koja ima najmanje 86 % identičnosti sa sekvencom definisanom u i), pri čemu se polipeptid vezuje za C5; pri čemu pomenuti motiv za vezivanje C5 obrazuje deo proteinskog domena troheliksnog svežnja, i pri čemu pomenuti polipeptid koji vezuje C5 ispoljava aktivnost vezivanja za humani C5 i za C5 u životinjskim modelima, kao što su mišiji ili pacovski.

Patent sadrži još 20 patentnih zahtjeva

(11) **03623** (13) **B**

..

(51) **A61K 9/14**^(2006.01)

A61K 31/724^(2006.01)

A61K 38/26^(2006.01)

A61P 3/00^(2006.01)

..

(21) P-2020-29

(22) 16.02.2016

(30) 201562117031 P 17.02.2015 US

(96) 16710352.2/16.02.2016

(86) US PCT/US2016/018003/16.02.2016

(87) WO 2016/133863/25.08.2016/2016/34

(97) EP 3258919/27.12.2017/2017/52

EP 3258919/15.01.2020/2020/03

(54) me **NAZALNA PRAŠKASTA FORMULACIJA, NAMIJENJENA LIJEČENJU HIPOGLIKEMIJE**
en **NASAL POWDER FORMULATION FOR TREATMENT OF HYPOGLYCEMIA**

(73) ELI LILLY AND COMPANY

Lilly Corporate Center, Indianapolis, IN 46285/ US

(72) MANTRIPRAGADA, Sankaram B.

c/o Eli Lilly and Company P. O. Box 6288, Indianapolis, Indiana 46206-6288/ US

PICHE, Claude A.

c/o Eli Lilly and Company P. O. Box 6288, Indianapolis, Indiana 46206-6288/ US

VAN BETSBRUGGE, Jo Jan Filip

c/o Eli Lilly and Company P. O. Box 6288, Indianapolis, Indiana 46206-6288/ US

(57) Praškasti pripravak koji sadrži glukagon (SEQ ID NO:1), -ciklodekstrin, te dodecilsfosfokolin, gdje je u najmanju ruku dio praha prisutan u fazi naznačenoj time što ima XRPD međusignal kao što je određen difrakcijom rendgenskih zraka na prahu.

Patent sadrži još 13 patentnih zahtjeva

(11) **03622** (13) **B**

..

(51) **C07K 16/28**^(2006.01)

..

(21) P-2020-3

(22) 08.06.2011

(30) 353082 P 09.06.2010 US

201000498 09.06.2010 DK

(96) 11726381.4/08.06.2011

(86) BI PCT/EP2011/059507/08.06.2011

(87) WO 2011/154453/15.12.2011/2011/50

(97) EP 2580243/17.04.2013/2013/16

EP 2580243/16.10.2019/2019/42

(54) me **ANTITELA PROTIV HUMANOG CD38**
en **ANTIBODIES AGAINST HUMAN CD38**

(73) Genmab A/S

Kalvebod Brygge 43, Copenhagen V, 1560/ DK

(72) WEERS, Michel de

Yalelaan 60, NL-3584 CM Utrecht/ NL

WALSETH, Tim

1952 Midland Hills Road, Roseville Minnesota 55113/ US

WINKEL, Jan van de

Yalelaan 60, NL-3584 CM Utrecht/ NL

VINK, Tom

Yalelaan 60, NL-3584 CM Utrecht/ NL

PARREN, Paul

Yalelaan 60, NL-3584 CM Utrecht/ NL

(57) Antitelo koje se vezuje za humani CD38 sa SEQ ID NO: S2, pri čemu se antitelo (i) ne vezuje za varijantu humanog CD38 gde je Asp na poziciji 202 supstituisan sa Gly, (ii) vezuje za varijantu humanog CD38 pri čemu je Gin na poziciji 272 supstituisan sa Arg, (iii) vezuje za varijantu humanog CD38 gde je Ser na poziciji 274 supstituisan sa Phe, i (iv) vezuje za varijantu humanog CD38 gde je Thr na poziciji 237 supstituisan sa Ala.

Patent sadrži još 24 patentnih zahtjeva

(11) **03626** (13) **B**

..

(51) **C07D 401/14**^(2006.01)

A61K 31/497^(2006.01)

A61K 31/506^(2006.01)

..

(21) P-2020-31

(22) 06.03.2014

(30) 201361773706 P 06.03.2013 US

201361776260 P 11.03.2013 US

201361784909 P 14.03.2013 US

(96) 14760540.6/06.03.2014

(86) US PCT/US2014/021130/06.03.2014

(87) WO 2014/138368/12.09.2014/2014/37

(97) EP 2964229/13.01.2016/2016/02

EP 2964229/11.12.2019/2019/50

(54) me **BENZOIMIDAZOL-2-IL PIRIMIDINSKI MODULATORI HISTAMINSKOG H4 RECEPTORA**
en **BENZOIMIDAZOL-2-YL PYRIMIDINE MODULATORS OF THE HISTAMINE H4 RECEPTOR**

(73) JANSSEN PHARMACEUTICA NV

Turnhoutseweg 30, 2340 Beerse/ BE

(72) HICKEY, Magali B.

440 Pond Street, Westwood, MA 02090/ US

HORNS, Stefan

J.J. Wepferstr 5, CH-8200 Schaffhausen/ CH

LOCHNER, Susanne

Tittisbühl 1, 78224 Singen/ DE

CONZA, Matteo

Bütenweg 8, 8240 Thayngen/ CH

(57) Hemitartarat tetrahidrat [5-(4,6-Dimetil-1H-benzoimidazol-2-il)-4-metil-pirimidin-2-il]-[3-(1-metil-piperidin-4-il)-propil]-amina formule:

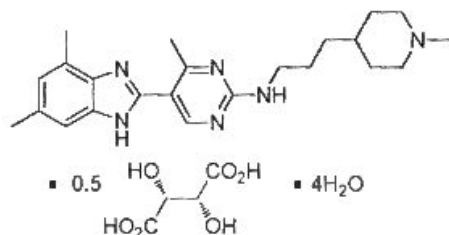

Patent sadrži još 12 patentnih zahtjeva

(11) **03627** (13) **B**

..

(51) **A61K 31/519**^(2006.01)

A61K 31/5377^(2006.01)

A61P 35/00^(2006.01)

..

(21) P-2020-32

(22) 28.02.2014

(30) 201361771480 P 01.03.2013 US

(96) 14710739.5/28.02.2014

(86) US PCT/US2014/019372/28.02.2014

(87) WO 2014/134426/04.09.2014/2014/36

(97) EP 2961410/06.01.2016/2016/01

EP 2961410/11.12.2019/2019/50

(54) me **UPOTREBA DERIVATA PIRAZOLOPIRIMIDINA ZA LEČENJE POREMEĆAJA POVEZANIH SA PI3K**
en **USE OF PYRAZOLOPYRIMIDINE DERIVATIVES FOR THE TREATMENT OF PI3K RELATED DISORDERS**

(73) INCYTE HOLDINGS CORPORATION

1801 Augustine Cut-Off, Wilmington, DE 19803/ US

(72) LI, Yun-Long

1 Pin Oak Drive, Chadds Ford, Pennsylvania 19317/ US

YAO, Wenqing

45 Magnolia Way, Chadds Ford, Pennsylvania 19317/ US

COMBS, Andrew P.

329 East Doe Run Road, Kennett Square, Pennsylvania 19348/ US

YUE, Eddy W.

9 Altemus Drive, Landenberg, Pennsylvania 19350/ US

MEI, Song

151 Monet Circle, Wilmington, Delaware 19808/ US

ZHU, Wenyu

30 Diemer Drive, Media, Pennsylvania 19063/ US

GLENN, Joseph

103 Deer Horn Drive, Mount Royal, New Jersey 8061/ US

MADUSKUIE, JR. Thomas P.

613 Foulkstone Road, Wilmington, Delaware 19803/ US

SPARKS, Richard B.

3316 Englewood Road, Wilmington, Delaware 19810/ US

DOUTY, Brent

3420 Strasburg Road East, Fallowfield, Pennsylvania 19320/ US

HE, Chunhong

40 Magnolia Way, Chadds Ford, Pennsylvania 19317/ US

(57) Jedinjenje za upotrebu u postupku tečenja idiopatske trombocitopenijske purpure (ITP), autoimunske hemolitičke anemije, Behčetoze, Koganovog sindroma, arteritisa džinovskih ćelija, reumatske polimijalgije (PMR), Takajašijevog arteritisa, Buergerove bolesti (lat. thromboangiitis obliterans), vaskulitisa centralnog nervnog sistema, Kavasakijeve bolesti, poliarteritis nodoze, Čarg-Štrausovog sindroma, vaskulitisa pomešane krioglobulinemije (esencijalne ili indukovane virusom hepatitis C (HCV)), Henoh-Šonlejnove purpure (HSP), hipersenzitivnog vaskulitisa, mikroskopskog poliangiitisa, Vegenerove granulomatoze, anti-neutrofilnih citoplazmatskih anititela povezanih sa (ANCA) sistemskim vaskulitisom (AASV), pemfigusa, membranozne nefropatije, hronične limfocitne leukemije (CLL), leukemije dlakastih ćelija, limfoma mantle ćelija, malog limfocitnog limfoma, folikularnog limfoma, limfoplazmatskog limfoma, limfoma ektranodalne marginalne zone, difuznog velikog B ćelijskog limfoma sličnog aktiviranoj B ćeliji (ABC), ili difuznog velikog B ćelijskog limfoma B ćelije germinalnog centra (GCB) kod pacijenta, gde je jedinjenje Formule IV:

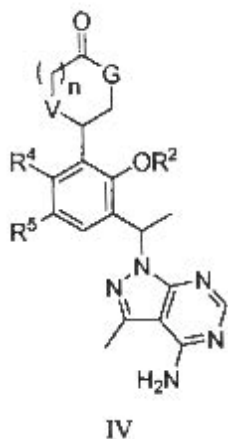

ili njegova farmaceutski prihvatljiva so, gde:

G je NH, n je 1, i V je O; ili

G je NH, n je 0, i V je CH₂; ili

G je O, n je 0 i V je NH;

R² je C₁₋₆ alkil ili C₁₋₆ haloalkil;

R⁴ je halo, OH, CN, C₁₋₄alkil, C₁₋₄haloalkil, C₁₋₄alkoksi, ili C₁₋₄ haloalkoksi;

R⁵ je halo, OH, CN, C₁₋₄alkil, C₁₋₄haloalkil, C₁₋₄alkoksi, ili C₁₋₄haloalkoksi.

Patent sadrži još 18 patentnih zahtjeva

(11) **03628** (13) **B**

..

(51) C07D 401/14 ^(2006.01)	C07D 215/48 ^(2006.01)
C07D 401/10 ^(2006.01)	C07D 417/14 ^(2006.01)
C07D 451/04 ^(2006.01)	C07D 471/04 ^(2006.01)
C07D 471/10 ^(2006.01)	C07D 487/04 ^(2006.01)
C07D 487/10 ^(2006.01)	C07D 493/10 ^(2006.01)
C12Q 1/6897 ^(2018.01)	G01N 33/50 ^(2006.01)
C07D 413/14 ^(2006.01)	C07D 403/14 ^(2006.01)
C07D 413/04 ^(2006.01)	

..

(21) P-2020-33

(22) 14.10.2014

(30) 201361890718 P 14.10.2013 US

(96) 14790937.8/14.10.2014

(86) PCT/US2014/060418/14.10.2014

(87) WO 2015/057659/23.04.2015/2015/16

(97) EP 3057964/24.08.2016/2016/34
EP 3057964/04.12.2019/2019/49

(54) me **SELEKTIVNO SUPSTITUISANA JEDINJENJA HINOLINA**
en **SELECTIVELY SUBSTITUTED QUINOLINE COMPOUNDS**

(73) EISAI R&D MANAGEMENT CO., LTD.
6-10, Koishikawa 4-chome Bunkyo-ku, Tokyo 112-8088/ JP

(72) HAWKINS, Lynn
963 Lowell Road, Concord, Massachusetts 01742/ US
CARLSON, Eric
14 Blair Road, Merrimack, New Hampshire 03054/ US
HANSEN, Hans
18 Sanborn Avenue Apartment 3, Somerville, Massachusetts 02143/ US
MACKEY, Matthew
52 Henry Avenue, Melrose, Massachusetts 02176/ US
SCHILLER, Shawn
614 Hilldale Avenue, Haverhill, Massachusetts 01832/ US
OGAWA, Chikako
Lichtstrasse 35, CH-4056 Basel/ CH
DAVIS, Heather
202 Morgan Drive, Haverhill, Massachusetts 01832/ US
ENDO, Atsushi
311 Lowell Street, Apartment 1123, Andover, MA 01810/ US

ISHIZAKA, Sally
110 Mountvale Road, Weston, MA 02493/ US

(57) Jedinjenje formule (I) ili njegova farmaceutski prihvatljiva so:

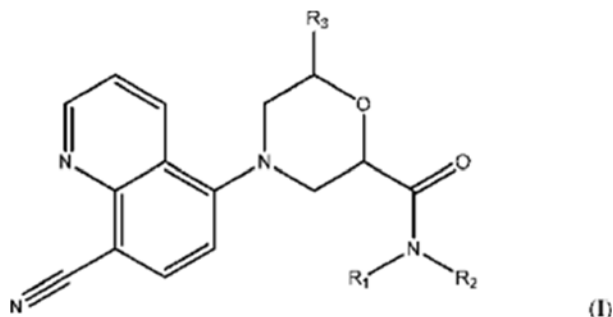

ili njegov stereoisomer ili smeša njegovih stereoisomera,
gde barem jedno od R1 i R2 je -H, metil, ili etil, i drugo je
-H; ili je drugi

C1-C6 alkil koji je opciono zamenjen sa:

-OH, metoksi, etoksi, -OCH(CH₃)₂, -O(CH₂)₂CH₃, fenil, furanil, - O(CH₂)₂OH, fenoksi, metiltio, -F, - N(CH₃)₂, cijano, piridiniloksi, fluorofenoksi, izohromanil, fenol, benzilamino, -NHCH₃, okso-, amino, karboksil, 7-člani spiroaminil, tri do šest članova cikloalkila, zasićen ili nezasićen i opciono uključuje jedan ili više heteroatoma izabranih između O i N i opciono supstituisanih u jedan ili više C ili N atoma metilom, cijanom, fluorom, metilaminom ili trifluorometilom; ili je drugi C3-C7 cikloalkan, zasićen ili nezasićen, opciono premošćen, opciono uključuje jedan ili više heteroatoma izabranih između O, S i N i opciono supstituisanih na jednom ili više C ili N atoma metilom, etilom, piridinilom, azetidilom, acetamidilom, karboksamidil cijanom, fluorom, metilaminom ili trifluorometilom; ili R1 i R2, zajedno sa atomom azota na koji su vezani, formiraju 8 do 11 članova spirodiamina, 8 člana biciklodiamina, 7 člana spiroksamina, piperidinil, opciono supstituisanog etilom, ili sa četiri do šest članova cikloalkila, opciono supstituisanim sa najmanje jednim karboksamidilom, aminometilom, metilom, (etilamino)metilom, (dimetilamino)metilom, dimetilaminom, (metilamino)metilom i aminom; i gde R3 je -H ili metil.

Patent sadrži još 13 patentnih zahtjeva

(11) **03629** (13) **B**

..

(51) **C07D 403/12**^(2006.01)

A61K 31/506^(2006.01)

A61P 25/00^(2006.01)

..

(21) P-2020-34

(22) 27.03.2015

(30) 20140000194 04.04.2014 DK

(96) 15713186.3/27.03.2015

(86) US PCT/EP2015/056713/27.03.2015

(87) WO 2015/150254/08.10.2015/2015/40

(97) EP 3126354/08.02.2017/2017/06

EP 3126354/22.01.2020/2020/04

(54) me **HALOGENOVANI KVINAZOLIN-TH F-AMINI KAO PDE1INHIBITORI**
en **HALOGENATED QUINAZOLIN-THF-AMINES AS PDE1 INHIBITORS**

(73) H. Lundbeck A/S

Ottiliavej 9, Valby, 2500 / DK

(72) KEHLER, Jan

Nymøllevej 28, DK-2800 Lyngby/ DK

RASMUSSEN, Lars Kyhn

Kaløvej 19, DK-2720 Vanløse/ DK

LANGGÅRD, Morten

Rågevej 20, DK-2600 Glostrup/ DK

(57) Jedinjenje koje ima strukturu

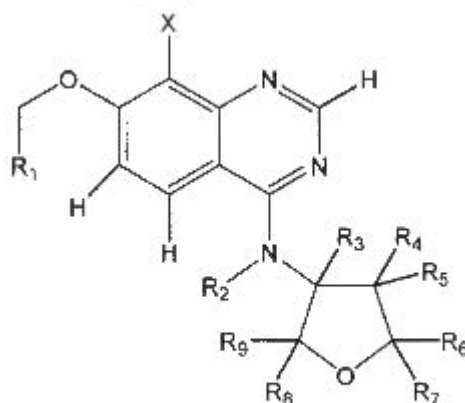

Jedinjenje (I)

u kojoj

X je halogen, poželjno fluor ili hlor ili brom;

R₁ je odabran iz grupe koju čine H i C₁-C₃ alkil, pri čemu taj alkil opciono može biti supstituisan jedanput, dva ili tri puta fluorom;

R₂ je odabran iz grupe koju čine H i C₁-C₄ alkil,

pri čemu je C₁-C₄ alkil opciono supstituisan jedanput ili više puta jednim ili više supstituenata nezavisno odabranih iz grupe koju čine fenil, monociklični 5- ili 6-člani heteroaril, C₃-C₆ cikloalkil, fluor, hlor, i alkoksi oblika -OR₁₀,

gde R₁₀ je C₁-C₅ alkil;

ili R₂ zajedno sa R₉ i atomima koji ih povezuju obrazuju zasićeni petočlani prsten;

R₃ je odabran iz grupe koju čine H i C₁-C₆ alkil,

u kojoj je C₁-C₆ alkil opciono supstituisan jedanput ili više puta jednim ili više supstituenata nezavisno odabranih iz grupe koju čine fenil, monociklični 5- ili 6-člani heteroaril, C₃-C₆ cikloalkil, fluor, hlor, i alkoksi oblika -OR₁₀,

gde R₁₀ je C₁-C₅ alkil;

R₄ i R₅ nezavisno jedan od drugog odabrani su iz grupe koju čine H, C₁-C₆ alkil, C₃-C₆ cikloalkil, fluor, hlor, hidroksi i alkoksi oblika -OR₁₀,

pri čemu je C₁-C₆ alkil opciono supstituisan jedanput ili više puta jednim ili više supstituenata nezavisno odabranih iz grupe koju čine fenil, monociklični 5- ili 6-člani heteroaril, C₃-C₆ cikloalkil, fluor, hlor, i alkoksi oblika -OR₁₀,

gde R₁₀ je C₁-C₅ alkil;

R₆ i R₇ nezavisno jedan od drugog odabrani su iz grupe koju čine H i C₁-C₆ alkil,

pri čemu je C₁-C₆ alkil opciono supstituisan jedanput ili više puta jednim ili više supstituenata nezavisno odabranih iz grupe koju čine C₃-C₆ cikloalkil, fluor, hlor, i alkoksi oblika -OR₁₀,

gde R₁₀ je C₁-C₅ alkil;

R₈ i R₉ nezavisno jedan od drugog odabrani su iz grupe koju čine H i C₁-C₆ alkil,

pri čemu R₉, kada R₉ je C₁-C₆alkil, može da obrazuje alifatični petočlani prsten sa R₂,

pri čemu je C₁-C₆alkil opciono supstituisan jedanput ili više puta jednim ili više supstituenata nezavisno odabranih iz grupe koju čine C₃-C₆cikloalkil, fluor, hlor, i alkoksi oblika -OR₁₀,

gde R₁₀ je C₁-C₅ alkil;

i farmaceutski prihvatljive adicione soli sa kiselinama Jedinjenja I, racemske mešavine Jedinjenja I, ili odgovarajući enantiomer i/ili optički izomer Jedinjenja I, i polimorfni oblici Jedinjenja I kao i tautomerni oblici Jedinjenja I.

Patent sadrži još 14 patentnih zahtjeva

(11) **03634** (13) **B**

..

(51) **F17C 13/04**^(2006.01)

..

(21) P-2020-35

(22) 28.10.2015

(30) 20140192891 12.11.2014 EP

(96) 15797869.3/28.10.2015

(86) EP PCT/EP2015/074950/28.10.2015

(87) WO 2016/074923/19.05.2016/2016/20

(97) EP 3218642/20.09.2017/2017/38
EP 3218642/27.11.2019/2019/48

(54) me **ARMATURA ZA BOCE ZA TEČNI GAS UKLJUČUJUĆII METODU PUNJENJA**
en **FITTING FOR LIQUID GAS CYLINDERS AND FILLING METHOD**

(73) CleanTech Swiss AG
Leuholz 14, 8855 Wangen/ CH

(72) TILHOF, Eckhard
Churerstrasse 31, 8852 Altendorf/ CH

(57) Armatura za bocu za tečni gas sa slavinom (2) za gas za ispuštanje gasa i sa otvorom (3) za ponovno punjenje boce za tečni gas, pri čemu je otvor (3) za ponovno punjenje boce za tečni gas gasovodno povezan sa vodom (27) armature u vidu creva ili cevi, koji može da se pruža u boci za tečni gas barem 300 mm, poželjno barem 400 mm, pri čemu se slavina (2) za gas može otvarati i zatvarati okretnom ručkom (16) i pri čemu postoji otvor (26) sa donje strane armature, pored voda (27) u vidu creva ili cevi, koji je gasovodno povezan sa slavinom za gas, pri čemu vod (27) u vidu creva ili cevi prednjači u odnosu na otvor (26), naznačena time, što je otvor (3) za ponovno punjenje boce za tečni gas postavljen sa donje strane armature (I).

Patent sadrži još 12 patentnih zahtjeva

(11) **03630** (13) **B**

..

(51) A61K 9/12 ^(2006.01)	A61K 9/00 ^(2006.01)
A61K 9/16 ^(2006.01)	A61K 31/40 ^(2006.01)
A61K 31/167 ^(2006.01)	A61K 31/56 ^(2006.01)
A61K 31/58 ^(2006.01)	A61K 31/46 ^(2006.01)
A61K 31/573 ^(2006.01)	A61P 11/00 ^(2006.01)
A61M 15/00 ^(2006.01)	

..

(21) P-2020-36

(22) 28.05.2010

(30) 20090182565P 29.05.2009 US

20090258172P 04.11.2009 US

20100309365P 01.03.2010 US

20100345536P 17.05.2010 US

(96) 16164844.9/28.05.2010

(97) EP 3111926/04.01.2017/2017/01

EP 3111926/11.12.2019/2019/50

(54) me **SASTAVI, POSTUPCI I SISTEMI ZA ISPORUKU DVA ILI VIŠE AKTIVNIH AGENASA U DISAJNE PUTEVE**
en **COMPOSITIONS, METHODS & SYSTEMS FOR RESPIRATORY DELIVERY OF TWO OR MORE ACTIVE AGENTS**

(73) PEARL THERAPEUTICS, INC.

200 Saginaw Drive, Redwood City, CA 94063/ US

(72) VEHRING, Reinhard

200 Saginaw Drive, Redwood City, CA 94063/ US

HARTMAN, Michael Steven

3820 Park Blvd. Apt. 23, Palo Alto, CA 94306/ US

SMITH, Adrian Edward

2 Wilmington Acres Court, Emerald Hills, CA 94062/ US

JOSHI, Vidya B.

812 Seal Pointe Drive, Redwood City, CA 94065/ US

DWIVEDI, Sarvajna Kumar

409 Whisper Lane, Redwood City, CA 94065/ US

LECHUGA-BALLESTEROS, David

1879 Blossom Hill Road, San Jose, CA 95124/ US

(57) Farmaceutski sastav koji se može isporučiti inhalatorom sa odmerenom dozom, koji sadrži:

suspenzivni medijum koji sadrži farmaceutski prihvatljiv potisni agens;

najmanje tri različite vrste čestica aktivnog agensa, gde svaka od najmanje tri različite vrste čestica aktivnog agensa sadrži različit aktivni agens, gde prva vrsta čestica aktivnog agensa sadrži glikopirolat, uključujući sve njegove farmaceutski prihvatljive soli, estre ili solvate,

druga vrsta čestica aktivnog agensa sadrži formoterol koji uključuje sve njegove farmaceutski prihvatljive soli, estre ili solvate i

treća vrsta čestica aktivnog agensa obuhvata beklometazon, budesonid, ciklesonid, flunizolid, flutikazon, metil-prednizolon, mometazon, prednizon i triamcinolon, uključujući sve njihove farmaceutski prihvatljive soli, estre ili solvate.

i najmanje 50%, po zapremini, materijala čestica aktivnog agensa ima optički prečnik od 4 Jlm ili manje; i

jedna ili više vrsta čestica suspenzije za udisanje;

gde najmanje jedna vrsta čestica suspenzije za udisanje sadrži perforirane fosfolipidne mikrostrukture;

gde ukupna masa najmanje jedne vrste čestica suspenzije premašuje ukupnu masu najmanje jedne vrste čestica aktivnog agensa, i tri ili više različitih vrsta čestica aktivnog agensa se ko-lociraju sa čestica suspenzije za udisanje unutar suspenzionog medijl.una kako bi nastala ko-suspenzija.

Patent sadrži još 24 patentnih zahtjeva

(11) **03631** (13) **B**

..

(51) A61K 9/12 ^(2006.01)	A61K 9/00 ^(2006.01)
A61K 31/40 ^(2006.01)	A61K 31/167 ^(2006.01)
A61K 31/56 ^(2006.01)	A61K 31/58 ^(2006.01)
A61K 31/46 ^(2006.01)	A61K 31/137 ^(2006.01)
A61P 11/00 ^(2006.01)	A61K 9/16 ^(2006.01)
A61K 31/573 ^(2006.01)	A61M 15/00 ^(2006.01)

..

(21) P-2020-37

(22) 28.05.2010

(30) 20090182565P 29.05.2009 US

20090258172P 04.11.2009 US

20100309365P 01.03.2010 US

20100345536P 17.05.2010 US

(96) 16164849.8/28.05.2010

(97) EP 3111927/04.01.2017/2017/01

EP 3111927/11.12.2019/2019/50

(54) me **SASTAVI ZA ISPORUKU AKTIVNIH AGENASA U DISAJNE PUTEVE I POVEZANI POSTUPCI I SISTEMI**
en **COMPOSITIONS FOR RESPIRATORY DELIVERY OF ACTIVE AGENTS AND ASSOCIATED METHODS AND SYSTEMS**

(73) Pearl Therapeutics, Inc.

200 Saginaw Drive, Redwood City, CA 94063/ US

(72) VEHRING, Reinhard

200 Saginaw Drive, Redwood City, CA 94063/ US

HARTMAN, Michael Steven

3820 Park Blvd. Apt. 23, Palo Alto, CA 94306/ US

SMITH, Adrian Edward

2 Wilmington Acres Court, Emerald Hills, CA 94062/ US

JOSHI, Vidya B.

812 Seal Pointe Drive, Redwood City, CA 94065/ US

DWIVEDI, Sarvajna Kumar

409 Whisper Drive, Redwood City, CA 94065/ US

(57) Ko-suspenzija koja se može isporučiti putem inhalatora s odmerenom dozom, gde stabilna ko-suspenzija sadrži:

suspenzivni medijum koji sadrži farmaceutski prihvatljiv potisni agens;

mnoštvo čestica aktivnog agensa gde čestice aktivnog agensa sadrže glikopirolat i najmanje 90%, po zapremini, čestica aktivnog agensa pokazuje optički prečnik od 7 μm ili manji; I mnoštvo čestica suspenzije za udisanje koje sadrže perforirane fosfolipidne mikrostrukture, gde ukupna masa čestica suspenzije za udisanje prevazilazi ukupnu masu čestica aktivnog agensa, mnoštvo čestica aktivnog agensa povezuje se sa mnoštvom čestica suspenzije za udisanje kako bi nastala ko-suspenzija uprkos razlikama uzgona između čestica aktivnog agensa i čestica suspenzije za udisanje unutar suspenzivnog medijuma.

Patent sadrži još 30 patentnih zahtjeva

(11) **03635** (13) **B**

..

(51) **C07C 49/697^(2006.01)**

..

(21) P-2020-38

(22) 19.12.2013

(30) 201200811 19.12.2012 DK

201261739095 P 19.12.2012 US

(96) 13811511.8/19.12.2013

(86) EP PCT/EP2013/077314/19.12.2013

(87) WO 2014/096151/26.06.2014/2014/26

(97) EP 2943460/18.11.2015/2015/47

EP 2943460/12.02.2020/2020/07

(54) me **6-HLOR0-3-(FENIL-D5)-INDEN-1-ON I NJEGOVA UPOTREBA**
en **6-CHLORO-3-(PHENYL-D5)-INDEN-1-ONE AND USE THEREOF**

(73) H. Lundbeck A/S

Ottiliavej 9, Valby, 2500 / DK

(72) JACOBSEN, Mikkel Fog

Nyelandsvej 54 4.th., DK-2000 Frederiksberg/ DK

BRANDES, Sebastian

Ringstedvej 53, DK-4000 Roskilde/ DK

(57) Postupak za proizvodnju jedinjenja (I)

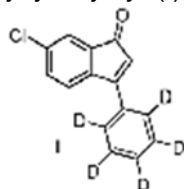

u kome je jedinjenje (I) dobijeno reakcijom 3-bromo-6-hloro-inden-1-ona sa 4,4,5,5-tetrametil-2-d5-fenil-[1,3,2]dioksaborolanom.

Patent sadrži još 13 patentnih zahtjeva

(11) **03636** (13) **B**

..

(51) **C07D 498/10**^(2006.01)

A61K 31/424^(2006.01)

..

(21) P-2020-39

(22) 21.10.2016

(30) 20150382523 23.10.2015 EP

(96) 16784795.3/21.10.2016

(86) EP PCT/EP2016/001742/21.10.2016

(87) WO 2017/067664/27.04.2017/2017/17

(97) EP 3365346/29.08.2018/201835
EP 3365346/04.12.2019/201949

(54) me **OKSA-DIAZASPIRO JEDINJENJA KOJA IMAJU AKTIVNOST PROTIV BOLA**
en **OXA-DIAZASPIRO COMPOUNDS HAVING ACTIVITY AGAINST PAIN**

(73) ESTEVE PHARMACEUTICALS, S.A.
Passeig de la Zona Franca, 109, 4^a Planta, 08038 Barcelona/ ES

(72) VIRGILI-BERNADO, Marina
C/Baldri Reixac 10, 08028 Baecelona/ ES
ALMANSA-ROSALES, Carmen
C/ Teodora Lamadrid No. 41 Ent. 4A, 08022 Barcelona/ ES
ALEGRET-MOLINA, Carlos
C/ Baldri Reixac 10, 08028 Barcelona/ ES

(57) Jedinjenje opšte Formule (I):

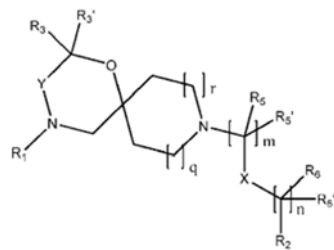

(I)

gde

R1 je

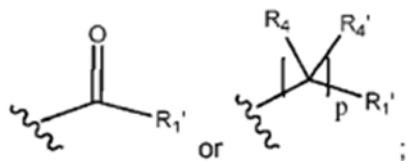

m iznosi 1, 2, 3, 4 ili 5;

n iznosi 0, 1, 2, 3, 4 ili 5;

p iznosi 0 ili 1;

q iznosi 0, 1 ili 2;

r iznosi 0, 1 ili 2;

X je veza, -C(RxRx')-, -C(O)-, -O-, -C(O)NR₇-, -NR₇C(O)- ili -C(O)O-;

gde Rx je izabran iz grupe koju čine halogen ili supstituisan ili nesupstituisan C1-6 alkil, supstituisan ili nesupstituisan C2-6 alkenil supstituisan ili nesupstituisan C2-6 alkinil, i -OR₇;

Rx' je izabran iz grupe koju čine vodonik, halogen ili supstituisan ili nesupstituisan C1-6 alkil, supstituisan ili nesupstituisan C2-6 alkenil i supstituisan ili nesupstituisan C2-6 alkinil;

R₇ je izabran iz grupe koju čine vodonik, supstituisan ili nesupstituisan C1-6 alkil, supstituisan ili nesupstituisan C2-6 alkenil i supstituisan ili nesupstituisan C2-6 alkinil;

Y je -CH₂- ili -C(O)-;

R₁' je izabran iz grupe koju čine supstituisan ili nesupstituisan C1-6 alkil, supstituisan ili nesupstituisan C2-6 alkenil, supstituisan ili nesupstituisan C2-6 alkinil, supstituisan ili nesupstituisan cikloalkil, supstituisan ili nesupstituisan aril i supstituisan ili nesupstituisan heterociklil;

R₂ je izabran iz grupe koju čine vodonik, supstituisan ili nesupstituisan C1-6 alkil, supstituisan ili nesupstituisan C2-6 alkenil, supstituisan ili nesupstituisan C2-6 alkinil, supstituisan ili nesupstituisan cikloalkil, supstituisan ili nesupstituisan aril i supstituisan ili nesupstituisan heterociklil;

R₃ je izabran iz grupe koju čine supstituisan ili nesupstituisan C1-6 alkil, supstituisan ili nesupstituisan C2-6 alkenil i supstituisan ili nesupstituisan C2-6 alkinil;

R₃' je izabran iz grupe koju čine vodonik, supstituisan ili nesupstituisan C1-6 alkil, supstituisan ili nesupstituisan C2-6 alkenil i supstituisan ili nesupstituisan C2-6 alkinil;

alternativno, R₃ i R₃' mogu, zajedno sa atomom ugljenika za koji su vezani, da formiraju supstituisan ili nesupstituisan cikloalkil;

R₄ i R₄' su nezavisno izabrani iz grupe koju čine vodonik, supstituisan ili nesupstituisan C1-6 alkil, supstituisan ili nesupstituisan C2-6 alkenil, supstituisan ili nesupstituisan C2-6 alkinil, -CHOR₉ i -C(O)OR₉;

gde R₉ je izabran iz grupe koju čine vodonik, supstituisan ili nesupstituisan C1-9 alkil, supstituisan ili nesupstituisan C2-9 alkenil i supstituisan ili nesupstituisan C2-9 alkinil;

R₅ i R₅' su nezavisno izabrani iz grupe koju čine vodonik, supstituisan ili nesupstituisan C1-6 alkil, supstituisan ili nesupstituisan C2-6 alkenil, supstituisan ili nesupstituisan C2-6 alkinil, supstituisan ili nesupstituisan cikloalkil, supstituisan ili nesupstituisan aril, supstituisan ili nesupstituisan heterociklil, -CHOR₈ i -C(O)OR₈;

gde R8 je izabran iz grupe koju čine vodonik, supstituisan ili nesupstituisan C1-6 alkil, supstituisan ili nesupstituisan C2-6 alkenil i supstituisan ili nesupstituisan C2-6 alkinil;

alternativno R5 i R5' uzeti zajedno za povezujućim C-atomom mogu da formiraju supstituisan ili nesupstituisan cikloalkil ili supstituisan ili nesupstituisan heterociklil;

R6 i R6' su nezavisno izabrani iz grupe koju čine vodonik, supstituisan ili nesupstituisan C1-6 alkil, supstituisan ili nesupstituisan C2-6 alkenil, supstituisan ili nesupstituisan C2-6 alkinil, -CHOR10 i -C(O)OR10;

gde R10 je izabran iz grupe koju čine vodonik, supstituisan ili nesupstituisan C1-6 alkil, supstituisan ili nesupstituisan C2-6 alkenil i supstituisan ili nesupstituisan C2-6 alkinil;

opciono je u obliku jednog od stereoizomera, poželjno enantiomera ili diastereomera, racemata ili u obliku smeše najmanje dva stereoizomera, poželjno enantiomera i/ili diastereomera, u bilo kom odnosu mešanja, ili u obliku njihove odgovarajuće soli ili njihovog odgovarajućeg solvata;

dok važe naredni uslovi:

- q ne iznosi 1 kada r iznosi 1;
- kada Y jeste -C(O)-, tada R1 nije

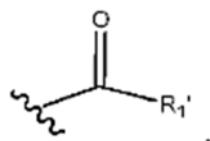

Patent sadrži još 16 patentnih zahtjeva

(11) **03621** (13) **B**

..

(51) **A61K 39/00**^(2006.01)

A61K 39/395^(2006.01)

..

(21) P-2020-5

(22) 21.11.2014

(30) 13193953 21.11.2013 EP

2834000 21.11.2013 CA

201314086696 21.11.2013 US

201414182776 18.02.2014 US

(96) 14802642.0/21.11.2014

(86) EP ???/ ??2014/075?15/21.11.2014

(87) WO 2015/075194/28.05.2015/2015/21

(97) EP 3071220/28.09.2016/2016/39

EP 3071220/25.12.2019/2019/52

(54) me **PREPARATI ZA LEČENJE GD2 POZITIVNOG KANCERA**
en **PREPARATIONS AND METHODS FOR TREATING A GD2 POSITIVE CANCER**

(73) Apeiron Biologics AG
Campus-Vienna-Biocenter 5, 1030 Wien/ AT

(72) LOIBNER, Hans
Heimgasse 23, A-1230 Vienna/ AT
MUTSCHLECHNER, Oliver
Reisenbauerring 8/2/21, A-2351 Wiener Neudorf/ AT
LADENSTEIN, Ruth
Roterdstrasse 7-9/1/2/5, A-1160 Vienna/ AT
KLIER, Isabel
Fuhrmannsgasse 8/21, A-1080 Vienna/ AT

(57) Preparat za lečenje neuroblastoma kod humanog pacijenta koji ima pomenut neuroblastom, pri čemu:

(a) preparat obuhvata monoklonalna antitela proizvedeno u CHO ćelijama, i koji obuhvata laki lanac SEQ ID N0:3 i teški lanac SEQ ID N0:4 (chl4.18/CHO);

(b) preparat treba da se da pacijentu bez pridruženog davanja IL-2 u okviru istog ciklusa lečenja; (e) chl4.18/CHO antitelo daje se pacijentu kao kontinualna infuzija tokom 24 sata dnevno

tokom 10 uzastopnih dana po ciklusu;i

(d) chl4.18/CHO antitelo treba da se da u dnevnoj dozi od 5 do 15 mg/m²/dan i u ukupnoj dozi od 50 do 150 mg/m²/ciklus.

Patent sadrži još 8 patentnih zahtjeva

(11) **03609** (13) **B**

..

(51) **H04L 1/00**^(2006.01)

..

(21) P-2020-7

(22) 24.08.2015

(30) 201462042721 P 27.08.2014 US

201514832994 21.08.2015 US

(96) 15757410.4/24.08.2015

(86) US PCT/US2015/046542/24.08.2015

(87) WO 2016/032959/03.03.2016/2016/09

(97) EP 3186911/05.07.2017/2017/27

EP 3186911/27.11.2019/2019/48

(54) me **SIGNALIZIRANJE RAZLIČITIH MCS SKUPOVA ZA RAZLIČITE PROPUSNE OPSEGE**
en **SIGNALING DIFFERENT MCS SETS FOR DIFFERENT BANDWIDTHS**

(73) QUALCOMM INCORPORATED

5775 Morehouse Drive, San Diego, CA 92121-1714/ US

(72) ASTERJADHI, Alfred

5775 Morehouse Drive, San Diego, California 92121-1714/ US

(57) Postupak (400) za bežičnu komunikaciju pomoću uređaja, koji sadrži:

generiranje frejma (402) koji poseduje prvo polje koje ukazuje na prvu šemu skupa modulacije i kodiranja, MCS, koje je uređaj sposoban da podrži u prvom propusnom opsegu iz većeg broja propusnih opsega i drugo polje koje ukazuje na drugu šemu skupa modulacije i kodiranja. MCS, koju je uređaj sposoban da podrži u drugom propusnom opsegu iz većeg broja propusnih opsega, gde različite vrednosti drugog polja ukazuju na različite MCS skupove koje je uređaj sposoban da podrži u drugom propusnom opsegu, i gde različiti MCS skupovi koji su naznačeni različitim vrednostima drugog polja odgovaraju različitim MCS skupovima koje uređaj može navesti putem različitih vrednosti prvog polja; I predaja (404) frejma na slanje, gde postupak (400) dalje obuhvata:

komunikaciju od strane uređaja korišćenjem najmanje jednog od prvog propusnog opsega i MCS iz prvog MCS skupa i drugog propusnog opsega i MCS iz drugog MCS skupa.

Patent sadrži još 10 patentnih zahtjeva

(11) **03619** (13) **B**

..

(51) A61K 31/513 ^(2006.01)	C07D 239/52 ^(2006.01)
C07D 239/54 ^(2006.01)	C07D 239/56 ^(2006.01)
C07D 401/14 ^(2006.01)	C07D 403/06 ^(2006.01)
C07D 403/14 ^(2006.01)	C07D 405/14 ^(2006.01)
C07D 471/04 ^(2006.01)	A61K 45/06 ^(2006.01)

..

(21) P-2020-8

(22) 07.10.2013

(30) PCT/CN2012/001358 08.10.2012 WO

(96) 17191307.2/07.10.2013

(97) EP 3295942/21.03.2018/2018/12
EP 3295942/20.11.2019/2019/47

(54) me **KOMBINACIJE KOJE SADRŽE DERIVATE 5-FENOKSI-3H-PIRIMIDIN-4-ONA 1 NJIHOVA UPOTREBA ZA PROFILAKSU ILI LEČENJE INFEKCIJE HIV-OM**
en **COMBINATIONS COMPRISING 5-PHENOXY-3H-PYRIMIDIN-4-ONE DERIVATIVES AND THEIR USE FOR THE PROPHYLAXIS OR TREATMENT OF INFECTION BY HIV**

(73) MERCK SHARP & DOHME CORP.
126 East Lincoln Avenue, Rahway, NJ 07065-0907/ US

(72) Arrington, Kenneth L.
770 Sumneytown Pike, West Point, Pennsylvania 19486/ US
Burgey, Christopher
770 Sumneytown Pike, West Point, Pennsylvania 19486/ US
Gilfillan, Robert
770 Sumneytown Pike, Westpoint, Pennsylvania 19486/ US
Han, Yongxin
2F No. 10 Building, Landscape No.88 Darwin Road, Zhangjiang High-tech Park,, Pudong, New District, Shanghai 201203/ CN
Patel, Mehul
770 Sumneytown Pike, West Point, Pennsylvania 19486/ US
Li, Chun Sing
288 Fute Zhong Road, Waigaoqiao Free Trade Zone, Shanghai 200131/ CN
Li, Yaozong
288 Fute Zhong Road, Waigaoqiao Free Trade Zone, Shanghai 200131/ CN
Luo, Yunfu
288 Fute Zhong Road, Waigaoqiao Free Trade Zone, Shanghai 200131/ CN
Xu, Jiayi
126 East Lincoln Avenue, Rahway, New Jersey 07065-0907/ US

(57) Kombinacija koja sadrži (i) jedinjenje formule I:

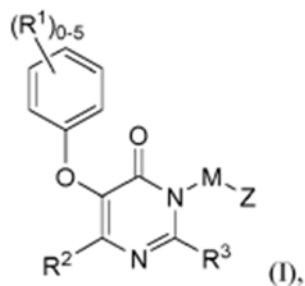

ili njegovu farmaceutski prihvatljivu so i (ii) jedno ili više sredstava protiv HIV-a izabranih od antivirusnih sredstava protiv HIV-a, imunomodulatora i anti-infektivnih sredstava, gde:

M je CH₂, CH₂CH₂, CH₂CH₂CH₂, CH(CH₃), C(CH₃)₂ ili C(O)N(RA);

Z je izabran iz grupe koja se sastoji od: piridazina, piridazinona, pirimidina, pirimidinona, pirazina, pirazinona, triazina i triazinona, svaki izborno supstituisan sa jednim ili više supstituenata do maksimalnog broja dozvoljenog valencom izabranog od R₄ i R₅;

svaki R₁ je nezavisno izabran iz grupe koja se sastoji od: halogena, CN, NO₂, C₁₋₄ alkila, C₁₋₄ haloalkila, C₂₋₄ alkenila, OH, O-C₁₋₄ alkila, O-C₁₋₄ haloalkila, N(RA)RB, C(O)N(RA)RB, C(O)RA, CO₂RA, SRA, S(O)RA, SO₂RA, SO₂N(RA)RB, SO₂N(RA)C(O)RB ili C₂₋₄ alkenila supstituisanog sa CN;

R₂ je izabran iz grupe koja se sastoji od:

(1) H,

(2) C₁₋₆ alkila,

(3) C₁₋₆ haloalkila,

(4) C₁₋₆ alkila supstituisanog sa od 1 do 3 supstituenta od kojih je svaki nezavisno OH, O-C₁₋₆ alkil, O-C₁₋₆ haloalkil, CN, NO₂, N(RA)RB, C(O)N(RA)RB, C(O)RA, CO₂RA, SRA, S(O)RA, S(O)₂RA, S(O)₂N(RA)RB, N(RA)C(O)RB, N(RA)CO₂RB, N(RA)S(O)₂RB, N(RA)S(O)₂N(RA)RB, OC(O)N(RA)RB, N(RA)C(O)N(RA)RB ili N(RA)C(O)C(O)N(RA)RB,

(5) O-C₁₋₆ alkila u kome alkil je izborno supstituisan sa 1 do 3 supstituenta nezavisno izabrana od OH, O-C₁₋₆ alkila, O-C₁₋₆ haloalkila, CN, N(RA)RB, C(O)N(RA)RB, C(O)RA, CO₂RA, SRA, S(O)RA, S(O)₂RA, ili S(O)₂N(RA)RB,

(6) O-C₁₋₆ haloalkila,

(7) halogena,

(8) CN,

(9) NO₂,

(10) N(RA)RB,

(11) C(O)N(RA)RB,

(12) C(O)RA,

(13) C(O)-C₁₋₆ haloalkila,

(14) C(O)ORA,

- (15) OC(O)RA,
- (16) OC(O)N(RA)RB,
- (17) SRA,
- (18) S(O)RA,
- (19) S(O)2RA,
- (20) S(O)2N(RA)RB,
- (21) N(RA)S(O)2RB,
- (22) N(RA)S(O)2N(RA)RB,
- (23) N(RA)C(O)RB,
- (24) N(RA)C(O)N(RA)RB,
- (25) N(RA)C(O)-C(O)N(RA)RB,
- (26) N(RA)CO2RB,
- (27) N(RC)RD,
- (28) C(O)N(RC)RD,
- (29) OC(O)N(RC)RD,
- (30) S(O)2N(RC)RD,
- (31) N(RA)S(O)2N(RC)RD,
- (32) N(RA)C(O)N(RC)RD,
- (33) N(RA)C(O)-C(O)N(RC)RD,
- (34) CycA,
- (35) -O-CycA,
- (36) ArilA, ili
- (37) HetA;

R3 je H, C1-6 alkil, halogen, CN, C1-6 fluoroalkil, OH, O-C1-6 alkil ili O-C1-6 haloalkil;

R4 i R5 su svaki nezavisno izabrani od:

- (1) H,
- (2) C1-6 alkila, C2-6 alkenila ili C2-6 alkinila, svaki izborno supstituisan sa jednim ili više supstituenata do maksimalnog broja dozvoljenog valencom izabranog od OH, O-C1-6 alkila, O-C1-6 haloalkila, CN, NO2, N(RA)RB, C(O)N(RA)RB, C(O)RA, CO2RA, SRA, S(O)RA, S(O)2RA, S(O)2N(RA)RB, N(RA)C(O)RB, N(RA)CO2RB, N(RA)S(O)2RB, N(RA)S(O)2N(RA)RB, OC(O)N(RA)RB, N(RA)C(O)N(RA)RB, N(RA)C(O)C(O)N(RA)RB, CycB, ArilB i HetB,
- (3) C1-6 haloalkila izborno dodatno supstituisanog sa jednim ili više supstituenata do maksimalnog broja dozvoljenog valencom izabranog od OH, O-C1-6 alkila, O-C1-6 haloalkila, CN, NO2, N(RA)RB, C(O)N(RA)RB, C(O)RA, CO2RA, SRA, S(O)RA, S(O)2RA, S(O)2N(RA)RB, N(RA)C(O)RB, N(RA)CO2RB,

N(RA)S(O)2RB, N(RA)S(O)2N(RA)RB, OC(O)N(RA)RB, N(RA)C(O)N(RA)RB, N(RA)C(O)C(O)N(RA)RB, CycB, ARIIB i HetB

(4) O-C1-6 alkila u kome je alkil deo izborno supstituisan sa jednim ili više supstituenata do maksimalnog broja dozvoljenog valencom izabranog od OH, O-C1-6 alkila, O-C1-6 haloalkila, CN, NO₂, N(RA)RB, C(O)N(RA)RB, C(O)RA, CO₂RA, SRA, S(O)RA, S(O)2RA, S(O)2N(RA)RB, N(RA)C(O)RB, N(RA)CO₂RB, N(RA)S(O)2RB, N(RA)S(O)2N(RA)RB, OC(O)N(RA)RB, N(RA)C(O)N(RA)RB, N(RA)C(O)C(O)N(RA)RB, CycB, ARIIB i HetB,

(5) O-C1-6 haloalkila, izborno dodatno supstituisanog sa jednim ili više supstituenata do maksimalnog broja dozvoljenog valencom izabranog od OH, O-C1-6 alkila, O-C1-6 haloalkila, CN, NO₂, N(RA)RB, C(O)N(RA)RB, C(O)RA, CO₂RA, SRA, S(O)RA, S(O)2RA, S(O)2N(RA)RB, N(RA)C(O)RB, N(RA)CO₂RB, N(RA)S(O)2RB, N(RA)S(O)2N(RA)RB, OC(O)N(RA)RB, N(RA)C(O)N(RA)RB, N(RA)C(O)C(O)N(RA)RB, CycB, ARIIB i HetB,

(6) halogena,

(7) CN,

(8) NO₂,

(9) N(RA)RB,

(10) C(O)N(RA)RB,

(11) C(O)RA,

(12) C(O)-C1-6 haloalkila,

(13) C(O)ORA,

(14) OC(O)RA,

(15) OC(O)N(RA)RB,

(16) SRA,

(17) S(O)RA,

(18) S(O)2RA,

(19) S(O)2N(RA)RB,

(20) N(RA)S(O)2RB,

(21) N(RA)S(O)2N(RA)RB,

(22) N(RA)C(O)RB,

(23) N(RA)C(O)N(RA)RB,

(24) N(RA)C(O)-C(O)N(RA)RB,

(25) N(RA)CO₂RB,

(26) N(RC)RD,

(27) C(O)N(RC)RD,

(28) OC(O)N(RC)RD,

- (29) S(O)2N(RC)RD,
- (30) N(RA)S(O)2N(RC)RD,
- (31) N(RA)C(O)N(RC)RD,
- (32) N(RA)C(O)-C(O)N(RC)RD,
- (33) OH,
- (34) CycB,
- (35) ArilB,
- (36) HetB,
- (37) -J-CycB,
- (38) -J-ArilB, i
- (39) -J-HetB,

ili R4 i R5 na susednim atomima mogu biti spojeni zajedno sa atomima za koje su vezani tako da formiraju fuzionisani CycC, ArilC ili HetC;

CycA, CycB i CycC su nezavisno karbociklil koji je C3-8 cikloalkil, C5-8 cikloalkenil ili C7-12 bicikličan, zasićeni ili nezasićeni, nearomatičan sistem prstena u kome je jedan prsten fuzionisan za ili premošćen sa drugim prstenom; pri čemu je karbociklil izborno supstituisan sa ukupno od 1 do 6 supstituenata, pri čemu:

(i) od nula do 6 supstituenata su svaki nezavisno:

- (1) halogen,
- (2) CN,
- (3) C1-6 alkil,
- (4) OH,
- (5) O-C1-6 alkil,
- (6) C1-6 haloalkil,
- (7) O-C1-6 haloalkil,
- (8) C1-6 alkenil, ili
- (9) C1-6 alkenil supstituisan sa CN, andi

(ii) od nula do 2 supstituenta su svaki nezavisno:

- (1) CycQ,
- (2) AriQ,
- (3) HetQ,
- (4) HetR,
- (5) J-CycQ,
- (6) J-AriQ,

(7) J-HetQ,

(8) J-HetR,

(9) C1-6 alkil supstituisan sa CycQ, AriQ, HetQ, HetR, J-CycQ, J-AriQ, J-HetQ, ili J-HetR,

(10) C2-6 alkenil supstituisan sa CycQ, AriQ, HetQ, HetR, J-CycQ, J-AriQ, J-HetQ, ili J-HetR, ili

(11) C2-6 alkinil supstituisan sa CycQ, AriQ, HetQ, HetR, J-CycQ, J-AriQ, J-HetQ, ili J-HetR;

ArilA, ArilB i ArilC su nezavisno aril koji je izborno supstituisan sa ukupno od 1 do 8 supstituenata, pri čemu:

(i) od nula do 8 supstituenata su svaki nezavisno:

(1) C1-6 alkil,

(2) C1-6 haloalkil, koji je izborno supstituisan sa 1 do 3 dodatna supstituenta od kojih je svaki nezavisno izabran od OH, O-C1-6 alkila, O-C1-6 haloalkila, CN, NO₂, N(RA)RB, C(O)N(RA)RB, C(O)RA, CO₂RA, SRA, S(O)RA, S(O)₂RA, S(O)₂N(RA)RB, N(RA)C(O)RB, N(RA)CO₂RB, N(RA)S(O)₂RB, N(RA)S(O)₂N(RA)RB, OC(O)N(RA)RB, N(RA)C(O)N(RA)RB, ili N(RA)C(O)C(O)N(RA)RB,

(3) C1-6 alkila supstituisanog sa od 1 do 3 supstituenta od kojih je svaki nezavisno izabran od OH, O-C1-6 alkila, O-C1-6 haloalkila, CN, NO₂, N(RA)RB, C(O)N(RA)RB, C(O)RA, CO₂RA, SRA, S(O)RA, S(O)₂RA, S(O)₂N(RA)RB, N(RA)C(O)RB, N(RA)CO₂RB, N(RA)S(O)₂RB, N(RA)S(O)₂N(RA)RB, OC(O)N(RA)RB, N(RA)C(O)N(RA)RB, ili N(RA)C(O)C(O)N(RA)RB,

(4) C2-6 alkenil,

(5) C2-6 alkenil supstituisan sa od 1 do 3 supstituenta od kojih je svaki nezavisno OH, O-C1-6 alkil, O-C1-6 haloalkil, CN, NO₂, N(RA)RB, C(O)N(RA)RB, C(O)RA, CO₂RA, SRA, S(O)RA, S(O)₂RA, S(O)₂N(RA)RB, N(RA)C(O)RB, N(RA)CO₂RB, N(RA)S(O)₂RB, N(RA)S(O)₂N(RA)RB, OC(O)N(RA)RB, N(RA)C(O)N(RA)RB, ili N(RA)C(O)C(O)N(RA)RB,

(6) C2-6 alkinil,

(7) C2-6 alkinil supstituisan sa od 1 do 3 supstituenta od kojih je svaki nezavisno OH, O-C1-6 alkil, O-C1-6 haloalkil, CN, NO₂, N(RA)RB, C(O)N(RA)RB, C(O)RA, CO₂RA, SRA, S(O)RA, S(O)₂RA, S(O)₂N(RA)RB, N(RA)C(O)RB, N(RA)CO₂RB, N(RA)S(O)₂RB, N(RA)S(O)₂N(RA)RB, OC(O)N(RA)RB, N(RA)C(O)N(RA)RB, ili N(RA)C(O)C(O)N(RA)RB,

(8) O-C1-6 alkil,

(9) O-C1-6 haloalkil,

(10) OH,

(11) halogen,

(12) CN,

(13) NO₂,

(14) N(RA)RB,

(15) C(O)N(RA)RB,

(16) C(O)RA,

(17) C(O)-C1-6 haloalkil,

- (18) C(O)ORA,
- (19) OC(O)N(RA)RB,
- (20) SRA,
- (21) S(O)RA,
- (22) S(O)2RA,
- (23) S(O)2N(RA)RB,
- (24) N(RA)S(O)2RB,
- (25) N(RA)S(O)2N(RA)RB,
- (26) N(RA)C(O)RB,
- (27) N(RA)C(O)N(RA)RB,
- (28) N(RA)C(O)-C(O)N(RA)RB, ili
- (29) N(RA)CO2RB, i

(ii) od nula do 2 supstituenta su svaki nezavisno:

- (1) CycQ,
- (2) AriQ,
- (3) HetQ,
- (4) HetR,
- (5) J-CycQ,
- (6) J-AriQ,
- (7) J-HetQ,
- (8) J-HetR,
- (9) C1-6 alkil supstituisan sa CycQ, AriQ, HetQ, HetR, J-CycQ, J-AriQ, J-HetQ, ili J-HetR,
- (10) C2-6 alkenil supstituisan sa CycQ, AriQ, HetQ, HetR, J-CycQ, J-AriQ, J-HetQ, ili J-HetR, ili
- (11) C2-6 alkinil supstituisan sa CycQ, AriQ, HetQ, HetR, J-CycQ, J-AriQ, J-HetQ, ili J-HetR;

HetA, HetB i HetC su nezavisno heterociklil ili heteroaril koji je izborno supstituisan sa ukupno od 1 do 8 supstituenata, gde:

(i) od nula do 8 supstituenata su svaki nezavisno:

- (1) C1-6 alkil,
- (2) C1-6 haloalkil, koji je izborno supstituisan sa 1 do 3 dodatna supstituenta od kojih je svaki nezavisno izabran od OH, O-C1-6 alkila, O-C1-6 haloalkila, CN, NO₂, N(RA)RB, C(O)N(RA)RB, C(O)RA, CO₂RA, SRA, S(O)RA, S(O)2RA, S(O)2N(RA)RB, N(RA)C(O)RB, N(RA)CO₂RB, N(RA)S(O)2RB, N(RA)S(O)2N(RA)RB, OC(O)N(RA)RB, N(RA)C(O)N(RA)RB, ili N(RA)C(O)C(O)N(RA)RB,
- (3) C1-6 alkil supstituisan sa od 1 do 3 supstituenta od kojih je svaki nezavisno izabran od OH, O-C1-6 alkila, O-C1-6 haloalkila, CN, NO₂, N(RA)RB, C(O)N(RA)RB, C(O)RA, CO₂RA, SRA, S(O)RA, S(O)2RA,

S(O)2N(RA)RB, N(RA)C(O)RB, N(RA)CO2RB, N(RA)S(O)2RB, N(RA)S(O)2N(RA)RB, OC(O)N(RA)RB, N(RA)C(O)N(RA)RB, ili N(RA)C(O)C(O)N(RA)RB,

(4) C2-6 alkenil,

(5) C2-6 alkenil supstituisan sa od 1 do 3 supstituenta od kojih je svaki nezavisno OH, O-C1-6 alkil, O-C1-6 haloalkil, CN, NO2, N(RA)RB, C(O)N(RA)RB, C(O)RA, CO2RA, SRA, S(O)RA, S(O)2RA, S(O)2N(RA)RB, N(RA)C(O)RB, N(RA)CO2RB, N(RA)S(O)2RB, N(RA)S(O)2N(RA)RB, OC(O)N(RA)RB, N(RA)C(O)N(RA)RB, ili N(RA)C(O)C(O)N(RA)RB,

(6) C2-6 alkinil,

(7) C2-6 alkinil supstituisan sa od 1 do 3 supstituenta od kojih je svaki nezavisno OH, O-C1-6 alkil, O-C1-6 haloalkil, CN, NO2, N(RA)RB, C(O)N(RA)RB, C(O)RA, CO2RA, SRA, S(O)RA, S(O)2RA, S(O)2N(RA)RB, N(RA)C(O)RB, N(RA)CO2RB, N(RA)S(O)2RB, N(RA)S(O)2N(RA)RB, OC(O)N(RA)RB, N(RA)C(O)N(RA)RB, ili N(RA)C(O)C(O)N(RA)RB,

(8) O-C1-6 alkil,

(9) O-C1-6 haloalkil,

(10) OH,

(11) okso,

(12) halogen,

(13) CN,

(14) NO2,

(15) N(RA)RB,

(16) C(O)N(RA)RB,

(17) C(O)RA,

(18) C(O)-C1-6 haloalkil,

(19) C(O)ORA,

(20) OC(O)N(RA)RB,

(21) SRA,

(22) S(O)RA,

(23) S(O)2RA,

(24) S(O)2N(RA)RB,

(25) N(RA)S(O)2RB,

(26) N(RA)S(O)2N(RA)RB,

(27) N(RA)C(O)RB,

(28) N(RA)C(O)N(RA)RB,

(29) N(RA)C(O)-C(O)N(RA)RB, or

(30) N(RA)CO₂RB, i

(ii) od nula do 2 supstituenta su svaki nezavisno:

(1) CycQ,

(2) AriQ,

(3) HetQ,

(4) HetR,

(5) J-CycQ,

(6) J-AriQ,

(7) J-HetQ,

(8) J-HetR,

(9) C₁₋₆ alkil supstituisan sa CycQ, AriQ, HetQ, HetR, J-CycQ, J-AriQ, J-HetQ, ili J-HetR,

(10) C₂₋₆ alkenil supstituisan sa CycQ, AriQ, HetQ, HetR, J-CycQ, J-AriQ, J-HetQ, ili J-HetR, ili

(11) C₂₋₆ alkinil supstituisan sa CycQ, AriQ, HetQ, HetR, J-CycQ, J-AriQ, J-HetQ, ili J-HetR;

svaki CycQ je nezavisno C₃₋₈ cikloalkil ili C₅₋₈ cikloalkenil, pri čemu cikloalkil ili cikloalkenil je izborno supstituisan sa od 1 do 4 supstituenta, od kojih je svaki nezavisno halogen, C₁₋₆ alkil, OH, O-C₁₋₆ alkil, C₁₋₆ haloalkil ili O-C₁₋₆ haloalkil;

svaki AriQ je nezavisno fenil ili naftil, gde je fenil ili naftil izborno supstituisan sa od 1 do 5 supstituenata od kojih je svaki nezavisno halogen, CN, NO₂, C₁₋₆ alkil, C₁₋₆ haloalkil, OH, O-C₁₋₆ alkil, O-C₁₋₆ haloalkil, N(RA)RB, C(O)N(RA)RB, C(O)RA, CO₂RA, SRA, S(O)RA, SO₂RA, SO₂N(RA)RB ili SO₂N(RA)C(O)RB;

svaki HetQ je nezavisno heteroaril koji je izborno supstituisan sa od 1 do 4 supstituenta od kojih je svaki nezavisno halogen, C₁₋₆ alkil, C₁₋₆ haloalkil, OH, O-C₁₋₆ alkil, O-C₁₋₆ haloalkil, N(RA)RB, C(O)N(RA)RB, C(O)RA, CO₂RA, SO₂RA, N(RA)C(O)N(RA)RB ili N(RA)CO₂RB;

svaki HetR je nezavisno 4- do 7-člani, zasićeni ili nezasićeni, nearomatični heterociklični prsten koji sadrži najmanje jedan atom ugljenika i od 1 do 4 heteroatoma nezavisno izabrana od N, O i S, gde je svaki S izborno oksidovan do S(O) ili S(O)₂, i gde je zasićeni ili nezasićeni heterociklični prsten izborno supstituisan sa od 1 do 4 supstituenta od kojih je svaki nezavisno halogen, CN, C₁₋₆ alkil, OH, okso, O-C₁₋₆ alkil, C₁₋₆ haloalkil, O-C₁₋₆ haloalkil, C(O)N(RA)RB, C(O)RA, CO₂RA, ili SO₂RA;

svaki J je nezavisno:

(i) O,

(ii) S,

(iii) S(O),

(iv) S(O)₂,

(v) O-C₁₋₆ alkilen,

(vi) S-C₁₋₆ alkilen,

(vii) S(O)-C₁₋₆ alkilen,

(viii) S(O)₂-C₁₋₆ alkilen,

(ix) N(RA), ili

(x) N(RA)-C1-6 alkilen;

svaki RA, RB, RC i RD su nezavisno izabrani od H, C1-6 alkila i C3-6cikloalkila, pri čemu su navedeni C1-6 alkil i C3-6cikloalkil izborno supstituisani sa jednim ili više supstituenata do maksimalnog broja dozvoljenog valencom izabranog iz grupe koja se sastoji od: halogena, OH, CN, C1-4alkoksi, C3-6cikloalkila i fenila;

ili alternativno svaki par RC i RD zajedno sa azotom za koji su oba vezani formiraju 4- do 7-člani zasićeni ili mono-nezasićeni prsten koji izborno sadrži heteroatom pored N za koji su RC i RD vezani, pri čemu je dodatni heteroatom izabran od N, O i S; pri čemu je prsten izborno supstituisan sa 1 ili 2 supstituenta od kojih je svaki nezavisno C1-6 alkil, C(O)RA, C(O)ORA, C(O)N(RA)RB ili S(O)2RA; i pri čemu je izborni S u prstenu izborno u obliku S(O) ili S(O)2

svaki aril je nezavisno (i) fenil, (ii) 9- ili 10-člani biciklični, fuzionisani karbociklični sistem prstena u kome je najmanje jedan prsten aromatičan, ili (iii) 11- do 14-člani tricikličan, fuzionisani karbocikličan sistem prstena u kome je najmanje jedan prsten aromatičan;

svaki heterociklil je nezavisno (i) 4- do 8-člani, zasićeni ili nezasićeni monociklični prsten, (ii) 7- do 12-člani biciklični sistem prstena, ili (iii) 10- do 18-člani tricikličan sistem prstena, gde je svaki prsten u (ii) ili (iii) nezavistan od, fuzionisan sa ili premošćen sa drugim prstenom ili prstenovima i svaki prsten je zasićen ili nezasićen; gde monocikličan prsten sadrži od 1 do 4 heteroatoma i ravnotežu atoma ugljenika; bicikličan sistem prstena ili tricikličan sistem prstena sadrži od 1 do 8 heteroatoma i ravnotežu atoma ugljenika, gde jedan ili više od prstenova sadrže jedan ili više od heteroatoma; gde su heteroatomi izabrani od N, O i S; i gde su bilo koji ili više od heteroatoma azota i sumpora izborno oksidovani, i bilo koji ili više od heteroatoma azota je izborno kvaternizovan;

svaki heteroaril je nezavisno (i) 5- ili 6-člani heteroaromatični prsten koji sadrži od 1 do 4 heteroatoma nezavisno izabrana od N, O i S, gde je svaki N izborno u obliku oksida, ili (ii) 9- ili 10-člani heterobicikličan, fuzionisani sistem prstena koji sadrži od 1 do 6 heteroatoma nezavisno izabrana od N, O i S, gde bilo koji ili oba prstena sadrže jedan ili više od heteroatoma, najmanje jedan prsten je aromatičan, svaki N je izborno u obliku oksida i svaki S u prstenu koji nije aromatičan je izborno S(O) ili S(O)2.

Patent sadrži još 10 patentnih zahtjeva

Objava zahtjeva za proširenje evropskih prijava patenata

- (51) MKP
B65B 25/00 2006 (97) EP 3168608
G01N 27/22 2006
G01N 33/02 2006
G01N 33/12 2006
- (96) EP 15306815.0 11/16/2015
(97) EP 3168608, 6/10/2020 202024, en
- (54) USE OF BIOPOLYMER IN A DIELECTRIC GAS SENSOR
(71) CENTRE NATIONAL DE LA RECHERCHE SCIENTIFIQUE, 3, rue Michel-Ange, 75794 Paris Cedex 16, FR
Institut national de recherche pour l'agriculture, l'alimentation et l'environnement, 147 rue de l'Université, 75007 Paris, FR
- (72) GONTARD, Nathalie, 3, impasse de la Gerbe, 34000 MONTPELLIER, FR
GUILLAUME, Carole, 1, rue du Pré de l'Aube Mas de Londres, 34380 MONTPELLIER, FR
SORLI, Brice, 5, rue Savignac, 34530 MONTAGNAC, FR
-
- (51) MKP
A01N 43/42 2006 (97) EP 3260457
A61K 31/44 2006
C07D 213/68 2006
C07D 213/80 2006
C07D 498/14 2006
- (96) EP 17165935.2 3/22/2011
(97) EP 3260457, 4/29/2020 202018, en
- (31) 316421 P (32) 23.03.2010 (33) US
- (54) PROCESS FOR PREPARING CARBAMOYLPIRIDONE DERIVATIVES AND INTERMEDIATES
(72) WANG, Huan, GlaxoSmithKline, c/o Global Patents 709 Swedeland Road, King of Prussia, PA Pennsylvania 19406, US
GOODMAN, Steven N, GlaxoSmithKline, c/o Global Patents 709 Swedeland Road, King of Prussia, PA Pennsylvania 19406, US
MANS, Douglas, GlaxoSmithKline, c/o Global Patents 709 Swedeland Road, King of Prussia, PA Pennsylvania 19406, US
KOWALSKI, Matthew, GlaxoSmithKline, c/o Global Patents 709 Swedeland Road, King of Prussia, PA Pennsylvania 19406, US
-
- (51) MKP
C04B 35/58 2006 (97) EP 3556901
C23C 14/06 2006
C23C 14/32 2006
C23C 14/56 2006
H01J 37/32 2006
- (96) EP 18168526.4 4/20/2018
(97) EP 3556901, 6/3/2020 202023, en
- (54) VACUUM ARC SOURCE
(71) PLANSEE COMPOSITE MATERIALS GMBH, Siebenbürgerstrasse 23, DE-86983 Lechbruck am See, DE
(72) POLCIK, Peter, Reimmichl Straße 5, 6600 Reutte, AT
KOLOZSVARI, Szilard, Lechfeldstraße 43, 86899 Landsberg am Lech, DE
ZHIRKOV, Igor, Linköpings Universitet (Linköping University), 58336 Linköping, SE
ROSÉN, Johanna, Linköpings Universitet (Linköping University), 58234 Linköping, SE
-
- (51) MKP
C09C 1/02 2006 (97) EP 3561002
D21H 17/67 2006
- (96) EP 18168806.0 4/23/2018
(97) EP 3561002, 5/13/2020 202020, en
- (54) USE OF ADDITIVES CONTAINING PRIMARY ALKANOLAMINES IN AQUEOUS MINERAL SUSPENSIONS
(72) BURI, Matthias, Mätteliweg 20, 4852 Rothrist, CH
RENTSCH, Samuel, Gurtengartenstrasse 1, 3095 Spiegel bei Bern, CH
IPPOLITO, Fabio, Kührainweg 12, 4803 Vordemwald, CH
-
- (51) MKP

H01H 1/00 2006 (97) EP 3564980
H01H 35/02 2006
H01H 35/06 2006

- (96) EP 18170467.7 5/2/2018
 (97) EP 3564980, 6/10/2020 202024, en
 (54) TWO-WIRE TILT SWITCH
 (71) Höhn Neigungstechnik GmbH, Meisenweg 1, 71144 Steinenbronn, DE
 (72) Höhn, Manfred, Kanalstr. 4/3, 70771 Leinfelden-Echterdingen, DE
 Hirt, Michael, Rechbergstraße 3, 72141 Walddorfhäslach, DE
-

(51) MKP
E04B 1/348 2006 (97) EP 3669032
E04B 9/06 2006
E04C 3/04 2006
E04C 3/07 2006

- (96) EP 17761184.5 8/18/2017
 (97) EP 3669032, 6/24/2020 202026, en
 (54) FRAME, BASIC FRAMEWORK, MODULE, PROFILE AND SET OF STRUCTURAL ELEMENTS FOR MODULAR CONSTRUCTION AND A MODULAR-CONSTRUCTION BUILDING
 (72) BINDER, Joachim, Pürbach 108, A-3944 Purbach, DE
-

(51) MKP
A61J 1/20 2006 (97) EP 3654910

- (96) EP 17742255.7 7/20/2017
 (97) EP 3654910, 5/27/2020 202022, en
 (54) DRUG MIXING DEVICE
 (72) TASHJIAN, Paul, 220 Great Valley Parkway, Malvern, PA 19355, US
-

(51) MKP
A61J 1/20 2006 (97) EP 3654911

- (96) EP 17742425.6 7/20/2017
 (97) EP 3654911, 5/27/2020 202022, en
 (54) DRUG MIXING DEVICE
 (72) TASHJIAN, Paul, 220 Great Valley Parkway, Malvern, PA 19355, US
-

(51) MKP
A61J 1/20 2006 (97) EP 3654912

- (96) EP 17742426.4 7/20/2017
 (97) EP 3654912, 5/27/2020 202022, en
 (54) DRUG MIXING DEVICE
 (72) TASHJIAN, Paul, 220 Great Valley Parkway, Malvern PA 19355, US
-

(51) MKP
A61J 1/20 2006 (97) EP 3654913

- (96) EP 17742427.2 7/20/2017
 (97) EP 3654913, 5/27/2020 202022, en
 (54) DRUG MIXING DEVICE
 (72) TASHJIAN, Paul, 220 Great Valley Parkway, Malvern PA 19355, US
-

(51) MKP
A61J 1/20 2006 (97) EP 3654914

- (96) EP 17742428.0 7/20/2017
 (97) EP 3654914, 5/27/2020 202022, en
 (54) DRUG MIXING DEVICE
 (72) TASHJIAN, Paul, 220 Great Valley Parkway, Malvern PA 19355, US
-

(51) MKP
A61J 1/20 2006 (97) EP 3654915

(96) EP 17742429.8 7/20/2017
 (97) EP 3654915, 5/27/2020 202022, en
 (54) DRUG MIXING DEVICE
 (72) TASHJIAN, Paul, 220 Great Valley Parkway, Malvern, PA 19355, US

(51) MKP
A61J 1/20 2006 (97) EP 3654916

(96) EP 17743011.3 7/20/2017
 (97) EP 3654916, 5/27/2020 202022, en
 (54) DRUG MIXING DEVICE
 (72) TASHJIAN, Paul, 220 Great Valley Parkway, Malvern, PA 19355, US

(51) MKP
A61K 39/395 2006 (97) EP 3638694
A61P 25/28 2006
C07K 16/18 2006

(96) EP 17743107.9 6/16/2017
 (97) EP 3638694, 4/22/2020 202017, en
 (54) COMPOSITIONS AND METHODS FOR TREATING TAUOPATHIES
 (72) TIRUCHERAI, Giridhar, 11 Maurice Court, Kendall Park, New Jersey 08824, US
 BURGESS, Michael Frans, 9 Meadowbrook Road, Chester, NJ 07930, US
 HUANG, Masano Tlaneci, 76 Old Trenton Road, Cranbury, NJ 08512, US
 BURTON, Lori S., 59 Eldridge Drive, Robbinsville, NJ 08691, US
 QUAN, Yong, 4950 Grayhawk Court, Dublin, CA 94568, US

(51) MKP
A62C 3/06 2006 (97) EP 3648848
A62C 35/02 2006
A62C 35/62 2006
A62C 99/00 2010

(96) EP 17743396.8 7/6/2017
 (97) EP 3648848, 5/13/2020 202020, en
 (54) INSTALLED FIRE EXTINGUISHING EQUIPMENT WITH EXTINGUISHING-LAUNCHING PART-UNIT
 (71) Swiss Fire Protection Research & Development AG, Kernserstrasse 17, 6060 Sarnen, CH
 (72) LOVAS, Laszlo, Viragos u. 3., 2132 Göd, HU

(51) MKP
A62C 3/06 2006 (97) EP 3648849
A62C 35/02 2006
A62C 35/15 2006
A62C 35/60 2006
A62C 99/00 2010

(96) EP 17743397.6 7/6/2017
 (97) EP 3648849, 5/13/2020 202020, en
 (54) INSTALLED FIRE EXTINGUISHING EQUIPMENT WITH IMPROVED CHARACTERISTICS
 (72) SZOCSNE VARGA, Ilona, Edvi Illés utca 37, 1121 Budapest, HU

(51) MKP
A62D 1/02 2006 (97) EP 3648850

(96) EP 17743398.4 7/6/2017
 (97) EP 3648850, 5/13/2020 202020, en
 (54) POST-FOAMING COMPOSITION FOR PROTECTION AGAINST FIRE AND/OR HEAT
 (72) LOVAS, Laszlo, Viragos u. 3., H-2132 Göd, HU

(51) MKP
A61K 9/48 2006 (97) EP 3628311
A61K 9/50 2006
A61K 31/4402 2006
A61K 31/4415 2006

(96) EP 18382687.4 9/27/2018
 (97) EP 3628311, 4/1/2020 202014, en

- (54) A PROCESS FOR THE PREPARATION OF A MODIFIED RELEASE MULTIPLE UNIT ORAL DOSAGE FORM OF DOXYLAMINE SUCCINATE AND PYRIDOXINE HYDROCHLORIDE
 (71) Inibsa Ginecologia, S.A., Crta. Sabadell a Granollers Km 14,5, 08185 Lliça de Vall, ES
 (72) Saura i Valls, Marc, Avinguda Pompeu Fabra nº 2, 4º, A, 08024 BARCELONA, ES
 Nebot Troyano, Joaquín, Avinguda Barcelona 141 3er 4a, 08750 MOLINS DE REI, ES
 Roca i Juanes, Ramon M., C. Rector Triadó, 94 5é1ª, 08014 BARCELONA, ES
-

- (51) MKP
A61K 9/20 2006 (97) EP 3556357
A61K 9/28 2006
A61K 9/50 2006
A61K 31/00 2006
 (96) EP 18386007.1 4/16/2018
 (97) EP 3556357, 6/3/2020 202023, en
 (54) SUSTAINED RELEASE PYRIDOSTIGMINE COMPOSITIONS
 (72) Nikolakakis, Ioannis, Evzonon 9A, 55236 Panorama Thessaloniki, GR
-

- (51) MKP
G01N 33/487 2006 (97) EP 3546935
G01N 33/50 2006
 (96) EP 18465611.4 10/24/2018
 (97) EP 3546935, 5/13/2020 202020, en
 (54) METHOD FOR IN VITRO DETECTION OF THE PROARRHYTHMOGENIC RISK OF A DRUG CANDIDATE ON HUMAN INDUCED PLURIPOTENT STEM CELL-DERIVED CARDIOMYOCYTES (HIPSC-CM)
 (71) Universitatea din Bucuresti, Bd. Mihail Kogalniceanu nr. 36-46 Sector 5, 050107 Bucharest, RO
 (72) AMUZESCU, Bogdan, Str. Ariesul Mare, nr. 7, Bl 31, Sc F, Et 1, ap 60, Sector 6, Bucuresti, RO
 RADU, Beatrice Mihaela, Calea 13 Septembrie, nr 75-79, bl 73-75, Sc A, Et 6, Ap 17, Sector 5, 050713 Bucuresti, RO
 MIHAILESCU, Dan Florin, Str. Islaz, nr. 9, Chitila, Jud. Ilfov, RO
 MANN, Stefan Alexander, Gregor-Mendel-Strasse 43, 50226 Frechen, DE
-

- (51) MKP
A61K 9/00 2006 (97) EP 3641728
A61K 9/107 2006
A61K 31/00 2006
A61K 47/14 2017
A61K 47/26 2006
A61K 47/34 2017
 (96) EP 18700437.9 1/18/2018
 (97) EP 3641728, 4/29/2020 202018, en
 (31) 17382393 (32) 23.06.2017 (33) EP
 (54) AN OIL-IN-WATER NANOEMULSION COMPOSITION OF CLOBETASOL
 (72) SANAGUSTIN AQUILUE, Javier, C. Gall 30-36, 08950 Esplugues de Llobregat, ES
 LEND NEZ GRIS, Mar a Del Carmen, C. Gall 30-36, 08950 Esplugues de Llobregat, ES
 DELGADO GA N, Maria Isabel, C. Gall 30-36, 08950 Esplugues de Llobregat, ES
-

- (51) MKP
C06B 25/20 2006 (97) EP 3642175
C06B 45/10 2006
 (96) EP 17791467.8 6/23/2017
 (97) EP 3642175, 4/29/2020 202018, en
 (54) COMPOSITION FOR SINGLE-BASE PROPELLING POWDER FOR AMMUNITION AND AMMUNITION PROVIDED WITH SUCH COMPOSITION
 (71) SIMMEL DIFESA S.p.A., Via Ariana Km. 5,2, 00034 Colferro (Roma), IT
 (72) IUDICI, Nicola, Via Edoardo Amaldi 250 A, 00134 Roma, IT
 GIROTTI, Michela, Via San Tommaso D'Aquino 13N, 00034 Colferro, Roma, IT
 LEPORE, Laura, Via Nicola Calipari 30, 00034 Colferro, Roma, IT
-

- (51) MKP
F16L 17/00 2006 (97) EP 3638992
G01F 1/66 2006
G01F 15/00 2006
G01F 25/00 2006
 (96) EP 17801186.2 11/3/2017

(97) EP 3638992, 4/22/2020 202017, en
 (31) 201715588630 (32) 06.05.2017 (33) US
 (54) PORTABLE VERIFICATION SYSTEM AND METHOD USED TO VERIFY AN IN-FIELD GAS FLOW METER
 (71) Big Elk Energy Systems, LLC, 4140 South Galveston Avenue, Tulsa, OK 74107, US
 (72) MCCLINTOCK, Dennis, 4140 South Galveston Avenue, Tulsa, OK 74107, US

(51) MKP
B60T 1/06 2006 (97) EP 3642509
B60T 1/10 2006
B60T 1/12 2006
B60T 13/06 2006
F16D 61/00 2006
F16D 63/00 2006
F16H 33/10 2006
G01C 19/00 2013
 (96) EP 17731896.1 6/21/2017
 (97) EP 3642509, 4/29/2020 202018, en
 (54) BRAKING DEVICE AND METHOD
 (72) ÖZTÜRK, Mustafa Naci, Acarlar Mah. Sülün Sok. No: 24 B-3 Günyüzü ko, 34800 Istanbul, TR

(51) MKP
B01D 53/72 2006 (97) EP 3533510
B01D 53/86 2006
 (96) EP 18159179.3 2/28/2018
 (97) EP 3533510, 5/13/2020 202020, en
 (54) AN EXHAUST GAS TREATMENT METHOD AND SYSTEM ARRANGED FOR TREATING EXHAUST GASES
 (71) Infuser IP ApS, Ole Maaløes Vej 5, 2200 Copenhagen N, DK
 (72) Rosenørn, Thomas, Carl Plougs Vej 54, 3460 Birkerød, DK
 Butcher, Andrew, Alstedvej 16, 2700 Brønshøj, DK
 Jensen, Kenth Wrist, Baunehøj 41, 4230 Lejre, DK

(51) MKP
G05B 19/042 2006 (97) EP 3534226
 (96) EP 18159820.2 3/2/2018
 (97) EP 3534226, 4/29/2020 202018, en
 (54) MODULAR CONTROL SYSTEM
 (72) Müller, Armin, Emm! solutions GmbH Egerlandstraße 60, 71263 Weil der Stadt, DE

(51) MKP
F01N 13/00 2010 (97) EP 3536921
 (96) EP 18160410.9 3/7/2018
 (97) EP 3536921, 6/17/2020 202025, en
 (54) A SYSTEM AND METHOD FOR ACCURATELY MEASURING NOX AND NH3 CONTENTS IN EXHAUST FUMES
 (71) CRMT, Parc d'affaires 3 chemin de la Brocardière, 69570 Dardilly, FR
 (72) GUIOT, Bernard, 5 rue des Maraichers, 69250 ALBIGNY SUR SAONE, FR

(51) MKP
C12Q 1/6869 2018 (97) EP 3658689
C12Q 1/6883 2018
G16B 30/00 2019
 (96) EP 17748700.6 7/26/2017
 (97) EP 3658689, 6/3/2020 202023, en
 (54) A METHOD FOR NON-INVASIVE PRENATAL DETECTION OF FETAL CHROMOSOME ANEUPLOIDY FROM MATERNAL BLOOD BASED ON BAYESIAN NETWORK
 (71) Trisomytest, s.r.o., Ilkovicova 8, 841 04 Bratislava - Karlova Ves, SK
 (72) BUDIS, Jaroslav, Bradacova 5, 85102 Bratislava, SK
 DURIS, Frantisek, Bratislavska 13, 01001 Zilina, SK
 KUCHARIK, Marcel, Lipova 8/987, 91501 Nove Mesto nad Vahom, SK
 GAZDARICA, Juraj, Pri vinohradoch 228, 83106 Bratislava, SK
 SZEMES, Tomas, Studenohorska 73, 841 03 Bratislava, SK

(51) MKP
A61J 1/20 2006 (97) EP 3654917
 (96) EP 17749625.4 7/20/2017
 (97) EP 3654917, 5/27/2020 202022, en
 (54) DRUG MIXING DEVICE
 (72) TASHJIAN, Paul, 220 Great Valley Parkway, Malvern, PA 19355, US

(51) MKP
A01G 17/06 2006 (97) EP 3672396
 (96) EP 17811730.5 8/25/2017
 (97) EP 3672396, 7/1/2020 202027, en
 (54) IMPROVED ELASTIC COMPENSATION DEVICE FOR ROWS OF PLANTS AND METHOD OF USE THEREOF
 (72) Bortolussi, Franco, Via Grigoletti 11, 33080 Fiume Veneto (PN), IT
 Bortolussi, Claudio, Via Grigoletti 3, 33080 Fiume Veneto (PN), IT

(51) MKP
A61J 1/20 2006 (97) EP 3654918
 (96) EP 17752018.6 7/20/2017
 (97) EP 3654918, 5/27/2020 202022, en
 (54) DRUG MIXING DEVICE
 (72) TASHJIAN, Paul, 220 Great Valley Parkway, Malvern PA 19355, US

(51) MKP
C12Q 1/6879 2018 (97) EP 3662479
G16B 20/00 2019
G16B 30/00 2019
 (96) EP 17754116.6 8/4/2017
 (97) EP 3662479, 6/10/2020 202024, en
 (54) A METHOD FOR NON-INVASIVE PRENATAL DETECTION OF FETAL SEX CHROMOSOMAL ABNORMALITIES AND FETAL SEX DETERMINATION FOR SINGLETON AND TWIN PREGNANCIES
 (72) DURIS, Frantisek, Bratislavská 13, 01001 Zilina, SK
 GAZDARICA, Juraj, Pri vinohradoch 228, 83106 Bratislava, SK
 KUCHARIK, Marcel, Lipová 8/987, 91501 Nové Mesto nad Váhom, SK
 HYBLOVÁ, Michaela, Tajovského 783, 90042 Miloslavov, SK
 SZEMES, Tomáš, Studenohorská 73, 84103 Bratislava, SK
 BUDIS, Jaroslav, Bradáčova 5, 85102 Bratislava, SK

(51) MKP
C08J 11/24 2006 (97) EP 3638720
C08L 67/02 2006
 (96) EP 17757575.0 6/16/2017
 (97) EP 3638720, 4/22/2020 202017, en
 (54) TREATMENT PLANT AND METHOD FOR PET GLYCOLYSIS
 (71) GREEN UNION S.R.L., Via De Chirico 4, 20900 Monza, Monza e Brianza, IT
 (72) LORENZI, Micaela, Via della Birona 58/D, 20900 Monza (Monza e Brianza), IT
 PASSONI, Ferdinando, Via Don Mario Ghiringhelli 25, 20025 Cerro Maggiore (Milano), IT

(51) MKP
A61M 5/178 2006 (97) EP 3665612
G06K 9/00 2006
G06K 9/32 2006
G06T 7/62 2017
 (96) EP 17758666.6 8/9/2017
 (97) EP 3665612, 6/17/2020 202025, en
 (54) IMAGE PROCESSING TECHNIQUES FOR PLUNGER DEPTH MEASUREMENT
 (72) MILNE, Graham F., 436 Poli Street Unit 309, Ventura, CA 93001, US
 PEARSON, Thomas Clark, 4182 Greenwood Drive, Newbury Park, CA 91320, US
 FREUND, Erwin, 12059 Pradera Road, Camarillo, CA 93012, US

(51) MKP

C02F 1/52 2006 (97) EP 3567012
C02F 1/66 2006
C02F 3/30 2006
C02F 11/04 2006
C02F 101/10 2006

- (96) EP 18000431.9 5/7/2018
 (97) EP 3567012, 6/10/2020 202024, en
 (54) METHOD FOR OPERATING A WASTEWATER TREATMENT PLANT FOR PHOSPHORUS TREATMENT OF EFFLUENT
 (71) Veolia environnement-VE, 21 rue de la Boétie, 75008 Paris, FR
 (72) Paillard, Hervé, L'Embrunchère, 86 340 Vernon, FR
 Sardet, Christophe, Jacobstrasse 21a, 04105 Leipzig, DE
 Bouchereau, Céline, Arthur-Hoffmann-Str. 78, 04275 Leipzig, DE
 Humbert, Hugues, 8 rue de Charny, 77410 Claye Souilly, FR

(51) MKP
B26D 7/18 2006 (97) EP 3656518
B26F 1/02 2006

- (96) EP 18000912.8 11/20/2018
 (97) EP 3656518, 5/27/2020 202022, en
 (54) DEVICE FOR DIE-CUTTING AND EJECTING ELASTOMER STOPPERS
 (72) Hernández Socastro, José Manuel, C/ Emilio Vargas n° 20, 4° E, 28043 Madrid, ES

(51) MKP
B26D 7/01 2006 (97) EP 3656519
B26D 7/18 2006
B26F 1/02 2006
B26F 1/38 2006

- (96) EP 18000913.6 11/20/2018
 (97) EP 3656519, 5/27/2020 202022, en
 (54) AUTOMATED DEVICE FOR MANUFACTURING ELASTOMER STOPPERS
 (71) Industrias Tecnológicas de Mecanización y Automatización, S.A., C/ Clos s/n., nave A4-A5, 08960 Sant Just Desvern (Barcelona), ES
 (72) Hernández Socastro, José Manuel, C/ Emilio Vargas n° 20, 4° E, 28043 Madrid, ES

(51) MKP
A23L 7/104 2016 (97) EP 3659444

- (96) EP 18000921.9 11/27/2018
 (97) EP 3659444, 6/3/2020 202023, en
 (54) GLUTEN-FREE GRAIN-CONCENTRATE SUBSTITUTE FOR FERMENTED WHEAT GERM FOOD PRODUCT AND METHOD OF PREPARATION
 (71) Bencze, Gyula, 21760 Woodrose Place, Salinas, CA 93908, US
 (72) The designation of the inventor has not yet been filed,

(51) MKP
B05D 3/02 2006 (97) EP 3498383
B05D 3/06 2006

- (96) EP 18020564.3 10/29/2018
 (97) EP 3498383, 4/29/2020 202018, de
 (31) 102017130241 (32) 15.12.2017 (33) DE
 102018103967 22.02.2018 DE
 (54) DEVICE FOR COATING WORKPIECES WITH AT LEAST ONE HIGH PERFORMANCE POLYMER; COATING METHOD
 (71) Eloxalwerk Ludwigsburg Helmut Zerrer GmbH, Neckartalstrasse 33, 71642 Ludwigsburg-Neckarweihingen, DE
 FRAUNHOFER-GESELLSCHAFT zur Förderung der angewandten Forschung e.V., Hansastrasse 27c, 80686 München, DE
 (72) SÄNDKER, Hendrik, Bassenhelmer Straße 80, 56218 Mülheim-Kärlich, DE
 STOLLENWERK, Jochen Dr., Von Clermontplein 30a, 6291 91 AV Yaals, NL
 ZERRER, Jorg, Neckartalstrasse 33, 71642 Ludwigsburg, DE
 BULING, Anna Dr., Silberbergstrasse 1a, 49076 Osnabrück, DE

(51) MKP
B05D 5/08 2006 (97) EP 3508283

- (96) EP 18020592.4 11/12/2018
 (97) EP 3508283, 5/13/2020 202020, de
 (31) 102017130241 (32) 15.12.2017 (33) DE

102017011842

18.12.2017

DE

(54) COATING DISPERSION; METHOD OF MANUFACTURING A COATING DISPERSION
(72)

(51) MKP
G03G 15/00 2006 (97) EP 3543793
G03G 21/16 2006
G03G 21/18 2006

(96) EP 18209121.5 11/29/2018

(97) EP 3543793, 4/29/2020 202018, en

(31) 2017238455 (32) 13.12.2017 (33) JP

(54) IMAGE FORMING APPARATUS AND CARTRIDGE

(72) MURAKAMI, Ryuta, c/o CANON KABUSHIKI KAISHA, 30-2, Shimomaruko 3-chome, Ohta-ku,, Tokyo, 146-8501, JP
MATSUMARU, Naoki, c/o CANON KABUSHIKI KAISHA, 30-2, Shimomaruko 3-chome, Ohta-ku,, Tokyo, 146-8501, JP
HORIKAWA, Tadashi, c/o CANON KABUSHIKI KAISHA, 30-2, Shimomaruko 3-chome, Ohta-ku,, Tokyo, 146-8501, JP
SUZUKI, Tetsuji, c/o CANON KABUSHIKI KAISHA, 30-2, Shimomaruko 3-chome, Ohta-ku,, Tokyo, 146-8501, JP

(51) MKP
C40B 40/10 2006 (97) EP 3540100
C40B 50/00 2006

(96) EP 18210289.7 9/27/2012

(97) EP 3540100, 5/27/2020 202022, en

(31) 201161539670 P (32) 27.09.2011 (33) US

(54) FIBRONECTIN TYOE III REPEAT BASED PROTEIN SCAFFOLDS WITH ALTERNATIVE BINDING SURFACES

(72) Diem, Michael, 1400 McKean Road, Spring House, PA 19044, US
Jacobs, Steven, 1400 McKean Road, Spring House, PA 19477, US

(51) MKP
A61K 38/12 2006 (97) EP 3527218

(96) EP 18211167.4 6/9/2012

(97) EP 3527218, 4/1/2020 202014, en

(31) 201261600237 P (32) 17.02.2012 (33) US

201161496543 P

13.06.2011

US

201161496540 P

13.06.2011

US

201161495818 P

10.06.2011

US

201161496542 P

13.06.2011

US

201261605540 P

01.03.2012

US

201161496541 P

13.06.2011

US

(54) PRO-COAGULANT COMPOUNDS AND METHODS OF USE THEREOF

(72) THORN, Karina, 49 North Main St., Newmarket, NH 03857, US
TOBY, Garabet G., 9 School Hill Lane, North Reading, MA 01864, US
MEZO, Adam R., 86 Arch Street, Needham, MA 02492, US

(51) MKP
C12N 15/10 2006 (97) EP 3540059

(96) EP 18211739.0 4/16/2011

(97) EP 3540059, 4/22/2020 202017, en

(31) 32516010 P (32) 16.04.2010 (33) US

PA201070149

16.04.2010

DK

(54) BI-FUNCTIONAL COMPLEXES AND METHODS FOR MAKING AND USING SUCH COMPLEXES

(72) GOULIAEV, Alex Haahr, Brøndsted 223, 3670 Veksø, DK
FRANCH, Thomas, Tjørnevej 26, 3070 Snekkersten, DK
GODSKESEN, Michael Anders, Plantagekrogen 8, 2950 Vedbæk, DK
JENSEN, Kim Birkebæk, Voldumvej 30C, 2610 Rødovre, DK

(51) MKP
A01G 5/06 2006 (97) EP 3666070
A01N 3/02 2006

(96) EP 18212002.2 12/12/2018

(97) EP 3666070, 6/17/2020 202025, de

- (54) METHOD FOR PRESERVATION OF AT LEAST ONE CUT FLOWER FOR TRANSPORT PURPOSES AND CUT FLOWER OBTAINED BY THE METHOD
 (72) Benscheld, Jörn, c/o Lidl Stiftung & Co. KG Stiftsbergstraße 1, 74172 Neckarsulm, DE
-

- (51) MKP
A61N 5/10 2006 (97) EP 3573075
G21K 1/093 2006
G21K 5/04 2006
 (96) EP 18173426.0 5/21/2018
 (97) EP 3573075, 7/1/2020 202027, en
 (54) A GANTRY AND APPARATUS FOR FOCUSING BEAMS OF CHARGED PARTICLES
 (71) CERN - European Organization For Nuclear Research, 1211 Geneva 23, CH
 (72) BOTTURA, Luca, Chemin de Riondet 3, CH-1291 Commugny, CH
-

- (51) MKP
B01F 3/10 2006 (97) EP 3574989
B01F 5/06 2006
B01F 15/02 2006
B05B 7/04 2006
B29B 7/74 2006
 (96) EP 18174921.9 5/29/2018
 (97) EP 3574989, 4/1/2020 202014, en
 (54) DISPENSING SYSTEM FOR MIXTURE OF TWO COMPONENTS AND STATIC MIXING NOZZLE THEREFOR
 (71) SOUDAL, Everdongenlaan 18-20, 2300 Turnhout, BE
 (72) GEBOES, Peter, Everdongenlaan 18-20, 2300 Turnhout, BE
 BOEYKENS, Ivan, Everdongenlaan 18-20, 2300 Turnhout, BE
 DUIJSTERS, Thomas, Everdongenlaan 18-20, 2300 Turnhout, BE
 SICHEN, Lieven, Everdongenlaan 18-20, 2300 Turnhout, BE
-

- (51) MKP
A61K 39/395 2006 (97) EP 3539984
A61P 35/00 2006
C07K 16/28 2006
 (96) EP 18193013.2 5/11/2012
 (97) EP 3539984, 4/22/2020 202017, en
 (54) METHODS OF TREATING CONDITIONS WITH ANTIBODIES THAT BIND COLONY STIMULATING FACTOR 1 RECEPTOR (CSF1R)
 (72) WONG, Brian, Two Corporate Drive, South San Francisco, CA 94080, US
 MASTELLER, Emma, Two Corporate Drive, South San Francisco, CA 94080, US
 WONG, Justin, Two Corporate Drive, South San Francisco, CA 94080, US
 LIN, Haishan, Two Corporate Drive, South San Francisco, CA 94080, US
-

- (51) MKP
A61K 31/4412 2006 (97) EP 3483143
A61P 35/00 2006
C07D 211/40 2006
C07D 279/02 2006
C07D 401/04 2006
C07D 401/06 2006
C07D 401/12 2006
C07D 407/04 2006
C07D 407/06 2006
C07D 409/04 2006
C07D 413/06 2006
C07D 417/06 2006
C07D 471/20 2006
C07D 498/08 2006
C07D 498/20 2006
 (96) EP 18197155.7 6/3/2011
 (97) EP 3483143, 4/15/2020 202016, en
 (31) 35182710 P (32) 04.06.2010 (33) US
 35232210 P 07.06.2010 US
 201161452578 P 14.03.2011 US
 (54) PIPERIDINONE DERIVATIVES AS MDM2 INHIBITORS FOR THE TREATMENT OF CANCER

- (72) Bartberger, Michael David, 4471 Ventura Canyon Avenue D-105, Sherman Oaks, CA 91423, US
 Gonzalez Buenrostro, Ana, 1409 Pershing Avenue, San Mateo, CA 94403, US
 Beck, Hilary Place, 115 Springdale Way, Emerald Hills, CA 94062, US
 Chen, Xiaoqi, 970 Blair Court, Palo Alto, CA 94303, US
 Connors, Richard Victor, 935 Crespi Drive, Pacifica, CA 94044, US
 Deignan, Jeffrey, 500 29th Street, San Francisco, CA 94131, US
 Duquette, Jason A., 460 Bayview Avenue, Millbrae, CA 90403, US
 Eksterowicz, John, 1845 Church Street, San Francisco, CA 94131, US
 Fisher, Benjamin, 1020 Yates Way Apt. 313, San Mateo, CA 94403, US
 Fox, Brian Matthew, 124 Swallowtail Court, Brisbane, CA 94005, US
 Fu, Jiasheng, 221 Pelican Court, Foster City, CA 94404, US
 Fu, Zice, 788 Santa Maria Lane, Foster City, CA 94404, US
 Gonzalez Lopez de Turiso, Felix, 10 De Sabla Road Apt. 509, San Mateo, CA 94402, US
 Gribble, Jr., Michael William, 11 Walter Terrace, Abt. One, Somerville, MA 02145, US
 Gustin, Darin James, 433 Kehoe Avenue, Half Moon, CA 94019, US
 Heath, Julie Anne, 6 Ivy Drive, Orinda, CA 94563, US
 Huang, Xin, 16 Abbott Road, Wellesly, MA 02481, US
 Jiao, Xianjun, 2603 All View Way, Belmont, CA 94002, US
 Johnson, Michael, 409 Clipper Street, San Francisco, CA 94114, US
 Kayser, Frank, 4150, 17th Street, Apt. 25, San Francisco, CA 94114, US
 Kopecky, David John, 548 Brannan Street 200, San Francisco, CA 94107, US
 Lai, Sujen, 1439 Floribunda Avenue 15, Burlingame, CA 94010, US
 Li, Yihong, 821 Taylor Boulevard, Millbrae, CA 94030, US
 Li, Zhihong, 467 Anita Drive, Millbrae, CA 94030, US
 Liu, Jiwen, 250 Trysail Court, Foster City, CA 94404, US
 Low, Jonathan Dante, 18644 Clark Street 5, Tarzana, CA 91356, US
 Lucas, Brian Stuart, 133 10th Avenue, San Francisco, CA 94118, US
 Ma, Zhihua, 733 Celestial Lane, Foster City, CA 94404, US
 McGee, Lawrence R., 39 Big Sur Way, Pacifica, CA 94044, US
 McIntosh, Joel, 540 Fremont Avenue, Pacifica, CA 94044, US
 McMinn, Dustin, 255 Kent Road, Pacifica, CA 94044, US
 Medina, Julio Cesar, 1407 Cedar Street, San Carlos, CA 94070, US
 Mihalic, Jeffrey Thomas, 300 3rd Street 523, San Francisco, CA 94107, US
 Olson, Steven Howard, 406 Green Hills Drive, Millbrae, CA 94030, US
 Rew, Yosup, 828 Juno Lane, Foster City, CA 94404, US
 Roveto, Philip Marley, 500 29th Street, San Francisco, CA 94131, US
 Sun, Daqing, 804 Cortez Lane, Foster City, CA 94404, US
 Wang, Xiaodong, 821 Taylor Boulevard, Millbrae, CA 94030, US
 Wang, Yingcai, 860 Helen Drive, Millbrae, CA 94030, US
 Yan, Xuelei, 1120 Nimitz Lane, Foster City, CA 94404, US
 Yu, Ming, 42 Williams Lane, Foster City, CA 94404, US
 Zhu, Jiang, 747 Coastland Drive, Palo Alto, CA 94303, US

- (51) MKP
A62C 37/11 2006 (97) EP 3650829
G01M 99/00 2011

(96) EP 19152517.9 1/18/2019

(97) EP 3650829, 5/13/2020 202020, de

(31)	18205130	(32)	08.11.2018	(33)	EP
	18214200		19.12.2018		EP

(54) TEST SYSTEM FOR PERFORMING A FIRE RESISTANCE PERIOD TEST FOR A WATER FLOW VALVE

(71) VdS Schadenverhütung GmbH, Amsterdamer Strasse 174, 50735 Köln, DE

(72)

- (51) MKP
A61K 39/395 2006 (97) EP 3520816
A61P 35/00 2006
C07K 16/30 2006
C07K 16/40 2006

(96) EP 19153014.6 10/22/2010

(97) EP 3520816, 5/20/2020 202021, en

(31)	25447409 P	(32)	23.10.2009	(33)	US
------	------------	------	------------	------	----

(54) ANTI-GCC ANTIBODY MOLECULES AND RELATED COMPOSITIONS AND METHODS

(72) NAM, Samuel, S., 92 Blaisdell Street, Haverhill, MA 01832, US

GREENFIELD, Edward, A., 160 Poskus Street, Stoughton, MA 02072, US

BABCOOK, John, 4480 West 12th Avenue, Vancouver, BC V6R 2R2, CA
 O'KEEFE, Theresa, 20 Richgrain Avenue, Waltham, MA 02453, US
 QIN, Shixin, 14 Tuft Avenue, Lexington, MA 02421, US

- (51) MKP
G01N 33/569 2006 (97) EP 3511717
G01N 33/68 2006
G01T 1/00 2006
- (96) EP 19153115.1 9/28/2012
 (97) EP 3511717, 4/29/2020 202018, en
 (31) 201161540584 P (32) 29.09.2011 (33) US
- (54) BIODOSIMETRY PANELS AND METHODS
 (71) Meso Scale Technologies, LLC., 1601 Research Boulevard, Rockville, MD 20850, US
 (72) BLAKELY, William, 4503 Gridley Road, Silver Spring, MD 20906, US
 GLEZER, Eli, 13746 Durango Drive, Del Mar, CA 92014, US
 KENTEN, John, 21021 Sugar Ridge Terrace, Boyds, MD 20841, US
 KUMAR, Sudeep, 20427 Ivybridge Ct., Gaithersburg, MD 20886, US
 MATHEW, Anu, 13925 Riding Loop Drive, North Potomac, MD 20878, US
 OSSETROVA, Natalia I., 4309 Emden Street, Silver Spring, MD 20906, US
 SIGAL, George, 5333 Trailway Drive, Rockville, MD 20853, US

- (51) MKP
A61K 39/395 2006 (97) EP 3530287
A61P 17/06 2006
A61P 25/00 2006
A61P 35/00 2006
C07K 16/30 2006
- (96) EP 19155167.0 9/9/2013
 (97) EP 3530287, 6/10/2020 202024, en
 (31) 201261698916 P (32) 10.09.2012 (33) US
 201261797179 P 30.11.2012 US
 201261797356 P 05.12.2012 US
- (54) ANTI-MCAM ANTIBODIES AND ASSOCIATED METHODS OF USE
 (72) FLANAGAN, Kenneth, 742 Palmera Ct, Alameda, CA 94501, US
 BAKER, Jeanne, 3878 Farm Hill Boulevard, Redwood City, California 94061, US
 YEDNOCK, Theodore A., P.O. Box 831, Forest Knolls, California 94933, US

- (51) MKP
A61K 38/36 2006 (97) EP 3552619
A61K 38/48 2006
A61K 39/395 2006
A61P 7/04 2006
- (96) EP 19156074.7 7/11/2011
 (97) EP 3552619, 5/20/2020 202021, en
 (31) 36306410 P (32) 09.07.2010 (33) US
 201161442079 P 11.02.2011 US
 201161430819 P 07.01.2011 US
 201161438572 P 01.02.2011 US
 201161470951 P 01.04.2011 US
 201061424555 P 17.12.2010 US
- (54) FACTOR IX POLYPEPTIDES AND METHODS OF USE THEREOF
 (72) PIERCE, Glenn, 14 Cambridge Center, Cambridge, MA Massachusetts 02142, US
 TRUEX, Samantha, 101 Longfellow Road, Sudbury, MA Massachusetts 01776, US
 PETERS, Robert, T., 51 New Field Street, West Roxbury, MA Massachusetts 02132, US
 JIANG, Haiyan, 3 Bayberry Lane, Belmont, MA Massachusetts 02478, US

- (51) MKP
A61B 17/068 2006 (97) EP 3508142
A61B 17/072 2006
- (96) EP 19156722.1 9/1/2015
 (97) EP 3508142, 6/24/2020 202026, en
 (31) 201414474750 (32) 02.09.2014 (33) US
- (54) DEVICES FOR FACILITATING CLOSING AND CLAMPING OF AN END EFFECTOR OF A SURGICAL DEVICE

(72) SHELTON, IV, Frederick E., 245 East Main Street, Hillsboro, OH Ohio 45133, US
 SCHELLIN, Emily A., 11919 Snider Road, Cincinnati, OH Ohio 45249, US
 SWAYZE, Jeffrey S., 7047 Birchley Drive, Hamilton, OH Ohio 45011, US
 HARRIS, Jason L., 5435 Hamilton Road, Levanon, OH Ohio, US
 MORGAN, Jerome R., 3275 South Whitetree Circle, Cincinnati, OH Ohio 45236, US

(51) MKP
C07D 207/26 2006 (97) EP 3536685

(96) EP 19157789.9 3/26/2015
 (97) EP 3536685, 4/15/2020 202016, en
 (31) 201461975473 P (32) 04.04.2014 (33) US

(54) BICYCLIC-FUSED HETEROARYL OR ARYL COMPOUNDS AND THEIR USE AS IRAK4 INHIBITORS
 (72) ANDERSON, David Randolph, 32 Fawn Run, Salem, CT 06420, US
 BUNNAGE, Mark Edward, 39 Southfield Circle, Concord, MA 01742, US
 CURRAN, Kevin Joseph, 18 Grouser Road, Somerset, NJ 08873, US
 DEHNHARDT, Christoph Martin, 1803-4400 Buchanan Street, Burnaby, British Columbia V5C 0E3, CA
 GAVRIN, Lori Krim, 306 Clairemont Road, Villanova, PA 19085, US
 GOLDBERG, Joel Adam, 2116 Short Street, New Orleans, LA 70118, US
 HAN, Seungil, 286 Deerfield Ridge Drive, Mystic, CT 06355, US
 HEPWORTH, David, 282 Sudbury Road, Concord, MA 01742, US
 HUANG, Horng-Chih, 1126 Nooning Tree Drive, Chesterfield, MO 63017, US
 LEE, Arthur, 7400 Damascus Road, Gaithersburg, MD 20882, US
 LEE, Katherine Lin, 167 Adams Avenue, West Newton, MA 02465, US
 LOVERING, Frank Eldridge, 2 Sutton Place, Acton, MA 01720, US
 LOWE, Michael Dennis, 4 Martine Avenue 118, White Plains, NY 10606, US
 MATHIAS, John Paul, 1338 Main Street, Concord, MA 01742, US
 PAPAIOANNOU, Nikolaos, 743 East 4th Street, Boston, MA 02127, US
 PATNY, Akshay, 600 Trapelo Road Unit 11, Waltham, MA 02452, US
 PIERCE, Betsy Susan, 237 Grassy Hill Road, East Lyme, CT 06333, US
 SAIHAH, Eddine, 19 Kenwood Street, Brookline, MA 02446, US
 STROHBACH, Joseph Walter, 114 Crockett Creek, Wentzville, MO 63385, US
 TRZUPEK, John David, 55 Station Landing 515, Medford, MA 02155, US
 VARGAS, Richard, 12 Jonathan Lane, Bedford, MA 01730, US
 WANG, Xiaolun, 13572 Golden Cypress Place, San Diego, CA 92130, US
 WRIGHT, Stephen Wayne, 1 Whitman Lane, Old Lyme, CT 06371, US
 ZAPF, Christoph Wolfgang, 48 Kinder Circle, Marlborough, MA 01752, US

(51) MKP
B65B 9/06 2012 (97) EP 3539882
B65B 9/20 2012
B65B 31/04 2006

(96) EP 19157821.0 2/18/2019
 (97) EP 3539882, 4/22/2020 202017, de
 (31) 102018002058 (32) 14.03.2018 (33) DE

(54) DEVICE FOR PACKAGING PRODUCTS
 (71) Messer Belgium N.V., Nieuwe Weg 1-Haven 1053, 2070 Zwijndrecht, BE
 (72) CLAEYS, Jean-Claude, Messer Belgium N.V. Post X Gebouw 28 Borsbeeksebrug 28, 2600 Berchem, BE

(51) MKP
F25D 3/10 2006 (97) EP 3550225

(96) EP 19157971.3 2/19/2019
 (97) EP 3550225, 5/20/2020 202021, de
 (31) 102018002750 (32) 06.04.2018 (33) DE

(54) DEVICE FOR COOLING PRODUCTS
 (72) Castel, Jean Michel, 33C avenue Jean Jaures, 78390 Bois-d'Arcy, FR
 Follut, Florian, 29 Rue Victor Hugo, 69330 Meyzieu, FR
 Tebib, Emir, 17 Allee d'Apollon, 77410 Gressy, FR

(51) MKP
A01N 43/80 2006 (97) EP 3560923
A01N 43/90 2006
A61K 31/437 2006

	A61K 38/05	2006				
	A61K 45/06	2006				
	A61P 33/00	2006				
	C07D 471/04	2006				
(96)	EP 19158131.3 12/16/2010					
(97)	EP 3560923, 5/27/2020 202022, en					
(31)	28754509 P		(32)	17.12.2009	(33)	US
(54)	ANTI PARASITIC DIHYDROAZOLE COMPOUNDS AND COMPOSITIONS COMPRISING SAME					
(72)	LE HIR DE FALLOIS, Loic Patrick, 2259 Fairhaven Circle NE, Atlanta, GA 30305, US LEE, Hyoung Lk, 103 Roundtop Road, Cary, NC 27519, US WILKINSON, Douglas Edward, 536 Rodney Bay Crossing, Wake Forest, NC 27587, US BECK, Brent Christopher, 710 Straywhite Avenue, Apex, NC 27539, US					
<hr/>						
(51)	MKP					
	A61K 31/44	2006	(97) EP 3546461			
	A61K 31/519	2006				
	A61K 45/06	2006				
	A61P 35/00	2006				
	C07D 471/14	2006				
(96)	EP 19158371.5 9/12/2014					
(97)	EP 3546461, 5/6/2020 202019, en					
(31)	201361904718 P		(32)	15.11.2013	(33)	US
	201414208657			13.03.2014		US
	201414341392			25.07.2014		US
	PCT/US2014/048241			25.07.2014		WO
(54)	7-BENZYL-4-(2-METHYLBENZYL)-2,4,6,7,8,9-HEXAHYDROIMIDAZO[1,2-A]PYRIDO[3,4-E]PYRIMIDIN-5(1H)-ONE, SALTS THEREOF AND METHODS OF USING THE SAME IN COMBINATION THERAPY					
(71)	Oncocoetics, Inc., 3675 Market Street Suite 200, Philadelphia, PA 19104, US					
(72)	STOGNIEW, Martin, 1870 Ferguson Lane, Blue Bell, PA Pennsylvania 19422, US ALLEN, Joshua E., 43 Chestnut St., Unit 311, New Haven, CT Connecticut 06511, US POTTORF, Richard S., 7550 Prairie View Dr., Indianapolis, IN Indiana 46526, US NALLAGANCHU, Bhaskara Rao, 99 Nostrand Road, Hillsborough, NJ New Jersey 08852, US OLSON, Gary L., 1505 Coles Avenue, Mountainside, NJ New Jersey 07092, US					
<hr/>						
(51)	MKP					
	F21V 29/70	2015	(97) EP 3640536			
	F21V 29/85	2015				
	F21W 131/103	2006				
	F21Y 115/10	2016				
(96)	EP 17909235.8 12/26/2017					
(97)	EP 3640536, 4/22/2020 202017, en					
(31)	201720516122 U		(32)	10.05.2017	(33)	CN
(54)	GRAPHENE HEAT-DISSIPATION LED LAMP					
(72)	LI, Heran, N°9, Huanghe Road Shijiazhuang High-tech Industrial Development Area, Shijiazhuang,, Hebei 050035, CN LI, Qing, N°9, Huanghe Road Shijiazhuang High-tech Industrial Development Area, Shijiazhuang,, Hebei 050035, CN CHEN, Wei, N°9, Huanghe Road Shijiazhuang High-tech Industrial Development Area, Shijiazhuang,, Hebei 050035, CN					
<hr/>						
(51)	MKP					
	F02C 6/00	2006	(97) EP 3640449			
(96)	EP 17911475.6 6/1/2017					
(97)	EP 3640449, 4/22/2020 202017, en					
(54)	STAGED COLD ENERGY STORAGE TYPE SUPERCRITICAL COMPRESSED AIR ENERGY STORAGE SYSTEM AND METHOD					
(71)	Institute Of Engineering Thermophysics, Chinese Academy Of Sciences, 11 Beisihuanxi Road Haidian District, Beijing 100190, CN					
(72)	LIN, Xipeng, No.11 Beisihuanxi Road Haidian District, Beijing 100190, CN WANG, Liang, No.11 Beisihuanxi Road Haidian District, Beijing 100190, CN CHEN, Haisheng, No.11 Beisihuanxi Road Haidian District, Beijing 100190, CN XIE, Ningning, No.11 Beisihuanxi Road Haidian District, Beijing 100190, CN YANG, Zheng, No.11 Beisihuanxi Road Haidian District, Beijing 100190, CN					
<hr/>						
(51)	MKP					
	F16M 11/12	2006	(97) EP 3636980			
(96)	EP 17912314.6 11/2/2017					

(97) EP 3636980, 4/15/2020 202016, en
 (31) 201720612395 U (32) 30.05.2017 (33) CN
 (54) HANGING TYPE POSITIONING AND SUPPORTING DEVICE FOR LASER LEVEL
 (71) Zhejiang Shijing Tools Co., Ltd, Changan Street 256-1 XuMin Jiangbin Industrial Zone Tongqin Town WuYi County, Jinhua, Zhejiang 321200, CN
 (72) XU, Min, Changan Street 256-1 XuMin Jiangbin Industrial Zone Tongqin Town WuYi County, Jinhua Zhejiang 321200, CN

(51) MKP
G06F 3/01 2006 (97) EP 3639114
G06Q 30/00 2012
 (96) EP 17913521.5 6/15/2017
 (97) EP 3639114, 4/22/2020 202017, en
 (54) SYSTEM AND METHOD OF INSTANTLY PREVIEWING IMMERSIVE CONTENT
 (72) JOSHI, Dhaval Jitendra, 35/F., Tencent Building Kejizhongyi Road Midwest District of Hi-tech Park Nanshan District, Shenzhen Guangdong 518057, CN
 CHEN, Jingzhou, 35/F., Tencent Building Kejizhongyi Road Midwest District of Hi-tech Park Nanshan District, Shenzhen Guangdong 518057, CN
 CHEN, Xiaomei, 35/F., Tencent Building Kejizhongyi Road Midwest District of Hi-tech Park Nanshan District, Shenzhen Guangdong 518057, CN
 WU, Wenjie, 35/F., Tencent Building Kejizhongyi Road Midwest District of Hi-tech Park Nanshan District, Shenzhen Guangdong 518057, CN

(51) MKP
E04D 12/00 2006 (97) EP 3650611
F24S 25/61 2018
H02S 20/23 2014
 (96) EP 17916551.9 7/7/2017
 (97) EP 3650611, 5/13/2020 202020, en
 (54) SUPPORT FOR ROOF PANELS
 (71) Galan Martin, Antonio, Mochuelo 2, 28750 San Agustin de Guadalix, ES
 (72) Galan Martin, Antonio, Mochuelo 2, 28750 San Agustin de Guadalix, ES

(51) MKP
G06T 15/00 2011 (97) EP 3675488
H04N 13/00 2018
 (96) EP 17922767.3 8/24/2017
 (97) EP 3675488, 7/1/2020 202027, en
 (54) METHOD FOR RECORDING VIDEO ON THE BASIS OF A VIRTUAL REALITY APPLICATION, TERMINAL DEVICE, AND STORAGE MEDIUM
 (72) CHEN, Yang, 35/F, Tencent Building Kejizhongyi Road, Midwest District of Hi-tech Park, Nanshan District, Shenzhen Guangdong 518057, CN
 HUANG, Yuchuan, 35/F, Tencent Building, Kejizhongyi Road, Midwest District of Hi-tech Park, Nanshan District, Shenzhen Guangdong 518057, CN
 SHEN, Xiaobin, 35/F, Tencent Building, Kejizhongyi Road, Midwest District of Hi-tech Park, Nanshan District, Shenzhen Guangdong 518057, CN
 MAI, Weiqiang, 35/F, Tencent Building, Kejizhongyi Road, Midwest District of Hi-tech Park, Nanshan District, Shenzhen Guangdong 518057, CN

(51) MKP
A61K 31/519 2006 (97) EP 3634419
A61P 15/00 2006
 (96) EP 18731976.9 6/5/2018
 (97) EP 3634419, 4/15/2020 202016, en
 (31) 201762515232 P (32) 05.06.2017 (33) US
 (54) GONADOTROPIN-RELEASING HORMONE ANTAGONIST DOSING REGIMENS FOR TREATING UTERINE FIBROIDS AND REDUCING MENSTRUAL BLOOD LOSS
 (72) LOUMAYE, Ernest, 29 Chemin de la Planta, 1223 Cologny, CH
 GOTTELAND, Jean-Pierre, 9 Rue Charles Humbert, 1205 Geneva, CH
 POHL, Oliver, c/o ObsEva S.A. Chemin des Aulx 12, 1228 Plan-les-Ouates, CH

(51) MKP
A61K 39/00 2006 (97) EP 3635005
C07K 16/28 2006
C07K 16/30 2006
 (96) EP 18731987.6 6/7/2018
 (97) EP 3635005, 4/15/2020 202016, en
 (31) 201762516489 P (32) 07.06.2017 (33) US
 201862614801 P 08.01.2018 US
 (54) THERAPEUTIC ANTIBODIES BASED ON MUTATED IGG HEXAMERS

(72) JENSEN, Mette, Hamborg, Thoravej 14 3 -2, 2400 Copenhagen NV, DK
 HARLOW, Lene, Schantz, Stockflethsvej 7 1.th., 2000 Frederiksberg, DK
 HAGARMAN, Andrew, 4517 Lazyriver Dr., Durham, NC 27712, US
 HALBLEIB, Cale, 208 Kings Castle Dr., Apex, NC 27502, US

(51) MKP
A61P 17/10 2006 (97) EP 3642230
C07K 16/18 2006
 (96) EP 18732016.3 6/13/2018
 (97) EP 3642230, 4/29/2020 202018, en
 (31) 17177657 (32) 23.06.2017 (33) EP
 17189938 07.09.2017 EP
 (54) TREATMENT OF INFLAMMATORY DISEASES WITH INHIBITORS OF C5A ACTIVITY
 (72) GUO, Renfeng, 821 Gallery Lane Ann Arbor, Miami, Florida 48103, US
 RIEDEMANN, Niels R, ber den Teufelslöchern 7, 07749 Jena, DE

(51) MKP
A61K 9/19 2006 (97) EP 3638273
A61K 31/19 2006
A61K 31/192 2006
A61K 31/194 2006
A61K 31/203 2006
A61K 35/74 2015
A61K 35/745 2015
A61K 35/747 2015
A61P 25/00 2006
A61P 25/28 2006
 (96) EP 18732044.5 6/14/2018
 (97) EP 3638273, 4/22/2020 202017, en
 (31) 201709468 (32) 14.06.2017 (33) GB
 201709534 15.06.2017 GB
 201712851 10.08.2017 GB
 201803826 09.03.2018 GB
 201805991 11.04.2018 GB
 201805990 11.04.2018 GB
 201805989 11.04.2018 GB
 201806779 25.04.2018 GB
 201806780 25.04.2018 GB
 (54) COMPOSITIONS COMPRISING BACTERIAL STRAINS
 (72) MULDER, Imke Elisabeth, c/o 4D Pharma Research Limited Life Sciences Innovation Building Cornhill Road, Aberdeen Aberdeenshire AB25 2ZS, GB
 ETTORRE, Anna, c/o 4D Pharma Research Limited Life Sciences Innovation Building Cornhill Road, Aberdeen Aberdeenshire AB25 2ZS, GB
 AHMED, Suaad, c/o 4D Pharma Research Limited Life Sciences Innovation Building Cornhill Road, Aberdeen Aberdeenshire AB25 2ZS, GB
 FOTIADOU, Parthena, c/o 4D Pharma Research Limited Life Sciences Innovation Building Cornhill Road, Aberdeen Aberdeenshire AB25 2ZS, GB
 YUILLE, Samantha, 27 Auchmill Terrace Bucksburn, Aberdeen Aberdeenshire AB21 9LF, GB
 URCIA, Joseph Roby Iringan, c/o 4D Pharma Research Limited Life Sciences Innovation Building Cornhill Road, Aberdeen Aberdeenshire AB25 2ZS, GB
 SAVIGNAC, Helene, c/o 4D Pharma Research Limited Life Sciences Innovation Building Cornhill Road, Aberdeen Aberdeenshire AB25 2ZS, GB

(51) MKP
A61K 39/00 2006 (97) EP 3638696
C07K 16/28 2006
 (96) EP 18732064.3 6/18/2018
 (97) EP 3638696, 4/22/2020 202017, en
 (31) 201709677 (32) 16.06.2017 (33) GB
 (54) USE OF ANTI CD70 ANTIBODY ARGX-110 TO TREAT ACUTE MYELOID LEUKAEMIA
 (71) University of Bern, Hochschulstrasse 4, 3012 Bern, CH
 (72) LEUPIN, Nicolas, c/o argenx BVBA Industriepark Zwijnaarde 7 Building C, B-9052 Gent, BE
 VAN ROMPAEY, Luc, c/o argenx BVBA Industriepark Zwijnaarde 7 Building C, B-9052 Gent, BE
 DE HAARD, Hans, c/o argenx BVBA Industriepark Zwijnaarde 7 Building C, B-9052 Gent, BE
 OCHSENBEIN, Adrian, Breitenrain 28, 3032 Hinterkappelen, CH
 RIETHER, Carsten, Gesellschaftsstrasse 44, 3012 Bern, CH

(51) MKP
A41D 19/00 2006 (97) EP 3635038
A61B 42/10 2016
A61F 6/04 2006
B32B 27/30 2006
C08J 3/24 2006
C08J 3/28 2006
C08L 25/08 2006
C08L 53/02 2006
(96) EP 18732150.0 5/28/2018
(97) EP 3635038, 4/15/2020 202016, en
(31) PI2017702080 (32) 06.06.2017 (33) MY
(54) **CROSSLINKED STYRENIC BLOCK COPOLYMER**
(71) **TOP GLOVE GLOBAL SDN BHD**, Level 21, Top Glove Tower 16 Persiaran Setia Dagang Setia Alam, Seksyen U13, 40170 Shah Alam, MY
(72) **TREILHES, Sebastien**, Vertiq 18-06 Persiaran Tunku Kudin, 11700 Gelugor Pulau Pinang, MY
HOERNER, Pierre, 4 Grande Rue, 60660 Maysel, FR
LOW, Chin Guan, 41 Jalan Langgak Tunku Taman Tunku, 50480 Kuala Lumpur, MY

(51) MKP
A61K 39/395 2006 (97) EP 3630824
C07K 16/24 2006
(96) EP 18732488.4 5/24/2018
(97) EP 3630824, 7/1/2020 202027, en
(31) 201762511441 P (32) 26.05.2017 (33) US
(54) **BIOPHARMACEUTICAL COMPOSITIONS AND RELATED METHODS**
(72) **GRANT, Steven**, GSK Gunnels Wood Road, Stevenage Hertfordshire SG 1 2NY, GB
AKINSEYE, Chika, Gunnels Wood Road, Stevenage Hertfordshire SG12NY, GB
BHINDER, Tejinder, Gunnels Wood Road, Stevenage Hertfordshire SG12NY, GB
HOOK, Laura, Gunnels Wood Road, Stevenage Hertfordshire SG12NY, GB
LEWIS, Alan Peter, Gunnels Wood Road, Stevenage Hertfordshire SG12NY, GB
ORECCHIA, Martin, 34 Uplands Avenue, Hitchin SG4 9NH, GB

(51) MKP
A61K 31/47 2006 (97) EP 3630726
A61P 35/00 2006
C07D 215/22 2006
(96) EP 18732548.5 5/26/2018
(97) EP 3630726, 4/15/2020 202016, en
(31) 201762511714 P (32) 26.05.2017 (33) US
(54) **CRYSTALLINE SOLID FORMS OF SALTS OF N-{4-[(6,7-DIMETHOXYQUINOLIN-4-YL) OXY]PHENYL}-N'-(4-FLUOROPHENYL) CYCLOPROPANE-1,1-DICARBOXAMIDE, PROCESSES FOR MAKING, AND METHODS OF USE**
(72) **SHAH, Khalid**, 281 Eagle Trace Drive, Half Moon Bay, CA 94019, US

(51) MKP
A61K 39/395 2006 (97) EP 3638305
C07K 16/28 2006
(96) EP 18732724.2 6/15/2018
(97) EP 3638305, 4/22/2020 202017, en
(31) 201709554 (32) 15.06.2017 (33) GB
201718589 10.11.2017 GB
(54) **METHOD FOR THE TREATMENT OF IMMUNE THROMBOCYTOPENIA**
(72) **LLEDO-GARCIA, Rocio**, c/o IPD UCB Celltech 208 Bath Road, Slough Berkshire SL1 3WE, GB
LANGDON, Grant, c/o Advantage Resourcing UK Limited Matrix House Basing View, Basingstoke Hampshire RG21 4FF, GB
KIESSLING, Claus Peter, c/o IPD UCB Biosciences GmbH Alfred-Nobel-Strasse 10, 40789 Monheim am Rhein, DE
SNIPES, Rose Gunter, c/o UCB Biosciences Inc. 1209 Orange Street, Wilmington Delaware 19801, US
MASSOW, Ute, c/o IPD UCB Biosciences GmbH Alfred-Nobel-Strasse 10, 40789 Monheim am Rhein, DE

(51) MKP
A61K 31/502 2006 (97) EP 3649119
A61P 29/00 2006
C07D 401/14 2006

C07D 403/04 2006
C07D 403/14 2006
C07D 405/14 2006
C07D 409/14 2006
C07D 471/04 2006

- (96) EP 18732777.0 6/21/2018
 (97) EP 3649119, 5/13/2020 202020, en
 (31) 201710851 (32) 06.07.2017 (33) GB
 (54) NOVEL COMPOUNDS AND PHARMACEUTICAL COMPOSITIONS THEREOF FOR THE TREATMENT OF FIBROSIS
 (72) MAMMOLITI, Oscar, Galapagos NV General de Wittelaan L11/A3, 2800 Mechelen, BE
 JANSEN, Koen, Karel, Sint Jorislaan 19, 2300 Turnhout, BE
 MENET, Christel, Jeanne, Marie, Confo Therapeutics Pleinlaan 2 Building E 7th floor E7.6, 1050 Brussels, BE
 PALISSE, Adeline, Marie, Elise, Galapagos NV Generaal De Wittelaan L11/A3, 2800 Mechelen, BE
 TRICARICO, Giovanni, Alessandro, Galapagos NV Generaal De Wittelaan L11/A3, 2800 Mechelen, BE
 EL BKASSINY, Sandy, Galapagos NV Generaal de Wittelaan L11/A3, 2800 Mechelen, BE
 JAUNET, Alexis, Patrick, Claude, Galapagos NV Generaal de Wittelaan L11/A3, 2800 Mechelen, BE
 ALLART, Brigitte, Galapagos NV Generaal De Wittelaan L11/A3, 2800 Mechelen, BE
 DUTHION, Béranger, c/o Galapagos SASU 102 Avenue Gaston Roussel, 93230 Romainville, FR
 BREBION, Franck Laurent, c/o Galapagos SASU 102 Avenue Gaston Roussel, 93230 Romainville, FR

- (51) MKP
A61K 31/517 2006 (97) EP 3645535
A61P 35/00 2006
C07D 487/04 2006
 (96) EP 18732820.8 6/28/2018
 (97) EP 3645535, 5/6/2020 202019, en
 (31) 17305826 (32) 29.06.2017 (33) EP
 (54) NEW SALT OF N-(2,6-DIETHYLPHENYL)-8-({4-[4-(DIMETHYLAMINO)PIPERIDIN-1-YL]-2-METHOXYPHENYL}AM INO)-1-METHYL-4,5-DIHYDRO-1H-PYRAZOLO[4,3-H]QUINAZOLINE-3-CARBOXAMIDE, ITS PREPARATION AND FORMULATIONS CONTAINING IT
 (72) ZAMPIERI, Massimo, Via Francesco Baracca 7, 20811 Cesano Maderno (MB), IT
 CALDARELLI, Marina, Via Delle Forze Armate 260, 20152 Milan, IT
 CANDIANI, Ilaria, Via Palestro 32, 21052 Busto Arsizio (VA), IT
 D'ANELLO, Matteo, Via Matteotti 18, 20026 Novate Milanese (MI), IT
 D'ARASMO, Germano, Via Campogallo 49/36 Arese (MI), 20020 Milan, IT

- (51) MKP
A61K 38/20 2006 (97) EP 3630812
A61K 39/00 2006
A61P 37/00 2006
C07K 16/10 2006
C07K 16/46 2006
 (96) EP 18732888.5 5/22/2018
 (97) EP 3630812, 4/15/2020 202016, en
 (31) 201762510514 P (32) 24.05.2017 (33) US
 (54) ANTIBODY-CYTOKINE ENGRAFTED PROTEINS AND METHODS OF USE FOR IMMUNE RELATED DISORDERS
 (72) DIAZ-DE-DURANA, Yaiza, c/o Novartis Institute for Functional Genomics Inc. dba Genomics Institute of the Novartis Research Foundation 10675 John Jay Hopkins Drive, San Diego, California 92121, US
 DIDONATO, Michael, c/o Novartis Institute for Functional Genomics Inc. dba Genomics Institute of the Novartis Research Foundation 10675 John Jay Hopkins Drive, San Diego, California 92121, US
 FILIPPI, Christophe, 4101 Arch Drive 123, Studio City, California 91604, US
 MEEUSEN, Shelly, c/o Novartis Institute for Functional Genomics Inc. dba Genomics Institute of the Novartis Research Foundation 10675 John Jay Hopkins Drive, San Diego, California 92121, US
 SPRAGGON, Glen, c/o Novartis Institute for Functional Genomics Inc. dba Genomics Institute of the Novartis Research Foundation 10675 John Jay Hopkins Drive, San Diego, California 92121, US

- (51) MKP
A61K 38/20 2006 (97) EP 3630813
A61K 39/00 2006
A61P 35/00 2006
C07K 16/10 2006
C07K 16/46 2006
 (96) EP 18732889.3 5/22/2018
 (97) EP 3630813, 4/15/2020 202016, en
 (31) 201762510533 P (32) 24.05.2017 (33) US

- (54) ANTIBODY-CYTOKINE ENGRAFTED PROTEINS AND METHODS OF USE IN THE TREATMENT OF CANCER
 (72) DEANE, Jonathan, c/o Novartis Institute for Functional Genomics Inc. dba Genomics Institute of the Novartis Research Foundation 10675 John Jay Hopkins Drive, San Diego, California 92121, US
 DIAZ-DE-DURANA, Yaiza, c/o Novartis Institute for Functional Genomics Inc. dba Genomics Institute of the Novartis Research Foundation 10675 John Jay Hopkins Drive, San Diego, California 92121, US
 DIDONATO, Michael, c/o Novartis Institute for Functional Genomics Inc. dba Genomics Institute of the Novartis Research Foundation 10675 John Jay Hopkins Drive, San Diego, California 92121, US
 FILIPPI, Christophe, 4101 Arch Drive 123, Studio City, California 91604, US
 SPRAGGON, Glen, c/o Novartis Institute for Functional Genomics Inc. dba Genomics Institute of the Novartis Research Foundation 10675 John Jay Hopkins Drive, San Diego, California 92121, US

- (51) MKP
A61J 1/10 2006 (97) EP 3651719
A61J 1/20 2006
F26B 5/06 2006
 (96) EP 18732906.5 5/24/2018
 (97) EP 3651719, 5/20/2020 202021, en
 (31) 201715609870 (32) 31.05.2017 (33) US
 (54) MULTI CHAMBER FLEXIBLE BAG AND METHODS OF USING SAME
 (72) DI NARO, Antonio Francesco, 7 Via San Bartolomee, 6922 Morcote, CH

- (51) MKP
A61K 31/438 2006 (97) EP 3630762
A61P 35/00 2006
C07D 471/04 2006
 (96) EP 18733045.1 5/25/2018
 (97) EP 3630762, 4/15/2020 202016, en
 (31) 201762511525 P (32) 26.05.2017 (33) US
 (54) CRYSTALLINE FORMS OF A FGFR INHIBITOR AND PROCESSES FOR PREPARING THE SAME
 (72) PAN, Yongchun, 1801 Augustine Cut-Off, Wilmington, Delaware 19803, US
 SHI, Chongsheng Eric, 1801 Augustine Cut-Off, Wilmington, Delaware 19803, US
 TAO, Ming, 1801 Augustine Cut-Off, Wilmington, Delaware 19803, US
 HAN, Wayne, 1801 Augustine Cut-Off, Wilmington, Delaware 19803, US
 XIA, Michael, 1801 Augustine Cut-Off, Wilmington, Delaware 19803, US
 WANG, Dengjin, 1801 Augustine Cut-Off, Wilmington, Delaware 19803, US
 JIA, Zhongjiang, 1801 Augustine Cut-Off, Wilmington, Delaware 19803, US
 ZHOU, Jiacheng, 1801 Augustine Cut-Off, Wilmington, Delaware 19803, US
 LI, Qun, 1801 Augustine Cut-Off, Wilmington, Delaware 19803, US

- (51) MKP
A61M 5/142 2006 (97) EP 3634539
A61M 5/145 2006
A61M 5/158 2006
A61M 5/28 2006
A61M 5/31 2006
 (96) EP 18733101.2 6/1/2018
 (97) EP 3634539, 4/15/2020 202016, en
 (31) 201762517017 P (32) 08.06.2017 (33) US
 (54) SYRINGE ASSEMBLY FOR A DRUG DELIVERY DEVICE AND METHOD OF ASSEMBLY
 (72) MCCULLOUGH, Adam, B., 2792 Great Smokey Court, Westlake Village, CA 91362, US
 KNUDSEN, Hans, Stenberg, c/o NNE Pharmaplan A/S Nybrovej 80, 2820 Gentofte, DK
 ØHLENSCHLAEGER, Rasmus, Valdemarsgade 37 5. Th., 1665 Kobenhavn V, DK

- (51) MKP
A61K 35/17 2015 (97) EP 3630132
A61P 35/00 2006
 (96) EP 18733466.9 6/1/2018
 (97) EP 3630132, 6/24/2020 202026, en
 (31) 201762514774 P (32) 02.06.2017 (33) US
 201762515530 P 05.06.2017 US
 201762521366 P 16.06.2017 US
 201762527000 P 29.06.2017 US
 201762549938 P 24.08.2017 US

	201762580425 P		01.11.2017		US
	201762593871 P		01.12.2017		US
	201762596764 P		08.12.2017		US
	201862614957 P		08.01.2018		US
(54)	ARTICLES OF MANUFACTURE AND METHODS FOR TREATMENT USING ADOPTIVE CELL THERAPY				
(72)	ALBERTSON, Tina, 400 Dexter Ave. N. Suite 1200, Seattle, WA 98109, US				
	WEBER, Clinton, 400 Dexter Ave. N. Suite 1200, Seattle, WA 98109, US				
	RAMSBORG, Christopher Glen, 400 Dexter Ave. N. Suite 1200, Seattle, WA 98109, US				
	GARCIA, Jacob Randolph, 400 Dexter Ave. N. Suite 1200, Seattle, WA 98109, US				
	SUTHERLAND, Claire L., 400 Dexter Ave. N. Suite 1200, Seattle, WA 98109, US				
	YOST, Rachel K., 400 Dexter Ave. N. Suite 1200, Seattle, WA 98109, US				
	CHRISTIN, Brian, 400 Dexter Ave. N. Suite 1200, Seattle, WA 98109, US				
	GILBERT, Mark J., 400 Dexter Ave. N. Suite 1200, Seattle, Washington 98109, US				
	LI, He, 400 Dexter Ave. N. Suite 1200, Seattle, Washington 98109, US				

(51)	MKP				
	A61M 5/20	2006	(97) EP 3634546		
	A61M 5/31	2006			
	A61M 5/315	2006			
(96)	EP 18733474.3 6/4/2018				
(97)	EP 3634546, 4/15/2020 202016, en				
(31)	201762516762 P		(32)	08.06.2017	(33) US
(54)	TORQUE DRIVEN DRUG DELIVERY DEVICE				
(72)	MCCULLOUGH, Adam, B., 2792 Great Smokey Court, Westlake Village, CA 91362, US				
	FORSTER, Ronald, 480 Willow Glen Circle, Simi Valley, CA 93065, US				
	IGLESIAS, Joseph, Michael, 540 San Vicente Boulevard, 16, Santa Monica, CA 90402, US				
	MELANDER, Matias, Thad Jones Vej 8 4.tv, 2450 Koebenhavn SV, DK				
	HLENSCHLAEGER, Rasmus, Valdemarsgade 37 5.th., 1665 Kobenhavn V, DK				
	PLAMBECH, Christian, Kong Hans Alle 10 1.tv., 2860 Soeborg, DK				
	STENHOLT, Lars, Humlebaek Strandvej 102 C, 3050 Humlebaek, DK				
	LUDVIG SVENDSEN, Bjarke, Lykke, Hejningevej 15, 4200 Slagelse, DK				

(51)	MKP				
	G01N 23/203	2006	(97) EP 3635392		
	G01N 23/223	2006			
	G01N 33/24	2006			
	G06T 7/00	2017			
(96)	EP 18733708.4 5/11/2018				
(97)	EP 3635392, 4/15/2020 202016, en				
(31)	201762506263 P		(32)	15.05.2017	(33) US
(54)	ANALYZING A ROCK SAMPLE				
(72)	JACOBI, David, Aramco Research Center 16300 Park Row, Houston, Texas 77084, US				
	LONGO, John, Aramco Research Center 16300 Park Row, Houston, Texas 77084, US				
	KONE, Jordan, Aramco Research Center 16300 Park Row, Houston, Texas 77084, US				
	SUN, Qishi, Aramco Research Center 16300 Park Row, Houston, Texas 77084, US				

(51)	MKP				
	A61K 9/16	2006	(97) EP 3638210		
	A61K 9/20	2006			
	A61K 9/28	2006			
	A61K 31/496	2006			
	A61P 25/18	2006			
	A61P 25/28	2006			
(96)	EP 18734306.6 6/12/2018				
(97)	EP 3638210, 4/22/2020 202017, en				
(31)	1700253		(32)	13.06.2017	(33) HU
(54)	SOLID PREPARATION OF CARIPRAZINE FOR ORAL ADMINISTRATION				
(72)	KONTA, Melinda, Napfény u. 5., 1098 Budapest, HU				
	SUBA, Edit, Suceava u.49/27, 540366 Marosvásárhely, RO				
	DARÓCZI, Tünde Beáta, Bicskei út 42., 2464 Gyúró, HU				
	MAGOS, Zoltán, Attila út 95., 1012 Budapest, HU				
	RAJSZKINÉ LABOS, Ramóna, Batthyány u. 149/A., 1196 Budapest, HU				

(51) MKP
C02F 1/66 2006 (97) EP 3652117
C02F 1/68 2006
(96) EP 18734603.6 7/6/2018
(97) EP 3652117, 5/20/2020 202021, en
(31) 17181016 (32) 12.07.2017 (33) EP
201762534268 P 19.07.2017 US
(54) METHOD FOR INCREASING THE MAGNESIUM ION CONCENTRATION IN FEED WATER
(72) NELSON, Nicholas Charles, Stationsstrasse 50, 8003 Zürich, CH
SCHMID, Marius, Unterwartweg 7, 4132 Muttenz, CH

(51) MKP
A61K 31/4196 2006 (97) EP 3642196
A61P 25/28 2006
A61P 35/00 2006
C07D 403/12 2006
(96) EP 18734921.2 6/19/2018
(97) EP 3642196, 4/29/2020 202018, en
(31) 201709824 (32) 20.06.2017 (33) GB
201803561 06.03.2018 GB
(54) SUBSTITUTED CYANOPYRROLIDINES WITH ACTIVITY AS DUB INHIBITORS
(72) STOCKLEY, Martin Lee, Moneta (Building 280) Babraham Research Campus, Cambridge Cambridgeshire CB22 3AT, GB
KEMP, Mark Ian, Moneta (Building 280) Babraham Research Campus, Cambridge Cambridgeshire CB22 3AT, GB

(51) MKP
A61K 31/519 2006 (97) EP 3634964
A61P 9/00 2006
A61P 13/12 2006
A61P 25/00 2006
A61P 25/18 2006
C07D 487/04 2006
(96) EP 18735038.4 6/6/2018
(97) EP 3634964, 4/15/2020 202016, en
(31) 201762516903 P (32) 08.06.2017 (33) US
201862665840 P 02.05.2018 US
(54) PYRAZOLOPYRIMIDINE PDE9 INHIBITORS
(72) ARASAPPAN, Ashok, 2000 Galloping Hill Road, Kenilworth, New Jersey 07033, US
COX, Jason, M., 2000 Galloping Hill Road, Kenilworth, New Jersey 07033, US
DEBENHAM, John, S., 2000 Galloping Hill Road, Kenilworth, New Jersey 07033, US
GUO, Zhuyan, 2000 Galloping Hill Road, Kenilworth, New Jersey 07033, US
HE, Jiafang, 2000 Galloping Hill Road, Kenilworth, New Jersey 07033, US
HUSSAIN, Zahid, 2000 Galloping Hill Road, Kenilworth, New Jersey 07033, US
LAI, Zhong, 2000 Galloping Hill Road, Kenilworth, New Jersey 07033, US
LI, Derun, 33 Avenue Louis Pasteur, Boston, Massachusetts 02115-5727, US
MENG, Dongfang, 2000 Galloping Hill Road, Kenilworth, New Jersey 07033, US
RAGHAVAN, Subharekha, 2000 Galloping Hill Road, Kenilworth, New Jersey 07033, US
TYAGARAJAN, Sriram, 2000 Galloping Hill Road, Kenilworth, New Jersey 07033, US

(51) MKP
A61K 31/4045 2006 (97) EP 3634402
A61K 31/443 2006
A61K 31/454 2006
A61K 31/47 2006
A61P 11/12 2006
(96) EP 18735090.5 6/8/2018
(97) EP 3634402, 4/15/2020 202016, en
(31) 201762517049 P (32) 08.06.2017 (33) US
201762533381 P 17.07.2017 US
201762562044 P 22.09.2017 US
201862623757 P 30.01.2018 US
201862633021 P 20.02.2018 US
201862649266 P 28.03.2018 US
(54) METHODS OF TREATMENT FOR CYSTIC FIBROSIS

(72) HASELTINE, Eric L., 50 Northern Avenue, Boston Massachusetts 02210, US
 MOSKOWITZ, Samuel, 50 Northern Avenue, Boston Massachusetts 02210, US
 ROBERTSON, Sarah, 50 Northern Avenue, Boston Massachusetts 02210, US
 WALTZ, David, 50 Northern Avenue, Boston Massachusetts 02210, US
 CHEN, Weichao George, 50 Northern Avenue, Boston, Massachusetts 02210, US

(51) MKP
A61K 9/00 2006 (97) EP 3634413
A61K 9/20 2006
A61K 31/47 2006
A61P 35/00 2006

(96) EP 18735102.8 6/8/2018

(97) EP 3634413, 4/15/2020 202016, en

(31) 201762517736 P (32) 09.06.2017 (33) US
 201762520768 P 16.06.2017 US

(54) LIQUID DOSAGE FORMS TO TREAT CANCER

(72) SHAH, Khalid, 281 Eagle Trace Drive, Half Moon Bay California 94019, US
 SCHWAB, Gisela, 25530 Dario Terrace, Hayward California 94541, US
 LACY, Steven, 17 Aragon Blvd., San Mateo California 94402, US

(51) MKP
A61M 5/20 2006 (97) EP 3641857
A61M 5/315 2006

(96) EP 18735156.4 6/12/2018

(97) EP 3641857, 4/29/2020 202018, en

(31) 201762523326 P (32) 22.06.2017 (33) US

(54) DEVICE ACTIVATION IMPACT/SHOCK REDUCTION

(72) HERING, Martin, 252 Spring Oak Road Unit 2411, Camarillo, CA 93010, US
 SMYTH, Brendan, 3809 Golden Pond Drive, Camarillo, CA 93012, US

(51) MKP
A61Q 7/00 2006 (97) EP 3652205
C07K 16/28 2006

(96) EP 18735315.6 7/3/2018

(97) EP 3652205, 5/20/2020 202021, en

(31) 17180554 (32) 10.07.2017 (33) EP

(54) PROLACTIN RECEPTOR ANTIBODY FOR MALE AND FEMALE PATTERN HAIR LOSS

(72) MAY, Ekkehard, Karmeliterstrasse 57, 13465 Berlin, DE
 JODL, Stefan, Joachim, Langendreesch 15, 14532 Kleinmachnow, DE
 KRÄTZSCHMAR, Jörn, Eiswaldtstrasse 23D, 12249 Berlin, DE
 OTTO, Christiane, Jaegerstrasse 2, 42117 Wuppertal, DE

(51) MKP
C07F 9/24 2006 (97) EP 3638684
C07H 1/02 2006
C07H 19/10 2006
C07H 19/20 2006

(96) EP 18735380.0 6/14/2018

(97) EP 3638684, 4/22/2020 202017, en

(31) 201709471 (32) 14.06.2017 (33) GB

(54) SYNTHESIS OF SUBSTANTIALLY DIASTEREOMERICALLY PURE PHOSPHATE PROTIDES

(72) GRIFFITH, Hugh, c/o NuCana plc 3 Lochside Way, Edinburgh EH12 9DT, GB
 KENNOVIN, Gordon, c/o NuCana plc 3 Lochside Way, Edinburgh EH12 9DT, GB
 DAMMALAPATI, Venkata Lakshmi Narasimha Rao, c/o Laurus Labs Private Ltd IKP Knowledge Park Genome Valley Turkapally Shameerpet Mandal, Hyderabad Telangana 500 078, IN
 KOTALA, Mani Bushan, c/o Laurus Labs Private Ltd IKP Knowledge Park Genome Valley Turkapally Shameerpet Mandal, Hyderabad Telangana 500 078, IN

(51) MKP
A61K 9/20 2006 (97) EP 3641736
A61K 9/28 2006
A61K 31/225 2006

(96)	EP 18735535.9	6/25/2018				
(97)	EP 3641736,	4/29/2020	202018,	en		
(31)	201710114		(32)	23.06.2017	(33)	GB
	17382402			27.06.2017		EP
(54)	PHARMACEUTICAL COMPOSITIONS COMPRISING DIMETHYL FUMARATE					
(72)	AUBETS MIR, Jorge, C/Laure Mir 408-410 Sant Feliu de Llobregat, 08980 Barcelona, ES					
<hr/>						
(51)	MKP					
	C07K 14/725	2006	(97) EP 3649149			
(96)	EP 18735571.4	7/2/2018				
(97)	EP 3649149,	5/13/2020	202020,	en		
(31)	201710620		(32)	03.07.2017	(33)	GB
(54)	TARGETED PROTEIN DEGRADATION					
(72)	BRAYSHAW, Lewis Lee, GlaxoSmithKline Gunnels Wood Road, Stevenage Hertfordshire SG1 2NY, GB HANN, Michael Menteith, GlaxoSmithKline Gunnels Wood Road, Stevenage Hertfordshire SG1 2NY, GB HERRING, Christopher, GlaxoSmithKline Gunnels Wood Road, Stevenage Hertfordshire SG1 2NY, GB MARTINEZ FLEITES, Carlos, GlaxoSmithKline Gunnels Wood Road, Stevenage Hertfordshire SG1 2NY, GB QUEISSER, Markus Alexander, GlaxoSmithKline Gunnels Wood Road, Stevenage Hertfordshire SG1 2NY, GB					
<hr/>						
(51)	MKP					
	A61K 31/519	2006	(97) EP 3652176			
	A61K 31/522	2006				
	C07D 487/04	2006				
(96)	EP 18735588.8	7/6/2018				
(97)	EP 3652176,	5/20/2020	202021,	en		
(31)	17180721		(32)	11.07.2017	(33)	EP
(54)	NOVEL SUBSTITUTED XANTHINE DERIVATIVES					
(71)	Hydra Biosciences, LLC, 405 Concord Avenue P.O. Box 147, Belmont, MA 02478, US					
(72)	GERLACH, Kai, c/o Boehringer Ingelheim International GmbH Corporate Patents Binger Strasse 173, 55216 Ingelheim am Rhein, DE EICKMEIER, Christian, c/o Boehringer Ingelheim International GmbH Corporate Patents Binger Strasse 173, 55216 Ingelheim am Rhein, DE SAUER, Achim, c/o Boehringer Ingelheim International GmbH Corporate Patents Binger Strasse 173, 55216 Ingelheim am Rhein, DE JUST, Stefan, c/o Boehringer Ingelheim International GmbH Corporate Patents Binger Strasse 173, 55216 Ingelheim am Rhein, DE CHENARD, Bertrand L., 7 Whaling Drive, Waterford, Connecticut 06385, US					
<hr/>						
(51)	MKP					
	A23B 7/01	2006	(97) EP 3634153			
	A23B 7/155	2006				
	A23L 19/00	2016				
(96)	EP 18735711.6	6/8/2018				
(97)	EP 3634153,	4/15/2020	202016,	en		
(31)	201700063635		(32)	09.06.2017	(33)	IT
(54)	PLANT AND METHOD OF PRODUCTION OF PUREE					
(71)	CFT S.p.A., Via Paradigna 94/A., 43122 Parma, IT					
(72)	CATELLI, Roberto, Via Togliatti 8, 43100 Parma, IT ROMEI, Stefano, Via Calatafimi 8, 43125 Parma, IT GOZZI, Mario, Via Traversetolo 95, 43123 Parma, IT					
<hr/>						
(51)	MKP					
	A61K 31/53	2006	(97) EP 3638245			
	A61P 35/00	2006				
(96)	EP 18737086.1	6/12/2018				
(97)	EP 3638245,	4/22/2020	202017,	en		
(31)	201762518565 P		(32)	12.06.2017	(33)	US
(54)	METHODS OF TREATING BRAIN TUMORS USING COMBINATION THERAPY					
(72)	MURTIE, Joshua, 34 Franklin Road, Winchester, MA 01890, US NAGARAJA, Nelamangala, 11 Barrymeade Drive, Lexington, MA 02421, US NICOLAY, Brandon, 12 Woodholm Road, Manchester, MA 01944, US SCHENKEIN, David, 21 Wormwood Street Apt. 622, Boston, MA 02210, US YEN, Katharine, 7 Norwich Road, Wellesley, MA 02481, US					
<hr/>						
(51)	MKP					

A61K 8/34 2006 (97) EP 3644945
A61K 8/60 2006
A61K 31/047 2006
A61K 31/702 2006
A61Q 17/00 2006
A61Q 19/00 2006
A61Q 19/10 2006
(96) EP 18737197.6 6/27/2018
(97) EP 3644945, 5/6/2020 202019, en
(31) 201762525489 P (32) 27.06.2017 (33) US
(54) ANTIBACTERIAL ACTIVITY OF GALACTOOLIGOSACCHARIDE AND XYLITOL IN DERMATOLOGICAL TREATMENTS
(71) Rottapharm SPA, Via Valosa di Sopra 9, 20900 Monza, IT
(72) ZANARDI, Andrea, Via Marcantonio dal Re 20, 20156 Milano, IT
CERACI, Alessandra, via Fenestrelle 63, 10040 Rivalta di Torino, IT
MONTALDO, Ivan, Via IV Novembre 54/A, 12050 Castagnito, IT

(51) MKP
A61K 9/00 2006 (97) EP 3644958
A61K 31/4439 2006
A61P 31/22 2006
(96) EP 18737204.0 6/28/2018
(97) EP 3644958, 5/6/2020 202019, en
(31) 17178439 (32) 28.06.2017 (33) EP
(54) INTRAVAGINALLY APPLICABLE DEVICES COMPRISING ANTIVIRAL COMPOUNDS
(71) Aicuris Anti-Infective Cures GmbH, Friedrich-Ebert-Strasse 475, 42117 Wuppertal, DE
(72) BACHHAV, Yogeshwar, C-201 Building No 27 Bharatkhand CHS Tilaknagar, 400089 Mumbai, IN
BONSMANN, Susanne, Franz-Michel-Str. 13, 50769 Köln, DE
PFAFF, Tamara, A sternweg 27, 40468 Düsseldorf, DE
BIRKMANN, Alexander, Heinrich-Heine-Straße 13, 42327 Wuppertal, DE
MALCOLM, Karl, 3 Briarwood Park, Gilnahirk Belfast BT5 7HZ, GB

(51) MKP
C02F 1/28 2006 (97) EP 3665127
C02F 101/30 2006
(96) EP 18737227.1 7/2/2018
(97) EP 3665127, 6/17/2020 202025, de
(31) 102017009037 (32) 27.09.2017 (33) DE
102017009038 27.09.2017 DE
102017126118 08.11.2017 DE
(54) METHOD AND SYSTEM FOR TREATING AND/OR PURIFYING WATER
(72) SCHÖNFELD, Raik, c/o Blücher GmbH Mettmannerstrasse 25, 40699 Erkrath, DE
FISCHER, Charlotte, c/o Blücher GmbH Mettmannerstrasse 25, 40699 Erkrath, DE
RAISER, Jan-Peter, c/o Blücher GmbH Mettmannerstrasse 25, 40699 Erkrath, DE

(51) MKP
B61B 12/00 2006 (97) EP 3649029
B61B 12/06 2006
(96) EP 18737232.1 7/2/2018
(97) EP 3649029, 5/13/2020 202020, de
(31) 505502017 (32) 04.07.2017 (33) AT
(54) CABLEWAY AND METHOD FOR OPERATING A CABLEWAY
(72) HOFMAYR, Christoph, Pongartgasse 6, 6850 Dornbirn, AT
PFEIFER, Daniel, Pfarriweg 33, 6580 Sankt Anton am Arlberg, AT

(51) MKP
H04N 7/18 2006 (97) EP 3649775
(96) EP 18737254.5 7/4/2018
(97) EP 3649775, 5/13/2020 202020, de
(31) 102017114962 (32) 05.07.2017 (33) DE
(54) MULTI-SENSOR CAMERA
(71) Dallmeier electronic GmbH & Co. KG, Bahnhofstrasse 16, 93047 Regensburg, DE
(72) DALLMEIER, Dieter, Zum Aichahof 3a, 93186 Pettendorf, DE

-
- (51) MKP
C02F 1/66 2006 (97) EP 3652118
C02F 1/68 2006
- (96) EP 18737280.0 7/10/2018
(97) EP 3652118, 5/20/2020 202021, en
- (31) 17181019 (32) 12.07.2017 (33) EP
201762534269 P 19.07.2017 US
- (54) METHOD FOR INCREASING THE MAGNESIUM ION CONCENTRATION IN FEED WATER
(72) NELSON, Nicholas Charles, Stationsstrasse 50, 8003 Zürich, CH
SCHMID, Marius, Unterwartweg 7, 4132 Muttenz, CH
-
- (51) MKP
C07K 16/38 2006 (97) EP 3645573
- (96) EP 18737546.4 6/28/2018
(97) EP 3645573, 5/6/2020 202019, en
- (31) 102017114737 (32) 30.06.2017 (33) DE
201762527844 P 30.06.2017 US
- (54) NOVEL T CELL RECEPTORS AND IMMUNE THERAPY USING THE SAME
(72) WAGNER, Claudia, Nürtinger Strasse 32, 72074 Tübingen, DE
ALTEN, Leonie, Heubergstr. 8, 72469 Meßstetten, DE
BUNK, Sebastian, Gertrud-Baeumer-Str. 19/1, 72074 Tübingen, DE
MAURER, Dominik, Fleinerweg 7, 72116 Moessingen, DE
-
- (51) MKP
C07H 1/00 2006 (97) EP 3652187
C07H 21/04 2006
- (96) EP 18737621.5 7/9/2018
(97) EP 3652187, 5/20/2020 202021, en
- (31) 17180426 (32) 10.07.2017 (33) EP
- (54) IMPROVED PROCESS FOR PREPARING IMETELSTAT
(71) GERON CORPORATION, 149 Commonwealth Drive, Menlo Park, CA 94025, US
(72) MUSLEHIDDINOGLU, Jale, Janssen Pharmaceutica NV Turnhoutseweg 30, 2340 Beerse, BE
GALA, Dinesh, Janssen Pharmaceutica NV Turnhoutseweg 30, 2340 Beerse, BE
ALBANEZE-WALKER, Jennifer, Elizabeth, Janssen Pharmaceutica NV Turnhoutseweg 30, 2340 Beerse, BE
-
- (51) MKP
A61K 31/4427 2006 (97) EP 3634967
A61K 31/444 2006
A61P 19/02 2006
C07D 493/08 2006
- (96) EP 18737718.9 6/7/2018
(97) EP 3634967, 4/15/2020 202016, en
- (31) 201762517394 P (32) 09.06.2017 (33) US
- (54) COMPOUNDS AND COMPOSITIONS FOR INDUCING CHONDROGENESIS
(72) CHOI, Ha-Soon, c/o Novartis Institute for Functional Genomics Inc. dba Genomics Institute of The Novartis Research Foundation 10675 John Jay Hopkins Drive, San Diego, California 92121, US
JIANG, Jiqing, c/o Novartis Institute for Functional Genomics Inc. dba Genomics Institute of The Novartis Research Foundation 10675 John Jay Hopkins Drive, San Diego, California 92121, US
LAJINESS, James Paul, c/o Novartis Institute for Functional Genomics Inc. dba Genomics Institute of The Novartis Research Foundation 10675 John Jay Hopkins Drive, San Diego, California 92121, US
NGUYEN, Bao, c/o Novartis Institute for Functional Genomics Inc. dba Genomics Institute of The Novartis Research Foundation 10675 John Jay Hopkins Drive, San Diego, California 92121, US
PETRASSI, Hank Michael James, 4695 Serenata Place, San Diego, California 92130, US
WANG, Zhicheng, c/o Novartis Institute for Functional Genomics Inc. dba Genomics Institute of The Novartis Research Foundation 10675 John Jay Hopkins Drive, San Diego, California 92121, US
-
- (51) MKP
A61K 31/7076 2006 (97) EP 3641784
A61P 7/02 2006
A61P 9/04 2006

(96) EP 18737821.1 6/22/2018
 (97) EP 3641784, 4/29/2020 202018, en
 (31) 201762524102 P (32) 23.06.2017 (33) US
 (54) METHOD OF PREVENTING OF SYSTEMIC-TO-PULMONARY-ARTERY SHUNT THROMBOSIS
 (72) DIACOVO, Thomas G., c/o CHIESI FARMACEUTICI S.p.A. Via Palermo 26/A, 43122 Parma, IT

(51) MKP
A61K 39/12 2006 (97) EP 3655032
C07K 14/005 2006
 (96) EP 18737921.9 7/12/2018
 (97) EP 3655032, 5/27/2020 202022, en
 (31) 17182075 (32) 19.07.2017 (33) EP
 17191083 14.09.2017 EP
 18158862 27.02.2018 EP
 18178358 18.06.2018 EP
 (54) TRIMER STABILIZING HIV ENVELOPE PROTEIN MUTATIONS
 (72) LANGEDIJK, Johannes, Petrus, Maria, Archimedesweg 4-6, 2333 CN Leiden, NL
 RUTTEN, Lucy, Archimedesweg 4-6, 2333 CN Leiden, NL
 STROKAPPE, Nika, Mindy, Archimedesweg 4-6, 2333 CN Leiden, NL
 TRUAN, Daphné, Archimedesweg 4-6, 2333 CN Leiden, NL

(51) MKP
A61K 31/506 2006 (97) EP 3649127
A61K 31/5377 2006
A61K 31/55 2006
A61P 3/00 2006
A61P 29/00 2006
A61P 35/00 2006
A61P 37/00 2006
C07D 471/04 2006
C07D 519/00 2006
 (96) EP 18739811.0 7/4/2018
 (97) EP 3649127, 5/13/2020 202020, en
 (31) 17180010 (32) 06.07.2017 (33) EP
 (54) NEW SUBSTITUTED AZAINDOLINE DERIVATIVES AS NIK INHIBITORS
 (72) HYND, George, Charles River Discovery Research Services UK Limited 8/9 Spire Green Flex Meadow, Harlow Essex CM19 5TR, GB
 MACLEOD, Calum, Charles River Discovery Research Services UK Limited 8/9 Spire Green Flex Meadow, Harlow Essex CM19 5TR, GB
 MANN, Samuel, Edward, Charles River Discovery Research Services UK Limited 8/9 Spire Green Flex Meadow, Harlow Essex CM19 5TR, GB
 KULAGOWSKI, Janusz, Jozef, Charles River Discovery Research Services UK Limited 8/9 Spire Green Flex Meadow, Harlow Essex CM19 5TR, GB
 STANSFIELD, Ian, Janssen-Cilag 1 rue Camille Desmoulins TSA 91003, 92787 Issy-les-Moulineaux Cedex 9, FR
 QUEROLLE, Olivier, Alexis, Georges, Janssen-Cilag 1 rue Camille Desmoulins TSA 91003, 92787 Issy-les-Moulineaux Cedex 9, FR
 PONCELET, Virginie, Sophie, Janssen-Cilag 1 rue Camille Desmoulins TSA 91003, 92787 Issy-les-Moulineaux Cedex 9, FR
 GROSS, Gerhard, Max, Janssen Pharmaceutica NV Turnhoutseweg 30, 2340 Beerse, BE
 JACOBY, Edgar, Janssen Pharmaceutica NV Turnhoutseweg 30, 2340 Beerse, BE
 MEERPOEL, Lieven, Janssen Pharmaceutica NV Turnhoutseweg 30, 2340 Beerse, BE

(51) MKP
A61K 9/10 2006 (97) EP 3651736
A61K 31/47 2006
A61K 47/26 2006
A61P 31/06 2006
A61P 31/08 2006
 (96) EP 18739856.5 7/13/2018
 (97) EP 3651736, 5/20/2020 202021, en
 (31) 17181354 (32) 14.07.2017 (33) EP
 18167463 16.04.2018 EP
 (54) LONG-ACTING FORMULATIONS
 (72) ANDRIES, Koenraad, Jozef, Lodewijk, Marcel, Janssen Pharmaceutica NV Turnhoutseweg 30, 2340 Beerse, BE
 BERNINI, Maristella, Janssen Pharmaceutica NV Turnhoutseweg 30, 2340 Beerse, BE
 BASSTANIE, Esther, Dina, Guido, Janssen Pharmaceutica NV Turnhoutseweg 30, 2340 Beerse, BE

(51) MKP

	B65D 85/804	2006	(97) EP 3649061				
(96)	EP 18739957.1 7/4/2018						
(97)	EP 3649061, 5/13/2020 202020, en						
(31)	201700074959		(32)	04.07.2017		(33)	IT
(54)	CAPSULE FOR INFUSION PRODUCTS						
(71)	Pepeimpex Ltd, 65 Vitosha Blvd, BG-1000 Sofia, BG						
(72)	RODRIGUEZ BERNAL, Mildrey, c/o Pepeimpex Ltd 65 Vitosha Blvd. Piano 1, 1000 Sofia, BG						
<hr/>							
(51)	MKP						
	A61K 31/7064	2006	(97) EP 3641887				
	A61P 1/16	2006					
(96)	EP 18740023.9 6/19/2018						
(97)	EP 3641887, 4/29/2020 202018, en						
(31)	201762522045 P		(32)	19.06.2017		(33)	US
(54)	COMPOUNDS AND METHODS FOR TREATMENT OF NAFLD AND NASH						
(72)	ADAMS, John W., 2515 Geranium Street, San Diego California 92109, US LIU, Que, 13298 Gunner Avenue, San Diego California 92129, US						
<hr/>							
(51)	MKP						
	A61K 31/495	2006	(97) EP 3641812				
	A61K 39/00	2006					
	A61K 39/395	2006					
	A61K 39/40	2006					
	C07K 16/28	2006					
(96)	EP 18740070.0 6/21/2018						
(97)	EP 3641812, 4/29/2020 202018, en						
(31)	201762523481 P		(32)	22.06.2017		(33)	US
	201862636510 P			28.02.2018			US
(54)	ANTIBODY MOLECULES TO CD73 AND USES THEREOF						
(71)	Surface Oncology, Inc., 50 Hampshire Street 8th Floor, Cambridge, MA 02139, US						
(72)	BROCK, Ansgar, 10847 Caminito Alto, San Diego, CA 92121, US CREMASCIO, Viviana, 250 Massachusetts Avenue, Cambridge, MA 02139, US SABATOS-PEYTON, Catherine, Anne, 250 Massachusetts Avenue, Cambridge, MA 02139, US DRANOFF, Glenn, 150 Concord Road, Sudbury, MA 01776, US PRINZ, Bianca, Adimab LLC 7 Lucent Drive, Lebanon, NH 03766, US THOMAS, Jerry, M., Adimab LLC 7 Lucent Drive, Lebanon, NH 03766, US CHAPPEL, Scott, Surface Oncology Inc. 50 Hampshire Street, Cambridge, MA 02139, US LAKE, Andrew, Surface Oncology Inc. 50 Hampshire Street, Cambridge, MA 02139, US PATERSON, Alison, Surface Oncology Inc. 50 Hampshire Street, Cambridge, MA 02139, US O'CONNOR, Rachel, W., Surface Oncology Inc. 50 Hampshire Street, Cambridge, MA 02139, US WARREN, Michael, Surface Oncology Inc. 50 Hampshire Street, Cambridge, MA 02139, US HOLLAND, Pamela, Surface Oncology Inc. 50 Hampshire Street, Cambridge, MA 02139, US SUBRAMANIAN, Kulandayan, Kasi, 250 Massachusetts Avenue, Cambridge, MA 02139, US FJAELLSKOG, Marie-Louise, 48 School Street, Lexington, MA 02421, US BUSSIÈRE, Dirksen, Emeryville Site 5300 Chiron Way Bldg. 4, Emeryville, CA 94608, US WOLDEGIORGIS, Mikias, Emeryville Site 5300 Chiron Way Bldg. 4, Emeryville, CA 94608, US SHU, Wei, Emeryville Site 5300 Chiron Way Bldg. 4, Emeryville, CA 94608, US VENABLE III, John, Delmas, Novartis Institute for Functional Genomics Inc. 10675 John Jay Hopkins Drive, San Diego, CA 92121, US GLADSTONE, Michael, Surface Oncology Inc. 50 Hampshire Street, Cambridge, MA 02139, US HILL, Jonathan, c/o Surface Oncology Inc. 50 Hampshire Street, Cambridge, MA 02139, US MILLER, Christine, c/o Surface Oncology Inc. 50 Hampshire Street, Cambridge, MA 02139, US						
<hr/>							
(51)	MKP						
	A61K 39/00	2006	(97) EP 3648790				
	A61P 35/00	2006					
	C07K 14/47	2006					
	C07K 16/30	2006					
(96)	EP 18740138.5 7/3/2018						
(97)	EP 3648790, 5/13/2020 202020, en						
(31)	102017115301		(32)	07.07.2017		(33)	DE
	201762529758 P			07.07.2017			US
(54)	NOVEL PEPTIDES AND COMBINATION OF PEPTIDES FOR USE IN IMMUNOTHERAPY AGAINST LUNG CANCER, INCLUDING NSCLC, SCLC AND OTHER CANCERS						

(72) FRITSCHKE, Jens, Lärchenweg 11, 72144 Dusslingen, DE
 SCHOOR, Oliver, Eichhaldenstrasse 19, 72074 Tübingen, DE
 SINGH, Harpreet, Heckscherstrasse 25a, 80804 München, DE
 WEINSCHENK, Toni, Im Morgenrain 15, 73773 Aichwald, DE
 SONG, Colette, Willi-Baumeister-Weg 21, 73760 Ostfildern, DE

(51) MKP
A61P 25/08 2006 (97) EP 3652182
C07D 513/04 2006
 (96) EP 18740155.9 7/5/2018
 (97) EP 3652182, 5/20/2020 202021, en
 (31) 17180431 (32) 10.07.2017 (33) EP
 (54) 2-OXO-1-IMIDAZOLIDINYL IMIDAZOTHIADIAZOLE DERIVATIVES
 (72) PROVINS, Laurent, c/o IPD UCB Biopharma SPRL Allée de la Recherche 60, 1070 Brussels, BE
 CHANTEUX, Hugues, c/o IP Department UCB Biopharma SPRL Allée de la Recherche 60, 1070 Brussels, BE

(51) MKP
A61K 31/433 2006 (97) EP 3652183
A61P 25/08 2006
C07D 513/04 2006
 (96) EP 18740157.5 7/5/2018
 (97) EP 3652183, 5/20/2020 202021, en
 (31) 17180432 (32) 10.07.2017 (33) EP
 (54) 2-OXO-1,3-OXAZOLIDINYL IMIDAZOTHIADIAZOLE DERIVATIVES
 (72) PROVINS, Laurent, c/o IPD UCB Biopharma SPRL Allée de la Recherche 60, 1070 Brussels, BE
 CHANTEUX, Hugues, c/o IP Department UCB Biopharma SPRL Allée de la Recherche 60, 1070 Brussels, BE
 QUESNEL, Yannick, c/o IP Department UCB Biopharma SPRL Allée de la Recherche 60, 1070 Brussels, BE

(51) MKP
A61K 31/505 2006 (97) EP 3654983
A61P 15/10 2006
 (96) EP 18740208.6 7/12/2018
 (97) EP 3654983, 5/27/2020 202022, en
 (31) 201762533448 P (32) 17.07.2017 (33) US
 (54) MPO INHIBITORS FOR USE IN MEDICINE
 (72) WHITTAKER, Andrew, 1 Francis Crick Avenue Cambridge Biomedical Campus, Cambridge Cambridgeshire CB2 0AA, GB
 SANGANEE, Hitesh, Jayantilal, 1 Francis Crick Avenue Cambridge Biomedical Campus, Cambridge Cambridgeshire CB2 0AA, GB

(51) MKP
A61K 31/519 2006 (97) EP 3642209
A61P 25/28 2006
A61P 29/00 2006
A61P 35/00 2006
C07D 495/04 2006
 (96) EP 18740405.8 6/20/2018
 (97) EP 3642209, 4/29/2020 202018, en
 (31) 201762523114 P (32) 21.06.2017 (33) US
 (54) COMPOUNDS THAT INTERACT WITH THE RAS SUPERFAMILY FOR THE TREATMENT OF CANCERS, INFLAMMATORY DISEASES, RASOPATHIES, AND FIBROTIC DISEASE
 (72) HADARI, Yaron R., 34 Bates Road, Harrison NY 10528, US
 CARTA, Luca, 300 S. Centrale Avenue C27, Hartsdale NY 10530, US
 SCHMERTZLER, Michael, 1300 Valley Road, New Canaan CT 06840, US
 WILLIAMS, Theresa M., 260 Shady Nook Road, Harleysville PA 19438, US
 REYNOLDS, Charles H., 5824 Brittllyns Court, Austin TX 78730, US
 HUTCHESON, Rebecca, 19 Pleasant Road, Lake Peekskill NY 10537, US

(51) MKP
A61K 38/26 2006 (97) EP 3642238
C07K 16/28 2006
 (96) EP 18740407.4 6/20/2018
 (97) EP 3642238, 4/29/2020 202018, en
 (31) 201762523216 P (32) 21.06.2017 (33) US

- (54) METHOD OF TREATING OR AMELIORATING METABOLIC DISORDERS USING ANTAGONISTIC BINDING PROTEINS FOR GASTRIC INHIBITORY PEPTIDE RECEPTOR (GIPR)/GLP-1 RECEPTOR AGONIST FUSION PROTEINS
 (72) WALKER, Kenneth W., 175 Mesa Avenue, Newbury Park California 91320, US
 HOLDER, Jerry Ryan, 1102 Waltham Road, Simi Valley California 93065, US
 LLOYD, David J., 458 Via Gregorio, Thousand Oaks California 91320, US
 LU, Shu-Chen, 2356 Rutland Place, Thousand Oaks California 91362, US
 VENIANT-ELLISON, Murielle M., 645 Camino Manzanas, Thousand Oaks California 91360, US
 STANISLAUS, Shanaka, 4196 Minnecota Drive, Thousand Oaks California 91360, US
-

- (51) MKP
C07K 16/28 2006 (97) EP 3642239
 (96) EP 18740409.0 6/20/2018
 (97) EP 3642239, 4/29/2020 202018, en
 (31) 201762522559 P (32) 20.06.2017 (33) US
 (54) METHOD OF TREATING OR AMELIORATING METABOLIC DISORDERS USING BINDING PROTEINS FOR GASTRIC INHIBITORY PEPTIDE RECEPTOR (GIPR) IN COMBINATION WITH GLP-1 AGONISTS
 (72) BATES, Darren L., 238 Saint Croix Court, Oak Park California 91377, US
 SHI, Donghui, 3198 Rickey Court, Thousand Oaks California 91362, US
 LLOYD, David J., 458 Via Gregorio, Thousand Oaks California 91320, US
 BONDARENKO, Pavel, 1774 Blossom Court, Thousand Oaks California 91320, US
 MICHAELS, Mark L., 5007 Texhoma Avenue, Encino California 91316, US
 HAGER, Todd, 28726 Aries Street, Agoura Hills California 91301, US
 MIN, Xiaoshan, 2108 Clarice Lane, Burlingame California 94010, US
 UMEDA, Aiko, 21400 Burbank Blvd. Apt. 318, Woodland Hills California 91367, US
 CHEN, Irwin, 1875 Kelton Avenue 202, Los Angeles California 90025, US
 WANG, Zhulun, 660 Glenbrook, Palo Alto California 94306, US
-

- (51) MKP
A61M 5/32 2006 (97) EP 3641861
 (96) EP 18740448.8 6/22/2018
 (97) EP 3641861, 4/29/2020 202018, en
 (31) 201762524185 P (32) 23.06.2017 (33) US
 (54) ELECTRONIC DRUG DELIVERY DEVICE COMPRISING A CAP ACTIVATED BY A SWITCH ASSEMBLY
 (72) CHANG, Sung Keun, 1853 Brush Oak Ct., Thousand Oaks CA 91320, US
 DEAN, Harold IV, 436 Banner Ave., Ventura CA 93004, US
 FRIEDMAN, Michael, 6 N Madrid Avenue, Newbury Park CA 91320, US
 JOHNSTON, Gordon, 1551 Oak Lawn Avenue Apt. 353, Dallas TX 75207, US
 JOHNSTON, Neal, 3309 Citation Drive, Dallas TX 75229, US
-

- (51) MKP
C09K 8/52 2006 (97) EP 3642299
C09K 8/72 2006
C23F 11/00 2006
 (96) EP 18740454.6 6/22/2018
 (97) EP 3642299, 4/29/2020 202018, en
 (31) 201762524385 P (32) 23.06.2017 (33) US
 (54) COMPOSITIONS AND METHODS FOR CONTROLLING STRONG ACID SYSTEMS
 (72) SAYED, Mohammed, c/o Aramco Services Company Two Allen Center 1200 Smith Street, Houston Texas 77002, US
 CAIRNS, Amy J., c/o Aramco Services Company Two Allen Center 1200 Smith Street, Houston Texas 77002, US
 ALDAKKAN, Bashayer S., c/o Research&Development Center GA-230 Building 2291 Saudi Aramco, Dhahran 31311, SA
 GOMAA, Ahmed M., c/o Research&Development Center GA-262 Building 2291 Saudi Aramco, Dhahran 31311, SA
 AL-NOAIMI, Khalid R., c/o Research&Development Center GA-219 Building 2291 Saudi Aramco, Dhahran 31311, SA
-

- (51) MKP
C08G 79/00 2006 (97) EP 3638716
C08G 79/04 2006
 (96) EP 18740671.5 6/11/2018
 (97) EP 3638716, 4/22/2020 202017, en
 (31) 201762518313 P (32) 12.06.2017 (33) US
 (54) POLY(PHOSPHOESTERS) FOR DELIVERY OF NUCLEIC ACIDS
 (72) DEROSA, Frank, c/o Translate Bio Inc. 29 Hartwell Avenue, Lexington MA 02421, US
 HEARTLEIN, Michael, c/o Translate Bio Inc. 29 Hartwell Avenue, Lexington MA 02421, US

KARVE, Shrirang, c/o Translate Bio Inc. 29 Hartwell Avenue, Lexington MA 02421, US
 ZHANG, Yi, c/o Translate Bio Inc. 29 Hartwell Avenue, Lexington MA 02421, US

- (51) MKP
C07K 16/46 2006 (97) EP 3652215
- (96) EP 18740829.9 7/13/2018
 (97) EP 3652215, 5/20/2020 202021, en
- (31) 102017115966 (32) 14.07.2017 (33) DE
 201762532713 P 14.07.2017 US
 102017119866 30.08.2017 DE
 102018108995 16.04.2018 DE
 201862658318 P 16.04.2018 US
- (54) IMPROVED DUAL SPECIFICITY POLYPEPTIDE MOLECULE
 (72) HOFMANN, Martin, Geissweg 20, 72076 Tübingen, DE
 UNVERDORBEN, Felix, Möhringer Strasse 157, 70199 Stuttgart, DE
 BUNK, Sebastian, Gertrud-Baeumer-Str. 19/1, 72074 Tübingen, DE
 MAURER, Dominik, Fleinerweg 7, 72116 Moessingen, DE

- (51) MKP
A61K 39/104 2006 (97) EP 3641828
A61K 39/108 2006
A61K 47/64 2017
C07K 14/195 2006
C07K 14/21 2006
C07K 14/26 2006
- (96) EP 18740975.0 6/22/2018
 (97) EP 3641828, 4/29/2020 202018, en
- (31) 201762524315 P (32) 23.06.2017 (33) US
 201862633807 P 22.02.2018 US
- (54) IMMUNOGENIC COMPOSITIONS
 (71) Nosocomial Vaccine Corporation, 7361 Calhoun Place Suite 510, Rockville, Maryland 20855, US
 University of Maryland, Baltimore, Office of Technology Transfer 620 W.Lexington Street, 4th Floor, Baltimore, MD 21201, US
 Affinivax, Inc., 700 Main Street, Cambridge, Massachusetts 02139, US
- (72) AMBROSINO, Donna, 2816 SE Dune Drive Unit 2209, Stuart Florida 34996, US
 BROERING, Teresa J., 74 Parkman St. 3, Brookline Massachusetts 02446, US
 CROSS, Alan, 6810 Brookville Road, Chevy Chase Maryland 20815, US
 MALLEY, Richard, 15 Bayview Avenue, Beverly Massachusetts 01915, US
 MICHON, Francis, 4401 Rosedale Ave., Bethesda Maryland 20814, US
 SIBER, George, Rainer, 2000 Broadway Penthouse 2B, New York New York 10023, US
 SIMON, Raphael, 6548 Pebble Brooke Road, Baltimore Maryland 21209, US
 TENNANT, Sharon, 2926 Montclair Dr., Ellicott City Maryland 21043, US

- (51) MKP
C07K 16/00 2006 (97) EP 3638692
C07K 16/08 2006
C07K 16/24 2006
C07K 16/46 2006
- (96) EP 18742595.4 6/8/2018
 (97) EP 3638692, 4/22/2020 202017, en
- (31) 201762518090 P (32) 12.06.2017 (33) US
- (54) METHOD OF MANUFACTURING BISPECIFIC ANTIBODIES, BISPECIFIC ANTIBODIES AND THERAPEUTIC USE OF SUCH ANTIBODIES
 (72) BARDROFF, Michael Otto, Novartis Pharma AG Werk Klybeck Postfach, 4002 Basel, CH
 BUCH, Tina, Novartis Pharma AG Werk Klybeck Postfach, 4002 Basel, CH
 GRAF, Christian, Novartis Pharma AG Postfach, 4002 Basel, CH
 HEITMANN, Daniel, Novartis Pharma AG Werk Klybeck Postfach, 4002 Basel, CH
 JOSTOCK, Thomas, Novartis Pharma AG Werk Klybeck Postfach, 4002 Basel, CH
 KNOPF, Hans-Peter, Novartis Pharma AG Postfach, 4002 Basel, CH
 KOEHLER, Rolf, Novartis Pharma AG Werk Klybeck Postfach, 4002 Basel, CH
 KOVARIK, Jiri, Novartis Pharma AG Postfach Novartis Institute for Biomed. Research, 4002 Basel, CH
 OLIVER, Stephen John, Novartis Pharma AG Postfach Novartis Institute for Biomed. Research, 4002 Basel, CH
 PATEL, Dhavalkumar, Novartis Pharma AG Postfach, 4002 Basel, CH
 WOISETSCHLAEGER, Maximilian, Novartis Pharma AG Postfach Novartis Institute for Biomed. Research, 4002 Basel, CH

- (51) MKP
A61K 31/4045 2006 (97) EP 3658550
A61K 31/437 2006
A61P 25/04 2006
C07D 409/06 2006
C07D 471/04 2006
- (96) EP 18743038.4 7/27/2018
(97) EP 3658550, 6/3/2020 202023, en
- (31) 17382502 (32) 27.07.2017 (33) EP
- (54) NEW PROPANAMINE DERIVATIVES FOR TREATING PAIN AND PAIN RELATED CONDITIONS
(72) VIRGILI-BERNADÓ, MARINA, Marina, Enantia S.L. Parc Científic Barcelona c/ Baldiri Reixac 10, 08028 Barcelona, ES
ALMANSA-ROSALES, Carmen, c/Teodora Lamadrid nº 41 Ent 4ª, 08022 Barcelona, ES
ALONSO-XALMA, Mónica, Enantia S.L. Parc Científic Barcelona c/ Baldiri Reixac 10, 08028 Barcelona, ES
OSORIO-PLANES, Laura, Enantia S.L. Parc Científic Barcelona c/ Baldiri Reixac 10, 08028 Barcelona, ES
-

- (51) MKP
E05F 15/643 2015 (97) EP 3673134
- (96) EP 18716008.0 3/13/2018
(97) EP 3673134, 7/1/2020 202027, en
- (54) MODULAR SLIDING MEMBER POWER MECHANISM AND METHOD FOR ITS OPERATION
(71) PIRNAR d.o.o., Bravnicarjeva ulica 20, 1000 Ljubljana, SI
(72) PIRNAR, Roman, Kermaunerjeva ulica 9, 1000 LJUBLJANA, SI
-

- (51) MKP
A01K 41/00 2006 (97) EP 3632204
A01K 41/06 2006
A01K 43/00 2006
- (96) EP 18198858.5 10/5/2018
(97) EP 3632204, 6/3/2020 202023, en
- (54) DEVICE FOR TRANSPORTING AND HATCHING EGGS ON FARM BREEDING
(71) Societa' Agricola la Pellegrina S.p.A., Via Valpantena, 18/G, 37034 Quinto di Valpantena Verona, IT
(72) DE RAMUNO, Mario, Societa' Agricola la Pellegrina S.p.A. Via Valpantena, 18/G, 37034 Quinto di Valpantena, IT
BAROSIO, Umberto, Societa' Agricola la Pellegrina S.p.A. Via Valpantena, 18/G, 37034 Quinto di Valpantena, IT
DE ZANE, Alberto, Societa' Agricola la Pellegrina S.p.A. Via Valpantena, 18/G, 37034 Quinto di Valpantena, IT
DALLA BARBA, Giulio, Societa' Agricola la Pellegrina S.p.A. Via Valpantena, 18/G, 37034 Quinto di Valpantena, IT
RAMINA, Flavio, Societa' Agricola la Pellegrina S.p.A. Via Valpantena, 18/G, 37034 Quinto di Valpantena, IT
MORANDINI, Emilio, Societa' Agricola la Pellegrina S.p.A. Via Valpantena, 18/G, 37034 Quinto di Valpantena, IT
FASOLATO, Luciano, Societa' Agricola la Pellegrina S.p.A. Via Valpantena, 18/G, 37034 Quinto di Valpantena, IT
-

- (51) MKP
A61K 47/68 2017 (97) EP 3545977
A61P 35/00 2006
- (96) EP 18199729.7 3/29/2012
(97) EP 3545977, 4/29/2020 202018, en
- (31) 201161468997 P (32) 29.03.2011 (33) US
- (54) PREPARATION OF MAYTANSINOID ANTIBODY CONJUGATES BY A ONE-STEP PROCESS
(72) LI, Xinfang, 85 Brookline Street, Newton, MA 02467, US
WORFUL, Jared, M., 127 Elm Street 1, Somerville, MA Massachusetts 02144, US
-

- (51) MKP
B23Q 1/26 2006 (97) EP 3643447
B23Q 11/08 2006
F16C 29/02 2006
F16C 29/08 2006
- (96) EP 18203008.0 10/28/2018
(97) EP 3643447, 4/29/2020 202018, en
- (54) LOW DUST LINEAR MODULE
(72) HUNG, Ciao-Cun, Hiwin Technologies Corp. No.7, Jingke Rd. Nantun Dist., 40852 Taichung City, TW
TSAI, Meng-Lung, Hiwin Technologies Corp. No.7, Jingke Rd. Nantun Dist., 40852 Taichung City, TW
PENG, Tsung-Wen, Hiwin Technologies Corp. No.7, Jingke Rd. Nantun Dist., 40852 Taichung City, TW
-

- (51) MKP

	B01D 39/16	2006	(97) EP 3658254			
(96)	EP 18765097.3 9/3/2018					
(97)	EP 3658254, 6/3/2020 202023, de					
(31)	102017010986		(32)	28.11.2017	(33)	DE
	102018100935			17.01.2018		DE
(54)	AIR-PERMEABLE SHEET FILTER MATERIAL, METHODS FOR THE PRODUCTION AND USE THEREOF					
(72)	BÖHRINGER, Bertram, Bussardweg 33, 42115 Wuppertal, DE FISCHER, Rainer, Ewald-Mataré-Strasse 22, 41470 Neuss, DE NGUYEN, Congminh, Lunsstrasse 78, 42277 Wuppertal, DE					
<hr/>						
(51)	MKP					
	A61M 5/142	2006	(97) EP 3672663			
(96)	EP 18765253.2 8/22/2018					
(97)	EP 3672663, 7/1/2020 202027, en					
(31)	201762548750 P		(32)	22.08.2017	(33)	US
(54)	NEEDLE INSERTION MECHANISM FOR DRUG DELIVERY DEVICE					
(72)	OLIVAS, Jerome, 1456 Calle Colina, Thousand Oaks, CA 91360, US HARRIS, Justin, 5621 Baird Ave., Reseda, CA 91335, US DUTTA RAY, Sudeshna, 300 Rolling Oaks Drive Apt. 119, Thousand Oaks, CA 91361, US COLEMAN, David, Hillview Cottage Lower Road Shankhill, Dublin 18, IE MCMANUS, Eoghan, 103 Kimmage Road West Kimmage, Dublin 12, IE					
<hr/>						
(51)	MKP					
	A61K 31/336	2006	(97) EP 3672586			
	A61K 31/343	2006				
	A61K 31/5377	2006				
	A61P 13/12	2006				
	A61P 37/06	2006				
(96)	EP 18765279.7 8/23/2018					
(97)	EP 3672586, 7/1/2020 202027, en					
(31)	201762549020 P		(32)	23.08.2017	(33)	US
(54)	IMMUNOPROTEASOME INHIBITORS AND IMMUNOSUPPRESSIVE AGENT IN THE TREATMENT OF AUTOIMMUNE DISORDERS					
(72)	MUCHAMUEL, Tony, 140 Dorrance Road, Boulder Creek CA 95006, US					
<hr/>						
(51)	MKP					
	B01D 53/14	2006	(97) EP 3672712			
(96)	EP 18765500.6 8/8/2018					
(97)	EP 3672712, 7/1/2020 202027, en					
(31)	201715683548		(32)	22.08.2017	(33)	US
(54)	METHOD FOR RECLAIMING AMINE ABSORPTION AGENT UNDER CONTROLLED TEMPERATURE					
(72)	ANDRIAN, Diki, Berri Box 8580, Al-Jubail, SA ALSHAER, Amjad A., Berri Box 8580, Al-Jubail, SA					
<hr/>						
(51)	MKP					
	A01N 43/54	2006	(97) EP 3655396			
	C07D 239/47	2006				
(96)	EP 18765708.5 7/16/2018					
(97)	EP 3655396, 5/27/2020 202022, en					
(31)	201762533509 P		(32)	17.07.2017	(33)	US
(54)	POLYMORPHS OF 5-FLUORO-4-IMINO-3-METHYL-1-TOSYL-3,4-DIHYDROPYRIMIDIN-2-ONE					
(71)	Adama Makhteshim Ltd., P.O. Box 60, 8410001 Beer-Sheva, IL					
(72)	GRABARNICK, Michael, 5 Shoal Steer, 8502500 Meitar, IL SUEZ, Gal, 22/18 Niv David Street, 8425626 Beer Sheva, IL NEMET, Zoltán, Ostenbergstrasse 9, 4410 Liestal, CH ALASIBI, Samaa, 87 Ali Ben Abi Taleb Street, 857300 Hura, IL					
<hr/>						
(51)	MKP					
	A23L 33/135	2016	(97) EP 3664824			
	A61K 35/744	2015				
	A61P 1/12	2006				

A61P 29/00 2006
A61P 35/00 2006
A61P 37/00 2006
(96) EP 18765808.3 8/10/2018
(97) EP 3664824, 6/17/2020 202025, en
(31) 201712857 (32) 10.08.2017 (33) GB
201800866 19.01.2018 GB
18183642 16.07.2018 EP
(54) COMPOSITIONS COMPRISING BACTERIAL STRAINS
(72) MULDER, Imke Elisabeth, c/o 4D Pharma Research Limited Life Sciences Innovation Building Cornhill Road, Aberdeen Aberdeenshire AB25 2ZS, GB
MCCLUSKEY, Seanin Marie, c/o 4D Pharma Research Limited Life Sciences Innovation Building Cornhill Road, Aberdeen Aberdeenshire AB25 2ZS, GB
SAVIGNAC, Helene, c/o 4D Pharma Research Limited Life Sciences Innovation Building Cornhill Road, Aberdeen Aberdeenshire AB25 2ZS, GB
JEFFERY, Ian, c/o 4D Pharma Cork Limited Room 447 Food Science Building University College, Co Cork, IE

(51) MKP
C07K 16/28 2006 (97) EP 3665198
C07K 16/46 2006
(96) EP 18766377.8 8/9/2018
(97) EP 3665198, 6/17/2020 202025, en
(31) 17185572 (32) 09.08.2017 (33) EP
(54) ANTIBODIES THAT BIND EGFR AND CMET
(72) GEUIJEN, Cecilia, Anna, Wilhelmina, c/o Yalelaan 62, 3584 CM Utrecht, NL
ROOVERS, Robertus, Cornelis, c/o Yalelaan 62, 3584 CM Utrecht, NL
THROSBY, Mark, c/o Yalelaan 62, 3584 CM Utrecht, NL
DE KRUIF, Cornelis, Adriaan, c/o Yalelaan 62, 3584 CM Utrecht, NL
LOGTENBERG, Ton, c/o Yalelaan 62, 3584 CM Utrecht, NL

(51) MKP
A01D 46/28 2006 (97) EP 3648569
(96) EP 18766394.3 7/2/2018
(97) EP 3648569, 5/13/2020 202020, en
(31) P20150673 (32) 03.07.2017 (33) RS
(54) PNEUMATIC CUSHIONS FOR SOFT RECEPTION OF HARVESTED FRUIT ON MECHANIZED FRUIT HARVESTING DEVICES
(72) Kokanovic, Momcilo, Kralja Milutina 9b, 11500 Obrenovac, RS

(51) MKP
A61K 31/522 2006 (97) EP 3668870
A61P 37/04 2006
C07D 473/18 2006
(96) EP 18766417.2 8/16/2018
(97) EP 3668870, 6/24/2020 202026, en
(31) 201762546211 P (32) 16.08.2017 (33) US
(54) 6-AMINO-7,9-DIHYDRO-8H-PURIN-8-ONE DERIVATIVES AS IMMUNOSTIMULANT TOLL-LIKE RECEPTOR 7 (TLR7) AGONISTS
(72) HE, Liqi, c/o Bristol-Myers Squibb Company 700 Bay Road, Redwood City CA 94063, US
GANGWAR, Sanjeev, c/o Bristol-Myers Squibb Company 700 Bay Road, Redwood City CA 94063, US
POSY, Shoshana, L., c/o Bristol-Myers Squibb Company 700 Bay Road, Redwood City CA 94063, US
POUDEL, Yam, B., c/o Bristol-Myers Squibb Company 700 Bay Road, Redwood City CA 94063, US
SIVAPRAKASAM, Prasanna, c/o Bristol-Myers Squibb Company 700 Bay Road, Redwood City CA 94063, US

(51) MKP
A61K 31/522 2006 (97) EP 3668871
A61P 37/04 2006
C07D 473/18 2006
(96) EP 18766418.0 8/16/2018
(97) EP 3668871, 6/24/2020 202026, en
(31) 201762546222 P (32) 16.08.2017 (33) US
(54) 6-AMINO-7,9-DIHYDRO-8H-PURIN-8-ONE DERIVATIVES AS IMMUNOSTIMULANT TOLL-LIKE RECEPTOR 7 (TLR7) AGONISTS
(72) HE, Liqi, c/o Bristol-Myers Squibb Company 700 Bay Road, Redwood City CA 94063, US
GANGWAR, Sanjeev, c/o Bristol-Myers Squibb Company 700 Bay Road, Redwood City CA 94063, US

POUDEL, Yam, B., c/o Bristol-Myers Squibb Company 700 Bay Road, Redwood City CA 94063, US
 SIVAPRAKASAM, Prasanna, c/o Bristol-Myers Squibb Company 700 Bay Road, Redwood City CA 94063, US

- (51) MKP
A61K 35/76 2015 (97) EP 3664844
A61K 39/395 2006
C07K 16/28 2006
- (96) EP 18768988.0 8/6/2018
 (97) EP 3664844, 6/17/2020 202025, en
 (31) 201762542046 P (32) 07.08.2017 (33) US
- (54) TREATMENT OF TRIPLE NEGATIVE BREAST CANCER OR COLORECTAL CANCER WITH LIVER METASTASES WITH AN ANTI PD-L1 ANTIBODY AND AN ONCOLYTIC VIRUS
- (72) GANSERT, Jennifer, Lorraine, 337 Longbranch Road, Simi Valley, CA 93065, US
 BHATTA, Sumita, Shankar, 2496 Seacrest Court, Thousand Oaks, CA 91362, US
 WOODARD, Joseph, Paul, 1 DNA Way, South San Francisco, CA 94080-4990, US
 CHA, Edward Namserk, 1 DNA Way, South San Francisco, CA 94080-4990, US

- (51) MKP
A01K 61/13 2017 (97) EP 3664602
A01K 61/95 2017
- (96) EP 18768989.8 8/6/2018
 (97) EP 3664602, 6/17/2020 202025, en
 (31) 201762541917 P (32) 07.08.2017 (33) US
- (54) LIVE FISH PROCESSING SYSTEM, AND ASSOCIATED METHODS
- (71) Pharmaq AS, Skogmo Industriområde Industrivegen 50, 7863 Overhalla, NO
 (72) PETTERSEN, Jørn, Ståle, c/o Pharmaq AS Skogmo Industriområde Industrivegen 50, 7863 Overhalla, NO
 ODDØY, Remy, Kristian, c/o Pharmaq AS Skogmo Industriområde Industrivegen 50, 7863 Overhalla, NO
 MOFLAG, Johan, Odd, c/o Pharmaq AS Skogmo Industriområde Industrivegen 50, 7863 Overhalla, NO
 LANGSETH, Steffen, c/o Pharmaq AS Skogmo Industriområde Industrivegen 50, 7863 Overhalla, NO

- (51) MKP
A61K 31/553 2006 (97) EP 3668878
A61P 35/00 2006
C07D 498/08 2006
- (96) EP 18769537.4 8/17/2018
 (97) EP 3668878, 6/24/2020 202026, en
 (31) 201762547589 P (32) 18.08.2017 (33) US
- (54) COMPOUNDS THAT INHIBIT MCL-1 PROTEIN
- (72) BROWN, Sean P., 28909 Hollowbrook Ave., Agoura Hills, California 91301, US
 LANMAN, Brian Alan, 6000 De Soto Avenue 305, Woodland Hills, California 91367, US
 LI, Kexue, 274 Via Antonio, Newbury Park, California 91320, US
 LI, Yunxiao, 25 McAfee Court, Thousand Oaks, California 91360, US
 REED, Anthony B., 3031 Charlotte Street, Newbury Park, California 91320, US

- (51) MKP
A61K 31/454 2006 (97) EP 3672949
A61K 31/4545 2006
A61P 35/00 2006
C07D 401/04 2006
C07D 401/14 2006
C07D 407/14 2006
C07D 409/14 2006
C07D 413/14 2006
C07D 417/14 2006
C07D 471/04 2006
C07D 487/04 2006
C07D 487/08 2006
C07D 495/04 2006
C07D 513/04 2006
- (96) EP 18772885.2 8/23/2018
 (97) EP 3672949, 7/1/2020 202027, en
 (31) 201762549225 P (32) 23.08.2017 (33) US
- (54) 3-(1-OXOISOINDOLIN-2-YL)PIPERIDINE-2,6-DIONE DERIVATIVES AND USES THEREOF

(72) BECKWITH, Rohan Eric John, Novartis Institutes for BioMedical Research Inc. 250 Massachusetts Avenue, Cambridge, Massachusetts 02139, US
 BONAZZI, Simone, Novartis Institutes for BioMedical Research Inc. 250 Massachusetts Avenue, Cambridge, Massachusetts 02139, US
 CERNIJENKO, Artiom, Novartis Institutes for BioMedical Research Inc. 250 Massachusetts Avenue, Cambridge, Massachusetts 02139, US
 FAZAL, Aleem, Novartis Institutes for BioMedical Research Inc. 250 Massachusetts Avenue, Cambridge, Massachusetts 02139, US
 TICHKULE, Ritesh Bhanudasji, Novartis Institutes for BioMedical Research Inc. 250 Massachusetts Avenue, Cambridge, Massachusetts 02139, US
 VISSER, Michael Scott, Novartis Institutes for BioMedical Research Inc. 250 Massachusetts Avenue, Cambridge, Massachusetts 02139, US

(51) MKP
C07K 14/755 2006 (97) EP 3665289
C12N 9/64 2006
C12N 15/86 2006

(96) EP 18772954.6 8/9/2018
 (97) EP 3665289, 6/17/2020 202025, en
 (31) 201762543297 P (32) 09.08.2017 (33) US

(54) NUCLEIC ACID MOLECULES AND USES THEREOF
 (72) SEREGIN, Alexey, 15 Commodore Way, Westford Massachusetts 01886, US
 LIU, Tongyao, 53 Buckman Drive, Lexington Massachusetts 02421, US
 PATARROYO-WHITE, Susannah, 225 Second Avenue, Waltham Massachusetts 02451, US
 DRAGER, Douglas, 225 Second Avenue, Waltham Massachusetts 02451, US
 PETERS, Robert T., 53 Parkinson Street, Needham Massachusetts 02492, US
 LIU, Jiayun, 297 Weston Rd, Wellesley Massachusetts 02482, US

(51) MKP
B61H 9/02 2006 (97) EP 3673231
G01B 7/00 2006
G01B 7/02 2006
G01D 5/22 2006
G01R 33/00 2006
G01V 3/10 2006
H03K 17/95 2006
H04B 5/00 2006
H04B 15/00 2006

(96) EP 18773075.9 8/23/2018
 (97) EP 3673231, 7/1/2020 202027, de
 (31) 507112017 (32) 25.08.2017 (33) AT

(54) INDUCTIVE SENSOR
 (72) HOFMAYR, Christoph, Pongartgasse 6, 6850 Dornbirn, AT
 MOHNI, Adrian, Bernhardswiesweg 2, 9014 St. Gallen, CH
 NAGEL, Helmut, Brugger Strasse 26B, 6973 Höchst, AT

(51) MKP
A61K 31/4545 2006 (97) EP 3649124
A61P 25/28 2006
C07D 413/04 2006

(96) EP 18773832.3 8/6/2018
 (97) EP 3649124, 5/13/2020 202020, en
 (31) 201741028024 (32) 07.08.2017 (33) IN

(54) FLUOROPIPERIDINE COMPOUNDS AS PURE 5-HT6 RECEPTOR ANTAGONISTS
 (72) NIROGI, Ramakrishna, Suven Life Sciences Limited Serene Chambers Road-5 Avenue 7 Banjara Hills, Hyderabad Telangana 500034, IN
 SHINDE, Anil Karbhari, Suven Life Sciences Limited Serene Chambers Road-5 Avenue 7 Banjara Hills, Hyderabad Telangana 500034, IN
 MOHAMMED, Abdul Rasheed, Suven Life Sciences Limited Serene Chambers Road-5 Avenue 7 Banjara Hills, Hyderabad Telangana 500034, IN
 BADANGE, Rajesh Kumar, Suven Life Sciences Limited Serene Chambers Road-5 Avenue 7 Banjara Hills, Hyderabad Telangana 500034, IN
 BOJJA, Kumar, Suven Life Sciences Limited Serene Chambers Road-5 Avenue 7 Banjara Hills, Hyderabad Telangana 500034, IN
 GOYAL, Vinod Kumar, Suven Life Sciences Limited Serene Chambers Road-5 Avenue 7 Banjara Hills, Hyderabad Telangana 500034, IN
 PANDEY, Santosh Kumar, Suven Life Sciences Limited Serene Chambers Road-5 Avenue 7 Banjara Hills, Hyderabad Telangana 500034, IN
 THENTU, Jagadeesh Babu, Suven Life Sciences Limited Serene Chambers Road-5 Avenue 7 Banjara Hills, Hyderabad Telangana 500034, IN
 JASTI, Venkateswarlu, Suven Life Sciences Limited Serene Chambers Road-5 Avenue 7 Banjara Hills, Hyderabad Telangana 500034, IN

(51) MKP

C12Q 1/6883 2018 (97) EP 3669004
G01N 33/574 2006
G01N 33/68 2006
(96) EP 18779017.5 8/15/2018
(97) EP 3669004, 6/24/2020 202026, en
(31) 201762546210 P (32) 16.08.2017 (33) US
(54) COMPOSITIONS AND METHODS FOR TREATMENT OF ATOPIC DERMATITIS AND TREATMENT SELECTION
(72) HOWELL, Michael D., c/o MEDIMMUNE LLC One MedImmune Way, Gaithersburg, Maryland 20878, US

(51) MKP
A61K 31/5025 2006 (97) EP 3668513
A61P 3/10 2006
A61P 7/06 2006
A61P 7/08 2006
A61P 35/00 2006
C07D 513/14 2006
(96) EP 18779068.8 8/15/2018
(97) EP 3668513, 6/24/2020 202026, en
(31) PCT/CN2017/097496 (32) 15.08.2017 (33) WO
201862673526 P 18.05.2018 US
201862673533 P 18.05.2018 US
(54) PYRUVATE KINASE ACTIVATORS FOR USE IN TREATING BLOOD DISORDERS
(72) CIANCHETTA, Giovanni, 82 Herrick Road, Boxford, MA 01921, US
LIU, Tao, 11 Frost Circle, Wellesley, MA 02482, US
PADYANA, Anil, Kumar, 20 Woodpark Circle, Lexington, MA 02421, US
SUI, Zhihua, 88 Sidney Street, Cambridge, MA 02139, US
CAI, Zhenwei, No. 66 Qingli Road Lane 425 Room 1102 Heqing Zhen Pudong, Shanghai 201201, CN
CUI, Dawei, Room 9-1001 288 Yaxiang Road Jiading District, Shanghai 201802, CN
JI, Jingjing, Room 401, No. 79, Lane 2077, Guangfuxi Road Putuo District, Shanghai, 200062, CN

(51) MKP
A61K 9/00 2006 (97) EP 3654988
A61K 31/65 2006
A61P 17/10 2006
A61P 43/00 2006
(96) EP 18779747.7 7/20/2018
(97) EP 3654988, 5/27/2020 202022, en
(31) 201762535572 P (32) 21.07.2017 (33) US
(54) TREATMENT OF NON-INFLAMMATORY LESIONS
(71) Almirall, LLC, 707 Eagleview Boulevard, Suite 200, Exton, Pennsylvania 19341, US
(72) BERK, David, 7108 San Joaquin Plz, Newport Beach CA 92660, US
KAOUKHOV, Alexandre, 4069 Rivoli, Newport Beach CA 92660, US
SNIUKIENE, Vilma, 125 New Jersey Ave, Lake Hopatcong NJ 07849, US
SCHMITZ, Carsten, 66 Juneberry, Irvine CA 92606, US

(51) MKP
H02P 7/00 2016 (97) EP 3665771
(96) EP 18780061.0 9/25/2018
(97) EP 3665771, 6/17/2020 202025, de
(31) 102017217626 (32) 04.10.2017 (33) DE
102018204531 23.03.2018 DE
(54) METHOD AND DEVICE FOR DETERMINING A ROTATION VARIABLE
(71) Brose Fahrzeugteile SE & Co. Kommanditgesellschaft, Bamberg, Berliner Ring 1, 96052 Bamberg, DE
(72) THOMANN, Christian, Krumbach 9, 96138 Burgebrach, DE
RUSS, Detlef, Lindenbergring 1, 96237 Ebersdorf, DE
NAUMANN, Guido, Grundweg 21, 35108 Allendorf, DE
BRAND, Christoph, Hinterhochstein 6, 96117 Memmelsdorf, DE

(51) MKP
A61K 31/444 2006 (97) EP 3653620
A61K 31/496 2006
A61P 35/00 2006

C07D 401/12 2006
C07D 401/14 2006
C07D 409/14 2006
(96) EP 18789777.2 7/9/2018
(97) EP 3653620, 5/20/2020 202021, en
(31) 17382447 (32) 10.07.2017 (33) EP
(54) NEW HETEROARYL AMIDE DERIVATIVES AS SELECTIVE INHIBITORS OF HISTONE DEACETYLASES 1 AND 2 (HDAC1-2)
(71) MEDIBIOFARMA, S.L., Plaza CEIN, Poligono Industrial Mocholi. Nave B-2, 31110 Noain-Navarra, ES
(72) CASTRO PALOMINO LARIA, Julio, PALOBIOFARMA S.L. Tecnocampus Mataró 3 Avenida Ernest Lluch 32 Planta 4 Oficina 01, E-08302 Mataró (Barcelona), ES
CAMACHO GÓMEZ, Juan, PALOBIOFARMA S.L. Tecnocampus Mataró 3 Avenida Ernest Lluch 32 Planta 4 Oficina 01, E-08302 Mataró (Barcelona), ES
RODRÍGUEZ IGLESIAS, Rodolfo, MEDIBIOFARMA S.L. Plaza CEIN Polígono Industrial Mocholí. Nave B-2, E-31110 Noaín (Navarra), ES

(51) MKP
A61K 39/00 2006 (97) EP 3539566
A61K 39/135 2006
A61K 39/385 2006
C07K 14/005 2006
C07K 14/32 2006
C12N 7/00 2006
(96) EP 19167578.4 11/16/2016
(97) EP 3539566, 4/22/2020 202017, en
(31) 201562259043 P (32) 23.11.2015 (33) US
(54) FMDV AND E2 FUSION PROTEINS AND USES THEREOF
(71) Boehringer Ingelheim Animal Health USA Inc., 3239 Satellite Boulevard, Bldg. 500, Duluth, GA 30096, US
(72) AUDONNET, Jean-christophe, 119 Rue De Crequi, 69006 Lyon, FR
REYNARD, Frederic, 35 Impasse Des Magnananelles, 69720 St Bonnet-de Mure, FR
BOMCHIL, Natalia, 9 Rue Des Alouettes, 69008 Lyon, FR
SIGOILLOT-CLAUDE, Cecile, 27 Rue De Merlo, 69600 Oullins, FR

(51) MKP
C12N 5/071 2010 (97) EP 3564361
C12N 5/074 2010
(96) EP 19167639.4 7/29/2011
(97) EP 3564361, 6/10/2020 202024, en
(31) 36873610 P (32) 29.07.2010 (33) US
10171265 29.07.2010 EP
201161520569 P 10.06.2011 US
(54) LIVER ORGANOID, USES THEREOF AND CULTURE METHOD FOR OBTAINING THEM
(72) HUCH ORTEGA,, Meritxell, Willem Barentszstraat 25-11, 3572 PB Utrecht, NL
CLEVERS, Johannes Carolus, Ruysdaellaan 7, 3712 AP Huis ter Heide, NL

(51) MKP
A61K 39/00 2006 (97) EP 3542816
(96) EP 19168987.6 2/13/2015
(97) EP 3542816, 4/29/2020 202018, en
(31) 201461940109 P (32) 14.02.2014 (33) US
201461985787 P 29.04.2014 US
201462022070 P 08.07.2014 US
201462072548 P 30.10.2014 US
201562101335 P 08.01.2015 US
(54) IMMUNOTHERAPY OF CANCER THROUGH COMBINATION OF LOCAL AND SYSTEMIC IMMUNE STIMULATION
(72) TER MEULEN, Jan, Henrik, 3842 West Mercer Way, Mercer Island, WA 98040, US
PAYA CUENCA, Carlos, V., 165 Collingwood Street, San Francisco, CA 94114, US

(51) MKP
A61P 17/06 2006 (97) EP 3536710
C07K 16/28 2006
(96) EP 19169065.0 11/14/2012
(97) EP 3536710, 4/15/2020 202016, en
(31) 201161560554 P (32) 16.11.2011 (33) US

	201261644111 P		08.05.2012		US
	201261713713 P		15.10.2012		US
(54)	ANTI IL-36R ANTIBODIES				
(72)	Brown, Su-Ellen, Boehringer Ingelheim USA Corp. P.O. Box 368 c/o VP IP Legal 900 Ridgebury Road, Ridgefield, CT 06877-0368, US Canada, Keith, Boehringer Ingelheim USA Corp. P.O. Box 368 c/o VP IP Legal 900 Ridgebury Road, Ridgefield, CT 06877-0368, US Chlewicki, Lukasz, Boehringer Ingelheim USA Corp. P.O. Box 368 c/o VP IP Legal 900 Ridgebury Road, Ridgefield, CT 06877-0368, US Howell, Michael, Boehringer Ingelheim USA Corp. P.O. Box 368 c/o VP IP Legal 900 Ridgebury Road, Ridgefield, CT 06877-0368, US Mennerich, Detlev, Boehringer Ingelheim GmbH Corporate Patents Binger Strasse 173, 55216 Ingelheim am Rhein, DE Woska Jr., Joseph Robert, Boehringer Ingelheim USA Corp. P.O. Box 368 c/o VP IP Legal 900 Ridgebury Road, Ridgefield, CT 06877-0368, US				

(51)	MKP				
	A61K 9/06	2006	(97) EP 3539534		
	A61K 31/496	2006			
	A61K 47/10	2017			
	A61K 47/32	2006			
	A61K 47/38	2006			
	A61P 25/18	2006			
	A61P 25/24	2006			
(96)	EP 19169193.0 4/23/2013				
(97)	EP 3539534, 4/22/2020 202017, en				
(31)	201261636938 P		(32)	23.04.2012	(33) US
	201361792089 P			15.03.2013	US
(54)	INJECTABLE PREPARATION				
(71)	Otsuka Pharmaceutical Co., Ltd., 9, Kanda-Tsukasamachi 2-chome, Chiyoda-ku, Tokyo 101-8535, JP				
(72)	Kaneko, Daiki, c/o OTSUKA PHARMACEUTICAL CO. LTD. 3-2-27, Otedori Chuo-ku Osaka-shi, Osaka, 540-0021, JP Matsuda, Takakuni, c/o OTSUKA PHARMACEUTICAL CO. LTD. 3-2-27, Otedori Chuo-ku Osaka-shi, Osaka, 540-0021, JP Hoshika, Yusuke, c/o OTSUKA PHARMACEUTICAL CO. LTD. 3-2-27, Otedori Chuo-ku Osaka-shi, Osaka, 540-0021, JP				

(51)	MKP				
	G06Q 50/02	2012	(97) EP 3564895		
(96)	EP 19169477.7 4/16/2019				
(97)	EP 3564895, 5/6/2020 202019, en				
(31)	201800005045		(32)	03.05.2018	(33) IT
(54)	METHOD FOR CERTIFICATION OF ORGANIC PRODUCTS				
(71)	Merendels - Società a Responsabilità Limitata, Viale dei Flavi 13, 02100 Rieti (RI), IT				
(72)	MUNGO, Elio, MERENDELS - SOCIETÀ A RESPONSABILITÀ LIMITATA Viale dei Flavi 13, I-02100 RIETI (RI), IT				

(51)	MKP				
	C07K 16/46	2006	(97) EP 3556777		
(96)	EP 19169534.5 6/25/2015				
(97)	EP 3556777, 6/3/2020 202023, en				
(31)	201411320		(32)	25.06.2014	(33) GB
(54)	MULTISPECIFIC ANTIBODY CONSTRUCTS				
(72)	BHATTA, Pallavi, UCB Celltech, IPD 208 Bath Road, Slough, Berkshire SL1 3WE, GB DAVE, Emma, UCB Celltech, IPD 208 Bath Road, Slough, Berkshire SL1 3WE, GB HEYWOOD, Sam Philip, UCB Celltech, IPD 208 Bath Road, Slough, Berkshire SL1 3WE, GB HUMPHREYS, David Paul, UCB Celltech, IPD 208 Bath Road, Slough, Berkshire SL1 3WE, GB				

(51)	MKP				
	C07H 21/04	2006	(97) EP 3540070		
	C07K 16/00	2006			
	C12P 21/08	2006			
(96)	EP 19169804.2 6/11/2013				
(97)	EP 3540070, 4/15/2020 202016, en				
(31)	201261658237 P		(32)	11.06.2012	(33) US
(54)	DUAL RECEPTOR ANTAGONISTIC ANTIGEN-BINDING PROTEINS AND USES THEREOF				
(72)	Han, Huiquan, C/o Amgen Inc One Amgen Center Drive, Thousand Oaks, CA 91320-1799, US Zhou, Xiaolan, C/o Amgen Inc One Amgen Center Drive, Thousand Oaks, CA 91320-1799, US Chen, Qing, C/o Amgen Inc One Amgen Center Drive, Thousand Oaks, CA 91320-1799, US Tsai, Mei-Mei, C/o Amgen Inc One Amgen Center Drive, Thousand Oaks, CA 91320-1799, US				

(51) MKP
A61K 31/519 2006 (97) EP 3536692
A61P 35/00 2006
C07D 487/04 2006
(96) EP 19170607.6 2/14/2013
(97) EP 3536692, 4/15/2020 202016, en
(31) 201261600070 P (32) 17.02.2012 (33) US
(54) PYRAZOLOPYRIMIDINYL INHIBITORS OF UBIQUITIN-ACTIVATING ENZYME
(72) AFROZE, Roushan, 19 Carson Road, Woburn, MA 01801, US
BHARATHAN, Indu, T., 101 Western Avenue, Apartment 45, Cambridge, MA 02139, US
CIAVARRI, Jeffrey, P., 30 Winthrop Avenue, Reading, MA 01867, US
FLEMING, Paul, E., 7 Sunnyside Avenue, Wellesley, MA 02482, US
GAULIN, Jeffrey, L., 17 Justin Circle, Londonderry, NH 03053, US
GIRARD, Mario, 175 Centre Street, Apt 904, Quincy, MA 02169, US
LANGSTON, Steven, P., 164 Mill Road, North Andover, MA 01845, US
SOUCY, Francois, R., 39 Ellen Road, Stoneham, MA 02180, US
WONG, Tzu-Tshin, 27 High St., Acton, MA 01720, US
YE, Yingchun, 36 Hurley Street, Belmont, MA 02478, US

(51) MKP
A61P 7/06 2006 (97) EP 3536711
A61P 37/06 2006
C07K 16/28 2006
(96) EP 19170670.4 2/19/2014
(97) EP 3536711, 4/15/2020 202016, en
(31) 13425029 (32) 19.02.2013 (33) EP
(54) ANTI-CD26 ANTIBODIES AND USES THEREOF
(72) DI NARO, Antonio Francesco, Via San Bartolomee, 6922 Morcote, CH

(51) MKP
A61K 31/519 2006 (97) EP 3572083
A61K 45/06 2006
A61P 35/00 2006
C07D 471/14 2006
(96) EP 19171477.3 3/13/2014
(97) EP 3572083, 7/11/2020 202027, en
(31) 201361779828 P (32) 13.03.2013 (33) US
201361904718 P 15.11.2013 US
(54) 7-BENZYL-10-(2-METHYLBENZYL)-2,6,7,8,9,10-HEXAHYDROIMIDAZO[1,2-A]PYRIDO[4,3-D]PYRIMIDIN-5(3H)-ON FOR USE IN THE TREATMENT OF CANCER
(72) STOGNIEW, Martin, 1870 Ferguson Ln., Blue Bell, PA Pennsylvania 19422, US
ALLEN, Joshua, E., 129 Tremont St, Cambridge, MA Massachusetts 02139, US
NALLAGANCHU, Bhaskara, Rao, 99 Norstrand Road, Hillsborough, NJ New Jersey 08852, US
POTTORF, Richard, S., 7550 Prairie View Dr., Indianapolis, IN Indiana 46526, US
OLSON, Gary, L., 7 Deer Park Drive Suite D, Monmouth Junction, NJ New Jersey 08852, US

(51) MKP
B66C 13/18 2006 (97) EP 3564181
B66D 1/08 2006
B66D 1/12 2006
(96) EP 19171514.3 4/29/2019
(97) EP 3564181, 6/3/2020 202023, en
(31) 201800005000 (32) 02.05.2018 (33) IT
(54) LIFTING SYSTEM
(71) E.C.E. - S.R.L., 21, Via della Pace Frazione: Casale, 43055 Mezzani (PR), IT
(72) GALARDI, Luca, 19, Via C. Colombo, 43121 PARMA, IT

(51) MKP
A61K 38/17 2006 (97) EP 3545966
C07K 14/47 2006
C12N 15/113 2010
(96) EP 19172033.3 5/7/2014
(97) EP 3545966, 5/13/2020 202020, en

(31) 13382167 (32) 07.05.2013 (33) EP
 (54) METHODS AND COMPOSITIONS FOR THE TREATMENT OF CANCER
 (72) SOUCEK, Laura, Fundació Privada Institut d'Investigació Oncològica de Vall Hebron Passeig Vall d'Hebron 119, Hospital Universitari de la Vall d'Hebron Edifici Maternoinfantil, planta, E-08035 Barcelona, ES
 BEAULIEU, Marie-Eve, Fundació Privada Institut d'Investigació Oncològica de Vall Hebron Passeig Vall d'Hebron 119, Hospital Universitari de la Vall d'Hebron Edifici Maternoinfantil, planta, E-08035 Barcelona, ES

(51) MKP
G06Q 20/34 2012 (97) EP 3564914
G07F 7/08 2006
 (96) EP 19172056.4 4/30/2019
 (97) EP 3564914, 5/6/2020 202019, fr
 (31) 1853789 (32) 02.05.2018 (33) FR
 201816171247 26.10.2018 US
 (54) METHOD AND SYSTEM FOR PERFORMING A SECURE DATA EXCHANGE
 (71) Marbeuf Conseil et Recherche, 42 rue de Maubeuge, 75009 Paris, FR
 (72) SANGLE FERRIERE, Bruno, 47 boulevard Beausejours, 75016 PARIS, FR

(51) MKP
A61K 31/433 2006 (97) EP 3556757
A61P 35/00 2006
C07D 417/08 2006
 (96) EP 19172254.5 4/17/2015
 (97) EP 3556757, 6/3/2020 202023, en
 (31) 201461986876 P (32) 30.04.2014 (33) US
 (54) CYCLOALKYL-LINKED DIHETEROCYCLE DERIVATIVES
 (72) BURNS, Aaron Craig, 18375 Camberwell Lane, San Diego, CA 92128, US
 COLLINS, Michael Raymond, 17330 Campillo Drive, San Diego, CA 92128, US
 GREASLEY, Samantha Elizabeth, Pfizer Inc. 10555 Science Center Drive, San Diego, CA 92121, US
 HOFFMAN, Robert Louis, 728 Foxhall Court, San Marcos, CA 92078, US
 HUANG, Qinhua, 4219 Calle Mar De Ballenas, San Diego, CA 92130, US
 KANIA, Robert Steven, 10670 Haven Brook Place, San Diego, CA 92130, US
 KUNG, Pei-Pei, 5504 Shannon Ridge Lane, San Diego, 92130, US
 LINTON, Maria Angelica, 10256 Rue Chamberry, San Diego, 92131, US
 NARASIMHAN, Lakshmi Sourirajan, 13572 Ginger Glen Road, San Diego, CA 92130, US
 RICHARDSON, Paul Francis, Pfizer Inc. 10555 Science Center Drive, San Diego, CA 92121, US
 RICHTER, Daniel Tyler, 2220 Chicago Street, San Diego, CA California 92110, US
 SMITH, Graham, Pfizer Inc. 10555 Science Center Drive, San Diego, CA 92121, US

(51) MKP
F41A 11/00 2006 (97) EP 3569965
F41A 17/36 2006
 (96) EP 19174261.8 5/14/2019
 (97) EP 3569965, 6/24/2020 202026, en
 (31) 18172419 (32) 15.05.2018 (33) EP
 500362019 17.01.2019 AT
 (54) FIREARM, IN PARTICULAR PISTOL, WITH A DEVICE FOR DISASSEMBLY
 (71) Glock Technology GmbH, Gaston-Glock-Park 1, 9170 Ferlach, AT
 (72) Dechant, Friedrich, Emmy-Stradalstrasse 31, 2020 Hollabrunn, AT

(51) MKP
B65D 5/02 2006 (97) EP 3569514
B65D 5/54 2006
 (96) EP 19174309.5 5/14/2019
 (97) EP 3569514, 6/10/2020 202024, en
 (31) 201862670997 P (32) 14.05.2018 (33) US
 (54) TAMPER EVIDENT CARTON
 (72) HAIDACHER, Victor Steven, Johnson & Johnson Consumer Inc. 7050 Camp Hill Road, Fort Washington, PA Pennsylvania 19034, US
 SCHENCK, Dustin R., Johnson & Johnson Consumer Inc. 7050 Camp Hill Road, Fort Washington, PA Pennsylvania 19034, US
 BANI, Edward A., Contemporary Graphic Solutions 1200 Ferry Avenue, Camden, NJ New Jersey 08104, US
 GALLAGHER, Megan, Contemporary Graphic Solutions 1200 Ferry Avenue, Camden, NJ New Jersey 08104, US
 IANNELLI, Greg, Contemporary Graphic Solutions 1200 Ferry Avenue, Camden, NJ New Jersey 08104, US

- (51) MKP
C12Q 1/68 2018 (97) EP 3550031
- (96) EP 19174436.6 7/23/2013
 (97) EP 3550031, 5/20/2020 202021, en
- (31) 201261675303 P (32) 24.07.2012 (33) US
 201261682688 P 13.08.2012 US
 201361780652 P 13.03.2013 US
- (54) MUTATIONS ASSOCIATED WITH RESISTANCE TO INHIBITORS OF BRUTON'S TYROSINE KINASE (BTK)
 (72) CHANG, Betty Y., 10375 Lindsay Avenue, Cupertino, CA California 95014, US
 BUGGY, Joseph J., 1229 Marilyn Avenue, Mountain View, CA California 94040, US
 STEGGERDA, Susanne M., 1286 8th Avenue, San Francisco, CA California 94122, US

- (51) MKP
A61K 31/506 2006 (97) EP 3560498
A61K 31/519 2006
A61P 35/00 2006
- (96) EP 19174594.2 10/15/2010
 (97) EP 3560498, 6/10/2020 202024, en
- (31) 25221309 P (32) 16.10.2009 (33) US
- (54) COMBINATION COMPRISING AN MEK INHIBITOR AND A B-RAF INHIBITOR
 (72) DUMBLE, Melissa, c/o GlaxoSmithKline, Global Patents Dept. 1250 South Collegeville Road P. O. Box 5089, Collegeville, Pennsylvania 19426, US
 KUMAR, Rakesh, c/o GlaxoSmithKline, Global Patents Dept. 1250 South Collegeville Road P. O. Box 5089, Collegeville, Pennsylvania 19426, US
 LAQUERRE, Sylvie, c/o GlaxoSmithKline, Global Patents Dept. 1250 South Collegeville Road P. O. Box 5089, Collegeville, Pennsylvania 19426, US
 LEBOWITZ, Peter, c/o GlaxoSmithKline, Global Patents Dept. 1250 South Collegeville Road P. O. Box 5089, Collegeville, 19426, US

- (51) MKP
C07F 9/6558 2006 (97) EP 3564248
C07F 9/6561 2006
- (96) EP 19174995.1 5/24/2017
 (97) EP 3564248, 6/10/2020 202024, en
- (31) 201662341049 P (32) 24.05.2016 (33) US
 201662357153 P 30.06.2016 US
 201662357166 P 30.06.2016 US
 201662357072 P 30.06.2016 US
 201662356923 P 30.06.2016 US
 201762508256 P 18.05.2017 US
- (54) PROCESSES FOR PREPARING PHOSPHORODIAMIDATE MORPHOLINO OLIGOMERS
 (72) CAI, Bao, c/o Sarepta Therapeutics, Inc. 215 First Street, Cambridge, MA 02142, US
 MARTINI, Mitchell, c/o Sarepta Therapeutics, Inc. 215 First Street, Cambridge, MA 02142, US
 SHIMABUKU, Ross, c/o Sarepta Therapeutics, Inc. 215 First Street, Cambridge, MA 02142, US
 THOMAS, Katie, c/o Sarepta Therapeutics, Inc. 215 First Street, Cambridge, MA 02142, US
 FRANK, Diane Elizabeth, c/o Sarepta Therapeutics, Inc. 215 First Street, Cambridge, MA 02142, US
 BESTWICK, Richard K., c/o Sarepta Therapeutics, Inc. 215 First Street, Cambridge, MA 02142, US

- (51) MKP
A61K 8/06 2006 (97) EP 3549573
A61K 8/37 2006
A61K 8/49 2006
A61K 8/73 2006
A61K 8/92 2006
A61Q 19/00 2006
- (96) EP 19175160.1 3/12/2018
 (97) EP 3549573, 5/13/2020 202020, en
- (31) 201762469666 P (32) 10.03.2017 (33) US
 201762488898 P 24.04.2017 US
- (54) METHOD FOR AFFECTING HAPTIC PERCEPTION
 (72) GARCIA, Devin, 333 Harris Avenue, Middlesex, NJ New Jersey 08846, US
 KAUR, Simarna, c/o Johnson & Johnson Consumer Inc. 199 Grandview Road, Skillman, NJ New Jersey 08558, US

NIKOLOVSKI, Janeta, c/o Johnson & Johnson Consumer Inc. 199 Grandview Road, Skillman, NJ New Jersey 08558, US
DeRIDDER, Louis, 55 Blanchard Road, Gansevoort, NY New York 12831, US

- (51) MKP
G03G 15/00 2006 (97) EP 3567437
G03G 21/16 2006
G03G 21/18 2006
- (96) EP 19175313.6 11/29/2018
(97) EP 3567437, 6/17/2020 202025, en
- (31) 2017238455 (32) 13.12.2017 (33) JP
- (54) IMAGE FORMING APPARATUS AND CARTRIDGE
(72) MURAKAMI, Ryuta, c/o CANON KABUSHIKI KAISHA 30-2, Shimomaruko 3-chome, Ohta-ku., Ohta-ku, Tokyo 146-8501, JP
MATSUMARU, Naoki, c/o CANON KABUSHIKI KAISHA 30-2, Shimomaruko 3-chome, Ohta-ku., Ohta-ku, Tokyo 146-8501, JP
HORIKAWA, Tadashi, c/o CANON KABUSHIKI KAISHA 30-2, Shimomaruko 3-chome, Ohta-ku., Ohta-ku, Tokyo 146-8501, JP
SUZUKI, Tetsuji, c/o CANON KABUSHIKI KAISHA 30-2, Shimomaruko 3-chome, Ohta-ku., Ohta-ku, Tokyo 146-8501, JP

- (51) MKP
A61K 9/00 2006 (97) EP 3566694
A61K 31/167 2006
A61K 31/40 2006
A61K 31/573 2006
A61K 31/58 2006
A61K 45/06 2006
A61M 15/00 2006
- (96) EP 19175726.9 12/23/2014
(97) EP 3566694, 6/10/2020 202024, en
- (31) 13199784 (32) 30.12.2013 (33) EP
- (54) STABLE PRESSURISED AEROSOL SOLUTION COMPOSITION OF GLYCOPYRRONIUM BROMIDE AND FORMOTEROL COMBINATION
(72) BONELLI, Sauro, c/o CHIESI FARMACEUTICI S.p.A. Via Palermo, 26/A, 43122 PARMA, IT
COPELLI, Diego, c/o CHIESI FARMACEUTICI S.p.A. Via Palermo, 26/A, 43122 PARMA, IT
DAGLI ALBERI, Massimiliano, c/o CHIESI FARMACEUTICI S.p.A. Via Palermo, 26/A, 43122 PARMA, IT
USBERTI, Francesca, c/o CHIESI FARMACEUTICI S.p.A. Via Palermo, 26/A, 43122 PARMA, IT
ZAMBELLI, Enrico, c/o CHIESI FARMACEUTICI S.p.A. Via Palermo, 26/A, 43122 PARMA, IT

- (51) MKP
A61K 48/00 2006 (97) EP 3572096
C07H 21/04 2006
- (96) EP 19175776.4 9/4/2012
(97) EP 3572096, 7/1/2020 202027, en
- (31) 201161532667 P (32) 09.09.2011 (33) US
- (54) A CONDITIONAL REPLICATING CYTOMEGALOVIRUS AS A VACCINE FOR CMV
(72) Fu, Ton-Ming, 770, Sumneytown Pike, West Point, PA 19486, US
Wang, Dai, 770, Sumneytown Pike, West Point, PA 19486, US
Medi, Muneeswara Babu, 770, Sumneytown Pike, West Point, PA 19486, US

- (51) MKP
E04F 13/08 2006 (97) EP 3572598
- (96) EP 19176785.4 5/27/2019
(97) EP 3572598, 5/6/2020 202019, en
- (31) 201805340 (32) 25.05.2018 (33) BE
- (54) MOUNTING BRACKET FOR MOUNTING A CLADDING TO A WALL, AND METHOD THEREFOR
(71) VBG bvba, Hollestraat 17, 3290 Deurne, BE
(72) Broos-Godts, Tobias, c/o Hollestraat 17, 3290 Deurne, BE

- (51) MKP
A61K 39/29 2006 (97) EP 3564384
C07K 16/00 2006
C07K 16/10 2006
C12P 21/08 2006
C12Q 1/70 2006
- (96) EP 19176924.9 12/23/2013

(97)	EP 3564384, 6/10/2020 202024, en					
(31)	201361783529 P	(32)	14.03.2013	(33)	US	
(54)	HCV CORE LIPID BINDING DOMAIN MONOCLONAL ANTIBODIES					
(72)	ZIEMANN, Robert, 100 Abbott Park Road, Abbott Park, IL 60064, US					
	AHLBERG, April, 100 Abbott Park Road, Abbott Park, IL 60064, US					
	HAWKSWORTH, David, 100 Abbott Park Road, Abbott Park, IL 60064, US					
	TIEMAN, Bryan, 100 Abbott Park Road, Abbott Park, IL 60064, US					
	MUERHOFF, A. Scott, 100 Abbott Park Road, Abbott Park, IL 60064, US					
	MAROHNIC, Christopher, 100 Abbott Park Road, Abbott Park, IL 60064, US					
	OTIS, Kathy, 100 Abbott Park Road, Abbott Park, IL 60064, US					
<hr/>						
(51)	MKP					
	A61P 41/00	2006			(97) EP 3569636	
	C07D 401/04	2006				
	C08G 73/06	2006				
	C08L 79/06	2006				
(96)	EP 19176981.9	5/17/2012				
(97)	EP 3569636, 6/24/2020 202026, en					
(31)	2011119848	(32)	17.05.2011	(33)	RU	
	2011153043		26.12.2011		RU	
(54)	COMPOUNDS, PHARMACEUTICAL COMPOSITIONS AND A METHOD FOR THE PROPHYLAXIS AND TREATMENT OF THE ADHESION PROCESS					
(72)	SHURYGIN, Mikhail Gennadievich, Marshal Zhukov Avenue 1-26, 664057 Irkutsk, RU					
	SHURYGINA, Irina Aleksandrovna, Marshal Zhukov Avenue 1-26, 664057 Irkutsk, RU					
<hr/>						
(51)	MKP					
	A61K 31/47	2006			(97) EP 3560920	
	A61K 31/4709	2006				
	A61P 29/00	2006				
	A61P 35/00	2006				
	C07D 215/227	2006				
	C07D 401/06	2006				
	C07D 401/14	2006				
	C07D 413/06	2006				
(96)	EP 19177961.0	10/15/2013				
(97)	EP 3560920, 5/6/2020 202019, en					
(54)	SECONDARY ALCOHOL QUINOLINYL MODULATORS OF ROR GAMMA T					
(72)	LEONARD, Kristi A., 108 Manor Drive, Lansdale, PA 19446, US					
	BARBAY, Kent, 6311 Sunnybrook Road, Flourtown, PA 19031, US					
	EDWARDS, James P., 8723 Hesby Court, San Diego, CA 92129, US					
	KREUTTER, Kevin D., 71 Thoreau Drive, Plainsboro, NJ 08536, US					
	KUMMER, David A., 3210 Merryfield Row, San Diego, CA 92121, US					
	MAHAROOOF, Umar, 128 Sunrise Drive, North Wales, PA 19454, US					
	NISHIMURA, Rachel, 3957 30th Street Unit 406, San Diego, CA 92104, US					
	URBANSKI, Maud, 14 McPherson Drive, Flemington, NJ 08822, US					
	VENKATESAN, Hariharan, 17065 Bernardo Oaks Drive, San Diego, CA 92128, US					
	WANG, Aihua, 1723 Foxwood Drive, Jamison, PA 18929, US					
	WOLIN, Ronald L., 16309 Los Rosales Street, San Diego, CA 92127, US					
	WOODS, Craig R., 6275 Lakewood Street, San Diego, CA 92122, US					
	FOURIE, Anne, 13060 Callcott Way, San Diego, CA 92130, US					
	XUE, Xiaohua, 3210 Merryfield Row, San Diego, CA 92121, US					
	CUMMINGS, Maxwell D., 1442 Jonathan Way, Ambler, PA 19002, US					
<hr/>						
(51)	MKP					
	A01B 17/00	2006			(97) EP 3578026	
	A01C 3/06	2006				
(96)	EP 19177969.3	6/3/2019				
(97)	EP 3578026, 6/24/2020 202026, en					
(31)	20180006004	(32)	04.06.2018	(33)	IT	
(54)	VEHICLE AND METHOD FOR THE DISTRIBUTION OF BIOSOLIDS					
(71)	Valli S.p.A., Via Lavagnone, 11, 25017 Lonato del Garda, Brescia, IT					
(72)	PAROLINI, Sergio, c/o Valli S.p.A. Via Lavagnone, 11, 25017 Lonato del Garda, Brescia, IT					

(51) MKP
A47B 67/02 2006 (97) EP 3578083
A47B 67/04 2006
A61F 17/00 2006
(96) EP 19178411.5 6/5/2019
(97) EP 3578083, 5/27/2020 202022, en
(31) 1850693 (32) 08.06.2018 (33) SE
(54) DISPENSER FOR MEDICAL ARTICLES
(71) Orkla Care AB, Box 1336, 171 26 Solna, SE
(72) CRAFOORD, David, Grönviksvägen 207, 167 76 BROMMA, SE
WIK, Maria, Bränningevägen 30A, 120 58 ÅRSTA, SE

(51) MKP
A61K 9/16 2006 (97) EP 3574897
A61K 9/50 2006
A61K 38/17 2006
A61K 39/00 2006
A61P 27/02 2006
(96) EP 19180351.9 11/18/2012
(97) EP 3574897, 6/3/2020 202023, en
(31) 201161561525 P (32) 18.11.2011 (33) US
(54) POLYMER PROTEIN MICROPARTICLES
(72) CHEN, Hunter, 777 Old Saw Mill River Road, Tarrytown, NY 10591, US
WALSH, Scott, 777 Old Saw Mill River Road, Tarrytown, NY 10591, US

(51) MKP
G01N 33/50 2006 (97) EP 3605101
G01N 33/574 2006
(96) EP 19180662.9 6/12/2013
(97) EP 3605101, 6/3/2020 202023, en
(31) 201213494618 (32) 12.06.2012 (33) US
(54) WHOLE CELL ASSAYS AND METHODS
(71) Celcuity Inc., 16305 36th Avenue North, Suite 100, Minneapolis, MN 55446, US
(72) LAING, Lance, Gavin, 12 Leslie Road, Belmont, MA Massachusetts 02478, US
SULLIVAN, Brian, Francis, 2400 Bantle Farm Road, Belmont, MN Minnesota 55340, US

(51) MKP
A61K 9/00 2006 (97) EP 3569222
A61K 31/167 2006
A61K 31/40 2006
A61K 31/573 2006
A61K 47/12 2006
A61K 47/26 2006
(96) EP 19182016.6 7/10/2014
(97) EP 3569222, 7/1/2020 202027, en
(31) 13176114 (32) 11.07.2013 (33) EP
13194763 28.11.2013 EP
(54) DRY POWDER FORMULATION COMPRISING AN ANTICHOLINERGIC, A CORTICOSTEROID AND A BETA-ADRENERGIC FOR
ADMINISTRATION BY INHALATION
(71) Chiesi Farmaceutici S.p.A., Via Palermo 26/A, 43122 Parma, IT
(72) Pasquali, Irene, Chiesi Farmaceutici S.p.A. Via Palermo, 26/A, 43122 Parma, IT
Musa, Rossella, Chiesi Farmaceutici S.p.A. Via Palermo, 26/A, 43122 Parma, IT
Schiaretti, Francesca, Chiesi Farmaceutici S.p.A. Via Palermo, 26/A, 43122 Parma, IT
Askey-Sarvar, Azita, Chiesi Farmaceutici S.p.A. Via Palermo, 26/A, 43122 Parma, IT

(51) MKP
C07K 16/28 2006 (97) EP 3572433
G01N 33/53 2006
(96) EP 19182386.3 11/12/2014
(97) EP 3572433, 6/24/2020 202026, en
(31) 201320066 (32) 13.11.2013 (33) GB
(54) ANTIBODIES SPECIFIC TO FCRN

(72) ATERFOLD, Paul Alan, c/o IPD UCB Celltech 208 Bath Road, Slough, Berkshire SL1 3WE, GB
 CESKA, Thomas Allen, c/o IPD UCB Celltech 208 Bath Road, Slough, Berkshire SL1 3WE, GB
 FINNEY, Helene Margaret, c/o IPD UCB Celltech 208 Bath Road, Slough, Berkshire SL1 3WE, GB
 KEVORKIAN, Lara, c/o IPD UCB Celltech 208 Bath Road, Slough, Berkshire SL1 3WE, GB
 SARKAR, Kaushik, c/o IPD UCB Celltech 208 Bath Road, Slough, Berkshire SL1 3WE, GB
 SMITH, Bryan John, c/o IPD UCB Celltech 208 Bath Road, Slough, Berkshire SL1 3WE, GB
 TYSON, Kerry Louise, c/o IPD UCB Celltech 208 Bath Road, Slough, Berkshire SL1 3WE, GB

(51) MKP
A61K 31/439 2006 (97) EP 3569604
A61P 1/04 2006
C07D 519/00 2006

(96) EP 19182836.7 5/26/2016

(97) EP 3569604, 6/17/2020 202025, en

(31) 201562167694 P (32) 28.05.2015 (33) US
 201662312273 P 23.03.2016 US

(54) PROCESS AND INTERMEDIATES FOR THE PREPARATION OF NAPHTHYRIDINE COMPOUNDS AS JAK KINASE INHIBITORS

(72) HUDSON, Ryan, P.O. Box CA 1454 Walbrook Drive, San Jose, CA 95129, US
 KOZAK, Jennifer, 771 Prairie Creek Drive, Pacifica, CA 94044, US
 FATHEREE, Paul R, 921 Minnesota Street, San Francisco, CA 94107, US
 PODESTO, Dante D, 1122 Trinity Avenue, Modesto, CA 95350, US
 BRANDT, Gary E.L., 2160 Buena Vista Avenue, Alameda, CA 94501, US
 FLEURY, Melissa, 47D Joy Avenue, Brisbane, CA 94005, US
 BEAUSOLEIL, Anne-Marie, 600 Brewster Avenue, Apt. 306, Redwood City, CA 94063, US
 HUANG, Xiaojun, 5978 Bollinger Road, San Jose, CA 95129, US
 THALLADI, Venkat R., 888 Foster City Boulevard Apt. E3, Foster City, CA 94404, US

(51) MKP
A61K 9/00 2006 (97) EP 3574895
A61K 9/14 2006

(96) EP 19182996.9 4/24/2014

(97) EP 3574895, 6/24/2020 202026, en

(31) 13165483 (32) 26.04.2013 (33) EP

(54) PARTICLE SIZE REDUCTION OF AN ANTIMUSCARINIC COMPOUND

(72) PASQUALI, Irene, c/o CHIESI FARMACEUTICI S.p.A. Via Palermo, 26/A, 43100 PARMA, IT
 CASAZZA, Andrea, c/o CHIESI FARMACEUTICI S.p.A. Via Palermo, 26/A, 43100 PARMA, IT
 SAUNDERS, Mark, c/o CHIESI FARMACEUTICI S.p.A. Via Palermo, 26/A, 43100 PARMA, IT
 LOSI, Elena, c/o CHIESI FARMACEUTICI S.p.A. Via Palermo, 26/A, 43100 PARMA, IT

(51) MKP
B65D 5/66 2006 (97) EP 3587293
B65D 5/72 2006

(96) EP 19183431.6 6/28/2019

(97) EP 3587293, 7/1/2020 202027, de

(31) 102018115892 (32) 29.06.2018 (33) DE

(54) FOLDING BOX

(72) Verlinden, Geert, Welstraat 7, 2350 Vosselaar, BE

(51) MKP
B60K 15/00 2006 (97) EP 3638939
B60S 5/02 2006
B67D 7/32 2010
F16K 1/00 2006
F16L 29/04 2006
F16L 37/248 2006
F16L 37/32 2006
F16L 55/10 2006
F17C 1/00 2006

(96) EP 18722521.4 5/4/2018

(97) EP 3638939, 4/22/2020 202017, de

(31) 102017005588 (32) 13.06.2017 (33) DE

(54) COUPLING FOR CRYOGENIC LIQUEFIED MEDIA

(72) FRÈRE, Émilien, 15 avenue Gallieni Appartement 18, 77100 Meaux, FR

(51) MKP
A01N 59/00 2006 (97) EP 3627987
A01N 59/06 2006
A01N 59/16 2006
A01P 3/00 2006

(96) EP 18722631.1 5/15/2018
(97) EP 3627987, 4/1/2020 202014, en
(31) 17171322 (32) 16.05.2017 (33) EP
201762509799 P 23.05.2017 US

(54) BIOCIDES FREE PRESERVATION
(72) GLAUBITZ, Joachim, Parkweier 1, 6264 Pfaffnau, CH
SÜTTERLIN, Klaus, Hauptstrasse 19, 79426 Buggingen, DE

(51) MKP
A61K 31/395 2006 (97) EP 3630112
A61K 31/44 2006
A61K 45/06 2006
A61P 35/00 2006

(96) EP 18725258.0 5/25/2018
(97) EP 3630112, 6/17/2020 202025, en
(31) 17174169 (32) 02.06.2017 (33) EP

(54) COMBINATION OF REGORAFENIB AND PD-1/PD-L1(2) INHIBITORS FOR TREATING CANCER
(72) HOFF, Sabine, Brunnenallee 11a, 14478 Postdam, DE
RÖSE, Lars, Fuchsring 82, 13465 Berlin, DE
ZOPF, Dieter, Neuwerker Weg 15a, 14167 Berlin, DE
KIESSLING, Fabian, Weissshausstrasse 33, 52066 Aachen, DE
LEDERLE, Wiltrud, Höhenweg 42, 52074 Aachen, DE
DOLESCHER, Dennis, Leenheerstraat 31, 6291JH Vaals, NL

(51) MKP
C12Q 1/68 2018 (97) EP 3635129

(96) EP 18727021.0 6/1/2018
(97) EP 3635129, 4/15/2020 202016, en
(31) PCT/EP2017/064112 (32) 09.06.2017 (33) WO

(54) METHODS FOR CHARACTERIZING LOSS OF ANTIGEN PRESENTATION
(72) SAHIN, Ugur, c/o BioNTech SE An der Goldgrube 12, 55131 Mainz, DE
SUCHAN, Martin, Neue Mainzer Str. 79, 55129 Mainz, DE
SCHRÖRS, Barbara, Kapellenstr. 34, 55124 Mainz, DE
LÖWER, Martin, Franziska-Kessel-Straße 61, 55131 Mainz, DE
OEHM, Petra, c/o BioNTech SE An der Goldgrube 12, 55131 Mainz, DE

(51) MKP
A61K 31/00 2006 (97) EP 3630177
A61K 39/395 2006
A61P 35/00 2006
C07K 16/28 2006

(96) EP 18728153.0 5/30/2018
(97) EP 3630177, 7/1/2020 202027, en
(31) 17173712 (32) 31.05.2017 (33) EP

(54) TREATMENT PARADIGM FOR AN ANTI-CD19 ANTIBODY AND VENETOCLAX COMBINATION TREATMENT
(72) KELEMEN, Peter, MorphoSys AG Semmelweisstr. 7, 82152 Planegg, DE
SCHWARZ, Michael, MorphoSys AG Semmelweisstr. 7, 82152 Planegg, DE
WINDERLICH, Mark, MorphoSys AG Semmelweisstr. 7, 82152 Planegg, DE
HEEGGER, Steffen, Richard-Wagner Stra e 56, 68165 Mannheim, DE
WEINELT, Dominika, MorphoSys AG Semmelweisstr. 7, 82152 Planegg, DE

(51) MKP
A61K 39/00 2006 (97) EP 3635408
G01N 33/68 2006

(96) EP 18728389.0 6/1/2018

(97) EP 3635408, 4/15/2020 202016, en
 (31) PCT/EP2017/064140 (32) 09.06.2017 (33) WO
 (54) METHODS FOR PREDICTING THE USEFULNESS OF DISEASE SPECIFIC AMINO ACID MODIFICATIONS FOR IMMUNOTHERAPY
 (72) SAHIN, Ugur, BioNTech RNA Pharmaceuticals GmbH An der Goldgrube 12, 55131 Mainz, DE

(51) MKP
A61K 31/403 2006 (97) EP 3630723
A61P 31/12 2006
C07D 209/08 2006
 (96) EP 18728541.6 5/18/2018
 (97) EP 3630723, 4/15/2020 202016, en
 (31) 17172237 (32) 22.05.2017 (33) EP
 (54) SUBSTITUTED INDOLINE DERIVATIVES AS DENGUE VIRAL REPLICATION INHIBITORS
 (72) BONFANTI, Jean-François, c/o Janssen-Cilag 1 rue Camille Desmoulins TSA 91003, 92787 Issy-les-Moulineaux Cedex 9, FR
 KESTELEYN, Bart, Rudolf, Romanie, c/o Janssen Pharmaceutica NV Turnhoutseweg 30, 2340 Beerse, BE
 BARDIOT, Dorothee, Alice, Marie-Eve, c/o Cistim Leuven vzw Gaston Geenslaan 2, 3001 Leuven (Heverlee), BE
 MARCHAND, Arnaud, Didier, M, c/o Cistim Leuven vzw Gaston Geenslaan 2, 3001 Leuven (Heverlee), BE
 COESEMANS, Erwin, c/o Janssen Pharmaceutica NV Turnhoutseweg 30, 2340 Beerse, BE
 FORTIN, Jérôme, Michel, Claude, c/o Janssen-Cilag 1 rue Camille Desmoulins TSA 91003, 92787 Issy-les-Moulineaux Cedex 9, FR
 MERCEY, Guillaume, Jean, Maurice, c/o Janssen-Cilag 1 rue Camille Desmoulins TSA 91003, 92787 Issy-les-Moulineaux Cedex 9, FR
 RABOISSON, Pierre, Jean-Marie, Bernard, c/o Janssen Pharmaceutica NV Turnhoutseweg 30, 2340 Beerse, BE

(51) MKP
A61K 31/4995 2006 (97) EP 3638675
A61K 31/5386 2006
A61P 11/00 2006
A61P 25/00 2006
C07D 471/08 2006
C07D 498/08 2006
 (96) EP 18728646.3 6/7/2018
 (97) EP 3638675, 4/22/2020 202017, de
 (31) 17176046 (32) 14.06.2017 (33) EP
 17193252 26.09.2017 EP
 (54) DIAZABICYCLIC SUBSTITUTED IMIDAZOPYRIMIDINES AND THEIR USE FOR THE TREATMENT OF BREATHING DISORDERS
 (71) Bayer AG, Kaiser-Wilhelm-Allee 1, 51373 Leverkusen, DE
 (72) DELBECK, Martina, Müllerweg 10, 42579 Heiligenhaus, DE
 HAHN, Michael, Rietherbach 42D, 40764 Langenfeld, DE
 MÜLLER, Thomas, Parkstr. 24, 40764 Langenfeld, DE
 LUSTIG, Klemens, Falkenberg 159, 42113 Wuppertal, DE
 COLLINS, Karl, Fürstenwall 135, 40215 Düsseldorf, DE
 LINDNER, Niels, Bodelschwingweg 4, 42115 Wuppertal, DE
 NICOLAI, Janine, Bernhardstr. 56, 45239 Essen, DE
 BECK-BROICHSITTER, Moritz, Im Hillsbruch 47, 64291 Darmstadt, DE
 ALBUS, Udo, Am Römerkastell 9, 61197 Florstadt, DE
 GEHRING, Doris, Frankfurter Str. 166, 65779 Kelkheim, DE
 ROSENSTEIN, Björn, Mühlenstr. 2, 63628 Bad Soden-Salmünster, DE

(51) MKP
A61K 31/216 2006 (97) EP 3634490
A61K 47/32 2006
A61K 47/34 2017
 (96) EP 18728712.3 5/23/2018
 (97) EP 3634490, 5/6/2020 202019, en
 (31) 201708224 (32) 23.05.2017 (33) GB
 (54) IMPLANTABLE DRUG DELIVERY DEVICE
 (71) Juniper Pharmaceuticals UK Limited, 8 Orchard Place Nottingham Business Park, Nottingham, Nottinghamshire NG8 6PX, GB
 (72) RIGBY-SINGLETON, Shellie, Juniper Pharmaceuticals UK Limited 8 Orchard Place Nottingham Business Park, Nottingham Nottinghamshire NG8 6PX, GB
 BARKER, Ian, Juniper Pharmaceuticals UK Limited 8 Orchard Place Nottingham Business Park, Nottingham Nottinghamshire NG8 6PX, GB
 LUK, Shen, Juniper Pharmaceuticals UK Limited 8 Orchard Place Nottingham Business Park, Nottingham Nottinghamshire NG8 6PX, GB
 PANKAJ LAD, Rajan, Juniper Pharmaceuticals UK Limited 8 Orchard Place Nottingham Business Park, Nottingham Nottinghamshire NG8 6PX, GB
 KUMAR, Sandeep, Juniper Pharmaceuticals UK Limited 8 Orchard Place Nottingham Business Park, Nottingham Nottinghamshire NG8 6PX, GB

(51)	MKP								
	A61K 31/404	2006	(97) EP 3630724						
	A61K 31/407	2006							
	A61K 31/437	2006							
	A61P 31/14	2006							
	C07D 209/30	2006							
	C07D 209/32	2006							
	C07D 209/42	2006							
	C07D 471/04	2006							
	C07D 513/04	2006							
(96)	EP 18729051.5	5/18/2018							
(97)	EP 3630724,	4/15/2020	202016,	en					
(31)	17172247		(32)	22.05.2017		(33)		EP	
(54)	SUBSTITUTED INDOLINE DERIVATIVES AS DENGUE VIRAL REPLICATION INHIBITORS								
(71)	Katholieke Universiteit Leuven, Waaistraat 6, Bus 5105, 3000 Leuven, BE								
(72)	BONFANTI, Jean-François, c/o Janssen-Cilag 1 rue Camille Desmoulins TSA 91003, 92787 Issy-les-Moulineaux Cedex 9, FR								
	KESTELEYN, Bart, Rudolf, Romanie, c/o Janssen Pharmaceutica NV Turnhoutseweg 30, 2340 Beerse, BE								
	BARDIOT, Dorothee, Alice, Marie-Eve, c/o Cistim Leuven vzw Gaston Geenslaan 2, 3001 Leuven (Heverlee), BE								
	MARCHAND, Arnaud, Didier, M, c/o Cistim Leuven vzw Gaston Geenslaan 2, 3001 Leuven (Heverlee), BE								
	COESEMANS, Erwin, c/o Janssen Pharmaceutica NV Turnhoutseweg 30, 2340 Beerse, BE								
	DE BOECK, Benoît, Christian, Albert, Ghislain, c/o Janssen Pharmaceutica NV Turnhoutseweg 30, 2340 Beerse, BE								
	RABOISSON, Pierre, Jean-Marie, Bernard, c/o Janssen Pharmaceutica NV Turnhoutseweg 30, 2340 Beerse, BE								
(51)	MKP								
	C08K 9/00	2006	(97) EP 3638738						
	C09C 1/02	2006							
(96)	EP 18729165.3	6/12/2018							
(97)	EP 3638738,	4/22/2020	202017,	en					
(31)	17176142		(32)	14.06.2017		(33)		EP	
	201762522759 P			21.06.2017				US	
(54)	PROCESS FOR PREPARING A SURFACE TREATED FILLER MATERIAL PRODUCT WITH MONO-SUBSTITUTED SUCCINIC ANHYDRIDE(S) AND A MIXTURE OF ALIPHATIC LINEAR OR BRANCHED CARBOXYLIC ACIDS COMPRISING STEARIC ACID								
(72)	PULLEGA, Francesco, Via dello Spiraglio 5, 40138 Bologna, IT								
	BLANCHARD, Pierre, 63 Chemin de Budron, 01600 Reyriex, FR								
	FORNERA, Tazio, Innere Altachen 12, 4800 Zofingen, CH								
	WELKER, Matthias, 11 Rue des Rossignols, 68220 Héisingue, FR								
(51)	MKP								
	B41M 3/00	2006	(97) EP 3642044						
	B41M 3/14	2006							
	B41M 5/323	2006							
(96)	EP 18729166.1	6/12/2018							
(97)	EP 3642044,	4/29/2020	202018,	en					
(31)	17177495		(32)	22.06.2017		(33)		EP	
	201762526424 P			29.06.2017				US	
(54)	TAMPER-PROOF MEDIUM FOR THERMAL PRINTING								
(72)	BOLLSTRÖM, Roger, Ackerstrasse 11, 4800 Zofingen, CH								
	BOTTU, Gilbert, Gebroeders Ummelsstraat 10, 6226 Maastricht, NL								
	HUNZIKER, Philipp, 1337 Harbor Cove, Loveland, Ohio 45140, US								
(51)	MKP								
	B21D 51/26	2006	(97) EP 3645187						
	B67B 1/04	2006							
	B67B 3/02	2006							
(96)	EP 18729218.0	4/14/2018							
(97)	EP 3645187,	5/6/2020	202019,	en					
(31)	201700190		(32)	26.06.2017		(33)		SI	
(54)	METHOD AND DEVICE FOR CLOSING OF CONTAINER								
(71)	Gea Vipoll, Oprema Za Industrijo Tekocin D.O.O., Bucecovci 1A, 9242 Krizevci Pri Ljutomeru, SI								
(72)	ZVER, Simon, Bucecovci 1B, 9242 Krizevci Pri Ljutomeru, SI								

- (51) MKP
A61K 31/498 2006 (97) EP 3634414
A61P 35/00 2006
- (96) EP 18729631.4 6/1/2018
(97) EP 3634414, 4/15/2020 202016, en
- (31) 17174295 (32) 02.06.2017 (33) EP
18171315 08.05.2018 EP
- (54) FGFR2 INHIBITORS FOR THE TREATMENT OF CHOLANGIOCARCINOMA
(72) BUSSOLARI, Jacqueline, Cirillo, Janssen Research&Development LLC 920 US Route 202 PO Box 300, Raritan New Jersey 08869, US
-
- (51) MKP
C07K 16/18 2006 (97) EP 3634997
C07K 16/24 2006
- (96) EP 18729642.1 6/4/2018
(97) EP 3634997, 4/15/2020 202016, en
- (31) 201762515293 P (32) 05.06.2017 (33) US
17195783 10.10.2017 EP
- (54) NOVEL ANTI-HSA ANTIBODIES
(72) GUNDE, Tea, Turbinenstrasse 33, 8005 Zurich, CH
MEYER, Sebastian, Kirchrainstrasse 6, 5445 Eggenwil, CH
HESS, Christian, Uetlibergstrasse 304, 8045 Zurich, CH
BIERI, Tessa, Rue des Charpentiers 4, 1110 Morges, CH
-
- (51) MKP
C07K 16/18 2006 (97) EP 3634998
C07K 16/24 2006
C07K 16/28 2006
C07K 16/32 2006
- (96) EP 18729644.7 6/4/2018
(97) EP 3634998, 4/15/2020 202016, en
- (31) 201762515293 P (32) 05.06.2017 (33) US
17203832 27.11.2017 EP
- (54) NOVEL ANTI-CD3 ANTIBODIES
(72) GUNDE, Tea, Turbinenstrasse 33, 8005 Zurich, CH
HESS, Christian, Uetlibergstrasse 304, 8045 Zurich, CH
MEYER, Sebastian, Kirchrainstrasse 6, 5445 Eggenwil, CH
SIMONIN, Alexandre, 5 rue de l'Au, 68128 Rosenau, FR
BELTRAMETTI, Teddy, B tzlingerstrasse 12, 6467 Schattdorf, CH
URECH, David, Sonnenblickstrasse 8, 8645 Jona, CH
-
- (51) MKP
A61K 39/00 2006 (97) EP 3634474
A61K 39/395 2006
C07K 16/28 2006
- (96) EP 18729680.1 6/8/2018
(97) EP 3634474, 4/15/2020 202016, en
- (31) 17175124 (32) 09.06.2017 (33) EP
- (54) TARGETING MODULES FOR UNIVERSAL CHIMERIC ANTIGEN RECEPTOR EXPRESSING IMMUNE CELLS AND USE IN THE TREATMENT OF CANCER INFECTIONS AND AUTOIMMUNE DISORDERS
(71) GEMoaB Monoclonals GmbH, Tatzberg 47, 01307 Dresden, DE
(72) Ehninger, Armin, Plattleite 18, 01326 Dresden, DE
-
- (51) MKP
A61K 31/40 2006 (97) EP 3630096
A61K 31/4025 2006
A61K 31/4155 2006
A61K 31/4439 2006
A61K 31/454 2006
A61K 31/496 2006
A61K 31/506 2006
A61K 31/5365 2006
A61P 3/00 2006
A61P 25/00 2006

A61P 29/00 2006
A61P 31/00 2006
A61P 35/00 2006
C07D 207/14 2006
C07D 401/12 2006
C07D 401/14 2006
C07D 403/12 2006
C07D 403/14 2006
C07D 487/04 2006
C07D 498/02 2006
(96) EP 18730047.0 5/30/2018
(97) EP 3630096, 4/15/2020 202016, en
(31) 201708652 (32) 31.05.2017 (33) GB
(54) SULFONAMIDE-SUBSTITUTED CYANOPYRROLIDINES WITH ACTIVITY AS DUB INHIBITORS
(71) Mission Therapeutics Limited, Babraham Hall Babraham, Cambridge CB22 3AT, GB
(72) STOCKLEY, Martin Lee, Moneta (Building 280) Babraham Research Campus, Cambridge Cambridgeshire CB22 3AT, GB
KEMP, Mark Ian, Moneta (Building 280) Babraham Research Campus, Cambridge Cambridgeshire CB223AT, GB
MADIN, Andrew, Moneta (Building 280) Babraham Research Campus, Cambridge Cambridgeshire CB22 3AT, GB
WOODROW, Michael David, Moneta (Building 280) Babraham Research Campus, Cambridge Cambridgeshire CB22 3AT, GB

(51) MKP
A61K 31/7088 2006 (97) EP 3641833
A61K 48/00 2006
C12N 15/113 2010
C12N 15/63 2006
(96) EP 18730384.7 6/19/2018
(97) EP 3641833, 4/29/2020 202018, en
(31) 17176725 (32) 19.06.2017 (33) EP
(54) METHODS AND COMPOSITIONS FOR CONTROLLING CARDIAC FIBROSIS AND REMODELING
(72) OUNZAIN, Samir, Chemin Isabelle-de-Montolieu 90, 1010 Lausanne, CH
PEDRAZZINI, Thierry, Chemin des Grisons 1, 1052 Le Mont-sur-Lausanne, CH

(51) MKP
B61B 12/00 2006 (97) EP 3638560
B61B 12/06 2006
(96) EP 18730750.9 6/11/2018
(97) EP 3638560, 4/22/2020 202017, de
(31) 504872017 (32) 12.06.2017 (33) AT
(54) CABLE CAR WITH LOCK MONITORING FOR A VEHICLE
(72) MOHR, Clemens, Nelkenweg 6, 6922 Wolfurt, AT
PFEIFER, Daniel, Pfarriweg 33, 6580 Sankt Anton am Arlberg, AT

(51) MKP
A61K 31/437 2006 (97) EP 3634961
A61P 11/00 2006
C07D 471/04 2006
(96) EP 18731001.6 6/4/2018
(97) EP 3634961, 4/15/2020 202016, en
(31) 17174686 (32) 07.06.2017 (33) EP
(54) (4-((1,2,4)TRIAZOLO[4,3-A]PYRIDINE-6-YL)OXY)-1,2,3,4-TETRAHYDRONAPHTHALEN-1-YL) UREIDO DERIVATIVES AS ANTI-INFLAMMATORY P38 MAPK INHIBITORS FOR TREATING DISEASES OF THE RESPIRATORY TRACT
(72) CAPALDI, Carmelida, c/o CHIESI FARMACEUTICI S.p.A. Via Palermo 26/A, 43122 Parma, IT
ARMANI, Elisabetta, c/o CHIESI FARMACEUTICI S.p.A. Via Palermo 26/A, 43122 Parma, IT
HURLEY, Christopher, c/o CHIESI FARMACEUTICI S.p.A. Via Palermo 26/A, 43122 Parma, IT
AVITABILE-WOO, Barbara Giuseppina, c/o CHIESI FARMACEUTICI S.p.A. Via Palermo 26/A, 43122 Parma, IT
LANARO, Roberta, c/o CHIESI FARMACEUTICI S.p.A. Via Palermo 26/A, 43122 Parma, IT
JENNINGS, Neil Stuart, c/o CHIESI FARMACEUTICI S.p.A. Via Palermo 26/A, 43122 Parma, IT

(51) MKP
B61B 12/06 2006 (97) EP 3638561
(96) EP 18731046.1 6/11/2018
(97) EP 3638561, 4/22/2020 202017, de

(31) 504952017 (32) 13.06.2017 (33) AT
 (54) METHOD FOR OPERATING A CABLEWAY
 (71) Innova Patent GmbH, Konrad-Doppelmayr-Strasse 1, 6922 Wolfurt, AT
 (72) PFEIFER, Daniel, Pfarriweg 33, 6580 Sankt Anton am Arlberg, AT
 BERDNIK, Alexander, Wichnerstra e 35, 6850 Dornbirn, AT
 GISINGER, Stefan, Fattstra e 4/2, 6922 Wolfurt, AT
 FEHLE, Markus, Kessestra e 2, 6922 Wolfurt, AT

(51) MKP
A01N 3/00 2006 (97) EP 3642176
A01N 27/00 2006
B01J 7/02 2006
C07C 1/32 2006
G05D 7/00 2006
 (96) EP 18731120.4 6/21/2018
 (97) EP 3642176, 4/29/2020 202018, en
 (31) 17177030 (32) 21.06.2017 (33) EP
 (54) DEVICE FOR GENERATING ULTRA PURE 1-METHYLCYCLOPROPENE
 (72) SCHOTSMANS, Wendy, Cony, Ria, Janssen Pharmaceutica NV Turnhoutseweg 30, 2340 Beerse, BE
 VAN TOL, Vincent, Jan, ACE Ingenieurs-& Adviesbureau Dr. Holtropaan 46, 5652 XR Eindhoven, NL
 BOON, Frank, Metatronics B.V. Torenallee 42-54, 5617 BD Eindhoven, NL

(51) MKP
C07K 16/00 2006 (97) EP 3642227
 (96) EP 18731127.9 6/21/2018
 (97) EP 3642227, 4/29/2020 202018, en
 (31) 17177322 (32) 22.06.2017 (33) EP
 (54) CANINE ANTIBODY LIBRARIES
 (72) TILLER, Thomas, Maxhofstraße 15, 81475 München, DE
 WALDHUBER, Markus, Neustätterstraße 4, 80636 München, DE
 STROHNER, Ralf, Allinger Str. 32, 82223 Eichenau, DE
 LADETZKI-BAEHS, Kathrin, Bahnhofstr. 36, 82152 Planegg, DE
 PRASSLER, Josef, Kriegerstrasse 8a, 82110 Germering, DE

(51) MKP
C07K 16/18 2006 (97) EP 3635014
C07K 16/28 2006
C07K 16/32 2006
 (96) EP 18731373.9 6/4/2018
 (97) EP 3635014, 4/15/2020 202016, en
 (31) 201762515293 P (32) 05.06.2017 (33) US
 (54) HETERO-DIMERIC MULTI-SPECIFIC ANTIBODY FORMAT TARGETING AT LEAST CD3 AND HSA
 (71) Numab Therapeutics AG, Einsiedlerstrasse 34, 8820 Wädenswil, CH
 (72) URECH, David, Sonnenblickstrasse 8, 8645 Jona, CH
 GUNDE, Tea, Turbinenstrasse 33, 8005 Zurich, CH
 MEYER, Sebastian, Kirchrainstrasse 6, 5445 Eggenwil, CH
 HESS, Christian, Uetlibergstrasse 304, 8045 Zurich, CH
 SIMONIN, Alexandre, 5 rue de l'Au, 68128 Rosenau, FR

(51) MKP
A61K 31/519 2006 (97) EP 3634418
A61P 15/00 2006
 (96) EP 18731378.8 6/5/2018
 (97) EP 3634418, 4/15/2020 202016, en
 (31) 201762515268 P (32) 05.06.2017 (33) US
 (54) GONADOTROPIN-RELEASING HORMONE ANTAGONIST DOSING REGIMENS FOR THE TREATMENT OF ENDOMETRIOSIS
 (72) LOUMAYE, Ernest, 29 Chemin de la Planta, 1223 Cologny, CH
 GOTTELAND, Jean-Pierre, 9 Rue Charles Humbert, 1205 Geneva, CH

(51) MKP

A61K 35/74 2015 (97) EP 3638271
A61P 25/00 2006
A61P 37/00 2006
(96) EP 18731444.8 6/14/2018
(97) EP 3638271, 4/22/2020 202017, en
(31) 201709466 (32) 14.06.2017 (33) GB
201709533 15.06.2017 GB
(54) COMPOSITIONS COMPRISING BACTERIAL STRAINS
(72) MULDER, Imke Elisabeth, c/o 4D Pharma Research Limited Life Sciences Innovation Building Cornhill Road, Aberdeen Aberdeenshire AB25 2ZS, GB
ETTORRE, Anna, c/o 4D Pharma Research Limited Life Sciences Innovation Building Cornhill Road, Aberdeen Aberdeenshire AB25 2ZS, GB
AHMED, Suaad, c/o 4D Pharma Research Limited Life Sciences Innovation Building Cornhill Road, Aberdeen Aberdeenshire AB25 2ZS, GB
FOTIADOU, Parthena, c/o 4D Pharma Research Limited Life Science Innovation Building Cornhill Road, Aberdeen Aberdeenshire AB25 2ZS, GB
YUILLE, Samantha, 27 Auchmill Terrace Bucksburn, Aberdeen Aberdeenshire AB21 9LF, GB
SAVIGNAC, Helene, c/o 4D Pharma Research Limited Life Sciences Innovation Building Cornhill Road, Aberdeen Aberdeenshire AB25 2ZS, GB

(51) MKP
A61M 11/00 2006 (97) EP 3641862
A61M 11/02 2006
A61M 11/06 2006
A61M 15/00 2006
A61M 15/02 2006
A61M 16/00 2006
A61M 16/10 2006
A61M 16/20 2006
B05B 1/26 2006
B05B 11/00 2006
(96) EP 18731475.2 6/22/2018
(97) EP 3641862, 4/29/2020 202018, en
(31) 17177462 (32) 22.06.2017 (33) EP
201762523578 P 22.06.2017 US
(54) INHALATION DEVICE WITH MULTILIQUID-NOZZLE AND METHOD
(72) BARTELS, Frank, Am Bennenbruch 4, 45527 Hattingen, DE
RAWERT, Jürgen, Im Rapsfeld 30c, 50933 K In, DE

(51) MKP
A61K 31/5383 2006 (97) EP 3638680
A61P 29/00 2006
C07D 498/04 2006
(96) EP 18731766.4 6/8/2018
(97) EP 3638680, 4/22/2020 202017, en
(31) 201762518106 P (32) 12.06.2017 (33) US
(54) HETEROAROMATIC COMPOUNDS AS VANIN INHIBITORS
(72) BOSANAC, Todd, c/o VP IP Legal / Boehringer Ingelheim USA Corp. 900 Ridgebury Road P.O. Box 368, Ridgefield, Connecticut 06877-0368, US
BURKE, Michael, J, 7 The Old Road, Newtown, Connecticut 06470, US
COOK, Brian, Nicholas, 4 Hayfield Road, New Milford, Connecticut 06776, US
DISALVO, Darren, Todd, 1 Elena Drive, New Milford, Connecticut 06776, US
KIRRANE JR., Thomas, Martin, 400 Washington Drive, Middlebury, Connecticut 06762, US
SHEN, Yue, c/o VP IP Legal / Boehringer Ingelheim USA Corp. 900 Ridgebury Road P.O. Box 368, Ridgefield, Connecticut 06877-0368, US

(51) MKP
A61K 31/519 2006 (97) EP 3641775
A61K 31/5377 2006
A61K 31/55 2006
A61K 45/06 2006
A61P 35/00 2006
(96) EP 18731845.6 6/21/2018
(97) EP 3641775, 4/29/2020 202018, en
(31) 201762523389 P (32) 22.06.2017 (33) US
17189550 06.09.2017 EP
(54) COMBINATION OF A MCL-1 INHIBITOR AND A STANDARD OF CARE TREATMENT FOR HEMATOLOGIC CANCERS, USES AND PHARMACEUTICAL COMPOSITIONS THEREOF

(72) WEI, Andrew, 14 The Avenue, Surrey Hills Victoria 3127, AU
 MOUJALLED, Donia, 13 Parfrey avenue, Lalor Victoria 3075, AU
 POMILIO, Giovanna, 33 Pleasant Street, Pascoe Vale Victoria 3044, AU
 GENESTE, Olivier, 17 rue Crevel Duval, 92500 Rueil-Malmaison, FR
 MARAGNO, Ana-Leticia, 4 Allée Anastasi, 78290 Croissy-Sur-Seine, FR

(51) MKP
A61M 11/06 2006 (97) EP 3641945
B05B 1/14 2006
B05B 1/26 2006

(96) EP 18731860.5 6/22/2018

(97) EP 3641945, 4/29/2020 202018, en

(31) 17177455 (32) 22.06.2017 (33) EP
 201762523574 P 22.06.2017 US

(54) MULTILIQUID-NOZZLE

(72) BARTELS, Frank, Am Bennenbruch 4, 45527 Hattingen, DE

RAWERT, Jürgen, Im Rapsfeld 30c, 50933 K In, DE

(51) MKP
A61K 9/51 2006 (97) EP 3641810
A61K 31/7105 2006
A61K 31/7115 2006
A61K 39/245 2006
A61P 31/22 2006
C12N 15/38 2006

(96) EP 18790572.4 4/25/2018

(97) EP 3641810, 4/29/2020 202018, en

(31) 201762490067 P (32) 26.04.2017 (33) US

(54) HERPES SIMPLEX VIRUS VACCINE

(72) BETT, Andrew, J., 65 Kulp Road West, Chalfont PA 18914, US

CASIMIRO, Danilo, R., 65 Kulp Road West, Chalfont PA 18914, US

WANG, Dai, 65 Kulp Road West, Chalfont PA 18914, US

ZHANG, Lan, 65 Kulp Road West, Chalfont PA 18914, US

CIARAMELLA, Giuseppe, 1 Hawes Road, Sudbury MA 01776, US

JOHN, Shinu, 593 Somerville Avenue 2, Somerville MA 02143, US

(51) MKP
B60R 19/34 2006 (97) EP 3665043
F16F 7/12 2006

(96) EP 18792993.0 9/13/2018

(97) EP 3665043, 6/17/2020 202025, en

(31) 201700103763 (32) 15.09.2017 (33) IT

(54) POLYMER ELEMENT FOR ABSORBING IMPACT FOR A VEHICLE AND BUMPER STRUCTURE

(71) SRT S.r.l., Via Europa 19, 20851 Lissone (MB), IT

(72) RIVA, Alessandro, Via Madre Teresa di Calcutta 5, 20020 Arese (MI), IT

(51) MKP
F17C 5/06 2006 (97) EP 3649395

(96) EP 18793044.1 6/21/2018

(97) EP 3649395, 5/13/2020 202020, en

(31) P20170683 (32) 05.07.2017 (33) RS

(54) MOBILE GAS FILLING STATION

(71) PGT doo Beograd-Stari Grad, Kralja Milana 4, Beograd 11000, RS

(72) GINZBURG, Yuri, 15 Mishol Ha-Veradim St., 4485500 Ginot Shomeron, IL

(51) MKP
A61K 39/395 2006 (97) EP 3628010
C07K 16/28 2006

(96) EP 18794020.0 5/2/2018

(97) EP 3628010, 4/1/2020 202014, en

(31) 201762500486 P (32) 02.05.2017 (33) US

201762502051 P 05.05.2017 US

(54) IMMUNOTHERAPEUTIC TUMOR TREATMENT METHOD
 (72) KIVIMAE, Saul, 1319 46th Avenue, San Francisco, CA 94122, US
 HENNESSY, Marlene, 1379 Keoncrest Avenue, San Jose, CA 95110, US
 ANAND, Neel, K., 542 Barneson Avenue, San Mateo, CA 94402, US
 CAI, Haiying, 7450 Barnhart Place, Cupertino, CA 95014, US
 DENG, Bo-Liang, 445 Pearl Crest Court, San Ramon, CA 94582, US
 REN, Zhongxu, 1301 Ribbon Street, Foster City, CA 94404, US
 JOSHI, Bhalchandra, V., 108 Glen View Drive, Madison, AL 35758, US

(51) MKP
A61K 49/14 2006 (97) EP 3638320
A61K 51/08 2006
A61K 51/10 2006
A61P 29/00 2006
A61P 35/00 2006

(96) EP 18794036.6 5/4/2018
 (97) EP 3638320, 4/22/2020 202017, en

(31) 201762502288 P (32) 05.05.2017 (33) US
 201762545945 P 15.08.2017 US

(54) IGF-1R MONOCLONAL ANTIBODIES AND USES THEREOF
 (72) BURAK, Eric Steven, 40 James Street, Cambridge, Ontario N1S 1C5, CA
 FORBES, John Richard, 2210 Irving Street, Burlington, Ontario L7L 6T3, CA
 MORAN, Matthew David Burr, 950 Lucerne Crescent, Mississauga, Ontario L5C 3Y6, CA
 SIMMS, Ryan Wayne, 70 Thirteenth Street, Toronto, Ontario M8V 3H6, CA
 VALLIANT, John Fitzmaurice, 15 Holkham Ave., Ancaster, Ontario L9K 1N8, CA

(51) MKP
A61K 38/17 2006 (97) EP 3628049
A61P 9/10 2006
A61P 9/12 2006
A61P 13/12 2006
A61P 35/00 2006
C07K 14/71 2006
C07K 16/46 2006

(96) EP 18794202.4 5/3/2018
 (97) EP 3628049, 4/1/2020 202014, en

(31) 201762501229 P (32) 04.05.2017 (33) US
 201762510422 P 24.05.2017 US
 201762578674 P 30.10.2017 US

(54) TGF-BETA RECEPTOR TYPE II FUSION PROTEINS AND USES THEREOF
 (72) KUMAR, Ravindra, 421 Arlington Street, Acton, MA 01720, US
 SAKO, Dianne S., 14 Mystic Street, Medford, MA 02155, US

(51) MKP
G08B 1/00 2006 (97) EP 3639249

(96) EP 18794261.0 2/19/2018
 (97) EP 3639249, 4/22/2020 202017, en

(31) 201762492353 P (32) 01.05.2017 (33) US

(54) MEDICAL HOME REMINDER UNIT AND SYSTEM
 (72) STARR, Eric, 217 Stirling Drive, Butler, PA 16001, US
 KNEWTSON, Molly, 217 Stirling Drive 3027 Walnut Street, No. 3, Pittsburgh, PA 15206, US
 CHE, Benjamin, 1400 Main Street Apt. 209, Canonsburg, PA 15317, US

(51) MKP
G06Q 20/00 2012 (97) EP 3635659

(96) EP 18798366.3 5/11/2018
 (97) EP 3635659, 4/15/2020 202016, en

(31) 201711016641 (32) 11.05.2017 (33) IN

(54) SAFEPAY PROCESS
 (71) Sharma, Gaurav, FC-95 Tagore Garden, New Delhi 110027, IN
 (72) Sharma, Gaurav, FC-95 Tagore Garden, New Delhi 110027, IN

(51) MKP
G06F 3/048 2013 (97) EP 3635598
G06F 21/31 2013
H04L 29/06 2006

(96) EP 18798650.0 5/11/2018
(97) EP 3635598, 4/15/2020 202016, en
(31) 201711016640 (32) 11.05.2017 (33) IN

(54) ULTRASAFE LOGIN
(71) Sharma, Gaurav, FC-55 Tagore Garden, New Delhi 110027, IN
(72) Sharma, Gaurav, FC-55 Tagore Garden, New Delhi 110027, IN

(51) MKP
A61K 31/519 2006 (97) EP 3672965
C07D 403/12 2006
C07D 451/04 2006
C07D 451/14 2006

(96) EP 18801171.2 10/26/2018
(97) EP 3672965, 7/1/2020 202027, en
(31) 201762577852 P (32) 27.10.2017 (33) US

(54) PYRIMIDINE COMPOUND AS JAK KINASE INHIBITOR
(72) KOZAK, Jennifer, 771 Prairie Creek Drive, Pacifica California 94044, US
HUDSON, Ryan, 1454 Walbrook Drive, San Jose California 95129, US
BRANDT, Gary E.L., 2160 Buena Vista Avenue, Alameda California 94501, US
MCKINNELL, Robert Murray, 321 Poplar Avenue, Millbrae California 94030, US
DABROS, Marta, 888 Foster City Boulevard Apt. Q2, Foster City California 94404, US
NZEREM, Jerry, 29 Woods Circle, South San Francisco California 94080, US

(51) MKP
A61K 31/401 2006 (97) EP 3634400
A61P 25/24 2006
C07D 207/16 2006

(96) EP 18802201.6 5/18/2018
(97) EP 3634400, 4/15/2020 202016, en
(31) 201762508830 P (32) 19.05.2017 (33) US

(54) NOVEL CRYSTALLINE FORMS
(72) GOPINATHAN, Nishanth, c/o Biogen Inc. 225 Binney Street, Cambridge, MA 02142, US
IRDAM, Erwin, c/o Biogen Inc. 225 Binney Street, Cambridge, MA 02142, US
KIESMAN, William, c/o Biogen Inc. 225 Binney Street, Cambridge, MA 02142, US
KWOK, Daw-Long, Albert, c/o Biogen Inc. 225 Binney Street, Cambridge, MA 02142, US
LIN, Yiqing, c/o Biogen Inc. 225 Binney Street, Cambridge, MA 02142, US
OSEI-YEBOAH, Frederick, c/o Biogen Inc. 225 Binney Street, Cambridge, MA 02142, US
PETERSON, Matthew, c/o Biogen Inc. 225 Binney Street, Cambridge, MA 02142, US
TRAN, Kenny, c/o Biogen Inc. 225 Binney Street, Cambridge, MA 02142, US
VASUDEVAN, Kalyan, c/o Biogen Inc. 225 Binney Street, Cambridge, MA 02142, US

(51) MKP
A61K 9/06 2006 (97) EP 3634391
A61K 31/122 2006
A61K 35/12 2015
A61K 38/00 2006
A61K 39/395 2006

(96) EP 18802596.9 5/16/2018
(97) EP 3634391, 4/15/2020 202016, en
(31) 201762507773 P (32) 17.05.2017 (33) US

(54) USE OF COENZYME Q10 FORMULATIONS IN THE TREATMENT AND PREVENTION OF EPIDERMOLYSIS BULLOSA
(71) Berg LLC, 500 Old Connecticut Path, Building B, Framingham, MA 01701, US
(72) NARAIN, Niven, Rajin, 73 Fresh Pond Parkway, Cambridge, MA 02138, US
SARANGARAJAN, Rangaprasad, 454 Central Street, Boylston, MA 01505, US
KIEBISH, Michael, Andrew, 2 Grove Street Apt. 2, Natick, MA 01760, US

(51) MKP

	A61K 39/395	2006	(97) EP 3661552				
	C07K 16/28	2006					
	C12Q 1/68	2018					
(96)	EP 18805031.4 5/22/2018						
(97)	EP 3661552, 6/10/2020 202024, en						
(31)	201762509671 P		(32)	22.05.2017		(33)	US
(54)	COMPOSITIONS AND METHODS FOR INHIBITION OF MICA/B SHEDDING						
(72)	FERRARI DE ANDRADE, Lucas, 67 Highland Road, Brookline MA 02445, US WUCHERPFENNIG, Kai, W., 67 Highland Road, Brookline MA 02445, US						
<hr/>							
(51)	MKP						
	F03D 5/04	2006	(97) EP 3640472				
	F03D 7/00	2006					
(96)	EP 18805162.7 5/22/2018						
(97)	EP 3640472, 4/22/2020 202017, en						
(31)	2017117570		(32)	22.05.2017		(33)	RU
	2017117571			22.05.2017			RU
(54)	METHOD AND SYSTEM FOR CONVERTING WIND ENERGY						
(71)	Sila Prirodi Limited Liability Company (Sila Prirodi LLC), kilometr Kievskogo shosse 22, p. Moskovskij, domovl. 4, str. 2 809V/3, blok V, etazh 8, Moscow, 108811, RU						
(72)	YAKIMCHUCK, Vyacheslav Antonovich, Ul. Geroya Rossii Solomatina 1-6 Poselenie Mosrentgen, Moscow 142704, RU						
<hr/>							
(51)	MKP						
	A61K 31/415	2006	(97) EP 3634404				
	A61K 31/4155	2006					
	A61K 31/495	2006					
	C07D 247/00	2006					
	C07D 401/12	2006					
	C07D 403/08	2006					
(96)	EP 18805515.6 5/22/2018						
(97)	EP 3634404, 4/15/2020 202016, en						
(31)	201762510223 P		(32)	23.05.2017		(33)	US
(54)	PYRAZOLE MAGL INHIBITORS						
(71)	Lundbeck La Jolla Research Center, Inc., 10835 Road to the Cure, Suite 250, San Diego, CA 92121, US						
(72)	GRICE, Cheryl A., 10835 Road to the Cure Suite 250, San Diego California 92121, US WEBER, Olivia D., 10835 Road to the Cure Suite 250, San Diego California 92121, US BUZARD, Daniel J., 10835 Road to the Cure Suite 250, San Diego California 92121, US SHAGHAFI, Michael B., 10835 Road to the Cure Suite 250, San Diego California 92121, US WIENER, John J. M., 10835 Road to the Cure Suite 250, San Diego California 92121, US CISAR, Justin S., 10835 Road to the Cure Suite 250, San Diego California 92121, US DUNCAN, Katharine K., 10835 Road to the Cure Suite 250, San Diego California 92121, US						
<hr/>							
(51)	MKP						
	A61K 38/00	2006	(97) EP 3630150				
	A61K 38/16	2006					
	A61P 33/10	2006					
(96)	EP 18805734.3 5/22/2018						
(97)	EP 3630150, 5/6/2020 202019, en						
(31)	201762510081 P		(32)	23.05.2017		(33)	US
(54)	PURIFIED ANTHELMINTIC COMPOSITIONS AND RELATED METHODS						
(72)	AROIAN, Raffi, Van, 8 Kalamat Farms Circle, Shrewsbury MA 01545, US OSTROFF, Gary, R., 301 Bridle Path, Worcester MA 01604, US						
<hr/>							
(51)	MKP						
	A61K 31/4155	2006	(97) EP 3630744				
	A61K 31/496	2006					
	C07D 401/06	2006					
	C07D 403/06	2006					
	C07D 403/14	2006					
(96)	EP 18806431.5 5/22/2018						
(97)	EP 3630744, 4/15/2020 202016, en						
(31)	201762510213 P		(32)	23.05.2017		(33)	US
(54)	PYRAZOLE MAGL INHIBITORS						

(72) GRICE, Cheryl A., 10835 Road to the Cure Suite 250, San Diego California 92121, US
 WIENER, John J. M., 10835 Road to the Cure Suite 250, San Diego California 92121, US
 WEBER, Olivia D., 10835 Road to the Cure Suite 250, San Diego California 92121, US
 DUNCAN, Katharine K., 10835 Road to the Cure Suite 250, San Diego California 92121, US

(51) MKP
A01K 67/027 2006 (97) EP 3636670
A61K 35/12 2015
A61K 35/34 2015
A61K 35/76 2015
A61K 39/395 2006
A61K 45/00 2006
A61K 48/00 2006
A61P 1/04 2006
A61P 1/12 2006
A61P 1/16 2006
A61P 1/18 2006
A61P 3/00 2006
A61P 3/04 2006
A61P 3/10 2006
A61P 9/00 2006
A61P 9/10 2006
A61P 9/14 2006
A61P 11/00 2006
A61P 13/08 2006
A61P 13/10 2006
C07K 16/28 2006

(96) EP 18808756.3 5/29/2018

(97) EP 3636670, 4/15/2020 202016, en

(31) 2017106529 (32) 30.05.2017 (33) JP

(54) ANTI-IGF-I RECEPTOR ANTIBODY

(72) EGUCHI, Hiroshi, c/o Teijin Pharma Limited 2-1 Kasumigaseki 3-chome Chiyoda-ku, Tokyo 100-0013, JP
 TANOKURA, Akira, c/o Teijin Pharma Limited 2-1 Kasumigaseki 3-chome Chiyoda-ku, Tokyo 100-0013, JP
 TAKAGI, Kenichiro, c/o Teijin Pharma Limited 2-1 Kasumigaseki 3-chome Chiyoda-ku, Tokyo 100-0013, JP
 KATO, Hirotsugu, c/o Teijin Pharma Limited 2-1 Kasumigaseki 3-chome Chiyoda-ku, Tokyo 100-0013, JP
 YAMAMURA, Satoshi, c/o Teijin Pharma Limited 2-1 Kasumigaseki 3-chome Chiyoda-ku, Tokyo 100-0013, JP
 NAMIKI, Naoko, c/o Teijin Pharma Limited 2-1 Kasumigaseki 3-chome Chiyoda-ku, Tokyo 100-0013, JP

(51) MKP
C07D 487/04 2006 (97) EP 3630774

(96) EP 18809125.0 5/29/2018

(97) EP 3630774, 4/15/2020 202016, en

(31) 201762513025 P (32) 31.05.2017 (33) US

(54) 5-5 FUSED RINGS AS C5a INHIBITORS

(72) FAN, Pingchen, 2157 Kalenda Commons, Fremont, California 94539, US
 LANGE, Christopher W., 6818 Cutting Boulevard, El Cerrito, California 94530, US
 LUI, Rebecca M., 3901 Lick Mill Boulevard, 346, Santa Clara, California 95054, US
 MALATHONG, Viengkham, 1221 Judson Street, Belmont, California 94002, US
 MALI, Venkat Reddy, 20200 Lucille Avenue Apt. 4, Cupertino, California 95014, US
 PUNNA, Sreenivas, 938 Fontana Terrace, Sunnyvale, California 94085, US
 ZENG, Yibin, 917 Aruba Lane, Foster City, California 94404, US
 ZHANG, Penglie, 1036 Jamaica Street, Foster City, California 94404, US

(51) MKP
C07D 487/04 2006 (97) EP 3630775

(96) EP 18809537.6 5/29/2018

(97) EP 3630775, 4/15/2020 202016, en

(31) 201762513010 P (32) 31.05.2017 (33) US

(54) 6-5 FUSED RINGS AS C5a INHIBITORS

(72) FAN, Pingchen, 2157 Kalenda Commons, Fremont, California 94539, US
 LANGE, Christopher W., 6818 Cutting Boulevard, El Cerrito, California 94530, US
 LUI, Rebecca M., 3901 Lick Mill Boulevard, 346, Santa Clara, California 95054, US
 MALATHONG, Viengkham, 1221 Judson Street, Belmont, California 94002, US

MALI, Venkat Reddy, 20200 Lucille Avenue Apt. 4, Cupertino, California 95014, US
 PUNNA, Sreenivas, 938 Fontana Terrace, Sunnyvale, California 94085, US
 SINGH, Rajinder, 1832 Hillman Avenue, Belmont, California 94002, US
 TANAKA, Hiroko, 600 Rainbow Drive, 148, Mountain View, California 94041, US
 ZENG, Yibin, 917 Aruba Lane, Foster City, California 94404, US
 ZHANG, Pengjie, 1036 Jamaica Street, Foster City, California 94404, US

- (51) MKP
G06F 21/56 2013 (97) EP 3635603
- (96) EP 18809684.6 5/30/2018
 (97) EP 3635603, 4/15/2020 202016, en
 (31) 201762512659 P (32) 30.05.2017 (33) US
- (54) REAL-TIME DETECTION OF AND PROTECTION FROM MALWARE AND STEGANOGRAPHY IN A KERNEL MODE
 (71) Cyemptive Technologies, Inc., 110 Cedar Ave, STE 103, Snohomish, WA 98290, US
 (72) MACLEOD, Stewart, P., Cyemptive Technologies, Inc. 110 Cedar Ave, STE 103, Snohomish, WA 98290, US
 PIKE, Robert, Cyemptive Technologies, Inc. 110 Cedar Ave, STE 103, Snohomish, WA 98290, US

- (51) MKP
A61K 38/46 2006 (97) EP 3634496
A61K 48/00 2006
A61P 35/00 2006
C12N 15/113 2010
- (96) EP 18812882.1 6/5/2018
 (97) EP 3634496, 4/15/2020 202016, en
 (31) 201762515738 P (32) 06.06.2017 (33) US
- (54) METHODS FOR SENSITIZING CANCER CELLS TO T CELL-MEDIATED KILLING BY MODULATING MOLECULAR PATHWAYS
 (71) Pan, Deng, 450 Brookline Avenue, Boston, MA 02215, US
 Wucherpfennig, Kai W., 67 Highland Road, Brookline, MA 02445, US
 (72) PAN, Deng, 67 Highland Road, Brookline, MA 02445, US
 WUCHERPFENNIG, Kai, W., 67 Highland Road, Brookline, MA 02445, US

- (51) MKP
A61K 39/395 2006 (97) EP 3634995
C07K 16/00 2006
C07K 16/28 2006
- (96) EP 18813493.6 6/4/2018
 (97) EP 3634995, 4/15/2020 202016, en
 (31) 201762515188 P (32) 05.06.2017 (33) US
 201862648114 P 26.03.2018 US
 201862673185 P 18.05.2018 US
- (54) ANTIBODIES THAT SPECIFICALLY BIND PD-1 AND METHODS OF USE
 (72) CHEN, Qiang, 3210 Merryfield Row, San Diego, California 92121, US
 COLE, Suzanne, 1400 McKean Road, Spring House, Pennsylvania 19477, US
 DUFFY, Karen, 1400 McKean Road, Spring House, Pennsylvania 19477, US
 GARDNER, Debra, 1400 McKean Road, Spring House, Pennsylvania 19477, US
 GUO, Yanxia, 41 Hillcroft Way, Newtown, Pennsylvania 18940, US
 HAMEL, Damon, 3573 Mount Abbey Avenue, San Diego, California 92111, US
 HITCHCOCK, Shannon, 1400 McKean Road, Pennsylvania 19477, US
 LACOMBE, Ann, 3210 Merryfield Row, San Diego, California 92121, US
 LUO, Jinquan, 1400 McKean Road, Spring House, Pennsylvania 19477, US
 MALAVIYA, Ravi, 1400 McKean Road, Spring House, Pennsylvania 19477, US
 ORLOVSKY, Yevgeniya, 1400 McKean Road, Spring House, Pennsylvania 19477, US
 SOROOSH, Pejman, 3210 Merryfield Row, San Diego, California 92121, US
 SWIECKI, Melissa, 1400 McKean Road, Spring House, Pennsylvania 19477, US
 WILKINSON, Deepti, 3210 Merryfield Row, San Diego, California 92121, US

- (51) MKP
A61F 2/14 2006 (97) EP 3634307
A61F 2/16 2006
A61F 9/00 2006
A61F 9/008 2006
A61F 9/013 2006
- (96) EP 18813963.8 6/5/2018

(97) EP 3634307, 4/15/2020 202016, en
 (31) 201762515528 P (32) 05.06.2017 (33) US
 (54) SYSTEMS AND METHODS FOR CORNEAL TRANSPLANTS
 (71) CorneaGen Inc., 1200 6th Avenue, Suite 300, Seattle, WA 98101, US
 (72) BARKER, Jerry, W., 3344 Midway Road, Gretna, VA 24557, US
 DRABBLE, Douglas, C., 4860 Century Oaks Lane, Winston-Salem, NC 27106, US
 GIEGENGACK, Matthew, 644 North Spring Street, Winston-Salem, NC 27101, US

(51) MKP
A61K 31/7034 2006 (97) EP 3634430
A61P 13/12 2006
 (96) EP 18814051.1 6/5/2018
 (97) EP 3634430, 4/15/2020 202016, en
 (31) 201762515409 P (32) 05.06.2017 (33) US
 201862613359 P 03.01.2018 US
 201862632531 P 20.02.2018 US
 (54) MULTIBIOTIC AGENTS AND METHODS OF USING THE SAME
 (71) Flagship Pioneering Innovations V, Inc., 55 Cambridge Parkway, 8th Floor, Cambridge, MA 02142, US
 (72) CASEY, Jr., John Patrick, 1 Goodwin Place 4, Boston, MA 02114, US
 BERRY, David, 155 Beethoven Avenue, Waban, MA 02468, US
 CASTRO, Alfredo, 14 Kelly Drive, Woburn, MA 01801, US
 TAYLOR, Steven J., 17 Hill Street, Winchester, MA 01890, US
 MASSARI, Ferdinand E., 33 Crescent Avenue, Beverly, MA 01915, US
 PROUDFOOT, John, 40 Currituck Road, Newtown, CT 06470, US
 BOGART, Elijah, 27 Putnam Avenue 2, Cambridge, MA 02139, US
 BRIGGS, Timothy F., 105 Vernon Street Unit 2, Waltham, MA 02453, US

(51) MKP
G06Q 30/00 2012 (97) EP 3637348
 (96) EP 18814060.2 3/22/2018
 (97) EP 3637348, 4/15/2020 202016, en
 (31) 17005655 (32) 07.06.2017 (33) CO
 (54) SYSTEM FOR DETECTING MATING BY MEANS OF INTRABODY COMMUNICATION (IBC)
 (71) Logsent S.A.S., Carrera 67 No. 100-20 Piso 2, Bogotá, CO
 (72) LOPEZ GALARZA, Edgar Hernando, Transversal 2 67-15, Bogot, CO
 LOPEZ GOMEZ, Jhon Fredy, Transversal 2 67-15, Bogot, CO

(51) MKP
A61K 31/417 2006 (97) EP 3638229
A61K 31/4184 2006
A61K 31/517 2006
C07D 233/54 2006
C07D 239/12 2006
C07D 239/14 2006
 (96) EP 18816547.6 6/14/2018
 (97) EP 3638229, 4/22/2020 202017, en
 (31) 201762520150 P (32) 15.06.2017 (33) US
 (54) IMIDAZOLE-CONTAINING INHIBITORS OF ALK2 KINASE
 (72) KOTIAN, Pravin L., 1139 Magnolia Run, Hoover AL 35226, US
 BABU, Yarlagadda,S., 4836 Southlake Parkway, Birmingham AL 35244, US
 KUMAR, V. Satish, 809 Mayapple Court, Birmingham AL 35244, US
 ZHANG, Weihe, 2645 Manchester Court, Vestavia Hills AL 35226, US
 LU, Peng-Cheng, 1816 Altadena Ridge Place, Vestavia Hills AL 35243, US
 RAMAN, Krishnan, 3739 Spearman Drive, Birmingham AL 35216, US

(51) MKP
A61K 48/00 2006 (97) EP 3638315
C12N 15/86 2006
 (96) EP 18816860.3 6/14/2018
 (97) EP 3638315, 4/22/2020 202017, en
 (31) 201762520084 P (32) 15.06.2017 (33) US
 201762554155 P 05.09.2017 US

- (54) AADC POLYNUCLEOTIDES FOR THE TREATMENT OF PARKINSON'S DISEASE
 (71) Voyager Therapeutics, Inc., 75 Sidney Street, Cambridge, Massachusetts 02139, US
 (72) SCHEEL, Maria, 31 Cresthaven Drive, Burlington, MA 01803, US
 RAVINA, Bernard, 8 Meadowbrook Road, Newton, MA08459, US

- (51) MKP
A61K 38/17 2006 (97) EP 3638289
A61K 39/39 2006
C07K 16/28 2006
C07K 19/00 2006
- (96) EP 18817018.7 6/12/2018
 (97) EP 3638289, 4/22/2020 202017, en
- | | | | | | |
|------|----------------|------|------------|------|----|
| (31) | 201762518078 P | (32) | 12.06.2017 | (33) | US |
| | 201762523850 P | | 23.06.2017 | | US |
| | 201762523862 P | | 23.06.2017 | | US |
| | 201762555313 P | | 07.09.2017 | | US |
- (54) PDE5 COMPOSITIONS AND METHODS FOR IMMUNOTHERAPY
 (72) SURI, Vipin, 3 Coolidge Road, Belmont, Massachusetts 02478, US
 DELABARRE, Byron, 50 Candia Street, Arlington, Massachusetts 02474, US
 GLADSTONE, Michael, N., 400 Technology Square 10th Floor, Cambridge, MA 02139, US
 RICHARDSON, Celeste, 199 Wolcott Road, Brookline, Massachusetts 02467, US
 DOLINSKI, Brian, c/o Obsidian Therapeutics, Inc. 1030 Massachusetts Avenue Fourth Floor, Cambridge, Massachusetts 02138, US
 KULKARNI, Abhishek, 360 Tappan Street 3, Brookline, Massachusetts 02445, US
 INNIS, Mara, Christine, 11 Highland Avenue Unit 2, Beverly, Massachusetts 01915, US
 SUN, Dexue, c/o Obsidian Therapeutics, Inc. 1030 Massachusetts Avenue Fourth Floor, Cambridge, Massachusetts 02138, US
 LI, Dan, Jun, c/o Obsidian Therapeutics, Inc. 1030 Massachusetts Avenue Fourth Floor, Cambridge, Massachusetts 02138, US
 OLINGER, Grace, Y., 22 Water Street 431, Cambridge, Massachusetts 02141, US
 HELLER, Scott, Francis, 559 Plain Street, Stoughton, Massachusetts 02072, US

- (51) MKP
A01N 43/836 2006 (97) EP 3640244
A01P 7/02 2006
A01P 7/04 2006
A61K 31/4245 2006
A61P 33/14 2006
C07D 271/12 2006
C07D 498/10 2006
- (96) EP 18817141.7 6/12/2018
 (97) EP 3640244, 4/22/2020 202017, en
- | | | | | | |
|------|------------|------|------------|------|----|
| (31) | 2017116852 | (32) | 14.06.2017 | (33) | JP |
| | 2017125842 | | 28.06.2017 | | JP |
| | 2017134971 | | 10.07.2017 | | JP |
| | 2017149700 | | 02.08.2017 | | JP |
| | 2017183870 | | 25.09.2017 | | JP |
| | 2017200523 | | 16.10.2017 | | JP |
- (54) OXADIAZOLINE COMPOUND AND PEST CONTROL AGENT
 (72) SHIBAYAMA Kotaro, c/o Odawara Research Center Nippon Soda Co. Ltd. 345 Takada, Odawara-shi Kanagawa 250-0280, JP
 SUZUKI Hiroto, c/o Odawara Research Center Nippon Soda Co. Ltd. 345 Takada, Odawara-shi Kanagawa 250-0280, JP
 IWASA Takao, c/o Odawara Research Center Nippon Soda Co. Ltd. 345 Takada, Odawara-shi Kanagawa 250-0280, JP
 HIRATA Koichi, c/o Odawara Research Center Nippon Soda Co. Ltd. 345 Takada, Odawara-shi Kanagawa 250-0280, JP
 KIYOTA Ryutarou, c/o Odawara Research Center Nippon Soda Co. Ltd. 345 Takada, Odawara-shi Kanagawa 250-0280, JP

- (51) MKP
G03G 15/08 2006 (97) EP 3640742
G03G 21/18 2006
- (96) EP 18817519.4 6/15/2018
 (97) EP 3640742, 4/22/2020 202017, en
- | | | | | | |
|------|------------|------|------------|------|----|
| (31) | 2017117890 | (32) | 15.06.2017 | (33) | JP |
|------|------------|------|------------|------|----|
- (54) CARTRIDGE AND ELECTROPHOTOGRAPHIC IMAGE FORMATION DEVICE
 (72) NISHIDA, Shinichi, c/o CANON KABUSHIKI KAISHA 30-2 Shimomaruko 3-chome Ohta-ku, Tokyo 146-8501, JP
 FUKUI, Yuichi, c/o CANON KABUSHIKI KAISHA 30-2 Shimomaruko 3-chome Ohta-ku, Tokyo 146-8501, JP
 UNEME, Tetsushi, c/o CANON KABUSHIKI KAISHA 30-2 Shimomaruko 3-chome Ohta-ku, Tokyo 146-8501, JP
 EGAMI, Yasuyuki, c/o CANON KABUSHIKI KAISHA 30-2 Shimomaruko 3-chome Ohta-ku, Tokyo 146-8501, JP
 ANZAI, Yohei, c/o CANON KABUSHIKI KAISHA 30-2 Shimo aruko 3-chome Ohta-ku, Tokyo 146-8501, JP

KAWANAMI, Takeo, c/o CANON KABUSHIKI KAISHA 30-2 Shimomaruko 3-chome Ohta-ku, Tokyo 146-8501, JP
 FUJINO, Toshiki, c/o CANON KABUSHIKI KAISHA 30-2 Shimomaruko 3-chome Ohta-ku, Tokyo 146-8501, JP
 SUGIMOTO, Sohta, c/o CANON KABUSHIKI KAISHA 30-2 Shimomaruko 3-chome Ohta-ku, Tokyo 146-8501, JP
 SAWASHIMA, Fumiya, c/o CANON KABUSHIKI KAISHA 30-2 Shimomaruko 3-chome Ohta-ku, Tokyo 146-8501, JP

- (51) MKP
A61K 9/51 2006 (97) EP 3638215
A61K 31/7088 2006
A61K 31/7105 2006
A61K 47/14 2017
A61K 47/24 2006
A61K 47/28 2006
A61K 47/54 2017
A61K 48/00 2006
C12N 15/88 2006
- (96) EP 18817653.1 6/15/2018
 (97) EP 3638215, 4/22/2020 202017, en
- (31) 201762520530 P (32) 15.06.2017 (33) US
 201762590200 P 22.11.2017 US
- (54) RNA FORMULATIONS
 (72) HOGE, Stephen, 320 Bent Street, Cambridge, MA 02141, US
 SCHARITER, Joseph, 207 Hammond Street, Waltham, MA 02451, US
 BOWERMAN, Charles, 745 South Street, Waltham, MA 02453, US
 SMITH, Michael, H., 25 Whiting Way, Needham, MA 02492, US
 XIA, Yan, 140 Lyman Street Apt. 5, Waltham, MA 02452, US

- (51) MKP
G06F 17/30 2006 (97) EP 3640823
- (96) EP 18817953.5 6/11/2018
 (97) EP 3640823, 4/22/2020 202017, en
- (31) 201710438944 (32) 12.06.2017 (33) CN
- (54) SERVICE DATA STORAGE METHOD, DEVICE, STORAGE MEDIUM, AND ELECTRONIC DEVICE
 (72) GUO, Rui, 35/F, Tencent Building, Kejizhongyi Road, Midwest District of Hi-tech Park, Nanshan District, Shenzhen,, Guangdong 518057, CN
 LI, Maocai, 35/F, Tencent Building, Kejizhongyi Road, Midwest District of Hi-tech Park, Nanshan District, Shenzhen,, Guangdong 518057, CN
 LIANG, Jun, 35/F, Tencent Building, Kejizhongyi Road, Midwest District of Hi-tech Park, Nanshan District, Shenzhen,, Guangdong 518057, CN
 ZHANG, Jianjun, 35/F, Tencent Building, Kejizhongyi Road, Midwest District of Hi-tech Park, Nanshan District, Shenzhen,, Guangdong 518057, CN
 WANG, Zongyou, 35/F, Tencent Building, Kejizhongyi Road, Midwest District of Hi-tech Park, Nanshan District, Shenzhen,, Guangdong 518057, CN
 ZHAO, Qi, 35/F, Tencent Building, Kejizhongyi Road, Midwest District of Hi-tech Park, Nanshan District, Shenzhen,, Guangdong 518057, CN
 TU, Haitao, 35/F, Tencent Building, Kejizhongyi Road, Midwest District of Hi-tech Park, Nanshan District, Shenzhen,, Guangdong 518057, CN
 LIU, Binhua, 35/F, Tencent Building, Kejizhongyi Road, Midwest District of Hi-tech Park, Nanshan District, Shenzhen,, Guangdong 518057, CN
 ZHU, Dawei, 35/F, Tencent Building, Kejizhongyi Road, Midwest District of Hi-tech Park, Nanshan District, Shenzhen,, Guangdong 518057, CN
 QIN, Qing, 35/F, Tencent Building, Kejizhongyi Road, Midwest District of Hi-tech Park, Nanshan District, Shenzhen,, Guangdong 518057, CN

- (51) MKP
C09K 8/24 2006 (97) EP 3642297
E21B 21/00 2006
E21B 21/06 2006
E21D 9/11 2006
E21D 9/13 2006
- (96) EP 18819655.4 6/22/2018
 (97) EP 3642297, 4/29/2020 202018, en
- (31) 201762524361 P (32) 23.06.2017 (33) US
- (54) DRILL FLUID AND METHOD FOR TUNNELING
 (71) Canadian Energy Services L.P., 1400, 700 - 4th Avenue SW, Calgary, Alberta T2P 3J4, CA
 (72) SMITH, Carl Keith, 59 Springbank Crescent SW, Calgary Alberta T3H 3S6, CA
 GAWRYLUK, Josh, 201 Windsor Avenue, Turner Valley Alberta T0L 2A0, CA

- (51) MKP
G06K 9/00 2006 (97) EP 3644219
- (96) EP 18819678.6 5/23/2018

(97) EP 3644219, 4/29/2020 202018, en
 (31) 201710473506 (32) 21.06.2017 (33) CN
 (54) HUMAN FACE FEATURE POINT TRACKING METHOD, DEVICE, STORAGE MEDIUM AND APPARATUS
 (72) LIN, Mengran, 35/F Tencent Building, Kejizhongyi Road, Midwest District of Hi-Tech Park, Nanshan District,, Shenzhen Guangdong 518057, CN
 WANG, Xinliang, 35/F, Tencent Building, Kejizhongyi Road, Midwest District of Hi-Tech Park, Nanshan District,, Shenzhen Guangdong 518057, CN
 LI, Bin, 35/F, Tencent Building, Kejizhongyi Road, Midwest District of Hi-Tech Park, Nanshan District,, Shenzhen Guangdong 518057, CN

(51) MKP
H04N 19/11 2014 (97) EP 3644605
H04N 19/147 2014
 (96) EP 18819921.0 5/15/2018
 (97) EP 3644605, 4/29/2020 202018, en
 (31) 201710486557 (32) 23.06.2017 (33) CN
 (54) PREDICTION MODE SELECTION METHOD, VIDEO ENCODING DEVICE AND STORAGE MEDIUM
 (72) MAO, Xunan, 35/F, Tencent Building, Kejizhongyi Road, Midwest District of Hi-tech Park, Nanshan District,, Shenzhen, Guangdong 518057,, CN

(51) MKP
A61K 38/00 2006 (97) EP 3642243
A61K 39/00 2006
C07K 16/28 2006
 (96) EP 18820336.8 6/20/2018
 (97) EP 3642243, 4/29/2020 202018, en
 (31) 201762522167 P (32) 20.06.2017 (33) US
 201762573264 P 17.10.2017 US
 201862677265 P 29.05.2018 US
 (54) METHODS FOR MODULATING REGULATORY T CELLS, REGULATORY B CELLS, AND IMMUNE RESPONSES USING MODULATORS OF THE APRIL-TACI INTERACTION
 (72) ANDERSON, Kenneth C., 22 Olde Field Road, Newton MA 02459, US
 TAI, Yu-Tzu, 22 Olde Field Road, Newton MA 02459, US

(51) MKP
H04L 9/32 2006 (97) EP 3644551
 (96) EP 18820580.1 5/18/2018
 (97) EP 3644551, 4/29/2020 202018, en
 (31) 201710472364 (32) 20.06.2017 (33) CN
 (54) METHOD AND DEVICE FOR FORWARDING MESSAGE, AND STORAGE MEDIUM
 (71) Tencent Technology (Shenzhen) Company Limited, 35/F, Tencent Building, Kejizhongyi Road, Midwest District of Hi-tech Park, Nanshan District, Shenzhen 518057, CN
 (72) HAN, Wuyuu, 35/F Tencent Building Kejizhongyi Road Midwest District of Hi-tech Park Nanshan District, Shenzhen City Guangdong 518057, CN

(51) MKP
C08J 9/36 2006 (97) EP 3638719
F16L 59/14 2006
 (96) EP 18820992.8 6/21/2018
 (97) EP 3638719, 4/22/2020 202017, en
 (31) 201762523563 P (32) 22.06.2017 (33) US
 201762527724 P 30.06.2017 US
 (54) COATED CLOSED-CELL FOAM TUBE INSULATIONS AND METHODS FOR PRODUCING THE SAME
 (71) L'isolante K-Flex S.p.A., Via Leonardo da Vinci 36, 20877 Roncello - MB, IT
 (72) BIJU VALAKKADAVIL, Thomas, 4116 Plum Branch Drive, Cary NC 27519, US

(51) MKP
C07J 41/00 2006 (97) EP 3642217
C07J 43/00 2006
 (96) EP 18821477.9 6/22/2018
 (97) EP 3642217, 4/29/2020 202018, en
 (31) 201762523937 P (32) 23.06.2017 (33) US
 (54) METHODS AND INTERMEDIATES FOR THE PREPARATION OF BILE ACID DERIVATIVES
 (72) PELLICCIARI, Roberto, via Ulisse Rocchi 60, 06100 Perugia, IT
 GIOIELLO, Antimo, via A. Pesenti 51, 06125 Perugia, IT

GALVIN, Gabriel, 13222 Salmon River Rd., San Diego California 92129, US
 LEWIS, Ronald D., 13838 Freeport Rd., San Diego CA 92129, US
 YANIK, Matthew, 4671 Torrey Circle F104, San Diego CA 92130, US
 KIM, Myoung Goo, 3508 Annry Drive, Summerfield NC 27358, US
 LEUSINK, Fred Ronald, Zonstraat 12, 9801 VW Zuidhorn, NL
 KONING, Bartjan, Burgemeester Seinenstraat 7, 9831 PS Aduard, NL
 HENSEL, Thomas, Uurwerkersgang 1a, 9712 EJ Groningen, NL

- (51) MKP
A61K 49/10 2006 (97) EP 3646888
A61K 49/18 2006
C07C 309/14 2006
- (96) EP 18823223.5 6/27/2018
 (97) EP 3646888, 5/6/2020 202019, en
 (31) 2017126755 (32) 28.06.2017 (33) JP
- (54) NANOPARTICLE, CONTRAST AGENT FOR MAGNETIC RESONANCE IMAGING CONTAINING SAME, AND LIGAND COMPOUND
 (71) Riken, 2-1, Hirosawa, Wako-shi, Saitama 351-0198, JP
 National Institutes for Quantum and Radiological Science and Technology, 4-9-1, Anagawa, Inage-ku Chiba-shi Chiba 263-8555, JP
 (72) MIYAJIMA, Daigo, c/o RIKEN 2-1 Hirosawa, Wako-shi Saitama 351-0198, JP
 TAKEUCHI, Toshiaki, c/o RIKEN 2-1 Hirosawa, Wako-shi Saitama 351-0198, JP
 SIM, Seunghyun, c/o RIKEN 2-1 Hirosawa, Wako-shi Saitama 351-0198, JP
 AIDA, Takuzo, c/o RIKEN 2-1 Hirosawa, Wako-shi Saitama 351-0198, JP
 AOKI, Ichio, c/o NATIONAL INSTITUTES FOR QUANTUM AND RADIOLOGICAL SCIENCE AND TECHNOLOGY 4-9-1 Anagawa Inage-ku, Chiba-shi Chiba 263-8555, JP

- (51) MKP
A01K 67/027 2006 (97) EP 3572517
C07K 16/46 2006
C12N 9/64 2006
C12N 15/85 2006
- (96) EP 19184217.8 8/3/2012
 (97) EP 3572517, 7/1/2020 202027, en
 (31) 201161515374 P (32) 05.08.2011 (33) US
- (54) HUMANIZED UNIVERSAL LIGHT CHAIN MICE
 (72) MCWHIRTER, John, 2035 Crescent Drive, Tarrytown, NY 10591, US
 MACDONALD, Lynn, 16 Gedney Way, White Plains, NY 10591, US
 STEVENS, Sean, 355 Berry Street 413, San Francisco, CA 94158, US
 DAVIS, Samuel, c/o Regeneron Pharmaceuticals, Inc. 777 Old Saw Mill River Road, Tarrytown, NY 10591, US
 BUCKLER, David R, 6 Erick Court, Chester, CA 07930, US
 HOSIAWA, Karolina A, 211 Benjamin Boulevard, Yorktown Heights New York 10598, US
 MURPHY, Andrew J, 10 Newton Court, Croton-on-hudson, CA 10520, US

- (51) MKP
F16B 13/12 2006 (97) EP 3604831
- (96) EP 19185074.2 7/8/2019
 (97) EP 3604831, 5/6/2020 202019, de
 (31) 202018003632 U (32) 03.08.2018 (33) DE
- (54) COMPOUND SEAL BLANK
 (71) Sopro Bauchemie GmbH, Biebricher Strasse 74, 65203 Wiesbaden, DE
 (72) Sommer, Mario, Sopro Bauchemie GmbH Lerchenweg 12, 65594 Runkel, DE

- (51) MKP
A61P 37/00 2006 (97) EP 3660034
C07K 14/24 2006
C12N 15/70 2006
C12N 15/74 2006
- (96) EP 19191383.9 5/20/2015
 (97) EP 3660034, 6/3/2020 202023, en
 (31) 14169335 (32) 21.05.2014 (33) EP
- (54) BACTERIA-BASED PROTEIN DELIVEY
 (72) ITTIG, Simon, Zehntenfreistrasse 32, 4103 Bottmingen, CH
 ARRIEUMERLOU, Cécile, 20 rue Madame, 92130 Issy les Moulineaux, FR

(51)	MKP							
	A61K 31/196	2006	(97) EP 3628317					
	A61K 31/343	2006						
	A61K 31/357	2006						
	A61P 1/04	2006						
(96)	EP 19192669.0	2/8/2013						
(97)	EP 3628317, 4/1/2020	202014, en						
(31)	12425027		(32)	09.02.2012		(33)	EP	
	201261644544 P			09.05.2012			US	
(54)	METHODS OF TREATING FIBROSIS							
(72)	BARONI, Sergio, Via Piazzola 3, I-24030 Villa D'Adda (BG), IT							
	VITI, Francesca, Via Stradone 34, 6872 Salorino, CH							
	BELLIN VIA, Salvatore, Viale Turconi 19, 6850 Mendrisio, CH							
(51)	MKP							
	A61K 31/713	2006	(97) EP 3647424					
	C12N 15/113	2010						
(96)	EP 19194079.0	11/10/2015						
(97)	EP 3647424, 5/6/2020	202019, en						
(31)	201462077672 P		(32)	10.11.2014		(33)	US	
	201462077799 P			10.11.2014			US	
	201562137464 P			24.03.2015			US	
(54)	HEPATITIS B VIRUS (HBV) IRNA COMPOSITIONS AND METHODS OF USE THEREOF							
(72)	HINKLE, Gregory, 300 Third Street 3rd Floor, Cambridge, MA 02142, US							
	SEPP-LORENZINO, Laura, 300 Third Street 3rd Floor, Cambridge, MA 02142, US							
	JADHAV, Vasant, 300 Third Street 3rd Floor, Cambridge, MA 02142, US							
	MAIER, Martin, 300 Third Street 3rd Floor, Cambridge, MA 02142, US							
	MILSTEIN, Stuart, 300 Third Street 3rd Floor, Cambridge, MA 02142, US							
	MANOHARAN, Muthiah, 300 Third Street 3er Floor, Cambridge, MA 02142, US							
	RAJEEV, Kallanthottathil, G., 300 Third Street 3rd Floor, Cambridge, MA 02142, US							
(51)	MKP							
	A61K 35/74	2015	(97) EP 3650033					
	A61K 35/745	2015						
	A61P 1/00	2006						
	A61P 11/06	2006						
	A61P 19/02	2006						
	A61P 25/28	2006						
	A61P 29/00	2006						
	A61P 35/00	2006						
	C12N 1/20	2006						
(96)	EP 19196804.9	6/15/2016						
(97)	EP 3650033, 5/13/2020	202020, en						
(31)	201510467		(32)	15.06.2015		(33)	GB	
	201520501			20.11.2015			GB	
(54)	COMPOSITIONS COMPRISING BACTERIAL STRAINS							
(72)	GRANT, George, Life Sciences Innovation Building Cornhill Road, Aberdeen, Aberdeenshire AB25 2ZS, GB							
	PATTERSON, Angela Margaret, Norwich Medical School, Faculty of Medicine and Health Sciences University of East Anglia, Norwich, Norfolk NR4 7JT, GB							
	MULDER, Imke, Life Sciences Innovation Building Cornhill Road, Aberdeen, Aberdeenshire AB25 2ZS, GB							
	MCCLUSKEY, Seanin, c/o 4D PHARMA PLC 3rd Floor 9 Bond Court, Leeds, Yorkshire LS1 2JZ, GB							
	RAFTIS, Emma, c/o 4D PHARMA PLC 3rd Floor 9 Bond Court, Leeds, Yorkshire LS1 2JZ, GB							
(51)	MKP							
	B01D 11/02	2006	(97) EP 3610935					
	B01D 11/04	2006						
	B01D 24/00	2006						
	B01D 29/56	2006						
	B01D 35/18	2006						
(96)	EP 19196809.8	11/5/2018						
(97)	EP 3610935, 6/3/2020	202023, en						
(31)	201715809980		(32)	10.11.2017		(33)	US	

(54) SYSTEM FOR STAGED CONTINUOUS COOLED FILTRATION
 (72) KO, Ryan Delmoral, c/o 68 Schooner Street Unit 3, Coquitlam, British Columbia V3K 7B1, CA

(51) MKP
A61K 47/68 2017 (97) EP 3626273

(96) EP 19197371.8 5/17/2017
 (97) EP 3626273, 5/13/2020 202020, en
 (31) 201662337796 P (32) 17.05.2016 (33) US
 (54) ANTI-CMET ANTIBODY DRUG CONJUGATES AND METHODS FOR THEIR USE
 (72) REILLY, Edward B, 1136 Winners Circle, Libertyville, IL 60048, US
 NAUMOVSKI, Louie, 570 Jay Street, Los Altos, CA 94022, US
 ALLAN, Christian B., 3434 Glendora Drive, San Mateo, CA 94403, US
 WANG, Jieyi, 2317 Hastings Drive, Belmont, CA 94002, US
 ANDERSON, Mark G., 410 Sommerset Drive, Grayslake, IL 60030, US
 AFAR, Daniel E., 12682 Roble Veneno Lane, Los Altos Hills, CA 94022, US

(51) MKP
A61K 31/4375 2006 (97) EP 3639824
A61K 31/4545 2006
A61K 31/4725 2006
A61K 31/4985 2006
A61K 31/5377 2006
A61K 31/538 2006
A61K 31/5383 2006
A61K 31/5415 2006
A61K 31/542 2006
A61K 31/554 2006
A61P 31/04 2006

(96) EP 19197439.3 8/20/2015
 (97) EP 3639824, 4/22/2020 202017, en
 (31) 201462040488 P (32) 22.08.2014 (33) US
 (54) TRICYCLIC NITROGEN CONTAINING COMPOUNDS FOR TREATING NEISSERIA GONORRHOEA INFECTION
 (72) WIDDOWSON, Katherine, Louisa, 709 Swedeland Road, King of Prussia, PA Pennsylvania 19406, US

(51) MKP
C12N 15/67 2006 (97) EP 3636764

(96) EP 19198322.0 10/5/2016
 (97) EP 3636764, 7/11/2020 202027, en
 (31) PCT/EP2015/073180 (32) 07.10.2015 (33) WO
 (54) 3' UTR SEQUENCES FOR STABILIZATION OF RNA
 (72) ORLANDINI VON NIESSEN, Alexandra, c/o BioNTech RNA Pharmaceuticals GmbH An der Goldgrube 12, 55131 Mainz, DE
 FESSER, Stephanie, c/o BioNTech RNA Pharmaceuticals GmbH An der Goldgrube 12, 55131 Mainz, DE
 VALLAZZA, Britta, c/o BioNTech RNA Pharmaceuticals GmbH An der Goldgrube 12, 55131 Mainz, DE
 BEISSERT, Tim, c/o BioNTech RNA Pharmaceuticals GmbH An der Goldgrube 12, 55131 Mainz, DE
 KUHN, Andreas, c/o BioNTech RNA Pharmaceuticals GmbH An der Goldgrube 12, 55131 Mainz, DE
 SAHIN, Ugur, c/o BioNTech RNA Pharmaceuticals GmbH An der Goldgrube 12, 55131 Mainz, DE
 POLEGANOV, Marco Alexander, c/o BioNTech RNA Pharmaceuticals GmbH An der Goldgrube 12, 55131 Mainz, DE

(51) MKP
A01N 37/02 2006 (97) EP 3639662
A01N 37/08 2006
A01N 37/10 2006
A01P 3/00 2006

(96) EP 19198407.9 9/19/2019
 (97) EP 3639662, 4/22/2020 202017, en
 (31) 201862746197 P (32) 16.10.2018 (33) US
 (54) METHODS FOR FUNGI INHIBITION ON LIVE PLANTS USING CARBOXYLIC ACIDS AND THEIR SALTS
 (71) Niacet Corporation, 400 47th Street Niagara Falls, New York 14304, US
 (72) RIJNEVELDSHOEK, Peter, Polderslaan 12, 3233 VL Oostvoorne, NL
 BRANNEN, Kelly, 12156 Seaward Drive East, North Palm Beach, Florida 33408, US
 SOJKA, Stanley, 2395 Bear Den Road, Frederick, Maryland 21701, US

(51) MKP
C05C 1/02 2006 (97) EP 3623362
C05G 3/90 2020
C07B 41/08 2006
C07D 231/12 2006
(96) EP 19199519.0 12/12/2014
(97) EP 3623362, 4/1/2020 202014, de
(31) 102013020588 (32) 13.12.2013 (33) DE
(54) NITRIFICATION INHIBITOR CONTAINING FERTILISER MIXTURE
(72) Peters, Nils, Wildstr. 16, 67227 Frankenthal, DE
Hähndel, Reinhardt, Schillerstr. 35, 67117 Limburgerhof, DE

(51) MKP
A61K 39/395 2006 (97) EP 3670534
A61P 1/16 2006
A61P 3/00 2006
A61P 3/04 2006
A61P 3/06 2006
A61P 3/10 2006
A61P 9/00 2006
A61P 43/00 2006
C07K 16/28 2006
C07K 16/40 2006
(96) EP 19200863.9 4/13/2011
(97) EP 3670534, 6/24/2020 202026, en
(31) 32469110 P (32) 15.04.2010 (33) US
39285910 P 13.10.2010 US
(54) HUMAN FGF RECEPTOR AND BETA-KLOTTHO BINDING PROTEINS
(72) Fachini, Roger, 119 Lear Circle, Thousand Oaks, CA 91360-5344, US
Foltz, Ian, 2108 Knightswood Place, Burnaby, British Columbia V5A 4B9, CA
Han, Seog Joon, 2645 Fall Creek Court, Simi Valley, CA 93063, US
Harris, Susie Miki, 197 Los Vientos Drive, Newbury Park, CA 91320, US
Hu, Shaw-Fen Sylvia, 986 Lynnmere Drive, Thousand Oaks, CA 91360, US
King, Chadwick Terence, 1325 Moody Avenue, North Vancouver, British Columbia V7L 3T5, CA
Li, Yang, 1142 Cuesta Drive, Mountain View, CA 94040, US
Lu, Ji, 1874 Brush Oak Court, Thousand Oaks, CA 91320, US
Michaels, Mark Leo, 5007 Texhoma Avenue, Encino, CA 91316, US
Sun, Jeonghoon, 4340 Camino De La Rosa, Thousand Oaks, CA 91320, US

(51) MKP
A61K 9/16 2006 (97) EP 3650013
A61K 9/20 2006
A61K 31/501 2006
A61K 31/513 2006
(96) EP 19203320.7 1/30/2014
(97) EP 3650013, 5/13/2020 202020, en
(31) 201361759320 P (32) 31.01.2013 (33) US
201361772292 P 04.03.2013 US
201361828899 P 30.05.2013 US
201361870729 P 27.08.2013 US
201361897793 P 30.10.2013 US
201361907332 P 21.11.2013 US
(54) COMBINATION FORMULATION OF TWO ANTIVIRAL COMPOUNDS
(72) CHAL, Ben, c/o Gilead Sciences, Inc. 333 Lakeside Drive, Foster City, CA California 94404, US
MOGALIAN, Erik, c/o Gilead Sciences, Inc. 333 Lakeside Drive, Foster City, CA California 94404, US
PAKDAMAN, Rowchanak, c/o Gilead Sciences, Inc. 333 Lakeside Drive, Foster City, CA California 94404, US
OLIYAI, Reza, c/o Gilead Sciences, Inc. 333 Lakeside Drive, Foster City, CA California 94404, US
STEFANIDIS, Dimitrios, c/o Gilead Sciences, Inc. 333 Lakeside Drive, Foster City, CA California 94404, US
ZIA, Vahid, c/o Gilead Sciences, Inc. 333 Lakeside Drive, Foster City, CA California 94404, US

(51) MKP

	A61K 31/404	2006	(97) EP 3636643				
	A61K 31/416	2006					
	A61P 29/00	2006					
	A61P 37/00	2006					
	C07D 209/14	2006					
	C07D 209/18	2006					
	C07D 235/16	2006					
	C07D 401/10	2006					
	C07D 403/10	2006					
	C07D 405/10	2006					
	C07D 405/14	2006					
	C07D 471/04	2006					
	C07D 487/04	2006					
	C07D 491/10	2006					
(96)	EP 19203418.9 6/8/2016						
(97)	EP 3636643, 4/15/2020 202016, en						
(31)	PCT/IB2015/001693		(32)	09.06.2015		(33)	WO
	201562257806 P			20.11.2015			US
	201662343905 P			01.06.2016			US
(54)	NUCLEAR RECEPTOR MODULATORS (ROR) FOR THE TREATMENT OF INFLAMMATORY AND AUTOIMMUNE DISEASES						
(72)	ARGIRIADI, Maria, A., 15 Sadie Hutt Lane, Southborough, MA 01772, US						
	BREINLINGER, Eric, C., 54 Hanson Road, Charlton, MA 01507, US						
	CUSACK, Kevin, P., 115 Jennifer Drive, Holden, MA 01520, US						
	HOBSON, Adrian, D., 25 Holman Street, Shrewsbury, MA 01545, US						
	POTIN, Dominique, 23 Chemin de Daix, 21240 Talant, FR						
	BARTH, Martine, 20 rue Claude Deschault, 21380 Asnières les Dijon, FR						
	AMAUDRUT, Jérôme, 30 boulevard Rembrandt, 21000 Dijon, FR						
	POUPARDIN, Olivia, 11 Promenade du Fort, 21490 Varois et Chaignot, FR						
	MOUNIER, Laurent, 3 Route de Savigny, 21380 Marsannay le Bois, FR						
	KORT, Michael, E, 507 Green Avenue, Lake Bluff, IL 60044, US						
<hr/>							
(51)	MKP						
	A61K 31/517	2006	(97) EP 3656764				
	C07C 269/06	2006					
	C07C 271/22	2006					
	C07D 239/70	2006					
	C12P 17/16	2006					
(96)	EP 19204562.3 11/13/2014						
(97)	EP 3656764, 5/27/2020 202022, en						
(31)	13193030		(32)	15.11.2013		(33)	EP
(54)	PROCESSES FOR THE PREPARATION OF PYRIMIDINYLCYCLOPENTANE COMPOUNDS						
(72)	IDING, Hans, Pappelweg 32, 4310 Rheinfelden, CH						
	REENTS, Reinhard, Drosselstrasse 3, 4142 Muenchenstein, CH						
	SCALONE, Michelangelo, Baslestrasse 14, 4127 Birsfelden, CH						
	GOSELIN, Francis, 1 DNA Way, South San Francisco, CA California 94080-4990, US						
<hr/>							
(51)	MKP						
	A01N 43/56	2006	(97) EP 3659439				
	A01N 53/00	2006					
	A61K 31/22	2006					
	A61K 31/415	2006					
	A61K 47/14	2017					
	A61K 47/20	2006					
	A61P 33/00	2006					
(96)	EP 19206350.1 2/22/2013						
(97)	EP 3659439, 6/3/2020 202023, en						
(31)	201261602472 P		(32)	23.02.2012		(33)	US
(54)	TOPICAL COMPOSITIONS COMPRISING FIPRONIL AND PERMETHRIN AND METHODS OF USE						
(72)	SOLL, Mark David, 605 Newport Shore, Alpharetta, GA Georgia 30005, US						
	PATE, James, 582 County Road 579, Hampton, NJ New Jersey 08827, US						
	BAKER, Lisa A., 224 Buckingham Way, Somerset, NJ New Jersey 08873, US						
<hr/>							
(51)	MKP						

	A61K 31/439	2006	(97) EP 3673906				
	A61K 31/454	2006					
	A61P 1/00	2006					
	A61P 3/00	2006					
	A61P 3/04	2006					
	A61P 3/10	2006					
	A61P 7/00	2006					
	A61P 9/10	2006					
	A61P 11/06	2006					
	A61P 13/12	2006					
	A61P 19/02	2006					
	A61P 25/00	2006					
	A61P 25/16	2006					
	A61P 25/28	2006					
	A61P 29/00	2006					
	A61P 31/04	2006					
	A61P 35/00	2006					
	A61P 43/00	2006					
	C07D 453/02	2006					
	C07D 455/02	2006					
	C07D 487/08	2006					
(96)	EP 19207540.6 3/16/2012						
(97)	EP 3673906, 7/1/2020 202027, en						
(31)	201161454034 P		(32)	18.03.2011		(33)	US
	201261590711 P			25.01.2012			US
(54)	GLUCOSYLCERAMIDE SYNTHASE INHIBITORS						
(72)	BOURQUE, Elyse, 153 Second Avenue, Waltham, MA 02451, US						
	CELATKA, Cassandra, 153 Second Avenue, Waltham, MA 02451, US						
	HIRTH, Bradford, 153 Second Avenue, Waltham, MA 02451, US						
	METZ, Markus, 153 Second Avenue, Waltham, MA 02451, US						
	ZHAO, Zhong, 153 Second Avenue, Waltham, MA 02451, US						
	SKERLJ, Renato, 153 Second Avenue, Waltham, MA 02451, US						
	XIANG, Yibin, 153 Second Avenue, Waltham, MA 02451, US						
	JANCISICS, Katherine, 153 Second Avenue, Waltham, MA 02451, US						
	GOOD, Andrew, 153 Second Avenue, Waltham, MA 02451, US						
	MARSHALL, John, 49 New York Avenue, Framingham, MA 01701, US						
	CHENG, Seng, 49 New York Avenue, Framingham, MA 01701, US						
	SCHEULE, Ronald, 49 New York Avenue, Framingham, MA 01701, US						
	CABRERA-SALAZAR, Mario, 49 New York Avenue, Framingham, MA 01701, US						
<hr/>							
(51)	MKP						
	A61K 39/00	2006	(97) EP 3656402				
	A61K 39/12	2006					
	A61K 39/39	2006					
	A61K 47/64	2017					
	A61P 31/00	2006					
	A61P 35/00	2006					
	A61P 37/00	2006					
(96)	EP 19208208.9 1/31/2013						
(97)	EP 3656402, 5/27/2020 202022, en						
(31)	PCT/EP2012/000420		(32)	31.01.2012		(33)	WO
(54)	PHARMACEUTICAL COMPOSITION COMPRISING A POLYMERIC CARRIER CARGO COMPLEX AND AT LEAST ONE PROTEIN OR PEPTIDE ANTIGEN						
(72)	Baumhof, Patrick, c/o IP DEPARTMENT CureVac AG Paul Ehrlich Str. 15, 72076 Tübingen, DE						
	Kramps, Thomas, c/o IP DEPARTMENT CureVac AG Paul Ehrlich Str. 15, 72076 Tübingen, DE						
	Voss, Söhnke, c/o IP DEPARTMENT CureVac AG Paul Ehrlich Str. 15, 72076 Tübingen, DE						
	Kallen, Karl-Josef, c/o IP DEPARTMENT CureVac AG Paul Ehrlich Str. 15, 72076 Tübingen, DE						
	Fotin-Mleczek, Mariola, c/o IP DEPARTMENT CureVac AG Paul Ehrlich Str. 15, 72076 Tübingen, DE						
<hr/>							
(51)	MKP						
	A61K 31/506	2006	(97) EP 3660013				
	A61P 3/00	2006					
	A61P 9/00	2006					
	A61P 15/00	2006					
	A61P 25/00	2006					

	A61P 35/00	2006				
	C07D 403/04	2006				
	C07D 413/14	2006				
	C07D 417/14	2006				
	C07D 471/04	2006				
	C07D 487/04	2006				
	C07D 495/04	2006				
(96)	EP 19208775.7 3/14/2014					
(97)	EP 3660013, 6/3/2020 202023, en					
(31)	201361790637 P		(32)	15.03.2013	(33)	US
	201361914915 P			11.12.2013		US
(54)	SGC STIMULATORS					
(72)	NAKAI, Takashi, 7 Gardner Street, Newton, MA 02458, US					
	MOORE, Joel, 4 Cherry Street, Lexington, MA 02421, US					
	PERL, Nicholas Robert, 7 Gibbens Street, Somerville, MA 02143, US					
	IYENGAR, Rajesh R., 23 Stratford Road, West Newton, MA 02465, US					
	MERMERIAN, Ara, 18 Island Hill Avenue, Unit 212, Melrose, MA 02176, US					
	IM, G-Yoon Jamie, 931 Massachusetts Avenue, Apt. 604, Cambridge, MA 02139, US					
	LEE, Thomas Wai-Ho, 665 Lowell Street, Unit 60, Lexington, MA 02420, US					
	HUDSON, Colleen, 146 Clifton St. 7, Malden, MA 02148, US					
	RENNIE, Glen Robert, 46 Elmwood St. 2, Somerville, MA 02144, US					
	JIA, James, 4 Jeanette Avenue, Apt. 3, Belmont, MA 02478, US					
	RENHOWER, Paul Allen, 19 Sky View Road, Sudbury, MA 01776, US					
	BARDEN, Timothy Claude, c/o Cycleron Therapeutics, Inc. 301 Binney Street, Cambridge, MA 02142, US					
	YU, Xiang Y, 2 Whispering Way, Acton, MA 01720, US					
	SHEPPECK, James Edward, 356 Crittenden Dr., Newtown, PA 18940, US					
	IYER, Karthik, c/o Cycleron Therapeutics, Inc. 301 Binney Street, Cambridge, MA 02142, US					
	JUNG, Joon, 111 Wendell Road, Newton, MA 02459, US					
	MILNE, George Todd, 169 Mason Terrace, Brookline, MA 02446, US					
	LONG, Kimberly Kafadar, 2 Jamaica Place, Unit 2, Boston, MA 02130, US					
	CURRIE, Mark G., 197 8th Street, Boston, MA 02129, US					

(51)	MKP					
	C07K 1/14	2006	(97)	EP 3660032		
	C07K 1/18	2006				
	C07K 1/22	2006				
	C07K 1/32	2006				
(96)	EP 19209054.6 6/24/2010					
(97)	EP 3660032, 6/3/2020 202023, en					
(31)	22047709 P		(32)	25.06.2009	(33)	US
(54)	CAPTURE PURIFICATION PROCESSES FOR PROTEINS EXPRESSED IN A NON-MAMMALIAN SYSTEM					
(72)	SCHULTZ, Joseph, Edward, 11675 Barranca Road, Santa Rose Valley, CA 93012, US					
	HART, Roger, 6958 West Country Road ,18, Loveland, CO 80537, US					

(51)	MKP					
	A61K 39/00	2006	(97)	EP 3639850		
	A61K 39/085	2006				
	A61K 39/39	2006				
	A61P 31/04	2006				
	C07K 14/31	2006				
(96)	EP 19211691.1 3/24/2015					
(97)	EP 3639850, 4/22/2020 202017, en					
(31)	14161861		(32)	26.03.2014	(33)	EP
	14192913			12.11.2014		EP
(54)	MUTANT STAPHYLOCOCCAL ANTIGENS					
(72)	BAGNOLI, Fabio, GlaxoSmithKline Via Fiorentina 1, I-53100 Siena, IT					
	FIASCHI, Luigi, GlaxoSmithKline Via Fiorentina 1, I-53100 Siena, IT					
	SCARSELLI, Maria, GlaxoSmithKline Via Fiorentina 1, I-53100 Siena, IT					

(51)	MKP					
	A61K 31/495	2006	(97)	EP 3653211		
	A61P 25/18	2006				
(96)	EP 19213168.8 11/28/2013					
(97)	EP 3653211, 5/20/2020 202021, en					

- (31) 1200691 (32) 29.11.2012 (33) HU
 (54) TRANS-4-[2-[4-(2,3-DICHLOROPHENYL)-PIPERAZIN-1-YL]-ETHYL]-N,N-DIMETHYLCARBAMOYL-CYCLO-HEXYLAMINE FOR TREATING NEGATIVE SYMPTOMS OF SCHIZOPHRENIA
 (72) Pitter, János György, Alsóerdősor u. 55/A., 2030 Érd, HU
 Szatmári, Balázs, Sarlósfecske u. 21., 1173 Budapest, HU
 Debelle, Marc, Emilio Noelting 16A, 68100 Mulhouse, FR
 Németh, György József, Hűvösvölgyi út 151/A., 1021 Budapest, HU
 Laszlovszky, István, Bartók Béla út 16., 1111 Budapest, HU
-

- (51) MKP
A61K 9/00 2006 (97) EP 3669879
A61K 9/10 2006
A61K 31/7048 2006
A61K 47/36 2006
A61P 9/00 2006

- (96) EP 19213282.7 12/20/2013
 (97) EP 3669879, 6/24/2020 202026, en

- (31) 1203579 (32) 21.12.2012 (33) FR
 (54) PHARMACEUTICAL COMPOSITION IN THE FORM OF AN ORAL SUSPENSION INCLUDING A FLAVONOID FRACTION COMPRISING DIOSMIN, AND XANTHAN GUM
 (71) Les Laboratoires Servier, 35, rue de Verdun, 92284 Suresnes, FR
 (72) MARSAS, Stéphanie, 6 allée des Chartreux, 45430 Checy, FR
 PEAN, Jean-Manuel, 12 rue Adolphe Crespin, 45000 Orléans, FR
-

- (51) MKP
B01J 21/06 2006 (97) EP 3662995
B01J 23/22 2006
B01J 37/00 2006
C01G 23/04 2006
C01G 31/02 2006

- (96) EP 19213552.3 6/15/2012
 (97) EP 3662995, 6/17/2020 202025, de

- (31) 102011105188 (32) 17.06.2011 (33) DE
 (54) POROUS MATERIALS ON THE BASIS OF OXIDES OF TITANIUM AND/OR VANADIUM AND PREPARATION AND USE THEREOF
 (72) GLÄSER, Roger, c/o Universität Leipzig, Institut für technische Chemie Linnéstrasse 3, 04103 Leipzig, DE
 LUTECKI, Michael, c/o Universität Leipzig, Institut für technische Chemie Linnéstrasse 3, 04103 Leipzig, DE
 WITH, Patrick, Hirtenweg 34, 04425 Taucha, DE
 HEINRICH, Astrid, c/o Universität Leipzig, Institut für technische Chemie Linnéstrasse 3, 04103 Leipzig, DE
 FICHTNER, Sven, c/o Blücher GmbH Mettmanner Str. 25, 40699 Erkrath, DE
 BÖHRINGER, Bertram, Bussardweg 33, 42115 Wuppertal, DE
-

- (51) MKP
A41D 19/00 2006 (97) EP 3663332
C08J 5/02 2006
C08K 3/08 2006
C08K 3/11 2018
C08K 3/22 2006
C08K 9/04 2006

- (96) EP 19214292.5 12/6/2019
 (97) EP 3663332, 6/10/2020 202024, en

- (31) 2018904670 (32) 07.12.2018 (33) AU
 (54) DETECTABLE AND MULTI DETECTABLE ARTICLES
 (71) Skinprotect Corporation SDN BHD, Lot 6487, Batu 5 ¾, Sementa Jalan Kapar Klang, 42100 Selangor, MY
 (72) FOO, Khon Pu, c/o SKINPROTECT CORPORATION SDN BHD Lot 6487, Batu 5 ¾, Sementa Jalan Kapar, 42100 Klang Selangor, MY
 LIM, Chin Keong, c/o SKINPROTECT CORPORATION SDN BHD Lot 6487, Batu 5 ¾, Sementa Jalan Kapar, 42100 Klang Selangor, MY
 BALAKRISHNA, Nurshamila Binti Shaari, c/o SKINPROTECT CORPORATION SDN BHD Lot 6487, Batu 5 ¾, Sementa Jalan Kapar, 42100 Klang Selangor, MY
-

- (51) MKP
A61K 9/00 2006 (97) EP 3650019
A61K 31/138 2006
A61K 31/439 2006
A61K 31/58 2006

	A61P 11/00	2006				
	A61P 11/06	2006				
(96)	EP 19214674.4 5/27/2015					
(97)	EP 3650019, 5/13/2020 202020, en					
(31)	201462003764 P		(32)	28.05.2014	(33)	US
	201462004304 P			29.05.2014		US
	201462042506 P			27.08.2014		US
(54)	FLUTICASONE FUROATE IN THE TREATMENT OF COPD					
(72)	BARNES, Neil Christopher, GlaxoSmithKline Unit 1A Horton Road, Uxbridge, Middlesex UB7 8JJ, GB PASCOE, Steven John, GlaxoSmithKline 5 Moore Drive, Research Triangle Park, North Carolina 27709, US					

(51)	MKP					
	A61K 31/404	2006	(97)	EP 3669881		
	A61K 31/428	2006				
	A61K 31/495	2006				
	A61K 31/496	2006				
	A61K 31/5377	2006				
	A61K 31/635	2006				
	A61K 31/728	2006				
	A61P 9/10	2006				
	A61P 11/00	2006				
	A61P 27/02	2006				
(96)	EP 19216214.7 1/28/2015					
(97)	EP 3669881, 6/24/2020 202026, en					
(31)	201461932704 P		(32)	28.01.2014	(33)	US
	201461932711 P			28.01.2014		US
	201461979911 P			15.04.2014		US
	201462002709 P			23.05.2014		US
	201462042708 P			27.08.2014		US
	201462044664 P			02.09.2014		US
	201462057820 P			30.09.2014		US
	201462057825 P			30.09.2014		US
	201462057828 P			30.09.2014		US
	201462061627 P			08.10.2014		US
	201462061629 P			08.10.2014		US
(54)	COMPOSITIONS FOR USE IN THE TREATMENT OF SENESCENCE-ASSOCIATED DISEASE AND DISORDERS					
(71)	Mayo Foundation for Medical Education and Research, Mayo Clinic, 200 First Street S.W., Rochester, Minnesota 55905, US					
(72)	LABERGE, Remi-Martin, 4 Lakeview Court, Novato, CA California 94947, US CAMPISI, Judith, 1 Roble Road, Berkeley, CA California 94705, US DAVALOS, Albert, 451 El Faisan Drive, San Rafael, CA California 94903, US DEMARIA, Marco, 7100 Geary Boulevard, San Francisco, CA California 94121, US DAVID, Nathaniel, 1700 Owens Street, San Francisco, CA California 94158, US VASSEROT, Alain, Philippe, 6421 La Paloma Street, Carlsbad, CA California 92009, US Baker, Darren, J., 5189 Scenic Oak Drive Southwest, Rochester, MN Minnesota 55902, US CHILDS, Bennett G., 1620 - 2nd Street Southeast, Rochester, MN Minnesota 55906, US KIRKLAND, James, L., 925 - 6th Street Southwest, Rochester, MN Minnesota 55902, US TCHKONIA, Tamar, 834 - 11th Street Northwest, Rochester, MN Minnesota 55901, US VAN DEURSEN, Jan, M.A., 1910 - Southwest 11th Street, Rochester, MN Minnesota 55902, US ZHU, Yi, 1532 - 10th Street Southeast Apt. 4C, Rochester, MN Minnesota 55904, US ELISSEEFF, Jennifer, 3007 St. Paul St., Baltimore, MD Maryland 21218, US JEON, Okhee, 103 East Mount Royal Ave. Apt. 501, Baltimore, MD Maryland 21202, US KIM, Chaekyu, 9018 Saracen Dr., Pikesville, MD Maryland 21208, US					

(51)	MKP					
	B65D 17/00	2006	(97)	EP 3674227		
	B65D 17/28	2006				
	B65D 17/34	2006				
	B65D 17/50	2006				
	B65D 77/20	2006				
	B65D 79/00	2006				
	B65D 81/22	2006				
(96)	EP 19220099.6 12/30/2019					
(97)	EP 3674227, 7/1/2020 202027, en					
(31)	26402918		(32)	30.12.2018	(33)	IL
	26904619			01.09.2019		IL

- (54) A CAN AND AN URGING MEMBER THEREFOR
 (71) Caniel Industries A. T. G. Ltd., 6 Levi Street, 4405201 Kfar Saba, IL
 (72) LEIZER, Tal, 2 Hanarkis Street, Zikhron Ya'akov 3093313, IL
 GABAY, Arie, 7 Keren Hayesod Street, Raanana 4330404, IL
 YEMINI, Lior, 10 Lachish Street, Shoham 6081210, IL
 ABRAMOVITCH, Offer, 13 HaShibolet Street, Givat Ada 3780800, IL
 SALAN, Menahem, 37 Mivza Moshe Street, Rishon Lezion 7544715, IL
 GORODNITSKY, Pavel, 18 Emek Haela AStreet, Modiin 7175521, IL

- (51) MKP
A61K 39/395 2006 (97) EP 3638698
A61P 31/16 2006
C07K 16/10 2006
C07K 16/28 2006
C07K 16/40 2006
 (96) EP 19701428.5 1/24/2019
 (97) EP 3638698, 4/22/2020 202017, en
 (31) 201862622292 P (32) 26.01.2018 (33) US
 (54) ANTI-TMPRSS2 ANTIBODIES AND ANTIGEN-BINDING FRAGMENTS
 (72) PURCELL, Lisa, c/o Regeneron Pharmaceuticals, Inc. 777 Old Saw Mill River Road, Tarrytown, NY 10591, US

- (51) MKP
C01F 5/24 2006 (97) EP 3655364
C11D 3/12 2006
C11D 7/02 2006
 (96) EP 19702372.4 1/25/2019
 (97) EP 3655364, 5/27/2020 202022, en
 (31) 18153662 (32) 26.01.2018 (33) EP
 (54) CARRIER MATERIAL FOR THE RELEASE OF ONE OR MORE ACTIVE AGENT(S) IN A HOME CARE FORMULATION
 (72) BUDDE, Tanja, Grubenring 3, 4805 Brittnau, CH
 KELLER, Tobias, Birkenstrasse 3, 5043 Holziken, CH

- (51) MKP
A23L 33/00 2016 (97) EP 3661373
A23L 33/10 2016
A23L 33/17 2016
A23L 33/18 2016
A23L 33/19 2016
A61K 38/40 2006
A61P 3/00 2006
A61P 25/00 2006
 (96) EP 19721718.5 3/4/2019
 (97) EP 3661373, 6/10/2020 202024, en
 (31) 201821008809 (32) 09.03.2018 (33) IN
 (54) A PHARMACEUTICAL COMPOSITION FOR ANAEMIA
 (72) SINGH, Ankit Shyam., A/8/124, Orchid Green Field, Applewood Township, Shantipura Rd, SP Ring Rd., Ahmedabad 380058, IN
 MISHRA, Vedprakash., 50, Shail Ganga Tenement, Near I.P. English School, chandkheda Sugda., Gandhinagar 382424, IN
 TONGRA, Neelima., A72, Model Town, Malviya Nagar, Jaipur 302017, IN

- (51) MKP
A61K 38/00 2006 (97) EP 3672614
A61K 39/00 2006
A61K 45/06 2006
 (96) EP 19731027.9 5/22/2019
 (97) EP 3672614, 7/1/2020 202027, en
 (31) 201962835430 P (32) 17.04.2019 (33) US
 PCT/US2018/061679 16.11.2018 WO
 (54) ENGINEERED EXTRACELLULAR VESICLES AND USES THEREOF
 (71) Codiak BioSciences, Inc., 500 Technology Square 9th Floor, Cambridge, Massachusetts 02139, US
 (72) DOOLEY, Kevin P., c/o Codiak BioSciences, Inc. 500 Technology Square 9th Floor, Cambridge, Massachusetts 02139, US
 HARRISON, Rane A., c/o Codiak BioSciences, Inc. 500 Technology Square 9th Floor, Cambridge, Massachusetts 02139, US
 XU, Ke, c/o Codiak BioSciences, Inc. 500 Technology Square 9th Floor, Cambridge, Massachusetts 02139, US
 HOUDE, Damian J., c/o Codiak BioSciences, Inc. 500 Technology Square 9th Floor, Cambridge, Massachusetts 02139, US

HAUPT, Sonya, c/o Codiak BioSciences, Inc. 500 Technology Square 9th Floor, Cambridge, Massachusetts 02139, US
 KULMAN, John D., c/o Codiak BioSciences, Inc. 500 Technology Square 9th Floor, Cambridge, Massachusetts 02139, US
 WILLIAMS, Douglas E., c/o Codiak BioSciences, Inc. 500 Technology Square 9th Floor, Cambridge, Massachusetts 02139, US
 MCCONNELL, Russell E., c/o Codiak BioSciences, Inc. 500 Technology Square 9th Floor, Cambridge, Massachusetts 02139, US
 YOUNISS, Madeleine, c/o Codiak BioSciences, Inc. 500 Technology Square 9th Floor, Cambridge, Massachusetts 02139, US

- (51) MKP
A61K 39/395 2006 (97) EP 3666794
A61P 1/02 2006
A61P 1/04 2006
A61P 3/10 2006
A61P 17/00 2006
A61P 25/00 2006
A61P 29/00 2006
A61P 31/00 2006
A61P 31/04 2006
A61P 31/12 2006
A61P 31/14 2006
A61P 31/16 2006
A61P 31/18 2006
A61P 31/20 2006
A61P 35/00 2006
A61P 35/02 2006
A61P 37/02 2006
A61P 37/04 2006
C07K 16/28 2006
C12N 15/13 2006
- (96) EP 20150603.7 11/1/2017
 (97) EP 3666794, 6/17/2020 202025, en
- (31) 201662416128 P (32) 01.11.2016 (33) US
 201662427777 P 29.11.2016 US
- (54) ANTIBODIES DIRECTED AGAINST PROGRAMMED DEATH- 1 (PD-1)
 (71) AnaptysBio, Inc., 10421 Pacific Center Court Suite 200, San Diego, CA 92121, US
 (72) KING, David J., 310 Cole Ranch Road, Encinitas, CA 92024, US
 KEHRY, Marilyn, 10440 Rock Creek Drive, San Diego, CA 92131, US
 HUANG, Baochuan, c/o Tesaro Inc. 1000 Winter Street North Suite 3300, Waltham, MA 02451, US

- (51) MKP
A61K 31/7088 2006 (97) EP 3657168
A61K 31/711 2006
A61K 38/17 2006
A61K 48/00 2006
A61P 25/28 2006
G01N 33/50 2006
- (96) EP 20151219.1 10/8/2013
 (97) EP 3657168, 5/27/2020 202022, en
- (31) 201261712322 P (32) 11.10.2012 (33) US
- (54) TREATMENT OF AMYOTROPHIC LATERAL SCLEROSIS
 (72) PETSKO, Greg, 51 Hampshire Street, West Newton, Massachusetts 02465, US
 RINGE, Dagmar, 983 Memorial Drive, Cambridge, Massachusetts 02138, US
 JU, Shulin, 3551 Harmeling Drive, Beavercreek, Ohio 45440, US

- (51) MKP
C23C 2/02 2006 (97) EP 3663429
C23C 2/06 2006
C23C 2/26 2006
C23C 2/30 2006
- (96) EP 20151616.8 3/13/2017
 (97) EP 3663429, 6/10/2020 202024, de
- (31) 102016007107 (32) 13.06.2016 (33) DE
 102016111725 27.06.2016 DE
- (54) HOT DIP GALVANIZING APPARATUS
 (72) BAUMGÜRTEL, Lars, Hövel 2, 48301 Nottuln, DE
 PINGER, Thomas, Zum Imberg 24, 45721 Haltern am See, DE

(51) MKP
A61K 39/12 2006 (97) EP 3663315
A61K 39/145 2006
C07K 16/00 2006
C07K 16/10 2006
C12N 15/00 2006

(96) EP 20153125.8 10/28/2015
(97) EP 3663315, 6/10/2020 202024, en

(31) 14190943 (32) 29.10.2014 (33) EP

(54) DIRECT EXPRESSION OF ANTIBODIES
(72) Geall, Andrew, Novartis Vaccines and Diagnostics, Inc. IP Services Bldg. 433 257, One Health Plaza, East Hanover, NJ 07936-1080, US
Alter, Galit, 400 Technology Square 7th floor, no. 784, Cambridge, MA 02139, US
Suscovich, Todd, 400 Technology Square 7th floor, no. 784, Cambridge, MA 02139, US

(51) MKP
A61K 31/4192 2006 (97) EP 3666771
A61K 31/4439 2006
A61P 11/06 2006
A61P 35/00 2006
C07D 249/06 2006
C07D 401/04 2006
C07D 401/14 2006

(96) EP 20154651.2 6/20/2017
(97) EP 3666771, 6/17/2020 202025, en

(31) 201662352792 P (32) 21.06.2016 (33) US

(54) LPA ANTAGONISTS
(71) Bristol-Myers Squibb Company, Route 206 & Province Line Road, Princeton, NJ 08543, US
(72) Cheng, Peter Tai Wah, Bristol-Myers Squibb Company 350 Carter Road, Hopewell, New Jersey 08540, US
Kaltenbach, Robert F. III, Bristol-Myers Squibb Company 350 Carter Road, Hopewell, New Jersey 08540, US
Li, Jun, Bristol-Myers Squibb Company 350 Carter Road, Hopewell, New Jersey 08540, US
Shi, Jun, Bristol-Myers Squibb Company 350 Carter Road, Hopewell, New Jersey 08540, US
Shi, Yan, Bristol-Myers Squibb Company 350 Carter Road, Hopewell, New Jersey 08540, US
Tao, Shiwei, Bristol-Myers Squibb Company 350 Carter Road, Hopewell, New Jersey 08540, US
Zhang, Hao, Bristol-Myers Squibb Company 350 Carter Road, Hopewell, New Jersey 08540, US
Dhanusu, Suresh, SYNGENE INTERNATIONAL LIMITED, Biocon Special Economic Zone Biocon Park Plot No. 2&3, Bommasandra Industrial Area IV Phase, Jigani Link Road Bommasandra, 560099 Bangalore, IN
Selvakumar, Kumaravel, SYNGENE INTERNATIONAL LIMITED, Biocon Special Economic Zone Biocon Park Plot No. 2&3, Bommasandra Industrial Area IV Phase, Jigani Link Road Bommasandra, 560099 Bangalore, IN
Reddigunta, Ramesh Babu, 26 Iruvaram Village and Post Chittoor District, 517128 Andhra Pradesh, IN
Walker, Steven J., Bristol-Myers Squibb Company Route 206 and Province Line Road, Princeton, New Jersey 08543, US
Kennedy, Lawrence J., Bristol-Myers Squibb Company 350 Carter Road, Hopewell, New Jersey 08540, US
Corte, James R., Bristol-Myers Squibb Company 350 Carter Road, Hopewell, New Jersey 08540, US
Fang, Tianan, Bristol-Myers Squibb Company 350 Carter Road, Hopewell, New Jersey 08540, US
Jusuf, Sutjano, Bristol-Myers Squibb Company 350 Carter Road, Hopewell, New Jersey 08540, US

(51) MKP
G06F 9/50 2006 (97) EP 3674950
G06F 21/57 2013
G06F 21/62 2013
H04L 29/06 2006
H04L 29/08 2006

(96) EP 20158563.5 1/19/2016
(97) EP 3674950, 7/11/2020 202027, en

(31) 201562105685 P (32) 20.01.2015 (33) US
201514857775 17.09.2015

(54) SYSTEM, COMPUTER READABLE MEDIUM AND METHOD FOR ROLLING SECURITY PLATFORM
(72) PIKE, Robert, Enzo Inc. 18433 22nd Way NE, Woodinville, WA Washington 98077, US

(51) MKP
B01F 9/00 2006 (97) EP 3645151
B01L 1/00 2006
B65D 25/14 2006

(96) EP 18743088.9 6/27/2018
 (97) EP 3645151, 5/6/2020 202019, en
 (31) 201710355 (32) 28.06.2017 (33) GB
 (54) METHOD AND APPARATUS FOR LINING A CHAMBER
 (71) 4D PHARMA LEÓN, S.L.U., Parque Tecnológico de León Parcela M-10.4 Armunia, 24009 León, ES
 (72) CARITE, Christophe, 4D Pharma PLC 5th Floor Bond Court, Leeds Yorkshire LS1 2JZ, GB
 ZAMBAUX, Jean-Pascal, 1c Chemin de Melac, F-33270 Bouliac, FR

(51) MKP
A61K 31/55 2006 (97) EP 3645513
A61P 13/12 2006
C07D 223/16 2006
C07D 401/06 2006
C07D 401/10 2006
C07D 401/14 2006
C07D 403/06 2006
C07D 405/12 2006
C07D 409/12 2006
 (96) EP 18743103.6 6/29/2018
 (97) EP 3645513, 5/6/2020 202019, en
 (31) PCT/JP2017/024211 (32) 30.06.2017 (33) WO
 (54) BENZAZEPINE DERIVATIVES
 (72) KAN, Keizo, c/o OTSUKA PHARMACEUTICAL CO. LTD. 3-2-27 Otedori Chuo-ku, Osaka-shi Osaka 540-0021, JP
 TAKUWA, Masatoshi, c/o OTSUKA PHARMACEUTICAL CO. LTD. 3-2-27 Otedori Chuo-ku, Osaka-shi Osaka 540-0021, JP
 TANAKA, Hirota, c/o OTSUKA PHARMACEUTICAL CO. LTD. 3-2-27 Otedori Chuo-ku, Osaka-shi Osaka 540-0021, JP
 FUJIWARA, Hideto, c/o OTSUKA PHARMACEUTICAL CO. LTD. 3-2-27 Otedori Chuo-ku, Osaka-shi Osaka 540-0021, JP
 YAMABE, Hokuto, c/o OTSUKA PHARMACEUTICAL CO. LTD. 3-2-27 Otedori Chuo-ku, Osaka-shi Osaka 540-0021, JP
 MATSUDA, Satoshi, c/o OTSUKA PHARMACEUTICAL CO. LTD. 3-2-27 Otedori Chuo-ku, Osaka-shi Osaka 540-0021, JP
 OHDACHI, Kazuhiro, c/o OTSUKA PHARMACEUTICAL CO. LTD. 3-2-27 Otedori Chuo-ku, Osaka-shi Osaka 540-0021, JP
 HANARI, Taiki, c/o OTSUKA PHARMACEUTICAL CO. LTD. 3-2-27 Otedori Chuo-ku, Osaka-shi Osaka 540-0021, JP
 MENJO, Yasuhiro, c/o OTSUKA PHARMACEUTICAL CO. LTD. 3-2-27 Otedori Chuo-ku, Osaka-shi Osaka 540-0021, JP
 URUSHIMA, Tatsuya, c/o OTSUKA PHARMACEUTICAL CO. LTD. 3-2-27 Otedori Chuo-ku, Osaka-shi Osaka 540-0021, JP
 FUJITA, Shigekazu, c/o OTSUKA PHARMACEUTICAL CO. LTD. 3-2-27 Otedori Chuo-ku, Osaka-shi Osaka 540-0021, JP

(51) MKP
B01L 9/06 2006 (97) EP 3655163
B03C 1/02 2006
G01N 35/00 2006
 (96) EP 18743219.0 6/27/2018
 (97) EP 3655163, 5/27/2020 202022, en
 (31) 201762534563 P (32) 19.07.2017 (33) US
 (54) MAGNETIC ASSISTED SEPARATION APPARATUSES AND RELATED METHODS
 (72) SCHULZ, Craig Michael, 397 Pepperwood Ct., Thousand Oaks, CA 91360, US
 PROVCHY, Justin James, 1732 Sitka Ave, Simi Valley, CA 93063, US
 KAWOoya, John Kasajja, 12565 Spring Creek Road, Moorpark, CA 93021, US

(51) MKP
A23K 20/20 2016 (97) EP 3634148
A23K 50/10 2016
 (96) EP 18743265.3 6/28/2018
 (97) EP 3634148, 4/15/2020 202016, en
 (31) 201715647944 (32) 12.07.2017 (33) US
 (54) METHOD AND COMPOSITION TO CONTROL RUMEN RELEASE OF COBALT TO RUMEN BACTERIA FOR MAKING VITAMIN B12
 (72) STARK, Peter, A., c/o Zinpro Corporation 10400 Viking Drive Suite 240, Eden Prairie MN 55344, US

(51) MKP
C07D 213/75 2006 (97) EP 3645518
C07D 295/205 2006
 (96) EP 18743314.9 6/29/2018
 (97) EP 3645518, 5/6/2020 202019, en
 (31) 201762527174 P (32) 30.06.2017 (33) US
 201862664363 P 30.04.2018
 (54) SYNTHESIS OF OMECAMTIV MECARBIL

- (72) CAILLE, Sebastien, 11521 Gentlewood Drive, Moorpark CA 93021, US
 QUASDORF, Kyle, 555 Laurie Lane B8, Thousand Oaks CA 91360, US
 ROOSEN, Philipp, 1710 Camino Olmo A, Thousand Oaks CA 91320, US
 SHI, Xiangqing, 477 Fallbrook Avenue, Newbury Park CA 91320, US
 COSBIE, Andrew, 2486 Scoter Avenue, Ventura CA 93003, US
 WANG, Fang, 149 Parkside Drive, Simi Valley CA 93065, US
 WU, Zufan, 668 Ash Meadow Drive, Walnut CA 91789, US
 NEERGUNDA, Archana, 3112 Anasazi Way, Simi Valley CA 93063, US
 QUAN, Bin, Peter, 5220 Premiere Hills Circle 226, Woodland CA 91364, US
 GUAN, Lianxiu, 2145 Euclid Avenue, Camarillo CA 93010, US

- (51) MKP
A61K 31/64 2006 (97) EP 3661925
C07D 205/04 2006
C07D 205/12 2006
C07D 207/12 2006
C07D 211/54 2006
C07D 217/22 2006
C07D 223/06 2006
C07D 239/66 2006
C07D 241/18 2006
C07D 401/04 2006
C07D 401/06 2006
C07D 401/12 2006
C07D 401/14 2006
C07D 403/04 2006
C07D 403/06 2006
C07D 405/04 2006
C07D 405/06 2006
C07D 409/04 2006
C07D 451/02 2006
C07D 451/14 2006

(96) EP 18743416.2 7/4/2018

(97) EP 3661925, 6/10/2020 202024, en

- | | | | | | |
|------|-----------|------|------------|------|----|
| (31) | 201710943 | (32) | 07.07.2017 | (33) | GB |
| | 201713079 | | 15.08.2017 | | GB |
| | 201713082 | | 15.08.2017 | | GB |
| | 201718561 | | 09.11.2017 | | GB |
| | 201718563 | | 09.11.2017 | | GB |
| | 201721726 | | 22.12.2017 | | GB |

(54) NOVEL SULFONAMIDE CARBOXAMIDE COMPOUNDS

- (72) COOPER, Matthew, c/o Inflazome UK Limited D6 Grain House Mill Court, Great Shelford Cambridge CB22 5LD, GB
 MILLER, David, c/o Inflazome UK Limited D6 Grain House Mill Court, Great Shelford Cambridge CB22 5LD, GB
 MACLEOD, Angus, c/o Inflazome UK Limited D6 Grain House Mill Court, Great Shelford Cambridge CB22 5LD, GB
 VAN WILTENBURG, Jimmy, c/o Syncom B.V. Kadijk 3, 9747 AT Groningen, NL
 THOM, Stephen, c/o Sygnature Discovery Limited The Discovery Building BioCity Pennyfoot Street, Nottingham NG1 1GR, GB
 ST-GALLAY, Stephen, c/o Sygnature Discovery Limited The Discovery Building BioCity Pennyfoot Street, Nottingham NG1 1GR, GB
 SHANNON, Jonathan, c/o Sygnature Discovery Limited The Discovery Building BioCity Pennyfoot Street, Nottingham NG1 1GR, GB

- (51) MKP
A01G 9/02 2018 (97) EP 3657933
A01G 31/06 2006

(96) EP 18745707.2 5/11/2018

(97) EP 3657933, 6/3/2020 202023, de

- | | | | | | |
|------|---------|------|------------|------|----|
| (31) | 6242017 | (32) | 10.05.2017 | (33) | CH |
|------|---------|------|------------|------|----|

(54) PLATES FORMING A SOIL-LESS CULTURE CONTAINER

(71) Erbacher, Clemens, Wallmersbach 45, 97215 Uffenheim, DE

(72) Erbacher, Clemens, Wallmersbach 45, 97215 Uffenheim, DE

- (51) MKP
A61K 9/127 2006 (97) EP 3638292
A61K 38/37 2006
A61P 7/04 2006

C07K 14/755 2006
C07K 16/28 2006
 (96) EP 18745717.1 6/13/2018
 (97) EP 3638292, 4/22/2020 202017, en
 (31) 201762519827 P (32) 14.06.2017 (33) US
 201762589914 P 22.11.2017 US
 201862663839 P 27.04.2018 US
 (54) POLYNUCLEOTIDES ENCODING COAGULATION FACTOR VIII
 (71) Seattle Children's Hospital d/b/a Seattle Children's Research Institute, 4800 Sand Point Way NE, Seattle, WA 98105, US
 (72) RAJENDRAN, Raj, c/o ModernaTX Inc. 200 Technology Square, Cambridge, Massachusetts 02139, US
 MARTINI, Paolo, c/o ModernaTX Inc. 200 Technology Square, Cambridge, Massachusetts 02139, US
 MIAO, Carol H., c/o Seattle Children's Hospital d/b/a Seattle Children's Research Institute 4800 Sand Point Way NE, Seattle, Washington 98105, US

(51) MKP
A61K 31/496 2006 (97) EP 3645002
A61P 9/04 2006
 (96) EP 18745732.0 6/29/2018
 (97) EP 3645002, 5/6/2020 202019, en
 (31) 201762527983 P (32) 30.06.2017 (33) US
 (54) METHODS OF TREATING HEART FAILURE WITH CARDIAC SARCOMERE ACTIVATORS
 (72) HONARPOUR, Narimon, One Amgen Center Drive, Thousand Oaks CA 91320, US
 FADY, Malik, One Amgen Center Drive, Thousand Oaks CA 91320, US

(51) MKP
A01K 67/027 2006 (97) EP 3644721
A61K 35/17 2015
C07K 16/28 2006
C07K 16/30 2006
G01N 33/50 2006
 (96) EP 18745744.5 6/29/2018
 (97) EP 3644721, 5/6/2020 202019, en
 (31) 201762527030 P (32) 29.06.2017 (33) US
 201762563635 P 26.09.2017 US
 201762584731 P 10.11.2017 US
 (54) MOUSE MODEL FOR ASSESSING TOXICITIES ASSOCIATED WITH IMMUNOTHERAPIES
 (72) CHADWICK, Eric Martin, 400 Dexter Ave. N Suite 1200, Seattle, WA 98109, US
 HAUSE, Ronald James JR., 400 Dexter Ave. N Suite 1200, Seattle, WA 98109, US
 JIANG, Yue, 400 Dexter Ave. N Suite 1200, Seattle, WA 98109, US
 LEVITSKY, Hyam I., 400 Dexter Ave. N Suite 1200, Seattle, WA 98109, US
 SALMON, Ruth Amanda, 400 Dexter Ave. N Suite 1200, Seattle, WA 98109, US
 PONCE, Rafael Angel, 400 Dexter Ave. N Suite 1200, Seattle, WA 98109, US
 OLSON, Nels Eric, 400 Dexter Avenue North Suite 1200, Seattle, WA 98109, US

(51) MKP
A61M 5/142 2006 (97) EP 3651832
 (96) EP 18745756.9 7/3/2018
 (97) EP 3651832, 5/20/2020 202021, en
 (31) 201762532868 P (32) 14.07.2017 (33) US
 (54) NEEDLE INSERTION-RETRACTION SYSTEM HAVING DUAL TORSION SPRING SYSTEM
 (72) MOJARRAD, Mehran, 2389 Fountain Crest Lane 23, Thousand Oaks CA 91362, US
 GIBSON, Scott, Robert, 12141 Bellando Court, Granada Hills CA 91344, US
 LIVINGSTON, Adam, 1350 Specialty Drive Suite A C/o Novo Engineering, Vista CA 92081, US

(51) MKP
A61P 35/00 2006 (97) EP 3652216
C07K 16/46 2006
 (96) EP 18745803.9 7/9/2018
 (97) EP 3652216, 5/20/2020 202021, en
 (31) 201762530436 P (32) 10.07.2017 (33) US
 (54) CHECKPOINT INHIBITOR BISPECIFIC ANTIBODIES

(72) KALOS, Michael, Dewain, c/o Eli Lilly and Company P.O. Box 6288, Indianapolis Indiana 46206-6288, US
 LI, Yiwen, c/o Eli Lilly and Company P.O. Box 6288, Indianapolis Indiana 46206-6288, US
 LUDWIG, Dale, Lincoln, c/o Eli Lilly and Company P.O. Box 6288, Indianapolis Indiana 46206-6288, US
 PLOWMAN, Gregory, D., c/o Eli Lilly and Company P.O. Box 6288, Indianapolis Indiana 46206-6288, US
 SHEN, Yang, c/o Eli Lilly and Company P.O. Box 6288, Indianapolis Indiana 46206-6288, US
 D'ANGELO, Igor Edmondo Paolo, c/o Zymeworks Inc. 540-1385 West 8th Avenue, Vancouver British Columbia V6H 3V9, CA

(51) MKP
E05B 47/06 2006 (97) EP 3665346

(96) EP 18745939.1 7/26/2018
 (97) EP 3665346, 6/17/2020 202025, de
 (31) 506582017 (32) 08.08.2017 (33) AT

(54) COUPLING SYSTEM FOR AN ELECTROMECHANICAL LOCK
 (72) NEUMAYER, Harald, Rennbahnweg 46/8/53, 1220 Wien, AT
 CHAVERT, Alfonso Bartolomé, Wittmayergasse 26/1/44, 1120 Wien, AT

(51) MKP
A23L 33/00 2016 (97) EP 3661949
C07K 14/245 2006
C07K 14/435 2006
C12N 9/10 2006
C12P 19/18 2006

(96) EP 18745960.7 8/1/2018
 (97) EP 3661949, 6/10/2020 202024, en
 (31) 17184232 (32) 01.08.2017 (33) EP

(54) MICROORGANISM FOR PRODUCING HUMAN MILK OLIGOSACCHARIDE
 (71) OligoScience Biotechnology GmbH, BioMedizinZentrumDortmund Otto-Hahn-Straße 15, 44227 Dortmund, DE
 (72) PERACHA, Max, c/o OligoScience Biotechnology GmbH BioMedizinZentrumDortmund Otto-Hahn-Straße 15, 44227 Dortmund, DE
 WEMHOFF, Sabrina, c/o OligoScience Biotechnology GmbH BioMedizinZentrumDortmund Otto-Hahn-Straße 15, 44227 Dortmund, DE
 MEINHARDT, Friedhelm, c/o OligoScience Biotechnology GmbH BioMedizinZentrumDortmund Otto-Hahn-Straße 15, 44227 Dortmund, DE

(51) MKP
A61K 31/7088 2006 (97) EP 3649242
A61P 35/00 2006
C12N 15/10 2006
C12N 15/113 2010

(96) EP 18746019.1 7/6/2018
 (97) EP 3649242, 5/13/2020 202020, en
 (31) 10201705556X (32) 06.07.2017 (33) SG

(54) METHODS OF INHIBITING CELL PROLIFERATION AND METTL8 ACTIVITY
 (72) FU, Xin-Yuan, c/o National University of Singapore Cancer Science Institute of Singapore 21 Lower Kent Ridge Road, Singapore 119077, SG
 LIU, Xinyu, c/o National University of Singapore Cancer Science Institute of Singapore 21 Lower Kent Ridge Road, Singapore 119077, SG
 XU, Lu Ang, c/o National University of Singapore Cancer Science Institute of Singapore 21 Lower Kent Ridge Road, Singapore 119077, SG

(51) MKP
A61K 38/48 2006 (97) EP 3641801
C07K 14/435 2006

(96) EP 18746035.7 6/21/2018
 (97) EP 3641801, 4/29/2020 202018, en
 (31) 201762523735 P (32) 22.06.2017 (33) US
 201862664051 P 27.04.2018 US

(54) MODIFIED MEMBRANE TYPE SERINE PROTEASE 1 (MTSP-1) POLYPEPTIDES AND METHODS OF USE
 (71) Catalyst Biosciences, Inc., 611 Gateway Blvd., Suite 710, South San Francisco, CA 94080, US
 (72) MADISON, Edwin, L., 558 48th Avenue, San Francisco, CA 94121, US
 SOROS, Vanessa, 1945 Pacific Avenue 4a, San Francisco, CA 94109, US
 POPKOV, Mikhail, 10812 Charbono Point, San Diego, CA 92131, US

(51) MKP
F03D 7/02 2006 (97) EP 3642479
F03D 13/25 2016

(96) EP 18746288.2 6/19/2018

(97) EP 3642479, 4/29/2020 202018, en
 (31) 201730817 (32) 20.06.2017 (33) ES
 (54) FLOATING STRUCTURE FOR OFFSHORE WIND TURBINE
 (71) Exponential Renewables S.L., Av. Pedralbes 18-20, 3-1-B, 08034 Barcelona, ES
 (72) CASANOVAS BERMEJO, Carlos, Carrer Jordi Girona 29, 08034 Barcelona, ES
 CASANOVAS RODRÍGUEZ, Juan, Carrer Jordi Girona 29, 08034 Barcelona, ES

(51) MKP
A61K 9/00 2006 (97) EP 3644961
A61K 9/20 2006
A61K 31/203 2006
A61P 31/00 2006
A61P 35/00 2006
 (96) EP 18746354.2 6/29/2018
 (97) EP 3644961, 5/6/2020 202019, en
 (31) 201762526743 P (32) 29.06.2017 (33) US
 (54) ISOTRETINOIN ORAL-MUCOSAL FORMULATIONS AND METHODS FOR USING SAME
 (71) Skyline Biosciences, LLC, 1033 Skokie Blvd, Northbrook, IL 60062, US
 (72) TAN, Hock, S., 7 Lavender Way, East Brunswick NJ 08816, US
 CHUNG, Siew, L., 7 Lavender Way, East Brunswick NJ 08816, US

(51) MKP
A61K 35/745 2015 (97) EP 3648780
A61K 45/06 2006
A61P 35/00 2006
 (96) EP 18746378.1 7/5/2018
 (97) EP 3648780, 5/13/2020 202020, en
 (31) 201762528669 P (32) 05.07.2017 (33) US
 (54) COMPOSITIONS AND METHODS OF TREATING CANCER USING BIFIDOBACTERIUM ANIMALIS SSP. LACTIS
 (71) Evelo Biosciences, Inc., 620 Memorial Drive Suite 200 West, Cambridge, MA 02139, US
 (72) SANDY, Peter, 198 Prospect Avenue, Revere MA 02151, US
 PAPKOFF, Jacqueline, 4373 21st Street, San Francisco CA 94114, US
 SIZOVA, Maria, 152 Walter Street Unit 1, Roslindale MA 02131, US
 GOODMAN, Brian, 16 McBride Street 1, Jamaica Plain MA 02130, US
 GARDNER, Humphrey, 23 Clifton Avenue, Marblehead MA 01945, US
 PONICHTERA, Holly, 530 3rd Street Unit 504, Cambridge MA 02142, US
 DUTTA, Anupriya, 30 Gardner Road, Apt.5H, Brookline MA 02445, US
 CAFFREY, William, 77 Trowbridge Street, Apt. 43, Cambridge MA 02138, US
 WU, Hank, 26 Hardwick Street, Unit 1, Cambridge MA 02140, US

(51) MKP
A61K 31/496 2006 (97) EP 3651766
A61K 31/573 2006
A61K 38/05 2006
A61P 35/00 2006
C07D 241/02 2006
 (96) EP 18746444.1 7/9/2018
 (97) EP 3651766, 5/20/2020 202021, en
 (31) 201762530778 P (32) 10.07.2017 (33) US
 201762593185 P 30.11.2017 US
 201862675581 P 23.05.2018 US
 (54) ANTIPROLIFERATIVE COMPOUNDS AND METHODS OF USE THEREOF
 (72) ALEXANDER, Matthew, D., 12488 Carmel Cape, San Diego, CA 92130, US
 ARTMAN, Gerald, D., III, 8 Halls Mill Road, Asbury, NJ 08802, US
 BRAY, Gordon, L., 301 Main Street Unit 8c, San Francisco, CA 94105, US
 CARMICHAEL, James, 11 Cherry Tree Lane, Edwalton, Nottingham NG124AL, GB
 CARRANCIO, Soraya, 5202 Fiore Terrace Apt. B419, San Diego, CA 92122, US
 CATHERS, Brian E., 10040 Branford Road, San Diego, CA 92126, US
 CORREA, Matthew, D., 9025 Three Seasons Road, San Diego, CA 92126, US
 HANSEN, Joshua, 5633 Bellevue Avenue, La Jolla, CA 92037, US
 HAVENS, Courtney, G., 3504 Felton Street, San Diego, CA 92104, US
 KERCHER, Timothy, S., 1829 Caleta Trail, Longmont, CO 80504, US
 LOPEZ-GIRONA, Antonia, 8959 January Place, San Diego, CA92122, US
 LU, Xiaoling, 3 Runnymede Court, Whippany, NJ 07981, US

MAN, Hon-Wah, 27 Grant Ways, Princeton, NJ 08540, US
 NAGY, Mark, A., 345 Willowspring Drive N., Encinitas, CA 92024, US
 NARLA, Rama, K., 5157 Great Meadow Drive, San Diego, CA 92130, US
 PICCOTTI, Joseph, R., 742 Rihely Place, Encinitas, CA 92024, US
 PIERCE, Daniel, W., 3406 Lodge Drive, Belmont, CA 94002, US
 TAVARES-GRECO, Paula, A., 217 Everett Rd., Parsippany, NJ 07054, US
 WHITEFIELD, Brandon, W., 6406 Friars Road Suite 335, San Diego, CA92075, US
 WONG, Lilly, L., 871 Viva Court, Solana Beach, CA 92075, US
 ZOU, Nanfei, 66 Woodland Avenue, Fanwood New Jersey 07023, US

(51) MKP
A61K 9/24 2006 (97) EP 3654955
A61K 31/00 2006
 (96) EP 18746471.4 7/10/2018
 (97) EP 3654955, 5/27/2020 202022, en
 (31) 201762533332 P (32) 17.07.2017 (33) US
 201762538936 P 31.07.2017 US
 (54) PHARMACEUTICAL COMPOSITIONS
 (72) ALLGEIER, Matthew Carl, c/o Eli Lilly and Company P.O. Box 6288, Indianapolis Indiana 46206-6288, US
 ZHANG, Tony Yantao, c/o Eli Lilly and Company P.O. Box 6288, Indianapolis Indiana 46206-6288, US

(51) MKP
A61M 5/142 2006 (97) EP 3658206
A61M 5/20 2006
A61M 5/24 2006
A61M 5/28 2006
A61M 39/18 2006
 (96) EP 18746512.5 7/11/2018
 (97) EP 3658206, 6/3/2020 202023, en
 (31) 201762536909 P (32) 25.07.2017 (33) US
 (54) DRUG DELIVERY DEVICE WITH CONTAINER ACCESS SYSTEM AND RELATED METHOD OF ASSEMBLY
 (72) MOBERG, Sheldon, 1030 Chalet Circle, Thousand Oaks, CA 91362, US
 JANKE, Matthew Wayne, 2795 Harrington Road, Simi Valley, CA 93065, US
 MISMAR, Wael, 1914 Nelson Avenue, Redondo Beach, CA 90278, US
 DECHELETTE, Alexis, 718 Rydal Road, Jankintown, PA 19046, US

(51) MKP
A61J 1/14 2006 (97) EP 3655063
A61J 1/20 2006
A61K 39/395 2006
A61M 5/142 2006
A61M 5/145 2006
A61M 5/158 2006
A61M 5/24 2006
A61M 5/315 2006
A61M 5/32 2006
A61M 5/34 2006
A61M 39/00 2006
A61M 39/18 2006
C07K 16/40 2006
 (96) EP 18746514.1 7/11/2018
 (97) EP 3655063, 5/27/2020 202022, en
 (31) 201762535777 P (32) 21.07.2017 (33) US
 (54) GAS PERMEABLE SEALING MEMBER FOR DRUG CONTAINER AND METHODS OF ASSEMBLY
 (72) CHOU, Cheng-chieh, 2033 Beloit Ave. Apt. 102, Los Angeles CA 90025, US
 EU, Ming-da, 4913 Santo Drive, Oak Park CA 91377, US
 FORNG, Ren-yo, 10224 Winddor View Drive, Potomac MD 20854, US
 MISMAR, Wael, 1914 Nelson Avenue, Redondo Beach CA 90278, US

(51) MKP
A61M 5/142 2006 (97) EP 3658203
A61M 5/145 2006
A61M 5/158 2006

A61M 5/24 2006
A61M 5/315 2006
B05C 17/01 2006
F04B 43/12 2006

- (96) EP 18746515.8 7/11/2018
 (97) EP 3658203, 6/3/2020 202023, en
 (31) 201762536911 P (32) 25.07.2017 (33) US
 (54) DRUG DELIVERY DEVICE WITH GEAR MODULE AND RELATED METHOD OF ASSEMBLY
 (72) OLIVAS, Jerome, 1456 Calle Colina, Thousand Oaks, CA 91360, US
 SONG, Guojie, 11254 Bentcreek Road, Moorpark, CA 93021, US
 DUTTA RAY, Sudeshna, 300 Rolling Oaks Drive Apt. 119, Thousand Oaks, CA 91361, US
-

- (51) MKP
C07D 231/20 2006 (97) EP 3652168
C07D 231/22 2006
C07D 231/56 2006
C07D 401/04 2006
C07D 403/12 2006
C07D 417/12 2006
C07D 417/14 2006
C07D 491/04 2006
C07D 495/04 2006
C07D 519/00 2006
 (96) EP 18746517.4 7/11/2018
 (97) EP 3652168, 5/20/2020 202021, en
 (31) 201762531563 P (32) 12.07.2017 (33) US
 (54) 5-MEMBERED AND BICYCLIC HETEROCYCLIC AMIDES AS INHIBITORS OF ROCK
 (72) GLUNZ, Peter W., c/o Bristol-Myers Squibb Company Route 206 and Province Line Road, Princeton, New Jersey 08543, US
 LADZIATA, Vladimir, c/o Bristol-Myers Squibb Company Route 206 and Province Line Road, Princeton, New Jersey 08543, US
 DE LUCCA, Indawati, 9 Hunters Ridge Drive, Pennington, New Jersey 08534, US
 TORA, George O., c/o Bristol-Myers Squibb Company Route 206 and Province Line Road, Princeton, New Jersey 08543, US
 MAISHAL, Tarun Kumar, c/o Syngene International Limited Biocon Special Economic Zone Biocon Park Plot No. 2&3 Bommasandra Industrial Area IV Phase Jigani Link Road Bommasandra, Bangalore Karnataka 560099, IN
 TANGIRALA, Raghuram, c/o Syngene International Limited Biocon Special Economic Zone Biocon Park Plot No. 2&3 Bommasandra Industrial Area IV Phase Jigani Link Road Bommasandra, Bangalore Karnataka 560099, IN
 THIYAGARAJAN, Kamalraj, c/o Syngene International Limited Biocon Special Economic Zone Biocon Park Plot No. 2&3 Bommasandra Industrial Area IV Phase Jigani Link Road Bommasandra, Bangalore Karnataka 560099, IN
-

- (51) MKP
C07K 16/28 2006 (97) EP 3652209
 (96) EP 18746519.0 7/11/2018
 (97) EP 3652209, 5/20/2020 202021, en
 (31) 201762531259 P (32) 11.07.2017 (33) US
 201762531190 P 11.07.2017 US
 201762568231 P 04.10.2017 US
 201762577257 P 26.10.2017 US
 201762577259 P 26.10.2017 US
 (54) AGONIST ANTIBODIES THAT BIND HUMAN CD137 AND USES THEREOF
 (71) Compass Therapeutics LLC, 245 First Street Third Floor, Cambridge, MA 02142, US
 (72) BOBROWICZ, Piotr, 245 First Street Third Floor, Cambridge, MA 02142, US
 WIDBOOM, Paul, 7 Lucent Drive, Lebanon, NH 03766, US
 SCHMIDT, Michael, March, 245 First Street Third Floor, Cambridge, MA 02142, US
 LAJOIE, Jason, M., 245 First Street Third Floor, Cambridge, MA 02142, US
 TIGHE, Robert, V., III, 245 First Street Third Floor, Cambridge, MA 02142, US
 LEUNG, Cheuk, Lun, 245 First Street Third Floor, Cambridge, MA 02142, US
 ESKIOCAK, Ugur, 245 First Street Third Floor, Cambridge, MA 02142, US
-

- (51) MKP
A61K 31/165 2006 (97) EP 3651752
A61P 29/02 2006
C07C 237/42 2006
C07D 213/81 2006
C07D 213/82 2006

(96)	EP 18746526.5	7/11/2018				
(97)	EP 3651752,	5/20/2020	202021,	en		
(31)	201762531313 P		(32)	11.07.2017	(33)	US
	201762608283 P			20.12.2017		US
(54)	CARBOXAMIDES AS MODULATORS OF SODIUM CHANNELS					
(72)	AHMAD, Nadia, 50 Northern Avenue, Boston, MA 02210, US					
	ANDERSON, Corey, 50 Northern Avenue, Boston, MA 02210, US					
	ARUMUGAM, Vijayalaksmi, 50 Northern Avenue, Boston, MA 02210, US					
	ASGIAN, Iuliana, Luci, 50 Northern Avenue, Boston, MA 02210, US					
	CAMP, Joanne, Louise, 50 Northern Avenue, Boston, MA 02210, US					
	FANNING, Lev Tyler, Dewey, 50 Northern Avenue, Boston, MA 02210, US					
	HADIDA RUAH, Sara, Sabina, 50 Northern Avenue, Boston, MA 02210, US					
	HURLEY, Dennis, 50 Northern Avenue, Boston, MA 02210, US					
	SCHMIDT, Yvonne, 50 Northern Avenue, Boston, MA 02210, US					
	SHAW, David, 50 Northern Avenue, Boston, MA 02210, US					
	PATEL, Urvi, 50 Northern Avenue, Boston, MA 02210, US					
	THOMSON, Stephen, Andrew, 50 Northern Avenue, Boston, MA 02210, US					
	MEIRELES, Lidio Marx Carvalho, 50 Northern Avenue, Boston, MA 02210, US					

(51)	MKP					
	A61K 31/435	2006	(97) EP 3652166			
	A61P 35/00	2006				
	A61P 37/00	2006				
	C07D 401/04	2006				
	C07D 401/14	2006				
	C07D 405/14	2006				
	C07D 409/14	2006				
(96)	EP 18746537.2	7/12/2018				
(97)	EP 3652166,	5/20/2020	202021,	en		
(31)	201762532932 P		(32)	14.07.2017	(33)	US
	201862662405 P			25.04.2018		US
	201862689412 P			25.06.2018		US
(54)	NLRP3 MODULATORS					
(72)	O'MALLEY, Daniel, c/o Bristol-Myers Squibb Company Route 206 and Province Line Road, Princeton, New Jersey 08543, US					
	GAVAI, Ashvinikumara V., c/o Bristol-Myers Squibb Company Route 206 and Province Line Road, Princeton, New Jersey 08543, US					
	GILL, Patrice, c/o Bristol-Myers Squibb Company Route 206 and Province Line Road, Princeton, New Jersey 08543, US					
	TARBY, Christine M., c/o Bristol-Myers Squibb Company Route 206 and Province Line Road, Princeton, New Jersey 08543, US					
	WATTERSON, Scott Hunter, c/o Bristol-Myers Squibb Company Route 206 and Province Line Road, Princeton, New Jersey 08543, US					
	GONG, Hua, c/o Bristol-Myers Squibb Company Route 206 and Province Line Road, Princeton, New Jersey 08543, US					
	WILLIAMS, David K., c/o Bristol-Myers Squibb Company Route 206 and Province Line Road, Princeton, New Jersey 08543, US					
	GHOSH, Shomir, 134 Sewall Avenue Unit 3, Brookline, Massachusetts 02446, US					
	ROUSH, William R., 1013 Town Hall Avenue, Jupiter, FL 33458, US					

(51)	MKP					
	A61K 39/395	2006	(97) EP 3655033			
	A61P 35/00	2006				
	C07K 16/28	2006				
(96)	EP 18746656.0	7/20/2018				
(97)	EP 3655033,	5/27/2020	202022,	en		
(31)	201711785		(32)	21.07.2017	(33)	GB
(54)	PHARMACEUTICAL COMBINATIONS COMPRISING AN ANTI BST-1 ANTIBODY AND A CYTIDINE ANALOGUE					
(72)	SIMONELLI, Cecilia, Menarini Ricerche via Sette Santi 3, Florence, IT					
	PELLACANI, Andrea, Menarini Ricerche via Sette Santi 3, Florence, IT					
	BINASCHI, Monica, Menarini Ricerche via Tito Speri 10 Pomezia, Rome, IT					
	BELLAROSA, Daniela, Menarini Ricerche via Tito Speri 10 Pomezia, Rome, IT					
	CARRISI, Corrado, Menarini Ricerche via Tito Speri 10 Pomezia, Rome, IT					

(51)	MKP					
	A61M 1/36	2006	(97) EP 3648814			
(96)	EP 18748028.0	2/5/2018				
(97)	EP 3648814,	5/13/2020	202020,	en		
(31)	201715425494		(32)	06.07.2017	(33)	US
(54)	SYSTEMS AND METHODS FOR TREATING BLOOD					

- (71) Humanity Life Extension, LLC, 545 Atwater Circle, St. Paul, MN 55103, US
 (72) SPEARMAN, Patrick, Richard, 15 Waterford Circle, The Woodlands TX 77381, US

- (51) MKP
C07D 213/56 2006 (97) EP 3658545
C07D 401/04 2006
C07D 487/04 2006
- (96) EP 18748889.5 7/27/2018
 (97) EP 3658545, 6/3/2020 202023, en
- (31) 201730986 (32) 28.07.2017 (33) ES
- (54) METHOD FOR PREPARING 3-[(3S)-7-BROMO-2-OXO-5-(PYRIDIN-2-YL)-2,3-DIHYDRO-1H-[1,4]-BENZODIAZEPIN-3-YL]PROPIONIC ACID METHYL ESTER, AND COMPOUNDS USEFUL IN THAT METHOD
- (71) Moehs Ibérica, S.L., César Martinell i Brunet 12a, 08191 Rubí-Barcelona, ES
 (72) SÁNCHEZ CASALS, Carles, Moehs Iberica S.L. Polígono Rubí Sur. César Martinell i Brunet 12A, E-08191 Rubí-Barcelona, ES
 DOBARRO RODRÍGUEZ, Alicia, Moehs Iberica S.L. Polígono Rubí Sur. César Martinell i Brunet 12A E-08191 Rubí, Barcelona, ES

- (51) MKP
A61K 31/44 2006 (97) EP 3661510
A61P 25/00 2006
A61P 25/08 2006
A61P 25/14 2006
A61P 25/16 2006
A61P 25/18 2006
A61P 25/24 2006
A61P 25/28 2006
A61P 25/30 2006
- (96) EP 18748921.6 8/3/2018
 (97) EP 3661510, 6/10/2020 202024, en
- (31) 17382544 (32) 03.08.2017 (33) EP
 17382545 03.08.2017 EP
 18382299 30.04.2018 EP
- (54) METHODS OF TREATING BEHAVIOR ALTERATIONS
- (71) Oryzon Genomics, S.A., Carrera de San Jerónimo 15, 2a planta, 28014 Madrid, ES
 (72) MAES, Tamara, Oryzon Genomics S.A. Sant Ferran 74, 08940 Cornellà de Llobregat, ES
 ROTLLANT POZO, David, Oryzon Genomics S.A. Sant Ferran 74, 08940 Cornellà de Llobregat, ES
 GRIÑÁN FERRE, Christian, Oryzon Genomics S.A. Sant Ferran 74, 08940 Cornellà de Llobregat, ES
 PALLÀS LLIBERIA, Mercè, Oryzon Genomics S.A. Sant Ferran 74, 08940 Cornellà de Llobregat, ES
 NADAL ALEMANY, Roser, Oryzon Genomics S.A. Sant Ferran 74, 08940 Cornellà de Llobregat, ES
 ARMARIO GARCÍA, Antonio, Oryzon Genomics S.A. Sant Ferran 74, 08940 Cornellà de Llobregat, ES

- (51) MKP
B03D 1/004 2006 (97) EP 3668653
B03D 1/01 2006
B03D 1/16 2006
- (96) EP 18748938.0 8/8/2018
 (97) EP 3668653, 6/24/2020 202026, en
- (31) 17186527 (32) 16.08.2017 (33) EP
 201762549047 P 23.08.2017 US
- (54) INDIRECT FLOTATION PROCESS FOR MANUFACTURING WHITE PIGMENT CONTAINING PRODUCTS
- (72) SÖTEMANN, Jörg, Fritz-Rössler-Strasse 14a, 79618 Rheinfelden, DE
 MAIER, Jörg, Teichweg 13, 9581 Mallenitzen, AT
 GILBERT, David, Mohnblumenweg 4C, 9500 Villach, AT
 NIITTI, Tomi Matti Juhani, Midstuveien 12, 6440 Elnesvagen, NO

- (51) MKP
A61K 38/00 2006 (97) EP 3665182
C07K 7/08 2006
C07K 14/47 2006
- (96) EP 18748945.5 8/8/2018
 (97) EP 3665182, 6/17/2020 202025, en
- (31) 17382558 (32) 08.08.2017 (33) EP
- (54) NOVEL COMPOUNDS ACTIVATING THE NRF2 PATHWAY

(72) PUIG DURAN, Carlos, C/ Laureà Miró 408-410 Sant Feliu de Llobregat, 08980 Barcelona, ES
 ALBERICIO PALOMERA, Fernando, C/ Diputación 259, 08007 Barcelona, ES
 GONGORA BENITEZ, Miriam, C/ Les Planes 7 1r Sant Joan Despí, 08970 Barcelona, ES
 PARADIS BAS, Marta, C/ Sant Feliu 25 2nB Vilassar de Mar, 08340 Barcelona, ES
 MIRET CASALS, Laia, C/ Les Escoles 27 El Papiolet (Sant Jaume del Domenys), 43713 Tarragona, ES
 RAMOS TOMILLERO, Ivan, C/ Terol 30 Cala de Bou (San Josep de sa Talaia), 07829 Ibiza, ES
 FIACCO, Stephen, EvoRx Technologies Inc. 129 N. Hill Avenue Suite 103, Pasadena California 91106, US
 DAVIS, Andrew, Astrazeneca AB, 151 85 Södertälje, SE
 GESCHWINDNER, Stefan, Astrazeneca AB, 151 85 Södertälje, SE
 BRUN CUBERO, Omar, C/ Tamarit 122 6° 1a, 08015 Barcelona, ES
 HERAS PANIAGUA, Carlos, C/ Olesa 45 Esc. D 4° 4a, 08027 Barcelona, ES
 TRALLERO CANELA, Nuria, C/ Cienfuegos 5 Esc. Esq. 4° 4a, 08027 Barcelona, ES

(51) MKP
C12N 7/00 2006 (97) EP 3658668

(96) EP 18749100.6 7/24/2018
 (97) EP 3658668, 6/3/2020 202023, en

(31) 201711971 (32) 25.07.2017 (33) GB
 201806375 19.04.2018 GB

(54) ADENOVIRAL VECTORS
 (71) Oxford Genetics Limited, First Floor Medawar 1 Robert Robinson Avenue The Oxford Science Park, Oxford, Oxfordshire OX4 4GA, GB
 (72) CAWOOD, Ryan, c/o Oxford Genetics Ltd First Floor Medawar 1 Robert Robinson Avenue The Oxford Science Park, Oxford Oxfordshire OX4 4GA, GB
 SU, Weiheng, c/o Oxford Genetics Ltd First Floor Medawar 1 Robert Robinson Avenue The Oxford Science Park, Oxford Oxfordshire OX4 4GA, GB

(51) MKP
A61K 31/198 2006 (97) EP 3638370
A61P 25/06 2006

(96) EP 18749124.6 6/25/2018
 (97) EP 3638370, 4/22/2020 202017, en

(31) 201709459 (32) 14.06.2017 (33) GB

(54) TREATMENT FOR MIGRAINE
 (72) STRUPP, Michael, The Department of Neurology and German Center for Vertigo and Balance Disorders Ludwig-Maximilians-University Hospital Munich Campus Grosshadern Marchioninstr. 15, 81377 Munich, DE
 FACTOR, Mallory, 34 Boiling Springs Road, Catherine AL 26728, US

(51) MKP
A61K 31/728 2006 (97) EP 3655138
B01D 61/14 2006
C08B 37/08 2006

(96) EP 18749157.6 7/17/2018
 (97) EP 3655138, 5/27/2020 202022, en

(31) 201700081449 (32) 18.07.2017 (33) IT
 201762533798 P 18.07.2017 US

(54) PROCESS FOR THE PURIFICATION OF HYALURONIC ACID
 (72) CORSA, Vincenza, c/o FIDIA FARMACEUTICI S.p.A. Via Ponte della Fabbrica 3/A, 35031 Abano Terme (PD), IT
 CARPANESE, Giancarlo, c/o FIDIA FARMACEUTICI S.p.A. Via Ponte della Fabbrica 3/A, 35031 Abano Terme (PD), IT

(51) MKP
A61K 39/395 2006 (97) EP 3649154
C07K 16/28 2006
C07K 16/46 2006

(96) EP 18749179.0 7/6/2018
 (97) EP 3649154, 5/13/2020 202020, en

(31) 17180064 (32) 06.07.2017 (33) EP

(54) BINDING MOLECULES THAT MODULATE A BIOLOGICAL ACTIVITY EXPRESSED BY A CELL
 (72) GEUIJEN, Cecilia Anna Wilhelmina, c/o Yalelaan 62, 3584 CM Utrecht, NL
 KLOOSTER, Rinse, c/o Yalelaan 62, 3584 CM Utrecht, NL
 DE KRUIF, Cornelis Adriaan, c/o Yalelaan 62, 3584 CM Utrecht, NL
 TACKEN, Paulus Johannes, c/o Yalelaan 62, 3584 CM Utrecht, NL

THROSBY, Mark, c/o Yalelaan 62, 3584 CM Utrecht, NL
 LOGTENBERG, Ton, c/o Yalelaan 62, 3584 CM Utrecht, NL

- (51) MKP
A61K 39/00 2006 (97) EP 3649155
C07K 16/28 2006
- (96) EP 18749180.8 7/6/2018
 (97) EP 3649155, 5/13/2020 202020, en
- (31) 17180061 (32) 06.07.2017 (33) EP
- (54) BISPECIFIC ANTI PD1-ANTI TIM3 ANTIBODIES
 (72) GEUIJEN, Cecilia Anna Wilhelmina, c/o Yalelaan 62, 3584 CM Utrecht, NL
 KLOOSTER, Rinse, c/o Yalelaan 62, 3584 CM Utrecht, NL
 DE KRUIF, Cornelis Adriaan, c/o Yalelaan 62, 3584 CM Utrecht, NL
 TACKEN, Paulus Johannes, c/o Yalelaan 62, 3584 CM Utrecht, NL
 THROSBY, Mark, c/o Yalelaan 62, 3584 CM Utrecht, NL
 LOGTENBERG, Ton, c/o Yalelaan 62, 3584 CM Utrecht, NL

- (51) MKP
C07K 16/12 2006 (97) EP 3649156
C07K 16/28 2006
C07K 16/46 2006
- (96) EP 18749181.6 7/6/2018
 (97) EP 3649156, 5/13/2020 202020, en
- (31) 17180070 (32) 06.07.2017 (33) EP
- (54) ANTIBODIES THAT MODULATE A BIOLOGICAL ACTIVITY EXPRESSED BY A CELL
 (72) GEUIJEN, Cecilia Anna Wilhelmina, c/o Yalelaan 62, 3584 CM Utrecht, NL
 KLOOSTER, Rinse, c/o Yalelaan 62, 3584 CM Utrecht, NL
 DE KRUIF, Cornelis Adriaan, c/o Yalelaan 62, 3584 CM Utrecht, NL
 TACKEN, Paulus Johannes, c/o Yalelaan 62, 3584 CM Utrecht, NL
 THROSBY, Mark, c/o Yalelaan 62, 3584 CM Utrecht, NL
 LOGTENBERG, Ton, c/o Yalelaan 62, 3584 CM Utrecht, NL

- (51) MKP
A61K 39/00 2006 (97) EP 3642234
C07K 16/24 2006
- (96) EP 18749503.1 6/22/2018
 (97) EP 3642234, 4/29/2020 202018, en
- (31) 201762523458 P (32) 22.06.2017 (33) US
 201762529515 P 07.07.2017 US
 201762550307 P 25.08.2017 US
 201762550325 P 25.08.2017 US
 201762596054 P 07.12.2017 US
 201862649631 P 29.03.2018 US
 PCT/IB2018/053096 03.05.2018 WO
 10715136 03.05.2018 TW
 201815970542 03.05.2018 US
- (54) IL-1BETA BINDING ANTIBODIES FOR USE IN TREATING CANCER
 (72) LIGUEROS-SAYLAN, Monica, c/o Novartis Pharmaceuticals Corporation One Health Plaza, East Hanover New Jersey 07936, US
 MATCHABA, Patrice, c/o Novartis Pharmaceuticals Corporation One Health Plaza, East Hanover New Jersey 07936, US
 THUREN, Tom, c/o Novartis Pharmaceuticals Corporation One Health Plaza, East Hanover New Jersey 07936, US
 RIDKER, Paul, c/o The Brigham and Women's Hospital 75 Francis Street, Boston Massachusetts 02115, US
 LIBBY, Peter, c/o The Brigham and Women's Hospital 75 Francis Street, Boston Massachusetts 02115, US
 OTTEWELL, Penelope, c/o The Medical School Beech Hill Road, Sheffield South Yorkshire S10 2RX, GB
 LAU, Yang Yi, c/o Novartis Pharmaceuticals Corporation One Health Plaza, East Hanover New Jersey 07936, US
 DUGAN, Margaret, c/o Novartis Pharmaceuticals Corporation One Health Plaza, East Hanover New Jersey 07936, US

- (51) MKP
A61K 31/496 2006 (97) EP 3648765
A61P 25/28 2006
- (96) EP 18749539.5 6/29/2018
 (97) EP 3648765, 5/13/2020 202020, en
- (31) 201741023375 (32) 03.07.2017 (33) IN
- (54) NEW USES OF A PURE 5-HT 6 RECEPTOR ANTAGONIST

(72) NIROGI, Ramakrishna, Suven Life Sciences Limited Serene Chambers Road 5 Avenue 7 Banjara Hills, Hyderabad Telangana 500034, IN
 GRANDHI, Venkata Ramalingaya, Suven Life Sciences Limited Serene Chambers Road 5 Avenue 7 Banjara Hills, Hyderabad Telangana 500034, IN
 JAYARAJAN, Pradeep, Suven Life Sciences Limited Serene Chambers Road 5 Avenue 7 Banjara Hills, Hyderabad Telangana 500034, IN
 JASTI, Venkateswarlu, Suven Life Sciences Limited Serene Chambers Road 5 Avenue 7 Banjara Hills, Hyderabad Telangana 500034, IN

(51) MKP
C08B 1/00 2006 (97) EP 3638803
C12P 7/06 2006
C12P 19/04 2006
D21C 5/00 2006

(96) EP 18749583.3 6/12/2018

(97) EP 3638803, 4/22/2020 202017, en

(31) 2019066 (32) 14.06.2017 (33) NL

(54) PROCESS FOR OBTAINING CELLULOSE FROM PLANT MATERIAL

(71) Innovative Sustainable Technologies B.V., Choorhoekseweg 8b, 4424 NW Wemeldinge, NL

(72) VAN LOON, Cornelis Adrianus Maria, Pauwenhof 35, 4461 SC Goes, NL

VAN ANTWERPEN, Eduard Jan, Hoofdstraat 102, 4441 AE Ovezande, NL

VAN KLINK, Johannes Izaak, Zeestraat 7, 4424 EX Wemeldinge, NL

DREIER, Ulrich, Champ de la Vigne 4, 1470 Estavayer-le-Lac, CH

STEINER, Manfred, Chemin des Cerisiers 3, 1185 Mont-Sur-Rolle, CH

(51) MKP
A61K 35/76 2015 (97) EP 3645551
A61K 48/00 2006
C07K 14/015 2006
C07K 16/18 2006
C07K 16/28 2006
C12N 5/10 2006
C12N 15/35 2006
C12N 15/864 2006

(96) EP 18749635.1 6/27/2018

(97) EP 3645551, 5/6/2020 202019, en

(31) 201762525704 P (32) 27.06.2017 (33) US

(54) TROPISM-MODIFIED RECOMBINANT VIRAL VECTORS AND USES THEREOF FOR THE TARGETED INTRODUCTION OF GENETIC MATERIAL INTO HUMAN CELLS

(72) KYRATSOUS, Christos, c/o Regeneron Pharmaceuticals, Inc. 777 Old Saw Mill River Road, Tarrytown, New York 10591, US

MURPHY, Andrew J., c/o Regeneron Pharmaceuticals, Inc. 777 Old Saw Mill River Road, Tarrytown, New York 10591, US

WANG, Cheng, c/o Regeneron Pharmaceuticals, Inc. 777 Old Saw Mill River Road, Tarrytown, New York 10591, US

SABIN, Leah, c/o Regeneron Pharmaceuticals, Inc. 777 Old Saw Mill River Road, Tarrytown, New York 10591, US

(51) MKP
A61K 48/00 2006 (97) EP 3645553
C07K 14/315 2006
C12N 7/00 2006

(96) EP 18749636.9 6/27/2018

(97) EP 3645553, 5/6/2020 202019, en

(31) 201762525708 P (32) 27.06.2017 (33) US

(54) TROPISM-MODIFIED RECOMBINANT VIRAL PARTICLES AND USES THEREOF FOR THE TARGETED INTRODUCTION OF GENETIC MATERIAL INTO HUMAN CELLS

(72) SABIN, Leah, c/o Regeneron Pharmaceuticals Inc. 777 Old Saw Mill River Road, Tarrytown New York 10591, US

SCHOENHERR, Christopher, c/o Regeneron Pharmaceuticals Inc. 777 Old Saw Mill River Road, Tarrytown New York 10591, US

ECONOMIDES, Aris N., c/o Regeneron Pharmaceuticals Inc. 777 Old Saw Mill River Road, Tarrytown New York 10591, US

KYRATSOUS, Christos, c/o Regeneron Pharmaceuticals Inc. 777 Old Saw Mill River Road, Tarrytown New York 10591, US

MURPHY, Andrew J., c/o Regeneron Pharmaceuticals Inc. 777 Old Saw Mill River Road, Tarrytown New York 10591, US

(51) MKP
A61K 39/12 2006 (97) EP 3638302
A61P 31/18 2006
C07K 14/16 2006

(96) EP 18749863.9 6/14/2018

(97) EP 3638302, 4/22/2020 202017, en

(31) 201762520079 P (32) 15.06.2017 (33) US

(54) POXVIRUS VECTORS ENCODING HIV ANTIGENS, AND METHODS OF USE THEREOF
 (71) Janssen Vaccines & Prevention B.V., Archimedesweg 4-6, 2333 CN Leiden, NL
 (72) WEGMANN, Frank, c/o Janssen Vaccines&Prevention B.V. Archimedesweg 4-6, 2333 CN Leiden, NL
 LANGEDIJK, Johannes Petrus Maria, c/o Janssen Vaccines&Prevention B.V. Archimedesweg 4-6, 2333 CN Leiden, NL
 CUSTERS, Jerome Hubertina Henricus Victor, c/o Janssen Vaccines&Prevention B.V. Archimedesweg 4-6, 2333 CN Leiden, NL
 BOCKSTAL, Viki, c/o Janssen Vaccines&Prevention B.V. Archimedesweg 4-6, 2333 CN Leiden, NL
 KALLA, Markus, Wolf 6C, 82377 Penzberg, DE

(51) MKP
B01D 53/047 2006 (97) EP 3648868
 (96) EP 18749868.8 7/3/2018
 (97) EP 3648868, 5/13/2020 202020, en
 (31) 201700074132 (32) 03.07.2017 (33) IT
 (54) A GAS-FILTERING SYSTEM AND METHOD
 (71) Ecospray Technologies S.r.l., Via Ricotti, 5, 27058 Voghera, IT
 (72) ARCHETTI, Maurizio, Via Caresg 15, 6653 Terre Di Pedemonte - Verscio, CH
 GALANTI OCCULTI, Leandro, Salita Nuova di Nostra Signora del Monte 7, 16143 Genova, IT

(51) MKP
G01B 11/25 2006 (97) EP 3652524
G01N 21/88 2006
 (96) EP 18749871.2 7/9/2018
 (97) EP 3652524, 5/20/2020 202021, en
 (31) 201700077459 (32) 10.07.2017 (33) IT
 (54) DEVICE AND PROCESS FOR DETECTING SURFACE DEFECTS
 (71) Tekno Idea S.r.l., Via Aterno 7, 65128 Pescara (PE), IT
 (72) DE NISCO, Bruno, c/o Tekno Idea S.r.l. Via Aterno 7, 65128 Pescara (PE), IT
 DI GIROLAMO, Alessandro, c/o Tekno Idea S.r.l. Via Aterno 7, 65128 Pescara (PE), IT

(51) MKP
A61K 31/404 2006 (97) EP 3654969
A61K 31/443 2006
A61K 31/4439 2006
A61K 31/47 2006
A61P 11/00 2006
 (96) EP 18749985.0 7/17/2018
 (97) EP 3654969, 5/27/2020 202022, en
 (31) 201762533392 P (32) 17.07.2017 (33) US
 201762562029 P 22.09.2017 US
 201862623748 P 30.01.2018 US
 201862633024 P 20.02.2018 US
 201862657508 P 13.04.2018 US
 (54) METHODS OF TREATMENT FOR CYSTIC FIBROSIS
 (72) HASELTINE, Eric L., 50 Northern Avenue, Boston, Massachusetts 02210, US
 MOSKOWITZ, Samuel, 50 Northern Avenue, Boston, Massachusetts 02210, US
 ROBERTSON, Sarah, 50 Northern Avenue, Boston, Massachusetts 02210, US
 WALTZ, David, 50 Northern Avenue, Boston, Massachusetts 02210, US
 CHEN, Weichao George, 50 Northern Avenue, Boston, Massachusetts 02210, US

(51) MKP
C09K 8/524 2006 (97) EP 3655494
C09K 8/60 2006
E21B 43/25 2006
 (96) EP 18750013.7 7/18/2018
 (97) EP 3655494, 5/27/2020 202022, en
 (31) 201762534927 P (32) 20.07.2017 (33) US
 (54) MITIGATION OF CONDENSATE BANKING USING SURFACE MODIFICATION
 (71) Saudi Arabian Oil Company, 1 Eastern Avenue, Dhahran 31311, SA
 (72) SAYED, Mohammed, c/o Aramco Services Company Two Allen Center 1200 Smith Street, Houston, Texas 77002, US
 LIANG, Feng, c/o Aramco Services Company Two Allen Center 1200 Smith Street, Houston, Texas 77002, US
 OW, Hooisweng, Aramco Research Center - Boston 400 Technology Square, Cambridge, Massachusetts 02139, US
 COX, Jason, Aramco Research Center - Boston 400 Technology Square, Cambridge, Massachusetts 02139, US

(51) MKP
A61K 39/00 2006 (97) EP 3658179

(96) EP 18762177.6 7/27/2018
 (97) EP 3658179, 6/3/2020 202023, en

(31) 201762538070 P (32) 28.07.2017 (33) US
 201762546259 P 16.08.2017 US

(54) METHODS AND COMPOSITIONS FOR HETEROLOGOUS REPRNA IMMUNIZATIONS
 (72) VOGELS, Ronald, Janssen Vaccines&Prevention B.V. Archimedesweg 4-6, 2333 CN Leiden, NL
 VAN DER NEUT KOLFSCHOTEN, Marijn, Janssen Vaccines&Prevention B.V. Archimedesweg 4-6, 2333 CN Leiden, NL
 IRVINE, Darrell J., 17 Gray St, Arlington MA 02476, US
 WEISS, Ron, 90 Olde Field Rd, Newton MA 02459, US
 PORTER, Ely Blanton, 112 Ashcroft Road, Medford MA 02155, US
 MELO, Mariane Bandeira, 37 Bonad Rd, Stoneham MA 02180, US
 KITADA, Tasuku, Filaturestraat 15, 9000 Gent, BE

(51) MKP
H02K 5/22 2006 (97) EP 3673567
H02K 7/14 2006
H02K 11/33 2016
H02K 15/14 2006

(96) EP 18762468.9 8/21/2018
 (97) EP 3673567, 7/1/2020 202027, de

(31) 102017214774 (32) 23.08.2017 (33) DE

(54) CONNECTING DEVICE AND ELECTRIC MOTOR
 (71) Brose Fahrzeugteile SE & Co. Kommanditgesellschaft, Würzburg, Ohmstraße 2a, 97076 Würzburg, DE
 (72) WISNER, Marko, Holzweg 21, 97297 Waldbüttelbrunn, DE
 SCHULZ, Janik, Valentin-Becker-Str. 10 A, 97072 Würzburg, DE
 SHENDARE, Keshar, F809, GKsilverland residerecy phase I, 421012 Pune, IN

(51) MKP
A23L 33/15 2016 (97) EP 3657963
A61K 31/122 2006
A61K 33/06 2006
A61K 33/26 2006
A61K 45/06 2006
A61P 9/00 2006

(96) EP 18762623.9 7/26/2018
 (97) EP 3657963, 6/3/2020 202023, en

(31) 201700085412 (32) 26.07.2017 (33) IT

(54) COMPOSITION FOR USE IN THE PREVENTION AND TREATMENT OF PATHOLOGIES OF THE CARDIOVASCULAR APPARATUS
 (72) LACORTE, Andrea, c/o PHARMANUTRA S.p.A via delle Lenze 216/B, 56122 Pisa, IT
 TARANTINO, Germano, c/o PHARMANUTRA S.p.A via delle Lenze 216/b, 56122 Pisa, IT
 BRILLI, Elisa, c/o PHARMANUTRA S.p.A via delle Lenze 216/b, 56122 Pisa, IT

(51) MKP
B31B 50/25 2017 (97) EP 3661849
B31B 50/54 2017
B31B 50/62 2017
B31B 100/00 2017
B31B 110/35 2017
B31B 120/10 2017
B31F 1/08 2006
B65B 5/02 2006
B65B 11/00 2006
B65B 35/24 2006
B65B 35/44 2006
B65B 43/12 2006
B65B 43/30 2006
B65B 49/10 2006
B65B 49/14 2006

(96) EP 18762626.2 7/31/2018
 (97) EP 3661849, 6/10/2020 202024, en

(31) 201700090029 (32) 03.08.2017 (33) IT
 (54) PLANT FOR AUTOMATED PACKAGING OF ITEMS IN CARDBOARD BOXES
 (71) Panotec SRL, Via G. Polese, 2, 31010 Cimadolmo (TV), IT
 (72) BENIN, Marco, via Fabio Filzi 43, 37047 San Bonifacio (VR), IT

(51) MKP
A61M 5/315 2006 (97) EP 3672668
 (96) EP 18762702.1 8/14/2018
 (97) EP 3672668, 7/1/2020 202027, en
 (31) 201762547928 P (32) 21.08.2017 (33) US
 201862676576 P 25.05.2018 US
 (54) MEDICATION DELIVERY DEVICE WITH SENSING SYSTEM
 (72) BYERLY, Roy Howard, c/o Eli Lilly and Company P.O. Box 6288, Indianapolis, Indiana 46206-6288, US
 NELSEN, Daniel Joseph, c/o Eli Lilly and Company P.O. Box 6288, Indianapolis, Indiana 46206-6288, US
 PERKINS, Russell Wayne, c/o Eli Lilly and Company P.O. Box 6288, Indianapolis, Indiana 46206-6288, US
 USCHOLD, Robert Charles, c/o Eli Lilly and Company P.O. Box 6288, Indianapolis, Indiana 46206-6288, US

(51) MKP
A23L 2/00 2006 (97) EP 3668499
A61K 9/00 2006
A61K 31/198 2006
A61K 31/4172 2006
A61K 38/00 2006
A61K 45/06 2006
A61P 1/16 2006
A61P 21/00 2006
A61P 31/00 2006
A61P 43/00 2006
 (96) EP 18762721.1 8/14/2018
 (97) EP 3668499, 6/24/2020 202026, en
 (31) 201762545362 P (32) 14.08.2017 (33) US
 201862614214 P 05.01.2018 US
 201862697772 P 13.07.2018 US
 (54) AMINO ACID COMPOSITIONS FOR THE TREATMENT OF LIVER DISEASE
 (72) COMB, William, c/o Axcella Health Inc. 840 Memorial Drive 3rd Floor, Cambridge, MA 02139, US
 CARROLL, Sean, c/o Axcella Health Inc. 840 Memorial Drive 3rd Floor, Cambridge, MA 02139, US
 AFEYAN, Raffi, c/o Axcella Health Inc. 840 Memorial Drive 3rd Floor, Cambridge, MA 02139, US
 HAMILL, Michael, c/o Axcella Health Inc. 840 Memorial Drive 3rd Floor, Cambridge, MA 02139, US

(51) MKP
A61K 39/395 2006 (97) EP 3672631
C07K 16/18 2006
 (96) EP 18762749.2 8/22/2018
 (97) EP 3672631, 7/1/2020 202027, en
 (31) 201762548583 P (32) 22.08.2017 (33) US
 (54) PHARMACEUTICAL COMPOSITIONS CONTAINING ANTI-BETA AMYLOID ANTIBODIES
 (72) LANTZ, Steven Andrew, Biogen MA Inc. 225 Binney Street, Cambridge Massachusetts 02142, US
 GUPTA, Kapil, Biogen MA Inc. 225 Binney Street, Cambridge Massachusetts 02142, US
 SULE, Shantanu, Biogen MA Inc. 225 Binney Street, Cambridge Massachusetts 02142, US
 ZUNIC, Adnan, Biogen MA Inc. 225 Binney Street, Cambridge Massachusetts 02142, US

(51) MKP
A61K 39/395 2006 (97) EP 3672632
C07K 16/18 2006
C07K 16/28 2006
 (96) EP 18762993.6 8/22/2018
 (97) EP 3672632, 7/1/2020 202027, en
 (31) 201762548772 P (32) 22.08.2017 (33) US
 (54) PHARMACEUTICAL COMPOSITIONS AND DOSAGE REGIMENS CONTAINING ANTI-ALPHA(V)BETA(6) ANTIBODIES
 (72) ESTEY, Tia Brie, Biogen MA Inc. 225 Binney Street, Cambridge Massachusetts 02142, US
 GOVINDAN, Geetha, Biogen MA Inc. 225 Binney Street, Cambridge Massachusetts 02142, US
 SALUJA, Sonal, Biogen MA Inc. 225 Binney Street, Cambridge Massachusetts 02142, US

GUPTA, Kapil, Biogen MA Inc. 225 Binney Street, Cambridge Massachusetts 02142, US
 MCGRATH, Margaret, Biogen MA Inc. 225 Binney Street, Cambridge Massachusetts 02142, US

- (51) MKP
G06Q 20/38 2012 (97) EP 3540674
G06Q 20/40 2012
G06Q 30/06 2012
- (96) EP 19158722.9 2/22/2019
 (97) EP 3540674, 4/22/2020 202017, en
- (31) 3052018 (32) 12.03.2018 (33) CH
 201800003461 12.03.2018 IT
- (54) METHOD AND SYSTEM FOR THE GENERATION OF USER-INITIATED FEDERATED IDENTITIES
 (71) Cornèr Banca SA, Via Canova 16, 6900 Lugano, CH
 (72) Marchetto, Jarno, Via al Maglio, 2, 6952 Canobbio, CH

- (51) MKP
A61K 31/5585 2006 (97) EP 3536380
A61K 38/28 2006
A61P 3/10 2006
- (96) EP 19161129.2 5/4/2015
 (97) EP 3536380, 4/15/2020 202016, en
- (31) 201461990402 P (32) 08.05.2014 (33) US
- (54) RAPID-ACTING INSULIN COMPOSITIONS
 (72) Christe, Michael Edward, c/o Eli Lilly and Company P.O. Box 6288, Indianapolis, Indiana 46206-6288, US
 Hardy, Thomas Andrew, c/o Eli Lilly and Company P.O. Box 6288, Indianapolis, Indiana 46206-6288, US

- (51) MKP
A61K 39/395 2006 (97) EP 3560959
C07K 16/28 2006
G01N 33/68 2006
- (96) EP 19161959.2 1/30/2015
 (97) EP 3560959, 6/10/2020 202024, en
- (31) 201461934469 P (32) 31.01.2014 (33) US
 201462094912 P 19.12.2014 US
- (54) ANTIBODY MOLECULES TO TIM-3 AND USES THEREOF
 (72) SABATOS-PEYTON, Catherine, Anne, 250 Massachusetts Avenue, Cambridge, MA Massachusetts 02139, US
 BRANNETTI, Barbara, Lichtstrasse 35, 4056 Basel, CH
 HARRIS, Alan, S., 250 Massachusetts Avenue, Cambridge, MA Massachusetts 02139, US
 HUBER, Thomas, Lichtstrasse 35, 4056 Basel, CH
 PIETZONKA, Thomas, Lichtstrasse 35, 4056 Basel, CH
 MATARAZA, Jennifer, Marie, 250 Massachusetts Avenue, Cambridge, MA Massachusetts 02139, US
 BLATTNER, Walter, A., 197 Mason Terrace, Brookline, MA Massachusetts 02446-2768, US
 HICKLIN, Daniel, J., 113 Clarewill Avenue, Montclair, NJ New Jersey 07043, US
 VASQUEZ, Maximiliano, 3813 Louis Road, Palo Alto, CA California, US
 DEKRUYFF, Rosemarie, H., 2 Sunhill, Portola Valley, CA California 94028, US
 UMETSU, Dale, T., 2 Sunhill, Portola Valley, CA California 94028, US
 FREEMAN, Gordon, James, 305 Walnut Street, Brookline, MA Massachusetts 02445, US
 HU, Tiancen, 250 Massachusetts Avenue, Cambridge, MA Massachusetts 02139, US
 TARASZKA, John, A., 250 Massachusetts Avenue, Cambridge, MA Massachusetts 02139, US
 XU, Fangmin, 250 Massachusetts Avenue, Cambridge, MA Massachusetts 02139, US

- (51) MKP
B21C 37/29 2006 (97) EP 3540356
F16L 1/00 2006
F16L 5/10 2006
F16L 13/02 2006
F24D 19/00 2006
F28D 1/053 2006
F28D 21/00 2006
F28F 9/02 2006
F28F 9/18 2006
F28F 9/26 2006
- (96) EP 19162139.0 3/12/2019

(97) EP 3540356, 4/15/2020 202016, en
 (31) 201800003546 (32) 14.03.2018 (33) IT
 (54) BUSHING JOINT FOR FORMING A RADIANT BODY
 (72) LOLLI, Valter, Via Baracca, 5, 40033 CASALECCHIO DI RENO, IT

(51) MKP
A61K 31/4353 2006 (97) EP 3539966
A61P 1/00 2006
A61P 17/06 2006
C07D 487/04 2006
 (96) EP 19162206.7 3/12/2019
 (97) EP 3539966, 4/22/2020 202017, en
 (31) 201862641728 P (32) 12.03.2018 (33) US
 (54) INHIBITORS OF TYROSINE KINASE 2 MEDIATED SIGNALING
 (72) ARGIRIADI, Maria A., 15 Sadie Hutt Lane, Southboro, MA Massachusetts 01772, US
 BREINLINGER, Eric C., 54 Hanson Road, Charlton, MA Massachusetts 01507, US
 CHIEN, Ellen Yulin Tsai, 23 Del Monte Place, San Mateo, CA California 94403, US
 COWART, Marlon D., 43 Dahlia Lane, Round Lake Beach, IL Illinois 60073, US
 FRANK, Kristine E., 364 Gatewood Lane, Grayslake, IL Illinois 60030, US
 FRIEDMAN, Michael M., 23 Goose Fair, Kennebunkport, ME Maine 04046, US
 HARDEE, David J., 1145 Museum Blvd., Unit 510, Vernon Hills, IL Illinois 60061, US
 HEROLD, J. Martin, 3 Metcalf Drive, Holliston, MA Massachusetts 01746, US
 LIU, Huaqing, P.O. Box 1695, Yonkers, NY 10704, US
 QIU, Wei, 7420 Brentwood Lane, Gurnee, IL Illinois 60031, US
 SCANIO, Marc J., 1112 Ashbury Lane, Libertyville, IL Illinois 60048, US
 SCHRIMPF, Michael R., 327 Cambridge Drive, Grayslake, IL Illinois 60030, US
 VARGO, Thomas R., 51 Orchard Drive, Stow, MA Massachusetts 01775, US
 VAN EPPS, Stacy A., 70 Carriage House Path, Ashland, MA Massachusetts 01721, US
 WEBSTER, Matthew P., 10713 69th Street, Kenosha, WI Wisconsin 53142, US
 LITTLE, Andrew J., 21 Bothwell Rd, Brighton, MA Massachusetts 02135, US
 DUNSTAN, Theresa A., 46 Cochituate Road, Apt No. 203, Framingham, MA Massachusetts 01701, US
 KATCHER, Matthew H., 1124 Foster St., Evanston, IL Illinois 60201, US
 SCHIEDLER, David A., 10 Hannah's Way, Charlton, MA Massachusetts 01507, US

(51) MKP
A61K 38/17 2006 (97) EP 3549611
A61K 48/00 2006
 (96) EP 19162250.5 7/27/2012
 (97) EP 3549611, 5/13/2020 202020, en
 (31) 201161513259 P (32) 29.07.2011 (33) US
 (54) SWITCH COSTIMULATORY RECEPTORS
 (71) The Trustees of the University of Pennsylvania, 3600 Civic Center Boulevard, 9th Floor, Philadelphia PA 19104-6283, US
 (72) JUNE, Carl, H., 409 Baird Road, Merion Station, PA 19066, US
 ZHAO, Yangbing, 6 Gladiola Lane, Lumberton, NJ 08048, US

(51) MKP
E03C 1/122 2006 (97) EP 3540139
E03D 11/16 2006
E03F 5/08 2006
 (96) EP 19162253.9 3/12/2019
 (97) EP 3540139, 4/29/2020 202018, fr
 (31) 1852125 (32) 12.03.2018 (33) FR
 1852570 23.03.2018
 (54) DEVICE FOR TOILET, CONNECTOR WITH VALVE FOR SIPHON AND CORRESPONDING METHOD
 (71) Delabre, Pierre-Yves, 543 F Les Hauts de Gaudon, 30300 Beaucaire, FR
 (72) Delabre, Pierre-Yves, 543 F Les Hauts de Gaudon, 30300 Beaucaire, FR

(51) MKP
A61K 39/00 2006 (97) EP 3536339
A61K 39/395 2006
A61P 11/06 2006
G01N 33/48 2006
 (96) EP 19162585.4 8/7/2014

(97) EP 3536339, 4/15/2020 202016, en
 (31) 201361864950 P (32) 12.08.2013 (33) US
 (54) METHODS FOR IMPROVING ASTHMA SYMPTOMS USING BENRALIZUMAB
 (72) WARD, Christine, MedImmune LLC One MedImmune Way, Gaithersburg, Maryland 20878, US
 ROSKOS, Lorin, MedImmune LLC One MedImmune Way, Gaithersburg, Maryland 20878, US
 WANG, Bing, MedImmune LLC One MedImmune Way, Gaithersburg, Maryland 20878, US
 RAIBLE, Donald, 317 Lenape Drive, Berwyn, Pennsylvania 19312, US

(51) MKP
F04B 27/00 2006 (97) EP 3543528
F04B 35/04 2006
F04B 39/06 2006
F04B 39/12 2006
F04B 39/16 2006
 (96) EP 19162590.4 3/13/2019
 (97) EP 3543528, 4/22/2020 202017, en
 (31) 201800003733 (32) 19.03.2018 (33) IT
 (54) ALTERNATIVE TWIN CYLINDER AIR COMPRESSOR
 (71) FIAC S.R.L., Via Vizzano 23, 40037 Sasso Marconi (BO), IT
 (72) BOCCATO, Lorenzo, VIA PORRETTANA 170, 40037 SASSO MARCONI, IT

(51) MKP
A61K 31/519 2006 (97) EP 3542820
A61K 39/395 2006
C07K 16/24 2006
 (96) EP 19162707.4 11/4/2011
 (97) EP 3542820, 4/29/2020 202018, en
 (31) 41053310 P (32) 05.11.2010 (33) US
 (54) METHODS OF TREATING PSORIATIC ARTHRITIS USING IL-17 ANTAGONISTS
 (72) MPOFU, Shepard, Novartis Pharma AG Postfach, 4002 Basel, CH
 RICHARDS, Hanno, Novartis Pharma AG Postfach, 4002 Basel, CH
 THANGAVELU, Karthinathan, Novartis Pharma AG Postfach, 4002 Basel, CH
 MACHACEK, Matthias, Novartis Pharma AG Postfach, 4002 Basel, CH

(51) MKP
A24F 47/00 2006 (97) EP 3527088
 (96) EP 19162965.8 5/19/2015
 (97) EP 3527088, 4/1/2020 202014, en
 (31) 201414282768 (32) 20.05.2014 (33) US
 (54) ELECTRICALLY-POWERED AEROSOL DELIVERY SYSTEM
 (72) SEARS, Stephen Benson, 4343 Old U.S. Highway 421 North, Siler City, NC North Carolina 27344, US
 TALUSKIE, Karen V, 650 Dover Drive, Winston-Salem, NC North Carolina 27104, US
 DAVIS, Michael F, 1788 Havenbrook Ct, Clemmons, NC North Carolina 27012, US
 ADEME, Balager, 6100 Herinhut Road, Winston-Salem, NC North Carolina 27127, US
 DUGGINS, Donna Walker, 255 Ju-Lenor Drive, Winston-Salem, NC North Carolina 27107, US
 GERARDI, Anthony Richard, 5208 Mountain View Road, Winston-Salem, NC North Carolina 27104, US

(51) MKP
F42B 5/02 2006 (97) EP 3537094
F42B 5/03 2006
F42B 8/14 2006
F42B 12/06 2006
F42B 12/36 2006
 (96) EP 19163022.7 12/8/2016
 (97) EP 3537094, 4/15/2020 202016, en
 (31) 201562267987 P (32) 16.12.2015 (33) US
 (54) IMPROVED FRAGMENTATION PROJECTILE AND METHOD FOR ITS MANUFACTURING
 (72) Muster, Michael, Scheibenstrasse 21a, 3600 Thun, CH
 Wolf, Juergen, Hohmadpark 5, 3604 Thun, CH
 Meyer, Donald, Les Thurlings 63, 1772 Grolley, CH
 Spatz, Peter, Auroraweg 24, 3185 Schmitten, CH

(51) MKP
A61K 31/00 2006 (97) EP 3539540
A61K 31/341 2006
A61K 38/28 2006
A61P 3/10 2006
(96) EP 19163940.0 11/7/2011
(97) EP 3539540, 4/22/2020 202017, en
(31) 10190303 (32) 08.11.2010 (33) EP
11151059 17.01.2011 EP
(54) PHARMACEUTICAL COMPOSITION, METHODS FOR TREATING AND USES THEREOF
(72) GREMLER, Rolf, Boehringer Ingelheim International GmbH, Corporate Patents Binger Strasse 173, 55216 INGELHEIM AM RHEIN, DE
JOHANSEN, Odd-Erik, Boehringer Ingelheim International GmbH, Corporate Patents Binger Strasse 173, 55216 INGELHEIM AM RHEIN, DE
KLEIN, Thomas, Boehringer Ingelheim International GmbH, Corporate Patents Binger Strasse 173, 55216 INGELHEIM AM RHEIN, DE
LUIPPOLD, Gerd, Boehringer Ingelheim International GmbH, Corporate Patents Binger Strasse 173, 55216 INGELHEIM AM RHEIN, DE
MARK, Michael, Boehringer Ingelheim International GmbH, Corporate Patents Binger Strasse 173, 55216 INGELHEIM AM RHEIN, DE

(51) MKP
A61K 9/20 2006 (97) EP 3542791
A61K 9/24 2006
A61K 9/28 2006
A61K 9/48 2006
(96) EP 19163986.3 10/29/2013
(97) EP 3542791, 4/29/2020 202018, en
(54) A DELAYED RELEASE DRUG FORMULATION
(72) VARUM, Felipe, José, Oliveria, Im Hirshalm 13, 4125 Riehen, CH
BRAVO GONZÁLEZ, Roberto Carlos, Im Klosteracker 57, 4102 Binningen, CH
BUSER, Thomas, Gempenstrasse 19, 4412 Nuglar, CH
BASIT, Abdul Waseh, 55 Alicia Gardens, Harrow, Middlesex HA3 8JB, GB
FREIRE, Ana Cristina, 92 West Cotton Close, Riverside Wharf, Northampton NN4 8BY, GB

(51) MKP
G03G 15/08 2006 (97) EP 3537223
G03G 21/16 2006
G03G 21/18 2006
(96) EP 19164338.6 7/31/2015
(97) EP 3537223, 4/15/2020 202016, en
(31) 2014158119 (32) 01.08.2014 (33) JP
2014158120 01.08.2014 JP
2015032063 20.02.2015 JP
(54) TONER CARTRIDGE, TONER SUPPLYING MECHANISM AND SHUTTER
(72) KASHIIDE, Yosuke, c/o CANON KABUSHIKI KAISHA 30-2, Shimomaruko 3-chome, Ohta-ku., Tokyo, 146-8501, JP
KIMURA, Takashi, c/o CANON KABUSHIKI KAISHA 30-2, Shimomaruko 3-chome, Ohta-ku., Tokyo, 146-8501, JP

(51) MKP
A61K 35/12 2015 (97) EP 3563860
A61K 35/44 2015
A61K 35/50 2015
A61P 27/02 2006
(96) EP 19164689.2 11/14/2012
(97) EP 3563860, 6/10/2020 202024, en
(31) 201261589741 P (32) 23.01.2012 (33) US
201161559521 P 14.11.2011 US
201261724047 P 08.11.2012 US
(54) PHARMACEUTICAL PREPARATIONS OF HUMAN RPE CELLS AND USES THEREOF
(71) Astellas Institute for Regenerative Medicine, 33 Locke Drive, Marlborough, MA 01752, US
(72) GAY, Roger, 18 Wiley Road, Belmont, MA Massachusetts 02478, US
KLIMANSKAYA, Irina, 75 Mechanic Street, Upton, MA Massachusetts, US
LANZA, Robert, 35 South Meadow Road, Clinton, MA Massachusetts 01510, US

(51) MKP

B32B 17/10 2006 (97) EP 3546211
B60J 1/00 2006
 (96) EP 19164805.4 3/25/2019
 (97) EP 3546211, 5/13/2020 202020, de
 (31) 102018107143 (32) 26.03.2018 (33) DE
 (54) VEHICLE WINDOW AND METHOD OF MANUFACTURING SAME
 (71) VOLKSWAGEN AKTIENGESELLSCHAFT, Berliner Ring 2, 38440 Wolfsburg, DE
 (72) Hacker, Roland, Amselweg 23, 38550 Isenbützel, DE

(51) MKP
A61K 31/517 2006 (97) EP 3539952
A61P 29/00 2006
C07D 239/70 2006
 (96) EP 19165684.2 7/30/2015
 (97) EP 3539952, 4/22/2020 202017, en
 (31) 14179288 (32) 31.07.2014 (33) EP
 (54) SUBSTITUTED BICYCLIC DIHYDROPYRIMIDINONES AND THEIR USE AS INHIBITORS OF NEUTROPHIL ELASTASE ACTIVITY
 (72) OOST, Thorsten, Boehringer Ingelheim GmbH, Corporate Patents Binger Strasse 173, 55216 INGELHEIM AM RHEIN, DE
 ANDERSKEWITZ, Ralf, Boehringer Ingelheim GmbH, Corporate Patents Binger Strasse 173, 55216 INGELHEIM AM RHEIN, DE
 GNAMM, Christian, Boehringer Ingelheim GmbH, Corporate Patents Binger Strasse 173, 55216 INGELHEIM AM RHEIN, DE
 HOESCH, Holger, Boehringer Ingelheim GmbH, Corporate Patents Binger Strasse 173, 55216 INGELHEIM AM RHEIN, DE
 MORSCHHAEUSER, Gerd, Boehringer Ingelheim GmbH, Corporate Patents Binger Strasse 173, 55216 INGELHEIM AM RHEIN, DE
 PETERS, Stefan, Boehringer Ingelheim GmbH, Corporate Patents Binger Strasse 173, 55216 INGELHEIM AM RHEIN, DE
 RIES, Uwe Joerg, Boehringer Ingelheim GmbH, Corporate Patents Binger Strasse 173, 55216 INGELHEIM AM RHEIN, DE

(51) MKP
A61K 31/437 2006 (97) EP 3539961
A61P 35/00 2006
C07D 471/04 2006
C07D 487/04 2006
C07D 498/04 2006
 (96) EP 19165726.1 6/27/2016
 (97) EP 3539961, 4/22/2020 202017, en
 (31) 201562185852 P (32) 29.06.2015 (33) US
 (54) POLYCYCLIC AMIDE DERIVATIVES AS CDK9 INHIBITORS
 (72) PIKE, Kurt, Gordon, AstraZeneca, Darwin Building, Cambridge Science Park Milton Road, Cambridge, CB4 0WG, GB
 BARLAAM, Bernard, Christophe, AstraZeneca, Alderley Park, Macclesfield, Cheshire SK10 4TG, GB
 HAWKINS, Janet, AstraZeneca, Alderley Park Cheshire, Macclesfield, Cheshire SK10 4TG, GB
 DE SAVI, Christopher, AstraZeneca 35 Gatehouse Drive, Waltham, Massachusetts 02451, US
 VASBINDER, Melissa Marie, AstraZeneca 35 Gatehouse Drive, Waltham, MA 02451, US
 HIRD, Alexander, AstraZeneca 35 Gatehouse Drive, Waltham, Massachusetts 02451, US
 LAMB, Michelle, AstraZeneca 35 Gatehouse Drive, Waltham, Massachusetts 02451, US

(51) MKP
A61K 31/7088 2006 (97) EP 3550019
C12N 15/11 2006
C12N 15/113 2010
 (96) EP 19166017.4 10/20/2015
 (97) EP 3550019, 5/20/2020 202021, en
 (31) 201462068141 P (32) 24.10.2014 (33) US
 (54) COMBINATION
 (72) WOESSNER, Richard, AstraZeneca 35 Gatehouse Drive, Waltham, MA 02451, US
 MCCOON, Patricia, Elizabeth, AstraZeneca 35 Gatehouse Drive, Waltham, MA 02451, US
 LYNE, Paul, Dermot, AstraZeneca 35 Gatehouse Drive, Waltham, MA 02451, US

(51) MKP
A61K 39/00 2006 (97) EP 3655438
C07K 16/28 2006
 (96) EP 18750343.8 7/18/2018
 (97) EP 3655438, 5/27/2020 202022, en
 (31) PA201700419 (32) 20.07.2017 (33) DK
 (54) AGENTS, USES AND METHODS FOR TREATMENT

(72) BIILMANN RØNN, Lars, Christian, c/o H. Lundbeck A/S Ottiliavej 9, 2500 Valby, DK
 MALIK, Ibrahim, John, c/o H. Lundbeck A/S Ottiliavej 9, 2500 Valby, DK
 STAVENHAGEN, Jeffrey, B, c/o H. Lundbeck A/S Ottiliavej 9, 2500Valby, DK
 CHRISTENSEN, Søren, c/o H. Lundbeck A/S Ottiliavej 9, 2500 Valby, DK
 EGEBJERG, Jan, c/o H. Lundbeck A/S Ottiliavej 9, 2500 Valby, DK
 STUMMANN, Tina, c/o H. Lundbeck A/S Ottiliavej 9, 2500 Valby, DK
 GERRITSEN, Arnout, c/o Genmab B.V. Yalelaan 60, NL-CM 3584 Utrecht, NL
 VAN DEN BRINK, Edward, c/o Genmab B.V. Yalelaan 60, NL-CM 3584 Utrecht, NL
 PARREN, Paul, c/o Genmab B.V. Yalelaan 60, NL-CM 3584 Utrecht, NL
 TRABJERG, Esben, c/o H. Lundbeck A/S Ottiliavej 9, 2500 Valby, DK
 RAND, Kasper Dyrberg, University of Copenhagen Universitetsparken 2, Copenhagen Ø 2100, DK

(51) MKP
C01B 25/01 2006 (97) EP 3665124
C01B 25/22 2006
C01B 25/225 2006
C01B 25/226 2006
C01B 25/32 2006

(96) EP 18750452.7 8/10/2018
 (97) EP 3665124, 6/17/2020 202025, fr
 (31) 201705554 (32) 11.08.2017 (33) BE
 (54) METHOD FOR ETCHING A PHOSPHATE SOURCE USING ACID
 (71) Prayon Technologies, Rue Joseph Wauters 144, 4480 Engis, BE
 (72) WAVREILLE, Alexandre, Rue Joseph Wauters 144, 4480 Engis, BE
 NINANE, Léon, Rue du Kerhuel 44, 29120 Combrit, FR

(51) MKP
A61K 31/438 2006 (97) EP 3668879
A61P 31/06 2006
C07D 498/10 2006

(96) EP 18752171.1 8/15/2018
 (97) EP 3668879, 6/24/2020 202026, en
 (31) 17382569 (32) 16.08.2017 (33) EP
 (54) NOVEL COMPOUNDS
 (71) Bioversys AG, Hochbergerstrasse 60c, 4057 Basel, CH
 (72) PORRAS DE FRANCISCO, Esther, GlaxoSmithKline Parque Tecnológico de Madrid Calle Doctor Severo Ochoa Tres Cantos, 28760 Madrid, ES
 REMUIÑAN-BLANCO, Modesto Jesús, GlaxoSmithKline Parque Tecnológico de Madrid Calle Doctor Severo Ochoa Tres Cantos, 28760 Madrid, ES
 BOUROTTE, Marilyne, 74 avenue du kemmel, 59840 Perenchies, FR
 DEPREZ, Benoit, 19 rue des Célestines, 59000 Lille, FR
 WILLAND, Nicolas, 8 rue de la Halle, 59000 Lille, FR

(51) MKP
A61K 31/4427 2006 (97) EP 3668853
A61K 31/4523 2006
A61K 31/497 2006
A61K 31/501 2006
A61K 31/506 2006
A61P 31/06 2006
C07D 401/04 2006

(96) EP 18752172.9 8/15/2018
 (97) EP 3668853, 6/24/2020 202026, en
 (31) 17382570 (32) 16.08.2017 (33) EP
 (54) NOVEL COMPOUNDS
 (72) PORRAS DE FRANCISCO, Esther, GlaxoSmithKline Parque Tecnológico de Madrid Calle Doctor Severo Ochoa Tres Cantos, 28760 Madrid, ES
 REMUIÑAN-BLANCO, Modesto Jesús, GlaxoSmithKline Parque Tecnológico de Madrid Calle Doctor Severo Ochoa Tres Cantos, 28760 Madrid, ES
 BOUROTTE, Marilyne, 74 avenue du kemmel, 59840 Perenchies, FR
 DEPREZ, Benoit, 19 rue des Célestines, 59000 Lille, FR
 WILLAND, Nicolas, 8 rue de la Halle, 59000 Lille, FR

(51) MKP

A61P 35/00 2006 (97) EP 3645122
C07K 14/54 2006
C07K 14/715 2006
C07K 16/28 2006
(96) EP 18752320.4 7/2/2018
(97) EP 3645122, 5/6/2020 202019, en
(31) 201762527898 P (32) 30.06.2017 (33) US
(54) TARGETED HETERODIMERIC FC FUSION PROTEINS CONTAINING IL-15/IL-15RA AND ANTIGEN BINDING DOMAINS
(72) BERNETT, Matthew J., C/o Xencor Inc. 111 West Lemon Avenue, Monrovia CA 91016, US
DESJARLAIS, John, c/o Xencor Inc. 111 West Lemon Avenue, Monrovia CT 91016, US
VARMA, Rajat, c/o Xencor Inc. 111 West Lemon Avenue, Monrovia CA 91016, US
SCHUBBERT, Suzanne, c/o Xencor Inc. 111 West Lemon Avenue, Monrovia CA 91016, US
DIAZ, Juan, c/o Xencor Inc. 111 West Lemon Avenue, Monrovia CA 91016, US

(51) MKP
A61K 31/352 2006 (97) EP 3654976
A61K 31/366 2006
A61K 31/404 2006
A61K 31/436 2006
A61K 31/4439 2006
A61K 39/395 2006
A61N 5/10 2006
A61P 35/00 2006
(96) EP 18752356.8 7/20/2018
(97) EP 3654976, 5/27/2020 202022, en
(31) 201762535682 P (32) 21.07.2017 (33) US
201862700783 P 19.07.2018 US
(54) METHODS OF USE OF ULTRA-HIGH DOSE RATE RADIATION AND THERAPEUTIC AGENTS
(71) Varian Medical Systems, Inc., 3100 Hansen Way M/S E-339, Palo Alto, CA 94304-1038, US
(72) PARRY, Renate, C/O VARIAN MEDICAL SYSTEMS INC. 3100 Hansen Way M/S E-339, Palo Alto, California 94304-1038, US
ABEL, Eric, C/O VARIAN MEDICAL SYSTEMS INC. 3100 Hansen Way M/S E-339, Palo Alto, California 94304-1038, US
GIRDHANI, Swati, C/O VARIAN MEDICAL SYSTEMS INC. 3100 Hansen Way M/S E-339, Palo Alto, California 94304-1038, US
MANSFIELD, Stanley, C/O VARIAN MEDICAL SYSTEMS INC. 3100 Hansen Way M/S E-339, Palo Alto, California 94304-1038, US
KUPELIAN, Patrick, C/O VARIAN MEDICAL SYSTEMS INC. 3100 Hansen Way M/S E-339, Palo Alto, California 94304-1038, US
KHUNTIA, Deepak, C/O VARIAN MEDICAL SYSTEMS INC. 3100 Hansen Way M/S E-339, Palo Alto, California 94304-1038, US

(51) MKP
A61K 31/175 2006 (97) EP 3658539
C07C 381/10 2006
C07D 205/04 2006
C07D 207/04 2006
C07D 207/10 2006
C07D 213/71 2006
C07D 217/22 2006
C07D 231/18 2006
C07D 231/56 2006
C07D 263/46 2006
C07D 265/30 2006
C07D 277/36 2006
C07D 307/64 2006
C07D 333/34 2006
C07D 417/12 2006
(96) EP 18752376.6 7/23/2018
(97) EP 3658539, 6/3/2020 202023, en
(31) 201762536271 P (32) 24.07.2017 (33) US
201762573894 P 18.10.2017 US
(54) COMPOUNDS AND COMPOSITIONS FOR TREATING CONDITIONS ASSOCIATED WITH NLRP ACTIVITY
(71) Novartis Inflammasome Research, Inc., 251 Little Falls Drive, Wilmington, DE 19808, US
(72) GLICK, Gary, 1663 Snowberry Ridge Rd., Ann Arbor, Michigan 48103, US
ROUSH, William R., 1013 Town Hall Avenue, Jupiter, Florida 33458, US
VENKATRAMAN, Shankar, 114 Country Lane, Lansdale, Pennsylvania 19446, US
SHEN, Dong-Ming, 855 Boylston Street, Boston, Massachusetts 02116, US
GHOSH, Shomir, 134 Sewall Avenue Unit C, Brookline, Massachusetts 02446, US
KATZ, Jason, 216 Woodcliff Road, Newton, Massachusetts 02461, US
SEIDEL, Hans Martin, 26 Revolutionary Rd, Concord, Massachusetts 01742, US

FRANCHI, Luigi, 1260 Barrister Road, Ann Arbor, Michigan 48105, US
 WINKLER, David Guenther, 127 George St., Arlington, Massachusetts 02476, US
 OPIPARI JR., Anthony William, 2816 Wylie Rd, Dexter, Michigan 48130, US

- (51) MKP
A61K 39/00 2006 (97) EP 3658193
A61K 49/00 2006
A61K 49/16 2006
A61K 51/10 2006
C07K 16/28 2006
G01N 33/53 2006
- (96) EP 18752377.4 7/23/2018
 (97) EP 3658193, 6/3/2020 202023, en
- (31) 201762536239 P (32) 24.07.2017 (33) US
 201862660902 P 20.04.2018 US
- (54) ANTI-CD8 ANTIBODIES AND USES THEREOF
 (72) GIURLEO, Jason T., c/o Regeneron Pharmaceuticals Inc. 777 Old Saw Mill River Road, Tarrytown, New York 10591, US
 MA, Dangshe, c/o Regeneron Pharmaceuticals Inc. 777 Old Saw Mill River Road, Tarrytown, New York 10591, US
 OLSON, William, c/o Regeneron Pharmaceuticals Inc. 777 Old Saw Mill River Road, Tarrytown, New York 10591, US
 TAVARE, Richard, c/o Regeneron Pharmaceuticals Inc. 777 Old Saw Mill River Road, Tarrytown, New York 10591, US
 THURSTON, Gavin, c/o Regeneron Pharmaceuticals Inc. 777 Old Saw Mill River Road, Tarrytown, New York 10591, US

- (51) MKP
A61K 38/46 2006 (97) EP 3658672
C12N 9/18 2006
- (96) EP 18752382.4 7/24/2018
 (97) EP 3658672, 6/3/2020 202023, en
- (31) 201762536000 P (32) 24.07.2017 (33) US
- (54) MODIFIED MRNA ENCODING A GLUCOSE-6-PHOSPHATASE AND USES THEREOF
 (72) FARELLI, Jeremiah, Modernatx, Inc., Cambridge, Massachusetts 02139, US
 ROSEMAN, Daniel, Modernatx, Inc. 200 Technology Square, Cambridge, Massachusetts 02139, US
 SUBRAMANIAN, Romesh R., Modernatx, Inc. 200 Technology Square, Cambridge, Massachusetts 02139, US

- (51) MKP
A61K 31/437 2006 (97) EP 3658555
A61P 29/00 2006
C07D 471/04 2006
- (96) EP 18752385.7 7/24/2018
 (97) EP 3658555, 6/3/2020 202023, en
- (31) 201762536114 P (32) 24.07.2017 (33) US
- (54) INHIBITORS OF ROR
 (72) DUGUID, Robert, J., 68 Patterson Drive, Glenmont, NY 12077, US
 GROSSO, John, A., 22 Newport Drive, Princeton Junction, NJ 08550, US
 KRASUTSKY, Sergiy, 182 Adams Street, Delmar, NY 12054, US

- (51) MKP
A61K 31/437 2006 (97) EP 3658556
A61P 29/00 2006
C07D 471/04 2006
- (96) EP 18752390.7 7/24/2018
 (97) EP 3658556, 6/3/2020 202023, en
- (31) PCT/CN2017/094043 (32) 24.07.2017 (33) WO
- (54) INHIBITORS OF ROR GAMMA
 (72) DENG, Chaoyi, STA Pharmaceutical a WuXi App Tec Company 90 Denlin Road Waigaoqiao, Shanghai 200131, CN
 HE, Jun, STA Pharmaceutical a WuXi App Tec Company 90 Denlin Road Waigaoqiao, Shanghai 200131, CN
 XU, Bo, STA Pharmaceutical a WuXi App Tec Company 90 Denlin Road Waigaoqiao, Shanghai 200131, CN

- (51) MKP
A61K 31/397 2006 (97) EP 3668854
A61P 31/06 2006
C07D 205/04 2006

	C07D 401/04	2006					
	C07D 405/04	2006					
(96)	EP 18752499.6 8/15/2018						
(97)	EP 3668854, 6/24/2020 202026, en						
(31)	17382571		(32)	16.08.2017		(33)	EP
(54)	NOVEL COMPOUNDS						
(72)	PORRAS DE FRANCISCO, Esther, GlaxoSmithKline Parque Tecnologico de Madrid Calle Doctor Severo Ochoa Tres Cantos, 28760 Madrid, ES						
	REMUIÑAN-BLANCO, Modesto Jesús, GlaxoSmithKline Parque Tecnologico de Madrid Calle Doctor Severo Ochoa Tres Cantos, 28760 Madrid, ES						
	BOUROTTE, Marilyne, 74 avenue du kemmel, 59840 Perenchies, FR						
	DEPREZ, Benoit, 19 rue des Célestines, 59000 Lille, FR						
	DEQUIREZ, Geoffroy, 435Bis Avenue de Dunkerque - Appartement B23, 59160 Lomme, FR						
	WILLAND, Nicolas, 8 rue de la Halle, 59000 Lille, FR						
<hr/>							
(51)	MKP						
	A61K 38/40	2006	(97) EP 3658174				
	A61P 31/00	2006					
(96)	EP 18752632.2 7/24/2018						
(97)	EP 3658174, 6/3/2020 202023, en						
(31)	201700085409		(32)	26.07.2017		(33)	IT
(54)	LACTOFERRICIN AND LACTOFERRAMPIN FOR TREATING INFECTIONS						
(71)	Bict Srl, Via Einstein Snc, 26900 Lodi, IT						
(72)	RAPACIOLI, Silvia, c/o BICT S.r.l. Via Einstein Snc, 26900 Lodi, IT						
	VERGA, Roberto, c/o BICT S.r.l. Via Einstein Snc, 26900 Lodi, IT						
	MAZZEI, Emma, c/o BICT S.r.l. Via Einstein Snc, 26900 Lodi, IT						
	ZUCCHINALI, Stefano, c/o BICT S.r.l. Via Einstein Snc, 26900 Lodi, IT						
<hr/>							
(51)	MKP						
	A61K 35/74	2015	(97) EP 3652318				
	A61P 35/00	2006					
	C12N 1/36	2006					
	C12N 15/113	2010					
(96)	EP 18752908.6 7/11/2018						
(97)	EP 3652318, 5/20/2020 202021, en						
(31)	201762531327 P		(32)	11.07.2017		(33)	US
	201862648380 P			26.03.2018			US
(54)	ENGINEERED IMMUNOSTIMULATORY BACTERIAL STRAINS AND USES THEREOF						
(71)	Actym Therapeutics, Inc., 626 Bancroft Way Suite A, Berkeley, CA 94710, US						
(72)	THANOS, Christopher, D., 38 Meadow Hill Drive, Tiburon, CA 94920, US						
	GLICKMAN, Laura, Hix, 36 Rydal Court, Oakland, CA 94611, US						
	SKOBLE, Justin, 2423 Roosevelt Avenue, Berkeley, CA 94703, US						
<hr/>							
(51)	MKP						
	A61K 31/7115	2006	(97) EP 3655040				
	A61K 48/00	2006					
	C12N 9/00	2006					
(96)	EP 18752916.9 7/20/2018						
(97)	EP 3655040, 5/27/2020 202022, en						
(31)	201762535289 P		(32)	21.07.2017		(33)	US
(54)	MODIFIED MRNA ENCODING A PROPIONYL-COA CARBOXYLASE AND USES THEREOF						
(72)	SOBOLOV-JAYNES, Susan, ModernaTX Inc. 200 Technology Square, Cambridge, Massachusetts 02139, US						
	SUBRAMANIAN, Romesh R., ModernaTX Inc. 200 Technology Square, Cambridge, Massachusetts 02139, US						
	CAMPAGNARI, Judith L., ModernaTX Inc. 200 Technology Square, Cambridge, Massachusetts 02139, US						
	VASAVADA, Haren, ModernaTX Inc. 200 Technology Square, Cambridge, Massachusetts 02139, US						
	CHENG, Zhiliang, ModernaTX Inc. 200 Technology Square, Cambridge, Massachusetts 02139, US						
<hr/>							
(51)	MKP						
	A61K 39/00	2006	(97) EP 3661544				
	A61P 35/00	2006					
	C07K 16/28	2006					
(96)	EP 18752950.8 7/25/2018						
(97)	EP 3661544, 6/10/2020 202024, en						
(31)	201762539687 P		(32)	01.08.2017		(33)	US

- (54) ANTI-CD137 ANTIBODIES
 (72) FRYE, Christopher Carl, c/o ELI LILLY AND COMPANY P.O. Box 6288, Indianapolis, Indiana 46206-6288, US
 KALOS, Michael Dewain, c/o ELI LILLY AND COMPANY P.O. Box 6288, Indianapolis, Indiana 46206-6288, US
 KOTANIDES, Helen, c/o ELI LILLY AND COMPANY P.O. Box 6288, Indianapolis, Indiana 46206-6288, US
 SANDEFUR, Stephanie Lynn, c/o ELI LILLY AND COMPANY P.O. Box 6288, Indianapolis, Indiana 46206-6288, US

- (51) MKP
A61K 9/20 2006 (97) EP 3654951
A61K 31/34 2006
A61K 31/513 2006
A61K 31/5377 2006
A61K 31/675 2006
 (96) EP 18753288.2 7/19/2018
 (97) EP 3654951, 5/27/2020 202022, en
 (31) 201762534885 P (32) 20.07.2017 (33) US
 201762571384 P 12.10.2017 US
 201862623174 P 29.01.2018 US
 201862665339 P 01.05.2018 US
 (54) COMPOSITIONS COMPRISING DARUNAVIR, COBICISTAT, EMTRICITABINE AND TENOFOVIR ALAFENAMIDE FOR USE IN THE TREATMENT OF HIV
 (72) BOVEN, Katia, c/o Janssen Pharmaceuticals Inc. 1125 Trenton-Harbourton Road, Titusville, New Jersey 08560, US
 DE SMEDT, Goedele, c/o Janssen Pharmaceutica NV Turnhoutseweg 30, 2340 Beerse 2340, BE
 DRIESEN, Regina, c/o Janssen Pharmaceutica NV Turnhoutseweg 30, 2340 Beerse 2340, BE
 HENRIST, Dominiek, c/o Janssen Pharmaceutica NV Turnhoutseweg 30, 2340 Beerse 2340, BE
 KAUWENBERGHS, Greet, c/o Janssen Pharmaceutica NV Turnhoutseweg 30, 2340 Beerse 2340, BE
 MATHUR, Sandeep, c/o Janssen Pharmaceuticals Inc. 1125 Trenton-Harbourton Road, Titusville, New Jersey 08560, US
 MCCALLISTER, Scott, 333 Lakeside Drive, Foster City, California 94404, US
 MERTENS, Roel, c/o Janssen Pharmaceutica NV Turnhoutseweg 30, 2340 Beerse 2340, BE
 NETTLES, Richard, Janssen Pharmaceuticals Inc. 1125 Trenton-Harbourton Road, Titusville, New Jersey 08560, US
 OPSOMER, Magda, Janssen Pharmaceutica NV Turnhoutseweg 30, 2340 Beerse 2340, BE
 PRYZ, William, Gilead Sciences Inc. 333 Lakeside Drive, Foster City, California 94404, US
 ZIA, Vahid, Gilead Sciences Inc. 333 Lakeside Drive, Foster City, California 94404, US

- (51) MKP
A61K 31/5395 2006 (97) EP 3661517
A61P 35/00 2006
C07D 273/04 2006
C07D 413/10 2006
C07D 417/10 2006
C07D 491/107 2006
 (96) EP 18755153.6 8/2/2018
 (97) EP 3661517, 6/10/2020 202024, en
 (31) 201762541627 P (32) 04.08.2017 (33) US
 (54) DIHYDROOXADIAZINONES
 (72) ELLERMANN, Manuel, Linienstr. 103, 10115 Berlin, DE
 GRADL, Stefan, Nikolaus, Rudolf-Ditzen-Weg 18/20, 13156 Berlin, DE
 KOPITZ, Charlotte, Christine, Ringstr. 33, 14612 Falkensee, DE
 LANGE, Martin, Reiterallee 77a, 13503 Berlin, DE
 TERSTEEGEN, Adrian, Rübzahlweg 8, 42111 Wuppertal, DE
 LIENAU, Philip, Jahnstr. 13, 10967 Berlin, DE
 HEGELE-HARTUNG, Christa, Leonhard-Stinnes-Str. 66, 45470 Mülheim an der Ruhr, DE
 SÜLZLE, Detlev, Otternweg 15, 13465 Berlin, DE
 LEWIS, Timothy, A., c/o The Broad Institute Inc. 415 Main Street, Cambridge Massachusetts 02142, US
 GREULICH, Heidi, c/o The Broad Institute Inc. 415 Main Street, Cambridge Massachusetts 02142, US
 WU, Xiaoyun, c/o The Broad Institute Inc. 415 Main Street, Cambridge Massachusetts 02142, US
 MEYERSON, Matthew, c/o Dana-Farber Cancer Institute Inc. 450 Brookline Avenue, Boston Massachusetts 02215, US
 BURGİN, Alex, c/o The Broad Institute Inc. 415 Main Street, Cambridge Massachusetts 02142, US

- (51) MKP
A61J 1/10 2006 (97) EP 3652491
F26B 5/06 2006
 (96) EP 18755314.4 7/16/2018
 (97) EP 3652491, 5/20/2020 202021, en
 (31) 201711359 (32) 14.07.2017 (33) GB

(54) PROCESS FOR LYOPHILISING A PRODUCT
 (72) CARITE, Christophe, 4D Pharma Plc 5th Floor Bond Court, Leeds LS1 2JZ, GB
 DECLOMESNIL, Sophie, 4D Pharma Plc 5th Floor Bond Court, Leeds LS1 2JZ, GB

(51) MKP
A61M 5/142 2006 (97) EP 3668567

(96) EP 18755372.2 7/31/2018
 (97) EP 3668567, 6/24/2020 202026, en
 (31) 201762547500 P (32) 18.08.2017 (33) US

(54) WEARABLE INJECTOR WITH STERILE ADHESIVE PATCH
 (72) NEKOUZADEH, Ali, 2485 Aurora Lane, Simi Valley, CA 93063, US
 OLIVAS, Jerome, 1456 Calle Colina, Thousand Oaks, CA 91360, US
 MERILOS, Joshua, 2421 Laurelpark Court, Thousand Oaks, CA 91362, US
 JANKE, Matthew, Wayne, 2795 Harrington Road, Simi Valley, CA 93065, US
 HARRIS, Justin, 5621 Baird Avenue, Reseda, CA 91335, US
 ORLOFF, Marc, 3512 Mesquite Drive, Calabasas, CA 91302, US
 NIELSEN, Edward, Stapleford, 263 Kennedy Avenue, Ventura, CA 93003, US
 NADIG, Chitra, 21335 Stanwell Street, Chatsworth, CA 91311, US
 DAMESTANI, Yasaman, 359 Hodencamp Road Apt. 134, Thousand Oaks, CA, US
 SONG, Guojie, 11254 Bentcreek Road, Moorpark, CA 93021, US
 DE GUIA, Bryton, One Amegen Center Drive, Thousand Oaks, CA 91320-1799, US

(51) MKP
A61K 9/00 2006 (97) EP 3651735
A61K 9/20 2006
A61K 9/50 2006
A61K 31/4439 2006

(96) EP 18755569.3 7/9/2018
 (97) EP 3651735, 5/20/2020 202021, en
 (31) 2017135046 (32) 10.07.2017 (33) JP

(54) PREPARATION COMPRISING VONOPRAZAN
 (72) FUJII, Hiroyuki, c/o TAKEDA PHARMACEUTICAL COMPANY LIMITED 17-85 Jusohonmachi 2-chome Yodogawa-ku, Osaka-shi Osaka 532-0024, JP
 SUZUKI, Akira, c/o TAKEDA CONSUMER HEALTHCARE COMPANY LIMITED 17-85 Jusohonmachi 2-chome Yodogawa-ku, Osaka-shi Osaka 532-0024, JP

(51) MKP
A61K 31/7125 2006 (97) EP 3658156
A61P 7/00 2006

(96) EP 18755608.9 7/27/2018
 (97) EP 3658156, 6/3/2020 202023, en
 (31) 201762538315 P (32) 28.07.2017 (33) US
 201762595329 P 06.12.2017 US
 201862685542 P 15.06.2018 US

(54) METHODS OF TREATING MYELODYSPLASTIC SYNDROME
 (72) RIZO, Aleksandra, 920 U.S. Route 202, Raritan New Jersey 08869, US
 BUSSOLARI, Jacqueline Cirillo, 920 US Route 202, Raritan New Jersey 08869, US

(51) MKP
A61K 31/416 2006 (97) EP 3652169
A61K 31/437 2006
A61K 31/519 2006
A61P 29/00 2006
C07D 403/12 2006
C07D 487/04 2006

(96) EP 18755621.2 7/31/2018
 (97) EP 3652169, 5/20/2020 202021, en
 (31) 201762539642 P (32) 01.08.2017 (33) US

(54) PYRAZOLO AND TRIAZOLO BICYCLIC COMPOUNDS AS JAK KINASE INHIBITORS
 (72) FENSTER, Erik, 535 Redwood Avenue, San Bruno California 94066, US
 LAM, Tom M., 1280 15th Avenue Apt. 201, San Francisco California 94122, US
 LOO, Mandy, 2119 Imwalle Court, San Jose California 95131, US

MCKINNELL, Robert Murray, 321 Poplar Avenue, Millbrae California 94030, US
 PALERMO, Anthony Francesco, 170 Scotia Avenue, San Francisco California 94124, US
 WANG, Diana Jin, 3590 Cydonia Ct., Dublin California 94568, US
 FRAGA, Breena, 9311 Road 29 1/2, Madera California 93637, US
 NZEREM, Jerry, 29 Woods Circle, South San Francisco California 94080, US
 DABROS, Marta, 888 Foster City Boulevard Apt. Q2, Foster City California 94404, US
 THALLADI, Venkat R., 888 Foster City Boulevard Apt. E3, Foster City California 94404, US
 RAPTA, Miroslav, 1240 Highland Court, San Carlos California 94070, US

(51) MKP
A61K 31/4196 2006 (97) EP 3661503
A61K 31/4439 2006
A61P 15/02 2006
A61P 31/10 2006
 (96) EP 18755632.9 7/31/2018
 (97) EP 3661503, 6/10/2020 202024, en
 (31) 201762541370 P (32) 04.08.2017 (33) US
 (54) ANTIFUNGAL AGENTS WITH ENHANCED ACTIVITY IN ACIDIC PH
 (71) Scynexis, Inc., 1 Evertrust Plaza, 13th Floor, Jersey City, NJ 07302, US
 (72) ANGULO GONZALEZ, David A., 8201 SW 180th Street, Palmetto Bay Florida 33157, US

(51) MKP
C07D 207/06 2006 (97) EP 3661915
C07D 207/263 2006
 (96) EP 18755654.3 8/2/2018
 (97) EP 3661915, 6/10/2020 202024, en
 (31) 201762540395 P (32) 02.08.2017 (33) US
 (54) PROCESSES FOR PREPARING PYRROLIDINE COMPOUNDS
 (72) ANGELL, Paul T., 50 Northern Avenue, Boston Massachusetts 02210, US
 LEWANDOWSKI, Berenice, 50 Northern Avenue, Boston Massachusetts 02210, US
 LITTLER, Benjamin J., 50 Northern Avenue, Boston Massachusetts 02210, US
 NUGENT, William A., 5065 Montview Way, Noblesville Indiana 46062, US
 SMITH, David, 50 Northern Avenue, Boston Massachusetts 02210, US
 STUDLEY, John, 50 Northern Avenue, Boston Massachusetts 02210, US
 HUGHES, Robert, M., 50 Northern Avenue, Boston, Massachusetts 02210, US

(51) MKP
A01N 63/00 2020 (97) EP 3661950
C07K 14/325 2006
C12N 15/82 2006
 (96) EP 18755657.6 8/2/2018
 (97) EP 3661950, 6/10/2020 202024, en
 (31) 201762540753 P (32) 03.08.2017 (33) US
 201862672193 P 16.05.2018 US
 (54) PESTICIDAL GENES AND METHODS OF USE
 (72) PARKS, Jessica, 115 Little Gem Lane, Apex, North Carolina 27560, US
 ROBERTS, Kira Bulazel, 1357 John Jones Road, Bahama North Carolina 27503, US
 THAYER, Rebecca E., 100 Hammond Wood Place, Morrisville North Carolina 27560, US

(51) MKP
G16H 20/10 2018 (97) EP 3665706
G16H 50/50 2018
 (96) EP 18755676.6 8/3/2018
 (97) EP 3665706, 6/17/2020 202025, en
 (31) 201715671310 (32) 08.08.2017 (33) US
 (54) GRAPHICAL USER INTERFACE FOR PERSONALIZED PREDICTION MODELING
 (72) BALABAN, David, J., 10457 Summer View Circle, Santa Rosa Valley, CA 93012, US
 BROWN, Allen, L., Jr., 11 94th Avenue NE, Bellevue, WA 98004, US
 GNACADJA, Gilles, 3865 Angeline Street, Newbury Park, CA 91320, US
 TOUPIKOV, Mikhail, 5548 Adelina Court, Agoura Hills, CA 91301, US
 DURST, Mark, J., 980 Estudillo Avenue, San Leandro, CA 94577, US
 LEWIS-SANDY, Darrell, L., 2725 NE West Port Madison Road, Bainbridge Island, WA 98100, US

(51)	MKP								
	B01D 11/04	2006	(97) EP 3658524						
	C07C 37/00	2006							
	C07C 37/70	2006							
	C07C 37/82	2006							
	C07C 39/23	2006							
	C07D 311/80	2006							
(96)	EP 18755722.8	7/26/2018							
(97)	EP 3658524,	6/3/2020 202023,	en						
(31)	201700085508			(32)	26.07.2017		(33)		IT
(54)	METHOD FOR THE PRODUCTION OF CANNABINOIDS FROM TYPES OF INDUSTRIAL HEMP								
(71)	Inalco S.r.l., Via A. Calabiana 18, 20139 Milano, IT								
(72)	CIPOLLETTI, Giovanni, Via Magolfa 13, 20143 Milano, IT								
	VAGNOLI, Luana, Loc. Quarata 141, 52040 Quarata - Arezzo, IT								
	MATULLI, Marina, Via Roma 66 Fraz. Molino del Pallone, 40045 Granaglione, IT								
	FEBBRUARI, Barbara, Via Baco 131/c Cantagrillo, 51034 Serravalle P.SE, IT								
	CHINI, Jacopo, Via A. Stoppani 26, 50131 Firenze, IT								
(51)	MKP								
	A61P 35/00	2006	(97) EP 3661960						
	C07K 16/10	2006							
	C07K 16/28	2006							
(96)	EP 18755732.7	8/2/2018							
(97)	EP 3661960,	6/10/2020 202024,	en						
(31)	PCT/EP2017/069839			(32)	04.08.2017		(33)		WO
	PCT/EP2018/052946				06.02.2018				WO
(54)	BINDING AGENTS BINDING TO PD-L1 AND CD137 AND USE THEREOF								
(72)	ALTINTAS, Isil, c/o Genmab B.V. Uppsalalaan 15, 3584 CT Utrecht, NL								
	SATIJN, David, c/o Genmab B.V. Uppsalalaan 15, 3584 CT Utrecht, NL								
	RADEMAKER, Rik, c/o Genmab B.V. Uppsalalaan 15, 3584 CT Utrecht, NL								
	PARREN, Paul, Werdorperwaard 17, 3984 PR Odijk, NL								
	SAHIN, Ugur, c/o BioNTech AG An der Goldgrube 12, 55131 Mainz, DE								
	GIESEKE, Friederike, c/o BioNTech AG An der Goldgrube 12, 55131 Mainz, DE								
	MUIK, Alexander, c/o BioNTech AG An der Goldgrube 12, 55131 Mainz, DE								
	GRUNWITZ, Christian, c/o BioNTech AG An der Goldgrube 12, 55131 Mainz, DE								
(51)	MKP								
	A61K 31/4192	2006	(97) EP 3668856						
	A61K 31/4196	2006							
	A61K 31/4439	2006							
	A61K 31/497	2006							
	A61K 31/501	2006							
	A61K 31/506	2006							
	A61P 31/06	2006							
	C07D 249/06	2006							
	C07D 257/04	2006							
	C07D 401/06	2006							
	C07D 403/06	2006							
	C07D 405/06	2006							
(96)	EP 18755815.0	8/16/2018							
(97)	EP 3668856,	6/24/2020 202026,	en						
(31)	17382574			(32)	17.08.2017		(33)		EP
(54)	NOVEL TETRAZOLE COMPOUNDS AND THEIR USE IN THE TREATMENT OF TUBERCULOSIS								
(72)	ALEMPARTE-GALLARDO, Carlos, GlaxoSmithKline Parque Tecnologico de Madrid Calle Doctor Severo Ochoa Tres Cantos, 28760 Madrid, ES								
	ENCINAS, Lourdes, GlaxoSmithKline Parque Tecnologico de Madrid Calle Doctor Severo Ochoa Tres Cantos, 28760 Madrid, ES								
	ESQUIVIAS PROVENCIO, Jorge, GlaxoSmithKline Parque Tecnologico de Madrid Calle Doctor Severo Ochoa Tres Cantos, 28760 Madrid, ES								
(51)	MKP								
	A23L 3/01	2006	(97) EP 3654778						
	A23L 33/00	2016							
	A23L 33/10	2016							

A61K 39/35 2006
A61P 37/00 2006
(96) EP 18755984.4 7/18/2018
(97) EP 3654778, 5/27/2020 202022, en
(31) 201762533826 P (32) 18.07.2017 (33) US
201762551395 P 29.08.2017 US
(54) METHODS FOR MAKING MIXED ALLERGEN COMPOSITIONS
(72) DOMBKOWSKI, Ashley, 560 Summit Springs Road, Woodside, CA 94062, US
CORNYN, Christopher, 241 La Questa Way, Woodside, CA 94062, US
ROSEVEAR, Albert E. Jr., 105 Walnut Street, Ithaca, NY 14850, US
WEIHE, Olivia M., 2250 North Triphammer Road Apt. FI-3, Ithaca, NY 14850, US
BELICIU, Cosmin M., 20 Oakcrest Road, Ithaca, NY 14850, US
RUSSELL, Alexandra F., 509 Lake Street Apt. F5, Ithaca, NY 14850, US
DE SENNA, Antoinette, 2441 Constitution Drive, Livermore, CA 94551, US

(51) MKP
A61K 39/00 2006 (97) EP 3658583
C07K 16/22 2006
C07K 16/28 2006
(96) EP 18756034.7 7/27/2018
(97) EP 3658583, 6/3/2020 202023, en
(31) 201762538476 P (32) 28.07.2017 (33) US
201762585148 P 13.11.2017 US
(54) LTBP COMPLEX-SPECIFIC INHIBITORS OF TGF-BETA 1 AND USES THEREOF
(71) Scholar Rock, Inc., 620 Memorial Drive, 2nd Floor, Cambridge, MA 02139, US
(72) SCHURPF, Thomas, 18 Cottage Park Avenue, Cambridge MA 02140, US
LITTLEFIELD, Christopher, 66 Lafayette Street, Marblehead MA 01945, US
CARVEN, Gregory, J., 89 Brooks Street, Maynard MA 01754, US
DATTA, Abhishek, 48 Hemman Street, Boston MA 02131, US

(51) MKP
A61K 9/00 2006 (97) EP 3661518
A61K 31/55 2006
A61P 1/14 2006
(96) EP 18756041.2 7/30/2018
(97) EP 3661518, 6/10/2020 202024, en
(31) 201762539229 P (32) 31.07.2017 (33) US
(54) METHODS OF TREATING SYMPTOMS OF GASTROPARESIS USING VELUSETRAG
(71) Alfasiigma S.p.A., Via Ragazzi del '99 n. 5, 40133 Bologna, IT
(72) BARNES, Christopher Noel, 32 Hidalgo Terrace, San Francisco California 94103, US
VISCOMI, Giuseppe Claudio, Alfasiigma S.P.A. Via Ragazzi del 99, 40133 Bologna, IT
RENZULLI, Cecilia, Alfasiigma S.P.A. Via Ragazzi del 99, 40133 Bologna, IT
GRIMALDI, Maria, Alfasiigma S.P.A. Via Ragazzi del 99, 40133 Bologna, IT

(51) MKP
H04L 9/32 2006 (97) EP 3652887
H04L 29/06 2006
(96) EP 18756275.6 7/10/2018
(97) EP 3652887, 5/20/2020 202021, en
(31) 201762530755 P (32) 10.07.2017 (33) US
(54) METHOD AND SYSTEM FOR DATA SECURITY WITHIN INDEPENDENT COMPUTER SYSTEMS AND DIGITAL NETWORKS
(71) Zamna Technologies Limited, 107 Cheapside, London EC2V 6DN, GB
(72) KHI, Irra, Ariella, c/o Orrick Herrington & Sutcliffe LLP 107 Cheapside, London EC2V 6DN, GB
GORELIK, Aleksandr, c/o Orrick Herrington & Sutcliffe LLP 107 Cheapside, London EC2V 6DN, GB

(51) MKP
B22F 3/105 2006 (97) EP 3638441
B29C 64/20 2017
B29C 64/264 2017
B29C 64/268 2017
B29C 64/277 2017
B33Y 10/00 2015
B33Y 30/00 2015

(96) EP 18756369.7 6/12/2018
 (97) EP 3638441, 4/22/2020 202017, en
 (31) 201700168 (32) 13.06.2017 (33) SI
 (54) A MACHINE AND A METHOD FOR ADDITIVE MANUFACTURING OF THREE-DIMENSIONAL OBJECTS
 (71) AIONIS, D.O.O., Svabiceva ulica 1, 1000 Ljubljana, SI
 (72) MUSEVIC, Natasa, Svabiceva 1, 1000 Ljubljana, SI

(51) MKP
A61K 38/40 2006 (97) EP 3665192
A61K 39/00 2006
C07K 14/705 2006
C07K 14/79 2006
 (96) EP 18756531.2 8/10/2018
 (97) EP 3665192, 6/17/2020 202025, en
 (31) 201762543658 P (32) 10.08.2017 (33) US
 201762583314 P 08.11.2017 US
 PCT/US2018/018371 15.02.2018 WO
 (54) ENGINEERED TRANSFERRIN RECEPTOR BINDING POLYPEPTIDES
 (72) CHEN, Xiaocheng, c/o Denali Therapeutics Inc. 151 Oyster Point Blvd. 2nd Floor, South San Francisco California 94080, US
 DENNIS, Mark S., c/o Denali Therapeutics Inc. 151 Oyster Point Blvd. 2nd Floor, South San Francisco California 94080, US
 KARIOLIS, Mihalios, c/o Denali Therapeutics Inc. 151 Oyster Point Blvd. 2nd Floor, South San Francisco California 94080, US
 SILVERMAN, Adam P., c/o Denali Therapeutics Inc. 151 Oyster Point Blvd. 2nd Floor, South San Francisco California 94080, US
 SRIVASTAVA, Ankita, c/o Denali Therapeutics Inc. 151 Oyster Point Blvd. 2nd Floor, South San Francisco California 94080, US
 WATTS, Ryan J., c/o Denali Therapeutics Inc. 151 Oyster Point Blvd. 2nd Floor, South San Francisco California 94080, US
 WELLS, Robert C., c/o Denali Therapeutics Inc. 151 Oyster Point Blvd. 2nd Floor, South San Francisco California 94080, US
 ZUCHERO, Joy Yu, c/o Denali Therapeutics Inc. 151 Oyster Point Blvd. 2nd Floor, South San Francisco California 94080, US

(51) MKP
A23L 2/60 2006 (97) EP 3665287
C12N 9/02 2006
C12N 9/10 2006
C12N 9/90 2006
C12N 15/81 2006
 (96) EP 18756533.8 8/10/2018
 (97) EP 3665287, 6/17/2020 202025, en
 (31) 201762544718 P (32) 11.08.2017 (33) US
 PCT/US2017/046637 11.08.2017 WO
 (54) PISUM SATIVUM KAURENE OXIDASE FOR HIGH EFFICIENCY PRODUCTION OF REBAUDIOSIDES
 (71) Amyris, Inc., 5885 Hollis Street, Suite 100, Emeryville, CA 94608, US
 (72) WICHMANN, Gale, c/o Amyris, Inc. 5885 Hollis Street Suite 100, Emeryville California 94608, US
 KHANKHOJE, Aditi, c/o Amyris, Inc. 5885 Hollis Street Suite 100, Emeryville California 94608, US
 MAHATDEJKUL-MEADOWS, Tina, c/o Amyris, Inc. 5885 Hollis Street Suite 100, Emeryville California 94608, US

(51) MKP
A61K 9/08 2006 (97) EP 3664780
A61K 31/166 2006
A61K 47/18 2017
A61K 47/26 2006
 (96) EP 18758700.1 8/13/2018
 (97) EP 3664780, 6/17/2020 202025, en
 (31) 201762544346 P (32) 11.08.2017 (33) US
 201713660 25.08.2017 GB
 (54) PHARMACEUTICAL COMPOSITIONS
 (72) COOK, Gary, 66 Griffin Road, Westford Massachusetts 01886, US
 MARSH, Sally, Louise, c/o Kalvista Pharmaceuticals Limited Building 227 Tetricus Science Park, Porton Down Salisbury SP4 0JQ, GB
 PETHEN, Stephen, John, c/o Kalvista Pharmaceuticals Limited Building 227 Tetricus Science Park, Porton Down Salisbury SP4 0JQ, GB
 ROE, Michael, Bryan, c/o Kalvista Pharmaceuticals Limited Building 227 Tetricus Science Park, Porton Down Salisbury SP4 0JQ, GB
 YEA, Christopher, Martyn, c/o Kalvista Pharmaceuticals Limited Building 227 Tetricus Science Park, Porton Down Salisbury SP4 0JQ, GB

(51) MKP
C02F 1/28 2006 (97) EP 3655365
D06F 39/10 2006
 (96) EP 18758750.6 7/19/2018

(97) EP 3655365, 5/27/2020 202022, en
 (31) PCT/SI2017/000019 (32) 20.07.2017 (33) WO
 (54) METHOD AND DEVICE FOR REMOVING PARTICLES FROM WASTE WATER
 (71) Planet Care Resitve za okolje, d.o.o, Stegne 21, 2000 Ljubljana, SI
 (72) ZUPAN, Mojca, Kokaljeva ulica 12, 1000 Ljubljana, SI

(51) MKP
A61K 8/00 2006 (97) EP 3661534
A61K 31/132 2006
A61K 31/4188 2006
A61K 36/53 2006
A61P 17/14 2006
 (96) EP 18758821.5 8/2/2018
 (97) EP 3661534, 6/10/2020 202024, en
 (31) 201700089680 (32) 03.08.2017 (33) IT
 (54) A SYNERGISTIC COMPOSITION AS A PROMOTER OF AUTOPHAGY
 (71) Giuliani S.p.A., Via Palagi, 2, 20129 Milano, IT
 (72) GIULIANI, Giammaria, Via Collina d'oro, 35, 6926 Montagnola, CH
 PAUS, Ralf, Hummelsbuetteler Kirchenweg 82, 22339 Hamburg, DE
 GRIMALDI, Benedetto, Via Ogerio Pane 3/21, 16135 Genova, IT
 MARZANI, Barbara, Via G. Marconi 13, 27020 Carbonara Al Ticino, IT
 BARONI, Sergio, Via Piazzolo 3, 24030 Villa D'Adda, IT

(51) MKP
G07G 1/00 2006 (97) EP 3659127
 (96) EP 18758936.1 7/26/2018
 (97) EP 3659127, 6/3/2020 202023, fr
 (31) 1757109 (32) 26.07.2017 (33) FR
 PCT/FR2017/052752 09.10.2017 WO
 (54) INSTALLATION AND METHOD FOR MANAGING PRODUCT DATA
 (72) JACQUET, Eric, 26 rue Chanoine Larose, 44100 Nanates, FR

(51) MKP
A61K 35/17 2015 (97) EP 3661528
C12N 5/0783 2010
 (96) EP 18759009.6 7/28/2018
 (97) EP 3661528, 6/10/2020 202024, en
 (31) 201762538671 P (32) 29.07.2017 (33) US
 201762596742 P 08.12.2017 US
 201862628889 P 09.02.2018 US
 201862665468 P 01.05.2018 US
 (54) REAGENTS FOR EXPANDING CELLS EXPRESSING RECOMBINANT RECEPTORS
 (72) HAUSKINS, Collin, 400 Dexter Ave. N Suite 1200, Seattle, Washington 98109, US
 HUSSELL, Scott, 400 Dexter Ave. N Suite 1200, Seattle, Washington 98109, US
 SIERRA, Catherine, 400 Dexter Ave. N Suite 1200, Seattle, Washington 98109, US
 WORKS, Melissa, 400 Dexter Ave. N Suite 1200, Seattle, Washington 98109, US

(51) MKP
A61K 31/64 2006 (97) EP 3668861
C07D 213/52 2006
C07D 231/18 2006
C07D 401/12 2006
C07D 401/14 2006
C07D 403/12 2006
C07D 405/04 2006
C07D 405/12 2006
C07D 407/12 2006
C07D 407/14 2006
C07D 413/12 2006
C07D 417/12 2006
C07D 471/08 2006

C07D 487/04 2006
C07D 491/048 2006
(96) EP 18759070.8 8/15/2018
(97) EP 3668861, 6/24/2020 202026, en
(31) 201713082 (32) 15.08.2017 (33) GB
201718563 09.11.2017 GB
201721726 22.12.2017 GB
201810983 04.07.2018 GB
(54) NOVEL SULFONAMIDE CARBOXAMIDE COMPOUNDS
(72) COOPER, Matthew, c/o Inflazome UK Limited D6 Grain House Mill Court, Great Shelford Cambridge CB22 5LD, GB
MILLER, David, c/o Inflazome UK Limited D6 Grain House Mill Court, Great Shelford Cambridge CB22 5LD, GB
MACLEOD, Angus, c/o Inflazome UK Limited D6 Grain House Mill Court, Great Shelford Cambridge CB22 5LD, GB
VAN WILTENBURG, Jimmy, c/o Syncom B.V. Kadijk 3, 9747 AT Groningen, NL
THOM, Stephen, c/o Sygnature Discovery Limited The Discovery Building BioCity Pennyfoot Street, Nottingham NG1 1GR, GB
ST-GALLAY, Stephen, c/o Sygnature Discovery Limited The Discovery Building BioCity Pennyfoot Street, Nottingham NG1 1GR, GB
SHANNON, Jonathan, c/o Sygnature Discovery Limited The Discovery Building BioCity Pennyfoot Street, Nottingham NG1 1GR, GB
ALANINE, Thomas, c/o Sygnature Discovery Limited The Discovery Building BioCity Pennyfoot Street, Nottingham NG1 1GR, GB
ONIONS, Stuart, c/o Sygnature Discovery Limited The Discovery Building BioCity Pennyfoot Street, Nottingham NG1 1GR, GB
STRUTT, Ian, c/o Sygnature Discovery Limited The Discovery Building BioCity Pennyfoot Street, Nottingham NG1 1GR, GB

(51) MKP
A61K 31/517 2006 (97) EP 3632912
A61P 17/06 2006
C07D 471/04 2006
(96) EP 18759146.6 5/31/2018
(97) EP 3632912, 4/15/2020 202016, en
(31) 201730759 (32) 01.06.2017 (33) ES
(54) PYRIDOQUINAZOLINE DERIVATIVES USEFUL AS PROTEIN KINASE INHIBITORS
(71) Oncostellae, S.L., Edificio FEUGA, D5 Campus Vida. Rúa Lope Gómez de Marzoa s/n, 15705 Santiago de Compostela, ES
(72) KURZ, Guido, Lluís Domenech i Montaner 6 Escalera 5, E-08950 Esplugues Llobregat Barcelona, ES
CAMACHO GÓMEZ, Juan, Estafeta 61 5-E, E-31001 Pamplona Navarra, ES

(51) MKP
G01N 1/34 2006 (97) EP 3662287
G01N 33/68 2006
(96) EP 18759204.3 8/1/2018
(97) EP 3662287, 6/10/2020 202024, en
(31) 201762539803 P (32) 01.08.2017 (33) US
(54) SYSTEMS AND METHODS FOR REAL TIME PREPARATION OF A POLYPEPTIDE SAMPLE FOR ANALYSIS WITH MASS SPECTROMETRY
(72) WU, Chao-Hsiang, 2812 Arbella Ln., Thousand Oaks CA 91362, US

(51) MKP
G01N 30/88 2006 (97) EP 3662288
G01N 33/68 2006
(96) EP 18759205.0 8/1/2018
(97) EP 3662288, 6/10/2020 202024, en
(31) 201762539798 P (32) 01.08.2017 (33) US
(54) SYSTEMS AND METHODS FOR PERFORMING A REAL-TIME GLYCAN ASSAY OF A SAMPLE
(72) WU, Chao-Hsiang, 2812 Arbella Ln., Thousand Oaks CA 91362, US

(51) MKP
A61K 47/54 2017 (97) EP 3661954
A61K 47/60 2017
C07K 14/54 2006
(96) EP 18759207.6 8/3/2018
(97) EP 3661954, 6/10/2020 202024, en
(31) 201762540692 P (32) 03.08.2017 (33) US
201862616733 P 12.01.2018 US
(54) INTERLEUKIN-21 MUTEINS AND METHODS OF TREATMENT
(72) ALI, Khaled, M.K.Z., One Amgen Center Drive, Thousand Oaks CA 91320, US
AGRAWAL, Neeraj, Jagdish, One Amgen Center Drive, Thousand Oaks CA 91320, US
KANNAN, Gunasekaran, One Amgen Center Drive, Thousand Oaks CA 91320, US
FOLTZ, Ian, One Amgen Center Drive, Thousand Oaks CA 91320, US

WANG, Zhulun, One Amgen Center Drive, Thousand Oaks CA 91320, US
 BATES, Daren, One Amgen Center Drive, Thousand Oaks CA 91320, US
 MOCK, Marissa, One Amgen Center Drive, Thousand Oaks CA 91320, US
 TAKENAKA, Shunseke, One Amgen Center Drive, Thousand Oaks CA 91320, US

- (51) MKP
A61K 31/513 2006 (97) EP 3661514
A61P 9/04 2006
A61P 9/10 2006
- (96) EP 18759209.2 8/3/2018
 (97) EP 3661514, 6/10/2020 202024, en
- (31) 201762541591 P (32) 04.08.2017 (33) US
 201762584537 P 10.11.2017 US
 201862639922 P 07.03.2018 US
 201862671585 P 15.05.2018 US
- (54) MAVACAMTEN FOR USE IN THE TREATMENT OF HYPERTROPHIC CARDIOMYOPATHY
 (72) SEMIGRAN, Marc J., 333 Allerton Avenue, South San Francisco California 94080, US
 LEE, June H., 333 Allerton Avenue, South San Francisco California 94080, US
 LAMBING, Joseph, 333 Allerton Avenue, South San Francisco California 94080, US
 GREEN, Eric, 333 Allerton Avenue, South San Francisco California 94080, US
 EVANCHIK, Marc, 333 Allerton Avenue, South San Francisco California 94080, US

- (51) MKP
A61M 5/142 2006 (97) EP 3664863
A61M 5/145 2006
- (96) EP 18759213.4 8/7/2018
 (97) EP 3664863, 6/17/2020 202025, en
- (31) 201762543058 P (32) 09.08.2017 (33) US
- (54) HYDRAULIC-PNEUMATIC PRESSURIZED CHAMBER DRUG DELIVERY SYSTEM
 (72) MOJARRAD, Mehran, 2389 Fountain Crest Lane 23, Thousand Oaks, CA 91362, US
 HOFFMAN, John, K., c/o Novo Engineering 1350 Specialty Drive Suite A, Vista, CA 92081, US
 FAUCHER, Paul, Daniel, 3424 Arborview Dr., San Marcos, CA 92078, US
 PACHECO, Matthew, c/o Novo Engineering 1350 Special Drive Suite A, Vista, CA 92018, US
 MAHER, Ed, 3650 Via Alicia, Oceanside, CA 92056, US

- (51) MKP
C12M 1/34 2006 (97) EP 3668966
C12M 1/42 2006
C12M 3/00 2006
C12N 5/0735 2010
C12N 5/077 2010
C12N 13/00 2006
G01N 27/27 2006
G01N 33/50 2006
- (96) EP 18759217.5 8/7/2018
 (97) EP 3668966, 6/24/2020 202026, en
- (31) 201762546445 P (32) 16.08.2017 (33) US
- (54) ADAPTIVE ELECTRODE ARRANGEMENT FOR IMPLEMENTATION IN A CELL INCUBATOR SYSTEM AND APPLICATIONS THEREOF
 (72) LI, Chuck, Z., 4565 Calle Norte, Thousand Oaks CA 91320, US
 SARICH, Brandon, Zachary, 367 Hodencamp Road 147, Thousand Oaks CA 91360, US
 NG, Phillip, 3533 Old Conejo Rd. Suite 112, Newbury Park CA 91320, US

- (51) MKP
A61P 3/10 2006 (97) EP 3668599
A61P 25/28 2006
A61P 29/00 2006
A61P 31/00 2006
A61P 35/00 2006
C07D 231/18 2006
C07D 233/84 2006
C07D 249/04 2006
C07D 249/12 2006
C07D 401/04 2006

	C07D 401/12	2006					
	C07D 403/04	2006					
	C07D 403/06	2006					
	C07D 403/12	2006					
	C07D 405/04	2006					
	C07D 405/12	2006					
	C07D 413/06	2006					
	C07D 417/04	2006					
	C07D 471/04	2006					
	C07D 487/04	2006					
(96)	EP 18759274.6 8/15/2018						
(97)	EP 3668599, 6/24/2020 202026, en						
(31)	201713082		(32)	15.08.2017		(33)	GB
	201718563			09.11.2017			GB
	201721731			22.12.2017			GB
	201721726			22.12.2017			GB
	201810983			04.07.2018			GB
(54)	SULFONYLUREAS AND SULFONYLTHIOUREAS AS NLRP3 INHIBITORS						
(72)	COOPER, Matthew, c/o Inflazome UK Limited D6 Grain House Mill Court, Great Shelford Cambridge CB22 5LD, GB						
	MILLER, David, c/o Inflazome UK Limited D6 Grain House Mill Court, Great Shelford Cambridge CB22 5LD, GB						
	MACLEOD, Angus, c/o Inflazome UK Limited D6 Grain House Mill Court, Great Shelford Cambridge CB22 5LD, GB						
	THOM, Stephen, c/o Sygnature Discovery Limited The Discovery Building BioCity Pennyfoot Street, Nottingham NG1 1GR, GB						
	ST-GALLAY, Stephen, c/o Sygnature Discovery Limited The Discovery Building BioCity Pennyfoot Street, Nottingham NG1 1GR, GB						
	SHANNON, Jonathan, c/o Sygnature Discovery Limited The Discovery Building BioCity Pennyfoot Street, Nottingham NG1 1GR, GB						
	ALANINE, Thomas, c/o Sygnature Discovery Limited The Discovery Building BioCity Pennyfoot Street, Nottingham NG1 1GR, GB						
	ONIONS, Stuart, c/o Sygnature Discovery Limited The Discovery Building BioCity Pennyfoot Street, Nottingham NG1 1GR, GB						
	STRUTT, Ian, c/o Sygnature Discovery Limited The Discovery Building BioCity Pennyfoot Street, Nottingham NG1 1GR, GB						
	CARRILLO ARREGUI, Jokin, c/o Sygnature Discovery Limited The Discovery Building BioCity Pennyfoot Street, Nottingham NG1 1GR, GB						
(51)	MKP						
	A61K 31/575	2006	(97)	EP 3661945			
	A61P 5/44	2006					
	C07J 63/00	2006					
(96)	EP 18759491.6 8/6/2018						
(97)	EP 3661945, 6/10/2020 202024, en						
(31)	201762541095 P		(32)	04.08.2017		(33)	US
(54)	GLYCYRRHETINIC ACID DERIVATIVES FOR TREATING HYPERKALEMIA						
(71)	Ardelyx, Inc., 34175 Ardenwood Blvd., Suite 200, Fremont, California 94555, US						
(72)	LUEHR, Gary, 8443 Hialeah Way, Fair Oaks, California 95628, US						
	DRAGOLI, Dean, 34175 Ardenwood Blvd. Suite 200, Fremont, California 94555, US						
	LEADBETTER, Michael, 34175 Ardenwood Blvd. Suite 200, Fremont, California 94555, US						
	CHEN, Tao, 34175 Ardenwood Blvd. Suite 200, Fremont, California 94555, US						
	LEWIS, Jason, 34175 Ardenwood Blvd. Suite 200, Fremont, California 94555, US						
(51)	MKP						
	A61K 31/437	2006	(97)	EP 3664802			
	A61P 25/28	2006					
(96)	EP 18759502.0 8/7/2018						
(97)	EP 3664802, 6/17/2020 202025, en						
(31)	201762541807 P		(32)	07.08.2017		(33)	US
(54)	BICYCLIC INHIBITORS OF HISTONE DEACETYLASE						
(71)	Rodin Therapeutics, Inc., 852 Winter Street, Waltham, MA 02451, US						
(72)	FULLER, Nathan, Oliver, 66 Freeman Street 2, Arlington, MA 02474, US						
	LOWE, John, A.III, 28 Coveside Lane, Stonington, CT 06378, US						
(51)	MKP						
	A61K 31/195	2006	(97)	EP 3664792			
	A61P 9/08	2006					
(96)	EP 18759520.2 8/7/2018						
(97)	EP 3664792, 6/17/2020 202025, en						
(31)	201762541956 P		(32)	07.08.2017		(33)	US
	201862711369 P			27.07.2018			US
(54)	METHODS OF TREATMENT						

(72) ADAMS, John W., 2515 Geranium Street, San Diego, California 92109, US
 ANDERSON, Christen M., 2632 South St. Louis Avenue, Tulsa, Oklahoma 74114, US
 SHANAHAN, William R., 4948 Rancho Viejo Drive, Del Mar, California 92014, US

(51) MKP
E04B 1/24 2006 (97) EP 3669033
E04B 1/348 2006
E04B 9/06 2006
E04C 3/04 2006
E04C 3/07 2006

(96) EP 18759550.9 8/7/2018

(97) EP 3669033, 6/24/2020 202026, en

(31) PCT/EP2017/000997 (32) 18.08.2017 (33) WO

(54) MODULAR SYSTEM FOR CREATING A STRUCTURE, MODULE CONNECTOR AND STRUCTURE COMPRISING A MODULAR SYSTEM

(72) BINDER, Joachim, Pürbach 108, 3944 Pürbach, AT

(51) MKP
A61K 31/64 2006 (97) EP 3668601
A61P 1/00 2006
A61P 9/00 2006
A61P 11/00 2006
A61P 13/12 2006
A61P 15/00 2006
A61P 17/00 2006
A61P 25/00 2006
A61P 31/00 2006
A61P 37/00 2006

(96) EP 18759581.4 8/15/2018

(97) EP 3668601, 6/24/2020 202026, en

(31)	201713083	(32)	15.08.2017	(33)	GB
	201713082		15.08.2017		GB
	201713079		15.08.2017		GB
	201718564		09.11.2017		GB
	201718563		09.11.2017		GB
	201718561		09.11.2017		GB
	201721726		22.12.2017		GB
	201810983		04.07.2018		GB
	201812225		26.07.2018		GB

(54) NOVEL SULFONAMIDE CARBOXAMIDE COMPOUNDS

(72) MILLER, David, c/o Inflazome UK Limited D6 Grain House Mill Court, Great Shelford Cambridge CB22 5LD, GB
 MACLEOD, Angus, c/o Inflazome UK Limited D6 Grain House Mill Court, Great Shelford Cambridge CB22 5LD, GB
 VAN WILTENBURG, Jimmy, c/o Syncom B.V. Kadijk 3, 9747 AT Groningen, NL
 THOM, Stephen, c/o Sygnature Discovery Limited The Discovery Building BioCity Pennyfoot Street, Nottingham NG1 1GR, GB
 ST-GALLAY, Stephen, c/o Sygnature Discovery Limited The Discovery Building BioCity Pennyfoot Street, Nottingham NG1 1GR, GB
 SHANNON, Jonathan, c/o Sygnature Discovery Limited The Discovery Building BioCity Pennyfoot Street, Nottingham NG1 1GR, GB

(51) MKP
A61K 47/68 2017 (97) EP 3661562
C07K 14/605 2006
C07K 16/00 2006

(96) EP 18759787.7 8/3/2018

(97) EP 3661562, 6/10/2020 202024, en

(31) 201762541522 P (32) 04.08.2017 (33) US

(54) METHOD OF CONJUGATION OF CYS-MABS

(72) ACHMATOWICZ, Michal, 1655 Woodscent Lane, Simi Valley California 93065, US
 ROMANINI, Dante, 5921 Tobias Avenue, Sherman Oaks California 91411, US
 FALSEY, James R., 13209 Peach Hill Road, Moorpark California 93021, US
 HERBERICH, Bradley J., 1746 Hays Drive, Newbury Park California 91320, US
 THIEL, Oliver R., 5174 Via Pisa, Thousand Oaks California 91320, US

(51) MKP

A61K 47/68 2017 (97) EP 3661963
A61P 35/00 2006
C07K 16/28 2006
(96) EP 18760047.3 7/31/2018
(97) EP 3661963, 6/10/2020 202024, en
(31) 201762539825 P (32) 01.08.2017 (33) US
201762596194 P 08.12.2017 US
(54) BCMA MONOCLONAL ANTIBODY-DRUG CONJUGATE
(72) KINNEER, Krista, c/o MedImmune, LLC One MedImmune Way, Gaithersburg, Maryland 20878, US
VARKEY, Reena, c/o MedImmune, LLC One MedImmune Way, Gaithersburg, Maryland 20878, US
XIAO, Xiaodong, 2201 Banner Hill Road, Frederick, Maryland 21702, US
HURT, Elaine M., c/o MedImmune, LLC One MedImmune Way, Gaithersburg, Maryland 20878, US
TICE, David, c/o MedImmune, LLC One MedImmune Way, Gaithersburg, Maryland 20878, US

(51) MKP
A61K 31/519 2006 (97) EP 3661519
A61K 31/55 2006
A61K 45/06 2006
A61P 35/00 2006
(96) EP 18760055.6 8/1/2018
(97) EP 3661519, 6/10/2020 202024, en
(31) 201762540594 P (32) 03.08.2017 (33) US
(54) THERAPEUTIC COMBINATION OF A THIRD GENERATION EGFR TYROSINE KINASE INHIBITOR AND A CYCLIN D KINASE INHIBITOR
(72) MOODY, Susan, c/o Novartis Institutes for BioMedical Research Inc. 250 Massachusetts Avenue, Cambridge, MA 02139, US
MULFORD, Iain, c/o Novartis Institutes for BioMedical Research Inc. 250 Massachusetts Avenue, Cambridge, MA 02139, US
BARRETINA, Jordi, c/o Novartis Institutes for BioMedical Research Inc. 250 Massachusetts Avenue, Cambridge, MA 02139, US

(51) MKP
A61K 31/5377 2006 (97) EP 3661516
A61K 31/55 2006
A61K 45/06 2006
A61P 35/00 2006
(96) EP 18760056.4 8/1/2018
(97) EP 3661516, 6/10/2020 202024, en
(31) 201762540595 P (32) 03.08.2017 (33) US
(54) THERAPEUTIC COMBINATION OF A THIRD-GENERATION EGFR TYROSINE KINASE INHIBITOR AND A RAF INHIBITOR
(72) MOODY, Susan, c/o Novartis Institutes for BioMedical Research Inc. 250 Massachusetts Avenue, Cambridge, MA 02139, US
PETRUZZELLI, Lilli, c/o Novartis Institutes for BioMedical Research Inc. 250 Massachusetts Avenue, Cambridge, MA 02139, US
ENGELMAN, Jeffrey, c/o Novartis Institutes for BioMedical Research Inc. 250 Massachusetts Avenue, Cambridge, MA 02139, US

(51) MKP
A61K 31/7064 2006 (97) EP 3665179
A61P 35/00 2006
A61P 35/02 2006
C07H 19/14 2006
(96) EP 18760136.4 8/9/2018
(97) EP 3665179, 6/17/2020 202025, en
(31) 201762543141 P (32) 09.08.2017 (33) US
201862630581 P 14.02.2018 US
201862664442 P 30.04.2018 US
(54) SELECTIVE INHIBITORS OF PROTEIN ARGININE METHYLTRANSFERASE 5 (PRMT5)
(71) Prelude Therapeutics, Incorporated, 200 Powder Mill Road Experimental Station E440/3213, Wilmington, DE 19803, US
(72) LUENGO, Juan, 50 Amherst Ct., Phoenixville PA 19460, US
LIN, Hong, 11 Fairwind Lane, Exton PA 19341, US
SHETTY, Rupa, 712 Amberley Drive, Blue Bell PA 19422, US
HAWKINS, Michael, 318 Heckler St., Ambler PA 19002, US

(51) MKP
A61K 31/4365 2006 (97) EP 3665169
A61K 31/496 2006
A61K 31/4995 2006
A61K 31/5386 2006
A61K 31/551 2006

	A61P 35/00	2006					
	C07D 405/14	2006					
	C07D 471/04	2006					
	C07D 487/04	2006					
	C07D 495/04	2006					
	C07D 519/00	2006					
(96)	EP 18760137.2 8/9/2018						
(97)	EP 3665169, 6/17/2020 202025, en						
(31)	201762544083 P		(32)	11.08.2017		(33)	US
(54)	CARBOXAMIDES AS UBIQUITIN-SPECIFIC PROTEASE INHIBITORS						
(72)	ZABLOCKI, Mary-Margaret, 500 Arsenal Street Suite 100, Watertown Massachusetts 02472, US						
	GUERIN, DavidJ., 500 Arsenal Street Suite 100, Watertown Massachusetts 02472, US						
	NG, Pui Yee, 500 Arsenal Street Suite 100, Watertown Massachusetts 02472, US						
	WANG, Zhongguo, 500 Arsenal Street Suite 100, Watertown Massachusetts 02472, US						
	SHELEKHIN, Tatiana, 500 Arsenal Street Suite 100, Watertown Massachusetts 02472, US						
	CARAVELLA, Justin, 500 Arsenal Street Suite 100, Watertown Massachusetts 02472, US						
	LI, Hongbin, 500 Arsenal Street Suite 100, Watertown Massachusetts 02472, US						
	IOANNIDIS, Stephanos, 500 Arsenal Street Suite 100, Watertown Massachusetts 02472, US						
<hr/>							
(51)	MKP						
	A61K 35/17	2015	(97)	EP 3664820			
	A61K 39/00	2006					
	A61K 39/395	2006					
	A61K 39/44	2006					
	C12N 5/0783	2010					
(96)	EP 18760159.6 8/9/2018						
(97)	EP 3664820, 6/17/2020 202025, en						
(31)	201762543363 P		(32)	09.08.2017		(33)	US
	201762596770 P			08.12.2017			US
(54)	METHODS FOR PRODUCING GENETICALLY ENGINEERED CELL COMPOSITIONS AND RELATED COMPOSITIONS						
(72)	MUJACIC, Mirna, 400 Dexter Ave. N Suite 1200, Seattle Washington 98109, US						
	RAHARDJO, Ayu, 400 Dexter Ave. N Suite 1200, Seattle Washington 98109, US						
<hr/>							
(51)	MKP						
	A61K 39/00	2006	(97)	EP 3664835			
	C12N 5/0783	2010					
(96)	EP 18760160.4 8/9/2018						
(97)	EP 3664835, 6/17/2020 202025, en						
(31)	201762543359 P		(32)	09.08.2017		(33)	US
(54)	METHODS AND COMPOSITIONS FOR PREPARING GENETICALLY ENGINEERED CELLS						
(72)	BONYHADI, Mark L., 400 Dexter Ave N Suite 1200, Seattle Washington 98109, US						
<hr/>							
(51)	MKP						
	A61K 31/505	2006	(97)	EP 3645003			
	A61K 31/513	2006					
	A61K 31/675	2006					
(96)	EP 18823998.2 6/27/2018						
(97)	EP 3645003, 5/6/2020 202019, en						
(31)	201762527169 P		(32)	30.06.2017		(33)	US
	201762535290 P			21.07.2017			US
	201717131			18.10.2017			GB
	201719377			22.11.2017			GB
	201762589576 P			22.11.2017			US
	201806490			20.04.2018			GB
(54)	COMBINATION AND USES AND TREATMENTS THEREOF						
(72)	CAMPBELL, Kenneth Churchill, David Jack Centre Park Road, Ware Hertfordshire SG12 0DP, GB						
	DELAET, Urbain Alfons C., c/o Janssen Pharmaceutica NV Turnhoutseweg 30, B-2340 Beerse, BE						
	GUAQUIÈRE, Juliette Segolène, David Jack Centre Park Road, Ware Hertfordshire SG12 0DP, GB						
	LAUGHERY, Thomas, 5 Moore Drive, Research Triangle Park, NC 27709-3398, US						
	LIMET, Dominique J., 980 Great West Road, Brentford Middlesex TW8 9GS, GB						
	POTTAGE, John C., 1250 South Collegeville Road, Collegeville PA 19426-0989, US						
	RENOU, Ludovic Sylvain Marc, Gunnels Wood Road, Stevenage Hertfordshire SG1 2NY, GB						
	SCOTT, Trevor R., 5 Moore Drive, Research Triangle Park NC 27709-3398, US						

SEILER, Christian, 980 Great West Road, Brentford Middlesex TW8 9GS, GB
 WOODWARD, Mary, David Jack Centre Park Road, Ware Hertfordshire SG12 0DP, GB

- (51) MKP
A61K 31/435 2006 (97) EP 3645526
A61P 35/00 2006
C07D 403/02 2006
C07D 403/14 2006
- (96) EP 18824291.1 6/26/2018
 (97) EP 3645526, 5/6/2020 202019, en
- (31) PCT/CN2017/090267 (32) 27.06.2017 (33) WO
- (54) NEW QUINOLINONE COMPOUNDS
- (72) GUO, Haibing, 5F Building 1 Jinchuang Mansion No.4560 Jinke Road Pudong District, Shanghai 201210, CN
 WAN, Zhao-Kui, 30 Sanderson Road, Lexington Massachusetts 02420, US
 QIN, Luoheng, 888/23/1901 Jinxiu Rd., Shanghai 200135, CN
 LIU, Qian, Rm 704 Building 174 715 Wanxia Rd. Pudong District, Shanghai 201202, CN
 CHEUNG, Wing Shun, Rm 301 Building 7 Yinxiao Road 100 Long Pudong District, Shanghai 201204, CN

- (51) MKP
A61K 31/396 2006 (97) EP 3645120
A61K 31/425 2006
A61K 45/06 2006
A61P 25/24 2006
C07D 498/04 2006
- (96) EP 18824955.1 6/28/2018
 (97) EP 3645120, 5/6/2020 202019, en
- (31) 201762527215 P (32) 30.06.2017 (33) US
- (54) NK-1 ANTAGONIST COMPOSITIONS AND METHODS FOR USE IN TREATING DEPRESSION
- (71) Chase Pharmaceuticals Corporation, 1825 K Street N.W. Suite 520, Washington, District of Columbia 20006, US
 (72) CHASE, Thomas, N., c/o Chase Therapeutics Corporation 1825 K Street NW Suite 520, Washington District of Columbia 20006, US
 CLARENCE-SMITH, Kathleen, E., c/o Chase Therapeutics Corporation 1825 K Street NW Suite 520, Washington District of Columbia 20006, US

- (51) MKP
A61K 31/437 2006 (97) EP 3646869
A61K 39/395 2006
A61K 45/00 2006
A61P 35/00 2006
A61P 37/04 2006
A61P 43/00 2006
C07D 471/04 2006
- (96) EP 18825157.3 6/29/2018
 (97) EP 3646869, 5/6/2020 202019, en
- (31) 2017128823 (32) 30.06.2017 (33) JP
 2017177390 15.09.2017 JP
 2018099931 24.05.2018 JP
- (54) CHEMOTHERAPY FOR CANCER USING AZABICYCLO COMPOUND
- (72) OHKUBO, Shuichi, c/o Taiho Pharmaceutical Co., Ltd. 2-4 Uchi-Kanda 1-chome Chiyoda-ku, Tokyo 101-0047, JP

- (51) MKP
C07K 1/13 2006 (97) EP 3650470
C07K 16/30 2006
C12N 1/15 2006
C12N 1/19 2006
C12N 1/21 2006
C12N 5/10 2006
C12N 15/13 2006
C12N 15/63 2006
C12P 21/08 2006
G01N 33/574 2006
- (96) EP 18827622.4 7/6/2018
 (97) EP 3650470, 5/13/2020 202020, en
- (31) 2017133698 (32) 07.07.2017 (33) JP
- (54) NOVEL ANTI-HUMAN CEACAM5 ANTIBODY FAB FRAGMENT

(72) DOIHARA, Hitoshi, c/o Astellas Pharma Inc. 5-1, Nihonbashi-Honcho 2-chome Chuo-ku, Tokyo 103-8411, JP
HIRAYAMA, Kazunori, c/o Astellas Pharma Inc. 5-1, Nihonbashi-Honcho 2-chome Chuo-ku, Tokyo 103-8411, JP
SHIRAI, Hiroki, c/o Astellas Pharma Inc. 5-1, Nihonbashi-Honcho 2-chome Chuo-ku, Tokyo 103-8411, JP

(51) MKP
A61K 31/22 2006 (97) EP 3648756
A61K 31/366 2006
A61K 31/40 2006
A61K 31/428 2006
A61K 31/44 2006
A61K 31/47 2006
A61K 31/505 2006
A61P 25/16 2006
A61P 25/28 2006

(96) EP 18827639.8 7/3/2018

(97) EP 3648756, 5/13/2020 202020, en

(31) 201762528204 P (32) 03.07.2017 (33) US

(54) STATIN COMPOSITIONS AND METHODS FOR USE IN TREATING SYNUCLEINOPATHIES

(71) Chase Therapeutics Corporation, 1825 K Street N.W. Suite 520, Washington, DC 20037-3213, US

(72) CHASE, Thomas N., c/o CHASE THERAPEUTICS CORPORATION 1825 K Street NW Suite 520, Washington District of Columbia 20006, US
 CLARENCE-SMITH, Kathleen E., c/o CHASE THERAPEUTICS CORPORATION 1825 K Street NW Suite 520, Washington District of Columbia 20006, US

(51) MKP
A61K 31/737 2006 (97) EP 3648775
A61K 38/01 2006
A61K 38/04 2006
A61K 38/39 2006
A61L 33/08 2006
A61P 1/16 2006

(96) EP 18827869.1 7/9/2018

(97) EP 3648775, 5/13/2020 202020, en

(31) 201762530066 P (32) 07.07.2017 (33) US

(54) BICONJUGATES WITH CHEMICALLY MODIFIED BACKBONES

(72) PADERI, John Eric, c/o Symic Bio Inc. 5980 Horton Street Suite 600, Emeryville, California 94608, US

PRESTWICH, Glenn, c/o Symic Bio Inc. 5980 Horton Street Suite 600, Emeryville, California 94608, US

STUART, Katherine Allison, c/o Symic Bio Inc. 5980 Horton Street Suite 600, Emeryville, California 94608, US

KABRA, Harsha, c/o Symic Bio Inc. 5980 Horton Street Suite 600, Emeryville, California 94608, US

IKWA, Elvis, c/o Symic Bio Inc. 5980 Horton Street Suite 600, Emeryville, California 94608, US

(51) MKP
A61K 9/10 2006 (97) EP 3648767
A61K 31/519 2006
A61P 29/00 2006

(96) EP 18827979.8 7/4/2018

(97) EP 3648767, 5/13/2020 202020, en

(31) PCT/CN2017/091819 (32) 05.07.2017 (33) WO
 PCT/CN2018/087058 16.05.2018 WO

(54) TOPICAL FORMULATIONS COMPRISING MONTELUKAST AND COMBINATIONS WITH MUSSEL ADHESIVE PROTEINS

(71) Jiangyin Mucocare Pharmaceutical Co., Ltd, B13, No. 2, Dongsheng West Road, Jiangyin, Jiangsu 214437, CN

(72) SAMUELSSON, Bengt Ingemar, Scheeles Vag 2 Scheeellaboratoriet Hus A4 Plan 4, 171 77 Stockholm, SE

GU, Ming, B13 No. 2 Dongsheng West Road, Jiangyin Jiangsu 214437, CN

(51) MKP
B65D 81/20 2006 (97) EP 3632816

(96) EP 18828699.1 1/29/2018

(97) EP 3632816, 7/1/2020 202027, en

(31) 201706859 U (32) 03.07.2017 (33) UA

(54) READY-TO-EAT FOOD PRODUCT IN VACUUM PACKAGING

(71) Gostyukhina, Ella Vasyilivna, Str. Profspilkova 154A, Khmelnitsky 29000, UA

(72) Gostyukhina, Ella Vasyilivna, Str. Profspilkova 154A, Khmelnitsky 29000, UA

(51) MKP
A61K 38/17 2006 (97) EP 3648785
A61P 17/00 2006
C07D 215/00 2006
(96) EP 18829003.5 7/4/2018
(97) EP 3648785, 5/13/2020 202020, en
(31) PCT/CN2017/091818 (32) 05.07.2017 (33) WO
(54) ANTI-INFLAMMATORY USE OF PEPTIDE
(71) Jiangyin Usun Pharmaceutical Co., Ltd., B13 No. 2 Dongsheng West Road, Jiangyin, Jiangsu 214437, CN
(72) SAMUELSSON, Bengt Ingemar, Scheeles Vag 2 Scheeelaboratoriet Hus A4 Plan 4, SE-171 77 Stockholm, SE
GU, Ming, B13 No. 2 Dongsheng West Road, Jiangyin Jiangsu 214437, CN

(51) MKP
A61K 31/715 2006 (97) EP 3648774
A61K 31/727 2006
A61K 31/728 2006
A61K 31/737 2006
A61K 38/00 2006
A61K 38/08 2019
(96) EP 18829053.0 7/9/2018
(97) EP 3648774, 5/13/2020 202020, en
(31) 201762530047 P (32) 07.07.2017 (33) US
(54) SYNTHETIC BIOCONJUGATES
(72) PADERI, John Eric, c/o Symic IP, LLC 1400 Pine Street No. 640505, San Francisco, California 94164, US
CHEN, Julia, c/o Symic IP, LLC 1400 Pine Street No. 640505, San Francisco, California 94164, US
SAHA, Sharmistha, c/o Symic IP, LLC 1400 Pine Street No. 640505, San Francisco, California 94164, US

(51) MKP
A61K 41/00 2020 (97) EP 3651801
(96) EP 18831089.0 7/11/2018
(97) EP 3651801, 5/20/2020 202021, en
(31) 201762531788 P (32) 12.07.2017 (33) US
(54) COMPOSITIONS AND METHODS FOR THE TREATMENT OF FUNGAL INFECTIONS
(72) BARTIZAL, Kenneth, 7520 Draper Avenue Unit 5, La Jolla, CA 92037, US
DARUWALA, Paul, 1141 Luneta Drive, Del Mar, CA 92014, US
HUGHES, David, 6755 Mira Mesa Boulevard Suite 123-217, San Diego, CA 92121, US
HUGHES, Martin, Patrick, 1402 East Houghton Court, Spokane, WA 99217, US
MALKAR, Navdeep, B., 313 Arlington Ridge Road, Cary, NC 27513, US
RADHAKRISHNAN, Balasingam, 209 Faison Road, Chapel Hill, NC 27517, US
VAIDYA, Anuradha, 100 New Londondale Drive, Cary, NC 27513, US

(51) MKP
B82Y 10/00 2011 (97) EP 3652106
G21K 1/00 2006
G21K 1/02 2006
(96) EP 18831504.8 7/13/2018
(97) EP 3652106, 5/20/2020 202021, en
(31) 201762531993 P (32) 13.07.2017 (33) US
201762589716 P 22.11.2017 US
(54) NEUTRAL ATOM QUANTUM INFORMATION PROCESSOR
(71) California Institute of Technology, 1200 East California Boulevard M/C 6-32, Pasadena, CA 91125, US
(72) KEESLING CONTRERAS, Alexander, 21 Ridgmont Street, Cambridge, Massachusetts 02135, US
BERNIEN, Hannes, 57 Bromfield Road, Somerville, Massachusetts 02144, US
SCHWARTZ, Sylvain, 35 Waterhouse Street, Somerville, Massachusetts 02144, US
LEVINE, Harry, Jay, 1537 Cambridge Street, Cambridge, Massachusetts 02139, US
OMRAN, Ahmed, 368 Washington Street, Somerville, Massachusetts 02143, US
LUKIN, Mikhail, D., 79 Larchwood Drive, Cambridge, Massachusetts 02138, US
VULETIC, Vladan, 9 Union Street, Cambridge, Massachusetts 02139, US
ENDRES, Manuel, West Bridge 154, Pasadena, California 91125, US
GREINER, Markus, 60 Carleton Rd., Belmont, Massachusetts 02478, US
PICHLER, Hannes, 24 Concord Avenue, 106, Cambridge, Massachusetts 02138, US
ZHOU, Leo, 24 Bolton Street Apt.31, Somerville Massachusetts 02143, US
WANG, Shengtao, 21 Carlton Street, 1, Somerville, Massachusetts 02153, US

CHOI, Soonwon, 17 Oxford Street, Cambridge, Massachusetts 02138, US
 KIM, Donggyu, 540 Memorial Drive Apt. 406, Cambridge, Massachusetts 02139, US
 ZIBROV, Alexander S., 65 Walden Street, Cambridge, Massachusetts 02140, US

- (51) MKP
A61K 31/381 2006 (97) EP 3651761
A61K 31/397 2006
C07K 14/47 2006
C07K 16/28 2006
- (96) EP 18831816.6 1/18/2018
 (97) EP 3651761, 5/20/2020 202021, en
- (31) 201762530125 P (32) 08.07.2017 (33) US
 201762535589 P 21.07.2017 US
- (54) SCREENING PLATFORM TO IDENTIFY THERAPEUTIC DRUGS OR AGENTS FOR TREATMENT OF ALZHEIMER'S DISEASE
 (72) TANZI, Rudolph E., 70 Black Rock Road, Cohasset, Massachusetts 02025, US
 QUINTI, Luisa, c/o The General Hospital Corporation 55 Fruit Street, Boston, Massachusetts 02114, US
 KIM, Doo Yeon, c/o The General Hospital Corporation 55 Fruit Street, Boston, Massachusetts 02114, US

- (51) MKP
A61K 31/5355 2006 (97) EP 3653623
A61P 25/20 2006
C07D 265/06 2006
C07D 413/14 2006
- (96) EP 18831921.4 7/11/2018
 (97) EP 3653623, 5/20/2020 202021, en
- (31) 2017137277 (32) 13.07.2017 (33) JP
- (54) METHOD FOR PRODUCING (2S)-2-[(1H-PYRAZOL-1-YL)METHYL]-1,3-OXAZINANE DERIVATIVE
 (72) MATSUBARA, Takaaki, c/o Taisho Pharmaceutical Co. Ltd. 24-1 Takada 3-chome Toshima-ku, Tokyo 170-8633, JP
 URABE, Hiroki, c/o Taisho Pharmaceutical Co. Ltd. 24-1 Takada 3-chome Toshima-ku, Tokyo 170-8633, JP
 SUZUKI, Ryo, c/o Taisho Pharmaceutical Co. Ltd. 24-1 Takada 3-chome Toshima-ku, Tokyo 170-8633, JP
 FUTAMURA, Aya, c/o Taisho Pharmaceutical Co. Ltd. 24-1 Takada 3-chome Toshima-ku, Tokyo 170-8633, JP
 KINOSHITA, Ryo, c/o Taisho Pharmaceutical Co. Ltd. 24-1 Takada 3-chome Toshima-ku, Tokyo 170-8633, JP
 HATTORI, Nobutaka, c/o Taisho Pharmaceutical Co. Ltd. 24-1 Takada 3-chome Toshima-ku, Tokyo 170-8633, JP
 TABUSE, Hideaki, c/o Taisho Pharmaceutical Co. Ltd. 24-1 Takada 3-chome Toshima-ku, Tokyo 170-8633, JP
 IMURA, Koreaki, c/o Taisho Pharmaceutical Co. Ltd. 24-1 Takada 3-chome Toshima-ku, Tokyo 170-8633, JP
 OTAKE, Norikazu, c/o Taisho Pharmaceutical Co. Ltd. 24-1 Takada 3-chome Toshima-ku, Tokyo 170-8633, JP

- (51) MKP
C12N 15/11 2006 (97) EP 3652316
C12P 21/00 2006
- (96) EP 18831973.5 7/10/2018
 (97) EP 3652316, 5/20/2020 202021, en
- (31) 201762531325 P (32) 11.07.2017 (33) US
- (54) INCORPORATION OF UNNATURAL NUCLEOTIDES AND METHODS THEREOF
 (71) Synthorx, Inc., 11099 North Torrey Pines Road Suite 290, La Jolla, California 92037, US
 (72) PTACIN, Jerod, 11099 North Torrey Pines Road Suite 290, La Jolla, California 92037, US
 CAFFARO, Carolina, 11099 North Torrey Pines Road Suite 290, La Jolla, California 92037, US
 AERNI, Hans, 11099 North Torrey Pines Road Suite 290, La Jolla, California 92037, US
 ZHANG, Yorke, 10550 North Torrey Pines Road, La Jolla, California 92037, US
 FISCHER, Emil C., 10550 North Torrey Pines Road, La Jolla, California 92037, US
 FELDMAN, Aaron W., 10550 North Torrey Pines Road, La Jolla, California 92037, US
 DIEN, Vivian T., 10550 North Torrey Pines Road, La Jolla, California 92037, US
 ROMESBERG, Floyd E., 10550 North Torrey Pines Road, La Jolla, California 92037, US

- (51) MKP
A61K 39/00 2006 (97) EP 3651794
A61P 31/04 2006
C07K 14/295 2006
- (96) EP 18832233.3 7/13/2018
 (97) EP 3651794, 5/20/2020 202021, en
- (31) 201762532348 P (32) 13.07.2017 (33) US
- (54) CHLAMYDIA NANOEMULSION VACCINE

(72) FATTOM, Ali, c/o NANOBIO CORPORATION 2311 Green Road Suite A, Ann Arbor, Michigan 48105, US
 BITKO, Vira, c/o NANOBIO CORPORATION 2311 Green Road Suite A, Ann Arbor, Michigan 48105, US

(51) MKP
C12Q 1/68 2018 (97) EP 3653722

(96) EP 18832456.0 4/12/2018
 (97) EP 3653722, 5/20/2020 202021, en
 (31) 201710573752 (32) 14.07.2017 (33) CN
 (54) APPLICATION OF CAS PROTEIN, METHOD FOR DETECTING TARGET NUCLEIC ACID MOLECULE AND KIT
 (71) Shanghai Tolo Biotechnology Company Limited, Room 246, Block A, 2F 420 Fenglin Road Xuhui District, Shanghai 200032, CN
 (72) WANG, Jin, 320 Yueyang Road Xuhui District, Shanghai 200031, CN
 CHENG, Qiuxiang, Room 3012 No. 51 Lane 588 Shuping Road Juyuan New Area Jiading District, Shanghai 201899, CN
 LI, Shiyuan, 320 Yueyang Road Xuhui District, Shanghai 200031, CN
 LI, Xiaoyan, Room 3012 No. 51 Lane 588 Shuping Road Juyuan New Area Jiading District, Shanghai 201899, CN
 LI, Linxian, 320 Yueyang Road Xuhui District, Shanghai 200031, CN

(51) MKP
A61C 7/00 2006 (97) EP 3651683

(96) EP 18832547.6 7/3/2018
 (97) EP 3651683, 5/20/2020 202021, en
 (31) 201715650068 (32) 14.07.2017 (33) US
 (54) USING IMMERSIVE PHOTOGRAPHS TO GUIDE PLACEMENT OF ORTHODONTIC BRACKETS, AND APPLICATIONS THEREOF
 (71) Dental Smartmirror, Inc., 1101 W. Monroe Street Suite 200, Chicago, Illinois 60607, US
 (72) ELAZAR, Gidon Oded, 1101 W. Monroe Street Suite 200, Chicago Illinois 60607, US
 HARKABI, Dan Zidkiah, 1101 W. Monroe Street Suite 200, Chicago Illinois 60607, US
 WACHSPRESS, Joshua Israel, 1101 W. Monroe Street Suite 200, Chicago Illinois 60607, US
 HARKABI, Yael Miriam, 1101 W. Monroe Street Suite 200, Chicago Illinois 60607, US

(51) MKP
B65D 5/42 2006 (97) EP 3653528
B65D 5/54 2006
B65D 71/52 2006

(96) EP 18832904.9 7/11/2018
 (97) EP 3653528, 5/20/2020 202021, en
 (31) 20170088253 (32) 12.07.2017 (33) KR
 (54) RESOURCE-SAVING, ENVIRONMENTALLY FRIENDLY ADHESIVE-FREE CUP CARRIER
 (71) RES Labs Inc., 8th floor, R847, 308, Dobong-ro, Gangbuk-gu Seoul 01062, KR
 (72) LEE, Cheolhee, A-dong B01ho, 4-19-ro 103 Gangbuk-gu, Seoul 01017, KR

(51) MKP
A61K 31/7088 2006 (97) EP 3651774
C07K 14/405 2006
C12N 5/10 2006
C12N 9/22 2006
C12N 15/10 2006
C12N 15/113 2010

(96) EP 18832929.6 7/10/2018
 (97) EP 3651774, 5/20/2020 202021, en
 (31) 201762531329 P (32) 11.07.2017 (33) US
 (54) INCORPORATION OF UNNATURAL NUCLEOTIDES AND METHODS OF USE IN VIVO
 (72) ROMESBERG, Floyd E., 10550 North Torrey Pines Road, La Jolla, California 92037, US
 ZHANG, Yorke, 10550 North Torrey Pines Road, La Jolla, California 92037, US
 FELDMAN, Aaron W., 10550 North Torrey Pines Road, La Jolla, California 92037, US
 DIEN, Vivian T., 10550 North Torrey Pines Road, La Jolla, California 92037, US

(51) MKP
A61K 47/68 2017 (97) EP 3658192
A61P 19/02 2006
C07K 16/24 2006

(96) EP 18833113.6 11/29/2018
 (97) EP 3658192, 6/3/2020 202023, en

(31)	201762593776 P	(32)	01.12.2017	(33)	US
	201762595054 P		05.12.2017		US

(54) GLUCOCORTICOID RECEPTOR AGONIST AND IMMUNOCONJUGATES THEREOF
 (72) HOBSON, Adrian D., 25 Holman Street, Shrewsbury Massachusetts 01545, US
 MCPHERSON, Michael J., 287 Pillsbury Road, Ashby Massachusetts 01431, US
 WAEGELL, Wendy, 7 Rice Corner Road, Brookfield Massachusetts 01506, US
 GOESS, Christian, 112 Mashapaug Road, Sturbridge Massachusetts 01566, US
 HERNANDEZ, Axel, Jr., 14 Laurie Lane, Charlton Massachusetts 01507, US
 WANG, Lu, 14 Stratton Way, Northborough Massachusetts 01532, US
 WANG, Lu, 12 Nipmuck Drive, Westborough Massachusetts 01581, US
 MARVIN, Christopher C., 242 Braxton Way, Grayslake Illinois 60030, US
 SANTORA, Ling C., 7 Thoreau Circle, Shrewsbury Massachusetts 01545, US

(51) MKP
G06F 9/445 2018 (97) EP 3657327
G06T 11/00 2006
G06T 15/00 2011

(96) EP 18834397.4 7/17/2018
 (97) EP 3657327, 5/27/2020 202022, en

(31)	201710600237	(32)	21.07.2017	(33)	CN
------	--------------	------	------------	------	----

(54) METHOD FOR RENDERING GAME, AND METHOD, APPARATUS AND DEVICE FOR GENERATING GAME RESOURCE FILE
 (72) XU, Minjun, 35/F, Tencent Building, Kejizhongyi Road, Midwest District of Hi-Tech Park, Nanshan District, Shenzhen, GUANGDONG 518057, CN

(51) MKP
A61K 38/12 2006 (97) EP 3655011

(96) EP 18834543.3 7/19/2018
 (97) EP 3655011, 5/27/2020 202022, en

(31)	201762534895 P	(32)	20.07.2017	(33)	US
------	----------------	------	------------	------	----

(54) METHODS FOR TREATMENT OR PREVENTION OF A NEUROLOGICAL IMMUNITY DISORDER
 (72) KIPNIS, Jonathan, 722 Preston Avenue Suite 107, Charlottesville, Virginia 22903, US
 LOUVEAU, Antoine, 722 Preston Avenue Suite 107, Charlottesville, Virginia 22903, US

(51) MKP
A61K 31/00 2006 (97) EP 3654956
A61K 31/496 2006
A61K 45/06 2006

(96) EP 18835463.3 7/19/2018
 (97) EP 3654956, 5/27/2020 202022, en

(31)	201762534532 P	(32)	19.07.2017	(33)	US
------	----------------	------	------------	------	----

(54) COMPOSITIONS AND METHODS FOR TREATING DISEASES ASSOCIATED WITH AN IMPRINTING DEFECT
 (72) ZHANG, Yi, c/o Children's Medical Center Corporation 55 Shattuck Street, Boston, Massachusetts 02115, US
 INOUE, Azusa, c/o Children's Medical Center Corporation 55 Shattuck Street, Boston, Massachusetts 02115, US

(51) MKP
A61K 39/00 2006 (97) EP 3655026
C07K 16/28 2006

(96) EP 18835568.9 7/17/2018
 (97) EP 3655026, 5/27/2020 202022, en

(31)	201762533341 P	(32)	17.07.2017	(33)	US
	201862625576 P		02.02.2018		US

(54) ANTIGEN BINDING REGIONS AGAINST FIBRONECTIN TYPE III DOMAINS AND METHODS OF USING THE SAME
 (72) HUANG, Chichi, 69 Highpoint Drive, Berwyn, Pennsylvania 19312, US
 LEE, John, 1400 McKean Road, Spring House, Pennsylvania 19477, US
 MOONEY, Jill, 4489 Rolfe Road, San Diego, California 92117, US
 NASO, Michael, 544 Bryn Mawr Avenue, Swarthmore, Pennsylvania 19081, US

(51) MKP
A61K 9/00 2006 (97) EP 3654953
A61K 9/20 2006
A61K 9/28 2006

(96) EP 18835584.6 7/19/2018

(97)	EP 3654953, 5/27/2020 202022, en					
(31)	201762534591 P	(32)	19.07.2017	(33)	US	
	201862681633 P		06.06.2018		US	
(54)	EFFICACY OF A GASTRO-RETENTIVE BILE ACID SEQUESTRANT DOSAGE FORM					
(72)	CURRIE, Mark, G., 197 8th Street PH21, Boston, Massachusetts 02129, US					
	HASHASH, Ahmad, 5 Oland Lane, Southborough, Massachusetts 01772, US					
	LAVINS, Bernard, Joseph, 21 Ellison Road, Lexington, Massachusetts 02421, US					
	HALL, Michael, 8 Highmeadow Road, Weston, Massachusetts 02493, US					
	KARASIK, Silva, 41 Boston Road Unit 442, Billerica, Massachusetts 01862, US					
(51)	MKP					
	C07K 14/00	2006		(97) EP 3658570		
	C12N 15/113	2010				
(96)	EP 18837280.9 7/19/2018					
(97)	EP 3658570, 6/3/2020 202023, en					
(31)	20170093605	(32)	24.07.2017	(33)	KR	
	20170167558		07.12.2017		KR	
(54)	TYROSINASE ANTISENSE OLIGONUCLEOTIDES					
(71)	Olipass Corporation, 20th Floor Ace Dongbaek Tower 16 Beon-gil 16-4 Dongbaek Jungang-ro Giheung-gu, Yongin-si, Gyeonggi-do 17105, KR					
(72)	JUNG, Daram, 1406-1502 19 Dongtandaerosibeom-gil, Hwaseong-si Gyeonggi-do 18477, KR					
	PARK, Hye Mi, 2-204 16 Ichon-ro 14-gil Yongsan-gu, Seoul 04374, KR					
	HAN, Seon-Young, 9-1 Hyomyeong 1-gil, Chuncheon-si Gangwon-do 24336, KR					
	KIM, Soyoung, 301 Ho 5 Doksan-ro 70a-gil Geumcheon-gu, Seoul 08558, KR					
(51)	MKP					
	A61K 31/506	2006		(97) EP 3658552		
	A61K 31/5377	2006				
	C07D 413/14	2006				
(96)	EP 18837360.9 7/25/2018					
(97)	EP 3658552, 6/3/2020 202023, en					
(31)	20170096212	(32)	28.07.2017	(33)	KR	
(54)	IMPROVED PROCESS FOR PREPARING AMINOPYRIMIDINE DERIVATIVES					
(72)	OH, Sang-Ho, 967-2004 6 Gosan-ro 539beon-gil, Gunpo-si Gyeonggi-do 15821, KR					
	KHOO, Ja-Heouk, 725-204 119 Gwangjeong-ro, Gunpo-si Gyeonggi-do 15825, KR					
	LIM, Jong-Chul, 3104-901 26 Dongbaek 4-ro Giheung-gu, Yongin-si Gyeonggi-do 17007, KR					
	LEE, Seong-Ran, 326-902 132 Cheongmyeong-ro Yeongtong-gu, Suwon-si Gyeonggi-do 16707, KR					
	JU, Hyun, 403-802 55 Dongtansunhwan-daero 26-gil, Hwaseong-si Gyeonggi-do 18466, KR					
	SHIN, Woo-Seob, 542-802 12 Maeyeong-ro 310beon-gil Yeongtong-gu, Suwon-si Gyeonggi-do 16697, KR					
	PARK, Dae-Gyu, 645-1104 27 Maeyeong-ro 310beon-gil Yeongtong-gu, Suwon-si Gyeonggi-do 16699, KR					
	PARK, Su-Min, 108-401 64 Gagyong-ro Heungdeok-gu, Cheongju-si Chungcheongbuk-do 28408, KR					
	HWANG, Yoon-Ah, 4009-602 156 Gwanggyomaeul-ro Yeongtong-gu, Suwon-si Gyeonggi-do 16510, KR					
(51)	MKP					
	E21B 43/30	2006		(97) EP 3658750		
	E21B 47/06	2012				
	G01V 1/00	2006				
(96)	EP 18837612.3 7/26/2018					
(97)	EP 3658750, 6/3/2020 202023, en					
(31)	201762537150 P	(32)	26.07.2017	(33)	US	
(54)	DRAINED RESERVOIR VOLUME DIAGNOSTICS FROM MANDEL-CRYER PRESSURE SIGNAL					
(72)	AGRAWAL, Samarth, 600 N. Dairy Ashford, Houston Texas 77079, US					
	ALBERT, Richard A., 600 N. Dairy Ashford, Houston Texas 77079, US					
(51)	MKP					
	A61K 31/015	2006		(97) EP 3658522		
	A61P 37/02	2006				
	C07C 15/24	2006				
(96)	EP 18837877.2 7/27/2018					
(97)	EP 3658522, 6/3/2020 202023, en					
(31)	201762538123 P	(32)	28.07.2017	(33)	US	
(54)	IMMUNOMODULATOR COMPOUNDS					
(72)	LANGE, Christopher, 6818 Cutting Boulevard, El Cerrito California 94530, US					
	MALATHONG, Viengkham, 121988 San Luis Avenue 3, Mountain View California 94043, US					

MALI, Venkat Reddy, 20200 Lucille Avenue Apt. 4, Cupertino California 95014, US
 MCMAHON, Jeffrey, 15 Alta Mar Way, San Francisco California 94121, US
 MCMURTRIE, Darren J., 886 Lakewood Drive, Sunnyvale California 94085, US
 PUNNA, Sreenivas, 938 Fontana Terrace, Sunnyvale California 94085, US
 ROTH, Howard S., 675 Tasman Drive Apt. 2320, Sunnyvale California 94089, US
 SINGH, Rajinder, 1832 Hillman Avenue, Belmont California 94002, US
 WANG, Yu, 550 Chimalus Drive, Palo Alto California 94306, US
 YANG, Ju, 966 Clara Drive, Palo Alto California 94303, US
 ZHANG, Penglie, 1036 Jamaica Street, Foster City California 94404, US

- (51) MKP
A61K 31/506 2006 (97) EP 3658553
A61K 31/5377 2006
C07D 413/14 2006
- (96) EP 18838173.5 7/25/2018
 (97) EP 3658553, 6/3/2020 202023, en
- (31) 20170096220 (32) 28.07.2017 (33) KR
- (54) NOVEL INTERMEDIATES USEFUL FOR THE SYNTHESIS OF AMINOPYRIMIDINE DERIVATIVES, PROCESS FOR PREPARING THE SAME, AND PROCESS FOR PREPARING AMINOPYRIMIDINE DERIVATIVES USING THE SAME
- (72) OH, Sang-Ho, 967-2004 6 Gosan-ro 539beon-gil, Gunpo-si Gyeonggi-do 15821, KR
 KHOO, Ja-Heouk, 725-204 119 Gwangjeong-ro, Gunpo-si Gyeonggi-do 15825, KR
 LIM, Jong-Chul, 3104-901 26 Dongbaek 4-ro Giheung-gu, Yongin-si Gyeonggi-do 17007, KR
 LEE, Doo-Byung, 203-401 66 Yonggu-daero 2771beon-gil Suji-gu, Yongin-si Gyeonggi-do 16865, KR
 LEE, Jung-Ae, 209-802 435 Olympic-ro Songpa-gu, Seoul 05507, KR
 LEE, Jun-Sup, 1001-1802 24 Heungdeokjungang-ro 105beon-gil Giheung-gu, Yongin-si Gyeonggi-do 16951, KR
 JU, Hyun, 403-802 55 Dongtansunhwan-daero 26-gil, Hwaseong-si Gyeonggi-do 18466, KR
 SHIN, Woo-Seob, 542-802 12 Maeyeong-ro 310beon-gil Yeongtong-gu, Suwon-si Gyeonggi-do 16697, KR
 JEON, Sang-Seol, 12-19 Yeongtong-ro 241beon-gil Yeongtong-gu, Suwon-si Gyeonggi-do 16679, KR

- (51) MKP
A01K 43/04 2006 (97) EP 3658893
G01J 3/28 2006
G01N 21/00 2006
G01N 21/25 2006
G01N 21/31 2006
- (96) EP 18838205.5 7/23/2018
 (97) EP 3658893, 6/3/2020 202023, en
- (31) 201762535917 P (32) 23.07.2017 (33) US
- (54) A SYSTEM AND METHOD FOR NON-INVASIVELY DETERMINING EGG PROPERTIES
- (71) Terahertz Group Ltd., 60th Ramat Yam Street, Herzliya 4685160, IL
 (72) GABBAI, Eran, Hanna Rovina 19, Herzeliya, 4650447, IL

- (51) MKP
A61K 9/06 2006 (97) EP 3658142
A61K 31/4188 2006
- (96) EP 18838277.4 7/27/2018
 (97) EP 3658142, 6/3/2020 202023, en
- (31) 201762538443 P (32) 28.07.2017 (33) US
- (54) COMPOSITIONS AND METHODS FOR TREATING GALACTOSEMIA
- (71) Applied Therapeutics Inc., 340 Madison Avenue 19th Floor, New York, New York 10173, US
 (72) SHENDELMAN, Shoshana, 5243 Sycamore Avenue, Riverdale New York 10471, US

- (51) MKP
A61K 31/575 2006 (97) EP 3658150
C07J 9/00 2006
- (96) EP 18838551.2 7/23/2018
 (97) EP 3658150, 6/3/2020 202023, en
- (31) 201762536326 P (32) 24.07.2017 (33) US
 201762536609 P 25.07.2017 US
- (54) ISOTOPICALLY LABELED BILE ACID DERIVATIVES
- (72) GALVIN, Gabriel, 13222 Salmon River Rd., San Diego, California 92129, US
 SCHAAB, Kevin, 4275 Orchard Drive, Spring Valley, California 91977, US
 YANIK, Matthew, 4671 Torrey Circle F104, San Diego, California 92130, US

- (51) MKP
A61K 31/506 2006 (97) EP 3658547
C07D 403/04 2006
C07D 413/14 2006
- (96) EP 18838718.7 7/25/2018
(97) EP 3658547, 6/3/2020 202023, en
- (31) 20170096226 (32) 28.07.2017 (33) KR
- (54) INTERMEDIATES USEFUL FOR THE SYNTHESIS OF A SELECTIVE INHIBITOR AGAINST PROTEIN KINASE AND PROCESSES FOR PREPARING THE SAME
- (72) OH, Sang-Ho, 967-2004 6 Gosan-ro 539beon-gil, Gunpo-si Gyeonggi-do 15821, KR
KHOO, Ja-Heouk, 725-204 119 Gwangjeong-ro, Gunpo-si Gyeonggi-do 15825, KR
LIM, Jong-Chul, 3104-901 26 Dongbaek 4-ro Giheung-gu, Yongin-si Gyeonggi-do 17007, KR
LEE, Doo-Byung, 203-401 66 Yonggu-daero 2771beon-gil Suji-gu, Yongin-si Gyeonggi-do 16865, KR
LEE, Jung-Ae, 209-802 435 Olympic-ro Songpa-gu, Seoul 05507, KR
LEE, Jun-Sup, 1001-1802 24 Heungdeokjungang-ro 105beon-gil Giheung-gu, Yongin-si Gyeonggi-do 16951, KR
JU, Hyun, 403-802 55 Dongtansunhwan-daero 26-gil, Hwaseong-si Gyeonggi-do 18466, KR
SHIN, Woo-Seob, 542-802 12 Maeyeong-ro 310beon-gil Yeongtong-gu, Suwon-si Gyeonggi-do 16697, KR
JEON, Sang-Seol, 12-19 Yeongtong-ro 241beon-gil Yeongtong-gu, Suwon-si Gyeonggi-do 16679, KR

- (51) MKP
A63F 13/52 2014 (97) EP 3659683
- (96) EP 18838756.7 7/17/2018
(97) EP 3659683, 6/3/2020 202023, en
- (31) 201710627213 (32) 27.07.2017 (33) CN
- (54) OBJECT DISPLAY METHOD AND DEVICE AND STORAGE MEDIUM
- (72) WANG, Yiran, 35/F, Tencent Building, Kejizhongyi Road, Midwest District of Hi-Tech Park, Nanshan District,, Shenzhen, Guangdong 518057, CN

- (51) MKP
A61K 31/05 2006 (97) EP 3658137
A61K 31/352 2006
A61K 31/353 2006
A61K 36/185 2006
A61K 47/12 2006
A61K 47/44 2017
- (96) EP 18838855.7 7/27/2018
(97) EP 3658137, 6/3/2020 202023, en
- (31) 201762537738 P (32) 27.07.2017 (33) US
- (54) CANNABINOID COMPOSITION HAVING AN OPTIMIZED FATTY ACID EXCIPIENT PROFILE
- (71) Shaaban, Basil Adil, 730 17th Street, Suite 420, Denver, Colorado 80202, US
(72) Shaaban, Basil Adil, 730 17th Street, Suite 420, Denver, Colorado 80202, US

- (51) MKP
G02B 1/00 2006 (97) EP 3658985
G02F 1/19 2019
H04B 10/25 2013
- (96) EP 18838938.1 7/24/2018
(97) EP 3658985, 6/3/2020 202023, en
- (31) 201762535980 P (32) 24.07.2017 (33) US
- (54) HIGH FREQUENCY OPTICAL SWITCH AND FABRICATION METHODS THEREOF
- (72) GABBAI, Eran, Hanna Rovina 19, Herzeliya, 4650447, IL

- (51) MKP
G06Q 30/08 2012 (97) EP 3659098
- (96) EP 18839212.0 7/23/2018
(97) EP 3659098, 6/3/2020 202023, en
- (31) 2017902890 (32) 24.07.2017 (33) AU
- (54) MOBILE REVERSE BIDDING SYSTEM AND METHOD
- (71) Better That Pty Ltd, Suite 1, Level GF 94 Beattie Street, Balmain NSW 2041, AU
(72) PHILLIPS, John, c/- Level 8 Waterfront Place 1 Eagle Street, Brisbane, QLD 4000, AU

- (51) MKP
A61K 31/7088 2006 (97) EP 3659609
A61K 31/7105 2006
A61K 31/713 2006
A61K 47/54 2017
A61K 48/00 2006
A61P 11/00 2006
A61P 43/00 2006
C12N 15/113 2010
- (96) EP 18839482.9 7/30/2018
(97) EP 3659609, 6/3/2020 202023, en
- (31) 2017146957 (32) 28.07.2017 (33) JP
- (54) THERAPEUTIC AGENT FOR FIBROSIS
(72) NAKAO, Kazuhisa, c/o WATARASE Research Center Kyorin Pharmaceutical Co. Ltd. 1848 Nogi Nogi-machi, Shimotsuga-gun Tochigi 329-0114, JP
ISHIYAMA, Junichi, c/o Watarase Research Center, KYORIN Pharmaceutical Co. Ltd., 1848 Nogi, Nogi-machi, Shimotsuga-gun, Tochigi 3290114, JP
ICHIKAWA, Wataru, 42-2 Gakuen-no-mori 3-chome, Tsukuba City, Ibaraki 3050816, JP
MASUI, Atsushi, c/o WATARASE Research Center Kyorin Pharmaceutical Co. Ltd. 1848 Nogi Nogi-machi, Shimotsuga-gun Tochigi 329-0114, JP
AKASAKA, Yunike, c/o WATARASE Research Center Kyorin Pharmaceutical Co. Ltd. 1848 Nogi Nogi-machi, Shimotsuga-gun Tochigi 329-0114, JP
TOYOFUKU, Hidekazu, c/o BONAC Corporation Fukuoka BIO Factory 1488-4 Aikawa-machi, Kurume-shi Fukuoka 839-0861, JP
HONDA, Aya, c/o WATARASE Research Center Kyorin Pharmaceutical Co. Ltd. 1848 Nogi Nogi-machi, Shimotsuga-gun Tochigi 329-0114, JP

- (51) MKP
A61F 9/007 2006 (97) EP 3661466
- (96) EP 18840143.4 8/3/2018
(97) EP 3661466, 6/10/2020 202024, en
- (31) 201762541233 P (32) 04.08.2017 (33) US
- (54) SYSTEMS AND METHODS FOR TISSUE DISSECTION IN CORNEAL TRANSPLANTS
(72) BARKER, Jerry W., 3344 Midway Road, Gretna VA 24557, US
DRABBLE, Douglas C., 4860 Century Oaks Lane, Winston-salem NC 27106, US
ANDREWS, Peter R., 3858 Campo Court, Boulder CO 80301, US

- (51) MKP
A01N 43/78 2006 (97) EP 3661505
A61K 31/426 2006
A61P 25/28 2006
C07D 277/66 2006
- (96) EP 18840208.5 8/1/2018
(97) EP 3661505, 6/10/2020 202024, en
- (31) 201762540311 P (32) 02.08.2017 (33) US
- (54) BENZOTHIAZOLE AND RELATED COMPOUNDS
(71) Spinogenix, Inc., 9620 Towne Centre Drive, Suite 100, San Diego, California 92121, US
(72) SARRAF, Stella, c/o Spinogenix, Inc. 9620 Towne Centre Drive, Suite 100, San Diego California 92121, US
SIMMON, Vincent F., c/o Spinogenix, Inc. 9620 Towne Centre Drive, Suite 100, San Diego California 92121, US
SWISS, Gerald F., c/o Spinogenix, Inc. 9620 Towne Centre Drive, Suite 100, San Diego California 92121, US

- (51) MKP
A61K 31/282 2006 (97) EP 3638367
A61N 5/06 2006
C07D 487/22 2006
- (96) EP 18840272.1 8/2/2018
(97) EP 3638367, 4/22/2020 202017, en
- (31) 201762540275 P (32) 02.08.2017 (33) US
201862623826 P 30.01.2018 US
- (54) NANOSCALE METAL-ORGANIC LAYERS AND METAL-ORGANIC NANOPLATES FOR X-RAY INDUCED PHOTODYNAMIC THERAPY, RADIOTHERAPY, RADIODYNAMIC THERAPY, CHEMOTHERAPY, IMMUNOTHERAPY, AND ANY COMBINATION THEREOF
(72) LIN, Wenbin, 120 E 56th St, Chicago, IL 60637, US
NI, Kaiyuan, The University of Chicago 6030 South Ellis Edelstone 2S, Chicago, IL 60637, US
LAN, Guangxu, The University of Chicago 6030 South Ellis Edelstone 2S, Chicago, IL 60637, US

(51) MKP
A61K 38/20 2006 (97) EP 3661955
C07K 14/55 2006
C12N 15/26 2006
(96) EP 18840563.3 8/3/2018
(97) EP 3661955, 6/10/2020 202024, en
(31) 201762540781 P (32) 03.08.2017 (33) US
(54) CYTOKINE CONJUGATES FOR THE TREATMENT OF AUTOIMMUNE DISEASES
(72) PTACIN, Jerod, 11099 North Torrey Pines Road Suite 290, La Jolla California 92037, US
CAFFARO, Carolina E., 11099 North Torrey Pines Road Suite 290, La Jolla California 92037, US
MILLA, Marcos, 11099 North Torrey Pines Road Suite 290, La Jolla California 92037, US

(51) MKP
A61K 39/395 2006 (97) EP 3661554
C07K 16/28 2006
C07K 16/46 2006
(96) EP 18840650.8 7/31/2018
(97) EP 3661554, 6/10/2020 202024, en
(31) 201762539421 P (32) 31.07.2017 (33) US
(54) PROTEINS BINDING NKG2D, CD16 AND FLT3
(72) CHANG, Gregory P., 143 Saunders Street, Medford MA 02155, US
CHEUNG, Ann F., 25 Morningside Lane, Lincoln MA 01773, US
HANEY, William, 61 Lincoln Road, Wayland MA 01778, US
LUNDE, Bradley M., 7 Lucent Drive, Lebanon NH 03766, US
PRINZ, Bianka, 7 Lucent Drive, Lebanon NH 03766, US

(51) MKP
A61K 38/20 2006 (97) EP 3661956
C07K 14/55 2006
C12N 15/26 2006
(96) EP 18840856.1 8/3/2018
(97) EP 3661956, 6/10/2020 202024, en
(31) 201762540781 P (32) 03.08.2017 (33) US
(54) CYTOKINE CONJUGATES FOR THE TREATMENT OF PROLIFERATIVE AND INFECTIOUS DISEASES
(72) PTACIN, Jerod, 11099 North Torrey Pines Road Suite 290, La Jolla California 92037, US
CAFFARO, Carolina E., 11099 North Torrey Pines Road Suite 290, La Jolla California 92037, US
MILLA, Marcos, 11099 North Torrey Pines Road Suite 290, La Jolla California 92037, US

(51) MKP
A61K 39/02 2006 (97) EP 3661547
A61K 39/08 2006
A61P 31/04 2006
(96) EP 18841409.8 8/3/2018
(97) EP 3661547, 6/10/2020 202024, en
(31) 201762541293 P (32) 04.08.2017 (33) US
(54) INDUCTION OF PROTECTIVE IMMUNITY AGAINST ANTIGENS
(72) CURTISS, Roy III, 3515 SW 39th Blvd. Apt. 32C, Gainesville, FL 32608-6547, US
WANG, Shifeng, 3515 SW 39th Blvd. Apt. 32C, Gainesville, FL 32608-6547, US

(51) MKP
A61K 31/381 2006 (97) EP 3661498
A61K 31/385 2006
A61K 31/424 2006
(96) EP 18841645.7 7/30/2018
(97) EP 3661498, 6/10/2020 202024, en
(31) 201762541174 P (32) 04.08.2017 (33) US
(54) BENZO[b]THIOPHENE STING AGONISTS FOR CANCER TREATMENT
(72) CEMERSKI, Saso, 33 Avenue Louis Pasteur, Boston Massachusetts 02115-5727, US
CUMMING, Jared, N., 33 Avenue Louis Pasteur, Boston Massachusetts 02115-5727, US
KOPINJA, Johnny, E., 33 Avenue Louis Pasteur, Boston Massachusetts 02115-5727, US
PERERA, Samantha, A., 33 Avenue Louis Pasteur, Boston Massachusetts 02115-5727, US

TROTTER, Benjamin Wesley, 33 Avenue Louis Pasteur, Boston Massachusetts 02115-5727, US
 TSE, Archie Ngai-Chiu, 126 East Lincoln Avenue, Rahway New Jersey 07065-0907, US

- (51) MKP
A61K 31/381 2006 (97) EP 3661499
A61K 39/395 2006
A61P 35/00 2006
- (96) EP 18841987.3 7/30/2018
 (97) EP 3661499, 6/10/2020 202024, en
- (31) 201762541180 P (32) 04.08.2017 (33) US
- (54) COMBINATIONS OF PD-1 ANTAGONISTS AND BENZO[b]
 (72) CEMERSKI, Saso, 33 Avenue Louis Pasteur, Boston Massachusetts 02115-5727, US
 CUMMING, Jared, N., 33 Avenue Louis Pasteur, Boston Massachusetts 02115-5727, US
 KOPINJA, Johnny, E., 33 Avenue Louis Pasteur, Boston Massachusetts 02115-5727, US
 PERERA, Samantha, A., 33 Avenue Louis Pasteur, Boston Massachusetts 02115-5727, US
 TROTTER, Benjamin Wesley, 33 Avenue Louis Pasteur, Boston Massachusetts 02115-5727, US
 TSE, Archie Ngai-Chiu, 126 East Lincoln Avenue, Rahway New Jersey 07065-0907, US

- (51) MKP
A61K 31/439 2006 (97) EP 3666766
A61K 31/4439 2006
A61K 31/444 2006
A61K 31/506 2006
A61K 31/5377 2006
A61P 13/12 2006
A61P 43/00 2006
C07D 401/04 2006
C07D 401/14 2006
C07D 405/14 2006
C07D 409/14 2006
C07D 413/04 2006
C07D 413/14 2006
C07D 417/04 2006
C07D 451/02 2006
C07D 487/04 2006
C07D 498/04 2006
- (96) EP 18843913.7 8/10/2018
 (97) EP 3666766, 6/17/2020 202025, en
- (31) 2017171584 (32) 10.08.2017 (33) JP
- (54) PYRIDINE COMPOUND SUBSTITUTED WITH AZOLE
 (72) TANAKA, Hiroaki, c/o Taisho Pharmaceutical Co. Ltd. 24-1 Takada 3-chome Toshima-ku, Tokyo 170-8633, JP
 KAWAMURA, Madoka, c/o Taisho Pharmaceutical Co. Ltd. 24-1 Takada 3-chome Toshima-ku, Tokyo 170-8633, JP
 HAMADA, Makoto, c/o Taisho Pharmaceutical Co. Ltd. 24-1 Takada 3-chome Toshima-ku, Tokyo 170-8633, JP
 KOBASHI, Yohei, c/o Taisho Pharmaceutical Co. Ltd. 24-1 Takada 3-chome Toshima-ku, Tokyo 170-8633, JP
 ITO, Yuji, c/o Taisho Pharmaceutical Co. Ltd. 24-1 Takada 3-chome Toshima-ku, Tokyo 170-8633, JP
 SUZUKI, Kazuaki, c/o Taisho Pharmaceutical Co. Ltd. 24-1 Takada 3-chome Toshima-ku, Tokyo 170-8633, JP
 BOHNO, Ayako, c/o Taisho Pharmaceutical Co. Ltd. 24-1 Takada 3-chome Toshima-ku, Tokyo 170-8633, JP
 FUNAYAMA, Kosuke, c/o Taisho Pharmaceutical Co. Ltd. 24-1 Takada 3-chome Toshima-ku, Tokyo 170-8633, JP

- (51) MKP
G06K 9/00 2006 (97) EP 3665620
G06K 9/46 2006
- (96) EP 18844081.2 8/7/2018
 (97) EP 3665620, 6/17/2020 202025, en
- (31) 201762541989 P (32) 07.08.2017 (33) US
- (54) SYSTEM AND METHOD FOR THE VISUALIZATION AND CHARACTERIZATION OF OBJECTS IN IMAGES
 (72) RAMSAY, Thomas, E., 221 Newhall Place S.W., Leeburg, VA 20175, US
 RAMSEY, Eugene, B., 7225 E. 18th Street, Tucson, AZ 85710, US

- (51) MKP
C07C 211/38 2006 (97) EP 3665156
C07C 217/52 2006
C07C 233/05 2006

(96) EP 18844666.0 8/8/2018
 (97) EP 3665156, 6/17/2020 202025, en
 (31) 201762543307 P (32) 09.08.2017 (33) US
 201762553728 P 01.09.2017 US
 201762608504 P 20.12.2017 US

(54) COMPOUNDS, COMPOSITIONS AND METHODS
 (72) CRAIG, Robert A., II, c/o Denali Therapeutics Inc. 161 Oyster Point Blvd., South San Francisco, California 94080, US
 ESTRADA, Anthony A., c/o Denali Therapeutics Inc. 161 Oyster Point Blvd., South San Francisco, California 94080, US
 FENG, Jianwen A., c/o Denali Therapeutics Inc. 161 Oyster Point Blvd., South San Francisco, California 94080, US
 FOX, Brian, c/o Denali Therapeutics Inc. 161 Oyster Point Blvd., South San Francisco, California 94080, US
 HALE, Christopher R. H., c/o Denali Therapeutics Inc. 161 Oyster Point Blvd., South San Francisco, California 94080, US
 LEXA, Katrina W., c/o Denali Therapeutics Inc. 161 Oyster Point Blvd., South San Francisco, California 94080, US
 OSIPOV, Maksim, c/o Denali Therapeutics Inc. 161 Oyster Point Blvd., South San Francisco, California 94080, US
 REMARCHUK, Travis, c/o Denali Therapeutics Inc. 161 Oyster Point Blvd., South San Francisco, California 94080, US
 SWEENEY, Zachary K., c/o Denali Therapeutics Inc. 161 Oyster Point Blvd., South San Francisco, California 94080, US
 DE VICENTE FIDALGO, Javier, c/o Denali Therapeutics Inc. 161 Oyster Point Blvd., South San Francisco, California 94080, US

(51) MKP
A61K 31/195 2006 (97) EP 3664793
A61K 31/335 2006
C07C 15/24 2006

(96) EP 18844749.4 8/7/2018
 (97) EP 3664793, 6/17/2020 202025, en
 (31) 201762542694 P (32) 08.08.2017 (33) US

(54) MACROCYCLIC IMMUNOMODULATORS
 (72) MALATHONG, Viengkham, 121988 San Luis Avenue 3, Mountain View, CA 94043, US
 MCMAHON, Jeffrey, 15 Alta Mar Way, San Francisco, CA 94121, US
 MCMURTRIE, Darren, J., 886 Lakewood Drive, Sunnyvale, CA 94085, US
 PUNNA, Sreenivas, 938 Fontana Terrace, Sunnyvale, CA 94085, US
 ROTH, Howard, S., 675 Tasman Drive Apt. 2320, Sunnyvale, CA 94089, US
 SINGH, Rajinder, 1832 Hillman Avenue, Belmont, CA 94002, US
 ZHANG, Penglie, 1036 Jamaica Street, Foster City, CA 94404, US

(51) MKP
A61K 31/513 2006 (97) EP 3668514
A61K 31/565 2006
A61K 31/57 2006

(96) EP 18845549.7 8/20/2018
 (97) EP 3668514, 6/24/2020 202026, en
 (31) 201762547410 P (32) 18.08.2017 (33) US
 201862660104 P 19.04.2018 US
 PCT/US2018/043321 23.07.2018 WO

(54) SOLID PHARMACEUTICAL FORMULATIONS FOR TREATING ENDOMETRIOSIS, UTERINE FIBROIDS, POLYCYSTIC OVARY SYNDROME AND ADENOMYOSIS
 (72) QIU, Yihong, 1 North Waukegan Road, North Chicago, Illinois 60064, US
 GONG, Yuchuan, 1 North Waukegan Road, North Chicago, Illinois 60064, US
 RUGGLES, Alexander, 175 Washington Cir., Lake Forest, Illinois 60045, US
 BAIRD, Jared A., 788 Alleghany Road, Grayslake, Illinois 60030, US
 CHWALISZ, Kristof, 20245 W. Indian Creek Road, Mundelein, Illinois 60060, US
 OWENS, Charlotte D., 1 North Waukegan Road, North Chicago, Illinois 60064, US
 THOMAS, James W., 151 Oxford Circle, Grayslake, Illinois 60030, US
 CASTELLI-HALEY, Jane, 900 Lake Shore Drive Apt. 2501, Chicago, Illinois 60611, US
 GORDON, Keith, 202 Whistler Road, Highland Park, Illinois 60035, US
 SNABES, Michael C., 1255 Spruce Street, Winnetka, Illinois 60093, US
 SOLIMAN, Ahmed M., 131 E. Park Avenue, Libertyville, Illinois 60048, US
 FLORES, Oscar Antunez, 1 North Waukegan Road, North Chicago, Illinois 60064, US
 JAIN, Rita, 1720 Maple Avenue, Evanston, Illinois 60201, US
 NG, Juki Wing-Keung, 1661 Cavell Avenue, Highland Park, Illinois 60035, US
 NORTH, Janine D., 2208 West Diversey Avenue, Chicago, Illinois 60647, US
 PALAC, Hannah, 1 North Waukegan Road, North Chicago, Illinois 60064, US
 PELOSO, Paul M., 5629 Chapel Hill, Gurnee, Illinois 60031, US
 WILLIAMS, Laura A., 1150 Hadley Circle, Gurnee, Illinois 60031, US
 ZU, Hui, 1 North Waukegan Road, North Chicago, Illinois 60064, US
 HU, Yuerong, 925 Saunders Road, Riverwoods, Illinois 60015, US

- (51) MKP
A61K 31/395 2006 (97) EP 3668502
A61P 35/00 2006
C07D 515/22 2006
- (96) EP 18845598.4 8/15/2018
(97) EP 3668502, 6/24/2020 202026, en
- | | | | | | |
|------|----------------|------|------------|------|----|
| (31) | 201762545872 P | (32) | 15.08.2017 | (33) | US |
| | 201762555477 P | | 07.09.2017 | | US |
| | 201862692667 P | | 30.06.2018 | | US |
- (54) MACROCYCLIC MCL-1 INHIBITORS AND METHODS OF USE
(71) Braje, Wilfried, Mainzer Str. 81, 65189 Wiesbaden, DE
Doherty, George, 1605 Bush Court, Libertyville, IL 60048, US
Jantos, Katja, Mainzer Str. 81, 65189 Wiesbaden, DE
Ji, Cheng, 930 Shady Grove Lane, Buffalo Grove, IL 60089, US
Judd, Andrew, 138 Mainsail Drive, Grayslake, IL 60030, US
Kunzer, Aaron, 903 West Berkley Drive, Arlington Heights, IL 60004, US
Mastracchio, Anthony, 1047 Crane Boulevard, Libertyville, IL 60048, US
Song, Xiaohong, 34037 Sulkey Drive, Grayslake, IL 60030, US
Souers, Andrew, 156 Blueberry Road, Libertyville, IL 60048, US
Sullivan, Gerard, 1312 Appletree Ln., Libertyville, IL 60048, US
Tao, Zhi-Fu, 303 Hobbleshush Lane, Vernon Hills, IL 60061, US
Lai, Chunqiu, 1103 Tamarack Lane, Libertyville, IL 60048, US
Kling, Andreas, Mainzer Str. 81, 65189 Wiesbaden, DE
Pohlki, Frauke, Mainzer Str. 81, 65189 Wiesbaden, DE
Teske, Jesse, 617 Smith Avenue, Lake Bluff, IL 60044, US
Wendt, Michael, 1455 Maidstone Drive, Vernon Hills, IL 60061, US
Brady, Patrick, 413 Ashford Lane, Grayslake, Illinois 60030, US
Wang, Xilu, 1617 Eric Lane, Libertyville, IL 60048, US
Penning, Thomas, 321 Highview, Elmhurst, IL 60126, US
Michaelides, Michael, 4452 W. Gavin Ln, Libertyville, IL 60048, US
- (72) BRAJE, Wilfried, 4452 W. Gavin Ln, Libertyville IL 60048, DE
DOHERTY, George, 4452 W. Gavin Ln, Libertyville IL 60048, US
JANTOS, Katja, 4452 W. Gavin Ln, Libertyville IL 60048, DE
JI, Cheng, 4452 W. Gavin Ln, Libertyville IL 60048, US
JUDD, Andrew, 4452 W. Gavin Ln, Libertyville IL 60048, US
KUNZER, Aaron, 4452 W. Gavin Ln, Libertyville IL 60048, US
MASTRACCHIO, Anthony, 4452 W. Gavin Ln, Libertyville IL 60048, US
SONG, Xiaohong, 4452 W. Gavin Ln, Libertyville IL 60048, US
SOUERS, Andrew, 4452 W. Gavin Ln, Libertyville IL 60048, US
SULLIVAN, Gerard, 4452 W. Gavin Ln, Libertyville IL 60048, US
TAO, Zhi-Fu, 4452 W. Gavin Ln, Libertyville IL 60048, US
LAI, Chunqui, 4452 W. Gavin Ln, Libertyville IL 60048, US
KLING, Andreas, 4452 W. Gavin Ln, Libertyville IL 60048, DE
POHLKI, Frauke, 4452 W. Gavin Ln, Libertyville IL 60048, DE
TESKE, Jessc, 4452 W. Gavin Ln, Libertyville IL 60048, US
WENDT, Michael, 4452 W. Gavin Ln, Libertyville IL 60048, US
BRADY, Patrick, 4452 W. Gavin Ln, Libertyville IL 60048, US
WANG, Xilu, 4452 W. Gavin Ln, Libertyville IL 60048, US
PENNING, Thomas, 4452 W. Gavin Ln, Libertyville IL 60048, US
MICHAELIDES, Michael, 4452 W. Gavin Ln, Libertyville IL 60048, US

- (51) MKP
C12N 9/12 2006 (97) EP 3668971
C12N 15/10 2006
- (96) EP 18845635.4 8/17/2018
(97) EP 3668971, 6/24/2020 202026, en
- | | | | | | |
|------|----------------|------|------------|------|----|
| (31) | 201762547677 P | (32) | 18.08.2017 | (33) | US |
| | 201862628484 P | | 09.02.2018 | | US |
| | 201862638684 P | | 05.03.2018 | | US |
| | 201862677527 P | | 29.05.2018 | | US |
- (54) RNA POLYMERASE VARIANTS
(72) RABIDEAU, Amy, E., 121 Pond Street Unit 1, Waltham, MA 02451, US
DOUSIS, Athanasios, 348 Franklin Street 4B, Cambridge, MA 02139, US

RAVICHANDRAN, Kanchana, 950 Massachusetts Avenue Apt. 420, Cambridge, MA 02139, US
 HOBERT, Elissa, 205B Rindge Avenue, Cambridge, MA 02140, US

(51) MKP
C12N 15/10 2006 (97) EP 3668977
G01N 30/02 2006
 (96) EP 18845636.2 8/17/2018
 (97) EP 3668977, 6/24/2020 202026, en
 (31) 201762547462 P (32) 18.08.2017 (33) US
 (54) ANALYTICAL HPLC METHODS
 (72) ISSA, William, 95 Kimball Road, Dedham, MA 02026, US
 PACKER, Meredith, 36 River Street Apt. 159, Waltham, MA 02453, US

(51) MKP
A61K 38/00 2006 (97) EP 3668531
A61K 38/48 2006
A61K 39/395 2006
C07K 16/40 2006
C12N 9/50 2006
 (96) EP 18845831.9 8/14/2018
 (97) EP 3668531, 6/24/2020 202026, en
 (31) 201762545864 P (32) 15.08.2017 (33) US
 201762574690 P 19.10.2017 US
 201862630756 P 14.02.2018 US
 201862637281 P 01.03.2018 US
 (54) METHODS FOR TREATING AND/OR PREVENTING GRAFT-VERSUS-HOST DISEASE AND/OR DIFFUSE ALVEOLAR HEMORRHAGE
 AND/OR VENO-OCCLUSIVE DISEASE ASSOCIATED WITH HEMATOPOIETIC STEM CELL TRANSPLANT
 (72) DEMOPULOS, Gregory A., 4845 Forest Avenue SE, Mercer Island, WA 98040, US
 DUDLER, Thomas, 13410 NE 36th Street, Bellevue, WA 98005, US
 SCHWAEBLE, Hans-Wilhelm, 36 The Green, Mountsorrel Leicestershire LE12 7AF, GB

(51) MKP
A61K 9/51 2006 (97) EP 3668522
A61K 31/7088 2006
A61K 39/145 2006
A61K 47/69 2017
A61P 31/16 2006
G01N 33/50 2006
 (96) EP 18846700.5 8/17/2018
 (97) EP 3668522, 6/24/2020 202026, en
 (31) 201762547665 P (32) 18.08.2017 (33) US
 201762560548 P 19.09.2017 US
 (54) EFFICACIOUS MRNA VACCINES
 (72) HOGE, Stephen, 200 Technology Square, Cambridge, MA 02139, US
 CIARAMELLA, Giuseppe, 1 Hawes Road, Sudbury, MA 01776, US

(51) MKP
A61K 31/395 2006 (97) EP 3652184
A61P 35/00 2006
C07D 515/22 2006
 (96) EP 18846737.7 8/15/2018
 (97) EP 3652184, 5/20/2020 202021, en
 (31) 201762545853 P (32) 15.08.2017 (33) US
 201762555475 P 07.09.2017 US
 201862692663 P 30.06.2018 US
 (54) MACROCYCLIC MCL-1 INHIBITORS AND METHODS OF USE
 (71) Abbvie Deutschland GmbH & Co. KG, Mainzer Straße 81, 65189 Wiesbaden, DE
 (72) BRAJE, Wilfried, c/o AbbVie Deutschland GmbH&Co. KG Mainzer Str. 81, 65189 Wiesbaden, DE
 DOHERTY, George, c/o AbbVie Deutschland GmbH&Co. KG Mainzer Str. 81, 65189 Wiesbaden, US
 JANTOS, Katja, c/o AbbVie Deutschland GmbH&Co. KG Mainzer Str. 81, 65189 Wiesbaden, DE
 JI, Cheng, c/o AbbVie Deutschland GmbH&Co. KG Mainzer Str. 81, 65189 Wiesbaden, US
 JUDD, Andrew, c/o AbbVie Deutschland GmbH&Co. KG Mainzer Str. 81, 65189 Wiesbaden, US
 KUNZER, Aaron, c/o AbbVie Deutschland GmbH&Co. KG Mainzer Str. 81, 65189 Wiesbaden, US

MASTRACCHIO, Anthony, c/o AbbVie Deutschland GmbH&Co. KG Mainzer Str. 81, 65189 Wiesbaden, US
 SONG, Xiaohong, c/o AbbVie Deutschland GmbH&Co. KG Mainzer Str. 81, 65189 Wiesbaden, US
 SOUERS, Andrew, c/o AbbVie Deutschland GmbH&Co. KG Mainzer Str. 81, 65189 Wiesbaden, US
 SULLIVAN, Gerard, c/o AbbVie Deutschland GmbH&Co. KG Mainzer Str. 81, 65189 Wiesbaden, US
 TAO, Zhi-Fu, c/o AbbVie Deutschland GmbH&Co. KG Mainzer Str. 81, 65189 Wiesbaden, US
 TESKE, Jesse, c/o AbbVie Deutschland GmbH&Co. KG Mainzer Str. 81, 65189 Wiesbaden, US
 WANG, Xilu, c/o AbbVie Deutschland GmbH&Co. KG Mainzer Str. 81, 65189 Wiesbaden, US
 WENDT, Michael, c/o AbbVie Deutschland GmbH&Co. KG Mainzer Str. 81, 65189 Wiesbaden, US
 PENNING, Thomas, c/o AbbVie Deutschland GmbH&Co. KG Mainzer Str. 81, 65189 Wiesbaden, US
 LAI, Chunqiu, c/o AbbVie Deutschland GmbH&Co. KG Mainzer Str. 81, 65189 Wiesbaden, US
 KLING, Andreas, c/o AbbVie Deutschland GmbH&Co. KG Mainzer Str. 81, 65189 Wiesbaden, DE
 POHLKI, Frauke, c/o AbbVie Deutschland GmbH&Co. KG Mainzer Str. 81, 65189 Wiesbaden, DE

- (51) MKP
A61K 31/395 2006 (97) EP 3668504
A61P 35/00 2006
C07D 515/22 2006
- (96) EP 18846740.1 8/15/2018
 (97) EP 3668504, 6/24/2020 202026, en
- | | | | | | |
|------|----------------|------|------------|------|----|
| (31) | 201762545836 P | (32) | 15.08.2017 | (33) | US |
| | 201762555470 P | | 07.09.2017 | | US |
- (54) MACROCYCLIC MCL-1 INHIBITORS AND METHODS OF USE
 (71) AbbVie Deutschland GmbH & Co. KG, Mainzer Strasse 81, 65189 Wiesbaden, DE
 (72) BRADY, Patrick, 413 Ashford Lane, Grayslake, IL 60030, US
 BRAJE, Wilfried, c/o Abbvie Deutschland GmbH & Co. KG Mainzer Strasse 81, 65189 Wiesbaden, DE
 DAI, Yujia, 1557 Camden Drive, Gurnee, IL 60031, US
 DOHERTY, George, 1605 Bush Court, Liberty, IL 60048, US
 GONG, Jane, 130 Frensdale Road, Deerfield, IL 60015, US
 JANTOS, Katja, c/o Abbvie Deutschland GmbH & Co. KG Mainzer Strasse 81, 65189 Wiesbaden, DE
 JI, Cheng, 930 Shady Grove Lane, Buffalo Grove, IL 60089, US
 JUDD, Andrew, 138 Mainsail Drive, Grayslake, IL 60030, US
 KUNZER, Aaron, 903 West Berkley Drive, Arlington Height, IL 60004, US
 MASTRACCHIO, Anthony, 1047 Crane Boulevard, Libertyville, IL 60048, US
 RISI, Roberto, 1565 112th Street, Pleasant Prairie, IL 53158, US
 SONG, Xiaohong, 34037 Sulkey Drive, Grayslake, IL 60030, US
 SOUERS, Andrew, 156 Blueberry Road, Liberty, IL 60048, US
 SULLIVAN, Gerard, 1312 Appletree Lane, Liberty Ville, IL 60048, US
 TAO, Zhi-Fu, 303 Hobbleshush Lane, Vernon Hills, IL 60061, US
 TESKE, Jesse, 617 Smith Avenue, Lake Bluff, IL 60044, US
 WANG, Xilu, 1617 Eric Lane, Libertyville, IL 60048, US
 WENDT, Michael, 1455 Maidstone Drive, Vernon Hills, IL 60061, US
 YU, Yiyun, 29549 North Waukegan Road Apt. 205, Lake Bluff, IL 60044, US
 ZHU, Guidong, 1395 Almaden Lane, Gurnee, IL 60031, US
 PENNING, Thomas, 321 Highview, Elmhurst, IL 60126, US
 LAI, Chunqiu, 1103 Tamarack Lane, Lybertyville, IL 60048, US
 KLING, Andreas, c/o Abbvie Deutschland GmbH & Co. KG Mainzer Strasse 81, 65189 Wiesbaden, DE
 POHLKI, Frauke, c/o Abbvie Deutschland GmbH & Co. KG Mainzer Strasse 81, 65189 Wiesbaden, DE
 POTIN, Dominique, c/o Inventiva 50 rue de Dijon, 21121 Daix, FR
 GUILLIER, Fabrice, c/o Inventiva 50 rue de Dijon, 21121 Daix, FR

- (51) MKP
A63H 27/20 2006 (97) EP 3668794
A63H 27/22 2006
B64C 39/02 2006
B64D 27/24 2006
B64D 39/00 2006
B64F 3/02 2006
H02J 50/27 2016
H02J 50/30 2016
H02J 50/80 2016
H02J 50/90 2016
- (96) EP 18846903.5 8/17/2018
 (97) EP 3668794, 6/24/2020 202026, en
- | | | | | | |
|------|----------------|------|------------|------|----|
| (31) | 201762546737 P | (32) | 17.08.2017 | (33) | US |
|------|----------------|------|------------|------|----|
- (54) SYSTEM AND METHOD FOR DISTRIBUTING POWER TO AIRCRAFT SYSTEMS

- (71) Columbiad Launch Services Inc., 141 Duke Street East, Kitchener, Ontario N2H 1A6, CA
 (72) OQAB, Haroon B., 212-511 The West Mall, Toronto Ontario M9C 1G5, CA
 DIETRICH, George, 141 Duke Street East, Kitchener Ontario N2H 1A6, CA

- (51) MKP
A61K 31/4184 2006 (97) EP 3668507
A61K 39/395 2006
A61P 35/00 2006
C07D 235/04 2006
 (96) EP 18846994.4 8/14/2018
 (97) EP 3668507, 6/24/2020 202026, en
 (31) 201762545427 P (32) 14.08.2017 (33) US
 (54) COMBINATION THERAPY
 (72) GOLD, Daniel P., 3611 Valley Centre Drive Suite 500, San Diego, California 92130, US

- (51) MKP
C12N 15/10 2006 (97) EP 3668979
G01N 30/02 2006
 (96) EP 18847000.9 8/17/2018
 (97) EP 3668979, 6/24/2020 202026, en
 (31) 201762547647 P (32) 18.08.2017 (33) US
 (54) METHODS FOR HPLC ANALYSIS
 (72) ISSA, William, 95 Kimball Road, Dedham, MA 02026, US
 PACKER, Meredith, 36 River Street Apa. 159, Waltham, MA 02453, US

- (51) MKP
A61K 31/513 2006 (97) EP 3668515
A61K 31/565 2006
A61K 31/57 2006
 (96) EP 18847001.7 8/20/2018
 (97) EP 3668515, 6/24/2020 202026, en
 (31) 201762547402 P (32) 18.08.2017 (33) US
 201862660102 P 19.04.2018 US
 PCT/US2018/043321 23.07.2018 WO
 (54) PHARMACEUTICAL FORMULATIONS FOR TREATING ENDOMETRIOSIS, UTERINE FIBROIDS, POLYCYSTIC OVARY SYNDROME OR ADENOMYOSIS
 (72) JAYANTH, Jayanthi, 915 Pine Tree Circle S, Buffalo Grove, Illinois 60089, US
 SPENCE, Kevin C., 205 S. Deerpath Drive, Vernon Hills, Illinois 60061, US
 MCCLELLAND, Gregory A., 14029 Via Corsini, San Diego, California 92128, US
 STEPANENKO, Anna V., 4903 Rancho Viejo Drive, Del Mar, California 92014, US
 CHWALISZ, Kristof, 20245 W. Indian Creek Road, Mundelein, Illinois 60060, US
 OWENS, Charlotte D., 1 North Waukegan Road, North Chicago, Illinois 60064, US
 THOMAS, James W., 151 Oxford Circle, Grayslake, Illinois 60030, US
 CASTELLI-HALEY, Jane, 900 Lake Shore Drive Apt. 2501, Chicago, Illinois 60611, US
 GORDON, Keith, 202 Whistler Road, Highland Park, Illinois 60035, US
 SNABES, Michael C., 1255 Spruce Street, Winnetka, Illinois 60093, US
 SOLIMAN, Ahmed M., 131 E. Park Avenue, Libertyville, Illinois 60048, US
 ZHANG, Geoff, 1372 N. Maidstone Drive, Vernon Hills, Illinois 60061, US
 METZGER, David, 6325 58th Avenue, Kenosha, Wisconsin 53142, US
 LI, Yanxia, 1617 Eric Lane, Libertyville, Illinois 60048, US
 JU, Tzuchi R., 1 North Waukegan Road, North Chicago, Illinois 60064, US
 SHAO, Xi, 29746 North Environ Circle, Lake Bluff, Illinois 60048, US
 FLORES, Oscar Antunez, 1 North Waukegan Road, North Chicago, Illinois 60064, US
 JAIN, Rita, 1720 Maple Avenue, Evanston, Illinois 60201, US
 NG, wing-Keung Juki, 1661 Cavell Avenue, Highland Park, Illinois 60035, US
 NORTH, Janine D., 2208 West Diversey Avenue, Chicago, Illinois 60647, US
 PALAC, Hannah, 1 North Waukegan Road, North Chicago, Illinois 60064, US
 PELOSO, Paul M., 5629 Chapel Hill, Gurnee, Illinois 60031, US
 WILLIAMS, Laura A., 1150 Hadley Circle, Gurnee, Illinois 60031, US

- (51) MKP
A61K 9/00 2006 (97) EP 3672653
A61K 9/127 2006

- A61K 31/685 2006**
A61L 27/50 2006
- (96) EP 18847493.6 8/21/2018
(97) EP 3672653, 7/1/2020 202027, en
(31) 201762548429 P (32) 22.08.2017 (33) US
- (54) LIPOSOMAL FORMULATION FOR JOINT LUBRICATION
(71) Moebius Medical Ltd., 27 HaBarzel Street, 67910 Tel Aviv, IL
(72) BARENHOLZ, Yechezkel, 18 Neve Shaanan Street, 9370719 Jerusalem, IL
DOLEV, Yaniv, 8 Moshe Dayan Street, 4358008 Raanana, IL
TURJEMAN, Keren, Derech Carmit Street 10 Apt. 22 Kiryat Yovel, 9574569 Jerusalem, IL
SARFATI, Gadi, Beit Guvrin, 7937000 Beit Guvrin, IL
AYAL-HERSHKOVITZ, Maty, 6 Bilu, 4642416 Herzliya, IL
-
- (51) MKP
A61K 39/395 2006 (97) EP 3672994
A61K 45/06 2006
C07K 16/40 2006
- (96) EP 18847767.3 8/21/2018
(97) EP 3672994, 7/1/2020 202027, en
(31) 201762550328 P (32) 25.08.2017 (33) US
- (54) HIGHLY CONCENTRATED LOW VISCOSITY MASP-2 INHIBITORY ANTIBODY FORMULATIONS, KITS, AND METHODS OF TREATING SUBJECTS SUFFERING FROM ATYPICAL HEMOLYTIC SYNDROME
(72) DEMOPULOS, Gregory, A., 4845 Forest Avenue SE, Mercer Island, WA 98040, US
FERGUSON, Kenneth, M., 2125 First Avenue 2902, Seattle, WA 98121, US
LAMBERT, William, Joseph, PO Box 3032, Incline Village, NV 89450-3032, US
WHITAKER, John, Steven, 1510 40th Avenue, Seattle, WA 98122, US
-
- (51) MKP
G01C 21/00 2006 (97) EP 3675084
G09B 29/00 2006
- (96) EP 18848064.4 5/21/2018
(97) EP 3675084, 7/1/2020 202027, en
(31) 201710740562 (32) 25.08.2017 (33) CN
- (54) MAP DISPLAY METHOD, APPARATUS, STORAGE MEDIUM AND TERMINAL
(72) ZENG, Chao, 35/F, Tencent Building, Kejizhongyi Road, Midwest District of Hi-tech Park, Nanshan District,, Shenzhen, Guangdong 518057, CN
-
- (51) MKP
B67D 7/00 2010 (97) EP 3655360
G01N 27/22 2006
- (96) EP 18848277.2 7/20/2018
(97) EP 3655360, 5/27/2020 202022, en
(31) 201710647 (32) 20.07.2017 (33) TR
- (54) A SMART FUELING ELBOW
(71) Bulgurcu Bilgen, Gözde, Barbaros Mah. Sar Mimoza Sk. Diamond V1-1 No:21 Bat, Atasehir/Istanbul, TR
Bulgurcu, Berkehan, Seyh Sadrettin Mah. Feritpasa Cad. Barkut Apt. Sitesi No:4 Daire:5, Konya, TR
(72) Bulgurcu Bilgen, Gözde, Barbaros Mah. Sar Mimoza Sk. Diamond V1-1 No:21 Bat, Atasehir/Istanbul, TR
Bulgurcu, Berkehan, Seyh Sadrettin Mah. Feritpasa Cad. Barkut Apt. Sitesi No:4 Daire:5, Konya, TR
-
- (51) MKP
A01N 43/40 2006 (97) EP 3674291
A01N 43/56 2006
A01N 43/60 2006
A01N 43/72 2006
A01N 43/76 2006
A01N 43/80 2006
A01N 43/836 2006
A01N 43/84 2006
A01N 43/86 2006
A01N 43/90 2006
A01N 47/02 2006
A01N 47/16 2006
A01N 47/40 2006
A01P 7/02 2006

	A01P 7/04	2006					
	A61K 31/444	2006					
	A61K 31/4545	2006					
	A61K 31/496	2006					
	A61K 31/5355	2006					
	A61K 31/5377	2006					
	C07D 213/85	2006					
(96)	EP 18848338.2 8/20/2018						
(97)	EP 3674291, 7/1/2020 202027, en						
(31)	2017159583		(32)	22.08.2017		(33)	JP
	2017174777			12.09.2017			JP
	2017221113			16.11.2017			JP
(54)	CYCLIC AMINE COMPOUND AND PEST CONTROL AGENT						
(72)	NISHIO Fumiya, c/o Odawara Research Center Nippon Soda Co. Ltd. 345 Takada, Odawara-shi Kanagawa 250-0280, JP IWATA Jun, c/o Odawara Research Center Nippon Soda Co. Ltd. 345 Takada, Odawara-shi Kanagawa 250-0280, JP MAKINO Satoshi, c/o Odawara Research Center Nippon Soda Co. Ltd. 345 Takada, Odawara-shi Kanagawa 250-0280, JP IWASA Takao, c/o Odawara Research Center Nippon Soda Co. Ltd. 345 Takada, Odawara-shi Kanagawa 250-0280, JP HIRATA Koichi, c/o Odawara Research Center Nippon Soda Co. Ltd. 345 Takada, Odawara-shi Kanagawa 250-0280, JP HAMAMOTO Isami, c/o Odawara Research Center Nippon Soda Co. Ltd. 345 Takada, Odawara-shi Kanagawa 250-0280, JP						
(51)	MKP						
	C07K 1/14	2006	(97)	EP 3672981			
	C07K 1/16	2006					
	C07K 16/00	2006					
(96)	EP 18848414.1 8/22/2018						
(97)	EP 3672981, 7/1/2020 202027, en						
(31)	201762548962 P		(32)	22.08.2017		(33)	US
(54)	METHODS FOR PURIFYING ANTIBODIES HAVING REDUCED HIGH MOLECULAR WEIGHT AGGREGATES						
(72)	WESTOBY, Matthew, 3 Defoe Ct., Chapel Hill NC 27517, US EVANGELIST, Greg, 104 Vyne Court, Cary NC 27519, US						
(51)	MKP						
	B01J 19/00	2006	(97)	EP 3672725			
	B01J 23/89	2006					
	B01J 37/34	2006					
(96)	EP 18848444.8 8/22/2018						
(97)	EP 3672725, 7/1/2020 202027, en						
(31)	201762549816 P		(32)	24.08.2017		(33)	US
(54)	COMPOSITIONS, METHODS, AND APPARATUSES FOR CATALYTIC COMBUSTION						
(71)	Star Scientific Limited, Suite 3.01 Level 3 828 Pacific Highway, Gordon, New South Wales 2072, AU						
(72)	HEATON, Steven James, c/- Star Scientific Limited 3 Metal Pit Drive, Mayfield West New South Wales 2304, AU KIRK, Samuel James, c/- Star Scientific Limited 3 Metal Pit Drive, Mayfield West New South Wales 2304, AU						
(51)	MKP						
	B25B 11/00	2006	(97)	EP 3672759			
(96)	EP 18848836.5 6/19/2018						
(97)	EP 3672759, 7/1/2020 202027, en						
(31)	201762549759 P		(32)	24.08.2017		(33)	US
(54)	METHOD OF SLICING A FOOD ITEM AND SLICING MECHANISM EMPLOYING A GRIPPING ELEMENT THAT GENERATES A VACUUM GRIP						
(71)	Cozzini LLC, 4300 W. Bryn Mawr Avenue, Chicago, IL 60646, US						
(72)	KING, Edwin, Earl, 302 Norton, Lombard, IL 60148, US WITKOWSKI, Frank, Edmund, 8212 West Orchard Drive, Frankfort, IL 60423, US						
(51)	MKP						
	A61K 45/00	2006	(97)	EP 3674325			
	A61P 35/00	2006					
	C07K 14/47	2006					
	C07K 14/82	2006					
	C07K 16/18	2006					
	C07K 16/32	2006					
	C07K 19/00	2006					

	C12N 1/15	2006				
	C12N 1/19	2006				
	C12N 1/21	2006				
	C12N 5/10	2006				
	C12N 9/12	2006				
	C12N 15/12	2006				
	C12N 15/54	2006				
	C12N 15/63	2006				
	C12Q 1/02	2006				
	C12Q 1/6806	2018				
	C12Q 1/6813	2018				
	G01N 33/15	2006				
	G01N 33/53	2006				
(96)	EP 18849160.9 8/20/2018					
(97)	EP 3674325, 7/1/2020 202027, en					
(31)	2017158796		(32)	21.08.2017	(33)	JP
(54)	FUSION PROTEIN OF DCTN1 PROTEIN WITH RET PROTEIN					
(72)	HAYASHI, Kohei, c/o TAIHO PHARMACEUTICAL CO., LTD. 3 Okubo, Tsukuba-shi Ibaraki 300-2611, JP ISHIDA, Keiji, c/o TAIHO PHARMACEUTICAL CO., LTD. 3 Okubo, Tsukuba-shi Ibaraki 300-2611, JP					

(51)	MKP					
	A61K 9/08	2006	(97)	EP 3673918		
	A61K 9/19	2006				
	A61K 31/4745	2006				
	A61K 39/395	2006				
	A61K 47/10	2017				
	A61K 47/22	2006				
	A61K 47/26	2006				
	A61K 47/68	2017				
	A61P 35/00	2006				
	A61P 35/02	2006				
	C07K 16/00	2006				
	C07K 19/00	2006				
(96)	EP 18849166.6 8/22/2018					
(97)	EP 3673918, 7/1/2020 202027, en					
(31)	2017160071		(32)	23.08.2017	(33)	JP
(54)	ANTIBODY-DRUG CONJUGATE PREPARATION AND LYOPHILIZATION FOR SAME					
(72)	KAMII, Tetsuo, c/o DAIICHI SANKYO COMPANY, LIMITED 3-5-1, Nihonbashi Honcho Chuo-ku, Tokyo 103-8426, JP NISHIMOTO, Norihiro, c/o DAIICHI SANKYO COMPANY, LIMITED 3-5-1, Nihonbashi Honcho Chuo-ku, Tokyo 103-8426, JP					

(51)	MKP					
	A61K 31/712	2006	(97)	EP 3672601		
	A61K 31/7125	2006				
	C12N 15/113	2010				
(96)	EP 18859106.9 9/25/2018					
(97)	EP 3672601, 7/1/2020 202027, en					
(31)	201762562741 P		(32)	25.09.2017	(33)	US
(54)	PROCESSES FOR PREPARING PHOSPHORODIAMIDATE MORPHOLINO OLIGOMERS VIA FAST-FLOW SYNTHESIS					
(72)	TOTARO, Kyle, A., 77 Massachusetts Avenue, Cambridge MA 02139, US SIMON, Mark, D., 77 Massachusetts Avenue, Cambridge MA 02139, US ZHOU, Ming, 215 First Street, Cambridge MA 02142, US ZONG, Hong, 215 First Street, Cambridge MA 02142, US HANSON, Gunnar, J., 215 First Street, Cambridge MA 02142, US PENDELUTE, Bradley, L., 77 Massachusetts Avenue, Cambridge MA 02139, US					

(51)	MKP					
	A61K 31/05	2006	(97)	EP 3645027		
	A61K 31/352	2006				
	A61K 36/185	2006				
	B01D 11/02	2006				
	C07C 39/23	2006				
	C07D 311/80	2006				
(96)	EP 18860631.3 9/7/2018					
(97)	EP 3645027, 5/6/2020 202019, en					

(31)	201715721344	(32)	29.09.2017	(33)	US
	201862675620 P		23.05.2018		US
	201862676261 P		24.05.2018		US
	201815993457		30.05.2018		US
	201816112033		24.08.2018		US

(54) CANNABINOID EXTRACTION PROCESS USING BRINE

(71) NextLeaf Solutions Ltd., 3-68 Schooner Street, Coquitlam, British Columbia V3K 7B1, CA

(72) KO, Ryan Delmoral, c/o NextLeaf Solutions Ltd 3-68 Schooner St, Coquitlam, British Columbia V3K 7B1, CA

HUGHES, Brock, c/o NextLeaf Solutions Ltd 3-68 Schooner St, Coquitlam, British Columbia V3K 7B1, CA

PAL, Krupal Devendra, c/o NextLeaf Solutions Ltd 3-68 Schooner St, Coquitlam, British Columbia V3K 7B1, CA

SAMUELSSON, Alexzander, c/o NextLeaf Solutions Ltd 3-68 Schooner St, Coquitlam, British Columbia V3K 7B1, CA

(51) MKP

C07H 21/02 2006 (97) EP 3668997

C12Q 1/68 2018

(96) EP 18863924.9 10/2/2018

(97) EP 3668997, 6/24/2020 202026, en

(31)	201762566966 P	(32)	02.10.2017	(33)	US
------	----------------	------	------------	------	----

(54) MIRNA DETARGETING SYSTEM FOR TISSUE SPECIFIC INTERFERENCE

(72) HARPER, Scott, Quenton, 384 Briarbend Boulevard, Powell, OH 43065, US

(51) MKP

A61K 31/00 2006 (97) EP 3672579

A61K 39/395 2006

A61P 27/02 2006

C12N 15/113 2010

(96) EP 18866282.9 10/9/2018

(97) EP 3672579, 7/1/2020 202027, en

(31)	201762570207 P	(32)	10.10.2017	(33)	US
------	----------------	------	------------	------	----

(54) COMPOSITIONS AND METHODS FOR TREATING AGE-RELATED MACULAR DEGENERATION AND GEOGRAPHIC ATROPHY

(71) University of Virginia Patent Foundation, 722 Preston Avenue, Suite 107, Charlottesville, VA 22903, US

(72) AMBATI, Jayakrishna, 2825 Cola Woods Lane, Charlottesville, VA 22901, US

KERUR, Nagaraj, 5516 Watervale Drive, Crozet, VA 22932, US

(51) MKP

A01K 61/54 2017 (97) EP 3651570

A01K 61/65 2017

(96) EP 18869476.4 9/13/2018

(97) EP 3651570, 5/20/2020 202021, en

(31)	201710289	(32)	13.07.2017	(33)	TR
------	-----------	------	------------	------	----

(54) DOUBLE PIPE CULTIVATION SYSTEM FOR REDUCING LOSSES OCCURRING DUE TO WIND, WAVE AND TIDE IN MUSSEL CULTIVATION FARMS

(71) Caganlar, Caglar, Hirfanli Sokak No:17/8 GOP, Ankara, TR

(72) Caganlar, Caglar, Hirfanli Sokak No:17/8 GOP, Ankara, TR

(51) MKP

F16H 59/02 2006 (97) EP 3639108

G05G 25/04 2006

(96) EP 18871125.3 10/4/2018

(97) EP 3639108, 4/22/2020 202017, en

(31)	201715067	(32)	05.10.2017	(33)	TR
------	-----------	------	------------	------	----

(54) SEALED REVERSE-FORWARD LEVER

(71) Serdar Plastik Sanayi Ve Ticaret Anonim Sirketi, Türkmenistan Caddesi No. 1-3 OSB, 06395 Sincan/Ankara, TR

(72) The designation of the inventor has not yet been filed,

(51) MKP

C04B 14/02 2006 (97) EP 3495335

C04B 28/00 2006

C08J 9/00 2006

C08J 9/16 2006

(96) EP 19150362.2 1/14/2016

(97) EP 3495335, 4/22/2020 202017, en

- | | | | | | |
|------|--|------|------------|------|----|
| (31) | 15461507 | (32) | 14.01.2015 | (33) | EP |
| (54) | PROCESS FOR THE PRODUCTION OF A GEOPOLYMER COMPOSITE | | | | |
| (72) | Kondratowicz, Filip Lukasz, Tymotkowa 28/4, 30-382 KRAKÓW, PL | | | | |
| | Rojek, Piotr, ul. Soltysowska 35a/4, 31-589 KRAKÓW, PL | | | | |
| | Mikoszek-Operchalska, Marzena, Lowiecka 15/1, 41-707 RUDA SLASKA, PL | | | | |
| | Utrata, Kamil, Cwiklice, Orzechowa 19A, 43-229 PSZCZYNA, PL | | | | |

Indeks brojeva zahtjeva za proširenje evropskih prijave patenta

Broj objave evropske prijave patenta (97)	MKP (51)
3168608	B65B 25/00 (2006.01) G01N 27/22 (2006.01) G01N 33/02 (2006.01) G01N 33/12 (2006.01)
3260457	A01N 43/42 (2006.01) A61K 31/44 (2006.01) C07D 213/68 (2006.01) C07D 213/80 (2006.01) C07D 498/14 (2006.01)
3556901	C04B 35/58 (2006.01) C23C 14/06 (2006.01) C23C 14/32 (2006.01) C23C 14/56 (2006.01) H01J 37/32 (2006.01)
3561002	C09C 1/02 (2006.01) D21H 17/67 (2006.01)
3564980	H01H 1/00 (2006.01) H01H 35/02 (2006.01) H01H 35/06 (2006.01)
3669032	E04B 1/348 (2006.01) E04B 9/06 (2006.01) E04C 3/04 (2006.01) E04C 3/07 (2006.01)
3654910	A61J 1/20 (2006.01)
3654911	A61J 1/20 (2006.01)
3654912	A61J 1/20 (2006.01)
3654913	A61J 1/20 (2006.01)
3654914	A61J 1/20 (2006.01)
3654915	A61J 1/20 (2006.01)
3654916	A61J 1/20 (2006.01)
3638694	A61K 39/395 (2006.01) A61P 25/28 (2006.01) C07K 16/18 (2006.01)
3648848	A62C 3/06 (2006.01) A62C 35/02 (2006.01) A62C 35/62 (2006.01) A62C 99/00 (2010.01)
3648849	A62C 3/06 (2006.01) A62C 35/02 (2006.01) A62C 35/15 (2006.01) A62C 35/60 (2006.01)

Broj objave evropske prijava patenta (97)	MKP (51)
	A62C 99/00 (2010.01)
3648850	A62D 1/02 (2006.01)
3628311	A61K 9/48 (2006.01) A61K 9/50 (2006.01) A61K 31/4402 (2006.01) A61K 31/4415 (2006.01)
3556357	A61K 9/20 (2006.01) A61K 9/28 (2006.01) A61K 9/50 (2006.01) A61K 31/00 (2006.01)
3546935	G01N 33/487 (2006.01) G01N 33/50 (2006.01)
3641728	A61K 9/00 (2006.01) A61K 9/107 (2006.01) A61K 31/00 (2006.01) A61K 47/14 (2017.01) A61K 47/26 (2006.01) A61K 47/34 (2017.01)
3642175	C06B 25/20 (2006.01) C06B 45/10 (2006.01)
3638992	F16L 17/00 (2006.01) G01F 1/66 (2006.01) G01F 15/00 (2006.01) G01F 25/00 (2006.01)
3642509	B60T 1/06 (2006.01) B60T 1/10 (2006.01) B60T 1/12 (2006.01) B60T 13/06 (2006.01) F16D 61/00 (2006.01) F16D 63/00 (2006.01) F16H 33/10 (2006.01) G01C 19/00 (2013.01)
3533510	B01D 53/72 (2006.01) B01D 53/86 (2006.01)
3534226	G05B 19/042 (2006.01)
3536921	F01N 13/00 (2010.01)
3658689	C12Q 1/6869 (2018.01) C12Q 1/6883 (2018.01) G16B 30/00 (2019.01)
3654917	A61J 1/20 (2006.01)
3672396	A01G 17/06 (2006.01)
3654918	A61J 1/20 (2006.01)
3662479	C12Q 1/6879 (2018.01) G16B 20/00 (2019.01)

Broj objave evropske prijave patenta (97)	MKP (51)
	G16B 30/00 (2019.01)
3638720	C08J 11/24 (2006.01) C08L 67/02 (2006.01)
3665612	A61M 5/178 (2006.01) G06K 9/00 (2006.01) G06K 9/32 (2006.01) G06T 7/62 (2017.01)
3567012	C02F 1/52 (2006.01) C02F 1/66 (2006.01) C02F 3/30 (2006.01) C02F 11/04 (2006.01) C02F 101/10 (2006.01)
3656518	B26D 7/18 (2006.01) B26F 1/02 (2006.01)
3656519	B26D 7/01 (2006.01) B26D 7/18 (2006.01) B26F 1/02 (2006.01) B26F 1/38 (2006.01)
3659444	A23L 7/104 (2016.01)
3498383	B05D 3/02 (2006.01) B05D 3/06 (2006.01)
3508283	B05D 5/08 (2006.01)
3543793	G03G 15/00 (2006.01) G03G 21/16 (2006.01) G03G 21/18 (2006.01)
3540100	C40B 40/10 (2006.01) C40B 50/00 (2006.01)
3527218	A61K 38/12 (2006.01)
3540059	C12N 15/10 (2006.01)
3666070	A01G 5/06 (2006.01) A01N 3/02 (2006.01)
3573075	A61N 5/10 (2006.01) G21K 1/093 (2006.01) G21K 5/04 (2006.01)
3574989	B01F 3/10 (2006.01) B01F 5/06 (2006.01) B01F 15/02 (2006.01) B05B 7/04 (2006.01) B29B 7/74 (2006.01)
3539984	A61K 39/395 (2006.01) A61P 35/00 (2006.01) C07K 16/28 (2006.01)

Broj objave evropske prijave patenta (97)	MKP (51)
3483143	A61K 31/4412 (2006.01) A61P 35/00 (2006.01) C07D 211/40 (2006.01) C07D 279/02 (2006.01) C07D 401/04 (2006.01) C07D 401/06 (2006.01) C07D 401/12 (2006.01) C07D 407/04 (2006.01) C07D 407/06 (2006.01) C07D 409/04 (2006.01) C07D 413/06 (2006.01) C07D 417/06 (2006.01) C07D 471/20 (2006.01) C07D 498/08 (2006.01) C07D 498/20 (2006.01)
3650829	A62C 37/11 (2006.01) G01M 99/00 (2011.01)
3520816	A61K 39/395 (2006.01) A61P 35/00 (2006.01) C07K 16/30 (2006.01) C07K 16/40 (2006.01)
3511717	G01N 33/569 (2006.01) G01N 33/68 (2006.01) G01T 1/00 (2006.01)
3530287	A61K 39/395 (2006.01) A61P 17/06 (2006.01) A61P 25/00 (2006.01) A61P 35/00 (2006.01) C07K 16/30 (2006.01)
3552619	A61K 38/36 (2006.01) A61K 38/48 (2006.01) A61K 39/395 (2006.01) A61P 7/04 (2006.01)
3508142	A61B 17/068 (2006.01) A61B 17/072 (2006.01)
3536685	C07D 207/26 (2006.01)
3539882	B65B 9/06 (2012.01) B65B 9/20 (2012.01) B65B 31/04 (2006.01)
3550225	F25D 3/10 (2006.01)
3560923	A01N 43/80 (2006.01) A01N 43/90 (2006.01) A61K 31/437 (2006.01) A61K 38/05 (2006.01) A61K 45/06 (2006.01) A61P 33/00 (2006.01) C07D 471/04 (2006.01)
3546461	A61K 31/44 (2006.01) A61K 31/519 (2006.01) A61K 45/06 (2006.01) A61P 35/00 (2006.01)

Broj objave evropske prijava patenta (97)	MKP (51)
	C07D 471/14 (2006.01)
3640536	F21V 29/70 (2015.01) F21V 29/85 (2015.01) F21W 131/103 (2006.01) F21Y 115/10 (2016.01)
3640449	F02C 6/00 (2006.01)
3636980	F16M 11/12 (2006.01)
3639114	G06F 3/01 (2006.01) G06Q 30/00 (2012.01)
3650611	E04D 12/00 (2006.01) F24S 25/61 (2018.01) H02S 20/23 (2014.01)
3675488	G06T 15/00 (2011.01) H04N 13/00 (2018.01)
3634419	A61K 31/519 (2006.01) A61P 15/00 (2006.01)
3635005	A61K 39/00 (2006.01) C07K 16/28 (2006.01) C07K 16/30 (2006.01)
3642230	A61P 17/10 (2006.01) C07K 16/18 (2006.01)
3638273	A61K 9/19 (2006.01) A61K 31/19 (2006.01) A61K 31/192 (2006.01) A61K 31/194 (2006.01) A61K 31/203 (2006.01) A61K 35/74 (2015.01) A61K 35/745 (2015.01) A61K 35/747 (2015.01) A61P 25/00 (2006.01) A61P 25/28 (2006.01)
3638696	A61K 39/00 (2006.01) C07K 16/28 (2006.01)
3635038	A41D 19/00 (2006.01) A61B 42/10 (2016.01) A61F 6/04 (2006.01) B32B 27/30 (2006.01) C08J 3/24 (2006.01) C08J 3/28 (2006.01) C08L 25/08 (2006.01) C08L 53/02 (2006.01)
3630824	A61K 39/395 (2006.01) C07K 16/24 (2006.01)
3630726	A61K 31/47 (2006.01) A61P 35/00 (2006.01) C07D 215/22 (2006.01)

Broj objave evropske prijava patenta (97)	MKP (51)
3638305	A61K 39/395 (2006.01) C07K 16/28 (2006.01)
3649119	A61K 31/502 (2006.01) A61P 29/00 (2006.01) C07D 401/14 (2006.01) C07D 403/04 (2006.01) C07D 403/14 (2006.01) C07D 405/14 (2006.01) C07D 409/14 (2006.01) C07D 471/04 (2006.01)
3645535	A61K 31/517 (2006.01) A61P 35/00 (2006.01) C07D 487/04 (2006.01)
3630812	A61K 38/20 (2006.01) A61K 39/00 (2006.01) A61P 37/00 (2006.01) C07K 16/10 (2006.01) C07K 16/46 (2006.01)
3630813	A61K 38/20 (2006.01) A61K 39/00 (2006.01) A61P 35/00 (2006.01) C07K 16/10 (2006.01) C07K 16/46 (2006.01)
3651719	A61J 1/10 (2006.01) A61J 1/20 (2006.01) F26B 5/06 (2006.01)
3630762	A61K 31/438 (2006.01) A61P 35/00 (2006.01) C07D 471/04 (2006.01)
3634539	A61M 5/142 (2006.01) A61M 5/145 (2006.01) A61M 5/158 (2006.01) A61M 5/28 (2006.01) A61M 5/31 (2006.01)
3630132	A61K 35/17 (2015.01) A61P 35/00 (2006.01)
3634546	A61M 5/20 (2006.01) A61M 5/31 (2006.01) A61M 5/315 (2006.01)
3635392	G01N 23/203 (2006.01) G01N 23/223 (2006.01) G01N 33/24 (2006.01) G06T 7/00 (2017.01)
3638210	A61K 9/16 (2006.01) A61K 9/20 (2006.01) A61K 9/28 (2006.01) A61K 31/496 (2006.01) A61P 25/18 (2006.01) A61P 25/28 (2006.01)

Broj objave evropske prijava patenta (97)	MKP (51)
3652117	C02F 1/66 (2006.01) C02F 1/68 (2006.01)
3642196	A61K 31/4196 (2006.01) A61P 25/28 (2006.01) A61P 35/00 (2006.01) C07D 403/12 (2006.01)
3634964	A61K 31/519 (2006.01) A61P 9/00 (2006.01) A61P 13/12 (2006.01) A61P 25/00 (2006.01) A61P 25/18 (2006.01) C07D 487/04 (2006.01)
3634402	A61K 31/4045 (2006.01) A61K 31/443 (2006.01) A61K 31/454 (2006.01) A61K 31/47 (2006.01) A61P 11/12 (2006.01)
3634413	A61K 9/00 (2006.01) A61K 9/20 (2006.01) A61K 31/47 (2006.01) A61P 35/00 (2006.01)
3641857	A61M 5/20 (2006.01) A61M 5/315 (2006.01)
3652205	A61Q 7/00 (2006.01) C07K 16/28 (2006.01)
3638684	C07F 9/24 (2006.01) C07H 1/02 (2006.01) C07H 19/10 (2006.01) C07H 19/20 (2006.01)
3641736	A61K 9/20 (2006.01) A61K 9/28 (2006.01) A61K 31/225 (2006.01)
3649149	C07K 14/725 (2006.01)
3652176	A61K 31/519 (2006.01) A61K 31/522 (2006.01) C07D 487/04 (2006.01)
3634153	A23B 7/01 (2006.01) A23B 7/155 (2006.01) A23L 19/00 (2016.01)
3638245	A61K 31/53 (2006.01) A61P 35/00 (2006.01)
3644945	A61K 8/34 (2006.01) A61K 8/60 (2006.01) A61K 31/047 (2006.01) A61K 31/702 (2006.01) A61Q 17/00 (2006.01) A61Q 19/00 (2006.01)

Broj objave evropske prijava patenta (97)	MKP (51)
	A61Q 19/10 (2006.01)
3644958	A61K 9/00 (2006.01) A61K 31/4439 (2006.01) A61P 31/22 (2006.01)
3665127	C02F 1/28 (2006.01) C02F 101/30 (2006.01)
3649029	B61B 12/00 (2006.01) B61B 12/06 (2006.01)
3649775	H04N 7/18 (2006.01)
3652118	C02F 1/66 (2006.01) C02F 1/68 (2006.01)
3645573	C07K 16/38 (2006.01)
3652187	C07H 1/00 (2006.01) C07H 21/04 (2006.01)
3634967	A61K 31/4427 (2006.01) A61K 31/444 (2006.01) A61P 19/02 (2006.01) C07D 493/08 (2006.01)
3641784	A61K 31/7076 (2006.01) A61P 7/02 (2006.01) A61P 9/04 (2006.01)
3655032	A61K 39/12 (2006.01) C07K 14/005 (2006.01)
3649127	A61K 31/506 (2006.01) A61K 31/5377 (2006.01) A61K 31/55 (2006.01) A61P 3/00 (2006.01) A61P 29/00 (2006.01) A61P 35/00 (2006.01) A61P 37/00 (2006.01) C07D 471/04 (2006.01) C07D 519/00 (2006.01)
3651736	A61K 9/10 (2006.01) A61K 31/47 (2006.01) A61K 47/26 (2006.01) A61P 31/06 (2006.01) A61P 31/08 (2006.01)
3649061	B65D 85/804 (2006.01)
3641887	A61K 31/7064 (2006.01) A61P 1/16 (2006.01)
3641812	A61K 31/495 (2006.01) A61K 39/00 (2006.01) A61K 39/395 (2006.01) A61K 39/40 (2006.01)

Broj objave evropske prijava patenta (97)	MKP (51)
	C07K 16/28 (2006.01)
3648790	A61K 39/00 (2006.01) A61P 35/00 (2006.01) C07K 14/47 (2006.01) C07K 16/30 (2006.01)
3652182	A61P 25/08 (2006.01) C07D 513/04 (2006.01)
3652183	A61K 31/433 (2006.01) A61P 25/08 (2006.01) C07D 513/04 (2006.01)
3654983	A61K 31/505 (2006.01) A61P 15/10 (2006.01)
3642209	A61K 31/519 (2006.01) A61P 25/28 (2006.01) A61P 29/00 (2006.01) A61P 35/00 (2006.01) C07D 495/04 (2006.01)
3642238	A61K 38/26 (2006.01) C07K 16/28 (2006.01)
3642239	C07K 16/28 (2006.01)
3641861	A61M 5/32 (2006.01)
3642299	C09K 8/52 (2006.01) C09K 8/72 (2006.01) C23F 11/00 (2006.01)
3638716	C08G 79/00 (2006.01) C08G 79/04 (2006.01)
3652215	C07K 16/46 (2006.01)
3641828	A61K 39/104 (2006.01) A61K 39/108 (2006.01) A61K 47/64 (2017.01) C07K 14/195 (2006.01) C07K 14/21 (2006.01) C07K 14/26 (2006.01)
3638692	C07K 16/00 (2006.01) C07K 16/08 (2006.01) C07K 16/24 (2006.01) C07K 16/46 (2006.01)
3658550	A61K 31/4045 (2006.01) A61K 31/437 (2006.01) A61P 25/04 (2006.01) C07D 409/06 (2006.01) C07D 471/04 (2006.01)
3673134	E05F 15/643 (2015.01)

Broj objave evropske prijava patenta (97)	MKP (51)
3632204	A01K 41/00 (2006.01) A01K 41/06 (2006.01) A01K 43/00 (2006.01)
3545977	A61K 47/68 (2017.01) A61P 35/00 (2006.01)
3643447	B23Q 1/26 (2006.01) B23Q 11/08 (2006.01) F16C 29/02 (2006.01) F16C 29/08 (2006.01)
3658254	B01D 39/16 (2006.01)
3672663	A61M 5/142 (2006.01)
3672586	A61K 31/336 (2006.01) A61K 31/343 (2006.01) A61K 31/5377 (2006.01) A61P 13/12 (2006.01) A61P 37/06 (2006.01)
3672712	B01D 53/14 (2006.01)
3655396	A01N 43/54 (2006.01) C07D 239/47 (2006.01)
3664824	A23L 33/135 (2016.01) A61K 35/744 (2015.01) A61P 1/12 (2006.01) A61P 29/00 (2006.01) A61P 35/00 (2006.01) A61P 37/00 (2006.01)
3665198	C07K 16/28 (2006.01) C07K 16/46 (2006.01)
3648569	A01D 46/28 (2006.01)
3668870	A61K 31/522 (2006.01) A61P 37/04 (2006.01) C07D 473/18 (2006.01)
3668871	A61K 31/522 (2006.01) A61P 37/04 (2006.01) C07D 473/18 (2006.01)
3664844	A61K 35/76 (2015.01) A61K 39/395 (2006.01) C07K 16/28 (2006.01)
3664602	A01K 61/13 (2017.01) A01K 61/95 (2017.01)
3668878	A61K 31/553 (2006.01) A61P 35/00 (2006.01) C07D 498/08 (2006.01)
3672949	A61K 31/454 (2006.01) A61K 31/4545 (2006.01)

Broj objave evropske prijave patenta (97)	MKP (51)
	A61P 35/00 (2006.01) C07D 401/04 (2006.01) C07D 401/14 (2006.01) C07D 407/14 (2006.01) C07D 409/14 (2006.01) C07D 413/14 (2006.01) C07D 417/14 (2006.01) C07D 471/04 (2006.01) C07D 487/04 (2006.01) C07D 487/08 (2006.01) C07D 495/04 (2006.01) C07D 513/04 (2006.01)
3665289	C07K 14/755 (2006.01) C12N 9/64 (2006.01) C12N 15/86 (2006.01)
3673231	B61H 9/02 (2006.01) G01B 7/00 (2006.01) G01B 7/02 (2006.01) G01D 5/22 (2006.01) G01R 33/00 (2006.01) G01V 3/10 (2006.01) H03K 17/95 (2006.01) H04B 5/00 (2006.01) H04B 15/00 (2006.01)
3649124	A61K 31/4545 (2006.01) A61P 25/28 (2006.01) C07D 413/04 (2006.01)
3669004	C12Q 1/6883 (2018.01) G01N 33/574 (2006.01) G01N 33/68 (2006.01)
3668513	A61K 31/5025 (2006.01) A61P 3/10 (2006.01) A61P 7/06 (2006.01) A61P 7/08 (2006.01) A61P 35/00 (2006.01) C07D 513/14 (2006.01)
3654988	A61K 9/00 (2006.01) A61K 31/65 (2006.01) A61P 17/10 (2006.01) A61P 43/00 (2006.01)
3665771	H02P 7/00 (2016.01)
3653620	A61K 31/444 (2006.01) A61K 31/496 (2006.01) A61P 35/00 (2006.01) C07D 401/12 (2006.01) C07D 401/14 (2006.01) C07D 409/14 (2006.01)
3539566	A61K 39/00 (2006.01) A61K 39/135 (2006.01) A61K 39/385 (2006.01) C07K 14/005 (2006.01) C07K 14/32 (2006.01) C12N 7/00 (2006.01)

Broj objave evropske prijava patenta (97)	MKP (51)
3564361	C12N 5/071 (2010.01) C12N 5/074 (2010.01)
3542816	A61K 39/00 (2006.01)
3536710	A61P 17/06 (2006.01) C07K 16/28 (2006.01)
3539534	A61K 9/06 (2006.01) A61K 31/496 (2006.01) A61K 47/10 (2017.01) A61K 47/32 (2006.01) A61K 47/38 (2006.01) A61P 25/18 (2006.01) A61P 25/24 (2006.01)
3564895	G06Q 50/02 (2012.01)
3556777	C07K 16/46 (2006.01)
3540070	C07H 21/04 (2006.01) C07K 16/00 (2006.01) C12P 21/08 (2006.01)
3536692	A61K 31/519 (2006.01) A61P 35/00 (2006.01) C07D 487/04 (2006.01)
3536711	A61P 7/06 (2006.01) A61P 37/06 (2006.01) C07K 16/28 (2006.01)
3572083	A61K 31/519 (2006.01) A61K 45/06 (2006.01) A61P 35/00 (2006.01) C07D 471/14 (2006.01)
3564181	B66C 13/18 (2006.01) B66D 1/08 (2006.01) B66D 1/12 (2006.01)
3545966	A61K 38/17 (2006.01) C07K 14/47 (2006.01) C12N 15/113 (2010.01)
3564914	G06Q 20/34 (2012.01) G07F 7/08 (2006.01)
3556757	A61K 31/433 (2006.01) A61P 35/00 (2006.01) C07D 417/08 (2006.01)
3569965	F41A 11/00 (2006.01) F41A 17/36 (2006.01)
3569514	B65D 5/02 (2006.01) B65D 5/54 (2006.01)
3550031	C12Q 1/68 (2018.01)

Broj objave evropske prijava patenta (97)	MKP (51)
3560498	A61K 31/506 (2006.01) A61K 31/519 (2006.01) A61P 35/00 (2006.01)
3564248	C07F 9/6558 (2006.01) C07F 9/6561 (2006.01)
3549573	A61K 8/06 (2006.01) A61K 8/37 (2006.01) A61K 8/49 (2006.01) A61K 8/73 (2006.01) A61K 8/92 (2006.01) A61Q 19/00 (2006.01)
3567437	G03G 15/00 (2006.01) G03G 21/16 (2006.01) G03G 21/18 (2006.01)
3566694	A61K 9/00 (2006.01) A61K 31/167 (2006.01) A61K 31/40 (2006.01) A61K 31/573 (2006.01) A61K 31/58 (2006.01) A61K 45/06 (2006.01) A61M 15/00 (2006.01)
3572096	A61K 48/00 (2006.01) C07H 21/04 (2006.01)
3572598	E04F 13/08 (2006.01)
3564384	A61K 39/29 (2006.01) C07K 16/00 (2006.01) C07K 16/10 (2006.01) C12P 21/08 (2006.01) C12Q 1/70 (2006.01)
3569636	A61P 41/00 (2006.01) C07D 401/04 (2006.01) C08G 73/06 (2006.01) C08L 79/06 (2006.01)
3560920	A61K 31/47 (2006.01) A61K 31/4709 (2006.01) A61P 29/00 (2006.01) A61P 35/00 (2006.01) C07D 215/227 (2006.01) C07D 401/06 (2006.01) C07D 401/14 (2006.01) C07D 413/06 (2006.01)
3578026	A01B 17/00 (2006.01) A01C 3/06 (2006.01)
3578083	A47B 67/02 (2006.01) A47B 67/04 (2006.01) A61F 17/00 (2006.01)
3574897	A61K 9/16 (2006.01) A61K 9/50 (2006.01) A61K 38/17 (2006.01) A61K 39/00 (2006.01)

Broj objave evropske prijava patenta (97)	MKP (51)
	A61P 27/02 (2006.01)
3605101	G01N 33/50 (2006.01) G01N 33/574 (2006.01)
3569222	A61K 9/00 (2006.01) A61K 31/167 (2006.01) A61K 31/40 (2006.01) A61K 31/573 (2006.01) A61K 47/12 (2006.01) A61K 47/26 (2006.01)
3572433	C07K 16/28 (2006.01) G01N 33/53 (2006.01)
3569604	A61K 31/439 (2006.01) A61P 1/04 (2006.01) C07D 519/00 (2006.01)
3574895	A61K 9/00 (2006.01) A61K 9/14 (2006.01)
3587293	B65D 5/66 (2006.01) B65D 5/72 (2006.01)
3638939	B60K 15/00 (2006.01) B60S 5/02 (2006.01) B67D 7/32 (2010.01) F16K 1/00 (2006.01) F16L 29/04 (2006.01) F16L 37/248 (2006.01) F16L 37/32 (2006.01) F16L 55/10 (2006.01) F17C 1/00 (2006.01)
3627987	A01N 59/00 (2006.01) A01N 59/06 (2006.01) A01N 59/16 (2006.01) A01P 3/00 (2006.01)
3630112	A61K 31/395 (2006.01) A61K 31/44 (2006.01) A61K 45/06 (2006.01) A61P 35/00 (2006.01)
3635129	C12Q 1/68 (2018.01)
3630177	A61K 31/00 (2006.01) A61K 39/395 (2006.01) A61P 35/00 (2006.01) C07K 16/28 (2006.01)
3635408	A61K 39/00 (2006.01) G01N 33/68 (2006.01)
3630723	A61K 31/403 (2006.01) A61P 31/12 (2006.01) C07D 209/08 (2006.01)
3638675	A61K 31/4995 (2006.01) A61K 31/5386 (2006.01)

Broj objave evropske prijave patenta (97)	MKP (51)
	A61P 11/00 (2006.01) A61P 25/00 (2006.01) C07D 471/08 (2006.01) C07D 498/08 (2006.01)
3634490	A61K 31/216 (2006.01) A61K 47/32 (2006.01) A61K 47/34 (2017.01)
3630724	A61K 31/404 (2006.01) A61K 31/407 (2006.01) A61K 31/437 (2006.01) A61P 31/14 (2006.01) C07D 209/30 (2006.01) C07D 209/32 (2006.01) C07D 209/42 (2006.01) C07D 471/04 (2006.01) C07D 513/04 (2006.01)
3638738	C08K 9/00 (2006.01) C09C 1/02 (2006.01)
3642044	B41M 3/00 (2006.01) B41M 3/14 (2006.01) B41M 5/323 (2006.01)
3645187	B21D 51/26 (2006.01) B67B 1/04 (2006.01) B67B 3/02 (2006.01)
3634414	A61K 31/498 (2006.01) A61P 35/00 (2006.01)
3634997	C07K 16/18 (2006.01) C07K 16/24 (2006.01)
3634998	C07K 16/18 (2006.01) C07K 16/24 (2006.01) C07K 16/28 (2006.01) C07K 16/32 (2006.01)
3634474	A61K 39/00 (2006.01) A61K 39/395 (2006.01) C07K 16/28 (2006.01)
3630096	A61K 31/40 (2006.01) A61K 31/4025 (2006.01) A61K 31/4155 (2006.01) A61K 31/4439 (2006.01) A61K 31/454 (2006.01) A61K 31/496 (2006.01) A61K 31/506 (2006.01) A61K 31/5365 (2006.01) A61P 3/00 (2006.01) A61P 25/00 (2006.01) A61P 29/00 (2006.01) A61P 31/00 (2006.01) A61P 35/00 (2006.01) C07D 207/14 (2006.01) C07D 401/12 (2006.01) C07D 401/14 (2006.01) C07D 403/12 (2006.01) C07D 403/14 (2006.01)

Broj objave evropske prijave patenta (97)	MKP (51)
	C07D 487/04 (2006.01) C07D 498/02 (2006.01)
3641833	A61K 31/7088 (2006.01) A61K 48/00 (2006.01) C12N 15/113 (2010.01) C12N 15/63 (2006.01)
3638560	B61B 12/00 (2006.01) B61B 12/06 (2006.01)
3634961	A61K 31/437 (2006.01) A61P 11/00 (2006.01) C07D 471/04 (2006.01)
3638561	B61B 12/06 (2006.01)
3642176	A01N 3/00 (2006.01) A01N 27/00 (2006.01) B01J 7/02 (2006.01) C07C 1/32 (2006.01) G05D 7/00 (2006.01)
3642227	C07K 16/00 (2006.01)
3635014	C07K 16/18 (2006.01) C07K 16/28 (2006.01) C07K 16/32 (2006.01)
3634418	A61K 31/519 (2006.01) A61P 15/00 (2006.01)
3638271	A61K 35/74 (2015.01) A61P 25/00 (2006.01) A61P 37/00 (2006.01)
3641862	A61M 11/00 (2006.01) A61M 11/02 (2006.01) A61M 11/06 (2006.01) A61M 15/00 (2006.01) A61M 15/02 (2006.01) A61M 16/00 (2006.01) A61M 16/10 (2006.01) A61M 16/20 (2006.01) B05B 1/26 (2006.01) B05B 11/00 (2006.01)
3638680	A61K 31/5383 (2006.01) A61P 29/00 (2006.01) C07D 498/04 (2006.01)
3641775	A61K 31/519 (2006.01) A61K 31/5377 (2006.01) A61K 31/55 (2006.01) A61K 45/06 (2006.01) A61P 35/00 (2006.01)
3641945	A61M 11/06 (2006.01) B05B 1/14 (2006.01) B05B 1/26 (2006.01)

Broj objave evropske prijave patenta (97)	MKP (51)
3641810	A61K 9/51 (2006.01) A61K 31/7105 (2006.01) A61K 31/7115 (2006.01) A61K 39/245 (2006.01) A61P 31/22 (2006.01) C12N 15/38 (2006.01)
3665043	B60R 19/34 (2006.01) F16F 7/12 (2006.01)
3649395	F17C 5/06 (2006.01)
3628010	A61K 39/395 (2006.01) C07K 16/28 (2006.01)
3638320	A61K 49/14 (2006.01) A61K 51/08 (2006.01) A61K 51/10 (2006.01) A61P 29/00 (2006.01) A61P 35/00 (2006.01)
3628049	A61K 38/17 (2006.01) A61P 9/10 (2006.01) A61P 9/12 (2006.01) A61P 13/12 (2006.01) A61P 35/00 (2006.01) C07K 14/71 (2006.01) C07K 16/46 (2006.01)
3639249	G08B 1/00 (2006.01)
3635659	G06Q 20/00 (2012.01)
3635598	G06F 3/048 (2013.01) G06F 21/31 (2013.01) H04L 29/06 (2006.01)
3672965	A61K 31/519 (2006.01) C07D 403/12 (2006.01) C07D 451/04 (2006.01) C07D 451/14 (2006.01)
3634400	A61K 31/401 (2006.01) A61P 25/24 (2006.01) C07D 207/16 (2006.01)
3634391	A61K 9/06 (2006.01) A61K 31/122 (2006.01) A61K 35/12 (2015.01) A61K 38/00 (2006.01) A61K 39/395 (2006.01)
3661552	A61K 39/395 (2006.01) C07K 16/28 (2006.01) C12Q 1/68 (2018.01)
3640472	F03D 5/04 (2006.01) F03D 7/00 (2006.01)
3634404	A61K 31/415 (2006.01) A61K 31/4155 (2006.01)

Broj objave evropske prijave patenta (97)	MKP (51)
	A61K 31/495 (2006.01) C07D 247/00 (2006.01) C07D 401/12 (2006.01) C07D 403/08 (2006.01)
3630150	A61K 38/00 (2006.01) A61K 38/16 (2006.01) A61P 33/10 (2006.01)
3630744	A61K 31/4155 (2006.01) A61K 31/496 (2006.01) C07D 401/06 (2006.01) C07D 403/06 (2006.01) C07D 403/14 (2006.01)
3636670	A01K 67/027 (2006.01) A61K 35/12 (2015.01) A61K 35/34 (2015.01) A61K 35/76 (2015.01) A61K 39/395 (2006.01) A61K 45/00 (2006.01) A61K 48/00 (2006.01) A61P 1/04 (2006.01) A61P 1/12 (2006.01) A61P 1/16 (2006.01) A61P 1/18 (2006.01) A61P 3/00 (2006.01) A61P 3/04 (2006.01) A61P 3/10 (2006.01) A61P 9/00 (2006.01) A61P 9/10 (2006.01) A61P 9/14 (2006.01) A61P 11/00 (2006.01) A61P 13/08 (2006.01) A61P 13/10 (2006.01) C07K 16/28 (2006.01)
3630774	C07D 487/04 (2006.01)
3630775	C07D 487/04 (2006.01)
3635603	G06F 21/56 (2013.01)
3634496	A61K 38/46 (2006.01) A61K 48/00 (2006.01) A61P 35/00 (2006.01) C12N 15/113 (2010.01)
3634995	A61K 39/395 (2006.01) C07K 16/00 (2006.01) C07K 16/28 (2006.01)
3634307	A61F 2/14 (2006.01) A61F 2/16 (2006.01) A61F 9/00 (2006.01) A61F 9/008 (2006.01) A61F 9/013 (2006.01)
3634430	A61K 31/7034 (2006.01) A61P 13/12 (2006.01)

Broj objave evropske prijava patenta (97)	MKP (51)
3637348	G06Q 30/00 (2012.01)
3638229	A61K 31/417 (2006.01) A61K 31/4184 (2006.01) A61K 31/517 (2006.01) C07D 233/54 (2006.01) C07D 239/12 (2006.01) C07D 239/14 (2006.01)
3638315	A61K 48/00 (2006.01) C12N 15/86 (2006.01)
3638289	A61K 38/17 (2006.01) A61K 39/39 (2006.01) C07K 16/28 (2006.01) C07K 19/00 (2006.01)
3640244	A01N 43/836 (2006.01) A01P 7/02 (2006.01) A01P 7/04 (2006.01) A61K 31/4245 (2006.01) A61P 33/14 (2006.01) C07D 271/12 (2006.01) C07D 498/10 (2006.01)
3640742	G03G 15/08 (2006.01) G03G 21/18 (2006.01)
3638215	A61K 9/51 (2006.01) A61K 31/7088 (2006.01) A61K 31/7105 (2006.01) A61K 47/14 (2017.01) A61K 47/24 (2006.01) A61K 47/28 (2006.01) A61K 47/54 (2017.01) A61K 48/00 (2006.01) C12N 15/88 (2006.01)
3640823	G06F 17/30 (2006.01)
3642297	C09K 8/24 (2006.01) E21B 21/00 (2006.01) E21B 21/06 (2006.01) E21D 9/11 (2006.01) E21D 9/13 (2006.01)
3644219	G06K 9/00 (2006.01)
3644605	H04N 19/11 (2014.01) H04N 19/147 (2014.01)
3642243	A61K 38/00 (2006.01) A61K 39/00 (2006.01) C07K 16/28 (2006.01)
3644551	H04L 9/32 (2006.01)
3638719	C08J 9/36 (2006.01) F16L 59/14 (2006.01)

Broj objave evropske prijava patenta (97)	MKP (51)
3642217	C07J 41/00 (2006.01) C07J 43/00 (2006.01)
3646888	A61K 49/10 (2006.01) A61K 49/18 (2006.01) C07C 309/14 (2006.01)
3572517	A01K 67/027 (2006.01) C07K 16/46 (2006.01) C12N 9/64 (2006.01) C12N 15/85 (2006.01)
3604831	F16B 13/12 (2006.01)
3660034	A61P 37/00 (2006.01) C07K 14/24 (2006.01) C12N 15/70 (2006.01) C12N 15/74 (2006.01)
3628317	A61K 31/196 (2006.01) A61K 31/343 (2006.01) A61K 31/357 (2006.01) A61P 1/04 (2006.01)
3647424	A61K 31/713 (2006.01) C12N 15/113 (2010.01)
3650033	A61K 35/74 (2015.01) A61K 35/745 (2015.01) A61P 1/00 (2006.01) A61P 11/06 (2006.01) A61P 19/02 (2006.01) A61P 25/28 (2006.01) A61P 29/00 (2006.01) A61P 35/00 (2006.01) C12N 1/20 (2006.01)
3610935	B01D 11/02 (2006.01) B01D 11/04 (2006.01) B01D 24/00 (2006.01) B01D 29/56 (2006.01) B01D 35/18 (2006.01)
3626273	A61K 47/68 (2017.01)
3639824	A61K 31/4375 (2006.01) A61K 31/4545 (2006.01) A61K 31/4725 (2006.01) A61K 31/4985 (2006.01) A61K 31/5377 (2006.01) A61K 31/538 (2006.01) A61K 31/5383 (2006.01) A61K 31/5415 (2006.01) A61K 31/542 (2006.01) A61K 31/554 (2006.01) A61P 31/04 (2006.01)
3636764	C12N 15/67 (2006.01)
3639662	A01N 37/02 (2006.01) A01N 37/08 (2006.01) A01N 37/10 (2006.01)

Broj objave evropske prijave patenta (97)	MKP (51)
	A01P 3/00 (2006.01)
3623362	C05C 1/02 (2006.01) C05G 3/90 (2020.01) C07B 41/08 (2006.01) C07D 231/12 (2006.01)
3670534	A61K 39/395 (2006.01) A61P 1/16 (2006.01) A61P 3/00 (2006.01) A61P 3/04 (2006.01) A61P 3/06 (2006.01) A61P 3/10 (2006.01) A61P 9/00 (2006.01) A61P 43/00 (2006.01) C07K 16/28 (2006.01) C07K 16/40 (2006.01)
3650013	A61K 9/16 (2006.01) A61K 9/20 (2006.01) A61K 31/501 (2006.01) A61K 31/513 (2006.01)
3636643	A61K 31/404 (2006.01) A61K 31/416 (2006.01) A61P 29/00 (2006.01) A61P 37/00 (2006.01) C07D 209/14 (2006.01) C07D 209/18 (2006.01) C07D 235/16 (2006.01) C07D 401/10 (2006.01) C07D 403/10 (2006.01) C07D 405/10 (2006.01) C07D 405/14 (2006.01) C07D 471/04 (2006.01) C07D 487/04 (2006.01) C07D 491/10 (2006.01)
3656764	A61K 31/517 (2006.01) C07C 269/06 (2006.01) C07C 271/22 (2006.01) C07D 239/70 (2006.01) C12P 17/16 (2006.01)
3659439	A01N 43/56 (2006.01) A01N 53/00 (2006.01) A61K 31/22 (2006.01) A61K 31/415 (2006.01) A61K 47/14 (2017.01) A61K 47/20 (2006.01) A61P 33/00 (2006.01)
3673906	A61K 31/439 (2006.01) A61K 31/454 (2006.01) A61P 1/00 (2006.01) A61P 3/00 (2006.01) A61P 3/04 (2006.01) A61P 3/10 (2006.01) A61P 7/00 (2006.01) A61P 9/10 (2006.01) A61P 11/06 (2006.01) A61P 13/12 (2006.01) A61P 19/02 (2006.01) A61P 25/00 (2006.01)

Broj objave evropske prijave patenta (97)	MKP (51)
	A61P 25/16 (2006.01) A61P 25/28 (2006.01) A61P 29/00 (2006.01) A61P 31/04 (2006.01) A61P 35/00 (2006.01) A61P 43/00 (2006.01) C07D 453/02 (2006.01) C07D 455/02 (2006.01) C07D 487/08 (2006.01)
3656402	A61K 39/00 (2006.01) A61K 39/12 (2006.01) A61K 39/39 (2006.01) A61K 47/64 (2017.01) A61P 31/00 (2006.01) A61P 35/00 (2006.01) A61P 37/00 (2006.01)
3660013	A61K 31/506 (2006.01) A61P 3/00 (2006.01) A61P 9/00 (2006.01) A61P 15/00 (2006.01) A61P 25/00 (2006.01) A61P 35/00 (2006.01) C07D 403/04 (2006.01) C07D 413/14 (2006.01) C07D 417/14 (2006.01) C07D 471/04 (2006.01) C07D 487/04 (2006.01) C07D 495/04 (2006.01)
3660032	C07K 1/14 (2006.01) C07K 1/18 (2006.01) C07K 1/22 (2006.01) C07K 1/32 (2006.01)
3639850	A61K 39/00 (2006.01) A61K 39/085 (2006.01) A61K 39/39 (2006.01) A61P 31/04 (2006.01) C07K 14/31 (2006.01)
3653211	A61K 31/495 (2006.01) A61P 25/18 (2006.01)
3669879	A61K 9/00 (2006.01) A61K 9/10 (2006.01) A61K 31/7048 (2006.01) A61K 47/36 (2006.01) A61P 9/00 (2006.01)
3662995	B01J 21/06 (2006.01) B01J 23/22 (2006.01) B01J 37/00 (2006.01) C01G 23/04 (2006.01) C01G 31/02 (2006.01)
3663332	A41D 19/00 (2006.01) C08J 5/02 (2006.01) C08K 3/08 (2006.01) C08K 3/11 (2018.01) C08K 3/22 (2006.01)

Broj objave evropske prijava patenta (97)	MKP (51)
	C08K 9/04 (2006.01)
3650019	A61K 9/00 (2006.01) A61K 31/138 (2006.01) A61K 31/439 (2006.01) A61K 31/58 (2006.01) A61P 11/00 (2006.01) A61P 11/06 (2006.01)
3669881	A61K 31/404 (2006.01) A61K 31/428 (2006.01) A61K 31/495 (2006.01) A61K 31/496 (2006.01) A61K 31/5377 (2006.01) A61K 31/635 (2006.01) A61K 31/728 (2006.01) A61P 9/10 (2006.01) A61P 11/00 (2006.01) A61P 27/02 (2006.01)
3674227	B65D 17/00 (2006.01) B65D 17/28 (2006.01) B65D 17/34 (2006.01) B65D 17/50 (2006.01) B65D 77/20 (2006.01) B65D 79/00 (2006.01) B65D 81/22 (2006.01)
3638698	A61K 39/395 (2006.01) A61P 31/16 (2006.01) C07K 16/10 (2006.01) C07K 16/28 (2006.01) C07K 16/40 (2006.01)
3655364	C01F 5/24 (2006.01) C11D 3/12 (2006.01) C11D 7/02 (2006.01)
3661373	A23L 33/00 (2016.01) A23L 33/10 (2016.01) A23L 33/17 (2016.01) A23L 33/18 (2016.01) A23L 33/19 (2016.01) A61K 38/40 (2006.01) A61P 3/00 (2006.01) A61P 25/00 (2006.01)
3672614	A61K 38/00 (2006.01) A61K 39/00 (2006.01) A61K 45/06 (2006.01)
3666794	A61K 39/395 (2006.01) A61P 1/02 (2006.01) A61P 1/04 (2006.01) A61P 3/10 (2006.01) A61P 17/00 (2006.01) A61P 25/00 (2006.01) A61P 29/00 (2006.01) A61P 31/00 (2006.01) A61P 31/04 (2006.01) A61P 31/12 (2006.01) A61P 31/14 (2006.01) A61P 31/16 (2006.01) A61P 31/18 (2006.01)

Broj objave evropske prijava patenta (97)	MKP (51)
	A61P 31/20 (2006.01) A61P 35/00 (2006.01) A61P 35/02 (2006.01) A61P 37/02 (2006.01) A61P 37/04 (2006.01) C07K 16/28 (2006.01) C12N 15/13 (2006.01)
3657168	A61K 31/7088 (2006.01) A61K 31/711 (2006.01) A61K 38/17 (2006.01) A61K 48/00 (2006.01) A61P 25/28 (2006.01) G01N 33/50 (2006.01)
3663429	C23C 2/02 (2006.01) C23C 2/06 (2006.01) C23C 2/26 (2006.01) C23C 2/30 (2006.01)
3663315	A61K 39/12 (2006.01) A61K 39/145 (2006.01) C07K 16/00 (2006.01) C07K 16/10 (2006.01) C12N 15/00 (2006.01)
3666771	A61K 31/4192 (2006.01) A61K 31/4439 (2006.01) A61P 11/06 (2006.01) A61P 35/00 (2006.01) C07D 249/06 (2006.01) C07D 401/04 (2006.01) C07D 401/14 (2006.01)
3674950	G06F 9/50 (2006.01) G06F 21/57 (2013.01) G06F 21/62 (2013.01) H04L 29/06 (2006.01) H04L 29/08 (2006.01)
3645151	B01F 9/00 (2006.01) B01L 1/00 (2006.01) B65D 25/14 (2006.01)
3645513	A61K 31/55 (2006.01) A61P 13/12 (2006.01) C07D 223/16 (2006.01) C07D 401/06 (2006.01) C07D 401/10 (2006.01) C07D 401/14 (2006.01) C07D 403/06 (2006.01) C07D 405/12 (2006.01) C07D 409/12 (2006.01)
3655163	B01L 9/06 (2006.01) B03C 1/02 (2006.01) G01N 35/00 (2006.01)
3634148	A23K 20/20 (2016.01) A23K 50/10 (2016.01)

Broj objave evropske prijava patenta (97)	MKP (51)
3645518	C07D 213/75 (2006.01) C07D 295/205 (2006.01)
3661925	A61K 31/64 (2006.01) C07D 205/04 (2006.01) C07D 205/12 (2006.01) C07D 207/12 (2006.01) C07D 211/54 (2006.01) C07D 217/22 (2006.01) C07D 223/06 (2006.01) C07D 239/66 (2006.01) C07D 241/18 (2006.01) C07D 401/04 (2006.01) C07D 401/06 (2006.01) C07D 401/12 (2006.01) C07D 401/14 (2006.01) C07D 403/04 (2006.01) C07D 403/06 (2006.01) C07D 405/04 (2006.01) C07D 405/06 (2006.01) C07D 409/04 (2006.01) C07D 451/02 (2006.01) C07D 451/14 (2006.01)
3657933	A01G 9/02 (2018.01) A01G 31/06 (2006.01)
3638292	A61K 9/127 (2006.01) A61K 38/37 (2006.01) A61P 7/04 (2006.01) C07K 14/755 (2006.01) C07K 16/28 (2006.01)
3645002	A61K 31/496 (2006.01) A61P 9/04 (2006.01)
3644721	A01K 67/027 (2006.01) A61K 35/17 (2015.01) C07K 16/28 (2006.01) C07K 16/30 (2006.01) G01N 33/50 (2006.01)
3651832	A61M 5/142 (2006.01)
3652216	A61P 35/00 (2006.01) C07K 16/46 (2006.01)
3665346	E05B 47/06 (2006.01)
3661949	A23L 33/00 (2016.01) C07K 14/245 (2006.01) C07K 14/435 (2006.01) C12N 9/10 (2006.01) C12P 19/18 (2006.01)
3649242	A61K 31/7088 (2006.01) A61P 35/00 (2006.01) C12N 15/10 (2006.01) C12N 15/113 (2010.01)

Broj objave evropske prijave patenta (97)	MKP (51)
3641801	A61K 38/48 (2006.01) C07K 14/435 (2006.01)
3642479	F03D 7/02 (2006.01) F03D 13/25 (2016.01)
3644961	A61K 9/00 (2006.01) A61K 9/20 (2006.01) A61K 31/203 (2006.01) A61P 31/00 (2006.01) A61P 35/00 (2006.01)
3648780	A61K 35/745 (2015.01) A61K 45/06 (2006.01) A61P 35/00 (2006.01)
3651766	A61K 31/496 (2006.01) A61K 31/573 (2006.01) A61K 38/05 (2006.01) A61P 35/00 (2006.01) C07D 241/02 (2006.01)
3654955	A61K 9/24 (2006.01) A61K 31/00 (2006.01)
3658206	A61M 5/142 (2006.01) A61M 5/20 (2006.01) A61M 5/24 (2006.01) A61M 5/28 (2006.01) A61M 39/18 (2006.01)
3655063	A61J 1/14 (2006.01) A61J 1/20 (2006.01) A61K 39/395 (2006.01) A61M 5/142 (2006.01) A61M 5/145 (2006.01) A61M 5/158 (2006.01) A61M 5/24 (2006.01) A61M 5/315 (2006.01) A61M 5/32 (2006.01) A61M 5/34 (2006.01) A61M 39/00 (2006.01) A61M 39/18 (2006.01) C07K 16/40 (2006.01)
3658203	A61M 5/142 (2006.01) A61M 5/145 (2006.01) A61M 5/158 (2006.01) A61M 5/24 (2006.01) A61M 5/315 (2006.01) B05C 17/01 (2006.01) F04B 43/12 (2006.01)
3652168	C07D 231/20 (2006.01) C07D 231/22 (2006.01) C07D 231/56 (2006.01) C07D 401/04 (2006.01) C07D 403/12 (2006.01) C07D 417/12 (2006.01) C07D 417/14 (2006.01) C07D 491/04 (2006.01) C07D 495/04 (2006.01)

Broj objave evropske prijava patenta (97)	MKP (51)
	C07D 519/00 (2006.01)
3652209	C07K 16/28 (2006.01)
3651752	A61K 31/165 (2006.01) A61P 29/02 (2006.01) C07C 237/42 (2006.01) C07D 213/81 (2006.01) C07D 213/82 (2006.01)
3652166	A61K 31/435 (2006.01) A61P 35/00 (2006.01) A61P 37/00 (2006.01) C07D 401/04 (2006.01) C07D 401/14 (2006.01) C07D 405/14 (2006.01) C07D 409/14 (2006.01)
3655033	A61K 39/395 (2006.01) A61P 35/00 (2006.01) C07K 16/28 (2006.01)
3648814	A61M 1/36 (2006.01)
3658545	C07D 213/56 (2006.01) C07D 401/04 (2006.01) C07D 487/04 (2006.01)
3661510	A61K 31/44 (2006.01) A61P 25/00 (2006.01) A61P 25/08 (2006.01) A61P 25/14 (2006.01) A61P 25/16 (2006.01) A61P 25/18 (2006.01) A61P 25/24 (2006.01) A61P 25/28 (2006.01) A61P 25/30 (2006.01)
3668653	B03D 1/004 (2006.01) B03D 1/01 (2006.01) B03D 1/16 (2006.01)
3665182	A61K 38/00 (2006.01) C07K 7/08 (2006.01) C07K 14/47 (2006.01)
3658668	C12N 7/00 (2006.01)
3638370	A61K 31/198 (2006.01) A61P 25/06 (2006.01)
3655138	A61K 31/728 (2006.01) B01D 61/14 (2006.01) C08B 37/08 (2006.01)
3649154	A61K 39/395 (2006.01) C07K 16/28 (2006.01) C07K 16/46 (2006.01)

Broj objave evropske prijava patenta (97)	MKP (51)
3649155	A61K 39/00 (2006.01) C07K 16/28 (2006.01)
3649156	C07K 16/12 (2006.01) C07K 16/28 (2006.01) C07K 16/46 (2006.01)
3642234	A61K 39/00 (2006.01) C07K 16/24 (2006.01)
3648765	A61K 31/496 (2006.01) A61P 25/28 (2006.01)
3638803	C08B 1/00 (2006.01) C12P 7/06 (2006.01) C12P 19/04 (2006.01) D21C 5/00 (2006.01)
3645551	A61K 35/76 (2015.01) A61K 48/00 (2006.01) C07K 14/015 (2006.01) C07K 16/18 (2006.01) C07K 16/28 (2006.01) C12N 5/10 (2006.01) C12N 15/35 (2006.01) C12N 15/864 (2006.01)
3645553	A61K 48/00 (2006.01) C07K 14/315 (2006.01) C12N 7/00 (2006.01)
3638302	A61K 39/12 (2006.01) A61P 31/18 (2006.01) C07K 14/16 (2006.01)
3648868	B01D 53/047 (2006.01)
3652524	G01B 11/25 (2006.01) G01N 21/88 (2006.01)
3654969	A61K 31/404 (2006.01) A61K 31/443 (2006.01) A61K 31/4439 (2006.01) A61K 31/47 (2006.01) A61P 11/00 (2006.01)
3655494	C09K 8/524 (2006.01) C09K 8/60 (2006.01) E21B 43/25 (2006.01)
3658179	A61K 39/00 (2006.01)
3673567	H02K 5/22 (2006.01) H02K 7/14 (2006.01) H02K 11/33 (2016.01) H02K 15/14 (2006.01)
3657963	A23L 33/15 (2016.01) A61K 31/122 (2006.01) A61K 33/06 (2006.01) A61K 33/26 (2006.01)

Broj objave evropske prijava patenta (97)	MKP (51)
	A61K 45/06 (2006.01) A61P 9/00 (2006.01)
3661849	B31B 50/25 (2017.01) B31B 50/54 (2017.01) B31B 50/62 (2017.01) B31B 100/00 (2017.01) B31B 110/35 (2017.01) B31B 120/10 (2017.01) B31F 1/08 (2006.01) B65B 5/02 (2006.01) B65B 11/00 (2006.01) B65B 35/24 (2006.01) B65B 35/44 (2006.01) B65B 43/12 (2006.01) B65B 43/30 (2006.01) B65B 49/10 (2006.01) B65B 49/14 (2006.01)
3672668	A61M 5/315 (2006.01)
3668499	A23L 2/00 (2006.01) A61K 9/00 (2006.01) A61K 31/198 (2006.01) A61K 31/4172 (2006.01) A61K 38/00 (2006.01) A61K 45/06 (2006.01) A61P 1/16 (2006.01) A61P 21/00 (2006.01) A61P 31/00 (2006.01) A61P 43/00 (2006.01)
3672631	A61K 39/395 (2006.01) C07K 16/18 (2006.01)
3672632	A61K 39/395 (2006.01) C07K 16/18 (2006.01) C07K 16/28 (2006.01)
3540674	G06Q 20/38 (2012.01) G06Q 20/40 (2012.01) G06Q 30/06 (2012.01)
3536380	A61K 31/5585 (2006.01) A61K 38/28 (2006.01) A61P 3/10 (2006.01)
3560959	A61K 39/395 (2006.01) C07K 16/28 (2006.01) G01N 33/68 (2006.01)
3540356	B21C 37/29 (2006.01) F16L 1/00 (2006.01) F16L 5/10 (2006.01) F16L 13/02 (2006.01) F24D 19/00 (2006.01) F28D 1/053 (2006.01) F28D 21/00 (2006.01) F28F 9/02 (2006.01) F28F 9/18 (2006.01) F28F 9/26 (2006.01)

Broj objave evropske prijava patenta (97)	MKP (51)
3539966	A61K 31/4353 (2006.01) A61P 1/00 (2006.01) A61P 17/06 (2006.01) C07D 487/04 (2006.01)
3549611	A61K 38/17 (2006.01) A61K 48/00 (2006.01)
3540139	E03C 1/122 (2006.01) E03D 11/16 (2006.01) E03F 5/08 (2006.01)
3536339	A61K 39/00 (2006.01) A61K 39/395 (2006.01) A61P 11/06 (2006.01) G01N 33/48 (2006.01)
3543528	F04B 27/00 (2006.01) F04B 35/04 (2006.01) F04B 39/06 (2006.01) F04B 39/12 (2006.01) F04B 39/16 (2006.01)
3542820	A61K 31/519 (2006.01) A61K 39/395 (2006.01) C07K 16/24 (2006.01)
3527088	A24F 47/00 (2006.01)
3537094	F42B 5/02 (2006.01) F42B 5/03 (2006.01) F42B 8/14 (2006.01) F42B 12/06 (2006.01) F42B 12/36 (2006.01)
3539540	A61K 31/00 (2006.01) A61K 31/341 (2006.01) A61K 38/28 (2006.01) A61P 3/10 (2006.01)
3542791	A61K 9/20 (2006.01) A61K 9/24 (2006.01) A61K 9/28 (2006.01) A61K 9/48 (2006.01)
3537223	G03G 15/08 (2006.01) G03G 21/16 (2006.01) G03G 21/18 (2006.01)
3563860	A61K 35/12 (2015.01) A61K 35/44 (2015.01) A61K 35/50 (2015.01) A61P 27/02 (2006.01)
3546211	B32B 17/10 (2006.01) B60J 1/00 (2006.01)
3539952	A61K 31/517 (2006.01) A61P 29/00 (2006.01) C07D 239/70 (2006.01)

Broj objave evropske prijava patenta (97)	MKP (51)
3539961	A61K 31/437 (2006.01) A61P 35/00 (2006.01) C07D 471/04 (2006.01) C07D 487/04 (2006.01) C07D 498/04 (2006.01)
3550019	A61K 31/7088 (2006.01) C12N 15/11 (2006.01) C12N 15/113 (2010.01)
3655438	A61K 39/00 (2006.01) C07K 16/28 (2006.01)
3665124	C01B 25/01 (2006.01) C01B 25/22 (2006.01) C01B 25/225 (2006.01) C01B 25/226 (2006.01) C01B 25/32 (2006.01)
3668879	A61K 31/438 (2006.01) A61P 31/06 (2006.01) C07D 498/10 (2006.01)
3668853	A61K 31/4427 (2006.01) A61K 31/4523 (2006.01) A61K 31/497 (2006.01) A61K 31/501 (2006.01) A61K 31/506 (2006.01) A61P 31/06 (2006.01) C07D 401/04 (2006.01)
3645122	A61P 35/00 (2006.01) C07K 14/54 (2006.01) C07K 14/715 (2006.01) C07K 16/28 (2006.01)
3654976	A61K 31/352 (2006.01) A61K 31/366 (2006.01) A61K 31/404 (2006.01) A61K 31/436 (2006.01) A61K 31/4439 (2006.01) A61K 39/395 (2006.01) A61N 5/10 (2006.01) A61P 35/00 (2006.01)
3658539	A61K 31/175 (2006.01) C07C 381/10 (2006.01) C07D 205/04 (2006.01) C07D 207/04 (2006.01) C07D 207/10 (2006.01) C07D 213/71 (2006.01) C07D 217/22 (2006.01) C07D 231/18 (2006.01) C07D 231/56 (2006.01) C07D 263/46 (2006.01) C07D 265/30 (2006.01) C07D 277/36 (2006.01) C07D 307/64 (2006.01) C07D 333/34 (2006.01) C07D 417/12 (2006.01)
3658193	A61K 39/00 (2006.01) A61K 49/00 (2006.01)

Broj objave evropske prijave patenta (97)	MKP (51)
	A61K 49/16 (2006.01) A61K 51/10 (2006.01) C07K 16/28 (2006.01) G01N 33/53 (2006.01)
3658672	A61K 38/46 (2006.01) C12N 9/18 (2006.01)
3658555	A61K 31/437 (2006.01) A61P 29/00 (2006.01) C07D 471/04 (2006.01)
3658556	A61K 31/437 (2006.01) A61P 29/00 (2006.01) C07D 471/04 (2006.01)
3668854	A61K 31/397 (2006.01) A61P 31/06 (2006.01) C07D 205/04 (2006.01) C07D 401/04 (2006.01) C07D 405/04 (2006.01)
3658174	A61K 38/40 (2006.01) A61P 31/00 (2006.01)
3652318	A61K 35/74 (2015.01) A61P 35/00 (2006.01) C12N 1/36 (2006.01) C12N 15/113 (2010.01)
3655040	A61K 31/7115 (2006.01) A61K 48/00 (2006.01) C12N 9/00 (2006.01)
3661544	A61K 39/00 (2006.01) A61P 35/00 (2006.01) C07K 16/28 (2006.01)
3654951	A61K 9/20 (2006.01) A61K 31/34 (2006.01) A61K 31/513 (2006.01) A61K 31/5377 (2006.01) A61K 31/675 (2006.01)
3661517	A61K 31/5395 (2006.01) A61P 35/00 (2006.01) C07D 273/04 (2006.01) C07D 413/10 (2006.01) C07D 417/10 (2006.01) C07D 491/107 (2006.01)
3652491	A61J 1/10 (2006.01) F26B 5/06 (2006.01)
3668567	A61M 5/142 (2006.01)
3651735	A61K 9/00 (2006.01) A61K 9/20 (2006.01) A61K 9/50 (2006.01) A61K 31/4439 (2006.01)

Broj objave evropske prijave patenta (97)	MKP (51)
3658156	A61K 31/7125 (2006.01) A61P 7/00 (2006.01)
3652169	A61K 31/416 (2006.01) A61K 31/437 (2006.01) A61K 31/519 (2006.01) A61P 29/00 (2006.01) C07D 403/12 (2006.01) C07D 487/04 (2006.01)
3661503	A61K 31/4196 (2006.01) A61K 31/4439 (2006.01) A61P 15/02 (2006.01) A61P 31/10 (2006.01)
3661915	C07D 207/06 (2006.01) C07D 207/263 (2006.01)
3661950	A01N 63/00 (2020.01) C07K 14/325 (2006.01) C12N 15/82 (2006.01)
3665706	G16H 20/10 (2018.01) G16H 50/50 (2018.01)
3658524	B01D 11/04 (2006.01) C07C 37/00 (2006.01) C07C 37/70 (2006.01) C07C 37/82 (2006.01) C07C 39/23 (2006.01) C07D 311/80 (2006.01)
3661960	A61P 35/00 (2006.01) C07K 16/10 (2006.01) C07K 16/28 (2006.01)
3668856	A61K 31/4192 (2006.01) A61K 31/4196 (2006.01) A61K 31/4439 (2006.01) A61K 31/497 (2006.01) A61K 31/501 (2006.01) A61K 31/506 (2006.01) A61P 31/06 (2006.01) C07D 249/06 (2006.01) C07D 257/04 (2006.01) C07D 401/06 (2006.01) C07D 403/06 (2006.01) C07D 405/06 (2006.01)
3654778	A23L 3/01 (2006.01) A23L 33/00 (2016.01) A23L 33/10 (2016.01) A61K 39/35 (2006.01) A61P 37/00 (2006.01)
3658583	A61K 39/00 (2006.01) C07K 16/22 (2006.01) C07K 16/28 (2006.01)
3661518	A61K 9/00 (2006.01) A61K 31/55 (2006.01)

Broj objave evropske prijava patenta (97)	MKP (51)
	A61P 1/14 (2006.01)
3652887	H04L 9/32 (2006.01) H04L 29/06 (2006.01)
3638441	B22F 3/105 (2006.01) B29C 64/20 (2017.01) B29C 64/264 (2017.01) B29C 64/268 (2017.01) B29C 64/277 (2017.01) B33Y 10/00 (2015.01) B33Y 30/00 (2015.01)
3665192	A61K 38/40 (2006.01) A61K 39/00 (2006.01) C07K 14/705 (2006.01) C07K 14/79 (2006.01)
3665287	A23L 2/60 (2006.01) C12N 9/02 (2006.01) C12N 9/10 (2006.01) C12N 9/90 (2006.01) C12N 15/81 (2006.01)
3664780	A61K 9/08 (2006.01) A61K 31/166 (2006.01) A61K 47/18 (2017.01) A61K 47/26 (2006.01)
3655365	C02F 1/28 (2006.01) D06F 39/10 (2006.01)
3661534	A61K 8/00 (2006.01) A61K 31/132 (2006.01) A61K 31/4188 (2006.01) A61K 36/53 (2006.01) A61P 17/14 (2006.01)
3659127	G07G 1/00 (2006.01)
3661528	A61K 35/17 (2015.01) C12N 5/0783 (2010.01)
3668861	A61K 31/64 (2006.01) C07D 213/52 (2006.01) C07D 231/18 (2006.01) C07D 401/12 (2006.01) C07D 401/14 (2006.01) C07D 403/12 (2006.01) C07D 405/04 (2006.01) C07D 405/12 (2006.01) C07D 407/12 (2006.01) C07D 407/14 (2006.01) C07D 413/12 (2006.01) C07D 417/12 (2006.01) C07D 471/08 (2006.01) C07D 487/04 (2006.01) C07D 491/048 (2006.01)
3632912	A61K 31/517 (2006.01) A61P 17/06 (2006.01)

Broj objave evropske prijave patenta (97)	MKP (51)
	C07D 471/04 (2006.01)
3662287	G01N 1/34 (2006.01) G01N 33/68 (2006.01)
3662288	G01N 30/88 (2006.01) G01N 33/68 (2006.01)
3661954	A61K 47/54 (2017.01) A61K 47/60 (2017.01) C07K 14/54 (2006.01)
3661514	A61K 31/513 (2006.01) A61P 9/04 (2006.01) A61P 9/10 (2006.01)
3664863	A61M 5/142 (2006.01) A61M 5/145 (2006.01)
3668966	C12M 1/34 (2006.01) C12M 1/42 (2006.01) C12M 3/00 (2006.01) C12N 5/0735 (2010.01) C12N 5/077 (2010.01) C12N 13/00 (2006.01) G01N 27/27 (2006.01) G01N 33/50 (2006.01)
3668599	A61P 3/10 (2006.01) A61P 25/28 (2006.01) A61P 29/00 (2006.01) A61P 31/00 (2006.01) A61P 35/00 (2006.01) C07D 231/18 (2006.01) C07D 233/84 (2006.01) C07D 249/04 (2006.01) C07D 249/12 (2006.01) C07D 401/04 (2006.01) C07D 401/12 (2006.01) C07D 403/04 (2006.01) C07D 403/06 (2006.01) C07D 403/12 (2006.01) C07D 405/04 (2006.01) C07D 405/12 (2006.01) C07D 413/06 (2006.01) C07D 417/04 (2006.01) C07D 471/04 (2006.01) C07D 487/04 (2006.01)
3661945	A61K 31/575 (2006.01) A61P 5/44 (2006.01) C07J 63/00 (2006.01)
3664802	A61K 31/437 (2006.01) A61P 25/28 (2006.01)
3664792	A61K 31/195 (2006.01) A61P 9/08 (2006.01)
3669033	E04B 1/24 (2006.01) E04B 1/348 (2006.01) E04B 9/06 (2006.01)

Broj objave evropske prijava patenta (97)	MKP (51)
	E04C 3/04 (2006.01) E04C 3/07 (2006.01)
3668601	A61K 31/64 (2006.01) A61P 1/00 (2006.01) A61P 9/00 (2006.01) A61P 11/00 (2006.01) A61P 13/12 (2006.01) A61P 15/00 (2006.01) A61P 17/00 (2006.01) A61P 25/00 (2006.01) A61P 31/00 (2006.01) A61P 37/00 (2006.01)
3661562	A61K 47/68 (2017.01) C07K 14/605 (2006.01) C07K 16/00 (2006.01)
3661963	A61K 47/68 (2017.01) A61P 35/00 (2006.01) C07K 16/28 (2006.01)
3661519	A61K 31/519 (2006.01) A61K 31/55 (2006.01) A61K 45/06 (2006.01) A61P 35/00 (2006.01)
3661516	A61K 31/5377 (2006.01) A61K 31/55 (2006.01) A61K 45/06 (2006.01) A61P 35/00 (2006.01)
3665179	A61K 31/7064 (2006.01) A61P 35/00 (2006.01) A61P 35/02 (2006.01) C07H 19/14 (2006.01)
3665169	A61K 31/4365 (2006.01) A61K 31/496 (2006.01) A61K 31/4995 (2006.01) A61K 31/5386 (2006.01) A61K 31/551 (2006.01) A61P 35/00 (2006.01) C07D 405/14 (2006.01) C07D 471/04 (2006.01) C07D 487/04 (2006.01) C07D 495/04 (2006.01) C07D 519/00 (2006.01)
3664820	A61K 35/17 (2015.01) A61K 39/00 (2006.01) A61K 39/395 (2006.01) A61K 39/44 (2006.01) C12N 5/0783 (2010.01)
3664835	A61K 39/00 (2006.01) C12N 5/0783 (2010.01)
3645003	A61K 31/505 (2006.01) A61K 31/513 (2006.01) A61K 31/675 (2006.01)

Broj objave evropske prijave patenta (97)	MKP (51)
3645526	A61K 31/435 (2006.01) A61P 35/00 (2006.01) C07D 403/02 (2006.01) C07D 403/14 (2006.01)
3645120	A61K 31/396 (2006.01) A61K 31/425 (2006.01) A61K 45/06 (2006.01) A61P 25/24 (2006.01) C07D 498/04 (2006.01)
3646869	A61K 31/437 (2006.01) A61K 39/395 (2006.01) A61K 45/00 (2006.01) A61P 35/00 (2006.01) A61P 37/04 (2006.01) A61P 43/00 (2006.01) C07D 471/04 (2006.01)
3650470	C07K 1/13 (2006.01) C07K 16/30 (2006.01) C12N 1/15 (2006.01) C12N 1/19 (2006.01) C12N 1/21 (2006.01) C12N 5/10 (2006.01) C12N 15/13 (2006.01) C12N 15/63 (2006.01) C12P 21/08 (2006.01) G01N 33/574 (2006.01)
3648756	A61K 31/22 (2006.01) A61K 31/366 (2006.01) A61K 31/40 (2006.01) A61K 31/428 (2006.01) A61K 31/44 (2006.01) A61K 31/47 (2006.01) A61K 31/505 (2006.01) A61P 25/16 (2006.01) A61P 25/28 (2006.01)
3648775	A61K 31/737 (2006.01) A61K 38/01 (2006.01) A61K 38/04 (2006.01) A61K 38/39 (2006.01) A61L 33/08 (2006.01) A61P 1/16 (2006.01)
3648767	A61K 9/10 (2006.01) A61K 31/519 (2006.01) A61P 29/00 (2006.01)
3632816	B65D 81/20 (2006.01)
3648785	A61K 38/17 (2006.01) A61P 17/00 (2006.01) C07D 215/00 (2006.01)
3648774	A61K 31/715 (2006.01) A61K 31/727 (2006.01) A61K 31/728 (2006.01) A61K 31/737 (2006.01) A61K 38/00 (2006.01)

Broj objave evropske prijava patenta (97)	MKP (51)
	A61K 38/08 (2019.01)
3651801	A61K 41/00 (2020.01)
3652106	B82Y 10/00 (2011.01) G21K 1/00 (2006.01) G21K 1/02 (2006.01)
3651761	A61K 31/381 (2006.01) A61K 31/397 (2006.01) C07K 14/47 (2006.01) C07K 16/28 (2006.01)
3653623	A61K 31/5355 (2006.01) A61P 25/20 (2006.01) C07D 265/06 (2006.01) C07D 413/14 (2006.01)
3652316	C12N 15/11 (2006.01) C12P 21/00 (2006.01)
3651794	A61K 39/00 (2006.01) A61P 31/04 (2006.01) C07K 14/295 (2006.01)
3653722	C12Q 1/68 (2018.01)
3651683	A61C 7/00 (2006.01)
3653528	B65D 5/42 (2006.01) B65D 5/54 (2006.01) B65D 71/52 (2006.01)
3651774	A61K 31/7088 (2006.01) C07K 14/405 (2006.01) C12N 5/10 (2006.01) C12N 9/22 (2006.01) C12N 15/10 (2006.01) C12N 15/113 (2010.01)
3658192	A61K 47/68 (2017.01) A61P 19/02 (2006.01) C07K 16/24 (2006.01)
3657327	G06F 9/445 (2018.01) G06T 11/00 (2006.01) G06T 15/00 (2011.01)
3655011	A61K 38/12 (2006.01)
3654956	A61K 31/00 (2006.01) A61K 31/496 (2006.01) A61K 45/06 (2006.01)
3655026	A61K 39/00 (2006.01) C07K 16/28 (2006.01)
3654953	A61K 9/00 (2006.01) A61K 9/20 (2006.01)

Broj objave evropske prijava patenta (97)	MKP (51)
	A61K 9/28 (2006.01)
3658570	C07K 14/00 (2006.01) C12N 15/113 (2010.01)
3658552	A61K 31/506 (2006.01) A61K 31/5377 (2006.01) C07D 413/14 (2006.01)
3658750	E21B 43/30 (2006.01) E21B 47/06 (2012.01) G01V 1/00 (2006.01)
3658522	A61K 31/015 (2006.01) A61P 37/02 (2006.01) C07C 15/24 (2006.01)
3658553	A61K 31/506 (2006.01) A61K 31/5377 (2006.01) C07D 413/14 (2006.01)
3658893	A01K 43/04 (2006.01) G01J 3/28 (2006.01) G01N 21/00 (2006.01) G01N 21/25 (2006.01) G01N 21/31 (2006.01)
3658142	A61K 9/06 (2006.01) A61K 31/4188 (2006.01)
3658150	A61K 31/575 (2006.01) C07J 9/00 (2006.01)
3658547	A61K 31/506 (2006.01) C07D 403/04 (2006.01) C07D 413/14 (2006.01)
3659683	A63F 13/52 (2014.01)
3658137	A61K 31/05 (2006.01) A61K 31/352 (2006.01) A61K 31/353 (2006.01) A61K 36/185 (2006.01) A61K 47/12 (2006.01) A61K 47/44 (2017.01)
3658985	G02B 1/00 (2006.01) G02F 1/19 (2019.01) H04B 10/25 (2013.01)
3659098	G06Q 30/08 (2012.01)
3659609	A61K 31/7088 (2006.01) A61K 31/7105 (2006.01) A61K 31/713 (2006.01) A61K 47/54 (2017.01) A61K 48/00 (2006.01) A61P 11/00 (2006.01) A61P 43/00 (2006.01) C12N 15/113 (2010.01)

Broj objave evropske prijave patenta (97)	MKP (51)
3661466	A61F 9/007 (2006.01)
3661505	A01N 43/78 (2006.01) A61K 31/426 (2006.01) A61P 25/28 (2006.01) C07D 277/66 (2006.01)
3638367	A61K 31/282 (2006.01) A61N 5/06 (2006.01) C07D 487/22 (2006.01)
3661955	A61K 38/20 (2006.01) C07K 14/55 (2006.01) C12N 15/26 (2006.01)
3661554	A61K 39/395 (2006.01) C07K 16/28 (2006.01) C07K 16/46 (2006.01)
3661956	A61K 38/20 (2006.01) C07K 14/55 (2006.01) C12N 15/26 (2006.01)
3661547	A61K 39/02 (2006.01) A61K 39/08 (2006.01) A61P 31/04 (2006.01)
3661498	A61K 31/381 (2006.01) A61K 31/385 (2006.01) A61K 31/424 (2006.01)
3661499	A61K 31/381 (2006.01) A61K 39/395 (2006.01) A61P 35/00 (2006.01)
3666766	A61K 31/439 (2006.01) A61K 31/4439 (2006.01) A61K 31/444 (2006.01) A61K 31/506 (2006.01) A61K 31/5377 (2006.01) A61P 13/12 (2006.01) A61P 43/00 (2006.01) C07D 401/04 (2006.01) C07D 401/14 (2006.01) C07D 405/14 (2006.01) C07D 409/14 (2006.01) C07D 413/04 (2006.01) C07D 413/14 (2006.01) C07D 417/04 (2006.01) C07D 451/02 (2006.01) C07D 487/04 (2006.01) C07D 498/04 (2006.01)
3665620	G06K 9/00 (2006.01) G06K 9/46 (2006.01)
3665156	C07C 211/38 (2006.01) C07C 217/52 (2006.01) C07C 233/05 (2006.01)
3664793	A61K 31/195 (2006.01) A61K 31/335 (2006.01)

Broj objave evropske prijava patenta (97)	MKP (51)
	C07C 15/24 (2006.01)
3668514	A61K 31/513 (2006.01) A61K 31/565 (2006.01) A61K 31/57 (2006.01)
3668502	A61K 31/395 (2006.01) A61P 35/00 (2006.01) C07D 515/22 (2006.01)
3668971	C12N 9/12 (2006.01) C12N 15/10 (2006.01)
3668977	C12N 15/10 (2006.01) G01N 30/02 (2006.01)
3668531	A61K 38/00 (2006.01) A61K 38/48 (2006.01) A61K 39/395 (2006.01) C07K 16/40 (2006.01) C12N 9/50 (2006.01)
3668522	A61K 9/51 (2006.01) A61K 31/7088 (2006.01) A61K 39/145 (2006.01) A61K 47/69 (2017.01) A61P 31/16 (2006.01) G01N 33/50 (2006.01)
3652184	A61K 31/395 (2006.01) A61P 35/00 (2006.01) C07D 515/22 (2006.01)
3668504	A61K 31/395 (2006.01) A61P 35/00 (2006.01) C07D 515/22 (2006.01)
3668794	A63H 27/20 (2006.01) A63H 27/22 (2006.01) B64C 39/02 (2006.01) B64D 27/24 (2006.01) B64D 39/00 (2006.01) B64F 3/02 (2006.01) H02J 50/27 (2016.01) H02J 50/30 (2016.01) H02J 50/80 (2016.01) H02J 50/90 (2016.01)
3668507	A61K 31/4184 (2006.01) A61K 39/395 (2006.01) A61P 35/00 (2006.01) C07D 235/04 (2006.01)
3668979	C12N 15/10 (2006.01) G01N 30/02 (2006.01)
3668515	A61K 31/513 (2006.01) A61K 31/565 (2006.01) A61K 31/57 (2006.01)
3672653	A61K 9/00 (2006.01) A61K 9/127 (2006.01)

Broj objave evropske prijava patenta (97)	MKP (51)
	A61K 31/685 (2006.01) A61L 27/50 (2006.01)
3672994	A61K 39/395 (2006.01) A61K 45/06 (2006.01) C07K 16/40 (2006.01)
3675084	G01C 21/00 (2006.01) G09B 29/00 (2006.01)
3655360	B67D 7/00 (2010.01) G01N 27/22 (2006.01)
3674291	A01N 43/40 (2006.01) A01N 43/56 (2006.01) A01N 43/60 (2006.01) A01N 43/72 (2006.01) A01N 43/76 (2006.01) A01N 43/80 (2006.01) A01N 43/836 (2006.01) A01N 43/84 (2006.01) A01N 43/86 (2006.01) A01N 43/90 (2006.01) A01N 47/02 (2006.01) A01N 47/16 (2006.01) A01N 47/40 (2006.01) A01P 7/02 (2006.01) A01P 7/04 (2006.01) A61K 31/444 (2006.01) A61K 31/4545 (2006.01) A61K 31/496 (2006.01) A61K 31/5355 (2006.01) A61K 31/5377 (2006.01) C07D 213/85 (2006.01)
3672981	C07K 1/14 (2006.01) C07K 1/16 (2006.01) C07K 16/00 (2006.01)
3672725	B01J 19/00 (2006.01) B01J 23/89 (2006.01) B01J 37/34 (2006.01)
3672759	B25B 11/00 (2006.01)
3674325	A61K 45/00 (2006.01) A61P 35/00 (2006.01) C07K 14/47 (2006.01) C07K 14/82 (2006.01) C07K 16/18 (2006.01) C07K 16/32 (2006.01) C07K 19/00 (2006.01) C12N 1/15 (2006.01) C12N 1/19 (2006.01) C12N 1/21 (2006.01) C12N 5/10 (2006.01) C12N 9/12 (2006.01) C12N 15/12 (2006.01) C12N 15/54 (2006.01) C12N 15/63 (2006.01) C12Q 1/02 (2006.01) C12Q 1/6806 (2018.01) C12Q 1/6813 (2018.01) G01N 33/15 (2006.01)

Broj objave evropske prijava patenta (97)	MKP (51)
	G01N 33/53 (2006.01)
3673918	A61K 9/08 (2006.01) A61K 9/19 (2006.01) A61K 31/4745 (2006.01) A61K 39/395 (2006.01) A61K 47/10 (2017.01) A61K 47/22 (2006.01) A61K 47/26 (2006.01) A61K 47/68 (2017.01) A61P 35/00 (2006.01) A61P 35/02 (2006.01) C07K 16/00 (2006.01) C07K 19/00 (2006.01)
3672601	A61K 31/712 (2006.01) A61K 31/7125 (2006.01) C12N 15/113 (2010.01)
3645027	A61K 31/05 (2006.01) A61K 31/352 (2006.01) A61K 36/185 (2006.01) B01D 11/02 (2006.01) C07C 39/23 (2006.01) C07D 311/80 (2006.01)
3668997	C07H 21/02 (2006.01) C12Q 1/68 (2018.01)
3672579	A61K 31/00 (2006.01) A61K 39/395 (2006.01) A61P 27/02 (2006.01) C12N 15/113 (2010.01)
3651570	A01K 61/54 (2017.01) A01K 61/65 (2017.01)
3639108	F16H 59/02 (2006.01) G05G 25/04 (2006.01)
3495335	C04B 14/02 (2006.01) C04B 28/00 (2006.01) C08J 9/00 (2006.01) C08J 9/16 (2006.01)

Indeks klasifikacijskih oznaka zahtjeva za proširenje evropskih prijava patenta prema Međunarodnoj klasifikaciji patenata

MKP (51)	Broj objave evropske prijave patenta (97)	Naziv pronalaska (54)
B65B 25/00 (2006.01)	3168608	USE OF BIOPOLYMER IN A DIELECTRIC GAS SENSOR
G01N 27/22 (2006.01)	3168608	USE OF BIOPOLYMER IN A DIELECTRIC GAS SENSOR
G01N 33/02 (2006.01)	3168608	USE OF BIOPOLYMER IN A DIELECTRIC GAS SENSOR
G01N 33/12 (2006.01)	3168608	USE OF BIOPOLYMER IN A DIELECTRIC GAS SENSOR
A01N 43/42 (2006.01)	3260457	PROCESS FOR PREPARING CARBAMOYLPIRIDONE DERIVATIVES AND INTERMEDIATES
A61K 31/44 (2006.01)	3260457	PROCESS FOR PREPARING CARBAMOYLPIRIDONE DERIVATIVES AND INTERMEDIATES
C07D 213/68 (2006.01)	3260457	PROCESS FOR PREPARING CARBAMOYLPIRIDONE DERIVATIVES AND INTERMEDIATES
C07D 213/80 (2006.01)	3260457	PROCESS FOR PREPARING CARBAMOYLPIRIDONE DERIVATIVES AND INTERMEDIATES
C07D 498/14 (2006.01)	3260457	PROCESS FOR PREPARING CARBAMOYLPIRIDONE DERIVATIVES AND INTERMEDIATES
C04B 35/58 (2006.01)	3556901	VACUUM ARC SOURCE
C23C 14/06 (2006.01)	3556901	VACUUM ARC SOURCE
C23C 14/32 (2006.01)	3556901	VACUUM ARC SOURCE
C23C 14/56 (2006.01)	3556901	VACUUM ARC SOURCE
H01J 37/32 (2006.01)	3556901	VACUUM ARC SOURCE
C09C 1/02 (2006.01)	3561002	USE OF ADDITIVES CONTAINING PRIMARY ALKANOLAMINES IN AQUEOUS MINERAL SUSPENSIONS
D21H 17/67 (2006.01)	3561002	USE OF ADDITIVES CONTAINING PRIMARY ALKANOLAMINES IN AQUEOUS MINERAL SUSPENSIONS
H01H 1/00 (2006.01)	3564980	TWO-WIRE TILT SWITCH
H01H 35/02 (2006.01)	3564980	TWO-WIRE TILT SWITCH
H01H 35/06 (2006.01)	3564980	TWO-WIRE TILT SWITCH
E04B 1/348 (2006.01)	3669032	FRAME, BASIC FRAMEWORK, MODULE, PROFILE AND SET OF STRUCTURAL ELEMENTS FOR MODULAR CONSTRUCTION AND A MODULAR-CONSTRUCTION BUILDING
E04B 9/06 (2006.01)	3669032	FRAME, BASIC FRAMEWORK, MODULE, PROFILE AND SET OF STRUCTURAL ELEMENTS FOR MODULAR CONSTRUCTION AND A MODULAR-CONSTRUCTION BUILDING
E04C 3/04 (2006.01)	3669032	FRAME, BASIC FRAMEWORK, MODULE, PROFILE AND SET OF STRUCTURAL ELEMENTS FOR MODULAR CONSTRUCTION AND A MODULAR-CONSTRUCTION BUILDING
E04C 3/07 (2006.01)	3669032	FRAME, BASIC FRAMEWORK, MODULE, PROFILE AND SET OF STRUCTURAL ELEMENTS FOR MODULAR CONSTRUCTION AND A MODULAR-CONSTRUCTION BUILDING
A61J 1/20 (2006.01)	3654910	DRUG MIXING DEVICE
A61J 1/20 (2006.01)	3654911	DRUG MIXING DEVICE
A61J 1/20 (2006.01)	3654912	DRUG MIXING DEVICE
A61J 1/20 (2006.01)	3654913	DRUG MIXING DEVICE
A61J 1/20 (2006.01)	3654914	DRUG MIXING DEVICE
A61J 1/20 (2006.01)	3654915	DRUG MIXING DEVICE
A61J 1/20 (2006.01)	3654916	DRUG MIXING DEVICE
A61K 39/395 (2006.01)	3638694	COMPOSITIONS AND METHODS FOR TREATING TAUOPATHIES
A61P 25/28 (2006.01)	3638694	COMPOSITIONS AND METHODS FOR TREATING TAUOPATHIES
C07K 16/18 (2006.01)	3638694	COMPOSITIONS AND METHODS FOR TREATING TAUOPATHIES
A62C 3/06 (2006.01)	3648848	INSTALLED FIRE EXTINGUISHING EQUIPMENT WITH EXTINGUISHING-LAUNCHING PART-UNIT
A62C 35/02 (2006.01)	3648848	INSTALLED FIRE EXTINGUISHING EQUIPMENT WITH EXTINGUISHING-LAUNCHING PART-UNIT
A62C 35/62 (2006.01)	3648848	INSTALLED FIRE EXTINGUISHING EQUIPMENT WITH EXTINGUISHING-LAUNCHING PART-UNIT
A62C 99/00 (2010.01)	3648848	INSTALLED FIRE EXTINGUISHING EQUIPMENT WITH EXTINGUISHING-LAUNCHING PART-UNIT

MKP (51)	Broj objave evropske prijave patenta (97)	Naziv pronalaska (54)
A62C 3/06 (2006.01)	3648849	INSTALLED FIRE EXTINGUISHING EQUIPMENT WITH IMPROVED CHARACTERISTICS
A62C 35/02 (2006.01)	3648849	INSTALLED FIRE EXTINGUISHING EQUIPMENT WITH IMPROVED CHARACTERISTICS
A62C 35/15 (2006.01)	3648849	INSTALLED FIRE EXTINGUISHING EQUIPMENT WITH IMPROVED CHARACTERISTICS
A62C 35/60 (2006.01)	3648849	INSTALLED FIRE EXTINGUISHING EQUIPMENT WITH IMPROVED CHARACTERISTICS
A62C 99/00 (2010.01)	3648849	INSTALLED FIRE EXTINGUISHING EQUIPMENT WITH IMPROVED CHARACTERISTICS
A62D 1/02 (2006.01)	3648850	POST-FOAMING COMPOSITION FOR PROTECTION AGAINST FIRE AND/OR HEAT
A61K 9/48 (2006.01)	3628311	A PROCESS FOR THE PREPARATION OF A MODIFIED RELEASE MULTIPLE UNIT ORAL DOSAGE FORM OF DOXYLAMINE SUCCINATE AND PYRIDOXINE HYDROCHLORIDE
A61K 9/50 (2006.01)	3628311	A PROCESS FOR THE PREPARATION OF A MODIFIED RELEASE MULTIPLE UNIT ORAL DOSAGE FORM OF DOXYLAMINE SUCCINATE AND PYRIDOXINE HYDROCHLORIDE
A61K 31/4402 (2006.01)	3628311	A PROCESS FOR THE PREPARATION OF A MODIFIED RELEASE MULTIPLE UNIT ORAL DOSAGE FORM OF DOXYLAMINE SUCCINATE AND PYRIDOXINE HYDROCHLORIDE
A61K 31/4415 (2006.01)	3628311	A PROCESS FOR THE PREPARATION OF A MODIFIED RELEASE MULTIPLE UNIT ORAL DOSAGE FORM OF DOXYLAMINE SUCCINATE AND PYRIDOXINE HYDROCHLORIDE
A61K 9/20 (2006.01)	3556357	SUSTAINED RELEASE PYRIDOSTIGMINE COMPOSITIONS
A61K 9/28 (2006.01)	3556357	SUSTAINED RELEASE PYRIDOSTIGMINE COMPOSITIONS
A61K 9/50 (2006.01)	3556357	SUSTAINED RELEASE PYRIDOSTIGMINE COMPOSITIONS
A61K 31/00 (2006.01)	3556357	SUSTAINED RELEASE PYRIDOSTIGMINE COMPOSITIONS
G01N 33/487 (2006.01)	3546935	METHOD FOR IN VITRO DETECTION OF THE PROARRHYTHMOGENIC RISK OF A DRUG CANDIDATE ON HUMAN INDUCED PLURIPOTENT STEM CELL-DERIVED CARDIOMYOCYTES (HIPSC-CM)
G01N 33/50 (2006.01)	3546935	METHOD FOR IN VITRO DETECTION OF THE PROARRHYTHMOGENIC RISK OF A DRUG CANDIDATE ON HUMAN INDUCED PLURIPOTENT STEM CELL-DERIVED CARDIOMYOCYTES (HIPSC-CM)
A61K 9/00 (2006.01)	3641728	AN OIL-IN-WATER NANOEMULSION COMPOSITION OF CLOBETASOL
A61K 9/107 (2006.01)	3641728	AN OIL-IN-WATER NANOEMULSION COMPOSITION OF CLOBETASOL
A61K 31/00 (2006.01)	3641728	AN OIL-IN-WATER NANOEMULSION COMPOSITION OF CLOBETASOL
A61K 47/14 (2017.01)	3641728	AN OIL-IN-WATER NANOEMULSION COMPOSITION OF CLOBETASOL
A61K 47/26 (2006.01)	3641728	AN OIL-IN-WATER NANOEMULSION COMPOSITION OF CLOBETASOL
A61K 47/34 (2017.01)	3641728	AN OIL-IN-WATER NANOEMULSION COMPOSITION OF CLOBETASOL
C06B 25/20 (2006.01)	3642175	COMPOSITION FOR SINGLE-BASE PROPELLING POWDER FOR AMMUNITION AND AMMUNITION PROVIDED WITH SUCH COMPOSITION
C06B 45/10 (2006.01)	3642175	COMPOSITION FOR SINGLE-BASE PROPELLING POWDER FOR AMMUNITION AND AMMUNITION PROVIDED WITH SUCH COMPOSITION
F16L 17/00 (2006.01)	3638992	PORTABLE VERIFICATION SYSTEM AND METHOD USED TO VERIFY AN IN-FIELD GAS FLOW METER
G01F 1/66 (2006.01)	3638992	PORTABLE VERIFICATION SYSTEM AND METHOD USED TO VERIFY AN IN-FIELD GAS FLOW METER
G01F 15/00 (2006.01)	3638992	PORTABLE VERIFICATION SYSTEM AND METHOD USED TO VERIFY AN IN-FIELD GAS FLOW METER
G01F 25/00 (2006.01)	3638992	PORTABLE VERIFICATION SYSTEM AND METHOD USED TO VERIFY AN IN-FIELD GAS FLOW METER
B60T 1/06 (2006.01)	3642509	BRAKING DEVICE AND METHOD
B60T 1/10 (2006.01)	3642509	BRAKING DEVICE AND METHOD

MKP (51)	Broj objave evropske prijave patenta (97)	Naziv pronalaska (54)
B60T 1/12 (2006.01)	3642509	BRAKING DEVICE AND METHOD
B60T 13/06 (2006.01)	3642509	BRAKING DEVICE AND METHOD
F16D 61/00 (2006.01)	3642509	BRAKING DEVICE AND METHOD
F16D 63/00 (2006.01)	3642509	BRAKING DEVICE AND METHOD
F16H 33/10 (2006.01)	3642509	BRAKING DEVICE AND METHOD
G01C 19/00 (2013.01)	3642509	BRAKING DEVICE AND METHOD
B01D 53/72 (2006.01)	3533510	AN EXHAUST GAS TREATMENT METHOD AND SYSTEM ARRANGED FOR TREATING EXHAUST GASES
B01D 53/86 (2006.01)	3533510	AN EXHAUST GAS TREATMENT METHOD AND SYSTEM ARRANGED FOR TREATING EXHAUST GASES
G05B 19/042 (2006.01)	3534226	MODULAR CONTROL SYSTEM
F01N 13/00 (2010.01)	3536921	A SYSTEM AND METHOD FOR ACCURATELY MEASURING NOX AND NH3 CONTENTS IN EXHAUST FUMES
C12Q 1/6869 (2018.01)	3658689	A METHOD FOR NON-INVASIVE PRENATAL DETECTION OF FETAL CHROMOSOME ANEUPLOIDY FROM MATERNAL BLOOD BASED ON BAYESIAN NETWORK
C12Q 1/6883 (2018.01)	3658689	A METHOD FOR NON-INVASIVE PRENATAL DETECTION OF FETAL CHROMOSOME ANEUPLOIDY FROM MATERNAL BLOOD BASED ON BAYESIAN NETWORK
G16B 30/00 (2019.01)	3658689	A METHOD FOR NON-INVASIVE PRENATAL DETECTION OF FETAL CHROMOSOME ANEUPLOIDY FROM MATERNAL BLOOD BASED ON BAYESIAN NETWORK
A61J 1/20 (2006.01)	3654917	DRUG MIXING DEVICE
A01G 17/06 (2006.01)	3672396	IMPROVED ELASTIC COMPENSATION DEVICE FOR ROWS OF PLANTS AND METHOD OF USE THEREOF
A61J 1/20 (2006.01)	3654918	DRUG MIXING DEVICE
C12Q 1/6879 (2018.01)	3662479	A METHOD FOR NON-INVASIVE PRENATAL DETECTION OF FETAL SEX CHROMOSOMAL ABNORMALITIES AND FETAL SEX DETERMINATION FOR SINGLETON AND TWIN PREGNANCIES
G16B 20/00 (2019.01)	3662479	A METHOD FOR NON-INVASIVE PRENATAL DETECTION OF FETAL SEX CHROMOSOMAL ABNORMALITIES AND FETAL SEX DETERMINATION FOR SINGLETON AND TWIN PREGNANCIES
G16B 30/00 (2019.01)	3662479	A METHOD FOR NON-INVASIVE PRENATAL DETECTION OF FETAL SEX CHROMOSOMAL ABNORMALITIES AND FETAL SEX DETERMINATION FOR SINGLETON AND TWIN PREGNANCIES
C08J 11/24 (2006.01)	3638720	TREATMENT PLANT AND METHOD FOR PET GLYCOLYSIS
C08L 67/02 (2006.01)	3638720	TREATMENT PLANT AND METHOD FOR PET GLYCOLYSIS
A61M 5/178 (2006.01)	3665612	IMAGE PROCESSING TECHNIQUES FOR PLUNGER DEPTH MEASUREMENT
G06K 9/00 (2006.01)	3665612	IMAGE PROCESSING TECHNIQUES FOR PLUNGER DEPTH MEASUREMENT
G06K 9/32 (2006.01)	3665612	IMAGE PROCESSING TECHNIQUES FOR PLUNGER DEPTH MEASUREMENT
G06T 7/62 (2017.01)	3665612	IMAGE PROCESSING TECHNIQUES FOR PLUNGER DEPTH MEASUREMENT
C02F 1/52 (2006.01)	3567012	METHOD FOR OPERATING A WASTEWATER TREATMENT PLANT FOR PHOSPHORUS TREATMENT OF EFFLUENT
C02F 1/66 (2006.01)	3567012	METHOD FOR OPERATING A WASTEWATER TREATMENT PLANT FOR PHOSPHORUS TREATMENT OF EFFLUENT
C02F 3/30 (2006.01)	3567012	METHOD FOR OPERATING A WASTEWATER TREATMENT PLANT FOR PHOSPHORUS TREATMENT OF EFFLUENT
C02F 11/04 (2006.01)	3567012	METHOD FOR OPERATING A WASTEWATER TREATMENT PLANT FOR PHOSPHORUS TREATMENT OF EFFLUENT
C02F 101/10 (2006.01)	3567012	METHOD FOR OPERATING A WASTEWATER TREATMENT PLANT FOR PHOSPHORUS TREATMENT OF EFFLUENT
B26D 7/18 (2006.01)	3656518	DEVICE FOR DIE-CUTTING AND EJECTING ELASTOMER STOPPERS
B26F 1/02 (2006.01)	3656518	DEVICE FOR DIE-CUTTING AND EJECTING ELASTOMER STOPPERS
B26D 7/01 (2006.01)	3656519	AUTOMATED DEVICE FOR MANUFACTURING ELASTOMER STOPPERS
B26D 7/18 (2006.01)	3656519	AUTOMATED DEVICE FOR MANUFACTURING ELASTOMER STOPPERS
B26F 1/02 (2006.01)	3656519	AUTOMATED DEVICE FOR MANUFACTURING ELASTOMER STOPPERS
B26F 1/38 (2006.01)	3656519	AUTOMATED DEVICE FOR MANUFACTURING ELASTOMER STOPPERS

MKP (51)	Broj objave evropske prijave patenta (97)	Naziv pronalaska (54)
A23L 7/104 (2016.01)	3659444	GLUTEN-FREE GRAIN-CONCENTRATE SUBSTITUTE FOR FERMENTED WHEAT GERM FOOD PRODUCT AND METHOD OF PREPARATION
B05D 3/02 (2006.01)	3498383	DEVICE FOR COATING WORKPIECES WITH AT LEAST ONE HIGH PERFORMANCE POLYMER; COATING METHOD
B05D 3/06 (2006.01)	3498383	DEVICE FOR COATING WORKPIECES WITH AT LEAST ONE HIGH PERFORMANCE POLYMER; COATING METHOD
B05D 5/08 (2006.01)	3508283	COATING DISPERSION; METHOD OF MANUFACTURING A COATING DISPERSION
G03G 15/00 (2006.01)	3543793	IMAGE FORMING APPARATUS AND CARTRIDGE
G03G 21/16 (2006.01)	3543793	IMAGE FORMING APPARATUS AND CARTRIDGE
G03G 21/18 (2006.01)	3543793	IMAGE FORMING APPARATUS AND CARTRIDGE
C40B 40/10 (2006.01)	3540100	FIBRONECTIN TYOE III REPEAT BASED PROTEIN SCAFFOLDS WITH ALTERNATIVE BINDING SURFACES
C40B 50/00 (2006.01)	3540100	FIBRONECTIN TYOE III REPEAT BASED PROTEIN SCAFFOLDS WITH ALTERNATIVE BINDING SURFACES
A61K 38/12 (2006.01)	3527218	PRO-COAGULANT COMPOUNDS AND METHODS OF USE THEREOF
C12N 15/10 (2006.01)	3540059	BI-FUNCTIONAL COMPLEXES AND METHODS FOR MAKING AND USING SUCH COMPLEXES
A01G 5/06 (2006.01)	3666070	METHOD FOR PRESERVATION OF AT LEAST ONE CUT FLOWER FOR TRANSPORT PURPOSES AND CUT FLOWER OBTAINED BY THE METHOD
A01N 3/02 (2006.01)	3666070	METHOD FOR PRESERVATION OF AT LEAST ONE CUT FLOWER FOR TRANSPORT PURPOSES AND CUT FLOWER OBTAINED BY THE METHOD
A61N 5/10 (2006.01)	3573075	A GANTRY AND APPARATUS FOR FOCUSING BEAMS OF CHARGED PARTICLES
G21K 1/093 (2006.01)	3573075	A GANTRY AND APPARATUS FOR FOCUSING BEAMS OF CHARGED PARTICLES
G21K 5/04 (2006.01)	3573075	A GANTRY AND APPARATUS FOR FOCUSING BEAMS OF CHARGED PARTICLES
B01F 3/10 (2006.01)	3574989	DISPENSING SYSTEM FOR MIXTURE OF TWO COMPONENTS AND STATIC MIXING NOZZLE THEREFOR
B01F 5/06 (2006.01)	3574989	DISPENSING SYSTEM FOR MIXTURE OF TWO COMPONENTS AND STATIC MIXING NOZZLE THEREFOR
B01F 15/02 (2006.01)	3574989	DISPENSING SYSTEM FOR MIXTURE OF TWO COMPONENTS AND STATIC MIXING NOZZLE THEREFOR
B05B 7/04 (2006.01)	3574989	DISPENSING SYSTEM FOR MIXTURE OF TWO COMPONENTS AND STATIC MIXING NOZZLE THEREFOR
B29B 7/74 (2006.01)	3574989	DISPENSING SYSTEM FOR MIXTURE OF TWO COMPONENTS AND STATIC MIXING NOZZLE THEREFOR
A61K 39/395 (2006.01)	3539984	METHODS OF TREATING CONDITIONS WITH ANTIBODIES THAT BIND COLONY STIMULATING FACTOR 1 RECEPTOR (CSF1R)
A61P 35/00 (2006.01)	3539984	METHODS OF TREATING CONDITIONS WITH ANTIBODIES THAT BIND COLONY STIMULATING FACTOR 1 RECEPTOR (CSF1R)
C07K 16/28 (2006.01)	3539984	METHODS OF TREATING CONDITIONS WITH ANTIBODIES THAT BIND COLONY STIMULATING FACTOR 1 RECEPTOR (CSF1R)
A61K 31/4412 (2006.01)	3483143	PIPERIDINONE DERIVATIVES AS MDM2 INHIBITORS FOR THE TREATMENT OF CANCER
A61P 35/00 (2006.01)	3483143	PIPERIDINONE DERIVATIVES AS MDM2 INHIBITORS FOR THE TREATMENT OF CANCER
C07D 211/40 (2006.01)	3483143	PIPERIDINONE DERIVATIVES AS MDM2 INHIBITORS FOR THE TREATMENT OF CANCER
C07D 279/02 (2006.01)	3483143	PIPERIDINONE DERIVATIVES AS MDM2 INHIBITORS FOR THE TREATMENT OF CANCER
C07D 401/04 (2006.01)	3483143	PIPERIDINONE DERIVATIVES AS MDM2 INHIBITORS FOR THE TREATMENT OF CANCER
C07D 401/06 (2006.01)	3483143	PIPERIDINONE DERIVATIVES AS MDM2 INHIBITORS FOR THE TREATMENT OF CANCER
C07D 401/12 (2006.01)	3483143	PIPERIDINONE DERIVATIVES AS MDM2 INHIBITORS FOR THE TREATMENT OF CANCER
C07D 407/04 (2006.01)	3483143	PIPERIDINONE DERIVATIVES AS MDM2 INHIBITORS FOR THE TREATMENT OF CANCER

MKP	Broj objave evropske prijave patenta (97)	Naziv pronalaska (54)
(51)	(97)	(54)
C07D 407/06 (2006.01)	3483143	PIPERIDINONE DERIVATIVES AS MDM2 INHIBITORS FOR THE TREATMENT OF CANCER
C07D 409/04 (2006.01)	3483143	PIPERIDINONE DERIVATIVES AS MDM2 INHIBITORS FOR THE TREATMENT OF CANCER
C07D 413/06 (2006.01)	3483143	PIPERIDINONE DERIVATIVES AS MDM2 INHIBITORS FOR THE TREATMENT OF CANCER
C07D 417/06 (2006.01)	3483143	PIPERIDINONE DERIVATIVES AS MDM2 INHIBITORS FOR THE TREATMENT OF CANCER
C07D 471/20 (2006.01)	3483143	PIPERIDINONE DERIVATIVES AS MDM2 INHIBITORS FOR THE TREATMENT OF CANCER
C07D 498/08 (2006.01)	3483143	PIPERIDINONE DERIVATIVES AS MDM2 INHIBITORS FOR THE TREATMENT OF CANCER
C07D 498/20 (2006.01)	3483143	PIPERIDINONE DERIVATIVES AS MDM2 INHIBITORS FOR THE TREATMENT OF CANCER
A62C 37/11 (2006.01)	3650829	TEST SYSTEM FOR PERFORMING A FIRE RESISTANCE PERIOD TEST FOR A WATER FLOW VALVE
G01M 99/00 (2011.01)	3650829	TEST SYSTEM FOR PERFORMING A FIRE RESISTANCE PERIOD TEST FOR A WATER FLOW VALVE
A61K 39/395 (2006.01)	3520816	ANTI-GCC ANTIBODY MOLECULES AND RELATED COMPOSITIONS AND METHODS
A61P 35/00 (2006.01)	3520816	ANTI-GCC ANTIBODY MOLECULES AND RELATED COMPOSITIONS AND METHODS
C07K 16/30 (2006.01)	3520816	ANTI-GCC ANTIBODY MOLECULES AND RELATED COMPOSITIONS AND METHODS
C07K 16/40 (2006.01)	3520816	ANTI-GCC ANTIBODY MOLECULES AND RELATED COMPOSITIONS AND METHODS
G01N 33/569 (2006.01)	3511717	BIODOSIMETRY PANELS AND METHODS
G01N 33/68 (2006.01)	3511717	BIODOSIMETRY PANELS AND METHODS
G01T 1/00 (2006.01)	3511717	BIODOSIMETRY PANELS AND METHODS
A61K 39/395 (2006.01)	3530287	ANTI-MCAM ANTIBODIES AND ASSOCIATED METHODS OF USE
A61P 17/06 (2006.01)	3530287	ANTI-MCAM ANTIBODIES AND ASSOCIATED METHODS OF USE
A61P 25/00 (2006.01)	3530287	ANTI-MCAM ANTIBODIES AND ASSOCIATED METHODS OF USE
A61P 35/00 (2006.01)	3530287	ANTI-MCAM ANTIBODIES AND ASSOCIATED METHODS OF USE
C07K 16/30 (2006.01)	3530287	ANTI-MCAM ANTIBODIES AND ASSOCIATED METHODS OF USE
A61K 38/36 (2006.01)	3552619	FACTOR IX POLYPEPTIDES AND METHODS OF USE THEREOF
A61K 38/48 (2006.01)	3552619	FACTOR IX POLYPEPTIDES AND METHODS OF USE THEREOF
A61K 39/395 (2006.01)	3552619	FACTOR IX POLYPEPTIDES AND METHODS OF USE THEREOF
A61P 7/04 (2006.01)	3552619	FACTOR IX POLYPEPTIDES AND METHODS OF USE THEREOF
A61B 17/068 (2006.01)	3508142	DEVICES FOR FACILITATING CLOSING AND CLAMPING OF AN END EFFECTOR OF A SURGICAL DEVICE
A61B 17/072 (2006.01)	3508142	DEVICES FOR FACILITATING CLOSING AND CLAMPING OF AN END EFFECTOR OF A SURGICAL DEVICE
C07D 207/26 (2006.01)	3536685	BICYCLIC-FUSED HETEROARYL OR ARYL COMPOUNDS AND THEIR USE AS IRAK4 INHIBITORS
B65B 9/06 (2012.01)	3539882	DEVICE FOR PACKAGING PRODUCTS
B65B 9/20 (2012.01)	3539882	DEVICE FOR PACKAGING PRODUCTS
B65B 31/04 (2006.01)	3539882	DEVICE FOR PACKAGING PRODUCTS
F25D 3/10 (2006.01)	3550225	DEVICE FOR COOLING PRODUCTS
A01N 43/80 (2006.01)	3560923	ANTI PARASITIC DIHYDROAZOLE COMPOUNDS AND COMPOSITIONS COMPRISING SAME
A01N 43/90 (2006.01)	3560923	ANTI PARASITIC DIHYDROAZOLE COMPOUNDS AND COMPOSITIONS COMPRISING SAME
A61K 31/437 (2006.01)	3560923	ANTI PARASITIC DIHYDROAZOLE COMPOUNDS AND COMPOSITIONS COMPRISING SAME
A61K 38/05 (2006.01)	3560923	ANTI PARASITIC DIHYDROAZOLE COMPOUNDS AND COMPOSITIONS COMPRISING SAME
A61K 45/06 (2006.01)	3560923	ANTI PARASITIC DIHYDROAZOLE COMPOUNDS AND COMPOSITIONS COMPRISING SAME
A61P 33/00 (2006.01)	3560923	ANTI PARASITIC DIHYDROAZOLE COMPOUNDS AND COMPOSITIONS COMPRISING SAME
C07D 471/04 (2006.01)	3560923	ANTI PARASITIC DIHYDROAZOLE COMPOUNDS AND COMPOSITIONS COMPRISING SAME

MKP (51)	Broj objave evropske prijave patenta (97)	Naziv pronalaska (54)
A61K 31/44 (2006.01)	3546461	7-BENZYL-4-(2-METHYLBENZYL)-2,4,6,7,8,9-HEXAHYDROIMIDAZO[1,2-A]PYRIDO[3,4-E]PYRIMIDIN-5(1H)-ONE, SALTS THEREOF AND METHODS OF USING THE SAME IN COMBINATION THERAPY
A61K 31/519 (2006.01)	3546461	7-BENZYL-4-(2-METHYLBENZYL)-2,4,6,7,8,9-HEXAHYDROIMIDAZO[1,2-A]PYRIDO[3,4-E]PYRIMIDIN-5(1H)-ONE, SALTS THEREOF AND METHODS OF USING THE SAME IN COMBINATION THERAPY
A61K 45/06 (2006.01)	3546461	7-BENZYL-4-(2-METHYLBENZYL)-2,4,6,7,8,9-HEXAHYDROIMIDAZO[1,2-A]PYRIDO[3,4-E]PYRIMIDIN-5(1H)-ONE, SALTS THEREOF AND METHODS OF USING THE SAME IN COMBINATION THERAPY
A61P 35/00 (2006.01)	3546461	7-BENZYL-4-(2-METHYLBENZYL)-2,4,6,7,8,9-HEXAHYDROIMIDAZO[1,2-A]PYRIDO[3,4-E]PYRIMIDIN-5(1H)-ONE, SALTS THEREOF AND METHODS OF USING THE SAME IN COMBINATION THERAPY
C07D 471/14 (2006.01)	3546461	7-BENZYL-4-(2-METHYLBENZYL)-2,4,6,7,8,9-HEXAHYDROIMIDAZO[1,2-A]PYRIDO[3,4-E]PYRIMIDIN-5(1H)-ONE, SALTS THEREOF AND METHODS OF USING THE SAME IN COMBINATION THERAPY
F21V 29/70 (2015.01)	3640536	GRAPHENE HEAT-DISSIPATION LED LAMP
F21V 29/85 (2015.01)	3640536	GRAPHENE HEAT-DISSIPATION LED LAMP
F21W 131/103 (2006.01)	3640536	GRAPHENE HEAT-DISSIPATION LED LAMP
F21Y 115/10 (2016.01)	3640536	GRAPHENE HEAT-DISSIPATION LED LAMP
F02C 6/00 (2006.01)	3640449	STAGED COLD ENERGY STORAGE TYPE SUPERCRITICAL COMPRESSED AIR ENERGY STORAGE SYSTEM AND METHOD
F16M 11/12 (2006.01)	3636980	HANGING TYPE POSITIONING AND SUPPORTING DEVICE FOR LASER LEVEL
G06F 3/01 (2006.01)	3639114	SYSTEM AND METHOD OF INSTANTLY PREVIEWING IMMERSIVE CONTENT
G06Q 30/00 (2012.01)	3639114	SYSTEM AND METHOD OF INSTANTLY PREVIEWING IMMERSIVE CONTENT
E04D 12/00 (2006.01)	3650611	SUPPORT FOR ROOF PANELS
F24S 25/61 (2018.01)	3650611	SUPPORT FOR ROOF PANELS
H02S 20/23 (2014.01)	3650611	SUPPORT FOR ROOF PANELS
G06T 15/00 (2011.01)	3675488	METHOD FOR RECORDING VIDEO ON THE BASIS OF A VIRTUAL REALITY APPLICATION, TERMINAL DEVICE, AND STORAGE MEDIUM
H04N 13/00 (2018.01)	3675488	METHOD FOR RECORDING VIDEO ON THE BASIS OF A VIRTUAL REALITY APPLICATION, TERMINAL DEVICE, AND STORAGE MEDIUM
A61K 31/519 (2006.01)	3634419	GONADOTROPIN-RELEASING HORMONE ANTAGONIST DOSING REGIMENS FOR TREATING UTERINE FIBROIDS AND REDUCING MENSTRUAL BLOOD LOSS
A61P 15/00 (2006.01)	3634419	GONADOTROPIN-RELEASING HORMONE ANTAGONIST DOSING REGIMENS FOR TREATING UTERINE FIBROIDS AND REDUCING MENSTRUAL BLOOD LOSS
A61K 39/00 (2006.01)	3635005	THERAPEUTIC ANTIBODIES BASED ON MUTATED IGG HEXAMERS
C07K 16/28 (2006.01)	3635005	THERAPEUTIC ANTIBODIES BASED ON MUTATED IGG HEXAMERS
C07K 16/30 (2006.01)	3635005	THERAPEUTIC ANTIBODIES BASED ON MUTATED IGG HEXAMERS
A61P 17/10 (2006.01)	3642230	TREATMENT OF INFLAMMATORY DISEASES WITH INHIBITORS OF C5A ACTIVITY
C07K 16/18 (2006.01)	3642230	TREATMENT OF INFLAMMATORY DISEASES WITH INHIBITORS OF C5A ACTIVITY
A61K 9/19 (2006.01)	3638273	COMPOSITIONS COMPRISING BACTERIAL STRAINS
A61K 31/19 (2006.01)	3638273	COMPOSITIONS COMPRISING BACTERIAL STRAINS
A61K 31/192 (2006.01)	3638273	COMPOSITIONS COMPRISING BACTERIAL STRAINS
A61K 31/194 (2006.01)	3638273	COMPOSITIONS COMPRISING BACTERIAL STRAINS
A61K 31/203 (2006.01)	3638273	COMPOSITIONS COMPRISING BACTERIAL STRAINS
A61K 35/74 (2015.01)	3638273	COMPOSITIONS COMPRISING BACTERIAL STRAINS
A61K 35/745 (2015.01)	3638273	COMPOSITIONS COMPRISING BACTERIAL STRAINS
A61K 35/747 (2015.01)	3638273	COMPOSITIONS COMPRISING BACTERIAL STRAINS
A61P 25/00 (2006.01)	3638273	COMPOSITIONS COMPRISING BACTERIAL STRAINS
A61P 25/28 (2006.01)	3638273	COMPOSITIONS COMPRISING BACTERIAL STRAINS

MKP	Broj objave evropske prijave patenta	Naziv pronalaska
(51)	(97)	(54)
A61K 39/00 (2006.01)	3638696	USE OF ANTI CD70 ANTIBODY ARGX-110 TO TREAT ACUTE MYELOID LEUKAEMIA
C07K 16/28 (2006.01)	3638696	USE OF ANTI CD70 ANTIBODY ARGX-110 TO TREAT ACUTE MYELOID LEUKAEMIA
A41D 19/00 (2006.01)	3635038	CROSSLINKED STYRENIC BLOCK COPOLYMER
A61B 42/10 (2016.01)	3635038	CROSSLINKED STYRENIC BLOCK COPOLYMER
A61F 6/04 (2006.01)	3635038	CROSSLINKED STYRENIC BLOCK COPOLYMER
B32B 27/30 (2006.01)	3635038	CROSSLINKED STYRENIC BLOCK COPOLYMER
C08J 3/24 (2006.01)	3635038	CROSSLINKED STYRENIC BLOCK COPOLYMER
C08J 3/28 (2006.01)	3635038	CROSSLINKED STYRENIC BLOCK COPOLYMER
C08L 25/08 (2006.01)	3635038	CROSSLINKED STYRENIC BLOCK COPOLYMER
C08L 53/02 (2006.01)	3635038	CROSSLINKED STYRENIC BLOCK COPOLYMER
A61K 39/395 (2006.01)	3630824	BIOPHARMACEUTICAL COMPOSITIONS AND RELATED METHODS
C07K 16/24 (2006.01)	3630824	BIOPHARMACEUTICAL COMPOSITIONS AND RELATED METHODS
A61K 31/47 (2006.01)	3630726	CRYSTALLINE SOLID FORMS OF SALTS OF N-{4-[(6,7-DIMETHOXYQUINOLIN-4-YL) OXY]PHENYL}-N'-(4-FLUOROPHENYL) CYCLOPROPANE-1,1-DICARBOXAMIDE, PROCESSES FOR MAKING, AND METHODS OF USE
A61P 35/00 (2006.01)	3630726	CRYSTALLINE SOLID FORMS OF SALTS OF N-{4-[(6,7-DIMETHOXYQUINOLIN-4-YL) OXY]PHENYL}-N'-(4-FLUOROPHENYL) CYCLOPROPANE-1,1-DICARBOXAMIDE, PROCESSES FOR MAKING, AND METHODS OF USE
C07D 215/22 (2006.01)	3630726	CRYSTALLINE SOLID FORMS OF SALTS OF N-{4-[(6,7-DIMETHOXYQUINOLIN-4-YL) OXY]PHENYL}-N'-(4-FLUOROPHENYL) CYCLOPROPANE-1,1-DICARBOXAMIDE, PROCESSES FOR MAKING, AND METHODS OF USE
A61K 39/395 (2006.01)	3638305	METHOD FOR THE TREATMENT OF IMMUNE THROMBOCYTOPENIA
C07K 16/28 (2006.01)	3638305	METHOD FOR THE TREATMENT OF IMMUNE THROMBOCYTOPENIA
A61K 31/502 (2006.01)	3649119	NOVEL COMPOUNDS AND PHARMACEUTICAL COMPOSITIONS THEREOF FOR THE TREATMENT OF FIBROSIS
A61P 29/00 (2006.01)	3649119	NOVEL COMPOUNDS AND PHARMACEUTICAL COMPOSITIONS THEREOF FOR THE TREATMENT OF FIBROSIS
C07D 401/14 (2006.01)	3649119	NOVEL COMPOUNDS AND PHARMACEUTICAL COMPOSITIONS THEREOF FOR THE TREATMENT OF FIBROSIS
C07D 403/04 (2006.01)	3649119	NOVEL COMPOUNDS AND PHARMACEUTICAL COMPOSITIONS THEREOF FOR THE TREATMENT OF FIBROSIS
C07D 403/14 (2006.01)	3649119	NOVEL COMPOUNDS AND PHARMACEUTICAL COMPOSITIONS THEREOF FOR THE TREATMENT OF FIBROSIS
C07D 405/14 (2006.01)	3649119	NOVEL COMPOUNDS AND PHARMACEUTICAL COMPOSITIONS THEREOF FOR THE TREATMENT OF FIBROSIS
C07D 409/14 (2006.01)	3649119	NOVEL COMPOUNDS AND PHARMACEUTICAL COMPOSITIONS THEREOF FOR THE TREATMENT OF FIBROSIS
C07D 471/04 (2006.01)	3649119	NOVEL COMPOUNDS AND PHARMACEUTICAL COMPOSITIONS THEREOF FOR THE TREATMENT OF FIBROSIS
A61K 31/517 (2006.01)	3645535	NEW SALT OF N-(2,6-DIETHYLPHENYL)-8-({4-[4-(DIMETHYLAMINO)PIPERIDIN-1-YL]-2-METHOXYPHENYL}AMINO)-1-METHYL-4,5-DIHYDRO-1H-PYRAZOLO[4,3-H]QUINAZOLINE-3-CARBOXAMIDE, ITS PREPARATION AND FORMULATIONS CONTAINING IT
A61P 35/00 (2006.01)	3645535	NEW SALT OF N-(2,6-DIETHYLPHENYL)-8-({4-[4-(DIMETHYLAMINO)PIPERIDIN-1-YL]-2-METHOXYPHENYL}AMINO)-1-METHYL-4,5-DIHYDRO-1H-PYRAZOLO[4,3-H]QUINAZOLINE-3-CARBOXAMIDE, ITS PREPARATION AND FORMULATIONS CONTAINING IT
C07D 487/04 (2006.01)	3645535	NEW SALT OF N-(2,6-DIETHYLPHENYL)-8-({4-[4-(DIMETHYLAMINO)PIPERIDIN-1-YL]-2-METHOXYPHENYL}AMINO)-1-METHYL-4,5-DIHYDRO-1H-PYRAZOLO[4,3-H]QUINAZOLINE-3-CARBOXAMIDE, ITS PREPARATION AND FORMULATIONS CONTAINING IT
A61K 38/20 (2006.01)	3630812	ANTIBODY-CYTOKINE ENGRAFTED PROTEINS AND METHODS OF USE FOR IMMUNE RELATED DISORDERS
A61K 39/00 (2006.01)	3630812	ANTIBODY-CYTOKINE ENGRAFTED PROTEINS AND METHODS OF USE FOR IMMUNE RELATED DISORDERS

MKP (51)	Broj objave evropske prijave patenta (97)	Naziv pronalaska (54)
A61P 37/00 (2006.01)	3630812	ANTIBODY-CYTOKINE ENGRAFTED PROTEINS AND METHODS OF USE FOR IMMUNE RELATED DISORDERS
C07K 16/10 (2006.01)	3630812	ANTIBODY-CYTOKINE ENGRAFTED PROTEINS AND METHODS OF USE FOR IMMUNE RELATED DISORDERS
C07K 16/46 (2006.01)	3630812	ANTIBODY-CYTOKINE ENGRAFTED PROTEINS AND METHODS OF USE FOR IMMUNE RELATED DISORDERS
A61K 38/20 (2006.01)	3630813	ANTIBODY-CYTOKINE ENGRAFTED PROTEINS AND METHODS OF USE IN THE TREATMENT OF CANCER
A61K 39/00 (2006.01)	3630813	ANTIBODY-CYTOKINE ENGRAFTED PROTEINS AND METHODS OF USE IN THE TREATMENT OF CANCER
A61P 35/00 (2006.01)	3630813	ANTIBODY-CYTOKINE ENGRAFTED PROTEINS AND METHODS OF USE IN THE TREATMENT OF CANCER
C07K 16/10 (2006.01)	3630813	ANTIBODY-CYTOKINE ENGRAFTED PROTEINS AND METHODS OF USE IN THE TREATMENT OF CANCER
C07K 16/46 (2006.01)	3630813	ANTIBODY-CYTOKINE ENGRAFTED PROTEINS AND METHODS OF USE IN THE TREATMENT OF CANCER
A61J 1/10 (2006.01)	3651719	MULTI CHAMBER FLEXIBLE BAG AND METHODS OF USING SAME
A61J 1/20 (2006.01)	3651719	MULTI CHAMBER FLEXIBLE BAG AND METHODS OF USING SAME
F26B 5/06 (2006.01)	3651719	MULTI CHAMBER FLEXIBLE BAG AND METHODS OF USING SAME
A61K 31/438 (2006.01)	3630762	CRYSTALLINE FORMS OF A FGFR INHIBITOR AND PROCESSES FOR PREPARING THE SAME
A61P 35/00 (2006.01)	3630762	CRYSTALLINE FORMS OF A FGFR INHIBITOR AND PROCESSES FOR PREPARING THE SAME
C07D 471/04 (2006.01)	3630762	CRYSTALLINE FORMS OF A FGFR INHIBITOR AND PROCESSES FOR PREPARING THE SAME
A61M 5/142 (2006.01)	3634539	SYRINGE ASSEMBLY FOR A DRUG DELIVERY DEVICE AND METHOD OF ASSEMBLY
A61M 5/145 (2006.01)	3634539	SYRINGE ASSEMBLY FOR A DRUG DELIVERY DEVICE AND METHOD OF ASSEMBLY
A61M 5/158 (2006.01)	3634539	SYRINGE ASSEMBLY FOR A DRUG DELIVERY DEVICE AND METHOD OF ASSEMBLY
A61M 5/28 (2006.01)	3634539	SYRINGE ASSEMBLY FOR A DRUG DELIVERY DEVICE AND METHOD OF ASSEMBLY
A61M 5/31 (2006.01)	3634539	SYRINGE ASSEMBLY FOR A DRUG DELIVERY DEVICE AND METHOD OF ASSEMBLY
A61K 35/17 (2015.01)	3630132	ARTICLES OF MANUFACTURE AND METHODS FOR TREATMENT USING ADOPTIVE CELL THERAPY
A61P 35/00 (2006.01)	3630132	ARTICLES OF MANUFACTURE AND METHODS FOR TREATMENT USING ADOPTIVE CELL THERAPY
A61M 5/20 (2006.01)	3634546	TORQUE DRIVEN DRUG DELIVERY DEVICE
A61M 5/31 (2006.01)	3634546	TORQUE DRIVEN DRUG DELIVERY DEVICE
A61M 5/315 (2006.01)	3634546	TORQUE DRIVEN DRUG DELIVERY DEVICE
G01N 23/203 (2006.01)	3635392	ANALYZING A ROCK SAMPLE
G01N 23/223 (2006.01)	3635392	ANALYZING A ROCK SAMPLE
G01N 33/24 (2006.01)	3635392	ANALYZING A ROCK SAMPLE
G06T 7/00 (2017.01)	3635392	ANALYZING A ROCK SAMPLE
A61K 9/16 (2006.01)	3638210	SOLID PREPARATION OF CARIPRAZINE FOR ORAL ADMINISTRATION
A61K 9/20 (2006.01)	3638210	SOLID PREPARATION OF CARIPRAZINE FOR ORAL ADMINISTRATION
A61K 9/28 (2006.01)	3638210	SOLID PREPARATION OF CARIPRAZINE FOR ORAL ADMINISTRATION
A61K 31/496 (2006.01)	3638210	SOLID PREPARATION OF CARIPRAZINE FOR ORAL ADMINISTRATION
A61P 25/18 (2006.01)	3638210	SOLID PREPARATION OF CARIPRAZINE FOR ORAL ADMINISTRATION
A61P 25/28 (2006.01)	3638210	SOLID PREPARATION OF CARIPRAZINE FOR ORAL ADMINISTRATION
C02F 1/66 (2006.01)	3652117	METHOD FOR INCREASING THE MAGNESIUM ION CONCENTRATION IN FEED WATER
C02F 1/68 (2006.01)	3652117	METHOD FOR INCREASING THE MAGNESIUM ION CONCENTRATION IN FEED WATER
A61K 31/4196 (2006.01)	3642196	SUBSTITUTED CYANOPYRROLIDINES WITH ACTIVITY AS DUB INHIBITORS

MKP (51)	Broj objave evropske prijave patenta (97)	Naziv pronalaska (54)
A61P 25/28 (2006.01)	3642196	SUBSTITUTED CYANOPYRROLIDINES WITH ACTIVITY AS DUB INHIBITORS
A61P 35/00 (2006.01)	3642196	SUBSTITUTED CYANOPYRROLIDINES WITH ACTIVITY AS DUB INHIBITORS
C07D 403/12 (2006.01)	3642196	SUBSTITUTED CYANOPYRROLIDINES WITH ACTIVITY AS DUB INHIBITORS
A61K 31/519 (2006.01)	3634964	PYRAZOLOPYRIMIDINE PDE9 INHIBITORS
A61P 9/00 (2006.01)	3634964	PYRAZOLOPYRIMIDINE PDE9 INHIBITORS
A61P 13/12 (2006.01)	3634964	PYRAZOLOPYRIMIDINE PDE9 INHIBITORS
A61P 25/00 (2006.01)	3634964	PYRAZOLOPYRIMIDINE PDE9 INHIBITORS
A61P 25/18 (2006.01)	3634964	PYRAZOLOPYRIMIDINE PDE9 INHIBITORS
C07D 487/04 (2006.01)	3634964	PYRAZOLOPYRIMIDINE PDE9 INHIBITORS
A61K 31/4045 (2006.01)	3634402	METHODS OF TREATMENT FOR CYSTIC FIBROSIS
A61K 31/443 (2006.01)	3634402	METHODS OF TREATMENT FOR CYSTIC FIBROSIS
A61K 31/454 (2006.01)	3634402	METHODS OF TREATMENT FOR CYSTIC FIBROSIS
A61K 31/47 (2006.01)	3634402	METHODS OF TREATMENT FOR CYSTIC FIBROSIS
A61P 11/12 (2006.01)	3634402	METHODS OF TREATMENT FOR CYSTIC FIBROSIS
A61K 9/00 (2006.01)	3634413	LIQUID DOSAGE FORMS TO TREAT CANCER
A61K 9/20 (2006.01)	3634413	LIQUID DOSAGE FORMS TO TREAT CANCER
A61K 31/47 (2006.01)	3634413	LIQUID DOSAGE FORMS TO TREAT CANCER
A61P 35/00 (2006.01)	3634413	LIQUID DOSAGE FORMS TO TREAT CANCER
A61M 5/20 (2006.01)	3641857	DEVICE ACTIVATION IMPACT/SHOCK REDUCTION
A61M 5/315 (2006.01)	3641857	DEVICE ACTIVATION IMPACT/SHOCK REDUCTION
A61Q 7/00 (2006.01)	3652205	PROLACTIN RECEPTOR ANTIBODY FOR MALE AND FEMALE PATTERN HAIR LOSS
C07K 16/28 (2006.01)	3652205	PROLACTIN RECEPTOR ANTIBODY FOR MALE AND FEMALE PATTERN HAIR LOSS
C07F 9/24 (2006.01)	3638684	SYNTHESIS OF SUBSTANTIALLY DIASTEREOMERICALLY PURE PHOSPHATE PROTIDES
C07H 1/02 (2006.01)	3638684	SYNTHESIS OF SUBSTANTIALLY DIASTEREOMERICALLY PURE PHOSPHATE PROTIDES
C07H 19/10 (2006.01)	3638684	SYNTHESIS OF SUBSTANTIALLY DIASTEREOMERICALLY PURE PHOSPHATE PROTIDES
C07H 19/20 (2006.01)	3638684	SYNTHESIS OF SUBSTANTIALLY DIASTEREOMERICALLY PURE PHOSPHATE PROTIDES
A61K 9/20 (2006.01)	3641736	PHARMACEUTICAL COMPOSITIONS COMPRISING DIMETHYL FUMARATE
A61K 9/28 (2006.01)	3641736	PHARMACEUTICAL COMPOSITIONS COMPRISING DIMETHYL FUMARATE
A61K 31/225 (2006.01)	3641736	PHARMACEUTICAL COMPOSITIONS COMPRISING DIMETHYL FUMARATE
C07K 14/725 (2006.01)	3649149	TARGETED PROTEIN DEGRADATION
A61K 31/519 (2006.01)	3652176	NOVEL SUBSTITUTED XANTHINE DERIVATIVES
A61K 31/522 (2006.01)	3652176	NOVEL SUBSTITUTED XANTHINE DERIVATIVES
C07D 487/04 (2006.01)	3652176	NOVEL SUBSTITUTED XANTHINE DERIVATIVES
A23B 7/01 (2006.01)	3634153	PLANT AND METHOD OF PRODUCTION OF PUREE
A23B 7/155 (2006.01)	3634153	PLANT AND METHOD OF PRODUCTION OF PUREE
A23L 19/00 (2016.01)	3634153	PLANT AND METHOD OF PRODUCTION OF PUREE
A61K 31/53 (2006.01)	3638245	METHODS OF TREATING BRAIN TUMORS USING COMBINATION THERAPY
A61P 35/00 (2006.01)	3638245	METHODS OF TREATING BRAIN TUMORS USING COMBINATION THERAPY
A61K 8/34 (2006.01)	3644945	ANTIBACTERIAL ACTIVITY OF GALACTOOLIGOSACCHARIDE AND XYLITOL IN DERMATOLOGICAL TREATMENTS
A61K 8/60 (2006.01)	3644945	ANTIBACTERIAL ACTIVITY OF GALACTOOLIGOSACCHARIDE AND XYLITOL IN DERMATOLOGICAL TREATMENTS
A61K 31/047 (2006.01)	3644945	ANTIBACTERIAL ACTIVITY OF GALACTOOLIGOSACCHARIDE AND XYLITOL IN DERMATOLOGICAL TREATMENTS
A61K 31/702 (2006.01)	3644945	ANTIBACTERIAL ACTIVITY OF GALACTOOLIGOSACCHARIDE AND XYLITOL IN DERMATOLOGICAL TREATMENTS
A61Q 17/00 (2006.01)	3644945	ANTIBACTERIAL ACTIVITY OF GALACTOOLIGOSACCHARIDE AND XYLITOL IN DERMATOLOGICAL TREATMENTS
A61Q 19/00 (2006.01)	3644945	ANTIBACTERIAL ACTIVITY OF GALACTOOLIGOSACCHARIDE AND XYLITOL IN DERMATOLOGICAL TREATMENTS
A61Q 19/10 (2006.01)	3644945	ANTIBACTERIAL ACTIVITY OF GALACTOOLIGOSACCHARIDE AND XYLITOL IN DERMATOLOGICAL TREATMENTS
A61K 9/00 (2006.01)	3644958	INTRAVAGINALLY APPLICABLE DEVICES COMPRISING ANTIVIRAL COMPOUNDS

MKP (51)	Broj objave evropske prijave patenta (97)	Naziv pronalaska (54)
A61K 31/4439 (2006.01)	3644958	INTRAVAGINALLY APPLICABLE DEVICES COMPRISING ANTIVIRAL COMPOUNDS
A61P 31/22 (2006.01)	3644958	INTRAVAGINALLY APPLICABLE DEVICES COMPRISING ANTIVIRAL COMPOUNDS
C02F 1/28 (2006.01)	3665127	METHOD AND SYSTEM FOR TREATING AND/OR PURIFYING WATER
C02F 101/30 (2006.01)	3665127	METHOD AND SYSTEM FOR TREATING AND/OR PURIFYING WATER
B61B 12/00 (2006.01)	3649029	CABLEWAY AND METHOD FOR OPERATING A CABLEWAY
B61B 12/06 (2006.01)	3649029	CABLEWAY AND METHOD FOR OPERATING A CABLEWAY
H04N 7/18 (2006.01)	3649775	MULTI-SENSOR CAMERA
C02F 1/66 (2006.01)	3652118	METHOD FOR INCREASING THE MAGNESIUM ION CONCENTRATION IN FEED WATER
C02F 1/68 (2006.01)	3652118	METHOD FOR INCREASING THE MAGNESIUM ION CONCENTRATION IN FEED WATER
C07K 16/38 (2006.01)	3645573	NOVEL T CELL RECEPTORS AND IMMUNE THERAPY USING THE SAME
C07H 1/00 (2006.01)	3652187	IMPROVED PROCESS FOR PREPARING IMETELSTAT
C07H 21/04 (2006.01)	3652187	IMPROVED PROCESS FOR PREPARING IMETELSTAT
A61K 31/4427 (2006.01)	3634967	COMPOUNDS AND COMPOSITIONS FOR INDUCING CHONDROGENESIS
A61K 31/444 (2006.01)	3634967	COMPOUNDS AND COMPOSITIONS FOR INDUCING CHONDROGENESIS
A61P 19/02 (2006.01)	3634967	COMPOUNDS AND COMPOSITIONS FOR INDUCING CHONDROGENESIS
C07D 493/08 (2006.01)	3634967	COMPOUNDS AND COMPOSITIONS FOR INDUCING CHONDROGENESIS
A61K 31/7076 (2006.01)	3641784	METHOD OF PREVENTING OF SYSTEMIC-TO-PULMONARY-ARTERY SHUNT THROMBOSIS
A61P 7/02 (2006.01)	3641784	METHOD OF PREVENTING OF SYSTEMIC-TO-PULMONARY-ARTERY SHUNT THROMBOSIS
A61P 9/04 (2006.01)	3641784	METHOD OF PREVENTING OF SYSTEMIC-TO-PULMONARY-ARTERY SHUNT THROMBOSIS
A61K 39/12 (2006.01)	3655032	TRIMER STABILIZING HIV ENVELOPE PROTEIN MUTATIONS
C07K 14/005 (2006.01)	3655032	TRIMER STABILIZING HIV ENVELOPE PROTEIN MUTATIONS
A61K 31/506 (2006.01)	3649127	NEW SUBSTITUTED AZAINDOLINE DERIVATIVES AS NIK INHIBITORS
A61K 31/5377 (2006.01)	3649127	NEW SUBSTITUTED AZAINDOLINE DERIVATIVES AS NIK INHIBITORS
A61K 31/55 (2006.01)	3649127	NEW SUBSTITUTED AZAINDOLINE DERIVATIVES AS NIK INHIBITORS
A61P 3/00 (2006.01)	3649127	NEW SUBSTITUTED AZAINDOLINE DERIVATIVES AS NIK INHIBITORS
A61P 29/00 (2006.01)	3649127	NEW SUBSTITUTED AZAINDOLINE DERIVATIVES AS NIK INHIBITORS
A61P 35/00 (2006.01)	3649127	NEW SUBSTITUTED AZAINDOLINE DERIVATIVES AS NIK INHIBITORS
A61P 37/00 (2006.01)	3649127	NEW SUBSTITUTED AZAINDOLINE DERIVATIVES AS NIK INHIBITORS
C07D 471/04 (2006.01)	3649127	NEW SUBSTITUTED AZAINDOLINE DERIVATIVES AS NIK INHIBITORS
C07D 519/00 (2006.01)	3649127	NEW SUBSTITUTED AZAINDOLINE DERIVATIVES AS NIK INHIBITORS
A61K 9/10 (2006.01)	3651736	LONG-ACTING FORMULATIONS
A61K 31/47 (2006.01)	3651736	LONG-ACTING FORMULATIONS
A61K 47/26 (2006.01)	3651736	LONG-ACTING FORMULATIONS
A61P 31/06 (2006.01)	3651736	LONG-ACTING FORMULATIONS
A61P 31/08 (2006.01)	3651736	LONG-ACTING FORMULATIONS
B65D 85/804 (2006.01)	3649061	CAPSULE FOR INFUSION PRODUCTS
A61K 31/7064 (2006.01)	3641887	COMPOUNDS AND METHODS FOR TREATMENT OF NAFLD AND NASH
A61P 1/16 (2006.01)	3641887	COMPOUNDS AND METHODS FOR TREATMENT OF NAFLD AND NASH
A61K 31/495 (2006.01)	3641812	ANTIBODY MOLECULES TO CD73 AND USES THEREOF
A61K 39/00 (2006.01)	3641812	ANTIBODY MOLECULES TO CD73 AND USES THEREOF
A61K 39/395 (2006.01)	3641812	ANTIBODY MOLECULES TO CD73 AND USES THEREOF
A61K 39/40 (2006.01)	3641812	ANTIBODY MOLECULES TO CD73 AND USES THEREOF
C07K 16/28 (2006.01)	3641812	ANTIBODY MOLECULES TO CD73 AND USES THEREOF

MKP (51)	Broj objave evropske prijave patenta (97)	Naziv pronalaska (54)
A61K 39/00 (2006.01)	3648790	NOVEL PEPTIDES AND COMBINATION OF PEPTIDES FOR USE IN IMMUNOTHERAPY AGAINST LUNG CANCER, INCLUDING NSCLC, SCLC AND OTHER CANCERS
A61P 35/00 (2006.01)	3648790	NOVEL PEPTIDES AND COMBINATION OF PEPTIDES FOR USE IN IMMUNOTHERAPY AGAINST LUNG CANCER, INCLUDING NSCLC, SCLC AND OTHER CANCERS
C07K 14/47 (2006.01)	3648790	NOVEL PEPTIDES AND COMBINATION OF PEPTIDES FOR USE IN IMMUNOTHERAPY AGAINST LUNG CANCER, INCLUDING NSCLC, SCLC AND OTHER CANCERS
C07K 16/30 (2006.01)	3648790	NOVEL PEPTIDES AND COMBINATION OF PEPTIDES FOR USE IN IMMUNOTHERAPY AGAINST LUNG CANCER, INCLUDING NSCLC, SCLC AND OTHER CANCERS
A61P 25/08 (2006.01)	3652182	2-OXO-1-IMIDAZOLIDINYL IMIDAZOTHIADIAZOLE DERIVATIVES
C07D 513/04 (2006.01)	3652182	2-OXO-1-IMIDAZOLIDINYL IMIDAZOTHIADIAZOLE DERIVATIVES
A61K 31/433 (2006.01)	3652183	2-OXO-1,3-OXAZOLIDINYL IMIDAZOTHIADIAZOLE DERIVATIVES
A61P 25/08 (2006.01)	3652183	2-OXO-1,3-OXAZOLIDINYL IMIDAZOTHIADIAZOLE DERIVATIVES
C07D 513/04 (2006.01)	3652183	2-OXO-1,3-OXAZOLIDINYL IMIDAZOTHIADIAZOLE DERIVATIVES
A61K 31/505 (2006.01)	3654983	MPO INHIBITORS FOR USE IN MEDICINE
A61P 15/10 (2006.01)	3654983	MPO INHIBITORS FOR USE IN MEDICINE
A61K 31/519 (2006.01)	3642209	COMPOUNDS THAT INTERACT WITH THE RAS SUPERFAMILY FOR THE TREATMENT OF CANCERS, INFLAMMATORY DISEASES, RASOPATHIES, AND FIBROTIC DISEASE
A61P 25/28 (2006.01)	3642209	COMPOUNDS THAT INTERACT WITH THE RAS SUPERFAMILY FOR THE TREATMENT OF CANCERS, INFLAMMATORY DISEASES, RASOPATHIES, AND FIBROTIC DISEASE
A61P 29/00 (2006.01)	3642209	COMPOUNDS THAT INTERACT WITH THE RAS SUPERFAMILY FOR THE TREATMENT OF CANCERS, INFLAMMATORY DISEASES, RASOPATHIES, AND FIBROTIC DISEASE
A61P 35/00 (2006.01)	3642209	COMPOUNDS THAT INTERACT WITH THE RAS SUPERFAMILY FOR THE TREATMENT OF CANCERS, INFLAMMATORY DISEASES, RASOPATHIES, AND FIBROTIC DISEASE
C07D 495/04 (2006.01)	3642209	COMPOUNDS THAT INTERACT WITH THE RAS SUPERFAMILY FOR THE TREATMENT OF CANCERS, INFLAMMATORY DISEASES, RASOPATHIES, AND FIBROTIC DISEASE
A61K 38/26 (2006.01)	3642238	METHOD OF TREATING OR AMELIORATING METABOLIC DISORDERS USING ANTAGONISTIC BINDING PROTEINS FOR GASTRIC INHIBITORY PEPTIDE RECEPTOR (GIPR)/GLP-1 RECEPTOR AGONIST FUSION PROTEINS
C07K 16/28 (2006.01)	3642238	METHOD OF TREATING OR AMELIORATING METABOLIC DISORDERS USING ANTAGONISTIC BINDING PROTEINS FOR GASTRIC INHIBITORY PEPTIDE RECEPTOR (GIPR)/GLP-1 RECEPTOR AGONIST FUSION PROTEINS
C07K 16/28 (2006.01)	3642239	METHOD OF TREATING OR AMELIORATING METABOLIC DISORDERS USING BINDING PROTEINS FOR GASTRIC INHIBITORY PEPTIDE RECEPTOR (GIPR) IN COMBINATION WITH GLP-1 AGONISTS
A61M 5/32 (2006.01)	3641861	ELECTRONIC DRUG DELIVERY DEVICE COMPRISING A CAP ACTIVATED BY A SWITCH ASSEMBLY
C09K 8/52 (2006.01)	3642299	COMPOSITIONS AND METHODS FOR CONTROLLING STRONG ACID SYSTEMS
C09K 8/72 (2006.01)	3642299	COMPOSITIONS AND METHODS FOR CONTROLLING STRONG ACID SYSTEMS
C23F 11/00 (2006.01)	3642299	COMPOSITIONS AND METHODS FOR CONTROLLING STRONG ACID SYSTEMS
C08G 79/00 (2006.01)	3638716	POLY(PHOSPHOESTERS) FOR DELIVERY OF NUCLEIC ACIDS
C08G 79/04 (2006.01)	3638716	POLY(PHOSPHOESTERS) FOR DELIVERY OF NUCLEIC ACIDS
C07K 16/46 (2006.01)	3652215	IMPROVED DUAL SPECIFICITY POLYPEPTIDE MOLECULE
A61K 39/104 (2006.01)	3641828	IMMUNOGENIC COMPOSITIONS
A61K 39/108 (2006.01)	3641828	IMMUNOGENIC COMPOSITIONS
A61K 47/64 (2017.01)	3641828	IMMUNOGENIC COMPOSITIONS
C07K 14/195 (2006.01)	3641828	IMMUNOGENIC COMPOSITIONS
C07K 14/21 (2006.01)	3641828	IMMUNOGENIC COMPOSITIONS
C07K 14/26 (2006.01)	3641828	IMMUNOGENIC COMPOSITIONS
C07K 16/00 (2006.01)	3638692	METHOD OF MANUFACTURING BISPECIFIC ANTIBODIES, BISPECIFIC ANTIBODIES AND THERAPEUTIC USE OF SUCH ANTIBODIES

MKP (51)	Broj objave evropske prijave patenta (97)	Naziv pronalaska (54)
C07K 16/08 (2006.01)	3638692	METHOD OF MANUFACTURING BISPECIFIC ANTIBODIES, BISPECIFIC ANTIBODIES AND THERAPEUTIC USE OF SUCH ANTIBODIES
C07K 16/24 (2006.01)	3638692	METHOD OF MANUFACTURING BISPECIFIC ANTIBODIES, BISPECIFIC ANTIBODIES AND THERAPEUTIC USE OF SUCH ANTIBODIES
C07K 16/46 (2006.01)	3638692	METHOD OF MANUFACTURING BISPECIFIC ANTIBODIES, BISPECIFIC ANTIBODIES AND THERAPEUTIC USE OF SUCH ANTIBODIES
A61K 31/4045 (2006.01)	3658550	NEW PROPANAMINE DERIVATIVES FOR TREATING PAIN AND PAIN RELATED CONDITIONS
A61K 31/437 (2006.01)	3658550	NEW PROPANAMINE DERIVATIVES FOR TREATING PAIN AND PAIN RELATED CONDITIONS
A61P 25/04 (2006.01)	3658550	NEW PROPANAMINE DERIVATIVES FOR TREATING PAIN AND PAIN RELATED CONDITIONS
C07D 409/06 (2006.01)	3658550	NEW PROPANAMINE DERIVATIVES FOR TREATING PAIN AND PAIN RELATED CONDITIONS
C07D 471/04 (2006.01)	3658550	NEW PROPANAMINE DERIVATIVES FOR TREATING PAIN AND PAIN RELATED CONDITIONS
E05F 15/643 (2015.01)	3673134	MODULAR SLIDING MEMBER POWER MECHANISM AND METHOD FOR ITS OPERATION
A01K 41/00 (2006.01)	3632204	DEVICE FOR TRANSPORTING AND HATCHING EGGS ON FARM BREEDING
A01K 41/06 (2006.01)	3632204	DEVICE FOR TRANSPORTING AND HATCHING EGGS ON FARM BREEDING
A01K 43/00 (2006.01)	3632204	DEVICE FOR TRANSPORTING AND HATCHING EGGS ON FARM BREEDING
A61K 47/68 (2017.01)	3545977	PREPARATION OF MAYTANSINOID ANTIBODY CONJUGATES BY A ONE-STEP PROCESS
A61P 35/00 (2006.01)	3545977	PREPARATION OF MAYTANSINOID ANTIBODY CONJUGATES BY A ONE-STEP PROCESS
B23Q 1/26 (2006.01)	3643447	LOW DUST LINEAR MODULE
B23Q 11/08 (2006.01)	3643447	LOW DUST LINEAR MODULE
F16C 29/02 (2006.01)	3643447	LOW DUST LINEAR MODULE
F16C 29/08 (2006.01)	3643447	LOW DUST LINEAR MODULE
B01D 39/16 (2006.01)	3658254	AIR-PERMEABLE SHEET FILTER MATERIAL, METHODS FOR THE PRODUCTION AND USE THEREOF
A61M 5/142 (2006.01)	3672663	NEEDLE INSERTION MECHANISM FOR DRUG DELIVERY DEVICE
A61K 31/336 (2006.01)	3672586	IMMUNOPROTEASOME INHIBITORS AND IMMUNOSUPPRESSIVE AGENT IN THE TREATMENT OF AUTOIMMUNE DISORDERS
A61K 31/343 (2006.01)	3672586	IMMUNOPROTEASOME INHIBITORS AND IMMUNOSUPPRESSIVE AGENT IN THE TREATMENT OF AUTOIMMUNE DISORDERS
A61K 31/5377 (2006.01)	3672586	IMMUNOPROTEASOME INHIBITORS AND IMMUNOSUPPRESSIVE AGENT IN THE TREATMENT OF AUTOIMMUNE DISORDERS
A61P 13/12 (2006.01)	3672586	IMMUNOPROTEASOME INHIBITORS AND IMMUNOSUPPRESSIVE AGENT IN THE TREATMENT OF AUTOIMMUNE DISORDERS
A61P 37/06 (2006.01)	3672586	IMMUNOPROTEASOME INHIBITORS AND IMMUNOSUPPRESSIVE AGENT IN THE TREATMENT OF AUTOIMMUNE DISORDERS
B01D 53/14 (2006.01)	3672712	METHOD FOR RECLAIMING AMINE ABSORPTION AGENT UNDER CONTROLLED TEMPERATURE
A01N 43/54 (2006.01)	3655396	POLYMORPHS OF 5-FLUORO-4-IMINO-3-METHYL-1-TOSYL-3,4-DIHYDROPYRIMIDIN-2-ONE
C07D 239/47 (2006.01)	3655396	POLYMORPHS OF 5-FLUORO-4-IMINO-3-METHYL-1-TOSYL-3,4-DIHYDROPYRIMIDIN-2-ONE
A23L 33/135 (2016.01)	3664824	COMPOSITIONS COMPRISING BACTERIAL STRAINS
A61K 35/744 (2015.01)	3664824	COMPOSITIONS COMPRISING BACTERIAL STRAINS
A61P 1/12 (2006.01)	3664824	COMPOSITIONS COMPRISING BACTERIAL STRAINS
A61P 29/00 (2006.01)	3664824	COMPOSITIONS COMPRISING BACTERIAL STRAINS
A61P 35/00 (2006.01)	3664824	COMPOSITIONS COMPRISING BACTERIAL STRAINS
A61P 37/00 (2006.01)	3664824	COMPOSITIONS COMPRISING BACTERIAL STRAINS
C07K 16/28 (2006.01)	3665198	ANTIBODIES THAT BIND EGFR AND CMET
C07K 16/46 (2006.01)	3665198	ANTIBODIES THAT BIND EGFR AND CMET

MKP (51)	Broj objave evropske prijave patenta (97)	Naziv pronalaska (54)
A01D 46/28 (2006.01)	3648569	PNEUMATIC CUSHIONS FOR SOFT RECEPTION OF HARVESTED FRUIT ON MECHANIZED FRUIT HARVESTING DEVICES
A61K 31/522 (2006.01)	3668870	6-AMINO-7,9-DIHYDRO-8H-PURIN-8-ONE DERIVATIVES AS IMMUNOSTIMULANT TOLL-LIKE RECEPTOR 7 (TLR7) AGONISTS
A61P 37/04 (2006.01)	3668870	6-AMINO-7,9-DIHYDRO-8H-PURIN-8-ONE DERIVATIVES AS IMMUNOSTIMULANT TOLL-LIKE RECEPTOR 7 (TLR7) AGONISTS
C07D 473/18 (2006.01)	3668870	6-AMINO-7,9-DIHYDRO-8H-PURIN-8-ONE DERIVATIVES AS IMMUNOSTIMULANT TOLL-LIKE RECEPTOR 7 (TLR7) AGONISTS
A61K 31/522 (2006.01)	3668871	6-AMINO-7,9-DIHYDRO-8H-PURIN-8-ONE DERIVATIVES AS IMMUNOSTIMULANT TOLL-LIKE RECEPTOR 7 (TLR7) AGONISTS
A61P 37/04 (2006.01)	3668871	6-AMINO-7,9-DIHYDRO-8H-PURIN-8-ONE DERIVATIVES AS IMMUNOSTIMULANT TOLL-LIKE RECEPTOR 7 (TLR7) AGONISTS
C07D 473/18 (2006.01)	3668871	6-AMINO-7,9-DIHYDRO-8H-PURIN-8-ONE DERIVATIVES AS IMMUNOSTIMULANT TOLL-LIKE RECEPTOR 7 (TLR7) AGONISTS
A61K 35/76 (2015.01)	3664844	TREATMENT OF TRIPLE NEGATIVE BREAST CANCER OR COLORECTAL CANCER WITH LIVER METASTASES WITH AN ANTI PD-L1 ANTIBODY AND AN ONCOLYTIC VIRUS
A61K 39/395 (2006.01)	3664844	TREATMENT OF TRIPLE NEGATIVE BREAST CANCER OR COLORECTAL CANCER WITH LIVER METASTASES WITH AN ANTI PD-L1 ANTIBODY AND AN ONCOLYTIC VIRUS
C07K 16/28 (2006.01)	3664844	TREATMENT OF TRIPLE NEGATIVE BREAST CANCER OR COLORECTAL CANCER WITH LIVER METASTASES WITH AN ANTI PD-L1 ANTIBODY AND AN ONCOLYTIC VIRUS
A01K 61/13 (2017.01)	3664602	LIVE FISH PROCESSING SYSTEM, AND ASSOCIATED METHODS
A01K 61/95 (2017.01)	3664602	LIVE FISH PROCESSING SYSTEM, AND ASSOCIATED METHODS
A61K 31/553 (2006.01)	3668878	COMPOUNDS THAT INHIBIT MCL-1 PROTEIN
A61P 35/00 (2006.01)	3668878	COMPOUNDS THAT INHIBIT MCL-1 PROTEIN
C07D 498/08 (2006.01)	3668878	COMPOUNDS THAT INHIBIT MCL-1 PROTEIN
A61K 31/454 (2006.01)	3672949	3-(1-OXOISOINDOLIN-2-YL)PIPERIDINE-2,6-DIONE DERIVATIVES AND USES THEREOF
A61K 31/4545 (2006.01)	3672949	3-(1-OXOISOINDOLIN-2-YL)PIPERIDINE-2,6-DIONE DERIVATIVES AND USES THEREOF
A61P 35/00 (2006.01)	3672949	3-(1-OXOISOINDOLIN-2-YL)PIPERIDINE-2,6-DIONE DERIVATIVES AND USES THEREOF
C07D 401/04 (2006.01)	3672949	3-(1-OXOISOINDOLIN-2-YL)PIPERIDINE-2,6-DIONE DERIVATIVES AND USES THEREOF
C07D 401/14 (2006.01)	3672949	3-(1-OXOISOINDOLIN-2-YL)PIPERIDINE-2,6-DIONE DERIVATIVES AND USES THEREOF
C07D 407/14 (2006.01)	3672949	3-(1-OXOISOINDOLIN-2-YL)PIPERIDINE-2,6-DIONE DERIVATIVES AND USES THEREOF
C07D 409/14 (2006.01)	3672949	3-(1-OXOISOINDOLIN-2-YL)PIPERIDINE-2,6-DIONE DERIVATIVES AND USES THEREOF
C07D 413/14 (2006.01)	3672949	3-(1-OXOISOINDOLIN-2-YL)PIPERIDINE-2,6-DIONE DERIVATIVES AND USES THEREOF
C07D 417/14 (2006.01)	3672949	3-(1-OXOISOINDOLIN-2-YL)PIPERIDINE-2,6-DIONE DERIVATIVES AND USES THEREOF
C07D 471/04 (2006.01)	3672949	3-(1-OXOISOINDOLIN-2-YL)PIPERIDINE-2,6-DIONE DERIVATIVES AND USES THEREOF
C07D 487/04 (2006.01)	3672949	3-(1-OXOISOINDOLIN-2-YL)PIPERIDINE-2,6-DIONE DERIVATIVES AND USES THEREOF
C07D 487/08 (2006.01)	3672949	3-(1-OXOISOINDOLIN-2-YL)PIPERIDINE-2,6-DIONE DERIVATIVES AND USES THEREOF
C07D 495/04 (2006.01)	3672949	3-(1-OXOISOINDOLIN-2-YL)PIPERIDINE-2,6-DIONE DERIVATIVES AND USES THEREOF
C07D 513/04 (2006.01)	3672949	3-(1-OXOISOINDOLIN-2-YL)PIPERIDINE-2,6-DIONE DERIVATIVES AND USES THEREOF
C07K 14/755 (2006.01)	3665289	NUCLEIC ACID MOLECULES AND USES THEREOF
C12N 9/64 (2006.01)	3665289	NUCLEIC ACID MOLECULES AND USES THEREOF
C12N 15/86 (2006.01)	3665289	NUCLEIC ACID MOLECULES AND USES THEREOF

MKP (51)	Broj objave evropske prijave patenta (97)	Naziv pronalaska (54)
B61H 9/02 (2006.01)	3673231	INDUCTIVE SENSOR
G01B 7/00 (2006.01)	3673231	INDUCTIVE SENSOR
G01B 7/02 (2006.01)	3673231	INDUCTIVE SENSOR
G01D 5/22 (2006.01)	3673231	INDUCTIVE SENSOR
G01R 33/00 (2006.01)	3673231	INDUCTIVE SENSOR
G01V 3/10 (2006.01)	3673231	INDUCTIVE SENSOR
H03K 17/95 (2006.01)	3673231	INDUCTIVE SENSOR
H04B 5/00 (2006.01)	3673231	INDUCTIVE SENSOR
H04B 15/00 (2006.01)	3673231	INDUCTIVE SENSOR
A61K 31/4545 (2006.01)	3649124	FLUOROPIPERIDINE COMPOUNDS AS PURE 5-HT6 RECEPTOR ANTAGONISTS
A61P 25/28 (2006.01)	3649124	FLUOROPIPERIDINE COMPOUNDS AS PURE 5-HT6 RECEPTOR ANTAGONISTS
C07D 413/04 (2006.01)	3649124	FLUOROPIPERIDINE COMPOUNDS AS PURE 5-HT6 RECEPTOR ANTAGONISTS
C12Q 1/6883 (2018.01)	3669004	COMPOSITIONS AND METHODS FOR TREATMENT OF ATOPIC DERMATITIS AND TREATMENT SELECTION
G01N 33/574 (2006.01)	3669004	COMPOSITIONS AND METHODS FOR TREATMENT OF ATOPIC DERMATITIS AND TREATMENT SELECTION
G01N 33/68 (2006.01)	3669004	COMPOSITIONS AND METHODS FOR TREATMENT OF ATOPIC DERMATITIS AND TREATMENT SELECTION
A61K 31/5025 (2006.01)	3668513	PYRUVATE KINASE ACTIVATORS FOR USE IN TREATING BLOOD DISORDERS
A61P 3/10 (2006.01)	3668513	PYRUVATE KINASE ACTIVATORS FOR USE IN TREATING BLOOD DISORDERS
A61P 7/06 (2006.01)	3668513	PYRUVATE KINASE ACTIVATORS FOR USE IN TREATING BLOOD DISORDERS
A61P 7/08 (2006.01)	3668513	PYRUVATE KINASE ACTIVATORS FOR USE IN TREATING BLOOD DISORDERS
A61P 35/00 (2006.01)	3668513	PYRUVATE KINASE ACTIVATORS FOR USE IN TREATING BLOOD DISORDERS
C07D 513/14 (2006.01)	3668513	PYRUVATE KINASE ACTIVATORS FOR USE IN TREATING BLOOD DISORDERS
A61K 9/00 (2006.01)	3654988	TREATMENT OF NON-INFLAMMATORY LESIONS
A61K 31/65 (2006.01)	3654988	TREATMENT OF NON-INFLAMMATORY LESIONS
A61P 17/10 (2006.01)	3654988	TREATMENT OF NON-INFLAMMATORY LESIONS
A61P 43/00 (2006.01)	3654988	TREATMENT OF NON-INFLAMMATORY LESIONS
H02P 7/00 (2016.01)	3665771	METHOD AND DEVICE FOR DETERMINING A ROTATION VARIABLE
A61K 31/444 (2006.01)	3653620	NEW HETEROARYL AMIDE DERIVATIVES AS SELECTIVE INHIBITORS OF HISTONE DEACETYLASES 1 AND 2 (HDAC1-2)
A61K 31/496 (2006.01)	3653620	NEW HETEROARYL AMIDE DERIVATIVES AS SELECTIVE INHIBITORS OF HISTONE DEACETYLASES 1 AND 2 (HDAC1-2)
A61P 35/00 (2006.01)	3653620	NEW HETEROARYL AMIDE DERIVATIVES AS SELECTIVE INHIBITORS OF HISTONE DEACETYLASES 1 AND 2 (HDAC1-2)
C07D 401/12 (2006.01)	3653620	NEW HETEROARYL AMIDE DERIVATIVES AS SELECTIVE INHIBITORS OF HISTONE DEACETYLASES 1 AND 2 (HDAC1-2)
C07D 401/14 (2006.01)	3653620	NEW HETEROARYL AMIDE DERIVATIVES AS SELECTIVE INHIBITORS OF HISTONE DEACETYLASES 1 AND 2 (HDAC1-2)
C07D 409/14 (2006.01)	3653620	NEW HETEROARYL AMIDE DERIVATIVES AS SELECTIVE INHIBITORS OF HISTONE DEACETYLASES 1 AND 2 (HDAC1-2)
A61K 39/00 (2006.01)	3539566	FMDV AND E2 FUSION PROTEINS AND USES THEREOF
A61K 39/135 (2006.01)	3539566	FMDV AND E2 FUSION PROTEINS AND USES THEREOF
A61K 39/385 (2006.01)	3539566	FMDV AND E2 FUSION PROTEINS AND USES THEREOF
C07K 14/005 (2006.01)	3539566	FMDV AND E2 FUSION PROTEINS AND USES THEREOF
C07K 14/32 (2006.01)	3539566	FMDV AND E2 FUSION PROTEINS AND USES THEREOF
C12N 7/00 (2006.01)	3539566	FMDV AND E2 FUSION PROTEINS AND USES THEREOF
C12N 5/071 (2010.01)	3564361	LIVER ORGANOID, USES THEREOF AND CULTURE METHOD FOR OBTAINING THEM
C12N 5/074 (2010.01)	3564361	LIVER ORGANOID, USES THEREOF AND CULTURE METHOD FOR OBTAINING THEM
A61K 39/00 (2006.01)	3542816	IMMUNOTHERAPY OF CANCER THROUGH COMBINATION OF LOCAL AND SYSTEMIC IMMUNE STIMULATION
A61P 17/06 (2006.01)	3536710	ANTI IL-36R ANTIBODIES
C07K 16/28 (2006.01)	3536710	ANTI IL-36R ANTIBODIES
A61K 9/06 (2006.01)	3539534	INJECTABLE PREPARATION
A61K 31/496 (2006.01)	3539534	INJECTABLE PREPARATION
A61K 47/10 (2017.01)	3539534	INJECTABLE PREPARATION

MKP (51)	Broj objave evropske prijave patenta (97)	Naziv pronalaska (54)
A61K 47/32 (2006.01)	3539534	INJECTABLE PREPARATION
A61K 47/38 (2006.01)	3539534	INJECTABLE PREPARATION
A61P 25/18 (2006.01)	3539534	INJECTABLE PREPARATION
A61P 25/24 (2006.01)	3539534	INJECTABLE PREPARATION
G06Q 50/02 (2012.01)	3564895	METHOD FOR CERTIFICATION OF ORGANIC PRODUCTS
C07K 16/46 (2006.01)	3556777	MULTISPECIFIC ANTIBODY CONSTRUCTS
C07H 21/04 (2006.01)	3540070	DUAL RECEPTOR ANTAGONISTIC ANTIGEN-BINDING PROTEINS AND USES THEREOF
C07K 16/00 (2006.01)	3540070	DUAL RECEPTOR ANTAGONISTIC ANTIGEN-BINDING PROTEINS AND USES THEREOF
C12P 21/08 (2006.01)	3540070	DUAL RECEPTOR ANTAGONISTIC ANTIGEN-BINDING PROTEINS AND USES THEREOF
A61K 31/519 (2006.01)	3536692	PYRAZOLOPYRIMIDINYL INHIBITORS OF UBIQUITIN-ACTIVATING ENZYME
A61P 35/00 (2006.01)	3536692	PYRAZOLOPYRIMIDINYL INHIBITORS OF UBIQUITIN-ACTIVATING ENZYME
C07D 487/04 (2006.01)	3536692	PYRAZOLOPYRIMIDINYL INHIBITORS OF UBIQUITIN-ACTIVATING ENZYME
A61P 7/06 (2006.01)	3536711	ANTI-CD26 ANTIBODIES AND USES THEREOF
A61P 37/06 (2006.01)	3536711	ANTI-CD26 ANTIBODIES AND USES THEREOF
C07K 16/28 (2006.01)	3536711	ANTI-CD26 ANTIBODIES AND USES THEREOF
A61K 31/519 (2006.01)	3572083	7-BENZYL-10-(2-METHYLBENZYL)-2,6,7,8,9,10-HEXAHYDROIMIDAZO[1,2-A]PYRIDO[4,3-D]PYRIMIDIN-5(3H)-ON FOR USE IN THE TREATMENT OF CANCER
A61K 45/06 (2006.01)	3572083	7-BENZYL-10-(2-METHYLBENZYL)-2,6,7,8,9,10-HEXAHYDROIMIDAZO[1,2-A]PYRIDO[4,3-D]PYRIMIDIN-5(3H)-ON FOR USE IN THE TREATMENT OF CANCER
A61P 35/00 (2006.01)	3572083	7-BENZYL-10-(2-METHYLBENZYL)-2,6,7,8,9,10-HEXAHYDROIMIDAZO[1,2-A]PYRIDO[4,3-D]PYRIMIDIN-5(3H)-ON FOR USE IN THE TREATMENT OF CANCER
C07D 471/14 (2006.01)	3572083	7-BENZYL-10-(2-METHYLBENZYL)-2,6,7,8,9,10-HEXAHYDROIMIDAZO[1,2-A]PYRIDO[4,3-D]PYRIMIDIN-5(3H)-ON FOR USE IN THE TREATMENT OF CANCER
B66C 13/18 (2006.01)	3564181	LIFTING SYSTEM
B66D 1/08 (2006.01)	3564181	LIFTING SYSTEM
B66D 1/12 (2006.01)	3564181	LIFTING SYSTEM
A61K 38/17 (2006.01)	3545966	METHODS AND COMPOSITIONS FOR THE TREATMENT OF CANCER
C07K 14/47 (2006.01)	3545966	METHODS AND COMPOSITIONS FOR THE TREATMENT OF CANCER
C12N 15/113 (2010.01)	3545966	METHODS AND COMPOSITIONS FOR THE TREATMENT OF CANCER
G06Q 20/34 (2012.01)	3564914	METHOD AND SYSTEM FOR PERFORMING A SECURE DATA EXCHANGE
G07F 7/08 (2006.01)	3564914	METHOD AND SYSTEM FOR PERFORMING A SECURE DATA EXCHANGE
A61K 31/433 (2006.01)	3556757	CYCLOALKYL-LINKED DIHETEROCYCLE DERIVATIVES
A61P 35/00 (2006.01)	3556757	CYCLOALKYL-LINKED DIHETEROCYCLE DERIVATIVES
C07D 417/08 (2006.01)	3556757	CYCLOALKYL-LINKED DIHETEROCYCLE DERIVATIVES
F41A 11/00 (2006.01)	3569965	FIREARM, IN PARTICULAR PISTOL, WITH A DEVICE FOR DISASSEMBLY
F41A 17/36 (2006.01)	3569965	FIREARM, IN PARTICULAR PISTOL, WITH A DEVICE FOR DISASSEMBLY
B65D 5/02 (2006.01)	3569514	TAMPER EVIDENT CARTON
B65D 5/54 (2006.01)	3569514	TAMPER EVIDENT CARTON
C12Q 1/68 (2018.01)	3550031	MUTATIONS ASSOCIATED WITH RESISTANCE TO INHIBITORS OF BRUTON'S TYROSINE KINASE (BTK)
A61K 31/506 (2006.01)	3560498	COMBINATION COMPRISING AN MEK INHIBITOR AND A B-RAF INHIBITOR
A61K 31/519 (2006.01)	3560498	COMBINATION COMPRISING AN MEK INHIBITOR AND A B-RAF INHIBITOR
A61P 35/00 (2006.01)	3560498	COMBINATION COMPRISING AN MEK INHIBITOR AND A B-RAF INHIBITOR
C07F 9/6558 (2006.01)	3564248	PROCESSES FOR PREPARING PHOSPHORODIAMIDATE MORPHOLINO OLIGOMERS
C07F 9/6561 (2006.01)	3564248	PROCESSES FOR PREPARING PHOSPHORODIAMIDATE MORPHOLINO OLIGOMERS
A61K 8/06 (2006.01)	3549573	METHOD FOR AFFECTING HAPTIC PERCEPTION

MKP (51)	Broj objave evropske prijave patenta (97)	Naziv pronalaska (54)
A61K 8/37 (2006.01)	3549573	METHOD FOR AFFECTING HAPTIK PERCEPTION
A61K 8/49 (2006.01)	3549573	METHOD FOR AFFECTING HAPTIK PERCEPTION
A61K 8/73 (2006.01)	3549573	METHOD FOR AFFECTING HAPTIK PERCEPTION
A61K 8/92 (2006.01)	3549573	METHOD FOR AFFECTING HAPTIK PERCEPTION
A61Q 19/00 (2006.01)	3549573	METHOD FOR AFFECTING HAPTIK PERCEPTION
G03G 15/00 (2006.01)	3567437	IMAGE FORMING APPARATUS AND CARTRIDGE
G03G 21/16 (2006.01)	3567437	IMAGE FORMING APPARATUS AND CARTRIDGE
G03G 21/18 (2006.01)	3567437	IMAGE FORMING APPARATUS AND CARTRIDGE
A61K 9/00 (2006.01)	3566694	STABLE PRESSURISED AEROSOL SOLUTION COMPOSITION OF GLYCOPYRRONIUM BROMIDE AND FORMOTEROL COMBINATION
A61K 31/167 (2006.01)	3566694	STABLE PRESSURISED AEROSOL SOLUTION COMPOSITION OF GLYCOPYRRONIUM BROMIDE AND FORMOTEROL COMBINATION
A61K 31/40 (2006.01)	3566694	STABLE PRESSURISED AEROSOL SOLUTION COMPOSITION OF GLYCOPYRRONIUM BROMIDE AND FORMOTEROL COMBINATION
A61K 31/573 (2006.01)	3566694	STABLE PRESSURISED AEROSOL SOLUTION COMPOSITION OF GLYCOPYRRONIUM BROMIDE AND FORMOTEROL COMBINATION
A61K 31/58 (2006.01)	3566694	STABLE PRESSURISED AEROSOL SOLUTION COMPOSITION OF GLYCOPYRRONIUM BROMIDE AND FORMOTEROL COMBINATION
A61K 45/06 (2006.01)	3566694	STABLE PRESSURISED AEROSOL SOLUTION COMPOSITION OF GLYCOPYRRONIUM BROMIDE AND FORMOTEROL COMBINATION
A61M 15/00 (2006.01)	3566694	STABLE PRESSURISED AEROSOL SOLUTION COMPOSITION OF GLYCOPYRRONIUM BROMIDE AND FORMOTEROL COMBINATION
A61K 48/00 (2006.01)	3572096	A CONDITIONAL REPLICATING CYTOMEGALOVIRUS AS A VACCINE FOR CMV
C07H 21/04 (2006.01)	3572096	A CONDITIONAL REPLICATING CYTOMEGALOVIRUS AS A VACCINE FOR CMV
E04F 13/08 (2006.01)	3572598	MOUNTING BRACKET FOR MOUNTING A CLADDING TO A WALL, AND METHOD THEREFOR
A61K 39/29 (2006.01)	3564384	HCV CORE LIPID BINDING DOMAIN MONOCLONAL ANTIBODIES
C07K 16/00 (2006.01)	3564384	HCV CORE LIPID BINDING DOMAIN MONOCLONAL ANTIBODIES
C07K 16/10 (2006.01)	3564384	HCV CORE LIPID BINDING DOMAIN MONOCLONAL ANTIBODIES
C12P 21/08 (2006.01)	3564384	HCV CORE LIPID BINDING DOMAIN MONOCLONAL ANTIBODIES
C12Q 1/70 (2006.01)	3564384	HCV CORE LIPID BINDING DOMAIN MONOCLONAL ANTIBODIES
A61P 41/00 (2006.01)	3569636	COMPOUNDS, PHARMACEUTICAL COMPOSITIONS AND A METHOD FOR THE PROPHYLAXIS AND TREATMENT OF THE ADHESION PROCESS
C07D 401/04 (2006.01)	3569636	COMPOUNDS, PHARMACEUTICAL COMPOSITIONS AND A METHOD FOR THE PROPHYLAXIS AND TREATMENT OF THE ADHESION PROCESS
C08G 73/06 (2006.01)	3569636	COMPOUNDS, PHARMACEUTICAL COMPOSITIONS AND A METHOD FOR THE PROPHYLAXIS AND TREATMENT OF THE ADHESION PROCESS
C08L 79/06 (2006.01)	3569636	COMPOUNDS, PHARMACEUTICAL COMPOSITIONS AND A METHOD FOR THE PROPHYLAXIS AND TREATMENT OF THE ADHESION PROCESS
A61K 31/47 (2006.01)	3560920	SECONDARY ALCOHOL QUINOLINYL MODULATORS OF ROR GAMMA T
A61K 31/4709 (2006.01)	3560920	SECONDARY ALCOHOL QUINOLINYL MODULATORS OF ROR GAMMA T
A61P 29/00 (2006.01)	3560920	SECONDARY ALCOHOL QUINOLINYL MODULATORS OF ROR GAMMA T
A61P 35/00 (2006.01)	3560920	SECONDARY ALCOHOL QUINOLINYL MODULATORS OF ROR GAMMA T
C07D 215/227 (2006.01)	3560920	SECONDARY ALCOHOL QUINOLINYL MODULATORS OF ROR GAMMA T

MKP (51)	Broj objave evropske prijave patenta (97)	Naziv pronalaska (54)
C07D 401/06 (2006.01)	3560920	SECONDARY ALCOHOL QUINOLINYL MODULATORS OF ROR GAMMA T
C07D 401/14 (2006.01)	3560920	SECONDARY ALCOHOL QUINOLINYL MODULATORS OF ROR GAMMA T
C07D 413/06 (2006.01)	3560920	SECONDARY ALCOHOL QUINOLINYL MODULATORS OF ROR GAMMA T
A01B 17/00 (2006.01)	3578026	VEHICLE AND METHOD FOR THE DISTRIBUTION OF BIOSOLIDS
A01C 3/06 (2006.01)	3578026	VEHICLE AND METHOD FOR THE DISTRIBUTION OF BIOSOLIDS
A47B 67/02 (2006.01)	3578083	DISPENSER FOR MEDICAL ARTICLES
A47B 67/04 (2006.01)	3578083	DISPENSER FOR MEDICAL ARTICLES
A61F 17/00 (2006.01)	3578083	DISPENSER FOR MEDICAL ARTICLES
A61K 9/16 (2006.01)	3574897	POLYMER PROTEIN MICROPARTICLES
A61K 9/50 (2006.01)	3574897	POLYMER PROTEIN MICROPARTICLES
A61K 38/17 (2006.01)	3574897	POLYMER PROTEIN MICROPARTICLES
A61K 39/00 (2006.01)	3574897	POLYMER PROTEIN MICROPARTICLES
A61P 27/02 (2006.01)	3574897	POLYMER PROTEIN MICROPARTICLES
G01N 33/50 (2006.01)	3605101	WHOLE CELL ASSAYS AND METHODS
G01N 33/574 (2006.01)	3605101	WHOLE CELL ASSAYS AND METHODS
A61K 9/00 (2006.01)	3569222	DRY POWDER FORMULATION COMPRISING AN ANTICHOLINERGIC, A CORTICOSTEROID AND A BETA-ADRENERGIC FOR ADMINISTRATION BY INHALATION
A61K 31/167 (2006.01)	3569222	DRY POWDER FORMULATION COMPRISING AN ANTICHOLINERGIC, A CORTICOSTEROID AND A BETA-ADRENERGIC FOR ADMINISTRATION BY INHALATION
A61K 31/40 (2006.01)	3569222	DRY POWDER FORMULATION COMPRISING AN ANTICHOLINERGIC, A CORTICOSTEROID AND A BETA-ADRENERGIC FOR ADMINISTRATION BY INHALATION
A61K 31/573 (2006.01)	3569222	DRY POWDER FORMULATION COMPRISING AN ANTICHOLINERGIC, A CORTICOSTEROID AND A BETA-ADRENERGIC FOR ADMINISTRATION BY INHALATION
A61K 47/12 (2006.01)	3569222	DRY POWDER FORMULATION COMPRISING AN ANTICHOLINERGIC, A CORTICOSTEROID AND A BETA-ADRENERGIC FOR ADMINISTRATION BY INHALATION
A61K 47/26 (2006.01)	3569222	DRY POWDER FORMULATION COMPRISING AN ANTICHOLINERGIC, A CORTICOSTEROID AND A BETA-ADRENERGIC FOR ADMINISTRATION BY INHALATION
C07K 16/28 (2006.01)	3572433	ANTIBODIES SPECIFIC TO FCRN
G01N 33/53 (2006.01)	3572433	ANTIBODIES SPECIFIC TO FCRN
A61K 31/439 (2006.01)	3569604	PROCESS AND INTERMEDIATES FOR THE PREPARATION OF NAPHTHYRIDINE COMPOUNDS AS JAK KINASE INHIBITORS
A61P 1/04 (2006.01)	3569604	PROCESS AND INTERMEDIATES FOR THE PREPARATION OF NAPHTHYRIDINE COMPOUNDS AS JAK KINASE INHIBITORS
C07D 519/00 (2006.01)	3569604	PROCESS AND INTERMEDIATES FOR THE PREPARATION OF NAPHTHYRIDINE COMPOUNDS AS JAK KINASE INHIBITORS
A61K 9/00 (2006.01)	3574895	PARTICLE SIZE REDUCTION OF AN ANTIMUSCARINIC COMPOUND
A61K 9/14 (2006.01)	3574895	PARTICLE SIZE REDUCTION OF AN ANTIMUSCARINIC COMPOUND
B65D 5/66 (2006.01)	3587293	FOLDING BOX
B65D 5/72 (2006.01)	3587293	FOLDING BOX
B60K 15/00 (2006.01)	3638939	COUPLING FOR CRYOGENIC LIQUEFIED MEDIA
B60S 5/02 (2006.01)	3638939	COUPLING FOR CRYOGENIC LIQUEFIED MEDIA
B67D 7/32 (2010.01)	3638939	COUPLING FOR CRYOGENIC LIQUEFIED MEDIA
F16K 1/00 (2006.01)	3638939	COUPLING FOR CRYOGENIC LIQUEFIED MEDIA
F16L 29/04 (2006.01)	3638939	COUPLING FOR CRYOGENIC LIQUEFIED MEDIA
F16L 37/248 (2006.01)	3638939	COUPLING FOR CRYOGENIC LIQUEFIED MEDIA
F16L 37/32 (2006.01)	3638939	COUPLING FOR CRYOGENIC LIQUEFIED MEDIA
F16L 55/10 (2006.01)	3638939	COUPLING FOR CRYOGENIC LIQUEFIED MEDIA
F17C 1/00 (2006.01)	3638939	COUPLING FOR CRYOGENIC LIQUEFIED MEDIA
A01N 59/00 (2006.01)	3627987	BIOCIDE FREE PRESERVATION
A01N 59/06 (2006.01)	3627987	BIOCIDE FREE PRESERVATION
A01N 59/16 (2006.01)	3627987	BIOCIDE FREE PRESERVATION
A01P 3/00 (2006.01)	3627987	BIOCIDE FREE PRESERVATION
A61K 31/395 (2006.01)	3630112	COMBINATION OF REGORAFENIB AND PD-1/PD-L1(2) INHIBITORS FOR TREATING CANCER

MKP (51)	Broj objave evropske prijave patenta (97)	Naziv pronalaska (54)
A61K 31/44 (2006.01)	3630112	COMBINATION OF REGORAFENIB AND PD-1/PD-L1(2) INHIBITORS FOR TREATING CANCER
A61K 45/06 (2006.01)	3630112	COMBINATION OF REGORAFENIB AND PD-1/PD-L1(2) INHIBITORS FOR TREATING CANCER
A61P 35/00 (2006.01)	3630112	COMBINATION OF REGORAFENIB AND PD-1/PD-L1(2) INHIBITORS FOR TREATING CANCER
C12Q 1/68 (2018.01)	3635129	METHODS FOR CHARACTERIZING LOSS OF ANTIGEN PRESENTATION
A61K 31/00 (2006.01)	3630177	TREATMENT PARADIGM FOR AN ANTI-CD19 ANTIBODY AND VENETOCLAX COMBINATION TREATMENT
A61K 39/395 (2006.01)	3630177	TREATMENT PARADIGM FOR AN ANTI-CD19 ANTIBODY AND VENETOCLAX COMBINATION TREATMENT
A61P 35/00 (2006.01)	3630177	TREATMENT PARADIGM FOR AN ANTI-CD19 ANTIBODY AND VENETOCLAX COMBINATION TREATMENT
C07K 16/28 (2006.01)	3630177	TREATMENT PARADIGM FOR AN ANTI-CD19 ANTIBODY AND VENETOCLAX COMBINATION TREATMENT
A61K 39/00 (2006.01)	3635408	METHODS FOR PREDICTING THE USEFULNESS OF DISEASE SPECIFIC AMINO ACID MODIFICATIONS FOR IMMUNOTHERAPY
G01N 33/68 (2006.01)	3635408	METHODS FOR PREDICTING THE USEFULNESS OF DISEASE SPECIFIC AMINO ACID MODIFICATIONS FOR IMMUNOTHERAPY
A61K 31/403 (2006.01)	3630723	SUBSTITUTED INDOLINE DERIVATIVES AS DENGUE VIRAL REPLICATION INHIBITORS
A61P 31/12 (2006.01)	3630723	SUBSTITUTED INDOLINE DERIVATIVES AS DENGUE VIRAL REPLICATION INHIBITORS
C07D 209/08 (2006.01)	3630723	SUBSTITUTED INDOLINE DERIVATIVES AS DENGUE VIRAL REPLICATION INHIBITORS
A61K 31/4995 (2006.01)	3638675	DIAZABICYCLIC SUBSTITUTED IMIDAZOPYRIMIDINES AND THEIR USE FOR THE TREATMENT OF BREATHING DISORDERS
A61K 31/5386 (2006.01)	3638675	DIAZABICYCLIC SUBSTITUTED IMIDAZOPYRIMIDINES AND THEIR USE FOR THE TREATMENT OF BREATHING DISORDERS
A61P 11/00 (2006.01)	3638675	DIAZABICYCLIC SUBSTITUTED IMIDAZOPYRIMIDINES AND THEIR USE FOR THE TREATMENT OF BREATHING DISORDERS
A61P 25/00 (2006.01)	3638675	DIAZABICYCLIC SUBSTITUTED IMIDAZOPYRIMIDINES AND THEIR USE FOR THE TREATMENT OF BREATHING DISORDERS
C07D 471/08 (2006.01)	3638675	DIAZABICYCLIC SUBSTITUTED IMIDAZOPYRIMIDINES AND THEIR USE FOR THE TREATMENT OF BREATHING DISORDERS
C07D 498/08 (2006.01)	3638675	DIAZABICYCLIC SUBSTITUTED IMIDAZOPYRIMIDINES AND THEIR USE FOR THE TREATMENT OF BREATHING DISORDERS
A61K 31/216 (2006.01)	3634490	IMPLANTABLE DRUG DELIVERY DEVICE
A61K 47/32 (2006.01)	3634490	IMPLANTABLE DRUG DELIVERY DEVICE
A61K 47/34 (2017.01)	3634490	IMPLANTABLE DRUG DELIVERY DEVICE
A61K 31/404 (2006.01)	3630724	SUBSTITUTED INDOLINE DERIVATIVES AS DENGUE VIRAL REPLICATION INHIBITORS
A61K 31/407 (2006.01)	3630724	SUBSTITUTED INDOLINE DERIVATIVES AS DENGUE VIRAL REPLICATION INHIBITORS
A61K 31/437 (2006.01)	3630724	SUBSTITUTED INDOLINE DERIVATIVES AS DENGUE VIRAL REPLICATION INHIBITORS
A61P 31/14 (2006.01)	3630724	SUBSTITUTED INDOLINE DERIVATIVES AS DENGUE VIRAL REPLICATION INHIBITORS
C07D 209/30 (2006.01)	3630724	SUBSTITUTED INDOLINE DERIVATIVES AS DENGUE VIRAL REPLICATION INHIBITORS
C07D 209/32 (2006.01)	3630724	SUBSTITUTED INDOLINE DERIVATIVES AS DENGUE VIRAL REPLICATION INHIBITORS
C07D 209/42 (2006.01)	3630724	SUBSTITUTED INDOLINE DERIVATIVES AS DENGUE VIRAL REPLICATION INHIBITORS
C07D 471/04 (2006.01)	3630724	SUBSTITUTED INDOLINE DERIVATIVES AS DENGUE VIRAL REPLICATION INHIBITORS
C07D 513/04 (2006.01)	3630724	SUBSTITUTED INDOLINE DERIVATIVES AS DENGUE VIRAL REPLICATION INHIBITORS

MKP (51)	Broj objave evropske prijave patenta (97)	Naziv pronalaska (54)
C08K 9/00 (2006.01)	3638738	PROCESS FOR PREPARING A SURFACE TREATED FILLER MATERIAL PRODUCT WITH MONO-SUBSTITUTED SUCCINIC ANHYDRIDE(S) AND A MIXTURE OF ALIPHATIC LINEAR OR BRANCHED CARBOXYLIC ACIDS COMPRISING STEARIC ACID
C09C 1/02 (2006.01)	3638738	PROCESS FOR PREPARING A SURFACE TREATED FILLER MATERIAL PRODUCT WITH MONO-SUBSTITUTED SUCCINIC ANHYDRIDE(S) AND A MIXTURE OF ALIPHATIC LINEAR OR BRANCHED CARBOXYLIC ACIDS COMPRISING STEARIC ACID
B41M 3/00 (2006.01)	3642044	TAMPER-PROOF MEDIUM FOR THERMAL PRINTING
B41M 3/14 (2006.01)	3642044	TAMPER-PROOF MEDIUM FOR THERMAL PRINTING
B41M 5/323 (2006.01)	3642044	TAMPER-PROOF MEDIUM FOR THERMAL PRINTING
B21D 51/26 (2006.01)	3645187	METHOD AND DEVICE FOR CLOSING OF CONTAINER
B67B 1/04 (2006.01)	3645187	METHOD AND DEVICE FOR CLOSING OF CONTAINER
B67B 3/02 (2006.01)	3645187	METHOD AND DEVICE FOR CLOSING OF CONTAINER
A61K 31/498 (2006.01)	3634414	FGFR2 INHIBITORS FOR THE TREATMENT OF CHOLANGIOCARCINOMA
A61P 35/00 (2006.01)	3634414	FGFR2 INHIBITORS FOR THE TREATMENT OF CHOLANGIOCARCINOMA
C07K 16/18 (2006.01)	3634997	NOVEL ANTI-HSA ANTIBODIES
C07K 16/24 (2006.01)	3634997	NOVEL ANTI-HSA ANTIBODIES
C07K 16/18 (2006.01)	3634998	NOVEL ANTI-CD3 ANTIBODIES
C07K 16/24 (2006.01)	3634998	NOVEL ANTI-CD3 ANTIBODIES
C07K 16/28 (2006.01)	3634998	NOVEL ANTI-CD3 ANTIBODIES
C07K 16/32 (2006.01)	3634998	NOVEL ANTI-CD3 ANTIBODIES
A61K 39/00 (2006.01)	3634474	TARGETING MODULES FOR UNIVERSAL CHIMERIC ANTIGEN RECEPTOR EXPRESSING IMMUNE CELLS AND USE IN THE TREATMENT OF CANCER INFECTIONS AND AUTOIMMUNE DISORDERS
A61K 39/395 (2006.01)	3634474	TARGETING MODULES FOR UNIVERSAL CHIMERIC ANTIGEN RECEPTOR EXPRESSING IMMUNE CELLS AND USE IN THE TREATMENT OF CANCER INFECTIONS AND AUTOIMMUNE DISORDERS
C07K 16/28 (2006.01)	3634474	TARGETING MODULES FOR UNIVERSAL CHIMERIC ANTIGEN RECEPTOR EXPRESSING IMMUNE CELLS AND USE IN THE TREATMENT OF CANCER INFECTIONS AND AUTOIMMUNE DISORDERS
A61K 31/40 (2006.01)	3630096	SULFONAMIDE-SUBSTITUTED CYANOPYRROLIDINES WITH ACTIVITY AS DUB INHIBITORS
A61K 31/4025 (2006.01)	3630096	SULFONAMIDE-SUBSTITUTED CYANOPYRROLIDINES WITH ACTIVITY AS DUB INHIBITORS
A61K 31/4155 (2006.01)	3630096	SULFONAMIDE-SUBSTITUTED CYANOPYRROLIDINES WITH ACTIVITY AS DUB INHIBITORS
A61K 31/4439 (2006.01)	3630096	SULFONAMIDE-SUBSTITUTED CYANOPYRROLIDINES WITH ACTIVITY AS DUB INHIBITORS
A61K 31/454 (2006.01)	3630096	SULFONAMIDE-SUBSTITUTED CYANOPYRROLIDINES WITH ACTIVITY AS DUB INHIBITORS
A61K 31/496 (2006.01)	3630096	SULFONAMIDE-SUBSTITUTED CYANOPYRROLIDINES WITH ACTIVITY AS DUB INHIBITORS
A61K 31/506 (2006.01)	3630096	SULFONAMIDE-SUBSTITUTED CYANOPYRROLIDINES WITH ACTIVITY AS DUB INHIBITORS
A61K 31/5365 (2006.01)	3630096	SULFONAMIDE-SUBSTITUTED CYANOPYRROLIDINES WITH ACTIVITY AS DUB INHIBITORS
A61P 3/00 (2006.01)	3630096	SULFONAMIDE-SUBSTITUTED CYANOPYRROLIDINES WITH ACTIVITY AS DUB INHIBITORS
A61P 25/00 (2006.01)	3630096	SULFONAMIDE-SUBSTITUTED CYANOPYRROLIDINES WITH ACTIVITY AS DUB INHIBITORS
A61P 29/00 (2006.01)	3630096	SULFONAMIDE-SUBSTITUTED CYANOPYRROLIDINES WITH ACTIVITY AS DUB INHIBITORS
A61P 31/00 (2006.01)	3630096	SULFONAMIDE-SUBSTITUTED CYANOPYRROLIDINES WITH ACTIVITY AS DUB INHIBITORS
A61P 35/00 (2006.01)	3630096	SULFONAMIDE-SUBSTITUTED CYANOPYRROLIDINES WITH ACTIVITY AS DUB INHIBITORS
C07D 207/14 (2006.01)	3630096	SULFONAMIDE-SUBSTITUTED CYANOPYRROLIDINES WITH ACTIVITY AS DUB INHIBITORS
C07D 401/12 (2006.01)	3630096	SULFONAMIDE-SUBSTITUTED CYANOPYRROLIDINES WITH ACTIVITY AS DUB INHIBITORS
C07D 401/14 (2006.01)	3630096	SULFONAMIDE-SUBSTITUTED CYANOPYRROLIDINES WITH ACTIVITY AS DUB INHIBITORS

MKP (51)	Broj objave evropske prijave patenta (97)	Naziv pronalaska (54)
C07D 403/12 (2006.01)	3630096	SULFONAMIDE-SUBSTITUTED CYANOPYRROLIDINES WITH ACTIVITY AS DUB INHIBITORS
C07D 403/14 (2006.01)	3630096	SULFONAMIDE-SUBSTITUTED CYANOPYRROLIDINES WITH ACTIVITY AS DUB INHIBITORS
C07D 487/04 (2006.01)	3630096	SULFONAMIDE-SUBSTITUTED CYANOPYRROLIDINES WITH ACTIVITY AS DUB INHIBITORS
C07D 498/02 (2006.01)	3630096	SULFONAMIDE-SUBSTITUTED CYANOPYRROLIDINES WITH ACTIVITY AS DUB INHIBITORS
A61K 31/7088 (2006.01)	3641833	METHODS AND COMPOSITIONS FOR CONTROLLING CARDIAC FIBROSIS AND REMODELING
A61K 48/00 (2006.01)	3641833	METHODS AND COMPOSITIONS FOR CONTROLLING CARDIAC FIBROSIS AND REMODELING
C12N 15/113 (2010.01)	3641833	METHODS AND COMPOSITIONS FOR CONTROLLING CARDIAC FIBROSIS AND REMODELING
C12N 15/63 (2006.01)	3641833	METHODS AND COMPOSITIONS FOR CONTROLLING CARDIAC FIBROSIS AND REMODELING
B61B 12/00 (2006.01)	3638560	CABLE CAR WITH LOCK MONITORING FOR A VEHICLE
B61B 12/06 (2006.01)	3638560	CABLE CAR WITH LOCK MONITORING FOR A VEHICLE
A61K 31/437 (2006.01)	3634961	(4-((1,2,4]TRIAZOLO[4,3-A]PYRIDINE-6-YL)OXY)-1,2,3,4-TETRAHYDRONAPHTHALEN-1-YL) UREIDO DERIVATIVES AS ANTI-INFLAMMATORY P38 MAPK INHIBITORS FOR TREATING DISEASES OF THE RESPIRATORY TRACT
A61P 11/00 (2006.01)	3634961	(4-((1,2,4]TRIAZOLO[4,3-A]PYRIDINE-6-YL)OXY)-1,2,3,4-TETRAHYDRONAPHTHALEN-1-YL) UREIDO DERIVATIVES AS ANTI-INFLAMMATORY P38 MAPK INHIBITORS FOR TREATING DISEASES OF THE RESPIRATORY TRACT
C07D 471/04 (2006.01)	3634961	(4-((1,2,4]TRIAZOLO[4,3-A]PYRIDINE-6-YL)OXY)-1,2,3,4-TETRAHYDRONAPHTHALEN-1-YL) UREIDO DERIVATIVES AS ANTI-INFLAMMATORY P38 MAPK INHIBITORS FOR TREATING DISEASES OF THE RESPIRATORY TRACT
B61B 12/06 (2006.01)	3638561	METHOD FOR OPERATING A CABLEWAY
A01N 3/00 (2006.01)	3642176	DEVICE FOR GENERATING ULTRA PURE 1-METHYLCYCLOPROPENE
A01N 27/00 (2006.01)	3642176	DEVICE FOR GENERATING ULTRA PURE 1-METHYLCYCLOPROPENE
B01J 7/02 (2006.01)	3642176	DEVICE FOR GENERATING ULTRA PURE 1-METHYLCYCLOPROPENE
C07C 1/32 (2006.01)	3642176	DEVICE FOR GENERATING ULTRA PURE 1-METHYLCYCLOPROPENE
G05D 7/00 (2006.01)	3642176	DEVICE FOR GENERATING ULTRA PURE 1-METHYLCYCLOPROPENE
C07K 16/00 (2006.01)	3642227	CANINE ANTIBODY LIBRARIES
C07K 16/18 (2006.01)	3635014	HETERO-DIMERIC MULTI-SPECIFIC ANTIBODY FORMAT TARGETING AT LEAST CD3 AND HSA
C07K 16/28 (2006.01)	3635014	HETERO-DIMERIC MULTI-SPECIFIC ANTIBODY FORMAT TARGETING AT LEAST CD3 AND HSA
C07K 16/32 (2006.01)	3635014	HETERO-DIMERIC MULTI-SPECIFIC ANTIBODY FORMAT TARGETING AT LEAST CD3 AND HSA
A61K 31/519 (2006.01)	3634418	GONADOTROPIN-RELEASING HORMONE ANTAGONIST DOSING REGIMENS FOR THE TREATMENT OF ENDOMETRIOSIS
A61P 15/00 (2006.01)	3634418	GONADOTROPIN-RELEASING HORMONE ANTAGONIST DOSING REGIMENS FOR THE TREATMENT OF ENDOMETRIOSIS
A61K 35/74 (2015.01)	3638271	COMPOSITIONS COMPRISING BACTERIAL STRAINS
A61P 25/00 (2006.01)	3638271	COMPOSITIONS COMPRISING BACTERIAL STRAINS
A61P 37/00 (2006.01)	3638271	COMPOSITIONS COMPRISING BACTERIAL STRAINS
A61M 11/00 (2006.01)	3641862	INHALATION DEVICE WITH MULTILIQUID-NOZZLE AND METHOD
A61M 11/02 (2006.01)	3641862	INHALATION DEVICE WITH MULTILIQUID-NOZZLE AND METHOD
A61M 11/06 (2006.01)	3641862	INHALATION DEVICE WITH MULTILIQUID-NOZZLE AND METHOD
A61M 15/00 (2006.01)	3641862	INHALATION DEVICE WITH MULTILIQUID-NOZZLE AND METHOD
A61M 15/02 (2006.01)	3641862	INHALATION DEVICE WITH MULTILIQUID-NOZZLE AND METHOD

MKP	Broj objave evropske prijave patenta	Naziv pronalaska
(51)	(97)	(54)
A61M 16/00 (2006.01)	3641862	INHALATION DEVICE WITH MULTILIQUID-NOZZLE AND METHOD
A61M 16/10 (2006.01)	3641862	INHALATION DEVICE WITH MULTILIQUID-NOZZLE AND METHOD
A61M 16/20 (2006.01)	3641862	INHALATION DEVICE WITH MULTILIQUID-NOZZLE AND METHOD
B05B 1/26 (2006.01)	3641862	INHALATION DEVICE WITH MULTILIQUID-NOZZLE AND METHOD
B05B 11/00 (2006.01)	3641862	INHALATION DEVICE WITH MULTILIQUID-NOZZLE AND METHOD
A61K 31/5383 (2006.01)	3638680	HETEROAROMATIC COMPOUNDS AS VANIN INHIBITORS
A61P 29/00 (2006.01)	3638680	HETEROAROMATIC COMPOUNDS AS VANIN INHIBITORS
C07D 498/04 (2006.01)	3638680	HETEROAROMATIC COMPOUNDS AS VANIN INHIBITORS
A61K 31/519 (2006.01)	3641775	COMBINATION OF A MCL-1 INHIBITOR AND A STANDARD OF CARE TREATMENT FOR HEMATOLOGIC CANCERS, USES AND PHARMACEUTICAL COMPOSITIONS THEREOF
A61K 31/5377 (2006.01)	3641775	COMBINATION OF A MCL-1 INHIBITOR AND A STANDARD OF CARE TREATMENT FOR HEMATOLOGIC CANCERS, USES AND PHARMACEUTICAL COMPOSITIONS THEREOF
A61K 31/55 (2006.01)	3641775	COMBINATION OF A MCL-1 INHIBITOR AND A STANDARD OF CARE TREATMENT FOR HEMATOLOGIC CANCERS, USES AND PHARMACEUTICAL COMPOSITIONS THEREOF
A61K 45/06 (2006.01)	3641775	COMBINATION OF A MCL-1 INHIBITOR AND A STANDARD OF CARE TREATMENT FOR HEMATOLOGIC CANCERS, USES AND PHARMACEUTICAL COMPOSITIONS THEREOF
A61P 35/00 (2006.01)	3641775	COMBINATION OF A MCL-1 INHIBITOR AND A STANDARD OF CARE TREATMENT FOR HEMATOLOGIC CANCERS, USES AND PHARMACEUTICAL COMPOSITIONS THEREOF
A61M 11/06 (2006.01)	3641945	MULTILIQUID-NOZZLE
B05B 1/14 (2006.01)	3641945	MULTILIQUID-NOZZLE
B05B 1/26 (2006.01)	3641945	MULTILIQUID-NOZZLE
A61K 9/51 (2006.01)	3641810	HERPES SIMPLEX VIRUS VACCINE
A61K 31/7105 (2006.01)	3641810	HERPES SIMPLEX VIRUS VACCINE
A61K 31/7115 (2006.01)	3641810	HERPES SIMPLEX VIRUS VACCINE
A61K 39/245 (2006.01)	3641810	HERPES SIMPLEX VIRUS VACCINE
A61P 31/22 (2006.01)	3641810	HERPES SIMPLEX VIRUS VACCINE
C12N 15/38 (2006.01)	3641810	HERPES SIMPLEX VIRUS VACCINE
B60R 19/34 (2006.01)	3665043	POLYMER ELEMENT FOR ABSORBING IMPACT FOR A VEHICLE AND BUMPER STRUCTURE
F16F 7/12 (2006.01)	3665043	POLYMER ELEMENT FOR ABSORBING IMPACT FOR A VEHICLE AND BUMPER STRUCTURE
F17C 5/06 (2006.01)	3649395	MOBILE GAS FILLING STATION
A61K 39/395 (2006.01)	3628010	IMMUNOTHERAPEUTIC TUMOR TREATMENT METHOD
C07K 16/28 (2006.01)	3628010	IMMUNOTHERAPEUTIC TUMOR TREATMENT METHOD
A61K 49/14 (2006.01)	3638320	IGF-1R MONOCLONAL ANTIBODIES AND USES THEREOF
A61K 51/08 (2006.01)	3638320	IGF-1R MONOCLONAL ANTIBODIES AND USES THEREOF
A61K 51/10 (2006.01)	3638320	IGF-1R MONOCLONAL ANTIBODIES AND USES THEREOF
A61P 29/00 (2006.01)	3638320	IGF-1R MONOCLONAL ANTIBODIES AND USES THEREOF
A61P 35/00 (2006.01)	3638320	IGF-1R MONOCLONAL ANTIBODIES AND USES THEREOF
A61K 38/17 (2006.01)	3628049	TGF-BETA RECEPTOR TYPE II FUSION PROTEINS AND USES THEREOF
A61P 9/10 (2006.01)	3628049	TGF-BETA RECEPTOR TYPE II FUSION PROTEINS AND USES THEREOF
A61P 9/12 (2006.01)	3628049	TGF-BETA RECEPTOR TYPE II FUSION PROTEINS AND USES THEREOF
A61P 13/12 (2006.01)	3628049	TGF-BETA RECEPTOR TYPE II FUSION PROTEINS AND USES THEREOF
A61P 35/00 (2006.01)	3628049	TGF-BETA RECEPTOR TYPE II FUSION PROTEINS AND USES THEREOF
C07K 14/71 (2006.01)	3628049	TGF-BETA RECEPTOR TYPE II FUSION PROTEINS AND USES THEREOF
C07K 16/46 (2006.01)	3628049	TGF-BETA RECEPTOR TYPE II FUSION PROTEINS AND USES THEREOF
G08B 1/00 (2006.01)	3639249	MEDICAL HOME REMINDER UNIT AND SYSTEM
G06Q 20/00 (2012.01)	3635598	SAFEPAY PROCESS
G06F 3/048 (2013.01)	3635598	ULTRASAFE LOGIN
G06F 21/31 (2013.01)	3635598	ULTRASAFE LOGIN
H04L 29/06 (2006.01)	3635598	ULTRASAFE LOGIN

MKP (51)	Broj objave evropske prijave patenta (97)	Naziv pronalaska (54)
A61K 31/519 (2006.01)	3672965	PYRIMIDINE COMPOUND AS JAK KINASE INHIBITOR
C07D 403/12 (2006.01)	3672965	PYRIMIDINE COMPOUND AS JAK KINASE INHIBITOR
C07D 451/04 (2006.01)	3672965	PYRIMIDINE COMPOUND AS JAK KINASE INHIBITOR
C07D 451/14 (2006.01)	3672965	PYRIMIDINE COMPOUND AS JAK KINASE INHIBITOR
A61K 31/401 (2006.01)	3634400	NOVEL CRYSTALLINE FORMS
A61P 25/24 (2006.01)	3634400	NOVEL CRYSTALLINE FORMS
C07D 207/16 (2006.01)	3634400	NOVEL CRYSTALLINE FORMS
A61K 9/06 (2006.01)	3634391	USE OF COENZYME Q10 FORMULATIONS IN THE TREATMENT AND PREVENTION OF EPIDERMOLYSIS BULLOSA
A61K 31/122 (2006.01)	3634391	USE OF COENZYME Q10 FORMULATIONS IN THE TREATMENT AND PREVENTION OF EPIDERMOLYSIS BULLOSA
A61K 35/12 (2015.01)	3634391	USE OF COENZYME Q10 FORMULATIONS IN THE TREATMENT AND PREVENTION OF EPIDERMOLYSIS BULLOSA
A61K 38/00 (2006.01)	3634391	USE OF COENZYME Q10 FORMULATIONS IN THE TREATMENT AND PREVENTION OF EPIDERMOLYSIS BULLOSA
A61K 39/395 (2006.01)	3634391	USE OF COENZYME Q10 FORMULATIONS IN THE TREATMENT AND PREVENTION OF EPIDERMOLYSIS BULLOSA
A61K 39/395 (2006.01)	3661552	COMPOSITIONS AND METHODS FOR INHIBITION OF MICA/B SHEDDING
C07K 16/28 (2006.01)	3661552	COMPOSITIONS AND METHODS FOR INHIBITION OF MICA/B SHEDDING
C12Q 1/68 (2018.01)	3661552	COMPOSITIONS AND METHODS FOR INHIBITION OF MICA/B SHEDDING
F03D 5/04 (2006.01)	3640472	METHOD AND SYSTEM FOR CONVERTING WIND ENERGY
F03D 7/00 (2006.01)	3640472	METHOD AND SYSTEM FOR CONVERTING WIND ENERGY
A61K 31/415 (2006.01)	3634404	PYRAZOLE MAGL INHIBITORS
A61K 31/4155 (2006.01)	3634404	PYRAZOLE MAGL INHIBITORS
A61K 31/495 (2006.01)	3634404	PYRAZOLE MAGL INHIBITORS
C07D 247/00 (2006.01)	3634404	PYRAZOLE MAGL INHIBITORS
C07D 401/12 (2006.01)	3634404	PYRAZOLE MAGL INHIBITORS
C07D 403/08 (2006.01)	3634404	PYRAZOLE MAGL INHIBITORS
A61K 38/00 (2006.01)	3630150	PURIFIED ANTHELMINTIC COMPOSITIONS AND RELATED METHODS
A61K 38/16 (2006.01)	3630150	PURIFIED ANTHELMINTIC COMPOSITIONS AND RELATED METHODS
A61P 33/10 (2006.01)	3630150	PURIFIED ANTHELMINTIC COMPOSITIONS AND RELATED METHODS
A61K 31/4155 (2006.01)	3630744	PYRAZOLE MAGL INHIBITORS
A61K 31/496 (2006.01)	3630744	PYRAZOLE MAGL INHIBITORS
C07D 401/06 (2006.01)	3630744	PYRAZOLE MAGL INHIBITORS
C07D 403/06 (2006.01)	3630744	PYRAZOLE MAGL INHIBITORS
C07D 403/14 (2006.01)	3630744	PYRAZOLE MAGL INHIBITORS
A01K 67/027 (2006.01)	3636670	ANTI-IGF-I RECEPTOR ANTIBODY
A61K 35/12 (2015.01)	3636670	ANTI-IGF-I RECEPTOR ANTIBODY
A61K 35/34 (2015.01)	3636670	ANTI-IGF-I RECEPTOR ANTIBODY
A61K 35/76 (2015.01)	3636670	ANTI-IGF-I RECEPTOR ANTIBODY
A61K 39/395 (2006.01)	3636670	ANTI-IGF-I RECEPTOR ANTIBODY
A61K 45/00 (2006.01)	3636670	ANTI-IGF-I RECEPTOR ANTIBODY
A61K 48/00 (2006.01)	3636670	ANTI-IGF-I RECEPTOR ANTIBODY
A61P 1/04 (2006.01)	3636670	ANTI-IGF-I RECEPTOR ANTIBODY
A61P 1/12 (2006.01)	3636670	ANTI-IGF-I RECEPTOR ANTIBODY
A61P 1/16 (2006.01)	3636670	ANTI-IGF-I RECEPTOR ANTIBODY
A61P 1/18 (2006.01)	3636670	ANTI-IGF-I RECEPTOR ANTIBODY
A61P 3/00 (2006.01)	3636670	ANTI-IGF-I RECEPTOR ANTIBODY
A61P 3/04 (2006.01)	3636670	ANTI-IGF-I RECEPTOR ANTIBODY
A61P 3/10 (2006.01)	3636670	ANTI-IGF-I RECEPTOR ANTIBODY
A61P 9/00 (2006.01)	3636670	ANTI-IGF-I RECEPTOR ANTIBODY
A61P 9/10 (2006.01)	3636670	ANTI-IGF-I RECEPTOR ANTIBODY
A61P 9/14 (2006.01)	3636670	ANTI-IGF-I RECEPTOR ANTIBODY
A61P 11/00 (2006.01)	3636670	ANTI-IGF-I RECEPTOR ANTIBODY
A61P 13/08 (2006.01)	3636670	ANTI-IGF-I RECEPTOR ANTIBODY
A61P 13/10 (2006.01)	3636670	ANTI-IGF-I RECEPTOR ANTIBODY
C07K 16/28 (2006.01)	3636670	ANTI-IGF-I RECEPTOR ANTIBODY
C07D 487/04 (2006.01)	3630774	5-5 FUSED RINGS AS C5a INHIBITORS
C07D 487/04 (2006.01)	3630775	6-5 FUSED RINGS AS C5a INHIBITORS
G06F 21/56 (2013.01)	3635603	REAL-TIME DETECTION OF AND PROTECTION FROM MALWARE AND STEGANOGRAPHY IN A KERNEL MODE

MKP	Broj objave evropske prijave patenta	Naziv pronalaska
(51)	(97)	(54)
A61K 38/46 (2006.01)	3634496	METHODS FOR SENSITIZING CANCER CELLS TO T CELL-MEDIATED KILLING BY MODULATING MOLECULAR PATHWAYS
A61K 48/00 (2006.01)	3634496	METHODS FOR SENSITIZING CANCER CELLS TO T CELL-MEDIATED KILLING BY MODULATING MOLECULAR PATHWAYS
A61P 35/00 (2006.01)	3634496	METHODS FOR SENSITIZING CANCER CELLS TO T CELL-MEDIATED KILLING BY MODULATING MOLECULAR PATHWAYS
C12N 15/113 (2010.01)	3634496	METHODS FOR SENSITIZING CANCER CELLS TO T CELL-MEDIATED KILLING BY MODULATING MOLECULAR PATHWAYS
A61K 39/395 (2006.01)	3634995	ANTIBODIES THAT SPECIFICALLY BIND PD-1 AND METHODS OF USE
C07K 16/00 (2006.01)	3634995	ANTIBODIES THAT SPECIFICALLY BIND PD-1 AND METHODS OF USE
C07K 16/28 (2006.01)	3634995	ANTIBODIES THAT SPECIFICALLY BIND PD-1 AND METHODS OF USE
A61F 2/14 (2006.01)	3634307	SYSTEMS AND METHODS FOR CORNEAL TRANSPLANTS
A61F 2/16 (2006.01)	3634307	SYSTEMS AND METHODS FOR CORNEAL TRANSPLANTS
A61F 9/00 (2006.01)	3634307	SYSTEMS AND METHODS FOR CORNEAL TRANSPLANTS
A61F 9/008 (2006.01)	3634307	SYSTEMS AND METHODS FOR CORNEAL TRANSPLANTS
A61F 9/013 (2006.01)	3634307	SYSTEMS AND METHODS FOR CORNEAL TRANSPLANTS
A61K 31/7034 (2006.01)	3634430	MULTIBIOTIC AGENTS AND METHODS OF USING THE SAME
A61P 13/12 (2006.01)	3634430	MULTIBIOTIC AGENTS AND METHODS OF USING THE SAME
G06Q 30/00 (2012.01)	3637348	SYSTEM FOR DETECTING MATING BY MEANS OF INTRABODY COMMUNICATION (IBC)
A61K 31/417 (2006.01)	3638229	IMIDAZOLE-CONTAINING INHIBITORS OF ALK2 KINASE
A61K 31/4184 (2006.01)	3638229	IMIDAZOLE-CONTAINING INHIBITORS OF ALK2 KINASE
A61K 31/517 (2006.01)	3638229	IMIDAZOLE-CONTAINING INHIBITORS OF ALK2 KINASE
C07D 233/54 (2006.01)	3638229	IMIDAZOLE-CONTAINING INHIBITORS OF ALK2 KINASE
C07D 239/12 (2006.01)	3638229	IMIDAZOLE-CONTAINING INHIBITORS OF ALK2 KINASE
C07D 239/14 (2006.01)	3638229	IMIDAZOLE-CONTAINING INHIBITORS OF ALK2 KINASE
A61K 48/00 (2006.01)	3638315	AADC POLYNUCLEOTIDES FOR THE TREATMENT OF PARKINSON'S DISEASE
C12N 15/86 (2006.01)	3638315	AADC POLYNUCLEOTIDES FOR THE TREATMENT OF PARKINSON'S DISEASE
A61K 38/17 (2006.01)	3638289	PDE5 COMPOSITIONS AND METHODS FOR IMMUNOTHERAPY
A61K 39/39 (2006.01)	3638289	PDE5 COMPOSITIONS AND METHODS FOR IMMUNOTHERAPY
C07K 16/28 (2006.01)	3638289	PDE5 COMPOSITIONS AND METHODS FOR IMMUNOTHERAPY
C07K 19/00 (2006.01)	3638289	PDE5 COMPOSITIONS AND METHODS FOR IMMUNOTHERAPY
A01N 43/836 (2006.01)	3640244	OXADIAZOLINE COMPOUND AND PEST CONTROL AGENT
A01P 7/02 (2006.01)	3640244	OXADIAZOLINE COMPOUND AND PEST CONTROL AGENT
A01P 7/04 (2006.01)	3640244	OXADIAZOLINE COMPOUND AND PEST CONTROL AGENT
A61K 31/4245 (2006.01)	3640244	OXADIAZOLINE COMPOUND AND PEST CONTROL AGENT
A61P 33/14 (2006.01)	3640244	OXADIAZOLINE COMPOUND AND PEST CONTROL AGENT
C07D 271/12 (2006.01)	3640244	OXADIAZOLINE COMPOUND AND PEST CONTROL AGENT
C07D 498/10 (2006.01)	3640244	OXADIAZOLINE COMPOUND AND PEST CONTROL AGENT
G03G 15/08 (2006.01)	3640742	CARTRIDGE AND ELECTROPHOTOGRAPHIC IMAGE FORMATION DEVICE
G03G 21/18 (2006.01)	3640742	CARTRIDGE AND ELECTROPHOTOGRAPHIC IMAGE FORMATION DEVICE
A61K 9/51 (2006.01)	3638215	RNA FORMULATIONS
A61K 31/7088 (2006.01)	3638215	RNA FORMULATIONS
A61K 31/7105 (2006.01)	3638215	RNA FORMULATIONS
A61K 47/14 (2017.01)	3638215	RNA FORMULATIONS
A61K 47/24 (2006.01)	3638215	RNA FORMULATIONS
A61K 47/28 (2006.01)	3638215	RNA FORMULATIONS
A61K 47/54 (2017.01)	3638215	RNA FORMULATIONS
A61K 48/00 (2006.01)	3638215	RNA FORMULATIONS
C12N 15/88 (2006.01)	3638215	RNA FORMULATIONS
G06F 17/30 (2006.01)	3640823	SERVICE DATA STORAGE METHOD, DEVICE, STORAGE MEDIUM, AND ELECTRONIC DEVICE
C09K 8/24 (2006.01)	3642297	DRILL FLUID AND METHOD FOR TUNNELING
E21B 21/00 (2006.01)	3642297	DRILL FLUID AND METHOD FOR TUNNELING
E21B 21/06 (2006.01)	3642297	DRILL FLUID AND METHOD FOR TUNNELING
E21D 9/11 (2006.01)	3642297	DRILL FLUID AND METHOD FOR TUNNELING
E21D 9/13 (2006.01)	3642297	DRILL FLUID AND METHOD FOR TUNNELING
G06K 9/00 (2006.01)	3644219	HUMAN FACE FEATURE POINT TRACKING METHOD, DEVICE, STORAGE MEDIUM AND APPARATUS
H04N 19/11 (2014.01)	3644605	PREDICTION MODE SELECTION METHOD, VIDEO ENCODING DEVICE AND STORAGE MEDIUM

MKP (51)	Broj objave evropske prijave patenta (97)	Naziv pronalaska (54)
H04N 19/147 (2014.01)	3644605	PREDICTION MODE SELECTION METHOD, VIDEO ENCODING DEVICE AND STORAGE MEDIUM
A61K 38/00 (2006.01)	3642243	METHODS FOR MODULATING REGULATORY T CELLS, REGULATORY B CELLS, AND IMMUNE RESPONSES USING MODULATORS OF THE APRIL-TACI INTERACTION
A61K 39/00 (2006.01)	3642243	METHODS FOR MODULATING REGULATORY T CELLS, REGULATORY B CELLS, AND IMMUNE RESPONSES USING MODULATORS OF THE APRIL-TACI INTERACTION
C07K 16/28 (2006.01)	3642243	METHODS FOR MODULATING REGULATORY T CELLS, REGULATORY B CELLS, AND IMMUNE RESPONSES USING MODULATORS OF THE APRIL-TACI INTERACTION
H04L 9/32 (2006.01)	3644551	METHOD AND DEVICE FOR FORWARDING MESSAGE, AND STORAGE MEDIUM
C08J 9/36 (2006.01)	3638719	COATED CLOSED-CELL FOAM TUBE INSULATIONS AND METHODS FOR PRODUCING THE SAME
F16L 59/14 (2006.01)	3638719	COATED CLOSED-CELL FOAM TUBE INSULATIONS AND METHODS FOR PRODUCING THE SAME
C07J 41/00 (2006.01)	3642217	METHODS AND INTERMEDIATES FOR THE PREPARATION OF BILE ACID DERIVATIVES
C07J 43/00 (2006.01)	3642217	METHODS AND INTERMEDIATES FOR THE PREPARATION OF BILE ACID DERIVATIVES
A61K 49/10 (2006.01)	3646888	NANOPARTICLE, CONTRAST AGENT FOR MAGNETIC RESONANCE IMAGING CONTAINING SAME, AND LIGAND COMPOUND
A61K 49/18 (2006.01)	3646888	NANOPARTICLE, CONTRAST AGENT FOR MAGNETIC RESONANCE IMAGING CONTAINING SAME, AND LIGAND COMPOUND
C07C 309/14 (2006.01)	3646888	NANOPARTICLE, CONTRAST AGENT FOR MAGNETIC RESONANCE IMAGING CONTAINING SAME, AND LIGAND COMPOUND
A01K 67/027 (2006.01)	3572517	HUMANIZED UNIVERSAL LIGHT CHAIN MICE
C07K 16/46 (2006.01)	3572517	HUMANIZED UNIVERSAL LIGHT CHAIN MICE
C12N 9/64 (2006.01)	3572517	HUMANIZED UNIVERSAL LIGHT CHAIN MICE
C12N 15/85 (2006.01)	3572517	HUMANIZED UNIVERSAL LIGHT CHAIN MICE
F16B 13/12 (2006.01)	3604831	COMPOUND SEAL BLANK
A61P 37/00 (2006.01)	3660034	BACTERIA-BASED PROTEIN DELIVERY
C07K 14/24 (2006.01)	3660034	BACTERIA-BASED PROTEIN DELIVERY
C12N 15/70 (2006.01)	3660034	BACTERIA-BASED PROTEIN DELIVERY
C12N 15/74 (2006.01)	3660034	BACTERIA-BASED PROTEIN DELIVERY
A61K 31/196 (2006.01)	3628317	METHODS OF TREATING FIBROSIS
A61K 31/343 (2006.01)	3628317	METHODS OF TREATING FIBROSIS
A61K 31/357 (2006.01)	3628317	METHODS OF TREATING FIBROSIS
A61P 1/04 (2006.01)	3628317	METHODS OF TREATING FIBROSIS
A61K 31/713 (2006.01)	3647424	HEPATITIS B VIRUS (HBV) RNA COMPOSITIONS AND METHODS OF USE THEREOF
C12N 15/113 (2010.01)	3647424	HEPATITIS B VIRUS (HBV) RNA COMPOSITIONS AND METHODS OF USE THEREOF
A61K 35/74 (2015.01)	3650033	COMPOSITIONS COMPRISING BACTERIAL STRAINS
A61K 35/745 (2015.01)	3650033	COMPOSITIONS COMPRISING BACTERIAL STRAINS
A61P 1/00 (2006.01)	3650033	COMPOSITIONS COMPRISING BACTERIAL STRAINS
A61P 11/06 (2006.01)	3650033	COMPOSITIONS COMPRISING BACTERIAL STRAINS
A61P 19/02 (2006.01)	3650033	COMPOSITIONS COMPRISING BACTERIAL STRAINS
A61P 25/28 (2006.01)	3650033	COMPOSITIONS COMPRISING BACTERIAL STRAINS
A61P 29/00 (2006.01)	3650033	COMPOSITIONS COMPRISING BACTERIAL STRAINS
A61P 35/00 (2006.01)	3650033	COMPOSITIONS COMPRISING BACTERIAL STRAINS
C12N 1/20 (2006.01)	3650033	COMPOSITIONS COMPRISING BACTERIAL STRAINS
B01D 11/02 (2006.01)	3610935	SYSTEM FOR STAGED CONTINUOUS COOLED FILTRATION
B01D 11/04 (2006.01)	3610935	SYSTEM FOR STAGED CONTINUOUS COOLED FILTRATION
B01D 24/00 (2006.01)	3610935	SYSTEM FOR STAGED CONTINUOUS COOLED FILTRATION
B01D 29/56 (2006.01)	3610935	SYSTEM FOR STAGED CONTINUOUS COOLED FILTRATION
B01D 35/18 (2006.01)	3610935	SYSTEM FOR STAGED CONTINUOUS COOLED FILTRATION
A61K 47/68 (2017.01)	3626273	ANTI-CMET ANTIBODY DRUG CONJUGATES AND METHODS FOR THEIR USE
A61K 31/4375 (2006.01)	3639824	TRICYCLIC NITROGEN CONTAINING COMPOUNDS FOR TREATING NEISSERIA GONORRHOEA INFECTION
A61K 31/4545 (2006.01)	3639824	TRICYCLIC NITROGEN CONTAINING COMPOUNDS FOR TREATING NEISSERIA GONORRHOEA INFECTION

MKP (51)	Broj objave evropske prijave patenta (97)	Naziv pronalaska (54)
A61K 31/4725 (2006.01)	3639824	TRICYCLIC NITROGEN CONTAINING COMPOUNDS FOR TREATING NEISSERIA GONORRHOEA INFECTION
A61K 31/4985 (2006.01)	3639824	TRICYCLIC NITROGEN CONTAINING COMPOUNDS FOR TREATING NEISSERIA GONORRHOEA INFECTION
A61K 31/5377 (2006.01)	3639824	TRICYCLIC NITROGEN CONTAINING COMPOUNDS FOR TREATING NEISSERIA GONORRHOEA INFECTION
A61K 31/538 (2006.01)	3639824	TRICYCLIC NITROGEN CONTAINING COMPOUNDS FOR TREATING NEISSERIA GONORRHOEA INFECTION
A61K 31/5383 (2006.01)	3639824	TRICYCLIC NITROGEN CONTAINING COMPOUNDS FOR TREATING NEISSERIA GONORRHOEA INFECTION
A61K 31/5415 (2006.01)	3639824	TRICYCLIC NITROGEN CONTAINING COMPOUNDS FOR TREATING NEISSERIA GONORRHOEA INFECTION
A61K 31/542 (2006.01)	3639824	TRICYCLIC NITROGEN CONTAINING COMPOUNDS FOR TREATING NEISSERIA GONORRHOEA INFECTION
A61K 31/554 (2006.01)	3639824	TRICYCLIC NITROGEN CONTAINING COMPOUNDS FOR TREATING NEISSERIA GONORRHOEA INFECTION
A61P 31/04 (2006.01)	3639824	TRICYCLIC NITROGEN CONTAINING COMPOUNDS FOR TREATING NEISSERIA GONORRHOEA INFECTION
C12N 15/67 (2006.01)	3636764	3' UTR SEQUENCES FOR STABILIZATION OF RNA
A01N 37/02 (2006.01)	3639662	METHODS FOR FUNGI INHIBITION ON LIVE PLANTS USING CARBOXYLIC ACIDS AND THEIR SALTS
A01N 37/08 (2006.01)	3639662	METHODS FOR FUNGI INHIBITION ON LIVE PLANTS USING CARBOXYLIC ACIDS AND THEIR SALTS
A01N 37/10 (2006.01)	3639662	METHODS FOR FUNGI INHIBITION ON LIVE PLANTS USING CARBOXYLIC ACIDS AND THEIR SALTS
A01P 3/00 (2006.01)	3639662	METHODS FOR FUNGI INHIBITION ON LIVE PLANTS USING CARBOXYLIC ACIDS AND THEIR SALTS
C05C 1/02 (2006.01)	3623362	NITRIFICATION INHIBITOR CONTAINING FERTILISER MIXTURE
C05G 3/90 (2020.01)	3623362	NITRIFICATION INHIBITOR CONTAINING FERTILISER MIXTURE
C07B 41/08 (2006.01)	3623362	NITRIFICATION INHIBITOR CONTAINING FERTILISER MIXTURE
C07D 231/12 (2006.01)	3623362	NITRIFICATION INHIBITOR CONTAINING FERTILISER MIXTURE
A61K 39/395 (2006.01)	3670534	HUMAN FGF RECEPTOR AND BETA-KLOTTHO BINDING PROTEINS
A61P 1/16 (2006.01)	3670534	HUMAN FGF RECEPTOR AND BETA-KLOTTHO BINDING PROTEINS
A61P 3/00 (2006.01)	3670534	HUMAN FGF RECEPTOR AND BETA-KLOTTHO BINDING PROTEINS
A61P 3/04 (2006.01)	3670534	HUMAN FGF RECEPTOR AND BETA-KLOTTHO BINDING PROTEINS
A61P 3/06 (2006.01)	3670534	HUMAN FGF RECEPTOR AND BETA-KLOTTHO BINDING PROTEINS
A61P 3/10 (2006.01)	3670534	HUMAN FGF RECEPTOR AND BETA-KLOTTHO BINDING PROTEINS
A61P 9/00 (2006.01)	3670534	HUMAN FGF RECEPTOR AND BETA-KLOTTHO BINDING PROTEINS
A61P 43/00 (2006.01)	3670534	HUMAN FGF RECEPTOR AND BETA-KLOTTHO BINDING PROTEINS
C07K 16/28 (2006.01)	3670534	HUMAN FGF RECEPTOR AND BETA-KLOTTHO BINDING PROTEINS
C07K 16/40 (2006.01)	3670534	HUMAN FGF RECEPTOR AND BETA-KLOTTHO BINDING PROTEINS
A61K 9/16 (2006.01)	3650013	COMBINATION FORMULATION OF TWO ANTIVIRAL COMPOUNDS
A61K 9/20 (2006.01)	3650013	COMBINATION FORMULATION OF TWO ANTIVIRAL COMPOUNDS
A61K 31/501 (2006.01)	3650013	COMBINATION FORMULATION OF TWO ANTIVIRAL COMPOUNDS
A61K 31/513 (2006.01)	3650013	COMBINATION FORMULATION OF TWO ANTIVIRAL COMPOUNDS
A61K 31/404 (2006.01)	3636643	NUCLEAR RECEPTOR MODULATORS (ROR) FOR THE TREATMENT OF INFLAMMATORY AND AUTOIMMUNE DISEASES
A61K 31/416 (2006.01)	3636643	NUCLEAR RECEPTOR MODULATORS (ROR) FOR THE TREATMENT OF INFLAMMATORY AND AUTOIMMUNE DISEASES
A61P 29/00 (2006.01)	3636643	NUCLEAR RECEPTOR MODULATORS (ROR) FOR THE TREATMENT OF INFLAMMATORY AND AUTOIMMUNE DISEASES

MKP (51)	Broj objave evropske prijave patenta (97)	Naziv pronalaska (54)
A61P 37/00 (2006.01)	3636643	NUCLEAR RECEPTOR MODULATORS (ROR) FOR THE TREATMENT OF INFLAMMATORY AND AUTOIMMUNE DISEASES
C07D 209/14 (2006.01)	3636643	NUCLEAR RECEPTOR MODULATORS (ROR) FOR THE TREATMENT OF INFLAMMATORY AND AUTOIMMUNE DISEASES
C07D 209/18 (2006.01)	3636643	NUCLEAR RECEPTOR MODULATORS (ROR) FOR THE TREATMENT OF INFLAMMATORY AND AUTOIMMUNE DISEASES
C07D 235/16 (2006.01)	3636643	NUCLEAR RECEPTOR MODULATORS (ROR) FOR THE TREATMENT OF INFLAMMATORY AND AUTOIMMUNE DISEASES
C07D 401/10 (2006.01)	3636643	NUCLEAR RECEPTOR MODULATORS (ROR) FOR THE TREATMENT OF INFLAMMATORY AND AUTOIMMUNE DISEASES
C07D 403/10 (2006.01)	3636643	NUCLEAR RECEPTOR MODULATORS (ROR) FOR THE TREATMENT OF INFLAMMATORY AND AUTOIMMUNE DISEASES
C07D 405/10 (2006.01)	3636643	NUCLEAR RECEPTOR MODULATORS (ROR) FOR THE TREATMENT OF INFLAMMATORY AND AUTOIMMUNE DISEASES
C07D 405/14 (2006.01)	3636643	NUCLEAR RECEPTOR MODULATORS (ROR) FOR THE TREATMENT OF INFLAMMATORY AND AUTOIMMUNE DISEASES
C07D 471/04 (2006.01)	3636643	NUCLEAR RECEPTOR MODULATORS (ROR) FOR THE TREATMENT OF INFLAMMATORY AND AUTOIMMUNE DISEASES
C07D 487/04 (2006.01)	3636643	NUCLEAR RECEPTOR MODULATORS (ROR) FOR THE TREATMENT OF INFLAMMATORY AND AUTOIMMUNE DISEASES
C07D 491/10 (2006.01)	3636643	NUCLEAR RECEPTOR MODULATORS (ROR) FOR THE TREATMENT OF INFLAMMATORY AND AUTOIMMUNE DISEASES
A61K 31/517 (2006.01)	3656764	PROCESSES FOR THE PREPARATION OF PYRIMIDINYLCYCLOPENTANE COMPOUNDS
C07C 269/06 (2006.01)	3656764	PROCESSES FOR THE PREPARATION OF PYRIMIDINYLCYCLOPENTANE COMPOUNDS
C07C 271/22 (2006.01)	3656764	PROCESSES FOR THE PREPARATION OF PYRIMIDINYLCYCLOPENTANE COMPOUNDS
C07D 239/70 (2006.01)	3656764	PROCESSES FOR THE PREPARATION OF PYRIMIDINYLCYCLOPENTANE COMPOUNDS
C12P 17/16 (2006.01)	3656764	PROCESSES FOR THE PREPARATION OF PYRIMIDINYLCYCLOPENTANE COMPOUNDS
A01N 43/56 (2006.01)	3659439	TOPICAL COMPOSITIONS COMPRISING FIPRONIL AND PERMETHRIN AND METHODS OF USE
A01N 53/00 (2006.01)	3659439	TOPICAL COMPOSITIONS COMPRISING FIPRONIL AND PERMETHRIN AND METHODS OF USE
A61K 31/22 (2006.01)	3659439	TOPICAL COMPOSITIONS COMPRISING FIPRONIL AND PERMETHRIN AND METHODS OF USE
A61K 31/415 (2006.01)	3659439	TOPICAL COMPOSITIONS COMPRISING FIPRONIL AND PERMETHRIN AND METHODS OF USE
A61K 47/14 (2017.01)	3659439	TOPICAL COMPOSITIONS COMPRISING FIPRONIL AND PERMETHRIN AND METHODS OF USE
A61K 47/20 (2006.01)	3659439	TOPICAL COMPOSITIONS COMPRISING FIPRONIL AND PERMETHRIN AND METHODS OF USE
A61P 33/00 (2006.01)	3659439	TOPICAL COMPOSITIONS COMPRISING FIPRONIL AND PERMETHRIN AND METHODS OF USE
A61K 31/439 (2006.01)	3673906	GLUCOSYLCERAMIDE SYNTHASE INHIBITORS
A61K 31/454 (2006.01)	3673906	GLUCOSYLCERAMIDE SYNTHASE INHIBITORS
A61P 1/00 (2006.01)	3673906	GLUCOSYLCERAMIDE SYNTHASE INHIBITORS
A61P 3/00 (2006.01)	3673906	GLUCOSYLCERAMIDE SYNTHASE INHIBITORS
A61P 3/04 (2006.01)	3673906	GLUCOSYLCERAMIDE SYNTHASE INHIBITORS
A61P 3/10 (2006.01)	3673906	GLUCOSYLCERAMIDE SYNTHASE INHIBITORS
A61P 7/00 (2006.01)	3673906	GLUCOSYLCERAMIDE SYNTHASE INHIBITORS
A61P 9/10 (2006.01)	3673906	GLUCOSYLCERAMIDE SYNTHASE INHIBITORS
A61P 11/06 (2006.01)	3673906	GLUCOSYLCERAMIDE SYNTHASE INHIBITORS
A61P 13/12 (2006.01)	3673906	GLUCOSYLCERAMIDE SYNTHASE INHIBITORS
A61P 19/02 (2006.01)	3673906	GLUCOSYLCERAMIDE SYNTHASE INHIBITORS

MKP (51)	Broj objave evropske prijave patenta (97)	Naziv pronalaska (54)
A61P 25/00 (2006.01)	3673906	GLUCOSYLCERAMIDE SYNTHASE INHIBITORS
A61P 25/16 (2006.01)	3673906	GLUCOSYLCERAMIDE SYNTHASE INHIBITORS
A61P 25/28 (2006.01)	3673906	GLUCOSYLCERAMIDE SYNTHASE INHIBITORS
A61P 29/00 (2006.01)	3673906	GLUCOSYLCERAMIDE SYNTHASE INHIBITORS
A61P 31/04 (2006.01)	3673906	GLUCOSYLCERAMIDE SYNTHASE INHIBITORS
A61P 35/00 (2006.01)	3673906	GLUCOSYLCERAMIDE SYNTHASE INHIBITORS
A61P 43/00 (2006.01)	3673906	GLUCOSYLCERAMIDE SYNTHASE INHIBITORS
C07D 453/02 (2006.01)	3673906	GLUCOSYLCERAMIDE SYNTHASE INHIBITORS
C07D 455/02 (2006.01)	3673906	GLUCOSYLCERAMIDE SYNTHASE INHIBITORS
C07D 487/08 (2006.01)	3673906	GLUCOSYLCERAMIDE SYNTHASE INHIBITORS
A61K 39/00 (2006.01)	3656402	PHARMACEUTICAL COMPOSITION COMPRISING A POLYMERIC CARRIER CARGO COMPLEX AND AT LEAST ONE PROTEIN OR PEPTIDE ANTIGEN
A61K 39/12 (2006.01)	3656402	PHARMACEUTICAL COMPOSITION COMPRISING A POLYMERIC CARRIER CARGO COMPLEX AND AT LEAST ONE PROTEIN OR PEPTIDE ANTIGEN
A61K 39/39 (2006.01)	3656402	PHARMACEUTICAL COMPOSITION COMPRISING A POLYMERIC CARRIER CARGO COMPLEX AND AT LEAST ONE PROTEIN OR PEPTIDE ANTIGEN
A61K 47/64 (2017.01)	3656402	PHARMACEUTICAL COMPOSITION COMPRISING A POLYMERIC CARRIER CARGO COMPLEX AND AT LEAST ONE PROTEIN OR PEPTIDE ANTIGEN
A61P 31/00 (2006.01)	3656402	PHARMACEUTICAL COMPOSITION COMPRISING A POLYMERIC CARRIER CARGO COMPLEX AND AT LEAST ONE PROTEIN OR PEPTIDE ANTIGEN
A61P 35/00 (2006.01)	3656402	PHARMACEUTICAL COMPOSITION COMPRISING A POLYMERIC CARRIER CARGO COMPLEX AND AT LEAST ONE PROTEIN OR PEPTIDE ANTIGEN
A61P 37/00 (2006.01)	3656402	PHARMACEUTICAL COMPOSITION COMPRISING A POLYMERIC CARRIER CARGO COMPLEX AND AT LEAST ONE PROTEIN OR PEPTIDE ANTIGEN
A61K 31/506 (2006.01)	3660013	SGC STIMULATORS
A61P 3/00 (2006.01)	3660013	SGC STIMULATORS
A61P 9/00 (2006.01)	3660013	SGC STIMULATORS
A61P 15/00 (2006.01)	3660013	SGC STIMULATORS
A61P 25/00 (2006.01)	3660013	SGC STIMULATORS
A61P 35/00 (2006.01)	3660013	SGC STIMULATORS
C07D 403/04 (2006.01)	3660013	SGC STIMULATORS
C07D 413/14 (2006.01)	3660013	SGC STIMULATORS
C07D 417/14 (2006.01)	3660013	SGC STIMULATORS
C07D 471/04 (2006.01)	3660013	SGC STIMULATORS
C07D 487/04 (2006.01)	3660013	SGC STIMULATORS
C07D 495/04 (2006.01)	3660013	SGC STIMULATORS
C07K 1/14 (2006.01)	3660032	CAPTURE PURIFICATION PROCESSES FOR PROTEINS EXPRESSED IN A NON-MAMMALIAN SYSTEM
C07K 1/18 (2006.01)	3660032	CAPTURE PURIFICATION PROCESSES FOR PROTEINS EXPRESSED IN A NON-MAMMALIAN SYSTEM
C07K 1/22 (2006.01)	3660032	CAPTURE PURIFICATION PROCESSES FOR PROTEINS EXPRESSED IN A NON-MAMMALIAN SYSTEM
C07K 1/32 (2006.01)	3660032	CAPTURE PURIFICATION PROCESSES FOR PROTEINS EXPRESSED IN A NON-MAMMALIAN SYSTEM
A61K 39/00 (2006.01)	3639850	MUTANT STAPHYLOCOCCAL ANTIGENS
A61K 39/085 (2006.01)	3639850	MUTANT STAPHYLOCOCCAL ANTIGENS
A61K 39/39 (2006.01)	3639850	MUTANT STAPHYLOCOCCAL ANTIGENS
A61P 31/04 (2006.01)	3639850	MUTANT STAPHYLOCOCCAL ANTIGENS
C07K 14/31 (2006.01)	3639850	MUTANT STAPHYLOCOCCAL ANTIGENS
A61K 31/495 (2006.01)	3653211	TRANS-4-(2-[4-(2,3-DICHLOROPHENYL)-PIPERAZIN-1-YL]- ETHYL)-N,N-DIMETHYLCARBAMOYL-CYCLO-HEXYLAMINE FOR TREATING NEGATIVE SYMPTOMS OF SCHIZOPHRENIA
A61P 25/18 (2006.01)	3653211	TRANS-4-(2-[4-(2,3-DICHLOROPHENYL)-PIPERAZIN-1-YL]- ETHYL)-N,N-DIMETHYLCARBAMOYL-CYCLO-HEXYLAMINE FOR TREATING NEGATIVE SYMPTOMS OF SCHIZOPHRENIA
A61K 9/00 (2006.01)	3669879	PHARMACEUTICAL COMPOSITION IN THE FORM OF AN ORAL SUSPENSION INCLUDING A FLAVONOID FRACTION COMPRISING DIOSMIN, AND XANTHAN GUM
A61K 9/10 (2006.01)	3669879	PHARMACEUTICAL COMPOSITION IN THE FORM OF AN ORAL SUSPENSION INCLUDING A FLAVONOID FRACTION COMPRISING DIOSMIN, AND XANTHAN GUM

MKP (51)	Broj objave evropske prijave patenta (97)	Naziv pronalaska (54)
A61K 31/7048 (2006.01)	3669879	PHARMACEUTICAL COMPOSITION IN THE FORM OF AN ORAL SUSPENSION INCLUDING A FLAVONOID FRACTION COMPRISING DIOSMIN, AND XANTHAN GUM
A61K 47/36 (2006.01)	3669879	PHARMACEUTICAL COMPOSITION IN THE FORM OF AN ORAL SUSPENSION INCLUDING A FLAVONOID FRACTION COMPRISING DIOSMIN, AND XANTHAN GUM
A61P 9/00 (2006.01)	3669879	PHARMACEUTICAL COMPOSITION IN THE FORM OF AN ORAL SUSPENSION INCLUDING A FLAVONOID FRACTION COMPRISING DIOSMIN, AND XANTHAN GUM
B01J 21/06 (2006.01)	3662995	POROUS MATERIALS ON THE BASIS OF OXIDES OF TITANIUM AND/OR VANADIUM AND PREPARATION AND USE THEREOF
B01J 23/22 (2006.01)	3662995	POROUS MATERIALS ON THE BASIS OF OXIDES OF TITANIUM AND/OR VANADIUM AND PREPARATION AND USE THEREOF
B01J 37/00 (2006.01)	3662995	POROUS MATERIALS ON THE BASIS OF OXIDES OF TITANIUM AND/OR VANADIUM AND PREPARATION AND USE THEREOF
C01G 23/04 (2006.01)	3662995	POROUS MATERIALS ON THE BASIS OF OXIDES OF TITANIUM AND/OR VANADIUM AND PREPARATION AND USE THEREOF
C01G 31/02 (2006.01)	3662995	POROUS MATERIALS ON THE BASIS OF OXIDES OF TITANIUM AND/OR VANADIUM AND PREPARATION AND USE THEREOF
A41D 19/00 (2006.01)	3663332	DETECTABLE AND MULTI DETECTABLE ARTICLES
C08J 5/02 (2006.01)	3663332	DETECTABLE AND MULTI DETECTABLE ARTICLES
C08K 3/08 (2006.01)	3663332	DETECTABLE AND MULTI DETECTABLE ARTICLES
C08K 3/11 (2018.01)	3663332	DETECTABLE AND MULTI DETECTABLE ARTICLES
C08K 3/22 (2006.01)	3663332	DETECTABLE AND MULTI DETECTABLE ARTICLES
C08K 9/04 (2006.01)	3663332	DETECTABLE AND MULTI DETECTABLE ARTICLES
A61K 9/00 (2006.01)	3650019	FLUTICASONE FUROATE IN THE TREATMENT OF COPD
A61K 31/138 (2006.01)	3650019	FLUTICASONE FUROATE IN THE TREATMENT OF COPD
A61K 31/439 (2006.01)	3650019	FLUTICASONE FUROATE IN THE TREATMENT OF COPD
A61K 31/58 (2006.01)	3650019	FLUTICASONE FUROATE IN THE TREATMENT OF COPD
A61P 11/00 (2006.01)	3650019	FLUTICASONE FUROATE IN THE TREATMENT OF COPD
A61P 11/06 (2006.01)	3650019	FLUTICASONE FUROATE IN THE TREATMENT OF COPD
A61K 31/404 (2006.01)	3669881	COMPOSITIONS FOR USE IN THE TREATMENT OF SENESCENCE-ASSOCIATED DISEASE AND DISORDERS
A61K 31/428 (2006.01)	3669881	COMPOSITIONS FOR USE IN THE TREATMENT OF SENESCENCE-ASSOCIATED DISEASE AND DISORDERS
A61K 31/495 (2006.01)	3669881	COMPOSITIONS FOR USE IN THE TREATMENT OF SENESCENCE-ASSOCIATED DISEASE AND DISORDERS
A61K 31/496 (2006.01)	3669881	COMPOSITIONS FOR USE IN THE TREATMENT OF SENESCENCE-ASSOCIATED DISEASE AND DISORDERS
A61K 31/5377 (2006.01)	3669881	COMPOSITIONS FOR USE IN THE TREATMENT OF SENESCENCE-ASSOCIATED DISEASE AND DISORDERS
A61K 31/635 (2006.01)	3669881	COMPOSITIONS FOR USE IN THE TREATMENT OF SENESCENCE-ASSOCIATED DISEASE AND DISORDERS
A61K 31/728 (2006.01)	3669881	COMPOSITIONS FOR USE IN THE TREATMENT OF SENESCENCE-ASSOCIATED DISEASE AND DISORDERS
A61P 9/10 (2006.01)	3669881	COMPOSITIONS FOR USE IN THE TREATMENT OF SENESCENCE-ASSOCIATED DISEASE AND DISORDERS
A61P 11/00 (2006.01)	3669881	COMPOSITIONS FOR USE IN THE TREATMENT OF SENESCENCE-ASSOCIATED DISEASE AND DISORDERS
A61P 27/02 (2006.01)	3669881	COMPOSITIONS FOR USE IN THE TREATMENT OF SENESCENCE-ASSOCIATED DISEASE AND DISORDERS
B65D 17/00 (2006.01)	3674227	A CAN AND AN URGING MEMBER THEREFOR
B65D 17/28 (2006.01)	3674227	A CAN AND AN URGING MEMBER THEREFOR
B65D 17/34 (2006.01)	3674227	A CAN AND AN URGING MEMBER THEREFOR
B65D 17/50 (2006.01)	3674227	A CAN AND AN URGING MEMBER THEREFOR
B65D 77/20 (2006.01)	3674227	A CAN AND AN URGING MEMBER THEREFOR
B65D 79/00 (2006.01)	3674227	A CAN AND AN URGING MEMBER THEREFOR
B65D 81/22 (2006.01)	3674227	A CAN AND AN URGING MEMBER THEREFOR
A61K 39/395 (2006.01)	3638698	ANTI-TMPRSS2 ANTIBODIES AND ANTIGEN-BINDING FRAGMENTS
A61P 31/16 (2006.01)	3638698	ANTI-TMPRSS2 ANTIBODIES AND ANTIGEN-BINDING FRAGMENTS
C07K 16/10 (2006.01)	3638698	ANTI-TMPRSS2 ANTIBODIES AND ANTIGEN-BINDING FRAGMENTS
C07K 16/28 (2006.01)	3638698	ANTI-TMPRSS2 ANTIBODIES AND ANTIGEN-BINDING FRAGMENTS
C07K 16/40 (2006.01)	3638698	ANTI-TMPRSS2 ANTIBODIES AND ANTIGEN-BINDING FRAGMENTS

MKP (51)	Broj objave evropske prijave patenta (97)	Naziv pronalaska (54)
C01F 5/24 (2006.01)	3655364	CARRIER MATERIAL FOR THE RELEASE OF ONE OR MORE ACTIVE AGENT(S) IN A HOME CARE FORMULATION
C11D 3/12 (2006.01)	3655364	CARRIER MATERIAL FOR THE RELEASE OF ONE OR MORE ACTIVE AGENT(S) IN A HOME CARE FORMULATION
C11D 7/02 (2006.01)	3655364	CARRIER MATERIAL FOR THE RELEASE OF ONE OR MORE ACTIVE AGENT(S) IN A HOME CARE FORMULATION
A23L 33/00 (2016.01)	3661373	A PHARMACEUTICAL COMPOSITION FOR ANAEMIA
A23L 33/10 (2016.01)	3661373	A PHARMACEUTICAL COMPOSITION FOR ANAEMIA
A23L 33/17 (2016.01)	3661373	A PHARMACEUTICAL COMPOSITION FOR ANAEMIA
A23L 33/18 (2016.01)	3661373	A PHARMACEUTICAL COMPOSITION FOR ANAEMIA
A23L 33/19 (2016.01)	3661373	A PHARMACEUTICAL COMPOSITION FOR ANAEMIA
A61K 38/40 (2006.01)	3661373	A PHARMACEUTICAL COMPOSITION FOR ANAEMIA
A61P 3/00 (2006.01)	3661373	A PHARMACEUTICAL COMPOSITION FOR ANAEMIA
A61P 25/00 (2006.01)	3661373	A PHARMACEUTICAL COMPOSITION FOR ANAEMIA
A61K 38/00 (2006.01)	3672614	ENGINEERED EXTRACELLULAR VESICLES AND USES THEREOF
A61K 39/00 (2006.01)	3672614	ENGINEERED EXTRACELLULAR VESICLES AND USES THEREOF
A61K 45/06 (2006.01)	3672614	ENGINEERED EXTRACELLULAR VESICLES AND USES THEREOF
A61K 39/395 (2006.01)	3666794	ANTIBODIES DIRECTED AGAINST PROGRAMMED DEATH- 1 (PD-1)
A61P 1/02 (2006.01)	3666794	ANTIBODIES DIRECTED AGAINST PROGRAMMED DEATH- 1 (PD-1)
A61P 1/04 (2006.01)	3666794	ANTIBODIES DIRECTED AGAINST PROGRAMMED DEATH- 1 (PD-1)
A61P 3/10 (2006.01)	3666794	ANTIBODIES DIRECTED AGAINST PROGRAMMED DEATH- 1 (PD-1)
A61P 17/00 (2006.01)	3666794	ANTIBODIES DIRECTED AGAINST PROGRAMMED DEATH- 1 (PD-1)
A61P 25/00 (2006.01)	3666794	ANTIBODIES DIRECTED AGAINST PROGRAMMED DEATH- 1 (PD-1)
A61P 29/00 (2006.01)	3666794	ANTIBODIES DIRECTED AGAINST PROGRAMMED DEATH- 1 (PD-1)
A61P 31/00 (2006.01)	3666794	ANTIBODIES DIRECTED AGAINST PROGRAMMED DEATH- 1 (PD-1)
A61P 31/04 (2006.01)	3666794	ANTIBODIES DIRECTED AGAINST PROGRAMMED DEATH- 1 (PD-1)
A61P 31/12 (2006.01)	3666794	ANTIBODIES DIRECTED AGAINST PROGRAMMED DEATH- 1 (PD-1)
A61P 31/14 (2006.01)	3666794	ANTIBODIES DIRECTED AGAINST PROGRAMMED DEATH- 1 (PD-1)
A61P 31/16 (2006.01)	3666794	ANTIBODIES DIRECTED AGAINST PROGRAMMED DEATH- 1 (PD-1)
A61P 31/18 (2006.01)	3666794	ANTIBODIES DIRECTED AGAINST PROGRAMMED DEATH- 1 (PD-1)
A61P 31/20 (2006.01)	3666794	ANTIBODIES DIRECTED AGAINST PROGRAMMED DEATH- 1 (PD-1)
A61P 35/00 (2006.01)	3666794	ANTIBODIES DIRECTED AGAINST PROGRAMMED DEATH- 1 (PD-1)
A61P 35/02 (2006.01)	3666794	ANTIBODIES DIRECTED AGAINST PROGRAMMED DEATH- 1 (PD-1)
A61P 37/02 (2006.01)	3666794	ANTIBODIES DIRECTED AGAINST PROGRAMMED DEATH- 1 (PD-1)
A61P 37/04 (2006.01)	3666794	ANTIBODIES DIRECTED AGAINST PROGRAMMED DEATH- 1 (PD-1)
C07K 16/28 (2006.01)	3666794	ANTIBODIES DIRECTED AGAINST PROGRAMMED DEATH- 1 (PD-1)
C12N 15/13 (2006.01)	3666794	ANTIBODIES DIRECTED AGAINST PROGRAMMED DEATH- 1 (PD-1)
A61K 31/7088 (2006.01)	3657168	TREATMENT OF AMYOTROPHIC LATERAL SCLEROSIS
A61K 31/711 (2006.01)	3657168	TREATMENT OF AMYOTROPHIC LATERAL SCLEROSIS
A61K 38/17 (2006.01)	3657168	TREATMENT OF AMYOTROPHIC LATERAL SCLEROSIS
A61K 48/00 (2006.01)	3657168	TREATMENT OF AMYOTROPHIC LATERAL SCLEROSIS
A61P 25/28 (2006.01)	3657168	TREATMENT OF AMYOTROPHIC LATERAL SCLEROSIS
G01N 33/50 (2006.01)	3657168	TREATMENT OF AMYOTROPHIC LATERAL SCLEROSIS
C23C 2/02 (2006.01)	3663429	HOT DIP GALVANIZING APPARATUS
C23C 2/06 (2006.01)	3663429	HOT DIP GALVANIZING APPARATUS

MKP (51)	Broj objave evropske prijave patenta (97)	Naziv pronalaska (54)
C23C 2/26 (2006.01)	3663429	HOT DIP GALVANIZING APPARATUS
C23C 2/30 (2006.01)	3663429	HOT DIP GALVANIZING APPARATUS
A61K 39/12 (2006.01)	3663315	DIRECT EXPRESSION OF ANTIBODIES
A61K 39/145 (2006.01)	3663315	DIRECT EXPRESSION OF ANTIBODIES
C07K 16/00 (2006.01)	3663315	DIRECT EXPRESSION OF ANTIBODIES
C07K 16/10 (2006.01)	3663315	DIRECT EXPRESSION OF ANTIBODIES
C12N 15/00 (2006.01)	3663315	DIRECT EXPRESSION OF ANTIBODIES
A61K 31/4192 (2006.01)	3666771	LPA ANTAGONISTS
A61K 31/4439 (2006.01)	3666771	LPA ANTAGONISTS
A61P 11/06 (2006.01)	3666771	LPA ANTAGONISTS
A61P 35/00 (2006.01)	3666771	LPA ANTAGONISTS
C07D 249/06 (2006.01)	3666771	LPA ANTAGONISTS
C07D 401/04 (2006.01)	3666771	LPA ANTAGONISTS
C07D 401/14 (2006.01)	3666771	LPA ANTAGONISTS
G06F 9/50 (2006.01)	3674950	SYSTEM, COMPUTER READABLE MEDIUM AND METHOD FOR ROLLING SECURITY PLATFORM
G06F 21/57 (2013.01)	3674950	SYSTEM, COMPUTER READABLE MEDIUM AND METHOD FOR ROLLING SECURITY PLATFORM
G06F 21/62 (2013.01)	3674950	SYSTEM, COMPUTER READABLE MEDIUM AND METHOD FOR ROLLING SECURITY PLATFORM
H04L 29/06 (2006.01)	3674950	SYSTEM, COMPUTER READABLE MEDIUM AND METHOD FOR ROLLING SECURITY PLATFORM
H04L 29/08 (2006.01)	3674950	SYSTEM, COMPUTER READABLE MEDIUM AND METHOD FOR ROLLING SECURITY PLATFORM
B01F 9/00 (2006.01)	3645151	METHOD AND APPARATUS FOR LINING A CHAMBER
B01L 1/00 (2006.01)	3645151	METHOD AND APPARATUS FOR LINING A CHAMBER
B65D 25/14 (2006.01)	3645151	METHOD AND APPARATUS FOR LINING A CHAMBER
A61K 31/55 (2006.01)	3645513	BENZAZEPINE DERIVATIVES
A61P 13/12 (2006.01)	3645513	BENZAZEPINE DERIVATIVES
C07D 223/16 (2006.01)	3645513	BENZAZEPINE DERIVATIVES
C07D 401/06 (2006.01)	3645513	BENZAZEPINE DERIVATIVES
C07D 401/10 (2006.01)	3645513	BENZAZEPINE DERIVATIVES
C07D 401/14 (2006.01)	3645513	BENZAZEPINE DERIVATIVES
C07D 403/06 (2006.01)	3645513	BENZAZEPINE DERIVATIVES
C07D 405/12 (2006.01)	3645513	BENZAZEPINE DERIVATIVES
C07D 409/12 (2006.01)	3645513	BENZAZEPINE DERIVATIVES
B01L 9/06 (2006.01)	3655163	MAGNETIC ASSISTED SEPARATION APPARATUSES AND RELATED METHODS
B03C 1/02 (2006.01)	3655163	MAGNETIC ASSISTED SEPARATION APPARATUSES AND RELATED METHODS
G01N 35/00 (2006.01)	3655163	MAGNETIC ASSISTED SEPARATION APPARATUSES AND RELATED METHODS
A23K 20/20 (2016.01)	3634148	METHOD AND COMPOSITION TO CONTROL RUMEN RELEASE OF COBALT TO RUMEN BACTERIA FOR MAKING VITAMIN B12
A23K 50/10 (2016.01)	3634148	METHOD AND COMPOSITION TO CONTROL RUMEN RELEASE OF COBALT TO RUMEN BACTERIA FOR MAKING VITAMIN B12
C07D 213/75 (2006.01)	3645518	SYNTHESIS OF OMECANTIV MECARBIL
C07D 295/205 (2006.01)	3645518	SYNTHESIS OF OMECANTIV MECARBIL
A61K 31/64 (2006.01)	3661925	NOVEL SULFONAMIDE CARBOXAMIDE COMPOUNDS
C07D 205/04 (2006.01)	3661925	NOVEL SULFONAMIDE CARBOXAMIDE COMPOUNDS
C07D 205/12 (2006.01)	3661925	NOVEL SULFONAMIDE CARBOXAMIDE COMPOUNDS
C07D 207/12 (2006.01)	3661925	NOVEL SULFONAMIDE CARBOXAMIDE COMPOUNDS
C07D 211/54 (2006.01)	3661925	NOVEL SULFONAMIDE CARBOXAMIDE COMPOUNDS
C07D 217/22 (2006.01)	3661925	NOVEL SULFONAMIDE CARBOXAMIDE COMPOUNDS
C07D 223/06 (2006.01)	3661925	NOVEL SULFONAMIDE CARBOXAMIDE COMPOUNDS
C07D 239/66 (2006.01)	3661925	NOVEL SULFONAMIDE CARBOXAMIDE COMPOUNDS
C07D 241/18 (2006.01)	3661925	NOVEL SULFONAMIDE CARBOXAMIDE COMPOUNDS
C07D 401/04 (2006.01)	3661925	NOVEL SULFONAMIDE CARBOXAMIDE COMPOUNDS
C07D 401/06 (2006.01)	3661925	NOVEL SULFONAMIDE CARBOXAMIDE COMPOUNDS
C07D 401/12 (2006.01)	3661925	NOVEL SULFONAMIDE CARBOXAMIDE COMPOUNDS
C07D 401/14 (2006.01)	3661925	NOVEL SULFONAMIDE CARBOXAMIDE COMPOUNDS
C07D 403/04 (2006.01)	3661925	NOVEL SULFONAMIDE CARBOXAMIDE COMPOUNDS
C07D 403/06 (2006.01)	3661925	NOVEL SULFONAMIDE CARBOXAMIDE COMPOUNDS
C07D 405/04 (2006.01)	3661925	NOVEL SULFONAMIDE CARBOXAMIDE COMPOUNDS
C07D 405/06 (2006.01)	3661925	NOVEL SULFONAMIDE CARBOXAMIDE COMPOUNDS
C07D 409/04 (2006.01)	3661925	NOVEL SULFONAMIDE CARBOXAMIDE COMPOUNDS
C07D 451/02 (2006.01)	3661925	NOVEL SULFONAMIDE CARBOXAMIDE COMPOUNDS
C07D 451/14 (2006.01)	3661925	NOVEL SULFONAMIDE CARBOXAMIDE COMPOUNDS

MKP	Broj objave evropske prijave patenta (97)	Naziv pronalaska (54)
(51)		
A01G 9/02 (2018.01)	3657933	PLATES FORMING A SOIL-LESS CULTURE CONTAINER
A01G 31/06 (2006.01)	3657933	PLATES FORMING A SOIL-LESS CULTURE CONTAINER
A61K 9/127 (2006.01)	3638292	POLYNUCLEOTIDES ENCODING COAGULATION FACTOR VIII
A61K 38/37 (2006.01)	3638292	POLYNUCLEOTIDES ENCODING COAGULATION FACTOR VIII
A61P 7/04 (2006.01)	3638292	POLYNUCLEOTIDES ENCODING COAGULATION FACTOR VIII
C07K 14/755 (2006.01)	3638292	POLYNUCLEOTIDES ENCODING COAGULATION FACTOR VIII
C07K 16/28 (2006.01)	3638292	POLYNUCLEOTIDES ENCODING COAGULATION FACTOR VIII
A61K 31/496 (2006.01)	3645002	METHODS OF TREATING HEART FAILURE WITH CARDIAC SARCOMERE ACTIVATORS
A61P 9/04 (2006.01)	3645002	METHODS OF TREATING HEART FAILURE WITH CARDIAC SARCOMERE ACTIVATORS
A01K 67/027 (2006.01)	3644721	MOUSE MODEL FOR ASSESSING TOXICITIES ASSOCIATED WITH IMMUNOTHERAPIES
A61K 35/17 (2015.01)	3644721	MOUSE MODEL FOR ASSESSING TOXICITIES ASSOCIATED WITH IMMUNOTHERAPIES
C07K 16/28 (2006.01)	3644721	MOUSE MODEL FOR ASSESSING TOXICITIES ASSOCIATED WITH IMMUNOTHERAPIES
C07K 16/30 (2006.01)	3644721	MOUSE MODEL FOR ASSESSING TOXICITIES ASSOCIATED WITH IMMUNOTHERAPIES
G01N 33/50 (2006.01)	3644721	MOUSE MODEL FOR ASSESSING TOXICITIES ASSOCIATED WITH IMMUNOTHERAPIES
A61M 5/142 (2006.01)	3651832	NEEDLE INSERTION-RETRACTION SYSTEM HAVING DUAL TORSION SPRING SYSTEM
A61P 35/00 (2006.01)	3652216	CHECKPOINT INHIBITOR BISPECIFIC ANTIBODIES
C07K 16/46 (2006.01)	3652216	CHECKPOINT INHIBITOR BISPECIFIC ANTIBODIES
E05B 47/06 (2006.01)	3665346	COUPLING SYSTEM FOR AN ELECTROMECHANICAL LOCK
A23L 33/00 (2016.01)	3661949	MICROORGANISM FOR PRODUCING HUMAN MILK OLIGOSACCHARIDE
C07K 14/245 (2006.01)	3661949	MICROORGANISM FOR PRODUCING HUMAN MILK OLIGOSACCHARIDE
C07K 14/435 (2006.01)	3661949	MICROORGANISM FOR PRODUCING HUMAN MILK OLIGOSACCHARIDE
C12N 9/10 (2006.01)	3661949	MICROORGANISM FOR PRODUCING HUMAN MILK OLIGOSACCHARIDE
C12P 19/18 (2006.01)	3661949	MICROORGANISM FOR PRODUCING HUMAN MILK OLIGOSACCHARIDE
A61K 31/7088 (2006.01)	3649242	METHODS OF INHIBITING CELL PROLIFERATION AND METTL8 ACTIVITY
A61P 35/00 (2006.01)	3649242	METHODS OF INHIBITING CELL PROLIFERATION AND METTL8 ACTIVITY
C12N 15/10 (2006.01)	3649242	METHODS OF INHIBITING CELL PROLIFERATION AND METTL8 ACTIVITY
C12N 15/113 (2010.01)	3649242	METHODS OF INHIBITING CELL PROLIFERATION AND METTL8 ACTIVITY
A61K 38/48 (2006.01)	3641801	MODIFIED MEMBRANE TYPE SERINE PROTEASE 1 (MTSP-1) POLYPEPTIDES AND METHODS OF USE
C07K 14/435 (2006.01)	3641801	MODIFIED MEMBRANE TYPE SERINE PROTEASE 1 (MTSP-1) POLYPEPTIDES AND METHODS OF USE
F03D 7/02 (2006.01)	3642479	FLOATING STRUCTURE FOR OFFSHORE WIND TURBINE
F03D 13/25 (2016.01)	3642479	FLOATING STRUCTURE FOR OFFSHORE WIND TURBINE
A61K 9/00 (2006.01)	3644961	ISOTRETINOIN ORAL-MUCOSAL FORMULATIONS AND METHODS FOR USING SAME
A61K 9/20 (2006.01)	3644961	ISOTRETINOIN ORAL-MUCOSAL FORMULATIONS AND METHODS FOR USING SAME
A61K 31/203 (2006.01)	3644961	ISOTRETINOIN ORAL-MUCOSAL FORMULATIONS AND METHODS FOR USING SAME
A61P 31/00 (2006.01)	3644961	ISOTRETINOIN ORAL-MUCOSAL FORMULATIONS AND METHODS FOR USING SAME
A61P 35/00 (2006.01)	3644961	ISOTRETINOIN ORAL-MUCOSAL FORMULATIONS AND METHODS FOR USING SAME
A61K 35/745 (2015.01)	3648780	COMPOSITIONS AND METHODS OF TREATING CANCER USING BIFIDOBACTERIUM ANIMALIS SSP. LACTIS
A61K 45/06 (2006.01)	3648780	COMPOSITIONS AND METHODS OF TREATING CANCER USING BIFIDOBACTERIUM ANIMALIS SSP. LACTIS
A61P 35/00 (2006.01)	3648780	COMPOSITIONS AND METHODS OF TREATING CANCER USING BIFIDOBACTERIUM ANIMALIS SSP. LACTIS
A61K 31/496 (2006.01)	3651766	ANTIPROLIFERATIVE COMPOUNDS AND METHODS OF USE THEREOF

MKP	Broj objave evropske prijave patenta (97)	Naziv pronalaska (54)
(51)		
A61K 31/573 (2006.01)	3651766	ANTIPROLIFERATIVE COMPOUNDS AND METHODS OF USE THEREOF
A61K 38/05 (2006.01)	3651766	ANTIPROLIFERATIVE COMPOUNDS AND METHODS OF USE THEREOF
A61P 35/00 (2006.01)	3651766	ANTIPROLIFERATIVE COMPOUNDS AND METHODS OF USE THEREOF
C07D 241/02 (2006.01)	3651766	ANTIPROLIFERATIVE COMPOUNDS AND METHODS OF USE THEREOF
A61K 9/24 (2006.01)	3654955	PHARMACEUTICAL COMPOSITIONS
A61K 31/00 (2006.01)	3654955	PHARMACEUTICAL COMPOSITIONS
A61M 5/142 (2006.01)	3658206	DRUG DELIVERY DEVICE WITH CONTAINER ACCESS SYSTEM AND RELATED METHOD OF ASSEMBLY
A61M 5/20 (2006.01)	3658206	DRUG DELIVERY DEVICE WITH CONTAINER ACCESS SYSTEM AND RELATED METHOD OF ASSEMBLY
A61M 5/24 (2006.01)	3658206	DRUG DELIVERY DEVICE WITH CONTAINER ACCESS SYSTEM AND RELATED METHOD OF ASSEMBLY
A61M 5/28 (2006.01)	3658206	DRUG DELIVERY DEVICE WITH CONTAINER ACCESS SYSTEM AND RELATED METHOD OF ASSEMBLY
A61M 39/18 (2006.01)	3658206	DRUG DELIVERY DEVICE WITH CONTAINER ACCESS SYSTEM AND RELATED METHOD OF ASSEMBLY
A61J 1/14 (2006.01)	3655063	GAS PERMEABLE SEALING MEMBER FOR DRUG CONTAINER AND METHODS OF ASSEMBLY
A61J 1/20 (2006.01)	3655063	GAS PERMEABLE SEALING MEMBER FOR DRUG CONTAINER AND METHODS OF ASSEMBLY
A61K 39/395 (2006.01)	3655063	GAS PERMEABLE SEALING MEMBER FOR DRUG CONTAINER AND METHODS OF ASSEMBLY
A61M 5/142 (2006.01)	3655063	GAS PERMEABLE SEALING MEMBER FOR DRUG CONTAINER AND METHODS OF ASSEMBLY
A61M 5/145 (2006.01)	3655063	GAS PERMEABLE SEALING MEMBER FOR DRUG CONTAINER AND METHODS OF ASSEMBLY
A61M 5/158 (2006.01)	3655063	GAS PERMEABLE SEALING MEMBER FOR DRUG CONTAINER AND METHODS OF ASSEMBLY
A61M 5/24 (2006.01)	3655063	GAS PERMEABLE SEALING MEMBER FOR DRUG CONTAINER AND METHODS OF ASSEMBLY
A61M 5/315 (2006.01)	3655063	GAS PERMEABLE SEALING MEMBER FOR DRUG CONTAINER AND METHODS OF ASSEMBLY
A61M 5/32 (2006.01)	3655063	GAS PERMEABLE SEALING MEMBER FOR DRUG CONTAINER AND METHODS OF ASSEMBLY
A61M 5/34 (2006.01)	3655063	GAS PERMEABLE SEALING MEMBER FOR DRUG CONTAINER AND METHODS OF ASSEMBLY
A61M 39/00 (2006.01)	3655063	GAS PERMEABLE SEALING MEMBER FOR DRUG CONTAINER AND METHODS OF ASSEMBLY
A61M 39/18 (2006.01)	3655063	GAS PERMEABLE SEALING MEMBER FOR DRUG CONTAINER AND METHODS OF ASSEMBLY
C07K 16/40 (2006.01)	3655063	GAS PERMEABLE SEALING MEMBER FOR DRUG CONTAINER AND METHODS OF ASSEMBLY
A61M 5/142 (2006.01)	3658203	DRUG DELIVERY DEVICE WITH GEAR MODULE AND RELATED METHOD OF ASSEMBLY
A61M 5/145 (2006.01)	3658203	DRUG DELIVERY DEVICE WITH GEAR MODULE AND RELATED METHOD OF ASSEMBLY
A61M 5/158 (2006.01)	3658203	DRUG DELIVERY DEVICE WITH GEAR MODULE AND RELATED METHOD OF ASSEMBLY
A61M 5/24 (2006.01)	3658203	DRUG DELIVERY DEVICE WITH GEAR MODULE AND RELATED METHOD OF ASSEMBLY
A61M 5/315 (2006.01)	3658203	DRUG DELIVERY DEVICE WITH GEAR MODULE AND RELATED METHOD OF ASSEMBLY
B05C 17/01 (2006.01)	3658203	DRUG DELIVERY DEVICE WITH GEAR MODULE AND RELATED METHOD OF ASSEMBLY
F04B 43/12 (2006.01)	3658203	DRUG DELIVERY DEVICE WITH GEAR MODULE AND RELATED METHOD OF ASSEMBLY
C07D 231/20 (2006.01)	3652168	5-MEMBERED AND BICYCLIC HETEROCYCLIC AMIDES AS INHIBITORS OF ROCK
C07D 231/22 (2006.01)	3652168	5-MEMBERED AND BICYCLIC HETEROCYCLIC AMIDES AS INHIBITORS OF ROCK
C07D 231/56 (2006.01)	3652168	5-MEMBERED AND BICYCLIC HETEROCYCLIC AMIDES AS INHIBITORS OF ROCK
C07D 401/04 (2006.01)	3652168	5-MEMBERED AND BICYCLIC HETEROCYCLIC AMIDES AS INHIBITORS OF ROCK

MKP (51)	Broj objave evropske prijave patenta (97)	Naziv pronalaska (54)
C07D 403/12 (2006.01)	3652168	5-MEMBERED AND BICYCLIC HETEROCYCLIC AMIDES AS INHIBITORS OF ROCK
C07D 417/12 (2006.01)	3652168	5-MEMBERED AND BICYCLIC HETEROCYCLIC AMIDES AS INHIBITORS OF ROCK
C07D 417/14 (2006.01)	3652168	5-MEMBERED AND BICYCLIC HETEROCYCLIC AMIDES AS INHIBITORS OF ROCK
C07D 491/04 (2006.01)	3652168	5-MEMBERED AND BICYCLIC HETEROCYCLIC AMIDES AS INHIBITORS OF ROCK
C07D 495/04 (2006.01)	3652168	5-MEMBERED AND BICYCLIC HETEROCYCLIC AMIDES AS INHIBITORS OF ROCK
C07D 519/00 (2006.01)	3652168	5-MEMBERED AND BICYCLIC HETEROCYCLIC AMIDES AS INHIBITORS OF ROCK
C07K 16/28 (2006.01)	3652209	AGONIST ANTIBODIES THAT BIND HUMAN CD137 AND USES THEREOF
A61K 31/165 (2006.01)	3651752	CARBOXAMIDES AS MODULATORS OF SODIUM CHANNELS
A61P 29/02 (2006.01)	3651752	CARBOXAMIDES AS MODULATORS OF SODIUM CHANNELS
C07C 237/42 (2006.01)	3651752	CARBOXAMIDES AS MODULATORS OF SODIUM CHANNELS
C07D 213/81 (2006.01)	3651752	CARBOXAMIDES AS MODULATORS OF SODIUM CHANNELS
C07D 213/82 (2006.01)	3651752	CARBOXAMIDES AS MODULATORS OF SODIUM CHANNELS
A61K 31/435 (2006.01)	3652166	NLRP3 MODULATORS
A61P 35/00 (2006.01)	3652166	NLRP3 MODULATORS
A61P 37/00 (2006.01)	3652166	NLRP3 MODULATORS
C07D 401/04 (2006.01)	3652166	NLRP3 MODULATORS
C07D 401/14 (2006.01)	3652166	NLRP3 MODULATORS
C07D 405/14 (2006.01)	3652166	NLRP3 MODULATORS
C07D 409/14 (2006.01)	3652166	NLRP3 MODULATORS
A61K 39/395 (2006.01)	3655033	PHARMACEUTICAL COMBINATIONS COMPRISING AN ANTI BST-1 ANTIBODY AND A CYTIDINE ANALOGUE
A61P 35/00 (2006.01)	3655033	PHARMACEUTICAL COMBINATIONS COMPRISING AN ANTI BST-1 ANTIBODY AND A CYTIDINE ANALOGUE
C07K 16/28 (2006.01)	3655033	PHARMACEUTICAL COMBINATIONS COMPRISING AN ANTI BST-1 ANTIBODY AND A CYTIDINE ANALOGUE
A61M 1/36 (2006.01)	3648814	SYSTEMS AND METHODS FOR TREATING BLOOD
C07D 213/56 (2006.01)	3658545	METHOD FOR PREPARING 3-[(3S)-7-BROMO-2-OXO-5-(PYRIDIN-2-YL)-2,3-DIHYDRO-1H-[1,4]-BENZODIAZEPIN-3-YL]PROPIONIC ACID METHYL ESTER, AND COMPOUNDS USEFUL IN THAT METHOD
C07D 401/04 (2006.01)	3658545	METHOD FOR PREPARING 3-[(3S)-7-BROMO-2-OXO-5-(PYRIDIN-2-YL)-2,3-DIHYDRO-1H-[1,4]-BENZODIAZEPIN-3-YL]PROPIONIC ACID METHYL ESTER, AND COMPOUNDS USEFUL IN THAT METHOD
C07D 487/04 (2006.01)	3658545	METHOD FOR PREPARING 3-[(3S)-7-BROMO-2-OXO-5-(PYRIDIN-2-YL)-2,3-DIHYDRO-1H-[1,4]-BENZODIAZEPIN-3-YL]PROPIONIC ACID METHYL ESTER, AND COMPOUNDS USEFUL IN THAT METHOD
A61K 31/44 (2006.01)	3661510	METHODS OF TREATING BEHAVIOR ALTERATIONS
A61P 25/00 (2006.01)	3661510	METHODS OF TREATING BEHAVIOR ALTERATIONS
A61P 25/08 (2006.01)	3661510	METHODS OF TREATING BEHAVIOR ALTERATIONS
A61P 25/14 (2006.01)	3661510	METHODS OF TREATING BEHAVIOR ALTERATIONS
A61P 25/16 (2006.01)	3661510	METHODS OF TREATING BEHAVIOR ALTERATIONS
A61P 25/18 (2006.01)	3661510	METHODS OF TREATING BEHAVIOR ALTERATIONS
A61P 25/24 (2006.01)	3661510	METHODS OF TREATING BEHAVIOR ALTERATIONS
A61P 25/28 (2006.01)	3661510	METHODS OF TREATING BEHAVIOR ALTERATIONS
A61P 25/30 (2006.01)	3661510	METHODS OF TREATING BEHAVIOR ALTERATIONS
B03D 1/004 (2006.01)	3668653	INDIRECT FLOTATION PROCESS FOR MANUFACTURING WHITE PIGMENT CONTAINING PRODUCTS
B03D 1/01 (2006.01)	3668653	INDIRECT FLOTATION PROCESS FOR MANUFACTURING WHITE PIGMENT CONTAINING PRODUCTS
B03D 1/16 (2006.01)	3668653	INDIRECT FLOTATION PROCESS FOR MANUFACTURING WHITE PIGMENT CONTAINING PRODUCTS
A61K 38/00 (2006.01)	3665182	NOVEL COMPOUNDS ACTIVATING THE NRF2 PATHWAY
C07K 7/08 (2006.01)	3665182	NOVEL COMPOUNDS ACTIVATING THE NRF2 PATHWAY
C07K 14/47 (2006.01)	3665182	NOVEL COMPOUNDS ACTIVATING THE NRF2 PATHWAY
C12N 7/00 (2006.01)	3658668	ADENOVIRAL VECTORS
A61K 31/198 (2006.01)	3638370	TREATMENT FOR MIGRAINE
A61P 25/06 (2006.01)	3638370	TREATMENT FOR MIGRAINE
A61K 31/728 (2006.01)	3655138	PROCESS FOR THE PURIFICATION OF HYALURONIC ACID
B01D 61/14 (2006.01)	3655138	PROCESS FOR THE PURIFICATION OF HYALURONIC ACID

MKP (51)	Broj objave evropske prijave patenta (97)	Naziv pronalaska (54)
C08B 37/08 (2006.01)	3655138	PROCESS FOR THE PURIFICATION OF HYALURONIC ACID
A61K 39/395 (2006.01)	3649154	BINDING MOLECULES THAT MODULATE A BIOLOGICAL ACTIVITY EXPRESSED BY A CELL
C07K 16/28 (2006.01)	3649154	BINDING MOLECULES THAT MODULATE A BIOLOGICAL ACTIVITY EXPRESSED BY A CELL
C07K 16/46 (2006.01)	3649154	BINDING MOLECULES THAT MODULATE A BIOLOGICAL ACTIVITY EXPRESSED BY A CELL
A61K 39/00 (2006.01)	3649155	BISPECIFIC ANTI PD1-ANTI TIM3 ANTIBODIES
C07K 16/28 (2006.01)	3649155	BISPECIFIC ANTI PD1-ANTI TIM3 ANTIBODIES
C07K 16/12 (2006.01)	3649156	ANTIBODIES THAT MODULATE A BIOLOGICAL ACTIVITY EXPRESSED BY A CELL
C07K 16/28 (2006.01)	3649156	ANTIBODIES THAT MODULATE A BIOLOGICAL ACTIVITY EXPRESSED BY A CELL
C07K 16/46 (2006.01)	3649156	ANTIBODIES THAT MODULATE A BIOLOGICAL ACTIVITY EXPRESSED BY A CELL
A61K 39/00 (2006.01)	3642234	IL-1BETA BINDING ANTIBODIES FOR USE IN TREATING CANCER
C07K 16/24 (2006.01)	3642234	IL-1BETA BINDING ANTIBODIES FOR USE IN TREATING CANCER
A61K 31/496 (2006.01)	3648765	NEW USES OF A PURE 5-HT 6 RECEPTOR ANTAGONIST
A61P 25/28 (2006.01)	3648765	NEW USES OF A PURE 5-HT 6 RECEPTOR ANTAGONIST
C08B 1/00 (2006.01)	3638803	PROCESS FOR OBTAINING CELLULOSE FROM PLANT MATERIAL
C12P 7/06 (2006.01)	3638803	PROCESS FOR OBTAINING CELLULOSE FROM PLANT MATERIAL
C12P 19/04 (2006.01)	3638803	PROCESS FOR OBTAINING CELLULOSE FROM PLANT MATERIAL
D21C 5/00 (2006.01)	3638803	PROCESS FOR OBTAINING CELLULOSE FROM PLANT MATERIAL
A61K 35/76 (2015.01)	3645551	TROPISM-MODIFIED RECOMBINANT VIRAL VECTORS AND USES THEREOF FOR THE TARGETED INTRODUCTION OF GENETIC MATERIAL INTO HUMAN CELLS
A61K 48/00 (2006.01)	3645551	TROPISM-MODIFIED RECOMBINANT VIRAL VECTORS AND USES THEREOF FOR THE TARGETED INTRODUCTION OF GENETIC MATERIAL INTO HUMAN CELLS
C07K 14/015 (2006.01)	3645551	TROPISM-MODIFIED RECOMBINANT VIRAL VECTORS AND USES THEREOF FOR THE TARGETED INTRODUCTION OF GENETIC MATERIAL INTO HUMAN CELLS
C07K 16/18 (2006.01)	3645551	TROPISM-MODIFIED RECOMBINANT VIRAL VECTORS AND USES THEREOF FOR THE TARGETED INTRODUCTION OF GENETIC MATERIAL INTO HUMAN CELLS
C07K 16/28 (2006.01)	3645551	TROPISM-MODIFIED RECOMBINANT VIRAL VECTORS AND USES THEREOF FOR THE TARGETED INTRODUCTION OF GENETIC MATERIAL INTO HUMAN CELLS
C12N 5/10 (2006.01)	3645551	TROPISM-MODIFIED RECOMBINANT VIRAL VECTORS AND USES THEREOF FOR THE TARGETED INTRODUCTION OF GENETIC MATERIAL INTO HUMAN CELLS
C12N 15/35 (2006.01)	3645551	TROPISM-MODIFIED RECOMBINANT VIRAL VECTORS AND USES THEREOF FOR THE TARGETED INTRODUCTION OF GENETIC MATERIAL INTO HUMAN CELLS
C12N 15/864 (2006.01)	3645551	TROPISM-MODIFIED RECOMBINANT VIRAL VECTORS AND USES THEREOF FOR THE TARGETED INTRODUCTION OF GENETIC MATERIAL INTO HUMAN CELLS
A61K 48/00 (2006.01)	3645553	TROPISM-MODIFIED RECOMBINANT VIRAL PARTICLES AND USES THEREOF FOR THE TARGETED INTRODUCTION OF GENETIC MATERIAL INTO HUMAN CELLS
C07K 14/315 (2006.01)	3645553	TROPISM-MODIFIED RECOMBINANT VIRAL PARTICLES AND USES THEREOF FOR THE TARGETED INTRODUCTION OF GENETIC MATERIAL INTO HUMAN CELLS
C12N 7/00 (2006.01)	3645553	TROPISM-MODIFIED RECOMBINANT VIRAL PARTICLES AND USES THEREOF FOR THE TARGETED INTRODUCTION OF GENETIC MATERIAL INTO HUMAN CELLS
A61K 39/12 (2006.01)	3638302	POXVIRUS VECTORS ENCODING HIV ANTIGENS, AND METHODS OF USE THEREOF
A61P 31/18 (2006.01)	3638302	POXVIRUS VECTORS ENCODING HIV ANTIGENS, AND METHODS OF USE THEREOF
C07K 14/16 (2006.01)	3638302	POXVIRUS VECTORS ENCODING HIV ANTIGENS, AND METHODS OF USE THEREOF

MKP (51)	Broj objave evropske prijave patenta (97)	Naziv pronalaska (54)
B01D 53/047 (2006.01)	3648868	A GAS-FILTERING SYSTEM AND METHOD
G01B 11/25 (2006.01)	3652524	DEVICE AND PROCESS FOR DETECTING SURFACE DEFECTS
G01N 21/88 (2006.01)	3652524	DEVICE AND PROCESS FOR DETECTING SURFACE DEFECTS
A61K 31/404 (2006.01)	3654969	METHODS OF TREATMENT FOR CYSTIC FIBROSIS
A61K 31/443 (2006.01)	3654969	METHODS OF TREATMENT FOR CYSTIC FIBROSIS
A61K 31/4439 (2006.01)	3654969	METHODS OF TREATMENT FOR CYSTIC FIBROSIS
A61K 31/47 (2006.01)	3654969	METHODS OF TREATMENT FOR CYSTIC FIBROSIS
A61P 11/00 (2006.01)	3654969	METHODS OF TREATMENT FOR CYSTIC FIBROSIS
C09K 8/524 (2006.01)	3655494	MITIGATION OF CONDENSATE BANKING USING SURFACE MODIFICATION
C09K 8/60 (2006.01)	3655494	MITIGATION OF CONDENSATE BANKING USING SURFACE MODIFICATION
E21B 43/25 (2006.01)	3655494	MITIGATION OF CONDENSATE BANKING USING SURFACE MODIFICATION
A61K 39/00 (2006.01)	3658179	METHODS AND COMPOSITIONS FOR HETEROLOGOUS REPRNA IMMUNIZATIONS
H02K 5/22 (2006.01)	3673567	CONNECTING DEVICE AND ELECTRIC MOTOR
H02K 7/14 (2006.01)	3673567	CONNECTING DEVICE AND ELECTRIC MOTOR
H02K 11/33 (2016.01)	3673567	CONNECTING DEVICE AND ELECTRIC MOTOR
H02K 15/14 (2006.01)	3673567	CONNECTING DEVICE AND ELECTRIC MOTOR
A23L 33/15 (2016.01)	3657963	COMPOSITION FOR USE IN THE PREVENTION AND TREATMENT OF PATHOLOGIES OF THE CARDIOVASCULAR APPARATUS
A61K 31/122 (2006.01)	3657963	COMPOSITION FOR USE IN THE PREVENTION AND TREATMENT OF PATHOLOGIES OF THE CARDIOVASCULAR APPARATUS
A61K 33/06 (2006.01)	3657963	COMPOSITION FOR USE IN THE PREVENTION AND TREATMENT OF PATHOLOGIES OF THE CARDIOVASCULAR APPARATUS
A61K 33/26 (2006.01)	3657963	COMPOSITION FOR USE IN THE PREVENTION AND TREATMENT OF PATHOLOGIES OF THE CARDIOVASCULAR APPARATUS
A61K 45/06 (2006.01)	3657963	COMPOSITION FOR USE IN THE PREVENTION AND TREATMENT OF PATHOLOGIES OF THE CARDIOVASCULAR APPARATUS
A61P 9/00 (2006.01)	3657963	COMPOSITION FOR USE IN THE PREVENTION AND TREATMENT OF PATHOLOGIES OF THE CARDIOVASCULAR APPARATUS
B31B 50/25 (2017.01)	3661849	PLANT FOR AUTOMATED PACKAGING OF ITEMS IN CARDBOARD BOXES
B31B 50/54 (2017.01)	3661849	PLANT FOR AUTOMATED PACKAGING OF ITEMS IN CARDBOARD BOXES
B31B 50/62 (2017.01)	3661849	PLANT FOR AUTOMATED PACKAGING OF ITEMS IN CARDBOARD BOXES
B31B 100/00 (2017.01)	3661849	PLANT FOR AUTOMATED PACKAGING OF ITEMS IN CARDBOARD BOXES
B31B 110/35 (2017.01)	3661849	PLANT FOR AUTOMATED PACKAGING OF ITEMS IN CARDBOARD BOXES
B31B 120/10 (2017.01)	3661849	PLANT FOR AUTOMATED PACKAGING OF ITEMS IN CARDBOARD BOXES
B31F 1/08 (2006.01)	3661849	PLANT FOR AUTOMATED PACKAGING OF ITEMS IN CARDBOARD BOXES
B65B 5/02 (2006.01)	3661849	PLANT FOR AUTOMATED PACKAGING OF ITEMS IN CARDBOARD BOXES
B65B 11/00 (2006.01)	3661849	PLANT FOR AUTOMATED PACKAGING OF ITEMS IN CARDBOARD BOXES
B65B 35/24 (2006.01)	3661849	PLANT FOR AUTOMATED PACKAGING OF ITEMS IN CARDBOARD BOXES
B65B 35/44 (2006.01)	3661849	PLANT FOR AUTOMATED PACKAGING OF ITEMS IN CARDBOARD BOXES
B65B 43/12 (2006.01)	3661849	PLANT FOR AUTOMATED PACKAGING OF ITEMS IN CARDBOARD BOXES
B65B 43/30 (2006.01)	3661849	PLANT FOR AUTOMATED PACKAGING OF ITEMS IN CARDBOARD BOXES
B65B 49/10 (2006.01)	3661849	PLANT FOR AUTOMATED PACKAGING OF ITEMS IN CARDBOARD BOXES
B65B 49/14 (2006.01)	3661849	PLANT FOR AUTOMATED PACKAGING OF ITEMS IN CARDBOARD BOXES

MKP (51)	Broj objave evropske prijave patenta (97)	Naziv pronalaska (54)
A61M 5/315 (2006.01)	3672668	MEDICATION DELIVERY DEVICE WITH SENSING SYSTEM
A23L 2/00 (2006.01)	3668499	AMINO ACID COMPOSITIONS FOR THE TREATMENT OF LIVER DISEASE
A61K 9/00 (2006.01)	3668499	AMINO ACID COMPOSITIONS FOR THE TREATMENT OF LIVER DISEASE
A61K 31/198 (2006.01)	3668499	AMINO ACID COMPOSITIONS FOR THE TREATMENT OF LIVER DISEASE
A61K 31/4172 (2006.01)	3668499	AMINO ACID COMPOSITIONS FOR THE TREATMENT OF LIVER DISEASE
A61K 38/00 (2006.01)	3668499	AMINO ACID COMPOSITIONS FOR THE TREATMENT OF LIVER DISEASE
A61K 45/06 (2006.01)	3668499	AMINO ACID COMPOSITIONS FOR THE TREATMENT OF LIVER DISEASE
A61P 1/16 (2006.01)	3668499	AMINO ACID COMPOSITIONS FOR THE TREATMENT OF LIVER DISEASE
A61P 21/00 (2006.01)	3668499	AMINO ACID COMPOSITIONS FOR THE TREATMENT OF LIVER DISEASE
A61P 31/00 (2006.01)	3668499	AMINO ACID COMPOSITIONS FOR THE TREATMENT OF LIVER DISEASE
A61P 43/00 (2006.01)	3668499	AMINO ACID COMPOSITIONS FOR THE TREATMENT OF LIVER DISEASE
A61K 39/395 (2006.01)	3672631	PHARMACEUTICAL COMPOSITIONS CONTAINING ANTI-BETA AMYLOID ANTIBODIES
C07K 16/18 (2006.01)	3672631	PHARMACEUTICAL COMPOSITIONS CONTAINING ANTI-BETA AMYLOID ANTIBODIES
A61K 39/395 (2006.01)	3672632	PHARMACEUTICAL COMPOSITIONS AND DOSAGE REGIMENS CONTAINING ANTI-ALPHA(V)BETA(6) ANTIBODIES
C07K 16/18 (2006.01)	3672632	PHARMACEUTICAL COMPOSITIONS AND DOSAGE REGIMENS CONTAINING ANTI-ALPHA(V)BETA(6) ANTIBODIES
C07K 16/28 (2006.01)	3672632	PHARMACEUTICAL COMPOSITIONS AND DOSAGE REGIMENS CONTAINING ANTI-ALPHA(V)BETA(6) ANTIBODIES
G06Q 20/38 (2012.01)	3540674	METHOD AND SYSTEM FOR THE GENERATION OF USER-INITIATED FEDERATED IDENTITIES
G06Q 20/40 (2012.01)	3540674	METHOD AND SYSTEM FOR THE GENERATION OF USER-INITIATED FEDERATED IDENTITIES
G06Q 30/06 (2012.01)	3540674	METHOD AND SYSTEM FOR THE GENERATION OF USER-INITIATED FEDERATED IDENTITIES
A61K 31/5585 (2006.01)	3536380	RAPID-ACTING INSULIN COMPOSITIONS
A61K 38/28 (2006.01)	3536380	RAPID-ACTING INSULIN COMPOSITIONS
A61P 3/10 (2006.01)	3536380	RAPID-ACTING INSULIN COMPOSITIONS
A61K 39/395 (2006.01)	3560959	ANTIBODY MOLECULES TO TIM-3 AND USES THEREOF
C07K 16/28 (2006.01)	3560959	ANTIBODY MOLECULES TO TIM-3 AND USES THEREOF
G01N 33/68 (2006.01)	3560959	ANTIBODY MOLECULES TO TIM-3 AND USES THEREOF
B21C 37/29 (2006.01)	3540356	BUSHING JOINT FOR FORMING A RADIANT BODY
F16L 1/00 (2006.01)	3540356	BUSHING JOINT FOR FORMING A RADIANT BODY
F16L 5/10 (2006.01)	3540356	BUSHING JOINT FOR FORMING A RADIANT BODY
F16L 13/02 (2006.01)	3540356	BUSHING JOINT FOR FORMING A RADIANT BODY
F24D 19/00 (2006.01)	3540356	BUSHING JOINT FOR FORMING A RADIANT BODY
F28D 1/053 (2006.01)	3540356	BUSHING JOINT FOR FORMING A RADIANT BODY
F28D 21/00 (2006.01)	3540356	BUSHING JOINT FOR FORMING A RADIANT BODY
F28F 9/02 (2006.01)	3540356	BUSHING JOINT FOR FORMING A RADIANT BODY
F28F 9/18 (2006.01)	3540356	BUSHING JOINT FOR FORMING A RADIANT BODY
F28F 9/26 (2006.01)	3540356	BUSHING JOINT FOR FORMING A RADIANT BODY
A61K 31/4353 (2006.01)	3539966	INHIBITORS OF TYROSINE KINASE 2 MEDIATED SIGNALING
A61P 1/00 (2006.01)	3539966	INHIBITORS OF TYROSINE KINASE 2 MEDIATED SIGNALING
A61P 17/06 (2006.01)	3539966	INHIBITORS OF TYROSINE KINASE 2 MEDIATED SIGNALING
C07D 487/04 (2006.01)	3539966	INHIBITORS OF TYROSINE KINASE 2 MEDIATED SIGNALING
A61K 38/17 (2006.01)	3549611	SWITCH COSTIMULATORY RECEPTORS
A61K 48/00 (2006.01)	3549611	SWITCH COSTIMULATORY RECEPTORS
E03C 1/122 (2006.01)	3540139	DEVICE FOR TOILET, CONNECTOR WITH VALVE FOR SIPHON AND CORRESPONDING METHOD
E03D 11/16 (2006.01)	3540139	DEVICE FOR TOILET, CONNECTOR WITH VALVE FOR SIPHON AND CORRESPONDING METHOD
E03F 5/08 (2006.01)	3540139	DEVICE FOR TOILET, CONNECTOR WITH VALVE FOR SIPHON AND CORRESPONDING METHOD
A61K 39/00 (2006.01)	3536339	METHODS FOR IMPROVING ASTHMA SYMPTOMS USING BENRALIZUMAB

MKP (51)	Broj objave evropske prijave patenta (97)	Naziv pronalaska (54)
A61K 39/395 (2006.01)	3536339	METHODS FOR IMPROVING ASTHMA SYMPTOMS USING BENRALIZUMAB
A61P 11/06 (2006.01)	3536339	METHODS FOR IMPROVING ASTHMA SYMPTOMS USING BENRALIZUMAB
G01N 33/48 (2006.01)	3536339	METHODS FOR IMPROVING ASTHMA SYMPTOMS USING BENRALIZUMAB
F04B 27/00 (2006.01)	3543528	ALTERNATIVE TWIN CYLINDER AIR COMPRESSOR
F04B 35/04 (2006.01)	3543528	ALTERNATIVE TWIN CYLINDER AIR COMPRESSOR
F04B 39/06 (2006.01)	3543528	ALTERNATIVE TWIN CYLINDER AIR COMPRESSOR
F04B 39/12 (2006.01)	3543528	ALTERNATIVE TWIN CYLINDER AIR COMPRESSOR
F04B 39/16 (2006.01)	3543528	ALTERNATIVE TWIN CYLINDER AIR COMPRESSOR
A61K 31/519 (2006.01)	3542820	METHODS OF TREATING PSORIATIC ARTHRITIS USING IL-17 ANTAGONISTS
A61K 39/395 (2006.01)	3542820	METHODS OF TREATING PSORIATIC ARTHRITIS USING IL-17 ANTAGONISTS
C07K 16/24 (2006.01)	3542820	METHODS OF TREATING PSORIATIC ARTHRITIS USING IL-17 ANTAGONISTS
A24F 47/00 (2006.01)	3527088	ELECTRICALLY-POWERED AEROSOL DELIVERY SYSTEM
F42B 5/02 (2006.01)	3537094	IMPROVED FRAGMENTATION PROJECTILE AND METHOD FOR ITS MANUFACTURING
F42B 5/03 (2006.01)	3537094	IMPROVED FRAGMENTATION PROJECTILE AND METHOD FOR ITS MANUFACTURING
F42B 8/14 (2006.01)	3537094	IMPROVED FRAGMENTATION PROJECTILE AND METHOD FOR ITS MANUFACTURING
F42B 12/06 (2006.01)	3537094	IMPROVED FRAGMENTATION PROJECTILE AND METHOD FOR ITS MANUFACTURING
F42B 12/36 (2006.01)	3537094	IMPROVED FRAGMENTATION PROJECTILE AND METHOD FOR ITS MANUFACTURING
A61K 31/00 (2006.01)	3539540	PHARMACEUTICAL COMPOSITION, METHODS FOR TREATING AND USES THEREOF
A61K 31/341 (2006.01)	3539540	PHARMACEUTICAL COMPOSITION, METHODS FOR TREATING AND USES THEREOF
A61K 38/28 (2006.01)	3539540	PHARMACEUTICAL COMPOSITION, METHODS FOR TREATING AND USES THEREOF
A61P 3/10 (2006.01)	3539540	PHARMACEUTICAL COMPOSITION, METHODS FOR TREATING AND USES THEREOF
A61K 9/20 (2006.01)	3542791	A DELAYED RELEASE DRUG FORMULATION
A61K 9/24 (2006.01)	3542791	A DELAYED RELEASE DRUG FORMULATION
A61K 9/28 (2006.01)	3542791	A DELAYED RELEASE DRUG FORMULATION
A61K 9/48 (2006.01)	3542791	A DELAYED RELEASE DRUG FORMULATION
G03G 15/08 (2006.01)	3537223	TONER CARTRIDGE, TONER SUPPLYING MECHANISM AND SHUTTER
G03G 21/16 (2006.01)	3537223	TONER CARTRIDGE, TONER SUPPLYING MECHANISM AND SHUTTER
G03G 21/18 (2006.01)	3537223	TONER CARTRIDGE, TONER SUPPLYING MECHANISM AND SHUTTER
A61K 35/12 (2015.01)	3563860	PHARMACEUTICAL PREPARATIONS OF HUMAN RPE CELLS AND USES THEREOF
A61K 35/44 (2015.01)	3563860	PHARMACEUTICAL PREPARATIONS OF HUMAN RPE CELLS AND USES THEREOF
A61K 35/50 (2015.01)	3563860	PHARMACEUTICAL PREPARATIONS OF HUMAN RPE CELLS AND USES THEREOF
A61P 27/02 (2006.01)	3563860	PHARMACEUTICAL PREPARATIONS OF HUMAN RPE CELLS AND USES THEREOF
B32B 17/10 (2006.01)	3546211	VEHICLE WINDOW AND METHOD OF MANUFACTURING SAME
B60J 1/00 (2006.01)	3546211	VEHICLE WINDOW AND METHOD OF MANUFACTURING SAME
A61K 31/517 (2006.01)	3539952	SUBSTITUTED BICYCLIC DIHYDROPYRIMIDINONES AND THEIR USE AS INHIBITORS OF NEUTROPHIL ELASTASE ACTIVITY
A61P 29/00 (2006.01)	3539952	SUBSTITUTED BICYCLIC DIHYDROPYRIMIDINONES AND THEIR USE AS INHIBITORS OF NEUTROPHIL ELASTASE ACTIVITY
C07D 239/70 (2006.01)	3539952	SUBSTITUTED BICYCLIC DIHYDROPYRIMIDINONES AND THEIR USE AS INHIBITORS OF NEUTROPHIL ELASTASE ACTIVITY
A61K 31/437 (2006.01)	3539961	POLYCYCLIC AMIDE DERIVATIVES AS CDK9 INHIBITORS
A61P 35/00 (2006.01)	3539961	POLYCYCLIC AMIDE DERIVATIVES AS CDK9 INHIBITORS
C07D 471/04 (2006.01)	3539961	POLYCYCLIC AMIDE DERIVATIVES AS CDK9 INHIBITORS

MKP (51)	Broj objave evropske prijave patenta (97)	Naziv pronalaska (54)
C07D 487/04 (2006.01)	3539961	POLYCYCLIC AMIDE DERIVATIVES AS CDK9 INHIBITORS
C07D 498/04 (2006.01)	3539961	POLYCYCLIC AMIDE DERIVATIVES AS CDK9 INHIBITORS
A61K 31/7088 (2006.01)	3550019	COMBINATION
C12N 15/11 (2006.01)	3550019	COMBINATION
C12N 15/113 (2010.01)	3550019	COMBINATION
A61K 39/00 (2006.01)	3655438	AGENTS, USES AND METHODS FOR TREATMENT
C07K 16/28 (2006.01)	3655438	AGENTS, USES AND METHODS FOR TREATMENT
C01B 25/01 (2006.01)	3665124	METHOD FOR ETCHING A PHOSPHATE SOURCE USING ACID
C01B 25/22 (2006.01)	3665124	METHOD FOR ETCHING A PHOSPHATE SOURCE USING ACID
C01B 25/225 (2006.01)	3665124	METHOD FOR ETCHING A PHOSPHATE SOURCE USING ACID
C01B 25/226 (2006.01)	3665124	METHOD FOR ETCHING A PHOSPHATE SOURCE USING ACID
C01B 25/32 (2006.01)	3665124	METHOD FOR ETCHING A PHOSPHATE SOURCE USING ACID
A61K 31/438 (2006.01)	3668879	NOVEL COMPOUNDS
A61P 31/06 (2006.01)	3668879	NOVEL COMPOUNDS
C07D 498/10 (2006.01)	3668879	NOVEL COMPOUNDS
A61K 31/4427 (2006.01)	3668853	NOVEL COMPOUNDS
A61K 31/4523 (2006.01)	3668853	NOVEL COMPOUNDS
A61K 31/497 (2006.01)	3668853	NOVEL COMPOUNDS
A61K 31/501 (2006.01)	3668853	NOVEL COMPOUNDS
A61K 31/506 (2006.01)	3668853	NOVEL COMPOUNDS
A61P 31/06 (2006.01)	3668853	NOVEL COMPOUNDS
C07D 401/04 (2006.01)	3668853	NOVEL COMPOUNDS
A61P 35/00 (2006.01)	3645122	TARGETED HETERODIMERIC FC FUSION PROTEINS CONTAINING IL-15/IL-15RA AND ANTIGEN BINDING DOMAINS
C07K 14/54 (2006.01)	3645122	TARGETED HETERODIMERIC FC FUSION PROTEINS CONTAINING IL-15/IL-15RA AND ANTIGEN BINDING DOMAINS
C07K 14/715 (2006.01)	3645122	TARGETED HETERODIMERIC FC FUSION PROTEINS CONTAINING IL-15/IL-15RA AND ANTIGEN BINDING DOMAINS
C07K 16/28 (2006.01)	3645122	TARGETED HETERODIMERIC FC FUSION PROTEINS CONTAINING IL-15/IL-15RA AND ANTIGEN BINDING DOMAINS
A61K 31/352 (2006.01)	3654976	METHODS OF USE OF ULTRA-HIGH DOSE RATE RADIATION AND THERAPEUTIC AGENTS
A61K 31/366 (2006.01)	3654976	METHODS OF USE OF ULTRA-HIGH DOSE RATE RADIATION AND THERAPEUTIC AGENTS
A61K 31/404 (2006.01)	3654976	METHODS OF USE OF ULTRA-HIGH DOSE RATE RADIATION AND THERAPEUTIC AGENTS
A61K 31/436 (2006.01)	3654976	METHODS OF USE OF ULTRA-HIGH DOSE RATE RADIATION AND THERAPEUTIC AGENTS
A61K 31/4439 (2006.01)	3654976	METHODS OF USE OF ULTRA-HIGH DOSE RATE RADIATION AND THERAPEUTIC AGENTS
A61K 39/395 (2006.01)	3654976	METHODS OF USE OF ULTRA-HIGH DOSE RATE RADIATION AND THERAPEUTIC AGENTS
A61N 5/10 (2006.01)	3654976	METHODS OF USE OF ULTRA-HIGH DOSE RATE RADIATION AND THERAPEUTIC AGENTS
A61P 35/00 (2006.01)	3654976	METHODS OF USE OF ULTRA-HIGH DOSE RATE RADIATION AND THERAPEUTIC AGENTS
A61K 31/175 (2006.01)	3658539	COMPOUNDS AND COMPOSITIONS FOR TREATING CONDITIONS ASSOCIATED WITH NLRP ACTIVITY
C07C 381/10 (2006.01)	3658539	COMPOUNDS AND COMPOSITIONS FOR TREATING CONDITIONS ASSOCIATED WITH NLRP ACTIVITY
C07D 205/04 (2006.01)	3658539	COMPOUNDS AND COMPOSITIONS FOR TREATING CONDITIONS ASSOCIATED WITH NLRP ACTIVITY
C07D 207/04 (2006.01)	3658539	COMPOUNDS AND COMPOSITIONS FOR TREATING CONDITIONS ASSOCIATED WITH NLRP ACTIVITY
C07D 207/10 (2006.01)	3658539	COMPOUNDS AND COMPOSITIONS FOR TREATING CONDITIONS ASSOCIATED WITH NLRP ACTIVITY
C07D 213/71 (2006.01)	3658539	COMPOUNDS AND COMPOSITIONS FOR TREATING CONDITIONS ASSOCIATED WITH NLRP ACTIVITY
C07D 217/22 (2006.01)	3658539	COMPOUNDS AND COMPOSITIONS FOR TREATING CONDITIONS ASSOCIATED WITH NLRP ACTIVITY
C07D 231/18 (2006.01)	3658539	COMPOUNDS AND COMPOSITIONS FOR TREATING CONDITIONS ASSOCIATED WITH NLRP ACTIVITY
C07D 231/56 (2006.01)	3658539	COMPOUNDS AND COMPOSITIONS FOR TREATING CONDITIONS ASSOCIATED WITH NLRP ACTIVITY
C07D 263/46 (2006.01)	3658539	COMPOUNDS AND COMPOSITIONS FOR TREATING CONDITIONS ASSOCIATED WITH NLRP ACTIVITY
C07D 265/30 (2006.01)	3658539	COMPOUNDS AND COMPOSITIONS FOR TREATING CONDITIONS ASSOCIATED WITH NLRP ACTIVITY

MKP	Broj objave evropske prijave patenta	Naziv pronalaska
(51)	(97)	(54)
C07D 277/36 (2006.01)	3658539	COMPOUNDS AND COMPOSITIONS FOR TREATING CONDITIONS ASSOCIATED WITH NLRP ACTIVITY
C07D 307/64 (2006.01)	3658539	COMPOUNDS AND COMPOSITIONS FOR TREATING CONDITIONS ASSOCIATED WITH NLRP ACTIVITY
C07D 333/34 (2006.01)	3658539	COMPOUNDS AND COMPOSITIONS FOR TREATING CONDITIONS ASSOCIATED WITH NLRP ACTIVITY
C07D 417/12 (2006.01)	3658539	COMPOUNDS AND COMPOSITIONS FOR TREATING CONDITIONS ASSOCIATED WITH NLRP ACTIVITY
A61K 39/00 (2006.01)	3658193	ANTI-CD8 ANTIBODIES AND USES THEREOF
A61K 49/00 (2006.01)	3658193	ANTI-CD8 ANTIBODIES AND USES THEREOF
A61K 49/16 (2006.01)	3658193	ANTI-CD8 ANTIBODIES AND USES THEREOF
A61K 51/10 (2006.01)	3658193	ANTI-CD8 ANTIBODIES AND USES THEREOF
C07K 16/28 (2006.01)	3658193	ANTI-CD8 ANTIBODIES AND USES THEREOF
G01N 33/53 (2006.01)	3658193	ANTI-CD8 ANTIBODIES AND USES THEREOF
A61K 38/46 (2006.01)	3658672	MODIFIED MRNA ENCODING A GLUCOSE-6-PHOSPHATASE AND USES THEREOF
C12N 9/18 (2006.01)	3658672	MODIFIED MRNA ENCODING A GLUCOSE-6-PHOSPHATASE AND USES THEREOF
A61K 31/437 (2006.01)	3658555	INHIBITORS OF ROR
A61P 29/00 (2006.01)	3658555	INHIBITORS OF ROR
C07D 471/04 (2006.01)	3658555	INHIBITORS OF ROR
A61K 31/437 (2006.01)	3658556	INHIBITORS OF ROR GAMMA
A61P 29/00 (2006.01)	3658556	INHIBITORS OF ROR GAMMA
C07D 471/04 (2006.01)	3658556	INHIBITORS OF ROR GAMMA
A61K 31/397 (2006.01)	3668854	NOVEL COMPOUNDS
A61P 31/06 (2006.01)	3668854	NOVEL COMPOUNDS
C07D 205/04 (2006.01)	3668854	NOVEL COMPOUNDS
C07D 401/04 (2006.01)	3668854	NOVEL COMPOUNDS
C07D 405/04 (2006.01)	3668854	NOVEL COMPOUNDS
A61K 38/40 (2006.01)	3658174	LACTOFERRICIN AND LACTOFERRAMPIN FOR TREATING INFECTIONS
A61P 31/00 (2006.01)	3658174	LACTOFERRICIN AND LACTOFERRAMPIN FOR TREATING INFECTIONS
A61K 35/74 (2015.01)	3652318	ENGINEERED IMMUNOSTIMULATORY BACTERIAL STRAINS AND USES THEREOF
A61P 35/00 (2006.01)	3652318	ENGINEERED IMMUNOSTIMULATORY BACTERIAL STRAINS AND USES THEREOF
C12N 1/36 (2006.01)	3652318	ENGINEERED IMMUNOSTIMULATORY BACTERIAL STRAINS AND USES THEREOF
C12N 15/113 (2010.01)	3652318	ENGINEERED IMMUNOSTIMULATORY BACTERIAL STRAINS AND USES THEREOF
A61K 31/7115 (2006.01)	3655040	MODIFIED MRNA ENCODING A PROPIONYL-COA CARBOXYLASE AND USES THEREOF
A61K 48/00 (2006.01)	3655040	MODIFIED MRNA ENCODING A PROPIONYL-COA CARBOXYLASE AND USES THEREOF
C12N 9/00 (2006.01)	3655040	MODIFIED MRNA ENCODING A PROPIONYL-COA CARBOXYLASE AND USES THEREOF
A61K 39/00 (2006.01)	3661544	ANTI-CD137 ANTIBODIES
A61P 35/00 (2006.01)	3661544	ANTI-CD137 ANTIBODIES
C07K 16/28 (2006.01)	3661544	ANTI-CD137 ANTIBODIES
A61K 9/20 (2006.01)	3654951	COMPOSITIONS COMPRISING DARUNAVIR, COBICISTAT, EMTRICITABINE AND TENOFOVIR ALAFENAMIDE FOR USE IN THE TREATMENT OF HIV
A61K 31/34 (2006.01)	3654951	COMPOSITIONS COMPRISING DARUNAVIR, COBICISTAT, EMTRICITABINE AND TENOFOVIR ALAFENAMIDE FOR USE IN THE TREATMENT OF HIV
A61K 31/513 (2006.01)	3654951	COMPOSITIONS COMPRISING DARUNAVIR, COBICISTAT, EMTRICITABINE AND TENOFOVIR ALAFENAMIDE FOR USE IN THE TREATMENT OF HIV
A61K 31/5377 (2006.01)	3654951	COMPOSITIONS COMPRISING DARUNAVIR, COBICISTAT, EMTRICITABINE AND TENOFOVIR ALAFENAMIDE FOR USE IN THE TREATMENT OF HIV
A61K 31/675 (2006.01)	3654951	COMPOSITIONS COMPRISING DARUNAVIR, COBICISTAT, EMTRICITABINE AND TENOFOVIR ALAFENAMIDE FOR USE IN THE TREATMENT OF HIV
A61K 31/5395 (2006.01)	3661517	DIHYDROOXADIAZINONES
A61P 35/00 (2006.01)	3661517	DIHYDROOXADIAZINONES
C07D 273/04 (2006.01)	3661517	DIHYDROOXADIAZINONES

MKP (51)	Broj objave evropske prijave patenta (97)	Naziv pronalaska (54)
C07D 413/10 (2006.01)	3661517	DIHYDROOXADIAZINONES
C07D 417/10 (2006.01)	3661517	DIHYDROOXADIAZINONES
C07D 491/107 (2006.01)	3661517	DIHYDROOXADIAZINONES
A61J 1/10 (2006.01)	3652491	PROCESS FOR LYOPHILISING A PRODUCT
F26B 5/06 (2006.01)	3652491	PROCESS FOR LYOPHILISING A PRODUCT
A61M 5/142 (2006.01)	3668567	WEARABLE INJECTOR WITH STERILE ADHESIVE PATCH
A61K 9/00 (2006.01)	3651735	PREPARATION COMPRISING VONOPRAZAN
A61K 9/20 (2006.01)	3651735	PREPARATION COMPRISING VONOPRAZAN
A61K 9/50 (2006.01)	3651735	PREPARATION COMPRISING VONOPRAZAN
A61K 31/4439 (2006.01)	3651735	PREPARATION COMPRISING VONOPRAZAN
A61K 31/7125 (2006.01)	3658156	METHODS OF TREATING MYELOYDYSPLASTIC SYNDROME
A61P 7/00 (2006.01)	3658156	METHODS OF TREATING MYELOYDYSPLASTIC SYNDROME
A61K 31/416 (2006.01)	3652169	PYRAZOLO AND TRIAZOLO BICYCLIC COMPOUNDS AS JAK KINASE INHIBITORS
A61K 31/437 (2006.01)	3652169	PYRAZOLO AND TRIAZOLO BICYCLIC COMPOUNDS AS JAK KINASE INHIBITORS
A61K 31/519 (2006.01)	3652169	PYRAZOLO AND TRIAZOLO BICYCLIC COMPOUNDS AS JAK KINASE INHIBITORS
A61P 29/00 (2006.01)	3652169	PYRAZOLO AND TRIAZOLO BICYCLIC COMPOUNDS AS JAK KINASE INHIBITORS
C07D 403/12 (2006.01)	3652169	PYRAZOLO AND TRIAZOLO BICYCLIC COMPOUNDS AS JAK KINASE INHIBITORS
C07D 487/04 (2006.01)	3652169	PYRAZOLO AND TRIAZOLO BICYCLIC COMPOUNDS AS JAK KINASE INHIBITORS
A61K 31/4196 (2006.01)	3661503	ANTIFUNGAL AGENTS WITH ENHANCED ACTIVITY IN ACIDIC PH
A61K 31/4439 (2006.01)	3661503	ANTIFUNGAL AGENTS WITH ENHANCED ACTIVITY IN ACIDIC PH
A61P 15/02 (2006.01)	3661503	ANTIFUNGAL AGENTS WITH ENHANCED ACTIVITY IN ACIDIC PH
A61P 31/10 (2006.01)	3661503	ANTIFUNGAL AGENTS WITH ENHANCED ACTIVITY IN ACIDIC PH
C07D 207/06 (2006.01)	3661915	PROCESSES FOR PREPARING PYRROLIDINE COMPOUNDS
C07D 207/263 (2006.01)	3661915	PROCESSES FOR PREPARING PYRROLIDINE COMPOUNDS
A01N 63/00 (2020.01)	3661950	PESTICIDAL GENES AND METHODS OF USE
C07K 14/325 (2006.01)	3661950	PESTICIDAL GENES AND METHODS OF USE
C12N 15/82 (2006.01)	3661950	PESTICIDAL GENES AND METHODS OF USE
G16H 20/10 (2018.01)	3665706	GRAPHICAL USER INTERFACE FOR PERSONALIZED PREDICTION MODELING
G16H 50/50 (2018.01)	3665706	GRAPHICAL USER INTERFACE FOR PERSONALIZED PREDICTION MODELING
B01D 11/04 (2006.01)	3658524	METHOD FOR THE PRODUCTION OF CANNABINOIDS FROM TYPES OF INDUSTRIAL HEMP
C07C 37/00 (2006.01)	3658524	METHOD FOR THE PRODUCTION OF CANNABINOIDS FROM TYPES OF INDUSTRIAL HEMP
C07C 37/70 (2006.01)	3658524	METHOD FOR THE PRODUCTION OF CANNABINOIDS FROM TYPES OF INDUSTRIAL HEMP
C07C 37/82 (2006.01)	3658524	METHOD FOR THE PRODUCTION OF CANNABINOIDS FROM TYPES OF INDUSTRIAL HEMP
C07C 39/23 (2006.01)	3658524	METHOD FOR THE PRODUCTION OF CANNABINOIDS FROM TYPES OF INDUSTRIAL HEMP
C07D 311/80 (2006.01)	3658524	METHOD FOR THE PRODUCTION OF CANNABINOIDS FROM TYPES OF INDUSTRIAL HEMP
A61P 35/00 (2006.01)	3661960	BINDING AGENTS BINDING TO PD-L1 AND CD137 AND USE THEREOF
C07K 16/10 (2006.01)	3661960	BINDING AGENTS BINDING TO PD-L1 AND CD137 AND USE THEREOF
C07K 16/28 (2006.01)	3661960	BINDING AGENTS BINDING TO PD-L1 AND CD137 AND USE THEREOF
A61K 31/4192 (2006.01)	3668856	NOVEL TETRAZOLE COMPOUNDS AND THEIR USE IN THE TREATMENT OF TUBERCULOSIS
A61K 31/4196 (2006.01)	3668856	NOVEL TETRAZOLE COMPOUNDS AND THEIR USE IN THE TREATMENT OF TUBERCULOSIS
A61K 31/4439 (2006.01)	3668856	NOVEL TETRAZOLE COMPOUNDS AND THEIR USE IN THE TREATMENT OF TUBERCULOSIS
A61K 31/497 (2006.01)	3668856	NOVEL TETRAZOLE COMPOUNDS AND THEIR USE IN THE TREATMENT OF TUBERCULOSIS

MKP (51)	Broj objave evropske prijave patenta (97)	Naziv pronalaska (54)
A61K 31/501 (2006.01)	3668856	NOVEL TETRAZOLE COMPOUNDS AND THEIR USE IN THE TREATMENT OF TUBERCULOSIS
A61K 31/506 (2006.01)	3668856	NOVEL TETRAZOLE COMPOUNDS AND THEIR USE IN THE TREATMENT OF TUBERCULOSIS
A61P 31/06 (2006.01)	3668856	NOVEL TETRAZOLE COMPOUNDS AND THEIR USE IN THE TREATMENT OF TUBERCULOSIS
C07D 249/06 (2006.01)	3668856	NOVEL TETRAZOLE COMPOUNDS AND THEIR USE IN THE TREATMENT OF TUBERCULOSIS
C07D 257/04 (2006.01)	3668856	NOVEL TETRAZOLE COMPOUNDS AND THEIR USE IN THE TREATMENT OF TUBERCULOSIS
C07D 401/06 (2006.01)	3668856	NOVEL TETRAZOLE COMPOUNDS AND THEIR USE IN THE TREATMENT OF TUBERCULOSIS
C07D 403/06 (2006.01)	3668856	NOVEL TETRAZOLE COMPOUNDS AND THEIR USE IN THE TREATMENT OF TUBERCULOSIS
C07D 405/06 (2006.01)	3668856	NOVEL TETRAZOLE COMPOUNDS AND THEIR USE IN THE TREATMENT OF TUBERCULOSIS
A23L 3/01 (2006.01)	3654778	METHODS FOR MAKING MIXED ALLERGEN COMPOSITIONS
A23L 33/00 (2016.01)	3654778	METHODS FOR MAKING MIXED ALLERGEN COMPOSITIONS
A23L 33/10 (2016.01)	3654778	METHODS FOR MAKING MIXED ALLERGEN COMPOSITIONS
A61K 39/35 (2006.01)	3654778	METHODS FOR MAKING MIXED ALLERGEN COMPOSITIONS
A61P 37/00 (2006.01)	3654778	METHODS FOR MAKING MIXED ALLERGEN COMPOSITIONS
A61K 39/00 (2006.01)	3658583	LTBP COMPLEX-SPECIFIC INHIBITORS OF TGF-BETA 1 AND USES THEREOF
C07K 16/22 (2006.01)	3658583	LTBP COMPLEX-SPECIFIC INHIBITORS OF TGF-BETA 1 AND USES THEREOF
C07K 16/28 (2006.01)	3658583	LTBP COMPLEX-SPECIFIC INHIBITORS OF TGF-BETA 1 AND USES THEREOF
A61K 9/00 (2006.01)	3661518	METHODS OF TREATING SYMPTOMS OF GASTROPARESIS USING VELUSETRAG
A61K 31/55 (2006.01)	3661518	METHODS OF TREATING SYMPTOMS OF GASTROPARESIS USING VELUSETRAG
A61P 1/14 (2006.01)	3661518	METHODS OF TREATING SYMPTOMS OF GASTROPARESIS USING VELUSETRAG
H04L 9/32 (2006.01)	3652887	METHOD AND SYSTEM FOR DATA SECURITY WITHIN INDEPENDENT COMPUTER SYSTEMS AND DIGITAL NETWORKS
H04L 29/06 (2006.01)	3652887	METHOD AND SYSTEM FOR DATA SECURITY WITHIN INDEPENDENT COMPUTER SYSTEMS AND DIGITAL NETWORKS
B22F 3/105 (2006.01)	3638441	A MACHINE AND A METHOD FOR ADDITIVE MANUFACTURING OF THREE-DIMENSIONAL OBJECTS
B29C 64/20 (2017.01)	3638441	A MACHINE AND A METHOD FOR ADDITIVE MANUFACTURING OF THREE-DIMENSIONAL OBJECTS
B29C 64/264 (2017.01)	3638441	A MACHINE AND A METHOD FOR ADDITIVE MANUFACTURING OF THREE-DIMENSIONAL OBJECTS
B29C 64/268 (2017.01)	3638441	A MACHINE AND A METHOD FOR ADDITIVE MANUFACTURING OF THREE-DIMENSIONAL OBJECTS
B29C 64/277 (2017.01)	3638441	A MACHINE AND A METHOD FOR ADDITIVE MANUFACTURING OF THREE-DIMENSIONAL OBJECTS
B33Y 10/00 (2015.01)	3638441	A MACHINE AND A METHOD FOR ADDITIVE MANUFACTURING OF THREE-DIMENSIONAL OBJECTS
B33Y 30/00 (2015.01)	3638441	A MACHINE AND A METHOD FOR ADDITIVE MANUFACTURING OF THREE-DIMENSIONAL OBJECTS
A61K 38/40 (2006.01)	3665192	ENGINEERED TRANSFERRIN RECEPTOR BINDING POLYPEPTIDES
A61K 39/00 (2006.01)	3665192	ENGINEERED TRANSFERRIN RECEPTOR BINDING POLYPEPTIDES
C07K 14/705 (2006.01)	3665192	ENGINEERED TRANSFERRIN RECEPTOR BINDING POLYPEPTIDES
C07K 14/79 (2006.01)	3665192	ENGINEERED TRANSFERRIN RECEPTOR BINDING POLYPEPTIDES
A23L 2/60 (2006.01)	3665287	PISUM SATIVUM KAURENE OXIDASE FOR HIGH EFFICIENCY PRODUCTION OF REBAUDIOSIDES
C12N 9/02 (2006.01)	3665287	PISUM SATIVUM KAURENE OXIDASE FOR HIGH EFFICIENCY PRODUCTION OF REBAUDIOSIDES
C12N 9/10 (2006.01)	3665287	PISUM SATIVUM KAURENE OXIDASE FOR HIGH EFFICIENCY PRODUCTION OF REBAUDIOSIDES

MKP (51)	Broj objave evropske prijave patenta (97)	Naziv pronalaska (54)
C12N 9/90 (2006.01)	3665287	PISUM SATIVUM KAURENE OXIDASE FOR HIGH EFFICIENCY PRODUCTION OF REBAUDIOSIDES
C12N 15/81 (2006.01)	3665287	PISUM SATIVUM KAURENE OXIDASE FOR HIGH EFFICIENCY PRODUCTION OF REBAUDIOSIDES
A61K 9/08 (2006.01)	3664780	PHARMACEUTICAL COMPOSITIONS
A61K 31/166 (2006.01)	3664780	PHARMACEUTICAL COMPOSITIONS
A61K 47/18 (2017.01)	3664780	PHARMACEUTICAL COMPOSITIONS
A61K 47/26 (2006.01)	3664780	PHARMACEUTICAL COMPOSITIONS
C02F 1/28 (2006.01)	3655365	METHOD AND DEVICE FOR REMOVING PARTICLES FROM WASTE WATER
D06F 39/10 (2006.01)	3655365	METHOD AND DEVICE FOR REMOVING PARTICLES FROM WASTE WATER
A61K 8/00 (2006.01)	3661534	A SYNERGISTIC COMPOSITION AS A PROMOTER OF AUTOPHAGY
A61K 31/132 (2006.01)	3661534	A SYNERGISTIC COMPOSITION AS A PROMOTER OF AUTOPHAGY
A61K 31/4188 (2006.01)	3661534	A SYNERGISTIC COMPOSITION AS A PROMOTER OF AUTOPHAGY
A61K 36/53 (2006.01)	3661534	A SYNERGISTIC COMPOSITION AS A PROMOTER OF AUTOPHAGY
A61P 17/14 (2006.01)	3661534	A SYNERGISTIC COMPOSITION AS A PROMOTER OF AUTOPHAGY
G07G 1/00 (2006.01)	3659127	INSTALLATION AND METHOD FOR MANAGING PRODUCT DATA
A61K 35/17 (2015.01)	3661528	REAGENTS FOR EXPANDING CELLS EXPRESSING RECOMBINANT RECEPTORS
C12N 5/0783 (2010.01)	3661528	REAGENTS FOR EXPANDING CELLS EXPRESSING RECOMBINANT RECEPTORS
A61K 31/64 (2006.01)	3668861	NOVEL SULFONAMIDE CARBOXAMIDE COMPOUNDS
C07D 213/52 (2006.01)	3668861	NOVEL SULFONAMIDE CARBOXAMIDE COMPOUNDS
C07D 231/18 (2006.01)	3668861	NOVEL SULFONAMIDE CARBOXAMIDE COMPOUNDS
C07D 401/12 (2006.01)	3668861	NOVEL SULFONAMIDE CARBOXAMIDE COMPOUNDS
C07D 401/14 (2006.01)	3668861	NOVEL SULFONAMIDE CARBOXAMIDE COMPOUNDS
C07D 403/12 (2006.01)	3668861	NOVEL SULFONAMIDE CARBOXAMIDE COMPOUNDS
C07D 405/04 (2006.01)	3668861	NOVEL SULFONAMIDE CARBOXAMIDE COMPOUNDS
C07D 405/12 (2006.01)	3668861	NOVEL SULFONAMIDE CARBOXAMIDE COMPOUNDS
C07D 407/12 (2006.01)	3668861	NOVEL SULFONAMIDE CARBOXAMIDE COMPOUNDS
C07D 407/14 (2006.01)	3668861	NOVEL SULFONAMIDE CARBOXAMIDE COMPOUNDS
C07D 413/12 (2006.01)	3668861	NOVEL SULFONAMIDE CARBOXAMIDE COMPOUNDS
C07D 417/12 (2006.01)	3668861	NOVEL SULFONAMIDE CARBOXAMIDE COMPOUNDS
C07D 471/08 (2006.01)	3668861	NOVEL SULFONAMIDE CARBOXAMIDE COMPOUNDS
C07D 487/04 (2006.01)	3668861	NOVEL SULFONAMIDE CARBOXAMIDE COMPOUNDS
C07D 491/048 (2006.01)	3668861	NOVEL SULFONAMIDE CARBOXAMIDE COMPOUNDS
A61K 31/517 (2006.01)	3632912	PYRIDOQUINAZOLINE DERIVATIVES USEFUL AS PROTEIN KINASE INHIBITORS
A61P 17/06 (2006.01)	3632912	PYRIDOQUINAZOLINE DERIVATIVES USEFUL AS PROTEIN KINASE INHIBITORS
C07D 471/04 (2006.01)	3632912	PYRIDOQUINAZOLINE DERIVATIVES USEFUL AS PROTEIN KINASE INHIBITORS
G01N 1/34 (2006.01)	3662287	SYSTEMS AND METHODS FOR REAL TIME PREPARATION OF A POLYPEPTIDE SAMPLE FOR ANALYSIS WITH MASS SPECTROMETRY
G01N 33/68 (2006.01)	3662287	SYSTEMS AND METHODS FOR REAL TIME PREPARATION OF A POLYPEPTIDE SAMPLE FOR ANALYSIS WITH MASS SPECTROMETRY
G01N 30/88 (2006.01)	3662288	SYSTEMS AND METHODS FOR PERFORMING A REAL-TIME GLYCAN ASSAY OF A SAMPLE
G01N 33/68 (2006.01)	3662288	SYSTEMS AND METHODS FOR PERFORMING A REAL-TIME GLYCAN ASSAY OF A SAMPLE
A61K 47/54 (2017.01)	3661954	INTERLEUKIN-21 MUTEINS AND METHODS OF TREATMENT
A61K 47/60 (2017.01)	3661954	INTERLEUKIN-21 MUTEINS AND METHODS OF TREATMENT
C07K 14/54 (2006.01)	3661954	INTERLEUKIN-21 MUTEINS AND METHODS OF TREATMENT
A61K 31/513 (2006.01)	3661514	MAVACAMTEN FOR USE IN THE TREATMENT OF HYPERTROPHIC CARDIOMYOPATHY
A61P 9/04 (2006.01)	3661514	MAVACAMTEN FOR USE IN THE TREATMENT OF HYPERTROPHIC CARDIOMYOPATHY
A61P 9/10 (2006.01)	3661514	MAVACAMTEN FOR USE IN THE TREATMENT OF HYPERTROPHIC CARDIOMYOPATHY

MKP (51)	Broj objave evropske prijave patenta (97)	Naziv pronalaska (54)
A61M 5/142 (2006.01)	3664863	HYDRAULIC-PNEUMATIC PRESSURIZED CHAMBER DRUG DELIVERY SYSTEM
A61M 5/145 (2006.01)	3664863	HYDRAULIC-PNEUMATIC PRESSURIZED CHAMBER DRUG DELIVERY SYSTEM
C12M 1/34 (2006.01)	3668966	ADAPTIVE ELECTRODE ARRANGEMENT FOR IMPLEMENTATION IN A CELL INCUBATOR SYSTEM AND APPLICATIONS THEREOF
C12M 1/42 (2006.01)	3668966	ADAPTIVE ELECTRODE ARRANGEMENT FOR IMPLEMENTATION IN A CELL INCUBATOR SYSTEM AND APPLICATIONS THEREOF
C12M 3/00 (2006.01)	3668966	ADAPTIVE ELECTRODE ARRANGEMENT FOR IMPLEMENTATION IN A CELL INCUBATOR SYSTEM AND APPLICATIONS THEREOF
C12N 5/0735 (2010.01)	3668966	ADAPTIVE ELECTRODE ARRANGEMENT FOR IMPLEMENTATION IN A CELL INCUBATOR SYSTEM AND APPLICATIONS THEREOF
C12N 5/077 (2010.01)	3668966	ADAPTIVE ELECTRODE ARRANGEMENT FOR IMPLEMENTATION IN A CELL INCUBATOR SYSTEM AND APPLICATIONS THEREOF
C12N 13/00 (2006.01)	3668966	ADAPTIVE ELECTRODE ARRANGEMENT FOR IMPLEMENTATION IN A CELL INCUBATOR SYSTEM AND APPLICATIONS THEREOF
G01N 27/27 (2006.01)	3668966	ADAPTIVE ELECTRODE ARRANGEMENT FOR IMPLEMENTATION IN A CELL INCUBATOR SYSTEM AND APPLICATIONS THEREOF
G01N 33/50 (2006.01)	3668966	ADAPTIVE ELECTRODE ARRANGEMENT FOR IMPLEMENTATION IN A CELL INCUBATOR SYSTEM AND APPLICATIONS THEREOF
A61P 3/10 (2006.01)	3668599	SULFONYLUREAS AND SULFONYLTHIOUREAS AS NLRP3 INHIBITORS
A61P 25/28 (2006.01)	3668599	SULFONYLUREAS AND SULFONYLTHIOUREAS AS NLRP3 INHIBITORS
A61P 29/00 (2006.01)	3668599	SULFONYLUREAS AND SULFONYLTHIOUREAS AS NLRP3 INHIBITORS
A61P 31/00 (2006.01)	3668599	SULFONYLUREAS AND SULFONYLTHIOUREAS AS NLRP3 INHIBITORS
A61P 35/00 (2006.01)	3668599	SULFONYLUREAS AND SULFONYLTHIOUREAS AS NLRP3 INHIBITORS
C07D 231/18 (2006.01)	3668599	SULFONYLUREAS AND SULFONYLTHIOUREAS AS NLRP3 INHIBITORS
C07D 233/84 (2006.01)	3668599	SULFONYLUREAS AND SULFONYLTHIOUREAS AS NLRP3 INHIBITORS
C07D 249/04 (2006.01)	3668599	SULFONYLUREAS AND SULFONYLTHIOUREAS AS NLRP3 INHIBITORS
C07D 249/12 (2006.01)	3668599	SULFONYLUREAS AND SULFONYLTHIOUREAS AS NLRP3 INHIBITORS
C07D 401/04 (2006.01)	3668599	SULFONYLUREAS AND SULFONYLTHIOUREAS AS NLRP3 INHIBITORS
C07D 401/12 (2006.01)	3668599	SULFONYLUREAS AND SULFONYLTHIOUREAS AS NLRP3 INHIBITORS
C07D 403/04 (2006.01)	3668599	SULFONYLUREAS AND SULFONYLTHIOUREAS AS NLRP3 INHIBITORS
C07D 403/06 (2006.01)	3668599	SULFONYLUREAS AND SULFONYLTHIOUREAS AS NLRP3 INHIBITORS
C07D 403/12 (2006.01)	3668599	SULFONYLUREAS AND SULFONYLTHIOUREAS AS NLRP3 INHIBITORS
C07D 405/04 (2006.01)	3668599	SULFONYLUREAS AND SULFONYLTHIOUREAS AS NLRP3 INHIBITORS
C07D 405/12 (2006.01)	3668599	SULFONYLUREAS AND SULFONYLTHIOUREAS AS NLRP3 INHIBITORS
C07D 413/06 (2006.01)	3668599	SULFONYLUREAS AND SULFONYLTHIOUREAS AS NLRP3 INHIBITORS
C07D 417/04 (2006.01)	3668599	SULFONYLUREAS AND SULFONYLTHIOUREAS AS NLRP3 INHIBITORS
C07D 471/04 (2006.01)	3668599	SULFONYLUREAS AND SULFONYLTHIOUREAS AS NLRP3 INHIBITORS
C07D 487/04 (2006.01)	3668599	SULFONYLUREAS AND SULFONYLTHIOUREAS AS NLRP3 INHIBITORS

MKP (51)	Broj objave evropske prijave patenta (97)	Naziv pronalaska (54)
A61K 31/575 (2006.01)	3661945	GLYCYRRHETINIC ACID DERIVATIVES FOR TREATING HYPERKALEMIA
A61P 5/44 (2006.01)	3661945	GLYCYRRHETINIC ACID DERIVATIVES FOR TREATING HYPERKALEMIA
C07J 63/00 (2006.01)	3661945	GLYCYRRHETINIC ACID DERIVATIVES FOR TREATING HYPERKALEMIA
A61K 31/437 (2006.01)	3664802	BICYCLIC INHIBITORS OF HISTONE DEACETYLASE
A61P 25/28 (2006.01)	3664802	BICYCLIC INHIBITORS OF HISTONE DEACETYLASE
A61K 31/195 (2006.01)	3664792	METHODS OF TREATMENT
A61P 9/08 (2006.01)	3664792	METHODS OF TREATMENT
E04B 1/24 (2006.01)	3669033	MODULAR SYSTEM FOR CREATING A STRUCTURE, MODULE CONNECTOR AND STRUCTURE COMPRISING A MODULAR SYSTEM
E04B 1/348 (2006.01)	3669033	MODULAR SYSTEM FOR CREATING A STRUCTURE, MODULE CONNECTOR AND STRUCTURE COMPRISING A MODULAR SYSTEM
E04B 9/06 (2006.01)	3669033	MODULAR SYSTEM FOR CREATING A STRUCTURE, MODULE CONNECTOR AND STRUCTURE COMPRISING A MODULAR SYSTEM
E04C 3/04 (2006.01)	3669033	MODULAR SYSTEM FOR CREATING A STRUCTURE, MODULE CONNECTOR AND STRUCTURE COMPRISING A MODULAR SYSTEM
E04C 3/07 (2006.01)	3669033	MODULAR SYSTEM FOR CREATING A STRUCTURE, MODULE CONNECTOR AND STRUCTURE COMPRISING A MODULAR SYSTEM
A61K 31/64 (2006.01)	3668601	NOVEL SULFONAMIDE CARBOXAMIDE COMPOUNDS
A61P 1/00 (2006.01)	3668601	NOVEL SULFONAMIDE CARBOXAMIDE COMPOUNDS
A61P 9/00 (2006.01)	3668601	NOVEL SULFONAMIDE CARBOXAMIDE COMPOUNDS
A61P 11/00 (2006.01)	3668601	NOVEL SULFONAMIDE CARBOXAMIDE COMPOUNDS
A61P 13/12 (2006.01)	3668601	NOVEL SULFONAMIDE CARBOXAMIDE COMPOUNDS
A61P 15/00 (2006.01)	3668601	NOVEL SULFONAMIDE CARBOXAMIDE COMPOUNDS
A61P 17/00 (2006.01)	3668601	NOVEL SULFONAMIDE CARBOXAMIDE COMPOUNDS
A61P 25/00 (2006.01)	3668601	NOVEL SULFONAMIDE CARBOXAMIDE COMPOUNDS
A61P 31/00 (2006.01)	3668601	NOVEL SULFONAMIDE CARBOXAMIDE COMPOUNDS
A61P 37/00 (2006.01)	3668601	NOVEL SULFONAMIDE CARBOXAMIDE COMPOUNDS
A61K 47/68 (2017.01)	3661562	METHOD OF CONJUGATION OF CYS-MABS
C07K 14/605 (2006.01)	3661562	METHOD OF CONJUGATION OF CYS-MABS
C07K 16/00 (2006.01)	3661562	METHOD OF CONJUGATION OF CYS-MABS
A61K 47/68 (2017.01)	3661963	BCMA MONOCLONAL ANTIBODY-DRUG CONJUGATE
A61P 35/00 (2006.01)	3661963	BCMA MONOCLONAL ANTIBODY-DRUG CONJUGATE
C07K 16/28 (2006.01)	3661963	BCMA MONOCLONAL ANTIBODY-DRUG CONJUGATE
A61K 31/519 (2006.01)	3661519	THERAPEUTIC COMBINATION OF A THIRD GENERATION EGFR TYROSINE KINASE INHIBITOR AND A CYCLIN D KINASE INHIBITOR
A61K 31/55 (2006.01)	3661519	THERAPEUTIC COMBINATION OF A THIRD GENERATION EGFR TYROSINE KINASE INHIBITOR AND A CYCLIN D KINASE INHIBITOR
A61K 45/06 (2006.01)	3661519	THERAPEUTIC COMBINATION OF A THIRD GENERATION EGFR TYROSINE KINASE INHIBITOR AND A CYCLIN D KINASE INHIBITOR
A61P 35/00 (2006.01)	3661519	THERAPEUTIC COMBINATION OF A THIRD GENERATION EGFR TYROSINE KINASE INHIBITOR AND A CYCLIN D KINASE INHIBITOR
A61K 31/5377 (2006.01)	3661516	THERAPEUTIC COMBINATION OF A THIRD-GENERATION EGFR TYROSINE KINASE INHIBITOR AND A RAF INHIBITOR
A61K 31/55 (2006.01)	3661516	THERAPEUTIC COMBINATION OF A THIRD-GENERATION EGFR TYROSINE KINASE INHIBITOR AND A RAF INHIBITOR
A61K 45/06 (2006.01)	3661516	THERAPEUTIC COMBINATION OF A THIRD-GENERATION EGFR TYROSINE KINASE INHIBITOR AND A RAF INHIBITOR
A61P 35/00 (2006.01)	3661516	THERAPEUTIC COMBINATION OF A THIRD-GENERATION EGFR TYROSINE KINASE INHIBITOR AND A RAF INHIBITOR
A61K 31/7064 (2006.01)	3665179	SELECTIVE INHIBITORS OF PROTEIN ARGININE METHYLTRANSFERASE 5 (PRMT5)
A61P 35/00 (2006.01)	3665179	SELECTIVE INHIBITORS OF PROTEIN ARGININE METHYLTRANSFERASE 5 (PRMT5)
A61P 35/02 (2006.01)	3665179	SELECTIVE INHIBITORS OF PROTEIN ARGININE METHYLTRANSFERASE 5 (PRMT5)

MKP (51)	Broj objave evropske prijave patenta (97)	Naziv pronalaska (54)
C07H 19/14 (2006.01)	3665179	SELECTIVE INHIBITORS OF PROTEIN ARGININE METHYLTRANSFERASE 5 (PRMT5)
A61K 31/4365 (2006.01)	3665169	CARBOXAMIDES AS UBIQUITIN-SPECIFIC PROTEASE INHIBITORS
A61K 31/496 (2006.01)	3665169	CARBOXAMIDES AS UBIQUITIN-SPECIFIC PROTEASE INHIBITORS
A61K 31/4995 (2006.01)	3665169	CARBOXAMIDES AS UBIQUITIN-SPECIFIC PROTEASE INHIBITORS
A61K 31/5386 (2006.01)	3665169	CARBOXAMIDES AS UBIQUITIN-SPECIFIC PROTEASE INHIBITORS
A61K 31/551 (2006.01)	3665169	CARBOXAMIDES AS UBIQUITIN-SPECIFIC PROTEASE INHIBITORS
A61P 35/00 (2006.01)	3665169	CARBOXAMIDES AS UBIQUITIN-SPECIFIC PROTEASE INHIBITORS
C07D 405/14 (2006.01)	3665169	CARBOXAMIDES AS UBIQUITIN-SPECIFIC PROTEASE INHIBITORS
C07D 471/04 (2006.01)	3665169	CARBOXAMIDES AS UBIQUITIN-SPECIFIC PROTEASE INHIBITORS
C07D 487/04 (2006.01)	3665169	CARBOXAMIDES AS UBIQUITIN-SPECIFIC PROTEASE INHIBITORS
C07D 495/04 (2006.01)	3665169	CARBOXAMIDES AS UBIQUITIN-SPECIFIC PROTEASE INHIBITORS
C07D 519/00 (2006.01)	3665169	CARBOXAMIDES AS UBIQUITIN-SPECIFIC PROTEASE INHIBITORS
A61K 35/17 (2015.01)	3664820	METHODS FOR PRODUCING GENETICALLY ENGINEERED CELL COMPOSITIONS AND RELATED COMPOSITIONS
A61K 39/00 (2006.01)	3664820	METHODS FOR PRODUCING GENETICALLY ENGINEERED CELL COMPOSITIONS AND RELATED COMPOSITIONS
A61K 39/395 (2006.01)	3664820	METHODS FOR PRODUCING GENETICALLY ENGINEERED CELL COMPOSITIONS AND RELATED COMPOSITIONS
A61K 39/44 (2006.01)	3664820	METHODS FOR PRODUCING GENETICALLY ENGINEERED CELL COMPOSITIONS AND RELATED COMPOSITIONS
C12N 5/0783 (2010.01)	3664820	METHODS FOR PRODUCING GENETICALLY ENGINEERED CELL COMPOSITIONS AND RELATED COMPOSITIONS
A61K 39/00 (2006.01)	3664835	METHODS AND COMPOSITIONS FOR PREPARING GENETICALLY ENGINEERED CELLS
C12N 5/0783 (2010.01)	3664835	METHODS AND COMPOSITIONS FOR PREPARING GENETICALLY ENGINEERED CELLS
A61K 31/505 (2006.01)	3645003	COMBINATION AND USES AND TREATMENTS THEREOF
A61K 31/513 (2006.01)	3645003	COMBINATION AND USES AND TREATMENTS THEREOF
A61K 31/675 (2006.01)	3645003	COMBINATION AND USES AND TREATMENTS THEREOF
A61K 31/435 (2006.01)	3645526	NEW QUINOLINONE COMPOUNDS
A61P 35/00 (2006.01)	3645526	NEW QUINOLINONE COMPOUNDS
C07D 403/02 (2006.01)	3645526	NEW QUINOLINONE COMPOUNDS
C07D 403/14 (2006.01)	3645526	NEW QUINOLINONE COMPOUNDS
A61K 31/396 (2006.01)	3645120	NK-1 ANTAGONIST COMPOSITIONS AND METHODS FOR USE IN TREATING DEPRESSION
A61K 31/425 (2006.01)	3645120	NK-1 ANTAGONIST COMPOSITIONS AND METHODS FOR USE IN TREATING DEPRESSION
A61K 45/06 (2006.01)	3645120	NK-1 ANTAGONIST COMPOSITIONS AND METHODS FOR USE IN TREATING DEPRESSION
A61P 25/24 (2006.01)	3645120	NK-1 ANTAGONIST COMPOSITIONS AND METHODS FOR USE IN TREATING DEPRESSION
C07D 498/04 (2006.01)	3645120	NK-1 ANTAGONIST COMPOSITIONS AND METHODS FOR USE IN TREATING DEPRESSION
A61K 31/437 (2006.01)	3646869	CHEMOTHERAPY FOR CANCER USING AZABICYCLO COMPOUND
A61K 39/395 (2006.01)	3646869	CHEMOTHERAPY FOR CANCER USING AZABICYCLO COMPOUND
A61K 45/00 (2006.01)	3646869	CHEMOTHERAPY FOR CANCER USING AZABICYCLO COMPOUND
A61P 35/00 (2006.01)	3646869	CHEMOTHERAPY FOR CANCER USING AZABICYCLO COMPOUND
A61P 37/04 (2006.01)	3646869	CHEMOTHERAPY FOR CANCER USING AZABICYCLO COMPOUND
A61P 43/00 (2006.01)	3646869	CHEMOTHERAPY FOR CANCER USING AZABICYCLO COMPOUND

MKP	Broj objave evropske prijave patenta	Naziv pronalaska
(51)	(97)	(54)
C07D 471/04 (2006.01)	3646869	CHEMOTHERAPY FOR CANCER USING AZABICYCLO COMPOUND
C07K 1/13 (2006.01)	3650470	NOVEL ANTI-HUMAN CEACAM5 ANTIBODY FAB FRAGMENT
C07K 16/30 (2006.01)	3650470	NOVEL ANTI-HUMAN CEACAM5 ANTIBODY FAB FRAGMENT
C12N 1/15 (2006.01)	3650470	NOVEL ANTI-HUMAN CEACAM5 ANTIBODY FAB FRAGMENT
C12N 1/19 (2006.01)	3650470	NOVEL ANTI-HUMAN CEACAM5 ANTIBODY FAB FRAGMENT
C12N 1/21 (2006.01)	3650470	NOVEL ANTI-HUMAN CEACAM5 ANTIBODY FAB FRAGMENT
C12N 5/10 (2006.01)	3650470	NOVEL ANTI-HUMAN CEACAM5 ANTIBODY FAB FRAGMENT
C12N 15/13 (2006.01)	3650470	NOVEL ANTI-HUMAN CEACAM5 ANTIBODY FAB FRAGMENT
C12N 15/63 (2006.01)	3650470	NOVEL ANTI-HUMAN CEACAM5 ANTIBODY FAB FRAGMENT
C12P 21/08 (2006.01)	3650470	NOVEL ANTI-HUMAN CEACAM5 ANTIBODY FAB FRAGMENT
G01N 33/574 (2006.01)	3650470	NOVEL ANTI-HUMAN CEACAM5 ANTIBODY FAB FRAGMENT
A61K 31/22 (2006.01)	3648756	STATIN COMPOSITIONS AND METHODS FOR USE IN TREATING SYNUCLEINOPATHIES
A61K 31/366 (2006.01)	3648756	STATIN COMPOSITIONS AND METHODS FOR USE IN TREATING SYNUCLEINOPATHIES
A61K 31/40 (2006.01)	3648756	STATIN COMPOSITIONS AND METHODS FOR USE IN TREATING SYNUCLEINOPATHIES
A61K 31/428 (2006.01)	3648756	STATIN COMPOSITIONS AND METHODS FOR USE IN TREATING SYNUCLEINOPATHIES
A61K 31/44 (2006.01)	3648756	STATIN COMPOSITIONS AND METHODS FOR USE IN TREATING SYNUCLEINOPATHIES
A61K 31/47 (2006.01)	3648756	STATIN COMPOSITIONS AND METHODS FOR USE IN TREATING SYNUCLEINOPATHIES
A61K 31/505 (2006.01)	3648756	STATIN COMPOSITIONS AND METHODS FOR USE IN TREATING SYNUCLEINOPATHIES
A61P 25/16 (2006.01)	3648756	STATIN COMPOSITIONS AND METHODS FOR USE IN TREATING SYNUCLEINOPATHIES
A61P 25/28 (2006.01)	3648756	STATIN COMPOSITIONS AND METHODS FOR USE IN TREATING SYNUCLEINOPATHIES
A61K 31/737 (2006.01)	3648775	BICONJUGATES WITH CHEMICALLY MODIFIED BACKBONES
A61K 38/01 (2006.01)	3648775	BICONJUGATES WITH CHEMICALLY MODIFIED BACKBONES
A61K 38/04 (2006.01)	3648775	BICONJUGATES WITH CHEMICALLY MODIFIED BACKBONES
A61K 38/39 (2006.01)	3648775	BICONJUGATES WITH CHEMICALLY MODIFIED BACKBONES
A61L 33/08 (2006.01)	3648775	BICONJUGATES WITH CHEMICALLY MODIFIED BACKBONES
A61P 1/16 (2006.01)	3648775	BICONJUGATES WITH CHEMICALLY MODIFIED BACKBONES
A61K 9/10 (2006.01)	3648767	TOPICAL FORMULATIONS COMPRISING MONTELUKAST AND COMBINATIONS WITH MUSSEL ADHESIVE PROTEINS
A61K 31/519 (2006.01)	3648767	TOPICAL FORMULATIONS COMPRISING MONTELUKAST AND COMBINATIONS WITH MUSSEL ADHESIVE PROTEINS
A61P 29/00 (2006.01)	3648767	TOPICAL FORMULATIONS COMPRISING MONTELUKAST AND COMBINATIONS WITH MUSSEL ADHESIVE PROTEINS
B65D 81/20 (2006.01)	3632816	READY-TO-EAT FOOD PRODUCT IN VACUUM PACKAGING
A61K 38/17 (2006.01)	3648785	ANTI-INFLAMMATORY USE OF PEPTIDE
A61P 17/00 (2006.01)	3648785	ANTI-INFLAMMATORY USE OF PEPTIDE
C07D 215/00 (2006.01)	3648785	ANTI-INFLAMMATORY USE OF PEPTIDE
A61K 31/715 (2006.01)	3648774	SYNTHETIC BIOCONJUGATES
A61K 31/727 (2006.01)	3648774	SYNTHETIC BIOCONJUGATES
A61K 31/728 (2006.01)	3648774	SYNTHETIC BIOCONJUGATES
A61K 31/737 (2006.01)	3648774	SYNTHETIC BIOCONJUGATES
A61K 38/00 (2006.01)	3648774	SYNTHETIC BIOCONJUGATES
A61K 38/08 (2019.01)	3648774	SYNTHETIC BIOCONJUGATES
A61K 41/00 (2020.01)	3651801	COMPOSITIONS AND METHODS FOR THE TREATMENT OF FUNGAL INFECTIONS
B82Y 10/00 (2011.01)	3652106	NEUTRAL ATOM QUANTUM INFORMATION PROCESSOR
G21K 1/00 (2006.01)	3652106	NEUTRAL ATOM QUANTUM INFORMATION PROCESSOR
G21K 1/02 (2006.01)	3652106	NEUTRAL ATOM QUANTUM INFORMATION PROCESSOR
A61K 31/381 (2006.01)	3651761	SCREENING PLATFORM TO IDENTIFY THERAPEUTIC DRUGS OR AGENTS FOR TREATMENT OF ALZHEIMER'S DISEASE
A61K 31/397 (2006.01)	3651761	SCREENING PLATFORM TO IDENTIFY THERAPEUTIC DRUGS OR AGENTS FOR TREATMENT OF ALZHEIMER'S DISEASE
C07K 14/47 (2006.01)	3651761	SCREENING PLATFORM TO IDENTIFY THERAPEUTIC DRUGS OR AGENTS FOR TREATMENT OF ALZHEIMER'S DISEASE
C07K 16/28 (2006.01)	3651761	SCREENING PLATFORM TO IDENTIFY THERAPEUTIC DRUGS OR AGENTS FOR TREATMENT OF ALZHEIMER'S DISEASE
A61K 31/5355 (2006.01)	3653623	METHOD FOR PRODUCING (2S)-2-[(1H-PYRAZOL-1-YL)METHYL]-1,3-OXAZINANE DERIVATIVE

MKP (51)	Broj objave evropske prijave patenta (97)	Naziv pronalaska (54)
A61P 25/20 (2006.01)	3653623	METHOD FOR PRODUCING (2S)-2-[(1H-PYRAZOL-1-YL)METHYL]-1,3-OXAZINANE DERIVATIVE
C07D 265/06 (2006.01)	3653623	METHOD FOR PRODUCING (2S)-2-[(1H-PYRAZOL-1-YL)METHYL]-1,3-OXAZINANE DERIVATIVE
C07D 413/14 (2006.01)	3653623	METHOD FOR PRODUCING (2S)-2-[(1H-PYRAZOL-1-YL)METHYL]-1,3-OXAZINANE DERIVATIVE
C12N 15/11 (2006.01)	3652316	INCORPORATION OF UNNATURAL NUCLEOTIDES AND METHODS THEREOF
C12P 21/00 (2006.01)	3652316	INCORPORATION OF UNNATURAL NUCLEOTIDES AND METHODS THEREOF
A61K 39/00 (2006.01)	3651794	CHLAMYDIA NANOEMULSION VACCINE
A61P 31/04 (2006.01)	3651794	CHLAMYDIA NANOEMULSION VACCINE
C07K 14/295 (2006.01)	3651794	CHLAMYDIA NANOEMULSION VACCINE
C12Q 1/68 (2018.01)	3653722	APPLICATION OF CAS PROTEIN, METHOD FOR DETECTING TARGET NUCLEIC ACID MOLECULE AND KIT
A61C 7/00 (2006.01)	3651683	USING IMMERSIVE PHOTOGRAPHS TO GUIDE PLACEMENT OF ORTHODONTIC BRACKETS, AND APPLICATIONS THEREOF
B65D 5/42 (2006.01)	3653528	RESOURCE-SAVING, ENVIRONMENTALLY FRIENDLY ADHESIVE-FREE CUP CARRIER
B65D 5/54 (2006.01)	3653528	RESOURCE-SAVING, ENVIRONMENTALLY FRIENDLY ADHESIVE-FREE CUP CARRIER
B65D 71/52 (2006.01)	3653528	RESOURCE-SAVING, ENVIRONMENTALLY FRIENDLY ADHESIVE-FREE CUP CARRIER
A61K 31/7088 (2006.01)	3651774	INCORPORATION OF UNNATURAL NUCLEOTIDES AND METHODS OF USE IN VIVO
C07K 14/405 (2006.01)	3651774	INCORPORATION OF UNNATURAL NUCLEOTIDES AND METHODS OF USE IN VIVO
C12N 5/10 (2006.01)	3651774	INCORPORATION OF UNNATURAL NUCLEOTIDES AND METHODS OF USE IN VIVO
C12N 9/22 (2006.01)	3651774	INCORPORATION OF UNNATURAL NUCLEOTIDES AND METHODS OF USE IN VIVO
C12N 15/10 (2006.01)	3651774	INCORPORATION OF UNNATURAL NUCLEOTIDES AND METHODS OF USE IN VIVO
C12N 15/113 (2010.01)	3651774	INCORPORATION OF UNNATURAL NUCLEOTIDES AND METHODS OF USE IN VIVO
A61K 47/68 (2017.01)	3658192	GLUCOCORTICOID RECEPTOR AGONIST AND IMMUNOCONJUGATES THEREOF
A61P 19/02 (2006.01)	3658192	GLUCOCORTICOID RECEPTOR AGONIST AND IMMUNOCONJUGATES THEREOF
C07K 16/24 (2006.01)	3658192	GLUCOCORTICOID RECEPTOR AGONIST AND IMMUNOCONJUGATES THEREOF
G06F 9/445 (2018.01)	3657327	METHOD FOR RENDERING GAME, AND METHOD, APPARATUS AND DEVICE FOR GENERATING GAME RESOURCE FILE
G06T 11/00 (2006.01)	3657327	METHOD FOR RENDERING GAME, AND METHOD, APPARATUS AND DEVICE FOR GENERATING GAME RESOURCE FILE
G06T 15/00 (2011.01)	3657327	METHOD FOR RENDERING GAME, AND METHOD, APPARATUS AND DEVICE FOR GENERATING GAME RESOURCE FILE
A61K 38/12 (2006.01)	3655011	METHODS FOR TREATMENT OR PREVENTION OF A NEUROLOGICAL IMMUNITY DISORDER
A61K 31/00 (2006.01)	3654956	COMPOSITIONS AND METHODS FOR TREATING DISEASES ASSOCIATED WITH AN IMPRINTING DEFECT
A61K 31/496 (2006.01)	3654956	COMPOSITIONS AND METHODS FOR TREATING DISEASES ASSOCIATED WITH AN IMPRINTING DEFECT
A61K 45/06 (2006.01)	3654956	COMPOSITIONS AND METHODS FOR TREATING DISEASES ASSOCIATED WITH AN IMPRINTING DEFECT
A61K 39/00 (2006.01)	3655026	ANTIGEN BINDING REGIONS AGAINST FIBRONECTIN TYPE III DOMAINS AND METHODS OF USING THE SAME
C07K 16/28 (2006.01)	3655026	ANTIGEN BINDING REGIONS AGAINST FIBRONECTIN TYPE III DOMAINS AND METHODS OF USING THE SAME
A61K 9/00 (2006.01)	3654953	EFFICACY OF A GASTRO-RETENTIVE BILE ACID SEQUESTRANT DOSAGE FORM
A61K 9/20 (2006.01)	3654953	EFFICACY OF A GASTRO-RETENTIVE BILE ACID SEQUESTRANT DOSAGE FORM
A61K 9/28 (2006.01)	3654953	EFFICACY OF A GASTRO-RETENTIVE BILE ACID SEQUESTRANT DOSAGE FORM
C07K 14/00 (2006.01)	3658570	TYROSINASE ANTISENSE OLIGONUCLEOTIDES
C12N 15/113 (2010.01)	3658570	TYROSINASE ANTISENSE OLIGONUCLEOTIDES

MKP (51)	Broj objave evropske prijave patenta (97)	Naziv pronalaska (54)
A61K 31/506 (2006.01)	3658552	IMPROVED PROCESS FOR PREPARING AMINOPYRIMIDINE DERIVATIVES
A61K 31/5377 (2006.01)	3658552	IMPROVED PROCESS FOR PREPARING AMINOPYRIMIDINE DERIVATIVES
C07D 413/14 (2006.01)	3658552	IMPROVED PROCESS FOR PREPARING AMINOPYRIMIDINE DERIVATIVES
E21B 43/30 (2006.01)	3658750	DRAINED RESERVOIR VOLUME DIAGNOSTICS FROM MANDEL-CRYER PRESSURE SIGNAL
E21B 47/06 (2012.01)	3658750	DRAINED RESERVOIR VOLUME DIAGNOSTICS FROM MANDEL-CRYER PRESSURE SIGNAL
G01V 1/00 (2006.01)	3658750	DRAINED RESERVOIR VOLUME DIAGNOSTICS FROM MANDEL-CRYER PRESSURE SIGNAL
A61K 31/015 (2006.01)	3658522	IMMUNOMODULATOR COMPOUNDS
A61P 37/02 (2006.01)	3658522	IMMUNOMODULATOR COMPOUNDS
C07C 15/24 (2006.01)	3658522	IMMUNOMODULATOR COMPOUNDS
A61K 31/506 (2006.01)	3658553	NOVEL INTERMEDIATES USEFUL FOR THE SYNTHESIS OF AMINOPYRIMIDINE DERIVATIVES, PROCESS FOR PREPARING THE SAME, AND PROCESS FOR PREPARING AMINOPYRIMIDINE DERIVATIVES USING THE SAME
A61K 31/5377 (2006.01)	3658553	NOVEL INTERMEDIATES USEFUL FOR THE SYNTHESIS OF AMINOPYRIMIDINE DERIVATIVES, PROCESS FOR PREPARING THE SAME, AND PROCESS FOR PREPARING AMINOPYRIMIDINE DERIVATIVES USING THE SAME
C07D 413/14 (2006.01)	3658553	NOVEL INTERMEDIATES USEFUL FOR THE SYNTHESIS OF AMINOPYRIMIDINE DERIVATIVES, PROCESS FOR PREPARING THE SAME, AND PROCESS FOR PREPARING AMINOPYRIMIDINE DERIVATIVES USING THE SAME
A01K 43/04 (2006.01)	3658893	A SYSTEM AND METHOD FOR NON-INVASIVELY DETERMINING EGG PROPERTIES
G01J 3/28 (2006.01)	3658893	A SYSTEM AND METHOD FOR NON-INVASIVELY DETERMINING EGG PROPERTIES
G01N 21/00 (2006.01)	3658893	A SYSTEM AND METHOD FOR NON-INVASIVELY DETERMINING EGG PROPERTIES
G01N 21/25 (2006.01)	3658893	A SYSTEM AND METHOD FOR NON-INVASIVELY DETERMINING EGG PROPERTIES
G01N 21/31 (2006.01)	3658893	A SYSTEM AND METHOD FOR NON-INVASIVELY DETERMINING EGG PROPERTIES
A61K 9/06 (2006.01)	3658142	COMPOSITIONS AND METHODS FOR TREATING GALACTOSEMIA
A61K 31/4188 (2006.01)	3658142	COMPOSITIONS AND METHODS FOR TREATING GALACTOSEMIA
A61K 31/575 (2006.01)	3658150	ISOTOPICALLY LABELED BILE ACID DERIVATIVES
C07J 9/00 (2006.01)	3658150	ISOTOPICALLY LABELED BILE ACID DERIVATIVES
A61K 31/506 (2006.01)	3658547	INTERMEDIATES USEFUL FOR THE SYNTHESIS OF A SELECTIVE INHIBITOR AGAINST PROTEIN KINASE AND PROCESSES FOR PREPARING THE SAME
C07D 403/04 (2006.01)	3658547	INTERMEDIATES USEFUL FOR THE SYNTHESIS OF A SELECTIVE INHIBITOR AGAINST PROTEIN KINASE AND PROCESSES FOR PREPARING THE SAME
C07D 413/14 (2006.01)	3658547	INTERMEDIATES USEFUL FOR THE SYNTHESIS OF A SELECTIVE INHIBITOR AGAINST PROTEIN KINASE AND PROCESSES FOR PREPARING THE SAME
A63F 13/52 (2014.01)	3659683	OBJECT DISPLAY METHOD AND DEVICE AND STORAGE MEDIUM
A61K 31/05 (2006.01)	3658137	CANNABINOID COMPOSITION HAVING AN OPTIMIZED FATTY ACID EXCIPIENT PROFILE
A61K 31/352 (2006.01)	3658137	CANNABINOID COMPOSITION HAVING AN OPTIMIZED FATTY ACID EXCIPIENT PROFILE
A61K 31/353 (2006.01)	3658137	CANNABINOID COMPOSITION HAVING AN OPTIMIZED FATTY ACID EXCIPIENT PROFILE
A61K 36/185 (2006.01)	3658137	CANNABINOID COMPOSITION HAVING AN OPTIMIZED FATTY ACID EXCIPIENT PROFILE
A61K 47/12 (2006.01)	3658137	CANNABINOID COMPOSITION HAVING AN OPTIMIZED FATTY ACID EXCIPIENT PROFILE
A61K 47/44 (2017.01)	3658137	CANNABINOID COMPOSITION HAVING AN OPTIMIZED FATTY ACID EXCIPIENT PROFILE
G02B 1/00 (2006.01)	3658985	HIGH FREQUENCY OPTICAL SWITCH AND FABRICATION METHODS THEREOF

MKP (51)	Broj objave evropske prijave patenta (97)	Naziv pronalaska (54)
G02F 1/19 (2019.01)	3658985	HIGH FREQUENCY OPTICAL SWITCH AND FABRICATION METHODS THEREOF
H04B 10/25 (2013.01)	3658985	HIGH FREQUENCY OPTICAL SWITCH AND FABRICATION METHODS THEREOF
G06Q 30/08 (2012.01)	3659098	MOBILE REVERSE BIDDING SYSTEM AND METHOD
A61K 31/7088 (2006.01)	3659609	THERAPEUTIC AGENT FOR FIBROSIS
A61K 31/7105 (2006.01)	3659609	THERAPEUTIC AGENT FOR FIBROSIS
A61K 31/713 (2006.01)	3659609	THERAPEUTIC AGENT FOR FIBROSIS
A61K 47/54 (2017.01)	3659609	THERAPEUTIC AGENT FOR FIBROSIS
A61K 48/00 (2006.01)	3659609	THERAPEUTIC AGENT FOR FIBROSIS
A61P 11/00 (2006.01)	3659609	THERAPEUTIC AGENT FOR FIBROSIS
A61P 43/00 (2006.01)	3659609	THERAPEUTIC AGENT FOR FIBROSIS
C12N 15/113 (2010.01)	3659609	THERAPEUTIC AGENT FOR FIBROSIS
A61F 9/007 (2006.01)	3661466	SYSTEMS AND METHODS FOR TISSUE DISSECTION IN CORNEAL TRANSPLANTS
A01N 43/78 (2006.01)	3661505	BENZOTHAZOLE AND RELATED COMPOUNDS
A61K 31/426 (2006.01)	3661505	BENZOTHAZOLE AND RELATED COMPOUNDS
A61P 25/28 (2006.01)	3661505	BENZOTHAZOLE AND RELATED COMPOUNDS
C07D 277/66 (2006.01)	3661505	BENZOTHAZOLE AND RELATED COMPOUNDS
A61K 31/282 (2006.01)	3638367	NANOSCALE METAL-ORGANIC LAYERS AND METAL-ORGANIC NANOPATES FOR X-RAY INDUCED PHOTODYNAMIC THERAPY, RADIOTHERAPY, RADIODYNAMIC THERAPY, CHEMOTHERAPY, IMMUNOTHERAPY, AND ANY COMBINATION THEREOF
A61N 5/06 (2006.01)	3638367	NANOSCALE METAL-ORGANIC LAYERS AND METAL-ORGANIC NANOPATES FOR X-RAY INDUCED PHOTODYNAMIC THERAPY, RADIOTHERAPY, RADIODYNAMIC THERAPY, CHEMOTHERAPY, IMMUNOTHERAPY, AND ANY COMBINATION THEREOF
C07D 487/22 (2006.01)	3638367	NANOSCALE METAL-ORGANIC LAYERS AND METAL-ORGANIC NANOPATES FOR X-RAY INDUCED PHOTODYNAMIC THERAPY, RADIOTHERAPY, RADIODYNAMIC THERAPY, CHEMOTHERAPY, IMMUNOTHERAPY, AND ANY COMBINATION THEREOF
A61K 38/20 (2006.01)	3661955	CYTOKINE CONJUGATES FOR THE TREATMENT OF AUTOIMMUNE DISEASES
C07K 14/55 (2006.01)	3661955	CYTOKINE CONJUGATES FOR THE TREATMENT OF AUTOIMMUNE DISEASES
C12N 15/26 (2006.01)	3661955	CYTOKINE CONJUGATES FOR THE TREATMENT OF AUTOIMMUNE DISEASES
A61K 39/395 (2006.01)	3661554	PROTEINS BINDING NKG2D, CD16 AND FLT3
C07K 16/28 (2006.01)	3661554	PROTEINS BINDING NKG2D, CD16 AND FLT3
C07K 16/46 (2006.01)	3661554	PROTEINS BINDING NKG2D, CD16 AND FLT3
A61K 38/20 (2006.01)	3661956	CYTOKINE CONJUGATES FOR THE TREATMENT OF PROLIFERATIVE AND INFECTIOUS DISEASES
C07K 14/55 (2006.01)	3661956	CYTOKINE CONJUGATES FOR THE TREATMENT OF PROLIFERATIVE AND INFECTIOUS DISEASES
C12N 15/26 (2006.01)	3661956	CYTOKINE CONJUGATES FOR THE TREATMENT OF PROLIFERATIVE AND INFECTIOUS DISEASES
A61K 39/02 (2006.01)	3661547	INDUCTION OF PROTECTIVE IMMUNITY AGAINST ANTIGENS
A61K 39/08 (2006.01)	3661547	INDUCTION OF PROTECTIVE IMMUNITY AGAINST ANTIGENS
A61P 31/04 (2006.01)	3661547	INDUCTION OF PROTECTIVE IMMUNITY AGAINST ANTIGENS
A61K 31/381 (2006.01)	3661498	BENZO[b]THIOPHENE STING AGONISTS FOR CANCER TREATMENT
A61K 31/385 (2006.01)	3661498	BENZO[b]THIOPHENE STING AGONISTS FOR CANCER TREATMENT
A61K 31/424 (2006.01)	3661498	BENZO[b]THIOPHENE STING AGONISTS FOR CANCER TREATMENT
A61K 31/381 (2006.01)	3661499	COMBINATIONS OF PD-1 ANTAGONISTS AND BENZO[b]
A61K 39/395 (2006.01)	3661499	COMBINATIONS OF PD-1 ANTAGONISTS AND BENZO[b]
A61P 35/00 (2006.01)	3661499	COMBINATIONS OF PD-1 ANTAGONISTS AND BENZO[b]
A61K 31/439 (2006.01)	3666766	PYRIDINE COMPOUND SUBSTITUTED WITH AZOLE
A61K 31/4439 (2006.01)	3666766	PYRIDINE COMPOUND SUBSTITUTED WITH AZOLE
A61K 31/444 (2006.01)	3666766	PYRIDINE COMPOUND SUBSTITUTED WITH AZOLE
A61K 31/506 (2006.01)	3666766	PYRIDINE COMPOUND SUBSTITUTED WITH AZOLE
A61K 31/5377 (2006.01)	3666766	PYRIDINE COMPOUND SUBSTITUTED WITH AZOLE
A61P 13/12 (2006.01)	3666766	PYRIDINE COMPOUND SUBSTITUTED WITH AZOLE
A61P 43/00 (2006.01)	3666766	PYRIDINE COMPOUND SUBSTITUTED WITH AZOLE

MKP	Broj objave evropske prijave patenta	Naziv pronalaska
(51)	(97)	(54)
C07D 401/04 (2006.01)	3666766	PYRIDINE COMPOUND SUBSTITUTED WITH AZOLE
C07D 401/14 (2006.01)	3666766	PYRIDINE COMPOUND SUBSTITUTED WITH AZOLE
C07D 405/14 (2006.01)	3666766	PYRIDINE COMPOUND SUBSTITUTED WITH AZOLE
C07D 409/14 (2006.01)	3666766	PYRIDINE COMPOUND SUBSTITUTED WITH AZOLE
C07D 413/04 (2006.01)	3666766	PYRIDINE COMPOUND SUBSTITUTED WITH AZOLE
C07D 413/14 (2006.01)	3666766	PYRIDINE COMPOUND SUBSTITUTED WITH AZOLE
C07D 417/04 (2006.01)	3666766	PYRIDINE COMPOUND SUBSTITUTED WITH AZOLE
C07D 451/02 (2006.01)	3666766	PYRIDINE COMPOUND SUBSTITUTED WITH AZOLE
C07D 487/04 (2006.01)	3666766	PYRIDINE COMPOUND SUBSTITUTED WITH AZOLE
C07D 498/04 (2006.01)	3666766	PYRIDINE COMPOUND SUBSTITUTED WITH AZOLE
G06K 9/00 (2006.01)	3665620	SYSTEM AND METHOD FOR THE VISUALIZATION AND CHARACTERIZATION OF OBJECTS IN IMAGES
G06K 9/46 (2006.01)	3665620	SYSTEM AND METHOD FOR THE VISUALIZATION AND CHARACTERIZATION OF OBJECTS IN IMAGES
C07C 211/38 (2006.01)	3665156	COMPOUNDS, COMPOSITIONS AND METHODS
C07C 217/52 (2006.01)	3665156	COMPOUNDS, COMPOSITIONS AND METHODS
C07C 233/05 (2006.01)	3665156	COMPOUNDS, COMPOSITIONS AND METHODS
A61K 31/195 (2006.01)	3664793	MACROCYCLIC IMMUNOMODULATORS
A61K 31/335 (2006.01)	3664793	MACROCYCLIC IMMUNOMODULATORS
C07C 15/24 (2006.01)	3664793	MACROCYCLIC IMMUNOMODULATORS
A61K 31/513 (2006.01)	3668514	SOLID PHARMACEUTICAL FORMULATIONS FOR TREATING ENDOMETRIOSIS, UTERINE FIBROIDS, POLYCYSTIC OVARY SYNDROME AND ADENOMYOSIS
A61K 31/565 (2006.01)	3668514	SOLID PHARMACEUTICAL FORMULATIONS FOR TREATING ENDOMETRIOSIS, UTERINE FIBROIDS, POLYCYSTIC OVARY SYNDROME AND ADENOMYOSIS
A61K 31/57 (2006.01)	3668514	SOLID PHARMACEUTICAL FORMULATIONS FOR TREATING ENDOMETRIOSIS, UTERINE FIBROIDS, POLYCYSTIC OVARY SYNDROME AND ADENOMYOSIS
A61K 31/395 (2006.01)	3668502	MACROCYCLIC MCL-1 INHIBITORS AND METHODS OF USE
A61P 35/00 (2006.01)	3668502	MACROCYCLIC MCL-1 INHIBITORS AND METHODS OF USE
C07D 515/22 (2006.01)	3668502	MACROCYCLIC MCL-1 INHIBITORS AND METHODS OF USE
C12N 9/12 (2006.01)	3668971	RNA POLYMERASE VARIANTS
C12N 15/10 (2006.01)	3668971	RNA POLYMERASE VARIANTS
C12N 15/10 (2006.01)	3668977	ANALYTICAL HPLC METHODS
G01N 30/02 (2006.01)	3668977	ANALYTICAL HPLC METHODS
A61K 38/00 (2006.01)	3668531	METHODS FOR TREATING AND/OR PREVENTING GRAFT-VERSUS-HOST DISEASE AND/OR DIFFUSE ALVEOLAR HEMORRHAGE AND/OR VENO-OCCLUSIVE DISEASE ASSOCIATED WITH HEMATOPOIETIC STEM CELL TRANSPLANT
A61K 38/48 (2006.01)	3668531	METHODS FOR TREATING AND/OR PREVENTING GRAFT-VERSUS-HOST DISEASE AND/OR DIFFUSE ALVEOLAR HEMORRHAGE AND/OR VENO-OCCLUSIVE DISEASE ASSOCIATED WITH HEMATOPOIETIC STEM CELL TRANSPLANT
A61K 39/395 (2006.01)	3668531	METHODS FOR TREATING AND/OR PREVENTING GRAFT-VERSUS-HOST DISEASE AND/OR DIFFUSE ALVEOLAR HEMORRHAGE AND/OR VENO-OCCLUSIVE DISEASE ASSOCIATED WITH HEMATOPOIETIC STEM CELL TRANSPLANT
C07K 16/40 (2006.01)	3668531	METHODS FOR TREATING AND/OR PREVENTING GRAFT-VERSUS-HOST DISEASE AND/OR DIFFUSE ALVEOLAR HEMORRHAGE AND/OR VENO-OCCLUSIVE DISEASE ASSOCIATED WITH HEMATOPOIETIC STEM CELL TRANSPLANT
C12N 9/50 (2006.01)	3668531	METHODS FOR TREATING AND/OR PREVENTING GRAFT-VERSUS-HOST DISEASE AND/OR DIFFUSE ALVEOLAR HEMORRHAGE AND/OR VENO-OCCLUSIVE DISEASE ASSOCIATED WITH HEMATOPOIETIC STEM CELL TRANSPLANT
A61K 9/51 (2006.01)	3668522	EFFICACIOUS MRNA VACCINES
A61K 31/7088 (2006.01)	3668522	EFFICACIOUS MRNA VACCINES
A61K 39/145 (2006.01)	3668522	EFFICACIOUS MRNA VACCINES
A61K 47/69 (2017.01)	3668522	EFFICACIOUS MRNA VACCINES
A61P 31/16 (2006.01)	3668522	EFFICACIOUS MRNA VACCINES
G01N 33/50 (2006.01)	3668522	EFFICACIOUS MRNA VACCINES
A61K 31/395 (2006.01)	3652184	MACROCYCLIC MCL-1 INHIBITORS AND METHODS OF USE

MKP (51)	Broj objave evropske prijave patenta (97)	Naziv pronalaska (54)
A61P 35/00 (2006.01)	3652184	MACROCYCLIC MCL-1 INHIBITORS AND METHODS OF USE
C07D 515/22 (2006.01)	3652184	MACROCYCLIC MCL-1 INHIBITORS AND METHODS OF USE
A61K 31/395 (2006.01)	3668504	MACROCYCLIC MCL-1 INHIBITORS AND METHODS OF USE
A61P 35/00 (2006.01)	3668504	MACROCYCLIC MCL-1 INHIBITORS AND METHODS OF USE
C07D 515/22 (2006.01)	3668504	MACROCYCLIC MCL-1 INHIBITORS AND METHODS OF USE
A63H 27/20 (2006.01)	3668794	SYSTEM AND METHOD FOR DISTRIBUTING POWER TO AIRCRAFT SYSTEMS
A63H 27/22 (2006.01)	3668794	SYSTEM AND METHOD FOR DISTRIBUTING POWER TO AIRCRAFT SYSTEMS
B64C 39/02 (2006.01)	3668794	SYSTEM AND METHOD FOR DISTRIBUTING POWER TO AIRCRAFT SYSTEMS
B64D 27/24 (2006.01)	3668794	SYSTEM AND METHOD FOR DISTRIBUTING POWER TO AIRCRAFT SYSTEMS
B64D 39/00 (2006.01)	3668794	SYSTEM AND METHOD FOR DISTRIBUTING POWER TO AIRCRAFT SYSTEMS
B64F 3/02 (2006.01)	3668794	SYSTEM AND METHOD FOR DISTRIBUTING POWER TO AIRCRAFT SYSTEMS
H02J 50/27 (2016.01)	3668794	SYSTEM AND METHOD FOR DISTRIBUTING POWER TO AIRCRAFT SYSTEMS
H02J 50/30 (2016.01)	3668794	SYSTEM AND METHOD FOR DISTRIBUTING POWER TO AIRCRAFT SYSTEMS
H02J 50/80 (2016.01)	3668794	SYSTEM AND METHOD FOR DISTRIBUTING POWER TO AIRCRAFT SYSTEMS
H02J 50/90 (2016.01)	3668794	SYSTEM AND METHOD FOR DISTRIBUTING POWER TO AIRCRAFT SYSTEMS
A61K 31/4184 (2006.01)	3668507	COMBINATION THERAPY
A61K 39/395 (2006.01)	3668507	COMBINATION THERAPY
A61P 35/00 (2006.01)	3668507	COMBINATION THERAPY
C07D 235/04 (2006.01)	3668507	COMBINATION THERAPY
C12N 15/10 (2006.01)	3668979	METHODS FOR HPLC ANALYSIS
G01N 30/02 (2006.01)	3668979	METHODS FOR HPLC ANALYSIS
A61K 31/513 (2006.01)	3668515	PHARMACEUTICAL FORMULATIONS FOR TREATING ENDOMETRIOSIS, UTERINE FIBROIDS, POLYCYSTIC OVARY SYNDROME OR ADENOMYOSIS
A61K 31/565 (2006.01)	3668515	PHARMACEUTICAL FORMULATIONS FOR TREATING ENDOMETRIOSIS, UTERINE FIBROIDS, POLYCYSTIC OVARY SYNDROME OR ADENOMYOSIS
A61K 31/57 (2006.01)	3668515	PHARMACEUTICAL FORMULATIONS FOR TREATING ENDOMETRIOSIS, UTERINE FIBROIDS, POLYCYSTIC OVARY SYNDROME OR ADENOMYOSIS
A61K 9/00 (2006.01)	3672653	LIPOSOMAL FORMULATION FOR JOINT LUBRICATION
A61K 9/127 (2006.01)	3672653	LIPOSOMAL FORMULATION FOR JOINT LUBRICATION
A61K 31/685 (2006.01)	3672653	LIPOSOMAL FORMULATION FOR JOINT LUBRICATION
A61L 27/50 (2006.01)	3672653	LIPOSOMAL FORMULATION FOR JOINT LUBRICATION
A61K 39/395 (2006.01)	3672994	HIGHLY CONCENTRATED LOW VISCOSITY MASP-2 INHIBITORY ANTIBODY FORMULATIONS, KITS, AND METHODS OF TREATING SUBJECTS SUFFERING FROM ATYPICAL HEMOLYTIC SYNDROME
A61K 45/06 (2006.01)	3672994	HIGHLY CONCENTRATED LOW VISCOSITY MASP-2 INHIBITORY ANTIBODY FORMULATIONS, KITS, AND METHODS OF TREATING SUBJECTS SUFFERING FROM ATYPICAL HEMOLYTIC SYNDROME
C07K 16/40 (2006.01)	3672994	HIGHLY CONCENTRATED LOW VISCOSITY MASP-2 INHIBITORY ANTIBODY FORMULATIONS, KITS, AND METHODS OF TREATING SUBJECTS SUFFERING FROM ATYPICAL HEMOLYTIC SYNDROME
G01C 21/00 (2006.01)	3675084	MAP DISPLAY METHOD, APPARATUS, STORAGE MEDIUM AND TERMINAL
G09B 29/00 (2006.01)	3675084	MAP DISPLAY METHOD, APPARATUS, STORAGE MEDIUM AND TERMINAL
B67D 7/00 (2010.01)	3655360	A SMART FUELING ELBOW
G01N 27/22 (2006.01)	3655360	A SMART FUELING ELBOW
A01N 43/40 (2006.01)	3674291	CYCLIC AMINE COMPOUND AND PEST CONTROL AGENT
A01N 43/56 (2006.01)	3674291	CYCLIC AMINE COMPOUND AND PEST CONTROL AGENT
A01N 43/60 (2006.01)	3674291	CYCLIC AMINE COMPOUND AND PEST CONTROL AGENT
A01N 43/72 (2006.01)	3674291	CYCLIC AMINE COMPOUND AND PEST CONTROL AGENT
A01N 43/76 (2006.01)	3674291	CYCLIC AMINE COMPOUND AND PEST CONTROL AGENT
A01N 43/80 (2006.01)	3674291	CYCLIC AMINE COMPOUND AND PEST CONTROL AGENT

MKP (51)	Broj objave evropske prijave patenta (97)	Naziv pronalaska (54)
A01N 43/836 (2006.01)	3674291	CYCLIC AMINE COMPOUND AND PEST CONTROL AGENT
A01N 43/84 (2006.01)	3674291	CYCLIC AMINE COMPOUND AND PEST CONTROL AGENT
A01N 43/86 (2006.01)	3674291	CYCLIC AMINE COMPOUND AND PEST CONTROL AGENT
A01N 43/90 (2006.01)	3674291	CYCLIC AMINE COMPOUND AND PEST CONTROL AGENT
A01N 47/02 (2006.01)	3674291	CYCLIC AMINE COMPOUND AND PEST CONTROL AGENT
A01N 47/16 (2006.01)	3674291	CYCLIC AMINE COMPOUND AND PEST CONTROL AGENT
A01N 47/40 (2006.01)	3674291	CYCLIC AMINE COMPOUND AND PEST CONTROL AGENT
A01P 7/02 (2006.01)	3674291	CYCLIC AMINE COMPOUND AND PEST CONTROL AGENT
A01P 7/04 (2006.01)	3674291	CYCLIC AMINE COMPOUND AND PEST CONTROL AGENT
A61K 31/444 (2006.01)	3674291	CYCLIC AMINE COMPOUND AND PEST CONTROL AGENT
A61K 31/4545 (2006.01)	3674291	CYCLIC AMINE COMPOUND AND PEST CONTROL AGENT
A61K 31/496 (2006.01)	3674291	CYCLIC AMINE COMPOUND AND PEST CONTROL AGENT
A61K 31/5355 (2006.01)	3674291	CYCLIC AMINE COMPOUND AND PEST CONTROL AGENT
A61K 31/5377 (2006.01)	3674291	CYCLIC AMINE COMPOUND AND PEST CONTROL AGENT
C07D 213/85 (2006.01)	3674291	CYCLIC AMINE COMPOUND AND PEST CONTROL AGENT
C07K 1/14 (2006.01)	3672981	METHODS FOR PURIFYING ANTIBODIES HAVING REDUCED HIGH MOLECULAR WEIGHT AGGREGATES
C07K 1/16 (2006.01)	3672981	METHODS FOR PURIFYING ANTIBODIES HAVING REDUCED HIGH MOLECULAR WEIGHT AGGREGATES
C07K 16/00 (2006.01)	3672981	METHODS FOR PURIFYING ANTIBODIES HAVING REDUCED HIGH MOLECULAR WEIGHT AGGREGATES
B01J 19/00 (2006.01)	3672725	COMPOSITIONS, METHODS, AND APPARATUSES FOR CATALYTIC COMBUSTION
B01J 23/89 (2006.01)	3672725	COMPOSITIONS, METHODS, AND APPARATUSES FOR CATALYTIC COMBUSTION
B01J 37/34 (2006.01)	3672725	COMPOSITIONS, METHODS, AND APPARATUSES FOR CATALYTIC COMBUSTION
B25B 11/00 (2006.01)	3672759	METHOD OF SLICING A FOOD ITEM AND SLICING MECHANISM EMPLOYING A GRIPPING ELEMENT THAT GENERATES A VACUUM GRIP
A61K 45/00 (2006.01)	3674325	FUSION PROTEIN OF DCTN1 PROTEIN WITH RET PROTEIN
A61P 35/00 (2006.01)	3674325	FUSION PROTEIN OF DCTN1 PROTEIN WITH RET PROTEIN
C07K 14/47 (2006.01)	3674325	FUSION PROTEIN OF DCTN1 PROTEIN WITH RET PROTEIN
C07K 14/82 (2006.01)	3674325	FUSION PROTEIN OF DCTN1 PROTEIN WITH RET PROTEIN
C07K 16/18 (2006.01)	3674325	FUSION PROTEIN OF DCTN1 PROTEIN WITH RET PROTEIN
C07K 16/32 (2006.01)	3674325	FUSION PROTEIN OF DCTN1 PROTEIN WITH RET PROTEIN
C07K 19/00 (2006.01)	3674325	FUSION PROTEIN OF DCTN1 PROTEIN WITH RET PROTEIN
C12N 1/15 (2006.01)	3674325	FUSION PROTEIN OF DCTN1 PROTEIN WITH RET PROTEIN
C12N 1/19 (2006.01)	3674325	FUSION PROTEIN OF DCTN1 PROTEIN WITH RET PROTEIN
C12N 1/21 (2006.01)	3674325	FUSION PROTEIN OF DCTN1 PROTEIN WITH RET PROTEIN
C12N 5/10 (2006.01)	3674325	FUSION PROTEIN OF DCTN1 PROTEIN WITH RET PROTEIN
C12N 9/12 (2006.01)	3674325	FUSION PROTEIN OF DCTN1 PROTEIN WITH RET PROTEIN
C12N 15/12 (2006.01)	3674325	FUSION PROTEIN OF DCTN1 PROTEIN WITH RET PROTEIN
C12N 15/54 (2006.01)	3674325	FUSION PROTEIN OF DCTN1 PROTEIN WITH RET PROTEIN
C12N 15/63 (2006.01)	3674325	FUSION PROTEIN OF DCTN1 PROTEIN WITH RET PROTEIN
C12Q 1/02 (2006.01)	3674325	FUSION PROTEIN OF DCTN1 PROTEIN WITH RET PROTEIN
C12Q 1/6806 (2018.01)	3674325	FUSION PROTEIN OF DCTN1 PROTEIN WITH RET PROTEIN
C12Q 1/6813 (2018.01)	3674325	FUSION PROTEIN OF DCTN1 PROTEIN WITH RET PROTEIN
G01N 33/15 (2006.01)	3674325	FUSION PROTEIN OF DCTN1 PROTEIN WITH RET PROTEIN
G01N 33/53 (2006.01)	3674325	FUSION PROTEIN OF DCTN1 PROTEIN WITH RET PROTEIN
A61K 9/08 (2006.01)	3673918	ANTIBODY-DRUG CONJUGATE PREPARATION AND LYOPHILIZATION FOR SAME
A61K 9/19 (2006.01)	3673918	ANTIBODY-DRUG CONJUGATE PREPARATION AND LYOPHILIZATION FOR SAME
A61K 31/4745 (2006.01)	3673918	ANTIBODY-DRUG CONJUGATE PREPARATION AND LYOPHILIZATION FOR SAME
A61K 39/395 (2006.01)	3673918	ANTIBODY-DRUG CONJUGATE PREPARATION AND LYOPHILIZATION FOR SAME
A61K 47/10 (2017.01)	3673918	ANTIBODY-DRUG CONJUGATE PREPARATION AND LYOPHILIZATION FOR SAME
A61K 47/22 (2006.01)	3673918	ANTIBODY-DRUG CONJUGATE PREPARATION AND LYOPHILIZATION FOR SAME
A61K 47/26 (2006.01)	3673918	ANTIBODY-DRUG CONJUGATE PREPARATION AND LYOPHILIZATION FOR SAME
A61K 47/68 (2017.01)	3673918	ANTIBODY-DRUG CONJUGATE PREPARATION AND LYOPHILIZATION FOR SAME
A61P 35/00 (2006.01)	3673918	ANTIBODY-DRUG CONJUGATE PREPARATION AND LYOPHILIZATION FOR SAME

MKP (51)	Broj objave evropske prijave patenta (97)	Naziv pronalaska (54)
A61P 35/02 (2006.01)	3673918	ANTIBODY-DRUG CONJUGATE PREPARATION AND LYOPHILIZATION FOR SAME
C07K 16/00 (2006.01)	3673918	ANTIBODY-DRUG CONJUGATE PREPARATION AND LYOPHILIZATION FOR SAME
C07K 19/00 (2006.01)	3673918	ANTIBODY-DRUG CONJUGATE PREPARATION AND LYOPHILIZATION FOR SAME
A61K 31/712 (2006.01)	3672601	PROCESSES FOR PREPARING PHOSPHORODIAMIDATE MORPHOLINO OLIGOMERS VIA FAST-FLOW SYNTHESIS
A61K 31/7125 (2006.01)	3672601	PROCESSES FOR PREPARING PHOSPHORODIAMIDATE MORPHOLINO OLIGOMERS VIA FAST-FLOW SYNTHESIS
C12N 15/113 (2010.01)	3672601	PROCESSES FOR PREPARING PHOSPHORODIAMIDATE MORPHOLINO OLIGOMERS VIA FAST-FLOW SYNTHESIS
A61K 31/05 (2006.01)	3645027	CANNABINOID EXTRACTION PROCESS USING BRINE
A61K 31/352 (2006.01)	3645027	CANNABINOID EXTRACTION PROCESS USING BRINE
A61K 36/185 (2006.01)	3645027	CANNABINOID EXTRACTION PROCESS USING BRINE
B01D 11/02 (2006.01)	3645027	CANNABINOID EXTRACTION PROCESS USING BRINE
C07C 39/23 (2006.01)	3645027	CANNABINOID EXTRACTION PROCESS USING BRINE
C07D 311/80 (2006.01)	3645027	CANNABINOID EXTRACTION PROCESS USING BRINE
C07H 21/02 (2006.01)	3668997	MiRNA DETARGETING SYSTEM FOR TISSUE SPECIFIC INTERFERENCE
C12Q 1/68 (2018.01)	3668997	MiRNA DETARGETING SYSTEM FOR TISSUE SPECIFIC INTERFERENCE
A61K 31/00 (2006.01)	3672579	COMPOSITIONS AND METHODS FOR TREATING AGE-RELATED MACULAR DEGENERATION AND GEOGRAPHIC ATROPHY
A61K 39/395 (2006.01)	3672579	COMPOSITIONS AND METHODS FOR TREATING AGE-RELATED MACULAR DEGENERATION AND GEOGRAPHIC ATROPHY
A61P 27/02 (2006.01)	3672579	COMPOSITIONS AND METHODS FOR TREATING AGE-RELATED MACULAR DEGENERATION AND GEOGRAPHIC ATROPHY
C12N 15/113 (2010.01)	3672579	COMPOSITIONS AND METHODS FOR TREATING AGE-RELATED MACULAR DEGENERATION AND GEOGRAPHIC ATROPHY
A01K 61/54 (2017.01)	3651570	DOUBLE PIPE CULTIVATION SYSTEM FOR REDUCING LOSSES OCCURRING DUE TO WIND, WAVE AND TIDE IN MUSSEL CULTIVATION FARMS
A01K 61/65 (2017.01)	3651570	DOUBLE PIPE CULTIVATION SYSTEM FOR REDUCING LOSSES OCCURRING DUE TO WIND, WAVE AND TIDE IN MUSSEL CULTIVATION FARMS
F16H 59/02 (2006.01)	3639108	SEALED REVERSE-FORWARD LEVER
G05G 25/04 (2006.01)	3639108	SEALED REVERSE-FORWARD LEVER
C04B 14/02 (2006.01)	3495335	PROCESS FOR THE PRODUCTION OF A GEOPOLYMER COMPOSITE
C04B 28/00 (2006.01)	3495335	PROCESS FOR THE PRODUCTION OF A GEOPOLYMER COMPOSITE
C08J 9/00 (2006.01)	3495335	PROCESS FOR THE PRODUCTION OF A GEOPOLYMER COMPOSITE
C08J 9/16 (2006.01)	3495335	PROCESS FOR THE PRODUCTION OF A GEOPOLYMER COMPOSITE

Indeks podnosilaca zahtjeva za proširenje evropskih prijava patenta

Podnosilac evropske prijave patenta (71)	MKP (51)	Broj objave evropske prijave patenta (97)	Naziv pronalaska (54)		
CENTRE NATIONAL DE LA RECHERCHE SCIENTIFIQUE Institut national de recherche pour l'agriculture, l'alimentation et l'environnement	B65B 25/00 (2006.01)	3168608	USE OF BIOPOLYMER IN A DIELECTRIC GAS SENSOR		
	G01N 27/22 (2006.01)				
	G01N 33/02 (2006.01)				
	G01N 33/12 (2006.01)				
PLANSEE COMPOSITE MATERIALS GMBH	A01N 43/42 (2006.01)	3260457	PROCESS FOR PREPARING CARBAMOYL PYRIDONE DERIVATIVES AND INTERMEDIATES		
	A61K 31/44 (2006.01)				
	C07D 213/68 (2006.01)				
	C07D 213/80 (2006.01)				
	C07D 498/14 (2006.01)				
PLANSEE COMPOSITE MATERIALS GMBH	C04B 35/58 (2006.01)	3556901	VACUUM ARC SOURCE		
	C23C 14/06 (2006.01)				
	C23C 14/32 (2006.01)				
	C23C 14/56 (2006.01)				
	H01J 37/32 (2006.01)				
	C09C 1/02 (2006.01)			3561002	USE OF ADDITIVES CONTAINING PRIMARY ALKANOLAMINES IN AQUEOUS MINERAL SUSPENSIONS
	D21H 17/67 (2006.01)				
Höhn Neigungstechnik GmbH	H01H 1/00 (2006.01)	3564980	TWO-WIRE TILT SWITCH		
	H01H 35/02 (2006.01)				
	H01H 35/06 (2006.01)				
	E04B 1/348 (2006.01)			3669032	FRAME, BASIC FRAMEWORK, MODULE, PROFILE AND SET OF STRUCTURAL ELEMENTS FOR MODULAR CONSTRUCTION AND A MODULAR-CONSTRUCTION BUILDING
	E04B 9/06 (2006.01)				
	E04C 3/04 (2006.01)				
Höhn Neigungstechnik GmbH	E04C 3/07 (2006.01)	3654910	CONSTRUCTION AND A MODULAR-CONSTRUCTION BUILDING		
	A61J 1/20 (2006.01)			DRUG MIXING DEVICE	
	A61J 1/20 (2006.01)			DRUG MIXING DEVICE	
	A61J 1/20 (2006.01)			DRUG MIXING DEVICE	
	A61J 1/20 (2006.01)			DRUG MIXING DEVICE	
	A61J 1/20 (2006.01)			DRUG MIXING DEVICE	
	A61J 1/20 (2006.01)			DRUG MIXING DEVICE	
	A61J 1/20 (2006.01)			DRUG MIXING DEVICE	
	A61J 1/20 (2006.01)			DRUG MIXING DEVICE	
	A61J 1/20 (2006.01)			DRUG MIXING DEVICE	
	A61J 1/20 (2006.01)			DRUG MIXING DEVICE	
	A61J 1/20 (2006.01)			DRUG MIXING DEVICE	
	A61K 39/395 (2006.01)			3638694	COMPOSITIONS AND METHODS FOR TREATING TAUOPATHIES
	A61P 25/28 (2006.01)			3648848	INSTALLED FIRE EXTINGUISHING EQUIPMENT WITH EXTINGUISHING-LAUNCHING PART-UNIT
C07K 16/18 (2006.01)					
Swiss Fire Protection Research & Development AG	A62C 3/06 (2006.01)	3648849	INSTALLED FIRE EXTINGUISHING EQUIPMENT WITH IMPROVED CHARACTERISTICS		
	A62C 35/02 (2006.01)				
	A62C 35/62 (2006.01)				
	A62C 99/00 (2010.01)				
	A62C 3/06 (2006.01)				
	A62C 35/02 (2006.01)				
	A62C 35/15 (2006.01)				
	A62C 35/60 (2006.01)				
	A62C 99/00 (2010.01)				
A62D 1/02 (2006.01)	3648850	POST-FOAMING COMPOSITION FOR PROTECTION AGAINST FIRE AND/OR HEAT			
Inibsa Ginecologia, S.A.	A61K 9/48 (2006.01)	3628311	A PROCESS FOR THE PREPARATION OF A MODIFIED RELEASE MULTIPLE UNIT ORAL DOSAGE FORM OF DOXYLAMINE SUCCINATE AND PYRIDOXINE HYDROCHLORIDE SUSTAINED RELEASE PYRIDOSTIGMINE COMPOSITIONS		
	A61K 9/50 (2006.01)				
	A61K 31/4402 (2006.01)				
	A61K 31/4415 (2006.01)				
	A61K 9/20 (2006.01)			3556357	
A61K 9/28 (2006.01)					
A61K 9/50 (2006.01)					
Inibsa Ginecologia, S.A.	A61K 31/00 (2006.01)	3556357	SUSTAINED RELEASE PYRIDOSTIGMINE COMPOSITIONS		
	A61K 31/00 (2006.01)				

Podnosilac evropske prijave patenta (71)	MKP (51)	Broj objave evropske prijave patenta (97)	Naziv pronalaska (54)		
Universitatea din Bucuresti	G01N 33/487 (2006.01)	3546935	METHOD FOR IN VITRO DETECTION OF THE PROARRHYTHMOGENIC RISK OF A DRUG CANDIDATE ON HUMAN INDUCED PLURIPOTENT STEM CELL- DERIVED CARDIOMYOCYTES (HIPSC-CM)		
	G01N 33/50 (2006.01)				
SIMMEL DIFESA S.p.A.	A61K 9/00 (2006.01)	3641728	AN OIL-IN-WATER NANOEMULSION COMPOSITION OF CLOBETASOL		
	A61K 9/107 (2006.01)				
	A61K 31/00 (2006.01)				
	A61K 47/14 (2017.01)				
	A61K 47/26 (2006.01)				
	A61K 47/34 (2017.01)				
Big Elk Energy Systems, LLC	C06B 25/20 (2006.01)	3642175	COMPOSITION FOR SINGLE- BASE PROPELLING POWDER FOR AMMUNITION AND AMMUNITION PROVIDED WITH SUCH COMPOSITION PORTABLE VERIFICATION SYSTEM AND METHOD USED TO VERIFY AN IN-FIELD GAS FLOW METER		
	C06B 45/10 (2006.01)				
Big Elk Energy Systems, LLC	F16L 17/00 (2006.01)	3638992	PORTABLE VERIFICATION SYSTEM AND METHOD USED TO VERIFY AN IN-FIELD GAS FLOW METER		
	G01F 1/66 (2006.01)				
	G01F 15/00 (2006.01)				
	G01F 25/00 (2006.01)				
	B60T 1/06 (2006.01)			3642509	BRAKING DEVICE AND METHOD
	B60T 1/10 (2006.01)				
	B60T 1/12 (2006.01)				
	B60T 13/06 (2006.01)				
	F16D 61/00 (2006.01)				
	F16D 63/00 (2006.01)				
Infuser IP ApS	F16H 33/10 (2006.01)	3533510	AN EXHAUST GAS TREATMENT METHOD AND SYSTEM ARRANGED FOR TREATING EXHAUST GASES MODULAR CONTROL SYSTEM		
	G01C 19/00 (2013.01)				
	B01D 53/72 (2006.01)				
CRMT	B01D 53/86 (2006.01)	3534226	A SYSTEM AND METHOD FOR ACCURATELY MEASURING NOX AND NH3 CONTENTS IN EXHAUST FUMES		
	G05B 19/042 (2006.01)				
Trisomytest, s.r.o.	F01N 13/00 (2010.01)	3536921	A METHOD FOR NON- INVASIVE PRENATAL DETECTION OF FETAL CHROMOSOME ANEUPLOIDY FROM MATERNAL BLOOD BASED ON BAYESIAN NETWORK		
	C12Q 1/6869 (2018.01)			3658689	A METHOD FOR NON- INVASIVE PRENATAL DETECTION OF FETAL CHROMOSOME ANEUPLOIDY FROM MATERNAL BLOOD BASED ON BAYESIAN NETWORK
	C12Q 1/6883 (2018.01)				
GREEN UNION S.R.L.	G16B 30/00 (2019.01)	3654917	DRUG MIXING DEVICE		
	A61J 1/20 (2006.01)				
	A01G 17/06 (2006.01)	3672396	IMPROVED ELASTIC COMPENSATION DEVICE FOR ROWS OF PLANTS AND METHOD OF USE THEREOF		
	A61J 1/20 (2006.01)	3654918	DRUG MIXING DEVICE		
	C12Q 1/6879 (2018.01)	3662479	A METHOD FOR NON- INVASIVE PRENATAL DETECTION OF FETAL SEX CHROMOSOMAL ABNORMALITIES AND FETAL SEX DETERMINATION FOR SINGLETON AND TWIN PREGNANCIES		
	G16B 20/00 (2019.01)				
	G16B 30/00 (2019.01)				
	G16B 30/00 (2019.01)				
	GREEN UNION S.R.L.	C08J 11/24 (2006.01)	3638720	TREATMENT PLANT AND METHOD FOR PET GLYCOLYSIS	
		C08L 67/02 (2006.01)			
A61M 5/178 (2006.01)		3665612	IMAGE PROCESSING TECHNIQUES FOR PLUNGER DEPTH MEASUREMENT		
G06K 9/00 (2006.01)					
G06K 9/32 (2006.01)					
G06T 7/62 (2017.01)					

Podnosilac evropske prijave patenta (71)	MKP (51)	Broj objave evropske prijave patenta (97)	Naziv pronalaska (54)	
Veolia environnement-VE	C02F 1/52 (2006.01)	3567012	METHOD FOR OPERATING A WASTEWATER TREATMENT PLANT FOR PHOSPHORUS TREATMENT OF EFFLUENT	
	C02F 1/66 (2006.01)			
	C02F 3/30 (2006.01)			
	C02F 11/04 (2006.01)			
	C02F 101/10 (2006.01)			
	B26D 7/18 (2006.01)			
	B26F 1/02 (2006.01)	3656518	DEVICE FOR DIE-CUTTING AND EJECTING ELASTOMER STOPPERS	
Industrias Tecnológicas de Mecanización y Automatización, S.A.	B26D 7/01 (2006.01)	3656519	AUTOMATED DEVICE FOR MANUFACTURING ELASTOMER STOPPERS	
	B26D 7/18 (2006.01)			
	B26F 1/02 (2006.01)			
	B26F 1/38 (2006.01)			
Bencze, Gyula	A23L 7/104 (2016.01)	3659444	GLUTEN-FREE GRAIN-CONCENTRATE SUBSTITUTE FOR FERMENTED WHEAT GERM FOOD PRODUCT AND METHOD OF PREPARATION	
Eloxalwerk Ludwigsburg Helmut Zerrer GmbH FRAUNHOFER-GESELLSCHAFT zur Förderung der angewandten Forschung e.V.	B05D 3/02 (2006.01)	3498383	DEVICE FOR COATING WORKPIECES WITH AT LEAST ONE HIGH PERFORMANCE POLYMER; COATING METHOD	
	B05D 3/06 (2006.01)			
	B05D 5/08 (2006.01)	3508283	COATING DISPERSION; METHOD OF MANUFACTURING A COATING DISPERSION	
	G03G 15/00 (2006.01)	3543793	IMAGE FORMING APPARATUS AND CARTRIDGE	
	G03G 21/16 (2006.01)			
	G03G 21/18 (2006.01)			
	C40B 40/10 (2006.01)	3540100	FIBRONECTIN TYOE III REPEAT BASED PROTEIN SCAFFOLDS WITH ALTERNATIVE BINDING SURFACES	
	C40B 50/00 (2006.01)			
		A61K 38/12 (2006.01)	3527218	PRO-COAGULANT COMPOUNDS AND METHODS OF USE THEREOF
		C12N 15/10 (2006.01)	3540059	BI-FUNCTIONAL COMPLEXES AND METHODS FOR MAKING AND USING SUCH COMPLEXES
	A01G 5/06 (2006.01)	3666070	METHOD FOR PRESERVATION OF AT LEAST ONE CUT FLOWER FOR TRANSPORT PURPOSES AND CUT FLOWER OBTAINED BY THE METHOD	
	A01N 3/02 (2006.01)			
CERN - European Organization For Nuclear Research SOULDAL	A61N 5/10 (2006.01)	3573075	A GANTRY AND APPARATUS FOR FOCUSING BEAMS OF CHARGED PARTICLES	
	G21K 1/093 (2006.01)			
	G21K 5/04 (2006.01)	3574989	DISPENSING SYSTEM FOR MIXTURE OF TWO COMPONENTS AND STATIC MIXING NOZZLE THEREFOR	
	B01F 3/10 (2006.01)			
	B01F 5/06 (2006.01)			
	B01F 15/02 (2006.01)			
	B05B 7/04 (2006.01)	3539984	METHODS OF TREATING CONDITIONS WITH ANTIBODIES THAT BIND COLONY STIMULATING FACTOR 1 RECEPTOR (CSF1R)	
	B29B 7/74 (2006.01)			
	A61K 39/395 (2006.01)			
	A61P 35/00 (2006.01)			
	C07K 16/28 (2006.01)	3483143	AS MDM2 INHIBITORS FOR THE TREATMENT OF CANCER	
A61K 31/4412 (2006.01)				
A61P 35/00 (2006.01)				
C07D 211/40 (2006.01)				
C07D 279/02 (2006.01)				
C07D 401/04 (2006.01)				
C07D 401/06 (2006.01)				
C07D 401/12 (2006.01)				
C07D 407/04 (2006.01)				

Podnosilac evropske prijave patenta (71)	MKP (51)	Broj objave evropske prijave patenta (97)	Naziv pronalaska (54)			
VdS Schadenverhütung GmbH	C07D 407/06 (2006.01)	3650829	TEST SYSTEM FOR PERFORMING A FIRE RESISTANCE PERIOD TEST FOR A WATER FLOW VALVE			
	C07D 409/04 (2006.01)					
	C07D 413/06 (2006.01)					
	C07D 417/06 (2006.01)					
	C07D 471/20 (2006.01)					
	C07D 498/08 (2006.01)					
	C07D 498/20 (2006.01)					
	A62C 37/11 (2006.01)					
	G01M 99/00 (2011.01)					
	Meso Scale Technologies, LLC.			A61K 39/395 (2006.01)	3520816	ANTI-GCC ANTIBODY MOLECULES AND RELATED COMPOSITIONS AND METHODS
A61P 35/00 (2006.01)		3511717	BIODOSIMETRY PANELS AND METHODS			
C07K 16/30 (2006.01)						
C07K 16/40 (2006.01)						
G01N 33/569 (2006.01)						
G01N 33/68 (2006.01)						
G01T 1/00 (2006.01)						
A61K 39/395 (2006.01)						
A61P 17/06 (2006.01)						
A61P 25/00 (2006.01)						
A61P 35/00 (2006.01)						
Messer Belgium N.V.	C07K 16/30 (2006.01)	3530287	ANTI-MCAM ANTIBODIES AND ASSOCIATED METHODS OF USE			
	A61K 38/36 (2006.01)	3552619	FACTOR IX POLYPEPTIDES AND METHODS OF USE THEREOF			
	A61K 38/48 (2006.01)					
	A61K 39/395 (2006.01)					
	A61P 7/04 (2006.01)					
	A61B 17/068 (2006.01)					
	A61B 17/072 (2006.01)					
	C07D 207/26 (2006.01)					
	B65B 9/06 (2012.01)			3508142	DEVICES FOR FACILITATING CLOSING AND CLAMPING OF AN END EFFECTOR OF A SURGICAL DEVICE	
	B65B 9/20 (2012.01)			3536685	BICYCLIC-FUSED HETEROARYL OR ARYL COMPOUNDS AND THEIR USE AS IRAK4 INHIBITORS	
B65B 31/04 (2006.01)						
F25D 3/10 (2006.01)						
A01N 43/80 (2006.01)						
A01N 43/90 (2006.01)						
A61K 31/437 (2006.01)						
A61K 38/05 (2006.01)						
A61K 45/06 (2006.01)						
A61P 33/00 (2006.01)						
C07D 471/04 (2006.01)						
Oncoceutics, Inc.	A61K 31/44 (2006.01)	3546461	7-BENZYL-4-(2-METHYLBENZYL)-2,4,6,7,8,9-HEXAHYDROIMIDAZO[1,2-A]PYRIDO[3,4-E]PYRIMIDIN-5(1H)-ONE, SALTS THEREOF AND METHODS OF USING THE SAME IN COMBINATION THERAPY			
	A61K 31/519 (2006.01)	3546461	7-BENZYL-4-(2-METHYLBENZYL)-2,4,6,7,8,9-HEXAHYDROIMIDAZO[1,2-A]PYRIDO[3,4-E]PYRIMIDIN-5(1H)-ONE, SALTS THEREOF AND METHODS OF USING THE SAME IN COMBINATION THERAPY			
	A61K 45/06 (2006.01)					
	A61P 35/00 (2006.01)					
	C07D 471/14 (2006.01)					
	F21V 29/70 (2015.01)					
	F21V 29/85 (2015.01)					
	F21W 131/103 (2006.01)					
	F21Y 115/10 (2016.01)					
	F02C 6/00 (2006.01)					
Institute Of Engineering Thermophysics, Chinese Academy Of Sciences	F21V 29/70 (2015.01)			3640536	GRAPHENE HEAT-DISSIPATION LED LAMP	
	F21V 29/85 (2015.01)	3640449	STAGED COLD ENERGY STORAGE TYPE SUPERCRITICAL COMPRESSED AIR ENERGY STORAGE SYSTEM AND METHOD			
	F21W 131/103 (2006.01)					
	F21Y 115/10 (2016.01)					
	F02C 6/00 (2006.01)					
	Zhejiang Shijing Tools Co., Ltd			F16M 11/12 (2006.01)	3636980	HANGING TYPE POSITIONING AND SUPPORTING DEVICE FOR LASER LEVEL

Podnosilac evropske prijave patenta (71)	MKP (51)	Broj objave evropske prijave patenta (97)	Naziv pronalaska (54)		
	G06F 3/01 (2006.01)	3639114	SYSTEM AND METHOD OF INSTANTLY PREVIEWING IMMERSIVE CONTENT SUPPORT FOR ROOF PANELS		
	G06Q 30/00 (2012.01)				
Galan Martin, Antonio	E04D 12/00 (2006.01)	3650611	METHOD FOR RECORDING VIDEO ON THE BASIS OF A VIRTUAL REALITY APPLICATION, TERMINAL DEVICE, AND STORAGE MEDIUM		
	F24S 25/61 (2018.01)				
	H02S 20/23 (2014.01)				
	G06T 15/00 (2011.01)				
	H04N 13/00 (2018.01)	3675488			
	A61K 31/519 (2006.01)	3634419	GONADOTROPIN-RELEASING HORMONE ANTAGONIST DOSING REGIMENS FOR TREATING UTERINE FIBROIDS AND REDUCING MENSTRUAL BLOOD LOSS		
	A61P 15/00 (2006.01)				
	A61K 39/00 (2006.01)	3635005	THERAPEUTIC ANTIBODIES BASED ON MUTATED IGG HEXAMERS		
	C07K 16/28 (2006.01)				
	C07K 16/30 (2006.01)				
	A61P 17/10 (2006.01)	3642230	TREATMENT OF INFLAMMATORY DISEASES WITH INHIBITORS OF C5A ACTIVITY		
	C07K 16/18 (2006.01)				
	A61K 9/19 (2006.01)	3638273	COMPOSITIONS COMPRISING BACTERIAL STRAINS		
	A61K 31/19 (2006.01)				
	A61K 31/192 (2006.01)				
	A61K 31/194 (2006.01)				
	A61K 31/203 (2006.01)				
	A61K 35/74 (2015.01)				
	A61K 35/745 (2015.01)				
	A61K 35/747 (2015.01)				
	A61P 25/00 (2006.01)				
	A61P 25/28 (2006.01)				
	A61K 39/00 (2006.01)				
University of Bern	C07K 16/28 (2006.01)	3638696	USE OF ANTI CD70 ANTIBODY ARGX-110 TO TREAT ACUTE MYELOID LEUKAEMIA		
TOP GLOVE GLOBAL SDN BHD	A41D 19/00 (2006.01)	3635038	CROSSLINKED STYRENIC BLOCK COPOLYMER		
	A61B 42/10 (2016.01)				
	A61F 6/04 (2006.01)				
	B32B 27/30 (2006.01)				
	C08J 3/24 (2006.01)				
	C08J 3/28 (2006.01)				
	C08L 25/08 (2006.01)				
	C08L 53/02 (2006.01)				
	A61K 39/395 (2006.01)				
	C07K 16/24 (2006.01)				
	A61K 31/47 (2006.01)			3630824	BIOPHARMACEUTICAL COMPOSITIONS AND RELATED METHODS
	A61P 35/00 (2006.01)				
				C07D 215/22 (2006.01)	3630726
	A61K 39/395 (2006.01)	3638305	METHOD FOR THE TREATMENT OF IMMUNE THROMBOCYTOPENIA		
	C07K 16/28 (2006.01)				
	A61K 31/502 (2006.01)	3649119	NOVEL COMPOUNDS AND PHARMACEUTICAL COMPOSITIONS THEREOF FOR THE TREATMENT OF FIBROSIS		
	A61P 29/00 (2006.01)				
	C07D 401/14 (2006.01)				
	C07D 403/04 (2006.01)				
	C07D 403/14 (2006.01)				
	C07D 405/14 (2006.01)				
	C07D 409/14 (2006.01)				
	C07D 471/04 (2006.01)				

Podnosilac evropske prijave patenta (71)	MKP (51)	Broj objave evropske prijave patenta (97)	Naziv pronalaska (54)
	A61K 31/517 (2006.01) A61P 35/00 (2006.01) C07D 487/04 (2006.01)	3645535	NEW SALT OF N-(2,6-DIETHYLPHENYL)-8-((4-[4-(DIMETHYLAMINO)PIPERIDIN-1-YL]-2-METHOXYPHENYL)AMINO)-1-METHYL-4,5-DIHYDRO-1H-PYRAZOLO[4,3-H]QUINAZOLINE-3-CARBOXAMIDE, ITS PREPARATION AND FORMULATIONS CONTAINING IT
	A61K 38/20 (2006.01) A61K 39/00 (2006.01) A61P 37/00 (2006.01) C07K 16/10 (2006.01) C07K 16/46 (2006.01)	3630812	ANTIBODY-CYTOKINE ENGRAFTED PROTEINS AND METHODS OF USE FOR IMMUNE RELATED DISORDERS
	A61K 38/20 (2006.01) A61K 39/00 (2006.01) A61P 35/00 (2006.01) C07K 16/10 (2006.01) C07K 16/46 (2006.01)	3630813	ANTIBODY-CYTOKINE ENGRAFTED PROTEINS AND METHODS OF USE IN THE TREATMENT OF CANCER
	A61J 1/10 (2006.01) A61J 1/20 (2006.01) F26B 5/06 (2006.01)	3651719	MULTI CHAMBER FLEXIBLE BAG AND METHODS OF USING SAME
	A61K 31/438 (2006.01) A61P 35/00 (2006.01) C07D 471/04 (2006.01)	3630762	CRYSTALLINE FORMS OF A FGFR INHIBITOR AND PROCESSES FOR PREPARING THE SAME
	A61M 5/142 (2006.01) A61M 5/145 (2006.01) A61M 5/158 (2006.01) A61M 5/28 (2006.01) A61M 5/31 (2006.01) A61K 35/17 (2015.01) A61P 35/00 (2006.01)	3634539	SYRINGE ASSEMBLY FOR A DRUG DELIVERY DEVICE AND METHOD OF ASSEMBLY
	A61M 5/20 (2006.01) A61M 5/31 (2006.01) A61M 5/315 (2006.01)	3630132	ARTICLES OF MANUFACTURE AND METHODS FOR TREATMENT USING ADOPTIVE CELL THERAPY
	G01N 23/203 (2006.01) G01N 23/223 (2006.01) G01N 33/24 (2006.01) G06T 7/00 (2017.01)	3634546	TORQUE DRIVEN DRUG DELIVERY DEVICE
	A61K 9/16 (2006.01) A61K 9/20 (2006.01) A61K 9/28 (2006.01) A61K 31/496 (2006.01) A61P 25/18 (2006.01) A61P 25/28 (2006.01)	3635392	ANALYZING A ROCK SAMPLE
	C02F 1/66 (2006.01) C02F 1/68 (2006.01)	3638210	SOLID PREPARATION OF CARIPRAZINE FOR ORAL ADMINISTRATION
	A61K 31/4196 (2006.01) A61P 25/28 (2006.01) A61P 35/00 (2006.01) C07D 403/12 (2006.01)	3652117	METHOD FOR INCREASING THE MAGNESIUM ION CONCENTRATION IN FEED WATER
	A61K 31/519 (2006.01) A61P 9/00 (2006.01) A61P 13/12 (2006.01) A61P 25/00 (2006.01) A61P 25/18 (2006.01) C07D 487/04 (2006.01)	3642196	SUBSTITUTED CYANOPYRROLIDINES WITH ACTIVITY AS DUB INHIBITORS
	A61K 31/4045 (2006.01) A61K 31/443 (2006.01) A61K 31/454 (2006.01) A61K 31/47 (2006.01) A61P 11/12 (2006.01)	3634964	PYRAZOLOPYRIMIDINE PDE9 INHIBITORS
		3634402	METHODS OF TREATMENT FOR CYSTIC FIBROSIS

Podnosilac evropske prijave patenta (71)	MKP (51)	Broj objave evropske prijave patenta (97)	Naziv pronalaska (54)
	A61K 9/00 (2006.01) A61K 9/20 (2006.01) A61K 31/47 (2006.01) A61P 35/00 (2006.01) A61M 5/20 (2006.01) A61M 5/315 (2006.01) A61Q 7/00 (2006.01) C07K 16/28 (2006.01)	3634413	LIQUID DOSAGE FORMS TO TREAT CANCER
	C07F 9/24 (2006.01) C07H 1/02 (2006.01) C07H 19/10 (2006.01) C07H 19/20 (2006.01) A61K 9/20 (2006.01) A61K 9/28 (2006.01) A61K 31/225 (2006.01) C07K 14/725 (2006.01)	3641857 3652205 3638684 3641736 3649149	DEVICE ACTIVATION IMPACT/SHOCK REDUCTION PROLACTIN RECEPTOR ANTIBODY FOR MALE AND FEMALE PATTERN HAIR LOSS SYNTHESIS OF SUBSTANTIALLY DIASTEREOMERICALLY PURE PHOSPHATE PROTIDES PHARMACEUTICAL COMPOSITIONS COMPRISING DIMETHYL FUMARATE TARGETED PROTEIN DEGRADATION
Hydra Biosciences, LLC	A61K 31/519 (2006.01) A61K 31/522 (2006.01) C07D 487/04 (2006.01)	3652176	NOVEL SUBSTITUTED XANTHINE DERIVATIVES
CFT S.p.A.	A23B 7/01 (2006.01) A23B 7/155 (2006.01) A23L 19/00 (2016.01) A61K 31/53 (2006.01) A61P 35/00 (2006.01)	3634153 3638245	PLANT AND METHOD OF PRODUCTION OF PUREE METHODS OF TREATING BRAIN TUMORS USING COMBINATION THERAPY
Rottapharm SPA	A61K 8/34 (2006.01) A61K 8/60 (2006.01) A61K 31/047 (2006.01) A61K 31/702 (2006.01) A61Q 17/00 (2006.01) A61Q 19/00 (2006.01) A61Q 19/10 (2006.01)	3644945	ANTIBACTERIAL ACTIVITY OF GALACTOOLIGOSACCHARIDE AND XYLITOL IN DERMATOLOGICAL TREATMENTS
Aicuris Anti-Infective Cures GmbH	A61K 9/00 (2006.01) A61K 31/4439 (2006.01) A61P 31/22 (2006.01)	3644958	INTRAVAGINALLY APPLICABLE DEVICES COMPRISING ANTIVIRAL COMPOUNDS
	C02F 1/28 (2006.01) C02F 101/30 (2006.01)	3665127	METHOD AND SYSTEM FOR TREATING AND/OR PURIFYING WATER
	B61B 12/00 (2006.01) B61B 12/06 (2006.01)	3649029	CABLEWAY AND METHOD FOR OPERATING A CABLEWAY
Dallmeier electronic GmbH & Co. KG	H04N 7/18 (2006.01)	3649775	MULTI-SENSOR CAMERA
	C02F 1/66 (2006.01) C02F 1/68 (2006.01)	3652118	METHOD FOR INCREASING THE MAGNESIUM ION CONCENTRATION IN FEED WATER
	C07K 16/38 (2006.01)	3645573	NOVEL T CELL RECEPTORS AND IMMUNE THERAPY USING THE SAME
GERON CORPORATION	C07H 1/00 (2006.01) C07H 21/04 (2006.01) A61K 31/4427 (2006.01) A61K 31/444 (2006.01) A61P 19/02 (2006.01) C07D 493/08 (2006.01) A61K 31/7076 (2006.01) A61P 7/02 (2006.01) A61P 9/04 (2006.01)	3652187 3634967 3641784	IMPROVED PROCESS FOR PREPARING IMETELSTAT COMPOUNDS AND COMPOSITIONS FOR INDUCING CHONDROGENESIS METHOD OF PREVENTING OF SYSTEMIC-TO-PULMONARY- ARTERY SHUNT THROMBOSIS
	A61K 39/12 (2006.01) C07K 14/005 (2006.01)	3655032	TRIMER STABILIZING HIV ENVELOPE PROTEIN MUTATIONS
	A61K 31/506 (2006.01) A61K 31/5377 (2006.01) A61K 31/55 (2006.01) A61P 3/00 (2006.01)	3649127	NEW SUBSTITUTED AZAINDOLINE DERIVATIVES AS NIK INHIBITORS

Podnosilac evropske prijave patenta (71)	MKP (51)	Broj objave evropske prijave patenta (97)	Naziv pronalaska (54)
Pepeimpex Ltd	A61P 29/00 (2006.01)	3651736	LONG-ACTING FORMULATIONS
	A61P 35/00 (2006.01)		
	A61P 37/00 (2006.01)		
	C07D 471/04 (2006.01)		
	C07D 519/00 (2006.01)		
	A61K 9/10 (2006.01)		
	A61K 31/47 (2006.01)		
	A61K 47/26 (2006.01)		
Pepeimpex Ltd	A61P 31/06 (2006.01)	3649061	CAPSULE FOR INFUSION PRODUCTS
	A61P 31/08 (2006.01)		
Surface Oncology, Inc.	B65D 85/804 (2006.01)	3641887	COMPOUNDS AND METHODS FOR TREATMENT OF NAFLD AND NASH
	A61K 31/7064 (2006.01)	3641812	ANTIBODY MOLECULES TO CD73 AND USES THEREOF
	A61P 1/16 (2006.01)		
	A61K 31/495 (2006.01)	3648790	NOVEL PEPTIDES AND COMBINATION OF PEPTIDES FOR USE IN IMMUNOTHERAPY AGAINST LUNG CANCER, INCLUDING NSCLC, SCLC AND OTHER CANCERS
	A61K 39/00 (2006.01)		
	A61K 39/395 (2006.01)		
	A61K 39/40 (2006.01)		
	C07K 16/28 (2006.01)		
	A61K 39/00 (2006.01)		
	A61P 35/00 (2006.01)		
C07K 14/47 (2006.01)			
C07K 16/30 (2006.01)			
Surface Oncology, Inc.	A61P 25/08 (2006.01)	3652182	2-OXO-1-IMIDAZOLIDINYL IMIDAZOTHIADIAZOLE DERIVATIVES
	C07D 513/04 (2006.01)	3652183	2-OXO-1,3-OXAZOLIDINYL IMIDAZOTHIADIAZOLE DERIVATIVES
A61K 31/433 (2006.01)			
Surface Oncology, Inc.	A61P 25/08 (2006.01)	3654983	MPO INHIBITORS FOR USE IN MEDICINE
	C07D 513/04 (2006.01)		
Surface Oncology, Inc.	A61K 31/505 (2006.01)	3642209	COMPOUNDS THAT INTERACT WITH THE RAS SUPERFAMILY FOR THE TREATMENT OF CANCERS, INFLAMMATORY DISEASES, RASOPATHIES, AND FIBROTIC DISEASE
	A61P 15/10 (2006.01)		
	A61K 31/519 (2006.01)		
	A61P 25/28 (2006.01)		
	A61P 29/00 (2006.01)		
	A61P 35/00 (2006.01)		
	A61P 35/00 (2006.01)		
	C07D 495/04 (2006.01)		
	A61K 38/26 (2006.01)		
	C07K 16/28 (2006.01)		
Surface Oncology, Inc.	A61K 38/26 (2006.01)	3642238	METHOD OF TREATING OR AMELIORATING METABOLIC DISORDERS USING ANTAGONISTIC BINDING PROTEINS FOR GASTRIC INHIBITORY PEPTIDE RECEPTOR (GIPR)/GLP-1 RECEPTOR AGONIST FUSION PROTEINS
	C07K 16/28 (2006.01)	3642239	METHOD OF TREATING OR AMELIORATING METABOLIC DISORDERS USING BINDING PROTEINS FOR GASTRIC INHIBITORY PEPTIDE RECEPTOR (GIPR) IN COMBINATION WITH GLP-1 AGONISTS
Surface Oncology, Inc.	A61M 5/32 (2006.01)	3641861	ELECTRONIC DRUG DELIVERY DEVICE COMPRISING A CAP ACTIVATED BY A SWITCH ASSEMBLY
	C09K 8/52 (2006.01)	3642299	COMPOSITIONS AND METHODS FOR CONTROLLING STRONG ACID SYSTEMS
	C09K 8/72 (2006.01)		
Surface Oncology, Inc.	C23F 11/00 (2006.01)		

Podnosilac evropske prijave patenta (71)	MKP (51)	Broj objave evropske prijave patenta (97)	Naziv pronalaska (54)	
	C08G 79/00 (2006.01)	3638716	POLY(PHOSPHOESTERS) FOR DELIVERY OF NUCLEIC ACIDS	
	C08G 79/04 (2006.01)			
Nosocomial Vaccine Corporation University of Maryland, Baltimore Affinivax, Inc.	C07K 16/46 (2006.01)	3652215	IMPROVED DUAL SPECIFICITY POLYPEPTIDE MOLECULE	
	A61K 39/104 (2006.01)	3641828	IMMUNOGENIC COMPOSITIONS	
	A61K 39/108 (2006.01)			
	A61K 47/64 (2017.01)	3638692	METHOD OF MANUFACTURING BISPECIFIC ANTIBODIES, BISPECIFIC ANTIBODIES AND THERAPEUTIC USE OF SUCH ANTIBODIES	
	C07K 14/195 (2006.01)			
	C07K 14/21 (2006.01)			
	C07K 14/26 (2006.01)			
	C07K 16/00 (2006.01)			
	C07K 16/08 (2006.01)			
	C07K 16/24 (2006.01)			
C07K 16/46 (2006.01)				
PIRNAR d.o.o.	A61K 31/4045 (2006.01)	3658550	NEW PROPANAMINE DERIVATIVES FOR TREATING PAIN AND PAIN RELATED CONDITIONS	
	A61K 31/437 (2006.01)	3673134	MODULAR SLIDING MEMBER POWER MECHANISM AND METHOD FOR ITS OPERATION	
	A61P 25/04 (2006.01)			
	C07D 409/06 (2006.01)			
	C07D 471/04 (2006.01)			
E05F 15/643 (2015.01)				
Societa' Agricola la Pellegrina S.p.A.	A01K 41/00 (2006.01)	3632204	DEVICE FOR TRANSPORTING AND HATCHING EGGS ON FARM BREEDING	
	A01K 41/06 (2006.01)	3545977	PREPARATION OF MAYTANSINOID ANTIBODY CONJUGATES BY A ONE- STEP PROCESS	
	A01K 43/00 (2006.01)			
	A61K 47/68 (2017.01)	3643447	LOW DUST LINEAR MODULE	
	A61P 35/00 (2006.01)			
	B23Q 1/26 (2006.01)			
	B23Q 11/08 (2006.01)			
		F16C 29/02 (2006.01)	3658254	AIR-PERMEABLE SHEET FILTER MATERIAL, METHODS FOR THE PRODUCTION AND USE THEREOF
		F16C 29/08 (2006.01)		
		B01D 39/16 (2006.01)	3672663	NEEDLE INSERTION MECHANISM FOR DRUG DELIVERY DEVICE
A61M 5/142 (2006.01)				
A61K 31/336 (2006.01)		3672586	IMMUNOPROTEASOME INHIBITORS AND IMMUNOSUPPRESSIVE AGENT IN THE TREATMENT OF AUTOIMMUNE DISORDERS	
A61K 31/343 (2006.01)				
A61K 31/5377 (2006.01)				
A61P 13/12 (2006.01)				
A61P 37/06 (2006.01)		3672712	METHOD FOR RECLAIMING AMINE ABSORPTION AGENT UNDER CONTROLLED TEMPERATURE	
B01D 53/14 (2006.01)				
Adama Makhteshim Ltd.	A01N 43/54 (2006.01)	3655396	POLYMORPHS OF 5-FLUORO- 4-IMINO-3-METHYL-1-TOSYL- 3,4-DIHYDROPYRIMIDIN-2- ONE	
	C07D 239/47 (2006.01)	3664824	COMPOSITIONS COMPRISING BACTERIAL STRAINS	
	A23L 33/135 (2016.01)			
	A61K 35/744 (2015.01)			
	A61P 1/12 (2006.01)			
	A61P 29/00 (2006.01)			
	A61P 35/00 (2006.01)			
	A61P 37/00 (2006.01)	3665198	ANTIBODIES THAT BIND EGFR AND CMET	
	C07K 16/28 (2006.01)			
	C07K 16/46 (2006.01)			
A01D 46/28 (2006.01)				
		3648569	PNEUMATIC CUSHIONS FOR SOFT RECEPTION OF HARVESTED FRUIT ON	

Podnosilac evropske prijave patenta (71)	MKP (51)	Broj objave evropske prijave patenta (97)	Naziv pronalaska (54)
	A61K 31/522 (2006.01) A61P 37/04 (2006.01) C07D 473/18 (2006.01)	3668870	MECHANIZED FRUIT HARVESTING DEVICES 6-AMINO-7,9-DIHYDRO-8H-PURIN-8-ONE DERIVATIVES AS IMMUNOSTIMULANT TOLL-LIKE RECEPTOR 7 (TLR7) AGONISTS
	A61K 31/522 (2006.01) A61P 37/04 (2006.01) C07D 473/18 (2006.01)	3668871	6-AMINO-7,9-DIHYDRO-8H-PURIN-8-ONE DERIVATIVES AS IMMUNOSTIMULANT TOLL-LIKE RECEPTOR 7 (TLR7) AGONISTS
	A61K 35/76 (2015.01) A61K 39/395 (2006.01) C07K 16/28 (2006.01)	3664844	TREATMENT OF TRIPLE NEGATIVE BREAST CANCER OR COLORECTAL CANCER WITH LIVER METASTASES WITH AN ANTI PD-L1 ANTIBODY AND AN ONCOLYTIC VIRUS
Pharmaq AS	A01K 61/13 (2017.01) A01K 61/95 (2017.01)	3664602	LIVE FISH PROCESSING SYSTEM, AND ASSOCIATED METHODS
	A61K 31/553 (2006.01) A61P 35/00 (2006.01) C07D 498/08 (2006.01)	3668878	COMPOUNDS THAT INHIBIT MCL-1 PROTEIN
	A61K 31/454 (2006.01) A61K 31/4545 (2006.01) A61P 35/00 (2006.01) C07D 401/04 (2006.01) C07D 401/14 (2006.01) C07D 407/14 (2006.01) C07D 409/14 (2006.01) C07D 413/14 (2006.01) C07D 417/14 (2006.01) C07D 471/04 (2006.01) C07D 487/04 (2006.01) C07D 487/08 (2006.01) C07D 495/04 (2006.01) C07D 513/04 (2006.01)	3672949	3-(1-OXOISOINDOLIN-2-YL)PIPERIDINE-2,6-DIONE DERIVATIVES AND USES THEREOF
	C07K 14/755 (2006.01) C12N 9/64 (2006.01) C12N 15/86 (2006.01)	3665289	NUCLEIC ACID MOLECULES AND USES THEREOF
	B61H 9/02 (2006.01) G01B 7/00 (2006.01) G01B 7/02 (2006.01) G01D 5/22 (2006.01) G01R 33/00 (2006.01) G01V 3/10 (2006.01) H03K 17/95 (2006.01) H04B 5/00 (2006.01) H04B 15/00 (2006.01)	3673231	INDUCTIVE SENSOR
	A61K 31/4545 (2006.01) A61P 25/28 (2006.01) C07D 413/04 (2006.01)	3649124	FLUOROPIPERIDINE COMPOUNDS AS PURE 5-HT6 RECEPTOR ANTAGONISTS
	C12Q 1/6883 (2018.01) G01N 33/574 (2006.01) G01N 33/68 (2006.01)	3669004	COMPOSITIONS AND METHODS FOR TREATMENT OF ATOPIC DERMATITIS AND TREATMENT SELECTION
	A61K 31/5025 (2006.01) A61P 3/10 (2006.01) A61P 7/06 (2006.01) A61P 7/08 (2006.01) A61P 35/00 (2006.01) C07D 513/14 (2006.01)	3668513	PYRUVATE KINASE ACTIVATORS FOR USE IN TREATING BLOOD DISORDERS
Almirall, LLC	A61K 9/00 (2006.01) A61K 31/65 (2006.01) A61P 17/10 (2006.01) A61P 43/00 (2006.01)	3654988	TREATMENT OF NON-INFLAMMATORY LESIONS

Podnosilac evropske prijave patenta (71)	MKP (51)	Broj objave evropske prijave patenta (97)	Naziv pronalaska (54)
Brose Fahrzeugteile SE & Co. Kommanditgesellschaft, Bamberg	H02P 7/00 (2016.01)	3665771	METHOD AND DEVICE FOR DETERMINING A ROTATION VARIABLE
MEDIBIOFARMA, S.L.	A61K 31/444 (2006.01) A61K 31/496 (2006.01) A61P 35/00 (2006.01) C07D 401/12 (2006.01) C07D 401/14 (2006.01) C07D 409/14 (2006.01)	3653620	NEW HETEROARYL AMIDE DERIVATIVES AS SELECTIVE INHIBITORS OF HISTONE DEACETYLASES 1 AND 2 (HDAC1-2)
Boehringer Ingelheim Animal Health USA Inc.	A61K 39/00 (2006.01) A61K 39/135 (2006.01) A61K 39/385 (2006.01) C07K 14/005 (2006.01) C07K 14/32 (2006.01) C12N 7/00 (2006.01) C12N 5/071 (2010.01) C12N 5/074 (2010.01)	3539566	FMDV AND E2 FUSION PROTEINS AND USES THEREOF
	A61K 39/00 (2006.01)	3564361	LIVER ORGANOID, USES THEREOF AND CULTURE METHOD FOR OBTAINING THEM
	A61K 39/00 (2006.01)	3542816	IMMUNOTHERAPY OF CANCER THROUGH COMBINATION OF LOCAL AND SYSTEMIC IMMUNE STIMULATION
	A61P 17/06 (2006.01) C07K 16/28 (2006.01)	3536710	ANTI IL-36R ANTIBODIES
Otsuka Pharmaceutical Co., Ltd.	A61K 9/06 (2006.01) A61K 31/496 (2006.01) A61K 47/10 (2017.01) A61K 47/32 (2006.01) A61K 47/38 (2006.01) A61P 25/18 (2006.01) A61P 25/24 (2006.01)	3539534	INJECTABLE PREPARATION
Merendels - Società a Responsabilità Limitata	G06Q 50/02 (2012.01)	3564895	METHOD FOR CERTIFICATION OF ORGANIC PRODUCTS
	C07K 16/46 (2006.01)	3556777	MULTISPECIFIC ANTIBODY CONSTRUCTS
	C07H 21/04 (2006.01) C07K 16/00 (2006.01) C12P 21/08 (2006.01)	3540070	DUAL RECEPTOR ANTAGONISTIC ANTIGEN-BINDING PROTEINS AND USES THEREOF
	A61K 31/519 (2006.01) A61P 35/00 (2006.01) C07D 487/04 (2006.01)	3536692	PYRAZOLOPYRIMIDINYL INHIBITORS OF UBIQUITIN-ACTIVATING ENZYME
	A61P 7/06 (2006.01) A61P 37/06 (2006.01) C07K 16/28 (2006.01)	3536711	ANTI-CD26 ANTIBODIES AND USES THEREOF
	A61K 31/519 (2006.01) A61K 45/06 (2006.01) A61P 35/00 (2006.01) C07D 471/14 (2006.01)	3572083	7-BENZYL-10-(2-METHYLBENZYL)-2,6,7,8,9,10-HEXAHYDROIMIDAZO[1,2-A]PYRIDO[4,3-D]PYRIMIDIN-5(3H)-ON FOR USE IN THE TREATMENT OF CANCER LIFTING SYSTEM
E.C.E. - S.R.L.	B66C 13/18 (2006.01) B66D 1/08 (2006.01) B66D 1/12 (2006.01)	3564181	
	A61K 38/17 (2006.01) C07K 14/47 (2006.01) C12N 15/113 (2010.01)	3545966	METHODS AND COMPOSITIONS FOR THE TREATMENT OF CANCER
Marbeuf Conseil et Recherche	G06Q 20/34 (2012.01) G07F 7/08 (2006.01)	3564914	METHOD AND SYSTEM FOR PERFORMING A SECURE DATA EXCHANGE
	A61K 31/433 (2006.01) A61P 35/00 (2006.01) C07D 417/08 (2006.01)	3556757	CYCLOALKYL-LINKED DIHETEROCYCLE DERIVATIVES
Glock Technology GmbH	F41A 11/00 (2006.01) F41A 17/36 (2006.01)	3569965	FIREARM, IN PARTICULAR PISTOL, WITH A DEVICE FOR DISASSEMBLY

Podnosilac evropske prijave patenta (71)	MKP (51)	Broj objave evropske prijave patenta (97)	Naziv pronalaska (54)
	B65D 5/02 (2006.01)	3569514	TAMPER EVIDENT CARTON
	B65D 5/54 (2006.01)		
	C12Q 1/68 (2018.01)	3550031	MUTATIONS ASSOCIATED WITH RESISTANCE TO INHIBITORS OF BRUTON'S TYROSINE KINASE (BTK)
	A61K 31/506 (2006.01)	3560498	COMBINATION COMPRISING AN MEK INHIBITOR AND A B-RAF INHIBITOR
	A61K 31/519 (2006.01)		
	A61P 35/00 (2006.01)		
	C07F 9/6558 (2006.01)	3564248	PROCESSES FOR PREPARING PHOSPHORODIAMIDATE MORPHOLINO OLIGOMERS
	C07F 9/6561 (2006.01)		
	A61K 8/06 (2006.01)	3549573	METHOD FOR AFFECTING HAPTIC PERCEPTION
	A61K 8/37 (2006.01)		
	A61K 8/49 (2006.01)		
	A61K 8/73 (2006.01)		
	A61K 8/92 (2006.01)		
	A61Q 19/00 (2006.01)		
	G03G 15/00 (2006.01)	3567437	IMAGE FORMING APPARATUS AND CARTRIDGE
	G03G 21/16 (2006.01)		
	G03G 21/18 (2006.01)		
	A61K 9/00 (2006.01)	3566694	STABLE PRESSURISED AEROSOL SOLUTION
	A61K 31/167 (2006.01)		
	A61K 31/40 (2006.01)		
	A61K 31/573 (2006.01)		
	A61K 31/58 (2006.01)		
	A61K 45/06 (2006.01)		
	A61M 15/00 (2006.01)		
	A61K 48/00 (2006.01)	3572096	A CONDITIONAL REPLICATING CYTOMEGALOVIRUS AS A VACCINE FOR CMV
	C07H 21/04 (2006.01)		
VBG bvba	E04F 13/08 (2006.01)	3572598	MOUNTING BRACKET FOR MOUNTING A CLADDING TO A WALL, AND METHOD THEREFOR
	A61K 39/29 (2006.01)	3564384	HCV CORE LIPID BINDING DOMAIN MONOCLONAL ANTIBODIES
	C07K 16/00 (2006.01)		
	C07K 16/10 (2006.01)		
	C12P 21/08 (2006.01)		
	C12Q 1/70 (2006.01)		
	A61P 41/00 (2006.01)	3569636	COMPOUNDS, PHARMACEUTICAL COMPOSITIONS AND A METHOD FOR THE PROPHYLAXIS AND TREATMENT OF THE ADHESION PROCESS
	C07D 401/04 (2006.01)		
	C08G 73/06 (2006.01)		
	C08L 79/06 (2006.01)		
	A61K 31/47 (2006.01)	3560920	SECONDARY ALCOHOL QUINOLINYL MODULATORS OF ROR GAMMA T
	A61K 31/4709 (2006.01)		
	A61P 29/00 (2006.01)		
	A61P 35/00 (2006.01)		
	C07D 215/227 (2006.01)		
	C07D 401/06 (2006.01)		
	C07D 401/14 (2006.01)		
	C07D 413/06 (2006.01)		
Valli S.p.A.	A01B 17/00 (2006.01)	3578026	VEHICLE AND METHOD FOR THE DISTRIBUTION OF BIOSOLIDS
	A01C 3/06 (2006.01)		
Orkla Care AB	A47B 67/02 (2006.01)	3578083	DISPENSER FOR MEDICAL ARTICLES
	A47B 67/04 (2006.01)		
	A61F 17/00 (2006.01)		
	A61K 9/16 (2006.01)	3574897	POLYMER PROTEIN MICROPARTICLES
	A61K 9/50 (2006.01)		
	A61K 38/17 (2006.01)		
	A61K 39/00 (2006.01)		
	A61P 27/02 (2006.01)		
Celcuity Inc.	G01N 33/50 (2006.01)	3605101	WHOLE CELL ASSAYS AND METHODS
	G01N 33/574 (2006.01)		

Podnosilac evropske prijave patenta (71)	MKP (51)	Broj objave evropske prijave patenta (97)	Naziv pronalaska (54)		
Chiesi Farmaceutici S.p.A.	A61K 9/00 (2006.01)	3569222	DRY POWDER FORMULATION COMPRISING AN ANTICHOLINERGIC, A CORTICOSTEROID AND A BETA-ADRENERGIC FOR ADMINISTRATION BY INHALATION		
	A61K 31/167 (2006.01)				
	A61K 31/40 (2006.01)				
	A61K 31/573 (2006.01)				
	A61K 47/12 (2006.01)				
	A61K 47/26 (2006.01)	3572433	ANTIBODIES SPECIFIC TO FCRN		
	C07K 16/28 (2006.01)				
	G01N 33/53 (2006.01)				
	A61K 31/439 (2006.01)	3569604	PROCESS AND INTERMEDIATES FOR THE PREPARATION OF NAPHTHYRIDINE COMPOUNDS AS JAK KINASE INHIBITORS		
	A61P 1/04 (2006.01)				
	C07D 519/00 (2006.01)	3574895	PARTICLE SIZE REDUCTION OF AN ANTIMUSCARINIC COMPOUND FOLDING BOX		
	A61K 9/00 (2006.01)				
	A61K 9/14 (2006.01)				
	B65D 5/66 (2006.01)	3587293	COUPLING FOR CRYOGENIC LIQUEFIED MEDIA		
	B65D 5/72 (2006.01)				
	B60K 15/00 (2006.01)	3638939			
	B60S 5/02 (2006.01)				
	B67D 7/32 (2010.01)				
	F16K 1/00 (2006.01)				
	F16L 29/04 (2006.01)				
	F16L 37/248 (2006.01)				
	F16L 37/32 (2006.01)				
	F16L 55/10 (2006.01)				
	F17C 1/00 (2006.01)				
	A01N 59/00 (2006.01)			3627987	BIOCIDE FREE PRESERVATION
	A01N 59/06 (2006.01)				
	A01N 59/16 (2006.01)				
	A01P 3/00 (2006.01)			3630112	COMBINATION OF REGORAFENIB AND PD-1/PD-L1(2) INHIBITORS FOR TREATING CANCER
	A61K 31/395 (2006.01)				
	A61K 31/44 (2006.01)				
	A61K 45/06 (2006.01)				
	A61P 35/00 (2006.01)	3635129	METHODS FOR CHARACTERIZING LOSS OF ANTIGEN PRESENTATION TREATMENT PARADIGM FOR AN ANTI-CD19 ANTIBODY AND VENETOCLAX COMBINATION TREATMENT METHODS FOR PREDICTING THE USEFULNESS OF DISEASE SPECIFIC AMINO ACID MODIFICATIONS FOR IMMUNOTHERAPY		
	C12Q 1/68 (2018.01)				
A61K 31/00 (2006.01)					
A61K 39/395 (2006.01)					
A61P 35/00 (2006.01)					
C07K 16/28 (2006.01)					
A61K 39/00 (2006.01)					
G01N 33/68 (2006.01)					
A61K 31/403 (2006.01)	3630723			SUBSTITUTED INDOLINE DERIVATIVES AS DENGUE VIRAL REPLICATION INHIBITORS	
A61P 31/12 (2006.01)					
C07D 209/08 (2006.01)					
Bayer AG	A61K 31/4995 (2006.01)	3638675	DIAZABICYCLIC SUBSTITUTED IMIDAZOPYRIMIDINES AND THEIR USE FOR THE TREATMENT OF BREATHING DISORDERS		
	A61K 31/5386 (2006.01)				
	A61P 11/00 (2006.01)				
	A61P 25/00 (2006.01)				
	C07D 471/08 (2006.01)				
C07D 498/08 (2006.01)	3634490	IMPLANTABLE DRUG DELIVERY DEVICE			
A61K 31/216 (2006.01)					
A61K 47/32 (2006.01)					
Juniper Pharmaceuticals UK Limited	A61K 47/34 (2017.01)	3630724	SUBSTITUTED INDOLINE DERIVATIVES AS DENGUE VIRAL REPLICATION INHIBITORS		
	A61K 31/404 (2006.01)				
Katholieke Universiteit Leuven	A61K 31/407 (2006.01)	3630724	SUBSTITUTED INDOLINE DERIVATIVES AS DENGUE VIRAL REPLICATION INHIBITORS		
	A61K 31/437 (2006.01)				
	A61P 31/14 (2006.01)				
	C07D 209/30 (2006.01)				
	C07D 209/32 (2006.01)				
C07D 209/42 (2006.01)					

Podnosilac evropske prijave patenta (71)	MKP (51)	Broj objave evropske prijave patenta (97)	Naziv pronalaska (54)	
Gea Vipoll, Oprema Za Industrijo Tekocin D.O.O.	C07D 471/04 (2006.01)	3638738	PROCESS FOR PREPARING A SURFACE TREATED FILLER MATERIAL PRODUCT WITH MONO-SUBSTITUTED SUCCINIC ANHYDRIDE(S) AND A MIXTURE OF ALIPHATIC LINEAR OR BRANCHED CARBOXYLIC ACIDS COMPRISING STEARIC ACID	
	C07D 513/04 (2006.01)			
	C08K 9/00 (2006.01)			
	C09C 1/02 (2006.01)			
	B41M 3/00 (2006.01)	3642044	TAMPER-PROOF MEDIUM FOR THERMAL PRINTING	
	B41M 3/14 (2006.01)	3645187	METHOD AND DEVICE FOR CLOSING OF CONTAINER	
	B41M 5/323 (2006.01)			
	B21D 51/26 (2006.01)			
	B67B 1/04 (2006.01)			
	B67B 3/02 (2006.01)	3634414	FGFR2 INHIBITORS FOR THE TREATMENT OF CHOLANGIOCARCINOMA	
A61K 31/498 (2006.01)				
A61P 35/00 (2006.01)	3634997	NOVEL ANTI-HSA ANTIBODIES		
C07K 16/18 (2006.01)				
GEMoaB Monoclonals GmbH	C07K 16/24 (2006.01)	3634998	NOVEL ANTI-CD3 ANTIBODIES	
	C07K 16/18 (2006.01)			
	C07K 16/24 (2006.01)	3634474	TARGETING MODULES FOR UNIVERSAL CHIMERIC ANTIGEN RECEPTOR EXPRESSING IMMUNE CELLS AND USE IN THE TREATMENT OF CANCER INFECTIONS AND AUTOIMMUNE DISORDERS	
	C07K 16/28 (2006.01)			
	C07K 16/32 (2006.01)			
	A61K 39/00 (2006.01)			
	A61K 39/395 (2006.01)	3630096	SULFONAMIDE-SUBSTITUTED CYANOPYRROLIDINES WITH ACTIVITY AS DUB INHIBITORS	
	C07K 16/28 (2006.01)			
	Mission Therapeutics Limited	A61K 31/40 (2006.01)	3641833	METHODS AND COMPOSITIONS FOR CONTROLLING CARDIAC FIBROSIS AND REMODELING
		A61K 31/4025 (2006.01)		
A61K 31/4155 (2006.01)				
A61K 31/4439 (2006.01)				
A61K 31/454 (2006.01)				
A61K 31/496 (2006.01)				
A61K 31/506 (2006.01)				
A61K 31/5365 (2006.01)				
A61P 3/00 (2006.01)				
A61P 25/00 (2006.01)				
A61P 29/00 (2006.01)				
A61P 31/00 (2006.01)				
A61P 35/00 (2006.01)				
C07D 207/14 (2006.01)				
C07D 401/12 (2006.01)				
C07D 401/14 (2006.01)				
C07D 403/12 (2006.01)				
C07D 403/14 (2006.01)				
C07D 487/04 (2006.01)				
C07D 498/02 (2006.01)				
A61K 31/7088 (2006.01)		3638560	CABLE CAR WITH LOCK MONITORING FOR A VEHICLE	
A61K 48/00 (2006.01)				
C12N 15/113 (2010.01)				
C12N 15/63 (2006.01)				
B61B 12/00 (2006.01)		3634961	(4-([1,2,4]TRIAZOLO[4,3-A]PYRIDINE-6-YL)OXY)-1,2,3,4-TETRAHYDRONAPHTHALEN-1-YL) UREIDO DERIVATIVES AS ANTI-INFLAMMATORY P38 MAPK INHIBITORS FOR TREATING DISEASES OF THE RESPIRATORY TRACT	
B61B 12/06 (2006.01)				
A61K 31/437 (2006.01)				
A61P 11/00 (2006.01)				
C07D 471/04 (2006.01)				

Podnosilac evropske prijave patenta (71)	MKP (51)	Broj objave evropske prijave patenta (97)	Naziv pronalaska (54)		
Innova Patent GmbH	B61B 12/06 (2006.01)	3638561	METHOD FOR OPERATING A CABLEWAY		
	A01N 3/00 (2006.01)	3642176	DEVICE FOR GENERATING ULTRA PURE 1-METHYLCYCLOPROPENE		
	A01N 27/00 (2006.01)				
	B01J 7/02 (2006.01)				
	C07C 1/32 (2006.01)				
	G05D 7/00 (2006.01)				
Numab Therapeutics AG	C07K 16/00 (2006.01)	3642227	CANINE ANTIBODY LIBRARIES		
	C07K 16/18 (2006.01)	3635014	HETERO-DIMERIC MULTI-SPECIFIC ANTIBODY FORMAT TARGETING AT LEAST CD3 AND HSA		
	C07K 16/28 (2006.01)				
	C07K 16/32 (2006.01)				
	A61K 31/519 (2006.01)	3634418	GONADOTROPIN-RELEASING HORMONE ANTAGONIST DOSING REGIMENS FOR THE TREATMENT OF		
	A61P 15/00 (2006.01)				
	A61K 35/74 (2015.01)	3638271	ENDOMETRIOSIS COMPOSITIONS COMPRISING BACTERIAL STRAINS		
	A61P 25/00 (2006.01)				
	A61P 37/00 (2006.01)				
	A61M 11/00 (2006.01)	3641862	INHALATION DEVICE WITH MULTILIQUID-NOZZLE AND METHOD		
	A61M 11/02 (2006.01)				
	A61M 11/06 (2006.01)				
	A61M 15/00 (2006.01)				
	A61M 15/02 (2006.01)				
	A61M 16/00 (2006.01)				
	A61M 16/10 (2006.01)				
	A61M 16/20 (2006.01)				
	B05B 1/26 (2006.01)				
	B05B 11/00 (2006.01)				
	A61K 31/5383 (2006.01)			3638680	HETEROAROMATIC COMPOUNDS AS VANIN INHIBITORS
	A61P 29/00 (2006.01)				
	C07D 498/04 (2006.01)			3641775	COMBINATION OF A MCL-1 INHIBITOR AND A STANDARD OF CARE TREATMENT FOR HEMATOLOGIC CANCERS, USES AND PHARMACEUTICAL COMPOSITIONS THEREOF
A61K 31/519 (2006.01)					
A61K 31/5377 (2006.01)					
A61K 31/55 (2006.01)					
A61K 45/06 (2006.01)					
A61P 35/00 (2006.01)					
A61M 11/06 (2006.01)	3641945	MULTILIQUID-NOZZLE			
B05B 1/14 (2006.01)					
B05B 1/26 (2006.01)					
A61K 9/51 (2006.01)	3641810	HERPES SIMPLEX VIRUS VACCINE			
A61K 31/7105 (2006.01)					
A61K 31/7115 (2006.01)					
A61K 39/245 (2006.01)					
A61P 31/22 (2006.01)					
C12N 15/38 (2006.01)					
SRT S.r.l.	B60R 19/34 (2006.01)	3665043	POLYMER ELEMENT FOR ABSORBING IMPACT FOR A VEHICLE AND BUMPER STRUCTURE		
	F16F 7/12 (2006.01)				
PGT doo Beograd-Stari Grad	F17C 5/06 (2006.01)	3649395	MOBILE GAS FILLING STATION		
	A61K 39/395 (2006.01)	3628010	IMMUNOTHERAPEUTIC TUMOR TREATMENT METHOD		
	C07K 16/28 (2006.01)				
	A61K 49/14 (2006.01)	3638320	IGF-1R MONOCLONAL ANTIBODIES AND USES THEREOF		
	A61K 51/08 (2006.01)				
	A61K 51/10 (2006.01)				
	A61P 29/00 (2006.01)				
	A61P 35/00 (2006.01)	3628049	TGF-BETA RECEPTOR TYPE II FUSION PROTEINS AND USES THEREOF		
	A61K 38/17 (2006.01)				
	A61P 9/10 (2006.01)				
A61P 9/12 (2006.01)					
A61P 13/12 (2006.01)					
A61P 35/00 (2006.01)					

Podnosilac evropske prijave patenta (71)	MKP (51)	Broj objave evropske prijave patenta (97)	Naziv pronalaska (54)
	C07K 14/71 (2006.01)	3639249	MEDICAL HOME REMINDER UNIT AND SYSTEM
	C07K 16/46 (2006.01)		
	G08B 1/00 (2006.01)		
Sharma, Gaurav Sharma, Gaurav	G06Q 20/00 (2012.01)	3635659	SAFEPAY PROCESS
	G06F 3/048 (2013.01)	3635598	ULTRASAFE LOGIN
Berg LLC	G06F 21/31 (2013.01)	3672965	PYRIMIDINE COMPOUND AS JAK KINASE INHIBITOR
	H04L 29/06 (2006.01)		
	A61K 31/519 (2006.01)		
	C07D 403/12 (2006.01)		
	C07D 451/04 (2006.01)		
	C07D 451/14 (2006.01)	3634400	NOVEL CRYSTALLINE FORMS
	A61K 31/401 (2006.01)		
	A61P 25/24 (2006.01)	3634391	USE OF COENZYME Q10 FORMULATIONS IN THE TREATMENT AND PREVENTION OF EPIDERMOLYSIS BULLOSA COMPOSITIONS AND METHODS FOR INHIBITION OF MICA/B SHEDDING
	C07D 207/16 (2006.01)		
	A61K 9/06 (2006.01)		
	A61K 31/122 (2006.01)		
A61K 35/12 (2015.01)			
A61K 38/00 (2006.01)			
Sila Prirodi Limited Liability Company (Sila Prirodi LLC) Lundbeck La Jolla Research Center, Inc.	A61K 39/395 (2006.01)	3661552	METHODS FOR INHIBITION OF MICA/B SHEDDING
	A61K 39/395 (2006.01)		
	C07K 16/28 (2006.01)	3640472	METHOD AND SYSTEM FOR CONVERTING WIND ENERGY
	C12Q 1/68 (2018.01)		
	F03D 5/04 (2006.01)	3634404	PYRAZOLE MAGL INHIBITORS
	F03D 7/00 (2006.01)		
	A61K 31/415 (2006.01)		
	A61K 31/4155 (2006.01)		
	A61K 31/495 (2006.01)		
	C07D 247/00 (2006.01)		
	C07D 401/12 (2006.01)		
	C07D 403/08 (2006.01)		
	A61K 38/00 (2006.01)		
	A61K 38/16 (2006.01)		
	A61P 33/10 (2006.01)		
	A61K 31/4155 (2006.01)	3630150	PURIFIED ANTHELMINTIC COMPOSITIONS AND RELATED METHODS
	A61K 31/496 (2006.01)		
	C07D 401/06 (2006.01)		
	C07D 403/06 (2006.01)		
	C07D 403/14 (2006.01)		
	A01K 67/027 (2006.01)		
	A61K 35/12 (2015.01)		
	A61K 35/34 (2015.01)		
	A61K 35/76 (2015.01)		
	A61K 39/395 (2006.01)		
	A61K 45/00 (2006.01)		
	A61K 48/00 (2006.01)		
	A61P 1/04 (2006.01)		
A61P 1/12 (2006.01)			
A61P 1/16 (2006.01)			
A61P 1/18 (2006.01)			
A61P 3/00 (2006.01)			
A61P 3/04 (2006.01)			
A61P 3/10 (2006.01)			
A61P 9/00 (2006.01)			
A61P 9/10 (2006.01)			
A61P 9/14 (2006.01)			
A61P 11/00 (2006.01)			
A61P 13/08 (2006.01)			
A61P 13/10 (2006.01)			
C07K 16/28 (2006.01)	3636670	ANTI-IGF-I RECEPTOR ANTIBODY	
C07D 487/04 (2006.01)			
	C07D 487/04 (2006.01)	3630774	5-5 FUSED RINGS AS C5a INHIBITORS
	C07D 487/04 (2006.01)	3630775	6-5 FUSED RINGS AS C5a INHIBITORS
Cyemprive Technologies, Inc.	G06F 21/56 (2013.01)	3635603	REAL-TIME DETECTION OF AND PROTECTION FROM MALWARE AND STEGANOGRAPHY IN A KERNEL MODE

Podnosilac evropske prijave patenta (71)	MKP (51)	Broj objave evropske prijave patenta (97)	Naziv pronalaska (54)	
Pan, Deng Wucherpennig, Kai W.	A61K 38/46 (2006.01) A61K 48/00 (2006.01) A61P 35/00 (2006.01) C12N 15/113 (2010.01)	3634496	METHODS FOR SENSITIZING CANCER CELLS TO T CELL- MEDIATED KILLING BY MODULATING MOLECULAR PATHWAYS	
	A61K 39/395 (2006.01) C07K 16/00 (2006.01) C07K 16/28 (2006.01)	3634995	ANTIBODIES THAT SPECIFICALLY BIND PD-1 AND METHODS OF USE	
CorneaGen Inc.	A61F 2/14 (2006.01) A61F 2/16 (2006.01) A61F 9/00 (2006.01) A61F 9/008 (2006.01) A61F 9/013 (2006.01)	3634307	SYSTEMS AND METHODS FOR CORNEAL TRANSPLANTS	
	A61K 31/7034 (2006.01) A61P 13/12 (2006.01)	3634430	MULTIBIOTIC AGENTS AND METHODS OF USING THE SAME	
	G06Q 30/00 (2012.01)	3637348	SYSTEM FOR DETECTING MATING BY MEANS OF INTRABODY COMMUNICATION (IBC)	
	A61K 31/417 (2006.01) A61K 31/4184 (2006.01) A61K 31/517 (2006.01) C07D 233/54 (2006.01) C07D 239/12 (2006.01) C07D 239/14 (2006.01)	3638229	IMIDAZOLE-CONTAINING INHIBITORS OF ALK2 KINASE	
	A61K 48/00 (2006.01) C12N 15/86 (2006.01)	3638315	AADC POLYNUCLEOTIDES FOR THE TREATMENT OF PARKINSON'S DISEASE	
Voyager Therapeutics, Inc.	A61K 38/17 (2006.01) A61K 39/39 (2006.01) C07K 16/28 (2006.01) C07K 19/00 (2006.01)	3638289	PDE5 COMPOSITIONS AND METHODS FOR IMMUNOTHERAPY	
	A01N 43/836 (2006.01) A01P 7/02 (2006.01) A01P 7/04 (2006.01) A61K 31/4245 (2006.01) A61P 33/14 (2006.01) C07D 271/12 (2006.01) C07D 498/10 (2006.01) G03G 15/08 (2006.01) G03G 21/18 (2006.01)	3640244	OXADIAZOLINE COMPOUND AND PEST CONTROL AGENT	
	A61K 9/51 (2006.01) A61K 31/7088 (2006.01) A61K 31/7105 (2006.01) A61K 47/14 (2017.01) A61K 47/24 (2006.01) A61K 47/28 (2006.01) A61K 47/54 (2017.01) A61K 48/00 (2006.01) C12N 15/88 (2006.01) G06F 17/30 (2006.01)	3640742	CARTRIDGE AND ELECTROPHOTOGRAPHIC IMAGE FORMATION DEVICE RNA FORMULATIONS	
	A61K 9/51 (2006.01) A61K 31/7088 (2006.01) A61K 31/7105 (2006.01) A61K 47/14 (2017.01) A61K 47/24 (2006.01) A61K 47/28 (2006.01) A61K 47/54 (2017.01) A61K 48/00 (2006.01) C12N 15/88 (2006.01) G06F 17/30 (2006.01)	3638215	CARTRIDGE AND ELECTROPHOTOGRAPHIC IMAGE FORMATION DEVICE RNA FORMULATIONS	
	A61K 9/51 (2006.01) A61K 31/7088 (2006.01) A61K 31/7105 (2006.01) A61K 47/14 (2017.01) A61K 47/24 (2006.01) A61K 47/28 (2006.01) A61K 47/54 (2017.01) A61K 48/00 (2006.01) C12N 15/88 (2006.01) G06F 17/30 (2006.01)	3640823	SERVICE DATA STORAGE METHOD, DEVICE, STORAGE MEDIUM, AND ELECTRONIC DEVICE	
	C09K 8/24 (2006.01) E21B 21/00 (2006.01) E21B 21/06 (2006.01) E21D 9/11 (2006.01) E21D 9/13 (2006.01) G06K 9/00 (2006.01)	3642297	DRILL FLUID AND METHOD FOR TUNNELING	
	Canadian Energy Services L.P.	G06K 9/00 (2006.01)	3644219	HUMAN FACE FEATURE POINT TRACKING METHOD, DEVICE, STORAGE MEDIUM AND APPARATUS
		H04N 19/11 (2014.01) H04N 19/147 (2014.01)	3644605	PREDICTION MODE SELECTION METHOD, VIDEO ENCODING DEVICE AND STORAGE MEDIUM

Podnosilac evropske prijave patenta (71)	MKP (51)	Broj objave evropske prijave patenta (97)	Naziv pronalaska (54)
	A61K 38/00 (2006.01) A61K 39/00 (2006.01) C07K 16/28 (2006.01)	3642243	METHODS FOR MODULATING REGULATORY T CELLS, REGULATORY B CELLS, AND IMMUNE RESPONSES USING MODULATORS OF THE APRIL-TACI INTERACTION
Tencent Technology (Shenzhen) Company Limited	H04L 9/32 (2006.01)	3644551	METHOD AND DEVICE FOR FORWARDING MESSAGE, AND STORAGE MEDIUM
L'Isolante K-Flex S.p.A.	C08J 9/36 (2006.01) F16L 59/14 (2006.01)	3638719	COATED CLOSED-CELL FOAM TUBE INSULATIONS AND METHODS FOR PRODUCING THE SAME
	C07J 41/00 (2006.01) C07J 43/00 (2006.01)	3642217	METHODS AND INTERMEDIATES FOR THE PREPARATION OF BILE ACID DERIVATIVES
Riken National Institutes for Quantum and Radiological Science and Technology	A61K 49/10 (2006.01) A61K 49/18 (2006.01) C07C 309/14 (2006.01)	3646888	NANOPARTICLE, CONTRAST AGENT FOR MAGNETIC RESONANCE IMAGING CONTAINING SAME, AND LIGAND COMPOUND
	A01K 67/027 (2006.01) C07K 16/46 (2006.01) C12N 9/64 (2006.01) C12N 15/85 (2006.01)	3572517	HUMANIZED UNIVERSAL LIGHT CHAIN MICE
Sopro Bauchemie GmbH	F16B 13/12 (2006.01) A61P 37/00 (2006.01) C07K 14/24 (2006.01) C12N 15/70 (2006.01) C12N 15/74 (2006.01)	3604831 3660034	COMPOUND SEAL BLANK BACTERIA-BASED PROTEIN DELIVERY
	A61K 31/196 (2006.01) A61K 31/343 (2006.01) A61K 31/357 (2006.01) A61P 1/04 (2006.01)	3628317	METHODS OF TREATING FIBROSIS
	A61K 31/713 (2006.01) C12N 15/113 (2010.01)	3647424	HEPATITIS B VIRUS (HBV) IRNA COMPOSITIONS AND METHODS OF USE THEREOF
	A61K 35/74 (2015.01) A61K 35/745 (2015.01) A61P 1/00 (2006.01) A61P 11/06 (2006.01) A61P 19/02 (2006.01) A61P 25/28 (2006.01) A61P 29/00 (2006.01) A61P 35/00 (2006.01) C12N 1/20 (2006.01)	3650033	COMPOSITIONS COMPRISING BACTERIAL STRAINS
	B01D 11/02 (2006.01) B01D 11/04 (2006.01) B01D 24/00 (2006.01) B01D 29/56 (2006.01) B01D 35/18 (2006.01) A61K 47/68 (2017.01)	3610935	SYSTEM FOR STAGED CONTINUOUS COOLED FILTRATION
	A61K 47/68 (2017.01)	3626273	ANTI-CMET ANTIBODY DRUG CONJUGATES AND METHODS FOR THEIR USE
	A61K 31/4375 (2006.01) A61K 31/4545 (2006.01) A61K 31/4725 (2006.01) A61K 31/4985 (2006.01) A61K 31/5377 (2006.01) A61K 31/538 (2006.01) A61K 31/5383 (2006.01) A61K 31/5415 (2006.01) A61K 31/542 (2006.01) A61K 31/554 (2006.01) A61P 31/04 (2006.01) C12N 15/67 (2006.01)	3639824	TRICYCLIC NITROGEN CONTAINING COMPOUNDS FOR TREATING NEISSERIA GONORRHOEA INFECTION
	C12N 15/67 (2006.01)	3636764	3' UTR SEQUENCES FOR STABILIZATION OF RNA
Niacet Corporation	A01N 37/02 (2006.01) A01N 37/08 (2006.01)	3639662	METHODS FOR FUNGI INHIBITION ON LIVE PLANTS

Podnosilac evropske prijave patenta (71)	MKP (51)	Broj objave evropske prijave patenta (97)	Naziv pronalaska (54)
	A01N 37/10 (2006.01)		USING CARBOXYLIC ACIDS
	A01P 3/00 (2006.01)		AND THEIR SALTS
	C05C 1/02 (2006.01)	3623362	NITRIFICATION INHIBITOR
	C05G 3/90 (2020.01)		CONTAINING FERTILISER
	C07B 41/08 (2006.01)		MIXTURE
	C07D 231/12 (2006.01)		
	A61K 39/395 (2006.01)	3670534	HUMAN FGF RECEPTOR AND
	A61P 1/16 (2006.01)		BETA-KLOTHO BINDING
	A61P 3/00 (2006.01)		PROTEINS
	A61P 3/04 (2006.01)		
	A61P 3/06 (2006.01)		
	A61P 3/10 (2006.01)		
	A61P 9/00 (2006.01)		
	A61P 43/00 (2006.01)		
	C07K 16/28 (2006.01)		
	C07K 16/40 (2006.01)		
	A61K 9/16 (2006.01)	3650013	COMBINATION
	A61K 9/20 (2006.01)		FORMULATION OF TWO
	A61K 31/501 (2006.01)		ANTIVIRAL COMPOUNDS
	A61K 31/513 (2006.01)		
	A61K 31/404 (2006.01)	3636643	NUCLEAR RECEPTOR
	A61K 31/416 (2006.01)		MODULATORS (ROR) FOR
	A61P 29/00 (2006.01)		THE TREATMENT OF
	A61P 37/00 (2006.01)		INFLAMMATORY AND
	C07D 209/14 (2006.01)		AUTOIMMUNE DISEASES
	C07D 209/18 (2006.01)		
	C07D 235/16 (2006.01)		
	C07D 401/10 (2006.01)		
	C07D 403/10 (2006.01)		
	C07D 405/10 (2006.01)		
	C07D 405/14 (2006.01)		
	C07D 471/04 (2006.01)		
	C07D 487/04 (2006.01)		
	C07D 491/10 (2006.01)		
	A61K 31/517 (2006.01)	3656764	PROCESSES FOR THE
	C07C 269/06 (2006.01)		PREPARATION OF
	C07C 271/22 (2006.01)		PYRIMIDINYLCYCLOPENTANE
	C07D 239/70 (2006.01)		COMPOUNDS
	C12P 17/16 (2006.01)		
	A01N 43/56 (2006.01)	3659439	TOPICAL COMPOSITIONS
	A01N 53/00 (2006.01)		COMPRISING FIPRONIL AND
	A61K 31/22 (2006.01)		PERMETHRIN AND METHODS
	A61K 31/415 (2006.01)		OF USE
	A61K 47/14 (2017.01)		
	A61K 47/20 (2006.01)		
	A61P 33/00 (2006.01)		
	A61K 31/439 (2006.01)	3673906	GLUCOSYLCERAMIDE
	A61K 31/454 (2006.01)		SYNTHASE INHIBITORS
	A61P 1/00 (2006.01)		
	A61P 3/00 (2006.01)		
	A61P 3/04 (2006.01)		
	A61P 3/10 (2006.01)		
	A61P 7/00 (2006.01)		
	A61P 9/10 (2006.01)		
	A61P 11/06 (2006.01)		
	A61P 13/12 (2006.01)		
	A61P 19/02 (2006.01)		
	A61P 25/00 (2006.01)		
	A61P 25/16 (2006.01)		
	A61P 25/28 (2006.01)		
	A61P 29/00 (2006.01)		
	A61P 31/04 (2006.01)		
	A61P 35/00 (2006.01)		
	A61P 43/00 (2006.01)		
	C07D 453/02 (2006.01)		
	C07D 455/02 (2006.01)		
	C07D 487/08 (2006.01)		
	A61K 39/00 (2006.01)	3656402	PHARMACEUTICAL
	A61K 39/12 (2006.01)		COMPOSITION COMPRISING
	A61K 39/39 (2006.01)		A POLYMERIC CARRIER

Podnosilac evropske prijave patenta (71)	MKP (51)	Broj objave evropske prijave patenta (97)	Naziv pronalaska (54)
	A61K 47/64 (2017.01) A61P 31/00 (2006.01) A61P 35/00 (2006.01) A61P 37/00 (2006.01) A61K 31/506 (2006.01) A61P 3/00 (2006.01) A61P 9/00 (2006.01) A61P 15/00 (2006.01) A61P 25/00 (2006.01) A61P 35/00 (2006.01) C07D 403/04 (2006.01) C07D 413/14 (2006.01) C07D 417/14 (2006.01) C07D 471/04 (2006.01) C07D 487/04 (2006.01) C07D 495/04 (2006.01) C07K 1/14 (2006.01) C07K 1/18 (2006.01) C07K 1/22 (2006.01) C07K 1/32 (2006.01) A61K 39/00 (2006.01) A61K 39/085 (2006.01) A61K 39/39 (2006.01) A61P 31/04 (2006.01) C07K 14/31 (2006.01) A61K 31/495 (2006.01) A61P 25/18 (2006.01)	3660013	CARGO COMPLEX AND AT LEAST ONE PROTEIN OR PEPTIDE ANTIGEN SGC STIMULATORS
	C07K 1/14 (2006.01) C07K 1/18 (2006.01) C07K 1/22 (2006.01) C07K 1/32 (2006.01) A61K 39/00 (2006.01) A61K 39/085 (2006.01) A61K 39/39 (2006.01) A61P 31/04 (2006.01) C07K 14/31 (2006.01) A61K 31/495 (2006.01) A61P 25/18 (2006.01)	3660032	CAPTURE PURIFICATION PROCESSES FOR PROTEINS EXPRESSED IN A NON-MAMMALIAN SYSTEM
	A61K 39/00 (2006.01) A61K 39/085 (2006.01) A61K 39/39 (2006.01) A61P 31/04 (2006.01) C07K 14/31 (2006.01) A61K 31/495 (2006.01) A61P 25/18 (2006.01)	3639850	MUTANT STAPHYLOCOCCAL ANTIGENS
	A61K 31/495 (2006.01) A61P 25/18 (2006.01)	3653211	TRANS-4-{2-[4-(2,3-DICHLOROPHENYL)-PIPERAZIN-1-YL]-ETHYL}-N,N-DIMETHYLCARBAMOYL-CYCLO-HEXYLAMINE FOR TREATING NEGATIVE SYMPTOMS OF SCHIZOPHRENIA
Les Laboratoires Servier	A61K 9/00 (2006.01) A61K 9/10 (2006.01) A61K 31/7048 (2006.01) A61K 47/36 (2006.01) A61P 9/00 (2006.01)	3669879	PHARMACEUTICAL COMPOSITION IN THE FORM OF AN ORAL SUSPENSION INCLUDING A FLAVONOID FRACTION COMPRISING DIOSMIN, AND XANTHAN GUM
	B01J 21/06 (2006.01) B01J 23/22 (2006.01) B01J 37/00 (2006.01) C01G 23/04 (2006.01) C01G 31/02 (2006.01)	3662995	POROUS MATERIALS ON THE BASIS OF OXIDES OF TITANIUM AND/OR VANADIUM AND PREPARATION AND USE THEREOF
Skinprotect Corporation SDN BHD	A41D 19/00 (2006.01) C08J 5/02 (2006.01) C08K 3/08 (2006.01) C08K 3/11 (2018.01) C08K 3/22 (2006.01) C08K 9/04 (2006.01)	3663332	DETECTABLE AND MULTI DETECTABLE ARTICLES
	A61K 9/00 (2006.01) A61K 31/138 (2006.01) A61K 31/439 (2006.01) A61K 31/58 (2006.01) A61P 11/00 (2006.01) A61P 11/06 (2006.01)	3650019	FLUTICASONE FUROATE IN THE TREATMENT OF COPD
Mayo Foundation for Medical Education and Research	A61K 31/404 (2006.01) A61K 31/428 (2006.01) A61K 31/495 (2006.01) A61K 31/496 (2006.01) A61K 31/5377 (2006.01) A61K 31/635 (2006.01) A61K 31/728 (2006.01) A61P 9/10 (2006.01) A61P 11/00 (2006.01) A61P 27/02 (2006.01)	3669881	COMPOSITIONS FOR USE IN THE TREATMENT OF SENESCENCE-ASSOCIATED DISEASE AND DISORDERS
Caniel Industries A. T. G. Ltd.	B65D 17/00 (2006.01) B65D 17/28 (2006.01) B65D 17/34 (2006.01)	3674227	A CAN AND AN URGING MEMBER THEREFOR

Podnosilac evropske prijave patenta (71)	MKP (51)	Broj objave evropske prijave patenta (97)	Naziv pronalaska (54)			
	B65D 17/50 (2006.01)	3638698	ANTI-TMPRSS2 ANTIBODIES AND ANTIGEN-BINDING FRAGMENTS			
	B65D 77/20 (2006.01)					
	B65D 79/00 (2006.01)					
	B65D 81/22 (2006.01)					
	A61K 39/395 (2006.01)					
	A61P 31/16 (2006.01)					
	C07K 16/10 (2006.01)					
	C07K 16/28 (2006.01)					
	C07K 16/40 (2006.01)					
	C01F 5/24 (2006.01)					
	C11D 3/12 (2006.01)	3655364	CARRIER MATERIAL FOR THE RELEASE OF ONE OR MORE ACTIVE AGENT(S) IN A HOME CARE FORMULATION			
	C11D 7/02 (2006.01)					
	A23L 33/00 (2016.01)			3661373	A PHARMACEUTICAL COMPOSITION FOR ANAEMIA	
	A23L 33/10 (2016.01)					
	A23L 33/17 (2016.01)					
	A23L 33/18 (2016.01)					
	A23L 33/19 (2016.01)					
	A61K 38/40 (2006.01)					
	A61P 3/00 (2006.01)					
	A61P 25/00 (2006.01)					
Codiak BioSciences, Inc.	A61K 38/00 (2006.01)	3672614	ENGINEERED EXTRACELLULAR VESICLES AND USES THEREOF			
	A61K 39/00 (2006.01)					
	A61K 45/06 (2006.01)					
	AnaptysBio, Inc.			A61K 39/395 (2006.01)	3666794	ANTIBODIES DIRECTED AGAINST PROGRAMMED DEATH- 1 (PD-1)
				A61P 1/02 (2006.01)		
				A61P 1/04 (2006.01)		
				A61P 3/10 (2006.01)		
				A61P 17/00 (2006.01)		
				A61P 25/00 (2006.01)		
				A61P 29/00 (2006.01)		
A61P 31/00 (2006.01)						
A61P 31/04 (2006.01)						
A61P 31/12 (2006.01)						
A61P 31/14 (2006.01)						
A61P 31/16 (2006.01)						
A61P 31/18 (2006.01)						
A61P 31/20 (2006.01)						
A61P 35/00 (2006.01)						
A61P 35/02 (2006.01)						
A61P 37/02 (2006.01)						
A61P 37/04 (2006.01)						
C07K 16/28 (2006.01)						
C12N 15/13 (2006.01)						
	A61K 31/7088 (2006.01)	3657168	TREATMENT OF AMYOTROPHIC LATERAL SCLEROSIS			
	A61K 31/711 (2006.01)					
	A61K 38/17 (2006.01)					
	A61K 48/00 (2006.01)					
	A61P 25/28 (2006.01)					
	G01N 33/50 (2006.01)					
				C23C 2/02 (2006.01)	3663429	HOT DIP GALVANIZING APPARATUS
				C23C 2/06 (2006.01)		
				C23C 2/26 (2006.01)		
				C23C 2/30 (2006.01)		
		A61K 39/12 (2006.01)	3663315	DIRECT EXPRESSION OF ANTIBODIES		
		A61K 39/145 (2006.01)				
		C07K 16/00 (2006.01)				
		C07K 16/10 (2006.01)				
		C12N 15/00 (2006.01)				
		Bristol-Myers Squibb Company				
	A61K 31/4439 (2006.01)					
	A61P 11/06 (2006.01)					
	A61P 35/00 (2006.01)					
	C07D 249/06 (2006.01)					
C07D 401/04 (2006.01)						
C07D 401/14 (2006.01)						
G06F 9/50 (2006.01)	3674950		SYSTEM, COMPUTER READABLE MEDIUM AND METHOD FOR ROLLING SECURITY PLATFORM			
G06F 21/57 (2013.01)						
G06F 21/62 (2013.01)						

Podnosilac evropske prijave patenta (71)	MKP (51)	Broj objave evropske prijave patenta (97)	Naziv pronalaska (54)		
4D PHARMA LEÓN, S.L.U.	H04L 29/06 (2006.01)	3645151	METHOD AND APPARATUS FOR LINING A CHAMBER		
	H04L 29/08 (2006.01)				
	B01F 9/00 (2006.01)	3645513	BENZAEPINE DERIVATIVES		
	B01L 1/00 (2006.01)				
	B65D 25/14 (2006.01)				
	A61K 31/55 (2006.01)				
	A61P 13/12 (2006.01)				
	C07D 223/16 (2006.01)				
	C07D 401/06 (2006.01)				
	C07D 401/10 (2006.01)				
	C07D 401/14 (2006.01)				
	C07D 403/06 (2006.01)				
	C07D 405/12 (2006.01)				
	C07D 409/12 (2006.01)				
	B01L 9/06 (2006.01)	3655163	MAGNETIC ASSISTED SEPARATION APPARATUSES AND RELATED METHODS		
	B03C 1/02 (2006.01)	3634148			
	G01N 35/00 (2006.01)				
	A23K 20/20 (2016.01)	3645518	METHOD AND COMPOSITION TO CONTROL RUMEN RELEASE OF COBALT TO RUMEN BACTERIA FOR MAKING VITAMIN B12		
	A23K 50/10 (2016.01)				
	C07D 213/75 (2006.01)			3661925	
C07D 295/205 (2006.01)					
A61K 31/64 (2006.01)	NOVEL SULFONAMIDE CARBOXAMIDE COMPOUNDS				
C07D 205/04 (2006.01)					
C07D 205/12 (2006.01)					
C07D 207/12 (2006.01)					
C07D 211/54 (2006.01)					
C07D 217/22 (2006.01)					
C07D 223/06 (2006.01)					
C07D 239/66 (2006.01)					
C07D 241/18 (2006.01)					
C07D 401/04 (2006.01)					
C07D 401/06 (2006.01)					
C07D 401/12 (2006.01)					
C07D 401/14 (2006.01)					
C07D 403/04 (2006.01)					
C07D 403/06 (2006.01)					
C07D 405/04 (2006.01)					
C07D 405/06 (2006.01)					
C07D 409/04 (2006.01)					
C07D 451/02 (2006.01)					
C07D 451/14 (2006.01)					
Erbacher, Clemens	A01G 9/02 (2018.01)	3657933	PLATES FORMING A SOIL- LESS CULTURE CONTAINER		
	A01G 31/06 (2006.01)				
Seattle Children's Hospital d/b/a Seattle Children's Research Institute	A61K 9/127 (2006.01)	3638292	POLYNUCLEOTIDES ENCODING COAGULATION FACTOR VIII		
	A61K 38/37 (2006.01)				
	A61P 7/04 (2006.01)	3645002	METHODS OF TREATING HEART FAILURE WITH CARDIAC SARCOMERE ACTIVATORS		
	C07K 14/755 (2006.01)				
	C07K 16/28 (2006.01)				
	A61K 31/496 (2006.01)				
	A61P 9/04 (2006.01)				
	A01K 67/027 (2006.01)			3644721	MOUSE MODEL FOR ASSESSING TOXICITIES ASSOCIATED WITH IMMUNOTHERAPIES
	A61K 35/17 (2015.01)				
	C07K 16/28 (2006.01)				
C07K 16/30 (2006.01)					
G01N 33/50 (2006.01)	3651832	NEEDLE INSERTION- RETRACTION SYSTEM HAVING DUAL TORSION SPRING SYSTEM			
A61M 5/142 (2006.01)					
	A61P 35/00 (2006.01)	3652216	CHECKPOINT INHIBITOR BISPECIFIC ANTIBODIES		
	C07K 16/46 (2006.01)				
	E05B 47/06 (2006.01)			3665346	COUPLING SYSTEM FOR AN ELECTROMECHANICAL LOCK

Podnosilac evropske prijave patenta (71)	MKP (51)	Broj objave evropske prijave patenta (97)	Naziv pronalaska (54)
OligoScience Biotechnology GmbH	A23L 33/00 (2016.01)	3661949	MICROORGANISM FOR PRODUCING HUMAN MILK OLIGOSACCHARIDE
	C07K 14/245 (2006.01)		
	C07K 14/435 (2006.01)		
	C12N 9/10 (2006.01)		
	C12P 19/18 (2006.01)		
	A61K 31/7088 (2006.01)		
Catalyst Biosciences, Inc.	A61P 35/00 (2006.01)	3649242	METHODS OF INHIBITING CELL PROLIFERATION AND METTL8 ACTIVITY
	C12N 15/10 (2006.01)		
	C12N 15/113 (2010.01)		
	A61K 38/48 (2006.01)		
	C07K 14/435 (2006.01)		
Exponential Renewables S.L.	F03D 7/02 (2006.01)	3642479	FLOATING STRUCTURE FOR OFFSHORE WIND TURBINE
Skyline Biosciences, LLC	F03D 13/25 (2016.01)	3644961	ISOTRETINOIN ORAL-MUCOSAL FORMULATIONS AND METHODS FOR USING SAME
	A61K 9/00 (2006.01)		
	A61K 9/20 (2006.01)		
	A61K 31/203 (2006.01)		
	A61P 31/00 (2006.01)		
	A61P 35/00 (2006.01)		
Evelo Biosciences, Inc.	A61K 35/745 (2015.01)	3648780	COMPOSITIONS AND METHODS OF TREATING CANCER USING BIFIDOBACTERIUM ANIMALIS SSP. LACTIS
	A61K 45/06 (2006.01)		
	A61P 35/00 (2006.01)	3651766	ANTIPROLIFERATIVE COMPOUNDS AND METHODS OF USE THEREOF
	A61K 31/496 (2006.01)		
	A61K 31/573 (2006.01)	3654955	PHARMACEUTICAL COMPOSITIONS
	A61K 38/05 (2006.01)		
	A61P 35/00 (2006.01)	3658206	DRUG DELIVERY DEVICE WITH CONTAINER ACCESS SYSTEM AND RELATED METHOD OF ASSEMBLY
	C07D 241/02 (2006.01)		
	A61K 9/24 (2006.01)	3655063	GAS PERMEABLE SEALING MEMBER FOR DRUG CONTAINER AND METHODS OF ASSEMBLY
	A61K 31/00 (2006.01)		
	A61M 5/142 (2006.01)	3658203	DRUG DELIVERY DEVICE WITH GEAR MODULE AND RELATED METHOD OF ASSEMBLY
	A61M 5/20 (2006.01)		
	A61M 5/24 (2006.01)	3652168	5-MEMBERED AND BICYCLIC HETEROCYCLIC AMIDES AS INHIBITORS OF ROCK
	A61M 5/28 (2006.01)		
	A61M 39/18 (2006.01)	3652209	AGONIST ANTIBODIES THAT BIND HUMAN CD137 AND USES THEREOF
	A61J 1/14 (2006.01)		
	A61J 1/20 (2006.01)	3652209	AGONIST ANTIBODIES THAT BIND HUMAN CD137 AND USES THEREOF
	A61K 39/395 (2006.01)		
	A61M 5/142 (2006.01)	3652209	AGONIST ANTIBODIES THAT BIND HUMAN CD137 AND USES THEREOF
	A61M 5/145 (2006.01)		
	A61M 5/158 (2006.01)	3652209	AGONIST ANTIBODIES THAT BIND HUMAN CD137 AND USES THEREOF
	A61M 5/24 (2006.01)		
	A61M 5/315 (2006.01)	3652209	AGONIST ANTIBODIES THAT BIND HUMAN CD137 AND USES THEREOF
	A61M 5/32 (2006.01)		
	A61M 5/34 (2006.01)	3652209	AGONIST ANTIBODIES THAT BIND HUMAN CD137 AND USES THEREOF
	A61M 39/00 (2006.01)		
	A61M 39/18 (2006.01)	3652209	AGONIST ANTIBODIES THAT BIND HUMAN CD137 AND USES THEREOF
	C07K 16/40 (2006.01)		
	A61M 5/142 (2006.01)	3652209	AGONIST ANTIBODIES THAT BIND HUMAN CD137 AND USES THEREOF
	A61M 5/145 (2006.01)		
	A61M 5/158 (2006.01)	3652209	AGONIST ANTIBODIES THAT BIND HUMAN CD137 AND USES THEREOF
	A61M 5/24 (2006.01)		
	A61M 5/315 (2006.01)	3652209	AGONIST ANTIBODIES THAT BIND HUMAN CD137 AND USES THEREOF
	B05C 17/01 (2006.01)		
	F04B 43/12 (2006.01)	3652209	AGONIST ANTIBODIES THAT BIND HUMAN CD137 AND USES THEREOF
	C07D 231/20 (2006.01)		
	C07D 231/22 (2006.01)	3652209	AGONIST ANTIBODIES THAT BIND HUMAN CD137 AND USES THEREOF
	C07D 231/56 (2006.01)		
	C07D 401/04 (2006.01)	3652209	AGONIST ANTIBODIES THAT BIND HUMAN CD137 AND USES THEREOF
	C07D 403/12 (2006.01)		
	C07D 417/12 (2006.01)	3652209	AGONIST ANTIBODIES THAT BIND HUMAN CD137 AND USES THEREOF
	C07D 417/14 (2006.01)		
	C07D 491/04 (2006.01)	3652209	AGONIST ANTIBODIES THAT BIND HUMAN CD137 AND USES THEREOF
	C07D 495/04 (2006.01)		
	C07D 519/00 (2006.01)	3652209	AGONIST ANTIBODIES THAT BIND HUMAN CD137 AND USES THEREOF
	C07K 16/28 (2006.01)		
Compass Therapeutics LLC	C07K 16/28 (2006.01)	3652209	AGONIST ANTIBODIES THAT BIND HUMAN CD137 AND USES THEREOF

Podnosilac evropske prijave patenta (71)	MKP (51)	Broj objave evropske prijave patenta (97)	Naziv pronalaska (54)
	A61K 31/165 (2006.01) A61P 29/02 (2006.01) C07C 237/42 (2006.01) C07D 213/81 (2006.01) C07D 213/82 (2006.01)	3651752	CARBOXAMIDES AS MODULATORS OF SODIUM CHANNELS
	A61K 31/435 (2006.01) A61P 35/00 (2006.01) A61P 37/00 (2006.01) C07D 401/04 (2006.01) C07D 401/14 (2006.01) C07D 405/14 (2006.01) C07D 409/14 (2006.01)	3652166	NLRP3 MODULATORS
	A61K 39/395 (2006.01) A61P 35/00 (2006.01) C07K 16/28 (2006.01)	3655033	PHARMACEUTICAL COMBINATIONS COMPRISING AN ANTI BST-1 ANTIBODY AND A CYTIDINE ANALOGUE SYSTEMS AND METHODS FOR TREATING BLOOD
Humanity Life Extension, LLC	A61M 1/36 (2006.01)	3648814	METHOD FOR PREPARING 3-[(3S)-7-BROMO-2-OXO-5-(PYRIDIN-2-YL)-2,3-DIHYDRO-1H-[1,4]-BENZODIAZEPIN-3-YL]PROPIONIC ACID METHYL ESTER, AND COMPOUNDS USEFUL IN THAT METHOD
Moehs Ibérica, S.L.	C07D 213/56 (2006.01) C07D 401/04 (2006.01) C07D 487/04 (2006.01)	3658545	METHODS OF TREATING BEHAVIOR ALTERATIONS
Oryzon Genomics, S.A.	A61K 31/44 (2006.01) A61P 25/00 (2006.01) A61P 25/08 (2006.01) A61P 25/14 (2006.01) A61P 25/16 (2006.01) A61P 25/18 (2006.01) A61P 25/24 (2006.01) A61P 25/28 (2006.01) A61P 25/30 (2006.01) B03D 1/004 (2006.01) B03D 1/01 (2006.01) B03D 1/16 (2006.01)	3661510	INDIRECT FLOTATION PROCESS FOR MANUFACTURING WHITE PIGMENT CONTAINING PRODUCTS
	A61K 38/00 (2006.01) C07K 7/08 (2006.01) C07K 14/47 (2006.01)	3665182	NOVEL COMPOUNDS ACTIVATING THE NRF2 PATHWAY
Oxford Genetics Limited	C12N 7/00 (2006.01) A61K 31/198 (2006.01) A61P 25/06 (2006.01) A61K 31/728 (2006.01) B01D 61/14 (2006.01) C08B 37/08 (2006.01) A61K 39/395 (2006.01) C07K 16/28 (2006.01) C07K 16/46 (2006.01)	3658668 3638370	ADENOVIRAL VECTORS TREATMENT FOR MIGRAINE
	A61K 39/00 (2006.01) C07K 16/28 (2006.01) C07K 16/12 (2006.01) C07K 16/28 (2006.01) C07K 16/46 (2006.01)	3655138 3649154	PROCESS FOR THE PURIFICATION OF HYALURONIC ACID BINDING MOLECULES THAT MODULATE A BIOLOGICAL ACTIVITY EXPRESSED BY A CELL
	A61K 39/00 (2006.01) C07K 16/28 (2006.01) C07K 16/12 (2006.01) C07K 16/28 (2006.01) C07K 16/46 (2006.01)	3649155 3649156	BISPECIFIC ANTI PD1-ANTI TIM3 ANTIBODIES THAT MODULATE A BIOLOGICAL ACTIVITY EXPRESSED BY A CELL
	A61K 39/00 (2006.01) C07K 16/24 (2006.01)	3642234	IL-1BETA BINDING ANTIBODIES FOR USE IN TREATING CANCER
	A61K 31/496 (2006.01) A61P 25/28 (2006.01) C08B 1/00 (2006.01) C12P 7/06 (2006.01) C12P 19/04 (2006.01) D21C 5/00 (2006.01)	3648765 3638803	NEW USES OF A PURE 5-HT 6 RECEPTOR ANTAGONIST PROCESS FOR OBTAINING CELLULOSE FROM PLANT MATERIAL
Innovative Sustainable Technologies B.V.	A61K 35/76 (2015.01) A61K 48/00 (2006.01) C07K 14/015 (2006.01)	3645551	TROPISM-MODIFIED RECOMBINANT VIRAL VECTORS AND USES

Podnosilac evropske prijave patenta (71)	MKP (51)	Broj objave evropske prijave patenta (97)	Naziv pronalaska (54)
	C07K 16/18 (2006.01) C07K 16/28 (2006.01) C12N 5/10 (2006.01) C12N 15/35 (2006.01) C12N 15/864 (2006.01) A61K 48/00 (2006.01) C07K 14/315 (2006.01) C12N 7/00 (2006.01)	3645553	THEREOF FOR THE TARGETED INTRODUCTION OF GENETIC MATERIAL INTO HUMAN CELLS
Janssen Vaccines & Prevention B.V.	A61K 39/12 (2006.01) A61P 31/18 (2006.01) C07K 14/16 (2006.01)	3638302	TROPISM-MODIFIED RECOMBINANT VIRAL PARTICLES AND USES THEREOF FOR THE TARGETED INTRODUCTION OF GENETIC MATERIAL INTO HUMAN CELLS
Ecospray Technologies S.r.l.	B01D 53/047 (2006.01)	3648868	POXVIRUS VECTORS ENCODING HIV ANTIGENS, AND METHODS OF USE THEREOF
Tekno Idea S.r.l.	G01B 11/25 (2006.01) G01N 21/88 (2006.01)	3652524	A GAS-FILTERING SYSTEM AND METHOD
	A61K 31/404 (2006.01) A61K 31/443 (2006.01) A61K 31/4439 (2006.01) A61K 31/47 (2006.01) A61P 11/00 (2006.01)	3654969	DEVICE AND PROCESS FOR DETECTING SURFACE DEFECTS
Saudi Arabian Oil Company	C09K 8/524 (2006.01) C09K 8/60 (2006.01) E21B 43/25 (2006.01)	3655494	METHODS OF TREATMENT FOR CYSTIC FIBROSIS
	A61K 39/00 (2006.01)	3658179	MITIGATION OF CONDENSATE BANKING USING SURFACE MODIFICATION
Brose Fahrzeugteile SE & Co. Kommanditgesellschaft, Würzburg	H02K 5/22 (2006.01) H02K 7/14 (2006.01) H02K 11/33 (2016.01) H02K 15/14 (2006.01) A23L 33/15 (2016.01) A61K 31/122 (2006.01) A61K 33/06 (2006.01) A61K 33/26 (2006.01) A61K 45/06 (2006.01) A61P 9/00 (2006.01)	3673567	METHODS AND COMPOSITIONS FOR HETEROLOGOUS REPRNA IMMUNIZATIONS
	A61K 31/122 (2006.01) A61K 33/06 (2006.01) A61K 33/26 (2006.01) A61K 45/06 (2006.01) A61P 9/00 (2006.01)	3657963	CONNECTING DEVICE AND ELECTRIC MOTOR
Panotec SRL	B31B 50/25 (2017.01) B31B 50/54 (2017.01) B31B 50/62 (2017.01) B31B 100/00 (2017.01) B31B 110/35 (2017.01) B31B 120/10 (2017.01) B31F 1/08 (2006.01) B65B 5/02 (2006.01) B65B 11/00 (2006.01) B65B 35/24 (2006.01) B65B 35/44 (2006.01) B65B 43/12 (2006.01) B65B 43/30 (2006.01) B65B 49/10 (2006.01) B65B 49/14 (2006.01) A61M 5/315 (2006.01)	3661849	COMPOSITION FOR USE IN THE PREVENTION AND TREATMENT OF PATHOLOGIES OF THE CARDIOVASCULAR APPARATUS
	A61M 5/315 (2006.01)	3672668	PLANT FOR AUTOMATED PACKAGING OF ITEMS IN CARDBOARD BOXES
	A23L 2/00 (2006.01) A61K 9/00 (2006.01) A61K 31/198 (2006.01) A61K 31/4172 (2006.01) A61K 38/00 (2006.01) A61K 45/06 (2006.01) A61P 1/16 (2006.01) A61P 21/00 (2006.01)	3668499	MEDICATION DELIVERY DEVICE WITH SENSING SYSTEM
	A23L 2/00 (2006.01) A61K 9/00 (2006.01) A61K 31/198 (2006.01) A61K 31/4172 (2006.01) A61K 38/00 (2006.01) A61K 45/06 (2006.01) A61P 1/16 (2006.01) A61P 21/00 (2006.01)	3668499	AMINO ACID COMPOSITIONS FOR THE TREATMENT OF LIVER DISEASE

Podnosilac evropske prijave patenta (71)	MKP (51)	Broj objave evropske prijave patenta (97)	Naziv pronalaska (54)	
	A61P 31/00 (2006.01)	3672631	PHARMACEUTICAL COMPOSITIONS CONTAINING ANTI-BETA AMYLOID ANTIBODIES	
	A61P 43/00 (2006.01)			
	A61K 39/395 (2006.01)			
	C07K 16/18 (2006.01)			
	A61K 39/395 (2006.01)			
	C07K 16/18 (2006.01)			
	C07K 16/28 (2006.01)	3672632	PHARMACEUTICAL COMPOSITIONS AND DOSAGE REGIMENS CONTAINING ANTI- ALPHA(V)BETA(6) ANTIBODIES	
	G06Q 20/38 (2012.01)	3540674	METHOD AND SYSTEM FOR THE GENERATION OF USER- INITIATED FEDERATED IDENTITIES	
	G06Q 20/40 (2012.01)			
	G06Q 30/06 (2012.01)			
	Cornèr Banca SA	A61K 31/5585 (2006.01)	3536380	RAPID-ACTING INSULIN COMPOSITIONS
		A61K 38/28 (2006.01)	3560959	ANTIBODY MOLECULES TO TIM-3 AND USES THEREOF
A61P 3/10 (2006.01)				
	A61K 39/395 (2006.01)	3540356	BUSHING JOINT FOR FORMING A RADIANT BODY	
	C07K 16/28 (2006.01)			
	G01N 33/68 (2006.01)			
	B21C 37/29 (2006.01)	3539966	INHIBITORS OF TYROSINE KINASE 2 MEDIATED SIGNALING	
	F16L 1/00 (2006.01)			
	F16L 5/10 (2006.01)			
	F16L 13/02 (2006.01)			
	F24D 19/00 (2006.01)			
	F28D 1/053 (2006.01)			
	F28D 21/00 (2006.01)			
	F28F 9/02 (2006.01)			
	F28F 9/18 (2006.01)			
	F28F 9/26 (2006.01)			
	A61K 31/4353 (2006.01)	3549611	SWITCH COSTIMULATORY RECEPTORS	
	A61P 1/00 (2006.01)			
	A61P 17/06 (2006.01)			
	The Trustees of the University of Pennsylvania Delabre, Pierre-Yves	C07D 487/04 (2006.01)	3540139	DEVICE FOR TOILET, CONNECTOR WITH VALVE FOR SIPHON AND CORRESPONDING METHOD
A61K 38/17 (2006.01)				
A61K 48/00 (2006.01)				
	E03C 1/122 (2006.01)	3536339	METHODS FOR IMPROVING ASTHMA SYMPTOMS USING BENRALIZUMAB	
	E03D 11/16 (2006.01)			
	E03F 5/08 (2006.01)	3543528	ALTERNATIVE TWIN CYLINDER AIR COMPRESSOR	
	A61K 39/00 (2006.01)			
	A61K 39/395 (2006.01)			
	A61P 11/06 (2006.01)			
	G01N 33/48 (2006.01)			
	F04B 27/00 (2006.01)			
	F04B 35/04 (2006.01)			
	F04B 39/06 (2006.01)			
F04B 39/12 (2006.01)				
FIAC S.R.L.	F04B 39/16 (2006.01)	3542820	METHODS OF TREATING PSORIATIC ARTHRITIS USING IL-17 ANTAGONISTS	
	A61K 31/519 (2006.01)			
	A61K 39/395 (2006.01)	3527088	ELECTRICALLY-POWERED AEROSOL DELIVERY SYSTEM IMPROVED FRAGMENTATION PROJECTILE AND METHOD FOR ITS MANUFACTURING	
	C07K 16/24 (2006.01)			
	A24F 47/00 (2006.01)			
	F42B 5/02 (2006.01)	3537094		
	F42B 5/03 (2006.01)			
	F42B 8/14 (2006.01)			
	F42B 12/06 (2006.01)			
	F42B 12/36 (2006.01)			
	A61K 31/00 (2006.01)	3539540	PHARMACEUTICAL COMPOSITION, METHODS FOR TREATING AND USES THEREOF	
	A61K 31/341 (2006.01)			
	A61K 38/28 (2006.01)			
	A61P 3/10 (2006.01)			
	A61K 9/20 (2006.01)			3542791
A61K 9/24 (2006.01)				
A61K 9/28 (2006.01)				
A61K 9/48 (2006.01)				

Podnosilac evropske prijave patenta (71)	MKP (51)	Broj objave evropske prijave patenta (97)	Naziv pronalaska (54)				
	G03G 15/08 (2006.01)	3537223	TONER CARTRIDGE, TONER SUPPLYING MECHANISM AND SHUTTER				
	G03G 21/16 (2006.01)						
	G03G 21/18 (2006.01)						
Astellas Institute for Regenerative Medicine	A61K 35/12 (2015.01)	3563860	PHARMACEUTICAL PREPARATIONS OF HUMAN RPE CELLS AND USES THEREOF				
	A61K 35/44 (2015.01)						
	A61K 35/50 (2015.01)						
	A61P 27/02 (2006.01)						
VOLKSWAGEN AKTIENGESELLSCHAFT	B32B 17/10 (2006.01)	3546211	VEHICLE WINDOW AND METHOD OF MANUFACTURING SAME				
	B60J 1/00 (2006.01)						
	A61K 31/517 (2006.01)			3539952	SUBSTITUTED BICYCLIC DIHYDROPYRIMIDINONES AND THEIR USE AS INHIBITORS OF NEUTROPHIL ELASTASE ACTIVITY		
A61P 29/00 (2006.01)							
C07D 239/70 (2006.01)							
Prayon Technologies	A61K 31/437 (2006.01)	3539961	POLYCYCLIC AMIDE DERIVATIVES AS CDK9 INHIBITORS				
	A61P 35/00 (2006.01)						
	C07D 471/04 (2006.01)						
	C07D 487/04 (2006.01)						
	C07D 498/04 (2006.01)						
	A61K 31/7088 (2006.01)			3550019	COMBINATION		
	C12N 15/11 (2006.01)						
	C12N 15/113 (2010.01)			3655438	AGENTS, USES AND METHODS FOR TREATMENT		
	A61K 39/00 (2006.01)						
	Bioersys AG			C07K 16/28 (2006.01)	3665124	METHOD FOR ETCHING A PHOSPHATE SOURCE USING ACID	
C01B 25/01 (2006.01)							
C01B 25/22 (2006.01)							
C01B 25/225 (2006.01)							
C01B 25/226 (2006.01)							
C01B 25/32 (2006.01)							
Bioersys AG	A61K 31/438 (2006.01)	3668879	NOVEL COMPOUNDS				
	A61P 31/06 (2006.01)						
	C07D 498/10 (2006.01)						
	A61K 31/4427 (2006.01)			3668853	NOVEL COMPOUNDS		
	A61K 31/4523 (2006.01)						
	A61K 31/497 (2006.01)						
	A61K 31/501 (2006.01)						
	A61K 31/506 (2006.01)						
	A61P 31/06 (2006.01)						
	C07D 401/04 (2006.01)						
	A61P 35/00 (2006.01)					3645122	TARGETED HETERODIMERIC FC FUSION PROTEINS CONTAINING IL-15/IL-15RA AND ANTIGEN BINDING DOMAINS
	C07K 14/54 (2006.01)						
C07K 14/715 (2006.01)							
C07K 16/28 (2006.01)							
A61K 31/352 (2006.01)	3654976	METHODS OF USE OF ULTRA-HIGH DOSE RATE RADIATION AND THERAPEUTIC AGENTS					
A61K 31/366 (2006.01)							
A61K 31/404 (2006.01)							
A61K 31/436 (2006.01)							
A61K 31/4439 (2006.01)							
A61K 39/395 (2006.01)							
Novartis Inflammasome Research, Inc.	A61N 5/10 (2006.01)	3658539	COMPOUNDS AND COMPOSITIONS FOR TREATING CONDITIONS ASSOCIATED WITH NLRP ACTIVITY				
	A61P 35/00 (2006.01)						
	A61K 31/175 (2006.01)						
	C07C 381/10 (2006.01)						
	C07D 205/04 (2006.01)						
	C07D 207/04 (2006.01)						
	C07D 207/10 (2006.01)						
	C07D 213/71 (2006.01)						
	C07D 217/22 (2006.01)						
	C07D 231/18 (2006.01)						
	C07D 231/56 (2006.01)						
	C07D 263/46 (2006.01)						
	C07D 265/30 (2006.01)						
	C07D 277/36 (2006.01)						
	C07D 307/64 (2006.01)						
	C07D 333/34 (2006.01)						
	C07D 417/12 (2006.01)						
	A61K 39/00 (2006.01)			3658193	ANTI-CD8 ANTIBODIES AND USES THEREOF		
	A61K 49/00 (2006.01)						

Podnosilac evropske prijave patenta (71)	MKP (51)	Broj objave evropske prijave patenta (97)	Naziv pronalaska (54)		
	A61K 49/16 (2006.01)	3658672	MODIFIED MRNA ENCODING A GLUCOSE-6-PHOSPHATASE AND USES THEREOF		
	A61K 51/10 (2006.01)				
	C07K 16/28 (2006.01)				
	G01N 33/53 (2006.01)				
	A61K 38/46 (2006.01)				
	C12N 9/18 (2006.01)				
	A61K 31/437 (2006.01)			3658555	INHIBITORS OF ROR
	A61P 29/00 (2006.01)				
	C07D 471/04 (2006.01)				
	A61K 31/437 (2006.01)			3658556	
A61P 29/00 (2006.01)					
C07D 471/04 (2006.01)					
A61K 31/397 (2006.01)	3668854	NOVEL COMPOUNDS			
A61P 31/06 (2006.01)					
C07D 205/04 (2006.01)					
C07D 401/04 (2006.01)					
C07D 405/04 (2006.01)					
A61K 38/40 (2006.01)	3658174		LACTOFERRICIN AND LACTOFERRAMPIN FOR TREATING INFECTIONS		
A61P 31/00 (2006.01)					
Actym Therapeutics, Inc.	A61K 35/74 (2015.01)			3652318	ENGINEERED IMMUNOSTIMULATORY BACTERIAL STRAINS AND USES THEREOF
	A61P 35/00 (2006.01)				
	C12N 1/36 (2006.01)				
	C12N 15/113 (2010.01)				
	A61K 31/7115 (2006.01)	3655040		MODIFIED MRNA ENCODING A PROPIONYL-COA CARBOXYLASE AND USES THEREOF	
	A61K 48/00 (2006.01)				
	C12N 9/00 (2006.01)				
	A61K 39/00 (2006.01)	3661544			
	A61P 35/00 (2006.01)				
	C07K 16/28 (2006.01)				
A61K 9/20 (2006.01)	3654951	COMPOSITIONS COMPRISING DARUNAVIR, COBICISTAT, EMTRICITABINE AND TENOFOVIR ALAFENAMIDE FOR USE IN THE TREATMENT OF HIV			
A61K 31/34 (2006.01)					
A61K 31/513 (2006.01)					
A61K 31/5377 (2006.01)					
A61K 31/675 (2006.01)					
A61K 31/5395 (2006.01)	3661517		DIHYDROOXADIAZINONES		
A61P 35/00 (2006.01)					
C07D 273/04 (2006.01)					
C07D 413/10 (2006.01)					
C07D 417/10 (2006.01)					
C07D 491/107 (2006.01)					
A61J 1/10 (2006.01)	3652491	PROCESS FOR LYOPHILISING A PRODUCT			
F26B 5/06 (2006.01)					
A61M 5/142 (2006.01)	3668567			WEARABLE INJECTOR WITH STERILE ADHESIVE PATCH PREPARATION COMPRISING VONOPRAZAN	
A61K 9/00 (2006.01)					
A61K 9/20 (2006.01)					
A61K 9/50 (2006.01)					
A61K 31/4439 (2006.01)					
A61K 31/7125 (2006.01)	3658156		METHODS OF TREATING MYELOYDYSPLASTIC SYNDROME		
A61P 7/00 (2006.01)					
A61K 31/416 (2006.01)	3652169				PYRAZOLO AND TRIAZOLO BICYCLIC COMPOUNDS AS JAK KINASE INHIBITORS
A61K 31/437 (2006.01)					
A61K 31/519 (2006.01)					
A61P 29/00 (2006.01)					
C07D 403/12 (2006.01)					
C07D 487/04 (2006.01)					
A61K 31/4196 (2006.01)	3661503	ANTIFUNGAL AGENTS WITH ENHANCED ACTIVITY IN ACIDIC PH			
A61K 31/4439 (2006.01)					
A61P 15/02 (2006.01)					
A61P 31/10 (2006.01)					
C07D 207/06 (2006.01)	3661915		PROCESSES FOR PREPARING PYRROLIDINE COMPOUNDS		
C07D 207/263 (2006.01)					
Scynexis, Inc.					

Podnosilac evropske prijave patenta (71)	MKP (51)	Broj objave evropske prijave patenta (97)	Naziv pronalaska (54)
	A01N 63/00 (2020.01) C07K 14/325 (2006.01) C12N 15/82 (2006.01) G16H 20/10 (2018.01) G16H 50/50 (2018.01)	3661950 3665706	PESTICIDAL GENES AND METHODS OF USE GRAPHICAL USER INTERFACE FOR PERSONALIZED PREDICTION MODELING
Inalco S.r.l.	B01D 11/04 (2006.01) C07C 37/00 (2006.01) C07C 37/70 (2006.01) C07C 37/82 (2006.01) C07C 39/23 (2006.01) C07D 311/80 (2006.01) A61P 35/00 (2006.01) C07K 16/10 (2006.01) C07K 16/28 (2006.01) A61K 31/4192 (2006.01) A61K 31/4196 (2006.01) A61K 31/4439 (2006.01) A61K 31/497 (2006.01) A61K 31/501 (2006.01) A61K 31/506 (2006.01) A61P 31/06 (2006.01) C07D 249/06 (2006.01) C07D 257/04 (2006.01) C07D 401/06 (2006.01) C07D 403/06 (2006.01) C07D 405/06 (2006.01)	3658524 3661960 3668856	METHOD FOR THE PRODUCTION OF CANNABINOIDS FROM TYPES OF INDUSTRIAL HEMP BINDING AGENTS BINDING TO PD-L1 AND CD137 AND USE THEREOF NOVEL TETRAZOLE COMPOUNDS AND THEIR USE IN THE TREATMENT OF TUBERCULOSIS
	A23L 3/01 (2006.01) A23L 33/00 (2016.01) A23L 33/10 (2016.01) A61K 39/35 (2006.01) A61P 37/00 (2006.01)	 3654778	METHODS FOR MAKING MIXED ALLERGEN COMPOSITIONS
Scholar Rock, Inc.	A61K 39/00 (2006.01) C07K 16/22 (2006.01) C07K 16/28 (2006.01)	3658583	LTBP COMPLEX-SPECIFIC INHIBITORS OF TGF-BETA 1 AND USES THEREOF
Alfasigma S.p.A.	A61K 9/00 (2006.01) A61K 31/55 (2006.01) A61P 1/14 (2006.01)	3661518	METHODS OF TREATING SYMPTOMS OF GASTROPARESIS USING VELUSETRAG
Zamna Technologies Limited	H04L 9/32 (2006.01) H04L 29/06 (2006.01)	3652887	METHOD AND SYSTEM FOR DATA SECURITY WITHIN INDEPENDENT COMPUTER SYSTEMS AND DIGITAL NETWORKS
AIONIS, D.O.O.	B22F 3/105 (2006.01) B29C 64/20 (2017.01) B29C 64/264 (2017.01) B29C 64/268 (2017.01) B29C 64/277 (2017.01) B33Y 10/00 (2015.01) B33Y 30/00 (2015.01) A61K 38/40 (2006.01) A61K 39/00 (2006.01) C07K 14/705 (2006.01) C07K 14/79 (2006.01)	3638441 3665192	A MACHINE AND A METHOD FOR ADDITIVE MANUFACTURING OF THREE-DIMENSIONAL OBJECTS ENGINEERED TRANSFERRIN RECEPTOR BINDING POLYPEPTIDES
Amyris, Inc.	A23L 2/60 (2006.01) C12N 9/02 (2006.01) C12N 9/10 (2006.01) C12N 9/90 (2006.01) C12N 15/81 (2006.01) A61K 9/08 (2006.01) A61K 31/166 (2006.01) A61K 47/18 (2017.01) A61K 47/26 (2006.01)	3665287 3664780	PISUM SATIVUM KAURENE OXIDASE FOR HIGH EFFICIENCY PRODUCTION OF REBAUDIOSIDES PHARMACEUTICAL COMPOSITIONS
Planet Care Resitve za okolje, d.o.o	C02F 1/28 (2006.01) D06F 39/10 (2006.01)	3655365	METHOD AND DEVICE FOR REMOVING PARTICLES FROM WASTE WATER

Podnosilac evropske prijave patenta (71)	MKP (51)	Broj objave evropske prijave patenta (97)	Naziv pronalaska (54)		
Giuliani S.p.A.	A61K 8/00 (2006.01)	3661534	A SYNERGISTIC COMPOSITION AS A PROMOTER OF AUTOPHAGY		
	A61K 31/132 (2006.01)				
	A61K 31/4188 (2006.01)				
	A61K 36/53 (2006.01)				
	A61P 17/14 (2006.01)				
	G07G 1/00 (2006.01)	3659127	INSTALLATION AND METHOD FOR MANAGING PRODUCT DATA		
	A61K 35/17 (2015.01)	3661528	REAGENTS FOR EXPANDING CELLS EXPRESSING RECOMBINANT RECEPTORS		
	C12N 5/0783 (2010.01)	3668861	NOVEL SULFONAMIDE CARBOXAMIDE COMPOUNDS		
	A61K 31/64 (2006.01)				
	C07D 213/52 (2006.01)				
C07D 231/18 (2006.01)					
C07D 401/12 (2006.01)					
C07D 401/14 (2006.01)					
C07D 403/12 (2006.01)					
C07D 405/04 (2006.01)					
C07D 405/12 (2006.01)					
C07D 407/12 (2006.01)					
Oncostellae, S.L.	C07D 407/14 (2006.01)	3632912	PYRIDOQUINAZOLINE DERIVATIVES USEFUL AS PROTEIN KINASE INHIBITORS		
	C07D 413/12 (2006.01)				
	C07D 417/12 (2006.01)				
	C07D 471/08 (2006.01)				
	C07D 487/04 (2006.01)				
	C07D 491/048 (2006.01)				
	A61K 31/517 (2006.01)			3662287	SYSTEMS AND METHODS FOR REAL TIME PREPARATION OF A POLYPEPTIDE SAMPLE FOR ANALYSIS WITH MASS SPECTROMETRY
	A61P 17/06 (2006.01)				
	C07D 471/04 (2006.01)			3662288	SYSTEMS AND METHODS FOR PERFORMING A REAL-TIME GLYCAN ASSAY OF A SAMPLE
	G01N 1/34 (2006.01)				
G01N 33/68 (2006.01)	3661954	INTERLEUKIN-21 MUTEINS AND METHODS OF TREATMENT			
G01N 30/88 (2006.01)					
G01N 33/68 (2006.01)					
A61K 47/54 (2017.01)	3661514	MAVACAMTEN FOR USE IN THE TREATMENT OF HYPERTROPHIC CARDIOMYOPATHY			
A61K 47/60 (2017.01)					
C07K 14/54 (2006.01)					
A61K 31/513 (2006.01)	3664863	HYDRAULIC-PNEUMATIC PRESSURIZED CHAMBER DRUG DELIVERY SYSTEM			
A61P 9/04 (2006.01)					
A61P 9/10 (2006.01)	3668966	ADAPTIVE ELECTRODE ARRANGEMENT FOR IMPLEMENTATION IN A CELL INCUBATOR SYSTEM AND APPLICATIONS THEREOF			
A61M 5/142 (2006.01)					
A61M 5/145 (2006.01)					
C12M 1/34 (2006.01)					
C12M 1/42 (2006.01)					
C12M 3/00 (2006.01)					
C12N 5/0735 (2010.01)					
C12N 5/077 (2010.01)					
C12N 13/00 (2006.01)					
G01N 27/27 (2006.01)					
Oncostellae, S.L.	G01N 33/50 (2006.01)	3668599	SULFONYLUREAS AND SULFONYLTHIOUREAS AS NLRP3 INHIBITORS		
	A61P 3/10 (2006.01)				
	A61P 25/28 (2006.01)				
	A61P 29/00 (2006.01)				
	A61P 31/00 (2006.01)				
	A61P 35/00 (2006.01)				
	C07D 231/18 (2006.01)				
	C07D 233/84 (2006.01)				
	C07D 249/04 (2006.01)				
	C07D 249/12 (2006.01)				
C07D 401/04 (2006.01)					
C07D 401/12 (2006.01)					
C07D 403/04 (2006.01)					
C07D 403/06 (2006.01)					

Podnosilac evropske prijave patenta (71)	MKP (51)	Broj objave evropske prijave patenta (97)	Naziv pronalaska (54)		
Ardelyx, Inc.	C07D 403/12 (2006.01)	3661945	GLYCYRRHETINIC ACID DERIVATIVES FOR TREATING HYPERKALEMIA		
	C07D 405/04 (2006.01)				
	C07D 405/12 (2006.01)				
	C07D 413/06 (2006.01)				
	C07D 417/04 (2006.01)				
	C07D 471/04 (2006.01)				
	C07D 487/04 (2006.01)				
	A61K 31/575 (2006.01)				
	A61P 5/44 (2006.01)				
	C07J 63/00 (2006.01)				
Rodin Therapeutics, Inc.	A61K 31/437 (2006.01)	3664802	BICYCLIC INHIBITORS OF HISTONE DEACETYLASE		
	A61P 25/28 (2006.01)	3664792	METHODS OF TREATMENT		
	A61K 31/195 (2006.01)				
	A61P 9/08 (2006.01)				
	E04B 1/24 (2006.01)			3669033	MODULAR SYSTEM FOR CREATING A STRUCTURE, MODULE CONNECTOR AND STRUCTURE COMPRISING A MODULAR SYSTEM
	E04B 1/348 (2006.01)			3668601	NOVEL SULFONAMIDE CARBOXAMIDE COMPOUNDS
	E04B 9/06 (2006.01)				
	E04C 3/04 (2006.01)				
	E04C 3/07 (2006.01)				
	A61K 31/64 (2006.01)				
A61P 1/00 (2006.01)					
A61P 9/00 (2006.01)					
A61P 11/00 (2006.01)					
A61P 13/12 (2006.01)					
A61P 15/00 (2006.01)					
A61P 17/00 (2006.01)	3661562	METHOD OF CONJUGATION OF CYS-MABS			
A61P 25/00 (2006.01)					
A61P 31/00 (2006.01)					
A61P 37/00 (2006.01)					
A61K 47/68 (2017.01)					
C07K 14/605 (2006.01)					
C07K 16/00 (2006.01)					
A61K 47/68 (2017.01)			3661963	BCMA MONOCLONAL ANTIBODY-DRUG CONJUGATE	
A61P 35/00 (2006.01)			3661519	THERAPEUTIC COMBINATION OF A THIRD GENERATION EGFR TYROSINE KINASE INHIBITOR AND A CYCLIN D KINASE INHIBITOR	
C07K 16/28 (2006.01)					
A61K 31/519 (2006.01)					
A61K 31/55 (2006.01)					
A61K 45/06 (2006.01)					
A61P 35/00 (2006.01)					
A61K 31/5377 (2006.01)	3661516	THERAPEUTIC COMBINATION OF A THIRD-GENERATION EGFR TYROSINE KINASE INHIBITOR AND A RAF INHIBITOR			
A61K 31/55 (2006.01)					
A61K 45/06 (2006.01)					
A61P 35/00 (2006.01)					
Prelude Therapeutics, Incorporated	A61K 31/7064 (2006.01)	3665179	SELECTIVE INHIBITORS OF PROTEIN ARGININE METHYLTRANSFERASE 5 (PRMT5)		
	A61P 35/00 (2006.01)	3665169	CARBOXAMIDES AS UBIQUITIN-SPECIFIC PROTEASE INHIBITORS		
	A61P 35/02 (2006.01)				
	C07H 19/14 (2006.01)				
	A61K 31/4365 (2006.01)				
	A61K 31/496 (2006.01)				
	A61K 31/4995 (2006.01)				
	A61K 31/5386 (2006.01)				
	A61K 31/551 (2006.01)				
	A61P 35/00 (2006.01)				
C07D 405/14 (2006.01)	3664820			METHODS FOR PRODUCING GENETICALLY ENGINEERED CELL COMPOSITIONS AND RELATED COMPOSITIONS	
C07D 471/04 (2006.01)					
C07D 487/04 (2006.01)					
C07D 495/04 (2006.01)					
C07D 519/00 (2006.01)					
A61K 35/17 (2015.01)					
A61K 39/00 (2006.01)					
A61K 39/395 (2006.01)					
A61K 39/44 (2006.01)					
C12N 5/0783 (2010.01)		3664835	METHODS AND COMPOSITIONS FOR PREPARING GENETICALLY ENGINEERED CELLS		
A61K 39/00 (2006.01)					
C12N 5/0783 (2010.01)					

Podnosilac evropske prijave patenta (71)	MKP (51)	Broj objave evropske prijave patenta (97)	Naziv pronalaska (54)	
Chase Pharmaceuticals Corporation	A61K 31/505 (2006.01)	3645003	COMBINATION AND USES AND TREATMENTS THEREOF	
	A61K 31/513 (2006.01)			
	A61K 31/675 (2006.01)			
	A61K 31/435 (2006.01)	3645526	NEW QUINOLINONE COMPOUNDS	
	A61P 35/00 (2006.01)			
	C07D 403/02 (2006.01)			
	C07D 403/14 (2006.01)			
	A61K 31/396 (2006.01)	3645120	NK-1 ANTAGONIST COMPOSITIONS AND METHODS FOR USE IN TREATING DEPRESSION	
	A61K 31/425 (2006.01)			
	A61K 45/06 (2006.01)			
	A61P 25/24 (2006.01)			
	C07D 498/04 (2006.01)	3646869	CHEMOTHERAPY FOR CANCER USING AZABICYCLO COMPOUND	
	A61K 31/437 (2006.01)			
A61K 39/395 (2006.01)				
A61K 45/00 (2006.01)				
A61P 35/00 (2006.01)				
A61P 37/04 (2006.01)				
A61P 43/00 (2006.01)				
C07D 471/04 (2006.01)				
C07K 1/13 (2006.01)	3650470			NOVEL ANTI-HUMAN CEACAM5 ANTIBODY FAB FRAGMENT
C07K 16/30 (2006.01)				
C12N 1/15 (2006.01)				
C12N 1/19 (2006.01)				
C12N 1/21 (2006.01)				
C12N 5/10 (2006.01)				
C12N 15/13 (2006.01)				
C12N 15/63 (2006.01)				
C12P 21/08 (2006.01)				
G01N 33/574 (2006.01)				
A61K 31/22 (2006.01)		3648756	STATIN COMPOSITIONS AND METHODS FOR USE IN TREATING SYNUCLEINOPATHIES	
A61K 31/366 (2006.01)				
A61K 31/40 (2006.01)				
A61K 31/428 (2006.01)				
A61K 31/44 (2006.01)				
A61K 31/47 (2006.01)				
A61K 31/505 (2006.01)				
A61P 25/16 (2006.01)				
A61P 25/28 (2006.01)				
A61K 31/737 (2006.01)	3648775			BICONJUGATES WITH CHEMICALLY MODIFIED BACKBONES
A61K 38/01 (2006.01)				
A61K 38/04 (2006.01)				
A61K 38/39 (2006.01)				
A61L 33/08 (2006.01)				
A61P 1/16 (2006.01)				
A61K 9/10 (2006.01)		3648767	TOPICAL FORMULATIONS COMPRISING MONTELUKAST AND COMBINATIONS WITH MUSSEL ADHESIVE PROTEINS	
A61K 31/519 (2006.01)				
A61P 29/00 (2006.01)				
Gostyukhina, Ella Vasylivna	B65D 81/20 (2006.01)	3632816	READY-TO-EAT FOOD PRODUCT IN VACUUM PACKAGING	
Jiangyin Usun Pharmaceutical Co., Ltd.	A61K 38/17 (2006.01)	3648785	ANTI-INFLAMMATORY USE OF PEPTIDE	
	A61P 17/00 (2006.01)			
Jiangyin Usun Pharmaceutical Co., Ltd.	C07D 215/00 (2006.01)	3648774	SYNTHETIC BIOCONJUGATES	
	A61K 31/715 (2006.01)			
	A61K 31/727 (2006.01)			
	A61K 31/728 (2006.01)			
	A61K 31/737 (2006.01)			
	A61K 38/00 (2006.01)			
	A61K 38/08 (2019.01)			
	A61K 41/00 (2020.01)			3651801
California Institute of Technology	B82Y 10/00 (2011.01)	3652106	NEUTRAL ATOM QUANTUM INFORMATION PROCESSOR	
	G21K 1/00 (2006.01)			
	G21K 1/02 (2006.01)	3651761	SCREENING PLATFORM TO IDENTIFY THERAPEUTIC	
	A61K 31/381 (2006.01)			
A61K 31/397 (2006.01)				

Podnosilac evropske prijave patenta (71)	MKP (51)	Broj objave evropske prijave patenta (97)	Naziv pronalaska (54)	
Synthorx, Inc.	C07K 14/47 (2006.01)		DRUGS OR AGENTS FOR TREATMENT OF ALZHEIMER'S DISEASE	
	C07K 16/28 (2006.01)			
	A61K 31/5355 (2006.01)	3653623	METHOD FOR PRODUCING (2S)-2-[(1H-PYRAZOL-1-YL)METHYL]-1,3-OXAZINANE DERIVATIVE	
	A61P 25/20 (2006.01)			
	C07D 265/06 (2006.01)			
	C07D 413/14 (2006.01)			
		C12N 15/11 (2006.01)	3652316	INCORPORATION OF UNNATURAL NUCLEOTIDES AND METHODS THEREOF
		C12P 21/00 (2006.01)		
	Shanghai Tolo Biotechnology Company Limited	A61K 39/00 (2006.01)	3651794	CHLAMYDIA NANOEMULSION VACCINE
		A61P 31/04 (2006.01)		
C07K 14/295 (2006.01)				
C12Q 1/68 (2018.01)				
Dental Smartmirror, Inc.	A61C 7/00 (2006.01)	3651683	APPLICATION OF CAS PROTEIN, METHOD FOR DETECTING TARGET NUCLEIC ACID MOLECULE AND KIT USING IMMERSIVE PHOTOGRAPHS TO GUIDE PLACEMENT OF ORTHODONTIC BRACKETS, AND APPLICATIONS THEREOF	
			RESOURCE-SAVING, ENVIRONMENTALLY FRIENDLY ADHESIVE-FREE CUP CARRIER	
RES Labs Inc.	B65D 5/42 (2006.01)	3653528	INCORPORATION OF UNNATURAL NUCLEOTIDES AND METHODS OF USE IN VIVO	
	B65D 5/54 (2006.01)			
	B65D 71/52 (2006.01)			
	A61K 31/7088 (2006.01)	3651774	GLUCOCORTICOID RECEPTOR AGONIST AND IMMUNOCONJUGATES THEREOF	
	C07K 14/405 (2006.01)			
	C12N 5/10 (2006.01)			
	C12N 9/22 (2006.01)			
	C12N 15/10 (2006.01)			
	C12N 15/113 (2010.01)			
	A61K 47/68 (2017.01)			
A61P 19/02 (2006.01)				
C07K 16/24 (2006.01)	3658192	METHOD FOR RENDERING GAME, AND METHOD, APPARATUS AND DEVICE FOR GENERATING GAME RESOURCE FILE		
G06F 9/445 (2018.01)				
G06T 11/00 (2006.01)				
G06T 15/00 (2011.01)	3657327	METHODS FOR TREATMENT OR PREVENTION OF A NEUROLOGICAL IMMUNITY DISORDER		
A61K 38/12 (2006.01)	3655011			
Olipass Corporation	A61K 31/00 (2006.01)	3654956	COMPOSITIONS AND METHODS FOR TREATING DISEASES ASSOCIATED WITH AN IMPRINTING DEFECT	
	A61K 31/496 (2006.01)			
	A61K 45/06 (2006.01)			
	A61K 39/00 (2006.01)	3655026	ANTIGEN BINDING REGIONS AGAINST FIBRONECTIN TYPE III DOMAINS AND METHODS OF USING THE SAME	
	C07K 16/28 (2006.01)			
	A61K 9/00 (2006.01)	3654953	EFFICACY OF A GASTRO-RETENTIVE BILE ACID SEQUESTRANT DOSAGE FORM	
	A61K 9/20 (2006.01)			
	A61K 9/28 (2006.01)	3658570	TYROSINASE ANTISENSE OLIGONUCLEOTIDES	
	C07K 14/00 (2006.01)			
	C12N 15/113 (2010.01)	3658552	IMPROVED PROCESS FOR PREPARING AMINOPYRIMIDINE DERIVATIVES	
A61K 31/506 (2006.01)				
A61K 31/5377 (2006.01)	3658750	DRAINED RESERVOIR VOLUME DIAGNOSTICS FROM MANDEL-CRYER PRESSURE SIGNAL		
C07D 413/14 (2006.01)				
E21B 43/30 (2006.01)				
E21B 47/06 (2012.01)				
G01V 1/00 (2006.01)				

Podnosilac evropske prijave patenta (71)	MKP (51)	Broj objave evropske prijave patenta (97)	Naziv pronalaska (54)
	A61K 31/015 (2006.01) A61P 37/02 (2006.01) C07C 15/24 (2006.01)	3658522	IMMUNOMODULATOR COMPOUNDS
	A61K 31/506 (2006.01) A61K 31/5377 (2006.01) C07D 413/14 (2006.01)	3658553	NOVEL INTERMEDIATES USEFUL FOR THE SYNTHESIS OF AMINOPYRIMIDINE DERIVATIVES, PROCESS FOR PREPARING THE SAME, AND PROCESS FOR PREPARING AMINOPYRIMIDINE DERIVATIVES USING THE SAME
Terahertz Group Ltd.	A01K 43/04 (2006.01) G01J 3/28 (2006.01) G01N 21/00 (2006.01) G01N 21/25 (2006.01) G01N 21/31 (2006.01)	3658893	A SYSTEM AND METHOD FOR NON-INVASIVELY DETERMINING EGG PROPERTIES
Applied Therapeutics Inc.	A61K 9/06 (2006.01) A61K 31/4188 (2006.01)	3658142	COMPOSITIONS AND METHODS FOR TREATING GALACTOSEMIA
	A61K 31/575 (2006.01) C07J 9/00 (2006.01)	3658150	ISOTOPICALLY LABELED BILE ACID DERIVATIVES
	A61K 31/506 (2006.01) C07D 403/04 (2006.01) C07D 413/14 (2006.01)	3658547	INTERMEDIATES USEFUL FOR THE SYNTHESIS OF A SELECTIVE INHIBITOR AGAINST PROTEIN KINASE AND PROCESSES FOR PREPARING THE SAME
	A63F 13/52 (2014.01)	3659683	OBJECT DISPLAY METHOD AND DEVICE AND STORAGE MEDIUM
Shaaban, Basil Adil	A61K 31/05 (2006.01) A61K 31/352 (2006.01) A61K 31/353 (2006.01) A61K 36/185 (2006.01) A61K 47/12 (2006.01) A61K 47/44 (2017.01)	3658137	CANNABINOID COMPOSITION HAVING AN OPTIMIZED FATTY ACID EXCIPIENT PROFILE
	G02B 1/00 (2006.01) G02F 1/19 (2019.01) H04B 10/25 (2013.01) G06Q 30/08 (2012.01)	3658985	HIGH FREQUENCY OPTICAL SWITCH AND FABRICATION METHODS THEREOF
Better That Pty Ltd	G06Q 30/08 (2012.01)	3659098	MOBILE REVERSE BIDDING SYSTEM AND METHOD
	A61K 31/7088 (2006.01) A61K 31/7105 (2006.01) A61K 31/713 (2006.01) A61K 47/54 (2017.01) A61K 48/00 (2006.01) A61P 11/00 (2006.01) A61P 43/00 (2006.01) C12N 15/113 (2010.01) A61F 9/007 (2006.01)	3659609	THERAPEUTIC AGENT FOR FIBROSIS
		3661466	SYSTEMS AND METHODS FOR TISSUE DISSECTION IN CORNEAL TRANSPLANTS
Spinogenix, Inc.	A01N 43/78 (2006.01) A61K 31/426 (2006.01) A61P 25/28 (2006.01) C07D 277/66 (2006.01)	3661505	BENZOTHIAZOLE AND RELATED COMPOUNDS
	A61K 31/282 (2006.01) A61N 5/06 (2006.01) C07D 487/22 (2006.01)	3638367	NANOSCALE METAL- ORGANIC LAYERS AND METAL-ORGANIC NANOPLATES FOR X-RAY INDUCED PHOTODYNAMIC THERAPY, RADIOTHERAPY, RADIODYNAMIC THERAPY, CHEMOTHERAPY, IMMUNOTHERAPY, AND ANY COMBINATION THEREOF
	A61K 38/20 (2006.01) C07K 14/55 (2006.01) C12N 15/26 (2006.01)	3661955	CYTOKINE CONJUGATES FOR THE TREATMENT OF AUTOIMMUNE DISEASES

Podnosilac evropske prijave patenta (71)	MKP (51)	Broj objave evropske prijave patenta (97)	Naziv pronalaska (54)
	A61K 39/395 (2006.01) C07K 16/28 (2006.01) C07K 16/46 (2006.01)	3661554	PROTEINS BINDING NKG2D, CD16 AND FLT3
	A61K 38/20 (2006.01) C07K 14/55 (2006.01) C12N 15/26 (2006.01)	3661956	CYTOKINE CONJUGATES FOR THE TREATMENT OF PROLIFERATIVE AND INFECTIOUS DISEASES
	A61K 39/02 (2006.01) A61K 39/08 (2006.01) A61P 31/04 (2006.01)	3661547	INDUCTION OF PROTECTIVE IMMUNITY AGAINST ANTIGENS
	A61K 31/381 (2006.01) A61K 31/385 (2006.01) A61K 31/424 (2006.01)	3661498	BENZO[b]THIOPHENE STING AGONISTS FOR CANCER TREATMENT
	A61K 31/381 (2006.01) A61K 39/395 (2006.01) A61P 35/00 (2006.01) A61K 31/439 (2006.01)	3661499	COMBINATIONS OF PD-1 ANTAGONISTS AND BENZO[b]
	A61K 31/4439 (2006.01) A61K 31/444 (2006.01) A61K 31/506 (2006.01) A61K 31/5377 (2006.01) A61P 13/12 (2006.01) A61P 43/00 (2006.01) C07D 401/04 (2006.01) C07D 401/14 (2006.01) C07D 405/14 (2006.01) C07D 409/14 (2006.01) C07D 413/04 (2006.01) C07D 413/14 (2006.01) C07D 417/04 (2006.01) C07D 451/02 (2006.01) C07D 487/04 (2006.01) C07D 498/04 (2006.01)	3666766	PYRIDINE COMPOUND SUBSTITUTED WITH AZOLE
	G06K 9/00 (2006.01) G06K 9/46 (2006.01)	3665620	SYSTEM AND METHOD FOR THE VISUALIZATION AND CHARACTERIZATION OF OBJECTS IN IMAGES
	C07C 211/38 (2006.01) C07C 217/52 (2006.01) C07C 233/05 (2006.01)	3665156	COMPOUNDS, COMPOSITIONS AND METHODS
	A61K 31/195 (2006.01) A61K 31/335 (2006.01) C07C 15/24 (2006.01)	3664793	MACROCYCLIC IMMUNOMODULATORS
	A61K 31/513 (2006.01) A61K 31/565 (2006.01) A61K 31/57 (2006.01)	3668514	SOLID PHARMACEUTICAL FORMULATIONS FOR TREATING ENDOMETRIOSIS, UTERINE FIBROIDS, POLYCYSTIC OVARY SYNDROME AND ADENOMYOSIS
Braje, Wilfried Doherty, George Jantos, Katja Ji, Cheng Judd, Andrew Kunzer, Aaron Mastracchio, Anthony Song, Xiaohong Souers, Andrew Sullivan, Gerard Tao, Zhi-Fu Lai, Chunqiu Kling, Andreas Pohlki, Frauke Teske, Jesse Wendt, Michael Brady, Patrick Wang, Xilu Penning, Thomas Michaelides, Michael	A61K 31/395 (2006.01) A61P 35/00 (2006.01) C07D 515/22 (2006.01)	3668502	MACROCYCLIC MCL-1 INHIBITORS AND METHODS OF USE

Podnosilac evropske prijave patenta (71)	MKP (51)	Broj objave evropske prijave patenta (97)	Naziv pronalaska (54)
	C12N 9/12 (2006.01)	3668971	RNA POLYMERASE VARIANTS
	C12N 15/10 (2006.01)		
	C12N 15/10 (2006.01)	3668977	ANALYTICAL HPLC METHODS
	G01N 30/02 (2006.01)		
	A61K 38/00 (2006.01)	3668531	METHODS FOR TREATING AND/OR PREVENTING GRAFT-VERSUS-HOST DISEASE AND/OR DIFFUSE ALVEOLAR HEMORRHAGE AND/OR VENO-OCCLUSIVE DISEASE ASSOCIATED WITH HEMATOPOIETIC STEM CELL TRANSPLANT
	A61K 38/48 (2006.01)		
	A61K 39/395 (2006.01)		
	C07K 16/40 (2006.01)		
	C12N 9/50 (2006.01)		
	A61K 9/51 (2006.01)	3668522	EFFICACIOUS MRNA VACCINES
	A61K 31/7088 (2006.01)		
	A61K 39/145 (2006.01)		
	A61K 47/69 (2017.01)		
	A61P 31/16 (2006.01)		
	G01N 33/50 (2006.01)		
Abbvie Deutschland GmbH & Co. KG	A61K 31/395 (2006.01)	3652184	MACROCYCLIC MCL-1 INHIBITORS AND METHODS OF USE
	A61P 35/00 (2006.01)		
	C07D 515/22 (2006.01)		
AbbVie Deutschland GmbH & Co. KG	A61K 31/395 (2006.01)	3668504	MACROCYCLIC MCL-1 INHIBITORS AND METHODS OF USE
	A61P 35/00 (2006.01)		
	C07D 515/22 (2006.01)		
Columbiad Launch Services Inc.	A63H 27/20 (2006.01)	3668794	SYSTEM AND METHOD FOR DISTRIBUTING POWER TO AIRCRAFT SYSTEMS
	A63H 27/22 (2006.01)		
	B64C 39/02 (2006.01)		
	B64D 27/24 (2006.01)		
	B64D 39/00 (2006.01)		
	B64F 3/02 (2006.01)		
	H02J 50/27 (2016.01)		
	H02J 50/30 (2016.01)		
	H02J 50/80 (2016.01)		
	H02J 50/90 (2016.01)		
	A61K 31/4184 (2006.01)	3668507	COMBINATION THERAPY
	A61K 39/395 (2006.01)		
	A61P 35/00 (2006.01)		
	C07D 235/04 (2006.01)		
	C12N 15/10 (2006.01)	3668979	METHODS FOR HPLC ANALYSIS
	G01N 30/02 (2006.01)		
	A61K 31/513 (2006.01)	3668515	PHARMACEUTICAL FORMULATIONS FOR TREATING ENDOMETRIOSIS, UTERINE FIBROIDS, POLYCYSTIC OVARY SYNDROME OR ADENOMYOSIS
	A61K 31/565 (2006.01)		
	A61K 31/57 (2006.01)		
Moebius Medical Ltd.	A61K 9/00 (2006.01)	3672653	LIPOSOMAL FORMULATION FOR JOINT LUBRICATION
	A61K 9/127 (2006.01)		
	A61K 31/685 (2006.01)		
	A61L 27/50 (2006.01)		
	A61K 39/395 (2006.01)	3672994	HIGHLY CONCENTRATED LOW VISCOSITY MASP-2 INHIBITORY ANTIBODY FORMULATIONS, KITS, AND METHODS OF TREATING SUBJECTS SUFFERING FROM ATYPICAL HEMOLYTIC SYNDROME
	A61K 45/06 (2006.01)		
	C07K 16/40 (2006.01)		
	G01C 21/00 (2006.01)	3675084	MAP DISPLAY METHOD, APPARATUS, STORAGE MEDIUM AND TERMINAL
	G09B 29/00 (2006.01)		
Bulgurcu Bilgen, Gözde	B67D 7/00 (2010.01)	3655360	A SMART FUELING ELBOW
Bulgurcu, Berkehan	G01N 27/22 (2006.01)		
	A01N 43/40 (2006.01)	3674291	CYCLIC AMINE COMPOUND AND PEST CONTROL AGENT
	A01N 43/56 (2006.01)		
	A01N 43/60 (2006.01)		
	A01N 43/72 (2006.01)		
	A01N 43/76 (2006.01)		

Podnosilac evropske prijave patenta (71)	MKP (51)	Broj objave evropske prijave patenta (97)	Naziv pronalaska (54)
	A01N 43/80 (2006.01) A01N 43/836 (2006.01) A01N 43/84 (2006.01) A01N 43/86 (2006.01) A01N 43/90 (2006.01) A01N 47/02 (2006.01) A01N 47/16 (2006.01) A01N 47/40 (2006.01) A01P 7/02 (2006.01) A01P 7/04 (2006.01) A61K 31/444 (2006.01) A61K 31/4545 (2006.01) A61K 31/496 (2006.01) A61K 31/5355 (2006.01) A61K 31/5377 (2006.01) C07D 213/85 (2006.01) C07K 1/14 (2006.01) C07K 1/16 (2006.01) C07K 16/00 (2006.01)	3672981	METHODS FOR PURIFYING ANTIBODIES HAVING REDUCED HIGH MOLECULAR WEIGHT AGGREGATES
Star Scientific Limited	B01J 19/00 (2006.01) B01J 23/89 (2006.01) B01J 37/34 (2006.01)	3672725	COMPOSITIONS, METHODS, AND APPARATUSES FOR CATALYTIC COMBUSTION
Cozzini LLC	B25B 11/00 (2006.01)	3672759	METHOD OF SLICING A FOOD ITEM AND SLICING MECHANISM EMPLOYING A GRIPPING ELEMENT THAT GENERATES A VACUUM GRIP
	A61K 45/00 (2006.01) A61P 35/00 (2006.01) C07K 14/47 (2006.01) C07K 14/82 (2006.01) C07K 16/18 (2006.01) C07K 16/32 (2006.01) C07K 19/00 (2006.01) C12N 1/15 (2006.01) C12N 1/19 (2006.01) C12N 1/21 (2006.01) C12N 5/10 (2006.01) C12N 9/12 (2006.01) C12N 15/12 (2006.01) C12N 15/54 (2006.01) C12N 15/63 (2006.01) C12Q 1/02 (2006.01) C12Q 1/6806 (2018.01) C12Q 1/6813 (2018.01) G01N 33/15 (2006.01) G01N 33/53 (2006.01) A61K 9/08 (2006.01) A61K 9/19 (2006.01) A61K 31/4745 (2006.01) A61K 39/395 (2006.01) A61K 47/10 (2017.01) A61K 47/22 (2006.01) A61K 47/26 (2006.01) A61K 47/68 (2017.01) A61P 35/00 (2006.01) A61P 35/02 (2006.01) C07K 16/00 (2006.01) C07K 19/00 (2006.01) A61K 31/712 (2006.01) A61K 31/7125 (2006.01) C12N 15/113 (2010.01)	3674325	FUSION PROTEIN OF DCTN1 PROTEIN WITH RET PROTEIN
	A61K 9/08 (2006.01) A61K 9/19 (2006.01) A61K 31/4745 (2006.01) A61K 39/395 (2006.01) A61K 47/10 (2017.01) A61K 47/22 (2006.01) A61K 47/26 (2006.01) A61K 47/68 (2017.01) A61P 35/00 (2006.01) A61P 35/02 (2006.01) C07K 16/00 (2006.01) C07K 19/00 (2006.01) A61K 31/712 (2006.01) A61K 31/7125 (2006.01) C12N 15/113 (2010.01)	3673918	ANTIBODY-DRUG CONJUGATE PREPARATION AND LYOPHILIZATION FOR SAME
	A61K 31/712 (2006.01) A61K 31/7125 (2006.01) C12N 15/113 (2010.01)	3672601	PROCESSES FOR PREPARING PHOSPHORODIAMIDATE MORPHOLINO OLIGOMERS VIA FAST-FLOW SYNTHESIS
NextLeaf Solutions Ltd.	A61K 31/05 (2006.01) A61K 31/352 (2006.01) A61K 36/185 (2006.01) B01D 11/02 (2006.01)	3645027	CANNABINOID EXTRACTION PROCESS USING BRINE

Podnosilac evropske prijave patenta (71)	MKP (51)	Broj objave evropske prijave patenta (97)	Naziv pronalaska (54)
	C07C 39/23 (2006.01) C07D 311/80 (2006.01) C07H 21/02 (2006.01) C12Q 1/68 (2018.01)	3668997	MIRNA DETARGETING SYSTEM FOR TISSUE SPECIFIC INTERFERENCE
University of Virginia Patent Foundation	A61K 31/00 (2006.01) A61K 39/395 (2006.01) A61P 27/02 (2006.01) C12N 15/113 (2010.01)	3672579	COMPOSITIONS AND METHODS FOR TREATING AGE-RELATED MACULAR DEGENERATION AND GEOGRAPHIC ATROPHY
Caganlar, Caglar	A01K 61/54 (2017.01) A01K 61/65 (2017.01)	3651570	DOUBLE PIPE CULTIVATION SYSTEM FOR REDUCING LOSSES OCCURRING DUE TO WIND, WAVE AND TIDE IN MUSSEL CULTIVATION FARMS
Serdar Plastik Sanayi Ve Ticaret Anonim Sirketi	F16H 59/02 (2006.01) G05G 25/04 (2006.01) C04B 14/02 (2006.01) C04B 28/00 (2006.01) C08J 9/00 (2006.01) C08J 9/16 (2006.01)	3639108 3495335	SEALED REVERSE-FORWARD LEVER PROCESS FOR THE PRODUCTION OF A GEPOLYMER COMPOSITE

OBJAVA UPISA PROMJENA U REGISTAR PATENATA
PUBLICATION OF RECORD OF CHANGES TO THE PATENT REGISTER

P-2008-856(00567)	AstraZeneca AB, SE 151 85 Södertälje Švedska	Covis Pharma B.V., Grafenauweg 12, CH-6300 Zug, Švajcarska	Prenos prava
P-2008-857(00568)	AstraZeneca AB, SE 151 85 Södertälje Švedska	Covis Pharma B.V., Grafenauweg 12, CH-6300 Zug, Švajcarska	Prenos prava
P-2013-88(01597)	Spinifex Pharmaceuticals Pty Ltd, South Yarra Corporate Centre Suite T18, Level 1, 122 Toorak Road, South Yarra, VIC 3141, (AU)	NOVARTIS AG, LICHTSTRASSE 35, 4056 BASEL, SWITZERLAND, CH.	Prenos prava
P-2013-105(01603)	Nycomed Germany Holding GmbH, Byk-Gulden-Straße 2, 78467 Konstanz, (DE)	Takeda GmbH., Byk-Gulden-Straße 2, 78467 Konstanz, (DE)	Promjena imena
P-2013-105(01603)	Takeda GmbH, Byk-Gulden-Straße 2, 78467 Konstanz, (DE)	Nycomed Asset Management GmbH, Byk-Gulden-Straße 2, 78467 Konstanz, (DE)	Prenos prava
P-2013-116(01565)	Spirogen Sàrl, Chemin de la Pacottaz 1, c/o Michael Forer, 1806, St-Légier-La Chiésaz / CH	Spirogen Sàrl, Rue du Grand-Chene 5, 1003 Lausanne / CH	Promjena adrese
P-2013-116(01565)	Spirogen Sàrl, Rue du Grand-Chene 5, 1003 Lausanne / CH	Medimmune Limited, Milstein Building, Granta Park, Cambridge, CB21 6GH, England, United Kingdom / UK	Prenos prava
P-2014-106(01908)	Boehringer Ingelheim International GmbH, Binger Strasse 173, 55216 Ingelheim am Rhein, DE	Centrexion Therapeutics Corporation, 509 South Exeter Street, Baltimore, Maryland 21202, US.	Prenos prava
P-2014-107(01903)	Pfizer Inc., 235 East 42nd Street, New York, NY 10017, USA	Biogen MA Inc., 225 Binney Street, Cambridge, Massachusetts 02142, USA	Prenos prava
P-2017-134(02765))	SANOFI, 54 rue la Boétie, 75008 PARIS, Francuska	Sanofi-Aventis Deutschland GmbH, Brüningstrasse 50, 65929 FRANKFURT AM MAIN, Njemacka	Prenos prava
P-2008-311(00199)	Alfa Wassermann S.p.A., Via Enrico Fermi n. 1, Alanno (PE), Italija	Alfasigma S.p.A., Viale Sarca n. 223, Milano (MI), Italija	Prenos prava
P-2008-344(00272)	Alfa Wassermann S.p.A., Via Enrico Fermi n. 1, Alanno (PE), Italija	Alfasigma S.p.A., Viale Sarca n. 223, Milano (MI), Italija	Prenos prava
P-2009-37(00592)	Sebela International Limited, H.P. House 21	Sebela International Bermuda Limited, H.P. House 21 Laffan	Prenos prava

	Laffan Street, Hamilton, Bermuda HM09	Street, Hamilton, Bermuda HM09	
P-2009-37(00592)	Sebela International Bermuda Limited, H.P. House 21 Laffan Street, Hamilton, Bermuda HM09	Sebela Ireland Limited, 3rd Floor, West Wing, Adelaide Chambers, Peter Street, Dublin 8, Ireland	Prenos prava
P-2009-81(00600)	Alfa Wassermann S.p.A., Via Enrico Fermi n. 1, Alanno (PE), Italija	Alfasigma S.p.A., Viale Sarca n. 223, Milano (MI), Italija	Prenos prava
P-2009-250(01702)	Sigma-Tau Industrie Farmaceutiche Riunite S.p.A., Viale Shakespeare n. 47, Rome (RM), Italija	Alfasigma S.p.A., Viale Sarca n. 223, Milano (MI), Italija	Promjena prava
P-2010-31(01845)	Sigma-Tau Industrie Farmaceutiche Riunite S.p.A., Viale Shakespeare n. 47, Rome (RM)	Alfasigma S.p.A., Viale Sarca n. 223, Milano (MI), Italija	Prenos prava
P-2015-107(02180)	Sigma-Tau Industrie Farmaceutiche Riunite S.p.A., Viale Shakespeare n. 47, Rome (RM), Italija	Alfasigma S.p.A., Viale Sarca n. 223, Milano (MI), Italija	Prenos prava
P-2015-159(02285)	Alfa Wassermann S.p.A., Via Enrico Fermi n. 1, Alanno (PE), Italija	Alfasigma S.p.A., Viale Sarca n. 223, Milano (MI), Italija	Prenos prava
P-2015-635(02259)	Bristol-Myers Squibb Holdings Ireland, Hinterbergstrasse 16, 6312 Steinhausen, Switzerland	Bristol-Myers Squibb Holdings Ireland Unlimited Company, Hinterbergstrasse 16, 6312 Steinhausen, Switzerland	Promjena imena
P-2017-168(02804)	Kyowa Hakko Kirin Co., Ltd., 1-6-1, Ohtemachi, Chiyoda-ku, Tokyo 100-8185, JP	Kyowa Kirin Co., Ltd., 1-9-2, Otemachi, Chiyoda-ku, Tokyo 100-0004, JP	Promjena imena i adrese
P-2017-225(02927)	Kyowa Hakko Kirin Co., Ltd., 1-6-1, Ohtemachi, Chiyoda-ku, Tokyo 100-8185, JP	Kyowa Kirin Co., Ltd., 1-9-2, Otemachi, Chiyoda-ku, Tokyo 100-0004, JP	Promjena imena i adrese
P-2017-233(02877)	Kyowa Hakko Kirin Co., Ltd., 1-6-1, Ohtemachi, Chiyoda-ku, Tokyo 100-8185, JP	Kyowa Kirin Co., Ltd., 1-9-2, Otemachi, Chiyoda-ku, Tokyo 100-0004, JP	Promjena imena i adrese
P-2018-299(03141)	Glock, Gaston, Klagenfurter Strasse 32a, 9220 Velden, Austria	Glock Ökoenergie GmbH, Bengerstr. 1, 9112Griffen, Austria	Prenos prava
P-2019-66(03362)	Gilead Sciences, Inc., 333 Lakeside Drive, Foster City, California 94404, U.S.A.	Gilead Pharmasset LLC, 333 Lakeside Drive, Foster City, California 94404, US	Prenos prava

--	--	--	--

ŽIGOVI
TRADEMARKS

MEĐUNARODNI KODOVI ZA IDENTIFIKACIJU BIBLIOGRAFSKIH PODATAKA O ŽIGOVIMA PREMA
WIPO ST 60
RECOMMENDATION CONCERNING BIBLIOGRAFIC DATA RELATING TO TRADEMARKS- WIPO-ST.

60

CRNOGORSKI	MDK	ENGLESKI
REGISTRARSKI BROJ	111	NUMBER OF THE REGISTRATION
DATUM REGISTRACIJE	151	DATE OF THE REGISTRATION
OČEKIVANI DATUM PRESTANKA VAŽENJA ŽIGA	181	EXPECTED EXPIRATION DATE OF THE REGISTRATION
BROJ PRIJAVE	210	NUMBER OF THE APPLICATION
DATUM PODNOŠENJA PRIJAVE	220	DATE OF FILING OF THE APPLICATION
PODACI O IZLOŽBENOM PRAVU PRVENSTVA	230	DATA CONCERNING EXHIBITIONS
PODACI O PRAVU PRVENSTVA NA OSNOVU PARISKE KONVENCIJE	300	DATA RELATING TO PRIORITY UNDER THE PARIS CONVENTION
DATUM OBJAVLJIVANJA PRIJAVE	442	DATA OF PUBLICATION OF APPLICATION
SPISAK ROBA I USLUGA PREMA NIČANSKOJ KLASIFIKACIJI ROBA I USLUGA	511	LIST OF GOODS AND SERVICES ACCORDING THE NICE CLASSIFICATION OF GOODS AND SERVICE
IZJAVA PODNOSIOCA PRIJAVE DA NE TRAŽE EKSKLUZIVNO PRAVO ZA POJEDINE NEDINSTIKTIVNE ELEMENTE ZNAKA	526	DISCLAIMER
IZGLED ZNAKA	540	REPRODUCTION OF THE MARK
NAZNAKA O PRIRODI ILI VRSTI ZNAKA	550	INDICATION RELATING TO THE NATURE OR KIND OF MARK
INFORMACIJA O ZATRAŽENIM BOJAMA NA ZNAKU	591	INFORMATION CONCERNING THE COLORS CLAIMED
PODACI O PODNOSIOCU PRIJAVE	731	NAME AND ADDRESS OF THE APPLICANT
IME I ADRESA NOSIOCA ŽIGA	732	NAME AND ADDRESS OF THE HOLDER OF THE REGISTRATION
INFORMACIJA O ZATRAŽENIM BOJAMA NA ZNAKU	591	INFORMATION CONCERNING THE COLORS CLAIMED
PODACI O PODNOSIOCU PRIJAVE	731	NAME AND ADDRESS OF THE APPLICANT
IME I ADRESA NOSIOCA ŽIGA	732	NAME AND ADDRESS OF THE HOLDER OF THE REGISTRATION
IME I ADRESA PUNOMOĆNIKA	740	NAME AND ADDRESS OF THE REPRESENTATIVE

OBJAVA PRIJAVA ŽIGOVA
PUBLICATION OF TRADEMARK APPLICATIONS

(210) **Ž-2018-29**

(220) 06.02.2018.

(731) Miomir Mrvaljević, Bulevar Svetog Petra Cetinjskog br. 54, Podgorica, ME

(540)



(550) I

(511) Klasa 3: Parfimerijski proizvodi, eterična ulja, kozmetički proizvodi, losioni za losu

Klasa 5: Higijenski proizvodi za upotrebu u medicini.

Klasa 14: Časovničarski proizvodi.

Klasa 16: Štamparski proizvodi.

Klasa 18: Proizvodi od kože i imitacije kože, koferi, torbe, kišobrani.

Klasa 20: Proizvodi od drveta, plute, trske, šiblja, roga, kosti i plastični proizvodi koji nijesu obuhvaćeni drugim klasama.

Klasa 21: Pribor i posuđe za domaćinstvo i kuhinju, četke, češljevi, sunđer i proizvodi od stakla.

Klasa 22: Šatori, cerade, jedra.

Klasa 24: Tkanine i tekstilni proizvodi koji nijesu obuhvaćeni drugim klasama, prekrivači za krevete i stolove.

Klasa 25: Odjeća, obuća, pokrivala za glavu.

Klasa 26: Čipka, vez, dugmad, vještačko cvijeće.

Klasa 27: Tepisi, prostirači, ostali prekrivači za podove, zidne tapete koje nijesu od tekstila.

Klasa 28: Igračke, sportski predmeti koji nijesu obuhvaćeni drugim klasama, prekrivači za krevete i stolove.

Klasa 29: Meso, mesni ekstrakti, konzervirano, sušeno i kuvano voće i povrće, džemovi, kompoti, jaja, mlijeko i mliječni proizvodi, jestiva ulja i masti.

Klasa 30: Kafa, čaj, hleb, kolači, med, začini.

Klasa 31: Poljoprivredni, povrtlarski, šumski proizvodi i bobice koji nijesu obuhvaćeni drugim klasama, žive životinje.

Klasa 32: Pivo, mineralne i gazirane vode i ostala bezalkoholna pića, voćni sokovi, sirupi.

Klasa 33: Alkoholna pića (osim piva)

Klasa 34: Duvan, pribor za pušaće, šibice.

Klasa 35: Oglašavanje i reklamiranje.

Klasa 36: Osiguranje, finansijski poslovi, monetarni poslovi, upravljanje nekretninama.

Klasa 38: Telekomunikacije.

Klasa 39: Prevoz, ambalažiranje i skladištenje proizvoda.

Klasa 41: Obuka, stručno osposobljavanje, razonoda, sportske i kulturne djelatnosti.

Klasa 43: Usluge obezbjeđivanja hrane i pića, privremeno primanje na stan.

Klasa 44: Higijenska njega i njega ljepote, usluge poljoprivrede, šumarstva i portlarstva.

Klasa 45: Pravne usluge, lične i društvene usluge koje pružaju drugi, namjenjene za zadovoljenje ljudskih potreba.

(210) **Ž-2018-144**

(220) 25.04.2018.

(731) KAFETERIJA&LOVE&BRANDS DOO, Studentski Trg 15, 6. Sprat, 11000, Beograd, RS

(540)

KAFETERIJA

(550) I

(511) Klasa 16: Kancelarijski materijal izuzev namjestaja; notesi; rokovnici; beljeznice; papirni filteri za kafu.

Klasa 20: Barski stolovi; pultovi.

Klasa 21: Šoljice; čajnici; tacne; tanjiri; ručni mlinovi za kafu; podmetači za čaše, nepapirni i neplatneni; servisi za kafu (stono posuđe); aparati za kuvanje i pripremu kafe, neelektrični; filteri za kafu, neelektrični.

Klasa 25: Odjeća; obuća; pokrivala za glavu.

Klasa 30: Kafa; arome za kafu; nepržena kafa; biljni preparati za upotrebu kao zamjena za kafu; pita na bazi kafe; pita na bazi kaka; pita na bazi čokolade; zamjena za kafu; kapučino; pita od kafe sa mlijekom.

Klasa 32: Voćni sokovi; limunade; sokovi od povrća; bezalkoholna pića.

Klasa 40: Prženje i obrada kafe.

Klasa 41: Organizacija i realizacija zabavnih, sportskih i kulturnih aktivnosti; organizacija zabavnih aktivnosti za djecu.

Klasa 43: Usluge obezbjeđivanja hrane i pića; iznajmljivanje privremenog smještaja.

Klasa 44: Usluge frizera i salona ljepote; usluge berbernica.

(210) **Ž-2018-160**

(220) 04.05.2018.

(731) Adriatic Marinas d.o.o., Obala bb, 85320, Tivat, ME

(540)

Riva Residences

(550) I

(740) Adriatic Marinas d.o.o., Obala bb, 85320, Tivat

(511) Klasa 36: Osiguranje; finansijski poslovi; novčani (monetarni) poslovi; poslovi vezani za nepokretnosti.

Klasa 39: Transportne usluge; pakovanje i skladištenje robe; organizovanje putovanja.

Klasa 41: Obrazovne usluge; pripremanje obuke; razonoda; sportske i kulturne aktivnosti.

Klasa 43: Usluge obezbjeđivanja hrane i pića; privremeni smještaj.

Klasa 44: Medicinske usluge; veterinarske usluge; higijenska zaštita i njega ljepote za ljude i životinje; agrikulturne, hortikulturne i šumarske usluge.

(210) **Ž-2018-178**

(220) 18.05.2018.

(731) Ivan Jovetić, Serdara Jola Piletica 11, 81000, Podgorica, ME

(540)



MEBAN
Crnogorska mreža biznis anđela

(550) I

(511) Klasa 35: Analiza proizvodne cijene, cijene (poređenje cijena), ekonomska predviđanja (prognoze), istraživanja za poslove, konsultacije u vezi vođenja poslova, poslovi (konsultacije za vođenja poslova), poslovi (pomoć u vođenju poslova), poslovi (savjetovanje u organizaciji i vođenju poslova), procjene komercijalnih poslova, prodaja (podsticaj prodaje) za treće osobe, proizvodne cijene (analiza proizvodnih cijena), računovostveni poslovi, sponzori (traženje sponzora), statistički podaci (izrada statističkih podataka), tržište (proučavanje tržišta), tržište (traženje tržišta), vođenje poslova (pomoć u vođenju poslova), vođenje poslova (savjetovanje o vođenju poslova), vođenje poslova (usluge savjetovanja u vezi vođenja poslova).

Klasa 36: Bankarske usluge, kućne, bankarski poslovi (transakcije), čekovi (ovjera čekova), efektna berza (službeno bilježenje kurseva ugovorenih vrijednosti na tržištu), finansije (savjetovanje u vezi finansija), finansijska analiza, finansijske procjene, (osiguranje, banke, nekretnine), finansijski (bankarski poslovi), finansijskim oglasima, finansijski poslovi (transakcije), finansiranje (usluge finansiranja), fiskalne procjene, fondovi (osnivanje fondova), imovina (upravljanje imovinom), izdavanje vrijedonosnih bonova, kapital (ulaganje kapitala), krediti, monetarni poslovi, novčana sredstva (elektronski prijenos novčanih sredstava), osnivanje kapitala, ovjeravanje čekova, procjene (fiskalne procjene), procjene finansijske procjene (osiguranje, bankarski promet, imovina), sredstva (stvaranje zajedničkih sredstava), štedionice (usluge štedionica), transakcije (finansijske transakcije), ulaganje sredstava, upravljanje imovinom, usluge fondova uzajamne pomoći, vrijedonosni bonovi (izdavanje vrijedonosnih bonova), vrijednosti (depoziti vrijednosti), zajmovi.

Klasa 41: akademije (obuka).

(210) **Ž-2018-228**

(220) 02.07.2018.

(731) "ZLATA A" DOO BAR, „, BAR, ME

(540)



(511) Klasa 29: Meso, riba, živina i divljač; mesne prerađevine; konzervisano, zamrznuto, sušeno i kuvano voće i povrće; želei, džemovi, kompoti; jaja, mlijeko i mliječni proizvodi; jestiva ulja i masti.

Klasa 39: Transportne usluge; pakovanje i skladištenje robe; organizovanje putovanja.

Klasa 40: Obrađivanje materijala.

(210) **Ž-2018-234**

(220) 03.07.2018.

(731) DRUŠTVO ZA TELEKOMUNIKACIJE ORION TELEKOM D.O.O. PODGORICA, Ulcinjska 7 d, Gorica C, 81000, Podgorica, ME

(540)



(550) I

(511) Klasa 9: Računarski programi, snimljeni; računarski programi [softveri koji se mogu preuzimati]; aplikacije za računarske softvere koje se mogu preuzimati; telefonski prijemnici; audio i video prijemnici . Računarski programi, snimljeni; računarski programi [softveri koji se mogu preuzimati]; aplikacije za računarske softvere koje se mogu preuzimati; telefonski prijemnici; audio i video prijemnici . Računarski

programi, snimljeni; računarski programi [softveri koji se mogu preuzimati]; aplikacije za računarske softvere koje se mogu preuzimati; telefonski prijemnici; audio i video prijemnici .

Klasa 38: Bežično emitovanje; forumi [pričaonice] na društvenim mrežama; usluge telekonferencija; usluge telekomunikacionog usmeravanja i povezivanja; usluge elektronskog biltena [telekomunikacione usluge]; usluge govorne pošte; usluge videokonferencija; telefonske usluge; telefonske komunikacije; striming [protok] podataka; slanje poruka; satelitski prenos; radio komunikacije; emitovanje kablovske televizije; emitovanje televizijskih programa; iznajmljivanje vremena pristupa globalnim računarskim mrežama; iznajmljivanje modema; iznajmljivanje telekomunikacione opreme; iznajmljivanje telefona; iznajmljivanje uređaja za slanje poruka; iznajmljivanje faksimil aparata; informacije o telekomunikacijama; komunikacija preko mreže optičkih vlakana ; komunikacija preko računarskih terminala; komunikacije mobilnim telefonima; obezbjeđenje korisničkog pristupa globalnoj računarskoj mreži; obezbjeđivanje telekomunikacionih veza sa globalnom računarskom mrežom; omogućavanje pristupa računarskim bazama podataka; prenos video sadržaja na zahtev; prenos digitalnih datoteka; prenos elektronske pošte; prenos poruka i slika posredstvom računara; prenos faksimilom .

Klasa 42: Čuvanje rezervne kopije podataka van mreže; hosting računarskih sajtova [veb sajtova]; savjetodavne usluge iz oblasti telekomunikacione tehnologije; server hosting; softver u vidu servisa [SaaS]; savjetodavne usluge iz oblasti kompjuterske tehnologije; savjetovanje u oblasti računarskog softvera; savjetovanje u oblasti dizajna i razvoja računarskog hardvera; savjetovanje u vezi informacionih tehnologija; savjetovanje o sigurnosti računara; savjetovanje o izradi veb sajtova; računarstvo u oblaku; računarsko programiranje; razvoj softvera u okviru izdavanja softvera; održavanje računarskog softvera; nadgledanje računarskih sistema radi otkrivanja kvarova; nadgledanje računarskih sistema radi otkrivanja neovlašćenog pristupa ili povrede podataka; kreiranje i dizajniranje za druge indeksa informacija zasnovanih na internetu [usluge informacione tehnologije]; konsultacije o sigurnosti podataka; konsultacije o bezbjednosti interneta; konvertovanje računarskih podataka i programa, osim fizičkog konvertovanja; instaliranje računarskog softvera; izrada i održavanje veb stranica za druge; iznajmljivanje računarskog softvera; iznajmljivanje računara; iznajmljivanje veb servera; zaštita od računarskih virusa; elektronsko pohranjivanje podataka; dizajniranje računarskog softvera; dizajniranje računarskih sistema; ažuriranje računarskog softvera; analize računarskih sistema; vođenje studija tehničkog projektovanja; platforma kao usluga (PaaS).

(210) **Ž-2018-273**

(220) 25.07.2018.

(731) Košarkaški klub Budućnost VOLI, Podgorica, Njegošev Park bb, Podgorica, ME

(540)



(550) I

(511) Klasa 35: Oglašavanje i reklamiranje; vođenje komercijalnih poslova; komercijalna administracija; kancelarijski poslovi; vođenje poslova poslovni za sportiste [poslovni menadžment]; televizijsko reklamiranje; sajmovi (organizovanje sajмова u komercijalne ili reklamne svrhe); reklamiranje putem televizije; marketing; javno mnijenje (istraživanje javnog mnjenja) [anketiranje]; javnost (odnosi s javnošću) [propaganda]; isporuka reklamnih materijala [letaka, prospekata, uzoraka].

Klasa 37: Izgradnja; popravke; usluge postavljanja (instaliranja); čišćenje zgrada [spoljnih površina]; izgradnja *; zaštite građevina od vlage [izgradnja]; zgrade (čišćenje zgrada) [spoljnih površina]; zgrade (unutrašnje čišćenje zgrada).

Klasa 41: Obuka; stručno osposobljavanje; razonoda; sportske i kulturne djelatnosti; objavljivanje knjiga i časopisa, elektronski on line; zdravstveni klubovi (usluge zdravstvenih klubova) [održavanje zdravlja i fizičke forme]; videotrake (montaža videotraka); videotrake (proizvodnja filmova na videotrakama); treniranje [fizička vježba]; sportska oprema (stavljanje na raspolaganje sportske opreme); sportska takmičenja (mjerenje vremena na sportskim takmičenjima); sportska takmičenja (organizovanje sportskih takmičenja); razonoda; rekreacija (obavještenja u vezi rekreacije); seminari (organizovanje i vođenje seminara); sportska usavršavanja (sportski kampovi za usavršavanje u sportu); sportske oprema (iznajmljivanje sportske opreme osim vozila); -stadioni (iznajmljivanje stadiona); priredbe (održavanje priredbi); organizovanje sportskih takmičenja; lični treneri (usluge ličnih trenera) [fitnes]; kampovi za sportsko usavršavanje; iznajmljivanje sportskih terena; fizičke vježbe [fizička kultura]; informacije u vezi rekreacije.

(210) **Ž-2018-321**

(220) 23.08.2018.

(731) Kamalaya Co., Ltd., 102/9 Moo 3, Laem Set Road, Na-Muang, Koh Samui, 84140, Suratthani, TH

(540)



(550) I

(740) Božidar Radulović, Studentska bb, Lamela 3/18, 81000, Podgorica

(511) Klasa 43: Agencije za smještaj (hotelski pansioni); rezervacija privremenog smještaja; usluge barova; katering hrane i pića; hoteli; iznajmljivanje prostorija za sastanke; iznajmljivanje privremenog smještaja; iznajmljivanje soba kao privremenog smještaja; restorani; usluge zdravstvenog odmarališta, naime, obezbjeđivanje hrane, tretmana i smještaja koji se specijalizuju za promovisanje opšteg zdravlja i blagostanja.

(210) **Ž-2018-329**

(220) 29.08.2018.

(731) Košarkaški klub Budućnost VOLI, Podgorica, Njegošev Park bb, Podgorica, ME

(540)



(550) I

(511) Klasa 35: Oglašavanje i reklamiranje; vođenje komercijalnih poslova; komercijalna administracija; kancelarijski poslovi.

Klasa 41: Obuka; stručno osposobljavanje; razonoda; sportske i kulturne djelatnosti.

(210) **Ž-2018-330**

(220) 30.08.2018.

(731) TELENOR DOO PODGORICA, Rimski trg br.4, 81000, Podgorica, ME

(540)

Zamislili sve

(550) I

(511) Klasa 1: Hemijski proizvodi koji se upotrebljavaju u industriji , nauci , fotografiji , poljoprivredi , hortikulturi i šumarstvu ; neprerađene vještačke smole , neprerađene plastične materije ; đubriva ; smješe za gašenje vatre ; preparati za kaljenje i zavarivanje ; hemijske supstance za očuvanje namirnica ; materije za štavljenje ; ljepljive supstance koje se upotrebljavaju u industriji.

Klasa 2: Boje, firnajzi, lakovi; sredstva za zaštitu od rđe i truljenja drveta; materije za bojenje; sredstva za nagrizanje; sirove prirodne smole; metali u obliku listova i praha za slikare, dekoratere, štampare i umjetnike.

Klasa 3: Sredstva za bijeljenje i druge supstance za upotrebu u perionicama; preparati za čišćenje, poliranje, ribanje i nagrizanje; sapuni; parfimerija, eterična ulja, kozmetika, losioni za kosu; paste za zube.

Klasa 4: Industrijska ulja i masti; maziva; jedinjenja za skupljanje prašine vlaženjem i vezivanjem; goriva (uključujući motorna tečna goriva) i materije za osvjtljavanje; svijeće i fitilji za osvjtljavanje.

Klasa 5: Farmaceutski i veterinarski preparati; sanitarni preparati za medicinsku upotrebu; dijetetske supstance prilagođene za upotrebu u medicini, hrana za bebe; flasteri, materijali za zavijanje; materijali za plombiranje zuba, zubarska smola; dezinfekciona sredstva; preparati za uništavanje štetočina; fungicidi, herbicidi.

Klasa 6: Obični metali i njihove legure; metalni građevinski materijali; metalne prenosne građevine; materijali od metala za željezničke šine; ne-električne kablove i žice od običnog metala; bravarski proizvodi, mali metalni gvoždarski proizvodi; cjevčice i cijevi od metala; sefovi; proizvodi od običnih metala koji nisu uključeni u druge klase; rude.

Klasa 7: Mašine i mašinski alati; motori i pogonske mašine (osim za suvozemna vozila); mašinske spojnice i transmisioni elementi (osim za suvozemna vozila); poljoprivredne sprave osim onih kojima se ručno upravlja; inkubatori za jaja; automatske mašine za prodaju.

Klasa 8: Ručni alati i sprave (kojima se ručno upravlja); pribor za jelo; hladno oružje; žileti.

Klasa 9: Aparati i instrumenti naučni, pomorski, geodetski, fotografski, kinematografski, optički, za vaganje, mjerenje, signalizaciju, kontrolu (inspekciju), spašavanje i nastavu; aparati i instrumenti za provođenje, prekid, transformaciju, akumulaciju, regulisanje ili kontrolu električne energije; aparati za snimanje, prenos i reprodukciju zvuka ili slike; magnetni nosioci podataka, diskovi za snimanje; kompakt diskovi, DVD i drugi digitalni nosači podataka; mehanizmi za aparate koji se pokreću novcem ili žetonom; registar kase, računarske mašine, oprema za obradu podataka i kompjuteri; računarski softver; aparati za gašenje požara.

Klasa 10: Hirurški, medicinski, zubarski i veterinarski aparati i instrumenti; vještački udovi, oči i zubi; ortopedski artikli; hirurški materijali za zašivanje.

Klasa 11: Aparati za osvjtljavanje, grijanje, proizvodnju pare, kuvanje, hlađenje, sušenje, ventilaciju, snabdijevanje vodom i za sanitarne svrhe.

Klasa 12: Vozila; aparati za kretanje po zemlji, vazduhu ili vodi.

Klasa 13: Vatrene oružje; municija i projektili; eksplozivi; sredstva za vatromet.

Klasa 14: Dragocjeni metali i njihove legure i proizvodi od dragocjenih metala ili sa prevlakom od njih, koji nisu uključeni u druge klase; nakit, drago kamenje; časovničarski i hronometrijski instrumenti.

Klasa 15: Muzički instrumenti.

Klasa 16: Hartija, karton i proizvodi od njih, koji nisu uključeni u druge klase; štampane stvari; knjigovezački materijal; fotografije; kancelarijski materijal; ljepila za kancelarijske i kućne potrebe; umjetnički materijali; kičice; pisaće mašine i kancelarijski rekviziti (izuzev namještaja); materijali za obuku i nastavu (izuzev aparata); plastični materijal za pakovanje (koji nije uključen u druge klase); štamparska slova; klišeji.

Klasa 17: Guma, gutaperka, kaučuk, azbest, liskun i proizvodi napravljeni od ovih materijala koji nisu uključeni u druge klase; polupreradaeni plastični proizvodi koji se koriste u proizvodnji; materijali za podbijanje (podloške), zaptivanje i izolovanje; savitljive nemetalne cijevi.

Klasa 18: Koža i imitacija kože, proizvodi izrađeni od ovih materijala koji nisu uključeni u druge klase; životinjska koža, krzno; koferi i putne torbe; kišobrani, suncobrani i štapovi za hodanje; bičevi, saračka i sedlarska oprema.

Klasa 19: Građevinski materijali (nemetalni); čvrste nemetalne cijevi za građevine; asfalt, cma smola i bitumen; nemetalne prenosne građevine; spomenici, koji nisu od metala.

Klasa 20: Namještaj, ogledala, okviri za slike; proizvodi (koji nisu obuhvaćeni drugim klasama) od drveta, plute, trske, rogoza, vrbovog pruća, roga, kosti, slonovače, kitove kosti, školjki, ćilibara, sedefa, morske pjene i zamjene svih ovih materijala, ili od plastike.

Klasa 21: Kućne ili kuhinjske sprave i posuđe češljevi i sunđer; četke (izuzev kičica); materijali za pravljenje četki; artikli koji se koriste pri čišćenju; čelična vuna; neprerađeno ili poluprerađeno staklo (osim stakla koje se koristi u građevinarstvu); staklarija, porcelan, fajans, grnčarija i lončarija koja nije uključena u druge klase.

Klasa 22: Užad, kanapi, mreže, šatori, nadstrešnice od cirade, cirade, jedra, vreće (džakovi) i torbe (koje nisu uključene u druge klase); materijali za punjenje madraca (osim od gume ili plastike); sirove vlaknaste tekstilne materije.

Klasa 23: Pređa i konac, za tekstilnu upotrebu.

Klasa 24: Tekstil i tekstilni proizvodi koji nisu obuhvaćeni drugim klasama; prekrivači za krevete i stolove.

Klasa 25: Odjeća, obuća, pokrivala za glavu.

Klasa 26: Čipka i vez, trake (pantljike) i gajtani; dugmad, kopče i petlje, špenadle i igle; vještačko cvijeće.

Klasa 27: Tepisi, asure, prostirke i otirači, linoleum i drugi materijali za pokrivanje podova; prekrivači za zidove (netekstilni).

Klasa 28: Igre i igračke; gimnastički i sportski artikli koji nisu obuhvaćeni drugim klasama; ukrasi za jelke.

Klasa 29: Meso, riba, živina i divljač; mesne prerađevine; konzervisano, zamrznuto, sušeno i kuvano voće i povrće; želei, džemovi, kompoti; jaja, mlijeko i mliječni proizvodi; jestiva ulja i masti.

Klasa 30: Kafa, čaj, kakao, šećer, pirinač, tapioka, sago, zamjena kafe; brašno i proizvodi od žitarica, hljeb, kolači i poslastice, sladoledi; med, melasa; kvasac, prašak za pecivo; so, senf; sirće, sosovi (kao dodaci); začini; led.

Klasa 31: Poljoprivredni, vrtlarski i šumarski proizvodi i zrnavlje koji nisu uključeni u druge klase; žive životinje; svježe voće i povrće; sjeme, prirodne biljke i cvijeće; hrana za životinje, slad.

Klasa 32: Pivo; mineralne i sodne vode i druga bezalkoholna pića; pića od voća i voćni sokovi; sirupi i drugi preparati za proizvodnju pića.

Klasa 33: Alkoholna pića (izuzev piva).

Klasa 34: Duvan; artikli za pušače; šibice.

Klasa 35: Oglašavanje; vođenje poslova; poslovno upravljanje; kancelarijski poslovi.

Klasa 36: Osiguranje; finansijski poslovi; novčani (monetami) poslovi; poslovi vezani za nepokretnosti.

Klasa 37: Građevinsko konstruisanje; popravljanje; usluge instaliranja (instalacione usluge).

Klasa 38: Telekomunikacije.

Klasa 39: Transportne usluge; pakovanje i skladištenje robe; organizovanje putovanja.

Klasa 40: Obrađivanje materijala.

Klasa 41: Obrazovne usluge; pripremanje obuke; razonoda; sportske i kulturne aktivnosti.

Klasa 42: Naučne i tehnološke usluge i istraživanje i projektovanje u vezi navedenih usluga; usluge industrijske analize i istraživanja; projektovanje i razvoj kompjuterskog hardvera i softvera.

Klasa 43: Usluge obezbjeđivanja hrane i pića; privremeni smeštaj.

Klasa 44: Medicinske usluge; veterinarske usluge; higijenska zaštita i njega ljepote za ljude ili životinje; agrikulturne, hortikulturne i šumarske usluge.

Klasa 45: Pravne usluge; usluge obezbjeđenja radi zaštite imovine i lica; individualne i društvene usluge koje pružaju drugi, radi zadovoljavanja potreba pojedinaca.

(210) **Ž-2018-333**

(220) 04.09.2018.

(731) MONTECCO INC DOO, Bandići bb, 81412, Spuž, Danilovgrad, ME

(540)

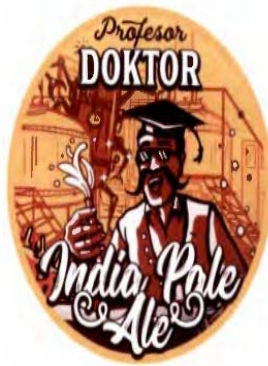

(550) I

(511) Klasa 32: Pivo

Klasa 35: Komercijalni poslovi i poslovno upravljanje prodajom proizvoda.

Klasa 39: Pakovanje i skladištenje robe, kao i transportne usluge.

Klasa 43: Usluge za pripremanje hrane i pića za dalju potrošnju.

(210) **Ž-2018-334**

(220) 04.09.2018.

(731) MONTECCO INC DOO, Bandići bb, 81412, Spuž, Danilovgrad, ME

(540)



(550) I

(511) Klasa 32: Pivo

Klasa 35: Komercijalni poslovi i poslovno upravljanje prodajom proizvoda.

Klasa 39: Pakovanje i skladištenje robe, kao i transportne usluge.

Klasa 43: Usluge za pripremanje hrane i pića za dalju potrošnju.

(210) **Ž-2018-335**

(220) 04.09.2018.

(731) MONTECCO INC DOO, Bandići bb, 81412, Spuž, Danilovgrad, ME

(540)



(550) I

(511) Klasa 32: Pivo

Klasa 35: Komercijalni poslovi i poslovno upravljanje prodajom proizvoda.

Klasa 39: Pakovanje i skladištenje robe, kao i transportne usluge.

Klasa 43: Usluge za pripremanje hrane i pića za dalju potrošnju.

(210) **Ž-2018-336**

(220) 04.09.2018.

(731) MONTECCO INC DOO, Bandići bb, 81412, Spuž, Danilovgrad, ME

(540)



(550) I

(511) Klasa 32: Pivo

Klasa 35: Komercijalni poslovi i poslovno upravljanje prodajom proizvoda.

Klasa 39: Pakovanje i skladištenje robe, kao i transportne usluge.

Klasa 43: Usluge za pripremanje hrane i pića za dalju potrošnju.

(210) **Ž-2018-337**

(220) 04.09.2018.

(731) MONTECCO INC DOO, Bandići bb, 81412, Spuž, Danilovgrad, ME

(540)

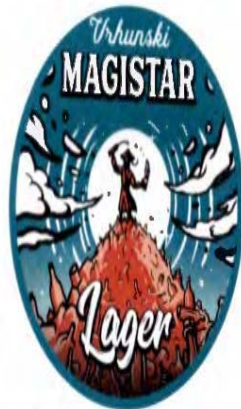

(550) I

(511) Klasa 32: Pivo

Klasa 35: Komercijalni poslovi i poslovno upravljanje prodajom proizvoda.

Klasa 39: Pakovanje i skladištenje robe, kao i transportne usluge.

Klasa 43: Usluge za pripremanje hrane i pića za dalju potrošnju.

(210) **Ž-2018-372**

(220) 28.09.2018.

(731) "BIZNIS ANDJEO"D.O.O., Vijenac kosovskih junaka 4, Podgorica, ME

(540)



(550) I

(511) Klasa 35: -Komercijalna prezentacija restorana i drugih ugostiteljskih objekata u Crnoj Gori na web site-u www.foodbook.me u cilju promocije i poboljšanja poslovanja klijenata . Pod komercijalnom prezentacijom podrazumijevaju se sljedeće aktivnosti: postavljanje promotivnog materijala na sajtu u vidu fotografija, video prezentacija, virtuelnih tura, promocija i aktuelnih akcija klijenata, objave događaja klijenata, promotivnih tekstova koji se prezentuju široj publici, tekstova i informacija koji se odnose na sadržaj usluga koje pruža restoran. -Marketing podrška klijentima preko savremenih alata digitalnog marketinga: podrška preko Facebook platforme, podrška preko Instagram platforme, Viber/Sms marketing, E-mail newsletter marketing -Online rezervacije: pružanje usluga online rezervacija mjesta u restoranima preko sistema za rezervacije koji se nalazi/će se nalaziti na sajtu www.foodbook.me -Online narudžbe hrane: mogućnost naručivanja hrane iz restorana preko sistema koji je razvijen na sajtu www.foodbook.me

(210) **Ž-2018-380**

(220) 09.10.2018.

(731) GODIVA BELGIUM B.V.B.A./S.P.R.L., Wapenstilstandstraat 5, 1081, Brussel, BE

(540)

GODIVA

(550) I

(740) Božidar S. Radulović, Studentska bb, Lamela 3/18, 81000, Podgorica

(511) Klasa 35: Usluge onlajn porudžbina koje uključuju hranu, odnosno slatkiše, maloprodaju bombona, usluge konditorskih proizvoda, oglašavanje i vođenje poslova.
Klasa 43: Usluge obezbjeđivanja hrane i pića; kafei; restorani.

(210) **Ž-2018-425**

(220) 09.11.2018.

(731) British American Tobacco (Brands) Limited, Globe House 4 Temple Place, WC2R 2PG, London, GB

(540)

VELVETY GREEN

(550) I

(511) Klasa 34: Cigarete; duvan, sirov ili prerađen; proizvodi od duvana; zamjene za duvan (ne u medicinske svrhe); cigare; cigarilosi; upaljači; šibice; artikli za pušače; cigaret papir, cigaret tube, filteri za cigarete; džepni aparati za zamotavanje cigareta; ručne mašine za ubrizgavanje duvana u papirne tube; elektronske cigarete; tečnosti za elektronske cigarete; duvanski proizvodi namijenjeni za zagrijavanje; uređaji i dijelovi za uređaje za zagrijanje duvana i zamjene za duvan za potrebe inhalacije.

(210) **Ž-2018-426**

(220) 09.11.2018.

(731) British American Tobacco (Brands) Limited, Globe House 4 Temple Place, WC2R 2PG, London, GB

(540)

COPPER

(550) I

(740) Miladin Popović, ul. Capital Plaza, ulica šeika Zajeda 13-IV/68, 81000, Podgorica

(511) Klasa 34: Cigarete; duvan, sirov ili prerađen; proizvodi od duvana; zamjene za duvan (ne u medicinske svrhe); cigare; cigarilosi; upaljači; šibice; artikli za pušače; cigaret papir, cigaret tube, filteri za cigarete; džepni aparati za zamotavanje cigareta; ručne mašine za ubrizgavanje duvana u papirne tube; elektronske cigarete; tečnosti za elektronske cigarete; duvanski proizvodi namijenjeni za zagrijavanje; uređaji i dijelovi za uređaje za zagrijanje duvana i zamjene za duvan za potrebe inhalacije.

(210) **Ž-2018-427**

(220) 09.11.2018.

(731) British American Tobacco (Brands) Limited, Globe House 4 Temple Place, WC2R 2PG, London, GB

(540)

MAROON

(550) I

(740) Miladin Popović, ul. Capital Plaza, ulica šeika Zajeda 13-IV/68, 81000, Podgorica

(511) Klasa 34: Cigarete; duvan, sirov ili prerađen; proizvodi od duvana; zamjene za duvan (ne u medicinske svrhe); cigare; cigarilosi; upaljači; šibice; artikli za pušače; cigaret papir, cigaret tube, filteri za cigarete; džepni aparati za zamotavanje cigareta; ručne mašine za ubrizgavanje duvana u papirne tube; elektronske cigarete; tečnosti za elektronske cigarete; duvanski proizvodi namijenjeni za zagrijavanje; uređaji i dijelovi za uređaje za zagrijanje duvana i zamjene za duvan za potrebe inhalacije.

(210) **Ž-2018-429**

(220) 09.11.2018.

(731) British American Tobacco (Brands) Limited, Globe House 4 Temple Place, WC2R 2PG, London, GB

(540)

NEO BRONZE

(550) I

(740) Miladin Popović, ul. Capital Plaza, ulica šeika Zajeda 13-IV/68, 81000, Podgorica

(511) Klasa 34: Duvan, sirov ili prerađen; proizvodi od duvana; zamjene za duvan (ne u medicinske svrhe); sve za svrhu zagrijavanja, ali ne i sagorijevanja; artikli za pušače; elektronski uređaji za zagrijavanje duvana i dijelovi za njih.

(210) **Ž-2018-464**

(220) 28.11.2018.

(731) British American Tobacco (Brands) Limited, Globe House 4 Temple Place, WC2R 2PG, London, GB

(540)

COOL PURPLE

(550) I

(740) Miladin Popović, ul. Capital Plaza, ulica šeika Zajeda 13-IV/68, 81000, Podgorica

(511) Klasa 34: Cigarete; duvan, sirov ili prerađen; proizvodi od duvana; zamjene za duvan (ne u medicinske svrhe); cigare; cigarilosi; upaljači; šibice; artikli za pušače; cigaret papir, cigaret tube, filteri za cigarete; džepni aparati za zamotavanje cigareta; ručne mašine za ubrizgavanje duvana u papirne tube; elektronske cigarete; tečnosti za elektronske cigarete; duvanski proizvodi namijenjeni za zagrijavanje; uređaji i dijelovi za uređaje za zagrijavanje duvana i zamjena za duvan za potrebe inhalacije.

(210) **Ž-2018-495**

(220) 14.12.2018.

(731) MONTENEGRO + d.o.o., Đuraševici bb, 85320, Tivat, ME

(540)



(550) I

(740) Milan Dulović, Nikole Tesle bb, 81000, Podgorica

(511) Klasa 39: Iznajmljivanje opreme za sport i razonodu; iznajmljivanje bicikala.
Klasa 41: Usluge razonode, razbibrige, razonode lica sa vodenim sportovima.

(210) **Ž-2019-13**

(220) 21.01.2019.

(731) Pharmacia & Upjohn Company LLC, 7000 Portage Road, MI 49001, Kalamazoo, Michigan, US

(540)



(550) I

(740) Jasna Jusić, Dalmatinska 2, 81000, Podgorica

(511) Klasa 5: Farmaceutski proizvodi, medicinski i veterinarski preparati; sanitarni preparati za medicinske svrhe; dijetetska hrana i supstance za medicinsku ili veterinarsku upotrebu, hrana za bebe; dijetetski suplementi za ljude i životinje; flasteri, materijali za zavijanje; materijali za plombiranje zuba, zubarska smola; dezinfekciona sredstva; preparati za uništavanje štetočina; fungicidi, herbicidi.

Klasa 10: Hirurški, medicinski, zubarski i veterinarski aparati i instrumenti; vještački udovi, oči i zubi; ortopedski artikli; hirurški materijali za zašivanje; terapijska i pomoćna sredstva prilagođena osobama sa invaliditetom; aparati za masažu; aparati, uređaji i artikli za dojenčad; aparati, uređaji i artikli za seksualne aktivnosti; medicinski uređaji za oftalmološku upotrebu.

Klasa 44: Medicinske usluge; veterinarske usluge; higijenska zaštita i njega ljepote za ljude ili životinje; agrikulturne, hortikulturne i šumarske usluge.

(210) **Ž-2019-64**

(220) 26.02.2019.

(731) Privredno društvo iz Republike Srbije "PRO DIVISION EVENTS" d.o.o. Beograd, Ul. Ilirska 5, 11000, Beograd, RS

(540)



(550) I

(740) Marko J. Gigić, Antifašističke borbe 23, lok 35, 11070, Novi Beograd

(511) Klasa 35: Distribucija reklamnog materijala; iznajmljivanje oglasnih materijala; iznajmljivanje prodajnih štandova; oglašavanje; organizovanje sajmova u komercijalne ili reklamne svrhe; promocija prodaje za druge; pružanje poslovnih informacija putem Internet stranice; reklamiranje preko plakata i reklamiranje preko televizije.

Klasa 41: Informacije iz oblasti zabave i razonode; muzičke dvorane; organizovanje i sprovođenje koncerata; planiranje zabave (zabava) i razonoda .

Klasa 43: Iznajmljivanje aparata za osvetljenje; iznajmljivanje šatora; rezervisanje privremenog smeštaja i iznajmljivanje automata za vodu i piće.

(210) **Ž-2019-78**

(220) 05.03.2019.

(731) Philip Morris Products S.A., Quai Jeanrenaud 3, 2000, Neuchâtel, CH

(540)

UNSMOKE YOUR WORLD

(550) I

(740) Milena Pejović, Cetinjski put 11, The Capital Plaza IV floor,, 81000, Podgorica

(511) Klasa 35: Saopštavanje za javnost o izjavama ili najavama bilo kojim sredstvima za širenje vesti i u vezi sa svim vrstama roba ili usluga, uključujući one koje se odnose na javno zdravlje, životni stil, duvan, zaštitu životne sredine; upravljanje programima lojalnosti pacijenata i potrošača. Usluge agencija za pružanje informacija, usluge oglašavanja; prezentacija robe; usluge demonstracije i veleprodaja ili maloprodaja proizvoda za negu, prirodnih prehrambenih proizvoda, kozmetike, higijene, proizvoda za prestanak pušenja. Usluge institucionalne kampanje, uključujući pomoć pušačima i nepušačima u pogledu duvana, nusproizvoda i zamene duvana.

Klasa 38: Telekomunikacije; usluge novinskih agencija; pružanje usluga internet foruma za diskusiju; emitovanje televizijskih programa; usluge koje omogućavaju pušačima i nepušačima da razgovaraju sa specialistima.

Klasa 41: Obrazovne usluge; pružanje usluge treniranja; usluge razonode; sportske i kulturne aktivnosti. Usluge iznajmljivanja iz biblioteke; usluge razonode, sportske, obrazovne klupske usluge; organizacija i vođenje sportskih takmičenja, kolokvijuma, konferencija, kongresa, predstava; nastavna ispitivanja, praktična nastava [obuka putem demonstracije]; časovi fitnesa; objavljivanje knjiga i magazina. Iznajmljivanje kinematografskih filmova; Podučavanje.

Klasa 44: Zdravstvene usluge, usluge savetovanja o zdravlju; medicinske usluge; veterinarske usluge; usluge održavanja higijene i usluge nege lepote za ljude ili životinje; usluge savetovanja o zdravlju; savetovanje, lečenje i terapijska ili informativna podrška za prestanak pušenja; usluge detoksikacije . Usluge u poljoprivredi, hortikulturi šumarstvu. Medicinske usluge; veterinarske usluge; usluge održavanja higijene usluge nege lepote za ljude ili životinje; usluge u poljoprivredi, hortikulturi šumarstvu. Usluge u vezi sa uzgojem biljaka. Iznajmljivanje medicinske opreme.

(210) **Ž-2019-95**

(220) 12.03.2019.

(731) Sanrio Company, Ltd.,, 1-6-1, Osaki, Shinagawa-Ku,, 141-8603, Tokyo , JP

(540)



(550) I

(740) Jelena Bogetić, Cetinjska 11, The Capital Plaza, 81000, Podgorica

(511) Klasa 3: Proizvodi za izbeljivanje i druge supstance za veš; proizvodi za čišćenje; preparati za poliranje; proizvodi za odstranjivanje i abrazivna sredstva; sapuni, nemedicinski; parfemi; eterična ulja; kozmetika, nemedicinska i toaletni preparat; balsami za kosu, nemedicinski; nemedicinski proizvodi za njegu zuba, nemedicinski; proizvodi za parfimisanje sobe; preparati za manikir; proizvodi i preparati za negu i čišćenje kose i kože; ljepila za kozmetičke potrebe; losioni za upotrebu poslije brijanja; toaletna sredstva protiv znojenja; proizvodi za neutralizovanje statičkog elektriciteta za domaćinstvo; arome [eterična ulja]; kora kvilaje za čišćenje [vrsta biljke]; soli za kupanje; kozmetički preparati za kupanje; maske za ljepotu; soli za izbjeljivanje; soda za bijeljenje rublja; plavila za veš; aerosol za osvježivanje daha; trake za osvježavanje daha; hemijski proizvodi za oživljavanje boja za upotrebu u domaćinstvu; proizvodi za uklanjanje ličilačkih boja; kozmetički nesereri [torbe s kozmetičkim proizvodima]; kozmetički proizvodi za mršavljenje; kozmetički proizvodi za životinje; vatirani štapići za kozmetičku upotrebu; vata za kozmetičke potrebe; kreme za

kozmetičke potrebe; kreme za čišćenje kože; kreme za kožne proizvode; proizvodi za uklanjanje masnih mrlja; preparati za poliranje zubnih proteza; sredstva za čišćenje zubnih proteza; dezodoransi za ljude; dezodoransi za životinje ili za kućne ljubimce; deterdženti; kozmetičke boje; kolonjska voda; toaletne vodice; boje za kosu; kreme za kosu; gel za kosu; šamponi; balzami za kosu; sredstva za vlaženje kose; mirisi [parfemi]; ruž [rumenilo] za usne; kreme i losioni za kožu i lice; vještački nokti; lakovi za nokte; razređivač laka za nokte; krema za sunčanje; izbjeljivači za kozmetičke potrebe; arome za kolače [eterična ulja]; toaletno mlijeko; kozmetički proizvodi za obrve; olovke za obrve; omekšivači; vještačke trepavice; podni vosak; lakovi za kosu; preparati za kovrdžanje kose; proizvodi za bijeljenje rublja; proizvodi za natapanje veša; skrobna apretura [štirak]; kozmetički losioni; šminka;; puder za šminkanje [milovka]; proizvodi za šminkanje; proizvodi za skidanje šminke; maskara; nemedicinski proizvodi za njegu usta; naljepnice za nokte; proizvodi za njegu noktiju; olovke za kozmetičke potrebe; vosak za podove [masti]; pomade za kozmetičke potrebe; potpuri [posudice s mirišljivim suhim laticama cvijeća]; kamen za glačanje [kamen vulkanskog porijekla]; platno za poliranje [peglanje]; brusni papir [šmirgla]; mirišljivo drvo; šamponi za kućne ljubimce; kreme za obuću; lak za obuću; vosak za obuću; sredstva za glačanje (štirkanje); sapuni za osvježavanje; skrob za laštenje; kozmetički preparati za sunčanje; maramice namočene u kozmetičke losione; sredstva za skidanje lakova; vosak za uklanjanje dlačica; vosak za veš; vosak za poliranje; vosak za kožne proizvode; proizvodi za uklanjanje dlačica; naftni žele za kozmetičke potrebe; ukrasni detalji za kozmetičku upotrebu; štapići tamjana za kađenje; papir koji upija ulje za kožu; upijajući papir za lice; sredstva za kupanje, ne za medicinske potrebe, mirisni štapići za osvježavanje prostora.

Klasa 9: Naučni uređaji, navigacioni uređaji, uređaji za ispitivanja, istraživanja, fotografiju, kinematografiju, audiovizuelni, optički uređaji, uređaji za vaganje, merenje, signaliziranje, detektovanje, testiranje, pregledanje, spasilački i nastavni uređaji i instrumenti; uređaji i instrumenti za sprovođenje, prijenos, transformisanje, akumuliranje, regulisanje ili kontrolu distribucije ili korišćenja električne energije; uređaji i instrumenti za snimanje, prijenos, reprodukciju ili obradu zvuka,slika ili podataka; snimljena sredstva koja se mogu preuzimati, kompjuterski programi, blanko digitalna ili analogna sredstva za snimanje i skladištenje; mehanizmi za aparate koji se pokreću novcem; kase; uređaji za računanje, kompjuteri i periferni kompjuterski uređaji; ; skafanderi za ronjenje, ronilačke maske, tamponi za uši prilikom ronjenja, štipaljke za nos za ronioce i plivače, ronilačke rukavice, uređaji za disanje pri podvodnom plivanju; uređaji za gašenje požara; računske sprave s kuglicama [računaljke]; uređaji za audiovizuelno učenje; baterije; kućišta akumulatora; transformatori za povećanje napona; dvogled [optika]; aritmetičke mašine; fotografski aparati; kamere [kinematografski uređaji]; delovi i oprema za kamere; objektiv kamere; sprave za mjerenje zapremine; animirani crteži; čitači kasete; lančići za naočare; kinematografski filmovi, snimljeni; uređaji za bilježenje vremena [satovi]; čitači kompaktnih diskova; kompaktni audio-video diskovi; kompaktni optički diskovi; kompjuterski programi [radni]; kompjuterski programi [snimljeni]; kompjuteri; štampači za kompjutere; kontaktna sočiva; torbice za kontaktna sočiva; uređaji za obradu podataka; krojački metri; zvonca, električna za vrata; džepni elektronski prevoditelji; filmske trake [osvijetljene]; alarmi za požare; blicevi [fotografski]; okviri za dijapozitive u fotografiji; uređaji za kontrolu topline; muzički automati koji se pokreću uz prethodno plaćanje (džuboks); optička sočiva; vage za pisma; pojasevi za spašavanje; pojasevi za spašavanje; prsluci za spašavanje; skele za spašavanje; brave, električne; elektronske brave i ključevi; magnetne kartice [kodirane]; magnetni uređaji za kodiranje; magneti; lupe [optika]; mjerni pribor; električni aparati za mjerenje; mjerni instrumenti; mikrofoni; mikroskopi; svjetleće cijevi za reklamne poruke; kompjuteri, džepni; elektronske olovke za jedinice za vizuelno prikazivanje; gramofonske ploče; fotokopirni uređaji; računske, džepne mašine [digitroni]; projektori; ekrani za projektovanje; T.S.F. uređaji [radiouređaji]; gramofoni; aparati za daljinsko upravljanje; lenjiri [mjerni instrumenti]; vage; kartice za mikroprocesore; detektori dima; električne utičnice; navlake za naočare; okviri za naočare; naočare [optika]; sunčane naočare; električni prekidači; magnetofoni s magnetnim trakama; telefonski uređaji; telefonski predajnici; telefonske žice; dvogled [teleskopij];

televizori; indikatori temperature; električni uređaji protiv krađe; toplomjeri, nemedicinski; termostati; videokasete; kasete za videoigre; video snimci; videotrake; videoekrani; magnetoskopi; programi za obradu teksta; kompaktni audio-video diskovi [diskovi]; DVD-jevi; čitač video kompaktnih diskova i DVD-jeva; audio-vizualni aparati sa karaoke uređajima; držači, nosači i futrole za audio i video kasete, kompakt diskove, laserske diskove, video diskove i DVD-jeve; podloge za kompjuterske miševe; telefoni; bežični telefoni, mobilni telefoni i delovi, oprema i dodaci za telefone; futrole i navlake za mobilne telefone; radiopejdžeri [dojavnici] i delovi i oprema za radiopejdžere; futrole i navlake za radiopejdžere; torbe, omotači, posude, nosači i držači za mobilne telefone i pejdžere; jastučići za uši za slušalice; slušalice za telefon i mikrofoni/telefonski zvučnici koji se koriste uz mobilne telefone; indikatori poziva za telefone; elektronički podsjetnici [agende]; električna zvonca; alarmni uređaji; čitači bar kodova; barometri; zujalice; električne zujalice; procesori [središnji uređaji za obradu podataka]; čipovi [integrirani krugovi]; hronografi [aparati za bilježenje trajanja]; tastature kompjutera; memorije za kompjutere; pomoćni uređaji kompjutera; akustični spojnice; prekidači s dva položaja [informatika]; optičke nosioci podataka; optički diskovi; magnetne table; aparat za ronioce; ronilačke maske; ronilačka odijela [kombinezoni]; elektronske oglasne table; elektronske olovke za jedinice za vizuelno prikazivanje; uzice za naočare; okulari; viziri [zaštitne naočare]; telefaksi; filteri za fotografske potrebe; flopi diskovi; trake za čišćenje glava za snimanje; higrometri, za mjerenje vlažnosti; integrisani krugovi; uređaji za međukomunikacije; interfejsi za kompjutere [informatika]; mašine za fakturisanje; poklopci za objektiv [kamere]; sklopovi s magnetnom trakom [informatika]; magnetne trake; kašike za doziranje; metronomi; mikroprocesori; modemi; uređaji za brojenje i razvrstavanje novca; monitori [kompjuterska oprema]; monitori [kompjuterski programi]; miš [informatika]; optička vlakna [vodiči za svjetlosne zrake]; optička stakla; optičarski proizvodi; parkometri [uređaji za mjerenje trajanja parkiranja]; uglomjeri [mjerni instrumenti]; radiotelegrafski uređaji; radiotelefonski uređaji; oprema za obradu podataka [skeneri] [informatika]; poluprovodnici; dijapozitivi; trake za snimanje zvuka; uređaji za demagnetizovanje magnetnih traka; telegrafске žice; telegrafi [uređaji]; teleprinteri; telekomunikacioni aktivatori za TV spikere; automatski uređaji za izdavanje karata; predajni telefonski uređaji; odašiljači [telekomunikacije]; vakumetri; video telefoni; zviždeći alarmi; sportske zviždaljke; ronilački tamponi za uši; pješčani satovi; naočare za sport; disaljke za ronjenje; zaštitne kacige za sport; navigacioni uređaji za vozila [brodski kompjuteri]; kompjuterski programi i softver za igre, snimljen; kompjuterski programi, koje se mogu preuzimati; elektronske publikacije [za skidanje s udaljenijeg na bliži kompjuter ili s jačeg na slabiji kompjuter]; aplikacije za kompjuterske softvere koje se mogu preuzimati; emotikoni za mobilne telefone, koji se mogu preuzeti; vokmeni; sateliti za naučne potrebe; oslonci za šaku za rad s informatičkom opremom; digitalni ramovi za fotografije; trake za mobilne telefone; stalak za mobilne telefone; stalci prilagođeni za laptopove; poklopci antene za mobilne telefone; futrole za pametne telefone; navlake za pametne telefone; elektronska kola i CD-ROM-ovi koji omogućavaju snimanje automatskog programa reprodukcije za upotrebu elektronskih muzičkih instrumenata; prijenosni multimedijalni čitači; slikovne datoteke koje se mogu preuzimati; grafike za mobilne telefone koje se mogu preuzimati; muzičke datoteke koje se mogu preuzimati; melodije za mobilne telefone koje se mogu preuzimati; čitači DVD-ja; uređaji za globalnu navigaciju [GPS]; USB uređaji [vanjski diskovi, priključci]; mehanizmi za pokretanje diska [informatika]; laptop kompjuteri; svijetleće diode [LED]; organske svijetleće diode [OLED] uređaji za ličnu zaštitu od nesretnih slučajeva; maske, zaštitne za radnike; kompasi [busole]; električne utičnice; zaštite za utičnice; distribucione konzole za elektrodistribuciju; dodaci za telefone za telefoniranje bez ruku, hands free; cijevi, vatrogasne; mlaznice za vatrogasna crijeva; programi za mašine za arkadne video igre; programi za mašine za kućne video igre; lični digitalni pomoćni uređaj; ronilački tamponi za uši; sunčane baterije; tablet kompjuteri; digitalne kamere; elektronski čitači knjiga; pametni telefoni; pametni satovi; pametne naočare; nosivi uređaji za praćenje aktivnosti; pametno prstenje; selfi štampovi [ručni monopodi]; elektronske interaktivne table; uređaji za električne i elektronske efekte za muzičke instrumente; audio interfejsi; zaštitne folije prilagođene za ekrane kompjutera; zaštitne

folije prilagođene za pametne telefone; setovi za virtuelnu realnost; laboratorijski roboti; roboti za nastavu, roboti za nadzor bezbednosti, humanoidni roboti sa veštačkom inteligencijom; roboti za telekomunikaciju; torbe za laptopove; specijalne navlake i torbe za fotografske aparate i instrumente; nosivi kompjuteri, džojstici koji se koriste uz kompjuter a nisu za video igre, baterije i punjači za elektronske cigarete; senzorske rukavice.

Klasa 14: Plemeniti metali i njihove legure i poluge od plemenitih metala; kutije od plemenitih metala; dugmad za manžetne, od plemenitih metala; kopče za kravate, od plemenitih metala; igle za kravate, od plemenitih metala; umjetnički predmeti od plemenitih metala; ukrasne igle od plemenitih metala; ukrasi za obuću od plemenitih metala; statue od plemenitih metala; figurine (statuete) od plemenitih metala; nakit; drago i polu-drago kamenje; imitacije nakita i ukrasa; horološki i hronometrijski instrumenti; broševi [nakit]; lančići [nakit]; ukrasi za priveske i lančiće za ključeve; privjesci [nakit]; metalni novac; žetoni, naime medalje i/ili novčići; dugmad za manžetne; naušnice; zlatne niti [nakit]; futrole za nakit; ogrlice [nakit]; igle pribadače [nakit]; igla za rever; prstenje [nakit]; kopče za kravate; satovi i zidni satovi, i delovi i oprema za njih; narukvice za satove; lančići za satove; kućišta ručnih satova; satovi, tačni sa zaustavljanjem [štoperice]; ukrasi (nakit); ukrasne igle; igle za kravate; privjesci za ključeve; ukrasni privjesci za ključeve, na uvlačenje; sitni ukrasi i ukrasni privjesci; lanci i futrole za ključeve/nosači plemenitih metala i/ili dragog kamenja; privjesci; narukvice [nakit]; kućišta zidnih satova; električni satovi i zidni satovi; sunčani satovi; dijamanti; vještački dijamanti; budilnici; šanil dugmad za manžetne; značke [amblemi] od plemenitih metala; pehari; komemorativni štitovi; amajlije za sreću; perle za izradu nakita; igle nakit za šesire.

Klasa 16: Papir; karton; štamparski proizvodi; pribor za uveze; fotografije [štampane]; papirni pribor, kancelarijski pribor [osim namještaja]; ljepljive materije za papirne proizvode i za domaćinstvo; materijal za crtanje i za umjetnike; slikarske četkice; nastavni materijal i materijal za obučavanje; plastične ploče, folije i omotači za pakiranje; štamparska slova; naljepnice, štamparski blokovi; kalendari; knjige; katalogi; poštanski dopisi; plakati [poster]; časopisi [periodični]; publikacije; novine; časopisi [revije]; čestitke; sprave za pisanje; gumene pečati; pečati; jastučići za pečate; jastučići za mastilo; foto albumi; podloge za uramljivanje slika i fotografija; slikarski stalci; papir koji upija ulje za kožu; stalci za fotografije; tuš [boja]; papirne maramice; papir, higijenski; papirne maramice za skidanje šminke; ubrusi od papira; stolni kompleti od papira; papirni podmetači za boce; papir za pakovanje, uvijanje i materijali za pakovanje; vodene boje za umetnike; grafičke reprodukcije, portreti; litografije [kamenotisci]; pera [kancelarijski pribor]; olovke; nalivpera; kuglice za hemijske olovke; pera za pisanje; držala za pera; nastavci za olovke; punjenja za olovke i instrumente za pisanje; ulošci za olovke [mine]; olovke u boji; pastele [olovke]; kutije za olovke; pernice; mašine za oštrenje olovaka; oštrila za olovke; kvačice za papire; pritiskači za papir; papirne igle; ekseri s pljosnatom glavom [rajsnegle]; ljepila za papirne proizvode ili za domaćinstvo; papir, kaširani; košare i postolja za pisma; držači za pisma; otvarači pisama; ljepljive trake za papirne proizvode ili za domaćinstvo; table za crtanje; pera za izvlačenje crta; setovi za crtanje; albumi za marke i metalni novac; vreće za smeće; kese za zamrzivač; kese za poklone; papirne kese; poštanske kese, kese za sendviče; kese za sendviče (od papira); papirne kese za žurke; papirne kese za poklone; kese za led, konusne papirne vrećice; plastične kese za sendviče; vrećice za kuvanje u mikrotalasnim pećima; papirne kese za kupovinu; plastične kese za kupovinu; papirne kese za otpad; ojačane kese od kartonskog materijala; omotnice [papirni proizvodi]; upijajuća hartija [bugačice]; stalci za pridržavanje knjiga; obeleživači za knjige; markeri stranica u knjizi; kutije za papirne proizvode [kancelarijske potrepštine]; slikarska platna; blokovi [notesi]; dnevници; fascikle [kancelarijski pribor]; blokovi za pisanje [papirni proizvodi] podsetnici; papir za pisma; papir za crtanje; papirni pribor za pisanje; mape za pisanje; kreda; školske table; tabla za plakate; džepići za pasoše; korice za blokove s čekovima; gumene trakice za povezivanje spisa; slike; matrice za umnožavanje [šablone]; matrice [papirni proizvodi]; proizvodi za brisanje; kancelarijski noževi za brisanje [radiranje]; tečni proizvodi za brisanje; električni otvarači za pisma; štampane muzičke partiture; bele table (koje se mogu brisati); ukrasi i dekoracije od papira i/ili kartona;

stolne salvete od papira; papirne kese za užinu; sanduci i torbe od kartona; bojanke; fascikle [papirni proizvodi]; papirno vezivo; džepne sveske; flomasteri; knjige za učenje čitanja (za decu); set grafitnih olovaka; set bojica; lenjiri za crtanje; podmetači za pisanje; autografske knjige; kvačice za papire; heftalice [kancelarijske mašine]; rezač trake [kancelarijski materijal]; znaci upozorenja; kancelarijski mašine za rezanje papira; CD narezivač za kućnu ili kancelarijsku upotrebu; mašine i aparati za oblaganje plastikom; električni aparat za ugradnju zaštitnog omotača za dokumente i fotografije putem toplotnog zaptivanja; držači i futrole za kartice; papirni ukrasi za kutije za ručak i namirnice; korice za neuvezane časopise; kutije, kartonske ili papirne; karte; stalci za pečate; novine sa stripovima; šestari za crtanje; papirne trake ili kartice za upis kompjuterskih programa; papir za kopiranje; korektori, tečni [kancelarijski pribor]; naprsci, gumeni [kancelarijski pribor]; zastavice od papira; fascikle za papir; noževi za savijanje ili rezanje papira [kancelarijski pribor]; trake, gumirane [papirnati proizvodi]; džepne maramice, papirnate; indeksne kartice; trake natopljene tintom; futrole za isprave; naljepnice [ne od tkanine]; geografske mape [geografske karte]; čestitke s muzikom; okružnice; kutije za slikarske boje [školski pribor]; brošure; kancelarijski mašine za rezanje papira; držači za mine za olovke; poštanske marke; samoljepljivi papirni proizvodi; ulaznice, vozne karte, birački listići i slični proizvodi; trake za pisaće mašine; pisaće mašine, električni ili neelektrični; papirni omoti [korice]; četkice za pisanje; kreda za pisanje; tableti za pisanje; ukrasne papirne vaze za cvijeće; portikle, papirne [djeci oko vrata protiv prljanja]; papirni filteri za kafu; knjižice [pasoši, radne knjižice itd.]; modeli za izradu veza; noževi za papir [kancelarijski pribor]; prekrivači stolova od papira; stolnjaci od papira; natpisi na papiru ili kartonu; metalni vrh za indeksne karte; papirni kvadrati; samoljepljivi papirni proizvodi (stikeri) za prenosive telefone; umjetničke slike, uokvirene ili neuokvirene; spravice za plastificiranje isprava [kancelarijski pribor]; kartonske kutije za šešire; ručne sprave za stavljanje naljepnica; markeri [pisaći pribor]; posude za boje; brisači za table za pisanje; papir Xuan [za slikare i kinesku kaligrafiju]; mehaničke olovke; vasi [japanski papir]; matrice za ukrašavanje hrane i pića; značke sa imenom [kancelarijski materijal]; trake za barkod; sjaj za papirnate proizvode; papirne oznake za potvrde za podizanje prtljaga; papirne maramice za čišćenje

Klasa 18: Koža i imitacije kože; životinjska koža; kišobrani; torbe za prtljag i za nošenje; kišobrani, suncobrani i štapovi za hodanje; bičevi, konjska oprema, i sedlarska roba; ogrlice za životinje; kožni povodci; odjeća za životinje; torbe; torbe za novac [vrećice za novce]; novčanici; putne torbe; torbe za isprave (aktovke); futrole za ključeve; vreće [omotači, džepovi], od kože za ambalažu; kutije za isprave; rančevi; torbe-navlake za odijela; torbe za namirnice; remeni, kožni za nošenje preko ramena ili leđa; sedlarski kaiševi; ugrađeni pojasevi za prtljag; štapovi od trske; futrole za podsjetnice; vezice od kože ili imitacije kože; kutije za toaletni pribor; brnjice; torbe za školu; kožni kaiševi; ručke za kofere; koferi, ručni; torbe za putovanja; kovčežići za prtljag; navlake za kišobrane; ručke za kišobrane; stolice-štapovi [stolice koje se po potrebi mogu preinačiti u štapove za šetnju]; kaiševi za prtljag; torbe za plažu; kutije, kožne ili od kartonske kože i kutije od kože i od kože i kartona; ručne torbe; planinarski štapovi; torbe za muzičke partiture; mreže za namirnice; ruksaci; torbe za alat [prazne]; mali koferi; torbe za divljač; vreće [omotači, džepovi], od kože za ambalažu; presvlake za domaćinstvo, od kože ili imitacije kože; okviri ručnih torbi; torbe za nošenje male djece; torbe na točkićima; sportske torbe; odjeća za kućne ljubimce; marame [ešarpe] za nošenje male djece; prekrivači za životinje; zaprežna oprema za životinje i kožni povodci, uzice; navlake za torbe za novac; futrole za poslovne kartice; randele (Japanske školske torbe); uzde za vođenje dece, motorizovani koferi, oznake za prtljag; tkanina od imitacije kože.

Klasa 25: Odjevni predmeti; obuća; pokrivala za glavu; kecelje [odjevni predmeti]; odjeća za plažu; kupaći kostimi; sportska odjeća; kabanice; rukavice; rukavice bez prstiju; rukavice sa svim spojenim prstima, osim palca; pojasevi [odjevni predmeti]; odjevni predmeti za decu, muškarce i žene; odjevni predmeti za bebe; pelene-gaćice za odojčad [odjeća]; portikle, nepapirne [djeci oko vrata protiv prljanja]; donje rublje; pidžame; ogrtači za kupanje; naramenice; šeširi; ženske kape; kačket; kačketai kao pokrivala za glavu; francuske kape;

kapice za kupanje i kapice za tuširanje; mufovi [odjevni predmeti]; neelektrične vrećice obložene krznom za grijanje nogu; pokrivači za uši [odjevni predmet]; odjeća za oko vrata; kravate; mašne [vrste kravate]; leptir mašna; kratke čarape [sokne] i čarape; hulahopke; podvezice od elastične tkanine; podvezice za čarape i podvezice [držači] za muške čarape; cipele i sportske cipele; papuče; obuća za plažu; odjeća za maskembale; štitnici za rukave; marame; ešarpe [šalovi]; sandale za kupanje; cipele za kupanje; skijaška obuća; čizme; grudnjaci; gaćice; ženske potkošulje; kaputi; manžetne [odjevni predmeti]; krzneni šalovi; kratki kaputi [sakoi]; žersej [odjevni predmet]; jakna ili košulja od platna ili serža za mornare; trikoi [odjevni predmeti]; spoljna odjeća; ogrtači [odjevni predmeti]; pantalone; vindjakne [kratki sportski kaputi s kapuljačom]; puloveri bez rukava; sandale; marame; šalovi [fulari]; košulje; slipovi [donji veš]; bluze [radničke bluze]; dokoljenice [gamaše]; sportska obuća; trikoi [gimnastički dresovi, majice]; odeli; tee-shirts [majice]; pantalone; odore [uniforme]; prsluci; kombinezoni za skijanje na vodi; potkošulje; gimnastičke papuče; gimnastička odjeća; lente [široki pojasevi]; odjeća za bicikliste; maske za spavanje; odjevni predmeti koji sadrže materije za mršavljenje; pleteni odjevni predmeti; štitnici peta za cipele.

Klasa 28: Igre, igračke i stvari za igru, uređaji za video igre, lutke [igračke]; igračke od pliša; plišani medvjedići; figure igračke; kompleti za igre; gimnastički i sportski artikli; kugle za igru; gumene lopte i baloni; praznične dekoracije i ukrasi; ukrasi i dekoracije za božićna drvca; oprema za ples; vozila [igračke]; električna vozila [igračke]; daske za talase [surfing]; daske za skijanje; roleri; klizaljke za led; skejtbord; zaštitni jastučići za sportsku odjeću; vazdušni pištolji [igračke]; torbe za štapove za golf, sa ili bez točkića; lopte za igru; zvončići za božićna drvca; bilijarske kuglice; bilijarski stolovi; građevinski elementi [igračke]; stolne igre; bomboni, praskavi božićni bomboni; klizaljke s čizmicama, za led; uređaji i mehanizmi za kuglanje; graditeljske igre; držači svjećica za božićna drvca; table za igranje dame; pribor za igru dame; šah [igra]; table za igranje šaha; božićna drvca-novogodišnje jelke od sintetičkog materijala; postolja za božićna drvca; pribor za mađioničare; pehari za nagrade u igrama; strelice; kockice za kockanje; kreveti za lutke; odjeća za lutke; kuće za lutke; sobe za lutke; pribor za igranje domina; tegovi za vežbanje; zaštita za laktove [sportski pribor]; gimnastičke protezaljke, za razvlačenje; jahaonica; flašice za lutke; udice; pribor za pecanje; peraje za plivače; plovci za pecanje; leteći tanjiri [igračke]; automatske igre; reketi; aparati za elektronske igre; mašine za video igre; prenosive video igrice sa zaslonima od tečnih kristala; elektronske mašine za video igre; torbe za štapove za golf; štapovi za golf; rukavice za golf; rukavice za igru i sport; varke [predmeti za prevaru za zabavu]; namotaji za papirne zmajevе; zmajevi, papirni; zaštita za koljena [sportski pribor]; ma-jong [kineska igra]; kuglice za igru [špekule]; pozorišne lutke [marionete]; maske, pozorišne; maske (igračke); mobilni [igračke sastavljene od više elemenata koji trepere uz najmanje strujanje vazduha]; mali modeli vozila; društvene igre; praskavi detonatori [igračke]; igračke za grickanje [kod nicanja zuba]; kolutovi za igru; konji-ljuljaške [igračke]; koturaljke; daske s jedrima, za vodu; skije; saonice za trke [bob sanke]; tobogani [igra]; igračke za pravljenje mjehurića od sapunice; zvrkovi [igračke]; odskočne daske [sportski artikli]; bicikli za treniranje na mjestu; bazeni [predmet za igru]; dušeci na naduvavanje; peraja za plivanje; daske za plivanje; peraja za plivanje za ruke; igračke na naduvavanje za bazene; ljuljaške; stolovi za stolni tenis; igračke za kućne ljubimce; skije za vodu; predmeti za igru za plivanje, igre, sportove i aktivnosti na vodi; lopte za plažu; automatske igre [mašine] uz prethodno plaćanje; navlake za skije i daske za surfovanje; bingo kartice; mrežice za leptire; karte za igru; konfeti; koturaljke s točkićima u nizu; pazle; kaleidoskopi; jarboli za daske s jedrom; vrećaste mreže za pecanje; vozila s daljinskim upravljanjem [igračke]; okretna ploča za rulet; staklene kugle sa snijegom; reketi za snijeg [krplje]; japanske karte za igru; prsluci za plivanje; pojasevi za plivanje; plutajući uređaji za kupanje i plivanje; plovci za plivanje i kupanje; šeširi od papira za zabave; sprave za jačanje mišića; žetoni za kockanje; kartice za struganje za lutriju; kompleti za izradu maketa; pačinko [mašine za igre]; aparati za kockanje [aparati za igre]; roboti igračke; dronovi (igračke); zaštitne folije prilagođenje za ekrane prenosnih igara; komandne palice [džojstici za video igre]; sličice za igre; šatori za igru; konzole za video igre; ručne konzole za igranje video igara.

Klasa 29: Meso, riba, živina i divljač; mesni ekstrati; konzervirano, sušeno i kuvano voće i povrće; želei, džemovi, kompoti; jaja, mlijeko, sir, puter, jogurt i drugi mliječni proizvodi; jestiva ulja i masti; supe, čiste, mesne [bujoni]; koncentрати čistih mesnih supa [bujona]; puter; kavijar; sir; mliječni proizvodi; prehrambeni proizvodi pravljeni od ribe; hrana pripremljena od ribe; zašćereno voće; zamrznuto voće; kriške voća; margarin; pekmezi; mesni žele; mesne konzerve; mliječni napitci; konzervisane gljive; pripremljeni orasi; paštete od jetre; puter od kikirikija; obrađeni kikiriki; konzervisani grašak; kora od limuna ili naranče; prženi krompirići [čips]; ušticipci od krompira; salate; kiseli kupus; kobasice [salame]; sezamovo ulje; sastojci za pripremanje supe od povrća; supe od mesnih koncentrata; tofi, grudve zgnječene soje; salate od povrća; pripremanje za supe od zeleniša; mućena pavlaka; jogurt; instant supe; instant varivo; instant pire krompir; instant miso supa; gotova kari jela; gotovo kari varivo; zakuske; alge (za jelo); obrađeno i konzervisano meso, riba, živina i divljač; slanina; sastojci za pripremanje mesnih juha [bujoni]; puter od oraha i čokolade; suhomesnati proizvodi; hrskavci [kroketi]; riblje konzerve; voćni želei [žele]; voćne salate; voćne konzerve; ulje od kukuruza; jestivo maslinovo ulje; grožđice [suvo grožđe]; pire od paradajza; konzerve od povrća; riba i plodovi mora (neživivi); riba i plodovi mora, obrađeni i konzervisani; konzerve, riblje i morski plodovi; prehrambeni proizvodi od/napravljeni od bjelančevine morskih plodova za kulinarske potrebe; alginati za kulinarstvo; konzervirani pasulj; mliječni frapei; mliječni napitci u kojima mlijeko prevladava; kimši [fermentisana hrana od povrća]; tahini [tijesto od sezamovog sjemena]; tostirani varek, prženi za jelo [morska trava]; surutka od mlijeka; aloe vera pripremljena za ljudsku ishranu; obrađena riblja ikra; ptićja gnijezda [jestiva]; napici s bakterijom za proizvodnju mliječne kiseline; bademovo mleko [napici]; napici od kikiriki mleka; konac za pravljenje kobasica; yakitori; yuba [tofu listići]; tajine [pripremljeni obrok od mesa, ribe ili povrća];

Klasa 30: Kafa, čaj, kakao i zamjene za kafu; riža; prehrambena tjestenina i rezanci; brašno tapioke za prehranu i sago [skrob iz sjemena palme sago]; brašno i preparati od žitarica; hljeb, slastičarski proizvodi i slatkiši, čokolada; sladoled, šerbet [voćni sladoled] i drugi jestivi smrznuti proizvodi; šećer, med, gusti tamni sirup; pjenica [kvasac]*, prašak za dizanje; so; začini, mirođije, zelen (konzervisano zelenje) [zaćini]; sirće; umaci, začinski [i drugi dresinzi]; led, sirovi (smrznuta voda); biskviti [suvi kolaćići]; prašak za kolaće; jestivi ukrasi za kolaće; arome za kolaće [osim eterićnih ulja]; kolaćići od riže; bomboni, čokolada; mlijeko, čokoladno [napitak]; pića od čokolade; namazi na bazi čokolade; šećerni proizvodi za ukrašavanje božićnih drvca; kakao s mlijekom; proizvodi od kakaoa; pića od kakaoa; arome za kafu; cikorija [zamjena za kafu] i biljni preparati kao zamjena kafe; pića od kafe; kukuruzne kokice [pucanci]; pahuljice, kukuruzne; pavlaka, smrznuta [šlag]; kari [zaćin]; engleska krema; pahuljice; arome [osim eterićnih ulja]; jogurt, smrznuti [vrsta sladoleda]; voćno tijesto [poslastica]; medenjaci; sirup; čajevi, nemedicinski; kećap [sos]; crni šećer, slatki korjen [poslastica]; mesne pite; proizvodi za omekšavanje mesa u domaćinstvu; palaćinke; pastile [bomboni]; biber; pizza; varenci [pućinzi]; ravioli [tjestenina]; matićna mlijek; šećer; wasabi pasta; pikantni umak od soje; tjestenina za prehranu, rezanci i rezanci za supe; udon [nudle na japanski naćin]; sushi [japansko jelo od riže]; vanila [aroma]; vafel proizvodi; perece; zakuske [mali obroci] od pšenice; mešavine zakuski koje se sastoje od krekeri, pereca i kokica; slatkiši od badema; aromatićni preparati za prehrambene potrebe; vezivni agensi za sladoled; fino sitno pecivo; pecivo [brioši]; kolaći; karamele [bomboni]; žvalaća guma; kukuruzno brašno; krekeri; ledeni sladoledi sirup od melase, šećerni sirup; makaroni [vrsta tjestenine]; marcipan [kolać od badema]; majonez; zobeno brašno; paprika [zaćin]; voćni kolaći; reliš [dodatak jelu]; dvopek [prepećenac]; so, kuhinjska; sendvići; umak od paradajza; začini; šerbet [voćni sladoled]; špageti; torte; brašno od žita; umaci za salatu; mesni sosovi [umaci]; sos za tjesteninu; pripremljeni obroci od rezanaca; zakuske [mali obroci] od žitarica; zakuske [mali brzi obroci] od riže; pahuljice, zobene; glukoza za kulinarstvo; visokoproteinske ploćice od žitarica; brašno*; dezertni musevi [poslastićarski proizvodi]; namirnice od zobi; tijesto od sojinog zrna [zaćin]; čaj (napitci od ćaja); bašenska zelen (konzervisano zelenje) [zaćini]; gluteinski dodaci za kulinarske svrhe; coulis [voćni preliv]; prerađeno seme za upotrebu kao zaćin; ramen (japansko

jelo na bazi rezanaca); zakuske od sira; senbei [krekeri od riže], pepermint za osvežavanje daha.

Klasa 35: Veleprodaja i maloprodaja i usluge naručivanja poštom vezane za prodaju artikala za zabave i prazničnih dekoracija i ukrasa, sapuna, parfimerijskih proizvoda, eteričnih ulja, kozmetičkih proizvoda, losiona za kosu, proizvoda za njegu kose, toaletnih proizvoda, proizvoda za njegu zuba. proizvoda za ličnu higijenu; Veleprodaja, maloprodaja i usluge naručivanja poštom vezane za prodaju proizvoda za čišćenje, poliranje, glačanje, materije za pranje, alata za manikir, proizvoda za njegu noktiju, laka za nokte, vještačkih noktiju; Veleprodaja i maloprodaja i usluge naručivanja poštom vezane za prodaju dijetetskih materija, hrane za bebe, sanitarnih proizvoda, sveća, gaze, traka za paljenje, masti, lubrikanata, ulja za slikanje; Veleprodaja i maloprodaja i usluge naručivanja poštom vezane za prodaju pribora za jelo, posuđa, torbi s priborom za manikiranje; instrumenata za brijanje; britvi, mašina i alata za mašine za domaćinstvo, ručnih alata; Veleprodaja i maloprodaja i usluge naručivanja poštom vezane za prodaju filmova, kamera, foto diskova, magnetoskopa, audio i vizuelnih proizvoda, audio i video traka, ploča i diskova, instrumenata i uređaja za snimanje, prijenos i/ili reprodukciju zvuka i/ili slika, televizora, čitača kasete i/ili magnetofona sa magnetnim trakama, video kasete i/ili čitača diskova i/ili magnetofona, radija; Veleprodaja i maloprodaja i usluge naručivanja poštom vezane za prodaju telefona, bežičnih telefona, mobilnih telefona, futrola za mobilne telefone, dekoracije i remena za telefone, indikatora za pozive, aritmetičkih mašina, digitrona; Veleprodaja i maloprodaja i usluge naručivanja poštom vezane za prodaju elektronskih i kompjuterskih igara, kinematografskih filmova, svijetiljki, ventilatora, sprava za kuvanje, kalupa za kolače i tijesto, tostera, rerni, kuhinjskog pribora, pribora i posuda za posluživanje ili skladištenje hrane i/ili napitaka; Veleprodaja i maloprodaja i usluge naručivanja poštom vezane za prodaju kineskih štapića za hranu, instrumenata za sečenje, porculana, predmeta od kristala, emajliranog posuđa, predmeta od srebra, staklarije, predmeta od pečene gline, poluporculana [majolika], keramike; Veleprodaja i maloprodaja i usluge naručivanja poštom vezane za prodaju sušila za kosu, rasvjetnih svijetiljki, sjenila i delova i opreme za sjenila; Veleprodaja i maloprodaja i usluge naručivanja poštom vezane za prodaju dječijih kolica, balona, truba za bicikle, zidnih satova i džepnih ili ručnih satova i dodatka i delova i opreme za njih; Veleprodaja i maloprodaja i usluge naručivanja poštom vezane za prodaju draguljarskih proizvoda i imitacije draguljarskih proizvoda, ukrasa [bižuterija], poluga [lingoti] od plemenitih metala, kutija od plemenitih metala; Veleprodaja i maloprodaja i usluge naručivanja poštom vezane za prodaju dugmića za narukvice od plemenitih metala, kvačica za kravatu od plemenitih metala, igli za kravatu od plemenitih metala; Veleprodaja i maloprodaja i usluge naručivanja poštom vezane za prodaju umjetničkih predmeta od plemenitih metala, ukrasnih igli od plemenitih metala, ukrasa za obuću od plemenitih metala, kipova od plemenitih metala, figurica od plemenitih metala; Veleprodaja i maloprodaja i usluge naručivanja poštom vezane za prodaju glazbenih kutija, glazbenih instrumenata, slika, fotografija, papirnatih proizvoda; Veleprodaja i maloprodaja i usluge naručivanja poštom vezane za prodaju papirnatih vreća za smeće, papirnatih ubrusa za skidanje šminke, ukrasnih papirne vaze za cvijeće, papirnatih traka, papirnatih filtara za kafu; Veleprodaja i maloprodaja i usluge naručivanja poštom vezane za prodaju toaletni peškiri od papira, pelene od papira, portikle, papirne [djeci oko vrata protiv prljanja], oznake za stranice u knjigama od papira; Veleprodaja i maloprodaja i usluge naručivanja poštom vezane za prodaju higijenskog papira, stolnih peškira od papira, papirnatih džepnih maramica, kutija od kartona ili papira, uskih stolnjaka od papira, stolnog rublja od papira; Veleprodaja i maloprodaja i usluge naručivanja poštom vezane za prodaju umjetničkih boja i materijala, kistova za slikanje, instrumenata za pisanje; Veleprodaja i maloprodaja i usluge naručivanja poštom vezane za prodaju štampanih stvari, knjiga, novina, magazina i periodika, čestitki i božićnih čestitki; Veleprodaja i maloprodaja i usluge naručivanja poštom vezane za prodaju igračkih karata, materijala za ambalažu; Veleprodaja i maloprodaja i usluge naručivanja poštom vezane za prodaju okvira za slike, stalaka za slike, ljepila za papir ili domaćinstvo; Veleprodaja i maloprodaja i usluge naručivanja poštom vezane za prodaju ukrasa od kože ili imitacije kože za nameštaj, kutije od kože ili imitacije kože, futrola za ključeve od kože ili imitacije kože; Veleprodaja i

maloprodaja i usluge naručivanja poštom vezane za prodaju obloga od kože ili imitacije kože, ormi, amova, uzdi za životinje od kože ili imitacije kože, trake od kože ili imitacije kože, remenje od kože ili imitacije kože i presvlake za nameštaj od kože ili imitacije kože; Veleprodaja i maloprodaja i usluge naručivanja poštom vezane za prodaju torbi i kofera, vrećica za novac i novčanika, kišobrana, štapova za hodanje; Veleprodaja i maloprodaja i usluge naručivanja poštom vezane za prodaju nameštaja, ogledala, vješalica za odjeću i klinova, kutija i posuda, ploča sa nazivima, malog pribora za domaćinstvo, pribora i posuda za domaćinstvo ili kuhinju, češljeva, sunđera, četki, pribora za čišćenje; Veleprodaja i maloprodaja i usluge naručivanja poštom vezane za prodaju naočara [optika], okvira za naočare i sunčane naočare i navlaka i dodataka za naočare, tekstila i tekstilnih proizvoda, posteljine, stolnog rublja i stolnjaka, salveta, papirnatih kolutova za stolove, nameštaja, ukrasa koji se apliciraju toplim postupkom za tekstilne proizvode [krojački pribor], džepnih maramica; Veleprodaja i maloprodaja i usluge naručivanja poštom vezane za prodaju odjevnih predmeta, obuće, pokrivala za glavu, dugmića, ukrasnih znački, traka i pletenica, čipke i tkanina s ucrtanim motivima za vezenje, igala za kosu i ukrasa, naramenica, ukrasa za obuću, ukrasa za šešire, rajsfešlusa [klizni zatvarači], tepiha i dušeka; Veleprodaja i maloprodaja i usluge naručivanja poštom vezane za prodaju igračaka i igara, lutaka, figurina, sportskih predmeta, dekoracije za božićna drvca; Veleprodaja i maloprodaja i usluge naručivanja poštom vezane za prodaju hrane i napitaka, slatkiša, proizvoda od cveća, šibica, cigara, cigareta i predmeti za pušaće; reklamiranje; organizovanje izložbi i sajмова u komercijalne ili reklamne svrhe; objavljivanje reklamnih tekstova; prodaja (podsticaj prodaje) za treće osobe; kancelarije za reklamiranje; profesionalno upravljanje umjetničkim poslovima; agencije za uvoz-izvoz; prikupljanje podataka za kompjuterske baze podataka; direktno reklamiranje poštom; administrativno upravljanje hotelima; istraživanje tržišta; reklamiranje na otvorenim površinama; zapošljavanje osoblja; reklamiranje putem radija; reklamiranje putem televizije; reklamiranje on-line na informatičkoj mreži; usluge nabave za treće [kupovina proizvoda i usluga za druga preduzeća]; iznajmljivanje vremena za reklamiranje na svim komunikacionim sredstvima; iznajmljivanje kancelarijskih mašina i aparata; iznajmljivanje automata za prodaju sitne robe; reklamiranje dopisnim putem; komercijalna administracija u vezi licenci proizvoda i usluga trećih lica; pružanje komercijalnih savjeta i informacija potrošačima; marketing; prezentacija proizvoda na svim komunikacionim sredstvima u svrhu prodaje na malo; proizvodnja reklamnih filmova; odnosi s javnošću [propaganda]; iznajmljivanje reklamnog materijala; iznajmljivanje reklamnih prostora; iznajmljivanje fotokopirnih uređaja; uređenje izloga; promovisanje dobara i usluga trećih lica putem izdavanja trgovinskih markica; usluge telemarketinga; administracija programa za česte putnike; usluge finansijskog revizora; usluge odnosa sa medijima; usluge korporativne komunikacije; iznajmljivanje kancelarijske opreme u zajedničkom radnom prostoru.

Klasa 41: Razonoda; zabava; cirkusi [zabavni parkovi]; usluge hala i dvorana za igre; obuka [predavanje]; organizovanje, proizvodnja i prikazivanje spektakala, koncerata, javnih nastupa, pozorišnih nastupa, izložbi, sportskih takmičenja, sportskih i kulturnih aktivnosti; muzičke sale; pozorišne predstave; prikazivanje igranih filmova; kabarei; kino studiji; usluge diskoteka; usluge klubova; izdavanje knjiga, tekstova, magazina, novina i časopisa; posuđivanje knjiga; usluge za ispunjavanje slobodnog vremena, izložbe, koncerti, spektakli, nastupi, sportovi, igre, rekreativne i kulturne aktivnosti; usluge zdravstvenih klubova [održavanje zdravlja i fizičke forme]; usluge kampova za ljetovanje [zabava]; informacije u vezi rekreacije; informacije o obrazovanju; informacije o razonodi, zabavi, sportu i kulturi; razonoda posredstvom televizije; razonoda putem radiofonije; montaža radio i televizijskih programa; proizvodnja filmova i video-a; iznajmljivanje kinematografskih filmova, videotraka, laserskih diskova, video diskova i DVD diskova; iznajmljivanje zvučnih snimaka; iznajmljivanje pozorišnog dekora; obuka za predškolski uzrast; klubovi i saloni sa instaliranim audio i video aparatima sa karaoke uređajima; sobe i sale za igre; organizovanje konkursa ljepote; cirkusi; obuka putem dopisivanja; obuka; igranje igara; gimnastičarska obuka; muzejske usluge [predstavljanje, izložbe]; organizovanje lutrije; usluge orkestra; planiranje prijema [razonoda]; izrada scenarijuma; pozorišne

predstave; usluge zooloških vrtova; mikroizdavaštvo; usluge igara pružene on-line [s jedne informatičke mreže]; tumačenje govora pokreta; profesionalna orijentacija [savjeti u vezi obrazovanja ili osposobljavanja]; snimanje na mikrofilmove; komponovanje muzike; fotografisanje; proizvodnja filmova na video kasetama; stavljanje na raspolaganje opreme za karaoke; iskorištavanje elektronskih publikacija koje se ne mogu prenositi on-line; objavljivanje knjiga i časopisa, elektronski on line; snimanje na videotrake; kuglane; omogućavanje korišćenja fitnes prostorija u oblasti bejzbola; omogućavanje korišćenja zatvorenih terena za bejzbol; razonoda u oblasti bejzbola (igre); prikazivanje filmova on-line; usluge razonode, naime omogućavanje korišćenja interaktivnih elektronskih igara putem kompjuterskih mreži; omogućavanje privremenog korišćenja interaktivnih igara koje se ne mogu preuzeti; iznajmljivanje opreme za igranje; iznajmljivanje audio uređaja; iznajmljivanje videokamera; iznajmljivanje rasvjetnih uređaja za pozorišnu dekoraciju i za televizijske studije; iznajmljivanje filmskih projektora i dodataka; iznajmljivanje radio i televizijskih aparata; iznajmljivanje dekora za priredbe; iznajmljivanje sportske opreme [osim vozila]; iznajmljivanje sportskih terena; iznajmljivanje stadiona; iznajmljivanje magnetoskopa; iznajmljivanje videotraka; iznajmljivanje igrački; kroćenje životinja [dresiranje]; praktična obuka [demonstriranje]; prevodilačke usluge; organizovanje i vođenje radionica za stručno osposobljavanje; usluge razonode, naime omogućavanje korišćenja audio-vizuelnih materijala, slika, televizijskih programa i kinematografskih filmova preko on-line kompjuterske mreže; omogućavanje korišćenja slika, zvuka i vida preko on-line mreža; omogućavanje korišćenja informacija o fiktivnim likovima; omogućavanje korišćenja on-line muzike i videa koji se ne mogu preuzeti; usluge stavljanja na raspolaganje filmova koji se ne mogu preuzeti, putem prenosa video zapisa na zahtev; usluge stavljanja na raspolaganje televizijskih programa koji se ne mogu preuzeti, putem prenosa video zapisa na zahtev; distribuiranje filmova; obrazovne usluge pružene od strane asistenata za posebne potrebe; obrazovno testiranje za korisnike da bi se kvalifikovali za pilote drona; usluge inženjeringa zvuka na događanjima; usluge tehničara osvjetljenja na događanjima; režiranje filmova, osim reklamnih filmova.

Klasa 42: Naučne i tehnološke usluge i naučna istraživanja, kao i sa tim povezano projektovanje; analiza delatnosti i usluge industrijskog istraživanja; izrada i razvoj kompjuterskog hardvera i softvera; savjetodavne usluge o nadzoru i arhitekturi; savjeti o gradnji; kompjutersko programiranje; održavanje kompjuterskih programa; izrada građevinskih planova; savjetodavne usluge u vezi zaštite okoline; industrijski dizajn; unutrašnje uređenje [dekoracija]; usluge dizajniranja ambalaže; usluge modnih dizajnera; usluge dizajniranja grafičke umjetnosti; vremenska prognoza; urbanističko planiranje; dupliciranje informatičkih programa; izrada kompjuterskih programa; instaliranje kompjuterskih programa; savjetovanje o kompjuterima; konverzija podataka ili dokumenata s jednog fizičkog na elektronski disk; kreiranje i održavanja web stranica za druge; konverzija informatičkih podataka i programa [nije fizička konverzija]; ugošćavanje informatičkih stranica; cloud computing; iznajmljivanje kompjutera; konsultacije u vezi kompjuterskih programa [softvera]; analiza kompjuterskih sastava; osmišljavanje informatičkih sistema; savjetodavne usluge iz oblasti kompjuterske tehnologije; digitalizacija dokumenata [skeniranje]; savjetovanje o informacionim tehnologijama; čuvanje rezervne kopije podataka van mreže; pružanje poslovnih informacija putem Internet stranice; softver u vidu servisa [SaaS]; savjetovanje o izradi veb sajtova; dizajn enterijera; kompjuterske i tehnološke usluga radi obezbeđivanja kompjuterskih i finansijskih podataka i podataka o ličnosti i za detekciju neovlašćenog pristupa podacima; razvoj kompjuterskih platformi; dizajniranje vizit karti; grafički dizajniranje promotivnih materijala.

Klasa 43: Usluge snabdevanja hranom i pićem; privremeni smeštaj; restorani; kafane-restorani; kafane [kafeterije]; usluge barova; menze; kantine; usluge kateringa; restorani sa samoposluživanjem; restorani za brzo i stalno posluživanje [snek-barovi]; koktel saloni; dekoracija hrane; dekoracija torti; informacije i savjeti u vezi sa pripremanjem obroka; usluge ličnog kuvara; usluge prijema za privremeni smeštaj [upravljanje dolascima i odlascima]; pružanje usluge i rezervisanje smeštaja, hotela, motela, pansiona i pružanje

informacija o tome; usluge povezane sa rezervisanjem soba u hotel od strane turističke agencije ili brokera; usluge kampova za ljetovanje; omogućavanje korišćenja prostorija za izložbe; restorani, kafane, kafeterije, barovi, menze, kantine i saloni sa instaliranom audio-vizuelnom opremom sa karaoke uređajima; usluge brige o deci; jaslice [dječije ustanove]; ljetovališta; organizovanje hrane i pića za svadbene prijeme; organizovanje svadbenih prijema [lokacija]; iznajmljivanje električnih tostera, mikrotalasnih, rešoa, aparata i sprava za pripremanje hrane i pića; pansioni za životinje; iskorištavanje terena za kampiranje; iznajmljivanje stolaca, stolova, escajga i staklenog posuđa; iznajmljivanje aparata za kuvanje; iznajmljivanje uređaja za pijeću vodu; iznajmljivanje sala, dvorana za sastanke; iznajmljivanje šatora; iznajmljivanje prenosivih građevinskih objekata.

(210) **Ž-2019-96**

(220) 12.03.2019.

(731) Sanrio Company, Ltd., 1-6-1, Osaki, Shinagawa-Ku,, 141-8603, Tokyo , JP

(540)



(550) I

(740) Jelena Bogetić, Cetinjska 11, The Capital Plaza, 81000, Podgorica

(511) Klasa 3: Proizvodi za izbeljivanje i druge supstance za veš; proizvodi za čišćenje; preparati za poliranje; proizvodi za odstranjivanje i abrazivna sredstva; sapuni, nemedicinski; parfemi; eterična ulja; kozmetika, nemedicinska i toaletni preparat; balsami za kosu, nemedicinski; nemedicinski proizvodi za njegu zuba, nemedicinski; proizvodi za parfimisanje sobe; preparati za manikir; proizvodi i preparati za negu i čišćenje kose i kože; ljepila za kozmetičke potrebe; losioni za upotrebu poslije brijanja; toaletna sredstva protiv znojenja; proizvodi za neutralizovanje statičkog elektriciteta za domaćinstvo; arome [eterična ulja]; kora kvilaje za čišćenje [vrsta biljke]; soli za kupanje; kozmetički preparati za kupanje; maske za ljepotu; soli za izbjeljivanje; soda za bijeljenje rublja; plavila za veš; aerosol za osvježivanje daha; trake za osvježavanje daha; hemijski proizvodi za oživljavanje boja za upotrebu u domaćinstvu; proizvodi za uklanjanje ličilačkih boja; kozmetički nesereri [torbe s kozmetičkim proizvodima]; kozmetički proizvodi za mršavljenje; kozmetički proizvodi za životinje; vatirani štapići za kozmetičku upotrebu; vata za kozmetičke potrebe; kreme za kozmetičke potrebe; kreme za čišćenje kože; kreme za kožne proizvode; proizvodi za uklanjanje masnih mrlja;

preparati za poliranje zubnih proteza; sredstva za čišćenje zubnih proteza; dezodoransi za ljude; dezodoransi za životinje ili za kućne ljubimce; deterdženti; kozmetičke boje; kolonjska voda; toaletne vodice; boje za kosu; kreme za kosu; gel za kosu; šamponi; balzami za kosu; sredstva za vlaženje kose; mirisi [parfemi]; ruž [rumenilo] za usne; kreme i losioni za kožu i lice; vještački nokti; lakovi za nokte; razređivač laka za nokte; krema za sunčanje; izbjeljivači za kozmetičke potrebe; arome za kolače [eterična ulja]; toaletno mlijeko; kozmetički proizvodi za obrve; olovke za obrve; omekšivači; vještačke trepavice; podni vosak; lakovi za kosu; preparati za kovrdžanje kose; proizvodi za bijeljenje rublja; proizvodi za natapanje veša; skrobna apretura [štirak]; kozmetički losioni; šminka;; puder za šminkanje [milovka]; proizvodi za šminkanje; proizvodi za skidanje šminke; maskara; nemedicinski proizvodi za njegu usta; naljepnice za nokte; proizvodi za njegu noktiju; olovke za kozmetičke potrebe; vosak za podove [masti]; pomade za kozmetičke potrebe; potpuri [posudice s mirišljivim suhim laticama cvijeća]; kamen za glačanje [kamen vulkanskog porijekla]; platno za poliranje [peglanje]; brusni papir [šmirgla]; mirišljivo drvo; šamponi za kućne ljubimce; kreme za obuću; lak za obuću; vosak za obuću; sredstva za glačanje (štirkanje); sapuni za osvježavanje; skrob za laštenje; kozmetički preparati za sunčanje; maramice namočene u kozmetičke losione; sredstva za skidanje lakova; vosak za uklanjanje dlačica; vosak za veš; vosak za poliranje; vosak za kožne proizvode; proizvodi za uklanjanje dlačica; naftni žele za kozmetičke potrebe; ukrasni detalji za kozmetičku upotrebu; štapići tamjana za kađenje; papir koji upija ulje za kožu; upijajući papir za lice; sredstva za kupanje, ne za medicinske potrebe, mirisni štapići za osvježavanje prostora.

Klasa 9: Naučni uređaji, navigacioni uređaji, uređaji za ispitivanja, istraživanja, fotografiju, kinematografiju, audiovizuelni, optički uređaji, uređaji za vaganje, merenje, signaliziranje, detektovanje, testiranje, pregledanje, spasilački i nastavni uređaji i instrumenti; uređaji i instrumenti za sprovođenje, prijenos, transformisanje, akumuliranje, regulisanje ili kontrolu distribucije ili korišćenja električne energije; uređaji i instrumenti za snimanje, prijenos, reprodukciju ili obradu zvuka, slika ili podataka; snimljena sredstva koja se mogu preuzimati, kompjuterski programi, blanko digitalna ili analogna sredstva za snimanje i skladištenje; mehanizmi za aparate koji se pokreću novcem; kase; uređaji za računanje, kompjuteri i periferni kompjuterski uređaji; ; skafanderi za ronjenje, ronilačke maske, tamponi za uši prilikom ronjenja, štupaljke za nos za ronioce i plivače, ronilačke rukavice, uređaji za disanje pri podvodnom plivanju; uređaji za gašenje požara; računске sprave s kuglicama [računaljke]; uređaji za audiovizuelno učenje; baterije; kućišta akumulatora; transformatori za povećanje napona; dvogled [optika]; aritmetičke mašine; fotografski aparati; kamere [kinematografski uređaji]; delovi i oprema za kamere; objektiv kamere; sprave za mjerenje zapremine; animirani crteži; čitači kasete; lančići za naočare; kinematografski filmovi, snimljeni; uređaji za bilježenje vremena [satovi]; čitači kompaktnih diskova; kompaktni audio-video diskovi; kompaktni optički diskovi; kompjuterski programi [radni]; kompjuterski programi [snimljeni]; kompjuteri; štampači za kompjutere; kontaktna sočiva; torbice za kontaktna sočiva; uređaji za obradu podataka; krojački metri; zvonca, električna za vrata; džepni elektronski prevoditelji; filmske trake [osvijetljene]; alarmi za požare; blicevi [fotografski]; okviri za dijapozitive u fotografiji; uređaji za kontrolu topline; muzički automati koji se pokreću uz prethodno plaćanje (džuboks); optička sočiva; vage za pisma; pojasevi za spašavanje; pojasevi za spašavanje; prsluci za spašavanje; skele za spašavanje; brave, električne; elektronske brave i ključevi; magnetne kartice [kodirane]; magnetni uređaji za kodiranje; magneti; lupe [optika]; mjerni pribor; električni aparati za mjerenje; mjerni instrumenti; mikrofoni; mikroskopi; svijetleće cijevi za reklamne poruke; kompjuteri, džepni; elektronske olovke za jedinice za vizuelno prikazivanje; gramofonske ploče; fotokopirni uređaji; računске, džepne mašine [digitroni]; projektori; ekrani za projektovanje; T.S.F. uređaji [radiouređaji]; gramofoni; aparati za daljinsko upravljanje; lenjiri [mjerni instrumenti]; vage; kartice za mikroprocesore; detektori dima; električne utičnice; navlake za naočare; okviri za naočare; naočare [optika]; sunčane naočare; električni prekidači; magnetofoni s magnetnim trakama; telefonski uređaji; telefonski predajnici; telefonske žice; dvogled [teleskopi]; televizori; indikatori temperature; električni uređaji protiv krađe; toplomjeri, nemedicinski; termostati;

videokasete; kasete za videoigre; video snimci; videotrake; videoekrani; magnetoskopi; programi za obradu teksta; kompaktni audio-video diskovi [diskovi]; DVD-jevi; čitač video kompaktnih diskova i DVD-jeva; audio-vizualni aparati sa karaoke uređajima; držači, nosači i futrole za audio i video kasete, kompakt diskove, laserske diskove, video diskove i DVD-jeve; podloge za kompjuterske miševe; telefoni; bežični telefoni, mobilni telefoni i delovi, oprema i dodaci za telefone; futrole i navlake za mobilne telefone; radiopejdžeri [dojavnici] i delovi i oprema za radiopejdžere; futrole i navlake za radiopejdžere; torbe, omotači, posude, nosači i držači za mobilne telefone i pejdžere; jastučići za uši za slušalice; slušalice za telefon i mikrofoni/telefonski zvučnici koji se koriste uz mobilne telefone; indikatori poziva za telefone; elektronički podsjetnici [agende]; električna zvonca; alarmni uređaji; čitači bar kodova; barometri; zujalice; električne zujalice; procesori [središnji uređaji za obradu podataka]; čipovi [integrirani krugovi]; hronografi [aparati za bilježenje trajanja]; tastature kompjutera; memorije za kompjutere; pomoćni uređaji kompjutera; akustični spojnice; prekidači s dva položaja [informatika]; optičke nosioci podataka; optički diskovi; magnetne table; aparat za ronioce; ronilačke maske; ronilačka odijela [kombinezoni]; elektronske oglasne table; elektronske olovke za jedinice za vizuelno prikazivanje; uzice za naočare; okulari; viziri [zaštitne naočare]; telefaksi; filteri za fotografske potrebe; flopi diskovi; trake za čišćenje glava za snimanje; higrometri, za mjerenje vlažnosti; integrisani krugovi; uređaji za međukomunikacije; interfejsi za kompjutere [informatika]; mašine za fakturisanje; poklopci za objektiv [kamere]; sklopovi s magnetnom trakom [informatika]; magnetne trake; kašike za doziranje; metronomi; mikroprocesori; modemi; uređaji za brojenje i razvrstavanje novca; monitori [kompjuterska oprema]; monitori [kompjuterski programi]; miš [informatika]; optička vlakna [vodiči za svjetlosne zrake]; optička stakla; optičarski proizvodi; parkometri [uređaji za mjerenje trajanja parkiranja]; uglomjeri [mjerni instrumenti]; radiotelegrafski uređaji; radiotelefonski uređaji; oprema za obradu podataka [skeneri] [informatika]; poluprovodnici; dijapozitivi; trake za snimanje zvuka; uređaji za demagnetizovanje magnetnih traka; telegrafске žice; telegrafi [uređaji]; teleprinteri; telekomunikacioni aktivatori za TV spikere; automatski uređaji za izdavanje karata; predajni telefonski uređaji; odašiljači [telekomunikacije]; vakummetri; video telefoni; zviždeći alarmi; sportske zviždaljke; ronilački tamponi za uši; pješčani satovi; naočare za sport; disaljke za ronjenje; zaštitne kacige za sport; navigacioni uređaji za vozila [brodski kompjuteri]; kompjuterski programi i softver za igre, snimljen; kompjuterski programi, koje se mogu preuzimati; elektronske publikacije [za skidanje s udaljenijeg na bliži kompjuter ili s jačeg na slabiji kompjuter]; aplikacije za kompjuterske softvere koje se mogu preuzimati; emotikoni za mobilne telefone, koji se mogu preuzeti; vokmeni; sateliti za naučne potrebe; oslonci za šaku za rad s informatičkom opremom; digitalni ramovi za fotografije; trake za mobilne telefone; stalak za mobilne telefone; stalci prilagođeni za laptopove; poklopci antene za mobilne telefone; futrole za pametne telefone; navlake za pametne telefone; elektronska kola i CD-ROM-ovi koji omogućavaju snimanje automatskog programa reprodukcije za upotrebu elektronskih muzičkih instrumenata; prijenosni multimedijalni čitači; slikovne datoteke koje se mogu preuzimati; grafike za mobilne telefone koje se mogu preuzimati; muzičke datoteke koje se mogu preuzimati; melodije za mobilne telefone koje se mogu preuzimati; čitači DVD-ja; uređaji za globalnu navigaciju [GPS]; USB uređaji [vanjski diskovi, priključci]; mehanizmi za pokretanje diska [informatika]; laptop kompjuteri; svijetleće diode [LED]; organske svijetleće diode [OLED] uređaji za ličnu zaštitu od nesretnih slučajeva; maske, zaštitne za radnike; kompasi [busole]; električne utičnice; zaštite za utičnice; distribucione konzole za elektrodistribuciju; dodaci za telefone za telefoniranje bez ruku, hands free; cijevi, vatrogasne; mlaznice za vatrogasna crijeva; programi za mašine za arkadne video igre; programi za mašine za kućne video igre; lični digitalni pomoćni uređaj; ronilački tamponi za uši; sunčane baterije; tablet kompjuteri; digitalne kamere; elektronski čitači knjiga; pametni telefoni; pametni satovi; pametne naočare; nosivi uređaji za praćenje aktivnosti; pametno prstenje; selfi štapovi [ručni monopodi]; elektronske interaktivne table; uređaji za električne i elektronske efekte za muzičke instrumente; audio interfejsi; zaštitne folije prilagođene za ekrane kompjutera; zaštitne folije prilagođene za pametne telefone; setovi za virtuelnu realnost; laboratorijski roboti; roboti za nastavu,

roboti za nadzor bezbednosti, humanoidni roboti sa veštačkom inteligencijom; roboti za telekomunikaciju; torbe za laptopove; specijalne navlake i torbe za fotografske aparate i instrumente; nosivi kompjuteri, džojstici koji se koriste uz kompjuter a nisu za video igre, baterije i punjači za elektronske cigarete; senzorske rukavice.

Klasa 14: Plemeniti metali i njihove legure i poluge od plemenitih metala; kutije od plemenitih metala; dugmad za manžetne, od plemenitih metala; kopče za kravate, od plemenitih metala; igle za kravate, od plemenitih metala; umjetnički predmeti od plemenitih metala; ukrasne igle od plemenitih metala; ukrasi za obuću od plemenitih metala; statue od plemenitih metala; figurine (statuete) od plemenitih metala; nakit; drago i polu-drago kamenje; imitacije nakita i ukrasa; horološki i hronometrijski instrumenti; broševi [nakit]; lančići [nakit]; ukrasi za priveske i lančiće za ključeve; privjesci [nakit]; metalni novac; žetoni, naime medalje i/ili novčići; dugmad za manžetne; naušnice; zlatne niti [nakit]; futrole za nakit; ogrlice [nakit]; igle pribadače [nakit]; igla za rever; prstenje [nakit]; kopče za kravate; satovi i zidni satovi, i delovi i oprema za njih; narukvice za satove; lančići za satove; kućišta ručnih satova; satovi, tačni sa zaustavljanjem [štoperice]; ukrasi (nakit); ukrasne igle; igle za kravate; privjesci za ključeve; ukrasni privjesci za ključeve, na uvlačenje; sitni ukrasi i ukrasni privjesci; lanci i futrole za ključeve/nosači plemenitih metala i/ili dragog kamenja; privjesci; narukvice [nakit]; kućišta zidnih satova; električni satovi i zidni satovi; sunčani satovi; dijamanti; vještački dijamanti; budilnici; šanil dugmad za manžetne; značke [amblemi] od plemenitih metala; pehari; komemorativni štitovi; amajlije za sreću; perle za izradu nakita; igle nakit za šešire.

Klasa 16: Papir; karton; štamparski proizvodi; pribor za uveze; fotografije [štampane]; papirni pribor, kancelarijski pribor [osim namještaja]; ljepljive materije za papirnate proizvode i za domaćinstvo; materijal za crtanje i za umjetnike; slikarske četkice; nastavni materijal i materijal za obučavanje; plastične ploče, folije i omotači za pakiranje; štamparska slova; naljepnice, štamparski blokovi; kalendari; knjige; katalogi; poštanski dopisi; plakati [poster]; časopisi [periodični]; publikacije; novine; časopisi [revije]; čestitke; sprave za pisanje; gumeni pečati; pečati; jastučići za pečate; jastučići za mastilo; foto albumi; podloge za uramljivanje slika i fotografija; slikarski stalci; papir koji upija ulje za kožu; stalci za fotografije; tuš [boja]; papirne maramice; papir, higijenski; papirne maramice za skidanje šminke; ubrusi od papira; stolni kompleti od papira; papirni podmetači za boce; papir za pakovanje, uvijanje i materijali za pakovanje; vodene boje za umetnike; grafičke reprodukcije, portreti; litografije [kamenotisci]; pera [kancelarijski pribor]; olovke; nalivpera; kuglice za hemijske olovke; pera za pisanje; držala za pera; nastavci za olovke; punjenja za olovke i instrumente za pisanje; ulošci za olovke [mine]; olovke u boji; pastele [olovke]; kutije za olovke; pernice; mašine za oštrenje olovaka; oštrila za olovke; kvačice za papire; pritiskači za papir; papirne igle; ekseri s pljosnatom glavom [rajsnegle]; ljepila za papirnate proizvode ili za domaćinstvo; papir, kaširani; košare i postolja za pisma; držači za pisma; otvarači pisama; ljepljive trake za papirne proizvode ili za domaćinstvo; table za crtanje; pera za izvlačenje crta; setovi za crtanje; albumi za marke i metalni novac; vreće za smeće; kese za zamrzivač; kese za poklone; papirne kese; poštanske kese, kese za sendviče; kese za sendviče (od papira); papirne kese za žurke; papirne kese za poklone; kese za led, konusne papirne vrećice; plastične kese za sendviče; vrećice za kuvanje u mikrotalasnim pećima; papirne kese za kupovinu; plastične kese za kupovinu; papirne kese za otpad; ojačane kese od kartonskog materijala; omotnice [papirni proizvodi]; upijajuća hartija [bugačice]; stalci za pridržavanje knjiga; obeleživači za knjige; markeri stranica u knjizi; kutije za papirne proizvode [kancelarijske potrepštine]; slikarska platna; blokovi [notesi]; dnevници; fascikle [kancelarijski pribor]; blokovi za pisanje [papirni proizvodi] podsetnici; papir za pisma; papir za crtanje; papirni pribor za pisanje; mape za pisanje; kreda; školske table; tabla za plakate; džepići za pasoše; korice za blokove s čekovima; gumene trakice za povezivanje spisa; slike; matrice za umnožavanje [šablone]; matrice [papirni proizvodi]; proizvodi za brisanje; kancelarijski noževi za brisanje [radiranje]; tečni proizvodi za brisanje; električni otvarači za pisma; štampane muzičke partiture; bele table (koje se mogu brisati); ukrasi i dekoracije od papira i/ili kartona; stolne salvete od papira; papirne kese za užinu; sanduci i torbe od kartona; bojanke; fascikle [papirni

proizvodi]; papirno vezivo; džepne sveske; flomasteri; knjige za učenje čitanja (za decu); set grafitnih olovaka; set bojica; lenjiri za crtanje; podmetači za pisanje; autografske knjige; kvačice za papire; heftalice [kancelarijske mašine]; rezač trake [kancelarijski materijal]; znaci upozorenja; kancelarijski mašine za rezanje papira; CD narezivač za kućnu ili kancelarijsku upotrebu; mašine i aparati za oblaganje plastikom; električni aparat za ugradnju zaštitnog omotača za dokumente i fotografije putem toplotnog zaptivanja; držači i futrole za kartice; papirni ukrasi za kutije za ručak i namirnice; korice za neuvezane časopise; kutije, kartonske ili papirne; karte; stalci za pečate; novine sa stripovima; šestari za crtanje; papirne trake ili kartice za upis kompjuterskih programa; papir za kopiranje; korektori, tečni [kancelarijski pribor]; naprsci, gumeni [kancelarijski pribor]; zastavice od papira; fascikle za papir; noževi za savijanje ili rezanje papira [kancelarijski pribor]; trake, gumirane [papirnati proizvodi]; džepne maramice, papirnate; indeksne kartice; trake natopljene tintom; futrole za isprave; naljepnice [ne od tkanine]; geografske mape [geografske karte]; čestitke s muzikom; okružnice; kutije za slikarske boje [školski pribor]; brošure; kancelarijski mašine za rezanje papira; držači za mine za olovke; poštanske marke; samoljepljivi papirni proizvodi; ulaznice, vozne karte, birački listići i slični proizvodi; trake za pisaće mašine; pisaće mašine, električni ili neelektrični; papirni omoti [korice]; četkice za pisanje; kreda za pisanje; tableti za pisanje; ukrasne papirne vaze za cvijeće; portikle, papirne [djeci oko vrata protiv prljanja]; papirni filteri za kafu; knjižice [pasoši, radne knjižice itd.]; modeli za izradu veza; noževi za papir [kancelarijski pribor]; prekrivači stolova od papira; stolnjaci od papira; natpisi na papiru ili kartonu; metalni vrh za indeksne karte; papirni kvadrati; samoljepljivi papirni proizvodi (stikeri) za prenosive telefone; umjetničke slike, uokvirene ili neuokvirene; spravice za plastificiranje isprava [kancelarijski pribor]; kartonske kutije za šešire; ručne sprave za stavljanje naljepnica; markeri [pisaći pribor]; posude za boje; brisači za table za pisanje; papir Xuan [za slikare i kinesku kaligrafiju]; mehaničke olovke; vasi [japanski papir]; matrice za ukrašavanje hrane i pića; značke sa imenom [kancelarijski materijal]; trake za barkod; sjaj za papirnate proizvode; papirne oznake za potvrde za podizanje prtljaga; papirne maramice za čišćenje

Klasa 18: Koža i imitacije kože; životinjska koža; kišobrani; torbe za prtljag i za nošenje; kišobrani, suncobrani i štapovi za hodanje; bičevi, konjska oprema, i sedlarska roba; ogrlice za životinje; kožni povodci; odjeća za životinje; torbe; torbe za novac [vrećice za novce]; novčanici; putne torbe; torbe za isprave (aktovke); futrole za ključeve; vreće [omotači, džepovi], od kože za ambalažu; kutije za isprave; rančevi; torbe-navlake za odijela; torbe za namirnice; remeni, kožni za nošenje preko ramena ili leđa; sedlarski kaiševi; ugrađeni pojasevi za prtljag; štapovi od trske; futrole za podsjetnice; vezice od kože ili imitacije kože; kutije za toaletni pribor; brnjice; torbe za školu; kožni kaiševi; ručke za kofere; koferi, ručni; torbe za putovanja; kovčežići za prtljag; navlake za kišobrane; ručke za kišobrane; stolice-štapovi [stolice koje se po potrebi mogu preinačiti u štapove za šetnju]; kaiševi za prtljag; torbe za plažu; kutije, kožne ili od kartonske kože i kutije od kože i od kože i kartona; ručne torbe; planinarski štapovi; torbe za muzičke partiture; mreže za namirnice; ruksaci; torbe za alat [prazne]; mali koferi; torbe za divljač; vreće [omotači, džepovi], od kože za ambalažu; presvlake za domaćinstvo, od kože ili imitacije kože; okviri ručnih torbi; torbe za nošenje male djece; torbe na točkicama; sportske torbe; odjeća za kućne ljubimce; marame [ešarpe] za nošenje male djece; prekrivači za životinje; zaprežna oprema za životinje i kožni povodci, uzice; navlake za torbe za novac; futrole za poslovne kartice; randele (Japanske školske torbe); uzde za vođenje dece, motorizovani koferi, oznake za prtljag; tkanina od imitacije kože.

Klasa 25: Odjevni predmeti; obuća; pokrivala za glavu; kecelje [odjevni predmeti]; odjeća za plažu; kupaći kostimi; sportska odjeća; kabanice; rukavice; rukavice bez prstiju; rukavice sa svim spojenim prstima, osim palca; pojasevi [odjevni predmeti]; odjevni predmeti za decu, muškarce i žene; odjevni predmeti za bebe; pelene-gaćice za odojčad [odjeća]; portikle, nepapirne [djeci oko vrata protiv prljanja]; donje rublje; pidžame; ogrtači za kupanje; naramenice; šeširi; ženske kape; kačket; kačketi kao pokrivala za glavu; francuske kape; kapice za kupanje i kapice za tuširanje; mufovi [odjevni predmeti]; neelektrične vrećice obložene krznom za

grijanje nogu; pokrivači za uši [odjevni predmet]; odjeća za oko vrata; kravate; mašne [vrste kravate]; leptir mašna; kratke čarape [sokne] i čarape; hulahopke; podvezice od elastične tkanine; podvezice za čarape i podvezice [držači] za muške čarape; cipele i sportske cipele; papuče; obuća za plažu; odjeća za maskembale; štitnici za rukave; marame; ešarpe [šalovi]; sandale za kupanje; cipele za kupanje; skijaška obuća; čizme; grudnjaci; gaćice; ženske potkošulje; kaputi; manžetne [odjevni predmeti]; krznene šalovi; kratki kaputi [sakoi]; žersej [odjevni predmet]; jakna ili košulja od platna ili serža za mornare; trikoi [odjevni predmeti]; spoljna odjeća; ogrtači [odjevni predmeti]; pantalone; vindjakne [kratki sportski kaputi s kapuljačom]; puloveri bez rukava; sandale; marame; šalovi [fulari]; košulje; slipovi [donji veš]; bluze [radničke bluze]; dokoljenice [gamaše]; sportska obuća; trikoi [gimnastički dresovi, majice]; odela; tee-shirts [majice]; pantalone; odore [uniforme]; prsluci; kombinezoni za skijanje na vodi; potkošulje; gimnastičke papuče; gimnastička odjeća; lente [široki pojasevi]; odjeća za bicikliste; maske za spavanje; odjevni predmeti koji sadrže materije za mršavljenje; pleteni odjevni predmeti; štitnici peta za cipele.

Klasa 28: Igre, igračke i stvari za igru, uređaji za video igre, lutke [igračke]; igračke od pliša; plišani medvjedići; figure igračke; kompleti za igre; gimnastički i sportski artikli; kugle za igru; gumene lopte i baloni; praznične dekoracije i ukrasi; ukrasi i dekoracije za božićna drvca; oprema za ples; vozila [igračke]; električna vozila [igračke]; daske za talase [surfing]; daske za skijanje; roleri; klizaljke za led; skejtbord; zaštitni jastučići za sportsku odjeću; vazdušni pištolji [igračke]; torbe za štapove za golf, sa ili bez točkića; lopte za igru; zvončići za božićna drvca; bilijarske kuglice; bilijarski stolovi; građevinski elementi [igračke]; stolne igre; bomboni, praskavi božićni bomboni; klizaljke s čizmicama, za led; uređaji i mehanizmi za kuglanje; graditeljske igre; držači svjećica za božićna drvca; table za igranje dame; pribor za igru dame; šah [igra]; table za igranje šaha; božićna drvca-novogodišnje jelke od sintetičkog materijala; postolja za božićna drvca; pribor za mađioničare; pehari za nagrade u igrama; strelice; kockice za kockanje; kreveti za lutke; odjeća za lutke; kuće za lutke; sobe za lutke; pribor za igranje domina; tegovi za vežbanje; zaštita za laktove [sportski pribor]; gimnastičke protezaljke, za razvlačenje; jahaonica; flašice za lutke; udice; pribor za pecanje; peraje za plivače; plovci za pecanje; leteći tanjiri [igračke]; automatske igre; reketi; aparati za elektronske igre; mašine za video igre; prenosive video igrice sa zaslonima od tečnih kristala; elektronske mašine za video igre; torbe za štapove za golf; štapovi za golf; rukavice za golf; rukavice za igru i sport; varke [predmeti za prevaru za zabavu]; namotaji za papirne zmajevе; zmajevi, papirni; zaštita za koljena [sportski pribor]; ma-jong [kineska igra]; kuglice za igru [špekule]; pozorišne lutke [marionete]; maske, pozorišne; maske (igračke); mobilni [igračke sastavljene od više elemenata koji trepere uz najmanje strujanje vazduha]; mali modeli vozila; društvene igre; praskavi detonatori [igračke]; igračke za grickanje [kod nicanja zuba]; kolutovi za igru; konji-ljuljaške [igračke]; koturaljke; daske s jedrima, za vodu; skije; saonice za trke [bob sanke]; tobogani [igra]; igračke za pravljenje mjehurića od saponice; zvrkovi [igračke]; odskočne daske [sportski artikli]; bicikli za treniranje na mjestu; bazeni [predmet za igru]; dušeci na naduvavanje; peraja za plivanje; daske za plivanje; peraja za plivanje za ruke; igračke na naduvavanje za bazene; ljuljaške; stolovi za stolni tenis; igračke za kućne ljubimce; skije za vodu; predmeti za igru za plivanje, igre, sportove i aktivnosti na vodi; lopte za plažu; automatske igre [mašine] uz prethodno plaćanje; navlake za skije i daske za surfovanje; bingo kartice; mrežice za leptire; karte za igru; konfeti; koturaljke s točkićima u nizu; pazle; kaleidoskopi; jarboli za daske s jedrom; vrećaste mreže za pecanje; vozila s daljinskim upravljanjem [igračke]; okretna ploča za rulet; staklene kugle sa snijegom; reketi za snijeg [krplje]; japanske karte za igru; prsluci za plivanje; pojasevi za plivanje; plutajući uređaji za kupanje i plivanje; plovci za plivanje i kupanje; šeširi od papira za zabave; sprave za jačanje mišića; žetoni za kockanje; kartice za struganje za lutriju; kompleti za izradu maketa; pačinko [mašine za igre]; aparati za kockanje [aparati za igre]; roboti igračke; dronovi (igračke); zaštitne folije prilagođenije za ekrane prenosnih igara; komandne palice [džojstici za video igre]; sličice za igre; šatori za igru; konzole za video igre; ručne konzole za igranje video igara.

Klasa 29: Meso, riba, živina i divljač; mesni ekstrati; konzervirano, sušeno i kuvano voće i povrće; želei,

džemovi, kompoti; jaja, mlijeko, sir, puter, jogurt i drugi mliječni proizvodi; jestiva ulja i masti; supe, čiste, mesne [bujoni]; koncentradi čistih mesnih supa [bujona]; puter; kavijar; sir; mliječni proizvodi; prehrambeni proizvodi pravljeni od ribe; hrana pripremljena od ribe; zašecereno voće; zamrznuto voće; kriške voća; margarin; pekmezi; mesni žele; mesne konzerve; mliječni napitci; konzervisane gljive; pripremljeni orasi; paštete od jetre; puter od kikirikija; obrađeni kikiriki; konzervisani grašak; kora od limuna ili naranče; prženi krompiri [čips]; uštupci od krompira; salate; kiseli kupus; kobasice [salame]; sezamovo ulje; sastojci za pripremanje supe od povrća; supe od mesnih koncentrata; tofi, grudve zgnječene soje; salate od povrća; pripremanje za supe od zeleniša; mućena pavlaka; jogurt; instant supe; instant varivo; instant pire krompir; instant miso supa; gotova kari jela; gotovo kari varivo; zakuske; alge (za jelo); obrađeno i konzervisano meso, riba, živina i divljač; slanina; sastojci za pripremanje mesnih juha [bujoni]; puter od oraha i čokolade; suhomesnati proizvodi; hrskavci [kroketi]; riblje konzerve; voćni želei [žele]; voćne salate; voćne konzerve; ulje od kukuruza; jestivo maslinovo ulje; grožđice [suvo grožđe]; pire od paradajza; konzerve od povrća; riba i plodovi mora (neživi); riba i plodovi mora, obrađeni i konzervisani; konzerve, riblje i morski plodovi; prehrambeni proizvodi od/napravljani od bjelančevine morskih plodova za kulinarske potrebe; alginati za kulinarstvo; konzervirani pasulj; mliječni frapei; mliječni napitci u kojima mlijeko prevladava; kimši [fermentisana hrana od povrća]; tahini [tijesto od sezamovog sjemena]; tostirani varek, prženi za jelo [morska trava]; surutka od mlijeka; aloe vera pripremljena za ljudsku ishranu; obrađena riblja ikra; ptičja gnijezda [jestiva]; napici s bakterijom za proizvodnju mliječne kiseline; bademovo mleko [napici]; napici od kikiriki mleka; konac za pravljenje kobasica; yakitori; yuba [tofu listići]; tajine [pripremljeni obrok od mesa, ribe ili povrća];

Klasa 30: Kafa, čaj, kakao i zamjene za kafu; riža; prehrambena tjestenina i rezanci; brašno tapioke za prehranu i sago [skrob iz sjemena palme sago]; brašno i preparati od žitarica; hljeb, slastičarski proizvodi i slatkiši, čokolada; sladoled, šerbet [voćni sladoled] i drugi jestivi smrznuti proizvodi; šećer, med, gusti tamni sirup; pjenica [kvasac]*, prašak za dizanje; so; začini, mirođije, zelen (konzervisano zelenje) [začini]; sirće; umaci, začinski [i drugi dresinzi]; led, sirovi (smrznuta voda); biskviti [suvi kolačići]; prašak za kolače; jestivi ukrasi za kolače; arome za kolače [osim eteričnih ulja]; kolačići od riže; bomboni; čokolada; mlijeko, čokoladno [napitak]; pića od čokolade; namazi na bazi čokolade; šećerni proizvodi za ukrašavanje božićnih drvca; kakao s mlijekom; proizvodi od kakaoa; pića od kakaoa; arome za kafu; cikorija [zamjena za kafu] i biljni preparati kao zamjena kafe; pića od kafe; kukuruzne kokice [pucanci]; pahuljice, kukuruzne; pavlaka, smrznuta [šlag]; kari [začin]; engleska krema; pahuljice; arome [osim eteričnih ulja]; jogurt, smrznuti [vrsta sladoleda]; voćno tijesto [poslastica]; medenjaci; sirup; čajevi, nemedicinski; kečap [sos]; crni šećer, slatki korjen [poslastica]; mesne pite; proizvodi za omekšavanje mesa u domaćinstvu; palačinke; pastile [bomboni]; biber; pizza; varenci [pudinzi]; ravioli [tjestenina]; matična mliječ; šećer; wasabi pasta; pikantni umak od soje; tjestenina za prehranu, rezanci i rezanci za supe; udon [nudle na japanski način]; sushi [japansko jelo od riže]; vanila [aroma]; vafel proizvodi; perece; zakuske [mali obroci] od pšenice; mešavine zakuski koje se sastoje od krekeri, pereca i kokica; slatkiši od badema; aromatični preparati za prehrambene potrebe; vezivni agensi za sladoled; fino sitno pecivo; pecivo [brioši]; kolači; karamele [bomboni]; žvalača guma; kukuruzno brašno; krekeri; ledeni sladoledi sirup od melase, šećerni sirup; makaroni [vrsta tjestenine]; marcipan [kolač od badema]; majonez; zobeno brašno; paprika [začin]; voćni kolači; reliš [dodatak jelu]; dvopek [prepečenac]; so, kuhinjska; sendviči; umak od paradajza; začini; šerbet [voćni sladoled]; špageti; torte; brašno od žita; umaci za salatu; mesni sosovi [umaci]; sos za tjesteninu; pripremljeni obroci od rezanaca; zakuske [mali obroci] od žitarica; zakuske [mali brzi obroci] od riže; pahuljice, zobene; glukoza za kulinarstvo; visokoproteinske pločice od žitarica; brašno*; dezertni musevi [poslastičarski proizvodi]; namirnice od zobi; tijesto od sojinog zrna [začin]; čaj (napitci od čaja); baštenska zelen (konzervisano zelenje) [začini]; glutenski dodaci za kulinarske svrhe; coulis [voćni preliv]; prerađeno seme za upotrebu kao začin; ramen (japansko jelo na bazi rezanaca); zakuske od sira; senbei [krekeri od riže], pepermint za osvežavanje daha.

Klasa 35: Veleprodaja i maloprodaja i usluge naručivanja poštom vezane za prodaju artikala za zabave i prazničnih dekoracija i ukrasa, sapuna, parfimerijskih proizvoda, eteričnih ulja, kozmetičkih proizvoda, losiona za kosu, proizvoda za njegu kose, toaletnih proizvoda, proizvoda za njegu zuba, proizvoda za ličnu higijenu; Veleprodaja, maloprodaja i usluge naručivanja poštom vezane za prodaju proizvoda za čišćenje, poliranje, glačanje, materije za pranje, alata za manikir, proizvoda za njegu noktiju, laka za nokte, vještačkih noktiju; Veleprodaja i maloprodaja i usluge naručivanja poštom vezane za prodaju dijetetskih materija, hrane za bebe, sanitarnih proizvoda, sveća, gaze, traka za paljenje, masti, lubrikanata, ulja za slikanje; Veleprodaja i maloprodaja i usluge naručivanja poštom vezane za prodaju pribora za jelo, posuđa, torbi s priborom za manikiranje; instrumenata za brijanje; britvi, mašina i alata za mašine za domaćinstvo, ručnih alata; Veleprodaja i maloprodaja i usluge naručivanja poštom vezane za prodaju filmova, kamera, foto diskova, magnetoskopa, audio i vizuelnih proizvoda, audio i video traka, ploča i diskova, instrumenata i uređaja za snimanje, prijenos i/ili reprodukciju zvuka i/ili slika, televizora, čitača kasete i/ili magnetofona sa magnetnim trakama, video kasete i/ili čitača diskova i/ili magnetofona, radija; Veleprodaja i maloprodaja i usluge naručivanja poštom vezane za prodaju telefona, bežičnih telefona, mobilnih telefona, futrola za mobilne telefone, dekoracije i remena za telefone, indikatora za pozive, aritmetičkih mašina, digitrona; Veleprodaja i maloprodaja i usluge naručivanja poštom vezane za prodaju elektronskih i kompjuterskih igara, kinematografskih filmova, svijetiljki, ventilatora, sprava za kuvanje, kalupa za kolače i tijesto, tostera, rerni, kuhinjskog pribora, pribora i posuda za posluživanje ili skladištenje hrane i/ili napitaka; Veleprodaja i maloprodaja i usluge naručivanja poštom vezane za prodaju kineskih štapića za hranu, instrumenata za sečenje, porculana, predmeta od kristala, emajliranog posuđa, predmeta od srebra, staklarije, predmeta od pečene gline, poluporculana [majolika], keramike; Veleprodaja i maloprodaja i usluge naručivanja poštom vezane za prodaju sušila za kosu, rasvjetnih svijetiljki, sjenila i delova i opreme za sjenila; Veleprodaja i maloprodaja i usluge naručivanja poštom vezane za prodaju dječijih kolica, balona, truba za bicikle, zidnih satova i džepnih ili ručnih satova i dodataka i delova i opreme za njih; Veleprodaja i maloprodaja i usluge naručivanja poštom vezane za prodaju draguljarskih proizvoda i imitacije draguljarskih proizvoda, ukrasa [bižuterija], poluga [lingoti] od plemenitih metala, kutija od plemenitih metala; Veleprodaja i maloprodaja i usluge naručivanja poštom vezane za prodaju dugmića za narukvice od plemenitih metala, kvačica za kravatu od plemenitih metala, igli za kravatu od plemenitih metala; Veleprodaja i maloprodaja i usluge naručivanja poštom vezane za prodaju umjetničkih predmeta od plemenitih metala, ukrasnih igli od plemenitih metala, ukrasa za obuću od plemenitih metala, kipova od plemenitih metala, figurica od plemenitih metala; Veleprodaja i maloprodaja i usluge naručivanja poštom vezane za prodaju glazbenih kutija, glazbenih instrumenata, slika, fotografija, papirnatih proizvoda; Veleprodaja i maloprodaja i usluge naručivanja poštom vezane za prodaju papirnatih vreća za smeće, papirnatih ubrusa za skidanje šminke, ukrasnih papirne vaze za cvijeće, papirnatih traka, papirnatih filtara za kafu; Veleprodaja i maloprodaja i usluge naručivanja poštom vezane za prodaju toaletni peškiri od papira, pelene od papira, portikle, papirne [djeci oko vrata protiv prljanja], oznake za stranice u knjigama od papira; Veleprodaja i maloprodaja i usluge naručivanja poštom vezane za prodaju higijenskog papira, stolnih peškira od papira, papirnatih džepnih maramica, kutija od kartona ili papira, uskih stolnjaka od papira, stolnog rublja od papira; Veleprodaja i maloprodaja i usluge naručivanja poštom vezane za prodaju umjetničkih boja i materijala, kistova za slikanje, instrumenata za pisanje; Veleprodaja i maloprodaja i usluge naručivanja poštom vezane za prodaju štampanih stvari, knjiga, novina, magazina i periodika, čestitki i božićnih čestitki; Veleprodaja i maloprodaja i usluge naručivanja poštom vezane za prodaju igračkih karata, materijala za ambalažu; Veleprodaja i maloprodaja i usluge naručivanja poštom vezane za prodaju okvira za slike, stalaka za slike, ljepila za papir ili domaćinstvo; Veleprodaja i maloprodaja i usluge naručivanja poštom vezane za prodaju ukrasa od kože ili imitacije kože za nameštaj, kutije od kože ili imitacije kože, futrola za ključeve od kože ili imitacije kože; Veleprodaja i maloprodaja i usluge naručivanja poštom vezane za prodaju obloga od kože ili imitacije kože, ormi, amova,

uzdi za životinje od kože ili imitacije kože, trake od kože ili imitacije kože, remenje od kože ili imitacije kože i presvlake za nameštaj od kože ili imitacije kože; Veleprodaja i maloprodaja i usluge naručivanja poštom vezane za prodaju torbi i kofera, vrećica za novac i novčanika, kišobrana, štapova za hodanje; Veleprodaja i maloprodaja i usluge naručivanja poštom vezane za prodaju nameštaja, ogledala, vješalica za odjeću i klinova, kutija i posuda, ploča sa nazivima, malog pribora za domaćinstvo, pribora i posuda za domaćinstvo ili kuhinju, češljeva, sunđera, četki, pribora za čišćenje; Veleprodaja i maloprodaja i usluge naručivanja poštom vezane za prodaju naočara [optika], okvira za naočare i sunčane naočare i navlaka i dodataka za naočare, tekstila i tekstilnih proizvoda, posteljine, stolnog rublja i stolnjaka, salveta, papirnatih kolutova za stolove, nameštaja, ukrasa koji se apliciraju toplim postupkom za tekstilne proizvode [krojački pribor], džepnih maramica; Veleprodaja i maloprodaja i usluge naručivanja poštom vezane za prodaju odjevnih predmeta, obuće, pokrivala za glavu, dugmića, ukrasnih znački, traka i pletenica, čipke i tkanina s ucrtanim motivima za vezenje, igala za kosu i ukrasa, naramenica, ukrasa za obuću, ukrasa za šešire, rajsfešlusa [klizni zatvarači], tepiha i dušeka; Veleprodaja i maloprodaja i usluge naručivanja poštom vezane za prodaju igračaka i igara, lutaka, figurina, sportskih predmeta, dekoracije za božićna drvca; Veleprodaja i maloprodaja i usluge naručivanja poštom vezane za prodaju hrane i napitaka, slatkiša, proizvoda od cveća, šibica, cigara, cigareta i predmeti za pušače; reklamiranje; organizovanje izložbi i sajмова u komercijalne ili reklamne svrhe; objavljivanje reklamnih tekstova; prodaja (podsticaj prodaje) za treće osobe; kancelarije za reklamiranje; profesionalno upravljanje umjetničkim poslovima; agencije za uvoz-izvoz; prikupljanje podataka za kompjuterske baze podataka; direktno reklamiranje poštom; administrativno upravljanje hotelima; istraživanje tržišta; reklamiranje na otvorenim površinama; zapošljavanje osoblja; reklamiranje putem radija; reklamiranje putem televizije; reklamiranje on-line na informatičkoj mreži; usluge nabave za treće [kupovina proizvoda i usluga za druga preduzeća]; iznajmljivanje vremena za reklamiranje na svim komunikacionim sredstvima; iznajmljivanje kancelarijskih mašina i aparata; iznajmljivanje automata za prodaju sitne robe; reklamiranje dopisnim putem; komercijalna administracija u vezi licenci proizvoda i usluga trećih lica; pružanje komercijalnih savjeta i informacija potrošačima; marketing; prezentacija proizvoda na svim komunikacionim sredstvima u svrhu prodaje na malo; proizvodnja reklamnih filmova; odnosi s javnošću [propaganda]; iznajmljivanje reklamnog materijala; iznajmljivanje reklamnih prostora; iznajmljivanje fotokopirnih uređaja; uređenje izloga; promovisanje dobara i usluga trećih lica putem izdavanja trgovinskih markica; usluge telemarketinga; administracija programa za česte putnike; usluge finansijskog revizora; usluge odnosa sa medijima; usluge korporativne komunikacije; iznajmljivanje kancelarijske opreme u zajedničkom radnom prostoru.

Klasa 41: Razonoda; zabava; cirkusi [zabavni parkovi]; usluge hala i dvorana za igre; obuka [predavanje]; organizovanje, proizvodnja i prikazivanje spektakala, koncerata, javnih nastupa, pozorišnih nastupa, izložbi, sportskih takmičenja, sportskih i kulturnih aktivnosti; muzičke sale; pozorišne predstave; prikazivanje igranih filmova; kabarei; kino studiji; usluge diskoteka; usluge klubova; izdavanje knjiga, tekstova, magazina, novina i časopisa; posuđivanje knjiga; usluge za ispunjavanje slobodnog vremena, izložbe, koncerti, spektakli, nastupi, sportovi, igre, rekreativne i kulturne aktivnosti; usluge zdravstvenih klubova [održavanje zdravlja i fizičke forme]; usluge kampova za ljetovanje [zabava]; informacije u vezi rekreacije; informacije o obrazovanju; informacije o razonodi, zabavi, sportu i kulturi; razonoda posredstvom televizije; razonoda putem radiofonije; montaža radio i televizijskih programa; proizvodnja filmova i video-a; iznajmljivanje kinematografskih filmova, videotraka, laserskih diskova, video diskova i DVD diskova; iznajmljivanje zvučnih snimaka; iznajmljivanje pozorišnog dekora; obuka za predškolski uzrast; klubovi i saloni sa instaliranim audio i video aparatima sa karaoke uređajima; sobe i sale za igre; organizovanje konkursa ljepote; cirkusi; obuka putem dopisivanja; obuka; igranje igara; gimnastičarska obuka; muzejske usluge [predstavljanje, izložbe]; organizovanje lutrije; usluge orkestra; planiranje prijema [razonoda]; izrada scenarijuma; pozorišne predstave; usluge zooloških vrtova; mikroizdavaštvo; usluge igara pružene on-line [s jedne informatičke

mreže]; tumačenje govora pokreta; profesionalna orijentacija [savjeti u vezi obrazovanja ili osposobljavanja]; snimanje na mikrofilmove; komponovanje muzike; fotografisanje; proizvodnja filmova na video kasetama; stavljanje na raspolaganje opreme za karaoke; iskorištavanje elektronskih publikacija koje se ne mogu prenositi on-line; objavljivanje knjiga i časopisa, elektronski on line; snimanje na videotrake; kuglane; omogućavanje korišćenja fitnes prostorija u oblasti bejzbola; omogućavanje korišćenja zatvorenih terena za bejzbol; razonoda u oblasti bejzbola (igre); prikazivanje filmova on-line; usluge razonode, naime omogućavanje korišćenja interaktivnih elektronskih igara putem kompjuterskih mreži; omogućavanje privremenog korišćenja interaktivnih igara koje se ne mogu preuzeti; iznajmljivanje opreme za igranje; iznajmljivanje audio uređaja; iznajmljivanje videokamera; iznajmljivanje rasvjetnih uređaja za pozorišnu dekoraciju i za televizijske studije; iznajmljivanje filmskih projektor i dodataka; iznajmljivanje radio i televizijskih aparata; iznajmljivanje dekora za priredbe; iznajmljivanje sportske opreme [osim vozila]; iznajmljivanje sportskih terena; iznajmljivanje stadiona; iznajmljivanje magnetoskopa; iznajmljivanje videotraka; iznajmljivanje igrački; kroćenje životinja [dresiranje]; praktična obuka [demonstriranje]; prevodilačke usluge; organizovanje i vođenje radionica za stručno osposobljavanje; usluge razonode, naime omogućavanje korišćenja audio-vizuelnih materijala, slika, televizijskih programa i kinematografskih filmova preko on-line kompjuterske mreže; omogućavanje korišćenja slika, zvuka i vida preko on-line mreža; omogućavanje korišćenja informacija o fiktivnim likovima; omogućavanje korišćenja on-line muzike i videa koji se ne mogu preuzeti; usluge stavljanja na raspolaganje filmova koji se ne mogu preuzeti, putem prenosa video zapisa na zahtev; usluge stavljanja na raspolaganje televizijskih programa koji se ne mogu preuzeti, putem prenosa video zapisa na zahtev; distribuiranje filmova; obrazovne usluge pružene od strane asistenata za posebne potrebe; obrazovno testiranje za korisnike da bi se kvalifikovali za pilote drona; usluge inženjeringa zvuka na događanjima; usluge tehničara osvjetljenja na događanjima; režiranje filmova, osim reklamnih filmova.

Klasa 42: Naučne i tehnološke usluge i naučna istraživanja, kao i sa tim povezano projektovanje; analiza delatnosti i usluge industrijskog istraživanja; izrada i razvoj kompjuterskog hardvera i softvera; savjetodavne usluge o nadzoru i arhitekturi; savjeti o gradnji; kompjutersko programiranje; održavanje kompjuterskih programa; izrada građevinskih planova; savjetodavne usluge u vezi zaštite okoline; industrijski dizajn; unutrašnje uređenje [dekoracija]; usluge dizajniranja ambalaže; usluge modnih dizajnera; usluge dizajniranja grafičke umjetnosti; vremenska prognoza; urbanističko planiranje; dupliciranje informatičkih programa; izrada kompjuterskih programa; instaliranje kompjuterskih programa; savjetovanje o kompjuterima; konverzija podataka ili dokumenata s jednog fizičkog na elektronski disk; kreiranje i održavanja web stranica za druge; konverzija informatičkih podataka i programa [nije fizička konverzija]; ugošćavanje informatičkih stranica; cloud computing; iznajmljivanje kompjutera; konsultacije u vezi kompjuterskih programa [softvera]; analiza kompjuterskih sastava; osmišljavanje informatičkih sistema; savjetodavne usluge iz oblasti kompjuterske tehnologije; digitalizacija dokumenata [skeniranje]; savjetovanje o informacionim tehnologijama; čuvanje rezervne kopije podataka van mreže; pružanje poslovnih informacija putem Internet stranice; softver u vidu servisa [SaaS]; savjetovanje o izradi veb sajtova; dizajn enterijera; kompjuterske i tehnološke usluga radi obezbeđivanja kompjuterskih i finansijskih podataka i podataka o ličnosti i za detekciju neovlašćenog pristupa podacima; razvoj kompjuterskih platformi; dizajniranje vizit karti; grafički dizajniranje promotivnih materijala.

Klasa 43: Usluge snabdevanja hranom i pićem; privremeni smeštaj; restorani; kafane-restorani; kafane [kafeterije]; usluge barova; menze; kantine; usluge kateringa; restorani sa samoposluživanjem; restorani za brzo i stalno posluživanje [snek-barovi]; koktel saloni; dekoracija hrane; dekoracija torti; informacije i savjeti u vezi sa pripremanjem obroka; usluge ličnog kuvara; usluge prijema za privremeni smeštaj [upravljanje dolascima i odlascima]; pružanje usluge i rezervisanje smeštaja, hotela, motela, pansiona i pružanje informacija o tome; usluge povezane sa rezervisanjem soba u hotel od strane turističke agencije ili brokera;

usluge kampova za ljetovanje; omogućavanje korišćenja prostorija za izložbe; restorani, kafane, kafeterije, barovi, menze, kantine i saloni sa instaliranom audio-vizuelnom opremom sa karaoke uređajima; usluge brige o deci; jaslice [dječije ustanove]; ljetovališta; organizovanje hrane i pića za svadbene prijeme; organizovanje svadbenih prijema [lokacija]; iznajmljivanje električnih tostera, mikrotalasnih, rešoa, aparata i sprava za pripremanje hrane i pića; pansioni za životinje; iskorištavanje terena za kampiranje; iznajmljivanje stolaca, stolova, escajga i staklenog posuđa; iznajmljivanje aparata za kuvanje; iznajmljivanje uređaja za pijeću vodu; iznajmljivanje sala, dvorana za sastanke; iznajmljivanje šatora; iznajmljivanje prenosivih građevinskih objekata.

(210) **Ž-2019-108**

(220) 19.03.2019.

(731) "PAUNOVIĆ & CO" DRUŠTVA SA OGRANIČENOM ODGOVORNOŠĆU PODGORICA, Lužnica, Nikšički put b.b. (bivša veleprodaja namještaja Đurovic), 81000, Podgorica, ME

(540)



(550) I

(740) Dragić Sava, Kragujevačka broj 5, 81000, Podgorica

(511) Klasa 32: Pivo

(210) **Ž-2019-169**

(220) 24.04.2019.

(731) Džervin Hodović, Zmajevac BB, Odžak, Pljevlja, ME

(540)



(550) I

(511) Klasa 9: Naučni, geodetski, fotografski i optički aparati i instrumenti, kao i instrumenti za signalizaciju, kontrolu, za pomoć (splašavanje) i obuku; aparati i instrumenti za vođenje, distribuciju, transformisanje, akumuliranje, podešavanje ili upravljanje električne struje; aparati za snimanje, prijenos, reprodukciju zvuka ili slika; nosači podataka (diskovi, hard, optika); registarske blagajne, računari, oprema za obradu podataka i kompjuteri; kompjuterski programi (softveri).

Klasa 18: Koža, imitacija kože, proizvodi od tih materijala koji nisu obuhvaćeni tim klasama; životinjske kože; koferi i torbe; sedlarsko remenarski poslovi, novčanici.

Klasa 35: Oglašavanje i reklamiranje; vođenje komercijalnih poslova; komercijalna administracija; kancelarijski poslovi.

(210) **Ž-2019-179**

(220) 07.05.2019.

(731) DRUŠTVO SA OGRANIČENOM ODGOVORNOŠĆU "DECOM MONTENEGRO" D.O.O. PODGORICA, ,, 81000, Podgorica, ME

(540)



(550) I

(511) Klasa 35: Konsultacije u poslovnom upravljanju; Poslovne procjene; Prepisivanje korespondencije (kancelarijske usluge); Usluge upravljanja poslovnim projektima za građevinske projekte.

Klasa 37: Konstruisanje; Građevinski nadzor; Informacije u vezi sa izgradnjom; Konsultacije o građenju.

Klasa 42: Savjetovanje iz oblasti arhitekture; Građevinsko projektovanje; Tehnička ispitivanja; Dizajn enterijera; Inženjerske usluge; Kontrola kvaliteta.

(210) **Ž-2019-185**

(220) 09.05.2019.

(731) Hemofarm A.D. farmaceutsko-hemijska industrija Vršac, Beogradski put bb, 26300, Vršac, RS

(540)

ZANIDA

(550) I

(740) AOD MSA IP - Milojević Sekulić Advokati, Karađorđeva 65, 11000, Beograd

(511) Klasa 5: Farmaceutski preparati namijenjeni liječenju epilepsije.

(210) **Ž-2019-227**

(220) 17.06.2019.

(731) Sheraton International IP, LLC, One Starpoint, 06902, Stamford, Connecticut, US

(540)



(550) I

(740) Branislav Lutovac, Bulevar Ivana Crnojevića 93, 81000, Podgorica

(511) Klasa 35: Usluge oglašavanja; usluge franšize, i to pružanje pomoći u poslovnom upravljanju u osnivanju i radu hotela, restorana, noćnih klubova, barova, spa centara, objekata za rekreaciju i fitness, maloprodajnih objekata, apartmana, stambenih zgrada, konferencijskih centara timesharea za druge; usluge poslovnog menadžmenta, i to upravljanje hotelima, restoranima, noćnim klubovima, barovima, spa centrima, rekreativnim i fitness objektima maloprodajnim objektima, apartmanima, stambenim zgradama, konferencijskim centrima, timeshare resortima, klubovima za rekreaciju, klubovima za odmor, vlasnički nepodijeljenim klubovima, privatni klubovi za stanovanje, pravo na korištenje klubova i dugoročni projekti zakupa za druge; maloprodaja, maloprodajni katalog i usluge maloprodaje na mreži, i to usluge poklona, suvenira i prodavnica u oblasti kozmetičkih proizvoda, toaletnih potrepština, mašina za upotrebu u

domaćinstvu, ručnih alata, optičkih proizvoda, kamera, CD, DVD, kućne električne i elektronske opreme, uključujući i bijelu tehniku, nakita, satova, ručnih satova, papirnog materijala, publikacija, kišobrana, suncobrana, prtljaga, torbi; maloprodaja, maloprodajni katalogi i usluge prodajne trgovine na mreži, i to usluge poklona, suvenira i trgovina u oblasti namještaja, toilet pribora, kućnih posuda i pribora, kuhinjskog pribora i opreme, opreme i pribora za vrtlarstvo; maloprodaja, maloprodajni katalogi i usluge maloprodaje na mreži, i to usluge poklona, suvenira i prodavnica u oblasti namještaja, kreveta, dušeka, posteljine, peškira, tekstila, odjeće, obuće, pokrivala za glavu, pozamanterije, igračka i igara, sportske opreme, prehrambenih proizvoda, pića, vina, cvijeća, i proizvodi od kože, i to: oznake, torbe, ručne torbe, novčanici, torbice, prtljaga, oznake z prtljag, kutije za ključeve i privjesci za ključeve; online maloprodajne usluge; usluge maloprodajnih kataloga; obezbjeđivanje prostorija za korišćenje kancelarijske opreme i mašina; usluge konsultacija za poslovno upravljanje; usluge poslovne administracije.

Klasa 36: Usluge u vezi s anekretninama, i to upravljanje, finansiranje, posredovanje, leasing, prodaja bi marketing apartmana, stanova, kondominijuma, stambenih jedinica; upravljanje, iznajmljivanje i zakup kancelarijskog i prodajnog prostora; usluge u vezi s nekretninama, i to upravljanje, finansiranje, posredovanje, lizing, prodaja i marketing timeshare nakretnina; usluge timeshare nakretnina za odmor; organizovanje time share razmjene; organizovanje time share odmora.

Klasa 43: Usluge privremenog smještaja; hotelske usluge; usluge restorana, ketereringa, bara i koktel bara; usluge smještaja; pružanje objekata opšte namjene za sastanke, konferencije i izložbe; pružanje usluga banketa i socijalno funkcionalnih prostorija za posebne prilike; usluge rezervacije hotelskog smještaja za druge.

(210) **Ž-2019-234**

(220) 21.06.2019.

(731) Džervin Hodović, Zmajevac bb, Odžak, Pljevlja, ME

(540)



(550) I

(511) Klasa 9: Naučni, nautički, geodetski, fotografski, kinematografski i optički aparati i instrumenti kao i aparati i instrumenti za vaganje, mjerenje, signalizaciju, kontrolu (inspekciju), za pomoć (spašavanje) i za obuku; aparati i instrumenti za vođenje, distribuciju, transformisanje, akumuliranje, podešavanje ili upravljanje električne struje; aparati za snimanje, prijenos, reprodukciju zvuka ili slika; magnetni nosači podataka, diskovi za snimanje; kompaktni diskovi, DVD i drugi numerički nosači za snimanje; mehanizmi za uređaje koji se pokreću uz prethodno ubacivanje novca ili žetona; registarske blagajne, računari, oprema za obradu podataka i kompjuteri; uređaji za gašenje požara; kompjuterski programi [softveri].

Klasa 18: Koža, imitacije kože, proizvodi od tih materijala koji nisu obuhvaćeni drugim klasama; životinjske kože; koferi i torbe; kišobrani, suncobrani i štapovi za hodanje; bičevi i sedlarsko remenarski proizvodi.

Klasa 35: Oglašavanje i reklamiranje; vođenje komercijalnih poslova; komercijalna administracija; kancelarijski poslovi.

(210) **Ž-2019-238**

(220) 25.06.2019.

(731) Zavarovalnica Triglav d.d., Miklošičeva 19, 1000, Ljubljana, SI

(540)



(550) I

(740) Nenad Pavličić, Ul. Novaka Miloševa br. 6/III, 81000, Podgorica

(511) Klasa 16: (Štampane publikacije i štampani materijali); posteri; štampane publikacije; oglasni panoi od papira ili kartona; plakati od papira ili kartona; fascikle (kancelarijske); omoti (kancelarijski); štampani rokovnici.

Klasa 25: (Promo materijali); kape; jakne; majice; rukavice; marama, šalovi.

Klasa 35: Širenje reklamnih sadržaja; pripremanje reklamnih rubrika; oglašavanje putem pošte; ažuriranje oglasnih materijala; iznajmljivanje oglasnih materijala; izdavanje oglasa; izdavanje reklamnih tekstova (oglasa); oglašavanje; reklamiranje; oglašavanje (reklamiranje) putem radija; služba za odnose sa javnošću; televizijske reklame; oglašavanje preko televizije; reklamne agencije; marketinška istraživanja; iznajmljivanje oglasnog prostora; iznajmljivanje vremena za reklamiranje u svim sredstvima komunikacije; marketing; reklamni filmovi; prezentacija proizvoda putem sredstava komunikacije, u svrhu prodaje.

Klasa 36: Finansijsko upravljanje; analize finansijske; finansijske konsultacije; posredovanje u osiguranju; finansijske informacije; agencija za naplatu dugovanja; davanje garancija, jemstva.

Klasa 38: Elektronska pošta; komunikacije mobilnim telefonima/mobilne aplikacije; prenos poruka i slika pomoću kompjutera; pristup globalnim kompjuterskim mrežama; prenos čestitki putem interneta (on-line); prenos digitalnih datoteka.

Klasa 41: Organizacija sportskih takmičenja; organizovanje (priprema) i vođenje seminara; priprema (organizovanje) i vođenje radionica za obuku; zabave, planiranje.

Klasa 42: Tehničko ispitivanje.

(210) **Ž-2019-260**

(220) 02.07.2019.

(731) DRUŠTVO SA OGRANIČENOM ODGOVORNOŠĆU "WINAPP TECHNOLOGIES" D.O.O. HERCEG NOVI, BIJELA BB, 85343, Herceg Novi, ME

(540)



(550) I

(740) AOD MSA IP - Milojević Sekulić Advokati, Karađorđeva 65, 11000, Beograd

(511) Klasa 9: Aplikacijski softver za mobilne uređaje.

Klasa 35: Obezbeđivanje onlajn tržišta za kupce i prodavce roba i usluga; usluge posredovanja koje se odnose na onlajn prodaju.

(210) **Ž-2019-279**

(220) 12.07.2019.

(731) Allied Beverages Adriatic d.o.o., Batajnički drum 18, Zemun, 11080, Beograd, RS

(540)

UVIJEK UZ TEBE

(550) I

(511) Klasa 32:

Pića, uključujući vode za piće, vode sa ukusom, mineralne i gazirane vode; ostala bezalkoholna pića, uključujući osvježavajuća bezalkoholna pića, energetska pića i pića za sportiste; voćni napici i sokovi uključujući kokosovu vodu; sirupi, koncentрати, praškovi i drugi preparati za pripremu pića, uključujući vode sa ukusom, mineralne i gazirane vode, osvježavajuća bezalkoholna pića, energetska pića, pića za sportiste, voćne napitke i sokove; napici i sokovi od povrća.

(210) **Ž-2019-280**

(220) 12.07.2019.

(731) Pharmaceutical chemical cosmetic industry ALKALOID AD Skopje, Blvd. Aleksandar Makedonski 12, 1000, Skopje, MK

(540)

PYNETRA

(550) I

(740) Miladin Popović, ul. Capital Plaza, ulica šeika Zajeda 13-IV/68, 81000, Podgorica

(511) Klasa 5: farmaceutski preparati

(210) **Ž-2019-313**

(220) 19.08.2019.

(731) "Durmitor Paradise", Sinjajevinska b.b., Žabljak, ME

(540)



(550) I

(511) Klasa 39: iznajmljivanje automobila; iznajmljivanje parkirališnih mjesta; nošenje (prtljaga); obilazak znamenitosti; organizovanje krstarenja; pratnja putnika; prevoz putnika; taksi usluge; usluge vozača.

Klasa 43: agencija za smještaj (hotelski, pansioni); hoteli; obezbeđivanje prostora za kampovanje; pansioni; restorani; rezervacija hotela; rezervacija pansiona; iznajmljivanje šatora; iznajmljivanje privremenih smještaja; rezervisanje privremenog smještaja, turistički apartmani; usluga kamp servisa; usluga prijema za privremeni smještaj (upravljanje dolascima i odlascima); usluge snabdijevanja hranom i pićem (catering);

Klasa 44: fizioterapija i masaža.

(210) **Ž-2019-323**

(220) 29.08.2019.

(731) Philip Morris Products S.A., Quai Jeanrenaud 3, 2000, Neuchâtel, CH

(540)



(550) I

(740) Milena Pejović, Cetinjski put 11/4, The Capital Plaza , 81000, Podgorica

(511) Klasa 9: Mobilne aplikacije, aplikacije za mobilne uređaje koje se mogu preuzimati.

Klasa 34: Duvan, sirov ili prerađen; duvanski proizvodi; cigare, cigarete, cigarilosi, duvan za uvijanje cigareta, duvan za lule, duvan za žvakanje, duvan za šmrkanje, kretek; snus (duvan u prahu); zamena za duvan (za nemedicinsku upotrebu); elektronske cigarete; duvanski proizvodi za zagrevanje; elektronski uređaji, i njihovi delovi, koji se koriste za zagrevanje cigareta ili duvana u cilju oslobađanja aerosola koji sadrži nikotin za inhalaciju; tečni nikotinski rastvori za upotrebu u elektronskim cigaretama; artikli za pušače, papir za cigarete, tube za cigarete, filteri za cigarete, kutije za duvan, kutije za cigarete, tabakere, pepeljare, lule, džepne mašine za uvijanje cigareta, upaljači; šibice.

Klasa 35: Usluge promovisanja trgovine, oglašavanje; distribucija reklamnog materijala; usluge marketinga i promocije; marketinške usluge koje se pružaju putem digitalnih mreža; upravljanje programima lojalnosti potrošača.

(210) **Ž-2019-328**

(220) 04.09.2019.

(731) Društvo sa ograničenom odgovornošću "CONCORD LIMOUSINES " doo Herceg Novi, Zemunska 143, Meljine, Herceg Novi, ME

(540)



(550) I

(511) Klasa 39: Usluge prevoza - usluge iznajmljivanja prevoznih sredstava.

(210) **Ž-2019-337**

(220) 05.09.2019.

(731) MARCO POLO TRAVEL AGENCY D.O.O. PODGORICA, CITY KVART B.B., 81000, PODGORICA, ME

(540)



(550) I

(511) Klasa 35: Oglašavanje i reklamiranje; Sortiranje izleta za račun drugih osoba kako bi omogućili klijentima lakše informisanje i kupovinu, posredstvom prodajnih flajera (kataloga), dopisno ili elektronskim putem, posredstvom elektronskih uređaja (touch panela), web-a, android aplikacija, društvenih mreža, email-a i putem telefona; Reklamiranje turističke ponude i Crne Gore kao turističke destinacije; Reklamiranje turističkih lokaliteta; Vođenje komercijalnih poslova; poslovi informisanja gostiju o ponudi i prodaji izleta u okviru unaprijed definisanog programa; Komercijalna administracija; Administrativni poslovi, izrada izvještaja, evidencija statističkih podataka, naplata; Kancelarijski poslovi; E-mail i telefonska korespondencija, štampanje i izdavanje izletničkih karata.

Klasa 39: Prevoz; Organizovanje transporta putnika koji je sastavni dio izletničkog programa kod većine ponuđenih turističkih proizvoda, sopstvenim ili iznajmljenim prevoznim sredstvom; Organizovanje putovanja — Organizovanje poludnevni i cjelodnevni izleta; Informisanje i obavještavanje o detaljima izleta, cijeni izleta, rasporedu polazaka i sl.; Usluge obavještavanja o putovanjima preko posrednika.

Klasa 41: Razonoda — Organizovanje izletničkog programa radi razonode i zabave.

Klasa 43: Usluge obezbjeđivanja hrane i pića.

(210) **Ž-2019-352**

(220) 12.09.2019.

(731) Domaća trgovina doo Podgorica, Ul.Josipa Broza Tita br.23a, 81000, Podgorica, ME

(540)

City

(550) I

(511) Klasa 3: Nemedicinska kozmetika i toaletni preparati; nemedicinska sredstva za čišćenje zuba; parfimerijski proizvodi, etarska ulja; sredstva za beljenje i druge supstance za upotrebu u perionicama;

preparati za čišćenje, poliranje, ribanje i abrazivni preparati.

Klasa 16: Hartija i karton; štampane stvari; knjigovezački materijal; fotografije; kancelarijski materijal i kancelarijski pribor, osim nameštaja; lepkovi za kancelarijske i kućne potrebe; materijali za crtanje i materijali za umetnike; kičice; materijali za obuku i nastavu; plastični omotači, folije i kese za umotavanje i pakovanje; štamparska slova, klišeji.

Klasa 29: Meso, riba, živina i divljač; mesni ekstrakti; konzervisano, zamrznuto, sušeno i kuvano voće i povrće; želei, džemovi, kompoti; jaja; mleko, sir, puter, jogurt i drugi mlečni proizvodi; ulja i masti za ishranu.

Klasa 30: Kafa, čaj, kakao i zamena kafe; pirinač, testenina i rezanci;; tapioka i sago; brašno i proizvodi od žitarica; hleb, peciva i konditorski proizvodi; čokolada;; sladoledi, sorbei i drugi jestivi led;; šećer, med, melasa; kvasac, prašak za pecivo; so, dodaci jelima, začini, konzervisano začinsko bilje;; sirće, sosovi i drugi dodaci jelu;; led (zamrznuta voda).

Klasa 31: Sirovi i neprerađeni poljoprivredni, akvakulturni, hortikulturni i šumarski proizvodi; sirovo i neprerađeno zrnavlje i semenje; sveže voće i povrće, sveže začinsko bilje; prirodne biljke i cveće; cvetne lukovice, sadnice i seme za sadnju; žive životinje; hrana i pića za životinje; slad.

Klasa 32: Pivo; bezalkoholni napici; mineralne i sodne vode; voćni napici i voćni sokovi; sirupi i drugi bezalkoholni preparati za pravljenje napitaka..

Klasa 33: Alkoholna pića, izuzev piva; alkoholni preparati za pravljenje napitaka..

Klasa 35: Oglašavanje; vođenje poslova; poslovno upravljanje; kancelarijski poslovi.

Klasa 43: Usluge obezbeđivanja hrane i pića; privremeni smeštaj.

(210) **Ž-2019-389**

(220) 11.10.2019.

(731) Mylan Healthcare GmbH, Lütticher Straße 5, 53842, Troisdorf, DE

(540)

Brufenex

(550) I

(740) Miladin Popović, ul. Capital Plaza, ulica šeika Zajeda 13-IV/68, 81000, Podgorica

(511) Klasa 5: Farmaceutski preparati posebno za liječenje prehlade, rinitisa, rinofaringitisa i gripa.

(210) **Ž-2019-399**

(220) 17.10.2019.

(731) Fareed Khalaf Sons Company (Khalaf Stores), P.O.Box 586, 11118, Amman, JO

(540)



(550) I

(740) Dejan Ćosović, 13. jula br. 1/5, 85310, Budva

(511) Klasa 29: Meso, riba, živina i divljač; ekstrati mesa; konzervisano, sušeno ili kuvano voće i povrće; želei, džemovi, kompoti; jaja, mlijeko i mliječni proizvodi; jestiva ulja i masti.

(210) **Ž-2019-418**

(220) 31.10.2019.

(731) BB&T Corporation, P.O. Box 1255, 27101, Winston-Salem, North Carolina, US

(540)

VOTION

(550) I

(740) Branislav Lutovac, Bulevar Ivana Crnojevića 93, 81000, Podgorica

(511) Klasa 36: Finansijske i osiguravajuće usluge, i to bankarstvo, upravljanje povjerenjem, upravljanje investicijama, investicijsko bankarstvo, međunarodno bankarstvo, korporativne finansije, faktoring, hipotekarno kreditiranje, finansijska klirinška kuća, finansiranje lizinga i finansiranje otkupa lizinga, finansijsko planiranje, analiza finansijskog portfelja i savjetovanje; usluge kreditnih kartica, usluge debitnih kartica, brokersko poslovanje i usluge zastupanja u osiguranju; onlajn bankarske usluge; usluge plaćanja računa putem veb stranice; usluge digitalnog bankarstva, naime, onlajn finansijsko upravljanje. Usluge savjetovanja u vezi benefita za zaposlene i brokerske usluge u osiguranju; Usluge konsultacija o zdravlju i dobrobiti zaposlenih; outsourcing administracije osiguranja.

(210) **Ž-2019-419**

(220) 31.10.2019.

(731) BB&T Corporation, P.O. Box 1255, 27101, Winston-Salem, North Carolina, US

(540)

RORA

(550) I

(740) Branislav Lutovac, Bulevar Ivana Crnojevića 93, 81000, Podgorica

(511) Klasa 36: Finansijske i osiguravajuće usluge, i to bankarstvo, upravljanje povjerenjem, upravljanje investicijama, investicijsko bankarstvo, međunarodno bankarstvo, korporativne finansije, faktoring, hipotekarno kreditiranje, finansijska klirinška kuća, finansiranje lizinga i finansiranje otkupa lizinga, finansijsko planiranje, analiza finansijskog portfelja i savjetovanje; usluge kreditnih kartica, usluge debitnih kartica, brokersko poslovanje i usluge zastupanja u osiguranju; onlajn bankarske usluge; usluge plaćanja računa putem veb stranice; usluge digitalnog bankarstva, naime, onlajn finansijsko upravljanje. Usluge savjetovanja u vezi benefita za zaposlene i brokerske usluge u osiguranju; Usluge konsultacija o zdravlju i dobrobiti zaposlenih; outsourcing administracije osiguranja.

(210) **Ž-2019-423**

(220) 04.11.2019.

(731) SINCOMMERCE doo, Ćemovsko polje b.b., Podgorica, ME

(540)



(550) I

(740) Ivanović Siniša, , Podgorica

(511) Klasa 1: Antifriz; Proizvodi za zaštitu od gubljenja sjaja stakla.
Klasa 7: Reparature kočionih kliješta; kočioni cilindri.

(210) **Ž-2019-425**

(220) 05.11.2019.

(731) Domaća trgovina doo Podgorica, Ul.Josipa Broza Tita br.23a, 81000, Podgorica, ME

(540)

SVE ZA TEBE

(550) I

(740) Goran Živković, ul. Petra Zvicera br.11, Podgorica

(511) Klasa 3: Bademovo ulje; bademov sapun; štirak za sjaj veša; štirak za pranje veša; štirak za veš; sapun*; sapun za izbeljivanje tekstila; plavilo za veš; etarsko ulje anisa; kozmetički preparati za kupanje sapun za brijanje; vatirani štapići za kozmetičke svrhe; pamučni štapići za kozmetičku upotrebu; kozmetičke maske; bergamot ulje; soli za izbeljivanje soda za izbeljivanje belila za veš; mirišljavo drvo; preparati za ispiranje usta, koji nisu medicinski; lak za nokte; preparati za šminkanje; losioni za kosu*; kreme za cipele; boje za kosu; preparati za kovrdžanje kose; preparati za čišćenje, poliranje; preparati za poliranje; vosak za cipele; sredstva za poliranje nameštaja i podova; preparati za sjaj [poliri]; obučarski vosak; vosak za parket; vosak za poliranje; etarska ulja limuna; kolonjska voda; boje za toaletnu upotrebu; preparati za zaštitu kože [poliranje]; preparati za očuvanje kože [poliranje]; kozmetički setovi; kozmetika; pamučna vuna za kozmetičku upotrebu; kreda za čišćenje; preparati za uklanjanje mrlja; kozmetičke olovke; kreme za poliranje; kozmetičke kreme; soda za pranje, čišćenje; paste za brijanje; kreme za kožne proizvode; vosak za kožne proizvode; deterdženti, koji nisu za upotrebu u proizvodnim procesima i za medicinsku upotrebu; rastvori za čišćenje; proizvodi za odmašćivanje, koji nisu za upotrebu u procesu proizvodnje; preparati za uklanjanje šminke sredstva za čišćenje zuba [paste, gelovi, tečnosti]*; preparati za uklanjanje kamenca za upotrebu u domaćinstvu; dijamantin, boraks [arbaziv] antistatički preparati za kućnu upotrebu; preparati za uklanjanje laka; preparati za uklanjanje boje odstranjivači laka; mirišljave vode; toaletne vode; preparati za depilaciju; vosak za depilaciju; preparati za natapanje u perionicama; etarske esencije; etarska ulja; etarska ulja; ekstrakti cveća [parfemi]; šminka; preparati za čišćenje; baze za cvetne parfeme; fumigacijska sredstva [parfemi]; arome za kolače [etarska ulja]; ulja za kozmetičku upotrebu; jasinovo ulje; ulje od lavande; ulja za čišćenje; ulja za parfeme i mirise; ružino ulje; toaletna ulja; losioni za kozmetičku upotrebu; mleko za čišćenje za toaletnu upotrebu; preparati za pranje; toaletni proizvodi [sredstva za ličnu higijenu]*; preparati za štirkanje; mirisna menta [etarsko ulje]; menta za parfimerijske proizvode kozmetika za obrve; šamponi*; parfemi; preparati za negu noktiju; parfimerija; kozmetički preparati za negu kože; sapun protiv znojenja nogu; kamen za poliranje; pomade za kozmetičku upotrebu; puder za šminkanje; preparati za brijanje; dezodorantni sapun; kesice sa mirisom za rublje; safrol; komadi toaletnog sapuna; komadi sapuna; olovke za izvlačenje obrva; talk puder, za toaletnu upotrebu; kozmetičke boje; krpe za poliranje; stakleno platno [abrazivno platno]; preparati protiv znojenja; sapun protiv znojenja; tripoli kamen za poliranje; abrazivi; bademovo mleko za kozmetičku upotrebu; preparati za uklanjanje rđe; preparati za sunčanje [kozmetički]; aromatična ulja [etarska ulja]; arome za pića [etarska ulja]; hemikalije za osvežavanje boja za upotrebu u domaćinstvu [pranje veša]; soli za kupanje koje nisu za medicinsku upotrebu; kozmetički preparati; preparati za uklanjanje boja; dezodoransi za ljude ili životinje; dekorativne nalepnice za kozmetičku upotrebu; astringentna sredstva; preparati za beljenje [skidanje boje] za kozmetičku upotrebu; oplemenjivači rublja za upotrebu u perionicama; preparati za otčepljivanje odvodnih cevi; šamponi za kućne ljubimce [nemedicinski preparati za negu]; maramice natopljene sa kozmetičkim losionima; sredstva za lepljenje za kozmetičku upotrebu; losioni posle brijanja; lakovi za kosu; maskare; potpuri [mirisi]; sprejevi za osvežavanje daha; preparati za hemijsko čišćenje; odstranjivači voska sa poda [sredstva za odstranjivanje]; neklizajući vosak za podove; neklizajuće tečnosti za podove; vazduh konzerviran pod pritiskom, za čišćenje i uklanjanje prašine; gelovi za izbeljivanje zuba; krpe namočene deterdžentom za čišćenje; preparati za sjaj; lišća biljaka; mirisni štapići; sredstva za sušenje sudova u mašinama za sudove; preparati za parfimisanje vazduha; trake za osvežavanje daha; dezodoransi za kućne ljubimce; preparati za tuširanje za ličnu higijenu i dezodorisanje [toaletni proizvodi]; preparati od aloe vere za kozmetičke namene; sjajevi za usne; balzami, osim za medicinske svrhe; šamponi za suvo pranje*; preparati za sunčanje; etarsko ulje limuna kana [kozmetička boja]; sredstva za čišćenje obuće; preparati za kupanje, ne za medicinske svrhe; balzami za kosu; proizvodi za ispravljanje kose; maramice natopljene

preparatima za skidanje šminke; preparati kolagena za kozmetičke svrhe; trake za izbeljivanje zuba; arome za hranu [etarska ulja]; fitokozmetički preparati; sredstva za čišćenje za intimnu ličnu higijenu, nemedicinska; biljni ekstrakti za kozmetičke namene; sredstva za odstranjivanje laka za nokte; sredstva za uklanjanje laka za nokte; vosak za podove; šamponi za životinje [nemedicinski preparati za negu]; sredstva za ispiranje očiju, ne za medicinske namene; sredstva za vaginalno ispiranje za ličnu higijenu ili dezodorisanje; hemijski preparati za čišćenje za upotrebu u domaćinstvu; raspršivači od trske za osvežavanje vazduha; preparati za beljenje [uklanjanje boja] za upotrebu u domaćinstvu; kozmetika za decu; preparati za osvežavanje daha za ličnu higijenu; maramice za bebe natopljene preparatima za čišćenje; basma [kozmetička boja]; gel jastučići za oči za kozmetičke namene.

Klasa 16: Nosači lepljivih traka [kancelarijski pribor]; papir; poster; oglasni panoi od papira ili kartona; spajalice [kancelarijski pribor]; klipse za olovke heftalice [kancelarijski rekvizit]; beležnice, notesi; albumi; slike; štampani materijal [viskoka štampa]; trake za cigare, za uvijanje cigareta; mašine za oštrenje olovaka, elektronske ili neelektronske podupirači za knjige; vodene boje [slikarske]; vodene boje, slikarske; akvarel boje; fascikle za spise [kancelarijski pribor]; tablice za pisanje; pisaljke za tablice; srebrni papir; olovke; novine; periodične publikacije; atlas; uložne mape sa prstenovima; registratori sa prstenovima; gumirane trake [kancelarijski materijal]; podmetači za pivske čaše; ulaznice; kliše; blokovi za crtanje blokovi [kancelarijski materijal]; klemi za trake sa mastilom; manžetne za držanje pribora za pisanje; pamfleti; špenadle kao kancelarijski materijal; čiode kao kancelarijski materijal; ovlaživači vrhova prstiju [kancelarijski pribor]; jastučići za mastilo; vosak za pečačenje; sveske; obrasci za precrtavanje; paus papir; štamparska slova; karbon papir; papir za mašine za snimanje; beležnice; ugaoni lenjiri za crtanje; karte; materijal za obuku [izuzev aparata]; listovi papira [kancelarijski] karton; tube od kartona; katalozi; metalni vrh za indeksne karte; spojeni ramovi [štamparski]; omoti za papir; košuljice za spise; brojevi [štamparski]; indijsko mastilo; fascikle [kancelarijski materijal]; bušilice za papir [zumba]; higijenski papir; toalet papir; knjige; šestari za crtanje; štamparski brojevi i slova; slova, štamparska; kompozeri za slaganje; posude za pisma; konusne papirne kese; korektivna tečnost [kancelarijski rekvizit]; korektivno mastilo[heliografsko]; grafitne mine za olovke; kreda za pisanje; držači olovaka; olovke sa grafitnom minom [tehničke olovke]; papirne kutije za krem; table za crtanje; materijali za crtanje; instrumenti za crtanje; kutije za olovke; proizvodi za brisanje; materijali za pisanje; štitnici za brisanje; gumice za brisanje; elektrokardiografski papir; probadači [kancelarijski materijal]; mastilo; mastiljave trake; fotografije [štampane]; brisači za naliv pera; pečati; knjigovodstvene knjige; indeks registri; formulari [štampani]; kancelarijski materijal, izuzev nameštaja; štampani rokovnici; ovlaživači za lepljenje koverti [kancelarijski rekviziti]; dopisnice, razglednice; štampane stvari; pribor za ručno lepljenje nalepnica; štampane publikacije priručnici; papir za pisanje; pritiskači za papir; igle za kopiranje za crtačke svrhe; olovke za crtanje; stolnjaci od papira; knjižice; svetleći papir; pelir papir za kopije [kancelarijski materijal]; maramice od papira; indigo papir za umnožavače; prekrivači stolova od papira; spajalice; kancelarijski materijal i kancelarijski pribor, osim nameštaja; pergament; pastelne bojice [krede u boji]; postolja za fotografije; nalivpera; omoti za saksije od papira; aparati i mašine za umnožavanje dokumenata; papirne trake i kartice za beleženje kompjuterskih programa; prospekti; naliv pera i hemijske olovke [kancelarijski pribor]; vrećice [koverte, kese] od papira ili plastike, za pakovanje; školska oprema [sveske i pribor za pisanje]; markeri za knjige čestitke, razglednice; lepak za papir ili upotrebu u domaćinstvu; lepljive trake za papir ili upotrebu u domaćinstvu; lepljive vrpce za papir ili upotrebu u domaćinstvu; kalendari; slikarske četkice; samolepljive trake za papir ili upotrebu u domaćinstvu; gumice [elastične trake] za kancelarije; portikle od papira; table od drvene pulpe[kancelarijske]; papir od pulpe, drvene mase papirne ili kartonske kutije; postolja za pera i olovke; ambalaža za flaše od papira ili kartona; podmetači za čaše od papira; plastična, mehurasta ambalaža za pakovanje ili umotavanje; lepak za kancelarijsku ili kućnu upotrebu; lepkovi za kancelarijsku ili upotrebu u domaćinstvu; noževi za papir [za otvaranje pisama]; vreće za đubre [od papira ili plastike]; zarezaci za olovke, elektronski i neelektronski; papirne maramice za uklanjanje šminke; stone salvete od papira; podmetači od

papira; ugaonici za crtanje; T-lenjiri za crtanje; držači za olovke; neseseri sa priborom za pisanje; omotači za flaše od kartona ili papira; plakati od papira ili kartona; ubrusi od papira; ubrusi za lice od papira; etikete od papira ili kartona; viskozni papir za umotavanje, ukrasni papir; sredstva za lepljenje za papire ili upotrebu u domaćinstvu; vreće za mikrotalasno kuvanje; papirni filteri za kafu; plastična tanka rastegljiva folija za obavijanje paleta; natpisi od papira ili kartona; nalepnice [kancelarijski pribor]; papir za kopiranje; muzičke čestitke, razglednice bilteni; plastifikatori dokumenata za kancelarijsku upotrebu; brisači za table za pisanje; pločice sa hvataljkom za listove papira; papirne mašne, koje nisu pozamanterija i ukrasi za kosu; upijajuće folije od papira ili plastike za pakovanje hrane; folije od papira ili plastike za održavanje vlage za pakovanje hrane; korektorske trake [kancelarijski pribor]; posudice za boje; markeri [pisači pribor]; letci, flajeri; držači spisa, dokumenata [kancelarijski pribor]; držači stranica knjiga; papirni i kartonski materijali za pakovanje [punjenje, oblaganje]; ispuna od papira ili kartona; vaučeri; plastične kese za odlaganje životinjskog izmeta; vaši [japanski papir]; nadstolnjaci od papira; štampane muzičke partiture; transparenti [baneri] od papira; navlake za kartice sa imenom; jo jo držači kartica sa imenom [kancelarijski pribor]; kopče za navlake za kartice sa imenom [kancelarijski pribor]; portikle sa rukavima, papirne sekači papira [kancelarijski pribor]; šabloni za ukrašavanje hrane i napitaka; bedževi sa imenom [kancelarijski pribor]; trake za bar kodove šljokice za kancelarijsku upotrebu; maramice od papira za čišćenje.

Klasa 29: Kulinarske namene ekstrakti algi za ishranu želatin*; jestive masti; inćuni, neživi; kikiriki puter; puter; kakao puter za ishranu; kokosov puter; puter krem; belance od jaja; kobasice krvavice; goveđa supa; goveđa supa, bujon; preparati za pravljenje bujona; kavijar; voće, konzervisano; suhomesnati proizvodi; čips od krompira; listići od krompira; kiseli kupus; kokos, osušeni; ulje repice za ishranu; repino ulje za ishranu; koncentracije za goveđu supu; koncentracije za bujon; džemovi; zaleđeno voće; supe; suvo grožđe; krastavčići; konzervisano povrće; kuvano povrće; sušeno povrće; ulja za ishranu; pavlaka [mlečni proizvod]; sir; smrznuto voće; kristalizovano voće; kroketi; ljuskari, koji nisu živi; urme; mleko; rak, koji nije živ; riblji fileti; sirište, sirilo; voće, kuvano; voćni žele; voćna pulpa; meso; riba, koja nije živa; žele za ishranu; žele od mesa; divljač, koja nije živa; đumbirov džem; konzervisana soja, za ishranu; masne supstance za proizvodnju jestive masti; smeše koje sadrže mast za kriške hleba; haringe, nežive; jastozi, koji nisu živi; kukuruzno ulje za ishranu; ulje palminih koštica za ishranu; susamovo ulje za ishranu; ostrige, koje nisu žive; riblji želatin za ishranu; šunka; žumance od jaja; jogurt; preparati za supu od povrća; sokovi od povrća za kuvanje; mesni ekstrakti; kefir [piće od mleka]; kumis [piće od mleka]; napici od mleka, u kojima mleko preovlađuje; surutka; proizvodi od mleka; bodljikavi jastog, koji nije živ; slanina; konzervisano sočivo; margarin; mermelada; životinjska moždina, srž, za ishranu; školjke, ljuskari, koji nisu živi; školjke, koje nisu žive; palmino ulje za ishranu; prerađen orah; jaja; jaja u prahu; jetrena pašteta; luk, konzervisan; masline, konzervisane; maslinovo ulje za ishranu; koštano ulje za ishranu; pektin za kulinarske namene; kiseli krastavac; grašak, konzervirani; kobasice; usoljeno meso; sastojci za pripremanje supe; paradajz pire; salate od povrća; svinjska mast; salate od voća; sardine, nežive; losos, neživ; bubrežni loj za ishranu; tunjevina, neživa; sok od paradajza za kuvanje; suncokretovo ulje za ishranu; škembići; konzervisana gomoljika, tartuf živina, koja nije živa; kora od voća; alginati za kulinarske namene; mleveni badem; kikiriki, pripremljen; konzervisane pečurke; kokosova mast; kokosovo ulje za ishranu; konzervisan pasulj; jetra; namirnice na bazi ribe; voćni čips; školjke kapice, koja nisu žive; voće konzervisano u alkoholu; polen pripremljen kao hrana; škampi, račići, koji nisu živi; konzervisana riba; konzervisano meso; morski račići, koji nisu živi; jaja puževa za jelo; tofu; mućena pavlaka, šlag; svinjetina; jestiva ptičja gnezda; riba u konzervi; riblje brašno za ljudsku ishranu; voće u konzervi; meso u konzervi; uštipci, krofne od krompira; usoljena riba; morski krastavac, koji nije živ; čaure svilene bube za ljudsku ishranu; povrće u konzervi; panirane kobasice; pahuljice od krompira; pire od jabuka; kompot od brusnice; tahini [namaz od susama]; humus [namaz od leblebija]; morske (nori) alge, konzervisane; grickalice na bazi voća; kiselo mleko; kimči [jelo od fermentisanog povrća]; sojino mleko; milk šejk; ajvar [konzervisana paprika]; suncokretove semenke, pripremljene; riblji musevi; bezalkoholni punč od žumanaca; musevi od povrća; riblja

ikra, pripremljena semenke, pripremljene*; aloe vera za ljudsku ishranu; konzervisan beli luk; proteinsko mleko; ulje od semena lana za ishranu; niskokalorični čips od krompira; niskokalorični hrskavi krompir; lecitin za kulinarske namene; mlečni fermenti za kulinarske namene; kompoti; kondenzovano mleko; smetana [kisela pavlaka]; raženka [fermentisano pečeno mleko]; fermentisano mleko; paradajz pire; pasta od povrća; pasta od plavog patlidžana; mleko od kikirikija za kulinarske svrhe; bademovo mleko za kulinarske svrhe; pirinčano mleko; artičoke, konzervirane; aranžmani od obrađenog voća; mleko u prahu*; jakitori [japanski ražnjici od piletine]; bulgogi [koreansko jelo od govedine]; kandirani orasi; začinjeno koštunjavo voće; začinjeni orasi; lešnici, pripremljeni; bobičasto voće, konzervirano; guakamol [pire od avokada]; prstenovi od luka [pohovani luk]; falafel; limunov sok za upotrebu u kulinarstvu; dehidrisano meso; zamrznuto-sušeno meso; liofilizovano meso; ovseno mleko; pavlaka [biljna] na bazi povrća; zamrznuto-sušeno povrće; liofilizovano povrće; dehidrisano povrće; ekstra devičansko maslinovo ulje za ishranu; galbi [jelo od grilovanog mesa]; eskamol [jestive larve mrava]; jestivi insekti, neživi; kukuruz šećerac, prerađen; namazi na bazi orašastih plodova; knedle na bazi krompira; viršle; viršle u kukuruznom testu na štapiću; sojino ulje za ishranu; zamene za mleko; bademovo mleko; mleko od kikirikija; kokosovo mleko; kokosovo mleko za kulinarsku upotrebu; napici na bazi kokosovog mleka; pirinčano mleko za kulinarsku upotrebu; napici na bazi bademovog mleka; napici na bazi mleka od kikirikija; creva za kobasice, prirodna ili veštačka; usoljen i sušeni bakalar; uštipci od svežeg sira; presovana voćna pasta; juba [tofu listići]; pljeskavice od soje; tofu pljeskavice; tadžin [gotovo jelo od mesa, ribe ili povrća];

Klasa 30: Alge [začin]; testenina; bademovo testo; seme anisa; seme zvezdastog anisa; konditorski proizvodi za ukrašavanje novogodišnje jelke; nemedicinski biljni čajevi; arome za kafu; aromatični dodaci za hranu; dodaci jelima; hleb bez kvasca; soli za konzervisanje namirnica; dvopek; biskviti, suvi kolačići keks; sladni biskviti; slatkiši od pepermint; slatkiši [bombone]; vafel proizvodi; slatke zemičke, kolačići kakao; kafa; nepržena kafa; biljni preparati za upotrebu kao zamena za kafu; kolači; cimet [začin]; kapra; karamele [bombone]; kari [začin]; preparati od žitarica; žvakaća guma*; cikorija [zamena za kafu]; čaj; čokolada; marcipan; karanfilić [začin]; začinski dodaci; slatkiši; slatkiši od šećera; kornfleks; kukuruzne pahuljice; kokice; preparati za učvršćivanje mučene pavlake, šlaga; sladoled; palačinke; esencije za ishranu, izuzev etarskih esencija i etarskih ulja; kuhinjska so; dodaci za zgušnjavanje hrane za kuvanje; kurkuma*; prirodni zaslađivači; začini; kolačići od đumbira; piment; brašno*; brašno od boba; kukuruzno brašno; kukuruzno brašno, krupno brašno od slačice; ječmeno brašno; sojino brašno; pšenično brašno; skrob za jelo; fermenti za testo; fondani [slatkiši]; sitni kolači; šećer*; arome za kolače, izuzev etarskih ulja; prašak za kolače; testo za kolače; đumbir [začin]; vezivni agensi za sladoled; led, prirodni ili veštački; led za osvežavanje; glukoza za kulinarsku namenu; gluten pripremljen kao hrana; prekrupa za ljudsku ishranu; sirće; kečap [sos]; kakao; napici sa mlekom; pića od kafe sa mlekom; pića od čokolade sa mlekom; sredstva za podizanje testa; kvasac; materijali za vezivanje kobasica; kolačići od badema [slatka peciva]; makaroni; mleveni kukuruz; kukuruz, mleveni kukuruz, prženi kukuruz; hleb*; maltoza; melasa za ishranu; zlatni sirup [šećerni sirup], melasa; mentol za poslastice; med; oljušteni ječam; senf; oraščići rezanci; tanki rezanci; pite; mleveni ječam; sendviči; pastile [bombone]; peciva; peti-ber keks; vekne hleba; začinska paprika; pice; biber; brašno od krompira*; puding; praline; ravioli; slatki koren [slatkiši]; pirinač šafran [začin]; sago; sosovi [dodaci hrani]; celerova so; griz; šerbet [zaleđeni]; sorbei [ledeni]; špageti; tapioka; brašno tapioke*; tart [slatka pita bez gornje kore]; aroma vanile za kulinarske namene; vanilin [zamena za vanilu]; rezanci za supu; pite od mesa; vekna sa mesom; sredstva za omekšavanje mesa za upotrebu u domaćinstvu; sladoledi; prašak za pravljenje sladoleda; slatkiši od badema; poslastice od kikirikija; arome, koje nisu etarska ulja; arome za pića, izuzev etarskih ulja; mleveni ovas; oljušteni ovas; hrana na bazi ovasa; ovsene pahuljice; ovseno brašno; štapovi od slatkog korenja [poslastica]; pivsko sirće; pića na bazi kafe; pića na bazi kakaoa; pića na bazi čokolade; zamene za kafu; bombone*; čips [proizvod od žitarica]; čau-čau [začin]; kus-kus [griz]; sladni ekstrakti za hranu; slad za ljudsku ishranu; propolis [pčelinji proizvod]*; propolis; reliš [dodatak jelu]; matični mleč*; morska voda za kuvanje; suši; umak od paradajza; majonez;

krekeri; engleski krem; voćni žele [slatkiši]; musli; kolači od pirinča; umak, sos od soje; smrznuti jogurt [poslastičarski]; čatni [dodatak jelima]; prolećne rolnice; tako tortilje; ledeni čaj; napici od čaja; preliv za salatu; hlebne mrvice; tabule, libanska salata; alva; kiš; sosovi za meso [umaci]; pasta od soje [dodatak jelima]; miso [dodatak jelima]; grickalice na bazi žitarica; grickalice na bazi pirinča; suva zrna kukuruza bez ljuske; kukuruzni griz; prašak za pecivo; bikarbona soda za kuvanje; soda bikarbona za kuvanje; konzervisane baštenske trave [začini]; gotovi obroci od rezanaca; glazure za kolače; čokoladni musevi; deserti u obliku musa [slatkiši]; voćni preliv [sosovi]; marinade; sendviči sa sirom [čizburgeri]; pesto [sos]; glazure za šunku; seme lana za kulinarsku upotrebu [začin]; laneno seme za kulinarsku upotrebu [začin]; pšenične klice za ljudsku ishranu; visokoproteinske pločice od žitarica; tartar krem za kuvanje; glutenski dodaci za kulinarske namene; sosovi za testenine; pločice od žitarica; palmin šećer; testo, poluprerađen proizvod; cvetovi ili lišće kao zamena za čaj; testo za slatka peciva; vareniki [punjene knedle]; peljmeni [knedle punjene mesom]; čokoladni ukrasi za torte; ukrasne bombone za torte; koštunjavo voće sa čokoladnim prelivom; sutlijaš; koštunjavo voće u prahu; beli luk u prahu [začin]; baozi [testo sa nadevom]; pirinčana kaša za kulinarske namene; jiaozi [punjene knedle]; ramen [japansko jelo na bazi rezanaca]; okonomijaki [japanske pikantne palačinke]; smese za okonomijaki [japanske pikantne palačinke]; buritosi; gimnap [koreansko jelo od pirinča]; jestivi papir; jestivi papir od pirinča; namazi na bazi čokolade; čokoladni namazi koji sadrže orašaste plodove; knedle na bazi brašna sirup od agave [prirodni zaslađivač]; staklene glazure; dehidrisana jela čiji je glavni sastojak pirinač; liofilizovana jela čiji je glavni sastojak pirinač; zamrznuta-sušena jela čiji je glavni sastojak pirinač; zamrznuta-sušena jela čiji je glavni sastojak testenina; liofilizovana jela čiji je glavni sastojak testenina; dehidrisana jela čiji je glavni sastojak testenina; napici na bazi kamilice; mlečni karamel krem; bibimbap [mešavina pirinča sa povrćem i junetinom]; onigiri [pirinčane kuglice]; instant pirinač sendvič sa viršlama; kocke leda; prerađeno seme za upotrebu kao začin; susamovo seme [začin]; pikalili; kinoa, prerađena; bulgur; heljda, prerađena brašno od heljde; sos od brusnice [začin]; sos od jabuka [začin]; krutoni; lomper [palačinke na bazi krompira]; zefir [poslastica]; pastila [poslastica]; senbei [pirinčani krekeri]; kimči [palačinke od ukiseljenog povrća]; strugani led sa zaslađenim crvenim pasuljem; mentol bombone za osvežavanje daha; žvakaće gume za osvežavanje daha; udon rezanci soba rezanci.

Klasa 31: Agrumi [južno voće], sveži; alge, neprerađene, za ljudsku ili životinjsku ishranu; morske alge, neprerađene, za ljudsku ili životinjsku ishranu; orašasto voće; životinjska menažerija; žive životinje; hrana za životinje; drveće; Božićne jelke*; stabla drveća; žbunje; ovas [zob]; bobičasto voće, sveže; so za stoku; repa, sveža; mekinje; trupci; kokosov orah, sirov; šećerna trska; rogač, sirov; seme žitarica, neprerađeno; gljive, sveže; uljaste pogače; stočne pogače; kesten, svež; kreč za životinjsku ishranu; koren cikoriije; cikoriija, sveža; biskviti za pse; limun, svež; ljuska kokosovog oraha; kokos; hrana za ptice; pogača od uljane repice za stoku; krastavci, sveži; hmeljne šišarke; kaša od mekinja za ishranu životinja; kopra; školjke [žive] sveže; povrće bundeve, sveže; venci od prirodnog cveća; jaja za uzgoj, oplodena; pomije; uzgajana stoka; preparati za tovljenje životinja; brašno od pirinča za stočnu ishranu; pasulj, svež; cveće, prirodno; cveće, za dekoraciju, osušeno; polen [sirovina]; seno; hrana za jačanje životinja; hrana za stoku; stočna hrana; pšenica voće, sveže; travnjaci, prirodni; trava, prirodna; smrekine bobice; semenske klice za botaničke svrhe; zrnevlje [žitarice]; seme za životinjsku konzumaciju; seme za sadnju; semenje; zobena krupica za živinu; baštenska trava, sveža biljke; sadnice; hmelj; orah biljke kole; zelena salata, sveža; sočivo, sveže; kvasac za ishranu životinja; pluta, sirova; laneno brašno [stočna hrana]; kukuruz; kukuruzna stočna pogača; slad za vrenje i destilaciju komina; ostaci voća [komina]; lešnik, svež; brašno za životinje; riblja ikra; jaja svilene bube; lukovice; cvetne lukovice; crni luk, svež; masline, sveže; pomorandže, sveže; ječam; kopriva; sipina kost za ptice; slamene prostirke; slama [stočna hrana]; palme [lišće palminog drveta]; stabla palme; kaša za tovljenje stoke; riba, živa; vinova loza; borova šišarka; biber [biljka]; biljke, sušene, za dekoraciju; praziluk, svež; grašak, svež; krompir, svež; preparati za živinu; nosilje; stajska hrana za životinje; korenje za ishranu životinja; grožđe, sveže; rabarbara, sveža; žbunovi ruža; raž; svilena buba; jestiv susam, neprerađen; tartufi, sveži; talog nakon destilacije; živina,

živa; algarovila za životinjsku ishranu; badem [voće]; kikiriki, svež; brašno od kikirikija za životinje; pogače od kikirikija za životinje; nus-proizvodi prerade žitarica za ishranu životinja; ostaci nakon prerade šećerne trske [sirovina]; mamci za pecanje, živi; rakovi, živi; ljuskari, živi; jastozi, živi; dagnje, žive; ostrige, žive; hrana za kućne ljubimce; sirova kora drveta; jastozi obični [živi]; hrana za preživljavanje za životinje; napitci za kućne ljubimce; riblje brašno za životinjsku ishranu; pirinač, neprerađen; morski krastavci [živi]; papir sa peskom [prostirka] za kućne ljubimce; mirisni pesak [prostirka] za kućne ljubimce; aloe vera biljke; spanać, svež; laneno seme za ishranu životinja; seme lana za ishranu životinja; brašno od semena lana za ishranu životinja; laneno brašno za ishranu životinja; pšenične klice za ishranu životinja; artičoke, sveže; haringa, živa; losos, živ; sardine, žive; tuna, živa; beli luk, svež; tikvice, sveže; jestivo seme lana, neprerađeno; jestive semenke lana, neprerađene; aranžmani od svežeg voća; incuni, živi; jestivi insekti, živi; neprerađeni klipovi kukuruza šećerca [oljušteni ili neoljušteni]; kino, neprerađena; heljda, neprerađena; koi šarani, živi.

Klasa 32: Bezalkoholni voćni ekstrakti; pivo; ale pivo od đumbira; pivo od đumbira; sladno pivo; pivski slad; bezalkoholni voćni napici; pića od surutke; bezalkoholni pripravci za pravljenje napitaka; koncentрати za pravljenje napitaka; voćni sokovi; sirupi za pića vode [pića]; preparati za pravljenje gazirane vode; litijum voda; mineralna voda [piće]; Seltzer voda; stone vode šira limunade; ekstrakti hmelja za proizvodnju piva; sokovi od povrća [pića]; sirupi za limunade; sladovina šira [nefermentisana]; bademov sirup; soda voda; šerbeti [pića]; sok od paradajza [piće]; bezalkoholna pića; pilule za gaziranje pića; praškovi za gaziranje pića; gazirana voda; sarsaparila [bezalkoholni napitak]; aperitivi, bezalkoholni; kokteli, bezalkoholni; voćni nektar [bezalkoholni]; izotonici; sok od jabuke, bezalkoholni; kvas [bezalkoholni napitak]; bezalkoholni napici na bazi meda; smutis [kašasti napici od voća ili povrća]; bezalkoholna pića od aloe vera; kokteli na bazi piva; napici od soje, osim zamena za mleko; napici za sportiste obogaćeni proteinima; napici na bazi pirinča, koji nisu zamena za mleko; bezalkoholni napici sa ukusom kafe; bezalkoholni napici sa ukusom čaja; osvežavajuća bezalkoholna pića; ječmeno vino [pivo]; energetska pića.

Klasa 33: Liker od pepermint; voćni ekstrakti, alkoholni; biteri [gorka alkoholna pića]; liker od anisa; aniset [liker]; aperitivi; arak; destilovana pića; jabukovača; kokteli; kurakao; digestivi [likeri i žestoka pića]; vino; džin; likeri; medovina; kiršć, višnjevača; žestoka pića; brendi; piket; kruškovača; sake; viski; alkoholna esencije; alkoholni ekstrakti; alkoholna pića, izuzev piva; alkoholna pića koja sadrže voće; alkohol od pirinča; rum; vodka; pomešana alkoholna pića, koja nisu na bazi piva; nira [alkoholno piće na bazi šećerne trske]; baijiu [kinesko piće od destilovanog alkohola].

Klasa 35: Pomoć u poslovnom upravljanju; obaveštenja o poslovima reklamiranje preko plakata; usluge agencija za uvoz i izvoz; usluge agencija za pružanje poslovnih informacija; analize cena i troškova; distribucija reklamnog materijala; računovodstvo; vođenje knjiga [knjigovodstvo]; revizija poslovanja; poslovno upravljanje i organizaciono savetovanje; konsultacije u poslovnom upravljanju; prezentacija robe; pomoć u poslovnom ili industrijskom upravljanju; ažuriranje oglasnih materijala; distribucija uzoraka; stručne usluge o poslovnoj efikasnosti; istraživanje tržišta; poslovne procene; poslovna ispitivanja; iznajmljivanje oglasnih materijala; konsultacije u vezi sa poslovnim organizovanjem; objavljivanje reklamnih tekstova; oglašavanje; reklamiranje; reklamiranje na radiju; poslovna istraživanja; usluge odnosa sa javnošću; reklamiranje preko televizije; prepisivanje korespondencije [kancelarijske usluge]; uređivanje izloga; usluge reklamnih agencija; savetodavne usluge u poslovnom upravljanju; marketinška istraživanja; kompjutersko upravljanje podacima; profesionalne poslovne konsultacije; organizovanje izložbi za privredne ili reklamne potrebe; poslovne informacije; ispitivanje javnog mnjenja; priprema platnih listi; pronalaženje osoblja; iznajmljivanje oglasnog prostora; obračun poreza; prikupljanje informacija u kompjuterske baze podataka; sistemacija informacija u kompjuterskim bazama podataka; organizovanje sajмова u komercijalne ili reklamne svrhe; onlajn reklamiranje na računarskoj mreži; usluge nabavke za treća lica [kupovina proizvoda i usluga za druge poslovne subjekte]; psihološko testiranje za izbor zaposlenih; usluge poređenja cena; prezentacija proizvoda putem sredstava komunikacije, u svrhu prodaje na malo; pružanje komercijalnih saveta i informacija

potrošačima pri izboru roba i usluga; dogovaranje pretplate za usluge telekomunikacija za treća lica; administrativna obrada narudžbenica za kupovinu; komercijalna administracija za licence roba i usluga trećih lica; usluge podugovaranja, autsorsing [pomoć u poslovanju]; fakturisanje; pisanje reklamnih tekstova; prikupljanje statističkih podataka; marketing; usluge maloprodaje farmaceutskih, veterinarskih i higijenskih preparata i medicinskog materijala; iznajmljivanje prodajnih štandova; pružanje komercijalnih i poslovnih kontakt informacija; optimizacija pretraživača za promociju prodaje; optimizacija saobraćaja sa Internet stranice; usluge posredovanja u trgovini; pružanje poslovnih informacija putem Internet stranice; obezbeđivanje onlajn tržišta za kupce i prodavce roba i usluga; dizajniranje reklamnog materijala; angažovanje spoljnih firmi za administrativno upravljanje kompanijama; usluge prijavljivanja poreza; poslovno upravljanje programima za nadoknadu za druge; iznajmljivanje bilborda [panoa za reklamiranje]; usluge zakazivanja sastanaka [kancelarijske usluge]; upravljanje programima lojalnosti potrošača; pisanje tekstova za reklamne namene; registrovanje pisane komunikacije i podataka ažuriranje i održavanje; informacija u registrima; sastavljanje popisa informacija za komercijalne i reklamne svrhe; poslovno upravljanje za nezavisne pružaoce usluga; pregovaranje i zaključivanje poslovnih transakcija za treća lica; usluge poslovnog posredovanja koje se odnose na povezivanje potencijalnih privatnih ulagača sa preduzetnicima kojima su potrebna finansijska sredstva; promocija robe i usluga kroz sponzorisanje sportskih događaja; usluge praćenja konkurencije; usluge praćenja tržišta; finansijska revizija; ciljni marketing; oglašavanje na otvorenom; usluge odnosa sa medijima usluge korporativne komunikacije; iznajmljivanje kancelarijske opreme u zajedničkim radnim prostorima; usluge komercijalnog lobiranja.

Klasa 43: Usluge agencija za smeštaj [hotelski, pansioniski]; katering hrane i pića; usluge kafea; usluge kafeterija; usluge kantina; iznajmljivanje privremenog smeštaja; pansionске usluge; usluge restorana; usluge restorana za samoposluživanje; usluge snek-barova; usluge barova; iznajmljivanje stolova, stolica, stolnjaka i staklenog posuđa; iznajmljivanje prostorija za sastanke; iznajmljivanje aparata za kuvanje; iznajmljivanje automata za vodu za piće; iznajmljivanje aparata za osvetljenje*; pravljenje skulptura od hrane; usluge vašoku restorana; usluge udon i soba restorana; dekorisanje hrane; dekorisanje kolača; informacije i saveti u vezi sa pripremanjem obroka; usluge ličnog šefa kuhinje.

(210) **Ž-2019-438**

(220) 08.11.2019.

(731) DIJAMANT akcionarsko društvo za proizvodnju ulja masti i margarina Zrenjanin, Temišvarski drum 14, 23000, Zrenjanin, RS

(540)



(550) I

(740) Milena Pejović, Cetinjski put 11, The Capital Plaza IV floor, 81000, Podgorica

(511) Klasa 1: Lepljive supstance namenjene industriji.

Klasa 5: Farmaceutski, veterinarski i sanitarni preparati: dietetski proizvodi za decu i bolesnike; flasteri,

materijal za zavoje; materijal za plombiranje zuba i uzimanje otisaka zuba; dezinfekciona sredstva; preparati za uništavanje korova i štetočina.

Klasa 29: Meso, riba, živina, divljač, ekstrati od mesa; voće i povrće konzervisano, sušeno i kuvano; žele, slatko: jaja, mleko i drugi mlečni proizvodi; jestiva ulja, masti; konzerve; turšije.

Klasa 30: Kafa, čaj, kakao, šećer, pirinač, tapioka, sago; zamena kafe, brašno i proizvodi od žitarica, hleb, biskviti, kolači, poslastice, bombone, sladoled; med; sirup od melase; kvasac, prašak za pecivo; so, slačica, biber, sirće; sosovi; začini, led; skrob, dekstroza, glikoza, glikozni sirup, modifikati od skroba, kukuruzna drozdina, gluten.

Klasa 31: Proizvodi poljoprivredni, vrtlarski, šumarski i zrnavlje koji nisu obuhvaćeni drugim klasama; žive životinje, sveže voće i povrće, seme žive biljke i prirodno cveće; hrana za životinje.

Klasa 32: Pivo, svetlo pivo i crno pivo, pivski slad; mineralne i sodne vode i druga bezalkoholna pića; sirupi i drugi preparati za proizvodnju pića.

Klasa 33: Vina, jaka alkoholna pića i likeri.

(210) **Ž-2019-439**

(220) 08.11.2019.

(731) DIJAMANT akcionarsko društvo za proizvodnju ulja masti i margarina Zrenjanin, Temišvarski drum 14, 23000, Zrenjanin, RS

(540)



(550) I

(740) Milena Pejović, Cetinjski put 11, The Capital Plaza IV floor, 81000, Podgorica

(511) Klasa 29: Margarin.

(210) **Ž-2019-441**

(220) 11.11.2019.

(731) British American Tobacco (Brands) Limited, Globe House, 4 Temple Place, WC2R 2PG, London, GB

(540)

NANO

(550) I

(740) Miladin Popović, Đoka Miraševića 21/III, 81000, Podgorica

(511) Klasa 34: Cigarete; duvan, sirov ili prerađen; proizvodi od duvana; zamjene za duvan (ne u medicinske svrhe); cigari; cigarilosi; upaljači; šibice; artikli za pušače; cigaret papir; cigaret tube; filteri za cigarete; džepni aparati za zamotavanje cigareta; ručne mašine za ubrizgavanje duvana u papirne tube; elektronske cigarete; punjenja za elektronske cigarete; tečnosti za elektronske cigarete; duvanski proizvodi namijenjeni za zagrijavanje; uređaji i djelovi za uređaje za zagrijavanje duvana; zamjene za duvan namijenjene za udisanje; cigarete koje sadrže zamjene za duvan; futrole za cigarete; kutije za cigarete; snus sa duvanom; burmut sa duvanom; snus bez duvana; burmut bez duvana; vrećice nikotina za oralnu upotrebu bez duvana (ne u medicinske svrhe).

(210) **Ž-2019-460**

(220) 22.11.2019.

(731) "ESSE" OOD, 95 "Hadzhi Dimitar Asenov" str. , 6000, Stara Zagora, BG

(540)

ELLA

(550) I

(740) Božidar S. Radulović, Studentska bb, Lamela 3/18, 81000, Podgorica

(511) Klasa 34: Duvan; cigare; cigarete; artikli za pušače; šibice.

(210) **Ž-2019-471**

(220) 29.11.2019.

(731) ADP, LLC, One ADP Boulevard, 07068, Roseland, New Jersey, US

(540)

PEOPLEFLOW

(550) I

(740) Jasna Jusić, Dalmatinska 2, 81000, Podgorica

(511) Klasa 35: Pružanje usluga unosa podataka u računare, usluge obrade podataka i stručnih usluga zaposlenima, naime, obrada platnih spiskova, podnošenje poreskog depozita i izvještavanje, upravljanje ljudskim resursima, vođenje evidencije o vremenu provedenom na radnom mjestu i prisustvu za druge, iznajmljivanje zaposlenih i konsultovanje o poslovnom upravljanju; usluge upravljanja kompjuterizovanom bazom podataka; obezbjeđivanje pripreme elektronskog poreza na plate; obezbjeđivanje upravljanje poslovnim evidencijama koje se odnose na zapošljavanje i statističkih podataka preduzećima i poslodavcima za poslovne svrhe; poslovne usluge, naime, usluge vođenja evidencije prisustva na poslu za druge; usluge poslovnog upravljanja; usluge poslovnog savjetovanja i konsultacija koje se odnose na usklađenost sa zakonskim, industrijskim odredbama ili odredbama koje se odnose na najbolje prakse; pružanje statističkih informacija za poslovne svrhe; usluge outsorovanja (korištenje spoljnih resursa poslovanja) u oblasti ljudskih resursa, angažovanja i zapošljavanja; pružanje usluga poslovnog upravljanja preduzećima i poslodavcima; pružanje usluga upravljanja finansijskom evidencijom u vezi sa podacima o platama preduzećima i poslodavcima; usluge poslovnog konsultovanja pružane preduzećima i poslodavcima; konsultacije o zapošljavanju i pronalaženje osoblja; usluge zapošljavanja osoblja i agencije za zapošljavanje; pružanje usluga onlajn zapošljavanja, naime, uparivanje radnih biografija i potencijalnih poslodavaca putem globalne računarske mreže; finansijsko vođenje evidencije za potrebe akumulacije penzije i isplate; poslovne istrage; sprovođenje poslovnih anketa; poslovno istraživanje; poslovna revizija; anketiranje zaposlenih za druge za potrebe unaprijeđenja učinka i morala zaposlenih; usluge poslovne administracije u oblasti planova za primanja zaposlenih osim planova za osiguranje i finansije; usluge zapošljavanja, angažovanja radnika, razmještaja, pronalaženje osoblja i karijernog umrežavanja; testiranje za utvrđivanje vještina prilikom zapošljavanja; obezbjeđivanje veb sajta koji sadrži informacije za brokere i konsultante za primanja zaposlenih u oblasti obrade platnih spiskova, predaje depozita za plaćanje poreza i izvještavanje, upravljanja ljudskim resursima, poslovnog upravljanja, vođenja evidencije o vremenu koje zaposleni provedu na radu i prisutnosti za potrebe platnih spiskova, angažovanja zaposlenih i outsorovanja (korištenje spoljnih resursa poslovanja); usluge obrade podataka; pružaooc usluga angažovan iz spoljnih resursa u oblasti poslovne analitike; pružanje poslovnih obavještajnih usluga; planiranje poslovnog kontinuiteta; savjet o poslovnoj organizaciji; izvještavanje o porezu na prodaju i korištenje u smislu određivanja poreza.

Klasa 42: Obezbeđivanje privremenog korišćenja onlajn računarskog softvera koji se ne može preuzimati za obezbjeđivanje poslodavcima kompatibilnog interfejsa između softvera za obradu platnih spiskova i softvera za finansijsko upravljanje i upravljanje ljudskim resursima; obezbjeđivanje privremenog korišćenja onlajn računarskog softvera koji se ne može preuzimati u oblasti računovodstva za pripremu i obradu poslovnih platnih spiskova zaposlenih za poslodavce i za štampanje platnih dokumenata, naime, izvještaja, čekova i poreskih obrazaca; obezbjeđivanje privremenog korišćenja računarskog softvera koji se ne može preuzimati za usluge koje se odnose na zaposlene i osoblje, naime, obrada platnih spiskova, priprema i administracija, izračunavanje poreza na zaradu i priprema, praćenje usklađenosti poreskih propisa, elektronska obrada platnog spiska, podnošenje poreske prijave i izvještavanje, štampanje platnih izvještaja, čekova i poreskih obrazaca, administracija primanja zaposlenih, upravljanje dokumentima o ljudskim resursima, obezbjeđivanje obuke zaposlenima na rizicima i bezbjednosti na radu, pružanje informacija o programima savjetovanja i podrške zaposlenima, administriranje penzionih fondova zaposlenih i fleksibilnih računa zaposlenih, administriranje potraživanja zaposlenih za naknadama i isplatama, obrada i čuvanje dokumenata za zapošljavanje, sprovođenje provjere obrazovanja i radnog iskustva prije zaposlenja, obrada evidencije o

broju sati koje zaposleni provedu na radnom mjestu i prisustvu, zakazivanje sastanaka, pružanje informacija novom zaposlenom radi integracije, upravljanje vođenjem evidencije o zaposlenom, upravljanje evidencijom i praćenjem učinka zaposlenog, upravljanje bazom podataka o nadoknadama, pružanje informacija o obuci zaposlenog na radnom mjestu i stručnom osposobljavanju i planiranju kontinuiteta; obezbjeđivanje veb sajta sa tehnologijom koja omogućava brokerima za primanja zaposlenih i konsultantskim korisnicima da gledaju onlajn video zapise u oblasti usluga administracije primanja, obrade platnih spiskova, podnošenja poreskih prijavi i izvještavanja, upravljanja ljudskim resursima, poslovnog upravljanja, vođenja evidencija o vremenu koje zaposleni provede na radnom mjestu u prisustvu, vođenja penzione evidencije, zapošljavanja, provjere obrazovanja i radnog iskustva prije zaposlenja, korištenja autsorsovanja (korištenje spoljnih resursa poslovanja), reforme zdravstvenog osiguranja i upravljanja naknadama za nezaposlene; obezbjeđivanje veb sajta sa onlajn softverom koji se ne može preuzimati a koji omogućava brokerima i konsultantima za primanja zaposlenih da obavljaju administraciju primanja zaposlenih, vođenje penzione evidencije i upravljanje naknadama za nezaposlene; usluge pružanja usluga podnošenja prijavi, naime, hostovanje, upravljanje, programiranje i održavanje softverskih aplikacija drugih u oblasti zapošljavanja da bi zaposleni na terenu mogli da poslodavcima podnose podatke o radnim satima i radu putem bežične komunikacije i bežičnog dostavljanja sadržaja na ručne računare i mobilne elektronske uređaje; usluge podržane računarskom tehnologijom, naime, usluge šaltera za informacije; planiranje, projektovanje i implementacija računarskih tehnologija za druge.

Obezbjeđivanje veb sajta koji sadrži informacije o javnim politikama za brokere i konsultante za primanja zaposlenih u oblasti reforme zdravstvenog osiguranja; obezbjeđivanje veb sajta koji sadrži informacije za brokere i konsultante za primanja zaposlenih u oblasti administracije planova primanja zaposlenih koji se tiču osiguranja i finansija i obrade potraživanja iz osiguranja u vezi sa naknadama nezaposlenima i upravljanjem finansijskim evidencijama u vezi sa penzijama za upravljanje fondovima.

(210) **Ž-2019-480**

(220) 09.12.2019.

(731) Nobel Quest International Limited, P.O.BOX 3152,Road Town, Tortola, VG

(540)

CHAUFFE

(550) I

(740) Dejan Raičević, Vojvode Boža br.1, 81250, Cetinje

(511) Klasa 34: Duvan; aritkli za pušače; šibice; cigarete; kutije za cigarete; filteri za cigarete; muštikle; papir za cigarete; usnici za cigarete; usnici za muštikle; lule; cigarilosii; cigare; pepeljare za pušače; upaljači za pušače.

(210) **Ž-2019-481**

(220) 09.12.2019.

(731) FCA US LLC, 1000 Chrysler Drive, 48326, Auburn Hills, Michigan, US

(540)

4XE

(550) I

(740) Miladin Popović, Đoka Miraševića 21/III, 81000, Podgorica

(511) Klasa 12: Mašine za vozila po zemlji; motori za vozila po zemlji.

(210) **Ž-2019-485**

(220) 10.12.2019.

(731) Foshan Haitian Flavouring & Food Co., Ltd., No.16, Wen Sha Road Foshan City, Guangdong Province, CN

(540)



(550) I

(740) Božidar S. Radulović, Studentska bb, Lamela 3/18, 81000, Podgorica

(511) Klasa 29: Ulja za ishranu; susamovo ulje za ishranu; jestive masti; suncokretovo ulje za ishranu; repino ulje za ishranu; kukuruzno ulje za ishranu; maslinovo ulje za ishranu; konzervisano povrće; kiseli krastavac; fermentirana zrna pasulja; albumen, bjelančevine, za kulinarske namjene; povrće u konzervi; tahini [namaz od susama]; koncentрати za bujon; namirnice na bazi ribe; jaja; puter; prerađen orah; sušene pečurke; konzervisane pečurke; želatin; obrađeni plodovi areka palme; ekstrakti algi za ishranu; crijeva za kobasice, prirodna ili vještačka.

(210) **Ž-2019-492**

(220) 13.12.2019.

(731) NOVA BRANDS S.A., 24, avenue Emile Reuter, 2420, Luxembourg, LU

(540)

Novalac Premium Symbiotic

(550) I

(740) Branislav Lutovac, Bulevar Ivana Crnojevića 93, 81000, Podgorica

(511) Klasa 5: Dijetetske supstance za medicinsku upotrebu; dijetetski dodaci ishrani za upotrebu u medicinske svrhe; hrana za bebe u svim oblicima; dijetetska hrana i supstance za djecu; mliječna formula za bebe.

(210) **Ž-2019-497**

(220) 13.12.2019.

(731) Philip Morris Products S.A., Quai Jeanrenaud 3, 2000, Neuchâtel, CH

(540)

TEREA

(550) I

(740) Milena Pejović, Cetinjski put 11, The Capital Plaza IV floor,, 81000, Podgorica

(511) Klasa 34: Žičani vaporizatori za elektronske cigarete i elektronske uređaje za pušenje; duvan, sirov ili prerađen; duvanski proizvodi uključujući cigare, cigarete, cigarilose, duvan za uvijanje cigareta, duvan za lule, duvan za žvakanje, duvan za šmrkanje, kretek; snus (duvan u prahu); zamena za duvan (za nemedicinsku upotrebu); artikli za pušače, uključujući papir za cigarete, tube za cigarete, filtere za cigarete, kutije za duvan, kutije za cigarete, tabakere i pepeljare, lule, džepne mašine za uvijanje cigareta, upaljače; šibice; duvanski štapići, duvanski proizvodi za zagrevanje, elektronski uređaji, i njihovi delovi, koji se koriste za zagrevanje cigareta ili duvana u cilju oslobađanja aerosola koji sadrži nikotin za inhalaciju; tečni nikotinski rastvori za upotrebu u elektronskim cigaretama; elektronski uređaji za pušenje; elektronske cigarete; elektronske cigarete kao zamena za tradicionalne cigarete; elektronski uređaji koji sadrže aerosol za inhalaciju nikotina; oralni vaporizatori za pušače, duvanski proizvodi i zamene za duvan; artikli za pušače elektronskih cigareta; delovi i oprema za navedene proizvode iz klase 34; uređaji za gašenje cigareta i cigara koje se zagrevaju i duvanskih štapića koji se zagrevaju; punjive elektronske kutije za cigarete.

(210) **Ž-2019-498**

(220) 13.12.2019.

(731) Philip Morris Products S.A., Quai Jeanrenaud 3, 2000, Neuchâtel, CH

(540)

ILUMA

(550) I

(740) Milena Pejović, Cetinjski put 11, The Capital Plaza IV floor,, 81000, Podgorica

(511) Klasa 9: Baterije za elektronske cigarete; baterije za elektronske uređaje koji se koriste za zagrevanje duvana, punjači za elektronske uređaje koji se koriste za zagrevanje duvana; USB punjači za elektronske uređaje koji se koriste za zagrevanje duvana; automobilski punjači za elektronske cigarete; automobilski punjači za uređaje koji se koriste za zagrevanje duvana; punjači za baterije za elektronske cigarete.

Klasa 34: Žičani vaporizatori za elektronske cigarete i elektronske uređaje za pušenje; duvan, sirov ili prerađen; duvanski proizvodi uključujući cigare, cigarete, cigarilose, duvan za uvijanje cigareta, duvan za lule, duvan za žvakanje, duvan za šmrkanje, kretek; snus (duvan u prahu); zamena za duvan (za nemedicinsku upotrebu); artikli za pušače, uključujući papir za cigarete, tube za cigarete, filtere za cigarete, kutije za duvan, kutije za cigarete, tabakere i pepeljare, lule, džepne mašine za uvijanje cigareta, upaljače; šibice; duvanski štapići, duvanski proizvodi za zagrevanje, elektronski uređaji, i njihovi delovi, koji se koriste za zagrevanje cigareta ili duvana u cilju oslobađanja aerosola koji sadrži nikotin za inhalaciju; tečni nikotinski rastvori za upotrebu u elektronskim cigaretama; elektronski uređaji za pušenje; elektronske cigarete; elektronske cigarete kao zamena za tradicionalne cigarete; elektronski uređaji koji sadrže aerosol za inhalaciju nikotina; oralni vaporizatori za pušače, duvanski proizvodi i zamene za duvan; artikli za pušače elektronskih cigareta; delovi i oprema za navedene proizvode iz klase 34; uređaji za gašenje cigareta i cigara koje se zagrevaju i duvanskih štapića koji se zagrevaju; punjive elektronske kutije za cigarete.

(210) **Ž-2019-519**

(220) 27.12.2019.

(731) Actual Press New d.o.o. , Ul. Ivana Milutinovića 10, Nikšić, ME

(540)



(550) I

(511) Klasa 16: Štampanje brošura, flajera, propagandnog materijala, publikacija, knjiga.
Klasa 35: Oglašavanje, reklamiranje sportske manifestacije (zimski automobilizam).
Klasa 41: Organizovanje sportskih i kulturno — turističkih aktivnosti vezanih za zimski automobilizam.

(210) **Ž-2019-520**

(220) 30.12.2019.

(731) Red Bull GmbH, Am Brunnen 1, 5330, Fuschl am See, AT

(540)

OKRIJEPLJUJE DUH I TELO

(550) I

(740) Jasna Jusić, Dalmatinska 2, 81000, Podgorica

(511) Klasa 32: Piva; mineralne vode; gazirane vode; bezalkoholna pića; voćna pića i voćni sokovi; sirupi za proizvodnju pića; bezalkoholni preparati za proizvodnju pića; energetska pića.

(210) **Ž-2019-522**

(220) 31.12.2019.

(731) MULTIFIT Tiernahrungs GmbH, Westpreußenstr. 32-38, 47809, Krefeld, DE

(540)



(550) I

(740) Jasna Jusić, Dalmatinska 2, 81000, Podgorica

(511) Klasa 31: Hrana za životinje; sijeno; kosti za žvakanje; pijesak (piljevina za životinje), posebno ptičji pijesak; piljevina za životinje.

(210) **Ž-2019-523**

(220) 31.12.2019.

(731) MULTIFIT Tiernahrungs GmbH, Westpreußenstr. 32-38, 47809, Krefeld, DE

(540)



(550) I

(740) Jasna Jusić, Dalmatinska 2, 81000, Podgorica

(511) Klasa 31: Hrana za životinje; sijeno; kosti za žvakanje; pijesak (piljevina za životinje), posebno ptičji pijesak; piljevina za životinje.

(210) **Ž-2020-8**

(220) 15.01.2020.

(731) Pharmaceutical chemical cosmetic industry ALKALOID AD Skopje, Blvd. Aleksandar Makedonski 12, 1000, Skopje, MK

(540)

FELKARID

(550) I

(740) Miladin Popović, ul. Capital Plaza, ulica šeika Zajeda 13-IV/68, 81000, Podgorica

(511) Klasa 5: Farmaceutski preparati.

(210) **Ž-2020-14**

(220) 22.01.2020.

(731) Bosnalijek, farmaceutska i hemijska industrija, dioničko društvo, Jukićeva 53, 71000, Sarajevo, BA

(540)

FOLESSA

(550) I

(740) Božidar S. Radulović, Studentska bb, Lamela 3/18, 81000, Podgorica

(511) Klasa 5: Farmaceutski proizvodi.

(210) **Ž-2020-15**

(220) 22.01.2020.

(731) Bosnalijek, farmaceutska i hemijska industrija, dioničko društvo, Jukićeva 53, 71000, Sarajevo, BA

(540)

LENOCOR

(550) I

(740) Božidar S. Radulović, Studentska bb, Lamela 3/18, 81000, Podgorica

(511) Klasa 5: Farmaceutski proizvodi.

(210) **Ž-2020-29**

(220) 31.01.2020.

(731) Monte Beauty d.o.o., Morinj bb, 85338, Kotor, ME

(540)

AQUASHINE

(550) I

(511) Klasa 3: Kozmetika, natme preparati za tretman glabelarnih bora, bora na licu, asimetrija nedostataka i stanja ljudske kože, kozmetički proizvodi za profesionalnu upotrebu i za upotrebu od strane krajnjeg potrošača; kozmetički kreme, emulzije, losioni, tečnosti, rastvori, mleka, gelovi i

ulja za kožu (lica, tela, ruku, nogu i vratu); sapuni; parfimerija; kozmetika. losioni za kosu; etericna ulja; paste za zube; ulja za kozmetičke svrhe; neseleri [torbe s kozmetičkim proizvodima]; kozmetički proizvodi i preparati za negu kože; kozmetičke maske; kozmetički preparata za mršavljenje, kozmetika za piling; kozmetički proizvodi za ekzofolijaciju; kozmetički pilinzi; kozmetika za glatkocu kože; kozmetika za obnovu i negu kose i kože glave, odnosno vlasista; kozmetički proizvodi i preparati za sunčanje (emulzije, losioni, mleka, gelovi, ulja, tečnosti); kozmetički preparati za izbeljivanje kože; kozmetički preparati za čišćenje kože; izbjeljivači za kozmetičke potrebe; kozmetički proizvodi za osvjetljavanje kože; kozmetički proizvodi za ujednačavanje tena kože i za usavršavanje tena; kozmetički proizvodi protiv bora; kozmetički proizvodi za podmlađivanje kože; kozmetički proizvodi za sjaj kože; kozmetički proizvodi za hidrataciju kože; kozmetika za toniranje kože; aromatični ekstrakti; toaletni proizvodi; preparati za čišćenje i osvežavanje prostora; dezodoransi za ličnu upotrebu; sanitarni preparati; deterdženti; sredstva za beljenje i druge supstance za upotrebu u perionicama; preparati za čišćenje, poliranje, ribanje i nagrizanje; abrazivni preparati, kreme za kozmetičke potrebe.

Klasa 5: Farmaceutski preparati za tretman glabelarnih bora, bora na licu, asimetrija i nedostataka i stanja ljudske kože; biološki dermalni implantati, naime, visko-suplementacioni rastvori za popunjavanje bora, farmaceutski preparati za terapijsko lečenje neuroloških poremećaja i mišićnih distonija, implantati (hirurški implantanti), hemijsko-farmaceutski proizvodi, dermalni filere za injekcije, hemijski preparati za farmaceutske potrebe, hemijski preparati za medicinske potrebe.

Klasa 10: Aparati za tretman glabelarnih bora, bora na licu, asimetrija i nedostataka i stanja ljudske kože; biološki dermalni implantati, igle za medicinske potrebe, špricei za medicinske potrebe, naime, visko-suplementacioni rastvori za popunjavanje bora, aparati za terapijsko lečenje neuroloških poremećaja i mišićnih distonija, implantati (vještački implantanti), medicinski uređaji i instrumenti.

Klasa 35: Predstavljanje preduzeća (usluge predstavljana preduzeća), prezentacija proizvoda na svim komunikacionim sredstvima u svrhu prodaje na malo, marketing, predstavljanje proizvoda [demonstracija].

(210) **Ž-2020-32**

(220) 31.01.2020.

(731) London Group, LLC, 8 Pinetree Lane, 11568, Old Westbury, New York, US

(540)

NUVO

(550) I

(740) Jasna Jusić, Dalmatinska 2, 81000, Podgorica

(511) Klasa 33: Alkoholna pića izuzev piva.

(210) **Ž-2020-34**

(220) 04.02.2020.

(731) "UP SERVICE COMPANY" DOO BUDVA, Žrtava Fašizma br.15, 85310, Budva, ME

(540)



(550) I

(511) Klasa 35: Oglašavanje i reklamiranje; Oglašavanje portala UP Service na društvenim mrežama i Internetu; Oglašavanje na uniformi zaposlenih naše kompanije (postavljenje logotipa); Oglašavanje na vozilima (automobili, motocikli, skuteri, trotineti) koja se koriste za obavljanje poslova UP Service; Reklamiranje partnera koji na portalu Upservice.me objavljuju informacije o njihovim uslugama i proizvodima; Proizvodnja i distribucija vlastitih promotivnih proizvoda s vlastitim korporativnim identitetom i logotipom UP Service; Postavljanje oglasa s logotipom i korporativnim identitetom na vanjskim medijima oglašavanja (bilbordi, citylight), na radiju, televiziji i drugim medijima.

Klasa 39: Prevoz; Kurirska služba; Usluge dostave proizvoda sa jednog na drugo mjesto, dostava hrane iz restorana, namirnica iz supermarketa, paketa, pošiljki, stvari i sl.; Usluge uskladištenja u svrhu zaštite i čuvanja.

(210) **Ž-2020-40**

(220) 07.02.2020.

(731) Max Rohr, Inc., 300 Delaware Avenue, DE 19801, Wilmington, Delaware, US

(540)



(550) I

(740) AOD "Ćupić", Bulevar Džordža Vašingtona 79, 81000, Podgorica

(511) Klasa 34:

Duvan, prerađen ili sirov; duvanski proizvodi; zamjene za duvan (za nemedicinsku upotrebu); cigarete; cigarilosi; cigare; džepne naprave za savijanje cigareta; tube za cigarete; filteri za cigarete; papirići za cigarete; elektronske cigarete; tekući rastvori za upotrebu u elektronskim cigaretama; šibice i pribor za pušače.

(210) **Ž-2020-43**

(220) 12.02.2020.

(731) NewCo Minex L.L.C., rr. e Prizrenit, 70000, Ferizaj, Republic of Kosovo, RS

(540)



(550) I

(740) Dejan Čosović, 13. jula br. 1/5, 85310, Budva

(511) Klasa 30: Kafa, čaj, kakao, šećer, pirinač, tapioka, sago, vještačka kafa; brašno i proizvodi napravljeni od žitarica, hljeb, pecivo i konditorski proizvodi, poslastice od leđa; med, sirup; kvasac, prašak za pecivo; so, senf; sirće, sosevi (začini); začini; led.

Klasa 32: Bezalkoholna osvježavajuća pića i gazirana pića.

(210) **Ž-2020-44**

(220) 12.02.2020.

(731) NewCo Minex L.L.C., rr. e Prizrenit, 70000, Ferizaj, Republic of Kosovo, RS

(540)



(550) I

(740) Dejan L. Čosović, 13. jula br.9, 85310, Budva

(511) Klasa 32: Bezalkoholna osvježavajuća pića i gazirana pića.

(210) **Ž-2020-45**

(220) 12.02.2020.

(731) NewCo Minex L.L.C., rr. e Prizrenit, 70000, Ferizaj, Republic of Kosovo, RS

(540)



(550) I

(740) Dejan L. Čosović, 13. jula br.9, 85310, Budva

(511) Klasa 30: Kafa, čaj, kakao, šećer, pirinač, tapioka, sago, vještačka kafa; brašno i proizvodi napravljeni od žitarica, hljeb, pecivo i konditorski proizvodi, poslastice od leda; med, sirup; kvasac, prašak za pecivo; so, senf; sirće, sosevi (začini); začini; led.

(210) **Ž-2020-46**

(220) 12.02.2020.

(731) NewCo Minex L.L.C., rr. e Prizrenit, 70000, Ferizaj, Republic of Kosovo, RS

(540)



(550) I

(740) Dejan L. Ćosović, 13. jula br.9, 85310, Budva

(511) Klasa 30: Kafa, čaj, kakao, šećer, pirinač, tapioka, sago, vještačka kafa; brašno i proizvodi napravljeni od žitarica, hleb, pecivo i konditorski proizvodi, poslastice od leda; med, sirup; kvasac, prašak za pecivo; so, senf; sirće, sosevi (začini); začini; led.

(210) **Ž-2020-47**

(220) 12.02.2020.

(731) NewCo Minex L.L.C., rr. e Prizrenit, 70000, Ferizaj, Republic of Kosovo, RS

(540)



(550) I

(740) Dejan L. Ćosović, 13. jula br.9, 85310, Budva

(511) Klasa 30: Kafa, čaj, kakao, šećer, pirinač, tapioka, sago, vještačka kafa; brašno i proizvodi napravljeni od žitarica, hljeb, pecivo i konditorski proizvodi, poslastice od leda; med, sirup; kvasac, prašak za pecivo; so, senf; sirće, sosevi (začini); začini; led.

(210) **Ž-2020-48**

(220) 21.02.2020.

(731) Obshestvo s Ogranichennoy Otvetstvennostyu "Parapharm" (Parapharm LLC)., ul.Sverdlova, build. 4, 440026, Penza, RU

(540)



(550) I

(740) Dejan Raičević, Vojvode Boža br.1, 81250, Cetinje

(511) Klasa 5: farmaceutski preparati; dodaci ishrani za ljude i životinje; biološki aktivini dodaci ishrani; mineralani dodaci i aditivi za hranu; dijetetska hrana prilagođena za medicinske namene; dijetetske supstance prilagođene za medicinsku upotrebu; tečni dijetetski dodaci ishrani za medicinsku upotrebu; dodaci ishrani; dijetetski dodaci ishrani; enzimi kao dodaci ishrani; biljni dodaci ishrani; mineralni dodaci ishrani; ne-medicinski farmaceutski preparati, odnosno prirodni biljni dodaci ishrani, homopatski dodaci ishrani; nutraceutici kao dijetetski dodaci.

(210) **Ž-2020-51**

(220) 13.02.2020.

(731) Marta Petrović, Škaljari br.20, 85330, Kotor, ME

(540)



(550) I

(511) Klasa 43: Usluge obezbjeđivanja hrane i pića; privremeno primanje na stan; usluge koje pružaju lica ili preduzeća čiji cilj je priprema jela ili pića za potrošnju kao i usluge ishrane i smještaja, koje pružaju hoteli, pansioni ili druga preduzeća koja osiguravaju privremeni smještaj; usluge rezervisanja smještaja za putnike, koje pružaju putničke agencije ili posrednici; usluge pansiona za životinje.

(210) **Ž-2020-52**

(220) 14.02.2020.

(731) Kraft Foods Sverige Intellectual Property AB, c/o Kraft Foods Sverige AB, 194 86, Upplands Väsby, SE

(540)



(550) I

(511) Klasa 29: Meso, riba, živina i divljač; mesni ekstrakti; konzervisano, sušeno i kuvano voće i povrće; želei, džemovi, mermelada, kompoti; jaja; mleko i mliječni proizvodi, jogurt; jestiva ulja i masti; paradajz pire i sok od paradajza; čips i grickalice na bazi krompira, povrća ili voća; orašasti plodovi pečeni, sušeni, usoljeni, začinjani i sa dodacima.

Klasa 30: Kafa, zamjene za kafu, čaj i kakao, uključujući napitke od njih; šećer i zaslađivači (prirodni); brašno i prehrambeni proizvodi od žitarica, žitarice za doručak, tjestenine i ostali proizvodi od tijesta, pice, ruske piroške, pite, hleb, peciva i konditorski proizvodi, uključujući čokolade i slatkiše; sladoled, sladoled od jogurta, smrznuti jogurt i led; so, senf, kečap, sirće, sosovi [dodaci hrani], začini, grickalice u obliku kokica i kukuruznog čipsa kao i grickalice na bazi kukuruza, pirinča, ječma, raži ili peciva.

(210) **Ž-2020-62**

(220) 20.02.2020.

(731) Predrag Šćepanović, Branka Miljkovića 46/10, 81000, Podgorica, ME

(540)

enemove

(550) I

(511) Klasa 12: Vozila; uređaji za kretanje po zemlji, po vodi ili vazduhu; alarmni uređaji protiv krađe vozila; amfibije (hidroavioni); amortizeri (ublaživači udara u vozila); amortizujuće opruge za vozila; autobusi za međugradski prevoz; autokaravani; autobili; automobili (amortizeri za automobile); automobili (branici za automobile); automobili (cerade automobilskih motora); automobili (lanci za automobile); automobili (zavjesice za automobile) (roletne); automobilske spoljašnje gume (točkovi); automobilski kosturi (šasiije); automobilski školjke (karoserije); avioni; baloni kojima se može upravljati (letjelice); baloni, vazdušni; betonjerke (vozila mješalice za beton); bicikli; bicikli (gume za točkove za bicikla); bicikli (gumeni djelovi točka bicikla); bicikli (indikator smjera kretanja za bicikle); bicikli (kočnice bicikla); bicikli (mrežice za bicikle); bicikli (okviri za bicikle) (rame); bicikli (osnove točka bicikla); bicikli (postolja bicikala); bicikli (postolja za bicikle); bicikli (pumpe za bicikle); bicikli (sjedišta za bicikle); bicikli (tamovi za bicikle) (felge); bicikli (točkovi bicikla);

bicikli (upravljači bicikla); bicikli (zupčanici za bicikle); bicikli (zvonca za bicikle); blatobrani; blatobrani za bicikla; bokobrani za brodove; branici na željezničkim vagonima; branici vozila; brisači automobilskih stakala; brisači farova; brodovi; brodovi (upravljački uređaji za brodove); brodovi (uređaji za izvlačenje broдова); brodovi (utovarne brodske rampe); brodska rebra; brodske kuke; brodski dimnjaci; brodski propeleri elise; brodski propeleri, elise; brodski prozorčići; brodski spoljašnji propeleri, elise; brodski trupovi; brzina (mjenjačke kutije za kopnena vozila); centriranje točkova na vozilima (olovo za centriranje točkova); cigare (automatski upaljači za cigare) za automobile; cijevi (kola za crijeva za polivanje); čamci; čamci (vesla za čamce); dimnjaci lokomotiva; dimnjaci, brodski; dizalice (sohe) za utovar na brodove; dječija kolica; ekseri za gume; električna vozila; električni motori za kopnena vozila; gažišta, gusjenice vozila; gepek vozila; golf (kolica za golf); gradski autobusi; guma (okrugli komadi ljepljive gume za popravku guma); gume (ljepljive gumene zakrpe za šivenje pneumatika); gume (torbe s proborom za šivenje pneumatika); gume za točkove bicikala; gume za točkove vozila; gumeni točkovi (spoljni omotači gumenih točkova); gumeni točkovi vozila (trake za izmjenu gumenih točkova na vozilima); hidraulični sastavi vozila; hidroavioni; hidroglicer; hidrottransformatori; hladnjače (vozila); indikatori smjera kretanja vozila; jahte; jarboli (jarboli za brodove); jarboli (brodarstvo); jarboli za brodove; jastuci za napuvavanje; kabine za žičare; kaiševi za mehaničke prenosnike; kaiševi za mehaničke prenosnike (naplaci glavina) (obodi); kamioneri; kamioni; kamioni (utovarne površine kamiona); karavani; karoserije (djelovi automobila); kočne obloge vozila; kočne papuče vozila; kočne pločice za automobile; kočni segmeni za vozila; kočnice bicikala; kočnice vozila; kola za crijeva za polivanje; kolica (krov dječijih kolica); kolica (seoska kolica bez osovine); kolica sa nagibom; kolica za crijeva za polivanje; kolica za čišćenje; kolica za golf-opremu; kolica za lijev; kolica za namirnice; kolica, dječija; kolica, okretna za istovar (kiper-kolica); kolica, utovarna sa podizačem; kormila; korpe (specijalne korpe prilagođene za motocikle); kosturi vozila (šasije); košare posebno proizvedene za bicikle; krađa vozila (alarmni uređaji protiv krađe vozila); krađa vozila (uređaji za zaštitu protiv krađe vozila); krajevi osovina (rukavci); krovici dječijih kolica; krovici, platneni za dječija kolica; kućišta za mehanizme kopnenih vozila (ne za motore); kuke za čamce (brodarstvo); kuke za vuču vozila; kuke, brodske; kvačila točkova vozila; kvačila za kopnena vozila; kvačila za kopnena vozila (mjenjači); lanci protiv klizanja; lanci za bicikle; lanci, pogonski za kopnena vozila; letjelice (vazdušne lađe); ležaji (kreveti u vozilima); lokomotive; lokomotive (dimnjaci lokomotiva); lokomotive željezničkih vagona; mehanički prenosnici za bicikle; mjenjačke kutije za kopnena vozila; mopedi; mopedi s prikolicom; motocikli; motocikli sa prikolicom; motori (poklopci motora); motori za dvokolice; motori za kopnena vozila; municija (kola za municija); nagibna plastična kolica; navlake za sjedišta bicikla ili motocikla; navlake za sjedišta za vozila; navlake za upravljače (volane) za vozila; nosači za skije na vozilima; obloge, kočne za vozila; obloge, unutrašnje za vozila (tapecirung); ogledala za gledanje unatrag (retrovizori); okviri bicikla; olovni tegovi za uravnoteženje točkova vozila (balansiranje); omnibusi; opruge vješanje za vozila; osovine na točkovima vozila; osovine vozila; padobrani; pedale bicikla; plovna vozila; pogonske mašine (lanci pogonskih mašina za kopnena vozila); pogonske mašine za kopnena vozila; pogonski mašine za pogonska vozila; pogonski mehanizmi za kopnena vozila; poklopci za motore vozila; poklopci, preklopni za vozila; poklopci, ukrasni na vozilima; pokretni bifei (vozila); pokrivači za vozila; pontoni; pretvarači zakretnog momenta za kopnena vozila; prevoz, kablovski (uređaji i postrojenja za kablovski prevoz); prijenosne osovine za kopnena vozila; prikolice (vozila); protivklizne sprave za točkove vozila; protivzasljepljujući uređaji za vozila; prskalice, vozila; pumpe, vazdušne (pribor za vozila); radilice za kopnena vozila; rašlje za vesla (ušice); reakcijski motori za kopnena vozila; reduktori za kopnena vozila (uređaji za smanjenje broja obrtaja); rezervni točkovi (zaštitni pokrivači rezervnih točkova); rezervoari za gorivo na vozilima (čepovi rezervoara za gorivo); ručke bicikla; ručna kolica (drezine); ručna kolica (tačke); sanke na nožno pokretanje; saonice (vozila); signalizatori za kretanje vozila unatrag; sigurnosna sjedišta za djecu u vozilima; sigurnosni kaiševi za sjedišta u vozilima; sigurnosni pojasevi za sjedišta u vozilima; sjedišta (navlake za sjedišta) za bicikle i motorbicikle; sjedišta u vozilima; sjedišta u vozilima (navlaek za sjedišta u vozilima); sjedišta u vozilima (oslonci za glavu na

sjedištima u vozilima); sjedišta za bicikle i motorbikikle; sjedišta, za avione; skale za ulaz u vozila; skele (plovila); skele (tegljanice); skijaški liftovi; skijaški liftovi; spojleri za vozila; spojnice osovina za točkove; spoljne gume vozila (uređaji protiv klizanja spoljnih guma vozila); spoljni rubovi željezničkih točkova; sportska vozila; sprava za održavanje bicikla u zaustavljenom položaju; stakla (brisači stakala); stubići za vezivanje plovila uz obalu (pomorstvo); svemirske letilice; šalupe (barke s 4-8 vesala); šasije za vozila; štitnici od sunca za automobile; teretne dvokolice (kubikaška kolica); točkići za kolica; točkovi (spojnice osovina na točkovima); točkovi (spoljašnje gume za točkove vozila); točkovi (unutrašnje gume za točkove vozila); točkovi vozila (felge za točkove vozila) (felge); točkovi vozila (glavine za vozila); točkovi vozila (osovine na točkovima vozila); točkovi vozila (slobodni točkovi za kopnena vozila); točkovi vozila (šarafi za gumene točkove); točkovi željezničkih vozila (unutrašnji rubovi točkova željezničkih vagona ili tramvaja); točkovi, spojnice osovina točkova (uređaji); torbe sa priborom za krpljenje guma; torziona za poluge za vozila; trake za izmjenu spoljašnjeg sloja automobilskih guma; tramvajska kola; tricikli; trupovi brodova; turbine za kopnena vozila; upravljači bicikla (ručice); upravljači vozila (volani); upravljački lanci za kopnena vozila; upravljački uređaji za brodove; uređaji za istovar, djelovi kamiona i vagona (djelovi vagona); utovar (dizalice za utovar za brodove); utovarne ograde (pokretne utovarne ograde) (djelovi na kopnenih vozila); utovarne površine kamiona; vagon restorani; vagoneti (točkići za vagonete); vagoni; vagoni; vagoni (postolja željezničkih vagona); vagoni hladnjače; vagoni sa ležajevima za spavanje (spavaći vagoni); vagonске spojnice za šine (uređaji za priključak vagona); vazduhoplovstvo (aeronautika) (aparati, mašine i uređaji za vazduhoplovstvo); vazдушna vozila; vazdušni baloni; vazdušni transporteri; ventili za gumene točkove vozila; vesla za čamce; vesla, kratka; viseći amortizeri vozila; vješanje (opruge za vješanje vozila); vjetrobranska stakla; vojna vozila za prevoz; vozila; vozila (alarmni uređaji protiv krađe vozila); vozila (amortizujuće opruge za vozila); vozila (branici vozila)vozila (cerade na vozila); vozila (električna vozila); vozila (felne točkova vozila) (obruči); vozila (gazišta vozila); vozila (gepeci vozila); vozila (glavine točkova vozila)vozila (gumeni točkovi vozila); vozila (hidraulin sistemi vozila); vozila (indikatori smjera vozila); vozila (kočnice vozila); vozila (kosturi vozila) (šasije); vozila (kuke za vuču vozila); vozila (ležaji u vozilima); vozila (motori za kopnena vozila); vozila (olovni tegovi za balansiranje vozila); vozila (osovine za točkove vozila); vozila (poklopci za vozila); vozila (pokrivači za vozila); vozila (protiv klizne sprave za točkove vozila); vozila (protiv zasljepljujući uređaji na vozilima); vozila (prozori vozila); vozila (sigurnosni pojasevi za sjedišta vozila); vozila (sjedišta u vozilima); vozila (spojnice za kopnena vozila) nijesu djelovi mašina; vozila (spoljne gume za točkove vozila); vozila (svemirska vozila); vozila (točkovi vozila); vozila (trube vozila); vozila (unutrašnje obloge vozila) (tapecirung); vozila (upravljači vozila) (volani); vozila (ventili za gumene točkove vozila); vozila (viseći amortizeri vozila); vozila (vrata vozila); vozila hitne pomoći; vozila hladnjače; vozila sa daljinskim upravljanjem (igračke); vozila sa daljinskim upravljanjem (nijesu igračke); vozila sa vazdušnim jastukom; vozila za kretanje po zemlji, po vazduhu, po vodi i na šinama; vozila za snijeg; vozila, vojna za prevoz; vrta vozila; vuča (kuke za vuču vozila); vučni motori; zatvarači za benzinske rezervoare na vozilima; zavjesice za automobile (štitnici od sunca); zupčanici za bicikle; zupčanici za kopnena vozila; zvonca za bicikle; željeznički točkovi (unutrašnji rubovi na točkovima željezničkih vagona ili tramvaja) (oplatnice); željeznički vagoni (postolja za željezničke vagone); željeznički vozni park; žičare; žičare; žičare (vozni park za žičare); žičare sa sjedištima.

Klasa 18: Odjeća, obuća, pokrivala za glavu; amovi za životinje (orma); bebe (nosiljke beba); bičevi; brnjice; brnjice kod duplih uzdi; crijeva za suhomesnate proizvode; djeca (torbe za nošenje djece sa naramenicama); domaćinstvo (kožne presvlake za domaćinstvo); drške štapova za hodanje; hamovi (metalni okovi na hamovima); isprave (dokumenti) (torbe za isprave); jahaća sedla (podmetači za jahaća sedla); jareća koža (koža); kampioni (torbe za kampioni); karton – koža; klizaljke (kaiševi za klizaljke); ključevi (futrele za ključeve); kobasice (crijeva za kobasice); konji (navlake za konjska sedla); konji (pokrivači za konje); konji (povoci za konje); konji (sedla za konje); konji (ulari i povoci za konje); konjska oprema; korbači (bičevi); korpice za podsjetnice; kostur na sedlima; kovčezi od vulkanizovanih vlakana; kovčezi, ručni; kovčežići za prtljag; koža

(imitacija kože); koža (štavljena koža) nije za čišćenje; koža (uzice od kože); koža (vještačka koža); koža (životinjska koža); koža, sirova ili poluobrađena; kože od klaoničke stoke; kožice (opnice dobijene od debelog goveđeg crijeva); kožne niti; kožni povoci, uzice; kožni ukrasi za namještaj; krzna (životinjske kože); kutije; kutije od kože i od kože i kartona; kutije od kože za šešire; kutije od vulkanizovanih vlakana; kutije za isprave; kutije za toaletni pribor; kutije, kožne ili od kartonske kože; lovačke torbe; mala djeca (marama (ešarpe) za nošenje male djece); marama (ešarpe) za nošenje male djece; mreže za nošenje namirnica; mreže, ručne; muzičke partiture (torbe za muzičke partiture); namirnice (mreže za namirnice); namirnice (torbe za namirnice); namještaj (kožni ukrasi za namještaj); naočnjaci za konje (orma); navlake za kišobrane; navlake za ključeve (kožna galanterija); novčanici; obloge za opruge, kožne; obruči (alkice) za kišobrane; odijela (torbe-navlake za odijela) (za putovanja); odjeća za životinje; okovi za ormu; okviri ručnih torbi; opruge (kožne obloge za opruge); orma, am, uzde (oprema za amove); orma, am, uzde (armatura za amove); orma, am, uzde za životinje; pkošce na sedlima; planinarske torbe; planinarski štapovi; plaža (torbe za plažu); podbradnici (kožne trake); podsjetnice (futrele za podsjetnice); pokrivači od krzna; pokrivači za konje; povodci (kaiševi); povodci (kožni povodci); presvlake, kožne za domaćinstvo; psi (ogrlice za pse); putni kovčežići; putni neseseri (kožna galanterija); putovanje (torbe za putovanje); rebra za kišobrane i suncobrane; remeni za vuču (sedlarstvo); remeni, kožni za nošenje preko ramena ili leđa; remenje od kože (remenarstvo); remenje za ormu; ručke za kišobrane; ručke za kovčege; ruksaci (ranci); ruksaci; sedla (konjska sedla); sedla (pritege na sedlima); sedlarski proizvodi; stočna hrana (zobnice (torbe) za stočnu hranu); stolice-štapovi (stolice koje se po potrebi mogu preinačiti u štapove za šetnju); suncobrani; šeširi (kožne kutije za šešire); šipke za kišobrane i suncobrane; školske torbe; štapovi od trske; štapovi za hodanje (ručke štapova za hodanje); štapovi za kišobrane; štapovi, planinarski; štavljena koža; štavljena koža (ne za čišćenje); štitnici za konska koljena; točkići (torbe na točkićima); torbe (ručne torbe); torbe (sportske torbe); torbe (kožna galanterija); torbe sa točkićima; torbe za alat (prazne); torbe za divljač; torbe za hranjenje, zobnice; torbe za kampovanje; torbe za namirnice; torbe za nošenje male djece; torbe za note; torbe za novac (vrećice za novce); torbe za novac, pletene; torbe za plažu; torbe za putovanja (kožna galanterija); torbe za spise (aktovke); torbe za školu; torbe, planinarske; torbe-navlake za odijela (za putovanja); trake kožne; trake od kože; ulari i povodci; uzde (konjska oprema); uzde; uzengije; uzengije (gumeni djelovi za uzengije); uzengije (metalne uzengije) (ostruge); uzice, kožne; ventili (ventili) od kože; vezice (kožne vezice); vojnička oprema od kože; vreće (omotači, džepovi), od kože za ambalažu; zaprežna oprema za životinje; životinje (orglice za životinje); životinjske kože pripremljene za izradu krznarskih proizvoda; životinjske kože

Klasa 24: Tkanine i tekstilni proizvodi koji nijesu obuhvaćeni drugim klasama; pokrivači za krevete i stolove; baloni (tkanine nepropustljive za plin za aeronautičke balone); bilijarski stolovi (uski pokrivači za bilijarske stolove); brokat (vrsta tkanine); damast (tkanina); damast za stolnjake (vrsta fino tkanog platna); domaćinstvo (presvlake od plastike za domaćinstvo; domaćinstvo (tkanine za domaćinstvo); domaćinstvo (zaštitne navlake za domaćinstvo); droget (vrsta poluvunene tkanine); dušeci (navlake za dušeke); dušeci (tkanina za dušeke); esparto (biljka) tkanine od esparta; filc od konoplje (pust); filterske tekstilne tkanine; filter-tkanine za štamparstvo, tekstilne; flanel (tkanina); flaner za sanitarne potrebe; flaše (podloge za flaše); friz (vunena tkanina); gaza (tkanina); grubo tkanje od konoplje; gumirano platno (ne za papirnate proizvode); jaka pamučna tkanina za zavjese (vrsta tkanine); jastuci (navlake za jastuke); jastučnice; juta platna za tapiserije ili za vezenje; jutene tkanine; konoplja (platno od konoplje); konoplja (tkanine od konoplje); krep (tkanina); krepon (tkanina); kreveti (gornji prekrivači za krevete); kreveti (papirni pokrivači za krevete); kreveti (pokrivači za krevete); kupanje (veš za kupanje, osim odjevnih predmeta); lanene tkanine; ljepljive tkanine koje se lijepu toplim postupkom; marabut (tkanina); maramice od tekstila za skidanje šminke; maramice od tekstila, toaletne; maramice džepne od tekstila; moleskin (tkanina); mrežice za kosu; naljepnice od tkanine; navlake lanene (platno); navlake za jastuke (jastučnice); navlake za zaštitu namještaja; obuća (tkanina za obuću); obuća (tkanina za postavljanje obuće); omotači za dušeke; pamučne tkanine; pamučno

platno; peškiri, tekstilni; palstični materijali (zamjene za tkanine); platno za duške; platno za posteljину; platno za sir; platno, gumirano (ne za papirnate proizvode); platno navoštено (stoljnajci); podmetači za boce (stono rublje); pokrivači za krevete; pokrivači za krevete (popluni); pokrivači za putovanje; pokrivači, papirni za krevete; postave (tkanine); postave za šešire; posteljina; posteljina; prekrivači za krevet od perja (prekrivači od perja za noge); presvlake, plastične za domaćinstvo; presvlake tekstilne za domaćinstvo; putni prekrivači; ramija (kineska trava) (tkanine od ramije); rastegljive tkanine; rublje (kućno rublje); rublje (tkanina za rublje); rublje za kupanje (osim odjevnih predmeta); rukavice za toaletne potrebe; salвете od tekstila za stolove; setovi za stol, nepapirnat; sir (platno za pravljenje sira); sita (rijetka tkanina za sita); skidanje šminke (tekstilni peškiri za skidanje šminke); somot (tkanina); somotska tkanina; spavanje (vreće za spavanje) (sašiveni omotači koji zamjenjuju posteljину); staklena vlakna (tkanina od staklenih vlakna za tekstil); staklo (tkanina za brisanje stakla); stolni peškiri, tekstilni; stolno rublje (nepapirnatо stolno rublje); stoljnajci (uski dugački); stoljnajci, nepapirnat; stolovi, bilijarski (pokrivači za bilijarske stolove); svilena tkanina; svilena tkanina za štamparske šablone; šeširi (postave za šešire); ševiot (vunena tkanina); štampane pamučne tkanine (tkanina); štamparstvo (filter-tkanina za štamparstvo; štamparstvo (svilena tkanina za štamparske matrice); taft (svila); tapete (tekstilne, zidne tapete); tekstil, netkani; tekstilni materijal (štofovi); til (tkanina); tkanina; tkanina koja imitira kožu životinja; tkanina koja se lijepi toplim postupkom; tkanina od konjske dlake; tkanina od staklenih vlakana za tekstil; tkanina sa ucrtanim motivima za vezenje; tkanina za brisanje stakla; tkanina za obuću; tkanina za postave; tkanina za tekstilne potrebe; tkanine sa rijetnim nitima; tkanine sa rijetnim nitima za velika sita; tkanine, rastegljive; toaletne daske (presvlake za toaletne daske); toaletne rukavice; toaletni peškiri, tekstilni; trake, tekstilne za zavjese; triko (tkanina); vezenje (tkanina sa ucrtanim motivima za vezenje); vještačka svila (tkanina od vještačke svile) (sintetika); voštana platna (stoljnajci od voštanog platna); vreće za spavanje (sašiveni omotači koji zamjenjuju posteljину); vunene tkanine; zastave (barjaci); zastavice, nepapirne; zastirači za krevete; zavjese, plastične za tuširanje; tavjese od tekstila ili pamučne; zavjese, tekstilne na vratima; zefir, vrsta tkanine; zidne tapete, tekstilne; žersez, vrsta tkanine; životinjska koža (tkanine koje imitiraju životinjsku kožu)

Klasa 25: Odjeća, obuća, pokrivala za glavu; automobilisti (odjeća za automobiliste); biciklisti (odjeća za bicikliste); bluže (radničke bluže); bodi (žensko donje rublje); boe (okovratnici od perja ili krzna); cilindri (pokrivala za glavu); cipele; čarape; čarape (pete čarapa); čarape (podvezice čarapa) (držači); čarape sa gaćicama (hulahopke); čizme (gornji dio čizama) (sare); čizme; čizmice; dodaci na košuljama; dokoljenice (gamaše); dokoljenice (odjevni predmeti); donji veš; donji veš za upijanje znoja; džemperi (puloveri); džepne maramice (odjevni predmeti); džepovi na odjeći; đonovi (đonovi); esparto cipele ili sandale (obuća od platna i šage); ešarpe (šalovi); francuske kape; fudbal (obuća za fudbal) (kopačke); gabardeni (odjevni predmeti); gaćice; gimnastička odjeća; gimnastičke papuče; grijanje nogu (neelektrične vrećice obložene krznom za grijanje nogu); grudnjaci; haljine; haljine na tregere; imitacija kože (odjeća od imitacije kože); jakna ili košulja od platna ili serža za mornare; kabanice; kaljače (galoše); kape, okrugle; kape za glavu; kapice za tuširanje; kapuljače (odjevni predmeti); kaputi; kecelje (odjevni predmeti); klobučarski proizvodi; klompe; kombinezoni (odjeća); kombinezoni za skijanje na vodi; konfekcijska odjeća; košulje; košulje (umeci na košuljama); košulje (zasebno načinjena prsa na košuljama) (plastroni); košulje sa kratkim rukavima); kožna odjeća; kožne trake za obrub (kožnate trake koje obučari ušivaju između dvije deblje kože na obući); kramponi za obuću za fudbal; kratke bluže; kratke čarape (sokne); kratki kaputi (sakoi); kravate; kravate (umjetničke kravate); krzna (odjevni predmeti od krzna); krzneni ogrtači (kaputi); krzneni šalovi (ženski šalovi od krzna); kućne haljine; kućni kupaći ogrtači; kupaći kostimi; kupanje (cipele za kupanje); kupanje (kapice za kupanje); kupanje (muške kupaće gaćice); kupanje (ogrtači za kupanje); kupanje (sandale za kupanje); lente (široki pojasevi); livreje (odore); manžetne (odjevni predmeti); marama za pokrivanje vrata; marama, šalovi (fulari); marama, šalovi za glavu; metalni djelovi za obuću; mitre, biskupske kape (odjevni predmeti); mornarske bluže (kaputi); mufovi (odjevni predmeti); muške gaće; muške kupaće gaće; muški ogrtači; naramenice; naručnici (ukrasi od

tkanine koje sveštenici nose na ruci za vrijeme liturgije); narukvice vunene (pletene); nazuvci, grijači nogu; nošnje; novac (pojasevi za nošenje novca) (odjevni predmeti); obuća (gornji djelovi obuće); obuća (kožne trake za obrub, koje postolari ušivaju između dvije deblje kože na obući); obuća (metalni djelovi za obuću); obuća (potpetice za obuću); obuća (sprave protiv klizanja obuće); obuća (sredstva protiv klizanja za obuću); obuća (vrhovi obuće); obuća; obuća za fudbal; obuća za fudbal (kramponi za obuću za fudbal); obuća za plažu; obuća za skijanje; odjeća (džepovi za odjeću); odjeća (gornja odjeća) (ogrtači); odjeća; odjeća za maskenbale; odjevni predmeti; odore (uniforme); ogrtači (odjevni predmeti); okovratnici koji se skidaju (lažni okovratnici); okovratnici na odjeći; okovratnici, lažni; okviri za šešire; pantalone; papirna odjeća; papuče; pelene od tekstila; pelene od tekstila, u obliku četvorougla za previjanje male djece; pelene za novorođenčad (povoji); pelene-gaćice za odojčad (odjeća); pelerine; pelerine sa kapuljačom; pete za obuću; pidžame; planinarske cipele; plaža (obuća za plažu); plaža (odjeća za plažu); podsuknje; podvezice (držači) za muške čarape; podvezice od elastične tkanine; podvezice za čarape; pojasevi (odjevni predmeti); pokrivači za uči (odjevni predmeti); pončo (vrsta ogrtača); portikle za bebe (nisu od papira); portikle, nepapirne (djeci oko vrata protiv prljanja); postave sašivene (dio odjeće); potkošulje; potkošulje za žene; potpetice; potpetice za čarape; potpetice za obuću; prsluci; prsluci uz tijelo; puloveri; puloveri bez rukava; ribarske bluze; rublje (donje rublje za upijanje znoja); rublje (donje rublje); rukavice (odjevni predmeti); rukavice bez prstiju (radničke rukavice); rukavice za skijanje; sandale; sare (gornji dio čizama); sari (ženski odjevni predmeti); sarong (odjevni predmeti); sjenila za kape; skijanje na vodi (kombinezoni za skijanje na vodi); skijaška obuća; slipovi (donji veš); spavanje (maske za spavanje); sportska obuća; sportske cipele; sportske gaćice; steznici; steznici od struka do kukova; suknje; suknje – pantalone; šeširi; šeširi (okviri za šešire); šeširi od papira; štitnici za kragne; tee-shirts (majce); toge; trake za glavu (odjevni predmeti); tregeri; trikoi (gimnastički dresovi, majce); trikoi (odjevni predmeti); trikotažni odjevni predmeti; turbani; tuširanje (kapice za tuširanje); unutrašnji đonovi (đonovi); vindjakne (kratki sportski kaputi sa kapuljačom); znojnice za pazuh; ženske kape; ženske potkošulje; žerzej (odjevni predmet).

(210) **Ž-2020-64**

(220) 21.02.2020.

(731) "SUNRAF BEACH PROPERTIES" DOO, VASA RAIČKOVIĆA 2B, 81000, PODGORICA, ME

(540)

RESTAURANT PIZZERIA NAPOLI

(550) I

(511) Klasa 35: Oglašavanje i reklamiranje; vođenje komercijalnih poslova; komercijalna administracija; kancelarijski poslovi; oglašavanje [reklamiranje], oglašavanje putem pošte, reklamiranje (iznajmljivanje prostora za potrebe reklamiranja), reklamiranje dopisnim putem, reklamiranje on-line na informatičkoj mreži, reklamiranje putem radija, reklamiranje putem televizije, reklamna dokumentacija (uređenje reklamne dokumentacije), reklamna pošta, reklamni filmovi (proizvodnja reklamnih filmova), reklamni

materijal (iznajmljivanje reklamnog materijala), reklamni materijal (razdioba reklamnog materijala), reklamni materijal (raznošenje reklamnog materijala), reklamni oglasi (širenje reklamnih oglasa), reklamni tekstovi (objavljivanje reklamnih tekstova), reklamni tekstovi (uređenje reklamnih tekstova), televizijsko reklamiranje, vođenje informatičkih kartoteka, vođenje knjiga, vođenje poslova (pomoć u vođenju poslova), vođenje poslova (savjetovanje o vođenju poslova), vođenje poslova (usluge savjetovanja u vezi vođenja poslova), hoteli (administrativno upravljanje hotelima), komercijalna administracija u vezi licenci proizvoda i usluga trećih lica, narudžbine (administrativna obrada narudžbina za kupovinu), organizovanje izložbi u komercijalne ili reklamne svrhe, potrošači (pružanje komercijalnih savjeta i informacija potrošačima), sajmovi (organizovanje sajmova u komercijalne ili reklamne svrhe), zapošljavanje (usluge kancelarije za zapošljavanje), kancelarije za reklamiranje, informacije (kancelarije za komercijalne informacije).

Klasa 36: Osiguranje; finansijski poslovi; monetarni poslovi; upravljanje nekretninama; osiguranje (informacije o osiguranju), finansijska analiza, finansijski poslovi [transakcije], savjetovanje o finansijskim pitanjima, monetarni poslovi, upravljanje građevinskim objektima, upravljanje imovinom, upravljanje nekretninama, zakup nekretnina (davanje u zakup nekretnina).

Klasa 39: Prevoz; ambalažiranje i skladištenje proizvoda; organizovanje putovanja; autobuski prevoz, lična vozila (prevoz ličnim vozilima), pomorski prevoz, prevoz brodom, prevoz robe, putnici (prevoz putnika), uputstva [informacije] o prevozu, zakup broda za prevoz tereta i putnika, ambalažiranje proizvoda, skladištenje, organizovanje putovanja, rezervisanje mjesta za putovanje.

Klasa 41: Obuka; stručno osposobljavanje; razonoda; sportske i kulturne djelatnosti; obuka, predškolska obuka, organizovanje i vođenje radionica za stručno osposobljavanje, profesionalna orijentacija [savjeti u vezi obrazovanja ili osposobljavanja], informacije o razonodi, ljetovanje (usluge kampova za ljetovanje), razonoda posredstvom radija, razonoda posredstvom televizije, iznajmljivanje sportske opreme, iznajmljivanje sportskih terena, kampovi za sportsko usavršavanje, organizovanje sportskih takmičenja, akademije, fizičke vježbe, organizovanje izložba u kulturne i obrazovne svrhe.

Klasa 43: Usluge obezbjeđivanja hrane i pića; privremeno primanje na stan; aranžiranje hrane, hoteli, kafeterije, kafići, restorani, restorani sa samoposluživanjem, rezervacije hotela, rezervisanje privremenog smještaja, turistički apartmani, usluge barova, usluge prijema za privremeni smještaj [upravljanje dolascima i odlascima], usluge snabdjevanja hranom i pićem (catering).

(210) **Ž-2020-65**

(220) 25.02.2020.

(731) Montenegro Adventures d.o.o., Ulica Jovana Tomaševića broj 35, Podgorica, ME

(540)



(550) I

(740) AOD Durutović, Vuksanović & Kraljević, Trg Nezavisnosti 1, 81000

(511) Klasa 39: Organizovanje putovanja.

(210) **Ž-2020-67**

(220) 25.02.2020.

(731) Bojan Joković, Petra Lubarde 114, 81000, Podgorica, ME

(540)



(550) I

(511) Klasa 37: Usluge izgradnje zgrada, puteva, mostova, brana, dalekovoda kao i usluge specijalizovanih preduzeća u području izgradnje, kao što su moleri, limari postavljači centralnog grijanja i pokrivači krovova; popravke, to jest usluge obnavljanja bilo kojeg dotrajalog, oštećenog ili djelimično razrušenog objekta (prenamjena ili obnavljanje zgrada ili nekog drugog objekta čije prvobitno stanje ne zadovoljava).

(210) **Ž-2020-70**

(220) 25.02.2020.

(731) Vans, Inc., 1588 South Coast Drive, 92626, Costa Mesa, California, US

(540)



(550) I

(740) Božidar S. Radulović, Studentska bb, Lamela 3/18, 81000, Podgorica

(511) Klasa 25: Obuća, sportska obuća, patike, čizme, sandale, čizme za skijanje na dasci, majice, košulje, majice bez rukava, puloveri, dukserice, džemperi, pantalone, farmerke, helanke, donji delovi trenerki, šorcevi, dugački šorcevi za kupanje, haljine, suknje, jakne, prsluci, odeća za skijanje, odeća za kupanje, jakne za kišu, pantalone za kišu, čarape, donji veš, kaiševi, rukavice sa jednim

prstom, šalovi i marame, gamašne, štitnici za uši, pokrivala za glavu, šeširi, kape, vunene kape, bandana marame.

(210) **Ž-2020-71**

(220) 26.02.2020.

(731) MARSENIĆ D.O.O. KOTOR, KAVAČ B.B., Kotor, ME

(540)



(550) I

(511) Klasa 43: Usluge obezbjeđivanja hrane i pića; privremeno primanje na stan; usluge koje pružaju lica ili preduzeća čiji cilj je priprema jela ili pića za potrošnju kao i usluge ishrane i smještaja, koje pružaju hoteli, pansioni ili druga preduzeća koja osiguravaju privremeni smještaj; usluge rezervisanja smještaja za putnike, koje pružaju putničke agencije ili posrednici; usluge pansiona za životinje.

(210) **Ž-2020-72**

(220) 27.02.2020.

(731) Colgate-Palmolive Company (a Delaware corporation), 300 Park Avenue, 10022, New York, New York, US

(540) HERBAL SMOOTHIE

(550) I

(740) Jasna Jusić, Dalmatinska 2, 81000, Podgorica

(511) Klasa 3: Pasta za zube i tečnost za ispiranje usta.

(210) **Ž-2020-76**

(220) 03.03.2020.

(731) CRIB & BEER D.O.O. PODGORICA, Njegoševa br.34, 81000, Podgorica, ME

(540)



(550) I

(740) Dragan S. Nikolić, Ul. Veliše Mugoše I/9, 81000, Podgorica

(511) Klasa 16: Ambalaža (kartonska ili papirnata za boce); boce (kartonska ili papirna ambalaža za boce); boce (kartonski ili papirni omoti za boce); boce (papirni podmetači za boce); brošure; časopisi [periodični]; časopisi [revije], čestitke fascikle [kancelarijski pribor]; fascikle [papirni proizvodi]; fascikle za papir; fotografije [štampane]; kalendari; kalendari [godišnjaci]; kalendari kojima se listovi trgaju; katalozi; knjige (oznake za stranice u knjigama); knjige sa pjesmama, letci, flajeri; naljepnice, štamparski blokovi; novine; novine sa stripovima; olovke, omotači za boce, papirnati ili kartonski; pakovanje hrane (folije od papira ili plastike za održavanje vlage, za pakovanje hrane); pivske čaše (podmetači za pivske čaše); plakati (papirnat ili kartonske podloge za plakate); plakati [poster]; plakati, papirni ili kartonski; salvete od papira za stolove; slikarska platna; slikarske četkice; slikarski stalci; slike; stripovi (novine sa stripovima); sveske za pisanje i crtanje; vrećice [omotnice, džepovi], od papira ili plastike za ambalažu.

Klasa 41: Dekor za priredbe (iznajmljivanje dekora za priredbe); digitalne slike (usluge digitalnog snimanja); disk džokeji (usluge disk džokeja) usluge; diskoteke (usluge diskoteka); elektronske publikacije (iskorištavanje elektronskih publikacija koje se ne mogu prenositi on-line); filmovi (prikazivanje igranih filmova); filmovi (proizvodnja filmova); fotografisanje; fotografske reportaže; igre za novac; informacije o obrazovanju; informacije o razonodi; informacije u vezi rekreacije; izdavanje knjiga; izložbe (organizovanje izložbi) u kulturne ili obrazovne svrhe; iznajmljivanje audio uređaja; iznajmljivanje dekora za priredbe; iznajmljivanje igrački; iznajmljivanje kinemato grafskih filmova; iznajmljivanje videokamera; iznajmljivanje videotraka; iznajmljivanje zvučnih snimaka; klubovi (usluge klubova [zabava ili obrazovanje]; knjige (izdavanje knjiga); knjige (posuđivanje knjiga); komponovanje muzike; komponovanje muzike (usluge komponovanja muzike); koncerti (organizovanje i vođenje koncerata); konferencije (organizovanje i vođenje konferencija); kongresi (organizovanje i vođenje kongresa); modne revije za zabavne svrhe (organizovanje); montaža radio i televizijskih programa, muzejske usluge [predstavljanje, izložbe]; muzičke sale; noćni klubovi; objavljivanje knjiga i časopisa, elektronski on line; objavljivanje tekstova [osim u reklamne svrhe]; obrazovanje (informacije o obrazovanju); obrazovanje [obuka]; obuka; obuka [predavanje]; obuka putem dopisivanja; organizovanje i vođenje koncerata; organizovanje i vođenje konferencija; organizovanje i vođenje kongresa; organizovanje i vođenje radionica za stručno osposobljavanje; organizovanje i vođenje razgovora; organizovanje i vođenje seminara;

organizovanje izložba u kulturne i obrazovne svrhe; organizovanje javnih konkursa [obrazovanje ili razonoda]; organizovanje konkursa ljepote; organizovanje plesova; organizovanje spektakla [usluge impresarija]; organizovanje sportskih takmičenja; orkestri (usluge orkestra); pisanje tekstova [ne u reklamne svrhe]; planiranje prijema [razonoda]; posuđivanje knjiga; pozorišne predstave; pozorišni dekor (iznajmljivanje pozorišnog dekora); pozorišni glumci (usluge pozorišnih glumaca); pozorišni preduzetnici [impresariji] (usluge pozorišnih preduzetnika); prijemi (planiranje prijema) [razonoda]; priredbe (iznajmljivanje dekora za priredbe); priredbe [održavanje priredbi]; priredbe (organizovanje priredbi) [usluge impresarija]; priredbe (proizvodnja priredbi); proizvodnja filmova; proizvodnja filmova na video- trakama; proizvodnja muzike; putujuće biblioteke (usluge putujućih biblioteka); radio televizijski programi (montaža radio televizijskih programa); radioaparati i televizori (iznajmljivanje radioaparata i televizora); razgovori (organizovanje i vođenje razgovora); razonoda; razonoda (informacije u vezi razonode); razonoda posredstvom radija; razonoda posredstvom televizije; rekreacija (obavještenja u vezi rekreacije); reportaže (fotografske reportaže); reporterske usluge; rezervisanje mjesta za priredbe; scenarijumi (izrada scenarijuma); seminari (organizovanje i vođenje seminara); simpozijumi (organizacija i vođenje simpozijuma); simpozijumi (organizovanje i vođenje simpozijuma); slobodno vrijeme (usluge za ispunjavane slobodnog vremena); snimanje na videotrake; sportska takmičenja (organizovanje sportskih takmičenja); sportska usavršavana (sportski kampovi za usavršavanje u sportu); sportske oprema (iznajmljivanje sportske opreme osim vozila); studio za snimanje usluge studija za snimanje); tekstovi (objavljivanje tekstova) [osim u reklamne svrhe]; tekstovi (sastavljanje tekstova) [ne u reklamne svrhe]; televizija (razonoda na televiziji); televizijski programi (montaža radio i televizijskih programa); televizori (iznajmljivanje televizora i radioaparata); titlovanje filmova; ulaznice za priredbe (agencije za ulaznice za priredbe) [razonoda]; videotrake (iznajmljivanje videotraka);- videotrake (montaža videotraka); videotrake (proizvodnja filmova na videotrakama); videotrake (snimanje na videotrake); zabavni parkovi(cirkusi); zdravstveni klubovi (usluge zdravstvenih klubova) [održavanje zdravlja i fizičke forme]; zvučni snimci (iznajmljivanje zvučnih).

Klasa 43: Agencije za smještaj [hotelski,pansionski], barovi (usluge barova); hotelske rezervacije (usluge rezervisanja hotela); hotelske usluge; iznajmljivanje aparata za kuvanje; iznajmljivanje privremenog smještaja; iznajmljivanje sala, dvorana za sastanke; iznajmljivanje stolaca, stolova, stolnog rublja i staklenog posuđa; kafane [kafeterije]; kafane;restorani; kantine; ljetovališta; ljetovanje (usluge kampova za ljetovanje); moteli (usluge motela); pansion za životinje; pansioni; pansioni (rezervisanje pansiona);privremeni smještaj (rezervisanje privremenog smještaja); restorani; restorani sa samoposluživanjem; restorani za brzo i stalno posluživanje [snek-barovi]; rezervisanje hotela; rezervisanje pansiona; rezervisanje privremenog smještaja; smještaj (agencije za izdavanje smještaja) [hoteli, pansioni]; smještaj (iznajmljivanje privremenog smještaja); ugostitelji (usluge kateringa).

(210) **Ž-2020-80**

(220) 06.03.2020.

(731) Milan Golović, Radoja Dakića 5/17 stan 24, Podgorica, ME

(540)



(550) I

(740) Dragan S. Nikolić, Ul. Veliše Mugoše I/9, 81000, Podgorica

(511) Klasa 16: Ambalaža (kartonska ili papirnata za boce); boce (kartonska ili papirna ambalaža za boce); boce (kartonski ili papirni omoti za boce); boce (papirni podmetači za boce); brošure; časopisi [periodični]; časopisi [revije], čestitke fascikle [kancelarijski pribor]; fascikle [papirni proizvodi]; fascikle za papir; fotografije [štampane]; kalendari; kalendari [godišnjaci]; kalendari kojima se listovi trgaju; katalogi; knjige (oznake za stranice u knjigama); knjige sa pjesmama, letci, flajeri; naljepnice, štamparski blokovi; novine; novine sa stripovima; olovke, omotači za boce, papirnati ili kartonski; pakovanje hrane (folije od papira ili plastike za održavanje vlage, za pakovanje hrane); pivske čaše (podmetači za pivske čaše); plakati (papirnat ili kartonske podloge za plakate); plakati [poster]; plakati, papirni ili kartonski; salvete od papira za stolove; slikarska platna; slikarske četkice; slikarski stalci; slike; stripovi (novine sa stripovima); sveske za pisanje i crtanje; vrećice [omotnice, džepovi], od papira ili plastike za ambalažu.

Klasa 41: Dekor za priredbe (iznajmljivanje dekora za priredbe); digitalne slike (usluge digitalnog snimanja); disk džokeji (usluge disk džokeja) usluge; diskoteke (usluge diskoteka); elektronske publikacije (iskorištavanje elektronskih publikacija koje se ne mogu prenositi on-line); filmovi (prikazivanje igranih filmova); filmovi (proizvodnja filmova); fotografisanje; fotografske reportaže; igre za novac; informacije o obrazovanju; informacije o razonodi; informacije u vezi rekreacije; izdavanje knjiga; izložbe (organizovanje izložbi) u kulturne ili obrazovne svrhe; iznajmljivanje audio uređaja; iznajmljivanje dekora za priredbe; iznajmljivanje igrački; iznajmljivanje kinemato grafskih filmova; iznajmljivanje videokamera; iznajmljivanje videotraka; iznajmljivanje zvučnih snimaka; klubovi (usluge klubova [zabava ili obrazovanje]; knjige (izdavanje knjiga); knjige (posuđivanje knjiga); komponovanje muzike; komponovanje muzike (usluge komponovanja muzike); koncerti (organizovanje i vođenje koncerata); konferencije (organizovanje i vođenje konferencija); kongresi (organizovanje i vođenje kongresa); modne revije za zabavne svrhe (organizovanje); montaža radio i televizijskih programa, muzejske usluge [predstavljanje, izložbe]; muzičke sale; noćni klubovi; objavljivanje knjiga i časopisa, elektronski on line; objavljivanje tekstova [osim u reklamne svrhe]; obrazovanje (informacije o obrazovanju); obrazovanje [obuka]; obuka; obuka [predavanje]; obuka putem dopisivanja; organizovanje i vođenje koncerata; organizovanje i vođenje konferencija; organizovanje i vođenje kongresa; organizovanje i vođenje radionica za stručno osposobljavanje; organizovanje i vođenje razgovora; organizovanje i vođenje seminara; organizovanje izložba u kulturne i obrazovne svrhe; organizovanje javnih konkursa [obrazovanje ili razonoda]; organizovanje konkursa ljepote; organizovanje plesova; organizovanje spektakla [usluge impresarija]; organizovanje sportskih takmičenja; orkestri (usluge orkestra); pisanje tekstova [ne u reklamne svrhe]; planiranje prijema [razonoda]; posuđivanje knjiga; pozorišne predstave; pozorišni dekor (iznajmljivanje pozorišnog dekora); pozorišni glumci (usluge pozorišnih glumaca); pozorišni preduzetnici [impresariji] (usluge pozorišnih preduzetnika); prijemi (planiranje prijema) [razonoda]; priredbe (iznajmljivanje dekora za priredbe); priredbe [održavanje priredbi]; priredbe (organizovanje priredbi) [usluge impresarija]; priredbe (proizvodnja priredbi); proizvodnja filmova; proizvodnja filmova na video- trakama;

proizvodnja muzike; putujuće biblioteke (usluge putujućih biblioteka); radio televizijski programi (montaža radio televizijskih programa); radioaparati i televizori (iznajmljivanje radioaparata i televizora); razgovori (organizovanje i vođenje razgovora); rasonoda; rasonoda (informacije u vezi rasonode); rasonoda posredstvom radija; rasonoda posredstvom televizije; rekreacija (obavještenja u vezi rekreacije); reportaže (fotografske reportaže); reporterske usluge; rezervisanje mjesta za priredbe; scenarijumi (izrada scenarijuma); seminari (organizovanje i vođenje seminara); simpozijumi (organizacija i vođenje simpozijuma); simpozijumi (organizovanje i vođenje simpozijuma); slobodno vrijeme (usluge za ispunjavane slobodnog vremena); snimanje na videotrake; sportska takmičenja (organizovanje sportskih takmičenja); sportska usavršavana (sportski kampovi za usavršavanje u sportu); sportske oprema (iznajmljivanje sportske opreme osim vozila); studio za snimanje usluge studija za snimanje); tekstovi (objavljivanje tekstova) [osim u reklamne svrhe]; tekstovi (sastavljanje tekstova) [ne u reklamne svrhe]; televizija (rasonoda na televiziji); televizijski programi (montaža radio i televizijskih programa); televizori (iznajmljivanje televizora i radioaparata); titlovanje filmova; ulaznice za priredbe (agencije za ulaznice za priredbe) [rasonoda]; videotrake (iznajmljivanje videotraka);- videotrake (montaža videotraka); videotrake (proizvodnja filmova na videotrakama); videotrake (snimanje na videotrake); zabavni parkovi(cirkusi); zdravstveni klubovi (usluge zdravstvenih klubova) [održavanje zdravlja i fizičke forme]; zvučni snimci (iznajmljivanje zvučnih).

Klasa 43: Agencije za smještaj [hotelski,pansionski], barovi (usluge barova); hotelske rezervacije (usluge rezervisanja hotela); hotelske usluge; iznajmljivanje aparata za kuvanje; iznajmljivanje privremenog smještaja; iznajmljivanje sala, dvorana za sastanke; iznajmljivanje stolaca, stolova, stolnog rublja i staklenog posuđa; kafane [kafeterije]; kafane;restorani; kantine; ljetovališta; ljetovanje (usluge kampova za ljetovanje); moteli (usluge motela); pansion za životinje; pansioni; pansioni (rezervisanje pansiona);privremeni smještaj (rezervisanje privremenog smještaja); restorani; restorani sa samoposluživanjem; restorani za brzo i stalno posluživanje [snek-barovi]; rezervisanje hotela; rezervisanje pansiona; rezervisanje privremenog smještaja; smještaj (agencije za izdavanje smještaja) [hoteli, pansioni]; smještaj (iznajmljivanje privremenog smještaja); ugostitelji (usluge kateringa).

(210) **Ž-2020-86**

(220) 06.03.2020.

(731) Lidl Stiftung & Co. KG , Stiftsbergstrasse 1, 74172, Neckarsulm, DE

(540)



(550) I

(740) Vuk Lutovac, Bulevar Ivana Crnojevića 93, 81000, Podgorica

(511) Klasa 33: Alkoholna pića (osim piva).

(210) **Ž-2020-87**

(220) 06.03.2020.

(731) Pharmaceutical chemical cosmetic industry ALKALOID AD Skopje, blvd. Aleksandar Makedonski 12, 1000, Skopje, MK

(540)



(550) I

(740) Miladin Popović, Đoka Miraševića 21/III, 81000, Podgorica

(511) Klasa 3: Nemedicinska kozmetika i toaletni preparati; nemedicinska sredstva za čišćenje zuba; parfimerija; etarska ulja; preparati za bjeljenje i druge supstance za upotrebu u perionicama; preparati za čišćenje, poliranje, ribanje i abrazivni preparati; sapuni; kozmetički preparati; losioni za kosu; maramice natopljene kozmetičkim losionima; preparati za čišćenje zuba; šamponi; parfemi; kozmetika za djecu; tečni deterdženti; kozmetički preparati za kupanje; toaletna voda; preparati za zaštitu od sunca; kozmetičke kreme; kozmetički preparati za njegu kože; losioni za kozmetičku upotrebu; ulja za kozmetičku upotrebu; ulje od jasmína; ulje od lavande; losioni za tijelo; kreme za lice; dezodoransi za tijelo; talk puder za toaletnu upotrebu.

Klasa 5: Farmaceutski, medicinski i veterinarski preparati; sanitarni preparati za upotrebu u medicini; dijetetska hrana i supstance prilagođene za upotrebu u medicini i veterinarstvu; hrana za bebe; pelene za bebe; dijetetski dodaci za ljude i životinje; flasteri; materijali za previjanje; materijali za plombiranje zuba, zubarski vosak; dezinfekciona sredstva; preparati za uništavanje štetočina; fungicidi, herbicidi.

Klasa 35: Oglašavanje; onlajn oglašavanje na kompjuterskoj mreži; poslovno upravljanje; poslovna administracija; kancelarijske usluge; reklamiranje.

(210) **Ž-2020-88**

(220) 06.03.2020.

(731) Pharmaceutical chemical cosmetic industry ALKALOID AD Skopje, blvd. Aleksandar Makedonski 12, 1000, Skopje, MK

(540)



(550) I

(740) Miladin Popović, Đoka Miraševića 21/III, 81000, Podgorica

(511) Klasa 3: Nemedicinska kozmetika i toaletni preparati; nemedicinska sredstva za čišćenje zuba; parfimerija; etarska ulja; preparati za bijeljenje i druge supstance za upotrebu u perionicama; preparati za čišćenje, poliranje, ribanje i abrazivni preparati; sapuni; kozmetički preparati; losioni za kosu; maramice natopljene kozmetičkim losionima; preparati za čišćenje zuba; šamponi; parfemi; kozmetika za djecu; tečni deterdženti; kozmetički preparati za kupanje; toaletna voda; preparati za zaštitu od sunca; kozmetičke kreme; kozmetički preparati za njegu kože; losioni za kozmetičku upotrebu; ulja za kozmetičku upotrebu; ulje od jasmína; ulje od lavande; losioni za tjelo; kreme za lice; dezodoransi za tjelo; talk puder za toaletnu upotrebu.

Klasa 5: Farmaceutski, medicinski i veterinarski preparati; sanitarni preparati za upotrebu u medicini; dijetetska hrana i supstance prilagođene za upotrebu u medicini i veterinarstvu; hrana za bebe; pelene za bebe; dijetetski dodaci za ljude i životinje; flasteri; materijali za previjanje; materijali za plombiranje zuba, zubarski vosak; dezinfekciona sredstva; preparati za uništavanje štetočina; fungicidi, herbicidi.

Klasa 35: Oglašavanje; onlajn oglašavanje na kompjuterskoj mreži; poslovno upravljanje; poslovna administracija; kancelarijske usluge; reklamiranje.

(210) **Ž-2020-89**

(220) 06.03.2020.

(731) Pharmaceutical chemical cosmetic industry ALKALOID AD Skopje, blvd. Aleksandar Makedonski 12, 1000, Skopje, MK

(540)



(550) I

(740) Miladin Popović, Đoka Miraševića 21/III, 81000, Podgorica

(511) Klasa 3: Nemedicinska kozmetika i toaletni preparati; nemedicinska sredstva za čišćenje zuba; parfimerija; etarska ulja; preparati za bijeljenje i druge supstance za upotrebu u perionicama; preparati za čišćenje, poliranje, ribanje i abrazivni preparati; sapuni; kozmetički preparati; losioni za kosu; maramice natopljene kozmetičkim losionima; preparati za čišćenje zuba; šamponi; parfemi; kozmetika za djecu; tečni deterdženti; kozmetički preparati za kupanje; toaletna voda; preparati za zaštitu od sunca; kozmetičke kreme; kozmetički preparati za njegu kože; losioni za kozmetičku upotrebu; ulja za kozmetičku upotrebu; ulje od jasmina; ulje od lavande; losioni za tjelo; kreme za lice; dezodoransi za tjelo; talk puder za toaletnu upotrebu.

Klasa 5: Farmaceutski, medicinski i veterinarski preparati; sanitarni preparati za upotrebu u medicini; dijetetska hrana i supstance prilagođene za upotrebu u medicini i veterinarstvu; hrana za bebe; pelene za bebe; dijetetski dodaci za ljude i životinje; flasteri; materijali za previjanje; materijali za plombiranje zuba, zubarski vosak; dezinfekciona sredstva; preparati za uništavanje štetočina; fungicidi, herbicidi.

Klasa 35: Oglašavanje; onlajn oglašavanje na kompjuterskoj mreži; poslovno upravljanje; poslovna administracija; kancelarijske usluge; reklamiranje.

(210) **Ž-2020-90**

(220) 06.03.2020.

(731) Pharmaceutical chemical cosmetic industry ALKALOID AD Skopje, blvd. Aleksandar Makedonski 12, 1000, Skopje, MK

(540)



(550) I

(740) Miladin Popović, Đoka Miraševića 21/III, 81000, Podgorica

(511) Klasa 3: Nemedicinska kozmetika i toaletni preparati; nemedicinska sredstva za čišćenje zuba; parfimerija; etarska ulja; preparati za bijeljenje i druge supstance za upotrebu u perionicama; preparati za čišćenje, poliranje, ribanje i abrazivni preparati; sapuni; kozmetički preparati; losioni za kosu; maramice natopljene kozmetičkim losionima; preparati za čišćenje zuba; šamponi; parfemi; kozmetika za djecu; tečni deterdženti; kozmetički preparati za kupanje; toaletna voda; preparati za zaštitu od sunca; kozmetičke

kreme; kozmetički preparati za njegu kože; losioni za kozmetičku upotrebu; ulja za kozmetičku upotrebu; ulje od jasmína; ulje od lavande; losioni za tjelo; kreme za lice; dezodoransi za tjelo; talk puder za toaletnu upotrebu.

Klasa 5: Farmaceutski, medicinski i veterinarski preparati; sanitarni preparati za upotrebu u medicini; dijetetska hrana i supstance prilagođene za upotrebu u medicini i veterinarstvu; hrana za bebe; pelene za bebe; dijetetski dodaci za ljude i životinje; flasteri; materijali za previjanje; materijali za plombranje zuba, zubarski vosak; dezinfekciona sredstva; preparati za uništavanje štetočina; fungicidi, herbicidi.

Klasa 35: Oglašavanje; onlajn oglašavanje na kompjuterskoj mreži; poslovno upravljanje; poslovna administracija; kancelarijske usluge; reklamiranje.

(210) **Ž-2020-91**

(220) 06.03.2020.

(731) KT & G Corporation , 71, Beotkkot-gil, Daedeok-gu, Daejeon, KR

(540)

ESSE GOLDEN LEAF

(550) I

(740) Miladin Popović, Đoka Miraševića 21/III, 81000, Podgorica

(511) Klasa 34: Duvan; cigarete; cigare; burmut; papir za cigarete; lule za duvan; filteri za cigarete; kutije za cigarete (ne od plemenitih metala); vrećice za duvan; upaljači za cigarete (ne od plemenitih metala); šibice; sredstva za čišćenje lula za duvan; pepeljare (ne od plemenitih metala); rezači za cigare.

(210) **Ž-2020-92**

(220) 06.03.2020.

(731) Khayrat Al-Manafa for General Trade and Public Transport Limited Liability company, 27, Saborni str., Varna, BG

(540)



(550) I

(740) Božidar S. Radulović, Studentska bb, Lamela 3/18, 81000, Podgorica

(511) Klasa 34: Duvan; duvan za zamotavanje; zamjena za duvan; proizvodi od duvana; aromatizovani duvan; filteri za duvan; lule za duvan; sirovi duvan; duvan za žvakanje; šibice; sigurnosne šibice; cigarete; cigare; proizvodi za pušače; pribor za pušenje; upaljači za pušače; pepeljare za pušače.

(210) **Ž-2020-93**

(220) 06.03.2020.

(731) Khayrat Al-Manafa for General Trade and Public Transport Limited Liability company, 27, Saborni str., Varna, BG

(540)



(550) I

(740) Božidar S. Radulović, Studentska bb, Lamela 3/18, 81000, Podgorica

(511) Klasa 34: Duvan; duvan za zamotavanje; zamjena za duvan; proizvodi od duvana; aromatizovani duvan; filteri za duvan; lule za duvan; sirovi duvan; duvan za žvakanje; šibice; sigurnosne šibice; cigarete; cigare; proizvodi za pušače; pribor za pušenje; upaljači za pušače; pepeljare za pušače.

(210) **Ž-2020-94**

(220) 06.03.2020.

(731) Pharmalys Laboratories SA, Siedereistrasse 9, Hochdorf, CH-6280, CH

(540)



(550) I

(740) Božidar S. Radulović, Studentska bb, Lamela 3/18, 81000, Podgorica

(511) Klasa 5: Farmaceutski i veterinarski proizvodi; dijetetska hrana i supstance za medicinsku ili veterinarsku upotrebu, hranu za bebe; dodaci ishrani za ljude i životinje; mlijeko u prahu za bebe; hrana za bebe; dijetetski dodaci ishrani.

(210) **Ž-2020-95**

(220) 06.03.2020.

(731) RELIGIOUS TECHNOLOGY CENTER, 1710 Ivar Avenue, Suite 1100, 90028, Los Angeles, California, US

(540)



(550) I

(740) Božidar S. Radulović, Studentska bb, Lamela 3/18, 81000, Podgorica

(511) Klasa 16: Štampane stvari, naime, knjige, magazini, bilteni, priručnici, informacioni paketi i knjige za kurseve u vezi sa religijom i filozofijom.

Klasa 41: Obrazovne usluge, naime, vođenje kurseva, seminara i predavanja u oblasti religije, filozofije i edukacija u vezi sa religijom i filozofijom.

(210) **Ž-2020-97**

(220) 09.03.2020.

(731) Crnogorska Komercijalna Banka AD Podgorica, Ulica Cetinjska br.11, VI sprat, Kula PC1, Poslovni centar The Capital Plaza, 81000, Podgorica, ME

(540)



(550) I

(511) Klasa 16: Brošure, hemijske olovke, kalendari, flajeri, fascikle, kese, rokovnici, koverta, vizit karte, memorandum, kišobrani, svjeske za pisanje, obavještenja.

Klasa 35: Reklamiranje i oglašavanje; vođenje komercijalnih poslova; komercijalna administracija; kancelarijski poslovi.

Klasa 36: Bankarski poslovi i usluge, depozitni poslovi, usluge depozita u sefovima, sigurnosne blagajne [sefovi], odlaganje u

sigurnosne blagajne; kreditni poslovi, krediti, otplata na rate, finansijski poslovi [transakcije], garancije [garancijski poslovi], zalog (davanje zajma uz zalog; monetarni poslovi, novčana sredstva (elektronski prijenos novčanih sredstava), poslovi platnog prometa, devizni poslovi, dugovanje (službe za kartice dugovanja (debit kartice)) izdavanje platnih kartica, kreditne kartice (službe za kreditne kartice), kreditne kartice (izdavanje kreditnih kartica), mjenjački poslovi- mijenjanje novca; finansijski poslovi, finansijske transakcije; poslovi sa hartijama od vrijednosti, brokersko-dilerski poslovi; kupovina, prodaja i naplata potraživanja; poslovi osiguranja - zastupanje u osiguranju, informacije o osiguranju.

Klasa 38: Radio i televizija, elektronske poruke, konferencije na daljinu (omogućavanje vođenja konferencija na daljinu), poruke (prijenos poruka).

(210) **Ž-2020-98**

(220) 09.03.2020.

(731) Crnogorska Komercijalna Banka AD Podgorica, Ulica Cetinjska br.11, VI sprat, Kula PC1, Poslovni centar The Capital Plaza, 81000, Podgorica, ME

(540)



(550) I

(511) Klasa 16: Brošure, hemijske olovke, kalendari, flajeri, fascikle, kese, rokovnici, koverta, vizit karte, memorandum, kišobrani, svjeske za pisanje, obavještenja.

Klasa 35: Reklamiranje i oglašavanje; vođenje komercijalnih poslova; komercijalna administracija; kancelarijski poslovi.

Klasa 36: Bankarski poslovi i usluge, depozitni poslovi, usluge depozita u sefovima, sigurnosne blagajne [sefovi], odlaganje u sigurnosne blagajne; kreditni poslovi, krediti, otplata na rate, finansijski poslovi [transakcije], garancije [garancijski poslovi], zalog (davanje zajma uz zalog; monetarni poslovi, novčana sredstva (elektronski prijenos novčanih sredstava), poslovi platnog prometa, devizni poslovi, dugovanje (službe za kartice dugovanja (debit kartice)) izdavanje platnih kartica, kreditne kartice (službe za kreditne kartice), kreditne kartice (izdavanje kreditnih kartica), mjenjački poslovi- mijenjanje novca; finansijski poslovi, finansijske transakcije; poslovi sa hartijama od vrijednosti, brokersko-dilerski poslovi; kupovina, prodaja i

naplata potraživanja; poslovi osiguranja - zastupanje u osiguranju, informacije o osiguranju.

Klasa 38: Radio i televizija, elektronske poruke, konferencije na daljinu (omogućavanje vođenja konferencija na daljinu), poruke (prijenos poruka).

(210) **Ž-2020-99**

(220) 09.03.2020.

(731) Crnogorska Komercijalna Banka AD Podgorica, Ulica Cetinjska br.11, VI sprat, Kula PC1, Poslovni centar The Capital Plaza, 81000, Podgorica, ME

(540)



(550) I

(511) Klasa 16: Brošure, hemijske olovke, kalendari, flajeri, fascikle, kese, rokovnici, koverta, vizit karte, memorandum, kišobrani, svjeske za pisanje, obavještenja.

Klasa 35: Reklamiranje i oglašavanje; vođenje komercijalnih poslova; komercijalna administracija; kancelarijski poslovi.

Klasa 36: Bankarski poslovi i usluge, depozitni poslovi, usluge depozita u sefovima, sigurnosne blagajne [sefovi], odlaganje u sigurnosne blagajne; kreditni poslovi, krediti, otplata na rate, finansijski poslovi [transakcije], garancije [garancijski poslovi], zalog (davanje zajma uz zalog; monetarni poslovi, novčana sredstva (elektronski prijenos novčanih sredstava), poslovi platnog prometa, devizni poslovi, dugovanje (službe za kartice dugovanja (debit kartice]) izdavanje platnih kartica, kreditne kartice (službe za kreditne kartice), kreditne kartice (izdavanje kreditnih kartica), mjenjački poslovi- mijenjanje novca; finansijski poslovi, finansijske transakcije; poslovi sa hartijama od vrijednosti, brokersko-dilerski poslovi; kupovina, prodaja i naplata potraživanja; poslovi osiguranja - zastupanje u osiguranju, informacije o osiguranju.

Klasa 38: Radio i televizija, elektronske poruke, konferencije na daljinu (omogućavanje vođenja konferencija na daljinu), poruke (prijenos poruka).

(210) **Ž-2020-100**

(220) 09.03.2020.

(731) Crnogorska Komercijalna Banka AD Podgorica, Ulica Cetinjska br.11, VI sprat, Kula PC1, Poslovni centar The Capital Plaza, 81000, Podgorica, ME

(540)



(550) I

(511) Klasa 16: Brošure, hemijske olovke, kalendari, flajeri, fascikle, kese, rokovnici, koverti, vizit karte, memorandum, kišobrani, svjeske za pisanje, obavještenja.

Klasa 35: Reklamiranje i oglašavanje; vođenje komercijalnih poslova; komercijalna administracija; kancelarijski poslovi.

Klasa 36: Bankarski poslovi i usluge, depozitni poslovi, usluge depozita u sefovima, sigurnosne blagajne [sefovi], odlaganje u sigurnosne blagajne; kreditni poslovi, krediti, otplata na rate, finansijski poslovi [transakcije], garancije [garancijski poslovi], zalog (davanje zajma uz zalog; monetarni poslovi, novčana sredstva (elektronski prijenos novčanih sredstava), poslovi platnog prometa, devizni poslovi, dugovanje (službe za kartice dugovanja (debit kartice]) izdavanje platnih kartica, kreditne kartice (službe za kreditne kartice), kreditne kartice (izdavanje kreditnih kartica), mjenjački poslovi- mijenjanje novca; finansijski poslovi, finansijske transakcije; poslovi sa hartijama od vrijednosti, brokersko-dilerski poslovi; kupovina, prodaja i naplata potraživanja; poslovi osiguranja - zastupanje u osiguranju, informacije o osiguranju.

Klasa 38: Radio i televizija, elektronske poruke, konferencije na daljinu (omogućavanje vođenja konferencija na daljinu), poruke (prijenos poruka).

(210) **Ž-2020-101**

(220) 09.03.2020.

(731) Crnogorska Komercijalna Banka AD Podgorica, Ulica Cetinjska br.11, VI sprat, Kula PC1, Poslovni centar The Capital Plaza, 81000, Podgorica, ME

(540)



(550) I

(511) Klasa 16: Brošure, hemijske olovke, kalendari, flajeri, fascikle, kese, rokovnici, koverti, vizit karte, memorandum, kišobrani, svjeske za pisanje, obavještenja.

Klasa 35: Reklamiranje i oglašavanje; vođenje komercijalnih poslova; komercijalna administracija; kancelarijski poslovi.

Klasa 36: Bankarski poslovi i usluge, depozitni poslovi, usluge depozita u sefovima, sigurnosne blagajne [sefovi], odlaganje u sigurnosne blagajne; kreditni poslovi, krediti, otplata na rate, finansijski poslovi [transakcije], garancije [garancijski poslovi], zalog (davanje zajma uz zalog; monetarni poslovi, novčana

sredstva (elektronski prijenos novčanih sredstava), poslovi platnog prometa, devizni poslovi, dugovanje (službe za kartice dugovanja (debit kartice]) izdavanje platnih kartica, kreditne kartice (službe za kreditne kartice), kreditne kartice (izdavanje kreditnih kartica), mjenjački poslovi- mijenjanje novca; finansijski poslovi, finansijske transakcije; poslovi sa hartijama od vrijednosti, brokersko-dilerski poslovi; kupovina, prodaja i naplata potraživanja; poslovi osiguranja - zastupanje u osiguranju, informacije o osiguranju.

Klasa 38: Radio i televizija, elektronske poruke, konferencije na daljinu (omogućavanje vođenja konferencija na daljinu), poruke (prijenos poruka).

(210) **Ž-2020-104**

(220) 11.03.2020.

(731) AKEBONO BRAKE INDUSTRY CO., LTD., 19-5, NIHONBASHI KOAMI-CHO, CHUO-KU, TOKYO, JP

(540)

AKEBONO

(550) I

(740) AOD MSA IP - Milojević Sekulić Advokati, Karađorđeva 65, 11000, Beograd

(511) Klasa 12: Železnička vozila i njihovi delovi i oprema; automobili i njihovi delovi i oprema; motorna vozila na dva točka i njihovi delovi i oprema; bicikli i njihovi delovi i oprema; kočnice (za kopnena vozila).

(210) **Ž-2020-107**

(220) 13.03.2020.

(731) Mika Montenegro DOO, Miloja Pavlovića br.5, 81000, Podgorica, ME

(540)



(550) I

(511) Klasa 29: Zakuske [mali obroci od voća pripremljeni na brzinu]; voćna kaša [pulpa]; voćne kriške; voćne salate; voće, kuvano; voće (konzervisano u alkoholu); uštipci od krompira; supe od mesnih koncentrata; supe od povrća (sastojci za pripremanje supe od povrća); supe od zeleniša; supe, čiste, mesne [bujoni]; salate od povrća; salate od voća; povrće (salate od povrća); pekmezi; mliječni frapei; meso; krompirići (prženi krompirići) [čips]; kobasice [salame]; džemovi.

Klasa 30: Zakuske [mali brzi obroci] od riže, zakuske [mali obroci] od žitarica, voćno tijesto [poslastica]; voćni kolači; visokoproteinske pločice od žitarica; vafel proizvodi; ukrasi za kolače, jestivi; torte; tortilje; tijesto za kolače; špageti; šerbet [voćni sladoled]; šećerni proizvodi; suvi kolačići; sushi [japansko jelo od riže]; sladoled; sendviči; sendviči od sira [cheeseburgeri]; salata (umaci za salatu); riža; riža (kolačići od riže); ravioli [tjestenina]; prehrambena tjestenina; praline; pizza; pića od čokolade; pića od kafe; pića od kakaoa; pecivo (fino sitno pecivo) pecivo [brioši]; palačinke; panceroate; mlijeko, čokoladno [napitak]; mesne pite; makaroni [vrsta tjestenine]; krekeri; kolači; krofna - obična / sa šećerom; krofne sa raznim voćnim / čokoladnim punjenjima i glazurom; jela od brašna; medenjaci; hljeb; čokolada; čokoladne figurice (srce, jaje, slovo, broj i razni predmeti); čokolada (piće od čokolade); čokoladni musevi [pjenice]; čajni kolačići [minjoni].

Klasa 35: Iznajmljivanje reklamnih prostora; marketing, objavljivanje reklamnih tekstova; odnosi s javnošću [propaganda]; oglašavanje [reklamiranje]; pomoć u vođenju poslova; poslovne informacije; preduzeća (pomoć u vođenju komercijalnih ili industrijskih preduzeća); reklamiranje on-line na informatičkoj mreži; reklamni tekstovi (objavljivanje reklamnih tekstova); sajmovi (organizovanje sajмова u komercijalne ili reklamne svrhe); savjeti o organizaciji i vođenju poslova; tržište (traženje tržišta).

Klasa 41: Seminari (organizovanje i vođenje seminara); organizovanje i vođenje seminara; organizovanje i vođenje radionica za stručno osposobljavanje; objavljivanje tekstova [osim u reklamne svrhe]; obuka [predavanje]; obuka putem dopisivanja; planiranje prijema [razonoda]; priredbe (održavanje priredbi); priredbe (organizovanje priredbi) [usluge impresarija]; priredbe (proizvodnja priredbi).

Klasa 43: Ugostitelji (usluge kateringa); restorani; restorani sa samoposluživanjem, restorani za brzo i stalno posluživanje [snek-barovi]; kafane [kafeterije]; kafane-restorani.

(210) **Ž-2020-108**

(220) 13.03.2020.

(731) Mika Montenegro DOO, Miloja Pavlovića br.5, 81000, Podgorica, ME

(540)

Šik&Šiz, LJUBAV NA PRVI GRIZ

(550) I

(511) Klasa 29: Zakuske [mali obroci od voća pripremljeni na brzinu]; voćna kaša [pulpa]; voćne kriške; voćne salate; voće, kuvano; voće (konzervisano u alkoholu); uštipci od krompira; supe od mesnih koncentrata; supe od povrća (sastojci za pripremanje supe od povrća); supe od zeleniša; supe, čiste, mesne [bujoni]; salate od povrća; salate od voća; povrće (salate od povrća); pekmezi; mliječni frapei; meso; krompirići (prženi krompirići) [čips]; kobasice [salame]; džemovi.

Klasa 30: Zakuske [mali brzi obroci] od riže, zakuske [mali obroci] od žitarica, voćno tijesto [poslastica]; voćni

kolači; visokoproteinske pločice od žitarica; vafel proizvodi; ukrasi za kolače, jestivi; torte; tortilje; tijesto za kolače; špageti; šerbet [voćni sladoled]; šećerni proizvodi; suvi kolačići; sushi [japansko jelo od riže]; sladoled; sendviči; sendviči od sira [cheeseburgeri]; salata (umaci za salatu); riža; riža (kolačići od riže); ravioli [tjestenina]; prehrambena tjestenina; praline; pizza; pića od čokolade; pića od kafe; pića od kakaoa; pecivo (fino sitno pecivo) pecivo [brioši]; palačinke; panceroate; mlijeko, čokoladno [napitak]; mesne pite; makaroni [vrsta tjestenine]; krekeri; kolači; krofna - obična / sa šećerom; krofne sa raznim voćnim / čokoladnim punjenjima i glazurom; jela od brašna; medenjaci; hljeb; čokolada; čokoladne figurice (srce, jaje, slovo, broj i razni predmeti); čokolada (piće od čokolade); čokoladni musevi [pjenice]; čajni kolačići [minjoni].

Klasa 35: Iznajmljivanje reklamnih prostora; marketing, objavljivanje reklamnih tekstova; odnosi s javnošću [propaganda]; oglašavanje [reklamiranje]; pomoć u vođenju poslova; poslovne informacije; preduzeća (pomoć u vođenju komercijalnih ili industrijskih preduzeća); reklamiranje on-line na informatičkoj mreži; reklamni tekstovi (objavljivanje reklamnih tekstova); sajmovi (organizovanje sajmova u komercijalne ili reklamne svrhe); savjeti o organizaciji i vođenju poslova; tržište (traženje tržišta).

Klasa 41: Seminari (organizovanje i vođenje seminara); organizovanje i vođenje seminara; organizovanje i vođenje radionica za stručno osposobljavanje; objavljivanje tekstova [osim u reklamne svrhe]; obuka [predavanje]; obuka putem dopisivanja; planiranje prijema [razonoda]; priredbe (održavanje priredbi); priredbe (organizovanje priredbi) [usluge impresarija]; priredbe (proizvodnja priredbi).

Klasa 43: Ugostitelji (usluge kateringa); restorani; restorani sa samoposluživanjem, restorani za brzo i stalno posluživanje [snek-barovi]; kafane [kafeterije]; kafane-restorani.

(210) **Ž-2020-109**

(220) 17.03.2020.

(731) Intercontinental Great Brands LLC, 100 Deforest Avenue, 07936, East Hanover, New Jersey, US

(540)

HALLS Udahni i tamo si

(550) I

(740) Miladin Popović, Đoka Miraševića 21/III, 81000, Podgorica

(511) Klasa 5: Medicinski konditorski proizvodi.

Klasa 30: Ne-medicinski konditorski proizvodi, čokolade, šećerni konditorski proizvodi, konditorski proizvodi uključujući sladić, karamele, slatkiše, žele, bombone, žvakaće gume, smrznute poslastice, ohlađene poslastice, sladoled, kolače, kekse i deserte.

(210) **Ž-2020-110**

(220) 17.03.2020.

(731) Bayer Consumer Care AG, Peter Merian Str. 84, 4052, Basel, CH

(540)



(550) I

(740) Jasna Jusić, Dalmatinska 2, 81000, Podgorica

(511) Klasa 5: Farmaceutski preparati; dodaci prehrani; dijetni prehrambeni proizvodi; dijetne supstance za medicinsku primjenu; dijetna vlakna; probiotički bakterijski preparati za medicinske svrhe; dodaci ishrani za medicinske svrhe.

(210) **Ž-2020-111**

(220) 18.03.2020.

(731) SIDELA SA, Juncal 1363, 11000, Montevideo, UY

(540)

POXIPOL

(550) I

(740) Jasna Jusić, Dalmatinska 2, 81000, Podgorica

(511) Klasa 1: Hemijski proizvodi koji se upotrebljavaju u industriji, nauci i fotografiji, kao i u poljoprivredi, hortikulturi i šumarstvu; neprerađene vještačke smole, neprerađene plastične materije; smješe za gašenje požara i za sprečavanje požara; preparati za kaljenje i zavarivanje; materije za štavljenje životinjske kože i krzna; ljepljive supstance koje se upotrebljavaju u industriji; gitovi i druge materije za punjenja; kompost, stajska đubriva, đubriva; biološki preparati za upotrebu u industriji i nauci.

Klasa 16: Papir i karton; štampane stvari; materijal za uvezivanje knjiga; fotografije; kancelarijski materijal i potrepštine za kancelariju, osim namještaja; ljepila za kancelarijske ili kućne svrhe; materijali za crtanje i materijali za umjetnike; slikarske četke; nastavni i obrazovni materijal; plastične folije, filmovi i kese za umotavanje i pakovanje; štamparska slova, klišeji.

(210) **Ž-2020-112**

(220) 18.03.2020.

(731) Raffles International Limited, 1 Wallich Street, #17-01 Guoco Tower, 078881, Singapore, SG

(540)



(550) I

(740) AOD "Ćupić", Bulevar Džordža Vašingtona 79, 81000, Podgorica

(511) Klasa 36: Poslovi sa nekretninama; upravljanje nekretninama; administracija nekretnina; upravljanje apartmanima ili vilama; usluge upravljanja apartmanima, zgradama i stambenim objektima; upravljanje zgradama [usluge nekretnina]; upravljanje stambenim zgradama; upravljanje finansijama i nekretninama za apartmane i smješta, kao što su hoteli, moteli, hotelski kompleksi, apartmani, rezidencijalni hoteli, turistički domovi i druge rezidencijalne zgrade za kuće za odmor i kampove za odmor; prodaja i iznajmljivanje smještaja, apartmana, studio apartmana, soba unutar hotelskih objekata, hotelskih kompleksa, rezidencijalnih hotela i drugih rezidencijalnih zgrada za kuće za odmor i kampove za odmor; iznajmljivanje i upravljanje smještajem za druge; iznajmljivanje nekretnina na bazi tajm-šera; usluge upravljanja i izdavanja nekretnina na bazi tajm-šeringa; usluge pomoći i konsultantske usluge u oblasti nekretnina; upravljanje i vođenje brendirantog smještaja; upravljanje i vođenje apartmanima i vilama za duži boravak sa odgovarajućom opremom i poslugom; iznajmljivanje stanova; iznajmljivanje i pružanje kancelarija, kancelarijskog prostora i radnih prostora za kolektivnu ili individualnu upotrebu; iznajmljivanje i pružanje zajedničkih radnih prostora ili radnih prostora koji se dijele; iznajmljivanje namještenih kancelarija; usluge u području finansiranja preduzeća i projekata.

Klasa 43: Usluge pružanja hrane i pića; privremeni smještaj; usluge hotela i odmarališta, usluge hotelskog smještaja; usluge rezervacija za hotelski smještaj; iznajmljivanje soba, rezervacija i buking privremenih smještaja; rezervacija za duži i kraći boravak u apartmanima i kondominiumima; pružanje prostora za konferencije, usluge banketa; usluge barova, kafea, restorana, usluge koktel barova i kafeterija, usluge spremanja hrane; rezervacije restorana i jela, objekata za bankete i društvena okupljanja za posebne prilike; informacije o hotelima, odmaralištima, smještajima i restoranima, dostupne kroz bazu podataka koja se može pretraživati preko interneta; pružanje web stranice koja sadrži usluge online rezervacije za smještaj u hotelima, pružanje prostora za kongrese i izložbe; usluge čuvanja djece [jaslice]; pružanje online rezervacija i bukinga za privremeno prenočište i smještaj; rezervacija hotela za druge; rezervacija i buking smještaja u hotelima za druge; informativne, savjetodavne i konsultantske usluge koje se odnose na sve gore navedene usluge; uključujući sve gore navedene usluge koje se pružaju elektronskim putem ili onlajn iz kompjuterske baze podataka ili putem interneta; koje sve usluge su obuhvaćene klasom 43.

(210) **Ž-2020-113**

(220) 19.03.2020.

(731) Century 21 Real Estate LLC, (Delaware limited liability corporation), 175, Park Avenue, NJ 07940, Madison, US

(540)

CENTURY 21 COMMERCIAL

(550) I

(740) Božidar S. Radulović, Studentska bb, Lamela 3/18, 81000, Podgorica

(511) Klasa 36: Osiguranje; finansijski poslovi; novčani (monetarni) poslovi; poslovi vezani za nepokretnosti; usluge posredovanja u poslovima koji se odnose na nepokretnosti; usluge franšiza, naročito obezbeđivanje finansijskih informacija i saveta u vezi sa osnivanjem i/ili upravljanjem poslovanjem koji se odnose na posredovanje u vezi sa nepokretnostima; usluge upravljanja imovinom; usluge agencija za nepokretnosti; lizing nepokretnosti; procena i određivanje vrednosti nepokretnosti; usluge izdavanja nepokretnosti; obezbeđivanje informacija u oblasti nepokretnosti preko interneta; usluge investiranja u nepokretnosti; eskro usluge koje se odnose na nepokretnosti; konsultantske usluge koje se odnose na nepokretnosti; savetodavne i administrativne usluge u vezi sa hipotekama.

(210) **Ž-2020-114**

(220) 19.03.2020.

(731) Century 21 Real Estate LLC, (Delaware limited liability corporation), 175, Park Avenue, NJ 07940, Madison, US

(540)



(550) I

(740) Božidar S. Radulović, Studentska bb, Lamela 3/18, 81000, Podgorica

(511) Klasa 36: Osiguranje; finansijski poslovi; novčani (monetarni) poslovi; poslovi vezani za nepokretnosti; usluge posredovanja u poslovima koji se odnose na nepokretnosti; usluge franšiza, naročito obezbeđivanje finansijskih informacija i saveta u vezi sa osnivanjem i/ili upravljanjem poslovanjem koji se odnose na posredovanje u vezi sa nepokretnostima; usluge upravljanja imovinom; usluge agencija za nepokretnosti; lizing nepokretnosti; procena i određivanje vrednosti nepokretnosti; usluge izdavanja nepokretnosti; obezbeđivanje informacija u oblasti nepokretnosti preko interneta; usluge investiranja u nepokretnosti;

eskre usluge koje se odnose na nepokretnosti; konsultantske usluge koje se odnose na nepokretnosti; savetodavne i administrativne usluge u vezi sa hipotekama.

(210) **Ž-2020-115**

(220) 19.03.2020.

(731) Century 21 Real Estate LLC, (Delaware limited liability corporation), 175, Park Avenue, NJ 07940, Madison, US

(540)

C21 COMMERCIAL

(550) I

(740) Božidar S. Radulović, Studentska bb, Lamela 3/18, 81000, Podgorica

(511) Klasa 36: Osiguranje; finansijski poslovi; novčani (monetarni) poslovi; poslovi vezani za nepokretnosti; usluge posredovanja u poslovima koji se odnose na nepokretnosti; usluge franšiza, naročito obezbeđivanje finansijskih informacija i saveta u vezi sa osnivanjem i/ili upravljanjem poslovanjem koji se odnose na posredovanje u vezi sa nepokretnostima; usluge upravljanja imovinom; usluge agencija za nepokretnosti; lizing nepokretnosti; procena i određivanje vrednosti nepokretnosti; usluge izdavanja nepokretnosti; obezbeđivanje informacija u oblasti nepokretnosti preko interneta; usluge investiranja u nepokretnosti; eskre usluge koje se odnose na nepokretnosti; konsultantske usluge koje se odnose na nepokretnosti; savetodavne i administrativne usluge u vezi sa hipotekama.

(210) **Ž-2020-117**

(220) 24.03.2020.

(731) Tav-Tech Ltd., Haatzmaut Street, Top Rasco Building 40, PO Box 1167, 56000, Yehud, IL

(540)

JETPEEL

(550) I

(740) Miladin Popović, Đoka Miraševića 21/III, 81000, Podgorica

(511) Klasa 10: Hirurški, medicinski i zubarski aparati i instrumenti; aparati za estetsku masažu; gore navedena roba nije u vezi sa aparatima i instrumentima za piling.

(210) **Ž-2020-118**

(220) 26.03.2020.

(731) Electronic Arts Inc., 209 Redwood Shores Parkway, 94065, Redwood City, California, US

(540)

ELECTRONIC ARTS

(550) I

(740) Miladin Popović, Đoka Miraševića 21/III, 81000, Podgorica

(511) Klasa 9: Softver za računarske igre; programi za video igre; programi za elektronske igre; softver za igre za upotrebu na bilo kojoj kompjuterizovanoj platformi, uključujući konzole za igre, terminale za igre, ručne elektronske uređaje, elektronske uređaje za zabavu, mašine za arkadne igre, telekomunikacione uređaje, mobilne telefone i uređaje za elektronsku komunikaciju; interaktivni, računarski, video i elektronski programi za igre koji se mogu preuzimati; softver za računarske igre koji se može preuzimati preko bežičnih uređaja; računarski softver za aplikacije za mobilne telefone; softver za računarske igre i softver za zabavu, naime, grafičke i digitalne muzičke datoteke za upotrebu na ili sa mobilnim i celularnim telefonima, koji se mogu držati u ruci ili samostalno stojati, i drugim bežičnim uređajima; softver za računarske igre i uputstva za korišćenje istih koji se prodaju zajedno kao jedinica i softver za računarske igre koji se može preuzimati; softver za interaktivne igre.

Klasa 41: Usluge zabave, naime, pružanje on-line računarskih igara; usluge zabave, naime, pružanje računarskih igara kojima se pristupa i igra putem mobilnih i celularnih telefona i drugih bežičnih uređaja; pružanje informacija u vezi s elektronskim računarskim igrama koje se pružaju putem Interneta; organizovanje, vođenje i rukovođenje takmičenjima i turnirima video igara; usluge zabave u vidu priređivanja takmičenja u elektronskim sportovima i video igrama, igrama, turnirima i nadmetanjima; usluge zabave, naime, obezbjeđivanje veb stranice sa video zapisima o takmičenjima u video igrama koje se igraju uživo od strane igrača video igara, a koje se ne mogu preuzimati.

(210) **Ž-2020-120**

(220) 02.04.2020.

(731) British American Tobacco (Brands) Inc., 251 Little Falls Drive, Suite 100, 19808-1674, Wilmington, Delaware, US

(540)

LUCKY STRIKE AMBER

(550) I

(740) Miladin Popović, Đoka Miraševića 21/III, 81000, Podgorica

(511) Klasa 34: Cigarete; duvan, sirov ili prerađen; rezani duvan; duvan za lule; proizvodi od duvana; zamjene za duvan (koje nijesu za upotrebu u medicini); cigare, cigarilosi; upaljači za cigarete; upaljači za cigare; šibice; proizvodi za pušače; papir za cigarete; tube za cigarete; filteri za cigarete; džepne mašine za motanje cigareta; ručne mašine za punjenje papirnih tuba duvanom; elektronske cigarete; tečnost za elektronske cigarete; proizvodi od duvana koji se zagrijavaju.

(210) **Ž-2020-121**

(220) 07.04.2020.

(731) AstraZeneca AB, ,, 151 85, Södertälje, SE

(540)

BAKALVIO

(550) I

(740) Branislav Lutovac, Bulevar Ivana Crnojevića 93, 81000, Podgorica

(511) Klasa 5: Farmaceutski preparati i supstance.

(210) **Ž-2020-122**

(220) 07.04.2020.

(731) Lidl Stiftung & Co. KG, Stiftsbergstrasse 1, 74172, Neckarsulm, DE

(540)

GLEN ORCHY

(550) I

(740) Branislav Lutovac, Bulevar Ivana Crnojevića 93, 81000, Podgorica

(511) Klasa 33: Alkoholna pića (osim piva), naročito vina; port vina; crna vina; bijela vina; nepjenušava vina; pjenušava vina; šampanjac; voćna vina; stona vina; kuvana vina; špricer; aperitivi; alkopop pića; apsint; armanjak; akvavit; biteri; brendi, konjak; kalvados; džin; rakija od loze; rakja od višnje; likeri; uzo; rum;

alkoholna pića na bazi ruma, osim pića koji sadrže ale pivo, pivo ili slad; tekila, škotski viski; rakije; viski; vermut, vodka, kokteli na bazi prethodno spomenute robe; međuproizvodi za pripremu alkoholnih pića, naročito sirupi ili koncentracije za proizvodnju alkoholnih koktela.

(210) **Ž-2020-123**

(220) 08.04.2020.

(731) Colgate-Palmolive Company (a Delaware Corporation), 300 Park Avenue, 10022, New York, New York, US

(540)

COLGATE FRUITY COCKTAIL

(550) I

(740) Jasna Jusić, Dalmatinska 2, 81000, Podgorica

(511) Klasa 3: Pasta za zube i tečnost za ispiranje usta.

(210) **Ž-2020-124**

(220) 15.04.2020.

(731) Chevron Intellectual Property LLC (Delaware limited liability company), 6001 Bollinger Canyon Road, 94583, San Ramon, California, US

(540)

VARTECH

(550) I

(740) Božidar S. Radulović, Studentska bb, Lamela 3/18, 81000, Podgorica

(511) Klasa 4: Ulja i masti za podmazivanje i motorna ulja.

(210) **Ž-2020-125**

(220) 16.04.2020.

(731) BÜROTIME MOBILYA SANAYI VE TICARET ANONIM ŞİRKETİ , Konya Organize Sanayi Bölgesi, Evrenköy Caddesi, No:5, Selçuklu-Konya, TR

(540)

bürotime

(550) I

(740) Miladin Popović, Đoka Miraševića 21/III, 81000, Podgorica

(511) Klasa 20: Namještaj, izrađen od bilo koje vrste materijala; dušeci, jastuci, vazdušni dušeci i jastuci, koji nijesu za medicinsku upotrebu, vodeni kreveti, koji nijesu za medicinsku upotrebu; ogledala; košnice, vještačka saća i dijelovi od drveta za saće; stolice za ljuljanje beba, ogradice za bebe, kolijevke, šetalice za bebe; oglasne table, okviri za slike i slikarske radove, identifikacione pločice, koje nijesu od metala; identifikacione oznake, koje nijesu od metala. pločice za ime, koje nijesu od metala; identifikacione oznake od drveta ili sintetičkog materijala; posude za pakovanje od drveta ili plastike, burad za upotrebu u transportu ili za skladištenje, bačve, bubnjevi za skladištenje, tankovi, kutije, kontejneri za skladištenje, kontejneri za transport, sanduci, palete za utovar i zatvarači za gore navedenu robu, sve od drveta ili plastike; sitno oruđe od drveta ili sintetičkih materijala koji su obučeni ovom klasom, oprema za namještaj, od drveta ili sintetičkih materijala, ukrasi i ukrasna roba od drveta, plute, trske za pletenje, trske, pruća, roga, kosti, slonovače, kitove kosti, školjke, ćilibara, sedefa, morske pjene, pčelinjeg voska, plastike ili gipsa, obuhvaćeni ovom klasom, naime figurine, praznični ornamenti za zidove i skulpture, sve izrađeno od drveta, plute, trske za pletenje, trske, pruća, roga, kosti, slonovače, kitove kosti, školjke, ćilibara, sedefa, morske pjene, pčelinjeg voska, plastike ili gipsa; korpe, koje nijesu od metala; korpe za ribolov; kućice, legla i kreveti za kućne ljubimce; prenosive merdevine i pokretne stepenice od drveta ili sintetičkih materijala; zavjese od bambusa, valjci za unutrašnje roletne od letvica [za enterijere], pločaste unutrašnje roletne, zavjese od perli za dekoraciju, kuke za zavjese, prstenovi za zavjese, omče i petlje za zavjese, šipke za zavjese; klinovi za točkiće, koji nijesu od metala.

(210) **Ž-2020-126**

(220) 21.04.2020.

(731) Allied Beverages Adriatic d.o.o., Batajnički drum 18, Zemun, 11080, Beograd, RS

(540)



(550) I

(740) Miladin Popović, Đoka Miraševića 21/III, 81000, Podgorica

(511) Klasa 32: Bezalkoholni napici, uključujući vode za piće, izvorsku vodu, vode sa ukusom, mineralne i gazirane vode; bezalkoholna pića, energetska pića i pića za sportiste; voćna pića i sokovi uključujući kokosovu vodu; i drugi bezalkoholni napici uključujući sirupe, koncentrate, praškove i druge preparate za pripremu napitaka

(210) **Ž-2020-127**

(220) 21.04.2020.

(731) UNITED CARIBBEAN RUM LIMITED, The West Indies Rum Distillery Limited, BB12051, Brighton, Black Rock, St. Michael, BB

(540)

STADES

(550) I

(740) Jasna Jusić, Dalmatinska 2, 81000, Podgorica

(511) Klasa 33: Alkoholna pića, osim piva; likeri; žestoka pića (napici); destilirano vino; rum.

(210) **Ž-2020-128**

(220) 21.04.2020.

(731) ECOSTAR EUROPE DOO, NJEGOŠEVA BR.8, TIVAT, ME

(540)

The logo for 'ecostar EUROPE' features the word 'ecostar' in a lowercase, sans-serif font. The 'e' is red, and the 'o' is grey. Below 'ecostar', the word 'EUROPE' is written in a smaller, red, uppercase, sans-serif font.

(550) I

(740) Jasna Jusić, Dalmatinska 2, 81000, Podgorica

(511) Klasa 9: Mjerni uređaji i oprema, uključujući one za naučne, nautičke, topografske, meteorološke, industrijske i laboratorijske svrhe, termometri, ne za medicinske svrhe, barometri, ampermetri, voltmetri,

higrometri, uređaji za ispitivanje koji se ne koriste u medicinske svrhe, teleskopi, periskopi, kompasi za usmjeravanje, indikatori brzine, laboratorijski aparati, mikroskopi, lupe, fotografije, dvogled, peći i peći za laboratorijske eksperimente; Uređaji za snimanje, prenos ili reprodukciju zvuka ili slike, fotoaparati, fotografske kamere, televizijski aparati, video rekorderi, CD i DVD

plejeri i snimači, MP3 plejeri, računari, desktop računari, tablet računari, nosivi tehnološki uređaji (pametni satovi, narukvice, uređaji koji se postavljaju na glavu), mikrofoni, zvučnici, slušalice, telekomunikacioni uređaji, uređaji za reprodukciju zvuka ili slike, računarski periferni uređaji, mobilni telefoni, maske za mobilne telefone, telefonski aparati, računarski štampači, skeneri [oprema za obradu podataka], fotokopir uređaji; magnetni i optički nosači podataka i računarski softver i programi snimljeni na njima, elektronske publikacije koje se mogu preuzeti i snimiti, kodirane magnetne i optičke kartice, filmovi, TV serije i video muzički snimci snimljeni na magnetnim, optičkim i elektronskim medijima; antene, satelitske antene, pojačala za antene, djelovi za gore navedene robe; uređaji za izdavanje karata, automati za prodaju (ATM); elektronske komponente koje se koriste u elektronskim djelovima mašina i uređaja, poluprovodnici, elektronski sklopovi, integrisana kola, čipovi [integrisana kola], diode, tranzistori [elektronski], magnetne glave za elektronske uređaje, elektronske brave, fotoćelije, uređaji za daljinsko otvaranje i zatvaranje vrata, optički senzori; brojači i indikatori količine za mjerenje količine potrošnje, automatski prekidači vremena; odjeća za zaštitu od nezgoda, radijacije i požara, sigurnosni prsluci i spasilački uređaji i oprema; naočare, sunčane naočare, optička sočiva i futrole, posude, njihovi djelovi i komponente; aparati i instrumenti za provođenje, transformisanje, akumuliranje ili kontrolu električne energije, električni utikači, razvodne kutije [struja], električni prekidači, prekidači, osigurači, prigušnice za rasvjetne uređaje, baterijski starter kablovi, table sa električnim kolima, električni otpornici, električne utičnice, transformatori [struja], električni adapteri, punjači za baterije, električna zvana na vratima, električni i elektronski kablovi, baterije, električni akumulatori, solarni paneli za proizvodnju električne energije; alarmi i protivprovalni alarmi, osim za vozila, električna zvana; signalni uređaji i instrumenti, svjetlosni ili mehanički znakovi za upotrebu u saobraćaju; aparati za gašenje požara, vatrogasne mašine, vatrogasno crijevo i mlaznice za protivpožarno crijevo; radarski uređaji, sonari, aparati i instrumenti za noćno osmatranje; ukrasni magneti; metronomi.

Klasa 11: Instalacije za osvjjetljenje, svjetla za vozila za unutrašnje i spoljašnje prostore; instalacije za grijanje koje koriste čvrsta, tečna ili gasna goriva ili struju, kotlovi za centralno grijanje, kotlovi za instalacije za grijanje, radijatori [grijanje], izmjenjivači toplote, koji nisu djelovi mašina, peći, kuhinjskih šporeta, solarni termički kolektori [grijanje]; generatori pare, gasa i magle, parni kotlovi, osim djelova mašina, acetilenski generatori, kiseonični generatori, generatori azota; instalacije za klimatizaciju i ventilaciju; rashladne instalacije i zamrzivači; električni i plinski uređaji, instalacije i uređaji za pripremanje hrane, sušenje i kuvanje, šporeti, električni lonci za kuvanje, električni grijači za vodu, roštilji, električne sušilice za rublje, fenovi za kosu, uređaji za sušenje ruku; sanitarne instalacije, česme [slavine], instalacije za tuširanje, toaleti [klozeti], tuš kabine i kade za kupanje, kade za kupatilo, šolje za toalete, sudopere, umivaonici [djelovi sanitarnih instalacija], prsteni za slavine za vodu, punjenja (ventili za slavine); aparati za omekšavanje vode, uređaji za prečišćavanje vode, instalacije za prečišćavanje vode, instalacije za prečišćavanje otpadnih voda; električni grijači za krevete i električni pokrivači, koji nisu za medicinsku upotrebu, električni grijači jastuka, električni ili neelektrični grijači za stopala, boce sa toplom vodom, električno grijane čarape; filteri za akvarijume i uređaji za filtriranje akvarijuma; instalacije industrijskog tipa za potrebe kuvanja, sušenja i hlađenja; pasterizatori i sterilizatori.

Klasa 35: Oglašavanje, marketing i odnosi sa javnošću, organizovanje izložbi i sajmova u komercijalne ili reklamne svrhe, dizajn za oglašavanje, obezbjeđivanje onlajn tržišta za kupce i prodavce roba i usluga; kancelarijski poslovi, sekretarske usluge, usluge obezbjeđivanja pretplate na novine za druge, prikupljanje statističkih podataka, iznajmljivanje kancelarijskih mašina, sistematizacija informacija u računarskim bazama podataka, usluge odgovaranja na telefonske pozive za nedostupne pretplatnike;

upravljanje poslovanjem, poslovna administracija i poslovno savjetovanje, računovodstvo, usluge komercijalnog savjetovanja, zapošljavanje osoblja, raspoređivanje osoblja, agencije za zapošljavanje, agencije za uvoz i izvoz, usluge privremenog raspoređivanja osoblja; usluge prodaje putem aukcije; grupisanje, u korist drugih lica, različitih roba, na primjer industrijskih ulja i masti, tečnosti za rezanje, kompozicija za apsorbovanje prašine, vlaženje i vezivanje, čvrstih goriva, uglja, drva za ogrijev, tečnih i gasnih goriva, benzina, dizel goriva, tečnog naftnog gasa, prirodnog gasa, lož ulja i njihovih nehemijskih dodataka, svijeća, fitilja, polurafinisanog voska, voska i parafina za osvjetljenje, električne energije, ruda neplemenitih metala, običnih metala i njihovih legura i poluproizvoda izrađenih od ovih materijala, roba i materijala od običnog metala koji se koriste za potrebe skladištenja, ambalaže, pakovanja i zaklona, metalnih kontejnera (skladištenje, transport), metalnih konstrukcija, metalnih okvira za građevinarstvo, metalnih stubova za građevinarstvo, metalnih kutija, metalnih posuda za ambalažu, aluminijumske folije, metalnih ograda, metalnih zaštitnih pregrada, metalnih cijevi, metalnih kontejnera za skladištenje, metalnih kontejnera za prevoz roba, metalnih merdevina, roba od običnog metala za filtriranje i prosijavanje, koji su uključeni u ovu klasu, vrata, prozora, prozorskih kapaka, roletni i njihovih kutija i fittinga od metala, neelektričnih kablova i žica od metala, željeza, malih metalnih okova, ventilacionih provodnika, ventilacionih otvora, poklopaca za ventilacione otvore, cijevi, poklopaca za dimnjake, poklopaca za šahte, metalnih rešetki za ventilaciju, grijanje, kanalizaciju, telefon, podzemne instalacije za struju i klimatizaciju, metalnih panela ili ploča (nesvjetleće i nemehaničke) za signalizaciju, prikazivanje ruta, reklamne svrhe, metalnih tabli sa natpisima, reklamnih metalnih stubova, metalnih signalnih tabli, nesvjetlećih i nemehaničkih saobraćajnih znakova od metala, metalnih cijevi za transport tečnosti i gasa, metalnih šupljih cijevi i njihovih metalnih fittinga, metalnih ventila, metalnih spojnica za cijevi, metalnih laktova za cijevi, metalnih spojeva za cijevi, metalnih konektora za cijevi, sefova (jake kutije) od metala, metalnih željezničkih materijala, metalnih šina, metalnih željezničkih veza, željezničkih skretnica, metalnih nosača, plutajućih dokova od metala, metalnih bova za sidrenje, sidra, metalnih kalupa za livenje, osim mašinskih djelova, umjetničkih djela od običnih metala ili njihovih legura, metalnih zatvarača, čepova za boce od metala, metalnih šipki, metalnih paleta i metalnih užadi za podizanje, utovar i svrhe transporta, metalnih vješalica, veza, kaiševa, traka i šipki koji se koriste za podizanje i nošenje tereta, klinova za sprječavanje pomijeranja točka, napravljenih prije svega od metala, metalnih letvica za vozila za svrhu dekoracije, mjernih aparata i opreme, uključujući one u naučne, nautičke, topografske, meteorološke, industrijske i laboratorijske svrhe, termometara, ne za medicinsku upotrebu, barometara, ampermetara, voltmetara, higrometara, uređaja za ispitivanje koji nisu za medicinske svrhe, teleskopa, periskopa, kompasa za usmjeravanje, indikatora brzine, laboratorijskih aparata, mikroskopa, lupa, fotografije (bez pokreta), dvogleda, rerni i peći za laboratorijske eksperimente, uređaja za snimanje, prenos ili reprodukciju zvuka ili slika, kamera, fotoaparata, televizora, video rekordera, CD i DVD plejera i rekordera, MP3 plejera, računara, desktop računara, tablet računara, nosivih tehnoloških uređaja (pametni satovi, narukvice, uređaji za glavu), mikrofona, zvučnika, slušalica, telekomunikacionih uređaja, uređaja za reprodukciju zvuka ili slike, računarskih perifernih uređaja, mobilnih telefona, futrola za mobilne telefone, telefona, štampača za računare, skenera [oprema za obradu podataka], fotokopir aparata, magnetnih i optičkih nosača podataka i računarskih softvera i programa snimljenih na njih, elektronskih publikacija koje se mogu preuzeti i snimiti, kodiranih magnetnih i optičkih kartica, filmova, TV serija i video muzičkih klipova snimljenih na magnetnim, optičkim i elektronskim medijima, antena, satelitskih antena, pojačivača za antene, djelova gore navedene robe, uređaja za izdavanje karata, automata za prodaju (ATM), elektronskih komponenti koje se koriste u elektronskim djelovima mašina i uređaja, poluprovodnika, elektronskih kola, integrisanih kola, čipova [integrisana kola], dioda, tranzistora [elektronski], magnetnih glava za elektronske aparate, elektronskih brava, fotočelija, uređaja za daljinsko otvaranje i zatvaranje vrata, optičkih senzora, brojača i indikatora količine za mjerenje potrošnje, automatskih prekidača vremena, odjeće za zaštitu od nezgoda, zračenja i požara, sigurnosnih prsluka kao i uređaja i opreme za spašavanje života,

naočara za vid, sunčanih naočara, optičkih sočiva i futrola, posuda, njihovih djelova i komponenti, uređaja i instrumenta za vođenje, transformisanje, akumuliranje ili kontrolu električne energije, električnih utičnica, razvodnih kutija [struja], električnih prekidača, strujnih prekidača, osigurača, prigušivača za rasvjetne uređaje, kablova za startere akumulatora, električnih štampanih ploča, električnih otpornika, električnih utičnica, transformatora [električna energija], električnih adaptera, punjača za baterije, električnih zvona na vratima, električnih i elektronskih kablova, baterija, električnih akumulatora, solarnih panela za proizvodnju električne energije, alarma i protivprovalnih alarma, osim za vozila, električnih zvona, signalnih aparata i instrumenata, svjetlosnih ili mehaničkih znakova za upotrebu u saobraćaju, aparata za gašenje požara, vatrogasnih vozila, protivpožarnih crijeva i mlaznica za vatrogasno crijevo, radarskih uređaja, sonara, aparata i instrumenata za noćno osmatranje, ukrasnih magneta, metronoma, rasvjetnih instalacija, svjetla za vozila za unutrašnje i spoljašnje prostore, instalacija za grijanje koje koriste čvrsta, tečna ili plinska goriva ili električnu energiju, kotlova za centralno grijanje, kotlova za instalacije za grijanje, radijatora [grijanje], razmjenjivača toplote, koji nisu djelovi mašina, peći, kuhinjskih šporeta, solarnih termičkih kolektora [grijanje], generatora pare, gasa i magle, parnih kotlova, osim djelova mašina, generatora acetilena, generatora kiseonika, generatora azota, instalacija za klimatizaciju i ventilaciju, rashladnih instalacija i zamrzivača, električnih i uređaja na gas, instalacija i uređaja za kuvanje, sušenje i ključanje, šporeta, električnih lonaca za kuvanje, električnih grijača vode, roštilja, električnih mašina za sušenje veša, fenova za kosu, uređaja za sušenje ruku, sanitarnih instalacija, slavina [česme], tuš instalacija, toaleta [klozeti], kabina za tuširanje i kupanje, kada, toaletnih šolja, sudopera, umivaonika [djelovi sanitarnih instalacija], prstenova za slavine za vodu, punjenja (ventili za slavine), uređaja za omekšavanje vode, uređaja za prečišćavanje vode, instalacija za prečišćavanje vode, instalacija za prečišćavanje otpadnih voda, električnih grijača za krevete i električnih ćebadi, ne za medicinsku upotrebu, električnih grijača za jastuke, električnih ili neelektričnih grijača za stopala, flaša sa toplom vodom, električno grijanih čarapa, filtera za akvarijume i aparata za filtriranje akvarijuma, industrijskih uređaja za kuvanje, sušenje i hlađenje, pasterizatora i sterilizatora, papira i kartona, papira i kartona za potrebe pakovanja i ambalaže, kartonskih kutija, papirnih peškira, toaletnih papira, papirnih salveta, plastičnih materijala za potrebe pakovanja i ambalaže, štamparskih klišeja i vrsta, materijala za uvezivanje knjiga, štampanih publikacija, štamparskih proizvoda, knjiga, časopisa, novina, knjiga računara, štampanih otpremnih listova, štampanih vaučera, kalendara, plakata, fotografija [štampane], slika, naljepnica [kancelarijski pribor], poštanskih markica, pribora za pisanje, kancelarijskog pribora, materijala za nastavu i obuku [osim namještaja i aparata], pribora za pisanje i crtanje, materijala za umjetnike, proizvoda od papira za kancelarijsku upotrebu, ljepila za kancelarijsku upotrebu, hemijskih olovaka, grafitnih olovaka, gumica, samoljepljivih traka za kancelarijsku upotrebu, kartonskih ambalaža [materijal za umjetnike], papira za pisanje, papira za kopiranje, papirnih rolni za izdavanje fiskalnih računa, materijala za crtanje, školskih tabli, olovaka za slikanje, vodenih bojica (slike), kancelarijskih rekvizita, valjaka i četkica za slikanje, omogućavajući kupcima da jednostavno pregledaju i kupe tu robu, takve usluge mogu pružiti maloprodajne radnje, veleprodajni objekti, putem elektronskih medija ili preko kataloga za naručivanje robe poštom.

Klasa 37: Građevinske usluge, iznajmljivanje građevinskih mašina i opreme; usluge čišćenja zgrada (unutrašnjih i vanjskih površina), javnih površina, industrijskih prostorija, usluge dezinfekcije, usluge uništavanja štetočina, osim u poljoprivredi, iznajmljivanje mašina i opreme za čišćenje; servisne stanice za kopnena vozila, održavanje, popravke i dopunjavanje goriva za kopnena vozila; servisne stanice za morska plovila, održavanje, popravke i dopunjavanje goriva za morska plovila; popravka i održavanje vazdušnih vozila; tapaciranje, popravka i restauracija namještaja; instalacija, održavanje i popravka instalacija za grijanje, hlađenje i sanitarije; čišćenje, zaštita i popravka odjeće; instalacija, održavanje i popravka industrijskih mašina i opreme, kancelarijskih mašina i opreme, komunikacijskih uređaja, električnih i

elektronskih uređaja; popravka i održavanje liftova; popravka satova i ručnih satova; rudarske usluge i vađenje rude; popravka obuće, torbi i kaiševa.

(210) **Ž-2020-129**

(220) 22.04.2020.

(731) The Procter & Gamble Company, One Procter & Gamble Plaza, 45202, Cincinnati, Ohio, US

(540)

LENOR PROFESSIONAL FORMULA

(550) I

(740) Branislav Lutovac, Bulevar Ivana Crnojevića 93, 81000, Podgorica

(511) Klasa 3: Sredstva za izbjeljivanje; preparati za čišćenje; eterična ulja; omekšivači za veš; izbjeljivači za veš; preparati za upotrebu prilikom pranja veša; ulja za čišćenje; sapun; sredstva za uklanjanje fleka.

(210) **Ž-2020-132**

(220) 28.04.2020.

(731) Dragutin Kontić, Trg Nikole Kovačevića br. 1, 81000, Podgorica, ME

(540)



(550) I

(511) Klasa 35: Oglašavanje i reklamiranje; vođenje komercijalnih poslova; komercijalna administracija; kancelarijski poslovi.

Klasa 38: Telekomunikacije.

Klasa 43: Usluge obezbjeđivanja hrane i pića.

(210) **Ž-2020-133**

(220) 30.04.2020.

(731) TMH Worldwide, LLC, 22 Sylvan Way, 07054, Parsippany, New Jersey, US

(540)

TRADEMARK COLLECTION

(550) I

(740) Jasna Jusić, Dalmatinska 2, 81000, Podgorica

(511) Klasa 43: Usluge smještaja u hotel rizortima, hotelima, motelima i restoranske usluge; pravljenje rezervacija smještaja u ime drugih; ugostiteljske usluge, naime, pružanje smještaja, hrane i pića; hotel, smeštaj i prenoćište.

(210) **Ž-2020-134**

(220) 30.04.2020.

(731) Lidl Stiftung & Co. KG , Stiftsbergstrasse 1, 74172, Neckarsulm, DE

(540)



(550) I

(740) Branislav Lutovac, Bulevar Ivana Crnojevića 93, 81000, Podgorica

(511) Klasa 33: Alkoholna pića (osim piva), naročito vermut, kokteli.

(210) **Ž-2020-135**

(220) 30.04.2020.

(731) Lidl Stiftung & Co. KG , Stiftsbergstrasse 1, 74172, Neckarsulm, DE

(540)



(550) I

(740) Branislav Lutovac, Bulevar Ivana Crnojevića 93, 81000, Podgorica

(511) Klasa 3: Sredstva za čišćenje zuba, za nemedicinsku upotrebu, preparati za oralnu i zubnu higijenu (osim sredstava za njegu usana), naročito preparati za ispiranje usta, sprejevi za usta, za nemedicinsku upotrebu, tablete za bojanje kamenca, preparati za izbjeljivanje zuba (za nemedicinsku upotrebu); sva gore navedena roba u klasi 03.

Klasa 5: Ljepila za proteze, ljepila za zubnu i stomatološku upotrebu.

Klasa 21: Četkice za zube, glave za četkice za zube, konac za čišćenje zuba.

(210) **Ž-2020-136**

(220) 30.04.2020.

(731) Alvogen Pharma Trading Europe EOOD (Bulgaria), 86A Bulgaria Blvd, 1st Floor., 1680, Sofia, BG

(540)

VARLOTA

(550) I

(740) Miladin Popović, Đoka Miraševića 21/III, 81000, Podgorica

(511) Klasa 5: Farmaceutski preparati, naročito za liječenje kancera, svi u klasi 05.

(210) **Ž-2020-137**

(220) 04.05.2020.

(731) Reign Beverage Company LLC, a Delaware limited liability company, 1547 N. Knowles Ave., 90063, Los Angeles, California, US

(540)



(550) I

(740) Božidar S. Radulović, Studentska bb, Lamela 3/18, 81000, Podgorica

(511) Klasa 32: Bezalkoholna pića, uključujući gazirana pića i energetska pića; sirupi, koncentri, praškasti preparati i drugi preparati za proizvodnju pića, uključujući gazirana pića i energetska pića; pivo.

(210) **Ž-2020-139**

(220) 05.05.2020.

(731) Benson & Hedges (Overseas) Limited, Globe House, 4 Temple Place, WC2R 2PG, London, GB

(540)

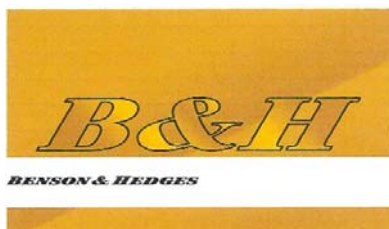

(550) I

(740) Miladin Popović, Đoka Miraševića 21/III, 81000, Podgorica

(511) Klasa 34: Cigarete; duvan, sirov ili prerađen; duvan za samostalno zamotavanje; duvan za lule; duvanski proizvodi; zamjene za duvan (koje nijesu za upotrebu u medicini); cigare; cigarilosi; upaljači za cigarete; upaljači za cigare; šibice; artikli za pušače; cigaret papir, cigaret tube, filteri za cigarete; džepni aparati za zamotavanje cigareta; ručne mašine za ubrizgavanje duvana u papirne tube; elektronske cigarete; tečnosti za elektronske cigarete; duvanski proizvodi namijenjeni za zagrijavanje.

(210) **Ž-2020-140**

(220) 05.05.2020.

(731) American-Cigarette Company (Overseas) Limited, Route de France 17, 2926, Boncourt, CH

(540)

PETER STUYVESANT

(550) I

(740) Miladin Popović, Đoka Miraševića 21/III, 81000, Podgorica

(511) Klasa 34: Cigarete; duvan, sirov ili prerađen; duvan za samostalno zamotavanje; duvan za lule; duvanski proizvodi; zamjene za duvan (koje nijesu za upotrebu u medicini); cigare; cigarilosi; upaljači za cigarete; upaljači za cigare; šibice; artikli za pušače; cigaret papir, cigaret tube, filteri za cigarete; džepni aparati za zamotavanje cigareta; ručne mašine za ubrizgavanje duvana u papirne tube; elektronske cigarete; tečnosti za elektronske cigarete; duvanski proizvodi namijenjeni za zagrijavanje.

(210) **Ž-2020-141**

(220) 06.05.2020.

(731) Colgate-Palmolive Company (a Delaware Corporation), 300 Park Avenue, 10022, New York, New York, US

(540)

COLGATE LINK

(550) I

(740) Jasna Jusić, Dalmatinska 2, 81000, Podgorica

(511) Klasa 21: Četkice za zube.

(210) **Ž-2020-142**

(220) 06.05.2020.

(731) Lambda Group d.o.o. Bar, Bulevar revolucije 10-B, 85000, Bar, ME

(540)



(550) I

(511) Klasa 36: Finansijski poslovi; Monetarni poslovi; Usluge u vezi sa finansijskim i monetarnim poslovima; Usluge u vezi sa izdavanjem faktura; usluge vođenja računovodstvene dokumentacije: usluge administriranja finansijskom dokumentacijom; usluge izrade finansijskih izvještaja; usluge elektronske fiskalizacije izdatih faktura/računa.

Klasa 42: Naučne i tehnološke usluge kao i pripadajuće usluge istraživanja i koncepcije; usluge industrijskih analiza i istraživanja; koncepcija i razvoj računara i računarskih programa/ hardvera i softvera/; usluge koje pružaju lica, individualno ili kolektivno, u vezi s teorijskim ili praktičnim vidovima složenih područja djelatnosti; usluge inženjera koji se bave procjenama, ocjenama, istraživanjima i izvještajima u području nauke i tehnologije; usluge naučnih istraživanja u statističke svrhe.

(210) **Ž-2020-143**

(220) 07.05.2020.

(731) KT & G Corporation , 71, Beotkkot-gil, Daedeok-gu, Daejeon, KR

(540)

KT&G EDGE GRIP

(550) I

(740) Miladin Popović, Đoka Miraševića 21/III, 81000, Podgorica

(511) Klasa 34: Duvan; cigarete; cigare; burmut; papir za cigarete; lule za duvan; filteri za cigarete; kutije za cigarete (ne od plemenitih metala); kesice za duvan; upaljači za cigarete (ne metala); rezači za cigarete od plemenitih metala); šibice; sredstva za čišćenje lula za duvan; pepeljare za pušaće (ne od plemenitih metala); rezači za cigare.

(210) **Ž-2020-144**

(220) 07.05.2020.

(731) KT & G Corporation , 71, Beotkkot-gil, Daedeok-gu, Daejeon, KR

(540)

KT&G EDGE POP

(550) I

(740) Miladin Popović, Đoka Miraševića 21/III, 81000, Podgorica

(511) Klasa 34: Duvan; cigarete; cigare; burmut; papir za cigarete; lule za duvan; filteri za cigarete; kutije za cigarete (ne od plemenitih metala); kesice za duvan; upaljači za cigarete (ne od plemenitih metala); šibice; sredstva za čišćenje lula za duvan; pepeljare za pušače (ne od plemenitih metala); rezači za cigare.

(210) **Ž-2020-145**

(220) 07.05.2020.

(731) KT & G Corporation , 71, Beotkkot-gil, Daedeok-gu, Daejeon, KR

(540)

KT&G RAISON

(550) I

(740) Miladin Popović, Đoka Miraševića 21/III, 81000, Podgorica

(511) Klasa 34: Duvan; cigarete; cigare; burmut; papir za cigarete; lule za duvan; filteri za cigarete; kutije za cigarete (ne od plemenitih metala); kesice za duvan; upaljači za cigarete (ne od plemenitih metala); šibice; sredstva za čišćenje lula za duvan; pepeljare za pušače (ne od plemenitih metala); rezači za cigare.

(210) **Ž-2020-146**

(220) 07.05.2020.

(731) KT & G Corporation , 71, Beotkkot-gil, Daedeok-gu, Daejeon, KR

(540)

KT&G THIS

(550) I

(740) Miladin Popović, Đoka Miraševića 21/III, 81000, Podgorica

(511) Klasa 34: Duvan; cigarete; cigare; burmut; papir za cigarete; lule za duvan; filteri za cigarete; kutije za cigarete (ne od plemenitih metala); kesice za duvan; upaljači za cigarete (ne od plemenitih metala); šibice; sredstva za čišćenje lula za duvan; pepeljare za pušače (ne od plemenitih metala); rezači za cigare.

(210) **Ž-2020-147**

(220) 07.05.2020.

(731) KT & G Corporation , 71, Beotkkot-gil, Daedeok-gu, Daejeon, KR

(540)

KT&G TIME

(550) I

(740) Miladin Popović, Đoka Miraševića 21/III, 81000, Podgorica

(511) Klasa 34: Duvan; cigarete; cigare; burmut; papir za cigarete; lule za duvan; filteri za cigarete; kutije za cigarete (ne od plemenitih metala); kesice za duvan; upaljači za cigarete (ne od plemenitih metala); šibice; sredstva za čišćenje lula za duvan; pepeljare za pušače (ne od plemenitih metala); rezači za cigare.

(210) **Ž-2020-148**

(220) 07.05.2020.

(731) KT & G Corporation , 71, Beotkkot-gil, Daedeok-gu, Daejeon, KR

(540)

KT&G TIMELESS TIME

(550) I

(740) Miladin Popović, Đoka Miraševića 21/III, 81000, Podgorica

(511) Klasa 34: Duvan; cigarete; cigare; burmut; papir za cigarete; lule za duvan; filteri za cigarete; kutije za cigarete (ne od plemenitih metala); kesice za duvan; upaljači za cigarete (ne od plemenitih metala); šibice; sredstva za čišćenje lula za duvan; pepeljare za pušače (ne od plemenitih metala); rezači za cigare.

(210) **Ž-2020-150**

(220) 07.05.2020.

(731) KT & G Corporation , 71, Beotkkot-gil, Daedeok-gu, Daejeon, KR

(540)

EDGE

(550) I

(740) Miladin Popović, Đoka Miraševića 21/III, 81000, Podgorica

(511) Klasa 34: Duvan; cigarete; cigare; burmut; papir za cigarete; lule za duvan; filteri za cigarete; kutije za cigarete (ne od plemenitih metala); kesice za duvan; upaljači za cigarete (ne od plemenitih metala); šibice; sredstva za čišćenje lula za duvan; pepeljare za pušače (ne od plemenitih metala); rezači za cigare.

(210) **Ž-2020-151**

(220) 07.05.2020.

(731) KT & G Corporation , 71, Beotkkot-gil, Daedeok-gu, Daejeon, KR

(540)

EDGE GRIP

(550) I

(740) Miladin Popović, Đoka Miraševića 21/III, 81000, Podgorica

(511) Klasa 34: Duvan; cigarete; cigare; burmut; papir za cigarete; lule za duvan; filteri za cigarete; kutije za cigarete (ne od plemenitih metala); kesice za duvan; upaljači za cigarete (ne od plemenitih metala); šibice; sredstva za čišćenje lula za duvan; pepeljare za pušače (ne od plemenitih metala); rezači za cigare.

(210) **Ž-2020-152**

(220) 07.05.2020.

(731) KT & G Corporation , 71, Beotkkot-gil, Daedeok-gu, Daejeon, KR

(540)

EDGE POP

(550) I

(740) Miladin Popović, Đoka Miraševića 21/III, 81000, Podgorica

(511) Klasa 34: Duvan; cigarete; cigare; burmut; papir za cigarete; lule za duvan; filteri za cigarete; kutije za cigarete (ne od plemenitih metala); kesice za duvan; upaljači za cigarete (ne od plemenitih metala); šibice; sredstva za čišćenje lula za duvan; pepeljare za pušače (ne od plemenitih metala); rezači za cigare.

(210) **Ž-2020-153**

(220) 07.05.2020.

(731) KT & G Corporation , 71, Beotkkot-gil, Daedeok-gu, Daejeon, KR

(540)

KT&G BOHEM

(550) I

(740) Miladin Popović, Đoka Miraševića 21/III, 81000, Podgorica

(511) Klasa 34: Duvan; cigarete; cigare; burmut; papir za cigarete; lule za duvan; filteri za cigarete; kutije za cigarete (ne od plemenitih metala); kesice za duvan; upaljači za cigarete (ne od plemenitih metala); šibice; sredstva za čišćenje lula za duvan; pepeljare za pušače (ne od plemenitih metala); rezači za cigare.

(210) **Ž-2020-154**

(220) 07.05.2020.

(731) KT & G Corporation , 71, Beotkkot-gil, Daedeok-gu, Daejeon, KR

(540)

KT&G EDGE

(550) I

(740) Miladin Popović, Đoka Miraševića 21/III, 81000, Podgorica

(511) Klasa 34: Duvan; cigarete; cigare; burmut; papir za cigarete; lule za duvan; filteri za cigarete; kutije za cigarete (ne od plemenitih metala); kesice za duvan; upaljači za cigarete (ne od plemenitih metala); šibice; sredstva za čišćenje lula za duvan; pepeljare za pušače (ne od plemenitih metala); rezači za cigare.

(210) **Ž-2020-155**

(220) 07.05.2020.

(731) KT & G Corporation , 71, Beotkkot-gil, Daedeok-gu, Daejeon, KR

(540)

THIS PLUS

(550) I

(740) Miladin Popović, Đoka Miraševića 21/III, 81000, Podgorica

(511) Klasa 34: Duvan; cigarete; cigare; burmut; papir za cigarete; lule za duvan; filteri za cigarete; kutije za cigarete (ne od plemenitih metala); kesice za duvan; upaljači za cigarete (ne od plemenitih metala); šibice; sredstva za čišćenje lula za duvan; pepeljare za pušače (ne od plemenitih metala); rezači za cigare.

(210) **Ž-2020-156**

(220) 07.05.2020.

(731) KT & G Corporation , 71, Beotkkot-gil, Daedeok-gu, Daejeon, KR

(540)

THIS

(550) I

(740) Miladin Popović, Đoka Miraševića 21/III, 81000, Podgorica

(511) Klasa 34: Duvan; cigarete; cigare; burmut; papir za cigarete; lule za duvan; filteri za cigarete; kutije za cigarete (ne od plemenitih metala); kesice za duvan; upaljači za cigarete (ne od plemenitih metala); šibice; sredstva za čišćenje lula za duvan; pepeljare za pušače (ne od plemenitih metala); rezači za cigare.

(210) **Ž-2020-157**

(220) 07.05.2020.

(731) KT & G Corporation , 71, Beotkkot-gil, Daedeok-gu, Daejeon, KR

(540)

RAISON

(550) I

(740) Miladin Popović, Đoka Miraševića 21/III, 81000, Podgorica

(511) Klasa 34: Duvan; cigarete; cigare; burmut; papir za cigarete; lule za duvan; filteri za cigarete; kutije za cigarete (ne od plemenitih metala); kesice za duvan; upaljači za cigarete (ne od plemenitih metala); šibice; sredstva za čišćenje lula za duvan; pepeljare za pušače (ne od plemenitih metala); rezači za cigare.

(210) **Ž-2020-158**

(220) 08.05.2020.

(731) BONIFAR d.o.o., Omladinskih brigada 80/1, 11070, Novi Beograd, RS

(540)

RESPILONG

(550) I

(740) Miladin Popović, Đoka Miraševića 21/III, 81000, Podgorica

(511) Klasa 5: Dijetetski proizvodi; farmaceutski preparati; sanitarni preparati za medicinsku upotrebu.

(210) **Ž-2020-159**

(220) 08.05.2020.

(731) Colgate-Palmolive Company, a Delaware Corporation, 300 Park Avenue, 10022, New York, New York, US

(540)

COLGATE ELIXIR

(550) I

(740) Jasna Jusić, Dalmatinska 2, 81000, Podgorica

(511) Klasa 3: Pasta za zube i tečnost za ispiranje usta.

(210) **Ž-2020-162**

(220) 19.05.2020.

(731) Vanguard Trademark Holdings USA LLC , 600 Corporate Park Drive, 63105, St. Louis, Missouri, US

(540)

ALAMO

(550) I

(740) Jasna Jusić, Dalmatinska 2, 81000, Podgorica

(511) Klasa 39: Usluge iznajmljivanja i lizinga vozila i usluge rezervisanja za iznajmljivanje i lizing vozila.

(210) **Ž-2020-163**

(220) 20.05.2020.

(731) Google LLC, 1600 Amphitheatre Parkway, 94043, Mountain View, California, US

(540)

WAZE

(550) I

(740) AOD "Ćupić", Bulevar Džordža Vašingtona 79, 81000, Podgorica

(511) Klasa 9: Računarski programi i računarski softveri za prikupljanje, kompilaciju, obradu, prenos i distribuciju podataka globalnog sastava za pozicioniranje (GPS) za korištenje na fiksnim, mobilnim i ručnim uređajima; elektronske baze podataka koje sadrže putne, geografske, kartografske i informacije o putovanjima zapisane na računarskim medijima i navigacijski softver za izračunavanje i prikaz ruta;satelitski navigacijski sistemi za automobile, naročito sistem za globalno pozicioniranje (GPS) koji sadrži digitalne kartografske prikaze, interaktivne upute i informacije koje generišu korisnici; interaktivni društveni računarski softver koji pruža putne, navigacijske, geografske, kartografske i informacije o putovanjima; interaktivni društveni računarski softver za omogućavanje prenosa informacija o mapiranju, navigaciji, saobraćaju, vremenu i tačkama interesa na telekomunikacijske mreže, mobilne telefone, navigacijske uređaje i druge mobilne i ručne uređaje; interaktivni društveni računarski softver za omogućavanje razmjene informacija među korisnicima.

Klasa 35: Usluge oglašavanja, marketinga i promotivne usluge.

Klasa 39: Praćenje putničkih i teretnih vozila računarskim putem, preko globalnih sistema za pozicioniranje (GPS); interaktivno i društveno online usmjeravanje vozila putem računarskih i podatkovnih mreža; pružanje putnih, geografskih, putničkih, kartografskih, navigacijskih, saobraćajnih informacija te informacija o geografskim interesnim tačkama putem telekomunikacijskih mreža, mobilnih telefona, ručnih uređaja i bežičnih navigacijskih uređaja; pružanje interaktivne online baze podataka koja sadrži putne, geografske, putničke, kartografske, navigacijske, saobraćajne i informacije o geografskim tačkama interesa.

Klasa 42: Naučno istraživanje i razvoj, naročito razvoj algoritama i računarskih metoda za obradu i optimizaciju podataka o navigaciji i putovanjima; naučno istraživanje i razvoj, naročito razvoj algoritama i računarskih metoda za obradu i optimizaciju podataka dobojenih od sistema za globalno pozicioniranje (GPS) i komunikacijskih mreža; projektovanje i razvoj navigacijskih softvera i softvera za planiranje puta; interaktivne društvene navigacijske usluge, naročito pružanje mrežne stranice koja sadrži tehnologiju koja omogućava razmjenu među korisnicima informacija u vezi sa putem, saobraćajem, geografijom, navigacijom, geografskim tačkama interesa, mapiranjem, vremenom te putničkim informacijama; organizovanje online prostora za vođenje interaktivnih rasprava; naučne, tehnološke, istraživačke i usluge projektovanja u vezi sa telekomunikacijama i navigacijskim signalima, naročito projektovanje i razvoj telekomunikacijskog i navigacijskog softvera i opreme.

(210) **Ž-2020-164**

(220) 25.05.2020.

(731) The Procter & Gamble Company, One Procter & Gamble Plaza, 45202, Cincinnati, Ohio, US

(540)

PAMPERS HARMONIE

(550) I

(740) Branislav Lutovac, Bulevar Ivana Crnojevića 93, 81000, Podgorica

(511) Klasa 3: Vlažne maramice od papira i/ili celuloze.

Klasa 5: Pelene od papira i/ili celuloze za jednokratnu upotrebu.

(210) **Ž-2020-165**

(220) 25.05.2020.

(731) The Procter & Gamble Company, One Procter & Gamble Plaza, 45202, Cincinnati, Ohio, US

(540)



(550) I

(740) Branislav Lutovac, Bulevar Ivana Crnojevića 93, 81000, Podgorica

(511) Klasa 3: Vlažne maramice od papira i/ili celuloze.
Klasa 5: Pelene od papira i/ili celuloze za jednokratnu upotrebu.

(210) **Ž-2020-166**

(220) 25.05.2020.

(731) BRAND HOTELS DOO BUDVA, XVI ulica br.5, 85310, Budva, ME

(540)



(550) I

(511) Klasa 43: Usluge obezbjeđivanja hrane i pića; privremeno primanje na stan; usluge koje pružaju lica ili preduzeća čiji cilj je priprema jela ili pića za potrošnju kao i usluge ishrane i smještaja, koje pružaju hoteli, pansioni ili druga preduzeća koja osiguravaju privremeni smještaj; usluge rezervisanja smještaja za putnike, koje pružaju putničke agencije ili posrednici; usluge pansiona za životinje.

(210) **Ž-2020-167**

(220) 25.05.2020.

(731) British American Tobacco (Brands) Inc., 251 Little Falls Drive, Suite 100, DE 19808-1674, Wilmington, Delaware, US

(540)

LUCKY STRIKE SLOW CURED

(550) I

(740) Miladin Popović, Đoka Miraševića 21/III, 81000, Podgorica

(511) Klasa 34: Cigarete; duvan, sirov ili prerađen; duvan za samostalno zamotavanje; duvan za lule; duvanski proizvodi; zamjene za duvan (koji nijesu za upotrebu u medicini); cigare; cigarilosi; upaljači za cigarete; upaljači za cigare; šibice; artikli za pušače; cigaret papir; cigaret tube; filteri za cigarete; džepni aparati za zamotavanje cigareta; ručne mašine za ubrizgavanje duvana u papirne tube; elektronske cigarete; tečnosti za elektronske cigarete; duvanski proizvodi namijenjeni za zagrijavanje.

(210) **Ž-2020-168**

(220) 25.05.2020.

(731) TOYOTA JIDOSHA KABUSHIKI KAISHA (also trading as TOYOTA MOTOR CORPORATION), 1, Toyota-cho, Toyota-shi, Aichi-ken, JP

(540)

TOYOTA BZ

(550) I

(740) Jasna Jusić, Dalmatinska 2, 81000, Podgorica

(511) Klasa 12: Automobili i njihovi strukturalni djelovi.

(210) **Ž-2020-169**

(220) 26.05.2020.

(731) ALLIANCE D.O.O., CETINJSKI PUT BB, 81000, PODGORICA, ME

(540)

Brandy Goren

(550) I

(511) Klasa 33: Vina (alkoholna pića).
Klasa 35: Maloprodaja: vina; Veleprodaja: vina.
Klasa 41: Učestvovanje na sajmovima.

(210) **Ž-2020-170**

(220) 26.05.2020.

(731) ALLIANCE D.O.O., CETINJSKI PUT BB, 81000, PODGORICA, ME

(540)

Vinarija Pavićević

(550) I

(511) Klasa 33: Vina (alkoholna pića).
Klasa 35: Maloprodaja: vina; Veleprodaja: vina.
Klasa 41: Učestvovanje na sajmovima.

(210) **Ž-2020-171**

(220) 26.05.2020.

(731) ALLIANCE D.O.O., CETINJSKI PUT BB, 81000, PODGORICA, ME

(540)

Vino Katardo

(550) I

(511) Klasa 33: Vina (alkoholna pića).
Klasa 35: Maloprodaja: vina; Veleprodaja: vina.
Klasa 41: Učestvovanje na sajmovima.

(210) **Ž-2020-173**

(220) 26.05.2020.

(731) TOYOTA JIDOSHA KABUSHIKI KAISHA (also trading as TOYOTA MOTOR CORPORATION), 1, Toyota-cho, Toyota-shi, Aichi-ken, JP

(540)

AYGO X

(550) I

(740) Jasna Jusić, Dalmatinska 2, 81000, Podgorica

(511) Klasa 12: Automobili i njihovi strukturalni djelovi.

(210) **Ž-2020-174**

(220) 27.05.2020.

(731) Top Learning (Beijing) Education Technology Co., Ltd., Rm. 136, 1/F, Bldg. No. 23, East Zone, Yard No. 10, Xibeiwang Rd. East, Haidian Dist., Beijing, CN

(540)



(550) I

(740) Ana Zeković, Bulevar Svetog Petra Cetinjskog 130/VII, 81000, Podgorica

(511) Klasa 9: Računari; tablet računari; računarski softver; računarski softver, snimljeni; aplikacije za računarske softvere koje se mogu preuzimati; računarske softverske platforme, snimljene ili koje se mogu preuzimati; aplikacije za softver za mobilne telefone koje se mogu preuzimati; aplikacije za mobilne telefone koje se mogu preuzeti; čitači elektronskih knjiga: elektronske publikacije koje se mogu preuzimati; uređaj za učenje; elektronski uređaj za učenje.

Klasa 41: Obrazovne usluge; usluge pružanja obuke; organizovanje i vođenje radionica {obuka}; organizovanje izložbi za kulturne ili obrazovne potrebe; elektronska izdanja elektronskih knjiga i časopisa; usluge omogućavanja korišćenja elektronskih publikacija, koje se mogu preuzimati; usluge stavljanja na raspolaganje filmova, koji se mogu preuzimati, putem video zapisa na zahtjev, usluge video igara koje se pružaju putem Interneta; prevođenje; usluge prevođenja; prevođenje jezika; bibliotekarske usluge; usluge pozajmljivanja knjiga u bibliotekama; pokretne biblioteke; bibliotekarske usluge (mobilne); usluge elektronske biblioteke.

(210) **Ž-2020-175**

(220) 29.05.2020.

(731) Dražen Raičković, Dalmatinska bb, 81000, Podgorica, ME

(540)



(550) I

(511) Klasa 35: Oglašavanje i reklamiranje; vođenje komercijalnih poslova; komercijalna administracija; kancelarijski poslovi; usluge koje pružaju lica ili organizacije, čija je glavna svrha: 1) pomoć u radu i upravljanju privrednim društvima, ili 2) pomoć u vođenju poslova ili komercijalnih funkcija industrijskog ili trgovačkog preduzeća, kao i usluge reklamnih ustanova koje se bave uglavnom reklamiranjem proizvoda i usluga putem svih vrsta medija; usluge koje se odnose na registraciju, prijepis, sastavljanje, kompilaciju ili sistematizaciju pisanih saopštenja i zapisa kao i obradu ili kompilaciju matematičkih ili statističkih podataka; usluge agencija za oglašavanje kao i usluge distribuiranja prospekata direktno ili poštom ili distribuiranje uzoraka; oglašavanja u vezi s drugim uslugama kao što su usluge u vezi bankarskih zajmova i oglašavanja putem radija; sortiranje za račun drugih osoba, raznih proizvoda (ne uključuje njihov prevoz) radi omogućavanja potrošaču njihovog lakšeg razgledanja i kupovine; ove usluge se mogu pružati u okviru prodavnica na malo, trgovina na veliko, posredstvom prodajnih kataloga, dopisno ili elektronskim putem, na primjer posredstvom weba ili putem telefona.

Klasa 42: Naučne i tehnološke usluge kao i pripadajuće usluge istraživanja i koncepcije; usluge industrijskih analiza i istraživanja; koncepcija i razvoj računara i računarskih programa /hardvera i softvera/; usluge koje pružaju lica, individualno ili kolektivno, u vezi s teorijskim ili praktičnim vidovima složenih područja djelatnosti; takve usluge pružaju predstavnici profesija kao što su hemičari, fizičari, inženjeri, informatičari,

itd.; usluge inženjera koji se bave procjenama, ocjenama, istraživanjima i izvještajima u području nauke i tehnologije; usluge naučnih istraživanja u medicinske svrhe.

Klasa 45: Pravne usluge; sigurnosne usluge za zaštitu imovine i lica; lične i društvene usluge koje pružaju drugi, namijenjene za zadovoljenje ljudskih potreba; usluge koje pružaju pravnici pojedincima ili grupama pojedinaca, organizacijama ili preduzećima; usluge sprovođenja anketa i nadzora u vezi sigurnosti osoba i zajednica; usluge koje pružaju osobe u svezi društvenih događanja kao što su usluge pratnje u društvu, usluge bračnih agencija, pogrebne usluge.

(210) **Ž-2020-177**

(220) 29.05.2020.

(731) Advanced New Technologies Co., Ltd., Cayman Corporate Centre, 27 Hospital Road, KY1-9008, George Town, Grand Cayman, KY

(540)

ANTCHAIN

(550) I

(740) Jasna Jusić, Dalmatinska 2, 81000, Podgorica

(511) Klasa 9: Aparati i instrumenti naučni, pomorski, geodetski, fotografski, kinematografski, optički, za vaganje, mjerenje, signalizaciju, kontrolu (inspekciju), spasavanje i nastavu; aparati i instrumenti za provođenje, prekid, transformaciju, akumulaciju, regulisanje ili kontrolu električne energije; aparati za snimanje, prenos i reprodukovanje zvuka ili slike; magnetni nosači podataka, diskovi za snimanje; mehanizmi za aparate koji se pokreću novcem; registar kase, računске mašine; oprema za obradu podataka i računari; kompjuterski softver; kompjuterski programi; kompjuterski softver u obliku aplikacije za mobilne uređaje i računara; softverske aplikacije za upotrebu sa mobilnim uređajima; softver za procesuiranje elektronskih plaćanja za druge i od drugih; kompjuterski softver i softverske aplikacije koje se koriste u vezi sa finansijskim uslugama, finansijskim transakcijama, elektronskom trgovinom, elektronskim plaćanjem, razmenom stranih valuta, uslugama trgovine i posredovanja i savjetodavnim uslugama o investiranju; softver za autentifikaciju; kompjuterski softver i kompjuterske softverske aplikacije (koji se mogu preuzeti); softver za razmjenu trenutnih poruka; softver za dijeljenje datoteka; komunikacijski softver za elektronsku razmjenu podataka, audio i video sadržaja, slika i grafika putem kompjuterskih, mobilnih, bežičnih i telekomunikacionih mreža; kompjuterski softver za obradu slika, grafika, audio i video sadržaja i teksta; kompjuterski softver koji se može preuzimati koji olakšava elektronski prenos informacija, podataka, dokumenata, glasa i slika preko Interneta; kompjuterski softver koji se može preuzimati koji omogućava korisnicima da učestvuju na onlajn sastancima i časovima, sa pristupom podacima, dokumentima, slikama i softverskim aplikacijama kroz Internet pretraživač; kompjuterski softver koji se može preuzeti, za pristup, pregled i upravljanje udaljenim kompjuterima i kompjuterskim mrežama; softver za računarstvo u oblaku koji se može preuzimati; softver koji se nalazi u oblaku, a koji se može preuzimati; kompjuterski softver za praćenje i procjenu kupaca i ličnog ponašanja u vezi sa odlukama koje se tiču kupovine; kompjuterske softverske aplikacije za upotrebu u vezi sa očuvanjem životne sredine, klimatskim promjenama i kompenzacijom za emisiju ugljenika; onlajn elektronske

publikacije (koje se mogu preuzeti sa interneta ili sa kompjuterske mreže ili iz kompjuterske baze podataka); elektronske publikacije koje se mogu preuzimati, u obliku časopisa, članaka, brošura, lifleta, tehničkih specifikacija, informacionih materijala, priručnika u oblastima poslovanja, elektronske trgovine, informacionih tehnologija, računarstva u oblaku, telekomunikacija, interneta, obuka u vezi sa poslovanjem i elektronskom trgovinom, upravljanja poslovanjem, prodajom, marketingom i finansijama; kompjuterske periferne jedinice; noutbuk računari; laptop računari; prenosivi računari; ručni računari; lični digitalni asistenti; lični media plejeri; mobilni telefoni; pametni telefoni; digitalne kamere; baterije, punjači za baterije; računarske radne stanice; računarski serveri; kompjuterski i telekomunikacioni mrežni hardver; kompjuterski mrežni adapteri, prekidači, ruteri i čvorovi; bežični i žični modemi i komunikacione kartice i uređaji; držači za laptop; torbe za računare; aparti za gašenje požara; kompjuterski hardver i firmver; automobilski sistemi za navigaciju; kompakt diskovi; digitalna muzika (koja se može preuzeti sa interneta); telekomunikacioni aparati; podloge za miševe; slušalice za mobilne telefone; dodaci za mobilne telefone; igre, slike, bioskopski filmovi, filmovi i muzika koji se mogu preuzeti; sistemi za alarme; bezbjednosne kamere; mobilne radio i televizijske jedinice za emitovanje; oprema za televizijsko emitovanje; kamere; video kamere; slušalice; telefonske slušalice koje se nose u uvetu; zvučnici; uređaji i oprema za globalno pozicionirajući sistem [GPS]; programi i softver za kompjuterske, elektronske i video igre (uključujući i softver koji se može preuzeti sa interneta); displeji od tečnih kristala za telekomunikacionu i elektronsku opremu; set top boks; daljinski upravljači; programi za skladištenje podataka; naočare i naočare za sunce; elektronske table sa natpisom; kodirane ili magnetne bankovne kreditne, debitne, gotovinske ili identifikacione kartice; automatski bankomati; čitači elektronskih knjiga; toner kertridži, prazni, za štampače i fotokopire; uređaji za nadgledanje beba; video uređaji za nadgledanje beba; poklopci za fotografska sočiva; tablet računari; kodirane ključ kartice; 3D naočare; memorijske kartice za mašine za video igre; nosivi računari, pametni telefoni, monitori, displeji, kompjuterski hardver, uređaji za praćenje aktivnosti, audio oprema, aparati za komunikaciju, telekomunikacioni aparati, kompjuterski periferni uređaji, nosivi media plejeri i digitalni elektronski uređaji za komunikaciju; nosivi računari, pametni telefoni, monitori, displeji, kompjuterski hardver, uređaji za praćenje aktivnosti, audio oprema, aparati za komunikaciju, telekomunikacioni aparati, kompjuterski periferni uređaji, nosivi media plejeri i digitalni elektronski uređaji za komunikaciju koji se koriste za olakšavanje transakcija plaćanja putem elektronskih sredstava i kako bi dozvolili kupcima da pristupe finansijskim informacijama i informacijama o bankovnom računu i da vrše transakcije bankovnih poslova; nosivi računari, pametni telefoni, monitori, displeji, kompjuterski hardver, uređaji za praćenje aktivnosti, audio oprema, aparati za komunikaciju, telekomunikacioni aparati, kompjuterski periferni uređaji, nosivi media plejeri i digitalni elektronski uređaji za komunikaciju koji mogu da pruže pristup bežičnim komunikacionim mrežama, telekomunikacionim mrežama i internetu; mobilne aplikacije koje se mogu preuzeti za upotrebu sa nosivim računarima, pametnim telefonima, monitorima, displejima, kompjuterskim hardverom, uređajima za praćenje aktivnosti, audio opremom, aparatima za komunikaciju, telekomunikacionim aparatima, kompjuterskim perifernim uređajima, nosivim media plejerima i digitalnim elektronskim uređajima za komunikaciju; kompjuterske softverske aplikacije za upotrebu sa nosivim računarima, pametnim telefonima, monitorima, displejima, kompjuterskim hardverom, uređajima za praćenje aktivnosti, audio opremom, aparatima za komunikaciju, telekomunikacionim aparatima, kompjuterskim perifernim uređajima, nosivim media plejerima i digitalnim elektronskim uređajima za komunikaciju; kodirane ili magnetne pripejd platne, bankovne, kreditne, debitne, gotovinske i identifikacione kartice.

Klasa 36: Osiguranje; finansijski poslovi; novčani poslovi; poslovi vezani za nepokretnosti; kliring i usklađivanje finansijskih transakcija putem globalne računarske mreže; onlajn bankarske usluge i finansijske usluge; usluge kreditnih kartica, procesuiranje i prenos računa i uplata, i pružanje osiguranja za finansijske transakcije; usluge prenosa sredstava; prenos sredstava elektronskim putem za druge; prenos uplata za druge

putem interneta; finansijske usluge u oblasti usluga obrade računa i uplata; organizovanja i upravljanje lizingom i zakupom; iznajmljivanje i lizing nepokretnosti; procjena nepokretnosti; valuacija nepokretnosti; finansijske usluge u vezi sa nepokretnostima, investiranje u nepokretnosti; brokerske usluge u vezi sa nepokretnostima; usluge agencija za nepokretnosti; usluge stambenih agencija; usluge aktuara; upravljanje nepokretnostima i konsalting usluge; ubiranje najamnine; iznajmljivanje kancelarija (nepokretnosti); iznajmljivanje apartmana i stanova; pružanje finansijskih informacija putem interneta; usluge depozita i usluge izdavanja putničkih vaučera; ulaganje kapitala; finansijske evaluacije (osiguranje, bankarstvo, nepokretnosti); finansijske i usluge upravljanja aktivom; osiguranje i finansijske usluge; finansijske usluge pružene putem telekomunikacijskih sredstava; finansijske konsalting i savjetodavne usluge; onlajn bankarstvo; bankarske usluge pružene onlajn sa računarskih baza podataka ili interneta; usluge posredovanja u prometu sa hartijama od vrijednosti, usluge notiranja cijena na berzi; posredovanje u vezi sa akcijama i obveznicama, finansijske analize; usluge debitnih kartica, usluge platnih kartica i usluge čekovne garancije; bankarske, usluge štednih računa i investiciona usluge; usluge finansijskog kliringa; kreditna verifikacija putem globalne računarske informacione mreže; elektronske usluge upravljanja rizikom kredita; usluge elektronskog plaćanja za kupovinu i elektronskog plaćanja računa; zaduživanje finansijskih računa i kreditne usluge; elektronske bankarske usluge; izdavanje pretplatničkih kartica, platnih kartica i debitnih kartica; usluge telefonskih kreditnih kartica; informativne usluge u vezi sa finansijama i osiguranjem, pružene onlajn sa računarske baze podataka ili interneta; agencija za prikupljanje naknada za gas i električnu energiju; procjena antikviteta; procjena umjetničkih djela; procjena nakita; procjena polovnih vozila; snabdijevanje poreskim informacijama (finansijske usluge); prikupljanje priloga za dobrotvorne fondove; organizovanja dobrotvornog prikupljanja; dobrotvorno prikupljanje; iznajmljivanje mašina za brojenje papirnog novca i kovanica; iznajmljivanje bankomata ili automatizovanih mašina za izdavanje gotovine; usluge onlajn plaćanja; organizovanja finansija za građevinske projekte; izdavanje vaučera; pružanje usluga elektronskog transfera sredstava; mjenjačke usluge, usluge izdavanja gotovine, pružanje pripejd kartica ili tokena, usluge transfera novca; uključujući sve gore navedene usluge pružene elektronskim putem; konsultantske, informativne i savjetodavne usluge u vezi sa elektronskim transferom sredstava; usluge transfera strane valute; razmjena stranih valuta; trgovina valutama; poslovanje u vezi sa valutama; posredovanje u vezi sa valutama; finansijske transakcije putem blokčejna; pružanje usluga dobrotvornog prikupljanja u vezi sa kompenzacijom za emisiju ugljenika; posredovanje u kompenzaciji za emisiju ugljenika; finansijska sponzorisane programa kompenzacije za emisiju ugljenika; finansiranje i ulaganje u projekte smanjenja emisije ugljenika; ulaganje u programe i projekte kompenzacije za emisiju ugljenika; ulaganje u fondove za smanjenje emisije ugljenika; pružanje zajmova; pružanje privremenih zajmova; konsultantske, informativne i savjetodavne usluge u vezi sa gore navedenim uslugama.

Klasa 42: Naučne i tehnološke usluge i istraživanja i projektovanja u vezi sa njima, usluge industrijskih analiza i istraživanja; projektovanje i razvoj računarskog hardvera i softvera; softver u vidu servisa (SaaS); blokčein kao vrsta usluge (BaaS); kodiranje, dekodiranje i autentifikacija informacija, poruka i podataka; pružanje usluga korisničke autentifikacije koristeći biometrijsku, autentifikaciju prepoznavanjem lica, otiskom prsta, prepoznavanje glasa i druge tipove hardverske i softverske tehnologije za autentifikaciju prilikom pružanja finansijskih usluga, elektronske trgovine, donacija, praćenja licenciranih proizvoda i angažovanja obožavatelja; usluge obezbjeđivanja podataka; IT bezbjednost, zaštita i obnova; analize računarskih bezbjednosnih prijetnji za zaštitu podataka; pružanje usluga bezbjednosti za računarske mreže, pristup računaru i kompjuterizovane transakcije; sertifikacija (kontrola kvaliteta) podataka putem blokčejna; autentifikacija podataka putem blokčejna; uključujući sve prethodno navedene usluge u vezi sa sistemima plaćanja; računarske usluge u vezi sa prenosom informacija, podataka, dokumenata i slika preko interneta; usluge provajdera aplikacija (ASP), naime, hosting računarskih softverskih aplikacija za druge; usluge provajdera aplikacija (ASP) za pružanje softvera u oblasti veb zasnovanih konferencija, audio konferencija,

elektronskih poruka, kolaboracije dokumenata, video konferencija, i obrade glasa i poziva; pružanje onlajn softvera koji se ne može preuzimati za olakšavanje interoperabilnosti više softverskih aplikacija; usluge tehničke podrške u vezi sa računarskim softverom i aplikacijama pruženim onlajn, putem email-a i telefona; računarske usluge, naime kreiranje onlajn zajednice za registrovane korisnike da učestvuju u raspravi, dobiju povratnu informaciju od svojih vršnjaka, formiraju virtuelne zajednice, učestvuju u društvenim mrežama i razmenjuju dokumenta; savjeti o računarskim tehnologijama pruženi internet korisnicima putem telefonske podrške; računarske usluge u vezi sa kreiranjem indeksa informacija, stranica i izvora na računarskoj mreži; pružanje alata za pretraživanje na internetu; dizajn računara, noutbuk računara, laptop računara, prenosivih računara i ručnih računara; dizajn ličnih digitalnih asistenata i ličnih media plejera; dizajn mobilnih telefona i pametnih telefona; dizajn digitalnih kamera; računarske usluge; računarska programiranje; računarske integracione usluge; usluge računarske analize; računarska programiranje u vezi sa odbranom od virusa; usluge računarskog sistemskog softvera; usluge projektovanja softvera; projektovanje i razvoj veb-stranica; hosting veb-stranica za druge; hosting softver računarskih aplikacija za pretraživanje i vraćanje informacija iz baze podataka i računarske mreže; pružanje tehničkih informacija po posebnom zahtjevu krajnjih korisnika putem telefona ili globalne računarske mreže; savjetodavne usluge u vezi sa računarskim softverom; računarske usluge u vezi sa prilagođenim pretraživanjem računarske baze podataka i veb-stranica; računarska i elektronsko kodiranje i dekodiranje signala; konverzija fizičkih podataka i dokumenata u elektronske medijske formate; testiranje proizvoda i usluge procjene; arhitektonske i usluge dizajna; dizajn enterijera zgrada, kancelarija i apartmana; računarske informativne usluge; mrežne informativne usluge, naime, pružanje tehničkih informacija u vezi sa računarima i mrežama u oblasti poslovanja i elektronske trgovine; pružanje računarskih programa za upravljanje rizikom bezbjednosti; usluge računarskih bezbjednosnih informacija, znanja i usluge testiranja; usluge osiguranja kvaliteta; računarske usluge u vezi sa sertifikacijom poslovnih transakcija i pripremanje izvještaja u vezi sa njima; računarske bezbjednosne usluge u vezi sa kontrolom pristupa računarima, elektronskim mrežama i bazama podataka; obezbjeđivanje prenosa podataka i transakcija putem računarskih mreža; konsultacije u oblasti bezbjednosti podataka; tehnološke konsultacije u vezi sa bezbjednošću telekomunikacija; bezbjednosne usluge kompjuterizovanih komunikacionih mreža; pružanje informacija u oblasti interneta, svjetske komunikacione mreže i bezbjednosti kompjuterizovanih komunikacionih mreža i sigurnog prenosa podataka i informacija; konsalting usluge u oblasti interneta, svjetske komunikacione mreže i bezbjednosti kompjuterizovanih komunikacionih mreža, usluge bezbjednosti informacija; usluge autentifikacije za bezbjednost računara; onlajn autentifikacija elektronskih potpisa; pohranjivanje rezervnih podataka van glavne lokacije (off-site); usluge čuvanja elektronskih podataka; pružanje informacija o računarskim tehnologijama i programiranju putem veb-stranica; kartografske usluge; računarstvo u oblaku; usluge hosting provajdera oblaka; pružanje privremene upotrebe softvera koji se zasniva na oblaku i koji se ne može preuzeti i softvera za računarstvo u oblaku; elektronsko pohranjivanje podataka; pružanje virtuelnih računarskih sistema i virtuelne računarske sredine putem računarstva u oblaku; iznajmljivanje softvera za zabavu; tehničko istraživanje u vezi sa kompenzacijom emisije ugljenika; pružanje informacija, savjeta i konsultacija u vezi sa kompenzacijom emisije ugljenika i zaštitom životne sredine; pružanje tehnoloških informacija o svijesti o životnoj sredini i ekološkim inovacijama; testiranje životne sredine, usluge procjene i monitoringa; istraživanja u oblasti zaštite i očuvanja životne sredine; istraživanja i pružanje naučnih informacija u oblasti klimatskih promjena; naučne i industrijske konsultativne usluge u vezi sa gorivima, emisijom goriva i ugljen-dioksida i problemima životne sredine; usluge naučnog i tehnološkog istraživanja u vezi sa preporukama za smanjenje ugljen-dioksida na ekonomičan način; usluge naučnog i tehnološkog istraživanja u vezi sa upravljanjem programima za kompenzaciju emisije ugljenika; usluge istraživanje životne sredine, usluge upravljanja i zaštite; konsultativne, informativne i savjetodavne usluge u vezi sa naprijed navedenim uslugama.

(210) **Ž-2020-179**

(220) 02.06.2020.

(731) Advanced New Technologies Co., Ltd., Cayman Corporate Centre, 27 Hospital Road, KY1-9008, George Town, Grand Cayman, KY

(540)

ANT

(550) I

(740) Jasna Jusić, Dalmatinska 2, 81000, Podgorica

(511) Klasa 9: Aparati i instrumenti naučni, pomorski, geodetski, fotografski, kinematografski, optički, za vaganje, mjerenje, signalizaciju, kontrolu (inspekciju), spasavanje i nastavu; aparati i instrumenti za provođenje, prekid, transformaciju, akumulaciju, regulisanje ili kontrolu električne energije; aparati za snimanje, prenos i reprodukovanje zvuka ili slike; magnetni nosači podataka, diskovi za snimanje; mehanizmi za aparate koji se pokreću novcem; registar kase, računске mašine; oprema za obradu podataka i računari; kompjuterski softver; kompjuterski programi; kompjuterski softver u obliku aplikacije za mobilne uređaje i računara; softverske aplikacije za upotrebu sa mobilnim uređajima; softver za procesuiranje elektronskih plaćanja za druge i od drugih; kompjuterski softver i softverske aplikacije koje se koriste u vezi sa finansijskim uslugama, finansijskim transakcijama, elektronskom trgovinom, elektronskim plaćanjem, razmenom stranih valuta, uslugama trgovine i posredovanja i savjetodavnim uslugama o investiranju; softver za autentifikaciju; kompjuterski softver i kompjuterske softverske aplikacije (koji se mogu preuzeti); softver za razmjenu trenutnih poruka; softver za dijeljenje datoteka; komunikacijski softver za elektronsku razmjenu podataka, audio i video sadržaja, slika i grafika putem kompjuterskih, mobilnih, bežičnih i telekomunikacionih mreža; kompjuterski softver za obradu slika, grafika, audio i video sadržaja i teksta; kompjuterski softver koji se može preuzimati koji olakšava elektronski prenos informacija, podataka, dokumenata, glasa i slika preko Interneta; kompjuterski softver koji se može preuzimati koji omogućava korisnicima da učestvuju na onlajn sastancima i časovima, sa pristupom podacima, dokumentima, slikama i softverskim aplikacijama kroz Internet pretraživač; kompjuterski softver koji se može preuzeti, za pristup, pregled i upravljanje udaljenim kompjuterima i kompjuterskim mrežama; softver za računarstvo u oblaku koji se može preuzimati; softver koji se nalazi u oblaku, a koji se može preuzimati; kompjuterski softver za praćenje i procjenu kupaca i ličnog ponašanja u vezi sa odlukama koje se tiču kupovine; kompjuterske softverske aplikacije za upotrebu u vezi sa očuvanjem životne sredine, klimatskim promenama i kompenzacijom za emisiju ugljenika; onlajn elektronske publikacije (koje se mogu preuzeti sa interneta ili sa kompjuterske mreže ili iz kompjuterske baze podataka); elektronske publikacije koje se mogu preuzimati, u obliku časopisa, članaka, brošura, lifleta, tehničkih specifikacija, informacionih materijala, priručnika u oblastima poslovanja, elektronske trgovine, informacionih tehnologija, računarstva u oblaku, telekomunikacija, interneta, obuka u vezi sa poslovanjem i elektronskom trgovinom, upravljanja poslovanjem, prodajom, marketingom i finansijama; kompjuterske periferne jedinice; noutbuk računari; laptop računari; prenosivi računari; ručni računari; lični digitalni asistenti; lični media plejeri; mobilni telefoni; pametni telefoni; digitalne kamere; baterije, punjači za baterije; računarske radne stanice; računarski serveri; kompjuterski i telekomunikacioni mrežni hardver; kompjuterski

mrežni adapteri, prekidači, ruteri i čvorovi; bežični i žični modemi i komunikacione kartice i uređaji; držači za laptop; torbe za računare; aparti za gašenje požara; kompjuterski hardver i firmver; automobilski sistemi za navigaciju; kompakt diskovi; digitalna muzika (koja se može preuzeti sa interneta); telekomunikacijski aparati; podloge za miševe; slušalice za mobilne telefone; dodaci za mobilne telefone; igre, slike, bioskopski filmovi, filmovi i muzika koji se mogu preuzeti; sistemi za alarme; bezbjednosne kamere; mobilne radio i televizijske jedinice za emitovanje; oprema za televizijsko emitovanje; kamere; video kamere; slušalice; telefonske slušalice koje se nose u uvetu; zvučnici; uređaji i oprema za globalno pozicionirajući sistem [GPS]; programi i softver za kompjuterske, elektronske i video igre (uključujući i softver koji se može preuzeti sa interneta); displeji od tečnih kristala za telekomunikacionu i elektronsku opremu; set top boks; daljinski upravljači; programi za skladištenje podataka; naočare i naočare za sunce; elektronske table sa natpisom; kodirane ili magnetne bankovne kreditne, debitne, gotovinske ili identifikacione kartice; automatski bankomati; čitači elektronskih knjiga; toner kertridži, prazni, za štampače i fotokopire; uređaji za nadgledanje beba; video uređaji za nadgledanje beba; poklopci za fotografska sočiva; tablet računari; kodirane ključ kartice; 3D naočare; memorijske kartice za mašine za video igre; nosivi računari, pametni telefoni, monitori, displeji, kompjuterski hardver, uređaji za praćenje aktivnosti, audio oprema, aparati za komunikaciju, telekomunikacioni aparati, kompjuterski periferni uređaji, nosivi media plejeri i digitalni elektronski uređaji za komunikaciju; nosivi računari, pametni telefoni, monitori, displeji, kompjuterski hardver, uređaji za praćenje aktivnosti, audio oprema, aparati za komunikaciju, telekomunikacioni aparati, kompjuterski periferni uređaji, nosivi media plejeri i digitalni elektronski uređaji za komunikaciju koji se koriste za olakšavanje transakcija plaćanja putem elektronskih sredstava i kako bi dozvolili kupcima da pristupe finansijskim informacijama i informacijama o bankovnom računu i da vrše transakcije bankovnih poslova; nosivi računari, pametni telefoni, monitori, displeji, kompjuterski hardver, uređaji za praćenje aktivnosti, audio oprema, aparati za komunikaciju, telekomunikacioni aparati, kompjuterski periferni uređaji, nosivi media plejeri i digitalni elektronski uređaji za komunikaciju koji mogu da pruže pristup bežičnim komunikacijskim mrežama, telekomunikacionim mrežama i internetu; mobilne aplikacije koje se mogu preuzeti za upotrebu sa nosivim računarima, pametnim telefonima, monitorima, displejima, kompjuterskim hardverom, uređajima za praćenje aktivnosti, audio opremom, aparatima za komunikaciju, telekomunikacionim aparatima, kompjuterskim perifernim uređajima, nosivim media plejerima i digitalnim elektronskim uređajima za komunikaciju; kompjuterske softverske aplikacije za upotrebu sa nosivim računarima, pametnim telefonima, monitorima, displejima, kompjuterskim hardverom, uređajima za praćenje aktivnosti, audio opremom, aparatima za komunikaciju, telekomunikacionim aparatima, kompjuterskim perifernim uređajima, nosivim media plejerima i digitalnim elektronskim uređajima za komunikaciju; kodirane ili magnetne pripejd platne, bankovne, kreditne, debitne, gotovinske i identifikacione kartice.

Klasa 36: Osiguranje; finansijski poslovi; novčani poslovi; poslovi vezani za nepokretnosti; kliring i usklađivanje finansijskih transakcija putem globalne računarske mreže; onlajn bankarske usluge i finansijske usluge; usluge kreditnih kartica, procesuiranje i prenos računa i uplata, i pružanje osiguranja za finansijske transakcije; usluge prenosa sredstava; prenos sredstava elektronskim putem za druge; prenos uplata za druge putem interneta; finansijske usluge u oblasti usluga obrade računa i uplata; organizovanja i upravljanje lizingom i zakupom; iznajmljivanje i lizing nepokretnosti; procjena nepokretnosti; valuacija nepokretnosti; finansijske usluge u vezi sa nepokretnostima, investiranje u nepokretnosti; brokerske usluge u vezi sa nepokretnostima; usluge agencija za nepokretnosti; usluge stambenih agencija; usluge aktuara; upravljanje nepokretnostima i konsalting usluge; ubiranje najamnine; iznajmljivanje kancelarija (nepokretnosti); iznajmljivanje apartmana i stanova; pružanje finansijskih informacija putem interneta; usluge depozita i usluge izdavanja putničkih vaučera; ulaganje kapitala; finansijske evaluacije (osiguranje, bankarstvo, nepokretnosti); finansijske i usluge upravljanja aktivom; osiguranje i finansijske usluge; finansijske usluge

pružene putem telekomunikacijskih sredstava; finansijske konsalting i savjetodavne usluge; onlajn bankarstvo; bankarske usluge pružene onlajn sa računarskih baza podataka ili interneta; usluge posredovanja u prometu sa hartijama od vrijednosti, usluge notiranja cijena na berzi; posredovanje u vezi sa akcijama i obveznicama, finansijske analize; usluge debitnih kartica, usluge platnih kartica i usluge čekovne garancije; bankarske, usluge štednih računa i investiciona usluge; usluge finansijskog kliringa; kreditna verifikacija putem globalne računarske informacione mreže; elektronske usluge upravljanja rizikom kredita; usluge elektronskog plaćanja za kupovinu i elektronskog plaćanja računa; zaduživanje finansijskih računa i kreditne usluge; elektronske bankarske usluge; izdavanje pretplatničkih kartica, platnih kartica i debitnih kartica; usluge telefonskih kreditnih kartica; informativne usluge u vezi sa finansijama i osiguranjem, pružene onlajn sa računarske baze podataka ili interneta; agencija za prikupljanje naknada za gas i električnu energiju; procjena antikviteta; procjena umjetničkih djela; procjena nakita; procjena polovnih vozila; snabdijevanje poreskim informacijama (finansijske usluge); prikupljanje priloga za dobrotvorne fondove; organizovanja dobrotvornog prikupljanja; dobrotvorno prikupljanje; iznajmljivanje mašina za brojenje papirnog novca i kovanica; iznajmljivanje bankomata ili automatizovanih mašina za izdavanje gotovine; usluge onlajn plaćanja; organizovanja finansija za građevinske projekte; izdavanje vaučera; pružanje usluga elektronskog transfera sredstava; mjenjačke usluge, usluge izdavanja gotovine, pružanje pripejd kartica ili tokena, usluge transfera novca; uključujući sve gore navedene usluge pružene elektronskim putem; konsultantske, informativne i savjetodavne usluge u vezi sa elektronskim transferom sredstava; usluge transfera strane valute; razmjena stranih valuta; trgovina valutama; poslovanje u vezi sa valutama; posredovanje u vezi sa valutama; finansijske transakcije putem blokčejna; pružanje usluga dobrotvornog prikupljanja u vezi sa kompenzacijom za emisiju ugljenika; posredovanje u kompenzaciji za emisiju ugljenika; finansijska sponzorisane programa kompenzacije za emisiju ugljenika; finansiranje i ulaganje u projekte smanjenja emisije ugljenika; ulaganje u programe i projekte kompenzacije za emisiju ugljenika; ulaganje u fondove za smanjenje emisije ugljenika; pružanje zajmova; pružanje privremenih zajmova; konsultantske, informativne i savjetodavne usluge u vezi sa gore navedenim uslugama.

Klasa 42: Naučne i tehnološke usluge i istraživanja i projektovanja u vezi sa njima, usluge industrijskih analiza i istraživanja; projektovanje i razvoj računarskog hardvera i softvera; softver u vidu servisa (SaaS); blokčein kao vrsta usluge (BaaS); kodiranje, dekodiranje i autentifikacija informacija, poruka i podataka; pružanje usluga korisničke autentifikacije koristeći biometrijsku, autentifikaciju prepoznavanjem lica, otiskom prsta, prepoznavanje glasa i druge tipove hardverske i softverske tehnologije za autentifikaciju prilikom pružanja finansijskih usluga, elektronske trgovine, donacija, praćenja licenciranih proizvoda i angažovanja obožavatelja; usluge obezbjeđivanja podataka; IT bezbjednost, zaštita i obnova; analize računarskih bezbjednosnih prijetnji za zaštitu podataka; pružanje usluga bezbjednosti za računarske mreže, pristup računaru i kompjuterizovane transakcije; sertifikacija (kontrola kvaliteta) podataka putem blokčejna; autentifikacija podataka putem blokčejna; uključujući sve prethodno navedene usluge u vezi sa sistemima plaćanja; računarske usluge u vezi sa prenosom informacija, podataka, dokumenata i slika preko interneta; usluge provajdera aplikacija (ASP), naime, hosting računarskih softverskih aplikacija za druge; usluge provajdera aplikacija (ASP) za pružanje softvera u oblasti veb zasnovanih konferencija, audio konferencija, elektronskih poruka, kolaboracije dokumenata, video konferencija, i obrade glasa i poziva; pružanje onlajn softvera koji se ne može preuzimati za olakšavanje interoperabilnosti više softverskih aplikacija; usluge tehničke podrške u vezi sa računarskim softverom i aplikacijama pruženim onlajn, putem email-a i telefona; računarske usluge, naime kreiranje onlajn zajednice za registrovane korisnike da učestvuju u raspravi, dobiju povratnu informaciju od svojih vršnjaka, formiraju virtuelne zajednice, učestvuju u društvenim mrežama i razmenjuju dokumenta; savjeti o računarskim tehnologijama pruženi internet korisnicima putem telefonske podrške; računarske usluge u vezi sa kreiranjem indeksa informacija, stranica i izvora na računarskoj mreži; pružanje alata za pretraživanje na internetu; dizajn računara, noutbuk računara, laptop računara, prenosivih

računara i ručnih računara; dizajn ličnih digitalnih asistenata i ličnih media plejera; dizajn mobilnih telefona i pametnih telefona; dizajn digitalnih kamera; računarske usluge; računarska programiranje; računarske integracione usluge; usluge računarske analize; računarska programiranje u vezi sa odbranom od virusa; usluge računarskog sistemskog softvera; usluge projektovanja softvera; projektovanje i razvoj veb-stranica; hosting veb-stranica za druge; hosting softver računarskih aplikacija za pretraživanje i vraćanje informacija iz baze podataka i računarske mreže; pružanje tehničkih informacija po posebnom zahtjevu krajnjih korisnika putem telefona ili globalne računarske mreže; savjetodavne usluge u vezi sa računarskim softverom; računarske usluge u vezi sa prilagođenim pretraživanjem računarske baze podataka i veb-stranica; računarska i elektronsko kodiranje i dekodiranje signala; konverzija fizičkih podataka i dokumenata u elektronske medijske formate; testiranje proizvoda i usluge procjene; arhitektonske i usluge dizajna; dizajn enterijera zgrada, kancelarija i apartmana; računarske informativne usluge; mrežne informativne usluge, naime, pružanje tehničkih informacija u vezi sa računarima i mrežama u oblasti poslovanja i elektronske trgovine; pružanje računarskih programa za upravljanje rizikom bezbjednosti; usluge računarskih bezbjednosnih informacija, znanja i usluge testiranja; usluge osiguranja kvaliteta; računarske usluge u vezi sa sertifikacijom poslovnih transakcija i pripremanje izvještaja u vezi sa njima; računarske bezbjednosne usluge u vezi sa kontrolom pristupa računarima, elektronskim mrežama i bazama podataka; obezbjeđivanje prenosa podataka i transakcija putem računarskih mreža; konsultacije u oblasti bezbjednosti podataka; tehnološke konsultacije u vezi sa bezbjednošću telekomunikacija; bezbjednosne usluge kompjuterizovanih komunikacionih mreža; pružanje informacija u oblasti interneta, svjetske komunikacione mreže i bezbjednosti kompjuterizovanih komunikacionih mreža i sigurnog prenosa podataka i informacija; konsalting usluge u oblasti interneta, svjetske komunikacione mreže i bezbjednosti kompjuterizovanih komunikacionih mreža, usluge bezbjednosti informacija; usluge autentifikacije za bezbjednost računara; onlajn autentifikacija elektronskih potpisa; pohranjivanje rezervnih podataka van glavne lokacije (off-site); usluge čuvanja elektronskih podataka; pružanje informacija o računarskim tehnologijama i programiranju putem veb-stranica; kartografske usluge; računarstvo u oblaku; usluge hosting provajdera oblaka; pružanje privremene upotrebe softvera koji se zasniva na oblaku i koji se ne može preuzeti i softvera za računarstvo u oblaku; elektronsko pohranjivanje podataka; pružanje virtuelnih računarskih sistema i virtuelne računarske sredine putem računarstva u oblaku; iznajmljivanje softvera za zabavu; tehničko istraživanje u vezi sa kompenzacijom emisije ugljenika; pružanje informacija, savjeta i konsultacija u vezi sa kompenzacijom emisije ugljenika i zaštitom životne sredine; pružanje tehnoloških informacija o svijesti o životnoj sredini i ekološkim inovacijama; testiranje životne sredine, usluge procjene i monitoringa; istraživanja u oblasti zaštite i očuvanja životne sredine; istraživanja i pružanje naučnih informacija u oblasti klimatskih promjena; naučne i industrijske konsultativne usluge u vezi sa gorivima, emisijom goriva i ugljen-dioksida i problemima životne sredine; usluge naučnog i tehnološkog istraživanja u vezi sa preporukama za smanjenje ugljen-dioksida na ekonomičan način; usluge naučnog i tehnološkog istraživanja u vezi sa upravljanjem programima za kompenzaciju emisije ugljenika; usluge istraživanje životne sredine, usluge upravljanja i zaštite; konsultativne, informativne i savjetodavne usluge u vezi sa naprijed navedenim uslugama.

(210) **Ž-2020-180**

(220) 04.06.2020.

(731) TOYOTA JIDOSHA KABUSHIKI KAISHA (also trading as TOYOTA MOTOR CORPORATION), 1, Toyota-cho, Toyota-shi, Aichi-ken, JP

(540)

BZ SERIES

(550) I

(740) Jasna Jusić, Dalmatinska 2, 81000, Podgorica

(511) Klasa 12: Automobili i njihovi strukturalni djelovi.

(210) **Ž-2020-181**

(220) 05.06.2020.

(731) Akoni S.A., Via G Marconi 4, Lugano, CH

(540)

AKONI

(550) I

(740) Miladin Popović, Đoka Miraševića 21/III, 81000, Podgorica

(511) Klasa 9: Naočare, sočiva za naočare za vid, sočiva za naočare za sunce, sočiva za staklene naočare, naočare, naočare za sunce.

Klasa 14: Nakit.

Klasa 25: Pokrivala za glavu; odjeća; obuća.

(210) **Ž-2020-182**

(220) 08.06.2020.

(731) TCT Mobile Europe SAS, Immeuble Le Capitole, Parc des Fontaines, 55 Avenue Des Champs Pierreux, F-92000, Nanterre, FR

(540)

NXTVISION

(550) I

(740) Jasna Jusić, Dalmatinska 2, 81000, Podgorica

(511) Klasa 9: Displeji za pametne telefone; ekrani za pametne telefone; ekrani za tablet računare; pametni telefoni; telefoni; mobilni telefoni; računari; tablet računari; nosivi digitalni uređaji za elektronsku komunikaciju; nosivi digitalni uređaji za elektronsku komunikaciju u obliku pametnih telefona, pametnih satova i nosivih računarskih perifernih uređaja; pametne narukvice; kaiševi za pametne satove; pametni satovi; pametne narukvice; pametne narukvice u obliku pratilaca aktivnosti i pametnih satova; digitalni fotoaparati; prenosivi medijski plejer; baterije koje se mogu puniti; punjači za baterije; baterije za telefone; baterije za tablet računare; slušalice koje se nose u ušima; slušalice koje se nose na glavi; futrole za mobilne telefone, pametne telefone i tablet računare; zvučnici; zvučnici, naime audio zvučnici i bežični zvučnici; kablovi za prenos podataka; USB kablovi; USB kablovi za telefone; kablovi za prenos zvuka i slike; računarski softver; aplikacije za pametne telefone koje se mogu preuzimati; aplikacije za pametne telefone koje se mogu preuzimati za poboljšanje kvaliteta slike sadržaja na pametnom telefonu i koji je preuzet na pametnom telefonu i za poboljšanje kvaliteta slike ekrana i kamere pametnog telefona; naočare za virtuelnu stvarnost; naočare za proširenu stvarnost; naočare sa proširenom stvarnošću sa ugrađenim kamerama i za upotrebu u softveru za igre i za gledanje sadržaja sa mobilnih uređaja, video zapisa, slika, video igara, čitanje e-knjiga i pretraživanje vebajtova i onlajn sadržaja; nosivi displej proizvodi; nosivi displej proizvodi u obliku pratilaca aktivnosti, monitora za video snimke, globalni sistem za pozicioniranje (GPS), računari u obliku pametnih satova, računari u obliku pametnih naočara; fleksibilni i sklopivi ekrani za mobilne telefone, tablete, računarske tablete i nosivi uređaji; fleksibilni i sklopivi ekrani za mobilne telefone, tablete, računarske tablete i nosive uređaje u vidu pametnih telefona, pametnih satova i nosivih računarskih perifernih uređaja; fleksibilni i sklopivi mobilni telefoni, tableti, računarski tableti i nosivi uređaji; fleksibilni i sklopivi mobilni telefoni, tableti, računarski tableti i nosivi uređaji u obliku pametnih telefona, pametnih satova i nosivih računarskih perifernih uređaja; ekrani sa ravnom pločom; elektronski displeji sa ravnim ekranom; fleksibilni elektronski displeji sa ravnim ekranom; fleksibilni displeji sa ravnim ekranom za računare i televizore; savitljivi elektronski displeji sa ravnim ekranom; prenosivi elektronski uređaji za primanje i čitanje teksta, slika i zvuka putem bežičnog pristupa; prenosivi elektronski uređaji za prijem i čitanje teksta, slika i zvuka putem bežičnog pristupa u obliku pametnih telefona, pametnih satova, računarskih tableta i nosivih računarskih perifernih uređaja.

(210) **Ž-2020-183**

(220) 10.04.2020.

(731) CHINA TOBACCO ZHEJIANG INDUSTRIAL CO., LTD., NO.77 ZHONGSHAN NAN ROAD, HANGZHOU CITY, ZHEJIANG PROVINCE, CN

(540)



(550) I

(740) Nenad Aleksić, Vasilija Ivanovića 12, 11000, Beograd

(511) Klasa 34: Duvan; duvan za žvakanje; cigarete; cigarete koje sadrže zamenu duvana, koje nisu za medicinsku upotrebu; cigarete; cigarilos; trave za pušenje; burmut; papir za cigarete; usnici za cigarete.

(210) **Ž-2020-184**

(220) 26.03.2020.

(731) Nissan Jidosha Kabushiki Kaisha (also trading as Nissan Motor Co., Ltd.), No. 2, Takara-cho, Kanagawa-ku, Yokohama-shi, Kanagawa-ken, JP

(540)



(550) I

(740) Milena Pejović, Cetinjski put 11, The Capital Plaza IV floor,, 81000, Podgorica

(511) Klasa 9: Računarski programi; računarski softver; računarski programi, koji se mogu preuzimati; računarski softver, koji se može preuzimati; računarski softver za pametne telefone; računarski aplikativni softver, koji se može preuzimati; računarski aplikativni softver za mobilne telefone, prenosive multimedijalne čitače (plejere) i tablet računare; računarski softver za upotrebu prilikom korišćenja telekomunikacionih usluga u vozilima; računarski softver za pristupanje uslugama navigacije vozila i uslugama sigurnosti vozila; elektronske publikacije, koje se mogu preuzimati.

(210) **Ž-2020-185**

(220) 23.03.2020.

(731) TAIYAKI FACTORY DOO BEOGRAD - STARI GRAD, Žorža Klemansoa 18, 11000, Beograd - Stari Grad, RS

(540)



(550) I

(740) Ana Vukčević, Bulevar Džordža Vašingtona br. 98, The Capital Plaza VIII sprat, 81000, Podgorica

(511) Klasa 30: Sladoled na točenje; kafa; zeleni čaj; palačinke; vafel proizvodi; desertni sufleji; korneti za sladoled.

Klasa 32: Voćni napici i sokovi;

Klasa 43: Usluge obezbeđivanja hrane i pića.

(210) **Ž-2020-191**

(220) 07.05.2020.

(731) Društvo za proizvodstvo, promet i usluge VIVAKS DOO uvoz-izvoz Skopje, Pero Nakov br.21, 1000, Skopje, MK

(540)



(550) I

(740) Milena Pejović, Cetinjski put 11, The Capital Plaza IV floor, 81000, Podgorica

(511) Klasa 32:

(210) **Ž-2020-192**

(220) 07.05.2020.

(731) Društvo za proizvodstvo, promet i uslugi VIVAKS DOO uvoz-izvoz Skopje, Pero Nakov br.21, 1000, Skopje, MK

(540)



(550) I

(740) Milena Pejović, Cetinjski put 11, The Capital Plaza IV floor, 81000, Podgorica

(511) Klasa 32: Pivo; mineralne i gazirane vode i ostala bezalkoholna pića; pića od voća i voćni sokovi; sirupi i ostali preparati za pripremanje napitaka.

(210) **Ž-2020-193**

(220) 07.05.2020.

(731) Društvo za proizvodstvo, promet i uslugi VIVAKS DOO uvoz-izvoz Skopje, Pero Nakov br.21, 1000, Skopje, MK

(540)



(550) I

(740) Milena Pejović, Cetinjski put 11, The Capital Plaza IV floor, 81000, Podgorica

(511) Klasa 32: Pivo; mineralne i gazirane vode i ostala bezalkoholna pića; pića od voća i voćni sokovi; sirupi i ostali preparati za pripremanje napitaka.

(210) **Ž-2020-194**

(220) 07.05.2020.

(731) IRIS LEATHER D.O.O., Cetinjski put bb lamela 5/22-City kvart, Podgorica, ME

(540)



(550) I

(511) Klasa 18: Koža; proizvodi od tih materijala koji nisu obuhvaćeni drugim klasama; životinjske kože; koferi i torbe; novčanici ; torbe(kožna galanterija).

Klasa 25: Cipele; obuća; kožna odjeća-jakne; obuća; pokrivala za glavu.

Klasa 35: Maloprodaja; sortiranje za račun drugih osoba, raznih proizvoda (ne uključuje njihov prevoz) radi omogućavanja potrošaču njihovog lakšeg razgledanja i kupovine; ove usluge se mogu pružati u okviru

prodavnica na malo, trgovina na veliko, posredstvom prodajnih kataloga, dopisno ili elektronskim putem, na primjer posredstvom weba ili putem telefona.

(210) **Ž-2020-197**

(220) 29.05.2020.

(731) DRUŠTVO SA OGRANIČENOM ODGOVORNOŠĆU "COMPANYWALL" DOO PODGORICA, Vasa Raičkovića br.4a, Podgorica, ME

(540)



(550) I

(511) Klasa 16: Papir i karton; Štamparski proizvodi; Proizvodi za uvezivanje knjiga; Fotografije; Kancelarijski materijal i potrepštine za kancelariju, osim namještaja; Ljepila (ljepljive materije za papirnate proizvode ili za kućne potrebe); Slikarske četke; Nastavni i obrazovni materijal; Plastične folije, filmovi i kese za umotavanje i pakovanje; Štamparska slova, klišeji.

Klasa 35: Oglašavanje; Vođenje komercijalnih poslova; Komercijalna administracija; Kancelarijski poslovi.

Klasa 36: Osiguranje; Financijski poslovi; Monetarni poslovi; Upravljanje nekretninama.

Klasa 42: Naučne i tehnološke usluge kao i pripadajuće usluge istraživanja i koncepcije; Usluge industrijskih analiza i istraživanja; Koncepcija i razvoj računara i računarskih programa / hardvera i softvera/.

(210) **Ž-2020-198**

(220) 10.06.2020.

(731) PREKOVEZE DOO Podgorica, ul. Sima Barovića br.20, Podgorica, ME

(540)



(550) I

(511) Klasa 16: Papir, karton i proizvodi od tih materijala koji nisu obuhvaćeni drugim klasama; štamparski proizvodi; proizvodi za uvezivanje knjiga; fotografije; pribor za pisanje; ljepila (ljepljive materije za papirne proizvode ili za kućne potrebe); slikarski pribor; kistovi; pisaće mašine i kancelarijski pribor (osim namještaja); oprema za nastavu i obuku (osim aparata); plastični materijali za ambalažu (koji nisu obuhvaćeni drugim klasama); štamparska slova; klišeji.

Klasa 35: Oglašavanje i reklamiranje; vođenje komercijalnih poslova; komercijalna administracija; kancelarijski poslovi.

Klasa 41: Obuka; stručno osposobljavanje; razonoda; sportske i kulturne djelatnosti.

(210) **Ž-2020-199**

(220) 10.06.2020.

(731) PREKOVEZE DOO Podgorica, ul. Sima Barovića br.20, Podgorica, ME

(540)



(550) I

(511) Klasa 16: Papir, karton i proizvodi od tih materijala koji nisu obuhvaćeni drugim klasama; štamparski proizvodi; proizvodi za uvezivanje knjiga; fotografije; pribor za pisanje; ljepila (ljepljive materije za papirne proizvode ili za kućne potrebe); slikarski pribor; kistovi; pisaće mašine i kancelarijski pribor (osim namještaja); oprema za nastavu i obuku (osim aparata); plastični materijali za ambalažu (koji nisu obuhvaćeni drugim klasama); štamparska slova; klišeji.

Klasa 35: Oglašavanje i reklamiranje; vođenje komercijalnih poslova; komercijalna administracija; kancelarijski poslovi.

Klasa 41: Obuka; stručno osposobljavanje; razonoda; sportske i kulturne djelatnosti.

(210) **Ž-2020-201**

(220) 11.06.2020.

(731) Colgate-Palmolive Company (a Delaware corporation), 300 Park Avenue, 10022, New York, New York, US

(540)

PALMOLIVE

(550) I

(740) Jasna Jusić, Dalmatinska 2, 81000, Podgorica

(511) Klasa 5: Antibakterijski sapun, sredstva za dezinfekciju ruku, dezinfekciona sredstva za čišćenje, antibakterijske maramice.

(210) **Ž-2020-202**

(220) 12.06.2020.

(731) Netflix, Inc., 100 Winchester Circle, 95032, Los Gatos, California, US

(540)



(550) I

(740) Jasna Jusić, Dalmatinska 2, 81000, Podgorica

(511) Klasa 9: Softver za striming audiovizuelnog i multimedijalnog sadržaja putem interneta i globalne komunikacione mreže; softver za striming audiovizuelnog i multimedijalnog sadržaja na mobilne digitalne elektronske uređaje; softver za pretraživanje, organizovanje, i preporučivanje multimedijalnog sadržaja; oprema za razvoj softvera za kreiranje softverskih i mobilnih aplikacija; računarski softver; računarski programi; računarske softverske aplikacije koje se mogu preuzimati; mobilne aplikacije koje se mogu preuzimati; softver za video igre; računarski softver za igre; interaktivni programi za video igre; kertridži i diskovi za računarske igre; programi i softveri za elektronske igre; softveri za elektronske igre za mobilne telefone, tablete, lične računare, i ručne elektronske uređaje; hardver i softver za igre virtuelne realnosti i proširene stvarnosti; igrani program i televizijske emisije koje se mogu preuzimati putem usluge video na zahtev; grafika koja sadrži setove digitalnih slika i ikona koja se može preuzimati za upotrebu na računarima, tabletima, i mobilnim telefonima; CD-ovi i DVD-ovi; igrani program i televizijske emisije koje se mogu preuzimati; audio knjige; melodije zvona i snimljeni zvuci koji se mogu preuzimati; audio i vizuelni snimci; muzički snimci; aparati za snimanje, prenos ili reprodukciju zvuka ili slike; audio i video snimci sa muzikom, muzičkim nastupima, i muzičkim spotovima koji se mogu preuzimati; podkastovi koji se mogu preuzimati; kodirane elektronske čip kartice; magnetno kodirane poklon kartice; elektronske publikacije; daljinski upravljači; uređaji za striming digitalnih medija; digitalni video rekorderi; DVD i plejeri za video diskove visoke rezolucije; sistemi za kućni bioskop koji se sastoje od audio i video resivera; disk plejeri; televizori; televizijski

set top boksovi; računarski hardver i periferni uređaji; podloge za miš; oslonci za zglob i ruku koji se koriste sa računarima; stalci prilagođeni za mobilne telefone, tablet računare; digitroni; kamere; digitalne kamere; radio; USB fleš uređaji; zvučnici; vezice za mobilni telefon; maske za mobilni telefon; futrole za mobilni telefon; tastature za tablete; maske za tablet računare; futrole za tablet računare; maske na preklop za tablet računare; zaštitne maske i futrole za elektronske uređaje naime, računare, tablet računare, mobilne telefone, digitalne kamere, digitalne medija plejere, elektronske čitače knjiga, konzole za video igre, i lične digitalne asistente; zaštitne maske za displej; adapteri; slušalice; slušalice koje se stavljaju u uši; voki-toki; mobilni telefoni; pametni satovi; naočare; sunčane naočare; futrole za naočare i sunčane naočare; binokulari; ukrasni magneti; merni lenjiri; uveličavajuće staklo; mikrofoni; sportske kacige; kacige za bicikliste.

Klasa 38: Usluge prenosa audio i video sadržaja na zahtev; striming audio i video sadržaja; usluge prenosa glasa, podataka, slika, signala, poruka i informacija; usluge audio i vizuelnog emitovanja; usluge prenosa i isporuke audio i vizuelnog sadržaja; usluge prenosa videa na zahtev; pružanje onlajn foruma na kojima korisnici mogu da objavljuju ocene, recenzije i preporuke za filmove i televizijske emisije kao i za događaje i aktivnosti u oblasti zabave i edukacije.

Klasa 41: Usluge zabave; informacije u vezi sa zabavom; usluge filmske produkcije, osim reklamnih filmova; usluge pružanja filmova i televizijskih emisija, koji se ne mogu preuzeti, putem servisa za prenos videa na zahtev; pružanje informacija iz oblasti zabave putem veb-stranice; usluge zabavnih parkova; usluge zabave u smislu televizijskih serija i filmova u žanrovima akciona avantura, animacija, anime, biografija, klasik, komedija, kriminalistički, dokumentarni, drama, religijski, porodični, fantazija, film noir, istorija, horor, međunarodni, mjuzikl, misterija, romantični, naučna fantastika, sportski, triler, ratni i vestern; usluge zabave u smislu vođenja izložbi i konvencija koje se tiču televizije i filma i televizijskih i filmskih likova; usluge zabave u smislu razvoja, kreiranja, produkcije, distribucije i post-produkcije igranih filmova, televizijskih emisija, posebnih događaja i multimedijalnog zabavnog sadržaja; usluge zabave u smislu pozorišnih, muzičkih ili komičarskih nastupa uživo; usluge klubova obožavalaca; usluge produkcije i distribucije igranih filmova i televizijskih emisija; pružanje usluga zabave putem globalne komunikacijske mreže u obliku onlajn igara i veb-stranica koje nude širok spektar informacija za zabavu od opšteg interesa u vezi sa igranim filmovima, televizijskim emisijama i programima, muzičkim videima, povezanim isečcima iz filmova, fotografijama i drugim multimedijalnim materijalima; usluge pružanja video klipova i drugog multimedijalnog sadržaja koji se ne može preuzeti, a koji sadrži audio, video, umetnička dela i tekst iz i u vezi sa zabavom, filmom, televizijom, televizijskim i filmskim likovima, muzikom i poznatim ličnostima; pružanje informacija iz oblasti zabave putem veb-sajta; usluge zabave, naime pružanje onlajn računarskih, elektronskih i video igara; usluge pružanja privremene upotrebe interaktivnih igara koje se ne mogu preuzeti; usluge pružanja informacija, recenzija i preporuka u vezi sa filmovima i televizijskim emisijama putem veb-sajta i servisa prenosa videa na zahtev; edukativne i zabavne usluge, naime pružanje interaktivnih onlajn televizijskih serija i filmova; usluge interaktivne zabave; usluge onlajn interaktivne zabave; usluge vođenja zabavnih događaja i aktivnosti; usluge interaktivnih, iskustvenih i duboko prožimajućih događaja za učešće publike i rekreativnih aktivnosti; usluge zabave u smislu organizacije i vođenja izložbi, konferencija i konvencija iz oblasti zabave, filma, televizije, televizijskih i filmskih likova, muzike i poznatih ličnosti; organizovanje i vođenje društvenih festivala koji promovišu muziku, umetnost, hranu, film, televiziju, pozorište, dramu, ples, muzičke nastupe uživo, govornike, pojavljivanja poznatih ličnosti i kulturne izložbe i aktivnosti; usluge pružanja onlajn stripova i grafičkih romana koji se ne mogu preuzeti; usluge radijske zabave; usluge produkcije i distribucije radio programa i zvučnih zapisa; usluge pružanja podkasta u oblasti zabave; usluge produkcije podkasta; usluge pružanja onlajn muzike koja se ne može preuzeti.

(220) 15.06.2020.

(731) TOYOTA JIDOSHA KABUSHIKI KAISHA (also trading as Toyoty Motor Corporation), 1, Toyota-cho, Toyota-shi, Aichi-ken, JP

(540)

BZ4X

(550) I

(740) Jasna Jusić, Dalmatinska 2, 81000, Podgorica

(511) Klasa 2: Automobili i njihovi strukturalni djelovi.

(210) **Ž-2020-206**

(220) 29.05.2020.

(731) DRUŠTVO SA OGRANIČENOM ODGOVORNOŠĆU "COMPANYWALL" DOO PODGORICA, Vasa Raičkovića br.4a, Podgorica, ME

(540)



(550) I

(511) Klasa 16: Papir i karton; Štamparski proizvodi; Proizvodi za uvezivanje knjiga; Fotografije; Kancelarijski materijal i potrepštine za kancelariju, osim namještaja; Ljepila (ljepljive materije za papirnate proizvode ili za kućne potrebe); Slikarske četke; Nastavni i obrazovni materijal; Plastične folije, filmovi i kese za umotavanje i pakovanje; Štamparska slova, klišeji.

Klasa 35: Ogllašavanje; Vođenje komercijalnih poslova; Komercijalna administracija; Kancelarijski poslovi.

Klasa 36: Osiguranje; Finansijski poslovi; Monetarni poslovi; Upravljanje nekretninama.

Klasa 42: Naučne i tehnološke usluge kao i pripadajuće usluge istraživanja i koncepcije; Usluge industrijskih analiza i istraživanja; Koncepcija i razvoj računara i računarskih programa /hardvera i softvera/.

(210) **Ž-2020-211**

(220) 22.06.2020.

(731) Lidl Stiftung & Co. KG , Stiftsbergstrasse 1, 74172, Neckarsulm, DE

(540)



(550) I

(740) Vuk Lutovac, Bulevar Ivana Crnojevića 93, 81000, Podgorica

(511) Klasa 29: Mlijeko i mliječni proizvodi, naročito svježi sir, nepasterizovani sir, mocarela, maskarpone sir, tvrdi sir.

(210) **Ž-2020-213**

(220) 22.06.2020.

(731) GENERAL HOTEL MANAGEMENT LTD., P.O.BOX 71 CRAIGMUIR CHAMBERS, ROAD TOWN, TORTOLA, VG

(540)



(550) I

(740) Jasna Jusić, Dalmatinska 2, 81000, Podgorica

(511) Klasa 43: Usluge biroa za smještaj (hoteli, pansioni); agencijske usluge za rezervaciju hotelskog smještaja; pružanje onlajn pregleda hotelskih smještaja; uređenje hotelskog smještaja; organizovanje hotelskih rezervacija; rezervacija hotelskog smještaja; usluge rezervacije hotela; usluge rezervacije hotelskog smještaja; usluge hotelskog smještaja; usluge kateringa za hotele; informacije o hotelima; usluge rezervacije hotela; usluge rezervacije hotela koje se pružaju putem interneta; rezervacije hotela; usluge bukiranja hotelskih soba; usluge rezervacije hotelskih soba; hotelske usluge; hotelske usluge za preferirane mušterije;

hoteli; pravljenje hotelskih rezervacija za druge;
pružanje smještaja u hotelima i motelima; obezbjeđivanje izložbenih objekata u hotelima; obezbjeđivanje hotelskog smještaja; pružanje onlajn informacija u vezi sa rezervacijama hotela; pružanje hotelskog smještaja; pružanje informacija koje se odnose na hotele; usluge prijema za privremeni smještaj (upravljanje dolascima i odlascima); katering za hranu i piće; priprema hrane i pića; obezbjeđivanje hrane i pića; pružanje usluga restorana; serviranje hrane i pića u restoranima i barovima; rezervacija hotelskog smještaja; usluge odmarališa; priređivanje svadbenih prijema (obezbjeđivanje hrane i pića); priređivanje svadbenih prijema (iznajmljivanje funkcionalnih soba).

(210) **Ž-2020-215**

(220) 18.06.2020.

(731) "OSMANAGIĆ CO" D.O.O. NIKŠIĆ, HERCEGOVAČKI PUT BROJ: 36, Nikšić, ME

(540)



(550) I

(511) Klasa 12: Vozila.

Klasa 35: Trgovina polovnih vozila svih brendova.

Klasa 37: Održavanje i popravka polovnih vozila svih brendova.

(210) **Ž-2020-219**

(220) 25.06.2020.

(731) NUVARIA GLOBAL SL, P.I. Las Dueñas, A-8,Hinojos, 21740, Huelva, ES

(540)



(550) I

(740) Milena Pejović, Cetinjski put 11, The Capital Plaza IV floor, 81000, Podgorica

(511) Klasa 3: Parfimerija; kozmetika; preparati za beljenje [uklanjanje boja] za upotrebu u domaćinstvu; preparati za poliranje; proizvodi za odmašćivanje, koji nisu za upotrebu u procesu proizvodnje; abrazivi; preparati za čišćenje; sapun; gelovi za izbeljivanje zuba; etarska ulja; losioni za kosu; sredstva za čišćenje zuba [paste, gelovi, tečnosti]; preparati za pranje; gelovi za kupanje; preparati za čišćenje; preparati za parfimisanje vazduha.

Klasa 21: Kozmetički pribor; raspršivači mirisa/mirisni isparivi raspršivači; instrumenti za čišćenje, ručni; toaletni pribor; sunđeri za upotrebu u domaćinstvu; sunđeri za pranje/ribanje; krpe za čišćenje; četke; materijali za pravljenje četki; četke za obuću; krpe za prašinu; rukavice za upotrebu u domaćinstvu; mopovi; kućne potrepštine; kutije za upotrebu u domaćinstvu ili kuhinji; češljevi; štikaljke za veš; sunđeri za šminkanje; četke; sunđeri; krpe za poliranje cipela; rukavice za čišćenje za upotrebu u domaćinstvu; mopovi; krpe za poliranje; krpe za čišćenje; krpe za pranje podova; krpe za prašnu; krpe za brisanje prašine sa nameštaja.

(210) **Ž-2020-221**

(220) 26.06.2020.

(731) PFIZER INC., 235 East 42nd Street, 10017, New York, NY, US

(540)

TRAZIMERA

(550) I

(740) Jasna Jusić, Dalmatinska 2, 81000, Podgorica

(511) Klasa 5: Farmaceutski preparati za liječenje raka.

(210) **Ž-2020-222**

(220) 29.06.2020.

(731) HELLENIC PETROLEUM S.A., 8A, Chimarras Street, 15125, Maroussi, Athens, GR

(540)



(550) I

(740) Jasna Jusić, Dalmatinska 2, 81000, Podgorica

(511) Klasa 4: Energija (električna -).

Klasa 9: Stanice za punjenje električnih vozila.

Klasa 35: Administrativno upravljanje voznim parkom električnih vozila.

Klasa 37: Punjenje akumulatora vozila; instalacijske usluge u vezi s električnom opremom za punjenje električnih vozila; usluge održavanja u vezi s infrastrukturom za punjenje električnih vozila.

Klasa 39: Iznajmljivanje električnih vozila; distribucija energije.

(210) **Ž-2020-223**

(220) 29.06.2020.

(731) HELLENIC PETROLEUM S.A., 8A, Chimarras Street, 15125, Maroussi, Athens, GR

(540)



(550) I

(740) Jasna Jusić, Dalmatinska 2, 81000, Podgorica

(511) Klasa 4: Energija (električna -).

Klasa 9: Stanice za punjenje električnih vozila.

Klasa 35: Administrativno upravljanje voznim parkom električnih vozila.

Klasa 37: Punjenje akumulatora vozila; instalacijske usluge u vezi s električnom opremom za punjenje električnih vozila; usluge održavanja u vezi s infrastrukturom za punjenje električnih vozila.

Klasa 39: Iznajmljivanje električnih vozila; distribucija energije.

(210) **Ž-2020-225**

(220) 29.06.2020.

(731) The Coca-Cola Company, One Coca-Cola Plaza, 30313, Atlanta, Georgia, US

(540)



(550) I

(740) Miladin Popović, Đoka Miraševića 21/III, 81000, Podgorica

(511) Klasa 5: Farmaceutski, medicinski i veterinarski preparati; sanitarni preparati za medicinske svrhe; dijetetska hrana i supstance prilagođene medicinskoj i veterinarskoj upotrebi, hrana za bebe; dijetetski suplementi za ljudsku upotrebu za ljude i životinje; flasteri, materijali za previjanje; materijali za plombiranje zuba, zubarska smola; dezinfektanti; preparati za uništavanje štetočina; fungicidi, herbicidi. Klasa 32: Piva; bezalkoholni napici; mineralne i gazirane vode; voćna pića i voćni sokovi; sirupi i drugi bezalkoholni preparati za pripremu napitaka.

OBJAVA ŽIGOVA
PUBLICATION OF TRADEMARKS

(111) **14673**

(151) 05.05.2020.

(210) Ž-2018-364

(220) 19.09.2018.

(732) BANAT 1984., Ulica Stepe Stepanovića br.6, Vršac, RS

(540)



(550) I

(511) Klasa 30: Kafa, čaj, kakao, šećer, pirinač, tapioka, sago, zamjena kafe; brašno i proizvodi od žitarica, hljeb, kolači, poslastice, sladoledi; med, melasa, kvasac, prašak za pecivo; so, senf; sirće, sosovi (kao začini); začini; led; prehrambeni proizvodi spremljeni od proizvoda koji su pripremljeni za upotrebu ili očuvanje, a naročito: pića od kakaoa, kafe, na bazi čokolade; žitarice pripremljene za ljudsku ishranu.

(111) **14525**

(151) 23.06.2020.

(210) Ž-2018-391

(220) 23.10.2018.

(732) VELETEX d.o.o., Cijevna b.b., Podgorica, ME

(540)



(550) I

(740) VELETEX, CIJEVNA BB PODGORICA, PODGORICA

(511) Klasa 1: Baštovanstvo (hemijski proizvodi za baštovanstvo) osim fungicida, herbicida, insekticida i sredstava protiv parazita; biljke (preparati za regulisanje rasta biljaka); biološki preparati [ne za medicinske ili veterinarske potrebe]; brašno za industrijske potrebe; drveće (kit za ispunjavanje šupljina u drveću) [arborikultura]; gnojenje obradivog zemljišta (hemijski proizvodi za gnojenje obradivog zemljišta); gnojiva za zemlju; hemijski proizvodi za poljoprivredu [osim fungicida, herbicida, insekticida i parazitocida]; hlor; kalemljenje drveća (vosak za kalemljenje drveća); kalemljenje drveća, kit za kalemljenje drveća; poljoprivreda (gnojiva za potrebe poljoprivrede); poljoprivreda (hemijski proizvodi za potrebe poljoprivrede) osim fungicida, herbicida, insekticida i sredstava protiv parazita; vinarstvo (baktericidi za vinarstvo) [hemikalije koje se upotrebljavaju u proizvodnji vina]; vino (proizvodi za bistrenje vina); vinova loza (hemikalije za zaštitu vinove loze od bolesti).

Klasa 5: Biocidi; dezodoransna sredstva osim onih za ličnu upotrebu ili za životinje; dezodoransna sredstva za odjeću i tekstil; enzimi za veterinarske potrebe; enzimski preparati za veterinarske potrebe; fungicidi; gamad (sredstva za uništavanje gamadi); gaza za zavijanje; grinje (sredstva protiv grinja) [akaricidi]; hemijski preparati za veterinarske potrebe; hemijski reagensi za medicinske ili veterinarske potrebe; hrana za odojčad [bebe]; hranjivi dodaci prehrani; insekti (proizvodi za odbijanje insekata); insekti (tamjan za odbijanje insekata), insekticidi; kreme za medicinske potrebe [pomade]; losioni za veterinarsku upotrebu; lijekovi za veterinarske potrebe; masti za veterinarske potrebe; muve (lijepak za muve); muve (proizvodi za uništavanje muva); ogrlice protiv parazita za životinje; otrov za pacove; paraziti (ogrlice protiv parazita) za životinje; paraziti (proizvodi protiv parazita); parazitocidi [sredstva za uništavanje parazita]; pesticidi; sumporne trake za dezinfekciju; tlo (sredstva za sterilizaciju zemljišta); vakcine, veterinarski proizvodi; vinova loza (hemijski proizvodi za liječenje bolesti vinove loze); životinje (proizvodi za pranje životinja).

Klasa 7: Akvarijumi (pumpe za provjetravanje akvarijuma); alat (držači alata) [dijelovi mašina]; alat [djelovi mašina]; boce (mašine za pečačenje boca), boce (mašine za zapušavanje boca); boce (mašine za zatvaranje boca kapicama); boce (uređaji za pranje boca); čišćenje (aparati za čišćenje pod pritiskom); filterski umeci za mašine za filtriranje; filtriranje (mašine za filtriranje); mašine za vađenje korova (mašine za vađenje korova); muzenje (mašine za muzenje); muzenje (sisaljke mašina za muzenje); plugovi; plugovi (rala plugova) [lemeši]; plugovi [kultivatori] za vinogradarstvo; poljoprivredne sprave [ne ručne]; poljoprivredne mašine; prese za grožđe; sijačice [mašine]; travnjaci (kosilice za travnjake) [mašine].

Klasa 29: Ajvar [konzervisana paprika]; bademi, pripremljeni; crveni luk, konzervisani [povrće]; češnjak, obrađeni; čips [prženi krompirići]; dagnje za jelo, nežive; džemovi; đumbir (džem od đumbira); fermenti (mliječni fermenti) za upotrebu u kulinarskom; fileti, riblji; gljive, konzervisane; grašak, konzervisani; grožđice [suvo grožđe]; jabuke (kompot od jabuka); jaja (bjelančevine i jaja); jaja (žumance jaja); jaja*; jaja u prahu; jela od ribe; jetra, jetrena pašteta; jogurt; kakao (puter od kakaoa); kikiriki (obrađeni kikiriki); kikiriki (puter od kikirikija); kiseli krastavci [začin]; kisjeli kupus; kisjelo mlijeko; kobasice (panirane kobasice); kobasice

[salame]; konzerve od povrća; konzerve, mesne; konzerve, riblje; konzerve, voćne; krastavci, ukiseljeni; kristalizovano voće; kriške voća; krompir (niskokalorični čips od krompira); krompiri (pahuljice od krompira); krompiri (prženi krompiri) [čips]; margarin; masline, konzervisane; maslinovo ulje, jestivo; meso; meso, konzervisano; meso, svinjsko meso mliječni frapei; mliječni napitci u kojima mlijeko prevladava; mliječni proizvodi; mlijeko; orasi, pripremljeni; pahuljice od krompira; paradajz (pire od paradajza); paradajz (sok od paradajza) za kuhinju; pasulj, konzervirani; pašteta od jetre; pavlaka [mliječni proizvod]; pekmezi; povrće (salate od povrća); povrće, konzervisano; povrće, kuvano; povrće, sušeno; pršuti; puter; puter (pavlaka za puter); puter od kakaoa; puter od kikirikija; rakovi (neživi, ružičasti morski rakovi) [škampi]; rakovi (neživi, sivi morski rakovi); rakovi (slatkovodni, neživi rakovi); riba; riba, konzervisana; riba, usoljena; salame; salate od povrća; salate od voća; sardine; sardine [riba]; sezamovo ulje; sirevi; sirilo, sirište vještačko; sjemenke, obrađene; slanine; sočivo, konzervisano [povrće]; soja (konzervisana sojina zrna za prehranu); sojino mlijeko [zamjena mlijeka]; sokovi, biljni za kuhinju; suhomesnati proizvodi; suncokret (ulje od suncokreta, jestivo); suncokretove sjemenke [obrađene]; supe od mesnih koncentrata; supe od povrća (sastojci za pripremanje supe od povrća); supe od zeleniša; supe, čiste, mesne [bujoni]; školjke, nežive; tunjevina; ulje za prehranu; urme; usoljeno meso, salame; uštipci od krompira; voće, konzervisano; voće, kuvano; voćna kaša [pulpa]; voćne kriške; voćne salate; voćni želei [žele]; zamrznuto voće; želatin *; želei za prehranu; živina (meso od živine).

Klasa 30: Aromatični preparati za prehrambene potrebe; arome [osim eteričnih ulja]; arome za kolače [osim eteričnih ulja]; bademi (slatkiši od badema); bademovo tijesto; beskvasni hljeb; biber; biskviti [suvi kolačići]; brašno [jela od brašna]; brašno (najfinije pšenično brašno); brašno *; celer (sol od celera); cikorija [zamjena za kafu]; cimet; crni šećer, slatki korjen (poslastica); čaj (napitci od čaja); čaj *; čajevi, nemedicinski; čajni kolačići [minjoni]; čokolada; čokolada (piće od čokolade); čokoladni musevi [pjesnice]; dezertni musevi [poslastičarski proizvodi]; dvopek [prepečenac]; đumbir [začin]; fermenti za tijesto; hljeb; hljebne mrvice; jela od brašna; jogurt, smrznuti [vrsta sladoleda]; kafa; kafa (arome za kafu); kafa (bijela kafa); kafa (biljni preparati kao zamjena kafe); kafa (pića od kafe); kafa (zamjene za kafu); kafa, nepržena; kakao; kakao (pića na bazi kakaoa); kakao (proizvodi od kakaoa); karanfilic začin; kari [začin]; kašice (mliječne kašice za prehranu); kečap [umak od paradajza]; keks [petits-beurre]; kikiriki (slatkiši od kikirikija); kolači; kolači (arome za kolače) [osim eteričnih ulja]; kolači (prašak za kolače); kolači (tijesto za kolače); kolačići (sačasti kolačići) [vafel]; kolačići od badema; krekeri krompirovo brašno za prehranu; kuhinjska sol; kukuruz, mljeveni; kukuruz, prženi; kukuruzna kaša, griz; kukuruzne pahuljice; kukuruzno brašno; kvasac; ledeni čaj; makaroni [vrsta tjestenine]; med; medenjaci; mirođija, začin; mirođije; mješavina različitih začina [začin]; mlijeko (kakao s mlijekom); mlijeko, čokoladno [napitak]; musli; oraščići; oraščići, muskatni; pahuljice od sušenih žitarica; paprika [začin]; paradajz (umak od paradajza); pastile [bomboni]; pavlaka, smrznuta [šlag]; pecivo (fino sitno pecivo); pecivo [brioši]; pića od čokolade; pića od kafe; pića od kakaoa; praline; prašak za dizanje; prašak za kolače; prehrambena tjestenina; ravioli [tjestenina]; rezanci; rezanci (pripremljeni obroci od rezanaca); rezanci za supe; riža; riža (kolačići od riže); senf [senf]; sirće; sladoled; sladoled (prašak za sladoled); slastičarski proizvodi; slatkiši; slatkiši raznih aroma [začin]; so za konzervisanje prehrambenih namirnica; so, kuhinjska; soda bikarbona za kuvanje; soja (pikantni umak od soje); suvi kolačići; šafran [začin]; šećer *; šećer, žuti za prehranu; šećerni proizvodi; špageti; tjestenina; tjestenina za prehranu; torte; tortilje; voćni kolači; začini začini [aromatične materije].

Klasa 31: Agrumi [južno voće]; aloe vera [živa biljka]; biljke; biljke, osušene za ukrašavanje; božićna drvca-novogodišnje jelke; cvijeće, prirodno; cvijeće, prirodno (vijenci od prirodnog cvijeća); cvijeće, sušeno za ukrašavanje; drveće [bilje]; grmlje; grožđe, svježe; hmelj; hrana za životinje; ječam *; kolačići za pse; krastavci, svježi; krompiri; kućni ljubimci (hrana za kućne ljubimce); kućni ljubimci (mirisni pijesak za kućne ljubimce); kućni ljubimci (napici za kućne ljubimce); kućni ljubimci (papir s pijeskom za kućne ljubimce) [stelja]; kukuruz; kukuruzna stočna pogača; limuni, svježi; luk, svježi [povrće]; lukovice cvijeća; lješnik; masline, svježe; naranče;

orasi; palme [stabla]; palmino lišće; paprika [biljka]; pasulj u svježem stanju; pogače, uljni kolači [krmivo]; poriluk, svježi; povrće, svježe; pseći kolačići; pšenica; pšenične klice za životinjsku prehranu; ptice (hrana za ptice); raž; ružini grmovi; salata, zelena [svježa]; sezam; sipina kost za ptice; sjeme; slad za pivare i fabrike alkohola; sočivo, svježe [povrće]; spanać, svježi; stočna hrana (kompleks vegetalnih supstanci za stočnu hranu); stočna hrana (nemedicinski dodaci stočnoj hrani); tikve [bundeve]; travnjaci, prirodni; tresetne podloge; vijenci od prirodnog cvijeća; vinova loza (čokoti vinove laze); voće, svježe; živina (hrana za nošenje jaja); životinje (hrana za životinje).

Klasa 32: Aloe vera (bezalkoholna pića od aloe vera); bezalkoholna pića koja sadrže voće; bezalkoholni voćni ekstrakti; gazirane vode; hmelj (ekstrakti hmelja) za proizvodnju piva; limunada; mineralne vode [piće]; napitci (sirupi za pripremu napitaka); nektar, voćni; pivo; sirupi za napitke; sok od paradajza [napitak]; sokovi, biljni [napitci]; sokovi, voćni; stolna voda [voda za piće]; voćni napitci bez alkohola; voćni sokovi; voda za piće; voda, gazirana; voda, mineralna [piće].

Klasa 33: Alkoholna pića (unaprijed pomiješana alkoholna pića, osim onih na bazi piva); alkoholna pića koja sadrže voće; alkoholna pića osim piva; aperitivi *; digestivi [žestoka alkoholna pića i likeri]; ekstrakti, voćni s alkoholom; jabukovača; klekovača [rakija]; kokteli *; kruskovača; likeri; pića (alkoholna pića osim piva); pića, destilirana; rakija; rum; vina; viski [alkoholno piće]; voće (alkoholna pića koja sadrže voće); voće (ekstrakti voća s alkoholom); votka; žestoka alkoholna pića. ----

Klasa 35: Agencije za uvoz-izvoz; fakturisanje; informacije (poslovne informacije); izvodi iz računa (davanje izvoda sa računa); izvoz-uvoz (agencije za izvoz-uvoz); javnost (odnosi s javnošću) [propaganda]; marketing; nabava za treće (usluge nabave za treće) [kupovina proizvoda i usluga za druga preduzeća] [odnosi s javnošću] [propaganda]; oglašavanje [reklamiranje]; podugovaranje (usluge podugovaranja) [komercijalna pomoć]; prodaja (podsticaj prodaje) za treće osobe; proučavanje tržišta [marketing]; računovodstveni poslovi; reklamiranje on-line na info mrežnoj mreži; reklamiranje putem radija; reklamiranje putem televizije; televizijsko reklamiranje; trgovački poslovi (procjene trgovačkih poslova); tržište (proučavanje tržišta); tržište (traženje tržišta); uvoz-izvoz (agencije za uvoz-izvoz); vođenje knjiga; vođenje poslova (pomoć u vođenju poslova); vođenje poslova (savjetovanje o vođenju poslova); vođenje poslova (usluge savjetovanja u vezi vođenja poslova).

Klasa 39: Brod (prevoz brodom); cvijeće (isporuka cvijeća); isporuka [distribucija] proizvoda; isporuka [distribucija] robe; isporuka cvijeća; isporuka paketa; istovar (usluge istovara); iznajmljivanje hladnjača; iznajmljivanje skladišta; pomorski prevoz; pomorsko posredovanje [mešetarenje]; posredovanje u prevozu; prevoz (informacije o prevozu); prevoz (posredovanje u prevozu); prevoz (rezervacije za prevoz); prevoz (riječni prevoz); prevoz brodom; prevoz kamionima; prevoz kolicima; prevoz robe; prevoznice [špediterske] usluge; skladišta (iznajmljivanje skladišta); skladištenje.

Klasa 44: Bašte (usluge uređivača bašta); bašte (uređenje bašta); baštovani-pejzažisti (usluge baštovana-pejzažista); cvijetni aranžmani (pravljenje cvijetnih aranžmana); drveće (obrezivanje drveća); drveće (sadnja drveća radi smanjenja emisije ugljenika); mgnojivo i ostali hemijski proizvodi namijenjeni za poljoprivredu (vazdušno ili drugačije razbacivanje [posipanje] gnojiva i ostalih hemijskih proizvoda za poljoprivredu); korov (uništavanje korova); obrezivanje drveća; održavanje travnjaka; pejzažna uređenja (konceptija uređenja pejzaža); poljoprivredna oprema (iznajmljivanje opreme za poljoprivredna imanja); povrtlarstvo; rasadničari (usluge rasadničara); razbacivanje, vazdušnog ili drugog gnojiva, i ostalih hemijskih proizvoda u poljoprivredi; štetočine (unistavanje životinjskih štetočina u poljoprivredi); travnjaci (održavanje travnjaka); uništavanje korova; vijenci od cvijeća (izrada vijenaca od cvijeća).

(111) **14526**

(151) 23.06.2020.

(210) Ž-2018-393

(220) 23.10.2018.

(732) NAŠE VOĆE d.o.o., Mjolje polje b.b., Nikšić, ME

(540)



(550) I

(740) NAŠE VOĆE DOO NIKŠIĆ, MIOLJE POLJE BB, NIKŠIĆ

(511) Klasa 31: Agrumi [južno voće]; biljke; drveće [bilje]; grmlje; ječam *; krompiri; kukuruz; lukovice cvijeća; lješnik; paprika [biljka]; pšenica; raž; ružini grmovi; sjeme; stočna hrana (kompleks vegetalnih supstanci za stočnu hrana); stočna hrana (nemedicinski dodaci stočnoj hrani); tikve [bundeve] vinova loza (čokoti vinove loze); povrće, svježe; voće, svježe.

Klasa 33: Alkoholna pića (unaprijed pomiješana alkoholna pića, osim onih na bazipiva); alkoholna pića koja sadrže voće; alkoholna pića osim piva; aperitivi *; digestivi [žestoka alkoholna pića i liker]; ekstrakti, voćni s alkoholom; jabukovača; klevkovača [rakija]; kokteli *; kruškovača; liker; pića (alkoholna pića osim piva); pića, destilirana; rakija; rum; vina; viski [alkoholno piće]; voće (alkoholna pića koja sadrže voće); voće (ekstrakti voća s alkoholom); votka; žestoka alkoholna pića.

(111) **14528**

(151) 23.06.2020.

(210) Ž-2018-258

(220) 24.07.2018.

(732) Climate Control Technologies PC, 14-16 Churchill Way, CF 102DX, Cardiff, Wales, GB

(540)



(550) I

(740) Dejan Raičević, Vojvode Boža br.1, 81250, Cetinje

(511) Klasa 11: Klima uređaji ; ventilatori za instalaciju i uređaje za klimatizaciju ; grijači vazduha ; električni radijatori ; električni ventilatori ; električni odstranjivači vlage ; prečistači i filteri vazduha ; električni grijači vode ; električni dispenceri vode za piće ; ovlaživači ; uređaji , aparati i instalacija za klimatizaciju , ventilatori koji su djelovi instalacija za klima uređaje ; filteri za klimatizaciju ; osvježivači vazduha , odnosno uređaji za prečišćavanje vazduha.

(111) **14529**

(151) 23.06.2020.

(210) Ž-2018-304

(220) 15.08.2018.

(732) Hemofarm A.D. farmaceutsko-hemijska industrija Vršac, Beogradski put bb, 26300, Vršac, RS

(540)

UROPOTENT

(550) I

(740) AOD MSA IP - Milojević Sekulić Advokati, Karađorđeva 65, 11000, Beograd

(511) Klasa 5: Farmaceutski proizvodi.

(111) **14530**

(151) 23.06.2020.

(210) Ž-2018-305

(220) 15.08.2018.

(732) Hemofarm A.D. farmaceutsko-hemijska industrija Vršac, Beogradski put bb, 26300, Vršac, RS

(540)

IBONI

(550) I

(740) AOD MSA IP - Milojević Sekulić Advokati, Karađorđeva 65, 11000, Beograd

(511) Klasa 5: Farmaceutski proizvodi.

(111) **14531**

(151) 23.06.2020.

(210) Ž-2018-308

(220) 15.08.2018.

(732) Hemofarm A.D. farmaceutsko-hemijska industrija Vršac, Beogradski put bb, 26300, Vršac, RS

(540)

KRITEO

(550) I

(740) AOD MSA IP - Milojević Sekulić Advokati, Karađorđeva 65, 11000, Beograd

(511) Klasa 5: Farmaceutski proizvodi.

(111) **14532**

(151) 23.06.2020.

(210) Ž-2018-344

(220) 07.09.2018.

(732) The Procter & Gamble Company, One Procter & Gamble Plaza, 45202, Cincinnati, Ohio, US

(540)

MYSTERY

(550) I

(740) Branislav Lutovac, Bulevar Ivana Crnojevića 93, 81000, Podgorica

(511) Klasa 3: Sredstva za pranje i druge supstance za upotrebu kod pranja veša; preparati za čišćenje, njegu, obradu i uljepšavanje tkanina; omekšivači za tkanine, sredstva za poboljšanje kondicije tkanine.

(111) **14533**

(151) 23.06.2020.

(210) Ž-2018-255

(220) 20.07.2018.

(732) Merck Sharp & Dohme Corp., a New Jersey corporation, One Merck Drive, 08889, Whitehouse Station, New Jersey, US

(540)

TEMODAL

(550) I

(740) Merck Sharp & Dohme Corp., a New Jersey corporation, One Merck Drive, 08889, Whitehouse Station

(511) Klasa 5: Farmaceutski preparati.

(111) **14534**

(151) 23.06.2020.

(210) Ž-2018-256

(220) 20.07.2018.

(732) Merck Sharp & Dohme Corp., a New Jersey corporation, One Merck Drive, 08889, Whitehouse Station, New Jersey, US

(540)

TOLVON

(550) I

(740) Merck Sharp & Dohme Corp., a New Jersey corporation, One Merck Drive, 08889, Whitehouse Station

(511) Klasa 5: Farmaceutski preparati.

(111) **14535**

(151) 23.06.2020.

(210) Ž-2018-320

(220) 23.08.2018.

(732) Kamalaya Co., Ltd., 102/9 Moo 3, Laem Set Road, Na-Muang, Koh Samui, 84140, Suratthani, TH

(540)



(550) I

(740) Božidar S. Radulović, Studentska bb, Lamela 3/18, 81000, Podgorica

(511) Klasa 44: Aromaterapija (usluge aromaterapije); saloni ljepote (za uljepšavanje); medicinske klinike; zdravstvene usluge, naime, spa programi sa mrežom međunarodnih zdravstvenih ustanova, odnosno detoks programi, programi za jogu, programi oslobađanja od stresa i programi sagorijevanja [terapeutska njega koju osobe ili ustanove pružaju ljudima], programi za gubljenje težine i fitnes programi [terapeutska njega ljudi koju pružaju osobe ili ustanove], planiranje dijete; zdravstvene spa usluge, naime, pružanje usluga masaže, usluge tretmana za lice i tijelo, usluge kozmetičke njege za tijelo, aromaterapeutska masaža, tretman limfne drenaže; usluge terapije masažom; farmaceutski savjeti; terapija, fizikalna; usluge frizerskog salona; sauna i usluge turskog kupatila; zdravstvene spa usluge za zdravlje i dobrobit uma, tijela i duha.

(111) **14536**

(151) 23.06.2020.

(210) Ž-2018-242

(220) 09.07.2018.

(732) Border I.P. Ltd, Global House, 5 Castle Street, CA3 8SY, Carlisle, GB

(540)

BÄUMLER

(550) I

(511) Klasa 3: Sapuni; parfimerijski proizvodi, eterična ulja, kozmetički proizvodi, losioni za kosu; paste za zube; toaletni proizvodi; proizvodi i preparati za njegu noktiju; preparati za njegu tijela i kose, i preparati za njegu ljepote; dezodoransi.

Klasa 18: Putne torbe, ručne torbe, torbe za nošenje preko ramena, sportske torbe i torbe za rekreaciju, rančevi, ceger torbe, torbe, torbe za kupovinu, torbe za nošenje oko pojasa, torbe za plažu, koferi, kozmetičke torbice (neseseri), aktentašne, futrole za ključeve, torbe-navlake za odijela; ženske tašne, i novčanici; kišobrani.

Klasa 25: Odjeća, pokrivala za glavu, obuća, kaiševi (odjeća).

(111) **14538**

(151) 23.06.2020.

(210) Ž-2018-198

(220) 11.06.2018.

(732) Montenegro's one investment and consulting, Bulevar Džordža Vašingtona, Capital Plaza, sprat IV, br. 98, 81000, Podgorica, ME

(540)

Ajran

(550) I

(740) Montenegro's one investment and consulting, Bulevar Džordža Vašingtona, Capital Plaza, sprat IV, br. 98, 81000, Podgorica

(511) Klasa 29: meso, riba, živina i divljač; mesni ekstrakti; konzervirano, sušeno i kuvano voće i povrće; želei, džemovi, kompoti; jaja, mlijeko i mliječni proizvodi; jestiva ulja i masti.
Klasa 43: usluge obezbjeđivanja hrane i pića; privremeno primanje na stan.

(111) **14539**

(151) 23.06.2020.

(210) Ž-2018-199

(220) 11.06.2018.

(732) Montenegro's one investment and consulting, Bulevar Džordža Vašingtona, Capital Plaza, sprat IV, br. 98, 81000, Podgorica, ME

(540)

Ayran

(550) I

(740) Montenegro's one investment and consulting, Bulevar Džordža Vašingtona, Capital Plaza, sprat IV, br. 98, 81000, Podgorica

(511) Klasa 29: meso, riba, živina i divljač; mesni ekstrakti; konzervirano, sušeno i kuvano voće i povrće; želei, džemovi, kompoti; jaja, mlijeko i mliječni proizvodi; jestiva ulja i masti.
Klasa 43: usluge obezbjeđivanja hrane i pića; privremeno primanje na stan.

(111) **14545**

(151) 16.03.2020.

(210) Ž-2019-129

(220) 26.03.2019.

(732) "CIPSIR" D.O.O., ul.Slobode bb, "Villa Edelweiss", Sveti Stefan, ME

(540)



(550) I

(740) mr Vasilije Knežević, Kralja Nikole bb, BC "Nikic", 81000, Podgorica

(511) Klasa 36: Agencije za nekretnine, Iznajmljivanje stanova, Naplata stanarine, Posredništvo u iznajmljivanju stanova, Posredovanje u prometu nekretnina, Upravljanje imovinom, Upravljanje nekretninama.

Klasa 39: Iznajmljivanje autobusa, Iznajmljivanje automobila, Iznajmljivanje brodova, Iznajmljivanje garaža, Iznajmljivanje parkiraliških mjesta, Iznajmljivanje vozila, Organizovanje putovanja, Parkiranje vozila, Posredovanje u prijevozu, Pratlja putnika, Prevoz autobusom, Prevoz barkom, Prevoz brodom, Prevoz putnika, Putovanje i prevoz putnika, Rezervacije putovanja, Rezervacije transporta, Rezervisanje mjesta za putovanje, Skladištenje čamaca, Transport brodovima koji nude rasonodu, Usluge prevoza automobilima, Usluge voza, Zakup broda za prevoz tereta i putnika.

Klasa 43: Agencije za smještaj (hotelski, pansionski), Bifei, Hoteli, Iznajmljivanje privremenih smještaja, Iznajmljivanje, prostorija za sastanke, Iznajmljivanje rasvjetnih uređaja, osim za pozorišnu dekoraciju i televizijske studije, Iznajmljivanje šatora, Iznajmljivanje stolica, stolova, stolnjaka, staklenog posuđa, Kafeterije, Kafići, Moteli, Turistički apartmani, Rezervacije hotela, Restorani sa samoposluživanjem,

Restorani, Pansioni, Obezbeđivanje prostora za kampovanje, Rezervisanje privremenog smještaja, Usluge barova, Usluge kamp servisa, smještaj, Usluge prijema za privremeni smještaj (upravljanje dolascima i odlascima), Usluge snadbijevanja hranom i pićem (ketering).

(111) **14548**

(151) 16.04.2020.

(210) Ž-2019-103

(220) 15.03.2019.

(732) Novartis AG, ,, 4002, Basel, CH

(540)

COUPET

(550) I

(740) AOD MSA IP - Milojević Sekulić Advokati, Karađorđeva 65, 11000, Beograd

(511) Klasa 5: Farmaceutski preparati za ljudsku upotrebu.

(111) **14549**

(151) 16.04.2020.

(210) Ž-2019-107

(220) 18.03.2019.

(732) Christian Louboutin, 1, rue Volney,, F-75002, Paris, FR

(540)



Louboutin

(550) I

(740) AOD "Ćupić", Bulevar Džordža Vašingtona 79, 81000, Podgorica

(511) Klasa 18: Koža i imitacija kože, i proizvodi od ovih materijala koji nijesu uključeni u druge klase; kovčezi i putne torbe; putnički sanduci; tašne; novčanici; ženske torbice bez ručke (klač torbice); velike torbe; torbice (omotnice, futrole) od kože; rančevi; kožni remeni za nošenje preko ramena; aktovke; kutije od kože ili vještačke kože; ženske tašne; torbe za kupovinu.

Klasa 25: Obuća, kaiševi.

(111) **14551**

(151) 21.04.2020.

(210) Ž-2018-415

(220) 06.11.2018.

(732) Pharmacia & Upjohn Company LLC, 7000 Portage Road, MI 49001, Kalamazoo, Michigan, US

(540)

UPJOHN

(550) I

(740) Jasna Jusić, Dalmatinska 2, 81000, Podgorica

(511) Klasa 44: Pružanje zdravstvenih i medicinskih informacija; zdravstvene usluge, naime pružanje informacija u oblasti zdravlja, velnesa i prehrane.

(111) **14552**

(151) 21.04.2020.

(210) Ž-2018-416

(220) 06.11.2018.

(732) Pharmacia & Upjohn Company LLC, 7000 Portage Road, 49001, Kalamazoo, Michigan, US

(540)

UPJOHN

(550) I

(740) Jasna Jusić, Dalmatinska 2, 81000, Podgorica

(511) Klasa 5: Cjelovita linija ljekova i farmaceutskih preparata, za upotrebu u vezi sa ljudima.

(111) **14553**

(151) 21.04.2020.

(210) Ž-2018-414

(220) 06.11.2018.

(732) HYUNDAI CORPORATION HOLDINGS Co., Ltd., 25, Yulgok-ro 2-gil Jongno-gu, Seoul, KR

(540)

HYUNDAI

(550) I

(740) Miladin Popović, Đoka Miraševića 21/III, 81000, Podgorica

(511) Klasa 7: Abrazivni proizvodi, poljoprivredne sprave os im onih koje se pokreću ručno, poljoprivredne mašine, poljoprivredne prskalice, vazдушna četka za nanošenje boje, vazdušni kompresor, vazdušna bušilica, vazdušna pjalica, vazdušni čekić, pistolj za naduvavanje vazduha, vazdušni zakivač eksera, vazdušne pumpe (instalacije za garaže), vazdušni zakivač, vazdušni šrafciğer, vazdušna prskalica, vazdušna heftalica, vazdušni alat, vazdušni ključ, alternatori, ugaona brusilica, aparati za gaziranje pića, aparati za gaziranje vode, aparati za zavarivanje sa lukom, automatske mašine za pranje sudova, mašine za pečenje za industrijsku namjenu, testera za piljenje, mašine za glačanje ječma, dio mašinskih alata, stona brusilica, stona testera, mašine za savijanje, aparati za vezivanje sijena, mašine i oprema za prevenciju štetočina, ventilator (ventilator sa motorom), ventilatori, mašine za sječenje hljeba, prekidač, testera za sječenje cigli, trimer, auto liftovi,

blokovi lanaca, motorna testera, sjeckalica, cirkularna testera, stezni uređaji, stege, uređaji za čišćenje koji koriste paru, šišači (mašine), mlinovi za kafu za domaćinstvo (osim ručnih), kombajni, sabijač (mašina), mikser za beton, testera za beton, vibrator za beton, mašine za proizvodnju konditorskih proizvoda, mašine za sušenje kukuruza, kultivatori (mašine), mašine za rezanje, sjekači, sjekači za gasno zavarivanje, bušenje kompresovanog vazduha, sjekači (mašine), točak za sječenje i brušenje, cijevi za sječenje (koje pokreće gas), mašine za sječenje, gorionici za sječenje, čekić za rušenje, dizel motori, mašine za pranje sudova za industrijske svrhe, mašine za sudove, kopači (plugovi), bušilica, valjak, mašine za sušenje za poljoprivredu, postrojenja za uklanjanje prašine u svrhu čišćenja, svrdlo za zemlju, aparati za elektro lučno sječenje, aparati za zavarivanje sa električnim lukom, električni aparati za pravljenje arepe, električni blenderi za upotrebu u domaćinstvu, električni bife poslužavnik, električni otvarači za konzerve, električne makaze, električni čistači za domaćinstvo, električne drobilice (mlinovi) za upotrebu u domaćinstvu, električni blenderi za hranu za upotrebu u domaćinstvu, električni prerađivači hrane (osim za potrebe domaćinstva), električne prese za voće za upotrebu u domaćinstvu, električni čekić, električni toplotni i pištolj za lijepljenje, električna mašina za gnječenje, električne mašine i aparati za čišćenje, električni mikseri za upotrebu u domaćinstvu električna mašina za tjestenine, električni poravnjivač, električni brusač, električni sjekač grmlja, električni rezači za domaćinstvo (mašina), električni aparat za proizvodnju vafila, električne mašine za pranje, električne mašine za pranje za upotrebu u domaćinstvu, električne mašine za pranje za industrijsku upotrebu, električni aparati za zavarivanje, električne pjalice za upotrebu u domaćinstvu, elektrode za mašine za zavarivanje, elektromehaničke mašine za pripremanje hrane, mašine za zavarivanje elektronskim snopom, sajle za lift, vrata za lift, aparati za upravljanje liftom, lift i dijelovi za lift, dizalice (liftovi), motor, motori za čamce, pokretne stepenice, mašine i uređaji za distribuciju đubriva, mašine za uklanjanje potkožnog tkiva i mesa pri štavljenu, podna testera, mašine za mljevenje brašna, mašine za obradu hrane i pića u industrijske svrhe, pumpe za doziranje goriva za servisne stanice, gasni aktivirajući alat, plamenik za rezanje gasom, mašine za gasno zavarivanje, gorionici za zavarivanje gasom, benzinski motor, benzinske pumpe za benzinske stanice, oprema za benzinske stanice, let lampa na gasni pogon i gorionik za zavarivanje, generator, drobilice za žitarice, mašine za ljušćenje žitarica, separatori žitarica, sjekači trave, trimeri za travu, drobilica, bušilica za teške metale, drljača, mašine za sušenje žetve, žetelac, mašine za žetvu, grijalice, trimer za živu ogradu, dizalica, poklopci (dijelovi mašina), noževi (mehaničko pražnjenje), lebdeće kosilice, hidraulični alat za stezanje, hidraulični alat za sječenje, hidraulični alati, mašine za proizvodnju ledenih poslastica, udarna bušilica, industrijski ventilator, industrijski usisivač, testere za bušenje, mašine za gnječenje, noževi za kosačice, mašine za lasersko sječenje, (radne) mašine za lasersku obradu, strugovi, kosilica za travu, grabulje za travu, liftovi, testere za panjeve, cjepač panjeva, pumpe za podmazivanje, mašine za pravljenje tjestenine, sjeckalice za meso (mašine), mlinovi za domaćinstvo (osim ručnih), kružna testera, motor, motorizovani kultivatori, motori za čamce, višenamjenski alat, mašine za izradu rezanaca, oksiacetilenske mašine za zavarivanje i rezanje, oksigen acetilenski zavarivači, uređaji za rezanje kiseonikom, mašine za ljušćenje, poravnjivači, plugovi, raonici, pneumatske pumpe, polir, alat koji se napaja strujom, električni alati, uređaj za pranje pod pritiskom, mašine za mješanje, mašine za grabuljanje, nabijač, snopovezačice i kosilice, vršilice i mlatilice, rebar (žičana) mašina za vezivanje, klipna testera, mašine za sortiranje pirinčanih zrna, mašine za glačanje pirinča ili ječma, mašine za sadnju pirinča, mašine za glačanje pirinča, mašinerija za izgradnju puteva, čistač puta, roboti, roboti (mašine), rotacioni alati, ruteri, mašine za hoblovanje, testere, mašina za oštrenje, estrih, srafciher, mašine za šivenje, mašine za šivenje za upotrebu u domaćinstvu, škare (električne), šreder, alatka za sječenje grmlja, bacač snijega, duvaljke za lemljenje mašina za sječenje gasom, aparati za lemljenje (gasni), cijevi za lemljenje (gasne), lemlice (električne), lemlice (gasne), let lampe, sijalice (mašine), centrifugalni sušači za domaćinstvo (bez grijača), mašine za skidanje zrna s grozdova, starteri za motore i mašine, mašine za završnu obradu slame, mašine za zavarivanje supersoničnim talasom, cirkular, pištolj s glavom, mašine za okretanje sijena, mašine za pranje tekstila za industrijske svrhe, rezač pločica, orač, mašine

za sabijanje smeća, mistrija, plugovi za uklanjanje busena, mašine za ultrazvučno zavarivanje, univerzalna testera, kese za usisivač, crijeva za usisivače, usisivač i, usisivači za industrijske svrhe, mašine za vakuumsko pakovanje, kabine liftova, aparati za pranje, mašine za pranje, mašine za pranje veša (vešeraj), mašine za pranje veša za industrijske svrhe, mašine za drobljenje otpada, vodena pumpa, mašine za zavarivanje talasima, mašine za vađenje korova, mašine za zavarivanje (električne), odvajači, ključ, mašine za cijedenje rublja.

Klasa 8: Podesivi ključevi, sjekire (alat), poljoprivredna sredstva (ručno upravljanje), svrdla (ručni alat), osovine, zakačaljke, glave svrdla (ručni alat), sječiva (ručni alat), granične škare, noževi za kalemljenje, dlijeta, klješta za sječenje (linemanova kljesta), alat za sječenje (ručni alat), kopači (ručni alat), burgija, bušilice, upravljači, električni epilator, električni ispravljač kose, električni trimer za kosu, električna pegla, električni brijlač, turp ije (alat), berači voća (ručni alat), rezači stakla, alati za graviranje (ručni alat), makaze za kosu za ličnu upotrebu/električne i ne-električne, čekići, ručni blok lanca, ručne bušilice (ručni alat), ručna paletna kolica, ručni alat (ručno upravljanje), motika (ručni alat), atomizatori insekticida (ručni alat), gvozdeni čekići, testera za bušenje, ključevi, makaze za travnjake (ručni instrumenti), grabulje za travnjake (samo za ručno upravljanje), poluge, dizalice, dizalice (za ručno upravljanje), brave, maljevi (ručni instrumenti), manuelne dizalice, glodalice (ručni alat), spravice za kosi rez (ručni alat), višenamjenski sklopivi džepni ručni alat, rašljaste poluge za vađenje eksera (ručni alat), alat za vađenje eksera, spravice za vađenje eksera, pijuci (ručni alat), pincete, rende, klješta za žicu, noževi za potkresivanje, baštovanske makaze, probijači (ručni alat), reze (ručni alat), brijlači, brijlači (električni ili ne-električni), zakivci, zakivači, testere (ručni alat), alat za izvlačenje žice (ručni alat), škare, lopate (ručni alat), srpovi, kovački maljevi, ašovi (ručni alat), ključevi za matice (ručni alat), trake za alate, trake za alate (držači), kutija za alat, spravice za prorjeđivanje grana, ključevi, višenamjenski komplet.

Klasa 9: 3D televizori, akustični (zvučni) alarmi, alarmni aparati, alarmi, alkalne baterije, protivprovalni upozoravajući aparati, audio i video prijemnici, audio zvučnici, audiovizuelni prijemnici, baterije za automobil, baterije za uređaj za besprekidno napajanje strujom (UPS) i inverter, uređaji za punjenje baterije, punjači baterija, baterije u obliku dugmeta, namotaji za kablove za domaćinstvo ili baštu, kamere za nadzor, kamere za vozila, navigacije za automobile, televizori za automobile, video rekorderi za automobile, futrole za mobilne telefone, CD plejeri, kinematografske mašine i aparati, aparati za komunikaciju za letjelice, aparati za komunikaciju za vozila, softver za kompjuterske igrice, kompjuterski softver za bespilotne letjelice, kontaktna sočiva, uređaji za upotrebu mobilnih telefona slobodnih ruku, uređaji za bežični radio prenos, digitalne kamere, digitalna brava, digitalni informativni displeji (did), digitalne olovke za kompjuter, digitalna signalizacija, digitalni snimaci zvuka, pokazivači smjera, primarne baterije, „suve ćelije“ (baterije), DVD plejeri, slušalice, električni akumulatori, električni akumulatori za vozila, aparati za elektrolučno rezanje, električne baterije, električni kablovi i namotaji kablova za upotrebu u domaćinstvu ili bašti, električni uvijači kose, električne pegle, električne table za obavještenje, električne brave, električne mašine za sječenje metala, električne mašine za sječenje metala (pomoću luka, gasa ili plazme), električne maske za varenje, električni i elektronski protivprovalni alarmi, oprema za elektrolučno rezanje, elektronski planeri, elektronske table, elektronski digitalni natpisi, elektronski displej, elektronski indikatori panela, elektronske table za obavještenja, elektronske olovke, elektronski fotokopiri, elektronski ramovi za slike, elektronski džepni prevodioci, opreme za analizu komponenti, protivpožarni alarmi, uređaji za globalno pozicionirajući sistem (GPS), globalno pozicionirajući sistem, ručni skener, trake za čišćenje glave za snimanje, slušalice, visokonaponske baterije, terminali visokog protoka, sistem za kućni bioskop, uređaji za internu komunikaciju, interfoni, invertori (za struju), mašine za karaoke, tastature za mobilne telefone, laserski mjerni aparat, laserski daljinometri, LCD televizori, litijumske baterije, aparati za mjerenje, meteorološke mašine i aparati, mikrofoni, baterije za mobilne telefone, mobilni telefoni, modemi, uređaji za montiranje kamera i monitora, mp3 plejeri, mp4 plejeri, multivizija, instalacije za mrežnu komunikaciju, niki-kadmijum baterije koje se mogu

puniti, niki metal hibridne baterije koje se mogu puniti, niki-kadmijum akumulator baterije, televizori sa OLED ekranima, lični digitalni asistenti (PDA), vokmeni, fablet, fotografski aparati i instrumenti, fototelegrafski aparati, fotonaponske ćelije, prenosivi komunikacioni aparati, prenosivi media plejeri, prenosivi punjači, prenosivi telefoni, prenosive baterije za napajanje, projektori, zaštitne maske za zavarivanje, instalacije za radar, radio, radio-telegrafski sklopovi, čitači (oprema za obradu podataka), kamere za vožnju unazad za vozila, prijemnici i prenosnici signata, satelitski prijemnici, gramofoni, aparati za daljinsko upravljanje, aparati za daljinsko upravljanje kamerama, kamere kojim se daljinski upravlja, senzorna svijetla, prijemnici (set-top box), pametne kartice, pametni punjači, pametne naočare, pametni tableti, pametni telefoni, pametni televizori, senzori za dim, utičnica, solarne baterije, aparati i instrumenti za snimanje zvuka, naočare (optičke), pokretači i prigušivači svijetla za lampe, pokretači aparata za osvjetljenje, prekidač, tablet kompjuteri, telefonski setovi, teleskopi, televizijski monitori, televizijski prijemnici, televizijski prijemnici (tv set), televizijski prenosnici, televizori, terminal za elektronske knjige, terminal za elektronske novine, terminal za elektronske publikacije, terminal za elektronske studijske knjige ili papire, terminali za radiotelefone, podloge za miš od kompjutera, prenosnici elektronskih signata, daljinski upravljači za televizor, Ultra HD televizori, UPS - neprekidni izvor napajanja, USB memorije, auto-radio, video kamere (kamkorderi), kartice za video igre, video rekorderi, aparati za video snimanje za vozila, video telefoni, video zid, olovno-kiselinska baterija regulisana ventilima (VRLA baterije), voki-toki, nosive bespilotne leteće kamere, oprema za varenje lukom, kacige za varenje, mašine za varenje, maske za varenje, sekundarne baterije („mokre ćelije“), električne žice, uređaji za pristupanje bežičnoj mreži (WAP), bežični zvučnici, rendgenski aparati ne za medicinsku upotrebu, cink karbonske baterije, cink hloridne baterije, biometrijski sigurnosni aparati, biometrijski čitači, biometrijski identifikacioni aparati, biometrijski uređaji za kontrolu pristupa, biometrijski identifikacioni uređaji za upravljanje vremenom i prisustvom, uređaji za identifikaciju pomoću crta lica za upravljanje vremenom i prisustvom, uređaji za vaskularnu identifikaciju za upravljanje vremenom i prisustvom, uređaji za identifikaciju pomoću otiska prsta za upravljanje vremenom i prisustvom, biometrijski skeneri, biometrijski skeneri mrežnjače, čitači biometrijskih informacija, biometrijski skeneri za otisak prsta, biometrijski skeneri za ruku, digitalni video rekorderi, mrežni video rekorderi, lične vage za mjerenje težine, zaštitna obuća, zaštitne naočare, zaštitni čepovi za uši, naočare i maske za zaštitu od prašine, štitovi za lice za zaštitne kacige, zaštitna odjeća, kacige za varenje, držači za dodatke mobilnim telefonima, zaštitna film maska za dodatke mobilnim telefonima, punjač za mobilne telefone, kablovi za pametne telefone, LED televizori .

Klasa 11: Klima uređaji, aparati za dezodorisanje vazduha, isušivači vazduha, aparati za prečišćavanje vazduha za upotrebu u domaćinstvu, sterilizatori vazduha, aparati za prečišćavanje pijaće vode, aparati za zagrijavanje/ventilaciju i klimatizaciju, aparati za zagrijavanje prostora, aparati za ventilaciju i klimatizaciju, svijetla za akvarijume, lampe sa svjetlosnim lukom, vještacke solarne lampe, autoklavi (električni uređaji za kuvanje pod pritiskom), pekarske peći, pećnice za upotrebu u domaćinstvu, kotlovi (koji nijesu djelovi mašina), kotlovi za upotrebu u domaćinstvu, uređaji za pečenje hljeba, uređaji za pravljenje hljeba, gorionici (izuzev za laboratorijsku upotrebu), prostirke, električno grijane, plafonska svijetla, kompaktne fluorescentne lampe („štedna sijalica“), lusteri, sprave za prženje kafe, kompresor za frižidere, šporeti, aparati i instalacije za kuvanje, oprema i instalacije za hlađenje, stone lampe, emisione svjetiljke i njihovi djelovi, aparati za dezinfekciju posuda za upotrebu u domaćinstvu, svjetli llike integrisane u plafon, aparati za elektrolučno sječenje, električni bidei, električna ćebad (ne za medicinsku upotrebu), električna ćebad za upotrebu u domaćinstvu, električni filteri za kafu, električne mašine za kafu, električne mašine za pravljenje kafe za upotrebu u domaćinstvu, električne posude za kuvanje kafe, električni šporeti, električne posude za kuvanje za upotrebu u domaćinstvu, električni štednjaci za upotrebu u domaćinstvu, električne kuhinjske sprave, električni dozatori za hladnu i toplu vodu, električne friteze za prženje u dubokoj masnoći, električne friteze, električni isušivači za upotrebu u domaćinstvu, električni dehidratori, električni dezinfekcioni aparati za posude za upotrebu u domaćinstvu, električne mašine za espresso kafu za upotrebu u domaćinstvu, električni

fenovi , električni fenovi za ličnu upotrebu, električni parni lonci, električni zamrzivači za upotrebu u domaćinstvu, električni tiganji, električne peći za upotrebu u domaćinstvu, električni fen, električni aparati za zagrijavanje, električni dušeci sa toplom vodom, električni ovlaživači, električni čajnici, električni čajnici za upotrebu u domaćinstvu, električne lampe, električni sušači veša, električne mašine za pravljenje kokica, električne posude za kuvanje pod pritiskom, električni grijači za upotrebu u domaćinstvu, električni radijatori, električni šporeti, električne rashladne vitrine, električni frižideri, električni frižideri za upotrebu u domaćinstvu, električni lonci za kuvanje pirinča, električni uređaji za pravljenje sendviča, električni lonac za sporo kuvanje, električni aparati za hlađenje prostora za upotrebu u domaćinstvu, električni štednjaci, električni tosteri, električni tosteri za upotrebu u domaćinstvu, električni pekači vafli, električni prečišćivači vode za upotrebu u domaćinstvu, električni rashladni uređaji za vino, električni kotlovi, električne mašine za kokice, elektromagnetni indukcijski šporeti za upotrebu u domaćinstvu, aspiratori za neutralisanje mirisa i pare u kuhinjama, propeleri za ventilatore, filteri za pijacu vodu, svjetiljke (lampe), reflektori, fluorescentne lampe, zamrzivači, gasni bojleri, gasni gorionici, peći za kuvanje na gas za upotrebu u domaćinstvu, plinska vatra, rostilj na gas, grijači na gas, šporeti na gas, frižideri na gas, štednjaci na gas, gasni grijači za vodu, aparati za pečenje, fenovi za kosu, halogene lampe, ognjišta, pumpe za grijanje, grijaci za kupati la, aparati za zagrijavanje i klimatizaciju, aparati za zagrijavanje, kotlovi za grijanje (izuzev za vozila), svjetiljka sa živom pod visokim pritiskom, svjetiljka sa natrijumom pod visokim pritiskom, aparati za topli vazduh, ovlaživači, mašine za led, frižideri za led, lampe sa žarnim nitima, unutrašnji i spoljašnji aparati za osvjetljenje, industrijske peći za kuvanje, infracrvene lampe, kuhinjski šporeti (peći), fenjeri za osvjetljenje, LED rasvjeta, instalacije za osvjetljenje, metal halogene svjetiljke, mikrotalasne pećnice, mikrotalasne pećnice (aparati za kuvanje), mikrotalasne pećnice za industrijsku upotrebu, neonske lampe, ne-električni prečišćivači vode za upotrebu u domaćinstvu, uljane peći (grijači prostora za upotrebu u domaćinstvu), pećnice, sporeti na petrolej, radijatori (grijanje), aspiratori za šporete (izduvne nape) za upotrebu u domaćinstvu, aspiratori za šporete za upotrebu u domaćinstvu, rashladni aparati i instalacije (izuzev za vozila), frižideri, rashladni uređaji za sobe, ražnjevi, sigurnosne lampe, tuševi, solarni lampe sa ultraljubičastim zracima (ne za medicinsku upotrebu), uređaji i instalacije za ventilaciju, ventilacioni aspiratori, ventilatori, posude za zagrijavanje, aparati za filtraciju vode, grijači za vodu, grijači za vodu (aparati), jonizatori vode za upotrebu u domaćinstvu, prečišćivači vode za upotrebu u domaćinstvu, aparati za prečišćavanje vode, sterilizatori vode, površinske lampe za vodu, maske za zavarivanje, omeksivaci vode.

(111) **14554**

(151) 24.04.2020.

(210) Ž-2018-174

(220) 16.05.2018.

(732) 7 Hills d.o.o. , Ulica Slobode br. 64, 81000, Podgorica , ME

(540)



(550) I

(511) Klasa 35: Oglasavanje; vodenje poslova; poslovno upravljanje; kancelarijski poslovi, usluge koje pružaju lica ili organizacije uglavnom radi: pomoći u radu ili upravljanju preduzecima pomoći u upravljanju poslovnom ili komercijalnom delatnošću u industrijskim ili komercijalnim privrednim društvima, usluge koje pružaju preduzeća koja se bave oglasavanjem (reklamiranjem), tako isto, za račun drugih lica, komuniciraju sa javnošću (reklama) putem prenosa bilo kakvih informacija o svim vrstama proizvoda proizvodima i uslugama; Sakupljanje u korist drugih, citavog niza roba (uključujući i njihov transport) omogućavajući klijentima da zgodno razgledaju i kupuju ovu robu; takve usluge mogu se pružati u prodavnicama na malo, rasprodajama, porudžbinama postom preko kataloga ili putem elektronskih medija, na primer preko web site-a ili televizijskih programa za kupovinu; Usluge koje se sastoje od registracije, transkripcije, kompozicije, kompilacije ili sistematizacije pisanih saopštenja i registracija i takođe kompilacije matematičkih ili statističkih podataka; Usluge reklamnih agencija i usluge kao što je deljenje prospekata. 1 direktno ili postom ili distribucija uzoraka, može da se odnosi na reklamiranje u vezi sa drugim uslugama, kao što su one u vezi sa bankarskim zajmovima ili reklamiranje putem radija.

Klasa 39: Transportne usluge; pakovanje i skladištenje robe; organizovanje putovanja, uključuje uglavnom usluge koje se pružaju pri transportu ljudi ili robe sa jednog mesta na drugo (bilo kojim sredstvom prevoza) kao i usluge koje su obavezno povezane sa ovakvim transportom (spediterke usluge), kao i usluge skladištenja u cilju čuvanja ili obezbeđenja, usluge koje pružaju preduzeća koja koriste mostove, železničke pruge, feribote i sva druga sredstva koja koriste prevoznici, usluge vezane za najam transportnih vozila; usluge veza ne za brodsku vuku, istovar robe, funkcionisanje dokova, spasavanje potonulih tereta; usluge funkcionisanja aerodroma; usluge pakovanja i sortiranja robe pre odpremanja; usluge koje pružaju turističke agencije a sastoje se u davanju informacija o putovanjima ili transportu robe, informacije o tarifama, redu vožnje i načinima transporta; usluge kontrole prevoznih sredstava ili robe pre transporta.

Klasa 43: Usluge obezbeđivanja hrane i pica; privremeni smestaj. uključuje uglavnom usluge koje pružaju lica ili ustanove čija je namena pripremanje hrane i pica za potrošnju i usluge obezbeđivanja ishrane i smestaja u hotelima, pansionima ili drugim ustanovama koje obezbeđuju privremeni smestaj, usluge rezervisanja turističkih smestaja, naročito preko turističkih agencija ili brokera; smestaj za životinje.

(111) **14555**

(151) 24.04.2020.

(210) Ž-2018-238

(220) 05.07.2018.

(732) Pascal Fernand Raynaud, Box 252 - 2 Old Brompton road, SW7 3DQ, London, GB

(540)



(550) I

(740) Jelena Bogetić, Cetinjska 11, The Capital Plaza, 81000, Podgorica

(511) Klasa 16: knjige; štampane publikacije.

Klasa 41: usluge stavljanja na raspolaganje filmova, koji se ne mogu preuzimati, putem video zapisa na zahtjev; izdavanje knjiga; pisanje pjesama; objavljivanje knjiga i časopisa, elektronski on-line; elektronske publikacije (iskorištavanje elektronskih publikacija koje se ne mogu prenositi on-line); omogućavanje korišćenja on-line muzike, koja se ne može preuzimati; omogućavanje korišćenja on-line video zapisa, koji se ne mogu preuzimati; usluge stavljanja na raspolaganje televizijskih programa, koji se ne mogu preuzimati, putem video zapisa na zahtjev; montaža radio i televizijskih programa; objavljivanje tekstova [osim u reklamne svrhe]; proizvodnja filmova koji nijesu reklamni filmovi.

(111) **14556**

(151) 24.04.2020.

(210) Ž-2018-239

(220) 05.07.2018.

(732) Pascal Fernand Raynaud, Box 252 - 2 Old Brompton road, SW7 3DQ, London, GB

(540)



(550) I

(740) Jelena Bogetić, Cetinjska 11, The Capital Plaza, 81000, Podgorica

(511) Klasa 16: knjige; štampane publikacije.

Klasa 41: usluge stavljanja na raspolaganje filmova, koji se ne mogu preuzimati, putem video zapisa na zahtjev; izdavanje knjiga; pisanje pjesama; objavljivanje knjiga i časopisa, elektronski on-line; elektronske publikacije (iskorištavanje elektronskih publikacija koje se ne mogu prenositi on-line); omogućavanje korišćenja on-line muzike, koja se ne može preuzimati; omogućavanje korišćenja on-line video zapisa, koji se ne mogu preuzimati; usluge stavljanja na raspolaganje televizijskih programa, koji se ne mogu preuzimati, putem video zapisa na zahtjev; montaža radio i televizijskih programa; objavljivanje tekstova [osim u reklamne svrhe]; proizvodnja filmova koji nijesu reklamni filmovi .

(111) **14557**

(151) 24.04.2020.

(210) Ž-2018-373

(220) 28.09.2018.

(732) "OOBLEE" D.O.O. PODGORICA, Bulevar Ivana Crnojevic 2/B - D3, Podgorica, ME

(540)

OOBLEE

(550) I

(511) Klasa 35: Pomoć u poslovnom upravljanju; obavještenja o poslovima; reklamiranje preko plakata; usluge agencija za uvoz i izvoz; usluge agencija za pružanje poslovnih informacija; analize cijena i troškova; distribucija reklamnog materijala; usluge fotokopiranja; usluge agencija za zapošljavanje; iznajmljivanje kancelarijskih mašina i opreme; računovodstvo; vođenje knjiga [knjigovodstvo]; izrada izvoda sa računara; revizija poslovanja; poslovno upravljanje i organizaciono savjetovanje; konsultacije u vezi sa izborom osoblja; konsultacije u poslovnom upravljanju; daktilografske usluge; prezentacija robe; neposredno oglašavanje putem pošte; pomoć u poslovnom ili industrijskom upravljanju; umnožavanje dokumenata; ažuriranje oglasnih materijala; distribucija uzoraka; stručne usluge o poslovnoj efikasnosti; usluge prodaje putem licitacije; istraživanje tržišta; poslovne procene; poslovna ispitivanja; iznajmljivanje oglasnih materijala; konsultacije u vezi sa poslovnim organizovanjem; objavljivanje reklamnih tekstova; reklamiranje; oglašavanje; reklamiranje na radiju; poslovna istraživanja; usluge odnosa sa javnošću; reklamiranje preko televizije; prepisivanje korespondencije kancelarijske usluge]; uređivanje izloga; usluge reklamnih agencija; savjetodavne usluge u poslovnom upravljanju; manekenske usluge u cilju reklamiranja ili prodajnih promocija; marketinška istraživanja; kompjutersko upravljanje podacima; profesionalne poslovne

konsultacije; ekonomske prognoze; organizovanje izložbi za privredne ili reklamne potrebe; poslovne informacije; ispitivanje javnog mnjenja; priprema platnih listi; pronalaženje osoblja; usluge preseljenja poslovnog sjedišta; iznajmljivanje oglasnog prostora; promocija prodaje za druge; sekretarske usluge; obračun poreza; usluge telefonskog odgovaranja za odsutne pretplatnike; obrada teksta; usluge pretplate na novine za druge; reklamiranje slanjem narudžbenica; poslovno upravljanje hotelima; poslovno upravljanje za scenske umjetnike; prikupljanje informacija u kompjuterske baze podataka; sistemacija informacija u kompjuterskim bazama podataka; organizovanje sajмова u komercijalne ili reklamne svrhe; izdavanje mašina za fotokopiranje; reklamiranje na računarskoj mreži; usluge nabavke za treća lica [kupovina proizvoda i usluga za druge poslovne subjekte]; pretraživanje podataka u računarskim datotekama za druge; iznajmljivanje vremena za reklamiranje u sredstvima komunikacije; usluge praćenja štampe; iznajmljivanje automata za prodaju; psihološko testiranje za izbor zaposlenih; usluge poređenja cijena prezentacija proizvoda putem sredstava komunikacije, u svrhu prodaje na malo; pružanje komercijalnih saveta i informacija potrošačima pri izboru roba i usluga; dogovaranje pretplate za usluge telekomunikacija za treća lica; administrativna obrada narudžbenica za kupovinu; komercijalna administracija za licence roba i usluga trećih lica; usluge podugovaranja, outsorsing [pomoć u poslovanju]; fakturisanje; pisanje reklamnih tekstova; prikupljanje statističkih podataka; usluge grafičke obrade materijala za reklamne svrhe; traženje sponzorstva; organizovanje modnih revija u promotivne svrhe; proizvodnja reklamnih filmova; poslovno upravljanje za sportiste; marketing; usluge telemarketinga; usluge maloprodaje farmaceutskih, veterinarskih i higijenskih preparata i medicinskog materijala; iznajmljivanje prodajnih štandova; pružanje komercijalnih i poslovnih kontakt informacija; optimizacija pretraživača za promociju prodaje; optimizacija saobraćaja sa Internet stranice; oglašavanje plaćanjem po kliku [pay per click oglašavanje]; usluge posredovanja u trgovini; poslovno upravljanje za nezavisne pružaoce usluga; pregovaranje i zaključivanje poslovnih transakcija za treća lica; ažuriranje i održavanje podatka u računarskim bazama podataka; usluge upravljanja poslovnim projektima za građevinske projekte; pružanje poslovnih informacija putem Internet stranice; obezbjeđivanje onlajn tržišta za kupce i prodavce roba i usluga; dizajniranje reklamnog materijala; angažovanje spoljnih firmi za administrativno upravljanje kompanijama; usluge prijavljivanja poreza; poslovno upravljanje programima refundiranja za druge; poslovno upravljanje programima za nadoknadu za druge; iznajmljivanje bilborda [panoa za reklamiranje] ; pisanje radnih biografija za druge; indeksiranje internet sajtova za komercijalne namjene ili namjene oglašavanja; upravljanje programima za putnike koji često lete avionom; usluge zakazivanja sastanaka [kancelarijske usluge]; usluge podsjećanja na ugovorene sastanke [kancelarijski poslovi] ; upravljanje programima lojalnosti potrošača; pisanje tekstova za reklamne namjene; registrovanje pisane komunikacije i podataka; ažuriranje i održavanje informacija u registrima; sastavljanje popisa informacija za komercijalne i reklamne svrhe; usluge poslovnog posredovanja koje se odnose na povezivanje; potencijalnih privatnih ulagača sa preduzetnicima kojima su potrebna finansijska sredstva; produkcija programa televizijske prodaje; produkcija emisija televizijske prodaje; konsultacije o strategiji komunikacije u odnosima sa javnošću; konsultacije o strategiji komunikacije u reklamiranju; pregovaranje o poslovnim ugovorima za druge; promocija robe i usluga kroz sponzorisane sporskih događaja; usluge praćenja konkurencije; usluge praćenja tržišta; finansijska revizija; usluge onlajn maloprodaje digitalne muzike koja se preuzima sa internet; usluge onlajn maloprodaje melodije zvona koje se preuzimaju sa internet; usluge onlajn maloprodaje prethodno snimljene muzike i filmova koji se preuzimaju sa internet; usluge veleprodaje farmaceutskih, veterinarskih i higijenskih preparata i medicinskog materijala; usluge popisivanja poklona; ciljni marketing; privremeno poslovno upravljanje; oglašavanje na otvorenom; usluge maloprodaje umjetničkih djela od strane umjetničkih galerija; administrativna pomoć pri odgovaranju na pozive za odnošenje ponuda; marketing u okviru izdavanja softvera.

Klasa 38: Emitovanje radio programa [radiodifuzija]; slanje poruka; emitovanje televizijskih programa; prenos telegrama; telegrafske usluge; usluge telegramskog komuniciranja; telefonske usluge; telefonske

komunikacije; teleks usluge; usluge novinskih agencija; emitovanje kablovske televizije; komunikacije mobilnim telefonima; komunikacija preko računarskih terminala; prenos poruka i slika posredstvom računara; prenos elektronske pošte; prenos faksimilom; informacije o telekomunikacijama; pejdžing usluge, radiom, telefonom ili drugim vidom elektronskog komuniciranja; iznajmljivanje uređaja za slanje poruka; komunikacija preko mreže optičkih vlakana; iznajmljivanje faksimil aparata; iznajmljivanje modema; iznajmljivanje telekomunikacione opreme; iznajmljivanje telefona; satelitski prenos; usluge elektronskog biltena [telekomunikacione usluge]; obezbjeđivanje telekomunikacionih veza sa globalnom računarskom mrežom; usluge telekomunikacionog usmjeravanja i povezivanja; usluge telekonferencija; obezbjeđenje korisničkog pristupa globalnoj računarskoj mreži; iznajmljivanje vremena pristupa globalnim računarskim mrežama; pružanje usluga telekomunikacionih kanala za usluge telešopinga; forumi [pričaonice] na društvenim mrežama; omogućavanje pristupa računarskim bazama podataka; usluge govorne pošte; prenos čestitki putem interneta; prenos digitalnih datoteka; bežično emitovanje; usluge videokonferencija; pružanje usluga onlajn foruma; striming [protok] podataka; radio komunikacije; prenos video sadržaja na zahtjev.

Klasa 42: Hemijske analize; analize za eksploataciju naftnih polja; arhitektonske usluge; bakteriološka ispitivanja; usluge iz oblasti hemije; hemijska ispitivanja; savjetovanje iz oblasti arhitekture; građevinsko projektovanje; tehnička ispitivanja; ispitivanje naftnih izvora; istraživanja iz oblasti kozmetike; dizajn enterijera [uređenje unutrašnjeg prostora]; industrijski dizajn; usluge dizajniranja pakovanja, ispitivanje materijala; vođenje studija tehničkog projektovanja; geološke ekspertize; ispitivanje naftnih polja; inženjerske usluge; vremenska prognoza; geodetsko mjerenje; iznajmljivanje računara; računarsko programiranje; istraživanje nafte; istraživanja iz oblasti fizike; istraživanja iz oblasti mehanike; testiranje tekstila; geološka ispitivanja terena; geološka istraživanja; utvrđivanje autentičnosti umjetničkih djela; kalibracija [mjerenje]; dizajniranje računarskog softvera; ažuriranje računarskog softvera; savjetovanje u oblasti dizajna i razvoja računarskog hardvera; dizajniranje odjeće; grafički dizajn; kontrola kvaliteta; iznajmljivanje računarskog softvera; istraživanje i razvoj novih proizvoda za druge; stilizacija [industrijski dizajn] ; podvodna istrživanja; ponovno uspostavljanje računarskih podataka; održavanje računarskog softvera; analize računarskih sistema; biološka istraživanja; urbanističko planiranje; mjerenje zemljišta; dizajniranje računarskih sistema; testiranje ispravnosti vozila; umnožavanje računarskih programa; konvertovanje podataka ili dokumenata sa fizičkih na elektronske nosače; izrada i održavanje veb stranica za druge; hosting računarskih sajtova [veb sajtova]; instaliranje računarskog softvera; zasejavanje oblaka; konvertovanje računarskih podataka i programa, osim fizičkog konvertovanja; savjetovanje u oblasti računarskog softvera; iznajmljivanje veb servera; zaštita od računarskih virusa; savjetovanje u vezi sa štednjom energije; istraživanje u oblasti zaštite životne sredine; obezbjeđivanje alata za pretraživanje [pretraživača] na internetu; digitalizacija dokumenata [skeniranje] ; analiza rukopisa [grafologija]; pružanje naučnih informacija, savjeta i konsultacija u vezi smanjenja emisije ugljenika; ocjenjivanje kvaliteta neposječenog drveta; procjenjivanje kvaliteta vune; praćenje računarskih sistema daljinskim pristupom; analiza vode; usluge naučnih laboratorija; energetska revizija; savjetovanje o izradi veb sajtova; softver u vidu servisa [SaaS]; savjetovanje u vezi informacionih tehnologija; naučna istraživanja; server hosting; klinička ispitivanja; čuvanje rezervne kopije podataka van mreže; elektronsko pohranjivanje podataka; pružanje informacija o računarskim tehnologijama i programiranju putem Internet stranice; kartografske usluge, računarstvo u oblaku; usluge spoljnih firmi u oblasti informacionih tehnologija; savjetodavne usluge iz oblasti tehnologije; savjetodavne usluge iz oblasti kompjuterske tehnologije; savjetodavne usluge iz oblasti telekomunikacione tehnologije; vremenska prognoza; savjetovanje o sigurnosti računara; pisanje tekstova o tehnicima; unutrašnji dizajn; otključavanje [dekodiranje] mobilnih telefona; nadgledanje računarskih sistema radi otkrivanja kvarova; kreiranje i dizajniranje za druge indeksa informacija zasnovanih na internetu [usluge informacione tehnologije] ; konsultacije o bezbjednosti interneta; konsultacije o sigurnosti podataka; usluge kodiranja podatka; nadgledanje računarskih sistema radi otkrivanja neovlašćenog pristupa ili povrede

podataka; elektronsko nadgledanje podataka o zaštiti ličnosti radi otkrivanja krađe identiteta putem interneta; elektronsko nadgledanje korišćenja kreditnih kartica radi otkrivanja internet prevare; razvoj softvera u okviru izdavanja softvera; platforma kao usluga [PaaS].

(111) **14558**

(151) 30.04.2020.

(210) Ž-2018-374

(220) 01.10.2018.

(732) Preduzeće za informisanje i marketing "PINK M COMPANY"D.O.O., Bulevar Ivana Crnojevića 97, Podgorica, ME

(540)



(550) I

(511) Klasa 35: Oglašavanje; usluge reklame i ekonomske propagande, kreiranje i sprovođenje propagandnih kampanja, usluge kreiranja i izrade komercijalnih poruka (reklamnih spotova i radio džinglova) za televiziju i radio, prodaja reklamnih termina i prostora za različita medijska oglašavanja, distribucija ili isporuka propagandnog materijala ili uzoraka, organizovanje sajmova i izložbi u komercijalne ili reklamne svrhe, istraživanje tržišta i ispitivanje javnog mnjenja, vođenje poslova; konsalting i menadžment poslovi, poslovno upravljanje; organizovanje i upravljanje drugim privrednim subjektima (holding poslovi), kancelarijski poslovi, knjigovodstvene usluge, usluge obrade podataka, štamparske usluge.

Klasa 38: Telekomunikacije; usluge bežičnog emitovanja radio i televizijskih programa (radio-difuzija), usluge emitovanja radio i televizijskih programa (kablovska difuzija), usluge žičnog emitovanja radio i televizijskih programa satelitskim putem, usluge prenosa podataka.

Klasa 41: Obrazovne usluge; pripremanje obuke; razonoda; usluge proizvodnje zabavnog programa u cilju zabave i rekreacije drugih lica; sportske i kulturne aktivnosti, organizovanje sajmova i izložbi kulturne i obrazovne svrhe, organizovanje sportskih takmičenja, izdavanje tekstova, knjiga, novina, časopisa, zvučnih

zapisa, radio i televizijske aktivnosti, proizvodnja radio i televizijskih programa (zabavnih, propagandnih, informativnih, obrazovnih, sportskih, kulturnih, za obučavanje).

(111) **14559**

(151) 30.04.2020.

(210) Ž-2018-375

(220) 01.10.2018.

(732) Preduzeće za informisanje i marketing "PINK M COMPANY"D.O.O., Bulevar Ivana Crnojevića 97, Podgorica, ME

(540)



(550) I

(740) Milena Vujisić, Bulevar Džordža Vašingtona 108 A16, 81000, Podgorica

(511) Klasa 35: Oglašavanje; usluge reklame i ekonomske propagande, kreiranje i sprovođenje propagandnih kampanja, usluge kreiranja i izrade komercijalnih poruka (reklamnih spotova i radio džinglova) za televiziju i radio, prodaja reklamnih termina i prostora za različita medijska oglašavanja, distribucija ili isporuka propagandnog materijala ili uzoraka, organizovanje sajmova i izložbi u komercijalne ili reklamne svrhe, istraživanje tržišta i ispitivanje javnog mnjenja, vođenje poslova; konsalting i menadžment poslovi, poslovno upravljanje; organizovanje i upravljanje drugim privrednim subjektima (holding poslovi), kancelarijski poslovi, knjigovodstvene usluge, usluge obrade podataka, štamparske usluge.

Klasa 38: Telekomunikacije; usluge bežičnog emitovanja radio i televizijskih programa (radio-difuzija), usluge emitovanja radio i televizijskih programa (kablovska difuzija), usluge žičnog emitovanja radio i televizijskih programa satelitskim putem, usluge prenosa podataka.

Klasa 41: Obrazovne usluge; pripremanje obuke; razonoda; usluge proizvodnje zabavnog programa u cilju zabave i rekreacije drugih lica; sportske i kulturne aktivnosti, organizovanje sajmova i izložbi kulturne i obrazovne svrhe, organizovanje sportskih takmičenja, izdavanje tekstova, knjiga, novina, časopisa, zvučnih zapisa, radio i televizijske aktivnosti, proizvodnja radio i televizijskih programa (zabavnih, propagandnih, informativnih, obrazovnih, sportskih, kulturnih, za obučavanje).

(111) **14560**

(151) 30.04.2020.

(210) Ž-2018-338

(220) 05.09.2018.

(732) VIA PARADISO DOO, UL.OKTOBARSKE REVOLUCIJE BR 5, PODGORICA, ME

(540)

ANTONY MORATO

(550) I

(511) Klasa 25: Odjeća, obuća, pokrivala za glavu.

(111) **14561**

(151) 05.05.2020.

(210) Ž-2018-378

(220) 08.10.2018.

(732) WebLab d.o.o., Obala Iva Novakovica 1, 85000, Bar, ME

(540)



(550) I

(511) Klasa 4: Aditivi za pogonska goriva (nehemijski aditivi pogonskim gorivima); benzin [gorivo]; dizel-gorivo; gorivo; mineralna goriva; nafta (sirova ili rafinirana nafta); plinovita goriva [mješavine]; podmazivanje (masti za podmazivanje); podmazivanje (sredstva za podmazivanje); podmazivanje (ulja za podmazivanje); ulje za motore; ulje za podmazivanje.

Klasa 35: Agencije za komercijalne oglase; agencije za uvoz-izvoz; analiza proizvodne cijene; aukcionarstvo (prodaja na aukciji); automati (iznajmljivanje automata); cijene (poređenje cijena); ekonomska predviđanja; [prognoze]; fakturisanje; informacije (kancelarije za komercijalne informacije); informacije (poslovne informacije); informaticke kartoteke (vođenje informatičkih kartoteka); informatički podaci (pretraživanje podataka u informatičkoj kartoteci za treće lice); isporuka [distribucija] uzoraka, isporuka reklamnih materijala [letaka, prospekata, uzoraka]; isporuka reklamnih oglasa; isprave (umnožavanje isprava); istraživanja za poslove; istraživanje javnog mišljenja; istraživanje za poslove; izložbe (organizovanje izložbi) u komercijalne ili reklamne svrhe; iznajmljivanje automata za prodaju sitne robe; iznajmijivanje reklamnih prostora; iznajmijivanje reklamnog materijala; iznajmijivanje vremena za reklamiranje na svim komunikacionim sredstvima; izvodi iz računa (davanje izvoda sa računa); izvoz-uvoz (agencije za izvoz-uvoz); javno mnjenje (istraživanje javnog mnjenja) [anketiranje]; javnost (odnosi s javnou) [propaganda]; kancelarije za reklamiranje; kancelarije za zapošljavanje; kartoteka (prikupljanje podataka u središnju kartoteku); kartoteka (sistemizovanje podataka za središnju kartoteku); komercijalna administracija u vezi licenci proizvoda i usluga trećih lica; komercijalna ili industrijska preduzeća (pomoć u vođenju komercijalnih ili industrijskih preduzeća); konsultacije u vezi vođenje poslova; lociranje teretnih vagona pomoću kompjutera; marketing; modne revije za promotivne svrhe (organizovanje); nabava za treće (usluge nabave za treće) [kupovina proizvoda i usluga za druga preduzeća]; nabava za treće osobe (usluge kupovine proizvoda i usluga za druga preduzeća); narudžbine (administrativna obrada narudžbina za kupovinu); novine (usluge pretplate novina) za treće osobe; objavljivanje reklamnih tekstova; odabir osobija psihotehničkim postupkom; odnosi s javnošću [propaganda]; oglašavanje [reklamiranje]; oglašavanje putem pošte; organizovanje izložbi u komercijalne ili reklamne svrhe; organizovanje poslova (savjetovanje o organiziranju poslova); osoblje (biranje osoblja psihotehničkim postupkom); osoblje (savjetovanje o osoblju); osoblje (zapošljavanje osoblja); plakatiranje [oglašavanje]; podsticaj prodaje za treće osobe; podugovaranje (usluge podugovaranja) [komercijalna pomoć]; pomoć u upravljanju industrijskim ili trgovačkim preduzećima; pomoć u vođenju poslova; poslovi (istraživanja za poslove); poslovi (istraživanje za poslove); poslovi (konsultacije za vođenja poslova); poslovi (obavještenja o poslovima); poslovi (pomoć u vođenju poslova); poslovi (savjetovanje o organizaciji i vođenju poslova); poslovi (vještačenje poslova) [ekspertize]; poslovne informacije; potrošači (pružanje komercijalnih savjeta i informacija potrošačima); predstavljanje proizvoda [demonstracija]; preduzeća (pomoć u vođenju komercijalnih ili industrijskih preduzeća); preduzeća (usluge preseljenja za preduzeća); prelamanje stranica u reklamne svrhe [stavljanje u štampu u reklamne svrhe] prepis saopštenja; pretplata na novine (usluge pretplate na novine) [za treće osobe]; prezentacija proizvoda na svim komunikacionim sredstvima u svrhu prodaje na malo; procjene komercijalnih poslova; prodaja (podsticaj prodaje) za treće osobe; prodaja na aukciji; proizvodne cijene (analiza proizvodnih cijena); proučavanje tržišta [marketing]; radio (reklamiranje putem radija); reklamiranje (iznajmljivanje prostora za potrebe reklamiranja); reklamiranje dopisnim putem, reklamiranje on-line na informatičkoj mreži; reklamiranje putem radija; reklamiranje putem televizije; reklamna dokumentacija (uređenje reklamne dokumentacije); reklamna pošta; reklamni filmovi (proizvodnja reklamnih filmova); reklamni materijal (iznajmljivanje reklamnog materijala); reklamni materijal (razdioba reklamnog materijala); reklamni materijal (raznošenje reklamnog materijala); reklamni oglasi (širenje reklamnih oglasa); reklamni tekstovi (objavljivanje reklamnih tekstova); reklamni tekstovi (uređenje reklamnih tekstova); sajmovi (organizovanje sajmova u komercijalne ili reklamne svrhe); saopštenja (prepisi, saopštenja); savjeti o organizaciji i vođenju poslova; savjetovanje (stručno savjetovanje o poslovima); sistemizovanje podataka za središnju kartoteku; sponzori (traženje

sponzora); statistički podaci (izrada statističkih podataka); stenografske usluge; stručne poslovne konsultacije; štampa (praćenje štampe); štampa (usluge pregleda štampe); tekst (obrada teksta); telefonski odgovori (usluge telefonskih odgovora) za odsutne pretplatnike; telemarketing (usluge telemarketinga); televizijsko reklamiranje; teretni vagoni (lociranje teretnih vagona pomoću kompjutera);trgovački poslovi (procjene trgovačkih poslova); trziste (proučavanje tržišta); tržište (traženje tržišta); umjetnički poslovi (profesionalno upravljanje umjetničkim poslovima); umnožavanje isprava; uvoz-izvoz (agencije za uvoz-izvoz); uzorci (isporuka uzoraka); vođenje informatičkih kartoteka; vođenje poslova (pomoć u vođenju poslova); vođenje poslova (savjetovanje o vođenju poslova); vođenje poslova (usluge savjetovanja u vezi vođenja poslova); vođenje poslova poslovni za sportiste [poslovni menadžment]; zapošljavanje (usluge kancelarije za zapošljavanje); zapošljavanje lica.

Klasa 36: Agencije za kredite; agencije za utjerivanje potraživanja; bolesničko osiguranje; dobrotvorne svrhe (skupljanje za dobrotvorne svrhe); efektna berza [službeno bilježenje kurseva ugovorenih vrijednosti na tržištu]; finansije (savjetovanje u vezi finansija); finansijska analiza; finansijske procjene [osiguranje, banke, nekretnine) finansijski [bankarski] poslovi; finansijski oglasi; finansijski poslovi [transakcije]; finansiranje (usluge finansiranja); fiskalne procjene; fondovi (osnivanje fondova); garancije [garancije]; građevinski objekti (upravljanje građevinskim objektima); imovina (upravljanje imovinom); informacije (finansijska obavještenja); informacije o osiguranju; iznajmljivanje kancelarija [nekretnine]; kapital (ulaganje kapitala); kompenzacijski poslovi [mijenjanje]; krediti; kreditne kartice (izdavanje kreditnih kartica); kreditne kartice (službe za kreditne kartice); naknada štete (finansijska procjena naknade štete); nekretnine (davanje u zakup nekretnina) [lizing];nezgode (osiguranje od nezgoda); novčana sredstva (elektronski prijenos novčanih sredstava); osiguranja; osiguranje (informacije o osiguranju); osiguranje (savjetovanje o osiguranju); osiguranje (usluge matematičkih stručnjaka [aktuara] za životno osiguranje); osnivanje kapitala; otplata na rate; pokroviteljstvo (finansijsko pokroviteljstvo); pomorsko osiguranje; posredovanje [mešetarenje]; posredovanje [mešetarenje] u trgovini nekretninama; posredovanje na berzi; posredovanje na berzi [mešetarenje];posredovanje u nekretn inama; posredovanje u osiguranju; pozajmljivanje na temelju zaloga; procjena starina [antikviteta]; procjena umjetnina; procjene (fiskalne procjene); procjene finansijske procjene [osiguranje, bankarski promet, imovina]; savjetovanje o finansijskim pitanjima; savjetovanje o osiguranju; skupljanje priloga; skupljanje za dobrotvorne svrhe; sredstva (stvaranje zajedničkih sredstava); starine (procjena starina); transakcije (finansijske transakcije); upravljanje građevinskim objektima; upravljanje imovinom; upravljanje nekretninama usluge fondova uzajamne pomoći; utjerivanje dugovanja (agencije za utjerivanje dugovanja); vrijednosni bonovi (izdavanje vrijednosnih bonova); vrijednosti (depoziti vrijednosti); zajam na temelju zaloga; zajmovi; zakup [vrsta iznajmljivanja dobara za profesionalne potrebe, koja temeljem ugovora mogu postati vlasništvo iznajmitelja] [lizing];zakup nekretnina (davanje u zakup nekretnina) [lizing]; zalog (davanje zajma uz zalog); životno osiguranje (potpisivanje polisa za osiguranje života).

Klasa 37: Automobili (održavanje i popravak automobila); automobili (pranje automobila);bageri (iznajmljivanje bagera); buldožeri (iznajmljivanje buldožera); čišćenje vozila; gume (zamjena guma); gume za točkove (vulkanizacija guma za točkove) [popravak]; informacije o popravkama; izgradnja (oglas o izgradnji); izgradnja *;izgradnja štandova i prodavaonica; iznajmljivanje bagera; iznajmljivanje buldožera; iznajmljivanje dizalica [mašine za gradilišta]; iznajmljivanje mašina za čišćenje; iznajmljivanje mašina za gradilišta; iznajmljivanje uređaja za čišćenje ulica; kancelarijski aparati (postavljanje, popravak i održavanje kancelarijskih aparata); kompjuteri (postavljanje održavanje i popravak kompjutera); krađa (postavljanje i popravak alarmnih uređaja protiv krađe); kvar na automobilu (pomoć pri kvaru na automobilu) [popravak]; lakiranje; mašine (obnavljanje istrošenih ili djelimično oštećenih mašina); mašine (postavljanje, održavanje i popravak mašina); motori (obnavljanje istrošenih ili djelimično oštećenih motora); održavanje vozila; podmazivanje vozila; poliranje vozila; pomoć pri kvaru vozila [popravak]; popravci (informacije o

popravicima); pranje; pranje automobila; pranje vozila; servisne stanice; stanice (servisne stanice); suvo čišćenje; vozila (čišćenje vozila); vozila (održavanje vozila); vozila (podmazivanje vozila); vozila (poliranje vozila); vozila (pomoć pri kvaru vozila) [popravak]; vozila (pranje vozila); vozila (zaštita vozila od rđe); vulkaniziranje gumenih točkova [popravka]; zamjena guma.

Klasa 38: Agencije za novosti; baze podataka (omogućavanje pristupa bazama podataka); bežična radiodifuzija; elektronska posta (omogućavanje elektronske pošte); elektronske poruke; emitiranje televizijskih programa; forumi za vođenje debata (omogućavanje održavanja foruma za vođenje debata); govorna pošta (omogućavanje govorne pošte); informacije o telekomunikacijama; informativne agencije [novosti]; iznajmljivanje aparata za prijenos poruka; iznajmljivanje modema; iznajmljivanje telefaks-uređaja; iznajmljivanje telefona; iznajmljivanje telekomunikacijskih uređaja; iznajmljivanje vremena pristupa svjetskim informatičkim mrežama; kompjuter (prijenos poruka i slika uz pomoć kompjutera); kompjuterski prijenos poruka i slika; kompjuterski terminali (komunikacije putem kompjuterskih terminala); komuniciranje posredstvom mreža optičkih kablova; komunikacije (radiotelefonske komunikacije); komunikacije (telefonske komunikacije); komunikacije (telegrafske komunikacije); komunikacije pomoću kompjuterskih terminala; konferencije na daljinu (omogućavanje vođenja konferencija na daljinu); kupovina putem telefona (pribavljanje komunikacionih kanala za kupovinu putem telefona), otprema pošiljki; plakatiranje (usluge elektronskog plakatiranja) [telekomunikacije]; pokretna radiotelefoniya; poruke (prijenos poruka), prijenos čestitki putem interneta; prijenos digitalnih datoteka; prijenos poruka; prijenos poruka (iznajmljivanje uređaja za prijenos poruka); prijenos poruka i slika kompjuterom; prijenos putem satelita; prijenos telegrama [telegrama]; prijenos televizijskih emisija pretplatnicima putem kabla [kablovska televizija]; pristup svjetskim informatičkim mrežama (iznajmljivanje vremena pristupa svjetskim informatičkim mrežama); pristup svjetskim informatičkim mrežama (omogućavanje pristupa svjetskim informatičkim mrežama); radio programi (emitovanje radio programa); radiodifuzija; radioelektronsko pozivanje (usluge radioelektronskog pozivanja) [radio, telefon ili ostala elektronska komunikaciona sredstva]; radiotelefonski prijenosi; sateliti (prijenos putem satelita); telefaks (prijenos poruka telefaksom); telefonske komunikacije; telefonske usluge; telegrafske komunikacije; telegrafske usluge; telegrami (pošiljka telegrama); telegrami (prijenos telegrama); telekomunikacije (informacije o telekomunikacijama); telekomunikacije (usluge telekomunikacionog rutera); telekomunikaciono priključenje na svjetsku informatičku mrežu; teleks (usluge teleksa); televizija (emitiranje televizijskih programa); televizijski programi (emitiranje televizijskih programa); vijesti (agencije za vijesti).

Klasa 39: Ambalažiranje proizvoda; garaže (iznajmljivanje garaža); informacije u vezi saobraćaja; informacije u vezi skladištenja; isporuka [distribucija] proizvoda; isporuka [distribucija] robe; isporuka novina; isporuka paketa isporuka proizvoda naručenih putem pošte; iznajmljivanje autobusa; iznajmljivanje automobila; iznajmljivanje garaža; iznajmljivanje nosača gepeka za automobile; iznajmljivanje parkirališta; iznajmljivanje skladišnih kontejnera; iznajmljivanje skladišta; iznajmljivanje trakaćih vozila; iznajmljivanje vozila; kontejneri za skladištenje (iznajmljivanje kontejnera za skladištenje); kvarovi vozila (tegljenje vozila u kvaru); lična vozila (iznajmljivanje vozila); lična vozila (prevoz ličnim vozilima); logističke usluge u vezi prevoza; navigacijske usluge; novine (distribucija novina); paketi (isporuka paketa); parkirališta (iznajmljivanje parkirališta); parkirališta (usluge parkirališta); pomoć (pružanje pomoći) [prevoz]; pomoć pri kvaru na vozilima [vuča]; pošiljka (usluge pošiljki); pošta (razdjela pošte); poštanske pošiljke [usluge prevoza poštanskih pošiljki ili robe]; prevoz (informacije o prevozu); prevoz (posredovanje u prevozu); prevoz (rezervacije za prevoz); prevoz (riječni prevoz); prevoz kamionima; prevoz robe; prevoznice [špediterske] usluge; prtljažni nosači za vozila (iznajmljivanje prtljažnih nosača za vozila); skladišta (iznajmljivanje skladišta); skladištenje; skladištenje (fizičko) elektronski sačuvanih podataka i dokumenata; skladištenje (informacije u vezi skladištenja); taksi – usluge; uputstva [informacije] o prevozu; vozači (usluge vozača); vozila (iznajmljivanje vozila); vozila u kvaru (vuča vozila u kvaru); vrijednosti (prevoz vrijednosti); vuča [tegljenje].

Klasa 40: Apertura papira; apertura tekstila (usluge aperture tekstila); iznajmljivanje generatora; ključevi

(usluge izrade kopija ključeva); niklovanje; ofset-štampanje; poliranje [struganje]; rafiniranje; štampanje (ofset-štampanje); štamparstvo; usluge farbanja.

Klasa 41: Agencije za modele za slikare i vajare; akademije [obuka]; digitalne slike (usluge digitalnog snimanja); dopisivanje (obuka putem dopisivanja); elektronske publikacije (iskorištavanje elektronskih publikacija koje se ne mogu prenositi on-line); filmovi (prikazivanje igranih filmova); filmovi (proizvodnja filmova); fotografisanje; fotografske reportaže; igre (usluge hala i dvorana za igre); igre (usluge igara) pružene on-line [s jedne informatičke mreže]; igre za novac; informacije o obrazovanju; informacije o razonodi; informacije u vezi rekreacije; izdavanje knjiga; izložbe (organizovanje izložbi) u kulturne ili obrazovne svrhe; iznajmljivanje sportske opreme [osim vozila]; iznajmljivanje sportskih terena; iznajmljivanje stadiona; javni konkursi (organizovanje javnih konkursa) [obuka ili zabava]; kampovi za ljetovanje (usluge kampova za ljetovanje) [zabava]; kampovi za sportsko usavršavanje; klubovi (usluge klubova) [zabava ili obrazovanje]; knjige (izdavanje knjiga); knjige (posuđivanje knjiga); kockarnice [igre] (usluge kockarnica); koncerti (organizovanje i vođenje koncerata); konferencije (organizovanje i vođenje konferencija); kongresi (organizovanje i vođenje kongresa); lutrija (organizovanje lutrije), mjerenje vremena na sportskim takmičenjima; modne revije za zabavne svrhe (organizovanje); muzejske usluge [predstavljanje, izložbe] muzičke sale; noćni klubovi; objavljivanje knjiga i časopisa, elektronski on line; objavljivanje tekstova [osim u reklamne svrhe]; obrazovanje (informacije o obrazovanju), obrazovanje [obuka]; obrazovni zavodi [internatij]; obuka; obuka [predavanje]; obuka putem dopisivanja; obuka za predškolski uzrast; organizovanje i vođenje koncerata, organizovanje i vođenje konferencija; organizovanje i vođenje kongresa; organizovanje i vođenje radionica za stručno osposobljavanje; organizovanje i vođenje razgovora; organizovanje i vođenje seminara; organizovanje izložba u kulturne i obrazovne svrhe; organizovanje javnih konkursa [obrazovanje ili razonoda]; organizovanje konkursa ljepote; organizovanje spektakla [usluge impresarija]; organizovanje sportskih takmičenja; pisanje tekstova [ne u reklamne svrhe]; planiranje prijema [razonoda]; posuđivanje knjiga; praktična obuka [demonstriranje]; predškolska obuka; prekvalifikacija (usluge prekvalifikacije); prelamanje slogova [ne u reklamne svrhe]; prijemi (planiranje prijema) [razonoda]; profesionalna orijentacija [savjeti u vezi obrazovanja ili osposobljavanja]; proizvodnja filmova; proizvodnja filmova na video-trakama; radio televizijski programi (montaža radio televizijskih programa); radiofonija (razonoda putem radiofonije); razgovori (organizovanje i vođenje razgovora); razonoda; razonoda (informacije u vezi razonode); razonoda posredstvom radija; razonoda posredstvom televizije; rekreacija (obavještenja u vezi rekreacije); reportaže (fotografske reportaže); reporterske usluge; seminari (organizovanje i vođenje seminara); simpozijumi (organizacija i vođenje simpozijuma); simpozijumi (organizovanje i vođenje simpozijuma); slobodno vrijeme (usluge za ispunjavanje slobodnog vremena); sportska oprema (stavljavanje na raspolaganje sportske opreme); sportska takmičenja (mjerenje vremena na sportskim takmičenjima); sportska takmičenja (organizovanje sportskih takmičenja); sportska usavršavanja (sportski kampovi za usavršavanje u sportu); sportske oprema (iznajmljivanje sportske opreme osim vozila); tekstovi (objavljivanje tekstova) [osim u reklamne svrhe]; tekstovi (sastavljanje tekstova) [ne u reklamne svrhe]; televizija (razonoda na televiziji); televizijski programi (montaža radio i televizijskih programa); ulaznice za priredbe (agencije za ulaznice za priredbe) [razonoda]; zdravstveni klubovi (usluge zdravstvenih klubova) [održavanje zdravlja i fizičke forme]; zvučni snimci (iznajmljivanje zvučnih snimaka).

Klasa 42: Ambalaža (usluge dizajniranja ambalaže); analiza kompjuterskih sastava; baze podataka (obnavljanje baza podataka); daljinski nadzor kompjuterskih sistema; digitalizacija dokumenata [skeniranje]; dizajneri (usluga modnih dizajnera); dizajniranje ambalaže (usluge dizajniranja ambalaže); dizajniranje grafičke umjetnosti (usluge dizajniranja grafičke umjetnosti); dupliciranje informatičkih programa; emisija ugljenika (pružanje naučnih informacija i savjeta u vezi smanjenja emisije ugljenika); grafička umjetnost (usluge dizajniranja grafičke umjetnosti); informatičke stranice (ugoščavanje informatičkih stranica); informatički programi (dupliciranje informatičkih programa); informatički programi (iznajmljivanje

informatičkih programa); informatički sistemi (osmišljavanje informatičkih sistema); informatički virusi (zaštita od informatičkih virusa) instaliranje kompjuterskih programa; internet (pružanje alata za pretraživanje na internetu); iznajmljivanje informatičkih programa; iznajmljivanje informatičkih programa; iznajmljivanje kompjutera; iznajmljivanje veb servera; izrada [koncipiranje] kompjuterskih programa; kalibracija [mjerenje]; kompjuteri (iznajmljivanje kompjutera); kompjuteri (programiranje za kompjutere); kompjuterski hardver (savjetovanje u vezi dizajna i razvoja kompjuterskog hardvera); kompjuterski programi (instaliranje kompjuterskih programa); kompjuterski programi (održavanje kompjuterskih programa); kompjuterski programi [softver] (izrada kompjuterskih programa); kompjuterski programi [softver] (osavremenjivanje kompjuterskih programa); konsultacije u vezi kompjuterskih programa [softvera]; kontrola kvaliteta; kontrola vozila (tehnička kontrola vozila i automobila); konverzija informatičkih podataka i programa [nije fizička konverzija]; konverzija podataka ili dokumenata s jednog fizičkog na elektronski disk; licence za intelektualnu svojinu (ustupanje licenci za intelektualnu svojinu); meteorološki izvještaji (usluge davanja meteoroloških izvještaja); modni dizajneri (usluge modnih dizajnera); programiranje za kompjuteri; regulisanje autorskih prava; savjetovanje o kompjuterima; tehnička kontrola automobila; web serveri (iznajmljivanje web servera); web stranice (kreiranje i održavanje web stranica za druge); zaštita od informatičkih virusa.

(111) **14562**

(151) 05.05.2020.

(210) Ž-2018-325

(220) 27.08.2018.

(732) TEAM SUCCESS (PACIFIC) LIMITED, RM. 3501-04, 35/F., TOWER ONE, LIPPO CENTRE, 89, QUEENSWAY, HK

(540)

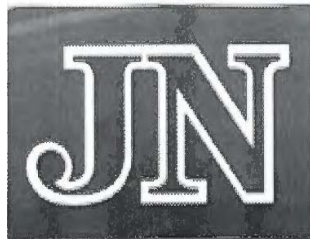

(550) I

(740) AOD "Ćupić", Bulevar Džordža Vašingtona 79, 81000, Podgorica

(511) Klasa 34: Duvan; duvan za žvakanje; cigarete koje sadrže zamjene za duvan, koje nijesu za upotrebu u medicini; cigarete; elektronske cigarete; tabakere; muštikle; pepeljare za pušače; papir za cigarete; rezani duvan.

(111) **14563**

(151) 06.05.2020.

(210) Ž-2018-225

(220) 26.06.2018.

(732) Diamond Quest Ltd, OMC Chambers, P.O.Box 3152, Road Town, Tortola, VG

(540)



(550) I

(740) Božidar S. Radulović, Studentska bb, Lamela 3/18, 81000, Podgorica

(511) Klasa 34: Duvan; artikli za pušače; šibice; cigarete; kutije za cigarete, tabakere; filteri za cigarete; muštikle; papir za cigarete; usnici za cigarete; usnici za muštikle; lule; cigarilosi; cigare; pepeljare za pušače; upaljači za pušače.

(111) **14564**

(151) 05.05.2020.

(210) Ž-2017-40

(220) 03.02.2017.

(732) DOO TEHNO MAX-PODGORICA, Bul.Pera Cetkovicica 43, Podgorica, ME

(540)

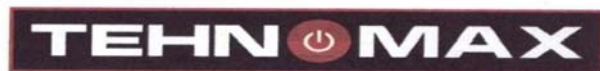

(550) I

(511) Klasa 35: oglašavanje I reklamiranje; • vođenje komercijalnih poslova; • komercijalna administracija; • uredski poslovi.

Klasa 39: prijevoz; • ambalažiranje I uskladištenje proizvoda; • organiziranje putovanja.

(111) **14565**

(151) 06.05.2020.

(210) Ž-2018-461

(220) 27.11.2018.

(732) TOYOTA JIDOSHA KABUSHIKI KAISHA (also trading as TOYOTA MOTOR CORPORATION), 1, Toyota-cho, Toyota-shi, 471-8571, Aichi-ken, JP

(540)

PROACE CITY

(550) I

(740) Mladen Đ. Čolović, Dalmatinska 2, 81000, Podgorica

(511) Klasa 12: Automobili i njihovi strukturalni djelovi.

(111) **14566**

(151) 06.05.2020.

(210) Ž-2018-462

(220) 28.11.2018.

(732) TOYOTA JIDOSHA KABUSHIKI KAISHA (also trading as TOYOTA MOTOR CORPORATION), 1, Toyota-cho, Toyota-shi, 471-8571, Aichi-ken, JP

(540)

YARIS CROSS

(550) I

(740) Mladen Đ. Čolović, Dalmatinska 2, 81000, Podgorica

(511) Klasa 12: Automobili i njihovi strukturalni djelovi.

(111) **14567**

(151) 06.05.2020.

(210) Ž-2018-233

(220) 03.07.2018.

(732) AMPLITUDO D.O.O., Bulevar Svetog Petra Cetinjskog 56, 81000, Podgorica, ME

(540)



(550) I

(511) Klasa 35: Administrativna obrada narudžbenica za kupovinu; administrativna pomoć pri odgovaranju na pozive za podnošenje ponuda; ažuriranje i održavanje informacija u registrima ; ažuriranje i održavanje

podatka u računarskim bazama podataka; ažuriranje oglasnih materijala; analize cijena i troškova; angažovanje spoljnih firmi za administrativno upravljanje kompanijama ; vođenje knjiga [knjigovodstvo] ; ekonomske prognoze; iznajmljivanje oglasnog prostora; istraživanje tržišta; kompjutersko upravljanje podacima; konsultacije u vezi sa poslovnim organizovanjem; konsultacije u poslovnom upravljanju; marketing; marketing u okviru izdavanja softvera; marketinška istraživanja; obezbeđivanje onlajn tržišta za kupce i prodavce roba i usluga; obrada teksta; obračun poreza, objavljivanje reklamnih tekstova; oglašavanje na otvorenom; oglašavanje; oglašavanje plaćanjem po kliku [pay per click oglašavanje] ; optimizacija pretraživača za promociju prodaje; optimizacija saobraćaja sa Internet stranice; organizovanje izložbi za privredne ili reklamne potrebe; organizovanje modnih revija u promotivne svrhe; pomoć u poslovnom upravljanju; pomoć u poslovnom ili industrijskom upravljanju ; poslovna istraživanja; poslovne informacije; poslovne procene; poslovno upravljanje za nezavisne pružaoce usluga; poslovno upravljanje i organizaciono savjetovanje; poslovno upravljanje programima za nadoknadu za druge ; prikupljanje informacija u kompjuterske baze podataka; prikupljanje statističkih podataka ; priprema platnih listi; pronalaženje osoblja; profesionalne poslovne konsultacije; administrativna obrada narudžbenica za kupovinu; administrativna pomoć pri odgovaranju na pozive za podnošenje ponuda; ažuriranje i održavanje informacija u registrima; ažuriranje i održavanje podatka u računarskim bazama podataka; ažuriranje oglasnih materijala; analize cijena i troškova; angažovanje spoljnih firmi za administrativno upravljanje kompanijama; vođenje knjiga [knjigovodstvo]; ekonomske prognoze; iznajmljivanje oglasnog prostora; istraživanje tržišta; kompjutersko upravljanje podacima; konsultacije u vezi sa poslovnim organizovanjem; konsultacije u poslovnom upravljanju; marketing; marketing u okviru izdavanja softvera; marketinška istraživanja; obezbeđivanje onlajn tržišta za kupce i prodavce roba i usluga; obrada teksta; obračun poreza; objavljivanje reklamnih tekstova; oglašavanje na otvorenom; oglašavanje; oglašavanje plaćanjem po kliku [pay per click oglašavanje]; optimizacija pretraživača za promociju prodaje; optimizacija saobraćaja sa Internet stranice; organizovanje izložbi za privredne ili reklamne potrebe; organizovanje modnih revija u promotivne svrhe; pomoć u poslovnom upravljanju; pomoć u poslovnom ili industrijskom upravljanju; poslovna istraživanja; poslovne informacije; poslovne procene; poslovno upravljanje za nezavisne pružaoce usluga; poslovno upravljanje i organizaciono savjetovanje; poslovno upravljanje programima za nadoknadu za druge; prikupljanje informacija u kompjuterske baze podataka; prikupljanje statističkih podataka; priprema platnih listi; pronalaženje osoblja; profesionalne poslovne konsultacije; pružanje komercijalnih i poslovnih kontakt informacija; pružanje komercijalnih saveta i informacija potrošačima pri izboru roba i usluga; pružanje poslovnih informacija putem Internet stranice; računovodstvo; revizija poslovanja; registrovanje pisane komunikacije i podataka; reklamiranje; reklamiranje na računarskoj mreži; reklamiranje slanjem narudžbenica; sekretarske usluge; sistemacija informacija u kompjuterskim bazama podataka; stručne usluge o poslovnoj efikasnosti; traženje sponzorstva ; upravljanje programima lojalnosti potrošača; usluge grafičke obrade materijala za reklamne svrhe; usluge zakazivanja sastanaka [kancelarijske usluge]; usluge podugovaranja, autsorsing [pomoć u poslovanju]; usluge poređenja cena; usluge praćenja konkurencije; usluge praćenja tržišta; fakturisanje; finansijska revizija; ciljni marketing.

Klasa 36: Davanje popusta trećim licima u objektima kroz upotrebu članskih karti ; elektronski prenos sredstava; zajmovi na rate; obrada plaćanja izvršenih kreditnim karticama; onlajn bankarstvo; pružanje informacija o finansijama putem internet stranice; usluge finansiranja; finansijske analize; finansijske informacije; finansijske konsultacije; finansijske procene odgovora na pozive za podnošenje ponuda; finansijske procene [osiguranje, bankarstvo, nekretnine]; finansijsko upravljanje; finansijsko upravljanje isplatama nadoknada za druge.

Klasa 42: Digitalizacija dokumenata [skeniranje]; elektronsko pohranjivanje podataka; zaštita od računarskih virusa; iznajmljivanje veb servera; liznajmljivanje računara; iznajmljivanje računarskog softvera; izrada i održavanje veb stranica za druge; instaliranje računarskog softvera; istraživanje i razvoj novih proizvoda za

druge; konsultacije o bezbednosti interneta; konsultacije o sigurnosti podataka; konvertovanje računarskih podataka i programa, osim fizičkog konvertovanja; konvertovanje podataka ili dokumenata sa fizičkih na elektronske nosače; kontrola kvaliteta; kreiranje i dizajniranje za druge indeksa informacija zasnovanih na internetu [usluge informacione tehnologije]; nadgledanje računarskih sistema radi otkrivanja neovlašćenog pristupa ili povrede podataka; nadgledanje računarskih sistema radi otkrivanja kvarova; obezbeđivanje alata za pretraživanje [pretraživača] na internetu; održavanje računarskog softvera; ponovno uspostavljanje računarskih podataka; praćenje računarskih sistema daljinskim pristupom; pružanje informacija o računarskim tehnologijama i programiranju putem Internet stranice; razvoj softvera u okviru izdavanja softvera; računarsko programiranje; računarstvo u oblaku; savjetovanje o izradi veb sajtova; savjetovanje o sigurnosti računara; savjetovanje u vezi informacionih tehnologija; savjetovanje u oblasti dizajna i razvoja računarskog hardvera; savjetovanje u oblasti računarskog softvera; savjetodavne usluge iz oblasti tehnologije; savjetodavne usluge iz oblasti kompjuterske tehnologije; server hosting; softver u vidu servisa [SaaS]; umnožavanje računarskih programa; usluge kodiranja+4078 podatka; hosting računarskih sajtova [veb sajtova].

(111) **14568**

(151) 25.05.2020.

(210) Ž-2019-43

(220) 31.01.2019.

(732) Bosnalijek, farmaceutska i hemijska industrija, dionicko društvo, Jukićeva 53, 71000, Sarajevo, BA

(540)

HYPRESSIN

(550) I

(740) Božidar S. Radulović, Studentska bb, Lamela 3/18, 81000, Podgorica

(511) Klasa 5: Farmaceutski proizvodi.

(111) **14569**

(151) 25.05.2020.

(210) Ž-2019-44

(220) 31.01.2019.

(732) Bosnalijek, farmaceutska i hemijska industrija, dionicko društvo, Jukićeva 53, 71000, Sarajevo, BA

(540)

HYPRESSIN PLUS

(550) I

(740) Božidar S. Radulović, Studentska bb, Lamela 3/18, 81000, Podgorica

(511) Klasa 5: Farmaceutski proizvodi.

(111) **14570**

(151) 25.05.2020.

(210) Ž-2019-50

(220) 07.02.2019.

(732) CJ Corporation , 12, Sowol-ro 2-gil Jung-gu, Seoul, KR

(540)



(550) I

(740) Miladin Popović, Đoka Miraševića 21/III, 81000, Podgorica

(511) Klasa 9: Kamere; naočare (optika); naočare za sunce; naočare; dvogledi za pozorište; sportske naočare; prsluci za spasavanje; punjači baterija; USB kablovi; električni audio i vizuelni aparati i instrumenti; računarski hardver i računarske periferni uređaji; aparati za čitanje digitalne muzike; zvučnici; slušalice; futrole za mobilne telefone; softver za elektronske igre; softver za igre virtuelne realnosti; aplikacije za pametne

telefone; računarski softver; kertridži za video igre; zaštitne rukavice; zaštitne kacige; zaštitne maske; gramofonske ploče; kompakt diskovi; DVD diskovi; digitalni video snimci koji se mogu preuzimati; mediji za digitalno snimanje; medijski sadržaji koji se mogu preuzimati; animacija koja se može preuzimati; muzički fajlovi koji se mogu preuzimati; fajlovi slika koji se mogu preuzimati; multimedijalni fajlovi koji se mogu preuzimati; kuponi koje se mogu preuzimati; crtani filmovi; elektronske publikacije koje se mogu preuzimati; programi za računarske igre; kinematografske mašine i aparati; kodirane magnetne kartice; vage koje nijesu za medicinsku upotrebu; telekomunikacione mašine i instrumenti; elektronski aparati za sprječavanje krađa, koji nijesu za vozila; sistem za kućni bioskop; mjerni aparati i instrumenti; matematički instrumenti; senzori za mjerenje temperature vazduha; slušalice sa mikrofonom za komunikaciju; rendgenski aparati; dekorativni magneti za frižidere.

(111) **14571**

(151) 25.05.2020.

(210) Ž-2019-51

(220) 07.02.2019.

(732) CJ Corporation , 12, Sowol-ro 2-gil Jung-gu, Seoul, KR

(540)



(550) I

(740) Miladin Popović, Đoka Miraševića 21/III, 81000, Podgorica

(511) Klasa 35: Pružanje usluga kupovine od kuće putem interneta i I ili televizije; online usluge maloprodajnih trgovina; obezbjeđivanje onlajn tržišta za kupce i prodavce roba i usluga; usluge maloprodaje koje nude robne kuće; supermarketi; maloprodajna trgovina; okupljanje različitih roba (izuzev prevoza istih) za dobrobit drugih, na taj način da se omogući kupcima da jednostavno pregledaju i kupe tu robu iz opšteg kataloga robe putem pošte ili putem telekomunikacionih sredstava; usluge poslovnog posredovanja u vezi sa komercijalizacijom robe; oglašavanje; promocija prodaje za druge; organizovanje komercijalnih transakcija, za druge, putem onlajn trgovina; usluge reklamiranja; prezentacija robe; iznajmljivanje reklamnog prostora

na veb stranicama; izdavanje reklamnog vremena na komunikacionim medijima; reklamiranje putem elektronskog rmedija ili Interneta; organizovanje izložbi za komercijalne ili reklamne svrhe; upravljanje i prikupljanje informacija u kompjuterske baze podataka; poslovno upravljanje i organizaciono savjetovanje; promocija robe i usluga za druge; usluge agencija za uvoz-izvoz; poslovno upravljanje za scenske umjetnike; usluge agencija za kupovinu karata, naime nabavka karata za zabavne događaje za druge u komercijalne svrhe; usluge naručivanja za dostavu robe; komercijalna administracija za licence roba i usluga za druge; usluge maloprodaje ili veleprodaje prerađenih žitarica, kafe, kolača, slatkiša, čokolade, šećera, arome i pojačivača ukusa, dodataka jelima, začinskim dodacima; hemijskih dodataka jelima, aroma za hranu (izuzev eteričnih ulja), pirinča, pšeničnog brašna, knedli, napitaka na bazi prerađenog voća (naime voćnih sokova), mineralne vode [napici], vodenih napitaka, mlijeka, farmaceutskih preparata, zdrave funkcionalne hrane, suplemenata za ishranu, vitaminskih preparata, dijetetskih dodataka ishrani, prerađenog mesa, isječene na kriške i začinjene roštiljske govedine (Bulgogi), fermentisanog povrća [Kimchi], hrane za životinje, živinu i proizvode iz vode, aditiva za krmno bilje, ne u medicinske svrhe, kancelarijskog pribora, igračaka, ličnih ukrasa (naime ukrasa [nakita]), torbi i tašni, odjeće, obuće, donjeg veša, opreme za fitnes, aparata za fizičke vježbe, kozmetike, kozmetičkog pribora, pribora za šminkanje, pribora za ljepotu (naime ručna sprava za kovrdžanje kose), toaletnih predmeta (naime toaletne četke), preparata za čišćenje i pasti za zube, parfemisanih svijeća, ukrasa za kosu (naime trake za kosu, ukosnice), boca za vodu, šolja, namještaja, posteljine, kućnih potrepština, stonog posuđa [noževa, viljušaka i kašika], fotografskih aparata i instrumenata, dodataka (naime kamera, filtera, ručnih monopoda), nakita i časovnika, telekomunikacionih mašina i implemenata (naime prenosnika), električnih audio i video aparata i instrumenata, DVD, mobilnih aplikacija [softver koji se može preuzimati ili snimljeni], magazina [periodičnih] i knjiga, aparata za prečišćavanje vazduha, aparata za ventilaciju i klimatizaciju, filetra za prečišćavanje vazduha, generatora kiseonika za prečišćavanje vazduha (dio mašine za prečišćavanje vazduha), sterilizatora za maske, namještaja, sjedišta za pozorište, stolica i sjedišta, stolica i sjedišta sa specijalnim efektima.

(111) **14572**

(151) 25.05.2020.

(210) Ž-2019-52

(220) 07.02.2019.

(732) CJ Corporation , 12, Sowol-ro 2-gil Jung-gu, Seoul, KR

(540)



(550) I

(740) Miladin Popović, Đoka Miraševića 21/III, 81000, Podgorica

(511) Klasa 38: Usluge satelitskog prenosa i emitovanja televizijskih programa; prenos slika, audio i multimedijalnog sadržaja putem interneta; usluge emitovanja putem interneta; emitovanje telešoping programa; emitovanje televizijskih programa korišćenjem televizijskih usluga videa na zahtjev i plaćanja po gledanju; emitovanje videa na zahtjev; emitovanje filmova i televizijskog sadržaja putem mobilnih komunikacionih mreža; usluge emitovanja televizijskog sadržaja koji zahtjeva pretplatu; omogućavanje pristupa mobilnim internet portalima; usluge striminga digitalnih medija; omogućavanje pristupa digitalnim muzičkim stranicama na internetu; usluge prenosa video sadržaja na zahtjev; usluga slanja elektronskih poruka za pružanje informacija o kupovini; usluge internet portala; prenos vijesti; usluge video striminga; kablovski prenos; emitovanje programa kablovske televizije; emitovanje televizijskih programa; prenos multimedijalnog sadržaja putem komunikacionih mreža; prenos digitalnih fajlova.

(111) **14573**

(151) 25.05.2020.

(210) Ž-2019-53

(220) 07.02.2019.

(732) CJ Corporation , 12, Sowol-ro 2-gil Jung-gu, Seoul, KR

(540)



(550) I

(740) Miladin Popović, Đoka Miraševića 21/III, 81000, Podgorica

(511) Klasa 41: Bioskopska pozorišta; bioskopska pozorišta koja pružaju efekte za publiku poput vjetra, mirisa, vodenog spreja, pokreta, vibracije, dima, mjhurića, lasera, ili blica; produkcija i distribucija radijskih i televizijskih programa; obezbjeđivanje filmova i televizijskih programa koji se ne mogu preuzimati putem usluge videa na zahtjev; bioskopske prezentacije virtuelne realnosti; produkcija audio snimaka; distribucija audio snimaka (izuzev prevoza); obezbjeđivanje muzike onlajn, koja se ne može preuzeti; izvođenje predstava uživo; predstavljanje muzičkih nastupa; usluge impresarija, naime, organizovanje predstava uživo iz oblasti

filma; usluge produkcije crtanih filmova; razonoda u vidu scenskih nastupa uživo u vidu predstava i koncerata; aranžiranje i vođenje kulturnih događaja; organizovanje i vođenje kulturnih predstava i nastupa; distribucija filmova; usluge razonode, naime, planiranje i vođenje serije filmskih festivala; produkcija filma; filmski studiji; izdavanje filmova; objavljivanje i uređivanje štampanog materijala; noćni klubovi; snimanje video rekorderom; usluge reporterskog izvještavanja; obezbjeđivanje objekata za zabavu; organizovanje rezervacija karata za filmove; organizovanje rezervacije karata za predstave i druge zabavne događaje; organizovanje i vođenje izložbi u zabavne, kulturne i edukativne svrhe; pružanje informacija i podataka koje se tiču filmova, usluge igara, usluge zabavnih parkova i tematskih parkova; fotografisanje; obrazovne usluge, naime, pružanje obuke i treninga u oblasti filmova, specijalnih efekata, tehnologija digitalnog snimanja, zabave; muzika, organizovanje modnih revija u zabavne svrhe; pružanje i upravljanje objektima za zabavu; pružanje objekata za zabavu, naime, objekata za prikazivanje filmova u bioskopima, mašine za arkadne video igre, vožnje kroz zabavni park, mašine za igru sa specijalnim efektima; pružanje objekata za filmove, izložbe, predstave, muzičku i obrazovnu nastavu; pružanje objekata za sport; planiranje zabave [razonode]; obučavanje u glumi, pjevanju i plesanju; usluge rezervacije karata i bukiranja za zabavne, sportske i kulturne događaje.

(111) **14574**

(151) 03.06.2020.

(210) Ž-2018-358

(220) 17.09.2018.

(732) Preduzeće za informisanje i marketing "PINK M COMPANY"D.O.O., Bulevar Ivana Crnojevića 97, Podgorica, ME

(540)

TV NOVA M

(550) I

(511) Klasa 35: Oglašavanje; usluge reklame i ekonomske propagande, kreiranje i sprovođenje propagandnih kampanja, usluge kreiranja i izrade komercijalnih poruka (reklamnih spotova i radio džinglova) za televiziju i radio, prodaja reklamnih termina i prostora za različita medijska oglašavanja, distribucija ili isporuka propagandnog materijala ili uzoraka, organizovanje sajmova i izložbi u komercijalne ili reklamne svrhe, istraživanje tržišta i ispitivanje javnog mnjenja, vođenje poslova; konsalting i menadžment poslovi, poslovno upravljanje; organizovanje i upravljanje drugim privrednim subjektima (holding poslovi), kancelarijski poslovi,

knjigovodstvene usluge, usluge obrade podataka, štamparske usluge.

Klasa 38: Telekomunikacije; usluge bežičnog emitovanja radio i televizijskih programa (radio-difuzija), usluge emitovanja radio i televizijskih programa (kablovska difuzija), usluge žičnog emitovanja radio i televizijskih programa satelitskim putem, usluge prenosa podataka.

Klasa 41: Obrazovne usluge; pripremanje obuke; razonoda; usluge proizvodnje zabavnog programa u cilju zabave i rekreacije drugih lica; sportske i kulturne aktivnosti, organizovanje sajмова i izložbi kulturne i obrazovne svrhe, organizovanje sportskih takmičenja, izdavanje tekstova, knjiga, novina, časopisa, zvučnih zapisa, radio i televizijske aktivnosti, proizvodnja radio i televizijskih programa (zabavnih, propagandnih, informativnih, obrazovnih, sportskih, kulturnih, za obučavanje).

(111) **14575**

(151) 03.06.2020.

(210) Ž-2018-331

(220) 31.08.2018.

(732) The Procter & Gamble Company, One Procter & Gamble Plaza, 45202, Cincinnati, Ohio, US

(540)

LENOR CHARM

(550) I

(740) Branislav Lutovac, Bulevar Ivana Crnojevića 93, 81000, Podgorica

(511) Klasa 3: Sredstva za pranje i druge supstance za upotrebu kod pranja veša; preparati za čišćenje, njegu, obradu i uljepšavanje tkanina; omekšivači za tkanine, sredstva za poboljšanje kondicije tkanine.

(111) **14577**

(151) 03.06.2020.

(210) Ž-2018-332

(220) 31.08.2018.

(732) The Procter & Gamble Company, One Procter & Gamble Plaza, 45202, Cincinnati, Ohio, US

(540)

LENOR BLUSH

(550) I

(740) Branislav Lutovac, Bulevar Ivana Crnojevića 93, 81000, Podgorica

(511) Klasa 3: Sredstva za pranje i druge supstance za upotrebu kod pranja veša; preparati za čišćenje, njegu, obradu i uljepšavanje tkanina; omekšivači za tkanine, sredstva za poboljšanje kondicije tkanine.

(111) **14578**

(151) 03.06.2020.

(210) Ž-2018-367

(220) 19.09.2018.

(732) TOYOTA JIDOSHA KABUSHIKI KAISHA (also trading as TOYOTA MOTOR CORPORATION), 1, Toyota-cho, Toyota-shi, 471-8571, Aichi-ken, JP

(540)

GR 86

(550) I

(740) Jasna Jusić, Dalmatinska 2, 81000, Podgorica

(511) Klasa 12: Automobili i njihovi strukturalni djelovi.

(111) **14579**

(151) 03.06.2020.

(210) Ž-2018-368

(220) 20.09.2018.

(732) NeoStrata Company, Inc. (Delaware corporation), 307 College Road East, NJ 08540, Princeton, US

(540)

AMINOFIL

(550) I

(740) Božidar S. Radulović, Studentska bb, Lamela 3/18, 81000, Podgorica

(511) Klasa 3: Sredstva za čišćenje lica, losioni za lice, sredstva za hidrataciju lica, kreme za lice, gelovi za lice, serumi za lice, sredstva za toniranje lica, kupke za ekfoliaciju lica, losioni za ekfoliaciju lica, skrabavi za lice, kreme za lice za zaštitu od sunca, maske za lice, piling za lice, kreme i serumi protiv starenja, za lice; sredstva za čišćenje tijela, losioni za tijela, sredstva za hidrataciju tijela, kreme za tijela, gelovi za tijela; kreme za oči, maske za oči; kozmetički proizvodi, naročito podloge i korektori.

(111) **14581**

(151) 03.06.2020.

(210) Ž-2018-399

(220) 23.10.2018.

(732) PEPSICO, INC., 700 Anderson Hill Road, 10577, Purchase, New York, US

(540)

(550) I

(740) Jasna Jusić, Dalmatinska 2, 81000, Podgorica

(511) Klasa 30: Kukuruzni čips, tortilja čips.

(111) **14582**

(151) 03.06.2020.

(210) Ž-2018-379

(220) 09.10.2018.

(732) PFIZER INC., 235 East 42nd Street, 10017, New York, New York, US

(540)

TALZENNA

(550) I

(740) Jasna Jusić, Dalmatinska 2, 81000, Podgorica

(511) Klasa 5: Farmaceutski i veterinarski preparati; sanitarni preparati za medicinske svrhe; dijetetska hrana i supstance prilagođene medicinskoj ili veterinarskoj upotrebi, hrana za bebe; dijetetski suplementi za ljude i životinje; flasteri, materijali za zavijanje; materijal za plombiranje zuba, zubarska smola; dezinfekciona sredstva; preparati za uništavanje štetočina; fungicidi, herbicidi.

(111) **14582**

(151) 03.06.2020.

(210) Ž-2018-384

(220) 12.10.2018.

(732) Marriott Worldwide Corporation, 10400 Fernwood Road, 20817, Bethesda, Maryland, US

(540)

COURTYARD BY MARRIOTT

(550) I

(740) Jasna Jusić, Dalmatinska 2, 81000, Podgorica

(511) Klasa 35: Usluge franšize, naime, pružanje pomoći u poslovnom upravljanju u osnivanju i radu hotela, restorana, barova, spa, rekreativnih i fitnes centara, i maloprodajnih objekata; usluge poslovnog upravljanja, naime, upravljanje i rad hotela, restorana, barova, spa, rekreativnih i fitnes centara, maloprodajnih objekata za druge; usluge poslovnog centra, odnosno iznajmljivanje kancelarijskih mašina i opreme, fotokopiranje, usluge obrade teksta i kucanja; konsultantske usluge za poslovno upravljanje; pružanje objekata za upotrebu kancelarijske opreme i mašina; usluge poslovne administracije; usluge planiranja poslovnih sastanaka.

Klasa 41: Obrazovanje; pružanje obuke; zabava; sportske i kulturne aktivnosti; usluge zdravstvenog kluba, odnosno pružanje instrukcija i konsultacija u oblasti fizičkih vježbi; iznajmljivanje opreme za vježbanje; obezbjeđivanje objekata za fitnes i vježbanje; usluge golf kluba, terena za golf i usluge obuke igranja golfa; obrazovanje; pružanje obuke; zabava; sportske i kulturne aktivnosti; obrazovanje i zabava, odnosno organizovanje konferencija, organizovanje izložbi u kulturne ili obrazovne svrhe; obezbjeđivanje objekata za rekreativne aktivnosti; obezbjeđivanje objekata i usluga za bazene i vodene sportove; obezbjeđivanje teniskih objekata, iznajmljivanje teniskih terena i obuke za tenis; usluge kazina i igara na sreću, noćni klubovi.

Klasa 43: Usluge pružanja hrane i pića; obezbjeđivanje privremenog smještaja; priprema hrane; rezervacija privremenog smještaja; hotelske usluge; usluge restorana, kateringa, bar i lounge bar usluge; usluge odmarališta i smještaja; obezbjeđivanje objekata opšte namjene za sastanke, konferencije i izložbe; obezbjeđivanje banketskih i prostorija za javne skupove za posebne prilike; i usluge rezervacije hotelskog smještaja; pružanje informacija i savjeta u vezi sa svim pomenutim uslugama.

(111) **14583**

(151) 03.06.2020.

(210) Ž-2018-180

(220) 23.05.2018.

(732) Natumin Pharma AB, Kungsängsvägen 27, 561 51, Huskvarna, SE

(540)

ECOMER

(550) I

(740) AOD MSA IP - Milojević Sekulić Advokati, Karađorđeva 65, 11000, Beograd

(511) Klasa 5: Farmaceutski i veterinarski preparati; sanitarni preparati za upotrebu u medicini; dijetetske supstance; dodaci ishrani; mineralni dodaci ishrani; dodaci ishrani na bazi vitamina; ljekovite biljke; vitaminski preparati.

(111) **14584**

(151) 05.06.2020.

(210) Ž-2018-403

(220) 25.10.2018.

(732) CNH America LLC, A Delaware Limited Liability Company, 700 State Street, 53404, Racine, Wisconsin, US

(540)

ABSOLUT

(550) I

(740) AOD "Ćupić", Bulevar Džordža Vašingtona 79, 81000, Podgorica

(511) Klasa 12: Poljoprivredni traktori i njihovi djelovi.

(111) **14586**

(151) 05.06.2020.

(210) Ž-2018-404

(220) 25.10.2018.

(732) CNH Industrial America LLC, A Delaware Limited Liability Company, 700 State Street, 53404, Racine, Wisconsin, US

(540)

IMPULS

(550) I

(740) AOD "Ćupić", Bulevar Džordža Vašingtona 79, 81000, Podgorica

(511) Klasa 12: Poljoprivredni traktori i njihovi djelovi.

(111) **14586**

(151) 05.06.2020.

(210) Ž-2018-410

(220) 02.11.2018.

(732) Alibaba Group Holding Limited, Fourth Floor, One Capital Place, P.O. Box 847, George Town, Grand Cayman, KY

(540)

ALIPAY

(550) I

(740) Jasna Jusić, Dalmatinska 2, 81000, Podgorica

(511) Klasa 9: Aparati i instrumenti naučni, pomorski, geodetski, fotografski, kinematografski, optički, za vaganje, mjerenje, signalizaciju, kontrolu (inspekciju), spašavanje i nastavu; aparati i instrumenti za provođenje, prekid, transformaciju, akumulaciju, regulisanje ili kontrolu električne energije; aparati za snimanje, prenos i reprodukciju zvuka ili slike; magnetni nosači podataka, diskovi za snimanje; mehanizmi za aparate koji se pokreću novcem; registar kase, računске mašine, oprema za obradu podataka i računari; računarski programi; softver za procesuiranje elektronskih plaćanja za druge i od drugih; softver za autentifikaciju; kompjuterski softver koji se može naći na internetu; kompjuterski softver za interaktivnu zabavu, koji omogućava korisnicima da prilagode iskustvo gledanja, slušanja i igre izborom i uređivanjem prikaza i performansi audio, video i audio-vizuelnih elemenata; audio, vizuelne i audio-vizuelne datoteke i snimci koji se mogu preuzimati, a koji sadrže multimedijalne zabavne programe i sadržaj; onlajn elektronske publikacije (koje se mogu preuzeti sa interneta ili kompjuterske mreže ili iz kompjuterske baze podataka); softver za razmjenu trenutnih poruka; softver za dijeljenje datoteka; komunikacijski softver za elektronsku razmjenu podataka, audio i video sadržaja, slika i grafika putem kompjuterskih, mobilnih, bežičnih i telekomunikacionih mreža; kompjuterski softver u obliku aplikacije za mobilne uređaje i računare; softverske aplikacije za upotrebu sa mobilnim uređajima; kompjuterski softver za obradu slika, grafika, audio i video

sadržaja i teksta; kompjuterski softver koji se može preuzimati koji olakšava elektronski prenos informacija, podataka, dokumenata, glasa i slika preko Interneta; kompjuterski softver koji se može preuzimati koji omogućava korisnicima da učestvuju na onlajn sastancima i časovima, sa pristupom podacima, dokumentima, slikama i softverskim aplikacijama kroz Internet pretraživač; kompjuterski softver koji se može preuzeti, za pristup, pregled i upravljanje udaljenim kompjuterima i kompjuterskim mrežama; softver za računarstvo u oblaku koji se može preuzimati; softver koji se nalazi u oblaku, a koji se može preuzimati; elektronske publikacije koje se mogu preuzimati, u obliku časopisa, članaka, brošura, lifleta, tehničkih specifikacija, informacionih materijala, priručnika u oblastima poslovanja, elektronske trgovine, informacionih tehnologija, računarstva u oblaku, telekomunikacija, interneta, obuka u vezi sa poslovanjem i elektronskom trgovinom, upravljanja poslovanjem, prodajom, marketingom i finansijama; kompjuterske periferne jedinice; noutbuk računari ; laptop računari ; prenosiivi računari; ručni računari ; lični digitalni asistenti ; lični media plejeri ; mobilni telefoni; pametni telefoni; digitalne kamere; baterije, punjači za baterije; računarske radne stanice; računarski serveri; kompjuterski i telekomunikacioni mrežni hardver; kompjuterski mrežni adapteri , prekidači, ruteri i čvorovi; bežični i žični modemi i komunikacione kartice i uređaji ; držači za laptop; torbe za računare; aparti za gašenje požara; kompjuterski hardver i firmver; kompjuterski softver (uključujući softver koji se može preuzeti sa interneta); automobilski sistem i za navigaciju; kompakt diskovi; digitalna muzika (koja se može preuzeti sa interneta); telekomunikacijski aparati; podloge za miševe; slušalice za mobilne telefone; dodaci za mobilne telefone; igre, slike, bioskopski filmovi, filmovi i muzika koji se mogu preuzeti ; sistemi za alarme; bezbjednosne kamere; mobilne radio i televizijske jedinice za emitovanje; oprema za televizijsko emitovanje; kamere; video kamere; slušalice; telefonske slušalice koje se nose u uvetu; zvučnici; uređaji i oprema za globalno pozicionirajući sistem [GPS]; programi i softver za kompjuterske, elektronske i video igre (uključujući i softver koji se može preuzeti sa interneta); displeji od tečnih kristala za telekomunikacionu i elektronsku opremu; set top boks; daljinski upravljači; programi za skladištenje podataka; naočare i naočare za sunce; elektronske table sa natpisom; kodirane ili magnetne bankovne kreditne, debitne, gotovinske ili identifikacione kartice; automatski bankomati; čitači elektronskih knjiga; toner kertridži , prazni , za štampače i fotokopire; uređaji za nadgledanje beba; video uređaji za nadgledanje beba; poklopci za fotografska sočiva; tablet računari ; kodirane ključ kartice; 3D naočare; memorijske kartice za mašine za video igre.

Klasa 35: Ogllašavanje; vođenje poslova; poslovno upravljanje; kancelarijski poslovi ; organizacija, rukovođenje i nadgledanje programa lojalnosti i podsticajnih programa; usluge oglašavanja koje se pružaju preko interneta; proizvodnja televizijskih i radio reklama; računovodstvo; usluge prodaje putem licitacije; organizovanje sajmova; ispitivanje javnog mnjenja; obrada podataka; pružanje poslovnih informacija; usluge reklamnih agencij a; reklamne usluge za druge; upravljanje bazama podataka; sakupljanje informacija u kompjuterske baze podataka; usluge poslovnog savjetovanja; usluge poslovnog savjetovanja u oblasti događaja, konferencija, trening programa, programa za učenje i seminara koji se održavaju onlajn; usluge poslovnog savjetovanja u oblasti pružanja znanja zasnovanog na veb-u; usluge poslovnog savjetovanja u oblasti onlajn saradnje i tehnologija saradnje; usluge poslovnog savjetovanja u oblastima prodaje i marketinga; usluge upravljanja poslovnim projektima u vezi sa razvojem, postavljanjem, organizovanjem, izradom, snimanjem, monitoringom i praćenjem onlajn događaja, konferencija, programa obuke, programa učenja i seminara; usluge istraživanja tržišta i poslovnog savjetovanja; usluge poslovnog savjetovanja u vezi sa olakšavanjem poslovnih transakcija putem lokalnih i globalnih računarskih mreža pronalazanjem i pružanjem preporuka za pružanje širokog spektra poslovnih i potrošačkih proizvoda i usluga; širenje poslovnih informacija u vezi sa robom i uslugama drugih putem lokalnih i globalnih računarskih mreža; poslovno savjetovanje u vezi sa pružanjem Internet stranica na globalnoj računarskoj mreži putem kojih treća lica mogu da nude i pronalaze robu i usluge, mjesta, utvrđuju status i ispunjavaju trgovinske liste i naloge, sklapaju ugovore i vrše poslovne transakcije; pružanje kompjuterizovanih usluga onlajn poručivanja;

reklamiranje robe i usluga drugih putem lokalnih i globalnih računarskih mreža; usluge međunarodnih agencija za uvoz i izvoz; iznajmljivanje reklamnog prostora na komunikacijskim medijima; usluge onlajn trgovine u vezi sa elektronskim licitacijama i pružanje onlajn poslovne procjene u vezi sa istim ; usluge onlajn maloprodaje potrošačke robe; obezbjeđivanje direktorijuma Internet stranica trećih strana za olakšavanje poslovnih transakcija; usluge poslovnog savjetovanja u vezi sa vođenjem elektronske berze za kupce i prodavce robe i/ili usluga na globalnoj računarskoj mreži ; poslovna pomoć u vezi sa olakšavanjem poslovnih transakcija putem lokalnih i globalnih računarskih mreža; konsultantske usluge za korporativni menadžment; usluge reklamiranja i promocije; objavljivanje materijala za reklamiranje; reklamiranje praznih prostorija; diseminacija reklamnog materijala, ažuriranje reklamnog materijala, sakupljanje reklama za upotrebu kao veb stranica na internetu; iznajmljivanje reklamnog prostora; kompjuterska obrada podataka; usluge informisanja o prodaji, poslovanju i promocijama; javljanje na telefon (za nedostupne pretplatnike); javljanje na telefon (za druge); usluge prodaje putem licitacije koje se pružaju na internetu; upravljanje osobljem ; pružanje informacija u vezi sa prodajom, poslovanjem i promocijama putem globalne računarske mreže i putem interneta; prezentacija robe na komunikacionim medijima u svrhu maloprodaje; združivanje, u korist drugih, raznovrsne robe, radi omogućavanja potrošačima da ih lakše pregledaju i kupe tu robu sa opšte prodajne internet stranice i na veleprodajnom tržištu; združivanje, u korist drugih, raznovrsne robe, radi omogućavanja potrošačima da ih lakše pregledaju i kupe tu robu iz opšteg prodajnog kataloga putem poštanske narudžbenice ili putem sredstava telekomunikacije; združivanje, u korist drugih, raznovrsne robe, radi omogućavanja potrošačima da ih lakše pregledaju i kupe tu robu iz maloprodajnih outlet radnji; maloprodaja i veleprodaja telefona, slušalica za mobilne telefone, dodataka za mobilne telefone, elektronske i telekomunikacione robe, kompjuterskog hardvera i kompjuterskog softvera, baterija, punjača za baterije, aparata i instrumenata za snimanje, primanje, emitovanje i/ili reprodukovanje podataka, informacija, crteža, slika, i/ili zvuka, plemenitih metala, nakita, dragog kamenja, štampanog materijala, kancelarijskog pribora, magnetnih i nemagnetnih kodiranih kartica, namještaja, ramova za slike, pribora za domaćinstvo i kuhinju, staklarije, porculana i grnčarije, tekstila, odjeće, obuće, pokrivala za glavu, čipke i veza, dugmadi, traka, špenadli i igala, vještačkog cvijeća, tepiha, ćilima, igara i elektronskih igračaka, hemikalija za korišćenje u industriji, nauci , fotografiji i poljoprivredi, boja, lakova i glazura, proizvoda za ličnu higijenu, sapuna, parfema, kozmetike, losiona za kosu i tijelo, esencijalnih ulja, preparata za čišćenje i izbjeljivanje, lubrikanata, goriva, svijeća, farmaceutskih , veterinarskih i sanitarnih preparata, sitne metalne robe i malih predmeta od metala, mašina i mašinskog alata, pribora za jelo, brijača i ručnog alata, računara, mašina za računanje, električnih, fotografskih , kinematografskih i optičkih aparata i instrumenata, naočara i naočara za sunce, hirurških i medicinskih aparata i instrumenata, aparata za osvjetljivanje, grijanje, proizvodnju pare, kuvanje, hlađenje, sušenje, ventilaciju, snabdijevanje vodom i sanitarnu upotrebu, vozila, vatrenog oružja, vatrometa, srebrnine, horoloških i hronometrijskih instrumenata, muzičkih instrumenata, časopisa, karti , papira i proizvoda od kartona, slika, pisaćih mašina i kancelarijskog pribora, materijala za pakovanje, gume i plastike za upotrebu u ručnoj proizvodnji, materijala za pakovanje i izolaciju, kože i imitacije kože i robe napravljene od tih materijala ručnih tašni , torbi , novčanika, kožnih držača, putnih torbi , prtljaga, kišobrana, ogledala, konopaca, uzica, mreža, šatora, pređa i konac za tekstilnu upotrebu, vješalica za kapute, podmetača, krojačke robe, prekrivača za stolove i krevete, igračka i sportskih artikala, hrane i pića, mesa, ribe, živine, konzervisanog, zamrznutog, sušenog i kivanog voća i povrća; džemova, voćnih sosova, jaja, mlijeka i mliječnih proizvoda, ulja i masti za ishranu, kafe, čaja, kakaoa, šećera, pirinča, brašna, hljeba i kolača, konditorskih proizvoda, svježeg voća i povrća, piva, mineralne vode, voćnih sokova i drugih bezalkoholnih pića, alkoholnih pića, cvjetnih proizvoda, duvana, predmeta za pušenje i šibica; reklamiranje direktnom poštom ; usluge agencija za kupovinu i prodaju za druge; izbor i nabavka robe za fizička i pravna lica; naručivanje usluga (za druge); usluge maloprodaje u robnim kućama; usluge maloprodaje u supermarketima; sekretarske usluge; pružanje poslovnih statističkih informacija; organizacija izložbi za komercijalne ili reklamne svrhe; usluge poslovne pomoći u vezi sa

sakupljanjem i iznajmljivanjem listi adresa; poslovno istraživanje; usluge poslovne administracije za obradu prodaje na internetu; usluge poslovnih preporuka i raspoređivanja osoblja; agencije za uvoz-izvoz (usluge agencija za uvoz-izvoz); agencije za novinske pretplate; reprodukcija dokumenata; transkripcija (uključujući pisanje na papirnim šablonima); iznajmljivanje kancelarijske opreme; upravljanje odnosima sa mušterijama; usluge poslovnog upravljanja u vezi sa elektronskom trgovinom ; usluge poslovnog upravljanja i administracije u vezi sa programima sponzorstava; računovodstvene usluge; dobrotvorne usluge, naime poslovna administracija u vezi sa organizacijom i vođenjem volonterskih programa i projekata društvenog servisa; iznajmljivanje štandova za prodaju; pružanje informacija o komercijalnim i poslovnim kontaktima; optimizacija pretraživača; optimizacija saobraćaja sa Internet stranice; oglašavanje plaćanjem po kliku; usluge komercijalnog posredovanja; poslovno upravljanje za nezavisne pružaoce usluga; pregovaranje i zaključivanje trgovinskih transakcija za treća lica; ažuriranje i održavanje podataka u kompjuterskim bazama podataka; usluge vođenja poslovnih projekata za građevinske projekte; pružanje poslovnih informacija putem Internet stranice; konsultantske, informativne i savjetodavne usluge u vezi sa gore navedenim uslugama.

Klasa 36: Osiguranje; finansijski poslovi; novčani poslovi ; poslovi vezani za nepokretnosti; kliring i usklađivanje finansijskih transakcija putem globalne računarske mreže; onlajn bankarske usluge i finansijske usluge; usluge kreditnih kartica, procesuiranje i prenos računa i uplata, i pružanje osiguranja za finansijske transakcije; usluge prenosa sredstava; prenos sredstava elektronskim putem za druge; prenos uplata za druge putem interneta; finansijske usluge u oblasti usluga obrade računa i uplata; organizovanje i upravljanje lizingom i zakupom; iznajmljivanje i lizing nepokretnosti; procjena nepokretnosti; valuacija nepokretnosti ; finansijske usluge u vezi sa nepokretnostima, investiranje u nepokretnosti; brokerske usluge u vezi sa nepokretnostima; usluge agencija za nepokretnosti ; usluge stambenih agencija; aktuarske usluge; upravljanje nepokretnostima i konsalting usluge; ubiranje najamnine; iznajmljivanje kancelarija (nepokretnosti); iznajmljivanje apartmana i stanova; pružanje finansijskih informacija putem interneta; usluge depozita i usluge izdavanja putničkih vaučera; ulaganje kapitala; finansijske evaluacije [osiguranje, bankarstvo, nepokretnosti]; finansijske i usluge upravljanja aktivom ; osiguranje i finansijske usluge; finansijske usluge pružene putem telekomunikacijskih sredstava; finansijske konsalting i savjetodavne usluge; onlajn bankarstvo; bankarske usluge pružene onlajn sa računarskih baza podataka ili interneta; usluge posredovanja u prometu sa hartijama od vrijednosti, usluge notiranja cijena na berzi ; posredovanje u vezi sa akcijama i obveznicama, finansijske analize; usluge debitnih kartica, usluge platnih kartica i usluge čekovne garancije; bankarske, usluge štednih računa i investicione usluge; usluge finansijskog kliringa; kreditna verifikacija putem globalne računarske informacione mreže; elektronske usluge upravljanja rizikom kredita; usluge elektronskog plaćanja za kupovinu i elektronskog plaćanja računa; zaduživanje finansijskih računa i kreditne usluge; elektronske bankarske usluge; izdavanje pretplatničkih kartica, platnih kartica i debitnih kartica; usluge telefonskih kreditnih kartica; informativne usluge u vezi sa finansijama i osiguranjem, pružene onlajn sa računarske baze podataka ili interneta; agencija za prikupljanje naknada za gas i električnu energiju; procjena antikviteta; procjena umjetničkih djela; procjena nakita; procjena polovnih vozila; snabdijevanje poreskim informacijama (finansijske usluge); prikupljanje priloga za dobrotvorne fondove; organizovanje dobrotvornog prikupljanja; dobrotvorno prikupljanje; iznajmljivanje mašina za brojenje papirnog novca i kovanica; iznajmljivanje bankomata ili automatizovanih mašina za izdavanje gotovine; usluge onlajn plaćanja; usluge depozita u sefovima; organizovanje finansija za građevinske projekte; usluge agencija za odobravanje uvoza-izvoza (carinska odobrenja); konsultacije, informacije i savjetodavne usluge u vezi sa naprijed navedenim uslugama.

Klasa 38: Telekomunikacije; telekomunikacijske usluge, naime usluge prenosa i prijema podataka putem telekomunikacionih mreža; pružanje usluga multimedijalnih telekonferencija, videokonferencija i sastanaka na veb-u koj i dozvoljavaju učesnicima da simultano i asinhrono pregledaju, dijele, uređuju i diskutuju dokumenta, podatke i slike putem Internet pretraživača; omogućavanje pristupa onlajn izvještajima u vezi sa

performansama, efikasnošću i statusom Internet aplikacija, telekonferencija, video konferencija i sastanaka za mušterije; omogućavanje korisnicima da bezbjedno pristupaju privatnim kompjuterskim mrežama na daljinu putem Interneta; pružanje informacija u oblasti bezbjednog prenosa podataka i informacija; konsultantske usluge u oblasti bezbjednog prenosa podataka i informacija; pružanje onlajn usluga saradnje (telekomunikacione usluge) koje omogućavaju korisnicima da pristupaju aplikacijama, platformama, zajednički dijeljenim dokumentima, podacima, listama zadataka i forumima za diskusiju; usluge emitovanja preko interneta, pružanje pristupa onlajn bazama podataka koje sadrže informacije o internet platformi za podnošenje žalbi u vezi sa emitovanjem programa; pružanje telekomunikacionog pristupa i veze sa kompjuterskom bazom podataka i sa internetom; elektronske komunikacione usluge; interaktivne telekomunikacione usluge; telekomunikacije u vezi sa informacijama (Internet stranice), kompjuterskim programima i podacima; pružanje telekomunikacionih veza sa Internetom ili bazama podataka; pružanje telekomunikacionog pristupa objektima i strukturama na internetu; komunikacija putem računarskih terminala; komunikacija putem mreža sa optičkim vlaknima; kompjuterski potpomognut prenos poruka, informacija, podataka, dokumenata i slika; prenos putem faksimila; slanje poruka; pejdžing usluge; iznajmljivanje modema; usluge komunikacije podataka elektronskim sredstvima; iznajmljivanje telekomunikacione opreme; usluge elektronskog slanja, primanja i prosljeđivanja poruka; pružanje telekomunikacionih usluga za prikupljanje, prenos i isporuku podataka elektronskim putem; elektronska razmjena glasa, podataka, audio zapisa, video zapisa, teksta i grafika kojima se može pristupiti preko kompjutera i telekomunikacionih mreža; usluge instant slanja poruka; usluge komunikacija putem mobilnih telefona; pružanje telekomunikacionih usluga za prikupljanje, prenos i isporuku poruka elektronske pošte, informacija u vidu nepomičnih i/ili pokretnih slika kao što su karakteri, poruke, muzika i slike, telegrami, informacije i podaci putem mehaničkih, elektronskih, telefonskih, teleks, kablovskih, kompjuterskih i satelitskih sredstava; prenos, emitovanje i prijem audio, video, nepomičnih i pokretnih slika i podataka u kompresovanom ili nekompresovanom obliku u realnom ili odloženom vremenu; usluge elektronskih poruka, konferencija i prenosa naloga; usluge video konferencija; komunikacija putem elektronskih biltena koji omogućava korisnicima da obavljaju interaktivne razgovore u realnom vremenu između kompjuterskog terminala i elektronskog biltena koji sadrži informacije sa nepomičnim i pokretnim slikama i glasovne informacije kao što su karakteri; pružanje elektronskih biltena i oglasnih tabli za prenos poruka; pružanje usluga onlajn foruma za diskusije; striming audio materijala na internetu; striming video materijala na internetu; usluge televizijskog emitovanja; usluge televizijskog prenosa koji se plaća po gledanju; usluge video emitovanja, emitovanje i prenos radio i televizijskih programa; emitovanje muzike; prenos muzičkih, filmskih, interaktivnih programa, videa, elektronskih kompjuterskih igara; prenos informacija u vezi sa onlajn kupovinom i opštim uslugama maloprodaje; usluge prenosa videa po zahtjevu; usluge novinskih agencija; pružanje pristupa kompjuterskim bazama podataka na globalnoj kompjuterskoj mreži za pretraživanje i vraćanje informacija, podataka, Internet stranica i resursa koji su dostupni na kompjuterskim mrežama; pružanje pristupa za korisnike kompjuterskim bazama podataka koje sadrže elektronske publikacije, biltene, baze podataka i informacije kojima se može pristupiti preko interneta; pružanje pristupa za korisnike kompjuterskim bazama podataka koje sadrže elektronske publikacije, biltene, baze podataka i informacije kojima se može pristupiti preko računara; upravljanje pričaonicama (usluge pričaonica); pristup za više korisnika globalnim kompjuterskim informacionim mrežama za transfer i diseminaciju širokog opsega informacija; pružanje pristupa Internet stranicama na globalnoj kompjuterskoj mreži putem koje treća lica mogu da nude robu i usluge, prave i popunjavaju porudžbine, sklapaju ugovore i vrše poslovne transakcije; pružanje pristupa interaktivnoj Internet stranici na globalnoj kompjuterskoj mreži za treća lica da postavljaju informacije, odgovaraju na zahtjeve i prave i popunjavaju porudžbine za proizvode, servise i poslovne prilike; komunikacijske usluge, naime usluge servisa tekstualnih i numeričkih digitalnih poruka; prenos informacija komunikacijom podataka radi pomoći pri donošenju odluka; prenos informacija kroz sisteme za video

komunikaciju; usluge onlajn konferencija; elektronske komunikacijske usluge za uspostavljanje virtuelnih pričaonica putem tekstualnih poruka; pružanje elektronskih biltena za postavljanje i prenos poruka između kompjuterskih korisnika u vezi sa proizvodima, uslugama i poslovnim prednostima i mogućnostima; pružanje onlajn interaktivnih biltena za postavljanje, promociju, prodaju i preprodaju artikala putem globalne kompjuterske mreže; pružanje usluga elektronske pošte i prosljeđivanja elektronske pošte; audio i video komunikacija putem računara i računarskih mreža i putem globalne komunikacione mreže; pružanje kompjuterskog pristupa i iznajmljivanje vremena za pristup interaktivnim biltenima i bazama podataka; pružanje pristupa elektronskim biltenima za postavljanje i prenos poruka između kompjuterskih korisnika u vezi sa proizvodima, uslugama i poslovnim prilikama; pružanje pristupa elektronskom kalendaru, adresaru i elektronskoj bilježnici putem globalne kompjuterske mreže; pružanje pristupa i prostora za video i/ili telefonske konferencije na daljinu; pružanje kompjuterskih veza za Internet stranice trećih lica kako bi se olakšala elektronska trgovina i poslovne transakcije u realnom svijetu; konsultantske, informacione i savjetodavne usluge u vezi sa gore navedenim uslugama.

Klasa 39: GPS (globalno pozicionirajući sistem) navigacione usluge; pružanje informacija koje se odnose na putovanja i turizam putem interneta i/ili putem telekomunikacijskih mreža; pružanje interaktivnih onlajn baza podataka sa informacijama o putevima, putovanjima, navigaciji, saobraćaju i tačkom interesovanja (u vezi sa putovanjima); pružanje informacija putnicima u vezi sa tarifama, redom vožnje i javnim prevozom; putničke i turističke informacije i usluge vodiča; usluge vođenja ruta i planiranja; aranžman putovanja; usluge putničkih agencija; usluge agencije u vezi sa putničkim kartama; organizovanje putovanja i informacije za njih, sve pruženo onlajn sa kompjuterske baze podataka ili interneta; putovanja jahtom i/ili brodovima; pružanje uputstava za vožnju za potrebe putovanja; iznajmljivanje navigacionih sistema; prevoz; pružanje informacija o putevima i saobraćaju; pružanje navigacionih i informacionih usluga, naime informacije u vezi sa saobraćajem i gužvama u saobraćaju; prevoz robe i putnika; auto prevoz; avio prevoz; iznajmljivanje vozila; usluge iznajmljivanja automobila; usluge vozača; transport cjevovodom; transportne usluge u vezi upravljanja transportom; pružanje područja za letjenje, naime pružanje pristupa pistama, trakama za slijetanje i zaletištim; pakovanje; pakovanje i skladištenje robe; fizičko skladištenje elektronski pohranjenih podataka ili dokumenata; dostavljanje poruka; dostavljanje robe po porudžbini; kurirske usluge [dostava pošiljki ili robe]; posredovanje u vezi sa brodovima (posredovanje u vezi sa pomorskim transportom); utovar i istovar tereta; posredovanje u prevozu robe; selidbene usluge; posredovanje u iznajmljivanju, lizingu; prodaji; kupovini i/ili čarteru brodova i/ili čamaca; spasavanje i podizanje potopljenih brodova i/ili čamaca; pilotiranje; distribucija gasa i snabdijevanje; distribucija električne struje i snabdijevanje; distribucija toplote i snabdijevanje; distribucija vode i snabdijevanje; usluge objekata za sidrenje; iznajmljivanje skladišta; iznajmljivanje i/ili lizing invalidskih kolica; iznajmljivanje i/ili lizing aviona; iznajmljivanje i/ili lizing bicikala; iznajmljivanje i/ili lizing automobila; iznajmljivanje i/ili lizing brodova i/ili čamaca; iznajmljivanje i/ili lizing vozila na ljudski pogon; iznajmljivanje i/ili lizing mehaničkih parking sistema; upravljanje parking prostorom; usluge parkiranja vozila; obezbjeđivanje pristupa putevima na kojima se plaća putarina; iznajmljivanje i/ili lizing kontejnera; iznajmljivanje i/ili lizing paleta; iznajmljivanje i/ili lizing mašina za pakovanje i umotavanje; iznajmljivanje i/ili lizing komora za hlađenje; skupljanje otpada i smeća iz domaćinstva; skupljanje industrijskog otpada i smeća; usluge agencija za carinsko posredovanje u vezi sa uvozom-izvozom (carinjenje); konsultacije, informacije i savjetodavne usluge u vezi sa naprijed navedenim uslugama.

Klasa 41: Obrazovanje; pružanje obuke; zabava; sportske i kulturne aktivnosti; izdavanje tekstova, knjiga i časopisa (osim reklamnih tekstova); izdavanje dijagrama, slika i fotografija; izdavanje novina, magazina i periodičnih publikacija; usluge obrazovanja, vježbe i pružanje obuka u vezi sa telekomunikacijama, računarima, računarskim programima, računarstvom u oblaku, dizajnom veb sajtova, elektronskom trgovinom, poslovnim upravljanjem, finansijskim upravljanjem i oglašavanjem; pružanje obrazovanja, rekreacije, instrukcija, podučavanja i obuke interaktivno i neinteraktivno; dizajn obrazovnih kurseva, ispita i

kvalifikacija; zabava pružena putem elektronskih i digitalnih interaktivnih medija; usluge elektronskih igara pružene putem interneta; pružanje informacija u vezi sa obrazovanjem, obukom, zabavom, rekreacijom, sportskim, društvenim i kulturnim aktivnostima; pružanje onlajn elektronskih publikacija (koje se ne mogu preuzimati); priređivanje, organizovanje, hosting i vođenje pjevačkih takmičenja; priređivanje, organizovanje, hosting i vođenje koncerta; priređivanje, organizovanje, hosting i vođenje događaja i takmičenja za obrazovne i zabavne potrebe; priređivanje, organizovanje, hosting i vođenje zabavnih igara i potraga; usluge agencija u vezi sa kartama za zabavne događaje; informacije u vezi sa zabavom ili obrazovanjem, koje se pružaju onlajn sa računarske baze podataka ili interneta; pružanje digitalne muzike (koja se ne može preuzimati) sa interneta; pružanje digitalne muzike (koja se ne može preuzimati) sa MP3 (Moving Picture Experts Group 1 audio layer 3) Internet veb-sajtova; zabavne i obrazovne usluge u vezi sa planiranjem, proizvodnjom i distribucijom zvuka, slika, digitalne muzike, filmova, uživo ili snimljenih audio, vizuelnih ili audiovizuelnih materijala za emitovanje na zemaljskim kanalima, satelitskim kanalima, internetu, bežičnim ili sistemima žične veze i drugih vidova komunikacija; usluge muzičke zabave; iznajmljivanje audio snimaka; pripremanje zabavnih, obrazovnih, dokumentarnih programa i vijesti za emitovanje; usluge reporterskog izvještavanja; informacije u vezi sa sportskim i kulturnim događajima, aktuelnim događajima i najvažnijim vijestima pružene putem televizijskog satelitskog prenosa, interneta ili drugih elektronskih načina; televizijski programi, radio i filmska produkcija; premijum ili plaćene usluge televizijskog programiranja i usluge televizijskog programiranja; planiranje TV zabavnih programa; pružanje zabavnih informacija, multimedijalnog sadržaja, TV zabavnih programa i pružanje onlajn filmova; pripremanje i produkcija televizijskih programa; pružanje informacija, podataka, grafike, zvuka, muzike, videa, animacije i tekstova za zabavne potrebe; usluge igara; pružanje klupske rekreacije, sportskih i gimnastičkih objekata; nastupi muzičkih sastava; klupska zabava, diskoteke, modne revije i usluge noćnih klubova; klupske usluge u vezi sa zabavom, obrazovanjem i kulturnim aktivnostima; organizovanje, vođenje i pružanje konferencija, konvencija, kongresa, seminara i radionica obuke; organizovanje, vođenje i pružanje konferencija, konvencija, kongresa, seminara i radionica obuke u vezi sa telekomunikacijama, računarima, računarskim programima, računarstvom u oblaku, dizajnom veb sajtova, elektronskom trgovinom, poslovnim upravljanjem, finansijskim upravljanjem i oglašavanjem; organizovanje i vođenje izložbi za kulturne i obrazovne potrebe, modnih revija, obrazovnih programa i kulturnih programa i predstava; umjetničke izložbe i usluge galerija; usluge umjetničkih galerija u vezi sa lizingom umjetničkih djela; usluge obuke u vezi sa zdravljem i bezbjednosti na radu, i održavanjem okoline; organizovanje časova u vezi sa cigarama, časova degustacije vina; pružanje obrazovnih informacija u vezi sa istraživanjem materijala i agencija za iste; aranžman, organizovanje, planiranje i upravljanje seminarima; obuka životinja; uputstva u produkciji programa za emitovanje; usluge instrukcija u vezi sa upravljanjem mašinama i opremom, uključujući audiovizuelnu opremu koja se koristi za produkciju programa za emitovanje; pružanje audio i vizuelnih studija; pružanje sportskih objekata; pružanje objekata za filmove, priredbe, predstave, muzičke ili obrazovne treninge; usluge agencija za rezervisanje zabavnih događaja; iznajmljivanje i lizing filmova; iznajmljivanje i lizing muzičkih instrumenata; iznajmljivanje i lizing televizijskih programa; iznajmljivanje i lizing televizijskih setova; usluge biblioteka; arhivske usluge biblioteka; usluge titlovanja; usluge tumačenja jezika znakova; pružanje video igara, računarskih igara, zvuka ili slika, ili filmova putem telekomunikacijskih ili računarskih mreža; pružanje onlajn računarskih igara i takmičenja; iznajmljivanje prethodno snimljenih video traka; iznajmljivanje i lizing mašina za igru; pozajmljivanje opreme za arkadne igre; pozajmljivanje slika; fotografisanje; prevođenje; usluge tumača; obrazovni i programi obuke u oblasti upravljanja rizikom; obrazovni i programi obuke u vezi sa sertifikacijom; pružanje obrazovnih i zabavnih vijesti; usluge igara na sreću; pružanje onlajn videa, koji se ne mogu preuzeti; podučavanje; konsultativne, informativne i savjetodavne usluge u vezi sa prethodno navedenim uslugama.

Klasa 42: Naučne i tehnološke usluge i istraživanja i projektovanja u vezi sa njima, usluge industrijskih analiza

i istraživanja; studije tehničkog projektovanja; pružanje vebajta sa tehnologijom koja omogućava korisnicima da dijele informacije i savjete; projektovanje i razvoj računarskog hardvera i softvera; softver u vidu servisa (SaaS); računarske usluge u vezi sa prenosom informacija, podataka, dokumenata, i slika putem interneta; računarske usluge u vezi sa pružanjem onlajn pristupa na interaktivnu računarsku bazu podataka sa tilmskim programom, pregledima, trejlerima, sportom, koncertima, vijestima o poznatim i zabavnim vijestima i drugim povezanim informacijama; usluge provajdera aplikacija (ASP), na ime, hosting računarskih softverskih aplikacija za druge; usluge provajdera aplikacija (ASP) pružanje softvera u oblasti veb zasnovanih konferencija, audio konferencija, elektronskih poruka, kolaboracije dokumenata, video konferencijama, i obrade glasa i poziva; pružanje onlajn softvera koji se ne mogu preuzimati za olakšavanje interoperabilnosti više softverskih aplikacija; usluge tehničke podrške (tehničke konsultacije) u vezi sa računarskim softverom i aplikacije pružene onlajn, putem email-a i telefona; računarske usluge, naime, kreiranje onlajn zajednice za registrovane korisnike da učestvuju u raspravi, dobiju povratnu informaciju od svojih vršnjaka, formiraju virtuelne zajednice, učestvuju u društvenim mrežama i razmjenjuju dokumenta; savjeti o računarskim tehnologijama pruženi internet korisnicima putem telefonske podrške; računarske usluge u vezi sa kreiranjem indeksa informacija, stranica i izvora na računarskoj mreži; pružanje alata za pretraživanje na internetu; dizajn računara, noutbuk računara, laptop računara, prenosivih računara i ručnih računara; dizajn ličnih digitalnih asistenata i ličnih media plejera; dizajn mobilnih telefona i pametnih telefona; dizajn digitalnih kamera; računarske usluge; računarsko programiranje; računarske integracione usluge; usluge računarske analize; računarsko programiranje u vezi sa odbranom od virusa; usluge računarskog sistemskog softvera; računarske usluge u vezi sa razmjenom podataka; računarske usluge u vezi sa pružanjem usluga direktne konekcije između korisnika računara za razmjenu podataka; dizajn računarskog softvera; dizajn računarskih Sistema; dizajn i razvoj veb-stranica; hosting veb-stranica za druge; hosting softver računarskih aplikacija za pretraživanje i vraćanje informacija iz baze podataka i računarske mreže; pružanje tehničkih informacija po posebnom zahtjevu krajnjih korisnika putem telefona ili globalne računarske mreže; konsalting usluge u vezi sa računarskim softverom; računarske usluge u vezi sa prilagođenim pretraživanjem računarske baze podataka i vebajtova; računarsko i elektronsko kodiranje i dekodiranje signala; konverzija fizičkih podataka i dokumenata u elektronske medijske formate; testiranje proizvoda i usluge procjene; arhitektonske i usluge dizajna; dizajn enterijera zgrada, kancelarija i apartmana; računarske i usluge informacija računarskih mreža; pružanje računarskih programa za upravljanje rizikom bezbjednosti; usluge računarskih bezbjednosnih informacija, znanje i usluge testiranja; usluge osiguranja kvaliteta; računarske usluge u vezi sa sertifikacijom poslovnih transakcija i pripremanje izvještaja u vezi sa njima; računarske bezbjednosne usluge u vezi sa kontrolom pristupa računarima, elektronskim mrežama i bazama podataka; obezbjeđivanje prenosa podataka i transakcija putem računarskih mreža; konsultacije u vezi sa područjem bezbjednosti podataka; tehnološke konsultacije u vezi sa bezbjednošću telekomunikacija; bezbjednosne usluge kompjuterizovanih komunikacionih mreža; pružanje informacija u oblasti interneta, svjetske mreže/www i bezbjednosti kompjuterizovanih komunikacionih mreža; konsalting usluge u oblasti interneta, svjetske mreže/www i bezbjednosti kompjuterizovanih komunikacionih mreža, usluge bezbjednosti informacija; usluge autentifikacije za bezbjednost računara; računarske usluge u vezi za onlajn autentifikacijom elektronskih potpisa; pohranjivanje rezervnih podataka van glavne lokacije (off-site); usluge čuvanja elektronskih podataka; pružanje informacija na računarskim tehnologijama i programiranje putem vebajta; računarstvo u oblaku; usluge hosting provajdera oblaka; pružanje privremene upotrebe softvera koji se zasniva na oblaku i koji se ne može preuzeti i softvera za računarstvo u oblaku; elektronsko pohranjivanje podataka; pružanje virtuelnih računarskih sistema i virtuelne računarske sredine putem računarstva u oblaku; iznajmljivanje softvera za zabavu; kartografske usluge; konsultacije, informacije i savjetodavne usluge u vezi sa naprijed navedenim uslugama.

Klasa 45: Individualne i društvene usluge koje pružaju drugi radi zadovoljavanja potreba pojedinaca; usluge

drušvenog rada; usluge agencija za posredovanje; pravne usluge; usluge registracije domena; usluge savjetovanja u intelektualnoj svojini; pravna istraživanja; usluge pripremanja pravnih dokumenata; pravna administracija licenci; licenciranje intelektualne svojine; parnične usluge; usluge mirnog rješavanja sporova; usluge arbitraže; usluge obezbjeđenja i čuvanja; usluge ličnog obezbjeđenja; iznajmljivanje odjeće; usluge pružanja zaštite (obezbjeđenje) putem električnih centralnih stanica za uljeze, protivprovalnih i protivpožarnih sistema; usluge monitoringa protivprovalnih i alarma protiv uljeza; usluge monitoringa uređaja za detektovanje požara i poplava i usluge monitoringa alarma; usluge održavanja domaćinstva; licenciranje digitalnih podataka, fotografija, video zapisa, audio zapisa i teksta; kreiranje, kompilacija i održavanje registra domena; pretraživanje prtljaga za bezbjednosne potrebe; usluge ličnog istraživanja; bezbjednosne usluge za zaštitu imovine i pojedinaca; onlajn autentifikacija elektronskih potpisa; pogrebne usluge; usluge onlajn društvenih mreža; usluge puštanja golubova za specijalne prilike; usluge balsamovanja; konsultacije, informacije i savjetodavne usluge u vezi sa naprijed navedenim uslugama. Individualne i društvene usluge koje pružaju drugi radi zadovoljavanja potreba pojedinaca; usluge drušvenog rada; usluge agencija za posredovanje; pravne usluge; usluge registracije domena; usluge savjetovanja u intelektualnoj svojini; pravna istraživanja; usluge pripremanja pravnih dokumenata; pravna administracija licenci; licenciranje intelektualne svojine; parnične usluge; usluge mirnog rješavanja sporova; usluge arbitraže; usluge obezbjeđenja i čuvanja; usluge ličnog obezbjeđenja; iznajmljivanje odjeće; usluge pružanja zaštite (obezbjeđenje) putem električnih centralnih stanica za uljeze, protivprovalnih i protivpožarnih sistema; usluge monitoringa protivprovalnih i alarma protiv uljeza; usluge monitoringa uređaja za detektovanje požara i poplava i usluge monitoringa alarma; usluge održavanja domaćinstva; licenciranje digitalnih podataka, fotografija, video zapisa, audio zapisa i teksta; kreiranje, kompilacija i održavanje registra domena; pretraživanje prtljaga za bezbjednosne potrebe; usluge ličnog istraživanja; bezbjednosne usluge za zaštitu imovine i pojedinaca; onlajn autentifikacija elektronskih potpisa; pogrebne usluge; usluge onlajn društvenih mreža; usluge puštanja golubova za specijalne prilike; usluge balsamovanja; konsultacije, informacije i savjetodavne usluge u vezi sa naprijed navedenim uslugama.

(111) **14587**

(151) 05.06.2020.

(210) Ž-2018-460

(220) 27.11.2018.

(732) Swissôtel Management GmbH, Balz Zimmermann-Strasse 7, 8302, Kloten, CH

(540)

Swissôtel Residences

(550) I

(740) Miladin Popović, Đoka Miraševića 21/III, 81000, Podgorica

(511) Klasa 36: Osiguranje; usluge agencije za nekretnine; upravljanje nekretninama; iznajmljivanje nekretnina; upravljanje servisiranim stanovima; usluge finansiranja; razmjena novca; stambeni agenti ; upravljanje stambenim objektima; iznajmljivanje apartmana; finansijsko savjetovanje; iznajmljivanje kancelarija (nekretnine).

(111) **14588**

(151) 05.06.2020.

(210) Ž-2018-355

(220) 13.09.2018.

(732) "AS JEWELRY" D.O.O, Kalimnaj bb, Tivat , ME

(540)



(550) I

(740) Ilhana Šabović, Ljubović 28 Podgorica

(511) Klasa 14: Dragocjeni metali i njihove legure i proizvodi od dragocjenih metala ili sa prevlakom od njih;nakit, drago kamenje; časovničarski i hronometrijski instrumenti; prstenje, ogrlice, narukvice, minduše, manžete, satovi, broševi, igle za kravate, toke za kaiš, privjesci za ključeve, nalipera.

(111) **14589**

(151) 05.06.2020.

(210) Ž-2018-356

(220) 13.09.2018.

(732) "Alsen leather" D.O.O, Kalimnaj bb, Tivat, ME

(540)



(550) I

(740) Ilhana Šabović, Ljubović 28 Podgorica

(511) Klasa 18: Koža i imitacija kože, proizvodi izrađeni od ovih materijala životinjska koža, krzno; koferi i putne torbe; kišobrani, štapovi za hodanje; bičevi, saračka i sedlarska oprema; torbe na rame, ruksaci, torbe za plažu, sportske torbe, torbice, kišobrani, novčanici, akt tašne, kaiševi.

Klasa 25: Odjeća, obuća, pokrivala za glavu; prsluci, jakne, sakoi, kaputi, bunde, kravate, šalovi, odijela, kape, šubare, remenje, kačketi, rukavice, košulje, patike, cipele, čizme, sandale.

(111) **14590**

(151) 05.06.2020.

(210) Ž-2018-409

(220) 02.11.2018.

(732) Kerzner International Limited, Atlantis Paradise Island, Coral Towers Executive Office, P. O. Box, N4777, Nassau, BS

(540)

WE CREATE JOY

(550) I

(740) Jasna Jusić, Dalmatinska 2, 81000, Podgorica

(511) Klasa 43: Pružanje usluga odmarališta i smještaja; pružanje privremenog smještaja; obezbjeđivanje hotelskog smještaja; hotelske usluge; usluge hotela rizorta u vidu organizovanja smještaja u odmaralištima; restoranske i barske usluge; obezbjeđivanje kongresnih objekata, pružanje objekata (smještaja) za priredbe i sastanke; usluge putničkih agencija, naime rezervisanje i bukiranje za privremeni smještaj, rezervisanje i bukiranje za objedovanje.

(111) **14591**

(151) 03.07.2020.

(210) Ž-2018-407

(220) 02.11.2018.

(732) Marriott Worldwide Corporation, 10400 Fernwood Road, 20817, Bethesda, Maryland, US

(540)

BONVOY

(550) I

(740) Jasna Jusić, Dalmatinska 2, 81000, Podgorica

(511) Klasa 35: Oglašavanje, biznis menadžment, poslovna administracija, kancelarijski poslovi; podsticajni nagradni programi; usluge promovisanje hotela, hotelskih kompleksa, avio kompanija, iznajmljivanja automobila, korištenja nekretnina u ograničenom vremenskom periodu, putovanja i godišnjih odmora putem podsticajnog nagradnog programa; organizovanje, sprovođenje i nadzor programa vjernosti.

Klasa 36: Osiguranje, finansijski poslovi, monetarni poslovi, nekretnine; usluge korištenja nekretnina u ograničenom vremenskom periodu koje obuhvataju podsticajni nagradni program; prodaja nekretnina, usluge iznajmljivanja i unajmljivanja kuća za stanovanje, stanova, soba u kućama, vikend kuća i vila u šta spada podsticajni nagradni program; usluge kreditnih kartica.

Klasa 43: Usluge obezbjeđenja hrane i pića; privremeni smještaj; hotelske usluge koje karakteriše podsticajni nagradni program; hotelske rezervacije.

(111) **14591**

(151) 03.07.2020.

(210) Ž-2018-408

(220) 02.11.2018.

(732) Marriott Worldwide Corporation, 10400 Fernwood Road, 20817, Bethesda, Maryland, US

(540) **MARRIOTT BONVOY**

(550) I

(740) Jasna Jusić, Dalmatinska 2, 81000, Podgorica

(511) Klasa 35: Oglašavanje, biznis menadžment, poslovna administracija, kancelarijski poslovi; podsticajni nagradni programi; usluge promovisanje hotela, hotelskih kompleksa, avio kompanija, iznajmljivanja automobila, korištenja nekretnina u ograničenom vremenskom periodu, putovanja i godišnjih odmora putem podsticajnog nagradnog programa; organizovanje, sprovođenje i nadzor programa vjernosti.

Klasa 36: Osiguranje, finansijski poslovi, monetarni poslovi, nekretnine; usluge korištenja nekretnina u ograničenom vremenskom periodu koje obuhvataju podsticajni nagradni program; prodaja nekretnina, usluge iznajmljivanja i unajmljivanja kuća za stanovanje, stanova, soba u kućama, vikend kuća i vila u šta spada podsticajni nagradni program; usluge kreditnih kartica.

Klasa 43: Usluge obezbjeđenja hrane i pića; privremeni smještaj; hotelske usluge koje karakteriše podsticajni nagradni program; hotelske rezervacije.

(111) **14592**

(151) 08.06.2020.

(210) Ž-2018-411

(220) 02.11.2018.

(732) Alibaba Group Holding Limited, Fourth Floor, One Capital Place, P.O. Box 847, George Town, Grand Cayman, KY

(540)



(550) I

(740) Jasna Jusić, Dalmatinska 2, 81000, Podgorica

(511) Klasa 9: Aparati i instrumenti naučni, pomorski, geodetski, fotografski, kinematografski, optički, za vaganje, mjerenje, signalizaciju, kontrolu (inspekciju), spašavanje i nastavu; aparati i instrumenti za provođenje, prekid, transformaciju, akumulaciju, regulisanje ili kontrolu električne energije; aparati za snimanje, prenos i reprodukciju zvuka ili slike; magnetni nosači podataka, diskovi za snimanje; mehanizmi za aparate koji se pokreću novcem; registar kase, računске mašine, oprema za obradu podataka i računari; računarski programi; softver za procesuiranje elektronskih plaćanja za druge i od drugih; softver za autentifikaciju; kompjuterski softver koji se može naći na internetu; kompjuterski softver za interaktivnu zabavu, koji omogućava korisnicima da prilagode iskustvo gledanja, slušanja i igre izborom i uređivanjem prikaza i performansi audio, video i audio-vizuelnih elemenata; audio, vizuelne i audio-vizuelne datoteke i snimci koji se mogu preuzimati, a koji sadrže multimedijalne zabavne programe i sadržaj; onlajn elektronske publikacije (koje se mogu preuzeti sa interneta ili kompjuterske mreže ili iz kompjuterske baze podataka); softver za razmjenu trenutnih poruka; softver za dijeljenje datoteka; komunikacijski softver za elektronsku razmjenu podataka, audio i video sadržaja, slika i grafika putem kompjuterskih, mobilnih, bežičnih i telekomunikacionih mreža; kompjuterski softver u obliku aplikacije za mobilne uređaje i računare; softverske aplikacije za upotrebu sa mobilnim uređajima; kompjuterski softver za obradu slika, grafika, audio i video sadržaja i teksta; kompjuterski softver koji se može preuzimati koji olakšava elektronski prenos informacija, podataka, dokumenata, glasa i slika preko Interneta; kompjuterski softver koji se može preuzimati koji omogućava korisnicima da učestvuju na onlajn sastancima i časovima, sa pristupom podacima, dokumentima, slikama i softverskim aplikacijama kroz Internet pretraživač; kompjuterski softver koji se može preuzeti, za pristup, pregled i upravljanje udaljenim kompjuterima i kompjuterskim mrežama; softver za računarstvo u oblaku koji se može preuzimati; softver koji se nalazi u oblaku, a koji se može preuzimati; elektronske publikacije koje se mogu preuzimati, u obliku časopisa, članaka, brošura, lifleta, tehničkih specifikacija, informacionih materijala, priručnika u oblastima poslovanja, elektronske trgovine, informacionih tehnologija, računarstva u oblaku, telekomunikacija, interneta, obuka u vezi sa poslovanjem i elektronskom trgovinom, upravljanja poslovanjem, prodajom, marketingom i finansijama; kompjuterske periferne jedinice; noutbuk računari; laptop računari; prenosivi računari; ručni računari; lični digitalni asistenti; lični media plejeri; mobilni telefoni; pametni telefoni; digitalne kamere; baterije, punjači za baterije; računarske radne stanice; računarski serveri; kompjuterski i telekomunikacioni mrežni hardver; kompjuterski mrežni adapteri, prekidači, ruteri i čvorovi; bežični i žični modemi i komunikacione kartice i uređaji; držači za laptop; torbe za računare; aparati za gašenje požara; kompjuterski hardver i firmver; kompjuterski softver (uključujući softver koji se može preuzeti sa interneta); automobilski sistem i za navigaciju; kompakt diskovi; digitalna muzika (koja se može preuzeti sa interneta); telekomunikacijski aparati; podloge za miševе; slušalice za mobilne telefone; dodaci za mobilne telefone; igre, slike, bioskopski filmovi, filmovi i muzika koji se mogu preuzeti; sistemi za alarme; bezbjednosne kamere; mobilne radio i televizijske jedinice za emitovanje; oprema za televizijsko emitovanje; kamere; video kamere; slušalice; telefonske slušalice koje se nose u uvetu; zvučnici; uređaji i oprema za globalno pozicionirajući sistem [GPS]; programi i softver za kompjuterske, elektronske i video igre (uključujući i softver koji se može preuzeti sa interneta); displeji od tečnih kristala za telekomunikacionu i elektronsku opremu; set top boks; daljinski upravljači; programi za skladištenje podataka; naočare i naočare za sunce; elektronske table sa natpisom; kodirane ili magnetne bankovne kreditne, debitne, gotovinske ili identifikacione kartice; automatski bankomati; čitači elektronskih knjiga; toner kertridži, prazni, za štampače i fotokopire; uređaji za nadgledanje beba; video uređaji za nadgledanje beba; poklopci za fotografska sočiva; tablet računari; kodirane ključ kartice; 3D naočare; memorijske kartice za mašine za video igre.

Klasa 36: Osiguranje; finansijski poslovi; novčani poslovi ; poslovi vezani za nepokretnosti; kliring i usklađivanje finansijskih transakcija putem globalne računarske mreže; onlajn bankarske usluge i finansijske usluge; usluge kreditnih kartica, procesuiranje i prenos računa i uplata, i pružanje osiguranja za finansijske transakcije; usluge prenosa sredstava; prenos sredstava elektronskim putem za druge; prenos uplata za druge putem interneta; finansijske usluge u oblasti usluga obrade računa i uplata; organizovanje i upravljanje lizingom i zakupom; iznajmljivanje i lizing nepokretnosti; procjena nepokretnosti; valuacija nepokretnosti ; finansijske usluge u vezi sa nepokretnostima, investiranje u nepokretnosti; brokerske usluge u vezi sa nepokretnostima; usluge agencija za nepokretnosti ; usluge stambenih agencija; aktuarske usluge; upravljanje nepokretnostima i konsalting usluge; ubiranje najamnine; iznajmljivanje kancelarija (nepokretnosti); iznajmljivanje apartmana i stanova; pružanje finansijskih informacija putem interneta; usluge depozita i usluge izdavanja putničkih vaučera; ulaganje kapitala; finansijske evaluacije [osiguranje, bankarstvo, nepokretnosti]; finansijske i usluge upravljanja aktivom ; osiguranje i finansijske usluge; finansijske usluge pružene putem telekomunikacijskih sredstava; finansijske konsalting i savjetodavne usluge; onlajn bankarstvo; bankarske usluge pružene onlajn sa računarskih baza podataka ili interneta; usluge posredovanja u prometu sa hartijama od vrijednosti, usluge notiranja cijena na berzi ; posredovanje u vezi sa akcijama i obveznicama, finansijske analize; usluge debitnih kartica, usluge platnih kartica i usluge čekovne garancije; bankarske, usluge štednih računa i investicione usluge; usluge finansijskog kliringa; kreditna verifikacija putem globalne računarske informacione mreže; elektronske usluge upravljanja rizikom kredita; usluge elektronskog plaćanja za kupovinu i elektronskog plaćanja računa; zaduživanje finansijskih računa i kreditne usluge; elektronske bankarske usluge; izdavanje pretplatničkih kartica, platnih kartica i debitnih kartica; usluge telefonskih kreditnih kartica; informativne usluge u vezi sa finansijama i osiguranjem, pružene onlajn sa računarske baze podataka ili interneta; agencija za prikupljanje naknada za gas i električnu energiju; procjena antikviteta; procjena umjetničkih djela; procjena nakita; procjena polovnih vozila; snabdijevanje poreskim informacijama (finansijske usluge); prikupljanje priloga za dobrotvorne fondove; organizovanje dobrotvornog prikupljanja; dobrotvorno prikupljanje; iznajmljivanje mašina za brojenje papirnog novca i kovanica; iznajmljivanje bankomata ili automatizovanih mašina za izdavanje gotovine; usluge onlajn plaćanja; usluge depozita u sefovima; organizovanje finansija za građevinske projekte; usluge agencija za odobravanje uvoza-izvoza (carinska odobrenja); konsultacije, informacije i savjetodavne usluge u vezi sa naprijed navedenim uslugama.

Klasa 42: Naučne i tehnološke usluge i istraživanja i projektovanja u vezi sa njima, usluge industrijskih analiza i istraživanja; studije tehničkog projektovanja; pružanje vebajta sa tehnologijom koja omogućava korisnicima da dijele informacije i savjete; projektovanje i razvoj računarskog hardvera i softvera; softver u vidu servisa (SaaS); računarske usluge u vezi sa prenosom informacija, podataka, dokumenata, i slika putem interneta; računarske usluge u vezi sa pružanjem onlajn pristupa na interaktivnu računarsku bazu podataka sa tilmskim programom, pregledima, trejlerima, sportom, koncertima, vijestima o poznatim i zabavnim vijestima i drugim povezanim informacijama; usluge provajdera aplikacija (ASP), na ime, hosting računarskih softverskih aplikacija za druge; usluge provajdera aplikacija (ASP) pružanje softvera u oblasti veb zasnovanih konferencija, audio konferencija, elektronskih poruka, kolaboracije dokumenata, video konferencijama, i obrade glasa i poziva; pružanje onlajn softvera koji se ne mogu preuzimati za olakšavanje interoperabilnosti više softverskih aplikacija; usluge tehničke podrške (tehničke konsultacije) u vezi sa računarskim softverom i aplikacije pružene onlajn, putem email-a i telefona; računarske usluge, naime, kreiranje onlajn zajednice za registrovane korisnike da učestvuju u raspravi , dobiju povratnu informaciju od svojih vršnjaka, formiraju virtualne zajednice, učestvuju u društvenim mrežama i razmjenjuju dokumenta; savjeti o računarskim tehnologijama pruženi internet korisnicima putem telefonske podrške; računarske usluge u vezi sa kreiranjem indeksa informacija, stranica i izvora na računarskoj mreži ; pružanje alata za pretraživanje na internetu; dizajn računara, noutbuk računara, laptop računara, prenosivih računara i ručnih računara; dizajn

ličnih digitalnih asistenata i ličnih media plejera; dizajn mobilnih telefona i pametnih telefona; dizajn digitalnih kamera; računarske usluge; računarsko programiranje; računarske integracione usluge; usluge računarske analize; računarsko programiranje u vezi sa odbranom od virusa; usluge računarskog sistemskog softvera; računarske usluge u vezi sa razmjenom podataka; računarske usluge u vezi sa pružanjem usluga direktne konekcije između korisnika računara za razmjenu podataka; dizajn računarskog softvera; dizajn računarskih Sistema; dizajn i razvoj veb-stranica; hosting veb-stranica za druge; hosting softver računarskih aplikacija za pretraživanje i vraćanje informacija iz baze podataka i računarske mreže; pružanje tehničkih informacija po posebnom zahtjevu krajnjih korisnika putem telefona ili globalne računarske mreže; konsalting usluge u vezi sa računarskim softverom; računarske usluge u vezi sa prilagođenim pretraživanjem računarske baze podataka i veb-sajtova; računarsko i elektronsko kodiranje i dekodiranje signala; konverzija fizičkih podataka i dokumenata u elektronske medijske formate; testiranje proizvoda i usluge procjene; arhitektonske i usluge dizajna; dizajn enterijera zgrada, kancelarija i apartmana; računarske i usluge informacija računarskih mreža; pružanje računarskih programa za upravljanje rizikom bezbjednosti; usluge računarskih bezbjednosnih informacija, znanje i usluge testiranja; usluge osiguranja kvaliteta; računarske usluge u vezi sa sertifikacijom poslovnih transakcija i pripremanje izvještaja u vezi sa njima; računarske bezbjednosne usluge u vezi sa kontrolom pristupa računarima, elektronskim mrežama i bazama podataka; obezbjeđivanje prenosa podataka i transakcija putem računarskih mreža; konsultacije u vezi sa područjem bezbjednosti podataka; tehnološke konsultacije u vezi sa bezbjednošću telekomunikacija; bezbjednosne usluge kompjuterizovanih komunikacionih mreža; pružanje informacija u oblasti interneta, svjetske mreže/www i bezbjednosti kompjuterizovanih komunikacionih mreža; konsalting usluge u oblasti interneta, svjetske mreže/www i bezbjednosti kompjuterizovanih komunikacionih mreža, usluge bezbjednosti informacija; usluge autentifikacije za bezbjednost računara; računarske usluge u vezi za onlajn autentifikacijom elektronskih potpisa; pohranjivanje rezervnih podataka van glavne lokacije (off-site); usluge čuvanja elektronskih podataka; pružanje informacija na računarskim tehnologijama i programiranje putem veb-sajta; računarstvo u oblaku; usluge hosting provajdera oblaka; pružanje privremene upotrebe softvera koji se zasniva na oblaku i koji se ne može preuzeti i softvera za računarstvo u oblaku; elektronsko pohranjivanje podataka; pružanje virtuelnih računarskih sistema i virtuelne računarske sredine putem računarstva u oblaku; iznajmljivanje softvera za zabavu; kartografske usluge; konsultacije, informacije i savjetodavne usluge u vezi sa naprijed navedenim uslugama.

(111) **14593**

(151) 08.06.2020.

(210) Ž-2018-413

(220) 02.11.2018.

(732) Alibaba Group Holding Limited, Fourth Floor, One Capital Place, P.O. Box 847, George Town, Grand Cayman, KY

(540)



(550) I

(740) Jasna Jusić, Dalmatinska 2, 81000, Podgorica

(511) Klasa 9: Aparati i instrumenti naučni, pomorski, geodetski, fotografski, kinematografski, optički, za vaganje, mjerenje, signalizaciju, kontrolu (inspekciju), spašavanje i nastavu; aparati i instrumenti za provođenje, prekid, transformaciju, akumulaciju, regulisanje ili kontrolu električne energije; aparati za snimanje, prenos i reprodukciju zvuka ili slike; magnetni nosači podataka, diskovi za snimanje; mehanizmi za aparate koji se pokreću novcem; registar kase, računске mašine, oprema za obradu podataka i računari; računarski programi; softver za procesuiranje elektronskih plaćanja za druge i od drugih; softver za autentifikaciju; kompjuterski softver koji se može naći na internetu; kompjuterski softver za interaktivnu zabavu, koji omogućava korisnicima da prilagode iskustvo gledanja, slušanja i igre izborom i uređivanjem prikaza i performansi audio, video i audio-vizuelnih elemenata; audio, vizuelne i audio-vizuelne datoteke i snimci koji se mogu preuzimati, a koji sadrže multimedijalne zabavne programe i sadržaj; onlajn elektronske publikacije (koje se mogu preuzeti sa interneta ili kompjuterske mreže ili iz kompjuterske baze podataka); softver za razmjenu trenutnih poruka; softver za dijeljenje datoteka; komunikacijski softver za elektronsku razmjenu podataka, audio i video sadržaja, slika i grafika putem kompjuterskih, mobilnih, bežičnih i telekomunikacionih mreža; kompjuterski softver u obliku aplikacije za mobilne uređaje i računare; softverske aplikacije za upotrebu sa mobilnim uređajima; kompjuterski softver za obradu slika, grafika, audio i video sadržaja i teksta; kompjuterski softver koji se može preuzimati koji olakšava elektronski prenos informacija, podataka, dokumenata, glasa i slika preko Interneta; kompjuterski softver koji se može preuzimati koji omogućava korisnicima da učestvuju na onlajn sastancima i časovima, sa pristupom podacima, dokumentima, slikama i softverskim aplikacijama kroz Internet pretraživač; kompjuterski softver koji se može preuzeti, za pristup, pregled i upravljanje udaljenim kompjuterima i kompjuterskim mrežama; softver za računarstvo u oblaku koji se može preuzimati; softver koji se nalazi u oblaku, a koji se može preuzimati; elektronske publikacije koje se mogu preuzimati, u obliku časopisa, članaka, brošura, lifleta, tehničkih specifikacija, informacionih materijala, priručnika u oblastima poslovanja, elektronske trgovine, informacionih tehnologija, računarstva u oblaku, telekomunikacija, interneta, obuka u vezi sa poslovanjem i elektronskom trgovinom, upravljanja poslovanjem, prodajom, marketingom i finansijama; kompjuterske periferne jedinice; noutbuk računari; laptop računari; prenosivi računari; ručni računari; lični digitalni asistenti; lični media plejeri; mobilni telefoni; pametni telefoni; digitalne kamere; baterije, punjači za baterije; računarske radne stanice; računarski serveri; kompjuterski i telekomunikacioni mrežni hardver;

kompjuterski mrežni adapteri , prekidači, ruteri i čvorovi; bežični i žični modemi i komunikacione kartice i uređaji ; držači za laptop; torbe za računare; aparti za gašenje požara; kompjuterski hardver i firmver; kompjuterski softver (uključujući softver koji se može preuzeti sa interneta); automobilski sistem i za navigaciju; kompakt diskovi; digitalna muzika (koja se može preuzeti sa interneta); telekomunikacijski aparati; podloge za miševe; slušalice za mobilne telefone; dodaci za mobilne telefone; igre, slike, bioskopski filmovi, filmovi i muzika koji se mogu preuzeti ; sistemi za alarme; bezbjednosne kamere; mobilne radio i televizijske jedinice za emitovanje; oprema za televizijsko emitovanje; kamere; video kamere; slušalice; telefonske slušalice koje se nose u uvetu; zvučnici; uređaji i oprema za globalno pozicionirajući sistem [GPS]; programi i softver za kompjuterske, elektronske i video igre (uključujući i softver koji se može preuzeti sa interneta); displeji od tečnih kristala za telekomunikacionu i elektronsku opremu; set top boks; daljinski upravljači; programi za skladištenje podataka; naočare i naočare za sunce; elektronske table sa natpisom; kodirane ili magnetne bankovne kreditne, debitne, gotovinske ili identifikacione kartice; automatski bankomati; čitači elektronskih knjiga; toner kertridži , prazni , za štampače i fotokopire; uređaji za nadgledanje beba; video uređaji za nadgledanje beba; poklopci za fotografska sočiva; tablet računari ; kodirane ključ kartice; 3D naočare; memorijske kartice za mašine za video igre.

Klasa 36: Osiguranje; finansijski poslovi; novčani poslovi ; poslovi vezani za nepokretnosti; kliring i usklađivanje finansijskih transakcija putem globalne računarske mreže; onlajn bankarske usluge i finansijske usluge; usluge kreditnih kartica, procesuiranje i prenos računa i uplata, i pružanje osiguranja za finansijske transakcije; usluge prenosa sredstava; prenos sredstava elektronskim putem za druge; prenos uplata za druge putem interneta; finansijske usluge u oblasti usluga obrade računa i uplata; organizovanje i upravljanje lizingom i zakupom; iznajmljivanje i lizing nepokretnosti; procjena nepokretnosti; valuacija nepokretnosti ; finansijske usluge u vezi sa nepokretnostima, investiranje u nepokretnosti; brokerske usluge u vezi sa nepokretnostima; usluge agencija za nepokretnosti ; usluge stambenih agencija; aktuarske usluge; upravljanje nepokretnostima i konsalting usluge; ubiranje najamnine; iznajmljivanje kancelarija (nepokretnosti); iznajmljivanje apartmana i stanova; pružanje finansijskih informacija putem interneta; usluge depozita i usluge izdavanja putničkih vaučera; ulaganje kapitala; finansijske evaluacije [osiguranje, bankarstvo, nepokretnosti]; finansijske i usluge upravljanja aktivom ; osiguranje i finansijske usluge; finansijske usluge pružene putem telekomunikacijskih sredstava; finansijske konsalting i savjetodavne usluge; onlajn bankarstvo; bankarske usluge pružene onlajn sa računarskih baza podataka ili interneta; usluge posredovanja u prometu sa hartijama od vrijednosti, usluge notiranja cijena na berzi ; posredovanje u vezi sa akcijama i obveznicama, finansijske analize; usluge debitnih kartica, usluge platnih kartica i usluge čekovne garancije; bankarske, usluge štednih računa i investicione usluge; usluge finansijskog kliringa; kreditna verifikacija putem globalne računarske informacione mreže; elektronske usluge upravljanja rizikom kredita; usluge elektronskog plaćanja za kupovinu i elektronskog plaćanja računa; zaduživanje finansijskih računa i kreditne usluge; elektronske bankarske usluge; izdavanje pretplatničkih kartica, platnih kartica i debitnih kartica; usluge telefonskih kreditnih kartica; informativne usluge u vezi sa finansijama i osiguranjem, pružene onlajn sa računarske baze podataka ili interneta; agencija za prikupljanje naknada za gas i električnu energiju; procjena antikviteta; procjena umjetničkih djela; procjena nakita; procjena polovnih vozila; snabdijevanje poreskim informacijama (finansijske usluge); prikupljanje priloga za dobrotvorne fondove; organizovanje dobrotvornog prikupljanja; dobrotvorno prikupljanje; iznajmljivanje mašina za brojenje papirnog novca i kovanica; iznajmljivanje bankomata ili automatizovanih mašina za izdavanje gotovine; usluge onlajn plaćanja; usluge depozita u sefovima; organizovanje finansija za građevinske projekte; usluge agencija za odobravanje uvoza-izvoza (carinska odobrenja); konsultacije, informacije i savjetodavne usluge u vezi sa naprijed navedenim uslugama.

Klasa 42: Naučne i tehnološke usluge i istraživanja i projektovanja u vezi sa njima, usluge industrijskih analiza i istraživanja; studije tehničkog projektovanja; pružanje vebajta sa tehnologijom koja omogućava

korisnicima da dijele informacije i savjete; projektovanje i razvoj računarskog hardvera i softvera; softver u vidu servisa (SaaS); računarske usluge u vezi sa prenosom informacija, podataka, dokumenata, i slika putem interneta; računarske usluge u vezi sa pružanjem onlajn pristupa na interaktivnu računarsku bazu podataka sa tilmskim programom, pregledima, trejlerima, sportom, koncertima, vijestima o poznatim i zabavnim vijestima i drugim povezanim informacijama; usluge provajdera aplikacija (ASP), na ime, hosting računarskih softverskih aplikacija za druge; usluge provajdera aplikacija (ASP) pružanje softvera u oblasti veb zasnovanih konferencija, audio konferencija, elektronskih poruka, kolaboracije dokumenata, video konferencijama, i obrade glasa i poziva; pružanje onlajn softvera koji se ne mogu preuzimati za olakšavanje interoperabilnosti više softverskih aplikacija; usluge tehničke podrške (tehničke konsultacije) u vezi sa računarskim softverom i aplikacije pružene onlajn, putem email-a i telefona; računarske usluge, naime, kreiranje onlajn zajednice za registrovane korisnike da učestvuju u raspravi, dobiju povratnu informaciju od svojih vršnjaka, formiraju virtuelne zajednice, učestvuju u društvenim mrežama i razmjenjuju dokumenta; savjeti o računarskim tehnologijama pruženi internet korisnicima putem telefonske podrške; računarske usluge u vezi sa kreiranjem indeksa informacija, stranica i izvora na računarskoj mreži; pružanje alata za pretraživanje na internetu; dizajn računara, noutbuk računara, laptop računara, prenosivih računara i ručnih računara; dizajn ličnih digitalnih asistenata i ličnih media plejera; dizajn mobilnih telefona i pametnih telefona; dizajn digitalnih kamera; računarske usluge; računarsko programiranje; računarske integracione usluge; usluge računarske analize; računarsko programiranje u vezi sa odbranom od virusa; usluge računarskog sistemskog softvera; računarske usluge u vezi sa razmjenom podataka; računarske usluge u vezi sa pružanjem usluga direktne konekcije između korisnika računara za razmjenu podataka; dizajn računarskog softvera; dizajn računarskih Sistema; dizajn i razvoj veb-stranica; hosting veb-stranica za druge; hosting softver računarskih aplikacija za pretraživanje i vraćanje informacija iz baze podataka i računarske mreže; pružanje tehničkih informacija po posebnom zahtjevu krajnjih korisnika putem telefona ili globalne računarske mreže; konsalting usluge u vezi sa računarskim softverom; računarske usluge u vezi sa prilagođenim pretraživanjem računarske baze podataka i veb-sajtova; računarsko i elektronsko kodiranje i dekodiranje signala; konverzija fizičkih podataka i dokumenata u elektronske medijske formate; testiranje proizvoda i usluge procjene; arhitektonske i usluge dizajna; dizajn enterijera zgrada, kancelarija i apartmana; računarske i usluge informacija računarskih mreža; pružanje računarskih programa za upravljanje rizikom bezbjednosti; usluge računarskih bezbjednosnih informacija, znanje i usluge testiranja; usluge osiguranja kvaliteta; računarske usluge u vezi sa sertifikacijom poslovnih transakcija i pripremanje izvještaja u vezi sa njima; računarske bezbjednosne usluge u vezi sa kontrolom pristupa računarima, elektronskim mrežama i bazama podataka; obezbjeđivanje prenosa podataka i transakcija putem računarskih mreža; konsultacije u vezi sa područjem bezbjednosti podataka; tehnološke konsultacije u vezi sa bezbjednošću telekomunikacija; bezbjednosne usluge kompjuterizovanih komunikacionih mreža; pružanje informacija u oblasti interneta, svjetske mreže/www i bezbjednosti kompjuterizovanih komunikacionih mreža; konsalting usluge u oblasti interneta, svjetske mreže/www i bezbjednosti kompjuterizovanih komunikacionih mreža, usluge bezbjednosti informacija; usluge autentifikacije za bezbjednost računara; računarske usluge u vezi za onlajn autentifikacijom elektronskih potpisa; pohranjivanje rezervnih podataka van glavne lokacije (off-site); usluge čuvanja elektronskih podataka; pružanje informacija na računarskim tehnologijama i programiranje putem veb-sajta; računarstvo u oblaku; usluge hosting provajdera oblaka; pružanje privremene upotrebe softvera koji se zasniva na oblaku i koji se ne može preuzeti i softvera za računarstvo u oblaku; elektronsko pohranjivanje podataka; pružanje virtuelnih računarskih sistema i virtuelne računarske sredine putem računarstva u oblaku; iznajmljivanje softvera za zabavu; kartografske usluge; konsultacije, informacije i savjetodavne usluge u vezi sa naprijed navedenim uslugama.

(111) **14594**

(151) 08.06.2020.

(210) Ž-2018-436

(220) 12.11.2018.

(732) SHAMDATH RAGOEBIER, Dr. Sophi Redmondstraat 176 B, Paramaribo, SR

(540)



(550) I

(740) Dragan Prelević, Bulevar Svetog Petra Cetinjskog 130/VII, 81000, Podgorica

(511) Klasa 34: Duvan; cigarete; predmeti za pušače; šibice.

(111) **14595**

(151) 08.06.2020.

(210) Ž-2018-439

(220) 12.11.2018.

(732) SHAMDATH RAGOEBIER, Dr. Sophi Redmondstraat 176 B, Paramaribo, SR

(540)



(550) I

(740) Dragan Prelević, Bulevar Svetog Petra Cetinjskog 130/VII, 81000, Podgorica

(511) Klasa 34: Duvan; cigarete; predmeti za pušače; šibice.

(111) **14596**

(151) 08.06.2020.

(210) Ž-2018-440

(220) 12.11.2018.

(732) SHAMDATH RAGOEBIER, Dr. Sophi Redmondstraat 176 B, Paramaribo, SR

(540)



(550) I

(740) Dragan Prelević, Bulevar Svetog Petra Cetinjskog 130/VII, 81000, Podgorica

(511) Klasa 34: Duvan; cigarete; predmeti za pušače; šibice.

(111) **14597**

(151) 08.06.2020.

(210) Ž-2018-354

(220) 12.09.2018.

(732) Monster Energy Company (a Delaware corporation), 1 Monster Way, 92879, Corona, California, US

(540)



(550) I

(740) Božidar S. Radulović, Studentska bb, Lamela 3/18, 81000, Podgorica

(511) Klasa 32: Bezalkoholna pića, uključujući gazirana pića i energetska pića; sirupi, koncentri, praškasti preparati i drugi preparati za proizvodnju pića, uključujući gazirana pića i energetska pića.

(111) **14598**

(151) 08.06.2020.

(210) Ž-2018-360

(220) 17.09.2018.

(732) Preduzeće za informisanje i marketing "PINK M COMPANY"D.O.O., Bulevar Ivana Crnojevića 97, Podgorica, ME

(540)

NOVA M TV

(550) I

(740) Preduzeće za informisanje i marketing "PINK M COMPANY"D.O.O., Bulevar Ivana Crnojevića 97, Podgorica

(511) Klasa 35: Oglašavanje; usluge reklame i ekonomske propagande, kreiranje i sprovođenje propagandnih kampanja, usluge kreiranja i izrade komercijalnih poruka (reklamnih spotova i radio džinglova) za televiziju i radio, prodaja reklamnih termina i prostora za različita medijska oglašavanja, distribucija ili isporuka propagandnog materijala ili uzoraka, organizovanje sajmova i izložbi u komercijalne ili reklamne svrhe, istraživanje tržišta i ispitivanje javnog mnjenja, vođenje poslova; konsalting i menadžment poslovi, poslovno upravljanje; organizovanje i upravljanje drugim privrednim subjektima (holding poslovi), kancelarijski poslovi, knjigovodstvene usluge, usluge obrade podataka, štamparske usluge.

Klasa 38: Telekomunikacije; usluge bežičnog emitovanja radio i televizijskih programa (radio-difuzija), usluge emitovanja radio i televizijskih programa (kablovska difuzija), usluge žičnog emitovanja radio i televizijskih programa satelitskim putem, usluge prenosa podataka.

Klasa 41: Obrazovne usluge; pripremanje obuke; razonoda; usluge proizvodnje zabavnog programa u cilju zabave i rekreacije drugih lica; sportske i kulturne aktivnosti, organizovanje sajmova i izložbi kulturne i obrazovne svrhe, organizovanje sportskih takmičenja, izdavanje tekstova, knjiga, novina, časopisa, zvučnih zapisa, radio i televizijske aktivnosti, proizvodnja radio i televizijskih programa (zabavnih, propagandnih, informativnih, obrazovnih, sportskih, kulturnih, za obučavanje).

(111) **14599**

(151) 08.06.2020.

(210) Ž-2018-259

(220) 24.07.2018.

(732) The Smiley Company SPRL, Avenue Louise 523, 1050, Brussels, BE

(540)



(550) I

(740) Dejan Raičević, Vojvode Boža br.1, 81250, Cetinje

(511) Klasa 14: Plemeniti metali i njihove legure; nakit, drago i poludrago kamenje; časovničarski i hronometrijski instrumenti.

Klasa 18: Koža i imitacija kože; životinjske kože i krzna; prtljažne i torbe za nošenje; kišobrani i suncobrani; štapovi za hodanje; bičevi, saračka i sedlarska oprema; ogrlice, povodci i odjeća za životinje.

Klasa 20: Namještaj, ogledala, okviri za slike; kontejneri, ne od metala, za skladištenje ili transport; neobrađena ili polu-obrađena kost, rog, kitova kost ili sedef; školjke; morska pjena (sepiolit); ćilibar.

Klasa 25: Odjeća, obuća, pokrivala za glavu.

Klasa 28: Igre, igračke i predmeti za igranje; aparati za video igre; gimnastički i sportski artikli; ukrasi za jelke.

Klasa 30: Kafa, čaj, kakao i zamjena kafe; pirinač; tapioka i sago; brašno i proizvodi od žitarica; hljeb, peciva i konditorski proizvodi; sladoledi; šećer, med, melasa; kvasac, prašak za pecivo; so; senf; sirće, sosovi (kao dodaci); začini ; led [zamrznuta voda].

(111) **14600**

(151) 08.06.2020.

(210) Ž-2018-412

(220) 02.11.2018.

(732) Alibaba Group Holding Limited, Fourth Floor, One Capital Place, P.O. Box 847, George Town, Grand Cayman, KY

(540)

ANT FINANCIAL

(550) I

(740) Jasna Jusić, Dalmatinska 2, 81000, Podgorica

(511) Klasa 9: Aparati i instrumenti naučni, pomorski, geodetski, fotografski, kinematografski, optički, za vaganje, mjerenje, signalizaciju, kontrolu (inspekciju), spašavanje i nastavu; aparati i instrumenti za provođenje, prekid, transformaciju, akumulaciju, regulisanje ili kontrolu električne energije; aparati za snimanje, prenos i rep rodukovanje zvuka ili slike; magnetni nosači podataka, diskovi za snimanje; mehanizmi za aparate koji se pokreću novcem; registar kase, računске mašine, oprema za obradu podataka i računari; računarski programi ; softver za procesuiranje elektronskih plaćanja za druge i od drugih; softver za autentifikaciju; kompjuterski softver koji se može naći na internetu; kompjuterski softver za interaktivnu zabavu, koji omogućava korisnicima da prilagode iskustvo gledanja, slušanja i igre izborom i uređivanjem prikaza i performansi audio, video i audio-vizuelnih elemenata; audio, vizuelne i audio-vizuelne datoteke i snimci koji se mogu preuzimati, a koji sadrže multimedijalne zabavne programe i sadržaj ; onlajn elektronske

publikacije (koje se mogu preuzeti sa interneta ili kompjuterske mreže ili iz kompjuterske baze podataka); softver za razmjenu trenutnih poruka; softver za dijeljenje datoteka; komunikacijski softver za elektronsku razmjenu podataka, audio i video sadržaja, slika i grafika putem kompjuterskih, mobilnih, bežičnih i telekomunikacionih mreža; kompjuterski softver u obliku aplikacije za mobilne uređaje i računare; softverske aplikacije za upotrebu sa mobilnim uređajima; kompjuterski softver za obradu slika, grafika, audio i video sadržaja i teksta; kompjuterski softver koji se može preuzimati koji olakšava elektronski prenos informacija, podataka, dokumenata, glasa i slika preko Interneta; kompjuterski softver koji se može preuzimati koji omogućava korisnicima da učestvuju na onlajn sastancima i časovima, sa pristupom podacima, dokumentima, slikama i softverskim aplikacijama kroz Internet pretraživač; kompjuterski softver koji se može preuzeti, za pristup, pregled i upravljanje udaljenim kompjuterima i kompjuterskim mrežama; softver za računarstvo u oblaku koji se može preuzimati; softver koji se nalazi u oblaku, a koji se može preuzimati; elektronske publikacije koje se mogu preuzimati, u obliku časopisa, članaka, brošura, lifleta, tehničkih specifikacija, informacionih materijala, priručnika u oblastima poslovanja, elektronske trgovine, informacionih tehnologija, računarstva u oblaku, telekomunikacija, interneta, obuka u vezi sa poslovanjem i elektronskom trgovinom, upravljanja poslovanjem, prodajom, marketingom i finansijama; kompjuterske periferne jedinice; noutbuk računari ; laptop računari ; prenosiivi računari; ručni računari ; lični digitalni asistenti ; lični media plejeri ; mobilni telefoni; pametni telefoni; digitalne kamere; baterije, punjači za baterije; računarske radne stanice; računarski serveri; kompjuterski i telekomunikacioni mrežni hardver; kompjuterski mrežni adapteri , prekidači, ruteri i čvorovi; bežični i žični modemi i komunikacione kartice i uređaji ; držači za laptop; torbe za računare; aparti za gašenje požara; kompjuterski hardver i firmver; kompjuterski softver (uključujući softver koji se može preuzeti sa interneta); automobilski sistem i za navigaciju; kompakt diskovi; digitalna muzika (koja se može preuzeti sa interneta); telekomunikacijski aparati; podloge za miševе; slušalice za mobilne telefone; dodaci za mobilne telefone; igre, slike, bioskopski filmovi, filmovi i muzika koji se mogu preuzeti ; sistemi za alarme; bezbjednosne kamere; mobilne radio i televizijske jedinice za emitovanje; oprema za televizijsko emitovanje; kamere; video kamere; slušalice; telefonske slušalice koje se nose u uvetu; zvučnici; uređaji i oprema za globalno pozicionirajući sistem [GPS]; programi i softver za kompjuterske, elektronske i video igre (uključujući i softver koji se može preuzeti sa interneta); displeji od tečnih kristala za telekomunikacionu i elektronsku opremu; set top boks; daljinski upravljači; programi za skladištenje podataka; naočare i naočare za sunce; elektronske table sa natpisom; kodirane ili magnetne bankovne kreditne, debitne, gotovinske ili identifikacione kartice; automatski bankomati; čitači elektronskih knjiga; toner kertridži , prazni , za štampače i fotokopire; uređaji za nadgledanje beba; video uređaji za nadgledanje beba; poklopci za fotografska sočiva; tablet računari ; kodirane ključ kartice; 3D naočare; memorijske kartice za mašine za video igre.

Klasa 35: Oglašavanje; vođenje poslova; poslovno upravljanje; kancelarijski poslovi ; organizacija, rukovođenje i nadgledanje programa lojalnosti i podsticajnih programa; usluge oglašavanja koje se pružaju preko interneta; proizvodnja televizijskih i radio reklama; računovodstvo; usluge prodaje putem licitacije; organizovanje sajmova; ispitivanje javnog mnjenja; obrada podataka; pružanje poslovnih informacija; usluge reklamnih agencij a; reklamne usluge za druge; upravljanje bazama podataka; sakupljanje informacija u kompjuterske baze podataka; usluge poslovnog savjetovanja; usluge poslovnog savjetovanja u oblasti događaja, konferencija, trening programa, programa za učenje i seminara koji se održavaju onlajn; usluge poslovnog savjetovanja u oblasti pružanja znanja zasnovanog na veb-u; usluge poslovnog savjetovanja u oblasti onlajn saradnje i tehnologija saradnje; usluge poslovnog savjetovanja u oblastima prodaje i marketinga; usluge upravljanja poslovnim projektima u vezi sa razvojem, postavljanjem, organizovanjem, izradom, snimanjem, monitoringom i praćenjem onlajn događaja, konferencija, programa obuke, programa učenja i seminara; usluge istraživanja tržišta i poslovnog savjetovanja; usluge poslovnog savjetovanja u vezi sa olakšavanjem poslovnih transakcija putem lokalnih i globalnih računarskih mreža pronalaženjem i

pružanjem preporuka za pružanje širokog spektra poslovnih i potrošačkih proizvoda i usluga; širenje poslovnih informacija u vezi sa robom i uslugama drugih putem lokalnih i globalnih računarskih mreža; poslovno savjetovanje u vezi sa pružanjem Internet stranica na globalnoj računarskoj mreži putem kojih treća lica mogu da nude i pronalaze robu i usluge, mjesta, utvrđuju status i ispunjavaju trgovinske liste i naloge, sklapaju ugovore i vrše poslovne transakcije; pružanje kompjuterizovanih usluga onlajn poručivanja; reklamiranje robe i usluga drugih putem lokalnih i globalnih računarskih mreža; usluge međunarodnih agencija za uvoz i izvoz; iznajmljivanje reklamnog prostora na komunikacijskim medijima; usluge onlajn trgovine u vezi sa elektronskim licitacijama i pružanje onlajn poslovne procjene u vezi sa istim ; usluge onlajn maloprodaje potrošačke robe; obezbjeđivanje direktorijuma Internet stranica trećih strana za olakšavanje poslovnih transakcija; usluge poslovnog savjetovanja u vezi sa vođenjem elektronske berze za kupce i prodavce robe i/ili usluga na globalnoj računarskoj mreži ; poslovna pomoć u vezi sa olakšavanjem poslovnih transakcija putem lokalnih i globalnih računarskih mreža; konsultantske usluge za korporativni menadžment; usluge reklamiranja i promocije; objavljivanje materijala za reklamiranje; reklamiranje praznih prostorija; diseminacija reklamnog materijala, ažuriranje reklamnog materijala, sakupljanje reklama za upotrebu kao veb stranica na internetu; iznajmljivanje reklamnog prostora; kompjuterska obrada podataka; usluge informisanja o prodaji, poslovanju i promocijama; javljanje na telefon (za nedostupne pretplatnike); javljanje na telefon (za druge); usluge prodaje putem licitacije koje se pružaju na internetu; upravljanje osobljem ; pružanje informacija u vezi sa prodajom, poslovanjem i promocijama putem globalne računarske mreže i putem interneta; prezentacija robe na komunikacionim medijima u svrhu maloprodaje; združivanje, u korist drugih, raznovrsne robe, radi omogućavanja potrošačima da ih lakše pregledaju i kupe tu robu sa opšte prodajne interent stranice i na veleprodajnom tržištu; združivanje, u korist drugih, raznovrsne robe, radi omogućavanja potrošačima da ih lakše pregledaju i kupe tu robu iz opšteg prodajnog kataloga putem poštanske narudžbenice ili putem sredstava telekomunikacije; združivanje, u korist drugih, raznovrsne robe, radi omogućavanja potrošačima da ih lakše pregledaju i kupe tu robu iz maloprodajnih outlet radnji; maloprodaja i veleprodaja telefona, slušalica za mobilne telefone, dodataka za mobilne telefone, elektronske i telekomunikacione robe, kompjuterskog hardvera i kompjuterskog softvera, baterija, punjača za baterije, aparata i instrumenata za snimanje, primanje, emitovanje i/ili reprodukovanje podataka, informacija, crteža, slika, i/ili zvuka, plemenitih metala, nakita, dragog kamenja, štampanog materijala, kancelarijskog pribora, magnetnih i nemagnetnih kodiranih kartica, namještaja, ramova za slike, pribora za domaćinstvo i kuhinju, staklarije, porculana i grnčarije, tekstila, odjeće, obuće, pokrivala za glavu, čipke i veza, dugmadi, traka, špenadli i igala, vještačkog cvijeća, tepiha, ćilima, igara i elektronskih igračaka, hemikalija za korišćenje u industriji, nauci , fotografiji i poljoprivredi, boja, lakova i glazura, proizvoda za ličnu higijenu, sapuna, parfema, kozmetike, losiona za kosu i tijelo, esencijalnih ulja, preparata za čišćenje i izbjeljivanje, lubrikanata, goriva, svijeća, farmaceutskih , veterinarskih i sanitarnih preparata, sitne metalne robe i malih predmeta od metala, mašina i mašinskog alata, pribora za jelo, brijača i ručnog alata, računara, mašina za računanje, električnih, fotografskih , kinematografskih i optičkih aparata i instrumenata, naočara i naočara za sunce, hirurških i medicinskih aparata i instrumenata, aparata za osvjetljivanje, grijanje, proizvodnju pare, kuvanje, hlađenje, sušenje, ventilaciju, snabdijevanje vodom i sanitarnu upotrebu, vozila, vatrenog oružja, vatrometa, srebrnine, horoloških i hronometrijskih instrumenata, muzičkih instrumenata, časopisa, karti , papira i proizvoda od kartona, slika, pisaaćih mašina i kancelarijskog pribora, materijala za pakovanje, gume i plastike za upotrebu u ručnoj proizvodnji, materijala za pakovanje i izolaciju, kože i imitacije kože i robe napravljene od tih materijala ručnih tašni , torbi , novčanika, kožnih držača, putnih torbi , prtljaga, kišobrana, ogledala, konopaca, uzica, mreža, šatora, pređa i konac za tekstilnu upotrebu, vješalica za kapute, podmetača, krojačke robe, prekrivača za stolove i krevete, igračaka i sportskih artikala, hrane i pića, mesa, ribe, živine, konzervisanog, zamrznutog, sušenog i kvanog voća i povrća; džemova, voćnih sosova, jaja, mlijeka i mliječnih proizvoda, ulja i masti za ishranu, kafe, čaja, kakaoa, šećera, pirinča, brašna, hljeba i kolača, konditorskih proizvoda, svježeg voća i

povrća, piva, mineralne vode, voćnih sokova i drugih bezalkoholnih pića, alkoholnih pića, cvjetnih proizvoda, duvana, predmeta za pušenje i šibica; reklamiranje direktnom poštom ; usluge agencija za kupovinu i prodaju za druge; izbor i nabavka robe za fizička i pravna lica; naručivanje usluga (za druge); usluge maloprodaje u robnim kućama; usluge maloprodaje u supermarketima; sekretarske usluge; pružanje poslovnih statističkih informacija; organizacija izložbi za komercijalne ili reklamne svrhe; usluge poslovne pomoći u vezi sa sakupljanjem i iznajmljivanjem listi adresa; poslovno istraživanje; usluge poslovne administracije za obradu prodaje na internetu; usluge poslovnih preporuka i raspoređivanja osoblja; agencije za uvoz-izvoz (usluge agencija za uvoz-izvoz); agencije za novinske pretplate; reprodukcija dokumenata; transkripcija (uključujući pisanje na papirnim šablonima); iznajmljivanje kancelarijske opreme; upravljanje odnosima sa mušterijama; usluge poslovnog upravljanja u vezi sa elektronskom trgovinom ; usluge poslovnog upravljanja i administracije u vezi sa programima sponzorstava; računovodstvene usluge; dobrotvorne usluge, naime poslovna administracija u vezi sa organizacijom i vođenjem volonterskih programa i projekata društvenog servisa; iznajmljivanje štandova za prodaju; pružanje informacija o komercijalnim i poslovnim kontaktima; optimizacija pretraživača; optimizacija saobraćaja sa Internet stranice; oglašavanje plaćanjem po kliku; usluge komercijalnog posredovanja; poslovno upravljanje za nezavisne pružaoce usluga; pregovaranje i zaključivanje trgovinskih transakcija za treća lica; ažuriranje i održavanje podataka u kompjuterskim bazama podataka; usluge vođenja poslovnih projekata za građevinske projekte; pružanje poslovnih informacija putem Internet stranice; konsultantske, informativne i savjetodavne usluge u vezi sa gore navedenim uslugama.

Klasa 36: Osiguranje; finansijski poslovi; novčani poslovi ; poslovi vezani za nepokretnosti; kliring i usklađivanje finansijskih transakcija putem globalne računarske mreže; onlajn bankarske usluge i finansijske usluge; usluge kreditnih kartica, procesuiranje i prenos računa i uplata, i pružanje osiguranja za finansijske transakcije; usluge prenosa sredstava; prenos sredstava elektronskim putem za druge; prenos uplata za druge putem interneta; finansijske usluge u oblasti usluga obrade računa i uplata; organizovanje i upravljanje lizingom i zakupom; iznajmljivanje i lizing nepokretnosti; procjena nepokretnosti; valuacija nepokretnosti ; finansijske usluge u vezi sa nepokretnostima, investiranje u nepokretnosti; brokerske usluge u vezi sa nepokretnostima; usluge agencija za nepokretnosti ; usluge stambenih agencija; aktuarske usluge; upravljanje nepokretnostima i konsalting usluge; ubiranje najamnine; iznajmljivanje kancelarija (nepokretnosti); iznajmljivanje apartmana i stanova; pružanje finansijskih informacija putem interneta; usluge depozita i usluge izdavanja putničkih vaučera; ulaganje kapitala; finansijske evaluacije [osiguranje, bankarstvo, nepokretnosti]; finansijske i usluge upravljanja aktivom ; osiguranje i finansijske usluge; finansijske usluge pružene putem telekomunikacijskih sredstava; finansijske konsalting i savjetodavne usluge; onlajn bankarstvo; bankarske usluge pružene onlajn sa računarskih baza podataka ili interneta; usluge posredovanja u prometu sa hartijama od vrijednosti, usluge notiranja cijena na berzi ; posredovanje u vezi sa akcijama i obveznicama, finansijske analize; usluge debitnih kartica, usluge platnih kartica i usluge čekovne garancije; bankarske, usluge štednih računa i investicione usluge; usluge finansijskog kliringa; kreditna verifikacija putem globalne računarske informacione mreže; elektronske usluge upravljanja rizikom kredita; usluge elektronskog plaćanja za kupovinu i elektronskog plaćanja računa; zaduživanje finansijskih računa i kreditne usluge; elektronske bankarske usluge; izdavanje pretplatničkih kartica, platnih kartica i debitnih kartica; usluge telefonskih kreditnih kartica; informativne usluge u vezi sa finansijama i osiguranjem, pružene onlajn sa računarske baze podataka ili interneta; agencija za prikupljanje naknada za gas i električnu energiju; procjena antikviteta; procjena umjetničkih djela; procjena nakita; procjena polovnih vozila; snabdijevanje poreskim informacijama (finansijske usluge); prikupljanje priloga za dobrotvorne fondove; organizovanje dobrotvornog prikupljanja; dobrotvorno prikupljanje; iznajmljivanje mašina za brojenje papirnog novca i kovanica; iznajmljivanje bankomata ili automatizovanih mašina za izdavanje gotovine; usluge onlajn plaćanja; usluge depozita u sefovima; organizovanje finansija za građevinske projekte; usluge agencija za odobravanje uvoza-izvoza (carinska odobrenja); konsultacije, informacije i savjetodavne usluge u vezi sa naprijed

navedenim uslugama.

Klasa 38: Telekomunikacije; telekomunikacijske usluge, naime usluge prenosa i prijema podataka putem telekomunikacionih mreža; pružanje usluga multimedijalnih telekonferencija, videokonferencija i sastanaka na veb-u koj i dozvoljavaju učesnicima da simultano i asinhrono pregledaju, dijele, uređuju i diskutuju dokumenta, podatke i slike putem Internet pretraživača; omogućavanje pristupa onlajn izvještajima u vezi sa performansama, efikasnošću i statusom Internet aplikacija, telekonferencija, video konferencija i sastanaka za mušterije; omogućavanje korisnicima da bezbjedno pristupaju privatnim kompjuterskim mrežama na daljinu putem Interneta; pružanje informacija u oblasti bezbjednog prenosa podataka i informacija; konsultantske usluge u oblasti bezbjednog prenosa podataka i informacija; pružanje onlajn usluga saradnje (telekomunikacione usluge) koje omogućavaju korisnicima da pristupaju aplikacijama, platformama, zajednički dijeljenim dokumentima, podacima, listama zadataka i forumima za diskusiju; usluge emitovanja preko interneta, pružanje pristupa onlajn bazama podataka koje sadrže informacije o internet platformi za podnošenje žalbi u vezi sa emitovanjem programa; pružanje telekomunikacionog pristupa i veze sa kompjuterskom bazom podataka i sa internetom; elektronske komunikacione usluge; interaktivne telekomunikacione usluge; telekomunikacije u vezi sa informacijama (Internet stranice), kompjuterskim programima i podacima; pružanje telekomunikacionih veza sa Internetom ili bazama podataka; pružanje telekomunikacionog pristupa objektima i strukturama na internetu; komunikacija putem računarskih terminala; komunikacija putem mreža sa optičkim vlaknima; kompjuterski potpomognut prenos poruka, informacija, podataka, dokumenata i slika; prenos putem faksimila; slanje poruka; pejdžing usluge; iznajmljivanje modema; usluge komunikacije podataka elektronskim sredstvima; iznajmljivanje telekomunikacione opreme; usluge elektronskog slanja, primanja i prosljeđivanja poruka; pružanje telekomunikacionih usluga za prikupljanje, prenos i isporuku podataka elektronskim putem; elektronska razmjena glasa, podataka, audio zapisa, video zapisa, teksta i grafika kojima se može pristupiti preko kompjutera i telekomunikacionih mreža; usluge instant slanja poruka; usluge komunikacija putem mobilnih telefona; pružanje telekomunikacionih usluga za prikupljanje, prenos i isporuku poruka elektronske pošte, informacija u vidu nepomičnih i/ili pokretnih slika kao sto su karakteri, poruke, muzika i slike, telegrami, informacije i podaci putem mehaničkih, elektronskih, telefonskih, teleks, kablovskih, kompjuterskih i satelitskih sredstava; prenos, emitovanje i prijem audio, video, nepomičnih i pokretnih slika i podataka u kompresovanom ili nekompresovanom obliku u realnom ili odloženom vremenu; usluge elektronskih poruka, konferencija i prenosa naloga; usluge video konferencija; komunikacija putem elektronskih biltena koji omogućava korisnicima da obavljaju interaktivne razgovore u realnom vremenu između kompjuterskog terminala i elektronskog biltena koji sadrži informacije sa nepomičnim i pokretnim slikama i glasovne informacije kao sto su karakteri; pružanje elektronskih biltena i oglasnih tabli za prenos poruka; pružanje usluga on lajn foruma za diskusije; striming audio materijala na internetu; striming video materijala na internetu; usluge televizijskog emitovanja; usluge televizijskog prenosa koji se plaća po gledanju; usluge video emitovanja, emitovanje i prenos radio i televizijskih programa; emitovanje muzike; prenos muzičkih, filmskih, interaktivnih programa, videa, elektronskih kompjuterskih igara; prenos informacija u vezi sa onlajn kupovinom i opštim uslugama maloprodaje; usluge prenosa videa po zahtjevu; usluge novinskih agencija; pružanje pristupa kompjuterskim bazama podataka na globalnoj kompjuterskoj mreži za pretraživanje i vraćanje informacija, podataka, Internet stranica i resursa koji su dostupni na kompjuterskim mrežama; pružanje pristupa za korisnike kompjuterskim bazama podataka koje sadrže elektronske publikacije, biltene, baze podataka i informacije kojima se može pristupiti preko interneta; pružanje pristupa za korisnike kompjuterskim bazama podataka koje sadrže elektronske publikacije, biltene, baze podataka i informacije kojima se može pristupiti preko računara; upravljanje pričaonicama (usluge pričaonica); pristup za više korisnika globalnim kompjuterskim informacionim mrežama za transfer i diseminaciju širokog opsega informacija; pružanje pristupa Internet stranicama na globalnoj kompjuterskoj mreži putem koje treća lica

mogu da nude robu i usluge, prave i popunjavaju porudžbine, sklapaju ugovore i vrše poslovne transakcije; pružanje pristupa interaktivnoj Internet stranici na globalnoj kompjuterskoj mreži za treća lica da postavljaju informacije, odgovaraju na zahtjeve i prave i popunjavaju porudžbine za proizvode, servise i poslovne prilike; komunikacijske usluge, naime usluge servisa tekstualnih i numeričkih digitalnih poruka; prenos informacija komunikacijom podataka radi pomoći pri donošenju odluka; prenos informacija kroz sisteme za video komunikaciju; usluge onlajn konferencija; elektronske komunikacijske usluge za uspostavljanje virtuelnih pričaonica putem tekstualnih poruka; pružanje elektronskih biltena za postavljanje i prenos poruka između kompjuterskih korisnika u vezi sa proizvodima, uslugama i poslovnim prednostima i mogućnostima; pružanje onlajn interaktivnih biltena za postavljanje, promociju, prodaju i preprodaju artikala putem globalne kompjuterske mreže; pružanje usluga elektronske pošte i prosljeđivanja elektronske pošte; audio i video komunikacija putem računara i računarskih mreža i putem globalne komunikacione mreže; pružanje kompjuterskog pristupa i iznajmljivanje vremena za pristup interaktivnim biltenima i bazama podataka; pružanje pristupa elektronskim biltenima za postavljanje i prenos poruka između kompjuterskih korisnika u vezi sa proizvodima, uslugama i poslovnim prilikama; pružanje pristupa elektronskom kalendaru, adresaru i elektronskoj bilježnici putem globalne kompjuterske mreže; pružanje pristupa i prostora za video i/ili telefonske konferencije na daljinu; pružanje kompjuterskih veza za Internet stranice trećih lica kako bi se olakšala elektronska trgovina i poslovne transakcije u realnom svijetu; konsultantske, informacione i savjetodavne usluge u vezi sa gore navedenim uslugama.

Klasa 39: GPS (globalno pozicionirajući sistem) navigacione usluge; pružanje informacija koje se odnose na putovanja i turizam putem interneta i/ili putem telekomunikacijskih mreža; pružanje interaktivnih onlajn baza podataka sa informacijama o putevima, putovanjima, navigaciji, saobraćaju i tačkom interesovanja (u vezi sa putovanjima); pružanje informacija putnicima u vezi sa tarifama, redom vožnje i javnim prevozom; putničke i turističke informacije i usluge vodiča; usluge vođenja ruta i planiranja; aranžman putovanja; usluge putničkih agencija; usluge agencije u vezi sa putničkim kartama; organizovanje putovanja i informacije za njih, sve pruženo onlajn sa kompjuterske baze podataka ili interneta; putovanja jahtom i/ili brodovima; pružanje uputstava za vožnju za potrebe putovanja; iznajmljivanje navigacionih sistema; prevoz; pružanje informacija o putevima i saobraćaju; pružanje navigacionih i informacionih usluga, naime informacije u vezi sa saobraćajem i gužvama u saobraćaju; prevoz robe i putnika; auto prevoz; avio prevoz; iznajmljivanje vozila; usluge iznajmljivanja automobila; usluge vozača; transport cjevovodom; transportne usluge u vezi upravljanja transportom; pružanje područja za letjenje, naime pružanje pristupa pistama, trakama za slijetanje i zaletištima; pakovanje; pakovanje i skladištenje robe; fizičko skladištenje elektronski pohranjenih podataka ili dokumenata; dostavljanje poruka; dostavljanje robe po porudžbini; kurirske usluge [dostava pošiljki ili robe]; posredovanje u vezi sa brodovima (posredovanje u vezi sa pomorskim transportom); utovar i istovar tereta; posredovanje u prevozu robe; selidbene usluge; posredovanje u iznajmljivanju, lizingu; prodaji; kupovini i/ili čarteru brodova i/ili čamaca; spasavanje i podizanje potopljenih brodova i/ili čamaca; pilotiranje; distribucija gasa i snabdijevanje; distribucija električne struje i snabdijevanje; distribucija toplote i snabdijevanje; distribucija vode i snabdijevanje; usluge objekata za sidrenje; iznajmljivanje skladišta; iznajmljivanje i/ili lizing invalidskih kolica; iznajmljivanje i/ili lizing aviona; iznajmljivanje i/ili lizing bicikala; iznajmljivanje i/ili lizing automobila; iznajmljivanje i/ili lizing brodova i/ili čamaca; iznajmljivanje i/ili lizing vozila na ljudski pogon; iznajmljivanje i/ili lizing mehaničkih parking sistema; upravljanje parking prostorom; usluge parkiranja vozila; obezbjeđivanje pristupa putevima na kojima se plaća putarina; iznajmljivanje i/ili lizing kontejnera; iznajmljivanje i/ili lizing paleta; iznajmljivanje i/ili lizing mašina za pakovanje i umotavanje; iznajmljivanje i/ili lizing komora za hlađenje; skupljanje otpada i smeća iz domaćinstva; skupljanje industrijskog otpada i smeća; usluge agencija za carinsko posredovanje u vezi sa uvozom-izvozom (carinjenje); konsultacije, informacije i savjetodavne usluge u vezi sa naprijed navedenim uslugama.

Klasa 41: Obrazovanje; pružanje obuke; zabava; sportske i kulturne aktivnosti; izdavanje tekstova, knjiga i

časopisa (osim reklamnih tekstova); izdavanje dijagrama, slika i fotografija; izdavanje novina, magazina i periodičnih publikacija; usluge obrazovanja, vježbe i pružanje obuka u vezi sa telekomunikacijama, računarima, računarskim programima, računarstvom u oblaku, dizajnom veb sajtova, elektronskom trgovinom, poslovnim upravljanjem, finansijskim upravljanjem i oglašavanjem; pružanje obrazovanja, rekreacije, instrukcija, podučavanja i obuke interaktivno i neinteraktivno; dizajn obrazovnih kurseva, ispita i kvalifikacija; zabava pružena putem elektronskih i digitalnih interaktivnih medija; usluge elektronskih igara pružene putem interneta; pružanje informacija u vezi sa obrazovanjem, obukom, zabavom, rekreacijom, sportskim, društvenim i kulturnim aktivnostima; pružanje onlajn elektronskih publikacija (koje se ne mogu preuzimati); priređivanje, organizovanje, hosting i vođenje pjevačkih takmičenja; priređivanje, organizovanje, hosting i vođenje koncerta; priređivanje, organizovanje, hosting i vođenje događaja i takmičenja za obrazovne i zabavne potrebe; priređivanje, organizovanje, hosting i vođenje zabavnih igara i potraga; usluge agencija u vezi sa kartama za zabavne događaje; informacije u vezi sa zabavom ili obrazovanjem, koje se pružaju onlajn sa računarske baze podataka ili interneta; pružanje digitalne muzike (koja se ne može preuzimati) sa interneta; pružanje digitalne muzike (koja se ne može preuzimati) sa MP3 (Moving Picture Experts Group 1 audio layer 3) Internet veb-sajtova; zabavne i obrazovne usluge u vezi sa planiranjem, proizvodnjom i distribucijom zvuka, slika, digitalne muzike, filmova, uživo ili snimljenih audio, vizuelnih ili audiovizuelnih materijala za emitovanje na zemaljskim kanalima, satelitskim kanalima, internetu, bežičnim ili sistemima žične veze i drugih vidova komunikacija; usluge muzičke zabave; iznajmljivanje audio snimaka; pripremanje zabavnih, obrazovnih, dokumentarnih programa i vijesti za emitovanje; usluge reporterskog izvještavanja; informacije u vezi sa sportskim i kulturnim događajima, aktuelnim događajima i najvažnijim vijestima pružene putem televizijskog satelitskog prenosa, interneta ili drugih elektronskih načina; televizijski programi, radio i filmska produkcija; premijum ili plaćene usluge televizijskog programiranja i usluge televizijskog programiranja; planiranje TV zabavnih programa; pružanje zabavnih informacija, multimedijalnog sadržaja, TV zabavnih programa i pružanje onlajn filmova; pripremanje i produkcija televizijskih programa; pružanje informacija, podataka, grafike, zvuka, muzike, videa, animacije i tekstova za zabavne potrebe; usluge igara; pružanje klupske rekreacije, sportskih i gimnastičkih objekata; nastupi muzičkih sastava; klupska zabava, diskoteke, modne revije i usluge noćnih klubova; klupske usluge u vezi sa zabavom, obrazovanjem i kulturnim aktivnostima; organizovanje, vođenje i pružanje konferencija, konvencija, kongresa, seminara i radionica obuke; organizovanje, vođenje i pružanje konferencija, konvencija, kongresa, seminara i radionica obuke u vezi sa telekomunikacijama, računarima, računarskim programima, računarstvom u oblaku, dizajnom veb sajtova, elektronskom trgovinom, poslovnim upravljanjem, finansijskim upravljanjem i oglašavanjem; organizovanje i vođenje izložbi za kulturne i obrazovne potrebe, modnih revija, obrazovnih programa i kulturnih programa i predstava; umjetničke izložbe i usluge galerija; usluge umjetničkih galerija u vezi sa lizingom umjetničkih djela; usluge obuke u vezi sa zdravljem i bezbjednosti na radu, i održavanjem okoline; organizovanje časova u vezi sa cigarama, časova degustacije vina; pružanje obrazovnih informacija u vezi sa istraživanjem materijala i agencija za iste; aranžman, organizovanje, planiranje i upravljanje seminarima; obuka životinja; uputstva u produkciji programa za emitovanje; usluge instrukcija u vezi sa upravljanjem mašinama i opremom, uključujući audiovizuelnu opremu koja se koristi za produkciju programa za emitovanje; pružanje audio i vizuelnih studija; pružanje sportskih objekata; pružanje objekata za filmove, priredbe, predstave, muzičke ili obrazovne treninge; usluge agencija za rezervisanje zabavnih događaja; iznajmljivanje i lizing filmova; iznajmljivanje i lizing muzičkih instrumenata; iznajmljivanje i lizing televizijskih programa; iznajmljivanje i lizing televizijskih setova; usluge biblioteka; arhivske usluge biblioteka; usluge titlovanja; usluge tumačenja jezika znakova; pružanje video igara, računarskih igara, zvuka ili slika, ili filmova putem telekomunikacijskih ili računarskih mreža; pružanje onlajn računarskih igara i takmičenja; iznajmljivanje prethodno snimljenih video traka; iznajmljivanje i lizing mašina za igru; pozajmljivanje opreme za arkadne igre; pozajmljivanje slika;

fotografisanje; prevođenje; usluge tumača; obrazovni i programi obuke u oblasti upravljanja rizikom ; obrazovni i programi obuke u vezi sa sertifikacijom; pružanje obrazovnih i zabavnih vijesti ; usluge igara na sreću; pružanje onlajn videa, koji se ne mogu preuzeti; podučavanje; konsultativne, informativne i savjetodavne usluge u vezi sa prethodno navedenim uslugama.

Klasa 42: Naučne i tehnološke usluge i istraživanja i projektovanja u vezi sa njima, usluge industrijskih analiza i istraživanja; studije tehničkog projektovanja; pružanje veb-sajta sa tehnologijom koja omogućava korisnicima da dijele informacije i savjete; projektovanje i razvoj računarskog hardvera i softvera; softver u vidu servisa (SaaS); računarske usluge u vezi sa prenosom informacija, podataka, dokumenata, i slika putem interneta; računarske usluge u vezi sa pružanjem onlajn pristupa na interaktivnu računarsku bazu podataka sa tilmskim programom, pregledima, trejlerima, sportom, koncertima, vijestima o poznatim i zabavnim vijestima i drugim povezanim informacijama; usluge provajdera aplikacija (ASP), na ime, hosting računarskih softverskih aplikacija za druge; usluge provajdera aplikacija (ASP) pružanje softvera u oblasti veb zasnovanih konferencija, audio konferencija, elektronskih poruka, kolaboracije dokumenata, video konferencijama, i obrade glasa i poziva; pružanje onlajn softvera koji se ne mogu preuzimati za olakšavanje interoperabilnosti više softverskih aplikacija; usluge tehničke podrške (tehničke konsultacije) u vezi sa računarskim softverom i aplikacije pružene onlajn, putem email-a i telefona; računarske usluge, naime, kreiranje onlajn zajednice za registrovane korisnike da učestvuju u raspravi , dobiju povratnu informaciju od svojih vršnjaka, formiraju virtuelne zajednice, učestvuju u društvenim mrežama i razmjenjuju dokumenta; savjeti o računarskim tehnologijama pruženi internet korisnicima putem telefonske podrške; računarske usluge u vezi sa kreiranjem indeksa informacija, stranica i izvora na računarskoj mreži ; pružanje alata za pretraživanje na internetu; dizajn računara, noutbuk računara, laptop računara, prenosivih računara i ručnih računara; dizajn ličnih digitalnih asistenata i ličnih media plejera; dizajn mobilnih telefona i pametnih telefona; dizajn digitalnih kamera; računarske usluge; računarsko programiranje; računarske integracione usluge; usluge računarske analize; računarsko programiranje u vezi sa odbranom od virusa; usluge računarskog sistemskog softvera; računarske usluge u vezi sa razmjenom podataka; računarske usluge u vezi sa pružanjem usluga direktne konekcije između korisnika računara za razmjenu podataka; dizajn računarskog softvera; dizajn računarskih Sistema; dizajn i razvoj veb-stranica; hosting veb-stranica za druge; hosting softver računarskih aplikacija za pretraživanje i vraćanje informacija iz baze podataka i računarske mreže; pružanje tehničkih informacija po posebnom zahtjevu krajnjih korisnika putem telefona ili globalne računarske mreže; konsalting usluge u vezi sa računarskim softverom; računarske usluge u vezi sa prilagođenim pretraživanjem računarske baze podataka i veb-sajtova; računarsko i elektronsko kodiranje i dekodiranje signala; konverzija fizičkih podataka i dokumenata u elektronske medijske formate; testiranje proizvoda i usluge procjene; arhitektonske i usluge dizajna; dizajn enterijera zgrada, kancelarija i apartmana; računarske i usluge informacija računarskih mreža; pružanje računarskih programa za upravljanje rizikom bezbjednosti; usluge računarskih bezbjednosnih informacija, znanje i usluge testiranja; usluge osiguranja kvaliteta; računarske usluge u vezi sa sertifikacijom poslovnih transakcija i pripremanje izvještaja u vezi sa njima; računarske bezbjednosne usluge u vezi sa kontrolom pristupa računarima, elektronskim mrežama i bazama podataka; obezbjeđivanje prenosa podataka i transakcija putem računarskih mreža; konsultacije u vezi sa područjem bezbjednosti podataka; tehnološke konsultacije u vezi sa bezbjednošću telekomunikacija; bezbjednosne usluge kompjuterizovanih komunikacionih mreža; pružanje informacija u oblasti interneta, svjetske mreže/www i bezbjednosti kompjuterizovanih komunikacionih mreža; konsalting usluge u oblasti interneta, svjetske mreže/www i bezbjednosti kompjuterizovanih komunikacionih mreža, usluge bezbjednosti informacija; usluge autentifikacije za bezbjednost računara; računarske usluge u vezi za onlajn autentifikacijom elektronskih potpisa; pohranjivanje rezervnih podataka van glavne lokacije (off-site); usluge čuvanja elektronskih podataka; pružanje informacija na računarskim tehnologijama i programiranje putem veb-sajta; računarstvo u oblaku; usluge hosting provajdera oblaka; pružanje privremene upotrebe softvera

koji se zasniva na oblaku i koji se ne može preuzeti i softvera za računarstvo u oblaku; elektronsko pohranjivanje podataka; pružanje virtuelnih računarskih sistema i virtuelne računarske sredine putem računarstva u oblaku; iznajmljivanje softvera za zabavu; kartografske usluge; konsultacije, informacije i savjetodavne usluge u vezi sa naprijed navedenim uslugama.

Klasa 45: Individualne i društvene usluge koje pružaju drugi radi zadovoljavanja potreba pojedinaca; usluge društvenog rada; usluge agencija za posredovanje; pravne usluge; usluge registracije domena; usluge savjetovanja u intelektualnoj svojini; pravna istraživanja; usluge pripremanja pravnih dokumenata; pravna administracija licenci; licenciranje intelektualne svojine; parnične usluge; usluge mirnog rješavanja sporova; usluge arbitraže; usluge obezbjeđenja i čuvanja; usluge ličnog obezbjeđenja; iznajmljivanje odjeće; usluge pružanja zaštite (obezbjeđenje) putem električnih centralnih stanica za uljeze, protivprovalnih i protivpožarnih sistema; usluge monitoringa protivprovalnih i alarma protiv uljeza; usluge monitoringa uređaja za detektovanje požara i poplava i usluge monitoringa alarma; usluge održavanja domaćinstva; licenciranje digitalnih podataka, fotografija, video zapisa, audio zapisa i teksta; kreiranje, kompilacija i održavanje registra domena; pretraživanje prtljaga za bezbjednosne potrebe; usluge ličnog istraživanja; bezbjednosne usluge za zaštitu imovine i pojedinaca; onlajn autentifikacija elektronskih potpisa; pogrebne usluge; usluge onlajn društvenih mreža; usluge puštanja golubova za specijalne prilike; usluge balsamovanja; konsultacije, informacije i savjetodavne usluge u vezi sa naprijed navedenim uslugama.

(111) **14601**

(151) 08.06.2020.

(210) Ž-2018-401

(220) 23.10.2018.

(732) HELLENIC FUELS AND LUBRICANTS SINGLE MEMBER INDUSTRIAL AND COMMERCIAL SOCIETE ANONYME, also trading as "EKO ABEE", 8A Cheimarras street, 15125, Marousi, GR

(540)



(550) I

(740) Jasna Jusić, Dalmatinska 2, 81000, Podgorica

(511) Klasa 1: Gasovi koji se koriste kod doziranja tečnosti; gasovi u tečnom stanju koji se koriste u industriji; kriogeni preparati u čvrstom, tečnom ili gasovitom stanju; butanol; butan (stvrđnut) za korištenje u industriji.

Klasa 4: Goriva; butan gorivo; butan za osvjetljenje; butan za upaljače; butan gas koji se koristi kao gorivo; butan gas koji se koristi kao gorivo za domaćinstva; propan, propan gas; propan za grijanje; propan za osvjetljenje; propan koji se koristi kao gorivo; propan gas koji se prodaje u bocama za korištenje u gorionicima; tečni gas; tečni naftni gas; tečni naftni gas za korištenje u motornim vozilima; tečni naftni gas za korištenje u domaćinstvima; tečni naftni gas za korištenje u industriji; ulje za rasvjetu; plinsko gorivo; očvršnuti gas [gorivo]; mješavina isparljivih goriva.

Klasa 6: Kontejneri od metala za tečni gas; metalne cijevi za dovod tečnosti i gasa; metalni kontejneri za komprimovani gas ili tečni vazduh ; metalne boce za komprimovani gas ili tečnosti (prazne); kontejneri od metala za hemikalije, komprimovani gas ili tečni vazduh; boce (metalni kontejneri) za komprimovani gas ili tečni vazduh; metalne boce za gas pod pritiskom.

Klasa 7: Pumpe, kompresori i ventilatori; pneumatske pumpe za dopremanje tečnih gasova.

Klasa 11: Grijalice za prostore na propan gas, grijalice na propan paru sa vertikalnom postavljenom cilindričnom konvekcijom; gorionici na butan za korištenje u kuhinji; aparat za zagrijavanje za čvrsta, tečna ili gasovita goriva; šporeti na gas; bojleri na gas; kombinovani šporeti i gasni kontejneri.

Klasa 35: Oglašavanje; poslovni menadžment; poslovna administracija; kancelarijski poslovi; usluge maloprodaje u vezi sa sljedećim proizvodima; gasovi koji se koriste kod doziranja tečnosti; gasovi u tečnom stanju koji se koriste u industriji; kriogeni preparati u čvrstom, tečnom ili gasovitom stanju; butanol; butan (stvrđnut) za korištenje u industriji; goriva; butan gorivo; butan za osvjetljenje; butan za upaljače; butan gas koji se koristi kao gorivo; butan gas koji se koristi kao gorivo za domaćinstva; propan, propan gas; propan za grijanje; propan za osvjetljenje; propan koji se koristi kao gorivo; propan gas koji se prodaje u bocama za korištenje u gorionicima; tečni gas; tečni naftni gas; tečni naftni gas za korištenje u motornim vozilima; tečni naftni gas za korištenje u domaćinstvima; tečni naftni gas za korištenje u industriji; ulje za rasvjetu; plinsko gorivo; očvršnuti gas [gorivo]; mješavina isparljivih goriva; metalni kontejneri za tečni gas; metalne cijevi za dovod tečnosti i gasa; metalni kontejneri za komprimovani gas ili tečni vazduh ; metalne boce za komprimovani gas ili tečnosti (prazne) ; kontejneri od metala za hemikalije, komprimovani gas ili tečni vazduh; boce (metalni kontejneri) za komprimovani gas ili tečni vazduh ; metalne boce za gas pod pritiskom; pumpe; kompresori i ventilatori; pneumatske pumpe za dopremanje tečnih gasova; grijalice za prostore na propan gas; grijalice na propan paru sa vertikalnom postavljenom cilindričnom konvekcijom; gorionici na butan za korištenje u kuhinji; aparat za zagrijavanje za čvrsta, tečna ili gasovita goriva; šporeti na gas; bojleri na gas; kombinovani šporeti i gasni kontejneri.

Klasa 40: Prevođenje naftnog gasa u tečno stanje.

Klasa 42: Naučne i tehnološke usluge i istraživanje i dizajn u vezi sa njima; usluge industrijske analize i istraživanja; dizajn i razvoj kompjuterskog hardvera i softvera; istraživanje i nalaženje nafte i gasa; geofizičko istraživanje za potrebe naftne, gasne i rudarske industrije; istraživanje i pronalaženje gasa i nafte.

(111) **14602**

(151) 09.06.2020.

(210) Ž-2019-56

(220) 11.02.2019.

(732) MFI Alter Modus doo, Studentska bb, Podgorica, ME

(540)



(550) I

(740) Tijana Janjušević, Studentska bb, Podgorica

(511) Klasa 35: Oglašavanje i reklamiranje, vođenje komercijalnih poslova, komercijalna administracija, kancelarijski poslovi.

Klasa 36: Osiguranje, finansijski poslovi, monetarni poslovi, upravljanje nekretninama.

(111) **14603**

(151) 09.06.2020.

(210) Ž-2019-57

(220) 11.02.2019.

(732) MFI Alter Modus doo, Studentska bb, Podgorica, ME

(540)



(550) I

(740) Tijana Janjušević, Studentska bb, Podgorica

(511) Klasa 35: Oglašavanje i reklamiranje, vođenje komercijalnih poslova, komercijalna administracija, kancelarijski poslovi.

Klasa 36: Osiguranje, finansijski poslovi, monetarni poslovi, upravljanje nekretninama.

(111) **14604**

(151) 09.06.2020.

(210) Ž-2018-420

(220) 09.11.2018.

(732) British American Tobacco (Brands) Limited, Globe House 4 Temple Place, WC2R 2PG, London, GB

(540)

DARK FRESH

(550) I

(740) Miladin Popović, Đoka Miraševića 21/III, 81000, Podgorica

(511) Klasa 34: Cigarete; duvan, sirov ili prerađen; proizvodi od duvana; zamjene za duvan (ne u medicinske svrhe); cigare; cigarilosi; upaljači; šibice; artikli za pušaće; cigaret papir, cigaret tube, filteri za cigarete; džepni aparati za zamotavanje cigareta; ručne mašine za ubrizgavanje duvana u papirne tube; elektronske cigarete; tečnosti za elektronske cigarete; duvanski proizvodi namijenjeni za zagrijavanje; uređaji i dijelovi za uređaje za zagrijanje duvana i zamjene za duvan za potrebe inhalacije.

(111) **14605**

(151) 09.06.2020.

(210) Ž-2018-431

(220) 09.11.2018.

(732) British American Tobacco (Brands) Limited, Globe House 4 Temple Place, WC2R 2PG, London, GB

(540)

NEO STICKS RICH TOBACCO

(550) I

(740) Miladin Popović, Đoka Miraševića 21/III, 81000, Podgorica

(511) Klasa 34: Duvan, sirov ili prerađen; proizvodi od duvana; zamjene za duvan (ne u medicinske svrhe); sve za svrhu zagrijavanja, ali ne i sagorijevanja; artikli za pušače; elektronski uređaji za zagrijavanje duvana i djelovi za njih.

(111) **14606**

(151) 09.06.2020.

(210) Ž-2018-432

(220) 09.11.2018.

(732) British American Tobacco (Brands) Limited, Globe House 4 Temple Place, WC2R 2PG, London, GB

(540)

NEO STICKS SPARK FRESH

(550) I

(740) Miladin Popović, Đoka Miraševića 21/III, 81000, Podgorica

(511) Klasa 34: Duvan, sirov ili prerađen; proizvodi od duvana; zamjene za duvan (ne u medicinske svrhe); sve za svrhu zagrijavanja, ali ne i sagorijevanja; artikli za pušače; elektronski uređaji za zagrijavanje duvana i djelovi za njih.

(111) **14607**

(151) 09.06.2020.

(210) Ž-2018-433

(220) 09.11.2018.

(732) British American Tobacco (Brands) Limited, Globe House 4 Temple Place, WC2R 2PG, London, GB

(540)

ROASTED TOBACCO

(550) I

(740) Miladin Popović, Đoka Miraševića 21/III, 81000, Podgorica

(511) Klasa 34: Cigarete; duvan, sirov ili prerađen; proizvodi od duvana; zamjene za duvan (ne u medicinske svrhe); cigare; cigarilosi; upaljači; šibice; artikli za pušače; cigaret papir, cigaret tube, filteri za cigarete; džepni aparati za zamotavanje cigareta; ručne mašine za ubrizgavanje duvana u papirne tube; elektronske cigarete; tečnosti za elektronske cigarete; duvanski proizvodi namijenjeni za zagrijavanje; uređaji i dijelovi za uređaje za zagrijanje duvana i zamjene za duvan za potrebe inhalacije.

(111) **14609**

(151) 10.06.2020.

(210) Ž-2018-289

(220) 31.07.2018.

(732) Reuters Limited, The Thomson Reuters Building 30 South Colonnade, Canary Wharf, E14 5EP, London, GB

(540)

REFINITIV

(550) I

(740) Jasna Jusić, Dalmatinska 2, 81000, Podgorica

(511) Klasa 9: Računarski softver i softver za mobilne aplikacije koji se može preuzimati sa interneta i koji sadrži referentne informacije iz oblasti finansija , investicija, poslovanja, vijesti; računarski programi za pristup raznim bazama podataka u oblastima poslovanja; komunikacioni softver koji olakšava prenos elektronskih podataka obezbjeđujući pristup bazama podataka koje pružaju informacije o poslovanju ; računarski programi za upotrebu u trgovanju akcijama i obveznicama; računarski softver vezan za prikupljanje i distribuciju podataka, finansijske razmjene, trgovanje udjelima u kompanijama, trgovanje akcijama i finansijske transakcije; softver za rutiranje i izvršenje naloga za kupovinu i prodaju hartija od vrijednosti koji koriste brokeri, dileri i njihovi kupci; softver koji se može preuzimati sa interneta i koji pruža informacije za korišćenje u vezi sa provjerom klijenta i analizom stanja, informacijama o usklađenosti finansijskih usluga sa propisima i procjene korporativnog rizika.

Klasa 16: Štampanje publikacije, naime, knjige, magazini, časopisi, imenici, pamfleti i brošure koje sadrže referentne informacije o različitim temama iz oblasti finansija , investicija, vlasništva nad preduzećima i poslovanja.

Klasa 35: Usluge obezbjeđivanja prilagođenih statističkih izveštaja o demografskim podacima; usluge poslovne procjene; usluge poslovnih informacija; agencije za komercijalne informacije; usluge ekonomskog predviđanja; usluge poslovnog istraživanja; obezbjeđivanje statističkih informacija; obezbjeđivanje informacija u vidu vijesti i komentara, analiza i izveštaja o rezultatima na tržištu i određivanju cijene opštinskih obveznica i vesti i analiza o novcu i usklađenosti korporativnog trezora, vijesti i analize o spajanjima i preuzimanjima, informacije o vlasništvu nad korporacijama, informacije o korporativnim i finansijskim rukovodiocima, poslovi nakon obavljenje trgovine u vidu trgovinske obrade i naplate, alokacije i poravnanja računa na globalnim tržištima hartija od vrijednosti.

Klasa 36: Pružanje informacija u vezi sa finansijskim savjetodavnim uslugama; pružanje istraživačke pomoći u vezi sa finansijskim savjetodavnim uslugama; pružanje prilagođenih statističkih izveštaja koji se odnose na finansijske podatke; finansijska analiza; finansijsko savjetovanje; fiskalne procjene; cijene na berzi; elektronski transfer sredstava; pružanje finansijskih informacija o obveznicama; garancije za obveznice, komercijalna prodaja i fondovi za razmjenu i ulaganje; finansijske usluge, naime, pružanje finansijskih informacija u smislu tržišne trgovine i informacije o cijenama za hartije od vrijednosti; usluge podrške trgovanju u oblasti finansijskih hartija od vrijednosti, naime, poređenje trgovine, prikupljanje, obrada, tabeliranje, distribucija, pregovaranje i izvršenje; pružanje informacija o trgovanju hartijama od vrijednosti, odnosno klasifikacija hartija od vrijednosti, brokera, dilera i izdavaoca; računanje, obezbjeđivanje i ažuriranje u korist drugih finansijskih indeksa hartija od vrijednosti i podindeksa; automatizovane finansijske usluge, naime, onlajn posredovanje hartijama od vrijednosti putem globalne računarske mreže; pružanje onlajn elektronskih računarskih baza podataka sa informacijama o hartijama od vrijednosti putem globalne računarske mreže; pružanje informacionih usluga u oblastima ekonomskih, finansijskih, monetarnih i berzanskih informacija, informacija o valutnoj trgovini.

Klasa 38: Telekomunikacijske usluge, naime, pružanje telekomunikacionih veza sa globalnom računarskom mrežom; komunikacija putem računarskih terminala, odnosno elektronskog prenosa podataka, poruka i dokumenata preko računarskih terminala; prenos podataka, poruka, informacija i slika pomoću računara; usluge elektronske pošte; elektronski prenos poruka; računarske usluge, naime, pružanje usluge baze podataka sa poslovnim vijestima i informacijama, podnošenje dokumentacije za poslovna preduzeća, i poslovni izvještaji pravnih istraživanja i usaglašavanja istraživanja koja omogućavaju onlajn pristup elektronskim računarskim bazama podataka sa informacijama o hartijama od vrijednosti putem globalne računarske mreže; pružanje onlajn elektronskih računarskih baza podataka koje korisnicima pružaju informacije o trgovanju koje se tiču hartija od vrijednosti i pružaju institucijama i pojedinačnim investitorima automatsku mrežu za trgovanje hartijama od vrijednosti.

Klasa 42: Softver kao usluga (SaaS) usluge sa softverom koji pruža finansijske informacije u smislu trgovanja, finansijskih razmjena, trgovinskih poravnanja, informacijama o finansijskim tržištima, informacijama za upotrebu u robnoj trgovini i prognoziranja; softver koji se ne može preuzeti a koji sadrži finansijske informacije, kao i baze podataka javnih arhiva za upotrebu u vezi sa provjerom klijenta i analizom stanja, i korporativnom procjenom rizika; softver koji se ne može preuzeti koji sadrži funkcije pretraživanja i povraćaja za javne dokumente koji pružaju informacije za korišćenje u vezi sa provjerom klijenta i analizom stanja, istraživanja i konsultacija u oblasti obavestajnih službi i bezbjednosti.

(111) **14610**

(151) 10.06.2020.

(210) Ž-2018-451

(220) 19.11.2018.

(732) Alberto-Culver USA, Inc., 700 Sylvan Avenue, NJ 07632, Englewood Cliffs, US

(540)

NOXZEMA

(550) I

(740) Miladin Popović, Đoka Miraševića 21/III, 81000, Podgorica

(511) Klasa 3: Sapun; preparati za čišćenje; parfimerija; esencijalna ulja; dezodoransi i antiperspiranti ; preparati za njegu kose; šamponi i balsami ; boje za kosu; proizvodi za oblikovanje kose; nemedicinski toaletni preparati; preparati za kupanje i tuširanje; preparati za njegu kože; ulja, kreme i losioni za kožu; preparati za brijanje; preparati za prije i za posle brijanja; kolonjska voda; preparati za depilaciju; preparati za sunčanje i za zaštitu od sunca; kozmetika; šminka i preparati za uklanjanje šminke; vazelin; preparati za njegu usana; talk puder; vata za kozmetičke svrhe; pamučni štapići za kozmetičke svrhe; maramice, jastučići ili maramice impregnirane ili prethodno navlažene ličnim losionom za čišćenje ili kozmetičkim losionom; maske za ljepotu, pakovanja za lice.

(111) **14611**

(151) 10.06.2020.

(210) Ž-2018-454

(220) 20.11.2018.

(732) THE BODY SHOP INTERNATIONAL LIMITED, Watersmead, BN17 6LS, Littlehampton, West Sussex, GB

(540)

WHITE MUSK

(550) I

(740) Miladin Popović, Đoka Miraševića 21/III, 81000, Podgorica

(511) Klasa 3: Kozmetika, preparati za njegu kože, preparati za njegu kose, preparati za njegu noktiju; podloga, korektor, maskara, sjenka za oči, olovke za oči i l ili obrve, ruž za usne, olovka za usne, balzam za usne, puder za lice, bronzer, rumenilo, hidratanti, sredstva za uklanjanje šminke, ne-medicinski puder za tijelo; sapuni za kožu, gel za kupanje, ulje za kupanje, soli za kupanje, kuglice za kupanje, preparati za kupanje sa mjehurićima; losioni za kožu, kreme, sredstva za čišćenje, pilinzi, maske i toneri za kožu; šamponi, balsami za kosu, završni lakovi za kosu i gelovi za kosu; lični dezodoransi, preparati za sunčanje, ulja i losioni za zaštitu od sunca, preparati za brijanje, paste za zube, parfemi, toaletne vode, eterična ulja za ličnu upotrebu, parfemska ulja, emajl za nokte, kamen za pete, pamučni štapići i tamponi od vate za ne-medicinske svrhe za upotrebu na tijelu, mirisi za sobe, mirišljavi štapići, potpuri i potpuri vrećice, napuderisane kozmetičke maramice, maramice impregnirane kozmetičkim losionima, kompleti i poklon setovi koji sadrže preparate za njegu kože, kose i l ili noktiju.

(111) **14612**

(151) 10.06.2020.

(210) Ž-2018-478

(220) 04.12.2018.

(732) International Foodstuffs Co LLC, P.O Box No. 4115, Sharjah, AE

(540)

PRISTINE

(550) I

(740) Miladin Popović, Đoka Miraševića 21/III, 81000, Podgorica

(511) Klasa 29: Jestiva ulja, masti, topljeno maslo, margarin, maslac, proizvodi za supu, mlijeko i mliječni proizvodi, mlijeko s ukusom, mliječni šejkovi, meso, riba, živina i divljač, mesni ekstrakti, konzervisano, sušeno i kuvano voće i povrće, prelive svih vrsta i opisa uključujući ne- mliječne prelive, slatka pavlaka, želei, džemovi, kompoti, jaja, grickalice na bazi krompira i bez krompira, čips od krompira i listići od krompira, sve vrste konzervisanog i osušenog sočiva, pasulja, graška i mahunarki (ne za poljoprivredne namjene), pečurke, konzervisani kikiriki.

Klasa 30: Čokolade, slatkiši, bombone, biskviti (svi tipovi), kolači, tjestenine, makaroni, rezanci, instant rezanci, špageti, rezanci za supu, kvasac, prašak za pecivo i ostali pekarski sastojci, prelive za salate, majonez, sirće, kečap i sosovi (začini), proizvodi od tijesta spremni za kuvanje, smrznuto tijesto, smrznute parate, sladoledi, ne-mliječni smrznuti deserti, smrznuti voćni deserti, ledeni deserti, kafa, čaj, kakao, šećer, pirinač, tapioka, sago, zamjena za kafu, hljeb, pecivo, melasa, so, senf, brašno od žitarica, začini, prehrambena pića (proizvodi na bazi zrnevlja i bilja), umaci, biljni čaj, med.

(111) **14613**

(151) 10.06.2020.

(210) Ž-2018-482

(220) 05.12.2018.

(732) Lidl Stiftung & Co. KG, Stiftsbergstraße 1, 74172, Neckarsulm, DE

(540)

MASSARI

(550) I

(740) Miladin Popović, ul. Capital Plaza, ulica šeika Zajeda 13-IV/68, 81000, Podgorica

(511) Klasa 33: Žestoka pića, naročito sambuka.

(111) **14614**

(151) 10.06.2020.

(210) Ž-2018-484

(220) 05.12.2018.

(732) TEVA PHARMACEUTICAL INDUSTRIES LTD, Science Based Industries Campus, Har Hotzim P.O. Box 1142, 921010, Jerusalem, IL

(540)

AJOVY

(550) I

(740) Miladin Popović, ul. Capital Plaza, ulica šeika Zajeda 13-IV/68, 81000, Podgorica

(511) Klasa 5: Farmaceutski preparati za liječenje migrena.

(111) **14615**

(151) 08.06.2020.

(210) Ž-2018-396

(220) 23.10.2018.

(732) PEPSICO, INC., 700 Anderson Hill Road, 10577, Purchase, New York, US

(540)



(550) I

(511) Klasa 30: Kukuruzni čips, tortilja čips.

(111) **14616**

(151) 10.06.2020.

(210) Ž-2018-397

(220) 23.10.2018.

(732) PEPSICO, INC., 700 Anderson Hill Road, 10577, Purchase, New York, US

(540)



(550) I

(740) Jasna Jusić, Dalmatinska 2, 81000, Podgorica

(511) Klasa 30: Kukuruzni čips, tortilja čips.

(111) **14617**

(151) 10.06.2020.

(210) Ž-2018-398

(220) 23.10.2018.

(732) PEPSICO, INC., 700 Anderson Hill Road, 10577, Purchase, New York, US

(540)



(550) I

(740) Jasna Jusić, Dalmatinska 2, 81000, Podgorica

(511) Klasa 30: Kukuruzni čips, tortilja čips.

(111) **14618**

(151) 11.06.2020.

(210) Ž-2018-303

(220) 15.08.2018.

(732) Hemofarm A.D. farmaceutsko-hemijska industrija Vršac, Beogradski put bb, 26300, Vršac, RS

(540)

URIFUR

(550) I

(740) AOD MSA IP - Milojević Sekulić Advokati, Karađorđeva 65, 11000, Beograd

(511) Klasa 5: Farmaceutski proizvodi.

(111) **14619**

(151) 11.06.2020.

(210) Ž-2018-343

(220) 05.09.2018.

(732) Hyatt International Corporation, 150 North Riverside Plaza, 14th Floor, IL 60606, Chicago, Illinois, US

(540)



(550) I

(740) Božidar Radulović, Studentska bb, Lamela 3/18, 81000, Podgorica

(511) Klasa 43: Hoteli; odmarališta; moteli; privremeni smještaj; organizovanje privremenog smještaja, naročito namještenih apartmana, apartmana i stanova; usluge putničke agencije za rezervaciju hotelskog smještaja; usluge rezervisanja za obezbjeđivanje privremenog kućnog smještaja za putnike i turiste; specijalizovane usluge hotela koje se pružaju kao dio programa za česte goste hotela; usluge restorana, barova i koktel barova ; katering ugostiteljstvo (hrana i piće); obezbjeđivanje mjesta za bankete i društvene događaje za specijalne prilike; obezbjeđivanje mjesta za održavanje konferencija, izložbi i sastanaka; iznajmljivanje stolica, stolova, stolnjaka i staklenog posuđa za konferencije, izložbe, sastanke i društvene događaje i bankete; iznajmljivanje prostorija za sastanke.

(111) **14620**

(151) 12.06.2020.

(210) Ž-2018-346

(220) 07.09.2018.

(732) JADRAN-galenski laboratorij d.d., Svilno 20, 51000, Rijeka, HR

(540)

RefluSTAT

(550) I

(511) Klasa 3: Toaletni proizvodi; kozmetički proizvodi; dezodoransi za ličnu upotrebu [parfimerijski proizvodi].

Klasa 5: Medicinski i veterinarski preparati i proizvodi; hemijsko-farmaceutski proizvodi; dijetetski proizvodi za medicinske potrebe; lijekovi.

(111) **14621**

(151) 12.06.2020.

(210) Ž-2018-394

(220) 23.10.2018.

(732) Yong Wai Hong, 23, Jalan Seksyen 2/14, Taman Kajang Utama, 43000, Kajang, MY

(540)

CONCEPT

(550) I

(740) Božidar S. Radulović, Studentska bb, Lamela 3/18, 81000, Podgorica

(511) Klasa 34: Upijajući papir za duvanske lule; kutije (za cigare), koje nisu od plemenitih metala; kutije (za cigarete), koje nisu od plemenitih metala; filteri za cigarete; muštikle (usnici za muštikle); papir za cigarete; papir za cigarete (blokovi papira za cigarete); usnici za cigarete ; cigarete; cigarete (džepne mašine za uvijanje); cigarete koje sadrže zamjenu duvana, koje nisu za medicinsku upotrebu; cigarilosi ; cigare; sjekači (za cigare); filteri (za cigarete); kremen ; trave za pušenje; usnici za muštikle; upaljači za pušače; šibice; lule (za duvan); kese (za duvan); pušači (upaljači za); usnici(cigarete); duvan; lule za duvan, kese za duvan.

(111) **14622**

(151) 12.06.2020.

(210) Ž-2019-27

(220) 29.01.2019.

(732) Exxon Mobil Corporation, 5959 Las Colinas Boulevard, 75039-2298, Irving, Texas, US

(540)

The Mobil logo consists of the word "Mobil" in a bold, sans-serif font. The letters "M", "o", "b", "i", and "l" are blue, while the letter "l" is red.

(550) I

(740) AOD "Ćupić", Bulevar Džordža Vašingtona 79, 81000, Podgorica

(511) Klasa 1: Hemijski proizvodi koji se upotrebljavaju u industriji, nauci i fotografiji, kao i u poljoprivredi, hortikulturi i šumarstvu; neprerađene vještačke smole, neprerađene plastične materije; smjese za gašenje požara i za sprječavanje požara; preparati za kaljenje i zavarivanje; materije za štavljenje životinjske kože i krzna; ljepljive supstance koje se upotrebljavaju u industriji; gitovi i druge materije za punjenja; kompost, stajska đubriva, đubriva; biološki preparati za upotrebu u industriji i nauci; transmisione tečnosti; hidraulične tečnosti; antifriz/rashladne tečnosti; tečnosti za odležavanje; kočione tečnosti; tečnosti za servo volan.

Klasa 4: Industrijska ulja i masti, vosak; maziva; jedinjenja za skupljanje, vlaženje i vezivanje prašine; goriva i materije za osvjetljavanje; svijeće i fitilji za osvjetljavanje; motorna ulja; mašinska ulja; ulja za podmazivanje; masti; maziva; sintetička mašinska maziva; vosak; bazna ulja; goriva; motorna goriva, naime benzin i dizel; kompresovan prirodni gas.

Klasa 37: Građevinsko konstruisanje; popravlanje; usluge instaliranja; usluge maloprodaje goriva na benzinskim pumpama; usluge pranja automobila; usluge podmazivanja vozila.

(111) **14623**

(151) 12.06.2020.

(210) Ž-2019-28

(220) 29.01.2019.

(732) Exxon Mobil Corporation, 5959 Las Colinas Boulevard, 75039-2298, Irving, Texas, US

(540)

MOBIL

(550) I

(740) AOD "Ćupić", Bulevar Džordža Vašingtona 79, 81000, Podgorica

(511) Klasa 1: Hemijski proizvodi koji se upotrebljavaju u industriji, nauci i fotografiji, kao i u poljoprivredi, hortikulturi i šumarstvu; neprerađene vještačke smole, neprerađene plastične materije; smjese za gašenje požara i za sprječavanje požara; preparati za kaljenje i zavarivanje; materije za štavljenje životinjske kože i krzna; ljepljive supstance koje se upotrebljavaju u industriji; gitovi i druge materije za punjenja; kompost, stajska đubriva, đubriva; biološki preparati za upotrebu u industriji i nauci; transmisione tečnosti; hidraulične

tečnosti ; antifriz/rashladne tečnosti; tečnosti za odleđivanje; kočione tečnosti; tečnosti za servo volan.

Klasa 4: Industrijska ulja i masti, vosak; maziva; jedinjenja za skupljanje, vlaženje i vezivanje prašine; goriva i materije za osvjetljavanje; svijeće i fitilji za osvjetljavanje; motorna ulja; mašinska ulja; ulja za podmazivanje; masti; maziva; sintetička mašinska maziva; vosak; bazna ulja; goriva; motorna goriva, naime benzin i dizel; kompresovan prirodni gas.

Klasa 37: Građevinsko konstruisanje; popravljanje; usluge instaliranja; usluge maloprodaje goriva na benzinskim pumpama; usluge pranja automobila; usluge podmazivanja vozila.

(111) **14624**

(151) 12.06.2020.

(210) Ž-2019-29

(220) 29.01.2019.

(732) Exxon Mobil Corporation, 5959 Las Colinas Boulevard, 75039-2298, Irving, Texas, US

(540)

ESP FORMULA

(550) I

(740) AOD "Ćupić", Bulevar Džordža Vašingtona 79, 81000, Podgorica

(511) Klasa 4: Industrijska ulja i masti, vosak; maziva; jedinjenja za skupljanje, vlaženje i vezivanje prašine; goriva i materije za osvjetljavanje; svijeće i fitilji za osvjetljavanje; motorna ulja; mašinska ulja.

(111) **14625**

(151) 12.06.2020.

(210) Ž-2019-30

(220) 29.01.2019.

(732) Exxon Mobil Corporation, 5959 Las Colinas Boulevard, 75039-2298, Irving, Texas, US

(540)

MOBIL SERV

(550) I

(740) AOD "Ćupić", Bulevar Džordža Vašingtona 79, 81000, Podgorica

(511) Klasa 35: Oglašavanje; vođenje poslova; poslovno upravljanje; kancelarijski poslovi; usluge pružanja informacija o potrošackim proizvodima putem onlajn alatke za odabir u svrhe biranja maziva koji odgovara potrebama potrošača.

Klasa 41: Obrazovne usluge; pripremanje obuke; razonoda; sportske i kulturne aktivnosti; usluge obuke na polju maziva.

Klasa 42: Naučne i tehnološke usluge, kao i usluge istraživanja i projektovanja u vezi sa njima; usluge industrijskih analiza i istraživanja; projektovanje i razvoj kompjuterskih hardvera i softvera; kontrola opreme; usluge analize kvarova proizvoda; testiranje, analiza i procjena performansi industrijskih, komercijalnih i pomorskih maziva baziranih na promjenljivim uslovima, uključujući kontaminaciju, radno okruženje i degradaciju maziva; sistematizacija potreba maziva za industrijska postrojenja, naime analiza trenutnih performansi i potreba maziva i preporuka za maziva, uključujući učestalost zamjene, servisne intervale i metod primjene, za unapređenje performansi maziva; usluge tehnoloških konsultacija iz oblasti maziva, uključujući konsultacije na polju skladištenja, rukovanja i upotrebe maziva, usluge studija o efikasnosti postrojenja koje se tiču upotrebe maziva, inženjeringa i podrške vezane za upotrebu i selekciju maziva, tehnološke konsultacije iz oblasti pripremanja i odavanja opreme u vezi sa mazivima.

(111) **14626**

(151) 12.06.2020.

(210) Ž-2019-31

(220) 29.01.2019.

(732) Exxon Mobil Corporation, 5959 Las Colinas Boulevard, 75039-2298, Irving, Texas, US

(540)

MOBILFLUID

(550) I

(740) AOD "Ćupić", Bulevar Džordža Vašingtona 79, 81000, Podgorica

(511) Klasa 1: Hemijski proizvodi koji se upotrebljavaju u industriji, nauci i fotografiji, kao i u poljoprivredi, hortikulturi i šumarstvu; neprerađene vještačke smole, neprerađene plastične materije; smješe za gašenje požara i za spriječavanje požara; preparati za kaljenje i zavarivanje; materije za štavljenje životinjske kože i

krzna; ljepljive supstance koje se upotrebljavaju u industriji; gitovi i druge materije za punjenja; kompost, stajska đubriva, đubriva; biološki preparati za upotrebu u industriji i nauci; transmisione tečnosti.

(111) **14627**

(151) 12.06.2020.

(210) Ž-2019-32

(220) 29.01.2019.

(732) Exxon Mobil Corporation, 5959 Las Colinas Boulevard, 75039-2298, Irving, Texas, US

(540)

MOBILGREASE

(550) I

(740) AOD "Ćupić", Bulevar Džordža Vašingtona 79, 81000, Podgorica

(511) Klasa 4: Industrijska ulja i masti, vosak; maziva; jedinjenja za skupljanje, vlaženje i vezivanje prašine; goriva i materije za osvjetljavanje; svijeće i fitilji za osvjetljavanje; masti.

(111) **14628**

(151) 12.06.2020.

(210) Ž-2019-33

(220) 29.01.2019.

(732) Exxon Mobil Corporation, 5959 Las Colinas Boulevard, 75039-2298, Irving, Texas, US

(540)

MOBILTHERM

(550) I

(740) AOD "Ćupić", Bulevar Džordža Vašingtona 79, 81000, Podgorica

(511) Klasa 4: Industrijska ulja i masti, vosak; maziva; jedinjenja za skupljanje, vlaženje i vezivanje prašine; goriva i materije za osvjetljavanje; svijeće i fitilji za osvjetljavanje; ulja za podmazivanje; ulja za prenos toplote.

(111) **14629**

(151) 12.06.2020.

(210) Ž-2019-34

(220) 29.01.2019.

(732) Exxon Mobil Corporation, 5959 Las Colinas Boulevard, 75039-2298, Irving, Texas, US

(540)

UNIVIS

(550) I

(740) AOD "Ćupić", Bulevar Džordža Vašingtona 79, 81000, Podgorica

(511) Klasa 4: Industrijska ulja i masti, vosak; maziva; jedinjenja za skupljanje, vlaženje i vezivanje prašine; goriva i materije za osvjetljavanje; svijeće i fitilji za osvjetljavanje; ulja za podmazivanje; hidraulična ulja.

(111) **14630**

(151) 12.06.2020.

(210) Ž-2019-35

(220) 29.01.2019.

(732) Exxon Mobil Corporation, 5959 Las Colinas Boulevard, 75039-2298, Irving, Texas, US

(540)

VELOCITE

(550) I

(740) AOD "Ćupić", Bulevar Džordža Vašingtona 79, 81000, Podgorica

(511) Klasa 4:

Industrijska ulja i masti, vosak; maziva; jedinjenja za skupljanje, vlaženje i vezivanje prašine; goriva i materije za osvetljavanje; svijeće i fitilji za osvetljavanje; ulja za podmazivanje; ulja za vretena i hidraulična ulja.

(111) **14631**

(151) 12.06.2020.

(210) Ž-2019-36

(220) 29.01.2019.

(732) Exxon Mobil Corporation, 5959 Las Colinas Boulevard, 75039-2298, Irving, Texas, US

(540)

WYROL

(550) I

(740) AOD "Ćupić", Bulevar Džordža Vašingtona 79, 81000, Podgorica

(511) Klasa 4:

Industrijska ulja i masti, vosak; maziva; jedinjenja za skupljanje, vlaženje i vezivanje prašine; goriva i materije za osvetljavanje; svijeće i fitilji za osvetljavanje; ulja za valjaonice; hidraulična ulja; ulja za zupčanike i ležajeve.

(111) **14632**

(151) 15.06.2020.

(210) Ž-2018-306

(220) 15.08.2018.

(732) Hemofarm A.D. farmaceutsko-hemijska industrija Vršac, Beogradski put bb, 26300, Vršac, RS

(540)

TRIOMA

(550) I

(511) Klasa 5: Farmaceutski proizvodi.

(111) **14633**

(151) 15.06.2020.

(210) Ž-2019-37

(220) 29.01.2019.

(732) Exxon Mobil Corporation, 5959 Las Colinas Boulevard, 75039-2298, Irving, Texas, US

(540)

XHP

(550) I

(740) AOD "Ćupić", Bulevar Džordža Vašingtona 79, 81000, Podgorica

(511) Klasa 4: Industrijska ulja i masti, vosak; maziva; jedinjenja za skupljanje, vlaženje i vezivanje prašine; goriva i materije za osvetljavanje; svijeće i fitilji za osvetljavanje; masti; motorna ulja; ulja za dizel motore.

(111) **14634**

(151) 15.06.2020.

(210) Ž-2019-38

(220) 29.01.2019.

(732) Exxon Mobil Corporation, 5959 Las Colinas Boulevard, 75039-2298, Irving, Texas, US

(540)

MOBILTRANS

(550) I

(740) AOD "Ćupić", Bulevar Džordža Vašingtona 79, 81000, Podgorica

(511) Klasa 1: Hemijski proizvodi koji se upotrebljavaju u industriji, nauci i fotografiji, kao i u poljoprivredi, hortikulturi i šumarstvu; neprerađene vještačke smole, neprerađene plastične materije; smjese za gašenje požara i za sprječavanje požara; preparati za kaljenje i zavarivanje; materije za štavljenje životinjske kože i krzna; ljepljive supstance koje se upotrebljavaju u industriji; gitovi i druge materije za punjenja; kompost, stajska đubriva, đubriva; biološki preparati za upotrebu u industriji i nauci; pogonske tečnosti; transmisione tečnosti.

(111) **14635**

(151) 15.06.2020.

(210) Ž-2019-39

(220) 29.01.2019.

(732) Exxon Mobil Corporation, 5959 Las Colinas Boulevard, 75039-2298, Irving, Texas, US

(540)

The logo for Mobil, featuring the word "Mobil" in a bold, sans-serif font. The letter 'o' is stylized as a circle with a smaller circle inside it, resembling an eye or a target.

(550) I

(740) AOD "Ćupić", Bulevar Džordža Vašingtona 79, 81000, Podgorica

(511) Klasa 1: Hemijski proizvodi koji se upotrebljavaju u industriji, nauci i fotografiji, kao i u poljoprivredi, hortikulturi i šumarstvu; neprerađene vještačke smole, neprerađene plastične materije; smješe za gašenje požara i za sprječavanje požara; preparati za kaljenje i zavarivanje; materije za štavljenje životinjske kože i krzna; ljepljive supstance koje se upotrebljavaju u industriji; gitovi i druge materije za punjenja; kompost, stajska đubriva, đubriva; biološki preparati za upotrebu u industriji i nauci; transmisione tečnosti; hidraulične

tečnosti; antifriz/rashladne tečnosti; tečnosti za odleđivanje; kočione tečnosti; tečnosti za servo volan.

Klasa 4: Industrijska ulja i masti, vosak; maziva; jedinjenja za skupljanje, vlaženje i vezivanje prašine; goriva i materije za osvetljavanje; svijeće i fitilji za osvetljavanje; motorna ulja; ulja za podmazivanje; masti; maziva; sintetička mašinska maziva; vosak; bazna ulja; motorna goriva, naime benzin i dizel; kompresovan prirodni gas.

Klasa 37: Građevinsko konstruisanje; popravljanje; usluge instaliranja; usluge maloprodaje goriva na benzinskim pumpama; usluge pranja automobila; usluge podmazivanja vozila.

(111) **14636**

(151) 15.06.2020.

(210) Ž-2019-40

(220) 29.01.2019.

(732) Exxon Mobil Corporation, 5959 Las Colinas Boulevard, 75039-2298, Irving, Texas, US

(540)

HYJET

(550) I

(740) AOD "Ćupić", Bulevar Džordža Vašingtona 79, 81000, Podgorica

(511) Klasa 1: Hidraulični fluidi.

(111) **14637**

(151) 15.06.2020.

(210) Ž-2018-474

(220) 30.11.2018.

(732) DON DON proizvodno in trgovsko podjetje d.o.o., Gasilska cesta 2, 1290, Grosuplje, SI

(540)



(550) I

(740) AOD "Ćupić", Bulevar Džordža Vašingtona 79, 81000, Podgorica

(511) Klasa 29: Meso, riba, živina i divljač; mesne prerađevine; konzervisano, sušeno i kuvano voće i povrće; želei, džemovi, kompoti; jaja, mlijeko i mliječni proizvodi; jestiva ulja i masti.

Klasa 30: Kafa, čaj, kakao, zamjena kafe; tapioka, sago; šećer, med, melasa; pirinač; brašno i proizvodi od žitarica; hljeb, kolači i poslastice; sladoledi; kvasac, prašak za pecivo; so; senf; sirće; sosovi (kao dodaci); začini; led.

Klasa 32: Pivo; mineralne i sodne vode i druga bezalkoholna pića; voćni napici i voćni sokovi; sirupi i drugi preparati za proizvodnju pića.

Klasa 39: Transportne usluge; pakovanje i skladištenje robe.

Klasa 43: Usluge obezbjeđivanja hrane i pića; privremeni smještaj.

(111) **14638**

(151) 15.06.2020.

(210) Ž-2019-45

(220) 31.01.2019.

(732) VIVA ŠPED D.O.O, KUĆE RAKICA BB, 81000, PODGORICA, ME

(540)



(550) I

(740) Senija Mažić, , 81000, Podgorica

(511) Klasa 34: Duvan; pribor za pušace; šibice.

(111) **14639**

(151) 16.06.2020.

(210) Ž-2019-105

(220) 15.03.2019.

(732) JAVNA USTANOVA "GRAD TEATAR" BUDVA, ul.13 jula bb, zgrada BSP-a, Budva, ME

(540)



(550) I

(511) Klasa 41: Obuka; stručno osposobljavanje; razonoda; sportske i kulturne djelatnosti, a naročito usluge zabavljača, umjetnika; iznajmljivanje scenskih dekora; pozorišna produkcija; produkcija predstava; iznajmljivanje pozorišnih dekora; organizovanje izložbi za kulturne ili obrazovne potrebe; izvođenje nastupa uživo; izvođenje predstava uživo; organizovanje predstava, svečanosti (usluge impresarija).

(111) **14640**

(151) 16.06.2020.

(210) Ž-2019-106

(220) 15.03.2019.

(732) JAVNA USTANOVA "GRAD TEATAR" BUDVA, ul.13 jula bb, zgrada BSP-a, Budva, ME

(540)

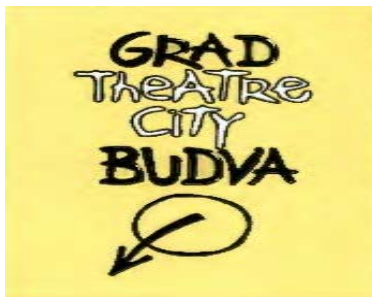

(550) I

(511) Klasa 41: Obuka; stručno osposobljavanje; razonoda; sportske i kulturne djelatnosti, a naročito usluge zabavljača, umjetnika; iznajmljivanje scenskih dekora; pozorišna produkcija; produkcija predstava; iznajmljivanje pozorišnih dekora; organizovanje izložbi za kulturne ili obrazovne potrebe; izvođenje nastupa uživo; izvođenje predstava uživo; organizovanje predstava, svečanosti (usluge impresarija).

(111) **14641**

(151) 16.06.2020.

(210) Ž-2019-123

(220) 26.03.2019.

(732) Philip Morris Products S.A., Quai Jeanrenaud 3, 2000, Neuchâtel, CH

(540)

HEETS AMBER SELECTION

(550) I

(740) Milena Pejović, Cetinjski put 11, The Capital Plaza IV floor,, 81000, Podgorica

(511) Klasa 34: Žičani vaporizatori za elektronske cigarete i elektronske uređaje za pušenje; duvan, sirov ili prerađen; duvanski proizvodi, cigare, cigarete, cigarilosi, duvan za uvijanje cigareta, duvan za lule, duvan za

žvakanje, duvan za šmrkanje, kretek; snus (duvan u prahu); zamena za duvan (za nemedicinsku upotrebu); artikli za pušače, papir za cigarete, tube za cigarete, filteri za cigarete, kutije za duvan, kutije za cigarete, tabakere i pepeljare, lule, džepne mašine za uvijanje cigareta, upaljači; šibice; duvanski štapići, duvanski proizvodi za zagrevanje, elektronski uređaji, i njihovi delovi, koji se koriste za zagrevanje cigareta ili duvana u cilju oslobađanja aerosola koji sadrži nikotin za inhalaciju; tečni nikotinski rastvori za upotrebu u elektronskim cigaretama; elektronski uređaji za pušenje; elektronske cigarete; elektronske cigarete kao zamena za tradicionalne cigarete; elektronski uređaji koji sadrže aerosol za inhalaciju nikotina; oralni vaporizatori za pušače, duvanski proizvodi i zamene za duvan; artikli za pušače elektronskih cigareta; delovi i oprema za navedene proizvode iz klase 34; uređaji za gašenje cigareta i cigara koje se zagrevaju i duvanskih štapića koji se zagrevaju; punjive elektronske kutije za cigarete.

(111) **14642**

(151) 16.06.2020.

(210) Ž-2019-114

(220) 21.03.2019.

(732) KT & G Corporation , 71, Beotkkot-gil, Daedeok-gu, Daejeon, KR

(540)

ESSE CLASSIC

(550) I

(740) Miladin Popović, Đoka Miraševića 21/III, 81000, Podgorica

(511) Klasa 34: Duvan; Cigarete; Cigare; Burmut; Papiri za cigarete; Lule za duvan, ne od plemenitih metala; Filteri za cigarete; Kutije za cigarete, ne od plemenitih metala; Kesice za duvan; Upaljači za cigarete, ne od plemenitih metala; Šibice; Sredstva za čišćenje lula za duvan; Pepeljare za pušače, ne od plemenitih metala; Rezači za cigare.

(111) **14643**

(151) 16.06.2020.

(210) Ž-2019-115

(220) 21.03.2019.

(732) KT & G Corporation , 71, Beotkkot-gil, Daedeok-gu, Daejeon, KR

(540)

ESSE BLUE

(550) I

(740) Miladin Popović, Đoka Miraševića 21/III, 81000, Podgorica

(511) Klasa 34: Duvan; Cigarete; Cigare; Burmut; Papiri za cigarete; Lule za duvan, ne od plemenitih metala; Filteri za cigarete; Kutije za cigarete, ne od plemenitih metala; Kesice za duvan; Upaljači za cigarete, ne od plemenitih metala; Šibice; Sredstva za čišćenje lula za duvan; Pepeljare za pušače, ne od plemenitih metala; Rezači za cigare.

(111) **14644**

(151) 16.06.2020.

(210) Ž-2019-116

(220) 22.03.2019.

(732) KT & G Corporation , 71, Beotkkot-gil, Daedeok-gu, Daejeon, KR

(540)

BLOOMING

(550) I

(740) Miladin Popović, Đoka Miraševića 21/III, 81000, Podgorica

(511) Klasa 34: Duvan; Cigarete; Cigare; Burmut; Papiri za cigarete; Lule za duvan, ne od plemenitih metala; Filteri za cigarete; Kutije za cigarete, ne od plemenitih metala; Kesice za duvan; Upaljači za cigarete, ne od plemenitih metala; Šibice; Sredstva za čišćenje lula za duvan; Pepeljare za pušače, ne od plemenitih metala; Rezači za cigare.

(111) **14645**

(151) 16.06.2020.

(210) Ž-2019-117

(220) 22.03.2019.

(732) KT & G Corporation , 71, Beotkkot-gil, Daedeok-gu, Daejeon, KR

(540)

TIMELESS TIME

(550) I

(740) Miladin Popović, Đoka Miraševića 21/III, 81000, Podgorica

(511) Klasa 34:

Duvan; Cigarete; Cigare; Burmut; Papiri za cigarete; Lule za duvan, ne od plemenitih metala; Filteri za cigarete; Kutije za cigarete, ne od plemenitih metala; Kesice za duvan; Upaljači za cigarete, ne od plemenitih metala; Šibice; Sredstva za čišćenje lula za duvan; Pepeljare za pušače, ne od plemenitih metala; Rezači za cigare.

(111) **14646**

(151) 15.06.2020.

(210) Ž-2018-341

(220) 05.09.2018.

(732) Hyatt International Corporation, 150 North Riverside Plaza, 14th Floor, IL 60606, Chicago, Illinois, US

(540)

HYATT HOTELS & RESORTS

(550) I

(740) AOD MSA IP - Milojević Sekulić Advokati, Karađorđeva 65, 11000, Beograd

(511) Klasa 43: Hoteli; odmarališta; moteli; privremeni smještaj; organizovanje privremenog smještaja, naročito namještenih apartmana, apartmana i stanova; usluge putničke agencije za rezervaciju hotelskog smještaja; usluge rezervisanja za obezbjeđivanje privremenog kućnog smještaja za putnike i turiste;

specijalizovane usluge hotela koje se pružaju kao dio programa za česte goste hotela; usluge restorana, barova i koktel barova ; katering ugostiteljstvo (hrana i piće); obezbjeđivanje mjesta za bankete i društvene događaje za specijalne prilike; obezbjeđivanje mjesta za održavanje konferencija, izložbi i sastanaka; iznajmljivanje stolica, stolova, stolnjaka i staklenog posuđa za konferencije, izložbe, sastanke i društvene događaje i bankete; iznajmljivanje prostorija za sastanke.

(111) **14647**

(151) 15.06.2020.

(210) Ž-2018-342

(220) 05.09.2018.

(732) Hyatt International Corporation, 150 North Riverside Plaza, 14th Floor, IL 60606, Chicago, Illinois, US

(540)



(550) I

(511) Klasa 43: Hoteli; odmarališta; moteli; privremeni smještaj; organizovanje privremenog smještaja, naročito namještenih apartmana, apartmana i stanova; usluge putničke agencije za rezervaciju hotelskog smještaja; usluge rezervisanja za obezbjeđivanje privremenog kućnog smještaja za putnike i turiste; specijalizovane usluge hotela koje se pružaju kao dio programa za česte goste hotela; usluge restorana, barova i koktel barova ; katering ugostiteljstvo (hrana i piće); obezbjeđivanje mjesta za bankete i društvene događaje za specijalne prilike; obezbjeđivanje mjesta za održavanje konferencija, izložbi i sastanaka; iznajmljivanje stolica, stolova, stolnjaka i staklenog posuđa za konferencije, izložbe, sastanke i društvene događaje i bankete; iznajmljivanje prostorija za sastanke.

(111) **14648**

(151) 25.02.2019.

(210) Ž-2018-315

(220) 21.08.2018.

(732) D.O.O. "Business Integration & Business Intelligence", Bulevar Pera Četkovića 137, 81000, Podgorica, ME

(540)



(550) I

(740) Božidar Radulović, Studentska bb, Lamela 3/18, 81000, Podgorica

(511) Klasa 9: Igre (kompjuterski programi za igre), informatički programi [snimljeni], kompjuteri, kompjuteri (memorije za kompjutere), kompjuteri (pomoćni uređaji kompjutera), kompjuteri (stampaci za kompjutere), kompjuteri, džepni kompjuterski programi (snimljeni kompjuterski programi), kompjuterski programi [radni], kompjuterski programi [snimljeni], kompjuterski programi [za skidanje s udaljenijeg na bliži kompjuter ili s jačeg na slabije kompjuter] mreža, miš (podloge za kompjuterske miševe), miš [informatika] modemi, monitori [kompjuterska oprema], monitori [kompjuterski programi], obrada podataka (uređaji za obradu podataka), optički diskovi [diskovi], oslonci za šaku za rad s informatičkom opremom, periferni kompjuterski uređaji, štampači za kompjutere, tastature kompjutera, USB uređaji [vanjski diskovi, priključci] Klasa 35: Oglašavanje putem pošte, organizovanje poslova (savjetovanje o organiziranju poslova), osoblje (savjetovanje o osoblju), osoblje (zapošljavanje osoblja), podsticaj prodaje za treće osobe, podugovaranje (usluge podugovaranja) [komercijalna pomoć], poslovi (konsultacije za vođenja poslova), potrošači (pružanje komercijalnih savjeta i informacija potrošačima), predstavljanje proizvoda [demonstracija], preduzeća (usluge preseljenja za preduzeća), preseljavanje preduzeća (usluge preseljavanja preduzeća), pretplata na telekomunikacione usluge za treća lica, prezentacija proizvoda na svim komunikacionim sredstvima u svrhu, prodaje na malo, reklamiranje (iznajmljivanje prostora za potrebe reklamiranja, reklamiranje on-line na informatičkoj mreži, reklamiranje putem radija, reklamiranje putem televizije, reklamna dokumentacija (uređenje reklamne dokumentacije), reklamna pošta, reklamni oglasi (širenje reklamnih oglasa), reklamni tekstovi (objavljivanje reklamnih tekstova), reklamni tekstovi (uređenje reklamnih tekstova), sajmovi (organizovanje sajmova u komercijalne ili reklamne svrhe), savjetovanje (stručno savjetovanje o poslovima), savjetovanje o osoblju, sistematizovanje podataka za središnju kartoteku, sponzori (traženje sponzora), stručne poslovne konsultacije, telefonski odgovori (usluge telefonskih odgovora) za odsutne pretplatnike, telekomunikacione usluge za treće lica (pretplata na telekomunikacione usluge za treće lica), telemarketing (usluge telemarketinga), televizijsko reklamiranje, teretni vagoni (lociranje teretnih vagona pomoću kompjutera), vođenje informatičkih kartoteka

Klasa 38: Baze podataka (omogućavanje pristupa bazama podataka), elektronska pošta (omogućavanje elektronske pošte), iznajmljivanje modema, iznajmljivanje telekomunikacijskih uređaja, kompjuter (prijenos poruka i slika uz pomoć kompjutera), kompjuterski prijenos poruka i slika, prijenos digitalnih datoteka

Klasa 41: Elektronske publikacije (iskorištavanje elektronskih publikacija koje se ne mogu prenositi online), igre (usluge igara) pružene on-line [s jedne informatičke mreže], izdavanje knjiga, knjige (izdavanje knjiga),

konferencije (organizovanje i vođenje konferencija), kongresi (organizovanje i vođenje kongresa), objavljivanje knjiga i časopisa elektronski on line, objavljivanje tekstova [osim u reklamne svrhe], obrazovanje (informacije o obrazovanju), obrazovanje [obuka], obuka, obuka [predavanje], obuka putem dopisivanja, organizovanje i vođenje konferencija, organizovanje i vođenje kongresa, organizovanje i vođenje radionica za stručno osposobljavanje, organizovanje i vođenje seminara, pisanje tekstova [ne u reklamne svrhe], praktična obuka [demonstriranje], radioaparati i televizori (iznajmljivanje radioaparata i televizora), seminari (organizovanje i vođenje seminara), simpozijumi (organizacija i vođenje simpozijuma), simpozijumi (organizovanje i vođenje simpozijuma), tekstovi (objavljivanje tekstova) [osim u reklamne svrhe], tekstovi (sastavljanje tekstova) [ne u reklamne svrhe], televizori (iznajmljivanje televizora i radioaparata)

Klasa 42: Analiza kompjuterskih sastava, baze podataka (obnavljanje baza podataka), daljinski nadzor kompjuterskih sistema, digitalizacija dokumenata [skeniranje], dupliciranje informatičkih programa, informatičke stranice (ugošćavanje informatičkih stranica), informatički programi (dupliciranje informatičkih programa), informatički programi (iznajmljivanje informatičkih programa), informatički sistemi (osmišljavanje informatičkih sistema), informatički virusi (zaštita od informatičkih virusa), instaliranje kompjuterskih programa, internet (pružanje alata za pretraživanje na internetu), istraživanja u vezi zaštite okoline ,istraživanje i razvoj novih proizvoda [za treće lice], iznajmljivanje informatičkih programa, iznajmljivanje informatičkih programa, iznajmljivanje kompjutera, iznajmljivanje veb server, izrada [koncipiranje] kompjuterskih programa, kompjuteri (iznajmljivanje kompjutera), kompjuteri (programiranje za kompjutere), kompjuterski hardver (savjetovanje u vezi dizajna i razvoja kompjuterskog hardvera), kompjuterski programi (instaliranje kompjuterskih programa), kompjuterski programi (održavanje kompjuterskih programa), kompjuterski programi [softver] (izrada kompjuterskih programa), kompjuterski programi [softver] (osavremenjivanje kompjuterskih programa), konsultacije u vezi kompjuterskih programa [softvera], konverzija informatičkih podataka i programa [nije fi zička konverzija], konverzija podataka ili dokumenata s jednog fi zičkog na elektronski disk, programiranje za kompjuteri, razrada tehničkih projekata, savjetovanje o kompjuterima, savjetovanje u vezi zaštite okoline, tehnički projekti (razrada tehničkih projekata), web serveri (iznajmljivanje web servera), web stranice (kreiranje i održavanja web stranica za druge), zaštita od informatičkih virusa, zaštita okoline (istraživanja u vezi zaštite okoline), zaštita okoline (savjetovanje u vezi zaštite okoline)

(111) **14649**

(151) 16.06.2020.

(210) Ž-2018-345

(220) 07.09.2018.

(732) LSG Lufthansa Service Holding AG, Dornhofstrasse 38, 63263, Neu-Isenburg, DE

(540) **EVERTASTE**

(550) I

(740) Miladin Popović, Đoka Miraševića 21/III, 81000, Podgorica

(511) Klasa 29: Voćna salata; supe; salata od povrća.

Klasa 30: Brašno; ječmeno brašno; brašno od boba; biskviti; kolačići ; hljeb; rolnice; burito; kolači; čizburger [sendviči]; čokoladni musevi; pite od mesa; pripremljena jela na bazi tjestenine; peciva; pite; pice; kiševi; sendviči; tartovi.

Klasa 35: Organizovanje distribucije reklamnih uzoraka; organizovanje i zaključivanje komercijalnih transakcija za druge; pregovaranje o poslovnim ugovorima za druge; promocija prodaje za druge; distribucija prehrambenih proizvoda, luksuzne hrane i alkohola, kao i toplih, rashlađenih ili zamrznutih gotovih jela.

Klasa 39: Razvoj i distribucija koncepata pakovanja prehrambenih proizvoda i luksuzne hrane i alkohola; razvoj i distribucija koncepata za proizvodnju i distribuciju pakovanja za hranu i luksuznu hranu i alkohol.

Klasa 40: Zamrzavanje hrane; proizvodnja hrane, luksuzne hrane i alkohola kao i toplih, rashlađenih i smrznutih gotovih jela; razvoj i distribucija koncepata za proizvodnju i distribuciju hrane i luksuzne hrane i alkohola.

Klasa 43: Usluge kateringa, naročito u avionima, vozovima, hotelima, maloprodajnim objektima i restoranima.

(111) **14650**

(151) 16.06.2020.

(210) Ž-2018-388

(220) 18.10.2018.

(732) PFIZER INC., 235 East 42nd Street, 10017, New York, New York, US

(540)

STAQUIS

(550) I

(740) Jasna Jusić, Dalmatinska 2, 81000, Podgorica

(511) Klasa 5: Farmaceutski preparati.

(111) **14652**

(151) 17.06.2020.

(210) Ž-2018-400

(220) 23.10.2018.

(732) PEPSICO, INC., 700 Anderson Hill Road, 10577, Purchase, New York, US

(540)

ZA ODVAŽNE

(550) I

(511) Klasa 29: Meso, riba, živina i divljač; mesni ekstrakti; konzervisano, smrznuto, sušeno i kuvano voće i povrće; žele, džemovi, kompoti; jaja, mlijeko i mliječni proizvodi; jestiva ulja i masti; grickalice na bazi voća, povrća, sira, mesa, oraha; pripremljeni orasi; grickalice na bazi krompira; čips; čips od krompira.

Klasa 30: Kafa, čaj, kakao, šećer, pirinač, tapioka i sago i zamjena kafe; brašno i proizvodi od žitarica, hljeba, kolača i poslastica; sladoledi; med, melasa; kvasac, prašak za pecivo; so, senf; sirće, sosovi (kao dodaci); začini; led, grickalice na bazi brašna, kukuruza, žitarica, pirinča; kukuruzni čips; tortilja čips.

(111) **14653**

(151) 16.06.2020.

(210) Ž-2018-288

(220) 31.07.2018.

(732) Reuters Limited, The Thomson Reuters Building 30 South Colonnade, Canary Wharf, E14 5EP, London, GB

(540)



(550) I

(740) Jasna Jusić, Dalmatinska 2, 81000, Podgorica

(511) Klasa 9: Računarski softver i softver za mobilne aplikacije koji se može preuzimati sa interneta i koji

sadrži referentne informacije iz oblasti finansija , investicija, poslovanja, vijesti; računarski programi za pristup raznim bazama podataka u oblastima poslovanja; komunikacioni softver koji olakšava prenos elektronskih podataka obezbjeđujući pristup bazama podataka koje pružaju informacije o poslovanju ; računarski programi za upotrebu u trgovanju akcijama i obveznicama; računarski softver vezan za prikupljanje i distribuciju podataka, finansijske razmjene, trgovanje udjelima u kompanijama, trgovanje akcijama i finansijske transakcije; softver za rutiranje i izvršenje naloga za kupovinu i prodaju hartija od vrijednosti koji koriste brokeri, dileri i njihovi kupci; softver koji se može preuzimati sa interneta i koji pruža informacije za korišćenje u vezi sa provjerom klijenta i analizom stanja, informacijama o usklađenosti finansijskih usluga sa propisima i procjene korporativnog rizika.

Klasa 16: Štampanje publikacije, naime, knjige, magazini, časopisi, imenici, pamfleti i brošure koje sadrže referentne informacije o različitim temama iz oblasti finansija , investicija, vlasništva nad preduzećima i poslovanja.

Klasa 35: Usluge obezbjeđivanja prilagođenih statističkih izveštaja o demografskim podacima; usluge poslovne procjene; usluge poslovnih informacija; agencije za komercijalne informacije; usluge ekonomskog predviđanja; usluge poslovnog istraživanja; obezbjeđivanje statističkih informacija; obezbjeđivanje informacija u vidu vijesti i komentara, analiza i izveštaja o rezultatima na tržištu i određivanju cijene opštinskih obveznica i vesti i analiza o novcu i usklađenosti korporativnog trezora, vijesti i analize o spajanjima i preuzimanjima, informacije o vlasništvu nad korporacijama, informacije o korporativnim i finansijskim rukovodiocima , poslovi nakon obavljenje trgovine u vidu trgovinske obrade i naplate, alokacije i poravnanja računa na globalnim tržištima hartija od vrijednosti.

Klasa 36: Pružanje informacija u vezi sa finansijskim savjetodavnim uslugama; pružanje istraživačke pomoći u vezi sa finansijskim savjetodavnim uslugama; pružanje prilagođenih statističkih izvještaja koji se odnose na finansijske podatke; finansijska analiza; finansijsko savjetovanje; fiskalne procjene; cijene na berzi; elektronski transfer sredstava; pružanje finansijskih informacija o obveznicama; garancije za obveznice, komercijalna prodaja i fondovi za razmjenu i ulaganje; finansijske usluge, naime, pružanje finansijskih informacija u smislu tržišne trgovine i informacije o cijenama za hartije od vrijednosti; usluge podrške trgovanju u oblasti finansijskih hartija od vrijednosti, naime, poređenje trgovine, prikupljanje, obrada, tabeliranje, distribucija, pregovaranje i izvršenje; pružanje informacija o trgovanju hartijama od vrijednosti, odnosno klasifikacija hartija od vrijednosti, brokeria, dilera i izdavaoca; računanje, obezbjeđivanje i ažuriranje u korist drugih finansijskih indeksa hartija od vrijednosti i podindeksa; automatizovane finansijske usluge, naime, onlajn posredovanje hartijama od vrijednosti putem globalne računarske mreže; pružanje onlajn elektronskih računarskih baza podataka sa informacijama o hartijama od vrijednosti putem globalne računarske mreže; pružanje informacionih usluga u oblastima ekonomskih , finansijskih , monetarnih i berzanskih informacija, informacija o valutnoj trgovini.

Klasa 38: Telekomunikacijske usluge, naime, pružanje telekomunikacionih veza sa globalnom računarskom mrežom; komunikacija putem računarskih terminala, odnosno elektronskog prenosa podataka, poruka i dokumenata preko računarskih terminala; prenos podataka, poruka, informacija i slika pomoću računara; usluge elektronske pošte; elektronski prenos poruka; računarske usluge, naime, pružanje usluge baze podataka sa poslovnim vijestima i informacijama, podnošenje dokumentacije za poslovna preduzeća, i poslovni izvještaji pravnih istraživanja i usaglašavanja istraživanja koja omogućavaju onlajn pristup elektronskim računarskim bazama podataka sa informacijama o hartijama od vrijednosti putem globalne računarske mreže; pružanje onlajn elektronskih računarskih baza podataka koje korisnicima pružaju informacije o trgovanju koje se tiču hartija od vrijednosti i pružaju institucijama i pojedinačnim investitorima automatsku mrežu za trgovanje hartijama od vrijednosti.

Klasa 42: Softver kao usluga (SaaS) usluge sa softverom koji pruža finansijske informacije u smislu trgovanja, finansijskih razmjena, trgovinskih poravnanja, informacijama o finansijskim tržištima, informacijama za

upotrebu u robnoj trgovini i prognoziranja; softver koji se ne može preuzeti a koji sadrži finansijske informacije, kao i baze podataka javnih arhiva za upotrebu u vezi sa provjerom klijenta i analizom stanja , i korporativnom procjenom rizika; softver koji se ne može preuzeti koji sadrži funkcije pretraživanja i povraćaja za javne dokumente koji pružaju informacije za korišćenje u vezi sa provjerom klijenta i analizom stanja, istraživanja i konsultacija u oblasti obavestajnih službi i bezbjednosti.

(111) **14654**

(151) 16.06.2020.

(210) Ž-2018-324

(220) 27.08.2018.

(732) COMPAÑIA DE TABACOS DEL MEDITERRANEO, S.A., Nuñez de Balboa, 108, 28006, Madrid, ES

(540)

The logo consists of the word "BRAVO" in a bold, red, sans-serif font. The letter 'O' is stylized as a circle with a smaller circle inside it, resembling an eye or a target.

(550) I

(740) Mladen Đ. Čolović, Dalmatinska 2, 81000, Podgorica

(511) Klasa 34: Duvan; cigare i cigarete; proizvodi za pušaće; šibice.

(111) **14655**

(151) 17.06.2020.

(210) Ž-2018-395

(220) 23.10.2018.

(732) MONTENEGRO TOBACO COMPANY, Polja bb, Mojkovac, ME

(540)



(550) I

(511) Klasa 34: Cigarete; promet i proizvodnja.

(111) **14655**

(151) 17.06.2020.

(210) Ž-2018-441

(220) 13.11.2018.

(732) ETI GIDA SANAYI VE TICARET ANONIM SIRKETI, Organize Sanayi Bolgesi 11., Cadde Eskisehir, TR

(540)



(550) I

(740) Miladin Popović, Đoka Miraševića 21/III, 81000, Podgorica

(511) Klasa 30: Biskviti; čokolade; peciva; krekeri; vafli; kolači; tartovi; deserti, naime, pekarski deserti, deserti na bazi brašna i čokolade, musevi, ledeni deserti; sladoledi; jestivi led.

(111) **14656**

(151) 17.06.2020.

(210) Ž-2018-463

(220) 28.11.2018.

(732) ETI GIDA SANAYI VE TICARET ANONIM SIRKETI, Organize Sanayi Bolgesi 11., Cadde Eskisehir, TR

(540)



(550) I

(740) Miladin Popović, ul. Capital Plaza, ulica šeika Zajeda 13-IV/68, 81000, Podgorica

(511) Klasa 30: Biskviti; čokolade; peciva; krekeri; vafli; kolači; tartovi; deserti, naime, pekarski deserti, deserti na bazi brašna i čokolade, musevi, ledeni deserti; sladoledi; jestivi led.

(111) **14657**

(151) 17.06.2020.

(210) Ž-2018-470

(220) 29.11.2018.

(732) ETI GIDA SANAYI VE TICARET ANONIM SIRKETI, Organize Sanayi Bolgesi 11., Cadde Eskisehir, TR

(540)



(550) I

(740) Miladin Popović, ul. Capital Plaza, ulica šeika Zajeda 13-IV/68, 81000, Podgorica

(511) Klasa 30: Biskviti.

(111) **14658**

(151) 17.06.2020.

(210) Ž-2018-476

(220) 30.11.2018.

(732) Victoria's Secret Stores Brand Management, Inc., Four Limited Parkway, 43068, Reynoldsburg, Ohio, US

(540)

PINK

(550) I

(740) Miladin Popović, Đoka Miraševića 21/III, 81000, Podgorica

(511) Klasa 9: Optičarski proizvodi i dodaci, naočare za sunce, futrole za naočare, okviri za naočare, kutije i futrole za kontaktna sočiva.

(111) **14659**

(151) 17.06.2020.

(210) Ž-2018-479

(220) 04.12.2018.

(732) ETI GIDA SANAYI VE TICARET ANONIM SIRKETI, Organize Sanayi Bolgesi 11., Cadde Eskisehir, TR

(540)

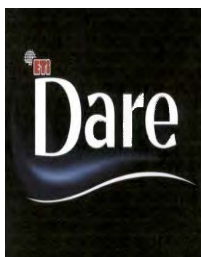

(550) I

(740) Miladin Popović, Đoka Miraševića 21/III, 81000, Podgorica

(511) Klasa 30: Biskviti; čokolade; peciva; krekeri; vafli; kolači; tartovi; deserti, naime, pekarski deserti, deserti na bazi brašna i čokolade, musevi, ledeni deserti; sladoledi; jestivi led.

(111) **14661**

(151) 17.06.2020.

(210) Ž-2017-65

(220) 20.02.2017.

(732) D.O.O. "Business Integration & Business Intelligence", Bulevar Pera Četkovića 137, 81000, Podgorica, ME

(540)

2BI

(550) I

(740)

(511) Klasa 9: igre (kompjuterski programi za igre), informatički programi [snimljeni], kompjuteri, kompjuteri (memorije za kompjutere). kompjuteri (pomoćni uređaji kompjutera), kompjuteri (štampači za

kompjutere), kompjuteri, džepni kompjuterski programi (snimljeni kompjuterski programi), kompjuterski programi [radni], kompjuterski programi [snimljeni], kompjuterski programi [za skidanje s udaljenijeg na bliži kompjuter ili s jačeg na slabije kompjuter] mreža, miš (podloge za kompjuterske miševe), miš [informatika] modemi, monitori [kompjuterska oprema], monitori (kompjuterski programi), obrada podataka (uređaji za obradu podataka), optički diskovi [diskovi], oslonci za šaku za rad s informatičkom opremom, periferni kompjuterski uređaji, štampači za kompjutere, tastature kompjutera, USB uređaji [vanjski djskovi, priključci]

Klasa 35: oglašavanje putem pošte, organizovanje poslova (savjetovanje o organiziranju poslova), osoblje (savjetovanje o osoblju), osoblje (zapošljavanje osoblja), podsticaj prodaje za treće osobe, podugovaranje (usluge podugovaranja) [komercijalna pomoć], poslovi (konsultacije za vođenja poslova), potrošači (pružanje komercijalnih savjeta i informacija potrošačima), predstavljanje proizvoda [demonstracija], preduzeća (usluge preseljenja za preduzeća), preseljavanje preduzeća (usluge preseljavanja preduzeća), pretplata na telekomunikacione usluge za treća lica, prezentacija proizvoda na svim komunikacionim sredstvima u svrhu, prodaje na malo, reklamiranje (iznajmljivanje prostora za potrebe reklamiranja, reklamiranje on-line na informatičkoj mreži, reklamiranje putem radija, reklamiranje putem televizije, reklamna dokumentacija (uređenje reklamne dokumentacije), reklamna pošta, reklamni oglasi (širenje reklamnih oglasa), reklamni tekstovi (objavljivanje reklamnih tekstova), reklamni tekstovi (uređenje reklamnih tekstova), sajmovi (organizovanje sajmova u komercijalne ili reklamne svrhe), savjetovanje (stručno savjetovanje o poslovima), savjetovanje o osoblju, sistematizovanje podataka za središnju kartoteku, sponzori (traženje sponzora), stručne poslovne konsultacije, telefonski odgovori (usluge telefonskih odgovora) za odsutne pretplatnike, telekomunikacione usluge za treće lica (pretplata na telekomunikacione usluge za treće lica), telemarketing (usluge telemarketinga), televizijsko reklamiranje, teretni vagoni (lociranje teretnih vagona pomoću kompjutera), vođenje informatičkih kartoteka.

Klasa 38: baze podataka (omogućavanje pristupa bazama podataka), elektronska pošta (omogućavanje elektronske pošte), iznajmljivanje modema, iznajmljivanje telekomunikacijskih uređaja, kompjuter (prijenos poruka i slika uz pomoć kompjutera), kompjuterski prijenos poruka i slika, prijenos digitalnih datoteka.

Klasa 41: elektronske publikacije (iskorištavanje elektronskih publikacija koje se ne mogu prenositi online), igre (usluge igara) pružene on-line [s jedne informatičke mreže], izdavanje knjiga, knjige (izdavanje knjiga), konferencije (organizovanje i vođenje konferencija), kongresi (organizovanje i vođenje kongresa), objavljivanje knjiga i časopisa elektronski on line, objavljivanje tekstova [osim u reklamne svrhe], obrazovanje (informacije o obrazovanju), obrazovanje [obuka], obuka, obuka [predavanje], obuka putem dopisivanja, organizovanje i vođenje konferencija, organizovanje i vođenje kongresa, organizovanje i vođenje radionica za stručno osposobljavanje, organizovanje i vođenje seminara, pisanje tekstova [ne u reklamne svrhe], pral'tična obuka [demonstriranje], radioaparati i televizori (iznajmljivanje radioaparata i televizora), seminari (organizovanje i vođenje seminara), simpozijurni (organizacija i vođenje simpozijuma), simpozijumi (organizovanje i vođenje simpozijuma), tekstovi (objavljivanje tekstova) [osim u reklamne svrhe], tekstovi (sastavljanje tekstova) [ne u reklamne svrhe], televizori (iznajmljivanje televizora i radioaparata).

Klasa 42: analiza kompjuterskih sastava, baze podataka (obnavljanje baza podataka), daljinski nadzor kompjuterskih sistema, digitalizacija dokumenata [skeniranje], dupliciranje informatičkih programa, informatičke stranice (ugošćavanje informatičkih stranica), informatički programi (dupliciranje informatičkih programa), informatički programi (iznajmljivanje informatičkih programa), informatički sistemi (osmišljavanje informatičkih sistema), informatički virusi (zaštita od informatičkih virusa), instaliranje kompjuterskih programa, internet (pružanje alata za pretraživanje na internetu), istraživanja u vezi zaštite okoline, istraživanje i razvoj novih proizvoda [za treće lica], iznajmljivanje informatičkih programa, iznajmljivanje kompjutera, iznajmljivanje veb server, izrada [koncipiranje] kompjuterskih programa, kompjuteri (iznajmljivanje kompjutera), kompjuteri (programiranje za kompjutere), kompjuterski hardver (savjetovanje u vezi dizajna i razvoja kompjuterskog hardvera),

kompjuterski programi (instaliranje kompjuterskih programa), kompjuterski programi (održavanje kompjuterskih programa), kompjuterski programi [softver] (izrada kompjuterskih programa), kompjuterski programi [softver] (osavremenjivanje kompjuterskih programa), konsultacije u vezi kompjuterskih programa [softvera], konverzija informatičkih podataka i programa [nije fi žička konverzija], konverzija podataka ili dokumenata s jednog fi žičkog na elektronski disk, programiranje za kompjuteri, razrada tehničkih projekata, savjetovanje o kompjuterima, savjetovanje u vezi zaštite okoline, tehnički projekti (razrada tehničkih projekata), web serveri (iznajmljivanje web servera), web stranice (kreiranje i održavanja web stranica za druge), zaštita od infonnatičkih virusa, zaštita okoline (istraživanja u vezi zaštite okoline), zaštita okoline (savjetovanje u vezi zaštite okoline).

(111) **14662**

(151) 18.06.2020.

(210) Ž-2017-64

(220) 20.02.2017.

(732) D.O.O. "Business Integration & Business Intelligence", Bulevar Pera ?etkovi?a 137, 81000, Podgorica, ME

(540)



(550) I

(511) Klasa 9: igre (kompjuterski programi za igre), informatički programi [snimljeni], kompjuteri, kompjuteri (memorije za kompjutere). kompjuteri (pomoćni uređaji kompjutera), kompjuteri (štampači za kompjutere),kompjuteri, džepni kompjuterski programi (snimljeni kompjuterski programi), kompjuterski programi [radni],kompjuterski programi [snimljeni],kompjuterski programi [za skidanje s udaljenijeg na bliži kompjuter ili s jačeg na slabije kompjuter] mreža, miš (podloge za kompjuterske miševe), miš [informatika] modemi,monitori [kompjuterska oprema], monitori (kompjuterski programi], obrada podataka (uređaji za obradu podataka), optički diskovi [diskovi], oslonci za šaku za rad s informatičkom opremom, periferni kompjuterski uređaji, štampači za kompjutere, tastature kompjutera, USB uređaji [vanjski djskovi, priključci] Klasa 35: oglašavanje putem pošte, organizovanje poslova (savjetovanje o organiziranju poslova), osoblje

(savjetovanje o osoblju), osoblje (zapošljavanje osoblja), podsticaj prodaje za treće osobe, podugovaranje (usluge podugovaranja) [komercijalna pomoć], poslovi (konsultacije za vođenja poslova), potrošači (pružanje komercijalnih savjeta i informacija potrošačima), predstavljanje proizvoda [demonstracija], preduzeća (usluge preseljenja za preduzeća), preseljavanje preduzeća (usluge preseljavanja preduzeća), pretplata na telekomunikacione usluge za treća lica, prezentacija proizvoda na svim komunikacionim sredstvima u svrhu, prodaje na malo, reklamiranje (iznajmljivanje prostora za potrebe reklamiranja, reklamiranje on-line na informatičkoj mreži, reklamiranje putem radija, reklamiranje putem televizije, reklamna dokumentacija (uređenje reklamne dokumentacije), reklamna pošta, reklamni oglasi (širenje reklamnih oglasa), reklamni tekstovi (objavljivanje reklamnih tekstova), reklamni tekstovi (uređenje reklamnih tekstova), sajmovi (organizovanje sajmova u komercijalne ili reklamne svrhe), savjetovanje (stručno savjetovanje o poslovima), savjetovanje o osoblju, sistematizovanje podataka za središnju kartoteku, sponzori (traženje sponzora), stručne poslovne konsultacije, telefonski odgovori (usluge telefonskih odgovora) za odsutne pretplatnike, telekomunikacione usluge za treće lica (pretplata na telekomunikacione usluge za treće lica), telemarketing (usluge telemarketinga), televizijsko reklamiranje, teretni vagoni (lociranje teretnih vagona pomoću kompjutera), vođenje informatičkih kartoteka.

Klasa 38: baze podataka (omogućavanje pristupa bazama podataka), elektronska pošta (omogućavanje elektronske pošte), iznajmljivanje modema, iznajmljivanje telekomunikacijskih uređaja, kompjuter (prijenos poruka i slika uz pomoć kompjutera), kompjuterski prijenos poruka i slika, prijenos digitalnih datoteka.

Klasa 41: elektronske publikacije (iskorištavanje elektronskih publikacija koje se ne mogu prenositi online), igre (usluge igara) pružene on-line [s jedne informatičke mreže], izdavanje knjiga, knjige (izdavanje knjiga), konferencije (organizovanje i vođenje konferencija), kongresi (organizovanje i vođenje kongresa), objavljivanje knjiga i časopisa elektronski on line, objavljivanje tekstova [osim u reklamne svrhe], obrazovanje (informacije o obrazovanju), obrazovanje [obuka], obuka, obuka [predavanje], obuka putem dopisivanja, organizovanje i vođenje konferencija, organizovanje i vođenje kongresa, organizovanje i vođenje radionica za stručno osposobljavanje, organizovanje i vođenje seminara, pisanje tekstova [ne u reklamne svrhe], pral'tična obuka [demonstriranje], radioaparati i televizori (iznajmljivanje radioaparata i televizora), seminari (organizovanje i vođenje seminara), simpozijurni (organizacija i vođenje simpozijuma), simpozijumi (organizovanje i vođenje simpozijuma), tekstovi (objavljivanje tekstova) [osim u reklamne svrhe], tekstovi (sastavljanje tekstova) [ne u reklamne svrhe], televizori (iznajmljivanje televizora i radioaparata).

Klasa 42: analiza kompjuterskih sastava, baze podataka (obnavljanje baza podataka), daljinski nadzor kompjuterskih sistema, digitalizacija dokumenata [skeniranje], dupliciranje informatičkih programa, informatičke stranice (ugoščavanje informatičkih stranica), informatički programi (dupliciranje informatičkih programa), informatički programi (iznajmljivanje informatičkih programa), informatički sistemi (osmišljavanje informatičkih sistema), informatički virusi (zaštita od informatičkih virusa), instaliranje kompjuterskih programa, internet (pružanje alata za pretraživanje na internetu), istraživanja u vezi zaštite okoline, istraživanje i razvoj novih proizvoda [za treće lica], iznajmljivanje informatičkih programa, iznajmljivanje informatičkih programa, iznajmljivanje kompjutera, iznajmljivanje veb server, izrada [koncipiranje] kompjuterskih programa, kompjuteri (iznajmljivanje kompjutera), kompjuteri (programiranje za kompjutere), kompjuterski hardver (savjetovanje u vezi dizajna i razvoja kompjuterskog hardvera), kompjuterski programi (instaliranje kompjuterskih programa), kompjuterski programi (održavanje kompjuterskih programa), kompjuterski programi [softver] (izrada kompjuterskih programa), kompjuterski programi [softver] (osavremenjivanje kompjuterskih programa), konsultacije u vezi kompjuterskih programa [softvera], konverzija informatičkih podataka i programa [nije fi zička konverzija], konverzija podataka ili dokumenata s jednog fi zičkog na elektronski disk, programiranje za kompjuteri, razrada tehničkih projekata, savjetovanje o kompjuterima, savjetovanje u vezi zaštite okoline, tehnički projekti (razrada tehničkih projekata), web serveri (iznajmljivanje web servera), web stranice (kreiranje i održavanja web stranica za

druge), zaštita od infonatičkih virusa, zaštita okoline (istraživanja u vezi zaštite okoline), zaštita okoline (savjetovanje u vezi zaštite okoline).

(111) **14663**

(151) 19.06.2020.

(210) Ž-2018-453

(220) 20.11.2018.

(732) Pharmacia & Upjohn Company LLC, 7000 Portage Road, 49001, Kalamazoo, Michigan, US

(540)

UPJOHN

(550) I

(740) Jasna Jusić, Dalmatinska 2, 81000, Podgorica

(511) Klasa 10: Hirurški, medicinski, zubarski i veterinarski aparati i instrumenti; vještački udovi, oči i zubi; ortopedski artikli; hirurški materijali za zašivanje; terapijski i pomoćni uređaji prilagođeni za osobe sa invaliditetom; aparati za masažu; aparati, uređaji i predmeti za odojčad; aparati za seksualnu aktivnost, uređaji i predmeti; medicinski uređaji za oftalmološku upotrebu.

(111) **14664**

(151) 19.06.2020.

(210) Ž-2019-41

(220) 30.01.2019.

(732) Six Continents Limited, Broadwater Park, UB9 5HR, Denham, Buckinghamshire, GB

(540)

VOCO

(550) I

(740) Mladen Đ. Čolović, Dalmatinska 2, 81000, Podgorica

(511) Klasa 35: Usluge hotelskog upravljanja za druge; usluge hotelskih franšiza , odnosno pružanje pomoći u poslovnom upravljanju u osnivanju i radu hotela; poslovno savjetovanje i konsultantske usluge u vezi s hotelijerstvom, poslovanjem i franšizom.

Klasa 43: Hotelske usluge; usluge privremenog smještaja; usluge bara i restorana; usluge salona za koktele; usluge hotelskih rezervacija; katering usluge za obezbjeđivanje hrane i pića; obezbjeđivanje objekata za konferencije, sastanke, izložbe i događaje opšte namjene.

(111) **14665**

(151) 19.06.2020.

(210) Ž-2019-42

(220) 30.01.2019.

(732) Six Continents Limited, Broadwater Park, UB9 5HR, Denham,Buckinghamshire, GB

(540)

VOCO

AN **IHG** HOTEL

(550) I

(740) Mladen Đ. Čolović, Dalmatinska 2, 81000, Podgorica

(511) Klasa 35: Usluge hotelskog upravljanja za druge; usluge hotelskih franšiza , odnosno pružanje pomoći u poslovnom upravljanju u osnivanju i radu hotela; poslovno savjetovanje i konsultantske usluge u vezi s hotelijerstvom, poslovanjem i franšizom.

Klasa 43: Hotelske usluge; usluge privremenog smještaja; usluge bara i restorana; usluge salona za koktele; usluge hotelskih rezervacija; katering usluge za obezbjeđivanje hrane i pića; obezbjeđivanje objekata za konferencije, sastanke, izložbe i događaje opšte namjene.

(111) **14666**

(151) 19.06.2020.

(210) Ž-2018-419

(220) 09.11.2018.

(732) ROUTEX B.V., Strawinskylaan 1725, 1077XX, Amsterdam, NL

(540)

ROUTEX

(550) I

(511) Klasa 4: Goriva (nehemijski dodaci tekućim pogonskim gorivima); benzinsko gorivo; tečna pogonska goriva; dizel-gorivo; etanol [gorivo]; gorivo; gazolin; podmazivanje (sredstva za podmazivanje); podmazivanje (ulja za podmazivanje); mineralna goriva; ulje za motore; benzin [gorivo].

Klasa 9: Kompjuterski programi (snimljen i kompjuterski programi); kompjuterski programi [radni]; kompjuterski programi [za skidanje s udaljenijeg na bliži kompjuter ili sa jačeg na slabije kompjuter] mreža; aplikacije za računarske softvere koje se mogu preuzimati; kompjuterske softverske platforme, snimljene ili preuzete; transponderi.

Klasa 16: Knjižice [pasoši, radne knjižice itd.]; knjige; časopisi [revije]; okružnice.

Klasa 35: Administrativna pomoć u odgovorima na pozive za tendere/ administrativna pomoć u odgovorima na zahtjeve za ponude; pružanje poslovnih informacija preko internet stranice; pružanje komercijalnih i poslovnih kontakata informacija; angažovanje spoljnih firmi za administrativno upravljanje kompanijama; sekretarske usluge (sekretarske usluge); ažuriranje i održavanje podataka u računarskim bazama podataka.

Klasa 36: Kreditne kartice (službe za kreditne kartice); dugovanje (službe za kartice dugovanja [debit kartice])

Klasa 37: Automobili (održavanje i popravak automobila); balansiranje guma; podmazivanje vozila; pranje vozila; poliranje vozila; servisne stanice; vozila (održavanje vozila); vozila (čišćenje vozila); vozila (pomoć pri kvaru vozila) [popravak]; punjenje baterija za vozila.

(111) **14667**

(151) 19.06.2020.

(210) Ž-2018-471

(220) 29.11.2018.

(732) C.THEODOSIOU ENTERPRISES LTD., 1 Androkleous Str. Mesa Geitonia, 4007, Limassol, CY

(540)

CHRISCO ROYAL CLASSIC

(550) I

(740) Saša Vujačić, Bulevar Ivana Crnojevića 56/2, 81000, Podgorica

(511) Klasa 34: Blokovi [svežnjevi] cigareta papira; cigare; cigare (kutije za cigare opremljene ovlaživačem); cigare (sjeckalice za cigare); cigarete; cigarete (džepne sprave za savijanje cigareta); cigarete (filteri za cigarete); cigarete (kutije za cigarete); cigarete (papir za cigarete); cigarete (vrhovi za cigarete); cigarete koje sadrže zamjenjivače duvana za nemedicinske potrebe; cigaretnici [držači cigareta]; cigarilosi [male cigare]; cigarnici [držači cigara]; držači za lule; duvan; duvan (ćupovi za duvan); duvan (kutije za duvan); duvan (vrećice za duvan); duvan za žvakanje; filteri za cigarete; kontejneri za plin za upaljače i za cigarete; kremen za upaljače; kutije za cigare; kutije za cigare opremljene ovlaživačem; kutije za cigarete; lule; lu1e (četkice za čišćenje lula) [pribor za pušače]; lule (upijajući papir za lule); motanje cigareta (džepne spravice za motanje cigareta); papir, upijajući za lule; papirici za cigarete; pepeljare za pušače; plin za upaljače (kontejneri za plin za upaljače); pljuvaonice za uživaocce duvana; posude za duvan; pušenje (trave za pušenje); sjeckalice za vrhove cigara; šibice; šibice (kutije za šibice); šibice (stalci za ši bice); šmrkanje (duvan za šmrkanje); trave za pušenje; upaljači (kontejneri plina za upaljače za cigarete); upaljači s kremenom za pušače; usnici od čilibara za nosače cigara ili cigareta; vrhovi cigarete; vrhovi cigarete [čibuke].

(111) **14668**

(151) 19.06.2020.

(210) Ž-2018-472

(220) 29.11.2018.

(732) C.THEODOSIOU ENTERPRISES LTD., 1 Androkleous Str. Mesa Geitonia, 4007, Limassol, CY

(540)



(550) I

(740) Saša Vujačić, Bulevar Ivana Crnojevića 56/2, 81000, Podgorica

(511) Klasa 34: Blokovi [svežnjevi] cigareta papira; cigare; cigare (kutije za cigare opremljene ovlaživačem); cigare (sjeckalice za cigare); cigarete; cigarete (džepne sprave za savijanje cigareta); cigarete (filteri za cigarete); cigarete (kutije za cigarete); cigarete (papir za cigarete); cigarete (vrhovi za cigarete); cigarete koje sadrže zamjenjivače duvana za nemedicinske potrebe; cigaretnici [držači cigareta]; cigarilosi [male cigare]; cigarnici [držači cigara]; držači za lule; duvan; duvan (ćupovi za duvan); duvan (kutije za duvan); duvan (vrećice za duvan); duvan za žvakanje; filteri za cigarete; kontejneri za plin za upaljače i za cigarete; kremen za upaljače; kutije za cigare; kutije za cigare opremljene ovlaživačem; kutije za cigarete; lule; lule (četkice za čišćenje lula) [pribor za pušače]; lule (upijajući papir za lule); motanje cigareta (džepne spravice za motanje cigareta); papir, upijajući za lule; papirici za cigarete; pepeljare za pušače; plin za upaljače (kontejneri za plin za upaljače); pljuvaonice za uživaocce duvana; posude za duvan; pušenje (trave za pušenje); sjeckalice za vrhove cigara; šibice; šibice (kutije za šibice); šibice (stalci za šibice); šmrkanje (duvan za šmrkanje); trave za pušenje; upaljači (kontejneri plina za upaljače za cigarete); upaljači s kremenom za pušače; usnici od ćilibara za nosače cigara ili cigareta; vrhovi cigarete; vrhovi cigarete [čibuke].

(111) **14669**

(151) 02.07.2020.

(210) Ž-2019-20

(220) 24.01.2019.

(732) Swissôtel Management GmbH, Balz-Zimmermannstrasse 7, 8302, Kloten, CH

(540)

SWISSÔTEL RESIDENCES

(550) I

(740) Miladin Popović, Đoka Miraševića 21/III, 81000, Podgorica

(511) Klasa 43: Usluge pružanja hrane i pića; privremeni smještaj; usluge hotela i odmarališta, usluge hotelskog smještaja; usluge rezervisanja hotelskog smještaja; iznajmljivanje soba; rezervisanje i bukiranje privremenog smještaja; rezervisanje dugoročnog i kratkoročnog boravka u apartmanima i kondominijumima; usluge obezbjeđivanja prostora za konferencije, usluge banketa; usluge barova, kafea, restorana, usluge koktel salona i kafića, usluge kuvanja hrane; angažovanje restorana i obroka, banketa i društvenih sadržaja za posebne prilike; informacije o hotelima, odmaralištima, smještajnim jedinicama i restoranima koje se obezbjeđuju putem onlajn pretražive kompjuterske baze podataka; pružanje veb stranice sa onlajn uslugom rezervisanja hotelskog smještaja; usluge obezbjeđivanja prostora za konvencije i izložbe; usluge brige o djeci [jaslice]; pružanje onlajn reze rvacija i bukiranja privremenog stana i smještaja; rezervisanje hotela za druge; rezervisanje i bukiranje smještaja u hotelima za druge; informacione, savjetodavne i konsultantske usluge koje se odnose na sve gore navedene usluge; uključujući sve gore navedene usluge koje se pružaju elektronskim putem ili onlajn iz baze podataka ili putem Interneta; sve uključeno u klasu 43.

(111) **14670**

(151) 02.07.2020.

(210) Ž-2019-21

(220) 25.01.2019.

(732) Swissôtel Management GmbH, Balz-Zimmermannstrasse 7, 8302, Kloten, CH

(540)

SWISSÔTEL

(550) I

(740) Miladin Popović, Đoka Miraševića 21/III, 81000, Podgorica

(511) Klasa 36: Usluge u vezi sa nekretninama; usluge u vezi sa nekretninama i finansijske usluge u vezi sa stambenim jedinicama, naime, usluge u vezi sa nekretninama i finansijske usluge u vezi sa prodajom, lizingom, upravljanjem pravom korišćenja i drugim nekretninama i finansijskim uslugama u vezi sa stanovima, kondominijumima, imovinom od djelimičnog interesa, uključujući nekretnine za dijeljenje vremena za odmor; usluge u vezi sa nekretninama i finansijske usluge koje se odnose na prodaju, lizing i upravljanje kondominijumima; upravljanje apartmanima; usluge upravljanja nekretninama, naime, podjela vlasničkih udjela na nekretninama uz odobravanje i upravljanje pravima drugih za korišćenje nekretnina; pružanje informacija o nekretninama, stambenim jedinicama, apartmanima, kondominijumima, nekretninama za dijeljenje vremena i imovinom od djelimičnog interesa; pružanje informacija o nekretninama, stambenim jedinicama, apartmanima, kondominijumima, nekretninama za dijeljenje vremena i imovinom od djelimičnog interesa putem onlajn pretražive kompjuterske baze podataka; usluge u vezi sa nekretninama i finansijske usluge u vezi sa kupovinom, prodajom i iznajmljivanjem nepokretnosti za dijeljenje vremena; upravljanje podjelom vremena u različitim jedinicama za dijeljenje vremena; pružanje informacija o apartmanima i kondominijumima, objektima za dijeljenje vremena, i zakup apartmana i kondominijuma; usluge u vezi sa nekretninama koje se odnose na razvoj nepokretnosti; davanje u zakup smještaja u ime drugih; usluge u vezi sa nekretninama i finansijske usluge koje se odnose na iznajmljivanje i prodaju komercijalnih nekretnina, trgovačkih centara, tržnih centara i drugih oblika nekretnina; pružanje informacija u vezi sa nekretninama i finansijama o apartmanima i kondominijumima, objektima za dijeljenje vremena i zakup apartmana i kondominijuma; usluge u vezi sa nekretninama i finansijske usluge koje se odnose na apartmane, rezidencije, imovinu od djelimičnog interesa, vremenski ograničeno vlasništvo nad imovinom, članove klubova za odmor, članstva u klubovima, nekretnine za dijeljenje vremena za odmor i nekretnine za dijeljenje vremena; finansijske usluge; usluge koje se odnose na hipoteke; usluge kreditnih kartica; monetarne usluge; usluge osiguranja; informacione, savjetodavne i konsultantske usluge koje se odnose na sve navedene usluge; uključujući sve gore navedene usluge koje se pružaju elektronski ili onlajn iz kompjuterske baze podataka ili putem Interneta; sve uključeno u klasu 36.

Klasa 41: Obrazovanje; pružanje obuke i kurseva; pružanje obuke i kurseva u ugostiteljskoj i spa industriji; zabava; sportske i kulturne aktivnosti; pružanje časova masaže i vježbi; pružanje fitnes i velnes seminara, seminara aerobnog plesa; pružanje zdravstvenih klubova, fitnes klubova, sala, golf i rekreativnih sadržaja i usluga; pružanje usluga kazina i kockanja; usluge podučavanja i obrazovanja koje se odnose na prehranu, zdravlje i fitnes; organizovanje i održavanje konferencija; planiranje zabava; usluge fotografisanja; proizvodnja zabavnih emisija; organizovanje i vođenje takmičenja; usluge sportskih kampova; predstavljanje nastupa uživo; usluge zabavnog parka; usluge automata za arkadne igrice; usluge objavljivanja; usluge izdavaštva; pružanje elektronskih publikacija, koje se ne mogu preuzimati; usluge filmske produkcije; usluge radio i televizijske produkcije; usluge pozorišta; obezbjeđivanje prostorija za bioskop i pozorište; obezbjeđivanje muzejskih objekata; usluge zoološkog vrta; obezbjeđivanje onlajn časopisa u oblasti putovanja, hrane, mode, umjetnosti i književnosti; obezbjeđivanje fotografija koje se ne mogu preuzimati u oblasti putovanja; informacione, savjetodavne i konsultantske usluge koje se odnose na sve navedene usluge; uključujući sve gore navedene usluge koje se pružaju elektronskim putem ili onlajn iz kompjuterske baze podataka ili putem Interneta; organizacija konvencija u poslovne i komercijalne svrhe; sve uključeno u klasu 41.

Klasa 43: Usluge pružanja hrane i pića; privremeni smještaj; usluge hotela i odmarališta, usluge hotelskog smještaja; usluge rezervisanja hotelskog smještaja; iznajmljivanje soba; rezervisanje i bukiranje privremenog smještaja; rezervisanje dugoročnog i kratkoročnog boravka u apartmanima i kondominijumima; usluge

obezbjeđivanja prostora za konferencije, usluge banketa; usluge barova, kafea, restorana, usluge koktel salona i kafića, usluge kuvanja hrane; angažovanje restorana i obroka, banketa i društvenih sadržaja za posebne prilike; informacije o hotelima, odmaralištima, smještajnim jedinicama i restoranima koje se obezbjeđuju putem onlajn pretražive kompjuterske baze podataka; pružanje veb stranice sa onlajn uslugom rezervisanja hotelskog smještaja; usluge obezbjeđivanja prostora za konvencije i izložbe; usluge brige o djeci [jaslice]; pružanje onlajn rezervacija i bukiranja privremenog stana i smještaja; rezervisanje hotela za druge; rezervisanje i bukiranje smještaja u hotelima za druge; informacione, savjetodavne i konsultantske usluge koje se odnose na sve gore navedene usluge; uključujući sve gore navedene usluge koje se pružaju elektronskim putem ili onlajn iz kompjuterske baze podataka ili putem Interneta; privremeni smještaj na kruzerima; sve uključeno u klasu 43.

(111) **14671**

(151) 06.07.2020.

(210) Ž-2018-458

(220) 27.11.2018.

(732) Društvo za telekomunikacije "Mtel" d.o.o, Ul. Kralja Nikole 27A, Podgorica, ME

(540)

m:SAT tv

(550) I

(511) Klasa 35: Telekomunikacije

Klasa 38: Oglašavanje i reklamiranje; vođenje komercijalnih poslova; komercijalna administracija; kancelarijski poslovi.

(111) **14672**

(151) 06.07.2020.

(210) Ž-2018-459

(220) 27.11.2018.

(732) Društvo za telekomunikacije "Mtel" d.o.o, Ul. Kralja Nikole 27A, Podgorica, ME

(540)

m:SAT^{tv}

(550) I

(511) Klasa 35: Telekomunikacije

Klasa 38: Oglašavanje i reklamiranje; vođenje komercijalnih poslova; komercijalna administracija; kancelarijski poslovi.

(111) **14674**

(151) 06.07.2020.

(210) Ž-2018-365

(220) 19.09.2018.

(732) BANAT 1984., Ulica Stepe Stepanovića br.6, Vršac, RS

(540)



(550) I

(511) Klasa 30: Kafa, čaj, kakao, šećer, pirinač, tapioka, sago, zamjena kafe; brašno i proizvodi od žitarica, hljeb, kolači, poslastice, sladoledi; med, melasa, kvasac, prašak za pecivo; so, senf; sirće, sosovi (kao začini); začini; led; prehrambeni proizvodi spremljeni od proizvoda koji su pripremljeni za upotrebu ili očuvanje, a naročito: pića od kakaoa, kafe, na bazi čokolade; žitarice pripremljene za ljudsku ishranu.

(111) **14675**

(151) 06.07.2020.

(210) Ž-2018-366

(220) 19.09.2018.

(732) BANAT 1984., Ulica Stepe Stepanovića br.6, Vršac, RS

(540)



(550) I

(511) Klasa 30: Kafa, čaj, kakao, šećer, pirinač, tapioka, sago, zamjena kafe; brašno i proizvodi od žitarica, hljeb, kolači, poslastice, sladoledi; med, melasa, kvasac, prašak za pecivo; so, senf; sirće, sosovi (kao začini); začini; led; prehrambeni proizvodi spremljeni od proizvoda koji su pripremljeni za upotrebu ili očuvanje, a naročito: pića od kakaoa, kafe, na bazi čokolade; žitarice pripremljene za ljudsku ishranu.

(111) **14676**

(151) 06.07.2020.

(210) Ž-2018-456

(220) 23.11.2018.

(732) Robert Balla, ul.Sent Laslo put 15. 3 sprat / 12 a, 1135, Budimpešta, HU

(540)



(550) I

(740) Valentina Dujović Radulović, ul. Špira Mugoše br. 4, Podgorica

(511) Klasa 35: Usluge oglašavanja, marketinga i promocije; Usluge poslovne analize, istraživanja i poslovnih informacija; Usluge poslovne pomoći, upravljanja i administracije; Iznajmljivanje prodajnih štandova; Veleprodajne usluge vezane uz jednokratne parirne proizvode, Maloprodajne usluge vezane za jednokratne papirne proizvode; Maloprodajne usluge u vezi s građevinskim materijalom, Veleprodajne usluge u vezi s opremom za informacionu tehnologiju; Maloprodajne usluge u vezi s opremom za informacionu tehnologiju; Maloprodajne usluge narudžbine kozmetičkih proizvoda poštom; Usluge online trgovina za maloprodaju kozmetičkih proizvoda; Maloprodajne usluge u vezi s računarskim softverom; Maloprodajne usluge u vezi sa računarskim hardverom; Maloprodajne usluge u vezi s pametnim telefonima; Maloprodajne usluge u vezi s pametnim satovima; Maloprodajne usluge u vezi s kancelarijskim priborom; Maloprodajne usluge u vezi s kućnim aparatima; Maloprodajne usluge u vezi s kućnom električnom opremom; Maloprodajne usluge povezane s prodajom pretplatničkih kutija koje sadržavaju čokolade; Veleprodajne usluge u vezi s navigacijskim uređajima; Veleprodajne usluge u vezi s računarskim softverom; usluge u vezi s računarskim hardverima; Maloprodajne usluge vezane za štampani materijal; Veleprodajne usluge u vezi s štampanim materijalom; Veleprodajne usluge u vez s kancelarijskim priborom; Maloprodajne usluge u vez s kancelarijskim priborom; Maloprodajne usluge vezane uz toaletne proizvode; Online maloprodajne usluge u vezi sa digitalnom muzikom koja se može preuzeti; Veleprodajne usluge u vezi sa školnim priborom; Online maloprodajne usluge u vezi sa zvukovima zvona koji se mogu preuzeti; Online maloprodajne usluge u vezi sa muzikom i filmovima koji se mogu preuzeti i onima koji su unaprijed snimljeni; Maloprodajne usluge u vezi sa gorivima; Veleprodajne usluge u vezi sa gorivima;

Klasa 36: Prikupljanje finansijskih sredstava i finansijsko pokroviteljstvo; Osiguravajuće usluge; Pružanje pripejd kartice i tokena; Usluge agencija za nekretnine, Usluge finansijske procjene; Finansijske i novčane usluge i bankarstvo; Usluge čuvanja u sefu; Prikupljanje finansijskih sredstava i pokroviteljstva;

Klasa 37: Istrebljivanje, dezinfekcija i uklanjanje štetočina; Vađenje prirodnih resursa, Izgradnja, građevinarstvo i rušenje; Iznajmljivanje alata, pogona i opreme za gradnju i rušenje; Usluge ukrasnog bojenja; Postavljanje pločica, cigli i blokova; Obnavljanje enterijera zgrada; Sanacija građevinskih radova; Čišćenje zidnih površina; Održavanje drvenih podova;

Klasa 45: Pravne usluge; Usluge spasavanja, sigurnosti i sprovođenje; Detektivske usluge, Konsultantske usluge u vezi sa sprječavanjem kriminala; Usluge online društvene mreže; Mentorstvo (duhovno); Usluge internetskog društvenog umrežavanja kojima se može pristupiti putem mobilnih aplikacija koje se mogu preuzeti; Stanovi (usluge čuvanja stanova u odsustvu vlasnika); Eskort usluge; Odabir ličnih poklona za druge; Pisanje ličnih pisama; Usluge ličnog predstavljanja; Usluge modnog savjetovanja u vezi sa ličnim stajlingom.

(111) **14677**

(151) 08.07.2020.

(210) Ž-2018-422

(220) 09.11.2018.

(732) British American Tobacco (Brands) Limited, Globe House 4 Temple Place, WC2R 2PG, London, GB

(540)

NEO STICKS GREEN

(550) I

(740) Miladin Popović, ul. Capital Plaza, ulica šeika Zajeda 13-IV/68, 81000, Podgorica

(511) Klasa 34: Duvan, sirov ili prerađen; proizvodi od duvana; zamjene za duvan (ne u medicinske svrhe); sve za svrhu zagrijavanja, ali ne i sagorijevanja; artikli za pušače; elektronski uređaji za zagrijavanje duvana i djelovi za njih.

(111) **14678**

(151) 08.07.2020.

(210) Ž-2018-421

(220) 09.11.2018.

(732) British American Tobacco (Brands) Limited, Globe House 4 Temple Place, WC2R 2PG, London, GB

(540)

NEO STICKS YELLOW

(550) I

(740) Miladin Popović, ul. Capital Plaza, ulica šeika Zajeda 13-IV/68, 81000, Podgorica

(511) Klasa 34: Duvan, sirov ili prerađen; proizvodi od duvana; zamjene za duvan (ne u medicinske svrhe); sve za svrhu zagrijavanja, ali ne i sagorijevanja; artikli za pušače; elektronski uređaji za zagrijavanje duvana i djelovi za njih.

(111) **14679**

(151) 08.07.2020.

(210) Ž-2018-487

(220) 10.12.2018.

(732) Nicoventures Holdings Limited, Globe House 1 Water Street, WC2R 3LA, London, GB

(540)



(550) I

(740) Miladin Popović, Đoka Miraševića 21/III, 81000, Podgorica

(511) Klasa 34: Elektronske cigarete; punjenja za elektronske cigarete; tečnosti za elektronske cigarete; cigarete koje sadrže zamjene za duvan; zamjene za duvan; cigarete; duvan; proizvodi od duvana; tabakere za cigarete; kutije za cigarete.

(111) **14680**

(151) 08.07.2020.

(210) Ž-2018-483

(220) 05.12.2018.

(732) British American Tobacco (Brands) Limited, Globe House 4 Temple Place, WC2R 2PG, London, GB

(540)

GLO MINI

(550) I

(740) Miladin Popović, ul. Capital Plaza, ulica šeiKa Zajeda 13-IV/68, 81000, Podgorica

(511) Klasa 34: Cigarete; duvan, sirov ili prerađen; proizvodi od duvana; zamjene za duvan (ne u medicinske svrhe); cigare; cigarilosi; upaljači; sibice; artikli za pušače, naime, pepeljare i kutije za cigarete; cigaret papir, cigaret tube, filteri za cigarete; džepni aparati za zamotavanje cigareta; ručne mašine za

ubrizgavanje duvana u papirne tube; elektronske cigarete; tečnosti za elektronske cigarete; duvanski proizvodi namijenjeni za zagrijavanje; uređaji i dijelovi za uređaje za zagrijanje duvana i zamjene za duvan za potrebe inhalacije.

(111) **14681**

(151) 08.07.2020.

(210) Ž-2019-376

(220) 01.10.2019.

(732) Goran Đukanović, Jelene Savojske 12, 81000, Podgorica, ME

(540)



(550) I

(511) Klasa 14: Medalje i pehari.

Klasa 35: Oglašavanje, reklamiranje, vođenje poslova, poslovno upravljanje, prodaja majica, suvenira, reklamnog materijala, on-line reklamiranje, on-line prodaja, majica, suvenira, reklamiranje materijala.

Klasa 41: Obuka, stručno osposobljavanje, razonoda, sportske i kulturne djelatnosti; organizovanje i vođenje seminara, kongresa; organizovanje sportskih takmičenja, sportskih kampova za usavršavanje u sportu; organizovanje sportskih takmičenja, informacije u vezi rekreacije.

(111) **14682**

(151) 08.07.2020.

(210) Ž-2018-466

(220) 28.11.2018.

(732) British American Tobacco (Brands) Limited, Globe House 4 Temple Place, WC2R 2PG, London, GB

(540)

NEO CLICK PURPLE

(550) I

(740) Miladin Popović, ul. Capital Plaza, ulica šeika Zajeda 13-IV/68, 81000, Podgorica

(511) Klasa 34: Duvan, sirov ili prerađen; proizvodi od duvana; zamjene za duvan (ne u medicinske svrhe); sve za potrebe zagrijavanja, ali ne spaljivanja; artikli za pušače; elektronski dijelovi i njihovi uređaji za potrebe zagrijavanja duvana.

(111) **14683**

(151) 08.07.2020.

(210) Ž-2018-108

(220) 04.04.2018.

(732) Arbnor Kastrati, Vellezrit Dragaj 25, 40.000, Mitrovica, RS

(540)

CALVIN

(550) I

(740) Božidar S. Radulović, Studentska bb, Lamela 3/18, 81000, Podgorica

(511) Klasa 34: Duvan; duvan za zamotavanje; zamjena za duvan; proizvodi od duvana; aromatizovani duvan; filteri za duvan; Lule za duvan; sirovi duvan; duvan za žvakanje; šibice; sigurnosne šibice; cigarete; cigare; proizvodi za pušače; upaljači za pušače, pepeljare za pušače; oralni vaporizeri za pušače.

(111) **14684**

(151) 08.07.2020.

(210) Ž-2018-467

(220) 28.11.2018.

(732) Eduard Orloff, Rainstrasse 51, 8706, Meilen, CH

(540)



(550) I

(740) Božidar S. Radulović, Studentska bb, Lamela 3/18, 81000, Podgorica

(511) Klasa 33: Votka.

OBJAVA UPISA PROMJENA U REGISTAR ŽIGOVA
PUBLICATION OF RECORD OF CHANGES TO THE TRADEMARK REGISTER

Prestaje da važi međunarodna registracija žiga IR 1226462 na osnovu pravosnažne presude Privrednog suda Crne Gore P. br. 821/16 kojom je ukunut navedeni žig.

DIZAJN

DESIGNS

MEĐUNARODNI KODOVI ZA IDENTIFIKACIJU BIBLIOGRAFSKIH PODATAKA O DIZAJNU PREMA WIPO CT.80

RECOMMENDATION CONCERNING BIBLIOGRAPHIC DATA RELATING TO INDUSTRIJAL DESIGNS WIPO CT.80

CRNOGORSKI	MDK	ENGLESKI
Registarski broj	11	Number of registration
Datum registracije	15	Date of the registration
Očekivani datum isteka registracije	18	Expected expiration date of the registration
Broj prijave	21	Number of the application
Datum podnošenja prijave	22	Date of filing of the application
Podaci o izložbenom pravu prvenstva	23	Exhibition priority data
Broj prijavljenih dizajna	28	Number of industrial designs included in the application
Podaci o pravu prvenstva na osnovu Pariske konvencije	30	Data relating to priority under the Paris Convention
Klasa i podklasa Lokarnske klasifikacije	51	Class and subclass of the Locarno Classification
Naziv dizajna	54	Title of the industrial design
Prikaz	55	Reproduction of the industrial design (e.g., drawing, photograph) and explanations relating to the reproduction
Ime autora dizajna	72	Name of the creator
Ime i adresa nosioca prava	73	Name and address of the owner
Ime i adresa punomoćnika	74	Name and address of the representative

OBJAVA UPISA PROMJENA U REGISTAR INDUSTRIJSKOG DIZAJNA
PUBLICATION OF RECORD OF CHANGES TO THE INDUSTRIAL DESIGN

Registarski broj dizajna	Ime i adresa nosioca industrijskog dizajna	Datum do kojeg važi obnova industrijskog dizajna
(11)	(73)	(18)
00030	Sony Computer Entertainment Inc., 2-6-21, Minami-Aoyama, Minato-ku, Tokyo 107-0062, Japan	14.03.2025.
00071	DUKAT mliječna industrija d.d. Marijana Čavića 9, 10000 Zagreb, Hrvatska, HR	29.03.2025.
00068	HONDA MOTOR CO.,LTD., 1-1, Minami-Aoyama 2-Chome, Minato-ku, Tokyo, Japan	29.04.2025.
00110	Farmaceutska hemiska kozmetička industrija "ALKALOID" AD SKOPJE, Bulevar Aleksandar Makedonski 12, 1000 Skopje, Republika Makedonija	28.06.2025.
00122	Deutsche Telekom AG, Friedrich-Ebert-Allee 140, 53113 Bonn, Njemačka	22.12.2024.

CIP - Каталогизација у публикацији
Централна народна библиотека Црне Горе, Цетиње
347.77/78(497.16)
CRNOGORSKI glasnik intelektualne svojine : Službeni glasnik
Ministarstva ekonomije Crne Gore = Official Gazete of the
Ministry of economy of Montenegro / glavni i odgovorni urednik
Biljana Jakić - 2020, br.33 - 794. - Podgorica
(Bulevar Mihaila Lalića br. 1) : Ministarstvo ekonomije, 2020. -
30 cm
Тромјесеčno.
ISSN 1800-8003 = Crnogorski glasnik intelektualne svojine
(Podgorica)
COBISS.CG-ID 15168784