



# CRNOGORSKI GLASNIK INTELEKTUALNE SVOJINE

INTELLECTUAL PROPERTY GAZETTE OF MONTENEGRO

Službeni glasnik Zavoda za intelektualnu svojinu Crne Gore  
Official Gazette of the Montenegrin Intellectual Property Office

# 11 / 2013



Zavod za intelektualnu svojinu Crne Gore  
ul. Rimski trg br. 46,  
81000 Podgorica,  
Crna Gora

# CRNOGORSKI GLASNIK INTELEKTUALNE SVOJINE

Godina IV

Datum objavljivanja: 20. 03. 2013. god.

*Izdavač:*

ZAVOD ZA INTELEKTUALNU  
SVOJINU CRNE GORE  
Rimski trg br. 46,  
81000 Podgorica, Crna Gora

*Za izdavača:*

Novak Adžić, direktor

*Glavni i odgovorni urednik:*

Novak Adžić

*Urednički odbor:*

Novak Adžić, Predrag Malbaša,  
Dušanka Perović, Milica Savić,  
Gordana Tripković

*Tehnički urednik:*

Predrag Malbaša

*Prevod:*

Gordana Tripković

*Dizajn:*

Aleksandar-Saša Samardžić

OVAJ BROJ SLUŽBENOG GLASNIKA OBJAVLJEN JE U ELEKTRONSKOJ FORMI

Crnogorski glasnik intelektualne svojine službeno je glasilo Zavoda za intelektualnu svojinu Crne Gore. U Glasniku se objavljuju sve relevantnim zakonima i pravilnicima propisane informacije iz postupka dodjele prava industrijskog vlasništva, informacije o dodijeljenim pravima te o kasnijim promjenama u vezi s tim pravima, kao i ostale službene informacije.

The Montenegrinan intellectual property gazette is the official gazette of the State Intellectual Property Office of the Montenegro. The Gazette publishes all the information, prescribed by the relevant laws and regulations, relating to the industrial property granting procedure concerning granted rights and subsequent changes made in connection with such right, as well as other official information.

## SADRŽAJ

DVOSLOVNE OZNAKE ZEMALJA, TERITORIJA I MEĐUNARODNIH ORGANIZACIJA TWO LETTER CODE COUNTRIES, TERRITORIES AND INTERNATIONAL ORGANIZATIONS .....	5
<b>PATENTI</b> <b>PATENTS .....</b>	<b>7</b>
MEĐUNARODNI KODOVI ZA IDENTIFIKACIJU BIBLIOGRAFSKIH PODATAKA O PATENTIMA PREMA WIPO STANDARDU ST. 9 RECOMMENDATION CONCERNING BIBLIOGRAFIC DATA ON AND RELATING TO PATENTS- WIPO-ST. 9.....	9
OBAVJEŠTENJE NOTICE .....	11
OBJAVE PRIJAVA PATENATA PUBLICATION OF PATENT APPLICATIONS.....	13
INDEKS NOSILACA PATENTA PATENT OWNER INDEX.....	91
INDEKS BROJEVA PRIJAVA PATENATA APPLICANTS NUMBER INDEX .....	103
INDEKS OBJAVLJENIH PRIJAVA PATENATA PREMA MKP INDEX OF PATENT APPLICANTS ACCORDINT TO IPC .....	107
OBJAVE ZAHTJEVA ZA PROŠIRENJE EVROPSKIH PRIJAVA PATENATA PUBLICATION OF REQUEST FOR THE EXTENSION OF THE EFFECTS OF EUROPEAN PATENT APPLICATIONS .....	115
INDEKS BROJEVA ZAHTJEVA ZA PROŠIRENJE EVROPSKIH PRIJAVA PATENTA INDEX ON NUMBER OF REQUESTS FOR EXTENSION ON EUROPEAN PATENT APPLICATIONS ...	227
INDEKS KLASIFIKACIJSKIH OZNAKA BROJEVA ZAHTJEVA ZA PROŠIRENJE EVROPSKIH PRIJAVA PATENTA PREMA MKP INDEX ON CLASSIFICATION MARKS ON REQUESTS FOR EXTENSION OF EUROPAN PATENT APPLICATION IN ACCORDANCE WITH THE INTERNATIONAL PATENT CLASSIFICATION ....	263
INDEKS PODNOSITELJA ZAHTJEVA ZA PROŠIRENJE EVROPSKIH PRIJAVA PATENTA INDEX ON NUMBER OF APPLICATIONS FOR EXTENSION OF EUROPEAN PATENT APPLICATION .....	345
OBJAVA POVUČENIH ZAHTJEVA ZA PROŠIRENJE EVROPSKIH PRIJAVA PATENTA PUBLICATION OF WITHDRAWN REQUESTS FOR EXTENSION OF EUROPEAN PATENT APPLICATION .....	403
OBJAVA PROŠIRENIH EUROPSKIH PATENATA PUBLICATION OF EXTENDED EUROPEAN PATENTS.....	405

<b>ŽIGOVI</b>	
<b>TRADEMARKS</b> .....	<b>491</b>
MEĐUNARODNI KODOVI ZA IDENTIFIKACIJU BIBLIOGRAFSKIH PODATAKA O ŽIGOVIMA PREMA WIPO ST 60 RECOMMENDATION CONCERNING BIBLIOGRAFIC DATA RELATING TO TRADEMARKS- WIPO-ST. 60 .....	493
OBAVJEŠTENJE NOTICE .....	495
OBJAVA PRIJAVA ŽIGOVA PUBLICATION OF TRADEMARK APPLICATIONS .....	497
OBJAVA ŽIGOVA PUBLICATION OF TRADEMARKS .....	633
OBJAVA ISPRAVKI CORRECTIONS.....	903
OBJAVA UPISA U REGISTAR ŽIGOVA CRNE GORE PUBLICATION OF THE ENTRY TRADEMARK REGISTER MONTENEGRO .....	905
<b>DIZAJN</b>	
<b>DESIGNS</b> .....	<b>933</b>
MEĐUNARODNI KODOVI ZA IDENTIFIKACIJU BIBLIOGRAFSKIH PODATAKA O DIZAJNU PREMA WIPO CT.80 RECOMMENDATION CONCERNING BIBLIOGRAPHIC DATA RELATING TO INDUSTRIJAL DESIGNS WIPO CT.80 .....	935
OBJAVE OBNOVE VAŽENJA INDUSTRIJSKOG DIZAJNA PUBLICATION OF INDUSTRIAL DESIGN RENEWAL .....	937
<b>INFORMATOR</b>	
<b>INFORMATION</b> .....	<b>939</b>

**DVOSLOVNE OZNAKE ZEMALJA, TERITORIJA I MEĐUNARODNIH  
ORGANIZACIJA  
(prema WIPO standardu ST. 3)**

<b>AD</b>	Andora	<b>CF</b>	Centralna Afrička Republika	<b>GB</b>	Velika Britanija
<b>AE</b>	Ujedinjeni Arapski Emirati	<b>CG</b>	Kongo	<b>GC</b>	Patentna kancelarija Savjeta za saradnju država Arapskog Zaliva (GCC)
<b>AF</b>	Afganistan	<b>CH</b>	Švajcarska	<b>GD</b>	Grenada
<b>AG</b>	Antigva i Barbuda	<b>CI</b>	Obala Bjelokosti	<b>GE</b>	Gruzija
<b>AI</b>	Angvila	<b>CK</b>	Kukova ostrva	<b>GG</b>	Guernsey
<b>AL</b>	Albanija	<b>CL</b>	Čile	<b>GH</b>	Gana
<b>AM</b>	Armenija	<b>CM</b>	Kamerun	<b>GI</b>	Gibraltar
<b>AN</b>	Holandski Antili	<b>CN</b>	Kina	<b>GL</b>	Grenland
<b>AO</b>	Angola	<b>CO</b>	Kolumbija	<b>GM</b>	Gambija
<b>AP</b>	Afrička regionalna organizacija za industrijsko vlasništvo (ARIPO)	<b>CR</b>	Kostarika	<b>GN</b>	Gvineja
<b>AR</b>	Argentina	<b>CU</b>	Kuba	<b>GQ</b>	Ekvatorska Gvineja
<b>AT</b>	Austrija	<b>CV</b>	Kabo Verde	<b>GR</b>	Grčka
<b>AU</b>	Australija	<b>CY</b>	Kipar	<b>GS</b>	Južna Džordžija i Ostrva Južni Sendvič
<b>AW</b>	Aruba	<b>CZ</b>	Češka Republika	<b>GT</b>	Gvatemala
<b>AZ</b>	Azerbejdžan	<b>DE</b>	Njemačka	<b>GW</b>	Gvineja-Bisao
<b>BA</b>	Bosna i Hercegovina	<b>DJ</b>	Džibuti	<b>GY</b>	Gvajana
<b>BB</b>	Barbados	<b>DK</b>	Danska	<b>HK</b>	Hongkong – Posebna administrativna regija
<b>BD</b>	Bangladeš	<b>DM</b>	Dominika	<b>HN</b>	NR Kine Honduras
<b>BE</b>	Belgija	<b>DO</b>	Dominikanska Republika	<b>HR</b>	Hrvatska
<b>BF</b>	Burkina Faso	<b>DZ</b>	Alžir	<b>HT</b>	Haiti
<b>BG</b>	Bugarska	<b>EA</b>	Evroazijska patentna organizacija (EAPO)	<b>HU</b>	Mađarska
<b>BH</b>	Bahrein	<b>EC</b>	Ekvador	<b>IB</b>	Međunarodna kancelarija Svjetske organizacije za intelektualno vlasništvo (WIPO)
<b>BI</b>	Burundi	<b>EE</b>	Estonija	<b>ID</b>	Indonezija
<b>BJ</b>	Benin	<b>EG</b>	Egipat	<b>IE</b>	Irska
<b>BM</b>	Bermudi	<b>EH</b>	Zapadna Sahara	<b>IL</b>	Izrael
<b>BN</b>	Brunej Darussalam	<b>EM</b>	Kancelarija za harmonizaciju Unutrašnjeg tržišta (žigovi i dizajn) (OHIM)	<b>IM</b>	Ostrvo Man
<b>BO</b>	Bolivija	<b>EP</b>	Evropska patentna kancelarija (EPO)	<b>IN</b>	Indija
<b>BR</b>	Brazil	<b>ER</b>	Eritreja	<b>IQ</b>	Irak
<b>BS</b>	Bahami	<b>ES</b>	Španija	<b>IR</b>	Iran (Islamska Republika)
<b>BT</b>	Butan	<b>ET</b>	Etiopija	<b>IS</b>	Island
<b>BV</b>	Ostrvo Buve	<b>FI</b>	Finska	<b>IT</b>	Italija
<b>BW</b>	Bocvana	<b>FJ</b>	Fidži	<b>JE</b>	Džersi
<b>BX</b>	Kancelarija za intelektualno vlasništvo Beneluksa (BOIP)	<b>FK</b>	Foklandska ostrva (Malvini)	<b>JM</b>	Jamajka
<b>BY</b>	Bjelorusija	<b>FO</b>	Farska Ostrva	<b>JO</b>	Jordan
<b>BZ</b>	Belize	<b>FR</b>	Francuska		
<b>CA</b>	Kanada	<b>GA</b>	Gabon		
<b>CD</b>	Demokratska Republika Kongo				

<b>JP</b>	Japan	<b>NA</b>	Namibija	<b>SY</b>	Sirijska Arapska Republika
<b>KE</b>	Kenija	<b>NE</b>	Niger	<b>SZ</b>	Svazi
<b>KG</b>	Kirgistan	<b>NG</b>	Nigerija	<b>TC</b>	Turska i Kajkoska Ostrva
<b>KH</b>	Kambodža	<b>NI</b>	Nikaragva	<b>TD</b>	Čad
<b>KI</b>	Kiribati	<b>NL</b>	Holandija	<b>TG</b>	Togo
<b>KM</b>	Komori	<b>NO</b>	Norveška	<b>TH</b>	Tajland
<b>KN</b>	Sveti Kristofor i Nevis	<b>NP</b>	Nepal	<b>TJ</b>	Tadžikistan
<b>KP</b>	Demokratska Narodna Republika Koreja	<b>NZ</b>	Novi Zeland	<b>TL</b>	Istočni Timor
<b>KR</b>	Republika Koreja	<b>OA</b>	Afrička organizacija za intelektualno vlasništvo (OAPI)	<b>TM</b>	Turkmenistan
<b>KW</b>	Kuvajt	<b>OM</b>	Oman	<b>TN</b>	Tunis
<b>KY</b>	Kajmanska Ostrva	<b>PA</b>	Panama	<b>TO</b>	Tonga
<b>KZ</b>	Kazahstan	<b>PE</b>	Peru	<b>TR</b>	Turska
<b>LA</b>	Narodna Demokratska Republika Laos	<b>PG</b>	Papuanska Nova Gvineja	<b>TT</b>	Trinidad i Tobago
<b>LB</b>	Libanon	<b>PH</b>	Filipini	<b>TV</b>	Tuvalu
<b>LC</b>	Sveta Lucija	<b>PK</b>	Pakistan	<b>TW</b>	Tajvan, Kineska Pokrajina
<b>LI</b>	Lihtenštajn	<b>PL</b>	Poljska	<b>TZ</b>	Ujedinjena Republika Tanzanija
<b>LK</b>	Šri Lanka	<b>PT</b>	Portugal	<b>UA</b>	Ukrajina
<b>LR</b>	Liberija	<b>PW</b>	Palau	<b>UG</b>	Uganda
<b>LS</b>	Lesoto	<b>PY</b>	Paragvaj	<b>US</b>	Sjedinjene Američke Države
<b>LT</b>	Litva	<b>QA</b>	Katar	<b>UY</b>	Urugvaj
<b>LU</b>	Luksemburg	<b>QZ</b>	Kancelarija Zajednice za biljne sorte (Evropska Unija) (CPVO)	<b>UZ</b>	Uzbekistan
<b>LV</b>	Latvija	<b>RO</b>	Rumunija	<b>VA</b>	Sveta Stolica (Vatikan)
<b>LY</b>	Libijska Arapska Džamahirija	<b>RS</b>	Srbija	<b>VC</b>	Sveti Vincent i Grenadini
<b>MA</b>	Maroko	<b>RU</b>	Ruska Federacija	<b>VE</b>	Venecuela
<b>MC</b>	Monako	<b>RW</b>	Ruanda	<b>VG</b>	Britanska Djevičanska Ostrva
<b>MD</b>	Republika Moldavija	<b>SA</b>	Saudijska Arabija	<b>VN</b>	Vijetnam
<b>ME</b>	Crna Gora	<b>SB</b>	Solomonska Ostrva	<b>VU</b>	Vanuatu
<b>MG</b>	Madagaskar	<b>SC</b>	Sejšeli	<b>WO</b>	Svjetska organizacije za intelektualno vlasništvo (WIPO) (Međunarodna kancelarija)
<b>MK</b>	Bivša Jugoslovenska Republika Makedonija	<b>SD</b>	Sudan	<b>WS</b>	Samoa
<b>ML</b>	Mali	<b>SE</b>	Švedska	<b>XN</b>	Nordijski institut za patente (NPI)
<b>MM</b>	Mianmar	<b>SG</b>	Singapur	<b>YE</b>	Jemen
<b>MN</b>	Mongolija	<b>SH</b>	Sveta Jelena	<b>ZA</b>	Južnoafrička Republika
<b>MO</b>	Makao	<b>SI</b>	Slovenija	<b>ZM</b>	Zambija
<b>MP</b>	Sjeverna Marijanska Ostrva	<b>SK</b>	Slovačka	<b>ZW</b>	Zimbabve
<b>MR</b>	Mauritanija	<b>SL</b>	Sijera Leone		
<b>MS</b>	Montserrat	<b>SM</b>	San Marino		
<b>MT</b>	Malta	<b>SN</b>	Senegal		
<b>MU</b>	Mauricijus	<b>SO</b>	Somalija		
<b>MV</b>	Maldivi	<b>SR</b>	Surinam		
<b>MW</b>	Malavi	<b>ST</b>	Sveti Toma i Princip		
<b>MX</b>	Meksiko	<b>SV</b>	Salvador		



# PATENTI

## PATENTS

Službeni glasnik Zavoda za intelektualnu svojinu Crne Gore  
Official Gazette of the Montenegrin Intellectual Property Office

# 11 / 2013



Zavod za intelektualnu svojinu Crne Gore  
ul. Rimski trg br. 46,  
81000 Podgorica,  
Crna Gora





**MEĐUNARODNI KODOVI ZA IDENTIFIKACIJU BIBLIOGRAFSKIH PODATAKA O PATENTIMA PREMA WIPO STANDARDU ST. 9**  
RECOMMENDATION CONCERNING BIBLIOGRAFIC DATA ON AND RELATING TO PATENTS- WIPO-ST. 9

CRNOGORSKI	MDK	ENGLSKI
IDENTIFIKATOR DOKUMENTA	<b>10</b>	IDENTIFICATION OF THE PATENT
BROJ DOKUMENTA	<b>11</b>	NUMBER OF THE PATENT
VRST DOKUMENTA	<b>13</b>	KIND-OF-DOCUMENT CODE ACCORDING TO WIPO STANDARD
BROJ PRIJAVE	<b>21</b>	NUMBER(S) ASSIGNED TO THE APPLICATION(S)
DATUM PODNOŠENJA PRIJAVE	<b>22</b>	DATE(S) OF FILING THE APPLICATION(S)
DATUM IZLAGANJA NA MEĐUNARODNOJ IZLOŽBI	<b>23</b>	DATE OF EXHIBITING AT THE INTERNATIONAL EXHIBITION
PODACI O PRAVU PRVJENSTVA	<b>30</b>	PRIORITY DATA
DATUM OBJAVLJIVANJA PRIJAVE	<b>43</b>	PUBLICATION DATE OF THE UNEXAMINED APPLICATION
DATUM OBJAVLJIVANJA PATENTA	<b>45</b>	PUBLICATION DATE OF REGISTERED PATENT
MEĐUNARODNA KLASIFIKACIJA PATENATA	<b>51</b>	INTERNATIONAL PATENT CLASSIFICATION CODE
NAZIV PRONALASKA	<b>54</b>	TITLE OF THE INVENTION
APSTRAKT ILI PATENTNI ZAHTJEV	<b>57</b>	ABSTRACT OR CLAIM
BROJ OSNOVNE PRIJAVE (ILI PATENTA) ZA KOJI SE PODNOSI DOPUNSKA PRIJAVA	<b>61</b>	NUMBER OF THE EARLIER APPLICATION (OR PATENT) TO WHICH THE PRESENT DOCUMENT IS AN ADDITION
BROJ PRVOBITNE PRIJAVE IZ KOJE JE PRIJAVA IZDOJENA	<b>62</b>	NUMBER OF THE EARLIER APPLICATION FROM WHICH THE PRESENT DOCUMENT HAS BEEN DIVIDED UP
IME PODNOSIOCA PRIJAVE	<b>71</b>	NAME OF THE APPLICANT
IME PRONALAZAČA	<b>72</b>	NAME OF THE INVENTOR
IME NOSIOCA PATENTA	<b>73</b>	NAME OF THE OWNER OF PATENT
IME PUNOMOĆNIKA	<b>74</b>	NAME OF THE REPRESENTATIVE
BROJ I DATUM PODNOŠENJA MEĐUNARODNE PRIJAVE	<b>86</b>	NUMBER AND FILING DATE OF THE INTERNATIONAL APPLICATION
BROJ I DATUM MEĐUNARODNE OBJAVE	<b>87</b>	NUMBER AND DATE OF THE PUBLICATION OF THE INTERNATIONAL APPLICATION

VRSTA DOKUMENTA		TYPES OF DOCUMENTS
OBJAVA PRIJAVA PATENATA	<b>A</b>	PUBLICATION OF PATENT APPLICATIONS
REGISTROVANI PATENTI	<b>B</b>	REGISTERED PATENTS



**OBAVJEŠTENJE**  
NOTICE

Obavještavamo korisnike da se od 6-og broja Crnogorskog glasnika za intelektualnu svojinu koji se objavljuje na web stranici Zavoda za intelektualnu svojinu Crne Gore, u elektronskoj formi, odnosno od 10.10.2011 godine (Glasnik broj 6/2011) uvode promjene u objavi patentnih dokumenata.

Tako, objavljena prijava patenta (dokument A) sadrži i broj pod kojim je patent upisan u Registar patenata, (međunarodni kod 11 – broj dokumenta), koji je do sada bio objavljivan u svakom narednom broju Crnogorskog glasnika za intelektualnu svojinu. Kako Zavoda za intelektualnu svojinu Crne Gore, ispituje samo formalne uslove za priznavanje patenta, izmjenu uvodimo da bi svi podaci o priznatom patentu bili u istom broju Crnogorskog glasnika za intelektualnu svojinu, a ujedno i pojednostavili put do dodjele isprave, sve u skladu sa članom 40 Zakona o patenima ("Sl. list CG" broj 66/2008 i 40/2010).



- (51) **C07K 16/18**  
**A61K 39/395**  
**G01N 33/577**  
**C12N 5/18**  
**C07K 14/47**  
**A61P 25/28**
- (11) **01095**  
(13) **A**
- (21) P-2010-69  
(22) 24.10.2008.  
(30) 07119537.4 29.10.2007 EP  
(86) PCT/EP2008/064432 24.10.2008  
(87) WO 2009/056490 07.05.2009
- (54) (ME) **NOVA ANTITIJELA SPECIFIČNA ZA  $\beta$ -AMILOIDNE PEPTIDE I NJIHOVA PRIMJENA KAO DIJAGNOSTIČKIH SREDSTAVA ILI LJEKOVA**  
(EN) NEW ANTIBODIES SPECIFIC OF THE  $\beta$ -AMYLOID PEPTIDES AND THEIR USES AS DIAGNOSTIC AGENTS OR DRUGS
- (73) INNOGENETICS NV; Industriepark Zwijnaarde 7, Box 4, B-9052 GENT-ZWIJNAARDE (BE)  
INSERM (INSTITUT NATIONAL DE LA SANTE ET DE LA RECHERCHE MEDICALE); 101, rue de Tolbiac F-75654 PARIS CEDEX 13 (FR)  
SANOFI-AVENTIS; 174, Avenue de France, F-75013 PARIS (FR)
- (72) VANMECHELEN, Eugeen; Ten Edestraat 101 B-9810 NAZARETH-EKE (BE)  
GROGNET, Pierre; 5 clos de l'Algarve B-1140 BRUXELLES EVERE (BE)  
SERGEANT, Nicolas; 9, rue Jean Jaurès F-59790 RONCHIN (FR)  
GOMPEL, Marie; 5, rue Canonniers F-59000 LILLE (FR)  
DELACOURTE, André; 75, rue Gambetta F-59115 FACHES THUMESNIL (FR)  
BUEE, Luc; 17, avenue Bel Air F-59175 TEMPLEMARS (FR)  
PRADIER, Laurent; 23, avenue Cambacérès F-91370 VERRIERES (FR)  
BLANCHARD-BREGEON, Véronique; c/o SANOFI-AVENTIS Patent Department 174, avenue de France F-75013 PARIS (FR)
- (74) Popović Miladin, Đoka Miraševića 21/III, Podgorica (ME)
- (57) Predmetni pronalazak odnosi se na monoklonsko antitijelo koje se specifično vezuje za N-terminalni region A $\beta$ 8-x peptida, gde se x sastoji od 11 do 42, i ne prepoznaje ni A $\beta$ 1-40 ni A $\beta$ 1-42, i koje pokazuje visok afinitet prema A $\beta$ 8-x peptidu, kako je određeno formiranjem imunološkog kompleksa između monoklonskog antitela i peptida A $\beta$ 8-x .

- (51) **C07D 489/00**  
**C07D 489/08**  
**A61K 31/485**  
**C07B 63/02**  
**A61P 29/00**
- (11) **01096**  
(13) **A**
- (21) P-2010-77  
(22) 06.11.2008.  
(30) 0758923 09.11.2007. (FR)  
61/021,949 18.01.2008. (US)  
(86) PCT/FR2008/001558 06.11.2008  
(87) WO 2009/092912 30.07.2009
- (54) (ME) **POSTUPAK DOBIJANJA JEDINJENJA MORFINA**  
(EN) METHOD FOR THE PREPARATION OF MORPHINE COMPOUNDS
- (73) SANOFI-AVENTIS; 174, avenue de France F-75013 Paris (FR)  
(72) DLUBALA, Alain; c/o Sanofi-Aventis Département Brevets 174, avenue de France F-75013 Paris (FR)  
(74) Ćupić Branislav, Dalmatinska 10, Podgorica (ME)
- (57) Predmetni pronalazak se odnosi na postupak dobijanja jedinjenja morfina sa niskim sadržajem a,3-nezasićena jedinjenja, a koji obuhvataju sledeće korake: (i) dovođenje sirovog jedinjenja morfina u kontakt sa bazom, na pH veće od 13, pod uslovima koji omogućavaju reakciju Michael-ove adicije na prisutna a, B-nezasićena jedinjenja; (ii) razdvajanje jedinjenja morfina iz reakcione smješe; i (iii) po potrebi, razdvajanje dobijenog adicionog proizvoda od jedinjenja morfina. Takođe se odnosi na kompozicije koje sadrže najmanje 99% suve težine jedinjenja morfina ili jedne od njegovih farmaceutski prihvatljivih soli i a,p-nezasićeno jedinjenje u količini manjoj od 100 ppm.

- (51) **A01N 43/54**  
**A61K 31/505**  
**C07D 239/42**
- (11) **01097**  
(13) **A**
- (21) P-2010-122  
(22) 23.01.2009.  
(30) 61/023,617 25.01.2008. US  
(86) PCT/US2009/031819 23.01.2009  
(87) WO 2009/094528 30.07.2009
- (54) (ME) **TRICIKLIČNA JEDINJENJA KAO MODULATORI SINTEZE TNF- $\alpha$  I KAO INHIBITORI PDE4**  
(EN) TRICYCLIC COMPOUNDS AS MODULATORS OF TNF- $\alpha$  SYNTHESIS AND AS PDE4 INHIBITORS
- (73) HIGH POINT PHARMACEUTICALS, LLC; 4170 Mendenhall Oaks Pkwy High Point, North Carolina 27265 (US)  
(72) MJALLI, Adnan M M; 6421 Ashton Park Drive Oak Ridge, North Carolina 27310 (US)  
GADDAM, Bapu; 3749 Single Leaf Circle High Point, North Carolina 27265 (US)  
POLISETTI, Dharma Rao; 3741 Deerfield St. High Point, North Carolina 27265 (US)  
KOSTURA, Matthew; 4201 New Hope Springs Drive Hillsborough, North Carolina 27278 (US)  
GUZEL, Mustafa; 4058 Gunsmith Court Jamestown, North Carolina 27282 (US)
- (74) Čejović Vladimir, 13. jul 21, Podgorica (ME)
- (57) Ovaj pronalazak se odnosi na hemijska jedinjenja sa Formulom (I), kao što su ovde definisana, na farmaceutske smješe i postupke za korišćenje u liječenju stanja ili poremećaja, koji su posredovani sa TNF- $\alpha$  ili PDE4, uključujući, ali bez ograničavanja, reumatioidnu artritis.

(51) **C07D 471/04**  
**C07D 213/28**  
**C07D 233/56**  
**A61K 31/437**  
**A61P 25/00**  
**A61P 19/00**  
**A61P 35/00**

(11) **01098**  
 (13) **A**

(21) P-2010-151

(22) 20.03.2009

(30) 0801580 21.03.2008. FR

(86) PCT/FR2009/000297 20.03.2009.

(87) WO 2009/144391 03.12.2009.

(54) (ME) **VIŠESTRUKO SUPSTITUISANI DERIVATI 2-ARIL-6-FENIL-IMIDAZO[1,2- A] PIRIDINA, I NJIHOVO DOBIJANJE I TERAPEUTSKA PRIMJENA**

(EN) POLYSUBSTITUTED DERIVATIVES OF 2-ARYL-6-PHENYL-IMIDAZO[L,2- A] PYRIDINES, AND PREPARATION AND THERAPEUTIC USE THEREOF

(73) SANOFI-AVENTIS; 174 avenue de France, F-75013 Paris (FR)

(72) DE PERETTI, Danielle; c/o Sanofi-aventis, Département Brevets, 174 avenue de France, F-75013 Paris (FR)

EVANNO, Yannick; c/o Sanofi-aventis Département Brevets, 174 avenue de France, F-75013 Paris (FR)

(74) Ćupić Branislav, Dalmatinska 10, Podgorica (ME)

(57) Jedinjenja formule (I) u kojoj : R1 predstavlja : fenil grupu ili naftil grupu , po izboru supstituisanu , jednim ili više atoma ili grupa; X predstavlja od 1 do 4 supstituenta, ista ili koji se razlikuju jedan od drugog, odabrana od halogena,(C1-C10)alkila, halo(C1- C10)alkila, (C1-C10)alkoksi , NRaRb, cijano, nitro, moguće je za (C1- C10)alkil da bude po izboru supstituisana halogenom ili NRaRb ili hidroksil grupom; R2 i R3 predstavljaju, nezavisno jedan od drugog, atom vodonika ili (C1- C10)alkil grupu, ova grupa je po izboru supstituisana sa Rf grupom, ili aril grupu , aril je po izboru supstituisan jednim ili više supstituenata odabranih od halogena ili (C1- C10)alkil, halo(C1-C10)alkil, (C1- C10)alkoksi, halo(C1- C10)alkoksi, NRaRb, hidroksil, nitro ili cijano grupe; R2 i X mogu zajedno da formiraju, sa atomima ugljenika koji ih nose, ugljenični prsten sa 5 do 7 atoma ugljenika; R4 predstavlja atom vodonika, (C1-C10)alkil grupu , po izboru supstituisanu sa Rf grupom, ili po izboru supstituisanu aril grupu , u obliku baze ili adicione soli sa kiselinom.

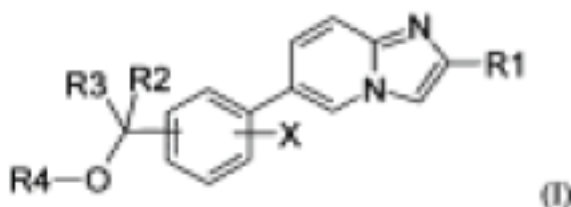



- (51) **B28B 11/12**  
**B28B 19/00**  
**B28B 21/02**  
**E04H 12/12**

(11) **01099**

(13) **A**

(21) P-2010-159

(22) 01.04.2009.

(30) 10 2008 016 828.9 01.04.2008. DE

(86) PCT/EP2009/002374 01.04.2009.

(87) WO 2009/121581 08.10.2009.

(54) (ME) **POSTUPAK ZA PROIZVODNJU GOTOVIH BETONSKIH BLOKOVA**  
 (EN) METHOD FOR PRODUCING CONCRETE PREFINISHED PARTS

(73) WOB BEN, Aloys; Argestrasse 19 26607 Aurich (DE)

(72) WOB BEN, Aloys; Argestrasse 19 26607 Aurich (DE)

HÖLSCHER, Norbert; Rüskenpad 5 26607 Aurich (DE)

(74) Čupić Branislav, Dalmatinska 10, Podgorica (ME)

(57) Pronalazak se odnosi na postupak za proizvodnju gotovih betonskih elemenata, naročito segmenata za tornjeve. Beton se uliva u jedan kalup za livenje sa potpuno ravnim dnom radi izrade potpuno ravne donje strane gotovog betonskog odlivka. Kada beton dostigne predhodno zadatu minimalnu čvrstoću, vrši se nanošenje izjednačavajućeg sloja (500) na naležuću površinu (110) koja je suprotna u odnosu na donju stranu gotovog betonskog elementa (100). Čim izjednačavajući sloj (500) dostigne predhodno zadatu minimalnu čvrstoću, postavlja se gotov betonski element (100) na jednu ravnu horizontalno usmerenu površinu i vrši se obrada gornje strane izjednačavajućeg sloja (110) potpuno paralelno sa donjom stranom gotovog betonskog elementa.

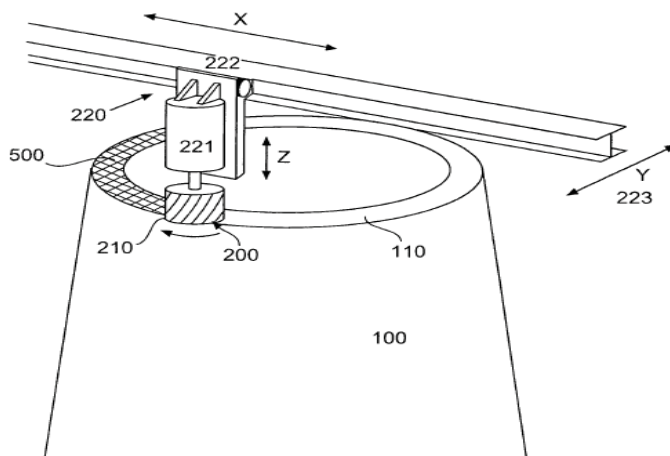

- (51) **A61K 31/343**  
**A61K 45/06**  
**A61P 43/00**  
**A61P 9/06**
- (11) **01100**  
(13) **A**
- (21) P-2010-160  
(22) 16.04.2009.  
(30) 08/02128 17.04.2008. FR  
61/045,999 18.04.2008. US  
(86) PCT/FR2009/000450 16.04.2009.  
(87) WO 2009/133310 05.11.2009
- (54) (ME) **KOMBINACIJA DRONEDARONA SA NAJMANJE JEDNIM DIURETIKOM I NJIHOVA TERAPEUTSKA PRIMJENA**  
(EN) COMBINATION OF DRONEDARONE WITH AT LEAST ONE DIURETIC, AND THERAPEUTIC USE THEREOF
- (73) SANOFI-AVENTIS, 174 Avenue de France F-75013 Paris (FR)  
(72) RADZIK, Davide; C/o Sanofi-Aventis Département Brevets 174 avenue de France F-75013 Paris (FR)  
VAN EICKELS, Martin; C/o Sanofi-aventis Deutschland GmbH 65926 Frankfurt (DE)  
(74) Ćupić Branislav, Dalmatinska 10, Podgorica (ME)  
(57) Kombinacija dronedarona ili njegove farmaceutski prihvatljive soli, sa najmanje jednim diuretikom i njihova terapijska primjena.

- (51) **C07D 401/14**  
**C07D 403/14**  
**C07D 413/14**  
**A61K 31/506**  
**A61K 31/5355**  
**A61K 31/553**  
**A61P 9/00**  
**A61P 13/12**  
**A61P 7/06**
- (11) **01130**  
(13) **A**
- (21) P-2010-165  
(22) 11.04.2009.  
(30) 10 2008 020 113.8 23.04.2008. DE  
(86) PCT/EP2009/002693 11.04.2009.  
(87) WO/2009/129945 29.10.2009.
- (54) (ME) **SUPSTITUCIJA DIHIDROPIRAZOLINA KAO INHIBITORA HIF-PROLIL-4-HIDROKSILAZA**  
(EN) SUBSTITUTED DIHYDROPYRAZOLONES AS INHIBITORS OF HIF-PROLYL-4-HYDROXYLASES
- (73) BAYER SCHERING PHARMA AKTIENGESELLSCHAFT Müllerstrasse 178, 13353 Berlin (DE)  
(72) JESKE, Mario; Schneebacher Weg 20 42699 Solingen (DE)  
FLAMME, Ingo; Auf den Schmitten 1 51580 Reichshof (DE)  
STOLL, Friederike; Remscheid Strasse 22 40215 Düsseldorf (DE)  
BECK, Hartmut; Lokomotivstr. 64 50733 Köln (DE)  
AKBABA, Metin; Meygner Busch 46 40880 Ratingen (DE)
- (74) Radulović Božidar, Jovana Tomaševića 9/III, Podgorica (ME)
- (57) Predstavljena aplikacija se odnosi na inovaciju substituisanih derivata dihidropirazolona, procese njihove pripreme, njihovo korištenje za tretman i/ili profilaksu oboljenja i njihovu upotrebu za pripremu medikamenata za tretman i/ili profilaksu oboljenja, posebno kardiovaskulrnih i hematoloških oboljenja i oboljenja bubrega, kao i za napredak u liječenju rana.

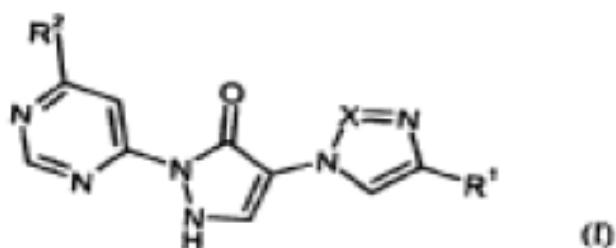

(51) **B01D 21/01**

(11) **01124**

(13) **A**

(21) P-2010-165

(22) 11.03.2009.

(30) 3900-2008 24.12.2008. CL

(86) PCT/US2009/036809 11.03.2009.

(87) WO 2010/074770 01.07.2010.

(54) **(ME) EFIKASNI POSTUPAK ZA FILTRIRANJE VODE U BAZENU ZA REKREACIJSKE I UKRASNE SVRHE, U KOJEM SE FILTRIRANJE VRŠI NA MALOM VOLUMENU VODE A NE NA UKUPNOM VOLUMENU VODE U BAZENU**

(EN) EFFICIENT FILTRATION PROCESS OF WATER IN A TANK FOR RECREATIONAL AND ORNAMENTAL USES, WHERE THE FILTRATION IS PERFORMED OVER A SMALL VOLUME OF WATER AND NOT OVER THE TOTALITY OF THE WATER FROM THE TANK

(73) CRYSTAL LAGOONS CORPORATION LLC; 16192 Coastal Highway Lewes, DE 19958-9776 (US)

(72) FISCHMANN TORRES, Fernando, Benjamin; Avda. Kennedy 8830 Las Condes, Santiago (CL)

(74) Čejović Vladimir, 13. jul 21, Podgorica (ME)

(57) Predmetni izum obuhvata efikasan postupak za filtriranje vode iz bazena, u kojem se filtriranje vrši na malom volumenu vode, a ne na cjelokupnoj količini vode u bazenu; taj postupak uključuje sledeće korake: (a) emitiranje ultrazvučnih valova u bazenu; (b) dodavanje sredstva za flokulaciju u vodu; (c) prelazak dna bazena s napravom za usisavanje koja usisava vodeni tok vode s flokuliranim česticama, izbacivanje u cijev za prikupljanje otpada; (d) filtriranje otpadnog protoka naprave za usisavanje iz navedene cijevi za prikupljanje otpada; i (e) vraćanje filtriranog toka u bazen. Predmetni izum osim toga uključuje i napravu za usisavanje koja se koristi u navedenom efikasnom postupku za filtriranje.

- (51) **C07D 215/48**  
**C07D 241/44**  
**C07D 403/12**  
**C07D 403/14**  
**A61K 31/4709**  
**A61K 31/498**  
**A61P 35/00**

- (11) **01121**  
(13) **A**

- (21) P-2010-175  
(22) 20.05.2009.  
(30) 08156846.1 23.05.2008 EP  
(86) PCT/EP2009/056154 20.05.2009.  
(87) WO 2009/141386 26.11.2009.

(54) (ME) **DERIVATI HINOLINA I HINOKSALINA KAO INHIBITORI PROTEIN TIROZIN KINAZE**

(EN) DERIVATIVES OF QUINOLINES AND QUINOXALINES AS PROTEIN TYROSINE KINASE INHIBITORS

- (73) NOVARTIS AG; Lichtstrasse 35 CH-4056 Basel (CH)  
(72) FURET, Pascal; Novartis Pharma AG Werk Klybeck Postfach CH-4002 Basel (CH)  
GRAUS PORTA, Diana; Novartis Pharma AG Werk Klybeck Postfach CH-4002 Basel (CH)  
GUAGNANO, Vito; Novartis Pharma AG Werk Klybeck Postfach CH-4002 Basel (CH)  
(74) Čejović Vladimir, 13. jul 21, Podgorica (ME)  
(57) Pronalazak se odnosi na jedinjenja formule (I) u kojoj su supstituenti definisani u prijavi, u slobodnom obliku ili u obliku njene farmaceutski prihvatljive soli, solvata, N-oksida; postupke za njihovo dobijanje; na farmaceutska sredstva koja sadrže ta jedinjenja, posebno za upotrebu u jednom ili više oboljenja posredovanih Protein tirozin kinazom.

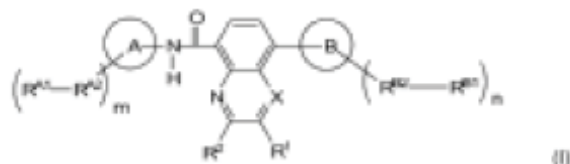

- (51) **A61K 31/343**  
**A61P 9/06**  
**A61P 43/00**  
**A61K 45/06**
- (11) **01126**  
(13) **A**
- (21) P-2010-180  
(22) 28.04.2009.  
(30) 08290407.9 28.04.2008. EP  
61/048,732 28.04.2008. US  
(86) PCT/IB2009/005930 28.04.2009.  
(87) WO 2009/133470 05.11.2009.
- (54) (ME) **UPOTREBA DRONEDERONA ZA DOBIJANJE LJEKOVA ZA LIJEČENJE PACIJENATA SA ARITMIJOM I PACIJENATA KOJI IMAJU POVEĆAN NIVO KREATININA USLED PRIMJENE DRONEDARONA**  
(EN) USE OF DRONEDARONE ALONE OR IN COMBINATION FOR PREPARING A MEDICAMENT FOR THE TREATMENT OF PATIENTS WITH ARRHYTHMIA AND HAVING AN INCREASE OF CREATININE LEVEL
- (73) SANOFI-AVENTIS; 174 Avenue de France F-75013 Paris (FR)  
(72) CLAUDEL, Sophie; c/o Sanofi-aventis, Département des Brevets, 174 avenue de France F-75013 Paris (FR)  
GAUDIN, Christophe; c/o Sanofi-aventis, Département des Brevets, 174 avenue de France F-75013 Paris (FR)  
(74) Ćupić Branislav, Dalmatinska 10, Podgorica (ME)  
(57) Upotreba dronedarona ili jedne od njegovih farmaceutski prihvatljivih soli za dobijanje lijeka za liječenje pacijenata sa aritmijom, navedeni pacijenti imaju povećanu vrijednost kreatinina zbog primjene dronedarona, navedena vrijednost kreatinina raste nakon početka liječenja dronedaronom, navedeni rast nivoa kreatinina dostiže gornju granicu (plato) i koristi se kao nova osnovna vrijednost, navedeno povećanje nivoa kreatinina je reverzibilno nakon prekida liječenja dronedaronom.

- (51) **A61K 31/56**  
**A61P 35/00**  
**A61K 31/4196**
- (11) **01122**  
(13) **A**
- (21) P-2010-181  
(22) 27.04.2009.  
(30) 61/048,452 28.04.2008. US  
(86) PCT/US2009/041836 27.04.2009.  
(87) WO 2009/134723 05.11.2009.
- (54) (ME) **JEDINJENJA I POSTUPCI ZA LIJEČENJE RAKA DOJKE**  
(EN) **PROGESTERONE ANTAGONISTS SUCH AS CDB-4124 IN THE TREATMENT OF BREAST CANCER**
- (73) REPOS THERAPEUTICS INC.; 2408 Timberloch Place, Suite B-7 The Woodlands, TX 77380 (US)
- (72) PODOLSKI, Joseph, S.; 3 Pebble Hollow Court The Woodlands, TX 77381 (US)  
WIEHLE, Ronald, D.; 13903 Viewfield Court Houston, TX 77059 (US)
- (74) Čejović Vladimir, 13. jul 21, Podgorica (ME)
- (57) Tema ovog izuma je relevantna za područje liječenja raka. Ovaj je izum posebno relevantan za liječenje i/ili prevenciju raka dojke kod pacijenata. Takođe su objelodanjenja jedinjenja za primjenu postupaka, uključujući selektivne modulare receptora progesterona, koji funkcionišu kao agonisti progesterona u materici i kao antagonisti progesterona u tkivu dojke i pokazuju samo niski afinitet za glukokortikoide i receptore estrogena. Oblici ovog izuma takođe objelodanjuju postupke za sprječavanje razvitka raka dojke kod pacijenata koji su podvrgnuti hormonskoj zamjenskoj terapiji ili estrogenskoj terapiji.

- (51) **A61K 31/56**  
**A61P 15/00**  
**A61P 15/04**  
**A61P 35/00**
- (11) **01123**  
(13) **A**
- (21) P-2010-182  
(22) 27.04.2009.  
(30) 61/048,472 28.04.2008. US  
(86) PCT/US2009/041826 27.04.2009.  
(87) WO/2009/134718 05.11.2009.
- (54) (ME) **REŽIM DOZIRANJA ANTIPROGESTINA**  
(EN) **PROGESTERONE ANTAGONISTS SUCH AS CDB-4124 IN THE TREATMENT OF ENDOMETRIOSIS, UTERINE FIBROIDS, DYSMENORRHEA, BREAST CANCER ETC**
- (73) **REPROS THERAPEUTICS INC.; 2408 Timberloch Place, Suite B-7 The Woodlands, TX 77380 (US)**
- (72) **PODOLSKI, Joseph, S.; 3 Pebble Hollow Court, The Woodlands, TX 773814 (US)**
- (74) **Čejović Vladimir, 13. jul 21, Podgorica (ME)**
- (57) Ovaj izum se odnosi na metode uzimanja jedinjenja uključujući antagonist receptora progesterona za upotrebu u liječenju estrogen-zavisnog stanja. Izum je takođe usmjeren na postupke tretiranja bolova koji se dovode u vezu s endometnozom. Jedinjenja se mogu davati ženama s endometnozom kao i ženama koje su izvrngute terapiji estrogenom i/ili selektivnim modulatorima receptora estrogena (SERM). U nekim svojim oblicima, izum daje postupak za potiskivanje endometrijske proliferacije.



(51) **A61K 9/00**  
**A61K 9/16**

(11) **01131**

(13) **A**

(21) P-2011-57

(22) 02.10.2009.

(30) 08382040.7 02.10.2008. EP  
61/104,113 09.10.2008. US

(86) PCT/EP2009/062821 02.10.2009.

(87) WO 2010/037845 08.04.2010.

(54) (ME) **ČESTICE ZA INHALIRANJE KOJE SADRŽE TIOTROPIJUM**  
(EN) **INHALABLE PARTICLES COMPRISING TIOTROPIUM**

(73) LABORATORIOS LICONSA, S.A.; Gran Via Carles III, 98 Ed. Trade E-08028 Barcelona (ES);  
Gran Via Carles III, 98 Ed. Trade E-08028 Barcelona (ES)

(72) AMIGHI, Karim; Clos Alberto Santos Dumont, 8 B-1150 Brussels (BE)  
SERENO GUERRA, Antonio; C. Pasiewijk, 21 B-1820 Melsbroeck (BE)

(74) Radulović Božidar, Jovana Tomaševića 9/III-1, Podgorica (ME)

(57) Ovaj pronalazak odnosi se na čestice za inhaliranje koje sadrže stabilizovanu amorfnu formu tiotropijuma s agensom za stabiliziranje. Pronalazak se takođe odnosi čestice za inhaliranje koje sadrže stabilizovanu amorfnu formu tiotropijuma s agensom za stabiliziranje koji je pomiješan s jednim ili više grubih ekscipijenata kojima je veličina čestica od 15 do 250 $\mu$ m. Pronalazak se takođe odnosi na farmaceutsku smjesu koja sadrži čestice za inhaliranje ovoga pronalaska, na proces njihova priređivanja te na njihovu upotrebu za priređivanje medikamenata namijenjenih tretiranju astme ili hronicne opstruktivne plućne bolesti (COPD).

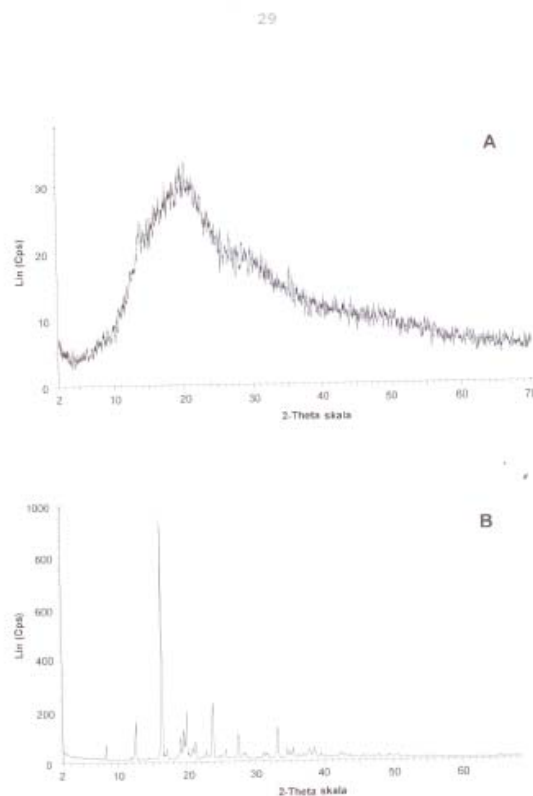

- (51) **A61K 31/7036**  
**A61P 11/00**  
**A61K 9/127**  
**A61K 47/44**
- (11) **01166**  
(13) **A**
- (21) P-2011-64  
(22) 13.10.2009.  
(30) 12/250,412 13.10.2008 US  
(86) PCT/US2009/060468 13.10.2009.  
(87) WO 2010/045209 22.04.2010.
- (54) (ME) **POSTUPCI LIJEČENJA PLUĆNIH POREMEĆAJA S LIPOSOMSKIM AMIKACIN FORMULACIJAMA**  
(EN) METHODS OF TREATING PULMONARY DISORDERS WITH LIPOSOMAL AMIKACIN FORMULATIONS
- (73) Insmmed Incorporated; Princeton Corporate Plaza, 11 Deer Park Drive, Suite 117 Monmouth Junction, NJ 08852-1923 (US)  
(72) GUPTA, Renu; 412 Salem Crossings Road Moorestown, NJ 08057 (US)  
(74) Čejović Vladimir, 13. jul 21, Podgorica (ME)
- (57) U predmetnom patentu opisani su postupci za liječenje plućnih poremećaja koji uključuju davanje bolesniku učinkovite doze nebuliziranog pripravka liposomskog amikacina u trajanju od najmanje jednog terapijskog ciklusa, pri čemu navedeni terapijski ciklus uključuje razdoblje davanja lijeka u trajanju od 15 do 75 dana, nakon čega slijedi razdoblje bez davanja lijeka u trajanju od 15 do 75 dana; učinkovita doza obuhvaća količinu amikacina u rasponu od 100 do 2.500 mg koji se daje svaki dan tokom razdoblja davanja lijeka.

(51) **C07C 205/12**  
**C07C 211/61**  
**C07C 17/25**  
**C07C 22/02**  
**C07C 23/08**

(11) **01141**  
 (13) **A**

(21) P-2011-68

(22) 28.09.2009.

(30) 08018721.4 27.10.2008. EP

09161388.5 28.05.2009. EP

(86) PCT/EP2009/062525 28.09.2009.

(87) WO 2010/049228 06.05.2010.

(54) (ME) **POSTUPAK ZA DOBIJANJE BENZONORBORNENA**

(EN) PROCESS FOR THE PREPARATION OF BENZONORBORNENES

(73) SYNGENTA PARTICIPATIONS AG; Schwarzwaldallee 215 CH-4058 Basel (CH)

(72) GRIBKOV, Denis; Syngenta Crop Protection Münchwilen AG, Breitenloh 5, CH-4333 Münchwilen (CH)

ANTELMANN, Björn; Syngenta Crop Protection Münchwilen AG, Breitenloh 5, CH-4333 Münchwilen (CH)

GIORDANO, Fanny; Syngenta Crop Protection Münchwilen AG, Breitenloh 5, CH-4332 Münchwilen (CH)

WALTER, Harald; Syngenta Crop Protection Münchwilen AG, Schaffhauserstrasse, CH-4332 Stein (CH)

DE MESMAEKER, Alain; Syngenta Crop Protection Münchwilen AG, Schaffhauserstrasse CH-4332 Stein (CH)

(74) Čejović Vladimir, 13. jul 21, Podgorica (ME)

(57) Ovaj pronalazak se odnosi na nov postupak dobijanja 9-dihlorometilen-1,2,3,4-tetrahidro-1,4-metano-naftalen- 5-ilamina, koji obuhvata

a) reakciju ciklopentadiena u prisustvu radikalnog inicijatora i CXCl<sub>3</sub>, gde je X hloro ili bromo, da bi se dobilo jedinjenje formule II

aa) reakciju ciklopentadiena sa CXCl<sub>3</sub>, gde je X hloro, u prisustvu metalnog katalizatora da bi se dobilo jedinjenje formule II gdje je X hloro,

b) reakciju jedinjenja formule II sa bazom u prisustvu odgovarajućeg rastvarača da bi se dobilo jedinjenje formule III

c) i prevođenje jedinjenja formule III u prisustvu 1,2-dehidrobenzena u jedinjenje formule IV

i d) hidrogenizaciju jedinjenja formule IV u prisustvu metalnog katalizatora.

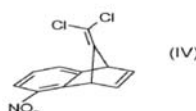
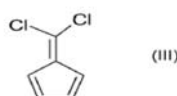

- (51) **C07D 401/14**  
**C07D 403/14**  
**C07D 407/14**  
**C07D 413/12**  
**C07D 413/14**  
**C07D 417/14**  
**A61P 25/00**  
**A61K 31/445**  
**A61K 31/497**  
**A61K 31/506**  
**A61K 31/501**  
**A61K 31/498**  
**A61K 31/4709**  
**A61K 31/502**  
**A61P 29/00**
- (11) **01132**  
(13) **A**
- (21) P-2011-70  
(22) 13.11.2009.  
(30) 0806371 14.11.2008. FR  
(86) PCT/FR2009/052179 13.11.2009.  
(87) WO 2010/055267 20.05.2010.
- (54) (ME) **KARBAMATNI DERIVATI ALKIL-HETEROCIKLA, NJHOVO DOBIJANJE I TERAPEUTSKA UPOTREBA**  
(EN) CARBAMATE DERIVATIVES OF ALKYL-HETEROCYCLES, PREPARATION THEREOF AND THERAPEUTIC USE THEREOF
- (73) SANOFI-AVENTIS; 174 avenue de France F-75013 Paris (FR)  
(72) ABOUABDELLAH, Ahmed; c/o sanofi-aventis Département Brevets 174 avenue de France F-75013 Paris (FR)  
CHEREZE, Nathalie; c/o sanofi-aventis Département Brevets 174 avenue de France F-75013 Paris (FR)  
FAYOL, Aude; c/o sanofi-aventis Département Brevets 174 avenue de France F-75013 Paris (FR)  
SAADY, Mourad; c/o sanofi-aventis Département Brevets 174 avenue de France F-75013 Paris (FR)  
VACHE, Julien; c/o sanofi-aventis Département Brevets 174 avenue de France F-75013 Paris (FR)  
VERONIQUE, Corinne; c/o sanofi-aventis Département Brevets 174 avenue de France F-75013 Paris (FR)  
YAICHE, Philippe; c/o sanofi-aventis Département Brevets 174 avenue de France F-75013 Paris (FR)
- (74) Ćupić Branislav, Dalmatinska 10, Podgorica (ME)
- (57) Jedinjenja opšte formule (I) u kojoj R2 predstavlja atom vodonika ili fluora ili hidrosil, cijano, trifluor-metil, C1-6-alkil, C1-6 alkoksi ili NR8 R9 grupu; n predstavlja broj 1,2 ili 3 i m predstavlja broj 1 ili 2; A predstavlja kovalenentnu vezu ili a C1-8-alkilen grupu; R1 predstavlja fenil, piridil, piridazinil, pirimidinil, pirazinil, triazinil, naftil, hinolinil, izohinolinil, ftalazinil, hinazolinil, hinoksalinil, cinnolinil ili naftiridinil grupu, ova grupa je po izboru subpstituisana; R3 predstavlja atom vodonika ili fluora, C1-6-alkil grupu ili trifluor-metil

grupu; R4 predstavlja grupu odabranu od furil, pirolil, tienil, izotiazolil, oksazolil, izoksazolil, pirazolil, oksadiazolil, tiadiazolil, imidazole, triazolil, tetrazolil, oksazon, oksazolidinon, izoksazon, izoksazolidinon, izotiazolon, izotiazolidinon, imidazon, imidazolidinon, pirazon, pirazolidinon, oksadiazolon, tiadiazolon i triazon grupe, ova grupa je po izboru supstituisana; u obliku baze ili adicione soli kiseline.  
Upotreba u terapiji.

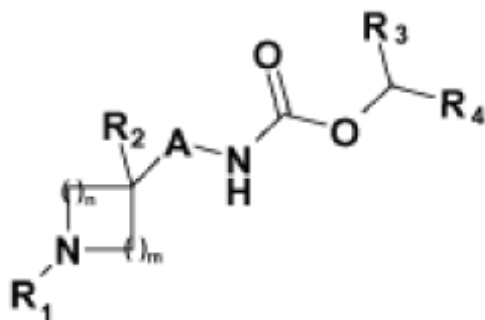

(I)

- (51) **A61K 51/04** (11) **01128**  
**G01N 33/60** (13) **A**
- (21) P-2011-72  
(22) 27.10.2009.  
(30) 08291013.4 28.10.2008. EP  
(86) PCT/IB2009/007562 27.10.2009.  
(87) WO 2010/049819 06.05.2010
- (54) (ME) **UPOTREBA 7-HLOR-N,N,5-TRIMETIL-4-OKSO-3-FENIL-3,5-DIHIDRO-4H-PIRIDAZINO[4,5-B]INDOL-1-ACETAMIDA KAO BIOMARKERA ZA NIVOE PERIFERNIH BENZODIAZEPINSKIH RECEPTORA**  
(EN) USE OF 7-CHLORO-N,N,5-TRIMETHYL-4-OXO-3-PHENYL-3,5-DIHYDRO-4H-PYRIDAZINO [4,5-B]INDOLE-1-ACETAMIDE AS A BIOMARKER OF PERIPHERAL BENZODIAZEPINE RECEPTOR LEVELS
- (73) SANOFI-AVENTIS , 174 avenue de France F-75013 Paris (FR)  
COMMISSARIAT A L'ENERGIE ATOMIQUE ET AUX ENERGIES ALTERNATIVES, Bâtiment Le po-  
nant D-25 rue Leblanc F-75015 Paris (FR)
- (72) BENAVIDES, Jesus; c/o Sanofi-Aventis Patent Department 174, Avenue de France F-75013 Paris (FR)  
BOUTIN, Hervé; 8 Hawphom drive, Manchester M191GX (GB)  
CASTEL, Marie-Noëlle; c/o Sanofi-Aventis Patent Department 174, Avenue de France F-75013 Paris (FR)  
DAMONT, Annelaure; 13 rue de la tour F-78117 Châteaufort (FR)  
DOLLE, Frédéric; 10, allée de Villeneuve F-91940 Gometz-le-Châtel (FR)  
HANTRAYE, Philippe; 8 Allée Jean François de la Pérouse F-91420 Morangis (FR)  
MARGUET, Frank; c/o Sanofi-Aventis Patent Department 174, Avenue de France F-75013 Paris (FR)  
ROONEY, Thomas; c/o Sanofi-Aventis Patent Department 174, Avenue de France F-75013 Paris (FR)  
RIVRON, Luc; c/o Sanofi-Aventis Patent Department 174, Avenue de France F-75013 Paris (FR)  
TAVITIAN, Bertrand; 186 rue de Vaugirard F-75015 Paris (FR)  
THOMINIAUX, Cyrille; 12 rue de la République, F-78470 Saint Rémy les Chevreuse (FR)
- (74) Ćupić Branislav, Dalmatinska 10, Podgorica (ME)
- (57) Upotreba radioobeleženog oblika 7-hlor-N,N,5-trimetil-4-okso-3-fenil-3,5-dihidro-4H-piridazino[4,5-b]indol-1-acetamida kao biomarkera za utvrđivanje nivoa PBR povezanih sa normalnim i patološkim stanjima kod pojedinaca. Postupak za određivanje nivoa F u vezi sa normalnim i patološkim stanjima. Dijagnostički komplet

- (51) **C07D 235/22**  
**C07D 403/04**  
**C07D 487/08**  
**A61K 31/496**  
**A61P 25/00**
- (11) **01129**  
(13) **A**
- (21) P-2011-75  
(22) 10.11.2009.  
(30) 61/113,296 11.11.2008. US  
(86) PCT/US2009/063816 10.11.2009.  
(87) WO 2010/056644 20.05.2010.
- (54) (ME) **1-(ARILSULFONIL)-4-(PIPERAZIN-1-IL)-1H-BENZIMIDAZOLI KAO LIGANDI**  
**TIPA 5- HIDROKSITRIPTAMINA -6**  
(EN) **1-(ARYLSULFONYL)-4-(PIPERAZIN-1-YL)-1H-BENZIMIDAZOLES AS 5- HYDROXYTRYPTAMINE -6 LIGANDS**
- (73) WYETH LLC; Patent Law Department Five Giralda Farms Madison, New Jersey 07940 (US)  
(72) HAYDAR, Simon N.; 23 Warwick Court Newtown, Pennsylvania 18940 (US)  
ANDRAE, Patrick M.; 110 Perrineville Road Jamesburg, New Jersey 08831 (US)  
YUN, Heedong; 8 Demott Street Tenafly, New Jersey 07670 (US)  
ROBICHAUD, Albert J.; 3 Riverview Court Ringoes, New Jersey 08551 (US)
- (74) Ćupić Branislav, Dalmatinska 10, Podgorica (ME)
- (57) Ovaj izum odnosi se na spojeve 1-(arilsulfonil)-4-(piperazin-1-il)-1H-benzimidazola Formule I, ili na njihove tautomere stereoizomere ili farmaceutski prihvatljive soli, gdje su varijacije sastava definirane u ovoj specifikaciji, na pripravke koji sadrže navedene spojeve, te na postupke dobivanja i upotrebe navedenih spojeva.

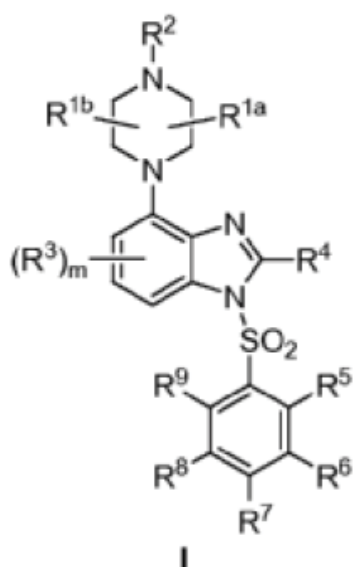

- (51) **C07K 16/28**  
**A61P 37/08**
- (11) **01167**  
(13) **A**
- (21) P-2011-76  
(22) 27.10.2009.  
(30) 12/260,307 29.10.2008 US  
(86) PCT/US2009/062168 27.10.2009.  
(87) WO 2010/053751 14.05.2010.
- (54) (ME) **HUMANA ANTITIJELA VISOKOG AFINITETA ZA HUMANI IL-4 RECEPTOR**  
(EN) HIGH AFFINITY HUMAN ANTIBODIES TO HUMAN IL-4 RECEPTOR
- (73) REGENERON PHARMACEUTICALS, INC.; 777 Old Saw Mill River Road Tarrytown, NY 10591 (US)
- (72) MARTIN, Joel, H.; 244 Church Road Putnam Valley, NY 10579 (US)  
HUANG, Tammy, T.; 10 Green Hill Road Golden Bridge, NY 10526 (US)  
FAIRHURST, Jeanette, L.; 23 Parkview Court White Plains, NY 10603 (US)  
PAPADOPOULOS, Nicholas, J.; 59 Heritage Lane Lagrangeville, NY 12540 (US)
- (74) Čejović Vladimir, 13. jul 21, Podgorica (ME)
- (57) Izolovano humano antitijelo ili njegov fragment antitijela, koje se vezuje za humani interleukin-4 receptor alfa (hIL-4R $\alpha$ ) sa visokim afinitetom (KD), koje može da blokira aktivnost hIL-4 i Hil-13.



(51) **G01R 21/133** (11) **01168**  
**G01R 22/06** (13) **A**  
**H02J 13/00**

(21) P-2011-78

(22) 29.10.2008.

(86) PCT/EP2008/064669 29.10.2008.

(87) WO 2010/048993 06.05.2010.

(54) (ME) **STRUJOMJER, DALJINSKI UPRAVLJIV MODUL ZA DISKONEKCIJU I ELEKTRIČNA INSTALACIJA SA STRUJOMJEROM**

(EN) **ELECTRICITY METER, REMOTE CONTROLLABLE DISCONNECTOR MODULE AND ELECTRICAL INSTALLATION COMPRISING THE ELECTRICITY METER**

(73) ENEL DISTRIBUZIONE S.P.A.; Via Ombrone, 2 I-00198 Rome (IT)

(72) VERONI, Fabio; Via Aldo Motta n.24/A, I-20059 Vimercate - Milano (IT)

(74) Radulović Božidar, Jovana Tomaševića 9/III, Podgorica (ME)

(57) Strujomer (3), instaliran u ili pri zgradi (100), za mjerenje potrošnje struje dostavljene potrošaču (A, B) sadrži mjerac snage (81) za određivanje vrijednosti snage dovedene u električno kolo (16); uređaj (82) za određivanje količine električne energije dovedene u električno kolo (16); monitoring uređaj (82) za praćenje da li je snaga dovedena električnom kolu (16) u okviru određenog limita; uređaj za izdavanje komandi (82), za izdavanje komande za diskonekciju kao odgovor na prekoračenje specifikovanog limita snage; i transmitter (6) za odašiljanje pomenute komande za diskonekciju pomoću kabla za komunikaciju, preko pomenutog električnog kola (16), povezanog sa pomenutim izlazom snage (32), do najmanje jednog, daljinski upravljivog modula (9), postavljenog u električno kolo (16, 14).

Fig. 1

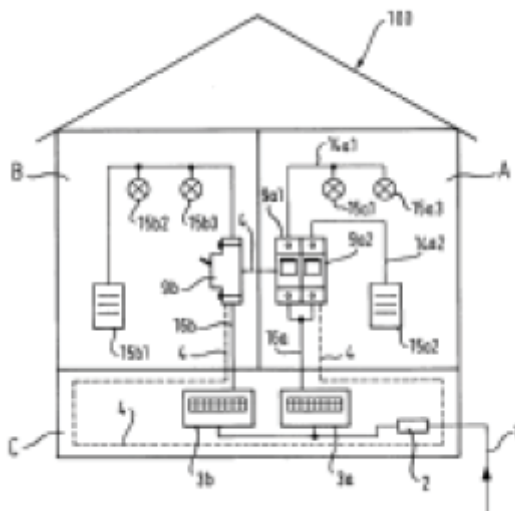

(51) **C07D 401/04**  
**A61K 31/454**  
**C07D 401/14**  
**C07D 405/14**  
**C07D 471/04**

(11) **01134**

(13) **A**

(21) P-2011-81

(22) 12.11.2009.

(30) 08169143.8 14.11.2008. EP

61/193,333 19.11.2008. US

(86) PCT/EP2009/065031 12.11.2009.

(87) WO 2010/055083 20.05.2010.

(54) (ME) **NOVI SASTOJCI PYRAZOLONA I NJIHOVA UPOTREBA KAO PD4 INHIBITORA**  
 (EN) **NOVEL PYRAZOLONE-DERIVATIVES AND THEIR USE AS PD4 INHIBITORS**

(73) NYCOMED GMBH ; Byk-Gulden-Str. 2 78467 Konstanz (DE)

(72) DR. SCHLEMMINGER, Imre; Mannheimer Str. 24 78467 Konstanz (DE)

DR. SCHMIDT, Beate; Allensbacher Str. 5 78476 Allensbach (DE)

DR. FLOCKERZI, Dieter; Ackerweg 26 78476 Allensbach (DE)

DR. TENOR, Hermann; Kapellenweg 15/1 78315 Radolfzell (DE)

DR. ZITT, Christof; Mainaustr. 209 D 78464 Konstanz (DE)

DR. HATZELMANN, Armin; Alter Wall 3 78467 Konstanz (DE)

DR. MARX, Degenhard; Obere Reute 15 78345 Moos (DE)

DR. BRAUN, Clemens; Sepp-Biehler-Str. 3 78464 Konstanz (DE)

DR. KÜLZER, Raimund; Nycomed GmbH P.O. Box 100310 78403 Konstanz Kontanz (DE)

DR. HEUSER, Anke; Hofweg 8 22085 Hamburg (DE)

DR. KLEY, Hans-Peter; Hafnerstraße 12 78476 Allensbach (DE)

DR. STERK, Geert Jan; Stadhouderslaan 38 NL-3583 Jj Utrecht (NL)

(74) Radulović Božidar, Jovana Tomaševića 9/III, Podgorica (ME)

(57) Sastojci formule 1, u kojoj R1, R10, R11, A i R12 imaju značenja koja su data u opisu, su efektivni inhibitori tipa 4 phosphodiesterase.

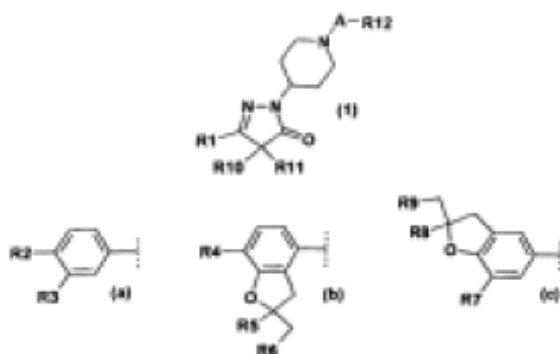

(51) B26B 27/00

(11) 01152

(13) A

(21) P-2011-88

(22) 26.11.2009.

(30) 0822316.6 08.12.2008. GB

(86) PCT/GB2009/002757 26.11.2009.

(87) WO 2010/067046 17.06.2010.

(54) (ME) **UREĐAJ I POSTUPAK ZA ISIJECANJE STAKLENIH PANELA MOTORNIM VOZILA**

(EN) VEHICLE GLAZING PANEL CUT OUT APPARATUS AND TECHNIQUE

(73) BELRON HUNGARY KFT-ZUG BRANCH; Gotthardstrasse 20 CH-6304 Zug (CH)

(72) FINCK, William ; 31 Doddinghurst Road Brentwood Essex CM15 9EP (GB)

(74) Popović Miladin, Đoka Miraševića 21/III, Podgorica (ME)

(57) Predmetni pronalazak odnosi se na uređaj za isijecanje staklenih panela, koji se, u kombinaciji sa žicom za siječenje (41), koristi za isijecanje vjetrobranskih stakala iz nosećih ramova motornih vozila. Pomenuti uređaj sadrži dispensersku jedinicu tj. sklop sa namotajima žice za siječenje (2), kao i sklop za namotavanje (1), pomoću koga se vrši namotavanje žice odmotane sa namotaja dispensorskog sklopa. Tokom izvođenja predmetnog postupka isijecanja staklenog panela, oba navedena uređaja, dispensorski sklop i sklop za namotavanje žice za siječenje, montiraju se na sam stakleni panel koji se isijeca. Uređaj za namotavanje sadrži jedan ili više kalemova (4, 5) na koje se namotava žica za siječenje (41) odmotana sa namotaja dispensorskog sklopa (2). Žica za siječenje kojom se vrši isijecanje staklenog panela odmotava se sa namotaja dispensorskog sklopa (2) koji je tokom izvođenja predmetnog postupka montiran na panelu koji se isijeca.

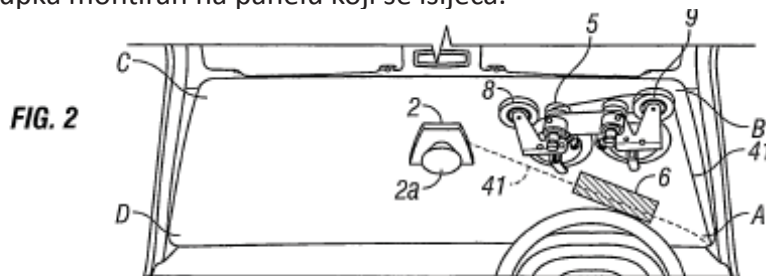

- (51) **A01N 43/42** (11) **01145**  
**A61K 31/44** (13) **A**
- (21) P-2011-89  
(22) 17.11.2009.  
(30) 61/116,810 21.11.2008. US  
(86) PCT/US2009/064776 17.11.2009.  
(87) WO 2010/059618 27.05.2010.
- (54) (ME) **JEDINJENJA ADAMANTIL BENZAMIDA**  
(EN) ADAMANTYL BENZAMIDE COMPOUNDS
- (73) HIGH POINT PHARMACEUTICALS, LLC; 4170 Mendenhall Oaks Parkway High Point, North Carolina 27265 (US)  
(72) POLISETTI, Dharma Rao; 3741 Deerfield Street High Point, North Carolina 27265 (US)  
GUPTA, Suparna; 2518 Brandt Forest Court Greensboro, North Carolina 27455 (US)  
EBDRUP, Soren; Nymarksvej 11 DK-4000 Roskilde (DK)
- (74) Čejović Vladimir, 13. jul 21, Podgorica (ME)
- (57) Ostvarenje ovog pronalaska obezbjeđuje derivate adamantil benzamida i farmaceutske smješe koje sadrže derivate adamantil benzamida. Takođe su obezbijedjeni i postupci upotrebe ovih jedinjenja i smješa za moduliranje aktivnosti 11 $\beta$ -hidroksisteroid dehidrogenaze tip 1 (11 $\beta$ HSD1) kod ispitanika.

- (51) **A61K 39/00**  
**A61K 31/00**  
**A61P 35/00**
- (11) **01136**  
(13) **A**
- (21) P-2011-93  
(22) 27.11.2009.  
(30) 08291116.5 28.11.2008. EP  
(86) PCT/IB2009/055389 27.11.2009.  
(87) WO 2010/061357 03.06.2010.
- (54) (ME) **ANTITUMORSKE KOMBINACIJE KOJE SADRŽE ANTITIJELA KOJA SPECIFIČNO PREPOZNAJU CD38 I MELFALAN**  
(EN) ANTITUMOR COMBINATIONS CONTAINING ANTIBODIES RECOGNIZING SPECIFICALLY CD38 AND MELPHALAN
- (73) SANOFI–AVENTIS; 174 avenue de France, F-75013 Paris (FR)  
(72) LEJEUNE, Pascale; c/o Sanofi-Aventis Patent Department 174 avenue de France, F-75013 Paris (FR)  
VRIGNAUD, Patricia; c/o Sanofi-Aventis Patent Department 174 avenue de France, F-75013 Paris (FR)  
(74) Ćupić Branislav, Dalmatinska 10, Podgorica (ME)  
(57) Farmaceutska kompozicija koja sadrži antitijelo koje specifično prepoznaje CD38 i melfalan.

- (51) **A61K 39/00**  
**A61K 31/00**  
**A61P 35/00**
- (11) **01137**  
(13) **A**
- (21) P-2011-94  
(22) 27.11.2009.  
(30) 08291117.3 28.11.2008.EP  
(86) PCT/IB2009/055390 27.11.2009.  
(87) WO 2010/061358 03.06.2010.
- (54) (ME) **ANTITUMORSKA KOMBINACIJA KOJA SADRŽI ANTITIJELA KOJA SPECIFIČNO PREPOZNAJU CD38 I VINKRISTIN**  
(EN) ANTITUMOR COMBINATIONS CONTAINING ANTIBODIES RECOGNIZING SPECIFICALLY CD38 AND VINCRISTINE
- (73) SANOFI-AVENTIS; 174 avenue de France F-75013 Paris (FR)  
(72) LEJEUNE, Pascale; c/o Sanofi-Aventis Département Brevets 174 Avenue de France, F-75013 Paris (FR)  
VRIGNAUD, Patricia; c/o Sanofi-Aventis Département Brevets 174 Avenue de France, F-75013 Paris (FR)  
(74) Ćupić Branislav, Dalmatinska 10, Podgorica (ME)  
(57) Farmaceutske kompozicije koje sadrže antitijelo koje specifično prepoznaje CD38 i vinkristin.

- (51) **A61K 39/00**  
**A61K 31/00**  
**A61P 35/00**
- (11) **01138**  
(13) **A**
- (21) P-2011-95  
(22) 27.11.2009.  
(30) 08291118.1 28.11.2008. EP  
(86) PCT/IB2009/055391 27.11.2009.  
(87) WO 2010/061359 03.06.2010.
- (54) (ME) **ANTITUMORSKE KOMBINACIJE KOJE SADRŽE ANTITIJELA KOJA SPECIFIČNO PREPOZNAJU CD38 I CITARABIN**  
(EN) ANTITUMOR COMBINATIONS CONTAINING ANTIBODIES RECOGNIZING SPECIFICALLY CD38 AND CYTARABINE
- (73) SANOFI-AVENTIS;174 avenue de France F-75013 Paris (FR)  
(72) LEJEUNE, Pascale; C/o Sanofi-Aventis Patent Department 174 avenue de France, F-75013 Paris (FR)  
VRIGNAUD, Patricia; C/o Sanofi-Aventis Patent Department 174 avenue de France, F-75013 Paris (FR)  
(74) Ćupić Branislav, Dalmatinska 10, Podgorica (ME)  
(57) Farmaceutska kompozicija koja sadrži antitijelo koje specifično prepoznaje CD38 i citarabin.

- (51) **A61K 39/00**  
**A61P 35/00**  
**A61K 31/00**
- (11) **01139**  
(13) **A**
- (21) P-2011-96  
(22) 27.11.2009  
(30) 08291119.9 28.11.2008. EP  
(86) PCT/IB2009/055392 27.11.2009.  
(87) WO 2010/061360 03.06.2010.
- (54) (ME) **ANTITUMORSKE KOMBINACIJE KOJE SADRŽE ANTITIJELA KOJA SPECIFIČNO PREPOZNAJU CD38 I CIKLOFOSFAMID**  
(EN) ANTITUMOR COMBINATIONS CONTAINING ANTIBODIES RECOGNIZING SPECIFICALLY CD38 AND CYLOPHOSPHAMIDE
- (73) SANOFI–AVENTIS; 174 avenue de France F-75013 Paris (FR)  
(72) LEJEUNE, Pascale; c/o Sanofi-Aventis Patent Department 174 avenue de France, F-75013 Paris (FR)  
VRIGNAUD, Patricia; c/o Sanofi-Aventis Patent Department 174 avenue de France, F-75013 Paris (FR)  
(74) Ćupić Branislav, Dalmatinska 10, Podgorica (ME)  
(57) Farmaceutska kompozicija koja sadrži antitijelo koje specifično prepoznaje CD38 i ciklofosfamid.



- (51) **C12N 7/04**  
**C07K 14/18**  
**C12N 15/86**  
**A61K 39/12**  
**C07K 16/10**  
**G01N 33/50**
- (11) **01140**  
(13) **A**
- (21) P-2011-98  
(22) 23.11.2009.  
(30) 61/119,594 03.12.2008. US  
61/173,363 28.04.2009. US  
(86) PCT/IB2009/055291 23.11.2009.  
(87) WO 2010/064164 10.06.2010.
- (54) (ME) **VIRUS GOVEĐE VIRUSNE DIJAREJE S MODIFIVANIM ERNS PROTEINIM**  
(EN) BOVINE VIRAL DIARRHEA VIRUS WITH A MODIFIED ERNS PROTEIN
- (73) PFIZER INC. ; 235 East 42nd Street New York, New York 10017 (US)
- (72) ANKENBAUER, Robert Gerard; Pfizer Global Research and Development, 7000 Portage Road Kalamazoo, Michigan 49001 (US)  
LUO, Yugang; Pfizer Global Research and Development, 7000 Portage Road Kalamazoo, Michigan 49001 (US)  
WELCH, Siao-Kun Wan; 9087 South 6th Street Kalamazoo, Michigan 49009 (US)  
YUAN, Ying; Pfizer Global Research and Development, 7000 Portage Road Kalaaoo, Michigan 49001 (US)
- (74) Ćupić Branislav, Dalmatinska 10, Podgorica (ME)
- (57) Predstavljeni pronalazak se odnosi na himerne pestiviruse koji imaju primjenu kao imunogene kompozicije i vakcine. Ovde su takođe opisani i postupci i kompleti za liječenje ili prevenciju sirenja virusne infekcije goveđe virusne dijereje, kao i postupci i kompleti za razlikovanje vakcinisanih životinja i životinja inficiranih divljim tipom virusa.

(51) **F16L 9/12**(11) **01150**(13) **A**

(21) P-2011-102

(22) 02.06.2011.

(54) (ME) **SPREGNUTI ARMIRANO BETONSKI I PLASTIČNI REBRASTI CJEVOVODI**  
(EN) PIPELINES MADE OF JOINT REINFORCED CONCRETE AND PLASTIC RIBBED TUBES

(73) Antunović Stojan, Put pored Bistrice bb, Nikšić (ME)

(72) Stojan Antunović; dipl.ing., Put pored Bistrice bb, 81400 Nikšić (ME)

Mr. Branislav Pavićević; dipl. ing., VI Crnogorske T6/II, 81400 Nikšić (ME)

Slobodan Banović; dipl. ing., Alekse Backovića S 115, 81400 Nikšić (ME)

(74) Antunović Stojan, Put pored Bistrice bb, Nikšić (ME)

(57) Spregnuti armirano betonski i plastični rebrasti cjevovodi široku i nezamjenljivu primjenu mogu naći u hidrotehnici, posebno kod cjevovoda za visoke pritiske (50 bara) i/ili većih prečnika. Sprezanjem dvije konstrukcije/(tri) materijala/:plastične(polietilenske, polipropilenske)rebrste cijevi sa ugrađenom elektrofuzionom spojnicom ili mogućnošću ekstruzionog varenja /unutrašnja cijev/ i armirano betonske obloge, uz precizne proračune na osnovu zahtijevanih parametara, dobija se nova, kompaktna konstrukcija - spregnuti cjevovod, koja zadovoljava sve tehničke, tehnološke, konstruktivne, ekološke, racionalne i ostale zahtjeve nove građevine - cjevovoda. Unutrašnja plastična (polietilenska, polipropilenska) rebrasta cijev obezbjeđuje kvalitetno sprezanje, vodonepropusnost i dobra hidraulična svojstva, a sva unutrašnja opterećenja prenosi na armirano betonsku oblogu, koja se dimenzionise tako da podnese sve unutrašnje pritiske i spoljna saobraćajna i seizmička opterećenja. Pravilnim izborom i proračunom armirano betonske obloge i kvalitetnom ugradnjom armature i betona mogu se postići svi potrebni uslovi/pritisci/ na bilo kojoj građevini -cjevovodu.

- (51) **E04C 2/54**  
**B28B 23/00**  
**E04B 2/02**

- (11) **01146**  
(13) **A**

- (21) P-2011-103  
(22) 10.12.2009.  
(30) MI2008A002190 11.12.2008. IT  
(86) PCT/EP2009/066813 10.12.2009.  
(87) WO 2010/066831 17.06.2010.

(54) (ME) **TRANSPARENTNI KOMPOZITNI PANEL IZVEDEN OD CEMENTNOG MALTERA**

(EN) COMPOSITE PANEL MADE FROM CEMENTITIOUS MORTAR WITH PROPERTIES OF TRANSPARENCY

- (73) ITALCEMENTI S.P.A.; Via G. Camozzi, 124 I-24121 Bergamo (IT)  
(72) CANGIANO, Stefano; Via A. Moro 73 I-24060 Torre De Roveri (IT)  
CARMINATI, Aronne; Via Europa 16 I-24030 Medolago (IT)  
(74) Popović Miladin, Đoka Miraševića 21/III, Podgorica (ME)  
(57) Predmetni pronalazak odnosi se na kompozitni panel izveden od cementnog maltera kroz koji prolazi veliki broj otvora ispunjenih materijalom svetlosno propusnih tj. transparentnih svojstava. Predmetni pronalazak odnosi se takođe i na postupak izrade pomenutog kompozitnog panela.

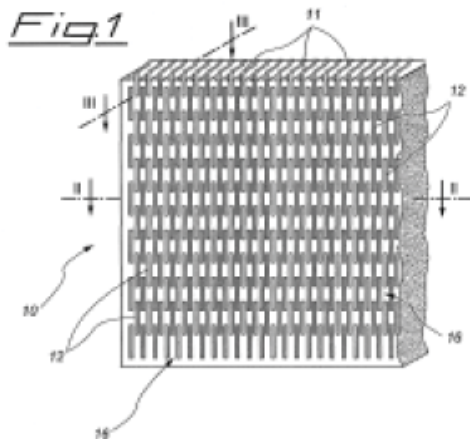

(51) **C07D 489/02**  
**C07H 17/04**  
**C07H 17/00**  
**C07H 15/24**  
**A61K 31/70**  
**A61K 31/485**  
**A61P 29/00**  
**A61P 25/04**

(11) **01149**  
 (13) **A**

(21) P-2011-106

(22) 08.12.2009.

(30) 0806948 10.12.2008. FR

(86) PCT/FR2009/052445 08.12.2009.

(87) WO 2010/067007 17.06.2010.

(54) (ME) **SINTEZA MORFINA-6-GLUKORONIDA ILI JEDOG OD NJегоVIH DERIVATA**  
 (EN) **SYNTHESIS OF MORPHINE-6-GLUCURONIDE OR ONE OF THE DERIVATIVES THEREOF**

(73) SANOFI; 174 avenue de France F-75013 Paris (FR)

(72) DLUBALA, Alain; c/o sanofi-aventis Département Brevets, 174 avenue de France, F-75013 Paris (FR)

RIPOCHE, Isabelle; Ecole Nationale Supérieure de Clermont-Ferrand, Campus Cezeaux BP, 187 F-63174 Aubiere Cedex (FR)

TRECANT, Claire; 16 rue de Copenhague F-67000 Strasbourg (FR)

(74) Ćupić Branislav, Dalmatinska 10, Podgorica (ME)

(57) Ovaj pronalazak se odnosi na postupak dobijanja morfin-6-glukuronida ili nekog njegovog derivata obuhvata korake koji se sastoje od : (i) reakcije jedinjenja formule (I) u kojoj: R1 predstavlja karbonilnu grupu, COR5CO ili SO2R6SO2, sa nekim derivatom glukuronske kiseline, koja odgovara narednoj formuli (II) u kojoj: PG predstavlja acetilnu, izobutirilnu, benzoilnu ili pivaloilnu grupu, X predstavlja trihalogenacetamidatnu grupu, i R4 predstavlja (C1-C4)alkilkarboksilatnu grupu, u prisustvu nekog aromatičnog rastvarača i trimetilsilan trifluorometansulfonila (ii) reakciju proizvoda dobijenog u etapi (i) sa jako baznim agensom, i zatim (iii) izdvajanje proizvoda dobijenog u koraku (ii)

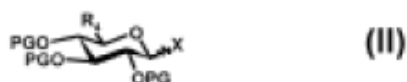
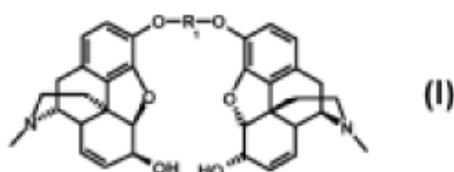

(51) **A61K 31/167**  
**A61K 31/337**  
**A61P 35/00**

(11) **01151**  
(13) **A**

(21) P-2011-107

(22) 10.12.2009.

(30) 08/06979 12.12.2008. FR

(86) PCT/FR2009/052475 10.12.2009.

(87) WO 2010/067027 17.06.2010.

(54) (ME) **KOMBINACIJA ZA LIJEČENJE TUMORA KOJA SADRŽI AVE8062 I DOCETAKSEL**

(EN) ANTITUMOR COMBINATION COMBINING AVE8062 AND DOCETAXEL

(73) SANOFI; 174 avenue de France F-75013 Paris (FR)

(72) BESEVAL, Michèle; c/o sanofi-aventis, Département Brevets, 174 avenue de France, F-75013 Paris (FR)

(74) Ćupić Branislav, Dalmatinska 10, Podgorica (ME)

(57) Predmetni pronalazak se odnosi na sekvencionalnu kombinaciju za liječenje tumora AVE8062-a ili soli AVE8062-a i docetaksela, naznačenu time što: AVE8062 je administriran pacijentu u dozama između 10 i 50 mg/m<sup>2</sup>, potom nekog drugog dana u nedelji, poželjno posle intervala od 24 sata, administriran je docetaxel u dozama između 50 i 120 mg/m<sup>2</sup>.

- (51) **C07D 453/02**  
**C07D 211/46**  
**C07D 207/12**  
**C07D 211/42**  
**C07D 451/10**  
**A61K 31/439**  
**A61P 11/08**  
**A61K 31/4465**  
**A61K 31/401**
- (11) **01185**  
(13) **A**
- (21) P-2011-114  
(22) 11.12.2009.  
(30) 08172818.0 23.12.2008. EP  
(86) PCT/EP2009/008870 11.12.2009.  
(87) WO 2010/072338 01.07.2010.
- (54) (ME) **DERIVATI ALKALOIDNIH AMINOESTARA I NJIHOVI LJEKOVITI PREPARATI**  
(EN) ALKALOID AMINOESTER DERIVATIVES AND MEDICINAL COMPOSITION THEREOF
- (73) CHIESI FARMACEUTICI S.P.A.; Via Palermo, 26/A I-43100 Parma (IT)  
(72) CALIGIURI, Antonio; Via Palermo, 26/A I-43100 Parma (IT)  
RICCABONI, Mauro; Via Palermo, 26/A I-43100 Parma (IT)  
AMARI, Gabriele; Via Palermo, 26/A I-43100 Parma (IT)  
(74) Radulović Božidar, Jovana Tomaševića 9/III, Podgorica (ME)  
(57) Predmetni pronalazak se odnosi na derivate alkaloidnih aminoestara koji djeluju kao antagonisti muskarinskog receptora, na postupke za dobijanje takvih derivata, na preparate koji ih sadrže i na terapijsku primenu takvih derivata.

- (51) **A61K 31/502**  
**C07D 401/14**  
**C07D 403/04**  
**A61P 35/00**
- (11) **01174**  
(13) **A**
- (21) P-2011-116  
(22) 18.12.2009.  
(30) 08360043.7 29.12.2008. EP  
(86) PCT/EP2009/067494 18.12.2009.  
(87) WO 2010/076238 08.07.2010.
- (54) (ME) **SUPSTITUISANA JEDINJENJA HINAZOLINA**  
(EN) SUBSTITUTED QUINAZOLINE COMPOUNDS
- (73) FOVEA PHARMACEUTICALS; Institut de la Vision 17 Rue Moreau F-75012 Paris (FR)  
(72) LERICHE, Caroline; 7 rue Antoine Chantin F-75014 Paris (FR)  
AUCLAIR, Eric; 119 Rue Paul Fort F-91310 Montlhery (FR)  
LE ROUX, Jacques; 18 Rue Garibaldi F-93310 Le Pre Saint Gervais (FR)  
MIDDLEMISS, David, N.; 61 Thorley Hill, Bishop's Stortford Hertfordshire CM23 3NF (GB)
- (74) Čupić Branislav, Dalmatinska 10, Podgorica (ME)
- (57) Pronalazak je usmjeren na određena nova jedinjenja, metode za dobijanje ovih jedinjenja i postupke liječenja ili poboljšanja poremećaja posredovanih kinazom. Detaljnije, predmetni pronalazak se odnosi na supstituisana jedinjenja hinazolina koji su korisni kao selektivni inhibitori kinaze, metode za dobijanje ovih jedinjenja i postupke liječenja ili poboljšanja poremećaja posredovanih kinazom. Tačnije, postupci se odnose na liječenje ili poboljšanje poremećaja posredovanih kinazom uključujući kardiovaskularne bolesti, dijabetes, poremećaje koji su povezani sa dijabetesom, inflamatorne bolesti, imunološke bolesti, kanceri i bolesti oka kao što su retinopatije ili makularna degeneracija ili druge vitreoretinalne bolesti i sl.

- (51) **C07D 401/04**  
**C07D 401/14**  
**C07D 409/14**  
**A61K 31/4439**  
**A61K 31/444**  
**A61K 31/4545**  
**A61K 31/497**  
**A61K 31/5375**  
**A61P 7/00**  
**A61P 9/00**  
**A61P 25/00**  
**A61P 27/00**  
**G01N 33/53**
- (11) **01169**  
(13) **A**
- (21) P-2011-117  
(22) 24.12.2009.  
(30) 0807474 29.12.2008. FR  
0904092 28.08.2009. FR  
(86) PCT/FR2009/052691 24.12.2009.  
(87) WO 2010/076524 08.07.2010.
- (54) (ME) **DERIVATI 2-PIRIDIN-2-IL-PIRAZOL-3(2H)-ONA, NJIHOVA PRIPREMA I PRIMJENA U LIJEČENJU KAO AKTIVATORA HIF-a**  
(EN) DERIVATIVES OF 2-PYRIDIN-2-YL-PYRAZOL-3(2H)-ONE, PREPARATION AND THERAPEUTIC USE THEREOF AS HIF ACTIVATORS
- (73) SANOFI; 174, avenue de France F-75013 Paris (FR)  
(72) ALTENBURGER, Jean-Michel; c/o Sanofi-Aventis Département Brevets 174, avenue de France F-75013 Paris (FR)  
FOSSEY, Valérie; c/o Sanofi-Aventis Département Brevets 174, avenue de France F-75013 Paris (FR)  
ILLIANO, Stéphane; c/o Sanofi-Aventis Département Brevets 174, avenue de France F-75013 Paris (FR)  
MANETTE, Géraldine; c/o Sanofi-Aventis Département Brevets 174, avenue de France F-75013 Paris (FR)
- (74) Ćupić Branislav, Dalmatinska 10, Podgorica (ME)  
(57) Predmet ovog pronalaska su jedinjenja koja odgovaraju formuli (I)  
**R** odgovara grupi -SO<sub>2</sub>-NR<sub>3</sub>R<sub>4</sub>, jednom atomu vodonika, jednom atomu halogena, grupi -halogeno(C<sub>1</sub>-C<sub>5</sub>)alkil, grupi -CO<sub>2</sub>R<sub>5</sub>, ili grupi -SO<sub>2</sub>-R<sub>4</sub>; **R1** odgovara grupi heterocikloalkil koja ne sadrži atom azota, grupi -W-(C<sub>3</sub>-C<sub>6</sub>)cikloalkil, grupi -W-aril. grupi -W-heteroaril, grupi -W-heterocikloalkil, grupi -W-COOR<sub>5</sub>, grupi -W-CONR<sub>5</sub>R<sub>6</sub>; **R2** odgovara jednom atomu vodonika, grupi (C<sub>1</sub>-C<sub>5</sub>)alkil, grupi (C<sub>1</sub>-C<sub>5</sub>)alkilen-O-(C<sub>1</sub>-C<sub>5</sub>)alkil, grupi -halogeno(C<sub>1</sub>-C<sub>5</sub>)alkil, grupi -W-COOR<sub>5</sub>, grupi -W-C(O)NHR<sub>5</sub> ili grupi -W-C(O)-NR<sub>5</sub>R<sub>6</sub>; **n** je jednako 0, 1 ili 2 ; **W** odgovara grupi -(C<sub>1</sub>-C<sub>5</sub>)alkilen, ili grupi -(C<sub>3</sub>-C<sub>6</sub>)cikloalkilen-; **R3** i **R4** idenitčni ili različiti, odgovaraju, nezavisno jedan od drugog, jednom atomu vodonika, grupi -(C<sub>1</sub>-C<sub>5</sub>)alkil, grupi -(C<sub>3</sub>-C<sub>6</sub>)cikloalkil, grupi -(C<sub>1</sub>-C<sub>5</sub>)alkilen-O-(C<sub>1</sub>-C<sub>5</sub>)alkil, jednom arilu, grupi -CH<sub>2</sub>-aril, jednom heteroarilu, jednom heterocikloalkilu, grupi -W-OH, grupi W-CHOH-CH<sub>2</sub>OH, grupi -W-CO<sub>2</sub>R<sub>5</sub>, grupi -W-NR<sub>5</sub>R<sub>6</sub> ili grupi -W-O-(CH<sub>2</sub>)<sub>n</sub>-aril ; ili pomenute grupe **R3** i **R4** formiraju zajedno sa atomom azota za koji ih nosi jednu grupu heterocikloalkil; **R5** i **R6** identični



ili različiti, odgovaraju nezavisno jedan od drugog, jednom atomu vodonika ili grupi -(C1-C5) alkil ili grupi -(C1-C5)halogenoalkil, kao i postupak za njihovo dobijanje i njihova primena u terapiji.

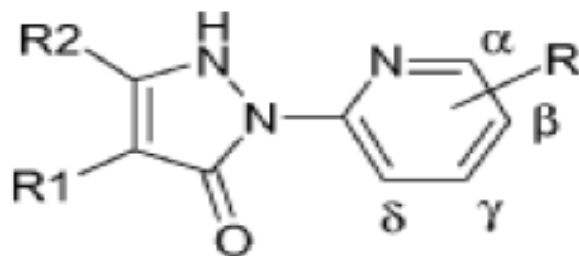

- (51) **C07D263/50**  
**C07D277/18**  
**C07D285/08**  
**C07D413/12**  
**C07D417/12**  
**C07D275/03**
- (11) **01153**  
(13) **A**
- (21) P-2011-122  
(22) 06.01.2010.  
(30) 61/143,920 12.01.2009. US  
61/245,726 25.09.2009. US  
61/258,760 06.11.2009. US  
(86) PCT/IB2010/050033 06.01.2010.  
(87) WO 2010/079443 15.07.2010.
- (54) (ME) **DERIVATI SULFONAMIDA**  
(EN) SULFONAMIDE DERIVATIVES
- (73) Pfizer Limited; Ramsgate Road, Sandwich, Kent CT13 9NJ (GB)  
Icagen, Inc.; 4222 Emperor Boulevard Suite 350, Durham, NC 27703 (US)
- (72) BEAUDOIN, Serge; Icagen Inc., 4222 Emperor Boulevard, Suite 350, Durham, North Carolina 27703 (US)  
LAUFERSWEILER, Michael Christopher; C/o Icagen Inc., 4222 Emperor Boulevard, Suite 350, Durham, North Carolina 27703 (US)  
MARKWORTH, Christopher John; Icagen Inc., 4222 Emperor Boulevard, Suite 350, Durham, North Carolina 27703 (US)  
MARRON, Brian Edward; Icagen Inc., 4222 Emperor Boulevard, Suite 350, Durham, North Carolina 27703 (US)  
MILLAN, David Simon; Pfizer Global Research and Development, Ramsgate Road, Sandwich Kent CT13 9NJ (GB)  
RAWSON, David James; Pfizer Global Research and Development, Ramsgate Road, Sandwich Kent CT13 9NJ (GB)  
REISTER, Steven Michael; Icagen Inc., 4222 Emperor Boulevard, Suite 350, Durham, North Carolina 27703 (US)  
SASAKI, Kosuke; Pfizer Global Research and Development, Ramsgate Road, Sandwich Kent CT13 9NJ (GB)  
STORER, Robert Ian; Pfizer Global Research and Development, Ramsgate Road, Sandwich Kent CT13 9NJ (GB)  
STUPPLE, Paul Anthony; Pfizer Global Research and Development, Ramsgate Road, Sandwich Kent CT13 9NJ (GB)  
SWAIN, Nigel Alan; Pfizer Global Research and Development, Ramsgate Road, Sandwich Kent CT13 9NJ (GB)  
WEST, Christopher William; Icagen Inc., 4222 Emperor Boulevard, Suite 350, Durham, North Carolina 27703 (US)  
ZHOU, Shulan; Icagen Inc., 4222 Emperor Boulevard, Suite 350, Durham, North Carolina 27703 (US)
- (74) Ćupić Branislav, Dalmatinska 10, Podgorica (ME)
- (57) Ovaj pronalazak se odnosi najedinjenja formule (I)  
i njihove farmaceutske prihvatljive soli, solvate ili tautomere, na procese za njihovu izradu, na međuproizvode koji se koriste u njihovoj izradi, na kompozicije koje sadrže ova jedinjenja i na upotrebu ovih jedinjenja, posebno za tretman bola.

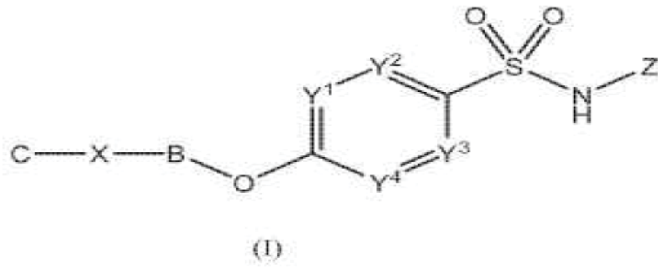

(51) **C08F 210/02**  
**B29C 55/04**

(11) **01190**  
(13) **A**

(21) P-2011-123

(22) 06.01.2010.

(30) 09150305.2 09.01.2009. EP

(86) PCT/EP2010/050063 06.01.2010.

(87) WO 2010/079172 15.07.2010.

(54) **ME) POLIETILENSKI FILM SA VISOKOM JAČINOM NA KIDANJE I VISOKOM ENERGIJOM LOMA PRI ZATEZANJU**

(EN) POLYETHYLENE FILM WITH HIGH TENSILE STRENGTH AND HIGH TENSILE ENERGY TO BREAK

(73) TEIJIN ARAMID B.V.; Velperweg 76 NL-6824 BM Arnheim (NL)

(72) EEM VAN DER, Joris; Vosdijk 24 NL-6824 BB Arnhem (NL)

DE WEIJER, Anton, Peter; Driehuizerweg 338 NL-6525 PN Nijmegen (NL)

RASTOGI, Sanjay; Menelaoslaan 10 NL-5631 LN Eindhoven (NL)

(74) Lutovac Branimir, Bulevar Ivana Crnojevića 93, Podgorica (ME)

(57) Ovaj pronalazak se odnosi na UHMWPE film, koji ima jačinu na kidanje od najmanje 2.0 GPa, energiju loma pri zatezanju od najmanje 30 J/g, Mw od najmanje 500.000 g/mol, i odnos Mw/Mn od najviše 6, i širinu filma od najmanje 5 mm. U poželjnoj realizaciji ovaj film ima širinu od najmanje 10 mm, određenije, od najmanje 20 mm, još određenije, od najmanje 40 mm, a denije od najmanje 3000 dtex, određenije, od najmanje 5000 dtex, još određenije, od najmanje 10000 dtex, čak i u određenim slučajevima od najmanje at least 15000 dtex, ili čak od najmanje 20000 dtex. Ovaj film se može proizvesti u procesu koji se sastoji od podvrgavanja polaznog UHMWPE sa prosečnom masenom molekulskom težinom od najmanje 500.000 g/mol, sa modulom elastičnosti na smicanje, određenim direktno posle topljenja na 160°C, od najviše 1.4 MPa, i odnosom Mw/Mn od najviše 6, koraku kompaktiranja i koraku istezanja, ali pod takvim uslovima da se temperatura polimera u bilo kojoj tački, tokom ove obrade polimera, ne povisi na neku vrijednost iznad njegove temperature topljenja. Ovaj film se može upotrebljavati kao polazni materijal u bilo kojim primenama gdje su značajni visoka jačina na kidanje i visoka enargija loma pri zatezanju. Pogodne primjene su balističke primjene, užad, kablovi, mreže, tkanine, i zaštitne primjene.

- (51) **A61K 31/192**  
**A61K 31/704**  
**A61K 45/06**  
**A61P 19/00**
- (11) **01193**  
(13) **A**
- (21) P-2011-131  
(22) 22.01.2009.  
(86) PCT/IN2009/000071 22.01.2009.  
(87) WO 2010/084500 29.07.2010.
- (54) (ME) **NOVA KOMBINACIJA AKTIVNIH SASTOJAKA KOJA SADRŽI NESTEROIDNI ANTI- INFLAMATORNI LIJEK I DERIVATE KOLHIKOZIDA**  
(EN) NEW COMBINATION OF ACTIVE INGREDIENTS CONTAINING A NON STEROIDAL ANTI INFLAMMATORY DRUG AND A COLCHICOSIDE DERIVATIVE
- (73) SANOFI 174 Avenue de France F-75013 Paris (FR)  
(72) KHULLAR, Praveen; Sanofi-Aventis Patent Department 174 Avenue de France F-75013 Paris (FR)  
SHINGTE, Mansing; Sanofi-Aventis Patent Department 174 Avenue de France F-75013 Paris (FR)  
PATEL, Shirishbhai; Sanofi-Aventis Patent Department 174 Avenue de France F-75013 Paris (FR)  
SUSEENDHARNATH, A.; Sanofi-Aventis Patent Department 174 Avenue de France F-75013 Paris (FR)  
RAJU, Krishna; Sanofi-Aventis Patent Department 174 Avenue de France F-75013 Paris (FR)  
REDDY, Vanga; Sanofi-Aventis Patent Department 174 Avenue de France F-75013 Paris (FR)
- (74) Čupić Branislav, Dalmatinska 10, Podgorica (ME)
- (57) Farmaceutska kompozicija koja sadrži kombinaciju nesteroidnog antiinflama-tornog lijeka i derivata kolhikozida, pri čemu su aktivni sastojci u slobodnom obliku ili obliku soli.

(51) **B60J 1/00** (11) **01186**  
**B65G 49/06** (13) **A**

(21) P-2011-136

(22) 22.02.2010.

(30) 0902953.9 20.02.2009. GB

(86) PCT/GB2010/000300 22.02.2010.

(87) WO 2010/094931 26.08.2010.

(54) (ME) **SISTEM ZA MANIPULACIJU PANELIMA ZA ZASTAKLJIVANJE**  
(EN) **GLAZING PANEL HANDLING SYSTEM**

(73) BELRON HUNGARY KFT - ZUG BRANCH;  
Gotthardstrasse 20 CH-6304 Zug (CH)

(72) FINCK, William; 31 Doddinghurst Road Brentwood Essex CM15 9EP (GB)

(74) Popović Miladin, Đoka Miraševića 21/III, Podgorica, (ME)

(57) Predmetni pronalazak odnosi se na noseću konstrukciju (21) koja služi za oslanjanje panela za zastakljivanje postavljenog u oboreni tj. horizontalni položaj u zoni pripremnog tj. pred-ugradnog pozicioniranja panela. Konfiguracija predmetne noseće konstrukcije je takva da tehničaru koji vrši manipulaciju panelom omogućava slobodan ulaz i/ili izlaz iz zone pripremnog pozicioniranja panela. Predmetna noseća konstrukcija sadrži jedan ili više nosećih elemenata, opremljenih segmentima za pozicioniranje, koji omogućavaju da stakleni panel u nosećoj konstrukciji bude postavljen na način koji omogućava njegovo nagnjanje ili okretanje. Predmetna noseća konstrukcija omogućava bolju manipulaciju panelima za zastakljivanje u poređenju sa metodama koje se koriste u aktuelnoj praksi.

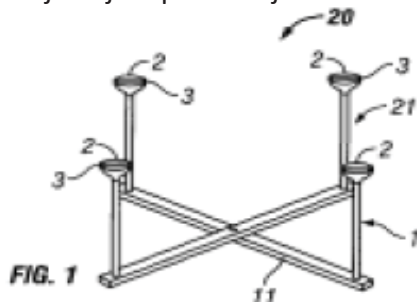

- (51) **C07H 15/24**  
**C07H 17/00**  
**C07H 7/06**  
**A61K 31/485**  
**A61K 31/519**  
**A61K 31/7042**  
**A61P 25/04**

- (11) **01147**  
(13) **A**

- (21) P-2011-104  
(22) 08.12.2009.  
(30) 0806974 11.12.2008. FR  
(86) PCT/FR2009/052446 08.12.2009.  
(87) WO 2010/067008 17.06.2010.

(54) (ME) **BICIKLIČNI DERIVATI MORFIN-6-GLUKURONIDA, NJHOVO DOBIJANJE I PRIMJENA U TERAPIJI**

(EN) BICYCLIC DERIVATIVES OF MORPHINE-6-GLUCURONIDE, PREPARATION METHOD THEREOF AND USE OF SAME IN THERAPEUTICS

- (73) SANOFI 174, avenue de France F-75013 Paris (FR)  
(72) DLUBALA, Alain; c/o Sanofi-Aventis Patent Department 174, avenue de France F-75013 Paris (FR)  
RIPOCHE, Isabelle; Ecole Nationale Supérieure de Clermont-Ferrand, Campus Cezeaux - BP 187, F-63174 Aubièze Cedex (FR)  
TRECANT, Claire; 16, rue de Copenhague F-67000 Strasbourg (FR)  
(74) Čupić Branislav, Dalmatinska 10, Podgorica (ME)

- (57) Ovaj pronalazak se odnosi na jedinjenja koja odgovaraju formuli (I) u kojoj: R1 predstavlja atom vodonika ili grupu (C1-C4)alkil, R2 predstavlja hidroksilnu grupu, tiol grupu, grupu (C1-C4)alkiloksi ili grupu tio(C1-C4)alkil, i n je cijeli broj 1 ili 2, u obliku baze ili adicione soli sa kiselinom kao i u obliku hidrata ili solvata. Ovaj pronalazak takođe obuhvata postupak njihovog dobijanja i terapijsku primjenu.

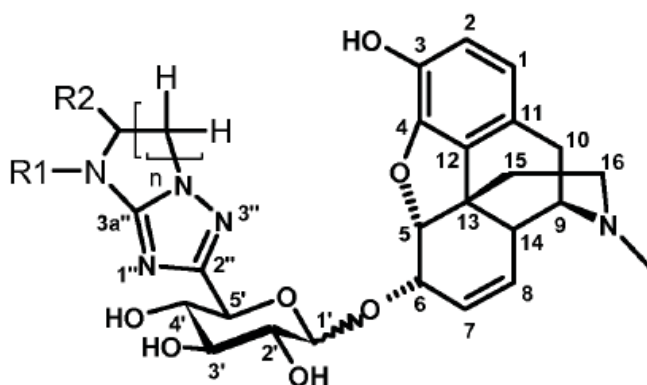

(51) **C07H 15/24**  
**C07H 17/04**  
**C07H 17/00**  
**C07H 7/06**  
**A61K 31/70**  
**A61K31/485**  
**A61P 29/00**  
**A61P 25/04**

(11) **01148**

(13) **A**

(21) P-2011-105

(22) 08.12.2009.

(30) 0806949 10.12.2008. FR

(86) PCT/FR2009/052448 08.12.2009.

(87) WO 2010/067010 17.06.2010.

(54) (ME) **DERIVATI MORFIN-6-GLIKORONIDA, NJHOVO DOBIJANJE I TERAPEUTSKA PRIMJENA**

(EN) DERIVATIVES OF MORPHINE-6-GLUCURONIDE, PREPARATION METHOD THEREOF AND USE OF SAME IN THERAPEUTICS

(73) SANOFI; 174, avenue de France F-75013 Paris (FR)

(72) DLUBALA, Alain; c/o Sanofi-Aventis Département Brevets 174, avenue de France, F-75013 Paris (FR)

RIPOCHE, Isabelle; Ecole Nationale Supérieure de Clermont-Ferrand, Campus Cezeaux, B.P. 187 F-63174 Aubière Cedex (FR)

TRECANT, Claire; 16, rue de Copenhague F-67000 Strasbourg (FR)

(74) Čupić Branislav, Dalmatinska 10, Podgorica (ME)

(57) Predmetni pronalazak se odnosi na derivate morfin-6-glukoronida formule (I) gdje:

R1 je 5- člana heteroaromatična grupa opciono supstituisana jednim ili više supstituenata izabranih od atoma halogena i grupa (C1-C4)alkil, halogene, hidroksilne, halo(C1-C4)alkil, halo(C1-C4)alkiloksi, (C1-C4)alkiloksi, aril(C1-C4)alkil i aril, naznačena aril grupa opciono supstituisana jednom ili više grupa izabranih od grupa (C1-C4)alkil, halo(C1-C4)alkil, hidroksilne i (C1-C4)alkiloksi, u obliku baze ili adicione soli kiseline, takođe i u obliku hidrata ili solvata. Predmetni pronalazak se takođe odnosi i na postupke za dobijanje ovih derivata kao i na njihovu terapeutsku upotrebu.

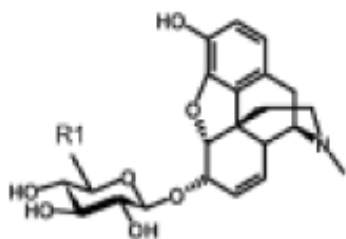



- (51) **A61K 38/07**  
**A61K 31/167**  
**A61K 38/08**  
**A61K 31/165**  
**A61K 38/04**  
**A61P 35/00**

- (11) **01133**  
(13) **A**

- (21) P-2011-71  
(22) 21.10.2009.  
(30) 61/196,945 21.10.2008. US  
(86) PCT/US2009/061498 21.10.2009.  
(87) WO 2010/048298 29.04.2010.

- (54) (ME) **KOMBINOVANA TERAPIJA SA PEPTIDNIM EPOKSIKETONIMA**  
(EN) COMBINATION THERAPY WITH PEPTIDE EPOXYKETONES

- (73) ONYX THERAPEUTICS, INC. 249 E. Grand Avenue South San Francisco, CA 94080 (US)

- (72) KIRK, Christopher, J.; 111 South Magnolia Avenue #4 Millbrae, CA 94030 (US)

DEMO, Susan, D.; 241 Downey Street San Francisco, CA 94117 (US)

BENNETT, Mark, K.; 9 Fieldbrook Place Moraga, CA 94556 (US)

- (74) Radulović Božidar, Jovana Tomaševića 9/III, Podgorica (ME)

- (57) Predmetni pronalazak obezbjeđuje kombinovanu terapiju. u kojoj se jedno ili veći broj drugih terapeutskih sredstava primjenjuje sa peptidnim epoksiketonima ili njihovim farmaceutski prihvatljivim solima. Još jedno rješenje predmetnog pronalaska odnosi se na liječenje kancera peptidnim epoksiketonom koji se primjenjuje u kombinaciji sa još jednim terapeutskim sredstvom.

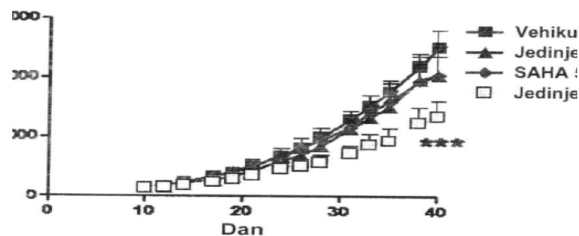

- (51) **C07D 471/10** (11) **01135**  
**A61K 31/435** (13) **A**  
**A61P 25/28**

- (21) P-2011-84  
 (22) 12.11.2009.  
 (30) 61/117,225 23.11.2008. US  
 (86) PCT/IB2009/055043 12.11.2009.  
 (87) WO 2010/058333 27.05.2010.

- (54) (ME) **LAKTAMI KAO INHIBITORI BETA SEKRETAZE**  
 (EN) LACTAMS AS BETA SECRETASE INHIBITORS

- (73) PFIZER INC. 235 East 42nd Street New York, New York 10017 (US)

- (72) BRODNEY, Michael Aaron; Pfizer Global Research and Development Eastern Point Road Groton, Connecticut 06340 (US)

EFREMOV, Ivan Viktorovich; Pfizer Global Research and Development Eastern Point Road Groton, Connecticut 06340 (US)

HELAL, Christopher John; Pfizer Global Research and Development Eastern Point Road Groton, Connecticut 06340 (US)

O'NEILL, Brian Thomas; Pfizer Global Research and Development Eastern Point Road Groton, Connecticut 06340 (US)

- (74) Ćupić Branislav, Dalmatinska 10, Podgorica (ME)

- (57) Opisana su jedinjenja i farmaceutski prihvatljive soli jedinjenja, pri čemu jedinjenja imaju strukturu formule (I), kao što je definisano u specifikaciji. Takođe su opisane odgovarajuće farmaceutske kompozicije, metode sinteze i intermedijeri i metode liječenja.

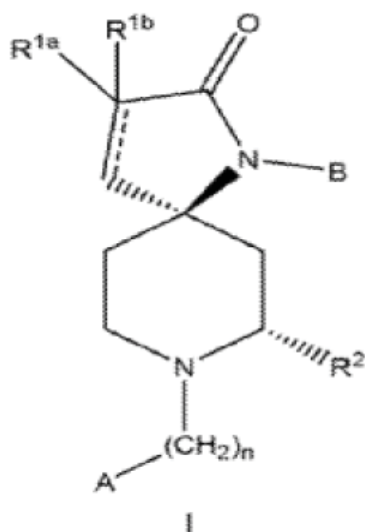

- (51) **C07D 487/08**  
**A61K 31/407**  
**A61P 29/02**  
**A61P 35/00**

- (11) **01144**  
 (13) **A**

- (21) P-2011-83  
 (22) 20.11.2009.  
 (30) 61/118,053 26.11.2008. US  
 (86) PCT/IB2009/055232 20.11.2009.  
 (87) WO 2010/061329 03.06.2010.

(54) (ME) **3-AMINOCIKLOPENTANKARBOKSAMIDI KAO MODULATORI HEMOKIN RECEPTORA**

(EN) 3-AMINOCYCLOPENTANECARBOXAMIDES AS CHEMOKINE RECEPTOR MODULATORS

- (73) PFIZER INC. ;235 East 42nd Street New York, New York 10017 (US)  
 (72) DEVRAJ, Rajesh Venkateswaran; 301 Palomino Hill Court Chesterfield, MO 63005 (US)  
 HUANG, Wei; 919 Crown Pointe Estates Drive Wildwood, MO 63021 (US)  
 HUGHES, Robert Owen; Pfizer Global Research & Development, 200 Cambridge Park Drive Cambridge, MA 02140 (US)  
 ROGIER JR., Donald Joseph; Pfizer Global Research & Development, Eastern Point Road Groton, CT 06340 (US)  
 TRUJILLO, John Isidro; Pfizer Global Research & Development, Eastern Point Road Groton, CT 06340 (US)  
 TURNER, Steve Ronald; 125 Skyview Lane Labadie, MO 63055 (US)  
 (74) Čupić Branislav, Dalmatinska 10, Podgorica (ME)  
 (57) Obezbijedeno je jedinjenje Formule I(a) ili I(b) ili njegova farmaceutski prihvatljiva so, pri čemu su različiti sipstituenti ovdje definisani.

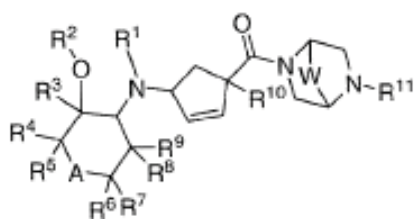

I(a)

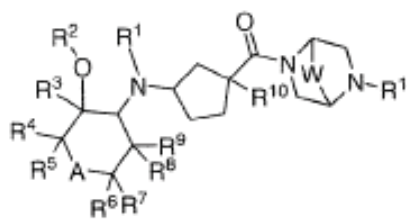

I(b)

- (51) **C07K 16/28**  
**A61K 39/395**  
**A61P 19/02**  
**A61P 37/06**
- (11) **01164**  
(13) **A**
- (21) P-2010-217  
(22) 15.07.2009  
(30) 08160671.7 17.07.2008 EP  
09160326.6 15.05.2009 EP  
(86) PCT/EP2009/059030 15.07.2009  
(87) WO/2010/007082 21.01.2010
- (54) (ME) **KOMPOZICIJE I POSTUPCI ZA UPOTREBU TERAPEUTSKIH ANTITIJELA**  
(EN) COMPOSITIONS AND METHODS OF USE FOR THERAPEUTIC ANTIBODIES
- (73) NOVARTIS AG ; Lichtstrasse 35 CH-4056 Basel (CH)  
(72) HEUSSER, Christoph; Novartis Pharma AG Postfach CH-4002 Basel (CH)  
NEUGEBAUER, Julia; Steinhauser Strasse 25B 81677 München (DE)  
SCHAADT, Eveline; Kolumbusstrasse 22 81543 München (DE)  
URLINGER, Stefanie; Asternstrasse 12 80689 München (DE)  
WOISETSCHLAEGER, Maximilian; Balthasar-Krauss-Gasse 44/3 A-2380 Perchtoldsdorf (AT)
- (74) Čejović Vladimir, 13. jul 21, Podgorica (ME)
- (57) Predmetni pronalazak se odnosi na antitela koja se specifično vezuju za BAFF receptor (BAFFR). Pronalazak se još konkretnije odnosi na specifična antitela koja su BAFFR antagonisti sa in vivo aktivnošću deplecije B ćelija i kompozicije i metode korišćenja pomenutih antitela za lečenje patoloških poremećaja koji se mogu lečiti uništavanjem ili deplecijom B ćelija, kao što je sistemski eritemski lupus ili reumatoidni artritis ili druge autoimune bolesti ili limfomi, leukemije i mijelomi

- (51) **C07D 401/14**  
**A61K 31/496**  
**A61P 25/00**  
**A61P 29/00**  
**A61P 35/00**

- (11) **01163**  
(13) **A**

- (21) P-2010-210  
(22) 12.06.2009  
(30) 0803298 13.06.2008 (FR)  
(86) PCT/FR2009/051117 12.06.2009  
(87) WO/2009/150387 17.12.2009

(54) (ME) **DERIVATI 2- OKSOALKIL-1-PIPERAZIN-2- ONA, NJHOVO DOBIJANJE I TERAPEUTSKA PRIMENA**

(EN) DERIVATIVES OF 2-OXO-ALKYL-1-PIPERAZIN-2-ONE, PREPARATION METHOD THEREOF AND THERAPEUTIC USE OF SAME

- (73) SANOFI-AVENTIS; 174 avenue de France F-75013 Paris (FR)  
(72) BARONI, Marco; C/o Sanofi-aventis Département Brevets 174 avenue de France F-75013 Paris (FR)  
BONO, Françoise; C/o Sanofi-aventis Département Brevets 174 avenue de France F-75013 Paris (FR)  
DELBARY-GOSSART, Sandrine; C/o Sanofi-aventis Département Brevets 174 avenue de France F-75013 Paris (FR)  
(74) Ćupić Branislav, Dalmatinska 10, Podgorica (ME)  
(57) Predmetni pronalazak se odnosi na derivate 4-{2- [fenil-3,6-dihidropiridin-1-il]-2-oksoalkil}-1-piperazin-2- ona i 4-{2- [fenil-2,5-dihidropirol-1-il]-2- oksoalkil}-1-piperazin-2-ona, opšte formule (I) gde A, B, m, R<sub>3</sub> i n su kao što je definisano u zahtjevu 1, na njihovo dobijanje i njihovu terapeutsku primjenu.

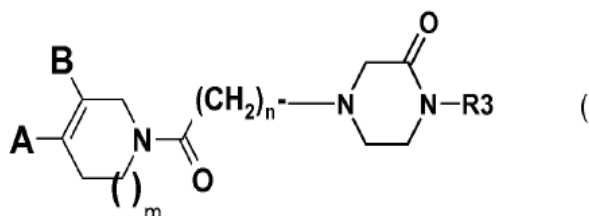

- (51) **C07D 471/08**  
**A61K 31/529**  
**A61P 25/00**  
**A61P 29/00**  
**A61P 35/00**  
**C07D 487/08**

- (11) **01162**  
 (13) **A**

- (21) P-2010-210  
 (22) 12.06.2009  
 (30) 0803299 13.06.2008 FR  
 (86) PCT/FR2009/051118 12.06.2009  
 (87) WO/2009/150388 17.12.2009

(54) **(ME)NOVI DERIVATI (PIPERANIZIL PONTE) - 1- ALKANONA I NJIHOVA PRIMENA  
 KAO INHIBITORA p75**

(EN) NOVEL DERIVATIVES OF (BRIDGED PIPERAZINYL)-1-ALCANONE AND USE THEREOF AS P75 INHIBITORS

- (73) SANOFI-AVENTIS, 174 avenue de France F-75013 Paris (FR)  
 (72) BARONI, Marco; C/o Sanof-aventis Département Brevets 174 Avenue de France F-75013 Paris (FR)  
 BONO, Françoise; C/o Sanof-aventis Département Brevets 174 Avenue de France F-75013 Paris (FR)  
 DELBARY-GOSSART, Sandrine; C/o Sanof-aventis Département Brevets 174 Avenue de France F-75013 Paris (FR)  
 (74) Ćupić Branislav, Dalmatinska 10, Podgorica (ME)  
 (57) Ovaj pronalazak ima za predmet derivate derivata ((fenil)- 3,6- dihidropiridin- lil) -(piperazinil ponte) - 1- alkanona i ((fenil) - 2.5- dihidro- pirol- 1- il) - (piperazinil ponte) - l-alkanona, opšte formule (I): u kojoj A,B. m, W, n i R5 su kao štoje definisano u zahtevu 1. kao i postupak za njihovo dobijanje i njihova terapeutska primena.

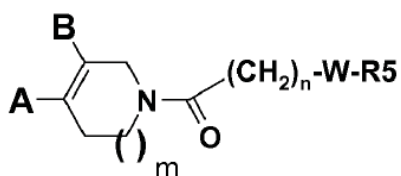

(51) **A47D 15/00**  
**A47C 7/62**  
**A47D 1/00**

(11) **01194**  
(13) **A**

(21) P-2010-196  
(22) 29.05.2009

(30) 20082491 04.06.2008 NO

(86) PCT/NO2009/000205 29.05.2009

(87) WO/2009/148325 10.12.2009

(54) (ME) **DODATAK ZA DJEČIJU STOLICU**  
(EN) DEVICE FOR A CHILD'S CHAIR

(73) STOKKE AS, Haahjem N-6260 Skodje (NO)

(72) ANGELFOSS, Hilde; c/o Stokke AS Håhjem N-6260 Skodje (NO)

(74) Čejović Vladimir, 13. jul 21, Podgorica (ME)

(57) ronazak se odnosi na klizni dodatak koji se montira na nogar dečije stolice, posebno na nogar dječije stolice, i koji sadrži ravnu površinu sa najmanje jednim otvorom za pričvršćivanje koja je glatka sa unutrašnje strane, i naznačena je time, što može biti pričvršćena u najmanje dva položaja za nogar stolice, pri čemu je dodatak u horizontalnom položaju i naleže na nogar stolice. Pronalazak se takođe odnosi i na sigurnosnu opremu koja sadrži i klizni dodatak i koji se takođe koristi.

Fig. 2

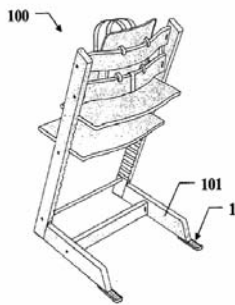

(51) **F23G 5/027**(11) **01158****F23G 5/50**(13) **A**

(21) P-2010-193

(22) 11.05.2009

(30) BO2008A000292 14.05.2008 IT

(86) PCT/IT2009/000208 11.05.2009

(87) WO/2009/139017 19.11.2009

(54) **(ME) POSTUPAK SAGORJEVANJA MATERIJALA I ODNOSNI UREĐAJI**  
(EN) COMBUSTION MATERIAL PROCESS AND RELATED APPARATUS

(73) LEON ENGINEERING S.P.A.; Via G. Leonardelli, 3 I-47891 Dogana (R.S.M.) (SM)

(72) AMADESI, Paolo; Via Andrea Costa, 152 I-40134 Bologna (BO) (IT)

(74) Čejović Vladimir, 13. jul 21, Podgorica (ME)

(57) Ovaj pronalazak se odnosi na postupak (1) za sagorevanje materijala (X) koji se sastoji od koraka: (a) ubacivanja pretpostavljeno sabijenih materijala (X) u reakcionu komoru (3) i zatvaranje komore (3), (b) ubrizgavanje struje gorljivog gasa i odgovarajuće struje gasa koji potpomaže sagorevanje koji su u 5 međusobnom stehiometrijskom odnosu u reakcionu komoru (3) da bi se aktiviralo sagorevanje materijala (X), (c) nastavljnje termohemijske reakcije elemenata koji mogu da oksidišu, na primer ugljenika, sa prisutnim kiseonikom bez daljeg uvođenja gasova. (d) ubrizgavanje gasa koji potpomaže sagorevanje radi napajanja termohemijskih reakcija elemenata koji mogu da oksidišu prisutnih u 10 materijalima (X) sve dok temperatura ne prestane da raste, (e) otvaranje prigušnog ventila (5) da bi se ispuštali gasovi i nastavljnje uvođenja gasa koji potpomaže sagorevanje pod uglavnom konstantnim pritiskom sve dok se ne izvrši -oksidacija sveg preostalog ugljenika i sve dok ne oksidišu jako vezani oksidi podvrgnuti pirolizi i prisutni metali.

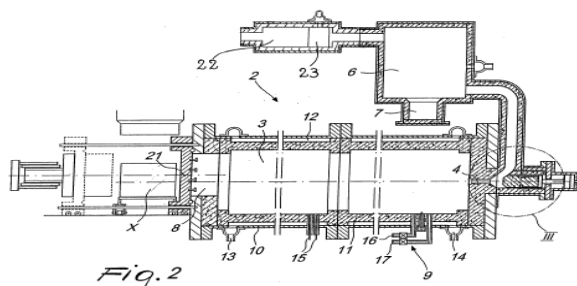



(51) E21D 21/00

(11) 01113

(13) A

(21) P-2010-135

(22) 29.02.2008

(86) PCT/EP2008/001625 29.02.2008

(87) WO/2009/106099 03.09.2009

(54) (ME) UNAPRIJEĐENI KLIZNI ANKER

(EN) IMPROVED SLIDING ANCHOR

(73) ATLAS COPCO MAI GMBH ; Werkstrasse 17 P.O. Box 1 A-9710 Feistritz/Drau (AT)

(72) MEIDL Michael; Dullhöhe 3 A-9871 Seeboden (AT)

CHARETTE François; 5 Lakeview Drive North Bay, Ontario P1C 1C7 (CA)

(74) Ćosović Dejan, 13. jula 1/5, Budva (ME)

(57) Pronalazak se odnosi na klizni anker (10) za ubacivanje u bušotinu, koji ima šipku ankera (12) na koju je smešten klizni kontrolni element (14) sa otvorom (18) kroz koji se pruža šipka ankera (12), gde se klizni kontrolni element (14) sastoji od kućišta kliznog tela (16) koje ima najmanje jedan kružni otvor (20) za prijem kliznog tela (22) koje je u kontaktu sa bočnom površinom šipke ankera (12), i koji ima ploču ankera (24) koja je predviđena da je postavljena nasuprot regionu koji okružuje usta bušotine kada klizni anker (10) bude uveden u bušotinu. U poređenju sa standardnim kliznim ankerima, ploča ankera (24) je u prenosno-opterećujućoj vezi sa kućištem kliznog tela (16) što kao rezultat ima da je lako moguće da se obezbedi uređaj koji ukazuje još uvek raspoloživ klizni put kliznog ankera.

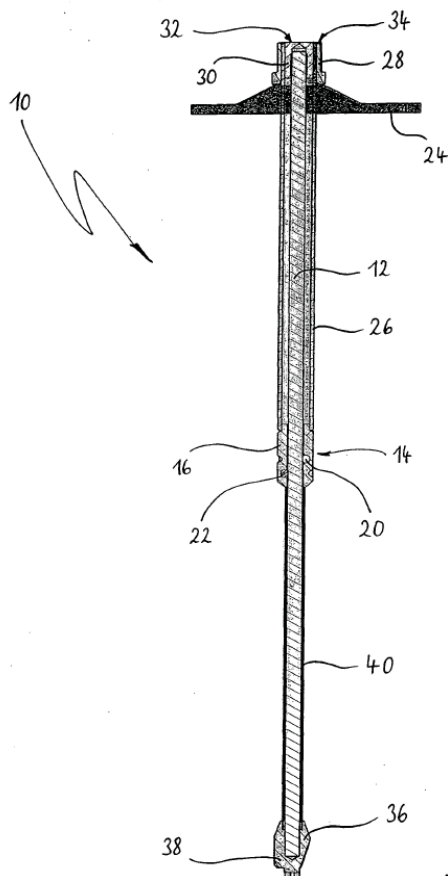

Fig. 1

- (51) **C07D 471/04**  
**A61K 31/437**  
**A61P 19/10**  
**A61P 29/00**  
**A61P 35/00**  
**A61P 9/00**  
**C07F 5/04**  
**C07F 7/08**

- (11) **01157**  
 (13) **A**

- (21) P-2010-103  
 (22) 31.12.2008.  
 (30) 0800005 02.01.2008 FR  
 (86) PCT/FR2008/001836 31.12.2008.  
 (87) WO/2009/106750 03.09.2009

- (54) (ME) **DERIVATI 6-HETEROCIKLIČNOG-IMIDAZO[l,2-a]PIRIDIN-2-KARBOKSAMIDA, NJIHOVA PRIPREMA I NJIHOVA PRIMJENA U LIJEČENJU**

(EN) DERIVATIVES OF 6-HETEROCYCLIC-IMIDAZO[L,2-A]PYRROINE-2-CARBOXAMIDES, PREPARATION THEREOF AND THERAPEUTIC APPLICATION THEREOF

- (73) SANOFI-AVENTIS; 174 avenue de France F-75013 Paris (FR)  
 (72) PEYRONEL, Jean-François; c/o Sanofi-Aventis Département Brevets 174 avenue de France F-75013 Paris (FR)  
 (74) Ćupić Branislav, Dalmatinska 10, Podgorica (ME)  
 (57) Pronalazak se odnosi na jedinjenja formule (I) u kojoj : X je opcionalno supstituisana fenil grupa; R<sup>1</sup> je atom vodonika, halogena, (C1-C6)alkoksi grupa, (C1-C6)alkil grupa, NRaRb grupa; R<sup>2</sup> je opcionalno supstituisana heterociklična grupa; R<sup>3</sup> je atom vodonika, (C1-C6)alkil grupa, (C1-C6)alkoksi grupa ili halogen atom; R<sup>4</sup> je atom vodonika, (C1-C4)alkd grupa, (C1-C4)alkoksi grupa ili atom fluora; navedena jedinjenja su u obliku baze ili soli adicione soli kisjeline. Ova jedinjenja se mogu koristiti u terapeutske svrhe.

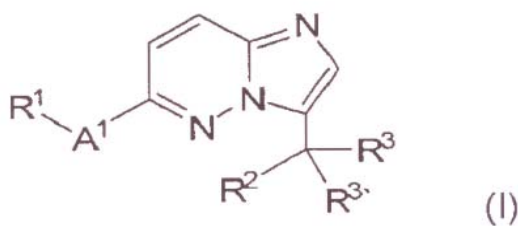

(51) **C12N 7/00**

(11) **01156**

(13) **A**

(21) P-2010-93

(22) 18.12.2008

(30) 61/015,894 21.12.2007 US

(86) PCT/US2008/087361 18.12.2008

(87) WO/2009/085912 09.07.2009

(54) **(ME) POSTUPCI I KOMPOZICIJE ZA IMUNIZACIJU SVINJA PROTIV SVINJSKOG CIRKOVIRUSA**

(EN) METHODS AND COMPOSITIONS FOR IMMUNIZING PIGS AGAINST PORCINE CIRCOVIRUS

(73) WYETH LLC; Five Giralda Farms Madison, New Jersey 07940 (US)

(72) WU, Stephen Qitu; 1921 Greenbrier Drive Fort Dodge, Iowa 50501 (US)

(74) Ćupić Branislav, Dalmatinska 10, Podgorica (ME)

(57) Predstavljani pronalazak se odnosi na izolaciju i identifikaciju dva nova soja svinjskog cirkovirusa tipa 2B. Ova dva nova soja svinjskog cirkovirusa mogu se koristiti za pripremu kompozicija vakcine ili imunogenih kompozicija za imunizaciju svinja protiv multisistemskog sindroma kržljivosti odbijene prasadi (PMWS). Prema tome, pronalazak daje postupke za izazivanje zaštitnog imunog odgovora protiv patogenog svinjskog cirkovirusa primenom na svinju imunogeno efikasne količine kompozicije vakcine ili imunogene kompozicije svinjskog cirkovirusa tipa 2B koja sadrži najmanje jedan od svinjskih cirkovirusa koji imaju nukleinsku kiselinu sekvencu kao što je navedena u SEQ ID NO: 1 ili 2, ili najmanje jedan protein od najmanje jednog od dva nova soja svinjskog cirkovirusa tipa 2B kao što je ovde opisano. Pronalazak se dalje odnosi na zaštitu svinje od bilo kog ili više simptoma ili posledica povezanih sa PMWS.

Figure 1 (SEQ ID NO: 1)

Complete Sequence of PCV2B-PD07 Genome

Comments for PCV2B-PD07 genome: 1767 bp ssDNA virus

Replication (replicase) gene: bases 51-995  
 Capsid gene: bases 1033-1734 C

```

10      20      30      40      50      60
ACCAGCGCAC TTGGGCGAGG GCAGGACCTC GGCAGCACCT CAGCAGCAAC ATGCCGAGCA
                                     M P S

70      80      90     100     110     120
AGAGAGATGG AAGAGCGGGA CCCCAACCCC ATAAAGGTG GGTGTTCAC TGAATAATC
K K N G R S G P Q P H K R W V P T L N N

130     140     150     160     170     180
CTTCGGAAGA CGAGCGCAAG AATAACGGG ATCTTCAAT ATCCCTATT GATTATTTA
P S E D E R K K I R D L P I S L F D Y F

190     200     210     220     230     240
TTGTTGGCGA GAGGGGTRAT GAGGAAGGAC GAACACTCA CCTCCAGGG TTGCTAATT
I V G E E G N E E G R T P H L Q G F A N

250     260     270     280     290     300
TTGTGAGGAA GCAGACTTTT AATAAAGTGA AGTGGTATT GGTGCCCGC TCCACATCG
F V K K Q T F N K V K W Y L G A R C H I

                                     >PstI
310     320     330     340     350     360
AGAAAGCCAA AGGAAACAGT CAGCAAAATA AAGAATACTG CAGTAAGAA GGCACCTTAC
E K A K G T D Q Q N K E Y C S K E G H L

                                     >BglIII
                                     >SacI
370     380     390     400     410     420
TGATTGAGTG TGGAGCTCCT AGATCTCAGG GACAAACGAG TGACCTGTCT ACTGCTGTGA
L I E C G A P R S Q G Q R S D L S T A V

430     440     450     460     470     480
GTACCTTOTT GGAGAGGGGG AGTCTGGTGA CCGTTCAGA GCAGTACCTT GTAACGTTTG
S T L L E S G S L V T V A E Q Y P V T F
    
```

- (51) **C07D 413/12** (11) **01155**  
**A01N 43/80** (13) **A**
- (21) P-2010-92  
 (22) 16.12.2008.  
 (30) 0725219.0 24.12.2007 GB  
 0813849.7 29.07.2008 GB  
 (86) PCT/EP2008/010701 16.12.2008.  
 (87) WO/2009/080250 02.07.2009
- (54) (ME) **INSEKTICIDNA JEDINJENJA**  
 (EN) INSECTICIDAL COMPOUNDS
- (73) SYNGENTA PARTICIPATIONS AG, Schwarzwaldallee 215, CH-4058 Basel (CH)
- (72) RENOLD, Peter; Syngenta Crop Protection AG, Werk Stein Schaffhauserstrasse CH-4332 Stein (CH)  
 ZAMBACH, Werner; Syngenta Crop Protection AG, Werk Stein Schaffhauserstrasse CH-4332 Stein (CH)  
 MAIENFISCH, Peter; Syngenta Crop Protection AG, Werk Stein Schaffhauserstrasse CH-4332 Stein (CH)  
 MUEHLEBACH, Michel; Syngenta Crop Protection AG, Werk Stein Schaffhauserstrasse CH-4332 Stein (CH)
- (74) Čejović Vladimir, 13. jul 21, Podgorica (ME)
- (57) Jedinjenja formule (I) u kojoj su A1, A2, A3, A4, G1, L, R1, R2, R3, R4, Y1, Y2 i Y3 defmisani u patentnom zahtevu 1; ili njena so ili jV-oksid.  
 Osim toga, dati pronalazak se odnosi na postupke i intermedijere za dobijanje jedinjenja formule (I), na jedinjenja sa insekticidnim, akaricidnim, moluspicidnim ili nematocidnim delovanjem koja ih obuhvataju i postupke za njihovu upotrebu za uništavanje i kontrolu (rasta) insekata, krpelja, mekušaca ili nematoda.

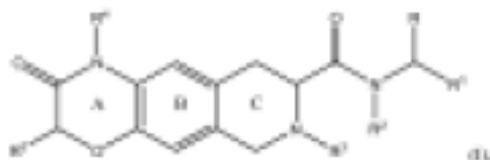

- (51) **C07D 207/26**  
**A61K 31/4015**  
**A61P 21/02**  
**A61P 25/00**  
**A61P 25/24**
- (11) **01192**  
(13) **A**
- (21) P-2009-293  
(22) 15.03.2007  
(30) P-06-45 16.03.2006 LV  
(86) PCT/EP2007/052424 15.03.2007  
(87) WO/2007/104780 20.09.2007
- (54) (ME) **METODE PRPREME I UPOTREBE FARMAKOLOŠKI AKTIVNOG N-KARBONILMETIL - 4- (R) -FENIL-2-PIROLIDINONA**  
(EN) N- CARBAMOYLMETHYL- 4- (R) -PHENYL-2-PYRROLIDINONE, METHOD OF ITS PREPARATION AND PHARMACEUTICAL USE
- (73) AKCIJU SABIEDRIBA 'OLAINFARM; Rupnicu iela 5, LV-2114 Olaine (LV)  
(72) VEINBERG, Grigory; Brivibas gatve 236-33 LV-1039 Riga (LV)  
VORONA, Maksim; Dammes iela 40-70 LV-1069 Riga (LV)  
ZVEJNIECE, Liga; Rostokas iela 34-16 LV-1029 Riga (LV)  
CHERNOBROVIJS, Aleksandrs; Parka iela 1-13 LV-2114 Olaine (LV)  
KALVINSH, Ivars; Libiesu iela 25 LV-5052 Ikskile (LV)  
KARINA, Ligita; Markalnes iela 3-11 LV-1024 Riga (LV)  
DAMBROVA, Maija; Grina bulv. 15-7 LV-1002 Riga (LV)
- (74) Čosović Dejan, 13. jula 1/5, Budva (ME)
- (57) Izum se odnosi na R-enantiomer N-karbamoilmetil-4-aril-2- pirolidinona (R-Karfedon) koji ima farmakološku vrednost. Metoda njegove pripreme uključuje jedinjenja (I) prema zahtjevu 1 pomoću N-alkilacije 4(R)-fenil-2-pirolidinona s etil bromacetatom koju sledi karbamoilacija intermedijarnog N-etoksikarbonilmetil-4(R)-aril-2-pirolidinon s amonijakom.

- (51) **A61K 31/202** (11) **01109**  
**A61K 31/216** (13) **A**  
**C07C 217/46**  
**C07C 229/12**  
**C07C 235/06**  
**C07C 323/52**  
**C07C 59/68**  
**C07C 59/70**  
**C07C 69/708**  
**C07C 69/736**

(21) P-2009-108

(22) 05.11.2002.

(30) 60/338,684 06.11.2001 US

(86) PCT/US2002/035318 05.11.2002.

(87) WO/2003/040080 15.05.2003

(54) (ME) **ANALOZI LIPOKSINA A4**

(EN) LIPOXIN A4 ANALOGS

(73) SCHERING AKTIENGESELLSCHAFT, 13342 Berlin (DE)

(72) BAUMAN, John, G.; 5466 Deer Run Drive El Sobrante, CA 94803 (US)

GUILFORD, William, J.; 1881 Robin Whipple Way Belmont, CA 94002 (US)

PARKINSON, John, F.; 6727 Waverly Road Martinez, CA 94553 (US)

SKUBALLA, Werner; Mattersburger Weg 12 13465 Berlin (DE)

SUBRAMANYAM, Babu; 497 McCall Drive Benicia, CA 94510 (US)

(74) Anđelić Branko, Svetozara Markovića 12, Podgorica (ME)

(57) Ovaj pronalazak je usmjeren na analoge lipoksina A4 sledeće formule (I) i (II): pri čemu su R<sub>1</sub>, R<sub>2</sub> i R<sub>3</sub>, R<sub>4</sub> i R<sub>5</sub> kako je to ovdje opisano. Ovi analozi su korisni u liječenju inflamatornih i autoimunih poremećaja kod ljudi. Ovi analozi su takođe korisni u liječenju inflamacije pulmonalnog i respiratornog trakta kod ljudi.

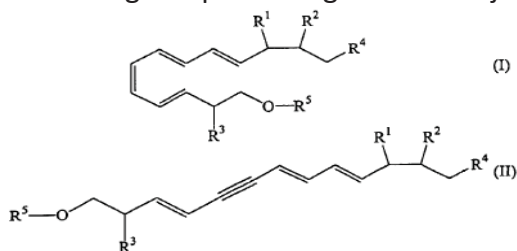







- (51) **C07K 16/28**  
**A61K 39/395**  
**A61P 35/00**  
**C12N 15/13**  
**C12N 5/18**
- (11) **01195**  
(13) **A**
- (21) P-2011-2  
(22) 07.07.2009  
(30) 08/03888 08.07.2008 FR  
(86) PCT/FR2009/051343 07.07.2009  
(87) WO/2010/004204 14.01.2010
- (54) (MN) **FGF-R4 RECEPTOR SPECIFIČNI ANTAGONISTI**  
(EN) FGF-R4 RECEPTOR-SPECIFIC ANTAGONISTS
- (73) SANOFI-AVENTIS; 174 avenue de France F-75013 Paris (FR)  
(72) BAURIN, Nicolas; c/o sanofi-aventis Département Brevets 174 Avenue de France F-75013 Paris (FR)  
BERNE, Pierre-François; c/o sanofi-aventis Département Brevets 174 Avenue de France F-75013 Paris (FR)  
BLANCHE, Francis; c/o sanofi-aventis Département Brevets 174 Avenue de France F-75013 Paris (FR)  
BONO, Françoise; c/o sanofi-aventis Département Brevets 174 Avenue de France F-75013 Paris (FR)  
CAMERON, Béatrice; c/o sanofi-aventis Département Brevets 174 Avenue de France F-75013 Paris (FR)  
DABDOUBI, Tarik; c/o sanofi-aventis Département Brevets 174 Avenue de France F-75013 Paris (FR)  
HERBERT, Corentin; c/o sanofi-aventis Département Brevets 174 Avenue de France F-75013 Paris (FR)  
MIKOL, Vincent; c/o sanofi-aventis Département Brevets 174 Avenue de France F-75013 Paris (FR)  
REMY, Elisabeth; c/o sanofi-aventis Département Brevets 174 Avenue de France F-75013 Paris (FR)
- (74) Ćupić Branislav, Dalmatinska 10, Podgorica (ME)
- (57) Predmetni pronalajak se odnosi na molekule FGF-R4- specifičnih antagonista koji omogućavaju inhibiciju ovog receptora. Ovi antagonist su pre svega FGF-R4-specifični antitela koja omogućavaju inhibiciju aktivnosti ovog receptora. Predmetni pronalazak se takode odnosi na terapijsku upotrebu ovih antitela, posebno u domenu angiogeneze i u lečenju određenih oblika kancera.

(51) **A01G 9/18**(11) **01196**(13) **A**

(21) P-2011-1

(22) 03.07.2009.

(30) BO2008A000429 08.07.2008 IT

(86) PCT/IT2009/000294 03.07.2009.

(87) WO/2010/004603 14.01.2010

(54) **(ME) APARAT ZA SMANJENJE KOLIČINE UGLJENDIOKSIDA SADRŽANOG U DIMU OD SAGORJEVANJA****(EN) APPAREIL DESTINÉ À RÉDUIRE LE DIOXYDE DE CARBONE CONTENU DANS DES FUMÉES DE COMBUSTION**

(73) LEON ENGINEERING S.P.A., Via G. Leonardelli, 3 I-47891 Dogana (R.S.M.) (SM)

(72) AMADESI, Paolo; Via Andrea Costa, 152 I-40134 Bologna (BO) (IT)

(74) Čejović Vladimir, 13. jul 21, Podgorica (ME)

(57) Ovaj pronalazak odnosi se na uređaj (1) za smanjenje količine ugljendioksida koji se nalazi u dimu od sagorevanja koji se sastoji od najmanje jednog ulaznog voda za dim (2) u najmanje jednoj radnoj komori (3) i najmanje jednog voda (4) za izbacivanje prečišćenih gasova. Rečena najmanje jedna komora (3) sadrži najmanje jednu biljku (10) postavljenu duž putanje dima koja ide od ulaznog voda (2) do izlaznog voda (4). Rečeni dim tokom cirkulacije udara u površinu biljke (10).

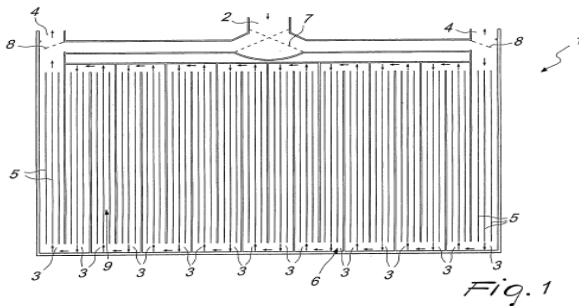

(51) **G06F 17/30**  
**G06K 9/00**

(11) **01110**  
(13) **A**

(21) P-2010-141

(22) 05.03.2009

(30) PA 2008 00345 07.03.2008 DK  
61/064,681 19.03.2008 US

(86) PCT/EP2009/052615 05.03.2009

(87) WO/2009/109626 11.09.2009

(54) (ME) **METODA SKENIRANJA**  
(EN) **METHOD OF SCANNING**

(73) JL HOLDINGS ApS, DK; c-o Brandt & Lauritzen A-S Amaliegade 35 DK-1256 Copenhagen K (DK)

(72) NIELSEN, Lars Stig; Hyllingebjergvej 74 DK-3360 Liseleje (DK)  
MEIBOM, Jacob; Helgesensgade 27, 1.th. DK-2100 Copenhagen Ø (DK)

(74) Radulović Božidar, Jovana Tomaševića 9 III-1, Podgorica (ME)

(57) Kompjuterska metoda skeniranja dokumenta (na primjer, novine ili knjiga) gdje se tekst može zakonski zaštititi od neautorizovanog kopiranja, sadrži korake: pohranjivanje u memoriju najmanje jednog snimka koji je vezan za polje koje pokriva ograničeno područje dokumenta; procesiranje najmanje jednog snimka za izvođenje prepoznavanja karaktera; kada je karakter prepoznat, njegovo registrovanje u memoriji, i ponavljano izvođenje gornjih koraka prilikom snimanja na pomjerenim pozicijama tako da se progresivno dobija niz karaktera; i evaluacija niza prema ranije definisanom uslovu; ako uslov nije ispunjen, utvrđivanje da li ukloniti iz memorije najmanje jednog dijela najmanje jednog snimka, a ako je uslov ispunjen obezbjeđivanje outputa i uklanjanje iz memorije najmanje dijela niza i najmanje dijela najmanje jednog snimka.

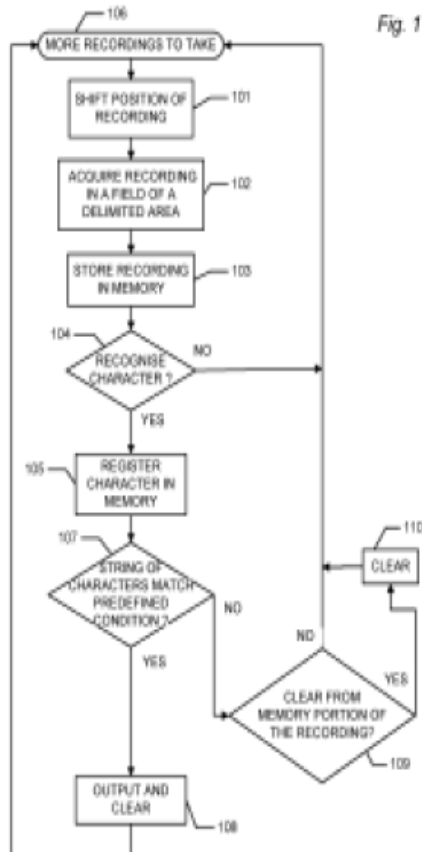

(51) E01F 7/04

(11) 01084

(13) A

(21) P-2010-134

(22) 27.02.2009.

(30) 2008-045936 27.02.2008 JP

(86) PCT/IB2009/050809 27.02.2009

(87) WO/2009/107104 03.09.2009

(54) (ME) **KONSTRUKCIJA ZA SPREČAVANJE ODRONA, METOD ZA SPREČAVANJE ODRONA, I METOD ZA PROJEKTOVANJE POMENUTE KONSTRUKCIJE**

(EN) A STRUCTURE FOR PREVENTING ROCKFALL, A ROCKFALL PREVENTION METHOD, AND A METHOD FOR DESIGNING SAID STRUCTURE

(73) OFFICINE MACCAFERRI S.P.A.; Via Kennedy, 10 I-40069 Zola Predosa (IT)

(72) FUJII, Tomohiro; c/o PROTEC ENGINEERING Inc. 5322-26 Hasugata, Seiro-machi Kitakanbara-gun, Niigata 957-0106 (JP)

NOMURA, Toshimitsu; c/o PROTEC ENGINEERING Inc. 5322-26 Hasugata, Seiro-machi Kitakanbara-gun, Niigata 957-0106 (JP)

(74) Ćosović Dejan, 13. jula 1/5, Budva (ME)

(57) Cilj pronalaska je da se spreči odronjavanje stena i površinskog sloja kosina koje su identifikovane kao mogući odroni. Kosina (1) je prekrivena mrežnom konstrukcijom (2) napravljenom od materijala užadi (3) i (4) kombinovanih u poprečnim preseccima i mrežom koja je povezana. Materijal užadi (3) i (4) i mrežna konstrukcija (2) su učvršene u kosinu (1) korišćenjem ankera (6). Ankeri (6) su insertovani u kosinu (1) kako bi se stabilizovao površinski sloj kosine (1), obezbeđujući ankerima (6) i mrežnoj konstrukciji (2) čvrstinu koja je u stanju da spreči pomeranje stenske mase (22) na kosini (1). Koristeći ankere (6) sprečava se pomeranje površinskog sloja kosine (1) i urušavanje istovremeno koristeći ankere (6) i mrežnu konstrukciju (2) a sprečava se pomeranje i padanje indentifikovane stenske mase (22) kosine (1).

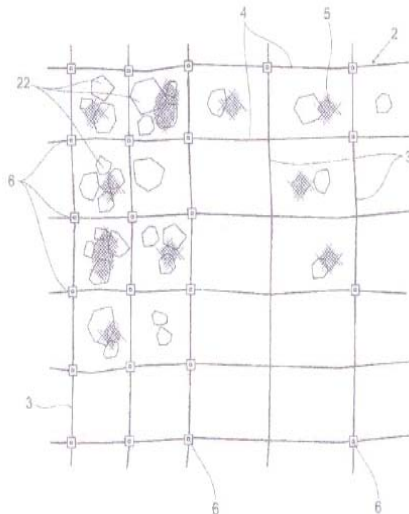

- (51) **C07D 471/14**  
**A61K 31/437**  
**A61P 35/00**
- (11) **01161**  
(13) **A**
- (21) P-2010-208  
(22) 11.06.2009  
(30) 08/03262 12.06.2008 FR  
(86) PCT/FR2009/051100 11.06.2009  
(87) WO/2009/150381 17.12.2009
- (54) (ME) **DERIVATI AZAKARBOLINA, NJIHOVO DOBIJANJEI TERAPEUTSKA UPOTREBA**  
(EN) AZACARBOLINE DERIVATIVES, PREPARATION THEREOF, AND THERAPEUTIC USE THEREOF AS KINASE INHIBITORS
- (73) SANOFI-AVENTIS; 174 avenue de France F-75013 Paris (FR)
- (72) ARENDT, Christopher; c/o Sanofi-Aventis 1041 Routes 202-206 Mail Code: D-303A Bridgewater, New Jersey 08807 (US)  
BABIN, Didier; c/o Sanofi-Aventis Département Brevets 174 avenue de France F-75013 Paris (FR)  
BEDEL, Olivier; c/o Sanofi-Aventis Département Brevets 174 avenue de France F-75013 Paris (FR)  
GOUYON, Thierry; c/o Sanofi-Aventis Département Brevets 174 avenue de France F-75013 Paris (FR)  
LEVIT, Mikhail; c/o Sanofi-Aventis 1041 Routes 202-206 Mail Code: D-303A Bridgewater, New Jersey 08807 (US)  
MIGNANI, Serge; c/o Sanofi-Aventis Département Brevets 174 avenue de France F-75013 Paris (FR)  
MOORCROFT, Neil; c/o Sanofi-Aventis 1041 Routes 202-206 Mail Code: D-303A Bridgewater, New Jersey 08807 (US)  
PAPIN, David; c/o Sanofi-Aventis Département Brevets 174 avenue de France F-75013 Paris (FR)  
LI, Ronghua; c/o Sanofi-Aventis 1041 Routes 202-206 Mail Code: D-303A Bridgewater, New Jersey 08807 (US)
- (74) Čupić Branislav, Dalmatinska 10, Podgorica (ME)
- (57) Novi azakarbolini formule:gdje: R3 i R4 predstavljaju, međusobno nezavisno, H; hal; CF<sub>3</sub>; supstituisani oksii; po izboru supstituisani alkoksi; po izboru supstituisani amino; supstituisani karbonil; po izboru supstituisani karboksil; po izboru supstituisani amid; sumpor kao što su po izboru supstituisani sulfidi, sulkoksidi ili sulfoni; linearni, granati ili cikličan C1-C10 alkil koji po izboru sadrži po izboru supstituisani heteroatom; po izboru supstituisani linearni granati ili cikličan C2-C7 alkenil; po izboru supstituisani linearan ili granati C2-C6 alkinil; po izboru supstituisani aril ili heteroaril; po izboru supstituisani heterocikloalkil; R6 predstavlja heteroaril, C(0)NR<sub>1</sub>aR<sub>1</sub>b, heterocikloalkil ili -C(0)heterocikloalkil, svi po izboru supstituisani; u obliku baze ili kisjele adicione soli. Pronalazak se takode odnosi na upotrebu u liječenju kancera, i sintetički postupci.

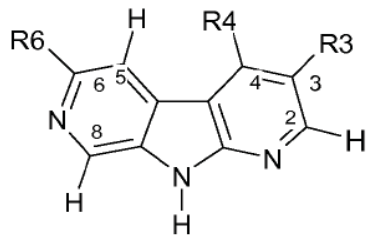

(51) **C07C 51/09**  
**C07C 17/14**  
**C07C 17/26**  
**C07C 25/18**  
**C07C 253/14**  
**C07C 255/35**  
**C07C 57/62**

(11) **01160**

(13) **A**

(21) P-2010-200

(22) 08.05.2009

(30) 08158022.7 11.06.2008 EP

(86) PCT/EP2009/003288 08.05.2009

(87) WO/2009/149797 17.12.2009

(54) (ME) **POSTUPAK ZA DOBIJANJE DERIVATA 1-(2-HALOBIFENIL-4-IL)-  
 CIKLOPROPANKARBOKSILNE KISJELINE**

(EN) PROCESS OF PREPARING DERIVATIVES OF 1-(2-HALOBIPHENYL-4-YL)-CYCLOPROPANE-CARBOXYLIC ACID

(73) CHIESI FARMACEUTICI S.P.A. ; Via Palermo, 26/A I-43100 Parma (IT)

(72) FOLLEAS, Benoit; c/o Chiesi Farmaceutici S.p.A. Via Palermo, 26A I-43100 Parma (IT)

BOTTE, Hubert; c/o Chiesi Farmaceutici S.p.A. Via Palermo, 26A I-43100 Parma (IT)

DELACROIX, Thomas; c/o Chiesi Farmaceutici S.p.A. Via Palermo, 26A I-43100 Parma (IT)

PIVETTI, Fausto; c/o Chiesi Farmaceutici S.p.A. Via Palermo, 26A I-43100 Parma (IT)

(74) Radulović Božidar, Jovana Tomaševića 9/III, Podgorica (ME)

(57) Predmetni pronalazak odnosi se na postupak za dobijanje jedinjenja sa formulom (I).  
 Predmetni pronalazak se također odnosi na korisne međuproizvode u navedenom postupku.

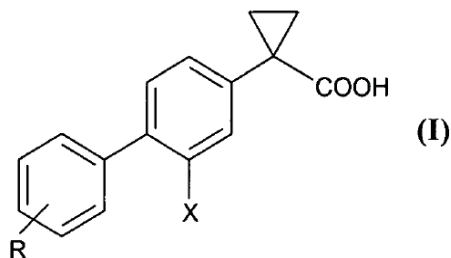

(51) **C07D 498/08**  
**A61K 31/53**  
**A61P 35/00**

(11) **01111**  
 (13) **A**

(21) P-2010-188

(22) 21.05.2009

(30) 61/055,661 23.05.2008 US

(86) PCT/US2009/044774 21.05.2009

(87) WO/2009/143313 26.11.2009

(54) (ME) **TRIAZINSKA JEDINJENJA KAO IHIBITORI P13 KINAZE I MTOR**  
 (EN) **TRIAZINE COMPOUNDS ASPBKINASE AND MTOR INHIBITORS**

(73) WYETH LLC; Patent Law Department Five Giralda Farms Madison, NJ 07940 (US)

(72) VENKATESAN, Aranapakam, M.; 97-07 63rd Road #9K Rego Park, NY 11374 (US)

CHEN, Zecheng; 2 Westgate Blvd. New City, NY 10956 (US)

DEHNHARDT, Christoph, M.; 423 East 83rd Street Apt #4E New York, NY 10128 (US)

DOS SANTOS, Osvaldo; 35-15 34th Street Apartment #B22 Astoria, NY 11106 (US)

DELOS SANTOS, Efren Guillermo; 38 Birchwood Terrace Nanuet, NY 10954 (US)

ZASK, Arie; 21 East 9th Street New York, NY 10128 (US)

VERHEIJEN, Jeroen, C.; 154 Schunnemunk Road Highland Mills, NY 10930 (US)

KAPLAN, Joshua, Aaron; 10 High Avenue Nyack, NY 10960 (US)

RICHARD, David, J.; 64 Old Ridge Road Warwick, NY 10990 (US)

AYRAL-KALOUSTIAN, Semiramis; 484 Carrollwood Drive Tarrytown, NY 10591 (US)

MANSOUR, Tarek, S.; 5 Overlook Road New City, NY 10956 (US)

GOPALSAMY, Ariamala; 21 Whispering Pines Drive Mahwah, NJ 07430 (US)

CURRAN, Kevin, J.; 198 Foltim Way Congers, NY 10920 (US)

SHI, Mengxiao; 57 Mill Road Eastchester, NY 10709 (US)

(74) Ćupić Branislav, Dalmatinska 10, Podgorica (ME)

(57) Jedinjenja formule, (I) gde: R1 predstavlja (II) ili (III); a R2, R4 i R6"9 su ovde definisani, i njihove farmaceutski prihvatljive soli i estri. Ova jedinjenja inhibiraju PB kinazu i mTOR, i mogu se koristiti za tretiranje bolesti posredovanih sa PB kinazom i mTOR, kao što su razni kanceri. Opisani su postupci za pravljenje i upotrebu jedinjenja iz ovog pronalaska. Opisane su takođe razne kompozicije koje sadrže jedinjenja iz ovog pronalaska.

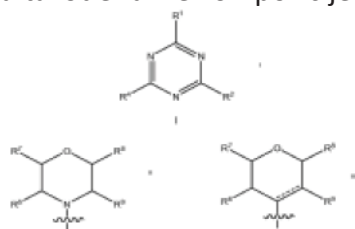



(51) **C07D 471/04**  
**A61K 31/437**  
**A61P 19/00**  
**A61P 25/00**  
**A61P 35/00**  
**C07D 213/28**  
**C07D 233/56**

(11) **01112**  
 (13) **A**

(21) P-2010-150

(22) 20.03.2009

(30) 0801585 21.03.2008 FR

(86) PCT/FR2009/000298 20.03.2009

(87) WO/2009/144392 03.12.2009

(54) (ME) **VIŠESUPSTITUISANI 6-HETEROARILIMIDAZO (1,2-A) PIRIDIN DERIVATI, NJIHOVO DOBIJANJE I NJIHOVA TERAPEUTSKA UPOTREBA**

(EN) POLYSUBSTITUTED DERIVATIVES OF 6-HETEROARYL-IMIDAZO[L,2- A] PYRIDINES, AND PREPARATION AND THERAPEUTIC USE THEREOF

(73) SANOFI-AVENTIS; 174 avenue de France F-75013 Paris (FR)

(72) DE PERETTI, Danielle; c/o Sanofi-aventis Département Brevets 174 avenue de France F-75013 Paris (FR)

EVANNO, Yannick; c/o Sanofi-aventis Département Brevets 174 avenue de France F-75013 Paris (FR)

MACHNIK, David; c/o Sanofi-aventis Département Brevets 174 avenue de France F-75013 Paris (FR)

RAKOTOARISOA; c/o Sanofi-aventis Département Brevets 174 avenue de France F-75013 Paris (FR)

(74) Ćupić Branislav, Dalmatinska 10, Podgorica (ME)

(57) Ri predstavlja fenil ili naftil grupu, ili heteroaril grupu ili heterocikličnu grupu, po izboru supstitusanu sa jednim ili vise atoma ili grupa; Het predstavlja monocikličnu heteroaril grupu koja sadrži od 5 do 6 atoma, uključujući od 1 do 3 heteroatoma koji su odabrani od N, O i S; X predstavlja od 1 do 3 supstituenta, koji su međusobno jednaki ili različiti, koji su odabrani od vodonika, halogena, (C1-C10)alkil, (d-C<sup>^</sup>alkoksi, NRaRb, nitro i cijano, moguće je da (C1-C10)alkil budu po izboru supstitusani sa jednom ili vise grupa koje se biraju od halogen, (C1-C10)alkoksi, (CrCi0)haloalkoksi, NRaRb ili hidrosil; R predstavlja, u položajima 3, 5, 7 ili 8 imidazo[1,2-a]piridina, od 1 do 4 supstituenta, koji su međusobno jednaki ili različiti, koji su odabrani od vodonika, halogena, (CrC10)alkil, halo(C1-C10)alkil i (C1-C10)alkoksi; R2 i R3 predstavljaju, nezavisno jedan od drugoga, atom vodonika, (d-C<sup>^</sup>alkil grupu, po izboru supstitusanu sa nekom Rf grupom, ili aril grupu, koja je po izboru supstitusana; R4 predstavlja atom vodonika, (C1-C10)alkil grupu, po izboru supstitusanu sa nekom Rf grupom, ili aril grupu, koja je po izboru supstitusana, u obliku baze ili neke adicione soli sa nekom kiselinom. Njihova terapijska upotreba i postupak za njihovu sintezu.

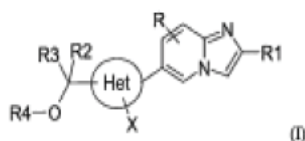

- (51) **A61K 9/16**  
**A61K 31/437**  
**A61K 47/10**  
**A61K 47/26**  
**A61K 47/38**  
**A61K 9/20**  
**A61K 9/28**  
**A61K 9/50**
- (11) **00600**  
(13) **A**
- (21) P-2009-81  
(22) 31.07.2007  
(30) MI2006A001692 05.09.2006 IT  
(86) PCT/IB2007/002199 31.07.2007  
(87) WO/2008/029208 13.03.2008
- (54) (ME) **UPOTREBA POLIOLA ZA DOBIJANJE STABILNIH POLIMORFNIH OBLIKA RIFAKSIMINA**  
(EN) USE OF POLYOLS TO OBTAIN STABLE POLYMORPHOUS FORMS OF RIFAXIMIN
- (73) ALFA WASSERMANN S.P.A. ; Via Enrico Fermi n. 1, I-65020 Alanno (PE) (IT)  
(72) MAFFEI, Paola; Via Ragazzi del '99 n. 5 I-40133 Bologna (IT)  
BACHETTI, Milena; Via Ragazzi del '99 n. 5 I-40133 Bologna (IT)  
BOTTONI, Giuseppe; Via Ragazzi del '99 n. 5 I-40133 Bologna (IT)  
VISCOMI, Giuseppe, Claudio; Via Ragazzi del '99 n. 5 I-40133 Bologna (IT)
- (74) Lutovac Branislav, bulevar Ivana Crnojevica 93, Podgorica (ME)
- (57) Polioli stabilizuju polimorfni oblik rifaksimina, a naročito P oblik. Kada se polioli koji imaju bar dve hidroksilne grupe dodaju u prah rifaksimina, polimorf P je stabilan i ostaje stabilan tokom vremena nezavisno od vlažnosti okoline. U ovom pronalasku, opisan je postupak za pripremanje formulacija koje se sastoje od stabilnih i čistih polimorfni oblika koji su u stanju da daju farmaceutski proizvod.

- (51) **A23K 1/16** (11) **00172**  
**A23K 1/18** (13) **A**
- (21) P-2008-128  
(22) 07.06.2005  
(30) 10 2004 028 193.9 09.06.2004 DE  
10 2004 059 761.8 11.12.2004 DE  
(86) PCT/EP2005/006110 07.06.2005  
(87) WO/2005/120246 WO/2005/120246
- (54) (ME ) **GUANIDINO SIRĆETNA KISJELINA KAO DODATAK HRANI ZA ŽIVOTINJE**  
(EN) **GUANIDINO ACETIC ACID USED AS AN ANIMAL FOOD ADDITIVE**
- (73) AlzChem Trostberg GmbH, Dr.Albert-Frank-Strasse 32, 83308 Trostberg, DE  
(72) GASTNER, Thomas; Garchingerstrasse 16A 84549 Engelsberg (DE)  
KRIMMER, Hans-Peter; Wiesenstrasse 3 84558 Kirchweidach (DE)  
(74) Popović Miladin, Đoka Miraševića 21/III, Podgorica (ME)
- (57) Pronalazak se odnosi na primenu guanidino sirćetne kiseline i/ili njenih soli kao dodatka za životinjsku hranu, pri čemu pretežno u vegetarijanskoj ishrani, posebno se koriste soli hlorovodonične kiseline, bromovodonične kiseline i fosforne kiseline. Njihova primena se izvodi, naročito, u pojedinačnim dozama od 0.01 do 100 g/kg životinjske hrane u obliku praška, granula, peleta ili kapsula, a dodatak životinjskoj hrani takode se može uzimati sa drugim fiziološki aktivnim korisnim supstancama. Primena prema pronalasku, koja je naročito korisna za uzgoj životinja i životinja koje se koriste za ishranu, odnosi se na stabilnost posebno u vodenom rastvoru, i koja se može prevesti fiziološkim jedinjenjima u kreatin i fiziološki opsezi primene su dati nasuprot drugim derivatima guanidina.

- (51) **A61K 39/39** (11) **01199**  
**A61K 39/00** (13) **A**  
**A61K 39/012**  
**A61K 39/02**
- (21) P-2010-194  
(22) 24.06.2009.  
(30) 61/076,232 27.06.2008 US  
61/214,557 24.04.2009 US  
(86) PCT/IB2009/052724 24.06.2009.  
(87) WO/2009/156960 30.12.2009
- (54) (ME) **NOVE KOMPOZICI.IE ADJUVANTA**  
(EN) NOVEL ADJUVANT COMPOSITIONS
- (73) PFIZER INC.; 235 East 42nd Street New York, New York 10017 (US)  
(72) BAGI, Cedo Martin; Pfizer Global Research and Development Eastern Point Road Groton, Connecticut 06340 (US)  
CHILDERS, Tedd Alan; Pfizer Global Research and Development 7000 Portage Road Kalamazoo, Michigan 49001 (US)  
DOMINOWSKI, Paul Joseph; Pfizer Global Research and Development 7000 Portage Road Kalamazoo, Michigan 49001 (US)  
KREBS, Richard Lee; Pfizer Inc. 601 West Cornhusker Highway Lincoln, Nebraska 68521 (US)  
MANNAN, Ramasamy Mannar; 550 Liberty Street #2403 Braintree, Massachusetts 02184 (US)  
OLSEN, Mary Kathryn; Pfizer Global Research and Development 7000 Portage Road Kalamazoo, Michigan 49001 (US)  
THOMPSON, James Richard; Pfizer Global Research and Development 7000 Portage Road Kalamazoo, Michigan 49001 (US)  
WEERATNA, Risini Dhammika; Pfizer Vaccines Research Ottawa Laboratories 340 Terry Fox Drive, Suite 200 Ottawa , Canada , Ontario K2K 3A2 (CA)  
YANCEY, Robert John, Jr.; Pfizer Global Research and Development 7000 Portage Road Kalamazoo, Michigan 49001 (US)  
ZHANG, Shucheng; Pfizer Global Research and Development 7000 Portage Road Kalamazoo, Michigan 49001 (US)
- (74) Ćupić Branislav, Dalmatinska 10, Podgorica (ME)
- (57) Ovaj pronalazak se odnosi na formulacije adjuvanta koje sadrže različite kombinacije triterpenoida. sterola. imunomodulatora, polimera i Th2 stimulatora; postupke za pripremu kompozicija adjuvanta; i na primenu formulacija adjuvanta u imunogenim kompozicijama i kompozicijama vakcine sa različitim antigenima. Ovaj pronalazak dalje se odnosi na primenu formulacija u lečenju životinja.

- (51) **A01N 37/40**  
**A01N 59/20**  
**A01N 25/14**  
**A01P 3/00**
- (11) **01197**  
(13) **A**
- (21) P-2011-121  
(22) 29.12.2009.  
(30) MI2009A 000001 02.01.2009. IT  
(86) PCT/EP2009/009351 29.12.2009.  
(87) WO 2010/076038 08.07.2010.
- (54) (ME) **FUNGICIDNE KOMPOZICIJE NA BAZI BAKARNIH SOLI**  
(EN) FUNGICIDAL COMPOSITIONS BASED ON COPPER SALTS
- (73) ISAGRO S.P.A.; Via Caldera 21, I-20153 Milano (IT)  
(72) FILIPPINI, Lucio; Corso Vercelli, 83/s I-28100 Novara (IT)  
GUSMEROLI, Marilena; Viale Libertà 114/B I-20052 Monza (MB) (IT)  
MORMILE, Silvia; Via Vicenza 9 I-28100 Novara (IT)  
VAZZOLA, Matteo, Santino; Via P. Mascagni 11 I-20020 Cogliate (MB) (IT)
- (74) Lutovac Branimir, Bulevar Ivana Crnojevića 93, Podgorica (ME)
- (57) Opisane su fungicidne kompozicije koje sadrže: A) bakar-salicilat, koji ima sledeću formulu molekula (1) :  $C_7H_4 O_3Cu \cdot (H_2O)_n$  (gdje n predstavlja 0, 1, 2 ili 3); B) bakar-hidroksid,  $Cu(OH)_2$  (II); C) so bakra, koja ima sledeću formulu (III):  $3Cu(OH)2X(Y)_m$  (III), gdje su: -X predstavlja kupri jon,  $Cu^{2+}$  ili kalcijumov jon,  $Ca^{2+}$ ; - Y predstavlja hloridni jon,  $Cl^-$  ili sulfatni jon,  $SO_4^{2-}$ ; - m je cio broj, jednak 1 ili 2; opciono u prisustvu disperzanata, razblaživača, surfaktanata i/ili ko-formulanata, koji su prihvatljivi u poljoprivredi, i srodne poljoprivredne formulacije. Opisana je takode i upotreba ovih fungicidnih kompozicija i formulacija za poljoprivredu za kontrolisanje fitopatogenih gljivica na poljoprivrednim usjevima.

- (51) **C07D 471/04**  
**C07D 491/04**  
**C07D 513/04**  
**A61K 31/4162**  
**A61P 27/06**  
**C07D 213/72**  
**C07D 213/77**  
**C07D 401/12**  
**C07D 405/12**  
**C07D 409/12**  
**C07D 403/04**  
**C07D 495/04**
- (11) **01200**  
(13) **A**
- (21) P-2011-118  
(22) 24.12.2009.  
(30) 08/07475 29.12.2008. FR  
09/04091 28.08.2009. FR  
(86) PCT/FR2009/052692 24.12.2009.  
(87) **WO 2010/076525 08.07.2010.**
- (54) (ME) **DERIVATI 2-PIRIDIN-2-IL-PIRAZOL-3(2H)-ON, NJIHOVA PRIPREMA I NJIHOVA UPOTREBA U LIJEČENJU**  
(EN) DERIVATIVES OF 2-PYRIDIN-2-YL-PYRAZOL-3(2H)-ONE, PREPARATION AND THERAPEUTIC USE THEREOF
- (73) SANOFI; 174, avenue de France F-75013 Paris (FR)  
(72) ALTENBURGER, Jean-Michel; c/o sanofi-Aventis Département Brevets 174, avenue de France F-75013 Paris (FR)  
FOSSEY, Valérie; c/o sanofi-Aventis Département Brevets 174, avenue de France F-75013 Paris (FR)  
ILLIANO, Stéphane; c/o sanofi-Aventis Département Brevets 174, avenue de France F-75013 Paris (FR)  
MANETTE, Géraldine; c/o sanofi-Aventis Département Brevets 174, avenue de France F-75013 Paris (FR)
- (74) Ćupić Branislav, Dalmatinska 10, Podgorica (ME)
- (57) Ovaj pronalazak se odnosi na jedinjenja koja odgovaraju formuli (I), u obliku baze ili adicione soli sa kiselinom. U kojoj: n je jednako 0, 1, 2, 3 ili 4; m je jednako 0, 1 ili 2; o je jednako 0 ili 1; X predstavlja grupu -CH<sub>2</sub>, -CH(R')-, -NH(R')- ili heteroatom odabran od O i S, gde se podrazumijeva da R' predstavlja grupu -(C1-C5)alkil, -(C1-C5)alkoksi, -CH<sub>2</sub>-aril, -C(O)R<sub>5</sub> ili -COOR<sub>5</sub>: R<sub>1</sub> predstavlja okso grupu, -COOR<sub>5</sub>, -W-OH ili -W-NR<sub>5</sub>R<sub>6</sub>, R<sub>2</sub> predstavlja jedan H atom ili grupu odabranu od grupa (i) -(C1-C5)alkil, (ii) -(C1-C5)alkoksi, (iii) -COOR<sub>5</sub>, (iv) -NR<sub>5</sub>R<sub>6</sub>, (v) -C(O)-NR<sub>5</sub>R<sub>6</sub>, (vi) -SO<sub>2</sub>-NR<sub>3</sub>R<sub>4</sub>. (vii) heteroaril opcionalno supstituisan sa grupom -(C1-C5)alkil, (viii) -W-aril. (ix) -W-heteroaril. (x) -O-W-aril. (xi) -O-W-heteroaril i (xii) -O-W-NR<sub>5</sub>R<sub>6</sub>; gde se podrazumijeva da R<sub>3</sub> i R<sub>4</sub>, (i) koji mogu biti isti ili različiti, predstavljaju, nezavisno jedan od drugoga, jedan H atom, grupu -(C1-C5)alkil, -(C3-C6)cikloalkil, aril, heteroaril, -CH<sub>2</sub>-heteroaril, -(C1-C5)alkil-NR<sub>5</sub>R<sub>6</sub>, -W-OH ili -W-NR<sub>5</sub>R<sub>6</sub>; ili (ii) formiraju za sa atomima azota koji ih nosi. heterocikloalkil grupu supstituisanu opcionalno sa jednom ili više grupa odabranih od grupa -(C1-C5)alkil i -CH<sub>2</sub>-aril; W je grupa -(C1-C5)alkilen, opcionalno supstituisana sa jednom ili više hidroksi grupa; R<sub>5</sub> i R<sub>6</sub>, koji mogu biti identični ili različiti, predstavljaju, nezavisno jedan od drugog, atom vodonika ili grupu odabranu od grupa -(C1-

C5)alkil i grupa -(C3-C6)cikloalkil, kao i postupak za njihovo dobijanje i njihova terapeutska primena.

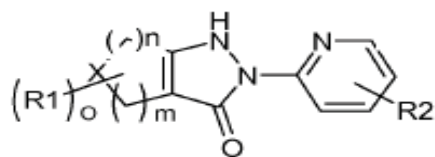

(51) **C07D 207/08**  
**C07D 4 03/06**  
**C07D 405/06**  
**C07D 413/06**  
**C07D 471/04**  
**A61K 31/4025**  
**A61P 35/00**  
**C07D 401/06**

(11) **01213**

(13) **A**

(21) P-2010-153

(22) 24.03.2009.

(30) 61/039,674 26.03.2008. US

(86) PCT/EP2009/053421 24.03.2009.

(87) WO 2009/118305 01.10.2009.

(54) (ME) **INHIBITORI DEACETILAZE B NA BAZI HIDROKSAMATA**

(EN) **HYDROXAMATE-BASED INHIBITORS OF DEACETYLASES B**

(73) **NOVARTIS AG**, Lichtstrasse 35, CH-4056 Basel (CH)

(72) **SHULTZ, Michael**; Novartis Institutes for BioMedical Research, Inc. 250 Massachusetts Avenue Cambridge, MA 02139 (US)

**CHEN, Christine, Hiu-Tung**; Novartis Institutes for BioMedical Research, Inc. 250; Massachusetts Avenue Cambridge, MA 02139 (US)

**CHO, Young Shin**; Novartis Institutes for BioMedical Research, Inc. 250 Massachusetts; Avenue Cambridge, MA 02139 (US)

**JIANG, Lei**; Novartis Institutes for BioMedical Research, Inc. 250 Massachusetts Avenue; Cambridge, MA 02139 (US)

**FAN, Jianmei**; Novartis Institutes for BioMedical Research, Inc. 250 Massachusetts; Avenue Cambridge, MA 02139 (US)

**LIU, Gang**; Novartis Institutes for BioMedical Research, Inc. 250 Massachusetts Avenue; Cambridge, MA 02139 (US)

**MAJUMDAR, Dyuti**; Novartis Institutes for BioMedical Research, Inc. 250 Massachusetts; Avenue Cambridge, MA 02139 (US)

**LI, Jianke**; 1413 Aspen Glen Drive Hamden, CT 06518 (US)

(74) **Čejović Vladimir**, 13. jul 21, Podgorica (ME)

(57) Dato učenje odnosi se na jedinjenja predstavljena formulom I, i farmaceutski prihvatljive soli, hidrate, estere i njihove proljekove, naznačen time što su R<sup>1</sup>, R<sup>2</sup>, R<sup>3</sup>, Y, Z, I (A) definisani ovdje u tekstu. Takođe, dato učenje opisuje postupke dobijanja jedinjenja predstavljenih formulom I i postupke korišćenja jedinjenja predstavljenih formulom I u liječenju, inhibiciji ili prevenciji patoloških stanja ili poremećaja koji su u celosti ili djelimično posredovani aktivnošću deacetilaza.

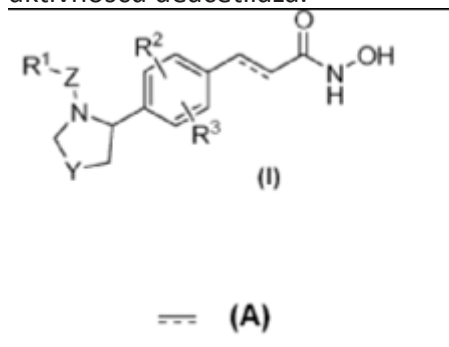



- (51) **C07D 471/04** (11) **01211**  
**A61K 31/437** (13) **A**  
**A61P 27/02**
- (21) P-2010-149  
(22) 09.02.2010.  
(30) 09360013.8 13.02.2009. EP  
(86) PCT/EP2010/051556 09.02.2010.  
(87) WO 2010/092041 19.08.2010.
- (54) (ME) **[1, 2, 4] TRIAZOLO [1, 5 -A] PIRIDINI KAO INHIBITORI KINAZE**  
(EN) [1, 2, 4] TRIAZOLO [1, 5 -A] PYRIDINES AS KINASE INHIBITORS
- (73) FOVEA PHARMACEUTICALS; Institut de la Vision 17 Rue Moreau F-75012 Paris (FR)  
(72) LERICHE, Caroline; 7, rue Antoine Chantin F-75014 Paris (FR)  
AUCLAIR, Eric; 119 Rue Paul Fort F-91310 Montlhery (FR)  
LE ROUX, Jacques; 18 Rue Garibaldi F-93310 Le Pre Saint Gervais (FR)  
MIDDLEMISS, David; 61, Thorley Hill Bishop's Stortford Hertfordshire CM23 3NF (GB)
- (74) Ćupić Branislav, Dalmatinska 10, Podgorica (ME)
- (57) Pronalazak je usmeren na određena nova jedinjenja, metode za dobijanje ovih jedinjenja i postupke liječenja ili poboljšanja poremećaja posredovanih kinazom. Detaljnije, predmetni pronalazak se odnosi na supstituisana jedinjenja triazolopiridina koja su korisni kao selektivni inhibitori kinaze, metode za dobijanje ovih jedinjenja i postupke liječenja ili poboljšanja poremećaja posredovanih kinazom. Posebno, postupci se odnose na liječenje ili poboljšanje poremećaja posredovanih kinazom uključujući kardiovaskularne bolesti, dijabetes, poremećaje koji su povezani sa dijabetesom, inflamatorne bolesti, imunološke bolesti, kancer i bolesti oka, kao što su retinopatije ili makularna degeneracija ili druge vitreoretinalne bolesti i sl.

(51) **A61K 39/12**(11) **01214**(13) **A**

(21) P-2010-179

(22) 08.04.2009.

(30) 61/124,383 16.04.2008. US

(86) PCT/US2009/002189 08.04.2009.

(87) WO 2009/128878 22.10.2009.

(54) (ME) **HIMERNI SVINJSKI CIRKOVIRUS PCV2Gen-1Rep I NJIHOVA UPOTREBA**  
(EN) CHIMERIC PORCINE CIRCOVIRUS PCV2Gen-1Rep AND USES THEREOF

(73) VIRGINIA TECH INTELLECTUAL PROPERTIES, INC., 2200 Kraft Drive Suite 1050 Blacksburg, VA 24060 (US)

(72) JUHAN, Nicole, M.; 117 Sherwood Drive Morganton, NC 28655 (US)

MENG, Xiang-jin; 212 Flippin Circle Blacksburg, VA 24060 (US)

(74) Lutovac Branimir, Bulevar Ivana Crnojevića 93, Podgorica (ME)

(57) Prikazani pronalazak se odnosi na nove himerne molekule nukleinske kiseline svinjskog cirkovirusa (PCV2Gen-1 Rep) koji obuhvataju molekul nukleinske kiseline koji kodira svinjski cirkovirus tipa 2 (PCV2) koji sadrži sekvence nukleinske kiseline koje kodiraju Rep protein svinjskog cirkovirusa tipa 1 (PCV1), naročito gde sekvenca nukleinske kiseline koja kodira Rep protein iz PCV1 je gen otvorenog okvira čitanja (ORF) i jos određenije, kada je ORF Rep gen ORF1. Vrlo poželjan himerni molekul nukleinske kiseline je konstruisan zamjenom ORF1 Rep gena iz PCV2 sa ORF1 Rep genom iz PCV1. Pronalazak takode obuhvata biološki funkcionalni plazmid ili virusni vektor koji sadrži jedinstvene himerne molekule nukleinske kiseline, pogodne ćelije domaćina transfektovane sa plazmidom ili vektorom. infektivne himerne svinjske cirkoviruse koji su proizvedeni od strane pogodnih ćelija domaćma, postupaka za dobijanje proizvoda imunogenih polipeptida korišćenjem novih himera, virusnih vakcina koje štite svinju protiv virusnih infekcija ili multisistemskog sindroma krzljivosti odbijene prasadi (PMWS) izazvanih sa PCV2, postupcima zaštite svinja protiv virusnih infekcija ili multisistemskog sindroma krzljivosti odbijene prasadi (PMWS) izazvanog sa PCV2. postupci dobijanja jedinstvene himere PCY2Gen-1Rep i slično. Ovaj pronalazak dalje obuhvata nove postupke za poboljšanje replikacije i titra PCV2 u ćelijskoj kulturi.

**INDEKS NOSILACA PATENTA**  
**PATENT OWNER INDEX**

(73)	(51)	(21)
AKCIJU SABIEDRIBA 'OLAINFARM	C07D 207/26 A61K 31/4015 A61P 21/02 A61P 25/00 A61P 25/24	P-2009-293
ALFA WASSERMANN S.P.A.	A61K 9/16 A61K 31/437 A61K 47/10 A61K 47/26 A61K 47/38 A61K 9/20 A61K 9/28 A61K 9/50	P-2009-81
AlzChem Trostberg GmbH	A23K 1/16 A23K 1/18	P-2008-128
Antunović Stojan	F16L 9/12	P-2011-102
ATLAS COPCO MAI GMBH	E21D 21/00	P-2010-135
BAYER SCHERING PHARMA	C07D 401/14 C07D 403/14 C07D 413/14 A61K 31/506 A61K 31/5355 A61K 31/553 A61P 9/00 A61P 13/12 A61P 7/06	P-2010-165
BELRON HUNGARY KFT - ZUG BRANCH	B60J 1/00 B65G 49/06	P-2011-136
BELRON HUNGARY KFT-ZUG BRANCH	B26B 27/00	P-2011-88
CHIESI FARMACEUTICI S.P.A.	C07C 51/09 C07C 17/14 C07C 17/26 C07C 25/18 C07C 253/14 C07C 255/35 C07C 57/62	P-2010-200

CHIESI FARMACEUTICI S.P.A.	C07D 453/02 C07D 211/46 C07D 207/12 C07D 211/42 C07D 451/10 A61K 31/439 A61P 11/08 A61K 31/4465 A61K 31/401	P-2011-114
CRYSTAL LAGOONS CORPORATION LLC	B01D 21/01	P-2010-165
ENEL DISTRIBUZIONE S.P.A.	G01R 21/133 G01R 22/06 H02J 13/00	P-2011-78
FOVEA PHARMACEUTICALS	A61K 31/502 C07D 401/14 C07D 403/04 A61P 35/00	P-2011-116
FOVEA PHARMACEUTICALS	C07D 471/04 A61K 31/437 A61P 27/02	P-2010-149
HIGH POINT PHARMACEUTICALS, LLC	A01N 43/42 A61K 31/44	P-2011-89
HIGH POINT PHARMACEUTICALS, LLC	A01N 43/54 A61K 31/505 C07D 239/42	P-2010-122
INNOGENETICS NV INSERM (INSTITUT NATIONAL DE LA SANTE ET DE LA RECHERCHE MEDICALE) SANOFI-AVENTIS	C07K 16/18 A61K 39/395 G01N 33/577 C12N 5/18 C07K 14/47 A61P 25/28	P-2010-69
Insmmed Incorporated	A61K 31/7036 A61P 11/00 A61K 9/127 A61K 47/44	P-2011-64
ISAGRO S.P.A.	A01N 37/40 A01N 59/20 A01N 25/14 A01P 3/00	P-2011-121
ITALCEMENTI S.P.A.	E04C 2/54 B28B 23/00 E04B 2/02	P-2011-103

JL HOLDINGS ApS	G06F 17/30 G06K 9/00	P-2010-141
LABORATORIOS LICONSA, S.A.	A61K 9/00 A61K 9/16	P-2011-57
LEON ENGINEERING S.P.A.	A01G 9/18	P-2011-1
LEON ENGINEERING S.P.A.	F23G 5/027 F23G 5/50	P-2010-193
NOVARTIS AG	C07K 16/28 A61K 39/395 A61P 19/02 A61P 37/06	P-2010-217
NOVARTIS AG	C07D 207/08 C07D 4 03/06 C07D 405/06 C07D 413/06 C07D 471/04 A61K 31/4025 A61P 35/00 C07D 401/06	P-2010-153
NOVARTIS AG	C07D 215/48 C07D 241/44 C07D 403/12 C07D 403/14 A61K 31/4709 A61K 31/498 A61P 35/00	P-2010-175
NYCOMED GMBH	C07D 401/04 A61K 31/454 C07D 401/14 C07D 405/14 C07D 471/04	P-2011-81
OFFICINE MACCAFERRI S.P.A.	E01F 7/04	P-2010-134
ONYX THERAPEUTICS	A61K 38/07 A61K 31/167 A61K 38/08 A61K 31/165 A61K 38/04 A61P 35/00	P-2011-71

PFIZER INC.	C12N 7/04 C07K 14/18 C12N 15/86 A61K 39/12 C07K 16/10 G01N 33/50	P-2011-98
PFIZER INC.	C07D 487/08 A61K 31/407 A61P 29/02 A61P 35/00	P-2011-83
PFIZER INC.	C07D 471/10 A61K 31/435 A61P 25/28	P-2011-84
SANOFI	C07D 401/04 C07D 401/14 C07D 409/14 A61K 31/4439 A61K 31/444 A61K 31/4545 A61K 31/497 A61K 31/5375 A61P 7/00 A61P 9/00 A61P 25/00 A61P 27/00 G01N 33/53	P-2011-117
SANOFI	C07H 15/24 C07H 17/04 C07H 17/00 C07H 7/06 A61K 31/70 A61K31/485 A61P 29/00 A61P 25/04	P-2011-105

SANOFI	C07D 471/04 C07D 491/04 C07D 513/04 A61K 31/4162 A61P 27/06 C07D 213/72 C07D 213/77 C07D 401/12 C07D 405/12 C07D 409/12 C07D 403/04 C07D 495/04	P-2011-118
SANOFI-AVENTIS	A61K 31/343 A61K 45/06 A61P 43/00 A61P 9/06	P-2010-160
SANOFI-AVENTIS	C07D 471/08 A61K 31/529 A61P 25/00 A61P 29/00 A61P 35/00 C07D 487/08	P-2010-210
SANOFI-AVENTIS	A61K 31/343 A61P 9/06 A61P 43/00 A61K 45/06	P-2010-180
SANOFI-AVENTIS	C07D 401/14 C07D 403/14 C07D 407/14 C07D 413/12 C07D 413/14 C07D 417/14 A61P 25/00 A61K 31/445 A61K 31/497 A61K 31/506 A61K 31/501 A61K 31/498 A61K 31/4709 A61K 31/502 A61P 29/00	P-2011-70
SANOFI-AVENTIS	A61K 39/00 A61K 31/00 A61P 35/00	P-2011-94

SANOFI-AVENTIS	C07D 401/14 A61K 31/496 A61P 25/00 A61P 29/00 A61P 35/00	P-2010-210
SANOFI-AVENTIS	C07D 471/04 A61K 31/437 A61P 19/10 A61P 29/00 A61P 35/00 A61P 9/00 C07F 5/04 C07F 7/08	P-2010-103
SANOFI-AVENTIS	C07D 471/04 A61K 31/4375 A61P 35/00	P-2011-3
SANOFI-AVENTIS	C07K 16/28 A61K 39/395 A61P 35/00 C12N 15/13 C12N 5/18	P-2011-2
SANOFI-AVENTIS	C07D 471/14 A61K 31/437 A61P 35/00	P-2010-208
SANOFI-AVENTIS	C07D 471/04 A61K 31/437 A61P 19/00 A61P 25/00 A61P 35/00 C07D 213/28 C07D 233/56	P-2010-150
SANOFI-AVENTIS	C07D 471/04 C07D 213/28 C07D 233/56 A61K 31/437 A61P 25/00 A61P 19/00 A61P 35/00	P-2010-151
SANOFI-AVENTIS	A61K 39/00 A61K 31/00 A61P 35/00	P-2011-93



SANOFI-AVENTIS	C07D 489/00 C07D 489/08 A61K 31/485 C07B 63/02 A61P 29/00	P-2010-77
SANOFI-AVENTIS	A61K 39/00 A61K 31/00 A61P 35/00	P-2011-95
SANOFI-AVENTIS	A61K 39/00 A61P 35/00 A61K 31/00	P-2011-96
SANOFI-AVENTIS COMMISSARIAT A L'ENERGIE ATOMIQUE ET AUX EN- ERGIES ALTERNATIVES	A61K 51/04 G01N 33/60	P-2011-72
SCHERING AKTIENGESELLSCHAFT	A61K 31/202 A61K 31/216 C07C 217/46 C07C 229/12 C07C 235/06 C07C 323/52 C07C 59/68 C07C 59/70 C07C 69/708 C07C 69/736	P-2009-108
SISTEMAS INTEGRALES DE MEDICIÓN Y CONTROL STELLUM S.A. DE C.V	G06Q 50/00 G01D 4/00 G01F 15/06 G06Q 20/00	P-2011-4
STOKKE AS	A47D 15/00 A47C 7/62 A47D 1/00	P-2010-196
SYNGENTA PARTICIPATIONS AG	C07D 413/12 A01N 43/80	P-2010-92
SYNGENTA PARTICIPATIONS AG	C07C 205/12 C07C 211/61 C07C 17/25 C07C 22/02 C07C 23/08	P-2011-68
TEIJIN ARAMID B.V.	C08F 210/02 B29C 55/04	P-2011-123
VIRGINIA TECH INTELLECTUAL PROPERTIES, INC.	A61K 39/12	P-2010-179

WOBBEN, Aloys	B28B 11/12 B28B 19/00 B28B 21/02 E04H 12/12	P-2010-159
WYETH LLC	C12N 7/00	P-2010-93
PFIZER INC.	A61K 39/39 A61K 39/00 A61K 39/012 A61K 39/02	P-2010-194
Pfizer Limited Icagen, Inc.	C07D263/50 C07D277/18 C07D285/08 C07D413/12 C07D417/12 C07D275/03	P-2011-122
REGENERON PHARMACEUTICALS, INC.	C07K 16/28 A61P 37/08	P-2011-76
REPROS THERAPEUTICS INC.	A61K 31/56 A61P 35/00 A61K 31/4196	P-2010-181
REPROS THERAPEUTICS INC.	A61K 31/56 A61P 15/00 A61P 15/04 A61P 35/00	P-2010-182
SANOFI	A61K 31/192 A61K 31/704 A61K 45/06 A61P 19/00	P-2011-131
SANOFI	C07H 15/24 C07H 17/00 C07H 7/06 A61K 31/485 A61K 31/519 A61K 31/7042 A61P 25/04	P-2011-104
SANOFI	C07D 489/02 C07H 17/04 C07H 17/00 C07H 15/24 A61K 31/70 A61K 31/485 A61P 29/00 A61P 25/04	P-2011-106

SANOFI	A61K 31/167 A61K 31/337 A61P 35/00	P-2011-107
WYETH LLC	C07D 235/22 C07D 403/04 C07D 487/08 A61K 31/496 A61P 25/00	P-2011-75
WYETH LLC	C07D 498/08 A61K 31/53 A61P 35/00	P-2010-188
PFIZER INC.	A61K 39/39 A61K 39/00 A61K 39/012 A61K 39/02	P-2010-194
Pfizer Limited Icagen, Inc.	C07D263/50 C07D277/18 C07D285/08 C07D413/12 C07D417/12 C07D275/03	P-2011-122
REGENERON PHARMACEUTICALS, INC.	C07K 16/28 A61P 37/08	P-2011-76
REPROS THERAPEUTICS INC.	A61K 31/56 A61P 35/00 A61K 31/4196	P-2010-181
REPROS THERAPEUTICS INC.	A61K 31/56 A61P 15/00 A61P 15/04 A61P 35/00	P-2010-182
SANOFI	A61K 31/192 A61K 31/704 A61K 45/06 A61P 19/00	P-2011-131
SANOFI	C07H 15/24 C07H 17/00 C07H 7/06 A61K 31/485 A61K 31/519 A61K 31/7042 A61P 25/04	P-2011-104

SANOFI	C07D 489/02 C07H 17/04 C07H 17/00 C07H 15/24 A61K 31/70 A61K 31/485 A61P 29/00 A61P 25/04	P-2011-106
SANOFI	A61K 31/167 A61K 31/337 A61P 35/00	P-2011-107
WYETH LLC	C07D 235/22 C07D 403/04 C07D 487/08 A61K 31/496 A61P 25/00	P-2011-75
WYETH LLC	C07D 498/08 A61K 31/53 A61P 35/00	P-2010-188
PFIZER INC.	A61K 39/39 A61K 39/00 A61K 39/012 A61K 39/02	P-2010-194
Pfizer Limited Icagen, Inc.	C07D263/50 C07D277/18 C07D285/08 C07D413/12 C07D417/12 C07D275/03	P-2011-122
REGENERON PHARMACEUTICALS, INC.	C07K 16/28 A61P 37/08	P-2011-76
REPROS THERAPEUTICS INC.	A61K 31/56 A61P 35/00 A61K 31/4196	P-2010-181
REPROS THERAPEUTICS INC.	A61K 31/56 A61P 15/00 A61P 15/04 A61P 35/00	P-2010-182
SANOFI	A61K 31/192 A61K 31/704 A61K 45/06 A61P 19/00	P-2011-131

SANOFI	C07H 15/24 C07H 17/00 C07H 7/06 A61K 31/485 A61K 31/519 A61K 31/7042 A61P 25/04	P-2011-104
SANOFI	C07D 489/02 C07H 17/04 C07H 17/00 C07H 15/24 A61K 31/70 A61K 31/485 A61P 29/00 A61P 25/04	P-2011-106
SANOFI	A61K 31/167 A61K 31/337 A61P 35/00	P-2011-107
WYETH LLC	C07D 235/22 C07D 403/04 C07D 487/08 A61K 31/496 A61P 25/00	P-2011-75
WYETH LLC	C07D 498/08 A61K 31/53 A61P 35/00	P-2010-188



**INDEKS BROJEVA PRIJAVA PATENATA**  
**APPLICANTS NUMBER INDEX**

(21)	(51)	(21)	(51)
P-2008-128	A23K 1/16 A23K 1/18	P-2010-103	C07D 471/04 A61K 31/437 A61P 19/10 A61P 29/00 A61P 35/00 A61P 9/00 C07F 5/04 C07F 7/08
P-2009-81	A61K 9/16 A61K 31/437 A61K 47/10 A61K 47/26 A61K 47/38 A61K 9/20 A61K 9/28 A61K 9/50	P-2010-122	A01N 43/54 A61K 31/505 C07D 239/42
P-2009-108	A61K 31/202 A61K 31/216 C07C 217/46 C07C 229/12 C07C 235/06 C07C 323/52 C07C 59/68 C07C 59/70 C07C 69/708 C07C 69/736	P-2010-134	E01F 7/04
P-2009-293	C07D 207/26 A61K 31/4015 A61P 21/02 A61P 25/00 A61P 25/24	P-2010-135	E21D 21/00
P-2010-69	C07K 16/18 A61K 39/395 G01N 33/577 C12N 5/18 C07K 14/47 A61P 25/28	P-2010-141	G06F 17/30 G06K 9/00
P-2010-77	C07D 489/00 C07D 489/08 A61K 31/485 C07B 63/02 A61P 29/00	P-2010-149	C07D 471/04 A61K 31/437 A61P 27/02
P-2010-92	C07D 413/12 A01N 43/80	P-2010-150	C07D 471/04 A61K 31/437 A61P 19/00 A61P 25/00 A61P 35/00 C07D 213/28 C07D 233/56
P-2010-93	C12N 7/00	P-2010-151	C07D 471/04 C07D 213/28 C07D 233/56 A61K 31/437 A61P 25/00 A61P 19/00 A61P 35/00
		P-2010-153	C07D 207/08 C07D 4 03/06 C07D 405/06 C07D 413/06 C07D 471/04 A61K 31/4025 A61P 35/00 C07D 401/06

(21)	(51)
P-2010-159	B28B 11/12 B28B 19/00 B28B 21/02 E04H 12/12
P-2010-160	A61K 31/343 A61K 45/06 A61P 43/00 A61P 9/06
P-2010-165	C07D 401/14 C07D 403/14 C07D 413/14 A61K 31/506 A61K 31/5355 A61K 31/553 A61P 9/00 A61P 13/12 A61P 7/06
P-2010-165	B01D 21/01
P-2010-175	C07D 215/48 C07D 241/44 C07D 403/12 C07D 403/14 A61K 31/4709 A61K 31/498 A61P 35/00
P-2010-179	A61K 39/12
P-2010-180	A61K 31/343 A61P 9/06 A61P 43/00 A61K 45/06
P-2010-181	A61K 31/56 A61P 35/00 A61K 31/4196
P-2010-182	A61K 31/56 A61P 15/00 A61P 15/04 A61P 35/00
P-2010-188	C07D 498/08 A61K 31/53 A61P 35/00
P-2010-193	F23G 5/027 F23G 5/50

(21)	(51)
P-2010-194	A61K 39/39 A61K 39/00 A61K 39/012 A61K 39/02
P-2010-196	A47D 15/00 A47C 7/62 A47D 1/00
P-2010-200	C07C 51/09 C07C 17/14 C07C 17/26 C07C 25/18 C07C 253/14 C07C 255/35 C07C 57/62
P-2010-208	C07D 471/14 A61K 31/437 A61P 35/00
P-2010-210	C07D 471/08 A61K 31/529 A61P 25/00 A61P 29/00 A61P 35/00 C07D 487/08
P-2010-210	C07D 401/14 A61K 31/496 A61P 25/00 A61P 29/00 A61P 35/00
P-2010-217	C07K 16/28 A61K 39/395 A61P 19/02 A61P 37/06
P-2011-1	A01G 9/18
P-2011-2	C07K 16/28 A61K 39/395 A61P 35/00 C12N 15/13 C12N 5/18
P-2011-3	C07D 471/04 A61K 31/4375 A61P 35/00



(21)	(51)	(21)	(51)
P-2011-4	G06Q 50/00 G01D 4/00 G01F 15/06 G06Q 20/00	P-2011-76	C07K 16/28 A61P 37/08
P-2011-57	A61K 9/00 A61K 9/16	P-2011-78	G01R 21/133 G01R 22/06 H02J 13/00
P-2011-64	A61K 31/7036 A61P 11/00 A61K 9/127 A61K 47/44	P-2011-81	C07D 401/04 A61K 31/454 C07D 401/14 C07D 405/14 C07D 471/04
P-2011-68	C07C 205/12 C07C 211/61 C07C 17/25 C07C 22/02 C07C 23/08	P-2011-83	C07D 487/08 A61K 31/407 A61P 29/02 A61P 35/00
P-2011-70	C07D 401/14 C07D 403/14 C07D 407/14 C07D 413/12 C07D 413/14 C07D 417/14 A61P 25/00 A61K 31/445 A61K 31/497 A61K 31/506 A61K 31/501 A61K 31/498 A61K 31/4709 A61K 31/502 A61P 29/00	P-2011-84	C07D 471/10 A61K 31/435 A61P 25/28
P-2011-71	A61K 38/07 A61K 31/167 A61K 38/08 A61K 31/165 A61K 38/04 A61P 35/00	P-2011-88	B26B 27/00
P-2011-72	A61K 51/04 G01N 33/60	P-2011-89	A01N 43/42 A61K 31/44
P-2011-75	C07D 235/22 C07D 403/04 C07D 487/08 A61K 31/496 A61P 25/00	P-2011-93	A61K 39/00 A61K 31/00 A61P 35/00
		P-2011-94	A61K 39/00 A61K 31/00 A61P 35/00
		P-2011-95	A61K 39/00 A61K 31/00 A61P 35/00
		P-2011-96	A61K 39/00 A61P 35/00 A61K 31/00
		P-2011-98	C12N 7/04 C07K 14/18 C12N 15/86 A61K 39/12 C07K 16/10 G01N 33/50
		P-2011-102	F16L 9/12
		P-2011-103	E04C 2/54 B28B 23/00 E04B 2/02

(21)	(51)	(21)	(51)
P-2011-104	C07H 15/24 C07H 17/00 C07H 7/06 A61K 31/485 A61K 31/519 A61K 31/7042 A61P 25/04	P-2011-117	C07D 401/04 C07D 401/14 C07D 409/14 A61K 31/4439 A61K 31/444 A61K 31/4545 A61K 31/497 A61K 31/5375 A61P 7/00 A61P 9/00 A61P 25/00 A61P 27/00 G01N 33/53
P-2011-105	C07H 15/24 C07H 17/04 C07H 17/00 C07H 7/06 A61K 31/70 A61K31/485 A61P 29/00 A61P 25/04	P-2011-118	C07D 471/04 C07D 491/04 C07D 513/04 A61K 31/4162 A61P 27/06 C07D 213/72 C07D 213/77 C07D 401/12 C07D 405/12 C07D 409/12 C07D 403/04 C07D 495/04
P-2011-106	C07D 489/02 C07H 17/04 C07H 17/00 C07H 15/24 A61K 31/70 A61K 31/485 A61P 29/00 A61P 25/04	P-2011-121	A01N 37/40 A01N 59/20 A01N 25/14 A01P 3/00
P-2011-107	A61K 31/167 A61K 31/337 A61P 35/00	P-2011-122	C07D263/50 C07D277/18 C07D285/08 C07D413/12 C07D417/12 C07D275/03
P-2011-114	C07D 453/02 C07D 211/46 C07D 207/12 C07D 211/42 C07D 451/10 A61K 31/439 A61P 11/08 A61K 31/4465 A61K 31/401	P-2011-123	C08F 210/02 B29C 55/04
P-2011-116	A61K 31/502 C07D 401/14 C07D 403/04 A61P 35/00	P-2011-131	A61K 31/192 A61K 31/704 A61K 45/06 A61P 19/00
		P-2011-136	B60J 1/00 B65G 49/06

**INDEKS OBJAVLJENIH PRIJAVA PATENATA PREMA MKP**  
**INDEX OF PATENT APPLICANTS ACCORDINT TO IPC**

(51)	(21)	(51)	(21)
A01G 9/18	P-2011-1	A61K 31/4025	P-2010-153
A01N 25/14	P-2011-121	A61K 31/407	P-2011-83
A01N 37/40	P-2011-121	A61K 31/4162	P-2011-118
A01N 43/42	P-2011-89	A61K 31/4196	P-2010-181
A01N 43/54	P-2010-122	A61K 31/435	P-2011-84
A01N 43/80	P-2010-92	A61K 31/437	P-2009-81
A01N 59/20	P-2011-121	A61K 31/437	P-2010-103
A01P 3/00	P-2011-121	A61K 31/437	P-2010-149
A23K 1/16	P-2008-128	A61K 31/437	P-2010-150
A23K 1/18	P-2008-128	A61K 31/437	P-2010-151
A47C 7/62	P-2010-196	A61K 31/437	P-2010-208
A47D 1/00	P-2010-196	A61K 31/4375	P-2011-3
A47D 15/00	P-2010-196	A61K 31/439	P-2011-114
A61K 31/00	P-2011-93	A61K 31/44	P-2011-89
A61K 31/00	P-2011-94	A61K 31/4439	P-2011-117
A61K 31/00	P-2011-95	A61K 31/444	P-2011-117
A61K 31/00	P-2011-96	A61K 31/445	P-2011-70
A61K 31/165	P-2011-71	A61K 31/4465	P-2011-114
A61K 31/167	P-2011-71	A61K 31/454	P-2011-81
A61K 31/167	P-2011-107	A61K 31/4545	P-2011-117
A61K 31/192	P-2011-131	A61K 31/4709	P-2010-175
A61K 31/202	P-2009-108	A61K 31/4709	P-2011-70
A61K 31/216	P-2009-108	A61K 31/485	P-2010-77
A61K 31/337	P-2011-107	A61K 31/485	P-2011-104
A61K 31/343	P-2010-160	A61K 31/485	P-2011-106
A61K 31/343	P-2010-180	A61K 31/485	P-2011-105
A61K 31/401	P-2011-114	A61K 31/496	P-2010-210
A61K 31/4015	P-2009-293	A61K 31/496	P-2011-75

(51)	(21)	(51)	(21)
A61K 31/497	P-2011-70	A61K 39/00	P-2011-96
A61K 31/497	P-2011-117	A61K 39/012	P-2010-194
A61K 31/498	P-2010-175	A61K 39/02	P-2010-194
A61K 31/498	P-2011-70	A61K 39/12	P-2010-179
A61K 31/501	P-2011-70	A61K 39/12	P-2011-98
A61K 31/502	P-2011-70	A61K 39/39	P-2010-194
A61K 31/502	P-2011-116	A61K 39/395	P-2010-69
A61K 31/505	P-2010-122	A61K 39/395	P-2010-217
A61K 31/506	P-2010-165	A61K 39/395	P-2011-2
A61K 31/506	P-2011-70	A61K 45/06	P-2010-160
A61K 31/519	P-2011-104	A61K 45/06	P-2010-180
A61K 31/529	P-2010-210	A61K 45/06	P-2011-131
A61K 31/53	P-2010-188	A61K 47/10	P-2009-81
A61K 31/5355	P-2010-165	A61K 47/26	P-2009-81
A61K 31/5375	P-2011-117	A61K 47/38	P-2009-81
A61K 31/553	P-2010-165	A61K 47/44	P-2011-64
A61K 31/56	P-2010-181	A61K 51/04	P-2011-72
A61K 31/56	P-2010-182	A61K 9/00	P-2011-57
A61K 31/70	P-2011-105	A61K 9/127	P-2011-64
A61K 31/70	P-2011-106	A61K 9/16	P-2009-81
A61K 31/7036	P-2011-64	A61K 9/16	P-2011-57
A61K 31/704	P-2011-131	A61K 9/20	P-2009-81
A61K 31/7042	P-2011-104	A61K 9/28	P-2009-81
A61K 38/04	P-2011-71	A61K 9/50	P-2009-81
A61K 38/07	P-2011-71	A61P 11/00	P-2011-64
A61K 38/08	P-2011-71	A61P 11/08	P-2011-114
A61K 39/00	P-2010-194	A61P 13/12	P-2010-165
A61K 39/00	P-2011-93	A61P 15/00	P-2010-182
A61K 39/00	P-2011-94	A61P 15/04	P-2010-182
A61K 39/00	P-2011-95	A61P 19/00	P-2010-150

(51)	(21)	(51)	(21)
A61P 19/00	P-2010-151	A61P 35/00	P-2010-103
A61P 19/00	P-2011-131	A61P 35/00	P-2010-150
A61P 19/02	P-2010-217	A61P 35/00	P-2010-151
A61P 19/10	P-2010-103	A61P 35/00	P-2010-153
A61P 21/02	P-2009-293	A61P 35/00	P-2010-175
A61P 25/00	P-2009-293	A61P 35/00	P-2010-181
A61P 25/00	P-2010-150	A61P 35/00	P-2010-182
A61P 25/00	P-2010-151	A61P 35/00	P-2010-188
A61P 25/00	P-2010-210	A61P 35/00	P-2010-208
A61P 25/00	P-2010-210	A61P 35/00	P-2010-210
A61P 25/00	P-2011-70	A61P 35/00	P-2010-210
A61P 25/00	P-2011-75	A61P 35/00	P-2011-2
A61P 25/00	P-2011-117	A61P 35/00	P-2011-3
A61P 25/04	P-2011-104	A61P 35/00	P-2011-71
A61P 25/04	P-2011-105	A61P 35/00	P-2011-83
A61P 25/04	P-2011-106	A61P 35/00	P-2011-93
A61P 25/24	P-2009-293	A61P 35/00	P-2011-94
A61P 25/28	P-2010-69	A61P 35/00	P-2011-95
A61P 25/28	P-2011-84	A61P 35/00	P-2011-96
A61P 27/00	P-2011-117	A61P 35/00	P-2011-107
A61P 27/02	P-2010-149	A61P 35/00	P-2011-116
A61P 27/06	P-2011-118	A61P 37/06	P-2010-217
A61P 29/00	P-2010-77	A61P 37/08	P-2011-76
A61P 29/00	P-2010-103	A61P 43/00	P-2010-160
A61P 29/00	P-2010-210	A61P 43/00	P-2010-180
A61P 29/00	P-2010-210	A61P 7/00	P-2011-117
A61P 29/00	P-2011-70	A61P 7/06	P-2010-165
A61P 29/00	P-2011-105	A61P 9/00	P-2010-103
A61P 29/00	P-2011-106	A61P 9/00	P-2010-165
A61P 29/02	P-2011-83	A61P 9/00	P-2011-117

(51)	(21)	(51)	(21)
A61P 9/06	P-2010-160	C07C 69/708	P-2009-108
A61P 9/06	P-2010-180	C07C 69/736	P-2009-108
B01D 21/01	P-2010-165	C07D 207/08	P-2010-153
B26B 27/00	P-2011-88	C07D 207/12	P-2011-114
B28B 11/12	P-2010-159	C07D 207/26	P-2009-293
B28B 19/00	P-2010-159	C07D 211/42	P-2011-114
B28B 21/02	P-2010-159	C07D 211/46	P-2011-114
B28B 23/00	P-2011-103	C07D 213/28	P-2010-150
B29C 55/04	P-2011-123	C07D 213/28	P-2010-151
B60J 1/00	P-2011-136	C07D 213/72	P-2011-118
B65G 49/06	P-2011-136	C07D 213/77	P-2011-118
C07B 63/02	P-2010-77	C07D 215/48	P-2010-175
C07C 17/14	P-2010-200	C07D 233/56	P-2010-150
C07C 17/25	P-2011-68	C07D 233/56	P-2010-151
C07C 17/26	P-2010-200	C07D 235/22	P-2011-75
C07C 205/12	P-2011-68	C07D 239/42	P-2010-122
C07C 211/61	P-2011-68	C07D 241/44	P-2010-175
C07C 217/46	P-2009-108	C07D 263/50	P-2011-122
C07C 22/02	P-2011-68	C07D 275/03	P-2011-122
C07C 229/12	P-2009-108	C07D 277/18	P-2011-122
C07C 23/08	P-2011-68	C07D 285/08	P-2011-122
C07C 235/06	P-2009-108	C07D 401/04	P-2011-81
C07C 25/18	P-2010-200	C07D 401/04	P-2011-117
C07C 253/14	P-2010-200	C07D 401/06	P-2010-153
C07C 255/35	P-2010-200	C07D 401/12	P-2011-118
C07C 323/52	P-2009-108	C07D 401/14	P-2010-165
C07C 51/09	P-2010-200	C07D 401/14	P-2010-210
C07C 57/62	P-2010-200	C07D 401/14	P-2011-70
C07C 59/68	P-2009-108	C07D 401/14	P-2011-81
C07C 59/70	P-2009-108	C07D 401/14	P-2011-116

(51)	(21)	(51)	(21)
C07D 401/14	P-2011-117	C07D 471/04	P-2011-3
C07D 403/04	P-2011-75	C07D 471/04	P-2011-81
C07D 403/04	P-2011-116	C07D 471/04	P-2011-118
C07D 403/04	P-2011-118	C07D 471/08	P-2010-210
C07D 403/06	P-2010-153	C07D 471/10	P-2011-84
C07D 403/12	P-2010-175	C07D 471/14	P-2010-208
C07D 403/14	P-2010-165	C07D 487/08	P-2010-210
C07D 403/14	P-2010-175	C07D 487/08	P-2011-75
C07D 403/14	P-2011-70	C07D 487/08	P-2011-83
C07D 405/06	P-2010-153	C07D 489/00	P-2010-77
C07D 405/12	P-2011-118	C07D 489/02	P-2011-106
C07D 405/14	P-2011-81	C07D 489/08	P-2010-77
C07D 407/14	P-2011-70	C07D 491/04	P-2011-118
C07D 409/12	P-2011-118	C07D 495/04	P-2011-118
C07D 409/14	P-2011-117	C07D 498/08	P-2010-188
C07D 413/06	P-2010-153	C07D 513/04	P-2011-118
C07D 413/12	P-2010-92	C07F 5/04	P-2010-103
C07D 413/12	P-2011-70	C07F 7/08	P-2010-103
C07D 413/12	P-2011-122	C07H 15/24	P-2011-104
C07D 413/14	P-2010-165	C07H 15/24	P-2011-105
C07D 413/14	P-2011-70	C07H 15/24	P-2011-106
C07D 417/12	P-2011-122	C07H 17/00	P-2011-104
C07D 417/14	P-2011-70	C07H 17/00	P-2011-105
C07D 451/10	P-2011-114	C07H 17/00	P-2011-106
C07D 453/02	P-2011-114	C07H 17/04	P-2011-105
C07D 471/04	P-2010-103	C07H 17/04	P-2011-106
C07D 471/04	P-2010-149	C07H 7/06	P-2011-104
C07D 471/04	P-2010-150	C07H 7/06	P-2011-105
C07D 471/04	P-2010-151	C07K 14/18	P-2011-98
C07D 471/04	P-2010-153	C07K 14/47	P-2010-69

(51)	(21)	(51)	(21)
C07K 16/10	P-2011-98	G06Q 20/00	P-2011-4
C07K 16/18	P-2010-69	G06Q 50/00	P-2011-4
C07K 16/28	P-2010-217	H02J 13/00	P-2011-78
C07K 16/28	P-2011-2		
C07K 16/28	P-2011-76		
C08F 210/02	P-2011-123		
C12N 15/13	P-2011-2		
C12N 15/86	P-2011-98		
C12N 5/18	P-2010-69		
C12N 5/18	P-2011-2		
C12N 7/00	P-2010-93		
C12N 7/04	P-2011-98		
E01F 7/04	P-2010-134		
E04B 2/02	P-2011-103		
E04C 2/54	P-2011-103		
E04H 12/12	P-2010-159		
E21D 21/00	P-2010-135		
F16L 9/12	P-2011-102		
F23G 5/027	P-2010-193		
F23G 5/50	P-2010-193		
G01D 4/00	P-2011-4		
G01F 15/06	P-2011-4		
G01N 33/50	P-2011-98		
G01N 33/53	P-2011-117		
G01N 33/577	P-2010-69		
G01N 33/60	P-2011-72		
G01R 21/133	P-2011-78		
G01R 22/06	P-2011-78		
G06F 17/30	P-2010-141		
G06K 9/00	P-2010-141		



**OBJAVA ISPRAVKI**

U „Crnogorskom glasniku intelektualne svojine“ broj **10. od 20.10.2012.** godine objavljeni su pogrešni podaci pronalazača za patent **P-2012-44.**

***Pogrešni podaci***

(72) Bojović Milan, Njegoševa 4, Žabljak (ME)

***Ispravni podaci***

(72) Bojović Milan, Njegoševa 4, Žabljak (ME)

Pejić Krstan, Kralja Petra I 4, Karađorđevo (SR)



**OBJAVE ZAHTJEVA ZA PROŠIRENJE EVROPSKIH PRIJAVA PATENATA  
PUBLICATION OF REQUEST FOR THE EXTENSION OF THE EFFECTS OF  
EUROPEAN PATENT APPLICATIONS**

- 
- (51) MKP  
**A61K 8/55 (2006.01)** (97) **2533752 \***  
**A61Q 19/00 (2006.01)**  
**A61K 8/41 (2006.01)**  
**A61K 8/73 (2006.01)**  
**A61K 8/19 (2006.01)**  
**A61K 8/97 (2006.01)**  
**A61K 8/49 (2006.01)**  
**A61Q 7/00 (2006.01)**  
**A61K 8/60 (2006.01)**  
**A61K 8/67 (2006.01)**  
(86) EP2011000340 26.01.2011  
(96) 11702791.2 19.12.2012  
(87) WO2011098216, 26.01.2011  
(97) 2533752, 19.12.2012 de  
(54) PREPARATIONS FOR STABILISING/FORMING THE TEXTURE OF LIVING TISSUE SUCH AS SKIN, AND USES THEREOF  
(71) Merz Pharma GmbH & Co. KGaA, Eckenheimer Landstrasse 100, 60318 Frankfurt am Main, DE  
(72) BEUTLER, Rolf, Stockwiesenstr. 28, 64739 Höchst, DE  
SCHMIDT, Karlheinz, Äußere Weiler Strasse 12, 72810 Gomaringen, DE
- 
- (51) MKP  
**A61K 36/53 (2006.01)** (97) **2452689**  
**A61K 36/534 (2006.01)**  
**A61P 15/08 (2006.01)**  
**A61K 36/288 (2006.01)**  
(96) 11008646.9 16.05.2012  
(97) 2452689, 16.05.2012 en  
(54) Phytotherapeutic preparation with stimulatory effect on libido and spermatogenesis  
(71) Bozo B.V., Hillevliet 128B, 3074 KD Rotterdam, NL  
(72) Bujic, Bozo, Hillevliet 128 B, 3074 KD Rotterdam, NL
- 
- (51) MKP  
**E05C 17/02 (2006.01)** (97) **2439364**  
**E05C 17/24 (2006.01)**  
(96) 11184539.2 11.04.2012  
(97) 2439364, 11.04.2012 en  
(54) Articulated shutter holder  
(71) I.Quattro S.r.l., Viale del Lavoro, 3, 60030 San Marcello (AN), IT  
(72) Cirilli, ALESSANDRO, Via San Francesco, 56, 60035 JESI, IT
- 
- (51) MKP  
**G06T 7/60 (2006.01)** (97) **2528504 \***  
**A61B 5/103 (2006.01)**  
(86) HU2011000013 28.01.2011  
(96) 11710024.8 05.12.2012  
(87) WO2011092531, 28.01.2011  
(97) 2528504, 05.12.2012 en  
(54) A METHOD AND A SYSTEM FOR MULTI-DIMENSIONAL VISUALIZATION OF THE SPINAL COLUMN BY VERTEBRA VECTORS, SACRUM VECTOR, SACRUM PLATEAU VECTOR AND PELVIS VECTORS  
(71) Pécsi Tudományegyetem, Szántó Kovács János u. 1/b, 7633 Pécs, HU  
(72) ILLES, Tamás, Szl I u. 26., H-7625 Pécs, HU  
SOMOSKEÖY, Szabolcs, Sz I u. 48/1., H-7625 Pécs, HU
- 
- (51) MKP  
**C12Q 1/68 (2006.01)** (97) **2529032 \***  
(86) IB2011000217 26.01.2011  
(96) 11709465.6 05.12.2012  
(87) WO2011092592, 26.01.2011  
(97) 2529032, 05.12.2012 en  
(54) METHODS AND COMPOSITIONS FOR NONINVASIVE PRENATAL DIAGNOSIS OF FETAL ANEUPLOIDIES  
(71) Nipd Genetics Ltd, 6 Airport Avenue, Nicosia 2370, CY  
(72) PATSALIS, Philippos, C., 34 Gr. Xenopoulos Street, Nicosia 2402, CY  
PAPAGEORGIU, Elisavet, A., Kykladon 80 Flat 201, Lakatamia, Nicosia 2301, CY
- 
- (51) MKP  
**C07K 16/28 (2006.01)** (97) **2534178 \***  
**A61K 39/395 (2006.01)**  
(86) US2011024511 11.02.2011  
(96) 11742858.1 19.12.2012  
(87) WO201100538, 11.02.2011  
(97) 2534178, 19.12.2012 en  
(54) THERAPEUTIC METHODS USING AN TI-CD200 ANTIBODIES  
(71) Alexion Pharmaceuticals, Inc., 352 Knotter Drive, Cheshire, CT 06410, US  
(72) ROTHER, Russell, P., 10325 Forest Meadow Drive, Oklahoma City, OK 73151, US  
YAN, Yan, 18 North Pond Road, Cheshire, CT 06410, US
- 
- (51) MKP  
**B01D 71/82 (2006.01)** (97) **2536485 \***  
**C12N 11/06 (2006.01)**  
**B01J 20/28 (2006.01)**  
**B01D 61/28 (2006.01)**  
**G01N 33/48 (2006.01)**  
**A61M 1/14 (2006.01)**  
**B01J 20/22 (2006.01)**  
**B01D 61/24 (2006.01)**  
(86) SG2011000069 18.02.2011  
(96) 11744984.3 26.12.2012  
(87) WO2011102807, 18.02.2011  
(97) 2536485, 26.12.2012 en  
(54) A SUBSTRATE FOR IMMOBILIZING FUNCTIONAL SUBSTANCES AND METHOD FOR PREPARING THE SAME  
(71) Temasek Polytechnic, 21 Tampines Avenue, 1, Singapore 529757, SG  
(72) BLUCHEL, Christian Gert, c/o Temasek Polytechnic Engineering Department 21 Tampines Avenue 1, Singapore 529757, SG  
WANG, Yanmei, c/o Temasek Polytechnic Engineering Department 21 Tampines Avenue 1, Singapore 529757, SG
- 
- (51) MKP  
**A61K 31/397 (2006.01)** (97) **2501379 \***  
(86) US2010056931 17.11.2010  
(96) 10832068.0 26.09.2012  
(87) WO2011062930, 17.11.2010  
(97) 2501379, 26.09.2012 en  
(54) COMBINATION  
(71) GlaxoSmithKline LLC, One Franklin Plaza 200 North 16th Street, Philadelphia, PA 19102, US  
(72) GILMER, Tona, Five Moore Drive, Research Triangle Park NC 27709, US  
KUMAR, Rakesh, 1250 South Collegeville Road, Collegeville PA 19426, US  
LAQUERRE, Sylvie, 709 Swedeland Road, King Of Prussia PA 19406, US
-

- (51) MKP  
**B42D 1/00 (2006.01)** (97) **2433809**  
**B42D 13/00 (2006.01)**  
**B42D 15/10 (2006.01)**  
(96) 10405179.2 28.03.2012  
(97) 2433809, 28.03.2012 de  
(54) Data pages for book-like documents and method of producing such data pages  
(71) Trüb AG, Hintere Bahnhofstrasse 12, CH-5001 Aarau, CH  
(72) Egli, Stefan, Hochstrasse 69, 4053 Basel, CH

- (51) MKP  
**A61P 9/00 (2006.01)** (97) **2523961 \***  
**A61K 31/519 (2006.01)**  
**C07D 498/04 (2006.01)**  
(86) EP2011050295 12.01.2011  
(96) 11700403.6 21.11.2012  
(87) WO2011086075, 12.01.2011  
(97) 2523961, 21.11.2012 de  
(54) 2,5,7-SUBSTITUTED OXAZOLOPYRIMIDINE DERIVATIVES  
(71) SANOFI, 54, rue de la Boétie, 75008 Paris, FR  
(72) KADEREIT, Dieter, c/o Sanofi-Aventis Deutschland GmbH, 65926 Frankfurt am Main, DE  
SCHAEFER, Matthias, c/o Sanofi-Aventis Deutschland GmbH, 65926 Frankfurt am Main, DE  
HACHTEL, Stephanie, c/o Sanofi-Aventis Deutschland GmbH, 65926 Frankfurt am Main, DE  
DIETRICH, Axel, c/o Sanofi-Aventis Deutschland GmbH, 65926 Frankfurt am Main, DE  
HUEBSCHLE, Thomas, c/o Sanofi-Aventis Deutschland GmbH, 65926 Frankfurt am Main, DE  
GILLE, Andreas, c/o Sanofi-Aventis Deutschland GmbH, 65926 Frankfurt am Main, DE  
HISS, Katrin, c/o Sanofi-Aventis Deutschland GmbH, 65926 Frankfurt am Main, DE

- (51) MKP  
**A61M 5/32 (2006.01)** (97) **2536453 \***  
**A61M 5/20 (2006.01)**  
(86) EP2011052299 16.02.2011  
(96) 11704065.9 26.12.2012  
(87) WO2011101377, 16.02.2011  
(97) 2536453, 26.12.2012 en  
(54) AUTO-INJECTOR  
(71) Sanofi-Aventis Deutschland GmbH, Brüningstraße 50, 65929 Frankfurt, DE  
(72) EKMAN, Matthew, 59 Ecton Avenue, Macclesfield Cheshire SK10 1RD, GB  
BARROW-WILLIAMS, Timothy Donald, 1 Grange Street, St. Albans Herts AL3 5NA, GB  
HOURMAND, Yannick, 14 The Elms, Haslingfield CB23 1ND, GB

- (51) MKP  
**F04C 15/00 (2006.01)** (97) **2434158**  
**F16D 1/06 (2006.01)**  
**F04C 2/344 (2006.01)**  
(96) 10180361.7 28.03.2012  
(97) 2434158, 28.03.2012 en  
(54) Drive shaft for a positive displacement pump  
(71) Delphi Technologies Holding S.à.r.l., Avenue de Luxembourg, 4940 Bascharage, LU  
(72) Rajaram, Kartik, 9 April Court, 43 Copers Cope Road, Beckenham Kent BR3 1NJ, GB  
Buckley, Paul, 7 Callams Close, Rainham Kent ME8 9ES, GB

- (51) MKP  
**A23L 1/30 (2006.01)** (97) **2515924 \***  
**A61K 36/536 (2006.01)**  
**A61P 25/00 (2006.01)**  
(86) KR2010007904 10.11.2010  
(96) 10839676.3 31.10.2012  
(87) WO2011078479, 10.11.2010  
(97) 2515924, 31.10.2012 en  
(54) A COMPOSITION COMPRISING THE EXTRACT OF PRUNELLA VULGARIS L. FOR PREVENTING AND TREATING ADHD DISEASE AND THE USE THEREOF  
(71) Dongkook Pharmaceutical Co., Ltd., 997-8, Daechi 3-dong Kangnam-gu, Seoul 135-502, KR  
(72) RYU, Jong Hoon, 101-609 MiDo Apt. Daechi-dong Gangnam-gu, Seoul 135-775, KR  
CHEONG, Jae Hoon, 201-511 Gangnam Kunyoung APT. 250-3 Toegyewon-ri Toegyewon-myeon, Namyangju-si Gyeonggi-do 472-824, KR  
SHIN, Chan Young, 1305ho 532dong Mok-dong 5dan-gi Apt. Mok-dong Yangcheon-gu, Seoul 158-756, KR  
PARK, Se Jin, 145 Sinjeong-ri Namil-myeon, Geumsan-gun Chungcheongnam-do 312-853, KR

- (51) MKP  
**H02G 3/04 (2006.01)** (97) **2537058 \***  
**G02B 6/46 (2006.01)**  
(86) CA2011050102 18.02.2011  
(96) 11744236.8 26.12.2012  
(87) WO2011100844, 18.02.2011  
(97) 2537058, 26.12.2012 en  
(54) DUCT SYSTEM FOR FIBRE OPTIC COMPONENTS  
(71) Teraspan Networks Inc., 6870 Palm Avenue, Burnaby, British Columbia V5J 4M3, CA  
(72) DOFFER, Darren, 2130 Grant Avenue, Port Coquitlam, British Columbia B3B 1R2, CA

- (51) MKP  
**G09B 23/32 (2006.01)** (97) **2534651 \***  
(86) US2011024291 10.02.2011  
(96) 11707515.0 19.12.2012  
(87) WO2011100393, 10.02.2011  
(97) 2534651, 19.12.2012 en  
(54) METHOD AND APPARATUS FOR IN VITRO TESTING FOR MEDICAL DEVICES  
(71) McNEIL-PPC, Inc., 199 Grandview Road, Skillman, NJ 08558, US  
(72) HOU, Mari, 125 Berkeley Circle, Basking Ridge, NJ 07920, US  
JUNIO, Joseph, 5 Vinne Court, Edison, NJ 08820, US

- (51) MKP  
**C07D 401/12 (2006.01)** (97) **2518064 \***  
**A61P 43/00 (2006.01)**  
**A61P 25/04 (2006.01)**  
**C07D 417/12 (2006.01)**  
**C07D 311/68 (2006.01)**  
**C07D 405/04 (2006.01)**  
**A61K 31/454 (2006.01)**  
**C07D 405/14 (2006.01)**  
**A61K 31/4433 (2006.01)**  
**C07D 405/12 (2006.01)**  
**A61K 31/496 (2006.01)**  
**C07D 413/04 (2006.01)**  
**A61K 31/501 (2006.01)**  
**C07D 413/12 (2006.01)**  
(86) JP2010073458 24.12.2010  
(96) 10839597.1 31.10.2012  
(87) WO2011078369, 24.12.2010  
(97) 2518064, 31.10.2012 en  
(54) NOVEL ARYL UREA DERIVATIVE  
(71) Mochida Pharmaceutical Co., Ltd., 7 Yotsuya 1-chome Shinjuku-ku, Tokyo 160-8515, JP  
(72) KAMINO Tomoyuki, c/o MOCHIDA PHARMACEUTICAL CO. LTD. 7 Yotsuya 1-chome Shinjuku-ku, Tokyo 160-8515, JP  
MAEDA Yoshitaka, c/o MOCHIDA PHARMACEUTICAL CO. LTD. 7 Yotsuya 1-chome Shinjuku-ku, Tokyo 160-8515, JP

(51) MKP  
**A61Q 19/00 (2006.01)** (97) **2509569 \***  
**C07C 409/34 (2006.01)**  
**A61K 8/38 (2006.01)**  
(86) EP2010069421 10.12.2010  
(96) 10790768.5 17.10.2012  
(87) WO2011070171, 10.12.2010  
(97) 2509569, 17.10.2012 en  
(54) DERIVATIVES OF NOVEL PEROXIDES, METHOD OF PREPARATION THEREOF AND USE THEREOF IN HUMAN MEDICINE AS WELL AS IN COSMETICS FOR THE TREATMENT OR PREVENTION OF ACNE  
(71) Galderma Research & Development, 2400 Route des Colles Les Templiers, 06410 Biot, FR  
(72) BOUIX-PETER, Claire, 48 chemin du Cannet, F-06220 Vallauris, FR  
PASCAL, Jean-Claude, 170 avenue de Gairaut, F-06100 Nice, FR  
RODEVILLE, Nicolas, 85 rue Henri Poincaré Résidence Oxford App A311, F-06410 Biot, FR

(51) MKP  
**A61K 9/16 (2006.01)** (97) **2503993 \***  
**A61P 25/00 (2006.01)**  
**A61K 31/4152 (2006.01)**  
**C07D 231/22 (2006.01)**  
(86) EP2010068256 25.11.2010  
(96) 10782303.1 03.10.2012  
(87) WO2011064315, 25.11.2010  
(97) 2503993, 03.10.2012 en  
(54) 4-[2-[[5-METHYL-1-(2-NAPHTALENYL)-1H-PYRAZOL-3-YL] OXY]ETHYL]MORPHOLINE SALTS  
(71) Laboratorios del. Dr. Esteve, S.A., Avda Mare de Deu de Montserrat 221, 08041 Barcelona, ES  
(72) CUBERES-ALTISENT, María Rosa, Barcelona, 2 D, E-08172 Sant Cugat del Vallés - Barcelona, ES  
SOLÀ - CARANDELL, Lluís, Espigol, 46 A, E-43893 Altafulla - Tarragona, ES  
GARCÍA - COUCEIRO, Urko, Jesús Galíndez 16, 12-D, E-48004 Bilbao - Vizcaya, ES

(51) MKP  
**D21H 17/00 (2006.01)** (97) **2505615**  
**C09C 1/02 (2006.01)**  
(96) 11160926.9 03.10.2012  
(97) 2505615, 03.10.2012 en  
(54) Self-binding pigment hybrid  
(71) Omya Development AG, Baslerstrasse 42, 4665 Oftringen, CH  
(72) Gane, Patrick A.C., Studenweg 8, 4852 Rothrist, CH  
Buri, Matthias, Mätteliweg 20, 4852 Rothrist, CH  
Rentsch, Samuel, Höheweg 1, 4663 Aarburg, CH  
Meuwly, Julie, Hofmattstrasse 11A, 4663 Aarburg, CH

(51) MKP  
**A61P 35/00 (2006.01)** (97) **2510002 \***  
**C07K 16/28 (2006.01)**  
**A61P 5/08 (2006.01)**  
**A61K 39/395 (2006.01)**  
(86) EP2010067747 18.11.2010  
(96) 10776753.5 17.10.2012  
(87) WO2011069799, 18.11.2010  
(97) 2510002, 17.10.2012 en  
(54) NEUTRALIZING PROLACTIN RECEPTOR ANTIBODIES AND THEIR THERAPEUTIC USE  
(71) Bayer Intellectual Property GmbH, Alfred-Nobel-Strasse 10, 40789 Monheim, DE  
(72) OTTO, Christiane, Monbijouplatz 9, 10178 Berlin, DE  
WOLF, Siegmund, Gerlindeweg 24, 13505 Berlin, DE  
FREIBERG, Christoph, Müller Strasse 83, 42115 Wuppertal, DE  
HARRENGA, Axel, Sadowastrasse 17, 42115 Wuppertal, DE  
GREVEN, Simone, Am Schneckenacker 45, 41541 Dormagen, DE  
TRAUTWEIN, Mark, Nelkenweg 2, 42489 Wülfrath, DE  
BRUDER, Sandra, Beethovenstrasse 33, 53175 Leverkusen, DE  
EICKER, Andrea, Ruckes 101, 41238 Mönchengladbach, DE  
WILMEN, Andreas, Arndtstrasse 5, 50676 Köln, DE

(51) MKP  
**A61K 39/39 (2006.01)** (97) **2531216 \***  
**A61K 39/395 (2006.01)**  
**A61K 35/12 (2006.01)**  
(86) US2011023744 04.02.2011  
(96) 11740423.6 12.12.2012  
(87) WO2011097477, 04.02.2011  
(97) 2531216, 12.12.2012 en  
(54) ICOS CRITICALLY REGULATES THE EXPANSION AND FUNCTION OF INFLAMMATORY HUMAN TH17 CELLS  
(71) The Trustees Of The University Of Pennsylvania, Center for Technology Transfer 3160 Chestnut Street Suite 200, Philadelphia, PA 19104-6283, US  
(72) RILEY, James, L., 435 Creekside Drive, Downingtown, PA 19335, US  
PAULOS, Chrystal, 68 N. 2nd Street Apt.3F, Philadelphia, PA 19106, US  
JUNE, Carl, H., 409 Baird Road, Merion Station, PA 19066-1416, US  
LEVINE, Bruce, 1258 Liberty Bell Drive, Cherry Hill, NJ 08003, US

(51) MKP  
**G07C 9/00 (2006.01)** (97) **2521100**  
**B60R 25/00 (2006.01)**  
(96) 12166836.2 07.11.2012  
(97) 2521100, 07.11.2012 en  
(54) Vehicular security system with configurable immobilization features  
(71) TriMark Corporation, 500 Bailey Avenue P.O. Box 350, New Hampton, IA 50659, US  
(72) Magner, David S., 500 Bailey Avenue P.O. Box 350, New Hampton IA 50659, US  
Reichling, Anita L., 500 Bailey Avenue P.O. Box 350, New Hampton IA 50659, US

(51) MKP  
**G01N 21/31 (2006.01)** (97) **2502050 \***  
(86) US2010003006 19.11.2010  
(96) 10801478.8 26.09.2012  
(87) WO2011062630, 19.11.2010  
(97) 2502050, 26.09.2012 en  
(54) PHOTONIC MEASUREMENT INSTRUMENT USING NON-SOLARIZING UV GRADE FIBER OPTICS  
(71) PerkinElmer Health Sciences, Inc., 940 Winter Street, Waltham, MA 02451, US  
(72) IVALDI, Juan, C., 2 Great Pond Lane, Redding, CT 06896, US  
ST. CYR, Paul, L., 10 Maple Ln. Ext., Shelton, CT 06484, US  
CHOW, Eugene, Blk 15. Ghim Moh Road 08 31, Singapore 270015, SG  
WERNER, Mark, C., C/o Perkinelmer Health Sciences Inc. 940 Winter Street, Waltham, MA 02451, US

(51) MKP  
**B41M 5/28 (2006.01)** (97) **2509795 \***  
**B41M 3/14 (2006.01)**  
**B42D 15/00 (2006.01)**  
**B42D 15/10 (2006.01)**  
(86) EP2010056873 19.05.2010  
(96) 10726011.9 17.10.2012  
(87) WO2011069689, 19.05.2010  
(97) 2509795, 17.10.2012 en  
(54) CHIRAL LIQUID CRYSTAL POLYMER MARKING  
(71) SICPA Holding SA, Avenue de Florissant 41, 1008 Prilly, CH  
TILLER, Thomas, Chemin du Cèdre 21, CH-1030 Bussigny, CH  
GREMAUD, Frédéric, Chemin de la Belle-Luce 15, CH-1663 Epagny, CH  
CALLEGARI, Andrea, Chemin des Berges 4, CH-1022 Chavannes-pres-renens, CH

(51) MKP  
**A61K 47/48 (2006.01)** (97) **2525831 \***  
(86) EP2011050819 21.01.2011  
(96) 11702163.4 28.11.2012  
(87) WO2011089214, 21.01.2011  
(97) 2525831, 28.11.2012 en  
(54) CARRIER-LINKED CARBAMATE PRODRUG LINKERS  
(71) Ascendis Pharma A/S, Tuborg Boulevard 12, 2900 Hellerup, DK  
(72) RAU, Harald, Talstrasse 41i, 69221 Dossenheim, DE  
LEßMANN, Torben, Hauberallee 11, 67434 Neustadt an der Weinstraße, DE

- (51) MKP  
**C07F 5/02 (2006.01)** (97) **2516449 \***  
 (86) US2010061695 22.12.2010  
 (96) 10798930.3 31.10.2012  
 (87) WO2011087822, 22.12.2010  
 (97) 2516449, 31.10.2012 en  
 (54) PROTEASOME INHIBITORS AND PROCESSES FOR THEIR PREPARATION, PURIFICATION AND USE  
 (71) Cephalon, Inc., 41 Moores Road, Frazer, Pennsylvania 19355, US  
 (72) ROEMMELE, Renee Caroline, 1030 Fulton Road, Maple Glen PA 19002, US

- (51) MKP  
**F21V 19/00 (2006.01)** (97) **2535640 \***  
**F21Y 101/02 (2006.01)**  
**F21V 29/00 (2006.01)**  
**F21V 23/00 (2006.01)**  
 (86) CN2011079234 01.09.2011  
 (96) 11823056.4 19.12.2012  
 (87) WO2012031533, 01.09.2011  
 (97) 2535640, 19.12.2012 en  
 (54) LED LAMP BULB AND LED LIGHTING BAR CAPABLE OF EMITTING LIGHT OVER 4  
 (71) Zhejiang Ledison Optoelectronics Co., Ltd., No.202 Room No.531 Jiaogong Road Xihu District, Hangzhou, Zhejiang 310012, CN  
 (72) GE, Shichao, No.202 Room No.531 Jiaogong Road Xihu District, Hangzhou Zhejiang 310012, CN  
 LIU, Huabin, No.202 Room No.531 Jiaogong Road Xihu District, Hangzhou Zhejiang 310012, CN  
 GE, Tiehan, No.202 Room No.531 Jiaogong Road Xihu District, Hangzhou Zhejiang 310012, CN

- (51) MKP  
**F24D 19/06 (2006.01)** (97) **2515047**  
 (96) 12158515.2 24.10.2012  
 (97) 2515047, 24.10.2012 en  
 (54) A radiator and a related intermediate connection piece  
 (71) Coskunöz Metal Form Makina Endüstriye Tic. A.S., Osb Mavi Cad. No: 5, Bursa, TR  
 (72) Kaya, Mesut, OSB Mavi Cad. No: 5, BURSA, TR

- (51) MKP  
**C12N 15/00 (2006.01)** (97) **2521776 \***  
 (86) IL2011000007 05.01.2011  
 (96) 11731733.9 14.11.2012  
 (87) WO2011083464, 05.01.2011  
 (97) 2521776, 14.11.2012 en  
 (54) METHODS FOR USE OF A SPECIFIC ANTI-ANGIOGENIC ADENOVIRAL AGENT  
 (71) Vascular Biogenics Ltd., 6 Yoni Netanyahu Street, 60376 Or Yehuda, IL  
 (72) COHEN, Yael, 100 Stern Street, 55602 Kiryat-Ono, IL  
 SHER, Naamit, 3 Paldi Street, 76248 Rechovot, IL  
 FEIGE, Erez, P.O. Box 170, 50295 Hemed, IL  
 BANGIO, Livnat, 1 Daniel Lifshitz Street, 49776 Petach-Tikva, IL  
 BREITBART, Eyal, 27 HaYitzhar Street, 73127 Hashmonaim, IL

- (51) MKP  
**C01B 25/37 (2006.01)** (97) **2529433 \***  
**H01M 4/58 (2010.01)**  
**H01M 4/62 (2006.01)**  
**H01M 4/04 (2006.01)**  
**H01M 10/0525 (2010.01)**  
**H01M 4/139 (2010.01)**  
 (86) EP2011051203 28.01.2011  
 (96) 11701509.9 05.12.2012  
 (87) WO2011092283, 28.01.2011  
 (97) 2529433, 05.12.2012 fr  
 (54) LITHIUM BATTERIES CONTAINING LITHIUM-BEARING IRON PHOSPHATE AND CARBON  
 (71) Prayon, Rue Joseph Wauters 144, 4480 Engis, BE  
 Commissariat à l'Energie Atomique, 25, rue Leblanc Bâtiment "Le Ponant D", 75015 Paris, FR  
 (72) PATOUX, Sébastien, 184 route de Saint sixte, Lieudit «Le Pilon», 38500 Saint Nicolas de Macherin, FR  
 MARTINET, Sébastien, 208 Rue du Moulin, 38210 St Quentin/Isère, FR  
 LAUNOIS, Sébastien, 18 Rue André Rivoire, 38100 Grenoble, FR  
 GOURGUE, Alain, Rue de la Bruyère 48, 4287 Lincent, BE  
 GERMEAU, Alain, 23 Rue Jean-Baptiste Vandercammen, 1160 Auderghem, BE

- (51) MKP  
**C08K 5/34 (2006.01)** (97) **2521750 \***  
**C08K 9/00 (2006.01)**  
 (86) GB2011000007 06.01.2011  
 (96) 11700697.3 14.11.2012  
 (87) WO2011083309, 06.01.2011  
 (97) 2521750, 14.11.2012 en  
 (54) CURING LIQUIDS  
 (71) OMG Additives Limited, Floor five 100 Wood Street, London EC2V 7EX, GB  
 (72) HAGE, Ronald, BioPartner Center Leiden Galileiweg 8, 2333 BD Leiden, NL  
 REICHERT, Richard, Allen, Jr., 365 Cypress Avenue, Akron OH 44301, US

- (51) MKP  
**A61K 33/30 (2006.01)** (97) **2501391 \***  
**A61K 31/728 (2006.01)**  
 (86) HU2010000125 18.11.2010  
 (96) 10812988.3 26.09.2012  
 (87) WO2011061554, 18.11.2010  
 (97) 2501391, 26.09.2012 en  
 (54) PHARMACEUTICAL COMPOSITION FOR THE TREATMENT OF BLADDER DISORDERS  
 (71) Richter Gedeon Nyrt., Gyömrői út 19-21., 1103 Budapest, HU  
 (72) LOVÁSZ, Sándor, Hegedüs Gyula u. 8, H-1136 Budapest, HU  
 FURKA, Beáta, Zsindely u. 47, H-1025 Budapest, HU  
 SZÉKELY, Ákosné, Wesselényi u. 130., H-1204 Budapest, HU  
 FORRAI, Gáborné, Pozsonyi u. 14, H-1162 Budapest, HU  
 RODENNÉ JUHÁSZ, Maria, Szélső u. 91/A, H-1188 Budapest, HU  
 SÉNYI, Lajos, Berda u. 40, H-1045 Budapest, HU

- (51) MKP  
**A61M 5/32 (2006.01)** (97) **2536451 \***  
**A61M 5/00 (2006.01)**  
**A61M 5/20 (2006.01)**  
 (86) EP2011052297 16.02.2011  
 (96) 11703888.5 26.12.2012  
 (87) WO2011101375, 16.02.2011  
 (97) 2536451, 26.12.2012 en  
 (54) AUTO-INJECTOR WITH A TORSION SPRING  
 (71) Sanofi-Aventis Deutschland GmbH, Brüningstraße 50, 65929 Frankfurt, DE  
 (72) EKMAN, Matthew, 59 Ecton Avenue, Macclesfield Cheshire SK10 1RD, GB  
 BARROW-WILLIAMS, Timothy Donald, 1 Grange Street, St. Albans Herts AL3 5NA, GB  
 HOURMAND, Yannick, 14 The Elms, Haslingfield CB23 1ND, GB

(51) MKP  
*E01F 15/04 (2006.01)* (97) **2511422**  
*E01F 8/00 (2006.01)*  
*E01F 15/08 (2006.01)*  
 (96) 11425108.5 17.10.2012  
 (97) 2511422, 17.10.2012 en  
 (54) A support base for the fencing of a building yard provided with an integrated guardrail  
 (71) Urbantech S.R.L., Via Lombardia 26 Zona Industriale Gello, 56025 Pontedera (PI), IT  
 (72) Tizzoni, Giampaolo, Via De Gasperi, 33, 56025 Pontedera (PI), IT

(51) MKP  
*G01N 33/53 (2006.01)* (97) **2526420 \***  
*C07K 4/00 (2006.01)*  
 (86) US2010057108 17.11.2010  
 (96) 10832139.9 28.11.2012  
 (87) WO2011063045, 17.11.2010  
 (97) 2526420, 28.11.2012 en  
 (54) METHODS FOR IMPROVING THE DESIGN, BIOAVAILABILITY, AND EFFICACY OF RANDOM SEQUENCE POLYMER COMPOSITIONS VIA SERUM PROTEIN-BASED DETECTION OF RANDOM SEQUENCE POLYMER COMPOSITIONS  
 (71) Ares Trading S.A., Zone Industrielle de l'Ouriettaz, 1170 Aubonne, CH  
 (72) ZANELLI, Eric, 160 Woodside Road, Sudbury, MA 01776, US  
 KRIEGER, Jeff, 152 Nevada Street, Newtonville, MA 02460, US  
 CONNOLLY, Joe, 17 Garfield Ave, Medford, MA 02144, US  
 COLLINS, Kathryn, H., 38 West Pond Road, Plymouth, MA 02360, US

(51) MKP  
*E03D 11/14 (2006.01)* (97) **2531661 \***  
*E03D 9/08 (2006.01)*  
 (86) CH2011000239 05.10.2011  
 (96) 11767605.6 12.12.2012  
 (87) WO2012051729, 05.10.2011  
 (97) 2531661, 12.12.2012 de  
 (54) TECHNICAL UNIT FOR A SANITARY FIXTURE  
 (71) Presano AG, Sonnenstrasse 1, 9444 Diepoldsau, CH  
 (72) GRABER, Daniel, Kirchweg 7, CH-9463 Oberriet, CH

(51) MKP  
*A61K 47/38 (2006.01)* (97) **2535048 \***  
*A61K 47/32 (2006.01)*  
*A61K 31/513 (2006.01)*  
*A61P 11/06 (2006.01)*  
 (86) JP2011052909 10.02.2011  
 (96) 11742316.0 19.12.2012  
 (87) WO2011099573, 10.02.2011  
 (97) 2535048, 19.12.2012 en  
 (54) EXTENDED RELEASE PREPARATION  
 (71) Taisho Pharmaceutical Co., Ltd., 24-1, Takada 3-chome Toshima-ku, Tokyo 170-8633, JP  
 Nissan Chemical Industries, Ltd., 7-1 Kanda-Nishiki-cho 3-chome, Chiyoda-ku Tokyo 101-0054, JP  
 (72) HIRASAWA Noriyuki, c/o TAISHO PHARMACEUTICAL CO. LTD. 24-1, Takada 3-chome Toshima-ku, Tokyo 170-8633, JP  
 KAMIKIDO Nobuyoshi, c/o TAISHO PHARMACEUTICAL CO. LTD. 24-1, Takada 3-chome Toshima-ku, Tokyo 170-8633, JP  
 TASAKI Akihiko, c/o TAISHO PHARMACEUTICAL CO. LTD. 24-1, Takada 3-chome Toshima-ku, Tokyo 170-8633, JP  
 ITO Shusei, c/o TAISHO PHARMACEUTICAL CO. LTD. 24-1, Takada 3-chome Toshima-ku, Tokyo 170-8633, JP

(51) MKP  
*A61K 31/08 (2006.01)* (97) **2514759 \***  
*A61K 31/704 (2006.01)*  
*C07J 63/00 (2006.01)*  
*A61K 31/56 (2006.01)*  
*A61K 31/136 (2006.01)*  
*A61K 31/135 (2006.01)*  
*A61K 31/19 (2006.01)*  
*A61K 31/185 (2006.01)*  
*A61K 31/085 (2006.01)*  
*A61P 1/16 (2006.01)*  
*A61K 31/12 (2006.01)*  
*A61P 31/14 (2006.01)*

(86) JP2010072564 15.12.2010  
 (96) 10837633.6 24.10.2012  
 (87) WO2011074607, 15.12.2010  
 (97) 2514759, 24.10.2012 en  
 (54) TRITERPENE DERIVATIVE, AND PROPHYLACTIC OR THERAPEUTIC AGENT FOR CHRONIC HEPATITIS C  
 (71) Meiji Seika Pharma Co., Ltd., 4-16, Kyobashi 2-Chome,, Chuo-ku Tokyo, JP  
 (72) ISHIKAWA Makoto, c/o Meiji Seika Pharma Co., Ltd. 4-16, Kyobashi 2-chome, Chuo-ku,, Tokyo 104-8002, JP  
 SUZUKI Shigeki, c/o Meiji Seika Pharma Co., Ltd. 4-16, Kyobashi 2-chome, Chuo-ku,, Tokyo 104-8002, JP  
 AOKI Makoto, c/o Meiji Seika Pharma Co., Ltd. 760 Morooka-cho Kouhoku-ku, Yokohama-shi Kanagawa 222-8567, JP  
 MINOWA Nobuto, c/o Meiji Seika Pharma Co., Ltd. 760 Morooka-cho Kouhoku-ku, Yokohama-shi Kanagawa 222-8567, JP  
 SUZUKI Kokichi, c/o Meiji Seika Pharma Co., Ltd. 760 Morooka-cho Kouhoku-ku, Yokohama-shi Kanagawa 222-8567, JP

(51) MKP  
*C07D 403/12 (2006.01)* (97) **2509960 \***  
*A61K 31/4164 (2006.01)*  
*C07D 233/64 (2006.01)*  
*A61P 3/04 (2006.01)*  
*A61K 31/4178 (2006.01)*  
*A61K 31/4439 (2006.01)*  
*C07D 233/84 (2006.01)*  
*A61K 31/454 (2006.01)*  
*A61K 31/496 (2006.01)*

(86) US2010045195 11.08.2010  
 (96) 10747545.1 17.10.2012  
 (87) WO2011071565, 11.08.2010  
 (97) 2509960, 17.10.2012 en  
 (54) TGR5 AGONISTS  
 (71) Exelixis, Inc., 210 East Grand Avenue P.O. Box 511, South San Francisco, CA 94083-0511, US  
 (72) BOLLU, Venkataiah, 10715 Wexford Street Unit 6, San Diego, CA 92131, US  
 BOREN, Brant, Clayton, 2130 33rd Street, San Diego, CA 92104, US  
 DALGARD, Jackline, 517 1/2 Stratford Court, Del Mar, CA 92014, US  
 FLATT, Brenton, T., 12721 Pedriza Drive, Poway, CA 92064, US  
 HAQ, Nadia, 1927 Bridgepointe Circle 314, San Mateo, CA 94404, US  
 HUDSON, Sarah, 3110 Laurel Street, San Diego, CA 92104, US  
 MOHAN, Raju, 3125 Caminito Ricardo, Encinitas, CA 92024, US  
 MORRISSEY, Michael, 129 Alta Vista Way, Danville, CA 94506, US  
 PRATT, Benjamin, 1057 Guadalajara Drive, Encinitas, CA 92024, US

(51) MKP  
*C10G 1/08 (2006.01)* (97) **2513252 \***  
 (86) DK2010000173 12.12.2010  
 (96) 10807522.7 24.10.2012  
 (87) WO2011069510, 12.12.2010  
 (97) 2513252, 24.10.2012 en  
 (54) CONVERSION OF ORGANIC MATTER INTO OIL  
 (71) Altaca Insaat ve Dis Ticaret A.S., Atasehir Bulvar 42A Ada Gardenya Plaza 5, Floor 20, 34758 Atasehir, Istanbul, TR  
 (72) IVERSEN, Steen Brummerstedt, Gøngehusvej 117, DK-2950 Vedbæk, DK

- (51) MKP  
**A61K 31/192 (2006.01)** (97) **2514419 \***  
**A61K 47/32 (2006.01)**  
**A61K 47/16 (2006.01)**  
**A61P 29/00 (2006.01)**  
**A61P 23/02 (2006.01)**  
**A61K 9/70 (2006.01)**  
**A61K 31/167 (2006.01)**  
(86) JP2010072453 14.12.2010  
(96) 10837592.4 24.10.2012  
(87) WO2011074566, 14.12.2010  
(97) 2514419, 24.10.2012 en  
(54) FELBINAC-CONTAINING TRANSDERMAL ABSORPTION PREPARATION  
(71) Teikoku Seiyaku Co., Ltd., 567 Sanbonmatsu, Higashikagawa-shi, Kagawa 769-2695, JP  
(72) KATAYAMA, Akiko, c/o TEIKOKU SEIYAKU CO. LTD. 567 Sanbonmatsu, Higashikagawa-shi Kagawa 769-2695, JP  
INO, Katsuyuki, c/o TEIKOKU SEIYAKU CO. LTD. 567 Sanbonmatsu, Higashikagawa-shi Kagawa 769-2695, JP

- (51) MKP  
**B01D 39/20 (2006.01)** (97) **2533877 \***  
(86) US2011024791 14.02.2011  
(96) 11704707.6 19.12.2012  
(87) WO2011100712, 14.02.2011  
(97) 2533877, 19.12.2012 en  
(54) LIQUID FILTRATION MEDIA  
(71) Donaldson Company, Inc., 1400 West 94th Street P.O. Box 1299, Minneapolis, MN 55440-1299, US  
(72) JONES, Derek, O., 15564 Vale Street NW, Andover Minnesota 55304, US  
DEMA, Keh, B., 4575 Nathan Lane 202, Plymouth Minnesota 55442, US  
LARSEN, Stephen, M., 3559 68th Street East, Inver Grove Heights Minnesota 55076, US  
MADSEN, Mike, J., 1101 Hesse Farm Road, Chaska Minnesota 55318, US  
DALLAS, Andrew, J., 5015 148th Path, Apple Valley Minnesota 55124, US  
ELSAIED, Yehya, A., 2111 Shale Lane, St. Paul Minnesota 55122, US  
YANG, Chuanfang, 13419 Caramel Trail, Eden Prairie Minnesota 55346, US

- (51) MKP  
**C07K 14/52 (2006.01)** (97) **2501720 \***  
(86) IB2010055253 18.11.2010  
(96) 10803636.9 26.09.2012  
(87) WO2011061700, 18.11.2010  
(97) 2501720, 26.09.2012 en  
(54) IFN INHIBITORS IN THE TREATMENT OF MOTONEURON DISEASES  
(71) Lascco SA, Rue de la Rotisserie 8, 1204 Geneva, CH  
INSERM (Institut National de la Santé et de la Recherche Médicale), 101, rue de Tolbiac, 75013 Paris, FR  
Université d'Aix-Marseille, Jardin du Pharo 58 boulevard Charles Livon, 13284 Marseille Cedex 07, FR  
(72) AZEREDO DA SILVEIRA LAJAUNIAS, Samareh, Avenue Maria Belgia 6, CH-1006 Lausanne, CH  
AEBISCHER, Julianne, Oberes Neugut 10, CH-3280 Morat, CH  
RAOUL, Cédric, 23 cours Pierre Puget, F-13006 Marseille, FR

- (51) MKP  
**A61K 31/7036 (2006.01)** (97) **2512439 \***  
**A61K 9/00 (2006.01)**  
(86) EP2010068109 24.11.2010  
(96) 10790833.7 24.10.2012  
(87) WO2011073002, 24.11.2010  
(97) 2512439, 24.10.2012 en  
(54) ANTIBIOTIC MICROPARTICLES FOR INHALATION  
(71) Chiesi Farmaceutici S.p.A., Via Palermo, 26/A, 43100 Parma, IT  
(72) MORTON, David, c/o Chiesi Farmaceutici S.p.A. Via Palermo 26/A, I-43100 Parma, IT  
QI ZHOU, Tony, c/o Chiesi Farmaceutici S.p.A. Via Palermo 26/A, I-43100 Parma, IT  
MUSA, Rossella, c/o Chiesi Farmaceutici S.p.A. Via Palermo 26/A, I-43100 Parma, IT

- (51) MKP  
**G01N 33/574 (2006.01)** (97) **2529229 \***  
(86) EP2011051209 28.01.2011  
(96) 11702009.9 05.12.2012  
(87) WO2011092286, 28.01.2011  
(97) 2529229, 05.12.2012 en  
(54) DIAGNOSING PROSTATE CANCER RELAPSE  
(71) IMG Institut für medizinische Genomforschung  
Planungsgesellschaft M.B.H., Kärntnerstrasse 21-23/2/10, 1010 Vienna, AT  
(72) WEINBERGER, Klaus, c/o Biocrates Lifescience AG Innrain 66/2, A-6020 Innsbruck, AT  
DEIGNER, Hans-Peter, c/o Biocrates Lifescience AG Innrain 66/2, A-6020 Innsbruck, AT  
IGWE, Emeka Ignatius, c/o Biocrates Lifescience AG Innrain 66/2, A-6020 Innsbruck, AT  
ENOT, David, c/o Biocrates Lifescience AG Innrain 66/2, A-6020 Innsbruck, AT  
DALLMANN, Guido, c/o Biocrates Lifescience AG Innrain 66/2, A-6020 Innsbruck, AT  
KLOCKER, Helmut, Ziegelstraße 46a, A-6401 Inzing, AT

- (51) MKP  
**A61K 31/44 (2006.01)** (97) **2536282 \***  
**A01N 43/42 (2006.01)**  
(86) US2011025170 17.02.2011  
(96) 11745200.3 26.12.2012  
(87) WO2011103246, 17.02.2011  
(97) 2536282, 26.12.2012 en  
(54) METHODS FOR TREATING INFECTION  
(71) Salix Pharmaceuticals, Ltd., 1700 Perimeter Park Drive, Morrisville, NC 27560, US  
Board of Regents of the University of Texas System, 201 West 7th Street, Austin, TX 78701, US  
(72) DU PONT, Herbert, L., 6720 Bertner Street, Suite 1164, Houston, TX 77030, US  
GOLDEN, Pam, 5 Fontana Ct., Durham, NC 27713, US  
JIANG, Zhi-Dong, 2631 Turning Row, Missouri City, Texas 77459, US  
DARKOH, Charles, 7490 Brompton St., Unit 355, Houston, Texas 77025, US  
BROWN, Eric, L., 2227 University Blvd., Houston, Texas 77030, US

- (51) MKP  
**A61P 35/00 (2006.01)** (97) **2534149 \***  
**A61P 31/00 (2006.01)**  
**A61K 31/522 (2006.01)**  
**A61P 29/00 (2006.01)**  
**A61P 37/08 (2006.01)**  
**C07D 473/18 (2006.01)**  
**A61P 11/06 (2006.01)**  
(86) EP2011051830 08.02.2011  
(96) 11709025.8 19.12.2012  
(87) WO2011098452, 08.02.2011  
(97) 2534149, 19.12.2012 en  
(54) 6-AMINO-2-[(1S)-1-METHYLBUTYL]OXY-9-[5-(1-PIPERIDINYL)-7,9-DIHYDRO-8H-PURIN-8-ONE MALEATE  
(71) GlaxoSmithKline LLC, One Franklin Plaza 200 North 16th Street, Philadelphia, PA 19102, US  
(72) GIBBON, Robert Hermann, GlaxoSmithKline Park Road, Ware Hertfordshire SG12 0DP, GB  
LUCAS, Amanda, GlaxoSmithKline GunnelsWood Road, Stevenage Hertfordshire SG1 2NY, GB  
HERMITAGE, Stephen Andrew, GlaxoSmithKline Gunnels Wood Road, Stevenage Hertfordshire SG1 2NY, GB



- (51) MKP  
**C09K 8/588 (2006.01)** (97) **2528984 \***  
**C09K 8/12 (2006.01)**  
**C09K 8/68 (2006.01)**  
(86) EP2011051091 26.01.2011  
(96) 11701136.1 05.12.2012  
(87) WO2011092221, 26.01.2011  
(97) 2528984, 05.12.2012 en  
(54) WATER-SOLUBLE POLYMERS FOR OIL RECOVERY  
(71) S.P.C.M. SA, ZAC de Milieux, 42160 Andrezieux Boutheon, FR  
(72) FAVERO, Cédric, 1 Impasse des Tramaris, F-42160 Saint-Romain-Le-Puy, FR  
GAILLARD, Nicolas, 29 Rue de la Résistance, F-42000 Saint-Etienne, FR  
MARRONI, Dennis, 2 Impasse de la Mollanche, F-42290 Sorbiers, FR

- (51) MKP  
**A61K 31/49 (2006.01)** (97) **2432471 \***  
**A61P 43/00 (2006.01)**  
(86) EP2010004214 12.07.2010  
(96) 10737496.9 28.03.2012  
(87) WO2011026536, 12.07.2010  
(97) 2432471, 28.03.2012 de  
(54) NOVEL THERAPEUTIC CONCEPTS FOR TREATING FIBROMYALGIA  
(71) Maria Clementine Martin Klosterfrau Vertriebsgesellschaft mbH, Gereonsmühlengasse 1-11, 50670 Köln, DE  
(72) GREVE, Harald, Schorlemerstraße 3 A, 40545 Düsseldorf, DE

- (51) MKP  
**C07C 49/643 (2006.01)** (97) **2535324 \***  
**C07C 45/80 (2006.01)**  
**C07C 45/68 (2006.01)**  
(86) JP2011052738 09.02.2011  
(96) 11742260.0 19.12.2012  
(87) WO2011099517, 09.02.2011  
(97) 2535324, 19.12.2012 en  
(54) 5-NORBORNENE-2-SPIRO- A-CYCLOALKANONE- A'-SPIRO-2"-5"-NORBORNENE AND METHOD FOR PRODUCING SAME  
(71) JX Nippon Oil & Energy Corporation, 6-3, Otemachi 2-chome, Chiyoda-ku Tokyo 100-8162, JP  
(72) KOMATSU Shinichi, c/o JX Nippon Oil & Energy Corporation 8 Chidori-cho Naka-ku, Yokohama-shi Kanagawa 231-0815, JP  
ADACHI Michiaki, c/o JX Nippon Oil & Energy Corporation 8 Chidori-cho Naka-ku, Yokohama-shi Kanagawa 231-0815, JP

- (51) MKP  
**A61K 31/415 (2006.01)** (97) **2521544 \***  
**A61P 25/06 (2006.01)**  
**A61P 35/00 (2006.01)**  
**A61K 9/06 (2006.01)**  
**A61P 25/00 (2006.01)**  
(86) US2011020462 07.01.2011  
(96) 11732180.2 14.11.2012  
(87) WO2011085162, 07.01.2011  
(97) 2521544, 14.11.2012 en  
(54) TOPICAL TRANSDERMAL DEXMEDETOMIDINE COMPOSITIONS AND METHODS OF USE THEREOF  
(71) Recro Pharma, Inc., 55 Valley Stream Parkway Suite 100, Malvern, PA 19355, US  
(72) HENWOOD, Geraldine, A., 3 Jorrock Lane, Malvern Pennsylvania 19355, US  
MACK, Randall, J., 1633 Valley Greene Road, Paoli Pennsylvania 19301, US  
SHARR, Christopher, T., 907 Brookmont Circle, Malvern Pennsylvania 19355, US  
KOLENG, John, J., 11113 Alison Parke Trail, Austin Texas 78750, US

- (51) MKP  
**A61K 39/04 (2006.01)** (97) **2528621 \***  
(86) EP2011051158 27.01.2011  
(96) 11700859.9 05.12.2012  
(87) WO2011092253, 27.01.2011  
(97) 2528621, 05.12.2012 en  
(54) MODIFIED TUBERCULOSIS ANTIGENS  
(71) GlaxoSmithKline Biologicals S.A., rue de l'Institut, 89, 1330 Rixensart, BE  
Glaxo Group Limited, Glaxo Wellcome House Berkeley Avenue Greenford, Middlesex UB6 0NN, GB  
(72) BLAIS, Normand, ID Biomedical Corporation of Quebec 525 Cartier Boulevard West, Laval, Quebec H7V 3S8, CA  
BROWN, James, GlaxoSmithKline 1250 South Collegeville Road PO Box 5089, Collegeville, Pennsylvania 19426, US  
GELINAS, Anne-Marie, ID Biomedical Corporation of Quebec 525 Cartier Boulevard West, Laval, Quebec H7V 3S8, CA  
METTENS, Pascal, GlaxoSmithKline Biologicals s.a. rue de l'Institut 89, B-1330 Rixensart, BE  
MURPHY, Dennis, c/o GlaxoSmithKline 1250 South Collegeville Road PO Box 5089, Collegeville, Pennsylvania 19426, US

- (51) MKP  
**H01H 3/12 (2006.01)** (97) **2474987**  
**H01H 13/06 (2006.01)**  
**H01H 13/02 (2006.01)**  
**H02B 1/044 (2006.01)**  
(96) 11150214.2 11.07.2012  
(97) 2474987, 11.07.2012 de  
(54) Built-in switch  
(71) EAO Holding AG, Tannwaldstrasse 88, 4601 Olten, CH  
(72) Furrer, Daniel, EAO Holding AG Burgackerring 11, 4652, Winznau, CH

- (51) MKP  
**G01N 22/00 (2006.01)** (97) **2505996 \***  
**G06T 7/60 (2006.01)**  
(86) RU2010000725 24.11.2010  
(96) 10833646.2 03.10.2012  
(87) WO2011065869, 24.11.2010  
(97) 2505996, 03.10.2012 en  
(54) METHOD FOR REMOTELY INSPECTING A TARGET IN A MONITORED AREA  
(71) "Applied Physics Science And Technology Center" Company With Limited Responsibility, Klinsky pr. 25 lit A pom. 3N, St. Petersburg 190013, RU  
(72) KUZNETSOV, Andrey Viktorovich, pr. Toreza 40 korp.7-52, St.Petersburg 194223, RU  
GORSHKOV, Igor Yurievich, V.O. Maly pr. 5-1, St.Petersburg 199178, RU  
AVERYANOV, Valery Petrovich, pr. Metallistov 112-2-19, St.Petersburg 195221, RU

- (51) MKP  
**A01H 5/00 (2006.01)** (97) **2512224 \***  
**C07K 14/325 (2006.01)**  
(86) US2010060826 16.12.2010  
(96) 10842617.2 24.10.2012  
(87) WO2011084627, 16.12.2010  
(97) 2512224, 24.10.2012 en  
(54) MODIFIED CRY1CA INSECTICIDAL CRY PROTEINS  
(71) Dow AgroSciences LLC, 9330 Zionsville Road, Indianapolis IN 46268-1054, US  
(72) MEADE, Thomas, 1141 Huntington Woods Pt., Zionsville, IN 46077, US  
NARVA, Kenneth, 4372 Creekside Pass, Zionsville, IN 46077, US  
HEY, Timothy, 1653 Catalina Way, Zionsville, IN 46077, US  
LARRINUA, Ignacio, 7332 Bramblewood Lane, Indianapolis, IN 46254, US  
WOOSLEY, Aaron, T., 8906 Tanner Drive, Fishers, IN 46038, US  
BURTON, Stephanie, L., 6820 Bluffgrove Drive, Indianapolis, IN 46278, US

- (51) MKP  
**C12R 1/225 (2006.01)** (97) **2525811 \***  
**A61P 17/00 (2006.01)**  
**A61K 35/74 (2006.01)**  
**A61K 39/00 (2006.01)**  
**A23L 1/30 (2006.01)**  
**C07H 3/06 (2006.01)**  
**A61K 31/702 (2006.01)**  
**A61P 11/06 (2006.01)**  
**A61P 37/08 (2006.01)**  
**A61P 11/00 (2006.01)**  
(86) US2011021506 18.01.2011  
(96) 11701334.2 28.11.2012  
(87) WO2011090926, 18.01.2011  
(97) 2525811, 28.11.2012 en  
(54) NUTRITIONAL FORMULAS CONTAINING SYNBIOTICS  
(71) Abbott Laboratories, Department D377/AP6P-1 100 Abbott Park Road, Abbott Park, Illinois 60064, US  
(72) THOMAS, Debra, L., 1078 Trentwood Road, Columbus Ohio 43221, US  
BUCK, Rachael, H., 3710 Peak Ridge Drive, Gahanna Ohio 43230, US
- 
- (51) MKP  
**G08G 1/14 (2006.01)** (97) **2447927**  
(96) 11405347.3 02.05.2012  
(97) 2447927, 02.05.2012 en  
(54) System and process for estimating the availability and/or occupied status of car parks located in a given urban area at a given time  
(71) Bmob Sagl, Via Maderno 24, 6900 Lugano, CH  
(72) Piorkowski, Michal, Place de la Gare 20, 1020 Renens (VD), CH  
Buros, Julien, Villaggio del Sole 2, 6990 Cassina d'Agno, CH  
Materni, Roberto, Via alla Chiesa 16, 6814 Lamone, CH
- 
- (51) MKP  
**C07D 317/18 (2006.01)** (97) **2513081 \***  
**C07D 333/78 (2006.01)**  
**C07D 333/32 (2006.01)**  
(86) JP2010072182 03.12.2010  
(96) 10801279.0 24.10.2012  
(87) WO2011074484, 03.12.2010  
(97) 2513081, 24.10.2012 en  
(54) PROCESS FOR PREPARING SUBSTITUTED 1-O-ACYL-2-DEOXY-2-FLUORO-4-THIO- -D-ARABINOFURANOSES  
(71) Libramedicina, Inc., 611 Tokyo Life Science Incubation Center 1-7-8 Kaigan Minato-ku, Tokyo 105-0022, JP  
(72) VOIGTLANDER, David, 100 Magnolia Court, West Lafayette, Indiana 47906, US  
SANDER, Michael, Hausacker 13, Rosrath (Hoffnungsthal) 51503, DE  
HARRE, Michael, Markelstr. 49, Berlin 12163, DE
- 
- (51) MKP  
**C07D 413/10 (2006.01)** (97) **2526090 \***  
**C07D 401/10 (2006.01)**  
**A61K 31/44 (2006.01)**  
**C07D 417/04 (2006.01)**  
**C07D 401/14 (2006.01)**  
**A61K 31/4427 (2006.01)**  
**C07D 405/04 (2006.01)**  
**A61P 33/06 (2006.01)**  
**C07D 401/04 (2006.01)**  
**C07D 471/06 (2006.01)**  
**C07D 413/14 (2006.01)**  
**C07D 213/73 (2006.01)**  
**C07D 417/14 (2006.01)**  
(86) IB2011050192 17.01.2011  
(96) 11704673.0 28.11.2012  
(87) WO2011086531, 17.01.2011  
(97) 2526090, 28.11.2012 en  
(54) NEW ANTI-MALARIAL AGENTS  
(71) MMV Medicines for Malaria Venture, 20, route de Pré-Bois, ICC, 1215 Geneva, CH  
(72) WITTY, Michael John, 2 Bridleway Whitfield, Dover Kent CT16 3NH, GB  
HARDICK, David, 9A Wilburton Road, Stretham Cambridgeshire CB6 3LL, GB
- 
- (51) MKP  
**A61K 39/395 (2006.01)** (97) **2512511 \***  
**C07K 16/46 (2006.01)**  
**A61P 17/06 (2006.01)**  
**A61P 37/00 (2006.01)**  
**C07K 16/28 (2006.01)**  
(86) EP2010067332 12.11.2010  
(96) 10779768.0 24.10.2012  
(87) WO2011061119, 12.11.2010  
(97) 2512511, 24.10.2012 en  
(54) HUMANIZED ANTIBODIES AGAINST HUMAN IL-22RA  
(71) Merck Serono S.A., Centre Industriel, 1267 Coinsins, CH  
(72) BECKMANN, Roland, Zehenthofgasse 35/4, 1190 Wien, AT  
JOHNSON-LEGER, Caroline, 603 Route des Luches, 74800 Saint Sixt, FR
- 
- (51) MKP  
**C07D 487/04 (2006.01)** (97) **2528625 \***  
**A61P 35/00 (2006.01)**  
**A61K 47/48 (2006.01)**  
(86) US2011032632 15.04.2011  
(96) 11716146.3 05.12.2012  
(87) WO2011130598, 15.04.2011  
(97) 2528625, 05.12.2012 en  
(54) PYRROLOBENZODIAZEPINES AND CONJUGATES THEREOF  
(71) Spirogen Developments SARL, Michael Forer Chemin de la Pacottaz 1, 1806 St-Légier-Chiésaz, CH  
(72) HOWARD, Philip, Wilson, Spirogen Limited School Of Pharmacy 29/39 Brunswick Square, London WC1N 1AX, GB  
MASTERSON, Luke, Spirogen Limited School Of Pharmacy 29/39 Brunswick Square, London WC1N 1AX, GB  
TIBERGHIE, Arnaud, Spirogen Limited School Of Pharmacy 29/39 Brunswick Square, London WC1N 1AX, GB  
FLYGARE, John, A., Genentech Inc. 1 Dna Way, South San Francisco, CA 94080, US  
GUNZNER, Janet, L., Genentech Inc. 1 Dna Way, South San Francisco, CA 94080, US  
POLAKIS, Paul, Genentech Inc. 1 Dna Way, South San Francisco, CA 94080, US  
POLSON, Andrew, Genentech Inc. 1 Dna Way, South San Francisco, CA 94080, US  
RAAB, Helga, E., Genentech Inc. 1 Dna Way, South San Francisco, CA 94080, US  
SPENCER, Susan, D., Genentech Inc. 1 Dna Way, South San Francisco, CA 94080, US
- 
- (51) MKP  
**G01C 9/06 (2006.01)** (97) **2423640**  
**G01C 9/20 (2006.01)**  
(96) 10173726.0 29.02.2012  
(97) 2423640, 29.02.2012 de  
(54) Inclination sensor for a device and method for determining the inclination of a device  
(71) Hexagon Technology Center GmbH, Heinrich-Wild-Strasse, 9435 Heerbrugg, CH  
(72) Lippuner, Heinz, Im Fuertli 9, CH-9445, Rebstein, CH  
Metzler, Bernhard, Druckergasse 15a, A-6850, Dornbirn, AT  
Amann, Werner, Taferstrasse 22, A-6800, Feldkirch, AT
- 
- (51) MKP  
**G06Q 30/00 (2012.01)** (97) **2517162 \***  
**G06F 17/50 (2006.01)**  
(86) US2010061905 22.12.2010  
(96) 10835281.6 31.10.2012  
(87) WO2011079229, 22.12.2010  
(97) 2517162, 31.10.2012 en  
(54) SYSTEM AND METHOD FOR AUTOMATED BUILDING SERVICES DESIGN  
(71) Aea Integration, 3035 South 72nd Street, Omaha, Nebraska 68124, US  
(72) SCHNACKEL, Gregory R., 3105 Armbrust Drive, Omaha Nebraska 68124, US

(51) MKP  
**H05H 1/00 (2006.01)** (97) **2534931 \***  
**C02F 1/00 (2006.01)**  
(86) IB2011000433 09.02.2011  
(96) 11741957.2 19.12.2012  
(87) WO2011098918, 09.02.2011  
(97) 2534931, 19.12.2012 en  
(54) METHOD AND APPARATUS FOR APPLYING PLASMA PARTICLES TO A LIQUID AND USE FOR DISINFECTING WATER  
(71) Zolezzi-Garreton, Alfredo, 1/2 Oriente 1050 Office 204, Vina Del Mar, CL  
(72) Zolezzi-Garreton, Alfredo, 1/2 Oriente 1050 Office 204, Vina Del Mar, CL

(51) MKP  
**A61B 17/00 (2006.01)** (97) **2519163 \***  
**A61B 17/068 (2006.01)**  
**A61B 17/072 (2006.01)**  
**A61B 17/28 (2006.01)**  
(86) US2010059143 06.12.2010  
(96) 10801022.4 07.11.2012  
(87) WO2011081791, 06.12.2010  
(97) 2519163, 07.11.2012 en  
(54) DAMPENING DEVICE FOR ENDOSCOPIC SURGICAL STAPLER  
(71) Ethicon Endo-Surgery, Inc., 4545 Creek Road, Cincinnati, OH 45242, US  
(72) BOUDREAUX, Chad P., 10840 Lakehurst Court, Cincinnati OH 45242, US

(51) MKP  
**A61K 9/32 (2006.01)** (97) **2512459 \***  
(86) US2010060575 15.12.2010  
(96) 10842557.0 24.10.2012  
(87) WO2011084521, 15.12.2010  
(97) 2512459, 24.10.2012 en  
(54) THERAPEUTIC POLYMERIC NANOPARTICLES COMPRISING EPOTHILONE AND METHODS OF MAKING AND USING SAME  
(71) Bind Biosciences, Inc., 64 Sidney Street, Cambridge, MA 02139, US  
(72) FIGUEIREDO, Maria, One Olive Square, Somerville MA 02143, US  
DEWITT, David, 37 Bayard Street, Allston MA 02134, US  
SONG, Young-ho, 33 Bradford Road, Natick MA 01760, US

(51) MKP  
**G01N 33/68 (2006.01)** (97) **2529233 \***  
**C07K 1/107 (2006.01)**  
(86) HR2011000002 11.01.2011  
(96) 11712318.2 05.12.2012  
(87) WO2011089453, 11.01.2011  
(97) 2529233, 05.12.2012 en  
(54) MASS SPECTROMETRY-BASED PROTEIN IDENTIFICATION  
(71) Rudjer Boskovic Institute, Bijenicka Cesta 54, 10000 Zagreb, HR  
(72) CINDRIC, Mario, Rudjer Boskovic Institute Bijenicka cesta 54, 10000 Zagreb, HR  
KRALJEVIC PAVELIC, Sandra, Rudjer Boskovic Institute Bijenicka cesta 54, 10000 Zagreb, HR  
HORVATIC, Anita, Rudjer Boskovic Institute Bijenicka cesta 54, 10000 Zagreb, HR  
DODIG, Ivana, Rudjer Boskovic Institute Bijenicka cesta 54, 10000 Zagreb, HR

(51) MKP  
**C12N 15/82 (2006.01)** (97) **2513317 \***  
(86) US2010060829 16.12.2010  
(96) 10842619.8 24.10.2012  
(87) WO2011084630, 16.12.2010  
(97) 2513317, 24.10.2012 en  
(54) USE OF CRY1DA IN COMBINATION WITH CRY1BE FOR MANAGEMENT OF RESISTANT INSECTS  
(71) Dow AgroSciences, LLC, 9330 Zionsville Road, Indianapolis, Indiana 46268, US  
(72) MEADE, Thomas, 1141 Huntington Woods Pt., Zionsville IN 46077, US  
NARVA, Kenneth, 4372 Creekside Pass, Zionsville IN 46077, US  
STORER, Nicholas, P., 10703 Lexington Street, Kensington MD 20895, US  
SHEETS, Joel, J., 10005 Oak Ridge Drive, Zionsville IN 46077, US  
WOOSLEY, Aaron, T., 8906 Tanner Drive, Fishers IN 46038, US  
BURTON, Stephanie, L., 6820 Bluffgrove Drive, Indianapolis IN 46278, US

(51) MKP  
**C07K 16/16 (2006.01)** (97) **2518148 \***  
**C07K 14/415 (2006.01)**  
**C12N 5/10 (2006.01)**  
**A01H 5/00 (2006.01)**  
**C12N 15/09 (2006.01)**  
**C12Q 1/68 (2006.01)**  
(86) JP2010073288 24.12.2010  
(96) 10839538.5 31.10.2012  
(87) WO2011078308, 24.12.2010  
(97) 2518148, 31.10.2012 en  
(54) GENE Dro1 CONTROLLING DEEP-ROOTED CHARACTERISTICS OF PLANT AND UTILIZATION OF SAME  
(71) National Institute Of Agrobiological Sciences, 1-2 Kannondai 2-chome Tsukuba-shi, Ibaraki 305-8602, JP  
(72) UGA, Yusaku, c/o NATIONAL INSTITUTE OF AGROBIOLOGICAL SCIENCES 1-2 Kannondai 2-chome, Tsukuba-shi Ibaraki 305-8602, JP

(51) MKP  
**C07D 333/40 (2006.01)** (97) **2523947 \***  
**A61K 31/381 (2006.01)**  
(86) HU2011000006 14.01.2011  
(96) 11703731.7 21.11.2012  
(87) WO2011086399, 14.01.2011  
(97) 2523947, 21.11.2012 en  
(54) PROCESS FOR THE PREPARATION OF STRONTIUM RANELATE  
(71) Richter Gedeon Nyrt., Gyömr i út 19-21., 1103 Budapest, HU  
(72) GARADNAY, Sándor, Bánomi lakótelep 12, H-2500 Esztergom, HU  
SZALMA, Nikoletta, Eszperantó u. 1/B, H-2500 Esztergom, HU  
NEU, József, Heged s Gyula u. 44/B, H-1133 Budapest, HU  
TÖRLEY, József, Katona József u. 41, H-1137 Budapest, HU  
DEMETER, Ádám, Egyenes u. 8. A/61, H-1144 Budapest, HU

(51) MKP  
**F16L 27/093 (2006.01)** (97) **2529134 \***  
**F16J 15/00 (2006.01)**  
**F16J 15/34 (2006.01)**  
**F16J 15/44 (2006.01)**  
**F16J 15/32 (2006.01)**  
(86) EP2011050769 20.01.2011  
(96) 11701240.1 05.12.2012  
(87) WO2011092111, 20.01.2011  
(97) 2529134, 05.12.2012 de  
(54) ROTARY SEAL ARRANGEMENT  
(71) Trelleborg Sealing Solutions Germany GmbH, Handwerkstrasse 5-7, 70565 Stuttgart, DE  
(72) JORDAN, Holger, Novizenweg 140, 73765 Neuhausen auf den Fildern, DE

- (51) MKP  
**C07D 213/64 (2006.01)** (97) **2508513 \***  
**A61K 31/496 (2006.01)**  
**A61P 19/06 (2006.01)**  
**A61K 31/4545 (2006.01)**  
**A61P 9/10 (2006.01)**  
**A61K 31/4439 (2006.01)**  
**A61P 3/10 (2006.01)**  
**A61K 31/4427 (2006.01)**  
**A61P 3/00 (2006.01)**  
**A61P 27/02 (2006.01)**  
**A61K 31/444 (2006.01)**  
**A61P 7/10 (2006.01)**  
**A61K 31/4433 (2006.01)**  
**A61P 3/06 (2006.01)**  
**C07D 401/10 (2006.01)**  
**A61K 31/443 (2006.01)**  
**A61P 3/04 (2006.01)**  
**A61P 43/00 (2006.01)**  
**A61K 31/4412 (2006.01)**  
**A61K 31/5377 (2006.01)**  
**A61P 25/00 (2006.01)**
- (86) JP2010071709 03.12.2010  
(96) 10834661.0 10.10.2012  
(87) WO2011068211, 03.12.2010  
(97) 2508513, 10.10.2012 en  
(54) 2-PYRIDONE COMPOUNDS  
(71) Taisho Pharmaceutical Co., Ltd., 24-1, Takada 3-chome  
Toshima-ku, Tokyo 170-8633, JP  
Nissan Chemical Industries, Ltd., 7-1 Kanda-Nishiki-cho  
3-chome, Chiyoda-ku Tokyo 101-0054, JP  
(72) KAWAGUCHI Takanori, c/o TAISHO PHARMACEUTICAL CO.  
LTD. 24-1 Takada 3-chome Toshima-ku, Tokyo 170-8633, JP  
WATATANI Kengo, c/o TAISHO PHARMACEUTICAL CO. LTD.  
24-1 Takada 3-chome Toshima-ku, Tokyo 170-8633, JP  
FUSEGI Keiko, c/o TAISHO PHARMACEUTICAL CO. LTD. 24-1  
Takada 3-chome Toshima-ku, Tokyo 170-8633, JP  
BOHNO Masahiro, c/o TAISHO PHARMACEUTICAL CO. LTD.  
24-1 Takada 3-chome Toshima-ku, Tokyo 170-8633, JP  
ASANUMA Hajime, c/o TAISHO PHARMACEUTICAL CO. LTD.  
24-1 Takada 3-chome Toshima-ku, Tokyo 170-8633, JP  
KURODA Shoichi, c/o TAISHO PHARMACEUTICAL CO. LTD.  
24-1 Takada 3-chome Toshima-ku, Tokyo 170-8633, JP  
IMAI Yudai, c/o TAISHO PHARMACEUTICAL CO. LTD. 24-1  
Takada 3-chome Toshima-ku, Tokyo 170-8633, JP  
CHONAN Tomomichi, c/o TAISHO PHARMACEUTICAL CO.  
LTD. 24-1 Takada 3-chome Toshima-ku, Tokyo 170-8633, JP  
SATO Nagaaki, c/o TAISHO PHARMACEUTICAL CO. LTD. 24-1  
Takada 3-chome Toshima-ku, Tokyo 170-8633, JP  
TOKITA Shigeru, c/o TAISHO PHARMACEUTICAL CO. LTD.  
24-1 Takada 3-chome Toshima-ku, Tokyo 170-8633, JP  
SASAKO Shigetada, c/o Chemical Research Laboratories  
NISSAN CHEMICAL INDUSTRIES LTD. 10-1 Tsuboi-Nishi  
2-chome, Funabashi-shi Chiba 274-8507, JP  
OKADA Takumi, c/o Chemical Research Laboratories NISSAN  
CHEMICAL INDUSTRIES LTD. 10-1 Tsuboi-Nishi 2-chome,  
Funabashi-shi Chiba 274-8507, JP  
HAYASHI Keishi, c/o Chemical Research Laboratories NISSAN  
CHEMICAL INDUSTRIES LTD. 10-1 Tsuboi-Nishi 2-chome,  
Funabashi-shi Chiba 274-8507, JP  
ITO Shin, c/o Chemical Research Laboratories NISSAN  
CHEMICAL INDUSTRIES LTD. 10-1 Tsuboi-Nishi 2-chome,  
Funabashi-shi Chiba 274-8507, JP  
SAITO Noriko, c/o Chemical Research Laboratories NISSAN  
CHEMICAL INDUSTRIES LTD. 10-1 Tsuboi-Nishi 2-chome,  
Funabashi-shi Chiba 274-8507, JP  
JIBIKI Rui, c/o Chemical Research Laboratories NISSAN  
CHEMICAL INDUSTRIES LTD. 10-1 Tsuboi-Nishi 2-chome,  
Funabashi-shi Chiba 274-8507, JP  
ISHIYAMA Seishi, c/o Chemical Research Laboratories NISSAN  
CHEMICAL INDUSTRIES LTD. 10-1 Tsuboi-Nishi 2-chome,  
Funabashi-shi Chiba 274-8507, JP  
OTA Hirofumi, c/o Chemical Research Laboratories NISSAN  
CHEMICAL INDUSTRIES LTD. 10-1 Tsuboi-Nishi 2-chome,  
Funabashi-shi Chiba 274-8507, JP
- (51) MKP  
**H01C 7/12 (2006.01)** (97) **2537164 \***  
(86) SI2011000008 18.02.2011  
(96) 11713385.0 26.12.2012  
(87) WO2011102811, 18.02.2011  
(97) 2537164, 26.12.2012 en  
(54) EXCESS VOLTAGE CIRCUIT-BREAKER WITH A ROTATIONAL  
DISC AND AN ELECTRONIC ASSEMBLY TO IMPROVE  
OPERATION RELIABILITY  
(71) Iskra Zascite D.o.o., Stegne 35, 1000 Ljubljana, SI  
(72) BURGER, Miran, Mer nikova ulica 5/a, 1111 Ljubljana, SI  
VUKOTI, Milenko, Clevelandska 43, 1111 Ljubljana, SI  
JURI EV, Igor, Smrekarjeva 19, 6310 Izola, SI
- (51) MKP  
**C07B 61/00 (2006.01)** (97) **2502897 \***  
**C12P 7/62 (2006.01)**  
**C07C 69/753 (2006.01)**  
**C07B 57/00 (2006.01)**  
**C07C 67/303 (2006.01)**  
**C07B 53/00 (2006.01)**
- (86) JP2010006756 18.11.2010  
(96) 10831333.9 26.09.2012  
(87) WO2011061934, 18.11.2010  
(97) 2502897, 26.09.2012 en  
(54) METHOD FOR PRODUCING OPTICALLY ACTIVE BICYCLO  
[3.1.0]HEXANE DERIVATIVE USING OXYGEN  
(71) Taisho Pharmaceutical Co., Ltd., 24-1, Takada 3-chome  
Toshima-ku, Tokyo 170-8633, JP  
(72) SASAKI, Joji, c/o TAISHO PHARMACEUTICAL CO. LTD. 24-1,  
Takada 3-chome Toshima-ku, Tokyo 170-8633, JP
- (51) MKP  
**A61K 38/16 (2006.01)** (97) **2509616 \***  
**C12P 21/04 (2006.01)**
- (86) US2010059292 07.12.2010  
(96) 10836553.7 17.10.2012  
(87) WO2011071926, 07.12.2010  
(97) 2509616, 17.10.2012 en  
(54) BCHE ALBUMIN FUSIONS FOR THE TREATMENT OF  
COCAINE ABUSE  
(71) Teva Pharmaceutical Industries Ltd., 5 Basel Street P.O. Box  
3190, 49131 Petach-Tikva, IL  
(72) SKLAIR-TAVRON, Liora, 10 Inbar St., Zichron Yaakov, IL  
ROSENSTOCK, Moti, Kibbutz Maanit, 37855 D.N. Menashe, IL  
SHEMESH-DARVISH, Liron, A'shkedia 13 St., 52447 Ramat-  
Gan, IL  
HALLAK, Hussein, 11 Rashid Street, 9500 Jerusalem, IL  
PIRYATINSKY, Victor, Oley Hagardom 10b/13, 42398 Netanya,  
IL  
ROSCHKE, Viktor, 4702 West Virginia Ave, Bethesda MD 20814,  
US  
LAFLEUR, David, 3142 Quesada St. NW, Washington DC  
20015, US
- (51) MKP  
**C07K 16/28 (2006.01)** (97) **2534177 \***
- (86) GB2011000175 10.02.2011  
(96) 11730035.0 19.12.2012  
(87) WO2011098762, 10.02.2011  
(97) 2534177, 19.12.2012 en  
(54) ANTIBODIES AGAINST CXCR4  
(71) Affitech Research AS, Oslo Research Park Gaustadallén 21,  
0349 Oslo, NO  
(72) KAVLIE, Anita, Strømsborgveien 39H, N-0287 Oslo, NO  
KIPRIJANOV, Sergej, Michailovi, Hovseterveien 98, N-0768  
Oslo, NO
- (51) MKP  
**E04B 2/16 (2006.01)** (97) **2536891 \***
- (86) CH2011000028 15.02.2011  
(96) 11705802.4 26.12.2012  
(87) WO2011100854, 15.02.2011  
(97) 2536891, 26.12.2012 en  
(54) ENERGY AND WEIGHT EFFICIENT BUILDING BLOCK,  
MANUFACTURING AND APPLICATION PROCESS THEREOF  
(71) WYW Block AG, Landstrasse 140, 9494 Schaan, LI  
(72) ANTAL, István, Ásványhát u.14, H-6753 Szeged, HU

(51) MKP  
**C12N 15/82 (2006.01)** (97) **2513315 \***  
 (86) US2010060825 16.12.2010  
 (96) 10842616.4 24.10.2012  
 (87) WO2011084626, 16.12.2010  
 (97) 2513315, 24.10.2012 en  
 (54) COMBINED USE OF CRY1FA AND CRY1AB PROTEINS FOR CONTROL OF CRY-RESISTANT SUGARCANE BORER AND FOR INSECT RESISTANCE MANAGEMENT IN SUGARCANE  
 (71) Dow AgroSciences, LLC, 9330 Zionsville Road, Indianapolis, Indiana 46268, US  
 (72) MEADE, Thomas, 1141 Huntington Woods Pt., Zionsville, IN 46077, US  
 NARVA, Kenneth, 4372 Creekside Pass, Zionsville, IN 46077, US  
 STORER, Nicholas, P., 10703 Lexington Street, Kensington, MD 20895, US  
 SHEETS, Joel, J., 10005 Oak Ridge Drive, Zionsville, IN 46077, US  
 BURTON, Stephanie, L., 6820 Bluffgrove Drive, Indianapolis, IN 46278, US

(51) MKP  
**F26B 11/16 (2006.01)** (97) **2511636**  
**F26B 23/00 (2006.01)**  
 (96) 11162682.6 17.10.2012  
 (97) 2511636, 17.10.2012 en  
 (54) Method for energy efficient drying of liquids, slurries, pastes, cakes and moist particles that forms particulate matter through drying in direct superheated steam dryer  
 (71) Epcon Evaporation Technology AS, Jarleveien 17, 7041 Trondheim, NO  
 (72) Halvorsen, Geir, Notenget 6A, 7500, Stjørdal, NO  
 Evenmo, Kjetil Olav, Ole Nordgaardsvei 24C, 7049, Trondheim, NO  
 Gotaas, Carl Ivar, Bukkvollan 8, 7020, Trondheim, NO  
 Hauan, Jørgen Guldborg, Sveiservegen 4, 7056, Ranheim, NO  
 Skjervold, Bård Egil, Rådmannsv. 14A, 7027, Trondheim, NO

(51) MKP  
**A61K 31/00 (2006.01)** (97) **2525790 \***  
 (86) US2010053624 21.10.2010  
 (96) 10825707.2 28.11.2012  
 (87) WO2011050211, 21.10.2010  
 (97) 2525790, 28.11.2012 en  
 (54) METHODS AND COMPOSITIONS FOR CELL-PROLIFERATION-RELATED DISORDERS  
 (71) Agios Pharmaceuticals, Inc., 38 Sidney Street, Cambridge, MA 02139, US  
 (72) SU, Shinsan, 346 Hartman Road, Newton MA 02459, US  
 DANG, Lenny, 30 Union Park Street, 201, Boston MA 02118, US  
 GROSS, Stefan, 14 Park Street, 1, Brookline MA 02446, US  
 JIN, Shengfang, 6 Audubon Drive, Newton MA 02467, US  
 CANTLEY, Lewis, C., 43 Larch Road, Cambridge MA 02138, US  
 SAUNDERS, Jeffrey, O., 117 Seymour Street, Concord MA 01742, US  
 FANTIN, Valeria, 195 Binney Street Apt. 4515, Cambridge MA 02142, US

(51) MKP  
**G01N 33/574 (2006.01)** (97) **2519826 \***  
 (86) US2011026943 03.03.2011  
 (96) 11707543.2 07.11.2012  
 (87) WO2011109572, 03.03.2011  
 (97) 2519826, 07.11.2012 en  
 (54) BIOLOGICAL MARKERS PREDICTIVE OF ANTI-CANCER RESPONSE TO INSULIN-LIKE GROWTH FACTOR-1 RECEPTOR KINASE INHIBITORS  
 (71) OSI Pharmaceuticals, LLC, 1 Bioscience Park Drive, Farmingdale, NY 11735, US  
 (72) BUCK, Elizabeth, A., OSI Pharmaceuticals Inc. Broadhollow Bioscience Park 1 Bioscience Park Drive, Farmingdale, NY 11735, US  
 EPSTEIN, David, M., OSI Pharmaceuticals Inc. Broadhollow Bioscience Park 1 Bioscience Park Drive, Farmingdale, NY 11735, US  
 MIGLARESE, Mark, R., OSI Pharmaceuticals Inc. 420 Saw Mill River Road, Ardsley, NY 10502, US

(51) MKP  
**B60H 1/00 (2006.01)** (97) **2512847 \***  
**F25B 45/00 (2006.01)**  
**F16L 37/36 (2006.01)**  
 (86) DK2010000162 01.12.2010  
 (96) 10798495.7 24.10.2012  
 (87) WO2011072680, 01.12.2010  
 (97) 2512847, 24.10.2012 en  
 (54) SERVICE EQUIPMENT FOR SERVICING COOLING SYSTEMS IN VEHICLES  
 (71) Agramkow Fluid Systems A/S, Augustenborg Landevej 19, 6400 Sønderborg, DK  
 (72) LUND, Bjarne, Agramkow Fluid Systems A/S Augustenborg Landevej 19, DK-6400 Sønderborg, DK

(51) MKP  
**G01N 33/68 (2006.01)** (97) **2496944 \***  
 (86) EP2010066786 04.11.2010  
 (96) 10773094.7 12.09.2012  
 (87) WO2011054893, 04.11.2010  
 (97) 2496944, 12.09.2012 en  
 (54) BIOMARKERS PREDICTIVE OF PROGRESSION OF FIBROSIS  
 (71) Novartis AG, Lichtstrasse 35, 4056 Basel, CH  
 The Regents of the University of Michigan, U-M Office of Technology Transfer 1600 Huron Parkway, 2nd Floor, Ann Arbor, MI 48104-2590, US  
 (72) HOGABOAM, Cory, The Regents of the University of Michigan Wolverine Tower Room 2071 3003 S. State Street, Ann Arbor, Michigan 48109-1280, US  
 KUNKEL, Steven, L., The Regents of the University of Michigan Wolverine Tower Room 2071 3003 S. State Street, Ann Arbor, Michigan 48109-1280, US  
 TRUJILLO, Glenda, The Regents of the University of Michigan Wolverine Tower Room 2071 3003 S. State Street, Ann Arbor, Michigan 48109-1280, US

(51) MKP  
**A61K 38/08 (2006.01)** (97) **2536421 \***  
**A61K 38/00 (2006.01)**  
 (86) IL2011000033 11.01.2011  
 (96) 11731746.1 26.12.2012  
 (87) WO2011083482, 11.01.2011  
 (97) 2536421, 26.12.2012 en  
 (54) METHOD FOR TREATMENT OF PSORIASIS  
 (71) HealOr Ltd., P.O.Box 4115, 74140 Ness Ziona, IL  
 (72) TENNENBAUM, Tamar, 12 Herzl Boulevard, 96105 Jerusalem, IL  
 BRAIMAN-WIKSMAN, Liora, 24 Stephan Wiess Street, 75400 Rishon Le-Zion, IL  
 SAGIV, Yuval, 12 Smadar Street, 70700 Gedera, IL  
 GARTSBEIN, Marina, 77 Pinsker Street, 49221 Petach Tikva, IL  
 BRENER, Ephraim, 4 Mania Shochat Street, Rishon Le Zion 75241, IL  
 BEN-HAMO, Moshe, 11 Zvi Herling Street, Bene Braq 51223, IL  
 HAMMER, Liat., 21/2 Itzhak Rabbin, Modlin, 71700, IL

(51) MKP  
**A61P 3/00 (2006.01)** (97) **2525807 \***  
**A61K 38/26 (2006.01)**  
**A61K 38/18 (2006.01)**  
 (86) EP2011050793 21.01.2011  
 (96) 11700669.2 28.11.2012  
 (87) WO2011089203, 21.01.2011  
 (97) 2525807, 28.11.2012 en  
 (54) PHARMACEUTICAL COMPOSITION FOR TREATING A METABOLIC SYNDROME  
 (71) SANOFI, 54, rue de la Boétie, 75008 Paris, FR  
 SOMMERFELD, Mark, Sanofi-Aventis Deutschland GmbH, 65926 Frankfurt am Main, DE  
 SCHAEFER, Hans-Ludwig, Sanofi-Aventis Deutschland GmbH, 65926 Frankfurt am Main, DE  
 BOSCHENIN, Oliver, Sanofi-Aventis Deutschland GmbH, 65926 Frankfurt am Main, DE  
 HABERMANN, Paul, Sanofi-Aventis Deutschland GmbH, 65926 Frankfurt am Main, DE  
 RAO, Ercole, Sanofi-Aventis Deutschland GmbH, 65926 Frankfurt am Main, DE  
 DREYER, Matthias, Sanofi-Aventis Deutschland GmbH, 65926 Frankfurt am Main, DE

(51) MKP  
**B01D 53/94 (2006.01)** (97) **2508724 \***  
**F01N 3/08 (2006.01)**  
**F01N 3/24 (2006.01)**  
(86) JP2010063758 13.08.2010  
(96) 10834419.3 10.10.2012  
(87) WO2011067966, 13.08.2010  
(97) 2508724, 10.10.2012 en  
(54) ENGINE EXHAUST-AIR PURIFYING APPARATUS  
(71) Volvo Powertrain Aktiebolag, null, 405 08 Gothenburg, SE  
(72) HONDA, Koutarou, c/o UD TRUCKS CORPORATION 1 Ooaza  
1-chome, Ageo-shi Saitama 362-8523, JP  
FUJISAWA, Norihiro, c/o UD TRUCKS CORPORATION 1 Ooaza  
1-chome, Ageo-shi Saitama 362-8523, JP

(51) MKP  
**F16J 15/32 (2006.01)** (97) **2533712 \***  
**A61B 17/32 (2006.01)**  
(86) US2011024190 09.02.2011  
(96) 11706978.1 19.12.2012  
(87) WO2011100321, 09.02.2011  
(97) 2533712, 19.12.2012 en  
(54) SEAL ARRANGEMENTS FOR ULTRASONICALLY POWERED  
SURGICAL INSTRUMENTS  
(71) Ethicon Endo-Surgery, Inc., 4545 Creek Road, Cincinnati, OH  
45242, US  
(72) ROBERTSON, Galen, C., 5752 Doerger Lane, Cincinnati, OH  
45212, US  
HOUSER, Kevin, L., 570 Foliage Lane, Springboro, OH 45066,  
US  
NEUROHR, Mark, A., 658 Nelson Place, Newport, KY 41071, US

(51) MKP  
**C07K 5/08 (2006.01)** (97) **2520180 \***  
**A23L 1/228 (2006.01)**  
**C07K 5/06 (2006.01)**  
(86) JP2010073721 28.12.2010  
(96) 10841040.8 07.11.2012  
(87) WO2011081185, 28.12.2010  
(97) 2520180, 07.11.2012 en  
(54) FLAVOR-ENRICHING AGENT  
(71) Ajinomoto Co., Inc., 15-1, Kyobashi 1-chome Chuo-ku, Tokyo,  
104-8315, JP  
(72) MIYAKI, Takashi, c/o AJINOMOTO CO. INC. 1-1, Suzuki-cho  
Kawasaki-ku, Kawasaki-shi Kanagawa 210-8681, JP  
MIYAMURA, Naohiro, c/o AJINOMOTO CO. INC. 1-1, Suzuki-  
cho Kawasaki-ku, Kawasaki-shi Kanagawa 210-8681, JP  
KANEKO, Megumi, c/o AJINOMOTO CO. INC. 1-1, Suzuki-cho  
Kawasaki-ku, Kawasaki-shi Kanagawa 210-8681, JP  
AMINO, Yusuke, c/o AJINOMOTO CO. INC. 1-1, Suzuki-cho  
Kawasaki-ku, Kawasaki-shi Kanagawa 210-8681, JP  
YASUDA, Reiko, c/o AJINOMOTO CO. INC. 1-1, Suzuki-cho  
Kawasaki-ku, Kawasaki-shi Kanagawa 210-8681, JP  
ETO, Yuzuru, c/o AJINOMOTO CO. INC. 1-1, Suzuki-cho  
Kawasaki-ku, Kawasaki-shi Kanagawa 210-8681, JP  
TAJIMA, Takaho, c/o AJINOMOTO CO. INC. 1-1, Suzuki-cho  
Kawasaki-ku, Kawasaki-shi Kanagawa 210-8681, JP

(51) MKP  
**A61P 17/06 (2006.01)** (97) **2501410 \***  
**A61K 9/00 (2006.01)**  
**A61P 17/10 (2006.01)**  
**A61K 31/00 (2006.01)**  
**A61K 9/06 (2006.01)**  
**A61K 31/196 (2006.01)**  
**A61P 17/00 (2006.01)**  
**A61K 45/06 (2006.01)**  
**A61K 31/498 (2006.01)**  
**A61P 17/04 (2006.01)**  
(86) EP2010067749 18.11.2010  
(96) 10777034.9 26.09.2012  
(87) WO2011061252, 18.11.2010  
(97) 2501410, 26.09.2012 en  
(54) COMBINATION OF ALPHA-2 ADRENERGIC RECEPTOR  
AGONIST AND NON-STEROIDAL ANTI-INFLAMMATORY  
AGENT FOR TREATING OR PREVENTING AN  
INFLAMMATORY SKIN DISORDER  
(71) Galderma Research & Development, 2400 Route des Colles  
Les Templiers, 06410 Biot, FR  
(72) JOMARD, André, 20 Bis avenue François Goby, F-06460 Saint  
Vallier de Thiey, FR  
DELAMADELEINE, Françoise, Rastines village 1233 chemin des  
Rastines, F-06600 Antibes, FR

(51) MKP  
**G06F 3/041 (2006.01)** (97) **2502215 \***  
**G08B 6/00 (2006.01)**  
(86) US2010056829 16.11.2010  
(96) 10787610.4 26.09.2012  
(87) WO2011062895, 16.11.2010  
(97) 2502215, 26.09.2012 en  
(54) SYSTEMS AND METHODS FOR INCREASING HAPTIC  
BANDWIDTH IN AN ELECTRONIC DEVICE  
(71) Immersion Corporation, 30 Rio Robles, San Jose, CA 95134, US  
(72) CRUZ-HERNANDEZ, Juan, Manuel, 4840 Ste-Catherine West,  
Montreal Québec H3Z 1T1, CA

(51) MKP  
**A61B 17/072 (2006.01)** (97) **2515769 \***  
(86) US2010059139 06.12.2010  
(96) 10795512.2 31.10.2012  
(87) WO2011078959, 06.12.2010  
(97) 2515769, 31.10.2012 en  
(54) SURGICAL CUTTING INSTRUMENT THAT ANALYZES TISSUE  
THICKNESS  
(71) Ethicon Endo-Surgery, Inc., 4545 Creek Road, Cincinnati, OH  
45242, US  
(72) SWENSGARD, Brett, E., 7936 Orchard Court, West Chester OH  
45069, US  
SMITH, Bret, W., 4736 Eastport Drive, Kings Mills OH 45034, US  
LAURENT, Ryan, J., 4560 Snowbird Drive, Liberty Township OH  
45011, US

(51) MKP  
**C12N 5/10 (2006.01)** (97) **2536267 \***  
**C07K 14/00 (2006.01)**  
**C12N 15/63 (2006.01)**  
**A01H 5/10 (2006.01)**  
**C07H 21/04 (2006.01)**  
**C12N 15/82 (2006.01)**  
**A01H 5/00 (2006.01)**  
**A01H 1/00 (2006.01)**  
**A01N 37/18 (2006.01)**  
**C12P 21/00 (2006.01)**  
**C12N 1/21 (2006.01)**  
**A01P 7/04 (2006.01)**  
(86) US2011025172 17.02.2011  
(96) 11730106.9 26.12.2012  
(87) WO2011103248, 17.02.2011  
(97) 2536267, 26.12.2012 en  
(54) AXMI221z, AXMI222z, AXMI223z, AXMI224z, AND AXMI225z  
DELTA-ENDOTOXIN GENES AND METHODS FOR THEIR USE  
(71) Athenix Corp., 3500 Paramount Parkway, Morrisville, NC 27560,  
US  
(72) SAMPSON, Kimberly, S., 5505 Frenchman's Creek Dr., Durham,  
NC 27713, US  
TOMSO, Daniel, John, 114 Vista Del Rio Dr., Bahama, NC  
27503, US

(51) MKP  
**A61K 9/00 (2006.01)** (97) **2515854 \***  
**A61K 31/40 (2006.01)**  
(86) EP2010070478 22.12.2010  
(96) 10799029.3 31.10.2012  
(87) WO2011076842, 22.12.2010  
(97) 2515854, 31.10.2012 en  
(54) AEROSOL FORMULATION FOR COPD  
(71) Chiesi Farmaceutici S.p.A., Via Palermo, 26/A, 43100 Parma, IT  
(72) BONELLI, Sauro, Chiesi Farmaceutici S.P.A. Via Palermo 26/A, I-43100 Parma, IT  
USBERTI, Francesca, Chiesi Farmaceutici S.P.A. Via Palermo 26/A, I-43100 Parma, IT  
ZAMBELLI, Enrico, Chiesi Farmaceutici S.P.A. Via Palermo 26/A, I-43100 Parma, IT

(51) MKP  
**C12N 9/12 (2006.01)** (97) **2374873**  
**C12P 13/08 (2006.01)**  
(96) 10003770.4 12.10.2011  
(97) 2374873, 12.10.2011 en  
(54) Modified aspartate kinase from corynebacterium and its application for amino acid production  
(71) Technische Universität Hamburg-Harburg, Schwarzenbergstrasse 95, 21073 Hamburg, DE  
TuTech Innovation GmbH, Harburger Schlosstrasse 6-12, 21079 Hamburg, DE  
(72) Zeng, An-Ping, Julius-Ludowiegstr. 54, 21071 Hamburg, DE  
Chen, Zhen, Julius-Ludowiegstr. 54, 21071 Hamburg, DE

(51) MKP  
**A01K 67/027 (2006.01)** (97) **2510087 \***  
**A61K 48/00 (2006.01)**  
**G01N 33/15 (2006.01)**  
**C12N 5/071 (2010.01)**  
**A61K 38/00 (2006.01)**  
**C12N 5/10 (2006.01)**  
(86) US2010059934 10.12.2010  
(96) 10836770.7 17.10.2012  
(87) WO2011072247, 10.12.2010  
(97) 2510087, 17.10.2012 en  
(54) PATHOGEN RESTRICTION FACTORS  
(71) The Brigham and Women's Hospital, Inc., 75 Francis Street, Boston, MA 02115, US  
The General Hospital Corporation, 55 Fruit Street, Boston, MA 02114, US  
(72) BRASS, Abe, 20 Parsons Street, Newton Massachusetts 02465, US  
ELLEDGE, Steve, 33 Chatham Street, Brookline Massachusetts 02446, US

(51) MKP  
**F28D 20/00 (2006.01)** (97) **2516953 \***  
**F24D 11/00 (2006.01)**  
**F24H 1/18 (2006.01)**  
(86) SE2010051414 17.12.2010  
(96) 10839888.4 31.10.2012  
(87) WO2011078767, 17.12.2010  
(97) 2516953, 31.10.2012 en  
(54) ACCUMULATOR TANK WITH PARTITION WALLS  
(71) Fueltech Sweden AB, P.O. Box 507, 372 25 Ronneby, SE  
(72) JÖNSSON, Mikael, Brittåsavägen 24, S-294 74 Sölvesborg, SE

(51) MKP  
**C21D 9/08 (2006.01)** (97) **2501829 \***  
(86) US2010056999 17.11.2010  
(96) 10832092.0 26.09.2012  
(87) WO2011062970, 17.11.2010  
(97) 2501829, 26.09.2012 en  
(54) IMPROVED FATIGUE-RESISTANT NITINOL INSTRUMENT  
(71) Johnson, William B., 7420 South Yale Avenue, Tulsa, OK 74136, US  
(72) Johnson, William B., 7420 South Yale Avenue, Tulsa, OK 74136, US

(51) MKP  
**A61P 25/00 (2006.01)** (97) **2509982 \***  
**A61P 25/28 (2006.01)**  
**A61K 31/4995 (2006.01)**  
**A61P 25/16 (2006.01)**  
**C07D 487/08 (2006.01)**  
(86) US2010058836 03.12.2010  
(96) 10787978.5 17.10.2012  
(87) WO2011071758, 03.12.2010  
(97) 2509982, 17.10.2012 en  
(54) 3,6-DIAZABICYCLO[3.1.1]HEPTANES AS NEURONAL NICOTINIC ACETYLCHOLINE RECEPTOR LIGANDS  
(71) Targacept, Inc., 200 East First Street, Suite 300, Winston-Salem, NC 27101-4165, US  
(72) AKIREDDY, Srinivasa Rao, 5829 Fox Point Circle, Winston-Salem North Carolina 27104, US  
BHATTI, Balwinder Singh, 2536 Polo Road, Winston-Salem North Carolina 27106, US  
HEEMSTRA, Ronald Joseph, 1145 Norwood Lane, Lewisville North Carolina 27023, US  
MURTHY, Srinivasa V., 5337 Hidden Stream Drive, Lewisville North Carolina 27023, US  
STRACHAN, Jon-Paul, 1871 Dunbar Place, Burlington North Carolina 27215, US  
XIAO, Yunde, 2079 Waterford Village Drive, Clemmons North Carolina 27012, US

(51) MKP  
**B23B 51/00 (2006.01)** (97) **2463047**  
(96) 10194704.2 13.06.2012  
(97) 2463047, 13.06.2012 de  
(54) Undercutting tool  
(71) Hasler, Josef, Bächis 18, 9452 Hinterforst, CH  
(72) Hasler, Josef, Bächis 18, 9452 Hinterforst, CH

(51) MKP  
**C10C 1/00 (2006.01)** (97) **2521758 \***  
(86) EP2010007840 21.12.2010  
(96) 10798967.5 14.11.2012  
(87) WO2011082810, 21.12.2010  
(97) 2521758, 14.11.2012 de  
(54) DEVICE AND METHOD FOR SEPARATING A SOLID MATTER-CONTAINING, LIQUID AND PUMPABLE TAR SUSPENSION AND USE OF THE SEPARATED SOLID MATTER FOR PRODUCING COKE  
(71) ThyssenKrupp Uhde GmbH, Friedrich-Uhde-Strasse 15, 44141 Dortmund, DE  
(72) THIELERT, Holger, Westerwikstr. 38, 44379 Dortmund, DE

(51) MKP  
**A61K 31/381 (2006.01)** (97) **2513108 \***  
**C07D 495/04 (2006.01)**  
**C07D 471/04 (2006.01)**  
**A61K 31/429 (2006.01)**  
**C07D 513/04 (2006.01)**  
(86) FR2010052685 13.12.2010  
(96) 10801662.7 24.10.2012  
(87) WO2011080444, 13.12.2010  
(97) 2513108, 24.10.2012 fr  
(54) NOVEL (HETEROCYCLE/CONDENSED PIPERIDINE)-(PIPERAZINYL)-1-ALCANONE OR (HETEROCYCLE/CONDENSED PYRROLIDINE)-(PIPERAZINYL)-1-ALCANONE DERIVATIVES, AND USE THEREOF AS P75 INHIBITORS  
(71) SANOFI, 54, rue de la Boétie, 75008 Paris, FR  
(72) BARONI, Marco, c/o Sanofi-Aventis Département Brevets 174 avenue de France, F-75013 Paris, FR  
BONO, Françoise, c/o Sanofi-Aventis Département Brevets 174 avenue de France, F-75013 Paris, FR  
DELBARY-GOSSART, Sandrine, c/o Sanofi-Aventis Département Brevets 174 avenue de France, F-75013 Paris, FR  
VERCESI, Valentina, c/o Sanofi-Aventis Département Brevets 174 avenue de France, F-75013 Paris, FR

- (51) MKP  
**E21B 34/10 (2006.01)** (97) **2513417 \***  
**E21B 43/14 (2006.01)**  
**E21B 43/12 (2006.01)**  
**E21B 33/124 (2006.01)**  
**E21B 34/14 (2006.01)**
- (86) CA2010001716 26.10.2010  
(96) 10836870.5 24.10.2012  
(87) WO2011072367, 26.10.2010  
(97) 2513417, 24.10.2012 en  
(54) DOWNHOLE SUB WITH HYDRAULICALLY ACTUABLE SLEEVE VALVE  
(71) Packers Plus Energy Services Inc., Bow Valley Square 2 Suite 2200, 205 - 5 Avenue SW, Calgary, Alberta T2P 2V7, CA  
(72) DESRANLEAU, Christopher , Denis, 307 Ridgeland Crescent, Sherwood Park Alberta T8A 3A5, CA  
THEMIG, Daniel Jon, 256 Woodhaven Place SW, Calgary Alberta T2W 5P9, CA  
DELUCIA, Frank, 11415 Lakewood Estates, Houston Texas 77070, US

- (51) MKP  
**A01N 45/00 (2006.01)** (97) **2512230 \***  
**A61K 31/74 (2006.01)**  
**A01N 25/00 (2006.01)**
- (86) US2010060489 15.12.2010  
(96) 10842529.9 24.10.2012  
(87) WO2011084473, 15.12.2010  
(97) 2512230, 24.10.2012 en  
(54) NON-IRRITATING OPHTHALMIC POVIDONE-IODINE COMPOSITIONS  
(71) Foresight Biotherapeutics, Inc., 50 W. 57th Street, 15th Floor, New York, NY 10019, US  
(72) LIANG, Bo, Bromley Place, East Brunswick NJ 08816, US  
CAPRIOTTI, Joseph, A., C. Taburiente No.19 Villa Amapola Los Mojones Pto. Del Carmen, 35510 Lanzarote Provincia De Las Palmas, ES  
SAMSON, C., Michael, 630 1st Ave., 25k, New York NY 10016, US  
STEIN, Jason, 500 E. 77th Street, Apt. 1035, New York NY 10162, US  
WEISER, Michael, 1020 Park Ave., Apt. 3c, New York NY 10028, US

- (51) MKP  
**C07K 14/245 (2006.01)** (97) **2524043 \***  
**C12N 15/70 (2006.01)**
- (86) EP2011050413 13.01.2011  
(96) 11701216.1 21.11.2012  
(87) WO2011086136, 13.01.2011  
(97) 2524043, 21.11.2012 en  
(54) BACTERIAL HOST STRAIN COMPRISING A MUTANT SPR GENE AND HAVING REDUCED TSP ACTIVITY  
(71) UCB Pharma, S.A., 60, allée de la Recherche, 1070 Brussels, BE  
(72) ELLIS, Mark, IPD UCB Celltech 208 Bath Road, Slough Berkshire SL1 3WE, GB  
HUMPHREYS, David, Paul, IPD UCB Celltech 208 Bath Road, Slough Berkshire SL1 3WE, GB

- (51) MKP  
**E02D 5/80 (2006.01)** (97) **2513378 \***
- (86) FR2010052031 28.09.2010  
(96) 10773370.1 24.10.2012  
(87) WO2011073545, 28.09.2010  
(97) 2513378, 24.10.2012 fr  
(54) DEVICE FOR ANCHORING IN MULTILAYER GROUND  
(71) Ancrest S.A., Zone Industrielle Légère 20 rue du Gros Hêtre B.P. 60085, 57503 Saint Avold Cedex, FR  
(72) MELINE, Christian, 71 route Touristique Allée des Pins, F-57160 Scy Chazelles, FR

- (51) MKP  
**A61K 9/70 (2006.01)** (97) **2524692 \***  
**A61K 47/22 (2006.01)**  
**A61K 31/40 (2006.01)**  
**A61K 47/32 (2006.01)**  
**A61K 47/20 (2006.01)**  
**A61K 47/10 (2006.01)**
- (86) JP2011050021 05.01.2011  
(96) 11731785.9 21.11.2012  
(87) WO2011083787, 05.01.2011  
(97) 2524692, 21.11.2012 en  
(54) ANTI-INFLAMMATORY ANALGESIC ADHESIVE PATCH FOR EXTERNAL USE  
(71) Teikoku Seiyaku Co., Ltd., 567 Sanbonmatsu, Higashikagawa-shi, Kagawa 769-2695, JP  
Ibsa Institut Biochimique S.A., Via al Ponte, 13, 6903 Massagno, CH  
(72) SHIBATA, Taiki, c/o TEIKOKU SEIYAKU CO. LTD. 567 Sanbonmatsu, Higashikagawa-shi Kagawa 769-2695, JP  
MABUCHI, Yuichiro, 519-1, Kirai, Higashikagawa-shi Kagawa 769-2704, JP  
HATTORI, Kenichi, c/o TEIKOKU SEIYAKU CO. LTD. 567 Sanbonmatsu, Higashikagawa-shi Kagawa 769-2695, JP  
KAMAKURA, Takashi, c/o TEIKOKU SEIYAKU CO. LTD. 567 Sanbonmatsu, Higashikagawa-shi Kagawa 769-2695, JP

- (51) MKP  
**E21C 29/02 (2006.01)** (97) **2499334 \***
- (86) PL2010000108 02.11.2010  
(96) 10788155.9 19.09.2012  
(87) WO2011059348, 02.11.2010  
(97) 2499334, 19.09.2012 en  
(54) DRIVE TRANSMISSION METHOD IN A LONGWALL SHEARER LOADER  
(71) Famur Spółka Akcyjna, Ul.Armi Krajowej 51, 40-698 Katowice, PL  
Famur Institute Sp. Z O.O., Ul. Armii Krajowej 51, 40-698 Katowice, PL  
(72) BEDNARZ, Ryszard, ul. Plochy 5/23, PL-40-756 Katowice, PL  
GWIAZDZINSKI, Pawel, ul. 1 Maja 49, PL-44-144 Zernica, PL  
GONSIOR, Lukasz, ul. Mokra 10, PL-44-321 Marklowice, PL  
GOLABEK, Mateusz, ul. Sportowa 12, PL-42-530 Dabrowa Górnicza, PL

- (51) MKP  
**B60B 19/00 (2006.01)** (97) **2531360 \***  
**B60B 9/00 (2006.01)**
- (86) IL2011000115 01.02.2011  
(96) 11706363.6 12.12.2012  
(87) WO2011092709, 01.02.2011  
(97) 2531360, 12.12.2012 en  
(54) DEFORMABLE WHEEL ASSEMBLY  
(71) Galileo Wheel Ltd, 1 Hamelacha St., 71520 Lod, IL  
(72) NOVOPLANSKI, Avishay, Netiv Haoranim St. 46, 90815 Moshav Beit-Zait, IL

- (51) MKP  
**H01M 4/583 (2010.01)** (97) **2509143 \***  
**H01M 4/525 (2010.01)**  
**H01M 10/0525 (2010.01)**  
**H01M 4/505 (2010.01)**
- (86) KR2010008674 06.12.2010  
(96) 10834806.1 10.10.2012  
(87) WO2011068391, 06.12.2010  
(97) 2509143, 10.10.2012 en  
(54) ANODE ACTIVE MATERIAL PRECURSOR AND ACTIVE MATERIAL FOR A RECHARGEABLE LITHIUM BATTERY COMPRISING HOLLOW NANOFIBROUS CARBON, AND A PRODUCTION METHOD THEREFOR  
(71) Route JJ Co., Ltd, 304 Sihwa Industrial Complex 2 Na 1261-3 Jeongwang-dong, Siheung-si, Gyeonggi-do 429-450, KR  
(72) HONG, Ji Jun, 501-205 Hyundai Apt. 172-3 Gaepo-dong Gangnam-gu, Seoul 135-240, KR  
BYUN, Ki Taek, 101-1204 Daedong Whangtobang Apt. 631-9 Deungchon 1-dong Gangseo-gu, Seoul 157-839, KR



- (51) MKP  
**C12P 21/08 (2006.01)** (97) **2504360 \***  
**C07K 16/00 (2006.01)**  
**C07H 21/00 (2006.01)**
- (86) US2010057662 22.11.2010  
(96) 10832331.2 03.10.2012  
(87) WO2011063348, 22.11.2010  
(97) 2504360, 03.10.2012 en  
(54) MONOMERIC ANTIBODY FC  
(71) Amgen Inc., One Amgen Center Drive, Thousand Oaks, California 91320-1799, US  
(72) ZHOU, Hongxing, c/o Amgen Inc. One Amgen Center Drive, Thousand Oaks, California 91320-1799, US  
KANNAN, Gunasekaran, c/o Amgen Inc. One Amgen Center Drive, Thousand Oaks, California 91320-1799, US  
SUN, Nancy, c/o Amgen Inc. One Amgen Center Drive, Thousand Oaks, California 91320-1799, US
- 
- (51) MKP  
**A61P 9/00 (2006.01)** (97) **2523962 \***  
**C07D 498/04 (2006.01)**  
**A61K 31/519 (2006.01)**
- (86) EP2011050301 12.01.2011  
(96) 11700404.4 21.11.2012  
(87) WO2011086079, 12.01.2011  
(97) 2523962, 21.11.2012 de  
(54) CARBOXYLIC ACID DERIVATIVES HAVING A 2,5-SUBSTITUTED OXAZOLOPYRIMIDINE RING  
(71) SANOFI, 54, rue de la Boétie, 75008 Paris, FR  
(72) KADEREIT, Dieter, Sanofi-Aventis Deutschland GmbH, 65926 Frankfurt am Main, DE  
SCHAEFER, Matthias, Sanofi-Aventis Deutschland GmbH, 65926 Frankfurt am Main, DE  
HACHTEL, Stephanie, Sanofi-Aventis Deutschland GmbH, 65926 Frankfurt am Main, DE  
DIETRICH, Axel, Sanofi-Aventis Deutschland GmbH, 65926 Frankfurt am Main, DE  
HUEBSCHLE, Thomas, Sanofi-Aventis Deutschland GmbH, 65926 Frankfurt am Main, DE  
HISS, Katrin, Sanofi-Aventis Deutschland GmbH, 65926 Frankfurt am Main, DE
- 
- (51) MKP  
**C07K 5/08 (2006.01)** (97) **2526116 \***  
**A61K 38/06 (2006.01)**  
**C07K 5/06 (2006.01)**  
**A61P 37/08 (2006.01)**  
**A01N 43/00 (2006.01)**
- (86) GB2011000079 21.01.2011  
(96) 11701854.9 28.11.2012  
(87) WO2011089396, 21.01.2011  
(97) 2526116, 28.11.2012 en  
(54) PYRUVAMIDE COMPOUNDS AS INHIBITORS OF DUST MITE GROUP 1 PEPTIDASE ALLERGEN  
(71) St. George's Hospital Medical School, Cranmer Terrace Tooting, London SW17 0RE, GB  
The University Of Manchester, Oxford Road, Manchester M13 9PL, GB  
(72) ROBINSON, Clive, St George's University of London Cranmer Terrace Tooting, London SW17 0RE, GB  
ZHANG, Jihui, St George's University of London Cranmer Terrace Tooting, London SW17 0RE, GB  
GARROD, David, Ronald, Faculty of Life Sciences University of Manchester Michael Smith Building Oxford Road, Manchester M13 9PT, GB  
PERRIOR, Trevor, Robert, Domainex Ltd 162 Cambridge Science Park Milton Road, Cambridge CB4 0GH, GB  
NEWTON, Gary, Karl, Domainex Ltd 162 Cambridge Science Park Milton Road, Cambridge CB4 0GH, GB  
JENKINS, Kerry, Domainex Ltd 162 Cambridge Science Park Milton Road, Cambridge CB4 0GH, GB  
BEEVERS, Rebekah, Elisabeth, Domainex Ltd 162 Cambridge Science Park Milton Road, Cambridge CB4 0GH, GB  
MAYOR, Meriel, Ruth, Domainex Ltd 162 Cambridge Science Park Milton Road, Cambridge CB4 0GH, GB  
STEWART, Mark, Richard, Domainex Ltd 162 Cambridge Science Park Milton Road, Cambridge CB4 0GH, GB
- 
- (51) MKP  
**C07D 471/04 (2006.01)** (97) **2521725 \***  
**A61P 9/00 (2006.01)**  
**C07C 311/21 (2006.01)**  
**A61K 31/519 (2006.01)**  
**C07F 5/02 (2006.01)**
- (86) FR2011050018 06.01.2011  
(96) 11704257.2 14.11.2012  
(87) WO2011083275, 06.01.2011  
(97) 2521725, 14.11.2012 fr  
(54) ARYLSULFONAMIDE PYRIDINE-PYRIDINONE DERIVATIVES, PREPARATION OF SAME, AND THERAPEUTIC USE THEREOF  
(71) SANOFI, 54, rue de la Boétie, 75008 Paris, FR  
(72) BELLEVERGUE, Patrice, c/o Sanofi-Aventis Département Brevets 174 avenue de France, F-75013 Paris, FR  
GRAILHE, Patrick, c/o Sanofi-Aventis Département Brevets 174 avenue de France, F-75013 Paris, FR  
MCCORT, Gary, c/o Sanofi-Aventis Département Brevets 174 avenue de France, F-75013 Paris, FR  
O'CONNOR, Stephen, c/o Sanofi-Aventis Département Brevets 174 avenue de France, F-75013 Paris, FR  
DUCLOS, Olivier, c/o Sanofi Département Brevets 54, rue de la Boétie, F-75008 Paris, FR
- 
- (51) MKP  
**C09J 5/00 (2006.01)** (97) **2522498**  
**B32B 3/00 (2006.01)**  
**C09J 7/00 (2006.01)**
- (96) 12167775.1 14.11.2012  
(97) 2522498, 14.11.2012 en  
(54) Dry adhesive comprising micro-featured and nano-featured surface  
(71) Mylan Group, Long Duc Industrial Park Travinh City, Travinh Province, VietNam, VN  
(72) Nguyen, My T., 2 McAdam St., Kirkland, Québec H9X 3Z3, CA  
Vinh Bui, Loc, 7355 Griffith Lane, Moorpark, CA California 93021, US
- 
- (51) MKP  
**A61M 5/32 (2006.01)** (97) **2531240 \***  
**A61M 5/28 (2006.01)**  
**A61M 5/24 (2006.01)**
- (86) EP2011051410 01.02.2011  
(96) 11702971.0 12.12.2012  
(87) WO2011095489, 01.02.2011  
(97) 2531240, 12.12.2012 en  
(54) PUSH ROD ACTIVATED MEDICATED MODULE  
(71) Sanofi-Aventis Deutschland GmbH, Brüningstraße 50, 65929 Frankfurt, DE  
(72) DAVIES, James, Alexander, 7 Old School Mews Cubbington Road, Leamington Spa Warwickshire CV32 7XB, GB  
WALLACE, Andrew, Gordon, The Old Gardens, Highleadon Gloucestershire GL18 1HJ, GB  
BOYD, Malcolm, Stanley, 28 Whitehead Drive, Wellsbourne Warwickshire CV35 9PW, GB  
SANDERS, David, Kettlewell Close Woodloes Park, Warwick Warwickshire CV34 5XE, GB
- 
- (51) MKP  
**C03B 35/16 (2006.01)** (97) **2531456 \***  
**F27D 25/00 (2010.01)**  
**B65G 45/10 (2006.01)**  
**F27B 9/30 (2006.01)**
- (86) IB2011050204 18.01.2011  
(96) 11705032.8 12.12.2012  
(87) WO2011095906, 18.01.2011  
(97) 2531456, 12.12.2012 en  
(54) ROLLER CLEANING DEVICE  
(71) Keraglass Engineering S.R.L., Via Sassogattone 7/B, 42031 Baiso (Reggio Emilia), IT  
(72) SPEZZANI, Stefano, Via Montecchio 1, I-42031 Baiso (Reggio Emilia), IT

- (51) MKP  
**A45D 40/10 (2006.01)** (97) **2515695 \***  
 (86) FR2010052869 22.12.2010  
 (96) 10809307.1 31.10.2012  
 (87) WO2011077042, 22.12.2010  
 (97) 2515695, 31.10.2012 fr  
 (54) CONTAINER FOR A STICK OF A COSMETIC OR HYGIENIC PRODUCT HAVING A RETRACTABLE APPLICATOR ELEMENT  
 (71) Chanel Parfums Beauté, 135 avenue Charles de Gaulle, 92200 Neuilly-sur-Seine, FR  
 (72) SALCIARINI, Christian, 13 rue Gouas, F-77860 Couilly Pont aux Dames, FR

- (51) MKP  
**C12N 15/11 (2006.01)** (97) **2513306 \***  
 (86) IB2010055840 15.12.2010  
 (96) 10818077.9 24.10.2012  
 (87) WO2011073925, 15.12.2010  
 (97) 2513306, 24.10.2012 en  
 (54) C. HISTOLYTICUM RECOMBINANT COLLAGENASES AND METHOD FOR THE MANUFACTURE THEREOF  
 (71) Abiel S.r.l., Via del Mare 3, 91021 Campobello di Mazara TP, IT  
 (72) BERTUZZI, Federico, Via Armellini 25, I-20161 Milano MI, IT  
 CUTTITTA, Angela, Piazza Niscemi 37, I-90146 Palermo PA, IT  
 GHERSI, Giulio, c/o Università degli Studi di Palermo Dip. to di Biologia Cellulare e dello Sviluppo Centro Interdep.le Biotechnologie Applicate Viale delle Scienze Edificio 16, I-90128 Palermo PA, IT  
 MAZZOLA, Salvatore, Via Villa Giocosa 9, I-90146 Palermo PA, IT  
 SALAMONE, Monica, Via Schioppettieri 8, I-90133 Palermo PA, IT  
 SEIDITA, Gregorio, Via Portogallo 11, I-90146 Palermo PA, IT

- (51) MKP  
**A61K 9/20 (2006.01)** (97) **2441445**  
**A61K 31/215 (2006.01)**  
 (96) 10013658.9 18.04.2012  
 (97) 2441445, 18.04.2012 en  
 (54) Coating of cetyl myristate and/or cetyl palmitate particles  
 (71) Deva Holding Anonim Sirketi, Patent Law Department Halkali Merkez Mah. Basın Ekspres Cad. No: 1,34303, Kucukcekmece/Istanbul, TR  
 (72) Haas, Philipp Daniel, Deva Holding Anonim Sirketi Patent Law Department Halkali Merkez Mah. Basın Ekspres Cad. No: 1,34303, Kucukcekmece/Istanbul, TR  
 Firat, Omer Faruk, Deva Holding Anonim Sirketi Patent Law Department Halkali Merkez Mah. Basın Ekspres Cad. No: 1,34303, Kucukcekmece/Istanbul, TR  
 Kandemir, Levent, Deva Holding Anonim Sirketi Patent Law Department Halkali Merkez Mah. Basın Ekspres Cad. No: 1,34303, Kucukcekmece/Istanbul, TR  
 Ozbek, Mahmut, Deva Holding Anonim Sirketi Patent Law Department Halkali Merkez Mah. Basın Ekspres Cad. No: 1,34303, Kucukcekmece/Istanbul, TR  
 Koc, Fikret, Deva Holding Anonim Sirketi Patent Law Department Halkali Merkez Mah. Basın Ekspres Cad. No: 1,34303, Kucukcekmece/Istanbul, TR

- (51) MKP  
**H01R 13/639 (2006.01)** (97) **2434588**  
**H01R 13/11 (2006.01)**  
 (96) 10178806.5 28.03.2012  
 (97) 2434588, 28.03.2012 en  
 (54) Connector  
 (71) PPC, A Division of John Mezzalingua Associates, Inc., 6176 E. Molloy Road, East Syracuse, NY 13057, US  
 (72) Eriksen, Kim Lundgren, Harevænget 46, 4733, Tappernøje, DK

- (51) MKP  
**A61P 31/16 (2006.01)** (97) **2513060 \***  
**C07D 213/81 (2006.01)**  
**A61K 31/4425 (2006.01)**  
 (86) EP2011059922 15.06.2011  
 (96) 11725450.8 24.10.2012  
 (87) WO2011157743, 15.06.2011  
 (97) 2513060, 24.10.2012 en  
 (54) ALPHA-CRYSTALLINE FORM OF CARBABENZOPYRIDE  
 (71) Farmak International Holding GmbH, Mariahilferstrasse 136 Office TOP 1.15, 1150 Vienna, AT  
 (72) ZHEBROVSKA, Filya, FARMAK JSC 63 Frunze Str., Kiev 04080, UA  
 MARGITYCH, Viktor, Farmak JSC 63 Frunze Str., Kiev 04080, UA  
 KOSTIUK, Grygorii, Farmak JSC 63 Frunze Str., Kiev 04080, UA  
 SYARKEVYCH, Oleh, FARMAK JSC 63 Frunze Str., Kiev 04080, UA  
 VANAT, Mykhailo, Farmak JSC 63 Frunze Str., Kiev 04080, UA

- (51) MKP  
**A61K 31/44 (2006.01)** (97) **2516400 \***  
**A61P 5/26 (2006.01)**  
**C07D 213/74 (2006.01)**  
**A61K 31/4409 (2006.01)**  
**A61P 5/28 (2006.01)**  
 (86) FR2010052874 22.12.2010  
 (96) 10808918.6 31.10.2012  
 (87) WO2011077046, 22.12.2010  
 (97) 2516400, 31.10.2012 fr  
 (54) PHENOL DERIVATIVES AND THE PHARMACEUTICAL OR COSMETIC USE THEREOF  
 (71) Galderma Research & Development, 2400 Route des Colles Les Templiers, 06410 Biot, FR  
 (72) POINSARD, Cédric, 13 chemin du Collet de St Marc, F-06130 Le Plan de Grasse, FR  
 COLLETTE, Pascal, 631 avenue du Général de Gaulle, F-06110 Le Cannet, FR  
 MAUVAIS, Pascale, 7 allée des fées Corniche des Cougoulins, F-06600 Antibes, FR  
 LINGET, Jean-Michel, 11A rue de Selestat, F-67230 Benfeld, FR  
 RETHORE, Sandrine, Résidence Pythagore 14 avenue de Pythagore, F-06560 Valbonne, FR

- (51) MKP  
**F28D 20/00 (2006.01)** (97) **2504653 \***  
**C09K 5/10 (2006.01)**  
**F01K 3/12 (2006.01)**  
 (86) IB2010055450 26.11.2010  
 (96) 10807371.9 03.10.2012  
 (87) WO2011064749, 26.11.2010  
 (97) 2504653, 03.10.2012 en  
 (54) PROCESS TO ACCUMULATE THERMAL ENERGY USING A HEAT-CARRIER FLUID AND CORRESPONDING SYSTEM  
 (71) Finocchiaro, Franco, Viale Bligny 36, 20136 Milano, IT  
 Ausy S.r.L., Via Mezzano 9/11/13, 27039 Sannazzaro De' Burgondi (PV), IT  
 (72) FINOCCHIARO, Franco, Viale Bligny, 36, 20136 Milano, IT

- (51) MKP  
**A61K 31/4468 (2006.01)** (97) **2521714 \***  
**A61P 29/00 (2006.01)**  
**A61K 31/4709 (2006.01)**  
**A61P 25/08 (2006.01)**  
**C07D 401/12 (2006.01)**  
**A61P 25/24 (2006.01)**  
**A61P 25/18 (2006.01)**  
**A61K 31/4725 (2006.01)**  
**C07D 401/14 (2006.01)**  
**A61P 25/28 (2006.01)**  
**C07D 211/58 (2006.01)**  
**A61P 25/22 (2006.01)**  
(86) IN2010000176 24.03.2010  
(96) 10725883.2 14.11.2012  
(87) WO2011083487, 24.03.2010  
(97) 2521714, 14.11.2012 en  
(54) SULFONE COMPOUNDS AS 5-HT6 RECEPTOR LIGANDS  
(71) Suven Life Sciences Limited, Serene Chambers Road No. 5, Avenue 7, Banjara Hills, Hyderabad 500 034, Andhra Pradesh, IN  
(72) NIROGI, Ramakrishna, Suven Life Sciences Limited Serene Chambers Road - 5 Avenue -7 Banjara Hills, Hyderabad 500 034 Andhra Pradesh, IN  
SHINDE, Anil, Karbhari, Suven Life Sciences Limited Serene Chambers Road - 5 Avenue -7 Banjara Hills, Hyderabad 500 034 Andhra Pradesh, IN  
KAMBHAMPATI, Rama, Sastri, Suven Life Sciences Limited Serene Chambers Road - 5 Avenue -7 Banjara Hills, Hyderabad 500 034 Andhra Pradesh, IN  
BADANGE, Rajesh, Kumar, Suven Life Sciences Limited Serene Chambers Road - 5 Avenue -7 Banjara Hills, Hyderabad 500 034 Andhra Pradesh, IN  
REBALLI, Veena, Suven Life Sciences Limited Serene Chambers Road - 5 Avenue -7 Banjara Hills, Hyderabad 500 034 Andhra Pradesh, IN  
CHINDHE, Anil, Kashinath, Suven Life Sciences Limited Serene Chambers Road - 5 Avenue -7 Banjara Hills, Hyderabad 500 034 Andhra Pradesh, IN  
NAMALA, Rambabu, Suven Life Sciences Limited Serene Chambers Road - 5 Avenue -7 Banjara Hills, Hyderabad 500 034 Andhra Pradesh, IN  
MULLA, Mohamad, Sadik, Abdulhamid, Suven Life Sciences Limited Serene Chambers Road - 5 Avenue -7 Banjara Hills, Hyderabad 500 034 Andhra Pradesh, IN  
AHMAD, Ishtiyaque, Suven Life Sciences Limited Serene Chambers Road - 5 Avenue -7 Banjara Hills, Hyderabad 500 034 Andhra Pradesh, IN  
ABRAHAM, Renny, Suven Life Sciences Limited Serene Chambers Road - 5 Avenue -7 Banjara Hills, Hyderabad 500 034 Andhra Pradesh, IN  
JASTI, Venkateswarlu, Suven Life Sciences Limited Serene Chambers Road - 5 Avenue -7 Banjara Hills, Hyderabad 500 034 Andhra Pradesh, IN
- 
- (51) MKP  
**A01N 43/54 (2006.01)** (97) **2501233 \***  
**A61K 31/517 (2006.01)**  
(86) US2010054927 01.11.2010  
(96) 10828947.1 26.09.2012  
(87) WO2011056740, 01.11.2010  
(97) 2501233, 26.09.2012 en  
(54) QUINAZOLINE COMPOUNDS  
(71) GlaxoSmithKline LLC, One Franklin Plaza 200 North 16th Street, Philadelphia, PA 19102, US  
(72) KALLANDER, Lara, S., 709 Swedeland Road, King of Prussia, PA 19406, US  
LAWHORN, Brian, Griffin, 709 Swedeland Road, King of Prussia, PA 19406, US  
PHILIP, Joanne, 709 Swedeland Road, King of Prussia, PA 19406, US
- 
- (51) MKP  
**H04L 12/28 (2006.01)** (97) **2507946 \***  
(86) US2010058485 01.12.2010  
(96) 10835020.8 10.10.2012  
(87) WO2011068824, 01.12.2010  
(97) 2507946, 10.10.2012 en  
(54) ADAPTATION PROTOCOLS FOR LOCAL PEER GROUP (LPG) NETWORKS IN DYNAMIC ROADWAY ENVIRONMENTS  
(71) Toyota InfoTechnology Center U.S.A., Inc., 465 Bernado Avenue, Mountain View, CA 94043, US  
Telcordia Technologies, Inc., 1 Telcordia Drive 5G116, Piscataway, NJ 08854-4157, US  
(72) CHEN, Wai, 5 Jagged Rock Road, Parsippany NJ 08854-4157, US  
KWON, Taek-jin, 426 Indigo Court, Morganville NJ 07751, US  
ONISHI, Ryokichi, 1-878-202 Kosugigoten-cho Nakahara-ku Kawasaki -shi Kanagawa, 221-0068, JP  
VUYURU, Rama, 2104 Holland Drive, Somerset NJ 08873, US
- 
- (51) MKP  
**F03B 9/00 (2006.01)** (97) **2438291 \***  
(86) CZ2010000064 27.05.2010  
(96) 10754400.9 11.04.2012  
(87) WO2010139287, 27.05.2010  
(97) 2438291, 11.04.2012 en  
(54) DEVICE FOR OBTAINING ENERGY FROM WATER  
(71) Paluka, Antonin, Neumerice 9, 27326 Neumerice, CZ  
(72) Paluka, Antonin, Neumerice 9, 27326 Neumerice, CZ
- 
- (51) MKP  
**A61K 31/55 (2006.01)** (97) **2525797 \***  
**A61K 45/06 (2006.01)**  
**A61P 23/00 (2006.01)**  
(86) US2010061713 22.12.2010  
(96) 10801767.4 28.11.2012  
(87) WO2011090669, 22.12.2010  
(97) 2525797, 28.11.2012 en  
(54) METHODS FOR TREATING PAIN  
(71) Abbott Laboratories, 100 Abbott Park Rd., Abbott Park, IL 60084, US  
(72) LEE, CHIH-Hung, 569 S. Central Park Place, Vernon Hills, Illinois 60061, US  
SCHRIMPFF, Michael R., 327 Cambridge Drive, Grayslake, Illinois 60030, US  
ESBENSHADE, Timothy A., 434 Timothy Court, Schaumburg, Illinois 60193, US  
ZHU, Chang Z., 1488 Woodbury Circle, Gurnee, Illinois 60031, US
- 
- (51) MKP  
**B01D 53/86 (2006.01)** (97) **2534422 \***  
**F24B 1/00 (2006.01)**  
**F23G 7/07 (2006.01)**  
(86) EP2011000613 09.02.2011  
(96) 11703610.3 19.12.2012  
(87) WO2011098267, 09.02.2011  
(97) 2534422, 19.12.2012 en  
(54) DEVICE FOR TREATING EXHAUST GASES FROM A SMALL HEATING SYSTEM  
(71) Dr. Pley Environmental GmbH, Kronacher Strasse 41, 96052 Bamberg, DE  
(72) PLEY, Martin, Heideweg 5, 69117 Memmelsdorf, DE
- 
- (51) MKP  
**C07K 16/46 (2006.01)** (97) **2519544 \***  
**A61P 35/00 (2006.01)**  
**A61P 37/00 (2006.01)**  
**A61K 39/395 (2006.01)**  
(86) US2010062404 29.12.2010  
(96) 10805670.6 07.11.2012  
(87) WO2011090754, 29.12.2010  
(97) 2519544, 07.11.2012 en  
(54) POLYPEPTIDE HETERODIMERS AND USES THEREOF  
(71) Emergent Product Development Seattle, LLC, 2401 Fourth Avenue, Suite 1050, Seattle, Washington 98121, US  
(72) BLANKENSHIP, John, W., 9709 6th Avenue Northwest, Seattle, Washington 98117, US  
TAN, Philip, 8704 200th Street SW, Edmonds, WA 98026, US

(51) MKP  
**B62J 11/00 (2006.01)** (97) **2516245 \***  
 (86) US2010059284 07.12.2010  
 (96) 10839979.1 31.10.2012  
 (87) WO2011078964, 07.12.2010  
 (97) 2516245, 31.10.2012 en  
 (54) SYSTEM FOR REMOVABLY ATTACHING OBJECTS TO VEHICLES NEGATING THE EFFECTS OF GRAVITATIONAL FORCES, VIBRATION AND SHOCK LOADING  
 (71) Brown, Gregory M., 2180 Meadow Sweet Lane, Erie, CO 80516, US  
 Kondilas, Robert A., 4807 Broad Brook Drive, Bethesda, MD 20814, US  
 (72) Brown, Gregory M., 2180 Meadow Sweet Lane, Erie, CO 80516, US  
 Kondilas, Robert A., 4807 Broad Brook Drive, Bethesda, MD 20814, US

(51) MKP  
**F03D 11/02 (2006.01)** (97) **2513473 \***  
**F03D 3/04 (2006.01)**  
**F03D 11/00 (2006.01)**  
**F03D 3/06 (2006.01)**  
 (86) US2010060342 14.12.2010  
 (96) 10842509.1 24.10.2012  
 (87) WO2011084432, 14.12.2010  
 (97) 2513473, 24.10.2012 en  
 (54) METHOD AND APPARATUS FOR WIND ENERGY SYSTEM  
 (71) Kawas, Percy, 1520 Oakhurst Avenue, Los Altos, CA 94024, US  
 Kawas, Gulnar, 1520 Oakhurst Avenue, Los Altos, CA 94024, US  
 (72) Kawas, Percy, 1520 Oakhurst Avenue, Los Altos, CA 94024, US  
 Kawas, Gulnar, 1520 Oakhurst Avenue, Los Altos, CA 94024, US

(51) MKP  
**C07H 19/16 (2006.01)** (97) **2501709 \***  
**A61P 31/20 (2006.01)**  
**A61K 31/7076 (2006.01)**  
**C07H 19/06 (2006.01)**  
**A61K 31/7064 (2006.01)**  
 (86) US2010056808 16.11.2010  
 (96) 10830894.1 26.09.2012  
 (87) WO2011060408, 16.11.2010  
 (97) 2501709, 26.09.2012 en  
 (54) 2'-FLUORO-6'-METHYLENE CARBOCYCLIC NUCLEOSIDES AND METHODS OF TREATING VIRAL INFECTIONS  
 (71) University Of Georgia Research Foundation, Inc., 630 Boyd Graduate Studies Research Center 200 D.W. Brooks Dr., Athens, GA 30602-7411, US  
 (72) CHU, Chung, K., 662 Garden Circle, Stratham GA 30665, US  
 WANG, Jianing, 100 Morningside Drive Apt. 5F, New York NY 10027, US

(51) MKP  
**A61K 47/10 (2006.01)** (97) **2515866 \***  
**A61K 47/14 (2006.01)**  
**A61K 47/22 (2006.01)**  
**A61K 31/593 (2006.01)**  
**A61K 9/06 (2006.01)**  
 (86) DK2010000184 22.12.2010  
 (96) 10803219.4 31.10.2012  
 (87) WO2011076209, 22.12.2010  
 (97) 2515866, 31.10.2012 en  
 (54) PHARMACEUTICAL COMPOSITION COMPRISING SOLVENT MIXTURE AND A VITAMIN D DERIVATIVE OR ANALOGUE  
 (71) Leo Pharma A/S, Patents Industriparken 55, 2750 Ballerup, DK  
 (72) PETERSSON, Karsten, Fuglehavevej 66, DK-2750 Ballerup, DK

(51) MKP  
**A61K 9/16 (2006.01)** (97) **2536396 \***  
**A61K 31/41 (2006.01)**  
**A61K 9/20 (2006.01)**  
 (86) LT2011000002 17.02.2011  
 (96) 11709813.7 26.12.2012  
 (87) WO2011102702, 17.02.2011  
 (97) 2536396, 26.12.2012 en  
 (54) PROCESS FOR THE PREPARATION OF ORAL SOLID DOSAGE FORMS COMPRISING VALSARTAN  
 (71) KRKA, D.D., Novo Mesto, Smarjeska cesta 6, 8501 Novo mesto, SI  
 UAB Krka Lietuva, Senasis Ukmerges kelias 4 Uzubaliu k., 14013 Vilniaus r., LT  
 (72) VRBINC, Miha, Gotna vas 20, 8000 Novo mesto, SI  
 OSOLNIK, Renata, Vavta vas 16, 8351 Straza, SI  
 VRECER, Franc, Potok 5b, 8351 Straza, SI  
 ZIBERT, Tanja, Cesta na polju 8, 1360 Vrhnika, SI  
 BUKOVEC, Polona, Regra vas 37a, 8000 Novo mesto, SI

(51) MKP  
**A61B 17/10 (2006.01)** (97) **2506779 \***  
**A61B 17/122 (2006.01)**  
**A61B 17/12 (2006.01)**  
**A61B 17/128 (2006.01)**  
 (86) IN2010000698 27.10.2010  
 (96) 10803517.1 10.10.2012  
 (87) WO2011067778, 27.10.2010  
 (97) 2506779, 10.10.2012 en  
 (54) AN IMPROVED LIGATION DEVICE ADAPTABLE FOR SURGICAL INTERVENTION  
 (71) Johnson And Johnson Ltd, 3 Wood Street, Kolkata 700 016, IN  
 (72) CHARUDATTA, Chandrakant Aradhya, D-211 Badridham C.H.S. Sant Janabai Road Ville Parle (East), Mumbai 400 057 Maharashtra, IN  
 DHANURAJ, Shiva Shetty, 135 Montgomery Street 16F, Jersey City, NJ 07302, US  
 MURTY, Natarajan Vyakarnam, 50 Maple Avenue Apt 224, Springfield, NJ 07081, US  
 YUFU, Li, 11 Hughes Road, Bridgewater, NJ 08807, US

(51) MKP  
**A61B 5/053 (2006.01)** (97) **2536330 \***  
 (86) PL2011000014 11.02.2011  
 (96) 11711400.9 26.12.2012  
 (87) WO2011102743, 11.02.2011  
 (97) 2536330, 26.12.2012 en  
 (54) METHOD AND APPARATUS FOR NON-INVASIVE ANALYSING THE STRUCTURE AND CHEMICAL COMPOSITION OF BONE TISSUE ELIMINATING THE INFLUENCE OF SURROUNDING TISSUES  
 (71) Bone Vitae S.A., Rondo ONZ 1, 00-124 Warszawa, PL  
 (72) JUST, Marcin, Pawe, ul. Po wi cka 17a/29, 51-128 Wroclaw, PL  
 O., Przemys aw, ul.Jesionowa 4, 55-040 urawice, PL  
 TYC Micha , Hugo, ul. Zemska 12/6, 54-438 Wroclaw, PL

(51) MKP  
**C12N 15/82 (2006.01)** (97) **2513314 \***  
 (86) US2010060819 16.12.2010  
 (96) 10842614.9 24.10.2012  
 (87) WO2011084622, 16.12.2010  
 (97) 2513314, 24.10.2012 en  
 (54) COMBINED USE OF CRY1CA AND CRY1AB PROTEINS FOR INSECT RESISTANCE MANAGEMENT  
 (71) Dow AgroSciences LLC, 9330 Zionsville Road, Indianapolis IN 46268-1054, US  
 (72) MEADE, Thomas, 1141 Huntington Woods Pt., Zionsville, IN 46077, US  
 NARVA, Kenneth, 4372 Creekside Pass, Zionsville, IN 46077, US  
 STORER, Nicholas, P., 10703 Lexington Street, Kensington, MD 20895, US  
 SHEETS, Joel, J., 10005 Oak Ridge Drive, Zionsville, IN 46077, US  
 WOOSLEY, Aaron, T., 8906 Tanner Drive, Fishers, IN 46038, US  
 BURTON, Stephanie, L., 6820 Bluffgrove Drive, Indianapolis, IN 46278, US

(51) MKP  
**A61M 15/00 (2006.01)** (97) **2504050 \***  
 (86) EP2010067896 22.11.2010  
 (96) 10779554.4 03.10.2012  
 (87) WO2011064160, 22.11.2010  
 (97) 2504050, 03.10.2012 en  
 (54) NEBULIZER  
 (71) Boehringer Ingelheim International GmbH, Binger Strasse 173, 55216 Ingelheim am Rhein, DE  
 (72) BACH, Alexander, Boehringer Ingelheim GmbH Corporate Patents Binger Str. 173, 55216 Ingelheim Am Rhein, DE  
 BESSELER, Jens, Boehringer Ingelheim GmbH Corporate Patents Binger Str. 173, 55216 Ingelheim Am Rhein, DE  
 GOLBERG, Christian, Boehringer Ingelheim GmbH Corporate Patents Binger Str. 173, 55216 Ingelheim Am Rhein, DE  
 HERRMANN, Frank, Boehringer Ingelheim GmbH Corporate Patents Binger Str. 173, 55216 Ingelheim Am Rhein, DE  
 HOLAKOVSKY, Holger, Boehringer Ingelheim GmbH Corporate Patents Binger Str. 173, 55216 Ingelheim Am Rhein, DE  
 DAELMAN, Manuel, Boehringer Ingelheim GmbH Corporate Patents Binger Str. 173, 55216 Ingelheim Am Rhein, DE  
 THOEMMES, Ralf, Boehringer Ingelheim GmbH Corporate Patents Binger Str. 173, 55216 Ingelheim Am Rhein, DE  
 WUTTKE, Gilbert, Boehringer Ingelheim GmbH Corporate Patents Binger Str. 173, 55216 Ingelheim Am Rhein, DE

(51) MKP  
**A01N 43/82 (2006.01)** (97) **2509424 \***  
**A61K 31/41 (2006.01)**  
 (86) US2010046424 24.08.2010  
 (96) 10836346.6 17.10.2012  
 (87) WO2011071570, 24.08.2010  
 (97) 2509424, 17.10.2012 en  
 (54) NOVEL OXADIAZOLE COMPOUNDS  
 (71) Abbott Laboratories, 100 Abbott Park Road, Abbott Park, IL 60064, US  
 (72) CUSACK, Kevin, P., 115 Jennifer Drive, Holden, MA 01520, US  
 BREINLINGER, Eric, C., 54 Hanson Road, Charlton, MA 01507, US  
 FIX-STENZEL, Shannon, R., 7018 N. Ashland Avenue Apt. 3S, Chicago, Illinois 60626, US  
 STOFFEL, Robert, H., 70 Westcott Road, Havar, Massachusetts 01451, US  
 WOLLER, Kevin, R., 1072 Joy Court, Anitoch, Illinois 60002, US

(51) MKP  
**A61P 11/00 (2006.01)** (97) **2516434 \***  
**C07D 487/04 (2006.01)**  
**A61P 37/00 (2006.01)**  
**A61K 31/437 (2006.01)**  
**A61P 29/00 (2006.01)**  
**A61P 17/00 (2006.01)**  
**A61P 19/00 (2006.01)**  
**C07D 471/04 (2006.01)**  
**A61P 35/00 (2006.01)**  
**A61P 7/00 (2006.01)**  
**A61K 31/519 (2006.01)**  
 (86) US2010061146 17.12.2010  
 (96) 10800835.0 31.10.2012  
 (87) WO2011079051, 17.12.2010  
 (97) 2516434, 31.10.2012 en  
 (54) FUSED HETEROAROMATIC PYRROLIDINONES AS SYK INHIBITORS  
 (71) Takeda Pharmaceutical Company Limited, 1-1 Doshomachi 4-chome Chuo-ku, Osaka-shi, Osaka 541-0045, JP  
 (72) ARIKAWA, Yasuyoshi, Takeda San Diego Inc. 10410 Science Center Drive, San Diego, California 92121, US  
 JONES, Benjamin, Takeda San Diego Inc. 10410 Science Center Drive, San Diego, California 92121, US  
 LAM, Betty, Takeda San Diego Inc. 10410 Science Center Drive, San Diego, California 92121, US  
 NIE, Zhe, Takeda San Diego Inc. 10410 Science Center Drive, San Diego, California 92121, US  
 SMITH, Christopher, Takeda San Diego Inc. 10410 Science Center Drive, San Diego, California 92121, US  
 TAKAHASHI, Masashi, Takeda San Diego Inc. 10410 Science Center Drive, San Diego, California 92121, US  
 DONG, Qing, Takeda San Diego Inc. 10410 Science Center Drive, San Diego, California 92121, US  
 FEHER, Victoria, Takeda San Diego Inc. 10410 Science Center Drive, San Diego, California 92121, US

(51) MKP  
**G01N 33/50 (2006.01)** (97) **2505662 \***  
**C12M 1/34 (2006.01)**  
**C12M 1/00 (2006.01)**  
**C12Q 1/68 (2006.01)**  
**C12N 15/09 (2006.01)**  
 (86) JP2010068909 26.10.2010  
 (96) 10833015.0 03.10.2012  
 (87) WO2011065168, 26.10.2010  
 (97) 2505662, 03.10.2012 en  
 (54) METHOD AND APPARATUS FOR PREDICTION OF PHARMACOLOGICAL EFFICACY OF HUMANIZED ANTI-TNF ANTIBODY DRUG ON RHEUMATOID ARTHRITIS  
 (71) KayteeBio Co. & Ltd., VenturePlaza Funabashi No.110, 1-17-25, Kita-Honcho Funabashi-shi, Chiba 273-0864, JP  
 (72) TSUZAKA, Kensei, VenturePlaza Funabashi 110, 1-17-25, Kita-Honcho, Funabashi-shi, Chiba 2730864, JP

(51) MKP  
**C22B 21/00 (2006.01)** (97) **2534272 \***  
**C22B 7/00 (2006.01)**  
 (86) GB2011000140 04.02.2011  
 (96) 11704824.9 19.12.2012  
 (87) WO2011098750, 04.02.2011  
 (97) 2534272, 19.12.2012 en  
 (54) METAL RECOVERY FROM CONTAMINATED METAL SCRAP  
 (71) Chalabi, Rifat Al, N°1 Nottingham Science Park Jesse Boot Avenue University Boulevard, Nottingham, Nottinghamshire NG7 2RU, GB  
 Perry, Ophneil Henry, N°1 Nottingham Science Park Jesse Boot Avenue University Boulevard, Nottingham, Nottinghamshire NG7 2RU, GB  
 (72) Chalabi, Rifat Al, N°1 Nottingham Science Park Jesse Boot Avenue University Boulevard, Nottingham, Nottinghamshire NG7 2RU, GB  
 Perry, Ophneil Henry, N°1 Nottingham Science Park Jesse Boot Avenue University Boulevard, Nottingham, Nottinghamshire NG7 2RU, GB

(51) MKP  
**A61K 9/08 (2006.01)** (97) **2503991 \***  
**A61K 31/435 (2006.01)**  
 (86) EP2010007042 19.11.2010  
 (96) 10785343.4 03.10.2012  
 (87) WO2011063915, 19.11.2010  
 (97) 2503991, 03.10.2012 en  
 (54) LIQUID PHARMACEUTICAL COMPOSITIONS  
 (71) Almirall S.A., Ronda del General Mitre, 151, 08022 Barcelona, ES  
 (72) DUARTE LOPEZ, Begoña, C/ Laureà Miró 408-410, E-08980 Sant Feliu de Llobregat-Barcelona, ES  
 GUIRO COLL, Pere, C/ Laureà Miró 408-410, E-08980 Sant Feliu de Llobregat-Barcelona, ES

(51) MKP  
**A61P 29/00 (2006.01)** (97) **2514424 \***  
**A61K 9/70 (2006.01)**  
**A61K 31/5415 (2006.01)**  
**A61K 47/32 (2006.01)**  
**A61K 47/18 (2006.01)**  
 (86) JP2010072452 14.12.2010  
 (96) 10837591.6 24.10.2012  
 (87) WO2011074565, 14.12.2010  
 (97) 2514424, 24.10.2012 en  
 (54) PIROXICAM-CONTAINING ENDERMIC PREPARATION  
 (71) Teikoku Seiyaku Co., Ltd., 567 Sanbonmatsu, Higashikagawa-shi, Kagawa 769-2695, JP  
 (72) KATAYAMA, Akiko, c/o TEIKOKU SEIYAKU CO. LTD. 567 Sanbonmatsu, Higashikagawa-shi Kagawa 769-2695, JP  
 INOO, Katsuyuki, c/o TEIKOKU SEIYAKU CO. LTD. 567 Sanbonmatsu, Higashikagawa-shi Kagawa 769-2695, JP

- (51) MKP  
**G06F 21/00 (2006.01)** (97) **2517141 \***  
 (86) FR2010052767 16.12.2010  
 (96) 10810772.3 31.10.2012  
 (87) WO2011083241, 16.12.2010  
 (97) 2517141, 31.10.2012 fr  
 (54) MULTIPLE APPLICATION CHIP CARD HAVING BIOMETRIC VALIDATION  
 (71) Mereal Biometrics, 141 bis rue de Saussure, 75017 Paris, FR  
 (72) PARTOUCHE, Patrick, Villa Pouiksan 13 Boulevard Cointet, F-06400 Cannes, FR  
 BLOT, Philippe, 25 rue Victor Hugo, F-78370 Plaisir, FR  
 MOBETIE, Didier, 70 rue de Montreuil, F-78000 Versailles, FR

- (51) MKP  
**C07D 495/04 (2006.01)** (97) **2516447 \***  
 (86) HU2010000149 21.12.2010  
 (96) 10807645.6 31.10.2012  
 (87) WO2011077174, 21.12.2010  
 (97) 2516447, 31.10.2012 en  
 (54) PROCESS FOR PREPARING PHARMACEUTICAL COMPOUNDS AND INTERMEDIATE COMPOUNDS  
 (71) Egis Gyógyszergyár Nyilvánosan Működő Részvénytársaság, Keresztúri út 30-38, 1106 Budapest, HU  
 (72) PORCS-MAKKAY, Márta, Bem József u. 21., H-2013 Pomáz, HU  
 VOLK, Balázs, Pilisi u. 54., H-1106 Budapest, HU  
 GREGOR, Tamás, Vágóhid u. 7., H-2141 Csömör, HU  
 BARKÓCZY, József, Szirem u. 4-6, H-1016 Budapest, HU  
 MEZEI, Tibor, Borz u. 4., H-1221 Budapest, HU  
 BRODA, Judit, T zk u. 2, H-1118 Budapest, HU  
 NYULASI, Bálint, Gombköt u.2, H-8500 Pápa, HU  
 RUZSICS, György, Bokay Janos u. 56, H-1083 Budapest, HU  
 MOLNÁR, Enik, Titkár u. 16., H-1030 Érd, HU  
 DEBRECZENI, József, Harang u. 19, H-1037 Budapest, HU  
 NAGY, Kálmán, Turista u. 2/A, H-1025 Budapest, HU  
 PANDUR, Angéla, Deák Ferenc u. 24., H-2235 Mende, HU  
 SZENT-KIRÁLLYI, Zsuzsanna, T zlliom u. 51., H-1223 Budapest, HU

- (51) MKP  
**D06F 95/00 (2006.01)** (97) **2441883**  
 (96) 11185178.8 18.04.2012  
 (97) 2441883, 18.04.2012 en  
 (54) Improved device for raising and/or drawing fabric handworks, particularly linen articles  
 (71) Torre Immobiliare 2002 S.r.l., Via Donatello 15, 00196 Roma, IT  
 (72) Mumelter, Heinrich, Via in Villa 23, 39100 BOLZANO, IT

- (51) MKP  
**A61K 31/416 (2006.01)** (97) **2531191 \***  
**A61K 31/415 (2006.01)**  
**A61P 29/00 (2006.01)**  
**A61K 31/4196 (2006.01)**  
 (86) EP2011051643 04.02.2011  
 (96) 11702057.8 12.12.2012  
 (87) WO2011095584, 04.02.2011  
 (97) 2531191, 12.12.2012 en  
 (54) SIGMA LIGANDS FOR USE IN THE PREVENTION AND/OR TREATMENT OF POSTOPERATIVE PAIN  
 (71) Laboratorios del. Dr. Esteve, S.A., Avda Mare de Deu de Montserrat 221, 08041 Barcelona, ES  
 (72) VELA HERNÁNDEZ, José Miguel, Avda. Badal nº 153, 8º, 3º, E-08028 Barcelona, ES  
 ZAMANILLO- CASTANEDO, Daniel, Avda. Mare de Dèu de Montserrat 252, 5º- 2º, E-08041 Barcelona, ES  
 PUIG-RIERA de CONIAS, Margarita, c/Roger de Lluria 8 3º1, E-08010 Barcelona, ES

- (51) MKP  
**B61H 5/00 (2006.01)** (97) **2507108 \***  
**F16D 55/02 (2006.01)**  
**F16D 65/12 (2006.01)**  
 (86) US2010058394 30.11.2010  
 (96) 10834046.4 10.10.2012  
 (87) WO2011066561, 30.11.2010  
 (97) 2507108, 10.10.2012 en  
 (54) RAILWAY VEHICLE BRAKE DISC  
 (71) Wabtec Holding Corp., 1001 Air Brake Avenue, Wilmerding, PA 15148, US  
 (72) FINCH, Glyn, A., Jr., 2 Ventana Court, Simpsonville SC 29681, US  
 MATHERN, Peter, D., 27 Mansell Ct, Greenville SC 29601-1531, US

- (51) MKP  
**A01N 43/00 (2006.01)** (97) **2528436 \***  
 (86) US2011022401 25.01.2011  
 (96) 11735350.8 05.12.2012  
 (87) WO2011091417, 25.01.2011  
 (97) 2528436, 05.12.2012 en  
 (54) HEPATITIS C VIRUS INHIBITORS  
 (71) Enanta Pharmaceuticals Inc., 500 Arsenal Street, Watertown, MA 02457, US  
 (72) QIU, Yao-Ling, 29 Linda Road, Andover MA 01810, US  
 WANG, Ce, 220 School Street Apt.9, Waltham MA 02451, US  
 PENG, Xiaowen, 66 Homer Avenue, 410, Cambridge MA 02138, US  
 YING, Lu, 4580 Duskin Road, Shanghai 200331, CN  
 CAO, Hui, 53 Hills Road, Belmont MA 02478, US  
 OR, Yat, Sun, 169 Fayette Street, Watertown MA 02472, US

- (51) MKP  
**C07K 7/08 (2006.01)** (97) **2536742 \***  
 (86) US2011025274 17.02.2011  
 (96) 11706694.4 26.12.2012  
 (87) WO2011103311, 17.02.2011  
 (97) 2536742, 26.12.2012 en  
 (54) TREATMENTS FOR GASTROINTESTINAL DISORDERS  
 (71) Ironwood Pharmaceuticals, Inc., 301 Binney Street, Cambridge, MA 02142, US  
 (72) FRETZEN, Angelika, 7 Avon Street, Somerville, MA 02143, US  
 ZHAO, Hong, 19 Middlebury Road, Lexington, MA 02121, US  
 KESSLER, Marco, 35 Collins Street Unit 13, Danvers, MA 01923, US

- (51) MKP  
**A61K 31/4418 (2006.01)** (97) **2506850 \***  
**A61K 31/4412 (2006.01)**  
**A61P 43/00 (2006.01)**  
**A61K 31/44 (2006.01)**  
 (86) US2010058943 03.12.2010  
 (96) 10835207.1 10.10.2012  
 (87) WO2011069094, 03.12.2010  
 (97) 2506850, 10.10.2012 en  
 (54) METHODS OF ADMINISTERING PIRFENIDONE THERAPY  
 (71) Intermune, Inc., 3280 Bayshore Boulevard, Brisbane, CA 94005-1021, US  
 (72) BRADFORD, Williamson, Ziegler, P.O. Box 566, Ross CA 94957, US  
 SZWARCBERG, Javier, 2173 Bunker Hill Drive, San Mateo CA 94402, US

- (51) MKP  
**C07D 417/12 (2006.01)** (97) **2513098 \***  
**A61P 11/06 (2006.01)**  
**A61P 11/00 (2006.01)**  
**A61P 35/00 (2006.01)**  
**A61P 29/00 (2006.01)**  
**C07D 417/14 (2006.01)**  
**A61K 31/497 (2006.01)**
- (86) US2010060454 15.12.2010  
(96) 10801736.9 24.10.2012  
(87) WO2011075515 15.12.2010  
(97) 2513098, 24.10.2012 en  
(54) AMINOPYRIMIDINES AS SYK INHIBITORS  
(71) Merck Sharp & Dohme Corp., 126 East Lincoln Avenue, Rahway, NJ 07065-0907, US  
Merck Canada Inc., 16711 Trans-Canada Highway, Kirkland, QC H9H 3L1, CA
- (72) FISCHER, Christian, 33 Avenue Louis Pasteur, Boston Massachusetts 02115-5727, US  
NORTHROP, Alan B., 33 Avenue Louis Pasteur, Boston Massachusetts 02115-5727, US  
TROTTER, B. Wesley, 33 Avenue Louis Pasteur, Boston Massachusetts 02115-5727, US  
ROBICHAUD, Joel S., 4591 Lake Road, Dollard des Ormeaux Québec H9G 2L8, CA  
ALTMANN, Michael D., 33 Avenue Louis Pasteur, Boston Massachusetts 02115-5727, US  
GUERIN, David Joseph, 33 Avenue Louis Pasteur, Boston Massachusetts 02115-5727, US  
O'BOYLE, Brendan M., 33 Avenue Louis Pasteur, Boston Massachusetts 02115-5727, US  
ZHOU, Hua, 33 Avenue Louis Pasteur, Boston Massachusetts 02115-5727, US  
GRIMM, Jonathan, 33 Avenue Louis Pasteur, Boston Massachusetts 02115-5727, US  
ANDRESEN, Brian M., 33 Avenue Louis Pasteur, Boston Massachusetts 02115-5727, US  
HAIDLE, Andrew M., 33 Avenue Louis Pasteur, Boston Massachusetts 02115-5727, US  
OTTE, Ryan D., 33 Avenue Louis Pasteur, Boston Massachusetts 02115-5727, US  
BURCH, Jason, 396 Grosvenor Avenue, Apt. 1, Westmount Québec PQ H3Z, CA  
MADDESS, Matthew L., 33 Avenue Louis Pasteur, Boston Massachusetts 02115-5727, US  
DI FRANCESCO, Maria Emilia, 33 Avenue Louis Pasteur, Boston Massachusetts 02115-5727, US  
LI, Chaomin, 33 Avenue Louis Pasteur, Boston Massachusetts 02115-5727, US  
ROMEO, Eric, 33 Avenue Louis Pasteur, Boston Massachusetts 02115-5727, US  
FOURNIER, Jean-Francois, 2200 Ward, App. 1111, Montreal Québec H4M 2R1, CA  
WOO, Hyun Chong, 33 Avenue Louis Pasteur, Boston Massachusetts 02115-5727, US  
CHILDERS, Kaleen Konrad, 33 Avenue Louis Pasteur, Boston Massachusetts 02115-5727, US  
KNOWLES, Sandra Lee, 33 Avenue Louis Pasteur, Boston Massachusetts 02115-5727, US  
REUTERSHAN, Michael H., 33 Avenue Louis Pasteur, Boston Massachusetts 02115-5727, US  
DUPONT-GAUDET, Kristina, 2287 Rue des Siffleurs, Vaudreuil-Dorion Québec J7V 9M9, CA  
SPENCER, Kerrie B., 33 Avenue Louis Pasteur, Boston Massachusetts 02115-5727, US  
ELLIS, John Michael, 33 Avenue Louis Pasteur, Boston Massachusetts 02115-5727, US  
MACHACEK, Michelle, 33 Avenue Louis Pasteur, Boston Massachusetts 02115-5727, US  
TAOKA, Brandon M., 33 Avenue Louis Pasteur, Boston Massachusetts 02115-5727, US  
GUAY, Daniel, 1990 Victoria, Lachine Québec H8S 4C9, CA  
DONÓFRIO, Anthony, 33 Avenue Louis Pasteur, Boston Massachusetts 02115-5727, US  
LIM, Jongwon, 33 Avenue Louis Pasteur, Boston Massachusetts 02115-5727, US  
SIU, Tony, 33 Avenue Louis Pasteur, Boston Massachusetts 02115-5727, US  
GAUTHIER, Jacques Yves, 413 rue Quesnel Laval des Rapides, Laval Québec H7N 5C2, CA  
BHAT, Sathesh, 50 Barnett, Dollard-des-Ormeaux Québec QC H9G 3C7, US  
ARRINGTON, Kenneth L., 33 Avenue Louis Pasteur, Boston Massachusetts 02115-5727, US  
KATTAR, Solomon, 33 Avenue Louis Pasteur, Boston Massachusetts 02115-5727, US  
PETROCCHI, Alessia, 33 Avenue Louis Pasteur, Boston Massachusetts 02115-5727, US  
COTE, Bernard, 113 Lucien-Theriault, Notre-Dame-de-L'Île-Perrot Québec J7V 7P2, CA  
SCHELL, Adam J., 33 Avenue Louis Pasteur, Boston Massachusetts 02115-5727, US

- (51) MKP  
**A61P 5/26 (2006.01)** (97) **2536708 \***  
**A61K 31/5025 (2006.01)**  
**A61K 31/4439 (2006.01)**  
**C07D 401/04 (2006.01)**  
**C07D 487/04 (2006.01)**  
**A61P 5/28 (2006.01)**
- (86) US2011025106 16.02.2011  
(96) 11745183.1 26.12.2012  
(87) WO2011103202, 16.02.2011  
(97) 2536708, 26.12.2012 en  
(54) ANDROGEN RECEPTOR MODULATORS AND USES THEREOF  
(71) Aragon Pharmaceuticals, Inc., 12780 El Camino Real Suite 301, San Diego, CA 92130, US  
(72) SMITH, Nicholas, D., 1204 Beryl Street, San Diego, CA 92109, US  
BONNEFOUS, Celine, 4425 Via Sepulveda Unit 3, San Diego, CA 92122, US  
JULIEN, Jackaline, D., 517 1/2 Stratford Ct., Del Mar, CA 92014, US

- (51) MKP  
**A01H 5/00 (2006.01)** (97) **2512219 \***  
**A01H 1/00 (2006.01)**  
**A01P 7/00 (2006.01)**
- (86) US2010060810 16.12.2010  
(96) 10838257.3 24.10.2012  
(87) WO2011075585, 16.12.2010  
(97) 2512219, 24.10.2012 en  
(54) COMBINED USE OF VIP3AB AND CRY1FA FOR MANAGEMENT OF RESISTANT INSECTS  
(71) Dow AgroSciences, LLC, 9330 Zionsville Road, Indianapolis, IN 46268, US  
(72) MEADE, Thomas, 1141 Huntington Woods Pt., Zionsville IN 46077, US  
NARVA, Kenneth, 4372 Creekside Pass, Zionsville IN 46077, US  
STORER, Nicholas, P., 10703 Lexington Street, Kensington MD 20895, US  
SHEETS, Joel, J., 10005 Oak Ridge Drive, Zionsville IN 46077, US  
WOOSLEY, Aaron, T., 8906 Tanner Drive, Fishers IN 46038, US  
BURTON, Stephanie, L., 6820 Bluffgrove Drive, Indianapolis IN 46278, US

- (51) MKP  
**C07K 16/32 (2006.01)** (97) **2513148 \***
- (86) US2010060533 15.12.2010  
(96) 10791036.6 24.10.2012  
(87) WO2011084496, 15.12.2010  
(97) 2513148, 24.10.2012 en  
(54) ANTI-HER2 ANTIBODIES AND THEIR USES  
(71) Abbott Biotherapeutics Corp., 1500 Seaport Boulevard, Redwood City CA 94063, US  
(72) HARDING, Fiona A., 772 Lewis Street, Santa Clara California 95050, US  
AKAMATSU, Yoshiko, 514 Driscoll Place, Palo Alto California 94306, US  
DUBRIDGE, Robert B., 825 Holly Road, Belmont California 94002, US  
POWERS, David B., 77 Live Oak Avenue, Fairfax California 94930, US

- (51) MKP  
**A61Q 17/04 (2006.01)** (97) **2533860 \***  
**A61Q 1/04 (2006.01)**  
**A61Q 1/02 (2006.01)**
- (86) US2011023870 07.02.2011  
(96) 11740480.6 19.12.2012  
(87) WO2011097555, 07.02.2011  
(97) 2533860, 19.12.2012 en  
(54) SUNSCREEN COMPOSITIONS COMPRISING AN ULTRAVIOLET RADIATION-ABSORBING POLYMER  
(71) Johnson & Johnson Consumer Companies Inc., Grandview Road, Skillman, NJ 08559, US  
(72) CLEMENTE, Rudy, 3548 Rue Dorion, Montreal, QC H2K 4B6, CA  
COLE, Curtis, 9 Orchard Road, Ringoes, NJ 08851, US  
DALY, Susan, 9 Clark Court, Basking Ridge, NJ 07920, US

- (51) MKP  
**B04B 5/02 (2006.01)** (97) **2519358 \***  
**B04B 9/10 (2006.01)**  
**B04B 9/08 (2006.01)**  
(86) NO2010000489 28.12.2010  
(96) 10803409.1 07.11.2012  
(87) WO2011081531, 28.12.2010  
(97) 2519358, 07.11.2012 en  
(54) CENTRIFUGATION APPARATUS, USE THEREOF AND CENTRIFUGATION METHOD  
(71) Sintef Stiftelsen, P.O. Box 124 Blindern, 0314 Oslo, NO  
(72) BORCH, Stig Morten, Dagaliveien 51, N-0783 Oslo, NO  
BECK, Esben, Fritjof Nansensvei 41, N-1472 Fjellhamar, NO

- (51) MKP  
**C12N 15/70 (2006.01)** (97) **2523969 \***  
**C07K 14/245 (2006.01)**  
(86) EP2011050416 13.01.2011  
(96) 11701045.4 21.11.2012  
(87) WO2011086139, 13.01.2011  
(97) 2523969, 21.11.2012 en  
(54) BACTERIAL HOST STRAIN EXPRESSING RECOMBINANT DSBC AND HAVING REDUCED TSP ACTIVITY  
(71) UCB Pharma, S.A., 60, allée de la Recherche, 1070 Brussels, BE  
(72) ELLIS, Mark, c/o IPD UCB Celltech 208 Bath Road, Slough Berkshire SL1 3WE, GB  
HUMPHREYS, David, Paul, c/o IPD Ucb Celltech 208 Bath Road, Slough Berkshire SL1 3WE, GB

- (51) MKP  
**F23G 7/06 (2006.01)** (97) **2528678 \***  
**B01D 53/72 (2006.01)**  
**B01D 53/00 (2006.01)**  
**F24J 2/06 (2006.01)**  
**F24J 2/07 (2006.01)**  
**B01J 19/12 (2006.01)**  
**F23J 15/02 (2006.01)**  
**B01D 53/73 (2006.01)**  
(86) GB2011000082 24.01.2011  
(96) 11702486.9 05.12.2012  
(87) WO2011092456, 24.01.2011  
(97) 2528678, 05.12.2012 en  
(54) IMPROVEMENTS IN THERMAL OXIDISERS, USING CONCENTRATED SUNLIGHT  
(71) Chalabi, Rifat Al, N<sup>o</sup>1 Nottingham Science Park Jesse Boot Avenue University Boulevard, Nottingham, Nottinghamshire NG7 2RU, GB  
Perry, Ophneil Henry, N<sup>o</sup>1 Nottingham Science Park Jesse Boot Avenue University Boulevard, Nottingham, Nottinghamshire NG7 2RU, GB  
(72) Chalabi, Rifat Al, N<sup>o</sup>1 Nottingham Science Park Jesse Boot Avenue University Boulevard, Nottingham, Nottinghamshire NG7 2RU, GB  
Perry, Ophneil Henry, N<sup>o</sup>1 Nottingham Science Park Jesse Boot Avenue University Boulevard, Nottingham, Nottinghamshire NG7 2RU, GB

- (51) MKP  
**F16D 1/08 (2006.01)** (97) **2520388**  
**B23C 3/30 (2006.01)**  
**B23F 5/20 (2006.01)**  
**F16D 3/06 (2006.01)**  
(96) 11183461.0 07.11.2012  
(97) 2520388, 07.11.2012 en  
(54) Splined member and process for manufacturing a splined member by shaping and milling  
(71) Fairfield Manufacturing Company, U.S. Route 52 South, West Lafayette, IN 47903, US  
(72) Phebus, Dan E., 5282 West County Road 750 North, Rossville, IN Indiana 46065, US  
Hayward, William H., 137 Indian Bend Road, Lafayette, IN Indiana 47909, US

- (51) MKP  
**F16F 15/31 (2006.01)** (97) **2420674**  
**F16F 7/10 (2006.01)**  
**F03G 3/08 (2006.01)**  
(86) 10461536.4 22.02.2012  
(97) 2420674, 22.02.2012 en  
(54) Method of accumulating kinetic energy and rotor device for accumulating and dissipating kinetic energy  
(71) Centrum Badawczo-Rozwojowe "EPAR" Sp.z o.o., ul. Ogrodowa 4, 58-530 Kowary, PL  
(72) Lagiewka, Przemyslaw, ul. Wiejska 29/5, 58-530 Kowary, PL  
Gumula, Stanislaw, Al. Kijowska 48/40, 30-079 Kraków, PL

- (51) MKP  
**A61K 9/00 (2006.01)** (97) **2515909 \***  
**A61K 31/542 (2006.01)**  
**A61K 47/02 (2006.01)**  
**A61K 9/20 (2006.01)**  
**A61K 47/12 (2006.01)**  
(86) IN2010000832 21.12.2010  
(96) 10838834.9 31.10.2012  
(87) WO2011077452, 21.12.2010  
(97) 2515909, 31.10.2012 en  
(54) FAST DISSOLVING PHARMACEUTICAL COMPOSITION COMPRISING LORNOXICAM  
(71) Abbot Healthcare Private Limited, Sion Trombay Road 4 Corporate Park, Mumbai 400 071, IN  
(72) BOLDHANE, Sanjay, 1 Nirlon Complex Off W.E. Highway Goregaon (East), Mumbai 400 063 Maharashtra, IN  
BHOKARE, Kuldeep, 1 Nirlon Complex Off W.E. Highway Goregaon (East), Mumbai 400 063 Maharashtra, IN  
Dr. JATHAR, Shripad, 1 Nirlon Complex Off W.E. Highway Goregaon (East), Mumbai 400 063 Maharashtra, IN  
ELLIOTT, Geraldine, Ann, 12 Mount Ommaney Drive, Jindalee QLD 4074, AU

- (51) MKP  
**C07K 16/12 (2006.01)** (97) **2536835 \***  
**C07K 16/46 (2006.01)**  
**A61K 39/395 (2006.01)**  
**C12N 15/09 (2006.01)**  
**C12P 21/08 (2006.01)**  
**C12N 5/10 (2006.01)**  
**G01N 33/569 (2006.01)**  
**A61P 31/04 (2006.01)**  
(86) JP2011054229 18.02.2011  
(96) 11744837.3 26.12.2012  
(87) WO2011102555, 18.02.2011  
(97) 2536835, 26.12.2012 en  
(54) ANTIBODY AGAINST SEROTYPE G LIPOPOLYSACCHARIDE OF PSEUDOMONAS AERUGINOSA  
(71) Meiji Seika Pharma Co., Ltd., 4-16, Kyobashi 2-chome Chuo-ku, Tokyo 104-8002, JP  
Symphogen A/S, Elektrovej Building 375, 2800 Lyngby, DK  
TANAKA, Jiro, c/o Meiji Seika Pharma Co., Ltd. 760 Morooka-cho Kohoku-ku, Yokohama-shi Kanagawa 222-8567, JP  
ANDERSEN, Peter Sejer, Adalsvej 21A, Vanlose 2720, DK  
OKUTOMI, Takafumi, c/o Meiji Seika Pharma Co., Ltd. 760 Morooka-cho Kohoku-ku, Yokohama-shi Kanagawa 222-8567, JP  
INABA, Tsuneyoshi, c/o Meiji Seika Pharma Co., Ltd. 760 Morooka-cho Kohoku-ku, Yokohama-shi Kanagawa 222-8567, JP  
OTSUKA, Keiko, c/o Meiji Seika Pharma Co., Ltd. 760 Morooka-cho Kohoku-ku, Yokohama-shi Kanagawa 222-8567, JP  
AKABANE, Hiroto, c/o Meiji Seika Pharma Co., Ltd. 760 Morooka-cho Kohoku-ku, Yokohama-shi Kanagawa 222-8567, JP  
HOSHINA, Yukari, c/o Meiji Seika Pharma Co., Ltd. 760 Morooka-cho Kohoku-ku, Yokohama-shi Kanagawa 222-8567, JP  
NAGASO, Hiroshi, c/o Meiji Seika Pharma Co., Ltd. 760 Morooka-cho Kohoku-ku, Yokohama-shi Kanagawa 222-8567, JP  
KUMAGAI, Masashi, c/o Meiji Seika Pharma Co., Ltd. 760 Morooka-cho Kohoku-ku, Yokohama-shi Kanagawa 222-8567, JP



- (51) MKP  
**C12Q 1/68 (2006.01)** (97) **2385135**  
 (96) 10159524.7 09.11.2011  
 (97) 2385135, 09.11.2011 en  
 (54) RAD51C as a human cancer susceptibility gene  
 (71) Hanenberg, Helmut, 7522 Sedge Meadow Drive, Indianapolis, IN 46202, US  
 Universität zu Köln, Albertus-Magnus-Platz, 50923 Köln, DE  
 (72) Hanenberg, Helmut, Im Benrader Feld 56, 47804 Krefeld, DE  
 Schmutzler, Rita, c/o Frauenklinik Universitätsklinikum Köln  
 Kerpenerstrasse 34, 50931 Köln, DE  
 Meindl, Alfons, c/o Frauenklinik der TU München Klinikum  
 Rechts der Isar Ismaninger Strasse 22, 81675 München, DE  
 Wiek, Constanze, Liebfrauenstrasse 13, 40591 Düsseldorf, DE  
 Erven, Verena, Krahkampweg 41, 40221 Düsseldorf, DE  
 Freund, Marcel, Birkinstrasse 71, 40233 Düsseldorf, DE

- (51) MKP  
**A61L 27/54 (2006.01)** (97) **2523701 \***  
**A61L 27/20 (2006.01)**  
 (86) IB2011000052 13.01.2011  
 (96) 11709184.3 21.11.2012  
 (87) WO2011086458, 13.01.2011  
 (97) 2523701, 21.11.2012 en  
 (54) STABLE HYDROGEL COMPOSITIONS INCLUDING ADDITIVES  
 (71) Allergan Industrie, SAS, Route de Promery One Artisanale de Pre-Mairy, 74370 Pringy, FR  
 (72) GOUSSE, Cécile, 836 route de Thones, F-74230 Dingy Saint Clair, FR  
 LEBRETON, Pierre, F., 7 rue Louis Revon, F-74000 Annecy, FR  
 PROST, Nicloas, Le close des senteurs 30 rue Victor Hugo, F-69440 Mornant, FR

- (51) MKP  
**C07C 409/34 (2006.01)** (97) **2519218 \***  
**A61K 8/38 (2006.01)**  
**A61Q 19/00 (2006.01)**  
 (86) FR2010052876 22.12.2010  
 (96) 10808919.4 07.11.2012  
 (87) WO2011080469, 22.12.2010  
 (97) 2519218, 07.11.2012 fr  
 (54) DIBENZOYL PEROXIDE DERIVATIVES, PREPARATION METHOD THEREOF AND COSMETIC OR DERMATOLOGICAL COMPOSITIONS CONTAINING SAME  
 (71) Galderma Research & Development, 2400 Route des Colles Les Templiers, 06410 Biot, FR  
 (72) RODEVILLE, Nicolas, 441 Avenue Marcel Pagnol Marina Parc B-233, F-06210 Mandelieu, FR  
 PASCAL, Jean-Claude, 170 avenue de Gairaut, F-06100 Nice, FR  
 BOUIX-PETER, Claire, 48 chemin du Cannet, F-06220 Vallauris, FR

- (51) MKP  
**C07K 16/28 (2006.01)** (97) **2528947 \***  
 (86) US2011022507 26.01.2011  
 (96) 11737543.6 05.12.2012  
 (87) WO2011094259, 26.01.2011  
 (97) 2528947, 05.12.2012 en  
 (54) CD127 BINDING PROTEINS  
 (71) Glaxo Group Limited, Glaxo Wellcome House Berkeley Avenue, Greenford, Middlesex UB6 0NN, GB  
 (72) KIRBY, Ian, Gunnels Wood, Stevenage Hertfordshire SG1 2NY, GB  
 TAYLOR, Alexander, H., 709 Swedeland Road, King Of Prussia, PA 19406, US  
 WEBB, Thomas, Matthew, Gunnels Wood, Stevenage Hertfordshire SG1 2NY, GB  
 XUE, Yu, 709 Swedeland Road, King Of Prussia, PA 19406, US

- (51) MKP  
**C08F 2/38 (2006.01)** (97) **2519547 \***  
 (86) US2010061966 23.12.2010  
 (96) 10809349.3 07.11.2012  
 (87) WO2011090683, 23.12.2010  
 (97) 2519547, 07.11.2012 en  
 (54) MACROMONOMER MIXTURE, TERMINAL-REACTIVE POLYMER MIXTURE, INTERMEDIATE FOR MACROMONOMER AND SILICONE HYDROGEL  
 (71) Johnson & Johnson Vision Care Inc., 7500 Centurion Parkway, Jacksonville, FL 32256, US  
 (72) FUJISAWA, Kazuhiko, 1-1-3-108 Kokubu Otsu, Shiga 520-0844, JP  
 NAKAMURA, Masataka, 48-43 Fujimidai Otsu, Shiga 520-0846, JP

- (51) MKP  
**A61K 31/7115 (2006.01)** (97) **2512491 \***  
**A61K 31/7125 (2006.01)**  
 (86) US2010052911 15.10.2010  
 (96) 10824199.3 24.10.2012  
 (87) WO2011047312, 15.10.2010  
 (97) 2512491, 24.10.2012 en  
 (54) HBV ANTISENSE INHIBITORS  
 (71) Glaxo Group Limited, Glaxo Wellcome House Berkeley Avenue Greenford, Middlesex UB6 0NN, GB  
 (72) HAMATAKE, Robert, c/o GlaxoSmithKline Global Patents Dept. Five Moore Drive P. O. Box 13398, Research Triangle Park, North Carolina 27709, US

- (51) MKP  
**C12N 15/53 (2006.01)** (97) **2524044 \***  
**C12N 15/82 (2006.01)**  
**A01H 5/12 (2006.01)**  
 (86) US2011021088 13.01.2011  
 (96) 11701711.1 21.11.2012  
 (87) WO2011088180, 13.01.2011  
 (97) 2524044, 21.11.2012 en  
 (54) COMPOSITIONS AND METHODS FOR MINIMIZING NORNICOTINE SYNTHESIS IN TOBACCO  
 (71) North Carolina State University, Campus Box 8210, Raleigh, NC 27695, US  
 (72) DEWEY, Ralph, E., 2403 Colony Woods Drive, Apex, NC 27523, US  
 LEWIS, Ramsey, S., 8640 Glade Hill Drive, Apex, NC 27539, US

- (51) MKP  
**A01H 5/00 (2006.01)** (97) **2525650 \***  
**C12N 15/82 (2006.01)**  
**C12N 15/29 (2006.01)**  
 (86) US2011022145 21.01.2011  
 (96) 11735271.6 28.11.2012  
 (87) WO2011091317, 21.01.2011  
 (97) 2525650, 28.11.2012 en  
 (54) ENGINEERED LANDING PADS FOR GENE TARGETING IN PLANTS  
 (71) Dow AgroSciences, LLC, 9330 Zionsville Road, Indianapolis, Indiana 46268, US  
 (72) AINLEY, William, Michael, 1474 Clearwater Ct, Carmel Indiana 46032, US  
 BLUE, Ryan, C., 10080 Glenn Abbey Lane, Fishers Indiana 46037, US  
 MURRAY, Michael, G., 19 Lakeshore Court, Carmel Indiana 46033, US  
 CORBIN, David, Richard, 2628 Towne Drive, Carmel Indiana 46032, US  
 MILES, Rebecca, Ruth, 572 Redwood Dr., Pendleton Indiana 46064, US  
 WEBB, Steven, R., 15416 Bloomfield Court, Westfield Indiana 46074, US

(51) MKP  
**A61K 31/437 (2006.01)** (97) **2516436 \***  
**C07D 471/04 (2006.01)**  
(86) EP2010007913 23.12.2010  
(86) 10803058.6 31.10.2012  
(87) WO2011076419, 23.12.2010  
(97) 2516436, 31.10.2012 en  
(54) IMIDAZOPYRIDINE DERIVATIVES AS JAK INHIBITORS  
(71) Almirall S.A., Ronda del General Mitre, 151, 08022 Barcelona, ES  
(72) EASTWOOD, Paul Robert, C/Laureà Mir 408-410, 08980 Sant Feliu de Llobregat, ES  
GONZALEZ RODRIGUEZ, Jacob, C/Laureà Mir 408-410, 08980 Sant Feliu de Llobregat, ES  
BACH TAÑA, Jordi, C/Laureà Mir 408-410, 08980 Sant Feliu de Llobregat, ES  
PAGES SANTACANA, Lluís Miquel, C/Laureà Mir 408-410, 08980 Sant Feliu de Llobregat, ES  
TALTAVULL MOLL, Joan, C/Laureà Mir 408-410, 08980 Sant Feliu de Llobregat, ES  
CATURLA JAVALOYES, Juan Francisco, C/Laureà Mir 408-410, 08980 Sant Feliu de Llobregat, ES  
MATASSA, Victor Giulio, C/Laureà Mir 408-410, 08980 Sant Feliu de Llobregat, ES

(51) MKP  
**E03C 1/01 (2006.01)** (97) **2521818 \***  
**F24D 17/00 (2006.01)**  
**F24H 9/20 (2006.01)**  
**E03C 1/044 (2006.01)**  
**E03D 9/08 (2006.01)**  
**F24H 1/20 (2006.01)**  
**G05D 23/00 (2006.01)**  
(86) CH2010000260 19.10.2010  
(96) 10776264.3 14.11.2012  
(87) WO2012051722, 19.10.2010  
(97) 2521818, 14.11.2012 de  
(54) DEVICE FOR HEATING WATER FOR A COMBINATION SHOWER-WC  
(71) Presano AG, Sonnenstrasse 1, 9444 Diepoldsau, CH  
(72) WÜRGLER, Hans, Auerstrasse 2, CH-9435 Heerbrugg, CH  
OEHY, Paul, Unt. Böschachstrasse 2b, CH-9444 Diepoldsau, CH  
GRABER, Daniel, Kirchweg 7, CH-9463 Oberriet, CH

(51) MKP  
**F16F 15/36 (2006.01)** (97) **2501609 \***  
**B63H 21/30 (2006.01)**  
(86) EP2010067687 17.11.2010  
(96) 10776390.6 26.09.2012  
(87) WO2011061228, 17.11.2010  
(97) 2501609, 26.09.2012 en  
(54) METHOD, APPARATUS AND SYSTEM FOR REDUCING VIBRATION IN A ROTARY SYSTEM OF A WATERCRAFT  
(71) Carnehammar, Lars Bertil, Sonnenbergstrasse 126, 8032 Zürich, CH  
(72) SEITZ, Norbert, Riegseestrasse 3, 82194 Gröbenzell, DE

(51) MKP  
**H04J 14/02 (2006.01)** (97) **2448159**  
(96) 10306172.7 02.05.2012  
(97) 2448159, 02.05.2012 en  
(54) Multidirectional add and drop devices for an optical network element  
(71) Alcatel Lucent, 3, avenue Octave Gréard, 75007 Paris, FR  
(72) Lavigne, Bruno, ALCATEL LUCENT BELL LABS FRANCE Centre de Villarceaux Route de Villejust, 91620 Nozay, FR  
Rouvillain, Delphine, ALCATEL LUCENT BELL LABS FRANCE Centre de Villarceaux, Route de Villejust, 91620 Nozay, FR  
Zami, Thierry, ALCATEL LUCENT BELL LABS FRANCE Centre de Villarceaux Route de Villejust, 91620 Nozay, FR

(51) MKP  
**A61K 31/53 (2006.01)** (97) **2531509 \***  
**A61P 29/00 (2006.01)**  
**A61P 37/00 (2006.01)**  
**A61P 35/00 (2006.01)**  
**A61P 1/00 (2006.01)**  
**A61P 11/00 (2006.01)**  
**C07D 487/04 (2006.01)**  
**A61P 9/00 (2006.01)**  
(86) US2011023464 02.02.2011  
(96) 11703989.1 12.12.2012  
(87) WO2011162835, 02.02.2011  
(97) 2531509, 12.12.2012 en  
(54) IMIDAZO[1,2-B][1,2,4]TRIAZINES AS C-MET INHIBITORS  
(71) Incyte Corporation, Experimental Station Route 141 & Henry Clay Road Building E336/207, Wilmington, DE 19880, US  
(72) ZHUO, Jincong, 17 Forwood Drive, Garnet Valley PA 19060, US  
HE, Chunhong, 40 Magnolia Way, Chadds Ford PA 19317, US  
YAO, Wenqing, 45 Magnolia Way, Chadds Ford PA 19317, US

(51) MKP  
**B29C 39/00 (2006.01)** (97) **2431147**  
**B29B 17/00 (2006.01)**  
**A47K 3/40 (2006.01)**  
(96) 10380118.9 21.03.2012  
(97) 2431147, 21.03.2012 en  
(54) Shower base improved by the inclusion in its material of flexible fillings made of recycled car tyres  
(71) Anguiano Poliuretanos, S.L., Crta. de Logroño, Km. 29,900, 26300 Nájera (La Rioja), ES  
(72) Anguiano Martinez, Jacinto, Crta. de Logroño, Km. 29,900, 26300 Nájera (La Rioja), ES

(51) MKP  
**C12N 15/88 (2006.01)** (97) **2506879 \***  
**C12N 15/87 (2006.01)**  
**A61K 47/22 (2006.01)**  
**A61K 9/14 (2006.01)**  
**A61K 47/18 (2006.01)**  
**C12N 15/10 (2006.01)**  
**C12N 15/113 (2010.01)**  
**A61K 31/7088 (2006.01)**  
(86) CA2010001919 01.12.2010  
(96) 10834125.6 10.10.2012  
(87) WO2011066651, 01.12.2010  
(97) 2506879, 10.10.2012 en  
(54) SNALP FORMULATIONS CONTAINING ANTIOXIDANTS  
Protiva Biotherapeutics Inc., 100-8900 Glenlyon Parkway, Burnaby, British Columbia V5J 5J8, CA  
(72) YAWORSKI, Ed, 23106-123B Avenue, Maple Ridge British Columbia V2X 9Z7, CA  
HEYES, James, 47-870 West 7th Avenue, Vancouver British Columbia V5Z 4C1, CA  
JUDGE, Adam, 1936 W. 11th Avenue, Vancouver British Columbia V6J 2C6, CA  
REID, Stephen, Apt. 303 1430 Chesterfield Avenue, Surrey British Columbia V7M 2N4, CA  
MACLACHLAN, Ian, 8040 Aves Terrace, Mission British Columbia V4S 1E5, CA

(51) MKP  
**A61P 25/02 (2006.01)** (97) **2525795 \***  
**A61K 31/4375 (2006.01)**  
**A61K 31/472 (2006.01)**  
**A61K 31/522 (2006.01)**  
(86) AU2011000051 19.01.2011  
(96) 11734246.9 28.11.2012  
(87) WO2011088504, 19.01.2011  
(97) 2525795, 28.11.2012 en  
(54) METHODS AND COMPOSITIONS FOR IMPROVED NERVE CONDUCTION VELOCITY  
(71) Spinifex Pharmaceuticals Pty Ltd, South Yarra Corporate Centre Suite T18, Level 1 122 Toorak Road, South Yarra VIC 3141, AU  
(72) MCCARTHY, Thomas David, 40 Tooronga Road, Malvern East Victoria 3145, AU  
BAKER, Andrew Rainsford, 37 Ashwood Avenue, Highett Victoria 3190, AU

(51) MKP  
**C07D 239/26 (2006.01)** (97) **2528903 \***  
**A61K 31/505 (2006.01)**  
**C07D 409/14 (2006.01)**  
**C07D 471/04 (2006.01)**  
**C07D 487/08 (2006.01)**  
**C07D 401/14 (2006.01)**  
**A61P 35/00 (2006.01)**  
**C07D 401/06 (2006.01)**  
**A61K 31/506 (2006.01)**  
**C07D 413/14 (2006.01)**  
**C07D 405/14 (2006.01)**  
(86) EP2011051061 26.01.2011  
(96) 11701130.4 05.12.2012  
(87) WO2011092198, 26.01.2011  
(97) 2528903, 05.12.2012 en  
(54) 5-ALKYNYL-PYRIMIDINES  
(71) Boehringer Ingelheim International GmbH, Binger Strasse 173, 55216 Ingelheim am Rhein, DE  
(72) SCHNEIDER, Siegfried, Boehringer Ingelheim GmbH Corporate Patents Binger Strasse 173, 55216 Ingelheim am Rhein, DE  
KESLER, Dirk, Boehringer Ingelheim GmbH Corporate Patents Binger Strasse 173, 55216 Ingelheim am Rhein, DE  
VAN DER VEEN, Lars, Boehringer Ingelheim GmbH Corporate Patents Binger Strasse 173, 55216 Ingelheim am Rhein, DE  
WUNBERG, Tobias, Boehringer Ingelheim GmbH Corporate Patents Binger Strasse 173, 55216 Ingelheim am Rhein, DE

(51) MKP  
**A61P 3/04 (2006.01)** (97) **2515927 \***  
**A61K 38/17 (2006.01)**  
**A61P 3/10 (2006.01)**  
**C07K 14/605 (2006.01)**  
**A61K 38/26 (2006.01)**  
(86) US2010060380 15.12.2010  
(96) 10799178.8 31.10.2012  
(87) WO2011087671, 15.12.2010  
(97) 2515927, 31.10.2012 en  
(54) OXYNTOMODULIN PEPTIDE ANALOGUE  
(71) Eli Lilly and Company, Lilly Corporate Center, Indianapolis, IN 46285, US  
(72) ALSINA-FERNANDEZ, Jorge, Eli Lilly And Company Lilly Corporate Center, Indianapolis, Indiana 46285, US  
KOHN, Wayne, David, Eli Lilly And Company Lilly Corporate Center, Indianapolis, Indiana 46285, US

(51) MKP  
**A61K 31/00 (2006.01)** (97) **2536399 \***  
(86) US2011025592 21.02.2011  
(96) 11745404.1 26.12.2012  
(87) WO2011103531, 21.02.2011  
(97) 2536399, 26.12.2012 en  
(54) Method for activation and conjugation of biomolecules  
(71) Bayer HealthCare LLC, 555 White Plains Road, Tarrytown, NY 10591, US  
(72) VOGEL, Jens H., 7401 Terrace Drive, El Cerrito California 94530, US  
TO, Chi Shung Brian, 3083 Silva Way, San Ramon California 94582, US  
BIANCO, Carolina Lucia, Jaegerstr. 33, 71394 Kernen i.R., DE

(51) MKP  
**A61K 31/20 (2006.01)** (97) **2521446 \***  
**A61K 31/44 (2006.01)**  
**A61K 31/35 (2006.01)**  
**A01N 25/26 (2006.01)**  
(86) US2011020221 05.01.2011  
(96) 11732084.6 14.11.2012  
(87) WO2011085000, 05.01.2011  
(97) 2521446, 14.11.2012 en  
(54) FATTY ACID DERIVATIVES AND ANALOGS OF DRUGS  
(71) The University of North Carolina At Chapel Hill, 308 Bynum Hall, Campus Box 4105, Chapel Hill, NC 27599-4105, US  
(72) CHO, Moo, J., 5401 Spring House Lane, Chapel Hill NC 27516, US  
HACKETT, Michael, 107 Isley Street, Chapel Hill NC 27516, US

(51) MKP  
**A61F 11/00 (2006.01)** (97) **2519199 \***  
**A61K 9/00 (2006.01)**  
**A61N 1/30 (2006.01)**  
(86) US2010058718 02.12.2010  
(96) 10793367.3 07.11.2012  
(87) WO2011081772, 02.12.2010  
(97) 2519199, 07.11.2012 en  
(54) SYSTEMS AND METHODS FOR ANESTHETIZING EAR TISSUE  
(71) Acclarent, Inc., 1525-B O'Brien Drive, Menlo Park, CA 94025, US  
(72) MORRIS, John, H., 725-A Wisconsin Street, San Francisco, CA 94107, US  
LIU, Gregory, 1244 Parkington Avenue, Sunnyvale, CA 94087, US  
GIOTRA, Rohit, 886-A DeHaro Street, San Francisco, CA 94107, US  
ANDREAS, Bernard, H., 933 Lundy Lane, Los Altos, CA 94024, US  
BARON, Scott, J., 591 Menlo Oaks Drive, Menlo Park, CA 94025, US  
HAYTER, Paul, G., 653 Lola Lane, Mountain View, CA 94040, US  
JENKINS, Thomas, 1000 Grand Street, Alameda, CA 94501, US  
NEUHAUSER, Richard, R. Jr., 632 California Way, Emerald Hills, CA 94062, US  
WALKER, Jeffrey, A., 2687 Elston Street, Livermore, CA 94550, US

(51) MKP  
**A61F 2/20 (2006.01)** (97) **2512368 \***  
**A61F 2/02 (2006.01)**  
(86) US2010059673 09.12.2010  
(96) 10798216.7 24.10.2012  
(87) WO2011075387, 09.12.2010  
(97) 2512368, 24.10.2012 en  
(54) FLUID FILLED IMPLANTS FOR TREATING MEDICAL CONDITIONS  
(71) Ethicon. Inc., P.O. Box 151 Route 22, Somerville, NJ 08876, US  
(72) ROUSSEAU, Robert, A., 736 Geigel Hill Road, Ottsville PA 18942, US

(51) MKP  
**A61F 13/15 (2006.01)** (97) **2537495**  
(96) 12173311.7 26.12.2012  
(97) 2537495, 26.12.2012 en  
(54) Methods and apparatus for application of nested zero waste ear to traveling web  
(71) Curt G. Joa, Inc., 100 Crocker Avenue, Sheboygan Falls, Wisconsin 53085, US  
(72) Andrews, Robert E, N7488 Sunset Circle Drive, Sheboygan, WI Wisconsin 53083, US  
Fritz, Jeff W, N4989 Country Aire Rd., Plymouth, WI Wisconsin, US  
McCabe, John A, 1141 Partridge Run, Sheboygan Falls, WI Wisconsin 53085, US  
Horneck, Noel, 11 Cochise Road, Cherokee Village, AR 72529, US  
Nelson, Anthony A, N1385 Hwy. 57, New Holstein, WI Wisconsin 53061, US  
Van Dyke, Daniel, 4136 N. 29th Street, Sheboygan, WI Wisconsin 53083, US

(51) MKP  
**C07K 4/00 (2006.01)** (97) **2526419 \***  
**G01N 33/53 (2006.01)**  
(86) US2010057106 17.11.2010  
(96) 10832138.1 28.11.2012  
(87) WO2011063043, 17.11.2010  
(97) 2526419, 28.11.2012 en  
(54) METHODS FOR IMPROVING THE DESIGN, BIOAVAILABILITY, AND EFFICACY OF DIRECTED SEQUENCE POLYMER COMPOSITIONS VIA SERUM PROTEIN-BASED DETECTION OF DIRECTED SEQUENCE POLYMER COMPOSITIONS  
(71) Ares Trading S.A., Zone Industrielle de l'Ouriettaz, 1170 Aubonne, CH  
(72) ZANELLI, Eric, 160 Woodside Road, Sudbury, MA 01776, US  
KRIEGER, Jeff, 152 Nevada Street, Newtonville, MA 02460, US  
CONNOLLY, Joe, 17 Garfield Ave, Medford, MA 02144, US  
COLLINS, Kathryn, H., 38 West Pond Road, Plymouth, MA 02360, US

(51) MKP  
**A61P 31/16 (2006.01)** (97) **2509595 \***  
**A61K 45/06 (2006.01)**  
**A61K 31/4155 (2006.01)**  
**G01N 33/50 (2006.01)**  
(86) GB2010052067 10.12.2010  
(96) 10788125.2 17.10.2012  
(87) WO2011070369, 10.12.2010  
(97) 2509595, 17.10.2012 en  
(54) INHIBITORS OF HEMOPOIETIC CELL KINASE (P59-HCK) AND THEIR USE IN THE TREATMENT OF INFLUENZA INFECTION  
(71) Respivert Limited, 50-100 Holmers Farm Way, High Wycombe Buckinghamshire HP12 4EG, GB  
(72) CHARRON, Catherine, Elisabeth, c/o Respivert Limited Imperial College Biolncubator Level 1 Bessemer Building Imperial College, London SW7 2AZ, GB  
FENTON, Robert, 44 Selby Road Ealing, London W5 1LX, GB  
CROWE, Scott, 25 Earlsmead Letchworth, Hertfordshire SG6 3UE, GB  
ITO, Kazuhiro, c/o Respivert Limited Imperial College Biolncubator Level 1 Bessemer Building Imperial College, London SW7 2AZ, GB  
STRONG, Peter, c/o Respivert Limited Imperial College Building Level 1 Bessemer Building Imperial College, London SW7 2AZ, GB  
RAPEPORT, Garth, c/o Respivert Limited Imperial College Biolncubator Level 1 Bessemer Building Imperial College, London SW7 2AZ, GB  
RAY, Keith, Malvern Cottage Greenlands Lane Prestwood, Buckinghamshire HP16 9QU, GB

(51) MKP  
**A24F 47/00 (2006.01)** (97) **2519122 \***  
(86) EP2010007876 22.12.2010  
(96) 10803241.8 07.11.2012  
(87) WO2011079933, 22.12.2010  
(97) 2519122, 07.11.2012 en  
(54) A SHAPED HEATER FOR AN AEROSOL GENERATING SYSTEM  
(71) Philip Morris Products S.A., Quai Jeanrenaud 3, 2000 Neuchâtel, CH  
(72) GREIM, Olivier, Chemin des Sources, CH-1423 Villars-Burquin, CH  
FERNANDO, Felix, 24 Tudor Close Workingham, Berkshire RG40 2LU, GB  
HIGGINS, Charles, T., 30 Glenbrooke Circle West, Richmond VA 23229, US

(51) MKP  
**B32B 3/00 (2006.01)** (97) **2522500**  
(96) 12167778.5 14.11.2012  
(97) 2522500, 14.11.2012 en  
(54) Laminating film  
(71) Mylan Group, Long Duc Industrial Park Travinh City, Travinh Province, VietNam, VN  
(72) NGUYEN, My T., 2 McAdam St., KIRKLAND, Québec H9X 3Z3, CA  
VINH BUI, Loc, 7355 Griffith Lane, Moorpark, CA California 93021, US

(51) MKP  
**A61M 1/12 (2006.01)** (97) **2528638 \***  
**A61M 1/10 (2006.01)**  
(86) FR2010052940 30.12.2010  
(96) 10808939.2 05.12.2012  
(87) WO2011092394, 30.12.2010  
(97) 2528638, 05.12.2012 fr  
(54) SELF-CONTAINED CARDIAC PUMP, AND METHOD IMPLEMENTED IN SUCH A PUMP  
(71) Fineheart, 88 Cours de Verdun Chez 3MR Conseil, 33000 Bordeaux, FR  
(72) GARRIGUE, Stéphane, 26 rue du Général Faidherbe, F-33130 Begles, FR

(51) MKP  
**A61K 31/53 (2006.01)** (97) **2536689 \***  
**C07D 213/74 (2006.01)**  
**A61K 31/4427 (2006.01)**  
**C07D 251/48 (2006.01)**  
**A61P 29/00 (2006.01)**  
**C07D 401/04 (2006.01)**  
**C07D 239/48 (2006.01)**  
**A61K 31/506 (2006.01)**  
**C07D 403/04 (2006.01)**  
**C07D 471/10 (2006.01)**  
**A61K 31/505 (2006.01)**  
(86) US2011025092 16.02.2011  
(96) 11706106.9 26.12.2012  
(87) WO2011103196, 16.02.2011  
(97) 2536689, 26.12.2012 en  
(54) ARYL CARBOXAMIDE DERIVATIVES AS SODIUM CHANNEL INHIBITORS FOR TREATMENT OF PAIN  
(71) Amgen Inc., One Amgen Center Drive, Thousand Oaks, California 91320-1799, US  
(72) BREGMAN, Howard, 12 Howard Street, Melrose, Massachusetts 02176, US  
BUCHANAN, John, L., 970 Dedham Street, Newton, Massachusetts 02459, US  
CHAKKA, Nagasree, 13 Judith Lane Apt. 1, Waltham, Massachusetts 02452, US  
DIMAURO, Erin, F., 113 Brookline Street, Cambridge, Massachusetts 02139, US  
DU, Bingfan, 18 Springfield Street, Cambridge, Massachusetts 02139, US  
NGUYEN, Hanh, Nho, 185 Brattle Street, Arlington, Massachusetts 02474, US  
ZHENG, Xiao, Mei, 23 Lakeview Gardens Apt. 716, Natwick, Massachusetts 01760, US

(51) MKP  
**F25B 29/00 (2006.01)** (97) **2534357 \***  
**F02G 1/04 (2006.01)**  
**F03G 7/00 (2006.01)**  
**F02G 1/043 (2006.01)**  
(86) FR2011050284 10.02.2011  
(96) 11708547.2 19.12.2012  
(87) WO2011098735, 10.02.2011  
(97) 2534357, 19.12.2012 fr  
(54) THERMOACOUSTIC MACHINE HAVING AN ELECTRIC FEEDBACK LOOP  
(71) Hekyom, 3 Place de la Croix Jaque, 91190 Saint-aubin, FR  
(72) FRANCOIS, Maurice-Xavier, 7 Route de Chevreuse, F-91190 Gif-sur-yvette, FR  
LE POLLES, Thierry, 80 Rue Compans, F-75019 Paris, FR  
BETRANCOURT, Adrien, 78 Rue de la Colonie, F-75013 Paris, FR

(51) MKP  
**A61K 9/20 (2006.01)** (97) **2512456 \***  
**A61K 31/485 (2006.01)**  
(86) US2010060755 16.12.2010  
(96) 10801741.9 24.10.2012  
(87) WO2011084593, 16.12.2010  
(97) 2512456, 24.10.2012 en  
(54) ABUSE-RESISTANT FORMULATIONS  
(71) Cima Labs Inc., 7325 Aspen Lane, Brooklyn Park, Minnesota 55428, US  
(72) HAMED, Ehab, 9206 Holly Lane North, Maple Grove Minnesota 55311, US  
VEGA ZEPEDA, Manuel A., 14118 Oakwood Road Extension, Minnetonka Minnesota 55345, US

(51) MKP  
**G01N 33/49 (2006.01)** (97) **2513647 \***  
**G01N 21/25 (2006.01)**  
**G01N 33/86 (2006.01)**  
(86) US2010060911 17.12.2010  
(96) 10838275.5 24.10.2012  
(87) WO2011075614, 17.12.2010  
(97) 2513647, 24.10.2012 en  
(54) PORTABLE COAGULATION MONITORING DEVICE AND METHOD OF ASSESSING COAGULATION RESPONSE  
(71) Entegriion, Inc., 4401 Research Commons Suite 200, Research Triangle Park, North Carolina 27709, US  
(72) DENNIS, Robert Glenn, 102 Butterfield Court, Chapel Hill North Carolina 27516, US  
FISCHER, Thomas H., 122 Murray Street, Hillsborough North Carolina 27278, US  
DACORTA, Joseph A., 6019 Old NC 86, Chapel Hill North Carolina 27516, US

(51) MKP  
**A61P 3/06 (2006.01)** (97) **2526089 \***  
**A61K 31/40 (2006.01)**  
**C07D 207/34 (2006.01)**  
(86) CZ2011000003 12.01.2011  
(96) 11707780.0 28.11.2012  
(87) WO2011088806, 12.01.2011  
(97) 2526089, 28.11.2012 en  
(54) A METHOD OF INDUSTRIAL PRODUCTION OF AN AMORPHOUS FORM OF ATORVASTATIN WITH A HIGH SPECIFIC SURFACE AREA AND ITS USE IN A DOSAGE FORM  
(71) Zentiva, K.S., U Kabelovny 130, 102 37 Praha 10, CZ  
(72) STACH, Jan, Slitrova 2006, 190 16 Praha 9, CZ  
HOLAN, Martin, Milanska 465, 109 00 Praha 15, CZ  
HAVLICEK, Jaroslav, Donovalska 1659, 149 00 Praha 4, CZ  
SIMEK, Stanislav, Kunicka 9, 102 00 Praha 10, CZ  
LINEK, Jan, Livornska 448, 109 00 Praha 15, CZ  
BRUSOVA, Hana, Martinicka 987/III, 197 00 Praha 9, CZ  
RADL, Stanislav, Ohnicova 127, 250 84 Kvetnice, CZ  
DUBOVSKA, Michaela, Rostovska 5, 101 00 Praha 10, CZ  
PROKOPOVA, Alena, Bulharska 12, 101 00 Praha 10, CZ  
RIHA, Jaroslav, U lipove aleje 21, 107 00 Praha 10, CZ  
SEBEK, Pavel, Radcina 12, 161 00 Praha 6, CZ

(51) MKP  
**C07D 498/00 (2006.01)** (97) **2536279 \***  
**A01N 43/00 (2006.01)**  
**A61K 31/55 (2006.01)**  
(86) US2011024883 15.02.2011  
(96) 11745114.6 26.12.2012  
(87) WO2011103089, 15.02.2011  
(97) 2536279, 26.12.2012 en  
(54) CRYSTALLINE FORMS OF SODIUM 4-[[9-CHLORO-7-(2-FLUORO-6-METHOXYPHENYL)-5H-PYRIMIDO[5,4-D][2]BENZAZEPIN-2YL]AMINO]-2-METHOXYBENZOATE  
(71) Millennium Pharmaceuticals, Inc., 40 Landsdowne Street, Cambridge, MA 02139, US  
(72) ARMITAGE, Ian, 57 Savin Street, Medford, MA 02155, US  
COOPER, Martin, I., 29 West Hill Road, Foxton Cambridge CB22 6SZ, GB  
EDDLESTON, Mark, D., 17 Harlech Rise, Nottingham NG9 5PD, GB  
FAIBER, Neil, C., 25 Valentine Road, Arlington, MA 02476, US  
MCCUBBIN, Quentin, J., 104 Cross Street, Belmont, MA 02478, US  
WATT, Stephen, W., 1 Lawson Way, Tranent East Lothian EH33 2QJ, GB

(51) MKP  
**A61N 1/04 (2006.01)** (97) **2517754 \***  
**A61N 1/30 (2006.01)**  
(86) JP2010072744 17.12.2010  
(96) 10839301.8 31.10.2012  
(87) WO2011078071, 17.12.2010  
(97) 2517754, 31.10.2012 en  
(54) ELECTRODE DEVICE USED FOR IONTOPHORESIS THERAPY  
(71) Teikoku Seiyaku Co., Ltd., 567 Sanbonmatsu, Higashikagawa-shi, Kagawa 769-2695, JP  
(72) HASUI, Akihiro, c/o TEIKOKU SEIYAKU CO. LTD. 567 Sanbonmatsu, Higashikagawa-shi Kagawa 769-2695, JP

(51) MKP  
**E21C 31/08 (2006.01)** (97) **2499335 \***  
(86) PL2010000109 02.11.2010  
(96) 10788156.7 19.09.2012  
(87) WO2011059349, 02.11.2010  
(97) 2499335, 19.09.2012 en  
(54) METHOD FOR MOUNTING A RANGING ARM ON A BODY OF A LONGWALL SHEARER LOADER  
(71) Famur Spółka Akcyjna, Ul. Armii Krajowej 51, 40-698 Katowice, PL  
Famur Institute Sp. Z O.O., Ul. Armii Krajowej 51, 40-698 Katowice, PL  
(72) BEDNARZ Ryszard, ul. Plochy 5/23, 40-756 Katowice, PL  
GWIAZDZINSKI Pawel, ul. 1 Maja 49, 44-144 Zernica, PL  
GONSIOR Lukasz, ul. Mokra 10, 44-321 Marklowice, PL  
OLSZANSKI Marek, ul. Jagiellonska 5/57, 41-200 Sosnowiec, PL

(51) MKP  
**C08K 5/00 (2006.01)** (97) **2528961 \***  
**C08J 11/10 (2006.01)**  
**C08G 18/08 (2006.01)**  
(86) IB2011050310 25.01.2011  
(96) 11708086.1 05.12.2012  
(87) WO2011089582, 25.01.2011  
(97) 2528961, 05.12.2012 en  
(54) PROCESS TO MAKE BIODEGRADABLE A SYNTHETIC POLYMER  
(71) Queensbrook Limited, 7th Floor, Hume House Ballsbridge, Dublin 4, IE  
(72) CATINARI, Madrisano, C.DA S. Domenico 31, I-62012 Civitanova Marche (Macerata), IT

(51) MKP  
**A61P 9/14 (2006.01)** (97) **2531189 \***  
**A61K 31/205 (2006.01)**  
**A61K 31/7048 (2006.01)**  
(86) IB2011000200 07.02.2011  
(96) 11709464.9 12.12.2012  
(87) WO2011095882, 07.02.2011  
(97) 2531189, 12.12.2012 en  
(54) COMBINATION COMPOSITION, COMPRISING AS ACTIVE INGREDIENT L-CARNITINE OR PROPIONYL L-CARNITINE, FOR THE PREVENTION OR TREATMENT OF CHRONIC VENOUS INSUFFICIENCY  
(71) Sigma-Tau Industrie Farmaceutiche Riunite S.P.A., Viale Shakespeare 47, 00144 Rome, IT  
(72) VIRMANI, Mohamed, Ashraf, Viale Shakespeare 47, I-00144 Rome, IT  
KOVERECH, Aleardo, Viale Shakespeare 47, I-00144 Rome, IT

(51) MKP  
**G01N 21/84 (2006.01)** (97) **2453222**  
**G01N 21/35 (2006.01)**  
**G01N 21/31 (2006.01)**  
(96) 11189019.0 16.05.2012  
(97) 2453222, 16.05.2012 fr  
(54) Apparatus and method for radiometry to determine the physico-chemical properties of a sample  
(71) Institut De Physique Du Globe De Paris (Établissement Public À Caractère Scientifique Et Technologique), 1 rue Jussieu, 75005 Paris, FR  
(72) Frangi, Jean-Pierre, 12 Avenue de la République, 94800 Villejuif, FR  
De Rosny, Gilles, 52 rue Etienne Marcel, 75002 Paris, FR  
Conejo, Elian, CICANUM Universidad de Costa Rica Apartado 11501-2060, San José, CR

- (51) MKP  
**A61K 31/425 (2006.01)** (97) **2521451 \***  
**A01N 43/78 (2006.01)**
- (86) US2011020416 06.01.2011  
(96) 11732162.0 14.11.2012  
(87) WO2011085128, 06.01.2011  
(97) 2521451, 14.11.2012 en  
(54) HEDGEHOG INHIBITORS  
(71) Selexagen Therapeutics, Inc., 4653 Carmel Mountain Road Suite 308, San Diego, CA 92130, US  
(72) VERNIER, Jean-Michel, 5150 Sea Mist Court, San Diego CA 92121, US  
MAY, John, 14169 Caminito Vistana, San Diego CA 92130, US  
O'CONNOR, Patrick, 3586 Torrey View Court, San Diego CA 92130, US  
RIPKA, William, 10819 Red Rock Road, San Diego CA 92131, US  
PINKERTON, Anthony, 7613 Mona Lane, San Diego CA 92130, US  
BOUNAUD, Pierre-Yves, 4610 Janet Place, San Diego CA 92115, US  
HOPKINS, Stephanie, 12716 Tustin Street, Poway CA 92064, US
- 
- (51) MKP  
**A01H 5/00 (2006.01)** (97) **2529019 \***  
**C12N 9/10 (2006.01)**  
**A01H 5/10 (2006.01)**  
**C12N 15/82 (2006.01)**
- (86) EP2011000365 24.01.2011  
(96) 11702149.3 05.12.2012  
(87) WO2011089021, 24.01.2011  
(97) 2529019, 05.12.2012 en  
(54) METHODS FOR MANUFACTURING PLANT CELL WALLS COMPRISING CHITIN  
(71) Bayer CropScience NV, J.E. Mommaertslaan 14, 1831 Diegem, BE  
Bulone, Vincent, Tibblevägen 3D, 183 56 Täby, SE  
Guerriero, Gea, Piazzetta Mondragone 13, 80132 Naples, IT  
(72) BULONE, Vincent, Tibblevägen 3D, SE-18356 Täby, SE  
GUERRIERO, Gea, Piazzetta Mondragone 13, IT-80132 Naples, IT  
DE BLOCK, Marc, Abrikozenstraat 26, BE-9820 Merelbeke, BE  
MEULEWAETER, Frank, Sparrenstraat 51, BE-9820 Merelbeke, BE
- 
- (51) MKP  
**A61M 5/172 (2006.01)** (97) **2506896 \***  
**A61M 5/00 (2006.01)**  
**A61M 5/142 (2006.01)**  
**A61M 5/315 (2006.01)**
- (86) EP2010068358 29.11.2010  
(96) 10787080.0 10.10.2012  
(87) WO2011067187, 29.11.2010  
(97) 2506896, 10.10.2012 en  
(54) DEVICE AND METHOD FOR DELIVERY OF TWO OR MORE DRUG AGENTS  
(71) Sanofi-Aventis Deutschland GmbH, Brüningstraße 50, 65929 Frankfurt, DE  
(72) DAY, Shane Alistair, 25 Shrerers Dyche Warwick, Warwickshire CV34 6BX, GB  
DE SAUSMAREZ LINTELL, Daniel Thomas, 6 Smithy Lane Church Lawford Rugby, Warwickshire CV23 9EQ, GB  
WIMPENNY, Steven, 12 Greatheed Road Leamington SPA, Warwickshire CV 31 3QH, GB  
JONES, Christopher, The Old Thatch Grafton Tewkesbury, Gloucestershire GL20 7AT, GB  
O'HARE, Aidan Michael, 18 Thickthorn Close Kenilworth, Warwickshire CV8 2AF, GB  
YATES, Barry, 1 Towers Close Kenilworth, Warwickshire CV34 6BX, GB  
VEASEY, Robert, 31 Lonsdale Road Lillington Leamington Spa, Warwickshire CV32 7EP, GB  
SMITH, Christopher James, c/o Sanofi-Aventis London Road Holmes Chapel Crewe, Cheshire CW4 8BE, GB  
BOYD, Malcolm, 28 Whitehead Drive, Wellsbourne Warwickshire CV35 9PW, GB  
LEAK, David Martin, 435 Rock Ridge Rd., Lake Hopatcong NJ 07849, US  
KEATING, Carmen Patricia, Emu Tops Australia Nowendoc, New South Wales, NSW 2354, AU  
SANDERS, David, 7 Kettlewell Close Woodloes Park Warwick, Warwickshire CV34 5XE, GB  
MARSHALL, Elizabeth Anne, 7 Clapham Square Leamington Spa, Warwickshire CV31 1JH, GB
- 
- (51) MKP  
**A61K 31/335 (2006.01)** (97) **2515898 \***  
**A61K 31/4745 (2006.01)**  
**A61K 31/704 (2006.01)**  
**A61K 31/24 (2006.01)**  
**A61P 35/00 (2006.01)**
- (86) EP2010068924 06.12.2010  
(96) 10788312.6 31.10.2012  
(87) WO2011076547, 06.12.2010  
(97) 2515898, 31.10.2012 en  
(54) ANTICANCER COMBINATION OF ARTEMISININ-BASED DRUGS AND OTHER CHEMOTHERAPEUTIC AGENTS  
(71) SIGMA-TAU Industrie Farmaceutiche Riunite S.p.A., Viale Shakespeare, 47, 00144 Rome, IT  
(72) PISANO, Claudio, Via Cherubini 60/B, I-04011 Aprilia (LT), IT  
VESCI, Loredana, Via Elio Petri 3, I-00128 Rome, IT
- 
- (51) MKP  
**A01N 43/90 (2006.01)** (97) **2521452 \***
- (86) US2011020351 06.01.2011  
(96) 11732133.1 14.11.2012  
(87) WO2011085084, 06.01.2011  
(97) 2521452, 14.11.2012 en  
(54) THIAZOLO[5,4-d]PYRIMIDINES AND THEIR USE AS AGROCHEMICALS  
(71) Dow AgroSciences LLC, 9330 Zionsville Road Law Department, Indianapolis, IN 46268, US  
(72) BREWSTER, William, 1927 Pamona Drive, Indianapolis IN 46214, US  
KLITTICH, Carla, 1621 Village Walk Drive, Zionsville IN 46077, US  
RIEDER, Brent, 3756 Forest Lane, Greenfield IN 46140, US  
SIDDALL, Thomas, 1925 South 900 East, Zionsville IN 46077, US  
YAO, Chenglin, 14178 Esprit Drive, Westfield IN 46074, US

(51) MKP  
**F16K 11/20 (2006.01)** (97) **2472150**  
**E03C 1/04 (2006.01)**  
**B67D 1/00 (2006.01)**  
(96) 11196117.3 04.07.2012  
(97) 2472150, 04.07.2012 en  
(54) System and valve unit  
(71) GM Rubinetterie S.r.l., Via Vittorio Veneto 95, 28040 Oleggio Castello, IT  
(72) Gioira, Luigi, c/o GM RUBINETTERIE S.r.l. Via Vittorio Veneto 95, 28040 Oleggio Castello, IT  
Gioira, Marco, c/o GM RUBINETTERIE S.r.l. Via Vittorio Veneto 95, 28040 Oleggio Castello, IT

(51) MKP  
**C07D 491/04 (2006.01)** (97) **2513115 \***  
**A61K 31/4741 (2006.01)**  
**A61K 31/4743 (2006.01)**  
**C07D 495/04 (2006.01)**  
**A61P 31/04 (2006.01)**  
(86) EP2010070043 17.12.2010  
(96) 10793255.0 24.10.2012  
(87) WO2011073378, 17.12.2010  
(97) 2513115, 24.10.2012 en  
(54) TRICYCLIC ANTIBIOTICS  
(71) Basilea Pharmaceutica AG, Grenzacherstrasse 487, 4005 Basel, CH  
(72) GAUCHER, Bérangère, 11 rue due Hohneck, F-68100 Mulhouse, FR  
DANEL, Franck, Hubert, 9 rue de Brunstatt, F-68440 Bruebach, FR  
TANG, XiaoHu, YiYangShanShuiJu Building Nr. 3 Room No. 561 YangZhuang HaiDian District, Beijing, CN  
XIE, Tong, Building No. 306 Room No. 502 East City Guardian, Haimen Jiangsu 226100, CN  
XU, Lin, No. 451 Yichuan Road Building 21 Room 207, Shanghai 200065, CN

(51) MKP  
**C07K 5/06 (2006.01)** (97) **2524925 \***  
**A23L 1/226 (2006.01)**  
**A23L 1/30 (2006.01)**  
**C07D 281/06 (2006.01)**  
(86) JP2010073720 28.12.2010  
(96) 10841039.0 21.11.2012  
(87) WO2011081184, 28.12.2010  
(97) 2524925, 21.11.2012 en  
(54) LANTHIONINE DERIVATIVE  
(71) Ajinomoto Co., Inc., 15-1, Kyobashi 1-chome Chuo-ku, Tokyo, 104-8315, JP  
(72) SATO Seiichi, c/o AJINOMOTO CO. INC. 1-1, Suzuki-cho Kawasaki-ku, Kawasaki-shi Kanagawa 210-8681, JP  
FUTAKI Fumie, c/o AJINOMOTO CO. INC. 1-1, Suzuki-cho Kawasaki-ku, Kawasaki-shi Kanagawa 210-8681, JP  
YASUDA Reiko, c/o AJINOMOTO CO. INC. 1-1, Suzuki-cho Kawasaki-ku, Kawasaki-shi Kanagawa 210-8681, JP  
ETO Sachise, c/o AJINOMOTO CO. INC. 1-1, Suzuki-cho Kawasaki-ku, Kawasaki-shi Kanagawa 210-8681, JP  
SUZUKI Yumiko, c/o AJINOMOTO CO. INC. 1-1, Suzuki-cho Kawasaki-ku, Kawasaki-shi Kanagawa 210-8681, JP  
TAJIMA Takaho, c/o AJINOMOTO CO. INC. 1-1, Suzuki-cho Kawasaki-ku, Kawasaki-shi Kanagawa 210-8681, JP  
ETO Yuzuru, c/o AJINOMOTO CO. INC. 1-1, Suzuki-cho Kawasaki-ku, Kawasaki-shi Kanagawa 210-8681, JP  
TAHARA Yuki, c/o AJINOMOTO CO. INC. 1-1, Suzuki-cho Kawasaki-ku, Kawasaki-shi Kanagawa 210-8681, JP

(51) MKP  
**A61K 39/395 (2006.01)** (97) **2521536 \***  
**A61K 9/08 (2006.01)**  
**A61K 9/00 (2006.01)**  
**A61K 31/485 (2006.01)**  
(86) US2011020457 07.01.2011  
(96) 11703294.6 14.11.2012  
(87) WO2011085158, 07.01.2011  
(97) 2521536, 14.11.2012 en  
(54) STABILIZED FORMULATIONS CONTAINING ANTI-INTERLEUKIN-6 RECEPTOR (IL-6R) ANTIBODIES  
(71) Regeneron Pharmaceuticals, Inc., 777 Old Saw Mill River Road, Tarrytown, NY 10591-6707, US  
Dix, Daniel B., 55 Memory Trail, Lagrangeville, NY 12540, US  
Graham, Kenneth S., 218 Robbout Road, Pleasant Valley, NY 12569, US  
Kamen, Douglas E., 21 Lyndsey Lane, Poughquag, NY 12570, US  
Walsh, Scott M., 302 Watch Hill Dr, Tarrytown, NY 10591, US  
(72) DIX, Daniel, B., 55 Memory Trail, Lagrangeville, NY 12540, US  
GRAHAM, Kenneth, S., 218 Robbout Road, Pleasant Valley, NY 12569, US  
KAMEN, Douglas, E., 21 Lyndsey Lane, Poughquag, NY 12570, US  
WALSH, Scott, M., 302 Watch Hill Dr, Tarrytown, NY 10591, US

(51) MKP  
**A01K 53/00 (2006.01)** (97) **2523549 \***  
(86) HU2010000147 20.12.2010  
(96) 10842933.3 21.11.2012  
(87) WO2011086397, 20.12.2010  
(97) 2523549, 21.11.2012 en  
(54) BEE FEEDER WITH AUTOMATIC PRESSURE CONTROL  
(71) Arany, Gábor, Körtársaság út.13., 5453 Mezöhék, HU  
(72) Arany, Gábor, Körtársaság út.13., 5453 Mezöhék, HU

(51) MKP  
**A62D 3/36 (2007.01)** (97) **2509688 \***  
**A62D 3/40 (2007.01)**  
**A62D 3/34 (2007.01)**  
(86) IB2010054276 22.09.2010  
(96) 10790668.7 17.10.2012  
(87) WO2011036629, 22.09.2010  
(97) 2509688, 17.10.2012 en  
(54) PROCESS AND APPARATUS FOR THE ANNIHILATION OF HARMFUL WASTE CONTAINING POLYCHLORINATED HYDROCARBONS  
(71) Magyar Tudományos Akadémia Kémiai Kutatóközpont, Pusztaszeri út 59-67, 1025 Budapest, HU  
Arend Kereskedelmi És Szolgáltató KFT., Tüzköhegyi u. 10., 2040 Budaörs, HU  
Procalor Környezetvédelmi És Energetikai Kutató-fejlesztő. Es Szolgál Tató KFT., Dózsa György u. 15., 2072 Zsámbék, HU  
Sirkó, Imre, Pollack Mihály u. 27., 2022 Tahitótfalu, HU  
(72) SIRKÓ, Imre, Pollack Mihály u. 27., H-2022 Tahitótfalu, HU  
MINK, György, Pentele u. 1., H-1116 Budapest, HU  
SZABÓ, Péter, Esze Tamás u. 17., H-2400 Dunaújváros, HU  
TÖRÖK, Ern, Dózsa György u. 15., H-2072 Zsámbék, HU  
FEJES, Szabolcs, Hunyadi János köz 29., H-8315 Gyenesdiás, HU  
LENGYEL, István, Hunyadi J. u. 3., H-1011 Budapest, HU

(51) MKP  
**A61M 5/24 (2006.01)** (97) **2450072**  
(96) 10189781.7 09.05.2012  
(97) 2450072, 09.05.2012 en  
(54) Medicated module with floating piston  
(71) Sanofi-Aventis Deutschland GmbH, Brüningstraße 50, 65929 Frankfurt, DE  
(72) Davies, James, 7 Old School Mews Cublington Road, Leamington Spa, Warwickshire, CV32 7XB, GB  
Wimpenny, Steven, 12 Greatheed Road, Leamington Spa, CV 31 3QH, Warwickshire, GB

- (51) MKP  
**A61P 9/00 (2006.01)** (97) **2521726 \***  
**A61K 31/519 (2006.01)**  
**C07D 471/04 (2006.01)**  
(86) FR2011050019 06.01.2011  
(96) 11704258.0 14.11.2012  
(87) WO2011086306, 06.01.2011  
(97) 2521726, 14.11.2012 fr  
(54) 5-OXO-5, 8-DIHYDROPIRIDO [2, 3-D]PYRIMIDINE DERIVATIVES AS CAMKII KINASE INHIBITORS FOR TREATING CARDIOVASCULAR DISEASES  
(71) SANOFI, 54, rue de la Boétie, 75008 Paris, FR  
(72) BEAUVERGER, Philippe, c/o Sanofi-Aventis Département Brevets 174 avenue de France, F-75013 Paris, FR  
BEGIS, Guillaume, c/o Sanofi-Aventis Département Brevets 174 avenue de France, F-75013 Paris, FR  
BISCARRAT, Sandrine, c/o Sanofi-Aventis Département Brevets 174 avenue de France, F-75013 Paris, FR  
DUCLLOS, Olivier, c/o Sanofi-Aventis Département Brevets 174 avenue de France, F-75013 Paris, FR  
MCCORT, Gary, c/o Sanofi-Aventis Département Brevets 174 avenue de France, F-75013 Paris, FR

- (51) MKP  
**A61B 17/072 (2006.01)** (97) **2512351 \***  
**A61B 17/29 (2006.01)**  
**A61B 17/115 (2006.01)**  
**A61B 19/00 (2006.01)**  
(86) US2010059034 06.12.2010  
(96) 10795822.5 24.10.2012  
(87) WO2011071793, 06.12.2010  
(97) 2512351, 24.10.2012 en  
(54) SURGICAL STAPLER WITH DISCRETE STAPLE HEIGHT ADJUSTMENT AND TACTILE FEEDBACK  
(71) Ethicon Endo-Surgery, Inc., 4545 Creek Road, Cincinnati, OH 45242, US  
(72) ZINGMAN, Aron, O., 2333 Salutaris Avenue N. 4, Cincinnati, OH 45206, US

- (51) MKP  
**C07K 16/28 (2006.01)** (97) **2523976 \***  
(86) US2011020750 11.01.2011  
(96) 11732296.6 21.11.2012  
(87) WO2011085343, 11.01.2011  
(97) 2523976, 21.11.2012 en  
(54) BIOMARKERS OF IMMUNOMODULATORY EFFECTS IN HUMANS TREATED WITH ANTI-CD200 ANTIBODIES  
(71) ALEXION PHARMACEUTICALS, INC., 352 Knotter Drive, Cheshire, CT 06410, US  
(72) FAAS MCKNIGHT, Susan, 14 Stonewood Drive, Old Lyme, CT 06371, US  
COFIELL, Roxanne, 83 Needletree Lane, Glastonbury, CT 06033, US  
YAN, Yan, 18 North Pond Road, Cheshire, CT 06410, US

- (51) MKP  
**C12N 15/85 (2006.01)** (97) **2501817 \***  
**C07K 16/46 (2006.01)**  
**A01K 67/027 (2006.01)**  
(86) US2011023971 08.02.2011  
(96) 11703799.4 26.09.2012  
(87) WO2011097603, 08.02.2011  
(97) 2501817, 26.09.2012 en  
(54) COMMON LIGHT CHAIN MOUSE  
(71) REGENERON PHARMACEUTICALS, INC., 777 Old Saw Mill River Road, Tarrytown, NY 10591, US  
(72) MCWHIRTER, John, 2035 Crescent Drive, Tarrytown, NY 10591, US  
MACDONALD, Lynn, 16 Gedney Way, White Plains, NY 10605, US  
STEVENS, Sean, 355 Berry Street 413, San Francisco, CA 94158, US  
DAVIS, Samuel, 332 West 88th Street, Apt. B2, New York, NY 10024, US  
MURPHY, Andrew, J., 10 Newton Court, Croton-On-Hudson, NY 10520, US

- (51) MKP  
**C07K 16/18 (2006.01)** (97) **2523974 \***  
(86) US2011020999 12.01.2011  
(96) 11733320.3 21.11.2012  
(87) WO2011088127, 12.01.2011  
(97) 2523974, 21.11.2012 en  
(54) WNT-BINDING AGENTS AND USES THEREOF  
(71) Oncomed Pharmaceuticals, Inc., 800 Chesapeake Drive, Redwood City, CA 94063-4748, US  
(72) GURNEY, Austin, L., 946 Diamond Street, San Francisco, CA 94114, US

- (51) MKP  
**C07K 16/22 (2006.01)** (97) **2510001 \***  
**A61K 39/395 (2006.01)**  
(86) EP2010069120 08.12.2010  
(96) 10794938.0 17.10.2012  
(87) WO2011070045, 08.12.2010  
(97) 2510001, 17.10.2012 en  
(54) MONOCLONAL ANTIBODIES AGAINST THE RGM A PROTEIN FOR USE IN THE TREATMENT OF RETINAL NERVE FIBER LAYER DEGENERATION  
(71) Abbott GmbH & Co. KG, Max-Planck-Ring 2, 65205 Wiesbaden, DE  
(72) MÜLLER, Bernhard, K., Altbachstr. 10 A, 67435 Neustadt, DE

- (51) MKP  
**A61M 5/315 (2006.01)** (97) **2509663 \***  
(86) EP2010068916 06.12.2010  
(96) 10800903.6 17.10.2012  
(87) WO2011069936, 06.12.2010  
(97) 2509663, 17.10.2012 en  
(54) DRIVE ASSEMBLY FOR A DRUG DELIVERY DEVICE AND DRUG DELIVERY DEVICE  
(71) Sanofi-Aventis Deutschland GmbH, Brüningstraße 50, 65929 Frankfurt, DE  
(72) DASBACH, Uwe, c/o Sanofi-Aventis Deutschland GmbH, 65926 Frankfurt am Main, DE  
RAAB, Steffen, c/o Sanofi-Aventis Deutschland GmbH, 65926 Frankfurt am Main, DE  
ROTTLUFF, Marianne, c/o Sanofi-Aventis Deutschland GmbH, 65926 Frankfurt am Main, DE

- (51) MKP  
**A01N 43/54 (2006.01)** (97) **2523559 \***  
(86) US2011020798 11.01.2011  
(96) 11733258.5 21.11.2012  
(87) WO2011088027, 11.01.2011  
(97) 2523559, 21.11.2012 en  
(54) COMPOUNDS AND METHODS  
(71) GlaxoSmithKline LLC, One Franklin Plaza 200 North 16th Street, Philadelphia, PA 19102, US  
(72) KALLANDER, Lara, S., 709 Swedeland Road, King of Prussia PA 19406, US  
LAWHORN, Brian, Griffin, 709 Swedeland Road, King of Prussia PA 19406, US  
PHILIP, Joanne, 709 Swedeland Road, King of Prussia PA 19406, US  
ZHAO, Yongdong, 709 Swedeland Road, King of Prussia PA 19406, US

- (51) MKP  
**A01N 43/00 (2006.01)** (97) **2531027 \***  
(86) US2011022219 24.01.2011  
(96) 11737484.3 12.12.2012  
(87) WO2011094150, 24.01.2011  
(97) 2531027, 12.12.2012 en  
(54) ANTIVIRAL THERAPY  
(71) VIIV Healthcare Company, Five Moore Drive, Research Triangle Park, NC 27709, US  
(72) UNDERWOOD, Mark, Richard, c/o GlaxoSmithKline Global Patents Dept. Five Moore Drive P. O. Box 13398, Research Triangle Park North Carolina 27709, US



(51) MKP  
**A61K 9/14 (2006.01)** (97) **2515874 \***  
**A61K 31/593 (2006.01)**  
 (86) DK2010000183 22.12.2010  
 (96) 10803440.6 31.10.2012  
 (87) WO2011076208, 22.12.2010  
 (97) 2515874, 31.10.2012 en  
 (54) CALCIPOTRIOL MONOHYDRATE NANOCRYSTALS  
 (71) Leo Pharma A/S, Patents Industriparken 55, 2750 Ballerup, DK  
 (72) PETERSSON, Karsten, Fuglehavevej 66, DK-2750 Ballerup, DK

(51) MKP  
**F22B 37/40 (2006.01)** (97) **2388519**  
**F22B 37/24 (2006.01)**  
 (96) 11163182.6 23.11.2011  
 (97) 2388519, 23.11.2011 de  
 (54) System for creating a protected working area within a working room separated by a wall  
 (71) Hitachi Power Europe GmbH, Schifferstrasse 80, 47059 Duisburg, DE  
 (72) Pauly, Axel, Ohmstr. 18, 45711 Datteln, DE  
 Furth, Thomas, Paulusstraße 12, 40237 Düsseldorf, DE  
 Blomeier, Marc, Gasstraße 39, 45731 Waltrop, DE

(51) MKP  
**C07D 407/12 (2006.01)** (97) **2519505 \***  
**C07D 491/113 (2006.01)**  
**C07D 215/48 (2006.01)**  
**A61P 31/10 (2006.01)**  
**C07D 401/06 (2006.01)**  
**C07D 401/12 (2006.01)**  
**C07D 407/06 (2006.01)**  
**A61K 31/4709 (2006.01)**  
**C07D 417/06 (2006.01)**  
 (86) EP2010070790 28.12.2010  
 (96) 10800763.4 07.11.2012  
 (87) WO2011080264, 28.12.2010  
 (97) 2519505, 07.11.2012 en  
 (54) NEW TERTIARY 8-HYDROXYQUINOLINE-7-CARBOXAMIDE DERIVATIVES AND USES THEREOF  
 (71) Polichem SA, 50, Val Fleuri, 1526 Luxembourg, LU  
 (72) GAGLIARDI, Stefania, Via Passirano 24, I-20059 Vimercate (MB), IT  
 DEL SORDO, Simone, Piazza Carlo Alberto dalla Chiesa 22, I-24047 Treviglio (BG), IT  
 MAILLAND, Federico, Strada Regina 10, CH-6900 Lugano, CH  
 LEGORA, Michela, Via Castellazzo 1/B, I-22070 Appiano Gentile (CO), IT

(51) MKP  
**A61K 47/36 (2006.01)** (97) **2509634 \***  
**A61P 35/00 (2006.01)**  
**A61K 47/30 (2006.01)**  
**A61K 47/40 (2006.01)**  
**A61K 31/335 (2006.01)**  
**A61K 47/02 (2006.01)**  
 (86) US2010059879 10.12.2010  
 (96) 10836748.3 17.10.2012  
 (87) WO2011072218, 10.12.2010  
 (97) 2509634, 17.10.2012 en  
 (54) STABLE FORMULATIONS FOR LYOPHILIZING THERAPEUTIC PARTICLES  
 (71) Bind Biosciences, Inc., 64 Sidney Street, Cambridge, MA 02139, US  
 (72) TROIANO, Greg, 38 Lily's Way, Pembroke MA 02359, US  
 ZALE, Stephen, E., One Norcross Road, Hopkinton MA 01748, US  
 WRIGHT, James, 24 Bloomfield Street, Lexington MA 02421, US  
 VAN GEEN UOVEN, Tina, 61 Needham Road, Denvers MA 01923, US  
 SONG, Young-ho, 33 Bradford Road, Natick MA 01760, US

(51) MKP  
**C12N 5/00 (2006.01)** (97) **2509605 \***  
**A61K 31/70 (2006.01)**  
 (86) US2010046818 26.08.2010  
 (96) 10814304.1 17.10.2012  
 (87) WO2011028611, 26.08.2010  
 (97) 2509605, 17.10.2012 en  
 (54) P2X7: INHIBITION OF EPITHELIAL CANCERS AND PAPILOMAS  
 (71) University Hospitals Of Cleveland, LKSD 1400 11100 Euclid Avenue, Cleveland, OH 44106, US  
 (72) GORODESKI, George, 25154 Bridgeton Drive, Beachwood OH 44122, US  
 FU, Wen, 6070 Stanton Dr SW, Edmonton Alberta TBX 0H2, CA

(51) MKP  
**A61P 19/10 (2006.01)** (97) **2515942 \***  
**A61P 11/06 (2006.01)**  
**A61K 9/127 (2006.01)**  
**A61P 29/00 (2006.01)**  
**A61K 47/30 (2006.01)**  
**A61K 31/337 (2006.01)**  
 (86) US2010060564 15.12.2010  
 (96) 10842554.7 31.10.2012  
 (87) WO2011084513, 15.12.2010  
 (97) 2515942, 31.10.2012 en  
 (54) THERAPEUTIC POLYMERIC NANOPARTICLE COMPOSITIONS WITH HIGH GLASS TRANSITION TEMPERATURE OR HIGH MOLECULAR WEIGHT COPOLYMERS  
 (71) Bind Biosciences, Inc., 64 Sidney Street, Cambridge, MA 02139, US  
 (72) ALI, Mir, Mukkaram, 53 Cedar Street Apt. 3205, Woburn MA 01801, US  
 SABNIS, Abhimanyu, 48 Brooks Avenue, Arlington MA 02474, US  
 DEWITT, David, 37 Bayard Street, Allston MA 02134, US  
 TROIANO, Greg, 38 Lily's Way, Pembroke MA 02359, US  
 WRIGHT, James, 24 Bloomfield Street, Lexington MA 02421, US  
 FIGUEIREDO, Maria, One Olive Square, Somerville MA 02143, US  
 FIGA, Michael, 76 Quint Avenue, Allston MA 02134, US  
 VAN GEEN HOVEN, Tina, 61 Needham Road, Danvers MA 01923, US  
 SONG, Young-Ho, 33 Bradford Road, Natick MA 01760, US  
 AUER, Jason, 19A Suffolk Street, Cambridge MA 02139, US  
 CAMPBELL, Tarikh, Christopher, 150 Huntington Avenue Apt. NBL, Boston MA 02115, US

(51) MKP  
**B01D 53/64 (2006.01)** (97) **2531276 \***  
 (86) US2011023758 04.02.2011  
 (96) 11740431.9 12.12.2012  
 (87) WO2011097488, 04.02.2011  
 (97) 2531276, 12.12.2012 en  
 (54) METHOD AND SYSTEM FOR CONTROLLING MERCURY EMISSIONS FROM COAL-FIRED THERMAL PROCESSES  
 (71) Ada Environmental Solutions, LLC, 8100 Southpark Way B-2, Littleton, CO 80120, US  
 (72) DURHAM, Michael, 5252 Lariat Drive, Castle Rock, CO 80108, US  
 FRENCH, Nina, Bergan, 2297 Monticello Road, Napa, CA 94558, US  
 BISQUE, Raymond, 9113 Fern Way, Golden, CO 80403-8333, US  
 BALDREY, Kenneth, E., 2746 West Yale Avenue, Denver, CO 80219, US

(51) MKP  
**A61B 5/103 (2006.01)** (97) **2512336 \***  
 (86) US2010056005 09.11.2010  
 (96) 10838072.6 24.10.2012  
 (87) WO2011075237, 09.11.2010  
 (97) 2512336, 24.10.2012 en  
 (54) METHOD AND APPARATUS PROVIDING TIMED VISUAL IMAGES DURING CHILDBIRTH  
 (71) Gauta, Joseph, 5941 Spanish Oaks Lane, Naples, FL 34119, US  
 (72) Gauta, Joseph, 5941 Spanish Oaks Lane, Naples, FL 34119, US

- (51) MKP  
**G06F 19/00 (2011.01)** (97) **2538362**  
 (96) 12174638.2 26.12.2012  
 (97) 2538362, 26.12.2012 en  
 (54) Method and system for patient-specific modeling of blood flow  
 (71) Heartflow, Inc., 1700 Seaport Boulevard Suite 400, Redwood City, CA 94063, US  
 (72) Taylor, Charles, A., 3 Vasilakos Court, Menlo Park, CA California 94025, US  
 Fonte, Timothy, A., 3587 17th Street, Apt. 1, San Francisco, CA California 94110, US  
 Choi, Gilwoo, 3943 El Camino Real, Apt. 2, Palo Alto, CA California 94306, US  
 Bai, Ying, 1105 North Road, Belmont, CA California 94002, US  
 Zarins, Christopher, K., 199 Seminary Drive, Menlo Park, CA California 94025, US

- (51) MKP  
**C08F 4/80 (2006.01)** (97) **2519350 \***  
**B01J 31/22 (2006.01)**  
**C07F 15/00 (2006.01)**  
 (86) CN2010080477 30.12.2010  
 (96) 10840586.1 07.11.2012  
 (87) WO2011079799, 30.12.2010  
 (97) 2519350, 07.11.2012 en  
 (54) HIGHLY ACTIVE METATHESIS CATALYSIS SELECTIVE FOR ROMP AND RCM  
 (71) Zannan Scitech Co., Ltd., 4299 Jindu Road Bldg. 1, Room 301, Shanghai 201 108, CN  
 (72) ZHAN, Zheng-Yun James, 4299 Jindu Rd. Bldg 1, Room 301 Minhang District, Shanghai 201108, CN

- (51) MKP  
**G06F 9/50 (2006.01)** (97) **2534579 \***  
 (86) US2011024540 11.02.2011  
 (96) 11706387.5 19.12.2012  
 (87) WO2011100557, 11.02.2011  
 (97) 2534579, 19.12.2012 en  
 (54) SCENARIO STATE PROCESSING SYSTEMS AND METHODS FOR OPERATION WITHIN A GRID COMPUTING ENVIRONMENT  
 (71) SAS INSTITUTE INC., SAS Campus Drive, Cary, NC 27513, US  
 (72) GOODNIGHT, James, Howard, 900 Appletree Lane, Cary, NC 27513, US  
 KRUEGER, Steve, 9408 Springdale Drive, Raleigh, NC 27613, US  
 SCHABENBERGER, Oliver, 205 North Becket Street, Cary, NC 27513, US  
 BAILEY, Christopher, D., 104 Benwell Court, Cary, NC 27519, US

- (51) MKP  
**A63B 23/02 (2006.01)** (97) **2428255**  
**A63B 21/045 (2006.01)**  
**A63B 22/14 (2006.01)**  
 (96) 11180410.0 14.03.2012  
 (97) 2428255, 14.03.2012 en  
 (54) Improved abdominal exerciser with rotatable seat and tandem pulley features  
 (71) E. Mishan&Sons, Inc., 230 Fifth Avenue, New York, NY 10001, US  
 (72) MISHAN, Edward I., E. Mishan & Sons, Inc. 230 Fifth Avenue, NEW YORK, NY New York 10001, US  
 MISHAN, Steven, E. Mishan & Sons, Inc. 230 Fifth Avenue, NEW YORK, NY New York 10001, US

- (51) MKP  
**A61K 31/165 (2006.01)** (97) **2533774 \***  
**A61P 25/22 (2006.01)**  
 (86) FR2011000080 10.02.2011  
 (96) 11708533.2 19.12.2012  
 (87) WO2011098689, 10.02.2011  
 (97) 2533774, 19.12.2012 fr  
 (54) USE OF AGOMELATINE FOR THE PREPARATION OF DRUGS FOR TREATING OBSESSIVE COMPULSIVE DISORDER (OCD)  
 (71) Les Laboratoires Servier, 35, rue de Verdun, 92284 Suresnes Cedex, FR  
 (72) LAIGLE, Laurence, 26, rue du Maréchal Foch, F-78600 Maisons Laffitte, FR  
 MOCAER, Elisabeth, 32, rue Chauveau, F-92200 Neuilly sur Seine, FR  
 MILLAN, Mark, J., 19, rue du Président Wilson, F-78230 Le Pecq, FR

- (51) MKP  
**A01P 13/00 (2006.01)** (97) **2503889 \***  
**A01N 43/40 (2006.01)**  
**A01N 33/12 (2006.01)**  
**A01N 25/12 (2006.01)**  
**A01N 25/14 (2006.01)**  
 (86) US2010057544 22.11.2010  
 (96) 10784924.2 03.10.2012  
 (87) WO2011063312, 22.11.2010  
 (97) 2503889, 03.10.2012 en  
 (54) IMPROVED PROCESS FOR PREPARING SOLUBLE GRANULES OF SALTS OF PYRIDINE-CARBOXYLIC ACIDS  
 (71) Dow AgroSciences LLC, 9330 Zionsville Road, Indianapolis, IN 46268, US  
 (72) KEENEY, Franklin, 12304 Windsor Drive, Carmel, IN 46033, US  
 FOSTER, Neil, 9 Rue Des Bouleaux, 67460 Souffelweyersheim, FR  
 LOGAN, Martin, 4204 North Meridian Street, Indianapolis, IN 46208, US  
 PERRY, Maria, 7974 S 675 W, Jamestown, IN 46147, US

- (51) MKP  
**G01N 33/68 (2006.01)** (97) **2504457 \***  
**C12N 15/12 (2006.01)**  
**C12Q 1/68 (2006.01)**  
 (86) US2010058099 24.11.2010  
 (96) 10833978.9 03.10.2012  
 (87) WO2011066458, 24.11.2010  
 (97) 2504457, 03.10.2012 en  
 (54) NOVEL GENOMIC BIOMARKERS FOR IRRITABLE BOWEL SYNDROME DIAGNOSIS  
 (71) Prometheus Laboratories Inc., 9410 Carroll Park Drive, San Diego, CA 92121-5201, US  
 (72) GONG, Hua, 12457 Carmel Park Drive, San Diego California 92130-2274, US  
 SINGH, Sharat, 8171 Top of the Morning Way, Rancho Santa Fe California 92127, US  
 HOE, Nicholas, 9072 Renato Street, San Diego California 92129, US

- (51) MKP  
**A61K 31/495 (2006.01)** (97) **2515900 \***  
**A61K 31/343 (2006.01)**  
**A61P 9/06 (2006.01)**  
 (86) US2010061257 20.12.2010  
 (96) 10798436.1 31.10.2012  
 (87) WO2011084733, 20.12.2010  
 (97) 2515900, 31.10.2012 en  
 (54) METHOD OF TREATING ATRIAL FIBRILLATION  
 (71) Gilead Sciences, Inc., 333 Lakeside Drive, Foster City, CA 94404, US  
 (72) ANTZELEVITCH, Charles, 101 Sylvan Way, New Hartford New York 13413, US  
 BELARDINELLI, Luiz, 205 Manzanita Ave., Palo Alto California 94304, US  
 BURASHNIKOV, Alexander, 59 Imperial Dr., New Hartford New York 13413, US  
 SHRYOCK, John, 2313 Vines Ct., East Palo Alto California 94303, US  
 ZENG, Dewan, 871 Sycamore Dr., Palo Alto California 94303, US

(51) MKP  
**A61N 5/06 (2006.01)** (97) **2353478**  
**A47K 3/28 (2006.01)**  
**A61H 33/06 (2006.01)**  
(96) 10450191.1 10.08.2011  
(97) 2353478, 10.08.2011 de  
(54) Shower device with thermal radiant source  
(71) Manufactur für Glas und Spiegel GmbH, Emailwerkstrasse 25, 9523 Villach-Landskron, AT  
(72) Ebner, Oliver, Reinerhofweg 4, 9500 Villach, AT  
Nachtmann, Markus, Poststrasse 1, 5310 Mondsee, AT  
Tschudnig, Herbert, Millstätterstr. 102, 9523 Villach-Landskron, AT  
Weberndorfer, Birgit, Nussdorfer Str. 62/24, 1090 Wien, AT

(51) MKP  
**A01B 69/00 (2006.01)** (97) **2454927**  
**A47B 88/04 (2006.01)**  
**A01D 34/835 (2006.01)**  
**A01D 34/00 (2006.01)**  
**E04D 11/00 (2006.01)**  
**A47B 88/00 (2006.01)**  
(96) 11189333.5 23.05.2012  
(97) 2454927, 23.05.2012 en  
(54) Mowing apparatus and grass maintenance system  
(71) SA Shuang, 100 13551 Verdun Place, Richmond, BC V6V 1W5, CA  
(72) Sa, Shuang, 100 13551 Verdun Place, Richmond, BC V6V 1W5, CA

(51) MKP  
**C07D 487/04 (2006.01)** (97) **2536730 \***  
**A61K 31/519 (2006.01)**  
**C07D 519/00 (2006.01)**  
**A61P 35/00 (2006.01)**  
**C07B 59/00 (2006.01)**  
(86) EP2011052353 17.02.2011  
(96) 11707115.9 26.12.2012  
(87) WO2011101409, 17.02.2011  
(97) 2536730, 26.12.2012 en  
(54) PYRROLOPYRIMIDINE COMPOUNDS AS INHIBITORS OF CDK4/6  
(71) Novartis AG, Lichtstrasse 35, 4056 Basel, CH  
BRAIN, Christopher, Thomas, Novartis Institutes for BioMedical Research Inc. 250 Massachusetts Avenue, Cambridge Massachusetts 02139, US  
CHO, Young Shin, Novartis Institutes for BioMedical Research Inc. 250 Massachusetts Avenue, Cambridge Massachusetts 02139, US  
GIRALDES, John, William, Novartis Institutes for BioMedical Research Inc. 250 Massachusetts Avenue, Cambridge, MA 02139, US  
LAGU, Bharat, Novartis Institutes for BioMedical Research Inc. 250 Massachusetts Avenue, Cambridge Massachusetts 02139, US  
LEVELL, Julian, Novartis Institutes for BioMedical Research Inc. 250 Massachusetts Avenue, Cambridge Massachusetts 02139, US  
LUZZIO, Michael, Novartis Institutes for BioMedical Research Inc. 250 Massachusetts Avenue, Cambridge Massachusetts 02139, US  
PEREZ, Lawrence, Blas, Novartis Institutes for BioMedical Research Inc. 250 Massachusetts Avenue, Cambridge Massachusetts 02139, US  
WANG, Yaping, 96 Patch Hill, Boxborough Massachusetts 01719, US  
YANG, Fan, Novartis Institutes for BioMedical Research Inc. 250 Massachusetts Avenue, Cambridge Massachusetts 02139, US

(51) MKP  
**C07D 405/12 (2006.01)** (97) **2504315 \***  
**C07D 401/04 (2006.01)**  
**C07D 417/04 (2006.01)**  
**A61P 25/28 (2006.01)**  
**C07D 401/10 (2006.01)**  
**A61K 31/4709 (2006.01)**  
**C07D 401/12 (2006.01)**  
**C07D 215/38 (2006.01)**  
(86) US2010057428 19.11.2010  
(96) 10782786.7 03.10.2012  
(87) WO2011063233, 19.11.2010  
(97) 2504315, 03.10.2012 en  
(54) AMINO HETEROARYL COMPOUNDS AS BETA-SECRETASE MODULATORS AND METHODS OF USE  
(71) Amgen Inc., One Amgen Center Drive, Thousand Oaks, CA 91320, US  
(72) CHENG, Yuan, 5329 Via Jacinto, Newbury Park, California 91320, US  
POWERS, Timothy, 31230 Bailard Road, Malibu, California 09265, US  
ASHTON, Kate, 30948 Minute Man Way, Westlake Village, California 91361, US  
BROWN, James, 4438 Appleglen Court, Moorpark, California 93021, US  
HARRIED, Scott, 22248 Archwood Street, Woodland Hills, California 91303, US  
HITCHCOCK, Stephen, 171 Florence Drive, Jupiter, Florida 33458, US  
JUDD, Ted, 610 Geranium Lane Unit A, Simi Valley, California 93065, US  
LOPEZ, Patricia, 22644 Saticoy Street, West Hills, California 91307, US  
NIXEY, Thomas, 4554 Via Laguna, Newbury Park, California 91320, US  
PARAS, Nick A., 3632 26th Street, San Francisco, California 94110, US  
POON, Steve F., 5147 Comercio Avenue, Woodland Hills, California 91364, US  
ST. JEAN JR., David J., 4690 Marissa Way, Camarillo, California 93012, US  
XUE, Qiufen, 5018 Via Mesita, Newbury Park, California 91320, US  
ZHONG, Wenge, 2921 Venezia Lane, Thousand Oaks, California 91362, US

- (51) MKP  
*C07D 213/84 (2006.01)* (97) **2507211 \***  
*C07D 405/14 (2006.01)*  
*C07D 213/74 (2006.01)*  
*C07D 405/12 (2006.01)*  
*C07D 209/08 (2006.01)*  
*C07D 401/14 (2006.01)*  
*C07D 211/58 (2006.01)*  
*C07D 403/12 (2006.01)*  
*C07D 231/56 (2006.01)*  
*C07D 413/12 (2006.01)*  
*C07D 309/04 (2006.01)*  
*C07D 235/06 (2006.01)*  
*C07D 417/12 (2006.01)*  
*C07D 277/24 (2006.01)*  
*C07D 471/04 (2006.01)*
- (86) US2010036844 01.06.2010  
(96) 10722500.5 10.10.2012  
(87) WO2011068560, 01.06.2010  
(97) 2507211, 10.10.2012 en  
(54) APOPTOSIS-INDUCING AGENTS FOR THE TREATMENT OF CANCER AND IMMUNE AND AUTOIMMUNE DISEASES  
(71) Abbott Laboratories, 100 Abbott Park Rd., Abbott Park, IL 60064, US  
(72) BRUNCKO, Milan, 31231 Prairie Ridge, Green Oaks, Illinois 60048, US  
DAI, Yujia, 1557 Camden Drive, Gurnee, Illinois 60031, US  
DING, Hong, 7465 Clem Drive, Gurnee, Illinois 60031, US  
DOHERTY, George A., 1605 Bush Court, Libertyville, Illinois 60048, US  
ELMORE, Steven W., 239 Ash Lane, Northbrook, Illinois 60062, US  
HASVOLD, Lisa, 552 Shakespeare Drive, Grayslake, Illinois 60030, US  
HEXAMER, Laura, 439 Gatewood Lane, Grayslake, Illinois 60030, US  
KUNZER, Aaron, 615 W. Burr Oak Drive, Arlington Heights, Illinois 60004, US  
MANTEI, Robert A., 4203 Carolyn Court, Franklin, Wisconsin 53132, US  
McCLELLAN, William J., 1212 North Sheridan Road, Waukegan, Illinois 60085, US  
PARK, Chang H., 2871 North Southern Hills, Wadsworth, Illinois 60083, US  
PARK, Cheol-Min, 5312 F. George Court, Gurnee, Illinois 60031, US  
PETROS, Andrew M., 940 Ambria Drive, Mundelein, Illinois 60060, US  
SONG, Xiaohong, 34037 Sulkey Drive, Grayslake, Illinois 60030, US  
SOUERS, Andrew J., 901 Hinman Apt. 3A, Evanston, Illinois 60202, US  
SULLIVAN, Gerard M., 1212 Tulip Tree Court, Lake Villa, Illinois 60046, US  
TAO, Zhi-Fu, 1532 Vineyard Drive, Gurnee, Illinois 60031, US  
WANG, Gary T., 1904 Darnell Street, Libertyville, Illinois 60048, US  
WANG, Le, 338 East Colonial Drive, Vernon Hills, Illinois 60061, US  
WANG, Xilu, 34056 Sulkey Drive, Grayslake, Illinois 60030, US  
WENDT, Michael D., 1445 Maidstone Drive, Vernon Hills, Illinois 60061, US  
HANSEN, Todd M., 191 Seymour Avenue, Grayslake, Illinois 60030, US
- 
- (51) MKP  
*A61K 31/435 (2006.01)* (97) **2509597 \***  
*A61K 31/335 (2006.01)*  
*A61K 31/38 (2006.01)*
- (86) US2010059690 09.12.2010  
(96) 10836683.2 17.10.2012  
(87) WO2011072127, 09.12.2010  
(97) 2509597, 17.10.2012 en  
(54) SELECTIVE BETA-GLUCURONIDASE INHIBITORS AS A TREATMENT FOR SIDE EFFECTS OF CAMPTOTHECIN ANTINEOPLASTIC AGENTS  
(71) The University of North Carolina At Chapel Hill, 308 Bynum Hall, Campus Box 4105, Chapel Hill, NC 27599-4105, US  
Albert Einstein College Of Medecine Of Yeshiva University, 1300 Morris Park Avenue, Bronx, NY 10461, US  
North Carolina Central University, 1801 Fayetteville Street., Durham, NC 27707, US  
(72) REDINBO, Matthew, R., 312 Sunset Creek Circle, Durham NC 27516, US  
MANI, Sridhar, 1500 Johnson Avenue Apt. 8G, Riverdale NY 10463, US  
WILLIAMS, Alfred, 102 Few Circle, Durham, NC 27705, US  
YEH, Li-an, 315 Council Gap Court, Cary, NC 27513, US  
SCOTT, John, 8 Russet Court, Durham, NC 27712, US  
WALLACE, Bret, David, 75 Weaver Dairy Road, Unit B, Chapel Hill, NC 27514, US  
LANE, Kimberly, Terry, 470 Majestic Drive, Christiansburg, VA 24073, US
- 
- (51) MKP  
*C07D 498/04 (2006.01)* (97) **2523963 \***  
*A61K 31/519 (2006.01)*  
*A61P 9/00 (2006.01)*
- (86) EP2011050303 12.01.2011  
(96) 11700529.8 21.11.2012  
(87) WO2011086081, 12.01.2011  
(97) 2523963, 21.11.2012 de  
(54) 2,5-SUBSTITUTED OXAZOOPYRIMIDINE DERIVATIVES  
(71) SANOFI, 54, rue de la Boétie, 75008 Paris, FR  
KADEREIT, Dieter, Sanofi-Aventis Deutschland GmbH, 65926 Frankfurt am Main, DE  
SCHAEFER, Matthias, Sanofi-Aventis Deutschland GmbH, 65926 Frankfurt am Main, DE  
HACHTEL, Stephanie, Sanofi-Aventis Deutschland GmbH, 65926 Frankfurt am Main, DE  
DIETRICH, Axel, Sanofi-Aventis Deutschland GmbH, 65926 Frankfurt am Main, DE  
HUEBSCHLE, Thomas, Sanofi-Aventis Deutschland GmbH, 65926 Frankfurt am Main, DE  
HISS, Katrin, Sanofi-Aventis Deutschland GmbH, 65926 Frankfurt am Main, DE
- 
- (51) MKP  
*A61K 47/48 (2006.01)* (97) **2525829 \***
- (86) EP2011050820 21.01.2011  
(96) 11700672.6 28.11.2012  
(87) WO2011089215, 21.01.2011  
(97) 2525829, 28.11.2012 en  
(54) DIPEPTIDE-BASED PRODRUG LINKERS FOR AROMATIC AMINE-CONTAINING DRUGS  
(71) Ascendis Pharma A/S, Tuborg Boulevard 12, 2900 Hellerup, DK  
(72) VETTER, Dirk, Ludolf-Kehl-Strasse 18, 69120 Heidelberg, DE  
RAU, Harald, Talstrasse 41f, 69221 Dossenheim, DE
- 
- (51) MKP  
*E01F 15/08 (2006.01)* (97) **2513376 \***
- (86) AT2010000473 09.12.2010  
(96) 10807310.7 24.10.2012  
(87) WO2011079328, 09.12.2010  
(97) 2513376, 24.10.2012 de  
(54) ROAD ARRANGEMENT  
(71) Kirchdorfer Fertigteillholding GmbH, Feuerwerksanstalt, 2752 Wöllersdorf, AT  
(72) EDL, Thomas, Zehnergasse 20/D/8, A-2700 Wr. Neustadt, AT  
BARNAS, Alexander, Matthäusgasse 6/25, A-1030 Wien, AT  
SPITZER, Franz, Kirchauerstraße 7, A-2831 Warth, AT

(51) MKP  
**A61K 39/395 (2006.01)** (97) **2523689 \***  
 (86) US2011020678 10.01.2011  
 (96) 11733234.6 21.11.2012  
 (87) WO2011087986, 10.01.2011  
 (97) 2523689, 21.11.2012 en  
 (54) IL-22-FC AND HEPICIDIN ACTIVITY  
 (71) Amgen Inc., One Amgen Center Drive, Thousand Oaks, California 91320-1799, US  
 (72) MAXWELL, Joseph, R., 8846B Midvale Avenue N, Seattle Washington 98103, US  
 ROTTMAN, James, B., 63 Willis Lake Drive, Sudbury Massachusetts 01776, US  
 SMITH, Carole, 6000 17th Avenue SW 10, Seattle Washington 98106, US  
 COOKE, Keegan, 85 Parkhill Circle, Ventura California 93003, US  
 ARVEDSON, Tara, 764 Cranmont Court, Simi Valley California 93065, US  
 SASU, Barbra, 4102 E. Hillcrest Drive, Westlake Village California 91362, US

(51) MKP  
**A61K 39/00 (2006.01)** (97) **2519253 \***  
**A61K 39/395 (2006.01)**  
 (86) US2010061296 20.12.2010  
 (96) 10844218.7 07.11.2012  
 (87) WO2011090648, 20.12.2010  
 (97) 2519253, 07.11.2012 en  
 (54) INHIBITORS OF VASCULAR ENDOTHELIAL GROWTH FACTOR (VEGF) RECEPTORS AND METHODS OF USE THEREOF  
 (71) Yale University, Two Whitney Avenue, New Haven, CT 06511, US  
 (72) SCHLESSINGER, Joseph, 50 Rock Hill Road, Woodbridge, CT 06525, US  
 YANG, Yan, 39 Ives Street 209, Hamden, CT 06518, US

(51) MKP  
**F16K 15/20 (2006.01)** (97) **2522532 \***  
**B60C 23/00 (2006.01)**  
**B60C 23/10 (2006.01)**  
 (86) IB2011001086 20.05.2011  
 (96) 11738035.2 14.11.2012  
 (87) WO2012059800, 20.05.2011  
 (97) 2522532, 14.11.2012 en  
 (54) AN AUTONOMOUS VALVE ASSEMBLY FOR THE REGULATION, DEPRESSURISATION AND PRESSURISATION OF PNEUMATIC EQUIPMENT  
 (71) Colussi, Rafael Antonio, Ruta 11, Km 814 Guadalupe Norte, S3574XAB Santa Fe, AR  
 Vénica, Néstor Juan, Ruta 11, Km. 814 Guadalupe Norte, S3574XAB Santa Fe, AR  
 (72) Colussi, Rafael Antonio, Ruta 11, Km 814 Guadalupe Norte, S3574XAB Santa Fe, AR  
 Vénica, Néstor Juan, Ruta 11, Km. 814 Guadalupe Norte, S3574XAB Santa Fe, AR

(51) MKP  
**A61K 39/00 (2006.01)** (97) **2533805 \***  
 (86) US2011023526 03.02.2011  
 (96) 11742633.8 19.12.2012  
 (87) WO2011100151, 03.02.2011  
 (97) 2533805, 19.12.2012 en  
 (54) 15-VALENT PNEUMOCOCCAL POLYSACCHARIDE-PROTEIN CONJUGATE VACCINE COMPOSITION  
 (71) Merck Sharp & Dohme Corp., 126 East Lincoln Avenue, Rahway, NJ 07065-0907, US  
 (72) CAULFIELD, Michael, J., 711 Prospect Avenue, Ft. Washington Pennsylvania 19034, US  
 AHL, Patrick, L., 770 Sumneytown Pike, West Point Pennsylvania 19486, US  
 BLUE, Jeffrey, T., 770 Sumneytown Pike, West Point Pennsylvania 19486, US  
 CANNON, Jayme, L., 770 Sumneytown Pike, West Point Pennsylvania 19486, US

(51) MKP  
**A61K 31/427 (2006.01)** (97) **2536717 \***  
**C07D 417/06 (2006.01)**  
**A61K 31/4439 (2006.01)**  
**A61P 19/00 (2006.01)**  
**C07D 417/14 (2006.01)**  
 (86) US2011025004 16.02.2011  
 (96) 11706982.3 26.12.2012  
 (87) WO2011103134, 16.02.2011  
 (97) 2536717, 26.12.2012 en  
 (54) AMINOTHIAZOLONES AS ESTROGEN RELATED RECEPTOR-ALPHA MODULATORS  
 (71) Janssen Pharmaceutica, N.V., Turnhoutseweg 30, 2340 Beerse, BE  
 (72) BIGNAN, Gilles, Welsh&McKean Roads, Spring House, PA 19477, US  
 GAUL, Micheal, Welsh&McKean Roads, Spring House, PA 19477, US  
 XU, Guozhang, Welsh&McKean Roads, Spring House, PA 19477, US  
 ZHAO, Bao-Ping, Welsh&McKean Roads, Spring House, PA 19477, US

(51) MKP  
**A61F 2/00 (2006.01)** (97) **2512367 \***  
 (86) US2010059681 09.12.2010  
 (96) 10796532.9 24.10.2012  
 (87) WO2011084344, 09.12.2010  
 (97) 2512367, 24.10.2012 en  
 (54) BROW LIFT IMPLANT  
 (71) Ethicon. Inc., P.O. Box 151 Route 22, Somerville, NJ 08876, US  
 (72) KNIZE, David, 112 Mayhurst Avenue, Colorado Springs, CO 80906, US  
 KOYFMAN, Ilya, S., 5 Messenger Lane, Ringoes, NJ 08551, US  
 YUAN, Jenny, J., 8 Christie Way, Branchburg, NJ 08853, US  
 HILL, Donald, G., 499 Kenbury Road, Branchburg, NJ 08876, US  
 HOFFMAN, Michael, 25 Gallop Lane, Somerset, NJ 08873, US

(51) MKP  
**A01P 7/04 (2006.01)** (97) **2536280 \***  
**A01N 43/40 (2006.01)**  
**A01P 13/00 (2006.01)**  
 (86) US2011025140 17.02.2011  
 (96) 11706408.9 26.12.2012  
 (87) WO2011103225, 17.02.2011  
 (97) 2536280, 26.12.2012 en  
 (54) SYNERGISTIC HERBICIDE/INSECTICIDE COMPOSITION CONTAINING CERTAIN PYRIDINE CARBOXYLIC ACIDS AND CERTAIN INSECTICIDES  
 (71) Dow AgroSciences LLC, 9330 Zionsville Road, Indianapolis, IN 46268, US  
 (72) SATCHIVI, Norbert, 3100 Cherub Court, Westfield, IN 46074, US  
 SCHMITZER, Paul, 7960 North Whittier Place, Indianapolis, IN 46250, US

(51) MKP  
**A61K 39/08 (2006.01)** (97) **2501403 \***  
 (86) US2010056742 15.11.2010  
 (96) 10830870.1 26.09.2012  
 (87) WO2011060379, 15.11.2010  
 (97) 2501403, 26.09.2012 en  
 (54) (POLY)-GLYCEROLPHOSPHATE-BASED ANTI-GRAM POSITIVE BACTERIAL VACCINE  
 (71) The Henry M. Jackson Foundation for the Advancement of Military Medicine, Inc., 6720-A Rockledge Drive, Suite 100, Bethesda, MD 20817, US  
 (72) SNAPPER, Clifford M., 7904 Ivy Mount Terrace, Potomac, MD 20854, US  
 LEES, Andrew, 1910 Glen Ross Road, Silver Spring, MD 20910, US  
 MOND, James J., 527 Northwest Drive, Silver Spring, MD 20910, US  
 SCHWARTZ, David, 9853 Pacific Heights Blvd, Ste H., San Diego, CA 92121, US

- (51) MKP  
**A61K 9/28 (2006.01)** (97) **2509587 \***  
**A61K 9/50 (2006.01)**  
**A61K 9/48 (2006.01)**  
(86) US2010059228 07.12.2010  
(96) 10799155.6 17.10.2012  
(87) WO2011071877, 07.12.2010  
(97) 2509587, 17.10.2012 en  
(54) PARTIAL DIP COATING OF DOSAGE FORMS FOR MODIFIED RELEASE  
(71) McNeil-PPC, Inc., 199 Grandview Avenue, Skillman, NJ 08558, US  
(72) BAGCHI, Saumitra, 12 Kent Court, Princeton NJ 08540, US  
VUPPALA, Murali, 3309 Arcola Road, Collegeville PA 19426, US

- (51) MKP  
**A01N 43/16 (2006.01)** (97) **2523554 \***  
**A01P 13/00 (2006.01)**  
(86) GB2010002268 10.12.2010  
(96) 10795440.6 21.11.2012  
(87) WO2011073615, 10.12.2010  
(97) 2523554, 21.11.2012 en  
(54) HERBICIDAL COMPOSITION COMPRISING A PYRANIDONE HERBICIDE AND A CO-HERBICIDE  
(71) Syngenta Limited, European Regional Centre Priestley Road Surrey Research Park, Guildford, Surrey GU2 7YH, GB  
(72) CORBIN, Jane, Elisabeth, c/o Syngenta Limited Jealotts Hill International Research Centre, Bracknell Berkshire RG42 6YA, GB  
MATHEWS, Christopher, John, c/o Syngenta Limited Jealotts Hill International Research Centre, Bracknell Berkshire RG42 6YA, GB  
MITCHELL, Glynn, c/o Syngenta Limited Jealotts Hill International Research Centre, Bracknell Berkshire RG42 6YA, GB  
SCREPANTI, Claudio, c/o Syngenta Limited Jealotts Hill International Research Centre, Bracknell Berkshire RG42 6YA, GB

- (51) MKP  
**B65D 81/34 (2006.01)** (97) **2484604**  
**B65D 81/32 (2006.01)**  
(96) 11187061.4 08.08.2012  
(97) 2484604, 08.08.2012 en  
(54) Package for the preservation and cooking of food products and method of its use  
(71) Pastificio Rana S.p.A., Via Pacinotti 25, 37057 San Giovanni Lupatoto (Verona), IT  
(72) Rana, Gianluca, Via Pacinotti 25, 37057 San Giovanni Lupatoto (Verona), IT

- (51) MKP  
**A61K 31/7076 (2006.01)** (97) **2523669 \***  
**A61P 27/02 (2006.01)**  
**A61K 31/5575 (2006.01)**  
(86) US2011020808 11.01.2011  
(96) 11732309.7 21.11.2012  
(87) WO2011085361, 11.01.2011  
(97) 2523669, 21.11.2012 en  
(54) COMBINATION, KIT AND METHOD OF REDUCING INTRAOCULAR PRESSURE  
(71) Inotek Pharmaceuticals Corporation, 131 Hartwell Avenue 1st Floor, Suite 105, Lexington, MA 02421, US  
(72) KIM, Norman, N., 2 Honeysuckle Road, Westford MA 01886, US  
MCVICAR, William, K., 31 Powers Road, Sudbury MA 01776, US  
MCCAULEY, Thomas, 85 Gore Street, Cambridge MA 02141, US  
BAUMGARTNER, Rudolf, A., 22 Munnings Drive, Sudbury MA 01776-1221, US

- (51) MKP  
**C07D 213/63 (2006.01)** (97) **2509949 \***  
**A61K 31/4439 (2006.01)**  
**A61K 31/4412 (2006.01)**  
**A61P 31/18 (2006.01)**  
**C07D 401/12 (2006.01)**  
(86) US2010059183 07.12.2010  
(96) 10836497.7 17.10.2012  
(87) WO2011071849, 07.12.2010  
(97) 2509949, 17.10.2012 en  
(54) PYRIDINONE HYDROXYCYCLOPENTYL CARBOXAMIDES: HIV INTEGRASE INHIBITORS WITH THERAPEUTIC APPLICATIONS  
(71) University Of Georgia Research Foundation, Inc., 629 Boyd Graduate Studies Research Center 200 D.W. Brooks Dr., Athens, GA 30602-7411, US  
(72) NAIR, Vasu, 1021 Knob Creek Drive, Athens GA 30606, US  
OKELLO, Maurice, O., 105 Royal Road Apt. 135, Athens GA 30605, US  
NISHONOV, Abdumalik, A., 3237 Redstone Road, Boulder CO 30305, US  
MISHRA, Sanjaykumar, 2091 South Milledge Ave. Apt. C-59, Athens, GA 30605, US

- (51) MKP  
**A61K 38/17 (2006.01)** (97) **2515928 \***  
**A61P 3/10 (2006.01)**  
**A61K 38/26 (2006.01)**  
**C07K 14/605 (2006.01)**  
**A61P 3/04 (2006.01)**  
(86) US2010060390 15.12.2010  
(96) 10801033.1 31.10.2012  
(87) WO2011087672, 15.12.2010  
(97) 2515928, 31.10.2012 en  
(54) OXYNTOMODULIN PEPTIDE ANALOGUE  
(71) Eli Lilly and Company, Lilly Corporate Center, Indianapolis, IN 46285, US  
(72) ALSINA-FERNANDEZ, Jorge, Eli Lilly And Company Lilly Corporate Center, Indianapolis, IN 46285, US  
KOHN, Wayne, David, Eli Lilly And Company Lilly Corporate Center, Indianapolis, IN 46285, US

- (51) MKP  
**C07D 471/04 (2006.01)** (97) **2536723 \***  
**A61P 35/00 (2006.01)**  
**A61K 31/4162 (2006.01)**  
(86) IB2011050667 17.02.2011  
(96) 11709807.9 26.12.2012  
(87) WO2011101804, 17.02.2011  
(97) 2536723, 26.12.2012 en  
(54) PYRAZOLO PIPERIDINE DERIVATIVES AS NADPH OXIDASE INHIBITORS  
(71) GenKyoTex SA, Chemin des Aulx 16, 1228 Plan-les-Ouates, CH  
(72) PAGE, Patrick, Naxos Les Cyclades 1 Avenue de Genève, F-74160 Saint-Julien-en-genevois, FR  
LALEU, Benoît, 519 route du poirier à l'âne, F-74160 Collonges-sous-saleve, FR  
GAGGINI, Francesca, Rue des Pecheries 14, CH-1205 Geneva, CH  
ORCHARD, Mike, 34 Spring Lane Watlington, Oxon OX 495QN, GB

- (51) MKP  
**A61K 9/127 (2006.01)** (97) **2512487 \***  
**A61K 31/56 (2006.01)**  
**A61K 31/573 (2006.01)**  
**A61K 47/48 (2006.01)**  
**A61K 47/30 (2006.01)**  
**A61K 9/22 (2006.01)**  
(86) US2010060570 15.12.2010  
(96) 10842556.2 24.10.2012  
(87) WO2011084518, 15.12.2010  
(97) 2512487, 24.10.2012 en  
(54) THERAPEUTIC POLYMERIC NANOPARTICLES COMPRISING CORTICOSTEROIDS AND METHODS OF MAKING AND USING SAME  
(71) Bind Biosciences, Inc., 64 Sidney Street, Cambridge, MA 02139, US  
(72) SABNIS, Abhimanyu, 48 Brooks Avenue, Arlington MA 02474, US  
TROIANO, Greg, 38 Lily's Way, Pembroke MA 02359, US

(51) MKP  
**A01N 43/90 (2006.01)** (97) **2528435 \***  
**A01P 13/00 (2006.01)**  
**A01N 33/22 (2006.01)**  
(86) US2011022686 27.01.2011  
(96) 11702117.0 05.12.2012  
(87) WO2011094386, 27.01.2011  
(97) 2528435, 05.12.2012 en  
(54) SYNERGISTIC HERBICIDAL COMPOSITION CONTAINING PENOXSULAM AND OXYFLUORFEN  
(71) Dow AgroSciences LLC, 9330 Zionsville Road, Indianapolis, IN 46268, US  
(72) JOUSSEAUME, Christian, CL/Sant Joaquim 9E, Vilanova I La Geltru, ES  
CARRASCO CAMPOS, Salvador, Avda. de la Filosofia nº 7, entrance 9, 2º B, Mairena Del Aljarafe, ES  
MANN, Richard, 1828 South 550 East, Franklin, IN 46131, US  
SORRIBAS AMELA, Monica, 949 Junction Place, Indianapolis, IN 46220, US

(51) MKP  
**A01H 5/00 (2006.01)** (97) **2536266 \***  
**C12N 5/10 (2006.01)**  
**A01P 7/04 (2006.01)**  
**C07H 21/04 (2006.01)**  
**C07K 14/00 (2006.01)**  
**A01H 1/00 (2006.01)**  
**C12N 15/63 (2006.01)**  
**C12P 21/00 (2006.01)**  
**A01N 37/18 (2006.01)**  
**A01H 5/10 (2006.01)**  
**C12N 1/21 (2006.01)**  
**C12N 15/82 (2006.01)**  
(86) US2011025171 17.02.2011  
(96) 11730105.1 26.12.2012  
(87) WO2011103247, 17.02.2011  
(97) 2536266, 26.12.2012 en  
(54) AXMI218, AXMI219, AXMI220, AXMI226, AXMI227, AXMI228, AXMI229, AXMI230, AND AXMI231 DELTA-ENDOTOXIN GENES AND METHODS FOR THEIR USE  
(71) Athenix Corp., 3500 Paramount Parkway, Morrisville, NC 27560, US  
(72) SAMPSON, Kimberly, S., 5505 Frenchman's Creek Dr., Durham, NC 27713, US  
TOMSO, Daniel, John, 114 Vista Del Rio Dr., Bahama, NC 27503, US

(51) MKP  
**A61K 9/20 (2006.01)** (97) **2441446**  
**A61K 31/215 (2006.01)**  
(86) 10013659.7 18.04.2012  
(97) 2441446, 18.04.2012 en  
(54) Using of superdisintegrants in cetyl myristate and/or cetyl palmitate formulations  
(71) Deva Holding Anonim Sirketi, Patent Law Department Halkali Merkez Mah. Basın Ekspres Cad. No: 1,34303, Kucukcekmece/Istanbul, TR  
(72) Haas, Philipp Daniel, Deva Holding Anonim Sirketi Patent Law Department Halkali Merkez Mah. Basın Ekspres Cad. No: 1,34303, Kucukcekmece/Istanbul, TR  
Firat, Omer Faruk, Deva Holding Anonim Sirketi Patent Law Department Halkali Merkez Mah. Basın Ekspres Cad. No: 1,34303, Kucukcekmece/Istanbul, TR  
Kandemir, Levent, Deva Holding Anonim Sirketi Patent Law Department Halkali Merkez Mah. Basın Ekspres Cad. No: 1,34303, Kucukcekmece/Istanbul, TR  
Ozbek, Mahmut, Deva Holding Anonim Sirketi Patent Law Department Halkali Merkez Mah. Basın Ekspres Cad. No: 1,34303, Kucukcekmece/Istanbul, TR  
Koc, Fikret, Deva Holding Anonim Sirketi Patent Law Department Halkali Merkez Mah. Basın Ekspres Cad. No: 1,34303, Kucukcekmece/Istanbul, TR

(51) MKP  
**G07F 17/32 (2006.01)** (97) **2420981**  
(86) 11176247.2 22.02.2012  
(97) 2420981, 22.02.2012 en  
(54) Certification method of a website for gambling  
(71) Squassi, Giovanni, Via Melegnano, 18, 20060 Colturano Fraz. di Balbiano (MI), IT  
(72) Squassi, Giovanni, Via Melegnano, 18, 20060 Colturano Fraz. di Balbiano (MI), IT

(51) MKP  
**A61K 39/00 (2006.01)** (97) **2523681 \***  
**C12N 15/861 (2006.01)**  
**C07K 14/475 (2006.01)**  
**C12N 7/02 (2006.01)**  
(86) IB2011050137 12.01.2011  
(96) 11706326.3 21.11.2012  
(87) WO2011086509, 12.01.2011  
(97) 2523681, 21.11.2012 en  
(54) METHODS OF PRODUCING ADENOVIRUS VECTORS AND VIRAL PREPARATIONS GENERATED THEREBY  
(71) Vascular Biogenics Ltd., 6 Yoni Netanyahu Street, 60376 Or Yehuda, IL  
(72) BANGIO, Livnat, 1 Daniel Lifshitz Street, 49776 Petach-Tikva, IL  
SHER, Naamit, 3 Paldi Street, 76248 Rechovot, IL  
BREITBART, Eyal, 27 HaYitzhar Street, 73127 Hashmonaim, IL

(51) MKP  
**H02P 29/02 (2006.01)** (97) **2530828**  
**H02P 9/10 (2006.01)**  
**H02P 9/00 (2006.01)**  
(86) 12168599.4 05.12.2012  
(97) 2530828, 05.12.2012 en  
(54) Electricity generation device and permanent-magnet electric generator  
(71) IHI Aerospace Co., Ltd., 1-1, Toyosu 3-chome., Koto-Ku, Tokyo 135-0061, JP  
Sinfonia Technology Co., Ltd., 1-30, Shiba-daimon 1-chome., Minato-ku, Tokyo 105-8564, JP  
(72) Oyori, Hitoshi, c/o IHI AEROSPACE CO., LTD. 1-1, Toyosu 3-chome, Koto-ku., Tokyo, Tokyo 135-0061, JP  
Shimomura, Yukio, c/o SINFONIA TECHNOLOGY CO., LTD. 1-30, Shiba-daimon 1-chome, Minato-ku, Tokyo, Tokyo 105-8564, JP

(51) MKP  
**G02B 5/28 (2006.01)** (97) **2521930 \***  
**G02B 6/293 (2006.01)**  
(86) US2011020438 07.01.2011  
(96) 11700380.6 14.11.2012  
(87) WO2011085144, 07.01.2011  
(97) 2521930, 14.11.2012 en  
(54) TUNABLE THIN-FILM FILTER  
(71) Semrock, Inc., 3625 Buffalo Road, Rochester, NY 14624, US  
WANG, Ligang, 9 Splendor Wood Drive, Penfield NY 14526, US  
ERDOGAN, Turan, 11 Deerborne Lane, Spencerport NY 14559, US

(51) MKP  
**F24D 3/12 (2006.01)** (97) **2532977 \***  
**E04F 15/00 (2006.01)**  
(86) KR2011000619 28.01.2011  
(96) 11739975.8 12.12.2012  
(87) WO2011096679, 28.01.2011  
(97) 2532977, 12.12.2012 en  
(54) HEATING STRUCTURE  
(71) Lee, Sang Won, Jugong Apt. 106-1404 Sanggye 6.7-dong Nowon-gu, Seoul 139-207, KR  
(72) Lee, Sang Won, Jugong Apt. 106-1404 Sanggye 6.7-dong Nowon-gu, Seoul 139-207, KR

(51) MKP  
**C04B 14/02 (2006.01)** (97) **2533976 \***  
**B32B 13/00 (2006.01)**  
**C04B 28/14 (2006.01)**  
**E04C 2/04 (2006.01)**  
(86) EP2011051801 08.02.2011  
(96) 11702251.7 19.12.2012  
(87) WO2011095634, 08.02.2011  
(97) 2533976, 19.12.2012 de  
(54) GYPSUM PLASTER BOARD AND A METHOD FOR PRODUCING A GYPSUM PLASTER BOARD  
(71) Knauf Gips KG, Am Bahnhof 7, 97346 Iphofen, DE  
(72) HUMMEL, Hans-Ulrich, Am Hündlein 54, 97346 Iphofen, DE  
SCHELLER, Lothar, Ägidienstrasse 7, 97346 Iphofen, DE  
STICH, Dietmar, Hüttenheim 196, 97348 Willanzheim, DE

- (51) MKP  
**A01N 43/58 (2006.01)** (97) **2506716 \***  
 (86) US2010058572 01.12.2010  
 (96) 10835061.2 10.10.2012  
 (87) WO2011068881, 01.12.2010  
 (97) 2506716, 10.10.2012 en  
 (54) NOVEL TRICYCLIC COMPOUNDS  
 (71) Abbott Laboratories, 100 Abbott Park Rd., Abbott Park, IL 60064, US  
 (72) WISHART, Neil, 406 Sterling Road, Jefferson Massachusetts 01522, US  
 ARGIRIADI, Maria, A., 273 Main Street, Wayland Massachusetts 01778, US  
 CALDERWOOD, David, J., 4 McCarthy Circle, Framingham MA 01702, US  
 ERICSSON, Anna, M., 16 Venus Drive, Shrewsbury MA 01545, US  
 FIAMENGO, Bryan, A., 1029 Pleasant Street Apt., Worcester Massachusetts 01602, US  
 FRANK, Kristine, E., 8 Pinewood Lane, Worcester MA 01609, US  
 FRIEDMAN, Michael, 27 Mechanic Street, Newton Massachusetts 02464, US  
 GEORGE, Dawn, M., 9 Pond Lane, Charlton MA 01507, US  
 GOEDKEN, Eric, R., 105 Hillcroft Avenue, Worcester Massachusetts 01606, US  
 JOSEPHSOHN, Nathan, S., 217 West Springfield No. 4, Boston Massachusetts 02118, US  
 LI, Biqin, C., 14 Joslin Lane, Southborough Massachusetts 01722, US  
 MORYTKO, Michael, J., 1296 Worcester Road No. 2510, Framingham Massachusetts 01701, US  
 STEWART, Kent, D., 4715 Kings Way N., Gurnee Illinois 60031, US  
 VOSS, Jeffrey, W., 257 Shrewsbury Street, Holden Massachusetts 01520, US  
 WALLACE, Grier, A., 204 Chace Hill Road, Sterling MA 01564, US  
 WANG, Lu, 14 Stratton Way, Northborough MA 01532, US  
 WOLLER, Kevin, R., 1072 Joy Court, Anitoch Illinois 60002, US

- (51) MKP  
**A61K 38/28 (2006.01)** (97) **2387989**  
**A61K 9/08 (2006.01)**  
**A61K 9/00 (2006.01)**  
 (96) 11166415.7 23.11.2011  
 (97) 2387989, 23.11.2011 en  
 (54) Long - acting formulations of insulins  
 (71) SANOFI, 54 rue La Boétie, 75008 Paris, FR  
 (72) Becker, Reinhard, Dr., c/o Sanofi-Aventis Deutschland GmbH, 65926 Frankfurt am Main, DE  
 Hahn, Anne, Dr., c/o Sanofi-Aventis Deutschland GmbH, 65926 Frankfurt am Main, DE  
 Boderke, Peter, Dr., Bockenheimer Strasse 3, 65824 Schwalbach, DE  
 Fuerst, Christiane, Dr., c/o Sanofi-Aventis Deutschland GmbH, 65926 Frankfurt am Main, DE  
 Mueller, Werner, Dr., c/o Sanofi-Aventis Deutschland GmbH, 65926 Frankfurt am Main, DE  
 Tertsch, Katrin, Dr., c/o Sanofi-Aventis Deutschland GmbH, 65926 Frankfurt am Main, DE  
 Werner, Ulrich, Dr., c/o Sanofi-Aventis Deutschland GmbH, 65926 Frankfurt am Main, DE  
 Loos, Petra, Dr., c/o Sanofi-Aventis Deutschland GmbH, 65926 Frankfurt am Main, DE

- (51) MKP  
**A61K 31/439 (2006.01)** (97) **2525796 \***  
**A61P 35/00 (2006.01)**  
**A61P 9/00 (2006.01)**  
**A61K 31/444 (2006.01)**  
**A61K 9/08 (2006.01)**  
**A61K 31/522 (2006.01)**  
**A61K 31/496 (2006.01)**  
**A61K 31/519 (2006.01)**  
**A61K 31/5377 (2006.01)**  
 (86) EP2011050854 21.01.2011  
 (96) 11701392.0 28.11.2012  
 (87) WO2011089234, 21.01.2011  
 (97) 2525796, 28.11.2012 en  
 (54) AQUEOUS SOLUTION COMPRISING 3-QUINUCLIDINONES FOR THE TREATMENT OF HYPERPROLIFERATIVE, AUTOIMMUNE AND HEART DISEASE  
 (71) APREA AB, Nobels väg 3, 171 65 Solna, SE  
 (72) BYSTRÖM, Styrbjörn, Hedäs vägen 1, S-187 36 Täby, SE  
 LILJEBRIS, Charlotta, Torpkällvägen 33, S-741 96 Knivsta, SE  
 CARAM-LELHAM, Ninus, Tiundagatan 61, S-752 30 Uppsala, SE

- (51) MKP  
**A61B 17/32 (2006.01)** (97) **2533709 \***  
**A61B 17/3207 (2006.01)**  
**A61B 10/02 (2006.01)**  
 (86) US2011024201 09.02.2011  
 (96) 11705106.0 19.12.2012  
 (87) WO2011100332, 09.02.2011  
 (97) 2533709, 19.12.2012 en  
 (54) ULTRASONIC SURGICAL INSTRUMENTS WITH PARTIALLY ROTATING BLADE AND FIXED PAD ARRANGEMENT  
 (71) Ethicon Endo-Surgery, Inc., 4545 Creek Road, Cincinnati, OH 45242, US  
 (72) ROBERTSON, Galen, C., 5752 Doerger Lane, Cincinnati, OH 45212, US  
 TIMM, Richard, W., 3405 Monteith Avenue 1, Cincinnati, OH 45208, US  
 DAVIS, Craig, T., 3724 Morris Place, Cincinnati, OH 45226, US  
 MUMAW, Daniel, J., 953 Long Lane, Milford, OH 45150, US  
 MORGAN, Jerome, R., 3275 S. Whitetree Circle, Cincinnati, OH 45236, US  
 MILLER, Matthew, C., 3524 Zumstein Avenue, Cincinnati, OH 45208, US  
 DANNAHER, William, D., 8907 Eldora Drive, Cincinnati, OH 45236, US

- (51) MKP  
**C07H 21/02 (2006.01)** (97) **2521777 \***  
**C12N 15/00 (2006.01)**  
 (86) IL2011000009 05.01.2011  
 (96) 11731735.4 14.11.2012  
 (87) WO2011083466, 05.01.2011  
 (97) 2521777, 14.11.2012 en  
 (54) COMPOSITIONS AND METHODS FOR TREATING GLOBLASTOMA GBM  
 (71) Vascular Biogenics Ltd., 6 Yoni Netanyahu Street, 60376 Or Yehuda, IL  
 (72) COHEN, Yael, 100 Stern Street, 55602 Kiryat-Ono, IL  
 BANGIO, Livnat, 1 Daniel Lifshitz Street, 49776 Petach-Tikva, IL  
 BRENNER, Andrew J., 8355 Settlers Peak, Boerne Texas 78015, US  
 BREITBART, Eyal, 27 HaYitzhar Street, 73127 Hashmonaim, IL



(51) MKP  
**C12P 17/18 (2006.01)** (97) **2530164 \***  
**C12N 1/21 (2006.01)**  
**C12N 1/15 (2006.01)**  
**C12N 5/10 (2006.01)**  
**C12N 1/19 (2006.01)**  
**C12N 15/09 (2006.01)**  
(86) JP2011050851 19.01.2011  
(96) 11736899.3 05.12.2012  
(87) WO2011093185, 19.01.2011  
2530164, 05.12.2012 en  
(54) METHOD FOR MANUFACTURING A PYRIPYROPENE  
(71) Meiji Seika Pharma Co., Ltd., 4-16, Kyobashi 2-chome Chuo-ku, Tokyo 104-8002, JP  
(72) ANZAI Hiroyuki, c/o The Ibaraki University 3-21-1 Chuo Amimachi, Inashiki-gun Ibaraki 300-0393, JP  
YAMAMOTO Kentaro, c/o Meiji Seika Pharma Co, Ltd. 760 Morooka-cho Kohoku-ku, Yokohama-shi Kanagawa 222-8567, JP  
OYAMA Kazuhiko, c/o Meiji Seika Pharma Co, Ltd. 760 Morooka-cho Kohoku-ku, Yokohama-shi Kanagawa 222-8567, JP  
TSUCHIDA Mariko, c/o Meiji Seika Pharma Co, Ltd. 760 Morooka-cho Kohoku-ku, Yokohama-shi Kanagawa 222-8567, JP  
GOTO Kimihiko, c/o Meiji Seika Pharma Co, Ltd. 760 Morooka-cho Kohoku-ku, Yokohama-shi Kanagawa 222-8567, JP  
MITOMI Masaaki, c/o Meiji Seika Pharma Co, Ltd. 760 Morooka-cho Kohoku-ku, Yokohama-shi Kanagawa 222-8567, JP

(51) MKP  
**B01J 20/20 (2006.01)** (97) **2536498 \***  
**B01J 20/28 (2006.01)**  
**B01J 20/26 (2006.01)**  
(86) EP2011000269 24.01.2011  
(96) 11702786.2 26.12.2012  
(87) WO2011098211, 24.01.2011  
(97) 2536498, 26.12.2012 de  
(54) ADSORPTIVE STRUCTURES HAVING A PARTICLE AND/OR AEROSOL FILTER FUNCTION AND METHOD FOR PRODUCING SUCH ADSORPTIVE STRUCTURES  
(71) Blücher GmbH, Mettmanner Strasse 25, 40699 Erkrath, DE  
(72) HEINRICH, Peter, James-Krüß-Strasse 7, 47447 Moers, DE  
GUERRA-GONZÁLEZ, Omar, Worringer Strasse 82, 40211 Düsseldorf, DE  
ECKLE, Ilsebill, Ückendorfer Strasse 12, 45886 Gelsenkirchen, DE  
BUCHTA, Ellen, Inntalstrasse 9, 83026 Rosenheim, DE  
NIENTIEDT, Jürgen, Eichenweg 40A, 83109 Großkarolinenfeld, DE

(51) MKP  
**A61K 45/00 (2006.01)** (97) **2521569 \***  
(86) IL2011000010 05.01.2011  
(96) 11731736.2 14.11.2012  
(87) WO2011083467, 05.01.2011  
(97) 2521569, 14.11.2012 en  
(54) COMBINED TREATMENT UTILIZING VB-201  
(71) Vascular Biogenics Ltd., 6 Yoni Netanyahu Street, 60376 Or Yehuda, IL  
(72) COHEN, Yael, 100 Stern Street, 55602 Kiryat-Ono, IL  
YACOV, Niva, 22/15 Hadar Yosef Street, 69705 Tel-Aviv, IL  
BREITBART, Eyal, 27 HaYitzhar Street, 73127 Hashmonaim, IL

(51) MKP  
**E03F 5/12 (2006.01)** (97) **2536890 \***  
(86) IB2011050498 04.02.2011  
(96) 11709475.5 26.12.2012  
(87) WO2011101770, 04.02.2011  
(97) 2536890, 26.12.2012 en  
(54) A FILTERING DEVICE  
(71) Friulana Costruzioni S.r.l., Via Pedrada 16, 33074 Vigonovo di Fontanafredda (Pordenone), IT  
(72) DANELUZ, Antonio, Via Capovilla 8, I-33080 Prata di Pordenone (Pordenone), IT  
RIGO, Michele, Via Brigata Osoppo 85, I-33074 Vigonovo di Fontanafredda (Pordenone), IT

(51) MKP  
**E21B 7/04 (2006.01)** (97) **2447462**  
**E21B 7/20 (2006.01)**  
**E21B 7/30 (2006.01)**  
(96) 10014133.2 02.05.2012  
(97) 2447462, 02.05.2012 de  
(54) Method for subterranean insertion of a conduit  
(71) T.I.C. Technology Innovation Consulting AG, Rue du Wildhorn 6, 1972 Anzère, CH  
(72) John, Hans-Jürgen, Bours Park 5, 22587 Hamburg, DE

(51) MKP  
**H04L 12/26 (2006.01)** (97) **2507949 \***  
**H04L 12/56 (2006.01)**  
(86) EP2010068961 06.12.2010  
(96) 10795262.4 10.10.2012  
(87) WO2011067406, 06.12.2010  
(97) 2507949, 10.10.2012 en  
(54) AN APPARATUS, AN ASSEMBLY AND A METHOD OF OPERATING A PLURALITY OF ANALYZING MEANS READING AND ORDERING DATA PACKETS  
(71) Napatech A/S, Tobaksvejen 23A, 2860 Søborg, DK  
(72) AGERHOLM, Alex Omø, Fjortenskæppevej 6, DK-4000 Roskilde, DK  
CHRISTOPHERSEN, Jens, Klavs Nebs Vej 10C, DK-2830 Virum, DK

(51) MKP  
**E21B 7/02 (2006.01)** (97) **2489823**  
(96) 12153379.8 22.08.2012  
(97) 2489823, 22.08.2012 de  
(54) Device for splitting solid materials  
(71) Syfrig, Leo, Bürgenstockstrasse 9, 6373 Ennetbürgen, CH  
(72) Syfrig, Leo, Bürgenstockstrasse 9, 6373 Ennetbürgen, CH

(51) MKP  
**A61B 17/32 (2006.01)** (97) **2533711 \***  
(86) US2011024184 09.02.2011  
(96) 11705352.0 19.12.2012  
(87) WO2011100317, 09.02.2011  
(97) 2533711, 19.12.2012 en  
(54) METHODS OF USING ULTRASONICALLY POWERED SURGICAL INSTRUMENTS WITH ROTATABLE CUTTING IMPLEMENTS  
(71) Ethicon Endo-Surgery, Inc., 4545 Creek Road, Cincinnati, OH 45242, US  
(72) ROBERTSON, Galen, C., 5752 Doerger Lane, Cincinnati OH 45212, US  
TIMM, Richard, W., 3405 Monteith Avenue 1, Cincinnati OH 45208, US  
MUMAW, Daniel, J., 953 Long Lane, Milford OH 45150, US  
STULEN, Foster, B., 6245 Bridgewater Court, Mason OH 45040, US  
JOHNSON, Gregory, W., 907 Center Street, Milford OH 45150, US  
MORGAN, Jerome, R., 3275 S. Whitetree Circle, Cincinnati OH 45236, US  
HOUSER, Kevin, L., 570 Foliage Lane, Springboro OH 45066, US  
NEUROHR, Mark, A., 658 Nelson Place, Newport KY 41071, US  
MALAVIYA, Prasanna, 5860 Maxfli Lane, Mason OH 45040, US  
FORTSON, Reginald, D., 3404 Walworth Avenue, Cincinnati OH 45226, US  
CONLON, Sean, P., 6234 North Shadow Hill Way Apt. C, Loveland OH 45140, US  
DANNAHER, William, D., 8907 Eldora Drive, Cincinnati OH 45236, US  
WEINER, Eitan, T., 9519 Croton Drive, Cincinnati, OH 45242, US  
BODIN, Kristi, M., 7449 Kilkenny Drive, West Chester, OH 45069, US  
JOACHIM, William, S., Jr., 7398 Airy View Drive, Liberty Township, OH 45044, US

(51) MKP  
**F17C 13/00 (2006.01)** (97) **2508787**  
(96) 12162803.6 10.10.2012  
(97) 2508787, 10.10.2012 de  
(54) Identification system for compressed gas bottles  
(71) Messer GasPack GmbH, Gahlingspfad 31, 47803 Krefeld, DE  
(72) Kriese, Alexander, Braitnerstrasse 30, 2500 Baden bei Wien, AT

- (51) MKP  
**F17C 9/00 (2006.01)** (97) **2504614 \***  
**F17C 7/02 (2006.01)**  
**F17C 13/02 (2006.01)**  
(86) NO2010000375 21.10.2010  
(96) 10776838.4 03.10.2012  
(87) WO2011049466, 21.10.2010  
(97) 2504614, 03.10.2012 en  
(54) METHOD FOR THE OPERATION AND CONTROL OF GAS FILLING  
(71) Nel Hydrogen AS, P.O. Box 24, 3671 Notodden, NO  
(72) KITTILSEN, Pål, Dalhaugveien 46, N-7020 Trondheim, NO  
MIDTBØEN, Pål, Gjølmeåsen 35, N-3970 Langesund, NO  
FJALESTAD, Kjetil, Nedre Gyltemyr 45, N-3731 Skien, NO

- (51) MKP  
**A63H 33/10 (2006.01)** (97) **2514496 \***  
(86) KR2010009090 17.12.2010  
(96) 10837918.1 24.10.2012  
(87) WO2011074922, 17.12.2010  
(97) 2514496, 24.10.2012 en  
(54) COMPONENT FOR MAGNETIC ATTACHMENT AND A MAGNETIC TOY  
(71) Orda Korea Co., Ltd., Wooje B/D, 3F, 261-8 Yangjae-dog, Seocho-gu, Seoul 137-130, KR  
(72) PARK, Kyung Hwa, 810-5 Simgokbon-dong Sosa-gu, Bucheon Gyeonggi-do 422-240, KR

- (51) MKP  
**A01N 57/00 (2006.01)** (97) **2521454 \***  
(86) IL2011000008 05.01.2011  
(96) 11731734.7 14.11.2012  
(87) WO2011083465, 05.01.2011  
(97) 2521454, 14.11.2012 en  
(54) TREATMENT WITH VB-201  
(71) Vascular Biogenics Ltd., 6 Yoni Netanyahu Street, 60376 Or Yehuda, IL  
(72) COHEN, Yael, 100 Stern Street, 55602 Kiryat-Ono, IL  
SHER, Naamit, 3 Paldi Street, 76248 Rechovot, IL  
MENDEL, Itzhak, 20/7 Shpinoza Street, 76452 Rechovot, IL  
YACOV, Niva, 22/15 Hadar Yosef Street, 69705 Tel-Aviv, IL  
BREITBART, Eyal, 27 HaYitzhar Street, 73127 Hashmonaim, IL

- (51) MKP  
**A22C 21/00 (2006.01)** (97) **2528446 \***  
(86) NL2011050042 25.01.2011  
(96) 11703275.5 05.12.2012  
(87) WO2011093698, 25.01.2011  
(97) 2528446, 05.12.2012 en  
(54) METHOD AND APPARATUS FOR REMOVING A SLEEVE OF MEAT FROM AN ANIMAL PART HAVING A BONE WITH KNUCKLES ON EACH OF ITS OPPOSITE ENDS  
(71) Foodmate B.V., Röntgenstraat 18, 3261 LK Oud-Beijerland, NL  
(72) STOOKER, Dirk Cornelis, Röntgenstraat 18, NL-3261 LK Oud-Beijerland, NL

- (51) MKP  
**C12N 15/62 (2006.01)** (97) **2536748 \***  
**C07K 14/475 (2006.01)**  
**A61K 39/395 (2006.01)**  
**C12N 15/113 (2010.01)**  
**A61P 35/00 (2006.01)**  
**C07K 14/71 (2006.01)**  
**A61K 31/7088 (2006.01)**  
**A61K 38/17 (2006.01)**  
(86) US2011025163 17.02.2011  
(96) 11706690.2 26.12.2012  
(87) WO2011103242, 17.02.2011  
(97) 2536748, 26.12.2012 en  
(54) NEUREGULIN ANTAGONISTS AND USE THEREOF IN TREATING CANCER  
(71) Genentech, Inc., 1 DNA Way, South San Francisco, CA 94080-4490, US  
The Board of Trustees of the Leland Stanford Junior University, 1705 El Camino Real, Palo Alto CA 94306-1106, US  
(72) JACKSON, Erica, c/o Genentech Inc. 1 DNA Way, South San Francisco California 94080, US  
SWEET-CORDERO, Eric, Alejandro, 1411 Church Street, San Francisco California 94131, US

- (51) MKP  
**F28C 3/06 (2006.01)** (97) **2507570 \***  
**F28B 3/06 (2006.01)**  
(86) HU2010000133 30.11.2010  
(96) 10809326.1 10.10.2012  
(87) WO2011064610, 30.11.2010  
(97) 2507570, 10.10.2012 en  
(54) METHOD AND APPARATUS FOR HANDLING GASES  
(71) Szentiványi, Péter, Óthalom u. 9., 6724 Szeged, HU  
(72) Szentiványi, Péter, Óthalom u. 9., 6724 Szeged, HU

- (51) MKP  
**A61G 7/10 (2006.01)** (97) **2501887 \***  
**E06B 3/46 (2006.01)**  
(86) IB2010002926 15.11.2010  
(96) 10787890.2 26.09.2012  
(87) WO2011061597, 15.11.2010  
(97) 2501887, 26.09.2012 en  
(54) COUNTERFRAME FOR RETRACTABLE SLIDING-DOOR WITH RAIL SUPPORTING TECHNICAL TRAVERSE IN ROOMS PROVIDED WITH INTER-ROOM CEILING GUIDING SYSTEMS TO MOVE DISABLED PERSONS  
(71) ECLISSE SRL, Via Sernaglia, 76, 31053 Pieve di Soligo TV, IT  
(72) DE FAVERI, Luigi, Via Vittoria 114, I-31020 Refrontolo (TV), IT

- (51) MKP  
**C12N 15/82 (2006.01)** (97) **2513316 \***  
(86) US2010060828 16.12.2010  
(96) 10842618.0 24.10.2012  
(87) WO2011084629, 16.12.2010  
(97) 2513316, 24.10.2012 en  
(54) USE OF CRY1DA IN COMBINATION WITH CRY1CA FOR MANAGEMENT OF RESISTANT INSECTS  
(71) Dow AgroSciences, LLC, 9330 Zionsville Road, Indianapolis, Indiana 46268, US  
(72) MEADE, Thomas, 1141 Huntington Woods Pt., Zionsville IN 46077, US  
NARVA, Kenneth, 4372 Creekside Pass, Zionsville IN 46077, US  
STORER, Nicholas, P., 10703 Lexington Street, Kensington MD 20895, US  
SHEETS, Joel, J., 10005 Oak Ridge Drive, Zionsville IN 46077, US  
WOOSLEY, Aaron, T., 8906 Tanner Drive, Fishers IN 46038, US  
BURTON, Stephanie, L., 6820 Bluffgrove Drive, Indianapolis IN 46278, US

- (51) MKP  
**A61B 17/32 (2006.01)** (97) **2533710 \***  
**A61B 17/3207 (2006.01)**  
(86) US2011024205 09.02.2011  
(96) 11705107.8 19.12.2012  
(87) WO2011100335, 09.02.2011  
(97) 2533710, 19.12.2012 en  
(54) DUAL PURPOSE SURGICAL INSTRUMENT FOR CUTTING AND COAGULATING TISSUE  
(71) Ethicon Endo-Surgery, Inc., 4545 Creek Road, Cincinnati, OH 45242, US  
(72) ROBERTSON, Galen, C., 5752 Doerger Lane, Cincinnati, OH 45212, US  
TIMM, Richard, W., 3405 Monteith Avenue 1, Cincinnati, OH 45208, US  
HOUSER, Kevin, L., 570 Foliage Lane, Springboro, OH 45066, US  
CONLON, Sean, P., 6234 North Shadow Hill Way Apt. C, Loveland, OH 45140, US  
ZINGMAN, Aron, O., 2333 Salutaris Avenue 4, Cincinnati, OH 45206, US

(51) MKP  
**G01N 25/48 (2006.01)** (97) **2504690 \***  
**G01N 21/65 (2006.01)**  
**G01J 3/44 (2006.01)**  
(86) US2010003038 24.11.2010  
(96) 10788426.4 03.10.2012  
(87) WO2011065970, 24.11.2010  
(97) 2504690, 03.10.2012 en  
(54) ANALYTICAL SYSTEM AND METHOD WITH COMBINED DIFFERENTIAL SCANNING CALORIMETRY (DSC) AND RAMAN SPECTROSCOPY  
(71) PerkinElmer Health Sciences, Inc., 940 Winter Street, Waltham, MA 02451, US  
PerkinElmer Ltd., Chalfont Road Seer Green Beaconsfield, Buckinghamshire HP9 2FX, GB  
(72) MENARD, Kevin, Peter, 2024 Pembroke Place, Denton TX 76205, US  
DIZ, Enrique, Lozano, Chalfont Road, Seer Green Beaconsfield Bucks, GB  
SPRAGG, Richard, 20 Amersham Hill Gardens, High Wycombe Bucks HP 13 6QR, GB

(51) MKP  
**A61K 31/33 (2006.01)** (97) **2519235 \***  
(86) US2010062432 29.12.2010  
(96) 10844293.0 07.11.2012  
(87) WO2011090760, 29.12.2010  
(97) 2519235, 07.11.2012 en  
(54) HETEROARYL COMPOUNDS AND USES THEREOF  
(71) Avila Therapeutics, Inc., 100 Beaver Street, First Floor, Waltham, MA 02453-8425, US  
(72) SINGH, Juswinder, 94 Heritage Avenue, Ashland MA 01721, US  
PETTER, Russell, 22 Robinwood Lane, Stow MA 01775, US  
TESTER, Richland, Wayne, 23 Gregoire Drive, Marlborough MA 01752, US  
KLUGE, Arthur, F., 111 Old Country Road, Lincoln MA 01773, US  
MAZDIYASNI, Hormoz, 27 Bouffard Drive, Marlborough MA 01752, US  
WESTLIN, III, William, Frederick, 130 Barteau Lane, Boxborough MA 01719, US  
NIU, Deqiang, 30 Grapevine Avenue, Lexington MA 02141, US  
QIAO, Lixin, 49 Blanchard Street, Andover MA 01810, US

(51) MKP  
**C09K 8/60 (2006.01)** (97) **2510080 \***  
**C11D 3/20 (2006.01)**  
(86) US2010058729 02.12.2010  
(96) 10836443.1 17.10.2012  
(87) WO2011071747, 02.12.2010  
(97) 2510080, 17.10.2012 en  
(54) LOW INTERFACIAL TENSION SURFACTANTS FOR PETROLEUM APPLICATIONS  
(71) Soane Energy, LLC, 35 Spinelli Place, Cambridge, MA 02138, US  
(72) SOANE, David, 9 Lawrence Road, Chestnut Hill MA 02467, US  
PORTILLA, Rosa Casado, 4231 Avalon Drive, Peabody MA 01960, US  
DISE, John, H., 402 4TH Avenue 402, Kirkland WA 98033, US  
MAHONEY, Robert, P., 2 Austin Lane, Newbury MA 01922, US

(51) MKP  
**A01N 3/02 (2006.01)** (97) **2512232 \***  
**A01N 25/10 (2006.01)**  
**A01N 3/00 (2006.01)**  
(86) US2010060067 13.12.2010  
(96) 10795543.7 24.10.2012  
(87) WO2011081877, 13.12.2010  
(97) 2512232, 24.10.2012 en  
(54) MATURATION OR RIPENING INHIBITOR RELEASE FROM POLYMER, FIBER, FILM, SHEET OR PACKAGING  
(71) Cellresin Technologies, LLC, 4567 American Boulevard West, Minneapolis, MN 55437, US  
(72) WOOD, Willard E., 3470 Siems Court, Arden Hills Minnesota 55112, US  
BEAVERSON, Neil J., 417 Bear Avenue SO., Vadnais Heights Minnesota 55127, US  
KUDUK, William J., 2716 Hennepin Avenue South Apt. B1, Minneapolis Minnesota 55408, US

(51) MKP  
**C07D 417/14 (2006.01)** (97) **2504333 \***  
**A61K 31/427 (2006.01)**  
**A61P 25/00 (2006.01)**  
(86) EP2010068193 25.11.2010  
(96) 10782609.1 03.10.2012  
(87) WO2011064288, 25.11.2010  
(97) 2504333, 03.10.2012 en  
(54) MORPHOLINOTHIAZOLES AS ALPHA 7 POSITIVE ALLOSTERIC MODULATORS  
(71) Janssen Pharmaceutica N.V., Turnhoutseweg 30, 2340 Beerse, BE  
(72) MACDONALD, Gregor, James, c/o Janssen Pharmaceutica NV Turnhoutseweg 30, B-2340 Beerse, BE  
DE BOECK, Benoît, Christian, Albert, Ghislain, c/o Janssen Pharmaceutica NV Turnhoutseweg 30, B-2340 Beerse, BE  
LEENAERTS, Joseph, Elisabeth, c/o Janssen Pharmaceutica NV Turnhoutseweg 30, B-2340 Beerse, BE

(51) MKP  
**C07D 413/14 (2006.01)** (97) **2516419 \***  
**C07D 498/14 (2006.01)**  
**C07D 401/14 (2006.01)**  
**C07D 405/14 (2006.01)**  
**C07D 409/14 (2006.01)**  
**A61P 29/00 (2006.01)**  
**A61K 31/454 (2006.01)**  
(86) US2010061461 21.12.2010  
(96) 10798928.7 31.10.2012  
(87) WO2011079102, 21.12.2010  
(97) 2516419, 31.10.2012 en  
(54) INDOLYL-PIPERIDINYL BENZYLAMINES AS BETA-TRYPTASE INHIBITORS  
(71) SANOFI, 54, rue de la Boétie, 75008 Paris, FR  
(72) CHOI-SLEDESKI, Yong Mi, c/o Sanofi-aventis U.S. 1041 Route 202-206 Mail Code: BWD-303A, Bridgewater, New Jersey 08807, US  
LIANG, Guyan, c/o Sanofi-aventis U.S. 1041 Route 202-206 Mail Code: BWD-303A, Bridgewater, New Jersey 08807, US  
NIEDUZAK, Thaddeus R., c/o Sanofi-aventis U.S. 1041 Route 202-206 Mail Code: BWD-303A, Bridgewater, New Jersey 08807, US  
POLI, Gregory B., c/o Sanofi-aventis U.S. 1041 Route 202-206 Mail Code: BWD-303A, Bridgewater, New Jersey 08807, US  
SHUM, Patrick Wai-Kwok, c/o Sanofi-aventis U.S. 1041 Route 202-206 Mail Code: BWD-303A, Bridgewater, New Jersey 08807, US  
STOKLOSA, Gregory T., c/o Sanofi-aventis U.S. 1041 Route 202-206 Mail Code: BWD-303A, Bridgewater, New Jersey 08807, US  
ZHAO, Zhicheng, c/o Sanofi-aventis U.S. 1041 Route 202-206 Mail Code: BWD-303A, Bridgewater, New Jersey 08807, US

(51) MKP  
**B65D 51/24 (2006.01)** (97) **2502021 \***  
**F42B 4/20 (2006.01)**  
(86) AT2010000437 12.11.2010  
(96) 10798453.6 26.09.2012  
(87) WO2011060464, 12.11.2010  
(97) 2502021, 26.09.2012 de  
(54) RETAINER FOR A FIREWORK THAT CAN BE USED INDOORS  
(71) Reichart, Norbert, 51 avenue Hector Otto, 98000 Monaco, MC  
(72) Reichart, Norbert, 51 avenue Hector Otto, 98000 Monaco, MC

- (51) MKP  
**B22D 15/00 (2006.01)** (97) **2533921 \***  
**B22D 7/02 (2006.01)**
- (86) CA2011000145 09.02.2011  
(96) 11741769.1 19.12.2012  
(87) WO2011097701, 09.02.2011  
(97) 2533921, 19.12.2012 en  
(54) CASTING COMPOSITE INGOT WITH METAL TEMPERATURE COMPENSATION
- (71) Novelis, Inc., 191 Evans Avenue, Toronto, ON M8Z 1J5, CA  
(72) WAGSTAFF, Robert Bruce, 22710 East Henry Road, Greenacres Washington 99216, US  
SINDEN, Aaron David, 13615 South Madison Road, Valleyford Washington 99036, US  
BISCHOFF, Todd F., 15702 East 21st Ct., Spokane Valley Washington 99037, US  
BALL, Eric, 5001 N. Harvard Ct., Spokane Washington 99206, US  
MCDERMOTT, Jeff, Apt. D205 21200 E. Country Vista Drive, Liberty Lake Washington 99019, US

- (51) MKP  
**A61K 31/403 (2006.01)** (97) **2532651**  
**A61P 25/00 (2006.01)**  
**C07D 209/52 (2006.01)**
- (96) 12171118.8 12.12.2012  
(97) 2532651, 12.12.2012 fr  
(54) Synthesis process, and crystalline form of 4-{3-[cis-hexahydrocyclopenta[c]pyrrol-2(1h)-yl]propoxy}benzamide hydrochloride and its free base as well as the pharmaceutical compositions containing them
- (71) Les Laboratoires Servier, 35, rue de Verdun, 92284 Suresnes Cedex, FR  
(72) Robert, Nicolas, 8, rue de Montmorency, 76600 Le Havre, FR  
Lerestif, Jean-Michel, 27 bis, rue de la Briqueterie, 76190 Yvetot, FR  
Lecouve, Jean-Pierre, 93, rue du Docteur Vigné, 76600 Le Havre, FR  
Gaillard, Marina, 11 bis, rue du Faubourg Saint Jean, 45000 Orléans, FR  
Meunier, Loïc, " ", décédé, FR  
Letellier, Philippe, 25, rue du Faubourg Saint Jean, 45000 Orléans, FR  
Boiret, Mathieu, 27 rue de Patay, 45000 Orléans, FR

- (51) MKP  
**G01N 33/50 (2006.01)** (97) **2504699 \***
- (86) US2010058101 24.11.2010  
(96) 10833980.5 03.10.2012  
(87) WO2011066460, 24.11.2010  
(97) 2504699, 03.10.2012 en  
(54) METHODS OF DETECTING OR MONITORING ACTIVITY OF AN INFLAMMATORY OR NEURODEGENERATIVE CONDITION
- (71) MSDX, Inc., 9040 South Rita Road, Suite 100, Tucson, AZ 85747, US  
(72) NAYAK, Ramesh, C., 1965 West Cholla Vista Drive, Tucson AZ 85704, US

- (51) MKP  
**A61K 8/49 (2006.01)** (97) **2516398 \***  
**C07D 213/74 (2006.01)**  
**A61P 17/00 (2006.01)**  
**C07D 241/20 (2006.01)**  
**A61P 15/00 (2006.01)**  
**A61K 31/4965 (2006.01)**  
**C07D 239/42 (2006.01)**  
**A61P 35/00 (2006.01)**  
**A61K 31/44 (2006.01)**  
**A61Q 19/00 (2006.01)**  
**A61K 31/505 (2006.01)**
- (86) FR2010052871 22.12.2010  
(96) 10808915.2 31.10.2012  
(87) WO2011077043, 22.12.2010  
(97) 2516398, 31.10.2012 fr  
(54) NOVEL PHENOL DERIVATIVES AND PHARMACEUTICAL OR COSMETIC USE THEREOF
- (71) Galderma Research & Development, 2400 Route des Colles Les Templiers, 06410 Biot, FR  
(72) POINSARD, Cédric, 13 chemin du Collet de St Marc, F-06130 Le Plan de Grasse, FR  
COLLETTE, Pascal, 631 avenue du Général de Gaulle, F-06110 Le Cannet, FR  
MAUVAIS, Pascale, 7 allée des fées Corniche des Cougoulins, F-06600 Antibes, FR  
LINGET, Jean-Michel, 11A rue de Selestat, F-67230 Benfeld, FR  
RETHORE, Sandrine, Résidence Pythagore 14 avenue de Pythagore, F-06560 Valbonne, FR

- (51) MKP  
**A24F 47/00 (2006.01)** (97) **2515690 \***
- (86) EP2010007874 22.12.2010  
(96) 10805211.9 31.10.2012  
(87) WO2011076407, 22.12.2010  
(97) 2515690, 31.10.2012 en  
(54) AN ELONGATE HEATER FOR AN ELECTRICALLY HEATED AEROSOL-GENERATING SYSTEM
- (71) Philip Morris Products S.A., Quai Jeanrenaud 3, 2000 Neuchâtel, CH  
(72) GREIM, Olivier, Chemin des Sources, CH-1423 Villars-Burquin, CH  
PLOJOUX, Julien, Rue Micheli-du-Crest, CH-1205 Geneva, CH  
RUSCIO, Dani, Route de Troub 29, CH-2088 Cressier, CH

- (51) MKP  
**A61K 9/08 (2006.01)** (97) **2455066**  
**A61K 9/10 (2006.01)**  
**A61K 9/107 (2006.01)**  
**A61K 9/70 (2006.01)**  
**A61K 31/16 (2006.01)**  
**A61P 29/00 (2006.01)**
- (96) 10190375.5 23.05.2012  
(97) 2455066, 23.05.2012 en  
(54) Pharmacological preparation for topical use containing n-palmitoyl-vanillamide
- (71) Epitech Group S.r.l., Via Egadi, 7, 20144 Milano, IT  
(72) Della Valle, Francesco, Via Duca degli Abruzzi, 12, I-35100, PADOVA, IT  
De Petrocellis, Luciano, Via Icaro, I-80078, Arco Felice, NAPOLI, IT  
Maione, Sabatino, Via Tito Livio, 472, I-80070, Bacoli, NAPOLI, IT  
Di Marzo, Vincenzo, Cupa Di S. Cesarea, 46, I-80145, NAPOLI, IT  
Della Valle, Maria Federica, Via Lepanto, 9, I-35141, PADOVA, IT

- (51) MKP  
**A61K 39/00 (2006.01)** (97) **2506871 \***  
**C12P 21/08 (2006.01)**
- (86) US2010058188 29.11.2010  
(96) 10834008.4 10.10.2012  
(87) WO2011066501, 29.11.2010  
(97) 2506871, 10.10.2012 en  
(54) ANTIBODY Fc MUTANTS WITH ABLATED EFFECTOR FUNCTIONS
- (71) Janssen Biotech, Inc., 800/850 Ridgeview Drive, Horsham, PA 19044, US  
(72) STROHL, William, 145 King of Prussia Road, Radnor, PA 19087, US  
VAFA, Omid, 145 King of Prussia Road, Radnor, PA 19087, US

- (51) MKP  
**F24H 3/06 (2006.01)** (97) **2521884 \***  
**G06F 1/20 (2006.01)**  
 (86) FR2010052788 17.12.2010  
 (96) 10807615.9 14.11.2012  
 (87) WO2011083244, 17.12.2010  
 (97) 2521884, 14.11.2012 fr  
 (54) ELECTRIC RADIATOR USING CALCULATING PROCESSORS AS A HEAT SOURCE  
 (71) Qarnot Computing, 10 rue Richer, 75009 Paris, FR  
 (72) BENOIT, Paul, 10 rue Richer, F-75009 Paris, FR

- (51) MKP  
**G07B 15/02 (2011.01)** (97) **2531981 \***  
**B63B 22/02 (2006.01)**  
 (86) SI2011000003 28.01.2011  
 (96) 11708592.8 12.12.2012  
 (87) WO2011096901, 28.01.2011  
 (97) 2531981, 12.12.2012 en  
 (54) SYSTEM FOR AUTOMATIC MANAGING AND CONTROLLING THE USE OF MOORINGS FOR VESSELS, COMPRISING AUTOMATED FLOATING BUOYS AND THE RELATED METHOD  
 (71) Sklad Nepremi Nin D.O.O., Proseni ko 99, 3230 Entjuz, SI  
 (72) GRIVI, Boris, Okrogarjeva 12, SI-3000 Celje, SI

- (51) MKP  
**A61P 25/00 (2006.01)** (97) **2531177 \***  
**A61K 9/16 (2006.01)**  
**A61K 31/4152 (2006.01)**  
**C07D 231/22 (2006.01)**  
 (86) EP2011051630 04.02.2011  
 (96) 11702056.0 12.12.2012  
 (87) WO2011095579, 04.02.2011  
 (97) 2531177, 12.12.2012 en  
 (54) 4-[-2-[[5-METHYL-1-(2-NAPHTALENYL)-1H-PYRAZOL-3-YL]OXY]ETHYL]MORPHOLINE HYDROCHLORIDE POLYMORPHS AND SOLVATES  
 (71) Laboratorios del. Dr. Esteve, S.A., Avda Mare de Deu de Montserrat 221, 08041 Barcelona, ES  
 (72) BERENQUER MAIMÓ, Ramón, Jovellanos 1 Izda. 4º 3ª, E-08001 Barcelona, ES  
 MEDRANO RUPÉREZ, Jorge, C/Rosari 18, atic 2a, E-08921 Santa Colonia de Gramenet Barcelona, ES  
 BENET BUCHHOLZ, Jordi, Plaza Romani 3 - Casa A, E-43893 Altafulla - Tarragona, ES  
 PUIG FERNANDEZ, Laura, El Maquinista de la General 37 - 2A, E-50019 Zaragoza, ES  
 PELLEJÀ PUXEU, Laia, Cigne 17 - Casa 6, E-43007 Tarragona, ES

- (51) MKP  
**G01N 33/50 (2006.01)** (97) **2501279 \***  
**A61B 5/0488 (2006.01)**  
**G01N 33/94 (2006.01)**  
**A61B 5/11 (2006.01)**  
 (86) EP2010006967 16.11.2010  
 (96) 10782550.7 26.09.2012  
 (87) WO2011060916, 16.11.2010  
 (97) 2501279, 26.09.2012 en  
 (54) ASSAY FOR QUANTIFYING CLOSTRIDIAL NEUROTOXIN  
 (71) Merz Pharma GmbH & Co. KGaA, Eckenheimer Landstrasse 100, 60318 Frankfurt am Main, DE  
 (72) MANDER, Gerd, J., Bertha-Bagge Str. 46, 60438 Frankfurt am Main, DE  
 TAYLOR, Harold, An den Drei Hohen 76, 60435 Frankfurt am Main, DE  
 VEY, Martin, Heinrich-Heine-Strasse 5, 35039 Marburg, DE  
 EISELE, Karl-Heinz, Parlamentsplatz 2b, 60385 Frankfurt am Main, DE

- (51) MKP  
**H03H 9/00 (2006.01)** (97) **2491652 \***  
 (86) US2010002418 02.09.2010  
 (96) 10825313.9 29.08.2012  
 (87) WO2011049598, 02.09.2010  
 (97) 2491652, 29.08.2012 en  
 (54) NOTCHED SAW IMAGE FREQUENCY REJECTION FILTER SYSTEM  
 (71) Lojack Operating Company, Lp, 200 Lowder Brook Drive Suite 1000, Westwood, MA 02090, US  
 (72) FEDAN, Orest, 22 Betts Road, Belmont MA 02478, US

- (51) MKP  
**H04L 29/06 (2006.01)** (97) **2502399 \***  
**G06F 21/00 (2006.01)**  
**G06F 9/455 (2006.01)**  
 (86) FR2010052449 18.11.2010  
 (96) 10793009.1 26.09.2012  
 (87) WO2011061448, 18.11.2010  
 (97) 2502399, 26.09.2012 fr  
 (54) METHOD AND DEVICE FOR SECURING THE CONNECTION OF A TERMINAL TO A COMPUTER NETWORK  
 (71) Saad, Clément, 1 Traverse de l'Artimon, 34970 Lattes, FR  
 (72) Saad, Clément, 1 Traverse de l'Artimon, 34970 Lattes, FR

- (51) MKP  
**H04L 12/56 (2006.01)** (97) **2507951 \***  
 (86) EP2010068964 06.12.2010  
 (96) 10795649.2 10.10.2012  
 (87) WO2011067408, 06.12.2010  
 (97) 2507951, 10.10.2012 en  
 (54) AN APPARATUS AND A METHOD OF RECEIVING AND STORING DATA PACKETS CONTROLLED BY A CENTRAL CONTROLLER  
 (71) Napatech A/S, Tobaksvejen 23A, 2860 Søborg, DK  
 (72) KORGER, Peter, Mødekærgårdsvej 10, DK-3540 Lyngby, DK

- (51) MKP  
**A61K 31/415 (2006.01)** (97) **2509957 \***  
**C07C 237/14 (2006.01)**  
**A61P 11/06 (2006.01)**  
**A61P 17/06 (2006.01)**  
**A61P 21/04 (2006.01)**  
**A61P 9/10 (2006.01)**  
**A61K 31/426 (2006.01)**  
**C07D 277/46 (2006.01)**  
**A61K 31/16 (2006.01)**  
**A61P 37/08 (2006.01)**  
**C07D 231/40 (2006.01)**  
**A61P 37/02 (2006.01)**  
 (86) IB2010055738 10.12.2010  
 (96) 10835594.2 17.10.2012  
 (87) WO2011070541, 10.12.2010  
 (97) 2509957, 17.10.2012 en  
 (54) CYSTEINE PROTEASE INHIBITORS  
 (71) Medivir UK Ltd, The Mansion Chesterford Research Park, Little Chesterford Essex CB10 1XL, GB  
 (72) AYESA, Susana, Medivir AB PO Box 1086, S-141 22 Huddinge, SE  
 CARLQUIST, Peter, Medivir AB PO Box 1086, S-141 22 Huddinge, SE  
 ERSMARK, Karolina, Medivir AB PO Box 1086, S-141 22 Huddinge, SE  
 GRABOWSKA, Urszula, Medivir AB PO Box 1086, S-141 22 Huddinge, SE  
 HEWITT, Ellen, Medivir AB PO Box 1086, S-141 22 Huddinge, SE  
 JÖNSSON, Daniel, Medivir AB PO Box 1086, S-141 22 Huddinge, SE  
 KAHNBERG, Pia, Medivir AB PO Box 1086, S-141 22 Huddinge, SE  
 KLASSON, Björn, Medivir AB PO Box 1086, S-141 22 Huddinge, SE  
 LIND, Peter, Medivir AB PO Box 1086, S-141 22 Huddinge, SE  
 ODÉN, Lourdes, Medivir AB PO Box 1086, S-141 22 Huddinge, SE  
 PARKES, Kevin, Medivir AB PO Box 1086, S-141 22 Huddinge, SE  
 WIKTELIUS, Daniel, Medivir AB PO Box 1086, S-141 22 Huddinge, SE

- (51) MKP  
**B42D 15/00 (2006.01)** (97) **2509792 \***  
**C09D 11/02 (2006.01)**  
**B41M 5/28 (2006.01)**  
**B41M 3/14 (2006.01)**  
**C09D 11/00 (2006.01)**  
**B42D 15/10 (2006.01)**
- (86) EP2010056874 19.05.2010  
(96) 10722053.5 17.10.2012  
(87) WO2011069690, 19.05.2010  
(97) 2509792, 17.10.2012 en  
(54) MODIFIED MARKING BASED ON CHIRAL LIQUID CRYSTAL POLYMERS
- (71) SICPA Holding SA, Avenue de Florissant 41, 1008 Prilly, CH  
(72) TILLER, Thomas, Chemin du Cèdre 21, CH-1030 Bussigny, CH  
GREMAUD, Frédéric, Chemin de la Belle-Luce 15, CH-1663 Epagny, CH  
CALLEGARI, Andrea, Chemin des Berges 4, CH-1022 Chavannes-Pres-Renens, CH  
ROZUMEK, Olivier, Route de Monchuplyon 12, CH-1661 Le Pâquier-Montbarry, CH  
KERKAR, Brahim, Chemin de Verney 3, CH-1009 Pully, CH

- (51) MKP  
**A61B 17/068 (2006.01)** (97) **2509512 \***  
**A61B 17/34 (2006.01)**  
**A61B 19/00 (2006.01)**  
**A61B 17/00 (2006.01)**  
**A61B 17/115 (2006.01)**
- (86) US2010057115 17.11.2010  
(96) 10782769.3 17.10.2012  
(87) WO2011063051, 17.11.2010  
(97) 2509512, 17.10.2012 en  
(54) CIRCULAR STAPLER INTRODUCER WITH RIGID DISTAL END PORTION
- (71) Ethicon Endo-Surgery, Inc., 4545 Creek Road, Cincinnati, OH 45242, US  
(72) BAXTER, III, Chester, O., 6375 Pawnee Ridge, Loveland, OH 45140, US  
HUNT, John V., 3654 Moorhill Drive, Cincinnati, OH 45241, US  
SILKAITIS, Danius P., 4680 Sarah Drive, Mason, OH 45040, US  
WILEY, Jeffrey P., 5585 Autumn Wynd Lane, Milford, OH 45150, US  
FRANER, Paul, T., 6217 Rapid Run Road, Cincinnati, OH 45233, US  
SCHULTE, John, B., 6769 Timberwood Drive, West Chester, OH 45069, US  
ABBOTT, Daniel, J., 5944 Marsh Circle, Loveland, OH 45140, US

- (51) MKP  
**A61M 5/315 (2006.01)** (97) **2512562 \***
- (86) EP2010069869 16.12.2010  
(96) 10796374.6 24.10.2012  
(87) WO2011073307, 16.12.2010  
(97) 2512562, 24.10.2012 en  
(54) PISTON FOR A CARTRIDGE AND PISTON ROD FOR A DRUG DELIVERY DEVICE
- (71) Sanofi-Aventis Deutschland GmbH, Brüningstraße 50, 65929 Frankfurt, DE  
(72) JUGL, Michael, Sanofi-Aventis Deutschland GmbH, 65926 Frankfurt am Main, DE  
OTTEN, Martin, Sanofi-Aventis Deutschland GmbH, 65926 Frankfurt am Main, DE

- (51) MKP  
**A61B 17/22 (2006.01)** (97) **2533704 \***  
**A61B 17/3207 (2006.01)**  
**A61B 17/32 (2006.01)**
- (86) US2011024192 09.02.2011  
(96) 11705354.6 19.12.2012  
(87) WO2011100323, 09.02.2011  
(97) 2533704, 19.12.2012 en  
(54) ULTRASONIC SURGICAL INSTRUMENTS WITH ROTATABLE BLADE AND HOLLOW SHEATH ARRANGEMENTS
- (71) Ethicon Endo-Surgery, Inc., 4545 Creek Road, Cincinnati, OH 45242, US  
(72) ROBERTSON, Galen, C., 5752 Doerger Lane, Cincinnati, OH 45212, US  
TIMM, Richard, W., 3405 Monteith Avenue 1, Cincinnati, OH 45208, US  
MUMAW, Daniel, J., 953 Long Lane, Milford, OH 45150, US  
HOUSER, Kevin, L., 570 Foliage Lane, Springboro, OH 45066, US  
MILLER, Matthew, C., 3524 Zumstein Avenue, Cincinnati, OH 45208, US  
SELL, Stacey, J., 3833 St. Johns Terrace, Cincinnati, OH 45236, US

- (51) MKP  
**C07D 471/04 (2006.01)** (97) **2504336 \***  
**A61P 35/00 (2006.01)**  
**A61K 31/4745 (2006.01)**
- (86) EP2010068119 24.11.2010  
(96) 10782280.1 03.10.2012  
(87) WO2011064250, 24.11.2010  
(97) 2504336, 03.10.2012 en  
(54) NOVEL NAPHTHYRIDINE DERIVATIVES AND THE USE THEREOF AS KINASE INHIBITORS
- (71) Aeterna Zentaris GmbH, Weismüllerstraße 50, 60314 Frankfurt am Main, DE  
(72) SCHUSTER, Tilmann, Valentin-Hock-Str. 32, 63762 Großostheim, DE  
GERLACH, Matthias, Pfarrgasse 1, 63636 Brachtal, DE  
SEIPELT, Irene, Hermannstraße 5, 63069 Offenbach, DE  
POLYMERPOULOS, Emmanuel, Beethovenstraße 60, 60325 Frankfurt am Main, DE  
MÜLLER, Gilbert, Bischofsweg 1 A, 60598 Frankfurt am Main, DE  
GÜNTHER, Eckhard, Wingertstraße 176, 63477 Maintal, DE  
MARCHAND, Pascal, 19 rue Meuris, F-44390 Nort-sur-Erdre, FR  
DEFAUX, Julien, 56 rue des Perrières, F-21000 Dijon, FR

- (51) MKP  
**A61B 17/115 (2006.01)** (97) **2509514 \***  
**A61B 17/11 (2006.01)**
- (86) US2010057103 17.11.2010  
(96) 10782149.8 17.10.2012  
(87) WO2011063040, 17.11.2010  
(97) 2509514, 17.10.2012 en  
(54) DEVICES FOR INTRODUCING A SURGICAL CIRCULAR STAPLING INSTRUMENT INTO A PATIENT
- (71) Ethicon Endo-Surgery, Inc., 4545 Creek Road, Cincinnati, OH 45242, US  
(72) BAXTER, Chester, O., III, 6375 Pawnee Ridge, Loveland, OH 45140, US  
HUNT, John, V., 3654 Moorhill Drive, Cincinnati, OH 45241, US  
SILKAITIS, Danius, P., 4680 Sarah Drive, Mason, OH 45040, US  
WILEY, Jeffrey, P., 5585 Autumn Wynd Lane, Milford, OH 45150, US  
FRANER, Paul, T., 6217 Rapid Run Road, Cincinnati, OH 45233, US  
SCHULTE, John, B., 6769 Timberwood Drive, West Chester, OH 45069, US  
ABBOTT, Daniel, J., 5944 Marsh Circle, Loveland, OH 45140, US

(51) MKP  
**C07K 16/00 (2006.01)** (97) **2531526 \***  
 (86) EP2011051450 02.02.2011  
 (96) 11702974.4 12.12.2012  
 (87) WO2011095506, 02.02.2011  
 (97) 2531526, 12.12.2012 en  
 (54) PROCESS FOR OBTAINING ANTIBODIES  
 (71) UCB Pharma S.A., Allée de la Recherche 60, 1070 Brussels, BE  
 (72) BILGISCHER, Jean-Pascal Pierre, c/o UCB PHARMA IP  
 Department 60 Allée de la Recherche, B-1070 Brussels, BE  
 BASSETT, Philip Jonathan, c/o UCB CELLTECH IP Department  
 208 Bath Road, Slough Berkshire SL1 3 WE, GB  
 PEARCE-HIGGINS, Mark Robert, c/o UCB CELLTECH IP  
 Department 208 Bath Road, Slough Berkshire SL 1 3WE, GB  
 KENNY, Andrew John, c/o UCB CELLTECH IP Department 208  
 Bath Road, Slough Berkshire SL1 3 WE, GB

(51) MKP  
**A61M 25/12 (2006.01)** (97) **2512578 \***  
 (86) US2010060898 16.12.2010  
 (96) 10842632.1 24.10.2012  
 (87) WO2011084655, 16.12.2010  
 (97) 2512578, 24.10.2012 en  
 (54) DEVICES AND METHODS FOR TREATING SINUS DISEASE  
 (71) Acclarent, Inc., 1525-B O'Brien Drive, Menlo Park, CA 94025,  
 US  
 (72) MUNI, Ketan, P., 300 Daisy Drive, San Jose, CA 95123, US  
 HA, Hung, V., 2974 Delancey Court, San Jose, CA 95135, US  
 CHAN, Randy, S., 1521 Wharton Court, San Jose CA 95132, US  
 HARFE, Daniel, T., 1575 Wistaria Lane, Los Altos, CA 94024, US  
 LEVINE, Howard, 3445 Winding Key Oaks Drive, Longboau Key,  
 FL 34228, US

(51) MKP  
**C12N 15/85 (2006.01)** (97) **2505654**  
**A01K 67/027 (2006.01)**  
**C07K 16/46 (2006.01)**  
 (96) 12173456.0 03.10.2012  
 (97) 2505654, 03.10.2012 en  
 (54) Common light chain mouse  
 (71) Regeneron Pharmaceuticals, Inc., 777 Old Saw Mill River Road,  
 Tarrytown, NY 10591, US  
 (72) McWhirter, John, 2035 Crescent Drive, Tarrytown, NY 10591, US  
 MacDonald, Lynn, 16 Gedney Way, White Plains, NY 10605, US  
 Stevens, Sean, 355 Berry Street, No. 413, San Francisco, CA  
 94158, US  
 Davis, Samuel, 332 West 88th Street Apt. B2, New York, NY  
 10024, US  
 Murphy, Andrew J., 10 Newton Court, Croton-on-hudson, NY  
 10520, US

(51) MKP  
**A61B 19/08 (2006.01)** (97) **2501322 \***  
**A61B 17/115 (2006.01)**  
**A61B 19/00 (2006.01)**  
 (86) US2010057120 17.11.2010  
 (96) 10787214.5 26.09.2012  
 (87) WO2011063056, 17.11.2010  
 (97) 2501322, 26.09.2012 en  
 (54) CIRCULAR STAPLER INTRODUCER WITH MULTI-LUMEN  
 SHEATH  
 (71) Ethicon Endo-Surgery, Inc., 4545 Creek Road, Cincinnati, OH  
 45242, US  
 (72) BAXTER, III, Chester, O., 6375 Pawnee Ridge, Loveland, OH  
 45140, US  
 HUNT, John, V., 3654 Moorhill Drive, Cincinnati, OH 45241, US  
 SILKAITIS, Danius, P., 4680 Sarah Drive, Mason, OH 45040, US  
 WILEY, Jeffrey, P., 5585 Autumn Wynd Lane, Milford, OH 45150,  
 US  
 FRANER, Paul, T., 6217 Rapid Run Road, Cincinnati, OH 45233,  
 US  
 SCHULTE, John, B., 6769 Timberwood Drive, West Chester, OH  
 45069, US  
 ABBOTT, Daniel, J., 5944 Marsh Circle, Loveland, OH 45140,  
 US

(51) MKP  
**C07K 16/00 (2006.01)** (97) **2526118 \***  
**C07K 17/14 (2006.01)**  
**C07K 17/00 (2006.01)**  
 (86) US2011022103 21.01.2011  
 (96) 11735250.0 28.11.2012  
 (87) WO2011091286, 21.01.2011  
 (97) 2526118, 28.11.2012 en  
 (54) COMPOSITIONS AND METHODS FOR TREATMENT OF  
 OVARIAN CANCER  
 (71) ImmunoGen, Inc., 830 Winter Street, Waltham, MA 02451, US  
 (72) WHITEMAN, Kathleen, R., 512 Shawsheen Avenue, Wilmington,  
 MA 01887, US  
 O'LEARY, James, J., 273 Watertown Street, Newton, MA 02458,  
 US  
 LUTZ, Robert, John, 218 Old Connecticut Path, Wayland, MA  
 01778, US

(51) MKP  
**B28B 3/20 (2006.01)** (97) **2501530 \***  
 (86) US2010003008 19.11.2010  
 (96) 10831904.7 26.09.2012  
 (87) WO2011062632, 19.11.2010  
 (97) 2501530, 26.09.2012 en  
 (54) INTEGRATED INSULATION EXTRUSION AND EXTRUSION  
 TECHNOLOGY FOR WINDOW AND DOOR SYSTEMS  
 (71) Mikron Industries, Inc., 1034 Sixth Avenue North, Kent, WA  
 98032, US  
 (72) MELKONIAN, George, 3617 S.w. 311th Lane, Federal Way WA  
 98023, US

(51) MKP  
**A61K 39/395 (2006.01)** (97) **2536834 \***  
**A61P 31/04 (2006.01)**  
**C12P 21/08 (2006.01)**  
**G01N 33/569 (2006.01)**  
**C12N 5/10 (2006.01)**  
**C07K 16/12 (2006.01)**  
**C07K 16/46 (2006.01)**  
**C12N 15/09 (2006.01)**  
 (86) JP2011054228 18.02.2011  
 (96) 11744836.5 26.12.2012  
 (87) WO2011102554, 18.02.2011  
 (97) 2536834, 26.12.2012 en  
 (54) ANTIBODY AGAINST SEROTYPE B LIPOPOLYSACCHARIDE  
 OF PSEUDOMONAS AERUGINOSA  
 (71) Meiji Seika Pharma Co., Ltd., 4-16, Kyobashi 2-chome Chuo-ku,  
 Tokyo 104-8002, JP  
 Symphogen A/S, Elektrovej Building 375, 2800 Lyngby, DK  
 (72) TANAKA, Jiro, c/o Meiji Seika Pharma Co., Ltd. 760 Morooka-  
 cho Kohoku-ku, Yokohama-shi Kanagawa 222-8567, JP  
 ANDERSEN, Peter Sejer, Adalsvej 21A, Vanlose 2720, DK  
 OKUTOMI, Takafumi, c/o Meiji Seika Pharma Co., Ltd. 760  
 Morooka-cho Kohoku-ku, Yokohama-shi Kanagawa 222-8567,  
 JP  
 INABA, Tsuneyoshi, c/o Meiji Seika Pharma Co., Ltd. 760  
 Morooka-cho Kohoku-ku, Yokohama-shi Kanagawa 222-8567,  
 JP  
 OTSUKA, Keiko, c/o Meiji Seika Pharma Co., Ltd. 760 Morooka-  
 cho Kohoku-ku, Yokohama-shi Kanagawa 222-8567, JP  
 AKABANE, Hiroto, c/o Meiji Seika Pharma Co., Ltd. 760  
 Morooka-cho Kohoku-ku, Yokohama-shi Kanagawa 222-8567,  
 JP  
 HOSHINA, Yukari, c/o Meiji Seika Pharma Co., Ltd. 760  
 Morooka-cho Kohoku-ku, Yokohama-shi Kanagawa 222-8567,  
 JP  
 NAGASO, Hiroshi, c/o Meiji Seika Pharma Co., Ltd. 760  
 Morooka-cho Kohoku-ku, Yokohama-shi Kanagawa 222-8567,  
 JP  
 KUMAGAI, Masashi, c/o Meiji Seika Pharma Co., Ltd. 760  
 Morooka-cho Kohoku-ku, Yokohama-shi Kanagawa 222-8567,  
 JP

- (51) MKP  
**A61K 31/7105 (2006.01)** (97) **2506857 \***  
**C07H 21/02 (2006.01)**  
(86) US2010058457 30.11.2010  
(96) 10835016.6 10.10.2012  
(87) WO2011068810, 30.11.2010  
(97) 2506857, 10.10.2012 en  
(54) DELIVERY OF MRNA FOR THE AUGMENTATION OF PROTEINS AND ENZYMES IN HUMAN GENETIC DISEASES  
(71) Shire Human Genetic Therapies, 700 Main Street, Cambridge, MA 02139, US  
(72) GUILD, Braydon, Charles, 109 Riverdale Road, Concord MA 01742, US  
DEROSA, Frank, 26 Mount Auburn Street, Chelmsford MA 01824, US  
HEARTLEIN, Michael, 167 Reed Farm Road, Boxborough MA 01719, US  
CONCINO, Michael, 297 Long Hill Road, Bolton, MA 01740, US

- (51) MKP  
**A61K 31/444 (2006.01)** (97) **2523952 \***  
**A61P 37/00 (2006.01)**  
**C07D 417/14 (2006.01)**  
**C07D 413/12 (2006.01)**  
**A61K 31/443 (2006.01)**  
**C07D 413/14 (2006.01)**  
**A61K 31/4436 (2006.01)**  
**A61P 35/00 (2006.01)**  
(86) EP2011050312 12.01.2011  
(96) 11702802.7 21.11.2012  
(87) WO2011086085, 12.01.2011  
(97) 2523952, 21.11.2012 en  
(54) THIAZOLE AND OXAZOLE KINASE INHIBITORS  
(71) AB Science, 3, avenue George V, 75008 Paris, FR  
(72) MOUSSY, Alain, 22 bis passage Dauphine, F-75006 Paris, FR  
BENJAHAD, Abdallah, 55-57 rue Diderot entrée 8, F-94500 Champigny Sur Marne, FR  
MARTIN, Jason, 19 avenue du Parc des sports, F-94260 Fresnes, FR  
CHEVENIER, Emmanuel, 12 Résidence Vaucouleur, F-91940 Les Ulis, FR  
PEZ, Didier, 132 Route de Montluel, F-01120 Nievroz, FR  
SANDRINELLI, Franck, 1 Lotissement Les Verts Prés, F-01360 Balan, FR  
PICOUL, Willy, 39 rue Jacquard, F-69004 Lyon, FR

- (51) MKP  
**A61K 38/08 (2006.01)** (97) **2523677 \***  
(86) IL2011000034 11.01.2011  
(96) 11731747.9 21.11.2012  
(87) WO2011083483, 11.01.2011  
(97) 2523677, 21.11.2012 en  
(54) METHOD FOR TREATMENT OF INFLAMMATORY DISEASE AND DISORDER  
(71) Healon Ltd., P.O. Box 4115, 74140 Ness-Ziona, IL  
(72) TENNENBAUM, Tamar, 12 Herzl Boulevard, 96105 Jerusalem, IL  
BRAIMAN-WIKSMAN, Liora, 24 Stephan Wiess Street, 75400 Rishon Le-Zion, IL  
SAGIV, Yuval, 12 Smadar Street, 70700 Gedera, IL  
GARTSBEIN, Marina, 77 Pinsker Street, 49221 Petach Tikva, IL  
SHEN, Shlomzion, 3 Avivim Street P.O. Box 227, 44810 Sha'arei Tikva, IL  
ALT, Addy, 197/8 Ahuza Street P.O. Box 622, 43106 Ra'anana, IL  
KUROKI, Toshio, 6-56-1-702 Kami-odanaka Nakahara-ku Kawasaki, 211 0053, JP  
SAMPSON, Sanford, 49 HaNassi HaRishon Street, 76303 Rehovot, IL  
BRENER, Ephraim, 4 Mania Shochat Street, Rishon Le Zion 75241, IL  
BEN-HAMO, Moshe, 11 Zvi Herling Street, Bene Braq 51223, IL  
HAMMER, Liat., 21/2 Itzhak Rabbim, 71700 Modiin, IL

- (51) MKP  
**A61M 5/24 (2006.01)** (97) **2525851 \***  
(86) EP2011050799 21.01.2011  
(96) 11701084.3 28.11.2012  
(87) WO2011089207, 21.01.2011  
(97) 2525851, 28.11.2012 en  
(54) CODED CARTRIDGE HOLDER AND FASTENER ENABLED BY CARTRIDGE SIZE  
(71) Sanofi-Aventis Deutschland GmbH, Brüningstraße 50, 65929 Frankfurt, DE  
(72) PLUMPTRE, David, 36 Shire Way, Droitwich Spa Worcestershire WR9 7RQ, GB  
LANGLEY, Christopher Nigel, 120 Leicester Lane, Leamington Spa Warwickshire CV32 7HH, GB  
AVERY, Richard James Vincent, 28 Nursery Close Mickleton, Chipping Campden Gloucestershire GL55 6TX, GB  
Butler, Joseph, 6 Hadfield Close, Clifton Rugby Warwickshire CV23 0DL, GB

- (51) MKP  
**A01N 43/00 (2006.01)** (97) **2512237 \***  
(86) EP2010069094 07.12.2010  
(96) 10788323.3 24.10.2012  
(87) WO2011073060, 07.12.2010  
(97) 2512237, 24.10.2012 en  
(54) 2-ARYL-3-HYDROXY-CYCLOPENTENONES AS INSECTICIDES, ACARICIDES, NEMATOCIDES AND MOLLUSCICIDES  
(71) Syngenta Participations AG, Schwarzwaldallee 215, 4058 Basel, CH  
Syngenta Limited, European Regional Centre Priestley Road Surrey Research Park, Guildford, Surrey GU2 7YH, GB  
(72) JEANMART, Stephane André Marie, Syngenta Crop Protection Münchwilen AG Schaffhauserstrasse, CH-4332 Stein, CH  
VINER, Russell, Syngenta Limited Jealotts Hill International Research Center Bracknell, Berkshire RG42 6EY, GB  
TAYLOR, John Benjamin, Syngenta Limited Jealotts Hill International Research Center Bracknell, Berkshire RG42 6EY, GB  
WHITTINGHAM, William Guy, Syngenta Limited Jealotts Hill International Research Center Bracknell, Berkshire RG42 6EY, GB  
WAILLES, Jeffrey Steven, Syngenta Limited Jealotts Hill International Research Center Bracknell, Berkshire RG42 6EY, GB  
TARGETT, Sarah Margaret, Syngenta Limited Jealotts Hill International Research Center Bracknell, Berkshire RG42 6EY, GB  
MATHEWS, Christopher John, Syngenta Limited Jealotts Hill International Research Center Bracknell, Berkshire RG42 6EY, GB  
MUEHLEBACH, Michel, Syngenta Crop Protection Münchwilen AG Schaffhauserstrasse, CH-4332 Stein, CH

- (51) MKP  
**C07D 513/04 (2006.01)** (97) **2513118 \***  
**A61K 31/429 (2006.01)**  
**A61P 25/18 (2006.01)**  
**A61K 31/428 (2006.01)**  
(86) EP2010069972 16.12.2010  
(96) 10790989.7 24.10.2012  
(87) WO2011073347, 16.12.2010  
(97) 2513118, 24.10.2012 en  
(54) BICYCLIC THIAZOLES AS ALLOSTERIC MODULATORS OF MGLUR5 RECEPTORS  
(71) Janssen Pharmaceutica, N.V., Turnhoutseweg 30, 2340 Beerse, BE  
(72) MACDONALD, Gregor, James, c/o Janssen Pharmaceutica NV Turnhoutseweg 30, B-2340 Beerse, BE  
TRESADERN, Gary, John, c/o Janssen-Cilag S.A. Calle Jarama 75 Poligono Industrial, E-45007 Toledo, ES  
TRABANCO-SUÁREZ, Andrés, Avelino, c/o Janssen-Cilag S.A. Calle Jarama 75 Poligono Industrial, E-45007 Toledo, ES  
PASTOR-FERNÁNDEZ, Joaquín, C/Hierbabuena 37 Urbanización La Hacienda Cobisa, E-45111 Toledo, ES



(51) MKP  
**F16K 3/30 (2006.01)** (97) **2518376 \***  
**F16K 3/28 (2006.01)**  
(86) CN2010002142 23.12.2010  
(96) 10838520.4 31.10.2012  
(87) WO2011075954, 23.12.2010  
(97) 2518376, 31.10.2012 en  
(54) NON-RISING STEM TYPE GATE VALVE  
(71) Tyco Water Valve (Shanghai) Co. Ltd., No. 399, Jiuye Road Qingpu Industrial Zone, Shanghai 201700, CN  
(72) TUCKER, Ealden, No. 399, Jiuye Road Qingpu Industrial Zone, Shanghai 201700, CN  
ZHANG, Ying, No. 399, Jiuye Road Qingpu Industrial Zone, Shanghai 201700, CN  
PU, Changlie, No. 399, Jiuye Road Qingpu Industrial Zone, Shanghai 201700, CN

(51) MKP  
**G09F 13/46 (2006.01)** (97) **2505955**  
**F42B 4/20 (2006.01)**  
**F42B 4/18 (2006.01)**  
(96) 11425089.7 03.10.2012  
(97) 2505955, 03.10.2012 en  
(54) An improvement of a pyrotechnic device for the realization of a luminous alphabet  
(71) Pyrogiochi S.R.L., Via Marche n. 16/18 Zona Ind. Gello, 56025 Pontedera (PI), IT  
(72) Turini, Giuseppe, Via Nenni n. 18, 56038 Ponsacco (PI), IT

(51) MKP  
**F16L 1/10 (2006.01)** (97) **2444197**  
**B23K 37/053 (2006.01)**  
(96) 11185611.8 25.04.2012  
(97) 2444197, 25.04.2012 en  
(54) Clamping device for centring pipes  
(71) Hercules Piping Tools Engineering B.V., Pascalbaan 1, 3439 MP Nieuwegein, NL  
(72) de Lange, Wilco, Måsjön 160, SE-84064 Kälarne, SE

(51) MKP  
**G01N 22/00 (2006.01)** (97) **2505995 \***  
(86) RU2010000724 24.11.2010  
(96) 10833645.4 03.10.2012  
(87) WO2011065868, 24.11.2010  
(97) 2505995, 03.10.2012 en  
(54) METHOD FOR DETERMINING THE DIELECTRIC PERMITTIVITY OF A DIELECTRIC OBJECT  
(71) "Applied Physics Science And Technology Center" Company With Limited Responsibility, Klinsky pr. 25 lit A pom. 3N, St. Petersburg 190013, RU  
(72) KUZNETSOV, Andrey Viktorovich, pr. Toreza 40 korp.7-52, St. Petersburg 194223, RU  
GORSHKOV, Igor Yurievich, V.O. Maly pr. 5-1, St. Petersburg 199178, RU  
AVERYANOV, Valery Petrovich, pr. Metallistov 112-2-19, St. Petersburg 195221, RU

(51) MKP  
**G06K 9/48 (2006.01)** (97) **2509029**  
(96) 11167601.1 10.10.2012  
(97) 2509029, 10.10.2012 en  
(54) System and method for identifying spam in rasterized images  
(71) Kaspersky Lab, ZAO, 10 Geroyev Panfilovtsev Street, Moscow 125363, RU  
(72) Smimov, Evgeny P., c/o KASPERSKY LAB ZAO 10/1 1st Volokolamsky Proezd, 123060 Moscow, RU

(51) MKP  
**C02F 11/14 (2006.01)** (97) **2504286 \***  
**C02F 11/00 (2006.01)**  
**C02F 1/36 (2006.01)**  
**C02F 103/06 (2006.01)**  
**C02F 1/68 (2006.01)**  
(86) HR2010000021 12.07.2010  
(96) 10749901.4 03.10.2012  
(87) WO2011015889, 12.07.2010  
(97) 2504286, 03.10.2012 en  
(54) DEVICE AND PROCESS FOR TREATMENT OF CONCENTRATED SOLUTIONS ORIGINATING FROM LANDFILL LEACHATE  
(71) Spanovic, Millii, Ogrizoviceva 7, 10000 Zagreb, HR  
(72) Spanovic, Millii, Ogrizoviceva 7, 10000 Zagreb, HR

(51) MKP  
**E04H 6/02 (2006.01)** (97) **2507449 \***  
**E04B 1/34 (2006.01)**  
**H01L 31/042 (2006.01)**  
(86) IB2010055594 06.12.2010  
(96) 10805331.5 10.10.2012  
(87) WO2011067743, 06.12.2010  
(97) 2507449, 10.10.2012 en  
(54) CARPORT STRUCTURE AND METHOD OF CONSTRUCTION THEREFOR  
(71) SolSPACE Limited, 10 Stoney Street, London SE1 9AD, GB  
(72) COX, Andrew, 10 Stoney St. Borough, London SE1 9AD, GB

(51) MKP  
**A61P 3/04 (2006.01)** (97) **2521719 \***  
**C07D 303/16 (2006.01)**  
**A61K 31/336 (2006.01)**  
(86) US2011020520 07.01.2011  
(96) 11701572.7 14.11.2012  
(87) WO2011085201, 07.01.2011  
(97) 2521719, 14.11.2012 en  
(54) FUMAGILLOL TYPE COMPOUNDS AND METHODS OF MAKING AND USING SAME  
(71) Zafgen Corporation, 5 Cambridge Center, FI 2, Cambridge, MA 02142, US  
(72) VATH, James, E., 3 Green Meadow Drive, Lynnfield MA 01940, US

(51) MKP  
**B65D 81/38 (2006.01)** (97) **2502850**  
(96) 12160830.1 26.09.2012  
(97) 2502850, 26.09.2012 de  
(54) Packaging container and process for its manufacture  
(71) Paccor Deutschland GmbH, Marienburgstraße 25a, 56856 Zell (Mosel), DE

(51) MKP  
**C10J 3/32 (2006.01)** (97) **2526176 \***  
**F23H 1/00 (2006.01)**  
**C10J 3/40 (2006.01)**  
**C10J 3/26 (2006.01)**  
(86) US2011021769 19.01.2011  
(96) 11703070.0 28.11.2012  
(87) WO2011091080, 19.01.2011  
(97) 2526176, 28.11.2012 en  
(54) DOWNDRAFT GASIFIER WITH IMPROVED STABILITY  
(71) Zeropoint Clean Tech, Inc., A Corporation Of The State Of Delaware P.O. Box 706, Potsdam, NY 13676, US  
(72) LEVESON, Philip, D., 440 Hadley Court, Sandy Springs GA 30350, US

(51) MKP  
**G05D 23/19 (2006.01)** (97) **2512204**  
**H02J 13/00 (2006.01)**  
**F24D 19/10 (2006.01)**  
**H05B 1/02 (2006.01)**  
(96) 11003144.0 17.10.2012  
(97) 2512204, 17.10.2012 en  
(54) Control unit for operating a conventional electric heater and a pilot wire heater  
(71) Feller AG, Bergstrasse 70, 8810 Horgen, CH  
(72) Egger, Stephane, Glärnischstrasse 9, CH-8134 Adliswil, CH  
Fritsche, Jakob, Zürichstrasse 3, CH-8840 Einsiedeln, CH

(51) MKP  
**C12P 21/08 (2006.01)** (97) **2533810 \***  
**A61K 39/395 (2006.01)**  
 (86) US2011024312 10.02.2011  
 (96) 11742780.7 19.12.2012  
 (87) WO2011100403, 10.02.2011  
 (97) 2533810, 19.12.2012 en  
 (54) CD20 ANTIBODIES AND USES THEREOF  
 (71) ImmunoGen, Inc., 830 Winter Street, Waltham, MA 02451, US  
 (72) DECKERT, Jutta, 16 Eaton Road, Lexington Massachusetts 02420, US  
 RUI, Lingyun, 11 Arrowhead Road, Weston Massachusetts 02493, US  
 PARK, Peter U., 25 Webster Avenue 301, Somerville Massachusetts 02143, US

(51) MKP  
**F25D 3/10 (2006.01)** (97) **2515057**  
**F28F 27/00 (2006.01)**  
 (96) 12162842.4 24.10.2012  
 (97) 2515057, 24.10.2012 de  
 (54) Method and device for regulating the temperature of a fluid medium  
 (71) Messer Group GmbH, Messer-Platz 1, 65812 Bad Soden, DE  
 (72) Herzog, Dr. Friedhelm, Josef-Brocker-Dyk 129, 47803 Krefeld, DE

(51) MKP  
**C07K 16/00 (2006.01)** (97) **2523682 \***  
**A61K 39/00 (2006.01)**  
 (86) US2011021135 13.01.2011  
 (96) 11733378.1 21.11.2012  
 (87) WO2011088215, 13.01.2011  
 (97) 2523682, 21.11.2012 en  
 (54) NOTCH1 BINDING AGENTS AND METHODS OF USE THEREOF  
 (71) Oncomed Pharmaceuticals, Inc., 800 Chesapeake Drive, Redwood City, CA 94063-4748, US  
 (72) VAN DER HORST, Edward, Thein Htun, 1824 Oak Creek Drive 406, Palo Alto, CA 94304, US

(51) MKP  
**A61K 9/16 (2006.01)** (97) **2512453 \***  
 (86) EP2010069733 15.12.2010  
 (96) 10793226.1 24.10.2012  
 (87) WO2011073245, 15.12.2010  
 (97) 2512453, 24.10.2012 en  
 (54) GRANULES FOR PHARMACEUTICAL PREPARATIONS, METHODS AND APPARATUS FOR THEIR PRODUCTION  
 (71) Ferring B.V., Polaris Avenue 144, 2132 JX Hoofddorp, NL  
 (72) HOEG-MOLLER, Carsten, Kratvej 24, DK-2760 Malov, DK  
 LARSEN, Crilles Casper, Chemin du Marais 6, CH-1031 Mex, CH  
 WITTENDORFF, Jorgen, 47 Sonderkaer, DK-2650 Hvidovre, DK  
 NISSEN, Brigitte, Linde Allé 1, DK-2600 Glostrup, DK  
 PEDERSEN, Kenneth Manby, Tarnbjerggardsvej 16, DK-4320 Lejre, DK  
 HANSEN, Tue, Strandholms Allé 6, DK-2650 Hvidovre, DK  
 POULSEN, Helle, Hellevaenget 7st, DK-2800 Lyngby, DK

(51) MKP  
**A61P 1/00 (2006.01)** (97) **2516446 \***  
**A61P 3/00 (2006.01)**  
**C07D 491/052 (2006.01)**  
**A61K 31/4439 (2006.01)**  
**A61P 25/00 (2006.01)**  
 (86) US2010060938 17.12.2010  
 (96) 10801042.2 31.10.2012  
 (87) WO2011087713, 17.12.2010  
 (97) 2516446, 31.10.2012 en  
 (54) SUBSTITUTED HEXAHYDROCHROMENO[3,4-B]PYRROLES WITH AFFINITY FOR THE SEROTONIN RECEPTOR (5-HT) FAMILY  
 (71) Cephalon, Inc., 41 Moores Road, Frazer, Pennsylvania 19355, US  
 (72) ALLWEIN, Shawn P., 395 Township Line Road, Downingtown Pennsylvania 19335, US  
 MORTON, George C., 313 Ross Lane, Collegeville Pennsylvania 19426, US  
 ROSSE, Gerard C., 216 Warren Court, Exton Pennsylvania 19341, US  
 WANG, Yi, 307 Dartmouth Road, Chester Springs Pennsylvania 19425, US

(51) MKP  
**A61K 36/899 (2006.01)** (97) **2512223 \***  
**A01H 5/00 (2006.01)**  
 (86) US2010060831 16.12.2010  
 (96) 10838262.3 24.10.2012  
 (87) WO2011075590, 16.12.2010  
 (97) 2512223, 24.10.2012 en  
 (54) INSECTICIDAL PROTEIN COMBINATION COMPRISING CRY1AB AND CRY2AA FOR CONTROLLING EUROPEAN CORN BORER, AND METHODS FOR INSECT RESISTANCE MANAGEMENT  
 (71) Dow AgroSciences, LLC, 9330 Zionsville Road, Indianapolis, Indiana 46268, US  
 (72) MEADE, Thomas, 1141 Huntington Woods Pt., Zionsville IN 46077, US  
 NARVA, Kenneth, 4372 Creekside Pass, Zionsville IN 46077, US  
 STORER, Nicholas, P., 10703 Lexington Street, Kensington MD 20895, US  
 SHEETS, Joel, J., 10005 Oak Ridge Drive, Zionsville IN 46077, US  
 WOOSLEY, Aaron, T., 8906 Tanner Drive, Fishers IN 46038, US  
 BURTON, Stephanie, L., 6820 Bluffgrove Drive, Indianapolis IN 46278, US

(51) MKP  
**A61K 8/49 (2006.01)** (97) **2516399 \***  
**C07D 213/74 (2006.01)**  
**A61Q 19/00 (2006.01)**  
**A61K 31/44 (2006.01)**  
 (86) FR2010052872 22.12.2010  
 (96) 10808916.0 31.10.2012  
 (87) WO2011077044, 22.12.2010  
 (97) 2516399, 31.10.2012 fr  
 (54) PHENOL DERIVATIVES AND PHARMACEUTICAL OR COSMETIC USE THEREOF  
 (71) Galderma Research & Development, 2400 Route des Colles Les Templiers, 06410 Biot, FR  
 (72) POINSARD, Cédric, 13 chemin du Collet de St Marc, F-06130 Le Plan de Grasse, FR  
 COLLETTE, Pascal, 631 avenue du Général de Gaulle, F-06110 Le Cannet, FR  
 MAUVAIS, Pascale, 7 allée des fées Corniche des Cougoulines, F-06600 Antibes, FR  
 LINGET, Jean-Michel, 11A rue de Selestat, F-67230 Benfeld, FR  
 RETHORE, Sandrine, Résidence Pythagore 14 avenue de Pythagore, F-06560 Valbonne, FR

- (51) MKP  
**A61P 31/00 (2006.01)** (97) **2519252 \***  
**A61K 39/00 (2006.01)**  
(86) US2010058554 01.12.2010  
(96) 10787241.8 07.11.2012  
(87) WO2011081765, 01.12.2010  
(97) 2519252, 07.11.2012 en  
(54) PYTHIUM IMMUNOTHERAPY  
(71) Board Of Trustees Of Michigan State University, Michigan State University 238 Administrative Building, Lansing, MI 48824, US  
(72) MENDOZA, Alberto, L., 1745 Nemoke Trails 9, Haslett MI 48840, US  
GLASS, Robert, L., 166 Brushy Creek Trail, Hutto TX 78634, US  
HANSEN, Richard, D., 321 E. Charlotte Terrace, Mustang OK 73064, US

- (51) MKP  
**C07D 413/14 (2006.01)** (97) **2507230 \***  
**C07D 419/12 (2006.01)**  
**C07D 413/12 (2006.01)**  
(86) EP2010068605 01.12.2010  
(96) 10787393.7 10.10.2012  
(87) WO2011067272, 01.12.2010  
(97) 2507230, 10.10.2012 en  
(54) INSECTICIDAL COMPOUNDS BASED ON ISOXAZOLINE DERIVATIVES  
(71) Syngenta Participations AG, Schwarzwaldallee 215, 4058 Basel, CH  
(72) CASSAYRE, Jérôme Yves, Syngenta Crop Protection Münchwilen AG Schaffhauserstrasse, CH-4332 Stein, CH  
RENOLD, Peter, Syngenta Crop Protection Münchwilen AG Schaffhauserstrasse, CH-4332 Stein, CH  
EL QACEMI, Myriem, Syngenta Crop Protection Münchwilen AG Schaffhauserstrasse, CH-4332 Stein, CH  
PITTERNA, Thomas, Syngenta Crop Protection Münchwilen AG Schaffhauserstrasse, CH-4332 Stein, CH  
TOUEG, Julie Clementine, Syngenta Crop Protection Münchwilen AG Schaffhauserstrasse, CH-4332 Stein, CH

- (51) MKP  
**B23K 23/00 (2006.01)** (97) **2509740 \***  
**B23K 37/00 (2006.01)**  
**B22D 19/04 (2006.01)**  
(86) US2010039895 25.06.2010  
(96) 10836340.9 17.10.2012  
(87) WO2011071561, 25.06.2010  
(97) 2509740, 17.10.2012 en  
(54) ALTERNATIVE IGNITION SOURCE SYSTEM FOR AN EXOTHERMIC REACTION MOLD DEVICE  
(71) Continental Industries, Inc., 4102 South 74th East Avenue, Tulsa, OK 74145, US  
(72) LOFTON, David, Lewis, 4207 East 7th Street, Tulsa, OK 74112, US

- (51) MKP  
**F23J 15/00 (2006.01)** (97) **2526177 \***  
**C10G 2/00 (2006.01)**  
**C07C 29/151 (2006.01)**  
**C10J 3/66 (2006.01)**  
(86) EP2011050788 20.01.2011  
(96) 11701082.7 28.11.2012  
(87) WO2011089200, 20.01.2011  
(97) 2526177, 28.11.2012 de  
(54) EMISSION-FREE DEVICES AND METHOD FOR PERFORMING MECHANICAL WORK AND FOR GENERATING ELECTRICAL AND THERMAL ENERGY  
(71) Rv Lizenz AG, Dammstrasse 19, 6301 Zug, CH  
(72) RÜDLINGER, Mikael, Römerstrasse 92, CH-8404 Winterthur, CH

- (51) MKP  
**E21B 33/128 (2006.01)** (97) **2527585**  
**E21B 33/12 (2006.01)**  
(86) 12168990.5 28.11.2012  
(97) 2527585, 28.11.2012 en  
(54) Packer for sealing against a wellbore wall  
(71) I-TEC AS, Fabrikveien 28, 4033 Stavanger, NO  
(72) Brække, Kristoffer, Kvernhusveien 1B, 4025 Stavanger, NO  
Angell, Bård-Einar, Austråttveien 81, 4326 Sandnes, NO  
Seguin, Melanie, Langgata 39, 4013 Stavanger, NO

- (51) MKP  
**C12N 5/10 (2006.01)** (97) **2536833 \***  
**G01N 33/569 (2006.01)**  
**C07K 16/12 (2006.01)**  
**A61P 31/04 (2006.01)**  
**A61K 39/395 (2006.01)**  
**C12P 21/08 (2006.01)**  
**C12N 15/09 (2006.01)**  
**C07K 16/46 (2006.01)**  
(86) JP2011054223 18.02.2011  
(96) 11744833.2 26.12.2012  
(87) WO2011102551, 18.02.2011  
(97) 2536833, 26.12.2012 en  
(54) ANTIBODY AGAINST SEROTYPE E LIPOPOLYSACCHARIDE OF PSEUDOMONAS AERUGINOSA  
(71) Meiji Seika Pharma Co., Ltd., 4-16, Kyobashi 2-chome Chuo-ku, Tokyo 104-8002, JP  
Symphogen A/S, Elektrovej Building 375, 2800 Lyngby, DK  
TANAKA, Jiro, c/o Meiji Seika Pharma Co., Ltd. 760 Morooka-cho Kohoku-ku, Yokohama-shi Kanagawa 222-8567, JP  
ANDERSEN, Peter Sejer, Adalsvej 21A, Vanlose 2720, DK  
OKUTOMI, Takafumi, c/o Meiji Seika Pharma Co., Ltd. 760 Morooka-cho Kohoku-ku, Yokohama-shi Kanagawa 222-8567, JP  
INABA, Tsuneyoshi, c/o Meiji Seika Pharma Co., Ltd. 760 Morooka-cho Kohoku-ku, Yokohama-shi Kanagawa 222-8567, JP  
OTSUKA, Keiko, c/o Meiji Seika Pharma Co., Ltd. 760 Morooka-cho Kohoku-ku, Yokohama-shi Kanagawa 222-8567, JP  
AKABANE, Hiroto, c/o Meiji Seika Pharma Co., Ltd. 760 Morooka-cho Kohoku-ku, Yokohama-shi Kanagawa 222-8567, JP  
HOSHINA, Yukari, c/o Meiji Seika Pharma Co., Ltd. 760 Morooka-cho Kohoku-ku, Yokohama-shi Kanagawa 222-8567, JP  
SAITO, Jun, c/o Meiji Seika Pharma Co., Ltd. 760 Morooka-cho Kohoku-ku, Yokohama-shi Kanagawa 222-8567, JP  
NAGASO, Hiroshi, c/o Meiji Seika Pharma Co., Ltd. 760 Morooka-cho Kohoku-ku, Yokohama-shi Kanagawa 222-8567, JP  
KUMAGAI, Masashi, c/o Meiji Seika Pharma Co., Ltd. 760 Morooka-cho Kohoku-ku, Yokohama-shi Kanagawa 222-8567, JP  
HAGIWARA, Yasuyo, c/o Meiji Seika Pharma Co., Ltd. 760 Morooka-cho Kohoku-ku, Yokohama-shi Kanagawa 222-8567, JP

- (51) MKP  
**A61K 31/66 (2006.01)** (97) **2533645 \***  
**A01N 57/00 (2006.01)**  
(86) US2011024256 09.02.2011  
(96) 11742761.7 19.12.2012  
(87) WO2011100373, 09.02.2011  
(97) 2533645, 19.12.2012 en  
(54) METHODS AND COMPOSITIONS FOR IMPROVING COGNITIVE FUNCTION  
(71) The Johns Hopkins University, 3400 North Charles Street Ames Hall, Baltimore, MD 21218, US  
(72) GALLAGHER, Michela, 3400 North Charles Street Ames Hall, Baltimore, Maryland 21218, US  
HABERMAN, Rebecca, 3400 North Charles Street Ames Hall, Baltimore, Maryland 21218, US  
KOH, Ming Teng, 3400 North Charles Street Ames Hall, Baltimore, Maryland 21218, US

- (51) MKP  
**B41M 5/28 (2006.01)** (97) **2509793 \***  
**B42D 15/00 (2006.01)**  
**B41M 3/14 (2006.01)**  
**B42D 15/10 (2006.01)**  
(86) EP2010056881 19.05.2010  
(96) 10722054.3 17.10.2012  
(87) WO2011069692, 19.05.2010  
(97) 2509793, 17.10.2012 en  
(54) MARKING BASED ON MODIFIED CHIRAL LIQUID CRYSTAL POLYMERS  
(71) SICPA Holding SA, Avenue de Florissant 41, 1008 Prilly, CH  
(72) TILLER, Thomas, Chemin du Cèdre 21, CH-1030 Bussigny, CH  
GREMAUD, Frédéric, Chemin de la Belle-Luce 15, CH-1663 Epagny, CH  
CALLEGARI, Andrea, Chemin des Berges 4, CH-1022 Chavannes-Pres-Renens, CH

- (51) MKP  
**A61K 31/403 (2006.01)** (97) **2509947 \***  
**A61P 25/00 (2006.01)**  
**C07D 209/52 (2006.01)**  
(86) FR2010000823 08.12.2010  
(96) 10799080.6 17.10.2012  
(87) WO2011070253, 08.12.2010  
(97) 2509947, 17.10.2012 fr  
(54) AZABICYCLO[3.1.0]HEX-2-YL DERIVATIVES, METHOD FOR PREPARING SAME, AND PHARMACEUTICAL COMPOSITIONS CONTAINING SAME  
(71) Les Laboratoires Servier, 35, rue de Verdun, 92284 Suresnes Cedex, FR  
(72) CASARA, Patrick, 740 chemin Pré Seigneur, F-78670 Villennes sur Seine, FR  
CHOLLET, Anne-Marie, 27 avenue d'Aligre, F-78230 Le Pecq, FR  
DHAINAUT, Alain, 7 rue des Guipières, F-78400 Châtou, FR  
HENLIN, Jean-Michel, 50 rue des Carrières, F-92150 Suresnes, FR  
LESTAGE, Pierre, 9 allée de la Grande Terre, F-78170 La Celle Saint Cloud, FR  
PANAYI, Fany, 44 Bd de Rochechouart, F-78018 Paris, FR

- (51) MKP  
**A61P 3/06 (2006.01)** (97) **2536733 \***  
**A61K 31/4741 (2006.01)**  
**C07D 491/04 (2006.01)**  
**C07D 215/56 (2006.01)**  
**A61P 9/00 (2006.01)**  
(86) EP2011052376 17.02.2011  
(96) 11704227.5 26.12.2012  
(87) WO2011101424, 17.02.2011  
(97) 2536733, 26.12.2012 en  
(54) TRICYCLIC PYRIDINE DERIVATIVES, MEDICAMENTS CONTAINING SUCH COMPOUNDS, THEIR USE AND PROCESS FOR THEIR PREPARATION  
(71) Boehringer Ingelheim International GmbH, Binger Strasse 173, 55216 Ingelheim am Rhein, DE  
(72) WAGNER, Holger, Boehringer Ingelheim GmbH Corporate Patents Binger Str. 173, 55216 Ingelheim am Rhein, DE  
BERTA, Daniela, Boehringer Ingelheim GmbH Corporate Patents Binger Str. 173, 55216 Ingelheim am Rhein, DE  
FUCHS, Klaus, Boehringer Ingelheim GmbH Corporate Patents Binger Str. 173, 55216 Ingelheim am Rhein, DE  
GIOVANNINI, Riccardo, Boehringer Ingelheim GmbH Corporate Patents Binger Str. 173, 55216 Ingelheim am Rhein, DE  
HAMPRECHT, Dieter, Wolfgang, Boehringer Ingelheim GmbH Corporate Patents Binger Str. 173, 55216 Ingelheim am Rhein, DE  
KONETZKI, Ingo, Boehringer Ingelheim GmbH Corporate Patents Binger Str. 173, 55216 Ingelheim am Rhein, DE  
STREICHER, Ruediger, Boehringer Ingelheim GmbH Corporate Patents Binger Str. 173, 55216 Ingelheim am Rhein, DE  
TRIESELMANN, Thomas, Boehringer Ingelheim GmbH Corporate Patents Binger Str. 173, 55216 Ingelheim am Rhein, DE

- (51) MKP  
**A01N 43/78 (2006.01)** (97) **2536285 \***  
**A61K 31/425 (2006.01)**  
(86) US2011024311 10.02.2011  
(96) 11745064.3 26.12.2012  
(87) WO2011103018, 10.02.2011  
(97) 2536285, 26.12.2012 en  
(54) SUBSTITUTED FUSED IMIDAZOLE DERIVATIVES, PHARMACEUTICAL COMPOSITIONS, AND METHODS OF USE THEREOF  
(71) High Point Pharmaceuticals, LLC, 4170 Mendenhall Oaks Parkway, High Point, NC 27265, US  
(72) MJALLI, Adnan, M., M., 6421 Ashton Park Drive, Oak Ridge, NC 27310, US  
POLISETTI, Dharma, Rao, 3741 Deerfield Street, High Point, NC 27265, US  
KASSIS, Jareer, Nabeel, 8300 Ballard Farm Court, Colfax, NC 27235, US  
KOSTURA, Matthew, J., 4201 New Hope Springs Drive, Hillsborough, NC 27278, US  
GUZEL, Mustafa, 4058 Gunsmith Court, Jamestown, NC 27282, US  
ATTUCKS, Otis, Clinton, 249 Alexander Preston Lane, Winston-salem, NC 27127, US  
ANDREWS, Robert, Carl, 3312 Morris Farm Drive, Jamestown, NC 27282, US  
VICTORY, Samuel, 5820 Elkton Drive, Oak Ridge, NC 27310, US  
GUPTA, Suparna, 2518 Brandt Forest Court, Greensboro, NC 27455, US

- (51) MKP  
**C12Q 1/68 (2006.01)** (97) **2519652 \***  
**G01N 33/15 (2006.01)**  
**C12R 1/32 (2006.01)**  
**C12N 15/31 (2006.01)**  
(86) US2010046042 19.08.2010  
(96) 10833713.0 07.11.2012  
(87) WO2011066008, 19.08.2010  
(97) 2519652, 07.11.2012 en  
(54) BLOOD TRANSCRIPTIONAL SIGNATURE OF ACTIVE VERSUS LATENT MYCOBACTERIUM TUBERCULOSIS INFECTION  
(71) Baylor Research Institute, 3310 Live Oak Street, Suite 501, Dallas, TX 75204, US  
Medical Research Council, 2nd Floor, David Phillips Building Polaris House North Star Avenue, Swindon SN2 1FL, GB  
Imperial College Healthcare NHS Trust, The Bays South Wharf Road St. Mary's Hospital, London W2 1NY, GB  
(72) BANCHEREAU, Jacques, F., 126 Lloyd Road, Montclair, NJ 07042, US  
CHAUSSABEL, Damien, 10900 Bill Point Court, Bainbridge Island, WA 98110, US  
O'GARRA, Anne, 116 Greenfield Gardens, London NW2 1HY, GB  
BERRY, Matthew, 303c West End Lane, London NW6 1RD, GB  
KON, Onn Min, 60 Llanvanor Road, London NW2 2AP, GB

- (51) MKP  
**H02K 53/00 (2006.01)** (97) **2512018**  
(96) 11462006.5 17.10.2012  
(97) 2512018, 17.10.2012 en  
(54) Method and apparatus for exploiting interaction energy of magnetic fields  
(71) Pinter, Csaba, Bogárczó köz 1, 6237 Kecel, HU  
Fekete, Gábor, Rákóczi Ferenc u. 28, 3530 Miskolc, HU  
(72) Pinter, Csaba, Bogárczó köz 1, 6237 Kecel, HU  
Fekete, Gábor, Rákóczi Ferenc u. 28, 3530 Miskolc, HU

- (51) MKP  
**A22C 21/00 (2006.01)** (97) **2528447 \***  
**A22C 17/00 (2006.01)**  
(86) NL2011050049 26.01.2011  
(96) 11706943.5 05.12.2012  
(87) WO2011093701, 26.01.2011  
(97) 2528447, 05.12.2012 en  
(54) METHOD AND APPARATUS FOR COLLECTING MEAT FROM AN ANIMAL PART  
(71) Foodmate B.V., Röntgenstraat 18, 3261 LK Oud-Beijerland, NL  
(72) STOOKER, Dirk Cornelis, Röntgenstraat 18, NL-3261 LK Oud-Beijerland, NL

(51) MKP  
**A01N 43/58 (2006.01)** (97) **2536283 \***  
**A61K 31/50 (2006.01)**  
**A61K 31/495 (2006.01)**  
(86) US2011024886 15.02.2011  
(96) 11745116.1 26.12.2012  
(87) WO2011103091, 15.02.2011  
(97) 2536283, 26.12.2012 en  
(54) PHENYL-HETEROARYL DERIVATIVES AND METHODS OF USE THEREOF  
(71) TransTech Pharma, Inc, 4170 Mendenhall Oaks Parkway, High Point, North Carolina 27265, US  
(72) GOHIMUKKULA, Devi, Reddy, 4061 Cobbler Ct., Jamestown, North Carolina 27282, US  
JONES, David, 5262 Wolfpen Pleasant Hill Road, Milford, Ohio 45150, US  
QABAJA, Ghassan, 6335 Stonewick Drive, Jamestown, North Carolina 27282, US  
ZHU, Jeff, Jiqun, 1978 Paragon Drive, Winston-Salem, NC 27127, US  
COOPER, Jeremy, T., 3917 Cedar Crest Lane, High Point, North Carolina 27265, US  
BANNER, William, Kenneth, 10 Country Walk Lane, Greensboro, North Carolina 27407, US  
SUNDERMANN, Kurt, 7642 Henson Forest Drive, Summerfield, North Carolina 27358, US  
BONDLELA, Muralidhar, 6527 Overland Park Drive, Greensboro, North Carolina 27410, US  
RAO, Mohan, 4914 Riding Ridge Drive, Greensboro, North Carolina 27410, US  
WANG, Pingzhen, 122 Kentland Ridge Drive, Kernersville, North Carolina 27284, US  
GOWDA, Raju, Bore, 601 Stafford Pointe Court, Oak Ridge, North Carolina 27310, US  
ANDREWS, Robert, C., 3312 Morris Farm Drive, Jamestown, North Carolina 27282, US  
GUPTA, Suparna, 2518 Brandt Forest Court, Greensboro, North Carolina 27455, US  
HARI, Anitha, 3712 Pemberton Way, High Point, North Carolina 27265, US

(51) MKP  
**A61L 28/00 (2006.01)** (97) **2501546 \***  
**B32B 27/30 (2006.01)**  
**B32B 27/32 (2006.01)**  
**A61J 1/05 (2006.01)**  
(86) US2010056285 11.11.2010  
(96) 10779415.8 26.09.2012  
(87) WO2011062828, 11.11.2010  
(97) 2501546, 26.09.2012 en  
(54) RADIO FREQUENCY SEALABLE FILM  
(71) Cryovac, Inc., 100 Rogers Bridge Road, Duncan, South Carolina 29334, US  
(72) BEKELE, Solomon, 4 Walden Way, Taylors SC 29687, US  
SPIGAROLI, Romano, C. Cattaneo 78, I-20025 Legnano, IT

(51) MKP  
**A61K 38/19 (2006.01)** (97) **2506867 \***  
**A61K 38/18 (2006.01)**  
**A61K 38/30 (2006.01)**  
**A61K 31/529 (2006.01)**  
**A61K 38/22 (2006.01)**  
**A61K 38/48 (2006.01)**  
(86) EP2010068700 02.12.2010  
(96) 10790375.9 10.10.2012  
(87) WO2011067317, 02.12.2010  
(97) 2506867, 10.10.2012 en  
(54) PHARMACEUTICAL COMPOSITIONS FOR THE STIMULATION OF STEM CELLS.  
(71) Cardio3 Biosciences S.A., Axis Business Parc Rue Edouard Belin 12, 1435 Mont-Saint-Guibert, BE  
(72) GORDON-BERESFORD, Roland, Avenue Antoinette Herlin 11, B-1310 La Hulpe, BE  
GAUSSIN, Vinciane, Avenue de l'Esplanade 6, B-1970 Wezembeek-oppem, BE  
LATERE DWAN'ISA, Jean-Pierre, rue Adolphe Bastin 21, B-5000 Namur, BE  
HOMSY, Christian, Avenue des Sittelles 99, B-1150 Bruxelles, BE

(51) MKP  
**B01L 3/00 (2006.01)** (97) **2519354 \***  
(86) NO2010000488 28.12.2010  
(96) 10803408.3 07.11.2012  
(87) WO2011081530, 28.12.2010  
(97) 2519354, 07.11.2012 en  
(54) SAMPLE PROCESSING CARTRIDGE AND METHOD OF PROCESSING AND/OR ANALYSING A SAMPLE UNDER CENTRIFUGAL FORCE  
(71) Sintef Stiftelsen, P.O. Box 124 Blindern, 0314 Oslo, NO  
(72) Borch, Stig Morten, Dagaliveien 51, 0783 Oslo, NO

(51) MKP  
**A43B 7/08 (2006.01)** (97) **2533659 \***  
**A43B 7/12 (2006.01)**  
**A43B 9/02 (2006.01)**  
(86) EP2011050921 24.01.2011  
(96) 11701251.8 19.12.2012  
(87) WO2011098344, 24.01.2011  
(97) 2533659, 19.12.2012 en  
(54) SHOE WITH WATERPROOF AND VAPOR-PERMEABLE UPPER AND SOLE  
(71) Geox S.p.A., Via Feltrina Centro, 16, 31044 Montebelluna Località Biadene (Treviso), IT  
(72) POLEGATO MORETTI, Mario, Via Fantin 96, I-31035 Crocetta Del Montello, IT

(51) MKP  
**A61B 17/32 (2006.01)** (97) **2533706 \***  
**A61B 17/00 (2006.01)**  
**A61B 17/3207 (2006.01)**  
(86) US2011024183 09.02.2011  
(96) 11704380.2 19.12.2012  
(87) WO2011100316, 09.02.2011  
(97) 2533706, 19.12.2012 en  
(54) ULTRASONICALLY POWERED SURGICAL INSTRUMENTS WITH ROTATING CUTTING IMPLEMENT  
(71) Ethicon Endo-Surgery, Inc., 4545 Creek Road, Cincinnati, OH 45242, US  
(72) ROBERTSON, Galen, C., 5752 Doerger Lane, Cincinnati, OH 45212, US  
TIMM, Richard, W., 3405 Monteith Avenue 1, Cincinnati, OH 45208, US  
MUMAW, Daniel, J., 953 Long Lane, Milford, OH 45150, US  
STULEN, Foster, B., 6245 Bridgewater Court, Mason, OH 45040, US  
JOHNSON, Gregory, W., 907 Center Street, Milford, OH 45150, US  
MORGAN, Jerome, R., 3275 S. Whitetree Circle, Cincinnati, OH 45236, US  
HOUSER, Kevin, L., 570 Foliage Lane, Springboro, OH 45066, US  
NEUROHR, Mark, A., 658 Nelson Place, Newport, KY 41071, US  
MALAVIYA, Prasanna, 5860 Maxfli Lane, Mason, OH 45040, US  
FORTSON, Reginald, D., 3404 Walworth Avenue, Cincinnati, OH 45226, US  
CONLON, Sean, P., 6234 North Shadow Hill Way Apt. C, Loveland, OH 45140, US  
DANNAHER, William, D., 8907 Eldora Drive, Cincinnati, OH 45236, US  
WIEINER, Eitan, T., 9519 Croton Drive, Cincinnati, OH 45242, US  
BODIN, Kristi, M., 7449 Kilkenny Drive, West Chester, OH 45069, US  
JOACHIM, William, S., Jr., 7398 Airy View Drive, Liberty Township OH 45044, US

(51) MKP  
**G02B 6/50 (2006.01)** (97) **2526450 \***  
**E02F 5/10 (2006.01)**  
**E01F 11/00 (2006.01)**  
(86) AT2011000025 17.01.2011  
(96) 11703572.5 28.11.2012  
(87) WO2011088486, 17.01.2011  
(97) 2526450, 28.11.2012 de  
(54) METHOD AND DEVICE FOR INTRODUCING A PIPE FOR OPTICAL CABLES INTO A SOLID LAYING FOUNDATION  
(71) Pichler, Jan Michael, Schwarzenberg 5, 3341 Ybbsitz, AT  
(72) PICHLER, Alois, Schwarzenberg 5, A-3341 Ybbsitz, AT

- (51) MKP  
**C07H 21/02 (2006.01)** (97) **2526112 \***  
**C12P 21/06 (2006.01)**  
(86) US2011000125 24.01.2011  
(96) 11734969.6 28.11.2012  
(87) WO2011090804, 24.01.2011  
(97) 2526112, 28.11.2012 en  
(54) TARGETED GENOMIC ALTERATION  
(71) Dow AgroSciences LLC, 9330 Zionsville Road, Indianapolis, IN 46268-1054, US  
Sangamo BioSciences, Inc., Point Richmond Tech. Center 501 Canal Boulevard, Suite A100, Richmond, CA 94804, US  
(72) AINLEY, William M., c/o Dow AgroSciences LLC 9330 Zionsville Road, Indianapolis, Indiana 46268, US  
MURRAY, Michael G., c/o Dow AgroSciences LLC 9330 Zionsville Road, Indianapolis, Indiana 46268, US  
URNOV, Fyodor, c/o Sangamo BioSciences Inc. Point Richmond Tech Center 501 Canal Blvd. Suite A100, Richmond, California 94804, US  
ZEITLER, Bryan, c/o Sangamo BioSciences Inc. Point Richmond Tech Center 501 Canal Blvd. Suite A100, Richmond, California 94804, US
- 
- (51) MKP  
**A61K 39/12 (2006.01)** (97) **2519627 \***  
**C12N 15/33 (2006.01)**  
**C07K 14/005 (2006.01)**  
**C12N 7/01 (2006.01)**  
(86) US2010062638 31.12.2010  
(96) 10841780.9 07.11.2012  
(87) WO2011082381, 31.12.2010  
(97) 2519627, 07.11.2012 en  
(54) PLASMIDS AND METHODS FOR PEPTIDE DISPLAY AND AFFINITY-SELECTION ON VIRUS-LIKE PARTICLES OF RNA BACTERIOPHAGES  
(71) STC.UNM, 801 University Blvd. SE, Suite 101, Albuquerque, NM 87106, US  
(72) PEABODY, David, S., 9420 Allande Rd., NE, Albuquerque, NM 87109, US  
CHACKERIAN, Bryce, 813 Loma Vista Dr., NE, Albuquerque, NM 87106, US
- 
- (51) MKP  
**C12N 15/863 (2006.01)** (97) **2529010 \***  
**C12N 7/02 (2006.01)**  
**A61K 39/275 (2006.01)**  
**C12N 7/00 (2006.01)**  
(86) EP2011000405 28.01.2011  
(96) 11701949.7 05.12.2012  
(87) WO2011092029, 28.01.2011  
(97) 2529010, 05.12.2012 en  
(54) VACCINIA VIRUS MUTANTS CONTAINING THE MAJOR GENOMIC DELETIONS OF MVA  
(71) Bavarian Nordic A/S, Hejreskovvej 10 A, 3490 Kvistgaard, DK  
(72) HAUSMANN, Juergen, Alte Bundesstrasse 130, 79194 Gundelfingen, DE  
MEISINGER-HENSCHHEL, Christine, Franz-Schuster-Str. 23A, 82061 Neuried, DE  
SUTER, Mark, Kapuzinerweg 11, CH-6006 Luzern, CH
- 
- (51) MKP  
**C07D 215/58 (2006.01)** (97) **2501680 \***  
(86) EP2010067828 19.11.2010  
(96) 10777039.8 26.09.2012  
(87) WO2011061292, 19.11.2010  
(97) 2501680, 26.09.2012 en  
(54) A PROCESS FOR A PREPARATION OF MARBOFLOXACIN AND INTERMEDIATE THEREOF  
(71) KRKA, TOVARNA ZDRAVIL, D.D., NOVO MESTO et al, Smarjeska cesta 6, 8501 Novo mesto, SI  
(72) ZUPET, Rok, Janeza Rozica 6, 1000 Ljubljana, SI  
ISKRA, Jernej, Jakopicева ulica 7, 1000 Ljubljana, SI  
RUZIC, Milos, Milke Kerinove 9, 3000 Celje, SI  
PECAVAR, Anica, Gotna vas 18, 8000 Novo mesto, SI  
KOLENC, Ivanka, Ulica Slavka Gruma 9, 8000 Novo mesto, SI  
PUCELJ, Jo e, Av iceva ulica 16, 8000 Novo mesto, SI  
PLAPER, Igor, marje ke Toplice 128, 8220 marje ke Toplice, SI
- 
- (51) MKP  
**A61F 2/06 (2006.01)** (97) **2503959 \***  
(86) US2010058021 24.11.2010  
(96) 10833934.2 03.10.2012  
(87) WO2011066401, 24.11.2010  
(97) 2503959, 03.10.2012 en  
(54) SMALL DIAMETER VASCULAR GRAFT PRODUCED BY A HYBRID METHOD  
(71) Drexel University, 3141 Chestnut Street, Philadelphia, PA 19104, US  
CHILDREN'S HOSPITAL OF PHILADELPHIA, 34th Street and Civic Center Boulevard, Philadelphia, PA 19104, US  
The Trustees Of The University Of Pennsylvania, Center for Technology Transfer 3160 Chestnut Street, Suite 200, Philadelphia PA 19104-6283, US  
(72) LELKES, Peter, I, 5 Hawthorne Drive, Cherry Hill NJ 08003, US  
LI, Mengyan, 14503 Valor Circle Apt. 303A, Tampa FL 33613, US  
PERETS, Anat, 326 Woodbine Avenue, Narberth PA 19072, US  
UTTAYARAT, Pimporn, 2045 S. Spruce Street, 2R, Philadelphia PA 19103, US  
LEVY, Robert, J., 440 Merion Road, Merion Station PA 19066, US  
COMPOSTO, Russell, J., 261 S. 25th Street, Philadelphia PA 19103, US
- 
- (51) MKP  
**A61M 5/20 (2006.01)** (97) **2536454 \***  
**A61M 5/00 (2006.01)**  
(86) EP2011052302 16.02.2011  
(96) 11704219.2 26.12.2012  
(87) WO2011101380, 16.02.2011  
(97) 2536454, 26.12.2012 en  
(54) AUTO-INJECTOR  
(71) Sanofi-Aventis Deutschland GmbH, Brüningstraße 50, 65929 Frankfurt, DE  
(72) EKMAN, Matthew, 59 Ecton Avenue, Macclesfield Cheshire SK10 1RD, GB  
BARROW-WILLIAMS, Timothy Donald, 1 Grange Street, St. Albans Herts AL3 5NA, GB  
HOURMAND, Yannick, 14 The Elms, Haslingfield CB23 1ND, GB
- 
- (51) MKP  
**A61M 5/315 (2006.01)** (97) **2506902 \***  
(86) EP2010068706 02.12.2010  
(96) 10795965.2 10.10.2012  
(87) WO2011067320, 02.12.2010  
(97) 2506902, 10.10.2012 en  
(54) A DRUG DELIVERY DEVICE  
(71) Sanofi-Aventis Deutschland GmbH, Brüningstraße 50, 65929 Frankfurt, DE  
(72) HELMER, Michael, c/o Sanofi-Aventis Deutschland GmbH, 65926 Frankfurt am Main, DE  
RAAB, Steffen, c/o Sanofi-Aventis Deutschland GmbH, 65926 Frankfurt am Main, DE
- 
- (51) MKP  
**A61L 27/38 (2006.01)** (97) **2439263**  
**C12N 5/00 (2006.01)**  
(96) 11183912.2 11.04.2012  
(97) 2439263, 11.04.2012 de  
(54) Flexible cell culture holder material with a porous three-dimensional structure  
(71) KET Kunststoff- und Elasttechnik GmbH Liegau-Augustusbad, Wachauer Strasse 3, 01454 Radeberg, DE  
(72) Wenske, Günther, Langebrücker Straße 128, 01454 Radeberg, DE  
Böttcher, Gunter, Siedlungsweg 8b, 01561 Würschnitz, DE  
Winkelmann, Claudia, An der Brauerei 11, 08412 Werdau OT Steinpleis, DE

(51) MKP  
**C12Q 1/68 (2006.01)** (97) **2519651 \***  
 (86) DK2010050358 23.12.2010  
 (96) 10805684.7 07.11.2012  
 (87) WO2011079846, 23.12.2010  
 (97) 2519651, 07.11.2012 en  
 (54) CLASSIFICATION OF THYROID FOLLICULAR NEOPLASIA BASED ON MRNA EXPRESSION  
 (71) Rigshospitalet, Blegdamsvej 9, 2100 Copenhagen Ø, DK Herlev Hospital, Herlev Ringvej 75, 2730 Herlev, DK  
 (72) ROSSING, Maria, Smutvej 1, DK-2920 Charlottenlund, DK NIELSEN, Finn Cilius, Vordingborggade 6E lejl. 33, DK-2100 Copenhagen Ø, DK  
 BENNEDBÆK, Finn Noe, Hjørtevænget 66, DK-2880 Bagsværd, DK  
 BORUP-HELWEG-LARSEN, Rehannah Holga Andrea, Apollovej 15, DK-2720 Vanløse, DK

(51) MKP  
**H04L 7/00 (2006.01)** (97) **2507950 \***  
**H04L 12/56 (2006.01)**  
 (86) EP2010068959 06.12.2010  
 (96) 10795648.4 10.10.2012  
 (87) WO2011067405, 06.12.2010  
 (97) 2507950, 10.10.2012 en  
 (54) DISTRIBUTED PROCESSING OF DATA FRAMES BY MULTIPLE ADAPTERS USING TIME STAMPING AND A CENTRAL CONTROLLER  
 (71) Napatech A/S, Tobaksvejen 23A, 2860 Søborg, DK  
 (72) KORGGER, Peter, Mødekærgårdsvej 10, DK-3540 Lynge, DK EKNER, Peter, Løngangsgade 34 C, DK-3400 Hillerød, DK

(51) MKP  
**A61P 3/04 (2006.01)** (97) **2510009 \***  
**C07K 14/71 (2006.01)**  
**A61K 39/395 (2006.01)**  
**C07K 16/28 (2006.01)**  
**C07K 19/00 (2006.01)**  
**C07K 16/18 (2006.01)**  
 (86) US2010058984 03.12.2010  
 (96) 10788204.5 17.10.2012  
 (87) WO2011071783, 03.12.2010  
 (97) 2510009, 17.10.2012 en  
 (54) HUMAN ANTIGEN BINDING PROTEINS THAT BIND BETA-KLOTRO, FGF RECEPTORS AND COMPLEXES THEREOF  
 (71) Amgen Inc., One Amgen Center Drive, Thousand Oaks, California 91320-1799, US  
 (72) HU, Shaw-Fen, Sylvia, 986 Lynnmere Drive, Thousand Oaks, CA 91360, US  
 FOLTZ, Ian, 2108 Knightswood Place, Burnaby British Columbia BC V5A 4B9, CA  
 KING, Chadwick Terence, 1325 Moody Avenue, North Vancouver British Columbia V7L 3T5, CA  
 LI, Yang, 1142 Cuesta Drive, Mountain View, CA 94040, US  
 ARORA, Taruna, 5380 Via Pisa, Thousand Oaks, CA 91320, US

(51) MKP  
**A61K 38/22 (2006.01)** (97) **2525808 \***  
 (86) US2011021634 19.01.2011  
 (96) 11735065.2 28.11.2012  
 (87) WO2011090971, 19.01.2011  
 (97) 2525808, 28.11.2012 en  
 (54) OSTEOCALCIN AS A TREATMENT FOR MALE REPRODUCTIVE DISORDERS  
 (71) The Trustees Of Columbia University In The City Of New York, 535 West 116th Street, New York, NY 10027, US  
 (72) KARSENTY, Gerard, 455 Central Park West Apt. 15C, New York, NY 10025, US  
 DUCY, Patricia, F., 455 Central Park West Apt. 15C, New York, NY 10025, US

(51) MKP  
**G06F 19/00 (2011.01)** (97) **2525850 \***  
**G06K 7/10 (2006.01)**  
**G06K 7/14 (2006.01)**  
**A61M 5/24 (2006.01)**  
 (86) EP2011050797 21.01.2011  
 (96) 11700455.6 28.11.2012  
 (87) WO2011089205, 21.01.2011  
 (97) 2525850, 28.11.2012 en  
 (54) METHOD AND SYSTEM FOR DETERMINING INFORMATION RELATED TO A DRUG RESERVOIR  
 (71) Sanofi-Aventis Deutschland GmbH, Brüningstraße 50, 65929 Frankfurt, DE  
 (72) DAY, Shane Alistair, 25 Sheres Dyche, Warwick Warwickshire CV34 6BX, GB  
 YATES, Barry, 1 Towers Close, Kenilworth Warwickshire CV34 6BX, GB  
 AVERY, Richard James Vincent, 28 Nursery Close, Mickleton Chipping Campden Gloucestershire GL55 6TX, GB

(51) MKP  
**G01V 5/00 (2006.01)** (97) **2437082**  
**B64F 1/36 (2006.01)**  
 (96) 10175776.3 04.04.2012  
 (97) 2437082, 04.04.2012 en  
 (54) Improved security check method and system  
 (71) CPH Inventions A/S, Prags Boulevard 47, 2300 Copenhagen S, DK  
 (72) Thøgersen, Lars, Svend Vonveds Vej 1, DK-2300, København S, DK

(51) MKP  
**G01N 33/53 (2006.01)** (97) **2536743 \***  
**C07K 14/16 (2006.01)**  
**C12N 7/00 (2006.01)**  
 (86) US2011025077 16.02.2011  
 (96) 11706105.1 26.12.2012  
 (87) WO2011103185, 16.02.2011  
 (97) 2536743, 26.12.2012 en  
 (54) HUMAN GROUP P IMMUNODEFICIENCY VIRUS AND USES THEREOF  
 (71) Brennan, Catherine A, 634 E Lincoln Avenue, Libertyville, Illinois 60048, US  
 Holzmayer, Vera, 2010 Kenton Lane, Green Oaks, Illinois 60048, US  
 Vallari, Anadruzela S, 5631 Forest View Lane, Libertyville, Illinois 60048, US  
 Yamaguchi, Julie, 3034 W Jerome, Chicago, Illinois 60645, US  
 (72) Brennan, Catherine A, 634 E Lincoln Avenue, Libertyville, Illinois 60048, US  
 Holzmayer, Vera, 2010 Kenton Lane, Green Oaks, Illinois 60048, US  
 Vallari, Anadruzela S, 5631 Forest View Lane, Libertyville, Illinois 60048, US  
 Yamaguchi, Julie, 3034 W Jerome, Chicago, Illinois 60645, US

(51) MKP  
**A61F 9/00 (2006.01)** (97) **2503969 \***  
**A61F 9/007 (2006.01)**  
 (86) US2010058129 26.11.2010  
 (96) 10787223.6 03.10.2012  
 (87) WO2011066479, 26.11.2010  
 (97) 2503969, 03.10.2012 en  
 (54) LACRIMAL IMPLANTS INCLUDING SPLIT AND INSERTABLE DRUG CORE  
 (71) QLT Inc., 887 Great Northern Way Suite 101, Vancouver, BC V5T 4T5, CA  
 (72) ZARINS, Sascha, K., 20746 Verde Vista Lane, Saratoga CA 95070, US  
 SCOTT, David, J., 2108 Hastings Shore Lane, Redwood City CA 94065, US  
 THOLFSEN, David, 771 Superior Avenue, San Leandro CA 94577, US

(51) MKP  
**C04B 40/06 (2006.01)** (97) **2510070 \***  
**C04B 24/26 (2006.01)**  
**C09K 8/42 (2006.01)**  
**C09K 8/467 (2006.01)**  
**E21B 43/04 (2006.01)**  
**C04B 28/02 (2006.01)**  
(86) GB2010002246 08.12.2010  
(96) 10793019.0 17.10.2012  
(87) WO2011070323, 08.12.2010  
(97) 2510070, 17.10.2012 en  
(54) A BIODEGRADABLE SET RETARDER FOR A CEMENT COMPOSITION  
(71) Halliburton Energy Services, Inc., 10200 Bellaire Blvd., Houston, TX 77072, US  
(72) SARAP, Girish Dinkar, 201 Richmond Terrace Right Bhusari Colony Poud Road Kothrud, Pune 411 038 Maharashtra, IN  
PATIL, Sandip Prabhakar, E-4 Gokul Nagari Tuljabhavani Nagar Pimple Gurav, Pune 411 027 Maharashtra, IN  
SENAPATI, Dibyadarshani, C-9 Duwankur Housing Society-1 Panchavati Pashan Road, Pune 411 008 Maharashtra, IN  
TARAFDAR, Abhijit, 29/1 Anad Park Vishrantwadi, Pune 411 015 Maharashtra, IN

(51) MKP  
**A61K 9/70 (2006.01)** (97) **2515887 \***  
**A61K 31/381 (2006.01)**  
(86) EP2010070563 22.12.2010  
(96) 10796399.3 31.10.2012  
(87) WO2011076879, 22.12.2010  
(97) 2515887, 31.10.2012 en  
(54) POLYVINYLPIRROLIDONE FOR THE STABILIZATION OF A SOLID DISPERSION OF THE NON-CRYSTALLINE FORM OF ROTIGOTINE  
(71) UCB Pharma GmbH, Alfred-Nobel-Strasse 10, 40789 Monheim, DE  
LTS LOHMANN Therapie-Systeme AG, Lohmannstrasse 2, 56626 Andernach, DE  
(72) WOLFF, Hans-Michael, Schwarz Biosciences GmbH Alfred-Nobel-Strasse 10, 40789 Monheim, DE  
ARTH, Christoph, Schwarz Biosciences GmbH Alfred-Nobel-Strasse 10, 40789 Monheim, DE  
QUERE, Luc, UCB Pharma SA Chemin du Foriest, B-1420 Braine-l'Alleud, BE  
MÜLLER, Walter, Hindenburgwall 12, 56626 Andernach, DE

(51) MKP  
**A61K 31/428 (2006.01)** (97) **2513068 \***  
**A61K 31/4523 (2006.01)**  
**A61K 31/423 (2006.01)**  
**C07D 417/14 (2006.01)**  
**C07D 277/82 (2006.01)**  
**A61P 29/00 (2006.01)**  
**C07D 417/12 (2006.01)**  
**C07D 413/12 (2006.01)**  
**C07D 263/58 (2006.01)**  
**A61P 11/00 (2006.01)**  
(86) US2010060981 17.12.2010  
(96) 10801505.8 24.10.2012  
(87) WO2011075631, 17.12.2010  
(97) 2513068, 24.10.2012 en  
(54) SUBSTITUTED BENZOTHAZOLE AND BENZOXAZOLE DERIVATIVES USEFUL AS INHIBITORS OF DPP-1  
(71) Janssen Pharmaceutica, N.V., Turnhoutseweg 30, 2340 Beerse, BE  
(72) JORDAN, Alfonzo, D., 329 Regency Drive, North Wales PA 19454, US  
DESJARLAIS, Renee, L., 11 Cornwall Circle, Saint Davids PA 19087, US  
HLASTA, Dennis, J., 5008 Davis Drive, Doylestown, PA 18902-1138, US  
PARKER, Michael, H., 3587 Gray Fox Drive, Chalfont PA 18914, US  
SCHUBERT, Carsten, 1006 Hares Hill Road, Phoenixville PA 19460, US  
WHITE, Kimberly, B., 100 Gwynedd Lea Drive, North Wales PA 19454, US

(51) MKP  
**B23D 31/00 (2006.01)** (97) **2415538**  
**B65G 29/00 (2006.01)**  
**B23Q 39/04 (2006.01)**  
**B21D 43/14 (2006.01)**  
**B23Q 7/02 (2006.01)**  
(96) 11006363.3 08.02.2012  
(97) 2415538, 08.02.2012 de  
(54) Device for processing workpieces  
(71) Mall + Herlan GMBH, Wöschbacher Strasse 33, 76327 Pfinztal, DE  
(72) Breil, Anton, Gerokweg 2, 73084 Salach, DE

(51) MKP  
**H01L 31/048 (2006.01)** (97) **2518779**  
**F24J 2/52 (2006.01)**  
(96) 12163751.6 31.10.2012  
(97) 2518779, 31.10.2012 en  
(54) Grounding system for photovoltaic arrays  
(71) Blue Sunny Skies LLC, 4001 Kennett Pike, Suite 318, Greenville, DE 19807, US  
(72) O'Brien, Edward Joseph, 454 Tavistock Blvd., Haddonfield, NJ 08033, US  
Moulder, Michael J., 506 Crest Road, Wilmington, DE 19803, US  
Layre, Kenneth A., 2121 Chapman Circle, Jamison, PA 18929, US

(51) MKP  
**G06F 3/041 (2006.01)** (97) **2534558 \***  
**G06F 3/01 (2006.01)**  
(86) US2011023569 03.02.2011  
(96) 11705334.8 19.12.2012  
(87) WO2011097356, 03.02.2011  
(97) 2534558, 19.12.2012 en  
(54) SYSTEMS AND METHODS FOR HAPTIC FEEDBACK USING LATERALLY DRIVEN PIEZOELECTRIC ACTUATORS  
(71) Immersion Corporation, 30 Rio Robles, San Jose, CA 95134, US  
(72) MODARRES, Ali, 3777 Cote-des-Neiges Apt. 520, Montreal, Québec H3H 1V8, CA  
JIANG, Li, 76 Barnes Court Apt. 116, Stanford, California 94305, US  
CRUZ-HERNANDEZ, Juan, Manuel, 4840 Ste-Catherine West, Montreal, Québec H3Z 1T1, CA  
PIERON, Remy, 5 Bayberry Street, Portola Valley, California 94028, US  
YE, Frank, 139 Gerbera Street, Danville, California 94506, US  
GREGORIO, Pedro, 7353 Dunver Crescent, Verdun, Québec H4H 2H6, CA  
GRANT, Danny, A., 1784 De Lunebourg, Laval, Québec H7M 2A1, CA  
OLIEN, Neil, T., 4455 Madison Avenue, Montreal, Québec H4B 2V3, CA

(51) MKP  
**B65D 47/32 (2006.01)** (97) **2531416 \***  
(86) US2011023511 02.02.2011  
(96) 11740314.7 12.12.2012  
(87) WO2011097322, 02.02.2011  
(97) 2531416, 12.12.2012 en  
(54) PRESSURE EQUALIZATION APPARATUS FOR A BOTTLE AND METHODS ASSOCIATED THEREWITH  
(71) Paha Designs, LLC, 818 Logan Street 1202, Denver, CO 80203, US  
(72) MEAGER, Benjamin, 235 Turtle Way, Bozeman, MT 59715, US



(51) MKP  
**A61K 31/13 (2006.01)** (97) **2515889 \***  
**A61K 31/19 (2006.01)**  
**A61K 31/731 (2006.01)**  
(86) EP2010007726 17.12.2010  
(96) 10810910.9 31.10.2012  
(87) WO2011076367, 17.12.2010  
(97) 2515889, 31.10.2012 en  
(54) SYNERGISTIC ANTIVIRAL COMPOSITION AND USE THEREOF  
(71) Marinomed Biotechnologie GmbH, Veterinärplatz 1 Gebäude HA/3/Stg. 3, 1210 Vienna, AT  
(72) GRASSAUER, Andreas, Kraygasse 94/2/8, A-1220 Vienna, AT  
PRIESCHL-GRASSAUER, Eva, Kraygasse 94/2/8, A-1220 Vienna, AT  
MEIER, Christiane, Hauptstrasse 20, A-2201 Seyring/Gerasdorf, AT  
KÖNIG-SCHUSTER, Marielle, Wehlstrasse 71 -81/8/22, A-1200 Wien, AT

(51) MKP  
**C07K 16/46 (2006.01)** (97) **2519543 \***  
**A61K 39/395 (2006.01)**  
**A61P 35/00 (2006.01)**  
**A61P 37/00 (2006.01)**  
(86) US2010062436 29.12.2010  
(96) 10803713.6 07.11.2012  
(87) WO2011090762, 29.12.2010  
(97) 2519543, 07.11.2012 en  
(54) HETERODIMER BINDING PROTEINS AND USES THEREOF  
(71) Emergent Product Development Seattle, LLC, 2401 Fourth Avenue, Suite 1050, Seattle, Washington 98121, US  
(72) BLANKENSHIP, John, W., 9709 6th Avenue Northwest, Seattle, Washington 98117, US  
TAN, Philip, 8704 200th Street SW, Edmonds, Washington 98026, US

(51) MKP  
**C07C 305/00 (2006.01)** (97) **2521711 \***  
(86) US2010062078 23.12.2010  
(96) 10842754.3 14.11.2012  
(87) WO2011084846, 23.12.2010  
(97) 2521711, 14.11.2012 en  
(54) QUATERNARY AMMONIUM SALT PRODRUGS  
(71) Alkermes, Inc., 852 Winter Street, Waltham, MA 02451, US  
(72) ALMARRSON, Orn, 22 Farmington Drive, Shrewsbury MA 01545, US  
BLUMBERG, Laura, Cook, 37 Mill Street, Lincoln MA 01773, US  
REMENAR, Julius, F., 9 Eaton Road, Framingham MA 01701, US

(51) MKP  
**F16L 33/00 (2006.01)** (97) **2507144 \***  
**F16L 33/22 (2006.01)**  
**B65D 63/02 (2006.01)**  
(86) US2010057215 18.11.2010  
(96) 10834945.7 10.10.2012  
(87) WO2011068689, 18.11.2010  
(97) 2507144, 10.10.2012 en  
(54) CABLE TIE  
(71) Band-It-IDEX, Inc., 4799 Dahlia Street, Denver, Colorado 80216, US  
(72) NELSON, Daniel, J., 2545 Benton Street, Edgewater CO 80214, US  
INGALLS, Douglas, John, 121 Fawn Drive, Bailey CO 80421, US  
BUSH, Matthew, D., 345 Snyder Mountain Road, Evergreen CO 80439, US

(51) MKP  
**A61K 9/70 (2006.01)** (97) **2514440 \***  
**A61K 45/06 (2006.01)**  
**A61K 47/18 (2006.01)**  
**A61K 31/42 (2006.01)**  
**A61P 29/00 (2006.01)**  
**A61P 23/02 (2006.01)**  
**A61K 31/167 (2006.01)**  
**A61K 31/245 (2006.01)**  
(86) JP2010072454 14.12.2010  
(96) 10837593.2 24.10.2012  
(87) WO2011074567, 14.12.2010  
(97) 2514440, 24.10.2012 en  
(54) TRANSDERMAL PREPARATION CONTAINING BASIC ANTI-INFLAMMATORY AGENT  
(71) Teikoku Seiyaku Co., Ltd., 567 Sanbonmatsu, Higashikagawa-shi, Kagawa 769-2695, JP  
(72) KATAYAMA, Akiko, c/o TEIKOKU SEIYAKU CO. LTD. 567 Sanbonmatsu, Higashikagawa-shi Kagawa 769-2695, JP  
INOO, Katsuyuki, c/o TEIKOKU SEIYAKU CO. LTD. 567 Sanbonmatsu, Higashikagawa-shi Kagawa 769-2695, JP

(51) MKP  
**A61K 31/44 (2006.01)** (97) **2506713 \***  
**A01N 43/42 (2006.01)**  
(86) US2010058598 01.12.2010  
(96) 10835075.2 10.10.2012  
(87) WO2011068899, 01.12.2010  
(97) 2506713, 10.10.2012 en  
(54) NOVEL TRICYCLIC COMPOUNDS  
(71) Abbott Laboratories, 100 Abbott Park Rd., Abbott Park, IL 60064, US  
(72) ERICSSON, Anna, M., 16 Venus Drive, Shrewsbury MA 01545, US  
STEWART, Kent, D., 4715 Kings Way N., Gurnee Illinois 60031, US  
BREINLINGER, Eric, C., 54 Hanson Road, Charlton MA 01507, US  
JOSEPHSOHN, Nathan, S., 217 West Springfield, No. 4, Boston Massachusetts 02118, US  
SOMAL, Gagandeep, 57 Auburn Street Ext. Apt. No. 5, Framingham Massachusetts 01701, US  
CALDERWOOD, David, J., 4 McCarthy Circle, Framingham MA 01702, US  
VOSS, Jeffrey, W., 257 Shrewsbury Street, Holden Massachusetts 01520, US  
WISHART, Neil, 406 Sterling Road, Jefferson Massachusetts 01522, US  
GEORGE, Dawn, M., 9 Pond Lane, Charlton MA 01507, US  
LI, Biqin, C., 14 Joslin Lane, Southborough Massachusetts 01722, US  
MULLEN, Kelly, D., 64 Cranberry Meadow Road, Charlton MA 01507, US  
FRANK, Kristine, E., 8 Pinewood Lane, Worcester MA 01609, US  
WANG, Lu, 14 Stratton Way, Northborough MA 01532, US  
FIAMENGO, Bryan, A., 1029 Pleasant Street Apt., Worcester Massachusetts 01602, US  
MORYTKO, Michael, J., 1296 Worcester Road, No. 2510, Framingham Massachusetts 01701, US  
WALLACE, Grier, A., 204 Chace Hill Road, Sterling MA 01564, US  
ARGIRIADI, Maria, A., 273 Main Street, Wayland Massachusetts 01778, US  
GOEDKEN, Eric, R., 105 Hillcroft Avenue, Worcester Massachusetts 01606, US  
WOLLER, Kevin, R., 1072 Joy Court, Anitoch Illinois 60002, US  
FRIEDMAN, Michael, 27 Mechanic Street, Newton Massachusetts 02464, US  
HOEMANN, Michael, Z., 41 Lilac Circle, Marlborough, MA 01752, US

- (51) MKP  
**C07K 14/475 (2006.01)** (97) **2516455 \***  
 (86) US2010061671 21.12.2010  
 (96) 10843557.9 31.10.2012  
 (87) WO2011087810, 21.12.2010  
 (97) 2516455, 31.10.2012 en  
 (54) MODIFIED PORCINE SOMATOTROPIN POLYPEPTIDES AND THEIR USES  
 (71) Ambrx, Inc., 10975 North Torrey Pines Road, Suite 100, La Jolla, CA 92037, US  
 (72) KNUDSEN, Nick, 10709 Matinal Circle, San Diego CA 92127, US  
 KRAYNOV, Vadim, 5457 White Oak Lane, San Diego CA 92130, US

- (51) MKP  
**A61K 9/20 (2006.01)** (97) **2441444**  
**A61K 31/215 (2006.01)**  
 (96) 10013657.1 18.04.2012  
 (97) 2441444, 18.04.2012 en  
 (54) Formulations of cetyl myristate and/or cetyl palmitate  
 (71) Deva Holding Anonim Sirketi, Patent Law Department Halkali Merkez Mah. Basın Ekspres Cad. No: 1,34303, Kucukcekmece/Istanbul, TR  
 (72) Haas, Philipp Daniel, Deva Holding Anonim Sirketi Patent Law Department Halkali Merkez Mah. Basın Ekspres Cad. No: 1,34303, Kucukcekmece/Istanbul, TR  
 Firat, Omer Faruk, Deva Holding Anonim Sirketi Patent Law Department Halkali Merkez Mah. Basın Ekspres Cad. No: 1,34303, Kucukcekmece/Istanbul, TR  
 Kandemir, Levent, Deva Holding Anonim Sirketi Patent Law Department Halkali Merkez Mah. Basın Ekspres Cad. No: 1,34303, Kucukcekmece/Istanbul, TR  
 Ozbek, Mahmut, Deva Holding Anonim Sirketi Patent Law Department Halkali Merkez Mah. Basın Ekspres Cad. No: 1,34303, Kucukcekmece/Istanbul, TR  
 Koc, Fikret, Deva Holding Anonim Sirketi Patent Law Department Halkali Merkez Mah. Basın Ekspres Cad. No: 1,34303, Kucukcekmece/Istanbul, TR

- (51) MKP  
**A61B 17/32 (2006.01)** (97) **2533708 \***  
**A61B 17/3207 (2006.01)**  
 (86) US2011024167 09.02.2011  
 (96) 11705105.2 19.12.2012  
 (87) WO2011100303, 09.02.2011  
 (97) 2533708, 19.12.2012 en  
 (54) ULTRASONIC SURGICAL INSTRUMENT WITH COMB-LIKE TISSUE TRIMMING DEVICE  
 (71) Ethicon Endo-Surgery, Inc., 4545 Creek Road, Cincinnati, OH 45242, US  
 (72) DIETZ, Timothy, G., 2 Elm Ledge, Terrace Park, OH 45174, US

- (51) MKP  
**B01D 47/06 (2006.01)** (97) **2527026 \***  
 (86) CL2011000002 10.01.2011  
 (96) 11734313.7 28.11.2012  
 (87) WO2011088584, 10.01.2011  
 (97) 2527026, 28.11.2012 en  
 (54) NEUTRALISATION OF GASEOUS CONTAMINANTS BY MEANS OF ARTIFICIAL PHOTOSYNTHESIS  
 (71) Masteridea S.A., Coquimbo 348, Santiago 7550000, CL  
 (72) GONZÁLEZ PORTALES, Luis Vicente, Blanco Encalada 1159 - Maipu, Santiago 7550000, CL  
 OLIGER GONZALEZ, Jean Paul, El Volcan 6349 - Loteo Las Vizcachas, Puente Alto Santiago 7550000, CL

- (51) MKP  
**B65C 3/18 (2006.01)** (97) **2531407 \***  
**B65C 3/16 (2006.01)**  
 (86) IB2011050390 28.01.2011  
 (96) 11711649.1 12.12.2012  
 (87) WO2011095921, 28.01.2011  
 (97) 2531407, 12.12.2012 en  
 (54) DEVICE AND METHOD FOR APPLYING SELF-ADHESIVE LABELS ON THE WALLS OF CONTAINERS  
 (71) Makro Labelling S.r.l., Via Don Doride Bertoldi 91 Marmirolo, 46045 Mantova, IT  
 (72) GHIZZI, Gilberto, Via Tazzoli 10 Marmirolo, I-46045 Mantova, IT

- (51) MKP  
**A61K 31/381 (2006.01)** (97) **2511271 \***  
**C07D 277/56 (2006.01)**  
**A61K 31/4525 (2006.01)**  
**C07D 405/06 (2006.01)**  
**A61P 3/04 (2006.01)**  
**A61P 3/06 (2006.01)**  
**A61K 31/426 (2006.01)**  
**C07D 333/38 (2006.01)**  
**A61K 31/4025 (2006.01)**  
**C07D 307/68 (2006.01)**  
**A61K 31/341 (2006.01)**  
**A61P 43/00 (2006.01)**  
**C07D 277/20 (2006.01)**  
**A61P 3/10 (2006.01)**  
 (86) JP2010071929 07.12.2010  
 (96) 10835968.8 17.10.2012  
 (87) WO2011071048, 07.12.2010  
 (97) 2511271, 17.10.2012 en  
 (54) HETEROARYLCARBOXYLIC ACID ESTER DERIVATIVE  
 (71) AJINOMOTO CO., INC., 15-1, Kyobashi 1-chome, Chuo-ku Tokyo 104-8315, JP  
 (72) KONISHI, Atsushi, c/o AJINOMOTO PHARMACEUTICALS CO. LTD. 1-1 Suzuki-cho Kawasaki-ku, Kawasaki-shi Kanagawa 210-0801, JP  
 TOKUMASU, Munetaka, c/o AJINOMOTO PHARMACEUTICALS CO. LTD. 1-1 Suzuki-cho Kawasaki-ku, Kawasaki-shi Kanagawa 210-0801, JP  
 SUZUKI, Tamotsu, c/o AJINOMOTO PHARMACEUTICALS CO. LTD. 1-1 Suzuki-cho Kawasaki-ku, Kawasaki-shi Kanagawa 210-0801, JP  
 KOSHIBA, Takahiro, c/o AJINOMOTO PHARMACEUTICALS CO. LTD. 1-1 Suzuki-cho Kawasaki-ku, Kawasaki-shi Kanagawa 210-0801, JP  
 OHSUMI, Koji, c/o AJINOMOTO PHARMACEUTICALS CO. LTD. 1-1 Suzuki-cho Kawasaki-ku, Kawasaki-shi Kanagawa 210-0801, JP  
 IKEHARA, Osamu, c/o AJINOMOTO PHARMACEUTICALS CO. LTD. 1-1 Suzuki-cho Kawasaki-ku, Kawasaki-shi Kanagawa 210-0801, JP  
 KODAMA, Yuko, c/o AJINOMOTO PHARMACEUTICALS CO. LTD. 1-1 Suzuki-cho Kawasaki-ku, Kawasaki-shi Kanagawa 210-0801, JP

- (51) MKP  
**C07D 239/34 (2006.01)** (97) **2464633 \***  
**C07D 239/42 (2006.01)**  
**C07D 239/47 (2006.01)**  
**C07D 239/48 (2006.01)**  
 (86) EP2010061839 13.08.2010  
 (96) 10744916.7 20.06.2012  
 (87) WO2011018517, 13.08.2010  
 (97) 2464633, 20.06.2012 en  
 (54) REGIOSELECTIVE PREPARATION OF 2-AMINO-5-TRIFLUOROMETHYLPYRIMIDINE DERIVATIVES  
 (71) Boehringer Ingelheim International GmbH, Binger Strasse 173, 55216 Ingelheim am Rhein, DE  
 (72) LINZ, Guenter, Boehringer Ingelheim GmbH Binger Str. 173, 55216 Ingelheim am Rhein, DE  
 KRAEMER, Gerd, Boehringer Ingelheim GmbH Binger Str. 173, 55216 Ingelheim am Rhein, DE

- (51) MKP  
**C07D 471/04 (2006.01)** (97) **2504334 \***  
 (86) EP2010067949 22.11.2010  
 (96) 10781686.0 03.10.2012  
 (87) WO2011064171, 22.11.2010  
 (97) 2504334, 03.10.2012 de  
 (54) METHOD FOR PRODUCING METHYL-[4,6-DIAMINO-2-[1-(2-FLUOROBENZYL)-1H-PYRAZOLO[3,4-B]PYRIDINO-3-YL]PYRIMIDINO-5-YL]METHYL CARBAMATE AND ITS PURIFICATION FOR USE THEREOF AS PHARMACEUTICAL SUBSTANCE  
 (71) Bayer Intellectual Property GmbH, Alfred-Nobel-Strasse 10, 40789 Monheim, DE  
 (72) MAIS, Franz-Josef, Otto-Hahn-Str.164, 40591 Düsseldorf, DE  
 REHSE, Joachim, Am Kloster 12, 42799 Leichlingen, DE  
 JOENTGEN, Winfried, Sprengelstraße 1, 50735 Köln, DE  
 SIEGEL, Konrad, Görresstr.13, 40597 Düsseldorf, DE

- (51) MKP  
**F03B 13/18 (2006.01)** (97) **2510226 \***  
**F03B 13/20 (2006.01)**
- (86) NO2010000449 07.12.2010  
(96) 10795788.8 17.10.2012  
(87) WO2011071390, 07.12.2010  
(97) 2510226, 17.10.2012 en  
(54) AN APPARATUS FOR EXTRACTING ENERGY FROM WAVES  
(71) Aker Engineering & Technology AS, P.O. Box 222, 1326 Lysaker, NO  
(72) ERSDAL, Svein, Vøyensvingen 16, N-0458 Oslo, NO  
ROGNE, Øyvind, Ygre, Båhusveien 20, N-0573 Oslo, NO

- (51) MKP  
**F03D 9/00 (2006.01)** (97) **2526291 \***
- (86) US2011021765 19.01.2011  
(96) 11735139.5 28.11.2012  
(87) WO2011091076, 19.01.2011  
(97) 2526291, 28.11.2012 en  
(54) LOW-PROFILE POWER-GENERATING WIND TURBINE  
(71) Wattenberg Industries, LLC, 1610 Tamarisk Drive, Palm Springs, CA 92262, US  
(72) STEINLECHNER, Johann, 1610 Tamarisk Drive, Palm Springs CA, US

- (51) MKP  
**A61K 31/497 (2006.01)** (97) **2523665 \***
- (86) US2011021114 13.01.2011  
(96) 11733370.8 21.11.2012  
(87) WO2011088201, 13.01.2011  
(97) 2523665, 21.11.2012 en  
(54) VOLTAGE-GATED SODIUM CHANNEL BLOCKERS  
(71) Glaxo Group Limited, Glaxo Wellcome House Berkeley Avenue Greenford, Middlesex UB6 0NN, GB  
(72) BOEHM, Jeffrey, Charles, 709 Swedeland Road, King Of Prussia, PA 19406, US  
DAVIS, Roderick, S., 709 Swedeland Road, King Of Prussia, PA 19406, US  
KERNS, Jeffrey, K., 709 Swedeland Road, King Of Prussia, PA 19406, US  
LIN, Guoliang, 709 Swedeland Road, King Of Prussia, PA 19406, US  
NIE, Hong, 709 Swedeland Road, King Of Prussia, PA 19406, US

- (51) MKP  
**C07D 498/04 (2006.01)** (97) **2523959 \***  
**A61K 9/00 (2006.01)**  
**A61K 31/519 (2006.01)**
- (86) EP2011050299 12.01.2011  
(96) 11700136.2 21.11.2012  
(87) WO2011086078, 12.01.2011  
(97) 2523959, 21.11.2012 de  
(54) HETEROCYCLIC CARBOXYLIC ACID DERIVATIVES HAVING A 2,5,7-SUBSTITUTED OXAZOLOPYRIMIDINE RING  
(71) SANOFI, 54, rue de la Boétie, 75008 Paris, FR  
(72) KADEREIT, Dieter, c/o Sanofi-Aventis Deutschland GmbH, 65926 Frankfurt am Main, DE  
SCHAEFER, Matthias, c/o Sanofi-Aventis Deutschland GmbH, 65926 Frankfurt am Main, DE  
HACHTEL, Stephanie, c/o Sanofi-Aventis Deutschland GmbH, 65926 Frankfurt am Main, DE  
DIETRICH, Axel, c/o Sanofi-Aventis Deutschland GmbH, 65926 Frankfurt am Main, DE  
HUEBSCHLE, Thomas, c/o Sanofi-Aventis Deutschland GmbH, 65926 Frankfurt am Main, DE  
GILLE, Andreas, c/o Sanofi-Aventis Deutschland GmbH, 65926 Frankfurt am Main, DE  
HISS, Katrin, c/o Sanofi-Aventis Deutschland GmbH, 65926 Frankfurt am Main, DE

- (51) MKP  
**A61K 31/535 (2006.01)** (97) **2511268 \***  
**C07D 413/12 (2006.01)**  
**A61P 25/16 (2006.01)**  
**A61P 25/28 (2006.01)**  
**A61P 27/02 (2006.01)**  
**A61K 31/5365 (2006.01)**  
**C07D 498/04 (2006.01)**  
**A61K 31/5355 (2006.01)**  
**C07D 413/14 (2006.01)**  
**C07D 265/06 (2006.01)**  
**C07D 265/08 (2006.01)**  
**A61P 43/00 (2006.01)**
- (86) JP2010072193 10.12.2010  
(96) 10836054.6 17.10.2012  
(87) WO2011071135, 10.12.2010  
(97) 2511268, 17.10.2012 en  
(54) OXAZINE DERIVATIVE  
(71) Shionogi & Co., Ltd., 1-8 Doshomachi 3-chome Chuo-ku Osaka-shi, Osaka 541-0045, JP  
(72) MASUI, Moriyasu, c/o Shionogi & Co. Ltd., Futabacho 3-chome, Toyonaka-shi Osaka 561-0825, JP  
HORI, Akihiro, c/o Shionogi&Co. Ltd., Futabacho 3-chome, Toyonaka-shi Osaka 561-0825, JP

- (51) MKP  
**B01J 37/04 (2006.01)** (97) **2529832 \***  
**B01J 31/22 (2006.01)**  
**C08F 10/00 (2006.01)**  
**B01J 37/34 (2006.01)**
- (86) RU2011000049 28.01.2011  
(96) 11737349.8 05.12.2012  
(87) WO2011093748, 28.01.2011  
(97) 2529832, 05.12.2012 en  
(54) CATALYST SYSTEM AND PROCESSES FOR THE (CO-)TRIMERIZATION OF OLEFINS AND THE (CO-)POLYMERIZATION OF OLEFIN OLIGOMERS  
(71) Open Joint Stock Company "Sibur Holding", ul. Galernaya, 5-Liter A, St. Petersburg 190000, RU  
(72) ZILBERSHTEIN, Timur Mikhailovich, ul. Zorge 90-36, Kazan 420138, RU  
LIPSKIKH, Maxim Vladimirovich, ul. Govorova 64-14, Tomsk 634059, RU  
NOSIKOV, Alexei Alexandrovich, ul. Oktyabrskaya 35 s. Turuntaevo Tomsky raion, Tomskaya obl. 634534, RU  
NESYN, Georgy Viktorovich, pr. Mira 13-21, Tomsk 634057, RU

- (51) MKP  
**A61K 31/536 (2006.01)** (97) **2536411 \***
- (86) US2011025558 18.02.2011  
(96) 11745392.8 26.12.2012  
(87) WO2011103516, 18.02.2011  
(97) 2536411, 26.12.2012 en  
(54) INHIBITORS OF LONG AND VERY LONG CHAIN FATTY ACID METABOLISM AS BROAD SPECTRUM ANTI-VIRALS  
(71) THE TRUSTEES OF PRINCETON UNIVERSITY, P.O. Box 36 New South Building, Princeton, New Jersey 08544, US  
(72) KOYUNCU, Emre, 465 Meadow Road Apt. 8302, Princeton, NJ 08540, US  
RABINOWITZ, Joshua, D., 17A Hulfish Street, Princeton NJ 08540, US  
SHENK, Thomas, 12 Boundinot St., Princeton NJ 08540, US

- (51) MKP  
**C07D 409/12 (2006.01)** (97) **2523951 \***  
**A61K 31/4436 (2006.01)**  
**A61K 31/381 (2006.01)**  
**C07D 493/04 (2006.01)**  
**A61P 31/00 (2006.01)**  
**C07D 409/14 (2006.01)**  
(86) US2011021279 14.01.2011  
(96) 11701588.3 21.11.2012  
(87) WO2011088303, 14.01.2011  
(97) 2523951, 21.11.2012 en  
(54) INHIBITORS OF FLAVIVIRIDAE VIRUSES  
(71) Gilead Sciences, Inc., 333 Lakeside Drive, Foster City, CA 94404, US  
(72) CANALES, Eda, 419 Turner Terrace Apt. 9, San Mateo, CA 94401, US  
CHONG, Lee, S., 37469 Marsten Drive, Newark, CA 94560, US  
CLARKE, Michael, O'Neil Hanrahan, 545 Seastorm Drive, Redwood City, CA 94065, US  
DOERFFLER, Edward, 2607 Royal Ann Drive, Union City, CA 94587, US  
LAZERWITH, Scott, E., 930 Scott Street 1, San Francisco, CA 94115, US  
LEW, Willard, 1437 Overland Drive, San Mateo, CA 94403, US  
MERTZMAN, Michael, 2603 Carlmont Drive, Belmont, CA 94002, US  
MORGANELLI, Philip, Anthony, 3923 Webster Street, Oakland, CA 94609, US  
WATKINS, William, J., 14275 Hilltop Way, Saratoga, CA 95070, US

- (51) MKP  
**C12P 19/62 (2006.01)** (97) **2501821 \***  
(86) HU2010000116 29.10.2010  
(96) 10795761.5 26.09.2012  
(87) WO2011051741, 29.10.2010  
(97) 2501821, 26.09.2012 en  
(54) PROCESS FOR PRODUCING PRIMYCIN, PRIMYCIN COMPONENT(S), PRECURSORS AND METABOLITES THEREOF VIA FEMENTATION BY THE USE OF BACTERIAL SPECIES SACCHAROMONOSPORA AZUREA  
(71) Pannonpharma Gyógyszergyártó Kft., Pannonpharma út 1, 7720 Pécsvárad, HU  
(72) JUHÁSZ, Ákos, Eper u. 14., H-6000 Kecskemét, HU  
PÉNZES, Ágota, Kossuth Lajos u. 106., H-9552 Vásárosmiske, HU  
PÉTERI, Zsanett, Adrienn, Homok u. 38., H-2243 Kóka, HU  
PALLOS, József, Péter, Lomnici u. 33., H-1221 Budapest, HU  
SEFFER, Dénes, Rákóczi u. 39., H-7720 Pécsvárad, HU  
FEISZT, Péter, Felsővámház u. 51. l.em.3., H-7626 Pécs, HU  
PESTI, Miklós, Péter, Alkotmány u. 42., H-7624 Pécs, HU  
FEKETE, Csaba, Alkotmány u. 42., H-7624 Pécs, HU  
VÁGVÖLGYI, Csaba, Magyar utca 181., H-6771 Szőreg, HU  
GAZDAG, Zoltán, Dóra u. 8., H-7632 Pécs, HU  
PAPP, Gábor, Garay út 4., H-7200 Dombóvár, HU

- (51) MKP  
**A01H 5/00 (2006.01)** (97) **2512220 \***  
**A01P 7/00 (2006.01)**  
**A01H 1/00 (2006.01)**  
(86) US2010060812 16.12.2010  
(96) 10838258.1 24.10.2012  
(87) WO2011075586, 16.12.2010  
(97) 2512220, 24.10.2012 en  
(54) INSECTICIDAL PROTEIN COMBINATIONS FOR CONTROLLING FALL ARMYWORM AND EUROPEAN CORN BORER, AND METHODS FOR INSECT RESISTANCE MANagements  
(71) Dow AgroSciences, LLC, 9330 Zionsville Road, Indianapolis, Indiana 46268, US  
(72) MEADE, Thomas, 1141 Huntington Woods Pt., Zionsville IN 46077, US  
NARVA, Kenneth, 4372 Creekside Pass, Zionsville IN 46077, US  
STORER, Nicholas, P., 10703 Lexington Street, Kensington MD 20895, US  
SHEETS, Joel, J., 10005 Oak Ridge Drive, Zionsville IN 46077, US  
BURTON, Stephanie, L., 6820 Bluffgrove Drive, Indianapolis IN 46278, US

- (51) MKP  
**A61P 35/00 (2006.01)** (97) **2504332 \***  
**C07D 405/06 (2006.01)**  
**A61K 31/4025 (2006.01)**  
(86) US2010057952 24.11.2010  
(96) 10785289.9 03.10.2012  
(87) WO2011066352, 24.11.2010  
(97) 2504332, 03.10.2012 en  
(54) AN AMORPHOUS AND A CRYSTALLINE FORM OF GENZ 112638 HEMITARTRATE AS INHIBITOR OF GLUCOSYLCERAMIDE SYNTHASE  
(71) Genzyme Corporation, 500 Kendall Street, Cambridge, MA 02142, US  
(72) LIU, Hanlan, 80 East Street, Lexington, MA 02420, US  
WILLIS, Chris, 7 Overlook Drive, Southborough, MA 01772, US  
BHARDWAJ, Renu, 1 Candlelight Way, Ashland, MA 01721, US  
COPELAND, Diane, P., 17 Hawks Ridge Road, Billerica, MA 01862, US  
HARIANAWALA, Abizer, 10 Wilson Lane, Acton, MA 01720, US  
SKELL, Jeffrey, 41 Hundreds Road, Westborough, MA 01581, US  
MARSHALL, John, 25 Northrop Street, Hopedale, MA 01747, US  
KOCHLING, Jianmei, 42 Oak Street, Wellesley, MA 02482, US  
PALACE, Gerard, 123 Millwood Street, Framingham, MA 01701, US  
PETERSCHMITT, Judith, 44 Harrington Street, Watertown, MA 02472, US  
SIEGEL, Craig, 15 Bradford Road, Woburn, MA 01801, US  
CHENG, Seng, 10 Jennison Circle, Natick, MA 01760, US

- (51) MKP  
**A01N 43/42 (2006.01)** (97) **2506712 \***  
(86) US2010052437 13.10.2010  
(96) 10834900.2 10.10.2012  
(87) WO2011068594, 13.10.2010  
(97) 2506712, 10.10.2012 en  
(54) MORPHINAN DERIVATIVES FOR THE TREATMENT OF DRUG OVERDOSE  
(71) Alkermes, Inc., 852 Winter Street, Waltham, MA 02451, US  
(72) SILVERMAN, Bernard, 311 Charles River Street, Needham MA 02492, US

- (51) MKP  
**A61K 31/34 (2006.01)** (97) **2512466 \***  
(86) US2010061122 17.12.2010  
(96) 10838317.5 24.10.2012  
(87) WO2011075684, 17.12.2010  
(97) 2512466, 24.10.2012 en  
(54) PRODRUGS OF INHIBITORS OF PLASMA KALLIKREIN  
(71) Activesite Pharmaceuticals, Inc., 187 Magellan Avenue, San Francisco, CA 94116, US  
(72) SINHA, Sukanto, 187 Magellan Avenue, San Francisco California 94116, US  
CHILCOTE, Tamie Jo, 187 Magellan Avenue, San Francisco California 94116, US

- (51) MKP  
**C12N 15/11 (2006.01)** (97) **2521781 \***  
**C12Q 1/68 (2006.01)**  
(86) KR2011000095 06.01.2011  
(96) 11731934.3 14.11.2012  
(87) WO2011083996, 06.01.2011  
(97) 2521781, 14.11.2012 en  
(54) PRIMERS FOR DIAGNOSING ANKYLOSING SPONDYLITIS, AND METHOD FOR DIAGNOSING ANKYLOSING SPONDYLITIS USING THE SAME  
(71) Kist-Europe FGmbH, Stuhlsatzenhausweg 97, 66123 Saarbruecken, DE  
(72) NAM, Chang Hoon, 209 Ensheimer Strasse, 66386 St. Ingbert, DE  
KIM, Yeon Joo, Campus E71, 66123 Saarbruecken, DE  
BACK, Han-Joo, Gachon University Gil Hospital 1198 Guwol-dong Namdong-gu, Incheon 405-760, KR

(51) MKP  
**B01D 17/02 (2006.01)** (97) **2512984 \***  
**C01B 17/02 (2006.01)**  
(86) US2010060079 13.12.2010  
(96) 10795544.5 24.10.2012  
(87) WO2011081880, 13.12.2010  
(97) 2512984, 24.10.2012 en  
(54) THREE PHASE SULFUR SEPARATION SYSTEM WITH INTERFACE CONTROL  
(71) MERICHEM COMPANY, 5455 Old Spanish Trail, Houston, TX 77023, US  
(72) NAGL, Gary, J., 200 Hidden Pines Drive, Deer Park IL 60010, US  
BARNETTE, Anthony, A., 5304 Memory Trail, McHenry IL 60051, US  
REICHER, Myron, 3116 N. Straford Road, Arlington Heights IL 60004, US

(51) MKP  
**E05C 17/02 (2006.01)** (97) **2439365**  
**E05C 17/24 (2006.01)**  
(96) 11184542.6 11.04.2012  
(97) 2439365, 11.04.2012 en  
(54) Shutter holder with selectable position  
(71) I.Quattro S.r.l., Viale del Lavoro, 3, 60030 San Marcello (AN), IT  
(72) Cirilli, Alessandro, Via San Francesco, 56, 60035 Jesi, IT

(51) MKP  
**C12Q 1/68 (2006.01)** (97) **2532755**  
**G01N 33/50 (2006.01)**  
(96) 11305731.9 12.12.2012  
(97) 2532755, 12.12.2012 en  
(54) Methods and uses based on Slfn2 expression and relating to the identification and profiling of compounds for use in the treatment or prevention of pain  
(71) Sanofi-Aventis, 174, Avenue de France, 75013 Paris, FR  
(72) The designation of the inventor has not yet been filed , null, null, null

(51) MKP  
**C07D 513/04 (2006.01)** (97) **2513117 \***  
**A61K 31/429 (2006.01)**  
**A61P 25/18 (2006.01)**  
**A61K 31/428 (2006.01)**  
(86) EP2010069957 16.12.2010  
(96) 10790574.7 24.10.2012  
(87) WO2011073339, 16.12.2010  
(97) 2513117, 24.10.2012 en  
(54) BICYCLIC THIAZOLES AS ALLOSTERIC MODULATORS OF MGLUR5 RECEPTORS  
(71) Janssen Pharmaceutica, N.V., Turnhoutseweg 30, 2340 Beerse, BE  
(72) MACDONALD, Gregor, James, Janssen Pharmaceutica NV Turnhoutseweg 30, B-2340 Beerse, BE  
TRABANCO-SUÁREZ, Andrés, Avelino, Janssen-Cilag S.A. Calle Jarama 75 Poligono Industrial, E-45007 Toledo, ES  
CONDE-CEIDE, Susana, Janssen-Cilag S.A. Calle Jarama 75 Poligono Industrial, E-45007 Toledo, ES  
TRESADERN, Gary, John, Janssen-Cilag S.A. Calle Jarama 75 Poligono Industrial, E-45007 Toledo, ES  
BARTOLOMÉ-NEBREDA, José, Manuel, Janssen-Cilag S.A. Calle Jarama 75 Poligono Industrial, E-45007 Toledo, ES  
PASTOR-FERNÁNDEZ, Joaquin, C/Hierbabuena 37 Urbanización La Hacienda Cobisa, E-45111 Toledo, ES

(51) MKP  
**A61P 33/00 (2006.01)** (97) **2513104 \***  
**A01P 7/04 (2006.01)**  
**A01N 43/90 (2006.01)**  
**A01P 5/00 (2006.01)**  
**A61K 31/437 (2006.01)**  
**C07D 471/04 (2006.01)**  
(86) US2010060833 16.12.2010  
(96) 10796566.7 24.10.2012  
(87) WO2011075591, 16.12.2010  
(97) 2513104, 24.10.2012 en  
(54) ANTI PARASITIC DIHYDROAZOLE COMPOUNDS AND COMPOSITIONS COMPRISING SAME  
(71) Merial Limited, 3239 Satellite Blvd., Duluth, GA 30096, US  
(72) LE HIR DE FALOIS, Loic, Patrick, 404 Holly Lane, Chapel Hill NC 27517, US  
LEE, Hyoung, Lk, 103 Roundtop Road, Cary NC 27519, US  
WILKINSON, Douglas, Edward, 536 Rodney Bay Crossing, Wake Forest NC 27587, US  
BECK, Brent, Christopher, 710 Straywhite Avenue, Apex NC 27539, US

(51) MKP  
**C12Q 1/68 (2006.01)** (97) **2531613 \***  
(86) US2011023484 02.02.2011  
(96) 11704360.4 12.12.2012  
(87) WO2011097301, 02.02.2011  
(97) 2531613, 12.12.2012 en  
(54) METHODS AND COMPOSITIONS FOR PREDICTING RESPONSIVENESS TO TREATMENT WITH TNF-ALPHA INHIBITOR  
(71) Abbott Biotechnology Ltd., Clarendon House 2 Church Street, Hamilton HM 11, BM  
(72) KUPPER, Hartmut, Lilienstrasse 43, 67112 Mutterstadt, DE  
SCHULZE-KOOPS, Hendrik, Schobertweg 3, 91056 Erlangen, DE  
SKAPENKO, Alla, Schmellerstrasse 21, 80337 Munchen, DE

(51) MKP  
**C07D 417/14 (2006.01)** (97) **2536716 \***  
**A61K 31/427 (2006.01)**  
**C07D 417/06 (2006.01)**  
**A61P 5/30 (2006.01)**  
(86) US2011024999 16.02.2011  
(96) 11705404.9 26.12.2012  
(87) WO2011103130, 16.02.2011  
(97) 2536716, 26.12.2012 en  
(54) AMINOTHIAZOLONES AS ESTROGEN RELATED RECEPTOR-ALPHA MODULATORS  
(71) Janssen Pharmaceutica, N.V., Turnhoutseweg 30, 2340 Beerse, BE  
(72) BIGNAN, Gilles, Welsh&McKean Roads, Spring House, PA 19477, US  
GAUL, Micheal, Welsh&McKean Roads, Spring House, PA 19477, US  
XU, Guozhang, Welsh&McKean Roads, Spring House, PA 19477, US  
ZHAO, Bao-ping, Welsh&McKean Roads, Spring House, PA 19477, US

(51) MKP  
**C07K 16/00 (2006.01)** (97) **2523972 \***  
(86) EP2011050333 12.01.2011  
(96) 11700101.6 21.11.2012  
(87) WO2011086091, 12.01.2011  
(97) 2523972, 21.11.2012 en  
(54) MULTIVALENT ANTIBODIES  
(71) UCB Pharma S.A., Allée de la Recherche 60, 1070 Brussels, BE  
(72) ADAMS, Ralph, c/o IPD UCB Celltech 208 Bath Road, Slough, Berkshire SL1 3WE, GB  
DAVE, Emma, c/o IPD UCB Celltech 208 Bath Road, Slough, Berkshire SL1 3WE, GB

- (51) MKP  
**A61P 1/16 (2006.01)** (97) **2528605 \***  
**A61K 31/4535 (2006.01)**  
**A61K 31/454 (2006.01)**
- (86) US2011022854 28.01.2011  
(96) 11703776.2 05.12.2012  
(87) WO2011094489, 28.01.2011  
(97) 2528605, 05.12.2012 en  
(54) THERAPIES FOR TREATING HEPATITIS C VIRUS INFECTION  
(71) Vertex Pharmaceuticals Incorporated, 130 Waverly Street, Cambridge, MA 02139, US  
(72) ROSARIO, Maria, 6 School Street Apt. 19, Mystic, CT 06355, US  
CHAURET, Nathalie, 275 Armand-frappier, Laval, QC H7V 4A7, CA  
GEORGE, Shelley, 52 Wareland Road, Wellesley, MA 02481, US  
KIEFFER, Tara, Lynn, 20 Abbottsford Road, Brookline, MA 02466, US  
KOZIEL, Margaret, James, 198 Washington Avenue, Needham, MA 02492, US  
NICOLAS, Olivier, 275 Armand-frappier, Laval, QC H7V 4A7, CA  
PROULX, Louise, 275 Armand-frappier, Laval, QC H7V 4A7, CA
- 
- (51) MKP  
**C12P 19/04 (2006.01)** (97) **2532448 \***  
**B09B 3/00 (2006.01)**
- (86) JP2011052553 07.02.2011  
(96) 11739914.7 12.12.2012  
(87) WO2011096567, 07.02.2011  
(97) 2532448, 12.12.2012 en  
(54) METHOD FOR DEGRADING ORGANIC MATERIAL USING MOTHER CELL LYASES FORMED IN ASSOCIATION WITH SPORE FORMATION OF MICROORGANISM  
(71) Meisho Co., Ltd, 1892-1, Ume Oaza Senzoku, Saiki-shi, Oita 879-3205, JP  
(72) MITARAI, Kaoru, 4547 Oaza Nagara, Saiki-shi Oita 876-1511, JP  
NAGAHAMA, Yoji, 4-26-3 Naka-Ochiai Shinjuku-ku, Tokyo 161-0032, JP
- 
- (51) MKP  
**A61M 39/04 (2006.01)** (97) **2531255 \***
- (86) US2011022707 27.01.2011  
(96) 11737633.5 12.12.2012  
(87) WO2011094397, 27.01.2011  
(97) 2531255, 12.12.2012 en  
(54) ANGIOCATHETER DEVICE WITH IMPROVED SAFETY FEATURES  
(71) Spurbeck, William Paul, 10393 E. Avalon Park, Tucson, AZ 85747, US  
Banister, Mark, 6550 E. Miramar Drive, Tucson, AZ 85715, US  
(72) Spurbeck, William Paul, 10393 E. Avalon Park, Tucson, AZ 85747, US  
Banister, Mark, 6550 E. Miramar Drive, Tucson, AZ 85715, US
- 
- (51) MKP  
**B65D 5/24 (2006.01)** (97) **2452886**  
**B65D 5/4805 (2006.01)**
- (96) 11450142.2 16.05.2012  
(97) 2452886, 16.05.2012 de  
(54) Folding box with storage compartments  
(71) Adi Corporation S.A., 10 Rue Willy Goergen, 1636 Luxembourg, LU  
(72) Lippitsch, Susanne, Dirmhirngasse 136, 1230 Wien, AT
- 
- (51) MKP  
**A61K 31/365 (2006.01)** (97) **2512467 \***  
**A61K 31/495 (2006.01)**  
**A61P 33/10 (2006.01)**
- (86) US2010060840 16.12.2010  
(96) 10801038.0 24.10.2012  
(87) WO2011075592, 16.12.2010  
(97) 2512467, 24.10.2012 en  
(54) COMPOSITIONS COMPRISING MACROCYCLIC LACTONE COMPOUNDS AND SPIRODIOXEPINOINDOLES  
(71) Merial Limited, 3239 Satellite Blvd., Duluth, GA 30096, US  
Holmes, Robert, 15 Calman Place Biirkenhead, Auckland, NZ  
(72) HOLMES, Robert, 15 Calman Place Biirkenhead, Auckland, NZ  
RAZZAK, Majid, 59 Bluebird Crescent The Palms Glenfield, Auckland, NZ
- 
- (51) MKP  
**C07D 215/38 (2006.01)** (97) **2522658 \***  
**C07D 215/18 (2006.01)**  
**A01N 43/42 (2006.01)**  
**C07D 471/04 (2006.01)**  
**A01P 3/00 (2006.01)**  
**C07D 495/04 (2006.01)**  
**C07D 221/04 (2006.01)**  
**A01N 55/00 (2006.01)**  
**C07D 491/048 (2006.01)**  
**C07D 215/14 (2006.01)**  
**C07D 401/12 (2006.01)**  
**C07D 215/20 (2006.01)**
- (86) JP2010073683 28.12.2010  
(96) 10841029.1 14.11.2012  
(87) WO2011081174, 28.12.2010  
(97) 2522658, 14.11.2012 en  
(54) NITROGEN-CONTAINING HETEROCYCLIC COMPOUND AND AGRICULTURAL/HORTICULTURAL GERMICIDE  
(71) Nippon Soda Co., Ltd., 2-1, Ohtemachi 2-chome Chiyoda-ku, Tokyo 100-8165, JP  
(72) SHIBAYAMA Kotaro, c/o Odawara Research Center Nippon Soda Co. Ltd. 345 Takada, Odawara-shi Kanagawa 250-0280, JP  
INAGAKI Jun, c/o Odawara Research Center Nippon Soda Co. Ltd. 345 Takada, Odawara-shi Kanagawa 250-0280, JP  
SAIKI Yuto, c/o Odawara Research Center Nippon Soda Co. Ltd. 345 Takada, Odawara-shi Kanagawa 250-0280, JP  
MITANI Akira, c/o Odawara Research Center Nippon Soda Co. Ltd. 345 Takada, Odawara-shi Kanagawa 250-0280, JP  
KUWAHARA Raito, c/o Odawara Research Center Nippon Soda Co. Ltd. 345 Takada, Odawara-shi Kanagawa 250-0280, JP  
SATO Motoaki, c/o Odawara Research Center Nippon Soda Co. Ltd. 345 Takada, Odawara-shi Kanagawa 250-0280, JP  
NISHIMURA Satoshi, c/o Odawara Research Center Nippon Soda Co. Ltd. 345 Takada, Odawara-shi Kanagawa 250-0280, JP  
KUBOKI Mami, c/o Odawara Research Center Nippon Soda Co. Ltd. 345 Takada, Odawara-shi Kanagawa 250-0280, JP
- 
- (51) MKP  
**C07D 495/04 (2006.01)** (97) **2501702 \***
- (86) FR2010052452 19.11.2010  
(96) 10799083.0 26.09.2012  
(87) WO2011061449, 19.11.2010  
(97) 2501702, 26.09.2012 fr  
(54) METHOD FOR PREPARING N-SUCCINIMIDYL N-BIOTINYL-6-AMINOCAPROATE  
(71) SANOFI, 54 rue La Boétie, 75008 Paris, FR  
(72) POTIER, Pierre, c/o Sanofi-Aventis Département Brevets 174 avenue de France, F-75013 Paris, FR  
SOLE, Raphaël, c/o Sanofi-Aventis Département Brevets 174 avenue de France, F-75013 Paris, FR  
TROUILLEUX, Patrick, c/o Sanofi-Aventis Département Brevets 174 avenue de France, F-75013 Paris, FR
- 
- (51) MKP  
**A61P 11/08 (2006.01)** (97) **2506844 \***  
**A61K 45/06 (2006.01)**  
**A61K 31/138 (2006.01)**  
**A61P 11/06 (2006.01)**  
**A61K 31/439 (2006.01)**
- (86) EP2010068429 29.11.2010  
(96) 10781527.6 10.10.2012  
(87) WO2011067212, 29.11.2010  
(97) 2506844, 10.10.2012 en  
(54) COMBINATIONS OF A MUSCARINIC RECEPTOR ANTAGONIST AND A BETA-2 ADRENORECEPTOR AGONIST  
(71) Glaxo Group Limited, Glaxo Wellcome House Berkeley Avenue Greenford, Middlesex UB6 0NN, GB  
(72) BAKER, Darrell, GlaxoSmithKline Ironbridge Road, Uxbridge Middlesex UB11 1BS, GB  
BRUCE, Mark, GlaxoSmithKline Gunnels Wood Road, Stevenage Hertfordshire SG1 2NY, GB  
CRATER, Glenn, GlaxoSmithKline Five Moore Drive P O Box 13398 Research Triangle Park, North Carolina 27709-3398, US  
NOGA, Brian, c/o GlaxoSmithKline Five Moore Drive P O Box 13398 Research Triangle Park, North Carolina 27709-3398, US  
THOMAS, Marian, GlaxoSmithKline Park Road, Ware Hertfordshire SG12 0DJ, GB  
WIRE, Patrick, GlaxoSmithKline Five Moore Drive P O Box 13398 Research Triangle Park, North Carolina 27709-3398, US

(51) MKP  
**A61K 31/00 (2006.01)** (97) **2519231 \***  
**A61K 45/06 (2006.01)**  
**A61K 35/00 (2006.01)**  
**A61K 31/69 (2006.01)**  
(86) EP2010005994 01.10.2010  
(96) 10807320.6 07.11.2012  
(87) WO2011038924, 01.10.2010  
(97) 2519231, 07.11.2012 en  
(54) TREATMENT OF DISEASE WITH PROTEASOME INHIBITORS  
BACKGROUND OF THE INVENTION  
(71) Janssen Pharmaceutica, N.V., Turnhoutseweg 30, 2340 Beerse, BE  
(72) DE COSTER, Roland, Gestelbos 26, B-2980 Zoersel, BE  
VAN DE VELDE, Helgi, Duinkerken 38, B-2470 Retie, BE  
BAYSSAS, Martine, Avenue Jordil 13, CH-1006 Lausanne, CH

(51) MKP  
**C02F 3/12 (2006.01)** (97) **2508490 \***  
**C02F 3/30 (2006.01)**  
**C02F 11/02 (2006.01)**  
(86) CN2010073333 28.05.2010  
(96) 10834169.4 10.10.2012  
(87) WO2011066736, 28.05.2010  
(97) 2508490, 10.10.2012 en  
(54) SLUDGE TREATMENT METHOD AND APPARATUS THEREOF  
AND APPLICATION TO WASTEWATER BIO-TREATMENT  
(71) Li, Jinmin, Jinluo Science and Technology Park Bancheng Town  
Lanshan District Linyi, Shandong 276036, CN  
Zhou, Liankui, Jinluo Science and Technology Park Bancheng  
Town Lanshan District Linyi, Shandong 276036, CN  
Li, Dayong, Jinluo Science and Technology Park Bancheng  
Town Lanshan District Linyi, Shandong 276036, CN  
(72) Li, Jinmin, Jinluo Science and Technology Park Bancheng Town  
Lanshan District Linyi, Shandong 276036, CN  
Zhou, Liankui, Jinluo Science and Technology Park Bancheng  
Town Lanshan District Linyi, Shandong 276036, CN  
Li, Dayong, Jinluo Science and Technology Park Bancheng  
Town Lanshan District Linyi, Shandong 276036, CN

(51) MKP  
**A61K 31/4152 (2006.01)** (97) **2503994 \***  
**A61K 9/16 (2006.01)**  
(86) EP2010068213 25.11.2010  
(96) 10787354.9 03.10.2012  
(87) WO2011064296, 25.11.2010  
(97) 2503994, 03.10.2012 en  
(54) PHARMACEUTICAL COMPOSITIONS COMPRISING SIGMA  
RECEPTOR LIGANDS  
(71) Laboratorios del. Dr. Esteve, S.A., Avda Mare de Deu de  
Montserrat 221, 08041 Barcelona, ES  
(72) SOLER RANZANI, Luis, Av. Diagonal 255-257, 2º 1ª, E-08013  
Barcelona, ES  
ESPOSITO, Pierandrea, Av. Diagonal 644, 7º 2ª, E-08017  
Barcelona, ES  
CASADEVALL PUJALS, Gemma, Pg. Garcia Faria, 57 4º 2ª,  
E-08019 Barcelona, ES  
CUBEL SUÑE, Nuria, Av. Via Augusta 138 2º 1ª, E-08174 Sant  
Cugat Del Vallés - Barcelona, ES

(51) MKP  
**A61P 25/00 (2006.01)** (97) **2516441 \***  
**C07D 475/04 (2006.01)**  
**C07D 475/12 (2006.01)**  
**A61K 31/4985 (2006.01)**  
(86) US2010061551 21.12.2010  
(96) 10798439.5 31.10.2012  
(87) WO2011079118, 21.12.2010  
(97) 2516441, 31.10.2012 en  
(54) PTERIDINONES AS INHIBITORS OF POLO-LIKE KINASE  
(71) Elan Pharmaceuticals Inc., 180 Oyster Point Blvd., South San  
Francisco, CA 94080, US  
(72) GALEMMO, Robert, A., Jr., 24 Whale Ship Plaza, San Francisco  
CA 94111, US  
ARTIS, Dean Richard, 50 Arlmont Drive, Kensington CA 94707,  
US  
YE, Xiaocong Michael, 3360 Ramona Street, Palo Alto CA  
94306, US  
AUBELE, Danielle, L., 1425 Bellevue Avenue, 3, Burlin ame CA  
94010, US  
TRUONG, Anh, P., 1031 Chula Vista Avenue, Burlingame CA  
94010, US  
BOWERS, Simeon, 3252 Birdsall Avenue, Oakland CA 94619,  
US  
HOM, Roy, K., 201 Laguna Street 14, San Francisco CA 94102,  
US  
ZHU, Yong-Liang, 43215 Fresco Terrace, Fremont CA 94539, US  
NEITZ, R., Jeffrey, 2658 23rd Avenue, San Francisco CA 94116,  
US  
SEALY, Jennifer, 1683 Miami Court, Oakland CA 94602, US  
ADLER, Marc, 110 El Toyonal Road, Orinda CA 94563, US  
BEROZA, Paul, 1011 Muir Way, Belmont CA 94002, US  
ANDERSON, John, P., 1323-A Lyon Street, San Francisco CA  
94115, US

(51) MKP  
**A61B 5/151 (2006.01)** (97) **2528507 \***  
(86) US2011021874 20.01.2011  
(96) 11737462.9 05.12.2012  
(87) WO2011094116, 20.01.2011  
(97) 2528507, 05.12.2012 en  
(54) ANALYTE MEASUREMENT DEVICE WITH A SINGLE SHOT  
ACTUATOR  
(71) Sanofi-Aventis Deutschland GmbH, Industriepark Hoechst  
Building K607, 65926 Frankfurt am Main, DE  
(72) ALDEN, Don, 1312 Nelson Way, Sunnyvale CA 94087, US

(51) MKP  
**A61B 17/00 (2006.01)** (97) **2509513 \***  
**A61B 17/34 (2006.01)**  
**A61B 17/068 (2006.01)**  
**A61B 19/00 (2006.01)**  
**A61B 17/115 (2006.01)**  
(86) US2010057104 17.11.2010  
(96) 10788438.9 17.10.2012  
(87) WO2011063041, 17.11.2010  
(97) 2509513, 17.10.2012 en  
(54) CIRCULAR STAPLER INTRODUCER WITH RIGID CAP  
ASSEMBLY CONFIGURED FOR EASY REMOVAL  
(71) Ethicon Endo-Surgery, Inc., 4545 Creek Road, Cincinnati, OH  
45242, US  
(72) BAXTER, Chester, O., 6375 Pawnee Ridge, Loveland, OH  
45140, US  
HUNT, John, V., 3654 Moorhill Drive, Cincinnati, OH 45241, US  
SILKAITIS, Danius, P., 4680 Sarah Drive, Mason, OH 45040, US  
WILEY, Jeffrey, P., 5585 Autumn Wynd Lane, Milford, OH 45150,  
US  
FRANER, Paul, T., 6217 Rapid Run Road, Cincinnati, OH 45233,  
US  
SCHULTE, John, B., 6769 Timberwood Drive, West Chester, OH  
45069, US  
ABBOTT, Daniel, J., 5944 Marsh Circle, Loveland, OH 45140,  
US

(51) MKP  
**E04F 15/02 (2006.01)** (97) **2529062 \***  
**E04F 15/024 (2006.01)**  
 (86) US2011022802 28.01.2011  
 (96) 11737683.0 05.12.2012  
 (87) WO2011094461, 28.01.2011  
 (97) 2529062, 05.12.2012 en  
 (54) SYNTHETIC FLOOR TILE HAVING PARTIALLY COMPLIANT SUPPORT STRUCTURE  
 (71) Connor Sport Court International, LCC., 939 South 700 West, Salt Lake City, UT 84104, US  
 (72) CERNY, Ronald, N., 1970 Kidd Circle, Park City, UT 84098, US  
 HEDQUIST, Dana, L., 2781 Denali Drive, West Jordan, UT 84084, US  
 BUERGER, Michael, A., 14742 Steep Mountain Drive, Draper, UT 84020, US  
 DAY, Gary, L., 211 North 800 East, Bountiful, UT 84010, US

(51) MKP  
**A61K 31/275 (2006.01)** (97) **2533634 \***  
**A01N 37/34 (2006.01)**  
 (86) US2011024594 11.02.2011  
 (96) 11742896.1 19.12.2012  
 (87) WO2011100589, 11.02.2011  
 (97) 2533634, 19.12.2012 en  
 (54) NEUROPROTECTION IN DEMYELINATING DISEASES  
 (71) Biogen Idec MA Inc., 14 Cambridge Center, Cambridge, MA 02142, US  
 (72) GOELZ, Susan, 6900 SE 35th Avenue, Portland, OR 97202, US  
 DAWSON, Kate, 561 Canton Street, Westwood, MA 02090, US  
 LINKER, Ralf, Grummer Strasse 34, 44809 Bochum, DE  
 GOLD, Ralf, Weg am Koetterberg 12, 44807 Bochum, DE

(51) MKP  
**A61P 1/04 (2006.01)** (97) **2515937 \***  
**A61K 39/07 (2006.01)**  
**A23L 1/30 (2006.01)**  
**A61K 36/899 (2006.01)**  
 (86) SE2010051464 22.12.2010  
 (96) 10839902.3 31.10.2012  
 (87) WO2011078781, 22.12.2010  
 (97) 2515937, 31.10.2012 en  
 (54) NON-FERMENTED COMPOSITIONS COMPRISING A CEREAL BASED FRACTION AND A PROBIOTIC AND USES THEREOF  
 (71) Probi AB, null, 223 70 Lund, SE  
 (72) BRÄNNING, Camilla, Magle Lilla Kyrkogata 1, S-223 51 Lund, SE  
 NYMAN, Margareta, Skånevägen 16, S-222 70 Lund, SE

(51) MKP  
**B21C 47/24 (2006.01)** (97) **2519366 \***  
**B21B 1/46 (2006.01)**  
**C21D 9/68 (2006.01)**  
 (86) EP2010070857 29.12.2010  
 (96) 10798572.3 07.11.2012  
 (87) WO2011080300, 29.12.2010  
 (97) 2519366, 07.11.2012 en  
 (54) WINDING/UNWINDING DEVICE AND METHOD FOR WINDING/UNWINDING A METAL PRODUCT IN A ROLLING LINE  
 (71) Danieli & C. Officine Meccaniche SpA, Via Nazionale 41, 33042 Buttrio (Udine), IT  
 (72) SANDRIN, Luca, Via Guido Rossa 6, I-33050 Terzo D'aquileia, IT  
 WESSEL, Karl-Heinz, Angelikastrasse 50, 46537 Dinslaken, DE  
 ROIATTI, Stefano, Via Aquileia 83, I-33031 Villaorba Di Basiliano, IT

(51) MKP  
**C07C 253/30 (2006.01)** (97) **2513046 \***  
**C07C 257/04 (2006.01)**  
 (86) HU2010000141 13.12.2010  
 (96) 10809329.5 24.10.2012  
 (87) WO2011073703, 13.12.2010  
 (97) 2513046, 24.10.2012 en  
 (54) PROCESS FOR THE PREPARATION OF 4-BROMOMETHYL-[1,1'-BIPHENYL]-2'-CARBONITRILE  
 (71) SANOFI, 54 rue La Boétie, 75008 Paris, FR  
 (72) HUSZÁR, Csaba, c/o Chinoin Gyógyszer és Vegyészeti Termékek Gyára Zrt. Iparjog Tó u.1-5, 1045 Budapest, HU  
 ÁRVAI, Géza, c/o Chinoin Gyógyszer és Vegyészeti Termékek Gyára Zrt. Iparjog Tó u.1-5, 1045 Budapest, HU  
 HEGEDUS, Adrienn, c/o Chinoin Gyógyszer és Vegyészeti Termékek Gyára Zrt. Iparjog Tó u.1-5, 1045 Budapest, HU

(51) MKP  
**C01G 49/02 (2006.01)** (97) **2528682 \***  
**B01J 21/02 (2006.01)**  
**C01F 7/06 (2006.01)**  
**C01F 7/16 (2006.01)**  
 (86) EP2011051223 28.01.2011  
 (96) 11702431.5 05.12.2012  
 (87) WO2011092292, 28.01.2011  
 (97) 2528682, 05.12.2012 de  
 (54) METHOD FOR PRODUCING A CATALYST FOR CRACKING ORGANIC CARBON COMPOUNDS  
 (71) Krause-Röhm-Systeme AG, Balanstraße 57, 81541 München, DE  
 (72) KRAUSE, Eberhard, Remanestr. 39, 16540 Hohen Neuendorf, DE

(51) MKP  
**A61K 31/497 (2006.01)** (97) **2533783 \***  
 (86) US2011021089 13.01.2011  
 (96) 11733353.4 19.12.2012  
 (87) WO2011088181, 13.01.2011  
 (97) 2533783, 19.12.2012 en  
 (54) COMPOUNDS AND METHODS  
 (71) Tempero Pharmaceuticals, Inc., 200 Technology Square, Cambridge, MA 02139, US  
 (72) BALOGLU, Erkan, 200 Technology Square, Cambridge, MA 02139, US  
 GHOSH, Shomir, 200 Technology Square, Cambridge, MA 02139, US  
 LOBERA, Mercedes, 200 Technology Square, Cambridge, MA 02139, US  
 SCHMIDT, Darby, 200 Technology Square, Cambridge, MA 02139, US

(51) MKP  
**A23K 1/175 (2006.01)** (97) **2520176**  
**A23K 1/18 (2006.01)**  
**A23K 1/14 (2006.01)**  
**A23K 1/16 (2006.01)**  
 (96) 11170890.5 07.11.2012  
 (97) 2520176, 07.11.2012 en  
 (54) Method for increasing the nutritional value of rapeseed and rape products with decreased oil content  
 (71) ROP Repce-olaj-pellet Kft., Erömu u. 15, 2440 Szazhalombatta, HU  
 (72) Pandur, József, ROP Repce-olaj-pellet Kft. Fecske u. 48., 2030 Erd, HU  
 Fekete, Imre, ROP Repce-olaj-pellet Kft. Fogoly u. 14., 2440 Szazhalombatta, HU  
 Bakos, Zoltán, ROP Repce-olaj-pellet Kft. Korizmics u. 84., 2111 Szada, HU



- (51) MKP  
**G01N 21/31 (2006.01)** (97) **2453221**  
**G01N 21/84 (2006.01)**  
**G01N 21/35 (2006.01)**
- (96) 11189017.4 16.05.2012  
(97) 2453221, 16.05.2012 fr
- (54) Apparatus for radiometry to determine the physico-chemical properties of a sample taking the thickness into account
- (71) Institut De Physique Du Globe De Paris (Établissement Public À Caractère Scientifique Et Technologique), 1 rue Jussieu, 75005 Paris, FR
- (72) Frangi, Jean-Pierre, 12 Avenue de la République, 94800 Villejuif, FR  
De Rosny, Gilles, 52 rue Etienne Marcel, 75002 Paris, FR  
Conejo, Elian, CICANUM Universidad de Costa Rica Apartado 11501-2060, San José, CR

- (51) MKP  
**E05D 15/06 (2006.01)** (97) **2526245 \***
- (86) EP2011050435 14.01.2011  
(96) 11700183.4 28.11.2012  
(87) WO2011089065, 14.01.2011  
(97) 2526245, 28.11.2012 en
- (54) DOOR LEAF SYSTEM FOR CLOSING AND/OR OPENING AN ENTRANCE
- (71) Pucci Saoro, S.R.L., Via E.e.P.Salani 31, 50050 Capraia e Limite (FI), IT
- (72) PUCCI, Andrea, Via Larini 7, I-50050 Capraia e Limite (FI), IT  
PUCCI, Luca, Via Larini 7, I-50050 Capraia e Limite (FI), IT

- (51) MKP  
**A61K 31/4439 (2006.01)** (97) **2505586 \***  
**A61P 37/08 (2006.01)**  
**A61K 31/437 (2006.01)**  
**A61P 37/06 (2006.01)**  
**A61K 31/433 (2006.01)**  
**A61P 37/02 (2006.01)**  
**A61K 31/427 (2006.01)**  
**A61P 29/00 (2006.01)**  
**A61K 31/4178 (2006.01)**  
**A61K 31/5377 (2006.01)**  
**C07D 403/14 (2006.01)**  
**A61K 31/416 (2006.01)**  
**A61K 31/496 (2006.01)**  
**C07D 403/04 (2006.01)**  
**A61K 31/422 (2006.01)**  
**A61K 31/55 (2006.01)**  
**C07D 405/14 (2006.01)**  
**C07D 401/14 (2006.01)**  
**A61K 31/454 (2006.01)**  
**A61P 43/00 (2006.01)**
- (86) JP2010070988 25.11.2010  
(96) 10833248.7 03.10.2012  
(87) WO2011065402, 25.11.2010  
(97) 2505586, 03.10.2012 en
- (54) INDOLE COMPOUND AND PHARMACEUTICAL USE THEREOF
- (71) Japan Tobacco, Inc., 2-1, Toranomom 2-chome Minato-ku, Tokyo 105-8422, JP
- (72) INOUE, Teruhiko, c/o Central Pharmaceutical Research Institute of Japan Tobacco Inc. 1-1, Murasaki-cho, Takatsuki-shi Osaka 569-1125, JP  
KAYA, Tetsudo, c/o Central Pharmaceutical Research Institute of Japan Tobacco Inc. 1-1, Murasaki-cho, Takatsuki-shi Osaka 569-1125, JP  
KIKUCHI, Shinichi, c/o Central Pharmaceutical Research Institute of Japan Tobacco Inc. 1-1, Murasaki-cho, Takatsuki-shi Osaka 569-1125, JP  
MATSUMURA, Koji, c/o Central Pharmaceutical Research Institute of Japan Tobacco Inc. 1-1, Murasaki-cho, Takatsuki-shi Osaka 569-1125, JP  
MASUO, Ritsuki, c/o Central Pharmaceutical Research Institute of Japan Tobacco Inc. 1-1, Murasaki-cho, Takatsuki-shi Osaka 569-1125, JP  
SUZUKI, Motoya, c/o Central Pharmaceutical Research Institute of Japan Tobacco Inc. 1-1, Murasaki-cho, Takatsuki-shi Osaka 569-1125, JP  
MAEKAWA, Michihide, c/o Central Pharmaceutical Research Institute of Japan Tobacco Inc. 1-1, Murasaki-cho, Takatsuki-shi Osaka 569-1125, JP

- (51) MKP  
**A61M 16/06 (2006.01)** (97) **2519296 \***
- (86) US2010062572 30.12.2010  
(96) 10841749.4 07.11.2012  
(87) WO2011082346, 30.12.2010  
(97) 2519296, 07.11.2012 en
- (54) DEVICES, SYSTEMS, AND METHODS FOR MONITORING, ANALYZING, AND/OR ADJUSTING SLEEP CONDITIONS
- (71) Doelling, Eric N., 718 Jura Way, Sunnyvale, CA 94087, US  
Hohenhorst, Winfried, Am Wunnesberg 35, 45149 Essen, DE  
Boucher, Ryan P., 2325 3rd Street 227, San Francisco, CA 94107, US
- (72) Doelling, Eric N., 718 Jura Way, Sunnyvale, CA 94087, US  
Hohenhorst, Winfried, Am Wunnesberg 35, 45149 Essen, DE  
Boucher, Ryan P., 2325 3rd Street 227, San Francisco, CA 94107, US

- (51) MKP  
**A61K 38/17 (2006.01)** (97) **2535057 \***  
**A61K 38/21 (2006.01)**
- (86) ES2011070077 07.02.2011  
(96) 11715008.6 19.12.2012  
(87) WO2011098644, 07.02.2011  
(97) 2535057, 19.12.2012 en
- (54) COMPOSITIONS FOR THE TREATMENT OF INFECTIOUS AND TUMOURAL DISEASES
- (71) Proyecto de Biomedicina Cima, S.L., Avda. Pío XII, 22 Oficina 1, 31008 Pamplona - Navarra, ES  
Digna Biotech, S.L., Avenida Pío XII, 22. Oficina 2, 31008 Pamplona Navarra, ES
- (72) ALDABE ARREGUI, Rafael, ICT(D.P.I.) Avda. Pío XII 53, E-31008 Pamplona - Navarra, ES  
GONZÁLEZ DE LA TAJADA, Iranzu, ICT (D.P.I.) Avda. Pío XII 53, E-31008 Pamplona - Navarra, ES  
LARREA LEOZ, María Esther, ICT (D.P.I.) Avda. Pío XII 53, E-31008 Pamplona - Navarra, ES  
PRIETO VALTUEÑA, Jesús María, ICT (D.P.I.) Avda. Pío XII 53, E-31008 Pamplona - Navarra, ES

- (51) MKP  
**A61K 31/4196 (2006.01)** (97) **2528598 \***  
**A61K 31/4545 (2006.01)**  
**A61K 31/428 (2006.01)**  
**A61K 31/4192 (2006.01)**  
**A61K 31/216 (2006.01)**  
**A61K 31/282 (2006.01)**  
**A61P 25/02 (2006.01)**  
**A61K 31/41 (2006.01)**  
**A61K 31/337 (2006.01)**  
**A61K 31/69 (2006.01)**
- (86) JP2011052077 26.01.2011  
(96) 11705047.6 05.12.2012  
(87) WO2011093512, 26.01.2011  
(97) 2528598, 05.12.2012 en
- (54) COMPOUNDS FOR SUPPRESSING A PERIPHERAL NERVE DISORDER INDUCED BY AN ANTI - CANCER AGENT
- (71) Takeda Pharmaceutical Company Limited, 1-1 Doshomachi 4-chome Chuo-ku, Osaka-shi, Osaka 541-0045, JP
- (72) KITAMOTO, Naomi, c/o TAKEDA PHARMACEUTICAL COMPANY LIMITED 26-1, Muraoka-Higashi 2-chome Fujisawa, Kanagawa 251-0012, JP

- (51) MKP  
**G06Q 20/00 (2012.01)** (97) **2519919 \***
- (86) US2010061462 21.12.2010  
(96) 10844222.9 07.11.2012  
(87) WO2011090655, 21.12.2010  
(97) 2519919, 07.11.2012 en
- (54) SYSTEM AND METHOD FOR PROCESSING PAYMENT TRANSACTION RECEIPTS
- (71) Visa International Service Association, P.O. Box 8999 MS M1-11F, San Francisco, CA 94128, US
- (72) SINGH, Shantnu, 9-12 Tower 1B East Point Green 1 Simei St 3, 529890, SG

- (51) MKP  
**A61K 9/70 (2006.01)** (97) **2506814 \***  
**A61F 13/00 (2006.01)**  
 (86) US2010001287 30.04.2010  
 (96) 10834854.1 10.10.2012  
 (87) WO2011068522, 30.04.2010  
 (97) 2506814, 10.10.2012 en  
 (54) PHARMACEUTICAL COMPOSITION CONTAINING  
 A HYPOMETHYLATING AGENT AND A HISTONE  
 DEACETYLASE INHIBITOR  
 (71) Nimble Epitech, LLC, 2029 Del Mar Heights Road, Del Mar, CA  
 92014, US  
 (72) EPNER, Elliot, M., 1000 Willoughby Road, Harrisburg, PA 17111,  
 US  
 VAUGHAN, Luke, M., 2029 Del Mar Heights Road, Del Mar, CA  
 92014, US

- (51) MKP  
**A61K 31/40 (2006.01)** (97) **2516416 \***  
**C07D 401/04 (2006.01)**  
**C07D 403/12 (2006.01)**  
**A61K 31/495 (2006.01)**  
**A61P 43/00 (2006.01)**  
**C07D 207/325 (2006.01)**  
**C07D 413/14 (2006.01)**  
 (86) US2010060671 16.12.2010  
 (96) 10798887.5 31.10.2012  
 (87) WO2011079007, 16.12.2010  
 (97) 2516416, 31.10.2012 en  
 (54) CRTH2 MODULATORS  
 (71) Ironwood Pharmaceuticals, Inc., 301 Binney Street, 2nd Floor,  
 Cambridge, MA 02142, US  
 (72) MERMERIAN, Ara, 206 Lowell Street, Somerville MA 02144, US  
 PENG, Bo, 282 Gray Street, Arlington MA 02476, US  
 HUDSON, Colleen, 146 Clifton Street 7, Malden MA 02148, US  
 KIM, Charles, 348 Franklin Street Apt. 4D, Cambridge MA 02139,  
 US  
 MOORE, Joel, 4 Cherry Street, Lexington MA 02421, US  
 ROHDE, Jason, 151 Temescal Circle, Emeryville, CA 94608, US  
 SPROTT, Kevin, 40 Rolling Lane, Needham MA 02492, US  
 GRAUL, Regina, 14 Pine Brook Way, Duxbury MA 02332, US  
 NAKAI, Takashi, 7 Gardner Street, Newton MA 02458, US  
 JIA, James, 209 Highland Avenue Apt. 3, Somerville MA 02143,  
 US  
 BARTOLINI, Wilmin, 3 Cottage Lane, Amesbury MA 01913, US

- (51) MKP  
**A61P 17/00 (2006.01)** (97) **2501374 \***  
**A61K 31/185 (2006.01)**  
**A61K 31/195 (2006.01)**  
**A61K 8/40 (2006.01)**  
**A61Q 5/00 (2006.01)**  
**A61K 8/36 (2006.01)**  
 (86) US2010056695 15.11.2010  
 (96) 10830852.9 26.09.2012  
 (87) WO2011060354, 15.11.2010  
 (97) 2501374, 26.09.2012 en  
 (54) COLORING COMPOSITION CONTAINING AN AROMATIC  
 COMPOUND AND AN INITIATOR  
 (71) Warner Babcock Institute For Green Chemistry LLC, 100  
 Research Drive, Wilmington, MA 01887, US  
 John Masters Organic Hair Care, Inc., 77 Sullivan Street, New  
 York, NY 10012, US  
 (72) WARNER, John, C., 100 Research Drive, Wilmington MA 01887,  
 US  
 STOLER, Emily, J., 100 Research Drive, Wilmington MA 01887,  
 US

- (51) MKP  
**A47B 96/02 (2006.01)** (97) **2305069**  
**A47B 57/58 (2006.01)**  
**A47B 57/10 (2006.01)**  
 (96) 10166748.3 06.04.2011  
 (97) 2305069, 06.04.2011 de  
 (54) Shelf floor  
 (71) Dinzi Ordnungstechnik GmbH, Industriestrasse 1, 91583  
 Schillingsfürst, DE  
 (72) Dinzi, Peter, Bildeichenweg 2, 91583, Schillingsfürst, DE

- (51) MKP  
**G07C 9/00 (2006.01)** (97) **2431949**  
 (96) 11007599.1 21.03.2012  
 (97) 2431949, 21.03.2012 de  
 (54) Electronic combination lock  
 (71) Free Aktiengesellschaft, Roeckenwiesenstrasse 62, 70197  
 Stuttgart, DE  
 (72) Rothebacher, Thomas, Mährenstrasse 18, 73431 Aalen, DE  
 Faber, Bernhard, Friedrich-Ebert-Strasse 25, 04109 Leipzig, DE

- (51) MKP  
**A23L 1/0524 (2006.01)** (97) **2518088 \***  
**C08B 37/06 (2006.01)**  
 (86) HU2010000146 20.12.2010  
 (96) 10838762.2 31.10.2012  
 (87) WO2011077172, 20.12.2010  
 (97) 2518088, 31.10.2012 en  
 (54) METHOD FOR PRODUCING LIQUID PECTIN FROM APPLE  
 POMACE  
 (71) Donchenko, Ljudmila, Molnar u. 20. 3/12A, 1056 Budapest, HU  
 Vasiliev, Andrey, Kezdö köz 20., 4551 Nyíregyháza Oros, HU  
 Vasiliev, Pavel, Kis Rákos u. 42/A, 1154 Budapest, HU  
 (72) Donchenko, Ljudmila, Molnar u. 20. 3/12A, 1056 Budapest, HU  
 Vasiliev, Andrey, Kezdö köz 20., 4551 Nyíregyháza Oros, HU  
 Vasiliev, Pavel, Kis Rákos u. 42/A, 1154 Budapest, HU

- (51) MKP  
**A61K 31/165 (2006.01)** (97) **2532647**  
**A61P 25/16 (2006.01)**  
**C07C 231/12 (2006.01)**  
**C07C 233/18 (2006.01)**  
**A61P 25/18 (2006.01)**  
**A61P 3/00 (2006.01)**  
**A61P 25/28 (2006.01)**  
 (96) 12171231.9 12.12.2012  
 (97) 2532647, 12.12.2012 fr  
 (54) New co-crystals of agomelatin  
 (71) Les Laboratoires Servier, 35, rue de Verdun, 92284 Suresnes  
 Cedex, FR  
 (72) Letellier, Philippe, 25, rue du Faubourg Saint Jean, 45000  
 Orléans, FR  
 Lynch, Michael, 74, rue des chaises, 45140 Saint Jean de la  
 Ruelle, FR  
 Pean, Jean-Manuel, 2 bis rue Adolphe Crespin, 45000  
 ORLEANS, FR

- (51) MKP  
**A61L 2/00 (2006.01)** (97) **2506882 \***  
 (86) US2010058459 30.11.2010  
 (96) 10834067.0 10.10.2012  
 (87) WO2011066588, 30.11.2010  
 (97) 2506882, 10.10.2012 en  
 (54) MICROFLUIDIC DEVICE REGENERATION  
 (71) Fluidigm Corporation, 7000 Shoreline Court, Suite 100, South  
 San Francisco, CA 94080, US  
 (72) WANG, Jing, 7000 Shoreline Court Suite 100, South San  
 Francisco California 94080, US  
 WOUDEBERG, Timothy M., 7000 Shoreline Court Suite 100,  
 South San Francisco California 94080, US

- (51) MKP  
**A61P 37/06 (2006.01)** (97) **2528894 \***  
**C07D 209/94 (2006.01)**  
**A61P 29/00 (2006.01)**  
**A61K 31/403 (2006.01)**  
(86) US2011000153 27.01.2011  
(96) 11703939.6 05.12.2012  
(87) WO2011094008, 27.01.2011  
(97) 2528894, 05.12.2012 en  
(54) PROCESSES FOR THE PREPARATION OF (R)-2-(7-(4-CYCLOPENTYL-3-(TRIFLUOROMETHYL)BENZYLOXY)-1,2,3,4-TETRAHYDROCYCLOPENTA[B]INDOL-3-YL)ACETIC ACID AND SALTS THEREOF  
(71) Arena Pharmaceuticals, Inc., 6166 Nancy Ridge Drive, San Diego, CA 92121, US  
(72) MONTALBAN, Antonio, Garrido, 10339 Azuaga Street No. 213, San Diego CA 92129, US  
BUZARD, Daniel, John, 14494 Janal Way, San Diego CA 92129, US  
DeMATTEI, John, Aldo, 8521 Clatsop Lane, San Diego CA 92129, US  
GHARBAOUI, Tawfik, 2340 Lomica Place, Escondido CA 92029, US  
JOHANNSEN, Stephen, Robert, 4437 Mentone Street No. 3, San Diego CA 92107, US  
KRISHNAN, Ashwin, M., 11023 Cedarcrest Way, San Diego CA 92121, US  
KUHLMAN, Young, Mi, 10840 Scripps Ranch Blvd. No. 301, San Diego CA 92131, US  
MA, You-An, 12820 Oakfield Way, Poway CA 92064, US  
MARTINELLI, Michael, John, 12860 Baywind Point, San Diego CA 92130, US  
SATO, Suzanne, Michiko, 11819 Miro Circle, San Diego CA 92131, US  
SENGUPTA, Dipanjan, 9121 Togan Avenue, San Diego CA 92129, US

- (51) MKP  
**C22B 26/12 (2006.01)** (97) **2450991**  
**C22B 47/00 (2006.01)**  
**H01M 10/54 (2006.01)**  
**C22B 15/00 (2006.01)**  
**H01M 6/52 (2006.01)**  
**C22B 23/00 (2006.01)**  
**C22B 7/00 (2006.01)**  
(96) 11185532.6 09.05.2012  
(97) 2450991, 09.05.2012 en  
(54) Plant and process for the treatment of exhausted accumulators and batteries  
(71) ECO Recycling s.r.l., Via Monticelli snc Località Gargarasse, 01033 Civita Castellana (VT), IT  
(72) Toro, Luigi, c/o ECO Recycling s.r.l. Via Monticelli snc Località Gargarasse, 01033 Civita Castellana (VT), IT  
Veglio, Francesco, c/o ECO Recycling s.r.l. Via Monticelli snc Località Gargarasse, 01033 Civita Castellana (VT), IT  
Beolchini, Francesca, c/o ECO Recycling s.r.l. Via Monticelli snc Località Gargarasse, 01033 Civita Castellana (VT), IT  
Pagnanelli, Francesca, c/o ECO Recycling s.r.l. Via Monticelli snc Località Gargarasse, 01033 Civita Castellana (VT), IT  
Furlani, Giuliana, c/o ECO Recycling s.r.l. Via Monticelli snc Località Gargarasse, 01033 Civita Castellana (VT), IT  
Granata, Giuseppe, c/o ECO Recycling s.r.l. Via Monticelli snc Località Gargarasse, 01033 Civita Castellana (VT), IT  
Moscardini, Emanuela, c/o ECO Recycling s.r.l. Via Monticelli snc Località Gargarasse, 01033 Civita Castellana (VT), IT

- (51) MKP  
**C12N 15/82 (2006.01)** (97) **2513318 \***  
(86) US2010060830 16.12.2010  
(96) 10842620.6 24.10.2012  
(87) WO2011084631, 16.12.2010  
(97) 2513318, 24.10.2012 en  
(54) USE OF CRY1AB IN COMBINATION WITH CRY1BE FOR MANAGEMENT OF RESISTANT INSECTS  
(71) Dow AgroSciences, LLC, 9330 Zionsville Road, Indianapolis, Indiana 46268, US  
(72) MEADE, Thomas, 1141 Huntington Woods Pt., Zionsville IN 46077, US  
NARVA, Kenneth, 4372 Creekside Pass, Zionsville IN 46077, US  
STORER, Nicholas, P., 10703 Lexington Street, Kensington MD 20895, US  
SHEETS, Joel, J., 10005 Oak Ridge Drive, Zionsville IN 46077, US  
WOOSLEY, Aaron, T., 8906 Tanner Drive, Fishers IN 46038, US  
BURTON, Stephanie, L., 6820 Bluffgrove Drive, Indianapolis IN 46278, US

- (51) MKP  
**G01N 3/34 (2006.01)** (97) **2439287**  
**C14B 1/40 (2006.01)**  
(96) 11425226.5 11.04.2012  
(97) 2439287, 11.04.2012 en  
(54) Method for evaluating the efficiency and/or operating state of a staking machine and industrial kit suitable to implement such a method  
(71) Equitan S.r.l., Via Cima Carega 43, 36072 Chiampo (VI), IT  
(72) Antoniazzi, Antonio, Equitan S.r.l. Via Cima Carega, 43, 36072 Chiampo (VI), IT

- (51) MKP  
**E03D 9/08 (2006.01)** (97) **2521822 \***  
(86) CH2010000262 19.10.2010  
(96) 10776075.3 14.11.2012  
(87) WO2012051724, 19.10.2010  
(97) 2521822, 14.11.2012 de  
(54) INTIMATE SHOWER FOR A WC  
(71) Presano AG, Sonnenstrasse 1, 9444 Diepoldsau, CH  
(72) FREI, Christian, Stein 7, CH-9463 Oberriet, CH

- (51) MKP  
**A61M 5/32 (2006.01)** (97) **2531237 \***  
**A61M 5/28 (2006.01)**  
**A61M 5/24 (2006.01)**  
(86) EP2011051401 01.02.2011  
(96) 11701674.1 12.12.2012  
(87) WO2011095483, 01.02.2011  
(97) 2531237, 12.12.2012 en  
(54) MEDICATED MODULE WITH TIME LOCK  
(71) Sanofi-Aventis Deutschland GmbH, Brüningstraße 50, 65929 Frankfurt, DE  
(72) BOYD, Malcolm, Stanley, 28 Whitehead Drive, Wellsbourne Warwickshire CV35 9PW, GB  
DAVIES, James, Alexander, 7 Old School Mews Cubbington Road, Leamington Spa Warwickshire CV32 7XB, GB  
WALLACE, Andrew, Gordon, The Old Gardens, Highleadon Gloucestershire GL18 1HJ, GB

- (51) MKP  
**A01N 43/42 (2006.01)** (97) **2512243 \***  
**A61K 31/47 (2006.01)**  
(86) US2010060007 13.12.2010  
(96) 10841821.1 24.10.2012  
(87) WO2011084368, 13.12.2010  
(97) 2512243, 24.10.2012 en  
(54) QUINOLINE AMIDE M1 RECEPTOR POSITIVE ALLOSTERIC MODULATORS  
(71) Merck Sharp & Dohme Corp., 126 East Lincoln Avenue, Rahway NJ 07065-0907, US  
(72) KUDUK, Scott, D., 770 Sumneytown Pike, West Point, Pennsylvania 19486, US  
SCHLEGEL, Kelly-Ann, 770 Sumneytown Pike, West Point, Pennsylvania 19486, US  
YANG, Zhi-Qiang, 770 Sumneytown Pike, West Point, Pennsylvania 19486, US

(51) MKP  
**A01P 13/00 (2006.01)** (97) **2523555 \***  
**A01N 43/16 (2006.01)**  
(86) GB2010002269 10.12.2010  
(96) 10796104.7 21.11.2012  
(87) WO2011073616, 10.12.2010  
(97) 2523555, 21.11.2012 en  
(54) HERBICIDAL COMPOSITIONS COMPRISING, AND METHODS OF USE OF, HERBICIDALLY ACTIVE PYRAN-DIONES  
(71) Syngenta Limited, European Regional Centre Priestley Road Surrey Research Park, Guildford, Surrey GU2 7YH, GB  
(72) CHUNG, Richard, Chi, Shing, c/o Syngenta Limited Jealott's Hill International Research Centre, Bracknell Berkshire RG42 6EY, GB  
CORBIN, Jane, Elisabeth, c/o Syngenta Limited Jealott's Hill International Research Centre, Bracknell Berkshire RG42 6EY, GB  
MATHEWS, Christopher, John, c/o Syngenta Limited Jealott's Hill International Research Centre, Bracknell Berkshire RG42 6EY, GB  
MITCHELL, Glynn, c/o Syngenta Limited Jealott's Hill International Research Centre, Bracknell Berkshire RG42 6EY, GB  
PIPER, Catherine, Julia, c/o Syngenta Limited Jealott's Hill International Research Centre, Bracknell Berkshire RG42 6EY, GB  
SCREPANTI, Claudio, c/o Syngenta Limited Jealott's Hill International Research Centre, Bracknell Berkshire RG42 6EY, GB  
SCUTT, James, Nicholas, c/o Syngenta Limited Jealott's Hill International Research Centre, Bracknell Berkshire RG42 6EY, GB

(51) MKP  
**C07D 405/14 (2006.01)** (97) **2518069 \***  
**A01P 7/02 (2006.01)**  
**C07D 401/12 (2006.01)**  
**C07D 451/06 (2006.01)**  
**A01N 43/42 (2006.01)**  
**C07D 409/14 (2006.01)**  
**C07D 401/14 (2006.01)**  
(86) JP2010072766 17.12.2010  
(96) 10839311.7 31.10.2012  
(87) WO2011078081, 17.12.2010  
(97) 2518069, 31.10.2012 en  
(54) CYCLIC AMINE COMPOUND AND ACARICIDE  
(71) Nippon Soda Co., Ltd., 2-1, Ohtemachi 2-chome Chiyoda-ku, Tokyo 100-8165, JP  
(72) HAMAMOTO Isami, c/o Odawara Research Center Nippon Soda Co. Ltd. 345 Takada, Odawara-shi Kanagawa 250-0280, JP  
KOIZUMI Keiji, c/o Odawara Research Center Nippon Soda Co. Ltd. 345 Takada, Odawara-shi Kanagawa 250-0280, JP  
YANO Makio, c/o Nippon Soda Co. Ltd. 2-1 Ohtemachi 2-chome Chiyoda-ku, Tokyo 100-8165, JP  
KAWAGUCHI Masahiro, c/o Odawara Research Center Nippon Soda Co. Ltd. 345 Takada, Odawara-shi Kanagawa 250-0280, JP  
NOMURA Hazumi, c/o Odawara Research Center Nippon Soda Co. Ltd. 345 Takada, Odawara-shi Kanagawa 250-0280, JP  
HARUYAMA Tetsuya, c/o Takaoka Plant Nippon Soda Co. Ltd. 300 Mukainohonmachi, Takaoka-shi Toyama 933-8507, JP

(51) MKP  
**A61K 31/4523 (2006.01)** (97) **2519520 \***  
**A61P 11/06 (2006.01)**  
**C07D 471/04 (2006.01)**  
(86) US2010060006 13.12.2010  
(96) 10793404.4 07.11.2012  
(87) WO2011078984, 13.12.2010  
(97) 2519520, 07.11.2012 en  
(54) [4-(3-AMINOMETHYL-PHENYL)-PIPERIDIN-1-YL]-(1H-PYRROLOPYRIDINYL)-METHANONE DERIVATIVES AS TRYPTASE INHIBITORS  
(71) SANOFI, 54, rue de la Boétie, 75008 Paris, FR  
(72) CHOI-SLEDESKI, Yong Mi, c/o sanofi-aventis U.S. 1041 Route 202-206 Mail Code: BWD 303A, Bridgewater, New Jersey 08807, US  
NIEDUZAK, Thaddeus R., c/osanofi-aventis U.S. 1041 Route 202-206 Mail Code: BWD 303A, Bridgewater, New Jersey 08807, US  
POLI, Gregory B., c/o sanofi-aventis U.S. 1041 Route 202-206 Mail Code: BWD 303A, Bridgewater, New Jersey 08807, US  
SHUM, Patrick Wai-Kwok, c/o sanofi-aventis U.S 1041 Route 202-206 Mail Code: BWD 303A, Bridgewater, New Jersey 08807, US  
STOKLOSA, Gregory T., c/o sanofi-aventis U.S. 1041 Route 202-206 Mail Code: BWD 303A, Bridgewater, New Jersey 08807, US  
ZHAO, Zhicheng, c/o sanofi-aventis U.S. 1041 Route 202-206 Mail Code: BWD 303A, Bridgewater, New Jersey 08807, US

(51) MKP  
**C12Q 1/68 (2006.01)** (97) **2532756**  
(96) 11305732.7 12.12.2012  
(97) 2532756, 12.12.2012 en  
(54) Methods and uses relating to the diagnosis or prognosis of pain-related tissue states or pain-related diseases such as pain.  
(71) Sanofi-Aventis, 174, Avenue de France, 75013 Paris, FR  
(72) The designation of the inventor has not yet been filed , null, null

(51) MKP  
**C12Q 1/68 (2006.01)** (97) **2504454 \***  
**C07H 21/00 (2006.01)**  
(86) US2010057869 23.11.2010  
(96) 10832373.4 03.10.2012  
(87) WO2011063411, 23.11.2010  
(97) 2504454, 03.10.2012 en  
(54) ELITE EVENT EE-GM3 AND METHODS AND KITS FOR IDENTIFYING SUCH EVENT IN BIOLOGICAL SAMPLES  
(71) Bayer CropScience NV, J.E. Mommaertsiaan 14, 1831 Diegem, BE  
M.S. Technologies LLC, 103 Avenue D, West Point, Iowa 52656, US  
(72) MASON, Justin, Thomas, 2417 White Oak Lane, Granger, Iowa 50109, US  
LETTOW, Leslie, James, 1682 250th Street, Guthrie Center, Iowa 50115, US  
EBY, Mark, Alan, 23374 Laredo Trail, Adel, Iowa 50003, US  
EBY, William, H., 4763 Panorama Drive, Panora, Iowa 50216, US  
WELZ, Günter, Vor den Garten 8, DE-38302 Wolfenbüttel, DE  
VERHAEGHE, Steven, Harrelstraat 21, BE-9800 Grammene-Deize, BE  
DE BEUCKELEER, Marc, Hofakkerstraat 54, BE-9052 Zwijnaarde, BE  
HABEX, Veerle, Hoge Voetweg 12, BE-8560 Gullegem, BE  
FERULLO, Jean-Marc, 8 rue des cerisiers, FR-59560 Comines, FR

(51) MKP  
**A61K 9/00 (2006.01)** (97) **2515853 \***  
**A61K 31/167 (2006.01)**  
**A61K 45/06 (2006.01)**  
**A61K 31/40 (2006.01)**  
(86) EP2010070477 22.12.2010  
(96) 10799028.5 31.10.2012  
(87) WO2011076841, 22.12.2010  
(97) 2515853, 31.10.2012 en  
(54) Combination therapy for COPD  
(71) Chiesi Farmaceutici S.p.A., Via Palermo, 26/A, 43100 Parma, IT  
Usberti, Francesca, Via Palermo 26/A, 43100 Parma, IT  
(72) BONELLI, Sauro, c/o CHIESI FARMACEUTICI S.P.A. Via  
Palermo 26/A, I-43100 Parma, IT  
ZAMBELLI, Enrico, c/o CHIESI FARMACEUTICI S.P.A. Via  
Palermo 26/A, I-43100 Parma, IT  
USBERTI, Francesca, c/o CHIESI FARMACEUTICI S.P.A. Via  
Palermo 26/A, I-43100 Parma, IT

(51) MKP  
**A61F 2/84 (2006.01)** (97) **2519300 \***  
**A61M 25/00 (2006.01)**  
**A61K 31/00 (2006.01)**  
**A61M 25/10 (2006.01)**  
**A61B 18/00 (2006.01)**  
**A61M 29/00 (2006.01)**  
**A61M 25/09 (2006.01)**  
**A61B 1/00 (2006.01)**  
**A61M 25/06 (2006.01)**  
**A61L 29/00 (2006.01)**  
**A61B 17/3207 (2006.01)**  
(86) US2010062161 27.12.2010  
(96) 10801347.5 07.11.2012  
(87) WO2011082139, 27.12.2010  
(97) 2519300, 07.11.2012 en  
(54) SYSTEM FOR TREATING TARGET TISSUE WITHIN THE  
EUSTACHIAN TUBE  
(71) Acclarent, Inc., 1525-B O'Brien Drive, Menlo Park, CA 94025,  
US  
(72) CLIFFORD, Anton, G., 194 Carmelita Drive, Mountain View  
California 94040, US  
MAKOWER, Joshua, 661 University Avenue, Los Altos California  
94022, US  
CHANG, John, Y., 354 Solana Drive, Los Altos, CA 94022, US  
MORRIS, John, H., 725-A Wisconsin Street, San Francisco  
California 94107, US  
BRIGHT, Earl, A., 25 Del Monte Avenue, Los Altos California  
94022, US  
GOLDFARB, Eric, 1506 Harbor Boulevard, Belmont California  
94002, US  
VRANY, Julia, D., 461 Carrol Street, Sunnyvale California 94086,  
US

(51) MKP  
**B65H 49/00 (2006.01)** (97) **2536540 \***  
**B26D 1/547 (2006.01)**  
(86) GB2011050299 16.02.2011  
(96) 11705235.7 26.12.2012  
(87) WO2011101667, 16.02.2011  
(97) 2536540, 26.12.2012 en  
(54) WIRE HANDLING FOR VEHICLE GLAZING PANEL CUT OUT  
(71) Belron Hungary Kft - Zug Branch, Gotthardstrasse 20, 6304 Zug,  
CH  
(72) FINCK, William, 31 Doddinghurst Road Brentwood, Essex CM15  
9EP, GB

(51) MKP  
**A61K 9/54 (2006.01)** (97) **2515882 \***  
**A61K 9/52 (2006.01)**  
**A61K 9/28 (2006.01)**  
(86) IN2010000829 20.12.2010  
(96) 10838833.1 31.10.2012  
(87) WO2011077451, 20.12.2010  
(97) 2515882, 31.10.2012 en  
(54) CONTROLLED RELEASE PHARMACEUTICAL COMPOSITION  
(71) Abbot Healthcare Private Limited, Sion Trombay Road 3-4  
Corporate Park, Chembur, Mumbai 400 071, IN  
BOLDHANE, Sanjay, 1 Nirlon Complex Off W.E. Highway  
Goregaon (East), Mumbai 400 063 Maharashtra, IN  
JATHAR, Shripad, 1 Nirlon Complex Off W.E. Highway Goregaon  
(East), Mumbai 400 063 Maharashtra, IN  
NERURKAR, Maneesh, 1 Nirlon Complex Off W.E. Highway  
Goregaon (East), Mumbai 400 063 Maharashtra, IN

(51) MKP  
**G01N 33/50 (2006.01)** (97) **2526206 \***  
**C12Q 1/68 (2006.01)**  
(86) EP2011050780 20.01.2011  
(96) 11701784.8 28.11.2012  
(87) WO2011089194, 20.01.2011  
(97) 2526206, 28.11.2012 en  
(54) METHODS AND USES RELATING TO THE IDENTIFICATION  
OF COMPOUND INVOLVED IN PAIN AS WELL AS METHODS  
OF DIAGNOSING ALGESIA  
(71) SANOFI, 54, rue de la Boétie, 75008 Paris, FR  
(72) GEBAUER, Mathias, c/o Sanofi-Aventis Deutschland GmbH,  
65926 Frankfurt am Main, DE  
MICHAELIS, Martin, c/o Sanofi-Aventis Deutschland GmbH,  
65926 Frankfurt, DE  
DING-PFENNIGDORFF, Danping, c/o Sanofi-Aventis  
Deutschland GmbH, 65926 Frankfurt am Main, DE  
SCHULTE, Anke M., c/o Sanofi-Aventis Deutschland GmbH,  
65926 Frankfurt am Main, DE  
ZIEMEK, Daniel, 53 Barnard Ave, Watertown, MA 02472, US  
METZ-WEIDMANN, Christiane, c/o Sanofi-Aventis Deutschland  
GmbH, 65926 Frankfurt am Main, DE

(51) MKP  
**C08L 97/02 (2006.01)** (97) **2531561 \***  
**C08G 18/64 (2006.01)**  
**C08H 8/00 (2010.01)**  
(86) GB2011050202 04.02.2011  
(96) 11704089.9 12.12.2012  
(87) WO2011095824, 04.02.2011  
(97) 2531561, 12.12.2012 en  
(54) PROCESS FOR THE ACETYLTATION OF WOOD ELEMENTS  
(71) Titan Wood Limited, Kensington Centre 66 Hammersmith Road,  
London W11 8UD, GB  
(72) MAES, Michel, Postbus 2147 Westervoortsedijk 73, NL-6802 CC  
Arnhem, NL  
POL, Beno, Postbus 2147 Westervoortsedijk 73, NL-6802 CC  
Arnhem, NL

(51) MKP  
**A61B 17/22 (2006.01)** (97) **2533705 \***  
**A61B 17/32 (2006.01)**  
**A61B 17/3207 (2006.01)**  
(86) US2011024197 09.02.2011  
(96) 11706383.4 19.12.2012  
(87) WO2011100328, 09.02.2011  
(97) 2533705, 19.12.2012 en  
(54) ROTATABLE CUTTING IMPLEMENT ARRANGEMENTS FOR  
ULTRASONIC SURGICAL INSTRUMENTS  
(71) Ethicon Endo-Surgery, Inc., 4545 Creek Road, Cincinnati, OH  
45242, US  
(72) ROBERTSON, Galen, C., 5752 Doerger Lane, Cincinnati, OH  
45212, US  
TIMM, Richard, W., 3405 Monteith Avenue 1, Cincinnati, OH  
45208, US  
RUPP, Kip, M., 2096 State Route 232, New Richmond, OH  
45147, US  
SNYDER, Kristina, A., 6090 Stone Post Road, Bath, PA 18014,  
US

- (51) MKP  
**A61K 31/437 (2006.01)** (97) **2516438 \***  
**C07D 471/04 (2006.01)**  
**A61P 35/00 (2006.01)**
- (86) US2010061601 21.12.2010  
(96) 10840075.5 31.10.2012  
(87) WO2011079133, 21.12.2010  
(97) 2516438, 31.10.2012 en  
(54) COMPOUNDS AND METHODS FOR KINASE MODULATION, AND INDICATIONS THEREFOR  
(71) Plexxikon, Inc., 91 Bolivar Drive, Suite A, Berkeley, CA 94710, US  
(72) IBRAHIM, Prabha N., 3380 Lubich Drive, Mountain View CA 94040, US  
WU, Guoxian, 240 Ventura Avenue, Palo Alto CA 94306, US  
LIN, Jack, 181 Falcon Way, Hercules California 94547, US  
SPEVAK, Wayne, 1585 Campus Drive, Berkeley California 94708, US  
CHO, Hanna, 4363 Terrabella Place, Oakland California 94619, US  
EWING, Todd, 20 Edmund Ct, Walnut Creek California 94596, US  
ZHANG, Chao, 397 Springfield Plaza, Moraga California 94556, US
- 
- (51) MKP  
**C07C 215/40 (2006.01)** (97) **2508522 \***  
**A61K 31/4245 (2006.01)**  
**C07C 215/08 (2006.01)**  
**A61P 9/12 (2006.01)**  
**C07D 413/10 (2006.01)**
- (86) CN2010079222 29.11.2010  
(96) 10832671.1 10.10.2012  
(87) WO2011063764, 29.11.2010  
(97) 2508522, 10.10.2012 en  
(54) AZILSARTAN ORGANIC AMINE SALTS, PREPARATION METHOD AND USE THEREOF  
(71) Jiangsu Hansoh Pharmaceutical Group Co., Ltd., The 10th Industrial Sub-zone of Development Zone Lianyungang, Jiangsu 222047, CN  
(72) LU, Aifeng, The 10th Industrial Sub-zone Of Development Zone, Lianyungang Jiangsu 222047, CN  
YANG, Baohai, The 10th Industrial Sub-zone Of Development Zone, Lianyungang Jiangsu 222047, CN
- 
- (51) MKP  
**B65D 47/20 (2006.01)** (97) **2516286 \***  
**B65D 47/30 (2006.01)**  
**B65D 47/26 (2006.01)**
- (86) IB2010055989 21.12.2010  
(96) 10813041.0 31.10.2012  
(87) WO2011077378, 21.12.2010  
(97) 2516286, 31.10.2012 en  
(54) DISPENSING BOTTLE-TOP FOR BOTTLE FOR PRODUCTS OF LIQUID OR VISCOUS CONSISTENCY AND BOTTLE FITTED WITH SUCH A BOTTLE-TOP  
(71) Chanel Parfums Beauté, 135 avenue Charles de Gaulle, 92200 Neuilly-sur-Seine, FR  
(72) MALLOCHET, Cédric, 1 rue Villa Bon Accueil, F-95870 Bezons, FR  
PERRIN, Olivier, 54 rue Lasègue, F-92320 Chatillon, FR  
HENGY, Gilles, 10 rue de Largitzen, F-68560 Hirsingue, FR  
WICKY, Jean-Jacques, 3 rue des sources, F-68730 Blotzheim, FR
- 
- (51) MKP  
**E04B 1/343 (2006.01)** (97) **2531675 \***  
**E04H 15/44 (2006.01)**
- (86) US2011023775 04.02.2011  
11740441.8 12.12.2012  
(96) WO2011097501, 04.02.2011  
(87) 2531675, 12.12.2012 en  
(54) COLLAPSIBLE CENTRAL SUPPORT DEVICE  
(71) Atico International USA, Inc., 501 South Andrews Avenue, Fort Lauderdale, FL 33301, US  
(72) LU, Ming Chin, 2F No. 3 Alley 19 Lane 281 Sing Sun Road, Neihu 114 Taipei, TW  
LIU, Shang Jen, 7F. No. 197-2 Sec. 5 Ming Sheng East Road, Taipei 114, TW  
HUNG, Chi-Ming, 1F. No. 12 Alley 1 Lane 18 Sin Po 1 Street, Hsintien City 111, TW  
CHEN, Tung Yang, 2F. No. 11 Hua-Ling Street, Shihlin Taipei 111, TW
- 
- (51) MKP  
**A61K 31/497 (2006.01)** (97) **2513088 \***  
**A61K 31/496 (2006.01)**  
**C07D 409/04 (2006.01)**  
**C07D 407/14 (2006.01)**  
**A61P 25/00 (2006.01)**  
**C07D 403/14 (2006.01)**  
**A61K 31/551 (2006.01)**  
**C07D 495/04 (2006.01)**  
**C07D 407/04 (2006.01)**  
**C07D 409/14 (2006.01)**  
**C07D 401/04 (2006.01)**  
**A61K 31/4995 (2006.01)**  
**C07D 401/14 (2006.01)**  
**A61K 31/506 (2006.01)**
- (86) FR2010052686 13.12.2010  
(96) 10801663.5 24.10.2012  
(87) WO2011080445, 13.12.2010  
(97) 2513088, 24.10.2012 fr  
(54) NOVEL (HETEROCYCLE/TETRAHYDROPIRIDINE)-(PIPERAZINYL)-1-ALCANONE AND (HETEROCYCLE/DIHYDROPIRROLIDINE)-(PIPERAZINYL)-1-ALCANONE DERIVATIVES, AND USE THEREOF AS P75 INHIBITORS  
(71) SANOFI, 54, rue de la Boétie, 75008 Paris, FR  
(72) BARONI, Marco, c/o Sanofi-Aventis Patent Department 174 avenue de France, F-75013 Paris, FR  
BONO, Françoise, c/o Sanofi-Aventis Patent Department 174 avenue de France, F-75013 Paris, FR  
DELBARY-GOSSART, Sandrine, c/o Sanofi-Aventis Patent Department 174 avenue de France, F-75013 Paris, FR  
VERCESI, Valentina, c/o Sanofi-Aventis Patent Department 174 avenue de France, F-75013 Paris, FR
- 
- (51) MKP  
**A61P 3/10 (2006.01)** (97) **2513109 \***  
**A61P 1/04 (2006.01)**  
**C07D 471/04 (2006.01)**  
**A61P 35/00 (2006.01)**  
**A61P 19/02 (2006.01)**  
**A61K 31/4375 (2006.01)**  
**C07D 519/00 (2006.01)**  
**A61P 9/10 (2006.01)**  
**A61P 17/06 (2006.01)**
- (86) US2010060978 17.12.2010  
(96) 10803182.4 24.10.2012  
(87) WO2011075628, 17.12.2010  
(97) 2513109, 24.10.2012 en  
(54) HETEROCYCLIC COMPOUNDS AND THEIR USES  
(71) Amgen Inc., One Amgen Center Drive, Thousand Oaks, California 91320-1799, US  
(72) CUSHING, Timothy D., 1064 Glacier Avenue, Pacifica California 94044, US  
GONZALEZ LOPEZ DE TURISO, Felix, 10 De Sabla Road 509, San Mateo California 94402, US  
HAO, Xiaolin, 637 Sandy Hook Court, Foster City California 94404, US  
SHIN, Youngsook, 64 Loop 22, Emeryville California 94608, US

(51) MKP  
**B28D 5/00 (2006.01)** (97) **2504139 \***  
 (86) EP2010067945 22.11.2010  
 (96) 10781685.2 03.10.2012  
 (87) WO2011064170, 22.11.2010  
 (97) 2504139, 03.10.2012 de  
 (54) METHOD AND DEVICE FOR TREATING ABRASIVE SLURRIES CONTAINING SI/SIC  
 (71) Messer Group GmbH, Otto-Volger-Strasse 3c, 65843 Sulzbach, DE  
 Coenen, Wolfgang, Dr. Ruckert Str. 3E, 28865 Lilienthal, DE  
 (72) COENEN, Wolfgang, Dr. Ruckert Str.3E, 28865 Lilienthal, DE  
 BERGER, Thomas, Priembergweg 48, 45257 Essen, DE  
 GOCKEL, Frank, wilhelminenstr. 107, 45881 Gelsenkirchen, DE

(51) MKP  
**B22D 41/14 (2006.01)** (97) **2523765 \***  
 (86) CA2011000018 11.01.2011  
 (96) 11732594.4 21.11.2012  
 (87) WO2011085471, 11.01.2011  
 (97) 2523765, 21.11.2012 en  
 (54) MOLTEN METAL CONTAINMENT STRUCTURE HAVING MOVABLE COVER  
 (71) Novelis, Inc., 191 Evans Avenue, Toronto, ON M8Z 1J5, CA  
 (72) REEVES, Eric W., 4683 E. Hudlow Road, Hayden Lake Idaho 83835, US

(51) MKP  
**E04B 2/96 (2006.01)** (97) **2450495**  
 (96) 10189760.1 09.05.2012  
 (97) 2450495, 09.05.2012 de  
 (54) Connection element for fixing an insulation element to a pressure bar of a mullion and transom facade  
 (71) Raico Bautechnik GmbH, Gewerbegebiet Nord 2, 87772 Pfaffenhausen, DE  
 (72) Vögele, Rainer, Lußmahd 11, 86470, Thannhausen, DE

(51) MKP  
**F24J 2/42 (2006.01)** (97) **2507555 \***  
**F23G 7/00 (2006.01)**  
**F23G 5/027 (2006.01)**  
**F23G 5/16 (2006.01)**  
 (86) GB2010002178 26.11.2010  
 (96) 10785494.5 10.10.2012  
 (87) WO2011067552, 26.11.2010  
 (97) 2507555, 10.10.2012 en  
 (54) GASIFICATION SYSTEM  
 (71) Chalabi, Rifat Al, N°1 Nottingham Science Park Jesse Boot Avenue University Boulevard, Nottingham, Nottinghamshire NG7 2RU, GB  
 Perry, Ophneil Henry, N°1 Nottingham Science Park Jesse Boot Avenue University Boulevard, Nottingham, Nottinghamshire NG7 2RU, GB  
 (72) Chalabi, Rifat Al, N°1 Nottingham Science Park Jesse Boot Avenue University Boulevard, Nottingham, Nottinghamshire NG7 2RU, GB  
 Perry, Ophneil Henry, N°1 Nottingham Science Park Jesse Boot Avenue University Boulevard, Nottingham, Nottinghamshire NG7 2RU, GB

(51) MKP  
**F02M 51/00 (2006.01)** (97) **2444650**  
**F02M 53/04 (2006.01)**  
**F02M 55/00 (2006.01)**  
**F02M 61/20 (2006.01)**  
 (96) 10188138.1 25.04.2012  
 (97) 2444650, 25.04.2012 en  
 (54) Improved fuel injector  
 (71) Delphi Technologies Holding S.à.r.l., Avenue de Luxembourg, 4940 Bascharage, LU  
 (72) Bimbenet, Bruno, 13 bis Rue du Bon Levrault, 41350, Saint-Claude-de-Diray, FR  
 Enters, Richard, 12 Rue François Villon, 41350, Vineuil, FR  
 Lecluse, Eric, 40 Rue de Vendôme, 41100, Pezou, FR  
 Oge, Jean-Christophe, La Boissière, 41250, Neuvy, FR  
 Thibault, Thierry, 62 Rue du Bois de la Chainée, 37530 Saint-Ouen-les-Vignes, FR

(51) MKP  
**A01K 67/027 (2006.01)** (97) **2512227 \***  
**C12N 15/85 (2006.01)**  
 (86) US2010058823 03.12.2010  
 (96) 10788203.7 24.10.2012  
 (87) WO2011084281, 03.12.2010  
 (97) 2512227, 24.10.2012 en  
 (54) ANIMAL MODEL EXPRESSING LUCIFERASE UNDER CONTROL OF THE MYELIN BASIC PROTEIN PROMOTER (MBP-LUCI) AND USE OF THE MODEL FOR BIOLUMINESCENCE IN VIVO IMAGING  
 (71) SANOFI, 54, rue de la Boétie, 75008 Paris, FR  
 (72) CAO, James, c/o Sanofi-aventis U.S. 1041 Route 202-206 Mail Code: BWD-303A, Bridgewater, New Jersey 08807, US  
 CHANDROSS, Karen, c/o Sanofi-aventis U.S. 1041 Route 202-206 Mail Code: BWD-303A, Bridgewater, New Jersey 08807, US  
 ECONIMIDES, Kyriakos, D., c/o Sanofi-aventis U.S. 1041 Route 202-206 Mail Code: BWD-303A, Bridgewater, New Jersey 08807, US  
 POLITES, Harry Gregory, c/o Sanofi-aventis U.S. 1041 Route 202-206 Mail Code: BWD-303A, Bridgewater, New Jersey 08807, US  
 WEINSTOCK, Daniel, c/o Sanofi-aventis U.S. 1041 Route 202-206 Mail Code: BWD-303A, Bridgewater, New Jersey 08807, US  
 YING, Xiaoyou, c/o Sanofi-aventis U.S. 1041 Route 202-206 Mail Code: BWD-303A, Bridgewater, New Jersey 08807, US

(51) MKP  
**A61K 31/4439 (2006.01)** (97) **2513070 \***  
**A61P 3/00 (2006.01)**  
**C07D 417/12 (2006.01)**  
**A61K 31/426 (2006.01)**  
**C07D 277/34 (2006.01)**  
**A61P 5/00 (2006.01)**  
 (86) US2010060439 15.12.2010  
 (96) 10796247.4 24.10.2012  
 (87) WO2011084453, 15.12.2010  
 (97) 2513070, 24.10.2012 en  
 (54) PPAR-SPARING THIAZOLIDINEDIONE SALTS FOR THE TREATMENT OF METABOLIC DISEASES  
 (71) Metabolic Solutions Development Company LLC, 161 East Michigan Avenue, 4th Floor, Kalamazoo, MI 49007, US  
 (72) COLCA, Gerard, R., 125 South Kalamazoo Mall 604, Kalamazoo, MI 49007, US  
 TANIS, Steven, P., 1750 Oriole Ct., Carlsbad, CA 92011, US  
 LARSEN, Scott, D., 13638 Cantaberry Ct., South Lyon, MI 48178, US

(51) MKP  
**C07D 307/81 (2006.01)** (97) **2513054 \***  
**C07D 417/12 (2006.01)**  
**C07D 333/58 (2006.01)**  
**C07D 409/12 (2006.01)**  
**C07D 235/14 (2006.01)**  
**C07D 405/06 (2006.01)**  
**C07D 407/04 (2006.01)**  
**C07D 405/14 (2006.01)**  
**C07D 405/12 (2006.01)**  
**C07D 209/14 (2006.01)**  
**C07D 403/12 (2006.01)**  
 (86) US2010060986 17.12.2010  
 (96) 10798434.6 24.10.2012  
 (87) WO2011075634, 17.12.2010  
 (97) 2513054, 24.10.2012 en  
 (54) BICYCLIC DERIVATIVES USEFUL AS INHIBITORS OF DPP-1  
 (71) Janssen Pharmaceutica, N.V., Turnhoutseweg 30, 2340 Beerse, BE  
 (72) LAWSON, Edward, C., 82 Ervin Road, Pipersville PA 18947, US  
 GHOSH, Shyamali, 906 Patriot Mane, Norristown PA 19403, US  
 DESJARLAIS, Renee, L., 11 Cornwell Circle, Saint Davids PA 19087, US  
 HLASTA, Dennis, J., 5008 Davis Drive, Doylestown PA 18902, US  
 SCHUBERT, Carsten, 1006 Hares Hill Road, Phoenixville PA 19460, US

- (51) MKP  
**A61P 35/00 (2006.01)** (97) **2509963 \***  
**C07D 239/48 (2006.01)**  
**A61K 31/506 (2006.01)**
- (86) US2010059108 06.12.2010  
(96) 10788479.3 17.10.2012  
(87) WO2011071821, 06.12.2010  
(97) 2509963, 17.10.2012 en
- (54) CRYSTALLINE FORMS OF 3-(2,6-DICHLORO-3,5-DIMETHOXY-PHENYL)-1-[6-[4-(4-ETHYL-PIPERAZIN-1-YL)-PHENYLAMINO]-PYRIMIDIN-4-YL]-1-METHYL-UREA AND SALTS THEREOF
- (71) Novartis AG, Lichtstrasse 35, 4056 Basel, CH  
(72) BERGHAUSEN, Joerg, Novartis Pharma AG Werk Klybeck Postfach, CH-4002 Basel, CH  
KAPA, Prasad, Koteswara, Novartis One Health Plaza, East Hanover, NJ 07936, US  
MCKENNA, Joseph, Novartis One Health Plaza, East Hanover New Jersey 07936, US  
SLADE, Joel, Novartis One Health Plaza, East Hanover New Jersey 07936, US  
WU, Raeann, Novartis One Health Plaza, East Hanover New Jersey 07936, US  
DU, Zhengming, Novartis One Health Plaza, East Hanover New Jersey 07936, US  
STOWASSER, Frank, Novartis Pharma AG Werk Klybeck Postfach, CH-4002 Basel, CH

- (51) MKP  
**C07D 451/02 (2006.01)** (97) **2516428 \***  
**A61K 31/46 (2006.01)**  
**A61P 29/00 (2006.01)**
- (86) US2010060004 13.12.2010  
(96) 10801488.7 31.10.2012  
(87) WO2011087652, 13.12.2010  
(97) 2516428, 31.10.2012 en
- (54) TROPINONE BENZYLAMINES AS BETA-TRYPTASE INHIBITORS
- (71) SANOFI, 54, rue de la Boétie, 75008 Paris, FR  
(72) CHOI-SLEDESKI, Yong Mi, c/o Sanofi-Aventis U.S. 1041 Route 202-206 Mail Code: BWD 303A, Bridgewater, New Jersey 08807, US  
LIANG, Guyan, c/o Sanofi-Aventis U.S. 1041 Route 202-206 Mail Code: BWD 303A, Bridgewater, New Jersey 08807, US  
SHUM, Patrick Wai-Kwok, c/o Sanofi-Aventis U.S. 1041 Route 202-206 Mail Code: BWD 303A, Bridgewater, New Jersey 08807, US

- (51) MKP  
**C12P 21/02 (2006.01)** (97) **2523975 \***  
**C07K 16/24 (2006.01)**  
**C12N 15/70 (2006.01)**  
**C12N 9/48 (2006.01)**
- (86) EP2011050415 13.01.2011  
(96) 11700144.6 21.11.2012  
(87) WO2011086138, 13.01.2011  
(97) 2523975, 21.11.2012 en
- (54) BACTERIAL HOST STRAIN COMPRISING A MUTANT SPR GENE AND A WILD-TYPE TSP GENE
- (71) UCB Pharma, S.A., 60, allée de la Recherche, 1070 Brussels, BE  
(72) ELLIS, Mark, c/o IPD UCB Celltech 208 Bath Road, Slough Berkshire SL1 3WE, GB  
HUMPHREYS, David Paul, c/o IPD UCB Celltech 208 Bath Road, Slough Berkshire SL1 3WE, GB

- (51) MKP  
**C07D 401/04 (2006.01)** (97) **2509961 \***  
**C07D 233/76 (2006.01)**  
**A61K 31/4166 (2006.01)**  
**C07D 403/04 (2006.01)**  
**A61P 25/18 (2006.01)**
- (86) EP2010068946 06.12.2010  
(96) 10788314.2 17.10.2012  
(87) WO2011069951, 06.12.2010  
(97) 2509961, 17.10.2012 en
- (54) IMIDAZOLIDINEDIONE DERIVATIVES
- (71) Autifony Therapeutics Limited, 90 High Holborn, London WC1V 6XX, GB  
(72) ALVARO, Giuseppe, Via Alessandro Fleming 2, I-37135 Verona, IT  
DECOR, Anne, Via Alessandro Fleming 2, I-37135 Verona, IT  
FONTANA, Stefano, Via Alessandro Fleming 2, I-37135 Verona, IT  
HAMPRECHT, Dieter, Via Alessandro Fleming 2, I-37135 Verona, IT  
LARGE, Charles, Via Alessandro Fleming 2, I-37135 Verona, IT  
MARASCO, Agostino, Via Alessandro Fleming 2, I-37135 Verona, IT

- (51) MKP  
**C12N 15/09 (2006.01)** (97) **2530149 \***  
**C12P 17/18 (2006.01)**  
**C12N 1/15 (2006.01)**
- (86) JP2011050852 19.01.2011  
(96) 11736900.9 05.12.2012  
(87) WO2011093186, 19.01.2011  
(97) 2530149, 05.12.2012 en
- (54) NUCLEIC ACID STRUCTURE CONTAINING A PYRIPYROPENE BIOSYNTHESIS GENE CLUSTER AND A MARKER GENE
- (71) Meiji Seika Pharma Co., Ltd., 4-16, Kyobashi 2-chome Chuo-ku, Tokyo 104-8002, JP  
(72) AIHARA Sato, c/o Meiji Seika Pharma co., Ltd. 788, Kayama, Odawara-shi Kanagawa 250-0852, JP  
SUMIDA Naomi, c/o Meiji Seika Pharma Co. Ltd. 788 Kayama, Odawara-shi Kanagawa 250-0852, JP  
MURASHIMA Koichiro, c/o Meiji Seika Pharma Co., Ltd. 788 Kayama, Odawara-shi Kanagawa 250-0852, JP  
YANAI Kouji, c/o Meiji Seika Pharma Co., Ltd. 788 Kayama, Odawara-shi Kanagawa 250-0852, JP  
ANZAI Hiroyuki, c/o The Ibaraki University 3-21-1 Chuo Amimachi, Inashiki-gun Ibaraki 300-0393, JP  
YAMAMOTO Kentaro, c/o Meiji Seika Pharma Co., Ltd. 760 Morooka-cho Kohoku-ku, Yokohama-shi Kanagawa 222-8567, JP

- (51) MKP  
**C07K 16/24 (2006.01)** (97) **2534175 \***
- (86) EP2011051749 07.02.2011  
(96) 11702830.8 19.12.2012  
(87) WO2011098424, 07.02.2011  
(97) 2534175, 19.12.2012 en
- (54) TREATMENT OF A METABOLIC DISORDER
- (71) Glaxo Group Limited, Glaxo Wellcome House Berkeley Avenue Greenford, Middlesex UB6 0NN, GB  
(72) BAYLIFFE, Andrew, Ian, GlaxoSmithKline Gunnels Wood Road, Stevenage Hertfordshire SG1 2NY, GB

- (51) MKP  
**A01N 37/10 (2006.01)** (97) **2509418 \***
- (86) US2010059584 08.12.2010  
(96) 10836658.4 17.10.2012  
(87) WO2011072086, 08.12.2010  
(97) 2509418, 17.10.2012 en
- (54) METHODS AND LOW DOSE REGIMENS FOR TREATING RED BLOOD CELL DISORDERS
- (71) Hemaquest Pharmaceuticals, Inc., 1229 Madison St., Seattle, WA 98104, US  
Trustees of Boston University, One Silber Way, Boston, MA 02215, US  
(72) PERRINE, Susan, 45 Beaver Road, Weston MA 02493, US  
BERENSON, Ronald, J., 7264 North Mercer Way, Mercer Island WA 98040, US  
FALLER, Douglas, V., 45 Beaver Road, Weston MA 02493, US



(51) MKP  
**A61L 24/00 (2006.01)** (97) **2512536 \***  
**A61L 24/08 (2006.01)**  
**A61L 24/02 (2006.01)**  
(86) IB2010055697 09.12.2010  
(96) 10807669.6 24.10.2012  
(87) WO2011073860, 09.12.2010  
(97) 2512536, 24.10.2012 en  
(54) A CALCIUM PHOSPHATE BONE CEMENT, PROCESS FOR ITS PREPARATION AND USES THEREOF  
(71) Merello, Luisa, Via Sapello 21/3, 16157 Genova (GE), IT  
(72) Merello, Luisa, Via Sapello 21/3, 16157 Genova (GE), IT

(51) MKP  
**B63B 1/04 (2006.01)** (97) **2507124 \***  
(86) EP2010007381 05.12.2010  
(96) 10819698.1 10.10.2012  
(87) WO2011069623, 05.12.2010  
(97) 2507124, 10.10.2012 de  
(54) WATERCRAFT COMPRISING UNDER-WATER FLOATING BODY AND ABOVE-WATER HELM STAND  
(71) Schädlich, Hartmut, Kurweg 62, 67316 Carlsberg, DE  
Schädlich, Jette, Montessoriweg 14/314, 71634 Ludwigsburg, DE  
(72) SCHÄDLICH, Hartmut, Kurweg 62, 67316 Carlsberg, DE

(51) MKP  
**A61K 36/899 (2006.01)** (97) **2512225 \***  
**A01H 5/00 (2006.01)**  
(86) US2010060835 16.12.2010  
(96) 10842622.2 24.10.2012  
(87) WO2011084634, 16.12.2010  
(97) 2512225, 24.10.2012 en  
(54) USE OF VIP3AB IN COMBINATION WITH CRY1CA FOR MANAGEMENT OF RESISTANT INSECTS  
(71) Dow AgroSciences, LLC, 9330 Zionsville Road, Indianapolis, IN 46268, US  
(72) MEADE, Thomas, 1141 Huntington Woods Pt., Zionsville IN 46077, US  
NARVA, Kenneth, 4372 Creekside Pass, Zionsville IN 46077, US  
STOREY, Nicholas, P., 10703 Lexington Street, Kensington MD 20895, US  
SHEETS, Joel, J., 10005 Oak Ridge Drive, Zionsville IN 46077, US  
WOOSLEY, Aaron, T., 8906 Tanner Drive, Fishers IN 46038, US  
BURTON, Stephanie, L., 6820 Bluffgrove Drive, Indianapolis IN 46278, US

(51) MKP  
**A61F 2/00 (2006.01)** (97) **2528537 \***  
(86) US2011022795 27.01.2011  
(96) 11737681.4 05.12.2012  
(87) WO2011094459, 27.01.2011  
(97) 2528537, 05.12.2012 en  
(54) DEVICE AND METHOD FOR PREVENTING STENOSIS AT AN ANASTOMOSIS SITE  
(71) Iyer, Sriram S., 181 E. 90th St. Apt. 12B, New York, NY 10128, US  
Dorros, Gerald, P.O. Box 1654 1120 South Thunder Road, Wilson, Wyoming 83014, US  
(72) Iyer, Sriram S., 181 E. 90th St. Apt. 12B, New York, NY 10128, US  
Dorros, Gerald, P.O. Box 1654 1120 South Thunder Road, Wilson, Wyoming 83014, US

(51) MKP  
**F27D 1/12 (2006.01)** (97) **2510297 \***  
**F27D 1/14 (2006.01)**  
(86) CA2010001936 08.12.2010  
(96) 10835334.3 17.10.2012  
(87) WO2011069249, 08.12.2010  
(97) 2510297, 17.10.2012 en  
(54) MOLTEN METAL CONTAINMENT STRUCTURE HAVING FLOW THROUGH VENTILATION  
(71) Novelis, Inc., 191 Evans Avenue, Toronto, ON M8Z 1J5, CA  
(72) REEVES, Eric W., 4683 E. Hudlow Road, Hayden Lake Idaho 83835, US  
HYMAS, Jason D., 18011 S. Forsland Road, Fairfield Washington 99012, US  
TINGEY, John Steven, 6797 W. Kamloops Drive, Rathdrum Idaho 83858, US

(51) MKP  
**A61K 38/17 (2006.01)** (97) **2523678 \***  
(86) US2011020994 12.01.2011  
(96) 11733316.1 21.11.2012  
(87) WO2011088123, 12.01.2011  
(97) 2523678, 21.11.2012 en  
(54) WNT ANTAGONISTS AND METHODS OF TREATMENT AND SCREENING  
(71) Oncomed Pharmaceuticals, Inc., 800 Chesapeake Drive, Redwood City, CA 94063-4748, US  
(72) SATYAL, Sanjeev, H., 965 Buckland Avenue, San Carlos CA 94070, US  
MITRA, Satyajit, Sujit, Kumar, 75 Duane Street Apt. 17, Redwood City CA 94062, US  
GURNEY, Austin, L., 946 Diamond Street, San Francisco CA 94114, US

(51) MKP  
**A61P 19/02 (2006.01)** (97) **2501387 \***  
**A61K 31/5513 (2006.01)**  
**A61P 19/00 (2006.01)**  
(86) US2010055254 03.11.2010  
(96) 10831981.5 26.09.2012  
(87) WO2011062765, 03.11.2010  
(97) 2501387, 26.09.2012 en  
(54) 1,4-BENZODIAZEPINE-2,5-DIONES AND RELATED COMPOUNDS WITH THERAPEUTIC PROPERTIES  
(71) The Regents Of The University Of Michigan, 1600 Huron Parkway, 2nd Floor, Ann Arbor, MI 48109-2590, US  
(72) GLICK, Gary D., 1663 Snowberry Ridge Road, Ann Arbor Michigan 48103, US

(51) MKP  
**H04L 12/56 (2006.01)** (97) **2523405 \***  
(86) JP2011050182 07.01.2011  
(96) 11731844.4 14.11.2012  
(87) WO2011083846, 07.01.2011  
(97) 2523405, 14.11.2012 en  
(54) COMMUNICATION SYSTEM, FORWARDING NODES, PATH MANAGEMENT SERVER AND COMMUNICATION METHOD  
(71) NEC Corporation, 7-1, Shiba 5-chome Minato-ku, Tokyo 108-8001, JP  
(72) AWANO, Jun, c/o NEC CORPORATION 7-1 Shiba 5-chome Minato-ku, Tokyo 108-8001, JP

(51) MKP  
**A61M 5/32 (2006.01)** (97) **2531239 \***  
**A61M 5/28 (2006.01)**  
**A61M 5/24 (2006.01)**  
(86) EP2011051408 01.02.2011  
(96) 11701827.5 12.12.2012  
(87) WO2011095488, 01.02.2011  
(97) 2531239, 12.12.2012 en  
(54) MEDICATED MODULE HAVING A DOUBLE NEEDLE GUARD  
(71) Sanofi-Aventis Deutschland GmbH, Brüningstraße 50, 65929 Frankfurt, DE  
(72) BILTON, Simon Lewis, 15 Clarendon Square, Leamington Spa Warwickshire CV32 5QT, GB  
BOYD, Malcolm Stanley, 28 Whitehead Drive, Wellsbourne Warwickshire CV35 9PW, GB  
DAVIES, James Alexander, 7 Old School Mews Cubbington Road, Leamington Spa Warwickshire CV32 7XB, GB  
CROSS, John David, 34 Station Road Long Buckby, Northhampton Northhamptonshire NN6 7QB, GB  
JAMES, Aled Meredydd, 5 Moorefield Avenue, Knowle B93 9RE, GB  
MOORE, David, 28 Bridle Path Road, Elmesthorpe Leicester LE9 7SA, GB  
DE SAUSMAREZ LINTELL, Daniel Thomas, 6 Smithy Lane Church Lawford, Rugby Warwickshire CV23 9EQ, GB

- (51) MKP  
**H01B 1/12 (2006.01)** (97) **2518075 \***  
**C07D 333/10 (2006.01)**  
**C07C 15/14 (2006.01)**  
**C07D 495/04 (2006.01)**  
**C07D 333/76 (2006.01)**  
**C07C 15/30 (2006.01)**  
(86) CN2010001174 03.08.2010  
(96) 10838498.3 31.10.2012  
(87) WO2011075932, 03.08.2010  
(97) 2518075, 31.10.2012 en  
(54) INDUCED LAYER MATERIAL FOR PREPARING NON-PLANAR METAL PHTHALOCYANINE WEAK EPITAXY GROWTH THIN FILM  
(71) Shanghai Casail Display Technology Ltd., 2/F, Building 12 No. 115, Lane 572 Bibo Road Pudong New District, Shanghai 201203, CN  
(72) YAN, Donghang, 2/F, Building 12 No. 115 Lane 572 Bibo Road Pudong New District, Shanghai 201203, CN  
GENG, Yanhou, 2/F, Building 12 No. 115 Lane 572 Bibo Road Pudong New District, Shanghai 201203, CN  
TIAN, Hongkun, 2/F, Building 12 No. 115 Lane 572 Bibo Road Pudong New District, Shanghai 201203, CN  
PAN, Feng, 2/F, Building 12 No. 115 Lane 572 Bibo Road Pudong New District, Shanghai 201203, CN  
HUANG, Lizhen, 2/F, Building 12 No. 115 Lane 572 Bibo Road Pudong New District, Shanghai 201203, CN
- 
- (51) MKP  
**A24F 47/00 (2006.01)** (97) **2503912 \***  
(86) EP2010007178 26.11.2010  
(96) 10793150.3 03.10.2012  
(87) WO2011063970, 26.11.2010  
(97) 2503912, 03.10.2012 en  
(54) AN ELECTRICALLY HEATED SMOKING SYSTEM WITH INTERNAL OR EXTERNAL HEATER  
(71) Philip Morris Products S.A., Quai Jeanrenaud 3, 2000 Neuchâtel, CH  
(72) GREIM, Olivier, Chemin des Sources, CH-1423 Villars-Burquin, CH  
PLOJOUX, Julien, Rue Micheli-du-Crest, CH-1205 Geneva, CH  
RUSCIO, Dani, Route de Troub 29, CH-2088 Cressier, CH  
ZUBER, Gerard, Route du Chalet a Gobet 2, 1055 Froidevilla, CH
- 
- (51) MKP  
**A61P 31/04 (2006.01)** (97) **2504353 \***  
**A61K 38/12 (2006.01)**  
**C07K 7/08 (2006.01)**  
**C07K 7/06 (2006.01)**  
**C07K 7/64 (2006.01)**  
(86) US2010057910 23.11.2010  
(96) 10832379.1 03.10.2012  
(87) WO2011063419, 23.11.2010  
(97) 2504353, 03.10.2012 en  
(54) LIPOPEPTIDE COMPOSITIONS AND RELATED METHODS  
(71) Cubist Pharmaceuticals, Inc., 65 Hayden Avenue, Lexington, MA 02421, US  
(72) SUN, Sophie, 20 Woodcliffe Road, Lexington Massachusetts 02421, US  
NAIK, Gaauri, 4 Trowbridge Place Unit 2D Harvard Square, Cambridge, MA 02138, US  
O'CONNOR, Sandra, 12 Copper Hill Road, Hudson New Hampshire 03051, US
- 
- (51) MKP  
**A61K 9/14 (2006.01)** (97) **2441441**  
**A61K 31/00 (2006.01)**  
(96) 10013660.5 18.04.2012  
(97) 2441441, 18.04.2012 en  
(54) A sieving method for cetyl myristate and/or cetyl palmitate  
(71) Deva Holding Anonim Sirketi, Patent Law Department Halkali Merkez Mah. Basin Ekspres Cad. No: 1,34303, Kucukcekmece/Istanbul, TR  
(72) Haas, Philipp Daniel, Deva Holding Anonim Sirketi Patent Law Department Halkali Merkez Mah. Basin Ekspres Cad. No: 1,34303, Kucukcekmece/Istanbul, TR  
Firat, Omer Faruk, Deva Holding Anonim Sirketi Patent Law Department Halkali Merkez Mah. Basin Ekspres Cad. No: 1,34303, Kucukcekmece/Istanbul, TR  
Kandemir, Levent, Deva Holding Anonim Sirketi Patent Law Department Halkali Merkez Mah. Basin Ekspres Cad. No: 1,34303, Kucukcekmece/Istanbul, TR  
Ozbek, Mahmut, Deva Holding Anonim Sirketi Patent Law Department Halkali Merkez Mah. Basin Ekspres Cad. No: 1,34303, Kucukcekmece/Istanbul, TR  
Koc, Fikret, Deva Holding Anonim Sirketi Patent Law Department Halkali Merkez Mah. Basin Ekspres Cad. No: 1,34303, Kucukcekmece/Istanbul, TR
- 
- (51) MKP  
**C07D 493/04 (2006.01)** (97) **2536706 \***  
**C07D 417/14 (2006.01)**  
**A61K 31/4412 (2006.01)**  
**C07D 407/12 (2006.01)**  
**C07D 409/14 (2006.01)**  
**C07D 413/14 (2006.01)**  
**A61P 35/00 (2006.01)**  
**C07D 487/04 (2006.01)**  
**C07D 401/04 (2006.01)**  
**C07D 491/107 (2006.01)**  
**C07D 401/14 (2006.01)**  
**C07D 407/14 (2006.01)**  
**C07D 495/04 (2006.01)**  
(86) US2011024269 10.02.2011  
(96) 11704156.6 26.12.2012  
(87) WO2011100380, 10.02.2011  
(97) 2536706, 26.12.2012 en  
(54) ARYLMETHOXY ISOINDOLINE DERIVATIVES AND COMPOSITIONS COMPRISING AND METHODS OF USING THE SAME  
(71) Celgene Corporation, 86 Morris Avenue, Summit, NJ 07901, US  
(72) MAN, Hon-Wah, 27 Grant Way, Princeton, NJ 08540, US  
MULLER, George, W., P.O. Box 3688, Rancho Santa Fe, CA 92067, US  
RUCHELMAN, Alexander, 15 Cutter Court, Cream Ridge, NJ 08514, US  
KHALIL, Ehab, M., 13 Indian Purchase, Whitehouse Station, NJ 08889, US  
CHEN, Roger, Shen-Chu, 1100 Christie Street, Edison, NJ 08820, US  
ZHANG, Weihong, 831-d Donaldson Street, Highland Park, NJ 08904, US
- 
- (51) MKP  
**H01R 13/52 (2006.01)** (97) **2437355**  
**H01R 4/70 (2006.01)**  
(96) 10182355.7 04.04.2012  
(97) 2437355, 04.04.2012 en  
(54) Cover for cable connectors  
(71) John Mezzalingua Associates, Inc., 6176 East Molloy Rd., East Syracuse, NY 13057, US  
(72) Montena, Noah, 124 Buckingham Avenue, Syracuse, NY 13210, US

(51) MKP  
**A61P 17/00 (2006.01)** (97) **2536729 \***  
**A61P 29/00 (2006.01)**  
**A61P 37/00 (2006.01)**  
**A61P 35/00 (2006.01)**  
**C07D 487/04 (2006.01)**  
**A61K 31/519 (2006.01)**  
**A61P 27/00 (2006.01)**  
(86) US2011025433 18.02.2011  
(96) 11706997.1 26.12.2012  
(87) WO2011103423, 18.02.2011  
(97) 2536729, 26.12.2012 en  
(54) CYCLOBUTANE AND METHYLCYCLOBUTANE DERIVATIVES AS JANUS KINASE INHIBITORS  
(71) Incyte Corporation, Route 141 & Henry Clay Road Experimental Station E336/205, Wilmington, DE 19880, US  
(72) Li, Yun-long, 1 Pin Oak Drive, Chadds Ford PA 19317, US  
RODGERS, James, D., 2 Hillside Lane, Landenberg PA 19350, US

(51) MKP  
**F41G 1/34 (2006.01)** (97) **2507579 \***  
(86) EP2010068644 01.12.2010  
(96) 10784807.9 10.10.2012  
(87) WO2011067291, 01.12.2010  
(97) 2507579, 10.10.2012 de  
(54) SIGHTING DEVICE  
(71) MB-Microtec Ag, Freiburgstrasse 624, 3172 Niederwangen bei Bern, CH  
(72) PROFOS, Markus, Spilstrasse 46G, CH-3020 Bern, CH

(51) MKP  
**A61K 9/16 (2006.01)** (97) **2515877 \***  
**A61K 9/00 (2006.01)**  
(86) EP2010070246 20.12.2010  
(96) 10803585.8 31.10.2012  
(87) WO2011080141, 20.12.2010  
(97) 2515877, 31.10.2012 en  
(54) DEGRADABLE REMOVABLE IMPLANT FOR THE SUSTAINED RELEASE OF AN ACTIVE COMPOUND  
(71) Janssen R&D Ireland, Eastgate Village, Eastgate, Little Island, County Cork, IE  
(72) SCHACHTER, Deborah M., 136 Washington Ave, Edison New Jersey 08817, US  
BAERT, Lieven Elvire Colette, Jozef Van Walleghemstraat 11, B-8200 Brugge 2, BE  
KRAUS, Guenter, De Billemontstraat 13, B-2860 Sint-Katelijne-Waver, BE  
ZHANG, Qiang, 27 La Costa Drive, Annandale New Jersey 08801, US  
CHUN, Iksoo, 269 Shadybrook Lane, Princeton New Jersey 08540, US

(51) MKP  
**G06F 21/02 (2006.01)** (97) **2524334 \***  
**H04L 9/08 (2006.01)**  
(86) US2011020930 12.01.2011  
(96) 11733288.2 21.11.2012  
(87) WO2011088074, 12.01.2011  
(97) 2524334, 21.11.2012 en  
(54) SYSTEM AND METHODS FOR GENERATING UNCLONABLE SECURITY KEYS IN INTEGRATED CIRCUITS  
(71) STC.UNM, 801 University Blvd. SE, Suite 101, Albuquerque, NM 87106, US  
(72) PLUSQUELLIC, James, 8100 Wyoming Blvd. NE M4-419, Albuquerque NM 87113, US  
ACHARYYA, Dhura, 1283 Laveille Ct., San Jose CA 95131, US  
HELINSKI, Ryan, L., 212 1/2 Mesa Street SE, Albuquerque NM 87106, US

(51) MKP  
**E04C 2/38 (2006.01)** (97) **2533960 \***  
**B29C 44/60 (2006.01)**  
**B29C 44/12 (2006.01)**  
**E04C 2/296 (2006.01)**  
**B29C 44/18 (2006.01)**  
(86) IB2011050598 14.02.2011  
(96) 11714659.7 19.12.2012  
(87) WO2011098984, 14.02.2011  
(97) 2533960, 19.12.2012 en  
(54) METHOD, DEVICE AND A COMPUTER PROGRAM FOR MANUFACTURING A PRE-INSULATED SKELETON FRAMING SEGMENT  
(71) Mopac Systems International S.A., 14 rue du Marché-aux-Herbes, 1728 Luxembourg, LU  
(72) ARNAUTS, Dirk, Steinkamp 59, 48703 Stadtlohn, DE

(51) MKP  
**A61K 39/00 (2006.01)** (97) **2534257 \***  
**C12P 21/08 (2006.01)**  
(86) US2011024554 11.02.2011  
(96) 11742877.1 19.12.2012  
(87) WO2011100566, 11.02.2011  
(97) 2534257, 19.12.2012 en  
(54) METHODS FOR IDENTIFYING AND ISOLATING CELLS EXPRESSING A POLYPEPTIDE  
(71) Oncomed Pharmaceuticals, Inc., 800 Chesapeake Drive, Redwood City, CA 94063-4748, US  
(72) GURNEY, Austin, L., 946 Diamond Street, San Francisco, CA 94114, US  
LAZETIC, Alexandra, L. L., 1256 Echo Ridge Court, San Jose, CA 95120, US  
BOND, Christopher, J., 511 30th Avenue, San Mateo, CA 94403, US

(51) MKP  
**G06F 19/00 (2011.01)** (97) **2538361**  
(96) 12174636.6 26.12.2012  
(97) 2538361, 26.12.2012 en  
(54) Method and system for patient-specific modeling of blood flow  
(71) Heartflow, Inc., 1700 Seaport Boulevard Suite 400, Redwood City, CA 94063, US  
(72) Taylor, Charles, A., 3 Vasilakos Court, Menlo Park, CA California 94025, US  
Fonte, Timothy, A., 3587 17th Street, Apt. 1, San Francisco, CA California 94110, US  
Choi, Gilwoo, 3943 El Camino Real, Apt. 2, Palo Alto, CA California 94306, US  
Bai, Ying, 1105 North Road, Belmont, CA California 94002, US  
Zarins, Christopher, K., 199 Seminary Drive, Menlo Park, CA California 94025, US

(51) MKP  
**A61K 38/22 (2006.01)** (97) **2509997 \***  
**C07K 14/605 (2006.01)**  
**C07K 14/575 (2006.01)**  
**A61K 38/26 (2006.01)**  
**C07K 16/00 (2006.01)**  
(86) US2010059342 07.12.2010  
(96) 10796219.3 17.10.2012  
(87) WO2011071957, 07.12.2010  
(97) 2509997, 17.10.2012 en  
(54) CONJUGATES COMPRISING AN ANTIBODY SURROGATE SCAFFOLD WITH IMPROVED PHARMACOKINETIC PROPERTIES  
(71) Sea Lane Biotechnologies, Inc., 356 Selby Lane, Atherton, CA 94027, US  
(72) HOROWITZ, Lawrence, 362 Selby Lane, Atherton, CA 94027, US  
BHATT, Ramesh, R., 2729 Waltham Cross, Belmont, CA 94002, US  
KURTZMAN, Aaron, L., 1017 Lupin Way, San Carlos, CA 94070, US

- (51) MKP  
**A61P 13/12 (2006.01)** (97) **2523958 \***  
**A61P 25/28 (2006.01)**  
**A61P 3/10 (2006.01)**  
**A61P 35/00 (2006.01)**  
**A61P 11/00 (2006.01)**  
**C07D 498/04 (2006.01)**  
**A61P 29/00 (2006.01)**  
**A61P 9/00 (2006.01)**  
**A61P 7/02 (2006.01)**  
**A61K 31/519 (2006.01)**  
**A61P 31/02 (2006.01)**  
(86) EP2011050298 12.01.2011  
(96) 11700098.4 21.11.2012  
(87) WO2011086077, 12.01.2011  
(97) 2523958, 21.11.2012 de  
(54) CARBOXYLIC ACID DERIVATIVES HAVING A  
2,5,7-SUBSTITUTED OXAZOLOPYRIMIDINE RING  
(71) SANOFI, 54, rue de la Boétie, 75008 Paris, FR  
(72) KADEREIT, Dieter, c/o Sanofi-Aventis Deutschland GmbH,  
65926 Frankfurt am Main, DE  
SCHAEFER, Matthias, c/o Sanofi-Aventis Deutschland GmbH,  
65926 Frankfurt am Main, DE  
HACHTEL, Stephanie, c/o Sanofi-Aventis Deutschland GmbH,  
65926 Frankfurt am Main, DE  
DIETRICH, Axel, c/o Sanofi-Aventis Deutschland GmbH, 65926  
Frankfurt am Main, DE  
HUEBSCHLE, Thomas, c/o Sanofi-Aventis Deutschland GmbH,  
65926 Frankfurt am Main, DE  
GILLE, Andreas, c/o Sanofi-Aventis Deutschland GmbH, 65926  
Frankfurt am Main, DE  
HISS, Katrin, c/o Sanofi-Aventis Deutschland GmbH, 65926  
Frankfurt am Main, DE
- 
- (51) MKP  
**A41D 1/06 (2006.01)** (97) **2401930**  
(96) 11165865.4 04.01.2012  
(97) 2401930, 04.01.2012 en  
(54) A pair of trousers  
(71) HLH Invest ApS, Ericavej 18, 8250 Egå, DK  
(72) Hansen, Lena Trend, Ericavej 18, 8250, Egå, DK
- 
- (51) MKP  
**C07K 14/00 (2006.01)** (97) **2501716 \***  
**C12N 9/00 (2006.01)**  
(86) IB2010003127 19.11.2010  
(96) 10803492.7 26.09.2012  
(87) WO2011061625, 19.11.2010  
(97) 2501716, 26.09.2012 en  
(54) COMPOSITIONS FOR INCREASING POLYPEPTIDE  
STABILITY AND ACTIVITY, AND RELATED METHODS  
(71) Solis Biodyne, Riia 185a, 51014 Tartu, EE  
(72) KAHRE, Olev, c/o Solis BioDyne Riia 185a, EE-51014 Tartu, EE  
ARTMA, Kadri, c/o Solis BioDyne Riia 185a, EE-51014 Tartu, EE  
KAHRE, Tiina, c/o Solis BioDyne Riia 185a, EE-51014 Tartu, EE
- 
- (51) MKP  
**A61K 31/185 (2006.01)** (97) **2519234 \***  
**A61K 31/20 (2006.01)**  
**A61P 25/28 (2006.01)**  
**A61K 31/23 (2006.01)**  
**A61K 31/25 (2006.01)**  
(86) US2010062054 23.12.2010  
(96) 10841613.2 07.11.2012  
(87) WO2011082111, 23.12.2010  
(97) 2519234, 07.11.2012 en  
(54) ANAPLEROTIC THERAPY FOR ALZHEIMER'S DISEASE AND  
THE AGING BRAIN  
(71) Baylor Research Institute, Suite 125, 3434 Live Oak Street,  
Dallas, TX 75204, US  
(72) BOTTIGLIERI, Teodoro, G., 3240 Lovers Lane, Dallas TX 75225,  
US  
ROE, Charles, R., 11 Northcrest Circle, Rockwall TX 75087, US
- 
- (51) MKP  
**B60V 3/08 (2006.01)** (97) **2527218 \***  
**B64B 1/20 (2006.01)**  
(86) RU2010000451 17.08.2010  
(96) 10845348.1 28.11.2012  
(87) WO2011096844, 17.08.2010  
(97) 2527218, 28.11.2012 en  
(54) AIRCRAFT ON AN AIR CUSHION WITH AEROSTATIC LOAD  
RELIEF  
(71) Filimonov, Alexandr Iosifovich, Ul. Minskaya 3-605, Tyumen  
625048, RU  
Shlyakhov, Alexandr Sergeevich, ul. Respubliki, 171-2-18,  
Tyumen 625038, RU  
(72) Filimonov, Alexandr Iosifovich, Ul. Minskaya 3-605, Tyumen  
625048, RU  
Shlyakhov, Alexandr Sergeevich, ul. Respubliki, 171-2-18,  
Tyumen 625038, RU
- 
- (51) MKP  
**B01D 21/00 (2006.01)** (97) **2452734**  
(96) 11189287.3 16.05.2012  
(97) 2452734, 16.05.2012 en  
(54) Filtering cartridge and dirt separation device for thermal fluids  
(71) Far Rubinetterie S.p.A., Via Morena 20, 28024 Gozzano (NO), IT  
(72) Allesina, Guerrino, c/o FAR RUBINETTERIE S.p.A. Via Morena  
20, 28024 Gozzano, IT
- 
- (51) MKP  
**G06F 17/00 (2006.01)** (97) **2502156 \***  
(86) US2010002975 15.11.2010  
(96) 10830331.4 26.09.2012  
(87) WO2011059506, 15.11.2010  
(97) 2502156, 26.09.2012 en  
(54) PAINT SAMPLE MIXING AND VENDING MACHINE  
(71) CPS Color Equipment S.p.A. con unico socio, Via dell'Agricoltura  
103, 41038 San Felice sul Panaro, MO, IT  
(72) BUSH, Daniel, 43475 Bennington Drive, Novi MI 48375, US  
JACKSON, John, 3319 Berkshire Drive, Bloomfield Township MI  
48301, US  
SAUVE, Stephane, 4433 Tumbleweed Crescent, Windsor ON  
N9G 3C1, CA  
ROTNER, William, 11420 Mayers Road, Acampo CA 95220, US
- 
- (51) MKP  
**A01N 43/52 (2006.01)** (97) **2531025 \***  
**A01N 37/50 (2006.01)**  
**A01P 3/00 (2006.01)**  
**A01N 37/44 (2006.01)**  
**A01N 43/653 (2006.01)**  
(86) CN2011070870 01.02.2011  
(96) 11739413.0 12.12.2012  
(87) WO2011095134, 01.02.2011  
(97) 2531025, 12.12.2012 en  
(54) METHOD FOR TREATING FUNGAL INFECTIONS,  
FUNGICIDAL COMPOSITIONS AND THEIR USE  
(71) Rotam Agrochem International Co., Ltd, 7/F Cheung Tat Centre  
18 Cheung Lee Street Chai Wan, Hong Kong, CN  
(72) BRISTOW, James Timothy, 7/F, Cheung Tat Centre 18 Cheung  
Lee Street Chai Wan, Hong Kong, CN
-

(51) MKP  
**C12N 15/62 (2006.01)** (97) **2536750 \***  
**C07K 14/705 (2006.01)**  
(86) US2010053157 19.10.2010  
(96) 10773766.0 26.12.2012  
(87) WO2011102860, 19.10.2010  
(97) 2536750, 26.12.2012 en  
(54) RAGE FUSION PROTEIN COMPOSITIONS AND METHODS OF USE  
(71) TransTech Pharma, Inc, 4170 Mendenhall Oaks Parkway, High Point, North Carolina 27265, US  
(72) ROTHLEIN, Robert, 6988 Saratoga Ct., Summerfield North Carolina 27358, US  
WEBSTER, Jeffrey, C., 4807 Worchester Place, Jamestown North Carolina 27282, US  
BLECK, Gregory, T., 1251 Gil's Way, Cross Plains Wisconsin 53528, US  
KATRAGADDA, Madan, 188 Ridge Lane Apt. 014, Waltham Massachusetts 02452, US  
RAJADHYAKSHA, Manoj, 32 Nutmeg Circle, Colchester Connecticut 06415, US  
VIOLAND, Bernard, N., 1710 Woods Bend Lane, Wildwood Missouri 63038, US  
WENTLAND, Jo-Ann, 182 South Anguilla Road, Pawcatuck Connecticut 06379, US

(51) MKP  
**A61K 31/05 (2006.01)** (97) **2506841 \***  
**A61K 9/06 (2006.01)**  
**A61P 15/00 (2006.01)**  
**A61P 31/18 (2006.01)**  
(86) EP2010068673 01.12.2010  
(96) 10798526.9 10.10.2012  
(87) WO2011067302, 01.12.2010  
(97) 2506841, 10.10.2012 en  
(54) TOPICAL USE OF HYDROXYTYROSOL AND DERIVATIVES FOR THE PREVENTION OF HIV INFECTION  
(71) Seprox Biotech, S.L., Conde de Aranda 16-16 Dcha., 28001 Madrid, ES  
(72) GÓMEZ-ACEBO, Eduardo, Seprox Biotech S.L. Conde de Aranda 16 - 1ª Dcha., E-28001 Madrid, ES  
ALCAMI PERTEJO, José, C/ Alcalde Sainz de Baranda 20, E-28009Madrid, ES  
AUNON CALLES, David, C/ Virgen 18, E-30833 Sangonera la Verde-Murcia, ES

(51) MKP  
**A61F 2/12 (2006.01)** (97) **2519192 \***  
**A61M 39/02 (2006.01)**  
(86) US2010059692 09.12.2010  
(96) 10798877.6 07.11.2012  
(87) WO2011081826, 09.12.2010  
(97) 2519192, 07.11.2012 en  
(54) BREAST IMPLANTS HAVING DRUG-ELUTING RESERVOIRS AND METHODS THEREFOR  
(71) Mentor Worldwide LLC, 5425 Hollister Avenue, Santa Barbara, CA 93111, US  
(72) BERG, Eric, Peter, 940 Spring Creek Drive, Grapevine TX 76051, US  
FALCON, Anita, Marie, 2424 Highway 121, Bedford TX 76021, US

(51) MKP  
**H01L 23/367 (2006.01)** (97) **2533282**  
(96) 12170798.8 12.12.2012  
(97) 2533282, 12.12.2012 en  
(54) Modular heat sink  
(71) Broccio, Giuseppe, Via Nuova Grangiara, 13, 98048 Spadafora (ME), IT  
Serraino, Carmelo, Piazza Sacro Cuore, 11, 98057 Milazzo (ME), IT  
Broccio, Concetta, Via Nuova Grangiara, 13, 98048 Spadafora (ME), IT  
Calapristi, Nunziata, Via Nuova Grangiara, 13, 98048 Spadafora (ME), IT  
(72) Broccio, Giuseppe, via Nuova Grangiara n. 13, 98048 Spadafora (ME), IT  
Serraino, Carmelo, piazza Sacro Cuore n. 11, 98057 Milazzo (ME), IT  
Broccio, Concetta, via Nuova Grangiara n. 13, 98048 Spadafora (ME), IT

(51) MKP  
**A01N 43/72 (2006.01)** (97) **2519104 \***  
(86) US2010062220 28.12.2010  
(96) 10841633.0 07.11.2012  
(87) WO2011082162, 28.12.2010  
(97) 2519104, 07.11.2012 en  
(54) PESTICIDAL COMPOSITION  
(71) Syngenta Participations AG, Schwarzwaldallee 215, 4058 Basel, CH  
(72) MILN, Colin D., Syngenta Crop Protection Inc. 410 Swing Road, Greensboro, North Carolina 27409, US  
RAMACHANDRAN, Ravi, Syngenta Crop Protection Canada Inc. 140 Research Lane, Guelph, Ontario N1G 4Z3, CA  
CAPUZZI, Giulia, Syngenta Crop Protection Inc. 410 Swing Road, Greensboro, North Carolina 27409, US

(51) MKP  
**B21D 51/26 (2006.01)** (97) **2523762 \***  
**B21D 26/02 (2011.01)**  
(86) CA2011000020 11.01.2011  
(96) 11732595.1 21.11.2012  
(87) WO2011085472, 11.01.2011  
(97) 2523762, 21.11.2012 en  
(54) METHODS OF PRESSURE FORMING METAL CONTAINERS AND THE LIKE FROM PREFORMS HAVING WALL THICKNESS GRADIENT  
(71) Novelis, Inc., 191 Evans Avenue, Toronto, ON M8Z 1J5, CA  
Montebello Packaging, A Division of Great Pacific Enterprises LP 1036 Aberdeen Street, Hawkesbury, Ontario K6A 1K5, CA  
(72) MALLORY, Robert, 4487 Hamby Pond Place NW, Acworth Georgia 30102, US  
SHI, Yihai, 286 Nicholson's Point Road, Loyalist Township Ontario K0H 1G0, CA

(51) MKP  
**C08B 37/10 (2006.01)** (97) **2526122 \***  
**C08B 37/00 (2006.01)**  
(86) US2011021582 18.01.2011  
(96) 11735052.0 28.11.2012  
(87) WO2011090948, 18.01.2011  
(97) 2526122, 28.11.2012 en  
(54) EVALUATING HEPARIN PREPARATIONS  
(71) Momenta Pharmaceuticals, Inc., 675 West Kendall Street, Cambridge, MA 02142, US  
(72) BECCATI, Daniela, 34 S. Russell Street 4, Boston MA 02114, US  
CAPILA, Ishan, 50 Kings Row, Ashland MA 01721, US  
GUNAY, Nur, Sibel, 26 Holly Lane Unit 24, Chestnut Hill MA 02467, US  
ROY, Sucharita, 7 Shakespeare Road, Tyngsboro MA 01879, US

(51) MKP  
**B65G 1/08 (2006.01)** (97) **2531424 \***  
**B65G 47/88 (2006.01)**  
(86) FR2011050232 04.02.2011  
(96) 11711608.7 12.12.2012  
(87) WO2011095749, 04.02.2011  
(97) 2531424, 12.12.2012 fr  
(54) COMPACT DEVICE FOR DISTRIBUTING OBJECTS, ESPECIALLY BOXES OF MEDICAMENTS, IN A PHARMACY  
(71) GB Developpement, 59 rue Voltaire, 92800 Puteaux, FR  
(72) BOULAIS, Guillaume, 44 rue Voltaire, F-92300 Levallois Perret, FR

- (51) MKP  
**A61K 38/27 (2006.01)** (97) **2512450 \***  
**A61K 38/00 (2006.01)**  
**A61K 47/48 (2006.01)**  
**A61K 9/14 (2006.01)**  
**A61K 47/26 (2006.01)**  
**A61K 9/19 (2006.01)**  
**A61K 9/00 (2006.01)**  
(86) EP2010069710 15.12.2010  
(96) 10790843.6 24.10.2012  
(87) WO2011073234, 15.12.2010  
(97) 2512450, 24.10.2012 en  
(54) DRY GROWTH HORMONE COMPOSITION TRANSIENTLY LINKED TO A POLYMER CARRIER  
(71) Ascendis Pharma A/S, Tuborg Boulevard 12, 2900 Hellerup, DK  
(72) RASMUSSEN, Grethe, Nørskov, Brudedalen 1, DK-3520 Farum, DK  
KINDERMANN, Susanne, Bachlettenstr.36, CH-4054 Basel, CH  
RAU, Harald, Talstrasse 41i, 69221 Dossenheim, DE  
WEGGE, Thomas, Kurfürstenanlage 45, 69115 Heidelberg, DE

- (51) MKP  
**A23J 3/16 (2006.01)** (97) **2515673 \***  
**A23J 1/14 (2006.01)**  
(86) CA2010002061 22.12.2010  
(96) 10838483.5 31.10.2012  
(87) WO2011075850, 22.12.2010  
(97) 2515673, 31.10.2012 en  
(54) pH ADJUSTED SOY PROTEIN ISOLATE AND USES  
(71) Burcon Nutrascience (MB) Corp., 1388 Waller Avenue, Winnipeg, Manitoba R3T 1P9, CA  
(72) GREEN, Brent E., 24 Poplarwood Drive Box 603, Warren Manitoba R0C 3E0, CA  
MEDINA, Sarah, 315 Wildwood Park, Winnipeg Manitoba R3T 0E5, CA  
SCHWEIZER, Martin, 117 Haig Avenue, Winnipeg Manitoba R2M 0E3, CA  
SEGALL, Kevin I., 31 Dunbar Crescent, Winnipeg Manitoba R3P 0W6, CA  
TERGESEN, Johann, 249 West 23rd Avenue, Vancouver British Columbia V5Y 2H2, CA  
SAMPSON, Russ, P.O. Box 60, Oakville Manitoba R0H 0Y0, CA  
ROSSET, Roland, 895 Bannatyne Avenue, Winnipeg Manitoba R3E 0W7, CA  
HAYDEN, Curtis D., 123 Meadowlake Drive, Winnipeg Manitoba R2C 4M1, CA  
CATIPON, Edwin, 1114 Sargent Avenue, Winnipeg Manitoba R3E 0E8, CA

- (51) MKP  
**A61K 48/00 (2006.01)** (97) **2536435 \***  
**C07K 14/00 (2006.01)**  
(86) US2011025052 16.02.2011  
(96) 11745161.7 26.12.2012  
(87) WO2011103164, 16.02.2011  
(97) 2536435, 26.12.2012 en  
(54) MONKEY HOMOLOG OF HUMAN INTERFERON OMEGA  
(71) Janssen Biotech, Inc., 800/850 Ridgeview Drive, Horsham, PA 19044, US  
(72) HUANG, Chichi, 145 King of Prussia Road, Radnor, PA 19087, US  
JORDAN, Jarrat, 145 King of Prussia Road, Radnor, PA 19087, US  
SCHREITER, Jessica, 145 King of Prussia Road, Radnor, PA 19087, US

- (51) MKP  
**C07D 401/06 (2006.01)** (97) **2516418 \***  
**A61P 29/00 (2006.01)**  
**A61K 31/454 (2006.01)**  
(86) US2010061434 21.12.2010  
(96) 10801761.7 31.10.2012  
(87) WO2011079095, 21.12.2010  
(97) 2516418, 31.10.2012 en  
(54) PRODRUGS OF [4-(5-AMINOMETHYL-2-FLUORO-PHENYL)-PIPERIDIN-1-YL]-(1H-PYRROLO-PYRIDIN-YL)-METHANONES AND SYNTHESIS THEREOF  
(71) SANOFI, 174, Avenue de France, 75013 Paris, FR  
(72) CHOI-SLEDESKI, Yong Mi, c/o Sanofi-Aventis U.S. 1041 Route 202-206 Mail Code: BWD-303A, Bridgewater, New Jersey 08807, US  
POLI, Gregory B., c/o Sanofi-Aventis U.S. 1041 Route 202-206 Mail Code: BWD-303A, Bridgewater, New Jersey 08807, US

- (51) MKP  
**F16L 41/03 (2006.01)** (97) **2521821 \***  
**E03D 9/05 (2006.01)**  
**E03D 1/38 (2006.01)**  
**E03D 9/08 (2006.01)**  
**E03C 1/02 (2006.01)**  
**E03D 11/13 (2006.01)**  
(86) CH2010000261 19.10.2010  
(96) 10776265.0 14.11.2012  
(87) WO2012051723, 19.10.2010  
(97) 2521821, 14.11.2012 de  
(54) PIPE CONNECTION FOR A COMBINATION SHOWER-WC  
(71) Presano AG, Sonnenstrasse 1, 9444 Diepoldsau, CH  
(72) WÜRGLER, Hans, Auerstrasse 2, CH-9435 Heerbrugg, CH  
FREI, Christian, Stein 7, CH-9463 Oberriet, CH

- (51) MKP  
**A24F 1/30 (2006.01)** (97) **2536303 \***  
**A24F 47/00 (2006.01)**  
**A24F 1/14 (2006.01)**  
(86) US2010061294 20.12.2010  
(96) 10838343.1 26.12.2012  
(87) WO2011075722, 20.12.2010  
(97) 2536303, 26.12.2012 en  
(54) ELECTRONIC HOOKAH  
(71) Capuano, Sammy, 1820 Ne 163rd Street Suite 305, North Miami Beach, FL 33162-4801, US  
(72) Capuano, Sammy, 1820 Ne 163rd Street Suite 305, North Miami Beach, FL 33162-4801, US

- (51) MKP  
**C07K 16/18 (2006.01)** (97) **2524233 \***  
**G01N 33/574 (2006.01)**  
(86) US2011021387 14.01.2011  
(96) 11733477.1 21.11.2012  
(87) WO2011088385, 14.01.2011  
(97) 2524233, 21.11.2012 en  
(54) COMPOSITIONS AND METHODS FOR DETECTING CANCER  
(71) The Regents of the University of California, 1111 Franklin Street, 12th Floor, Oakland, CA 94607-5200, US  
Sialix, Inc., 1396 Poinsettia Avenue, Vista, CA 92081, US  
(72) VARKI, Ajit, 2664 Costebelle Drive, La Jolla, CA 92037, US  
SCHWAB, Richard, B., 9728 Keeneland Row, La Jolla, CA 92037, US  
PADLER-KARAVANI, Vered, 7689 Palmilla Drive 1105, San Diego, CA 92122, US  
HURTADO-ZIOLA, Nancy, 3290 Caminito Ameca, La Jolla, CA 92037, US

(51) MKP  
**C07D 277/56 (2006.01)** (97) **2536699 \***  
**A61P 19/06 (2006.01)**  
**A61K 31/426 (2006.01)**  
(86) IN2011000100 18.02.2011  
(96) 11725524.0 26.12.2012  
(87) WO2011101867, 18.02.2011  
(97) 2536699, 26.12.2012 en  
(54) SUBSTANTIALLY PURE SALTS OF FEBUXOSTAT AND PROCESSES FOR PREPARATION THEREOF  
(71) Cadila Healthcare Limited, Zydus Tower Satellite Cross Roads, Ahmedabad 380 015, Gujarat, IN  
(72) DWIVEDI, Shriprakash, Dhar, Cadila Healthcare Limited Zydus Tower Satellite Cross Road Ahmedabad 380 015, Gujarat, IN PRASAD, Ashok, Cadila Healthcare Limited Zydus Tower Satellite Cross Road Ahmedabad 380 015, Gujarat, IN ROY, Rushikesh, Udaykumar, Cadila Healthcare Limited Zydus Tower Satellite Cross Road Ahmedabad 380 015, Gujarat, IN PATEL, Mayur, Ramnikhbhai, Cadila Healthcare Limited Zydus Tower Satellite Cross Road Ahmedabad 380 015, Gujarat, IN

(51) MKP  
**C07K 19/00 (2006.01)** (97) **2501407 \***  
**C07K 16/28 (2006.01)**  
**A61P 37/06 (2006.01)**  
**A61K 39/395 (2006.01)**  
**C07K 14/705 (2006.01)**  
(86) US2010057496 19.11.2010  
(96) 10788171.6 26.09.2012  
(87) WO2011063277, 19.11.2010  
(97) 2501407, 26.09.2012 en  
(54) ANTI-ORAI1 ANTIGEN BINDING PROTEINS AND USES THEREOF  
(71) Amgen Inc., Patent Operations M/S 28-2-C One Amgen Center Drive, Thousand Oaks, California 91320-1799, US  
(72) NGUYEN, Hung, Q., 2801 Avenida De Autlan, Camarillo, CA 93010, US  
LIN, Fen-Fen, 1245 Belleflower Road, Carlsbad, CA 92011, US  
BI, Xiao-juan, 5186 Via Capote, Newbury Park, CA 91320, US  
MCBRIDE, Helen J., 4510 Santa Lucia Drive, Woodland Hills, CA 91364, US  
HU, Shaw-Fen, Sylvia, 986 Lynnmere Drive, Thousand Oaks, CA 91360, US

(51) MKP  
**C02F 1/46 (2006.01)** (97) **2531452 \***  
**C02F 9/14 (2006.01)**  
**C02F 1/48 (2006.01)**  
(86) KR2010008243 22.11.2010  
(96) 10845323.4 12.12.2012  
(87) WO2011096636, 22.11.2010  
(97) 2531452, 12.12.2012 en  
(54) ADVANCED TREATMENT SYSTEM OF WASTEWATER HAVING PLASMA DISCHARGING VESSEL  
(71) Hoseo University Academic Cooperation Foundation, Sechul-ri Baebang-myeon Asan-si, Chungcheongnam-do 336-851, KR Kumkang Environmental Engineering Co. Ltd., 407 Cheonanatechnotown 5-2 Chaam-dong Cheonan-si, Chungcheongnam-do 331-200, KR  
(72) CHANG, In Soung, 502-50 WolbongHyundai Apt. Ssangyong2-dong Seobuk-gu, Cheonan-si Chungcheongnam-do 331-726, KR LEE, Ji Sun, 210-9 Naehyeon-ri Guhang-myeon, Hongseong-gun Chungcheongnam-do 350-842, KR JOUNG, Seun Young, 407 Cheonanatechnotown 5-2 Chaam-dong, Cheonan-si Chungcheongnam-do 331-200, KR LEE, Cheol Ku, 410-1204 Jugong Apt. 9 Danji Ssangyong-dong Seobuk-gu, Cheonan-si Chungcheongnam-do 331-090, KR

(51) MKP  
**A61K 9/16 (2006.01)** (97) **2515873 \***  
**A61P 25/16 (2006.01)**  
**A61P 25/18 (2006.01)**  
**A61K 9/20 (2006.01)**  
**A61K 31/517 (2006.01)**  
**A61P 25/08 (2006.01)**  
**A61K 9/14 (2006.01)**  
**A61P 25/28 (2006.01)**  
**A61P 25/24 (2006.01)**  
(86) US2010061553 21.12.2010  
(96) 10803319.2 31.10.2012  
(87) WO2011079119, 21.12.2010  
(97) 2515873, 31.10.2012 en  
(54) FORMULATION COMPRISING 1 H - QUINAZOLINE - 2, 4 - DIONE AMPA RECEPTOR ANTAGONISTS, IN THE FORM OF IMMEDIATE RELEASE TABLETS AND PREPARATION THEREOF  
(71) Novartis AG, Lichtstrasse 35, 4056 Basel, CH  
(72) ZIELINSKI, Joseph Lawrence, Novartis One Health Plaza, East Hanover, New Jersey 07936, US  
VRETTOS, John, Novartis One Health Plaza, East Hanover, New Jersey 07936, US  
JI, Qin, Novartis One Health Plaza, East Hanover, New Jersey 07936, US  
PATEL, Subash, Novartis One Health Plaza, East Hanover, New Jersey 07936, US

(51) MKP  
**C09J 7/00 (2006.01)** (97) **2522499**  
**B32B 3/00 (2006.01)**  
**C09J 5/00 (2006.01)**  
(96) 12167776.9 14.11.2012  
(97) 2522499, 14.11.2012 en  
(54) Dry adhesive comprising micro-featured and nano-featured surface area and compliant surface area  
(71) Mylan Group, Long Duc Industrial Park Travinh City, Travinh Province, VietNam, VN  
(72) Nguyen, My T., 2 McAdam St., Kirkland, Québec H9X 3Z3, CA Vinh Bui, Loc, 7355 Griffith Lane, Moorpark, CA California 93021, US

(51) MKP  
**A61K 39/395 (2006.01)** (97) **2534176 \***  
**C07K 16/28 (2006.01)**  
(86) EP2011051958 10.02.2011  
(96) 11702650.0 19.12.2012  
(87) WO2011098520, 10.02.2011  
(97) 2534176, 19.12.2012 en  
(54) AGONIST DR5 BINDING POLYPEPTIDES  
(71) Novartis AG, Lichtstrasse 35, 4056 Basel, CH  
Ablynx N.V., Technologiepark 21, 9052 Ghent-Zwijnaarde, BE  
CROMIE, Karen, Ablynx NV Technologiepark 4, 9052 Zwijnaarde, BE  
DOMBRECHT, Bruno, Ablynx NV Technologiepark 4, 9052 Zwijnaarde, BE  
ETTENBERG, Seth, Novartis Institutes for BioMedical Research Inc. 250 Massachusetts Avenue, Cambridge, Massachusetts 02139, US  
KOLKMAN, Joost, Ablynx NV Technologiepark 4, 9052 Zwijnaarde, BE  
LI, Jing, Novartis Institutes for BioMedical Research Inc. 200 Technology Square, Cambridge, Massachusetts 02139, US  
MEERSCHAERT, Kris, Ablynx NV Technologiepark 4, 9052 Zwijnaarde, BE  
STOVER, David Raymond, 15093 Hesby ST, Sherman Oaks, California 91403, US  
ZHANG, Jingxin, 8 Shoreview Lane, Walpole, Massachusetts 02081, US

- (51) MKP  
**A23L 1/238 (2006.01)** (97) **2517577 \***  
 (86) JP2010073342 24.12.2010  
 (96) 10839554.2 31.10.2012  
 (87) WO2011078324, 24.12.2010  
 (97) 2517577, 31.10.2012 en  
 (54) SOY SAUCE HAVING HYPOTENSIVE EFFECT AND METHOD FOR PRODUCING SAME  
 (71) Kikkoman Corporation, 250, Noda Noda-shi, Chiba 278-8601, JP  
 (72) ENDO Yoshikazu, c/o Kikkoman Food Products Company 250 Noda, Noda-shi Chiba 278-8601, JP  
 TANIZAWA Shigeki, c/o Kikkoman Food Products Company 250 Noda, Noda-shi Chiba 278-8601, JP  
 NAKAHARA Takeharu, c/o Kikkoman Corporation 250 Noda, Noda-shi Chiba 278-8601, JP  
 AOTA Hitomi, c/o Kikkoman Corporation 250 Noda, Noda-shi Chiba 278-8601, JP  
 ONO Hiroki, c/o Kikkoman Food Products Company 250 Noda, Noda-shi Chiba 278-8601, JP  
 HANADA Yoichi, c/o Kikkoman Food Products Company 250 Noda, Noda-shi Chiba 278-8601, JP  
 UCHIDA Riichiro, c/o Kikkoman Corporation 250 Noda, Noda-shi Chiba 278-8601, JP

- (51) MKP  
**A61K 31/675 (2006.01)** (97) **2523948 \***  
**C07F 9/24 (2006.01)**  
**A61P 31/00 (2006.01)**  
**C07D 401/14 (2006.01)**  
**A61K 31/4725 (2006.01)**  
**C07D 401/04 (2006.01)**  
**C07D 405/14 (2006.01)**  
 (86) US2011020040 03.01.2011  
 (96) 11700465.5 21.11.2012  
 (87) WO2011084922, 03.01.2011  
 (97) 2523948, 21.11.2012 en  
 (54) PRO-DRUGS OF (E) -7- (3- (2-AMINO-1-FLUOROETHYLIDENE) PIPERIDIN-1-YL) -1-CYCLOPROPYL-6-FLUORO-8-METHOXY-4-OXO-1,4-DIHYDROQUINOLINE-3-CARBOXYLIC ACID  
 (71) Janssen Pharmaceutica, N.V., Turnhoutseweg 30, 2340 Beerse, BE  
 (72) MACIELAG, Mark, 1505 Valley View Dr, Ambler PA 19002-1905, US  
 EICHENBAUM, Gary, 112 Ketcham Road, Belle Mead NJ 08502, US  
 GAEKENS, Tim, Planetariumlaan 195, B-2610 Wilrijk, BE  
 GUILLAUME, Michel, 13 Sinte Veerledreef, B-1820 Steenokkerzeel, BE  
 SHOOK, Brian, 300 East Buchert Road, Gilbertsville PA 19525, US

- (51) MKP  
**C07D 207/48 (2006.01)** (97) **2509945 \***  
**A61K 31/451 (2006.01)**  
**C07D 211/96 (2006.01)**  
**A61P 17/00 (2006.01)**  
 (86) EP2010069195 08.12.2010  
 (96) 10787772.2 17.10.2012  
 (87) WO2011070080, 08.12.2010  
 (97) 2509945, 17.10.2012 en  
 (54) 4- (AZACYCLOALKYL) -BENZENE-1, 3 -DIOL DERIVATIVES AS TYROSINASE INHIBITORS AND THEIR SYNTHESIS AND USE THEREOF  
 (71) Galderma Research & Development, 2400 Route des Colles Les Templiers, 06410 Biot, FR  
 (72) BOITEAU, Jean-Guy, 136 B Chemin du Ribas, F-06560 Valbonne, FR  
 LUZY, Anne-Pascale, Les Hauts de Valbonne 6 allée des Pins, F-06560 Valbonne, FR

- (51) MKP  
**A61B 17/068 (2006.01)** (97) **2525724 \***  
**A61B 17/128 (2006.01)**  
 (86) US2011020472 07.01.2011  
 (96) 11700762.5 28.11.2012  
 (87) WO2011090831, 07.01.2011  
 (97) 2525724, 28.11.2012 en  
 (54) APPARATUS FOR FEEDING STAPLES IN A LOW PROFILE SURGICAL STAPLER  
 (71) Ethicon Endo-Surgery, Inc., 4545 Creek Road, Cincinnati, OH 45242, US  
 (72) CRAINICH, Lawrence, 264 Ceda Road, Charlestown NH 03603, US  
 HARRIS, Jason, L., 3896 Top Flite Lane, Mason OH 45040, US  
 STOKES, Michael, J., 8 Sleepy Hollow Lane, Cincinnati OH 45244, US  
 HOLCOMB, Matthew, D., 2021 Buckeye Field Court, Lebanon OH 45036, US  
 O'KEEFE, Jonathan, B., 45 Alton Road, North Attleboro MA 02760, US  
 BOUDREAU, Keith, D., 16 Noble Hill Road, Beverly MA 01915, US  
 CERIER, Jeffrey, C., 11 Orchard Street, Franklin MA 02038, US

- (51) MKP  
**B29C 65/08 (2006.01)** (97) **2522491**  
**B31B 19/90 (2006.01)**  
 (96) 12003753.6 14.11.2012  
 (97) 2522491, 14.11.2012 en  
 (54) Longitudinal continuous welding device for packaging machines  
 (71) Eficiencia y Tecnologia, S.A., Bellvei, 41-49, Nave 9 (pol.Ind. Can Salvatella), 08210 Barbera Del Vallès Barcelona, ES  
 (72) M<sup>a</sup> Broto Solano, Jose, Bellvei, 41-49, Nave 9, 08210 Barberà Del Vallés (Barcelona), ES

- (51) MKP  
**G06K 9/68 (2006.01)** (97) **2447884**  
 (96) 10189225.5 02.05.2012  
 (97) 2447884, 02.05.2012 en  
 (54) Method for detecting and recognising an object in an image, and an apparatus and a computer program therefor  
 (71) CycloMedia Technology B.V., Achterweg 38, 4181 AE Waardenburg, NL  
 (72) Herbschleb, Ernst David, Headyk 45, 9035 VE Dronrijp, NL  
 De With, Peter Hendrik Nelis, Van den Elsenstraat 67, 5694 NE Son en Breugel, NL



(51) MKP  
*C07D 401/10 (2006.01)* (97) **2516009 \***  
*C07D 417/12 (2006.01)*  
*A61K 31/495 (2006.01)*  
*C07D 413/10 (2006.01)*  
*C07D 401/14 (2006.01)*  
*C07D 413/14 (2006.01)*  
*C07D 405/12 (2006.01)*  
*A61P 35/00 (2006.01)*  
*C07D 409/12 (2006.01)*  
*C07D 401/12 (2006.01)*  
*C07D 405/14 (2006.01)*  
*C07D 401/04 (2006.01)*  
*C07D 413/12 (2006.01)*  
*C07D 405/04 (2006.01)*  
*C07D 217/24 (2006.01)*  
(86) EP2010070364 21.12.2010  
(96) 10792944.0 31.10.2012  
(87) WO2011076786, 21.12.2010  
(97) 2516009, 31.10.2012 en  
(54) SUBSTITUTED ISOQUINOLINONES AND QUINAZOLINONES  
(71) Novartis AG, Lichtstrasse 35, 4056 Basel, CH  
(72) BERGHAUSEN, Joerg, Novartis Pharma AG Werk Klybeck Postfach, CH-4002 Basel, CH  
BUSCHMANN, Nicole, Novartis Pharma AG Werk Klybeck Postfach, CH-4002 Basel, CH  
FURET, Pascal, Novartis Pharma AG Werk Klybeck Postfach, CH-4002 Basel, CH  
GESSIER, François, Novartis Pharma AG Postfach, CH-4002 Basel, CH  
HERGOVICH LISZTAN, Joanna, Novartis Pharma AG Werk Klybeck Postfach, CH-4002 Basel, CH  
HOLZER, Philipp, Novartis Pharma AG Werk Klybeck Postfach, CH-4002 Basel, CH  
JACOBY, Edgar, Novartis Pharma AG Postfach, CH-4002 Basel, CH  
KALLEN, Joerg, Novartis Pharma AG Postfach, CH-4002 Basel, CH  
MASUYA, Keiichi, Novartis Pharma AG Werk Klybeck Postfach, CH-4002 Basel, CH  
PISSOT SOLDERMANN, Carole, Novartis Pharma AG Werk Klybeck Postfach, CH-4002 Basel, CH  
REN, Haixia, China Novartis Institutes for BioMedical Research Co. Ltd. Room 402 Pu Ruan Building No. 2 Boyun Road Zhangjiang Hi-Tech Park Shanghai, 201203, CN  
STUTZ, Stefan, Novartis Pharma AG Werk Klybeck Postfach, CH-4002 Basel, CH

(51) MKP  
*B60N 2/02 (2006.01)* (97) **2509868 \***  
*B61D 33/00 (2006.01)*  
*B60N 3/06 (2006.01)*  
*B64D 11/06 (2006.01)*  
(86) IB2010055705 10.12.2010  
(96) 10835588.4 17.10.2012  
(87) WO2011070531, 10.12.2010  
(97) 2509868, 17.10.2012 en  
(54) A SEAT AND RELATED LEG REST AND MECHANISM AND METHOD THEREFOR  
(71) Air New Zealand Limited, 185 Fanshawe Street, Auckland 1010, NZ  
(72) MEJUHAS, Marsel, Neisseweg 19, 74523 Schwaebisch Hall, DE

(51) MKP  
*A01H 5/00 (2006.01)* (97) **2512222 \***  
*A01P 7/00 (2006.01)*  
*A01H 1/00 (2006.01)*  
(86) US2010060817 16.12.2010  
(96) 10838260.7 24.10.2012  
(87) WO2011075588, 16.12.2010  
(97) 2512222, 24.10.2012 en  
(54) COMBINED USE OF CRY1Ca AND CRY1Fa PROTEINS FOR INSECT RESISTANCE MANAGEMENT  
(71) Dow AgroSciences LLC, 9330 Zionsville Road, Indianapolis IN 46268-1054, US  
(72) MEADE, Thomas, 1141 Huntington Woods Pt., Zionsville, IN 46077, US  
NARVA, Kenneth, 4372 Creekside Pass, Zionsville, IN 46077, US  
STORER, Nicholas, P., 10703 Lexington Street, Kensington, MD 20895, US  
SHEETS, Joel, J., 10005 Oak Ridge Drive, Zionsville, IN 46077, US  
WOOSLEY, Aaron, T., 8906 Tanner Drive, Fishers, IN 46038, US  
BURTON, Stephanie, L., 6820 Bluffgrove Drive, Indianapolis, IN 46278, US

(51) MKP  
*C07K 19/00 (2006.01)* (97) **2511294 \***  
*C07K 14/54 (2006.01)*  
*A61K 38/17 (2006.01)*  
*C07K 14/715 (2006.01)*  
*A61K 48/00 (2006.01)*  
*C07K 14/775 (2006.01)*  
*C12N 1/21 (2006.01)*  
*C12N 1/15 (2006.01)*  
*C12N 15/62 (2006.01)*  
*C12N 5/10 (2006.01)*  
(86) ES2010070818 10.12.2010  
(96) 10814739.8 17.10.2012  
(87) WO2011070214, 10.12.2010  
(97) 2511294, 17.10.2012 en  
(54) CONJUGATES AND COMPOSITIONS FOR IMMUNOTHERAPY AND ANTI-TUMOR TREATMENT  
(71) Proyecto de Biomedicina Cima, S.L., Avda. Pío XII, 22 Oficina 1, 31008 Pamplona - Navarra, ES  
Research Center Borstel, Parkallee 1-40, 23845 Borstel, DE  
(72) BERRAONDO LÓPEZ, Pedro, Instituto Científico y Tecnológico de Navarra S.A. (D.P.I.) Avenida Pio XII 53, E-31008 Pamplona (Navarra), ES  
FIORAVANTI, Jessica, Instituto Científico y Tecnológico de Navarra S.A. (D.P.I.) Avenida Pio XII 53, E-31008 Pamplona (Navarra), ES  
MEDINA ECHEVERZ, José, Instituto Científico y Tecnológico de Navarra S.A. (D.P.I.) Avenida Pio XII 53, E-31008 Pamplona (Navarra), ES  
MELERO BERMEJO, Ignacio Javier, Instituto Científico y Tecnológico de Navarra S.A. (D.P.I.) Avenida Pio XII 53, E-31008 Pamplona (Navarra), ES  
OCHOA NIETO, Maria del Carmen, Instituto Científico y Tecnológico de Navarra S.A. (D.P.I.) Avenida Pio XII 53, E-31008 Pamplona (Navarra), ES  
PALAZON GARCIA, Francisco de Asis, Instituto Científico y Tecnológico de Navarra S.A. (D.P.I.) Avenida Pio XII 53, E-31008 Pamplona (Navarra), ES  
BULFONE-PAUS, Silvia, Research Center Borstel Parkallee 1-40, 23845 Borstel, DE  
DUITMAN, Erwin, Hans, Research Center Borstel Parkallee 1-40, 23845 Borstel, DE

(51) MKP  
**C25B 1/16 (2006.01)** (97) **2510135 \***  
 (86) US2010056243 10.11.2010  
 (96) 10836395.3 17.10.2012  
 (87) WO2011071653, 10.11.2010  
 (97) 2510135, 17.10.2012 en  
 (54) METHOD AND SYSTEM FOR PRODUCING HYDROGEN USING SODIUM ION SEPARATION MEMBRANES  
 (71) Battelle Energy Alliance, LLC, P.O. Box 1625, Idaho Falls, ID 83415-3899, US  
 (72) BINGHAM, Dennis, N., 2728 West 17th South, Idaho Falls, ID 83402, US  
 KLINGLER, Kerry, M., 2385 Bramble Lane, Idaho Falls, ID 83402, US  
 TURNER, Terry, D., 4577 E. 9th N., Idaho Falls, ID 83401, US  
 WILDING, Bruce, M., 2818 Honeysuckle, Idaho Falls, ID 83402, US  
 FROST, Lyman, 1283 Links Drive, Midway, UT 84049, US

(51) MKP  
**A61K 31/277 (2006.01)** (97) **2506852 \***  
**A61P 35/00 (2006.01)**  
**A61K 31/275 (2006.01)**  
**A61K 31/216 (2006.01)**  
**A61K 31/445 (2006.01)**  
**A61K 31/4465 (2006.01)**  
 (86) US2010059005 04.12.2010  
 (96) 10835242.8 10.10.2012  
 (87) WO2011069141, 04.12.2010  
 (97) 2506852, 10.10.2012 en  
 (54) INTERFERON THERAPIES IN COMBINATION WITH BLOCKADE OF STAT3 ACTIVATION  
 (71) Board of Regents, The University of Texas System, 201 West 7th Street, Austin, TX 78701, US  
 (72) PRIEBE, Waldemar, 4239 Emory Avenue, Houston TX 77005, US  
 HEIMBERGER, Amy, 412 East 7th Street, Houston TX 77007, US  
 FOKT, Izabela, 7500 Kirby Lane 1128, Houston TX 77030, US  
 ARUMUGAM, Ayakumar, 115 High Meadow Drive, Sugar Land TX 77479, US  
 KONG, Ling-yuan, 1307 Purple Rose Court, Houston TX 77094, US  
 MADDEN, Timothy, 1811 Brinam Glen Drive, Sugar Land TX 77479, US  
 CONRAD, Charles, 15911 Harwick Drive, Spring TX 77379, US

(51) MKP  
**F02D 41/20 (2006.01)** (97) **2504551 \***  
**F02M 51/00 (2006.01)**  
**F02D 41/24 (2006.01)**  
 (86) EP2010068155 24.11.2010  
 (96) 10782603.4 03.10.2012  
 (87) WO2011064270, 24.11.2010  
 (97) 2504551, 03.10.2012 en  
 (54) FUEL INJECTOR COMMUNICATION SYSTEM  
 (71) Delphi Technologies Holding S.à.r.l., Avenue de Luxembourg, 4940 Bascharage, LU  
 (72) ARCHER, Michael, 49 Whitton Road, Twickenham Middlesex TW1 1BH, GB  
 FALLAHI, Abdolreza, 11 Lincoln Close, Harrow Midd HA2 7RJ, GB

(51) MKP  
**C03B 37/16 (2006.01)** (97) **2481539**  
**B26F 3/00 (2006.01)**  
 (86) 11009762.3 01.08.2012  
 (97) 2481539, 01.08.2012 de  
 (54) Device for cutting insulation material  
 (71) Keller HCW GmbH, Carl-Keller-Strasse 2-10, 49479 Ibbenbüren-Laggenbeck, DE  
 (72) Barkowsky, Udo, Riegesbreen 21 A, 49124 Georgsmarienhütte, DE  
 Herdering, Christian, Tulpenweg 8, 48629 Metelen, DE  
 Meyer, Björn, Von Stephan-Strasse 10, 49163 Bohmte, DE

(51) MKP  
**A61K 31/4418 (2006.01)** (97) **2506849 \***  
**A61P 43/00 (2006.01)**  
**A61K 31/4412 (2006.01)**  
**A61K 31/44 (2006.01)**  
 (86) US2010058936 03.12.2010  
 (96) 10835205.5 10.10.2012  
 (87) WO2011069089, 03.12.2010  
 (97) 2506849, 10.10.2012 en  
 (54) PIRFENIDONE THERAPY AND INDUCERS OF CYTOCHROME P450  
 (71) Intermune, Inc., 3280 Bayshore Boulevard, Brisbane, CA 94005-1021, US  
 (72) BRADFORD, Williamson, Ziegler, Po Box 566, Ross CA 94957, US  
 SZWARCBERG, Javier, 2173 Bunker Hill Drive, San Mateo CA 94402, US

(51) MKP  
**G01N 33/53 (2006.01)** (97) **2507627 \***  
**G01N 33/68 (2006.01)**  
 (86) US2010058872 03.12.2010  
 (96) 10795506.4 10.10.2012  
 (87) WO2011069056, 03.12.2010  
 (97) 2507627, 10.10.2012 en  
 (54) ANTENNARY FUCOSYLATION IN GLYCOPROTEINS FROM CHO CELLS  
 (71) Momenta Pharmaceuticals, Inc., 675 West Kendall Street, Cambridge, MA 02141, US  
 (72) BOSQUES, Carlos, J., 40 Brattle Street, 7, Arlington MA 02476, US  
 LIU, Cuihua, 16 Merrill Avenue, Belmont MA 02478, US  
 MURPHY, Jennifer, 51 Plymouth Avenue, Marshfield MA 02050, US  
 WASHBURN, Nathaniel, J., 543 King Street, Littleton Massachusetts 01460, US  
 XU, Xiao-Jin, 6 Jamaicaaway Court, Jamaica Plain Massachusetts 02130, US

(51) MKP  
**F16L 9/00 (2006.01)** (97) **2447585**  
**F16L 9/127 (2006.01)**  
**F16L 11/12 (2006.01)**  
 (96) 10014018.5 02.05.2012  
 (97) 2447585, 02.05.2012 de  
 (54) Pipe  
 (71) Dipl.-ing. I. Özpolat Kunststoffzeugnisse GmbH, Alter Weg 9-11, 64385 Reichelsheim (Odenwald), DE  
 (72) Özpolat, Ilgaz, Alter Weg 9, 64385 Reichelsheim, DE

(51) MKP  
**A61M 5/24 (2006.01)** (97) **2528643 \***  
**A61M 5/315 (2006.01)**  
 (86) EP2011050898 24.01.2011  
 (96) 11701655.0 05.12.2012  
 (87) WO2011089246, 24.01.2011  
 (97) 2528643, 05.12.2012 en  
 (54) DRIVE ASSEMBLY FOR A DRUG DELIVERY DEVICE AND DRUG DELIVERY DEVICE  
 (71) Sanofi-Aventis Deutschland GmbH, Brüningstraße 50, 65929 Frankfurt, DE  
 (72) LANGLEY, Christopher, 120 Leicester Lane Leamington Spa, Warwickshire CV32 7HH, GB  
 JONES, Christopher, The Old Thatch Grafton, Tewkesbury Gloucestershire GL20 7AT, GB  
 DRAPER, Paul, 2 Clyde Avenue, Evesham Worcestershire WR11 3, GB

(51) MKP  
**B64C 27/00 (2006.01)** (97) **2501958 \***  
**F16F 15/36 (2006.01)**  
**F16F 15/16 (2006.01)**  
**G01M 1/36 (2006.01)**  
(86) EP2010067686 17.11.2010  
(96) 10776389.8 26.09.2012  
(87) WO2011061227, 17.11.2010  
(97) 2501958, 26.09.2012 en  
(54) METHOD, APPARATUS AND SYSTEM FOR REDUCING VIBRATION IN A ROTARY SYSTEM OF A VEHICLE  
(71) Carnehmhammar, Lars Bertil, Sonnenbergstrasse 126, 8032 Zürich, CH  
(72) SEITZ, Norbert, Riegseestrasse 3, 82194 Gröbenzell, DE

(51) MKP  
**A23G 1/30 (2006.01)** (97) **2509439 \***  
**A23L 1/00 (2006.01)**  
**A23G 1/50 (2006.01)**  
**A23L 1/09 (2006.01)**  
**A23L 1/03 (2006.01)**  
**A23L 1/30 (2006.01)**  
**A23L 1/0562 (2006.01)**  
**A23G 3/54 (2006.01)**  
**A23L 1/305 (2006.01)**  
**A23L 1/227 (2006.01)**  
**A23G 1/54 (2006.01)**  
(86) EP2010007448 08.12.2010  
(96) 10790899.8 17.10.2012  
(87) WO2011069644, 08.12.2010  
(97) 2509439, 17.10.2012 de  
(54) CHOCOLATE PRODUCT  
(71) Funfoods K.S., Bernecká 1823, 936 01 Sahy, SK  
(72) VON NIESSEN, Stephanie, Beim Wasserturm 21, 73527 Schwäbisch Gmünd, DE

(51) MKP  
**B29C 45/44 (2006.01)** (97) **2444224**  
**B29C 45/26 (2006.01)**  
**B29C 45/56 (2006.01)**  
(96) 11184732.3 25.04.2012  
(97) 2444224, 25.04.2012 de  
(54) Method and device for producing ball bearing rings  
(71) NP Poschmann GmbH, Zur Heide 33, 59929 Brilon, DE  
(72) Baukloh, Horst, Südstraße 8, 58540 Meinerzhagen, DE

(51) MKP  
**A01H 5/00 (2006.01)** (97) **2525649 \***  
**C12N 15/29 (2006.01)**  
**C12N 15/82 (2006.01)**  
(86) US2011022135 21.01.2011  
(96) 11735267.4 28.11.2012  
(87) WO2011091311, 21.01.2011  
(97) 2525649, 28.11.2012 en  
(54) EXCISION OF TRANSGENES IN GENETICALLY MODIFIED ORGANISMS  
(71) Dow AgroSciences, LLC, 9330 Zionsville Road, Indianapolis, IN 46268, US  
(72) RUSSELL, Sean, 9234 Eden Woods Ct, Indianapolis Indiana 46260, US  
PETOLINO, Joseph F., 270 Woodstock Ct., Zionsville Indiana 46077, US

(51) MKP  
**A61K 31/519 (2006.01)** (97) **2523960 \***  
**A61P 9/00 (2006.01)**  
**C07D 498/04 (2006.01)**  
(86) EP2011050302 12.01.2011  
(96) 11700339.2 21.11.2012  
(87) WO2011086080, 12.01.2011  
(97) 2523960, 21.11.2012 de  
(54) HETEROCYCLIC CARBOXYLIC ACID DERIVATIVES HAVING A 2,5-SUBSTITUTED OXAZOLOPYRIMIDINE RING  
(71) SANOFI, 54, rue de la Boétie, 75008 Paris, FR  
(72) KADEREIT, Dieter, c/o Sanofi-Aventis Deutschland GmbH, 65926 Frankfurt am Main, DE  
SCHAEFER, Matthias, c/o Sanofi-Aventis Deutschland GmbH, 65926 Frankfurt am Main, DE  
HACHTEL, Stephanie, c/o Sanofi-Aventis Deutschland GmbH, 65926 Frankfurt am Main, DE  
DIETRICH, Axel, c/o Sanofi-Aventis Deutschland GmbH, 65926 Frankfurt am Main, DE  
HUEBSCHLE, Thomas, c/o Sanofi-Aventis Deutschland GmbH, 65926 Frankfurt am Main, DE  
HISS, Katrin, c/o Sanofi-Aventis Deutschland GmbH, 65926 Frankfurt am Main, DE

(51) MKP  
**A61K 9/00 (2006.01)** (97) **2515878 \***  
**A61K 9/16 (2006.01)**  
**A61P 35/00 (2006.01)**  
**A61K 38/00 (2006.01)**  
(86) JP2010073665 21.12.2010  
(96) 10805747.2 31.10.2012  
(87) WO2011078394, 21.12.2010  
(97) 2515878, 31.10.2012 en  
(54) SUSTAINED-RELEASE FORMULATION  
(71) Takeda Pharmaceutical Company Limited, 1-1 Doshomachi 4-chome Chuo-ku, Osaka-shi, Osaka 541-0045, JP  
(72) FUTO, Tomomichi, c/o TAKEDA PHARMACEUTICAL COMPANY LIMITED 17-85 Jusohonmachi 2-chome Yodogawa-ku, Osaka-shi Osaka 532-8686, JP  
TAIRA, Hikaru, c/o TAKEDA PHARMACEUTICAL COMPANY LIMITED 17-85 Jusohonmachi 2-chome Yodogawa-ku, Osaka-shi Osaka 532-8686, JP  
MIZUKAMI, Seitaro, c/o TAKEDA PHARMACEUTICAL COMPANY LIMITED 17-85 Jusohonmachi 2-chome Yodogawa-ku, Osaka-shi Osaka 532-8686, JP  
MURATA, Naoyuki, c/o TAKEDA PHARMACEUTICAL COMPANY LIMITED 17-85 Jusohonmachi 2-chome Yodogawa-ku, Osaka-shi Osaka 532-8686, JP

(51) MKP  
**A01H 5/00 (2006.01)** (97) **2503873 \***  
**C12Q 1/68 (2006.01)**  
(86) US2010057886 23.11.2010  
(96) 10832375.9 03.10.2012  
(87) WO2011063413, 23.11.2010  
(97) 2503873, 03.10.2012 en  
(54) HERBICIDE TOLERANT SOYBEAN PLANTS AND METHODS FOR IDENTIFYING SAME  
(71) Bayer CropScience NV, J.E. Mommaertsiaan 14, 1831 Diegem, BE  
M.S. Technologies LLC, 103 Avenue D, West Point, Iowa 52656, US  
(72) MASON, Justin, Thomas, 2417 White Oak Lane, Granger, Iowa 50109, US  
LETTOW, Leslie, James, 1682 250th Street, Guthrie Center, Iowa 50115, US  
EBY, Mark, Alan, 23374 Laredo Trail, Adel, Iowa 50003, US  
EBY, William, H., 4763 Panorama Drive, Panora, Iowa 50216, US  
WELZ, Günter, Vor den Garten 8, DE-38302 Wolfenbüttel, DE  
VERHAEGHE, Steven, Harrelstraat 21, BE-9800 Grammene-Deize, BE  
DE BEUCKELEER, Marc, Hofakkerstraat 54, BE-9052 Zwijnaarde, BE  
HABEX, Veerle, Hoge Voetweg 12, BE-8560 Gullegem, BE  
FERULLO, Jean-Marc, 8 rue des cerisiers, FR-59560 Comines, FR

- (51) MKP  
**G06F 3/048 (2006.01)** (97) **2524294 \***  
 (86) FR2011052964 13.12.2011  
 (96) 11811101.2 21.11.2012  
 (87) WO2012136901, 13.12.2011  
 (97) 2524294, 21.11.2012 fr  
 (54) METHOD FOR SELECTING AN ELEMENT OF A USER INTERFACE AND DEVICE IMPLEMENTING SUCH A METHOD  
 (71) Archos, 12, rue Ampère - ZI, 91430 Igny, FR  
 (72) La désignation de l'inventeur n'a pas encore été déposée, null, null, null

- (51) MKP  
**A61B 17/24 (2006.01)** (97) **2519168 \***  
**A61B 17/32 (2006.01)**  
**A61M 29/02 (2006.01)**  
**A61B 17/3205 (2006.01)**  
**A61B 17/22 (2006.01)**  
 (86) US2010061850 22.12.2010  
 (96) 10801777.3 07.11.2012  
 (87) WO2011082074, 22.12.2010  
 (97) 2519168, 07.11.2012 en  
 (54) TISSUE REMOVAL IN THE PARANASAL SINUS AND NASAL CAVITY  
 (71) Acclarent, Inc., 1525-B O'Brien Drive, Menlo Park, CA 94025, US  
 (72) MAKOWER, Joshua, 661 University Avenue, Los Altos California 94022, US  
 CHANG, John, Y., 13080 Lorene Court, Mountain View California 94040, US  
 GOLDFARB, Eric, 1506 Harbor Boulevard, Belmont California 94002, US  
 ANDREAS, Bernard, H., 633 California Way, Redwood City CA 94062, US  
 JENKINS, Thomas, 571 Mira Vista Avenue, Oakland California 94610, US  
 SHERMAN, Nick, 806 Deer Cross Lane, Waxhaw, North Carolina 28173, US  
 HEISER, Ronda, M., 676 North 16th Street, San Jose California 95112, US  
 HA, Hung, V., 2974 Delancy Court, San Jose California 95135, US  
 MORRISS, John, H., 725-A Wisconsin Street, San Francisco California 94107, US

- (51) MKP  
**F23M 5/00 (2006.01)** (97) **2529158 \***  
**F23L 7/00 (2006.01)**  
**F23M 5/08 (2006.01)**  
**F02C 1/00 (2006.01)**  
 (86) US2011022553 26.01.2011  
 (96) 11705069.0 05.12.2012  
 (87) WO2011094294, 26.01.2011  
 (97) 2529158, 05.12.2012 en  
 (54) SYSTEM AND METHOD FOR HIGH EFFICIENCY POWER GENERATION USING A CARBON DIOXIDE CIRCULATING WORKING FLUID  
 (71) Palmer Labs, LLC, 300 Fuller Street, Durham, North Carolina 27701, US  
 8 Rivers Capital, LLC, 300 Fuller Street, Durham, North Carolina 27701, US  
 (72) ALLAM, Rodney, John, Lanhill House Lanhill, Chippenham Wiltshire SN14 6LY, GB  
 PALMER, Miles, R., 203 Hogan Woods Circle, Chapel Hill, North Carolina 27516, US  
 BROWN, Glenn, William, Jr., 3603 Dairy Pond Place, Durham, North Carolina 27705, US

- (51) MKP  
**F41H 1/02 (2006.01)** (97) **2507582 \***  
**D04B 21/14 (2006.01)**  
 (86) US2010054501 28.10.2010  
 (96) 10834908.5 10.10.2012  
 (87) WO2011068607, 28.10.2010  
 (97) 2507582, 10.10.2012 en  
 (54) STAPLE FIBER CONDUCTIVE FABRIC  
 (71) Schultz, Gregory Russell, 16721 West Falcon Lane, Marana, AZ 85653, US  
 (72) Schultz, Gregory Russell, 16721 West Falcon Lane, Marana, AZ 85653, US

- (51) MKP  
**C07K 16/18 (2006.01)** (97) **2512600 \***  
**A61K 39/395 (2006.01)**  
**A61P 13/12 (2006.01)**  
 (86) US2010060992 17.12.2010  
 (96) 10801508.2 24.10.2012  
 (87) WO2011075636, 17.12.2010  
 (97) 2512600, 24.10.2012 en  
 (54) WISE BINDING AGENTS AND EPITOPES  
 (71) AMGEN INC., One Amgen Center Drive, Thousand Oaks, CA 91320-1799, US  
 (72) QIAN, Xueming, 596 Myrtle Court, Oak Park, CA 91377, US  
 WINTERS, Aaron George, 2501 Pierpont Blvd., Ventura, CA 93001, US  
 HORTTER, Michelle, 1135 Mission Verde Drive, Camarillo, CA 93012, US  
 GRAHAM, Kevin, 1627 Charterwood Court, Thousand Oaks, CA 91362, US  
 TSAI, Mei-Mei, 87 East Gainsborough Road, Thousand Oaks, CA 91360, US

- (51) MKP  
**C07C 409/34 (2006.01)** (97) **2509944 \***  
**A61Q 19/00 (2006.01)**  
**A61K 8/38 (2006.01)**  
 (86) EP2010069418 10.12.2010  
 (96) 10790945.9 17.10.2012  
 (87) WO2011070170, 10.12.2010  
 (97) 2509944, 17.10.2012 en  
 (54) NOVEL PEROXIDE DERIVATIVES, THEIR PROCESS OF PREPARATION AND THEIR USE IN HUMAN MEDICINE AND IN COSMETICS FOR THE TREATMENT OR PREVENTION OF ACNE  
 (71) Galderma Research & Development, 2400 Route des Colles Les Templiers, 06410 Biot, FR  
 (72) BOUX-PETER, Claire, 48 chemin du Cannet, F-06220 Vallauris, FR  
 PASCAL, Jean-Claude, 170 avenue de Gairaut, F-06100 Nice, FR  
 RODEVILLE, Nicolas, 85 rue Henri Poincaré Résidence Oxford App A311, F-06410 Biot, FR

- (51) MKP  
**C12P 19/34 (2006.01)** (97) **2513326 \***  
**C07H 21/04 (2006.01)**  
 (86) US2010061036 17.12.2010  
 (96) 10838293.8 24.10.2012  
 (87) WO2011075648, 17.12.2010  
 (97) 2513326, 24.10.2012 en  
 (54) ENDPOINT TAQMAN METHODS FOR DETERMINING ZYGOSITY OF CORN COMPRISING TC1507 EVENTS  
 (71) Dow AgroSciences, LLC, 9330 Zionsville Road, Indianapolis, Indiana 46268, US  
 (72) CHEN, Wei, 13232 Tanzanite Circle, Carmel IN 46033, US  
 MARCHIONE, Wesley, 1802 Willowview Court, Greenfield IN 46140, US  
 NOVAK, Stephen, 509 Viburnum Run, Westfield IN 46074, US  
 GUPTA, Manju, 13463 Winamac Court, Carmel IN, US  
 GREENE, Thomas, W., 5535 Glen Oaks Pointe, West Des Moines, Iowa 50266, US  
 KUMPATLA, Siva, 14524 Baldwin Lane, Carmel IN 46032, US

- (51) MKP  
**A61M 5/32 (2006.01)** (97) **2536455 \***  
**A61M 5/20 (2006.01)**  
 (86) EP2011052300 16.02.2011  
 (96) 11705852.9 26.12.2012  
 (87) WO2011101378, 16.02.2011  
 (97) 2536455, 26.12.2012 en  
 (54) FINGER GUARD FOR AN INJECTION DEVICE  
 (71) Sanofi-Aventis Deutschland GmbH, Brüningstraße 50, 65929 Frankfurt, DE  
 (72) EKMAN, Matthew, 59 Ecton Avenue, Macclesfield Cheshire SK10 1RD, GB  
 BARROW-WILLIAMS, Timothy Donald, 1 Grange Street St. Albans, Herts AL3 5NA, GB  
 HOURMAND, Yannick, 14 The Elms, Haslingfield CB23 1ND, GB

(51) MKP  
**A61P 9/00 (2006.01)** (97) **2516433 \***  
**A61P 19/08 (2006.01)**  
**C07D 519/00 (2006.01)**  
**C07D 471/04 (2006.01)**  
**A61P 29/00 (2006.01)**  
**A61K 31/437 (2006.01)**  
**A61K 31/4985 (2006.01)**  
**A61P 35/00 (2006.01)**  
(86) US2010061341 20.12.2010  
(96) 10798683.8 31.10.2012  
(87) WO2011079076, 20.12.2010  
(97) 2516433, 31.10.2012 en  
(54) SUBSTITUTED N-(1H-INDAZOL-4-YL)IMIDAZO[1, 2-A]PYRIDINE-3- CARBOXAMIDE COMPOUNDS AS CFMS INHIBITORS  
(71) Array Biopharma, Inc., 3200 Walnut Street, Boulder, CO 80301, US  
(72) BOYS, Mark Laurence, c/o Array BioPharma Inc. 3200 Walnut Street, Boulder, Colorado 80301, US  
BRADLEY, Michael F., c/o Array BioPharma Inc. 3200 Walnut Street, Boulder, Colorado 80301, US  
DELISLE, Robert Kirk, c/o Array BioPharma Inc. 3200 Walnut Street, Boulder, Colorado 80301, US  
HENNING, D. David, c/o Array BioPharma Inc. 3200 Walnut Street, Boulder, Colorado 80301, US  
KENNEDY, April L., 2435 California Street, Denver, Colorado 80205, US  
MARMSATER, Fredrik P., 2865 Telluride Place, Boulder, Colorado 80305, US  
MEDINA, Matthew David, c/o Array BioPharma Inc. 3200 Walnut Street, Boulder, Colorado 80301, US  
MUNSON, Mark C., 45 Central Street, Acton, MA 01720, US  
RAST, Bryson, 9802 Quay Way, Westminster, Colorado 80021, US  
RIZZI, James P., 3724 Woodshadow Lane, Addison, TX 75001, US  
RODRIGUEZ, Martha E., 1315 Lambert Circle, Lafayette, Colorado 80026, US  
TOPALOV, George T., 3428 Brookdale Drive, Pittsburgh, PA 15241, US  
ZHAO, Qian, 681 St. Andrews Lane, Louisville, Colorado 80027, US

(51) MKP  
**B25H 3/02 (2006.01)** (97) **2516115 \***  
(86) SE2010051240 11.11.2010  
(96) 10839884.3 31.10.2012  
(87) WO2011078763, 11.11.2010  
(97) 2516115, 31.10.2012 en  
(54) MODULE SYSTEM COMPRISING A CASE AND A NUMBER OF BOXES  
(71) ESSVE Produkter AB, P.O. Box 770, 191 27 Sollentuna, SE  
(72) KARLSSON, Samuel, c/o ESSVE Produkter AB P.O. Box 770, S-191 27 Sollentuna, SE  
NILSSON, Magnus, c/o ESSVE Produkter AB P.O. Box 770, S-191 27 Sollentuna, SE  
LARSON, Ove, c/o ESSVE Produkter AB P.O. Box 770, S-191 27 Sollentuna, SE

(51) MKP  
**A61K 35/74 (2006.01)** (97) **2528611 \***  
**A61K 38/47 (2006.01)**  
(86) EP2011000510 04.02.2011  
(96) 11707070.6 05.12.2012  
(87) WO2011095339, 04.02.2011  
(97) 2528611, 05.12.2012 en  
(54) A COMPOSITION FOR USE IN THE THERAPY OF LACTOSE INTOLERANCE OR CONDITIONS ARISING FROM LACTASE DEFICIENCY  
(71) Vitacare GmbH & Co. KG, Konrad-Adenauer-Allee 8-10, 61118 Bad Vilbel, DE  
(72) WYROBNIK, Daniel, Henry, Justinianstrasse 4, 60322 Frankfurt, DE  
WYROBNIK, Isaac, Harry, Gottfried-Keller str. 90, 60431 Frankfurt, DE

(51) MKP  
**H05B 7/09 (2006.01)** (97) **2514269 \***  
(86) EP2010069547 13.12.2010  
(96) 10787804.3 24.10.2012  
(87) WO2011073153, 13.12.2010  
(97) 2514269, 24.10.2012 en  
(54) ELECTRODE PASTE FOR ELECTRODES IN BINDER-FREE GRAPHITE WITH HYDROCARBON BASE  
(71) Italgisa S.p.A., Via Gramsci 184, 25021 Bagnolo Mella (Brescia), IT  
(72) FERRARI, Sandro, Via Carlo Serassi 11, I-24125 Bergamo, IT  
CAVALLOTTI, Irma, Via Fara 3/A, I-24129 Bergamo, IT  
CONTI, Giuseppe, Via Antonio Mambretti 22, I-20157 Milano, IT  
DUSI, Maurizio, Vicolo Molino 1, I-25021 Bagnolo Mella (Brescia), IT

(51) MKP  
**A61K 31/135 (2006.01)** (97) **2515891 \***  
(86) US2010061565 21.12.2010  
(96) 10843543.9 31.10.2012  
(87) WO2011087791, 21.12.2010  
(97) 2515891, 31.10.2012 en  
(54) 3-KETO-N-PROPARGYL-1-AMINOINDAN  
(71) Teva Pharmaceutical Industries Ltd., 5 Basel Street P.O. Box 3190, 49131 Petah Tiqva, IL  
(72) FRENKEL, Anton, 15 Amnon VE Tamar Str. Apt.10, 42202 Netanya, IL  
LIDOR-HADAS, Ramy, 19 Mor Str., 44242 Kfar-Saba, IL  
BAHAR, Eliezer, 95 Haim Levanon Str., 69345 Tel-Aviv, IL

(51) MKP  
**C07D 487/04 (2006.01)** (97) **2523955 \***  
**A61P 25/28 (2006.01)**  
**C07D 471/04 (2006.01)**  
**A61K 31/4196 (2006.01)**  
(86) EP2011050349 12.01.2011  
(96) 11700171.9 21.11.2012  
(87) WO2011086098, 12.01.2011  
(97) 2523955, 21.11.2012 en  
(54) NOVEL SUBSTITUTED BICYCLIC TRIAZOLE DERIVATIVES AS GAMMA SECRETASE MODULATORS  
(71) Janssen Pharmaceuticals Inc., 1125 Trenton-Harbourton Road, Titusville NJ 08560, US  
(72) DE CLEYN, Michel, Anna, Jozef, c/o Janssen Pharmaceutica NV Turnhoutseweg 30, B-2340 Beerse, BE  
VAN BRANDT, Sven, Franciscus, Anna, c/o Janssen Pharmaceutica NV Turnhoutseweg 30, B-2340 Beerse, BE  
GIJSEN, Henricus, Jacobus, Maria, c/o Janssen Pharmaceutica NV Turnhoutseweg 30, B-2340 Beerse, BE  
BERTHELOT, Didier, Jean-Claude, c/o Janssen Pharmaceutica NV Turnhoutseweg 30, B-2340 Beerse, BE  
OEHLRICH, Daniel, c/o Janssen Pharmaceutica NV Turnhoutseweg 30, B-2340 Beerse, BE

(51) MKP  
**G06Q 10/00 (2012.01)** (97) **2529342 \***  
(86) US2011022545 26.01.2011  
(96) 11737560.0 05.12.2012  
(87) WO2011094289, 26.01.2011  
(97) 2529342, 05.12.2012 en  
(54) SYSTEMS AND METHODS FOR MANAGING EVENTS  
(71) Eved, L.L.C., 4811 Oakton Street Suite 250, Skokie, IL 60077, US  
(72) MASHIACH, Talia, 2917 West Chase Avenue, Chicago, IL 60645, US  
FIFIELD, Kelly, 1225 Johnson Drive Apt. 2514, Buffalo Grove, IL 60689, US  
BUCKLES, Susan, 24939 West Illini Drive, Plainfield, IL 60544, US  
LAMBERT, Michael, 754 Lyster Road, Highwood, IL 60040, US

- (51) MKP  
**C07J 71/00 (2006.01)** (97) **2531516 \***  
**A61K 31/58 (2006.01)**  
**A61P 5/44 (2006.01)**
- (86) EP2011051537 03.02.2011  
(96) 11703638.4 12.12.2012  
(87) WO2011095535, 03.02.2011  
(97) 2531516, 12.12.2012 en
- (54) PREGNANE COMPOUNDS CONDENSED IN POSITION 16,17 WITH A PYROLIDINE RING WITH GLUCOCORTICOID ACTIVITY
- (71) Chiesi Farmaceutici S.p.A., Via Palermo, 26/A, 43100 Parma, IT  
(72) GHIDINI, Eleonora, c/o Chiesi Farmaceutici S.p.A. Via Palermo 26/A, I-43100 Parma, IT  
RIZZI, Andrea, c/o Chiesi Farmaceutici S.p.A. Via Palermo 26/A, I-43100 Parma, IT  
VIRDIS, Andrea, c/o Chiesi Farmaceutici S.p.A. Via Palermo 26/A, I-43100 Parma, IT  
RANCATI, Fabio, c/o Chiesi Farmaceutici S.p.A. Via Palermo 26/A, I-43100 Parma, IT  
RENCUROSÌ, Anna, c/o Chiesi Farmaceutici S.p.A. Via Palermo 26/A, I-43100 Parma, IT
- 
- (51) MKP  
**C12N 15/113 (2010.01)** (97) **2507373 \***
- (86) US2010059090 06.12.2010  
(96) 10835249.3 10.10.2012  
(87) WO2011069155, 06.12.2010  
(97) 2507373, 10.10.2012 en
- (54) COMPOSITIONS AND METHODS FOR INHIBITION OF VEGF
- (71) Opko Ophthalmics, LLC, 4400 Biscayne Boulevard Suite 1180, Miami, FL 33137, US  
(72) DEJNEKA, Nadine, Apt. B412 200 North Wynnewood Avenue, Wynnewood, PA 19096, US
- 
- (51) MKP  
**A61P 17/06 (2006.01)** (97) **2516467 \***  
**A61P 37/00 (2006.01)**  
**C07K 16/24 (2006.01)**  
**A61K 39/395 (2006.01)**  
**A61P 19/02 (2006.01)**
- (86) US2010062081 23.12.2010  
(96) 10803327.5 31.10.2012  
(87) WO2011079308, 23.12.2010  
(97) 2516467, 31.10.2012 en
- (54) COMPOSITIONS COMPRISING TNF-ALPHA AND IL-6 ANTAGONISTS AND METHODS OF USE THEREOF
- (71) Emergent Product Development Seattle, LLC, 2401 Fourth Avenue, Suite 1050, Seattle, Washington 98121, US  
(72) MISHER, Lynda, E., 10614 10th Place Northeast, Seattle, Washington 98125, US  
LOFQUIST, Alan, Keith, 9422 Northeast 130th Place, Kirkland, Washington 98034, US
- 
- (51) MKP  
**A61P 13/00 (2006.01)** (97) **2521716 \***  
**C07D 249/12 (2006.01)**  
**A61P 13/12 (2006.01)**  
**A61K 31/4196 (2006.01)**
- (86) US2011020233 05.01.2011  
(96) 11732089.5 14.11.2012  
(87) WO2011085009, 05.01.2011  
(97) 2521716, 14.11.2012 en
- (54) POLYMORPHIC, CRYSTALLINE AND MESOPHASE FORMS OF SODIUM 2-(5-BROMO-4-(4-CYCLOPROPYLNAPHTHALEN-1-YL)-4H-1,2,4-TRIAZOL-3-YLTHIO)ACETATE, AND USES THEREOF
- (71) Ardea Biosciences, Inc., 4939 Directors Place, San Diego, CA 92121, US  
(72) ZAMANSKY, Irina, 2539 Ivy Road, Oceanside CA 92054, US  
GALVIN, Gabriel, 13257 Via Santillana, San Diego CA 92129, US  
GIRARDET, Jean-luc, 16763 Santa Corina Court, San Diego CA 92127, US
- 
- (51) MKP  
**B01J 20/28 (2006.01)** (97) **2536497 \***  
**B01J 20/26 (2006.01)**  
**C02F 1/28 (2006.01)**  
**B01J 20/32 (2006.01)**  
**B01J 20/20 (2006.01)**  
**B01D 53/02 (2006.01)**
- (86) EP2011000268 24.01.2011  
(96) 11701021.5 26.12.2012  
(87) WO2011098210, 24.01.2011  
(97) 2536497, 26.12.2012 de
- (54) AGGLOMERATES OF ADSORBER PARTICLES AND METHODS FOR PRODUCING SUCH ADSORBER PARTICLES
- (71) Blücher GmbH, Mettmanner Strasse 25, 40699 Erkrath, DE  
(72) GIEBELHAUSEN, Jann-Michael, An der Herrenlake 35, 14712 Rathenow, DE  
FICHTNER, Sven, Alte Potsdamer Strasse 35, 14776 Brandenburg, DE  
BÖHRINGER, Bertram, Bussardweg 33, 42115 Wuppertal, DE
- 
- (51) MKP  
**A61B 17/00 (2006.01)** (97) **2501298 \***  
**A61B 19/02 (2006.01)**  
**A61B 19/08 (2006.01)**  
**A61B 19/00 (2006.01)**
- (86) US2010057101 17.11.2010  
(96) 10781571.4 26.09.2012  
(87) WO2011063038, 17.11.2010  
(97) 2501298, 26.09.2012 en
- (54) SURGICAL INSTRUMENTS AND COMPONENTS FOR USE IN STERILE ENVIRONMENTS
- (71) Ethicon Endo-Surgery, Inc., 4545 Creek Road, Cincinnati, OH 45242, US  
(72) BOUDREAUX, Chad, P., 10840 Lakehurst Court, Cincinnati, OH 45242, US  
SHELTON, Frederick, E., IV, 245 East Main Street, Hillsboro, OH 45133, US  
SMITH, Bret, W., 4736 Eastport Drive, Kings Mills, OH 45034, US  
ABBOTT, Daniel, J., 5944 Marsh Circle, Loveland, 45140, US
- 
- (51) MKP  
**C07D 498/00 (2006.01)** (97) **2536734 \***
- (86) US2011024981 16.02.2011  
(96) 11745134.4 26.12.2012  
(87) WO2011103120, 16.02.2011  
(97) 2536734, 26.12.2012 en
- (54) FORMS OF RIFAXIMIN AND USES THEREOF
- (71) Salix Pharmaceuticals, Ltd., 8510 Colonnade Center Drive, Raleigh, NC 27615, US  
(72) GUSHURST, Karen, S., 110 Heron Court, West Lafayette, IN 47906, US  
YANG, Donglai, 61 La Costa Drive, Annandale, NJ 08801, US  
VLAHOVA, Petinka, 1041 Shootingstar Court, West Lafayette, IN 47909, US  
STULTS, Jeffrey, S., 3240 Hendrickson Lane, Lafayette, IN 47906, US
- 
- (51) MKP  
**A47J 37/04 (2006.01)** (97) **2464265 \***
- (86) EP2010059979 12.07.2010  
(96) 10730477.6 20.06.2012  
(87) WO2011006868, 12.07.2010  
(97) 2464265, 20.06.2012 en
- (54) AN OVEN FOR HEAT-TREATING FOOD PIECES
- (71) Mom's A/S, Seebladsgade 2, 5000 Odense C, DK  
(72) IVERSEN, Per Heindorf, Rolf Krakes Vej 68 Thurø, DK-5700 Svendborg, DK

(51) MKP  
**A61B 17/115 (2006.01)** (97) **2512350 \***  
**A61B 17/11 (2006.01)**  
**A61B 19/00 (2006.01)**  
**A61B 17/00 (2006.01)**  
(86) US2010057109 17.11.2010  
(96) 10781572.2 24.10.2012  
(87) WO2011063046, 17.11.2010  
(97) 2512350, 24.10.2012 en  
(54) CIRCULAR STAPLER INTRODUCER WITH RADIALLY-OPENABLE DISTAL END PORTION  
(71) Ethicon Endo-Surgery, Inc., 4545 Creek Road, Cincinnati, OH 45242, US  
(72) BAXTER, Chester, O., Ill, 6375 Pawnee Ridge, Loveland, OH 45140, US  
HUNT, John, V., 3654 Moorhill Drive, Cincinnati, OH 45241, US  
SILKAITIS, Danius, P., 4680 Sarah Drive, Mason, OH 45040, US  
WILEY, Jeffrey, P., 5585 Autumn Wynd Lane, Milford, OH 45150, US  
FRANER, Paul, T., 6217 Rapid Run Road, Cincinnati, OH 45233, US  
SCHULTE, John, B., 6769 Timberwood Drive, West Chester, OH 45069, US  
ABBOTT, Daniel, J., 5944 Marsh Circle, Loveland, OH 45140, US

(51) MKP  
**A61K 9/50 (2006.01)** (97) **2515851 \***  
**A61K 9/16 (2006.01)**  
**A61K 9/06 (2006.01)**  
**A61P 1/00 (2006.01)**  
**A61K 9/10 (2006.01)**  
**A61K 9/12 (2006.01)**  
**A61K 9/00 (2006.01)**  
**A61K 31/404 (2006.01)**  
**A61K 9/20 (2006.01)**  
**A61K 9/08 (2006.01)**  
(86) US2010060002 13.12.2010  
(96) 10795532.0 31.10.2012  
(87) WO2011078983, 13.12.2010  
(97) 2515851, 31.10.2012 en  
(54) TREATMENT FOR INFLAMMATORY BOWEL DISEASE  
(71) SANOFI, 54 rue La Boétie, 75008 Paris, FR  
(72) MINNICH, Anne, c/o Sanofi-Aventis U.S. 1041 Route 202-206 Mail Code: BWD 303A, Bridgewater, New Jersey 08807, US  
BEKASI, Eszter, c/o Chinnoin To utca 1-5, H-1045 Budapest, HU  
CHOI-SLEDESKI, Yong Mi, c/o Sanofi-Aventis U.S. 1041 Route 202-206 Mail Code: BWD 303A, Bridgewater, New Jersey 08807, US

(51) MKP  
**A61K 38/18 (2006.01)** (97) **2501399 \***  
(86) DK2010050306 15.11.2010  
(96) 10781412.1 26.09.2012  
(87) WO2011060789, 15.11.2010  
(97) 2501399, 26.09.2012 en  
(54) TREATMENT OF ACUTE ISCHEMIC STROKE OR INTRACRANIAL BLEEDING WITH TPA AND CARBAMYLATED ERYTHROPOIETIN  
(71) H. Lundbeck A/S, Otiliavej 9, 2500 Valby, DK  
(72) SAGER, Thomas, Nikolaj, Stormosevej 35, DK-2765 Smørum, DK  
CHRISTENSEN, Søren, Lystbådevej 32, DK-4040 Jyllinge, DK  
JØRGENSEN, Steffen, Wad, Gl. Vallerødvej 24, DK-2960 Rungsted Kyst, DK  
CHOPP, Michael, 28415 Brooks Lane Southfield, Michigan, MI 48034, US  
ZHANG, Zheng, Gang, 47 Glenshire Dr., Troy, MI 48085, US

(51) MKP  
**F23L 7/00 (2006.01)** (97) **2526339 \***  
(86) US2011022159 21.01.2011  
(96) 11735279.9 28.11.2012  
(87) WO2011091327, 21.01.2011  
(97) 2526339, 28.11.2012 en  
(54) GENERATING STEAM FROM CARBONACEOUS MATERIAL  
(71) Powerdyne, Inc., 4740 Von Karman Avenue Suite 300, Newport Beach, California 92660, US  
(72) HIRSON, Geoffrey, 208 Grand Canal, Newport Beach CA 92662, US  
SHOUSE, Gus, F., 2525 Ocean Suite H1, Corona Del Mar CA 92625, US  
HIRSON, Daniel, M., 4740 Von-karman Suite 300, Newport Beach CA 92660, US

(51) MKP  
**A61K 45/06 (2006.01)** (97) **2531182 \***  
**A61K 31/4155 (2006.01)**  
**A61K 31/00 (2006.01)**  
**A61P 25/04 (2006.01)**  
(86) EP2011051644 04.02.2011  
(96) 11702633.6 12.12.2012  
(87) WO2011095585, 04.02.2011  
(97) 2531182, 12.12.2012 en  
(54) SIGMA LIGANDS FOR POTENTIATING THE ANALGESIC EFFECT OF OPIOIDS AND OPIATES IN POST-OPERATIVE PAIN AND ATTENUATING THE DEPENDENCY THEREOF  
(71) Laboratorios del. Dr. Esteve, S.A., Avda Mare de Deu de Montserrat 221, 08041 Barcelona, ES  
(72) VELA HERNÁNDEZ, José Miguel, Laboratorios Del Dr. Esteve S.A. Avda. Badal nº 153, 8º, 3ª, E-08028 Barcelona, ES  
ZAMANILLO- CASTANEDO, Daniel, Laboratorios Del Dr. Esteve S.A. Avda. Mare de Dèu de Montserrat 252, 5º- 2ª, E-08041 Barcelona, ES

(51) MKP  
**H04L 12/56 (2006.01)** (97) **2523402 \***  
(86) JP2011050009 04.01.2011  
(96) 11731778.4 14.11.2012  
(87) WO2011083780, 04.01.2011  
(97) 2523402, 14.11.2012 en  
(54) COMMUNICATION SYSTEM, CONTROL APPARATUS, PROCESSING RULE SETTING METHOD, PACKET TRANSMITTING METHOD AND PROGRAM  
(71) NEC Corporation, 7-1, Shiba 5-chome Minato-ku, Tokyo 108-8001, JP  
(72) YAMATO, Junichi, c/o NEC CORPORATION 7-1 Shiba 5-chome Minato-ku, Tokyo 108-8001, JP  
HAMA, Takayuki, c/o NEC CORPORATION 7-1 Shiba 5-chome Minato-ku, Tokyo 108-8001, JP  
HIEDA, Satoshi, c/o NEC CORPORATION 7-1 Shiba 5-chome Minato-ku, Tokyo 108-8001, JP  
UCHIDA, Satoshi, c/o NEC CORPORATION 7-1 Shiba 5-chome Minato-ku, Tokyo 108-8001, JP

(51) MKP  
**A61B 19/00 (2006.01)** (97) **2523613 \***  
**A61B 17/34 (2006.01)**  
(86) US2011021349 14.01.2011  
(96) 11703519.6 21.11.2012  
(87) WO2011088357, 14.01.2011  
(97) 2523613, 21.11.2012 en  
(54) SYSTEMS AND METHODS FOR MINIMALLY INVASIVE SURGICAL TOOLS WITH HAPTIC FEEDBACK  
(71) Immersion Corporation, 30 Rio Robles, San Jose, CA 95134, US  
(72) ULLRICH, Christopher, J., 227 Palomares Avenue, Ventura, California 93003, US

- (51) MKP  
**F21V 17/06 (2006.01)** (97) **2502244 \***  
**F21V 19/04 (2006.01)**  
**H01F 38/14 (2006.01)**  
**H05B 41/46 (2006.01)**
- (86) AU2010001513 12.11.2010  
(96) 10829360.6 26.09.2012  
(87) WO2011057343, 12.11.2010  
(97) 2502244, 26.09.2012 en  
(54) CONTACTLESS COUPLING AND METHOD FOR USE WITH AN ELECTRICAL APPLIANCE
- (71) 300K Enterprises Pty Ltd, 22 Park Street, Wynyard, Tasmania 7325, AU  
(72) TREWIN, Christopher Scott, c/o 300K Enterprises Pty Ltd 22 Park Street, Wynyard Tasmania 7325, AU  
RUSSELL, Johnny Fabian, 5/1 Castray Esplanade, Battery Point Tasmania 7004, AU  
WEIMANN, Christian Albin, Lot 6 111 Gums Rd, Mountain River Tasmania 7109, AU  
RODWAY, Michael, 102 Old Station Rd, Lower Snug Tasmania 7054, AU
- 
- (51) MKP  
**A61K 38/10 (2006.01)** (97) **2509992 \***  
**C07K 7/08 (2006.01)**
- (86) US2010059294 07.12.2010  
(96) 10795838.1 17.10.2012  
(87) WO2011071927, 07.12.2010  
(97) 2509992, 17.10.2012 en  
(54) TREATMENTS FOR GASTROINTESTINAL DISORDERS
- (71) Ironwood Pharmaceuticals, Inc., 301 Binney Street, Cambridge, MA 02142, US  
(72) CURRIE, Mark G., 18 Hall Avenue, Sterling MA 01564, US  
ZIMMER, Daniel P., 453 Broadway Unit 2, Somerville MA 02145, US  
FRETZEN, Angelika, 7 Avon Street, Somerville MA 02143, US  
KESSELER, Marco, 35 Collins Street Unit 13, Danvers MA 01923, US  
CALI, Brian M., 100 Hillside Avenue, Arlington MA 02476, US
- 
- (51) MKP  
**A61K 31/437 (2006.01)** (97) **2531502 \***  
**C07D 471/04 (2006.01)**  
**A61P 35/00 (2006.01)**
- (86) GB2011000106 27.01.2011  
(96) 11701856.4 12.12.2012  
(87) WO2011092469, 27.01.2011  
(97) 2531502, 12.12.2012 en  
(54) 1-(5-TERT-BUTYL-2-PHENYL-2H-PYRAZOL-3-YL)-3-[2-FLUORO-4-(1-METHYL-2-OXO-2,3-DIHYDRO-1H-IMIDAZO[4,5-B]PYRIDIN-7-YLOXY)-PHENYL]-UREA AND RELATED COMPOUNDS AND THEIR USE IN THERAPY
- (71) Cancer Research Technology Limited, Angel Building 407 St John Street, London EC1V 4AD, GB  
The Institute of Cancer Research: Royal Cancer Hospital, 123 Old Brompton Road, London SW7 3RP, GB  
(72) SPRINGER, Caroline, The Institute of Cancer Research Cancer Research UK Center for Cancer Therapeutics 15 Costwold Road, Sutton, Surrey SM2 5NG, GB  
NICULESCU-DUVAZ, Ion, The Institute of Cancer Research Cancer Research UK Center for Cancer Therapeutics 15 Costwold Road, Sutton, Surrey SM2 5NG, GB  
MARAIS, Richard, The Institute of Cancer Research Section of Cell and Molecular Biology 237 Fulham Road, London SW3 6JB, GB  
NICULESCU-DUVAZ, Dan, The Institute of Cancer Research Cancer Research UK Center for Cancer Therapeutics 15 Costwold Road, Sutton, Surrey SM2 5NG, GB  
ZAMBON, Alfonso, The Institute of Cancer Research Cancer Research UK Center for Cancer Therapeutics 15 Costwold Road, Sutton, Surrey SM2 5NG, GB  
MENARD, Delphine, 27 Rue Jules Massenet, F-72700 Allonnes, FR
- 
- (51) MKP  
**A61K 38/17 (2006.01)** (97) **2523679 \***
- (86) US2011021109 13.01.2011  
(96) 11733365.8 21.11.2012  
(87) WO2011088196, 13.01.2011  
(97) 2523679, 21.11.2012 en  
(54) INHIBITORS OF RECEPTOR TYROSINE KINASES (RTK) AND METHODS OF USE THEREOF
- (71) Yale University, Inc., 2 Whitney Avenue, New Haven, CT 06511, US  
(72) BAE, Jae, Hyun, 53 Brushy Plain Road Unit 5, Branford, CT 06405, US  
LAX, Irit, 50 Rock Hill Road, Woodbridge, CT 06525, US  
SCHLESSINGER, Joseph, 50 Rock Hill Road, Woodbridge, CT 06525, US
- 
- (51) MKP  
**A61L 15/44 (2006.01)** (97) **2533772 \***  
**B32B 27/00 (2006.01)**  
**A61F 13/00 (2006.01)**  
**A61K 9/70 (2006.01)**  
**A61K 33/38 (2006.01)**
- (86) US2011024344 10.02.2011  
(96) 11742789.8 19.12.2012  
(87) WO2011100425, 10.02.2011  
(97) 2533772, 19.12.2012 en  
(54) METHODS AND COMPOSITIONS FOR WOUND HEALING
- (71) Wound Engineering LLC, 2822 Lalor Road, Oregon, Wisconsin 53575, US  
(72) ABBOTT, Nicholas L., 2120 Jefferson St., Madison, Wisconsin 53711, US  
AGARWAL, Ankit, 5002 Sheboygan Ave Apt 130, Madison, Wisconsin 53705, US  
MURPHY, Christopher J., 1 Shields Ave, Davis, California 95616, US  
MCANULTY, Jonathan F., 2822 Lalor Rd, Oregon, Wisconsin 53575, US
- 
- (51) MKP  
**A61K 38/10 (2006.01)** (97) **2521561 \***  
**A61P 1/10 (2006.01)**
- (86) US2010055270 03.11.2010  
(96) 10782076.3 14.11.2012  
(87) WO2011056850, 03.11.2010  
(97) 2521561, 14.11.2012 en  
(54) LINACLOTIDE FOR THE TREATMENT OF CHRONIC CONSTIPATION
- (71) Ironwood Pharmaceuticals, Inc., 301 Binney Street, Cambridge, MA 02142, US  
Forest Laboratories Holdings Limited, 18 Parliament Street Milner House, Hamilton HM12, BM  
(72) JOHNSTON, Jeffrey, 26 Hanson Street Unit 2, Boston, MA 02118, US  
FRETZEN, Angelika, 7 Avon Street, Somerville, MA 02143, US  
WITOWSKI, Steven, 171 Laurel Street, Melrose, MA 02176, US  
GROSSI, Alfredo, 102 Ten Hills Road, Somerville, MA 02145, US  
ZHAO, Hong, 74 Craigie Street Apt. 31, Somerville, MA 02143, US  
LAVINS, Bernard, Joseph, 21 Ellison Road, Lexington, MA 02421, US  
DEDHIYA, Mahendra, 1 Lea Court, Pomona, NY 10970-3219, US  
SCHNEIER, Harvey, 25 Harrison Street, New York, NY 10013, US
- 
- (51) MKP  
**C02F 3/04 (2006.01)** (97) **2501656 \***
- (86) IL2010000949 16.11.2010  
(96) 10829625.2 26.09.2012  
(87) WO2011058566, 16.11.2010  
(97) 2501656, 26.09.2012 en  
(54) MULTISTAGE BIOLOGICAL REACTOR
- (71) Treatac 21 Industries Ltd., 1 HaYasor St. P.O.Box 5062, 60920 Kadima, IL  
(72) ATZMON, Joseph, Olesh P.O.Box 57, 42855 Lev HaSharon, IL



- (51) MKP  
**A61P 35/00 (2006.01)** (97) **2534156 \***  
**C07D 491/048 (2006.01)**  
**A61K 31/4355 (2006.01)**
- (86) US2011024449 11.02.2011  
(96) 11704517.9 19.12.2012  
(87) WO2011100502, 11.02.2011  
(97) 2534156, 19.12.2012 en
- (54) 7-AMINOFUROPYRIDINE DERIVATIVES
- (71) OSI Pharmaceuticals, LLC, 1 Bioscience Park Drive, Farmingdale, NY 11735, US
- (72) HORNBERGER, Keith, R., OSI Pharmaceuticals Inc. Broadhollow Bioscience Park 1 Bioscience Park Drive, Farmingdale, NY 11735, US  
BERGER, Dan, M., OSI Pharmaceuticals Inc. Broadhollow Bioscience Park 1 Bioscience Park Drive, Farmingdale, NY 11735, US  
CHEN, Xin, OSI Pharmaceuticals Inc. Broadhollow Bioscience Park 1 Bioscience Park Drive, Farmingdale, NY 11735, US  
CREW, Andrew, P., OSI Pharmaceuticals Inc. Broadhollow Bioscience Park 1 Bioscience Park Drive, Farmingdale, NY 11735, US  
DONG, Hangqing, OSI Pharmaceuticals Inc. Broadhollow Bioscience Park 1 Bioscience Park Drive, Farmingdale, NY 11735, US  
KLEINBERG, Andrew, OSI Pharmaceuticals Inc. Broadhollow Bioscience Park 1 Bioscience Park Drive, Farmingdale, NY 11735, US  
LI, An-Hu, OSI Pharmaceuticals Inc. Broadhollow Bioscience Park 1 Bioscience Park Drive, Farmingdale, NY 11735, US  
MA, Lifu, OSI Pharmaceuticals Inc. Broadhollow Bioscience Park 1 Bioscience Park Drive, Farmingdale, NY 11735, US  
MULVIHILL, Mark, J., OSI Pharmaceuticals Inc. Broadhollow Bioscience Park 1 Bioscience Park Drive, Farmingdale, NY 11735, US  
PANICKER, Bijoy, Angion Biomedica Corp. 1050 Stewart Ave., Garden City, NY 11530, US  
SIU, Kam, W., OSI Pharmaceuticals Inc. Broadhollow Bioscience Park 1 Bioscience Park Drive, Farmingdale, NY 11735, US  
STEINIG, Amo, G., OSI Pharmaceuticals Inc. Broadhollow Bioscience Park 1 Bioscience Park Drive, Farmingdale, NY 11735, US  
TARRANT, James, G., Angion Biomedica 1050 Stewart Avenue 230, Garden City, NY 11530, US  
WANG, Jing, OSI Pharmaceuticals Inc. Broadhollow Bioscience Park 1 Bioscience Park Drive, Farmingdale, NY 11735, US  
WENG, Qinghua, OSI Pharmaceuticals Inc. Broadhollow Bioscience Park 1 Bioscience Park Drive, Farmingdale, NY 11735, US  
SANGEM, Rajaram, Chem-Master International Inc. Stony Brook University - Chemistry Building, Stony Brook, NY 11794-3400, US  
GUPTA, Ramesh, C., Chem-Master International Inc. Stony Brook University - Chemistry Building, Stony Brook, NY 11794-3400, US
- 
- (51) MKP  
**A61F 13/02 (2006.01)** (97) **2520257 \***  
**A61M 35/00 (2006.01)**  
**A61K 9/70 (2006.01)**
- (86) JP2010072451 14.12.2010  
(96) 10840875.8 07.11.2012  
(87) WO2011081017, 14.12.2010  
(97) 2520257, 07.11.2012 en
- (54) ADHESIVE TAPE PREPARATION
- (71) Teikoku Seiyaku Co., Ltd., 567 Sanbonmatsu, Higashikagawa-shi, Kagawa 769-2695, JP
- (72) UEMATSU, Masanori, c/o TEIKOKU SEIYAKU CO. LTD. 567 Sanbonmatsu, Higashikagawa-shi Kagawa 769-2695, JP
- 
- (51) MKP  
**C12N 9/02 (2006.01)** (97) **2501804 \***  
**C12N 15/82 (2006.01)**
- (86) EP2010007028 19.11.2010  
(96) 10781843.7 26.09.2012  
(87) WO2011060946, 19.11.2010  
(97) 2501804, 26.09.2012 en
- (54) BRASSICA PLANTS COMPRISING MUTANT FAD3 ALLELES
- (71) Bayer CropScience NV, J.E. Mommaertsiaan 14, 1831 Diegem, BE
- (72) LAGA, Benjamin, Rakestraat 4, B-8750 Wingene, BE  
DENOLF, Peter, Schonenberg 6, B-9620 Velzeke, BE
- 
- (51) MKP  
**A61P 35/00 (2006.01)** (97) **2509593 \***  
**A61P 31/00 (2006.01)**  
**A61K 38/21 (2006.01)**  
**A61P 31/12 (2006.01)**  
**A61K 31/40 (2006.01)**
- (86) US2010059714 09.12.2010  
(96) 10836693.1 17.10.2012  
(87) WO2011072138, 09.12.2010  
(97) 2509593, 17.10.2012 en
- (54) THERAPEUTIC USE OF PROTEIN-POLYMER CONJUGATES
- (71) Pharmaessentia Corp., 13F, No. 3 YuanQu St. NanKang District, Taipei 115, TW
- (72) LIN, Ko-Chung, 253 Lincoln Street, Lexington Massachusetts 02421, US  
WIDMANN, Rudolf, Dr., Wintergasse 85/1B, A-3002 Purkesdorf, AT
- 
- (51) MKP  
**C07D 307/80 (2006.01)** (97) **2521720 \***  
**C07D 307/79 (2006.01)**
- (86) HU2010000143 15.12.2010  
(96) 10809330.3 14.11.2012  
(87) WO2011083346, 15.12.2010  
(97) 2521720, 14.11.2012 en
- (54) NEW PROCESS FOR THE PREPARATION OF DRONEDARONE
- (71) SANOFI, 54, rue de la Boétie, 75008 Paris, FR
- (72) FRIESZ, Antal, c/o Chinoin Gyógyszer és Vegyékék Gyára Zrt. Iparjog, Budapest, Tó u. 1-5. H-1045, HU  
CSATÁRINÉ NAGY, Marianna, c/o Chinoin Gyógyszer és Vegyékék Gyára Zrt. Iparjog, Budapest, Tó u. 1-5. H-1045, HU
- 
- (51) MKP  
**C07D 223/16 (2006.01)** (97) **2534135 \***  
**A61K 31/55 (2006.01)**  
**A61P 9/10 (2006.01)**
- (86) EP2011052068 11.02.2011  
(96) 11702672.4 19.12.2012  
(87) WO2011098582, 11.02.2011  
(97) 2534135, 19.12.2012 en
- (54) NOVEL FORMS OF IVABRADINE HYDROCHLORIDE
- (71) KRKA, D.D., Novo Mesto, Smarjeska cesta 6, 8501 Novo mesto, SI
- (72) KOTAR-JORDAN, Berta, Vodeniska 19, 8311 Kostanjevica na Krki, SI  
GOJAK, Urska, Kotnikova 29, 1000 Ljubljana, SI  
SMRKOLJ, Matej, Orehovica 4, 1411 Izlake, SI

- (51) MKP  
**C07D 403/14 (2006.01)** (97) **2515902 \***  
**A61P 31/14 (2006.01)**  
**A61K 31/4155 (2006.01)**
- (86) US2010062168 27.12.2010  
(96) 10801348.3 31.10.2012  
(87) WO2011079327, 27.12.2010  
(97) 2515902, 31.10.2012 en
- (54) ANALOGUES FOR THE TREATMENT OR PREVENTION OF FLAVIVIRUS INFECTIONS
- (71) Vertex Pharmaceuticals Incorporated, 130 Waverly Street, Cambridge, MA 02139, US
- (72) LIU, Bingcan, 204 St. Aubin Street, Montreal, Québec H4M 2H9, CA  
POISSON, Carl, 1170 de Louvain Est Street, Montreal, Quebec H2M 1B5, CA  
KONG, Laval Chan Chun, 27 Levere Street, Kirkland, Québec H9J 3X8, CA  
DAS, Sanjoy Kumar, 4451 King Street, Pierrefonds, Québec H9H 2G2, CA  
YANNOPOULOS, Constantin, 55 Poncelet Street, Notre-Dame de l'île Perrot, Québec J7V 8X3, CA  
CADILHAC, Caroline, 4376 Oxford, Montreal, Québec H4A 2Y6, CA  
REDDY, T. Jagadeerswar, 12546 Bedford, Pierrefonds, Québec H9A 3K5, CA  
VAILLANCOURT, Louis, 2775 rue des Futaies, Mascouche, Québec J7K 4B8, CA  
FALARDEAU, Guy, 5635 Cleroux Boulevard, Laval, Québec H7X 4A5, CA  
PEREIRA, Oswy W., 12 Daudelin Street, Kirkland, Québec H9J 1L8, CA  
BUBENIK, Monica, 2775 Rue des Futaies, Mascouche, Québec J7K 4B8, CA  
MAXWELL, John, 69 Gilford Road, Hingham, Massachusetts 02043, US

- (51) MKP  
**A61P 11/06 (2006.01)** (97) **2513119 \***  
**A61P 11/00 (2006.01)**  
**C07D 519/00 (2006.01)**  
**A61K 31/519 (2006.01)**  
**A61P 11/08 (2006.01)**
- (86) EP2010069704 15.12.2010  
(96) 10790569.7 24.10.2012  
(87) WO2011073231, 15.12.2010  
(97) 2513119, 24.10.2012 en
- (54) 3,4,4A,10B-TETRAHYDRO-1H-THIOPYRANO-[4, 3-c] ISOQUINOLINE DERIVATIVES
- (71) Nycomed GmbH, Byk-Gulden-Strasse 2, 78467 Konstanz, DE  
(72) FLOCKERZI, Dieter, Ackerweg 26, 78476 Allensbach, DE  
STENGEL, Thomas, Mainaustr. 209c, 78464 Konstanz, DE  
MANN, Alexander, Emilie-Schneider-Str. 2, 78315 Radolfzell, DE  
OHMER, Harald, Alemannenfeld 8, 78224 Singen, DE  
KAUTZ, Ulrich, Prof.-Schmider-Str. 12, 78476 Allensbach, DE  
WEINBRENNER, Steffen, Luzzilonweg 4, 78465 Konstanz, DE  
FISCHER, Stefan, Dr. Kausch Straße 40a, 67251 Freinsheim, DE  
ZITT, Christof, Mainaustr. 209 D, 78464 Konstanz, DE  
HATZELMANN, Armin, Alter Wall 3, 78467 Konstanz, DE  
DUNKERN, Torsten, Humboldtstr. 18, 41363 Jüchen Gierath, DE  
HESSLINGER, Christian, Untere Haldenäcker 6, 78357 Zoznegg, DE  
MAIER, Thomas, Panoramaweg 31, 78333 Stockach, DE  
TENOR, Hermann, Kapellenweg 15/1, 78315 Radolfzell, DE  
BRAUN, Clemens, Sepp-Biehler-Str. 3, 78464 Konstanz, DE  
KÜLZER, Raimund, c/o Nycomed GmbH Byk-Gulden-Str. 2, 78467 Konstanz, DE  
MARX, Degenhard, Obere Reute 15, 78345 Moos, DE

- (51) MKP  
**A23L 1/236 (2006.01)** (97) **2536298 \***  
**A23L 1/30 (2006.01)**  
**A23L 2/52 (2006.01)**  
**A23L 2/60 (2006.01)**  
**A23L 1/09 (2006.01)**
- (86) EP2010006953 16.11.2010  
(96) 10781831.2 26.12.2012  
(87) WO2011101002, 16.11.2010  
(97) 2536298, 26.12.2012 de
- (54) NOVEL SWEETENER COMPOSITIONS
- (71) Krüger GmbH & Co. KG, Senefelderstrasse 44, 51469 Bergisch-Gladbach, DE
- (72) KRÜGER, Willibert, Zaunkönigweg 5, 51467 Bergisch Gladbach, DE

- (51) MKP  
**A61K 9/00 (2006.01)** (97) **2501384 \***  
**A61K 31/506 (2006.01)**  
**A61P 35/00 (2006.01)**
- (86) US2010056926 17.11.2010  
(96) 10781781.9 26.09.2012  
(87) WO2011062927, 17.11.2010  
(97) 2501384, 26.09.2012 en
- (54) METHOD OF TREATING PROLIFERATIVE DISORDERS AND OTHER PATHOLOGICAL CONDITIONS MEDIATED BY BCR-ABL, C-KIT, DDR1, DDR2 OR PDGF-R KINASE ACTIVITY
- (71) Novartis AG, Lichtstrasse 35, 4056 Basel, CH  
(72) GALLAGHER, Neil, Novartis Pharma AG Postfach, CH-4002 Basel, CH  
YIN, Ophelia, 66 Henning Terrace, Denville New Jersey 07834, US

- (51) MKP  
**C07D 209/16 (2006.01)** (97) **2516394 \***  
**C07D 209/10 (2006.01)**  
**C07D 209/14 (2006.01)**
- (86) DK2010050348 20.12.2010  
(96) 10803222.8 31.10.2012  
(87) WO2011076212, 20.12.2010  
(97) 2516394, 31.10.2012 en
- (54) PROCESSES FOR THE MANUFACTURE OF A PHARMACEUTICALLY ACTIVE AGENT
- (71) H. Lundbeck A/S, Ottiliavej 9, 2500 Valby, DK  
(72) THERKELSEN, Frans, Gærdet 10, DK-4300 Holbæk, DK  
ROCK, Michael, Harold, Frederiksberg Allé 47, DK-1820 Frederiksberg C., DK  
TREPPEHAHL, Svend, Frederiksdalsvej 221, DK-2830 Virum, DK

- (51) MKP  
**F02G 5/02 (2006.01)** (97) **2519728 \***  
**F02G 1/04 (2006.01)**
- (86) FR2010052868 22.12.2010  
(96) 10808914.5 07.11.2012  
(87) WO2011080467, 22.12.2010  
(97) 2519728, 07.11.2012 fr
- (54) HEAT ENGINE WITH EXTERNAL HEAT SOURCE AND ASSOCIATED POWER GENERATION UNIT AND VEHICLE
- (71) Thevenod, Frédéric Olivier, 2bis rue du Bouloi, 75001 Paris, FR  
(72) Thevenod, Frédéric Olivier, 2bis rue du Bouloi, 75001 Paris, FR

(51) MKP  
**A61K 39/395 (2006.01)** (97) **2509627 \***  
 (86) US2010059221 07.12.2010  
 (96) 10836513.1 17.10.2012  
 (87) WO2011071871, 07.12.2010  
 (97) 2509627, 17.10.2012 en  
 (54) METHODS FOR ENHANCING ANTI-TUMOR ANTIBODY THERAPY  
 (71) The Board of Trustees of the Leland Stanford Junior University, 1705 El Camino Real, Palo Alto CA 94306-1106, US  
 (72) KOHRT, Holbrook, 38 Genoa Place, San Francisco California 94133, US  
 HOUOT, Roch, 5 rue Alfred de Musset, F-35700 Rennes, FR  
 LEVY, Ronald, 966 Mears Court, Stanford California 94305, US  
 ALIZADEH, Arash Ash, Stanford University Department of Medicine Division of Oncology and Hematology Lorry Lokey Building SIM1 Room G2120B, Stanford, CA 94305, US  
 GOLDSTEIN, Matthew J., 840 Longview Road, Hillsborough California 94010, US  
 TORCHIA, James, 269 Campus Drive, Stanford California 94305, US

(51) MKP  
**F03B 17/00 (2006.01)** (97) **2520801**  
**F03G 7/10 (2006.01)**  
 (96) 11003694.4 07.11.2012  
 (97) 2520801, 07.11.2012 de  
 (54) Residual energy through displacement (renewable energy)  
 (71) Rybka, Bodo, Vettweisser Strasse 41, 52391 Vettweiss, DE  
 (72) Rybka, Bodo, Vettweisser Strasse 41, 52391 Vettweiss, DE

(51) MKP  
**F02M 25/07 (2006.01)** (97) **2524116 \***  
**F01N 3/28 (2006.01)**  
**F01N 3/20 (2006.01)**  
**F01N 3/035 (2006.01)**  
 (86) EP2011050400 13.01.2011  
 (96) 11700916.7 21.11.2012  
 (87) WO2011086129, 13.01.2011  
 (97) 2524116, 21.11.2012 en  
 (54) COMPRESSION-IGNITION ENGINE WITH EXHAUST SYSTEM  
 (71) Delphi Technologies Holding S.a.r.l., Avenue de Luxembourg, 4940 Bascharage, LU  
 (72) SCHREURS, Bart, 69 Rue du Pannebourg, B-6700 Arlon, BE

(51) MKP  
**A61K 31/33 (2006.01)** (97) **2519527 \***  
**C07D 495/04 (2006.01)**  
**A61P 3/10 (2006.01)**  
 (86) EP2010070811 28.12.2010  
 (96) 10800766.7 07.11.2012  
 (87) WO2011080277, 28.12.2010  
 (97) 2519527, 07.11.2012 en  
 (54) THIENO [2,3-B]PYRIDINEDIONE ACTIVATORS OF AMPK AND THERAPEUTIC USES THEREOF  
 (71) Poxel, 200 avenue Jean Jaurès, 69007 Lyon, FR  
 (72) CRAVO, Daniel, 18 bis chemin des Murgers, F-78360 Montesson, FR  
 HALLAKOU-BOZEC, Sophie, 166 avenue Henri Ginoux, F-92120 Montrouge, FR  
 BOLZE, Sébastien, 382 chemin des Dorriers, F-01600 Massieux, FR  
 LEPIFRE, Franck, 3 rue Arthur Rimbaud, F-91400 Saclay, FR  
 FAVERIEL, Laurent, 27 rue Copernic, F-91160 Longjumeau, FR  
 DURAND, Jean-Denis, 85 rue de Paris, F-93100 Montreuil-Sous-Bois, FR  
 CHARON, Christine, 1 chemin de la Justice, F-91940 Gometz-Le-Chatel, FR

(51) MKP  
**H05B 3/58 (2006.01)** (97) **2519121 \***  
**A24F 47/00 (2006.01)**  
 (86) EP2010007875 22.12.2010  
 (96) 10803240.0 07.11.2012  
 (87) WO2011079932, 22.12.2010  
 (97) 2519121, 07.11.2012 en  
 (54) AN IMPROVED HEATER FOR AN ELECTRICALLY HEATED AEROSOL GENERATING SYSTEM  
 (71) Philip Morris Products S.A., Quai Jeanrenaud 3, 2000 Neuchâtel, CH  
 (72) THORENS, Michel, Les Combremonts 24, CH-1510 Moudon, CH  
 FLICK, Jean-Marc, Rue de la Poste 3, CH-1405 Pomy, CH  
 COCHAND, Olivier, Yves, Faubourg 30, CH-2056 Dombresson, CH  
 DUBIEF, Flavien, Rue du Rocher 52, CH-2000 Neuchatel, CH

(51) MKP  
**B01J 21/00 (2006.01)** (97) **2521613 \***  
 (86) US2011020116 04.01.2011  
 (96) 11728562.7 14.11.2012  
 (87) WO2011082418, 04.01.2011  
 (97) 2521613, 14.11.2012 en  
 (54) SCALABLE PRODUCTION OF PRECISION HYDROCARBONS FROM TRIALKYLALUMINUM VIA TERNARY LIVING COORDINATIVE CHAIN TRANSFER POLYMERIZATION  
 (71) University of Maryland, College Park, 0133 Cole Student Activities Building, College Park, Maryland 20742-1001, US  
 (72) SITA, Lawrence, R., 1425 Crestridge Drive, Silver Spring, MD 20910, US  
 WEI, Jia, 11316 Evans Trail Apt. 202, Beltsville, MD 20705, US

(51) MKP  
**F27D 1/14 (2006.01)** (97) **2510299 \***  
 (86) CA2010001938 08.12.2010  
 (96) 10835336.8 17.10.2012  
 (87) WO2011069251, 08.12.2010  
 (97) 2510299, 17.10.2012 en  
 (54) MOLTEN METAL-CONTAINING VESSEL AND METHODS OF PRODUCING SAME  
 (71) Novelis, Inc., 191 Evans Avenue, Toronto, ON M8Z 1J5, CA  
 (72) REEVES, Eric W., 4683 E. Hudlow Road, Hayden Lake Idaho 83835, US  
 BOORMAN, James E., 2207 N. Flora, Greenacres Washington 99016, US  
 BRUSKI, Richard Scott, 8406 E. Sandalwood Lane, Spokane Washington 99217, US

(51) MKP  
**A61K 31/44 (2006.01)** (97) **2509586 \***  
**A61K 31/00 (2006.01)**  
**A61K 47/36 (2006.01)**  
**A61K 9/20 (2006.01)**  
 (86) EP2010069313 09.12.2010  
 (96) 10792884.8 17.10.2012  
 (87) WO2011070125, 09.12.2010  
 (97) 2509586, 17.10.2012 en  
 (54) MUCOADHESIVE BUCCAL TABLETS FOR THE TREATMENT OF OROFACIAL HERPES  
 (71) BioAlliance Pharma, 49, boulevard du Général Martial Valin, 75015 Paris, FR  
 (72) ATTALI, Pierre, 2 rue du lieutenant Heitz, F-94300 Vincennes, FR  
 COSTANTINI, Dominique, 284 boulevard Raspail, F-75014 Paris, FR  
 LEMARCHAND, Caroline, 11 bis rue Maison Dieu, F-75014 Paris, FR

- (51) MKP  
**C08L 5/08 (2006.01)** (97) **2501754 \***  
**C08K 11/00 (2006.01)**  
**A61K 35/14 (2006.01)**  
**C08K 3/00 (2006.01)**
- (86) CA2010001842 18.11.2010  
(96) 10831000.4 26.09.2012  
(87) WO2011060544, 18.11.2010  
(97) 2501754, 26.09.2012 en  
(54) NOVEL FORMULATION OF PHYSIOLOGICAL CHITOSAN-INORGANIC SALT SOLUTION/BLOOD MIXTURES FOR TISSUE REPAIR
- (71) Corporation De L'école Polytechnique De Montréal, 2900 boul. Édouard-Montpetit Campus de l'Université de Montréal 2500 chemin de Polytechnique, Montréal, Québec H3T 1J4, CA  
(72) OUYANG, Wei, 5000 Clanranald Apt. 301, Montréal, Québec H3X 2S2, CA  
BUSCHMANN, Michael, 4329 King Edward, Montréal, Québec H4B 2H4, CA  
HOEMANN, Caroline, 4329 King Edward, Montréal, Québec H4B 2H4, CA  
LAVERTU, Marc, 139 Broadview, Pointe-Claire, Québec H9R 3Z5, CA  
CHEVRIER, Anik, 24 De Compton Crescent, Pointe-Claire, Québec H9R 5V5, CA
- 
- (51) MKP  
**A61L 31/14 (2006.01)** (97) **2506887 \***  
**A61L 31/16 (2006.01)**  
**A61L 31/06 (2006.01)**
- (86) GB2010002219 02.12.2010  
(96) 10801196.6 10.10.2012  
(87) WO2011067569, 02.12.2010  
(97) 2506887, 10.10.2012 en  
(54) BIODEGRADABLE STENT COMPRISING AN ACID SCAVENGING AGENT
- (71) Arterius Limited, 64 Broomfield, Leeds, W York LS16 7AD, GB  
(72) AL-LAMEE, Kadem, Gayad, Arterius Limited 64 Broomfield Leeds, W York LS16 7AD, GB
- 
- (51) MKP  
**A61K 31/506 (2006.01)** (97) **2475653 \***  
**C07D 403/06 (2006.01)**  
**A61P 35/00 (2006.01)**  
**C07D 413/14 (2006.01)**  
**A61K 31/4439 (2006.01)**  
**C07D 401/14 (2006.01)**  
**A61K 31/541 (2006.01)**  
**C07D 403/14 (2006.01)**  
**C07D 401/04 (2006.01)**  
**A61K 31/5377 (2006.01)**  
**C07D 405/14 (2006.01)**
- (86) EP2010005297 28.08.2010  
(96) 10747836.4 18.07.2012  
(87) WO2011029537, 28.08.2010  
(97) 2475653, 18.07.2012 en  
(54) SUBSTITUTED ( HETEROARYLMETHYL ) THIOHYDANTOINS AS ANTICANCER DRUGS
- (71) Bayer Intellectual Property GmbH, Alfred-Nobel-Strasse 10, 40789 Monheim, DE  
(72) LÜCKING, Ulrich, Paula-Fürst-Str. 2, 10317 Berlin, DE  
CLEVE, Arwed, Konstanzer Str. 8, 10707 Berlin, DE  
HAENDLER, Bernard, Am Biberbau 8, 13465 Berlin, DE  
FAUS GIMENEZ, Hortensia, Stargarder Str. 74, 10437 Berlin, DE  
KÖHR, Silke, Fritz-Reuter-Allee 146, 12359 Berlin, DE  
IRLBACHER, Horst, Immanuelkirchstr. 2, 10405 Berlin, DE
- 
- (51) MKP  
**E06B 9/386 (2006.01)** (97) **2510178 \***  
**G02B 17/00 (2006.01)**  
**E06B 9/264 (2006.01)**
- (86) IT2010000408 27.09.2010  
(96) 10774009.4 17.10.2012  
(87) WO2012032551, 27.09.2010  
(97) 2510178, 17.10.2012 en  
(54) GLASS-ENCLOSED CHAMBER AND INTERNAL VENETIAN BLIND HAVING SLATS OF IMPROVED REFLECTANCE AND DIFFUSIVITY OVER A WIDER SPECTRAL INTERVAL OF INCIDENT SOLAR RADIATION
- (71) Pellini S.p.A., Via Fusari 19, 26845 Codogno (Lodi), IT  
(72) PELLINI Alessandro, Vicolo Monfenera 9, 26045 CODOGNO (Lodi), IT  
NICOLOSI Giovanni, Via G. Di Vittorio 4, 20070 DRESANO (Milano), IT  
GENTILI Massimo, Piazza Dei Daini 4, 20126 MILANO (Mi), IT
- 
- (51) MKP  
**C09C 1/02 (2006.01)** (97) **2537900**  
**C01F 11/18 (2006.01)**
- (96) 11170652.9 26.12.2012  
(97) 2537900, 26.12.2012 en  
(54) Process for the production of precipitated calcium carbonate, precipitated calcium carbonate and uses thereof
- (71) Ormya Development AG, Baslerstrasse 42, 4665 Oftringen, CH  
(72) Skrzypczak, Mathieu, 92A Avenue de Bâle, 68300 Saint-Louis, FR  
Maurer, Marc, 8 rue de la Pyramide, 68128 Village-Neuf, FR  
Schmölzer, Thomas, Hauptschulstrasse 6/6, 9523 Landskron, AT
- 
- (51) MKP  
**A61K 31/4192 (2006.01)** (97) **2521545 \***
- (86) US2010062085 23.12.2010  
(96) 10842756.8 14.11.2012  
(87) WO2011084848, 23.12.2010  
(97) 2521545, 14.11.2012 en  
(54) PRODRUGS OF HETERAROMATIC COMPOUNDS
- (71) Alkermes, Inc., 852 Winter Street, Waltham, MA 02451, US  
(72) BLUMBERG, Laura, Cook, 37 Mill Street, Lincoln MA 01773, US  
ALMARRSON, Orn, 22 Farmington Drive, Shrewsbury MA 01545, US
- 
- (51) MKP  
**C09K 8/03 (2006.01)** (97) **2450416**  
**C09K 8/40 (2006.01)**  
**C09K 8/42 (2006.01)**  
**E21B 21/00 (2006.01)**
- (96) 10290552.8 09.05.2012  
(97) 2450416, 09.05.2012 en  
(54) Methods and compositions for suspending fluids in a wellbore
- (71) Services Pétroliers Schlumberger, 42, rue Saint Dominique, 75007 Paris, FR  
Schlumberger Technology B.V. (STBV), Parkstraat 83-89, 2514 JG The Hague, NL  
Schlumberger Holdings Limited, P.O. Box 71 Craigmuir Chamber Road Town, Tortola, VG  
PRAD Research and Development Limited, P.O. Box 71 Craigmuir Chambers, Road Town, Tortola, VG  
(72) Daccord, Gérard, 7, Rue Des Caves, 91439 Vauhallan, FR  
Chougnet-Sirapian, Alice, 11, Allée Du Parc De La Bièvre, 94249 L'Hay Les Roses, FR
-

- (51) MKP  
**A61P 35/00 (2006.01)** (97) **2501413 \***  
**C08G 65/08 (2006.01)**  
**A61K 47/48 (2006.01)**  
**C08G 65/14 (2006.01)**  
**C08G 65/26 (2006.01)**  
(86) US2010057289 18.11.2010  
(96) 10782159.7 26.09.2012  
(87) WO2011063156, 18.11.2010  
(97) 2501413, 26.09.2012 en  
(54) ACID SALT FORMS OF POLYMER-DRUG CONJUGATES AND ALKOXYLATION METHODS  
(71) Nektar Therapeutics, 455 Mission Bay Boulevard South Suite 100, San Francisco, CA 94158, US  
(72) CHONG, Anthony, O., 117 Windridge Way SW, Huntsville, AL 35824, US  
LEE, Seojun, 108 Alisha Circle, Madison, AL 35756, US  
JOSHI, Bhalchandra, V., 1211 Willowbrook Drive 2, Huntsville, AL 35802, US  
BRAY, Brian, 512 Farmingdale Road, Huntsville, AL 35802, US  
NIE, Shaoyong, 922 Willowbrook Drive 6, Huntsville, AL 35802, US  
SPENCE, Patrick, 110 Porch Light Place, Madison, AL 35756, US  
KOZLOWSKI, Antoni, 2103 Greenslope Trail, Huntsville, AL 35811, US  
MCMANUS, Samuel, 8867 Tacoma Trail, Huntsville, AL 35802, US  
TIPNIS, Sachin, 12850 Whittington Drive 1506, Houston, TX 77077, US  
LAVATY, Greg, 826 Bel Mar Street, Sugar Land, TX 77478, US  
SWALLOW, David, 9407 Funchrch Drive, Spring, TX 77379, US

- (51) MKP  
**E04C 2/04 (2006.01)** (97) **2507442 \***  
(86) US2010055375 04.11.2010  
(96) 10834914.3 10.10.2012  
(87) WO2011068617, 04.11.2010  
(97) 2507442, 10.10.2012 en  
(54) BASALT COMPOSITE PANEL  
(71) AA Technology LLC, 2624 Salem Street, Lafayette, Indiana 47904, US  
(72) HANUSA, Lotar, 6966 Edgerton Avenue, Pittsburgh Pennsylvania 15208, US  
THAN, Maung, Aye, 2624 Salem Street, Lafayette Indiana 47904, US

- (51) MKP  
**C07J 19/00 (2006.01)** (97) **2523966 \***  
**A61K 31/585 (2006.01)**  
**A61P 35/00 (2006.01)**  
(86) CN2011000065 14.01.2011  
(96) 11732631.4 21.11.2012  
(87) WO2011085641, 14.01.2011  
(97) 2523966, 21.11.2012 en  
(54) CERTAIN CHEMICAL ENTITIES, COMPOSITIONS, AND METHODS  
(71) Suzhou Neupharma Co., Ltd, Suite A3-307 218 Xinghu Road Suzhou Industrial Park, Suzhou, Jiangsu 215123, CN  
(72) QIAN, Xiangping, 114 Mira St., Foster City, California 94404, US

- (51) MKP  
**A61K 38/37 (2006.01)** (97) **2506868 \***  
(86) US2010059136 06.12.2010  
(96) 10835255.0 10.10.2012  
(87) WO2011069164, 06.12.2010  
(97) 2506868, 10.10.2012 en  
(54) FACTOR VIII-FC CHIMERIC AND HYBRID POLYPEPTIDES, AND METHODS OF USE THEREOF  
(71) BIOGEN IDEC HEMOPHILIA INC., 9 Fourth Avenue, Waltham, MA 02451, US  
(72) DUMONT, Jennifer, A., 37 Fawn Terrace Lane, Groton MA 01450, US  
LOW, Susan, 87 Brookline Street, Pepperill MA 01463, US  
BITONTI, Alan, J., 32 Carlton Drive, Acton MA 01720, US  
PIERCE, Glenn, PO Box 675486, Rancho Santa Fe CA 92067, US  
LUK, Alvin, 101 Canal Street N907, Boston MA 02114-1897, US  
JIANG, Haiyan, 3 Bayberry Lane, Belmont MA 02478, US  
MCKINNEY, Byron, 7234 Shoreline Drive 156, San Diego CA 92122, US  
OTTMER, Matt, 112 Gibbs Street, Newton MA 02459, US  
SOMMER, Jurg, 30 Hampshire Road, Wayland, MA 01778, US  
NUGENT, Karen, Owlswick Farmhouse Owlswick, Princes Risborough Buckinghamshire HP27 9RH, GB  
LI, Lian, 10 Carol Lane, Lexington MA 02420, US  
PETERS, Robert, 51 New Filed Street, West Roxbury MA 02132, US

- (51) MKP  
**A61B 17/32 (2006.01)** (97) **2533707 \***  
(86) US2011024209 09.02.2011  
(96) 11704381.0 19.12.2012  
(87) WO2011100338, 09.02.2011  
(97) 2533707, 19.12.2012 en  
(54) OUTER SHEATH AND BLADE ARRANGEMENTS FOR ULTRASONIC SURGICAL INSTRUMENTS  
(71) Ethicon Endo-Surgery, Inc., 4545 Creek Road, Cincinnati, OH 45242, US  
(72) ROBERTSON, Galen, C., 5752 Doerger Lane, Cincinnati, OH 45212, US  
MILLER, Matthew, C., 3524 Zumstein Avenue, Cincinnati, OH 45208, US  
MALAVIYA, Prasanna, 5860 Maxfli Lane, Mason, OH 45040, US

- (51) MKP  
**B60K 6/46 (2007.10)** (97) **2428384**  
**B60K 25/06 (2006.01)**  
**B60K 17/28 (2006.01)**  
**B60K 6/44 (2007.10)**  
**F16H 3/091 (2006.01)**  
(96) 11173706.0 14.03.2012  
(97) 2428384, 14.03.2012 de  
(54) Power train for vehicles with power take-off shafts for driving additional devices  
(71) REFORM-WERKE BAUER & CO. GESELLSCHAFT M.B.H., Haidestrasse 40, A-4600 Wels, AT  
(72) Gattermair, Gerhard, Wintersberg 10, 4710 Schlüsselberg, AT

- (51) MKP  
**D21H 17/67 (2006.01)** (97) **2392622**  
**C09C 1/02 (2006.01)**  
(96) 10165053.9 07.12.2011  
(97) 2392622, 07.12.2011 en  
(54) Use of 2-aminoethanol as additive in aqueous suspensions of calcium carbonate comprising materials  
(71) Omya Development AG, Baslerstrasse 42, 4665 Oftringen, CH  
(72) Buri, Matthias, Mätteliweg 20, 4852 Rothrist, CH  
Rentsch, Samuel, Höhweg 1, 4663 Aarburg, CH  
Gane, Patrick A.C., Studenweg 8, 4852 Rothrist, CH

- (51) MKP  
**A61K 31/196 (2006.01)** (97) **2521713 \***  
**A61P 29/00 (2006.01)**  
**A61K 31/10 (2006.01)**  
**C07C 323/59 (2006.01)**  
**A61P 11/06 (2006.01)**
- (86) US2011020264 05.01.2011  
(96) 11732103.4 14.11.2012  
(87) WO2011085033, 05.01.2011  
(97) 2521713, 14.11.2012 en  
(54) DP2 ANTAGONIST AND USES THEREOF  
(71) Panmira Pharmaceuticals, LLC, 9535 Waples Street, Suite 100, San Diego, CA 92121, US  
(72) BRITTAIN, Jason, Edward, 1580 Chiswick Court, El Cajon CA 92020, US  
KING, Christopher, David, 7396 Escallonia Court, Carlsbad CA 92011, US  
STEARNS, Brian, Andrew, 157 Beechtree Drive, Encinitas CA 92024, US

- (51) MKP  
**A61M 5/24 (2006.01)** (97) **2531235 \***  
**A61M 5/32 (2006.01)**  
**A61M 5/28 (2006.01)**
- (86) EP2011051393 01.02.2011  
(96) 11701523.0 12.12.2012  
(87) WO2011095478, 01.02.2011  
(97) 2531235, 12.12.2012 en  
(54) FLEXIBLE RESERVOIR FOR A MEDICATED MODULE  
(71) Sanofi-Aventis Deutschland GmbH, Brüningstraße 50, 65929 Frankfurt, DE  
(72) BOYD, Malcolm Stanley, 28 Whitehead Drive, Wellsbourne Warwickshire CV35 9PW, GB  
DAVIES, James Alexander, 7 Old School Mews Cubbington Road, Leamington Spa Warwickshire CV32 7XB, GB  
WALLACE, Andrew Gordon, The Old Gardens, Highleadon Gloucestershire GL18 1HJ, GB  
SANDERS, David, Kettlewell Close Woodloes Park, Warwick Warwickshire CV34 5XE, GB

- (51) MKP  
**A61K 31/56 (2006.01)** (97) **2504012 \***  
**A61K 47/44 (2006.01)**  
**A61K 9/00 (2006.01)**  
**A61K 9/06 (2006.01)**
- (86) EP2010068157 24.11.2010  
(96) 10784299.9 03.10.2012  
(87) WO2011064271, 24.11.2010  
(97) 2504012, 03.10.2012 de  
(54) USE OF AN OLEO GEL CONTAINING TRITERPENE FOR HEALING WOUNDS  
(71) Birken AG, Streiflingsweg 11, 75223 Niefern-Öschelbronn, DE  
(72) SCHEFFLER, Armin, Forststraße 7, 75229 Niefern-Öschelbronn, DE

- (51) MKP  
**A61K 31/496 (2006.01)** (97) **2509600 \***  
**C07D 405/12 (2006.01)**  
**A61K 31/551 (2006.01)**  
**C07D 243/08 (2006.01)**  
**A61K 31/495 (2006.01)**  
**A61P 35/00 (2006.01)**  
**A61K 31/506 (2006.01)**
- (86) US2010059778 09.12.2010  
(96) 10796233.4 17.10.2012  
(87) WO2011072174, 09.12.2010  
(97) 2509600, 17.10.2012 en  
(54) THERAPEUTICALLY ACTIVE COMPOUNDS FOR USE IN THE TREATMENT OF CANCER CHARACTERIZED AS HAVING AN IDH MUTATION  
(71) Agios Pharmaceuticals, Inc., 38 Sidney Street, Cambridge, MA 02139, US  
(72) SALITURO, Francesco, G., 25 Baker Drive, Marlborough MA 01752, US  
SAUNDERS, Jeffrey, O., 117 Seymour Street, Concord MA 01742, US

- (51) MKP  
**C07D 231/40 (2006.01)** (97) **2509956 \***  
**A61P 11/06 (2006.01)**  
**C07D 277/46 (2006.01)**  
**A61K 31/4155 (2006.01)**  
**A61P 37/02 (2006.01)**  
**A61K 31/4164 (2006.01)**  
**A61P 37/08 (2006.01)**  
**A61K 31/42 (2006.01)**  
**C07C 271/20 (2006.01)**  
**A61K 31/415 (2006.01)**  
**A61P 21/04 (2006.01)**  
**A61K 31/27 (2006.01)**  
**A61P 17/06 (2006.01)**  
**C07D 405/12 (2006.01)**  
**A61P 9/10 (2006.01)**  
**C07D 261/14 (2006.01)**  
**A61K 31/426 (2006.01)**  
**C07D 233/88 (2006.01)**
- (86) IB2010055732 10.12.2010  
(96) 10835593.4 17.10.2012  
(87) WO2011070539, 10.12.2010  
(97) 2509956, 17.10.2012 en  
(54) CYSTEINE PROTEASE INHIBITORS  
(71) Medivir UK Ltd, The Mansion Chesterford Research Park, Little Chesterford Essex CB10 1XL, GB  
(72) AYESA, Susana, Medivir AB PO Box 1086, S-141 22 Huddinge, SE  
ERSMARK, Karolina, Medivir AB PO Box 1086, S-141 22 Huddinge, SE  
GRABOWSKA, Urszula, Medivir AB PO Box 1086, S-141 22 Huddinge, SE  
HEWITT, Ellen, Medivir AB PO Box 1086, S-141 22 Huddinge, SE  
JÖNSSON, Daniel, Medivir AB PO Box 1086, S-141 22 Huddinge, SE  
KAHNBERG, Pia, Medivir AB PO Box 1086, S-141 22 Huddinge, SE  
KLASSON, Björn, Medivir AB PO Box 1086, S-141 22 Huddinge, SE  
LIND, Peter, Medivir AB PO Box 1086, S-141 22 Huddinge, SE  
LUNDGREN, Stina, Medivir AB PO Box 1086, S-141 22 Huddinge, SE  
ODÉN, Lourdes, Medivir AB PO Box 1086, S-141 22 Huddinge, SE  
PARKES, Kevin, Medivir AB PO Box 1086, S-141 22 Huddinge, SE  
WIKTELIUS, Daniel, Medivir AB PO Box 1086, S-141 22 Huddinge, SE

- (51) MKP  
**C07D 493/04 (2006.01)** (97) **2530165 \***  
**C12N 15/09 (2006.01)**  
**C12P 17/18 (2006.01)**
- (86) JP2011050853 19.01.2011  
(96) 11736901.7 05.12.2012  
(87) WO2011093187, 19.01.2011  
(97) 2530165, 05.12.2012 en  
(54) METHOD FOR PRODUCING PYRIPYROPENE DERIVATIVE BY ENZYMATIC PROCESS  
(71) Meiji Seika Pharma Co., Ltd., 4-16, Kyobashi 2-Chome., Chuo-ku Tokyo, JP  
(72) YAMAMOTO Kentaro, c/o Meiji Seika Pharma Co, Ltd. 760 Morooka-cho Kohoku-ku, Yokohama-shi Kanagawa 222-8567, JP  
TSUCHIDA Mariko, c/o Meiji Seika Pharma Co, Ltd. 760 Morooka-cho Kohoku-ku, Yokohama-shi Kanagawa 222-8567, JP  
OYAMA Kazuhiko, c/o Meiji Seika Pharma Co, Ltd. 760 Morooka-cho Kohoku-ku, Yokohama-shi Kanagawa 222-8567, JP  
GOTO Kimihiko, c/o Meiji Seika Pharma Co, Ltd. 760 Morooka-cho Kohoku-ku, Yokohama-shi Kanagawa 222-8567, JP  
MITOMI Masaaki, c/o Meiji Seika Pharma Co, Ltd. 760 Morooka-cho Kohoku-ku, Yokohama-shi Kanagawa 222-8567, JP

(51) MKP  
**A61G 5/04 (2006.01)** (97) **2531157 \***  
**B62D 55/075 (2006.01)**  
**B62D 61/10 (2006.01)**  
(86) FR2011050250 07.02.2011  
(96) 11707465.8 12.12.2012  
(87) WO2011095753, 07.02.2011  
(97) 2531157, 12.12.2012 fr  
(54) DEVICE ENABLING AN ELECTRIC WHEELCHAIR TO CROSS OBSTACLES  
(71) New Live, 3 rue de Sultz, 67510 Climbach, FR  
(72) OHRUH, Michel, 11b rue de Wissembourg, F-67510 Climbach, FR

(51) MKP  
**A61K 9/44 (2006.01)** (97) **2525788 \***  
**A61K 9/32 (2006.01)**  
**A61K 31/27 (2006.01)**  
(86) EP2011050633 18.01.2011  
(96) 11705469.2 28.11.2012  
(87) WO2011089126, 18.01.2011  
(97) 2525788, 28.11.2012 en  
(54) NOVEL RETIGABINE COMPOSITION  
(71) Glaxo Group Limited, Glaxo Wellcome House Berkeley Avenue Greenford, Middlesex UB6 0NN, GB  
(72) BURKE, Matthew, GlaxoSmithKline 5 Moore Drive Research Triangle Park Durham, NC 27709, US  
RHODES, Charles, Harding, GlaxoSmithKline 5 Moore Drive Research Triangle Park Durham, NC 27709, US

(51) MKP  
**C07C 43/23 (2006.01)** (97) **2501669 \***  
**A61K 31/09 (2006.01)**  
**C07C 62/34 (2006.01)**  
**A61K 31/125 (2006.01)**  
**C07C 43/215 (2006.01)**  
**A61K 31/216 (2006.01)**  
**A61K 31/192 (2006.01)**  
**C07D 311/80 (2006.01)**  
**A61P 25/00 (2006.01)**  
**C07C 49/753 (2006.01)**  
**A61P 25/28 (2006.01)**  
**A61K 31/352 (2006.01)**  
**A61P 19/00 (2006.01)**  
**C07C 69/757 (2006.01)**  
**A61P 25/04 (2006.01)**  
(86) IL2010000970 18.11.2010  
(96) 10795060.2 26.09.2012  
(87) WO2011061744, 18.11.2010  
(97) 2501669, 26.09.2012 en  
(54) NOVEL ARYLATED CAMPHENES, PROCESSES FOR THEIR PREPARATION AND USES THEREOF  
(71) Yissum Research Development Company of the Hebrew University of Jerusalem, Ltd., Hi Tech Park Edmond Safra Campus Givat Ram, Jerusalem 91390, IL  
(72) MECHOULAM, Raphael, 12 Tchernichovsky St., 92581 Jerusalem, IL  
MAGID, Lital, Gelber St. 20/11, Jerusalem 96755, IL  
SHOHAMI, Esther, 34/1 Meron St., 90805 Mevasseret Zion, IL  
BAB, Itai, 26 Hateena St., 99797 Carmei Yossef, IL

(51) MKP  
**E01C 7/26 (2006.01)** (97) **2441887**  
**E01C 7/32 (2006.01)**  
**E01C 11/16 (2006.01)**  
(96) 10187752.0 18.04.2012  
(97) 2441887, 18.04.2012 en  
(54) Heat-resistant road paving and relative manufacturing process  
(71) Impresa Bacchi S.r.l., Via Trieste 6, 20097 San Donato Milanese (Milan), IT  
(72) Bacchi, Mauro, Via Don Giuseppe Dossetti, 19, 20080 Carpiano (MI), IT  
Da Rios, Giovanni, c/o Politecnico di Milano Piazza Leonardo da Vinci, 32, 20133 Milano, IT  
Crispino, Maurizio, c/o Politecnico di Milano Piazza Leonardo da Vinci, 32, 20133 Milano, IT  
Toraldo, Emanuele, c/o Politecnico di Milano Piazza Leonardo da Vinci, 32, 20133 Milano, IT  
Fiori, Federico, c/o Politecnico di Milano Piazza Leonardo da Vinci, 32, 20133 Milano, IT  
Bacchi, Matteo Giorgio, c/o Politecnico di Milano Piazza Leonardo da Vinci, 32, 20133 Milano, IT

(51) MKP  
**A01N 43/90 (2006.01)** (97) **2531035 \***  
**A01P 13/00 (2006.01)**  
**A01N 47/36 (2006.01)**  
(86) US2011023274 01.02.2011  
(96) 11702771.4 12.12.2012  
(87) WO2011097191, 01.02.2011  
(97) 2531035, 12.12.2012 en  
(54) SYNERGISTIC HERBICIDAL COMPOSITION CONTAINING PENOXSULAM AND FLAZASULFURON  
(71) Dow AgroSciences LLC, 9330 Zionsville Road, Indianapolis, IN 46268, US  
(72) HUFNAGL, Andrea, 150 Alee des Magnans, 06370 Mouans-Sartoux, FR  
MANN, Richard, 1828 South 550 East, Franklin, IN 46131, US

(51) MKP  
**G06Q 10/00 (2012.01)** (97) **2517158 \***  
**G06F 17/30 (2006.01)**  
(86) EP2010007873 22.12.2010  
(96) 10805210.1 31.10.2012  
(87) WO2011076406, 22.12.2010  
(97) 2517158, 31.10.2012 en  
(54) METHOD AND APPARATUS FOR DEFINING MANUFACTURED ITEMS AND STORING DATA RELATING TO THE MANUFACTURED ITEMS  
(71) Philip Morris Products S.A., Quai Jeanrenaud 3, 2000 Neuchâtel, CH  
(72) FRADET, Erwan, Chemin du Grabe 3A, 1091 Grandvaux, CH  
SAGER, Alain, Route de Reynet 4, CH-1615 Bossonnens, CH  
MAUROUX, Patrick, Route de Plattiez 3, CH-1670 Ursy, CH  
CHANEZ, Patrick, Rte d'Yverdon-les Bains 405, CH-1468 Cheyres, CH  
CHATELAIN, Philippe, Chemin de Chaudremont 12a, CH-1373 Chavornay, CH

(51) MKP  
**C07D 407/12 (2006.01)** (97) **2519504 \***  
**C07D 413/12 (2006.01)**  
**A61K 31/4709 (2006.01)**  
**A61P 31/10 (2006.01)**  
**C07D 215/48 (2006.01)**  
**C07D 401/12 (2006.01)**  
**C07D 417/12 (2006.01)**  
**C07D 409/12 (2006.01)**  
(86) EP2010070793 28.12.2010  
(96) 10798129.2 07.11.2012  
(87) WO2011080266, 28.12.2010  
(97) 2519504, 07.11.2012 en  
(54) NEW SECONDARY 8-HYDROXYQUINOLINE-7-CARBOXAMIDE DERIVATIVES.  
(71) Polichem SA, 50, Val Fleuri, 1526 Luxembourg, LU  
(72) GAGLIARDI, Stefania, Via Passirano 24, I-20059 Vimercate (MB), IT  
DEL SORDO, Simone, Piazza Carlo Alberto dalla Chiesa 22, I-24047 Treviglio (BG), IT  
MAILLAND, Federico, Strada Regina 10, CH-6900 Lugano, CH  
LEGORA, Michela, Via Castellazzo 1/B, I-22070 Appiano Gentile (CO), IT

(51) MKP  
**A61P 3/04 (2006.01)** (97) **2504026 \***  
**A61K 38/46 (2006.01)**  
**A61K 38/48 (2006.01)**  
(86) EP2011069045 28.10.2011  
(96) 11778574.1 03.10.2012  
(87) WO2012056024, 28.10.2011  
(97) 2504026, 03.10.2012 fr  
(54) COMPOSITION COMPRISING A COMBINATION OF AT LEAST ONE PROTEOLYTIC ENZYME AND AT LEAST ONE LIPOLYTIC ENZYME, FOR USE IN PREVENTING TRIGLYCERIDE SYNTHESIS  
(71) Imarko Research S.A., 23, Avenue De La Porte-Neuve, 2227 Luxembourg, LU  
(72) ROMBI, Max, Via degli Inglesi 49, I-18022 Bordighera, IT

- (51) MKP  
**A61K 31/444 (2006.01)** (97) **2501703 \***  
**C07D 495/20 (2006.01)**  
**A61P 25/00 (2006.01)**
- (86) US2010056180 10.11.2010  
(96) 10782482.3 26.09.2012  
(87) WO2011060035, 10.11.2010  
(97) 2501703, 26.09.2012 en  
(54) SPIROPIPERIDINE COMPOUNDS AS ORL-1 RECEPTOR ANTAGONISTS
- (71) Eli Lilly and Company, Lilly Corporate Center, Indianapolis, IN 46285, US  
(72) BENITO COLLADO, Ana Belen, Lilly S.A. Avendia de la Industria 30, 28108 Alcobendas Madrid, ES  
DIAZ BUEZO, Nuria, Lilly S.A. Avendia de la Industria 30, Madrid, ES  
JIMENEZ-AGUADO, Alma Maria, Lilly S.A. Avendia de la Industria 30, Madrid, ES  
LAFUENTE BLANCO, Celia, Lilly S.A. Avendia de la Industria 30, Madrid, ES  
MARTINEZ-GRAU, Maria Angeles, Lilly S.A. Avendia de la Industria 30, Madrid, ES  
PEDREGAL-TERCERO, Concepcion, Lilly S.A. Avendia de la Industria 30, Madrid, ES  
TOLEDO ESCRIBANO, Miguel Angel, Lilly S.A. Avendia de la Industria 30, Madrid, ES

- (51) MKP  
**A61K 31/4162 (2006.01)** (97) **2536721 \***  
**C07D 471/04 (2006.01)**
- (86) IB2011050668 17.02.2011  
(96) 11709483.9 26.12.2012  
(87) WO2011101805, 17.02.2011  
(97) 2536721, 26.12.2012 en  
(54) PYRAZOLO PIPERIDINE DERIVATIVES AS NADPH OXIDASE INHIBITORS
- (71) GenKyoTex SA, Chemin des Aulx 16, 1228 Plan-les-Ouates, CH  
(72) PAGE, Patrick, Naxos Les Cyclades 1 Avenue de Genève, F-74160 Saint-Julien-en-genevois, FR  
LALEU, Benoît, 519 route du poirier à l'âne, F-74160 Collonges-sous-saleve, FR  
GAGGINI, Francesca, Rue des Pecheries 14, CH-1205 Geneva, CH  
ORCHARD, Mike, 34 Spring Lane Watlington, Oxon OX49 5QN, GB

- (51) MKP  
**A47J 42/04 (2006.01)** (97) **2510845**  
**A47J 42/08 (2006.01)**
- (96) 11425099.6 17.10.2012  
(97) 2510845, 17.10.2012 en  
(54) Grinding device
- (71) Drogheria e Alimentari S.r.l., Viale Nilde lotti 23/25, 50037 San Piero a Sieve, IT  
(72) Carapelli, Giacinto, Via Montorsoli, 631, 50036 Vaglia, Firenze, IT

- (51) MKP  
**A61K 38/12 (2006.01)** (97) **2531205 \***  
**C07K 7/54 (2006.01)**
- (86) GB2011000134 01.02.2011  
(96) 11704292.9 12.12.2012  
(87) WO2011095769, 01.02.2011  
(97) 2531205, 12.12.2012 en  
(54) ACTAGARDINE DERIVATIVES, AND PHARMACEUTICAL USE THEREOF
- (71) Novacta Biosystems Limited, BioPark Hertfordshire Broadwater Road, Welwyn Garden City, Hertfordshire AL7 3AX, GB  
(72) DAWSON, Michael, John, Novacta Biosystems Limited BioPark Hertfordshire Broadwater Road, Welwyn Garden City Hertfordshire AL7 3AX, GB  
APPLEYARD, Antony, Nicholas, Novacta Biosystems Limited BioPark Hertfordshire Broadwater Road, Welwyn Garden City Hertfordshire AL7 3AX, GB  
CORTES BARGALLO, Jesus, Novacta Biosystems Limited BioPark Hertfordshire Broadwater Road, Welwyn Garden City Hertfordshire AL7 3AX, GB  
WADMAN, Sjoerd, Nicholas, Novacta Biosystems Limited BioPark Hertfordshire Broadwater Road, Welwyn Garden City Hertfordshire AL7 3AX, GB

- (51) MKP  
**A01G 23/02 (2006.01)** (97) **2512213 \***  
**A01C 5/04 (2006.01)**
- (86) NL2010050821 06.12.2010  
(96) 10798637.4 24.10.2012  
(87) WO2011068411, 06.12.2010  
(97) 2512213, 24.10.2012 en  
(54) A METHOD OF PLANTING A SEED, PLANT, BUSH OR TREE, AND A DRILL
- (71) Holding P.M.M. Hoff B.V., Franseweg 9, 4651 PV Steenberghe, NL  
(72) HOFF, Petrus Mattheus Maria, Carel Willinkplein 17, NL-4703 HD Roosendaal, NL

- (51) MKP  
**C12Q 1/68 (2006.01)** (97) **2526203 \***
- (86) EP2011050771 20.01.2011  
(96) 11700561.1 28.11.2012  
(87) WO2012052189, 20.01.2011  
(97) 2526203, 28.11.2012 en  
(54) METHODS AND USES RELATING TO THE IDENTIFICATION OF COMPOUND INVOLVED IN PAIN AS WELL AS METHODS OF DIAGNOSING ALGESIA
- (71) SANOFI, 54 rue La Boétie, 75008 Paris, FR  
(72) GEBAUER, Mathias, Sanofi-Aventis Deutschland GmbH, 65926 Frankfurt am Main, DE  
MICHAELIS, Martin, Sanofi-Aventis Deutschland GmbH, 65926 Frankfurt, DE  
DING-PFENNIGDORFF, Danping, Sanofi-Aventis Deutschland GmbH, 65926 Frankfurt am Main, DE  
SCHULTE, Anke M., Sanofi-Aventis Deutschland GmbH, 65926 Frankfurt am Main, DE  
ZIEMEK, Daniel, 53 Barnard Ave, Watertown Massachusetts 02472, US  
METZ-WEIDMANN, Christiane, Sanofi-Aventis Deutschland GmbH, 65926 Frankfurt am Main, DE

- (51) MKP  
**G06Q 20/00 (2012.01)** (97) **2524471 \***  
**H04L 9/14 (2006.01)**  
**H04L 9/32 (2006.01)**
- (86) US2011020973 12.01.2011  
(96) 11733308.8 21.11.2012  
(87) WO2011088109, 12.01.2011  
(97) 2524471, 21.11.2012 en  
(54) ANYTIME VALIDATION FOR VERIFICATION TOKENS
- (71) Visa International Service Association, P.O. Box 8999 MS M1-11F, San Francisco, CA 94128, US  
(72) HURRY, Simon, 515 Trinidad Lane, Foster City CA 94404, US  
HAMMAD, Ayman, 6981 Corte Mercado, Pleasanton CA 94566, US

- (51) MKP  
**A61K 31/4439 (2006.01)** (97) **2512470 \***  
**A61K 31/4436 (2006.01)**  
**A61P 25/28 (2006.01)**  
**A61K 31/426 (2006.01)**
- (86) US2010060449 15.12.2010  
(96) 10798884.2 24.10.2012  
(87) WO2011075514, 15.12.2010  
(97) 2512470, 24.10.2012 en  
(54) PPAR-SPARING THIAZOLIDINEDIONES AND COMBINATIONS FOR THE TREATMENT OF NEURODEGENERATIVE DISEASES
- (71) Metabolic Solutions Development Company LLC, 161 East Michigan Avenue, 4th Floor, Kalamazoo, MI 49007, US  
(72) COLCA, Gerard R., 125 South Kalamazoo Mall 604, Kalamazoo MI 49007, US  
KLETZIEN, Rolf F., 10264 W. Gull Lake Drive, Richland MI 49083, US  
TANIS, Steven P., 1750 Oriole Ct., Carlsbad CA 92011, US  
LARSEN, Scott D., 13638 Cantaberry Ct., South Lyon MI 48178, US



(51) MKP  
**A61K 9/107 (2006.01)** (97) **2515865 \***  
**A61K 31/593 (2006.01)**  
**A61K 47/10 (2006.01)**  
**A61K 9/06 (2006.01)**  
**A61K 47/22 (2006.01)**  
**A61K 47/14 (2006.01)**  
(86) DK2010000182 22.12.2010  
(96) 10803218.6 31.10.2012  
(87) WO2011076207, 22.12.2010  
(97) 2515865, 31.10.2012 en  
(54) CUTANEOUS COMPOSITION COMPRISING VITAMIN D ANALOGUE AND A MIXTURE OF SOLVENT AND SURFACTANTS  
(71) Leo Pharma A/S, Patents Industriparken 55, 2750 Ballerup, DK  
(72) PETERSSON, Karsten, Fuglehavevej 66, DK-2750 Ballerup, DK

(51) MKP  
**A61P 25/28 (2006.01)** (97) **2513106 \***  
**A61P 25/18 (2006.01)**  
**A61K 31/437 (2006.01)**  
**A61K 31/4196 (2006.01)**  
**C07D 471/04 (2006.01)**  
(86) DK2010050344 15.12.2010  
(96) 10797991.6 24.10.2012  
(87) WO2011072697, 15.12.2010  
(97) 2513106, 24.10.2012 en  
(54) HETEROAROMATIC ARYL TRIAZOLE DERIVATIVES AS PDE10A ENZYME INHIBITORS  
(71) H. Lundbeck A/S, Ottiliavej 9, 2500 Valby, DK  
(72) PÜSCHL, Ask, Harsdorffsvej 7A 4.tv., DK-1874 Frederiksberg C, DK  
NIELSEN, Jacob, Dannebrogsgade 17 t.th., DK-1660 København V, DK  
KEHLER, Jan, Nymøllevej 28, DK-2800 Lyngby, DK  
KILBURN, John, Paul, Kærsgårdvej 7, DK-4690 Haslev, DK  
MARIGO, Mauro, Jyttevej 23, DK-2740 Skovlunde, DK  
LANGGÅRD, Morten, Rågevej 20, DK-2600 Glostrup, DK

(51) MKP  
**A61P 25/22 (2006.01)** (97) **2519514 \***  
**A61P 25/30 (2006.01)**  
**C07D 401/14 (2006.01)**  
**A61P 25/08 (2006.01)**  
**C07D 403/04 (2006.01)**  
**A61P 25/04 (2006.01)**  
**C07D 403/06 (2006.01)**  
**A61P 25/18 (2006.01)**  
**C07D 405/06 (2006.01)**  
**A61P 25/16 (2006.01)**  
**C07D 401/04 (2006.01)**  
**A61P 25/28 (2006.01)**  
**A61P 3/04 (2006.01)**  
**C07D 401/06 (2006.01)**  
**A61P 25/24 (2006.01)**  
**A61K 31/403 (2006.01)**  
**A61P 25/20 (2006.01)**  
(86) IN2010000285 03.05.2010  
(96) 10750186.8 07.11.2012  
(87) WO2011080751, 03.05.2010  
(97) 2519514, 07.11.2012 en  
(54) ALPHA4BETA2 NEURONAL NICOTINIC ACETYLCHOLINE RECEPTOR LIGANDS  
(71) Suven Life Sciences Limited, Serene Chambers Road No. 5, Avenue 7, Banjara Hills, Hyderabad 500 034, Andhra Pradesh, IN  
(72) NIROGI, Ramakrishna, Suven Life Sciences Limited Serene Chambers Road - 5 Avenue - 7 Banjara Hills, Hyderabad 500 034 Andhra Pradesh, IN  
MOHAMMED, Abdul Rasheed, Suven Life Sciences Limited Serene Chambers Road - 5 Avenue - 7 Banjara Hills, Hyderabad 500 034 Andhra Pradesh, IN  
KUMAWAT, Kana Ram, Suven Life Sciences Limited Serene Chambers Road - 5 Avenue - 7 Banjara Hills, Hyderabad 500 034 Andhra Pradesh, IN  
AHMAD, Ishtiyaque, Suven Life Sciences Limited Serene Chambers Road - 5 Avenue - 7 Banjara Hills, Hyderabad 500 034 Andhra Pradesh, IN  
JAYARAJAN, Pradeep, Suven Life Sciences Limited Serene Chambers Road - 5 Avenue - 7 Banjara Hills, Hyderabad 500 034 Andhra Pradesh, IN  
SHINDE, Anil Karbhari, Suven Life Sciences Limited Serene Chambers Road - 5 Avenue - 7 Banjara Hills, Hyderabad 500 034 Andhra Pradesh, IN  
KANDIKERE, Nagaraj Vishwottam, Suven Life Sciences Limited Serene Chambers Road - 5 Avenue - 7 Banjara Hills, Hyderabad 500 034 Andhra Pradesh, IN  
MUDIGONDA, Koteswara, Suven Life Sciences Limited Serene Chambers Road - 5 Avenue - 7 Banjara Hills, Hyderabad 500 034 Andhra Pradesh, IN  
JASTI, Venkateswarlu, Suven Life Sciences Limited Serene Chambers Road - 5 Avenue - 7 Banjara Hills, Hyderabad 500034 Andhra Pradesh, IN

(51) MKP  
**C10L 5/42 (2006.01)** (97) **2536813 \***  
**C10L 5/46 (2006.01)**  
**C10L 5/44 (2006.01)**  
**C10B 53/02 (2006.01)**  
**C10B 47/00 (2006.01)**  
(86) NL2011050121 21.02.2011  
(96) 11707499.7 26.12.2012  
(87) WO2011102726, 21.02.2011  
(97) 2536813, 26.12.2012 en  
(54) METHODS AND PROCEDURES FOR PRODUCING USEFUL PRODUCTS FROM WASTE MATERIALS  
(71) Enerpy B.V., Karbindersstraat 12, 5914 NW Venlo, NL  
Enerpy S.a.c.i., Emeterio Miranda 808, Asunción, PY  
(72) PENTRY, Dieter Peter, Emeterio Miranda 808, Asunción, PY  
ACOSTA AYALA, Aldo Mario Higinio, Emeterio Miranda 808, Asunción, PY  
BARRIOS MACIEL, Andrés Anastacio, Emeterio Miranda 808, Asunción, PY  
VERA VERA, León Isaac, Emeterio Miranda 808, Asunción, PY

- (51) MKP  
**A61M 5/32 (2006.01)** (97) **2531236 \***  
**A61M 5/28 (2006.01)**  
**A61M 5/24 (2006.01)**
- (86) EP2011051395 01.02.2011  
(96) 11701524.8 12.12.2012  
(87) WO2011095480, 01.02.2011  
(97) 2531236, 12.12.2012 en
- (54) MEDICATED MODULE WITH DUAL SAFETY GUARDS  
(71) Sanofi-Aventis Deutschland GmbH, Brüningstraße 50, 65929 Frankfurt, DE  
(72) BOYD, Malcolm, Stanley, 28 Whitehead Drive, Wellsbourne Warwickshire CV35 9PW, GB  
DAVIES, James Alexander, 7 Old School Mews Cubbington Road, Leamington Spa Warwickshire CV32 7XB, GB  
REKAYA, Naceur, 8 The Old Stone Yard 74 Rugby Road Leamington Spa, Warwickshire CV32 6DQ, GB
- 
- (51) MKP  
**A61K 31/327 (2006.01)** (97) **2501376 \***  
**A61P 31/02 (2006.01)**  
**A61K 31/46 (2006.01)**  
**A61P 31/00 (2006.01)**  
**A61K 31/351 (2006.01)**  
**A61K 31/575 (2006.01)**
- (86) IL2011000272 24.03.2011  
(96) 11715050.8 26.09.2012  
(87) WO2011117870, 24.03.2011  
(97) 2501376, 26.09.2012 en
- (54) COMPOSITIONS FOR TOPICAL ADMINISTRATION  
(71) Sol-Gel Technologies Ltd., Gloda Meir Street 7 Weizmann Science Park, Ness Ziona 74036, IL  
(72) TOLEDANO, Ofer, 15A Emek Zvulon Street, 44623 Kfar Saba, IL  
NEIMANN, Karine, 10 David Elazar St., 74027 Ness Ziona, IL  
SHROOT, Braham, 1810 Barclay Boulevard, Princeton New Jersey 08540, US
- 
- (51) MKP  
**A61P 31/04 (2006.01)** (97) **2536836 \***  
**C07K 16/12 (2006.01)**  
**C12N 15/09 (2006.01)**  
**C12P 21/08 (2006.01)**  
**G01N 33/569 (2006.01)**  
**C07K 16/46 (2006.01)**  
**C12N 5/10 (2006.01)**  
**A61K 39/395 (2006.01)**
- (86) JP2011054230 18.02.2011  
(96) 11744838.1 26.12.2012  
(87) WO2011102556, 18.02.2011  
(97) 2536836, 26.12.2012 en
- (54) ANTIBODY AGAINST SEROTYPE A LIPOPOLYSACCHARIDE OF PSEUDOMONAS AERUGINOSA  
(71) Meiji Seika Pharma Co., Ltd., 4-16, Kyobashi 2-chome Chuo-ku, Tokyo 104-8002, JP  
Symphogen A/S, Elektrovej Building 375, 2800 Lyngby, DK  
(72) TANAKA, Jiro, c/o Meiji Seika Pharma Co., Ltd. 760 Moroooka-cho Kohoku-ku, Yokohama-shi Kanagawa 222-8567, JP  
ANDERSEN, Peter Sejer, Adalsvej 21A, Vanlose 2720, DK  
OKUTOMI, Takafumi, c/o Meiji Seika Pharma Co., Ltd. 760 Moroooka-cho Kohoku-ku, Yokohama-shi Kanagawa 222-8567, JP  
INABA, Tsuneyoshi, c/o Meiji Seika Pharma Co., Ltd. 760 Moroooka-cho Kohoku-ku, Yokohama-shi Kanagawa 222-8567, JP  
OTSUKA, Keiko, c/o Meiji Seika Pharma Co., Ltd. 760 Moroooka-cho Kohoku-ku, Yokohama-shi Kanagawa 222-8567, JP  
AKABANE, Hirotomo, c/o Meiji Seika Pharma Co., Ltd. 760 Moroooka-cho Kohoku-ku, Yokohama-shi Kanagawa 222-8567, JP  
HOSHINA, Yukari, c/o Meiji Seika Pharma Co., Ltd. 760 Moroooka-cho Kohoku-ku, Yokohama-shi Kanagawa 222-8567, JP  
NAGASO, Hiroshi, c/o Meiji Seika Pharma Co., Ltd. 760 Moroooka-cho Kohoku-ku, Yokohama-shi Kanagawa 222-8567, JP  
KUMAGAI, Masashi, c/o Meiji Seika Pharma Co., Ltd. 760 Moroooka-cho Kohoku-ku, Yokohama-shi Kanagawa 222-8567, JP
- 
- (51) MKP  
**A61P 9/10 (2006.01)** (97) **2501695 \***  
**C07D 487/04 (2006.01)**  
**C07D 403/10 (2006.01)**  
**C07D 471/04 (2006.01)**  
**A61K 31/437 (2006.01)**  
**A61P 9/12 (2006.01)**  
**C07D 401/10 (2006.01)**  
**A61K 31/5513 (2006.01)**
- (86) US2010055255 03.11.2010  
(96) 10831982.3 26.09.2012  
(87) WO2011062766, 03.11.2010  
(97) 2501695, 26.09.2012 en
- (54) 1,4-BENZODIAZEPINE-2,5-DIONES AND RELATED COMPOUNDS WITH THERAPEUTIC PROPERTIES  
(71) The Regents Of The University Of Michigan, 1600 Huron Parkway, 2nd Floor, Ann Arbor, MI 48109-2590, US  
(72) GLICK, Gary D., 1663 Snowberry Ridge Road, Ann Arbor Michigan 48103, US
- 
- (51) MKP  
**C07D 215/44 (2006.01)** (97) **2432764 \***  
**C07D 401/12 (2006.01)**  
**A61K 31/4709 (2006.01)**  
**A61P 35/00 (2006.01)**
- (86) EP2010056968 20.05.2010  
(96) 10723066.6 28.03.2012  
(87) WO2010133669, 20.05.2010  
(97) 2432764, 28.03.2012 en
- (54) SUBSTITUTED QUINOLINES FOR USE AS VEGF INHIBITORS  
(71) ClanoTech AB, Fogdevreten 2, 171 65 Solna, SE  
(72) MALM, Johan, Bridgevägen 9B, S-142 66 Trångsund, SE  
RINGOM, Rune, Murargatan 20A, S-754 37 Uppsala, SE  
CALDIROLA, Patrizia, Källbovägen 12A, S-756 46 Uppsala, SE  
WESTMAN, Jacob, Blomsberg 109, S-740 21 Järlåsa, SE
- 
- (51) MKP  
**A61K 31/52 (2006.01)** (97) **2521550 \***
- (86) US2011020231 05.01.2011  
(96) 11732087.9 14.11.2012  
(87) WO2011085007, 05.01.2011  
(97) 2521550, 14.11.2012 en
- (54) TREATMENT METHOD  
(71) Glaxo Wellcome Manufacturing Pte Ltd, 1 Pioneer Sector 1, Jurong 628413, SG  
(72) DAMIAN-IORDACHE, Valeriu, GlaxoSmithKline c/o Global Patents 709 Swedeland Road, King of Prussia, Pennsylvania 19406, US  
KING, Andrew, GlaxoSmithKline c/o Global Patents 1250 South Collegeville Road PO Box 5089, Collegeville, Pennsylvania 19426, US  
MCLAUGHLIN, Megan M, GlaxoSmithKline c/o Global Patents 1250 South Collegeville Road PO Box 5089, Collegeville, Pennsylvania 19426, US  
SUTTLE, Albert B, GlaxoSmithKline c/o Global Patents 5 Moore Drive C.2111.2F PO Box 13398, RTP, North Carolina 27709, US
- 
- (51) MKP  
**A61M 5/28 (2006.01)** (97) **2531238 \***  
**A61M 5/24 (2006.01)**  
**A61M 5/32 (2006.01)**
- (86) EP2011051405 01.02.2011  
(96) 11701826.7 12.12.2012  
(87) WO2011095486, 01.02.2011  
(97) 2531238, 12.12.2012 en
- (54) MEDICATED MODULE WITH LOCKABLE NEEDLE GUARD  
(71) Sanofi-Aventis Deutschland GmbH, Brüningstraße 50, 65929 Frankfurt, DE  
(72) BOYD, Malcolm, Stanley, 28 Whitehead Drive, Wellsbourne Warwickshire CV35 9PW, GB  
DAVIES, James, Alexander, 7 Old School Mews Cubbington Road, Leamington Spa Warwickshire CV32 7XB, GB  
DE SAUSMAREZ LINTELL, Daniel, Thomas, 6 Smithy Lane Church Lawford, Rugby Warwickshire CV23 9EQ, GB

- (51) MKP  
**A61K 31/7088 (2006.01)** (97) **2531261 \***  
**A61P 3/10 (2006.01)**  
**A61K 39/395 (2006.01)**  
(86) US2011023299 01.02.2011  
(96) 11737851.3 12.12.2012  
(87) WO2011094731, 01.02.2011  
(97) 2531261, 12.12.2012 en  
(54) METHODS FOR DIAGNOSIS AND TREATMENT OF NON-INSULIN DEPENDENT DIABETES MELLITUS  
(71) The Board Of Trustees Of The University Of the Leland Stanford Junior University, 1705 El Camino Real, Palo Alto, CA 94306-1106, US  
(72) BUTTE, Atul J., 251 Campus Drive MSOB X215 MS-54679, Stanford, California 94305, US  
KODAMA, Keiichi, 251 Campus Drive MSOB X153, Stanford, California 94305, US

- (51) MKP  
**B27M 3/00 (2006.01)** (97) **2504134 \***  
**B27D 3/02 (2006.01)**  
**F26B 7/00 (2006.01)**  
**F26B 3/20 (2006.01)**  
**B32B 21/13 (2006.01)**  
**B32B 13/14 (2006.01)**  
**F26B 3/00 (2006.01)**  
**B30B 15/34 (2006.01)**  
(86) NZ2010000228 16.11.2010  
(96) 10833635.5 03.10.2012  
(87) WO2011065845, 16.11.2010  
(97) 2504134, 03.10.2012 en  
(54) ENGINEERED TIMBER PRODUCTS, COMPONENTS AND METHODOLOGIES  
(71) Wood Engineering Technology Limited, 80 Hastie Avenue, Mangere Bridge, Auckland 2022, NZ  
(72) BOSSON, Warwick, 22 Lochiel Road Remuera Auckland, 1050, NZ  
HARRISON, Roger, 59 Ripon Crescent Meadowbank Auckland, 1072, NZ

- (51) MKP  
**C07D 417/12 (2006.01)** (97) **2519503 \***  
**A61P 31/10 (2006.01)**  
**C07D 401/12 (2006.01)**  
**C07D 407/12 (2006.01)**  
**C07D 409/12 (2006.01)**  
**C07D 413/12 (2006.01)**  
**C07D 215/48 (2006.01)**  
**A61K 31/4709 (2006.01)**  
(86) EP2010070791 28.12.2010  
(96) 10798128.4 07.11.2012  
(87) WO2011080265, 28.12.2010  
(97) 2519503, 07.11.2012 en  
(54) SECONDARY 8-HYDROXYQUINOLINE-7-CARBOXAMIDE DERIVATIVES FOR USE AS ANTIFUNGAL AGENTS  
(71) POLICHEM S.A., 50 Val Fleuri, 1526 Luxembourg, LU  
(72) GAGLIARDI, Stefania, Via Passirano 24, I-20059 Vimercate (MB), IT  
DEL SORDO, Simone, Piazza Carlo Alberto dalla Chiesa 22, I-24047 Treviglio (BG), IT  
MAILLAND, Federico, Strada Regina 10, CH-6900 Lugano, CH  
LEGORA, Michela, Via Castellazzo 1/B, I-22070 Appiano Gentile (CO), IT

- (51) MKP  
**B32B 27/32 (2006.01)** (97) **2501346 \***  
**A61F 5/445 (2006.01)**  
(86) US2010056289 11.11.2010  
(96) 10779187.3 26.09.2012  
(87) WO2011062829, 11.11.2010  
(97) 2501346, 26.09.2012 en  
(54) NOISE DAMPENING FILM  
(71) Cryovac, Inc., 100 Rogers Bridge Road, Duncan, South Carolina 29334, US  
(72) BEKELE, Solomon, 4 Walden Way, Taylors SC 29687, US

- (51) MKP  
**C07C 69/757 (2006.01)** (97) **2502903 \***  
**C07C 227/18 (2006.01)**  
**C07C 255/47 (2006.01)**  
**C07C 227/02 (2006.01)**  
**C07C 235/82 (2006.01)**  
**C07D 235/02 (2006.01)**  
**C07C 229/50 (2006.01)**  
**C07C 227/12 (2006.01)**  
(86) JP2010006757 18.11.2010  
(96) 10831334.7 26.09.2012  
(87) WO2011061935, 18.11.2010  
(97) 2502903, 26.09.2012 en  
(54) PROCESS FOR PRODUCING 3-ALKOXY-2-AMINO-6-FLUOROBICYCLO[3.1.0]HEXANE-2,6-DICARBOXYLIC ACID DERIVATIVE AND INTERMEDIATE THEREOF  
(71) Taisho Pharmaceutical Co., Ltd., 24-1, Takada 3-chome Toshima-ku, Tokyo 170-8633, JP  
(72) MURASE, Noriaki, c/o TAISHO PHARMACEUTICAL CO. LTD. 24-1, Takada 3-chome Toshima-ku, Tokyo 170-8633, JP  
KUMAGAI, Toshihito, c/o TAISHO PHARMACEUTICAL CO. LTD. 24-1, Takada 3-chome Toshima-ku, Tokyo 170-8633, JP  
WADA, Hisaya, c/o TAISHO PHARMACEUTICAL CO. LTD. 24-1, Takada 3-chome Toshima-ku, Tokyo 170-8633, JP  
TANIMOTO, Hisahide, c/o TAISHO PHARMACEUTICAL CO. LTD. 24-1, Takada 3-chome Toshima-ku, Tokyo 170-8633, JP  
OHTA, Koumei, c/o TAISHO PHARMACEUTICAL CO. LTD. 24-1, Takada 3-chome Toshima-ku, Tokyo 170-8633, JP  
KIMURA, Yoshihiro, c/o TAISHO PHARMACEUTICAL CO. LTD. 24-1, Takada 3-chome Toshima-ku, Tokyo 170-8633, JP

- (51) MKP  
**C07K 14/475 (2006.01)** (97) **2516454 \***  
(86) US2010061669 21.12.2010  
(96) 10843555.3 31.10.2012  
(87) WO2011087808, 21.12.2010  
(97) 2516454, 31.10.2012 en  
(54) MODIFIED BOVINE SOMATOTROPIN POLYPEPTIDES AND THEIR USES  
(71) Ambrx, Inc., 10975 North Torrey Pines Road, Suite 100, La Jolla, CA 92037, US  
(72) PUTNAM, Anna-Maria, A. Hays, 11522 Cesped Drive, San Diego, CA 92124, US

- (51) MKP  
**C07D 471/04 (2006.01)** (97) **2519524 \***  
**A61K 31/437 (2006.01)**  
**C07D 487/04 (2006.01)**  
**A61P 35/00 (2006.01)**  
**A61K 31/4985 (2006.01)**  
(86) CN2010080499 30.12.2010  
(96) 10840591.1 07.11.2012  
(87) WO2011079804, 30.12.2010  
(97) 2519524, 07.11.2012 en  
(54) CERTAIN TRIAZOLOPYRIDINES AND TRIAZOLOPYRAZINES, COMPOSITIONS THEREOF AND METHODS OF USE THEREFOR  
(71) Hutchison Medipharma Limited, 720 Cai Lun Road Building 4, Pudong, Shanghai 201203, CN  
(72) SU, Wei-Guo, 720 Cai Lun Road Building 4 Pudong, Shanghai 201203, CN  
JIA, Hong, 720 Cai Lun Road Building 4 Pudong, Shanghai 201203, CN  
DAI, Guangxiu, 720 Cai Lun Road Building 4 Pudong, Shanghai 201203, CN

- (51) MKP  
**A61P 31/04 (2006.01)** (97) **2531519 \***  
**A61K 38/10 (2006.01)**  
**C07K 7/08 (2006.01)**  
(86) GB2011000133 01.02.2011  
(96) 11705953.5 12.12.2012  
(87) WO2011095768, 01.02.2011  
(97) 2531519, 12.12.2012 en  
(54) LANTIBIOTIC SALTS  
(71) Novacta Biosystems Limited, BioPark Hertfordshire Broadwater Road, Welwyn Garden City Hertfordshire AL7 3AX, GB  
(72) WADMAN, Sjoerd Nicholaas, Novacta Biosystems Limited BioPark Hertfordshire Broadwater toad, Welwyn Garden City Hertfordshire AL7 3AX, GB  
APPLEYARD, Antony Nicholas, Novacta Biosystems Limited BioPark Hertfordshire Broadwater toad, Welwyn Garden City Hertfordshire AL7 3AX, GB

- (51) MKP  
**A61L 15/64 (2006.01)** (97) **2506859 \***  
**C08J 9/00 (2006.01)**  
**A61K 9/14 (2006.01)**  
**A61K 31/718 (2006.01)**  
**C08B 31/04 (2006.01)**  
**A61L 15/28 (2006.01)**  
(86) SE2010051268 17.11.2010  
(96) 10834831.9 10.10.2012  
(87) WO2011068455, 17.11.2010  
(97) 2506859, 10.10.2012 en  
(54) MICROSPHERES OF HYDROLYSED STARCH WITH ENDOGENOUS, CHARGED LIGANDS  
(71) Magle AB, Magle Stora Kyrkogata 6, 223 50 Lund, SE  
(72) MALMSJÖ, Malin, Storgatan 24, S-234 31 Lomma, SE  
THORDARSON, Eddie, Per Ols väg 5, S-237 37 Bjärred, SE  
APPELL, Sten Peter, Stora Hjortaröd 917, S-260 24 Röstänga, SE  
FYHR, Peter, Lilla Skedets väg 21-10, S-297 30 Arkelstorp, SE

- (51) MKP  
**D21H 17/00 (2006.01)** (97) **2505614**  
**C09C 1/02 (2006.01)**  
(86) 11160900.4 03.10.2012  
(97) 2505614, 03.10.2012 en  
(54) Process for preparing self-binding pigment particles  
(71) Omya Development AG, Baslerstrasse 42, 4665 Oftringen, CH  
(72) Gane, Patrick A.C., Studenweg 8, 4852 Rothrist, CH  
Buri, Matthias, Mätteliweg 20, 4852 Rothrist, CH  
Rentsch, Samuel, Höheweg 1, 4663 Aarburg, CH  
Meuwly, Julie M., Hofmattstrasse 11A, 4663 Aarburg, CH

- (51) MKP  
**A61P 25/28 (2006.01)** (97) **2504330 \***  
**C07D 401/06 (2006.01)**  
**C07D 401/14 (2006.01)**  
**C07D 401/12 (2006.01)**  
**A61K 31/4709 (2006.01)**  
(86) US2010057488 19.11.2010  
(96) 10787618.7 03.10.2012  
(87) WO2011063272, 19.11.2010  
(97) 2504330, 03.10.2012 en  
(54) AMINO HETEROARYL COMPOUNDS AS BETA-SECRETASE MODULATORS AND METHODS OF USE  
(71) Amgen Inc., One Amgen Center Drive, Thousand Oaks, CA 91320, US  
(72) PARAS, Nick A., 300 Parkwood Avenue 3632 26th Street, San Francisco, California 94110, US  
CHENG, Yuan, 5329 Via Jacinto, Newbury Park, California 91320, US  
POWERS, Timothy, 31209 Pacific Coast Hwy, Malibu, California 09265, US  
BROWN, James, 4438 Appleglen Court, Moorpark, California 93021, US  
HITCHCOCK, Stephen, 171 Florence Drive, Jupiter, Florida 33458, US  
JUDD, Ted, 610 Geranium Lane Unit A, Simi Valley, California 93065, US  
LOPEZ, Patricia, 22644 Saticoy Street, Woodland Hills, California 91307, US  
XUE, Qiufen, 5018 Via Mesita, Newbury Park, California 91320, US  
YANG, Bryant, 637 Warrendale Avenue, Simi Valley, California 93065, US

- (51) MKP  
**F27D 1/14 (2006.01)** (97) **2510300 \***  
(86) CA2010001939 08.12.2010  
(96) 10835337.6 17.10.2012  
(87) WO2011069252, 08.12.2010  
(97) 2510300, 17.10.2012 en  
(54) METHOD OF FORMING SEALED REFRACTORY JOINTS IN METAL-CONTAINMENT VESSELS, AND VESSELS CONTAINING SEALED JOINTS  
(71) Novelis, Inc., 191 Evans Avenue, Toronto, ON M8Z 1J5, CA  
(72) BOORMAN, James E., 2207 N. Flora, Greenacres Washington 99016, US  
REEVES, Eric W., 4683 E. Hudlow Road, Hayden Lake Idaho 83835, US  
WAGSTAFF, Robert Bruce, 22710 East Henry Road, Greenacres Washington 99216, US  
WOMACK, Randy, P.O. Box 96, Spokane Valley Washington 99037, US

- (51) MKP  
**A61M 29/00 (2006.01)** (97) **2515990 \***  
(86) US2010061399 21.12.2010  
(96) 10840044.1 31.10.2012  
(87) WO2011079088, 21.12.2010  
(97) 2515990, 31.10.2012 en  
(54) IMPROVED EXTERNAL NASAL DILATOR  
GlaxoSmithKline LLC, One Franklin Plaza 200 North 16th Street, Philadelphia, PA 19102, US  
(72) FENTON, Gustav, R., 3730 Garfield Ave S., Minneapolis, MN 55409, US  
MISHRA, Snigdha, 1500 Littleton Road, Parsippany, NJ 07054, US

- (51) MKP  
**A61P 35/00 (2006.01)** (97) **2519541 \***  
**C07K 16/28 (2006.01)**  
**A61K 39/395 (2006.01)**  
**A61P 37/00 (2006.01)**  
(86) US2010062434 29.12.2010  
(96) 10803712.8 07.11.2012  
(87) WO2011090761, 29.12.2010  
(97) 2519541, 07.11.2012 en  
(54) RON BINDING CONSTRUCTS AND METHODS OF USE THEREOF  
(71) Emergent Product Development Seattle, LLC, 2401 Fourth Avenue, Suite 1050, Seattle, Washington 98121, US  
(72) BLANKENSHIP, John, W., 9709 6th Avenue Northwest, Seattle, Washington 98117, US  
TAN, Philip, 8704 200th Street SW, Edmonds, Washington 98026, US  
NATARAJAN, Sateesh, Kumar, 4627 168th Court Northeast, Redmond, Washington 98052, US  
ALGATE, Paul, A., 580 Kalmia Place Northwest, Issaquah, Washington 98027, US  
CHENAULT, Ruth, A., 4403 221st Place SW, Mountlake Terrace, Washington 98043, US

- (51) MKP  
**C08G 61/08 (2006.01)** (97) **2520956 \***  
**H01L 51/50 (2006.01)**  
**G02B 5/30 (2006.01)**  
**G02F 1/13363 (2006.01)**  
**C08J 5/18 (2006.01)**  
(86) JP2010073387 24.12.2010  
(96) 10840957.4 07.11.2012  
(87) WO2011081101, 24.12.2010  
(97) 2520956, 07.11.2012 en  
(54) PHASE DIFFERENCE FILM, ORGANIC EL DISPLAY DEVICE AND LIQUID CRYSTAL DISPLAY USING THE SAME  
(71) JX Nippon Oil & Energy Corporation, 6-3, Otemachi 2-chome, Chiyoda-ku Tokyo 100-8162, JP  
(72) KOIKE Takeshi, c/o JX Nippon Oil&Energy Corporation 6-3, Otemachi 2-chome Chiyoda-ku, Tokyo 100-8162, JP  
KOMATSU Shinichi, c/o JX Nippon Oil&Energy Corporation 6-3, Otemachi 2-chome Chiyoda-ku, Tokyo 100-8162, JP  
UESAKA Tetsuya, c/o JX Nippon Oil&Energy Corporation 6-3, Otemachi 2-chome Chiyoda-ku, Tokyo 100-8162, JP  
SONE Hisashi, c/o JX Nippon Oil&Energy Corporation 6-3, Otemachi 2-chome Chiyoda-ku, Tokyo 100-8162, JP  
TAKAHASHI Yuji, c/o JX Nippon Oil&Energy Corporation 6-3, Otemachi 2-chome Chiyoda-ku, Tokyo 100-8162, JP

- (51) MKP  
**C12M 1/00 (2006.01)** (97) **2523911 \***  
**C02F 3/10 (2006.01)**  
**C02F 3/12 (2006.01)**  
(86) HU2011000005 13.01.2011  
(96) 11705249.8 21.11.2012  
(87) WO2011086398, 13.01.2011  
(97) 2523911, 21.11.2012 en  
(54) CARRIER INSERT FOR ACCOMMODATING AND MAINTAINING THE BIOFILM CULTURE OF FLUID CLEANING STRUCTURES  
(71) Organica Zártkörűen Működő Részvénytársaság (ZRT.), Tüzoltó u. 59., 1094 Budapest, HU  
(72) KENYERES, István, Törökbálinti út 3/B., H-1121 Budapest, HU  
KOVÁCS, Róbert, Nap u. 41., H-1161 Budapest, HU

- (51) MKP  
**A61P 5/00 (2006.01)** (97) **2523731 \***  
**A61K 31/55 (2006.01)**  
**A61K 31/4188 (2006.01)**  
(86) US2011021100 13.01.2011  
(96) 11702096.6 21.11.2012  
(87) WO2011088188, 13.01.2011  
(97) 2523731, 21.11.2012 en  
(54) USE OF AN ADRENAL HORMONE-MODIFYING AGENT  
(71) Novartis AG, Lichtstrasse 35, 4056 Basel, CH  
(72) HU, Qi-Ying, Novartis Institutes for BioMedical Research Inc. 100 Technology Square, Cambridge, Massachusetts 02139, US  
KSANDER, Gary, 37 The Flume, Amherst, New Hampshire 03031, US  
MEREDITH, Erik, Novartis Institutes for BioMedical Research Inc. 100 Technology Square, Cambridge, Massachusetts 02139, US  
MONOVICH, Lauren G., Novartis Institutes for BioMedical Research Inc. 100 Technology Square, Cambridge, Massachusetts 02139, US  
PAPILLON, Julien, Novartis Institutes for BioMedical Research Inc. 100 Technology Square, Cambridge, Massachusetts 02139, US  
SCHUMACHER, Christoph, Novartis Pharma AG Postfach, CH-4002 Basel, CH

- (51) MKP  
**C07K 1/107 (2006.01)** (97) **2525830 \***  
**A61K 47/48 (2006.01)**  
**C07K 1/13 (2006.01)**  
(86) EP2011050821 21.01.2011  
(96) 11700673.4 28.11.2012  
(87) WO2011089216, 21.01.2011  
(97) 2525830, 28.11.2012 en  
(54) DIPEPTIDE-BASED PRODRUG LINKERS FOR ALIPHATIC AMINE-CONTAINING DRUGS  
(71) Ascendis Pharma A/S, Tuborg Boulevard 12, 2900 Hellerup, DK  
(72) RAU, Harald, Talstrasse 41i, 69221 Dossenheim, DE  
LEBMANN, Torben, Hauberallee 11, 67434 Neustadt an der Weinstraße, DE

- (51) MKP  
**F03B 13/16 (2006.01)** (97) **2504566 \***  
**F03B 13/22 (2006.01)**  
**F03B 13/20 (2006.01)**  
**F03B 13/24 (2006.01)**  
**F03B 13/14 (2006.01)**  
(86) NO2010000436 26.11.2010  
(96) 10833631.4 03.10.2012  
(87) WO2011065841, 26.11.2010  
(97) 2504566, 03.10.2012 en  
(54) WAVE POWER PLANT  
(71) Intenium AS, Drengsåsen 4, 3261 Larvik, NO  
(72) EDVARDSEN, Lars, Drengsåsen 4, N-3261 Larvik, NO

- (51) MKP  
**C07D 471/04 (2006.01)** (97) **2504335 \***  
(86) EP2010067884 22.11.2010  
(96) 10781894.0 03.10.2012  
(87) WO2011064156, 22.11.2010  
(97) 2504335, 03.10.2012 de  
(54) METHOD FOR PRODUCING METHYL-[4,6-DIAMINO-2-[1-(2-FLUOROBENZYL)-1H-PYRAZOLO[3,4-B]PYRIDINO-3-YL]PYRIMIDINO-5-YL} CARBAMATE AND ITS PURIFICATION FOR USE THEREOF AS PHARMACEUTICAL SUBSTANCE  
(71) Bayer Intellectual Property GmbH, Alfred-Nobel-Strasse 10, 40789 Monheim, DE  
(72) MAIS, Franz-Josef, Otto-Hahn-Str. 164, 40591 Düsseldorf, DE  
REHSE, Joachim, Am Kloster 12, 42799 Leichlingen, DE  
JOENTGEN, Winfried, Sprengelstr. 1, 50735 Köln, DE  
SIEGEL, Konrad, Augsburgstrasse 11, 40597 Düsseldorf, DE

- (51) MKP  
**A61P 17/06 (2006.01)** (97) **2523688 \***  
**C07K 16/28 (2006.01)**  
**A61K 39/395 (2006.01)**  
(86) US2011020985 12.01.2011  
(96) 11705713.3 21.11.2012  
(87) WO2011088120, 12.01.2011  
(97) 2523688, 21.11.2012 en  
(54) ANTIBODY FORMULATION AND THERAPEUTIC REGIMENS  
(71) Kirin-Amgen, Inc., One Amgen Center Drive, Thousand Oaks CA 91320-1799, US  
(72) LIU, Dingjiang, 766 Bellagio Court, Oak Park California 91377, US  
HUANG, Holly Zhuohong, 1792 Amarelle Street, Thousand Oaks California 91320, US  
MARTIN, David Andrew, 6515 20th Avenue NE, Seattle Washington 98115, US  
RUSSELL, Christopher Boyd, 3570 Crystal Springs Dr. NE, Bainbridge Island Washington 98110, US  
SALINGER, David H., 6234 29th Avenue NE, Seattle Washington 98115, US  
BAUMGARTNER, Scott Walter, 3020 Hollycrest Avenue, Thousand Oaks California 91362, US  
ENDRES, Christopher J., 3258 NW Market Street, Seattle Washington 98107, US

- (51) MKP  
**A61M 5/315 (2006.01)** (97) **2509662 \***  
(86) EP2010068915 06.12.2010  
(96) 10790536.6 17.10.2012  
(87) WO2011069935, 06.12.2010  
(97) 2509662, 17.10.2012 en  
(54) DRIVE ASSEMBLY FOR A DRUG DELIVERY DEVICE AND DRUG DELIVERY DEVICE  
(71) Sanofi-Aventis Deutschland GmbH, Brüningstraße 50, 65929 Frankfurt, DE  
(72) RAAB, Steffen, c/o Sanofi-Aventis Deutschland GmbH, 65926 Frankfurt am Main, DE  
DASBACH, Uwe, c/o Sanofi-Aventis Deutschland GmbH, 65926 Frankfurt am Main, DE

- (51) MKP  
**C09C 1/36 (2006.01)** (97) **2510058 \***  
**C09C 1/40 (2006.01)**  
**B03B 1/04 (2006.01)**  
**B02C 23/06 (2006.01)**  
**C09C 1/02 (2006.01)**  
(86) IB2010003084 01.12.2010  
(96) 10805299.4 17.10.2012  
(87) WO2011070418, 01.12.2010  
(97) 2510058, 17.10.2012 fr  
(54) METHOD FOR CLASSIFYING MINERAL MATERIAL IN THE PRESENCE OF GLYCEROL-CONTAINING ADDITIVES, PRODUCTS OBTAINED, AND USES THEREOF  
(71) Omya Development AG, Baslerstrasse 42, 4665 Oftringen, CH  
(72) GANE, Patrick, A., C., Studenweg 8, CH-4852 Rothrist, CH  
BURI, Matthias, Mätteliweg 20, CH-4852 Rothrist, CH

- (51) MKP  
**F03D 11/04 (2006.01)** (97) **2529111 \***  
 (86) EP2011051116 27.01.2011  
 (96) 11702953.8 05.12.2012  
 (87) WO2011092235, 27.01.2011  
 (97) 2529111, 05.12.2012 de  
 (54) WIND POWER PLANT AND WIND POWER PLANT TOWER SEGMENT  
 (71) Wobben Properties GmbH, Dreekamp 5, 26605 Aurich, DE  
 (72) KAPITZA, Jan, Neuer Weg 8, 26629 Großefehn, DE  
 PAPADOPOULOS, Panos, Esenserstr. 6, 26603 Aurich, DE  
 HÖLSCHER, Norbert, Rüskenpad 5, 26607 Aurich, DE

- (51) MKP  
**H02P 9/04 (2006.01)** (97) **2516853 \***  
**F03D 9/00 (2006.01)**  
 (86) US2010061183 18.12.2010  
 (96) 10843506.6 31.10.2012  
 (87) WO2011087732, 18.12.2010  
 (97) 2516853, 31.10.2012 en  
 (54) IMPROVED DESIGNS FOR TURBINE ASSEMBLIES  
 (71) Lucid Energy, Inc., 108 NW 9th Avenue, Suite 201, Portland, OR 97209, US  
 (72) COSBY, Mark Rydell, 14801 County Road 40, Goshen Indiana 46528, US  
 SCHLABACH, Roderic Alan, 1120 S. 7th Street, Goshen Indiana 46526, US

- (51) MKP  
**B65D 83/16 (2006.01)** (97) **2528652 \***  
**A61M 35/00 (2006.01)**  
 (86) IB2010054537 07.10.2010  
 (96) 10776161.1 05.12.2012  
 (87) WO2011089484, 07.10.2010  
 (97) 2528652, 05.12.2012 en  
 (54) TANNING DEVICE AND METHOD  
 (71) Bronze Italia S.r.l., Via Circumvallazione Esterna 6, 80144 Napoli, IT  
 (72) GHEDA, Nicola, c/o Bronze Italia S.R.L. Via Circumvallazione Esterna 6, I-80144 Napoli, IT

- (51) MKP  
**A61K 48/00 (2006.01)** (97) **2501414 \***  
 (86) US2010056985 17.11.2010  
 (96) 10832087.0 26.09.2012  
 (87) WO2011062962, 17.11.2010  
 (97) 2501414, 26.09.2012 en  
 (54) SMNDELTA7 DEGRON: NOVEL COMPOSITIONS AND METHODS OF USE  
 (71) The Trustees Of The University Of Pennsylvania, Center for Technology Transfer 3160 Chestnut Street, Suite 200, Philadelphia PA 19104-6283, US  
 (72) DREYFUSS, Gideon, 343 Aubrey Road, Wynnewood, PA 19096, US  
 CHO, Sungchan, 329 S. 42nd Street, Apt D-8, Philadelphia, PA 19104, US

- (51) MKP  
**C12P 21/08 (2006.01)** (97) **2536759 \***  
**C07K 16/12 (2006.01)**  
**C12N 15/09 (2006.01)**  
**C12N 5/10 (2006.01)**  
**C07K 16/46 (2006.01)**  
**A61K 39/395 (2006.01)**  
**A61P 31/04 (2006.01)**  
**G01N 33/569 (2006.01)**  
 (86) JP2011054227 18.02.2011  
 (96) 11744835.7 26.12.2012  
 (87) WO2011102553, 18.02.2011  
 (97) 2536759, 26.12.2012 en  
 (54) ANTIBODY AGAINST SEROTYPE I LIPOPOLYSACCHARIDE OF PSEUDOMONAS AERUGINOSA  
 (71) Meiji Seika Pharma Co., Ltd., 4-16, Kyobashi 2-chome Chuo-ku, Tokyo 104-8002, JP  
 Symphogen A/S, Elektrovej Building 375, 2800 Lyngby, DK  
 (72) TANAKA, Jiro, c/o Meiji Seika Pharma Co., Ltd. 760 Morooka-cho Kohoku-ku, Yokohama-shi Kanagawa 222-8567, JP  
 ANDERSEN, Peter Sejer, Adalsvej 21A, Vanløese 2720, DK  
 OKUTOMI, Takafumi, c/o Meiji Seika Pharma Co., Ltd. 760 Morooka-cho Kohoku-ku, Yokohama-shi Kanagawa 222-8567, JP  
 INABA, Tsuneyoshi, c/o Meiji Seika Pharma Co., Ltd. 760 Morooka-cho Kohoku-ku, Yokohama-shi Kanagawa 222-8567, JP  
 OTSUKA, Keiko, c/o Meiji Seika Pharma Co., Ltd. 760 Morooka-cho Kohoku-ku, Yokohama-shi Kanagawa 222-8567, JP  
 AKABANE, Hiroto, c/o Meiji Seika Pharma Co., Ltd. 760 Morooka-cho Kohoku-ku, Yokohama-shi Kanagawa 222-8567, JP  
 HOSHINA, Yukari, c/o Meiji Seika Pharma Co., Ltd. 760 Morooka-cho Kohoku-ku, Yokohama-shi Kanagawa 222-8567, JP  
 NAGASO, Hiroshi, c/o Meiji Seika Pharma Co., Ltd. 760 Morooka-cho Kohoku-ku, Yokohama-shi Kanagawa 222-8567, JP  
 KUMAGAI, Masashi, c/o Meiji Seika Pharma Co., Ltd. 760 Morooka-cho Kohoku-ku, Yokohama-shi Kanagawa 222-8567, JP

- (51) MKP  
**F41A 17/44 (2006.01)** (97) **2524186 \***  
**F41A 17/38 (2006.01)**  
**F41A 17/42 (2006.01)**  
 (86) DE2010075162 14.12.2010  
 (96) 10809143.0 21.11.2012  
 (87) WO2011085712, 14.12.2010  
 (97) 2524186, 21.11.2012 de  
 (54) SAFETY MAGAZINE FOR A FIREARM HAVING A MECHANISM FOR LOCKING AGAINST THE BREECH FACE  
 (71) TLS System Unternehmersgesellschaft, Krefelder Straße 117, 40549 Düsseldorf, DE  
 (72) HELLEBRANDT, Manfred, Oberkasseler Straße 94, 40545 Düsseldorf, DE  
 COENEN, Goetz, Boesinghovener Str. 46, 40668 Meerbusch, DE

- (51) MKP  
**A61B 17/32 (2006.01)** (97) **2533703 \***  
**A61B 17/22 (2006.01)**  
**A61B 17/3207 (2006.01)**
- (86) US2011024180 09.02.2011  
(96) 11705351.2 19.12.2012  
(87) WO2011100313, 09.02.2011  
(97) 2533703, 19.12.2012 en
- (54) ULTRASONIC SURGICAL INSTRUMENTS WITH MOVING CUTTING IMPLEMENT
- (71) Ethicon Endo-Surgery, Inc., 4545 Creek Road, Cincinnati, OH 45242, US
- (72) DIETZ, Timothy, G., 2 Elm Ledge, Terrace Park, OH 45174, US  
JOHNSON, Gregory, W., 907 Center Street, Milford, OH 45150, US  
CONLON, Sean, P., 6234 North Shadow Hill Way Apt. C, Loveland, OH 45140, US  
MUMAW, Daniel, J., 953 Long Lane, Milford, OH 45150, US  
MORGAN, Jerome, R., 3275 S. Whitetree Circle, Cincinnati, OH 45236, US  
DANNAHER, William, D., 8907 Eldora Drive, Cincinnati, OH 45236, US  
VAKHARIA, Omar, J., 2243 Sussex Avenue, Cincinnati, OH 45230, US  
TIMM, Richard, W., 3405 Monteith Avenue 1, Cincinnati, OH 45208, US  
MILLER, Matthew, C., 3524 Zumstein Avenue, Cincinnati, OH 45208, US  
ROBERTSON, Galen, C., 5752 Doerger Lane, Cincinnati, OH 45212, US

- (51) MKP  
**C07D 211/08 (2006.01)** (97) **2509940 \***  
**A61P 25/28 (2006.01)**  
**C07C 255/43 (2006.01)**  
**A61K 31/277 (2006.01)**  
**C07D 265/30 (2006.01)**
- (86) US2010059952 10.12.2010  
(96) 10836776.4 17.10.2012  
(87) WO2011072257, 10.12.2010  
(97) 2509940, 17.10.2012 en
- (54) AMYLOID BINDING AGENTS
- (71) The Regents of the University of California, 1111 Franklin Street, 12th Floor, Oakland, CA 94607, US
- (72) YANG, Jerry, 7715 Ivanhoe Avenue, La Jolla California 92037, US  
THEODORAKIS, Emmanuel A., 3905 Caminito Terviso, San Diego California 92122, US

- (51) MKP  
**E21B 17/00 (2006.01)** (97) **2521839 \***  
**E21B 43/12 (2006.01)**  
**E21B 43/22 (2006.01)**
- (86) CA2010002072 30.12.2010  
(96) 10840260.3 14.11.2012  
(87) WO2011079391, 30.12.2010  
(97) 2521839, 14.11.2012 en
- (54) WELLBORE TREATMENT APPARATUS AND METHOD
- (71) Packers Plus Energy Services Inc., Bow Valley Square 2 Suite 2200, 205 - 5 Avenue SW, Calgary, Alberta T2P 2V7, CA
- (72) THEMIG, Daniel Jon, 256 Woodhaven Place SW, Calgary Alberta T2W 5P9, CA  
DESARANLEAU, Christopher, Denis, 307 Ridgeland Crescent, Sherwood Park Alberta T8A 3A5, CA  
COON, Robert, Joe, c/o 11221 Cutten Road 2, Houston Texas 77066, US

- (51) MKP  
**A61M 5/315 (2006.01)** (97) **2512563 \***
- (86) EP2010069863 16.12.2010  
(96) 10798299.3 24.10.2012  
(87) WO2011073302, 16.12.2010  
(97) 2512563, 24.10.2012 en
- (54) DOSE SETTING MECHANISM WITH MAXIMUM DOSE LIMITING ELEMENT
- (71) Sanofi-Aventis Deutschland GmbH, Brüningstraße 50, 65929 Frankfurt, DE
- (72) SMITH, Christopher James, 4 Elm Drive Holmes Chapel, Crewe Cheshire CW4 7QG, GB  
OAKLAND, Philip, 22 Swythamley Road Cheadle Heath Stockport, Cheshire SK3 ONE, GB

- (51) MKP  
**C09B 62/00 (2006.01)** (97) **2516555 \***  
**C09B 62/453 (2006.01)**
- (86) US2010061578 21.12.2010  
(96) 10842727.9 31.10.2012  
(87) WO2011084803, 21.12.2010  
(97) 2516555, 31.10.2012 en
- (54) COLORING AGENTS AND METHODS OF USE THEREOF
- (71) Living Proof, Inc., 61 Rogers Street, Cambridge, MA 02142, US
- (72) PUERTA, David, 19 Reed Bent Road, Rockland MA 02370, US  
NAGAMOOTO-CASSE, Lorna, 37 Anderson Street Apt. 8, Boston, MA 02114, US  
LEWIS, Jana, 30 Brainard Ave. Apt. 107, Medford MA 02155, US

- (51) MKP  
**A61K 31/722 (2006.01)** (97) **2501392 \***  
**C08K 3/16 (2006.01)**  
**C08K 3/00 (2006.01)**  
**C08L 5/08 (2006.01)**  
**A61K 35/14 (2006.01)**  
**C08K 11/00 (2006.01)**  
**C08K 5/521 (2006.01)**
- (86) CA2010001858 19.11.2010  
(96) 10831011.1 26.09.2012  
(87) WO2011060555, 19.11.2010  
(97) 2501392, 26.09.2012 en
- (54) SOLUBLE PHYSIOLOGICAL CHITOSAN FORMULATIONS COMBINED WITH PLATELET-RICH PLASMA (PRP) FOR TISSUE REPAIR
- (71) Corporation De L'école Polytechnique De Montréal, 2900 boul. Édouard-Montpetit Campus de l'Université de Montréal 2500 chemin de Polytechnique, Montréal, Québec H3T 1J4, CA
- (72) OUYANG, Wei, 5000 Clanranald Apt. 301, Montréal, Québec H3X 2S2, CA  
BUSCHMANN, Michael, 4329 King Edward, Montréal, Québec H4B 2H4, CA  
CHEVRIER, Anik, 24 De Compton Crescent, Montréal, Québec H9R 5V5, CA

- (51) MKP  
**G01L 7/08 (2006.01)** (97) **2513623 \***  
**B64C 3/00 (2006.01)**  
**G01L 7/02 (2006.01)**  
**G01L 9/06 (2006.01)**  
**B64C 99/00 (2010.01)**
- (86) US2010059896 10.12.2010  
(96) 10842472.2 24.10.2012  
(87) WO2011084358, 10.12.2010  
(97) 2513623, 24.10.2012 en
- (54) WEATHERIZED DIRECT-MOUNT ABSOLUTE PRESSURE SENSOR
- (71) Meggitt (San Juan Capistrano), Inc., 30700 Rancho Viejo Drive, San Juan Capistrano, CA 92675, US
- (72) KWA, Tom, 867 Cape Colony Dr., San Jose, CA 95133, US  
DANIELSON, Don, L., 4463 Thomas Drive, Palo Alto, CA 94303, US

- (51) MKP  
**C07D 487/04 (2006.01)** (97) **2536728 \***  
**A61P 35/00 (2006.01)**  
**A61K 31/437 (2006.01)**  
**A61K 31/4985 (2006.01)**
- (86) EP2011000792 18.02.2011  
(96) 11704553.4 26.12.2012  
(87) WO2011101161, 18.02.2011  
(97) 2536728, 26.12.2012 en
- (54) PYRAZOLE DERIVATIVES AS JAK INHIBITORS
- (71) Almirall S.A., Ronda del General Mitre, 151, 08022 Barcelona, ES
- (72) BACH TANA, Jordi, C/ Laureà Mir 408-410, E-08980 Sant Feliu de Llobregat (Barcelona), ES  
PAGES SANTACANA, Lluís, Miquel, C/ Laureà Mir 408-410, E-08980 Sant Feliu de Llobregat (Barcelona), ES  
TALTAVULL MOLL, Joan, C/ Laureà Mir 408-410, E-08980 Sant Feliu de Llobregat (Barcelona), ES  
EASTWOOD, Paul, Robert, C/ Laureà Mir 408-410, E-08980 Sant Feliu de Llobregat (Barcelona), ES  
GONZALEZ RODRIGUES, Jacob, C/ Laureà Mir 408-410, E-08980 Sant Feliu de Llobregat (Barcelona), ES  
GIULIO MATASSA, Victor, C/ Laureà Mir 408-410, E-08980 Sant Feliu de Llobregat (Barcelona), ES

- (51) MKP  
**C08G 63/199 (2006.01)** (97) **2507280 \***  
**C08G 63/183 (2006.01)**  
**C08G 63/672 (2006.01)**  
**C08G 18/32 (2006.01)**  
**C08G 63/42 (2006.01)**  
**C08G 18/73 (2006.01)**  
**C08G 18/76 (2006.01)**
- (86) AU2010001628 02.12.2010  
(96) 10834096.9 10.10.2012  
(87) WO2011066616, 02.12.2010  
(97) 2507280, 10.10.2012 en  
(54) POLYMERIC MATERIALS  
(71) Commonwealth Scientific and Industrial Research Organisation, Limestone Avenue, Campbell, Australian Capital Territory 2612, AU  
(72) GRAICHEN, Florian Hans Maximilian, 6/23 River Street, Richmond Victoria 3121, AU  
LEITA, Benjamin Aldo, 4 Adrian Place, Rowville Victoria 3178, AU  
O'SHEA, Michael Shane, 4 Worthing Court, Mulgrave Victoria 3170, AU
- 
- (51) MKP  
**C08J 7/06 (2006.01)** (97) **2418238**  
**B01J 21/06 (2006.01)**  
**B05D 5/00 (2006.01)**  
**C09G 1/00 (2006.01)**
- (96) 10425272.1 15.02.2012  
(97) 2418238, 15.02.2012 en  
(54) Titanium dioxide-coated expanded polymer sheet having photocatalytic activity, container and packaging for foodstuffs obtained from such polymer sheet  
(71) SIRAP-GEMA S.p.A., 1/3 Via Industriale, I-25028 Verolanuova (Brescia), IT  
(72) Garavaglia, Luigi, c/o SIRAP-GEMA S.p.A. Via Industriale, 1/3, 25028 Verolanuova (Brescia), IT  
Brazzoli, Matteo, c/o SIRAP-GEMA S.p.A. Via Industriale, 1/3, 25028 Verolanuova (Brescia), IT  
Palmisano, Giovanni, c/o Università degli Studi di Palermo Dipartimento di Ingegneria Chimica, dei processi e dei materiali Viale delle Scienze, 90128 Palermo, IT  
Palmisano, Leonardo, c/o Università degli Studi di Palermo Dipartimento di Ingegneria Chimica, dei processi e dei materiali Viale delle Scienze, 90128 Palermo, IT  
Loddo, Vittorio, c/o Università degli Studi di Palermo Dipartimento di Ingegneria Chimica, dei processi e dei materiali Viale delle Scienze, 90128 Palermo, IT  
Marci, Giuseppe, c/o Università degli Studi di Palermo Dipartimento di Ingegneria Chimica, dei processi e dei materiali Viale delle Scienze, 90128 Palermo, IT  
Yurdakal, Sedat, c/o Università degli Studi di Palermo Dipartimento di Ingegneria Chimica, dei processi e dei materiali Viale delle Scienze, 90128 Palermo, IT
- 
- (51) MKP  
**B01D 17/02 (2006.01)** (97) **2512615 \***
- (86) HU2010000142 14.12.2010  
(96) 10812990.9 24.10.2012  
(87) WO2011073704, 14.12.2010  
(97) 2512615, 24.10.2012 en  
(54) METHOD AND APPARATUS FOR HANDLING DRILLING MUD CONTAINING AN OIL/WATER EMULSION  
(71) Mudmax KFT., Bercsényi u. 9., 1111 Budapest, HU  
(72) HORVÁTH, László, Klauzál Gábor u. 35., H-1223 Budapest, HU  
SZABÓ, Gergely, Völgy u. 35., H-1021 Budapest, HU
- 
- (51) MKP  
**A61P 35/00 (2006.01)** (97) **2501412 \***  
**A61K 47/48 (2006.01)**
- (86) US2010057292 18.11.2010  
(96) 10781794.2 26.09.2012  
(87) WO2011063158, 18.11.2010  
(97) 2501412, 26.09.2012 en  
(54) SALT FORM OF A MULTI-ARM POLYMER-DRUG CONJUGATE  
(71) Nektar Therapeutics, 455 Mission Bay Boulevard South Suite 100, San Francisco, CA 94158, US  
(72) CHONG, Anthony, O., 117 Windridge Way SW, Huntsville, AL 35824, US  
LEE, Seou, 108 Alisha Circle, Madison, AL 35756, US  
JOSHI, Bhalchandra, V., 1211 Willowbrook Drive 2, Huntsville, AL 35802, US  
BRAY, Brian, 512 Farmingdale Road, Huntsville, AL 35802, US  
NIE, Shaoyong, 922 Willowbrook Drive 6, Huntsville, AL 35802, US  
SPENCE, Patrick, 110 Porch Light Place, Madison, AL 35756, US  
KOZLOWSKI, Antoni, 2103 Greenslope Trail, Huntsville, AL 35811, US  
MCMANUS, Samuel, 8867 Tacoma Trail, Huntsville, AL 35802, US  
TIPNIS, Sachin, 12850 Whittington Drive 1506, Houston, TX 77077, US  
LAVATY, Greg, 826 Bel Mar Street, Sugar Land, TX 77478, US  
SWALLOW, David, 9407 Funchurch Drive, Spring, TX 77379, US
- 
- (51) MKP  
**H01L 31/042 (2006.01)** (97) **2535661**  
**F24J 2/52 (2006.01)**
- (96) 11425260.4 19.12.2012  
(97) 2535661, 19.12.2012 en  
(54) Modular type assembly system for the installation of photovoltaic system  
(71) Doors Sistem S.r.L., Via Guglielmo Marconi n. 37/A, 35020 Brugine (PD), IT  
(72) Durello, Mariano, Via P. Neruda n. 7, 35020 Sant'Angelo di Piove di Sacco (PD), IT
- 
- (51) MKP  
**C07C 237/04 (2006.01)** (97) **2507218 \***  
**C07D 263/06 (2006.01)**
- (86) FR2010052592 02.12.2010  
(96) 10801618.9 10.10.2012  
(87) WO2011067538, 02.12.2010  
(97) 2507218, 10.10.2012 fr  
(54) COMBRETASTATIN DERIVATIVE PREPARATION METHOD  
(71) SANOFI, 54 rue La Boétie, 75008 Paris, FR  
(72) BESSE, Pascal, c/o sanofi-aventis Département Brevets 174 Avenue de France, F-75013 Paris, FR  
DIDIER, Eric, c/o sanofi-aventis Département Brevets 174 Avenue de France, F-75013 Paris, FR  
TREMAUDEUX, Nicolas, c/o sanofi-aventis Département Brevets 174 Avenue de France, F-75013 Paris, FR
- 
- (51) MKP  
**C07D 307/82 (2006.01)** (97) **2509971 \***
- (86) HU2010000128 23.11.2010  
(96) 10809325.3 17.10.2012  
(87) WO2011070380, 23.11.2010  
(97) 2509971, 17.10.2012 en  
(54) NEW PROCESS FOR THE PREPARATION OF DRONEDARONE  
(71) SANOFI, 54 rue La Boétie, 75008 Paris, FR  
(72) FRIESZ, Antal, null, Budapest, HU  
DOMBRÁDY, Zsolt, null, Budapest, HU  
CSATÁRIN NAGY, Marianna, null, Erd Kertes, HU
-



(51) MKP  
**A61K 31/40 (2006.01)** (97) **2515856 \***  
**A61K 9/00 (2006.01)**  
(86) EP2010070476 22.12.2010  
(96) 10800932.5 31.10.2012  
(87) WO2011076840, 22.12.2010  
(97) 2515856, 31.10.2012 en  
(54) AEROSOL FORMULATION FOR COPD  
(71) Chiesi Farmaceutici S.p.A., Via Palermo, 26/A, 43100 Parma, IT  
(72) BONELLI, Sauro, Chiesi Farmaceutici S.P.A. Via Palermo 26/A, I-43100 Parma, IT  
USBERTI, Francesca, Chiesi Farmaceutici S.P.A. Via Palermo 26/A, I-43100 Parma, IT  
ZAMBELLI, Enrico, Chiesi Farmaceutici S.P.A. Via Palermo 26/A, I-43100 Parma, IT

(51) MKP  
**H04L 12/56 (2006.01)** (97) **2507952 \***  
(86) EP2010068967 06.12.2010  
(96) 10795979.3 10.10.2012  
(87) WO2011067409, 06.12.2010  
(97) 2507952, 10.10.2012 en  
(54) AN ASSEMBLY AND A METHOD OF RECEIVING AND STORING DATA WHILE SAVING BANDWIDTH BY CONTROLLING UPDATING OF FILL LEVELS OF QUEUES  
(71) Napatech A/S, Tobaksvejen 23A, 2860 Søborg, DK  
(72) KORGER, Peter, Mødekærgårdsvej 10, DK-3540 Lyngby, DK

(51) MKP  
**C07D 405/06 (2006.01)** (97) **2507228 \***  
**A61K 31/438 (2006.01)**  
**C07D 417/06 (2006.01)**  
**C07D 409/06 (2006.01)**  
**C07D 471/10 (2006.01)**  
**C07D 413/06 (2006.01)**  
**A61P 3/10 (2006.01)**  
(86) US2010057359 19.11.2010  
(96) 10784390.6 10.10.2012  
(87) WO2011066183, 19.11.2010  
(97) 2507228, 10.10.2012 en  
(54) NOVEL SPIROPIPERIDINE COMPOUNDS  
(71) Eli Lilly and Company, Lilly Corporate Center, Indianapolis, IN 46285, US  
(72) HAMDouchi, Chafiq, Eli Lilly and Company Lilly Corporate Center, Indianapolis, Indiana 46285, US  
LINESWALA, Jayana, Pankaj, Eli Lilly and Company Lilly Corporate Center, Indianapolis, Indiana 46285, US  
MAITI, Pranab, 96 Industrial Suburb Second Phase, Yeswantpur Bangalore Karnataka 560022, IN

(51) MKP  
**G01N 33/487 (2006.01)** (97) **2531852 \***  
(86) GB2011000143 03.02.2011  
(96) 11704295.2 12.12.2012  
(87) WO2011095775, 03.02.2011  
(97) 2531852, 12.12.2012 en  
(54) SHAPE MEMORY ALLOY EJECTION MECHANISM FOR EJECTING A TEST STRIP FROM A TEST METER  
(71) Lifescan Scotland Limited, Beechwood Business Park North Inverness, Inverness-Shire IV2 3ED, GB  
(72) DEANGELI, Marco, Via Marconi 34, 24030 Barzana, IT  
VALSECCHI, Luca, Via M. Lutero 8, 20126 Milano, IT

(51) MKP  
**A61P 15/08 (2006.01)** (97) **2535342 \***  
**A61P 5/04 (2006.01)**  
**A61P 35/00 (2006.01)**  
**A61K 31/519 (2006.01)**  
**A61P 15/18 (2006.01)**  
**A61P 15/16 (2006.01)**  
**C07D 495/04 (2006.01)**  
(86) JP2011052719 09.02.2011  
(96) 11742250.1 19.12.2012  
(87) WO2011099507, 09.02.2011  
(97) 2535342, 19.12.2012 en  
(54) SALT OF FUSED HETEROCYCLIC DERIVATIVE AND CRYSTAL THEREOF  
(71) Kissei Pharmaceutical Co., Ltd., 19-48, Yoshino, Matsumoto-shi Nagano 399-8710, JP  
(72) JO, Kazumichi, c/o Joetsu Chemical Laboratories Kissei Pharmaceutical Co. Ltd. 197-5, Kamiyoshi Kubiki-ku, Joetsu-shi Niigata 942-0145, JP  
TAKEUCHI, Hideki, c/o Joetsu Chemical Laboratories Kissei Pharmaceutical Co. Ltd. 197-5, Kamiyoshi Kubiki-ku, Joetsu-shi Niigata 942-0145, JP

(51) MKP  
**A61K 31/436 (2006.01)** (97) **2501370 \***  
**A61P 35/00 (2006.01)**  
**A61K 31/501 (2006.01)**  
**A61K 31/5377 (2006.01)**  
**A61K 31/00 (2006.01)**  
(86) US2010056942 17.11.2010  
(96) 10782767.7 26.09.2012  
(87) WO2011062939, 17.11.2010  
(97) 2501370, 26.09.2012 en  
(54) METHODS AND COMPOSITIONS FOR TREATING SOLID TUMORS AND OTHER MALIGNANCIES  
(71) Novartis AG, Lichtstrasse 35, 4056 Basel, CH  
BUONAMICI, Silvia, Novartis Institutes for BioMedical Research Inc. 250 Massachusetts Avenue, Cambridge, Massachusetts 02139, US  
(72) DORSCH, Marion, 17 Neillian Crescent, Jamaica Plain Massachusetts 02130, US  
GARCIA-ECHEVERRIA, Carlos, 11 Boulevard de la Republique, F-92210 Saint-Cloud, FR

(51) MKP  
**C12Q 1/68 (2006.01)** (97) **2526204 \***  
**G01N 33/50 (2006.01)**  
(86) EP2011050776 20.01.2011  
(96) 11700668.4 28.11.2012  
(87) WO2011089192, 20.01.2011  
(97) 2526204, 28.11.2012 en  
(54) METHODS AND USES RELATING TO THE IDENTIFICATION OF COMPOUND INVOLVED IN PAIN AS WELL AS METHODS OF DIAGNOSING ALGESIA  
(71) SANOFI, 54, rue de la Boétie, 75008 Paris, FR  
(72) GEBAUER, Mathias, c/o Sanofi-Aventis Deutschland GmbH, 65926 Frankfurt am Main, DE  
MICHAELIS, Martin, c/o Sanofi-Aventis Deutschland GmbH, 65926 Frankfurt, DE  
DING-PFENNIGDORFF, Danping, c/o Sanofi-Aventis Deutschland GmbH, 65926 Frankfurt am Main, DE  
SCHULTE, Anke M., c/o Sanofi-Aventis Deutschland GmbH, 65926 Frankfurt am Main, DE  
ZIEMEK, Daniel, 53 Barnard Ave, Watertown, MA 02472, US  
METZ-WEIDMANN, Christiane, c/o Sanofi-Aventis Deutschland GmbH, 65926 Frankfurt am Main, DE

- (51) MKP  
**C07K 16/44 (2006.01)** (97) **2525812 \***  
**A61K 39/00 (2006.01)**
- (86) EP2011050749 20.01.2011  
(96) 11703410.8 28.11.2012  
(87) WO2011089183, 20.01.2011  
(97) 2525812, 28.11.2012 en  
(54) ANTICOAGULANT ANTIDOTES  
(71) Boehringer Ingelheim International GmbH, Binger Strasse 173, 55216 Ingelheim am Rhein, DE  
(72) VAN RYN, Joanne, Boehringer Ingelheim GmbH Corporate Patents Binger Str. 173, 55216 Ingelheim am Rhein, DE  
PARK, John Edward, Boehringer Ingelheim GmbH Corporate Patents Binger Str. 173, 55216 Ingelheim am Rhein, DE  
HAUEL, Norbert, Boehringer Ingelheim GmbH Corporate Patents Binger Str. 173, 55216 Ingelheim am Rhein, DE  
KUNZ, Ulrich, Boehringer Ingelheim GmbH Corporate Patents Binger Str. 173, 55216 Ingelheim am Rhein, DE  
LITZENBURGER, Tobias, Boehringer Ingelheim GmbH Corporate Patents Binger Str. 173, 55216 Ingelheim am Rhein, DE  
CANADA, Keith, Boehringer Ingelheim Pharmaceuticals Inc. 900 Ridgebury Road, Ridgefield, CT 06877, US  
SINGH, Sanjaya, Boehringer Ingelheim Pharmaceuticals Inc. 900 Ridgebury Road, Ridgefield, CT 06877, US  
WATERMAN, Alisa, Boehringer Ingelheim Pharmaceuticals Inc. 900 Ridgebury Road, Ridgefield, CT 06877, US
- 
- (51) MKP  
**A41B 17/00 (2006.01)** (97) **2520187 \***  
**A41D 31/00 (2006.01)**
- (86) ES2010070779 26.11.2010  
(96) 10840620.8 07.11.2012  
(87) WO2011080368, 26.11.2010  
(97) 2520187, 07.11.2012 en  
(54) INSULATING GARMENT  
(71) Sutran I Mas D, S.L., C/ Más nº 153, 08904 Hospitalet de Llobregat (Barcelona), ES  
(72) CAHISA GALLARDO, David, C/ Más nº 153, E-08904 Hospitalet de Llobregat (Barcelona), ES  
DEUMAL RUBIO, Oscar, C/ Más nº 153, E-08904 Hospitalet de Llobregat (Barcelona), ES  
REXACH ALABART, Sergi, C/ Más nº 153, E-08904 Hospitalet de Llobregat (Barcelona), ES
- 
- (51) MKP  
**G06F 11/30 (2006.01)** (97) **2510441 \***  
**G06F 17/13 (2006.01)**  
**F01K 13/02 (2006.01)**  
**G05B 1/11 (2006.01)**  
**F02B 43/02 (2006.01)**  
**F01D 17/00 (2006.01)**  
**G05B 6/05 (2006.01)**  
**F22B 35/18 (2006.01)**
- (86) NZ2010000222 08.11.2010  
(96) 10828599.0 17.10.2012  
(87) WO2011056081, 08.11.2010  
(97) 2510441, 17.10.2012 en  
(54) SYSTEM AND METHOD FOR MAXIMISING THERMAL EFFICIENCY OF A POWER PLANT  
(71) Exergy Limited, 1 Fairway Drive, Avalon, Lower Hutt, NZ  
(72) YASNI, Eli, 833 Cumberland Street, Dunedin, NZ
- 
- (51) MKP  
**C12N 15/86 (2006.01)** (97) **2524060 \***  
**C12Q 1/70 (2006.01)**
- (86) US2011020832 11.01.2011  
(96) 11732315.4 21.11.2012  
(87) WO2011085369, 11.01.2011  
(97) 2524060, 21.11.2012 en  
(54) ASSAY FOR JC VIRUS ANTIBODIES  
(71) Biogen Idec MA Inc., 14 Cambridge Center, Cambridge, MA 02142, US  
(72) GORELIK, Leonid, 216 Parke Avenue, Quincy MA 02171, US  
SIMON, Kenneth, J., 454 Windsor Street, Cambridge MA 02141, US  
SUBRAMANYAM, Meena, 3 Corey Avenue, Stoneham MA 02180, US  
RUSHE, Mia, Marie, 30 Henry Street, Everett MA 02149, US
- 
- (51) MKP  
**C07K 14/435 (2006.01)** (97) **2536746 \***
- (86) GB2011050325 18.02.2011  
(96) 11730044.2 26.12.2012  
(87) WO2011101681, 18.02.2011  
(97) 2536746, 26.12.2012 en  
(54) DISULPHIDE BOND-STABILIZED FUNCTIONAL SOLUBLE MHC CLASS II HETERODIMERS  
(71) Universitetet I Oslo, Boks 1072 Blindern, 0316 Oslo, NO  
(72) LØSET, Geir Åge, Midtveien 17E, 0583 Oslo, NO  
FRIGSTAD, Terje, Minister Ditleffs vei 11a, 0862 Oslo, NO  
SANDLIE, Inger, Røaveien 16A, 0752 Oslo, NO  
BOGEN, Bjarne, Pelvikveien 28, 1367 Snarøya, NO
- 
- (51) MKP  
**A61P 35/00 (2006.01)** (97) **2507229 \***  
**C07D 295/14 (2006.01)**  
**A61K 31/404 (2006.01)**  
**C07D 249/04 (2006.01)**  
**C07D 217/16 (2006.01)**  
**C07D 405/14 (2006.01)**  
**C07D 405/12 (2006.01)**  
**C07D 235/26 (2006.01)**  
**C07D 209/32 (2006.01)**  
**C07D 309/14 (2006.01)**  
**C07D 215/20 (2006.01)**  
**C07D 231/56 (2006.01)**  
**C07D 211/96 (2006.01)**  
**C07D 401/12 (2006.01)**  
**C07D 213/64 (2006.01)**  
**C07D 295/125 (2006.01)**
- (86) US2010036919 01.06.2010  
(96) 10727241.1 10.10.2012  
(87) WO2011068561, 01.06.2010  
(97) 2507229, 10.10.2012 en  
(54) SULFONAMIDE DERIVATIVES AS BCL-2-SELECTIVE APOPTOSIS-INDUCING AGENTS FOR THE TREATMENT OF CANCER AND IMMUNE DISEASES  
(71) Abbott Laboratories, 100 Abbott Park Rd., Abbott Park, IL 60064, US  
(72) PARK, Chang, H., 2871 North Southern Hills Wadsworth, Illinois 60083, US  
BRUNCKO, Milan, 31231 Prairie Ridge, Green Oaks Illinois 60048, US  
DING, Hong, 7465 Clem Drive, Gurnee Illinois 60031, US  
DOHERTY, George A., 1605 Bush Court, Libertyville Illinois 60048, US  
ELMORE, Steven, W., 239 Ash Lane, Northbrook Illinois 60062, US  
HASVOLD, Lisa, 552 Shakespeare Drive, Grayslake Illinois 60030, US  
HEXAMER, Laura, 439 Gatewood Lane, Grayslake Illinois 60030, US  
KUNZER, Aaron, 615 W. Burr Oak Drive, Arlington Heights Illinois 60004, US  
MANTEI, Robert, A., 4203 Carolyn Court, Franklin Wisconsin 53132, US  
McCLELLAN, William, J., 1212 North Sheridan Road, Waukegan Illinois 60085, US  
PARK, Cheol-Min, 5312 F. George Court, Gurnee Illinois 60031, US  
PETROS, Andrew, M., 940 Ambria Drive, Mundelein Illinois 60060, US  
SONG, Xiaohong, 34037 Sulkey Drive, Grayslake Illinois 60030, US  
SQUERS, Andrew, J., 901 Hinman Apt. 3A Evanston, Illinois 60202, US  
SULLIVAN, Gerard, M., 1212 Tulip Tree Court, Lake Villa Illinois 60046, US  
TAO, Zhi-Fu, 1532 Vineyard Drive, Gurnee Illinois 60031, US  
WANG, Gary, T., 1904 Darnell Street, Libertyville Illinois 60048, US  
WANG, Le, 338 East Colonial Drive, Vernon Hills Illinois 60061, US  
WANG, Xilu, 34056 Sulkey Drive, Grayslake, Illinois 60030, US  
WENDT, Michael, D., 1445 Maidstone Drive, Vernon Hills, Illinois 60061, US  
HANSEN, Todd, M., 191 Seymour Avenue, Grayslake, Illinois 60030, US

(51) MKP  
**G01N 33/48 (2006.01)** (97) **2506853 \***  
**A61K 31/635 (2006.01)**  
**A61K 31/675 (2006.01)**  
**A61K 31/5377 (2006.01)**  
**A61K 31/454 (2006.01)**  
**C12Q 1/68 (2006.01)**  
**A61P 35/00 (2006.01)**  
**A61K 31/506 (2006.01)**  
**A61K 45/06 (2006.01)**  
(86) US2010058549 01.12.2010  
(96) 10787240.0 10.10.2012  
(87) WO2011068863, 01.12.2010  
(97) 2506853, 10.10.2012 en  
(54) COMBINATION THERAPY FOR TREATING CANCER AND DIAGNOSTIC ASSAYS FOR USE THEREIN  
(71) Abbott Laboratories, 100 Abbott Park Rd., Abbott Park, IL 60064, US  
(72) SHAH, Omar Jameel, 25306 SE 133rd Street, Issaquah, WA 98027, US  
SHEN, Yu, 7227 Buchanan Drive, Gurnee Illinois 60031, US  
LIN, Xiaoya, 34198 Old Walnut Circle, Gurnee Illinois 60031, US  
ANDERSON, Mark, 410 Sommerset Drive, Grayslake Illinois 60030, US  
HUANG, Xiaoli, 12545 Meadow Circle, Lake Bluff Illinois 60044, US  
LI, Junling, 1220 Vista Drive, Gurnee Illinois 60031, US  
LI, Leiming, 1166 Gail Drive, Buffalo Grove Illinois 60089, US

(51) MKP  
**C07D 513/04 (2006.01)** (97) **2516445 \***  
**A61P 25/24 (2006.01)**  
**A61P 25/08 (2006.01)**  
**A61P 25/36 (2006.01)**  
**A61P 25/16 (2006.01)**  
**C07D 491/153 (2006.01)**  
**A61P 25/28 (2006.01)**  
**A61K 31/4355 (2006.01)**  
**A61P 25/30 (2006.01)**  
**A61P 25/06 (2006.01)**  
**A61P 25/32 (2006.01)**  
**C07D 491/20 (2006.01)**  
**A61P 25/22 (2006.01)**  
**C07D 491/048 (2006.01)**  
**A61P 25/18 (2006.01)**  
(86) US2010060937 17.12.2010  
(96) 10799203.4 31.10.2012  
(87) WO2011087712, 17.12.2010  
(97) 2516445, 31.10.2012 en  
(54) TRICYCLIC DERIVATIVES AND THEIR PHARMACEUTICAL USE AND COMPOSITIONS  
(71) Cephalon, Inc., 41 Moores Road, Frazer, Pennsylvania 19355, US  
(72) BACON, Edward R., 1006 Skyline Circle, Audubon Pennsylvania 19403, US  
BAILEY, Thomas R., 217 Amanda Lane, Phoenixville Pennsylvania 19460, US  
DUNN, Derek D., 2202 Persimmon Drive, Coatesville Pennsylvania 19320, US  
HOSTETTLER, Greg A., 416 Arrowood Lane, Newark Delaware 19702, US  
MCHUGH, Robert J., 12172 St. Andrews Place, Miramar Florida 33025, US  
MORTON, George C., 313 Ross Lane, Collegeville Pennsylvania 19426, US  
ROSSE, Gerard C., 216 Warren Court, Exton Pennsylvania 19341, US  
SALVINO, Joseph M., 324 Welsh Circle, Chester Springs Pennsylvania 19425, US  
SUNDAR, Babu G., 208 Sidesaddle Place, West Chester Pennsylvania 19382, US  
TRIPATHY, Rabindranath, 131 Edwards Drive, Churchville Pennsylvania 18966, US

(51) MKP  
**B60V 3/08 (2006.01)** (97) **2508401 \***  
**B64C 5/06 (2006.01)**  
(86) RU2010000355 24.06.2010  
(96) 10842327.8 10.10.2012  
(87) WO2011084081, 24.06.2010  
(97) 2508401, 10.10.2012 en  
(54) COMBINED AIRCRAFT  
(71) Filimonov, Alexandr Iosifovich, Ul. Minskaya 3-605, Tyumen 625048, RU  
(72) FILIMONOVA, Lyudmila Yakovlevna, ul. Minskaya 3-605, Tyumen 625048, RU

(51) MKP  
**A61L 17/14 (2006.01)** (97) **2425865**  
(96) 10172204.9 07.03.2012  
(97) 2425865, 07.03.2012 en  
(54) Medicinal thread having a polyhydroxyalkanoate coating  
(71) Aesculap AG, Am Aesculap-Platz, 78532 Tuttlingen/Donau, DE  
Odermatt, Erich, Dr., Fernsichtsrasse, 7a, Schaffhausen, CH  
Bargon, Rainer, Dr., Semmelweisstrasse 5, 78532 Tuttlingen, DE

(51) MKP  
**B29C 44/12 (2006.01)** (97) **2536547 \***  
**B29C 70/44 (2006.01)**  
**B29C 45/14 (2006.01)**  
**B29C 70/54 (2006.01)**  
(86) EP2011052422 18.02.2011  
(96) 11703714.3 26.12.2012  
(87) WO2011101437, 18.02.2011  
(97) 2536547, 26.12.2012 de  
(54) METHOD FOR PRODUCING WIND POWER PLANT ROTOR BLADES AND A WIND POWER PLANT ROTOR BLADE  
(71) Wobben Properties GmbH, Dreekamp 5, 26605 Aurich, DE  
(72) MUSCHKE, Sven, Bahnweg 46, 26419 Schortens, DE  
KANNENBERG, Johannes, Eschener Gaste 58, 26603 Aurich, DE

(51) MKP  
**A61M 5/32 (2006.01)** (97) **2536452 \***  
**A61M 5/00 (2006.01)**  
**A61M 5/20 (2006.01)**  
(86) EP2011052301 16.02.2011  
(96) 11703889.3 26.12.2012  
(87) WO2011101379, 16.02.2011  
(97) 2536452, 26.12.2012 en  
(54) AUTO-INJECTOR  
(71) Sanofi-Aventis Deutschland GmbH, Brüningstraße 50, 65929 Frankfurt, DE  
(72) EKMAN, Matthew, 59 Ecton Avenue, Macclesfield Cheshire SK10 1RD, GB  
BARROW-WILLIAMS, Timothy Donald, 1 Grange Street, St. Albans Herts AL3 5NA, GB  
HOURMAND, Yannick, 14 The Elms, Haslingfield CB23 1ND, GB

(51) MKP  
**A01K 95/00 (2006.01)** (97) **2476310**  
(96) 11194840.2 18.07.2012  
(97) 2476310, 18.07.2012 en  
(54) A ballast weight for a fishing line  
(71) Gaudieri, Gianni, Via G. Giorgis 105, 00054 Fiumicino (Roma), IT  
(72) Gaudieri, Gianni, Via G. Giorgis 105, 00054 Fiumicino (Roma), IT

- (51) MKP  
**B41M 3/14 (2006.01)** (97) **2509794 \***  
**B42D 15/10 (2006.01)**  
**B42D 15/00 (2006.01)**  
**C09D 11/00 (2006.01)**  
**B41M 5/28 (2006.01)**  
**C09D 11/02 (2006.01)**  
(86) EP2010056879 19.05.2010  
(96) 10724343.8 17.10.2012  
(87) WO2011069691, 19.05.2010  
(97) 2509794, 17.10.2012 en  
(54) MARKING BASED ON CHIRAL LIQUID CRYSTAL POLYMERS  
(71) SICPA Holding SA, Avenue de Florissant 41, 1008 Prilly, CH  
(72) TILLER, Thomas, Chemin du Cèdre 21, CH-1030 Bussigny, CH  
GREMAUD, Frédéric, Chemin de la Belle-Luce 15, CH-1663 Epagny, CH  
CALLEGARI, Andrea, Chemin des Berges 4, CH-1022 Chavannes-Pres-Renens, CH
- 
- (51) MKP  
**F27D 1/14 (2006.01)** (97) **2510298 \***  
(86) CA2010001937 08.12.2010  
(96) 10835335.0 17.10.2012  
(87) WO2011069250, 08.12.2010  
(97) 2510298, 17.10.2012 en  
(54) COMPRESSIVE ROD ASSEMBLY FOR MOLTEN METAL CONTAINMENT STRUCTURE  
(71) Novelis, Inc., 191 Evans Avenue, Toronto, ON M8Z 1J5, CA  
(72) REEVES, Eric W., 4683 E. Hudlow Road, Hayden Lake Idaho 83835, US  
BOORMAN, James E., 2207 N. Flora, Greenacres Washington 99016, US  
HYMAS, Jason D., 18011 S. Forsland Road, Fairfield Washington 99012, US  
WAGSTAFF, Robert Bruce, 22710 East Henry Road, Greenacres Washington 99216, US  
WOMACK, Randy, P.O. Box 96, Spokane Valley Washington 99037, US
- 
- (51) MKP  
**A61M 5/315 (2006.01)** (97) **2506901 \***  
(86) EP2010068596 01.12.2010  
(96) 10784544.8 10.10.2012  
(87) WO2011067270, 01.12.2010  
(97) 2506901, 10.10.2012 en  
(54) DRIVE MECHANISM FOR DRUG DELIVERY DEVICES  
(71) Sanofi-Aventis Deutschland GmbH, Brüningsstraße 50, 65929 Frankfurt, DE  
(72) BODE, Andreas, c/o Sanofi-Aventis Deutschland GmbH, 65926 Frankfurt am Main, DE
- 
- (51) MKP  
**A61K 9/12 (2006.01)** (97) **2525802 \***  
**A61P 11/02 (2006.01)**  
**A61K 33/00 (2006.01)**  
**A61K 33/14 (2006.01)**  
**A61P 11/04 (2006.01)**  
(86) US2011021524 18.01.2011  
(96) 11735037.1 28.11.2012  
(87) WO2011090932, 18.01.2011  
(97) 2525802, 28.11.2012 en  
(54) A METHOD OF TREATING SINUSITIS, INCLUDING CHRONIC SINUSITIS  
(71) Sinox Pharma, Inc., 21995 Saddle Peak Road, Topanga, CA 90290, US  
(72) ALLIGER, Howard, M., 10 Ponderosa Drive, Melville NY 11747-2405, US
- 
- (51) MKP  
**C04B 28/14 (2006.01)** (97) **2507190 \***  
**C04B 28/16 (2006.01)**  
(86) GB2010052011 02.12.2010  
(96) 10787543.7 10.10.2012  
(87) WO2011067601, 02.12.2010  
(97) 2507190, 10.10.2012 en  
(54) LIGHTWEIGHT GYPSUM PRODUCTS HAVING ENHANCED WATER RESISTANCE  
(71) BPB Limited, Saint-Gobain House, Binley Business Park Coventry CV3 2TT, GB  
(72) FISHER, Robin Daniel, Saint-Gobain House Binley Business Park Coventry, West Midlands CV3 2TT, GB
- 
- (51) MKP  
**A61H 39/02 (2006.01)** (97) **2512587 \***  
**A61N 1/04 (2006.01)**  
**A61N 1/08 (2006.01)**  
(86) US2010059687 09.12.2010  
(96) 10798217.5 24.10.2012  
(87) WO2011075389, 09.12.2010  
(97) 2512587, 24.10.2012 en  
(54) PLACEMENT DEVICES THAT ENABLE PATIENTS TO ACCURATELY POSITION MEDICAL PATCHES AT TARGET LOCATIONS AND METHODS THEREFOR  
(71) Ethicon, Inc., P.O. Box 151 Route 22, Somerville, NJ 08876, US  
(72) WAHLGREN, Stephen, B., 835 Gates Avenue, Easton PA 18040, US  
TOMKO, Andrea Slater, 165 Yacht Club Drive, Greentown PA 18426, US  
STAHL, Glenn, H., 2 Woodstock Circle, Colledgeville PA 19426, US  
MARCH, Andrew, Joseph, 24671 Via Princesa, Lake Forest CA 92630, US  
KLEINBERG, Rochelle, 25 West 74th Street Apt. 4A, New York NY 10023, US  
TAYLOR, Karin, Elise, 504 Grand Street, H53, New York NY 10002, US  
NOHILLY, Martin, J., 26 Chestnut Hill Drive, Murray Hill NJ 07974, US  
AMMERMAN, Michael, William, 30 Via Caramica, San Clemente CA 92673, US
- 
- (51) MKP  
**A61M 5/00 (2006.01)** (97) **2536458 \***  
**A61M 5/32 (2006.01)**  
**A61M 5/20 (2006.01)**  
(86) EP2011052298 16.02.2011  
(96) 11704218.4 26.12.2012  
(87) WO2011101376, 16.02.2011  
(97) 2536458, 26.12.2012 en  
(54) CLUTCH MECHANISM  
(71) Sanofi-Aventis Deutschland GmbH, Brüningsstraße 50, 65929 Frankfurt, DE  
(72) EKMAN, Matthew, 59 Ecton Avenue, Macclesfield Cheshire SK10 1RD, GB  
BARROW-WILLIAMS, Timothy Donald, 1 Grange Street, St. Albans Herts AL3 5NA, GB  
HOURMAND, Yannick, 14 The Elms, Haslingfield CB23 1ND, GB
- 
- (51) MKP  
**G04B 37/14 (2006.01)** (97) **2442192**  
**A44C 3/00 (2006.01)**  
(96) 11181585.8 18.04.2012  
(97) 2442192, 18.04.2012 de  
(54) Holder unit  
(71) Kimetec GmbH, Gerlinger Strasse 36/38, 71254 Gerlingen, DE  
(72) Kirchner, Hansjörd, Am Mühlberg 45, 71706 Markgröningen, DE
- 
- (51) MKP  
**A61J 1/06 (2006.01)** (97) **2525763 \***  
**A61M 5/24 (2006.01)**  
**G06K 7/10 (2006.01)**  
(86) EP2011050794 21.01.2011  
(96) 11700932.4 28.11.2012  
(87) WO2011089204, 21.01.2011  
(97) 2525763, 28.11.2012 en  
(54) A MULTI-DIMENSIONAL IDENTIFIER  
(71) Sanofi-Aventis Deutschland GmbH, Brüningsstraße 50, 65929 Frankfurt, DE  
(72) LANGLEY, Christopher Nigel, 120 Leicester Lane, Leamington Spa Warwickshire CV32 7HH, GB  
RUTTER, Paul Benedict, 51 Highfield Hatton Park, Warwick Warwickshire CV35 7TQ, GB  
AVERY, Richard James Vincent, 28 Nursery Close, Mickleton Chipping Campden Gloucestershire GL55 6TX, GB

(51) MKP  
**A61B 17/068 (2006.01)** (97) **2515768 \***  
**A61B 17/072 (2006.01)**  
**H01H 13/00 (2006.01)**  
**A61B 17/00 (2006.01)**  
(86) US2010059141 06.12.2010  
(96) 10788482.7 31.10.2012  
(87) WO2011078960, 06.12.2010  
(97) 2515768, 31.10.2012 en  
(54) MOTOR-DRIVEN SURGICAL CUTTING INSTRUMENT WITH ELECTRIC ACTUATOR DIRECTIONAL CONTROL ASSEMBLY  
(71) Ethicon Endo-Surgery, Inc., 4545 Creek Road, Cincinnati, OH 45242, US  
(72) SWENSGARD, Brett, E., 7936 Orchard Court, West Chester OH 45069, US  
SMITH, Bret, W., 4736 Eastport Drive, Kings Mills OH 45034, US  
LAURENT, Ryan, J., 4560 Snowbird Drive, Liberty Township OH 45011, US

(51) MKP  
**B42D 15/10 (2006.01)** (97) **2529940**  
**B41M 3/00 (2006.01)**  
**B44F 7/00 (2006.01)**  
**G02B 5/30 (2006.01)**  
**B41M 3/06 (2006.01)**  
**G02B 27/22 (2006.01)**  
(96) 11168298.5 05.12.2012  
(97) 2529940, 05.12.2012 en  
(54) Printed device with three dimensional appearance  
(71) SICPA HOLDING SA, Avenue de Florissant 41, 1008 Prilly, CH  
(72) Lefèbvre, Olivier, Chemin du reposoir 5, 1007 Lausanne, CH  
Degott, Pierre, Chemin des Falaises 15, 1023 Crissier, CH  
Demange, Raynald, Cotty-Dessus 8bis, 1442 Montagny-près-Yverdon, CH  
Pietrolungo, Nicolas, Route de Vevey 22, 1615 Bossonnens, CH

(51) MKP  
**B65F 1/14 (2006.01)** (97) **2501631 \***  
(86) IB2010002903 15.11.2010  
(96) 10805291.1 26.09.2012  
(87) WO2011058429, 15.11.2010  
(97) 2501631, 26.09.2012 en  
(54) DUMPSTER FOR HOLDING WASTE MATERIAL  
(71) Ferraccioli, Luca, Via del Cavo 18, Sant' Agostino, IT  
(72) Ferraccioli, Luca, Via del Cavo 18, Sant' Agostino, IT

(51) MKP  
**C07D 413/04 (2006.01)** (97) **2523949 \***  
**C07D 403/12 (2006.01)**  
**C07D 471/04 (2006.01)**  
**C07D 487/04 (2006.01)**  
**A61K 31/4196 (2006.01)**  
**C07D 401/14 (2006.01)**  
**A61P 25/28 (2006.01)**  
**C07D 401/12 (2006.01)**  
**C07D 403/14 (2006.01)**  
**C07D 403/10 (2006.01)**  
(86) EP2011050350 12.01.2011  
(96) 11700832.6 21.11.2012  
(87) WO2011086099, 12.01.2011  
(97) 2523949, 21.11.2012 en  
(54) NOVEL SUBSTITUTED TRIAZOLE DERIVATIVES AS GAMMA SECRETASE MODULATORS  
(71) Janssen Pharmaceuticals Inc., 1125 Trenton-Harbourton Road, Titusville NJ 08560, US  
(72) VAN BRANDT, Sven, Franciscus, Anna, Janssen Pharmaceutica NV Turnhoutseweg 30, B-2340 Beerse, BE  
DE CLEYN, Michel, Anna, Jozef, Janssen Pharmaceutica NV Turnhoutseweg 30, B-2340 Beerse, BE  
GIJSEN, Henricus, Jacobus, Maria, Janssen Pharmaceutica NV Turnhoutseweg 30, B-2340 Beerse, BE  
BERTHELOT, Didier, Jean-Claude, Janssen Pharmaceutica NV Turnhoutseweg 30, B-2340 Beerse, BE  
SURKYN, Michel, Janssen Pharmaceutica NV Turnhoutseweg 30, B-2340 Beerse, BE

(51) MKP  
**A01H 1/00 (2006.01)** (97) **2512221 \***  
**A01H 5/00 (2006.01)**  
**A01P 7/00 (2006.01)**  
(86) US2010060815 16.12.2010  
(96) 10838259.9 24.10.2012  
(87) WO2011075587, 16.12.2010  
(97) 2512221, 24.10.2012 en  
(54) COMBINED USE OF CRY1DA AND CRY1FA PROTEINS FOR INSECT RESISTANCE MANAGEMENT  
(71) Dow AgroSciences, LLC, 9330 Zionsville Road, Indianapolis, Indiana 46268, US  
(72) MEADE, Thomas, 1141 Huntington Woods Pt., Zionsville IN 46077, US  
NARVA, Kenneth, 4372 Creekside Pass, Zionsville IN 46077, US  
STORER, Nicholas, P., 10703 Lexington Street, Kensington MD 20895, US  
SHEETS, Joel, J., 10005 Oak Ridge Drive, Zionsville IN 46077, US  
WOOSLEY, Aaron, T., 8906 Tanner Drive, Fishers IN 46038, US  
BURTON, Stephanie, L., 6820 Bluffgrove Drive, Indianapolis IN 46278, US

(51) MKP  
**A61K 38/18 (2006.01)** (97) **2506861 \***  
**C07K 14/475 (2006.01)**  
**A61K 38/00 (2006.01)**  
(86) US2010058587 01.12.2010  
(96) 10787243.4 10.10.2012  
(87) WO2011068893, 01.12.2010  
(97) 2506861, 10.10.2012 en  
(54) BINDING PROTEINS THAT BIND TO HUMAN FGFR1C, HUMAN B-KLOTHO AND BOTH HUMAN FGFR1C AND HUMAN B-KLOTHO  
(71) Amgen Inc., One Amgen Center Drive, Thousand Oaks, California 91320-1799, US  
(72) SMITH, Richard, 1374 Sunnyslope Avenue, Belmont CA 94002, US  
BAKKER, Alice, 1234 Bubb Road, Cupertino CA 95014, US  
DUGUAY, Amy, N., 18242 Baylor Avenue, Saratoga CA 95070, US  
LI, Peng, 1220 14th Avenue, San Francisco CA 94122, US  
LI, Yang, 1142 Cuesta Drive, Mountain View CA 94040, US

(51) MKP  
**A61K 31/445 (2006.01)** (97) **2520296**  
**A61K 31/403 (2006.01)**  
**A61K 45/06 (2006.01)**  
**A61K 31/55 (2006.01)**  
**A61P 25/16 (2006.01)**  
**A61K 31/27 (2006.01)**  
**A61P 25/28 (2006.01)**  
**A61K 9/20 (2006.01)**  
(96) 12166348.8 07.11.2012  
(97) 2520296, 07.11.2012 fr  
(54) New association between 4-{3-[cis-hexahydrocyclopenta[c]pyrrol-2(1h)-yl]propoxy}benzamide and an acetylcholinesterase inhibitor, and pharmaceutical compositions containing it.  
(71) Les Laboratoires Servier, 35, rue de Verdun, 92284 Suresnes Cedex, FR  
(72) Trocme-Thibierge, Caryn, 74, rue Adolphe Guyot, 92270 BOIS COLOMBES, FR  
Sors, Aurore, 131, rue de Javel, 75015 PARIS, FR  
Keime Guibert, Florence, 136 Laurel Wood Avenue The Tenneriffe, 275851 SINGAPOUR, SG

- (51) MKP  
**C10L 5/44 (2006.01)** (97) **2504411 \***  
**C10J 3/46 (2006.01)**  
**C10J 3/66 (2006.01)**  
**C10B 53/02 (2006.01)**  
(86) EP2010007181 26.11.2010  
(96) 10790727.1 03.10.2012  
(87) WO2011063971, 26.11.2010  
(97) 2504411, 03.10.2012 de  
(54) DEVICE AND METHOD FOR GENERATING A SYNTHESIS GAS FROM PROCESSED BIOMASS BY ENTRAINED-FLOW GASIFICATION  
(71) Linde Aktiengesellschaft, Klosterhofstrasse 1, 80331 München, DE  
(72) RÜGER, Dietmar, Carl-Bantzer-Strasse 7, 01728 Bannewitz, DE  
SCHULZE, Olaf, Lindenweg 16, 09633 Tuttendorf, DE  
ALTHAPP, Anton, Novalisweg 13, 09600 Oberschöna, DE  
EICHHORN, Christian, Schmiedestrasse 8, 09599 Freiberg, DE  
KRETSCHMER, Horst, Am Wäldchen 5, 09600 Weißßenborn, DE

- (51) MKP  
**B21B 1/085 (2006.01)** (97) **2504112 \***  
(86) EP2010007102 24.11.2010  
(96) 10787018.0 03.10.2012  
(87) WO2011063935, 24.11.2010  
(97) 2504112, 03.10.2012 en  
(54) A METHOD OF ROLLING RAILS, APPARATUS FOR ROLLING RAILS AND RAIL PRODUCED ACCORDING TO SAID METHOD  
(71) Tata Steel UK Limited, 30 Millbank, London SW1P 4WY, GB  
(72) SHIPTON, Damian, Gerard, Tata Steel Nederland Technology B.V. Tata Steel - Group Intellectual Property Services P.O. Box 10000, NL-1970 CA IJmuiden, NL  
NORFOLK, Darren, Michael, Tata Steel Nederland Technology B.V. Tata Steel - Group Intellectual Property Services P.O. Box 10000, NL-1970 CA IJmuiden, NL

- (51) MKP  
**C07D 405/14 (2006.01)** (97) **2513093 \***  
**A61P 29/00 (2006.01)**  
**C07D 491/10 (2006.01)**  
**A61K 31/506 (2006.01)**  
(86) EP2010069549 13.12.2010  
(96) 10796336.5 24.10.2012  
(87) WO2011073154, 13.12.2010  
(97) 2513093, 24.10.2012 en  
(54) NEW CCR2 RECEPTOR ANTAGONISTS AND USES THEREOF  
(71) Boehringer Ingelheim International GmbH, Binger Strasse 173, 55216 Ingelheim am Rhein, DE  
(72) EBEL, Heiner, BOEHRINGER INGELHEIM GMBH Corporate Patents Binger Str. 173, 55216 Ingelheim am Rhein, DE  
FRATTINI, Sara, BOEHRINGER INGELHEIM GMBH Corporate Patents Binger Str. 173, 55216 Ingelheim am Rhein, DE  
GERLACH, Kai, BOEHRINGER INGELHEIM GMBH Corporate Patents Binger Str. 173, 55216 Ingelheim am Rhein, DE  
GIOVANNINI, Riccardo, BOEHRINGER INGELHEIM GMBH Corporate Patents Binger Str. 173, 55216 Ingelheim am Rhein, DE  
HOENKE, Christoph, BOEHRINGER INGELHEIM GMBH Corporate Patents Binger Str. 173, 55216 Ingelheim am Rhein, DE  
MAZZAFERRO, Rocco, BOEHRINGER INGELHEIM GMBH Corporate Patents Binger Str. 173, 55216 Ingelheim am Rhein, DE  
SANTAGOSTINO, Marco, BOEHRINGER INGELHEIM GMBH Corporate Patent Binger Str. 173, 55216 Ingelheim am Rhein, DE  
SCHEUERER, Stefan, BOEHRINGER INGELHEIM GMBH Corporate Patents Binger Str. 173, 55216 Ingelheim am Rhein, DE  
TAUTERMANN, Christofer, BOEHRINGER INGELHEIM GMBH Corporate Patents Binger Str. 173, 55216 Ingelheim am Rhein, DE  
TRIESELMANN, Thomas, BOEHRINGER INGELHEIM GMBH Corporate Patents Binger Str. 173, 55216 Ingelheim am Rhein, DE

- (51) MKP  
**A61M 5/24 (2006.01)** (97) **2531233 \***  
(86) EP2011051306 31.01.2011  
(96) 11703167.4 12.12.2012  
(87) WO2011092326, 31.01.2011  
(97) 2531233, 12.12.2012 en  
(54) CARTRIDGE HOLDER, DRUG DELIVERY DEVICE AND METHOD FOR SECURING A CARTRIDGE IN A CARTRIDGE HOLDER  
(71) Sanofi-Aventis Deutschland GmbH, Brüningstraße 50, 65929 Frankfurt, DE  
(72) RAAB, Steffen, c/o Sanofi-Aventis Deutschland GmbH, 65926 Frankfurt, DE  
ARNHOLD, Sandra, c/o Sanofi-Aventis Deutschland GmbH, 65926 Frankfurt am Main, DE

- (51) MKP  
**A61K 38/24 (2006.01)** (97) **2533800 \***  
(86) IN2011000090 11.02.2011  
(96) 11741984.6 19.12.2012  
(87) WO2011099036, 11.02.2011  
(97) 2533800, 19.12.2012 en  
(54) LIQUID FORMULATION OF FOLLICLE STIMULATING HORMONE  
(71) Intas Biopharmaceuticals Limited, Plot No: 423/P/A/GIDC Sarkhej-Bavla Highway Moraiya, Tal: Sanand Ahmedabad - 382 213, Gujarat, IN  
(72) MAJUMDER, Sudip Kumar, School Road Raiganj Uttar Dinajpur 733 134, West Bengal, IN  
SHARMA, Manish Kumar, C-5 Deep Nagar Muthiyaan Residency Aurangabad 431 001, Maharashtra, IN  
GUPTA, Tarun Kumar, Hayatnagar P.O. Saraitarin Sambhal Moradabad 244 303, Uttar Pradesh, IN

- (51) MKP  
**C07D 413/10 (2006.01)** (97) **2526092 \***  
**C07D 405/04 (2006.01)**  
**A61K 31/4709 (2006.01)**  
**C07D 215/38 (2006.01)**  
**C07D 471/08 (2006.01)**  
**C07D 405/10 (2006.01)**  
**A61P 25/28 (2006.01)**  
**C07D 405/12 (2006.01)**  
**C07D 403/10 (2006.01)**  
**A61K 31/47 (2006.01)**  
**C07D 471/04 (2006.01)**  
**C07D 401/10 (2006.01)**  
**C07D 498/08 (2006.01)**  
(86) US2011021423 14.01.2011  
(96) 11702316.8 28.11.2012  
(87) WO2011090911, 14.01.2011  
(97) 2526092, 28.11.2012 en  
(54) AMINO HETEROARYL COMPOUNDS AS BETA-SECRETASE MODULATORS AND METHODS OF USE  
(71) Amgen Inc., One Amgen Center Drive, Thousand Oaks, CA 91320, US  
(72) PARAS, Nick A., 3632 26th Street, San Francisco, California 94110, US  
BROWN, James, 4438 Appleglen Court, Moorpark California 93021, US  
CHENG, Yuan, 5329 Via Jacinto, Newbury Park California 91320, US  
HITCHCOCK, Stephen, 171 Florence Drive, Jupiter Florida 33458, US  
JUDD, Ted, 610 Geranium Lane Unit A, Simi Valley California 93065, US  
LOPEZ, Patricia, 22644 Saticoy Street, Woodland Hills California 91307, US  
MINATTI, Ana Elena, 2219 3rd Street Unit 6, Santa Monica California 90405, US  
NIXEY, Thomas, 4554 Via Laguna, Newbury Park California 91320, US  
POWERS, Timothy, 31230 Bailard Road, Malibu California 09265, US  
TEGLEY, Christopher M., 478 Thunderhead Street, Thousand Oaks California 91360, US  
XUE, Qiufen, 5018 Via Mesita, Newbury Park California 91320, US  
YANG, Bryant, 637 Warrendale Avenue, Simi Valley California 93065, US  
ZHONG, Wenge, 2921 Venezia Lane, Thousand Oaks California 91362, US

(51) MKP  
**F26B 23/00 (2006.01)** (97) **2511637**  
**F26B 11/16 (2006.01)**  
(96) 11162729.5 17.10.2012  
(97) 2511637, 17.10.2012 en  
(54) Method for drying wet particulate matter, wherein the dried particulate matter is a white mineral having a brightness Ry of at least 65%, through drying in a direct superheated steam dryer  
(71) Omya Development AG, Baslerstrasse 42, 4665 Oftringen, CH  
(72) Bergset, Olav, 6 Rue de Huningue, 68870 Bartenheim, FR  
Cremaschi, Alain, 27 Route de Chalons, 51240 Saint Germain La Ville, FR  
Gutsche, Robert, Im Gwänd 3, 4143 Dornach, CH  
Hautcoeur, Ludovic, 2 Rue Flaubert, 51460 Courtisols, FR

(51) MKP  
**A01P 7/00 (2006.01)** (97) **2512218 \***  
**A01H 5/00 (2006.01)**  
**A01H 1/00 (2006.01)**  
(86) US2010060808 16.12.2010  
(96) 10838256.5 24.10.2012  
(87) WO2011075584, 16.12.2010  
(97) 2512218, 24.10.2012 en  
(54) INSECT RESISTANCE MANAGEMENT WITH COMBINATIONS OF CRY1BE AND CRY1F PROTEINS  
(71) Dow AgroSciences, LLC, 9330 Zionsville Road, Indianapolis, Indiana 46268, US  
(72) MEADE, Thomas, 1141 Huntington Woods Pt., Zionsville, IN 46077, US  
NARVA, Kenneth, 4372 Creekside Pass, Zionsville, IN 46077, US  
STORER, Nicholas, P., 10703 Lexington Street, Kensington, MD 20895, US  
SHEETS, Joel, J., 10005 Oak Ridge Drive, Zionsville, IN 46077, US  
WOOSLEY, Aaron, T., 8906 Tanner Drive, Fishers, IN 46038, US  
BURTON, Stephenie, L., 6820 Bluffgrove Drive, Indianapolis, IN 46278, US

(51) MKP  
**A61K 9/00 (2006.01)** (97) **2515855 \***  
**A61K 31/167 (2006.01)**  
**A61K 45/06 (2006.01)**  
**A61K 31/40 (2006.01)**  
(86) EP2010070479 22.12.2010  
(96) 10799030.1 31.10.2012  
(87) WO2011076843, 22.12.2010  
(97) 2515855, 31.10.2012 en  
(54) Combination therapy for COPD  
(71) Chiesi Farmaceutici S.p.A., Via Palermo, 26/A, 43100 Parma, IT  
BONELLI, Sauro, c/o CHIESI FARMACEUTICI S.P.A. Via Palermo 26/A, I-43100 Parma, IT  
USBERTI, Francesca, c/o CHIESI FARMACEUTICI S.P.A. Via Palermo 26/A, I-43100 Parma, IT  
ZAMBELLI, Enrico, c/o CHIESI FARMACEUTICI S.P.A. Via Palermo 26/A, I-43100 Parma, IT

(51) MKP  
**A61P 35/00 (2006.01)** (97) **2524232 \***  
**G01N 33/574 (2006.01)**  
**C12Q 1/68 (2006.01)**  
**G01N 33/15 (2006.01)**  
(86) US2011021026 12.01.2011  
(96) 11733335.1 21.11.2012  
(87) WO2011088149, 12.01.2011  
(97) 2524232, 21.11.2012 en  
(54) METHODS FOR PREDICTING RESPONSE OF TRIPLE-NEGATIVE BREAST CANCER TO THERAPY  
(71) Nestec S.A., Avenue Nestlé 55, 1800 Vevey, CH  
(72) LIU, Xinjun, 12890 Caminito Diego, San Diego, California 92130, US  
KIM, Phillip, 28 Exeter, Irvine, California 92612, US  
KIRKLAND, Richard, 3677 Brookshire Street, San Diego, California 92111, US  
LEE, Tani, 4454 Bertha Court, San Diego, California 92117, US  
YBARRONDO, Belen, 4570 Orchard Avenue, San Diego, California 92107, US  
SINGH, Sharat, 8171 Top of the Morning Way, Rancho Santa Fe, California 92127, US

(51) MKP  
**C07D 491/04 (2006.01)** (97) **2513096 \***  
**C07D 487/08 (2006.01)**  
**A61K 31/496 (2006.01)**  
**C07D 417/10 (2006.01)**  
**C07D 417/14 (2006.01)**  
**C07D 417/06 (2006.01)**  
**A61P 35/00 (2006.01)**  
(86) US2010060720 16.12.2010  
(96) 10798426.2 24.10.2012  
(87) WO2011075565, 16.12.2010  
(97) 2513096, 24.10.2012 en  
(54) SUBSTITUTED AMINOTHIAZOLONE INDAZOLES AS ESTROGEN RELATED RECEPTOR-A MODULATORS  
(71) Janssen Pharmaceutica, N.V., Turnhoutseweg 30, 2340 Beerse, BE  
(72) BIGNAN, Gilles, 4 Burr Street, Bridgewater NJ 08807, US  
GAUL, Micheal, 656 Burgundy Place, Yardley PA 19067, US  
XU, Guozhang, 106 Tatham Road, Bensalem PA 19020, US  
ZHAO, Bao-Ping, 5 Windsor Pond Road, West Windsor NJ 08850, US

(51) MKP  
**B32B 7/00 (2006.01)** (97) **2535178**  
**B32B 7/04 (2006.01)**  
**B32B 27/00 (2006.01)**  
**B32B 27/08 (2006.01)**  
**B32B 25/08 (2006.01)**  
**B32B 5/04 (2006.01)**  
**B32B 3/26 (2006.01)**  
**B32B 5/02 (2006.01)**  
**B32B 25/00 (2006.01)**  
(96) 12171854.8 19.12.2012  
(97) 2535178, 19.12.2012 en  
(54) Registered stretch laminate and methods for forming a registered stretch laminate  
(71) Curt G. Joa, Inc., 100 Crocker Avenue, Sheboygan Falls, Wisconsin 53085, US  
(72) Handziak, Perry, 5187 Lakeview Ridge Road, Belgium, WI Wisconsin 53004, US  
Peterson, Daniel A, 1817 South 8th Street, Sheboygan, WI Wisconsin 53081, US

(51) MKP  
**F23J 15/06 (2006.01)** (97) **2501786 \***  
**C07C 29/151 (2006.01)**  
**C10G 2/00 (2006.01)**  
**F01K 23/06 (2006.01)**  
**C10J 3/66 (2006.01)**  
**F02C 3/28 (2006.01)**  
(86) EP2010067847 19.11.2010  
(96) 10777041.4 26.09.2012  
(87) WO2011061299, 19.11.2010  
(97) 2501786, 26.09.2012 de  
(54) THERMAL-CHEMICAL UTILIZATION OF CARBON-CONTAINING MATERIALS, IN PARTICULAR FOR THE EMISSION-FREE GENERATION OF ENERGY  
(71) RV Lizenz AG, Dammstrasse 19, 6300 Zug, CH  
(72) RÜDLINGER, Mikael, Römerstrasse 92, CH-8404 Winterthur, CH

(51) MKP  
**A01D 43/08 (2006.01)** (97) **2452550**  
(96) 11178215.7 16.05.2012  
(97) 2452550, 16.05.2012 de  
(54) Agricultural harvester  
(71) CLAAS Selbstfahrende Erntemaschinen GmbH, Münsterstrasse 33, 33428 Harsewinkel, DE  
(72) Diekhans, Norbert, Dr., Sebastianweg 19, 33335 Gütersloh, DE  
Huster, Jochen, Wilhelm-Baumann-Str. 11a, 33330 Gütersloh, DE  
Claussen, Frank, Römerweg 14, 33428 Harsewinkel, DE

- (51) MKP  
**C07K 16/40 (2006.01)** (97) **2510013 \***  
**A61P 3/06 (2006.01)**  
**A61K 39/395 (2006.01)**
- (86) US2010059959 10.12.2010  
(96) 10795172.5 17.10.2012  
(87) WO2011072263, 10.12.2010  
(97) 2510013, 17.10.2012 en  
(54) PCSK9 ANTAGONISTS  
(71) IRM LLC, 131 Front Street, Hamilton, HM LX, BM  
Novartis AG, Lichtstrasse 35, 4056 Basel, CH  
(72) RUE, Sarah, 4028 Carmel Springs Way, San Diego California  
92130, US  
COHEN, Steven, B., 4104 Via Candizid 89, San Diego California  
92130, US  
LI, Jun, 11618 Trailbrush Point, San Diego California 92126, US  
YOWE, David, 34 Fairview Avenue, Belmont Massachusetts  
02478, US

- (51) MKP  
**C02F 1/74 (2006.01)** (97) **2451747 \***  
**C02F 1/32 (2006.01)**  
**C02F 1/44 (2006.01)**  
**C02F 1/72 (2006.01)**
- (86) IB2010000982 30.04.2010  
(96) 10727828.5 16.05.2012  
(87) WO2010125450, 30.04.2010  
(97) 2451747, 16.05.2012 en  
(54) PURIFYING DEVICE AND METHOD FOR ELIMINATION OF  
XENOBIOTICS IN WATER  
(71) Loïra, ZA des Landes Allée du Cers, 31850 Mondouzil, FR  
(72) OLIVEROS, Esther, 3 lot. Communal, F-31620 Cepet, FR  
BRAUN, André, 3 lot. Communal, F-31620 Cepet, FR  
MAURETTE, Marie-Thérèse, 5 rue Emile Guyou, F-31400  
Toulouse, FR  
BENOIT-MARQUIE, Florence, 223 route de Bessières, F-31660  
Buzet sur Tarn, FR  
DEBUIRE, Jacques, 29 avenue de la Valade, F-31380  
Montastruc la Conseillère, FR

- (51) MKP  
**A61K 35/12 (2006.01)** (97) **2513311 \***  
**C12N 15/117 (2010.01)**  
**A61P 37/04 (2006.01)**
- (86) EP2010007751 17.12.2010  
(96) 10795952.0 24.10.2012  
(87) WO2011072871, 17.12.2010  
(97) 2513311, 24.10.2012 en  
(54) PRODUCTION OF IFN-LAMBDA BY CONVENTIONAL  
DENDRITIC CELLS AND USES THEREOF  
(71) Bavarian Nordic A/S, Hejreskovvej 10 A, 3490 Kvistgaard, DK  
(72) HOCHREIN, Hubertus, Haffstrasse 134, 81825 Munich, DE

- (51) MKP  
**B01J 19/18 (2006.01)** (97) **2516051 \***  
**B01J 8/10 (2006.01)**  
**B02C 13/04 (2006.01)**
- (86) SE2010051452 21.12.2010  
(96) 10839900.7 31.10.2012  
(87) WO2011078779, 21.12.2010  
(97) 2516051, 31.10.2012 en  
(54) REACTOR COMPRISING A ROTOR  
(71) Cassandra Oil AB., Kilpatrick Townsend Box 5421, 114 84  
Stockholm, SE  
(72) OLSSON, Anders, Wellpools Farm Stanhill, Charlwood, Surrey  
RH60ES, GB

- (51) MKP  
**A61K 31/4436 (2006.01)** (97) **2523950 \***  
**A61P 31/00 (2006.01)**  
**A61K 31/381 (2006.01)**  
**C07D 409/12 (2006.01)**
- (86) US2011021335 14.01.2011  
(96) 11700988.6 21.11.2012  
(87) WO2011088345, 14.01.2011  
(97) 2523950, 21.11.2012 en  
(54) INHIBITORS OF FLAVIVIRIDAE VIRUSES  
(71) Gilead Sciences, Inc., 333 Lakeside Drive, Foster City, CA  
94404, US  
(72) CANALES, Eda, 419 Turner Terrace Apt. 9, San Mateo, CA  
94401, US  
CLARKE, Michael, O'Neil Hanrahan, 545 Seastorm Drive,  
Redwood City, CA 94065, US  
LAZERWITH, Scott, E., 930 Scott Street 1, San Francisco, CA  
94115, US  
LEW, Willard, 1437 Overland Drive, San Mateo, CA 94403, US  
MORGANELLI, Philip, Anthony, 3923 Webster Street, Oakland,  
CA 94609, US  
WATKINS, William, J., 14275 Hilltop Way, Saratoga, CA 95070,  
US

- (51) MKP  
**A61M 5/00 (2006.01)** (97) **2512553 \***
- (86) EP2010069903 16.12.2010  
(96) 10792925.9 24.10.2012  
(87) WO2011080092, 16.12.2010  
(97) 2512553, 24.10.2012 en  
(54) MEDICAL DEVICE AND METHOD OF ASSEMBLY  
(71) Sanofi-Aventis Deutschland GmbH, Brüningstraße 50, 65929  
Frankfurt, DE

- (51) MKP  
**H01L 41/053 (2006.01)** (97) **2426749**
- (96) 10174799.6 07.03.2012  
(97) 2426749, 07.03.2012 en  
(54) Actuator arrangement for use in a fuel injector  
(71) Delphi Technologies Holding S.à.r.l., Avenue de Luxembourg,  
4940 Bascharage, LU  
(72) Cooke, Michael, 52 Burnt Oak Terrace, Gillingham, Kent ME7  
1DR, GB

- (51) MKP  
**E03D 9/08 (2006.01)** (97) **2295653**  
**A61H 33/14 (2006.01)**
- (96) 10171233.9 16.03.2011  
(97) 2295653, 16.03.2011 en  
(54) Toilet with bidet function  
(71) TOTO LTD., 1-1, Nakashima 2-chome, Kokurakita-ku,  
Kitakyushu-shi Fukuoka 802-8601, JP  
(72) Morotomi, Yo, TOTO LTD. 1-1 Nakashima 2-chome, Kokurakita-  
ku., Kitakyushu-shi Fukuoka 802-8601, JP  
Umemoto, Ayumu, TOTO LTD. 1-1 Nakashima 2-chome,  
Kokurakita-ku., Kitakyushu-shi Fukuoka 802-8601, JP  
Matsushita, Koichiro, TOTO LTD. 1-1 Nakashima 2-chome,  
Kokurakita-ku., Kitakyushu-shi Fukuoka 802-8601, JP

- (51) MKP  
**C08L 67/06 (2006.01)** (97) **2513224 \***  
**H01B 1/24 (2006.01)**  
**C08K 3/04 (2006.01)**
- (86) MY2010000320 15.12.2010  
(96) 10837935.5 24.10.2012  
(87) WO2011074940, 15.12.2010  
(97) 2513224, 24.10.2012 en  
(54) CONDUCTIVE TANK SUMP AND DISPENSER SUMP,  
AND METHOD OF EARTHING PROCESS OF THE SAME,  
AND ELECTRICALLY-CONDUCTIVE COMPOSITION FOR  
FABRICATION OF TANK SUMP  
(71) Guardian Venture Oil&Gas Sdn. Bhd., 25-31, Jalan Apollo  
U5/186 Seksyen U5 Bandar Pinggiran Subang 40150 Shah  
Alam, Selangor Darul Ehsan, MY  
(72) JOSEPH, Brian John, (NRIC NO. 590616-10-6659) P 07-04  
Selat Horizon Condo Klebang, Melaka, MY



(51) MKP  
**A61K 31/549 (2006.01)** (97) **2521552 \***  
**A61P 25/00 (2006.01)**  
(86) EP2011050049 04.01.2011  
(96) 11700071.1 14.11.2012  
(87) WO2011080344, 04.01.2011  
(97) 2521552, 14.11.2012 en  
(54) DIAZOXIDE FOR USE IN THE TREATMENT OF A CENTRAL NERVOUS SYSTEM (CNS) AUTOIMMUNE DEMYELINATING DISEASE  
(71) Neurotec Pharma, S.L., Josep Samitier, 1-5, 08028 Barcelona, ES  
(72) PUGLIESE, Marco, Neurotec Pharma S.L. Josep Samitier 1-5, E-08028 Barcelona, ES  
MAHY GEHENNE, Josette-Nicole, Neurotec Pharma S.L. Josep Samitier 1-5, E-08028 Barcelona, ES  
RODRIGUEZ ALLUÉ, Manuel, Neurotec Pharma S.L. Josep Samitier 1-5, E-08028 Barcelona, ES  
ESPINOSA PARRILLA, Juan Francisco, Neurotec Pharma S.L. Josep Samitier 1-5, E-08028 Barcelona, ES  
VIRGILI TRESERRES, Noemí, Neurotec Pharma S.L. Josep Samitier 1-5, E-08028 Barcelona, ES  
MANCERA AROCA, Pilar, Neurotec Pharma S.L. Josep Samitier 1-5, E-08028 Barcelona, ES  
PASTÉN ZAMORANO, Andrea, Neurotec Pharma S.L. Josep Samitier 1-5, E-08028 Barcelona, ES

(51) MKP  
**B65D 81/32 (2006.01)** (97) **2519457 \***  
**A61J 9/00 (2006.01)**  
**B65D 47/24 (2006.01)**  
**A45F 3/16 (2006.01)**  
(86) NO2010000492 30.12.2010  
(96) 10845874.6 07.11.2012  
(87) WO2011099864, 30.12.2010  
(97) 2519457, 07.11.2012 en  
(54) DRINKING BOTTLE WITH MULTIPLE COMPARTMENTS AND REPLACEABLE AMPOULES  
(71) Injection Bottle Development AS, Vollsveien 9, 1366 Lysaker, NO  
(72) KNUTSEN, Stian, Valentin, Nes terrasse 33, N-1394 Nesbru, NO

(51) MKP  
**C12Q 1/68 (2006.01)** (97) **2519649 \***  
(86) US2010062295 29.12.2010  
(96) 10803548.6 07.11.2012  
(87) WO2011082200, 29.12.2010  
(97) 2519649, 07.11.2012 en  
(54) TOOL FOR DIAGNOSIS AND PROGNOSIS OF MATURE B-CELL NEOPLASMS  
(71) Cancer Genetics, Inc., Meadows Office Complex 201 Route 17 North 2nd Floor, Rutherford NJ 07070, US  
(72) CHAGANTI, Raju, S.K., 235 Pascack Road, Hillsdale, NJ 07642, US  
HOULDSWORTH, Jane, 637 Franklin Avenue, Franklin Lakes, NJ 07417, US

(51) MKP  
**C07D 401/06 (2006.01)** (97) **2528910 \***  
**A61K 31/506 (2006.01)**  
**C07D 491/113 (2006.01)**  
**C07D 487/04 (2006.01)**  
**C07D 401/14 (2006.01)**  
**A61P 35/00 (2006.01)**  
**C07D 405/14 (2006.01)**  
**C07D 413/14 (2006.01)**  
**C07D 471/10 (2006.01)**  
**C07D 498/04 (2006.01)**  
(86) EP2011051060 26.01.2011  
(96) 11701988.5 05.12.2012  
(87) WO2011092197, 26.01.2011  
(97) 2528910, 05.12.2012 en  
(54) 5-ALKYNYL PYRIMIDINES AND THEIR USE AS KINASE INHIBITORS  
(71) Boehringer Ingelheim International GmbH, Binger Strasse 173, 55216 Ingelheim am Rhein, DE  
(72) SCHNEIDER, Siegfried, Boehringer Ingelheim GmbH Corporate Patents Binger Strasse 173, 55216 Ingelheim am Rhein, DE  
KESSLER, Dirk, Boehringer Ingelheim GmbH Corporate Patents Binger Strasse 173, 55216 Ingelheim am Rhein, DE  
VAN DER VEEN, Lars, Boehringer Ingelheim GmbH Corporate Patents Binger Strasse 173, 55216 Ingelheim am Rhein, DE  
WUNBERG, Tobias, Boehringer Ingelheim GmbH Corporate Patents Binger Strasse 173, 55216 Ingelheim am Rhein, DE



**INDEKS BROJEVA ZAHTJEVA ZA PROŠIRENJE EVROPSKIH PRIJAVA  
PATENTA**  
INDEX ON NUMBER OF REQUESTS FOR EXTENSION ON EUROPEAN PATENT  
APPLICATIONS

Broj objave evropske prijave patenta (97)	MKP (51)	Broj objave evropske prijave patenta (97)	MKP (51)	Broj objave evropske prijave patenta (97)	MKP (51)
2533752 *	<b>A61K 8/55</b> (2006.01) <b>A61Q 19/00</b> (2006.01) <b>A61K 8/41</b> (2006.01) <b>A61K 8/73</b> (2006.01) <b>A61K 8/19</b> (2006.01) <b>A61K 8/97</b> (2006.01) <b>A61K 8/49</b> (2006.01) <b>A61Q 7/00</b> (2006.01) <b>A61K 8/60</b> (2006.01) <b>A61K 8/67</b> (2006.01)	2536485 *	<b>B01D 71/82</b> (2006.01) <b>C12N 11/06</b> (2006.01) <b>B01J 20/28</b> (2006.01) <b>B01D 61/28</b> (2006.01) <b>G01N 33/48</b> (2006.01) <b>A61M 1/14</b> (2006.01) <b>B01J 20/22</b> (2006.01) <b>B01D 61/24</b> (2006.01)	2534651 *	<b>G09B 23/32</b> (2006.01)
				2518064 *	<b>C07D 401/12</b> (2006.01) <b>A61P 43/00</b> (2006.01) <b>A61P 25/04</b> (2006.01) <b>C07D 417/12</b> (2006.01) <b>C07D 311/68</b> (2006.01) <b>C07D 405/04</b> (2006.01) <b>A61K 31/454</b> (2006.01) <b>C07D 405/14</b> (2006.01) <b>A61K 31/4433</b> (2006.01) <b>C07D 405/12</b> (2006.01) <b>A61K 31/496</b> (2006.01) <b>C07D 413/04</b> (2006.01) <b>A61K 31/501</b> (2006.01) <b>C07D 413/12</b> (2006.01)
2452689	<b>A61K 36/53</b> (2006.01) <b>A61K 36/534</b> (2006.01) <b>A61P 15/08</b> (2006.01) <b>A61K 36/288</b> (2006.01)	2433809	<b>B42D 1/00</b> (2006.01) <b>B42D 13/00</b> (2006.01) <b>B42D 15/10</b> (2006.01)		
		2523961 *	<b>A61P 9/00</b> (2006.01) <b>A61K 31/519</b> (2006.01) <b>C07D 498/04</b> (2006.01)	2509569 *	<b>A61Q 19/00</b> (2006.01) <b>C07C 409/34</b> (2006.01) <b>A61K 8/38</b> (2006.01)
2439364	<b>E05C 17/02</b> (2006.01) <b>E05C 17/24</b> (2006.01)				
2528504 *	<b>G06T 7/60</b> (2006.01) <b>A61B 5/103</b> (2006.01)	2536453 *	<b>A61M 5/32</b> (2006.01) <b>A61M 5/20</b> (2006.01)	2503993 *	<b>A61K 9/16</b> (2006.01) <b>A61P 25/00</b> (2006.01) <b>A61K 31/4152</b> (2006.01) <b>C07D 231/22</b> (2006.01)
2529032 *	<b>C12Q 1/68</b> (2006.01)	2434158	<b>F04C 15/00</b> (2006.01) <b>F16D 1/06</b> (2006.01) <b>F04C 2/344</b> (2006.01)		
2534178 *	<b>C07K 16/28</b> (2006.01) <b>A61K 39/395</b> (2006.01)	2515924 *	<b>A23L 1/30</b> (2006.01) <b>A61K 36/536</b> (2006.01) <b>A61P 25/00</b> (2006.01)	2505615	<b>D21H 17/00</b> (2006.01) <b>C09C 1/02</b> (2006.01)
		2537058 *	<b>H02G 3/04</b> (2006.01) <b>G02B 6/46</b> (2006.01)		

Broj objave evropske prijava patenta (97)	MKP (51)	Broj objave evropske prijava patenta (97)	MKP (51)	Broj objave evropske prijava patenta (97)	MKP (51)
2510002 *	<b>A61P 35/00</b> (2006.01) <b>C07K 16/28</b> (2006.01) <b>A61P 5/08</b> (2006.01) <b>A61K 39/395</b> (2006.01)	2529433 *	<b>C01B 25/37</b> (2006.01) <b>H01M 4/58</b> (2010.01) <b>H01M 4/62</b> (2006.01) <b>H01M 4/04</b> (2006.01) <b>H01M 10/0525</b> (2010.01) <b>H01M 4/139</b> (2010.01)	2514759 *	<b>A61K 31/08</b> (2006.01) <b>A61K 31/704</b> (2006.01) <b>C07J 63/00</b> (2006.01) <b>A61K 31/56</b> (2006.01) <b>A61K 31/136</b> (2006.01) <b>A61K 31/135</b> (2006.01) <b>A61K 31/19</b> (2006.01) <b>A61K 31/185</b> (2006.01) <b>A61K 31/085</b> (2006.01) <b>A61P 1/16</b> (2006.01) <b>A61K 31/12</b> (2006.01) <b>A61P 31/14</b> (2006.01)
2531216 *	<b>A61K 39/39</b> (2006.01) <b>A61K 39/395</b> (2006.01) <b>A61K 35/12</b> (2006.01)	2521750 *	<b>C08K 5/34</b> (2006.01) <b>C08K 9/00</b> (2006.01)	2509960 *	<b>C07D 403/12</b> (2006.01) <b>A61K 31/4164</b> (2006.01) <b>C07D 233/64</b> (2006.01) <b>A61P 3/04</b> (2006.01) <b>A61K 31/4178</b> (2006.01) <b>A61K 31/4439</b> (2006.01) <b>C07D 233/84</b> (2006.01) <b>A61K 31/454</b> (2006.01) <b>A61K 31/496</b> (2006.01)
2521100	<b>G07C 9/00</b> (2006.01) <b>B60R 25/00</b> (2006.01)	2501391 *	<b>A61K 33/30</b> (2006.01) <b>A61K 31/728</b> (2006.01)	2511422	<b>E01F 15/04</b> (2006.01) <b>E01F 8/00</b> (2006.01) <b>E01F 15/08</b> (2006.01)
2502050 *	<b>G01N 21/31</b> (2006.01)	2536451 *	<b>A61M 5/32</b> (2006.01) <b>A61M 5/00</b> (2006.01) <b>A61M 5/20</b> (2006.01)	2513252 *	<b>C10G 1/08</b> (2006.01)
2509795 *	<b>B41M 5/28</b> (2006.01) <b>B41M 3/14</b> (2006.01) <b>B42D 15/00</b> (2006.01) <b>B42D 15/10</b> (2006.01)	2511422	<b>E01F 15/04</b> (2006.01) <b>E01F 8/00</b> (2006.01) <b>E01F 15/08</b> (2006.01)	2514419 *	<b>A61K 31/192</b> (2006.01) <b>A61K 47/32</b> (2006.01) <b>A61K 47/16</b> (2006.01) <b>A61P 29/00</b> (2006.01) <b>A61P 23/02</b> (2006.01) <b>A61K 9/70</b> (2006.01) <b>A61K 31/167</b> (2006.01)
2525831 *	<b>A61K 47/48</b> (2006.01)	2526420 *	<b>G01N 33/53</b> (2006.01) <b>C07K 4/00</b> (2006.01)	2533877 *	<b>B01D 39/20</b> (2006.01)
2516449 *	<b>C07F 5/02</b> (2006.01)	2531661 *	<b>E03D 11/14</b> (2006.01) <b>E03D 9/08</b> (2006.01)	2501720 *	<b>C07K 14/52</b> (2006.01)
2535640 *	<b>F21V 19/00</b> (2006.01) <b>F21Y 101/02</b> (2006.01) <b>F21V 29/00</b> (2006.01) <b>F21V 23/00</b> (2006.01)	2535048 *	<b>A61K 47/38</b> (2006.01) <b>A61K 47/32</b> (2006.01) <b>A61K 31/513</b> (2006.01) <b>A61P 11/06</b> (2006.01)		
2515047	<b>F24D 19/06</b> (2006.01)				
2521776 *	<b>C12N 15/00</b> (2006.01)				

Broj objave evropske prijave patenta (97)	MKP (51)	Broj objave evropske prijave patenta (97)	MKP (51)	Broj objave evropske prijave patenta (97)	MKP (51)
2512439 *	<b>A61K 31/7036</b> (2006.01) <b>A61K 9/00</b> (2006.01)	2474987	<b>H01H 3/12</b> (2006.01) <b>H01H 13/06</b> (2006.01) <b>H01H 13/02</b> (2006.01) <b>H02B 1/044</b> (2006.01)	2526090 *	<b>C07D 413/10</b> (2006.01) <b>C07D 401/10</b> (2006.01) <b>A61K 31/44</b> (2006.01) <b>C07D 417/04</b> (2006.01) <b>C07D 401/14</b> (2006.01) <b>A61K 31/4427</b> (2006.01) <b>C07D 405/04</b> (2006.01) <b>A61P 33/06</b> (2006.01) <b>C07D 401/04</b> (2006.01) <b>C07D 471/06</b> (2006.01) <b>C07D 413/14</b> (2006.01) <b>C07D 213/73</b> (2006.01) <b>C07D 417/14</b> (2006.01)
2529229 *	<b>G01N 33/574</b> (2006.01)	2505996 *	<b>G01N 22/00</b> (2006.01) <b>G06T 7/60</b> (2006.01)	2512511 *	<b>A61K 39/395</b> (2006.01) <b>C07K 16/46</b> (2006.01) <b>A61P 17/06</b> (2006.01) <b>A61P 37/00</b> (2006.01) <b>C07K 16/28</b> (2006.01)
2536282 *	<b>A61K 31/44</b> (2006.01) <b>A01N 43/42</b> (2006.01)	2512224 *	<b>A01H 5/00</b> (2006.01) <b>C07K 14/325</b> (2006.01)	2528625 *	<b>C07D 487/04</b> (2006.01) <b>A61P 35/00</b> (2006.01) <b>A61K 47/48</b> (2006.01)
2534149 *	<b>A61P 35/00</b> (2006.01) <b>A61P 31/00</b> (2006.01) <b>A61K 31/522</b> (2006.01) <b>A61P 29/00</b> (2006.01) <b>A61P 37/08</b> (2006.01) <b>C07D 473/18</b> (2006.01) <b>A61P 11/06</b> (2006.01)	2525811 *	<b>C12R 1/225</b> (2006.01) <b>A61P 17/00</b> (2006.01) <b>A61K 35/74</b> (2006.01) <b>A61K 39/00</b> (2006.01) <b>A23L 1/30</b> (2006.01) <b>C07H 3/06</b> (2006.01) <b>A61K 31/702</b> (2006.01) <b>A61P 11/06</b> (2006.01) <b>A61P 37/08</b> (2006.01) <b>A61P 11/00</b> (2006.01)	2423640	<b>G01C 9/06</b> (2006.01) <b>G01C 9/20</b> (2006.01)
2528984 *	<b>C09K 8/588</b> (2006.01) <b>C09K 8/12</b> (2006.01) <b>C09K 8/68</b> (2006.01)	2447927	<b>G08G 1/14</b> (2006.01)	2517162 *	<b>G06Q 30/00</b> (2012.01) <b>G06F 17/50</b> (2006.01)
2432471 *	<b>A61K 31/49</b> (2006.01) <b>A61P 43/00</b> (2006.01)	2513081 *	<b>C07D 317/18</b> (2006.01) <b>C07D 333/78</b> (2006.01) <b>C07D 333/32</b> (2006.01)	2534931 *	<b>H05H 1/00</b> (2006.01) <b>C02F 1/00</b> (2006.01)
2535324 *	<b>C07C 49/643</b> (2006.01) <b>C07C 45/80</b> (2006.01) <b>C07C 45/68</b> (2006.01)				
2521544 *	<b>A61K 31/415</b> (2006.01) <b>A61P 25/06</b> (2006.01) <b>A61P 35/00</b> (2006.01) <b>A61K 9/06</b> (2006.01) <b>A61P 25/00</b> (2006.01)				
2528621 *	<b>A61K 39/04</b> (2006.01)				

Broj objave evropske prijava patenta (97)	MKP (51)	Broj objave evropske prijava patenta (97)	MKP (51)	Broj objave evropske prijava patenta (97)	MKP (51)
2519163 *	<b>A61B 17/00</b> (2006.01) <b>A61B 17/068</b> (2006.01) <b>A61B 17/072</b> (2006.01) <b>A61B 17/28</b> (2006.01)	2508513 *	<b>C07D 213/64</b> (2006.01) <b>A61K 31/496</b> (2006.01) <b>A61P 19/06</b> (2006.01) <b>A61K 31/4545</b> (2006.01) <b>A61P 9/10</b> (2006.01) <b>A61K 31/4439</b> (2006.01) <b>A61P 3/10</b> (2006.01) <b>A61K 31/4427</b> (2006.01) <b>A61P 3/00</b> (2006.01) <b>A61P 27/02</b> (2006.01) <b>A61K 31/444</b> (2006.01) <b>A61P 7/10</b> (2006.01) <b>A61K 31/4433</b> (2006.01) <b>A61P 3/06</b> (2006.01) <b>C07D 401/10</b> (2006.01) <b>A61K 31/443</b> (2006.01) <b>A61P 3/04</b> (2006.01) <b>A61P 43/00</b> (2006.01) <b>A61K 31/4412</b> (2006.01) <b>A61K 31/5377</b> (2006.01) <b>A61P 25/00</b> (2006.01)	2534177 *	<b>C07K 16/28</b> (2006.01)
2512459 *	<b>A61K 9/32</b> (2006.01)	2513315 *		2513315 *	<b>C12N 15/82</b> (2006.01)
2529233 *	<b>G01N 33/68</b> (2006.01) <b>C07K 11/107</b> (2006.01)	2511636		2511636	<b>F26B 11/16</b> (2006.01) <b>F26B 23/00</b> (2006.01)
2513317 *	<b>C12N 15/82</b> (2006.01)	2525790 *		2525790 *	<b>A61K 31/00</b> (2006.01)
2518148 *	<b>C07K 16/16</b> (2006.01) <b>C07K 14/415</b> (2006.01) <b>C12N 5/10</b> (2006.01) <b>A01H 5/00</b> (2006.01) <b>C12N 15/09</b> (2006.01) <b>C12Q 1/68</b> (2006.01)	2519826 *		2519826 *	<b>G01N 33/574</b> (2006.01)
2523947 *	<b>C07D 333/40</b> (2006.01) <b>A61K 31/381</b> (2006.01)	2512847 *		2512847 *	<b>B60H 1/00</b> (2006.01) <b>F25B 45/00</b> (2006.01) <b>F16L 37/36</b> (2006.01)
2529134 *	<b>F16L 27/093</b> (2006.01) <b>F16J 15/00</b> (2006.01) <b>F16J 15/34</b> (2006.01) <b>F16J 15/44</b> (2006.01) <b>F16J 15/32</b> (2006.01)	2496944 *		2496944 *	<b>G01N 33/68</b> (2006.01)
		2536421 *		2536421 *	<b>A61K 38/08</b> (2006.01) <b>A61K 38/00</b> (2006.01)
		2525807 *		2525807 *	<b>A61P 3/00</b> (2006.01) <b>A61K 38/26</b> (2006.01) <b>A61K 38/18</b> (2006.01)
		2536891 *	<b>E04B 2/16</b> (2006.01)	2508724 *	<b>B01D 53/94</b> (2006.01) <b>F01N 3/08</b> (2006.01) <b>F01N 3/24</b> (2006.01)
		2537164 *	<b>H01C 7/12</b> (2006.01)	2533712 *	<b>F16J 15/32</b> (2006.01) <b>A61B 17/32</b> (2006.01)
		2502897 *	<b>C07B 61/00</b> (2006.01) <b>C12P 7/62</b> (2006.01) <b>C07C 69/753</b> (2006.01) <b>C07B 57/00</b> (2006.01) <b>C07C 67/303</b> (2006.01) <b>C07B 53/00</b> (2006.01)	2520180 *	<b>C07K 5/08</b> (2006.01) <b>A23L 1/228</b> (2006.01) <b>C07K 5/06</b> (2006.01)
		2509616 *	<b>A61K 38/16</b> (2006.01) <b>C12P 21/04</b> (2006.01)		

Broj objave evropske prijava patenta (97)	MKP (51)	Broj objave evropske prijava patenta (97)	MKP (51)	Broj objave evropske prijava patenta (97)	MKP (51)
2501410 *	<b>A61P 17/06</b> (2006.01) <b>A61K 9/00</b> (2006.01) <b>A61P 17/10</b> (2006.01) <b>A61K 31/00</b> (2006.01) <b>A61K 9/06</b> (2006.01) <b>A61K 31/196</b> (2006.01) <b>A61P 17/00</b> (2006.01) <b>A61K 45/06</b> (2006.01) <b>A61K 31/498</b> (2006.01) <b>A61P 17/04</b> (2006.01)	2510087 *	<b>A01K 67/027</b> (2006.01) <b>A61K 48/00</b> (2006.01) <b>G01N 33/15</b> (2006.01) <b>C12N 5/071</b> (2010.01) <b>A61K 38/00</b> (2006.01) <b>C12N 5/10</b> (2006.01)	2512230 *	<b>A01N 45/00</b> (2006.01) <b>A61K 31/74</b> (2006.01) <b>A01N 25/00</b> (2006.01)
		2516953 *	<b>F28D 20/00</b> (2006.01) <b>F24D 11/00</b> (2006.01) <b>F24H 1/18</b> (2006.01)	2524043 *	<b>C07K 14/245</b> (2006.01) <b>C12N 15/70</b> (2006.01)
		2501829 *	<b>C21D 9/08</b> (2006.01)	2513378 *	<b>E02D 5/80</b> (2006.01)
2502215 *	<b>G06F 3/041</b> (2006.01) <b>G08B 6/00</b> (2006.01)	2509982 *	<b>A61P 25/00</b> (2006.01) <b>A61P 25/28</b> (2006.01) <b>A61K 31/4995</b> (2006.01) <b>A61P 25/16</b> (2006.01) <b>C07D 487/08</b> (2006.01)	2524692 *	<b>A61K 9/70</b> (2006.01) <b>A61K 47/22</b> (2006.01) <b>A61K 31/40</b> (2006.01) <b>A61K 47/32</b> (2006.01) <b>A61K 47/20</b> (2006.01) <b>A61K 47/10</b> (2006.01)
2515769 *	<b>A61B 17/072</b> (2006.01)			2499334 *	<b>E21C 29/02</b> (2006.01)
2536267 *	<b>C12N 5/10</b> (2006.01) <b>C07K 14/00</b> (2006.01) <b>C12N 15/63</b> (2006.01) <b>A01H 5/10</b> (2006.01) <b>C07H 21/04</b> (2006.01) <b>C12N 15/82</b> (2006.01) <b>A01H 5/00</b> (2006.01) <b>A01H 1/00</b> (2006.01) <b>A01N 37/18</b> (2006.01) <b>C12P 21/00</b> (2006.01) <b>C12N 1/21</b> (2006.01) <b>A01P 7/04</b> (2006.01)	2463047	<b>B23B 51/00</b> (2006.01)	2531360 *	<b>B60B 19/00</b> (2006.01) <b>B60B 9/00</b> (2006.01)
		2521758 *	<b>C10C 1/00</b> (2006.01)	2509143 *	<b>H01M 4/583</b> (2010.01) <b>H01M 4/525</b> (2010.01) <b>H01M 10/0525</b> (2010.01) <b>H01M 4/505</b> (2010.01)
		2513108 *	<b>A61K 31/381</b> (2006.01) <b>C07D 495/04</b> (2006.01) <b>C07D 471/04</b> (2006.01) <b>A61K 31/429</b> (2006.01) <b>C07D 513/04</b> (2006.01)	2504360 *	<b>C12P 21/08</b> (2006.01) <b>C07K 16/00</b> (2006.01) <b>C07H 21/00</b> (2006.01)
		2513417 *	<b>E21B 34/10</b> (2006.01) <b>E21B 43/14</b> (2006.01) <b>E21B 43/12</b> (2006.01) <b>E21B 33/124</b> (2006.01) <b>E21B 34/14</b> (2006.01)	2523962 *	<b>A61P 9/00</b> (2006.01) <b>C07D 498/04</b> (2006.01) <b>A61K 31/519</b> (2006.01)
2515854 *	<b>A61K 9/00</b> (2006.01) <b>A61K 31/40</b> (2006.01)				
2374873	<b>C12N 9/12</b> (2006.01) <b>C12P 13/08</b> (2006.01)				

Broj objave evropske prijava patenta (97)	MKP (51)	Broj objave evropske prijava patenta (97)	MKP (51)	Broj objave evropske prijava patenta (97)	MKP (51)
2526116 *	<b>C07K 5/08</b> (2006.01) <b>A61K 38/06</b> (2006.01) <b>C07K 5/06</b> (2006.01) <b>A61P 37/08</b> (2006.01) <b>A01N 43/00</b> (2006.01)	2513060 *	<b>A61P 31/16</b> (2006.01) <b>C07D 213/81</b> (2006.01) <b>A61K 31/4425</b> (2006.01)	2525797 *	<b>A61K 31/55</b> (2006.01) <b>A61K 45/06</b> (2006.01) <b>A61P 23/00</b> (2006.01)
2521725 *	<b>C07D 471/04</b> (2006.01) <b>A61P 9/00</b> (2006.01) <b>C07C 311/21</b> (2006.01) <b>A61K 31/519</b> (2006.01) <b>C07F 5/02</b> (2006.01)	2516400 *	<b>A61K 31/44</b> (2006.01) <b>A61P 5/26</b> (2006.01) <b>C07D 213/74</b> (2006.01) <b>A61K 31/4409</b> (2006.01) <b>A61P 5/28</b> (2006.01)	2534422 *	<b>B01D 53/86</b> (2006.01) <b>F24B 1/00</b> (2006.01) <b>F23G 7/07</b> (2006.01)
2522498	<b>C09J 5/00</b> (2006.01) <b>B32B 3/00</b> (2006.01) <b>C09J 7/00</b> (2006.01)	2504653 *	<b>F28D 20/00</b> (2006.01) <b>C09K 5/10</b> (2006.01) <b>F01K 3/12</b> (2006.01)	2519544 *	<b>C07K 16/46</b> (2006.01) <b>A61P 35/00</b> (2006.01) <b>A61P 37/00</b> (2006.01) <b>A61K 39/395</b> (2006.01)
2531240 *	<b>A61M 5/32</b> (2006.01) <b>A61M 5/28</b> (2006.01) <b>A61M 5/24</b> (2006.01)	2521714 *	<b>A61K 31/4468</b> (2006.01) <b>A61P 29/00</b> (2006.01) <b>A61K 31/4709</b> (2006.01) <b>A61P 25/08</b> (2006.01) <b>C07D 401/12</b> (2006.01) <b>A61P 25/24</b> (2006.01)	2516245 *	<b>B62J 11/00</b> (2006.01)
2531456 *	<b>C03B 35/16</b> (2006.01) <b>F27D 25/00</b> (2010.01) <b>B65G 45/10</b> (2006.01) <b>F27B 9/30</b> (2006.01)	2501709 *	<b>A61P 25/18</b> (2006.01) <b>A61K 31/4725</b> (2006.01) <b>C07D 401/14</b> (2006.01) <b>A61P 25/28</b> (2006.01) <b>C07D 211/58</b> (2006.01) <b>A61P 25/22</b> (2006.01)	2513473 *	<b>F03D 11/02</b> (2006.01) <b>F03D 3/04</b> (2006.01) <b>F03D 11/00</b> (2006.01) <b>F03D 3/06</b> (2006.01)
2515695 *	<b>A45D 40/10</b> (2006.01)	2515866 *	<b>A01N 43/54</b> (2006.01) <b>A61K 31/517</b> (2006.01)	2501709 *	<b>C07H 19/16</b> (2006.01) <b>A61P 31/20</b> (2006.01) <b>A61K 31/7076</b> (2006.01) <b>C07H 19/06</b> (2006.01) <b>A61K 31/7064</b> (2006.01)
2513306 *	<b>C12N 15/11</b> (2006.01)	2501233 *	<b>A01N 43/54</b> (2006.01) <b>A61K 31/517</b> (2006.01)	2515866 *	<b>A61K 47/10</b> (2006.01) <b>A61K 47/14</b> (2006.01) <b>A61K 47/22</b> (2006.01) <b>A61K 31/593</b> (2006.01) <b>A61K 9/06</b> (2006.01)
2441445	<b>A61K 9/20</b> (2006.01) <b>A61K 31/215</b> (2006.01)	2507946 *	<b>H04L 12/28</b> (2006.01)	2515866 *	<b>A61K 47/10</b> (2006.01) <b>A61K 47/14</b> (2006.01) <b>A61K 47/22</b> (2006.01) <b>A61K 31/593</b> (2006.01) <b>A61K 9/06</b> (2006.01)
2434588	<b>H01R 13/639</b> (2006.01) <b>H01R 13/11</b> (2006.01)	2438291 *	<b>F03B 9/00</b> (2006.01)	2536396 *	<b>A61K 9/16</b> (2006.01) <b>A61K 31/41</b> (2006.01) <b>A61K 9/20</b> (2006.01)



Broj objave evropske prijave patenta (97)	MKP (51)	Broj objave evropske prijave patenta (97)	MKP (51)	Broj objave evropske prijave patenta (97)	MKP (51)
2506779 *	<b>A61B 17/10</b> (2006.01) <b>A61B 17/122</b> (2006.01) <b>A61B 17/12</b> (2006.01) <b>A61B 17/128</b> (2006.01)	2514424 *	<b>A61P 29/00</b> (2006.01) <b>A61K 9/70</b> (2006.01) <b>A61K 31/5415</b> (2006.01) <b>A61K 47/32</b> (2006.01) <b>A61K 47/18</b> (2006.01)	2536708 *	<b>A61P 5/26</b> (2006.01) <b>A61K 31/5025</b> (2006.01) <b>A61K 31/4439</b> (2006.01) <b>C07D 401/04</b> (2006.01) <b>C07D 487/04</b> (2006.01) <b>A61P 5/28</b> (2006.01)
2536330 *	<b>A61B 5/053</b> (2006.01)	2517141 *	<b>G06F 21/00</b> (2006.01)	2512219 *	<b>A01H 5/00</b> (2006.01) <b>A01H 1/00</b> (2006.01) <b>A01P 7/00</b> (2006.01)
2513314 *	<b>C12N 15/82</b> (2006.01)	2516447 *	<b>C07D 495/04</b> (2006.01)		
2504050 *	<b>A61M 15/00</b> (2006.01)	2441883	<b>D06F 95/00</b> (2006.01)		
2509424 *	<b>A01N 43/82</b> (2006.01) <b>A61K 31/41</b> (2006.01)	2531191 *	<b>A61K 31/416</b> (2006.01) <b>A61K 31/415</b> (2006.01) <b>A61P 29/00</b> (2006.01) <b>A61K 31/4196</b> (2006.01)	2513148 *	<b>C07K 16/32</b> (2006.01)
2516434 *	<b>A61P 11/00</b> (2006.01) <b>C07D 487/04</b> (2006.01) <b>A61P 37/00</b> (2006.01) <b>A61K 31/437</b> (2006.01) <b>A61P 29/00</b> (2006.01) <b>A61P 17/00</b> (2006.01) <b>A61P 19/00</b> (2006.01) <b>C07D 471/04</b> (2006.01) <b>A61P 35/00</b> (2006.01) <b>A61P 7/00</b> (2006.01) <b>A61K 31/519</b> (2006.01)	2507108 *	<b>B61H 5/00</b> (2006.01) <b>F16D 55/02</b> (2006.01) <b>F16D 65/12</b> (2006.01)	2519358 *	<b>B04B 5/02</b> (2006.01) <b>B04B 9/10</b> (2006.01) <b>B04B 9/08</b> (2006.01)
		2528436 *	<b>A01N 43/00</b> (2006.01)	2523969 *	<b>C12N 15/70</b> (2006.01) <b>C07K 14/245</b> (2006.01)
		2536742 *	<b>C07K 7/08</b> (2006.01)		
		2506850 *	<b>A61K 31/4418</b> (2006.01) <b>A61K 31/4412</b> (2006.01) <b>A61P 43/00</b> (2006.01) <b>A61K 31/44</b> (2006.01)	2528678 *	<b>F23G 7/06</b> (2006.01) <b>B01D 53/72</b> (2006.01) <b>B01D 53/00</b> (2006.01) <b>F24J 2/06</b> (2006.01) <b>F24J 2/07</b> (2006.01) <b>B01J 19/12</b> (2006.01) <b>F23J 15/02</b> (2006.01) <b>B01D 53/73</b> (2006.01)
2505662 *	<b>G01N 33/50</b> (2006.01) <b>C12M 1/34</b> (2006.01) <b>C12M 1/00</b> (2006.01) <b>C12Q 1/68</b> (2006.01) <b>C12N 15/09</b> (2006.01)	2513098 *	<b>C07D 417/12</b> (2006.01) <b>A61P 11/06</b> (2006.01) <b>A61P 11/00</b> (2006.01) <b>A61P 35/00</b> (2006.01) <b>A61P 29/00</b> (2006.01) <b>C07D 417/14</b> (2006.01) <b>A61K 31/497</b> (2006.01)		
2534272 *	<b>C22B 21/00</b> (2006.01) <b>C22B 7/00</b> (2006.01)				
2503991 *	<b>A61K 9/08</b> (2006.01) <b>A61K 31/435</b> (2006.01)				

Broj objave evropske prijave patenta (97)	MKP (51)	Broj objave evropske prijave patenta (97)	MKP (51)	Broj objave evropske prijave patenta (97)	MKP (51)
2520388	<b>F16D 1/08</b> (2006.01) <b>B23C 3/30</b> (2006.01) <b>B23F 5/20</b> (2006.01) <b>F16D 3/06</b> (2006.01)	2512491 *	<b>A61K 31/7115</b> (2006.01) <b>A61K 31/7125</b> (2006.01)	2431147	<b>B29C 39/00</b> (2006.01) <b>B29B 17/00</b> (2006.01) <b>A47K 3/40</b> (2006.01)
2420674	<b>F16F 15/31</b> (2006.01) <b>F16F 7/10</b> (2006.01) <b>F03G 3/08</b> (2006.01)	2524044 *	<b>C12N 15/53</b> (2006.01) <b>C12N 15/82</b> (2006.01) <b>A01H 5/12</b> (2006.01)	2506879 *	<b>C12N 15/88</b> (2006.01) <b>C12N 15/87</b> (2006.01) <b>A61K 47/22</b> (2006.01) <b>A61K 9/14</b> (2006.01) <b>A61K 47/18</b> (2006.01) <b>C12N 15/10</b> (2006.01) <b>C12N 15/113</b> (2010.01) <b>A61K 31/7088</b> (2006.01)
2515909 *	<b>A61K 9/00</b> (2006.01) <b>A61K 31/542</b> (2006.01) <b>A61K 47/02</b> (2006.01) <b>A61K 9/20</b> (2006.01) <b>A61K 47/12</b> (2006.01)	2525650 *	<b>A01H 5/00</b> (2006.01) <b>C12N 15/82</b> (2006.01) <b>C12N 15/29</b> (2006.01)	2525795 *	<b>A61P 25/02</b> (2006.01) <b>A61K 31/4375</b> (2006.01) <b>A61K 31/472</b> (2006.01) <b>A61K 31/522</b> (2006.01)
2536835 *	<b>C07K 16/12</b> (2006.01) <b>C07K 16/46</b> (2006.01) <b>A61K 39/395</b> (2006.01) <b>C12N 15/09</b> (2006.01) <b>C12P 21/08</b> (2006.01) <b>C12N 5/10</b> (2006.01) <b>G01N 33/569</b> (2006.01) <b>A61P 31/04</b> (2006.01)	2516436 *	<b>A61K 31/437</b> (2006.01) <b>C07D 471/04</b> (2006.01)	2528903 *	<b>C07D 239/26</b> (2006.01) <b>A61K 31/505</b> (2006.01) <b>C07D 409/14</b> (2006.01) <b>C07D 471/04</b> (2006.01) <b>C07D 487/08</b> (2006.01) <b>C07D 401/14</b> (2006.01) <b>A61P 35/00</b> (2006.01) <b>C07D 401/06</b> (2006.01) <b>A61K 31/506</b> (2006.01) <b>C07D 413/14</b> (2006.01) <b>C07D 405/14</b> (2006.01)
2385135	<b>C12Q 1/68</b> (2006.01)	2521818 *	<b>E03C 1/01</b> (2006.01) <b>F24D 17/00</b> (2006.01) <b>F24H 9/20</b> (2006.01) <b>E03C 1/044</b> (2006.01) <b>E03D 9/08</b> (2006.01) <b>F24H 1/20</b> (2006.01) <b>G05D 23/00</b> (2006.01)	2501609 *	<b>F16F 15/36</b> (2006.01) <b>B63H 21/30</b> (2006.01)
2523701 *	<b>A61L 27/54</b> (2006.01) <b>A61L 27/20</b> (2006.01)	2501609 *	<b>F16F 15/36</b> (2006.01) <b>B63H 21/30</b> (2006.01)	2448159	<b>H04J 14/02</b> (2006.01)
2519218 *	<b>C07C 409/34</b> (2006.01) <b>A61K 8/38</b> (2006.01) <b>A61Q 19/00</b> (2006.01)	2531509 *	<b>A61K 31/53</b> (2006.01) <b>A61P 29/00</b> (2006.01) <b>A61P 37/00</b> (2006.01) <b>A61P 35/00</b> (2006.01) <b>A61P 1/00</b> (2006.01) <b>A61P 11/00</b> (2006.01) <b>C07D 487/04</b> (2006.01) <b>A61P 9/00</b> (2006.01)	2515927 *	<b>A61P 3/04</b> (2006.01) <b>A61K 38/17</b> (2006.01) <b>A61P 3/10</b> (2006.01) <b>C07K 14/605</b> (2006.01) <b>A61K 38/26</b> (2006.01)
2528947 *	<b>C07K 16/28</b> (2006.01)	2519547 *	<b>C08F 2/38</b> (2006.01)		

Broj objave evropske prijave patenta (97)	MKP (51)	Broj objave evropske prijave patenta (97)	MKP (51)	Broj objave evropske prijave patenta (97)	MKP (51)
2536399 *	<b>A61K 31/00</b> (2006.01)	2536689 *	<b>A61K 31/53</b> (2006.01) <b>C07D 213/74</b> (2006.01) <b>A61K 31/4427</b> (2006.01) <b>C07D 251/48</b> (2006.01) <b>A61P 29/00</b> (2006.01) <b>C07D 401/04</b> (2006.01) <b>C07D 239/48</b> (2006.01) <b>A61K 31/506</b> (2006.01) <b>C07D 403/04</b> (2006.01) <b>C07D 471/10</b> (2006.01) <b>A61K 31/505</b> (2006.01)	2528961 *	<b>C08K 5/00</b> (2006.01) <b>C08J 11/10</b> (2006.01) <b>C08G 18/08</b> (2006.01)
2521446 *	<b>A61K 31/20</b> (2006.01) <b>A61K 31/44</b> (2006.01) <b>A61K 31/35</b> (2006.01) <b>A01N 25/26</b> (2006.01)			2531189 *	<b>A61P 9/14</b> (2006.01) <b>A61K 31/205</b> (2006.01) <b>A61K 31/7048</b> (2006.01)
2519199 *	<b>A61F 11/00</b> (2006.01) <b>A61K 9/00</b> (2006.01) <b>A61N 1/30</b> (2006.01)			2453222	<b>G01N 21/84</b> (2006.01) <b>G01N 21/35</b> (2006.01) <b>G01N 21/31</b> (2006.01)
2512368 *	<b>A61F 2/20</b> (2006.01) <b>A61F 2/02</b> (2006.01)	2534357 *	<b>F25B 29/00</b> (2006.01) <b>F02G 1/04</b> (2006.01) <b>F03G 7/00</b> (2006.01) <b>F02G 1/043</b> (2006.01)	2521451 *	<b>A61K 31/425</b> (2006.01) <b>A01N 43/78</b> (2006.01)
2537495	<b>A61F 13/15</b> (2006.01)			2529019 *	<b>A01H 5/00</b> (2006.01) <b>C12N 9/10</b> (2006.01) <b>A01H 5/10</b> (2006.01) <b>C12N 15/82</b> (2006.01)
2526419 *	<b>C07K 4/00</b> (2006.01) <b>G01N 33/53</b> (2006.01)	2512456 *	<b>A61K 9/20</b> (2006.01) <b>A61K 31/485</b> (2006.01)		
2509595 *	<b>A61P 31/16</b> (2006.01) <b>A61K 45/06</b> (2006.01) <b>A61K 31/4155</b> (2006.01) <b>G01N 33/50</b> (2006.01)	2513647 *	<b>G01N 33/49</b> (2006.01) <b>G01N 21/25</b> (2006.01) <b>G01N 33/86</b> (2006.01)	2506896 *	<b>A61M 5/172</b> (2006.01) <b>A61M 5/00</b> (2006.01) <b>A61M 5/142</b> (2006.01) <b>A61M 5/315</b> (2006.01)
2519122 *	<b>A24F 47/00</b> (2006.01)	2526089 *	<b>A61P 3/06</b> (2006.01) <b>A61K 31/40</b> (2006.01) <b>C07D 207/34</b> (2006.01)	2515898 *	<b>A61K 31/335</b> (2006.01) <b>A61K 31/4745</b> (2006.01) <b>A61K 31/704</b> (2006.01) <b>A61K 31/24</b> (2006.01) <b>A61P 35/00</b> (2006.01)
2522500	<b>B32B 3/00</b> (2006.01)	2536279 *	<b>C07D 498/00</b> (2006.01) <b>A01N 43/00</b> (2006.01) <b>A61K 31/55</b> (2006.01)	2521452 *	<b>A01N 43/90</b> (2006.01)
2528638 *	<b>A61M 1/12</b> (2006.01) <b>A61M 1/10</b> (2006.01)	2517754 *	<b>A61N 1/04</b> (2006.01) <b>A61N 1/30</b> (2006.01)	2472150	<b>F16K 11/20</b> (2006.01) <b>E03C 1/04</b> (2006.01) <b>B67D 1/00</b> (2006.01)
		2499335 *	<b>E21C 31/08</b> (2006.01)		

Broj objave evropske prijava patenta (97)	MKP (51)	Broj objave evropske prijava patenta (97)	MKP (51)	Broj objave evropske prijava patenta (97)	MKP (51)
2513115 *	<b>C07D 491/04</b> (2006.01) <b>A61K 31/4741</b> (2006.01) <b>A61K 31/4743</b> (2006.01) <b>C07D 495/04</b> (2006.01) <b>A61P 31/04</b> (2006.01)	2501817 *	<b>C12N 15/85</b> (2006.01) <b>C07K 16/46</b> (2006.01) <b>A01K 67/027</b> (2006.01)	2509605 *	<b>C12N 5/00</b> (2006.01) <b>A61K 31/70</b> (2006.01)
		2523974 *	<b>C07K 16/18</b> (2006.01)	2515942 *	<b>A61P 19/10</b> (2006.01) <b>A61P 11/06</b> (2006.01) <b>A61K 9/127</b> (2006.01) <b>A61P 29/00</b> (2006.01) <b>A61K 47/30</b> (2006.01) <b>A61K 31/337</b> (2006.01)
2524925 *	<b>C07K 5/06</b> (2006.01) <b>A23L 1/226</b> (2006.01) <b>A23L 1/30</b> (2006.01) <b>C07D 281/06</b> (2006.01)	2510001 *	<b>C07K 16/22</b> (2006.01) <b>A61K 39/395</b> (2006.01)		
		2509663 *	<b>A61M 5/315</b> (2006.01)	2531276 *	<b>B01D 53/64</b> (2006.01)
2521536 *	<b>A61K 39/395</b> (2006.01) <b>A61K 9/08</b> (2006.01) <b>A61K 9/00</b> (2006.01) <b>A61K 31/485</b> (2006.01)	2523559 *	<b>A01N 43/54</b> (2006.01)	2512336 *	<b>A61B 5/103</b> (2006.01)
		2531027 *	<b>A01N 43/00</b> (2006.01)	2538362	<b>G06F 19/00</b> (2011.01)
		2515874 *	<b>A61K 9/14</b> (2006.01) <b>A61K 31/593</b> (2006.01)	2519350 *	<b>C08F 4/80</b> (2006.01) <b>B01J 31/22</b> (2006.01) <b>C07F 15/00</b> (2006.01)
2523549 *	<b>A01K 53/00</b> (2006.01)	2388519	<b>F22B 37/40</b> (2006.01) <b>F22B 37/24</b> (2006.01)	2534579 *	<b>G06F 9/50</b> (2006.01)
2509688 *	<b>A62D 3/36</b> (2007.01) <b>A62D 3/40</b> (2007.01) <b>A62D 3/34</b> (2007.01)	2519505 *	<b>C07D 407/12</b> (2006.01) <b>C07D 491/113</b> (2006.01) <b>C07D 215/48</b> (2006.01) <b>A61P 31/10</b> (2006.01) <b>C07D 401/06</b> (2006.01) <b>C07D 401/12</b> (2006.01) <b>C07D 407/06</b> (2006.01) <b>A61K 31/4709</b> (2006.01) <b>C07D 417/06</b> (2006.01)	2428255	<b>A63B 23/02</b> (2006.01) <b>A63B 21/045</b> (2006.01) <b>A63B 22/14</b> (2006.01)
2450072	<b>A61M 5/24</b> (2006.01)			2533774 *	<b>A61K 31/165</b> (2006.01) <b>A61P 25/22</b> (2006.01)
2521726 *	<b>A61P 9/00</b> (2006.01) <b>A61K 31/519</b> (2006.01) <b>C07D 471/04</b> (2006.01)			2503889 *	<b>A01P 13/00</b> (2006.01) <b>A01N 43/40</b> (2006.01) <b>A01N 33/12</b> (2006.01) <b>A01N 25/12</b> (2006.01) <b>A01N 25/14</b> (2006.01)
2512351 *	<b>A61B 17/072</b> (2006.01) <b>A61B 17/29</b> (2006.01) <b>A61B 17/115</b> (2006.01) <b>A61B 19/00</b> (2006.01)	2509634 *	<b>A61K 47/36</b> (2006.01) <b>A61P 35/00</b> (2006.01) <b>A61K 47/30</b> (2006.01) <b>A61K 47/40</b> (2006.01) <b>A61K 31/335</b> (2006.01) <b>A61K 47/02</b> (2006.01)		
2523976 *	<b>C07K 16/28</b> (2006.01)				

Broj objave evropske prijave patenta (97)	MKP (51)	Broj objave evropske prijave patenta (97)	MKP (51)	Broj objave evropske prijave patenta (97)	MKP (51)
2504457 *	<b>G01N 33/68</b> (2006.01) <b>C12N 15/12</b> (2006.01) <b>C12Q 1/68</b> (2006.01)	2507211 *	<b>C07D 213/84</b> (2006.01) <b>C07D 405/14</b> (2006.01) <b>C07D 213/74</b> (2006.01) <b>C07D 405/12</b> (2006.01) <b>C07D 209/08</b> (2006.01) <b>C07D 401/14</b> (2006.01) <b>C07D 211/58</b> (2006.01) <b>C07D 403/12</b> (2006.01) <b>C07D 231/56</b> (2006.01) <b>C07D 413/12</b> (2006.01) <b>C07D 309/04</b> (2006.01) <b>C07D 235/06</b> (2006.01) <b>C07D 417/12</b> (2006.01) <b>C07D 277/24</b> (2006.01) <b>C07D 471/04</b> (2006.01)	2533805 *	<b>A61K 39/00</b> (2006.01)
2515900 *	<b>A61K 31/495</b> (2006.01) <b>A61K 31/343</b> (2006.01) <b>A61P 9/06</b> (2006.01)	2512367 *	<b>A61F 2/00</b> (2006.01)	2536717 *	<b>A61K 31/427</b> (2006.01) <b>C07D 417/06</b> (2006.01) <b>A61K 31/4439</b> (2006.01) <b>A61P 19/00</b> (2006.01) <b>C07D 417/14</b> (2006.01)
2353478	<b>A61N 5/06</b> (2006.01) <b>A47K 3/28</b> (2006.01) <b>A61H 33/06</b> (2006.01)	2536280 *	<b>A01P 7/04</b> (2006.01) <b>A01N 43/40</b> (2006.01) <b>A01P 13/00</b> (2006.01)	2501403 *	<b>A61K 39/08</b> (2006.01)
2454927	<b>A01B 69/00</b> (2006.01) <b>A47B 88/04</b> (2006.01) <b>A01D 34/835</b> (2006.01) <b>A01D 34/00</b> (2006.01) <b>E04D 11/00</b> (2006.01) <b>A47B 88/00</b> (2006.01)	2509587 *	<b>A61K 9/28</b> (2006.01) <b>A61K 9/50</b> (2006.01) <b>A61K 9/48</b> (2006.01)	2509587 *	<b>A61K 9/28</b> (2006.01) <b>A61K 9/50</b> (2006.01) <b>A61K 9/48</b> (2006.01)
2536730 *	<b>C07D 487/04</b> (2006.01) <b>A61K 31/519</b> (2006.01) <b>C07D 519/00</b> (2006.01) <b>A61P 35/00</b> (2006.01) <b>C07B 59/00</b> (2006.01)	2509597 *	<b>A61K 31/435</b> (2006.01) <b>A61K 31/335</b> (2006.01) <b>A61K 31/38</b> (2006.01)	2523554 *	<b>A01N 43/16</b> (2006.01) <b>A01P 13/00</b> (2006.01)
2504315 *	<b>C07D 405/12</b> (2006.01) <b>C07D 401/04</b> (2006.01) <b>C07D 417/04</b> (2006.01) <b>A61P 25/28</b> (2006.01) <b>C07D 401/10</b> (2006.01) <b>A61K 31/4709</b> (2006.01) <b>C07D 401/12</b> (2006.01) <b>C07D 215/38</b> (2006.01)	2523963 *	<b>C07D 498/04</b> (2006.01) <b>A61K 31/519</b> (2006.01) <b>A61P 9/00</b> (2006.01)	2484604	<b>B65D 81/34</b> (2006.01) <b>B65D 81/32</b> (2006.01)
		2525829 *	<b>A61K 47/48</b> (2006.01)	2523669 *	<b>A61K 31/7076</b> (2006.01) <b>A61P 27/02</b> (2006.01) <b>A61K 31/5575</b> (2006.01)
		2513376 *	<b>E01F 15/08</b> (2006.01)	2509949 *	<b>C07D 213/63</b> (2006.01) <b>A61K 31/4439</b> (2006.01) <b>A61K 31/4412</b> (2006.01) <b>A61P 31/18</b> (2006.01) <b>C07D 401/12</b> (2006.01)
		2523689 *	<b>A61K 39/395</b> (2006.01)		
		2519253 *	<b>A61K 39/00</b> (2006.01) <b>A61K 39/395</b> (2006.01)		
		2522532 *	<b>F16K 15/20</b> (2006.01) <b>B60C 23/00</b> (2006.01) <b>B60C 23/10</b> (2006.01)		

Broj objave evropske prijave patenta (97)	MKP (51)	Broj objave evropske prijave patenta (97)	MKP (51)	Broj objave evropske prijave patenta (97)	MKP (51)
2515928 *	<b>A61K 38/17</b> (2006.01) <b>A61P 3/10</b> (2006.01) <b>A61K 38/26</b> (2006.01) <b>C07K 14/605</b> (2006.01) <b>A61P 3/04</b> (2006.01)	2420981	<b>G07F 17/32</b> (2006.01)	2533709 *	<b>A61B 17/32</b> (2006.01) <b>A61B 17/3207</b> (2006.01) <b>A61B 10/02</b> (2006.01)
2536723 *	<b>C07D 471/04</b> (2006.01) <b>A61P 35/00</b> (2006.01) <b>A61K 31/4162</b> (2006.01)	2523681 *	<b>A61K 39/00</b> (2006.01) <b>C12N 15/861</b> (2006.01) <b>C07K 14/475</b> (2006.01) <b>C12N 7/02</b> (2006.01)	2521777 *	<b>C07H 21/02</b> (2006.01) <b>C12N 15/00</b> (2006.01)
2512487 *	<b>A61K 9/127</b> (2006.01) <b>A61K 31/56</b> (2006.01) <b>A61K 31/573</b> (2006.01) <b>A61K 47/48</b> (2006.01) <b>A61K 47/30</b> (2006.01) <b>A61K 9/22</b> (2006.01)	2530828	<b>H02P 29/02</b> (2006.01) <b>H02P 9/10</b> (2006.01) <b>H02P 9/00</b> (2006.01)	2530164 *	<b>C12P 17/18</b> (2006.01) <b>C12N 1/21</b> (2006.01) <b>C12N 1/15</b> (2006.01) <b>C12N 5/10</b> (2006.01) <b>C12N 1/19</b> (2006.01) <b>C12N 15/09</b> (2006.01)
2528435 *	<b>A01N 43/90</b> (2006.01) <b>A01P 13/00</b> (2006.01) <b>A01N 33/22</b> (2006.01)	2521930 *	<b>G02B 5/28</b> (2006.01) <b>G02B 6/293</b> (2006.01)	2532977 *	<b>B01J 20/20</b> (2006.01) <b>B01J 20/28</b> (2006.01) <b>B01J 20/26</b> (2006.01)
2536266 *	<b>A01H 5/00</b> (2006.01) <b>C12N 5/10</b> (2006.01) <b>A01P 7/04</b> (2006.01) <b>C07H 21/04</b> (2006.01) <b>C07K 14/00</b> (2006.01) <b>A01H 1/00</b> (2006.01) <b>C12N 15/63</b> (2006.01) <b>C12P 21/00</b> (2006.01) <b>A01N 37/18</b> (2006.01) <b>A01H 5/10</b> (2006.01) <b>C12N 1/21</b> (2006.01) <b>C12N 15/82</b> (2006.01)	2533976 *	<b>F24D 3/12</b> (2006.01) <b>E04F 15/00</b> (2006.01)	2536498 *	<b>C04B 14/02</b> (2006.01) <b>B32B 13/00</b> (2006.01) <b>C04B 28/14</b> (2006.01) <b>E04C 2/04</b> (2006.01)
2441446	<b>A61K 9/20</b> (2006.01) <b>A61K 31/215</b> (2006.01)	2506716 *	<b>A01N 43/58</b> (2006.01)	2521569 *	<b>A61K 45/00</b> (2006.01)
		2387989	<b>A61K 38/28</b> (2006.01) <b>A61K 9/08</b> (2006.01) <b>A61K 9/00</b> (2006.01)	2536890 *	<b>E03F 5/12</b> (2006.01)
		2525796 *	<b>A61K 31/439</b> (2006.01) <b>A61P 35/00</b> (2006.01) <b>A61P 9/00</b> (2006.01) <b>A61K 31/444</b> (2006.01) <b>A61K 9/08</b> (2006.01) <b>A61K 31/522</b> (2006.01) <b>A61K 31/496</b> (2006.01) <b>A61K 31/519</b> (2006.01) <b>A61K 31/5377</b> (2006.01)	2447462	<b>E21B 7/04</b> (2006.01) <b>E21B 7/20</b> (2006.01) <b>E21B 7/30</b> (2006.01)
				2507949 *	<b>H04L 12/26</b> (2006.01) <b>H04L 12/56</b> (2006.01)
				2489823	<b>E21B 7/02</b> (2006.01)
				2533711 *	<b>A61B 17/32</b> (2006.01)
				2508787	<b>F17C 13/00</b> (2006.01)

Broj objave evropske prijave patenta (97)	MKP (51)	Broj objave evropske prijave patenta (97)	MKP (51)	Broj objave evropske prijave patenta (97)	MKP (51)
2504614 *	<b>F17C 9/00</b> (2006.01) <b>F17C 7/02</b> (2006.01) <b>F17C 13/02</b> (2006.01)	2510080 *	<b>C09K 8/60</b> (2006.01) <b>C11D 3/20</b> (2006.01)	2516398 *	<b>A61K 8/49</b> (2006.01) <b>C07D 213/74</b> (2006.01) <b>A61P 17/00</b> (2006.01) <b>C07D 241/20</b> (2006.01) <b>A61P 15/00</b> (2006.01) <b>A61K 31/4965</b> (2006.01) <b>C07D 239/42</b> (2006.01) <b>A61P 35/00</b> (2006.01) <b>A61K 31/44</b> (2006.01) <b>A61Q 19/00</b> (2006.01) <b>A61K 31/505</b> (2006.01)
2514496 *	<b>A63H 33/10</b> (2006.01)	2512232 *	<b>A01N 3/02</b> (2006.01) <b>A01N 25/10</b> (2006.01) <b>A01N 3/00</b> (2006.01)	2515690 *	<b>A24F 47/00</b> (2006.01)
2521454 *	<b>A01N 57/00</b> (2006.01)	2504333 *	<b>C07D 417/14</b> (2006.01) <b>A61K 31/427</b> (2006.01) <b>A61P 25/00</b> (2006.01)	2455066	<b>A61K 9/08</b> (2006.01) <b>A61K 9/10</b> (2006.01) <b>A61K 9/107</b> (2006.01) <b>A61K 9/70</b> (2006.01) <b>A61K 31/16</b> (2006.01) <b>A61P 29/00</b> (2006.01)
2528446 *	<b>A22C 21/00</b> (2006.01)	2516419 *	<b>C07D 413/14</b> (2006.01) <b>C07D 498/14</b> (2006.01) <b>C07D 401/14</b> (2006.01) <b>C07D 405/14</b> (2006.01) <b>C07D 409/14</b> (2006.01) <b>A61P 29/00</b> (2006.01) <b>A61K 31/454</b> (2006.01)	2506871 *	<b>A61K 39/00</b> (2006.01) <b>C12P 21/08</b> (2006.01)
2536748 *	<b>C12N 15/62</b> (2006.01) <b>C07K 14/475</b> (2006.01) <b>A61K 39/395</b> (2006.01) <b>C12N 15/113</b> (2010.01) <b>A61P 35/00</b> (2006.01) <b>C07K 14/71</b> (2006.01) <b>A61K 31/7088</b> (2006.01) <b>A61K 38/17</b> (2006.01)	2502021 *	<b>B65D 51/24</b> (2006.01) <b>F42B 4/20</b> (2006.01)	2521884 *	<b>F24H 3/06</b> (2006.01) <b>G06F 1/20</b> (2006.01)
2507570 *	<b>F28C 3/06</b> (2006.01) <b>F28B 3/06</b> (2006.01)	2533921 *	<b>B22D 15/00</b> (2006.01) <b>B22D 7/02</b> (2006.01)	2531981 *	<b>G07B 15/02</b> (2011.01) <b>B63B 22/02</b> (2006.01)
2501887 *	<b>A61G 7/10</b> (2006.01) <b>E06B 3/46</b> (2006.01)	2532651	<b>A61K 31/403</b> (2006.01) <b>A61P 25/00</b> (2006.01) <b>C07D 209/52</b> (2006.01)	2531177 *	<b>A61P 25/00</b> (2006.01) <b>A61K 9/16</b> (2006.01) <b>A61K 31/4152</b> (2006.01) <b>C07D 231/22</b> (2006.01)
2513316 *	<b>C12N 15/82</b> (2006.01)	2504699 *	<b>G01N 33/50</b> (2006.01)		
2533710 *	<b>A61B 17/32</b> (2006.01) <b>A61B 17/3207</b> (2006.01)				
2504690 *	<b>G01N 25/48</b> (2006.01) <b>G01N 21/65</b> (2006.01) <b>G01J 3/44</b> (2006.01)				
2519235 *	<b>A61K 31/33</b> (2006.01)				

Broj objave evropske prijava patenta (97)	MKP (51)	Broj objave evropske prijava patenta (97)	MKP (51)	Broj objave evropske prijava patenta (97)	MKP (51)
2501279 *	<b>G01N 33/50</b> (2006.01) <b>A61B 5/0488</b> (2006.01) <b>G01N 33/94</b> (2006.01) <b>A61B 5/11</b> (2006.01)	2509512 *	<b>A61B 17/068</b> (2006.01) <b>A61B 17/34</b> (2006.01) <b>A61B 19/00</b> (2006.01) <b>A61B 17/00</b> (2006.01) <b>A61B 17/115</b> (2006.01)	2536834 *	<b>A61K 39/395</b> (2006.01) <b>A61P 31/04</b> (2006.01) <b>C12P 21/08</b> (2006.01) <b>G01N 33/569</b> (2006.01) <b>C12N 5/10</b> (2006.01) <b>C07K 16/12</b> (2006.01) <b>C07K 16/46</b> (2006.01) <b>C12N 15/09</b> (2006.01)
2491652 *	<b>H03H 9/00</b> (2006.01)	2512562 *	<b>A61M 5/315</b> (2006.01)	2506857 *	<b>A61K 31/7105</b> (2006.01) <b>C07H 21/02</b> (2006.01)
2502399 *	<b>H04L 29/06</b> (2006.01) <b>G06F 21/00</b> (2006.01) <b>G06F 9/455</b> (2006.01)	2533704 *	<b>A61B 17/22</b> (2006.01) <b>A61B 17/3207</b> (2006.01) <b>A61B 17/32</b> (2006.01)	2504336 *	<b>A61K 31/444</b> (2006.01) <b>A61P 37/00</b> (2006.01) <b>C07D 417/14</b> (2006.01) <b>C07D 413/12</b> (2006.01) <b>A61K 31/443</b> (2006.01) <b>C07D 413/14</b> (2006.01) <b>A61K 31/4436</b> (2006.01) <b>A61P 35/00</b> (2006.01)
2507951 *	<b>H04L 12/56</b> (2006.01)	2509514 *	<b>A61B 17/115</b> (2006.01) <b>A61B 17/11</b> (2006.01)	2523677 *	<b>A61K 38/08</b> (2006.01)
2509957 *	<b>A61K 31/415</b> (2006.01) <b>C07C 237/14</b> (2006.01) <b>A61P 11/06</b> (2006.01) <b>A61P 17/06</b> (2006.01) <b>A61P 21/04</b> (2006.01) <b>A61P 9/10</b> (2006.01) <b>A61K 31/426</b> (2006.01) <b>C07D 277/46</b> (2006.01) <b>A61K 31/16</b> (2006.01) <b>A61P 37/08</b> (2006.01) <b>C07D 231/40</b> (2006.01) <b>A61P 37/02</b> (2006.01)	2531526 *	<b>C07K 16/00</b> (2006.01)	2525851 *	<b>A61M 5/24</b> (2006.01)
2509792 *	<b>B42D 15/00</b> (2006.01) <b>C09D 11/02</b> (2006.01) <b>B41M 5/28</b> (2006.01) <b>B41M 3/14</b> (2006.01) <b>C09D 11/00</b> (2006.01) <b>B42D 15/10</b> (2006.01)	2512578 *	<b>A61M 25/12</b> (2006.01)	2512237 *	<b>A01N 43/00</b> (2006.01)
		2505654	<b>C12N 15/85</b> (2006.01) <b>A01K 67/027</b> (2006.01) <b>C07K 16/46</b> (2006.01)	2513118 *	<b>C07D 513/04</b> (2006.01) <b>A61K 31/429</b> (2006.01) <b>A61P 25/18</b> (2006.01) <b>A61K 31/428</b> (2006.01)
		2501322 *	<b>A61B 19/08</b> (2006.01) <b>A61B 17/115</b> (2006.01) <b>A61B 19/00</b> (2006.01)	2518376 *	<b>F16K 3/30</b> (2006.01) <b>F16K 3/28</b> (2006.01)
		2526118 *	<b>C07K 16/00</b> (2006.01) <b>C07K 17/14</b> (2006.01) <b>C07K 17/00</b> (2006.01)		
		2501530 *	<b>B28B 3/20</b> (2006.01)		



Broj objave evropske prijava patenta (97)	MKP (51)	Broj objave evropske prijava patenta (97)	MKP (51)	Broj objave evropske prijava patenta (97)	MKP (51)
2505955	<b>G09F 13/46</b> (2006.01) <b>F42B 4/20</b> (2006.01) <b>F42B 4/18</b> (2006.01)	2533810 *	<b>C12P 21/08</b> (2006.01) <b>A61K 39/395</b> (2006.01)	2526177 *	<b>F23J 15/00</b> (2006.01) <b>C10G 2/00</b> (2006.01) <b>C07C 29/151</b> (2006.01) <b>C10J 3/66</b> (2006.01)
2444197	<b>F16L 1/10</b> (2006.01) <b>B23K 37/053</b> (2006.01)	2515057	<b>F25D 3/10</b> (2006.01) <b>F28F 27/00</b> (2006.01)	2527585	<b>E21B 33/128</b> (2006.01) <b>E21B 33/12</b> (2006.01)
2505995 *	<b>G01N 22/00</b> (2006.01)	2523682 *	<b>C07K 16/00</b> (2006.01) <b>A61K 39/00</b> (2006.01)	2536833 *	<b>C12N 5/10</b> (2006.01) <b>G01N 33/569</b> (2006.01) <b>C07K 16/12</b> (2006.01) <b>A61P 31/04</b> (2006.01) <b>A61K 39/395</b> (2006.01) <b>C12P 21/08</b> (2006.01) <b>C12N 15/09</b> (2006.01) <b>C07K 16/46</b> (2006.01)
2509029	<b>G06K 9/48</b> (2006.01)	2512453 *	<b>A61K 9/16</b> (2006.01)	2533645 *	<b>A61K 31/66</b> (2006.01) <b>A01N 57/00</b> (2006.01)
2504286 *	<b>C02F 11/14</b> (2006.01) <b>C02F 11/00</b> (2006.01) <b>C02F 1/36</b> (2006.01) <b>C02F 103/06</b> (2006.01) <b>C02F 1/68</b> (2006.01)	2516446 *	<b>A61P 1/00</b> (2006.01) <b>A61P 3/00</b> (2006.01) <b>C07D 491/052</b> (2006.01) <b>A61K 31/4439</b> (2006.01) <b>A61P 25/00</b> (2006.01)	2509793 *	<b>B41M 5/28</b> (2006.01) <b>B42D 15/00</b> (2006.01) <b>B41M 3/14</b> (2006.01) <b>B42D 15/10</b> (2006.01)
2507449 *	<b>E04H 6/02</b> (2006.01) <b>E04B 1/34</b> (2006.01) <b>H01L 31/042</b> (2006.01)	2512223 *	<b>A61K 36/899</b> (2006.01) <b>A01H 5/00</b> (2006.01)	2509947 *	<b>A61K 31/403</b> (2006.01) <b>A61P 25/00</b> (2006.01) <b>C07D 209/52</b> (2006.01)
2521719 *	<b>A61P 3/04</b> (2006.01) <b>C07D 303/16</b> (2006.01) <b>A61K 31/336</b> (2006.01)	2516399 *	<b>A61K 8/49</b> (2006.01) <b>C07D 213/74</b> (2006.01) <b>A61Q 19/00</b> (2006.01) <b>A61K 31/44</b> (2006.01)	2536733 *	<b>A61P 3/06</b> (2006.01) <b>A61K 31/4741</b> (2006.01) <b>C07D 491/04</b> (2006.01) <b>C07D 215/56</b> (2006.01) <b>A61P 9/00</b> (2006.01)
2502850	<b>B65D 81/38</b> (2006.01)	2519252 *	<b>A61P 31/00</b> (2006.01) <b>A61K 39/00</b> (2006.01)	2507230 *	
2526176 *	<b>C10J 3/32</b> (2006.01) <b>F23H 1/00</b> (2006.01) <b>C10J 3/40</b> (2006.01) <b>C10J 3/26</b> (2006.01)	2507230 *	<b>C07D 413/14</b> (2006.01) <b>C07D 419/12</b> (2006.01) <b>C07D 413/12</b> (2006.01)		
2512204	<b>G05D 23/19</b> (2006.01) <b>H02J 13/00</b> (2006.01) <b>F24D 19/10</b> (2006.01) <b>H05B 1/02</b> (2006.01)	2509740 *	<b>B23K 23/00</b> (2006.01) <b>B23K 37/00</b> (2006.01) <b>B22D 19/04</b> (2006.01)		

Broj objave evropske prijave patenta (97)	MKP (51)	Broj objave evropske prijave patenta (97)	MKP (51)	Broj objave evropske prijave patenta (97)	MKP (51)
2536285 *	<b>A01N 43/78</b> (2006.01) <b>A61K 31/425</b> (2006.01)	2533706 *	<b>A61B 17/32</b> (2006.01) <b>A61B 17/00</b> (2006.01) <b>A61B 17/3207</b> (2006.01)	2510009 *	<b>A61P 3/04</b> (2006.01) <b>C07K 14/71</b> (2006.01) <b>A61K 39/395</b> (2006.01) <b>C07K 16/28</b> (2006.01) <b>C07K 19/00</b> (2006.01) <b>C07K 16/18</b> (2006.01)
2519652 *	<b>C12Q 1/68</b> (2006.01) <b>G01N 33/15</b> (2006.01) <b>C12R 1/32</b> (2006.01) <b>C12N 15/31</b> (2006.01)	2526450 *	<b>G02B 6/50</b> (2006.01) <b>E02F 5/10</b> (2006.01) <b>E01F 11/00</b> (2006.01)	2525808 *	<b>A61K 38/22</b> (2006.01)
2512018	<b>H02K 53/00</b> (2006.01)	2526112 *	<b>C07H 21/02</b> (2006.01) <b>C12P 21/06</b> (2006.01)	2525850 *	<b>G06F 19/00</b> (2011.01) <b>G06K 7/10</b> (2006.01) <b>G06K 7/14</b> (2006.01) <b>A61M 5/24</b> (2006.01)
2528447 *	<b>A22C 21/00</b> (2006.01) <b>A22C 17/00</b> (2006.01)	2519627 *	<b>A61K 39/12</b> (2006.01) <b>C12N 15/33</b> (2006.01) <b>C07K 14/005</b> (2006.01) <b>C12N 7/01</b> (2006.01)	2437082	<b>G01V 5/00</b> (2006.01) <b>B64F 1/36</b> (2006.01)
2536283 *	<b>A01N 43/58</b> (2006.01) <b>A61K 31/50</b> (2006.01) <b>A61K 31/495</b> (2006.01)	2529010 *	<b>C12N 15/863</b> (2006.01) <b>C12N 7/02</b> (2006.01) <b>A61K 39/275</b> (2006.01) <b>C12N 7/00</b> (2006.01)	2536743 *	<b>G01N 33/53</b> (2006.01) <b>C07K 14/16</b> (2006.01) <b>C12N 7/00</b> (2006.01)
2501546 *	<b>A61L 28/00</b> (2006.01) <b>B32B 27/30</b> (2006.01) <b>B32B 27/32</b> (2006.01) <b>A61J 1/05</b> (2006.01)	2501680 *	<b>C07D 215/58</b> (2006.01)	2503969 *	<b>A61F 9/00</b> (2006.01) <b>A61F 9/007</b> (2006.01)
2506867 *	<b>A61K 38/19</b> (2006.01) <b>A61K 38/18</b> (2006.01) <b>A61K 38/30</b> (2006.01) <b>A61K 31/529</b> (2006.01) <b>A61K 38/22</b> (2006.01) <b>A61K 38/48</b> (2006.01)	2503959 *	<b>A61F 2/06</b> (2006.01)	2510070 *	<b>C04B 40/06</b> (2006.01) <b>C04B 24/26</b> (2006.01) <b>C09K 8/42</b> (2006.01) <b>C09K 8/467</b> (2006.01) <b>E21B 43/04</b> (2006.01) <b>C04B 28/02</b> (2006.01)
2519354 *	<b>B01L 3/00</b> (2006.01)	2536454 *	<b>A61M 5/20</b> (2006.01) <b>A61M 5/00</b> (2006.01)	2506902 *	<b>A61M 5/315</b> (2006.01)
2533659 *	<b>A43B 7/08</b> (2006.01) <b>A43B 7/12</b> (2006.01) <b>A43B 9/02</b> (2006.01)	2506902 *	<b>A61M 5/315</b> (2006.01)	2439263	<b>A61L 27/38</b> (2006.01) <b>C12N 5/00</b> (2006.01)
		2519651 *	<b>C12Q 1/68</b> (2006.01)	2515887 *	<b>A61K 9/70</b> (2006.01) <b>A61K 31/381</b> (2006.01)
		2507950 *	<b>H04L 7/00</b> (2006.01) <b>H04L 12/56</b> (2006.01)		

Broj objave evropske prijave patenta (97)	MKP (51)	Broj objave evropske prijave patenta (97)	MKP (51)	Broj objave evropske prijave patenta (97)	MKP (51)
2513068 *	<b>A61K 31/428</b> (2006.01) <b>A61K 31/4523</b> (2006.01) <b>A61K 31/423</b> (2006.01) <b>C07D 417/14</b> (2006.01) <b>C07D 277/82</b> (2006.01) <b>A61P 29/00</b> (2006.01) <b>C07D 417/12</b> (2006.01) <b>C07D 413/12</b> (2006.01) <b>C07D 263/58</b> (2006.01) <b>A61P 11/00</b> (2006.01)	2507144 *	<b>F16L 33/00</b> (2006.01) <b>F16L 33/22</b> (2006.01) <b>B65D 63/02</b> (2006.01)	2511271 *	<b>A61K 31/381</b> (2006.01) <b>C07D 277/56</b> (2006.01) <b>A61K 31/4525</b> (2006.01) <b>C07D 405/06</b> (2006.01) <b>A61P 3/04</b> (2006.01) <b>A61P 3/06</b> (2006.01) <b>A61K 31/426</b> (2006.01) <b>C07D 333/38</b> (2006.01) <b>A61K 31/4025</b> (2006.01) <b>C07D 307/68</b> (2006.01) <b>A61K 31/341</b> (2006.01) <b>A61P 43/00</b> (2006.01) <b>C07D 277/20</b> (2006.01) <b>A61P 3/10</b> (2006.01)
2415538	<b>B23D 31/00</b> (2006.01) <b>B65G 29/00</b> (2006.01) <b>B23Q 39/04</b> (2006.01) <b>B21D 43/14</b> (2006.01) <b>B23Q 7/02</b> (2006.01)	2514440 *	<b>A61K 9/70</b> (2006.01) <b>A61K 45/06</b> (2006.01) <b>A61K 47/18</b> (2006.01) <b>A61K 31/42</b> (2006.01) <b>A61P 29/00</b> (2006.01) <b>A61P 23/02</b> (2006.01) <b>A61K 31/167</b> (2006.01) <b>A61K 31/245</b> (2006.01)	2464633 *	<b>C07D 239/34</b> (2006.01) <b>C07D 239/42</b> (2006.01) <b>C07D 239/47</b> (2006.01) <b>C07D 239/48</b> (2006.01)
2518779	<b>H01L 31/048</b> (2006.01) <b>F24J 2/52</b> (2006.01)	2506713 *	<b>A61K 31/44</b> (2006.01) <b>A01N 43/42</b> (2006.01)	2504334 *	<b>C07D 471/04</b> (2006.01)
2534558 *	<b>G06F 3/041</b> (2006.01) <b>G06F 3/01</b> (2006.01)	2516455 *	<b>C07K 14/475</b> (2006.01)	2510226 *	<b>F03B 13/18</b> (2006.01) <b>F03B 13/20</b> (2006.01)
2531416 *	<b>B65D 47/32</b> (2006.01)	2441444	<b>A61K 9/20</b> (2006.01) <b>A61K 31/215</b> (2006.01)	2527026 *	<b>B01D 47/06</b> (2006.01)
2515889 *	<b>A61K 31/13</b> (2006.01) <b>A61K 31/19</b> (2006.01) <b>A61K 31/731</b> (2006.01)	2533708 *	<b>A61B 17/32</b> (2006.01) <b>A61B 17/3207</b> (2006.01)	2526291 *	<b>F03D 9/00</b> (2006.01)
2519543 *	<b>C07K 16/46</b> (2006.01) <b>A61K 39/395</b> (2006.01) <b>A61P 35/00</b> (2006.01) <b>A61P 37/00</b> (2006.01)	2531407 *	<b>B65C 3/18</b> (2006.01) <b>B65C 3/16</b> (2006.01)	2523665 *	<b>A61K 31/497</b> (2006.01)
2521711 *	<b>C07C 305/00</b> (2006.01)	2523959 *			<b>C07D 498/04</b> (2006.01) <b>A61K 9/00</b> (2006.01) <b>A61K 31/519</b> (2006.01)

Broj objave evropske prijave patenta (97)	MKP (51)	Broj objave evropske prijave patenta (97)	MKP (51)	Broj objave evropske prijave patenta (97)	MKP (51)
2511268 *	<b>A61K 31/535</b> (2006.01) <b>C07D 413/12</b> (2006.01) <b>A61P 25/16</b> (2006.01) <b>A61P 25/28</b> (2006.01) <b>A61P 27/02</b> (2006.01) <b>A61K 31/5365</b> (2006.01) <b>C07D 498/04</b> (2006.01) <b>A61K 31/5355</b> (2006.01) <b>C07D 413/14</b> (2006.01) <b>C07D 265/06</b> (2006.01) <b>C07D 265/08</b> (2006.01) <b>A61P 43/00</b> (2006.01)	2506712 *	<b>A01N 43/42</b> (2006.01)	2528605 *	<b>A61P 1/16</b> (2006.01) <b>A61K 31/4535</b> (2006.01) <b>A61K 31/454</b> (2006.01)
		2512466 *	<b>A61K 31/34</b> (2006.01)		
		2521781 *	<b>C12N 15/11</b> (2006.01) <b>C12Q 1/68</b> (2006.01)	2532448 *	<b>C12P 19/04</b> (2006.01) <b>B09B 3/00</b> (2006.01)
		2512984 *	<b>B01D 17/02</b> (2006.01) <b>C01B 17/02</b> (2006.01)	2531255 *	<b>A61M 39/04</b> (2006.01)
		2439365	<b>E05C 17/02</b> (2006.01) <b>E05C 17/24</b> (2006.01)	2452886	<b>B65D 5/24</b> (2006.01) <b>B65D 5/4805</b> (2006.01)
		2532755	<b>C12Q 1/68</b> (2006.01) <b>G01N 33/50</b> (2006.01)	2512467 *	<b>A61K 31/365</b> (2006.01) <b>A61K 31/495</b> (2006.01) <b>A61P 33/10</b> (2006.01)
2529832 *	<b>B01J 37/04</b> (2006.01) <b>B01J 31/22</b> (2006.01) <b>C08F 10/00</b> (2006.01) <b>B01J 37/34</b> (2006.01)	2513117 *	<b>C07D 513/04</b> (2006.01) <b>A61K 31/429</b> (2006.01) <b>A61P 25/18</b> (2006.01) <b>A61K 31/428</b> (2006.01)	2522658 *	<b>C07D 215/38</b> (2006.01) <b>C07D 215/18</b> (2006.01) <b>A01N 43/42</b> (2006.01) <b>C07D 471/04</b> (2006.01) <b>A01P 3/00</b> (2006.01) <b>C07D 495/04</b> (2006.01) <b>C07D 221/04</b> (2006.01) <b>A01N 55/00</b> (2006.01) <b>C07D 491/048</b> (2006.01) <b>C07D 215/14</b> (2006.01) <b>C07D 401/12</b> (2006.01) <b>C07D 215/20</b> (2006.01)
2536411 *	<b>A61K 31/536</b> (2006.01)				
2523951 *	<b>C07D 409/12</b> (2006.01) <b>A61K 31/4436</b> (2006.01) <b>A61K 31/381</b> (2006.01) <b>C07D 493/04</b> (2006.01) <b>A61P 31/00</b> (2006.01) <b>C07D 409/14</b> (2006.01)	2513104 *	<b>A61P 33/00</b> (2006.01) <b>A01P 7/04</b> (2006.01) <b>A01N 43/90</b> (2006.01) <b>A01P 5/00</b> (2006.01) <b>A61K 31/437</b> (2006.01) <b>C07D 471/04</b> (2006.01)		
2501821 *	<b>C12P 19/62</b> (2006.01)	2531613 *	<b>C12Q 1/68</b> (2006.01)		
2512220 *	<b>A01H 5/00</b> (2006.01) <b>A01P 7/00</b> (2006.01) <b>A01H 1/00</b> (2006.01)	2536716 *	<b>C07D 417/14</b> (2006.01) <b>A61K 31/427</b> (2006.01) <b>C07D 417/06</b> (2006.01) <b>A61P 5/30</b> (2006.01)	2501702 *	<b>C07D 495/04</b> (2006.01)
				2506844 *	<b>A61P 11/08</b> (2006.01) <b>A61K 45/06</b> (2006.01) <b>A61K 31/138</b> (2006.01) <b>A61P 11/06</b> (2006.01) <b>A61K 31/439</b> (2006.01)
2504332 *	<b>A61P 35/00</b> (2006.01) <b>C07D 405/06</b> (2006.01) <b>A61K 31/4025</b> (2006.01)	2523972 *	<b>C07K 16/00</b> (2006.01)		

Broj objave evropske prijave patenta (97)	MKP (51)	Broj objave evropske prijave patenta (97)	MKP (51)	Broj objave evropske prijave patenta (97)	MKP (51)
2519231 *	<b>A61K 31/00</b> (2006.01) <b>A61K 45/06</b> (2006.01) <b>A61K 35/00</b> (2006.01) <b>A61K 31/69</b> (2006.01)	2519366 *	<b>B21C 47/24</b> (2006.01) <b>B21B 1/46</b> (2006.01) <b>C21D 9/68</b> (2006.01)	2505586 *	<b>A61K 31/4439</b> (2006.01) <b>A61P 37/08</b> (2006.01) <b>A61K 31/437</b> (2006.01) <b>A61P 37/06</b> (2006.01) <b>A61K 31/433</b> (2006.01) <b>A61P 37/02</b> (2006.01) <b>A61K 31/427</b> (2006.01) <b>A61P 29/00</b> (2006.01) <b>A61K 31/4178</b> (2006.01) <b>A61K 31/5377</b> (2006.01) <b>C07D 403/14</b> (2006.01) <b>A61K 31/416</b> (2006.01) <b>A61K 31/496</b> (2006.01) <b>C07D 403/04</b> (2006.01) <b>A61K 31/422</b> (2006.01) <b>A61K 31/55</b> (2006.01) <b>C07D 405/14</b> (2006.01) <b>C07D 401/14</b> (2006.01) <b>A61K 31/454</b> (2006.01) <b>A61P 43/00</b> (2006.01)
2508490 *	<b>C02F 3/12</b> (2006.01) <b>C02F 3/30</b> (2006.01) <b>C02F 11/02</b> (2006.01)	2513046 *	<b>C07C 253/30</b> (2006.01) <b>C07C 257/04</b> (2006.01)		
2503994 *	<b>A61K 31/4152</b> (2006.01) <b>A61K 9/16</b> (2006.01)	2528682 *	<b>C01G 49/02</b> (2006.01) <b>B01J 21/02</b> (2006.01) <b>C01F 7/06</b> (2006.01) <b>C01F 7/16</b> (2006.01)		
2516441 *	<b>A61P 25/00</b> (2006.01) <b>C07D 475/04</b> (2006.01) <b>C07D 475/12</b> (2006.01) <b>A61K 31/4985</b> (2006.01)	2533783 *	<b>A61K 31/497</b> (2006.01)		
2528507 *	<b>A61B 5/151</b> (2006.01)	2520176	<b>A23K 1/175</b> (2006.01) <b>A23K 1/18</b> (2006.01) <b>A23K 1/14</b> (2006.01) <b>A23K 1/16</b> (2006.01)		
2509513 *	<b>A61B 17/00</b> (2006.01) <b>A61B 17/34</b> (2006.01) <b>A61B 17/068</b> (2006.01) <b>A61B 19/00</b> (2006.01) <b>A61B 17/115</b> (2006.01)	2453221	<b>G01N 21/31</b> (2006.01) <b>G01N 21/84</b> (2006.01) <b>G01N 21/35</b> (2006.01)	2519296 *	<b>A61M 16/06</b> (2006.01)
2529062 *	<b>E04F 15/02</b> (2006.01) <b>E04F 15/024</b> (2006.01)	2526245 *	<b>E05D 15/06</b> (2006.01)	2535057 *	<b>A61K 38/17</b> (2006.01) <b>A61K 38/21</b> (2006.01)
2533634 *	<b>A61K 31/275</b> (2006.01) <b>A01N 37/34</b> (2006.01)				
2515937 *	<b>A61P 1/04</b> (2006.01) <b>A61K 39/07</b> (2006.01) <b>A23L 1/30</b> (2006.01) <b>A61K 36/899</b> (2006.01)				

Broj objave evropske prijava patenta (97)	MKP (51)	Broj objave evropske prijava patenta (97)	MKP (51)	Broj objave evropske prijava patenta (97)	MKP (51)
2528598 *	<b>A61K 31/4196</b> (2006.01) <b>A61K 31/4545</b> (2006.01) <b>A61K 31/428</b> (2006.01) <b>A61K 31/4192</b> (2006.01) <b>A61K 31/216</b> (2006.01) <b>A61K 31/282</b> (2006.01) <b>A61P 25/02</b> (2006.01) <b>A61K 31/41</b> (2006.01) <b>A61K 31/337</b> (2006.01) <b>A61K 31/69</b> (2006.01)	2518088 *	<b>A23L 1/0524</b> (2006.01) <b>C08B 37/06</b> (2006.01)	2512243 *	<b>A01N 43/42</b> (2006.01) <b>A61K 31/47</b> (2006.01)
		2532647	<b>A61K 31/165</b> (2006.01) <b>A61P 25/16</b> (2006.01) <b>C07C 231/12</b> (2006.01) <b>C07C 233/18</b> (2006.01) <b>A61P 25/18</b> (2006.01) <b>A61P 3/00</b> (2006.01) <b>A61P 25/28</b> (2006.01)	2523555 *	<b>A01P 13/00</b> (2006.01) <b>A01N 43/16</b> (2006.01)
		2506882 *	<b>A61L 2/00</b> (2006.01)	2518069 *	<b>C07D 405/14</b> (2006.01) <b>A01P 7/02</b> (2006.01) <b>C07D 401/12</b> (2006.01) <b>C07D 451/06</b> (2006.01) <b>A01N 43/42</b> (2006.01) <b>C07D 409/14</b> (2006.01) <b>C07D 401/14</b> (2006.01)
2519919 *	<b>G06Q 20/00</b> (2012.01)	2528894 *	<b>A61P 37/06</b> (2006.01) <b>C07D 209/94</b> (2006.01) <b>A61P 29/00</b> (2006.01) <b>A61K 31/403</b> (2006.01)	2519520 *	<b>A61K 31/4523</b> (2006.01) <b>A61P 11/06</b> (2006.01) <b>C07D 471/04</b> (2006.01)
2506814 *	<b>A61K 9/70</b> (2006.01) <b>A61F 13/00</b> (2006.01)				
2516416 *	<b>A61K 31/40</b> (2006.01) <b>C07D 401/04</b> (2006.01) <b>C07D 403/12</b> (2006.01) <b>A61K 31/495</b> (2006.01) <b>A61P 43/00</b> (2006.01) <b>C07D 207/325</b> (2006.01) <b>C07D 413/14</b> (2006.01)	2450991	<b>C22B 26/12</b> (2006.01) <b>C22B 47/00</b> (2006.01) <b>H01M 10/54</b> (2006.01) <b>C22B 15/00</b> (2006.01) <b>H01M 6/52</b> (2006.01) <b>C22B 23/00</b> (2006.01) <b>C22B 7/00</b> (2006.01)	2532756	<b>C12Q 1/68</b> (2006.01)
				2504454 *	<b>C12Q 1/68</b> (2006.01) <b>C07H 21/00</b> (2006.01)
				2515853 *	<b>A61K 9/00</b> (2006.01) <b>A61K 31/167</b> (2006.01) <b>A61K 45/06</b> (2006.01) <b>A61K 31/40</b> (2006.01)
2501374 *	<b>A61P 17/00</b> (2006.01) <b>A61K 31/185</b> (2006.01) <b>A61K 31/195</b> (2006.01) <b>A61K 8/40</b> (2006.01) <b>A61Q 5/00</b> (2006.01) <b>A61K 8/36</b> (2006.01)	2513318 *	<b>C12N 15/82</b> (2006.01)		
		2439287	<b>G01N 3/34</b> (2006.01) <b>C14B 1/40</b> (2006.01)		
		2521822 *	<b>E03D 9/08</b> (2006.01)		
2305069	<b>A47B 96/02</b> (2006.01) <b>A47B 57/58</b> (2006.01) <b>A47B 57/10</b> (2006.01)	2531237 *	<b>A61M 5/32</b> (2006.01) <b>A61M 5/28</b> (2006.01) <b>A61M 5/24</b> (2006.01)		
2431949	<b>G07C 9/00</b> (2006.01)				

Broj objave evropske prijave patenta (97)	MKP (51)	Broj objave evropske prijave patenta (97)	MKP (51)	Broj objave evropske prijave patenta (97)	MKP (51)
2519300 *	<b>A61F 2/84</b> (2006.01) <b>A61M 25/00</b> (2006.01) <b>A61K 31/00</b> (2006.01) <b>A61M 25/10</b> (2006.01) <b>A61B 18/00</b> (2006.01) <b>A61M 29/00</b> (2006.01) <b>A61M 25/09</b> (2006.01) <b>A61B 1/00</b> (2006.01) <b>A61M 25/06</b> (2006.01) <b>A61L 29/00</b> (2006.01) <b>A61B 17/3207</b> (2006.01)	2508522 *	<b>C07C 215/40</b> (2006.01) <b>A61K 31/4245</b> (2006.01) <b>C07C 215/08</b> (2006.01) <b>A61P 9/12</b> (2006.01) <b>C07D 413/10</b> (2006.01)	2513109 *	<b>A61P 3/10</b> (2006.01) <b>A61P 1/04</b> (2006.01) <b>C07D 471/04</b> (2006.01) <b>A61P 35/00</b> (2006.01) <b>A61P 19/02</b> (2006.01) <b>A61K 31/4375</b> (2006.01) <b>C07D 519/00</b> (2006.01) <b>A61P 9/10</b> (2006.01) <b>A61P 17/06</b> (2006.01)
		2516286 *	<b>B65D 47/20</b> (2006.01) <b>B65D 47/30</b> (2006.01) <b>B65D 47/26</b> (2006.01)		
		2531675 *	<b>E04B 1/343</b> (2006.01) <b>E04H 15/44</b> (2006.01)	2504139 *	<b>B28D 5/00</b> (2006.01)
2536540 *	<b>B65H 49/00</b> (2006.01) <b>B26D 1/547</b> (2006.01)	2513088 *	<b>A61K 31/497</b> (2006.01) <b>A61K 31/496</b> (2006.01) <b>C07D 409/04</b> (2006.01) <b>C07D 407/14</b> (2006.01) <b>A61P 25/00</b> (2006.01) <b>C07D 403/14</b> (2006.01) <b>A61K 31/551</b> (2006.01) <b>C07D 495/04</b> (2006.01) <b>C07D 407/04</b> (2006.01) <b>C07D 409/14</b> (2006.01) <b>C07D 401/04</b> (2006.01) <b>A61K 31/4995</b> (2006.01) <b>C07D 401/14</b> (2006.01) <b>A61K 31/506</b> (2006.01)	2523765 *	<b>B22D 41/14</b> (2006.01)
				2450495	<b>E04B 2/96</b> (2006.01)
2515882 *	<b>A61K 9/54</b> (2006.01) <b>A61K 9/52</b> (2006.01) <b>A61K 9/28</b> (2006.01)			2507555 *	<b>F24J 2/42</b> (2006.01) <b>F23G 7/00</b> (2006.01) <b>F23G 5/027</b> (2006.01) <b>F23G 5/16</b> (2006.01)
2526206 *	<b>G01N 33/50</b> (2006.01) <b>C12Q 1/68</b> (2006.01)			2444650	<b>F02M 51/00</b> (2006.01) <b>F02M 53/04</b> (2006.01) <b>F02M 55/00</b> (2006.01) <b>F02M 61/20</b> (2006.01)
2531561 *	<b>C08L 97/02</b> (2006.01) <b>C08G 18/64</b> (2006.01) <b>C08H 8/00</b> (2010.01)			2512227 *	<b>A01K 67/027</b> (2006.01) <b>C12N 15/85</b> (2006.01)
2533705 *	<b>A61B 17/22</b> (2006.01) <b>A61B 17/32</b> (2006.01) <b>A61B 17/3207</b> (2006.01)			2513070 *	<b>A61K 31/4439</b> (2006.01) <b>A61P 3/00</b> (2006.01) <b>C07D 417/12</b> (2006.01) <b>A61K 31/426</b> (2006.01) <b>C07D 277/34</b> (2006.01) <b>A61P 5/00</b> (2006.01)
2516438 *	<b>A61K 31/437</b> (2006.01) <b>C07D 471/04</b> (2006.01) <b>A61P 35/00</b> (2006.01)				

Broj objave evropske prijave patenta (97)	MKP (51)	Broj objave evropske prijave patenta (97)	MKP (51)	Broj objave evropske prijave patenta (97)	MKP (51)
2513054 *	<b>C07D 307/81</b> (2006.01) <b>C07D 417/12</b> (2006.01) <b>C07D 333/58</b> (2006.01) <b>C07D 409/12</b> (2006.01) <b>C07D 235/14</b> (2006.01) <b>C07D 405/06</b> (2006.01) <b>C07D 407/04</b> (2006.01) <b>C07D 405/14</b> (2006.01) <b>C07D 405/12</b> (2006.01) <b>C07D 209/14</b> (2006.01) <b>C07D 403/12</b> (2006.01)	2509418 *	<b>A01N 37/10</b> (2006.01)	2504353 *	<b>A61P 31/04</b> (2006.01) <b>A61K 38/12</b> (2006.01) <b>C07K 7/08</b> (2006.01) <b>C07K 7/06</b> (2006.01) <b>C07K 7/64</b> (2006.01)
		2512536 *	<b>A61L 24/00</b> (2006.01) <b>A61L 24/08</b> (2006.01) <b>A61L 24/02</b> (2006.01)		
		2507124 *	<b>B63B 1/04</b> (2006.01)	2441441	<b>A61K 9/14</b> (2006.01) <b>A61K 31/00</b> (2006.01)
		2512225 *	<b>A61K 36/899</b> (2006.01) <b>A01H 5/00</b> (2006.01)	2536706 *	<b>C07D 493/04</b> (2006.01) <b>C07D 417/14</b> (2006.01) <b>A61K 31/4412</b> (2006.01) <b>C07D 407/12</b> (2006.01) <b>C07D 409/14</b> (2006.01) <b>C07D 413/14</b> (2006.01) <b>A61P 35/00</b> (2006.01) <b>C07D 487/04</b> (2006.01) <b>C07D 401/04</b> (2006.01) <b>C07D 491/107</b> (2006.01) <b>C07D 401/14</b> (2006.01) <b>C07D 407/14</b> (2006.01) <b>C07D 495/04</b> (2006.01)
		2528537 *	<b>A61F 2/00</b> (2006.01)		
2509963 *	<b>A61P 35/00</b> (2006.01) <b>C07D 239/48</b> (2006.01) <b>A61K 31/506</b> (2006.01)	2510297 *	<b>F27D 1/12</b> (2006.01) <b>F27D 1/14</b> (2006.01)		
		2523678 *	<b>A61K 38/17</b> (2006.01)		
2516428 *	<b>C07D 451/02</b> (2006.01) <b>A61K 31/46</b> (2006.01) <b>A61P 29/00</b> (2006.01)	2501387 *	<b>A61P 19/02</b> (2006.01) <b>A61K 31/5513</b> (2006.01) <b>A61P 19/00</b> (2006.01)		
		2523405 *	<b>H04L 12/56</b> (2006.01)		
2523975 *	<b>C12P 21/02</b> (2006.01) <b>C07K 16/24</b> (2006.01) <b>C12N 15/70</b> (2006.01) <b>C12N 9/48</b> (2006.01)	2531239 *	<b>A61M 5/32</b> (2006.01) <b>A61M 5/28</b> (2006.01) <b>A61M 5/24</b> (2006.01)	2437355	<b>H01R 13/52</b> (2006.01) <b>H01R 4/70</b> (2006.01)
2509961 *	<b>C07D 401/04</b> (2006.01) <b>C07D 233/76</b> (2006.01) <b>A61K 31/4166</b> (2006.01) <b>C07D 403/04</b> (2006.01) <b>A61P 25/18</b> (2006.01)	2518075 *	<b>H01B 1/12</b> (2006.01) <b>C07D 333/10</b> (2006.01) <b>C07C 15/14</b> (2006.01) <b>C07D 495/04</b> (2006.01) <b>C07D 333/76</b> (2006.01) <b>C07C 15/30</b> (2006.01)	2536729 *	<b>A61P 17/00</b> (2006.01) <b>A61P 29/00</b> (2006.01) <b>A61P 37/00</b> (2006.01) <b>A61P 35/00</b> (2006.01) <b>C07D 487/04</b> (2006.01) <b>A61K 31/519</b> (2006.01) <b>A61P 27/00</b> (2006.01)
2530149 *	<b>C12N 15/09</b> (2006.01) <b>C12P 17/18</b> (2006.01) <b>C12N 1/15</b> (2006.01)	2503912 *	<b>A24F 47/00</b> (2006.01)	2507579 *	<b>F41G 1/34</b> (2006.01)
2534175 *	<b>C07K 16/24</b> (2006.01)				



Broj objave evropske prijave patenta (97)	MKP (51)	Broj objave evropske prijave patenta (97)	MKP (51)	Broj objave evropske prijave patenta (97)	MKP (51)
2515877 *	<b>A61K 9/16</b> (2006.01) <b>A61K 9/00</b> (2006.01)	2501716 *	<b>C07K 14/00</b> (2006.01) <b>C12N 9/00</b> (2006.01)	2523762 *	<b>B21D 51/26</b> (2006.01) <b>B21D 26/02</b> (2011.01)
2524334 *	<b>G06F 21/02</b> (2006.01) <b>H04L 9/08</b> (2006.01)	2519234 *	<b>A61K 31/185</b> (2006.01) <b>A61K 31/20</b> (2006.01) <b>A61P 25/28</b> (2006.01) <b>A61K 31/23</b> (2006.01) <b>A61K 31/25</b> (2006.01)	2526122 *	<b>C08B 37/10</b> (2006.01) <b>C08B 37/00</b> (2006.01)
2533960 *	<b>E04C 2/38</b> (2006.01) <b>B29C 44/60</b> (2006.01) <b>B29C 44/12</b> (2006.01) <b>E04C 2/296</b> (2006.01) <b>B29C 44/18</b> (2006.01)	2527218 *	<b>B60V 3/08</b> (2006.01) <b>B64B 1/20</b> (2006.01)	2531424 *	<b>B65G 1/08</b> (2006.01) <b>B65G 47/88</b> (2006.01)
2534257 *	<b>A61K 39/00</b> (2006.01) <b>C12P 21/08</b> (2006.01)	2452734	<b>B01D 21/00</b> (2006.01)	2512450 *	<b>A61K 38/27</b> (2006.01) <b>A61K 38/00</b> (2006.01) <b>A61K 47/48</b> (2006.01) <b>A61K 9/14</b> (2006.01) <b>A61K 47/26</b> (2006.01) <b>A61K 9/19</b> (2006.01) <b>A61K 9/00</b> (2006.01)
2538361	<b>G06F 19/00</b> (2011.01)	2502156 *	<b>G06F 17/00</b> (2006.01)	2515673 *	<b>A23J 3/16</b> (2006.01) <b>A23J 1/14</b> (2006.01)
2509997 *	<b>A61K 38/22</b> (2006.01) <b>C07K 14/605</b> (2006.01) <b>C07K 14/575</b> (2006.01) <b>A61K 38/26</b> (2006.01) <b>C07K 16/00</b> (2006.01)	2531025 *	<b>A01N 43/52</b> (2006.01) <b>A01N 37/50</b> (2006.01) <b>A01P 3/00</b> (2006.01) <b>A01N 37/44</b> (2006.01) <b>A01N 43/653</b> (2006.01)	2536435 *	<b>A61K 48/00</b> (2006.01) <b>C07K 14/00</b> (2006.01)
2523958 *	<b>A61P 13/12</b> (2006.01) <b>A61P 25/28</b> (2006.01) <b>A61P 3/10</b> (2006.01) <b>A61P 35/00</b> (2006.01) <b>A61P 11/00</b> (2006.01) <b>C07D 498/04</b> (2006.01) <b>A61P 29/00</b> (2006.01) <b>A61P 9/00</b> (2006.01) <b>A61P 7/02</b> (2006.01) <b>A61K 31/519</b> (2006.01) <b>A61P 31/02</b> (2006.01)	2536750 *	<b>C12N 15/62</b> (2006.01) <b>C07K 14/705</b> (2006.01)	2516418 *	<b>C07D 401/06</b> (2006.01) <b>A61P 29/00</b> (2006.01) <b>A61K 31/454</b> (2006.01)
2401930	<b>A41D 1/06</b> (2006.01)	2506841 *	<b>A61K 31/05</b> (2006.01) <b>A61K 9/06</b> (2006.01) <b>A61P 15/00</b> (2006.01) <b>A61P 31/18</b> (2006.01)	2521821 *	<b>F16L 41/03</b> (2006.01) <b>E03D 9/05</b> (2006.01) <b>E03D 1/38</b> (2006.01) <b>E03D 9/08</b> (2006.01) <b>E03C 1/02</b> (2006.01) <b>E03D 11/13</b> (2006.01)
		2519192 *	<b>A61F 2/12</b> (2006.01) <b>A61M 39/02</b> (2006.01)	2536303 *	<b>A24F 1/30</b> (2006.01) <b>A24F 47/00</b> (2006.01) <b>A24F 1/14</b> (2006.01)
		2533282	<b>H01L 23/367</b> (2006.01)		
		2519104 *	<b>A01N 43/72</b> (2006.01)		

Broj objave evropske prijava patenta (97)	MKP (51)	Broj objave evropske prijava patenta (97)	MKP (51)	Broj objave evropske prijava patenta (97)	MKP (51)
2524233 *	<b>C07K 16/18</b> (2006.01) <b>G01N 33/574</b> (2006.01)	2523948 *	<b>A61K 31/675</b> (2006.01) <b>C07F 9/24</b> (2006.01) <b>A61P 31/00</b> (2006.01) <b>C07D 401/14</b> (2006.01) <b>A61K 31/4725</b> (2006.01) <b>C07D 401/04</b> (2006.01) <b>C07D 405/14</b> (2006.01)	2509868 *	<b>B60N 2/02</b> (2006.01) <b>B61D 33/00</b> (2006.01) <b>B60N 3/06</b> (2006.01) <b>B64D 11/06</b> (2006.01)
2536699 *	<b>C07D 277/56</b> (2006.01) <b>A61P 19/06</b> (2006.01) <b>A61K 31/426</b> (2006.01)			2512222 *	<b>A01H 5/00</b> (2006.01) <b>A01P 7/00</b> (2006.01) <b>A01H 1/00</b> (2006.01)
2501407 *	<b>C07K 19/00</b> (2006.01) <b>C07K 16/28</b> (2006.01) <b>A61P 37/06</b> (2006.01) <b>A61K 39/395</b> (2006.01) <b>C07K 14/705</b> (2006.01)	2509945 *	<b>C07D 207/48</b> (2006.01) <b>A61K 31/451</b> (2006.01) <b>C07D 211/96</b> (2006.01) <b>A61P 17/00</b> (2006.01)	2511294 *	<b>C07K 19/00</b> (2006.01) <b>C07K 14/54</b> (2006.01) <b>A61K 38/17</b> (2006.01) <b>C07K 14/715</b> (2006.01) <b>A61K 48/00</b> (2006.01) <b>C07K 14/775</b> (2006.01) <b>C12N 1/21</b> (2006.01) <b>C12N 1/15</b> (2006.01) <b>C12N 15/62</b> (2006.01) <b>C12N 5/10</b> (2006.01)
2531452 *	<b>C02F 1/46</b> (2006.01) <b>C02F 9/14</b> (2006.01) <b>C02F 1/48</b> (2006.01)	2525724 *	<b>A61B 17/068</b> (2006.01) <b>A61B 17/128</b> (2006.01)		
2515873 *	<b>A61K 9/16</b> (2006.01) <b>A61P 25/16</b> (2006.01) <b>A61P 25/18</b> (2006.01) <b>A61K 9/20</b> (2006.01) <b>A61K 31/517</b> (2006.01) <b>A61P 25/08</b> (2006.01) <b>A61K 9/14</b> (2006.01) <b>A61P 25/28</b> (2006.01) <b>A61P 25/24</b> (2006.01)	2522491	<b>B29C 65/08</b> (2006.01) <b>B31B 19/90</b> (2006.01)		
		2447884	<b>G06K 9/68</b> (2006.01)		
		2516009 *	<b>C07D 401/10</b> (2006.01) <b>C07D 417/12</b> (2006.01) <b>A61K 31/495</b> (2006.01) <b>C07D 413/10</b> (2006.01) <b>C07D 401/14</b> (2006.01) <b>C07D 413/14</b> (2006.01) <b>C07D 405/12</b> (2006.01) <b>A61P 35/00</b> (2006.01) <b>C07D 409/12</b> (2006.01) <b>C07D 401/12</b> (2006.01) <b>C07D 405/14</b> (2006.01) <b>C07D 401/04</b> (2006.01) <b>C07D 413/12</b> (2006.01) <b>C07D 405/04</b> (2006.01) <b>C07D 217/24</b> (2006.01)	2510135 *	<b>C25B 1/16</b> (2006.01)
				2506852 *	<b>A61K 31/277</b> (2006.01) <b>A61P 35/00</b> (2006.01) <b>A61K 31/275</b> (2006.01) <b>A61K 31/216</b> (2006.01) <b>A61K 31/445</b> (2006.01) <b>A61K 31/4465</b> (2006.01)
2522499	<b>C09J 7/00</b> (2006.01) <b>B32B 3/00</b> (2006.01) <b>C09J 5/00</b> (2006.01)			2504551 *	<b>F02D 41/20</b> (2006.01) <b>F02M 51/00</b> (2006.01) <b>F02D 41/24</b> (2006.01)
2534176 *	<b>A61K 39/395</b> (2006.01) <b>C07K 16/28</b> (2006.01)				
2517577 *	<b>A23L 1/238</b> (2006.01)			2481539	<b>C03B 37/16</b> (2006.01) <b>B26F 3/00</b> (2006.01)

Broj objave evropske prijava patenta (97)	MKP (51)	Broj objave evropske prijava patenta (97)	MKP (51)	Broj objave evropske prijava patenta (97)	MKP (51)
2506849 *	<b>A61K 31/4418</b> (2006.01) <b>A61P 43/00</b> (2006.01) <b>A61K 31/4412</b> (2006.01) <b>A61K 31/44</b> (2006.01)	2525649 *	<b>A01H 5/00</b> (2006.01) <b>C12N 15/29</b> (2006.01) <b>C12N 15/82</b> (2006.01)	2509944 *	<b>C07C 409/34</b> (2006.01) <b>A61Q 19/00</b> (2006.01) <b>A61K 8/38</b> (2006.01)
2507627 *	<b>G01N 33/53</b> (2006.01) <b>G01N 33/68</b> (2006.01)	2523960 *	<b>A61K 31/519</b> (2006.01) <b>A61P 9/00</b> (2006.01) <b>C07D 498/04</b> (2006.01)	2513326 *	<b>C12P 19/34</b> (2006.01) <b>C07H 21/04</b> (2006.01)
2447585	<b>F16L 9/00</b> (2006.01) <b>F16L 9/127</b> (2006.01) <b>F16L 11/12</b> (2006.01)	2515878 *	<b>A61K 9/00</b> (2006.01) <b>A61K 9/16</b> (2006.01) <b>A61P 35/00</b> (2006.01) <b>A61K 38/00</b> (2006.01)	2536455 *	<b>A61M 5/32</b> (2006.01) <b>A61M 5/20</b> (2006.01)
2528643 *	<b>A61M 5/24</b> (2006.01) <b>A61M 5/315</b> (2006.01)	2503873 *	<b>A01H 5/00</b> (2006.01) <b>C12Q 1/68</b> (2006.01)	2516433 *	<b>A61P 9/00</b> (2006.01) <b>A61P 19/08</b> (2006.01) <b>C07D 519/00</b> (2006.01) <b>C07D 471/04</b> (2006.01) <b>A61P 29/00</b> (2006.01) <b>A61K 31/437</b> (2006.01) <b>A61K 31/4985</b> (2006.01) <b>A61P 35/00</b> (2006.01)
2501958 *	<b>B64C 27/00</b> (2006.01) <b>F16F 15/36</b> (2006.01) <b>F16F 15/16</b> (2006.01) <b>G01M 1/36</b> (2006.01)	2524294 *	<b>G06F 3/048</b> (2006.01)	2516115 *	<b>B25H 3/02</b> (2006.01)
2509439 *	<b>A23G 1/30</b> (2006.01) <b>A23L 1/00</b> (2006.01) <b>A23G 1/50</b> (2006.01) <b>A23L 1/09</b> (2006.01) <b>A23L 1/03</b> (2006.01) <b>A23L 1/30</b> (2006.01) <b>A23L 1/0562</b> (2006.01) <b>A23G 3/54</b> (2006.01) <b>A23L 1/305</b> (2006.01) <b>A23L 1/227</b> (2006.01) <b>A23G 1/54</b> (2006.01)	2519168 *	<b>A61B 17/24</b> (2006.01) <b>A61B 17/32</b> (2006.01) <b>A61M 29/02</b> (2006.01) <b>A61B 17/3205</b> (2006.01) <b>A61B 17/22</b> (2006.01)	2528611 *	<b>A61K 35/74</b> (2006.01) <b>A61K 38/47</b> (2006.01)
2444224	<b>B29C 45/44</b> (2006.01) <b>B29C 45/26</b> (2006.01) <b>B29C 45/56</b> (2006.01)	2529158 *	<b>F23M 5/00</b> (2006.01) <b>F23L 7/00</b> (2006.01) <b>F23M 5/08</b> (2006.01) <b>F02C 1/00</b> (2006.01)	2514269 *	<b>H05B 7/09</b> (2006.01)
		2507582 *	<b>F41H 1/02</b> (2006.01) <b>D04B 21/14</b> (2006.01)	2515891 *	<b>A61K 31/135</b> (2006.01)
		2512600 *	<b>C07K 16/18</b> (2006.01) <b>A61K 39/395</b> (2006.01) <b>A61P 13/12</b> (2006.01)	2523955 *	<b>C07D 487/04</b> (2006.01) <b>A61P 25/28</b> (2006.01) <b>C07D 471/04</b> (2006.01) <b>A61K 31/4196</b> (2006.01)
				2529342 *	<b>G06Q 10/00</b> (2012.01)

Broj objave evropske prijave patenta (97)	MKP (51)	Broj objave evropske prijave patenta (97)	MKP (51)	Broj objave evropske prijave patenta (97)	MKP (51)
2531516 *	<b>C07J 71/00</b> (2006.01) <b>A61K 31/58</b> (2006.01) <b>A61P 5/44</b> (2006.01)	2515851 *	<b>A61K 9/50</b> (2006.01) <b>A61K 9/16</b> (2006.01) <b>A61K 9/06</b> (2006.01) <b>A61P 1/00</b> (2006.01) <b>A61K 9/10</b> (2006.01) <b>A61K 9/12</b> (2006.01) <b>A61K 9/00</b> (2006.01) <b>A61K 31/404</b> (2006.01) <b>A61K 9/20</b> (2006.01) <b>A61K 9/08</b> (2006.01)	2523679 *	<b>A61K 38/17</b> (2006.01)
2507373 *	<b>C12N 15/113</b> (2010.01)			2533772 *	<b>A61L 15/44</b> (2006.01) <b>B32B 27/00</b> (2006.01) <b>A61F 13/00</b> (2006.01) <b>A61K 9/70</b> (2006.01) <b>A61K 33/38</b> (2006.01)
2516467 *	<b>A61P 17/06</b> (2006.01) <b>A61P 37/00</b> (2006.01) <b>C07K 16/24</b> (2006.01) <b>A61K 39/395</b> (2006.01) <b>A61P 19/02</b> (2006.01)			2521561 *	<b>A61K 38/10</b> (2006.01) <b>A61P 1/10</b> (2006.01)
2521716 *	<b>A61P 13/00</b> (2006.01) <b>C07D 249/12</b> (2006.01) <b>A61P 13/12</b> (2006.01) <b>A61K 31/4196</b> (2006.01)	2501399 *	<b>A61K 38/18</b> (2006.01)	2501656 *	<b>C02F 3/04</b> (2006.01)
		2526339 *	<b>F23L 7/00</b> (2006.01)	2534156 *	<b>A61P 35/00</b> (2006.01) <b>C07D 491/048</b> (2006.01) <b>A61K 31/4355</b> (2006.01)
2536497 *	<b>B01J 20/28</b> (2006.01) <b>B01J 20/26</b> (2006.01) <b>C02F 1/28</b> (2006.01) <b>B01J 20/32</b> (2006.01) <b>B01J 20/20</b> (2006.01) <b>B01D 53/02</b> (2006.01)	2531182 *	<b>A61K 45/06</b> (2006.01) <b>A61K 31/4155</b> (2006.01) <b>A61K 31/00</b> (2006.01) <b>A61P 25/04</b> (2006.01)	2520257 *	<b>A61F 13/02</b> (2006.01) <b>A61M 35/00</b> (2006.01) <b>A61K 9/70</b> (2006.01)
		2523402 *	<b>H04L 12/56</b> (2006.01)	2501804 *	<b>C12N 9/02</b> (2006.01) <b>C12N 15/82</b> (2006.01)
2501298 *	<b>A61B 17/00</b> (2006.01) <b>A61B 19/02</b> (2006.01) <b>A61B 19/08</b> (2006.01) <b>A61B 19/00</b> (2006.01)	2523613 *	<b>A61B 19/00</b> (2006.01) <b>A61B 17/34</b> (2006.01)	2509593 *	<b>A61P 35/00</b> (2006.01) <b>A61P 31/00</b> (2006.01) <b>A61K 38/21</b> (2006.01) <b>A61P 31/12</b> (2006.01) <b>A61K 31/40</b> (2006.01)
2536734 *	<b>C07D 498/00</b> (2006.01)	2502244 *	<b>F21V 17/06</b> (2006.01) <b>F21V 19/04</b> (2006.01) <b>H01F 38/14</b> (2006.01) <b>H05B 41/46</b> (2006.01)	2521720 *	<b>C07D 307/80</b> (2006.01) <b>C07D 307/79</b> (2006.01)
2464265 *	<b>A47J 37/04</b> (2006.01)	2509992 *	<b>A61K 38/10</b> (2006.01) <b>C07K 7/08</b> (2006.01)		
2512350 *	<b>A61B 17/115</b> (2006.01) <b>A61B 17/11</b> (2006.01) <b>A61B 19/00</b> (2006.01) <b>A61B 17/00</b> (2006.01)	2531502 *	<b>A61K 31/437</b> (2006.01) <b>C07D 471/04</b> (2006.01) <b>A61P 35/00</b> (2006.01)	2534135 *	<b>C07D 223/16</b> (2006.01) <b>A61K 31/55</b> (2006.01) <b>A61P 9/10</b> (2006.01)

Broj objave evropske prijave patenta (97)	MKP (51)	Broj objave evropske prijave patenta (97)	MKP (51)	Broj objave evropske prijave patenta (97)	MKP (51)
2515902 *	<b>C07D 403/14</b> (2006.01) <b>A61P 31/14</b> (2006.01) <b>A61K 31/4155</b> (2006.01)	2519527 *	<b>A61K 31/33</b> (2006.01) <b>C07D 495/04</b> (2006.01) <b>A61P 3/10</b> (2006.01)	2510178 *	<b>E06B 9/386</b> (2006.01) <b>G02B 17/00</b> (2006.01) <b>E06B 9/264</b> (2006.01)
2513119 *	<b>A61P 11/06</b> (2006.01) <b>A61P 11/00</b> (2006.01) <b>C07D 519/00</b> (2006.01) <b>A61K 31/519</b> (2006.01) <b>A61P 11/08</b> (2006.01)	2519121 *	<b>H05B 3/58</b> (2006.01) <b>A24F 47/00</b> (2006.01)	2537900	<b>C09C 1/02</b> (2006.01) <b>C01F 11/18</b> (2006.01)
		2521613 *	<b>B01J 21/00</b> (2006.01)	2521545 *	<b>A61K 31/4192</b> (2006.01)
		2510299 *	<b>F27D 1/14</b> (2006.01)	2450416	<b>C09K 8/03</b> (2006.01) <b>C09K 8/40</b> (2006.01) <b>C09K 8/42</b> (2006.01) <b>E21B 21/00</b> (2006.01)
2536298 *	<b>A23L 1/236</b> (2006.01) <b>A23L 1/30</b> (2006.01) <b>A23L 2/52</b> (2006.01) <b>A23L 2/60</b> (2006.01) <b>A23L 1/09</b> (2006.01)	2509586 *	<b>A61K 31/44</b> (2006.01) <b>A61K 31/00</b> (2006.01) <b>A61K 47/36</b> (2006.01) <b>A61K 9/20</b> (2006.01)	2501413 *	<b>A61P 35/00</b> (2006.01) <b>C08G 65/08</b> (2006.01) <b>A61K 47/48</b> (2006.01) <b>C08G 65/14</b> (2006.01) <b>C08G 65/26</b> (2006.01)
		2501754 *	<b>C08L 5/08</b> (2006.01) <b>C08K 11/00</b> (2006.01) <b>A61K 35/14</b> (2006.01) <b>C08K 3/00</b> (2006.01)		
2501384 *	<b>A61K 9/00</b> (2006.01) <b>A61K 31/506</b> (2006.01) <b>A61P 35/00</b> (2006.01)			2507442 *	<b>E04C 2/04</b> (2006.01)
		2506887 *	<b>A61L 31/14</b> (2006.01) <b>A61L 31/16</b> (2006.01) <b>A61L 31/06</b> (2006.01)	2523966 *	<b>C07J 19/00</b> (2006.01) <b>A61K 31/585</b> (2006.01) <b>A61P 35/00</b> (2006.01)
2516394 *	<b>C07D 209/16</b> (2006.01) <b>C07D 209/10</b> (2006.01) <b>C07D 209/14</b> (2006.01)			2506868 *	<b>A61K 38/37</b> (2006.01)
		2475653 *	<b>A61K 31/506</b> (2006.01) <b>C07D 403/06</b> (2006.01) <b>A61P 35/00</b> (2006.01) <b>C07D 413/14</b> (2006.01) <b>A61K 31/4439</b> (2006.01) <b>C07D 401/14</b> (2006.01) <b>A61K 31/541</b> (2006.01) <b>C07D 403/14</b> (2006.01) <b>C07D 401/04</b> (2006.01) <b>A61K 31/5377</b> (2006.01) <b>C07D 405/14</b> (2006.01)	2533707 *	<b>A61B 17/32</b> (2006.01)
2519728 *	<b>F02G 5/02</b> (2006.01) <b>F02G 1/04</b> (2006.01)			2428384	<b>B60K 6/46</b> (2007.10) <b>B60K 25/06</b> (2006.01) <b>B60K 17/28</b> (2006.01) <b>B60K 6/44</b> (2007.10) <b>F16H 3/091</b> (2006.01)
2509627 *	<b>A61K 39/395</b> (2006.01)				
2520801	<b>F03B 17/00</b> (2006.01) <b>F03G 7/10</b> (2006.01)				
2524116 *	<b>F02M 25/07</b> (2006.01) <b>F01N 3/28</b> (2006.01) <b>F01N 3/20</b> (2006.01) <b>F01N 3/035</b> (2006.01)				

Broj objave evropske prijava patenta (97)	MKP (51)	Broj objave evropske prijava patenta (97)	MKP (51)	Broj objave evropske prijava patenta (97)	MKP (51)
2392622	<b>D21H 17/67</b> (2006.01) <b>C09C 1/02</b> (2006.01)	2509956 *	<b>C07D 231/40</b> (2006.01) <b>A61P 11/06</b> (2006.01) <b>C07D 277/46</b> (2006.01) <b>A61K 31/4155</b> (2006.01) <b>A61P 37/02</b> (2006.01) <b>A61K 31/4164</b> (2006.01) <b>A61P 37/08</b> (2006.01) <b>A61K 31/42</b> (2006.01) <b>C07C 271/20</b> (2006.01) <b>A61K 31/415</b> (2006.01) <b>A61P 21/04</b> (2006.01) <b>A61K 31/27</b> (2006.01) <b>A61P 17/06</b> (2006.01) <b>C07D 405/12</b> (2006.01) <b>A61P 9/10</b> (2006.01) <b>C07D 261/14</b> (2006.01) <b>A61K 31/426</b> (2006.01) <b>C07D 233/88</b> (2006.01)	2501669 *	<b>C07C 43/23</b> (2006.01) <b>A61K 31/09</b> (2006.01) <b>C07C 62/34</b> (2006.01) <b>A61K 31/125</b> (2006.01) <b>C07C 43/215</b> (2006.01) <b>A61K 31/216</b> (2006.01) <b>A61K 31/192</b> (2006.01) <b>C07D 311/80</b> (2006.01) <b>A61P 25/00</b> (2006.01) <b>C07C 49/753</b> (2006.01) <b>A61P 25/28</b> (2006.01) <b>A61K 31/352</b> (2006.01) <b>A61P 19/00</b> (2006.01) <b>C07C 69/757</b> (2006.01) <b>A61P 25/04</b> (2006.01)
2521713 *	<b>A61K 31/196</b> (2006.01) <b>A61P 29/00</b> (2006.01) <b>A61K 31/10</b> (2006.01) <b>C07C 323/59</b> (2006.01) <b>A61P 11/06</b> (2006.01)				
2531235 *	<b>A61M 5/24</b> (2006.01) <b>A61M 5/32</b> (2006.01) <b>A61M 5/28</b> (2006.01)				
2504012 *	<b>A61K 31/56</b> (2006.01) <b>A61K 47/44</b> (2006.01) <b>A61K 9/00</b> (2006.01) <b>A61K 9/06</b> (2006.01)			2441887	<b>E01C 7/26</b> (2006.01) <b>E01C 7/32</b> (2006.01) <b>E01C 11/16</b> (2006.01)
2509600 *	<b>A61K 31/496</b> (2006.01) <b>C07D 405/12</b> (2006.01) <b>A61K 31/551</b> (2006.01) <b>C07D 243/08</b> (2006.01) <b>A61K 31/495</b> (2006.01) <b>A61P 35/00</b> (2006.01) <b>A61K 31/506</b> (2006.01)	2530165 *	<b>C07D 493/04</b> (2006.01) <b>C12N 15/09</b> (2006.01) <b>C12P 17/18</b> (2006.01)	2531035 *	<b>A01N 43/90</b> (2006.01) <b>A01P 13/00</b> (2006.01) <b>A01N 47/36</b> (2006.01)
		2531157 *	<b>A61G 5/04</b> (2006.01) <b>B62D 55/075</b> (2006.01) <b>B62D 61/10</b> (2006.01)	2517158 *	<b>G06Q 10/00</b> (2012.01) <b>G06F 17/30</b> (2006.01)
		2525788 *	<b>A61K 9/44</b> (2006.01) <b>A61K 9/32</b> (2006.01) <b>A61K 31/27</b> (2006.01)	2519504 *	<b>C07D 407/12</b> (2006.01) <b>C07D 413/12</b> (2006.01) <b>A61K 31/4709</b> (2006.01) <b>A61P 31/10</b> (2006.01) <b>C07D 215/48</b> (2006.01) <b>C07D 401/12</b> (2006.01) <b>C07D 417/12</b> (2006.01) <b>C07D 409/12</b> (2006.01)

Broj objave evropske prijave patenta (97)	MKP (51)	Broj objave evropske prijave patenta (97)	MKP (51)	Broj objave evropske prijave patenta (97)	MKP (51)
2504026 *	<b>A61P 3/04</b> (2006.01) <b>A61K 38/46</b> (2006.01) <b>A61K 38/48</b> (2006.01)	2513106 *	<b>A61P 25/28</b> (2006.01) <b>A61P 25/18</b> (2006.01) <b>A61K 31/437</b> (2006.01) <b>A61K 31/4196</b> (2006.01) <b>C07D 471/04</b> (2006.01)	2501376 *	<b>A61K 31/327</b> (2006.01) <b>A61P 31/02</b> (2006.01) <b>A61K 31/46</b> (2006.01) <b>A61P 31/00</b> (2006.01) <b>A61K 31/351</b> (2006.01) <b>A61K 31/575</b> (2006.01)
2501703 *	<b>A61K 31/444</b> (2006.01) <b>C07D 495/20</b> (2006.01) <b>A61P 25/00</b> (2006.01)	2519514 *	<b>A61P 25/22</b> (2006.01) <b>A61P 25/30</b> (2006.01) <b>C07D 401/14</b> (2006.01) <b>A61P 25/08</b> (2006.01) <b>C07D 403/04</b> (2006.01) <b>A61P 25/04</b> (2006.01) <b>C07D 403/06</b> (2006.01) <b>A61P 25/18</b> (2006.01) <b>C07D 405/06</b> (2006.01) <b>A61P 25/16</b> (2006.01) <b>C07D 401/04</b> (2006.01) <b>A61P 25/28</b> (2006.01) <b>A61P 3/04</b> (2006.01) <b>C07D 401/06</b> (2006.01) <b>A61P 25/24</b> (2006.01) <b>A61K 31/403</b> (2006.01) <b>A61P 25/20</b> (2006.01)	2536836 *	<b>A61P 31/04</b> (2006.01) <b>C07K 16/12</b> (2006.01) <b>C12N 15/09</b> (2006.01) <b>C12P 21/08</b> (2006.01) <b>G01N 33/569</b> (2006.01) <b>C07K 16/46</b> (2006.01) <b>C12N 5/10</b> (2006.01) <b>A61K 39/395</b> (2006.01)
2536721 *	<b>A61K 31/4162</b> (2006.01) <b>C07D 471/04</b> (2006.01)			2501695 *	<b>A61P 9/10</b> (2006.01) <b>C07D 487/04</b> (2006.01) <b>C07D 403/10</b> (2006.01) <b>C07D 471/04</b> (2006.01) <b>A61K 31/437</b> (2006.01) <b>A61P 9/12</b> (2006.01) <b>C07D 401/10</b> (2006.01) <b>A61K 31/5513</b> (2006.01)
2510845	<b>A47J 42/04</b> (2006.01) <b>A47J 42/08</b> (2006.01)				
2531205 *	<b>A61K 38/12</b> (2006.01) <b>C07K 7/54</b> (2006.01)				
2512213 *	<b>A01G 23/02</b> (2006.01) <b>A01C 5/04</b> (2006.01)				
2526203 *	<b>C12Q 1/68</b> (2006.01)				
2524471 *	<b>G06Q 20/00</b> (2012.01) <b>H04L 9/14</b> (2006.01) <b>H04L 9/32</b> (2006.01)				
2512470 *	<b>A61K 31/4439</b> (2006.01) <b>A61K 31/4436</b> (2006.01) <b>A61P 25/28</b> (2006.01) <b>A61K 31/426</b> (2006.01)	2536813 *	<b>C10L 5/42</b> (2006.01) <b>C10L 5/46</b> (2006.01) <b>C10L 5/44</b> (2006.01) <b>C10B 53/02</b> (2006.01) <b>C10B 47/00</b> (2006.01)	2432764 *	<b>C07D 215/44</b> (2006.01) <b>C07D 401/12</b> (2006.01) <b>A61K 31/4709</b> (2006.01) <b>A61P 35/00</b> (2006.01)
2515865 *	<b>A61K 9/107</b> (2006.01) <b>A61K 31/593</b> (2006.01) <b>A61K 47/10</b> (2006.01) <b>A61K 9/06</b> (2006.01) <b>A61K 47/22</b> (2006.01) <b>A61K 47/14</b> (2006.01)	2531236 *	<b>A61M 5/32</b> (2006.01) <b>A61M 5/28</b> (2006.01) <b>A61M 5/24</b> (2006.01)	2521550 *	<b>A61K 31/52</b> (2006.01)
				2531238 *	<b>A61M 5/28</b> (2006.01) <b>A61M 5/24</b> (2006.01) <b>A61M 5/32</b> (2006.01)

Broj objave evropske prijava patenta (97)	MKP (51)	Broj objave evropske prijava patenta (97)	MKP (51)	Broj objave evropske prijava patenta (97)	MKP (51)
2531261 *	<b>A61K 31/7088</b> (2006.01) <b>A61P 3/10</b> (2006.01) <b>A61K 39/395</b> (2006.01)	2519524 *	<b>C07D 471/04</b> (2006.01) <b>A61K 31/437</b> (2006.01) <b>C07D 487/04</b> (2006.01) <b>A61P 35/00</b> (2006.01) <b>A61K 31/4985</b> (2006.01)	2520956 *	<b>C08G 61/08</b> (2006.01) <b>H01L 51/50</b> (2006.01) <b>G02B 5/30</b> (2006.01) <b>G02F 1/13363</b> (2006.01) <b>C08J 5/18</b> (2006.01)
2504134 *	<b>B27M 3/00</b> (2006.01) <b>B27D 3/02</b> (2006.01) <b>F26B 7/00</b> (2006.01) <b>F26B 3/20</b> (2006.01) <b>B32B 21/13</b> (2006.01) <b>B32B 13/14</b> (2006.01) <b>F26B 3/00</b> (2006.01) <b>B30B 15/34</b> (2006.01)	2531519 *	<b>A61P 31/04</b> (2006.01) <b>A61K 38/10</b> (2006.01) <b>C07K 7/08</b> (2006.01)	2523911 *	<b>C12M 1/00</b> (2006.01) <b>C02F 3/10</b> (2006.01) <b>C02F 3/12</b> (2006.01)
2519503 *	<b>C07D 417/12</b> (2006.01) <b>A61P 31/10</b> (2006.01) <b>C07D 401/12</b> (2006.01) <b>C07D 407/12</b> (2006.01) <b>C07D 409/12</b> (2006.01) <b>C07D 413/12</b> (2006.01) <b>C07D 215/48</b> (2006.01) <b>A61K 31/4709</b> (2006.01)	2506859 *	<b>A61L 15/64</b> (2006.01) <b>C08J 9/00</b> (2006.01) <b>A61K 9/14</b> (2006.01) <b>A61K 31/718</b> (2006.01) <b>C08B 31/04</b> (2006.01) <b>A61L 15/28</b> (2006.01)	2523731 *	<b>A61P 5/00</b> (2006.01) <b>A61K 31/55</b> (2006.01) <b>A61K 31/4188</b> (2006.01)
2501346 *	<b>B32B 27/32</b> (2006.01) <b>A61F 5/445</b> (2006.01)	2505614	<b>D21H 17/00</b> (2006.01) <b>C09C 1/02</b> (2006.01)	2525830 *	<b>C07K 1/107</b> (2006.01) <b>A61K 47/48</b> (2006.01) <b>C07K 1/13</b> (2006.01)
2502903 *	<b>C07C 69/757</b> (2006.01) <b>C07C 227/18</b> (2006.01) <b>C07C 255/47</b> (2006.01) <b>C07C 227/02</b> (2006.01) <b>C07C 235/82</b> (2006.01) <b>C07D 235/02</b> (2006.01) <b>C07C 229/50</b> (2006.01) <b>C07C 227/12</b> (2006.01)	2504330 *	<b>A61P 25/28</b> (2006.01) <b>C07D 401/06</b> (2006.01) <b>C07D 401/14</b> (2006.01) <b>C07D 401/12</b> (2006.01) <b>A61K 31/4709</b> (2006.01)	2504566 *	<b>F03B 13/16</b> (2006.01) <b>F03B 13/22</b> (2006.01) <b>F03B 13/20</b> (2006.01) <b>F03B 13/24</b> (2006.01) <b>F03B 13/14</b> (2006.01)
2516454 *	<b>C07K 14/475</b> (2006.01)	2510300 *	<b>F27D 1/14</b> (2006.01)	2504335 *	<b>C07D 471/04</b> (2006.01)
		2515990 *	<b>A61M 29/00</b> (2006.01)	2523688 *	<b>A61P 17/06</b> (2006.01) <b>C07K 16/28</b> (2006.01) <b>A61K 39/395</b> (2006.01)
		2519541 *	<b>A61P 35/00</b> (2006.01) <b>C07K 16/28</b> (2006.01) <b>A61K 39/395</b> (2006.01) <b>A61P 37/00</b> (2006.01)	2509662 *	<b>A61M 5/315</b> (2006.01)
				2510058 *	<b>C09C 1/36</b> (2006.01) <b>C09C 1/40</b> (2006.01) <b>B03B 1/04</b> (2006.01) <b>B02C 23/06</b> (2006.01) <b>C09C 1/02</b> (2006.01)



Broj objave evropske prijave patenta (97)	MKP (51)	Broj objave evropske prijave patenta (97)	MKP (51)	Broj objave evropske prijave patenta (97)	MKP (51)
2529111 *	<b>F03D 11/04</b> (2006.01)	2512563 *	<b>A61M 5/315</b> (2006.01)	2512615 *	<b>B01D 17/02</b> (2006.01)
2516853 *	<b>H02P 9/04</b> (2006.01) <b>F03D 9/00</b> (2006.01)	2516555 *	<b>C09B 62/00</b> (2006.01) <b>C09B 62/453</b> (2006.01)	2501412 *	<b>A61P 35/00</b> (2006.01) <b>A61K 47/48</b> (2006.01)
2528652 *	<b>B65D 83/16</b> (2006.01) <b>A61M 35/00</b> (2006.01)	2501392 *	<b>A61K 31/722</b> (2006.01) <b>C08K 3/16</b> (2006.01) <b>C08K 3/00</b> (2006.01) <b>C08L 5/08</b> (2006.01) <b>A61K 35/14</b> (2006.01) <b>C08K 11/00</b> (2006.01) <b>C08K 5/521</b> (2006.01)	2535661	<b>H01L 31/042</b> (2006.01) <b>F24J 2/52</b> (2006.01)
2501414 *	<b>A61K 48/00</b> (2006.01)	2507218 *	<b>C07C 237/04</b> (2006.01) <b>C07D 263/06</b> (2006.01)		
2536759 *	<b>C12P 21/08</b> (2006.01) <b>C07K 16/12</b> (2006.01) <b>C12N 15/09</b> (2006.01) <b>C12N 5/10</b> (2006.01) <b>C07K 16/46</b> (2006.01) <b>A61K 39/395</b> (2006.01) <b>A61P 31/04</b> (2006.01) <b>G01N 33/569</b> (2006.01)	2509971 *	<b>C07D 307/82</b> (2006.01)	2515856 *	<b>A61K 31/40</b> (2006.01) <b>A61K 9/00</b> (2006.01)
		2513623 *	<b>G01L 7/08</b> (2006.01) <b>B64C 3/00</b> (2006.01) <b>G01L 7/02</b> (2006.01) <b>G01L 9/06</b> (2006.01) <b>B64C 99/00</b> (2010.01)	2507952 *	<b>H04L 12/56</b> (2006.01)
2524186 *	<b>F41A 17/44</b> (2006.01) <b>F41A 17/38</b> (2006.01) <b>F41A 17/42</b> (2006.01)	2536728 *	<b>C07D 487/04</b> (2006.01) <b>A61P 35/00</b> (2006.01) <b>A61K 31/437</b> (2006.01) <b>A61K 31/4985</b> (2006.01)	2507228 *	<b>C07D 405/06</b> (2006.01) <b>A61K 31/438</b> (2006.01) <b>C07D 417/06</b> (2006.01) <b>C07D 409/06</b> (2006.01) <b>C07D 471/10</b> (2006.01) <b>C07D 413/06</b> (2006.01) <b>A61P 3/10</b> (2006.01)
2533703 *	<b>A61B 17/32</b> (2006.01) <b>A61B 17/22</b> (2006.01) <b>A61B 17/3207</b> (2006.01)	2507280 *	<b>C08G 63/199</b> (2006.01) <b>C08G 63/183</b> (2006.01) <b>C08G 63/672</b> (2006.01) <b>C08G 18/32</b> (2006.01) <b>C08G 63/42</b> (2006.01) <b>C08G 18/73</b> (2006.01) <b>C08G 18/76</b> (2006.01)	2531852 *	<b>G01N 33/487</b> (2006.01)
2509940 *	<b>C07D 211/08</b> (2006.01) <b>A61P 25/28</b> (2006.01) <b>C07C 255/43</b> (2006.01) <b>A61K 31/277</b> (2006.01) <b>C07D 265/30</b> (2006.01)	2418238	<b>C08J 7/06</b> (2006.01) <b>B01J 21/06</b> (2006.01) <b>B05D 5/00</b> (2006.01) <b>C09G 1/00</b> (2006.01)	2535342 *	<b>A61P 15/08</b> (2006.01) <b>A61P 5/04</b> (2006.01) <b>A61P 35/00</b> (2006.01) <b>A61K 31/519</b> (2006.01) <b>A61P 15/18</b> (2006.01) <b>A61P 15/16</b> (2006.01) <b>C07D 495/04</b> (2006.01)
2521839 *	<b>E21B 17/00</b> (2006.01) <b>E21B 43/12</b> (2006.01) <b>E21B 43/22</b> (2006.01)				

Broj objave evropske prijave patenta (97)	MKP (51)	Broj objave evropske prijave patenta (97)	MKP (51)	Broj objave evropske prijave patenta (97)	MKP (51)
2501370 *	<b>A61K 31/436</b> (2006.01) <b>A61P 35/00</b> (2006.01) <b>A61K 31/501</b> (2006.01) <b>A61K 31/5377</b> (2006.01) <b>A61K 31/00</b> (2006.01)	2507229 *	<b>A61P 35/00</b> (2006.01) <b>C07D 295/14</b> (2006.01) <b>A61K 31/404</b> (2006.01) <b>C07D 249/04</b> (2006.01) <b>C07D 217/16</b> (2006.01) <b>C07D 405/14</b> (2006.01) <b>C07D 405/12</b> (2006.01) <b>C07D 235/26</b> (2006.01) <b>C07D 209/32</b> (2006.01) <b>C07D 309/14</b> (2006.01) <b>C07D 215/20</b> (2006.01) <b>C07D 231/56</b> (2006.01) <b>C07D 211/96</b> (2006.01) <b>C07D 401/12</b> (2006.01) <b>C07D 213/64</b> (2006.01) <b>C07D 295/125</b> (2006.01)	2516445 *	<b>C07D 513/04</b> (2006.01) <b>A61P 25/24</b> (2006.01) <b>A61P 25/08</b> (2006.01) <b>A61P 25/36</b> (2006.01) <b>A61P 25/16</b> (2006.01) <b>C07D 491/153</b> (2006.01) <b>A61P 25/28</b> (2006.01) <b>A61K 31/4355</b> (2006.01) <b>A61P 25/30</b> (2006.01) <b>A61P 25/06</b> (2006.01) <b>A61P 25/32</b> (2006.01) <b>C07D 491/20</b> (2006.01) <b>A61P 25/22</b> (2006.01) <b>C07D 491/048</b> (2006.01) <b>A61P 25/18</b> (2006.01)
2526204 *	<b>C12Q 1/68</b> (2006.01) <b>G01N 33/50</b> (2006.01)	2506853 *	<b>G01N 33/48</b> (2006.01) <b>A61K 31/635</b> (2006.01) <b>A61K 31/675</b> (2006.01) <b>A61K 31/5377</b> (2006.01) <b>A61K 31/454</b> (2006.01) <b>C12Q 1/68</b> (2006.01) <b>A61P 35/00</b> (2006.01) <b>A61K 31/506</b> (2006.01) <b>A61K 45/06</b> (2006.01)	2508401 *	<b>B60V 3/08</b> (2006.01) <b>B64C 5/06</b> (2006.01)
2525812 *	<b>C07K 16/44</b> (2006.01) <b>A61K 39/00</b> (2006.01)			2425865	<b>A61L 17/14</b> (2006.01)
2520187 *	<b>A41B 17/00</b> (2006.01) <b>A41D 31/00</b> (2006.01)			2536547 *	<b>B29C 44/12</b> (2006.01) <b>B29C 70/44</b> (2006.01) <b>B29C 45/14</b> (2006.01) <b>B29C 70/54</b> (2006.01)
2510441 *	<b>G06F 11/30</b> (2006.01) <b>G06F 17/13</b> (2006.01) <b>F01K 13/02</b> (2006.01) <b>G05B 1/11</b> (2006.01) <b>F02B 43/02</b> (2006.01) <b>F01D 17/00</b> (2006.01) <b>G05B 6/05</b> (2006.01) <b>F22B 35/18</b> (2006.01)			2536452 *	<b>A61M 5/32</b> (2006.01) <b>A61M 5/00</b> (2006.01) <b>A61M 5/20</b> (2006.01)
2524060 *	<b>C12N 15/86</b> (2006.01) <b>C12Q 1/70</b> (2006.01)			2476310	<b>A01K 95/00</b> (2006.01)
2536746 *	<b>C07K 14/435</b> (2006.01)				

Broj objave evropske prijava patenta (97)	MKP (51)	Broj objave evropske prijava patenta (97)	MKP (51)	Broj objave evropske prijava patenta (97)	MKP (51)
2509794 *	<b>B41M 3/14</b> (2006.01) <b>B42D 15/10</b> (2006.01) <b>B42D 15/00</b> (2006.01) <b>C09D 11/00</b> (2006.01) <b>B41M 5/28</b> (2006.01) <b>C09D 11/02</b> (2006.01)	2515768 *	<b>A61B 17/068</b> (2006.01) <b>A61B 17/072</b> (2006.01) <b>H01H 13/00</b> (2006.01) <b>A61B 17/00</b> (2006.01)	2520296	<b>A61K 31/445</b> (2006.01) <b>A61K 31/403</b> (2006.01) <b>A61K 45/06</b> (2006.01) <b>A61K 31/55</b> (2006.01) <b>A61P 25/16</b> (2006.01) <b>A61K 31/27</b> (2006.01) <b>A61P 25/28</b> (2006.01) <b>A61K 9/20</b> (2006.01)
2510298 *	<b>F27D 1/14</b> (2006.01)	2529940	<b>B42D 15/10</b> (2006.01) <b>B41M 3/00</b> (2006.01) <b>B44F 7/00</b> (2006.01) <b>G02B 5/30</b> (2006.01) <b>B41M 3/06</b> (2006.01) <b>G02B 27/22</b> (2006.01)	2504411 *	<b>C10L 5/44</b> (2006.01) <b>C10J 3/46</b> (2006.01) <b>C10J 3/66</b> (2006.01) <b>C10B 53/02</b> (2006.01)
2506901 *	<b>A61M 5/315</b> (2006.01)	2501631 *	<b>B65F 1/14</b> (2006.01)	2504112 *	<b>B21B 1/085</b> (2006.01)
2525802 *	<b>A61K 9/12</b> (2006.01) <b>A61P 11/02</b> (2006.01) <b>A61K 33/00</b> (2006.01) <b>A61K 33/14</b> (2006.01) <b>A61P 11/04</b> (2006.01)	2523949 *	<b>C07D 413/04</b> (2006.01) <b>C07D 403/12</b> (2006.01) <b>C07D 471/04</b> (2006.01) <b>C07D 487/04</b> (2006.01) <b>A61K 31/4196</b> (2006.01) <b>C07D 401/14</b> (2006.01) <b>A61P 25/28</b> (2006.01) <b>C07D 401/12</b> (2006.01) <b>C07D 403/14</b> (2006.01) <b>C07D 403/10</b> (2006.01)	2513093 *	<b>C07D 405/14</b> (2006.01) <b>A61P 29/00</b> (2006.01) <b>C07D 491/10</b> (2006.01) <b>A61K 31/506</b> (2006.01)
2507190 *	<b>C04B 28/14</b> (2006.01) <b>C04B 28/16</b> (2006.01)	2512587 *	<b>A61H 39/02</b> (2006.01) <b>A61N 1/04</b> (2006.01) <b>A61N 1/08</b> (2006.01)	2531233 *	<b>A61M 5/24</b> (2006.01)
2536458 *	<b>A61M 5/00</b> (2006.01) <b>A61M 5/32</b> (2006.01) <b>A61M 5/20</b> (2006.01)	2533800 *	<b>A01H 1/00</b> (2006.01) <b>A01H 5/00</b> (2006.01) <b>A01P 7/00</b> (2006.01)	2533800 *	<b>A61K 38/24</b> (2006.01)
2442192	<b>G04B 37/14</b> (2006.01) <b>A44C 3/00</b> (2006.01)	2512221 *	<b>A01H 1/00</b> (2006.01) <b>A01H 5/00</b> (2006.01) <b>A01P 7/00</b> (2006.01)		
2525763 *	<b>A61J 1/06</b> (2006.01) <b>A61M 5/24</b> (2006.01) <b>G06K 7/10</b> (2006.01)	2506861 *	<b>A61K 38/18</b> (2006.01) <b>C07K 14/475</b> (2006.01) <b>A61K 38/00</b> (2006.01)		

Broj objave evropske prijava patenta (97)	MKP (51)	Broj objave evropske prijava patenta (97)	MKP (51)	Broj objave evropske prijava patenta (97)	MKP (51)
2526092 *	<b>C07D 413/10</b> (2006.01) <b>C07D 405/04</b> (2006.01) <b>A61K 31/4709</b> (2006.01) <b>C07D 215/38</b> (2006.01) <b>C07D 471/08</b> (2006.01) <b>C07D 405/10</b> (2006.01) <b>A61P 25/28</b> (2006.01) <b>C07D 405/12</b> (2006.01) <b>C07D 403/10</b> (2006.01) <b>A61K 31/47</b> (2006.01) <b>C07D 471/04</b> (2006.01) <b>C07D 401/10</b> (2006.01) <b>C07D 498/08</b> (2006.01)	2513096 *	<b>C07D 491/04</b> (2006.01) <b>C07D 487/08</b> (2006.01) <b>A61K 31/496</b> (2006.01) <b>C07D 417/10</b> (2006.01) <b>C07D 417/14</b> (2006.01) <b>C07D 417/06</b> (2006.01) <b>A61P 35/00</b> (2006.01)	2513311 *	<b>A61K 35/12</b> (2006.01) <b>C12N 15/117</b> (2010.01) <b>A61P 37/04</b> (2006.01)
		2535178	<b>B32B 7/00</b> (2006.01) <b>B32B 7/04</b> (2006.01) <b>B32B 27/00</b> (2006.01) <b>B32B 27/08</b> (2006.01) <b>B32B 25/08</b> (2006.01) <b>B32B 5/04</b> (2006.01) <b>B32B 3/26</b> (2006.01) <b>B32B 5/02</b> (2006.01) <b>B32B 25/00</b> (2006.01)	2516051 *	<b>B01J 19/18</b> (2006.01) <b>B01J 8/10</b> (2006.01) <b>B02C 13/04</b> (2006.01)
2511637	<b>F26B 23/00</b> (2006.01) <b>F26B 11/16</b> (2006.01)			2523950 *	<b>A61K 31/4436</b> (2006.01) <b>A61P 31/00</b> (2006.01) <b>A61K 31/381</b> (2006.01) <b>C07D 409/12</b> (2006.01)
2512218 *	<b>A01P 7/00</b> (2006.01) <b>A01H 5/00</b> (2006.01) <b>A01H 1/00</b> (2006.01)	2501786 *	<b>F23J 15/06</b> (2006.01) <b>C07C 29/151</b> (2006.01) <b>C10G 2/00</b> (2006.01) <b>F01K 23/06</b> (2006.01) <b>C10J 3/66</b> (2006.01) <b>F02C 3/28</b> (2006.01)	2512553 *	<b>A61M 5/00</b> (2006.01)
2515855 *	<b>A61K 9/00</b> (2006.01) <b>A61K 31/167</b> (2006.01) <b>A61K 45/06</b> (2006.01) <b>A61K 31/40</b> (2006.01)			2426749	<b>H01L 41/053</b> (2006.01)
2524232 *	<b>A61P 35/00</b> (2006.01) <b>G01N 33/574</b> (2006.01) <b>C12Q 1/68</b> (2006.01) <b>G01N 33/15</b> (2006.01)	2452550	<b>A01D 43/08</b> (2006.01)	2295653	<b>E03D 9/08</b> (2006.01) <b>A61H 33/14</b> (2006.01)
		2510013 *	<b>C07K 16/40</b> (2006.01) <b>A61P 3/06</b> (2006.01) <b>A61K 39/395</b> (2006.01)	2513224 *	<b>C08L 67/06</b> (2006.01) <b>H01B 1/24</b> (2006.01) <b>C08K 3/04</b> (2006.01)
		2451747 *	<b>C02F 1/74</b> (2006.01) <b>C02F 1/32</b> (2006.01) <b>C02F 1/44</b> (2006.01) <b>C02F 1/72</b> (2006.01)	2521552 *	<b>A61K 31/549</b> (2006.01) <b>A61P 25/00</b> (2006.01)
				2519649 *	<b>C12Q 1/68</b> (2006.01)

Broj objave evropske prijave patenta (97)	MKP (51)
2528910 *	<b>C07D 401/06</b> (2006.01) <b>A61K 31/506</b> (2006.01) <b>C07D 491/113</b> (2006.01) <b>C07D 487/04</b> (2006.01) <b>C07D 401/14</b> (2006.01) <b>A61P 35/00</b> (2006.01) <b>C07D 405/14</b> (2006.01) <b>C07D 413/14</b> (2006.01) <b>C07D 471/10</b> (2006.01) <b>C07D 498/04</b> (2006.01)
2519457 *	<b>B65D 81/32</b> (2006.01) <b>A61J 9/00</b> (2006.01) <b>B65D 47/24</b> (2006.01) <b>A45F 3/16</b> (2006.01)



**INDEKS KLASIFIKACIJSKIH OZNAKA BROJEVA ZAHTJEVA ZA PROŠIRENJE  
EVROPSKIH PRIJAVA PATENTA PREMA MKP  
INDEX ON CLASSIFICATION MARKS ON REQUESTS FOR EXTENSION  
OF EUROPEAN PATENT APPLICATION IN ACCORDANCE WITH THE  
INTERNATIONAL PATENT CLASSIFICATION**

MKP (51)	Broj objave evropske prijava patenta (97)	Naziv pronalaska (54)
<b>A61K 8/55</b> (2006.01)	2533752 *	PREPARATIONS FOR STABILISING/FORMING THE TEXTURE OF LIVING TISSUE SUCH AS SKIN, AND USES THEREOF
<b>A61Q 19/00</b> (2006.01)	2533752 *	PREPARATIONS FOR STABILISING/FORMING THE TEXTURE OF LIVING TISSUE SUCH AS SKIN, AND USES THEREOF
<b>A61K 8/41</b> (2006.01)	2533752 *	PREPARATIONS FOR STABILISING/FORMING THE TEXTURE OF LIVING TISSUE SUCH AS SKIN, AND USES THEREOF
<b>A61K 8/73</b> (2006.01)	2533752 *	PREPARATIONS FOR STABILISING/FORMING THE TEXTURE OF LIVING TISSUE SUCH AS SKIN, AND USES THEREOF
<b>A61K 8/19</b> (2006.01)	2533752 *	PREPARATIONS FOR STABILISING/FORMING THE TEXTURE OF LIVING TISSUE SUCH AS SKIN, AND USES THEREOF
<b>A61K 8/97</b> (2006.01)	2533752 *	PREPARATIONS FOR STABILISING/FORMING THE TEXTURE OF LIVING TISSUE SUCH AS SKIN, AND USES THEREOF
<b>A61K 8/49</b> (2006.01)	2533752 *	PREPARATIONS FOR STABILISING/FORMING THE TEXTURE OF LIVING TISSUE SUCH AS SKIN, AND USES THEREOF
<b>A61Q 7/00</b> (2006.01)	2533752 *	PREPARATIONS FOR STABILISING/FORMING THE TEXTURE OF LIVING TISSUE SUCH AS SKIN, AND USES THEREOF
<b>A61K 8/60</b> (2006.01)	2533752 *	PREPARATIONS FOR STABILISING/FORMING THE TEXTURE OF LIVING TISSUE SUCH AS SKIN, AND USES THEREOF
<b>A61K 8/67</b> (2006.01)	2533752 *	PREPARATIONS FOR STABILISING/FORMING THE TEXTURE OF LIVING TISSUE SUCH AS SKIN, AND USES THEREOF
<b>A61K 36/53</b> (2006.01)	2452689	Phytotherapeutic preparation with stimulatory effect on libido and spermatogenesis
<b>A61K 36/534</b> (2006.01)	2452689	Phytotherapeutic preparation with stimulatory effect on libido and spermatogenesis
<b>A61P 15/08</b> (2006.01)	2452689	Phytotherapeutic preparation with stimulatory effect on libido and spermatogenesis
<b>A61K 36/288</b> (2006.01)	2452689	Phytotherapeutic preparation with stimulatory effect on libido and spermatogenesis
<b>E05C 17/02</b> (2006.01)	2439364	Articulated shutter holder
<b>E05C 17/24</b> (2006.01)	2439364	Articulated shutter holder
<b>G06T 7/60</b> (2006.01)	2528504 *	A METHOD AND A SYSTEM FOR MULTI-DIMENSIONAL VISUALIZATION OF THE SPINAL COLUMN BY VERTEBRA VECTORS, SACRUM VECTOR, SACRUM PLATEAU VECTOR AND PELVIS VECTORS
<b>A61B 5/103</b> (2006.01)	2528504 *	A METHOD AND A SYSTEM FOR MULTI-DIMENSIONAL VISUALIZATION OF THE SPINAL COLUMN BY VERTEBRA VECTORS, SACRUM VECTOR, SACRUM PLATEAU VECTOR AND PELVIS VECTORS
<b>C12Q 1/68</b> (2006.01)	2529032 *	METHODS AND COMPOSITIONS FOR NONINVASIVE PRENATAL DIAGNOSIS OF FETAL ANEUPLOIDIES
<b>C07K 16/28</b> (2006.01)	2534178 *	THERAPEUTIC METHODS USING AN TI-CD200 ANTIBODIES
<b>A61K 39/395</b> (2006.01)	2534178 *	THERAPEUTIC METHODS USING AN TI-CD200 ANTIBODIES
<b>B01D 71/82</b> (2006.01)	2536485 *	A SUBSTRATE FOR IMMOBILIZING FUNCTIONAL SUBSTANCES AND METHOD FOR PREPARING THE SAME
<b>C12N 11/06</b> (2006.01)	2536485 *	A SUBSTRATE FOR IMMOBILIZING FUNCTIONAL SUBSTANCES AND METHOD FOR PREPARING THE SAME
<b>B01J 20/28</b> (2006.01)	2536485 *	A SUBSTRATE FOR IMMOBILIZING FUNCTIONAL SUBSTANCES AND METHOD FOR PREPARING THE SAME
<b>B01D 61/28</b> (2006.01)	2536485 *	A SUBSTRATE FOR IMMOBILIZING FUNCTIONAL SUBSTANCES AND METHOD FOR PREPARING THE SAME
<b>G01N 33/48</b> (2006.01)	2536485 *	A SUBSTRATE FOR IMMOBILIZING FUNCTIONAL SUBSTANCES AND METHOD FOR PREPARING THE SAME
<b>A61M 1/14</b> (2006.01)	2536485 *	A SUBSTRATE FOR IMMOBILIZING FUNCTIONAL SUBSTANCES AND METHOD FOR PREPARING THE SAME

MKP (51)	Broj objave evropske prijava patenta (97)	Naziv pronalaska (54)
<b>B01J 20/22</b> (2006.01)	2536485 *	A SUBSTRATE FOR IMMOBILIZING FUNCTIONAL SUBSTANCES AND METHOD FOR PREPARING THE SAME
<b>B01D 61/24</b> (2006.01)	2536485 *	A SUBSTRATE FOR IMMOBILIZING FUNCTIONAL SUBSTANCES AND METHOD FOR PREPARING THE SAME
<b>A61K 31/397</b> (2006.01)	2501379 *	COMBINATION
<b>B42D 1/00</b> (2006.01)	2433809	Data pages for book-like documents and method of producing such data pages
<b>B42D 13/00</b> (2006.01)	2433809	Data pages for book-like documents and method of producing such data pages
<b>B42D 15/10</b> (2006.01)	2433809	Data pages for book-like documents and method of producing such data pages
<b>A61P 9/00</b> (2006.01)	2523961 *	2,5,7-SUBSTITUTED OXAZOLOPYRIMIDINE DERIVATIVES
<b>A61K 31/519</b> (2006.01)	2523961 *	2,5,7-SUBSTITUTED OXAZOLOPYRIMIDINE DERIVATIVES
<b>C07D 498/04</b> (2006.01)	2523961 *	2,5,7-SUBSTITUTED OXAZOLOPYRIMIDINE DERIVATIVES
<b>A61M 5/32</b> (2006.01)	2536453 *	AUTO-INJECTOR
<b>A61M 5/20</b> (2006.01)	2536453 *	AUTO-INJECTOR
<b>F04C 15/00</b> (2006.01)	2434158	Drive shaft for a positive displacement pump
<b>F16D 1/06</b> (2006.01)	2434158	Drive shaft for a positive displacement pump
<b>F04C 2/344</b> (2006.01)	2434158	Drive shaft for a positive displacement pump
<b>A23L 1/30</b> (2006.01)	2515924 *	A COMPOSITION COMPRISING THE EXTRACT OF PRUNELLA VULGARIS L. FOR PREVENTING AND TREATING ADHD DISEASE AND THE USE THEREOF
<b>A61K 36/536</b> (2006.01)	2515924 *	A COMPOSITION COMPRISING THE EXTRACT OF PRUNELLA VULGARIS L. FOR PREVENTING AND TREATING ADHD DISEASE AND THE USE THEREOF
<b>A61P 25/00</b> (2006.01)	2515924 *	A COMPOSITION COMPRISING THE EXTRACT OF PRUNELLA VULGARIS L. FOR PREVENTING AND TREATING ADHD DISEASE AND THE USE THEREOF
<b>H02G 3/04</b> (2006.01)	2537058 *	DUCT SYSTEM FOR FIBRE OPTIC COMPONENTS
<b>G02B 6/46</b> (2006.01)	2537058 *	DUCT SYSTEM FOR FIBRE OPTIC COMPONENTS
<b>G09B 23/32</b> (2006.01)	2534651 *	METHOD AND APPARATUS FOR IN VITRO TESTING FOR MEDICAL DEVICES
<b>C07D 401/12</b> (2006.01)	2518064 *	NOVEL ARYL UREA DERIVATIVE
<b>A61P 43/00</b> (2006.01)	2518064 *	NOVEL ARYL UREA DERIVATIVE
<b>A61P 25/04</b> (2006.01)	2518064 *	NOVEL ARYL UREA DERIVATIVE
<b>C07D 417/12</b> (2006.01)	2518064 *	NOVEL ARYL UREA DERIVATIVE
<b>C07D 311/68</b> (2006.01)	2518064 *	NOVEL ARYL UREA DERIVATIVE
<b>C07D 405/04</b> (2006.01)	2518064 *	NOVEL ARYL UREA DERIVATIVE
<b>A61K 31/454</b> (2006.01)	2518064 *	NOVEL ARYL UREA DERIVATIVE
<b>C07D 405/14</b> (2006.01)	2518064 *	NOVEL ARYL UREA DERIVATIVE
<b>A61K 31/4433</b> (2006.01)	2518064 *	NOVEL ARYL UREA DERIVATIVE
<b>C07D 405/12</b> (2006.01)	2518064 *	NOVEL ARYL UREA DERIVATIVE
<b>A61K 31/496</b> (2006.01)	2518064 *	NOVEL ARYL UREA DERIVATIVE
<b>C07D 413/04</b> (2006.01)	2518064 *	NOVEL ARYL UREA DERIVATIVE
<b>A61K 31/501</b> (2006.01)	2518064 *	NOVEL ARYL UREA DERIVATIVE
<b>C07D 413/12</b> (2006.01)	2518064 *	NOVEL ARYL UREA DERIVATIVE
<b>A61Q 19/00</b> (2006.01)	2509569 *	DERIVATIVES OF NOVEL PEROXIDES, METHOD OF PREPARATION THEREOF AND USE THEREOF IN HUMAN MEDICINE AS WELL AS IN COSMETICS FOR THE TREATMENT OR PREVENTION OF ACNE
<b>C07C 409/34</b> (2006.01)	2509569 *	DERIVATIVES OF NOVEL PEROXIDES, METHOD OF PREPARATION THEREOF AND USE THEREOF IN HUMAN MEDICINE AS WELL AS IN COSMETICS FOR THE TREATMENT OR PREVENTION OF ACNE
<b>A61K 8/38</b> (2006.01)	2509569 *	DERIVATIVES OF NOVEL PEROXIDES, METHOD OF PREPARATION THEREOF AND USE THEREOF IN HUMAN MEDICINE AS WELL AS IN COSMETICS FOR THE TREATMENT OR PREVENTION OF ACNE
<b>A61K 9/16</b> (2006.01)	2503993 *	4-[2-[[5-METHYL-1-(2-NAPHTALENYL)-1H-PYRAZOL-3-YL]OXY]ETHYL]MORPHOLINE SALTS
<b>A61P 25/00</b> (2006.01)	2503993 *	4-[2-[[5-METHYL-1-(2-NAPHTALENYL)-1H-PYRAZOL-3-YL]OXY]ETHYL]MORPHOLINE SALTS



MKP (51)	Broj objave evropske prijava patenta (97)	Naziv pronalaska (54)
<b>A61K 31/4152</b> (2006.01)	2503993 *	4-[2-[[5-METHYL-1-(2-NAPHTALENYL)-1H-PYRAZOL-3-YL]OXY]ETHYL]MORPHOLINE SALTS
<b>C07D 231/22</b> (2006.01)	2503993 *	4-[2-[[5-METHYL-1-(2-NAPHTALENYL)-1H-PYRAZOL-3-YL]OXY]ETHYL]MORPHOLINE SALTS
<b>D21H 17/00</b> (2006.01)	2505615	Self-binding pigment hybrid
<b>C09C 1/02</b> (2006.01)	2505615	Self-binding pigment hybrid
<b>A61P 35/00</b> (2006.01)	2510002 *	NEUTRALIZING PROLACTIN RECEPTOR ANTIBODIES AND THEIR THERAPEUTIC USE
<b>C07K 16/28</b> (2006.01)	2510002 *	NEUTRALIZING PROLACTIN RECEPTOR ANTIBODIES AND THEIR THERAPEUTIC USE
<b>A61P 5/08</b> (2006.01)	2510002 *	NEUTRALIZING PROLACTIN RECEPTOR ANTIBODIES AND THEIR THERAPEUTIC USE
<b>A61K 39/395</b> (2006.01)	2510002 *	NEUTRALIZING PROLACTIN RECEPTOR ANTIBODIES AND THEIR THERAPEUTIC USE
<b>A61K 39/39</b> (2006.01)	2531216 *	ICOS CRITICALLY REGULATES THE EXPANSION AND FUNCTION OF INFLAMMATORY HUMAN TH17 CELLS
<b>A61K 39/395</b> (2006.01)	2531216 *	ICOS CRITICALLY REGULATES THE EXPANSION AND FUNCTION OF INFLAMMATORY HUMAN TH17 CELLS
<b>A61K 35/12</b> (2006.01)	2531216 *	ICOS CRITICALLY REGULATES THE EXPANSION AND FUNCTION OF INFLAMMATORY HUMAN TH17 CELLS
<b>G07C 9/00</b> (2006.01)	2521100	Vehicular security system with configurable immobilization features
<b>B60R 25/00</b> (2006.01)	2521100	Vehicular security system with configurable immobilization features
<b>G01N 21/31</b> (2006.01)	2502050 *	PHOTONIC MEASUREMENT INSTRUMENT USING NON-SOLARIZING UV GRADE FIBER OPTICS
<b>B41M 5/28</b> (2006.01)	2509795 *	CHIRAL LIQUID CRYSTAL POLYMER MARKING
<b>B41M 3/14</b> (2006.01)	2509795 *	CHIRAL LIQUID CRYSTAL POLYMER MARKING
<b>B42D 15/00</b> (2006.01)	2509795 *	CHIRAL LIQUID CRYSTAL POLYMER MARKING
<b>B42D 15/10</b> (2006.01)	2509795 *	CHIRAL LIQUID CRYSTAL POLYMER MARKING
<b>A61K 47/48</b> (2006.01)	2525831 *	CARRIER-LINKED CARBAMATE PRODRUG LINKERS
<b>C07F 5/02</b> (2006.01)	2516449 *	PROTEASOME INHIBITORS AND PROCESSES FOR THEIR PREPARATION, PURIFICATION AND USE
<b>F21V 19/00</b> (2006.01)	2535640 *	LED LAMP BULB AND LED LIGHTING BAR CAPABLE OF EMITTING LIGHT OVER 4
<b>F21Y 101/02</b> (2006.01)	2535640 *	LED LAMP BULB AND LED LIGHTING BAR CAPABLE OF EMITTING LIGHT OVER 4
<b>F21V 29/00</b> (2006.01)	2535640 *	LED LAMP BULB AND LED LIGHTING BAR CAPABLE OF EMITTING LIGHT OVER 4
<b>F21V 23/00</b> (2006.01)	2535640 *	LED LAMP BULB AND LED LIGHTING BAR CAPABLE OF EMITTING LIGHT OVER 4
<b>F24D 19/06</b> (2006.01)	2515047	A radiator and a related intermediate connection piece
<b>C12N 15/00</b> (2006.01)	2521776 *	METHODS FOR USE OF A SPECIFIC ANTI-ANGIOGENIC ADENOVIRAL AGENT
<b>C01B 25/37</b> (2006.01)	2529433 *	LITHIUM BATTERIES CONTAINING LITHIUM-BEARING IRON PHOSPHATE AND CARBON
<b>H01M 4/58</b> (2010.01)	2529433 *	LITHIUM BATTERIES CONTAINING LITHIUM-BEARING IRON PHOSPHATE AND CARBON
<b>H01M 4/62</b> (2006.01)	2529433 *	LITHIUM BATTERIES CONTAINING LITHIUM-BEARING IRON PHOSPHATE AND CARBON
<b>H01M 4/04</b> (2006.01)	2529433 *	LITHIUM BATTERIES CONTAINING LITHIUM-BEARING IRON PHOSPHATE AND CARBON
<b>H01M 10/0525</b> (2010.01)	2529433 *	LITHIUM BATTERIES CONTAINING LITHIUM-BEARING IRON PHOSPHATE AND CARBON
<b>H01M 4/139</b> (2010.01)	2529433 *	LITHIUM BATTERIES CONTAINING LITHIUM-BEARING IRON PHOSPHATE AND CARBON
<b>C08K 5/34</b> (2006.01)	2521750 *	CURING LIQUIDS
<b>C08K 9/00</b> (2006.01)	2521750 *	CURING LIQUIDS

MKP (51)	Broj objave evropske prijava patenta (97)	Naziv pronalaska (54)
<b>A61K 33/30</b> (2006.01)	2501391 *	PHARMACEUTICAL COMPOSITION FOR THE TREATMENT OF BLADDER DISORDERS
<b>A61K 31/728</b> (2006.01)	2501391 *	PHARMACEUTICAL COMPOSITION FOR THE TREATMENT OF BLADDER DISORDERS
<b>A61M 5/32</b> (2006.01)	2536451 *	AUTO-INJECTOR WITH A TORSION SPRING
<b>A61M 5/00</b> (2006.01)	2536451 *	AUTO-INJECTOR WITH A TORSION SPRING
<b>A61M 5/20</b> (2006.01)	2536451 *	AUTO-INJECTOR WITH A TORSION SPRING
<b>E01F 15/04</b> (2006.01)	2511422	A support base for the fencing of a building yard provided with an integrated guardrail
<b>E01F 8/00</b> (2006.01)	2511422	A support base for the fencing of a building yard provided with an integrated guardrail
<b>E01F 15/08</b> (2006.01)	2511422	A support base for the fencing of a building yard provided with an integrated guardrail
<b>G01N 33/53</b> (2006.01)	2526420 *	METHODS FOR IMPROVING THE DESIGN, BIOAVAILABILITY, AND EFFICACY OF RANDOM SEQUENCE POLYMER COMPOSITIONS VIA SERUM PROTEIN-BASED DETECTION OF RANDOM SEQUENCE POLYMER COMPOSITIONS
<b>C07K 4/00</b> (2006.01)	2526420 *	METHODS FOR IMPROVING THE DESIGN, BIOAVAILABILITY, AND EFFICACY OF RANDOM SEQUENCE POLYMER COMPOSITIONS VIA SERUM PROTEIN-BASED DETECTION OF RANDOM SEQUENCE POLYMER COMPOSITIONS
<b>E03D 11/14</b> (2006.01)	2531661 *	TECHNICAL UNIT FOR A SANITARY FIXTURE
<b>E03D 9/08</b> (2006.01)	2531661 *	TECHNICAL UNIT FOR A SANITARY FIXTURE
<b>A61K 47/38</b> (2006.01)	2535048 *	EXTENDED RELEASE PREPARATION
<b>A61K 47/32</b> (2006.01)	2535048 *	EXTENDED RELEASE PREPARATION
<b>A61K 31/513</b> (2006.01)	2535048 *	EXTENDED RELEASE PREPARATION
<b>A61P 11/06</b> (2006.01)	2535048 *	EXTENDED RELEASE PREPARATION
<b>A61K 31/08</b> (2006.01)	2514759 *	TRITERPENE DERIVATIVE, AND PROPHYLACTIC OR THERAPEUTIC AGENT FOR CHRONIC HEPATITIS C
<b>A61K 31/704</b> (2006.01)	2514759 *	TRITERPENE DERIVATIVE, AND PROPHYLACTIC OR THERAPEUTIC AGENT FOR CHRONIC HEPATITIS C
<b>C07J 63/00</b> (2006.01)	2514759 *	TRITERPENE DERIVATIVE, AND PROPHYLACTIC OR THERAPEUTIC AGENT FOR CHRONIC HEPATITIS C
<b>A61K 31/56</b> (2006.01)	2514759 *	TRITERPENE DERIVATIVE, AND PROPHYLACTIC OR THERAPEUTIC AGENT FOR CHRONIC HEPATITIS C
<b>A61K 31/136</b> (2006.01)	2514759 *	TRITERPENE DERIVATIVE, AND PROPHYLACTIC OR THERAPEUTIC AGENT FOR CHRONIC HEPATITIS C
<b>A61K 31/135</b> (2006.01)	2514759 *	TRITERPENE DERIVATIVE, AND PROPHYLACTIC OR THERAPEUTIC AGENT FOR CHRONIC HEPATITIS C
<b>A61K 31/19</b> (2006.01)	2514759 *	TRITERPENE DERIVATIVE, AND PROPHYLACTIC OR THERAPEUTIC AGENT FOR CHRONIC HEPATITIS C
<b>A61K 31/185</b> (2006.01)	2514759 *	TRITERPENE DERIVATIVE, AND PROPHYLACTIC OR THERAPEUTIC AGENT FOR CHRONIC HEPATITIS C
<b>A61K 31/085</b> (2006.01)	2514759 *	TRITERPENE DERIVATIVE, AND PROPHYLACTIC OR THERAPEUTIC AGENT FOR CHRONIC HEPATITIS C
<b>A61P 1/16</b> (2006.01)	2514759 *	TRITERPENE DERIVATIVE, AND PROPHYLACTIC OR THERAPEUTIC AGENT FOR CHRONIC HEPATITIS C
<b>A61K 31/12</b> (2006.01)	2514759 *	TRITERPENE DERIVATIVE, AND PROPHYLACTIC OR THERAPEUTIC AGENT FOR CHRONIC HEPATITIS C
<b>A61P 31/14</b> (2006.01)	2514759 *	TRITERPENE DERIVATIVE, AND PROPHYLACTIC OR THERAPEUTIC AGENT FOR CHRONIC HEPATITIS C
<b>C07D 403/12</b> (2006.01)	2509960 *	TGR5 AGONISTS
<b>A61K 31/4164</b> (2006.01)	2509960 *	TGR5 AGONISTS
<b>C07D 233/64</b> (2006.01)	2509960 *	TGR5 AGONISTS
<b>A61P 3/04</b> (2006.01)	2509960 *	TGR5 AGONISTS
<b>A61K 31/4178</b> (2006.01)	2509960 *	TGR5 AGONISTS
<b>A61K 31/4439</b> (2006.01)	2509960 *	TGR5 AGONISTS

MKP (51)	Broj objave evropske prijava patenta (97)	Naziv pronalaska (54)
<b>C07D 233/84</b> (2006.01)	2509960 *	TGR5 AGONISTS
<b>A61K 31/454</b> (2006.01)	2509960 *	TGR5 AGONISTS
<b>A61K 31/496</b> (2006.01)	2509960 *	TGR5 AGONISTS
<b>C10G 1/08</b> (2006.01)	2513252 *	CONVERSION OF ORGANIC MATTER INTO OIL
<b>A61K 31/192</b> (2006.01)	2514419 *	FELBINAC-CONTAINING TRANSDERMAL ABSORPTION PREPARATION
<b>A61K 47/32</b> (2006.01)	2514419 *	FELBINAC-CONTAINING TRANSDERMAL ABSORPTION PREPARATION
<b>A61K 47/16</b> (2006.01)	2514419 *	FELBINAC-CONTAINING TRANSDERMAL ABSORPTION PREPARATION
<b>A61P 29/00</b> (2006.01)	2514419 *	FELBINAC-CONTAINING TRANSDERMAL ABSORPTION PREPARATION
<b>A61P 23/02</b> (2006.01)	2514419 *	FELBINAC-CONTAINING TRANSDERMAL ABSORPTION PREPARATION
<b>A61K 9/70</b> (2006.01)	2514419 *	FELBINAC-CONTAINING TRANSDERMAL ABSORPTION PREPARATION
<b>A61K 31/167</b> (2006.01)	2514419 *	FELBINAC-CONTAINING TRANSDERMAL ABSORPTION PREPARATION
<b>B01D 39/20</b> (2006.01)	2533877 *	LIQUID FILTRATION MEDIA
<b>C07K 14/52</b> (2006.01)	2501720 *	IFN INHIBITORS IN THE TREATMENT OF MOTONEURON DISEASES
<b>A61K 31/7036</b> (2006.01)	2512439 *	ANTIBIOTIC MICROPARTICLES FOR INHALATION
<b>A61K 9/00</b> (2006.01)	2512439 *	ANTIBIOTIC MICROPARTICLES FOR INHALATION
<b>G01N 33/574</b> (2006.01)	2529229 *	DIAGNOSING PROSTATE CANCER RELAPSE
<b>A61K 31/44</b> (2006.01)	2536282 *	METHODS FOR TREATING INFECTION
<b>A01N 43/42</b> (2006.01)	2536282 *	METHODS FOR TREATING INFECTION
<b>A61P 35/00</b> (2006.01)	2534149 *	6-AMINO-2-[[ (1S)-1-METHYLBUTYL]OXY]-9-[5-(1-PIPERIDINYL)-7,9-DIHYDRO-8H-PURIN-8-ONE MALEATE
<b>A61P 31/00</b> (2006.01)	2534149 *	6-AMINO-2-[[ (1S)-1-METHYLBUTYL]OXY]-9-[5-(1-PIPERIDINYL)-7,9-DIHYDRO-8H-PURIN-8-ONE MALEATE
<b>A61K 31/522</b> (2006.01)	2534149 *	6-AMINO-2-[[ (1S)-1-METHYLBUTYL]OXY]-9-[5-(1-PIPERIDINYL)-7,9-DIHYDRO-8H-PURIN-8-ONE MALEATE
<b>A61P 29/00</b> (2006.01)	2534149 *	6-AMINO-2-[[ (1S)-1-METHYLBUTYL]OXY]-9-[5-(1-PIPERIDINYL)-7,9-DIHYDRO-8H-PURIN-8-ONE MALEATE
<b>A61P 37/08</b> (2006.01)	2534149 *	6-AMINO-2-[[ (1S)-1-METHYLBUTYL]OXY]-9-[5-(1-PIPERIDINYL)-7,9-DIHYDRO-8H-PURIN-8-ONE MALEATE
<b>C07D 473/18</b> (2006.01)	2534149 *	6-AMINO-2-[[ (1S)-1-METHYLBUTYL]OXY]-9-[5-(1-PIPERIDINYL)-7,9-DIHYDRO-8H-PURIN-8-ONE MALEATE
<b>A61P 11/06</b> (2006.01)	2534149 *	6-AMINO-2-[[ (1S)-1-METHYLBUTYL]OXY]-9-[5-(1-PIPERIDINYL)-7,9-DIHYDRO-8H-PURIN-8-ONE MALEATE
<b>C09K 8/588</b> (2006.01)	2528984 *	WATER-SOLUBLE POLYMERS FOR OIL RECOVERY
<b>C09K 8/12</b> (2006.01)	2528984 *	WATER-SOLUBLE POLYMERS FOR OIL RECOVERY
<b>C09K 8/68</b> (2006.01)	2528984 *	WATER-SOLUBLE POLYMERS FOR OIL RECOVERY
<b>A61K 31/49</b> (2006.01)	2432471 *	NOVEL THERAPEUTIC CONCEPTS FOR TREATING FIBROMYALGIA
<b>A61P 43/00</b> (2006.01)	2432471 *	NOVEL THERAPEUTIC CONCEPTS FOR TREATING FIBROMYALGIA
<b>C07C 49/643</b> (2006.01)	2535324 *	5-NORBORNENE-2-SPIRO- A-CYCLOALKANONE- A'-SPIRO-2"-5"-NORBORNENE AND METHOD FOR PRODUCING SAME
<b>C07C 45/80</b> (2006.01)	2535324 *	5-NORBORNENE-2-SPIRO- A-CYCLOALKANONE- A'-SPIRO-2"-5"-NORBORNENE AND METHOD FOR PRODUCING SAME
<b>C07C 45/68</b> (2006.01)	2535324 *	5-NORBORNENE-2-SPIRO- A-CYCLOALKANONE- A'-SPIRO-2"-5"-NORBORNENE AND METHOD FOR PRODUCING SAME
<b>A61K 31/415</b> (2006.01)	2521544 *	TOPICAL TRANSDERMAL DEXMEDETOMIDINE COMPOSITIONS AND METHODS OF USE THEREOF
<b>A61P 25/06</b> (2006.01)	2521544 *	TOPICAL TRANSDERMAL DEXMEDETOMIDINE COMPOSITIONS AND METHODS OF USE THEREOF
<b>A61P 35/00</b> (2006.01)	2521544 *	TOPICAL TRANSDERMAL DEXMEDETOMIDINE COMPOSITIONS AND METHODS OF USE THEREOF
<b>A61K 9/06</b> (2006.01)	2521544 *	TOPICAL TRANSDERMAL DEXMEDETOMIDINE COMPOSITIONS AND METHODS OF USE THEREOF
<b>A61P 25/00</b> (2006.01)	2521544 *	TOPICAL TRANSDERMAL DEXMEDETOMIDINE COMPOSITIONS AND METHODS OF USE THEREOF

MKP (51)	Broj objave evropske prijava patenta (97)	Naziv pronalaska (54)
<b>A61K 39/04</b> (2006.01)	2528621 *	MODIFIED TUBERCULOSIS ANTIGENS
<b>H01H 3/12</b> (2006.01)	2474987	Built-in switch
<b>H01H 13/06</b> (2006.01)	2474987	Built-in switch
<b>H01H 13/02</b> (2006.01)	2474987	Built-in switch
<b>H02B 1/044</b> (2006.01)	2474987	Built-in switch
<b>G01N 22/00</b> (2006.01)	2505996 *	METHOD FOR REMOTELY INSPECTING A TARGET IN A MONITORED AREA
<b>G06T 7/60</b> (2006.01)	2505996 *	METHOD FOR REMOTELY INSPECTING A TARGET IN A MONITORED AREA
<b>A01H 5/00</b> (2006.01)	2512224 *	MODIFIED CRY1CA INSECTICIDAL CRY PROTEINS
<b>C07K 14/325</b> (2006.01)	2512224 *	MODIFIED CRY1CA INSECTICIDAL CRY PROTEINS
<b>C12R 1/225</b> (2006.01)	2525811 *	NUTRITIONAL FORMULAS CONTAINING SYNBIOTICS
<b>A61P 17/00</b> (2006.01)	2525811 *	NUTRITIONAL FORMULAS CONTAINING SYNBIOTICS
<b>A61K 35/74</b> (2006.01)	2525811 *	NUTRITIONAL FORMULAS CONTAINING SYNBIOTICS
<b>A61K 39/00</b> (2006.01)	2525811 *	NUTRITIONAL FORMULAS CONTAINING SYNBIOTICS
<b>A23L 1/30</b> (2006.01)	2525811 *	NUTRITIONAL FORMULAS CONTAINING SYNBIOTICS
<b>C07H 3/06</b> (2006.01)	2525811 *	NUTRITIONAL FORMULAS CONTAINING SYNBIOTICS
<b>A61K 31/702</b> (2006.01)	2525811 *	NUTRITIONAL FORMULAS CONTAINING SYNBIOTICS
<b>A61P 11/06</b> (2006.01)	2525811 *	NUTRITIONAL FORMULAS CONTAINING SYNBIOTICS
<b>A61P 37/08</b> (2006.01)	2525811 *	NUTRITIONAL FORMULAS CONTAINING SYNBIOTICS
<b>A61P 11/00</b> (2006.01)	2525811 *	NUTRITIONAL FORMULAS CONTAINING SYNBIOTICS
<b>G08G 1/14</b> (2006.01)	2447927	System and process for estimating the availability and/or occupied status of car parks located in a given urban area at a given time
<b>C07D 317/18</b> (2006.01)	2513081 *	PROCESS FOR PREPARING SUBSTITUTED 1-O-ACYL-2-DEOXY-2-FLUORO-4-THIO- -D-ARABINOFURANOSES
<b>C07D 333/78</b> (2006.01)	2513081 *	PROCESS FOR PREPARING SUBSTITUTED 1-O-ACYL-2-DEOXY-2-FLUORO-4-THIO- -D-ARABINOFURANOSES
<b>C07D 333/32</b> (2006.01)	2513081 *	PROCESS FOR PREPARING SUBSTITUTED 1-O-ACYL-2-DEOXY-2-FLUORO-4-THIO- -D-ARABINOFURANOSES
<b>C07D 413/10</b> (2006.01)	2526090 *	NEW ANTI-MALARIAL AGENTS
<b>C07D 401/10</b> (2006.01)	2526090 *	NEW ANTI-MALARIAL AGENTS
<b>A61K 31/44</b> (2006.01)	2526090 *	NEW ANTI-MALARIAL AGENTS
<b>C07D 417/04</b> (2006.01)	2526090 *	NEW ANTI-MALARIAL AGENTS
<b>C07D 401/14</b> (2006.01)	2526090 *	NEW ANTI-MALARIAL AGENTS
<b>A61K 31/4427</b> (2006.01)	2526090 *	NEW ANTI-MALARIAL AGENTS
<b>C07D 405/04</b> (2006.01)	2526090 *	NEW ANTI-MALARIAL AGENTS
<b>A61P 33/06</b> (2006.01)	2526090 *	NEW ANTI-MALARIAL AGENTS
<b>C07D 401/04</b> (2006.01)	2526090 *	NEW ANTI-MALARIAL AGENTS
<b>C07D 471/06</b> (2006.01)	2526090 *	NEW ANTI-MALARIAL AGENTS
<b>C07D 413/14</b> (2006.01)	2526090 *	NEW ANTI-MALARIAL AGENTS
<b>C07D 213/73</b> (2006.01)	2526090 *	NEW ANTI-MALARIAL AGENTS
<b>C07D 417/14</b> (2006.01)	2526090 *	NEW ANTI-MALARIAL AGENTS
<b>A61K 39/395</b> (2006.01)	2512511 *	HUMANIZED ANTIBODIES AGAINST HUMAN IL-22RA
<b>C07K 16/46</b> (2006.01)	2512511 *	HUMANIZED ANTIBODIES AGAINST HUMAN IL-22RA
<b>A61P 17/06</b> (2006.01)	2512511 *	HUMANIZED ANTIBODIES AGAINST HUMAN IL-22RA
<b>A61P 37/00</b> (2006.01)	2512511 *	HUMANIZED ANTIBODIES AGAINST HUMAN IL-22RA
<b>C07K 16/28</b> (2006.01)	2512511 *	HUMANIZED ANTIBODIES AGAINST HUMAN IL-22RA
<b>C07D 487/04</b> (2006.01)	2528625 *	PYRROLOBENZODIAZEPINES AND CONJUGATES THEREOF
<b>A61P 35/00</b> (2006.01)	2528625 *	PYRROLOBENZODIAZEPINES AND CONJUGATES THEREOF
<b>A61K 47/48</b> (2006.01)	2528625 *	PYRROLOBENZODIAZEPINES AND CONJUGATES THEREOF
<b>G01C 9/06</b> (2006.01)	2423640	Inclination sensor for a device and method for determining the inclination of a device
<b>G01C 9/20</b> (2006.01)	2423640	Inclination sensor for a device and method for determining the inclination of a device

MKP (51)	Broj objave evropske prijava patenta (97)	Naziv pronalaska (54)
<b>G06Q 30/00</b> (2012.01)	2517162 *	SYSTEM AND METHOD FOR AUTOMATED BUILDING SERVICES DESIGN
<b>G06F 17/50</b> (2006.01)	2517162 *	SYSTEM AND METHOD FOR AUTOMATED BUILDING SERVICES DESIGN
<b>H05H 1/00</b> (2006.01)	2534931 *	METHOD AND APPARATUS FOR APPLYING PLASMA PARTICLES TO A LIQUID AND USE FOR DISINFECTING WATER
<b>C02F 1/00</b> (2006.01)	2534931 *	METHOD AND APPARATUS FOR APPLYING PLASMA PARTICLES TO A LIQUID AND USE FOR DISINFECTING WATER
<b>A61B 17/00</b> (2006.01)	2519163 *	DAMPENING DEVICE FOR ENDOSCOPIC SURGICAL STAPLER
<b>A61B 17/068</b> (2006.01)	2519163 *	DAMPENING DEVICE FOR ENDOSCOPIC SURGICAL STAPLER
<b>A61B 17/072</b> (2006.01)	2519163 *	DAMPENING DEVICE FOR ENDOSCOPIC SURGICAL STAPLER
<b>A61B 17/28</b> (2006.01)	2519163 *	DAMPENING DEVICE FOR ENDOSCOPIC SURGICAL STAPLER
<b>A61K 9/32</b> (2006.01)	2512459 *	THERAPEUTIC POLYMERIC NANOPARTICLES COMPRISING EPOTHILONE AND METHODS OF MAKING AND USING SAME
<b>G01N 33/68</b> (2006.01)	2529233 *	MASS SPECTROMETRY-BASED PROTEIN IDENTIFICATION
<b>C07K 1/107</b> (2006.01)	2529233 *	MASS SPECTROMETRY-BASED PROTEIN IDENTIFICATION
<b>C12N 15/82</b> (2006.01)	2513317 *	USE OF CRY1DA IN COMBINATION WITH CRY1BE FOR MANAGEMENT OF RESISTANT INSECTS
<b>C07K 16/16</b> (2006.01)	2518148 *	GENE Dro1 CONTROLLING DEEP-ROOTED CHARACTERISTICS OF PLANT AND UTILIZATION OF SAME
<b>C07K 14/415</b> (2006.01)	2518148 *	GENE Dro1 CONTROLLING DEEP-ROOTED CHARACTERISTICS OF PLANT AND UTILIZATION OF SAME
<b>C12N 5/10</b> (2006.01)	2518148 *	GENE Dro1 CONTROLLING DEEP-ROOTED CHARACTERISTICS OF PLANT AND UTILIZATION OF SAME
<b>A01H 5/00</b> (2006.01)	2518148 *	GENE Dro1 CONTROLLING DEEP-ROOTED CHARACTERISTICS OF PLANT AND UTILIZATION OF SAME
<b>C12N 15/09</b> (2006.01)	2518148 *	GENE Dro1 CONTROLLING DEEP-ROOTED CHARACTERISTICS OF PLANT AND UTILIZATION OF SAME
<b>C12Q 1/68</b> (2006.01)	2518148 *	GENE Dro1 CONTROLLING DEEP-ROOTED CHARACTERISTICS OF PLANT AND UTILIZATION OF SAME
<b>C07D 333/40</b> (2006.01)	2523947 *	PROCESS FOR THE PREPARATION OF STRONTIUM RANELATE
<b>A61K 31/381</b> (2006.01)	2523947 *	PROCESS FOR THE PREPARATION OF STRONTIUM RANELATE
<b>F16L 27/093</b> (2006.01)	2529134 *	ROTARY SEAL ARRANGEMENT
<b>F16J 15/00</b> (2006.01)	2529134 *	ROTARY SEAL ARRANGEMENT
<b>F16J 15/34</b> (2006.01)	2529134 *	ROTARY SEAL ARRANGEMENT
<b>F16J 15/44</b> (2006.01)	2529134 *	ROTARY SEAL ARRANGEMENT
<b>F16J 15/32</b> (2006.01)	2529134 *	ROTARY SEAL ARRANGEMENT
<b>C07D 213/64</b> (2006.01)	2508513 *	2-PYRIDONE COMPOUNDS
<b>A61K 31/496</b> (2006.01)	2508513 *	2-PYRIDONE COMPOUNDS
<b>A61P 19/06</b> (2006.01)	2508513 *	2-PYRIDONE COMPOUNDS
<b>A61K 31/4545</b> (2006.01)	2508513 *	2-PYRIDONE COMPOUNDS
<b>A61P 9/10</b> (2006.01)	2508513 *	2-PYRIDONE COMPOUNDS
<b>A61K 31/4439</b> (2006.01)	2508513 *	2-PYRIDONE COMPOUNDS
<b>A61P 3/10</b> (2006.01)	2508513 *	2-PYRIDONE COMPOUNDS
<b>A61K 31/4427</b> (2006.01)	2508513 *	2-PYRIDONE COMPOUNDS
<b>A61P 3/00</b> (2006.01)	2508513 *	2-PYRIDONE COMPOUNDS
<b>A61P 27/02</b> (2006.01)	2508513 *	2-PYRIDONE COMPOUNDS
<b>A61K 31/444</b> (2006.01)	2508513 *	2-PYRIDONE COMPOUNDS
<b>A61P 7/10</b> (2006.01)	2508513 *	2-PYRIDONE COMPOUNDS
<b>A61K 31/4433</b> (2006.01)	2508513 *	2-PYRIDONE COMPOUNDS
<b>A61P 3/06</b> (2006.01)	2508513 *	2-PYRIDONE COMPOUNDS

MKP (51)	Broj objave evropske prijava patenta (97)	Naziv pronalaska (54)
<b>C07D 401/10</b> (2006.01)	2508513 *	2-PYRIDONE COMPOUNDS
<b>A61K 31/443</b> (2006.01)	2508513 *	2-PYRIDONE COMPOUNDS
<b>A61P 3/04</b> (2006.01)	2508513 *	2-PYRIDONE COMPOUNDS
<b>A61P 43/00</b> (2006.01)	2508513 *	2-PYRIDONE COMPOUNDS
<b>A61K 31/4412</b> (2006.01)	2508513 *	2-PYRIDONE COMPOUNDS
<b>A61K 31/5377</b> (2006.01)	2508513 *	2-PYRIDONE COMPOUNDS
<b>A61P 25/00</b> (2006.01)	2508513 *	2-PYRIDONE COMPOUNDS
<b>E04B 2/16</b> (2006.01)	2536891 *	ENERGY AND WEIGHT EFFICIENT BUILDING BLOCK, MANUFACTURING AND APPLICATION PROCESS THEREOF
<b>H01C 7/12</b> (2006.01)	2537164 *	EXCESS VOLTAGE CIRCUIT-BREAKER WITH A ROTATIONAL DISC AND AN ELECTRONIC ASSEMBLY TO IMPROVE OPERATION RELIABILITY
<b>C07B 61/00</b> (2006.01)	2502897 *	METHOD FOR PRODUCING OPTICALLY ACTIVE BICYCLO [3.1.0]HEXANE DERIVATIVE USING OXYGEN
<b>C12P 7/62</b> (2006.01)	2502897 *	METHOD FOR PRODUCING OPTICALLY ACTIVE BICYCLO [3.1.0]HEXANE DERIVATIVE USING OXYGEN
<b>C07C 69/753</b> (2006.01)	2502897 *	METHOD FOR PRODUCING OPTICALLY ACTIVE BICYCLO [3.1.0]HEXANE DERIVATIVE USING OXYGEN
<b>C07B 57/00</b> (2006.01)	2502897 *	METHOD FOR PRODUCING OPTICALLY ACTIVE BICYCLO [3.1.0]HEXANE DERIVATIVE USING OXYGEN
<b>C07C 67/303</b> (2006.01)	2502897 *	METHOD FOR PRODUCING OPTICALLY ACTIVE BICYCLO [3.1.0]HEXANE DERIVATIVE USING OXYGEN
<b>C07B 53/00</b> (2006.01)	2502897 *	METHOD FOR PRODUCING OPTICALLY ACTIVE BICYCLO [3.1.0]HEXANE DERIVATIVE USING OXYGEN
<b>A61K 38/16</b> (2006.01)	2509616 *	BCHE ALBUMIN FUSIONS FOR THE TREATMENT OF COCAINE ABUSE
<b>C12P 21/04</b> (2006.01)	2509616 *	BCHE ALBUMIN FUSIONS FOR THE TREATMENT OF COCAINE ABUSE
<b>C07K 16/28</b> (2006.01)	2534177 *	ANTIBODIES AGAINST CXCR4
<b>C12N 15/82</b> (2006.01)	2513315 *	COMBINED USE OF CRY1FA AND CRY1AB PROTEINS FOR CONTROL OF CRY-RESISTANT SUGARCANE BORER AND FOR INSECT RESISTANCE MANAGEMENT IN SUGARCANE
<b>F26B 11/16</b> (2006.01)	2511636	Method for energy efficient drying of liquids, slurries, pastes, cakes and moist particles that forms particulate matter through drying in direct superheated steam dryer
<b>F26B 23/00</b> (2006.01)	2511636	Method for energy efficient drying of liquids, slurries, pastes, cakes and moist particles that forms particulate matter through drying in direct superheated steam dryer
<b>A61K 31/00</b> (2006.01)	2525790 *	METHODS AND COMPOSITIONS FOR CELL-PROLIFERATION-RELATED DISORDERS
<b>G01N 33/574</b> (2006.01)	2519826 *	BIOLOGICAL MARKERS PREDICTIVE OF ANTI-CANCER RESPONSE TO INSULIN-LIKE GROWTH FACTOR-1 RECEPTOR KINASE INHIBITORS
<b>B60H 1/00</b> (2006.01)	2512847 *	SERVICE EQUIPMENT FOR SERVICING COOLING SYSTEMS IN VEHICLES
<b>F25B 45/00</b> (2006.01)	2512847 *	SERVICE EQUIPMENT FOR SERVICING COOLING SYSTEMS IN VEHICLES
<b>F16L 37/36</b> (2006.01)	2512847 *	SERVICE EQUIPMENT FOR SERVICING COOLING SYSTEMS IN VEHICLES
<b>G01N 33/68</b> (2006.01)	2496944 *	BIOMARKERS PREDICTIVE OF PROGRESSION OF FIBROSIS
<b>A61K 38/08</b> (2006.01)	2536421 *	METHOD FOR TREATMENT OF PSORIASIS
<b>A61K 38/00</b> (2006.01)	2536421 *	METHOD FOR TREATMENT OF PSORIASIS
<b>A61P 3/00</b> (2006.01)	2525807 *	PHARMACEUTICAL COMPOSITION FOR TREATING A METABOLIC SYNDROME
<b>A61K 38/26</b> (2006.01)	2525807 *	PHARMACEUTICAL COMPOSITION FOR TREATING A METABOLIC SYNDROME
<b>A61K 38/18</b> (2006.01)	2525807 *	PHARMACEUTICAL COMPOSITION FOR TREATING A METABOLIC SYNDROME
<b>B01D 53/94</b> (2006.01)	2508724 *	ENGINE EXHAUST-AIR PURIFYING APPARATUS
<b>F01N 3/08</b> (2006.01)	2508724 *	ENGINE EXHAUST-AIR PURIFYING APPARATUS
<b>F01N 3/24</b> (2006.01)	2508724 *	ENGINE EXHAUST-AIR PURIFYING APPARATUS
<b>F16J 15/32</b> (2006.01)	2533712 *	SEAL ARRANGEMENTS FOR ULTRASONICALLY POWERED SURGICAL INSTRUMENTS

MKP (51)	Broj objave evropske prijava patenta (97)	Naziv pronalaska (54)
<b>A61B 17/32</b> (2006.01)	2533712 *	SEAL ARRANGEMENTS FOR ULTRASONICALLY POWERED SURGICAL INSTRUMENTS
<b>C07K 5/08</b> (2006.01)	2520180 *	FLAVOR-ENRICHING AGENT
<b>A23L 1/228</b> (2006.01)	2520180 *	FLAVOR-ENRICHING AGENT
<b>C07K 5/06</b> (2006.01)	2520180 *	FLAVOR-ENRICHING AGENT
<b>A61P 17/06</b> (2006.01)	2501410 *	COMBINATION OF ALPHA-2 ADRENERGIC RECEPTOR AGONIST AND NON-STEROIDAL ANTI-INFLAMMATORY AGENT FOR TREATING OR PREVENTING AN INFLAMMATORY SKIN DISORDER
<b>A61K 9/00</b> (2006.01)	2501410 *	COMBINATION OF ALPHA-2 ADRENERGIC RECEPTOR AGONIST AND NON-STEROIDAL ANTI-INFLAMMATORY AGENT FOR TREATING OR PREVENTING AN INFLAMMATORY SKIN DISORDER
<b>A61P 17/10</b> (2006.01)	2501410 *	COMBINATION OF ALPHA-2 ADRENERGIC RECEPTOR AGONIST AND NON-STEROIDAL ANTI-INFLAMMATORY AGENT FOR TREATING OR PREVENTING AN INFLAMMATORY SKIN DISORDER
<b>A61K 31/00</b> (2006.01)	2501410 *	COMBINATION OF ALPHA-2 ADRENERGIC RECEPTOR AGONIST AND NON-STEROIDAL ANTI-INFLAMMATORY AGENT FOR TREATING OR PREVENTING AN INFLAMMATORY SKIN DISORDER
<b>A61K 9/06</b> (2006.01)	2501410 *	COMBINATION OF ALPHA-2 ADRENERGIC RECEPTOR AGONIST AND NON-STEROIDAL ANTI-INFLAMMATORY AGENT FOR TREATING OR PREVENTING AN INFLAMMATORY SKIN DISORDER
<b>A61K 31/196</b> (2006.01)	2501410 *	COMBINATION OF ALPHA-2 ADRENERGIC RECEPTOR AGONIST AND NON-STEROIDAL ANTI-INFLAMMATORY AGENT FOR TREATING OR PREVENTING AN INFLAMMATORY SKIN DISORDER
<b>A61P 17/00</b> (2006.01)	2501410 *	COMBINATION OF ALPHA-2 ADRENERGIC RECEPTOR AGONIST AND NON-STEROIDAL ANTI-INFLAMMATORY AGENT FOR TREATING OR PREVENTING AN INFLAMMATORY SKIN DISORDER
<b>A61K 45/06</b> (2006.01)	2501410 *	COMBINATION OF ALPHA-2 ADRENERGIC RECEPTOR AGONIST AND NON-STEROIDAL ANTI-INFLAMMATORY AGENT FOR TREATING OR PREVENTING AN INFLAMMATORY SKIN DISORDER
<b>A61K 31/498</b> (2006.01)	2501410 *	COMBINATION OF ALPHA-2 ADRENERGIC RECEPTOR AGONIST AND NON-STEROIDAL ANTI-INFLAMMATORY AGENT FOR TREATING OR PREVENTING AN INFLAMMATORY SKIN DISORDER
<b>A61P 17/04</b> (2006.01)	2501410 *	COMBINATION OF ALPHA-2 ADRENERGIC RECEPTOR AGONIST AND NON-STEROIDAL ANTI-INFLAMMATORY AGENT FOR TREATING OR PREVENTING AN INFLAMMATORY SKIN DISORDER
<b>G06F 3/041</b> (2006.01)	2502215 *	SYSTEMS AND METHODS FOR INCREASING HAPTIC BANDWIDTH IN AN ELECTRONIC DEVICE
<b>G08B 6/00</b> (2006.01)	2502215 *	SYSTEMS AND METHODS FOR INCREASING HAPTIC BANDWIDTH IN AN ELECTRONIC DEVICE
<b>A61B 17/072</b> (2006.01)	2515769 *	SURGICAL CUTTING INSTRUMENT THAT ANALYZES TISSUE THICKNESS
<b>C12N 5/10</b> (2006.01)	2536267 *	AXMI221z, AXMI222z, AXMI223z, AXMI224z, AND AXMI225z DELTA-ENDOTOXIN GENES AND METHODS FOR THEIR USE
<b>C07K 14/00</b> (2006.01)	2536267 *	AXMI221z, AXMI222z, AXMI223z, AXMI224z, AND AXMI225z DELTA-ENDOTOXIN GENES AND METHODS FOR THEIR USE
<b>C12N 15/63</b> (2006.01)	2536267 *	AXMI221z, AXMI222z, AXMI223z, AXMI224z, AND AXMI225z DELTA-ENDOTOXIN GENES AND METHODS FOR THEIR USE
<b>A01H 5/10</b> (2006.01)	2536267 *	AXMI221z, AXMI222z, AXMI223z, AXMI224z, AND AXMI225z DELTA-ENDOTOXIN GENES AND METHODS FOR THEIR USE
<b>C07H 21/04</b> (2006.01)	2536267 *	AXMI221z, AXMI222z, AXMI223z, AXMI224z, AND AXMI225z DELTA-ENDOTOXIN GENES AND METHODS FOR THEIR USE
<b>C12N 15/82</b> (2006.01)	2536267 *	AXMI221z, AXMI222z, AXMI223z, AXMI224z, AND AXMI225z DELTA-ENDOTOXIN GENES AND METHODS FOR THEIR USE
<b>A01H 5/00</b> (2006.01)	2536267 *	AXMI221z, AXMI222z, AXMI223z, AXMI224z, AND AXMI225z DELTA-ENDOTOXIN GENES AND METHODS FOR THEIR USE
<b>A01H 1/00</b> (2006.01)	2536267 *	AXMI221z, AXMI222z, AXMI223z, AXMI224z, AND AXMI225z DELTA-ENDOTOXIN GENES AND METHODS FOR THEIR USE
<b>A01N 37/18</b> (2006.01)	2536267 *	AXMI221z, AXMI222z, AXMI223z, AXMI224z, AND AXMI225z DELTA-ENDOTOXIN GENES AND METHODS FOR THEIR USE

MKP (51)	Broj objave evropske prijava patenta (97)	Naziv pronalaska (54)
<b>C12P 21/00</b> (2006.01)	2536267 *	AXMI221z, AXMI222z, AXMI223z, AXMI224z, AND AXMI225z DELTA-ENDOTOXIN GENES AND METHODS FOR THEIR USE
<b>C12N 1/21</b> (2006.01)	2536267 *	AXMI221z, AXMI222z, AXMI223z, AXMI224z, AND AXMI225z DELTA-ENDOTOXIN GENES AND METHODS FOR THEIR USE
<b>A01P 7/04</b> (2006.01)	2536267 *	AXMI221z, AXMI222z, AXMI223z, AXMI224z, AND AXMI225z DELTA-ENDOTOXIN GENES AND METHODS FOR THEIR USE
<b>A61K 9/00</b> (2006.01)	2515854 *	AEROSOL FORMULATION FOR COPD
<b>A61K 31/40</b> (2006.01)	2515854 *	AEROSOL FORMULATION FOR COPD
<b>C12N 9/12</b> (2006.01)	2374873	Modified aspartate kinase from corynebacterium and its application for amino acid production
<b>C12P 13/08</b> (2006.01)	2374873	Modified aspartate kinase from corynebacterium and its application for amino acid production
<b>A01K 67/027</b> (2006.01)	2510087 *	PATHOGEN RESTRICTION FACTORS
<b>A61K 48/00</b> (2006.01)	2510087 *	PATHOGEN RESTRICTION FACTORS
<b>G01N 33/15</b> (2006.01)	2510087 *	PATHOGEN RESTRICTION FACTORS
<b>C12N 5/071</b> (2010.01)	2510087 *	PATHOGEN RESTRICTION FACTORS
<b>A61K 38/00</b> (2006.01)	2510087 *	PATHOGEN RESTRICTION FACTORS
<b>C12N 5/10</b> (2006.01)	2510087 *	PATHOGEN RESTRICTION FACTORS
<b>F28D 20/00</b> (2006.01)	2516953 *	ACCUMULATOR TANK WITH PARTITION WALLS
<b>F24D 11/00</b> (2006.01)	2516953 *	ACCUMULATOR TANK WITH PARTITION WALLS
<b>F24H 1/18</b> (2006.01)	2516953 *	ACCUMULATOR TANK WITH PARTITION WALLS
<b>C21D 9/08</b> (2006.01)	2501829 *	IMPROVED FATIGUE-RESISTANT NITINOL INSTRUMENT
<b>A61P 25/00</b> (2006.01)	2509982 *	3,6-DIAZABICYCLO[3.1.1]HEPTANES AS NEURONAL NICOTINIC ACETYLCHOLINE RECEPTOR LIGANDS
<b>A61P 25/28</b> (2006.01)	2509982 *	3,6-DIAZABICYCLO[3.1.1]HEPTANES AS NEURONAL NICOTINIC ACETYLCHOLINE RECEPTOR LIGANDS
<b>A61K 31/4995</b> (2006.01)	2509982 *	3,6-DIAZABICYCLO[3.1.1]HEPTANES AS NEURONAL NICOTINIC ACETYLCHOLINE RECEPTOR LIGANDS
<b>A61P 25/16</b> (2006.01)	2509982 *	3,6-DIAZABICYCLO[3.1.1]HEPTANES AS NEURONAL NICOTINIC ACETYLCHOLINE RECEPTOR LIGANDS
<b>C07D 487/08</b> (2006.01)	2509982 *	3,6-DIAZABICYCLO[3.1.1]HEPTANES AS NEURONAL NICOTINIC ACETYLCHOLINE RECEPTOR LIGANDS
<b>B23B 51/00</b> (2006.01)	2463047	Undercutting tool
<b>C10C 1/00</b> (2006.01)	2521758 *	DEVICE AND METHOD FOR SEPARATING A SOLID MATTER-CONTAINING, LIQUID AND PUMPABLE TAR SUSPENSION AND USE OF THE SEPARATED SOLID MATTER FOR PRODUCING COKE
<b>A61K 31/381</b> (2006.01)	2513108 *	NOVEL (HETEROCYCLE/CONDENSED PIPERIDINE)-(PIPERAZINYL)-1-ALCANONE OR (HETEROCYCLE/CONDENSED PYRROLIDINE)-(PIPERAZINYL)-1-ALCANONE DERIVATIVES, AND USE THEREOF AS P75 INHIBITORS
<b>C07D 495/04</b> (2006.01)	2513108 *	NOVEL (HETEROCYCLE/CONDENSED PIPERIDINE)-(PIPERAZINYL)-1-ALCANONE OR (HETEROCYCLE/CONDENSED PYRROLIDINE)-(PIPERAZINYL)-1-ALCANONE DERIVATIVES, AND USE THEREOF AS P75 INHIBITORS
<b>C07D 471/04</b> (2006.01)	2513108 *	NOVEL (HETEROCYCLE/CONDENSED PIPERIDINE)-(PIPERAZINYL)-1-ALCANONE OR (HETEROCYCLE/CONDENSED PYRROLIDINE)-(PIPERAZINYL)-1-ALCANONE DERIVATIVES, AND USE THEREOF AS P75 INHIBITORS
<b>A61K 31/429</b> (2006.01)	2513108 *	NOVEL (HETEROCYCLE/CONDENSED PIPERIDINE)-(PIPERAZINYL)-1-ALCANONE OR (HETEROCYCLE/CONDENSED PYRROLIDINE)-(PIPERAZINYL)-1-ALCANONE DERIVATIVES, AND USE THEREOF AS P75 INHIBITORS
<b>C07D 513/04</b> (2006.01)	2513108 *	NOVEL (HETEROCYCLE/CONDENSED PIPERIDINE)-(PIPERAZINYL)-1-ALCANONE OR (HETEROCYCLE/CONDENSED PYRROLIDINE)-(PIPERAZINYL)-1-ALCANONE DERIVATIVES, AND USE THEREOF AS P75 INHIBITORS
<b>E21B 34/10</b> (2006.01)	2513417 *	DOWNHOLE SUB WITH HYDRAULICALLY ACTUABLE SLEEVE VALVE
<b>E21B 43/14</b> (2006.01)	2513417 *	DOWNHOLE SUB WITH HYDRAULICALLY ACTUABLE SLEEVE VALVE
<b>E21B 43/12</b> (2006.01)	2513417 *	DOWNHOLE SUB WITH HYDRAULICALLY ACTUABLE SLEEVE VALVE
<b>E21B 33/124</b> (2006.01)	2513417 *	DOWNHOLE SUB WITH HYDRAULICALLY ACTUABLE SLEEVE VALVE
<b>E21B 34/14</b> (2006.01)	2513417 *	DOWNHOLE SUB WITH HYDRAULICALLY ACTUABLE SLEEVE VALVE



MKP (51)	Broj objave evropske prijava patenta (97)	Naziv pronalaska (54)
<b>A01N 45/00</b> (2006.01)	2512230 *	NON-IRRITATING OPHTHALMIC POVIDONE-IODINE COMPOSITIONS
<b>A61K 31/74</b> (2006.01)	2512230 *	NON-IRRITATING OPHTHALMIC POVIDONE-IODINE COMPOSITIONS
<b>A01N 25/00</b> (2006.01)	2512230 *	NON-IRRITATING OPHTHALMIC POVIDONE-IODINE COMPOSITIONS
<b>C07K 14/245</b> (2006.01)	2524043 *	BACTERIAL HOST STRAIN COMPRISING A MUTANT SPR GENE AND HAVING REDUCED TSP ACTIVITY
<b>C12N 15/70</b> (2006.01)	2524043 *	BACTERIAL HOST STRAIN COMPRISING A MUTANT SPR GENE AND HAVING REDUCED TSP ACTIVITY
<b>E02D 5/80</b> (2006.01)	2513378 *	DEVICE FOR ANCHORING IN MULTILAYER GROUND
<b>A61K 9/70</b> (2006.01)	2524692 *	ANTI-INFLAMMATORY ANALGESIC ADHESIVE PATCH FOR EXTERNAL USE
<b>A61K 47/22</b> (2006.01)	2524692 *	ANTI-INFLAMMATORY ANALGESIC ADHESIVE PATCH FOR EXTERNAL USE
<b>A61K 31/40</b> (2006.01)	2524692 *	ANTI-INFLAMMATORY ANALGESIC ADHESIVE PATCH FOR EXTERNAL USE
<b>A61K 47/32</b> (2006.01)	2524692 *	ANTI-INFLAMMATORY ANALGESIC ADHESIVE PATCH FOR EXTERNAL USE
<b>A61K 47/20</b> (2006.01)	2524692 *	ANTI-INFLAMMATORY ANALGESIC ADHESIVE PATCH FOR EXTERNAL USE
<b>A61K 47/10</b> (2006.01)	2524692 *	ANTI-INFLAMMATORY ANALGESIC ADHESIVE PATCH FOR EXTERNAL USE
<b>E21C 29/02</b> (2006.01)	2499334 *	DRIVE TRANSMISSION METHOD IN A LONGWALL SHEARER LOADER
<b>B60B 19/00</b> (2006.01)	2531360 *	DEFORMABLE WHEEL ASSEMBLY
<b>B60B 9/00</b> (2006.01)	2531360 *	DEFORMABLE WHEEL ASSEMBLY
<b>H01M 4/583</b> (2010.01)	2509143 *	ANODE ACTIVE MATERIAL PRECURSOR AND ACTIVE MATERIAL FOR A RECHARGEABLE LITHIUM BATTERY COMPRISING HOLLOW NANOFIBROUS CARBON, AND A PRODUCTION METHOD THEREFOR
<b>H01M 4/525</b> (2010.01)	2509143 *	ANODE ACTIVE MATERIAL PRECURSOR AND ACTIVE MATERIAL FOR A RECHARGEABLE LITHIUM BATTERY COMPRISING HOLLOW NANOFIBROUS CARBON, AND A PRODUCTION METHOD THEREFOR
<b>H01M 10/0525</b> (2010.01)	2509143 *	ANODE ACTIVE MATERIAL PRECURSOR AND ACTIVE MATERIAL FOR A RECHARGEABLE LITHIUM BATTERY COMPRISING HOLLOW NANOFIBROUS CARBON, AND A PRODUCTION METHOD THEREFOR
<b>H01M 4/505</b> (2010.01)	2509143 *	ANODE ACTIVE MATERIAL PRECURSOR AND ACTIVE MATERIAL FOR A RECHARGEABLE LITHIUM BATTERY COMPRISING HOLLOW NANOFIBROUS CARBON, AND A PRODUCTION METHOD THEREFOR
<b>C12P 21/08</b> (2006.01)	2504360 *	MONOMERIC ANTIBODY FC
<b>C07K 16/00</b> (2006.01)	2504360 *	MONOMERIC ANTIBODY FC
<b>C07H 21/00</b> (2006.01)	2504360 *	MONOMERIC ANTIBODY FC
<b>A61P 9/00</b> (2006.01)	2523962 *	CARBOXYLIC ACID DERIVATIVES HAVING A 2,5-SUBSTITUTED OXAZOLOPYRIMIDINE RING
<b>C07D 498/04</b> (2006.01)	2523962 *	CARBOXYLIC ACID DERIVATIVES HAVING A 2,5-SUBSTITUTED OXAZOLOPYRIMIDINE RING
<b>A61K 31/519</b> (2006.01)	2523962 *	CARBOXYLIC ACID DERIVATIVES HAVING A 2,5-SUBSTITUTED OXAZOLOPYRIMIDINE RING
<b>C07K 5/08</b> (2006.01)	2526116 *	PYRUVAMIDE COMPOUNDS AS INHIBITORS OF DUST MITE GROUP 1 PEPTIDASE ALLERGEN
<b>A61K 38/06</b> (2006.01)	2526116 *	PYRUVAMIDE COMPOUNDS AS INHIBITORS OF DUST MITE GROUP 1 PEPTIDASE ALLERGEN
<b>C07K 5/06</b> (2006.01)	2526116 *	PYRUVAMIDE COMPOUNDS AS INHIBITORS OF DUST MITE GROUP 1 PEPTIDASE ALLERGEN
<b>A61P 37/08</b> (2006.01)	2526116 *	PYRUVAMIDE COMPOUNDS AS INHIBITORS OF DUST MITE GROUP 1 PEPTIDASE ALLERGEN
<b>A01N 43/00</b> (2006.01)	2526116 *	PYRUVAMIDE COMPOUNDS AS INHIBITORS OF DUST MITE GROUP 1 PEPTIDASE ALLERGEN
<b>C07D 471/04</b> (2006.01)	2521725 *	ARYLSULFONAMIDE PYRIDINE-PYRIDINONE DERIVATIVES, PREPARATION OF SAME, AND THERAPEUTIC USE THEREOF
<b>A61P 9/00</b> (2006.01)	2521725 *	ARYLSULFONAMIDE PYRIDINE-PYRIDINONE DERIVATIVES, PREPARATION OF SAME, AND THERAPEUTIC USE THEREOF
<b>C07C 311/21</b> (2006.01)	2521725 *	ARYLSULFONAMIDE PYRIDINE-PYRIDINONE DERIVATIVES, PREPARATION OF SAME, AND THERAPEUTIC USE THEREOF
<b>A61K 31/519</b> (2006.01)	2521725 *	ARYLSULFONAMIDE PYRIDINE-PYRIDINONE DERIVATIVES, PREPARATION OF SAME, AND THERAPEUTIC USE THEREOF

MKP (51)	Broj objave evropske prijava patenta (97)	Naziv pronalaska (54)
<b>C07F 5/02</b> (2006.01)	2521725 *	ARYLSULFONAMIDE PYRIDINE-PYRIDINONE DERIVATIVES, PREPARATION OF SAME, AND THERAPEUTIC USE THEREOF
<b>C09J 5/00</b> (2006.01)	2522498	Dry adhesive comprising micro-featured and nano-featured surface
<b>B32B 3/00</b> (2006.01)	2522498	Dry adhesive comprising micro-featured and nano-featured surface
<b>C09J 7/00</b> (2006.01)	2522498	Dry adhesive comprising micro-featured and nano-featured surface
<b>A61M 5/32</b> (2006.01)	2531240 *	PUSH ROD ACTIVATED MEDICATED MODULE
<b>A61M 5/28</b> (2006.01)	2531240 *	PUSH ROD ACTIVATED MEDICATED MODULE
<b>A61M 5/24</b> (2006.01)	2531240 *	PUSH ROD ACTIVATED MEDICATED MODULE
<b>C03B 35/16</b> (2006.01)	2531456 *	ROLLER CLEANING DEVICE
<b>F27D 25/00</b> (2010.01)	2531456 *	ROLLER CLEANING DEVICE
<b>B65G 45/10</b> (2006.01)	2531456 *	ROLLER CLEANING DEVICE
<b>F27B 9/30</b> (2006.01)	2531456 *	ROLLER CLEANING DEVICE
<b>A45D 40/10</b> (2006.01)	2515695 *	CONTAINER FOR A STICK OF A COSMETIC OR HYGIENIC PRODUCT HAVING A RETRACTABLE APPLICATOR ELEMENT
<b>C12N 15/11</b> (2006.01)	2513306 *	C. HISTOLYTICUM RECOMBINANT COLLAGENASES AND METHOD FOR THE MANUFACTURE THEREOF
<b>A61K 9/20</b> (2006.01)	2441445	Coating of cetyl myristate and/or cetyl palmitate particles
<b>A61K 31/215</b> (2006.01)	2441445	Coating of cetyl myristate and/or cetyl palmitate particles
<b>H01R 13/639</b> (2006.01)	2434588	Connector
<b>H01R 13/11</b> (2006.01)	2434588	Connector
<b>A61P 31/16</b> (2006.01)	2513060 *	ALPHA-CRYSTALLINE FORM OF CARBABENZPYRIDE
<b>C07D 213/81</b> (2006.01)	2513060 *	ALPHA-CRYSTALLINE FORM OF CARBABENZPYRIDE
<b>A61K 31/4425</b> (2006.01)	2513060 *	ALPHA-CRYSTALLINE FORM OF CARBABENZPYRIDE
<b>A61K 31/44</b> (2006.01)	2516400 *	PHENOL DERIVATIVES AND THE PHARMACEUTICAL OR COSMETIC USE THEREOF
<b>A61P 5/26</b> (2006.01)	2516400 *	PHENOL DERIVATIVES AND THE PHARMACEUTICAL OR COSMETIC USE THEREOF
<b>C07D 213/74</b> (2006.01)	2516400 *	PHENOL DERIVATIVES AND THE PHARMACEUTICAL OR COSMETIC USE THEREOF
<b>A61K 31/4409</b> (2006.01)	2516400 *	PHENOL DERIVATIVES AND THE PHARMACEUTICAL OR COSMETIC USE THEREOF
<b>A61P 5/28</b> (2006.01)	2516400 *	PHENOL DERIVATIVES AND THE PHARMACEUTICAL OR COSMETIC USE THEREOF
<b>F28D 20/00</b> (2006.01)	2504653 *	PROCESS TO ACCUMULATE THERMAL ENERGY USING A HEAT- CARRIER FLUID AND CORRESPONDING SYSTEM
<b>C09K 5/10</b> (2006.01)	2504653 *	PROCESS TO ACCUMULATE THERMAL ENERGY USING A HEAT- CARRIER FLUID AND CORRESPONDING SYSTEM
<b>F01K 3/12</b> (2006.01)	2504653 *	PROCESS TO ACCUMULATE THERMAL ENERGY USING A HEAT- CARRIER FLUID AND CORRESPONDING SYSTEM
<b>A61K 31/4468</b> (2006.01)	2521714 *	SULFONE COMPOUNDS AS 5-HT6 RECEPTOR LIGANDS
<b>A61P 29/00</b> (2006.01)	2521714 *	SULFONE COMPOUNDS AS 5-HT6 RECEPTOR LIGANDS
<b>A61K 31/4709</b> (2006.01)	2521714 *	SULFONE COMPOUNDS AS 5-HT6 RECEPTOR LIGANDS
<b>A61P 25/08</b> (2006.01)	2521714 *	SULFONE COMPOUNDS AS 5-HT6 RECEPTOR LIGANDS
<b>C07D 401/12</b> (2006.01)	2521714 *	SULFONE COMPOUNDS AS 5-HT6 RECEPTOR LIGANDS
<b>A61P 25/24</b> (2006.01)	2521714 *	SULFONE COMPOUNDS AS 5-HT6 RECEPTOR LIGANDS
<b>A61P 25/18</b> (2006.01)	2521714 *	SULFONE COMPOUNDS AS 5-HT6 RECEPTOR LIGANDS
<b>A61K 31/4725</b> (2006.01)	2521714 *	SULFONE COMPOUNDS AS 5-HT6 RECEPTOR LIGANDS
<b>C07D 401/14</b> (2006.01)	2521714 *	SULFONE COMPOUNDS AS 5-HT6 RECEPTOR LIGANDS
<b>A61P 25/28</b> (2006.01)	2521714 *	SULFONE COMPOUNDS AS 5-HT6 RECEPTOR LIGANDS
<b>C07D 211/58</b> (2006.01)	2521714 *	SULFONE COMPOUNDS AS 5-HT6 RECEPTOR LIGANDS

MKP (51)	Broj objave evropske prijava patenta (97)	Naziv pronalaska (54)
<b>A61P 25/22</b> (2006.01)	2521714 *	SULFONE COMPOUNDS AS 5-HT6 RECEPTOR LIGANDS
<b>A01N 43/54</b> (2006.01)	2501233 *	QUINAZOLINE COMPOUNDS
<b>A61K 31/517</b> (2006.01)	2501233 *	QUINAZOLINE COMPOUNDS
<b>H04L 12/28</b> (2006.01)	2507946 *	ADAPTATION PROTOCOLS FOR LOCAL PEER GROUP (LPG) NETWORKS IN DYNAMIC ROADWAY ENVIRONMENTS
<b>F03B 9/00</b> (2006.01)	2438291 *	DEVICE FOR OBTAINING ENERGY FROM WATER
<b>A61K 31/55</b> (2006.01)	2525797 *	METHODS FOR TREATING PAIN
<b>A61K 45/06</b> (2006.01)	2525797 *	METHODS FOR TREATING PAIN
<b>A61P 23/00</b> (2006.01)	2525797 *	METHODS FOR TREATING PAIN
<b>B01D 53/86</b> (2006.01)	2534422 *	DEVICE FOR TREATING EXHAUST GASES FROM A SMALL HEATING SYSTEM
<b>F24B 1/00</b> (2006.01)	2534422 *	DEVICE FOR TREATING EXHAUST GASES FROM A SMALL HEATING SYSTEM
<b>F23G 7/07</b> (2006.01)	2534422 *	DEVICE FOR TREATING EXHAUST GASES FROM A SMALL HEATING SYSTEM
<b>C07K 16/46</b> (2006.01)	2519544 *	POLYPEPTIDE HETERODIMERS AND USES THEREOF
<b>A61P 35/00</b> (2006.01)	2519544 *	POLYPEPTIDE HETERODIMERS AND USES THEREOF
<b>A61P 37/00</b> (2006.01)	2519544 *	POLYPEPTIDE HETERODIMERS AND USES THEREOF
<b>A61K 39/395</b> (2006.01)	2519544 *	POLYPEPTIDE HETERODIMERS AND USES THEREOF
<b>B62J 11/00</b> (2006.01)	2516245 *	SYSTEM FOR REMOVABLY ATTACHING OBJECTS TO VEHICLES NEGATING THE EFFECTS OF GRAVITATIONAL FORCES, VIBRATION AND SHOCK LOADING
<b>F03D 11/02</b> (2006.01)	2513473 *	METHOD AND APPARATUS FOR WIND ENERGY SYSTEM
<b>F03D 3/04</b> (2006.01)	2513473 *	METHOD AND APPARATUS FOR WIND ENERGY SYSTEM
<b>F03D 11/00</b> (2006.01)	2513473 *	METHOD AND APPARATUS FOR WIND ENERGY SYSTEM
<b>F03D 3/06</b> (2006.01)	2513473 *	METHOD AND APPARATUS FOR WIND ENERGY SYSTEM
<b>C07H 19/16</b> (2006.01)	2501709 *	2'-FLUORO-6'-METHYLENE CARBOCYCLIC NUCLEOSIDES AND METHODS OF TREATING VIRAL INFECTIONS
<b>A61P 31/20</b> (2006.01)	2501709 *	2'-FLUORO-6'-METHYLENE CARBOCYCLIC NUCLEOSIDES AND METHODS OF TREATING VIRAL INFECTIONS
<b>A61K 31/7076</b> (2006.01)	2501709 *	2'-FLUORO-6'-METHYLENE CARBOCYCLIC NUCLEOSIDES AND METHODS OF TREATING VIRAL INFECTIONS
<b>C07H 19/06</b> (2006.01)	2501709 *	2'-FLUORO-6'-METHYLENE CARBOCYCLIC NUCLEOSIDES AND METHODS OF TREATING VIRAL INFECTIONS
<b>A61K 31/7064</b> (2006.01)	2501709 *	2'-FLUORO-6'-METHYLENE CARBOCYCLIC NUCLEOSIDES AND METHODS OF TREATING VIRAL INFECTIONS
<b>A61K 47/10</b> (2006.01)	2515866 *	PHARMACEUTICAL COMPOSITION COMPRISING SOLVENT MIXTURE AND A VITAMIN D DERIVATIVE OR ANALOGUE
<b>A61K 47/14</b> (2006.01)	2515866 *	PHARMACEUTICAL COMPOSITION COMPRISING SOLVENT MIXTURE AND A VITAMIN D DERIVATIVE OR ANALOGUE
<b>A61K 47/22</b> (2006.01)	2515866 *	PHARMACEUTICAL COMPOSITION COMPRISING SOLVENT MIXTURE AND A VITAMIN D DERIVATIVE OR ANALOGUE
<b>A61K 31/593</b> (2006.01)	2515866 *	PHARMACEUTICAL COMPOSITION COMPRISING SOLVENT MIXTURE AND A VITAMIN D DERIVATIVE OR ANALOGUE
<b>A61K 9/06</b> (2006.01)	2515866 *	PHARMACEUTICAL COMPOSITION COMPRISING SOLVENT MIXTURE AND A VITAMIN D DERIVATIVE OR ANALOGUE
<b>A61K 9/16</b> (2006.01)	2536396 *	PROCESS FOR THE PREPARATION OF ORAL SOLID DOSAGE FORMS COMPRISING VALSARTAN
<b>A61K 31/41</b> (2006.01)	2536396 *	PROCESS FOR THE PREPARATION OF ORAL SOLID DOSAGE FORMS COMPRISING VALSARTAN
<b>A61K 9/20</b> (2006.01)	2536396 *	PROCESS FOR THE PREPARATION OF ORAL SOLID DOSAGE FORMS COMPRISING VALSARTAN
<b>A61B 17/10</b> (2006.01)	2506779 *	AN IMPROVED LIGATION DEVICE ADAPTABLE FOR SURGICAL INTERVENTION
<b>A61B 17/122</b> (2006.01)	2506779 *	AN IMPROVED LIGATION DEVICE ADAPTABLE FOR SURGICAL INTERVENTION
<b>A61B 17/12</b> (2006.01)	2506779 *	AN IMPROVED LIGATION DEVICE ADAPTABLE FOR SURGICAL INTERVENTION
<b>A61B 17/128</b> (2006.01)	2506779 *	AN IMPROVED LIGATION DEVICE ADAPTABLE FOR SURGICAL INTERVENTION

MKP (51)	Broj objave evropske prijava patenta (97)	Naziv pronalaska (54)
<b>A61B 5/053</b> (2006.01)	2536330 *	METHOD AND APPARATUS FOR NON-INVASIVE ANALYSING THE STRUCTURE AND CHEMICAL COMPOSITION OF BONE TISSUE ELIMINATING THE INFLUENCE OF SURROUNDING TISSUES
<b>C12N 15/82</b> (2006.01)	2513314 *	COMBINED USE OF CRY1CA AND CRY1AB PROTEINS FOR INSECT RESISTANCE MANAGEMENT
<b>A61M 15/00</b> (2006.01)	2504050 *	NEBULIZER
<b>A01N 43/82</b> (2006.01)	2509424 *	NOVEL OXADIAZOLE COMPOUNDS
<b>A61K 31/41</b> (2006.01)	2509424 *	NOVEL OXADIAZOLE COMPOUNDS
<b>A61P 11/00</b> (2006.01)	2516434 *	FUSED HETEROAROMATIC PYRROLIDINONES AS SYK INHIBITORS
<b>C07D 487/04</b> (2006.01)	2516434 *	FUSED HETEROAROMATIC PYRROLIDINONES AS SYK INHIBITORS
<b>A61P 37/00</b> (2006.01)	2516434 *	FUSED HETEROAROMATIC PYRROLIDINONES AS SYK INHIBITORS
<b>A61K 31/437</b> (2006.01)	2516434 *	FUSED HETEROAROMATIC PYRROLIDINONES AS SYK INHIBITORS
<b>A61P 29/00</b> (2006.01)	2516434 *	FUSED HETEROAROMATIC PYRROLIDINONES AS SYK INHIBITORS
<b>A61P 17/00</b> (2006.01)	2516434 *	FUSED HETEROAROMATIC PYRROLIDINONES AS SYK INHIBITORS
<b>A61P 19/00</b> (2006.01)	2516434 *	FUSED HETEROAROMATIC PYRROLIDINONES AS SYK INHIBITORS
<b>C07D 471/04</b> (2006.01)	2516434 *	FUSED HETEROAROMATIC PYRROLIDINONES AS SYK INHIBITORS
<b>A61P 35/00</b> (2006.01)	2516434 *	FUSED HETEROAROMATIC PYRROLIDINONES AS SYK INHIBITORS
<b>A61P 7/00</b> (2006.01)	2516434 *	FUSED HETEROAROMATIC PYRROLIDINONES AS SYK INHIBITORS
<b>A61K 31/519</b> (2006.01)	2516434 *	FUSED HETEROAROMATIC PYRROLIDINONES AS SYK INHIBITORS
<b>G01N 33/50</b> (2006.01)	2505662 *	METHOD AND APPARATUS FOR PREDICTION OF PHARMACOLOGICAL EFFICACY OF HUMANIZED ANTI-TNF ANTIBODY DRUG ON RHEUMATOID ARTHRITIS
<b>C12M 1/34</b> (2006.01)	2505662 *	METHOD AND APPARATUS FOR PREDICTION OF PHARMACOLOGICAL EFFICACY OF HUMANIZED ANTI-TNF ANTIBODY DRUG ON RHEUMATOID ARTHRITIS
<b>C12M 1/00</b> (2006.01)	2505662 *	METHOD AND APPARATUS FOR PREDICTION OF PHARMACOLOGICAL EFFICACY OF HUMANIZED ANTI-TNF ANTIBODY DRUG ON RHEUMATOID ARTHRITIS
<b>C12Q 1/68</b> (2006.01)	2505662 *	METHOD AND APPARATUS FOR PREDICTION OF PHARMACOLOGICAL EFFICACY OF HUMANIZED ANTI-TNF ANTIBODY DRUG ON RHEUMATOID ARTHRITIS
<b>C12N 15/09</b> (2006.01)	2505662 *	METHOD AND APPARATUS FOR PREDICTION OF PHARMACOLOGICAL EFFICACY OF HUMANIZED ANTI-TNF ANTIBODY DRUG ON RHEUMATOID ARTHRITIS
<b>C22B 21/00</b> (2006.01)	2534272 *	METAL RECOVERY FROM CONTAMINATED METAL SCRAP
<b>C22B 7/00</b> (2006.01)	2534272 *	METAL RECOVERY FROM CONTAMINATED METAL SCRAP
<b>A61K 9/08</b> (2006.01)	2503991 *	LIQUID PHARMACEUTICAL COMPOSITIONS
<b>A61K 31/435</b> (2006.01)	2503991 *	LIQUID PHARMACEUTICAL COMPOSITIONS
<b>A61P 29/00</b> (2006.01)	2514424 *	PIROXICAM-CONTAINING ENDERMIC PREPARATION
<b>A61K 9/70</b> (2006.01)	2514424 *	PIROXICAM-CONTAINING ENDERMIC PREPARATION
<b>A61K 31/5415</b> (2006.01)	2514424 *	PIROXICAM-CONTAINING ENDERMIC PREPARATION
<b>A61K 47/32</b> (2006.01)	2514424 *	PIROXICAM-CONTAINING ENDERMIC PREPARATION
<b>A61K 47/18</b> (2006.01)	2514424 *	PIROXICAM-CONTAINING ENDERMIC PREPARATION
<b>G06F 21/00</b> (2006.01)	2517141 *	MULTIPLE APPLICATION CHIP CARD HAVING BIOMETRIC VALIDATION
<b>C07D 495/04</b> (2006.01)	2516447 *	PROCESS FOR PREPARING PHARMACEUTICAL COMPOUNDS AND INTERMEDIATE COMPOUNDS
<b>D06F 95/00</b> (2006.01)	2441883	Improved device for raising and/or drawing fabric handworks, particularly linen articles
<b>A61K 31/416</b> (2006.01)	2531191 *	SIGMA LIGANDS FOR USE IN THE PREVENTION AND/OR TREATMENT OF POSTOPERATIVE PAIN
<b>A61K 31/415</b> (2006.01)	2531191 *	SIGMA LIGANDS FOR USE IN THE PREVENTION AND/OR TREATMENT OF POSTOPERATIVE PAIN
<b>A61P 29/00</b> (2006.01)	2531191 *	SIGMA LIGANDS FOR USE IN THE PREVENTION AND/OR TREATMENT OF POSTOPERATIVE PAIN

MKP (51)	Broj objave evropske prijava patenta (97)	Naziv pronalaska (54)
<b>A61K 31/4196</b> (2006.01)	2531191 *	SIGMA LIGANDS FOR USE IN THE PREVENTION AND/OR TREATMENT OF POSTOPERATIVE PAIN
<b>B61H 5/00</b> (2006.01)	2507108 *	RAILWAY VEHICLE BRAKE DISC
<b>F16D 55/02</b> (2006.01)	2507108 *	RAILWAY VEHICLE BRAKE DISC
<b>F16D 65/12</b> (2006.01)	2507108 *	RAILWAY VEHICLE BRAKE DISC
<b>A01N 43/00</b> (2006.01)	2528436 *	HEPATITIS C VIRUS INHIBITORS
<b>C07K 7/08</b> (2006.01)	2536742 *	TREATMENTS FOR GASTROINTESTINAL DISORDERS
<b>A61K 31/4418</b> (2006.01)	2506850 *	METHODS OF ADMINISTERING PIRFENIDONE THERAPY
<b>A61K 31/4412</b> (2006.01)	2506850 *	METHODS OF ADMINISTERING PIRFENIDONE THERAPY
<b>A61P 43/00</b> (2006.01)	2506850 *	METHODS OF ADMINISTERING PIRFENIDONE THERAPY
<b>A61K 31/44</b> (2006.01)	2506850 *	METHODS OF ADMINISTERING PIRFENIDONE THERAPY
<b>C07D 417/12</b> (2006.01)	2513098 *	AMINOPYRIMIDINES AS SYK INHIBITORS
<b>A61P 11/06</b> (2006.01)	2513098 *	AMINOPYRIMIDINES AS SYK INHIBITORS
<b>A61P 11/00</b> (2006.01)	2513098 *	AMINOPYRIMIDINES AS SYK INHIBITORS
<b>A61P 35/00</b> (2006.01)	2513098 *	AMINOPYRIMIDINES AS SYK INHIBITORS
<b>A61P 29/00</b> (2006.01)	2513098 *	AMINOPYRIMIDINES AS SYK INHIBITORS
<b>C07D 417/14</b> (2006.01)	2513098 *	AMINOPYRIMIDINES AS SYK INHIBITORS
<b>A61K 31/497</b> (2006.01)	2513098 *	AMINOPYRIMIDINES AS SYK INHIBITORS
<b>A61P 5/26</b> (2006.01)	2536708 *	ANDROGEN RECEPTOR MODULATORS AND USES THEREOF
<b>A61K 31/5025</b> (2006.01)	2536708 *	ANDROGEN RECEPTOR MODULATORS AND USES THEREOF
<b>A61K 31/4439</b> (2006.01)	2536708 *	ANDROGEN RECEPTOR MODULATORS AND USES THEREOF
<b>C07D 401/04</b> (2006.01)	2536708 *	ANDROGEN RECEPTOR MODULATORS AND USES THEREOF
<b>C07D 487/04</b> (2006.01)	2536708 *	ANDROGEN RECEPTOR MODULATORS AND USES THEREOF
<b>A61P 5/28</b> (2006.01)	2536708 *	ANDROGEN RECEPTOR MODULATORS AND USES THEREOF
<b>A01H 5/00</b> (2006.01)	2512219 *	COMBINED USE OF VIP3AB AND CRY1FA FOR MANAGEMENT OF RESISTANT INSECTS
<b>A01H 1/00</b> (2006.01)	2512219 *	COMBINED USE OF VIP3AB AND CRY1FA FOR MANAGEMENT OF RESISTANT INSECTS
<b>A01P 7/00</b> (2006.01)	2512219 *	COMBINED USE OF VIP3AB AND CRY1FA FOR MANAGEMENT OF RESISTANT INSECTS
<b>C07K 16/32</b> (2006.01)	2513148 *	ANTI-HER2 ANTIBODIES AND THEIR USES
<b>A61Q 17/04</b> (2006.01)	2533860 *	SUNSCREEN COMPOSITIONS COMPRISING AN ULTRAVIOLET RADIATION-ABSORBING POLYMER
<b>A61Q 1/04</b> (2006.01)	2533860 *	SUNSCREEN COMPOSITIONS COMPRISING AN ULTRAVIOLET RADIATION-ABSORBING POLYMER
<b>A61Q 1/02</b> (2006.01)	2533860 *	SUNSCREEN COMPOSITIONS COMPRISING AN ULTRAVIOLET RADIATION-ABSORBING POLYMER
<b>B04B 5/02</b> (2006.01)	2519358 *	CENTRIFUGATION APPARATUS, USE THEREOF AND CENTRIFUGATION METHOD
<b>B04B 9/10</b> (2006.01)	2519358 *	CENTRIFUGATION APPARATUS, USE THEREOF AND CENTRIFUGATION METHOD
<b>B04B 9/08</b> (2006.01)	2519358 *	CENTRIFUGATION APPARATUS, USE THEREOF AND CENTRIFUGATION METHOD
<b>C12N 15/70</b> (2006.01)	2523969 *	BACTERIAL HOST STRAIN EXPRESSING RECOMBINANT DSBC AND HAVING REDUCED TSP ACTIVITY
<b>C07K 14/245</b> (2006.01)	2523969 *	BACTERIAL HOST STRAIN EXPRESSING RECOMBINANT DSBC AND HAVING REDUCED TSP ACTIVITY
<b>F23G 7/06</b> (2006.01)	2528678 *	IMPROVEMENTS IN THERMAL OXIDISERS, USING CONCENTRATED SUNLIGHT

MKP (51)	Broj objave evropske prijava patenta (97)	Naziv pronalaska (54)
<b>B01D 53/72</b> (2006.01)	2528678 *	IMPROVEMENTS IN THERMAL OXIDISERS, USING CONCENTRATED SUNLIGHT
<b>B01D 53/00</b> (2006.01)	2528678 *	IMPROVEMENTS IN THERMAL OXIDISERS, USING CONCENTRATED SUNLIGHT
<b>F24J 2/06</b> (2006.01)	2528678 *	IMPROVEMENTS IN THERMAL OXIDISERS, USING CONCENTRATED SUNLIGHT
<b>F24J 2/07</b> (2006.01)	2528678 *	IMPROVEMENTS IN THERMAL OXIDISERS, USING CONCENTRATED SUNLIGHT
<b>B01J 19/12</b> (2006.01)	2528678 *	IMPROVEMENTS IN THERMAL OXIDISERS, USING CONCENTRATED SUNLIGHT
<b>F23J 15/02</b> (2006.01)	2528678 *	IMPROVEMENTS IN THERMAL OXIDISERS, USING CONCENTRATED SUNLIGHT
<b>B01D 53/73</b> (2006.01)	2528678 *	IMPROVEMENTS IN THERMAL OXIDISERS, USING CONCENTRATED SUNLIGHT
<b>F16D 1/08</b> (2006.01)	2520388	Splined member and process for manufacturing a splined member by shaping and milling
<b>B23C 3/30</b> (2006.01)	2520388	Splined member and process for manufacturing a splined member by shaping and milling
<b>B23F 5/20</b> (2006.01)	2520388	Splined member and process for manufacturing a splined member by shaping and milling
<b>F16D 3/06</b> (2006.01)	2520388	Splined member and process for manufacturing a splined member by shaping and milling
<b>F16F 15/31</b> (2006.01)	2420674	Method of accumulating kinetic energy and rotor device for accumulating and dissipating kinetic energy
<b>F16F 7/10</b> (2006.01)	2420674	Method of accumulating kinetic energy and rotor device for accumulating and dissipating kinetic energy
<b>F03G 3/08</b> (2006.01)	2420674	Method of accumulating kinetic energy and rotor device for accumulating and dissipating kinetic energy
<b>A61K 9/00</b> (2006.01)	2515909 *	FAST DISSOLVING PHARMACEUTICAL COMPOSITION COMPRISING LORNOXICAM
<b>A61K 31/542</b> (2006.01)	2515909 *	FAST DISSOLVING PHARMACEUTICAL COMPOSITION COMPRISING LORNOXICAM
<b>A61K 47/02</b> (2006.01)	2515909 *	FAST DISSOLVING PHARMACEUTICAL COMPOSITION COMPRISING LORNOXICAM
<b>A61K 9/20</b> (2006.01)	2515909 *	FAST DISSOLVING PHARMACEUTICAL COMPOSITION COMPRISING LORNOXICAM
<b>A61K 47/12</b> (2006.01)	2515909 *	FAST DISSOLVING PHARMACEUTICAL COMPOSITION COMPRISING LORNOXICAM
<b>C07K 16/12</b> (2006.01)	2536835 *	ANTIBODY AGAINST SEROTYPE G LIPOPOLYSACCHARIDE OF PSEUDOMONAS AERUGINOSA
<b>C07K 16/46</b> (2006.01)	2536835 *	ANTIBODY AGAINST SEROTYPE G LIPOPOLYSACCHARIDE OF PSEUDOMONAS AERUGINOSA
<b>A61K 39/395</b> (2006.01)	2536835 *	ANTIBODY AGAINST SEROTYPE G LIPOPOLYSACCHARIDE OF PSEUDOMONAS AERUGINOSA
<b>C12N 15/09</b> (2006.01)	2536835 *	ANTIBODY AGAINST SEROTYPE G LIPOPOLYSACCHARIDE OF PSEUDOMONAS AERUGINOSA
<b>C12P 21/08</b> (2006.01)	2536835 *	ANTIBODY AGAINST SEROTYPE G LIPOPOLYSACCHARIDE OF PSEUDOMONAS AERUGINOSA
<b>C12N 5/10</b> (2006.01)	2536835 *	ANTIBODY AGAINST SEROTYPE G LIPOPOLYSACCHARIDE OF PSEUDOMONAS AERUGINOSA
<b>G01N 33/569</b> (2006.01)	2536835 *	ANTIBODY AGAINST SEROTYPE G LIPOPOLYSACCHARIDE OF PSEUDOMONAS AERUGINOSA
<b>A61P 31/04</b> (2006.01)	2536835 *	ANTIBODY AGAINST SEROTYPE G LIPOPOLYSACCHARIDE OF PSEUDOMONAS AERUGINOSA
<b>C12Q 1/68</b> (2006.01)	2385135	RAD51C as a human cancer susceptibility gene
<b>A61L 27/54</b> (2006.01)	2523701 *	STABLE HYDROGEL COMPOSITIONS INCLUDING ADDITIVES
<b>A61L 27/20</b> (2006.01)	2523701 *	STABLE HYDROGEL COMPOSITIONS INCLUDING ADDITIVES

MKP (51)	Broj objave evropske prijava patenta (97)	Naziv pronalaska (54)
<b>C07C 409/34</b> (2006.01)	2519218 *	DIBENZOYL PEROXIDE DERIVATIVES, PREPARATION METHOD THEREOF AND COSMETIC OR DERMATOLOGICAL COMPOSITIONS CONTAINING SAME
<b>A61K 8/38</b> (2006.01)	2519218 *	DIBENZOYL PEROXIDE DERIVATIVES, PREPARATION METHOD THEREOF AND COSMETIC OR DERMATOLOGICAL COMPOSITIONS CONTAINING SAME
<b>A61Q 19/00</b> (2006.01)	2519218 *	DIBENZOYL PEROXIDE DERIVATIVES, PREPARATION METHOD THEREOF AND COSMETIC OR DERMATOLOGICAL COMPOSITIONS CONTAINING SAME
<b>C07K 16/28</b> (2006.01)	2528947 *	CD127 BINDING PROTEINS
<b>C08F 2/38</b> (2006.01)	2519547 *	MACROMONOMER MIXTURE, TERMINAL-REACTIVE POLYMER MIXTURE, INTERMEDIATE FOR MACROMONOMER AND SILICONE HYDROGEL
<b>A61K 31/7115</b> (2006.01)	2512491 *	HBV ANTISENSE INHIBITORS
<b>A61K 31/7125</b> (2006.01)	2512491 *	HBV ANTISENSE INHIBITORS
<b>C12N 15/53</b> (2006.01)	2524044 *	COMPOSITIONS AND METHODS FOR MINIMIZING NORNICOTINE SYNTHESIS IN TOBACCO
<b>C12N 15/82</b> (2006.01)	2524044 *	COMPOSITIONS AND METHODS FOR MINIMIZING NORNICOTINE SYNTHESIS IN TOBACCO
<b>A01H 5/12</b> (2006.01)	2524044 *	COMPOSITIONS AND METHODS FOR MINIMIZING NORNICOTINE SYNTHESIS IN TOBACCO
<b>A01H 5/00</b> (2006.01)	2525650 *	ENGINEERED LANDING PADS FOR GENE TARGETING IN PLANTS
<b>C12N 15/82</b> (2006.01)	2525650 *	ENGINEERED LANDING PADS FOR GENE TARGETING IN PLANTS
<b>C12N 15/29</b> (2006.01)	2525650 *	ENGINEERED LANDING PADS FOR GENE TARGETING IN PLANTS
<b>A61K 31/437</b> (2006.01)	2516436 *	IMIDAZOPYRIDINE DERIVATIVES AS JAK INHIBITORS
<b>C07D 471/04</b> (2006.01)	2516436 *	IMIDAZOPYRIDINE DERIVATIVES AS JAK INHIBITORS
<b>E03C 1/01</b> (2006.01)	2521818 *	DEVICE FOR HEATING WATER FOR A COMBINATION SHOWER-WC
<b>F24D 17/00</b> (2006.01)	2521818 *	DEVICE FOR HEATING WATER FOR A COMBINATION SHOWER-WC
<b>F24H 9/20</b> (2006.01)	2521818 *	DEVICE FOR HEATING WATER FOR A COMBINATION SHOWER-WC
<b>E03C 1/044</b> (2006.01)	2521818 *	DEVICE FOR HEATING WATER FOR A COMBINATION SHOWER-WC
<b>E03D 9/08</b> (2006.01)	2521818 *	DEVICE FOR HEATING WATER FOR A COMBINATION SHOWER-WC
<b>F24H 1/20</b> (2006.01)	2521818 *	DEVICE FOR HEATING WATER FOR A COMBINATION SHOWER-WC
<b>G05D 23/00</b> (2006.01)	2521818 *	DEVICE FOR HEATING WATER FOR A COMBINATION SHOWER-WC
<b>F16F 15/36</b> (2006.01)	2501609 *	METHOD, APPARATUS AND SYSTEM FOR REDUCING VIBRATION IN A ROTARY SYSTEM OF A WATERCRAFT
<b>B63H 21/30</b> (2006.01)	2501609 *	METHOD, APPARATUS AND SYSTEM FOR REDUCING VIBRATION IN A ROTARY SYSTEM OF A WATERCRAFT
<b>H04J 14/02</b> (2006.01)	2448159	Multidirectional add and drop devices for an optical network element
<b>A61K 31/53</b> (2006.01)	2531509 *	IMIDAZO[1,2-B][1,2,4]TRIAZINES AS C-MET INHIBITORS
<b>A61P 29/00</b> (2006.01)	2531509 *	IMIDAZO[1,2-B][1,2,4]TRIAZINES AS C-MET INHIBITORS
<b>A61P 37/00</b> (2006.01)	2531509 *	IMIDAZO[1,2-B][1,2,4]TRIAZINES AS C-MET INHIBITORS
<b>A61P 35/00</b> (2006.01)	2531509 *	IMIDAZO[1,2-B][1,2,4]TRIAZINES AS C-MET INHIBITORS
<b>A61P 1/00</b> (2006.01)	2531509 *	IMIDAZO[1,2-B][1,2,4]TRIAZINES AS C-MET INHIBITORS
<b>A61P 11/00</b> (2006.01)	2531509 *	IMIDAZO[1,2-B][1,2,4]TRIAZINES AS C-MET INHIBITORS
<b>C07D 487/04</b> (2006.01)	2531509 *	IMIDAZO[1,2-B][1,2,4]TRIAZINES AS C-MET INHIBITORS
<b>A61P 9/00</b> (2006.01)	2531509 *	IMIDAZO[1,2-B][1,2,4]TRIAZINES AS C-MET INHIBITORS
<b>B29C 39/00</b> (2006.01)	2431147	Shower base improved by the inclusion in its material of flexible fillings made of recycled car tyres
<b>B29B 17/00</b> (2006.01)	2431147	Shower base improved by the inclusion in its material of flexible fillings made of recycled car tyres
<b>A47K 3/40</b> (2006.01)	2431147	Shower base improved by the inclusion in its material of flexible fillings made of recycled car tyres
<b>C12N 15/88</b> (2006.01)	2506879 *	SNALP FORMULATIONS CONTAINING ANTIOXIDANTS
<b>C12N 15/87</b> (2006.01)	2506879 *	SNALP FORMULATIONS CONTAINING ANTIOXIDANTS
<b>A61K 47/22</b> (2006.01)	2506879 *	SNALP FORMULATIONS CONTAINING ANTIOXIDANTS

MKP (51)	Broj objave evropske prijava patenta (97)	Naziv pronalaska (54)
<b>A61K 9/14</b> (2006.01)	2506879 *	SNALP FORMULATIONS CONTAINING ANTIOXIDANTS
<b>A61K 47/18</b> (2006.01)	2506879 *	SNALP FORMULATIONS CONTAINING ANTIOXIDANTS
<b>C12N 15/10</b> (2006.01)	2506879 *	SNALP FORMULATIONS CONTAINING ANTIOXIDANTS
<b>C12N 15/113</b> (2010.01)	2506879 *	SNALP FORMULATIONS CONTAINING ANTIOXIDANTS
<b>A61K 31/7088</b> (2006.01)	2506879 *	SNALP FORMULATIONS CONTAINING ANTIOXIDANTS
<b>A61P 25/02</b> (2006.01)	2525795 *	METHODS AND COMPOSITIONS FOR IMPROVED NERVE CONDUCTION VELOCITY
<b>A61K 31/4375</b> (2006.01)	2525795 *	METHODS AND COMPOSITIONS FOR IMPROVED NERVE CONDUCTION VELOCITY
<b>A61K 31/472</b> (2006.01)	2525795 *	METHODS AND COMPOSITIONS FOR IMPROVED NERVE CONDUCTION VELOCITY
<b>A61K 31/522</b> (2006.01)	2525795 *	METHODS AND COMPOSITIONS FOR IMPROVED NERVE CONDUCTION VELOCITY
<b>C07D 239/26</b> (2006.01)	2528903 *	5-ALKYNYL-PYRIMIDINES
<b>A61K 31/505</b> (2006.01)	2528903 *	5-ALKYNYL-PYRIMIDINES
<b>C07D 409/14</b> (2006.01)	2528903 *	5-ALKYNYL-PYRIMIDINES
<b>C07D 471/04</b> (2006.01)	2528903 *	5-ALKYNYL-PYRIMIDINES
<b>C07D 487/08</b> (2006.01)	2528903 *	5-ALKYNYL-PYRIMIDINES
<b>C07D 401/14</b> (2006.01)	2528903 *	5-ALKYNYL-PYRIMIDINES
<b>A61P 35/00</b> (2006.01)	2528903 *	5-ALKYNYL-PYRIMIDINES
<b>C07D 401/06</b> (2006.01)	2528903 *	5-ALKYNYL-PYRIMIDINES
<b>A61K 31/506</b> (2006.01)	2528903 *	5-ALKYNYL-PYRIMIDINES
<b>C07D 413/14</b> (2006.01)	2528903 *	5-ALKYNYL-PYRIMIDINES
<b>C07D 405/14</b> (2006.01)	2528903 *	5-ALKYNYL-PYRIMIDINES
<b>A61P 3/04</b> (2006.01)	2515927 *	OXYNTOMODULIN PEPTIDE ANALOGUE
<b>A61K 38/17</b> (2006.01)	2515927 *	OXYNTOMODULIN PEPTIDE ANALOGUE
<b>A61P 3/10</b> (2006.01)	2515927 *	OXYNTOMODULIN PEPTIDE ANALOGUE
<b>C07K 14/605</b> (2006.01)	2515927 *	OXYNTOMODULIN PEPTIDE ANALOGUE
<b>A61K 38/26</b> (2006.01)	2515927 *	OXYNTOMODULIN PEPTIDE ANALOGUE
<b>A61K 31/00</b> (2006.01)	2536399 *	Method for activation and conjugation of biomolecules
<b>A61K 31/20</b> (2006.01)	2521446 *	FATTY ACID DERIVATIVES AND ANALOGS OF DRUGS
<b>A61K 31/44</b> (2006.01)	2521446 *	FATTY ACID DERIVATIVES AND ANALOGS OF DRUGS
<b>A61K 31/35</b> (2006.01)	2521446 *	FATTY ACID DERIVATIVES AND ANALOGS OF DRUGS
<b>A01N 25/26</b> (2006.01)	2521446 *	FATTY ACID DERIVATIVES AND ANALOGS OF DRUGS
<b>A61F 11/00</b> (2006.01)	2519199 *	SYSTEMS AND METHODS FOR ANESTHETIZING EAR TISSUE
<b>A61K 9/00</b> (2006.01)	2519199 *	SYSTEMS AND METHODS FOR ANESTHETIZING EAR TISSUE
<b>A61N 1/30</b> (2006.01)	2519199 *	SYSTEMS AND METHODS FOR ANESTHETIZING EAR TISSUE
<b>A61F 2/20</b> (2006.01)	2512368 *	FLUID FILLED IMPLANTS FOR TREATING MEDICAL CONDITIONS
<b>A61F 2/02</b> (2006.01)	2512368 *	FLUID FILLED IMPLANTS FOR TREATING MEDICAL CONDITIONS
<b>A61F 13/15</b> (2006.01)	2537495	Methods and apparatus for application of nested zero waste ear to traveling web
<b>C07K 4/00</b> (2006.01)	2526419 *	METHODS FOR IMPROVING THE DESIGN, BIOAVAILABILITY, AND EFFICACY OF DIRECTED SEQUENCE POLYMER COMPOSITIONS VIA SERUM PROTEIN-BASED DETECTION OF DIRECTED SEQUENCE POLYMER COMPOSITIONS
<b>G01N 33/53</b> (2006.01)	2526419 *	METHODS FOR IMPROVING THE DESIGN, BIOAVAILABILITY, AND EFFICACY OF DIRECTED SEQUENCE POLYMER COMPOSITIONS VIA SERUM PROTEIN-BASED DETECTION OF DIRECTED SEQUENCE POLYMER COMPOSITIONS
<b>A61P 31/16</b> (2006.01)	2509595 *	INHIBITORS OF HEMOPOIETIC CELL KINASE (P59-HCK) AND THEIR USE IN THE TREATMENT OF INFLUENZA INFECTION
<b>A61K 45/06</b> (2006.01)	2509595 *	INHIBITORS OF HEMOPOIETIC CELL KINASE (P59-HCK) AND THEIR USE IN THE TREATMENT OF INFLUENZA INFECTION
<b>A61K 31/4155</b> (2006.01)	2509595 *	INHIBITORS OF HEMOPOIETIC CELL KINASE (P59-HCK) AND THEIR USE IN THE TREATMENT OF INFLUENZA INFECTION



MKP (51)	Broj objave evropske prijava patenta (97)	Naziv pronalaska (54)
<b>G01N 33/50</b> (2006.01)	2509595 *	INHIBITORS OF HEMOPOIETIC CELL KINASE (P59-HCK) AND THEIR USE IN THE TREATMENT OF INFLUENZA INFECTION
<b>A24F 47/00</b> (2006.01)	2519122 *	A SHAPED HEATER FOR AN AEROSOL GENERATING SYSTEM
<b>B32B 3/00</b> (2006.01)	2522500	Laminating film
<b>A61M 1/12</b> (2006.01)	2528638 *	SELF-CONTAINED CARDIAC PUMP, AND METHOD IMPLEMENTED IN SUCH A PUMP
<b>A61M 1/10</b> (2006.01)	2528638 *	SELF-CONTAINED CARDIAC PUMP, AND METHOD IMPLEMENTED IN SUCH A PUMP
<b>A61K 31/53</b> (2006.01)	2536689 *	ARYL CARBOXAMIDE DERIVATIVES AS SODIUM CHANNEL INHIBITORS FOR TREATMENT OF PAIN
<b>C07D 213/74</b> (2006.01)	2536689 *	ARYL CARBOXAMIDE DERIVATIVES AS SODIUM CHANNEL INHIBITORS FOR TREATMENT OF PAIN
<b>A61K 31/4427</b> (2006.01)	2536689 *	ARYL CARBOXAMIDE DERIVATIVES AS SODIUM CHANNEL INHIBITORS FOR TREATMENT OF PAIN
<b>C07D 251/48</b> (2006.01)	2536689 *	ARYL CARBOXAMIDE DERIVATIVES AS SODIUM CHANNEL INHIBITORS FOR TREATMENT OF PAIN
<b>A61P 29/00</b> (2006.01)	2536689 *	ARYL CARBOXAMIDE DERIVATIVES AS SODIUM CHANNEL INHIBITORS FOR TREATMENT OF PAIN
<b>C07D 401/04</b> (2006.01)	2536689 *	ARYL CARBOXAMIDE DERIVATIVES AS SODIUM CHANNEL INHIBITORS FOR TREATMENT OF PAIN
<b>C07D 239/48</b> (2006.01)	2536689 *	ARYL CARBOXAMIDE DERIVATIVES AS SODIUM CHANNEL INHIBITORS FOR TREATMENT OF PAIN
<b>A61K 31/506</b> (2006.01)	2536689 *	ARYL CARBOXAMIDE DERIVATIVES AS SODIUM CHANNEL INHIBITORS FOR TREATMENT OF PAIN
<b>C07D 403/04</b> (2006.01)	2536689 *	ARYL CARBOXAMIDE DERIVATIVES AS SODIUM CHANNEL INHIBITORS FOR TREATMENT OF PAIN
<b>C07D 471/10</b> (2006.01)	2536689 *	ARYL CARBOXAMIDE DERIVATIVES AS SODIUM CHANNEL INHIBITORS FOR TREATMENT OF PAIN
<b>A61K 31/505</b> (2006.01)	2536689 *	ARYL CARBOXAMIDE DERIVATIVES AS SODIUM CHANNEL INHIBITORS FOR TREATMENT OF PAIN
<b>F25B 29/00</b> (2006.01)	2534357 *	THERMOACOUSTIC MACHINE HAVING AN ELECTRIC FEEDBACK LOOP
<b>F02G 1/04</b> (2006.01)	2534357 *	THERMOACOUSTIC MACHINE HAVING AN ELECTRIC FEEDBACK LOOP
<b>F03G 7/00</b> (2006.01)	2534357 *	THERMOACOUSTIC MACHINE HAVING AN ELECTRIC FEEDBACK LOOP
<b>F02G 1/043</b> (2006.01)	2534357 *	THERMOACOUSTIC MACHINE HAVING AN ELECTRIC FEEDBACK LOOP
<b>A61K 9/20</b> (2006.01)	2512456 *	ABUSE-RESISTANT FORMULATIONS
<b>A61K 31/485</b> (2006.01)	2512456 *	ABUSE-RESISTANT FORMULATIONS
<b>G01N 33/49</b> (2006.01)	2513647 *	PORTABLE COAGULATION MONITORING DEVICE AND METHOD OF ASSESSING COAGULATION RESPONSE
<b>G01N 21/25</b> (2006.01)	2513647 *	PORTABLE COAGULATION MONITORING DEVICE AND METHOD OF ASSESSING COAGULATION RESPONSE
<b>G01N 33/86</b> (2006.01)	2513647 *	PORTABLE COAGULATION MONITORING DEVICE AND METHOD OF ASSESSING COAGULATION RESPONSE
<b>A61P 3/06</b> (2006.01)	2526089 *	A METHOD OF INDUSTRIAL PRODUCTION OF AN AMORPHOUS FORM OF ATORVASTATIN WITH A HIGH SPECIFIC SURFACE AREA AND ITS USE IN A DOSAGE FORM
<b>A61K 31/40</b> (2006.01)	2526089 *	A METHOD OF INDUSTRIAL PRODUCTION OF AN AMORPHOUS FORM OF ATORVASTATIN WITH A HIGH SPECIFIC SURFACE AREA AND ITS USE IN A DOSAGE FORM
<b>C07D 207/34</b> (2006.01)	2526089 *	A METHOD OF INDUSTRIAL PRODUCTION OF AN AMORPHOUS FORM OF ATORVASTATIN WITH A HIGH SPECIFIC SURFACE AREA AND ITS USE IN A DOSAGE FORM
<b>C07D 498/00</b> (2006.01)	2536279 *	CRYSTALLINE FORMS OF SODIUM 4-[[9-CHLORO-7-(2-FLUORO-6-METHOXYPHENYL)-5H-PYRIMIDO[5,4-D][2]BENZAZEPIN-2YL]AMINO]-2-METHOXYBENZOATE
<b>A01N 43/00</b> (2006.01)	2536279 *	CRYSTALLINE FORMS OF SODIUM 4-[[9-CHLORO-7-(2-FLUORO-6-METHOXYPHENYL)-5H-PYRIMIDO[5,4-D][2]BENZAZEPIN-2YL]AMINO]-2-METHOXYBENZOATE

MKP (51)	Broj objave evropske prijava patenta (97)	Naziv pronalaska (54)
<b>A61K 31/55</b> (2006.01)	2536279 *	CRYSTALLINE FORMS OF SODIUM 4-([9-CHLORO-7-(2-FLUORO-6-METHOXYPHENYL)-5H-PYRIMIDO[5,4-D][2]BENZAZEPIN-2YL]AMINO)-2-METHOXYBENZOATE
<b>A61N 1/04</b> (2006.01)	2517754 *	ELECTRODE DEVICE USED FOR IONTOPHORESIS THERAPY
<b>A61N 1/30</b> (2006.01)	2517754 *	ELECTRODE DEVICE USED FOR IONTOPHORESIS THERAPY
<b>E21C 31/08</b> (2006.01)	2499335 *	METHOD FOR MOUNTING A RANGING ARM ON A BODY OF A LONGWALL SHEARER LOADER
<b>C08K 5/00</b> (2006.01)	2528961 *	PROCESS TO MAKE BIODEGRADABLE A SYNTHETIC POLYMER
<b>C08J 11/10</b> (2006.01)	2528961 *	PROCESS TO MAKE BIODEGRADABLE A SYNTHETIC POLYMER
<b>C08G 18/08</b> (2006.01)	2528961 *	PROCESS TO MAKE BIODEGRADABLE A SYNTHETIC POLYMER
<b>A61P 9/14</b> (2006.01)	2531189 *	COMBINATION COMPOSITION, COMPRISING AS ACTIVE INGREDIENT L-CARNITINE OR PROPIONYL L-CARNITINE, FOR THE PREVENTION OR TREATMENT OF CHRONIC VENOUS INSUFFICIENCY
<b>A61K 31/205</b> (2006.01)	2531189 *	COMBINATION COMPOSITION, COMPRISING AS ACTIVE INGREDIENT L-CARNITINE OR PROPIONYL L-CARNITINE, FOR THE PREVENTION OR TREATMENT OF CHRONIC VENOUS INSUFFICIENCY
<b>A61K 31/7048</b> (2006.01)	2531189 *	COMBINATION COMPOSITION, COMPRISING AS ACTIVE INGREDIENT L-CARNITINE OR PROPIONYL L-CARNITINE, FOR THE PREVENTION OR TREATMENT OF CHRONIC VENOUS INSUFFICIENCY
<b>G01N 21/84</b> (2006.01)	2453222	Apparatus and method for radiometry to determine the physico-chemical properties of a sample
<b>G01N 21/35</b> (2006.01)	2453222	Apparatus and method for radiometry to determine the physico-chemical properties of a sample
<b>G01N 21/31</b> (2006.01)	2453222	Apparatus and method for radiometry to determine the physico-chemical properties of a sample
<b>A61K 31/425</b> (2006.01)	2521451 *	HEDGEHOG INHIBITORS
<b>A01N 43/78</b> (2006.01)	2521451 *	HEDGEHOG INHIBITORS
<b>A01H 5/00</b> (2006.01)	2529019 *	METHODS FOR MANUFACTURING PLANT CELL WALLS COMPRISING CHITIN
<b>C12N 9/10</b> (2006.01)	2529019 *	METHODS FOR MANUFACTURING PLANT CELL WALLS COMPRISING CHITIN
<b>A01H 5/10</b> (2006.01)	2529019 *	METHODS FOR MANUFACTURING PLANT CELL WALLS COMPRISING CHITIN
<b>C12N 15/82</b> (2006.01)	2529019 *	METHODS FOR MANUFACTURING PLANT CELL WALLS COMPRISING CHITIN
<b>A61M 5/172</b> (2006.01)	2506896 *	DEVICE AND METHOD FOR DELIVERY OF TWO OR MORE DRUG AGENTS
<b>A61M 5/00</b> (2006.01)	2506896 *	DEVICE AND METHOD FOR DELIVERY OF TWO OR MORE DRUG AGENTS
<b>A61M 5/142</b> (2006.01)	2506896 *	DEVICE AND METHOD FOR DELIVERY OF TWO OR MORE DRUG AGENTS
<b>A61M 5/315</b> (2006.01)	2506896 *	DEVICE AND METHOD FOR DELIVERY OF TWO OR MORE DRUG AGENTS
<b>A61K 31/335</b> (2006.01)	2515898 *	ANTICANCER COMBINATION OF ARTEMISININ-BASED DRUGS AND OTHER CHEMOTHERAPEUTIC AGENTS
<b>A61K 31/4745</b> (2006.01)	2515898 *	ANTICANCER COMBINATION OF ARTEMISININ-BASED DRUGS AND OTHER CHEMOTHERAPEUTIC AGENTS
<b>A61K 31/704</b> (2006.01)	2515898 *	ANTICANCER COMBINATION OF ARTEMISININ-BASED DRUGS AND OTHER CHEMOTHERAPEUTIC AGENTS
<b>A61K 31/24</b> (2006.01)	2515898 *	ANTICANCER COMBINATION OF ARTEMISININ-BASED DRUGS AND OTHER CHEMOTHERAPEUTIC AGENTS
<b>A61P 35/00</b> (2006.01)	2515898 *	ANTICANCER COMBINATION OF ARTEMISININ-BASED DRUGS AND OTHER CHEMOTHERAPEUTIC AGENTS
<b>A01N 43/90</b> (2006.01)	2521452 *	THIAZOLO[5,4-d]PYRIMIDINES AND THEIR USE AS AGROCHEMICALS
<b>F16K 11/20</b> (2006.01)	2472150	System and valve unit
<b>E03C 1/04</b> (2006.01)	2472150	System and valve unit
<b>B67D 1/00</b> (2006.01)	2472150	System and valve unit
<b>C07D 491/04</b> (2006.01)	2513115 *	TRICYCLIC ANTIBIOTICS
<b>A61K 31/4741</b> (2006.01)	2513115 *	TRICYCLIC ANTIBIOTICS
<b>A61K 31/4743</b> (2006.01)	2513115 *	TRICYCLIC ANTIBIOTICS
<b>C07D 495/04</b> (2006.01)	2513115 *	TRICYCLIC ANTIBIOTICS

MKP (51)	Broj objave evropske prijave patenta (97)	Naziv pronalaska (54)
<b>A61P 31/04</b> (2006.01)	2513115 *	TRICYCLIC ANTIBIOTICS
<b>C07K 5/06</b> (2006.01)	2524925 *	LANTHIONINE DERIVATIVE
<b>A23L 1/226</b> (2006.01)	2524925 *	LANTHIONINE DERIVATIVE
<b>A23L 1/30</b> (2006.01)	2524925 *	LANTHIONINE DERIVATIVE
<b>C07D 281/06</b> (2006.01)	2524925 *	LANTHIONINE DERIVATIVE
<b>A61K 39/395</b> (2006.01)	2521536 *	STABILIZED FORMULATIONS CONTAINING ANTI-INTERLEUKIN-6 RECEPTOR (IL-6R) ANTIBODIES
<b>A61K 9/08</b> (2006.01)	2521536 *	STABILIZED FORMULATIONS CONTAINING ANTI-INTERLEUKIN-6 RECEPTOR (IL-6R) ANTIBODIES
<b>A61K 9/00</b> (2006.01)	2521536 *	STABILIZED FORMULATIONS CONTAINING ANTI-INTERLEUKIN-6 RECEPTOR (IL-6R) ANTIBODIES
<b>A61K 31/485</b> (2006.01)	2521536 *	STABILIZED FORMULATIONS CONTAINING ANTI-INTERLEUKIN-6 RECEPTOR (IL-6R) ANTIBODIES
<b>A01K 53/00</b> (2006.01)	2523549 *	BEE FEEDER WITH AUTOMATIC PRESSURE CONTROL
<b>A62D 3/36</b> (2007.01)	2509688 *	PROCESS AND APPARATUS FOR THE ANNIHILATION OF HARMFUL WASTE CONTAINING POLYCHLORINATED HYDROCARBONS
<b>A62D 3/40</b> (2007.01)	2509688 *	PROCESS AND APPARATUS FOR THE ANNIHILATION OF HARMFUL WASTE CONTAINING POLYCHLORINATED HYDROCARBONS
<b>A62D 3/34</b> (2007.01)	2509688 *	PROCESS AND APPARATUS FOR THE ANNIHILATION OF HARMFUL WASTE CONTAINING POLYCHLORINATED HYDROCARBONS
<b>A61M 5/24</b> (2006.01)	2450072	Medicated module with floating piston
<b>A61P 9/00</b> (2006.01)	2521726 *	5-OXO-5, 8-DIHYDROPYRIDO [2, 3-D]PYRIMIDINE DERIVATIVES AS CAMKII KINASE INHIBITORS FOR TREATING CARDIOVASCULAR DISEASES
<b>A61K 31/519</b> (2006.01)	2521726 *	5-OXO-5, 8-DIHYDROPYRIDO [2, 3-D]PYRIMIDINE DERIVATIVES AS CAMKII KINASE INHIBITORS FOR TREATING CARDIOVASCULAR DISEASES
<b>C07D 471/04</b> (2006.01)	2521726 *	5-OXO-5, 8-DIHYDROPYRIDO [2, 3-D]PYRIMIDINE DERIVATIVES AS CAMKII KINASE INHIBITORS FOR TREATING CARDIOVASCULAR DISEASES
<b>A61B 17/072</b> (2006.01)	2512351 *	SURGICAL STAPLER WITH DISCRETE STAPLE HEIGHT ADJUSTMENT AND TACTILE FEEDBACK
<b>A61B 17/29</b> (2006.01)	2512351 *	SURGICAL STAPLER WITH DISCRETE STAPLE HEIGHT ADJUSTMENT AND TACTILE FEEDBACK
<b>A61B 17/115</b> (2006.01)	2512351 *	SURGICAL STAPLER WITH DISCRETE STAPLE HEIGHT ADJUSTMENT AND TACTILE FEEDBACK
<b>A61B 19/00</b> (2006.01)	2512351 *	SURGICAL STAPLER WITH DISCRETE STAPLE HEIGHT ADJUSTMENT AND TACTILE FEEDBACK
<b>C07K 16/28</b> (2006.01)	2523976 *	BIOMARKERS OF IMMUNOMODULATORY EFFECTS IN HUMANS TREATED WITH ANTI-CD200 ANTIBODIES
<b>C12N 15/85</b> (2006.01)	2501817 *	COMMON LIGHT CHAIN MOUSE
<b>C07K 16/46</b> (2006.01)	2501817 *	COMMON LIGHT CHAIN MOUSE
<b>A01K 67/027</b> (2006.01)	2501817 *	COMMON LIGHT CHAIN MOUSE
<b>C07K 16/18</b> (2006.01)	2523974 *	WNT-BINDING AGENTS AND USES THEREOF
<b>C07K 16/22</b> (2006.01)	2510001 *	MONOCLONAL ANTIBODIES AGAINST THE RGM A PROTEIN FOR USE IN THE TREATMENT OF RETINAL NERVE FIBER LAYER DEGENERATION
<b>A61K 39/395</b> (2006.01)	2510001 *	MONOCLONAL ANTIBODIES AGAINST THE RGM A PROTEIN FOR USE IN THE TREATMENT OF RETINAL NERVE FIBER LAYER DEGENERATION
<b>A61M 5/315</b> (2006.01)	2509663 *	DRIVE ASSEMBLY FOR A DRUG DELIVERY DEVICE AND DRUG DELIVERY DEVICE
<b>A01N 43/54</b> (2006.01)	2523559 *	COMPOUNDS AND METHODS
<b>A01N 43/00</b> (2006.01)	2531027 *	ANTIVIRAL THERAPY
<b>A61K 9/14</b> (2006.01)	2515874 *	CALCIPOTRIOL MONOHYDRATE NANOCRYSTALS
<b>A61K 31/593</b> (2006.01)	2515874 *	CALCIPOTRIOL MONOHYDRATE NANOCRYSTALS
<b>F22B 37/40</b> (2006.01)	2388519	System for creating a protected working area within a working room separated by a wall
<b>F22B 37/24</b> (2006.01)	2388519	System for creating a protected working area within a working room separated by a wall

MKP (51)	Broj objave evropske prijava patenta (97)	Naziv pronalaska (54)
<b>C07D 407/12</b> (2006.01)	2519505 *	NEW TERTIARY 8-HYDROXYQUINOLINE-7-CARBOXAMIDE DERIVATIVES AND USES THEREOF
<b>C07D 491/113</b> (2006.01)	2519505 *	NEW TERTIARY 8-HYDROXYQUINOLINE-7-CARBOXAMIDE DERIVATIVES AND USES THEREOF
<b>C07D 215/48</b> (2006.01)	2519505 *	NEW TERTIARY 8-HYDROXYQUINOLINE-7-CARBOXAMIDE DERIVATIVES AND USES THEREOF
<b>A61P 31/10</b> (2006.01)	2519505 *	NEW TERTIARY 8-HYDROXYQUINOLINE-7-CARBOXAMIDE DERIVATIVES AND USES THEREOF
<b>C07D 401/06</b> (2006.01)	2519505 *	NEW TERTIARY 8-HYDROXYQUINOLINE-7-CARBOXAMIDE DERIVATIVES AND USES THEREOF
<b>C07D 401/12</b> (2006.01)	2519505 *	NEW TERTIARY 8-HYDROXYQUINOLINE-7-CARBOXAMIDE DERIVATIVES AND USES THEREOF
<b>C07D 407/06</b> (2006.01)	2519505 *	NEW TERTIARY 8-HYDROXYQUINOLINE-7-CARBOXAMIDE DERIVATIVES AND USES THEREOF
<b>A61K 31/4709</b> (2006.01)	2519505 *	NEW TERTIARY 8-HYDROXYQUINOLINE-7-CARBOXAMIDE DERIVATIVES AND USES THEREOF
<b>C07D 417/06</b> (2006.01)	2519505 *	NEW TERTIARY 8-HYDROXYQUINOLINE-7-CARBOXAMIDE DERIVATIVES AND USES THEREOF
<b>A61K 47/36</b> (2006.01)	2509634 *	STABLE FORMULATIONS FOR LYOPHILIZING THERAPEUTIC PARTICLES
<b>A61P 35/00</b> (2006.01)	2509634 *	STABLE FORMULATIONS FOR LYOPHILIZING THERAPEUTIC PARTICLES
<b>A61K 47/30</b> (2006.01)	2509634 *	STABLE FORMULATIONS FOR LYOPHILIZING THERAPEUTIC PARTICLES
<b>A61K 47/40</b> (2006.01)	2509634 *	STABLE FORMULATIONS FOR LYOPHILIZING THERAPEUTIC PARTICLES
<b>A61K 31/335</b> (2006.01)	2509634 *	STABLE FORMULATIONS FOR LYOPHILIZING THERAPEUTIC PARTICLES
<b>A61K 47/02</b> (2006.01)	2509634 *	STABLE FORMULATIONS FOR LYOPHILIZING THERAPEUTIC PARTICLES
<b>C12N 5/00</b> (2006.01)	2509605 *	P2X7: INHIBITION OF EPITHELIAL CANCERS AND PAPILLOMAS
<b>A61K 31/70</b> (2006.01)	2509605 *	P2X7: INHIBITION OF EPITHELIAL CANCERS AND PAPILLOMAS
<b>A61P 19/10</b> (2006.01)	2515942 *	THERAPEUTIC POLYMERIC NANOPARTICLE COMPOSITIONS WITH HIGH GLASS TRANSITION TEMPERATURE OR HIGH MOLECULAR WEIGHT COPOLYMERS
<b>A61P 11/06</b> (2006.01)	2515942 *	THERAPEUTIC POLYMERIC NANOPARTICLE COMPOSITIONS WITH HIGH GLASS TRANSITION TEMPERATURE OR HIGH MOLECULAR WEIGHT COPOLYMERS
<b>A61K 9/127</b> (2006.01)	2515942 *	THERAPEUTIC POLYMERIC NANOPARTICLE COMPOSITIONS WITH HIGH GLASS TRANSITION TEMPERATURE OR HIGH MOLECULAR WEIGHT COPOLYMERS
<b>A61P 29/00</b> (2006.01)	2515942 *	THERAPEUTIC POLYMERIC NANOPARTICLE COMPOSITIONS WITH HIGH GLASS TRANSITION TEMPERATURE OR HIGH MOLECULAR WEIGHT COPOLYMERS
<b>A61K 47/30</b> (2006.01)	2515942 *	THERAPEUTIC POLYMERIC NANOPARTICLE COMPOSITIONS WITH HIGH GLASS TRANSITION TEMPERATURE OR HIGH MOLECULAR WEIGHT COPOLYMERS
<b>A61K 31/337</b> (2006.01)	2515942 *	THERAPEUTIC POLYMERIC NANOPARTICLE COMPOSITIONS WITH HIGH GLASS TRANSITION TEMPERATURE OR HIGH MOLECULAR WEIGHT COPOLYMERS
<b>B01D 53/64</b> (2006.01)	2531276 *	METHOD AND SYSTEM FOR CONTROLLING MERCURY EMISSIONS FROM COAL-FIRED THERMAL PROCESSES
<b>A61B 5/103</b> (2006.01)	2512336 *	METHOD AND APPARATUS PROVIDING TIMED VISUAL IMAGES DURING CHILDBIRTH
<b>G06F 19/00</b> (2011.01)	2538362	Method and system for patient-specific modeling of blood flow
<b>C08F 4/80</b> (2006.01)	2519350 *	HIGHLY ACTIVE METATHESIS CATALYSIS SELECTIVE FOR ROMP AND RCM
<b>B01J 31/22</b> (2006.01)	2519350 *	HIGHLY ACTIVE METATHESIS CATALYSIS SELECTIVE FOR ROMP AND RCM
<b>C07F 15/00</b> (2006.01)	2519350 *	HIGHLY ACTIVE METATHESIS CATALYSIS SELECTIVE FOR ROMP AND RCM
<b>G06F 9/50</b> (2006.01)	2534579 *	SCENARIO STATE PROCESSING SYSTEMS AND METHODS FOR OPERATION WITHIN A GRID COMPUTING ENVIRONMENT
<b>A63B 23/02</b> (2006.01)	2428255	Improved abdominal exerciser with rotatable seat and tandem pulley features
<b>A63B 21/045</b> (2006.01)	2428255	Improved abdominal exerciser with rotatable seat and tandem pulley features

MKP (51)	Broj objave evropske prijava patenta (97)	Naziv pronalaska (54)
<b>A63B 22/14</b> (2006.01)	2428255	Improved abdominal exerciser with rotatable seat and tandem pulley features
<b>A61K 31/165</b> (2006.01)	2533774 *	USE OF AGOMELATINE FOR THE PREPARATION OF DRUGS FOR TREATING OBSESSIVE COMPULSIVE DISORDER (OCD)
<b>A61P 25/22</b> (2006.01)	2533774 *	USE OF AGOMELATINE FOR THE PREPARATION OF DRUGS FOR TREATING OBSESSIVE COMPULSIVE DISORDER (OCD)
<b>A01P 13/00</b> (2006.01)	2503889 *	IMPROVED PROCESS FOR PREPARING SOLUBLE GRANULES OF SALTS OF PYRIDINE-CARBOXYLIC ACIDS
<b>A01N 43/40</b> (2006.01)	2503889 *	IMPROVED PROCESS FOR PREPARING SOLUBLE GRANULES OF SALTS OF PYRIDINE-CARBOXYLIC ACIDS
<b>A01N 33/12</b> (2006.01)	2503889 *	IMPROVED PROCESS FOR PREPARING SOLUBLE GRANULES OF SALTS OF PYRIDINE-CARBOXYLIC ACIDS
<b>A01N 25/12</b> (2006.01)	2503889 *	IMPROVED PROCESS FOR PREPARING SOLUBLE GRANULES OF SALTS OF PYRIDINE-CARBOXYLIC ACIDS
<b>A01N 25/14</b> (2006.01)	2503889 *	IMPROVED PROCESS FOR PREPARING SOLUBLE GRANULES OF SALTS OF PYRIDINE-CARBOXYLIC ACIDS
<b>G01N 33/68</b> (2006.01)	2504457 *	NOVEL GENOMIC BIOMARKERS FOR IRRITABLE BOWEL SYNDROME DIAGNOSIS
<b>C12N 15/12</b> (2006.01)	2504457 *	NOVEL GENOMIC BIOMARKERS FOR IRRITABLE BOWEL SYNDROME DIAGNOSIS
<b>C12Q 1/68</b> (2006.01)	2504457 *	NOVEL GENOMIC BIOMARKERS FOR IRRITABLE BOWEL SYNDROME DIAGNOSIS
<b>A61K 31/495</b> (2006.01)	2515900 *	METHOD OF TREATING ATRIAL FIBRILLATION
<b>A61K 31/343</b> (2006.01)	2515900 *	METHOD OF TREATING ATRIAL FIBRILLATION
<b>A61P 9/06</b> (2006.01)	2515900 *	METHOD OF TREATING ATRIAL FIBRILLATION
<b>A61N 5/06</b> (2006.01)	2353478	Shower device with thermal radiant source
<b>A47K 3/28</b> (2006.01)	2353478	Shower device with thermal radiant source
<b>A61H 33/06</b> (2006.01)	2353478	Shower device with thermal radiant source
<b>A01B 69/00</b> (2006.01)	2454927	Mowing apparatus and grass maintenance system
<b>A47B 88/04</b> (2006.01)	2454927	Mowing apparatus and grass maintenance system
<b>A01D 34/835</b> (2006.01)	2454927	Mowing apparatus and grass maintenance system
<b>A01D 34/00</b> (2006.01)	2454927	Mowing apparatus and grass maintenance system
<b>E04D 11/00</b> (2006.01)	2454927	Mowing apparatus and grass maintenance system
<b>A47B 88/00</b> (2006.01)	2454927	Mowing apparatus and grass maintenance system
<b>C07D 487/04</b> (2006.01)	2536730 *	PYRROLOPYRIMIDINE COMPOUNDS AS INHIBITORS OF CDK4/6
<b>A61K 31/519</b> (2006.01)	2536730 *	PYRROLOPYRIMIDINE COMPOUNDS AS INHIBITORS OF CDK4/6
<b>C07D 519/00</b> (2006.01)	2536730 *	PYRROLOPYRIMIDINE COMPOUNDS AS INHIBITORS OF CDK4/6
<b>A61P 35/00</b> (2006.01)	2536730 *	PYRROLOPYRIMIDINE COMPOUNDS AS INHIBITORS OF CDK4/6
<b>C07B 59/00</b> (2006.01)	2536730 *	PYRROLOPYRIMIDINE COMPOUNDS AS INHIBITORS OF CDK4/6
<b>C07D 405/12</b> (2006.01)	2504315 *	AMINO HETEROARYL COMPOUNDS AS BETA-SECRETASE MODULATORS AND METHODS OF USE
<b>C07D 401/04</b> (2006.01)	2504315 *	AMINO HETEROARYL COMPOUNDS AS BETA-SECRETASE MODULATORS AND METHODS OF USE
<b>C07D 417/04</b> (2006.01)	2504315 *	AMINO HETEROARYL COMPOUNDS AS BETA-SECRETASE MODULATORS AND METHODS OF USE
<b>A61P 25/28</b> (2006.01)	2504315 *	AMINO HETEROARYL COMPOUNDS AS BETA-SECRETASE MODULATORS AND METHODS OF USE
<b>C07D 401/10</b> (2006.01)	2504315 *	AMINO HETEROARYL COMPOUNDS AS BETA-SECRETASE MODULATORS AND METHODS OF USE
<b>A61K 31/4709</b> (2006.01)	2504315 *	AMINO HETEROARYL COMPOUNDS AS BETA-SECRETASE MODULATORS AND METHODS OF USE
<b>C07D 401/12</b> (2006.01)	2504315 *	AMINO HETEROARYL COMPOUNDS AS BETA-SECRETASE MODULATORS AND METHODS OF USE
<b>C07D 215/38</b> (2006.01)	2504315 *	AMINO HETEROARYL COMPOUNDS AS BETA-SECRETASE MODULATORS AND METHODS OF USE

MKP (51)	Broj objave evropske prijava patenta (97)	Naziv pronalaska (54)
<b>C07D 213/84</b> (2006.01)	2507211 *	APOPTOSIS-INDUCING AGENTS FOR THE TREATMENT OF CANCER AND IMMUNE AND AUTOIMMUNE DISEASES
<b>C07D 405/14</b> (2006.01)	2507211 *	APOPTOSIS-INDUCING AGENTS FOR THE TREATMENT OF CANCER AND IMMUNE AND AUTOIMMUNE DISEASES
<b>C07D 213/74</b> (2006.01)	2507211 *	APOPTOSIS-INDUCING AGENTS FOR THE TREATMENT OF CANCER AND IMMUNE AND AUTOIMMUNE DISEASES
<b>C07D 405/12</b> (2006.01)	2507211 *	APOPTOSIS-INDUCING AGENTS FOR THE TREATMENT OF CANCER AND IMMUNE AND AUTOIMMUNE DISEASES
<b>C07D 209/08</b> (2006.01)	2507211 *	APOPTOSIS-INDUCING AGENTS FOR THE TREATMENT OF CANCER AND IMMUNE AND AUTOIMMUNE DISEASES
<b>C07D 401/14</b> (2006.01)	2507211 *	APOPTOSIS-INDUCING AGENTS FOR THE TREATMENT OF CANCER AND IMMUNE AND AUTOIMMUNE DISEASES
<b>C07D 211/58</b> (2006.01)	2507211 *	APOPTOSIS-INDUCING AGENTS FOR THE TREATMENT OF CANCER AND IMMUNE AND AUTOIMMUNE DISEASES
<b>C07D 403/12</b> (2006.01)	2507211 *	APOPTOSIS-INDUCING AGENTS FOR THE TREATMENT OF CANCER AND IMMUNE AND AUTOIMMUNE DISEASES
<b>C07D 231/56</b> (2006.01)	2507211 *	APOPTOSIS-INDUCING AGENTS FOR THE TREATMENT OF CANCER AND IMMUNE AND AUTOIMMUNE DISEASES
<b>C07D 413/12</b> (2006.01)	2507211 *	APOPTOSIS-INDUCING AGENTS FOR THE TREATMENT OF CANCER AND IMMUNE AND AUTOIMMUNE DISEASES
<b>C07D 309/04</b> (2006.01)	2507211 *	APOPTOSIS-INDUCING AGENTS FOR THE TREATMENT OF CANCER AND IMMUNE AND AUTOIMMUNE DISEASES
<b>C07D 235/06</b> (2006.01)	2507211 *	APOPTOSIS-INDUCING AGENTS FOR THE TREATMENT OF CANCER AND IMMUNE AND AUTOIMMUNE DISEASES
<b>C07D 417/12</b> (2006.01)	2507211 *	APOPTOSIS-INDUCING AGENTS FOR THE TREATMENT OF CANCER AND IMMUNE AND AUTOIMMUNE DISEASES
<b>C07D 277/24</b> (2006.01)	2507211 *	APOPTOSIS-INDUCING AGENTS FOR THE TREATMENT OF CANCER AND IMMUNE AND AUTOIMMUNE DISEASES
<b>C07D 471/04</b> (2006.01)	2507211 *	APOPTOSIS-INDUCING AGENTS FOR THE TREATMENT OF CANCER AND IMMUNE AND AUTOIMMUNE DISEASES
<b>A61K 31/435</b> (2006.01)	2509597 *	SELECTIVE BETA-GLUCURONIDASE INHIBITORS AS A TREATMENT FOR SIDE EFFECTS OF CAMPTOTHECIN ANTINEOPLASTIC AGENTS
<b>A61K 31/335</b> (2006.01)	2509597 *	SELECTIVE BETA-GLUCURONIDASE INHIBITORS AS A TREATMENT FOR SIDE EFFECTS OF CAMPTOTHECIN ANTINEOPLASTIC AGENTS
<b>A61K 31/38</b> (2006.01)	2509597 *	SELECTIVE BETA-GLUCURONIDASE INHIBITORS AS A TREATMENT FOR SIDE EFFECTS OF CAMPTOTHECIN ANTINEOPLASTIC AGENTS
<b>C07D 498/04</b> (2006.01)	2523963 *	2,5-SUBSTITUTED OXAZOLOPYRIMIDINE DERIVATIVES
<b>A61K 31/519</b> (2006.01)	2523963 *	2,5-SUBSTITUTED OXAZOLOPYRIMIDINE DERIVATIVES
<b>A61P 9/00</b> (2006.01)	2523963 *	2,5-SUBSTITUTED OXAZOLOPYRIMIDINE DERIVATIVES
<b>A61K 47/48</b> (2006.01)	2525829 *	DIPEPTIDE-BASED PRODRUG LINKERS FOR AROMATIC AMINE-CONTAINING DRUGS
<b>E01F 15/08</b> (2006.01)	2513376 *	ROAD ARRANGEMENT
<b>A61K 39/395</b> (2006.01)	2523689 *	IL-22-FC AND HEPICIDIN ACTIVITY
<b>A61K 39/00</b> (2006.01)	2519253 *	INHIBITORS OF VASCULAR ENDOTHELIAL GROWTH FACTOR (VEGF) RECEPTORS AND METHODS OF USE THEREOF
<b>A61K 39/395</b> (2006.01)	2519253 *	INHIBITORS OF VASCULAR ENDOTHELIAL GROWTH FACTOR (VEGF) RECEPTORS AND METHODS OF USE THEREOF
<b>F16K 15/20</b> (2006.01)	2522532 *	AN AUTONOMOUS VALVE ASSEMBLY FOR THE REGULATION, DEPRESSURISATION AND PRESSURISATION OF PNEUMATIC EQUIPMENT
<b>B60C 23/00</b> (2006.01)	2522532 *	AN AUTONOMOUS VALVE ASSEMBLY FOR THE REGULATION, DEPRESSURISATION AND PRESSURISATION OF PNEUMATIC EQUIPMENT
<b>B60C 23/10</b> (2006.01)	2522532 *	AN AUTONOMOUS VALVE ASSEMBLY FOR THE REGULATION, DEPRESSURISATION AND PRESSURISATION OF PNEUMATIC EQUIPMENT
<b>A61K 39/00</b> (2006.01)	2533805 *	15-VALENT PNEUMOCOCCAL POLYSACCHARIDE-PROTEIN CONJUGATE VACCINE COMPOSITION
<b>A61K 31/427</b> (2006.01)	2536717 *	AMINOTHIAZOLONES AS ESTROGEN RELATED RECEPTOR-ALPHA MODULATORS

MKP (51)	Broj objave evropske prijava patenta (97)	Naziv pronalaska (54)
<b>C07D 417/06</b> (2006.01)	2536717 *	AMINOTHAZOLONES AS ESTROGEN RELATED RECEPTOR-ALPHA MODULATORS
<b>A61K 31/4439</b> (2006.01)	2536717 *	AMINOTHAZOLONES AS ESTROGEN RELATED RECEPTOR-ALPHA MODULATORS
<b>A61P 19/00</b> (2006.01)	2536717 *	AMINOTHAZOLONES AS ESTROGEN RELATED RECEPTOR-ALPHA MODULATORS
<b>C07D 417/14</b> (2006.01)	2536717 *	AMINOTHAZOLONES AS ESTROGEN RELATED RECEPTOR-ALPHA MODULATORS
<b>A61F 2/00</b> (2006.01)	2512367 *	BROW LIFT IMPLANT
<b>A01P 7/04</b> (2006.01)	2536280 *	SYNERGISTIC HERBICIDE/INSECTICIDE COMPOSITION CONTAINING CERTAIN PYRIDINE CARBOXYLIC ACIDS AND CERTAIN INSECTICIDES
<b>A01N 43/40</b> (2006.01)	2536280 *	SYNERGISTIC HERBICIDE/INSECTICIDE COMPOSITION CONTAINING CERTAIN PYRIDINE CARBOXYLIC ACIDS AND CERTAIN INSECTICIDES
<b>A01P 13/00</b> (2006.01)	2536280 *	SYNERGISTIC HERBICIDE/INSECTICIDE COMPOSITION CONTAINING CERTAIN PYRIDINE CARBOXYLIC ACIDS AND CERTAIN INSECTICIDES
<b>A61K 39/08</b> (2006.01)	2501403 *	(POLY)-GLYCEROLPHOSPHATE-BASED ANTI-GRAM POSITIVE BACTERIAL VACCINE
<b>A61K 9/28</b> (2006.01)	2509587 *	PARTIAL DIP COATING OF DOSAGE FORMS FOR MODIFIED RELEASE
<b>A61K 9/50</b> (2006.01)	2509587 *	PARTIAL DIP COATING OF DOSAGE FORMS FOR MODIFIED RELEASE
<b>A61K 9/48</b> (2006.01)	2509587 *	PARTIAL DIP COATING OF DOSAGE FORMS FOR MODIFIED RELEASE
<b>A01N 43/16</b> (2006.01)	2523554 *	HERBICIDAL COMPOSITION COMPRISING A PYRANDIONE HERBICIDE AND A CO-HERBICIDE
<b>A01P 13/00</b> (2006.01)	2523554 *	HERBICIDAL COMPOSITION COMPRISING A PYRANDIONE HERBICIDE AND A CO-HERBICIDE
<b>B65D 81/34</b> (2006.01)	2484604	Package for the preservation and cooking of food products and method of its use
<b>B65D 81/32</b> (2006.01)	2484604	Package for the preservation and cooking of food products and method of its use
<b>A61K 31/7076</b> (2006.01)	2523669 *	COMBINATION, KIT AND METHOD OF REDUCING INTRAOCULAR PRESSURE
<b>A61P 27/02</b> (2006.01)	2523669 *	COMBINATION, KIT AND METHOD OF REDUCING INTRAOCULAR PRESSURE
<b>A61K 31/5575</b> (2006.01)	2523669 *	COMBINATION, KIT AND METHOD OF REDUCING INTRAOCULAR PRESSURE
<b>C07D 213/63</b> (2006.01)	2509949 *	PYRIDINONE HYDROXYCYCLOPENTYL CARBOXAMIDES: HIV INTEGRASE INHIBITORS WITH THERAPEUTIC APPLICATIONS
<b>A61K 31/4439</b> (2006.01)	2509949 *	PYRIDINONE HYDROXYCYCLOPENTYL CARBOXAMIDES: HIV INTEGRASE INHIBITORS WITH THERAPEUTIC APPLICATIONS
<b>A61K 31/4412</b> (2006.01)	2509949 *	PYRIDINONE HYDROXYCYCLOPENTYL CARBOXAMIDES: HIV INTEGRASE INHIBITORS WITH THERAPEUTIC APPLICATIONS
<b>A61P 31/18</b> (2006.01)	2509949 *	PYRIDINONE HYDROXYCYCLOPENTYL CARBOXAMIDES: HIV INTEGRASE INHIBITORS WITH THERAPEUTIC APPLICATIONS
<b>C07D 401/12</b> (2006.01)	2509949 *	PYRIDINONE HYDROXYCYCLOPENTYL CARBOXAMIDES: HIV INTEGRASE INHIBITORS WITH THERAPEUTIC APPLICATIONS
<b>A61K 38/17</b> (2006.01)	2515928 *	OXYNTOMODULIN PEPTIDE ANALOGUE
<b>A61P 3/10</b> (2006.01)	2515928 *	OXYNTOMODULIN PEPTIDE ANALOGUE
<b>A61K 38/26</b> (2006.01)	2515928 *	OXYNTOMODULIN PEPTIDE ANALOGUE
<b>C07K 14/605</b> (2006.01)	2515928 *	OXYNTOMODULIN PEPTIDE ANALOGUE
<b>A61P 3/04</b> (2006.01)	2515928 *	OXYNTOMODULIN PEPTIDE ANALOGUE
<b>C07D 471/04</b> (2006.01)	2536723 *	PYRAZOLO PIPERIDINE DERIVATIVES AS NADPH OXIDASE INHIBITORS
<b>A61P 35/00</b> (2006.01)	2536723 *	PYRAZOLO PIPERIDINE DERIVATIVES AS NADPH OXIDASE INHIBITORS
<b>A61K 31/4162</b> (2006.01)	2536723 *	PYRAZOLO PIPERIDINE DERIVATIVES AS NADPH OXIDASE INHIBITORS
<b>A61K 9/127</b> (2006.01)	2512487 *	THERAPEUTIC POLYMERIC NANOPARTICLES COMPRISING CORTICOSTEROIDS AND METHODS OF MAKING AND USING SAME
<b>A61K 31/56</b> (2006.01)	2512487 *	THERAPEUTIC POLYMERIC NANOPARTICLES COMPRISING CORTICOSTEROIDS AND METHODS OF MAKING AND USING SAME

MKP (51)	Broj objave evropske prijava patenta (97)	Naziv pronalaska (54)
<b>A61K 31/573</b> (2006.01)	2512487 *	THERAPEUTIC POLYMERIC NANOPARTICLES COMPRISING CORTICOSTEROIDS AND METHODS OF MAKING AND USING SAME
<b>A61K 47/48</b> (2006.01)	2512487 *	THERAPEUTIC POLYMERIC NANOPARTICLES COMPRISING CORTICOSTEROIDS AND METHODS OF MAKING AND USING SAME
<b>A61K 47/30</b> (2006.01)	2512487 *	THERAPEUTIC POLYMERIC NANOPARTICLES COMPRISING CORTICOSTEROIDS AND METHODS OF MAKING AND USING SAME
<b>A61K 9/22</b> (2006.01)	2512487 *	THERAPEUTIC POLYMERIC NANOPARTICLES COMPRISING CORTICOSTEROIDS AND METHODS OF MAKING AND USING SAME
<b>A01N 43/90</b> (2006.01)	2528435 *	SYNERGISTIC HERBICIDAL COMPOSITION CONTAINING PENOXSULAM AND OXYFLUORFEN
<b>A01P 13/00</b> (2006.01)	2528435 *	SYNERGISTIC HERBICIDAL COMPOSITION CONTAINING PENOXSULAM AND OXYFLUORFEN
<b>A01N 33/22</b> (2006.01)	2528435 *	SYNERGISTIC HERBICIDAL COMPOSITION CONTAINING PENOXSULAM AND OXYFLUORFEN
<b>A01H 5/00</b> (2006.01)	2536266 *	AXMI218, AXMI219, AXMI220, AXMI226, AXMI227, AXMI228, AXMI229, AXMI230, AND AXMI231 DELTA-ENDOTOXIN GENES AND METHODS FOR THEIR USE
<b>C12N 5/10</b> (2006.01)	2536266 *	AXMI218, AXMI219, AXMI220, AXMI226, AXMI227, AXMI228, AXMI229, AXMI230, AND AXMI231 DELTA-ENDOTOXIN GENES AND METHODS FOR THEIR USE
<b>A01P 7/04</b> (2006.01)	2536266 *	AXMI218, AXMI219, AXMI220, AXMI226, AXMI227, AXMI228, AXMI229, AXMI230, AND AXMI231 DELTA-ENDOTOXIN GENES AND METHODS FOR THEIR USE
<b>C07H 21/04</b> (2006.01)	2536266 *	AXMI218, AXMI219, AXMI220, AXMI226, AXMI227, AXMI228, AXMI229, AXMI230, AND AXMI231 DELTA-ENDOTOXIN GENES AND METHODS FOR THEIR USE
<b>C07K 14/00</b> (2006.01)	2536266 *	AXMI218, AXMI219, AXMI220, AXMI226, AXMI227, AXMI228, AXMI229, AXMI230, AND AXMI231 DELTA-ENDOTOXIN GENES AND METHODS FOR THEIR USE
<b>A01H 1/00</b> (2006.01)	2536266 *	AXMI218, AXMI219, AXMI220, AXMI226, AXMI227, AXMI228, AXMI229, AXMI230, AND AXMI231 DELTA-ENDOTOXIN GENES AND METHODS FOR THEIR USE
<b>C12N 15/63</b> (2006.01)	2536266 *	AXMI218, AXMI219, AXMI220, AXMI226, AXMI227, AXMI228, AXMI229, AXMI230, AND AXMI231 DELTA-ENDOTOXIN GENES AND METHODS FOR THEIR USE
<b>C12P 21/00</b> (2006.01)	2536266 *	AXMI218, AXMI219, AXMI220, AXMI226, AXMI227, AXMI228, AXMI229, AXMI230, AND AXMI231 DELTA-ENDOTOXIN GENES AND METHODS FOR THEIR USE
<b>A01N 37/18</b> (2006.01)	2536266 *	AXMI218, AXMI219, AXMI220, AXMI226, AXMI227, AXMI228, AXMI229, AXMI230, AND AXMI231 DELTA-ENDOTOXIN GENES AND METHODS FOR THEIR USE
<b>A01H 5/10</b> (2006.01)	2536266 *	AXMI218, AXMI219, AXMI220, AXMI226, AXMI227, AXMI228, AXMI229, AXMI230, AND AXMI231 DELTA-ENDOTOXIN GENES AND METHODS FOR THEIR USE
<b>C12N 1/21</b> (2006.01)	2536266 *	AXMI218, AXMI219, AXMI220, AXMI226, AXMI227, AXMI228, AXMI229, AXMI230, AND AXMI231 DELTA-ENDOTOXIN GENES AND METHODS FOR THEIR USE
<b>C12N 15/82</b> (2006.01)	2536266 *	AXMI218, AXMI219, AXMI220, AXMI226, AXMI227, AXMI228, AXMI229, AXMI230, AND AXMI231 DELTA-ENDOTOXIN GENES AND METHODS FOR THEIR USE
<b>A61K 9/20</b> (2006.01)	2441446	Using of superdisintegrants in cetyl myristate and/or cetyl palmitate formulations
<b>A61K 31/215</b> (2006.01)	2441446	Using of superdisintegrants in cetyl myristate and/or cetyl palmitate formulations
<b>G07F 17/32</b> (2006.01)	2420981	Certification method of a website for gambling
<b>A61K 39/00</b> (2006.01)	2523681 *	METHODS OF PRODUCING ADENOVIRUS VECTORS AND VIRAL PREPARATIONS GENERATED THEREBY
<b>C12N 15/861</b> (2006.01)	2523681 *	METHODS OF PRODUCING ADENOVIRUS VECTORS AND VIRAL PREPARATIONS GENERATED THEREBY
<b>C07K 14/475</b> (2006.01)	2523681 *	METHODS OF PRODUCING ADENOVIRUS VECTORS AND VIRAL PREPARATIONS GENERATED THEREBY
<b>C12N 7/02</b> (2006.01)	2523681 *	METHODS OF PRODUCING ADENOVIRUS VECTORS AND VIRAL PREPARATIONS GENERATED THEREBY
<b>H02P 29/02</b> (2006.01)	2530828	Electricity generation device and permanent-magnet electric generator
<b>H02P 9/10</b> (2006.01)	2530828	Electricity generation device and permanent-magnet electric generator
<b>H02P 9/00</b> (2006.01)	2530828	Electricity generation device and permanent-magnet electric generator
<b>G02B 5/28</b> (2006.01)	2521930 *	TUNABLE THIN-FILM FILTER
<b>G02B 6/293</b> (2006.01)	2521930 *	TUNABLE THIN-FILM FILTER
<b>F24D 3/12</b> (2006.01)	2532977 *	HEATING STRUCTURE
<b>E04F 15/00</b> (2006.01)	2532977 *	HEATING STRUCTURE



MKP (51)	Broj objave evropske prijava patenta (97)	Naziv pronalaska (54)
<b>C04B 14/02</b> (2006.01)	2533976 *	GYPSUM PLASTER BOARD AND A METHOD FOR PRODUCING A GYPSUM PLASTER BOARD
<b>B32B 13/00</b> (2006.01)	2533976 *	GYPSUM PLASTER BOARD AND A METHOD FOR PRODUCING A GYPSUM PLASTER BOARD
<b>C04B 28/14</b> (2006.01)	2533976 *	GYPSUM PLASTER BOARD AND A METHOD FOR PRODUCING A GYPSUM PLASTER BOARD
<b>E04C 2/04</b> (2006.01)	2533976 *	GYPSUM PLASTER BOARD AND A METHOD FOR PRODUCING A GYPSUM PLASTER BOARD
<b>A01N 43/58</b> (2006.01)	2506716 *	NOVEL TRICYCLIC COMPOUNDS
<b>A61K 38/28</b> (2006.01)	2387989	Long - acting formulations of insulins
<b>A61K 9/08</b> (2006.01)	2387989	Long - acting formulations of insulins
<b>A61K 9/00</b> (2006.01)	2387989	Long - acting formulations of insulins
<b>A61K 31/439</b> (2006.01)	2525796 *	AQUEOUS SOLUTION COMPRISING 3-QUINUCLIDINONES FOR THE TREATMENT OF HYPERPROLIFERATIVE, AUTOIMMUNE AND HEART DISEASE
<b>A61P 35/00</b> (2006.01)	2525796 *	AQUEOUS SOLUTION COMPRISING 3-QUINUCLIDINONES FOR THE TREATMENT OF HYPERPROLIFERATIVE, AUTOIMMUNE AND HEART DISEASE
<b>A61P 9/00</b> (2006.01)	2525796 *	AQUEOUS SOLUTION COMPRISING 3-QUINUCLIDINONES FOR THE TREATMENT OF HYPERPROLIFERATIVE, AUTOIMMUNE AND HEART DISEASE
<b>A61K 31/444</b> (2006.01)	2525796 *	AQUEOUS SOLUTION COMPRISING 3-QUINUCLIDINONES FOR THE TREATMENT OF HYPERPROLIFERATIVE, AUTOIMMUNE AND HEART DISEASE
<b>A61K 9/08</b> (2006.01)	2525796 *	AQUEOUS SOLUTION COMPRISING 3-QUINUCLIDINONES FOR THE TREATMENT OF HYPERPROLIFERATIVE, AUTOIMMUNE AND HEART DISEASE
<b>A61K 31/522</b> (2006.01)	2525796 *	AQUEOUS SOLUTION COMPRISING 3-QUINUCLIDINONES FOR THE TREATMENT OF HYPERPROLIFERATIVE, AUTOIMMUNE AND HEART DISEASE
<b>A61K 31/496</b> (2006.01)	2525796 *	AQUEOUS SOLUTION COMPRISING 3-QUINUCLIDINONES FOR THE TREATMENT OF HYPERPROLIFERATIVE, AUTOIMMUNE AND HEART DISEASE
<b>A61K 31/519</b> (2006.01)	2525796 *	AQUEOUS SOLUTION COMPRISING 3-QUINUCLIDINONES FOR THE TREATMENT OF HYPERPROLIFERATIVE, AUTOIMMUNE AND HEART DISEASE
<b>A61K 31/5377</b> (2006.01)	2525796 *	AQUEOUS SOLUTION COMPRISING 3-QUINUCLIDINONES FOR THE TREATMENT OF HYPERPROLIFERATIVE, AUTOIMMUNE AND HEART DISEASE
<b>A61B 17/32</b> (2006.01)	2533709 *	ULTRASONIC SURGICAL INSTRUMENTS WITH PARTIALLY ROTATING BLADE AND FIXED PAD ARRANGEMENT
<b>A61B 17/3207</b> (2006.01)	2533709 *	ULTRASONIC SURGICAL INSTRUMENTS WITH PARTIALLY ROTATING BLADE AND FIXED PAD ARRANGEMENT
<b>A61B 10/02</b> (2006.01)	2533709 *	ULTRASONIC SURGICAL INSTRUMENTS WITH PARTIALLY ROTATING BLADE AND FIXED PAD ARRANGEMENT
<b>C07H 21/02</b> (2006.01)	2521777 *	COMPOSITIONS AND METHODS FOR TREATING GLIOBLASTOMA GBM
<b>C12N 15/00</b> (2006.01)	2521777 *	COMPOSITIONS AND METHODS FOR TREATING GLIOBLASTOMA GBM
<b>C12P 17/18</b> (2006.01)	2530164 *	METHOD FOR MANUFACTURING A PYRIPYROPENE
<b>C12N 1/21</b> (2006.01)	2530164 *	METHOD FOR MANUFACTURING A PYRIPYROPENE
<b>C12N 1/15</b> (2006.01)	2530164 *	METHOD FOR MANUFACTURING A PYRIPYROPENE
<b>C12N 5/10</b> (2006.01)	2530164 *	METHOD FOR MANUFACTURING A PYRIPYROPENE
<b>C12N 1/19</b> (2006.01)	2530164 *	METHOD FOR MANUFACTURING A PYRIPYROPENE
<b>C12N 15/09</b> (2006.01)	2530164 *	METHOD FOR MANUFACTURING A PYRIPYROPENE
<b>B01J 20/20</b> (2006.01)	2536498 *	ADSORPTIVE STRUCTURES HAVING A PARTICLE AND/OR AEROSOL FILTER FUNCTION AND METHOD FOR PRODUCING SUCH ADSORPTIVE STRUCTURES
<b>B01J 20/28</b> (2006.01)	2536498 *	ADSORPTIVE STRUCTURES HAVING A PARTICLE AND/OR AEROSOL FILTER FUNCTION AND METHOD FOR PRODUCING SUCH ADSORPTIVE STRUCTURES
<b>B01J 20/26</b> (2006.01)	2536498 *	ADSORPTIVE STRUCTURES HAVING A PARTICLE AND/OR AEROSOL FILTER FUNCTION AND METHOD FOR PRODUCING SUCH ADSORPTIVE STRUCTURES
<b>A61K 45/00</b> (2006.01)	2521569 *	COMBINED TREATMENT UTILIZING VB-201
<b>E03F 5/12</b> (2006.01)	2536890 *	A FILTERING DEVICE
<b>E21B 7/04</b> (2006.01)	2447462	Method for subterranean insertion of a conduit

MKP (51)	Broj objave evropske prijava patenta (97)	Naziv pronalaska (54)
<b>E21B 7/20</b> (2006.01)	2447462	Method for subterranean insertion of a conduit
<b>E21B 7/30</b> (2006.01)	2447462	Method for subterranean insertion of a conduit
<b>H04L 12/26</b> (2006.01)	2507949 *	AN APPARATUS, AN ASSEMBLY AND A METHOD OF OPERATING A PLURALITY OF ANALYZING MEANS READING AND ORDERING DATA PACKETS
<b>H04L 12/56</b> (2006.01)	2507949 *	AN APPARATUS, AN ASSEMBLY AND A METHOD OF OPERATING A PLURALITY OF ANALYZING MEANS READING AND ORDERING DATA PACKETS
<b>E21B 7/02</b> (2006.01)	2489823	Device for splitting solid materials
<b>A61B 17/32</b> (2006.01)	2533711 *	METHODS OF USING ULTRASONICALLY POWERED SURGICAL INSTRUMENTS WITH ROTATABLE CUTTING IMPLEMENTS
<b>F17C 13/00</b> (2006.01)	2508787	Identification system for compressed gas bottles
<b>F17C 9/00</b> (2006.01)	2504614 *	METHOD FOR THE OPERATION AND CONTROL OF GAS FILLING
<b>F17C 7/02</b> (2006.01)	2504614 *	METHOD FOR THE OPERATION AND CONTROL OF GAS FILLING
<b>F17C 13/02</b> (2006.01)	2504614 *	METHOD FOR THE OPERATION AND CONTROL OF GAS FILLING
<b>A63H 33/10</b> (2006.01)	2514496 *	COMPONENT FOR MAGNETIC ATTACHMENT AND A MAGNETIC TOY
<b>A01N 57/00</b> (2006.01)	2521454 *	TREATMENT WITH VB-201
<b>A22C 21/00</b> (2006.01)	2528446 *	METHOD AND APPARATUS FOR REMOVING A SLEEVE OF MEAT FROM AN ANIMAL PART HAVING A BONE WITH KNUCKLES ON EACH OF ITS OPPOSITE ENDS
<b>C12N 15/62</b> (2006.01)	2536748 *	NEUREGULIN ANTAGONISTS AND USE THEREOF IN TREATING CANCER
<b>C07K 14/475</b> (2006.01)	2536748 *	NEUREGULIN ANTAGONISTS AND USE THEREOF IN TREATING CANCER
<b>A61K 39/395</b> (2006.01)	2536748 *	NEUREGULIN ANTAGONISTS AND USE THEREOF IN TREATING CANCER
<b>C12N 15/113</b> (2010.01)	2536748 *	NEUREGULIN ANTAGONISTS AND USE THEREOF IN TREATING CANCER
<b>A61P 35/00</b> (2006.01)	2536748 *	NEUREGULIN ANTAGONISTS AND USE THEREOF IN TREATING CANCER
<b>C07K 14/71</b> (2006.01)	2536748 *	NEUREGULIN ANTAGONISTS AND USE THEREOF IN TREATING CANCER
<b>A61K 31/7088</b> (2006.01)	2536748 *	NEUREGULIN ANTAGONISTS AND USE THEREOF IN TREATING CANCER
<b>A61K 38/17</b> (2006.01)	2536748 *	NEUREGULIN ANTAGONISTS AND USE THEREOF IN TREATING CANCER
<b>F28C 3/06</b> (2006.01)	2507570 *	METHOD AND APPARATUS FOR HANDLING GASES
<b>F28B 3/06</b> (2006.01)	2507570 *	METHOD AND APPARATUS FOR HANDLING GASES
<b>A61G 7/10</b> (2006.01)	2501887 *	COUNTERFRAME FOR RETRACTABLE SLIDING-DOOR WITH RAIL SUPPORTING TECHNICAL TRAVERSE IN ROOMS PROVIDED WITH INTER-ROOM CEILING GUIDING SYSTEMS TO MOVE DISABLED PERSONS
<b>E06B 3/46</b> (2006.01)	2501887 *	COUNTERFRAME FOR RETRACTABLE SLIDING-DOOR WITH RAIL SUPPORTING TECHNICAL TRAVERSE IN ROOMS PROVIDED WITH INTER-ROOM CEILING GUIDING SYSTEMS TO MOVE DISABLED PERSONS
<b>C12N 15/82</b> (2006.01)	2513316 *	USE OF CRY1DA IN COMBINATION WITH CRY1CA FOR MANAGEMENT OF RESISTANT INSECTS
<b>A61B 17/32</b> (2006.01)	2533710 *	DUAL PURPOSE SURGICAL INSTRUMENT FOR CUTTING AND COAGULATING TISSUE
<b>A61B 17/3207</b> (2006.01)	2533710 *	DUAL PURPOSE SURGICAL INSTRUMENT FOR CUTTING AND COAGULATING TISSUE
<b>G01N 25/48</b> (2006.01)	2504690 *	ANALYTICAL SYSTEM AND METHOD WITH COMBINED DIFFERENTIAL SCANNING CALORIMETRY (DSC) AND RAMAN SPECTROSCOPY
<b>G01N 21/65</b> (2006.01)	2504690 *	ANALYTICAL SYSTEM AND METHOD WITH COMBINED DIFFERENTIAL SCANNING CALORIMETRY (DSC) AND RAMAN SPECTROSCOPY
<b>G01J 3/44</b> (2006.01)	2504690 *	ANALYTICAL SYSTEM AND METHOD WITH COMBINED DIFFERENTIAL SCANNING CALORIMETRY (DSC) AND RAMAN SPECTROSCOPY
<b>A61K 31/33</b> (2006.01)	2519235 *	HETEROARYL COMPOUNDS AND USES THEREOF
<b>C09K 8/60</b> (2006.01)	2510080 *	LOW INTERFACIAL TENSION SURFACTANTS FOR PETROLEUM APPLICATIONS
<b>C11D 3/20</b> (2006.01)	2510080 *	LOW INTERFACIAL TENSION SURFACTANTS FOR PETROLEUM APPLICATIONS
<b>A01N 3/02</b> (2006.01)	2512232 *	MATURATION OR RIPENING INHIBITOR RELEASE FROM POLYMER, FIBER, FILM, SHEET OR PACKAGING
<b>A01N 25/10</b> (2006.01)	2512232 *	MATURATION OR RIPENING INHIBITOR RELEASE FROM POLYMER, FIBER, FILM, SHEET OR PACKAGING

MKP (51)	Broj objave evropske prijava patenta (97)	Naziv pronalaska (54)
<b>A01N 3/00</b> (2006.01)	2512232 *	MATURATION OR RIPENING INHIBITOR RELEASE FROM POLYMER, FIBER, FILM, SHEET OR PACKAGING
<b>C07D 417/14</b> (2006.01)	2504333 *	MORPHOLINOTHIAZOLES AS ALPHA 7 POSITIVE ALLOSTERIC MODULATORS
<b>A61K 31/427</b> (2006.01)	2504333 *	MORPHOLINOTHIAZOLES AS ALPHA 7 POSITIVE ALLOSTERIC MODULATORS
<b>A61P 25/00</b> (2006.01)	2504333 *	MORPHOLINOTHIAZOLES AS ALPHA 7 POSITIVE ALLOSTERIC MODULATORS
<b>C07D 413/14</b> (2006.01)	2516419 *	INDOLYL-PIPERIDINYL BENZYLAMINES AS BETA-TRYPTASE INHIBITORS
<b>C07D 498/14</b> (2006.01)	2516419 *	INDOLYL-PIPERIDINYL BENZYLAMINES AS BETA-TRYPTASE INHIBITORS
<b>C07D 401/14</b> (2006.01)	2516419 *	INDOLYL-PIPERIDINYL BENZYLAMINES AS BETA-TRYPTASE INHIBITORS
<b>C07D 405/14</b> (2006.01)	2516419 *	INDOLYL-PIPERIDINYL BENZYLAMINES AS BETA-TRYPTASE INHIBITORS
<b>C07D 409/14</b> (2006.01)	2516419 *	INDOLYL-PIPERIDINYL BENZYLAMINES AS BETA-TRYPTASE INHIBITORS
<b>A61P 29/00</b> (2006.01)	2516419 *	INDOLYL-PIPERIDINYL BENZYLAMINES AS BETA-TRYPTASE INHIBITORS
<b>A61K 31/454</b> (2006.01)	2516419 *	INDOLYL-PIPERIDINYL BENZYLAMINES AS BETA-TRYPTASE INHIBITORS
<b>B65D 51/24</b> (2006.01)	2502021 *	RETAINER FOR A FIREWORK THAT CAN BE USED INDOORS
<b>F42B 4/20</b> (2006.01)	2502021 *	RETAINER FOR A FIREWORK THAT CAN BE USED INDOORS
<b>B22D 15/00</b> (2006.01)	2533921 *	CASTING COMPOSITE INGOT WITH METAL TEMPERATURE COMPENSATION
<b>B22D 7/02</b> (2006.01)	2533921 *	CASTING COMPOSITE INGOT WITH METAL TEMPERATURE COMPENSATION
<b>A61K 31/403</b> (2006.01)	2532651	Synthesis process, and crystalline form of 4-{3-[cis-hexahydrocyclopenta[c]pyrrol-2(1h)-yl]propoxy}benzamide hydrochloride and its free base as well as the pharmaceutical compositions containing them
<b>A61P 25/00</b> (2006.01)	2532651	Synthesis process, and crystalline form of 4-{3-[cis-hexahydrocyclopenta[c]pyrrol-2(1h)-yl]propoxy}benzamide hydrochloride and its free base as well as the pharmaceutical compositions containing them
<b>C07D 209/52</b> (2006.01)	2532651	Synthesis process, and crystalline form of 4-{3-[cis-hexahydrocyclopenta[c]pyrrol-2(1h)-yl]propoxy}benzamide hydrochloride and its free base as well as the pharmaceutical compositions containing them
<b>G01N 33/50</b> (2006.01)	2504699 *	METHODS OF DETECTING OR MONITORING ACTIVITY OF AN INFLAMMATORY OR NEURODEGENERATIVE CONDITION
<b>A61K 8/49</b> (2006.01)	2516398 *	NOVEL PHENOL DERIVATIVES AND PHARMACEUTICAL OR COSMETIC USE THEREOF
<b>C07D 213/74</b> (2006.01)	2516398 *	NOVEL PHENOL DERIVATIVES AND PHARMACEUTICAL OR COSMETIC USE THEREOF
<b>A61P 17/00</b> (2006.01)	2516398 *	NOVEL PHENOL DERIVATIVES AND PHARMACEUTICAL OR COSMETIC USE THEREOF
<b>C07D 241/20</b> (2006.01)	2516398 *	NOVEL PHENOL DERIVATIVES AND PHARMACEUTICAL OR COSMETIC USE THEREOF
<b>A61P 15/00</b> (2006.01)	2516398 *	NOVEL PHENOL DERIVATIVES AND PHARMACEUTICAL OR COSMETIC USE THEREOF
<b>A61K 31/4965</b> (2006.01)	2516398 *	NOVEL PHENOL DERIVATIVES AND PHARMACEUTICAL OR COSMETIC USE THEREOF
<b>C07D 239/42</b> (2006.01)	2516398 *	NOVEL PHENOL DERIVATIVES AND PHARMACEUTICAL OR COSMETIC USE THEREOF
<b>A61P 35/00</b> (2006.01)	2516398 *	NOVEL PHENOL DERIVATIVES AND PHARMACEUTICAL OR COSMETIC USE THEREOF
<b>A61K 31/44</b> (2006.01)	2516398 *	NOVEL PHENOL DERIVATIVES AND PHARMACEUTICAL OR COSMETIC USE THEREOF
<b>A61Q 19/00</b> (2006.01)	2516398 *	NOVEL PHENOL DERIVATIVES AND PHARMACEUTICAL OR COSMETIC USE THEREOF
<b>A61K 31/505</b> (2006.01)	2516398 *	NOVEL PHENOL DERIVATIVES AND PHARMACEUTICAL OR COSMETIC USE THEREOF
<b>A24F 47/00</b> (2006.01)	2515690 *	AN ELONGATE HEATER FOR AN ELECTRICALLY HEATED AEROSOL-GENERATING SYSTEM
<b>A61K 9/08</b> (2006.01)	2455066	Pharmacological preparation for topical use containing n-palmitoyl-vanillamide
<b>A61K 9/10</b> (2006.01)	2455066	Pharmacological preparation for topical use containing n-palmitoyl-vanillamide
<b>A61K 9/107</b> (2006.01)	2455066	Pharmacological preparation for topical use containing n-palmitoyl-vanillamide
<b>A61K 9/70</b> (2006.01)	2455066	Pharmacological preparation for topical use containing n-palmitoyl-vanillamide

MKP (51)	Broj objave evropske prijava patenta (97)	Naziv pronalaska (54)
<b>A61K 31/16</b> (2006.01)	2455066	Pharmacological preparation for topical use containing n-palmitoyl-vanillamide
<b>A61P 29/00</b> (2006.01)	2455066	Pharmacological preparation for topical use containing n-palmitoyl-vanillamide
<b>A61K 39/00</b> (2006.01)	2506871 *	ANTIBODY Fc MUTANTS WITH ABLATED EFFECTOR FUNCTIONS
<b>C12P 21/08</b> (2006.01)	2506871 *	ANTIBODY Fc MUTANTS WITH ABLATED EFFECTOR FUNCTIONS
<b>F24H 3/06</b> (2006.01)	2521884 *	ELECTRIC RADIATOR USING CALCULATING PROCESSORS AS A HEAT SOURCE
<b>G06F 1/20</b> (2006.01)	2521884 *	ELECTRIC RADIATOR USING CALCULATING PROCESSORS AS A HEAT SOURCE
<b>G07B 15/02</b> (2011.01)	2531981 *	SYSTEM FOR AUTOMATIC MANAGING AND CONTROLLING THE USE OF MOORINGS FOR VESSELS, COMPRISING AUTOMATED FLOATING BUOYS AND THE RELATED METHOD
<b>B63B 22/02</b> (2006.01)	2531981 *	SYSTEM FOR AUTOMATIC MANAGING AND CONTROLLING THE USE OF MOORINGS FOR VESSELS, COMPRISING AUTOMATED FLOATING BUOYS AND THE RELATED METHOD
<b>A61P 25/00</b> (2006.01)	2531177 *	4-[2-[[[5-METHYL-1-(2-NAPHTALENYL)-1H-PYRAZOL-3-YL]OXY]ETHYL]MORPHOLINE HYDROCHLORIDE POLYMORPHS AND SOLVATES
<b>A61K 9/16</b> (2006.01)	2531177 *	4-[2-[[[5-METHYL-1-(2-NAPHTALENYL)-1H-PYRAZOL-3-YL]OXY]ETHYL]MORPHOLINE HYDROCHLORIDE POLYMORPHS AND SOLVATES
<b>A61K 31/4152</b> (2006.01)	2531177 *	4-[2-[[[5-METHYL-1-(2-NAPHTALENYL)-1H-PYRAZOL-3-YL]OXY]ETHYL]MORPHOLINE HYDROCHLORIDE POLYMORPHS AND SOLVATES
<b>C07D 231/22</b> (2006.01)	2531177 *	4-[2-[[[5-METHYL-1-(2-NAPHTALENYL)-1H-PYRAZOL-3-YL]OXY]ETHYL]MORPHOLINE HYDROCHLORIDE POLYMORPHS AND SOLVATES
<b>G01N 33/50</b> (2006.01)	2501279 *	ASSAY FOR QUANTIFYING CLOSTRIDIAL NEUROTOXIN
<b>A61B 5/0488</b> (2006.01)	2501279 *	ASSAY FOR QUANTIFYING CLOSTRIDIAL NEUROTOXIN
<b>G01N 33/94</b> (2006.01)	2501279 *	ASSAY FOR QUANTIFYING CLOSTRIDIAL NEUROTOXIN
<b>A61B 5/11</b> (2006.01)	2501279 *	ASSAY FOR QUANTIFYING CLOSTRIDIAL NEUROTOXIN
<b>H03H 9/00</b> (2006.01)	2491652 *	NOTCHED SAW IMAGE FREQUENCY REJECTION FILTER SYSTEM
<b>H04L 29/06</b> (2006.01)	2502399 *	METHOD AND DEVICE FOR SECURING THE CONNECTION OF A TERMINAL TO A COMPUTER NETWORK
<b>G06F 21/00</b> (2006.01)	2502399 *	METHOD AND DEVICE FOR SECURING THE CONNECTION OF A TERMINAL TO A COMPUTER NETWORK
<b>G06F 9/455</b> (2006.01)	2502399 *	METHOD AND DEVICE FOR SECURING THE CONNECTION OF A TERMINAL TO A COMPUTER NETWORK
<b>H04L 12/56</b> (2006.01)	2507951 *	AN APPARATUS AND A METHOD OF RECEIVING AND STORING DATA PACKETS CONTROLLED BY A CENTRAL CONTROLLER
<b>A61K 31/415</b> (2006.01)	2509957 *	CYSTEINE PROTEASE INHIBITORS
<b>C07C 237/14</b> (2006.01)	2509957 *	CYSTEINE PROTEASE INHIBITORS
<b>A61P 11/06</b> (2006.01)	2509957 *	CYSTEINE PROTEASE INHIBITORS
<b>A61P 17/06</b> (2006.01)	2509957 *	CYSTEINE PROTEASE INHIBITORS
<b>A61P 21/04</b> (2006.01)	2509957 *	CYSTEINE PROTEASE INHIBITORS
<b>A61P 9/10</b> (2006.01)	2509957 *	CYSTEINE PROTEASE INHIBITORS
<b>A61K 31/426</b> (2006.01)	2509957 *	CYSTEINE PROTEASE INHIBITORS
<b>C07D 277/46</b> (2006.01)	2509957 *	CYSTEINE PROTEASE INHIBITORS
<b>A61K 31/16</b> (2006.01)	2509957 *	CYSTEINE PROTEASE INHIBITORS
<b>A61P 37/08</b> (2006.01)	2509957 *	CYSTEINE PROTEASE INHIBITORS
<b>C07D 231/40</b> (2006.01)	2509957 *	CYSTEINE PROTEASE INHIBITORS
<b>A61P 37/02</b> (2006.01)	2509957 *	CYSTEINE PROTEASE INHIBITORS
<b>B42D 15/00</b> (2006.01)	2509792 *	MODIFIED MARKING BASED ON CHIRAL LIQUID CRYSTAL POLYMERS
<b>C09D 11/02</b> (2006.01)	2509792 *	MODIFIED MARKING BASED ON CHIRAL LIQUID CRYSTAL POLYMERS
<b>B41M 5/28</b> (2006.01)	2509792 *	MODIFIED MARKING BASED ON CHIRAL LIQUID CRYSTAL POLYMERS
<b>B41M 3/14</b> (2006.01)	2509792 *	MODIFIED MARKING BASED ON CHIRAL LIQUID CRYSTAL POLYMERS
<b>C09D 11/00</b> (2006.01)	2509792 *	MODIFIED MARKING BASED ON CHIRAL LIQUID CRYSTAL POLYMERS
<b>B42D 15/10</b> (2006.01)	2509792 *	MODIFIED MARKING BASED ON CHIRAL LIQUID CRYSTAL POLYMERS

MKP (51)	Broj objave evropske prijava patenta (97)	Naziv pronalaska (54)
<b>A61B 17/068</b> (2006.01)	2509512 *	CIRCULAR STAPLER INTRODUCER WITH RIGID DISTAL END PORTION
<b>A61B 17/34</b> (2006.01)	2509512 *	CIRCULAR STAPLER INTRODUCER WITH RIGID DISTAL END PORTION
<b>A61B 19/00</b> (2006.01)	2509512 *	CIRCULAR STAPLER INTRODUCER WITH RIGID DISTAL END PORTION
<b>A61B 17/00</b> (2006.01)	2509512 *	CIRCULAR STAPLER INTRODUCER WITH RIGID DISTAL END PORTION
<b>A61B 17/115</b> (2006.01)	2509512 *	CIRCULAR STAPLER INTRODUCER WITH RIGID DISTAL END PORTION
<b>A61M 5/315</b> (2006.01)	2512562 *	PISTON FOR A CARTRIDGE AND PISTON ROD FOR A DRUG DELIVERY DEVICE
<b>A61B 17/22</b> (2006.01)	2533704 *	ULTRASONIC SURGICAL INSTRUMENTS WITH ROTATABLE BLADE AND HOLLOW SHEATH ARRANGEMENTS
<b>A61B 17/3207</b> (2006.01)	2533704 *	ULTRASONIC SURGICAL INSTRUMENTS WITH ROTATABLE BLADE AND HOLLOW SHEATH ARRANGEMENTS
<b>A61B 17/32</b> (2006.01)	2533704 *	ULTRASONIC SURGICAL INSTRUMENTS WITH ROTATABLE BLADE AND HOLLOW SHEATH ARRANGEMENTS
<b>C07D 471/04</b> (2006.01)	2504336 *	NOVEL NAPHTHYRIDINE DERIVATIVES AND THE USE THEREOF AS KINASE INHIBITORS
<b>A61P 35/00</b> (2006.01)	2504336 *	NOVEL NAPHTHYRIDINE DERIVATIVES AND THE USE THEREOF AS KINASE INHIBITORS
<b>A61K 31/4745</b> (2006.01)	2504336 *	NOVEL NAPHTHYRIDINE DERIVATIVES AND THE USE THEREOF AS KINASE INHIBITORS
<b>A61B 17/115</b> (2006.01)	2509514 *	DEVICES FOR INTRODUCING A SURGICAL CIRCULAR STAPLING INSTRUMENT INTO A PATIENT
<b>A61B 17/11</b> (2006.01)	2509514 *	DEVICES FOR INTRODUCING A SURGICAL CIRCULAR STAPLING INSTRUMENT INTO A PATIENT
<b>C07K 16/00</b> (2006.01)	2531526 *	PROCESS FOR OBTAINING ANTIBODIES
<b>A61M 25/12</b> (2006.01)	2512578 *	DEVICES AND METHODS FOR TREATING SINUS DISEASE
<b>C12N 15/85</b> (2006.01)	2505654	Common light chain mouse
<b>A01K 67/027</b> (2006.01)	2505654	Common light chain mouse
<b>C07K 16/46</b> (2006.01)	2505654	Common light chain mouse
<b>A61B 19/08</b> (2006.01)	2501322 *	CIRCULAR STAPLER INTRODUCER WITH MULTI-LUMEN SHEATH
<b>A61B 17/115</b> (2006.01)	2501322 *	CIRCULAR STAPLER INTRODUCER WITH MULTI-LUMEN SHEATH
<b>A61B 19/00</b> (2006.01)	2501322 *	CIRCULAR STAPLER INTRODUCER WITH MULTI-LUMEN SHEATH
<b>C07K 16/00</b> (2006.01)	2526118 *	COMPOSITIONS AND METHODS FOR TREATMENT OF OVARIAN CANCER
<b>C07K 17/14</b> (2006.01)	2526118 *	COMPOSITIONS AND METHODS FOR TREATMENT OF OVARIAN CANCER
<b>C07K 17/00</b> (2006.01)	2526118 *	COMPOSITIONS AND METHODS FOR TREATMENT OF OVARIAN CANCER
<b>B28B 3/20</b> (2006.01)	2501530 *	INTEGRATED INSULATION EXTRUSION AND EXTRUSION TECHNOLOGY FOR WINDOW AND DOOR SYSTEMS
<b>A61K 39/395</b> (2006.01)	2536834 *	ANTIBODY AGAINST SEROTYPE B LIPOPOLYSACCHARIDE OF PSEUDOMONAS AERUGINOSA
<b>A61P 31/04</b> (2006.01)	2536834 *	ANTIBODY AGAINST SEROTYPE B LIPOPOLYSACCHARIDE OF PSEUDOMONAS AERUGINOSA
<b>C12P 21/08</b> (2006.01)	2536834 *	ANTIBODY AGAINST SEROTYPE B LIPOPOLYSACCHARIDE OF PSEUDOMONAS AERUGINOSA
<b>G01N 33/569</b> (2006.01)	2536834 *	ANTIBODY AGAINST SEROTYPE B LIPOPOLYSACCHARIDE OF PSEUDOMONAS AERUGINOSA
<b>C12N 5/10</b> (2006.01)	2536834 *	ANTIBODY AGAINST SEROTYPE B LIPOPOLYSACCHARIDE OF PSEUDOMONAS AERUGINOSA
<b>C07K 16/12</b> (2006.01)	2536834 *	ANTIBODY AGAINST SEROTYPE B LIPOPOLYSACCHARIDE OF PSEUDOMONAS AERUGINOSA
<b>C07K 16/46</b> (2006.01)	2536834 *	ANTIBODY AGAINST SEROTYPE B LIPOPOLYSACCHARIDE OF PSEUDOMONAS AERUGINOSA
<b>C12N 15/09</b> (2006.01)	2536834 *	ANTIBODY AGAINST SEROTYPE B LIPOPOLYSACCHARIDE OF PSEUDOMONAS AERUGINOSA
<b>A61K 31/7105</b> (2006.01)	2506857 *	DELIVERY OF MRNA FOR THE AUGMENTATION OF PROTEINS AND ENZYMES IN HUMAN GENETIC DISEASES
<b>C07H 21/02</b> (2006.01)	2506857 *	DELIVERY OF MRNA FOR THE AUGMENTATION OF PROTEINS AND ENZYMES IN HUMAN GENETIC DISEASES

MKP (51)	Broj objave evropske prijava patenta (97)	Naziv pronalaska (54)
<b>A61K 31/444</b> (2006.01)	2523952 *	THIAZOLE AND OXAZOLE KINASE INHIBITORS
<b>A61P 37/00</b> (2006.01)	2523952 *	THIAZOLE AND OXAZOLE KINASE INHIBITORS
<b>C07D 417/14</b> (2006.01)	2523952 *	THIAZOLE AND OXAZOLE KINASE INHIBITORS
<b>C07D 413/12</b> (2006.01)	2523952 *	THIAZOLE AND OXAZOLE KINASE INHIBITORS
<b>A61K 31/443</b> (2006.01)	2523952 *	THIAZOLE AND OXAZOLE KINASE INHIBITORS
<b>C07D 413/14</b> (2006.01)	2523952 *	THIAZOLE AND OXAZOLE KINASE INHIBITORS
<b>A61K 31/4436</b> (2006.01)	2523952 *	THIAZOLE AND OXAZOLE KINASE INHIBITORS
<b>A61P 35/00</b> (2006.01)	2523952 *	THIAZOLE AND OXAZOLE KINASE INHIBITORS
<b>A61K 38/08</b> (2006.01)	2523677 *	METHOD FOR TREATMENT OF INFLAMMATORY DISEASE AND DISORDER
<b>A61M 5/24</b> (2006.01)	2525851 *	CODED CARTRIDGE HOLDER AND FASTENER ENABLED BY CARTRIDGE SIZE
<b>A01N 43/00</b> (2006.01)	2512237 *	2 -ARYL-3 -HYDROXY-CYCLOPENTENONES AS INSECTICIDES, ACARICIDES, NEMATOCIDES AND MOLLUSCICIDES
<b>C07D 513/04</b> (2006.01)	2513118 *	BICYCLIC THIAZOLES AS ALLOSTERIC MODULATORS OF MGLUR5 RECEPTORS
<b>A61K 31/429</b> (2006.01)	2513118 *	BICYCLIC THIAZOLES AS ALLOSTERIC MODULATORS OF MGLUR5 RECEPTORS
<b>A61P 25/18</b> (2006.01)	2513118 *	BICYCLIC THIAZOLES AS ALLOSTERIC MODULATORS OF MGLUR5 RECEPTORS
<b>A61K 31/428</b> (2006.01)	2513118 *	BICYCLIC THIAZOLES AS ALLOSTERIC MODULATORS OF MGLUR5 RECEPTORS
<b>F16K 3/30</b> (2006.01)	2518376 *	NON-RISING STEM TYPE GATE VALVE
<b>F16K 3/28</b> (2006.01)	2518376 *	NON-RISING STEM TYPE GATE VALVE
<b>G09F 13/46</b> (2006.01)	2505955	An improvement of a pyrotechnic device for the realization of a luminous alphabet
<b>F42B 4/20</b> (2006.01)	2505955	An improvement of a pyrotechnic device for the realization of a luminous alphabet
<b>F42B 4/18</b> (2006.01)	2505955	An improvement of a pyrotechnic device for the realization of a luminous alphabet
<b>F16L 1/10</b> (2006.01)	2444197	Clamping device for centring pipes
<b>B23K 37/053</b> (2006.01)	2444197	Clamping device for centring pipes
<b>G01N 22/00</b> (2006.01)	2505995 *	METHOD FOR DETERMINING THE DIELECTRIC PERMITTIVITY OF A DIELECTRIC OBJECT
<b>G06K 9/48</b> (2006.01)	2509029	System and method for identifying spam in rasterized images
<b>C02F 11/14</b> (2006.01)	2504286 *	DEVICE AND PROCESS FOR TREATMENT OF CONCENTRATED SOLUTIONS ORIGINATING FROM LANDFILL LEACHATE
<b>C02F 11/00</b> (2006.01)	2504286 *	DEVICE AND PROCESS FOR TREATMENT OF CONCENTRATED SOLUTIONS ORIGINATING FROM LANDFILL LEACHATE
<b>C02F 1/36</b> (2006.01)	2504286 *	DEVICE AND PROCESS FOR TREATMENT OF CONCENTRATED SOLUTIONS ORIGINATING FROM LANDFILL LEACHATE
<b>C02F 103/06</b> (2006.01)	2504286 *	DEVICE AND PROCESS FOR TREATMENT OF CONCENTRATED SOLUTIONS ORIGINATING FROM LANDFILL LEACHATE
<b>C02F 1/68</b> (2006.01)	2504286 *	DEVICE AND PROCESS FOR TREATMENT OF CONCENTRATED SOLUTIONS ORIGINATING FROM LANDFILL LEACHATE
<b>E04H 6/02</b> (2006.01)	2507449 *	CARPORT STRUCTURE AND METHOD OF CONSTRUCTION THEREFOR
<b>E04B 1/34</b> (2006.01)	2507449 *	CARPORT STRUCTURE AND METHOD OF CONSTRUCTION THEREFOR
<b>H01L 31/042</b> (2006.01)	2507449 *	CARPORT STRUCTURE AND METHOD OF CONSTRUCTION THEREFOR
<b>A61P 3/04</b> (2006.01)	2521719 *	FUMAGILLOL TYPE COMPOUNDS AND METHODS OF MAKING AND USING SAME
<b>C07D 303/16</b> (2006.01)	2521719 *	FUMAGILLOL TYPE COMPOUNDS AND METHODS OF MAKING AND USING SAME
<b>A61K 31/336</b> (2006.01)	2521719 *	FUMAGILLOL TYPE COMPOUNDS AND METHODS OF MAKING AND USING SAME
<b>B65D 81/38</b> (2006.01)	2502850	Packaging container and process for its manufacture
<b>C10J 3/32</b> (2006.01)	2526176 *	DOWNDRAFT GASIFIER WITH IMPROVED STABILITY
<b>F23H 1/00</b> (2006.01)	2526176 *	DOWNDRAFT GASIFIER WITH IMPROVED STABILITY
<b>C10J 3/40</b> (2006.01)	2526176 *	DOWNDRAFT GASIFIER WITH IMPROVED STABILITY

MKP (51)	Broj objave evropske prijava patenta (97)	Naziv pronalaska (54)
<b>C10J 3/26</b> (2006.01)	2526176 *	DOWNDRAFT GASIFIER WITH IMPROVED STABILITY
<b>G05D 23/19</b> (2006.01)	2512204	Control unit for operating a conventional electric heater and a pilot wire heater
<b>H02J 13/00</b> (2006.01)	2512204	Control unit for operating a conventional electric heater and a pilot wire heater
<b>F24D 19/10</b> (2006.01)	2512204	Control unit for operating a conventional electric heater and a pilot wire heater
<b>H05B 1/02</b> (2006.01)	2512204	Control unit for operating a conventional electric heater and a pilot wire heater
<b>C12P 21/08</b> (2006.01)	2533810 *	CD20 ANTIBODIES AND USES THEREOF
<b>A61K 39/395</b> (2006.01)	2533810 *	CD20 ANTIBODIES AND USES THEREOF
<b>F25D 3/10</b> (2006.01)	2515057	Method and device for regulating the temperature of a fluid medium
<b>F28F 27/00</b> (2006.01)	2515057	Method and device for regulating the temperature of a fluid medium
<b>C07K 16/00</b> (2006.01)	2523682 *	NOTCH1 BINDING AGENTS AND METHODS OF USE THEREOF
<b>A61K 39/00</b> (2006.01)	2523682 *	NOTCH1 BINDING AGENTS AND METHODS OF USE THEREOF
<b>A61K 9/16</b> (2006.01)	2512453 *	GRANULES FOR PHARMACEUTICAL PREPARATIONS, METHODS AND APPARATUS FOR THEIR PRODUCTION
<b>A61P 1/00</b> (2006.01)	2516446 *	SUBSTITUTED HEXAHYDROCHROMENO[3,4-B]PYRROLES WITH AFFINITY FOR THE SEROTONIN RECEPTOR (5-HT) FAMILY
<b>A61P 3/00</b> (2006.01)	2516446 *	SUBSTITUTED HEXAHYDROCHROMENO[3,4-B]PYRROLES WITH AFFINITY FOR THE SEROTONIN RECEPTOR (5-HT) FAMILY
<b>C07D 491/052</b> (2006.01)	2516446 *	SUBSTITUTED HEXAHYDROCHROMENO[3,4-B]PYRROLES WITH AFFINITY FOR THE SEROTONIN RECEPTOR (5-HT) FAMILY
<b>A61K 31/4439</b> (2006.01)	2516446 *	SUBSTITUTED HEXAHYDROCHROMENO[3,4-B]PYRROLES WITH AFFINITY FOR THE SEROTONIN RECEPTOR (5-HT) FAMILY
<b>A61P 25/00</b> (2006.01)	2516446 *	SUBSTITUTED HEXAHYDROCHROMENO[3,4-B]PYRROLES WITH AFFINITY FOR THE SEROTONIN RECEPTOR (5-HT) FAMILY
<b>A61K 36/899</b> (2006.01)	2512223 *	INSECTICIDAL PROTEIN COMBINATION COMPRISING CRY1AB AND CRY2AA FOR CONTROLLING EUROPEAN CORN BORER, AND METHODS FOR INSECT RESISTANCE MANAGEMENT
<b>A01H 5/00</b> (2006.01)	2512223 *	INSECTICIDAL PROTEIN COMBINATION COMPRISING CRY1AB AND CRY2AA FOR CONTROLLING EUROPEAN CORN BORER, AND METHODS FOR INSECT RESISTANCE MANAGEMENT
<b>A61K 8/49</b> (2006.01)	2516399 *	PHENOL DERIVATIVES AND PHARMACEUTICAL OR COSMETIC USE THEREOF
<b>C07D 213/74</b> (2006.01)	2516399 *	PHENOL DERIVATIVES AND PHARMACEUTICAL OR COSMETIC USE THEREOF
<b>A61Q 19/00</b> (2006.01)	2516399 *	PHENOL DERIVATIVES AND PHARMACEUTICAL OR COSMETIC USE THEREOF
<b>A61K 31/44</b> (2006.01)	2516399 *	PHENOL DERIVATIVES AND PHARMACEUTICAL OR COSMETIC USE THEREOF
<b>A61P 31/00</b> (2006.01)	2519252 *	PYTHIUM IMMUNOTHERAPY
<b>A61K 39/00</b> (2006.01)	2519252 *	PYTHIUM IMMUNOTHERAPY
<b>C07D 413/14</b> (2006.01)	2507230 *	INSECTICIDAL COMPOUNDS BASED ON ISOXAZOLINE DERIVATIVES
<b>C07D 419/12</b> (2006.01)	2507230 *	INSECTICIDAL COMPOUNDS BASED ON ISOXAZOLINE DERIVATIVES
<b>C07D 413/12</b> (2006.01)	2507230 *	INSECTICIDAL COMPOUNDS BASED ON ISOXAZOLINE DERIVATIVES
<b>B23K 23/00</b> (2006.01)	2509740 *	ALTERNATIVE IGNITION SOURCE SYSTEM FOR AN EXOTHERMIC REACTION MOLD DEVICE
<b>B23K 37/00</b> (2006.01)	2509740 *	ALTERNATIVE IGNITION SOURCE SYSTEM FOR AN EXOTHERMIC REACTION MOLD DEVICE
<b>B22D 19/04</b> (2006.01)	2509740 *	ALTERNATIVE IGNITION SOURCE SYSTEM FOR AN EXOTHERMIC REACTION MOLD DEVICE
<b>F23J 15/00</b> (2006.01)	2526177 *	EMISSION-FREE DEVICES AND METHOD FOR PERFORMING MECHANICAL WORK AND FOR GENERATING ELECTRICAL AND THERMAL ENERGY
<b>C10G 2/00</b> (2006.01)	2526177 *	EMISSION-FREE DEVICES AND METHOD FOR PERFORMING MECHANICAL WORK AND FOR GENERATING ELECTRICAL AND THERMAL ENERGY
<b>C07C 29/151</b> (2006.01)	2526177 *	EMISSION-FREE DEVICES AND METHOD FOR PERFORMING MECHANICAL WORK AND FOR GENERATING ELECTRICAL AND THERMAL ENERGY
<b>C10J 3/66</b> (2006.01)	2526177 *	EMISSION-FREE DEVICES AND METHOD FOR PERFORMING MECHANICAL WORK AND FOR GENERATING ELECTRICAL AND THERMAL ENERGY
<b>E21B 33/128</b> (2006.01)	2527585	Packer for sealing against a wellbore wall
<b>E21B 33/12</b> (2006.01)	2527585	Packer for sealing against a wellbore wall

MKP (51)	Broj objave evropske prijava patenta (97)	Naziv pronalaska (54)
<b>C12N 5/10</b> (2006.01)	2536833 *	ANTIBODY AGAINST SEROTYPE E LIPOPOLYSACCHARIDE OF PSEUDOMONAS AERUGINOSA
<b>G01N 33/569</b> (2006.01)	2536833 *	ANTIBODY AGAINST SEROTYPE E LIPOPOLYSACCHARIDE OF PSEUDOMONAS AERUGINOSA
<b>C07K 16/12</b> (2006.01)	2536833 *	ANTIBODY AGAINST SEROTYPE E LIPOPOLYSACCHARIDE OF PSEUDOMONAS AERUGINOSA
<b>A61P 31/04</b> (2006.01)	2536833 *	ANTIBODY AGAINST SEROTYPE E LIPOPOLYSACCHARIDE OF PSEUDOMONAS AERUGINOSA
<b>A61K 39/395</b> (2006.01)	2536833 *	ANTIBODY AGAINST SEROTYPE E LIPOPOLYSACCHARIDE OF PSEUDOMONAS AERUGINOSA
<b>C12P 21/08</b> (2006.01)	2536833 *	ANTIBODY AGAINST SEROTYPE E LIPOPOLYSACCHARIDE OF PSEUDOMONAS AERUGINOSA
<b>C12N 15/09</b> (2006.01)	2536833 *	ANTIBODY AGAINST SEROTYPE E LIPOPOLYSACCHARIDE OF PSEUDOMONAS AERUGINOSA
<b>C07K 16/46</b> (2006.01)	2536833 *	ANTIBODY AGAINST SEROTYPE E LIPOPOLYSACCHARIDE OF PSEUDOMONAS AERUGINOSA
<b>A61K 31/66</b> (2006.01)	2533645 *	METHODS AND COMPOSITIONS FOR IMPROVING COGNITIVE FUNCTION
<b>A01N 57/00</b> (2006.01)	2533645 *	METHODS AND COMPOSITIONS FOR IMPROVING COGNITIVE FUNCTION
<b>B41M 5/28</b> (2006.01)	2509793 *	MARKING BASED ON MODIFIED CHIRAL LIQUID CRYSTAL POLYMERS
<b>B42D 15/00</b> (2006.01)	2509793 *	MARKING BASED ON MODIFIED CHIRAL LIQUID CRYSTAL POLYMERS
<b>B41M 3/14</b> (2006.01)	2509793 *	MARKING BASED ON MODIFIED CHIRAL LIQUID CRYSTAL POLYMERS
<b>B42D 15/10</b> (2006.01)	2509793 *	MARKING BASED ON MODIFIED CHIRAL LIQUID CRYSTAL POLYMERS
<b>A61K 31/403</b> (2006.01)	2509947 *	AZABICYCLO[3.1.0]HEX-2-YL DERIVATIVES, METHOD FOR PREPARING SAME, AND PHARMACEUTICAL COMPOSITIONS CONTAINING SAME
<b>A61P 25/00</b> (2006.01)	2509947 *	AZABICYCLO[3.1.0]HEX-2-YL DERIVATIVES, METHOD FOR PREPARING SAME, AND PHARMACEUTICAL COMPOSITIONS CONTAINING SAME
<b>C07D 209/52</b> (2006.01)	2509947 *	AZABICYCLO[3.1.0]HEX-2-YL DERIVATIVES, METHOD FOR PREPARING SAME, AND PHARMACEUTICAL COMPOSITIONS CONTAINING SAME
<b>A61P 3/06</b> (2006.01)	2536733 *	TRICYCLIC PYRIDINE DERIVATIVES, MEDICAMENTS CONTAINING SUCH COMPOUNDS, THEIR USE AND PROCESS FOR THEIR PREPARATION
<b>A61K 31/4741</b> (2006.01)	2536733 *	TRICYCLIC PYRIDINE DERIVATIVES, MEDICAMENTS CONTAINING SUCH COMPOUNDS, THEIR USE AND PROCESS FOR THEIR PREPARATION
<b>C07D 491/04</b> (2006.01)	2536733 *	TRICYCLIC PYRIDINE DERIVATIVES, MEDICAMENTS CONTAINING SUCH COMPOUNDS, THEIR USE AND PROCESS FOR THEIR PREPARATION
<b>C07D 215/56</b> (2006.01)	2536733 *	TRICYCLIC PYRIDINE DERIVATIVES, MEDICAMENTS CONTAINING SUCH COMPOUNDS, THEIR USE AND PROCESS FOR THEIR PREPARATION
<b>A61P 9/00</b> (2006.01)	2536733 *	TRICYCLIC PYRIDINE DERIVATIVES, MEDICAMENTS CONTAINING SUCH COMPOUNDS, THEIR USE AND PROCESS FOR THEIR PREPARATION
<b>A01N 43/78</b> (2006.01)	2536285 *	SUBSTITUTED FUSED IMIDAZOLE DERIVATIVES, PHARMACEUTICAL COMPOSITIONS, AND METHODS OF USE THEREOF
<b>A61K 31/425</b> (2006.01)	2536285 *	SUBSTITUTED FUSED IMIDAZOLE DERIVATIVES, PHARMACEUTICAL COMPOSITIONS, AND METHODS OF USE THEREOF
<b>C12Q 1/68</b> (2006.01)	2519652 *	BLOOD TRANSCRIPTIONAL SIGNATURE OF ACTIVE VERSUS LATENT MYCOBACTERIUM TUBERCULOSIS INFECTION
<b>G01N 33/15</b> (2006.01)	2519652 *	BLOOD TRANSCRIPTIONAL SIGNATURE OF ACTIVE VERSUS LATENT MYCOBACTERIUM TUBERCULOSIS INFECTION
<b>C12R 1/32</b> (2006.01)	2519652 *	BLOOD TRANSCRIPTIONAL SIGNATURE OF ACTIVE VERSUS LATENT MYCOBACTERIUM TUBERCULOSIS INFECTION
<b>C12N 15/31</b> (2006.01)	2519652 *	BLOOD TRANSCRIPTIONAL SIGNATURE OF ACTIVE VERSUS LATENT MYCOBACTERIUM TUBERCULOSIS INFECTION
<b>H02K 53/00</b> (2006.01)	2512018	Method and apparatus for exploiting interaction energy of magnetic fields
<b>A22C 21/00</b> (2006.01)	2528447 *	METHOD AND APPARATUS FOR COLLECTING MEAT FROM AN ANIMAL PART
<b>A22C 17/00</b> (2006.01)	2528447 *	METHOD AND APPARATUS FOR COLLECTING MEAT FROM AN ANIMAL PART
<b>A01N 43/58</b> (2006.01)	2536283 *	PHENYL-HETEROARYL DERIVATIVES AND METHODS OF USE THEREOF
<b>A61K 31/50</b> (2006.01)	2536283 *	PHENYL-HETEROARYL DERIVATIVES AND METHODS OF USE THEREOF
<b>A61K 31/495</b> (2006.01)	2536283 *	PHENYL-HETEROARYL DERIVATIVES AND METHODS OF USE THEREOF



MKP (51)	Broj objave evropske prijava patenta (97)	Naziv pronalaska (54)
<b>A61L 28/00</b> (2006.01)	2501546 *	RADIO FREQUENCY SEALABLE FILM
<b>B32B 27/30</b> (2006.01)	2501546 *	RADIO FREQUENCY SEALABLE FILM
<b>B32B 27/32</b> (2006.01)	2501546 *	RADIO FREQUENCY SEALABLE FILM
<b>A61J 1/05</b> (2006.01)	2501546 *	RADIO FREQUENCY SEALABLE FILM
<b>A61K 38/19</b> (2006.01)	2506867 *	PHARMACEUTICAL COMPOSITIONS FOR THE STIMULATION OF STEM CELLS.
<b>A61K 38/18</b> (2006.01)	2506867 *	PHARMACEUTICAL COMPOSITIONS FOR THE STIMULATION OF STEM CELLS.
<b>A61K 38/30</b> (2006.01)	2506867 *	PHARMACEUTICAL COMPOSITIONS FOR THE STIMULATION OF STEM CELLS.
<b>A61K 31/529</b> (2006.01)	2506867 *	PHARMACEUTICAL COMPOSITIONS FOR THE STIMULATION OF STEM CELLS.
<b>A61K 38/22</b> (2006.01)	2506867 *	PHARMACEUTICAL COMPOSITIONS FOR THE STIMULATION OF STEM CELLS.
<b>A61K 38/48</b> (2006.01)	2506867 *	PHARMACEUTICAL COMPOSITIONS FOR THE STIMULATION OF STEM CELLS.
<b>B01L 3/00</b> (2006.01)	2519354 *	SAMPLE PROCESSING CARTRIDGE AND METHOD OF PROCESSING AND/OR ANALYSING A SAMPLE UNDER CENTRIFUGAL FORCE
<b>A43B 7/08</b> (2006.01)	2533659 *	SHOE WITH WATERPROOF AND VAPOR-PERMEABLE UPPER AND SOLE
<b>A43B 7/12</b> (2006.01)	2533659 *	SHOE WITH WATERPROOF AND VAPOR-PERMEABLE UPPER AND SOLE
<b>A43B 9/02</b> (2006.01)	2533659 *	SHOE WITH WATERPROOF AND VAPOR-PERMEABLE UPPER AND SOLE
<b>A61B 17/32</b> (2006.01)	2533706 *	ULTRASONICALLY POWERED SURGICAL INSTRUMENTS WITH ROTATING CUTTING IMPLEMENT
<b>A61B 17/00</b> (2006.01)	2533706 *	ULTRASONICALLY POWERED SURGICAL INSTRUMENTS WITH ROTATING CUTTING IMPLEMENT
<b>A61B 17/3207</b> (2006.01)	2533706 *	ULTRASONICALLY POWERED SURGICAL INSTRUMENTS WITH ROTATING CUTTING IMPLEMENT
<b>G02B 6/50</b> (2006.01)	2526450 *	METHOD AND DEVICE FOR INTRODUCING A PIPE FOR OPTICAL CABLES INTO A SOLID LAYING FOUNDATION
<b>E02F 5/10</b> (2006.01)	2526450 *	METHOD AND DEVICE FOR INTRODUCING A PIPE FOR OPTICAL CABLES INTO A SOLID LAYING FOUNDATION
<b>E01F 11/00</b> (2006.01)	2526450 *	METHOD AND DEVICE FOR INTRODUCING A PIPE FOR OPTICAL CABLES INTO A SOLID LAYING FOUNDATION
<b>C07H 21/02</b> (2006.01)	2526112 *	TARGETED GENOMIC ALTERATION
<b>C12P 21/06</b> (2006.01)	2526112 *	TARGETED GENOMIC ALTERATION
<b>A61K 39/12</b> (2006.01)	2519627 *	PLASMIDS AND METHODS FOR PEPTIDE DISPLAY AND AFFINITY-SELECTION ON VIRUS-LIKE PARTICLES OF RNA BACTERIOPHAGES
<b>C12N 15/33</b> (2006.01)	2519627 *	PLASMIDS AND METHODS FOR PEPTIDE DISPLAY AND AFFINITY-SELECTION ON VIRUS-LIKE PARTICLES OF RNA BACTERIOPHAGES
<b>C07K 14/005</b> (2006.01)	2519627 *	PLASMIDS AND METHODS FOR PEPTIDE DISPLAY AND AFFINITY-SELECTION ON VIRUS-LIKE PARTICLES OF RNA BACTERIOPHAGES
<b>C12N 7/01</b> (2006.01)	2519627 *	PLASMIDS AND METHODS FOR PEPTIDE DISPLAY AND AFFINITY-SELECTION ON VIRUS-LIKE PARTICLES OF RNA BACTERIOPHAGES
<b>C12N 15/863</b> (2006.01)	2529010 *	VACCINIA VIRUS MUTANTS CONTAINING THE MAJOR GENOMIC DELETIONS OF MVA
<b>C12N 7/02</b> (2006.01)	2529010 *	VACCINIA VIRUS MUTANTS CONTAINING THE MAJOR GENOMIC DELETIONS OF MVA
<b>A61K 39/275</b> (2006.01)	2529010 *	VACCINIA VIRUS MUTANTS CONTAINING THE MAJOR GENOMIC DELETIONS OF MVA
<b>C12N 7/00</b> (2006.01)	2529010 *	VACCINIA VIRUS MUTANTS CONTAINING THE MAJOR GENOMIC DELETIONS OF MVA
<b>C07D 215/58</b> (2006.01)	2501680 *	A PROCESS FOR A PREPARATION OF MARBOFLOXACIN AND INTERMEDIATE THEREOF
<b>A61F 2/06</b> (2006.01)	2503959 *	SMALL DIAMETER VASCULAR GRAFT PRODUCED BY A HYBRID METHOD
<b>A61M 5/20</b> (2006.01)	2536454 *	AUTO-INJECTOR
<b>A61M 5/00</b> (2006.01)	2536454 *	AUTO-INJECTOR
<b>A61M 5/315</b> (2006.01)	2506902 *	A DRUG DELIVERY DEVICE
<b>A61L 27/38</b> (2006.01)	2439263	Flexible cell culture holder material with a porous three-dimensional structure
<b>C12N 5/00</b> (2006.01)	2439263	Flexible cell culture holder material with a porous three-dimensional structure

MKP (51)	Broj objave evropske prijava patenta (97)	Naziv pronalaska (54)
<b>C12Q 1/68</b> (2006.01)	2519651 *	CLASSIFICATION OF THYROID FOLLICULAR NEOPLASIA BASED ON MRNA EXPRESSION
<b>H04L 7/00</b> (2006.01)	2507950 *	DISTRIBUTED PROCESSING OF DATA FRAMES BY MULTIPLE ADAPTERS USING TIME STAMPING AND A CENTRAL CONTROLLER
<b>H04L 12/56</b> (2006.01)	2507950 *	DISTRIBUTED PROCESSING OF DATA FRAMES BY MULTIPLE ADAPTERS USING TIME STAMPING AND A CENTRAL CONTROLLER
<b>A61P 3/04</b> (2006.01)	2510009 *	HUMAN ANTIGEN BINDING PROTEINS THAT BIND BETA-KLOTHO, FGF RECEPTORS AND COMPLEXES THEREOF
<b>C07K 14/71</b> (2006.01)	2510009 *	HUMAN ANTIGEN BINDING PROTEINS THAT BIND BETA-KLOTHO, FGF RECEPTORS AND COMPLEXES THEREOF
<b>A61K 39/395</b> (2006.01)	2510009 *	HUMAN ANTIGEN BINDING PROTEINS THAT BIND BETA-KLOTHO, FGF RECEPTORS AND COMPLEXES THEREOF
<b>C07K 16/28</b> (2006.01)	2510009 *	HUMAN ANTIGEN BINDING PROTEINS THAT BIND BETA-KLOTHO, FGF RECEPTORS AND COMPLEXES THEREOF
<b>C07K 19/00</b> (2006.01)	2510009 *	HUMAN ANTIGEN BINDING PROTEINS THAT BIND BETA-KLOTHO, FGF RECEPTORS AND COMPLEXES THEREOF
<b>C07K 16/18</b> (2006.01)	2510009 *	HUMAN ANTIGEN BINDING PROTEINS THAT BIND BETA-KLOTHO, FGF RECEPTORS AND COMPLEXES THEREOF
<b>A61K 38/22</b> (2006.01)	2525808 *	OSTEOCALCIN AS A TREATMENT FOR MALE REPRODUCTIVE DISORDERS
<b>G06F 19/00</b> (2011.01)	2525850 *	METHOD AND SYSTEM FOR DETERMINING INFORMATION RELATED TO A DRUG RESERVOIR
<b>G06K 7/10</b> (2006.01)	2525850 *	METHOD AND SYSTEM FOR DETERMINING INFORMATION RELATED TO A DRUG RESERVOIR
<b>G06K 7/14</b> (2006.01)	2525850 *	METHOD AND SYSTEM FOR DETERMINING INFORMATION RELATED TO A DRUG RESERVOIR
<b>A61M 5/24</b> (2006.01)	2525850 *	METHOD AND SYSTEM FOR DETERMINING INFORMATION RELATED TO A DRUG RESERVOIR
<b>G01V 5/00</b> (2006.01)	2437082	Improved security check method and system
<b>B64F 1/36</b> (2006.01)	2437082	Improved security check method and system
<b>G01N 33/53</b> (2006.01)	2536743 *	HUMAN GROUP P IMMUNODEFICIENCY VIRUS AND USES THEREOF
<b>C07K 14/16</b> (2006.01)	2536743 *	HUMAN GROUP P IMMUNODEFICIENCY VIRUS AND USES THEREOF
<b>C12N 7/00</b> (2006.01)	2536743 *	HUMAN GROUP P IMMUNODEFICIENCY VIRUS AND USES THEREOF
<b>A61F 9/00</b> (2006.01)	2503969 *	LACRIMAL IMPLANTS INCLUDING SPLIT AND INSERTABLE DRUG CORE
<b>A61F 9/007</b> (2006.01)	2503969 *	LACRIMAL IMPLANTS INCLUDING SPLIT AND INSERTABLE DRUG CORE
<b>C04B 40/06</b> (2006.01)	2510070 *	A BIODEGRADABLE SET RETARDER FOR A CEMENT COMPOSITION
<b>C04B 24/26</b> (2006.01)	2510070 *	A BIODEGRADABLE SET RETARDER FOR A CEMENT COMPOSITION
<b>C09K 8/42</b> (2006.01)	2510070 *	A BIODEGRADABLE SET RETARDER FOR A CEMENT COMPOSITION
<b>C09K 8/467</b> (2006.01)	2510070 *	A BIODEGRADABLE SET RETARDER FOR A CEMENT COMPOSITION
<b>E21B 43/04</b> (2006.01)	2510070 *	A BIODEGRADABLE SET RETARDER FOR A CEMENT COMPOSITION
<b>C04B 28/02</b> (2006.01)	2510070 *	A BIODEGRADABLE SET RETARDER FOR A CEMENT COMPOSITION
<b>A61K 9/70</b> (2006.01)	2515887 *	POLYVINYLPYRROLIDONE FOR THE STABILIZATION OF A SOLID DISPERSION OF THE NON-CRYSTALLINE FORM OF ROTIGOTINE
<b>A61K 31/381</b> (2006.01)	2515887 *	POLYVINYLPYRROLIDONE FOR THE STABILIZATION OF A SOLID DISPERSION OF THE NON-CRYSTALLINE FORM OF ROTIGOTINE
<b>A61K 31/428</b> (2006.01)	2513068 *	SUBSTITUTED BENZOTHAIAZOLE AND BENZOXAZOLE DERIVATIVES USEFUL AS INHIBITORS OF DPP-1
<b>A61K 31/4523</b> (2006.01)	2513068 *	SUBSTITUTED BENZOTHAIAZOLE AND BENZOXAZOLE DERIVATIVES USEFUL AS INHIBITORS OF DPP-1
<b>A61K 31/423</b> (2006.01)	2513068 *	SUBSTITUTED BENZOTHAIAZOLE AND BENZOXAZOLE DERIVATIVES USEFUL AS INHIBITORS OF DPP-1
<b>C07D 417/14</b> (2006.01)	2513068 *	SUBSTITUTED BENZOTHAIAZOLE AND BENZOXAZOLE DERIVATIVES USEFUL AS INHIBITORS OF DPP-1
<b>C07D 277/82</b> (2006.01)	2513068 *	SUBSTITUTED BENZOTHAIAZOLE AND BENZOXAZOLE DERIVATIVES USEFUL AS INHIBITORS OF DPP-1

MKP (51)	Broj objave evropske prijava patenta (97)	Naziv pronalaska (54)
<b>A61P 29/00</b> (2006.01)	2513068 *	SUBSTITUTED BENZOTHIAZOLE AND BENZOXAZOLE DERIVATIVES USEFUL AS INHIBITORS OF DPP-1
<b>C07D 417/12</b> (2006.01)	2513068 *	SUBSTITUTED BENZOTHIAZOLE AND BENZOXAZOLE DERIVATIVES USEFUL AS INHIBITORS OF DPP-1
<b>C07D 413/12</b> (2006.01)	2513068 *	SUBSTITUTED BENZOTHIAZOLE AND BENZOXAZOLE DERIVATIVES USEFUL AS INHIBITORS OF DPP-1
<b>C07D 263/58</b> (2006.01)	2513068 *	SUBSTITUTED BENZOTHIAZOLE AND BENZOXAZOLE DERIVATIVES USEFUL AS INHIBITORS OF DPP-1
<b>A61P 11/00</b> (2006.01)	2513068 *	SUBSTITUTED BENZOTHIAZOLE AND BENZOXAZOLE DERIVATIVES USEFUL AS INHIBITORS OF DPP-1
<b>B23D 31/00</b> (2006.01)	2415538	Device for processing workpieces
<b>B65G 29/00</b> (2006.01)	2415538	Device for processing workpieces
<b>B23Q 39/04</b> (2006.01)	2415538	Device for processing workpieces
<b>B21D 43/14</b> (2006.01)	2415538	Device for processing workpieces
<b>B23Q 7/02</b> (2006.01)	2415538	Device for processing workpieces
<b>H01L 31/048</b> (2006.01)	2518779	Grounding system for photovoltaic arrays
<b>F24J 2/52</b> (2006.01)	2518779	Grounding system for photovoltaic arrays
<b>G06F 3/041</b> (2006.01)	2534558 *	SYSTEMS AND METHODS FOR HAPTIC FEEDBACK USING LATERALLY DRIVEN PIEZOELECTRIC ACTUATORS
<b>G06F 3/01</b> (2006.01)	2534558 *	SYSTEMS AND METHODS FOR HAPTIC FEEDBACK USING LATERALLY DRIVEN PIEZOELECTRIC ACTUATORS
<b>B65D 47/32</b> (2006.01)	2531416 *	PRESSURE EQUALIZATION APPARATUS FOR A BOTTLE AND METHODS ASSOCIATED THEREWITH
<b>A61K 31/13</b> (2006.01)	2515889 *	SYNERGISTIC ANTIVIRAL COMPOSITION AND USE THEREOF
<b>A61K 31/19</b> (2006.01)	2515889 *	SYNERGISTIC ANTIVIRAL COMPOSITION AND USE THEREOF
<b>A61K 31/731</b> (2006.01)	2515889 *	SYNERGISTIC ANTIVIRAL COMPOSITION AND USE THEREOF
<b>C07K 16/46</b> (2006.01)	2519543 *	HETERODIMER BINDING PROTEINS AND USES THEREOF
<b>A61K 39/395</b> (2006.01)	2519543 *	HETERODIMER BINDING PROTEINS AND USES THEREOF
<b>A61P 35/00</b> (2006.01)	2519543 *	HETERODIMER BINDING PROTEINS AND USES THEREOF
<b>A61P 37/00</b> (2006.01)	2519543 *	HETERODIMER BINDING PROTEINS AND USES THEREOF
<b>C07C 305/00</b> (2006.01)	2521711 *	QUATERNARY AMMONIUM SALT PRODRUGS
<b>F16L 33/00</b> (2006.01)	2507144 *	CABLE TIE
<b>F16L 33/22</b> (2006.01)	2507144 *	CABLE TIE
<b>B65D 63/02</b> (2006.01)	2507144 *	CABLE TIE
<b>A61K 9/70</b> (2006.01)	2514440 *	TRANSDERMAL PREPARATION CONTAINING BASIC ANTI-INFLAMMATORY AGENT
<b>A61K 45/06</b> (2006.01)	2514440 *	TRANSDERMAL PREPARATION CONTAINING BASIC ANTI-INFLAMMATORY AGENT
<b>A61K 47/18</b> (2006.01)	2514440 *	TRANSDERMAL PREPARATION CONTAINING BASIC ANTI-INFLAMMATORY AGENT
<b>A61K 31/42</b> (2006.01)	2514440 *	TRANSDERMAL PREPARATION CONTAINING BASIC ANTI-INFLAMMATORY AGENT
<b>A61P 29/00</b> (2006.01)	2514440 *	TRANSDERMAL PREPARATION CONTAINING BASIC ANTI-INFLAMMATORY AGENT
<b>A61P 23/02</b> (2006.01)	2514440 *	TRANSDERMAL PREPARATION CONTAINING BASIC ANTI-INFLAMMATORY AGENT
<b>A61K 31/167</b> (2006.01)	2514440 *	TRANSDERMAL PREPARATION CONTAINING BASIC ANTI-INFLAMMATORY AGENT
<b>A61K 31/245</b> (2006.01)	2514440 *	TRANSDERMAL PREPARATION CONTAINING BASIC ANTI-INFLAMMATORY AGENT
<b>A61K 31/44</b> (2006.01)	2506713 *	NOVEL TRICYCLIC COMPOUNDS
<b>A01N 43/42</b> (2006.01)	2506713 *	NOVEL TRICYCLIC COMPOUNDS
<b>C07K 14/475</b> (2006.01)	2516455 *	MODIFIED PORCINE SOMATOTROPIN POLYPEPTIDES AND THEIR USES
<b>A61K 9/20</b> (2006.01)	2441444	Formulations of cetyl myristate and/or cetyl palmitate

MKP (51)	Broj objave evropske prijava patenta (97)	Naziv pronalaska (54)
<b>A61K 31/215</b> (2006.01)	2441444	Formulations of cetyl myristate and/or cetyl palmitate
<b>A61B 17/32</b> (2006.01)	2533708 *	ULTRASONIC SURGICAL INSTRUMENT WITH COMB-LIKE TISSUE TRIMMING DEVICE
<b>A61B 17/3207</b> (2006.01)	2533708 *	ULTRASONIC SURGICAL INSTRUMENT WITH COMB-LIKE TISSUE TRIMMING DEVICE
<b>B01D 47/06</b> (2006.01)	2527026 *	NEUTRALISATION OF GASEOUS CONTAMINANTS BY MEANS OF ARTIFICIAL PHOTOSYNTHESIS
<b>B65C 3/18</b> (2006.01)	2531407 *	DEVICE AND METHOD FOR APPLYING SELF-ADHESIVE LABELS ON THE WALLS OF CONTAINERS
<b>B65C 3/16</b> (2006.01)	2531407 *	DEVICE AND METHOD FOR APPLYING SELF-ADHESIVE LABELS ON THE WALLS OF CONTAINERS
<b>A61K 31/381</b> (2006.01)	2511271 *	HETEROARYLCARBOXYLIC ACID ESTER DERIVATIVE
<b>C07D 277/56</b> (2006.01)	2511271 *	HETEROARYLCARBOXYLIC ACID ESTER DERIVATIVE
<b>A61K 31/4525</b> (2006.01)	2511271 *	HETEROARYLCARBOXYLIC ACID ESTER DERIVATIVE
<b>C07D 405/06</b> (2006.01)	2511271 *	HETEROARYLCARBOXYLIC ACID ESTER DERIVATIVE
<b>A61P 3/04</b> (2006.01)	2511271 *	HETEROARYLCARBOXYLIC ACID ESTER DERIVATIVE
<b>A61P 3/06</b> (2006.01)	2511271 *	HETEROARYLCARBOXYLIC ACID ESTER DERIVATIVE
<b>A61K 31/426</b> (2006.01)	2511271 *	HETEROARYLCARBOXYLIC ACID ESTER DERIVATIVE
<b>C07D 333/38</b> (2006.01)	2511271 *	HETEROARYLCARBOXYLIC ACID ESTER DERIVATIVE
<b>A61K 31/4025</b> (2006.01)	2511271 *	HETEROARYLCARBOXYLIC ACID ESTER DERIVATIVE
<b>C07D 307/68</b> (2006.01)	2511271 *	HETEROARYLCARBOXYLIC ACID ESTER DERIVATIVE
<b>A61K 31/341</b> (2006.01)	2511271 *	HETEROARYLCARBOXYLIC ACID ESTER DERIVATIVE
<b>A61P 43/00</b> (2006.01)	2511271 *	HETEROARYLCARBOXYLIC ACID ESTER DERIVATIVE
<b>C07D 277/20</b> (2006.01)	2511271 *	HETEROARYLCARBOXYLIC ACID ESTER DERIVATIVE
<b>A61P 3/10</b> (2006.01)	2511271 *	HETEROARYLCARBOXYLIC ACID ESTER DERIVATIVE
<b>C07D 239/34</b> (2006.01)	2464633 *	REGIOSELECTIVE PREPARATION OF 2-AMINO-5-TRIFLUOROMETHYLPYRIMIDINE DERIVATIVES
<b>C07D 239/42</b> (2006.01)	2464633 *	REGIOSELECTIVE PREPARATION OF 2-AMINO-5-TRIFLUOROMETHYLPYRIMIDINE DERIVATIVES
<b>C07D 239/47</b> (2006.01)	2464633 *	REGIOSELECTIVE PREPARATION OF 2-AMINO-5-TRIFLUOROMETHYLPYRIMIDINE DERIVATIVES
<b>C07D 239/48</b> (2006.01)	2464633 *	REGIOSELECTIVE PREPARATION OF 2-AMINO-5-TRIFLUOROMETHYLPYRIMIDINE DERIVATIVES
<b>C07D 471/04</b> (2006.01)	2504334 *	METHOD FOR PRODUCING METHYL-{4,6-DIAMINO-2-[1-(2-FLUOROBENZYL)-1H-PYRAZOLO[3,4-B]PYRIDINO-3-YL]PYRIMIDINO-5-YL}METHYL CARBAMATE AND ITS PURIFICATION FOR USE THEREOF AS PHARMACEUTICAL SUBSTANCE
<b>F03B 13/18</b> (2006.01)	2510226 *	AN APPARATUS FOR EXTRACTING ENERGY FROM WAVES
<b>F03B 13/20</b> (2006.01)	2510226 *	AN APPARATUS FOR EXTRACTING ENERGY FROM WAVES
<b>F03D 9/00</b> (2006.01)	2526291 *	LOW-PROFILE POWER-GENERATING WIND TURBINE
<b>A61K 31/497</b> (2006.01)	2523665 *	VOLTAGE-GATED SODIUM CHANNEL BLOCKERS
<b>C07D 498/04</b> (2006.01)	2523959 *	HETEROCYCLIC CARBOXYLIC ACID DERIVATIVES HAVING A 2,5,7-SUBSTITUTED OXAZOLOPYRIMIDINE RING
<b>A61K 9/00</b> (2006.01)	2523959 *	HETEROCYCLIC CARBOXYLIC ACID DERIVATIVES HAVING A 2,5,7-SUBSTITUTED OXAZOLOPYRIMIDINE RING
<b>A61K 31/519</b> (2006.01)	2523959 *	HETEROCYCLIC CARBOXYLIC ACID DERIVATIVES HAVING A 2,5,7-SUBSTITUTED OXAZOLOPYRIMIDINE RING
<b>A61K 31/535</b> (2006.01)	2511268 *	OXAZINE DERIVATIVE
<b>C07D 413/12</b> (2006.01)	2511268 *	OXAZINE DERIVATIVE
<b>A61P 25/16</b> (2006.01)	2511268 *	OXAZINE DERIVATIVE
<b>A61P 25/28</b> (2006.01)	2511268 *	OXAZINE DERIVATIVE
<b>A61P 27/02</b> (2006.01)	2511268 *	OXAZINE DERIVATIVE

MKP (51)	Broj objave evropske prijava patenta (97)	Naziv pronalaska (54)
<b>A61K 31/5365</b> (2006.01)	2511268 *	OXAZINE DERIVATIVE
<b>C07D 498/04</b> (2006.01)	2511268 *	OXAZINE DERIVATIVE
<b>A61K 31/5355</b> (2006.01)	2511268 *	OXAZINE DERIVATIVE
<b>C07D 413/14</b> (2006.01)	2511268 *	OXAZINE DERIVATIVE
<b>C07D 265/06</b> (2006.01)	2511268 *	OXAZINE DERIVATIVE
<b>C07D 265/08</b> (2006.01)	2511268 *	OXAZINE DERIVATIVE
<b>A61P 43/00</b> (2006.01)	2511268 *	OXAZINE DERIVATIVE
<b>B01J 37/04</b> (2006.01)	2529832 *	CATALYST SYSTEM AND PROCESSES FOR THE (CO-)TRIMERIZATION OF OLEFINS AND THE (CO-)POLYMERIZATION OF OLEFIN OLIGOMERS
<b>B01J 31/22</b> (2006.01)	2529832 *	CATALYST SYSTEM AND PROCESSES FOR THE (CO-)TRIMERIZATION OF OLEFINS AND THE (CO-)POLYMERIZATION OF OLEFIN OLIGOMERS
<b>C08F 10/00</b> (2006.01)	2529832 *	CATALYST SYSTEM AND PROCESSES FOR THE (CO-)TRIMERIZATION OF OLEFINS AND THE (CO-)POLYMERIZATION OF OLEFIN OLIGOMERS
<b>B01J 37/34</b> (2006.01)	2529832 *	CATALYST SYSTEM AND PROCESSES FOR THE (CO-)TRIMERIZATION OF OLEFINS AND THE (CO-)POLYMERIZATION OF OLEFIN OLIGOMERS
<b>A61K 31/536</b> (2006.01)	2536411 *	INHIBITORS OF LONG AND VERY LONG CHAIN FATTY ACID METABOLISM AS BROAD SPECTRUM ANTI-VIRALS
<b>C07D 409/12</b> (2006.01)	2523951 *	INHIBITORS OF FLAVIVIRIDAE VIRUSES
<b>A61K 31/4436</b> (2006.01)	2523951 *	INHIBITORS OF FLAVIVIRIDAE VIRUSES
<b>A61K 31/381</b> (2006.01)	2523951 *	INHIBITORS OF FLAVIVIRIDAE VIRUSES
<b>C07D 493/04</b> (2006.01)	2523951 *	INHIBITORS OF FLAVIVIRIDAE VIRUSES
<b>A61P 31/00</b> (2006.01)	2523951 *	INHIBITORS OF FLAVIVIRIDAE VIRUSES
<b>C07D 409/14</b> (2006.01)	2523951 *	INHIBITORS OF FLAVIVIRIDAE VIRUSES
<b>C12P 19/62</b> (2006.01)	2501821 *	PROCESS FOR PRODUCING PRIMYCIN, PRIMYCIN COMPONENT(S), PRECURSORS AND METABOLITES THEREOF VIA FERMENTATION BY THE USE OF BACTERIAL SPECIES SACCHAROMONOSPORAZUREA
<b>A01H 5/00</b> (2006.01)	2512220 *	INSECTICIDAL PROTEIN COMBINATIONS FOR CONTROLLING FALL ARMYWORM AND EUROPEAN CORN BORER, AND METHODS FOR INSECT RESISTANCE MANagements
<b>A01P 7/00</b> (2006.01)	2512220 *	INSECTICIDAL PROTEIN COMBINATIONS FOR CONTROLLING FALL ARMYWORM AND EUROPEAN CORN BORER, AND METHODS FOR INSECT RESISTANCE MANagements
<b>A01H 1/00</b> (2006.01)	2512220 *	INSECTICIDAL PROTEIN COMBINATIONS FOR CONTROLLING FALL ARMYWORM AND EUROPEAN CORN BORER, AND METHODS FOR INSECT RESISTANCE MANagements
<b>A61P 35/00</b> (2006.01)	2504332 *	AN AMORPHOUS AND A CRYSTALLINE FORM OF GENZ 112638 HEMITARTRATE AS INHIBITOR OF GLUCOSYLCERAMIDE SYNTHASE
<b>C07D 405/06</b> (2006.01)	2504332 *	AN AMORPHOUS AND A CRYSTALLINE FORM OF GENZ 112638 HEMITARTRATE AS INHIBITOR OF GLUCOSYLCERAMIDE SYNTHASE
<b>A61K 31/4025</b> (2006.01)	2504332 *	AN AMORPHOUS AND A CRYSTALLINE FORM OF GENZ 112638 HEMITARTRATE AS INHIBITOR OF GLUCOSYLCERAMIDE SYNTHASE
<b>A01N 43/42</b> (2006.01)	2506712 *	MORPHINAN DERIVATIVES FOR THE TREATMENT OF DRUG OVERDOSE
<b>A61K 31/34</b> (2006.01)	2512466 *	PRODRUGS OF INHIBITORS OF PLASMA KALLIKREIN
<b>C12N 15/11</b> (2006.01)	2521781 *	PRIMERS FOR DIAGNOSING ANKYLOSING SPONDYLITIS, AND METHOD FOR DIAGNOSING ANKYLOSING SPONDYLITIS USING THE SAME
<b>C12Q 1/68</b> (2006.01)	2521781 *	PRIMERS FOR DIAGNOSING ANKYLOSING SPONDYLITIS, AND METHOD FOR DIAGNOSING ANKYLOSING SPONDYLITIS USING THE SAME
<b>B01D 17/02</b> (2006.01)	2512984 *	THREE PHASE SULFUR SEPARATION SYSTEM WITH INTERFACE CONTROL
<b>C01B 17/02</b> (2006.01)	2512984 *	THREE PHASE SULFUR SEPARATION SYSTEM WITH INTERFACE CONTROL
<b>E05C 17/02</b> (2006.01)	2439365	Shutter holder with selectable position
<b>E05C 17/24</b> (2006.01)	2439365	Shutter holder with selectable position
<b>C12Q 1/68</b> (2006.01)	2532755	Methods and uses based on Slfn2 expression and relating to the identification and profiling of compounds for use in the treatment or prevention of pain

MKP (51)	Broj objave evropske prijava patenta (97)	Naziv pronalaska (54)
<b>G01N 33/50</b> (2006.01)	2532755	Methods and uses based on Sln2 expression and relating to the identification and profiling of compounds for use in the treatment or prevention of pain
<b>C07D 513/04</b> (2006.01)	2513117 *	BICYCLIC THIAZOLES AS ALLOSTERIC MODULATORS OF MGLUR5 RECEPTORS
<b>A61K 31/429</b> (2006.01)	2513117 *	BICYCLIC THIAZOLES AS ALLOSTERIC MODULATORS OF MGLUR5 RECEPTORS
<b>A61P 25/18</b> (2006.01)	2513117 *	BICYCLIC THIAZOLES AS ALLOSTERIC MODULATORS OF MGLUR5 RECEPTORS
<b>A61K 31/428</b> (2006.01)	2513117 *	BICYCLIC THIAZOLES AS ALLOSTERIC MODULATORS OF MGLUR5 RECEPTORS
<b>A61P 33/00</b> (2006.01)	2513104 *	ANTI PARASITIC DIHYDROAZOLE COMPOUNDS AND COMPOSITIONS COMPRISING SAME
<b>A01P 7/04</b> (2006.01)	2513104 *	ANTI PARASITIC DIHYDROAZOLE COMPOUNDS AND COMPOSITIONS COMPRISING SAME
<b>A01N 43/90</b> (2006.01)	2513104 *	ANTI PARASITIC DIHYDROAZOLE COMPOUNDS AND COMPOSITIONS COMPRISING SAME
<b>A01P 5/00</b> (2006.01)	2513104 *	ANTI PARASITIC DIHYDROAZOLE COMPOUNDS AND COMPOSITIONS COMPRISING SAME
<b>A61K 31/437</b> (2006.01)	2513104 *	ANTI PARASITIC DIHYDROAZOLE COMPOUNDS AND COMPOSITIONS COMPRISING SAME
<b>C07D 471/04</b> (2006.01)	2513104 *	ANTI PARASITIC DIHYDROAZOLE COMPOUNDS AND COMPOSITIONS COMPRISING SAME
<b>C12Q 1/68</b> (2006.01)	2531613 *	METHODS AND COMPOSITIONS FOR PREDICTING RESPONSIVENESS TO TREATMENT WITH TNF-ALPHA INHIBITOR
<b>C07D 417/14</b> (2006.01)	2536716 *	AMINOTHIAZOLONES AS ESTROGEN RELATED RECEPTOR-ALPHA MODULATORS
<b>A61K 31/427</b> (2006.01)	2536716 *	AMINOTHIAZOLONES AS ESTROGEN RELATED RECEPTOR-ALPHA MODULATORS
<b>C07D 417/06</b> (2006.01)	2536716 *	AMINOTHIAZOLONES AS ESTROGEN RELATED RECEPTOR-ALPHA MODULATORS
<b>A61P 5/30</b> (2006.01)	2536716 *	AMINOTHIAZOLONES AS ESTROGEN RELATED RECEPTOR-ALPHA MODULATORS
<b>C07K 16/00</b> (2006.01)	2523972 *	MULTIVALENT ANTIBODIES
<b>A61P 1/16</b> (2006.01)	2528605 *	THERAPIES FOR TREATING HEPATITIS C VIRUS INFECTION
<b>A61K 31/4535</b> (2006.01)	2528605 *	THERAPIES FOR TREATING HEPATITIS C VIRUS INFECTION
<b>A61K 31/454</b> (2006.01)	2528605 *	THERAPIES FOR TREATING HEPATITIS C VIRUS INFECTION
<b>C12P 19/04</b> (2006.01)	2532448 *	METHOD FOR DEGRADING ORGANIC MATERIAL USING MOTHER CELL LYASES FORMED IN ASSOCIATION WITH SPORE FORMATION OF MICROORGANISM
<b>B09B 3/00</b> (2006.01)	2532448 *	METHOD FOR DEGRADING ORGANIC MATERIAL USING MOTHER CELL LYASES FORMED IN ASSOCIATION WITH SPORE FORMATION OF MICROORGANISM
<b>A61M 39/04</b> (2006.01)	2531255 *	ANGIOTHETER DEVICE WITH IMPROVED SAFETY FEATURES
<b>B65D 5/24</b> (2006.01)	2452886	Folding box with storage compartments
<b>B65D 5/4805</b> (2006.01)	2452886	Folding box with storage compartments
<b>A61K 31/365</b> (2006.01)	2512467 *	COMPOSITIONS COMPRISING MACROCYCLIC LACTONE COMPOUNDS AND SPIRODIOXEPINOINDOLES
<b>A61K 31/495</b> (2006.01)	2512467 *	COMPOSITIONS COMPRISING MACROCYCLIC LACTONE COMPOUNDS AND SPIRODIOXEPINOINDOLES
<b>A61P 33/10</b> (2006.01)	2512467 *	COMPOSITIONS COMPRISING MACROCYCLIC LACTONE COMPOUNDS AND SPIRODIOXEPINOINDOLES
<b>C07D 215/38</b> (2006.01)	2522658 *	NITROGEN-CONTAINING HETEROCYCLIC COMPOUND AND AGRICULTURAL/ HORTICULTURAL GERMICIDE
<b>C07D 215/18</b> (2006.01)	2522658 *	NITROGEN-CONTAINING HETEROCYCLIC COMPOUND AND AGRICULTURAL/ HORTICULTURAL GERMICIDE

MKP (51)	Broj objave evropske prijava patenta (97)	Naziv pronalaska (54)
<b>A01N 43/42</b> (2006.01)	2522658 *	NITROGEN-CONTAINING HETEROCYCLIC COMPOUND AND AGRICULTURAL/HORTICULTURAL GERMICIDE
<b>C07D 471/04</b> (2006.01)	2522658 *	NITROGEN-CONTAINING HETEROCYCLIC COMPOUND AND AGRICULTURAL/HORTICULTURAL GERMICIDE
<b>A01P 3/00</b> (2006.01)	2522658 *	NITROGEN-CONTAINING HETEROCYCLIC COMPOUND AND AGRICULTURAL/HORTICULTURAL GERMICIDE
<b>C07D 495/04</b> (2006.01)	2522658 *	NITROGEN-CONTAINING HETEROCYCLIC COMPOUND AND AGRICULTURAL/HORTICULTURAL GERMICIDE
<b>C07D 221/04</b> (2006.01)	2522658 *	NITROGEN-CONTAINING HETEROCYCLIC COMPOUND AND AGRICULTURAL/HORTICULTURAL GERMICIDE
<b>A01N 55/00</b> (2006.01)	2522658 *	NITROGEN-CONTAINING HETEROCYCLIC COMPOUND AND AGRICULTURAL/HORTICULTURAL GERMICIDE
<b>C07D 491/048</b> (2006.01)	2522658 *	NITROGEN-CONTAINING HETEROCYCLIC COMPOUND AND AGRICULTURAL/HORTICULTURAL GERMICIDE
<b>C07D 215/14</b> (2006.01)	2522658 *	NITROGEN-CONTAINING HETEROCYCLIC COMPOUND AND AGRICULTURAL/HORTICULTURAL GERMICIDE
<b>C07D 401/12</b> (2006.01)	2522658 *	NITROGEN-CONTAINING HETEROCYCLIC COMPOUND AND AGRICULTURAL/HORTICULTURAL GERMICIDE
<b>C07D 215/20</b> (2006.01)	2522658 *	NITROGEN-CONTAINING HETEROCYCLIC COMPOUND AND AGRICULTURAL/HORTICULTURAL GERMICIDE
<b>C07D 495/04</b> (2006.01)	2501702 *	METHOD FOR PREPARING N-SUCCINIMIDYL N-BIOTINYL-6-AMINOCAPROATE
<b>A61P 11/08</b> (2006.01)	2506844 *	COMBINATIONS OF A MUSCARINIC RECEPTOR ANTAGONIST AND A BETA-2 ADRENORECEPTOR AGONIST
<b>A61K 45/06</b> (2006.01)	2506844 *	COMBINATIONS OF A MUSCARINIC RECEPTOR ANTAGONIST AND A BETA-2 ADRENORECEPTOR AGONIST
<b>A61K 31/138</b> (2006.01)	2506844 *	COMBINATIONS OF A MUSCARINIC RECEPTOR ANTAGONIST AND A BETA-2 ADRENORECEPTOR AGONIST
<b>A61P 11/06</b> (2006.01)	2506844 *	COMBINATIONS OF A MUSCARINIC RECEPTOR ANTAGONIST AND A BETA-2 ADRENORECEPTOR AGONIST
<b>A61K 31/439</b> (2006.01)	2506844 *	COMBINATIONS OF A MUSCARINIC RECEPTOR ANTAGONIST AND A BETA-2 ADRENORECEPTOR AGONIST
<b>A61K 31/00</b> (2006.01)	2519231 *	TREATMENT OF DISEASE WITH PROTEASOME INHIBITORS BACKGROUND OF THE INVENTION
<b>A61K 45/06</b> (2006.01)	2519231 *	TREATMENT OF DISEASE WITH PROTEASOME INHIBITORS BACKGROUND OF THE INVENTION
<b>A61K 35/00</b> (2006.01)	2519231 *	TREATMENT OF DISEASE WITH PROTEASOME INHIBITORS BACKGROUND OF THE INVENTION
<b>A61K 31/69</b> (2006.01)	2519231 *	TREATMENT OF DISEASE WITH PROTEASOME INHIBITORS BACKGROUND OF THE INVENTION
<b>C02F 3/12</b> (2006.01)	2508490 *	SLUDGE TREATMENT METHOD AND APPARATUS THEREOF AND APPLICATION TO WASTEWATER BIO-TREATMENT
<b>C02F 3/30</b> (2006.01)	2508490 *	SLUDGE TREATMENT METHOD AND APPARATUS THEREOF AND APPLICATION TO WASTEWATER BIO-TREATMENT
<b>C02F 11/02</b> (2006.01)	2508490 *	SLUDGE TREATMENT METHOD AND APPARATUS THEREOF AND APPLICATION TO WASTEWATER BIO-TREATMENT
<b>A61K 31/4152</b> (2006.01)	2503994 *	PHARMACEUTICAL COMPOSITIONS COMPRISING SIGMA RECEPTOR LIGANDS
<b>A61K 9/16</b> (2006.01)	2503994 *	PHARMACEUTICAL COMPOSITIONS COMPRISING SIGMA RECEPTOR LIGANDS
<b>A61P 25/00</b> (2006.01)	2516441 *	PTERIDINONES AS INHIBITORS OF POLO-LIKE KINASE
<b>C07D 475/04</b> (2006.01)	2516441 *	PTERIDINONES AS INHIBITORS OF POLO-LIKE KINASE
<b>C07D 475/12</b> (2006.01)	2516441 *	PTERIDINONES AS INHIBITORS OF POLO-LIKE KINASE
<b>A61K 31/4985</b> (2006.01)	2516441 *	PTERIDINONES AS INHIBITORS OF POLO-LIKE KINASE
<b>A61B 5/151</b> (2006.01)	2528507 *	ANALYTE MEASUREMENT DEVICE WITH A SINGLE SHOT ACTUATOR
<b>A61B 17/00</b> (2006.01)	2509513 *	CIRCULAR STAPLER INTRODUCER WITH RIGID CAP ASSEMBLY CONFIGURED FOR EASY REMOVAL

MKP (51)	Broj objave evropske prijava patenta (97)	Naziv pronalaska (54)
<b>A61B 17/34</b> (2006.01)	2509513 *	CIRCULAR STAPLER INTRODUCER WITH RIGID CAP ASSEMBLY CONFIGURED FOR EASY REMOVAL
<b>A61B 17/068</b> (2006.01)	2509513 *	CIRCULAR STAPLER INTRODUCER WITH RIGID CAP ASSEMBLY CONFIGURED FOR EASY REMOVAL
<b>A61B 19/00</b> (2006.01)	2509513 *	CIRCULAR STAPLER INTRODUCER WITH RIGID CAP ASSEMBLY CONFIGURED FOR EASY REMOVAL
<b>A61B 17/115</b> (2006.01)	2509513 *	CIRCULAR STAPLER INTRODUCER WITH RIGID CAP ASSEMBLY CONFIGURED FOR EASY REMOVAL
<b>E04F 15/02</b> (2006.01)	2529062 *	SYNTHETIC FLOOR TILE HAVING PARTIALLY COMPLIANT SUPPORT STRUCTURE
<b>E04F 15/024</b> (2006.01)	2529062 *	SYNTHETIC FLOOR TILE HAVING PARTIALLY COMPLIANT SUPPORT STRUCTURE
<b>A61K 31/275</b> (2006.01)	2533634 *	NEUROPROTECTION IN DEMYELINATING DISEASES
<b>A01N 37/34</b> (2006.01)	2533634 *	NEUROPROTECTION IN DEMYELINATING DISEASES
<b>A61P 1/04</b> (2006.01)	2515937 *	NON-FERMENTED COMPOSITIONS COMPRISING A CEREAL BASED FRACTION AND A PROBIOTIC AND USES THEREOF
<b>A61K 39/07</b> (2006.01)	2515937 *	NON-FERMENTED COMPOSITIONS COMPRISING A CEREAL BASED FRACTION AND A PROBIOTIC AND USES THEREOF
<b>A23L 1/30</b> (2006.01)	2515937 *	NON-FERMENTED COMPOSITIONS COMPRISING A CEREAL BASED FRACTION AND A PROBIOTIC AND USES THEREOF
<b>A61K 36/899</b> (2006.01)	2515937 *	NON-FERMENTED COMPOSITIONS COMPRISING A CEREAL BASED FRACTION AND A PROBIOTIC AND USES THEREOF
<b>B21C 47/24</b> (2006.01)	2519366 *	WINDING/UNWINDING DEVICE AND METHOD FOR WINDING/UNWINDING A METAL PRODUCT IN A ROLLING LINE
<b>B21B 1/46</b> (2006.01)	2519366 *	WINDING/UNWINDING DEVICE AND METHOD FOR WINDING/UNWINDING A METAL PRODUCT IN A ROLLING LINE
<b>C21D 9/68</b> (2006.01)	2519366 *	WINDING/UNWINDING DEVICE AND METHOD FOR WINDING/UNWINDING A METAL PRODUCT IN A ROLLING LINE
<b>C07C 253/30</b> (2006.01)	2513046 *	PROCESS FOR THE PREPARATION OF 4-BROMOMETHYL-[1,1'-BIPHENYL]-2'-CARBONITRILE
<b>C07C 257/04</b> (2006.01)	2513046 *	PROCESS FOR THE PREPARATION OF 4-BROMOMETHYL-[1,1'-BIPHENYL]-2'-CARBONITRILE
<b>C01G 49/02</b> (2006.01)	2528682 *	METHOD FOR PRODUCING A CATALYST FOR CRACKING ORGANIC CARBON COMPOUNDS
<b>B01J 21/02</b> (2006.01)	2528682 *	METHOD FOR PRODUCING A CATALYST FOR CRACKING ORGANIC CARBON COMPOUNDS
<b>C01F 7/06</b> (2006.01)	2528682 *	METHOD FOR PRODUCING A CATALYST FOR CRACKING ORGANIC CARBON COMPOUNDS
<b>C01F 7/16</b> (2006.01)	2528682 *	METHOD FOR PRODUCING A CATALYST FOR CRACKING ORGANIC CARBON COMPOUNDS
<b>A61K 31/497</b> (2006.01)	2533783 *	COMPOUNDS AND METHODS
<b>A23K 1/175</b> (2006.01)	2520176	Method for increasing the nutritional value of rapeseed and rape products with decreased oil content
<b>A23K 1/18</b> (2006.01)	2520176	Method for increasing the nutritional value of rapeseed and rape products with decreased oil content
<b>A23K 1/14</b> (2006.01)	2520176	Method for increasing the nutritional value of rapeseed and rape products with decreased oil content
<b>A23K 1/16</b> (2006.01)	2520176	Method for increasing the nutritional value of rapeseed and rape products with decreased oil content
<b>G01N 21/31</b> (2006.01)	2453221	Apparatus for radiometry to determine the physico-chemical properties of a sample taking the thickness into account
<b>G01N 21/84</b> (2006.01)	2453221	Apparatus for radiometry to determine the physico-chemical properties of a sample taking the thickness into account
<b>G01N 21/35</b> (2006.01)	2453221	Apparatus for radiometry to determine the physico-chemical properties of a sample taking the thickness into account
<b>E05D 15/06</b> (2006.01)	2526245 *	DOOR LEAF SYSTEM FOR CLOSING AND/OR OPENING AN ENTRANCE



MKP (51)	Broj objave evropske prijava patenta (97)	Naziv pronalaska (54)
<b>A61K 31/4439</b> (2006.01)	2505586 *	INDOLE COMPOUND AND PHARMACEUTICAL USE THEREOF
<b>A61P 37/08</b> (2006.01)	2505586 *	INDOLE COMPOUND AND PHARMACEUTICAL USE THEREOF
<b>A61K 31/437</b> (2006.01)	2505586 *	INDOLE COMPOUND AND PHARMACEUTICAL USE THEREOF
<b>A61P 37/06</b> (2006.01)	2505586 *	INDOLE COMPOUND AND PHARMACEUTICAL USE THEREOF
<b>A61K 31/433</b> (2006.01)	2505586 *	INDOLE COMPOUND AND PHARMACEUTICAL USE THEREOF
<b>A61P 37/02</b> (2006.01)	2505586 *	INDOLE COMPOUND AND PHARMACEUTICAL USE THEREOF
<b>A61K 31/427</b> (2006.01)	2505586 *	INDOLE COMPOUND AND PHARMACEUTICAL USE THEREOF
<b>A61P 29/00</b> (2006.01)	2505586 *	INDOLE COMPOUND AND PHARMACEUTICAL USE THEREOF
<b>A61K 31/4178</b> (2006.01)	2505586 *	INDOLE COMPOUND AND PHARMACEUTICAL USE THEREOF
<b>A61K 31/5377</b> (2006.01)	2505586 *	INDOLE COMPOUND AND PHARMACEUTICAL USE THEREOF
<b>C07D 403/14</b> (2006.01)	2505586 *	INDOLE COMPOUND AND PHARMACEUTICAL USE THEREOF
<b>A61K 31/416</b> (2006.01)	2505586 *	INDOLE COMPOUND AND PHARMACEUTICAL USE THEREOF
<b>A61K 31/496</b> (2006.01)	2505586 *	INDOLE COMPOUND AND PHARMACEUTICAL USE THEREOF
<b>C07D 403/04</b> (2006.01)	2505586 *	INDOLE COMPOUND AND PHARMACEUTICAL USE THEREOF
<b>A61K 31/422</b> (2006.01)	2505586 *	INDOLE COMPOUND AND PHARMACEUTICAL USE THEREOF
<b>A61K 31/55</b> (2006.01)	2505586 *	INDOLE COMPOUND AND PHARMACEUTICAL USE THEREOF
<b>C07D 405/14</b> (2006.01)	2505586 *	INDOLE COMPOUND AND PHARMACEUTICAL USE THEREOF
<b>C07D 401/14</b> (2006.01)	2505586 *	INDOLE COMPOUND AND PHARMACEUTICAL USE THEREOF
<b>A61K 31/454</b> (2006.01)	2505586 *	INDOLE COMPOUND AND PHARMACEUTICAL USE THEREOF
<b>A61P 43/00</b> (2006.01)	2505586 *	INDOLE COMPOUND AND PHARMACEUTICAL USE THEREOF
<b>A61M 16/06</b> (2006.01)	2519296 *	DEVICES, SYSTEMS, AND METHODS FOR MONITORING, ANALYZING, AND/OR ADJUSTING SLEEP CONDITIONS
<b>A61K 38/17</b> (2006.01)	2535057 *	COMPOSITIONS FOR THE TREATMENT OF INFECTIOUS AND TUMOURAL DISEASES
<b>A61K 38/21</b> (2006.01)	2535057 *	COMPOSITIONS FOR THE TREATMENT OF INFECTIOUS AND TUMOURAL DISEASES
<b>A61K 31/4196</b> (2006.01)	2528598 *	COMPOUNDS FOR SUPPRESSING A PERIPHERAL NERVE DISORDER INDUCED BY AN ANTI - CANCER AGENT
<b>A61K 31/4545</b> (2006.01)	2528598 *	COMPOUNDS FOR SUPPRESSING A PERIPHERAL NERVE DISORDER INDUCED BY AN ANTI - CANCER AGENT
<b>A61K 31/428</b> (2006.01)	2528598 *	COMPOUNDS FOR SUPPRESSING A PERIPHERAL NERVE DISORDER INDUCED BY AN ANTI - CANCER AGENT
<b>A61K 31/4192</b> (2006.01)	2528598 *	COMPOUNDS FOR SUPPRESSING A PERIPHERAL NERVE DISORDER INDUCED BY AN ANTI - CANCER AGENT
<b>A61K 31/216</b> (2006.01)	2528598 *	COMPOUNDS FOR SUPPRESSING A PERIPHERAL NERVE DISORDER INDUCED BY AN ANTI - CANCER AGENT
<b>A61K 31/282</b> (2006.01)	2528598 *	COMPOUNDS FOR SUPPRESSING A PERIPHERAL NERVE DISORDER INDUCED BY AN ANTI - CANCER AGENT
<b>A61P 25/02</b> (2006.01)	2528598 *	COMPOUNDS FOR SUPPRESSING A PERIPHERAL NERVE DISORDER INDUCED BY AN ANTI - CANCER AGENT
<b>A61K 31/41</b> (2006.01)	2528598 *	COMPOUNDS FOR SUPPRESSING A PERIPHERAL NERVE DISORDER INDUCED BY AN ANTI - CANCER AGENT
<b>A61K 31/337</b> (2006.01)	2528598 *	COMPOUNDS FOR SUPPRESSING A PERIPHERAL NERVE DISORDER INDUCED BY AN ANTI - CANCER AGENT
<b>A61K 31/69</b> (2006.01)	2528598 *	COMPOUNDS FOR SUPPRESSING A PERIPHERAL NERVE DISORDER INDUCED BY AN ANTI - CANCER AGENT
<b>G06Q 20/00</b> (2012.01)	2519919 *	SYSTEM AND METHOD FOR PROCESSING PAYMENT TRANSACTION RECEIPTS
<b>A61K 9/70</b> (2006.01)	2506814 *	PHARMACEUTICAL COMPOSITION CONTAINING A HYPOMETHYLATING AGENT AND A HISTONE DEACETYLASE INHIBITOR
<b>A61F 13/00</b> (2006.01)	2506814 *	PHARMACEUTICAL COMPOSITION CONTAINING A HYPOMETHYLATING AGENT AND A HISTONE DEACETYLASE INHIBITOR

MKP (51)	Broj objave evropske prijava patenta (97)	Naziv pronalaska (54)
<b>A61K 31/40</b> (2006.01)	2516416 *	CRTH2 MODULATORS
<b>C07D 401/04</b> (2006.01)	2516416 *	CRTH2 MODULATORS
<b>C07D 403/12</b> (2006.01)	2516416 *	CRTH2 MODULATORS
<b>A61K 31/495</b> (2006.01)	2516416 *	CRTH2 MODULATORS
<b>A61P 43/00</b> (2006.01)	2516416 *	CRTH2 MODULATORS
<b>C07D 207/325</b> (2006.01)	2516416 *	CRTH2 MODULATORS
<b>C07D 413/14</b> (2006.01)	2516416 *	CRTH2 MODULATORS
<b>A61P 17/00</b> (2006.01)	2501374 *	COLORING COMPOSITION CONTAINING AN AROMATIC COMPOUND AND AN INITIATOR
<b>A61K 31/185</b> (2006.01)	2501374 *	COLORING COMPOSITION CONTAINING AN AROMATIC COMPOUND AND AN INITIATOR
<b>A61K 31/195</b> (2006.01)	2501374 *	COLORING COMPOSITION CONTAINING AN AROMATIC COMPOUND AND AN INITIATOR
<b>A61K 8/40</b> (2006.01)	2501374 *	COLORING COMPOSITION CONTAINING AN AROMATIC COMPOUND AND AN INITIATOR
<b>A61Q 5/00</b> (2006.01)	2501374 *	COLORING COMPOSITION CONTAINING AN AROMATIC COMPOUND AND AN INITIATOR
<b>A61K 8/36</b> (2006.01)	2501374 *	COLORING COMPOSITION CONTAINING AN AROMATIC COMPOUND AND AN INITIATOR
<b>A47B 96/02</b> (2006.01)	2305069	Shelf floor
<b>A47B 57/58</b> (2006.01)	2305069	Shelf floor
<b>A47B 57/10</b> (2006.01)	2305069	Shelf floor
<b>G07C 9/00</b> (2006.01)	2431949	Electronic combination lock
<b>A23L 1/0524</b> (2006.01)	2518088 *	METHOD FOR PRODUCING LIQUID PECTIN FROM APPLE POMACE
<b>C08B 37/06</b> (2006.01)	2518088 *	METHOD FOR PRODUCING LIQUID PECTIN FROM APPLE POMACE
<b>A61K 31/165</b> (2006.01)	2532647	New co-crystals of agomelatin
<b>A61P 25/16</b> (2006.01)	2532647	New co-crystals of agomelatin
<b>C07C 231/12</b> (2006.01)	2532647	New co-crystals of agomelatin
<b>C07C 233/18</b> (2006.01)	2532647	New co-crystals of agomelatin
<b>A61P 25/18</b> (2006.01)	2532647	New co-crystals of agomelatin
<b>A61P 3/00</b> (2006.01)	2532647	New co-crystals of agomelatin
<b>A61P 25/28</b> (2006.01)	2532647	New co-crystals of agomelatin
<b>A61L 2/00</b> (2006.01)	2506882 *	MICROFLUIDIC DEVICE REGENERATION
<b>A61P 37/06</b> (2006.01)	2528894 *	PROCESSES FOR THE PREPARATION OF (R)-2-(7-(4-CYCLOPENTYL-3-(TRIFLUOROMETHYL)BENZYLOXY)-1,2,3,4-TETRAHYDROCYCLOPENTA[B]INDOL-3-YL)ACETIC ACID AND SALTS THEREOF
<b>C07D 209/94</b> (2006.01)	2528894 *	PROCESSES FOR THE PREPARATION OF (R)-2-(7-(4-CYCLOPENTYL-3-(TRIFLUOROMETHYL)BENZYLOXY)-1,2,3,4-TETRAHYDROCYCLOPENTA[B]INDOL-3-YL)ACETIC ACID AND SALTS THEREOF
<b>A61P 29/00</b> (2006.01)	2528894 *	PROCESSES FOR THE PREPARATION OF (R)-2-(7-(4-CYCLOPENTYL-3-(TRIFLUOROMETHYL)BENZYLOXY)-1,2,3,4-TETRAHYDROCYCLOPENTA[B]INDOL-3-YL)ACETIC ACID AND SALTS THEREOF
<b>A61K 31/403</b> (2006.01)	2528894 *	PROCESSES FOR THE PREPARATION OF (R)-2-(7-(4-CYCLOPENTYL-3-(TRIFLUOROMETHYL)BENZYLOXY)-1,2,3,4-TETRAHYDROCYCLOPENTA[B]INDOL-3-YL)ACETIC ACID AND SALTS THEREOF
<b>C22B 26/12</b> (2006.01)	2450991	Plant and process for the treatment of exhausted accumulators and batteries
<b>C22B 47/00</b> (2006.01)	2450991	Plant and process for the treatment of exhausted accumulators and batteries
<b>H01M 10/54</b> (2006.01)	2450991	Plant and process for the treatment of exhausted accumulators and batteries
<b>C22B 15/00</b> (2006.01)	2450991	Plant and process for the treatment of exhausted accumulators and batteries
<b>H01M 6/52</b> (2006.01)	2450991	Plant and process for the treatment of exhausted accumulators and batteries
<b>C22B 23/00</b> (2006.01)	2450991	Plant and process for the treatment of exhausted accumulators and batteries
<b>C22B 7/00</b> (2006.01)	2450991	Plant and process for the treatment of exhausted accumulators and batteries
<b>C12N 15/82</b> (2006.01)	2513318 *	USE OF CRY1AB IN COMBINATION WITH CRY1BE FOR MANAGEMENT OF RESISTANT INSECTS

MKP (51)	Broj objave evropske prijava patenta (97)	Naziv pronalaska (54)
<b>G01N 3/34</b> (2006.01)	2439287	Method for evaluating the efficiency and/or operating state of a staking machine and industrial kit suitable to implement such a method
<b>C14B 1/40</b> (2006.01)	2439287	Method for evaluating the efficiency and/or operating state of a staking machine and industrial kit suitable to implement such a method
<b>E03D 9/08</b> (2006.01)	2521822 *	INTIMATE SHOWER FOR A WC
<b>A61M 5/32</b> (2006.01)	2531237 *	MEDICATED MODULE WITH TIME LOCK
<b>A61M 5/28</b> (2006.01)	2531237 *	MEDICATED MODULE WITH TIME LOCK
<b>A61M 5/24</b> (2006.01)	2531237 *	MEDICATED MODULE WITH TIME LOCK
<b>A01N 43/42</b> (2006.01)	2512243 *	QUINOLINE AMIDE M1 RECEPTOR POSITIVE ALLOSTERIC MODULATORS
<b>A61K 31/47</b> (2006.01)	2512243 *	QUINOLINE AMIDE M1 RECEPTOR POSITIVE ALLOSTERIC MODULATORS
<b>A01P 13/00</b> (2006.01)	2523555 *	HERBICIDAL COMPOSITIONS COMPRISING, AND METHODS OF USE OF, HERBICIDALLY ACTIVE PYRANDIONES
<b>A01N 43/16</b> (2006.01)	2523555 *	HERBICIDAL COMPOSITIONS COMPRISING, AND METHODS OF USE OF, HERBICIDALLY ACTIVE PYRANDIONES
<b>C07D 405/14</b> (2006.01)	2518069 *	CYCLIC AMINE COMPOUND AND ACARICIDE
<b>A01P 7/02</b> (2006.01)	2518069 *	CYCLIC AMINE COMPOUND AND ACARICIDE
<b>C07D 401/12</b> (2006.01)	2518069 *	CYCLIC AMINE COMPOUND AND ACARICIDE
<b>C07D 451/06</b> (2006.01)	2518069 *	CYCLIC AMINE COMPOUND AND ACARICIDE
<b>A01N 43/42</b> (2006.01)	2518069 *	CYCLIC AMINE COMPOUND AND ACARICIDE
<b>C07D 409/14</b> (2006.01)	2518069 *	CYCLIC AMINE COMPOUND AND ACARICIDE
<b>C07D 401/14</b> (2006.01)	2518069 *	CYCLIC AMINE COMPOUND AND ACARICIDE
<b>A61K 31/4523</b> (2006.01)	2519520 *	[4-(3-AMINOMETHYL-PHENYL)-PIPERIDIN-1-YL]-(1H-PYRROLOPYRIDINYL)-METHANONE DERIVATIVES AS TRYPTASE INHIBITORS
<b>A61P 11/06</b> (2006.01)	2519520 *	[4-(3-AMINOMETHYL-PHENYL)-PIPERIDIN-1-YL]-(1H-PYRROLOPYRIDINYL)-METHANONE DERIVATIVES AS TRYPTASE INHIBITORS
<b>C07D 471/04</b> (2006.01)	2519520 *	[4-(3-AMINOMETHYL-PHENYL)-PIPERIDIN-1-YL]-(1H-PYRROLOPYRIDINYL)-METHANONE DERIVATIVES AS TRYPTASE INHIBITORS
<b>C12Q 1/68</b> (2006.01)	2532756	Methods and uses relating to the diagnosis or prognosis of pain-related tissue states or pain-related diseases such as pain.
<b>C12Q 1/68</b> (2006.01)	2504454 *	ELITE EVENT EE-GM3 AND METHODS AND KITS FOR IDENTIFYING SUCH EVENT IN BIOLOGICAL SAMPLES
<b>C07H 21/00</b> (2006.01)	2504454 *	ELITE EVENT EE-GM3 AND METHODS AND KITS FOR IDENTIFYING SUCH EVENT IN BIOLOGICAL SAMPLES
<b>A61K 9/00</b> (2006.01)	2515853 *	Combination therapy for COPD
<b>A61K 31/167</b> (2006.01)	2515853 *	Combination therapy for COPD
<b>A61K 45/06</b> (2006.01)	2515853 *	Combination therapy for COPD
<b>A61K 31/40</b> (2006.01)	2515853 *	Combination therapy for COPD
<b>A61F 2/84</b> (2006.01)	2519300 *	SYSTEM FOR TREATING TARGET TISSUE WITHIN THE EUSTACHIAN TUBE
<b>A61M 25/00</b> (2006.01)	2519300 *	SYSTEM FOR TREATING TARGET TISSUE WITHIN THE EUSTACHIAN TUBE
<b>A61K 31/00</b> (2006.01)	2519300 *	SYSTEM FOR TREATING TARGET TISSUE WITHIN THE EUSTACHIAN TUBE
<b>A61M 25/10</b> (2006.01)	2519300 *	SYSTEM FOR TREATING TARGET TISSUE WITHIN THE EUSTACHIAN TUBE
<b>A61B 18/00</b> (2006.01)	2519300 *	SYSTEM FOR TREATING TARGET TISSUE WITHIN THE EUSTACHIAN TUBE
<b>A61M 29/00</b> (2006.01)	2519300 *	SYSTEM FOR TREATING TARGET TISSUE WITHIN THE EUSTACHIAN TUBE
<b>A61M 25/09</b> (2006.01)	2519300 *	SYSTEM FOR TREATING TARGET TISSUE WITHIN THE EUSTACHIAN TUBE
<b>A61B 1/00</b> (2006.01)	2519300 *	SYSTEM FOR TREATING TARGET TISSUE WITHIN THE EUSTACHIAN TUBE
<b>A61M 25/06</b> (2006.01)	2519300 *	SYSTEM FOR TREATING TARGET TISSUE WITHIN THE EUSTACHIAN TUBE
<b>A61L 29/00</b> (2006.01)	2519300 *	SYSTEM FOR TREATING TARGET TISSUE WITHIN THE EUSTACHIAN TUBE
<b>A61B 17/3207</b> (2006.01)	2519300 *	SYSTEM FOR TREATING TARGET TISSUE WITHIN THE EUSTACHIAN TUBE
<b>B65H 49/00</b> (2006.01)	2536540 *	WIRE HANDLING FOR VEHICLE GLAZING PANEL CUT OUT
<b>B26D 1/547</b> (2006.01)	2536540 *	WIRE HANDLING FOR VEHICLE GLAZING PANEL CUT OUT
<b>A61K 9/54</b> (2006.01)	2515882 *	CONTROLLED RELEASE PHARMACEUTICAL COMPOSITION

MKP (51)	Broj objave evropske prijave patenta (97)	Naziv pronalaska (54)
<b>A61K 9/52</b> (2006.01)	2515882 *	CONTROLLED RELEASE PHARMACEUTICAL COMPOSITION
<b>A61K 9/28</b> (2006.01)	2515882 *	CONTROLLED RELEASE PHARMACEUTICAL COMPOSITION
<b>G01N 33/50</b> (2006.01)	2526206 *	METHODS AND USES RELATING TO THE IDENTIFICATION OF COMPOUND INVOLVED IN PAIN AS WELL AS METHODS OF DIAGNOSING ALGESIA
<b>C12Q 1/68</b> (2006.01)	2526206 *	METHODS AND USES RELATING TO THE IDENTIFICATION OF COMPOUND INVOLVED IN PAIN AS WELL AS METHODS OF DIAGNOSING ALGESIA
<b>C08L 97/02</b> (2006.01)	2531561 *	PROCESS FOR THE ACETYLATION OF WOOD ELEMENTS
<b>C08G 18/64</b> (2006.01)	2531561 *	PROCESS FOR THE ACETYLATION OF WOOD ELEMENTS
<b>C08H 8/00</b> (2010.01)	2531561 *	PROCESS FOR THE ACETYLATION OF WOOD ELEMENTS
<b>A61B 17/22</b> (2006.01)	2533705 *	ROTATABLE CUTTING IMPLEMENT ARRANGEMENTS FOR ULTRASONIC SURGICAL INSTRUMENTS
<b>A61B 17/32</b> (2006.01)	2533705 *	ROTATABLE CUTTING IMPLEMENT ARRANGEMENTS FOR ULTRASONIC SURGICAL INSTRUMENTS
<b>A61B 17/3207</b> (2006.01)	2533705 *	ROTATABLE CUTTING IMPLEMENT ARRANGEMENTS FOR ULTRASONIC SURGICAL INSTRUMENTS
<b>A61K 31/437</b> (2006.01)	2516438 *	COMPOUNDS AND METHODS FOR KINASE MODULATION, AND INDICATIONS THEREFOR
<b>C07D 471/04</b> (2006.01)	2516438 *	COMPOUNDS AND METHODS FOR KINASE MODULATION, AND INDICATIONS THEREFOR
<b>A61P 35/00</b> (2006.01)	2516438 *	COMPOUNDS AND METHODS FOR KINASE MODULATION, AND INDICATIONS THEREFOR
<b>C07C 215/40</b> (2006.01)	2508522 *	AZILSARTAN ORGANIC AMINE SALTS, PREPARATION METHOD AND USE THEREOF
<b>A61K 31/4245</b> (2006.01)	2508522 *	AZILSARTAN ORGANIC AMINE SALTS, PREPARATION METHOD AND USE THEREOF
<b>C07C 215/08</b> (2006.01)	2508522 *	AZILSARTAN ORGANIC AMINE SALTS, PREPARATION METHOD AND USE THEREOF
<b>A61P 9/12</b> (2006.01)	2508522 *	AZILSARTAN ORGANIC AMINE SALTS, PREPARATION METHOD AND USE THEREOF
<b>C07D 413/10</b> (2006.01)	2508522 *	AZILSARTAN ORGANIC AMINE SALTS, PREPARATION METHOD AND USE THEREOF
<b>B65D 47/20</b> (2006.01)	2516286 *	DISPENSING BOTTLE-TOP FOR BOTTLE FOR PRODUCTS OF LIQUID OR VISCOUS CONSISTENCY AND BOTTLE FITTED WITH SUCH A BOTTLE-TOP
<b>B65D 47/30</b> (2006.01)	2516286 *	DISPENSING BOTTLE-TOP FOR BOTTLE FOR PRODUCTS OF LIQUID OR VISCOUS CONSISTENCY AND BOTTLE FITTED WITH SUCH A BOTTLE-TOP
<b>B65D 47/26</b> (2006.01)	2516286 *	DISPENSING BOTTLE-TOP FOR BOTTLE FOR PRODUCTS OF LIQUID OR VISCOUS CONSISTENCY AND BOTTLE FITTED WITH SUCH A BOTTLE-TOP
<b>E04B 1/343</b> (2006.01)	2531675 *	COLLAPSIBLE CENTRAL SUPPORT DEVICE
<b>E04H 15/44</b> (2006.01)	2531675 *	COLLAPSIBLE CENTRAL SUPPORT DEVICE
<b>A61K 31/497</b> (2006.01)	2513088 *	NOVEL (HETEROCYCLE/TETRAHYDROPIRIDINE)-(PIPERAZINYL)-1-ALCANONE AND (HETEROCYCLE/DIHYDROPIRROLIDINE)-(PIPERAZINYL)-1-ALCANONE DERIVATIVES, AND USE THEREOF AS P75 INHIBITORS
<b>A61K 31/496</b> (2006.01)	2513088 *	NOVEL (HETEROCYCLE/TETRAHYDROPIRIDINE)-(PIPERAZINYL)-1-ALCANONE AND (HETEROCYCLE/DIHYDROPIRROLIDINE)-(PIPERAZINYL)-1-ALCANONE DERIVATIVES, AND USE THEREOF AS P75 INHIBITORS
<b>C07D 409/04</b> (2006.01)	2513088 *	NOVEL (HETEROCYCLE/TETRAHYDROPIRIDINE)-(PIPERAZINYL)-1-ALCANONE AND (HETEROCYCLE/DIHYDROPIRROLIDINE)-(PIPERAZINYL)-1-ALCANONE DERIVATIVES, AND USE THEREOF AS P75 INHIBITORS
<b>C07D 407/14</b> (2006.01)	2513088 *	NOVEL (HETEROCYCLE/TETRAHYDROPIRIDINE)-(PIPERAZINYL)-1-ALCANONE AND (HETEROCYCLE/DIHYDROPIRROLIDINE)-(PIPERAZINYL)-1-ALCANONE DERIVATIVES, AND USE THEREOF AS P75 INHIBITORS
<b>A61P 25/00</b> (2006.01)	2513088 *	NOVEL (HETEROCYCLE/TETRAHYDROPIRIDINE)-(PIPERAZINYL)-1-ALCANONE AND (HETEROCYCLE/DIHYDROPIRROLIDINE)-(PIPERAZINYL)-1-ALCANONE DERIVATIVES, AND USE THEREOF AS P75 INHIBITORS
<b>C07D 403/14</b> (2006.01)	2513088 *	NOVEL (HETEROCYCLE/TETRAHYDROPIRIDINE)-(PIPERAZINYL)-1-ALCANONE AND (HETEROCYCLE/DIHYDROPIRROLIDINE)-(PIPERAZINYL)-1-ALCANONE DERIVATIVES, AND USE THEREOF AS P75 INHIBITORS

MKP (51)	Broj objave evropske prijava patenta (97)	Naziv pronalaska (54)
<b>A61K 31/551</b> (2006.01)	2513088 *	NOVEL (HETEROCYCLE/TETRAHYDROPYRIDINE)-(PIPERAZINYL)-1-ALCANONE AND (HETEROCYCLE/DIHYDROPYRROLIDINE)-(PIPERAZINYL)-1-ALCANONE DERIVATIVES, AND USE THEREOF AS P75 INHIBITORS
<b>C07D 495/04</b> (2006.01)	2513088 *	NOVEL (HETEROCYCLE/TETRAHYDROPYRIDINE)-(PIPERAZINYL)-1-ALCANONE AND (HETEROCYCLE/DIHYDROPYRROLIDINE)-(PIPERAZINYL)-1-ALCANONE DERIVATIVES, AND USE THEREOF AS P75 INHIBITORS
<b>C07D 407/04</b> (2006.01)	2513088 *	NOVEL (HETEROCYCLE/TETRAHYDROPYRIDINE)-(PIPERAZINYL)-1-ALCANONE AND (HETEROCYCLE/DIHYDROPYRROLIDINE)-(PIPERAZINYL)-1-ALCANONE DERIVATIVES, AND USE THEREOF AS P75 INHIBITORS
<b>C07D 409/14</b> (2006.01)	2513088 *	NOVEL (HETEROCYCLE/TETRAHYDROPYRIDINE)-(PIPERAZINYL)-1-ALCANONE AND (HETEROCYCLE/DIHYDROPYRROLIDINE)-(PIPERAZINYL)-1-ALCANONE DERIVATIVES, AND USE THEREOF AS P75 INHIBITORS
<b>C07D 401/04</b> (2006.01)	2513088 *	NOVEL (HETEROCYCLE/TETRAHYDROPYRIDINE)-(PIPERAZINYL)-1-ALCANONE AND (HETEROCYCLE/DIHYDROPYRROLIDINE)-(PIPERAZINYL)-1-ALCANONE DERIVATIVES, AND USE THEREOF AS P75 INHIBITORS
<b>A61K 31/4995</b> (2006.01)	2513088 *	NOVEL (HETEROCYCLE/TETRAHYDROPYRIDINE)-(PIPERAZINYL)-1-ALCANONE AND (HETEROCYCLE/DIHYDROPYRROLIDINE)-(PIPERAZINYL)-1-ALCANONE DERIVATIVES, AND USE THEREOF AS P75 INHIBITORS
<b>C07D 401/14</b> (2006.01)	2513088 *	NOVEL (HETEROCYCLE/TETRAHYDROPYRIDINE)-(PIPERAZINYL)-1-ALCANONE AND (HETEROCYCLE/DIHYDROPYRROLIDINE)-(PIPERAZINYL)-1-ALCANONE DERIVATIVES, AND USE THEREOF AS P75 INHIBITORS
<b>A61K 31/506</b> (2006.01)	2513088 *	NOVEL (HETEROCYCLE/TETRAHYDROPYRIDINE)-(PIPERAZINYL)-1-ALCANONE AND (HETEROCYCLE/DIHYDROPYRROLIDINE)-(PIPERAZINYL)-1-ALCANONE DERIVATIVES, AND USE THEREOF AS P75 INHIBITORS
<b>A61P 3/10</b> (2006.01)	2513109 *	HETEROCYCLIC COMPOUNDS AND THEIR USES
<b>A61P 1/04</b> (2006.01)	2513109 *	HETEROCYCLIC COMPOUNDS AND THEIR USES
<b>C07D 471/04</b> (2006.01)	2513109 *	HETEROCYCLIC COMPOUNDS AND THEIR USES
<b>A61P 35/00</b> (2006.01)	2513109 *	HETEROCYCLIC COMPOUNDS AND THEIR USES
<b>A61P 19/02</b> (2006.01)	2513109 *	HETEROCYCLIC COMPOUNDS AND THEIR USES
<b>A61K 31/4375</b> (2006.01)	2513109 *	HETEROCYCLIC COMPOUNDS AND THEIR USES
<b>C07D 519/00</b> (2006.01)	2513109 *	HETEROCYCLIC COMPOUNDS AND THEIR USES
<b>A61P 9/10</b> (2006.01)	2513109 *	HETEROCYCLIC COMPOUNDS AND THEIR USES
<b>A61P 17/06</b> (2006.01)	2513109 *	HETEROCYCLIC COMPOUNDS AND THEIR USES
<b>B28D 5/00</b> (2006.01)	2504139 *	METHOD AND DEVICE FOR TREATING ABRASIVE SLURRIES CONTAINING Si/SiC
<b>B22D 41/14</b> (2006.01)	2523765 *	MOLTEN METAL CONTAINMENT STRUCTURE HAVING MOVABLE COVER
<b>E04B 2/96</b> (2006.01)	2450495	Connection element for fixing an insulation element to a pressure bar of a mullion and transom facade
<b>F24J 2/42</b> (2006.01)	2507555 *	GASIFICATION SYSTEM
<b>F23G 7/00</b> (2006.01)	2507555 *	GASIFICATION SYSTEM
<b>F23G 5/027</b> (2006.01)	2507555 *	GASIFICATION SYSTEM
<b>F23G 5/16</b> (2006.01)	2507555 *	GASIFICATION SYSTEM
<b>F02M 51/00</b> (2006.01)	2444650	Improved fuel injector
<b>F02M 53/04</b> (2006.01)	2444650	Improved fuel injector
<b>F02M 55/00</b> (2006.01)	2444650	Improved fuel injector
<b>F02M 61/20</b> (2006.01)	2444650	Improved fuel injector
<b>A01K 67/027</b> (2006.01)	2512227 *	ANIMAL MODEL EXPRESSING LUCIFERASE UNDER CONTROL OF THE MYELIN BASIC PROTEIN PROMOTER (MBP-LUCI) AND USE OF THE MODEL FOR BIOLUMINESCENCE IN VIVO IMAGING
<b>C12N 15/85</b> (2006.01)	2512227 *	ANIMAL MODEL EXPRESSING LUCIFERASE UNDER CONTROL OF THE MYELIN BASIC PROTEIN PROMOTER (MBP-LUCI) AND USE OF THE MODEL FOR BIOLUMINESCENCE IN VIVO IMAGING
<b>A61K 31/4439</b> (2006.01)	2513070 *	PPAR-SPARING THIAZOLIDINEDIONE SALTS FOR THE TREATMENT OF METABOLIC DISEASES
<b>A61P 3/00</b> (2006.01)	2513070 *	PPAR-SPARING THIAZOLIDINEDIONE SALTS FOR THE TREATMENT OF METABOLIC DISEASES

MKP (51)	Broj objave evropske prijava patenta (97)	Naziv pronalaska (54)
<b>C07D 417/12</b> (2006.01)	2513070 *	PPAR-SPARING THIAZOLIDINEDIONE SALTS FOR THE TREATMENT OF METABOLIC DISEASES
<b>A61K 31/426</b> (2006.01)	2513070 *	PPAR-SPARING THIAZOLIDINEDIONE SALTS FOR THE TREATMENT OF METABOLIC DISEASES
<b>C07D 277/34</b> (2006.01)	2513070 *	PPAR-SPARING THIAZOLIDINEDIONE SALTS FOR THE TREATMENT OF METABOLIC DISEASES
<b>A61P 5/00</b> (2006.01)	2513070 *	PPAR-SPARING THIAZOLIDINEDIONE SALTS FOR THE TREATMENT OF METABOLIC DISEASES
<b>C07D 307/81</b> (2006.01)	2513054 *	BICYCLIC DERIVATIVES USEFUL AS INHIBITORS OF DPP-1
<b>C07D 417/12</b> (2006.01)	2513054 *	BICYCLIC DERIVATIVES USEFUL AS INHIBITORS OF DPP-1
<b>C07D 333/58</b> (2006.01)	2513054 *	BICYCLIC DERIVATIVES USEFUL AS INHIBITORS OF DPP-1
<b>C07D 409/12</b> (2006.01)	2513054 *	BICYCLIC DERIVATIVES USEFUL AS INHIBITORS OF DPP-1
<b>C07D 235/14</b> (2006.01)	2513054 *	BICYCLIC DERIVATIVES USEFUL AS INHIBITORS OF DPP-1
<b>C07D 405/06</b> (2006.01)	2513054 *	BICYCLIC DERIVATIVES USEFUL AS INHIBITORS OF DPP-1
<b>C07D 407/04</b> (2006.01)	2513054 *	BICYCLIC DERIVATIVES USEFUL AS INHIBITORS OF DPP-1
<b>C07D 405/14</b> (2006.01)	2513054 *	BICYCLIC DERIVATIVES USEFUL AS INHIBITORS OF DPP-1
<b>C07D 405/12</b> (2006.01)	2513054 *	BICYCLIC DERIVATIVES USEFUL AS INHIBITORS OF DPP-1
<b>C07D 209/14</b> (2006.01)	2513054 *	BICYCLIC DERIVATIVES USEFUL AS INHIBITORS OF DPP-1
<b>C07D 403/12</b> (2006.01)	2513054 *	BICYCLIC DERIVATIVES USEFUL AS INHIBITORS OF DPP-1
<b>A61P 35/00</b> (2006.01)	2509963 *	CRYSTALLINE FORMS OF 3-(2,6-DICHLORO-3,5-DIMETHOXY-PHENYL)-1-{6-[4-(4-ETHYL-PIPERAZIN-1-YL)-PHENYLAMINO]-PYRIMIDIN-4-YL}-1-METHYL-UREA AND SALTS THEREOF.
<b>C07D 239/48</b> (2006.01)	2509963 *	CRYSTALLINE FORMS OF 3-(2,6-DICHLORO-3,5-DIMETHOXY-PHENYL)-1-{6-[4-(4-ETHYL-PIPERAZIN-1-YL)-PHENYLAMINO]-PYRIMIDIN-4-YL}-1-METHYL-UREA AND SALTS THEREOF.
<b>A61K 31/506</b> (2006.01)	2509963 *	CRYSTALLINE FORMS OF 3-(2,6-DICHLORO-3,5-DIMETHOXY-PHENYL)-1-{6-[4-(4-ETHYL-PIPERAZIN-1-YL)-PHENYLAMINO]-PYRIMIDIN-4-YL}-1-METHYL-UREA AND SALTS THEREOF.
<b>C07D 451/02</b> (2006.01)	2516428 *	TROPINONE BENZYLAMINES AS BETA-TRYPTASE INHIBITORS
<b>A61K 31/46</b> (2006.01)	2516428 *	TROPINONE BENZYLAMINES AS BETA-TRYPTASE INHIBITORS
<b>A61P 29/00</b> (2006.01)	2516428 *	TROPINONE BENZYLAMINES AS BETA-TRYPTASE INHIBITORS
<b>C12P 21/02</b> (2006.01)	2523975 *	BACTERIAL HOST STRAIN COMPRISING A MUTANT SPR GENE AND A WILD-TYPE TSP GENE
<b>C07K 16/24</b> (2006.01)	2523975 *	BACTERIAL HOST STRAIN COMPRISING A MUTANT SPR GENE AND A WILD-TYPE TSP GENE
<b>C12N 15/70</b> (2006.01)	2523975 *	BACTERIAL HOST STRAIN COMPRISING A MUTANT SPR GENE AND A WILD-TYPE TSP GENE
<b>C12N 9/48</b> (2006.01)	2523975 *	BACTERIAL HOST STRAIN COMPRISING A MUTANT SPR GENE AND A WILD-TYPE TSP GENE
<b>C07D 401/04</b> (2006.01)	2509961 *	IMIDAZOLIDINEDIONE DERIVATIVES
<b>C07D 233/76</b> (2006.01)	2509961 *	IMIDAZOLIDINEDIONE DERIVATIVES
<b>A61K 31/4166</b> (2006.01)	2509961 *	IMIDAZOLIDINEDIONE DERIVATIVES
<b>C07D 403/04</b> (2006.01)	2509961 *	IMIDAZOLIDINEDIONE DERIVATIVES
<b>A61P 25/18</b> (2006.01)	2509961 *	IMIDAZOLIDINEDIONE DERIVATIVES
<b>C12N 15/09</b> (2006.01)	2530149 *	NUCLEIC ACID STRUCTURE CONTAINING A PYRIPYROPENE BIOSYNTHESIS GENE CLUSTER AND A MARKER GENE
<b>C12P 17/18</b> (2006.01)	2530149 *	NUCLEIC ACID STRUCTURE CONTAINING A PYRIPYROPENE BIOSYNTHESIS GENE CLUSTER AND A MARKER GENE
<b>C12N 1/15</b> (2006.01)	2530149 *	NUCLEIC ACID STRUCTURE CONTAINING A PYRIPYROPENE BIOSYNTHESIS GENE CLUSTER AND A MARKER GENE
<b>C07K 16/24</b> (2006.01)	2534175 *	TREATMENT OF A METABOLIC DISORDER
<b>A01N 37/10</b> (2006.01)	2509418 *	METHODS AND LOW DOSE REGIMENS FOR TREATING RED BLOOD CELL DISORDERS

MKP (51)	Broj objave evropske prijava patenta (97)	Naziv pronalaska (54)
<b>A61L 24/00</b> (2006.01)	2512536 *	A CALCIUM PHOSPHATE BONE CEMENT, PROCESS FOR ITS PREPARATION AND USES THEREOF
<b>A61L 24/08</b> (2006.01)	2512536 *	A CALCIUM PHOSPHATE BONE CEMENT, PROCESS FOR ITS PREPARATION AND USES THEREOF
<b>A61L 24/02</b> (2006.01)	2512536 *	A CALCIUM PHOSPHATE BONE CEMENT, PROCESS FOR ITS PREPARATION AND USES THEREOF
<b>B63B 1/04</b> (2006.01)	2507124 *	WATERCRAFT COMPRISING UNDER-WATER FLOATING BODY AND ABOVE-WATER HELM STAND
<b>A61K 36/899</b> (2006.01)	2512225 *	USE OF VIP3AB IN COMBINATION WITH CRY1CA FOR MANAGEMENT OF RESISTANT INSECTS
<b>A01H 5/00</b> (2006.01)	2512225 *	USE OF VIP3AB IN COMBINATION WITH CRY1CA FOR MANAGEMENT OF RESISTANT INSECTS
<b>A61F 2/00</b> (2006.01)	2528537 *	DEVICE AND METHOD FOR PREVENTING STENOSIS AT AN ANASTOMOSIS SITE
<b>F27D 1/12</b> (2006.01)	2510297 *	MOLTEN METAL CONTAINMENT STRUCTURE HAVING FLOW THROUGH VENTILATION
<b>F27D 1/14</b> (2006.01)	2510297 *	MOLTEN METAL CONTAINMENT STRUCTURE HAVING FLOW THROUGH VENTILATION
<b>A61K 38/17</b> (2006.01)	2523678 *	WNT ANTAGONISTS AND METHODS OF TREATMENT AND SCREENING
<b>A61P 19/02</b> (2006.01)	2501387 *	1,4-BENZODIAZEPINE-2,5-DIONES AND RELATED COMPOUNDS WITH THERAPEUTIC PROPERTIES
<b>A61K 31/5513</b> (2006.01)	2501387 *	1,4-BENZODIAZEPINE-2,5-DIONES AND RELATED COMPOUNDS WITH THERAPEUTIC PROPERTIES
<b>A61P 19/00</b> (2006.01)	2501387 *	1,4-BENZODIAZEPINE-2,5-DIONES AND RELATED COMPOUNDS WITH THERAPEUTIC PROPERTIES
<b>H04L 12/56</b> (2006.01)	2523405 *	COMMUNICATION SYSTEM, FORWARDING NODES, PATH MANAGEMENT SERVER AND COMMUNICATION METHOD
<b>A61M 5/32</b> (2006.01)	2531239 *	MEDICATED MODULE HAVING A DOUBLE NEEDLE GUARD
<b>A61M 5/28</b> (2006.01)	2531239 *	MEDICATED MODULE HAVING A DOUBLE NEEDLE GUARD
<b>A61M 5/24</b> (2006.01)	2531239 *	MEDICATED MODULE HAVING A DOUBLE NEEDLE GUARD
<b>H01B 1/12</b> (2006.01)	2518075 *	INDUCED LAYER MATERIAL FOR PREPARING NON-PLANAR METAL PHTHALOCYANINE WEAK EPITAXY GROWTH THIN FILM
<b>C07D 333/10</b> (2006.01)	2518075 *	INDUCED LAYER MATERIAL FOR PREPARING NON-PLANAR METAL PHTHALOCYANINE WEAK EPITAXY GROWTH THIN FILM
<b>C07C 15/14</b> (2006.01)	2518075 *	INDUCED LAYER MATERIAL FOR PREPARING NON-PLANAR METAL PHTHALOCYANINE WEAK EPITAXY GROWTH THIN FILM
<b>C07D 495/04</b> (2006.01)	2518075 *	INDUCED LAYER MATERIAL FOR PREPARING NON-PLANAR METAL PHTHALOCYANINE WEAK EPITAXY GROWTH THIN FILM
<b>C07D 333/76</b> (2006.01)	2518075 *	INDUCED LAYER MATERIAL FOR PREPARING NON-PLANAR METAL PHTHALOCYANINE WEAK EPITAXY GROWTH THIN FILM
<b>C07C 15/30</b> (2006.01)	2518075 *	INDUCED LAYER MATERIAL FOR PREPARING NON-PLANAR METAL PHTHALOCYANINE WEAK EPITAXY GROWTH THIN FILM
<b>A24F 47/00</b> (2006.01)	2503912 *	AN ELECTRICALLY HEATED SMOKING SYSTEM WITH INTERNAL OR EXTERNAL HEATER
<b>A61P 31/04</b> (2006.01)	2504353 *	LIPOPEPTIDE COMPOSITIONS AND RELATED METHODS
<b>A61K 38/12</b> (2006.01)	2504353 *	LIPOPEPTIDE COMPOSITIONS AND RELATED METHODS
<b>C07K 7/08</b> (2006.01)	2504353 *	LIPOPEPTIDE COMPOSITIONS AND RELATED METHODS
<b>C07K 7/06</b> (2006.01)	2504353 *	LIPOPEPTIDE COMPOSITIONS AND RELATED METHODS
<b>C07K 7/64</b> (2006.01)	2504353 *	LIPOPEPTIDE COMPOSITIONS AND RELATED METHODS
<b>A61K 9/14</b> (2006.01)	2441441	A sieving method for cetyl myristate and/or cetyl palmitate
<b>A61K 31/00</b> (2006.01)	2441441	A sieving method for cetyl myristate and/or cetyl palmitate
<b>C07D 493/04</b> (2006.01)	2536706 *	ARYLMETHOXY ISOINDOLINE DERIVATIVES AND COMPOSITIONS COMPRISING AND METHODS OF USING THE SAME
<b>C07D 417/14</b> (2006.01)	2536706 *	ARYLMETHOXY ISOINDOLINE DERIVATIVES AND COMPOSITIONS COMPRISING AND METHODS OF USING THE SAME

MKP (51)	Broj objave evropske prijava patenta (97)	Naziv pronalaska (54)
<b>A61K 31/4412</b> (2006.01)	2536706 *	ARYLMETHOXY ISOINDOLINE DERIVATIVES AND COMPOSITIONS COMPRISING AND METHODS OF USING THE SAME
<b>C07D 407/12</b> (2006.01)	2536706 *	ARYLMETHOXY ISOINDOLINE DERIVATIVES AND COMPOSITIONS COMPRISING AND METHODS OF USING THE SAME
<b>C07D 409/14</b> (2006.01)	2536706 *	ARYLMETHOXY ISOINDOLINE DERIVATIVES AND COMPOSITIONS COMPRISING AND METHODS OF USING THE SAME
<b>C07D 413/14</b> (2006.01)	2536706 *	ARYLMETHOXY ISOINDOLINE DERIVATIVES AND COMPOSITIONS COMPRISING AND METHODS OF USING THE SAME
<b>A61P 35/00</b> (2006.01)	2536706 *	ARYLMETHOXY ISOINDOLINE DERIVATIVES AND COMPOSITIONS COMPRISING AND METHODS OF USING THE SAME
<b>C07D 487/04</b> (2006.01)	2536706 *	ARYLMETHOXY ISOINDOLINE DERIVATIVES AND COMPOSITIONS COMPRISING AND METHODS OF USING THE SAME
<b>C07D 401/04</b> (2006.01)	2536706 *	ARYLMETHOXY ISOINDOLINE DERIVATIVES AND COMPOSITIONS COMPRISING AND METHODS OF USING THE SAME
<b>C07D 491/107</b> (2006.01)	2536706 *	ARYLMETHOXY ISOINDOLINE DERIVATIVES AND COMPOSITIONS COMPRISING AND METHODS OF USING THE SAME
<b>C07D 401/14</b> (2006.01)	2536706 *	ARYLMETHOXY ISOINDOLINE DERIVATIVES AND COMPOSITIONS COMPRISING AND METHODS OF USING THE SAME
<b>C07D 407/14</b> (2006.01)	2536706 *	ARYLMETHOXY ISOINDOLINE DERIVATIVES AND COMPOSITIONS COMPRISING AND METHODS OF USING THE SAME
<b>C07D 495/04</b> (2006.01)	2536706 *	ARYLMETHOXY ISOINDOLINE DERIVATIVES AND COMPOSITIONS COMPRISING AND METHODS OF USING THE SAME
<b>H01R 13/52</b> (2006.01)	2437355	Cover for cable connectors
<b>H01R 4/70</b> (2006.01)	2437355	Cover for cable connectors
<b>A61P 17/00</b> (2006.01)	2536729 *	CYCLOBUTANE AND METHYLCYCLOBUTANE DERIVATIVES AS JANUS KINASE INHIBITORS
<b>A61P 29/00</b> (2006.01)	2536729 *	CYCLOBUTANE AND METHYLCYCLOBUTANE DERIVATIVES AS JANUS KINASE INHIBITORS
<b>A61P 37/00</b> (2006.01)	2536729 *	CYCLOBUTANE AND METHYLCYCLOBUTANE DERIVATIVES AS JANUS KINASE INHIBITORS
<b>A61P 35/00</b> (2006.01)	2536729 *	CYCLOBUTANE AND METHYLCYCLOBUTANE DERIVATIVES AS JANUS KINASE INHIBITORS
<b>C07D 487/04</b> (2006.01)	2536729 *	CYCLOBUTANE AND METHYLCYCLOBUTANE DERIVATIVES AS JANUS KINASE INHIBITORS
<b>A61K 31/519</b> (2006.01)	2536729 *	CYCLOBUTANE AND METHYLCYCLOBUTANE DERIVATIVES AS JANUS KINASE INHIBITORS
<b>A61P 27/00</b> (2006.01)	2536729 *	CYCLOBUTANE AND METHYLCYCLOBUTANE DERIVATIVES AS JANUS KINASE INHIBITORS
<b>F41G 1/34</b> (2006.01)	2507579 *	SIGHTING DEVICE
<b>A61K 9/16</b> (2006.01)	2515877 *	DEGRADABLE REMOVABLE IMPLANT FOR THE SUSTAINED RELEASE OF AN ACTIVE COMPOUND
<b>A61K 9/00</b> (2006.01)	2515877 *	DEGRADABLE REMOVABLE IMPLANT FOR THE SUSTAINED RELEASE OF AN ACTIVE COMPOUND
<b>G06F 21/02</b> (2006.01)	2524334 *	SYSTEM AND METHODS FOR GENERATING UNCLONABLE SECURITY KEYS IN INTEGRATED CIRCUITS
<b>H04L 9/08</b> (2006.01)	2524334 *	SYSTEM AND METHODS FOR GENERATING UNCLONABLE SECURITY KEYS IN INTEGRATED CIRCUITS
<b>E04C 2/38</b> (2006.01)	2533960 *	METHOD, DEVICE AND A COMPUTER PROGRAM FOR MANUFACTURING A PRE-INSULATED SKELETON FRAMING SEGMENT
<b>B29C 44/60</b> (2006.01)	2533960 *	METHOD, DEVICE AND A COMPUTER PROGRAM FOR MANUFACTURING A PRE-INSULATED SKELETON FRAMING SEGMENT
<b>B29C 44/12</b> (2006.01)	2533960 *	METHOD, DEVICE AND A COMPUTER PROGRAM FOR MANUFACTURING A PRE-INSULATED SKELETON FRAMING SEGMENT
<b>E04C 2/296</b> (2006.01)	2533960 *	METHOD, DEVICE AND A COMPUTER PROGRAM FOR MANUFACTURING A PRE-INSULATED SKELETON FRAMING SEGMENT
<b>B29C 44/18</b> (2006.01)	2533960 *	METHOD, DEVICE AND A COMPUTER PROGRAM FOR MANUFACTURING A PRE-INSULATED SKELETON FRAMING SEGMENT



MKP (51)	Broj objave evropske prijava patenta (97)	Naziv pronalaska (54)
<b>A61K 39/00</b> (2006.01)	2534257 *	METHODS FOR IDENTIFYING AND ISOLATING CELLS EXPRESSING A POLYPEPTIDE
<b>C12P 21/08</b> (2006.01)	2534257 *	METHODS FOR IDENTIFYING AND ISOLATING CELLS EXPRESSING A POLYPEPTIDE
<b>G06F 19/00</b> (2011.01)	2538361	Method and system for patient-specific modeling of blood flow
<b>A61K 38/22</b> (2006.01)	2509997 *	CONJUGATES COMPRISING AN ANTIBODY SURROGATE SCAFFOLD WITH IMPROVED PHARMACOKINETIC PROPERTIES
<b>C07K 14/605</b> (2006.01)	2509997 *	CONJUGATES COMPRISING AN ANTIBODY SURROGATE SCAFFOLD WITH IMPROVED PHARMACOKINETIC PROPERTIES
<b>C07K 14/575</b> (2006.01)	2509997 *	CONJUGATES COMPRISING AN ANTIBODY SURROGATE SCAFFOLD WITH IMPROVED PHARMACOKINETIC PROPERTIES
<b>A61K 38/26</b> (2006.01)	2509997 *	CONJUGATES COMPRISING AN ANTIBODY SURROGATE SCAFFOLD WITH IMPROVED PHARMACOKINETIC PROPERTIES
<b>C07K 16/00</b> (2006.01)	2509997 *	CONJUGATES COMPRISING AN ANTIBODY SURROGATE SCAFFOLD WITH IMPROVED PHARMACOKINETIC PROPERTIES
<b>A61P 13/12</b> (2006.01)	2523958 *	CARBOXYLIC ACID DERIVATIVES HAVING A 2,5,7-SUBSTITUTED OXAZOLOPYRIMIDINE RING
<b>A61P 25/28</b> (2006.01)	2523958 *	CARBOXYLIC ACID DERIVATIVES HAVING A 2,5,7-SUBSTITUTED OXAZOLOPYRIMIDINE RING
<b>A61P 3/10</b> (2006.01)	2523958 *	CARBOXYLIC ACID DERIVATIVES HAVING A 2,5,7-SUBSTITUTED OXAZOLOPYRIMIDINE RING
<b>A61P 35/00</b> (2006.01)	2523958 *	CARBOXYLIC ACID DERIVATIVES HAVING A 2,5,7-SUBSTITUTED OXAZOLOPYRIMIDINE RING
<b>A61P 11/00</b> (2006.01)	2523958 *	CARBOXYLIC ACID DERIVATIVES HAVING A 2,5,7-SUBSTITUTED OXAZOLOPYRIMIDINE RING
<b>C07D 498/04</b> (2006.01)	2523958 *	CARBOXYLIC ACID DERIVATIVES HAVING A 2,5,7-SUBSTITUTED OXAZOLOPYRIMIDINE RING
<b>A61P 29/00</b> (2006.01)	2523958 *	CARBOXYLIC ACID DERIVATIVES HAVING A 2,5,7-SUBSTITUTED OXAZOLOPYRIMIDINE RING
<b>A61P 9/00</b> (2006.01)	2523958 *	CARBOXYLIC ACID DERIVATIVES HAVING A 2,5,7-SUBSTITUTED OXAZOLOPYRIMIDINE RING
<b>A61P 7/02</b> (2006.01)	2523958 *	CARBOXYLIC ACID DERIVATIVES HAVING A 2,5,7-SUBSTITUTED OXAZOLOPYRIMIDINE RING
<b>A61K 31/519</b> (2006.01)	2523958 *	CARBOXYLIC ACID DERIVATIVES HAVING A 2,5,7-SUBSTITUTED OXAZOLOPYRIMIDINE RING
<b>A61P 31/02</b> (2006.01)	2523958 *	CARBOXYLIC ACID DERIVATIVES HAVING A 2,5,7-SUBSTITUTED OXAZOLOPYRIMIDINE RING
<b>A41D 1/06</b> (2006.01)	2401930	A pair of trousers
<b>C07K 14/00</b> (2006.01)	2501716 *	COMPOSITIONS FOR INCREASING POLYPEPTIDE STABILITY AND ACTIVITY, AND RELATED METHODS
<b>C12N 9/00</b> (2006.01)	2501716 *	COMPOSITIONS FOR INCREASING POLYPEPTIDE STABILITY AND ACTIVITY, AND RELATED METHODS
<b>A61K 31/185</b> (2006.01)	2519234 *	ANAPLEROTIC THERAPY FOR ALZHEIMER'S DISEASE AND THE AGING BRAIN
<b>A61K 31/20</b> (2006.01)	2519234 *	ANAPLEROTIC THERAPY FOR ALZHEIMER'S DISEASE AND THE AGING BRAIN
<b>A61P 25/28</b> (2006.01)	2519234 *	ANAPLEROTIC THERAPY FOR ALZHEIMER'S DISEASE AND THE AGING BRAIN
<b>A61K 31/23</b> (2006.01)	2519234 *	ANAPLEROTIC THERAPY FOR ALZHEIMER'S DISEASE AND THE AGING BRAIN
<b>A61K 31/25</b> (2006.01)	2519234 *	ANAPLEROTIC THERAPY FOR ALZHEIMER'S DISEASE AND THE AGING BRAIN
<b>B60V 3/08</b> (2006.01)	2527218 *	AIRCRAFT ON AN AIR CUSHION WITH AEROSTATIC LOAD RELIEF
<b>B64B 1/20</b> (2006.01)	2527218 *	AIRCRAFT ON AN AIR CUSHION WITH AEROSTATIC LOAD RELIEF
<b>B01D 21/00</b> (2006.01)	2452734	Filtering cartridge and dirt separation device for thermal fluids
<b>G06F 17/00</b> (2006.01)	2502156 *	PAINT SAMPLE MIXING AND VENDING MACHINE
<b>A01N 43/52</b> (2006.01)	2531025 *	METHOD FOR TREATING FUNGAL INFECTIONS, FUNGICIDAL COMPOSITIONS AND THEIR USE
<b>A01N 37/50</b> (2006.01)	2531025 *	METHOD FOR TREATING FUNGAL INFECTIONS, FUNGICIDAL COMPOSITIONS AND THEIR USE

MKP (51)	Broj objave evropske prijava patenta (97)	Naziv pronalaska (54)
<b>A01P 3/00</b> (2006.01)	2531025 *	METHOD FOR TREATING FUNGAL INFECTIONS, FUNGICIDAL COMPOSITIONS AND THEIR USE
<b>A01N 37/44</b> (2006.01)	2531025 *	METHOD FOR TREATING FUNGAL INFECTIONS, FUNGICIDAL COMPOSITIONS AND THEIR USE
<b>A01N 43/653</b> (2006.01)	2531025 *	METHOD FOR TREATING FUNGAL INFECTIONS, FUNGICIDAL COMPOSITIONS AND THEIR USE
<b>C12N 15/62</b> (2006.01)	2536750 *	RAGE FUSION PROTEIN COMPOSITIONS AND METHODS OF USE
<b>C07K 14/705</b> (2006.01)	2536750 *	RAGE FUSION PROTEIN COMPOSITIONS AND METHODS OF USE
<b>A61K 31/05</b> (2006.01)	2506841 *	TOPICAL USE OF HYDROXYTYROSOL AND DERIVATIVES FOR THE PREVENTION OF HIV INFECTION
<b>A61K 9/06</b> (2006.01)	2506841 *	TOPICAL USE OF HYDROXYTYROSOL AND DERIVATIVES FOR THE PREVENTION OF HIV INFECTION
<b>A61P 15/00</b> (2006.01)	2506841 *	TOPICAL USE OF HYDROXYTYROSOL AND DERIVATIVES FOR THE PREVENTION OF HIV INFECTION
<b>A61P 31/18</b> (2006.01)	2506841 *	TOPICAL USE OF HYDROXYTYROSOL AND DERIVATIVES FOR THE PREVENTION OF HIV INFECTION
<b>A61F 2/12</b> (2006.01)	2519192 *	BREAST IMPLANTS HAVING DRUG-ELUTING RESERVOIRS AND METHODS THEREFOR
<b>A61M 39/02</b> (2006.01)	2519192 *	BREAST IMPLANTS HAVING DRUG-ELUTING RESERVOIRS AND METHODS THEREFOR
<b>H01L 23/367</b> (2006.01)	2533282	Modular heat sink
<b>A01N 43/72</b> (2006.01)	2519104 *	PESTICIDAL COMPOSITION
<b>B21D 51/26</b> (2006.01)	2523762 *	METHODS OF PRESSURE FORMING METAL CONTAINERS AND THE LIKE FROM PREFORMS HAVING WALL THICKNESS GRADIENT
<b>B21D 26/02</b> (2011.01)	2523762 *	METHODS OF PRESSURE FORMING METAL CONTAINERS AND THE LIKE FROM PREFORMS HAVING WALL THICKNESS GRADIENT
<b>C08B 37/10</b> (2006.01)	2526122 *	EVALUATING HEPARIN PREPARATIONS
<b>C08B 37/00</b> (2006.01)	2526122 *	EVALUATING HEPARIN PREPARATIONS
<b>B65G 1/08</b> (2006.01)	2531424 *	COMPACT DEVICE FOR DISTRIBUTING OBJECTS, ESPECIALLY BOXES OF MEDICAMENTS, IN A PHARMACY
<b>B65G 47/88</b> (2006.01)	2531424 *	COMPACT DEVICE FOR DISTRIBUTING OBJECTS, ESPECIALLY BOXES OF MEDICAMENTS, IN A PHARMACY
<b>A61K 38/27</b> (2006.01)	2512450 *	DRY GROWTH HORMONE COMPOSITION TRANSIENTLY LINKED TO A POLYMER CARRIER
<b>A61K 38/00</b> (2006.01)	2512450 *	DRY GROWTH HORMONE COMPOSITION TRANSIENTLY LINKED TO A POLYMER CARRIER
<b>A61K 47/48</b> (2006.01)	2512450 *	DRY GROWTH HORMONE COMPOSITION TRANSIENTLY LINKED TO A POLYMER CARRIER
<b>A61K 9/14</b> (2006.01)	2512450 *	DRY GROWTH HORMONE COMPOSITION TRANSIENTLY LINKED TO A POLYMER CARRIER
<b>A61K 47/26</b> (2006.01)	2512450 *	DRY GROWTH HORMONE COMPOSITION TRANSIENTLY LINKED TO A POLYMER CARRIER
<b>A61K 9/19</b> (2006.01)	2512450 *	DRY GROWTH HORMONE COMPOSITION TRANSIENTLY LINKED TO A POLYMER CARRIER
<b>A61K 9/00</b> (2006.01)	2512450 *	DRY GROWTH HORMONE COMPOSITION TRANSIENTLY LINKED TO A POLYMER CARRIER
<b>A23J 3/16</b> (2006.01)	2515673 *	pH ADJUSTED SOY PROTEIN ISOLATE AND USES
<b>A23J 1/14</b> (2006.01)	2515673 *	pH ADJUSTED SOY PROTEIN ISOLATE AND USES
<b>A61K 48/00</b> (2006.01)	2536435 *	MONKEY HOMOLOG OF HUMAN INTERFERON OMEGA
<b>C07K 14/00</b> (2006.01)	2536435 *	MONKEY HOMOLOG OF HUMAN INTERFERON OMEGA
<b>C07D 401/06</b> (2006.01)	2516418 *	PRODRUGS OF [4[4-(5-AMINOMETHYL-2-FLUORO-PHENYL)-PIPERIDIN-1-YL]-(1H-PYRROLO-PYRIDIN-YL)-METHANONES AND SYNTHESIS THEREOF
<b>A61P 29/00</b> (2006.01)	2516418 *	PRODRUGS OF [4[4-(5-AMINOMETHYL-2-FLUORO-PHENYL)-PIPERIDIN-1-YL]-(1H-PYRROLO-PYRIDIN-YL)-METHANONES AND SYNTHESIS THEREOF
<b>A61K 31/454</b> (2006.01)	2516418 *	PRODRUGS OF [4[4-(5-AMINOMETHYL-2-FLUORO-PHENYL)-PIPERIDIN-1-YL]-(1H-PYRROLO-PYRIDIN-YL)-METHANONES AND SYNTHESIS THEREOF

MKP (51)	Broj objave evropske prijava patenta (97)	Naziv pronalaska (54)
<b>F16L 41/03</b> (2006.01)	2521821 *	PIPE CONNECTION FOR A COMBINATION SHOWER-WC
<b>E03D 9/05</b> (2006.01)	2521821 *	PIPE CONNECTION FOR A COMBINATION SHOWER-WC
<b>E03D 1/38</b> (2006.01)	2521821 *	PIPE CONNECTION FOR A COMBINATION SHOWER-WC
<b>E03D 9/08</b> (2006.01)	2521821 *	PIPE CONNECTION FOR A COMBINATION SHOWER-WC
<b>E03C 1/02</b> (2006.01)	2521821 *	PIPE CONNECTION FOR A COMBINATION SHOWER-WC
<b>E03D 11/13</b> (2006.01)	2521821 *	PIPE CONNECTION FOR A COMBINATION SHOWER-WC
<b>A24F 1/30</b> (2006.01)	2536303 *	ELECTRONIC HOOKAH
<b>A24F 47/00</b> (2006.01)	2536303 *	ELECTRONIC HOOKAH
<b>A24F 1/14</b> (2006.01)	2536303 *	ELECTRONIC HOOKAH
<b>C07K 16/18</b> (2006.01)	2524233 *	COMPOSITIONS AND METHODS FOR DETECTING CANCER
<b>G01N 33/574</b> (2006.01)	2524233 *	COMPOSITIONS AND METHODS FOR DETECTING CANCER
<b>C07D 277/56</b> (2006.01)	2536699 *	SUBSTANTIALLY PURE SALTS OF FEBUXOSTAT AND PROCESSES FOR PREPARATION THEREOF
<b>A61P 19/06</b> (2006.01)	2536699 *	SUBSTANTIALLY PURE SALTS OF FEBUXOSTAT AND PROCESSES FOR PREPARATION THEREOF
<b>A61K 31/426</b> (2006.01)	2536699 *	SUBSTANTIALLY PURE SALTS OF FEBUXOSTAT AND PROCESSES FOR PREPARATION THEREOF
<b>C07K 19/00</b> (2006.01)	2501407 *	ANTI-ORAI1 ANTIGEN BINDING PROTEINS AND USES THEREOF
<b>C07K 16/28</b> (2006.01)	2501407 *	ANTI-ORAI1 ANTIGEN BINDING PROTEINS AND USES THEREOF
<b>A61P 37/06</b> (2006.01)	2501407 *	ANTI-ORAI1 ANTIGEN BINDING PROTEINS AND USES THEREOF
<b>A61K 39/395</b> (2006.01)	2501407 *	ANTI-ORAI1 ANTIGEN BINDING PROTEINS AND USES THEREOF
<b>C07K 14/705</b> (2006.01)	2501407 *	ANTI-ORAI1 ANTIGEN BINDING PROTEINS AND USES THEREOF
<b>C02F 1/46</b> (2006.01)	2531452 *	ADVANCED TREATMENT SYSTEM OF WASTEWATER HAVING PLASMA DISCHARGING VESSEL
<b>C02F 9/14</b> (2006.01)	2531452 *	ADVANCED TREATMENT SYSTEM OF WASTEWATER HAVING PLASMA DISCHARGING VESSEL
<b>C02F 1/48</b> (2006.01)	2531452 *	ADVANCED TREATMENT SYSTEM OF WASTEWATER HAVING PLASMA DISCHARGING VESSEL
<b>A61K 9/16</b> (2006.01)	2515873 *	FORMULATION COMPRISING 1 H - QUINAZOLINE - 2, 4 - DIONE AMPA RECEPTOR ANTAGONISTS, IN THE FORM OF IMMEDIATE RELEASE TABLETS AND PREPARATION THEREOF
<b>A61P 25/16</b> (2006.01)	2515873 *	FORMULATION COMPRISING 1 H - QUINAZOLINE - 2, 4 - DIONE AMPA RECEPTOR ANTAGONISTS, IN THE FORM OF IMMEDIATE RELEASE TABLETS AND PREPARATION THEREOF
<b>A61P 25/18</b> (2006.01)	2515873 *	FORMULATION COMPRISING 1 H - QUINAZOLINE - 2, 4 - DIONE AMPA RECEPTOR ANTAGONISTS, IN THE FORM OF IMMEDIATE RELEASE TABLETS AND PREPARATION THEREOF
<b>A61K 9/20</b> (2006.01)	2515873 *	FORMULATION COMPRISING 1 H - QUINAZOLINE - 2, 4 - DIONE AMPA RECEPTOR ANTAGONISTS, IN THE FORM OF IMMEDIATE RELEASE TABLETS AND PREPARATION THEREOF
<b>A61K 31/517</b> (2006.01)	2515873 *	FORMULATION COMPRISING 1 H - QUINAZOLINE - 2, 4 - DIONE AMPA RECEPTOR ANTAGONISTS, IN THE FORM OF IMMEDIATE RELEASE TABLETS AND PREPARATION THEREOF
<b>A61P 25/08</b> (2006.01)	2515873 *	FORMULATION COMPRISING 1 H - QUINAZOLINE - 2, 4 - DIONE AMPA RECEPTOR ANTAGONISTS, IN THE FORM OF IMMEDIATE RELEASE TABLETS AND PREPARATION THEREOF
<b>A61K 9/14</b> (2006.01)	2515873 *	FORMULATION COMPRISING 1 H - QUINAZOLINE - 2, 4 - DIONE AMPA RECEPTOR ANTAGONISTS, IN THE FORM OF IMMEDIATE RELEASE TABLETS AND PREPARATION THEREOF
<b>A61P 25/28</b> (2006.01)	2515873 *	FORMULATION COMPRISING 1 H - QUINAZOLINE - 2, 4 - DIONE AMPA RECEPTOR ANTAGONISTS, IN THE FORM OF IMMEDIATE RELEASE TABLETS AND PREPARATION THEREOF
<b>A61P 25/24</b> (2006.01)	2515873 *	FORMULATION COMPRISING 1 H - QUINAZOLINE - 2, 4 - DIONE AMPA RECEPTOR ANTAGONISTS, IN THE FORM OF IMMEDIATE RELEASE TABLETS AND PREPARATION THEREOF
<b>C09J 7/00</b> (2006.01)	2522499	Dry adhesive comprising micro-featured and nano-featured surface area and compliant surface area

MKP (51)	Broj objave evropske prijava patenta (97)	Naziv pronalaska (54)
<b>B32B 3/00</b> (2006.01)	2522499	Dry adhesive comprising micro-featured and nano-featured surface area and compliant surface area
<b>C09J 5/00</b> (2006.01)	2522499	Dry adhesive comprising micro-featured and nano-featured surface area and compliant surface area
<b>A61K 39/395</b> (2006.01)	2534176 *	AGONIST DR5 BINDING POLYPEPTIDES
<b>C07K 16/28</b> (2006.01)	2534176 *	AGONIST DR5 BINDING POLYPEPTIDES
<b>A23L 1/238</b> (2006.01)	2517577 *	SOY SAUCE HAVING HYPOTENSIVE EFFECT AND METHOD FOR PRODUCING SAME
<b>A61K 31/675</b> (2006.01)	2523948 *	PRO-DRUGS OF (E) -7- (3- (2-AMINO-1-FLUOROETHYLIDENE) PIPERIDIN-1-YL) -1-CYCLOPROPYL-6-FLUORO-8-METHOXY-4-OXO-1,4-DIHYDROQUINOLINE-3-CARBOXYLIC ACID
<b>C07F 9/24</b> (2006.01)	2523948 *	PRO-DRUGS OF (E) -7- (3- (2-AMINO-1-FLUOROETHYLIDENE) PIPERIDIN-1-YL) -1-CYCLOPROPYL-6-FLUORO-8-METHOXY-4-OXO-1,4-DIHYDROQUINOLINE-3-CARBOXYLIC ACID
<b>A61P 31/00</b> (2006.01)	2523948 *	PRO-DRUGS OF (E) -7- (3- (2-AMINO-1-FLUOROETHYLIDENE) PIPERIDIN-1-YL) -1-CYCLOPROPYL-6-FLUORO-8-METHOXY-4-OXO-1,4-DIHYDROQUINOLINE-3-CARBOXYLIC ACID
<b>C07D 401/14</b> (2006.01)	2523948 *	PRO-DRUGS OF (E) -7- (3- (2-AMINO-1-FLUOROETHYLIDENE) PIPERIDIN-1-YL) -1-CYCLOPROPYL-6-FLUORO-8-METHOXY-4-OXO-1,4-DIHYDROQUINOLINE-3-CARBOXYLIC ACID
<b>A61K 31/4725</b> (2006.01)	2523948 *	PRO-DRUGS OF (E) -7- (3- (2-AMINO-1-FLUOROETHYLIDENE) PIPERIDIN-1-YL) -1-CYCLOPROPYL-6-FLUORO-8-METHOXY-4-OXO-1,4-DIHYDROQUINOLINE-3-CARBOXYLIC ACID
<b>C07D 401/04</b> (2006.01)	2523948 *	PRO-DRUGS OF (E) -7- (3- (2-AMINO-1-FLUOROETHYLIDENE) PIPERIDIN-1-YL) -1-CYCLOPROPYL-6-FLUORO-8-METHOXY-4-OXO-1,4-DIHYDROQUINOLINE-3-CARBOXYLIC ACID
<b>C07D 405/14</b> (2006.01)	2523948 *	PRO-DRUGS OF (E) -7- (3- (2-AMINO-1-FLUOROETHYLIDENE) PIPERIDIN-1-YL) -1-CYCLOPROPYL-6-FLUORO-8-METHOXY-4-OXO-1,4-DIHYDROQUINOLINE-3-CARBOXYLIC ACID
<b>C07D 207/48</b> (2006.01)	2509945 *	4- (AZACYCLOALKYL) -BENZENE-1, 3 -DIOL DERIVATIVES AS TYROSINASE INHIBITORS AND THEIR SYNTHESIS AND USE THEREOF
<b>A61K 31/451</b> (2006.01)	2509945 *	4- (AZACYCLOALKYL) -BENZENE-1, 3 -DIOL DERIVATIVES AS TYROSINASE INHIBITORS AND THEIR SYNTHESIS AND USE THEREOF
<b>C07D 211/96</b> (2006.01)	2509945 *	4- (AZACYCLOALKYL) -BENZENE-1, 3 -DIOL DERIVATIVES AS TYROSINASE INHIBITORS AND THEIR SYNTHESIS AND USE THEREOF
<b>A61P 17/00</b> (2006.01)	2509945 *	4- (AZACYCLOALKYL) -BENZENE-1, 3 -DIOL DERIVATIVES AS TYROSINASE INHIBITORS AND THEIR SYNTHESIS AND USE THEREOF
<b>A61B 17/068</b> (2006.01)	2525724 *	APPARATUS FOR FEEDING STAPLES IN A LOW PROFILE SURGICAL STAPLER
<b>A61B 17/128</b> (2006.01)	2525724 *	APPARATUS FOR FEEDING STAPLES IN A LOW PROFILE SURGICAL STAPLER
<b>B29C 65/08</b> (2006.01)	2522491	Longitudinal continuous welding device for packaging machines
<b>B31B 19/90</b> (2006.01)	2522491	Longitudinal continuous welding device for packaging machines
<b>G06K 9/68</b> (2006.01)	2447884	Method for detecting and recognising an object in an image, and an apparatus and a computer program therefor
<b>C07D 401/10</b> (2006.01)	2516009 *	SUBSTITUTED ISOQUINOLINONES AND QUINAZOLINONES
<b>C07D 417/12</b> (2006.01)	2516009 *	SUBSTITUTED ISOQUINOLINONES AND QUINAZOLINONES
<b>A61K 31/495</b> (2006.01)	2516009 *	SUBSTITUTED ISOQUINOLINONES AND QUINAZOLINONES
<b>C07D 413/10</b> (2006.01)	2516009 *	SUBSTITUTED ISOQUINOLINONES AND QUINAZOLINONES
<b>C07D 401/14</b> (2006.01)	2516009 *	SUBSTITUTED ISOQUINOLINONES AND QUINAZOLINONES
<b>C07D 413/14</b> (2006.01)	2516009 *	SUBSTITUTED ISOQUINOLINONES AND QUINAZOLINONES
<b>C07D 405/12</b> (2006.01)	2516009 *	SUBSTITUTED ISOQUINOLINONES AND QUINAZOLINONES
<b>A61P 35/00</b> (2006.01)	2516009 *	SUBSTITUTED ISOQUINOLINONES AND QUINAZOLINONES
<b>C07D 409/12</b> (2006.01)	2516009 *	SUBSTITUTED ISOQUINOLINONES AND QUINAZOLINONES
<b>C07D 401/12</b> (2006.01)	2516009 *	SUBSTITUTED ISOQUINOLINONES AND QUINAZOLINONES
<b>C07D 405/14</b> (2006.01)	2516009 *	SUBSTITUTED ISOQUINOLINONES AND QUINAZOLINONES
<b>C07D 401/04</b> (2006.01)	2516009 *	SUBSTITUTED ISOQUINOLINONES AND QUINAZOLINONES
<b>C07D 413/12</b> (2006.01)	2516009 *	SUBSTITUTED ISOQUINOLINONES AND QUINAZOLINONES

MKP (51)	Broj objave evropske prijava patenta (97)	Naziv pronalaska (54)
<b>C07D 405/04</b> (2006.01)	2516009 *	SUBSTITUTED ISOQUINOLINONES AND QUINAZOLINONES
<b>C07D 217/24</b> (2006.01)	2516009 *	SUBSTITUTED ISOQUINOLINONES AND QUINAZOLINONES
<b>B60N 2/02</b> (2006.01)	2509868 *	A SEAT AND RELATED LEG REST AND MECHANISM AND METHOD THEREFOR
<b>B61D 33/00</b> (2006.01)	2509868 *	A SEAT AND RELATED LEG REST AND MECHANISM AND METHOD THEREFOR
<b>B60N 3/06</b> (2006.01)	2509868 *	A SEAT AND RELATED LEG REST AND MECHANISM AND METHOD THEREFOR
<b>B64D 11/06</b> (2006.01)	2509868 *	A SEAT AND RELATED LEG REST AND MECHANISM AND METHOD THEREFOR
<b>A01H 5/00</b> (2006.01)	2512222 *	COMBINED USE OF CRY1Ca AND CRY1Fa PROTEINS FOR INSECT RESISTANCE MANAGEMENT
<b>A01P 7/00</b> (2006.01)	2512222 *	COMBINED USE OF CRY1Ca AND CRY1Fa PROTEINS FOR INSECT RESISTANCE MANAGEMENT
<b>A01H 1/00</b> (2006.01)	2512222 *	COMBINED USE OF CRY1Ca AND CRY1Fa PROTEINS FOR INSECT RESISTANCE MANAGEMENT
<b>C07K 19/00</b> (2006.01)	2511294 *	CONJUGATES AND COMPOSITIONS FOR IMMUNOTHERAPY AND ANTI-TUMOR TREATMENT
<b>C07K 14/54</b> (2006.01)	2511294 *	CONJUGATES AND COMPOSITIONS FOR IMMUNOTHERAPY AND ANTI-TUMOR TREATMENT
<b>A61K 38/17</b> (2006.01)	2511294 *	CONJUGATES AND COMPOSITIONS FOR IMMUNOTHERAPY AND ANTI-TUMOR TREATMENT
<b>C07K 14/715</b> (2006.01)	2511294 *	CONJUGATES AND COMPOSITIONS FOR IMMUNOTHERAPY AND ANTI-TUMOR TREATMENT
<b>A61K 48/00</b> (2006.01)	2511294 *	CONJUGATES AND COMPOSITIONS FOR IMMUNOTHERAPY AND ANTI-TUMOR TREATMENT
<b>C07K 14/775</b> (2006.01)	2511294 *	CONJUGATES AND COMPOSITIONS FOR IMMUNOTHERAPY AND ANTI-TUMOR TREATMENT
<b>C12N 1/21</b> (2006.01)	2511294 *	CONJUGATES AND COMPOSITIONS FOR IMMUNOTHERAPY AND ANTI-TUMOR TREATMENT
<b>C12N 1/15</b> (2006.01)	2511294 *	CONJUGATES AND COMPOSITIONS FOR IMMUNOTHERAPY AND ANTI-TUMOR TREATMENT
<b>C12N 15/62</b> (2006.01)	2511294 *	CONJUGATES AND COMPOSITIONS FOR IMMUNOTHERAPY AND ANTI-TUMOR TREATMENT
<b>C12N 5/10</b> (2006.01)	2511294 *	CONJUGATES AND COMPOSITIONS FOR IMMUNOTHERAPY AND ANTI-TUMOR TREATMENT
<b>C25B 1/16</b> (2006.01)	2510135 *	METHOD AND SYSTEM FOR PRODUCING HYDROGEN USING SODIUM ION SEPARATION MEMBRANES
<b>A61K 31/277</b> (2006.01)	2506852 *	INTERFERON THERAPIES IN COMBINATION WITH BLOCKADE OF STAT3 ACTIVATION
<b>A61P 35/00</b> (2006.01)	2506852 *	INTERFERON THERAPIES IN COMBINATION WITH BLOCKADE OF STAT3 ACTIVATION
<b>A61K 31/275</b> (2006.01)	2506852 *	INTERFERON THERAPIES IN COMBINATION WITH BLOCKADE OF STAT3 ACTIVATION
<b>A61K 31/216</b> (2006.01)	2506852 *	INTERFERON THERAPIES IN COMBINATION WITH BLOCKADE OF STAT3 ACTIVATION
<b>A61K 31/445</b> (2006.01)	2506852 *	INTERFERON THERAPIES IN COMBINATION WITH BLOCKADE OF STAT3 ACTIVATION
<b>A61K 31/4465</b> (2006.01)	2506852 *	INTERFERON THERAPIES IN COMBINATION WITH BLOCKADE OF STAT3 ACTIVATION
<b>F02D 41/20</b> (2006.01)	2504551 *	FUEL INJECTOR COMMUNICATION SYSTEM
<b>F02M 51/00</b> (2006.01)	2504551 *	FUEL INJECTOR COMMUNICATION SYSTEM
<b>F02D 41/24</b> (2006.01)	2504551 *	FUEL INJECTOR COMMUNICATION SYSTEM
<b>C03B 37/16</b> (2006.01)	2481539	Device for cutting insulation material
<b>B26F 3/00</b> (2006.01)	2481539	Device for cutting insulation material
<b>A61K 31/4418</b> (2006.01)	2506849 *	PIRFENIDONE THERAPY AND INDUCERS OF CYTOCHROME P450
<b>A61P 43/00</b> (2006.01)	2506849 *	PIRFENIDONE THERAPY AND INDUCERS OF CYTOCHROME P450
<b>A61K 31/4412</b> (2006.01)	2506849 *	PIRFENIDONE THERAPY AND INDUCERS OF CYTOCHROME P450

MKP (51)	Broj objave evropske prijava patenta (97)	Naziv pronalaska (54)
<b>A61K 31/44</b> (2006.01)	2506849 *	PIRFENIDONE THERAPY AND INDUCERS OF CYTOCHROME P450
<b>G01N 33/53</b> (2006.01)	2507627 *	ANTENNARY FUCOSYLATION IN GLYCOPROTEINS FROM CHO CELLS
<b>G01N 33/68</b> (2006.01)	2507627 *	ANTENNARY FUCOSYLATION IN GLYCOPROTEINS FROM CHO CELLS
<b>F16L 9/00</b> (2006.01)	2447585	Pipe
<b>F16L 9/127</b> (2006.01)	2447585	Pipe
<b>F16L 11/12</b> (2006.01)	2447585	Pipe
<b>A61M 5/24</b> (2006.01)	2528643 *	DRIVE ASSEMBLY FOR A DRUG DELIVERY DEVICE AND DRUG DELIVERY DEVICE
<b>A61M 5/315</b> (2006.01)	2528643 *	DRIVE ASSEMBLY FOR A DRUG DELIVERY DEVICE AND DRUG DELIVERY DEVICE
<b>B64C 27/00</b> (2006.01)	2501958 *	METHOD, APPARATUS AND SYSTEM FOR REDUCING VIBRATION IN A ROTARY SYSTEM OF A VEHICLE
<b>F16F 15/36</b> (2006.01)	2501958 *	METHOD, APPARATUS AND SYSTEM FOR REDUCING VIBRATION IN A ROTARY SYSTEM OF A VEHICLE
<b>F16F 15/16</b> (2006.01)	2501958 *	METHOD, APPARATUS AND SYSTEM FOR REDUCING VIBRATION IN A ROTARY SYSTEM OF A VEHICLE
<b>G01M 1/36</b> (2006.01)	2501958 *	METHOD, APPARATUS AND SYSTEM FOR REDUCING VIBRATION IN A ROTARY SYSTEM OF A VEHICLE
<b>A23G 1/30</b> (2006.01)	2509439 *	CHOCOLATE PRODUCT
<b>A23L 1/00</b> (2006.01)	2509439 *	CHOCOLATE PRODUCT
<b>A23G 1/50</b> (2006.01)	2509439 *	CHOCOLATE PRODUCT
<b>A23L 1/09</b> (2006.01)	2509439 *	CHOCOLATE PRODUCT
<b>A23L 1/03</b> (2006.01)	2509439 *	CHOCOLATE PRODUCT
<b>A23L 1/30</b> (2006.01)	2509439 *	CHOCOLATE PRODUCT
<b>A23L 1/0562</b> (2006.01)	2509439 *	CHOCOLATE PRODUCT
<b>A23G 3/54</b> (2006.01)	2509439 *	CHOCOLATE PRODUCT
<b>A23L 1/305</b> (2006.01)	2509439 *	CHOCOLATE PRODUCT
<b>A23L 1/227</b> (2006.01)	2509439 *	CHOCOLATE PRODUCT
<b>A23G 1/54</b> (2006.01)	2509439 *	CHOCOLATE PRODUCT
<b>B29C 45/44</b> (2006.01)	2444224	Method and device for producing ball bearing rings
<b>B29C 45/26</b> (2006.01)	2444224	Method and device for producing ball bearing rings
<b>B29C 45/56</b> (2006.01)	2444224	Method and device for producing ball bearing rings
<b>A01H 5/00</b> (2006.01)	2525649 *	EXCISION OF TRANSGENES IN GENETICALLY MODIFIED ORGANISMS
<b>C12N 15/29</b> (2006.01)	2525649 *	EXCISION OF TRANSGENES IN GENETICALLY MODIFIED ORGANISMS
<b>C12N 15/82</b> (2006.01)	2525649 *	EXCISION OF TRANSGENES IN GENETICALLY MODIFIED ORGANISMS
<b>A61K 31/519</b> (2006.01)	2523960 *	HETEROCYCLIC CARBOXYLIC ACID DERIVATIVES HAVING A 2,5-SUBSTITUTED OXAZOLOPYRIMIDINE RING
<b>A61P 9/00</b> (2006.01)	2523960 *	HETEROCYCLIC CARBOXYLIC ACID DERIVATIVES HAVING A 2,5-SUBSTITUTED OXAZOLOPYRIMIDINE RING
<b>C07D 498/04</b> (2006.01)	2523960 *	HETEROCYCLIC CARBOXYLIC ACID DERIVATIVES HAVING A 2,5-SUBSTITUTED OXAZOLOPYRIMIDINE RING
<b>A61K 9/00</b> (2006.01)	2515878 *	SUSTAINED-RELEASE FORMULATION
<b>A61K 9/16</b> (2006.01)	2515878 *	SUSTAINED-RELEASE FORMULATION
<b>A61P 35/00</b> (2006.01)	2515878 *	SUSTAINED-RELEASE FORMULATION
<b>A61K 38/00</b> (2006.01)	2515878 *	SUSTAINED-RELEASE FORMULATION
<b>A01H 5/00</b> (2006.01)	2503873 *	HERBICIDE TOLERANT SOYBEAN PLANTS AND METHODS FOR IDENTIFYING SAME
<b>C12Q 1/68</b> (2006.01)	2503873 *	HERBICIDE TOLERANT SOYBEAN PLANTS AND METHODS FOR IDENTIFYING SAME
<b>G06F 3/048</b> (2006.01)	2524294 *	METHOD FOR SELECTING AN ELEMENT OF A USER INTERFACE AND DEVICE IMPLEMENTING SUCH A METHOD
<b>A61B 17/24</b> (2006.01)	2519168 *	TISSUE REMOVAL IN THE PARANASAL SINUS AND NASAL CAVITY
<b>A61B 17/32</b> (2006.01)	2519168 *	TISSUE REMOVAL IN THE PARANASAL SINUS AND NASAL CAVITY

MKP (51)	Broj objave evropske prijava patenta (97)	Naziv pronalaska (54)
<b>A61M 29/02</b> (2006.01)	2519168 *	TISSUE REMOVAL IN THE PARANASAL SINUS AND NASAL CAVITY
<b>A61B 17/3205</b> (2006.01)	2519168 *	TISSUE REMOVAL IN THE PARANASAL SINUS AND NASAL CAVITY
<b>A61B 17/22</b> (2006.01)	2519168 *	TISSUE REMOVAL IN THE PARANASAL SINUS AND NASAL CAVITY
<b>F23M 5/00</b> (2006.01)	2529158 *	SYSTEM AND METHOD FOR HIGH EFFICIENCY POWER GENERATION USING A CARBON DIOXIDE CIRCULATING WORKING FLUID
<b>F23L 7/00</b> (2006.01)	2529158 *	SYSTEM AND METHOD FOR HIGH EFFICIENCY POWER GENERATION USING A CARBON DIOXIDE CIRCULATING WORKING FLUID
<b>F23M 5/08</b> (2006.01)	2529158 *	SYSTEM AND METHOD FOR HIGH EFFICIENCY POWER GENERATION USING A CARBON DIOXIDE CIRCULATING WORKING FLUID
<b>F02C 1/00</b> (2006.01)	2529158 *	SYSTEM AND METHOD FOR HIGH EFFICIENCY POWER GENERATION USING A CARBON DIOXIDE CIRCULATING WORKING FLUID
<b>F41H 1/02</b> (2006.01)	2507582 *	STAPLE FIBER CONDUCTIVE FABRIC
<b>D04B 21/14</b> (2006.01)	2507582 *	STAPLE FIBER CONDUCTIVE FABRIC
<b>C07K 16/18</b> (2006.01)	2512600 *	WISE BINDING AGENTS AND EPITOPES
<b>A61K 39/395</b> (2006.01)	2512600 *	WISE BINDING AGENTS AND EPITOPES
<b>A61P 13/12</b> (2006.01)	2512600 *	WISE BINDING AGENTS AND EPITOPES
<b>C07C 409/34</b> (2006.01)	2509944 *	NOVEL PEROXIDE DERIVATIVES, THEIR PROCESS OF PREPARATION AND THEIR USE IN HUMAN MEDICINE AND IN COSMETICS FOR THE TREATMENT OR PREVENTION OF ACNE
<b>A61Q 19/00</b> (2006.01)	2509944 *	NOVEL PEROXIDE DERIVATIVES, THEIR PROCESS OF PREPARATION AND THEIR USE IN HUMAN MEDICINE AND IN COSMETICS FOR THE TREATMENT OR PREVENTION OF ACNE
<b>A61K 8/38</b> (2006.01)	2509944 *	NOVEL PEROXIDE DERIVATIVES, THEIR PROCESS OF PREPARATION AND THEIR USE IN HUMAN MEDICINE AND IN COSMETICS FOR THE TREATMENT OR PREVENTION OF ACNE
<b>C12P 19/34</b> (2006.01)	2513326 *	ENDPOINT TAQMAN METHODS FOR DETERMINING ZYGOSITY OF CORN COMPRISING TC1507 EVENTS
<b>C07H 21/04</b> (2006.01)	2513326 *	ENDPOINT TAQMAN METHODS FOR DETERMINING ZYGOSITY OF CORN COMPRISING TC1507 EVENTS
<b>A61M 5/32</b> (2006.01)	2536455 *	FINGER GUARD FOR AN INJECTION DEVICE
<b>A61M 5/20</b> (2006.01)	2536455 *	FINGER GUARD FOR AN INJECTION DEVICE
<b>A61P 9/00</b> (2006.01)	2516433 *	SUBSTITUTED N-(1H-INDAZOL-4-YL)IMIDAZO[1, 2-A]PYRIDINE-3-CARBOXAMIDE COMPOUNDS AS CFMS INHIBITORS
<b>A61P 19/08</b> (2006.01)	2516433 *	SUBSTITUTED N-(1H-INDAZOL-4-YL)IMIDAZO[1, 2-A]PYRIDINE-3-CARBOXAMIDE COMPOUNDS AS CFMS INHIBITORS
<b>C07D 519/00</b> (2006.01)	2516433 *	SUBSTITUTED N-(1H-INDAZOL-4-YL)IMIDAZO[1, 2-A]PYRIDINE-3-CARBOXAMIDE COMPOUNDS AS CFMS INHIBITORS
<b>C07D 471/04</b> (2006.01)	2516433 *	SUBSTITUTED N-(1H-INDAZOL-4-YL)IMIDAZO[1, 2-A]PYRIDINE-3-CARBOXAMIDE COMPOUNDS AS CFMS INHIBITORS
<b>A61P 29/00</b> (2006.01)	2516433 *	SUBSTITUTED N-(1H-INDAZOL-4-YL)IMIDAZO[1, 2-A]PYRIDINE-3-CARBOXAMIDE COMPOUNDS AS CFMS INHIBITORS
<b>A61K 31/437</b> (2006.01)	2516433 *	SUBSTITUTED N-(1H-INDAZOL-4-YL)IMIDAZO[1, 2-A]PYRIDINE-3-CARBOXAMIDE COMPOUNDS AS CFMS INHIBITORS
<b>A61K 31/4985</b> (2006.01)	2516433 *	SUBSTITUTED N-(1H-INDAZOL-4-YL)IMIDAZO[1, 2-A]PYRIDINE-3-CARBOXAMIDE COMPOUNDS AS CFMS INHIBITORS
<b>A61P 35/00</b> (2006.01)	2516433 *	SUBSTITUTED N-(1H-INDAZOL-4-YL)IMIDAZO[1, 2-A]PYRIDINE-3-CARBOXAMIDE COMPOUNDS AS CFMS INHIBITORS
<b>B25H 3/02</b> (2006.01)	2516115 *	MODULE SYSTEM COMPRISING A CASE AND A NUMBER OF BOXES
<b>A61K 35/74</b> (2006.01)	2528611 *	A COMPOSITION FOR USE IN THE THERAPY OF LACTOSE INTOLERANCE OR CONDITIONS ARISING FROM LACTASE DEFICIENCY
<b>A61K 38/47</b> (2006.01)	2528611 *	A COMPOSITION FOR USE IN THE THERAPY OF LACTOSE INTOLERANCE OR CONDITIONS ARISING FROM LACTASE DEFICIENCY
<b>H05B 7/09</b> (2006.01)	2514269 *	ELECTRODE PASTE FOR ELECTRODES IN BINDER-FREE GRAPHITE WITH HYDROCARBON BASE
<b>A61K 31/135</b> (2006.01)	2515891 *	3-KETO-N-PROPARGYL-1-AMINOINDAN

MKP (51)	Broj objave evropske prijava patenta (97)	Naziv pronalaska (54)
<b>C07D 487/04</b> (2006.01)	2523955 *	NOVEL SUBSTITUTED BICYCLIC TRIAZOLE DERIVATIVES AS GAMMA SECRETASE MODULATORS
<b>A61P 25/28</b> (2006.01)	2523955 *	NOVEL SUBSTITUTED BICYCLIC TRIAZOLE DERIVATIVES AS GAMMA SECRETASE MODULATORS
<b>C07D 471/04</b> (2006.01)	2523955 *	NOVEL SUBSTITUTED BICYCLIC TRIAZOLE DERIVATIVES AS GAMMA SECRETASE MODULATORS
<b>A61K 31/4196</b> (2006.01)	2523955 *	NOVEL SUBSTITUTED BICYCLIC TRIAZOLE DERIVATIVES AS GAMMA SECRETASE MODULATORS
<b>G06Q 10/00</b> (2012.01)	2529342 *	SYSTEMS AND METHODS FOR MANAGING EVENTS
<b>C07J 71/00</b> (2006.01)	2531516 *	PREGNANE COMPOUNDS CONDENSED IN POSITION 16,17 WITH A PYROLIDINE RING WITH GLUCOCORTICOID ACTIVITY
<b>A61K 31/58</b> (2006.01)	2531516 *	PREGNANE COMPOUNDS CONDENSED IN POSITION 16,17 WITH A PYROLIDINE RING WITH GLUCOCORTICOID ACTIVITY
<b>A61P 5/44</b> (2006.01)	2531516 *	PREGNANE COMPOUNDS CONDENSED IN POSITION 16,17 WITH A PYROLIDINE RING WITH GLUCOCORTICOID ACTIVITY
<b>C12N 15/113</b> (2010.01)	2507373 *	COMPOSITIONS AND METHODS FOR INHIBITION OF VEGF
<b>A61P 17/06</b> (2006.01)	2516467 *	COMPOSITIONS COMPRISING TNF-ALPHA AND IL-6 ANTAGONISTS AND METHODS OF USE THEREOF
<b>A61P 37/00</b> (2006.01)	2516467 *	COMPOSITIONS COMPRISING TNF-ALPHA AND IL-6 ANTAGONISTS AND METHODS OF USE THEREOF
<b>C07K 16/24</b> (2006.01)	2516467 *	COMPOSITIONS COMPRISING TNF-ALPHA AND IL-6 ANTAGONISTS AND METHODS OF USE THEREOF
<b>A61K 39/395</b> (2006.01)	2516467 *	COMPOSITIONS COMPRISING TNF-ALPHA AND IL-6 ANTAGONISTS AND METHODS OF USE THEREOF
<b>A61P 19/02</b> (2006.01)	2516467 *	COMPOSITIONS COMPRISING TNF-ALPHA AND IL-6 ANTAGONISTS AND METHODS OF USE THEREOF
<b>A61P 13/00</b> (2006.01)	2521716 *	POLYMORPHIC, CRYSTALLINE AND MESOPHASE FORMS OF SODIUM 2-(5-BROMO-4-(4-CYCLOPROPYLNAPHTHALEN-1-YL)-4H-1,2,4-TRIAZOL-3-YLTHIO)ACETATE, AND USES THEREOF
<b>C07D 249/12</b> (2006.01)	2521716 *	POLYMORPHIC, CRYSTALLINE AND MESOPHASE FORMS OF SODIUM 2-(5-BROMO-4-(4-CYCLOPROPYLNAPHTHALEN-1-YL)-4H-1,2,4-TRIAZOL-3-YLTHIO)ACETATE, AND USES THEREOF
<b>A61P 13/12</b> (2006.01)	2521716 *	POLYMORPHIC, CRYSTALLINE AND MESOPHASE FORMS OF SODIUM 2-(5-BROMO-4-(4-CYCLOPROPYLNAPHTHALEN-1-YL)-4H-1,2,4-TRIAZOL-3-YLTHIO)ACETATE, AND USES THEREOF
<b>A61K 31/4196</b> (2006.01)	2521716 *	POLYMORPHIC, CRYSTALLINE AND MESOPHASE FORMS OF SODIUM 2-(5-BROMO-4-(4-CYCLOPROPYLNAPHTHALEN-1-YL)-4H-1,2,4-TRIAZOL-3-YLTHIO)ACETATE, AND USES THEREOF
<b>B01J 20/28</b> (2006.01)	2536497 *	AGGLOMERATES OF ADSORBER PARTICLES AND METHODS FOR PRODUCING SUCH ADSORBER PARTICLES
<b>B01J 20/26</b> (2006.01)	2536497 *	AGGLOMERATES OF ADSORBER PARTICLES AND METHODS FOR PRODUCING SUCH ADSORBER PARTICLES
<b>C02F 1/28</b> (2006.01)	2536497 *	AGGLOMERATES OF ADSORBER PARTICLES AND METHODS FOR PRODUCING SUCH ADSORBER PARTICLES
<b>B01J 20/32</b> (2006.01)	2536497 *	AGGLOMERATES OF ADSORBER PARTICLES AND METHODS FOR PRODUCING SUCH ADSORBER PARTICLES
<b>B01J 20/20</b> (2006.01)	2536497 *	AGGLOMERATES OF ADSORBER PARTICLES AND METHODS FOR PRODUCING SUCH ADSORBER PARTICLES
<b>B01D 53/02</b> (2006.01)	2536497 *	AGGLOMERATES OF ADSORBER PARTICLES AND METHODS FOR PRODUCING SUCH ADSORBER PARTICLES
<b>A61B 17/00</b> (2006.01)	2501298 *	SURGICAL INSTRUMENTS AND COMPONENTS FOR USE IN STERILE ENVIRONMENTS
<b>A61B 19/02</b> (2006.01)	2501298 *	SURGICAL INSTRUMENTS AND COMPONENTS FOR USE IN STERILE ENVIRONMENTS
<b>A61B 19/08</b> (2006.01)	2501298 *	SURGICAL INSTRUMENTS AND COMPONENTS FOR USE IN STERILE ENVIRONMENTS
<b>A61B 19/00</b> (2006.01)	2501298 *	SURGICAL INSTRUMENTS AND COMPONENTS FOR USE IN STERILE ENVIRONMENTS



MKP (51)	Broj objave evropske prijava patenta (97)	Naziv pronalaska (54)
<b>C07D 498/00</b> (2006.01)	2536734 *	FORMS OF RIFAXIMIN AND USES THEREOF
<b>A47J 37/04</b> (2006.01)	2464265 *	AN OVEN FOR HEAT-TREATING FOOD PIECES
<b>A61B 17/115</b> (2006.01)	2512350 *	CIRCULAR STAPLER INTRODUCER WITH RADially-OPENABLE DISTAL END PORTION
<b>A61B 17/11</b> (2006.01)	2512350 *	CIRCULAR STAPLER INTRODUCER WITH RADially-OPENABLE DISTAL END PORTION
<b>A61B 19/00</b> (2006.01)	2512350 *	CIRCULAR STAPLER INTRODUCER WITH RADially-OPENABLE DISTAL END PORTION
<b>A61B 17/00</b> (2006.01)	2512350 *	CIRCULAR STAPLER INTRODUCER WITH RADially-OPENABLE DISTAL END PORTION
<b>A61K 9/50</b> (2006.01)	2515851 *	TREATMENT FOR INFLAMMATORY BOWEL DISEASE
<b>A61K 9/16</b> (2006.01)	2515851 *	TREATMENT FOR INFLAMMATORY BOWEL DISEASE
<b>A61K 9/06</b> (2006.01)	2515851 *	TREATMENT FOR INFLAMMATORY BOWEL DISEASE
<b>A61P 1/00</b> (2006.01)	2515851 *	TREATMENT FOR INFLAMMATORY BOWEL DISEASE
<b>A61K 9/10</b> (2006.01)	2515851 *	TREATMENT FOR INFLAMMATORY BOWEL DISEASE
<b>A61K 9/12</b> (2006.01)	2515851 *	TREATMENT FOR INFLAMMATORY BOWEL DISEASE
<b>A61K 9/00</b> (2006.01)	2515851 *	TREATMENT FOR INFLAMMATORY BOWEL DISEASE
<b>A61K 31/404</b> (2006.01)	2515851 *	TREATMENT FOR INFLAMMATORY BOWEL DISEASE
<b>A61K 9/20</b> (2006.01)	2515851 *	TREATMENT FOR INFLAMMATORY BOWEL DISEASE
<b>A61K 9/08</b> (2006.01)	2515851 *	TREATMENT FOR INFLAMMATORY BOWEL DISEASE
<b>A61K 38/18</b> (2006.01)	2501399 *	TREATMENT OF ACUTE ISCHEMIC STROKE OR INTRACRANIAL BLEEDING WITH TPA AND CARBAMYLATED ERYTHROPOIETIN
<b>F23L 7/00</b> (2006.01)	2526339 *	GENERATING STEAM FROM CARBONACEOUS MATERIAL
<b>A61K 45/06</b> (2006.01)	2531182 *	SIGMA LIGANDS FOR POTENTIATING THE ANALGESIC EFFECT OF OPIOIDS AND OPIATES IN POST-OPERATIVE PAIN AND ATTENUATING THE DEPENDENCY THEREOF
<b>A61K 31/4155</b> (2006.01)	2531182 *	SIGMA LIGANDS FOR POTENTIATING THE ANALGESIC EFFECT OF OPIOIDS AND OPIATES IN POST-OPERATIVE PAIN AND ATTENUATING THE DEPENDENCY THEREOF
<b>A61K 31/00</b> (2006.01)	2531182 *	SIGMA LIGANDS FOR POTENTIATING THE ANALGESIC EFFECT OF OPIOIDS AND OPIATES IN POST-OPERATIVE PAIN AND ATTENUATING THE DEPENDENCY THEREOF
<b>A61P 25/04</b> (2006.01)	2531182 *	SIGMA LIGANDS FOR POTENTIATING THE ANALGESIC EFFECT OF OPIOIDS AND OPIATES IN POST-OPERATIVE PAIN AND ATTENUATING THE DEPENDENCY THEREOF
<b>H04L 12/56</b> (2006.01)	2523402 *	COMMUNICATION SYSTEM, CONTROL APPARATUS, PROCESSING RULE SETTING METHOD, PACKET TRANSMITTING METHOD AND PROGRAM
<b>A61B 19/00</b> (2006.01)	2523613 *	SYSTEMS AND METHODS FOR MINIMALLY INVASIVE SURGICAL TOOLS WITH HAPTIC FEEDBACK
<b>A61B 17/34</b> (2006.01)	2523613 *	SYSTEMS AND METHODS FOR MINIMALLY INVASIVE SURGICAL TOOLS WITH HAPTIC FEEDBACK
<b>F21V 17/06</b> (2006.01)	2502244 *	CONTACTLESS COUPLING AND METHOD FOR USE WITH AN ELECTRICAL APPLIANCE
<b>F21V 19/04</b> (2006.01)	2502244 *	CONTACTLESS COUPLING AND METHOD FOR USE WITH AN ELECTRICAL APPLIANCE
<b>H01F 38/14</b> (2006.01)	2502244 *	CONTACTLESS COUPLING AND METHOD FOR USE WITH AN ELECTRICAL APPLIANCE
<b>H05B 41/46</b> (2006.01)	2502244 *	CONTACTLESS COUPLING AND METHOD FOR USE WITH AN ELECTRICAL APPLIANCE
<b>A61K 38/10</b> (2006.01)	2509992 *	TREATMENTS FOR GASTROINTESTINAL DISORDERS
<b>C07K 7/08</b> (2006.01)	2509992 *	TREATMENTS FOR GASTROINTESTINAL DISORDERS
<b>A61K 31/437</b> (2006.01)	2531502 *	1-(5-TERT-BUTYL-2-PHENYL-2H-PYRAZOL-3-YL)-3-[2-FLUORO-4-(1-METHYL-2-OXO-2,3-DIHYDRO-1H-IMIDAZO[4,5-B]PYRIDIN-7-YLOXY)-PHENYL]-UREA AND RELATED COMPOUNDS AND THEIR USE IN THERAPY

MKP (51)	Broj objave evropske prijava patenta (97)	Naziv pronalaska (54)
<b>C07D 471/04</b> (2006.01)	2531502 *	1-(5-TERT-BUTYL-2-PHENYL-2H-PYRAZOL-3-YL)-3-[2-FLUORO-4-(1-METHYL-2-OXO-2,3-DIHYDRO-1H-IMIDAZO[4,5-B]PYRIDIN-7-YLOXY)-PHENYL]-UREA AND RELATED COMPOUNDS AND THEIR USE IN THERAPY
<b>A61P 35/00</b> (2006.01)	2531502 *	1-(5-TERT-BUTYL-2-PHENYL-2H-PYRAZOL-3-YL)-3-[2-FLUORO-4-(1-METHYL-2-OXO-2,3-DIHYDRO-1H-IMIDAZO[4,5-B]PYRIDIN-7-YLOXY)-PHENYL]-UREA AND RELATED COMPOUNDS AND THEIR USE IN THERAPY
<b>A61K 38/17</b> (2006.01)	2523679 *	INHIBITORS OF RECEPTOR TYROSINE KINASES (RTK) AND METHODS OF USE THEREOF
<b>A61L 15/44</b> (2006.01)	2533772 *	METHODS AND COMPOSITIONS FOR WOUND HEALING
<b>B32B 27/00</b> (2006.01)	2533772 *	METHODS AND COMPOSITIONS FOR WOUND HEALING
<b>A61F 13/00</b> (2006.01)	2533772 *	METHODS AND COMPOSITIONS FOR WOUND HEALING
<b>A61K 9/70</b> (2006.01)	2533772 *	METHODS AND COMPOSITIONS FOR WOUND HEALING
<b>A61K 33/38</b> (2006.01)	2533772 *	METHODS AND COMPOSITIONS FOR WOUND HEALING
<b>A61K 38/10</b> (2006.01)	2521561 *	LINACLOTIDE FOR THE TREATMENT OF CHRONIC CONSTIPATION
<b>A61P 1/10</b> (2006.01)	2521561 *	LINACLOTIDE FOR THE TREATMENT OF CHRONIC CONSTIPATION
<b>C02F 3/04</b> (2006.01)	2501656 *	MULTISTAGE BIOLOGICAL REACTOR
<b>A61P 35/00</b> (2006.01)	2534156 *	7-AMINOFUOPYRIDINE DERIVATIVES
<b>C07D 491/048</b> (2006.01)	2534156 *	7-AMINOFUOPYRIDINE DERIVATIVES
<b>A61K 31/4355</b> (2006.01)	2534156 *	7-AMINOFUOPYRIDINE DERIVATIVES
<b>A61F 13/02</b> (2006.01)	2520257 *	ADHESIVE TAPE PREPARATION
<b>A61M 35/00</b> (2006.01)	2520257 *	ADHESIVE TAPE PREPARATION
<b>A61K 9/70</b> (2006.01)	2520257 *	ADHESIVE TAPE PREPARATION
<b>C12N 9/02</b> (2006.01)	2501804 *	BRASSICA PLANTS COMPRISING MUTANT FAD3 ALLELES
<b>C12N 15/82</b> (2006.01)	2501804 *	BRASSICA PLANTS COMPRISING MUTANT FAD3 ALLELES
<b>A61P 35/00</b> (2006.01)	2509593 *	THERAPEUTIC USE OF PROTEIN-POLYMER CONJUGATES
<b>A61P 31/00</b> (2006.01)	2509593 *	THERAPEUTIC USE OF PROTEIN-POLYMER CONJUGATES
<b>A61K 38/21</b> (2006.01)	2509593 *	THERAPEUTIC USE OF PROTEIN-POLYMER CONJUGATES
<b>A61P 31/12</b> (2006.01)	2509593 *	THERAPEUTIC USE OF PROTEIN-POLYMER CONJUGATES
<b>A61K 31/40</b> (2006.01)	2509593 *	THERAPEUTIC USE OF PROTEIN-POLYMER CONJUGATES
<b>C07D 307/80</b> (2006.01)	2521720 *	NEW PROCESS FOR THE PREPARATION OF DRONEDARONE
<b>C07D 307/79</b> (2006.01)	2521720 *	NEW PROCESS FOR THE PREPARATION OF DRONEDARONE
<b>C07D 223/16</b> (2006.01)	2534135 *	NOVEL FORMS OF IVABRADINE HYDROCHLORIDE
<b>A61K 31/55</b> (2006.01)	2534135 *	NOVEL FORMS OF IVABRADINE HYDROCHLORIDE
<b>A61P 9/10</b> (2006.01)	2534135 *	NOVEL FORMS OF IVABRADINE HYDROCHLORIDE
<b>C07D 403/14</b> (2006.01)	2515902 *	ANALOGUES FOR THE TREATMENT OR PREVENTION OF FLAVIVIRUS INFECTIONS
<b>A61P 31/14</b> (2006.01)	2515902 *	ANALOGUES FOR THE TREATMENT OR PREVENTION OF FLAVIVIRUS INFECTIONS
<b>A61K 31/4155</b> (2006.01)	2515902 *	ANALOGUES FOR THE TREATMENT OR PREVENTION OF FLAVIVIRUS INFECTIONS
<b>A61P 11/06</b> (2006.01)	2513119 *	3,4,4A,10B-TETRAHYDRO-1H-THIOPYRANO-[4, 3-c]ISOQUINOLINE DERIVATIVES
<b>A61P 11/00</b> (2006.01)	2513119 *	3,4,4A,10B-TETRAHYDRO-1H-THIOPYRANO-[4, 3-c]ISOQUINOLINE DERIVATIVES
<b>C07D 519/00</b> (2006.01)	2513119 *	3,4,4A,10B-TETRAHYDRO-1H-THIOPYRANO-[4, 3-c]ISOQUINOLINE DERIVATIVES
<b>A61K 31/519</b> (2006.01)	2513119 *	3,4,4A,10B-TETRAHYDRO-1H-THIOPYRANO-[4, 3-c]ISOQUINOLINE DERIVATIVES
<b>A61P 11/08</b> (2006.01)	2513119 *	3,4,4A,10B-TETRAHYDRO-1H-THIOPYRANO-[4, 3-c]ISOQUINOLINE DERIVATIVES
<b>A23L 1/236</b> (2006.01)	2536298 *	NOVEL SWEETENER COMPOSITIONS
<b>A23L 1/30</b> (2006.01)	2536298 *	NOVEL SWEETENER COMPOSITIONS

MKP (51)	Broj objave evropske prijava patenta (97)	Naziv pronalaska (54)
<b>A23L 2/52</b> (2006.01)	2536298 *	NOVEL SWEETENER COMPOSITIONS
<b>A23L 2/60</b> (2006.01)	2536298 *	NOVEL SWEETENER COMPOSITIONS
<b>A23L 1/09</b> (2006.01)	2536298 *	NOVEL SWEETENER COMPOSITIONS
<b>A61K 9/00</b> (2006.01)	2501384 *	METHOD OF TREATING PROLIFERATIVE DISORDERS AND OTHER PATHOLOGICAL CONDITIONS MEDIATED BY BCR-ABL, C-KIT, DDR1, DDR2 OR PDGF-R KINASE ACTIVITY
<b>A61K 31/506</b> (2006.01)	2501384 *	METHOD OF TREATING PROLIFERATIVE DISORDERS AND OTHER PATHOLOGICAL CONDITIONS MEDIATED BY BCR-ABL, C-KIT, DDR1, DDR2 OR PDGF-R KINASE ACTIVITY
<b>A61P 35/00</b> (2006.01)	2501384 *	METHOD OF TREATING PROLIFERATIVE DISORDERS AND OTHER PATHOLOGICAL CONDITIONS MEDIATED BY BCR-ABL, C-KIT, DDR1, DDR2 OR PDGF-R KINASE ACTIVITY
<b>C07D 209/16</b> (2006.01)	2516394 *	PROCESSES FOR THE MANUFACTURE OF A PHARMACEUTICALLY ACTIVE AGENT
<b>C07D 209/10</b> (2006.01)	2516394 *	PROCESSES FOR THE MANUFACTURE OF A PHARMACEUTICALLY ACTIVE AGENT
<b>C07D 209/14</b> (2006.01)	2516394 *	PROCESSES FOR THE MANUFACTURE OF A PHARMACEUTICALLY ACTIVE AGENT
<b>F02G 5/02</b> (2006.01)	2519728 *	HEAT ENGINE WITH EXTERNAL HEAT SOURCE AND ASSOCIATED POWER GENERATION UNIT AND VEHICLE
<b>F02G 1/04</b> (2006.01)	2519728 *	HEAT ENGINE WITH EXTERNAL HEAT SOURCE AND ASSOCIATED POWER GENERATION UNIT AND VEHICLE
<b>A61K 39/395</b> (2006.01)	2509627 *	METHODS FOR ENHANCING ANTI-TUMOR ANTIBODY THERAPY
<b>F03B 17/00</b> (2006.01)	2520801	Residual energy through displacement (renewable energy)
<b>F03G 7/10</b> (2006.01)	2520801	Residual energy through displacement (renewable energy)
<b>F02M 25/07</b> (2006.01)	2524116 *	COMPRESSION-IGNITION ENGINE WITH EXHAUST SYSTEM
<b>F01N 3/28</b> (2006.01)	2524116 *	COMPRESSION-IGNITION ENGINE WITH EXHAUST SYSTEM
<b>F01N 3/20</b> (2006.01)	2524116 *	COMPRESSION-IGNITION ENGINE WITH EXHAUST SYSTEM
<b>F01N 3/035</b> (2006.01)	2524116 *	COMPRESSION-IGNITION ENGINE WITH EXHAUST SYSTEM
<b>A61K 31/33</b> (2006.01)	2519527 *	THIENO [2,3-B]PYRIDINEDIONE ACTIVATORS OF AMPK AND THERAPEUTIC USES THEREOF
<b>C07D 495/04</b> (2006.01)	2519527 *	THIENO [2,3-B]PYRIDINEDIONE ACTIVATORS OF AMPK AND THERAPEUTIC USES THEREOF
<b>A61P 3/10</b> (2006.01)	2519527 *	THIENO [2,3-B]PYRIDINEDIONE ACTIVATORS OF AMPK AND THERAPEUTIC USES THEREOF
<b>H05B 3/58</b> (2006.01)	2519121 *	AN IMPROVED HEATER FOR AN ELECTRICALLY HEATED AEROSOL GENERATING SYSTEM
<b>A24F 47/00</b> (2006.01)	2519121 *	AN IMPROVED HEATER FOR AN ELECTRICALLY HEATED AEROSOL GENERATING SYSTEM
<b>B01J 21/00</b> (2006.01)	2521613 *	SCALABLE PRODUCTION OF PRECISION HYDROCARBONS FROM TRIALKYLALUMINUM VIA TERNARY LIVING COORDINATIVE CHAIN TRANSFER POLYMERIZATION
<b>F27D 1/14</b> (2006.01)	2510299 *	MOLTEN METAL-CONTAINING VESSEL AND METHODS OF PRODUCING SAME
<b>A61K 31/44</b> (2006.01)	2509586 *	MUCOADHESIVE BUCCAL TABLETS FOR THE TREATMENT OF OROFACIAL HERPES
<b>A61K 31/00</b> (2006.01)	2509586 *	MUCOADHESIVE BUCCAL TABLETS FOR THE TREATMENT OF OROFACIAL HERPES
<b>A61K 47/36</b> (2006.01)	2509586 *	MUCOADHESIVE BUCCAL TABLETS FOR THE TREATMENT OF OROFACIAL HERPES
<b>A61K 9/20</b> (2006.01)	2509586 *	MUCOADHESIVE BUCCAL TABLETS FOR THE TREATMENT OF OROFACIAL HERPES
<b>C08L 5/08</b> (2006.01)	2501754 *	NOVEL FORMULATION OF PHYSIOLOGICAL CHITOSAN-INORGANIC SALT SOLUTION/BLOOD MIXTURES FOR TISSUE REPAIR
<b>C08K 11/00</b> (2006.01)	2501754 *	NOVEL FORMULATION OF PHYSIOLOGICAL CHITOSAN-INORGANIC SALT SOLUTION/BLOOD MIXTURES FOR TISSUE REPAIR
<b>A61K 35/14</b> (2006.01)	2501754 *	NOVEL FORMULATION OF PHYSIOLOGICAL CHITOSAN-INORGANIC SALT SOLUTION/BLOOD MIXTURES FOR TISSUE REPAIR

MKP (51)	Broj objave evropske prijava patenta (97)	Naziv pronalaska (54)
<b>C08K 3/00</b> (2006.01)	2501754 *	NOVEL FORMULATION OF PHYSIOLOGICAL CHITOSAN-INORGANIC SALT SOLUTION/BLOOD MIXTURES FOR TISSUE REPAIR
<b>A61L 31/14</b> (2006.01)	2506887 *	BIODEGRADABLE STENT COMPRISING AN ACID SCAVENGING AGENT
<b>A61L 31/16</b> (2006.01)	2506887 *	BIODEGRADABLE STENT COMPRISING AN ACID SCAVENGING AGENT
<b>A61L 31/06</b> (2006.01)	2506887 *	BIODEGRADABLE STENT COMPRISING AN ACID SCAVENGING AGENT
<b>A61K 31/506</b> (2006.01)	2475653 *	SUSTITUTED ( HETEROARYLMETHYL ) THIOHYDANTOINS AS ANTICANCER DRUGS
<b>C07D 403/06</b> (2006.01)	2475653 *	SUSTITUTED ( HETEROARYLMETHYL ) THIOHYDANTOINS AS ANTICANCER DRUGS
<b>A61P 35/00</b> (2006.01)	2475653 *	SUSTITUTED ( HETEROARYLMETHYL ) THIOHYDANTOINS AS ANTICANCER DRUGS
<b>C07D 413/14</b> (2006.01)	2475653 *	SUSTITUTED ( HETEROARYLMETHYL ) THIOHYDANTOINS AS ANTICANCER DRUGS
<b>A61K 31/4439</b> (2006.01)	2475653 *	SUSTITUTED ( HETEROARYLMETHYL ) THIOHYDANTOINS AS ANTICANCER DRUGS
<b>C07D 401/14</b> (2006.01)	2475653 *	SUSTITUTED ( HETEROARYLMETHYL ) THIOHYDANTOINS AS ANTICANCER DRUGS
<b>A61K 31/541</b> (2006.01)	2475653 *	SUSTITUTED ( HETEROARYLMETHYL ) THIOHYDANTOINS AS ANTICANCER DRUGS
<b>C07D 403/14</b> (2006.01)	2475653 *	SUSTITUTED ( HETEROARYLMETHYL ) THIOHYDANTOINS AS ANTICANCER DRUGS
<b>C07D 401/04</b> (2006.01)	2475653 *	SUSTITUTED ( HETEROARYLMETHYL ) THIOHYDANTOINS AS ANTICANCER DRUGS
<b>A61K 31/5377</b> (2006.01)	2475653 *	SUSTITUTED ( HETEROARYLMETHYL ) THIOHYDANTOINS AS ANTICANCER DRUGS
<b>C07D 405/14</b> (2006.01)	2475653 *	SUSTITUTED ( HETEROARYLMETHYL ) THIOHYDANTOINS AS ANTICANCER DRUGS
<b>E06B 9/386</b> (2006.01)	2510178 *	GLASS-ENCLOSED CHAMBER AND INTERNAL VENETIAN BLIND HAVING SLATS OF IMPROVED REFLECTANCE AND DIFFUSIVITY OVER A WIDER SPECTRAL INTERVAL OF INCIDENT SOLAR RADIATION
<b>G02B 17/00</b> (2006.01)	2510178 *	GLASS-ENCLOSED CHAMBER AND INTERNAL VENETIAN BLIND HAVING SLATS OF IMPROVED REFLECTANCE AND DIFFUSIVITY OVER A WIDER SPECTRAL INTERVAL OF INCIDENT SOLAR RADIATION
<b>E06B 9/264</b> (2006.01)	2510178 *	GLASS-ENCLOSED CHAMBER AND INTERNAL VENETIAN BLIND HAVING SLATS OF IMPROVED REFLECTANCE AND DIFFUSIVITY OVER A WIDER SPECTRAL INTERVAL OF INCIDENT SOLAR RADIATION
<b>C09C 1/02</b> (2006.01)	2537900	Process for the production of precipitated calcium carbonate, precipitated calcium carbonate and uses thereof
<b>C01F 11/18</b> (2006.01)	2537900	Process for the production of precipitated calcium carbonate, precipitated calcium carbonate and uses thereof
<b>A61K 31/4192</b> (2006.01)	2521545 *	PRODRUGS OF HETERAROMATIC COMPOUNDS
<b>C09K 8/03</b> (2006.01)	2450416	Methods and compositions for suspending fluids in a wellbore
<b>C09K 8/40</b> (2006.01)	2450416	Methods and compositions for suspending fluids in a wellbore
<b>C09K 8/42</b> (2006.01)	2450416	Methods and compositions for suspending fluids in a wellbore
<b>E21B 21/00</b> (2006.01)	2450416	Methods and compositions for suspending fluids in a wellbore
<b>A61P 35/00</b> (2006.01)	2501413 *	ACID SALT FORMS OF POLYMER-DRUG CONJUGATES AND ALKOXYLATION METHODS
<b>C08G 65/08</b> (2006.01)	2501413 *	ACID SALT FORMS OF POLYMER-DRUG CONJUGATES AND ALKOXYLATION METHODS
<b>A61K 47/48</b> (2006.01)	2501413 *	ACID SALT FORMS OF POLYMER-DRUG CONJUGATES AND ALKOXYLATION METHODS
<b>C08G 65/14</b> (2006.01)	2501413 *	ACID SALT FORMS OF POLYMER-DRUG CONJUGATES AND ALKOXYLATION METHODS
<b>C08G 65/26</b> (2006.01)	2501413 *	ACID SALT FORMS OF POLYMER-DRUG CONJUGATES AND ALKOXYLATION METHODS
<b>E04C 2/04</b> (2006.01)	2507442 *	BASALT COMPOSITE PANEL

MKP (51)	Broj objave evropske prijava patenta (97)	Naziv pronalaska (54)
<b>C07J 19/00</b> (2006.01)	2523966 *	CERTAIN CHEMICAL ENTITIES, COMPOSITIONS, AND METHODS
<b>A61K 31/585</b> (2006.01)	2523966 *	CERTAIN CHEMICAL ENTITIES, COMPOSITIONS, AND METHODS
<b>A61P 35/00</b> (2006.01)	2523966 *	CERTAIN CHEMICAL ENTITIES, COMPOSITIONS, AND METHODS
<b>A61K 38/37</b> (2006.01)	2506868 *	FACTOR VIII-FC CHIMERIC AND HYBRID POLYPEPTIDES, AND METHODS OF USE THEREOF
<b>A61B 17/32</b> (2006.01)	2533707 *	OUTER SHEATH AND BLADE ARRANGEMENTS FOR ULTRASONIC SURGICAL INSTRUMENTS
<b>B60K 6/46</b> (2007.10)	2428384	Power train for vehicles with power take-off shafts for driving additional devices
<b>B60K 25/06</b> (2006.01)	2428384	Power train for vehicles with power take-off shafts for driving additional devices
<b>B60K 17/28</b> (2006.01)	2428384	Power train for vehicles with power take-off shafts for driving additional devices
<b>B60K 6/44</b> (2007.10)	2428384	Power train for vehicles with power take-off shafts for driving additional devices
<b>F16H 3/091</b> (2006.01)	2428384	Power train for vehicles with power take-off shafts for driving additional devices
<b>D21H 17/67</b> (2006.01)	2392622	Use of 2-aminoethanol as additive in aqueous suspensions of calcium carbonate comprising materials
<b>C09C 1/02</b> (2006.01)	2392622	Use of 2-aminoethanol as additive in aqueous suspensions of calcium carbonate comprising materials
<b>A61K 31/196</b> (2006.01)	2521713 *	DP2 ANTAGONIST AND USES THEREOF
<b>A61P 29/00</b> (2006.01)	2521713 *	DP2 ANTAGONIST AND USES THEREOF
<b>A61K 31/10</b> (2006.01)	2521713 *	DP2 ANTAGONIST AND USES THEREOF
<b>C07C 323/59</b> (2006.01)	2521713 *	DP2 ANTAGONIST AND USES THEREOF
<b>A61P 11/06</b> (2006.01)	2521713 *	DP2 ANTAGONIST AND USES THEREOF
<b>A61M 5/24</b> (2006.01)	2531235 *	FLEXIBLE RESERVOIR FOR A MEDICATED MODULE
<b>A61M 5/32</b> (2006.01)	2531235 *	FLEXIBLE RESERVOIR FOR A MEDICATED MODULE
<b>A61M 5/28</b> (2006.01)	2531235 *	FLEXIBLE RESERVOIR FOR A MEDICATED MODULE
<b>A61K 31/56</b> (2006.01)	2504012 *	USE OF AN OLEO GEL CONTAINING TRITERPENE FOR HEALING WOUNDS
<b>A61K 47/44</b> (2006.01)	2504012 *	USE OF AN OLEO GEL CONTAINING TRITERPENE FOR HEALING WOUNDS
<b>A61K 9/00</b> (2006.01)	2504012 *	USE OF AN OLEO GEL CONTAINING TRITERPENE FOR HEALING WOUNDS
<b>A61K 9/06</b> (2006.01)	2504012 *	USE OF AN OLEO GEL CONTAINING TRITERPENE FOR HEALING WOUNDS
<b>A61K 31/496</b> (2006.01)	2509600 *	THERAPEUTICALLY ACTIVE COMPOUNDS FOR USE IN THE TREATMENT OF CANCER CHARACTERIZED AS HAVING AN IDH MUTATION
<b>C07D 405/12</b> (2006.01)	2509600 *	THERAPEUTICALLY ACTIVE COMPOUNDS FOR USE IN THE TREATMENT OF CANCER CHARACTERIZED AS HAVING AN IDH MUTATION
<b>A61K 31/551</b> (2006.01)	2509600 *	THERAPEUTICALLY ACTIVE COMPOUNDS FOR USE IN THE TREATMENT OF CANCER CHARACTERIZED AS HAVING AN IDH MUTATION
<b>C07D 243/08</b> (2006.01)	2509600 *	THERAPEUTICALLY ACTIVE COMPOUNDS FOR USE IN THE TREATMENT OF CANCER CHARACTERIZED AS HAVING AN IDH MUTATION
<b>A61K 31/495</b> (2006.01)	2509600 *	THERAPEUTICALLY ACTIVE COMPOUNDS FOR USE IN THE TREATMENT OF CANCER CHARACTERIZED AS HAVING AN IDH MUTATION
<b>A61P 35/00</b> (2006.01)	2509600 *	THERAPEUTICALLY ACTIVE COMPOUNDS FOR USE IN THE TREATMENT OF CANCER CHARACTERIZED AS HAVING AN IDH MUTATION
<b>A61K 31/506</b> (2006.01)	2509600 *	THERAPEUTICALLY ACTIVE COMPOUNDS FOR USE IN THE TREATMENT OF CANCER CHARACTERIZED AS HAVING AN IDH MUTATION
<b>C07D 231/40</b> (2006.01)	2509956 *	CYSTEINE PROTEASE INHIBITORS
<b>A61P 11/06</b> (2006.01)	2509956 *	CYSTEINE PROTEASE INHIBITORS
<b>C07D 277/46</b> (2006.01)	2509956 *	CYSTEINE PROTEASE INHIBITORS
<b>A61K 31/4155</b> (2006.01)	2509956 *	CYSTEINE PROTEASE INHIBITORS
<b>A61P 37/02</b> (2006.01)	2509956 *	CYSTEINE PROTEASE INHIBITORS
<b>A61K 31/4164</b> (2006.01)	2509956 *	CYSTEINE PROTEASE INHIBITORS
<b>A61P 37/08</b> (2006.01)	2509956 *	CYSTEINE PROTEASE INHIBITORS
<b>A61K 31/42</b> (2006.01)	2509956 *	CYSTEINE PROTEASE INHIBITORS
<b>C07C 271/20</b> (2006.01)	2509956 *	CYSTEINE PROTEASE INHIBITORS

MKP (51)	Broj objave evropske prijava patenta (97)	Naziv pronalaska (54)
<b>A61K 31/415</b> (2006.01)	2509956 *	CYSTEINE PROTEASE INHIBITORS
<b>A61P 21/04</b> (2006.01)	2509956 *	CYSTEINE PROTEASE INHIBITORS
<b>A61K 31/27</b> (2006.01)	2509956 *	CYSTEINE PROTEASE INHIBITORS
<b>A61P 17/06</b> (2006.01)	2509956 *	CYSTEINE PROTEASE INHIBITORS
<b>C07D 405/12</b> (2006.01)	2509956 *	CYSTEINE PROTEASE INHIBITORS
<b>A61P 9/10</b> (2006.01)	2509956 *	CYSTEINE PROTEASE INHIBITORS
<b>C07D 261/14</b> (2006.01)	2509956 *	CYSTEINE PROTEASE INHIBITORS
<b>A61K 31/426</b> (2006.01)	2509956 *	CYSTEINE PROTEASE INHIBITORS
<b>C07D 233/88</b> (2006.01)	2509956 *	CYSTEINE PROTEASE INHIBITORS
<b>C07D 493/04</b> (2006.01)	2530165 *	METHOD FOR PRODUCING PYRIPYROPENE DERIVATIVE BY ENZYMATIC PROCESS
<b>C12N 15/09</b> (2006.01)	2530165 *	METHOD FOR PRODUCING PYRIPYROPENE DERIVATIVE BY ENZYMATIC PROCESS
<b>C12P 17/18</b> (2006.01)	2530165 *	METHOD FOR PRODUCING PYRIPYROPENE DERIVATIVE BY ENZYMATIC PROCESS
<b>A61G 5/04</b> (2006.01)	2531157 *	DEVICE ENABLING AN ELECTRIC WHEELCHAIR TO CROSS OBSTACLES
<b>B62D 55/075</b> (2006.01)	2531157 *	DEVICE ENABLING AN ELECTRIC WHEELCHAIR TO CROSS OBSTACLES
<b>B62D 61/10</b> (2006.01)	2531157 *	DEVICE ENABLING AN ELECTRIC WHEELCHAIR TO CROSS OBSTACLES
<b>A61K 9/44</b> (2006.01)	2525788 *	NOVEL RETIGABINE COMPOSITION
<b>A61K 9/32</b> (2006.01)	2525788 *	NOVEL RETIGABINE COMPOSITION
<b>A61K 31/27</b> (2006.01)	2525788 *	NOVEL RETIGABINE COMPOSITION
<b>C07C 43/23</b> (2006.01)	2501669 *	NOVEL ARYLATED CAMPHENES, PROCESSES FOR THEIR PREPARATION AND USES THEREOF
<b>A61K 31/09</b> (2006.01)	2501669 *	NOVEL ARYLATED CAMPHENES, PROCESSES FOR THEIR PREPARATION AND USES THEREOF
<b>C07C 62/34</b> (2006.01)	2501669 *	NOVEL ARYLATED CAMPHENES, PROCESSES FOR THEIR PREPARATION AND USES THEREOF
<b>A61K 31/125</b> (2006.01)	2501669 *	NOVEL ARYLATED CAMPHENES, PROCESSES FOR THEIR PREPARATION AND USES THEREOF
<b>C07C 43/215</b> (2006.01)	2501669 *	NOVEL ARYLATED CAMPHENES, PROCESSES FOR THEIR PREPARATION AND USES THEREOF
<b>A61K 31/216</b> (2006.01)	2501669 *	NOVEL ARYLATED CAMPHENES, PROCESSES FOR THEIR PREPARATION AND USES THEREOF
<b>A61K 31/192</b> (2006.01)	2501669 *	NOVEL ARYLATED CAMPHENES, PROCESSES FOR THEIR PREPARATION AND USES THEREOF
<b>C07D 311/80</b> (2006.01)	2501669 *	NOVEL ARYLATED CAMPHENES, PROCESSES FOR THEIR PREPARATION AND USES THEREOF
<b>A61P 25/00</b> (2006.01)	2501669 *	NOVEL ARYLATED CAMPHENES, PROCESSES FOR THEIR PREPARATION AND USES THEREOF
<b>C07C 49/753</b> (2006.01)	2501669 *	NOVEL ARYLATED CAMPHENES, PROCESSES FOR THEIR PREPARATION AND USES THEREOF
<b>A61P 25/28</b> (2006.01)	2501669 *	NOVEL ARYLATED CAMPHENES, PROCESSES FOR THEIR PREPARATION AND USES THEREOF
<b>A61K 31/352</b> (2006.01)	2501669 *	NOVEL ARYLATED CAMPHENES, PROCESSES FOR THEIR PREPARATION AND USES THEREOF
<b>A61P 19/00</b> (2006.01)	2501669 *	NOVEL ARYLATED CAMPHENES, PROCESSES FOR THEIR PREPARATION AND USES THEREOF
<b>C07C 69/757</b> (2006.01)	2501669 *	NOVEL ARYLATED CAMPHENES, PROCESSES FOR THEIR PREPARATION AND USES THEREOF
<b>A61P 25/04</b> (2006.01)	2501669 *	NOVEL ARYLATED CAMPHENES, PROCESSES FOR THEIR PREPARATION AND USES THEREOF
<b>E01C 7/26</b> (2006.01)	2441887	Heat-resistant road paving and relative manufacturing process
<b>E01C 7/32</b> (2006.01)	2441887	Heat-resistant road paving and relative manufacturing process
<b>E01C 11/16</b> (2006.01)	2441887	Heat-resistant road paving and relative manufacturing process

MKP (51)	Broj objave evropske prijava patenta (97)	Naziv pronalaska (54)
<b>A01N 43/90</b> (2006.01)	2531035 *	SYNERGISTIC HERBICIDAL COMPOSITION CONTAINING PENOXSULAM AND FLAZASULFURON
<b>A01P 13/00</b> (2006.01)	2531035 *	SYNERGISTIC HERBICIDAL COMPOSITION CONTAINING PENOXSULAM AND FLAZASULFURON
<b>A01N 47/36</b> (2006.01)	2531035 *	SYNERGISTIC HERBICIDAL COMPOSITION CONTAINING PENOXSULAM AND FLAZASULFURON
<b>G06Q 10/00</b> (2012.01)	2517158 *	METHOD AND APPARATUS FOR DEFINING MANUFACTURED ITEMS AND STORING DATA RELATING TO THE MANUFACTURED ITEMS
<b>G06F 17/30</b> (2006.01)	2517158 *	METHOD AND APPARATUS FOR DEFINING MANUFACTURED ITEMS AND STORING DATA RELATING TO THE MANUFACTURED ITEMS
<b>C07D 407/12</b> (2006.01)	2519504 *	NEW SECONDARY 8-HYDROXYQUINOLINE-7-CARBOXAMIDE DERIVATIVES.
<b>C07D 413/12</b> (2006.01)	2519504 *	NEW SECONDARY 8-HYDROXYQUINOLINE-7-CARBOXAMIDE DERIVATIVES.
<b>A61K 31/4709</b> (2006.01)	2519504 *	NEW SECONDARY 8-HYDROXYQUINOLINE-7-CARBOXAMIDE DERIVATIVES.
<b>A61P 31/10</b> (2006.01)	2519504 *	NEW SECONDARY 8-HYDROXYQUINOLINE-7-CARBOXAMIDE DERIVATIVES.
<b>C07D 215/48</b> (2006.01)	2519504 *	NEW SECONDARY 8-HYDROXYQUINOLINE-7-CARBOXAMIDE DERIVATIVES.
<b>C07D 401/12</b> (2006.01)	2519504 *	NEW SECONDARY 8-HYDROXYQUINOLINE-7-CARBOXAMIDE DERIVATIVES.
<b>C07D 417/12</b> (2006.01)	2519504 *	NEW SECONDARY 8-HYDROXYQUINOLINE-7-CARBOXAMIDE DERIVATIVES.
<b>C07D 409/12</b> (2006.01)	2519504 *	NEW SECONDARY 8-HYDROXYQUINOLINE-7-CARBOXAMIDE DERIVATIVES.
<b>A61P 3/04</b> (2006.01)	2504026 *	COMPOSITION COMPRISING A COMBINATION OF AT LEAST ONE PROTEOLYTIC ENZYME AND AT LEAST ONE LIPOLYTIC ENZYME, FOR USE IN PREVENTING TRIGLYCERIDE SYNTHESIS
<b>A61K 38/46</b> (2006.01)	2504026 *	COMPOSITION COMPRISING A COMBINATION OF AT LEAST ONE PROTEOLYTIC ENZYME AND AT LEAST ONE LIPOLYTIC ENZYME, FOR USE IN PREVENTING TRIGLYCERIDE SYNTHESIS
<b>A61K 38/48</b> (2006.01)	2504026 *	COMPOSITION COMPRISING A COMBINATION OF AT LEAST ONE PROTEOLYTIC ENZYME AND AT LEAST ONE LIPOLYTIC ENZYME, FOR USE IN PREVENTING TRIGLYCERIDE SYNTHESIS
<b>A61K 31/444</b> (2006.01)	2501703 *	SPIROPIPERIDINE COMPOUNDS AS ORL-1 RECEPTOR ANTAGONISTS
<b>C07D 495/20</b> (2006.01)	2501703 *	SPIROPIPERIDINE COMPOUNDS AS ORL-1 RECEPTOR ANTAGONISTS
<b>A61P 25/00</b> (2006.01)	2501703 *	SPIROPIPERIDINE COMPOUNDS AS ORL-1 RECEPTOR ANTAGONISTS
<b>A61K 31/4162</b> (2006.01)	2536721 *	PYRAZOLO PIPERIDINE DERIVATIVES AS NADPH OXIDASE INHIBITORS
<b>C07D 471/04</b> (2006.01)	2536721 *	PYRAZOLO PIPERIDINE DERIVATIVES AS NADPH OXIDASE INHIBITORS
<b>A47J 42/04</b> (2006.01)	2510845	Grinding device
<b>A47J 42/08</b> (2006.01)	2510845	Grinding device
<b>A61K 38/12</b> (2006.01)	2531205 *	ACTAGARDINE DERIVATIVES, AND PHARMACEUTICAL USE THEREOF
<b>C07K 7/54</b> (2006.01)	2531205 *	ACTAGARDINE DERIVATIVES, AND PHARMACEUTICAL USE THEREOF
<b>A01G 23/02</b> (2006.01)	2512213 *	A METHOD OF PLANTING A SEED, PLANT, BUSH OR TREE, AND A DRILL
<b>A01C 5/04</b> (2006.01)	2512213 *	A METHOD OF PLANTING A SEED, PLANT, BUSH OR TREE, AND A DRILL
<b>C12Q 1/68</b> (2006.01)	2526203 *	METHODS AND USES RELATING TO THE IDENTIFICATION OF COMPOUND INVOLVED IN PAIN AS WELL AS METHODS OF DIAGNOSING ALGESIA
<b>G06Q 20/00</b> (2012.01)	2524471 *	ANYTIME VALIDATION FOR VERIFICATION TOKENS
<b>H04L 9/14</b> (2006.01)	2524471 *	ANYTIME VALIDATION FOR VERIFICATION TOKENS
<b>H04L 9/32</b> (2006.01)	2524471 *	ANYTIME VALIDATION FOR VERIFICATION TOKENS
<b>A61K 31/4439</b> (2006.01)	2512470 *	PPAR-SPARING THIAZOLIDINEDIONES AND COMBINATIONS FOR THE TREATMENT OF NEURODEGENERATIVE DISEASES
<b>A61K 31/4436</b> (2006.01)	2512470 *	PPAR-SPARING THIAZOLIDINEDIONES AND COMBINATIONS FOR THE TREATMENT OF NEURODEGENERATIVE DISEASES
<b>A61P 25/28</b> (2006.01)	2512470 *	PPAR-SPARING THIAZOLIDINEDIONES AND COMBINATIONS FOR THE TREATMENT OF NEURODEGENERATIVE DISEASES
<b>A61K 31/426</b> (2006.01)	2512470 *	PPAR-SPARING THIAZOLIDINEDIONES AND COMBINATIONS FOR THE TREATMENT OF NEURODEGENERATIVE DISEASES
<b>A61K 9/107</b> (2006.01)	2515865 *	CUTANEOUS COMPOSITION COMPRISING VITAMIN D ANALOGUE AND A MIXTURE OF SOLVENT AND SURFACTANTS

MKP (51)	Broj objave evropske prijava patenta (97)	Naziv pronalaska (54)
<b>A61K 31/593</b> (2006.01)	2515865 *	CUTANEOUS COMPOSITION COMPRISING VITAMIN D ANALOGUE AND A MIXTURE OF SOLVENT AND SURFACTANTS
<b>A61K 47/10</b> (2006.01)	2515865 *	CUTANEOUS COMPOSITION COMPRISING VITAMIN D ANALOGUE AND A MIXTURE OF SOLVENT AND SURFACTANTS
<b>A61K 9/06</b> (2006.01)	2515865 *	CUTANEOUS COMPOSITION COMPRISING VITAMIN D ANALOGUE AND A MIXTURE OF SOLVENT AND SURFACTANTS
<b>A61K 47/22</b> (2006.01)	2515865 *	CUTANEOUS COMPOSITION COMPRISING VITAMIN D ANALOGUE AND A MIXTURE OF SOLVENT AND SURFACTANTS
<b>A61K 47/14</b> (2006.01)	2515865 *	CUTANEOUS COMPOSITION COMPRISING VITAMIN D ANALOGUE AND A MIXTURE OF SOLVENT AND SURFACTANTS
<b>A61P 25/28</b> (2006.01)	2513106 *	HETEROAROMATIC ARYL TRIAZOLE DERIVATIVES AS PDE10A ENZYME INHIBITORS
<b>A61P 25/18</b> (2006.01)	2513106 *	HETEROAROMATIC ARYL TRIAZOLE DERIVATIVES AS PDE10A ENZYME INHIBITORS
<b>A61K 31/437</b> (2006.01)	2513106 *	HETEROAROMATIC ARYL TRIAZOLE DERIVATIVES AS PDE10A ENZYME INHIBITORS
<b>A61K 31/4196</b> (2006.01)	2513106 *	HETEROAROMATIC ARYL TRIAZOLE DERIVATIVES AS PDE10A ENZYME INHIBITORS
<b>C07D 471/04</b> (2006.01)	2513106 *	HETEROAROMATIC ARYL TRIAZOLE DERIVATIVES AS PDE10A ENZYME INHIBITORS
<b>A61P 25/22</b> (2006.01)	2519514 *	ALPHA4BETA2 NEURONAL NICOTINIC ACETYLCHOLINE RECEPTOR LIGANDS
<b>A61P 25/30</b> (2006.01)	2519514 *	ALPHA4BETA2 NEURONAL NICOTINIC ACETYLCHOLINE RECEPTOR LIGANDS
<b>C07D 401/14</b> (2006.01)	2519514 *	ALPHA4BETA2 NEURONAL NICOTINIC ACETYLCHOLINE RECEPTOR LIGANDS
<b>A61P 25/08</b> (2006.01)	2519514 *	ALPHA4BETA2 NEURONAL NICOTINIC ACETYLCHOLINE RECEPTOR LIGANDS
<b>C07D 403/04</b> (2006.01)	2519514 *	ALPHA4BETA2 NEURONAL NICOTINIC ACETYLCHOLINE RECEPTOR LIGANDS
<b>A61P 25/04</b> (2006.01)	2519514 *	ALPHA4BETA2 NEURONAL NICOTINIC ACETYLCHOLINE RECEPTOR LIGANDS
<b>C07D 403/06</b> (2006.01)	2519514 *	ALPHA4BETA2 NEURONAL NICOTINIC ACETYLCHOLINE RECEPTOR LIGANDS
<b>A61P 25/18</b> (2006.01)	2519514 *	ALPHA4BETA2 NEURONAL NICOTINIC ACETYLCHOLINE RECEPTOR LIGANDS
<b>C07D 405/06</b> (2006.01)	2519514 *	ALPHA4BETA2 NEURONAL NICOTINIC ACETYLCHOLINE RECEPTOR LIGANDS
<b>A61P 25/16</b> (2006.01)	2519514 *	ALPHA4BETA2 NEURONAL NICOTINIC ACETYLCHOLINE RECEPTOR LIGANDS
<b>C07D 401/04</b> (2006.01)	2519514 *	ALPHA4BETA2 NEURONAL NICOTINIC ACETYLCHOLINE RECEPTOR LIGANDS
<b>A61P 25/28</b> (2006.01)	2519514 *	ALPHA4BETA2 NEURONAL NICOTINIC ACETYLCHOLINE RECEPTOR LIGANDS
<b>A61P 3/04</b> (2006.01)	2519514 *	ALPHA4BETA2 NEURONAL NICOTINIC ACETYLCHOLINE RECEPTOR LIGANDS
<b>C07D 401/06</b> (2006.01)	2519514 *	ALPHA4BETA2 NEURONAL NICOTINIC ACETYLCHOLINE RECEPTOR LIGANDS
<b>A61P 25/24</b> (2006.01)	2519514 *	ALPHA4BETA2 NEURONAL NICOTINIC ACETYLCHOLINE RECEPTOR LIGANDS
<b>A61K 31/403</b> (2006.01)	2519514 *	ALPHA4BETA2 NEURONAL NICOTINIC ACETYLCHOLINE RECEPTOR LIGANDS
<b>A61P 25/20</b> (2006.01)	2519514 *	ALPHA4BETA2 NEURONAL NICOTINIC ACETYLCHOLINE RECEPTOR LIGANDS
<b>C10L 5/42</b> (2006.01)	2536813 *	METHODS AND PROCEDURES FOR PRODUCING USEFUL PRODUCTS FROM WASTE MATERIALS
<b>C10L 5/46</b> (2006.01)	2536813 *	METHODS AND PROCEDURES FOR PRODUCING USEFUL PRODUCTS FROM WASTE MATERIALS
<b>C10L 5/44</b> (2006.01)	2536813 *	METHODS AND PROCEDURES FOR PRODUCING USEFUL PRODUCTS FROM WASTE MATERIALS
<b>C10B 53/02</b> (2006.01)	2536813 *	METHODS AND PROCEDURES FOR PRODUCING USEFUL PRODUCTS FROM WASTE MATERIALS
<b>C10B 47/00</b> (2006.01)	2536813 *	METHODS AND PROCEDURES FOR PRODUCING USEFUL PRODUCTS FROM WASTE MATERIALS
<b>A61M 5/32</b> (2006.01)	2531236 *	MEDICATED MODULE WITH DUAL SAFETY GUARDS
<b>A61M 5/28</b> (2006.01)	2531236 *	MEDICATED MODULE WITH DUAL SAFETY GUARDS
<b>A61M 5/24</b> (2006.01)	2531236 *	MEDICATED MODULE WITH DUAL SAFETY GUARDS
<b>A61K 31/327</b> (2006.01)	2501376 *	COMPOSITIONS FOR TOPICAL ADMINISTRATION
<b>A61P 31/02</b> (2006.01)	2501376 *	COMPOSITIONS FOR TOPICAL ADMINISTRATION
<b>A61K 31/46</b> (2006.01)	2501376 *	COMPOSITIONS FOR TOPICAL ADMINISTRATION
<b>A61P 31/00</b> (2006.01)	2501376 *	COMPOSITIONS FOR TOPICAL ADMINISTRATION



MKP (51)	Broj objave evropske prijava patenta (97)	Naziv pronalaska (54)
<b>A61K 31/351</b> (2006.01)	2501376 *	COMPOSITIONS FOR TOPICAL ADMINISTRATION
<b>A61K 31/575</b> (2006.01)	2501376 *	COMPOSITIONS FOR TOPICAL ADMINISTRATION
<b>A61P 31/04</b> (2006.01)	2536836 *	ANTIBODY AGAINST SEROTYPE A LIPOPOLYSACCHARIDE OF PSEUDOMONAS AERUGINOSA
<b>C07K 16/12</b> (2006.01)	2536836 *	ANTIBODY AGAINST SEROTYPE A LIPOPOLYSACCHARIDE OF PSEUDOMONAS AERUGINOSA
<b>C12N 15/09</b> (2006.01)	2536836 *	ANTIBODY AGAINST SEROTYPE A LIPOPOLYSACCHARIDE OF PSEUDOMONAS AERUGINOSA
<b>C12P 21/08</b> (2006.01)	2536836 *	ANTIBODY AGAINST SEROTYPE A LIPOPOLYSACCHARIDE OF PSEUDOMONAS AERUGINOSA
<b>G01N 33/569</b> (2006.01)	2536836 *	ANTIBODY AGAINST SEROTYPE A LIPOPOLYSACCHARIDE OF PSEUDOMONAS AERUGINOSA
<b>C07K 16/46</b> (2006.01)	2536836 *	ANTIBODY AGAINST SEROTYPE A LIPOPOLYSACCHARIDE OF PSEUDOMONAS AERUGINOSA
<b>C12N 5/10</b> (2006.01)	2536836 *	ANTIBODY AGAINST SEROTYPE A LIPOPOLYSACCHARIDE OF PSEUDOMONAS AERUGINOSA
<b>A61K 39/395</b> (2006.01)	2536836 *	ANTIBODY AGAINST SEROTYPE A LIPOPOLYSACCHARIDE OF PSEUDOMONAS AERUGINOSA
<b>A61P 9/10</b> (2006.01)	2501695 *	1,4-BENZODIAZEPINE-2,5-DIONES AND RELATED COMPOUNDS WITH THERAPEUTIC PROPERTIES
<b>C07D 487/04</b> (2006.01)	2501695 *	1,4-BENZODIAZEPINE-2,5-DIONES AND RELATED COMPOUNDS WITH THERAPEUTIC PROPERTIES
<b>C07D 403/10</b> (2006.01)	2501695 *	1,4-BENZODIAZEPINE-2,5-DIONES AND RELATED COMPOUNDS WITH THERAPEUTIC PROPERTIES
<b>C07D 471/04</b> (2006.01)	2501695 *	1,4-BENZODIAZEPINE-2,5-DIONES AND RELATED COMPOUNDS WITH THERAPEUTIC PROPERTIES
<b>A61K 31/437</b> (2006.01)	2501695 *	1,4-BENZODIAZEPINE-2,5-DIONES AND RELATED COMPOUNDS WITH THERAPEUTIC PROPERTIES
<b>A61P 9/12</b> (2006.01)	2501695 *	1,4-BENZODIAZEPINE-2,5-DIONES AND RELATED COMPOUNDS WITH THERAPEUTIC PROPERTIES
<b>C07D 401/10</b> (2006.01)	2501695 *	1,4-BENZODIAZEPINE-2,5-DIONES AND RELATED COMPOUNDS WITH THERAPEUTIC PROPERTIES
<b>A61K 31/5513</b> (2006.01)	2501695 *	1,4-BENZODIAZEPINE-2,5-DIONES AND RELATED COMPOUNDS WITH THERAPEUTIC PROPERTIES
<b>C07D 215/44</b> (2006.01)	2432764 *	SUBSTITUTED QUINOLINES FOR USE AS VEGF INHIBITORS
<b>C07D 401/12</b> (2006.01)	2432764 *	SUBSTITUTED QUINOLINES FOR USE AS VEGF INHIBITORS
<b>A61K 31/4709</b> (2006.01)	2432764 *	SUBSTITUTED QUINOLINES FOR USE AS VEGF INHIBITORS
<b>A61P 35/00</b> (2006.01)	2432764 *	SUBSTITUTED QUINOLINES FOR USE AS VEGF INHIBITORS
<b>A61K 31/52</b> (2006.01)	2521550 *	TREATMENT METHOD
<b>A61M 5/28</b> (2006.01)	2531238 *	MEDICATED MODULE WITH LOCKABLE NEEDLE GUARD
<b>A61M 5/24</b> (2006.01)	2531238 *	MEDICATED MODULE WITH LOCKABLE NEEDLE GUARD
<b>A61M 5/32</b> (2006.01)	2531238 *	MEDICATED MODULE WITH LOCKABLE NEEDLE GUARD
<b>A61K 31/7088</b> (2006.01)	2531261 *	METHODS FOR DIAGNOSIS AND TREATMENT OF NON-INSULIN DEPENDENT DIABETES MELLITUS
<b>A61P 3/10</b> (2006.01)	2531261 *	METHODS FOR DIAGNOSIS AND TREATMENT OF NON-INSULIN DEPENDENT DIABETES MELLITUS
<b>A61K 39/395</b> (2006.01)	2531261 *	METHODS FOR DIAGNOSIS AND TREATMENT OF NON-INSULIN DEPENDENT DIABETES MELLITUS
<b>B27M 3/00</b> (2006.01)	2504134 *	ENGINEERED TIMBER PRODUCTS, COMPONENTS AND METHODOLOGIES
<b>B27D 3/02</b> (2006.01)	2504134 *	ENGINEERED TIMBER PRODUCTS, COMPONENTS AND METHODOLOGIES
<b>F26B 7/00</b> (2006.01)	2504134 *	ENGINEERED TIMBER PRODUCTS, COMPONENTS AND METHODOLOGIES
<b>F26B 3/20</b> (2006.01)	2504134 *	ENGINEERED TIMBER PRODUCTS, COMPONENTS AND METHODOLOGIES
<b>B32B 21/13</b> (2006.01)	2504134 *	ENGINEERED TIMBER PRODUCTS, COMPONENTS AND METHODOLOGIES
<b>B32B 13/14</b> (2006.01)	2504134 *	ENGINEERED TIMBER PRODUCTS, COMPONENTS AND METHODOLOGIES

MKP (51)	Broj objave evropske prijava patenta (97)	Naziv pronalaska (54)
<b>F26B 3/00</b> (2006.01)	2504134 *	ENGINEERED TIMBER PRODUCTS, COMPONENTS AND METHODOLOGIES
<b>B30B 15/34</b> (2006.01)	2504134 *	ENGINEERED TIMBER PRODUCTS, COMPONENTS AND METHODOLOGIES
<b>C07D 417/12</b> (2006.01)	2519503 *	SECONDARY 8-HYDROXYQUINOLINE-7-CARBOXAMIDE DERIVATIVES FOR USE AS ANTIFUNGAL AGENTS
<b>A61P 31/10</b> (2006.01)	2519503 *	SECONDARY 8-HYDROXYQUINOLINE-7-CARBOXAMIDE DERIVATIVES FOR USE AS ANTIFUNGAL AGENTS
<b>C07D 401/12</b> (2006.01)	2519503 *	SECONDARY 8-HYDROXYQUINOLINE-7-CARBOXAMIDE DERIVATIVES FOR USE AS ANTIFUNGAL AGENTS
<b>C07D 407/12</b> (2006.01)	2519503 *	SECONDARY 8-HYDROXYQUINOLINE-7-CARBOXAMIDE DERIVATIVES FOR USE AS ANTIFUNGAL AGENTS
<b>C07D 409/12</b> (2006.01)	2519503 *	SECONDARY 8-HYDROXYQUINOLINE-7-CARBOXAMIDE DERIVATIVES FOR USE AS ANTIFUNGAL AGENTS
<b>C07D 413/12</b> (2006.01)	2519503 *	SECONDARY 8-HYDROXYQUINOLINE-7-CARBOXAMIDE DERIVATIVES FOR USE AS ANTIFUNGAL AGENTS
<b>C07D 215/48</b> (2006.01)	2519503 *	SECONDARY 8-HYDROXYQUINOLINE-7-CARBOXAMIDE DERIVATIVES FOR USE AS ANTIFUNGAL AGENTS
<b>A61K 31/4709</b> (2006.01)	2519503 *	SECONDARY 8-HYDROXYQUINOLINE-7-CARBOXAMIDE DERIVATIVES FOR USE AS ANTIFUNGAL AGENTS
<b>B32B 27/32</b> (2006.01)	2501346 *	NOISE DAMPENING FILM
<b>A61F 5/445</b> (2006.01)	2501346 *	NOISE DAMPENING FILM
<b>C07C 69/757</b> (2006.01)	2502903 *	PROCESS FOR PRODUCING 3-ALKOXY-2-AMINO-6-FLUOROBICYCLO[3.1.0]HEXANE-2,6-DICARBOXYLIC ACID DERIVATIVE AND INTERMEDIATE THEREOF
<b>C07C 227/18</b> (2006.01)	2502903 *	PROCESS FOR PRODUCING 3-ALKOXY-2-AMINO-6-FLUOROBICYCLO[3.1.0]HEXANE-2,6-DICARBOXYLIC ACID DERIVATIVE AND INTERMEDIATE THEREOF
<b>C07C 255/47</b> (2006.01)	2502903 *	PROCESS FOR PRODUCING 3-ALKOXY-2-AMINO-6-FLUOROBICYCLO[3.1.0]HEXANE-2,6-DICARBOXYLIC ACID DERIVATIVE AND INTERMEDIATE THEREOF
<b>C07C 227/02</b> (2006.01)	2502903 *	PROCESS FOR PRODUCING 3-ALKOXY-2-AMINO-6-FLUOROBICYCLO[3.1.0]HEXANE-2,6-DICARBOXYLIC ACID DERIVATIVE AND INTERMEDIATE THEREOF
<b>C07C 235/82</b> (2006.01)	2502903 *	PROCESS FOR PRODUCING 3-ALKOXY-2-AMINO-6-FLUOROBICYCLO[3.1.0]HEXANE-2,6-DICARBOXYLIC ACID DERIVATIVE AND INTERMEDIATE THEREOF
<b>C07D 235/02</b> (2006.01)	2502903 *	PROCESS FOR PRODUCING 3-ALKOXY-2-AMINO-6-FLUOROBICYCLO[3.1.0]HEXANE-2,6-DICARBOXYLIC ACID DERIVATIVE AND INTERMEDIATE THEREOF
<b>C07C 229/50</b> (2006.01)	2502903 *	PROCESS FOR PRODUCING 3-ALKOXY-2-AMINO-6-FLUOROBICYCLO[3.1.0]HEXANE-2,6-DICARBOXYLIC ACID DERIVATIVE AND INTERMEDIATE THEREOF
<b>C07C 227/12</b> (2006.01)	2502903 *	PROCESS FOR PRODUCING 3-ALKOXY-2-AMINO-6-FLUOROBICYCLO[3.1.0]HEXANE-2,6-DICARBOXYLIC ACID DERIVATIVE AND INTERMEDIATE THEREOF
<b>C07K 14/475</b> (2006.01)	2516454 *	MODIFIED BOVINE SOMATOTROPIN POLYPEPTIDES AND THEIR USES
<b>C07D 471/04</b> (2006.01)	2519524 *	CERTAIN TRIAZOLOPYRIDINES AND TRIAZOLOPYRAZINES, COMPOSITIONS THEREOF AND METHODS OF USE THEREFOR
<b>A61K 31/437</b> (2006.01)	2519524 *	CERTAIN TRIAZOLOPYRIDINES AND TRIAZOLOPYRAZINES, COMPOSITIONS THEREOF AND METHODS OF USE THEREFOR
<b>C07D 487/04</b> (2006.01)	2519524 *	CERTAIN TRIAZOLOPYRIDINES AND TRIAZOLOPYRAZINES, COMPOSITIONS THEREOF AND METHODS OF USE THEREFOR
<b>A61P 35/00</b> (2006.01)	2519524 *	CERTAIN TRIAZOLOPYRIDINES AND TRIAZOLOPYRAZINES, COMPOSITIONS THEREOF AND METHODS OF USE THEREFOR
<b>A61K 31/4985</b> (2006.01)	2519524 *	CERTAIN TRIAZOLOPYRIDINES AND TRIAZOLOPYRAZINES, COMPOSITIONS THEREOF AND METHODS OF USE THEREFOR
<b>A61P 31/04</b> (2006.01)	2531519 *	LANTIBIOTIC SALTS
<b>A61K 38/10</b> (2006.01)	2531519 *	LANTIBIOTIC SALTS
<b>C07K 7/08</b> (2006.01)	2531519 *	LANTIBIOTIC SALTS
<b>A61L 15/64</b> (2006.01)	2506859 *	MICROSOPHERES OF HYDROLYSED STARCH WITH ENDOGENOUS, CHARGED LIGANDS
<b>C08J 9/00</b> (2006.01)	2506859 *	MICROSOPHERES OF HYDROLYSED STARCH WITH ENDOGENOUS, CHARGED LIGANDS
<b>A61K 9/14</b> (2006.01)	2506859 *	MICROSOPHERES OF HYDROLYSED STARCH WITH ENDOGENOUS, CHARGED LIGANDS

MKP (51)	Broj objave evropske prijava patenta (97)	Naziv pronalaska (54)
<b>A61K 31/718</b> (2006.01)	2506859 *	MICROSPHERES OF HYDROLYSED STARCH WITH ENDOGENOUS, CHARGED LIGANDS
<b>C08B 31/04</b> (2006.01)	2506859 *	MICROSPHERES OF HYDROLYSED STARCH WITH ENDOGENOUS, CHARGED LIGANDS
<b>A61L 15/28</b> (2006.01)	2506859 *	MICROSPHERES OF HYDROLYSED STARCH WITH ENDOGENOUS, CHARGED LIGANDS
<b>D21H 17/00</b> (2006.01)	2505614	Process for preparing self-binding pigment particles
<b>C09C 1/02</b> (2006.01)	2505614	Process for preparing self-binding pigment particles
<b>A61P 25/28</b> (2006.01)	2504330 *	AMINO HETEROARYL COMPOUNDS AS BETA-SECRETASE MODULATORS AND METHODS OF USE
<b>C07D 401/06</b> (2006.01)	2504330 *	AMINO HETEROARYL COMPOUNDS AS BETA-SECRETASE MODULATORS AND METHODS OF USE
<b>C07D 401/14</b> (2006.01)	2504330 *	AMINO HETEROARYL COMPOUNDS AS BETA-SECRETASE MODULATORS AND METHODS OF USE
<b>C07D 401/12</b> (2006.01)	2504330 *	AMINO HETEROARYL COMPOUNDS AS BETA-SECRETASE MODULATORS AND METHODS OF USE
<b>A61K 31/4709</b> (2006.01)	2504330 *	AMINO HETEROARYL COMPOUNDS AS BETA-SECRETASE MODULATORS AND METHODS OF USE
<b>F27D 1/14</b> (2006.01)	2510300 *	METHOD OF FORMING SEALED REFRACTORY JOINTS IN METAL-CONTAINMENT VESSELS, AND VESSELS CONTAINING SEALED JOINTS
<b>A61M 29/00</b> (2006.01)	2515990 *	IMPROVED EXTERNAL NASAL DILATOR
<b>A61P 35/00</b> (2006.01)	2519541 *	RON BINDING CONSTRUCTS AND METHODS OF USE THEREOF
<b>C07K 16/28</b> (2006.01)	2519541 *	RON BINDING CONSTRUCTS AND METHODS OF USE THEREOF
<b>A61K 39/395</b> (2006.01)	2519541 *	RON BINDING CONSTRUCTS AND METHODS OF USE THEREOF
<b>A61P 37/00</b> (2006.01)	2519541 *	RON BINDING CONSTRUCTS AND METHODS OF USE THEREOF
<b>C08G 61/08</b> (2006.01)	2520956 *	PHASE DIFFERENCE FILM, ORGANIC EL DISPLAY DEVICE AND LIQUID CRYSTAL DISPLAY USING THE SAME
<b>H01L 51/50</b> (2006.01)	2520956 *	PHASE DIFFERENCE FILM, ORGANIC EL DISPLAY DEVICE AND LIQUID CRYSTAL DISPLAY USING THE SAME
<b>G02B 5/30</b> (2006.01)	2520956 *	PHASE DIFFERENCE FILM, ORGANIC EL DISPLAY DEVICE AND LIQUID CRYSTAL DISPLAY USING THE SAME
<b>G02F 1/13363</b> (2006.01)	2520956 *	PHASE DIFFERENCE FILM, ORGANIC EL DISPLAY DEVICE AND LIQUID CRYSTAL DISPLAY USING THE SAME
<b>C08J 5/18</b> (2006.01)	2520956 *	PHASE DIFFERENCE FILM, ORGANIC EL DISPLAY DEVICE AND LIQUID CRYSTAL DISPLAY USING THE SAME
<b>C12M 1/00</b> (2006.01)	2523911 *	CARRIER INSERT FOR ACCOMMODATING AND MAINTAINING THE BIOFILM CULTURE OF FLUID CLEANING STRUCTURES
<b>C02F 3/10</b> (2006.01)	2523911 *	CARRIER INSERT FOR ACCOMMODATING AND MAINTAINING THE BIOFILM CULTURE OF FLUID CLEANING STRUCTURES
<b>C02F 3/12</b> (2006.01)	2523911 *	CARRIER INSERT FOR ACCOMMODATING AND MAINTAINING THE BIOFILM CULTURE OF FLUID CLEANING STRUCTURES
<b>A61P 5/00</b> (2006.01)	2523731 *	USE OF AN ADRENAL HORMONE-MODIFYING AGENT
<b>A61K 31/55</b> (2006.01)	2523731 *	USE OF AN ADRENAL HORMONE-MODIFYING AGENT
<b>A61K 31/4188</b> (2006.01)	2523731 *	USE OF AN ADRENAL HORMONE-MODIFYING AGENT
<b>C07K 1/107</b> (2006.01)	2525830 *	DIPEPTIDE-BASED PRODRUG LINKERS FOR ALIPHATIC AMINE-CONTAINING DRUGS
<b>A61K 47/48</b> (2006.01)	2525830 *	DIPEPTIDE-BASED PRODRUG LINKERS FOR ALIPHATIC AMINE-CONTAINING DRUGS
<b>C07K 1/13</b> (2006.01)	2525830 *	DIPEPTIDE-BASED PRODRUG LINKERS FOR ALIPHATIC AMINE-CONTAINING DRUGS
<b>F03B 13/16</b> (2006.01)	2504566 *	WAVE POWER PLANT
<b>F03B 13/22</b> (2006.01)	2504566 *	WAVE POWER PLANT
<b>F03B 13/20</b> (2006.01)	2504566 *	WAVE POWER PLANT
<b>F03B 13/24</b> (2006.01)	2504566 *	WAVE POWER PLANT

MKP (51)	Broj objave evropske prijave patenta (97)	Naziv pronalaska (54)
<b>F03B 13/14</b> (2006.01)	2504566 *	WAVE POWER PLANT
<b>C07D 471/04</b> (2006.01)	2504335 *	METHOD FOR PRODUCING METHYL-{4,6-DIAMINO-2-[1-(2-FLUOROBENZYL)-1H-PYRAZOLO[3,4-B]PYRIDINO-3-YL]PYRIMIDINO-5-YL} CARBAMATE AND ITS PURIFICATION FOR USE THEREOF AS PHARMACEUTICAL SUBSTANCE
<b>A61P 17/06</b> (2006.01)	2523688 *	ANTIBODY FORMULATION AND THERAPEUTIC REGIMENS
<b>C07K 16/28</b> (2006.01)	2523688 *	ANTIBODY FORMULATION AND THERAPEUTIC REGIMENS
<b>A61K 39/395</b> (2006.01)	2523688 *	ANTIBODY FORMULATION AND THERAPEUTIC REGIMENS
<b>A61M 5/315</b> (2006.01)	2509662 *	DRIVE ASSEMBLY FOR A DRUG DELIVERY DEVICE AND DRUG DELIVERY DEVICE
<b>C09C 1/36</b> (2006.01)	2510058 *	METHOD FOR CLASSIFYING MINERAL MATERIAL IN THE PRESENCE OF GLYCEROL-CONTAINING ADDITIVES, PRODUCTS OBTAINED, AND USES THEREOF
<b>C09C 1/40</b> (2006.01)	2510058 *	METHOD FOR CLASSIFYING MINERAL MATERIAL IN THE PRESENCE OF GLYCEROL-CONTAINING ADDITIVES, PRODUCTS OBTAINED, AND USES THEREOF
<b>B03B 1/04</b> (2006.01)	2510058 *	METHOD FOR CLASSIFYING MINERAL MATERIAL IN THE PRESENCE OF GLYCEROL-CONTAINING ADDITIVES, PRODUCTS OBTAINED, AND USES THEREOF
<b>B02C 23/06</b> (2006.01)	2510058 *	METHOD FOR CLASSIFYING MINERAL MATERIAL IN THE PRESENCE OF GLYCEROL-CONTAINING ADDITIVES, PRODUCTS OBTAINED, AND USES THEREOF
<b>C09C 1/02</b> (2006.01)	2510058 *	METHOD FOR CLASSIFYING MINERAL MATERIAL IN THE PRESENCE OF GLYCEROL-CONTAINING ADDITIVES, PRODUCTS OBTAINED, AND USES THEREOF
<b>F03D 11/04</b> (2006.01)	2529111 *	WIND POWER PLANT AND WIND POWER PLANT TOWER SEGMENT
<b>H02P 9/04</b> (2006.01)	2516853 *	IMPROVED DESIGNS FOR TURBINE ASSEMBLIES
<b>F03D 9/00</b> (2006.01)	2516853 *	IMPROVED DESIGNS FOR TURBINE ASSEMBLIES
<b>B65D 83/16</b> (2006.01)	2528652 *	TANNING DEVICE AND METHOD
<b>A61M 35/00</b> (2006.01)	2528652 *	TANNING DEVICE AND METHOD
<b>A61K 48/00</b> (2006.01)	2501414 *	SMNDELTA7 DEGRON: NOVEL COMPOSITIONS AND METHODS OF USE
<b>C12P 21/08</b> (2006.01)	2536759 *	ANTIBODY AGAINST SEROTYPE I LIPOPOLYSACCHARIDE OF PSEUDOMONAS AERUGINOSA
<b>C07K 16/12</b> (2006.01)	2536759 *	ANTIBODY AGAINST SEROTYPE I LIPOPOLYSACCHARIDE OF PSEUDOMONAS AERUGINOSA
<b>C12N 15/09</b> (2006.01)	2536759 *	ANTIBODY AGAINST SEROTYPE I LIPOPOLYSACCHARIDE OF PSEUDOMONAS AERUGINOSA
<b>C12N 5/10</b> (2006.01)	2536759 *	ANTIBODY AGAINST SEROTYPE I LIPOPOLYSACCHARIDE OF PSEUDOMONAS AERUGINOSA
<b>C07K 16/46</b> (2006.01)	2536759 *	ANTIBODY AGAINST SEROTYPE I LIPOPOLYSACCHARIDE OF PSEUDOMONAS AERUGINOSA
<b>A61K 39/395</b> (2006.01)	2536759 *	ANTIBODY AGAINST SEROTYPE I LIPOPOLYSACCHARIDE OF PSEUDOMONAS AERUGINOSA
<b>A61P 31/04</b> (2006.01)	2536759 *	ANTIBODY AGAINST SEROTYPE I LIPOPOLYSACCHARIDE OF PSEUDOMONAS AERUGINOSA
<b>G01N 33/569</b> (2006.01)	2536759 *	ANTIBODY AGAINST SEROTYPE I LIPOPOLYSACCHARIDE OF PSEUDOMONAS AERUGINOSA
<b>F41A 17/44</b> (2006.01)	2524186 *	SAFETY MAGAZINE FOR A FIREARM HAVING A MECHANISM FOR LOCKING AGAINST THE BREECH FACE
<b>F41A 17/38</b> (2006.01)	2524186 *	SAFETY MAGAZINE FOR A FIREARM HAVING A MECHANISM FOR LOCKING AGAINST THE BREECH FACE
<b>F41A 17/42</b> (2006.01)	2524186 *	SAFETY MAGAZINE FOR A FIREARM HAVING A MECHANISM FOR LOCKING AGAINST THE BREECH FACE
<b>A61B 17/32</b> (2006.01)	2533703 *	ULTRASONIC SURGICAL INSTRUMENTS WITH MOVING CUTTING IMPLEMENT
<b>A61B 17/22</b> (2006.01)	2533703 *	ULTRASONIC SURGICAL INSTRUMENTS WITH MOVING CUTTING IMPLEMENT
<b>A61B 17/3207</b> (2006.01)	2533703 *	ULTRASONIC SURGICAL INSTRUMENTS WITH MOVING CUTTING IMPLEMENT
<b>C07D 211/08</b> (2006.01)	2509940 *	AMYLOID BINDING AGENTS

MKP (51)	Broj objave evropske prijava patenta (97)	Naziv pronalaska (54)
<b>A61P 25/28</b> (2006.01)	2509940 *	AMYLOID BINDING AGENTS
<b>C07C 255/43</b> (2006.01)	2509940 *	AMYLOID BINDING AGENTS
<b>A61K 31/277</b> (2006.01)	2509940 *	AMYLOID BINDING AGENTS
<b>C07D 265/30</b> (2006.01)	2509940 *	AMYLOID BINDING AGENTS
<b>E21B 17/00</b> (2006.01)	2521839 *	WELLBORE TREATMENT APPARATUS AND METHOD
<b>E21B 43/12</b> (2006.01)	2521839 *	WELLBORE TREATMENT APPARATUS AND METHOD
<b>E21B 43/22</b> (2006.01)	2521839 *	WELLBORE TREATMENT APPARATUS AND METHOD
<b>A61M 5/315</b> (2006.01)	2512563 *	DOSE SETTING MECHANISM WITH MAXIMUM DOSE LIMITING ELEMENT
<b>C09B 62/00</b> (2006.01)	2516555 *	COLORING AGENTS AND METHODS OF USE THEREOF
<b>C09B 62/453</b> (2006.01)	2516555 *	COLORING AGENTS AND METHODS OF USE THEREOF
<b>A61K 31/722</b> (2006.01)	2501392 *	SOLUBLE PHYSIOLOGICAL CHITOSAN FORMULATIONS COMBINED WITH PLATELET-RICH PLASMA (PRP) FOR TISSUE REPAIR
<b>C08K 3/16</b> (2006.01)	2501392 *	SOLUBLE PHYSIOLOGICAL CHITOSAN FORMULATIONS COMBINED WITH PLATELET-RICH PLASMA (PRP) FOR TISSUE REPAIR
<b>C08K 3/00</b> (2006.01)	2501392 *	SOLUBLE PHYSIOLOGICAL CHITOSAN FORMULATIONS COMBINED WITH PLATELET-RICH PLASMA (PRP) FOR TISSUE REPAIR
<b>C08L 5/08</b> (2006.01)	2501392 *	SOLUBLE PHYSIOLOGICAL CHITOSAN FORMULATIONS COMBINED WITH PLATELET-RICH PLASMA (PRP) FOR TISSUE REPAIR
<b>A61K 35/14</b> (2006.01)	2501392 *	SOLUBLE PHYSIOLOGICAL CHITOSAN FORMULATIONS COMBINED WITH PLATELET-RICH PLASMA (PRP) FOR TISSUE REPAIR
<b>C08K 11/00</b> (2006.01)	2501392 *	SOLUBLE PHYSIOLOGICAL CHITOSAN FORMULATIONS COMBINED WITH PLATELET-RICH PLASMA (PRP) FOR TISSUE REPAIR
<b>C08K 5/521</b> (2006.01)	2501392 *	SOLUBLE PHYSIOLOGICAL CHITOSAN FORMULATIONS COMBINED WITH PLATELET-RICH PLASMA (PRP) FOR TISSUE REPAIR
<b>G01L 7/08</b> (2006.01)	2513623 *	WEATHERIZED DIRECT-MOUNT ABSOLUTE PRESSURE SENSOR
<b>B64C 3/00</b> (2006.01)	2513623 *	WEATHERIZED DIRECT-MOUNT ABSOLUTE PRESSURE SENSOR
<b>G01L 7/02</b> (2006.01)	2513623 *	WEATHERIZED DIRECT-MOUNT ABSOLUTE PRESSURE SENSOR
<b>G01L 9/06</b> (2006.01)	2513623 *	WEATHERIZED DIRECT-MOUNT ABSOLUTE PRESSURE SENSOR
<b>B64C 99/00</b> (2010.01)	2513623 *	WEATHERIZED DIRECT-MOUNT ABSOLUTE PRESSURE SENSOR
<b>C07D 487/04</b> (2006.01)	2536728 *	PYRAZOLE DERIVATIVES AS JAK INHIBITORS
<b>A61P 35/00</b> (2006.01)	2536728 *	PYRAZOLE DERIVATIVES AS JAK INHIBITORS
<b>A61K 31/437</b> (2006.01)	2536728 *	PYRAZOLE DERIVATIVES AS JAK INHIBITORS
<b>A61K 31/4985</b> (2006.01)	2536728 *	PYRAZOLE DERIVATIVES AS JAK INHIBITORS
<b>C08G 63/199</b> (2006.01)	2507280 *	POLYMERIC MATERIALS
<b>C08G 63/183</b> (2006.01)	2507280 *	POLYMERIC MATERIALS
<b>C08G 63/672</b> (2006.01)	2507280 *	POLYMERIC MATERIALS
<b>C08G 18/32</b> (2006.01)	2507280 *	POLYMERIC MATERIALS
<b>C08G 63/42</b> (2006.01)	2507280 *	POLYMERIC MATERIALS
<b>C08G 18/73</b> (2006.01)	2507280 *	POLYMERIC MATERIALS
<b>C08G 18/76</b> (2006.01)	2507280 *	POLYMERIC MATERIALS
<b>C08J 7/06</b> (2006.01)	2418238	Titanium dioxide-coated expanded polymer sheet having photocatalytic activity, container and packaging for foodstuffs obtained from such polymer sheet
<b>B01J 21/06</b> (2006.01)	2418238	Titanium dioxide-coated expanded polymer sheet having photocatalytic activity, container and packaging for foodstuffs obtained from such polymer sheet
<b>B05D 5/00</b> (2006.01)	2418238	Titanium dioxide-coated expanded polymer sheet having photocatalytic activity, container and packaging for foodstuffs obtained from such polymer sheet
<b>C09G 1/00</b> (2006.01)	2418238	Titanium dioxide-coated expanded polymer sheet having photocatalytic activity, container and packaging for foodstuffs obtained from such polymer sheet
<b>B01D 17/02</b> (2006.01)	2512615 *	METHOD AND APPARATUS FOR HANDLING DRILLING MUD CONTAINING AN OIL/WATER EMULSION
<b>A61P 35/00</b> (2006.01)	2501412 *	SALT FORM OF A MULTI-ARM POLYMER-DRUG CONJUGATE
<b>A61K 47/48</b> (2006.01)	2501412 *	SALT FORM OF A MULTI-ARM POLYMER-DRUG CONJUGATE

MKP (51)	Broj objave evropske prijava patenta (97)	Naziv pronalaska (54)
<b>H01L 31/042</b> (2006.01)	2535661	Modular type assembly system for the installation of photovoltaic system
<b>F24J 2/52</b> (2006.01)	2535661	Modular type assembly system for the installation of photovoltaic system
<b>C07C 237/04</b> (2006.01)	2507218 *	COMBRETASTATIN DERIVATIVE PREPARATION METHOD
<b>C07D 263/06</b> (2006.01)	2507218 *	COMBRETASTATIN DERIVATIVE PREPARATION METHOD
<b>C07D 307/82</b> (2006.01)	2509971 *	NEW PROCESS FOR THE PREPARATION OF DRONEDARONE
<b>A61K 31/40</b> (2006.01)	2515856 *	AEROSOL FORMULATION FOR COPD
<b>A61K 9/00</b> (2006.01)	2515856 *	AEROSOL FORMULATION FOR COPD
<b>H04L 12/56</b> (2006.01)	2507952 *	AN ASSEMBLY AND A METHOD OF RECEIVING AND STORING DATA WHILE SAVING BANDWIDTH BY CONTROLLING UPDATING OF FILL LEVELS OF QUEUES
<b>C07D 405/06</b> (2006.01)	2507228 *	NOVEL SPIROPIPERIDINE COMPOUNDS
<b>A61K 31/438</b> (2006.01)	2507228 *	NOVEL SPIROPIPERIDINE COMPOUNDS
<b>C07D 417/06</b> (2006.01)	2507228 *	NOVEL SPIROPIPERIDINE COMPOUNDS
<b>C07D 409/06</b> (2006.01)	2507228 *	NOVEL SPIROPIPERIDINE COMPOUNDS
<b>C07D 471/10</b> (2006.01)	2507228 *	NOVEL SPIROPIPERIDINE COMPOUNDS
<b>C07D 413/06</b> (2006.01)	2507228 *	NOVEL SPIROPIPERIDINE COMPOUNDS
<b>A61P 3/10</b> (2006.01)	2507228 *	NOVEL SPIROPIPERIDINE COMPOUNDS
<b>G01N 33/487</b> (2006.01)	2531852 *	SHAPE MEMORY ALLOY EJECTION MECHANISM FOR EJECTING A TEST STRIP FROM A TEST METER
<b>A61P 15/08</b> (2006.01)	2535342 *	SALT OF FUSED HETEROCYCLIC DERIVATIVE AND CRYSTAL THEREOF
<b>A61P 5/04</b> (2006.01)	2535342 *	SALT OF FUSED HETEROCYCLIC DERIVATIVE AND CRYSTAL THEREOF
<b>A61P 35/00</b> (2006.01)	2535342 *	SALT OF FUSED HETEROCYCLIC DERIVATIVE AND CRYSTAL THEREOF
<b>A61K 31/519</b> (2006.01)	2535342 *	SALT OF FUSED HETEROCYCLIC DERIVATIVE AND CRYSTAL THEREOF
<b>A61P 15/18</b> (2006.01)	2535342 *	SALT OF FUSED HETEROCYCLIC DERIVATIVE AND CRYSTAL THEREOF
<b>A61P 15/16</b> (2006.01)	2535342 *	SALT OF FUSED HETEROCYCLIC DERIVATIVE AND CRYSTAL THEREOF
<b>C07D 495/04</b> (2006.01)	2535342 *	SALT OF FUSED HETEROCYCLIC DERIVATIVE AND CRYSTAL THEREOF
<b>A61K 31/436</b> (2006.01)	2501370 *	METHODS AND COMPOSITIONS FOR TREATING SOLID TUMORS AND OTHER MALIGNANCIES
<b>A61P 35/00</b> (2006.01)	2501370 *	METHODS AND COMPOSITIONS FOR TREATING SOLID TUMORS AND OTHER MALIGNANCIES
<b>A61K 31/501</b> (2006.01)	2501370 *	METHODS AND COMPOSITIONS FOR TREATING SOLID TUMORS AND OTHER MALIGNANCIES
<b>A61K 31/5377</b> (2006.01)	2501370 *	METHODS AND COMPOSITIONS FOR TREATING SOLID TUMORS AND OTHER MALIGNANCIES
<b>A61K 31/00</b> (2006.01)	2501370 *	METHODS AND COMPOSITIONS FOR TREATING SOLID TUMORS AND OTHER MALIGNANCIES
<b>C12Q 1/68</b> (2006.01)	2526204 *	METHODS AND USES RELATING TO THE IDENTIFICATION OF COMPOUND INVOLVED IN PAIN AS WELL AS METHODS OF DIAGNOSING ALGESIA
<b>G01N 33/50</b> (2006.01)	2526204 *	METHODS AND USES RELATING TO THE IDENTIFICATION OF COMPOUND INVOLVED IN PAIN AS WELL AS METHODS OF DIAGNOSING ALGESIA
<b>C07K 16/44</b> (2006.01)	2525812 *	ANTICOAGULANT ANTIDOTES
<b>A61K 39/00</b> (2006.01)	2525812 *	ANTICOAGULANT ANTIDOTES
<b>A41B 17/00</b> (2006.01)	2520187 *	INSULATING GARMENT
<b>A41D 31/00</b> (2006.01)	2520187 *	INSULATING GARMENT
<b>G06F 11/30</b> (2006.01)	2510441 *	SYSTEM AND METHOD FOR MAXIMISING THERMAL EFFICIENCY OF A POWER PLANT
<b>G06F 17/13</b> (2006.01)	2510441 *	SYSTEM AND METHOD FOR MAXIMISING THERMAL EFFICIENCY OF A POWER PLANT
<b>F01K 13/02</b> (2006.01)	2510441 *	SYSTEM AND METHOD FOR MAXIMISING THERMAL EFFICIENCY OF A POWER PLANT
<b>G05B 1/11</b> (2006.01)	2510441 *	SYSTEM AND METHOD FOR MAXIMISING THERMAL EFFICIENCY OF A POWER PLANT
<b>F02B 43/02</b> (2006.01)	2510441 *	SYSTEM AND METHOD FOR MAXIMISING THERMAL EFFICIENCY OF A POWER PLANT

MKP (51)	Broj objave evropske prijava patenta (97)	Naziv pronalaska (54)
<b>F01D 17/00</b> (2006.01)	2510441 *	SYSTEM AND METHOD FOR MAXIMISING THERMAL EFFICIENCY OF A POWER PLANT
<b>G05B 6/05</b> (2006.01)	2510441 *	SYSTEM AND METHOD FOR MAXIMISING THERMAL EFFICIENCY OF A POWER PLANT
<b>F22B 35/18</b> (2006.01)	2510441 *	SYSTEM AND METHOD FOR MAXIMISING THERMAL EFFICIENCY OF A POWER PLANT
<b>C12N 15/86</b> (2006.01)	2524060 *	ASSAY FOR JC VIRUS ANTIBODIES
<b>C12Q 1/70</b> (2006.01)	2524060 *	ASSAY FOR JC VIRUS ANTIBODIES
<b>C07K 14/435</b> (2006.01)	2536746 *	DISULPHIDE BOND-STABILIZED FUNCTIONAL SOLUBLE MHC CLASS II HETERODIMERS
<b>A61P 35/00</b> (2006.01)	2507229 *	SULFONAMIDE DERIVATIVES AS BCL-2-SELECTIVE APOPTOSIS-INDUCING AGENTS FOR THE TREATMENT OF CANCER AND IMMUNE DISEASES
<b>C07D 295/14</b> (2006.01)	2507229 *	SULFONAMIDE DERIVATIVES AS BCL-2-SELECTIVE APOPTOSIS-INDUCING AGENTS FOR THE TREATMENT OF CANCER AND IMMUNE DISEASES
<b>A61K 31/404</b> (2006.01)	2507229 *	SULFONAMIDE DERIVATIVES AS BCL-2-SELECTIVE APOPTOSIS-INDUCING AGENTS FOR THE TREATMENT OF CANCER AND IMMUNE DISEASES
<b>C07D 249/04</b> (2006.01)	2507229 *	SULFONAMIDE DERIVATIVES AS BCL-2-SELECTIVE APOPTOSIS-INDUCING AGENTS FOR THE TREATMENT OF CANCER AND IMMUNE DISEASES
<b>C07D 217/16</b> (2006.01)	2507229 *	SULFONAMIDE DERIVATIVES AS BCL-2-SELECTIVE APOPTOSIS-INDUCING AGENTS FOR THE TREATMENT OF CANCER AND IMMUNE DISEASES
<b>C07D 405/14</b> (2006.01)	2507229 *	SULFONAMIDE DERIVATIVES AS BCL-2-SELECTIVE APOPTOSIS-INDUCING AGENTS FOR THE TREATMENT OF CANCER AND IMMUNE DISEASES
<b>C07D 405/12</b> (2006.01)	2507229 *	SULFONAMIDE DERIVATIVES AS BCL-2-SELECTIVE APOPTOSIS-INDUCING AGENTS FOR THE TREATMENT OF CANCER AND IMMUNE DISEASES
<b>C07D 235/26</b> (2006.01)	2507229 *	SULFONAMIDE DERIVATIVES AS BCL-2-SELECTIVE APOPTOSIS-INDUCING AGENTS FOR THE TREATMENT OF CANCER AND IMMUNE DISEASES
<b>C07D 209/32</b> (2006.01)	2507229 *	SULFONAMIDE DERIVATIVES AS BCL-2-SELECTIVE APOPTOSIS-INDUCING AGENTS FOR THE TREATMENT OF CANCER AND IMMUNE DISEASES
<b>C07D 309/14</b> (2006.01)	2507229 *	SULFONAMIDE DERIVATIVES AS BCL-2-SELECTIVE APOPTOSIS-INDUCING AGENTS FOR THE TREATMENT OF CANCER AND IMMUNE DISEASES
<b>C07D 215/20</b> (2006.01)	2507229 *	SULFONAMIDE DERIVATIVES AS BCL-2-SELECTIVE APOPTOSIS-INDUCING AGENTS FOR THE TREATMENT OF CANCER AND IMMUNE DISEASES
<b>C07D 231/56</b> (2006.01)	2507229 *	SULFONAMIDE DERIVATIVES AS BCL-2-SELECTIVE APOPTOSIS-INDUCING AGENTS FOR THE TREATMENT OF CANCER AND IMMUNE DISEASES
<b>C07D 211/96</b> (2006.01)	2507229 *	SULFONAMIDE DERIVATIVES AS BCL-2-SELECTIVE APOPTOSIS-INDUCING AGENTS FOR THE TREATMENT OF CANCER AND IMMUNE DISEASES
<b>C07D 401/12</b> (2006.01)	2507229 *	SULFONAMIDE DERIVATIVES AS BCL-2-SELECTIVE APOPTOSIS-INDUCING AGENTS FOR THE TREATMENT OF CANCER AND IMMUNE DISEASES
<b>C07D 213/64</b> (2006.01)	2507229 *	SULFONAMIDE DERIVATIVES AS BCL-2-SELECTIVE APOPTOSIS-INDUCING AGENTS FOR THE TREATMENT OF CANCER AND IMMUNE DISEASES
<b>C07D 295/125</b> (2006.01)	2507229 *	SULFONAMIDE DERIVATIVES AS BCL-2-SELECTIVE APOPTOSIS-INDUCING AGENTS FOR THE TREATMENT OF CANCER AND IMMUNE DISEASES
<b>G01N 33/48</b> (2006.01)	2506853 *	COMBINATION THERAPY FOR TREATING CANCER AND DIAGNOSTIC ASSAYS FOR USE THEREIN
<b>A61K 31/635</b> (2006.01)	2506853 *	COMBINATION THERAPY FOR TREATING CANCER AND DIAGNOSTIC ASSAYS FOR USE THEREIN
<b>A61K 31/675</b> (2006.01)	2506853 *	COMBINATION THERAPY FOR TREATING CANCER AND DIAGNOSTIC ASSAYS FOR USE THEREIN
<b>A61K 31/5377</b> (2006.01)	2506853 *	COMBINATION THERAPY FOR TREATING CANCER AND DIAGNOSTIC ASSAYS FOR USE THEREIN
<b>A61K 31/454</b> (2006.01)	2506853 *	COMBINATION THERAPY FOR TREATING CANCER AND DIAGNOSTIC ASSAYS FOR USE THEREIN
<b>C12Q 1/68</b> (2006.01)	2506853 *	COMBINATION THERAPY FOR TREATING CANCER AND DIAGNOSTIC ASSAYS FOR USE THEREIN
<b>A61P 35/00</b> (2006.01)	2506853 *	COMBINATION THERAPY FOR TREATING CANCER AND DIAGNOSTIC ASSAYS FOR USE THEREIN
<b>A61K 31/506</b> (2006.01)	2506853 *	COMBINATION THERAPY FOR TREATING CANCER AND DIAGNOSTIC ASSAYS FOR USE THEREIN

MKP (51)	Broj objave evropske prijava patenta (97)	Naziv pronalaska (54)
<b>A61K 45/06</b> (2006.01)	2506853 *	COMBINATION THERAPY FOR TREATING CANCER AND DIAGNOSTIC ASSAYS FOR USE THEREIN
<b>C07D 513/04</b> (2006.01)	2516445 *	TRICYCLIC DERIVATIVES AND THEIR PHARMACEUTICAL USE AND COMPOSITIONS
<b>A61P 25/24</b> (2006.01)	2516445 *	TRICYCLIC DERIVATIVES AND THEIR PHARMACEUTICAL USE AND COMPOSITIONS
<b>A61P 25/08</b> (2006.01)	2516445 *	TRICYCLIC DERIVATIVES AND THEIR PHARMACEUTICAL USE AND COMPOSITIONS
<b>A61P 25/36</b> (2006.01)	2516445 *	TRICYCLIC DERIVATIVES AND THEIR PHARMACEUTICAL USE AND COMPOSITIONS
<b>A61P 25/16</b> (2006.01)	2516445 *	TRICYCLIC DERIVATIVES AND THEIR PHARMACEUTICAL USE AND COMPOSITIONS
<b>C07D 491/153</b> (2006.01)	2516445 *	TRICYCLIC DERIVATIVES AND THEIR PHARMACEUTICAL USE AND COMPOSITIONS
<b>A61P 25/28</b> (2006.01)	2516445 *	TRICYCLIC DERIVATIVES AND THEIR PHARMACEUTICAL USE AND COMPOSITIONS
<b>A61K 31/4355</b> (2006.01)	2516445 *	TRICYCLIC DERIVATIVES AND THEIR PHARMACEUTICAL USE AND COMPOSITIONS
<b>A61P 25/30</b> (2006.01)	2516445 *	TRICYCLIC DERIVATIVES AND THEIR PHARMACEUTICAL USE AND COMPOSITIONS
<b>A61P 25/06</b> (2006.01)	2516445 *	TRICYCLIC DERIVATIVES AND THEIR PHARMACEUTICAL USE AND COMPOSITIONS
<b>A61P 25/32</b> (2006.01)	2516445 *	TRICYCLIC DERIVATIVES AND THEIR PHARMACEUTICAL USE AND COMPOSITIONS
<b>C07D 491/20</b> (2006.01)	2516445 *	TRICYCLIC DERIVATIVES AND THEIR PHARMACEUTICAL USE AND COMPOSITIONS
<b>A61P 25/22</b> (2006.01)	2516445 *	TRICYCLIC DERIVATIVES AND THEIR PHARMACEUTICAL USE AND COMPOSITIONS
<b>C07D 491/048</b> (2006.01)	2516445 *	TRICYCLIC DERIVATIVES AND THEIR PHARMACEUTICAL USE AND COMPOSITIONS
<b>A61P 25/18</b> (2006.01)	2516445 *	TRICYCLIC DERIVATIVES AND THEIR PHARMACEUTICAL USE AND COMPOSITIONS
<b>B60V 3/08</b> (2006.01)	2508401 *	COMBINED AIRCRAFT
<b>B64C 5/06</b> (2006.01)	2508401 *	COMBINED AIRCRAFT
<b>A61L 17/14</b> (2006.01)	2425865	Medicinal thread having a polyhydroxyalkanoate coating
<b>B29C 44/12</b> (2006.01)	2536547 *	METHOD FOR PRODUCING WIND POWER PLANT ROTOR BLADES AND A WIND POWER PLANT ROTOR BLADE
<b>B29C 70/44</b> (2006.01)	2536547 *	METHOD FOR PRODUCING WIND POWER PLANT ROTOR BLADES AND A WIND POWER PLANT ROTOR BLADE
<b>B29C 45/14</b> (2006.01)	2536547 *	METHOD FOR PRODUCING WIND POWER PLANT ROTOR BLADES AND A WIND POWER PLANT ROTOR BLADE
<b>B29C 70/54</b> (2006.01)	2536547 *	METHOD FOR PRODUCING WIND POWER PLANT ROTOR BLADES AND A WIND POWER PLANT ROTOR BLADE
<b>A61M 5/32</b> (2006.01)	2536452 *	AUTO-INJECTOR
<b>A61M 5/00</b> (2006.01)	2536452 *	AUTO-INJECTOR
<b>A61M 5/20</b> (2006.01)	2536452 *	AUTO-INJECTOR
<b>A01K 95/00</b> (2006.01)	2476310	A ballast weight for a fishing line
<b>B41M 3/14</b> (2006.01)	2509794 *	MARKING BASED ON CHIRAL LIQUID CRYSTAL POLYMERS
<b>B42D 15/10</b> (2006.01)	2509794 *	MARKING BASED ON CHIRAL LIQUID CRYSTAL POLYMERS
<b>B42D 15/00</b> (2006.01)	2509794 *	MARKING BASED ON CHIRAL LIQUID CRYSTAL POLYMERS
<b>C09D 11/00</b> (2006.01)	2509794 *	MARKING BASED ON CHIRAL LIQUID CRYSTAL POLYMERS
<b>B41M 5/28</b> (2006.01)	2509794 *	MARKING BASED ON CHIRAL LIQUID CRYSTAL POLYMERS
<b>C09D 11/02</b> (2006.01)	2509794 *	MARKING BASED ON CHIRAL LIQUID CRYSTAL POLYMERS
<b>F27D 1/14</b> (2006.01)	2510298 *	COMPRESSIVE ROD ASSEMBLY FOR MOLTEN METAL CONTAINMENT STRUCTURE



MKP (51)	Broj objave evropske prijava patenta (97)	Naziv pronalaska (54)
<b>A61M 5/315</b> (2006.01)	2506901 *	DRIVE MECHANISM FOR DRUG DELIVERY DEVICES
<b>A61K 9/12</b> (2006.01)	2525802 *	A METHOD OF TREATING SINUSITIS, INCLUDING CHRONIC SINUSITIS
<b>A61P 11/02</b> (2006.01)	2525802 *	A METHOD OF TREATING SINUSITIS, INCLUDING CHRONIC SINUSITIS
<b>A61K 33/00</b> (2006.01)	2525802 *	A METHOD OF TREATING SINUSITIS, INCLUDING CHRONIC SINUSITIS
<b>A61K 33/14</b> (2006.01)	2525802 *	A METHOD OF TREATING SINUSITIS, INCLUDING CHRONIC SINUSITIS
<b>A61P 11/04</b> (2006.01)	2525802 *	A METHOD OF TREATING SINUSITIS, INCLUDING CHRONIC SINUSITIS
<b>C04B 28/14</b> (2006.01)	2507190 *	LIGHTWEIGHT GYPSUM PRODUCTS HAVING ENHANCED WATER RESISTANCE
<b>C04B 28/16</b> (2006.01)	2507190 *	LIGHTWEIGHT GYPSUM PRODUCTS HAVING ENHANCED WATER RESISTANCE
<b>A61H 39/02</b> (2006.01)	2512587 *	PLACEMENT DEVICES THAT ENABLE PATIENTS TO ACCURATELY POSITION MEDICAL PATCHES AT TARGET LOCATIONS AND METHODS THEREFOR
<b>A61N 1/04</b> (2006.01)	2512587 *	PLACEMENT DEVICES THAT ENABLE PATIENTS TO ACCURATELY POSITION MEDICAL PATCHES AT TARGET LOCATIONS AND METHODS THEREFOR
<b>A61N 1/08</b> (2006.01)	2512587 *	PLACEMENT DEVICES THAT ENABLE PATIENTS TO ACCURATELY POSITION MEDICAL PATCHES AT TARGET LOCATIONS AND METHODS THEREFOR
<b>A61M 5/00</b> (2006.01)	2536458 *	CLUTCH MECHANISM
<b>A61M 5/32</b> (2006.01)	2536458 *	CLUTCH MECHANISM
<b>A61M 5/20</b> (2006.01)	2536458 *	CLUTCH MECHANISM
<b>G04B 37/14</b> (2006.01)	2442192	Holder unit
<b>A44C 3/00</b> (2006.01)	2442192	Holder unit
<b>A61J 1/06</b> (2006.01)	2525763 *	A MULTI-DIMENSIONAL IDENTIFIER
<b>A61M 5/24</b> (2006.01)	2525763 *	A MULTI-DIMENSIONAL IDENTIFIER
<b>G06K 7/10</b> (2006.01)	2525763 *	A MULTI-DIMENSIONAL IDENTIFIER
<b>A61B 17/068</b> (2006.01)	2515768 *	MOTOR-DRIVEN SURGICAL CUTTING INSTRUMENT WITH ELECTRIC ACTUATOR DIRECTIONAL CONTROL ASSEMBLY
<b>A61B 17/072</b> (2006.01)	2515768 *	MOTOR-DRIVEN SURGICAL CUTTING INSTRUMENT WITH ELECTRIC ACTUATOR DIRECTIONAL CONTROL ASSEMBLY
<b>H01H 13/00</b> (2006.01)	2515768 *	MOTOR-DRIVEN SURGICAL CUTTING INSTRUMENT WITH ELECTRIC ACTUATOR DIRECTIONAL CONTROL ASSEMBLY
<b>A61B 17/00</b> (2006.01)	2515768 *	MOTOR-DRIVEN SURGICAL CUTTING INSTRUMENT WITH ELECTRIC ACTUATOR DIRECTIONAL CONTROL ASSEMBLY
<b>B42D 15/10</b> (2006.01)	2529940	Printed device with three dimensional appearance
<b>B41M 3/00</b> (2006.01)	2529940	Printed device with three dimensional appearance
<b>B44F 7/00</b> (2006.01)	2529940	Printed device with three dimensional appearance
<b>G02B 5/30</b> (2006.01)	2529940	Printed device with three dimensional appearance
<b>B41M 3/06</b> (2006.01)	2529940	Printed device with three dimensional appearance
<b>G02B 27/22</b> (2006.01)	2529940	Printed device with three dimensional appearance
<b>B65F 1/14</b> (2006.01)	2501631 *	DUMPSTER FOR HOLDING WASTE MATERIAL
<b>C07D 413/04</b> (2006.01)	2523949 *	NOVEL SUBSTITUTED TRIAZOLE DERIVATIVES AS GAMMA SECRETASE MODULATORS
<b>C07D 403/12</b> (2006.01)	2523949 *	NOVEL SUBSTITUTED TRIAZOLE DERIVATIVES AS GAMMA SECRETASE MODULATORS
<b>C07D 471/04</b> (2006.01)	2523949 *	NOVEL SUBSTITUTED TRIAZOLE DERIVATIVES AS GAMMA SECRETASE MODULATORS
<b>C07D 487/04</b> (2006.01)	2523949 *	NOVEL SUBSTITUTED TRIAZOLE DERIVATIVES AS GAMMA SECRETASE MODULATORS
<b>A61K 31/4196</b> (2006.01)	2523949 *	NOVEL SUBSTITUTED TRIAZOLE DERIVATIVES AS GAMMA SECRETASE MODULATORS
<b>C07D 401/14</b> (2006.01)	2523949 *	NOVEL SUBSTITUTED TRIAZOLE DERIVATIVES AS GAMMA SECRETASE MODULATORS
<b>A61P 25/28</b> (2006.01)	2523949 *	NOVEL SUBSTITUTED TRIAZOLE DERIVATIVES AS GAMMA SECRETASE MODULATORS

MKP (51)	Broj objave evropske prijava patenta (97)	Naziv pronalaska (54)
<b>C07D 401/12</b> (2006.01)	2523949 *	NOVEL SUBSTITUTED TRIAZOLE DERIVATIVES AS GAMMA SECRETASE MODULATORS
<b>C07D 403/14</b> (2006.01)	2523949 *	NOVEL SUBSTITUTED TRIAZOLE DERIVATIVES AS GAMMA SECRETASE MODULATORS
<b>C07D 403/10</b> (2006.01)	2523949 *	NOVEL SUBSTITUTED TRIAZOLE DERIVATIVES AS GAMMA SECRETASE MODULATORS
<b>A01H 1/00</b> (2006.01)	2512221 *	COMBINED USE OF CRY1DA AND CRY1FA PROTEINS FOR INSECT RESISTANCE MANAGEMENT
<b>A01H 5/00</b> (2006.01)	2512221 *	COMBINED USE OF CRY1DA AND CRY1FA PROTEINS FOR INSECT RESISTANCE MANAGEMENT
<b>A01P 7/00</b> (2006.01)	2512221 *	COMBINED USE OF CRY1DA AND CRY1FA PROTEINS FOR INSECT RESISTANCE MANAGEMENT
<b>A61K 38/18</b> (2006.01)	2506861 *	BINDING PROTEINS THAT BIND TO HUMAN FGFR1C, HUMAN B-KLOTHO AND BOTH HUMAN FGFR1C AND HUMAN B-KLOTHO
<b>C07K 14/475</b> (2006.01)	2506861 *	BINDING PROTEINS THAT BIND TO HUMAN FGFR1C, HUMAN B-KLOTHO AND BOTH HUMAN FGFR1C AND HUMAN B-KLOTHO
<b>A61K 38/00</b> (2006.01)	2506861 *	BINDING PROTEINS THAT BIND TO HUMAN FGFR1C, HUMAN B-KLOTHO AND BOTH HUMAN FGFR1C AND HUMAN B-KLOTHO
<b>A61K 31/445</b> (2006.01)	2520296	New association between 4-{3-[cis-hexahydrocyclopenta[c]pyrrol-2(1h)-yl]propoxy} benzamide and an acetylcholinesterase inhibitor, and pharmaceutical compositions containing it.
<b>A61K 31/403</b> (2006.01)	2520296	New association between 4-{3-[cis-hexahydrocyclopenta[c]pyrrol-2(1h)-yl]propoxy} benzamide and an acetylcholinesterase inhibitor, and pharmaceutical compositions containing it.
<b>A61K 45/06</b> (2006.01)	2520296	New association between 4-{3-[cis-hexahydrocyclopenta[c]pyrrol-2(1h)-yl]propoxy} benzamide and an acetylcholinesterase inhibitor, and pharmaceutical compositions containing it.
<b>A61K 31/55</b> (2006.01)	2520296	New association between 4-{3-[cis-hexahydrocyclopenta[c]pyrrol-2(1h)-yl]propoxy} benzamide and an acetylcholinesterase inhibitor, and pharmaceutical compositions containing it.
<b>A61P 25/16</b> (2006.01)	2520296	New association between 4-{3-[cis-hexahydrocyclopenta[c]pyrrol-2(1h)-yl]propoxy} benzamide and an acetylcholinesterase inhibitor, and pharmaceutical compositions containing it.
<b>A61K 31/27</b> (2006.01)	2520296	New association between 4-{3-[cis-hexahydrocyclopenta[c]pyrrol-2(1h)-yl]propoxy} benzamide and an acetylcholinesterase inhibitor, and pharmaceutical compositions containing it.
<b>A61P 25/28</b> (2006.01)	2520296	New association between 4-{3-[cis-hexahydrocyclopenta[c]pyrrol-2(1h)-yl]propoxy} benzamide and an acetylcholinesterase inhibitor, and pharmaceutical compositions containing it.
<b>A61K 9/20</b> (2006.01)	2520296	New association between 4-{3-[cis-hexahydrocyclopenta[c]pyrrol-2(1h)-yl]propoxy} benzamide and an acetylcholinesterase inhibitor, and pharmaceutical compositions containing it.
<b>C10L 5/44</b> (2006.01)	2504411 *	DEVICE AND METHOD FOR GENERATING A SYNTHESIS GAS FROM PROCESSED BIOMASS BY ENTRAINED-FLOW GASIFICATION
<b>C10J 3/46</b> (2006.01)	2504411 *	DEVICE AND METHOD FOR GENERATING A SYNTHESIS GAS FROM PROCESSED BIOMASS BY ENTRAINED-FLOW GASIFICATION
<b>C10J 3/66</b> (2006.01)	2504411 *	DEVICE AND METHOD FOR GENERATING A SYNTHESIS GAS FROM PROCESSED BIOMASS BY ENTRAINED-FLOW GASIFICATION
<b>C10B 53/02</b> (2006.01)	2504411 *	DEVICE AND METHOD FOR GENERATING A SYNTHESIS GAS FROM PROCESSED BIOMASS BY ENTRAINED-FLOW GASIFICATION
<b>B21B 1/085</b> (2006.01)	2504112 *	A METHOD OF ROLLING RAILS, APPARATUS FOR ROLLING RAILS AND RAIL PRODUCED ACCORDING TO SAID METHOD
<b>C07D 405/14</b> (2006.01)	2513093 *	NEW CCR2 RECEPTOR ANTAGONISTS AND USES THEREOF
<b>A61P 29/00</b> (2006.01)	2513093 *	NEW CCR2 RECEPTOR ANTAGONISTS AND USES THEREOF
<b>C07D 491/10</b> (2006.01)	2513093 *	NEW CCR2 RECEPTOR ANTAGONISTS AND USES THEREOF
<b>A61K 31/506</b> (2006.01)	2513093 *	NEW CCR2 RECEPTOR ANTAGONISTS AND USES THEREOF
<b>A61M 5/24</b> (2006.01)	2531233 *	CARTRIDGE HOLDER, DRUG DELIVERY DEVICE AND METHOD FOR SECURING A CARTRIDGE IN A CARTRIDGE HOLDER

MKP (51)	Broj objave evropske prijava patenta (97)	Naziv pronalaska (54)
<b>A61K 38/24</b> (2006.01)	2533800 *	LIQUID FORMULATION OF FOLLICLE STIMULATING HORMONE
<b>C07D 413/10</b> (2006.01)	2526092 *	AMINO HETEROARYL COMPOUNDS AS BETA-SECRETASE MODULATORS AND METHODS OF USE
<b>C07D 405/04</b> (2006.01)	2526092 *	AMINO HETEROARYL COMPOUNDS AS BETA-SECRETASE MODULATORS AND METHODS OF USE
<b>A61K 31/4709</b> (2006.01)	2526092 *	AMINO HETEROARYL COMPOUNDS AS BETA-SECRETASE MODULATORS AND METHODS OF USE
<b>C07D 215/38</b> (2006.01)	2526092 *	AMINO HETEROARYL COMPOUNDS AS BETA-SECRETASE MODULATORS AND METHODS OF USE
<b>C07D 471/08</b> (2006.01)	2526092 *	AMINO HETEROARYL COMPOUNDS AS BETA-SECRETASE MODULATORS AND METHODS OF USE
<b>C07D 405/10</b> (2006.01)	2526092 *	AMINO HETEROARYL COMPOUNDS AS BETA-SECRETASE MODULATORS AND METHODS OF USE
<b>A61P 25/28</b> (2006.01)	2526092 *	AMINO HETEROARYL COMPOUNDS AS BETA-SECRETASE MODULATORS AND METHODS OF USE
<b>C07D 405/12</b> (2006.01)	2526092 *	AMINO HETEROARYL COMPOUNDS AS BETA-SECRETASE MODULATORS AND METHODS OF USE
<b>C07D 403/10</b> (2006.01)	2526092 *	AMINO HETEROARYL COMPOUNDS AS BETA-SECRETASE MODULATORS AND METHODS OF USE
<b>A61K 31/47</b> (2006.01)	2526092 *	AMINO HETEROARYL COMPOUNDS AS BETA-SECRETASE MODULATORS AND METHODS OF USE
<b>C07D 471/04</b> (2006.01)	2526092 *	AMINO HETEROARYL COMPOUNDS AS BETA-SECRETASE MODULATORS AND METHODS OF USE
<b>C07D 401/10</b> (2006.01)	2526092 *	AMINO HETEROARYL COMPOUNDS AS BETA-SECRETASE MODULATORS AND METHODS OF USE
<b>C07D 498/08</b> (2006.01)	2526092 *	AMINO HETEROARYL COMPOUNDS AS BETA-SECRETASE MODULATORS AND METHODS OF USE
<b>F26B 23/00</b> (2006.01)	2511637	Method for drying wet particulate matter, wherein the dried particulate matter is a white mineral having a brightness Ry of at least 65%, through drying in a direct superheated steam dryer
<b>F26B 11/16</b> (2006.01)	2511637	Method for drying wet particulate matter, wherein the dried particulate matter is a white mineral having a brightness Ry of at least 65%, through drying in a direct superheated steam dryer
<b>A01P 7/00</b> (2006.01)	2512218 *	INSECT RESISTANCE MANAGEMENT WITH COMBINATIONS OF CRY1BE AND CRY1F PROTEINS
<b>A01H 5/00</b> (2006.01)	2512218 *	INSECT RESISTANCE MANAGEMENT WITH COMBINATIONS OF CRY1BE AND CRY1F PROTEINS
<b>A01H 1/00</b> (2006.01)	2512218 *	INSECT RESISTANCE MANAGEMENT WITH COMBINATIONS OF CRY1BE AND CRY1F PROTEINS
<b>A61K 9/00</b> (2006.01)	2515855 *	Combination therapy for COPD
<b>A61K 31/167</b> (2006.01)	2515855 *	Combination therapy for COPD
<b>A61K 45/06</b> (2006.01)	2515855 *	Combination therapy for COPD
<b>A61K 31/40</b> (2006.01)	2515855 *	Combination therapy for COPD
<b>A61P 35/00</b> (2006.01)	2524232 *	METHODS FOR PREDICTING RESPONSE OF TRIPLE-NEGATIVE BREAST CANCER TO THERAPY
<b>G01N 33/574</b> (2006.01)	2524232 *	METHODS FOR PREDICTING RESPONSE OF TRIPLE-NEGATIVE BREAST CANCER TO THERAPY
<b>C12Q 1/68</b> (2006.01)	2524232 *	METHODS FOR PREDICTING RESPONSE OF TRIPLE-NEGATIVE BREAST CANCER TO THERAPY
<b>G01N 33/15</b> (2006.01)	2524232 *	METHODS FOR PREDICTING RESPONSE OF TRIPLE-NEGATIVE BREAST CANCER TO THERAPY
<b>C07D 491/04</b> (2006.01)	2513096 *	SUBSTITUTED AMINOTHIAZOLONE INDAZOLES AS ESTROGEN RELATED RECEPTOR-A MODULATORS
<b>C07D 487/08</b> (2006.01)	2513096 *	SUBSTITUTED AMINOTHIAZOLONE INDAZOLES AS ESTROGEN RELATED RECEPTOR-A MODULATORS
<b>A61K 31/496</b> (2006.01)	2513096 *	SUBSTITUTED AMINOTHIAZOLONE INDAZOLES AS ESTROGEN RELATED RECEPTOR-A MODULATORS

MKP (51)	Broj objave evropske prijava patenta (97)	Naziv pronalaska (54)
<b>C07D 417/10</b> (2006.01)	2513096 *	SUBSTITUTED AMINOTHIAZOLONE INDAZOLES AS ESTROGEN RELATED RECEPTOR-A MODULATORS
<b>C07D 417/14</b> (2006.01)	2513096 *	SUBSTITUTED AMINOTHIAZOLONE INDAZOLES AS ESTROGEN RELATED RECEPTOR-A MODULATORS
<b>C07D 417/06</b> (2006.01)	2513096 *	SUBSTITUTED AMINOTHIAZOLONE INDAZOLES AS ESTROGEN RELATED RECEPTOR-A MODULATORS
<b>A61P 35/00</b> (2006.01)	2513096 *	SUBSTITUTED AMINOTHIAZOLONE INDAZOLES AS ESTROGEN RELATED RECEPTOR-A MODULATORS
<b>B32B 7/00</b> (2006.01)	2535178	Registered stretch laminate and methods for forming a registered stretch laminate
<b>B32B 7/04</b> (2006.01)	2535178	Registered stretch laminate and methods for forming a registered stretch laminate
<b>B32B 27/00</b> (2006.01)	2535178	Registered stretch laminate and methods for forming a registered stretch laminate
<b>B32B 27/08</b> (2006.01)	2535178	Registered stretch laminate and methods for forming a registered stretch laminate
<b>B32B 25/08</b> (2006.01)	2535178	Registered stretch laminate and methods for forming a registered stretch laminate
<b>B32B 5/04</b> (2006.01)	2535178	Registered stretch laminate and methods for forming a registered stretch laminate
<b>B32B 3/26</b> (2006.01)	2535178	Registered stretch laminate and methods for forming a registered stretch laminate
<b>B32B 5/02</b> (2006.01)	2535178	Registered stretch laminate and methods for forming a registered stretch laminate
<b>B32B 25/00</b> (2006.01)	2535178	Registered stretch laminate and methods for forming a registered stretch laminate
<b>F23J 15/06</b> (2006.01)	2501786 *	THERMAL-CHEMICAL UTILIZATION OF CARBON-CONTAINING MATERIALS, IN PARTICULAR FOR THE EMISSION-FREE GENERATION OF ENERGY
<b>C07C 29/151</b> (2006.01)	2501786 *	THERMAL-CHEMICAL UTILIZATION OF CARBON-CONTAINING MATERIALS, IN PARTICULAR FOR THE EMISSION-FREE GENERATION OF ENERGY
<b>C10G 2/00</b> (2006.01)	2501786 *	THERMAL-CHEMICAL UTILIZATION OF CARBON-CONTAINING MATERIALS, IN PARTICULAR FOR THE EMISSION-FREE GENERATION OF ENERGY
<b>F01K 23/06</b> (2006.01)	2501786 *	THERMAL-CHEMICAL UTILIZATION OF CARBON-CONTAINING MATERIALS, IN PARTICULAR FOR THE EMISSION-FREE GENERATION OF ENERGY
<b>C10J 3/66</b> (2006.01)	2501786 *	THERMAL-CHEMICAL UTILIZATION OF CARBON-CONTAINING MATERIALS, IN PARTICULAR FOR THE EMISSION-FREE GENERATION OF ENERGY
<b>F02C 3/28</b> (2006.01)	2501786 *	THERMAL-CHEMICAL UTILIZATION OF CARBON-CONTAINING MATERIALS, IN PARTICULAR FOR THE EMISSION-FREE GENERATION OF ENERGY
<b>A01D 43/08</b> (2006.01)	2452550	Agricultural harvester
<b>C07K 16/40</b> (2006.01)	2510013 *	PCSK9 ANTAGONISTS
<b>A61P 3/06</b> (2006.01)	2510013 *	PCSK9 ANTAGONISTS
<b>A61K 39/395</b> (2006.01)	2510013 *	PCSK9 ANTAGONISTS
<b>C02F 1/74</b> (2006.01)	2451747 *	PURIFYING DEVICE AND METHOD FOR ELIMINATION OF XENOBIOTICS IN WATER
<b>C02F 1/32</b> (2006.01)	2451747 *	PURIFYING DEVICE AND METHOD FOR ELIMINATION OF XENOBIOTICS IN WATER
<b>C02F 1/44</b> (2006.01)	2451747 *	PURIFYING DEVICE AND METHOD FOR ELIMINATION OF XENOBIOTICS IN WATER
<b>C02F 1/72</b> (2006.01)	2451747 *	PURIFYING DEVICE AND METHOD FOR ELIMINATION OF XENOBIOTICS IN WATER
<b>A61K 35/12</b> (2006.01)	2513311 *	PRODUCTION OF IFN-LAMBDA BY CONVENTIONAL DENDRITIC CELLS AND USES THEREOF
<b>C12N 15/117</b> (2010.01)	2513311 *	PRODUCTION OF IFN-LAMBDA BY CONVENTIONAL DENDRITIC CELLS AND USES THEREOF
<b>A61P 37/04</b> (2006.01)	2513311 *	PRODUCTION OF IFN-LAMBDA BY CONVENTIONAL DENDRITIC CELLS AND USES THEREOF
<b>B01J 19/18</b> (2006.01)	2516051 *	REACTOR COMPRISING A ROTOR
<b>B01J 8/10</b> (2006.01)	2516051 *	REACTOR COMPRISING A ROTOR
<b>B02C 13/04</b> (2006.01)	2516051 *	REACTOR COMPRISING A ROTOR
<b>A61K 31/4436</b> (2006.01)	2523950 *	INHIBITORS OF FLAVIVIRIDAE VIRUSES
<b>A61P 31/00</b> (2006.01)	2523950 *	INHIBITORS OF FLAVIVIRIDAE VIRUSES
<b>A61K 31/381</b> (2006.01)	2523950 *	INHIBITORS OF FLAVIVIRIDAE VIRUSES

MKP (51)	Broj objave evropske prijava patenta (97)	Naziv pronalaska (54)
<b>C07D 409/12</b> (2006.01)	2523950 *	INHIBITORS OF FLAVIVIRIDAE VIRUSES
<b>A61M 5/00</b> (2006.01)	2512553 *	MEDICAL DEVICE AND METHOD OF ASSEMBLY
<b>H01L 41/053</b> (2006.01)	2426749	Actuator arrangement for use in a fuel injector
<b>E03D 9/08</b> (2006.01)	2295653	Toilet with bidet function
<b>A61H 33/14</b> (2006.01)	2295653	Toilet with bidet function
<b>C08L 67/06</b> (2006.01)	2513224 *	CONDUCTIVE TANK SUMP AND DISPENSER SUMP, AND METHOD OF EARTHING PROCESS OF THE SAME, AND ELECTRICALLY-CONDUCTIVE COMPOSITION FOR FABRICATION OF TANK SUMP
<b>H01B 1/24</b> (2006.01)	2513224 *	CONDUCTIVE TANK SUMP AND DISPENSER SUMP, AND METHOD OF EARTHING PROCESS OF THE SAME, AND ELECTRICALLY-CONDUCTIVE COMPOSITION FOR FABRICATION OF TANK SUMP
<b>C08K 3/04</b> (2006.01)	2513224 *	CONDUCTIVE TANK SUMP AND DISPENSER SUMP, AND METHOD OF EARTHING PROCESS OF THE SAME, AND ELECTRICALLY-CONDUCTIVE COMPOSITION FOR FABRICATION OF TANK SUMP
<b>A61K 31/549</b> (2006.01)	2521552 *	DIAZOXIDE FOR USE IN THE TREATMENT OF A CENTRAL NERVOUS SYSTEM (CNS) AUTOIMMUNE DEMYELINATING DISEASE
<b>A61P 25/00</b> (2006.01)	2521552 *	DIAZOXIDE FOR USE IN THE TREATMENT OF A CENTRAL NERVOUS SYSTEM (CNS) AUTOIMMUNE DEMYELINATING DISEASE
<b>C12Q 1/68</b> (2006.01)	2519649 *	TOOL FOR DIAGNOSIS AND PROGNOSIS OF MATURE B-CELL NEOPLASMS
<b>C07D 401/06</b> (2006.01)	2528910 *	5-ALKYNYL PYRIMIDINES AND THEIR USE AS KINASE INHIBITORS
<b>A61K 31/506</b> (2006.01)	2528910 *	5-ALKYNYL PYRIMIDINES AND THEIR USE AS KINASE INHIBITORS
<b>C07D 491/113</b> (2006.01)	2528910 *	5-ALKYNYL PYRIMIDINES AND THEIR USE AS KINASE INHIBITORS
<b>C07D 487/04</b> (2006.01)	2528910 *	5-ALKYNYL PYRIMIDINES AND THEIR USE AS KINASE INHIBITORS
<b>C07D 401/14</b> (2006.01)	2528910 *	5-ALKYNYL PYRIMIDINES AND THEIR USE AS KINASE INHIBITORS
<b>A61P 35/00</b> (2006.01)	2528910 *	5-ALKYNYL PYRIMIDINES AND THEIR USE AS KINASE INHIBITORS
<b>C07D 405/14</b> (2006.01)	2528910 *	5-ALKYNYL PYRIMIDINES AND THEIR USE AS KINASE INHIBITORS
<b>C07D 413/14</b> (2006.01)	2528910 *	5-ALKYNYL PYRIMIDINES AND THEIR USE AS KINASE INHIBITORS
<b>C07D 471/10</b> (2006.01)	2528910 *	5-ALKYNYL PYRIMIDINES AND THEIR USE AS KINASE INHIBITORS
<b>C07D 498/04</b> (2006.01)	2528910 *	5-ALKYNYL PYRIMIDINES AND THEIR USE AS KINASE INHIBITORS
<b>B65D 81/32</b> (2006.01)	2519457 *	DRINKING BOTTLE WITH MULTIPLE COMPARTMENTS AND REPLACEABLE AMPOULES
<b>A61J 9/00</b> (2006.01)	2519457 *	DRINKING BOTTLE WITH MULTIPLE COMPARTMENTS AND REPLACEABLE AMPOULES
<b>B65D 47/24</b> (2006.01)	2519457 *	DRINKING BOTTLE WITH MULTIPLE COMPARTMENTS AND REPLACEABLE AMPOULES
<b>A45F 3/16</b> (2006.01)	2519457 *	DRINKING BOTTLE WITH MULTIPLE COMPARTMENTS AND REPLACEABLE AMPOULES









**INDEKS PODNOSITELJA ZAHTEVA ZA PROŠIRENJE EVROPSKIH PRIJAVA  
PATENTA**

**INDEX ON NUMBER OF APPLICATIONS FOR EXTENSION OF EUROPEAN  
PATENT APPLICATION**

Podnosilac evropske prijave patenta (71)	MKP (51)	Broj objave evropske prijave patenta (97)	Naziv pronalaska (54)
Merz Pharma GmbH & Co. KGaA	<b>A61K 8/55</b> (2006.01) <b>A61Q 19/00</b> (2006.01) <b>A61K 8/41</b> (2006.01) <b>A61K 8/73</b> (2006.01) <b>A61K 8/19</b> (2006.01) <b>A61K 8/97</b> (2006.01) <b>A61K 8/49</b> (2006.01) <b>A61Q 7/00</b> (2006.01) <b>A61K 8/60</b> (2006.01) <b>A61K 8/67</b> (2006.01)	2533752 *	PREPARATIONS FOR STABILISING/FORMING THE TEXTURE OF LIVING TISSUE SUCH AS SKIN, AND USES THEREOF
Bozo B.V.	<b>A61K 36/53</b> (2006.01) <b>A61K 36/53A</b> (2006.01) <b>A61P 15/08</b> (2006.01) <b>A61K 36/288</b> (2006.01)	2452689	Phytherapeutic preparation with stimulatory effect on libido and spermatogenesis
I.Quattro S.r.l.	<b>E05C 17/02</b> (2006.01) <b>E05C 17/24</b> (2006.01)	2439364	Articulated shutter holder
Pécsi Tudományegyetem	<b>G06T 7/60</b> (2006.01) <b>A61B 5/103</b> (2006.01)	2528504 *	A METHOD AND A SYSTEM FOR MULTI-DIMENSIONAL VISUALIZATION OF THE SPINAL COLUMN BY VERTEBRA VECTORS, SACRUM VECTOR, SACRUM PLATEAU VECTOR AND PELVIS VECTORS
Nipd Genetics Ltd	<b>C12Q 1/68</b> (2006.01)	2529032 *	METHODS AND COMPOSITIONS FOR NONINVASIVE PRENATAL DIAGNOSIS OF FETAL ANEUPLOIDIES
Alexion Pharmaceuticals, Inc.	<b>C07K 16/28</b> (2006.01) <b>A61K 39/395</b> (2006.01)	2534178 *	THERAPEUTIC METHODS USING AN TI-CD200 ANTIBODIES
Temasek Polytechnic	<b>B01D 71/82</b> (2006.01) <b>C12N 11/06</b> (2006.01) <b>B01J 20/28</b> (2006.01) <b>B01D 61/28</b> (2006.01) <b>G01N 33/48</b> (2006.01) <b>A61M 1/14</b> (2006.01) <b>B01J 20/22</b> (2006.01) <b>B01D 61/24</b> (2006.01)	2536485 *	A SUBSTRATE FOR IMMOBILIZING FUNCTIONAL SUBSTANCES AND METHOD FOR PREPARING THE SAME
GlaxoSmithKline LLC	<b>A61K 31/397</b> (2006.01)	2501379 *	COMBINATION
Trüb AG	<b>B42D 1/00</b> (2006.01) <b>B42D 13/00</b> (2006.01) <b>B42D 15/10</b> (2006.01)	2433809	Data pages for book-like documents and method of producing such data pages
SANOFI	<b>A61P 9/00</b> (2006.01) <b>A61K 31/519</b> (2006.01) <b>C07D 498/04</b> (2006.01)	2523961 *	2,5,7-SUBSTITUTED OXAZOLOPYRIMIDINE DERIVATIVES
Sanofi-Aventis Deutschland GmbH	<b>A61M 5/32</b> (2006.01) <b>A61M 5/20</b> (2006.01)	2536453 *	AUTO-INJECTOR
Delphi Technologies Holding S.à.r.l.	<b>F04C 15/00</b> (2006.01) <b>F16D 1/06</b> (2006.01) <b>F04C 2/344</b> (2006.01)	2434158	Drive shaft for a positive displacement pump
Dongkook Pharmaceutical Co., Ltd.	<b>A23L 1/30</b> (2006.01) <b>A61K 36/536</b> (2006.01) <b>A61P 25/00</b> (2006.01)	2515924 *	A COMPOSITION COMPRISING THE EXTRACT OF PRUNELLA VULGARIS L. FOR PREVENTING AND TREATING ADHD DISEASE AND THE USE THEREOF
Teraspan Networks Inc.	<b>H02G 3/04</b> (2006.01) <b>G02B 6/46</b> (2006.01)	2537058 *	DUCT SYSTEM FOR FIBRE OPTIC COMPONENTS
McNEIL-PPC, Inc.	<b>G09B 23/32</b> (2006.01)	2534651 *	METHOD AND APPARATUS FOR IN VITRO TESTING FOR MEDICAL DEVICES

Podnosilac evropske prijave patenta (71)	MKP (51)	Broj objave evropske prijave patenta (97)	Naziv pronalaska (54)
Mochida Pharmaceutical Co., Ltd.	<b>C07D 401/12</b> (2006.01) <b>A61P 43/00</b> (2006.01) <b>A61P 25/04</b> (2006.01) <b>C07D 417/12</b> (2006.01) <b>C07D 311/68</b> (2006.01) <b>C07D 405/04</b> (2006.01) <b>A61K 31/454</b> (2006.01) <b>C07D 405/14</b> (2006.01) <b>A61K 31/4433</b> (2006.01) <b>C07D 405/12</b> (2006.01) <b>A61K 31/496</b> (2006.01) <b>C07D 413/04</b> (2006.01) <b>A61K 31/501</b> (2006.01) <b>C07D 413/12</b> (2006.01)	2518064 *	NOVEL ARYL UREA DERIVATIVE
Galderma Research & Development	<b>A61Q 19/00</b> (2006.01) <b>C07C 409/34</b> (2006.01) <b>A61K 8/38</b> (2006.01)	2509569 *	DERIVATIVES OF NOVEL PEROXIDES, METHOD OF PREPARATION THEREOF AND USE THEREOF IN HUMAN MEDICINE AS WELL AS IN COSMETICS FOR THE TREATMENT OR PREVENTION OF ACNE
Laboratorios del. Dr. Esteve, S.A.	<b>A61K 9/16</b> (2006.01) <b>A61P 25/00</b> (2006.01) <b>A61K 31/4152</b> (2006.01) <b>C07D 231/22</b> (2006.01)	2503993 *	4-[2-[[5-METHYL-1-(2-NAPHTALENYL)-1H-PYRAZOL-3-YL]OXY]ETHYL]MORPHOLINE SALTS
Omya Development AG	<b>D21H 17/00</b> (2006.01) <b>C09C 1/02</b> (2006.01)	2505615	Self-binding pigment hybrid
Bayer Intellectual Property GmbH	<b>A61P 35/00</b> (2006.01) <b>C07K 16/28</b> (2006.01) <b>A61P 5/08</b> (2006.01) <b>A61K 39/395</b> (2006.01)	2510002 *	NEUTRALIZING PROLACTIN RECEPTOR ANTIBODIES AND THEIR THERAPEUTIC USE
The Trustees Of The University Of Pennsylvania	<b>A61K 39/39</b> (2006.01) <b>A61K 39/395</b> (2006.01) <b>A61K 35/12</b> (2006.01)	2531216 *	ICOS CRITICALLY REGULATES THE EXPANSION AND FUNCTION OF INFLAMMATORY HUMAN TH17 CELLS
TriMark Corporation	<b>G07C 9/00</b> (2006.01) <b>B60R 25/00</b> (2006.01)	2521100	Vehicular security system with configurable immobilization features
PerkinElmer Health Sciences, Inc.	<b>G01N 21/31</b> (2006.01)	2502050 *	PHOTONIC MEASUREMENT INSTRUMENT USING NON-SOLARIZING UV GRADE FIBER OPTICS
SICPA Holding SA	<b>B41M 5/28</b> (2006.01) <b>B41M 3/14</b> (2006.01) <b>B42D 15/00</b> (2006.01) <b>B42D 15/10</b> (2006.01)	2509795 *	CHIRAL LIQUID CRYSTAL POLYMER MARKING
Ascendis Pharma A/S	<b>A61K 47/48</b> (2006.01)	2525831 *	CARRIER-LINKED CARBAMATE PRODRUG LINKERS
Cephalon, Inc.	<b>C07F 5/02</b> (2006.01)	2516449 *	PROTEASOME INHIBITORS AND PROCESSES FOR THEIR PREPARATION, PURIFICATION AND USE
Zhejiang Ledison Optoelectronics Co., Ltd.	<b>F21V 19/00</b> (2006.01) <b>F21Y 101/02</b> (2006.01) <b>F21V 29/00</b> (2006.01) <b>F21V 23/00</b> (2006.01)	2535640 *	LED LAMP BULB AND LED LIGHTING BAR CAPABLE OF EMITTING LIGHT OVER 4
Coskunöz Metal Form Makina Endüstrive Tic. A.S.	<b>F24D 19/06</b> (2006.01)	2515047	A radiator and a related intermediate connection piece
Vascular Biogenics Ltd.	<b>C12N 15/00</b> (2006.01)	2521776 *	METHODS FOR USE OF A SPECIFIC ANTI-ANGIOGENIC ADENOVIRAL AGENT
Prayon	<b>C01B 25/37</b> (2006.01) <b>H01M 4/58</b> (2010.01) <b>H01M 4/62</b> (2006.01) <b>H01M 4/04</b> (2006.01) <b>H01M 10/0525</b> (2010.01) <b>H01M 4/139</b> (2010.01)	2529433 *	LITHIUM BATTERIES CONTAINING LITHIUM-BEARING IRON PHOSPHATE AND CARBON

Podnosilac evropske prijave patenta (71)	MKP (51)	Broj objave evropske prijave patenta (97)	Naziv pronalaska (54)
Commissariat à l'Energie Atomique	<b>C01B 25/37</b> (2006.01) <b>H01M 4/58</b> (2010.01) <b>H01M 4/62</b> (2006.01) <b>H01M 4/04</b> (2006.01) <b>H01M 10/0525</b> (2010.01) <b>H01M 4/139</b> (2010.01)	2529433 *	LITHIUM BATTERIES CONTAINING LITHIUM-BEARING IRON PHOSPHATE AND CARBON
OMG Additives Limited	<b>C08K 5/34</b> (2006.01) <b>C08K 9/00</b> (2006.01)	2521750 *	CURING LIQUIDS
Richter Gedeon Nyrt.	<b>A61K 33/30</b> (2006.01) <b>A61K 31/728</b> (2006.01)	2501391 *	PHARMACEUTICAL COMPOSITION FOR THE TREATMENT OF BLADDER DISORDERS
Sanofi-Aventis Deutschland GmbH	<b>A61M 5/32</b> (2006.01) <b>A61M 5/00</b> (2006.01) <b>A61M 5/20</b> (2006.01)	2536451 *	AUTO-INJECTOR WITH A TORSION SPRING
Urbantech S.R.L.	<b>E01F 15/04</b> (2006.01) <b>E01F 8/00</b> (2006.01) <b>E01F 15/08</b> (2006.01)	2511422	A support base for the fencing of a building yard provided with an integrated guardrail
Ares Trading S.A.	<b>G01N 33/53</b> (2006.01) <b>C07K 4/00</b> (2006.01)	2526420 *	METHODS FOR IMPROVING THE DESIGN, BIOAVAILABILITY, AND EFFICACY OF RANDOM SEQUENCE POLYMER COMPOSITIONS VIA SERUM PROTEIN-BASED DETECTION OF RANDOM SEQUENCE POLYMER COMPOSITIONS
Presano AG	<b>E03D 11/14</b> (2006.01) <b>E03D 9/08</b> (2006.01)	2531661 *	TECHNICAL UNIT FOR A SANITARY FIXTURE
Taisho Pharmaceutical Co., Ltd.	<b>A61K 47/38</b> (2006.01) <b>A61K 47/32</b> (2006.01) <b>A61K 31/513</b> (2006.01) <b>A61P 11/06</b> (2006.01)	2535048 *	EXTENDED RELEASE PREPARATION
Nissan Chemical Industries, Ltd.	<b>A61K 47/38</b> (2006.01) <b>A61K 47/32</b> (2006.01) <b>A61K 31/513</b> (2006.01) <b>A61P 11/06</b> (2006.01)	2535048 *	EXTENDED RELEASE PREPARATION
Meiji Seika Pharma Co., Ltd.	<b>A61K 31/08</b> (2006.01) <b>A61K 31/704</b> (2006.01) <b>C07J 63/00</b> (2006.01) <b>A61K 31/56</b> (2006.01) <b>A61K 31/136</b> (2006.01) <b>A61K 31/135</b> (2006.01) <b>A61K 31/19</b> (2006.01) <b>A61K 31/185</b> (2006.01) <b>A61K 31/085</b> (2006.01) <b>A61P 1/16</b> (2006.01) <b>A61K 31/12</b> (2006.01) <b>A61P 31/14</b> (2006.01)	2514759 *	TRITERPENE DERIVATIVE, AND PROPHYLACTIC OR THERAPEUTIC AGENT FOR CHRONIC HEPATITIS C
Exelixis, Inc.	<b>C07D 403/12</b> (2006.01) <b>A61K 31/4164</b> (2006.01) <b>C07D 233/64</b> (2006.01) <b>A61P 3/04</b> (2006.01) <b>A61K 31/4178</b> (2006.01) <b>A61K 31/4439</b> (2006.01) <b>C07D 233/84</b> (2006.01) <b>A61K 31/454</b> (2006.01) <b>A61K 31/496</b> (2006.01)	2509960 *	TGR5 AGONISTS
Altaca Insaat ve Dis Ticaret A.S.	<b>C10G 1/08</b> (2006.01)	2513252 *	CONVERSION OF ORGANIC MATTER INTO OIL
Teikoku Seiyaku Co., Ltd.	<b>A61K 31/192</b> (2006.01) <b>A61K 47/32</b> (2006.01) <b>A61K 47/16</b> (2006.01) <b>A61P 29/00</b> (2006.01) <b>A61P 23/02</b> (2006.01) <b>A61K 9/70</b> (2006.01) <b>A61K 31/167</b> (2006.01)	2514419 *	FELBINAC-CONTAINING TRANSDERMAL ABSORPTION PREPARATION
Donaldson Company, Inc.	<b>B01D 39/20</b> (2006.01)	2533877 *	LIQUID FILTRATION MEDIA

Podnosilac evropske prijave patenta (71)	MKP (51)	Broj objave evropske prijave patenta (97)	Naziv pronalaska (54)
Lascco SA	<b>C07K 14/52</b> (2006.01)	2501720 *	IFN INHIBITORS IN THE TREATMENT OF MOTONEURON DISEASES
INSERM (Institut National de la Santé et de la Recherche Médicale)	<b>C07K 14/52</b> (2006.01)	2501720 *	IFN INHIBITORS IN THE TREATMENT OF MOTONEURON DISEASES
Université d'Aix-Marseille	<b>C07K 14/52</b> (2006.01)	2501720 *	IFN INHIBITORS IN THE TREATMENT OF MOTONEURON DISEASES
Chiesi Farmaceutici S.p.A.	<b>A61K 31/7036</b> (2006.01) <b>A61K 9/00</b> (2006.01)	2512439 *	ANTIBIOTIC MICROPARTICLES FOR INHALATION
IMG Institut für medizinische Genomforschung Planungsgesellschaft M.B.H.	<b>G01N 33/574</b> (2006.01)	2529229 *	DIAGNOSING PROSTATE CANCER RELAPSE
Salix Pharmaceuticals, Ltd.	<b>A61K 31/44</b> (2006.01) <b>A01N 43/42</b> (2006.01)	2536282 *	METHODS FOR TREATING INFECTION
Board of Regents of the University of Texas System	<b>A61K 31/44</b> (2006.01) <b>A01N 43/42</b> (2006.01)	2536282 *	METHODS FOR TREATING INFECTION
GlaxoSmithKline LLC	<b>A61P 35/00</b> (2006.01) <b>A61P 31/00</b> (2006.01) <b>A61K 31/522</b> (2006.01) <b>A61P 29/00</b> (2006.01) <b>A61P 37/08</b> (2006.01) <b>C07D 473/18</b> (2006.01) <b>A61P 11/06</b> (2006.01)	2534149 *	6-AMINO-2-[[ (1S)-1-METHYLBUTYL]OXY]-9-[5-(1-PIPERIDINYL)-7,9-DIHYDRO-8H-PURIN-8-ONE MALEATE
S.P.C.M. SA	<b>C09K 8/588</b> (2006.01) <b>C09K 8/12</b> (2006.01) <b>C09K 8/68</b> (2006.01)	2528984 *	WATER-SOLUBLE POLYMERS FOR OIL RECOVERY
Maria Clementine Martin Klosterfrau Vertriebsgesellschaft mbH	<b>A61K 31/49</b> (2006.01) <b>A61P 43/00</b> (2006.01)	2432471 *	NOVEL THERAPEUTIC CONCEPTS FOR TREATING FIBROMYALGIA
JX Nippon Oil & Energy Corporation	<b>C07C 49/643</b> (2006.01) <b>C07C 45/80</b> (2006.01) <b>C07C 45/68</b> (2006.01)	2535324 *	5-NORBORNENE-2-SPIRO- A-CYCLOALKANONE-A'-SPIRO-2''-5''-NORBORNENE AND METHOD FOR PRODUCING SAME
Recro Pharma, Inc.	<b>A61K 31/415</b> (2006.01) <b>A61P 25/06</b> (2006.01) <b>A61P 35/00</b> (2006.01) <b>A61K 9/06</b> (2006.01) <b>A61P 25/00</b> (2006.01)	2521544 *	TOPICAL TRANSDERMAL DEXMEDETOMIDINE COMPOSITIONS AND METHODS OF USE THEREOF
GlaxoSmithKline Biologicals S.A.	<b>A61K 39/04</b> (2006.01)	2528621 *	MODIFIED TUBERCULOSIS ANTIGENS
Glaxo Group Limited	<b>A61K 39/04</b> (2006.01)	2528621 *	MODIFIED TUBERCULOSIS ANTIGENS
EAO Holding AG	<b>H01H 3/12</b> (2006.01) <b>H01H 13/06</b> (2006.01) <b>H01H 13/02</b> (2006.01) <b>H02B 1/044</b> (2006.01)	2474987	Built-in switch
"Applied Physics Science And Technology Center" Company With Limited Responsibility	<b>G01N 22/00</b> (2006.01) <b>G06T 7/60</b> (2006.01)	2505996 *	METHOD FOR REMOTELY INSPECTING A TARGET IN A MONITORED AREA
Dow AgroSciences LLC	<b>A01H 5/00</b> (2006.01) <b>C07K 14/325</b> (2006.01)	2512224 *	MODIFIED CRY1CA INSECTICIDAL CRY PROTEINS

Podnosilac evropske prijave patenta (71)	MKP (51)	Broj objave evropske prijave patenta (97)	Naziv pronalaska (54)
Abbott Laboratories	<b>C12R 1/225</b> (2006.01) <b>A61P 17/00</b> (2006.01) <b>A61K 35/74</b> (2006.01) <b>A61K 39/00</b> (2006.01) <b>A23L 1/30</b> (2006.01) <b>C07H 3/06</b> (2006.01) <b>A61K 31/702</b> (2006.01) <b>A61P 11/06</b> (2006.01) <b>A61P 37/08</b> (2006.01) <b>A61P 11/00</b> (2006.01)	2525811 *	NUTRITIONAL FORMULAS CONTAINING SYNBIOTICS
Bmob Sagl	<b>G08G 1/14</b> (2006.01)	2447927	System and process for estimating the availability and/or occupied status of car parks located in a given urban area at a given time
Libramedicina, Inc.	<b>C07D 317/18</b> (2006.01) <b>C07D 333/78</b> (2006.01) <b>C07D 333/32</b> (2006.01)	2513081 *	PROCESS FOR PREPARING SUBSTITUTED 1-O-ACYL-2-DEOXY-2-FLUORO-4-THIO-D-ARABINOFURANOSSES
MMV Medicines for Malaria Venture	<b>C07D 413/10</b> (2006.01) <b>C07D 401/10</b> (2006.01) <b>A61K 31/44</b> (2006.01) <b>C07D 417/04</b> (2006.01) <b>C07D 401/14</b> (2006.01) <b>A61K 31/4427</b> (2006.01) <b>C07D 405/04</b> (2006.01) <b>A61P 33/06</b> (2006.01) <b>C07D 401/04</b> (2006.01) <b>C07D 471/06</b> (2006.01) <b>C07D 413/14</b> (2006.01) <b>C07D 213/73</b> (2006.01) <b>C07D 417/14</b> (2006.01)	2526090 *	NEW ANTI-MALARIAL AGENTS
Merck Serono S.A.	<b>A61K 39/395</b> (2006.01) <b>C07K 16/46</b> (2006.01) <b>A61P 17/06</b> (2006.01) <b>A61P 37/00</b> (2006.01) <b>C07K 16/28</b> (2006.01)	2512511 *	HUMANIZED ANTIBODIES AGAINST HUMAN IL-22RA
Spirogen Developments SARL	<b>C07D 487/04</b> (2006.01) <b>A61P 35/00</b> (2006.01) <b>A61K 47/48</b> (2006.01)	2528625 *	PYRROLOBENZODIAZEPINES AND CONJUGATES THEREOF
Hexagon Technology Center GmbH	<b>G01C 9/06</b> (2006.01) <b>G01C 9/20</b> (2006.01)	2423640	Inclination sensor for a device and method for determining the inclination of a device
Aea Integration	<b>G06Q 30/00</b> (2012.01) <b>G06F 17/50</b> (2006.01)	2517162 *	SYSTEM AND METHOD FOR AUTOMATED BUILDING SERVICES DESIGN
Zolezzi-Garretton, Alfredo	<b>H05H 1/00</b> (2006.01) <b>C02F 1/00</b> (2006.01)	2534931 *	METHOD AND APPARATUS FOR APPLYING PLASMA PARTICLES TO A LIQUID AND USE FOR DISINFECTING WATER
Ethicon Endo-Surgery, Inc.	<b>A61B 17/00</b> (2006.01) <b>A61B 17/068</b> (2006.01) <b>A61B 17/072</b> (2006.01) <b>A61B 17/28</b> (2006.01)	2519163 *	DAMPENING DEVICE FOR ENDOSCOPIC SURGICAL STAPLER
Bind Biosciences, Inc.	<b>A61K 9/32</b> (2006.01)	2512459 *	THERAPEUTIC POLYMERIC NANOPARTICLES COMPRISING EPOTHILONE AND METHODS OF MAKING AND USING SAME
Rudjer Boskovic Institute	<b>G01N 33/68</b> (2006.01) <b>C07K 1/107</b> (2006.01)	2529233 *	MASS SPECTROMETRY-BASED PROTEIN IDENTIFICATION
Dow AgroSciences, LLC	<b>C12N 15/82</b> (2006.01)	2513317 *	USE OF CRY1DA IN COMBINATION WITH CRY1BE FOR MANAGEMENT OF RESISTANT INSECTS
National Institute Of Agrobiological Sciences	<b>C07K 16/16</b> (2006.01) <b>C07K 14/415</b> (2006.01) <b>C12N 5/10</b> (2006.01) <b>A01H 5/00</b> (2006.01) <b>C12N 15/09</b> (2006.01) <b>C12Q 1/68</b> (2006.01)	2518148 *	GENE DRO1 CONTROLLING DEEP-ROOTED CHARACTERISTICS OF PLANT AND UTILIZATION OF SAME
Richter Gedeon Nyrt.	<b>C07D 333/40</b> (2006.01) <b>A61K 31/381</b> (2006.01)	2523947 *	PROCESS FOR THE PREPARATION OF STRONTIUM RANELATE

Podnosilac evropske prijave patenta (71)	MKP (51)	Broj objave evropske prijave patenta (97)	Naziv pronalaska (54)
Trelleborg Sealing Solutions Germany GmbH	<b>F16L 27/093</b> (2006.01) <b>F16J 15/00</b> (2006.01) <b>F16J 15/34</b> (2006.01) <b>F16J 15/44</b> (2006.01) <b>F16J 15/32</b> (2006.01)	2529134 *	ROTARY SEAL ARRANGEMENT
Taisho Pharmaceutical Co., Ltd.	<b>C07D 213/64</b> (2006.01) <b>A61K 31/496</b> (2006.01) <b>A61P 19/06</b> (2006.01) <b>A61K 31/4545</b> (2006.01) <b>A61P 9/10</b> (2006.01) <b>A61K 31/4439</b> (2006.01) <b>A61P 3/10</b> (2006.01) <b>A61K 31/4427</b> (2006.01) <b>A61P 3/00</b> (2006.01) <b>A61P 27/02</b> (2006.01) <b>A61K 31/444</b> (2006.01) <b>A61P 7/10</b> (2006.01) <b>A61K 31/4433</b> (2006.01) <b>A61P 3/06</b> (2006.01) <b>C07D 401/10</b> (2006.01) <b>A61K 31/443</b> (2006.01) <b>A61P 3/04</b> (2006.01) <b>A61P 43/00</b> (2006.01) <b>A61K 31/4412</b> (2006.01) <b>A61K 31/5377</b> (2006.01) <b>A61P 25/00</b> (2006.01)	2508513 *	2-PYRIDONE COMPOUNDS
Nissan Chemical Industries, Ltd.	<b>C07D 213/64</b> (2006.01) <b>A61K 31/496</b> (2006.01) <b>A61P 19/06</b> (2006.01) <b>A61K 31/4545</b> (2006.01) <b>A61P 9/10</b> (2006.01) <b>A61K 31/4439</b> (2006.01) <b>A61P 3/10</b> (2006.01) <b>A61K 31/4427</b> (2006.01) <b>A61P 3/00</b> (2006.01) <b>A61P 27/02</b> (2006.01) <b>A61K 31/444</b> (2006.01) <b>A61P 7/10</b> (2006.01) <b>A61K 31/4433</b> (2006.01) <b>A61P 3/06</b> (2006.01) <b>C07D 401/10</b> (2006.01) <b>A61K 31/443</b> (2006.01) <b>A61P 3/04</b> (2006.01) <b>A61P 43/00</b> (2006.01) <b>A61K 31/4412</b> (2006.01) <b>A61K 31/5377</b> (2006.01) <b>A61P 25/00</b> (2006.01)	2508513 *	2-PYRIDONE COMPOUNDS
WYW Block AG	<b>E04B 2/16</b> (2006.01)	2536891 *	ENERGY AND WEIGHT EFFICIENT BUILDING BLOCK, MANUFACTURING AND APPLICATION PROCESS THEREOF
Iskra Zascite D.o.o.	<b>H01C 7/12</b> (2006.01)	2537164 *	EXCESS VOLTAGE CIRCUIT-BREAKER WITH A ROTATIONAL DISC AND AN ELECTRONIC ASSEMBLY TO IMPROVE OPERATION RELIABILITY
Taisho Pharmaceutical Co., Ltd.	<b>C07B 61/00</b> (2006.01) <b>C12P 7/62</b> (2006.01) <b>C07C 69/753</b> (2006.01) <b>C07B 57/00</b> (2006.01) <b>C07C 67/303</b> (2006.01) <b>C07B 53/00</b> (2006.01)	2502897 *	METHOD FOR PRODUCING OPTICALLY ACTIVE BICYCLO [3.1.0]HEXANE DERIVATIVE USING OXYGEN
Teva Pharmaceutical Industries Ltd.	<b>A61K 38/16</b> (2006.01) <b>C12P 21/04</b> (2006.01)	2509616 *	BCHE ALBUMIN FUSIONS FOR THE TREATMENT OF COCAINE ABUSE
Affitech Research AS	<b>C07K 16/28</b> (2006.01)	2534177 *	ANTIBODIES AGAINST CXCR4
Dow AgroSciences, LLC	<b>C12N 15/82</b> (2006.01)	2513315 *	COMBINED USE OF CRY1FA AND CRY1AB PROTEINS FOR CONTROL OF CRY-RESISTANT SUGARCANE BORER AND FOR INSECT RESISTANCE MANAGEMENT IN SUGARCANE

Podnosilac evropske prijave patenta (71)	MKP (51)	Broj objave evropske prijave patenta (97)	Naziv pronalaska (54)
Epcon Evaporation Technology AS	<b>F26B 11/16</b> (2006.01) <b>F26B 23/00</b> (2006.01)	2511636	Method for energy efficient drying of liquids, slurries, pastes, cakes and moist particles that forms particulate matter through drying in direct superheated steam dryer
Agios Pharmaceuticals, Inc.	<b>A61K 31/00</b> (2006.01)	2525790 *	METHODS AND COMPOSITIONS FOR CELL-PROLIFERATION-RELATED DISORDERS
OSI Pharmaceuticals, LLC	<b>G01N 33/574</b> (2006.01)	2519826 *	BIOLOGICAL MARKERS PREDICTIVE OF ANTI-CANCER RESPONSE TO INSULIN-LIKE GROWTH FACTOR-1 RECEPTOR KINASE INHIBITORS
Agramkow Fluid Systems A/S	<b>B60H 1/00</b> (2006.01) <b>F25B 45/00</b> (2006.01) <b>F16L 37/36</b> (2006.01)	2512847 *	SERVICE EQUIPMENT FOR SERVICING COOLING SYSTEMS IN VEHICLES
Novartis AG	<b>G01N 33/68</b> (2006.01)	2496944 *	BIOMARKERS PREDICTIVE OF PROGRESSION OF FIBROSIS
The Regents of the University of Michigan	<b>G01N 33/68</b> (2006.01)	2496944 *	BIOMARKERS PREDICTIVE OF PROGRESSION OF FIBROSIS
HealOr Ltd.	<b>A61K 38/08</b> (2006.01) <b>A61K 38/00</b> (2006.01)	2536421 *	METHOD FOR TREATMENT OF PSORIASIS
SANOFI	<b>A61P 3/00</b> (2006.01) <b>A61K 38/26</b> (2006.01) <b>A61K 38/18</b> (2006.01)	2525807 *	PHARMACEUTICAL COMPOSITION FOR TREATING A METABOLIC SYNDROME
Volvo Powertrain Aktiebolag	<b>B01D 53/94</b> (2006.01) <b>F01N 3/08</b> (2006.01) <b>F01N 3/24</b> (2006.01)	2508724 *	ENGINE EXHAUST-AIR PURIFYING APPARATUS
Ethicon Endo-Surgery, Inc.	<b>F16J 15/32</b> (2006.01) <b>A61B 17/32</b> (2006.01)	2533712 *	SEAL ARRANGEMENTS FOR ULTRASONICALLY POWERED SURGICAL INSTRUMENTS
Ajinomoto Co., Inc.	<b>C07K 5/08</b> (2006.01) <b>A23L 1/228</b> (2006.01) <b>C07K 5/06</b> (2006.01)	2520180 *	FLAVOR-ENRICHING AGENT
Galderma Research & Development	<b>A61P 17/06</b> (2006.01) <b>A61K 9/00</b> (2006.01) <b>A61P 17/10</b> (2006.01) <b>A61K 31/00</b> (2006.01) <b>A61K 9/06</b> (2006.01) <b>A61K 31/196</b> (2006.01) <b>A61P 17/00</b> (2006.01) <b>A61K 45/06</b> (2006.01) <b>A61K 31/498</b> (2006.01) <b>A61P 17/04</b> (2006.01)	2501410 *	COMBINATION OF ALPHA-2 ADRENERGIC RECEPTOR AGONIST AND NON-STEROIDAL ANTI-INFLAMMATORY AGENT FOR TREATING OR PREVENTING AN INFLAMMATORY SKIN DISORDER
Immersion Corporation	<b>G06F 3/041</b> (2006.01) <b>G08B 6/00</b> (2006.01)	2502215 *	SYSTEMS AND METHODS FOR INCREASING HAPTIC BANDWIDTH IN AN ELECTRONIC DEVICE
Ethicon Endo-Surgery, Inc.	<b>A61B 17/072</b> (2006.01)	2515769 *	SURGICAL CUTTING INSTRUMENT THAT ANALYZES TISSUE THICKNESS
Athenix Corp.	<b>C12N 5/10</b> (2006.01) <b>C07K 14/00</b> (2006.01) <b>C12N 15/63</b> (2006.01) <b>A01H 5/10</b> (2006.01) <b>C07H 21/04</b> (2006.01) <b>C12N 15/82</b> (2006.01) <b>A01H 5/00</b> (2006.01) <b>A01H 1/00</b> (2006.01) <b>A01N 37/18</b> (2006.01) <b>C12P 21/00</b> (2006.01) <b>C12N 1/21</b> (2006.01) <b>A01P 7/04</b> (2006.01)	2536267 *	AXMI221z, AXMI222z, AXMI223z, AXMI224z, AND AXMI225z DELTA-ENDOTOXIN GENES AND METHODS FOR THEIR USE
Chiesi Farmaceutici S.p.A.	<b>A61K 9/00</b> (2006.01) <b>A61K 31/40</b> (2006.01)	2515854 *	AEROSOL FORMULATION FOR COPD
Technische Universität Hamburg-Harburg	<b>C12N 9/12</b> (2006.01) <b>C12P 13/08</b> (2006.01)	2374873	Modified aspartate kinase from corynebacterium and its application for amino acid production
TuTech Innovation GmbH	<b>C12N 9/12</b> (2006.01) <b>C12P 13/08</b> (2006.01)	2374873	Modified aspartate kinase from corynebacterium and its application for amino acid production

Podnosilac evropske prijave patenta (71)	MKP (51)	Broj objave evropske prijave patenta (97)	Naziv pronalaska (54)
The Brigham and Women's Hospital, Inc.	<b>A01K 67/027</b> (2006.01) <b>A61K 48/00</b> (2006.01) <b>G01N 33/15</b> (2006.01) <b>C12N 5/071</b> (2010.01) <b>A61K 38/00</b> (2006.01) <b>C12N 5/10</b> (2006.01)	2510087 *	PATHOGEN RESTRICTION FACTORS
The General Hospital Corporation	<b>A01K 67/027</b> (2006.01) <b>A61K 48/00</b> (2006.01) <b>G01N 33/15</b> (2006.01) <b>C12N 5/071</b> (2010.01) <b>A61K 38/00</b> (2006.01) <b>C12N 5/10</b> (2006.01)	2510087 *	PATHOGEN RESTRICTION FACTORS
Fueltech Sweden AB	<b>F28D 20/00</b> (2006.01) <b>F24D 11/00</b> (2006.01) <b>F24H 1/18</b> (2006.01)	2516953 *	ACCUMULATOR TANK WITH PARTITION WALLS
Johnson, William B.	<b>C21D 9/08</b> (2006.01)	2501829 *	IMPROVED FATIGUE-RESISTANT NITINOL INSTRUMENT
Targacept, Inc.	<b>A61P 25/00</b> (2006.01) <b>A61P 25/28</b> (2006.01) <b>A61K 31/4995</b> (2006.01) <b>A61P 25/16</b> (2006.01) <b>C07D 487/08</b> (2006.01)	2509982 *	3,6-DIAZABICYCLO[3.1.1]HEPTANES AS NEURONAL NICOTINIC ACETYLCHOLINE RECEPTOR LIGANDS
Hasler, Josef	<b>B23B 51/00</b> (2006.01)	2463047	Undercutting tool
ThyssenKrupp Uhde GmbH	<b>C10C 1/00</b> (2006.01)	2521758 *	DEVICE AND METHOD FOR SEPARATING A SOLID MATTER-CONTAINING, LIQUID AND PUMPABLE TAR SUSPENSION AND USE OF THE SEPARATED SOLID MATTER FOR PRODUCING COKE
SANOFI	<b>A61K 31/381</b> (2006.01) <b>C07D 495/04</b> (2006.01) <b>C07D 471/04</b> (2006.01) <b>A61K 31/429</b> (2006.01) <b>C07D 513/04</b> (2006.01)	2513108 *	NOVEL (HETEROCYCLE/CONDENSED PIPERIDINE)-(PIPERAZINYL)-1-ALCANONE OR (HETEROCYCLE/CONDENSED PYRROLIDINE)-(PIPERAZINYL)-1-ALCANONE DERIVATIVES, AND USE THEREOF AS P75 INHIBITORS
Packers Plus Energy Services Inc.	<b>E21B 34/10</b> (2006.01) <b>E21B 43/14</b> (2006.01) <b>E21B 43/12</b> (2006.01) <b>E21B 33/124</b> (2006.01) <b>E21B 34/14</b> (2006.01)	2513417 *	DOWNHOLE SUB WITH HYDRAULICALLY ACTUABLE SLEEVE VALVE
Foresight Biotherapeutics, Inc.	<b>A01N 45/00</b> (2006.01) <b>A61K 31/74</b> (2006.01) <b>A01N 25/00</b> (2006.01)	2512230 *	NON-IRRITATING OPHTHALMIC POVIDONE- IODINE COMPOSITIONS
UCB Pharma, S.A.	<b>C07K 14/245</b> (2006.01) <b>C12N 15/70</b> (2006.01)	2524043 *	BACTERIAL HOST STRAIN COMPRISING A MUTANT SPR GENE AND HAVING REDUCED TSP ACTIVITY
Ancrest S.A.	<b>E02D 5/80</b> (2006.01)	2513378 *	DEVICE FOR ANCHORING IN MULTILAYER GROUND
Teikoku Seiyaku Co., Ltd.	<b>A61K 9/70</b> (2006.01) <b>A61K 47/22</b> (2006.01) <b>A61K 31/40</b> (2006.01) <b>A61K 47/32</b> (2006.01) <b>A61K 47/20</b> (2006.01) <b>A61K 47/10</b> (2006.01)	2524692 *	ANTI-INFLAMMATORY ANALGESIC ADHESIVE PATCH FOR EXTERNAL USE
Ibsa Institut Biochimique S.A.	<b>A61K 9/70</b> (2006.01) <b>A61K 47/22</b> (2006.01) <b>A61K 31/40</b> (2006.01) <b>A61K 47/32</b> (2006.01) <b>A61K 47/20</b> (2006.01) <b>A61K 47/10</b> (2006.01)	2524692 *	ANTI-INFLAMMATORY ANALGESIC ADHESIVE PATCH FOR EXTERNAL USE
Famur Spółka Akcyjna	<b>E21C 29/02</b> (2006.01)	2499334 *	DRIVE TRANSMISSION METHOD IN A LONGWALL SHEARER LOADER
Famur Institute Sp. Z O.O.	<b>E21C 29/02</b> (2006.01)	2499334 *	DRIVE TRANSMISSION METHOD IN A LONGWALL SHEARER LOADER
Galileo Wheel Ltd	<b>B60B 19/00</b> (2006.01) <b>B60B 9/00</b> (2006.01)	2531360 *	DEFORMABLE WHEEL ASSEMBLY



Podnosilac evropske prijave patenta (71)	MKP (51)	Broj objave evropske prijave patenta (97)	Naziv pronalaska (54)
Route JJ Co., Ltd	<b>H01M 4/583</b> (2010.01) <b>H01M 4/525</b> (2010.01) <b>H01M 10/0525</b> (2010.01) <b>H01M 4/505</b> (2010.01)	2509143 *	ANODE ACTIVE MATERIAL PRECURSOR AND ACTIVE MATERIAL FOR A RECHARGEABLE LITHIUM BATTERY COMPRISING HOLLOW NANOFIBROUS CARBON, AND A PRODUCTION METHOD THEREFOR
Amgen Inc.	<b>C12P 21/08</b> (2006.01) <b>C07K 16/00</b> (2006.01) <b>C07H 21/00</b> (2006.01)	2504360 *	MONOMERIC ANTIBODY FC
SANOFI	<b>A61P 9/00</b> (2006.01) <b>C07D 498/04</b> (2006.01) <b>A61K 31/519</b> (2006.01)	2523962 *	CARBOXYLIC ACID DERIVATIVES HAVING A 2,5-SUBSTITUTED OXAZOLOPYRIMIDINE RING
St. George's Hospital Medical School	<b>C07K 5/08</b> (2006.01) <b>A61K 38/06</b> (2006.01) <b>C07K 5/06</b> (2006.01) <b>A61P 37/08</b> (2006.01) <b>A01N 43/00</b> (2006.01)	2526116 *	PYRUVAMIDE COMPOUNDS AS INHIBITORS OF DUST MITE GROUP 1 PEPTIDASE ALLERGEN
The University Of Manchester	<b>C07K 5/08</b> (2006.01) <b>A61K 38/06</b> (2006.01) <b>C07K 5/06</b> (2006.01) <b>A61P 37/08</b> (2006.01) <b>A01N 43/00</b> (2006.01)	2526116 *	PYRUVAMIDE COMPOUNDS AS INHIBITORS OF DUST MITE GROUP 1 PEPTIDASE ALLERGEN
SANOFI	<b>C07D 471/04</b> (2006.01) <b>A61P 9/00</b> (2006.01) <b>C07C 311/21</b> (2006.01) <b>A61K 31/519</b> (2006.01) <b>C07F 5/02</b> (2006.01)	2521725 *	ARYLSULFONAMIDE PYRIDINE-PYRIDINONE DERIVATIVES, PREPARATION OF SAME, AND THERAPEUTIC USE THEREOF
Mylan Group	<b>C09J 5/00</b> (2006.01) <b>B32B 3/00</b> (2006.01) <b>C09J 7/00</b> (2006.01)	2522498	Dry adhesive comprising micro-featured and nano-featured surface
Sanofi-Aventis Deutschland GmbH	<b>A61M 5/32</b> (2006.01) <b>A61M 5/28</b> (2006.01) <b>A61M 5/24</b> (2006.01)	2531240 *	PUSH ROD ACTIVATED MEDICATED MODULE
Keraglass Engineering S.R.L.	<b>C03B 35/16</b> (2006.01) <b>F27D 25/00</b> (2010.01) <b>B65G 45/10</b> (2006.01) <b>F27B 9/30</b> (2006.01)	2531456 *	ROLLER CLEANING DEVICE
Chanel Parfums Beauté	<b>A45D 40/10</b> (2006.01)	2515695 *	CONTAINER FOR A STICK OF A COSMETIC OR HYGIENIC PRODUCT HAVING A RETRACTABLE APPLICATOR ELEMENT
Abiel S.r.l.	<b>C12N 15/11</b> (2006.01)	2513306 *	C. HISTOLYTICUM RECOMBINANT COLLAGENASES AND METHOD FOR THE MANUFACTURE THEREOF
Deva Holding Anonim Sirketi	<b>A61K 9/20</b> (2006.01) <b>A61K 31/215</b> (2006.01)	2441445	Coating of cetyl myristate and/or cetyl palmitate particles
PPC, A Division of John Mezzalingua Associates, Inc.	<b>H01R 13/639</b> (2006.01) <b>H01R 13/11</b> (2006.01)	2434588	Connector
Farmak International Holding GmbH	<b>A61P 31/16</b> (2006.01) <b>C07D 213/81</b> (2006.01) <b>A61K 31/4425</b> (2006.01)	2513060 *	ALPHA-CRYSTALLINE FORM OF CARBABENZPYRIDE
Galderma Research & Development	<b>A61K 31/44</b> (2006.01) <b>A61P 5/26</b> (2006.01) <b>C07D 213/74</b> (2006.01) <b>A61K 31/4409</b> (2006.01) <b>A61P 5/28</b> (2006.01)	2516400 *	PHENOL DERIVATIVES AND THE PHARMACEUTICAL OR COSMETIC USE THEREOF
Finocchiaro, Franco	<b>F28D 20/00</b> (2006.01) <b>C09K 5/10</b> (2006.01) <b>F01K 3/12</b> (2006.01)	2504653 *	PROCESS TO ACCUMULATE THERMAL ENERGY USING A HEAT- CARRIER FLUID AND CORRESPONDING SYSTEM
Ausy S.r.L.	<b>F28D 20/00</b> (2006.01) <b>C09K 5/10</b> (2006.01) <b>F01K 3/12</b> (2006.01)	2504653 *	PROCESS TO ACCUMULATE THERMAL ENERGY USING A HEAT- CARRIER FLUID AND CORRESPONDING SYSTEM

Podnosilac evropske prijave patenta (71)	MKP (51)	Broj objave evropske prijave patenta (97)	Naziv pronalaska (54)
Suven Life Sciences Limited	<b>A61K 31/4468</b> (2006.01) <b>A61P 29/00</b> (2006.01) <b>A61K 31/4709</b> (2006.01) <b>A61P 25/08</b> (2006.01) <b>C07D 401/12</b> (2006.01) <b>A61P 25/24</b> (2006.01) <b>A61P 25/18</b> (2006.01) <b>A61K 31/4725</b> (2006.01) <b>C07D 401/14</b> (2006.01) <b>A61P 25/28</b> (2006.01) <b>C07D 211/58</b> (2006.01) <b>A61P 25/22</b> (2006.01)	2521714 *	SULFONE COMPOUNDS AS 5-HT6 RECEPTOR LIGANDS
GlaxoSmithKline LLC	<b>A01N 43/54</b> (2006.01) <b>A61K 31/517</b> (2006.01)	2501233 *	QUINAZOLINE COMPOUNDS
Toyota InfoTechnology Center U.S.A., Inc.	<b>H04L 12/28</b> (2006.01)	2507946 *	ADAPTATION PROTOCOLS FOR LOCAL PEER GROUP (LPG) NETWORKS IN DYNAMIC ROADWAY ENVIRONMENTS
Telcordia Technologies, Inc.	<b>H04L 12/28</b> (2006.01)	2507946 *	ADAPTATION PROTOCOLS FOR LOCAL PEER GROUP (LPG) NETWORKS IN DYNAMIC ROADWAY ENVIRONMENTS
Paluka, Antonín	<b>F03B 9/00</b> (2006.01)	2438291 *	DEVICE FOR OBTAINING ENERGY FROM WATER
Abbott Laboratories	<b>A61K 31/55</b> (2006.01) <b>A61K 45/06</b> (2006.01) <b>A61P 23/00</b> (2006.01)	2525797 *	METHODS FOR TREATING PAIN
Dr. Pley Environmental GmbH	<b>B01D 53/86</b> (2006.01) <b>F24B 1/00</b> (2006.01) <b>F23G 7/07</b> (2006.01)	2534422 *	DEVICE FOR TREATING EXHAUST GASES FROM A SMALL HEATING SYSTEM
Emergent Product Development Seattle, LLC	<b>C07K 16/46</b> (2006.01) <b>A61P 35/00</b> (2006.01) <b>A61P 37/00</b> (2006.01) <b>A61K 39/395</b> (2006.01)	2519544 *	POLYPEPTIDE HETERODIMERS AND USES THEREOF
Brown, Gregory M.	<b>B62J 11/00</b> (2006.01)	2516245 *	SYSTEM FOR REMOVABLY ATTACHING OBJECTS TO VEHICLES NEGATING THE EFFECTS OF GRAVITATIONAL FORCES, VIBRATION AND SHOCK LOADING
Kondilas, Robert A.	<b>B62J 11/00</b> (2006.01)	2516245 *	SYSTEM FOR REMOVABLY ATTACHING OBJECTS TO VEHICLES NEGATING THE EFFECTS OF GRAVITATIONAL FORCES, VIBRATION AND SHOCK LOADING
Kawas, Percy	<b>F03D 11/02</b> (2006.01) <b>F03D 3/04</b> (2006.01) <b>F03D 11/00</b> (2006.01) <b>F03D 3/06</b> (2006.01)	2513473 *	METHOD AND APPARATUS FOR WIND ENERGY SYSTEM
Kawas, Gulnar	<b>F03D 11/02</b> (2006.01) <b>F03D 3/04</b> (2006.01) <b>F03D 11/00</b> (2006.01) <b>F03D 3/06</b> (2006.01)	2513473 *	METHOD AND APPARATUS FOR WIND ENERGY SYSTEM
University Of Georgia Research Foundation, Inc.	<b>C07H 19/16</b> (2006.01) <b>A61P 31/20</b> (2006.01) <b>A61K 31/7076</b> (2006.01) <b>C07H 19/06</b> (2006.01) <b>A61K 31/7064</b> (2006.01)	2501709 *	2'-FLUORO-6'-METHYLENE CARBOCYCLIC NUCLEOSIDES AND METHODS OF TREATING VIRAL INFECTIONS
Leo Pharma A/S	<b>A61K 47/10</b> (2006.01) <b>A61K 47/14</b> (2006.01) <b>A61K 47/22</b> (2006.01) <b>A61K 31/593</b> (2006.01) <b>A61K 9/06</b> (2006.01)	2515866 *	PHARMACEUTICAL COMPOSITION COMPRISING SOLVENT MIXTURE AND A VITAMIN D DERIVATIVE OR ANALOGUE
KRKA, D.D., Novo Mesto	<b>A61K 9/16</b> (2006.01) <b>A61K 31/41</b> (2006.01) <b>A61K 9/20</b> (2006.01)	2536396 *	PROCESS FOR THE PREPARATION OF ORAL SOLID DOSAGE FORMS COMPRISING VALSARTAN
UAB Krka Lietuva	<b>A61K 9/16</b> (2006.01) <b>A61K 31/41</b> (2006.01) <b>A61K 9/20</b> (2006.01)	2536396 *	PROCESS FOR THE PREPARATION OF ORAL SOLID DOSAGE FORMS COMPRISING VALSARTAN

Podnosilac evropske prijave patenta (71)	MKP (51)	Broj objave evropske prijave patenta (97)	Naziv pronalaska (54)
Johnson And Johnson Ltd	<b>A61B 17/10</b> (2006.01) <b>A61B 17/122</b> (2006.01) <b>A61B 17/12</b> (2006.01) <b>A61B 17/128</b> (2006.01)	2506779 *	AN IMPROVED LIGATION DEVICE ADAPTABLE FOR SURGICAL INTERVENTION
Bone Vitae S.A.	<b>A61B 5/053</b> (2006.01)	2536330 *	METHOD AND APPARATUS FOR NON-INVASIVE ANALYSING THE STRUCTURE AND CHEMICAL COMPOSITION OF BONE TISSUE ELIMINATING THE INFLUENCE OF SURROUNDING TISSUES
Dow AgroSciences LLC	<b>C12N 15/82</b> (2006.01)	2513314 *	COMBINED USE OF CRY1CA AND CRY1AB PROTEINS FOR INSECT RESISTANCE MANAGEMENT
Boehringer Ingelheim International GmbH	<b>A61M 15/00</b> (2006.01)	2504050 *	NEBULIZER
Abbott Laboratories	<b>A01N 43/82</b> (2006.01) <b>A61K 31/41</b> (2006.01)	2509424 *	NOVEL OXADIAZOLE COMPOUNDS
Takeda Pharmaceutical Company Limited	<b>A61P 11/00</b> (2006.01) <b>C07D 487/04</b> (2006.01) <b>A61P 37/00</b> (2006.01) <b>A61K 31/437</b> (2006.01) <b>A61P 29/00</b> (2006.01) <b>A61P 17/00</b> (2006.01) <b>A61P 19/00</b> (2006.01) <b>C07D 471/04</b> (2006.01) <b>A61P 35/00</b> (2006.01) <b>A61P 7/00</b> (2006.01) <b>A61K 31/519</b> (2006.01)	2516434 *	FUSED HETEROAROMATIC PYRROLIDINONES AS SYK INHIBITORS
KayteeBio Co. & Ltd.	<b>G01N 33/50</b> (2006.01) <b>C12M 1/34</b> (2006.01) <b>C12M 1/00</b> (2006.01) <b>C12Q 1/68</b> (2006.01) <b>C12N 15/09</b> (2006.01)	2505662 *	METHOD AND APPARATUS FOR PREDICTION OF PHARMACOLOGICAL EFFICACY OF HUMANIZED ANTI-TNF ANTIBODY DRUG ON RHEUMATOID ARTHRITIS
Chalabi, Rifat Al	<b>C22B 21/00</b> (2006.01) <b>C22B 7/00</b> (2006.01)	2534272 *	METAL RECOVERY FROM CONTAMINATED METAL SCRAP
Perry, Ophneil Henry	<b>C22B 21/00</b> (2006.01) <b>C22B 7/00</b> (2006.01)	2534272 *	METAL RECOVERY FROM CONTAMINATED METAL SCRAP
Almirall S.A.	<b>A61K 9/08</b> (2006.01) <b>A61K 31/435</b> (2006.01)	2503991 *	LIQUID PHARMACEUTICAL COMPOSITIONS
Teikoku Seiyaku Co., Ltd.	<b>A61P 29/00</b> (2006.01) <b>A61K 9/70</b> (2006.01) <b>A61K 31/5415</b> (2006.01) <b>A61K 47/32</b> (2006.01) <b>A61K 47/18</b> (2006.01)	2514424 *	PIROXICAM-CONTAINING ENDERMIC PREPARATION
Mereal Biometrics	<b>G06F 21/00</b> (2006.01)	2517141 *	MULTIPLE APPLICATION CHIP CARD HAVING BIOMETRIC VALIDATION
Egis Gyógyszergyár Nyilvánosan Működő Részvénytársaság	<b>C07D 495/04</b> (2006.01)	2516447 *	PROCESS FOR PREPARING PHARMACEUTICAL COMPOUNDS AND INTERMEDIATE COMPOUNDS
Torre Immobiliare 2002 S.r.l.	<b>D06F 95/00</b> (2006.01)	2441883	Improved device for raising and/or drawing fabric handworks, particularly linen articles
Laboratorios del. Dr. Esteve, S.A.	<b>A61K 31/416</b> (2006.01) <b>A61K 31/415</b> (2006.01) <b>A61P 29/00</b> (2006.01) <b>A61K 31/4196</b> (2006.01)	2531191 *	SIGMA LIGANDS FOR USE IN THE PREVENTION AND/OR TREATMENT OF POSTOPERATIVE PAIN
Wabtec Holding Corp.	<b>B61H 5/00</b> (2006.01) <b>F16D 55/02</b> (2006.01) <b>F16D 65/12</b> (2006.01)	2507108 *	RAILWAY VEHICLE BRAKE DISC
Enanta Pharmaceuticals Inc.	<b>A01N 43/00</b> (2006.01)	2528436 *	HEPATITIS C VIRUS INHIBITORS
Ironwood Pharmaceuticals, Inc.	<b>C07K 7/08</b> (2006.01)	2536742 *	TREATMENTS FOR GASTROINTESTINAL DISORDERS

Podnosilac evropske prijave patenta (71)	MKP (51)	Broj objave evropske prijave patenta (97)	Naziv pronalaska (54)
Intermune, Inc.	<b>A61K 31/4418</b> (2006.01) <b>A61K 31/4412</b> (2006.01) <b>A61P 43/00</b> (2006.01) <b>A61K 31/44</b> (2006.01)	2506850 *	METHODS OF ADMINISTERING PIRFENIDONE THERAPY
Merck Sharp & Dohme Corp.	<b>C07D 417/12</b> (2006.01) <b>A61P 11/06</b> (2006.01) <b>A61P 11/00</b> (2006.01) <b>A61P 35/00</b> (2006.01) <b>A61P 29/00</b> (2006.01) <b>C07D 417/14</b> (2006.01) <b>A61K 31/497</b> (2006.01)	2513098 *	AMINOPYRIMIDINES AS SYK INHIBITORS
Merck Canada Inc.	<b>C07D 417/12</b> (2006.01) <b>A61P 11/06</b> (2006.01) <b>A61P 11/00</b> (2006.01) <b>A61P 35/00</b> (2006.01) <b>A61P 29/00</b> (2006.01) <b>C07D 417/14</b> (2006.01) <b>A61K 31/497</b> (2006.01)	2513098 *	AMINOPYRIMIDINES AS SYK INHIBITORS
Aragon Pharmaceuticals, Inc.	<b>A61P 5/26</b> (2006.01) <b>A61K 31/5025</b> (2006.01) <b>A61K 31/4439</b> (2006.01) <b>C07D 401/04</b> (2006.01) <b>C07D 487/04</b> (2006.01) <b>A61P 5/28</b> (2006.01)	2536708 *	ANDROGEN RECEPTOR MODULATORS AND USES THEREOF
Dow AgroSciences, LLC	<b>A01H 5/00</b> (2006.01) <b>A01H 1/00</b> (2006.01) <b>A01P 7/00</b> (2006.01)	2512219 *	COMBINED USE OF VIP3AB AND CRY1FA FOR MANAGEMENT OF RESISTANT INSECTS
Abbott Biotherapeutics Corp.	<b>C07K 16/32</b> (2006.01)	2513148 *	ANTI-HER2 ANTIBODIES AND THEIR USES
Johnson & Johnson Consumer Companies Inc.	<b>A61Q 17/04</b> (2006.01) <b>A61Q 1/04</b> (2006.01) <b>A61Q 1/02</b> (2006.01)	2533860 *	SUNSCREEN COMPOSITIONS COMPRISING AN ULTRAVIOLET RADIATION-ABSORBING POLYMER
Sintef Stiftelsen	<b>B04B 5/02</b> (2006.01) <b>B04B 9/10</b> (2006.01) <b>B04B 9/08</b> (2006.01)	2519358 *	CENTRIFUGATION APPARATUS, USE THEREOF AND CENTRIFUGATION METHOD
UCB Pharma, S.A.	<b>C12N 15/70</b> (2006.01) <b>C07K 14/245</b> (2006.01)	2523969 *	BACTERIAL HOST STRAIN EXPRESSING RECOMBINANT DSBC AND HAVING REDUCED TSP ACTIVITY
Chalabi, Rifat Al	<b>F23G 7/06</b> (2006.01) <b>B01D 53/72</b> (2006.01) <b>B01D 53/00</b> (2006.01) <b>F24J 2/06</b> (2006.01) <b>F24J 2/07</b> (2006.01) <b>B01J 19/12</b> (2006.01) <b>F23J 15/02</b> (2006.01) <b>B01D 53/73</b> (2006.01)	2528678 *	IMPROVEMENTS IN THERMAL OXIDISERS, USING CONCENTRATED SUNLIGHT
Perry, Ophneil Henry	<b>F23G 7/06</b> (2006.01) <b>B01D 53/72</b> (2006.01) <b>B01D 53/00</b> (2006.01) <b>F24J 2/06</b> (2006.01) <b>F24J 2/07</b> (2006.01) <b>B01J 19/12</b> (2006.01) <b>F23J 15/02</b> (2006.01) <b>B01D 53/73</b> (2006.01)	2528678 *	IMPROVEMENTS IN THERMAL OXIDISERS, USING CONCENTRATED SUNLIGHT
Fairfield Manufacturing Company	<b>F16D 1/08</b> (2006.01) <b>B23C 3/30</b> (2006.01) <b>B23F 5/20</b> (2006.01) <b>F16D 3/06</b> (2006.01)	2520388	Splined member and process for manufacturing a splined member by shaping and milling
Centrum Badawczo-Rozwojowe "EPAR" Sp.z o.o.	<b>F16F 15/31</b> (2006.01) <b>F16F 7/10</b> (2006.01) <b>F03G 3/08</b> (2006.01)	2420674	Method of accumulating kinetic energy and rotor device for accumulating and dissipating kinetic energy

Podnosilac evropske prijave patenta (71)	MKP (51)	Broj objave evropske prijave patenta (97)	Naziv pronalaska (54)
Abbot Healthcare Private Limited	<b>A61K 9/00</b> (2006.01) <b>A61K 31/542</b> (2006.01) <b>A61K 47/02</b> (2006.01) <b>A61K 9/20</b> (2006.01) <b>A61K 47/12</b> (2006.01)	2515909 *	FAST DISSOLVING PHARMACEUTICAL COMPOSITION COMPRISING LORNOXICAM
Meiji Seika Pharma Co., Ltd.	<b>C07K 16/12</b> (2006.01) <b>C07K 16/46</b> (2006.01) <b>A61K 39/395</b> (2006.01) <b>C12N 15/09</b> (2006.01) <b>C12P 21/08</b> (2006.01) <b>C12N 5/10</b> (2006.01) <b>G01N 33/569</b> (2006.01) <b>A61P 31/04</b> (2006.01)	2536835 *	ANTIBODY AGAINST SEROTYPE G LIPOPOLYSACCHARIDE OF PSEUDOMONAS AERUGINOSA
Symphogen A/S	<b>C07K 16/12</b> (2006.01) <b>C07K 16/46</b> (2006.01) <b>A61K 39/395</b> (2006.01) <b>C12N 15/09</b> (2006.01) <b>C12P 21/08</b> (2006.01) <b>C12N 5/10</b> (2006.01) <b>G01N 33/569</b> (2006.01) <b>A61P 31/04</b> (2006.01)	2536835 *	ANTIBODY AGAINST SEROTYPE G LIPOPOLYSACCHARIDE OF PSEUDOMONAS AERUGINOSA
Hanenberg, Helmut	<b>C12Q 1/68</b> (2006.01)	2385135	RAD51C as a human cancer susceptibility gene
Universität zu Köln	<b>C12Q 1/68</b> (2006.01)	2385135	RAD51C as a human cancer susceptibility gene
Allergan Industrie, SAS	<b>A61L 27/54</b> (2006.01) <b>A61L 27/20</b> (2006.01)	2523701 *	STABLE HYDROGEL COMPOSITIONS INCLUDING ADDITIVES
Galderma Research & Development	<b>C07C 409/34</b> (2006.01) <b>A61K 8/38</b> (2006.01) <b>A61Q 19/00</b> (2006.01)	2519218 *	DIBENZOYL PEROXIDE DERIVATIVES, PREPARATION METHOD THEREOF AND COSMETIC OR DERMATOLOGICAL COMPOSITIONS CONTAINING SAME
Glaxo Group Limited	<b>C07K 16/28</b> (2006.01)	2528947 *	CD127 BINDING PROTEINS
Johnson & Johnson Vision Care Inc.	<b>C08F 2/38</b> (2006.01)	2519547 *	MACROMONOMER MIXTURE, TERMINAL-REACTIVE POLYMER MIXTURE, INTERMEDIATE FOR MACROMONOMER AND SILICONE HYDROGEL
Glaxo Group Limited	<b>A61K 31/7115</b> (2006.01) <b>A61K 31/7125</b> (2006.01)	2512491 *	HBV ANTISENSE INHIBITORS
North Carolina State University	<b>C12N 15/53</b> (2006.01) <b>C12N 15/82</b> (2006.01) <b>A01H 5/12</b> (2006.01)	2524044 *	COMPOSITIONS AND METHODS FOR MINIMIZING NORNICOTINE SYNTHESIS IN TOBACCO
Dow AgroSciences, LLC	<b>A01H 5/00</b> (2006.01) <b>C12N 15/82</b> (2006.01) <b>C12N 15/29</b> (2006.01)	2525650 *	ENGINEERED LANDING PADS FOR GENE TARGETING IN PLANTS
Almirall S.A.	<b>A61K 31/437</b> (2006.01) <b>C07D 471/04</b> (2006.01)	2516436 *	IMIDAZOPYRIDINE DERIVATIVES AS JAK INHIBITORS
Presano AG	<b>E03C 1/01</b> (2006.01) <b>F24D 17/00</b> (2006.01) <b>F24H 9/20</b> (2006.01) <b>E03C 1/044</b> (2006.01) <b>E03D 9/08</b> (2006.01) <b>F24H 1/20</b> (2006.01) <b>G05D 23/00</b> (2006.01)	2521818 *	DEVICE FOR HEATING WATER FOR A COMBINATION SHOWER-WC
Carnehammar, Lars Bertil	<b>F16F 15/36</b> (2006.01) <b>B63H 21/30</b> (2006.01)	2501609 *	METHOD, APPARATUS AND SYSTEM FOR REDUCING VIBRATION IN A ROTARY SYSTEM OF A WATERCRAFT
Alcatel Lucent	<b>H04J 14/02</b> (2006.01)	2448159	Multidirectional add and drop devices for an optical network element

Podnosilac evropske prijave patenta (71)	MKP (51)	Broj objave evropske prijave patenta (97)	Naziv pronalaska (54)
Incyte Corporation	<b>A61K 31/53</b> (2006.01) <b>A61P 29/00</b> (2006.01) <b>A61P 37/00</b> (2006.01) <b>A61P 35/00</b> (2006.01) <b>A61P 1/00</b> (2006.01) <b>A61P 11/00</b> (2006.01) <b>C07D 487/04</b> (2006.01) <b>A61P 9/00</b> (2006.01)	2531509 *	IMIDAZO[1,2-B][1,2,4]TRIAZINES AS C-MET INHIBITORS
Anguiano Poliuretanos, S.L.	<b>B29C 39/00</b> (2006.01) <b>B29B 17/00</b> (2006.01) <b>A47K 3/40</b> (2006.01)	2431147	Shower base improved by the inclusion in its material of flexible fillings made of recycled car tyres
Protiva Biotherapeutics Inc.	<b>C12N 15/88</b> (2006.01) <b>C12N 15/87</b> (2006.01) <b>A61K 47/22</b> (2006.01) <b>A61K 9/14</b> (2006.01) <b>A61K 47/18</b> (2006.01) <b>C12N 15/10</b> (2006.01) <b>C12N 15/113</b> (2010.01) <b>A61K 31/7088</b> (2006.01)	2506879 *	SNALP FORMULATIONS CONTAINING ANTIOXIDANTS
Spinifex Pharmaceuticals Pty Ltd	<b>A61P 25/02</b> (2006.01) <b>A61K 31/4375</b> (2006.01) <b>A61K 31/472</b> (2006.01) <b>A61K 31/522</b> (2006.01)	2525795 *	METHODS AND COMPOSITIONS FOR IMPROVED NERVE CONDUCTION VELOCITY
Boehringer Ingelheim International GmbH	<b>C07D 239/26</b> (2006.01) <b>A61K 31/505</b> (2006.01) <b>C07D 409/14</b> (2006.01) <b>C07D 471/04</b> (2006.01) <b>C07D 487/08</b> (2006.01) <b>C07D 401/14</b> (2006.01) <b>A61P 35/00</b> (2006.01) <b>C07D 401/06</b> (2006.01) <b>A61K 31/506</b> (2006.01) <b>C07D 413/14</b> (2006.01) <b>C07D 405/14</b> (2006.01)	2528903 *	5-ALKYNYL-PYRIMIDINES
Eli Lilly and Company	<b>A61P 3/04</b> (2006.01) <b>A61K 38/17</b> (2006.01) <b>A61P 3/10</b> (2006.01) <b>C07K 14/605</b> (2006.01) <b>A61K 38/26</b> (2006.01)	2515927 *	OXYNTOMODULIN PEPTIDE ANALOGUE
Bayer HealthCare LLC	<b>A61K 31/00</b> (2006.01)	2536399 *	Method for activation and conjugation of biomolecules
The University of North Carolina At Chapel Hill	<b>A61K 31/20</b> (2006.01) <b>A61K 31/44</b> (2006.01) <b>A61K 31/35</b> (2006.01) <b>A01N 25/26</b> (2006.01)	2521446 *	FATTY ACID DERIVATIVES AND ANALOGS OF DRUGS
Acclarent, Inc.	<b>A61F 11/00</b> (2006.01) <b>A61K 9/00</b> (2006.01) <b>A61N 1/30</b> (2006.01)	2519199 *	SYSTEMS AND METHODS FOR ANESTHETIZING EAR TISSUE
Ethicon, Inc.	<b>A61F 2/20</b> (2006.01) <b>A61F 2/02</b> (2006.01)	2512368 *	FLUID FILLED IMPLANTS FOR TREATING MEDICAL CONDITIONS
Curt G. Joa, Inc.	<b>A61F 13/15</b> (2006.01)	2537495	Methods and apparatus for application of nested zero waste ear to traveling web
Ares Trading S.A.	<b>C07K 4/00</b> (2006.01) <b>G01N 33/53</b> (2006.01)	2526419 *	METHODS FOR IMPROVING THE DESIGN, BIOAVAILABILITY, AND EFFICACY OF DIRECTED SEQUENCE POLYMER COMPOSITIONS VIA SERUM PROTEIN-BASED DETECTION OF DIRECTED SEQUENCE POLYMER COMPOSITIONS
Respivert Limited	<b>A61P 31/16</b> (2006.01) <b>A61K 45/06</b> (2006.01) <b>A61K 31/4155</b> (2006.01) <b>G01N 33/50</b> (2006.01)	2509595 *	INHIBITORS OF HEMOPOIETIC CELL KINASE (P59-HCK) AND THEIR USE IN THE TREATMENT OF INFLUENZA INFECTION
Philip Morris Products S.A.	<b>A24F 47/00</b> (2006.01)	2519122 *	A SHAPED HEATER FOR AN AEROSOL GENERATING SYSTEM

Podnosilac evropske prijave patenta (71)	MKP (51)	Broj objave evropske prijave patenta (97)	Naziv pronalaska (54)
Mylan Group	<b>B32B 3/00</b> (2006.01)	2522500	Laminating film
Fineheart	<b>A61M 1/12</b> (2006.01) <b>A61M 1/10</b> (2006.01)	2528638 *	SELF-CONTAINED CARDIAC PUMP, AND METHOD IMPLEMENTED IN SUCH A PUMP
Amgen Inc.	<b>A61K 31/53</b> (2006.01) <b>C07D 213/74</b> (2006.01) <b>A61K 31/4427</b> (2006.01) <b>C07D 251/48</b> (2006.01) <b>A61P 29/00</b> (2006.01) <b>C07D 401/04</b> (2006.01) <b>C07D 239/48</b> (2006.01) <b>A61K 31/506</b> (2006.01) <b>C07D 403/04</b> (2006.01) <b>C07D 471/10</b> (2006.01) <b>A61K 31/505</b> (2006.01)	2536689 *	ARYL CARBOXAMIDE DERIVATIVES AS SODIUM CHANNEL INHIBITORS FOR TREATMENT OF PAIN
Hekyom	<b>F25B 29/00</b> (2006.01) <b>F02G 1/04</b> (2006.01) <b>F03G 7/00</b> (2006.01) <b>F02G 1/043</b> (2006.01)	2534357 *	THERMOACOUSTIC MACHINE HAVING AN ELECTRIC FEEDBACK LOOP
Cima Labs Inc.	<b>A61K 9/20</b> (2006.01) <b>A61K 31/485</b> (2006.01)	2512456 *	ABUSE-RESISTANT FORMULATIONS
Entegriion, Inc.	<b>G01N 33/49</b> (2006.01) <b>G01N 21/25</b> (2006.01) <b>G01N 33/86</b> (2006.01)	2513647 *	PORTABLE COAGULATION MONITORING DEVICE AND METHOD OF ASSESSING COAGULATION RESPONSE
Zentiva, K.S.	<b>A61P 3/06</b> (2006.01) <b>A61K 31/40</b> (2006.01) <b>C07D 207/34</b> (2006.01)	2526089 *	A METHOD OF INDUSTRIAL PRODUCTION OF AN AMORPHOUS FORM OF ATORVASTATIN WITH A HIGH SPECIFIC SURFACE AREA AND ITS USE IN A DOSAGE FORM
Millennium Pharmaceuticals, Inc.	<b>C07D 498/00</b> (2006.01) <b>A01N 43/00</b> (2006.01) <b>A61K 31/55</b> (2006.01)	2536279 *	CRYSTALLINE FORMS OF SODIUM 4-[[9-CHLORO-7-(2-FLUORO-6-METHOXYPHENYL)-5H-PYRIMIDO[5,4-D][2] BENZAZEPIN-2YL]AMINO)-2-METHOXYBENZOATE
Teikoku Seiyaku Co., Ltd.	<b>A61N 1/04</b> (2006.01) <b>A61N 1/30</b> (2006.01)	2517754 *	ELECTRODE DEVICE USED FOR IONTOPHORESIS THERAPY
Famur Spółka Akcyjna	<b>E21C 31/08</b> (2006.01)	2499335 *	METHOD FOR MOUNTING A RANGING ARM ON A BODY OF A LONGWALL SHEARER LOADER
Famur Institute Sp. Z O.O.	<b>E21C 31/08</b> (2006.01)	2499335 *	METHOD FOR MOUNTING A RANGING ARM ON A BODY OF A LONGWALL SHEARER LOADER
Queensbrook Limited	<b>C08K 5/00</b> (2006.01) <b>C08J 11/10</b> (2006.01) <b>C08G 18/08</b> (2006.01)	2528961 *	PROCESS TO MAKE BIODEGRADABLE A SYNTHETIC POLYMER
Sigma-Tau Industrie Farmaceutiche Riunite S.P.A.	<b>A61P 9/14</b> (2006.01) <b>A61K 31/205</b> (2006.01) <b>A61K 31/7048</b> (2006.01)	2531189 *	COMBINATION COMPOSITION, COMPRISING AS ACTIVE INGREDIENT L-CARNITINE OR PROPIONYL L-CARNITINE, FOR THE PREVENTION OR TREATMENT OF CHRONIC VENOUS INSUFFICIENCY
Institut De Physique Du Globe De Paris (Établissement Public À Caractère Scientifique Et Technologique)	<b>G01N 21/84</b> (2006.01) <b>G01N 21/35</b> (2006.01) <b>G01N 21/31</b> (2006.01)	2453222	Apparatus and method for radiometry to determine the physico-chemical properties of a sample
Selexagen Therapeutics, Inc.	<b>A61K 31/425</b> (2006.01) <b>A01N 43/78</b> (2006.01)	2521451 *	HEDGEHOG INHIBITORS
Bayer CropScience NV	<b>A01H 5/00</b> (2006.01) <b>C12N 9/10</b> (2006.01) <b>A01H 5/10</b> (2006.01) <b>C12N 15/82</b> (2006.01)	2529019 *	METHODS FOR MANUFACTURING PLANT CELL WALLS COMPRISING CHITIN
Bulone, Vincent	<b>A01H 5/00</b> (2006.01) <b>C12N 9/10</b> (2006.01) <b>A01H 5/10</b> (2006.01) <b>C12N 15/82</b> (2006.01)	2529019 *	METHODS FOR MANUFACTURING PLANT CELL WALLS COMPRISING CHITIN

Podnosilac evropske prijave patenta (71)	MKP (51)	Broj objave evropske prijave patenta (97)	Naziv pronalaska (54)
Guerriero, Gea	<b>A01H 5/00</b> (2006.01) <b>C12N 9/10</b> (2006.01) <b>A01H 5/10</b> (2006.01) <b>C12N 15/82</b> (2006.01)	2529019 *	METHODS FOR MANUFACTURING PLANT CELL WALLS COMPRISING CHITIN
Sanofi-Aventis Deutschland GmbH	<b>A61M 5/172</b> (2006.01) <b>A61M 5/00</b> (2006.01) <b>A61M 5/142</b> (2006.01) <b>A61M 5/315</b> (2006.01)	2506896 *	DEVICE AND METHOD FOR DELIVERY OF TWO OR MORE DRUG AGENTS
SIGMA-TAU Industrie Farmaceutiche Riunite S.p.A.	<b>A61K 31/335</b> (2006.01) <b>A61K 31/4745</b> (2006.01) <b>A61K 31/704</b> (2006.01) <b>A61K 31/24</b> (2006.01) <b>A61P 35/00</b> (2006.01)	2515898 *	ANTICANCER COMBINATION OF ARTEMISININ-BASED DRUGS AND OTHER CHEMOTHERAPEUTIC AGENTS
Dow AgroSciences LLC	<b>A01N 43/90</b> (2006.01)	2521452 *	THIAZOLO[5,4-d]PYRIMIDINES AND THEIR USE AS AGROCHEMICALS
GM Rubinetterie S.r.l.	<b>F16K 11/20</b> (2006.01) <b>E03C 1/04</b> (2006.01) <b>B67D 1/00</b> (2006.01)	2472150	System and valve unit
Basilea Pharmaceutica AG	<b>C07D 491/04</b> (2006.01) <b>A61K 31/4741</b> (2006.01) <b>A61K 31/4743</b> (2006.01) <b>C07D 495/04</b> (2006.01) <b>A61P 31/04</b> (2006.01)	2513115 *	TRICYCLIC ANTIBIOTICS
Ajinomoto Co., Inc.	<b>C07K 5/06</b> (2006.01) <b>A23L 1/226</b> (2006.01) <b>A23L 1/30</b> (2006.01) <b>C07D 281/06</b> (2006.01)	2524925 *	LANTHONINE DERIVATIVE
Regeneron Pharmaceuticals, Inc.	<b>A61K 39/395</b> (2006.01) <b>A61K 9/08</b> (2006.01) <b>A61K 9/00</b> (2006.01) <b>A61K 31/485</b> (2006.01)	2521536 *	STABILIZED FORMULATIONS CONTAINING ANTI-INTERLEUKIN-6 RECEPTOR (IL-6R) ANTIBODIES
Dix, Daniel B.	<b>A61K 39/395</b> (2006.01) <b>A61K 9/08</b> (2006.01) <b>A61K 9/00</b> (2006.01) <b>A61K 31/485</b> (2006.01)	2521536 *	STABILIZED FORMULATIONS CONTAINING ANTI-INTERLEUKIN-6 RECEPTOR (IL-6R) ANTIBODIES
Graham, Kenneth S.	<b>A61K 39/395</b> (2006.01) <b>A61K 9/08</b> (2006.01) <b>A61K 9/00</b> (2006.01) <b>A61K 31/485</b> (2006.01)	2521536 *	STABILIZED FORMULATIONS CONTAINING ANTI-INTERLEUKIN-6 RECEPTOR (IL-6R) ANTIBODIES
Kamen, Douglas E.	<b>A61K 39/395</b> (2006.01) <b>A61K 9/08</b> (2006.01) <b>A61K 9/00</b> (2006.01) <b>A61K 31/485</b> (2006.01)	2521536 *	STABILIZED FORMULATIONS CONTAINING ANTI-INTERLEUKIN-6 RECEPTOR (IL-6R) ANTIBODIES
Walsh, Scott M.	<b>A61K 39/395</b> (2006.01) <b>A61K 9/08</b> (2006.01) <b>A61K 9/00</b> (2006.01) <b>A61K 31/485</b> (2006.01)	2521536 *	STABILIZED FORMULATIONS CONTAINING ANTI-INTERLEUKIN-6 RECEPTOR (IL-6R) ANTIBODIES
Arany, Gábor	<b>A01K 53/00</b> (2006.01)	2523549 *	BEE FEEDER WITH AUTOMATIC PRESSURE CONTROL
Magyar Tudományos Akadémia Kémiai Kutatóközpont	<b>A62D 3/36</b> (2007.01) <b>A62D 3/40</b> (2007.01) <b>A62D 3/34</b> (2007.01)	2509688 *	PROCESS AND APPARATUS FOR THE ANNIHILATION OF HARMFUL WASTE CONTAINING POLYCHLORINATED HYDROCARBONS
Arend Kereskedelmi És Szolgáltató KFT.	<b>A62D 3/36</b> (2007.01) <b>A62D 3/40</b> (2007.01) <b>A62D 3/34</b> (2007.01)	2509688 *	PROCESS AND APPARATUS FOR THE ANNIHILATION OF HARMFUL WASTE CONTAINING POLYCHLORINATED HYDROCARBONS
Procalor Környezetvédelmi És Energetikai Kutató-fejlesztő. Es Szolgáltató KFT.	<b>A62D 3/36</b> (2007.01) <b>A62D 3/40</b> (2007.01) <b>A62D 3/34</b> (2007.01)	2509688 *	PROCESS AND APPARATUS FOR THE ANNIHILATION OF HARMFUL WASTE CONTAINING POLYCHLORINATED HYDROCARBONS



Podnosilac evropske prijave patenta (71)	MKP (51)	Broj objave evropske prijave patenta (97)	Naziv pronalaska (54)
Sirkó, Imre	<b>A62D 3/36</b> (2007.01) <b>A62D 3/40</b> (2007.01) <b>A62D 3/34</b> (2007.01)	2509688 *	PROCESS AND APPARATUS FOR THE ANNIHILATION OF HARMFUL WASTE CONTAINING POLYCHLORINATED HYDROCARBONS
Sanofi-Aventis Deutschland GmbH	<b>A61M 5/24</b> (2006.01)	2450072	Medicated module with floating piston
SANOFI	<b>A61P 9/00</b> (2006.01) <b>A61K 31/519</b> (2006.01) <b>C07D 471/04</b> (2006.01)	2521726 *	5-OXO-5, 8-DIHYDROPYRIDO [2, 3-D]PYRIMIDINE DERIVATIVES AS CAMKII KINASE INHIBITORS FOR TREATING CARDIOVASCULAR DISEASES
Ethicon Endo-Surgery, Inc.	<b>A61B 17/072</b> (2006.01) <b>A61B 17/29</b> (2006.01) <b>A61B 17/115</b> (2006.01) <b>A61B 19/00</b> (2006.01)	2512351 *	SURGICAL STAPLER WITH DISCRETE STAPLE HEIGHT ADJUSTMENT AND TACTILE FEEDBACK
ALEXION PHARMACEUTICALS, INC.	<b>C07K 16/28</b> (2006.01)	2523976 *	BIOMARKERS OF IMMUNOMODULATORY EFFECTS IN HUMANS TREATED WITH ANTI-CD200 ANTIBODIES
REGENERON PHARMACEUTICALS, INC.	<b>C12N 15/85</b> (2006.01) <b>C07K 16/46</b> (2006.01) <b>A01K 67/027</b> (2006.01)	2501817 *	COMMON LIGHT CHAIN MOUSE
Oncomed Pharmaceuticals, Inc.	<b>C07K 16/18</b> (2006.01)	2523974 *	WNT-BINDING AGENTS AND USES THEREOF
Abbott GmbH & Co. KG	<b>C07K 16/22</b> (2006.01) <b>A61K 39/395</b> (2006.01)	2510001 *	MONOCLONAL ANTIBODIES AGAINST THE RGM A PROTEIN FOR USE IN THE TREATMENT OF RETINAL NERVE FIBER LAYER DEGENERATION
Sanofi-Aventis Deutschland GmbH	<b>A61M 5/315</b> (2006.01)	2509663 *	DRIVE ASSEMBLY FOR A DRUG DELIVERY DEVICE AND DRUG DELIVERY DEVICE
GlaxoSmithKline LLC	<b>A01N 43/54</b> (2006.01)	2523559 *	COMPOUNDS AND METHODS
VIIV Healthcare Company	<b>A01N 43/00</b> (2006.01)	2531027 *	ANTIVIRAL THERAPY
Leo Pharma A/S	<b>A61K 9/14</b> (2006.01) <b>A61K 31/593</b> (2006.01)	2515874 *	CALCIPOTRIOL MONOHYDRATE NANOCRYSTALS
Hitachi Power Europe GmbH	<b>F22B 37/40</b> (2006.01) <b>F22B 37/24</b> (2006.01)	2388519	System for creating a protected working area within a working room separated by a wall
Polichem SA	<b>C07D 407/12</b> (2006.01) <b>C07D 491/113</b> (2006.01) <b>C07D 215/48</b> (2006.01) <b>A61P 31/10</b> (2006.01) <b>C07D 401/06</b> (2006.01) <b>C07D 401/12</b> (2006.01) <b>C07D 407/06</b> (2006.01) <b>A61K 31/4709</b> (2006.01) <b>C07D 417/06</b> (2006.01)	2519505 *	NEW TERTIARY 8-HYDROXYQUINOLINE-7-CARBOXAMIDE DERIVATIVES AND USES THEREOF
Bind Biosciences, Inc.	<b>A61K 47/36</b> (2006.01) <b>A61P 35/00</b> (2006.01) <b>A61K 47/30</b> (2006.01) <b>A61K 47/40</b> (2006.01) <b>A61K 31/335</b> (2006.01) <b>A61K 47/02</b> (2006.01)	2509634 *	STABLE FORMULATIONS FOR LYOPHILIZING THERAPEUTIC PARTICLES
University Hospitals Of Cleveland	<b>C12N 5/00</b> (2006.01) <b>A61K 31/70</b> (2006.01)	2509605 *	P2X7: INHIBITION OF EPITHELIAL CANCERS AND PAPILOMAS
Bind Biosciences, Inc.	<b>A61P 19/10</b> (2006.01) <b>A61P 11/06</b> (2006.01) <b>A61K 9/127</b> (2006.01) <b>A61P 29/00</b> (2006.01) <b>A61K 47/30</b> (2006.01) <b>A61K 31/337</b> (2006.01)	2515942 *	THERAPEUTIC POLYMERIC NANOPARTICLE COMPOSITIONS WITH HIGH GLASS TRANSITION TEMPERATURE OR HIGH MOLECULAR WEIGHT COPOLYMERS
Ada Environmental Solutions, LLC	<b>B01D 53/64</b> (2006.01)	2531276 *	METHOD AND SYSTEM FOR CONTROLLING MERCURY EMISSIONS FROM COAL-FIRED THERMAL PROCESSES
Gauta, Joseph	<b>A61B 5/103</b> (2006.01)	2512336 *	METHOD AND APPARATUS PROVIDING TIMED VISUAL IMAGES DURING CHILDBIRTH

Podnosilac evropske prijave patenta (71)	MKP (51)	Broj objave evropske prijave patenta (97)	Naziv pronalaska (54)
Heartflow, Inc.	<b>G06F 19/00</b> (2011.01)	2538362	Method and system for patient-specific modeling of blood flow
Zannan Scitech Co., Ltd.	<b>C08F 4/80</b> (2006.01) <b>B01J 31/22</b> (2006.01) <b>C07F 15/00</b> (2006.01)	2519350 *	HIGHLY ACTIVE METATHESIS CATALYSIS SELECTIVE FOR ROMP AND RCM
SAS INSTITUTE INC.	<b>G06F 9/50</b> (2006.01)	2534579 *	SCENARIO STATE PROCESSING SYSTEMS AND METHODS FOR OPERATION WITHIN A GRID COMPUTING ENVIRONMENT
E. Mishan&Sons, Inc.	<b>A63B 23/02</b> (2006.01) <b>A63B 21/045</b> (2006.01) <b>A63B 22/14</b> (2006.01)	2428255	Improved abdominal exerciser with rotatable seat and tandem pulley features
Les Laboratoires Servier	<b>A61K 31/165</b> (2006.01) <b>A61P 25/22</b> (2006.01)	2533774 *	USE OF AGOMELATINE FOR THE PREPARATION OF DRUGS FOR TREATING OBSESSIVE COMPULSIVE DISORDER (OCD)
Dow AgroSciences LLC	<b>A01P 13/00</b> (2006.01) <b>A01N 43/40</b> (2006.01) <b>A01N 33/12</b> (2006.01) <b>A01N 25/12</b> (2006.01) <b>A01N 25/14</b> (2006.01)	2503889 *	IMPROVED PROCESS FOR PREPARING SOLUBLE GRANULES OF SALTS OF PYRIDINE-CARBOXYLIC ACIDS
Prometheus Laboratories Inc.	<b>G01N 33/68</b> (2006.01) <b>C12N 15/12</b> (2006.01) <b>C12Q 1/68</b> (2006.01)	2504457 *	NOVEL GENOMIC BIOMARKERS FOR IRRITABLE BOWEL SYNDROME DIAGNOSIS
Gilead Sciences, Inc.	<b>A61K 31/495</b> (2006.01) <b>A61K 31/343</b> (2006.01) <b>A61P 9/06</b> (2006.01)	2515900 *	METHOD OF TREATING ATRIAL FIBRILLATION
Manufactur für Glas und Spiegel GmbH	<b>A61N 5/06</b> (2006.01) <b>A47K 3/28</b> (2006.01) <b>A61H 33/06</b> (2006.01)	2353478	Shower device with thermal radiant source
SA Shuang	<b>A01B 69/00</b> (2006.01) <b>A47B 88/04</b> (2006.01) <b>A01D 34/835</b> (2006.01) <b>A01D 34/00</b> (2006.01) <b>E04D 11/00</b> (2006.01) <b>A47B 88/00</b> (2006.01)	2454927	Mowing apparatus and grass maintenance system
Novartis AG	<b>C07D 487/04</b> (2006.01) <b>A61K 31/519</b> (2006.01) <b>C07D 519/00</b> (2006.01) <b>A61P 35/00</b> (2006.01) <b>C07B 59/00</b> (2006.01)	2536730 *	PYRROLOPYRIMIDINE COMPOUNDS AS INHIBITORS OF CDK4/6
Amgen Inc.	<b>C07D 405/12</b> (2006.01) <b>C07D 401/04</b> (2006.01) <b>C07D 417/04</b> (2006.01) <b>A61P 25/28</b> (2006.01) <b>C07D 401/10</b> (2006.01) <b>A61K 31/4709</b> (2006.01) <b>C07D 401/12</b> (2006.01) <b>C07D 215/38</b> (2006.01)	2504315 *	AMINO HETEROARYL COMPOUNDS AS BETA-SECRETASE MODULATORS AND METHODS OF USE
Abbott Laboratories	<b>C07D 213/84</b> (2006.01) <b>C07D 405/14</b> (2006.01) <b>C07D 213/74</b> (2006.01) <b>C07D 405/12</b> (2006.01) <b>C07D 209/08</b> (2006.01) <b>C07D 401/14</b> (2006.01) <b>C07D 211/58</b> (2006.01) <b>C07D 403/12</b> (2006.01) <b>C07D 231/56</b> (2006.01) <b>C07D 413/12</b> (2006.01) <b>C07D 309/04</b> (2006.01) <b>C07D 235/06</b> (2006.01) <b>C07D 417/12</b> (2006.01) <b>C07D 277/24</b> (2006.01) <b>C07D 471/04</b> (2006.01)	2507211 *	APOPTOSIS-INDUCING AGENTS FOR THE TREATMENT OF CANCER AND IMMUNE AND AUTOIMMUNE DISEASES
The University of North Carolina At Chapel Hill	<b>A61K 31/435</b> (2006.01) <b>A61K 31/335</b> (2006.01) <b>A61K 31/38</b> (2006.01)	2509597 *	SELECTIVE BETA-GLUCURONIDASE INHIBITORS AS A TREATMENT FOR SIDE EFFECTS OF CAMPTOTHECIN ANTINEOPLASTIC AGENTS

Podnosilac evropske prijave patenta (71)	MKP (51)	Broj objave evropske prijave patenta (97)	Naziv pronalaska (54)
Albert Einstein College Of Medecine Of Yeshiva University	<b>A61K 31/435</b> (2006.01) <b>A61K 31/335</b> (2006.01) <b>A61K 31/38</b> (2006.01)	2509597 *	SELECTIVE BETA-GLUCURONIDASE INHIBITORS AS A TREATMENT FOR SIDE EFFECTS OF CAMPTOTHECIN ANTINEOPLASTIC AGENTS
North Carolina Central University	<b>A61K 31/435</b> (2006.01) <b>A61K 31/335</b> (2006.01) <b>A61K 31/38</b> (2006.01)	2509597 *	SELECTIVE BETA-GLUCURONIDASE INHIBITORS AS A TREATMENT FOR SIDE EFFECTS OF CAMPTOTHECIN ANTINEOPLASTIC AGENTS
SANOFI	<b>C07D 498/04</b> (2006.01) <b>A61K 31/519</b> (2006.01) <b>A61P 9/00</b> (2006.01)	2523963 *	2,5-SUBSTITUTED OXAZOLOPYRIMIDINE DERIVATIVES
Ascendis Pharma A/S	<b>A61K 47/48</b> (2006.01)	2525829 *	DIPEPTIDE-BASED PRODRUG LINKERS FOR AROMATIC AMINE-CONTAINING DRUGS
Kirchdorfer Fertigteilholding GmbH	<b>E01F 15/08</b> (2006.01)	2513376 *	ROAD ARRANGEMENT
Amgen Inc.	<b>A61K 39/395</b> (2006.01)	2523689 *	IL-22-FC AND HEPICIDIN ACTIVITY
Yale University	<b>A61K 39/00</b> (2006.01) <b>A61K 39/395</b> (2006.01)	2519253 *	INHIBITORS OF VASCULAR ENDOTHELIAL GROWTH FACTOR (VEGF) RECEPTORS AND METHODS OF USE THEREOF
Colussi, Rafael Antonio	<b>F16K 15/20</b> (2006.01) <b>B60C 23/00</b> (2006.01) <b>B60C 23/10</b> (2006.01)	2522532 *	AN AUTONOMOUS VALVE ASSEMBLY FOR THE REGULATION, DEPRESSURISATION AND PRESSURISATION OF PNEUMATIC EQUIPMENT
Vénica, Néstor Juan	<b>F16K 15/20</b> (2006.01) <b>B60C 23/00</b> (2006.01) <b>B60C 23/10</b> (2006.01)	2522532 *	AN AUTONOMOUS VALVE ASSEMBLY FOR THE REGULATION, DEPRESSURISATION AND PRESSURISATION OF PNEUMATIC EQUIPMENT
Merck Sharp & Dohme Corp.	<b>A61K 39/00</b> (2006.01)	2533805 *	15-VALENT PNEUMOCOCCAL POLYSACCHARIDE-PROTEIN CONJUGATE VACCINE COMPOSITION
Janssen Pharmaceutica, N.V.	<b>A61K 31/427</b> (2006.01) <b>C07D 417/06</b> (2006.01) <b>A61K 31/4439</b> (2006.01) <b>A61P 19/00</b> (2006.01) <b>C07D 417/14</b> (2006.01)	2536717 *	AMINOTHIAZOLONES AS ESTROGEN RELATED RECEPTOR-ALPHA MODULATORS
Ethicon. Inc.	<b>A61F 2/00</b> (2006.01)	2512367 *	BROW LIFT IMPLANT
Dow AgroSciences LLC	<b>A01P 7/04</b> (2006.01) <b>A01N 43/40</b> (2006.01) <b>A01P 13/00</b> (2006.01)	2536280 *	SYNERGISTIC HERBICIDE/INSECTICIDE COMPOSITION CONTAINING CERTAIN PYRIDINE CARBOXYLIC ACIDS AND CERTAIN INSECTICIDES
The Henry M. Jackson Foundation for the Advancement of Military Medicine, Inc.	<b>A61K 39/08</b> (2006.01)	2501403 *	(POLY)-GLYCEROLPHOSPHATE-BASED ANTI-GRAM POSITIVE BACTERIAL VACCINE
McNeil-PPC, Inc.	<b>A61K 9/28</b> (2006.01) <b>A61K 9/50</b> (2006.01) <b>A61K 9/48</b> (2006.01)	2509587 *	PARTIAL DIP COATING OF DOSAGE FORMS FOR MODIFIED RELEASE
Syngenta Limited	<b>A01N 43/16</b> (2006.01) <b>A01P 13/00</b> (2006.01)	2523554 *	HERBICIDAL COMPOSITION COMPRISING A PYRANDIONE HERBICIDE AND A CO-HERBICIDE
Pastificio Rana S.p.A.	<b>B65D 81/34</b> (2006.01) <b>B65D 81/32</b> (2006.01)	2484604	Package for the preservation and cooking of food products and method of its use
Inotek Pharmaceuticals Corporation	<b>A61K 31/7076</b> (2006.01) <b>A61P 27/02</b> (2006.01) <b>A61K 31/5575</b> (2006.01)	2523669 *	COMBINATION, KIT AND METHOD OF REDUCING INTRAOCULAR PRESSURE
University Of Georgia Research Foundation, Inc.	<b>C07D 213/63</b> (2006.01) <b>A61K 31/4439</b> (2006.01) <b>A61K 31/4412</b> (2006.01) <b>A61P 31/18</b> (2006.01) <b>C07D 401/12</b> (2006.01)	2509949 *	PYRIDINONE HYDROXYCYCLOPENTYL CARBOXAMIDES: HIV INTEGRASE INHIBITORS WITH THERAPEUTIC APPLICATIONS
Eli Lilly and Company	<b>A61K 38/17</b> (2006.01) <b>A61P 3/10</b> (2006.01) <b>A61K 38/26</b> (2006.01) <b>C07K 14/605</b> (2006.01) <b>A61P 3/04</b> (2006.01)	2515928 *	OXYNTOMODULIN PEPTIDE ANALOGUE

Podnosilac evropske prijave patenta (71)	MKP (51)	Broj objave evropske prijave patenta (97)	Naziv pronalaska (54)
GenKyoTex SA	<b>C07D 471/04</b> (2006.01) <b>A61P 35/00</b> (2006.01) <b>A61K 31/4162</b> (2006.01)	2536723 *	PYRAZOLO PIPERIDINE DERIVATIVES AS NADPH OXIDASE INHIBITORS
Bind Biosciences, Inc.	<b>A61K 9/127</b> (2006.01) <b>A61K 31/56</b> (2006.01) <b>A61K 31/573</b> (2006.01) <b>A61K 47/48</b> (2006.01) <b>A61K 47/30</b> (2006.01) <b>A61K 9/22</b> (2006.01)	2512487 *	THERAPEUTIC POLYMERIC NANOPARTICLES COMPRISING CORTICOSTEROIDS AND METHODS OF MAKING AND USING SAME
Dow AgroSciences LLC	<b>A01N 43/90</b> (2006.01) <b>A01P 13/00</b> (2006.01) <b>A01N 33/22</b> (2006.01)	2528435 *	SYNERGISTIC HERBICIDAL COMPOSITION CONTAINING PENOXSULAM AND OXYFLUORFEN
Athenix Corp.	<b>A01H 5/00</b> (2006.01) <b>C12N 5/10</b> (2006.01) <b>A01P 7/04</b> (2006.01) <b>C07H 21/04</b> (2006.01) <b>C07K 14/00</b> (2006.01) <b>A01H 1/00</b> (2006.01) <b>C12N 15/63</b> (2006.01) <b>C12P 21/00</b> (2006.01) <b>A01N 37/18</b> (2006.01) <b>A01H 5/10</b> (2006.01) <b>C12N 1/21</b> (2006.01) <b>C12N 15/82</b> (2006.01)	2536266 *	AXMI218, AXMI219, AXMI220, AXMI226, AXMI227, AXMI228, AXMI229, AXMI230, AND AXMI231 DELTA-ENDOTOXIN GENES AND METHODS FOR THEIR USE
Deva Holding Anonim Sirketi	<b>A61K 9/20</b> (2006.01) <b>A61K 31/215</b> (2006.01)	2441446	Using of superdisintegrants in cetyl myristate and/or cetyl palmitate formulations
Squassi, Giovanni	<b>G07F 17/32</b> (2006.01)	2420981	Certification method of a website for gambling
Vascular Biogenics Ltd.	<b>A61K 39/00</b> (2006.01) <b>C12N 15/861</b> (2006.01) <b>C07K 14/475</b> (2006.01) <b>C12N 7/02</b> (2006.01)	2523681 *	METHODS OF PRODUCING ADENOVIRUS VECTORS AND VIRAL PREPARATIONS GENERATED THEREBY
IHI Aerospace Co., Ltd.	<b>H02P 29/02</b> (2006.01) <b>H02P 9/10</b> (2006.01) <b>H02P 9/00</b> (2006.01)	2530828	Electricity generation device and permanent-magnet electric generator
Sinfonia Technology Co., Ltd.	<b>H02P 29/02</b> (2006.01) <b>H02P 9/10</b> (2006.01) <b>H02P 9/00</b> (2006.01)	2530828	Electricity generation device and permanent-magnet electric generator
Semrock, Inc.	<b>G02B 5/28</b> (2006.01) <b>G02B 6/293</b> (2006.01)	2521930 *	TUNABLE THIN-FILM FILTER
Lee, Sang Won	<b>F24D 3/12</b> (2006.01) <b>E04F 15/00</b> (2006.01)	2532977 *	HEATING STRUCTURE
Knauf Gips KG	<b>C04B 14/02</b> (2006.01) <b>B32B 13/00</b> (2006.01) <b>C04B 28/14</b> (2006.01) <b>E04C 2/04</b> (2006.01)	2533976 *	GYPSUM PLASTER BOARD AND A METHOD FOR PRODUCING A GYPSUM PLASTER BOARD
Abbott Laboratories	<b>A01N 43/58</b> (2006.01)	2506716 *	NOVEL TRICYCLIC COMPOUNDS
SANOFI	<b>A61K 38/28</b> (2006.01) <b>A61K 9/08</b> (2006.01) <b>A61K 9/00</b> (2006.01)	2387989	Long - acting formulations of insulins
APREA AB	<b>A61K 31/439</b> (2006.01) <b>A61P 35/00</b> (2006.01) <b>A61P 9/00</b> (2006.01) <b>A61K 31/444</b> (2006.01) <b>A61K 9/08</b> (2006.01) <b>A61K 31/522</b> (2006.01) <b>A61K 31/496</b> (2006.01) <b>A61K 31/519</b> (2006.01) <b>A61K 31/5377</b> (2006.01)	2525796 *	AQUEOUS SOLUTION COMPRISING 3-QUINUCLIDINONES FOR THE TREATMENT OF HYPERPROLIFERATIVE, AUTOIMMUNE AND HEART DISEASE
Ethicon Endo-Surgery, Inc.	<b>A61B 17/32</b> (2006.01) <b>A61B 17/3207</b> (2006.01) <b>A61B 10/02</b> (2006.01)	2533709 *	ULTRASONIC SURGICAL INSTRUMENTS WITH PARTIALLY ROTATING BLADE AND FIXED PAD ARRANGEMENT
Vascular Biogenics Ltd.	<b>C07H 21/02</b> (2006.01) <b>C12N 15/00</b> (2006.01)	2521777 *	COMPOSITIONS AND METHODS FOR TREATING GLIOBLASTOMA GBM

Podnosilac evropske prijave patenta (71)	MKP (51)	Broj objave evropske prijave patenta (97)	Naziv pronalaska (54)
Meiji Seika Pharma Co., Ltd.	<b>C12P 17/18</b> (2006.01) <b>C12N 1/21</b> (2006.01) <b>C12N 1/15</b> (2006.01) <b>C12N 5/10</b> (2006.01) <b>C12N 1/19</b> (2006.01) <b>C12N 15/09</b> (2006.01)	2530164 *	METHOD FOR MANUFACTURING A PYRIPYROPENE
Blücher GmbH	<b>B01J 20/20</b> (2006.01) <b>B01J 20/28</b> (2006.01) <b>B01J 20/26</b> (2006.01)	2536498 *	ADSORPTIVE STRUCTURES HAVING A PARTICLE AND/OR AEROSOL FILTER FUNCTION AND METHOD FOR PRODUCING SUCH ADSORPTIVE STRUCTURES
Vascular Biogenics Ltd.	<b>A61K 45/00</b> (2006.01)	2521569 *	COMBINED TREATMENT UTILIZING VB-201
Friulana Costruzioni S.r.l.	<b>E03F 5/12</b> (2006.01)	2536890 *	A FILTERING DEVICE
T.I.C. Technology Innovation Consulting AG	<b>E21B 7/04</b> (2006.01) <b>E21B 7/20</b> (2006.01) <b>E21B 7/30</b> (2006.01)	2447462	Method for subterranean insertion of a conduit
Napatech A/S	<b>H04L 12/26</b> (2006.01) <b>H04L 12/56</b> (2006.01)	2507949 *	AN APPARATUS, AN ASSEMBLY AND A METHOD OF OPERATING A PLURALITY OF ANALYZING MEANS READING AND ORDERING DATA PACKETS
Syfrig, Leo	<b>E21B 7/02</b> (2006.01)	2489823	Device for splitting solid materials
Ethicon Endo-Surgery, Inc.	<b>A61B 17/32</b> (2006.01)	2533711 *	METHODS OF USING ULTRASONICALLY POWERED SURGICAL INSTRUMENTS WITH ROTATABLE CUTTING IMPLEMENTS
Messer GasPack GmbH	<b>F17C 13/00</b> (2006.01)	2508787	Identification system for compressed gas bottles
Nel Hydrogen AS	<b>F17C 9/00</b> (2006.01) <b>F17C 7/02</b> (2006.01) <b>F17C 13/02</b> (2006.01)	2504614 *	METHOD FOR THE OPERATION AND CONTROL OF GAS FILLING
Orda Korea Co., Ltd.	<b>A63H 33/10</b> (2006.01)	2514496 *	COMPONENT FOR MAGNETIC ATTACHMENT AND A MAGNETIC TOY
Vascular Biogenics Ltd.	<b>A01N 57/00</b> (2006.01)	2521454 *	TREATMENT WITH VB-201
Foodmate B.V.	<b>A22C 21/00</b> (2006.01)	2528446 *	METHOD AND APPARATUS FOR REMOVING A SLEEVE OF MEAT FROM AN ANIMAL PART HAVING A BONE WITH KNUCKLES ON EACH OF ITS OPPOSITE ENDS
Genentech, Inc.	<b>C12N 15/62</b> (2006.01) <b>C07K 14/475</b> (2006.01) <b>A61K 39/395</b> (2006.01) <b>C12N 15/113</b> (2010.01) <b>A61P 35/00</b> (2006.01) <b>C07K 14/71</b> (2006.01) <b>A61K 31/7088</b> (2006.01) <b>A61K 38/17</b> (2006.01)	2536748 *	NEUREGULIN ANTAGONISTS AND USE THEREOF IN TREATING CANCER
The Board of Trustees of the Leland Stanford Junior University	<b>C12N 15/62</b> (2006.01) <b>C07K 14/475</b> (2006.01) <b>A61K 39/395</b> (2006.01) <b>C12N 15/113</b> (2010.01) <b>A61P 35/00</b> (2006.01) <b>C07K 14/71</b> (2006.01) <b>A61K 31/7088</b> (2006.01) <b>A61K 38/17</b> (2006.01)	2536748 *	NEUREGULIN ANTAGONISTS AND USE THEREOF IN TREATING CANCER
Szentiványi, Péter	<b>F28C 3/06</b> (2006.01) <b>F28B 3/06</b> (2006.01)	2507570 *	METHOD AND APPARATUS FOR HANDLING GASES
ECLISSE SRL	<b>A61G 7/10</b> (2006.01) <b>E06B 3/46</b> (2006.01)	2501887 *	COUNTERFRAME FOR RETRACTABLE SLIDING-DOOR WITH RAIL SUPPORTING TECHNICAL TRAVERSE IN ROOMS PROVIDED WITH INTER-ROOM CEILING GUIDING SYSTEMS TO MOVE DISABLED PERSONS
Dow AgroSciences, LLC	<b>C12N 15/82</b> (2006.01)	2513316 *	USE OF CRY1DA IN COMBINATION WITH CRY1CA FOR MANAGEMENT OF RESISTANT INSECTS
Ethicon Endo-Surgery, Inc.	<b>A61B 17/32</b> (2006.01) <b>A61B 17/3207</b> (2006.01)	2533710 *	DUAL PURPOSE SURGICAL INSTRUMENT FOR CUTTING AND COAGULATING TISSUE

Podnosilac evropske prijave patenta (71)	MKP (51)	Broj objave evropske prijave patenta (97)	Naziv pronalaska (54)
PerkinElmer Health Sciences, Inc.	<b>G01N 25/48</b> (2006.01) <b>G01N 21/65</b> (2006.01) <b>G01J 3/44</b> (2006.01)	2504690 *	ANALYTICAL SYSTEM AND METHOD WITH COMBINED DIFFERENTIAL SCANNING CALORIMETRY (DSC) AND RAMAN SPECTROSCOPY
PerkinElmer Ltd.	<b>G01N 25/48</b> (2006.01) <b>G01N 21/65</b> (2006.01) <b>G01J 3/44</b> (2006.01)	2504690 *	ANALYTICAL SYSTEM AND METHOD WITH COMBINED DIFFERENTIAL SCANNING CALORIMETRY (DSC) AND RAMAN SPECTROSCOPY
Avila Therapeutics, Inc.	<b>A61K 31/33</b> (2006.01)	2519235 *	HETEROARYL COMPOUNDS AND USES THEREOF
Soane Energy, LLC	<b>C09K 8/60</b> (2006.01) <b>C11D 3/20</b> (2006.01)	2510080 *	LOW INTERFACIAL TENSION SURFACTANTS FOR PETROLEUM APPLICATIONS
Cellresin Technologies, LLC	<b>A01N 3/02</b> (2006.01) <b>A01N 25/10</b> (2006.01) <b>A01N 3/00</b> (2006.01)	2512232 *	MATURATION OR RIPENING INHIBITOR RELEASE FROM POLYMER, FIBER, FILM, SHEET OR PACKAGING
Janssen Pharmaceutica N.V.	<b>C07D 417/14</b> (2006.01) <b>A61K 31/427</b> (2006.01) <b>A61P 25/00</b> (2006.01)	2504333 *	MORPHOLINOTHIAZOLES AS ALPHA 7 POSITIVE ALLOSTERIC MODULATORS
SANOFI	<b>C07D 413/14</b> (2006.01) <b>C07D 498/14</b> (2006.01) <b>C07D 401/14</b> (2006.01) <b>C07D 405/14</b> (2006.01) <b>C07D 409/14</b> (2006.01) <b>A61P 29/00</b> (2006.01) <b>A61K 31/454</b> (2006.01)	2516419 *	INDOLYL-PIPERIDINYL BENZYLAMINES AS BETA-TRYPTASE INHIBITORS
Reichart, Norbert	<b>B65D 51/24</b> (2006.01) <b>F42B 4/20</b> (2006.01)	2502021 *	RETAINER FOR A FIREWORK THAT CAN BE USED INDOORS
Novelis, Inc.	<b>B22D 15/00</b> (2006.01) <b>B22D 7/02</b> (2006.01)	2533921 *	CASTING COMPOSITE INGOT WITH METAL TEMPERATURE COMPENSATION
Les Laboratoires Servier	<b>A61K 31/403</b> (2006.01) <b>A61P 25/00</b> (2006.01) <b>C07D 209/52</b> (2006.01)	2532651	Synthesis process, and crystalline form of 4-{3-[cis-hexahydrocyclopenta[c]pyrrol-2(1h)-yl]propoxy} benzamide hydrochloride and its free base as well as the pharmaceutical compositions containing them
MSDX, Inc.	<b>G01N 33/50</b> (2006.01)	2504699 *	METHODS OF DETECTING OR MONITORING ACTIVITY OF AN INFLAMMATORY OR NEURODEGENERATIVE CONDITION
Galderma Research & Development	<b>A61K 8/49</b> (2006.01) <b>C07D 213/74</b> (2006.01) <b>A61P 17/00</b> (2006.01) <b>C07D 241/20</b> (2006.01) <b>A61P 15/00</b> (2006.01) <b>A61K 31/4965</b> (2006.01) <b>C07D 239/42</b> (2006.01) <b>A61P 35/00</b> (2006.01) <b>A61K 31/44</b> (2006.01) <b>A61Q 19/00</b> (2006.01) <b>A61K 31/505</b> (2006.01)	2516398 *	NOVEL PHENOL DERIVATIVES AND PHARMACEUTICAL OR COSMETIC USE THEREOF
Philip Morris Products S.A.	<b>A24F 47/00</b> (2006.01)	2515690 *	AN ELONGATE HEATER FOR AN ELECTRICALLY HEATED AEROSOL-GENERATING SYSTEM
Epitech Group S.r.l.	<b>A61K 9/08</b> (2006.01) <b>A61K 9/10</b> (2006.01) <b>A61K 9/107</b> (2006.01) <b>A61K 9/70</b> (2006.01) <b>A61K 31/16</b> (2006.01) <b>A61P 29/00</b> (2006.01)	2455066	Pharmacological preparation for topical use containing n-palmitoyl-vanillamide
Janssen Biotech, Inc.	<b>A61K 39/00</b> (2006.01) <b>C12P 21/08</b> (2006.01)	2506871 *	ANTIBODY Fc MUTANTS WITH ABLATED EFFECTOR FUNCTIONS
Qarnot Computing	<b>F24H 3/06</b> (2006.01) <b>G06F 1/20</b> (2006.01)	2521884 *	ELECTRIC RADIATOR USING CALCULATING PROCESSORS AS A HEAT SOURCE
Sklad Nepremi Nin D.O.O.	<b>G07B 15/02</b> (2011.01) <b>B63B 22/02</b> (2006.01)	2531981 *	SYSTEM FOR AUTOMATIC MANAGING AND CONTROLLING THE USE OF MOORINGS FOR VESSELS, COMPRISING AUTOMATED FLOATING BUOYS AND THE RELATED METHOD

Podnosilac evropske prijave patenta (71)	MKP (51)	Broj objave evropske prijave patenta (97)	Naziv pronalaska (54)
Laboratorios del. Dr. Esteve, S.A.	<b>A61P 25/00</b> (2006.01) <b>A61K 9/16</b> (2006.01) <b>A61K 31/4152</b> (2006.01) <b>C07D 231/22</b> (2006.01)	2531177 *	4-[-2-[[5-METHYL-1-(2-NAPHTALENYL)-1H-PYRAZOL-3-YL]OXY]ETHYL]MORPHOLINE HYDROCHLORIDE POLYMORPHS AND SOLVATES
Merz Pharma GmbH & Co. KGaA	<b>G01N 33/50</b> (2006.01) <b>A61B 5/0488</b> (2006.01) <b>G01N 33/94</b> (2006.01) <b>A61B 5/11</b> (2006.01)	2501279 *	ASSAY FOR QUANTIFYING CLOSTRIDIAL NEUROTOXIN
Lojack Operating Company, Lp	<b>H03H 9/00</b> (2006.01)	2491652 *	NOTCHED SAW IMAGE FREQUENCY REJECTION FILTER SYSTEM
Saad, Clément	<b>H04L 29/06</b> (2006.01) <b>G06F 21/00</b> (2006.01) <b>G06F 9/455</b> (2006.01)	2502399 *	METHOD AND DEVICE FOR SECURING THE CONNECTION OF A TERMINAL TO A COMPUTER NETWORK
Napatech A/S	<b>H04L 12/56</b> (2006.01)	2507951 *	AN APPARATUS AND A METHOD OF RECEIVING AND STORING DATA PACKETS CONTROLLED BY A CENTRAL CONTROLLER
Medivir UK Ltd	<b>A61K 31/415</b> (2006.01) <b>C07C 237/14</b> (2006.01) <b>A61P 11/06</b> (2006.01) <b>A61P 17/06</b> (2006.01) <b>A61P 21/04</b> (2006.01) <b>A61P 9/10</b> (2006.01) <b>A61K 31/426</b> (2006.01) <b>C07D 277/46</b> (2006.01) <b>A61K 31/16</b> (2006.01) <b>A61P 37/08</b> (2006.01) <b>C07D 231/40</b> (2006.01) <b>A61P 37/02</b> (2006.01)	2509957 *	CYSTEINE PROTEASE INHIBITORS
SICPA Holding SA	<b>B42D 15/00</b> (2006.01) <b>C09D 11/02</b> (2006.01) <b>B41M 5/28</b> (2006.01) <b>B41M 3/14</b> (2006.01) <b>C09D 11/00</b> (2006.01) <b>B42D 15/10</b> (2006.01)	2509792 *	MODIFIED MARKING BASED ON CHIRAL LIQUID CRYSTAL POLYMERS
Ethicon Endo-Surgery, Inc.	<b>A61B 17/068</b> (2006.01) <b>A61B 17/34</b> (2006.01) <b>A61B 19/00</b> (2006.01) <b>A61B 17/00</b> (2006.01) <b>A61B 17/115</b> (2006.01)	2509512 *	CIRCULAR STAPLER INTRODUCER WITH RIGID DISTAL END PORTION
Sanofi-Aventis Deutschland GmbH	<b>A61M 5/315</b> (2006.01)	2512562 *	PISTON FOR A CARTRIDGE AND PISTON ROD FOR A DRUG DELIVERY DEVICE
Ethicon Endo-Surgery, Inc.	<b>A61B 17/22</b> (2006.01) <b>A61B 17/3207</b> (2006.01) <b>A61B 17/32</b> (2006.01)	2533704 *	ULTRASONIC SURGICAL INSTRUMENTS WITH ROTATABLE BLADE AND HOLLOW SHEATH ARRANGEMENTS
Æterna Zentaris GmbH	<b>C07D 471/04</b> (2006.01) <b>A61P 35/00</b> (2006.01) <b>A61K 31/4745</b> (2006.01)	2504336 *	NOVEL NAPHTHYRIDINE DERIVATIVES AND THE USE THEREOF AS KINASE INHIBITORS
Ethicon Endo-Surgery, Inc.	<b>A61B 17/115</b> (2006.01) <b>A61B 17/11</b> (2006.01)	2509514 *	DEVICES FOR INTRODUCING A SURGICAL CIRCULAR STAPLING INSTRUMENT INTO A PATIENT
UCB Pharma S.A.	<b>C07K 16/00</b> (2006.01)	2531526 *	PROCESS FOR OBTAINING ANTIBODIES
Acclarent, Inc.	<b>A61M 25/12</b> (2006.01)	2512578 *	DEVICES AND METHODS FOR TREATING SINUS DISEASE
Regeneron Pharmaceuticals, Inc.	<b>C12N 15/85</b> (2006.01) <b>A01K 67/027</b> (2006.01) <b>C07K 16/46</b> (2006.01)	2505654	Common light chain mouse
Ethicon Endo-Surgery, Inc.	<b>A61B 19/08</b> (2006.01) <b>A61B 17/115</b> (2006.01) <b>A61B 19/00</b> (2006.01)	2501322 *	CIRCULAR STAPLER INTRODUCER WITH MULTI-LUMEN SHEATH
ImmunoGen, Inc.	<b>C07K 16/00</b> (2006.01) <b>C07K 17/14</b> (2006.01) <b>C07K 17/00</b> (2006.01)	2526118 *	COMPOSITIONS AND METHODS FOR TREATMENT OF OVARIAN CANCER

Podnosilac evropske prijave patenta (71)	MKP (51)	Broj objave evropske prijave patenta (97)	Naziv pronalaska (54)
Mikron Industries, Inc.	<b>B28B 3/20</b> (2006.01)	2501530 *	INTEGRATED INSULATION EXTRUSION AND EXTRUSION TECHNOLOGY FOR WINDOW AND DOOR SYSTEMS
Meiji Seika Pharma Co., Ltd.	<b>A61K 39/395</b> (2006.01) <b>A61P 31/04</b> (2006.01) <b>C12P 21/08</b> (2006.01) <b>G01N 33/569</b> (2006.01) <b>C12N 5/10</b> (2006.01) <b>C07K 16/12</b> (2006.01) <b>C07K 16/46</b> (2006.01) <b>C12N 15/09</b> (2006.01)	2536834 *	ANTIBODY AGAINST SEROTYPE B LIPOPOLYSACCHARIDE OF PSEUDOMONAS AERUGINOSA
Symphogen A/S	<b>A61K 39/395</b> (2006.01) <b>A61P 31/04</b> (2006.01) <b>C12P 21/08</b> (2006.01) <b>G01N 33/569</b> (2006.01) <b>C12N 5/10</b> (2006.01) <b>C07K 16/12</b> (2006.01) <b>C07K 16/46</b> (2006.01) <b>C12N 15/09</b> (2006.01)	2536834 *	ANTIBODY AGAINST SEROTYPE B LIPOPOLYSACCHARIDE OF PSEUDOMONAS AERUGINOSA
Shire Human Genetic Therapies	<b>A61K 31/7105</b> (2006.01) <b>C07H 21/02</b> (2006.01)	2506857 *	DELIVERY OF MRNA FOR THE AUGMENTATION OF PROTEINS AND ENZYMES IN HUMAN GENETIC DISEASES
AB Science	<b>A61K 31/444</b> (2006.01) <b>A61P 37/00</b> (2006.01) <b>C07D 417/14</b> (2006.01) <b>C07D 413/12</b> (2006.01) <b>A61K 31/443</b> (2006.01) <b>C07D 413/14</b> (2006.01) <b>A61K 31/4436</b> (2006.01) <b>A61P 35/00</b> (2006.01)	2523952 *	THIAZOLE AND OXAZOLE KINASE INHIBITORS
Healor Ltd.	<b>A61K 38/08</b> (2006.01)	2523677 *	METHOD FOR TREATMENT OF INFLAMMATORY DISEASE AND DISORDER
Sanofi-Aventis Deutschland GmbH	<b>A61M 5/24</b> (2006.01)	2525851 *	CODED CARTRIDGE HOLDER AND FASTENER ENABLED BY CARTRIDGE SIZE
Syngenta Participations AG	<b>A01N 43/00</b> (2006.01)	2512237 *	2 -ARYL-3 -HYDROXY-CYCLOPENTENONES AS INSECTICIDES, ACARICIDES, NEMATOCIDES AND MOLLUSCICIDES
Syngenta Limited	<b>A01N 43/00</b> (2006.01)	2512237 *	2 -ARYL-3 -HYDROXY-CYCLOPENTENONES AS INSECTICIDES, ACARICIDES, NEMATOCIDES AND MOLLUSCICIDES
Janssen Pharmaceutica, N.V.	<b>C07D 513/04</b> (2006.01) <b>A61K 31/429</b> (2006.01) <b>A61P 25/18</b> (2006.01) <b>A61K 31/428</b> (2006.01)	2513118 *	BICYCLIC THIAZOLES AS ALLOSTERIC MODULATORS OF MGLUR5 RECEPTORS
Tyco Water Valve (Shanghai) Co. Ltd.	<b>F16K 3/30</b> (2006.01) <b>F16K 3/28</b> (2006.01)	2518376 *	NON-RISING STEM TYPE GATE VALVE
Pyrogiochi S.R.L.	<b>G09F 13/46</b> (2006.01) <b>F42B 4/20</b> (2006.01) <b>F42B 4/18</b> (2006.01)	2505955	An improvement of a pyrotechnic device for the realization of a luminous alphabet
Hercules Piping Tools Engineering B.V.	<b>F16L 1/10</b> (2006.01) <b>B23K 37/053</b> (2006.01)	2444197	Clamping device for centring pipes
"Applied Physics Science And Technology Center" Company With Limited Responsibility	<b>G01N 22/00</b> (2006.01)	2505995 *	METHOD FOR DETERMINING THE DIELECTRIC PERMITTIVITY OF A DIELECTRIC OBJECT
Kaspersky Lab, ZAO	<b>G06K 9/48</b> (2006.01)	2509029	System and method for identifying spam in rasterized images
Spanovic, Milli	<b>C02F 11/14</b> (2006.01) <b>C02F 11/00</b> (2006.01) <b>C02F 1/36</b> (2006.01) <b>C02F 103/06</b> (2006.01) <b>C02F 1/68</b> (2006.01)	2504286 *	DEVICE AND PROCESS FOR TREATMENT OF CONCENTRATED SOLUTIONS ORIGINATING FROM LANDFILL LEACHATE



Podnosilac evropske prijave patenta (71)	MKP (51)	Broj objave evropske prijave patenta (97)	Naziv pronalaska (54)
Solspace Limited	<b>E04H 6/02</b> (2006.01) <b>E04B 1/34</b> (2006.01) <b>H01L 31/042</b> (2006.01)	2507449 *	CARPORT STRUCTURE AND METHOD OF CONSTRUCTION THEREFOR
Zafgen Corporation	<b>A61P 3/04</b> (2006.01) <b>C07D 303/16</b> (2006.01) <b>A61K 31/336</b> (2006.01)	2521719 *	FUMAGILLOL TYPE COMPOUNDS AND METHODS OF MAKING AND USING SAME
Paccor Deutschland GmbH	<b>B65D 81/38</b> (2006.01)	2502850	Packaging container and process for its manufacture
Zeropoint Clean Tech, Inc.	<b>C10J 3/32</b> (2006.01) <b>F23H 1/00</b> (2006.01) <b>C10J 3/40</b> (2006.01) <b>C10J 3/26</b> (2006.01)	2526176 *	DOWNDRAFT GASIFIER WITH IMPROVED STABILITY
Feller AG	<b>G05D 23/19</b> (2006.01) <b>H02J 13/00</b> (2006.01) <b>F24D 19/10</b> (2006.01) <b>H05B 1/02</b> (2006.01)	2512204	Control unit for operating a conventional electric heater and a pilot wire heater
ImmunoGen, Inc.	<b>C12P 21/08</b> (2006.01) <b>A61K 39/395</b> (2006.01)	2533810 *	CD20 ANTIBODIES AND USES THEREOF
Messer Group GmbH	<b>F25D 3/10</b> (2006.01) <b>F28F 27/00</b> (2006.01)	2515057	Method and device for regulating the temperature of a fluid medium
Oncomed Pharmaceuticals, Inc.	<b>C07K 16/00</b> (2006.01) <b>A61K 39/00</b> (2006.01)	2523682 *	NOTCH1 BINDING AGENTS AND METHODS OF USE THEREOF
Ferring B.V.	<b>A61K 9/16</b> (2006.01)	2512453 *	GRANULES FOR PHARMACEUTICAL PREPARATIONS, METHODS AND APPARATUS FOR THEIR PRODUCTION
Cephalon, Inc.	<b>A61P 1/00</b> (2006.01) <b>A61P 3/00</b> (2006.01) <b>C07D 491/052</b> (2006.01) <b>A61K 31/4439</b> (2006.01) <b>A61P 25/00</b> (2006.01)	2516446 *	SUBSTITUTED HEXAHYDROCHROMENO[3,4-B]PYRROLES WITH AFFINITY FOR THE SEROTONIN RECEPTOR (5-HT) FAMILY
Dow AgroSciences, LLC	<b>A61K 36/899</b> (2006.01) <b>A01H 5/00</b> (2006.01)	2512223 *	INSECTICIDAL PROTEIN COMBINATION COMPRISING CRY1AB AND CRY2AA FOR CONTROLLING EUROPEAN CORN BORER, AND METHODS FOR INSECT RESISTANCE MANAGEMENT
Galderma Research & Development	<b>A61K 8/49</b> (2006.01) <b>C07D 213/74</b> (2006.01) <b>A61Q 19/00</b> (2006.01) <b>A61K 31/44</b> (2006.01)	2516399 *	PHENOL DERIVATIVES AND PHARMACEUTICAL OR COSMETIC USE THEREOF
Board Of Trustees Of Michigan State University	<b>A61P 31/00</b> (2006.01) <b>A61K 39/00</b> (2006.01)	2519252 *	PYTHIUM IMMUNOTHERAPY
Syngenta Participations AG	<b>C07D 413/14</b> (2006.01) <b>C07D 419/12</b> (2006.01) <b>C07D 413/12</b> (2006.01)	2507230 *	INSECTICIDAL COMPOUNDS BASED ON ISOXAZOLINE DERIVATIVES
Continental Industries, Inc.	<b>B23K 23/00</b> (2006.01) <b>B23K 37/00</b> (2006.01) <b>B22D 19/04</b> (2006.01)	2509740 *	ALTERNATIVE IGNITION SOURCE SYSTEM FOR AN EXOTHERMIC REACTION MOLD DEVICE
Rv Lizenz AG	<b>F23J 15/00</b> (2006.01) <b>C10G 2/00</b> (2006.01) <b>C07C 29/151</b> (2006.01) <b>C10J 3/66</b> (2006.01)	2526177 *	EMISSION-FREE DEVICES AND METHOD FOR PERFORMING MECHANICAL WORK AND FOR GENERATING ELECTRICAL AND THERMAL ENERGY
I-TEC AS	<b>E21B 33/128</b> (2006.01) <b>E21B 33/12</b> (2006.01)	2527585	Packer for sealing against a wellbore wall
Meiji Seika Pharma Co., Ltd.	<b>C12N 5/10</b> (2006.01) <b>G01N 33/569</b> (2006.01) <b>C07K 16/12</b> (2006.01) <b>A61P 31/04</b> (2006.01) <b>A61K 39/395</b> (2006.01) <b>C12P 21/08</b> (2006.01) <b>C12N 15/09</b> (2006.01) <b>C07K 16/46</b> (2006.01)	2536833 *	ANTIBODY AGAINST SEROTYPE E LIPOPOLYSACCHARIDE OF PSEUDOMONAS AERUGINOSA

Podnosilac evropske prijave patenta (71)	MKP (51)	Broj objave evropske prijave patenta (97)	Naziv pronalaska (54)
Symphogen A/S	<b>C12N 5/10</b> (2006.01) <b>G01N 33/569</b> (2006.01) <b>C07K 16/12</b> (2006.01) <b>A61P 31/04</b> (2006.01) <b>A61K 39/395</b> (2006.01) <b>C12P 21/08</b> (2006.01) <b>C12N 15/09</b> (2006.01) <b>C07K 16/46</b> (2006.01)	2536833 *	ANTIBODY AGAINST SEROTYPE E LIPOPOLYSACCHARIDE OF PSEUDOMONAS AERUGINOSA
The Johns Hopkins University	<b>A61K 31/66</b> (2006.01) <b>A01N 57/00</b> (2006.01)	2533645 *	METHODS AND COMPOSITIONS FOR IMPROVING COGNITIVE FUNCTION
SICPA Holding SA	<b>B41M 5/28</b> (2006.01) <b>B42D 15/00</b> (2006.01) <b>B41M 3/14</b> (2006.01) <b>B42D 15/10</b> (2006.01)	2509793 *	MARKING BASED ON MODIFIED CHIRAL LIQUID CRYSTAL POLYMERS
Les Laboratoires Servier	<b>A61K 31/403</b> (2006.01) <b>A61P 25/00</b> (2006.01) <b>C07D 209/52</b> (2006.01)	2509947 *	AZABICYCLO[3.1.0]HEX-2-YL DERIVATIVES, METHOD FOR PREPARING SAME, AND PHARMACEUTICAL COMPOSITIONS CONTAINING SAME
Boehringer Ingelheim International GmbH	<b>A61P 3/06</b> (2006.01) <b>A61K 31/4741</b> (2006.01) <b>C07D 491/04</b> (2006.01) <b>C07D 215/56</b> (2006.01) <b>A61P 9/00</b> (2006.01)	2536733 *	TRICYCLIC PYRIDINE DERIVATIVES, MEDICAMENTS CONTAINING SUCH COMPOUNDS, THEIR USE AND PROCESS FOR THEIR PREPARATION
High Point Pharmaceuticals, LLC	<b>A01N 43/78</b> (2006.01) <b>A61K 31/425</b> (2006.01)	2536285 *	SUBSTITUTED FUSED IMIDAZOLE DERIVATIVES, PHARMACEUTICAL COMPOSITIONS, AND METHODS OF USE THEREOF
Baylor Research Institute	<b>C12Q 1/68</b> (2006.01) <b>G01N 33/15</b> (2006.01) <b>C12R 1/32</b> (2006.01) <b>C12N 15/31</b> (2006.01)	2519652 *	BLOOD TRANSCRIPTIONAL SIGNATURE OF ACTIVE VERSUS LATENT MYCOBACTERIUM TUBERCULOSIS INFECTION
Medical Research Council	<b>C12Q 1/68</b> (2006.01) <b>G01N 33/15</b> (2006.01) <b>C12R 1/32</b> (2006.01) <b>C12N 15/31</b> (2006.01)	2519652 *	BLOOD TRANSCRIPTIONAL SIGNATURE OF ACTIVE VERSUS LATENT MYCOBACTERIUM TUBERCULOSIS INFECTION
Imperial College Healthcare NHS Trust	<b>C12Q 1/68</b> (2006.01) <b>G01N 33/15</b> (2006.01) <b>C12R 1/32</b> (2006.01) <b>C12N 15/31</b> (2006.01)	2519652 *	BLOOD TRANSCRIPTIONAL SIGNATURE OF ACTIVE VERSUS LATENT MYCOBACTERIUM TUBERCULOSIS INFECTION
Pinter, Csaba	<b>H02K 53/00</b> (2006.01)	2512018	Method and apparatus for exploiting interaction energy of magnetic fields
Fekete, Gábor	<b>H02K 53/00</b> (2006.01)	2512018	Method and apparatus for exploiting interaction energy of magnetic fields
Foodmate B.V.	<b>A22C 21/00</b> (2006.01) <b>A22C 17/00</b> (2006.01)	2528447 *	METHOD AND APPARATUS FOR COLLECTING MEAT FROM AN ANIMAL PART
TransTech Pharma, Inc	<b>A01N 43/58</b> (2006.01) <b>A61K 31/50</b> (2006.01) <b>A61K 31/495</b> (2006.01)	2536283 *	PHENYL-HETEROARYL DERIVATIVES AND METHODS OF USE THEREOF
Cryovac, Inc.	<b>A61L 28/00</b> (2006.01) <b>B32B 27/30</b> (2006.01) <b>B32B 27/32</b> (2006.01) <b>A61J 1/05</b> (2006.01)	2501546 *	RADIO FREQUENCY SEALABLE FILM
Cardio3 Biosciences S.A.	<b>A61K 38/19</b> (2006.01) <b>A61K 38/18</b> (2006.01) <b>A61K 38/30</b> (2006.01) <b>A61K 31/529</b> (2006.01) <b>A61K 38/22</b> (2006.01) <b>A61K 38/48</b> (2006.01)	2506867 *	PHARMACEUTICAL COMPOSITIONS FOR THE STIMULATION OF STEM CELLS.
Sintef Stiftelsen	<b>B01L 3/00</b> (2006.01)	2519354 *	SAMPLE PROCESSING CARTRIDGE AND METHOD OF PROCESSING AND/OR ANALYSING A SAMPLE UNDER CENTRIFUGAL FORCE
Geox S.p.A.	<b>A43B 7/08</b> (2006.01) <b>A43B 7/12</b> (2006.01) <b>A43B 9/02</b> (2006.01)	2533659 *	SHOE WITH WATERPROOF AND VAPOR-PERMEABLE UPPER AND SOLE

Podnosilac evropske prijave patenta (71)	MKP (51)	Broj objave evropske prijave patenta (97)	Naziv pronalaska (54)
Ethicon Endo-Surgery, Inc.	<b>A61B 17/32</b> (2006.01) <b>A61B 17/00</b> (2006.01) <b>A61B 17/3207</b> (2006.01)	2533706 *	ULTRASONICALLY POWERED SURGICAL INSTRUMENTS WITH ROTATING CUTTING IMPLEMENT
Pichler, Jan Michael	<b>G02B 6/50</b> (2006.01) <b>E02F 5/10</b> (2006.01) <b>E01F 11/00</b> (2006.01)	2526450 *	METHOD AND DEVICE FOR INTRODUCING A PIPE FOR OPTICAL CABLES INTO A SOLID LAYING FOUNDATION
Dow AgroSciences LLC	<b>C07H 21/02</b> (2006.01) <b>C12P 21/06</b> (2006.01)	2526112 *	TARGETED GENOMIC ALTERATION
Sangamo BioSciences, Inc.	<b>C07H 21/02</b> (2006.01) <b>C12P 21/06</b> (2006.01)	2526112 *	TARGETED GENOMIC ALTERATION
STC.UNM	<b>A61K 39/12</b> (2006.01) <b>C12N 15/33</b> (2006.01) <b>C07K 14/005</b> (2006.01) <b>C12N 7/01</b> (2006.01)	2519627 *	PLASMIDS AND METHODS FOR PEPTIDE DISPLAY AND AFFINITY-SELECTION ON VIRUS-LIKE PARTICLES OF RNA BACTERIOPHAGES
Bavarian Nordic A/S	<b>C12N 15/863</b> (2006.01) <b>C12N 7/02</b> (2006.01) <b>A61K 39/275</b> (2006.01) <b>C12N 7/00</b> (2006.01)	2529010 *	VACCINIA VIRUS MUTANTS CONTAINING THE MAJOR GENOMIC DELETIONS OF MVA
KRKA, TOVARNA ZDRAVIL, D.D., NOVO MESTO et al	<b>C07D 215/58</b> (2006.01)	2501680 *	A PROCESS FOR A PREPARATION OF MARBOFLOXACIN AND INTERMEDIATE THEREOF
Drexel University	<b>A61F 2/06</b> (2006.01)	2503959 *	SMALL DIAMETER VASCULAR GRAFT PRODUCED BY A HYBRID METHOD
CHILDREN'S HOSPITAL OF PHILADELPHIA	<b>A61F 2/06</b> (2006.01)	2503959 *	SMALL DIAMETER VASCULAR GRAFT PRODUCED BY A HYBRID METHOD
The Trustees Of The University Of Pennsylvania	<b>A61F 2/06</b> (2006.01)	2503959 *	SMALL DIAMETER VASCULAR GRAFT PRODUCED BY A HYBRID METHOD
Sanofi-Aventis Deutschland GmbH	<b>A61M 5/20</b> (2006.01) <b>A61M 5/00</b> (2006.01)	2536454 *	AUTO-INJECTOR
Sanofi-Aventis Deutschland GmbH	<b>A61M 5/315</b> (2006.01)	2506902 *	A DRUG DELIVERY DEVICE
KET Kunststoff- und Elasttechnik GmbH Liegau-Augustusbad	<b>A61L 27/38</b> (2006.01) <b>C12N 5/00</b> (2006.01)	2439263	Flexible cell culture holder material with a porous three-dimensional structure
Rigshospitalet	<b>C12Q 1/68</b> (2006.01)	2519651 *	CLASSIFICATION OF THYROID FOLLICULAR NEOPLASIA BASED ON MRNA EXPRESSION
Herlev Hospital	<b>C12Q 1/68</b> (2006.01)	2519651 *	CLASSIFICATION OF THYROID FOLLICULAR NEOPLASIA BASED ON MRNA EXPRESSION
Napatech A/S	<b>H04L 7/00</b> (2006.01) <b>H04L 12/56</b> (2006.01)	2507950 *	DISTRIBUTED PROCESSING OF DATA FRAMES BY MULTIPLE ADAPTERS USING TIME STAMPING AND A CENTRAL CONTROLLER
Amgen Inc.	<b>A61P 3/04</b> (2006.01) <b>C07K 14/71</b> (2006.01) <b>A61K 39/395</b> (2006.01) <b>C07K 16/28</b> (2006.01) <b>C07K 19/00</b> (2006.01) <b>C07K 16/18</b> (2006.01)	2510009 *	HUMAN ANTIGEN BINDING PROTEINS THAT BIND BETA-KLOTTHO, GGF RECEPTORS AND COMPLEXES THEREOF
The Trustees Of Columbia University In The City Of New York	<b>A61K 38/22</b> (2006.01)	2525808 *	OSTEOCALCIN AS A TREATMENT FOR MALE REPRODUCTIVE DISORDERS
Sanofi-Aventis Deutschland GmbH	<b>G06F 19/00</b> (2011.01) <b>G06K 7/10</b> (2006.01) <b>G06K 7/14</b> (2006.01) <b>A61M 5/24</b> (2006.01)	2525850 *	METHOD AND SYSTEM FOR DETERMINING INFORMATION RELATED TO A DRUG RESERVOIR
CPH Inventures A/S	<b>G01V 5/00</b> (2006.01) <b>B64F 1/36</b> (2006.01)	2437082	Improved security check method and system
Brennan, Catherine A	<b>G01N 33/53</b> (2006.01) <b>C07K 14/16</b> (2006.01) <b>C12N 7/00</b> (2006.01)	2536743 *	HUMAN GROUP P IMMUNODEFICIENCY VIRUS AND USES THEREOF

Podnosilac evropske prijave patenta (71)	MKP (51)	Broj objave evropske prijave patenta (97)	Naziv pronalaska (54)
Holzmayr, Vera	<b>G01N 33/53</b> (2006.01) <b>C07K 14/16</b> (2006.01) <b>C12N 7/00</b> (2006.01)	2536743 *	HUMAN GROUP P IMMUNODEFICIENCY VIRUS AND USES THEREOF
Vallari, Anadruzela S	<b>G01N 33/53</b> (2006.01) <b>C07K 14/16</b> (2006.01) <b>C12N 7/00</b> (2006.01)	2536743 *	HUMAN GROUP P IMMUNODEFICIENCY VIRUS AND USES THEREOF
Yamaguchi, Julie	<b>G01N 33/53</b> (2006.01) <b>C07K 14/16</b> (2006.01) <b>C12N 7/00</b> (2006.01)	2536743 *	HUMAN GROUP P IMMUNODEFICIENCY VIRUS AND USES THEREOF
QLT Inc.	<b>A61F 9/00</b> (2006.01) <b>A61F 9/007</b> (2006.01)	2503969 *	LACRIMAL IMPLANTS INCLUDING SPLIT AND INSERTABLE DRUG CORE
Halliburton Energy Services, Inc.	<b>C04B 40/06</b> (2006.01) <b>C04B 24/26</b> (2006.01) <b>C09K 8/42</b> (2006.01) <b>C09K 8/467</b> (2006.01) <b>E21B 43/04</b> (2006.01) <b>C04B 28/02</b> (2006.01)	2510070 *	A BIODEGRADABLE SET RETARDER FOR A CEMENT COMPOSITION
UCB Pharma GmbH	<b>A61K 9/70</b> (2006.01) <b>A61K 31/381</b> (2006.01)	2515887 *	POLYVINYLPIRROLIDONE FOR THE STABILIZATION OF A SOLID DISPERSION OF THE NON-CRYSTALLINE FORM OF ROTIGOTINE
LTS LOHMANN Therapie-Systeme AG	<b>A61K 9/70</b> (2006.01) <b>A61K 31/381</b> (2006.01)	2515887 *	POLYVINYLPIRROLIDONE FOR THE STABILIZATION OF A SOLID DISPERSION OF THE NON-CRYSTALLINE FORM OF ROTIGOTINE
Janssen Pharmaceutica, N.V.	<b>A61K 31/428</b> (2006.01) <b>A61K 31/4523</b> (2006.01) <b>A61K 31/423</b> (2006.01) <b>C07D 417/14</b> (2006.01) <b>C07D 277/82</b> (2006.01) <b>A61P 29/00</b> (2006.01) <b>C07D 417/12</b> (2006.01) <b>C07D 413/12</b> (2006.01) <b>C07D 263/58</b> (2006.01) <b>A61P 11/00</b> (2006.01)	2513068 *	SUBSTITUTED BENZOTHAZOLE AND BENZOXAZOLE DERIVATIVES USEFUL AS INHIBITORS OF DPP-1
Mall + Herlan GMBH	<b>B23D 31/00</b> (2006.01) <b>B65G 29/00</b> (2006.01) <b>B23Q 39/04</b> (2006.01) <b>B21D 43/14</b> (2006.01) <b>B23Q 7/02</b> (2006.01)	2415538	Device for processing workpieces
Blue Sunny Skies LLC	<b>H01L 31/048</b> (2006.01) <b>F24J 2/52</b> (2006.01)	2518779	Grounding system for photovoltaic arrays
Immersion Corporation	<b>G06F 3/041</b> (2006.01) <b>G06F 3/01</b> (2006.01)	2534558 *	SYSTEMS AND METHODS FOR HAPTIC FEEDBACK USING Laterally Driven Piezoelectric Actuators
Paha Designs, LLC	<b>B65D 47/32</b> (2006.01)	2531416 *	PRESSURE EQUALIZATION APPARATUS FOR A BOTTLE AND METHODS ASSOCIATED THEREWITH
Marinomed Biotechnologie GmbH	<b>A61K 31/13</b> (2006.01) <b>A61K 31/19</b> (2006.01) <b>A61K 31/731</b> (2006.01)	2515889 *	SYNERGISTIC ANTIVIRAL COMPOSITION AND USE THEREOF
Emergent Product Development Seattle, LLC	<b>C07K 16/46</b> (2006.01) <b>A61K 39/395</b> (2006.01) <b>A61P 35/00</b> (2006.01) <b>A61P 37/00</b> (2006.01)	2519543 *	HETERODIMER BINDING PROTEINS AND USES THEREOF
Alkermes, Inc.	<b>C07C 305/00</b> (2006.01)	2521711 *	QUATERNARY AMMONIUM SALT PRODRUGS
Band-It-IDEX, Inc.	<b>F16L 33/00</b> (2006.01) <b>F16L 33/22</b> (2006.01) <b>B65D 63/02</b> (2006.01)	2507144 *	CABLE TIE

Podnosilac evropske prijave patenta (71)	MKP (51)	Broj objave evropske prijave patenta (97)	Naziv pronalaska (54)
Teikoku Seiyaku Co., Ltd.	<b>A61K 9/70</b> (2006.01) <b>A61K 45/06</b> (2006.01) <b>A61K 47/18</b> (2006.01) <b>A61K 31/42</b> (2006.01) <b>A61P 29/00</b> (2006.01) <b>A61P 23/02</b> (2006.01) <b>A61K 31/167</b> (2006.01) <b>A61K 31/245</b> (2006.01)	2514440 *	TRANSDERMAL PREPARATION CONTAINING BASIC ANTI-INFLAMMATORY AGENT
Abbott Laboratories	<b>A61K 31/44</b> (2006.01) <b>A01N 43/42</b> (2006.01)	2506713 *	NOVEL TRICYCLIC COMPOUNDS
Ambrx, Inc.	<b>C07K 14/475</b> (2006.01)	2516455 *	MODIFIED PORCINE SOMATOTROPIN POLYPEPTIDES AND THEIR USES
Deva Holding Anonim Sirketi	<b>A61K 9/20</b> (2006.01) <b>A61K 31/215</b> (2006.01)	2441444	Formulations of cetyl myristate and/or cetyl palmitate
Ethicon Endo-Surgery, Inc.	<b>A61B 17/32</b> (2006.01) <b>A61B 17/3207</b> (2006.01)	2533708 *	ULTRASONIC SURGICAL INSTRUMENT WITH COMB-LIKE TISSUE TRIMMING DEVICE
Masteridea S.A.	<b>B01D 47/06</b> (2006.01)	2527026 *	NEUTRALISATION OF GASEOUS CONTAMINANTS BY MEANS OF ARTIFICIAL PHOTOSYNTHESIS
Makro Labelling S.r.l.	<b>B65C 3/18</b> (2006.01) <b>B65C 3/16</b> (2006.01)	2531407 *	DEVICE AND METHOD FOR APPLYING SELF-ADHESIVE LABELS ON THE WALLS OF CONTAINERS
AJINOMOTO CO., INC.	<b>A61K 31/381</b> (2006.01) <b>C07D 277/56</b> (2006.01) <b>A61K 31/4525</b> (2006.01) <b>C07D 405/06</b> (2006.01) <b>A61P 3/04</b> (2006.01) <b>A61P 3/06</b> (2006.01) <b>A61K 31/426</b> (2006.01) <b>C07D 333/38</b> (2006.01) <b>A61K 31/4025</b> (2006.01) <b>C07D 307/68</b> (2006.01) <b>A61K 31/341</b> (2006.01) <b>A61P 43/00</b> (2006.01) <b>C07D 277/20</b> (2006.01) <b>A61P 3/10</b> (2006.01)	2511271 *	HETEROARYLCARBOXYLIC ACID ESTER DERIVATIVE
Boehringer Ingelheim International GmbH	<b>C07D 239/34</b> (2006.01) <b>C07D 239/42</b> (2006.01) <b>C07D 239/47</b> (2006.01) <b>C07D 239/48</b> (2006.01)	2464633 *	REGIOSELECTIVE PREPARATION OF 2-AMINO-5-TRIFLUOROMETHYLPYRIMIDINE DERIVATIVES
Bayer Intellectual Property GmbH	<b>C07D 471/04</b> (2006.01)	2504334 *	METHOD FOR PRODUCING METHYL-{4,6-DIAMINO-2-[1-(2-FLUOROBENZYL)-1H-PYRAZOLO[3,4-B]PYRIDINO-3-YL]PYRIMIDINO-5-YL}METHYL CARBAMATE AND ITS PURIFICATION FOR USE THEREOF AS PHARMACEUTICAL SUBSTANCE
Aker Engineering & Technology AS	<b>F03B 13/18</b> (2006.01) <b>F03B 13/20</b> (2006.01)	2510226 *	AN APPARATUS FOR EXTRACTING ENERGY FROM WAVES
Wattenberg Industries, LLC	<b>F03D 9/00</b> (2006.01)	2526291 *	LOW-PROFILE POWER-GENERATING WIND TURBINE
Glaxo Group Limited	<b>A61K 31/497</b> (2006.01)	2523665 *	VOLTAGE-GATED SODIUM CHANNEL BLOCKERS
SANOFI	<b>C07D 498/04</b> (2006.01) <b>A61K 9/00</b> (2006.01) <b>A61K 31/519</b> (2006.01)	2523959 *	HETEROCYCLIC CARBOXYLIC ACID DERIVATIVES HAVING A 2,5,7-SUBSTITUTED OXAZOLOPYRIMIDINE RING

Podnosilac evropske prijave patenta (71)	MKP (51)	Broj objave evropske prijave patenta (97)	Naziv pronalaska (54)
Shionogi & Co., Ltd.	<b>A61K 31/535</b> (2006.01) <b>C07D 413/12</b> (2006.01) <b>A61P 25/16</b> (2006.01) <b>A61P 25/28</b> (2006.01) <b>A61P 27/02</b> (2006.01) <b>A61K 31/5365</b> (2006.01) <b>C07D 498/04</b> (2006.01) <b>A61K 31/5355</b> (2006.01) <b>C07D 413/14</b> (2006.01) <b>C07D 265/06</b> (2006.01) <b>C07D 265/08</b> (2006.01) <b>A61P 43/00</b> (2006.01)	2511268 *	OXAZINE DERIVATIVE
Open Joint Stock Company "Sibur Holding"	<b>B01J 37/04</b> (2006.01) <b>B01J 31/22</b> (2006.01) <b>C08F 10/00</b> (2006.01) <b>B01J 37/34</b> (2006.01)	2529832 *	CATALYST SYSTEM AND PROCESSES FOR THE (CO-)TRIMERIZATION OF OLEFINS AND THE (CO-)POLYMERIZATION OF OLEFIN OLIGOMERS
THE TRUSTEES OF PRINCETON UNIVERSITY	<b>A61K 31/536</b> (2006.01)	2536411 *	INHIBITORS OF LONG AND VERY LONG CHAIN FATTY ACID METABOLISM AS BROAD SPECTRUM ANTI-VIRALS
Gilead Sciences, Inc.	<b>C07D 409/12</b> (2006.01) <b>A61K 31/4436</b> (2006.01) <b>A61K 31/381</b> (2006.01) <b>C07D 493/04</b> (2006.01) <b>A61P 31/00</b> (2006.01) <b>C07D 409/14</b> (2006.01)	2523951 *	INHIBITORS OF FLAVIVIRIDAE VIRUSES
Pannonpharma Gyógyszergyártó Kft.	<b>C12P 19/62</b> (2006.01)	2501821 *	PROCESS FOR PRODUCING PRIMYCIN, PRIMYCIN COMPONENT(S), PRECURSORS AND METABOLITES THEREOF VIA FERMENTATION BY THE USE OF BACTERIAL SPECIES SACCHAROMONOSPORAZUREA
Dow AgroSciences, LLC	<b>A01H 5/00</b> (2006.01) <b>A01P 7/00</b> (2006.01) <b>A01H 1/00</b> (2006.01)	2512220 *	INSECTICIDAL PROTEIN COMBINATIONS FOR CONTROLLING FALL ARMYWORM AND EUROPEAN CORN BORER, AND METHODS FOR INSECT RESISTANCE MANagements
Genzyme Corporation	<b>A61P 35/00</b> (2006.01) <b>C07D 405/06</b> (2006.01) <b>A61K 31/4025</b> (2006.01)	2504332 *	AN AMORPHOUS AND A CRYSTALLINE FORM OF GENZ 112638 HEMITARTRATE AS INHIBITOR OF GLUCOSYL CERAMIDE SYNTHASE
Alkermes, Inc.	<b>A01N 43/42</b> (2006.01)	2506712 *	MORPHINAN DERIVATIVES FOR THE TREATMENT OF DRUG OVERDOSE
Activesite Pharmaceuticals, Inc.	<b>A61K 31/34</b> (2006.01)	2512466 *	PRODRUGS OF INHIBITORS OF PLASMA KALLIKREIN
Kist-Europe FGmbH	<b>C12N 15/11</b> (2006.01) <b>C12Q 1/68</b> (2006.01)	2521781 *	PRIMERS FOR DIAGNOSING ANKYLOSING SPONDYLITIS, AND METHOD FOR DIAGNOSING ANKYLOSING SPONDYLITIS USING THE SAME
MERICHEM COMPANY	<b>B01D 17/02</b> (2006.01) <b>C01B 17/02</b> (2006.01)	2512984 *	THREE PHASE SULFUR SEPARATION SYSTEM WITH INTERFACE CONTROL
I.Quattro S.r.l.	<b>E05C 17/02</b> (2006.01) <b>E05C 17/24</b> (2006.01)	2439365	Shutter holder with selectable position
Sanofi-Aventis	<b>C12Q 1/68</b> (2006.01) <b>G01N 33/50</b> (2006.01)	2532755	Methods and uses based on Slfn2 expression and relating to the identification and profiling of compounds for use in the treatment or prevention of pain
Janssen Pharmaceutica, N.V.	<b>C07D 513/04</b> (2006.01) <b>A61K 31/429</b> (2006.01) <b>A61P 25/18</b> (2006.01) <b>A61K 31/428</b> (2006.01)	2513117 *	BICYCLIC THIAZOLES AS ALLOSTERIC MODULATORS OF MGLUR5 RECEPTORS
Meriel Limited	<b>A61P 33/00</b> (2006.01) <b>A01P 7/04</b> (2006.01) <b>A01N 43/90</b> (2006.01) <b>A01P 5/00</b> (2006.01) <b>A61K 31/437</b> (2006.01) <b>C07D 471/04</b> (2006.01)	2513104 *	ANTI PARASITIC DIHYDROAZOLE COMPOUNDS AND COMPOSITIONS COMPRISING SAME

Podnosilac evropske prijave patenta (71)	MKP (51)	Broj objave evropske prijave patenta (97)	Naziv pronalaska (54)
Abbott Biotechnology Ltd.	<b>C12Q 1/68</b> (2006.01)	2531613 *	METHODS AND COMPOSITIONS FOR PREDICTING RESPONSIVENESS TO TREATMENT WITH TNF-ALPHA INHIBITOR
Janssen Pharmaceutica, N.V.	<b>C07D 417/14</b> (2006.01) <b>A61K 31/427</b> (2006.01) <b>C07D 417/06</b> (2006.01) <b>A61P 5/30</b> (2006.01)	2536716 *	AMINOTHIAZOLONES AS ESTROGEN RELATED RECEPTOR-ALPHA MODULATORS
UCB Pharma S.A.	<b>C07K 16/00</b> (2006.01)	2523972 *	MULTIVALENT ANTIBODIES
Vertex Pharmaceuticals Incorporated	<b>A61P 1/16</b> (2006.01) <b>A61K 31/4535</b> (2006.01) <b>A61K 31/454</b> (2006.01)	2528605 *	THERAPIES FOR TREATING HEPATITIS C VIRUS INFECTION
Meisho.Co., Ltd	<b>C12P 19/04</b> (2006.01) <b>B09B 3/00</b> (2006.01)	2532448 *	METHOD FOR DEGRADING ORGANIC MATERIAL USING MOTHER CELL LYASES FORMED IN ASSOCIATION WITH SPORE FORMATION OF MICROORGANISM
Spurbeck, William Paul	<b>A61M 39/04</b> (2006.01)	2531255 *	ANGIOCATHETER DEVICE WITH IMPROVED SAFETY FEATURES
Banister, Mark	<b>A61M 39/04</b> (2006.01)	2531255 *	ANGIOCATHETER DEVICE WITH IMPROVED SAFETY FEATURES
Adi Corporation S.A.	<b>B65D 5/24</b> (2006.01) <b>B65D 5/4805</b> (2006.01)	2452886	Folding box with storage compartments
Merial Limited	<b>A61K 31/365</b> (2006.01) <b>A61K 31/495</b> (2006.01) <b>A61P 33/10</b> (2006.01)	2512467 *	COMPOSITIONS COMPRISING MACROCYCLIC LACTONE COMPOUNDS AND SPIRODIOXEPINOINDOLES
Holmes, Robert	<b>A61K 31/365</b> (2006.01) <b>A61K 31/495</b> (2006.01) <b>A61P 33/10</b> (2006.01)	2512467 *	COMPOSITIONS COMPRISING MACROCYCLIC LACTONE COMPOUNDS AND SPIRODIOXEPINOINDOLES
Nippon Soda Co., Ltd.	<b>C07D 215/38</b> (2006.01) <b>C07D 215/18</b> (2006.01) <b>A01N 43/42</b> (2006.01) <b>C07D 471/04</b> (2006.01) <b>A01P 3/00</b> (2006.01) <b>C07D 495/04</b> (2006.01) <b>C07D 221/04</b> (2006.01) <b>A01N 55/00</b> (2006.01) <b>C07D 491/048</b> (2006.01) <b>C07D 215/14</b> (2006.01) <b>C07D 401/12</b> (2006.01) <b>C07D 215/20</b> (2006.01)	2522658 *	NITROGEN-CONTAINING HETEROCYCLIC COMPOUND AND AGRICULTURAL/ HORTICULTURAL GERMICIDE
SANOFI	<b>C07D 495/04</b> (2006.01)	2501702 *	METHOD FOR PREPARING N-SUCCINIMIDYL N-BIOTINYL-6-AMINOCAPROATE
Glaxo Group Limited	<b>A61P 11/08</b> (2006.01) <b>A61K 45/06</b> (2006.01) <b>A61K 31/138</b> (2006.01) <b>A61P 11/06</b> (2006.01) <b>A61K 31/439</b> (2006.01)	2506844 *	COMBINATIONS OF A MUSCARINIC RECEPTOR ANTAGONIST AND A BETA-2 ADRENORECEPTOR AGONIST
Janssen Pharmaceutica, N.V.	<b>A61K 31/00</b> (2006.01) <b>A61K 45/06</b> (2006.01) <b>A61K 35/00</b> (2006.01) <b>A61K 31/69</b> (2006.01)	2519231 *	TREATMENT OF DISEASE WITH PROTEASOME INHIBITORS BACKGROUND OF THE INVENTION
Li, Jinmin	<b>C02F 3/12</b> (2006.01) <b>C02F 3/30</b> (2006.01) <b>C02F 11/02</b> (2006.01)	2508490 *	SLUDGE TREATMENT METHOD AND APPARATUS THEREOF AND APPLICATION TO WASTEWATER BIO-TREATMENT
Zhou, Liankui	<b>C02F 3/12</b> (2006.01) <b>C02F 3/30</b> (2006.01) <b>C02F 11/02</b> (2006.01)	2508490 *	SLUDGE TREATMENT METHOD AND APPARATUS THEREOF AND APPLICATION TO WASTEWATER BIO-TREATMENT
Li, Dayong	<b>C02F 3/12</b> (2006.01) <b>C02F 3/30</b> (2006.01) <b>C02F 11/02</b> (2006.01)	2508490 *	SLUDGE TREATMENT METHOD AND APPARATUS THEREOF AND APPLICATION TO WASTEWATER BIO-TREATMENT
Laboratorios del. Dr. Esteve, S.A.	<b>A61K 31/4152</b> (2006.01) <b>A61K 9/16</b> (2006.01)	2503994 *	PHARMACEUTICAL COMPOSITIONS COMPRISING SIGMA RECEPTOR LIGANDS

Podnosilac evropske prijave patenta (71)	MKP (51)	Broj objave evropske prijave patenta (97)	Naziv pronalaska (54)
Elan Pharmaceuticals Inc.	<b>A61P 25/00</b> (2006.01) <b>C07D 475/04</b> (2006.01) <b>C07D 475/12</b> (2006.01) <b>A61K 31/4985</b> (2006.01)	2516441 *	PTERIDINONES AS INHIBITORS OF POLO-LIKE KINASE
Sanofi-Aventis Deutschland GmbH	<b>A61B 5/151</b> (2006.01)	2528507 *	ANALYTE MEASUREMENT DEVICE WITH A SINGLE SHOT ACTUATOR
Ethicon Endo-Surgery, Inc.	<b>A61B 17/00</b> (2006.01) <b>A61B 17/34</b> (2006.01) <b>A61B 17/068</b> (2006.01) <b>A61B 19/00</b> (2006.01) <b>A61B 17/115</b> (2006.01)	2509513 *	CIRCULAR STAPLER INTRODUCER WITH RIGID CAP ASSEMBLY CONFIGURED FOR EASY REMOVAL
Connor Sport Court International, LCC.	<b>E04F 15/02</b> (2006.01) <b>E04F 15/024</b> (2006.01)	2529062 *	SYNTHETIC FLOOR TILE HAVING PARTIALLY COMPLIANT SUPPORT STRUCTURE
Biogen Idec MA Inc.	<b>A61K 31/275</b> (2006.01) <b>A01N 37/34</b> (2006.01)	2533634 *	NEUROPROTECTION IN DEMYELINATING DISEASES
Probi AB	<b>A61P 1/04</b> (2006.01) <b>A61K 39/07</b> (2006.01) <b>A23L 1/30</b> (2006.01) <b>A61K 36/899</b> (2006.01)	2515937 *	NON-FERMENTED COMPOSITIONS COMPRISING A CEREAL BASED FRACTION AND A PROBIOTIC AND USES THEREOF
Danieli & C. Officine Meccaniche SpA	<b>B21C 47/24</b> (2006.01) <b>B21B 1/46</b> (2006.01) <b>C21D 9/68</b> (2006.01)	2519366 *	WINDING/UNWINDING DEVICE AND METHOD FOR WINDING/UNWINDING A METAL PRODUCT IN A ROLLING LINE
SANOFI	<b>C07C 253/30</b> (2006.01) <b>C07C 257/04</b> (2006.01)	2513046 *	PROCESS FOR THE PREPARATION OF 4-BROMOMETHYL-[1,1'-BIPHENYL]-2'-CARBONITRILE
Krause-Röhm-Systeme AG	<b>C01G 49/02</b> (2006.01) <b>B01J 21/02</b> (2006.01) <b>C01F 7/06</b> (2006.01) <b>C01F 7/16</b> (2006.01)	2528682 *	METHOD FOR PRODUCING A CATALYST FOR CRACKING ORGANIC CARBON COMPOUNDS
Tempero Pharmaceuticals, Inc.	<b>A61K 31/497</b> (2006.01)	2533783 *	COMPOUNDS AND METHODS
ROP Repce-olaj-pellet Kft.	<b>A23K 1/175</b> (2006.01) <b>A23K 1/18</b> (2006.01) <b>A23K 1/14</b> (2006.01) <b>A23K 1/16</b> (2006.01)	2520176	Method for increasing the nutritional value of rapeseed and rape products with decreased oil content
Institut De Physique Du Globe De Paris (Établissement Public À Caractère Scientifique Et Technologique)	<b>G01N 21/31</b> (2006.01) <b>G01N 21/84</b> (2006.01) <b>G01N 21/35</b> (2006.01)	2453221	Apparatus for radiometry to determine the physico-chemical properties of a sample taking the thickness into account
Pucci Saoro, S.R.L.	<b>E05D 15/06</b> (2006.01)	2526245 *	DOOR LEAF SYSTEM FOR CLOSING AND/OR OPENING AN ENTRANCE
Japan Tobacco, Inc.	<b>A61K 31/4439</b> (2006.01) <b>A61P 37/08</b> (2006.01) <b>A61K 31/437</b> (2006.01) <b>A61P 37/06</b> (2006.01) <b>A61K 31/433</b> (2006.01) <b>A61P 37/02</b> (2006.01) <b>A61K 31/427</b> (2006.01) <b>A61P 29/00</b> (2006.01) <b>A61K 31/4178</b> (2006.01) <b>A61K 31/5377</b> (2006.01) <b>C07D 403/14</b> (2006.01) <b>A61K 31/416</b> (2006.01) <b>A61K 31/496</b> (2006.01) <b>C07D 403/04</b> (2006.01) <b>A61K 31/422</b> (2006.01) <b>A61K 31/55</b> (2006.01) <b>C07D 405/14</b> (2006.01) <b>C07D 401/14</b> (2006.01) <b>A61K 31/454</b> (2006.01) <b>A61P 43/00</b> (2006.01)	2505586 *	INDOLE COMPOUND AND PHARMACEUTICAL USE THEREOF



Podnosilac evropske prijave patenta (71)	MKP (51)	Broj objave evropske prijave patenta (97)	Naziv pronalaska (54)
Doelling, Eric N.	<b>A61M 16/06</b> (2006.01)	2519296 *	DEVICES, SYSTEMS, AND METHODS FOR MONITORING, ANALYZING, AND/OR ADJUSTING SLEEP CONDITIONS
Hohenhorst, Winfried	<b>A61M 16/06</b> (2006.01)	2519296 *	DEVICES, SYSTEMS, AND METHODS FOR MONITORING, ANALYZING, AND/OR ADJUSTING SLEEP CONDITIONS
Boucher, Ryan P.	<b>A61M 16/06</b> (2006.01)	2519296 *	DEVICES, SYSTEMS, AND METHODS FOR MONITORING, ANALYZING, AND/OR ADJUSTING SLEEP CONDITIONS
Proyecto de Biomedicina Cima, S.L.	<b>A61K 38/17</b> (2006.01) <b>A61K 38/21</b> (2006.01)	2535057 *	COMPOSITIONS FOR THE TREATMENT OF INFECTIOUS AND TUMOURAL DISEASES
Digna Biotech, S.L.	<b>A61K 38/17</b> (2006.01) <b>A61K 38/21</b> (2006.01)	2535057 *	COMPOSITIONS FOR THE TREATMENT OF INFECTIOUS AND TUMOURAL DISEASES
Takeda Pharmaceutical Company Limited	<b>A61K 31/4196</b> (2006.01) <b>A61K 31/4545</b> (2006.01) <b>A61K 31/428</b> (2006.01) <b>A61K 31/4192</b> (2006.01) <b>A61K 31/216</b> (2006.01) <b>A61K 31/282</b> (2006.01) <b>A61P 25/02</b> (2006.01) <b>A61K 31/41</b> (2006.01) <b>A61K 31/337</b> (2006.01) <b>A61K 31/69</b> (2006.01)	2528598 *	COMPOUNDS FOR SUPPRESSING A PERIPHERAL NERVE DISORDER INDUCED BY AN ANTI - CANCER AGENT
Visa International Service Association	<b>G06Q 20/00</b> (2012.01)	2519919 *	SYSTEM AND METHOD FOR PROCESSING PAYMENT TRANSACTION RECEIPTS
Nimble Epitech, LLC	<b>A61K 9/70</b> (2006.01) <b>A61F 13/00</b> (2006.01)	2506814 *	PHARMACEUTICAL COMPOSITION CONTAINING A HYPOMETHYLATING AGENT AND A HISTONE DEACETYLASE INHIBITOR
Ironwood Pharmaceuticals, Inc.	<b>A61K 31/40</b> (2006.01) <b>C07D 401/04</b> (2006.01) <b>C07D 403/12</b> (2006.01) <b>A61K 31/495</b> (2006.01) <b>A61P 43/00</b> (2006.01) <b>C07D 207/325</b> (2006.01) <b>C07D 413/14</b> (2006.01)	2516416 *	CRTH2 MODULATORS
Warner Babcock Institute For Green Chemistry LLC	<b>A61P 17/00</b> (2006.01) <b>A61K 31/185</b> (2006.01) <b>A61K 31/195</b> (2006.01) <b>A61K 8/40</b> (2006.01) <b>A61Q 5/00</b> (2006.01) <b>A61K 8/36</b> (2006.01)	2501374 *	COLORING COMPOSITION CONTAINING AN AROMATIC COMPOUND AND AN INITIATOR
John Masters Organic Hair Care, Inc.	<b>A61P 17/00</b> (2006.01) <b>A61K 31/185</b> (2006.01) <b>A61K 31/195</b> (2006.01) <b>A61K 8/40</b> (2006.01) <b>A61Q 5/00</b> (2006.01) <b>A61K 8/36</b> (2006.01)	2501374 *	COLORING COMPOSITION CONTAINING AN AROMATIC COMPOUND AND AN INITIATOR
Dinzl Ordnungstechnik GmbH	<b>A47B 96/02</b> (2006.01) <b>A47B 57/58</b> (2006.01) <b>A47B 57/10</b> (2006.01)	2305069	Shelf floor
Free Aktiengesellschaft	<b>G07C 9/00</b> (2006.01)	2431949	Electronic combination lock
Donchenko, Ljudmila	<b>A23L 1/0524</b> (2006.01) <b>C08B 37/06</b> (2006.01)	2518088 *	METHOD FOR PRODUCING LIQUID PECTIN FROM APPLE POMACE
Vasiliev, Andrey	<b>A23L 1/0524</b> (2006.01) <b>C08B 37/06</b> (2006.01)	2518088 *	METHOD FOR PRODUCING LIQUID PECTIN FROM APPLE POMACE
Vasiliev, Pavel	<b>A23L 1/0524</b> (2006.01) <b>C08B 37/06</b> (2006.01)	2518088 *	METHOD FOR PRODUCING LIQUID PECTIN FROM APPLE POMACE

Podnosilac evropske prijave patenta (71)	MKP (51)	Broj objave evropske prijave patenta (97)	Naziv pronalaska (54)
Les Laboratoires Servier	<b>A61K 31/165</b> (2006.01) <b>A61P 25/16</b> (2006.01) <b>C07C 231/12</b> (2006.01) <b>C07C 233/18</b> (2006.01) <b>A61P 25/18</b> (2006.01) <b>A61P 3/00</b> (2006.01) <b>A61P 25/28</b> (2006.01)	2532647	New co-crystals of agomelatin
Fluidigm Corporation	<b>A61L 2/00</b> (2006.01)	2506882 *	MICROFLUIDIC DEVICE REGENERATION
Arena Pharmaceuticals, Inc.	<b>A61P 37/06</b> (2006.01) <b>C07D 209/94</b> (2006.01) <b>A61P 29/00</b> (2006.01) <b>A61K 31/403</b> (2006.01)	2528894 *	PROCESSES FOR THE PREPARATION OF (R)-2-(7-(4-CYCLOPENTYL-3-(TRIFLUOROMETHYL)BENZYLOXY)-1,2,3,4-TETRAHYDROCYCLOPENTA[B]INDOL-3-YL) ACETIC ACID AND SALTS THEREOF
ECO Recycling s.r.l.	<b>C22B 26/12</b> (2006.01) <b>C22B 47/00</b> (2006.01) <b>H01M 10/54</b> (2006.01) <b>C22B 15/00</b> (2006.01) <b>H01M 6/52</b> (2006.01) <b>C22B 23/00</b> (2006.01) <b>C22B 7/00</b> (2006.01)	2450991	Plant and process for the treatment of exhausted accumulators and batteries
Dow AgroSciences, LLC	<b>C12N 15/82</b> (2006.01)	2513318 *	USE OF CRY1AB IN COMBINATION WITH CRY1BE FOR MANAGEMENT OF RESISTANT INSECTS
Equitan S.r.l.	<b>G01N 3/34</b> (2006.01) <b>C14B 1/40</b> (2006.01)	2439287	Method for evaluating the efficiency and/or operating state of a staking machine and industrial kit suitable to implement such a method
Presano AG	<b>E03D 9/08</b> (2006.01)	2521822 *	INTIMATE SHOWER FOR A WC
Sanofi-Aventis Deutschland GmbH	<b>A61M 5/32</b> (2006.01) <b>A61M 5/28</b> (2006.01) <b>A61M 5/24</b> (2006.01)	2531237 *	MEDICATED MODULE WITH TIME LOCK
Merck Sharp & Dohme Corp.	<b>A01N 43/42</b> (2006.01) <b>A61K 31/47</b> (2006.01)	2512243 *	QUINOLINE AMIDE M1 RECEPTOR POSITIVE ALLOSTERIC MODULATORS
Syngenta Limited	<b>A01P 13/00</b> (2006.01) <b>A01N 43/16</b> (2006.01)	2523555 *	HERBICIDAL COMPOSITIONS COMPRISING, AND METHODS OF USE OF, HERBICIDALLY ACTIVE PYRANIDIONES
Nippon Soda Co., Ltd.	<b>C07D 405/14</b> (2006.01) <b>A01P 7/02</b> (2006.01) <b>C07D 401/12</b> (2006.01) <b>C07D 451/06</b> (2006.01) <b>A01N 43/42</b> (2006.01) <b>C07D 409/14</b> (2006.01) <b>C07D 401/14</b> (2006.01)	2518069 *	CYCLIC AMINE COMPOUND AND ACARICIDE
SANOFI	<b>A61K 31/4523</b> (2006.01) <b>A61P 11/06</b> (2006.01) <b>C07D 471/04</b> (2006.01)	2519520 *	[4-(3-AMINOMETHYL-PHENYL)-PIPERIDIN-1-YL]-(1H-PYRROLOPYRIDINYL)-METHANONE DERIVATIVES AS TRYPTASE INHIBITORS
Sanofi-Aventis	<b>C12Q 1/68</b> (2006.01)	2532756	Methods and uses relating to the diagnosis or prognosis of pain-related tissue states or pain-related diseases such as pain.
Bayer CropScience NV	<b>C12Q 1/68</b> (2006.01) <b>C07H 21/00</b> (2006.01)	2504454 *	ELITE EVENT EE-GM3 AND METHODS AND KITS FOR IDENTIFYING SUCH EVENT IN BIOLOGICAL SAMPLES
M.S. Technologies LLC	<b>C12Q 1/68</b> (2006.01) <b>C07H 21/00</b> (2006.01)	2504454 *	ELITE EVENT EE-GM3 AND METHODS AND KITS FOR IDENTIFYING SUCH EVENT IN BIOLOGICAL SAMPLES
Chiesi Farmaceutici S.p.A.	<b>A61K 9/00</b> (2006.01) <b>A61K 31/167</b> (2006.01) <b>A61K 45/06</b> (2006.01) <b>A61K 31/40</b> (2006.01)	2515853 *	Combination therapy for COPD
Usberti, Francesca	<b>A61K 9/00</b> (2006.01) <b>A61K 31/167</b> (2006.01) <b>A61K 45/06</b> (2006.01) <b>A61K 31/40</b> (2006.01)	2515853 *	Combination therapy for COPD

Podnosilac evropske prijave patenta (71)	MKP (51)	Broj objave evropske prijave patenta (97)	Naziv pronalaska (54)
Acclarent, Inc.	<b>A61F 2/84</b> (2006.01) <b>A61M 25/00</b> (2006.01) <b>A61K 31/00</b> (2006.01) <b>A61M 25/10</b> (2006.01) <b>A61B 18/00</b> (2006.01) <b>A61M 29/00</b> (2006.01) <b>A61M 25/09</b> (2006.01) <b>A61B 1/00</b> (2006.01) <b>A61M 25/06</b> (2006.01) <b>A61L 29/00</b> (2006.01) <b>A61B 17/3207</b> (2006.01)	2519300 *	SYSTEM FOR TREATING TARGET TISSUE WITHIN THE EUSTACHIAN TUBE
Belron Hungary Kft - Zug Branch	<b>B65H 49/00</b> (2006.01) <b>B26D 1/547</b> (2006.01)	2536540 *	WIRE HANDLING FOR VEHICLE GLAZING PANEL CUT OUT
Abbot Healthcare Private Limited	<b>A61K 9/54</b> (2006.01) <b>A61K 9/52</b> (2006.01) <b>A61K 9/28</b> (2006.01)	2515882 *	CONTROLLED RELEASE PHARMACEUTICAL COMPOSITION
SANOFI	<b>G01N 33/50</b> (2006.01) <b>C12Q 1/68</b> (2006.01)	2526206 *	METHODS AND USES RELATING TO THE IDENTIFICATION OF COMPOUND INVOLVED IN PAIN AS WELL AS METHODS OF DIAGNOSING ALGESIA
Titan Wood Limited	<b>C08L 97/02</b> (2006.01) <b>C08G 18/64</b> (2006.01) <b>C08H 8/00</b> (2010.01)	2531561 *	PROCESS FOR THE ACETYLATION OF WOOD ELEMENTS
Ethicon Endo-Surgery, Inc.	<b>A61B 17/22</b> (2006.01) <b>A61B 17/32</b> (2006.01) <b>A61B 17/3207</b> (2006.01)	2533705 *	ROTATABLE CUTTING IMPLEMENT ARRANGEMENTS FOR ULTRASONIC SURGICAL INSTRUMENTS
Plexxikon, Inc.	<b>A61K 31/437</b> (2006.01) <b>C07D 471/04</b> (2006.01) <b>A61P 35/00</b> (2006.01)	2516438 *	COMPOUNDS AND METHODS FOR KINASE MODULATION, AND INDICATIONS THEREFOR
Jiangsu Hansoh Pharmaceutical Group Co., Ltd.	<b>C07C 215/40</b> (2006.01) <b>A61K 31/4245</b> (2006.01) <b>C07C 215/08</b> (2006.01) <b>A61P 9/12</b> (2006.01) <b>C07D 413/10</b> (2006.01)	2508522 *	AZILSARTAN ORGANIC AMINE SALTS, PREPARATION METHOD AND USE THEREOF
Chanel Parfums Beauté	<b>B65D 47/20</b> (2006.01) <b>B65D 47/30</b> (2006.01) <b>B65D 47/26</b> (2006.01)	2516286 *	DISPENSING BOTTLE-TOP FOR BOTTLE FOR PRODUCTS OF LIQUID OR VISCOUS CONSISTENCY AND BOTTLE FITTED WITH SUCH A BOTTLE-TOP
Atico International USA, Inc.	<b>E04B 1/343</b> (2006.01) <b>E04H 15/44</b> (2006.01)	2531675 *	COLLAPSIBLE CENTRAL SUPPORT DEVICE
SANOFI	<b>A61K 31/497</b> (2006.01) <b>A61K 31/496</b> (2006.01) <b>C07D 409/04</b> (2006.01) <b>C07D 407/14</b> (2006.01) <b>A61P 25/00</b> (2006.01) <b>C07D 403/14</b> (2006.01) <b>A61K 31/551</b> (2006.01) <b>C07D 495/04</b> (2006.01) <b>C07D 407/04</b> (2006.01) <b>C07D 409/14</b> (2006.01) <b>C07D 401/04</b> (2006.01) <b>A61K 31/4995</b> (2006.01) <b>C07D 401/14</b> (2006.01) <b>A61K 31/506</b> (2006.01)	2513088 *	NOVEL (HETEROCYCLE/TETRAHYDROPYRIDINE)-(PIPERAZINYL)-1-ALCANONE AND (HETEROCYCLE/DIHYDROPYRROLIDINE)-(PIPERAZINYL)-1-ALCANONE DERIVATIVES, AND USE THEREOF AS P75 INHIBITORS
Amgen Inc.	<b>A61P 3/10</b> (2006.01) <b>A61P 1/04</b> (2006.01) <b>C07D 471/04</b> (2006.01) <b>A61P 35/00</b> (2006.01) <b>A61P 19/02</b> (2006.01) <b>A61K 31/4375</b> (2006.01) <b>C07D 519/00</b> (2006.01) <b>A61P 9/10</b> (2006.01) <b>A61P 17/06</b> (2006.01)	2513109 *	HETEROCYCLIC COMPOUNDS AND THEIR USES
Messer Group GmbH	<b>B28D 5/00</b> (2006.01)	2504139 *	METHOD AND DEVICE FOR TREATING ABRASIVE SLURRIES CONTAINING SI/SIC

Podnosilac evropske prijave patenta (71)	MKP (51)	Broj objave evropske prijave patenta (97)	Naziv pronalaska (54)
Coenen, Wolfgang	<b>B28D 5/00</b> (2006.01)	2504139 *	METHOD AND DEVICE FOR TREATING ABRASIVE SLURRIES CONTAINING SI/SIC
Novelis, Inc.	<b>B22D 41/14</b> (2006.01)	2523765 *	MOLTEN METAL CONTAINMENT STRUCTURE HAVING MOVABLE COVER
Raico Bautechnik GmbH	<b>E04B 2/96</b> (2006.01)	2450495	Connection element for fixing an insulation element to a pressure bar of a mullion and transom facade
Chalabi, Rifat Al	<b>F24J 2/42</b> (2006.01) <b>F23G 7/00</b> (2006.01) <b>F23G 5/027</b> (2006.01) <b>F23G 5/16</b> (2006.01)	2507555 *	GASIFICATION SYSTEM
Perry, Ophneil Henry	<b>F24J 2/42</b> (2006.01) <b>F23G 7/00</b> (2006.01) <b>F23G 5/027</b> (2006.01) <b>F23G 5/16</b> (2006.01)	2507555 *	GASIFICATION SYSTEM
Delphi Technologies Holding S.à.r.l.	<b>F02M 51/00</b> (2006.01) <b>F02M 53/04</b> (2006.01) <b>F02M 55/00</b> (2006.01) <b>F02M 61/20</b> (2006.01)	2444650	Improved fuel injector
SANOFI	<b>A01K 67/027</b> (2006.01) <b>C12N 15/85</b> (2006.01)	2512227 *	ANIMAL MODEL EXPRESSING LUCIFERASE UNDER CONTROL OF THE MYELIN BASIC PROTEIN PROMOTER (MBP-LUC1) AND USE OF THE MODEL FOR BIOLUMINESCENCE IN VIVO IMAGING
Metabolic Solutions Development Company LLC	<b>A61K 31/4439</b> (2006.01) <b>A61P 3/00</b> (2006.01) <b>C07D 417/12</b> (2006.01) <b>A61K 31/426</b> (2006.01) <b>C07D 277/34</b> (2006.01) <b>A61P 5/00</b> (2006.01)	2513070 *	PPAR-SPARING THIAZOLIDINEDIONE SALTS FOR THE TREATMENT OF METABOLIC DISEASES
Janssen Pharmaceutica, N.V.	<b>C07D 307/81</b> (2006.01) <b>C07D 417/12</b> (2006.01) <b>C07D 333/58</b> (2006.01) <b>C07D 409/12</b> (2006.01) <b>C07D 235/14</b> (2006.01) <b>C07D 405/06</b> (2006.01) <b>C07D 407/04</b> (2006.01) <b>C07D 405/14</b> (2006.01) <b>C07D 405/12</b> (2006.01) <b>C07D 209/14</b> (2006.01) <b>C07D 403/12</b> (2006.01)	2513054 *	BICYCLIC DERIVATIVES USEFUL AS INHIBITORS OF DPP-1
Novartis AG	<b>A61P 35/00</b> (2006.01) <b>C07D 239/48</b> (2006.01) <b>A61K 31/506</b> (2006.01)	2509963 *	CRYSTALLINE FORMS OF 3-(2,6-DICHLORO-3,5-DIMETHOXY-PHENYL)-1-[6-[4-(4-ETHYL-PIPERAZIN-1-YL)-PHENYLAMINO]-PYRIMIDIN-4-YL]-1-METHYL-UREA AND SALTS THEREOF.
SANOFI	<b>C07D 451/02</b> (2006.01) <b>A61K 31/46</b> (2006.01) <b>A61P 29/00</b> (2006.01)	2516428 *	TROPINONE BENZYLAMINES AS BETA-TRYPTASE INHIBITORS
UCB Pharma, S.A.	<b>C12P 21/02</b> (2006.01) <b>C07K 16/24</b> (2006.01) <b>C12N 15/70</b> (2006.01) <b>C12N 9/48</b> (2006.01)	2523975 *	BACTERIAL HOST STRAIN COMPRISING A MUTANT SPR GENE AND A WILD-TYPE TSP GENE
Autifony Therapeutics Limited	<b>C07D 401/04</b> (2006.01) <b>C07D 233/76</b> (2006.01) <b>A61K 31/4166</b> (2006.01) <b>C07D 403/04</b> (2006.01) <b>A61P 25/18</b> (2006.01)	2509961 *	IMIDAZOLIDINEDIONE DERIVATIVES
Meiji Seika Pharma Co., Ltd.	<b>C12N 15/09</b> (2006.01) <b>C12P 17/18</b> (2006.01) <b>C12N 1/15</b> (2006.01)	2530149 *	NUCLEIC ACID STRUCTURE CONTAINING A PYRIPYROPENE BIOSYNTHESIS GENE CLUSTER AND A MARKER GENE
Glaxo Group Limited	<b>C07K 16/24</b> (2006.01)	2534175 *	TREATMENT OF A METABOLIC DISORDER
Hemaquest Pharmaceuticals, Inc.	<b>A01N 37/10</b> (2006.01)	2509418 *	METHODS AND LOW DOSE REGIMENS FOR TREATING RED BLOOD CELL DISORDERS

Podnosilac evropske prijave patenta (71)	MKP (51)	Broj objave evropske prijave patenta (97)	Naziv pronalaska (54)
Trustees of Boston University	<b>A01N 37/10</b> (2006.01)	2509418 *	METHODS AND LOW DOSE REGIMENS FOR TREATING RED BLOOD CELL DISORDERS
Merello, Luisa	<b>A61L 24/00</b> (2006.01) <b>A61L 24/08</b> (2006.01) <b>A61L 24/02</b> (2006.01)	2512536 *	A CALCIUM PHOSPHATE BONE CEMENT, PROCESS FOR ITS PREPARATION AND USES THEREOF
Schädlich, Hartmut	<b>B63B 1/04</b> (2006.01)	2507124 *	WATERCRAFT COMPRISING UNDER-WATER FLOATING BODY AND ABOVE-WATER HELM STAND
Schädlich, Jette	<b>B63B 1/04</b> (2006.01)	2507124 *	WATERCRAFT COMPRISING UNDER-WATER FLOATING BODY AND ABOVE-WATER HELM STAND
Dow AgroSciences, LLC	<b>A61K 36/899</b> (2006.01) <b>A01H 5/00</b> (2006.01)	2512225 *	USE OF VIP3AB IN COMBINATION WITH CRY1CA FOR MANAGEMENT OF RESISTANT INSECTS
Iyer, Sriram S.	<b>A61F 2/00</b> (2006.01)	2528537 *	DEVICE AND METHOD FOR PREVENTING STENOSIS AT AN ANASTOMOSIS SITE
Dorros, Gerald	<b>A61F 2/00</b> (2006.01)	2528537 *	DEVICE AND METHOD FOR PREVENTING STENOSIS AT AN ANASTOMOSIS SITE
Novelis, Inc.	<b>F27D 1/12</b> (2006.01) <b>F27D 1/14</b> (2006.01)	2510297 *	MOLTEN METAL CONTAINMENT STRUCTURE HAVING FLOW THROUGH VENTILATION
Oncomed Pharmaceuticals, Inc.	<b>A61K 38/17</b> (2006.01)	2523678 *	WNT ANTAGONISTS AND METHODS OF TREATMENT AND SCREENING
The Regents Of The University Of Michigan	<b>A61P 19/02</b> (2006.01) <b>A61K 31/5513</b> (2006.01) <b>A61P 19/00</b> (2006.01)	2501387 *	1,4-BENZODIAZEPINE-2,5-DIONES AND RELATED COMPOUNDS WITH THERAPEUTIC PROPERTIES
NEC Corporation	<b>H04L 12/56</b> (2006.01)	2523405 *	COMMUNICATION SYSTEM, FORWARDING NODES, PATH MANAGEMENT SERVER AND COMMUNICATION METHOD
Sanofi-Aventis Deutschland GmbH	<b>A61M 5/32</b> (2006.01) <b>A61M 5/28</b> (2006.01) <b>A61M 5/24</b> (2006.01)	2531239 *	MEDICATED MODULE HAVING A DOUBLE NEEDLE GUARD
Shanghai Casail Display Technology Ltd.	<b>H01B 1/12</b> (2006.01) <b>C07D 333/10</b> (2006.01) <b>C07C 15/14</b> (2006.01) <b>C07D 495/04</b> (2006.01) <b>C07D 333/76</b> (2006.01) <b>C07C 15/30</b> (2006.01)	2518075 *	INDUCED LAYER MATERIAL FOR PREPARING NON-PLANAR METAL PHTHALOCYANINE WEAK EPITAXY GROWTH THIN FILM
Philip Morris Products S.A.	<b>A24F 47/00</b> (2006.01)	2503912 *	AN ELECTRICALLY HEATED SMOKING SYSTEM WITH INTERNAL OR EXTERNAL HEATER
Cubist Pharmaceuticals, Inc.	<b>A61P 31/04</b> (2006.01) <b>A61K 38/12</b> (2006.01) <b>C07K 7/08</b> (2006.01) <b>C07K 7/06</b> (2006.01) <b>C07K 7/64</b> (2006.01)	2504353 *	LIPOPEPTIDE COMPOSITIONS AND RELATED METHODS
Deva Holding Anonim Sirketi	<b>A61K 9/14</b> (2006.01) <b>A61K 31/00</b> (2006.01)	2441441	A sieving method for cetyl myristate and/or cetyl palmitate
Celgene Corporation	<b>C07D 493/04</b> (2006.01) <b>C07D 417/14</b> (2006.01) <b>A61K 31/4412</b> (2006.01) <b>C07D 407/12</b> (2006.01) <b>C07D 409/14</b> (2006.01) <b>C07D 413/14</b> (2006.01) <b>A61P 35/00</b> (2006.01) <b>C07D 487/04</b> (2006.01) <b>C07D 401/04</b> (2006.01) <b>C07D 491/107</b> (2006.01) <b>C07D 401/14</b> (2006.01) <b>C07D 407/14</b> (2006.01) <b>C07D 495/04</b> (2006.01)	2536706 *	ARYLMETHOXY ISOINDOLINE DERIVATIVES AND COMPOSITIONS COMPRISING AND METHODS OF USING THE SAME
John Mezzalingua Associates, Inc.	<b>H01R 13/52</b> (2006.01) <b>H01R 4/70</b> (2006.01)	2437355	Cover for cable connectors

Podnosilac evropske prijave patenta (71)	MKP (51)	Broj objave evropske prijave patenta (97)	Naziv pronalaska (54)
Incyte Corporation	<b>A61P 17/00</b> (2006.01) <b>A61P 29/00</b> (2006.01) <b>A61P 37/00</b> (2006.01) <b>A61P 35/00</b> (2006.01) <b>C07D 487/04</b> (2006.01) <b>A61K 31/519</b> (2006.01) <b>A61P 27/00</b> (2006.01)	2536729 *	CYCLOBUTANE AND METHYLCYCLOBUTANE DERIVATIVES AS JANUS KINASE INHIBITORS
MB-Microtec Ag	<b>F41G 1/34</b> (2006.01)	2507579 *	SIGHTING DEVICE
Janssen R&D Ireland	<b>A61K 9/16</b> (2006.01) <b>A61K 9/00</b> (2006.01)	2515877 *	DEGRADABLE REMOVABLE IMPLANT FOR THE SUSTAINED RELEASE OF AN ACTIVE COMPOUND
STC.UNM	<b>G06F 21/02</b> (2006.01) <b>H04L 9/08</b> (2006.01)	2524334 *	SYSTEM AND METHODS FOR GENERATING UNCLONABLE SECURITY KEYS IN INTEGRATED CIRCUITS
Mopac Systems International S.A.	<b>E04C 2/38</b> (2006.01) <b>B29C 44/60</b> (2006.01) <b>B29C 44/12</b> (2006.01) <b>E04C 2/296</b> (2006.01) <b>B29C 44/18</b> (2006.01)	2533960 *	METHOD, DEVICE AND A COMPUTER PROGRAM FOR MANUFACTURING A PRE-INSULATED SKELETON FRAMING SEGMENT
Oncomed Pharmaceuticals, Inc.	<b>A61K 39/00</b> (2006.01) <b>C12P 21/08</b> (2006.01)	2534257 *	METHODS FOR IDENTIFYING AND ISOLATING CELLS EXPRESSING A POLYPEPTIDE
Heartflow, Inc.	<b>G06F 19/00</b> (2011.01)	2538361	Method and system for patient-specific modeling of blood flow
Sea Lane Biotechnologies, llc.	<b>A61K 38/22</b> (2006.01) <b>C07K 14/605</b> (2006.01) <b>C07K 14/575</b> (2006.01) <b>A61K 38/26</b> (2006.01) <b>C07K 16/00</b> (2006.01)	2509997 *	CONJUGATES COMPRISING AN ANTIBODY SURROGATE SCAFFOLD WITH IMPROVED PHARMACOKINETIC PROPERTIES
SANOFI	<b>A61P 13/12</b> (2006.01) <b>A61P 25/28</b> (2006.01) <b>A61P 3/10</b> (2006.01) <b>A61P 35/00</b> (2006.01) <b>A61P 11/00</b> (2006.01) <b>C07D 498/04</b> (2006.01) <b>A61P 29/00</b> (2006.01) <b>A61P 9/00</b> (2006.01) <b>A61P 7/02</b> (2006.01) <b>A61K 31/519</b> (2006.01) <b>A61P 31/02</b> (2006.01)	2523958 *	CARBOXYLIC ACID DERIVATIVES HAVING A 2,5,7-SUBSTITUTED OXAZOLOPYRIMIDINE RING
HLH Invest ApS	<b>A41D 1/06</b> (2006.01)	2401930	A pair of trousers
Solis Biodyne	<b>C07K 14/00</b> (2006.01) <b>C12N 9/00</b> (2006.01)	2501716 *	COMPOSITIONS FOR INCREASING POLYPEPTIDE STABILITY AND ACTIVITY, AND RELATED METHODS
Baylor Research Institute	<b>A61K 31/185</b> (2006.01) <b>A61K 31/20</b> (2006.01) <b>A61P 25/28</b> (2006.01) <b>A61K 31/23</b> (2006.01) <b>A61K 31/25</b> (2006.01)	2519234 *	ANAPLEROTIC THERAPY FOR ALZHEIMER'S DISEASE AND THE AGING BRAIN
Filimonov, Alexandr Iosifovich	<b>B60V 3/08</b> (2006.01) <b>B64B 1/20</b> (2006.01)	2527218 *	AIRCRAFT ON AN AIR CUSHION WITH AEROSTATIC LOAD RELIEF
Shlyakhov, Alexandr Sergeevich	<b>B60V 3/08</b> (2006.01) <b>B64B 1/20</b> (2006.01)	2527218 *	AIRCRAFT ON AN AIR CUSHION WITH AEROSTATIC LOAD RELIEF
Far Rubinetterie S.P.A.	<b>B01D 21/00</b> (2006.01)	2452734	Filtering cartridge and dirt separation device for thermal fluids
CPS Color Equipment S.p.A. con unico socio	<b>G06F 17/00</b> (2006.01)	2502156 *	PAINT SAMPLE MIXING AND VENDING MACHINE
Rotam Agrochem International Co., Ltd	<b>A01N 43/52</b> (2006.01) <b>A01N 37/50</b> (2006.01) <b>A01P 3/00</b> (2006.01) <b>A01N 37/44</b> (2006.01) <b>A01N 43/653</b> (2006.01)	2531025 *	METHOD FOR TREATING FUNGAL INFECTIONS, FUNGICIDAL COMPOSITIONS AND THEIR USE
TransTech Pharma, Inc	<b>C12N 15/62</b> (2006.01) <b>C07K 14/705</b> (2006.01)	2536750 *	RAGE FUSION PROTEIN COMPOSITIONS AND METHODS OF USE

Podnosilac evropske prijave patenta (71)	MKP (51)	Broj objave evropske prijave patenta (97)	Naziv pronalaska (54)
SeproxBiotech, S.L.	<b>A61K 31/05</b> (2006.01) <b>A61K 9/06</b> (2006.01) <b>A61P 15/00</b> (2006.01) <b>A61P 31/18</b> (2006.01)	2506841 *	TOPICAL USE OF HYDROXYTYROSOL AND DERIVATIVES FOR THE PREVENTION OF HIV INFECTION
Mentor Worldwide LLC	<b>A61F 2/12</b> (2006.01) <b>A61M 39/02</b> (2006.01)	2519192 *	BREAST IMPLANTS HAVING DRUG-ELUTING RESERVOIRS AND METHODS THEREFOR
Broccio, Giuseppe	<b>H01L 23/367</b> (2006.01)	2533282	Modular heat sink
Serraino, Carmelo	<b>H01L 23/367</b> (2006.01)	2533282	Modular heat sink
Broccio, Concetta	<b>H01L 23/367</b> (2006.01)	2533282	Modular heat sink
Calapristi, Nunziata	<b>H01L 23/367</b> (2006.01)	2533282	Modular heat sink
Syngenta Participations AG	<b>A01N 43/72</b> (2006.01)	2519104 *	PESTICIDAL COMPOSITION
Novelis, Inc.	<b>B21D 51/26</b> (2006.01) <b>B21D 26/02</b> (2011.01)	2523762 *	METHODS OF PRESSURE FORMING METAL CONTAINERS AND THE LIKE FROM PREFORMS HAVING WALL THICKNESS GRADIENT
Montebello Packaging	<b>B21D 51/26</b> (2006.01) <b>B21D 26/02</b> (2011.01)	2523762 *	METHODS OF PRESSURE FORMING METAL CONTAINERS AND THE LIKE FROM PREFORMS HAVING WALL THICKNESS GRADIENT
Momenta Pharmaceuticals, Inc.	<b>C08B 37/10</b> (2006.01) <b>C08B 37/00</b> (2006.01)	2526122 *	EVALUATING HEPARIN PREPARATIONS
GB Developpement	<b>B65G 1/08</b> (2006.01) <b>B65G 47/88</b> (2006.01)	2531424 *	COMPACT DEVICE FOR DISTRIBUTING OBJECTS, ESPECIALLY BOXES OF MEDICAMENTS, IN A PHARMACY
Ascendis Pharma A/S	<b>A61K 38/27</b> (2006.01) <b>A61K 38/00</b> (2006.01) <b>A61K 47/48</b> (2006.01) <b>A61K 9/14</b> (2006.01) <b>A61K 47/26</b> (2006.01) <b>A61K 9/19</b> (2006.01) <b>A61K 9/00</b> (2006.01)	2512450 *	DRY GROWTH HORMONE COMPOSITION TRANSIENTLY LINKED TO A POLYMER CARRIER
Burcon Nutrascience (MB) Corp.	<b>A23J 3/16</b> (2006.01) <b>A23J 1/14</b> (2006.01)	2515673 *	pH ADJUSTED SOY PROTEIN ISOLATE AND USES
Janssen Biotech, Inc.	<b>A61K 48/00</b> (2006.01) <b>C07K 14/00</b> (2006.01)	2536435 *	MONKEY HOMOLOG OF HUMAN INTERFERON OMEGA
SANOFI	<b>C07D 401/06</b> (2006.01) <b>A61P 29/00</b> (2006.01) <b>A61K 31/454</b> (2006.01)	2516418 *	PRODRUGS OF [4[4-(5-AMINOMETHYL-2-FLUORO-PHENYL)-PIPERIDIN-1-YL]-(1H-PYRROLO-PYRIDIN-YL)-METHANONES AND SYNTHESIS THEREOF
Presano AG	<b>F16L 41/03</b> (2006.01) <b>E03D 9/05</b> (2006.01) <b>E03D 1/38</b> (2006.01) <b>E03D 9/08</b> (2006.01) <b>E03C 1/02</b> (2006.01) <b>E03D 11/13</b> (2006.01)	2521821 *	PIPE CONNECTION FOR A COMBINATION SHOWER-WC
Capuano, Sammy	<b>A24F 1/30</b> (2006.01) <b>A24F 47/00</b> (2006.01) <b>A24F 1/14</b> (2006.01)	2536303 *	ELECTRONIC HOOKAH
The Regents of the University of California	<b>C07K 16/18</b> (2006.01) <b>G01N 33/574</b> (2006.01)	2524233 *	COMPOSITIONS AND METHODS FOR DETECTING CANCER
Sialix, Inc.	<b>C07K 16/18</b> (2006.01) <b>G01N 33/574</b> (2006.01)	2524233 *	COMPOSITIONS AND METHODS FOR DETECTING CANCER
Cadila Healthcare Limited	<b>C07D 277/56</b> (2006.01) <b>A61P 19/06</b> (2006.01) <b>A61K 31/426</b> (2006.01)	2536699 *	SUBSTANTIALLY PURE SALTS OF FEBUXOSTAT AND PROCESSES FOR PREPARATION THEREOF
Amgen Inc.	<b>C07K 19/00</b> (2006.01) <b>C07K 16/28</b> (2006.01) <b>A61P 37/06</b> (2006.01) <b>A61K 39/395</b> (2006.01) <b>C07K 14/705</b> (2006.01)	2501407 *	ANTI-ORAI1 ANTIGEN BINDING PROTEINS AND USES THEREOF

Podnosilac evropske prijave patenta (71)	MKP (51)	Broj objave evropske prijave patenta (97)	Naziv pronalaska (54)
Hoseo University Academic Cooperation Foundation	<b>C02F 1/46</b> (2006.01) <b>C02F 9/14</b> (2006.01) <b>C02F 1/48</b> (2006.01)	2531452 *	ADVANCED TREATMENT SYSTEM OF WASTEWATER HAVING PLASMA DISCHARGING VESSEL
Kumkang Environmental Engineering Co. Ltd.	<b>C02F 1/46</b> (2006.01) <b>C02F 9/14</b> (2006.01) <b>C02F 1/48</b> (2006.01)	2531452 *	ADVANCED TREATMENT SYSTEM OF WASTEWATER HAVING PLASMA DISCHARGING VESSEL
Novartis AG	<b>A61K 9/16</b> (2006.01) <b>A61P 25/16</b> (2006.01) <b>A61P 25/18</b> (2006.01) <b>A61K 9/20</b> (2006.01) <b>A61K 31/517</b> (2006.01) <b>A61P 25/08</b> (2006.01) <b>A61K 9/14</b> (2006.01) <b>A61P 25/28</b> (2006.01) <b>A61P 25/24</b> (2006.01)	2515873 *	FORMULATION COMPRISING 1 H - QUINAZOLINE - 2, 4 - DIONE AMPA RECEPTOR ANTAGONISTS, IN THE FORM OF IMMEDIATE RELEASE TABLETS AND PREPARATION THEREOF
Mylan Group	<b>C09J 7/00</b> (2006.01) <b>B32B 3/00</b> (2006.01) <b>C09J 5/00</b> (2006.01)	2522499	Dry adhesive comprising micro-featured and nano-featured surface area and compliant surface area
Novartis AG	<b>A61K 39/395</b> (2006.01) <b>C07K 16/28</b> (2006.01)	2534176 *	AGONIST DR5 BINDING POLYPEPTIDES
Ablynx N.V.	<b>A61K 39/395</b> (2006.01) <b>C07K 16/28</b> (2006.01)	2534176 *	AGONIST DR5 BINDING POLYPEPTIDES
Kikkoman Corporation	<b>A23L 1/238</b> (2006.01)	2517577 *	SOY SAUCE HAVING HYPOTENSIVE EFFECT AND METHOD FOR PRODUCING SAME
Janssen Pharmaceutica, N.V.	<b>A61K 31/675</b> (2006.01) <b>C07F 9/24</b> (2006.01) <b>A61P 31/00</b> (2006.01) <b>C07D 401/14</b> (2006.01) <b>A61K 31/4725</b> (2006.01) <b>C07D 401/04</b> (2006.01) <b>C07D 405/14</b> (2006.01)	2523948 *	PRO-DRUGS OF (E) -7- (3- (2-AMINO-1-FLUOROETHYLIDENE) PIPERIDIN-1-YL) -1-CYCLOPROPYL-6-FLUORO-8-METHOXY-4-OXO-1,4-DIHYDROQUINOLINE-3-CARBOXYLIC ACID
Galderma Research & Development	<b>C07D 207/48</b> (2006.01) <b>A61K 31/451</b> (2006.01) <b>C07D 211/96</b> (2006.01) <b>A61P 17/00</b> (2006.01)	2509945 *	4- (AZACYCLOALKYL) -BENZENE-1, 3 -DIOL DERIVATIVES AS TYROSINASE INHIBITORS AND THEIR SYNTHESIS AND USE THEREOF
Ethicon Endo-Surgery, Inc.	<b>A61B 17/068</b> (2006.01) <b>A61B 17/128</b> (2006.01)	2525724 *	APPARATUS FOR FEEDING STAPLES IN A LOW PROFILE SURGICAL STAPLER
Eficiencia y Tecnologia, S.A.	<b>B29C 65/08</b> (2006.01) <b>B31B 19/90</b> (2006.01)	2522491	Longitudinal continuous welding device for packaging machines
CycloMedia Technology B.V.	<b>G06K 9/68</b> (2006.01)	2447884	Method for detecting and recognising an object in an image, and an apparatus and a computer program therefor
Novartis AG	<b>C07D 401/10</b> (2006.01) <b>C07D 417/12</b> (2006.01) <b>A61K 31/495</b> (2006.01) <b>C07D 413/10</b> (2006.01) <b>C07D 401/14</b> (2006.01) <b>C07D 413/14</b> (2006.01) <b>C07D 405/12</b> (2006.01) <b>A61P 35/00</b> (2006.01) <b>C07D 409/12</b> (2006.01) <b>C07D 401/12</b> (2006.01) <b>C07D 405/14</b> (2006.01) <b>C07D 401/04</b> (2006.01) <b>C07D 413/12</b> (2006.01) <b>C07D 405/04</b> (2006.01) <b>C07D 217/24</b> (2006.01)	2516009 *	SUBSTITUTED ISOQUINOLINONES AND QUINAZOLINONES
Air New Zealand Limited	<b>B60N 2/02</b> (2006.01) <b>B61D 33/00</b> (2006.01) <b>B60N 3/06</b> (2006.01) <b>B64D 11/06</b> (2006.01)	2509868 *	A SEAT AND RELATED LEG REST AND MECHANISM AND METHOD THEREFOR
Dow AgroSciences LLC	<b>A01H 5/00</b> (2006.01) <b>A01P 7/00</b> (2006.01) <b>A01H 1/00</b> (2006.01)	2512222 *	COMBINED USE OF CRY1Ca AND CRY1Fa PROTEINS FOR INSECT RESISTANCE MANAGEMENT



Podnosilac evropske prijave patenta (71)	MKP (51)	Broj objave evropske prijave patenta (97)	Naziv pronalaska (54)
Proyecto de Biomedicina Cima, S.L.	<b>C07K 19/00</b> (2006.01) <b>C07K 14/54</b> (2006.01) <b>A61K 38/17</b> (2006.01) <b>C07K 14/715</b> (2006.01) <b>A61K 48/00</b> (2006.01) <b>C07K 14/775</b> (2006.01) <b>C12N 1/21</b> (2006.01) <b>C12N 1/15</b> (2006.01) <b>C12N 15/62</b> (2006.01) <b>C12N 5/10</b> (2006.01)	2511294 *	CONJUGATES AND COMPOSITIONS FOR IMMUNOTHERAPY AND ANTI-TUMOR TREATMENT
Research Center Borstel	<b>C07K 19/00</b> (2006.01) <b>C07K 14/54</b> (2006.01) <b>A61K 38/17</b> (2006.01) <b>C07K 14/715</b> (2006.01) <b>A61K 48/00</b> (2006.01) <b>C07K 14/775</b> (2006.01) <b>C12N 1/21</b> (2006.01) <b>C12N 1/15</b> (2006.01) <b>C12N 15/62</b> (2006.01) <b>C12N 5/10</b> (2006.01)	2511294 *	CONJUGATES AND COMPOSITIONS FOR IMMUNOTHERAPY AND ANTI-TUMOR TREATMENT
Battelle Energy Alliance, LLC	<b>C25B 1/16</b> (2006.01)	2510135 *	METHOD AND SYSTEM FOR PRODUCING HYDROGEN USING SODIUM ION SEPARATION MEMBRANES
Board of Regents, The University of Texas System	<b>A61K 31/277</b> (2006.01) <b>A61P 35/00</b> (2006.01) <b>A61K 31/275</b> (2006.01) <b>A61K 31/216</b> (2006.01) <b>A61K 31/445</b> (2006.01) <b>A61K 31/4465</b> (2006.01)	2506852 *	INTERFERON THERAPIES IN COMBINATION WITH BLOCKADE OF STAT3 ACTIVATION
Delphi Technologies Holding S.à.r.l.	<b>F02D 41/20</b> (2006.01) <b>F02M 51/00</b> (2006.01) <b>F02D 41/24</b> (2006.01)	2504551 *	FUEL INJECTOR COMMUNICATION SYSTEM
Keller HCW GmbH	<b>C03B 37/16</b> (2006.01) <b>B26F 3/00</b> (2006.01)	2481539	Device for cutting insulation material
Intermune, Inc.	<b>A61K 31/4418</b> (2006.01) <b>A61P 43/00</b> (2006.01) <b>A61K 31/4412</b> (2006.01) <b>A61K 31/44</b> (2006.01)	2506849 *	PIRFENIDONE THERAPY AND INDUCERS OF CYTOCHROME P450
Momenta Pharmaceuticals, Inc.	<b>G01N 33/53</b> (2006.01) <b>G01N 33/68</b> (2006.01)	2507627 *	ANTENNARY FUCOSYLATION IN GLYCOPROTEINS FROM CHO CELLS
Dipl.-ing. I. Özpölat Kunststoffzeugnisse GmbH	<b>F16L 9/00</b> (2006.01) <b>F16L 9/127</b> (2006.01) <b>F16L 11/12</b> (2006.01)	2447585	Pipe
Sanofi-Aventis Deutschland GmbH	<b>A61M 5/24</b> (2006.01) <b>A61M 5/315</b> (2006.01)	2528643 *	DRIVE ASSEMBLY FOR A DRUG DELIVERY DEVICE AND DRUG DELIVERY DEVICE
Carnehammar, Lars Bertil	<b>B64C 27/00</b> (2006.01) <b>F16F 15/36</b> (2006.01) <b>F16F 15/16</b> (2006.01) <b>G01M 1/36</b> (2006.01)	2501958 *	METHOD, APPARATUS AND SYSTEM FOR REDUCING VIBRATION IN A ROTARY SYSTEM OF A VEHICLE
Funfoods K.S.	<b>A23G 1/30</b> (2006.01) <b>A23L 1/00</b> (2006.01) <b>A23G 1/50</b> (2006.01) <b>A23L 1/09</b> (2006.01) <b>A23L 1/03</b> (2006.01) <b>A23L 1/30</b> (2006.01) <b>A23L 1/0562</b> (2006.01) <b>A23G 3/54</b> (2006.01) <b>A23L 1/305</b> (2006.01) <b>A23L 1/227</b> (2006.01) <b>A23G 1/54</b> (2006.01)	2509439 *	CHOCOLATE PRODUCT
NP Poschmann GmbH	<b>B29C 45/44</b> (2006.01) <b>B29C 45/26</b> (2006.01) <b>B29C 45/56</b> (2006.01)	2444224	Method and device for producing ball bearing rings

Podnosilac evropske prijave patenta (71)	MKP (51)	Broj objave evropske prijave patenta (97)	Naziv pronalaska (54)
Dow AgroSciences, LLC	<b>A01H 5/00</b> (2006.01) <b>C12N 15/29</b> (2006.01) <b>C12N 15/82</b> (2006.01)	2525649 *	EXCISION OF TRANSGENES IN GENETICALLY MODIFIED ORGANISMS
SANOFI	<b>A61K 31/519</b> (2006.01) <b>A61P 9/00</b> (2006.01) <b>C07D 498/04</b> (2006.01)	2523960 *	HETEROCYCLIC CARBOXYLIC ACID DERIVATIVES HAVING A 2,5-SUBSTITUTED OXAZOLOPYRIMIDINE RING
Takeda Pharmaceutical Company Limited	<b>A61K 9/00</b> (2006.01) <b>A61K 9/16</b> (2006.01) <b>A61P 35/00</b> (2006.01) <b>A61K 38/00</b> (2006.01)	2515878 *	SUSTAINED-RELEASE FORMULATION
Bayer CropScience NV	<b>A01H 5/00</b> (2006.01) <b>C12Q 1/68</b> (2006.01)	2503873 *	HERBICIDE TOLERANT SOYBEAN PLANTS AND METHODS FOR IDENTIFYING SAME
M.S. Technologies LLC	<b>A01H 5/00</b> (2006.01) <b>C12Q 1/68</b> (2006.01)	2503873 *	HERBICIDE TOLERANT SOYBEAN PLANTS AND METHODS FOR IDENTIFYING SAME
Archos	<b>G06F 3/048</b> (2006.01)	2524294 *	METHOD FOR SELECTING AN ELEMENT OF A USER INTERFACE AND DEVICE IMPLEMENTING SUCH A METHOD
Acclarent, Inc.	<b>A61B 17/24</b> (2006.01) <b>A61B 17/32</b> (2006.01) <b>A61M 29/02</b> (2006.01) <b>A61B 17/3205</b> (2006.01) <b>A61B 17/22</b> (2006.01)	2519168 *	TISSUE REMOVAL IN THE PARANASAL SINUS AND NASAL CAVITY
Palmer Labs, LLC	<b>F23M 5/00</b> (2006.01) <b>F23L 7/00</b> (2006.01) <b>F23M 5/08</b> (2006.01) <b>F02C 1/00</b> (2006.01)	2529158 *	SYSTEM AND METHOD FOR HIGH EFFICIENCY POWER GENERATION USING A CARBON DIOXIDE CIRCULATING WORKING FLUID
8 Rivers Capital, LLC	<b>F23M 5/00</b> (2006.01) <b>F23L 7/00</b> (2006.01) <b>F23M 5/08</b> (2006.01) <b>F02C 1/00</b> (2006.01)	2529158 *	SYSTEM AND METHOD FOR HIGH EFFICIENCY POWER GENERATION USING A CARBON DIOXIDE CIRCULATING WORKING FLUID
Schultz, Gregory Russell	<b>F41H 1/02</b> (2006.01) <b>D04B 21/14</b> (2006.01)	2507582 *	STAPLE FIBER CONDUCTIVE FABRIC
AMGEN INC.	<b>C07K 16/18</b> (2006.01) <b>A61K 39/395</b> (2006.01) <b>A61P 13/12</b> (2006.01)	2512600 *	WISE BINDING AGENTS AND EPITOPES
Galderma Research & Development	<b>C07C 409/34</b> (2006.01) <b>A61Q 19/00</b> (2006.01) <b>A61K 8/38</b> (2006.01)	2509944 *	NOVEL PEROXIDE DERIVATIVES, THEIR PROCESS OF PREPARATION AND THEIR USE IN HUMAN MEDICINE AND IN COSMETICS FOR THE TREATMENT OR PREVENTION OF ACNE
Dow AgroSciences, LLC	<b>C12P 19/34</b> (2006.01) <b>C07H 21/04</b> (2006.01)	2513326 *	ENDPOINT TAQMAN METHODS FOR DETERMINING ZYGOSITY OF CORN COMPRISING TC1507 EVENTS
Sanofi-Aventis Deutschland GmbH	<b>A61M 5/32</b> (2006.01) <b>A61M 5/20</b> (2006.01)	2536455 *	FINGER GUARD FOR AN INJECTION DEVICE
Array Biopharma, Inc.	<b>A61P 9/00</b> (2006.01) <b>A61P 19/08</b> (2006.01) <b>C07D 519/00</b> (2006.01) <b>C07D 471/04</b> (2006.01) <b>A61P 29/00</b> (2006.01) <b>A61K 31/437</b> (2006.01) <b>A61K 31/4985</b> (2006.01) <b>A61P 35/00</b> (2006.01)	2516433 *	SUBSTITUTED N-(1H-INDAZOL-4-YL)IMIDAZO[1,2-A]PYRIDINE-3-CARBOXAMIDE COMPOUNDS AS CFMS INHIBITORS
ESSVE Produkter AB	<b>B25H 3/02</b> (2006.01)	2516115 *	MODULE SYSTEM COMPRISING A CASE AND A NUMBER OF BOXES
Vitacare GmbH & Co. KG	<b>A61K 35/74</b> (2006.01) <b>A61K 38/47</b> (2006.01)	2528611 *	A COMPOSITION FOR USE IN THE THERAPY OF LACTOSE INTOLERANCE OR CONDITIONS ARISING FROM LACTASE DEFICIENCY
Italgisa S.p.A.	<b>H05B 7/09</b> (2006.01)	2514269 *	ELECTRODE PASTE FOR ELECTRODES IN BINDER-FREE GRAPHITE WITH HYDROCARBON BASE
Teva Pharmaceutical Industries Ltd.	<b>A61K 31/135</b> (2006.01)	2515891 *	3-KETO-N-PROPARGYL-1-AMINOINDAN

Podnosilac evropske prijave patenta (71)	MKP (51)	Broj objave evropske prijave patenta (97)	Naziv pronalaska (54)
Janssen Pharmaceuticals Inc.	<b>C07D 487/04</b> (2006.01) <b>A61P 25/28</b> (2006.01) <b>C07D 471/04</b> (2006.01) <b>A61K 31/4196</b> (2006.01)	2523955 *	NOVEL SUBSTITUTED BICYCLIC TRIAZOLE DERIVATIVES AS GAMMA SECRETASE MODULATORS
Eved, L.L.C.	<b>G06Q 10/00</b> (2012.01)	2529342 *	SYSTEMS AND METHODS FOR MANAGING EVENTS
Chiesi Farmaceutici S.p.A.	<b>C07J 71/00</b> (2006.01) <b>A61K 31/58</b> (2006.01) <b>A61P 5/44</b> (2006.01)	2531516 *	PREGNANE COMPOUNDS CONDENSED IN POSITION 16,17 WITH A PYROLIDINE RING WITH GLUCOCORTICOID ACTIVITY
Opko Ophthalmics, LLC	<b>C12N 15/113</b> (2010.01)	2507373 *	COMPOSITIONS AND METHODS FOR INHIBITION OF VEGF
Emergent Product Development Seattle, LLC	<b>A61P 17/06</b> (2006.01) <b>A61P 37/00</b> (2006.01) <b>C07K 16/24</b> (2006.01) <b>A61K 39/395</b> (2006.01) <b>A61P 19/02</b> (2006.01)	2516467 *	COMPOSITIONS COMPRISING TNF-ALPHA AND IL-6 ANTAGONISTS AND METHODS OF USE THEREOF
Ardea Biosciences, Inc.	<b>A61P 13/00</b> (2006.01) <b>C07D 249/12</b> (2006.01) <b>A61P 13/12</b> (2006.01) <b>A61K 31/4196</b> (2006.01)	2521716 *	POLYMORPHIC, CRYSTALLINE AND MESOPHASE FORMS OF SODIUM 2-(5-BROMO-4-(4-CYCLOPROPYLNAPHTHALEN-1-YL)-4H-1,2,4-TRIAZOL-3-YLTHIO)ACETATE, AND USES THEREOF
Blücher GmbH	<b>B01J 20/28</b> (2006.01) <b>B01J 20/26</b> (2006.01) <b>C02F 1/28</b> (2006.01) <b>B01J 20/32</b> (2006.01) <b>B01J 20/20</b> (2006.01) <b>B01D 53/02</b> (2006.01)	2536497 *	AGGLOMERATES OF ADSORBER PARTICLES AND METHODS FOR PRODUCING SUCH ADSORBER PARTICLES
Ethicon Endo-Surgery, Inc.	<b>A61B 17/00</b> (2006.01) <b>A61B 19/02</b> (2006.01) <b>A61B 19/08</b> (2006.01) <b>A61B 19/00</b> (2006.01)	2501298 *	SURGICAL INSTRUMENTS AND COMPONENTS FOR USE IN STERILE ENVIRONMENTS
Salix Pharmaceuticals, Ltd.	<b>C07D 498/00</b> (2006.01)	2536734 *	FORMS OF RIFAXIMIN AND USES THEREOF
Mom's A/S	<b>A47J 37/04</b> (2006.01)	2464265 *	AN OVEN FOR HEAT-TREATING FOOD PIECES
Ethicon Endo-Surgery, Inc.	<b>A61B 17/115</b> (2006.01) <b>A61B 17/11</b> (2006.01) <b>A61B 19/00</b> (2006.01) <b>A61B 17/00</b> (2006.01)	2512350 *	CIRCULAR STAPLER INTRODUCER WITH RADIALLY-OPENABLE DISTAL END PORTION
SANOFI	<b>A61K 9/50</b> (2006.01) <b>A61K 9/16</b> (2006.01) <b>A61K 9/06</b> (2006.01) <b>A61P 1/00</b> (2006.01) <b>A61K 9/10</b> (2006.01) <b>A61K 9/12</b> (2006.01) <b>A61K 9/00</b> (2006.01) <b>A61K 31/404</b> (2006.01) <b>A61K 9/20</b> (2006.01) <b>A61K 9/08</b> (2006.01)	2515851 *	TREATMENT FOR INFLAMMATORY BOWEL DISEASE
H. Lundbeck A/S	<b>A61K 38/18</b> (2006.01)	2501399 *	TREATMENT OF ACUTE ISCHEMIC STROKE OR INTRACRANIAL BLEEDING WITH TPA AND CARBAMYLATED ERYTHROPOIETIN
Powerdyne, Inc.	<b>F23L 7/00</b> (2006.01)	2526339 *	GENERATING STEAM FROM CARBONACEOUS MATERIAL
Laboratorios del. Dr. Esteve, S.A.	<b>A61K 45/06</b> (2006.01) <b>A61K 31/4155</b> (2006.01) <b>A61K 31/00</b> (2006.01) <b>A61P 25/04</b> (2006.01)	2531182 *	SIGMA LIGANDS FOR POTENTIATING THE ANALGESIC EFFECT OF OPIOIDS AND OPIATES IN POST-OPERATIVE PAIN AND ATTENUATING THE DEPENDENCY THEREOF
NEC Corporation	<b>H04L 12/56</b> (2006.01)	2523402 *	COMMUNICATION SYSTEM, CONTROL APPARATUS, PROCESSING RULE SETTING METHOD, PACKET TRANSMITTING METHOD AND PROGRAM

Podnosilac evropske prijave patenta (71)	MKP (51)	Broj objave evropske prijave patenta (97)	Naziv pronalaska (54)
Immersion Corporation	<b>A61B 19/00</b> (2006.01) <b>A61B 17/34</b> (2006.01)	2523613 *	SYSTEMS AND METHODS FOR MINIMALLY INVASIVE SURGICAL TOOLS WITH HAPTIC FEEDBACK
300K Enterprises Pty Ltd	<b>F21V 17/06</b> (2006.01) <b>F21V 19/04</b> (2006.01) <b>H01F 38/14</b> (2006.01) <b>H05B 41/46</b> (2006.01)	2502244 *	CONTACTLESS COUPLING AND METHOD FOR USE WITH AN ELECTRICAL APPLIANCE
Ironwood Pharmaceuticals, Inc.	<b>A61K 38/10</b> (2006.01) <b>C07K 7/08</b> (2006.01)	2509992 *	TREATMENTS FOR GASTROINTESTINAL DISORDERS
Cancer Research Technology Limited	<b>A61K 31/437</b> (2006.01) <b>C07D 471/04</b> (2006.01) <b>A61P 35/00</b> (2006.01)	2531502 *	1-(5-TERT-BUTYL-2-PHENYL-2H-PYRAZOL-3-YL)-3-[2-FLUORO-4-(1-METHYL-2-OXO-2,3-DIHYDRO-1H-IMIDAZO[4,5-B]PYRIDIN-7-YLOXY)-PHENYL]-UREA AND RELATED COMPOUNDS AND THEIR USE IN THERAPY
The Institute of Cancer Research: Royal Cancer Hospital	<b>A61K 31/437</b> (2006.01) <b>C07D 471/04</b> (2006.01) <b>A61P 35/00</b> (2006.01)	2531502 *	1-(5-TERT-BUTYL-2-PHENYL-2H-PYRAZOL-3-YL)-3-[2-FLUORO-4-(1-METHYL-2-OXO-2,3-DIHYDRO-1H-IMIDAZO[4,5-B]PYRIDIN-7-YLOXY)-PHENYL]-UREA AND RELATED COMPOUNDS AND THEIR USE IN THERAPY
Yale University, Inc.	<b>A61K 38/17</b> (2006.01)	2523679 *	INHIBITORS OF RECEPTOR TYROSINE KINASES (RTK) AND METHODS OF USE THEREOF
Wound Engineering LLC	<b>A61L 15/44</b> (2006.01) <b>B32B 27/00</b> (2006.01) <b>A61F 13/00</b> (2006.01) <b>A61K 9/70</b> (2006.01) <b>A61K 33/38</b> (2006.01)	2533772 *	METHODS AND COMPOSITIONS FOR WOUND HEALING
Ironwood Pharmaceuticals, Inc.	<b>A61K 38/10</b> (2006.01) <b>A61P 1/10</b> (2006.01)	2521561 *	LINACLOTIDE FOR THE TREATMENT OF CHRONIC CONSTIPATION
Forest Laboratories Holdings Limited	<b>A61K 38/10</b> (2006.01) <b>A61P 1/10</b> (2006.01)	2521561 *	LINACLOTIDE FOR THE TREATMENT OF CHRONIC CONSTIPATION
Treatec 21 Industries Ltd.	<b>C02F 3/04</b> (2006.01)	2501656 *	MULTISTAGE BIOLOGICAL REACTOR
OSI Pharmaceuticals, LLC	<b>A61P 35/00</b> (2006.01) <b>C07D 491/048</b> (2006.01) <b>A61K 31/4355</b> (2006.01)	2534156 *	7-AMINOFUOPYRIDINE DERIVATIVES
Teikoku Seiyaku Co., Ltd.	<b>A61F 13/02</b> (2006.01) <b>A61M 35/00</b> (2006.01) <b>A61K 9/70</b> (2006.01)	2520257 *	ADHESIVE TAPE PREPARATION
Bayer CropScience NV	<b>C12N 9/02</b> (2006.01) <b>C12N 15/82</b> (2006.01)	2501804 *	BRASSICA PLANTS COMPRISING MUTANT FAD3 ALLELES
Pharmaessentia Corp.	<b>A61P 35/00</b> (2006.01) <b>A61P 31/00</b> (2006.01) <b>A61K 38/21</b> (2006.01) <b>A61P 31/12</b> (2006.01) <b>A61K 31/40</b> (2006.01)	2509593 *	THERAPEUTIC USE OF PROTEIN-POLYMER CONJUGATES
SANOFI	<b>C07D 307/80</b> (2006.01) <b>C07D 307/79</b> (2006.01)	2521720 *	NEW PROCESS FOR THE PREPARATION OF DRONEDARONE
KRKA, D.D., Novo Mesto	<b>C07D 223/16</b> (2006.01) <b>A61K 31/55</b> (2006.01) <b>A61P 9/10</b> (2006.01)	2534135 *	NOVEL FORMS OF IVABRADINE HYDROCHLORIDE
Vertex Pharmaceuticals Incorporated	<b>C07D 403/14</b> (2006.01) <b>A61P 31/14</b> (2006.01) <b>A61K 31/4155</b> (2006.01)	2515902 *	ANALOGUES FOR THE TREATMENT OR PREVENTION OF FLAVIVIRUS INFECTIONS
Nycomed GmbH	<b>A61P 11/06</b> (2006.01) <b>A61P 11/00</b> (2006.01) <b>C07D 519/00</b> (2006.01) <b>A61K 31/519</b> (2006.01) <b>A61P 11/08</b> (2006.01)	2513119 *	3,4,4A,10B-TETRAHYDRO-1H-THIOPYRANO-[4,3-c]ISOQUINOLINE DERIVATIVES

Podnosilac evropske prijave patenta (71)	MKP (51)	Broj objave evropske prijave patenta (97)	Naziv pronalaska (54)
Krüger GmbH & Co. KG	<b>A23L 1/236</b> (2006.01) <b>A23L 1/30</b> (2006.01) <b>A23L 2/52</b> (2006.01) <b>A23L 2/60</b> (2006.01) <b>A23L 1/09</b> (2006.01)	2536298 *	NOVEL SWEETENER COMPOSITIONS
Novartis AG	<b>A61K 9/00</b> (2006.01) <b>A61K 31/506</b> (2006.01) <b>A61P 35/00</b> (2006.01)	2501384 *	METHOD OF TREATING PROLIFERATIVE DISORDERS AND OTHER PATHOLOGICAL CONDITIONS MEDIATED BY BCR-ABL, C-KIT, DDR1, DDR2 OR PDGF-R KINASE ACTIVITY
H. Lundbeck A/S	<b>C07D 209/16</b> (2006.01) <b>C07D 209/10</b> (2006.01) <b>C07D 209/14</b> (2006.01)	2516394 *	PROCESSES FOR THE MANUFACTURE OF A PHARMACEUTICALLY ACTIVE AGENT
Thevenod, Frédéric Olivier	<b>F02G 5/02</b> (2006.01) <b>F02G 1/04</b> (2006.01)	2519728 *	HEAT ENGINE WITH EXTERNAL HEAT SOURCE AND ASSOCIATED POWER GENERATION UNIT AND VEHICLE
The Board of Trustees of the Leland Stanford Junior University	<b>A61K 39/395</b> (2006.01)	2509627 *	METHODS FOR ENHANCING ANTI-TUMOR ANTIBODY THERAPY
Rybka, Bodo	<b>F03B 17/00</b> (2006.01) <b>F03G 7/10</b> (2006.01)	2520801	Residual energy through displacement (renewable energy)
Delphi Technologies Holding S.a.r.l.	<b>F02M 25/07</b> (2006.01) <b>F01N 3/28</b> (2006.01) <b>F01N 3/20</b> (2006.01) <b>F01N 3/035</b> (2006.01)	2524116 *	COMPRESSION-IGNITION ENGINE WITH EXHAUST SYSTEM
Poxel	<b>A61K 31/33</b> (2006.01) <b>C07D 495/04</b> (2006.01) <b>A61P 3/10</b> (2006.01)	2519527 *	THIENO [2,3-B]PYRIDINEDIONE ACTIVATORS OF AMPK AND THERAPEUTIC USES THEREOF
Philip Morris Products S.A.	<b>H05B 3/58</b> (2006.01) <b>A24F 47/00</b> (2006.01)	2519121 *	AN IMPROVED HEATER FOR AN ELECTRICALLY HEATED AEROSOL GENERATING SYSTEM
University of Maryland, College Park	<b>B01J 21/00</b> (2006.01)	2521613 *	SCALABLE PRODUCTION OF PRECISION HYDROCARBONS FROM TRIALKYLALUMINUM VIA TERNARY LIVING COORDINATIVE CHAIN TRANSFER POLYMERIZATION
Novelis, Inc.	<b>F27D 1/14</b> (2006.01)	2510299 *	MOLTEN METAL-CONTAINING VESSEL AND METHODS OF PRODUCING SAME
BioAlliance Pharma	<b>A61K 31/44</b> (2006.01) <b>A61K 31/00</b> (2006.01) <b>A61K 47/36</b> (2006.01) <b>A61K 9/20</b> (2006.01)	2509586 *	MUCOADHESIVE BUCCAL TABLETS FOR THE TREATMENT OF OROFACIAL HERPES
Corporation De L'école Polytechnique De Montréal	<b>C08L 5/08</b> (2006.01) <b>C08K 11/00</b> (2006.01) <b>A61K 35/14</b> (2006.01) <b>C08K 3/00</b> (2006.01)	2501754 *	NOVEL FORMULATION OF PHYSIOLOGICAL CHITOSAN-INORGANIC SALT SOLUTION/BLOOD MIXTURES FOR TISSUE REPAIR
Arterius Limited	<b>A61L 31/14</b> (2006.01) <b>A61L 31/16</b> (2006.01) <b>A61L 31/06</b> (2006.01)	2506887 *	BIODEGRADABLE STENT COMPRISING AN ACID SCAVENGING AGENT
Bayer Intellectual Property GmbH	<b>A61K 31/506</b> (2006.01) <b>C07D 403/06</b> (2006.01) <b>A61P 35/00</b> (2006.01) <b>C07D 413/14</b> (2006.01) <b>A61K 31/4439</b> (2006.01) <b>C07D 401/14</b> (2006.01) <b>A61K 31/541</b> (2006.01) <b>C07D 403/14</b> (2006.01) <b>C07D 401/04</b> (2006.01) <b>A61K 31/5377</b> (2006.01) <b>C07D 405/14</b> (2006.01)	2475653 *	SUSTITUTED ( HETEROARYLMETHYL ) THIOHYDANTOINS AS ANTICANCER DRUGS
Pellini S.p.A.	<b>E06B 9/386</b> (2006.01) <b>G02B 17/00</b> (2006.01) <b>E06B 9/264</b> (2006.01)	2510178 *	GLASS-ENCLOSED CHAMBER AND INTERNAL VENETIAN BLIND HAVING SLATS OF IMPROVED REFLECTANCE AND DIFFUSIVITY OVER A WIDER SPECTRAL INTERVAL OF INCIDENT SOLAR RADIATION

Podnosilac evropske prijave patenta (71)	MKP (51)	Broj objave evropske prijave patenta (97)	Naziv pronalaska (54)
Omya Development AG	<b>C09C 1/02</b> (2006.01) <b>C01F 11/18</b> (2006.01)	2537900	Process for the production of precipitated calcium carbonate, precipitated calcium carbonate and uses thereof
Alkermes, Inc.	<b>A61K 31/4192</b> (2006.01)	2521545 *	PRODRUGS OF HETERAROMATIC COMPOUNDS
Services Pétroliers Schlumberger	<b>C09K 8/03</b> (2006.01) <b>C09K 8/40</b> (2006.01) <b>C09K 8/42</b> (2006.01) <b>E21B 21/00</b> (2006.01)	2450416	Methods and compositions for suspending fluids in a wellbore
Schlumberger Technology B.V. (STBV)	<b>C09K 8/03</b> (2006.01) <b>C09K 8/40</b> (2006.01) <b>C09K 8/42</b> (2006.01) <b>E21B 21/00</b> (2006.01)	2450416	Methods and compositions for suspending fluids in a wellbore
Schlumberger Holdings Limited	<b>C09K 8/03</b> (2006.01) <b>C09K 8/40</b> (2006.01) <b>C09K 8/42</b> (2006.01) <b>E21B 21/00</b> (2006.01)	2450416	Methods and compositions for suspending fluids in a wellbore
PRAD Research and Development Limited	<b>C09K 8/03</b> (2006.01) <b>C09K 8/40</b> (2006.01) <b>C09K 8/42</b> (2006.01) <b>E21B 21/00</b> (2006.01)	2450416	Methods and compositions for suspending fluids in a wellbore
Nektar Therapeutics	<b>A61P 35/00</b> (2006.01) <b>C08G 65/08</b> (2006.01) <b>A61K 47/48</b> (2006.01) <b>C08G 65/14</b> (2006.01) <b>C08G 65/26</b> (2006.01)	2501413 *	ACID SALT FORMS OF POLYMER-DRUG CONJUGATES AND ALKOXYLATION METHODS
AA Technology LLC	<b>E04C 2/04</b> (2006.01)	2507442 *	BASALT COMPOSITE PANEL
Suzhou Neupharma Co., Ltd	<b>C07J 19/00</b> (2006.01) <b>A61K 31/585</b> (2006.01) <b>A61P 35/00</b> (2006.01)	2523966 *	CERTAIN CHEMICAL ENTITIES, COMPOSITIONS, AND METHODS
BIOGEN IDEC HEMOPHILIA INC.	<b>A61K 38/37</b> (2006.01)	2506868 *	FACTOR VIII-FC CHIMERIC AND HYBRID POLYPEPTIDES, AND METHODS OF USE THEREOF
Ethicon Endo-Surgery, Inc.	<b>A61B 17/32</b> (2006.01)	2533707 *	OUTER SHEATH AND BLADE ARRANGEMENTS FOR ULTRASONIC SURGICAL INSTRUMENTS
REFORM-WERKE BAUER & CO. GESELLSCHAFT M.B.H.	<b>B60K 6/46</b> (2007.10) <b>B60K 25/06</b> (2006.01) <b>B60K 17/28</b> (2006.01) <b>B60K 6/44</b> (2007.10) <b>F16H 3/091</b> (2006.01)	2428384	Power train for vehicles with power take-off shafts for driving additional devices
Omya Development AG	<b>D21H 17/67</b> (2006.01) <b>C09C 1/02</b> (2006.01)	2392622	Use of 2-aminoethanol as additive in aqueous suspensions of calcium carbonate comprising materials
Panmira Pharmaceuticals, LLC	<b>A61K 31/196</b> (2006.01) <b>A61P 29/00</b> (2006.01) <b>A61K 31/10</b> (2006.01) <b>C07C 323/59</b> (2006.01) <b>A61P 11/06</b> (2006.01)	2521713 *	DP2 ANTAGONIST AND USES THEREOF
Sanofi-Aventis Deutschland GmbH	<b>A61M 5/24</b> (2006.01) <b>A61M 5/32</b> (2006.01) <b>A61M 5/28</b> (2006.01)	2531235 *	FLEXIBLE RESERVOIR FOR A MEDICATED MODULE
Birken AG	<b>A61K 31/56</b> (2006.01) <b>A61K 47/44</b> (2006.01) <b>A61K 9/00</b> (2006.01) <b>A61K 9/06</b> (2006.01)	2504012 *	USE OF AN OLEO GEL CONTAINING TRITERPENE FOR HEALING WOUNDS
Agios Pharmaceuticals, Inc.	<b>A61K 31/496</b> (2006.01) <b>C07D 405/12</b> (2006.01) <b>A61K 31/551</b> (2006.01) <b>C07D 243/08</b> (2006.01) <b>A61K 31/495</b> (2006.01) <b>A61P 35/00</b> (2006.01) <b>A61K 31/506</b> (2006.01)	2509600 *	THERAPEUTICALLY ACTIVE COMPOUNDS FOR USE IN THE TREATMENT OF CANCER CHARACTERIZED AS HAVING AN IDH MUTATION

Podnosilac evropske prijave patenta (71)	MKP (51)	Broj objave evropske prijave patenta (97)	Naziv pronalaska (54)
Medivir UK Ltd	<b>C07D 231/40</b> (2006.01) <b>A61P 11/06</b> (2006.01) <b>C07D 277/46</b> (2006.01) <b>A61K 31/4155</b> (2006.01) <b>A61P 37/02</b> (2006.01) <b>A61K 31/4164</b> (2006.01) <b>A61P 37/08</b> (2006.01) <b>A61K 31/42</b> (2006.01) <b>C07C 271/20</b> (2006.01) <b>A61K 31/415</b> (2006.01) <b>A61P 21/04</b> (2006.01) <b>A61K 31/27</b> (2006.01) <b>A61P 17/06</b> (2006.01) <b>C07D 405/12</b> (2006.01) <b>A61P 9/10</b> (2006.01) <b>C07D 261/14</b> (2006.01) <b>A61K 31/426</b> (2006.01) <b>C07D 233/88</b> (2006.01)	2509956 *	CYSTEINE PROTEASE INHIBITORS
Meiji Seika Pharma Co., Ltd.	<b>C07D 493/04</b> (2006.01) <b>C12N 15/09</b> (2006.01) <b>C12P 17/18</b> (2006.01)	2530165 *	METHOD FOR PRODUCING PYRIPYROPENE DERIVATIVE BY ENZYMATIC PROCESS
New Live	<b>A61G 5/04</b> (2006.01) <b>B62D 55/075</b> (2006.01) <b>B62D 61/10</b> (2006.01)	2531157 *	DEVICE ENABLING AN ELECTRIC WHEELCHAIR TO CROSS OBSTACLES
Glaxo Group Limited	<b>A61K 9/44</b> (2006.01) <b>A61K 9/32</b> (2006.01) <b>A61K 31/27</b> (2006.01)	2525788 *	NOVEL RETIGABINE COMPOSITION
Yissum Research Development Company of the Hebrew University of Jerusalem, Ltd.	<b>C07C 43/23</b> (2006.01) <b>A61K 31/09</b> (2006.01) <b>C07C 62/34</b> (2006.01) <b>A61K 31/125</b> (2006.01) <b>C07C 43/215</b> (2006.01) <b>A61K 31/216</b> (2006.01) <b>A61K 31/192</b> (2006.01) <b>C07D 311/80</b> (2006.01) <b>A61P 25/00</b> (2006.01) <b>C07C 49/753</b> (2006.01) <b>A61P 25/28</b> (2006.01) <b>A61K 31/352</b> (2006.01) <b>A61P 19/00</b> (2006.01) <b>C07C 69/757</b> (2006.01) <b>A61P 25/04</b> (2006.01)	2501669 *	NOVEL ARYLATED CAMPHENES, PROCESSES FOR THEIR PREPARATION AND USES THEREOF
Impresa Bacchi S.r.l.	<b>E01C 7/26</b> (2006.01) <b>E01C 7/32</b> (2006.01) <b>E01C 11/16</b> (2006.01)	2441887	Heat-resistant road paving and relative manufacturing process
Dow AgroSciences LLC	<b>A01N 43/90</b> (2006.01) <b>A01P 13/00</b> (2006.01) <b>A01N 47/36</b> (2006.01)	2531035 *	SYNERGISTIC HERBICIDAL COMPOSITION CONTAINING PENOXSULAM AND FLAZASULFURON
Philip Morris Products S.A.	<b>G06Q 10/00</b> (2012.01) <b>G06F 17/30</b> (2006.01)	2517158 *	METHOD AND APPARATUS FOR DEFINING MANUFACTURED ITEMS AND STORING DATA RELATING TO THE MANUFACTURED ITEMS
Policchem SA	<b>C07D 407/12</b> (2006.01) <b>C07D 413/12</b> (2006.01) <b>A61K 31/4709</b> (2006.01) <b>A61P 31/10</b> (2006.01) <b>C07D 215/48</b> (2006.01) <b>C07D 401/12</b> (2006.01) <b>C07D 417/12</b> (2006.01) <b>C07D 409/12</b> (2006.01)	2519504 *	NEW SECONDARY 8-HYDROXYQUINOLINE-7-CARBOXAMIDE DERIVATIVES.
Imarko Research S.A.	<b>A61P 3/04</b> (2006.01) <b>A61K 38/46</b> (2006.01) <b>A61K 38/48</b> (2006.01)	2504026 *	COMPOSITION COMPRISING A COMBINATION OF AT LEAST ONE PROTEOLYTIC ENZYME AND AT LEAST ONE LIPOLYTIC ENZYME, FOR USE IN PREVENTING TRIGLYCERIDE SYNTHESIS
Eli Lilly and Company	<b>A61K 31/444</b> (2006.01) <b>C07D 495/20</b> (2006.01) <b>A61P 25/00</b> (2006.01)	2501703 *	SPIROPIPERIDINE COMPOUNDS AS ORL-1 RECEPTOR ANTAGONISTS

Podnosilac evropske prijave patenta (71)	MKP (51)	Broj objave evropske prijave patenta (97)	Naziv pronalaska (54)
GenKyoTex SA	<b>A61K 31/4162</b> (2006.01) <b>C07D 471/04</b> (2006.01)	2536721 *	PYRAZOLO PIPERIDINE DERIVATIVES AS NADPH OXIDASE INHIBITORS
Drogheria e Alimentari S.r.l.	<b>A47J 42/04</b> (2006.01) <b>A47J 42/08</b> (2006.01)	2510845	Grinding device
Novacta Biosystems Limited	<b>A61K 38/12</b> (2006.01) <b>C07K 7/54</b> (2006.01)	2531205 *	ACTAGARDINE DERIVATIVES, AND PHARMACEUTICAL USE THEREOF
Holding P.M.M. Hoff B.V.	<b>A01G 23/02</b> (2006.01) <b>A01C 5/04</b> (2006.01)	2512213 *	A METHOD OF PLANTING A SEED, PLANT, BUSH OR TREE, AND A DRILL
SANOFI	<b>C12Q 1/68</b> (2006.01)	2526203 *	METHODS AND USES RELATING TO THE IDENTIFICATION OF COMPOUND INVOLVED IN PAIN AS WELL AS METHODS OF DIAGNOSING ALGESIA
Visa International Service Association	<b>G06Q 20/00</b> (2012.01) <b>H04L 9/14</b> (2006.01) <b>H04L 9/32</b> (2006.01)	2524471 *	ANYTIME VALIDATION FOR VERIFICATION TOKENS
Metabolic Solutions Development Company LLC	<b>A61K 31/4439</b> (2006.01) <b>A61K 31/4436</b> (2006.01) <b>A61P 25/28</b> (2006.01) <b>A61K 31/426</b> (2006.01)	2512470 *	PPAR-SPARING THIAZOLIDINEDIONES AND COMBINATIONS FOR THE TREATMENT OF NEURODEGENERATIVE DISEASES
Leo Pharma A/S	<b>A61K 9/107</b> (2006.01) <b>A61K 31/593</b> (2006.01) <b>A61K 47/10</b> (2006.01) <b>A61K 9/06</b> (2006.01) <b>A61K 47/22</b> (2006.01) <b>A61K 47/14</b> (2006.01)	2515865 *	CUTANEOUS COMPOSITION COMPRISING VITAMIN D ANALOGUE AND A MIXTURE OF SOLVENT AND SURFACTANTS
H. Lundbeck A/S	<b>A61P 25/28</b> (2006.01) <b>A61P 25/18</b> (2006.01) <b>A61K 31/437</b> (2006.01) <b>A61K 31/4196</b> (2006.01) <b>C07D 471/04</b> (2006.01)	2513106 *	HETEROAROMATIC ARYL TRIAZOLE DERIVATIVES AS PDE10A ENZYME INHIBITORS
Suven Life Sciences Limited	<b>A61P 25/22</b> (2006.01) <b>A61P 25/30</b> (2006.01) <b>C07D 401/14</b> (2006.01) <b>A61P 25/08</b> (2006.01) <b>C07D 403/04</b> (2006.01) <b>A61P 25/04</b> (2006.01) <b>C07D 403/06</b> (2006.01) <b>A61P 25/18</b> (2006.01) <b>C07D 405/06</b> (2006.01) <b>A61P 25/16</b> (2006.01) <b>C07D 401/04</b> (2006.01) <b>A61P 25/28</b> (2006.01) <b>A61P 3/04</b> (2006.01) <b>C07D 401/06</b> (2006.01) <b>A61P 25/24</b> (2006.01) <b>A61K 31/403</b> (2006.01) <b>A61P 25/20</b> (2006.01)	2519514 *	ALPHA4BETA2 NEURONAL NICOTINIC ACETYLCHOLINE RECEPTOR LIGANDS
Energy B.V.	<b>C10L 5/42</b> (2006.01) <b>C10L 5/46</b> (2006.01) <b>C10L 5/44</b> (2006.01) <b>C10B 53/02</b> (2006.01) <b>C10B 47/00</b> (2006.01)	2536813 *	METHODS AND PROCEDURES FOR PRODUCING USEFUL PRODUCTS FROM WASTE MATERIALS
Energy S.a.c.i.	<b>C10L 5/42</b> (2006.01) <b>C10L 5/46</b> (2006.01) <b>C10L 5/44</b> (2006.01) <b>C10B 53/02</b> (2006.01) <b>C10B 47/00</b> (2006.01)	2536813 *	METHODS AND PROCEDURES FOR PRODUCING USEFUL PRODUCTS FROM WASTE MATERIALS
Sanofi-Aventis Deutschland GmbH	<b>A61M 5/32</b> (2006.01) <b>A61M 5/28</b> (2006.01) <b>A61M 5/24</b> (2006.01)	2531236 *	MEDICATED MODULE WITH DUAL SAFETY GUARDS



Podnosilac evropske prijave patenta (71)	MKP (51)	Broj objave evropske prijave patenta (97)	Naziv pronalaska (54)
Sol-Gel Technologies Ltd.	<b>A61K 31/327</b> (2006.01) <b>A61P 31/02</b> (2006.01) <b>A61K 31/46</b> (2006.01) <b>A61P 31/00</b> (2006.01) <b>A61K 31/351</b> (2006.01) <b>A61K 31/575</b> (2006.01)	2501376 *	COMPOSITIONS FOR TOPICAL ADMINISTRATION
Meiji Seika Pharma Co., Ltd.	<b>A61P 31/04</b> (2006.01) <b>C07K 16/12</b> (2006.01) <b>C12N 15/09</b> (2006.01) <b>C12P 21/08</b> (2006.01) <b>G01N 33/569</b> (2006.01) <b>C07K 16/46</b> (2006.01) <b>C12N 5/10</b> (2006.01) <b>A61K 39/395</b> (2006.01)	2536836 *	ANTIBODY AGAINST SEROTYPE A LIPOPOLYSACCHARIDE OF PSEUDOMONAS AERUGINOSA
Symphogen A/S	<b>A61P 31/04</b> (2006.01) <b>C07K 16/12</b> (2006.01) <b>C12N 15/09</b> (2006.01) <b>C12P 21/08</b> (2006.01) <b>G01N 33/569</b> (2006.01) <b>C07K 16/46</b> (2006.01) <b>C12N 5/10</b> (2006.01) <b>A61K 39/395</b> (2006.01)	2536836 *	ANTIBODY AGAINST SEROTYPE A LIPOPOLYSACCHARIDE OF PSEUDOMONAS AERUGINOSA
The Regents Of The University Of Michigan	<b>A61P 9/10</b> (2006.01) <b>C07D 487/04</b> (2006.01) <b>C07D 403/10</b> (2006.01) <b>C07D 471/04</b> (2006.01) <b>A61K 31/437</b> (2006.01) <b>A61P 9/12</b> (2006.01) <b>C07D 401/10</b> (2006.01) <b>A61K 31/5513</b> (2006.01)	2501695 *	1,4-BENZODIAZEPINE-2,5-DIONES AND RELATED COMPOUNDS WITH THERAPEUTIC PROPERTIES
ClanoTech AB	<b>C07D 215/44</b> (2006.01) <b>C07D 401/12</b> (2006.01) <b>A61K 31/4709</b> (2006.01) <b>A61P 35/00</b> (2006.01)	2432764 *	SUBSTITUTED QUINOLINES FOR USE AS VEGF INHIBITORS
Glaxo Wellcome Manufacturing Pte Ltd	<b>A61K 31/52</b> (2006.01)	2521550 *	TREATMENT METHOD
Sanofi-Aventis Deutschland GmbH	<b>A61M 5/28</b> (2006.01) <b>A61M 5/24</b> (2006.01) <b>A61M 5/32</b> (2006.01)	2531238 *	MEDICATED MODULE WITH LOCKABLE NEEDLE GUARD
The Board Of Trustees Of The University Of The Leland Stanford Junior University	<b>A61K 31/7088</b> (2006.01) <b>A61P 3/10</b> (2006.01) <b>A61K 39/395</b> (2006.01)	2531261 *	METHODS FOR DIAGNOSIS AND TREATMENT OF NON-INSULIN DEPENDENT DIABETES MELLITUS
Wood Engineering Technology Limited	<b>B27M 3/00</b> (2006.01) <b>B27D 3/02</b> (2006.01) <b>F26B 7/00</b> (2006.01) <b>F26B 3/20</b> (2006.01) <b>B32B 21/13</b> (2006.01) <b>B32B 13/14</b> (2006.01) <b>F26B 3/00</b> (2006.01) <b>B30B 15/34</b> (2006.01)	2504134 *	ENGINEERED TIMBER PRODUCTS, COMPONENTS AND METHODOLOGIES
POLICHEM S.A.	<b>C07D 417/12</b> (2006.01) <b>A61P 31/10</b> (2006.01) <b>C07D 401/12</b> (2006.01) <b>C07D 407/12</b> (2006.01) <b>C07D 409/12</b> (2006.01) <b>C07D 413/12</b> (2006.01) <b>C07D 215/48</b> (2006.01) <b>A61K 31/4709</b> (2006.01)	2519503 *	SECONDARY 8-HYDROXYQUINOLINE-7-CARBOXAMIDE DERIVATIVES FOR USE AS ANTIFUNGAL AGENTS
Cryovac, Inc.	<b>B32B 27/32</b> (2006.01) <b>A61F 5/445</b> (2006.01)	2501346 *	NOISE DAMPENING FILM

Podnosilac evropske prijave patenta (71)	MKP (51)	Broj objave evropske prijave patenta (97)	Naziv pronalaska (54)
Taisho Pharmaceutical Co., Ltd.	<b>C07C 69/757</b> (2006.01) <b>C07C 227/18</b> (2006.01) <b>C07C 255/47</b> (2006.01) <b>C07C 227/02</b> (2006.01) <b>C07C 235/82</b> (2006.01) <b>C07D 235/02</b> (2006.01) <b>C07C 229/50</b> (2006.01) <b>C07C 227/12</b> (2006.01)	2502903 *	PROCESS FOR PRODUCING 3-ALKOXY-2-AMINO-6-FLUOROBICYCLO[3.1.0]HEXANE-2,6-DICARBOXYLIC ACID DERIVATIVE AND INTERMEDIATE THEREOF
Ambrx, Inc.	<b>C07K 14/475</b> (2006.01)	2516454 *	MODIFIED BOVINE SOMATOTROPIN POLYPEPTIDES AND THEIR USES
Hutchison Medipharma Limited	<b>C07D 471/04</b> (2006.01) <b>A61K 31/437</b> (2006.01) <b>C07D 487/04</b> (2006.01) <b>A61P 35/00</b> (2006.01) <b>A61K 31/4985</b> (2006.01)	2519524 *	CERTAIN TRIAZOLOPYRIDINES AND TRIAZOLOPYRAZINES, COMPOSITIONS THEREOF AND METHODS OF USE THEREFOR
Novacta Biosystems Limited	<b>A61P 31/04</b> (2006.01) <b>A61K 38/10</b> (2006.01) <b>C07K 7/08</b> (2006.01)	2531519 *	LANTIBIOTIC SALTS
Magle AB	<b>A61L 15/64</b> (2006.01) <b>C08J 9/00</b> (2006.01) <b>A61K 9/14</b> (2006.01) <b>A61K 31/718</b> (2006.01) <b>C08B 31/04</b> (2006.01) <b>A61L 15/28</b> (2006.01)	2506859 *	MICROSPHERES OF HYDROLYSED STARCH WITH ENDOGENOUS, CHARGED LIGANDS
Omya Development AG	<b>D21H 17/00</b> (2006.01) <b>C09C 1/02</b> (2006.01)	2505614	Process for preparing self-binding pigment particles
Amgen Inc.	<b>A61P 25/28</b> (2006.01) <b>C07D 401/06</b> (2006.01) <b>C07D 401/14</b> (2006.01) <b>C07D 401/12</b> (2006.01) <b>A61K 31/4709</b> (2006.01)	2504330 *	AMINO HETEROARYL COMPOUNDS AS BETA-SECRETASE MODULATORS AND METHODS OF USE
Novelis, Inc.	<b>F27D 1/14</b> (2006.01)	2510300 *	METHOD OF FORMING SEALED REFRACTORY JOINTS IN METAL-CONTAINMENT VESSELS, AND VESSELS CONTAINING SEALED JOINTS
GlaxoSmithKline LLC	<b>A61M 29/00</b> (2006.01)	2515990 *	IMPROVED EXTERNAL NASAL DILATOR
Emergent Product Development Seattle, LLC	<b>A61P 35/00</b> (2006.01) <b>C07K 16/28</b> (2006.01) <b>A61K 39/395</b> (2006.01) <b>A61P 37/00</b> (2006.01)	2519541 *	RON BINDING CONSTRUCTS AND METHODS OF USE THEREOF
JX Nippon Oil & Energy Corporation	<b>C08G 61/08</b> (2006.01) <b>H01L 51/50</b> (2006.01) <b>G02B 5/30</b> (2006.01) <b>G02F 1/13363</b> (2006.01) <b>C08J 5/18</b> (2006.01)	2520956 *	PHASE DIFFERENCE FILM, ORGANIC EL DISPLAY DEVICE AND LIQUID CRYSTAL DISPLAY USING THE SAME
Organica Zártkörűen Működő Részvénytársaság (ZRT.)	<b>C12M 1/00</b> (2006.01) <b>C02F 3/10</b> (2006.01) <b>C02F 3/12</b> (2006.01)	2523911 *	CARRIER INSERT FOR ACCOMMODATING AND MAINTAINING THE BIOFILM CULTURE OF FLUID CLEANING STRUCTURES
Novartis AG	<b>A61P 5/00</b> (2006.01) <b>A61K 31/55</b> (2006.01) <b>A61K 31/4188</b> (2006.01)	2523731 *	USE OF AN ADRENAL HORMONE-MODIFYING AGENT
Ascendis Pharma A/S	<b>C07K 1/107</b> (2006.01) <b>A61K 47/48</b> (2006.01) <b>C07K 1/13</b> (2006.01)	2525830 *	DIPEPTIDE-BASED PRODRUG LINKERS FOR ALIPHATIC AMINE-CONTAINING DRUGS
Intention AS	<b>F03B 13/16</b> (2006.01) <b>F03B 13/22</b> (2006.01) <b>F03B 13/20</b> (2006.01) <b>F03B 13/24</b> (2006.01) <b>F03B 13/14</b> (2006.01)	2504566 *	WAVE POWER PLANT

Podnosilac evropske prijave patenta (71)	MKP (51)	Broj objave evropske prijave patenta (97)	Naziv pronalaska (54)
Bayer Intellectual Property GmbH	<b>C07D 471/04</b> (2006.01)	2504335 *	METHOD FOR PRODUCING METHYL-{4,6-DIAMINO-2-[1-(2-FLUOROBENZYL)-1H-PYRAZOLO[3,4-B]PYRIDINO-3-YL]PYRIMIDINO-5-YL} CARBAMATE AND ITS PURIFICATION FOR USE THEREOF AS PHARMACEUTICAL SUBSTANCE
Kirin-Amgen, Inc.	<b>A61P 17/06</b> (2006.01) <b>C07K 16/28</b> (2006.01) <b>A61K 39/395</b> (2006.01)	2523688 *	ANTIBODY FORMULATION AND THERAPEUTIC REGIMENS
Sanofi-Aventis Deutschland GmbH	<b>A61M 5/315</b> (2006.01)	2509662 *	DRIVE ASSEMBLY FOR A DRUG DELIVERY DEVICE AND DRUG DELIVERY DEVICE
Omya Development AG	<b>C09C 1/36</b> (2006.01) <b>C09C 1/40</b> (2006.01) <b>B03B 1/04</b> (2006.01) <b>B02C 23/06</b> (2006.01) <b>C09C 1/02</b> (2006.01)	2510058 *	METHOD FOR CLASSIFYING MINERAL MATERIAL IN THE PRESENCE OF GLYCEROL-CONTAINING ADDITIVES, PRODUCTS OBTAINED, AND USES THEREOF
Wobben Properties GmbH	<b>F03D 11/04</b> (2006.01)	2529111 *	WIND POWER PLANT AND WIND POWER PLANT TOWER SEGMENT
Lucid Energy, Inc.	<b>H02P 9/04</b> (2006.01) <b>F03D 9/00</b> (2006.01)	2516853 *	IMPROVED DESIGNS FOR TURBINE ASSEMBLIES
Bronze Italia S.r.l.	<b>B65D 83/16</b> (2006.01) <b>A61M 35/00</b> (2006.01)	2528652 *	TANNING DEVICE AND METHOD
The Trustees Of The University Of Pennsylvania	<b>A61K 48/00</b> (2006.01)	2501414 *	SMNDELTA7 DEGRON: NOVEL COMPOSITIONS AND METHODS OF USE
Meiji Seika Pharma Co., Ltd.	<b>C12P 21/08</b> (2006.01) <b>C07K 16/12</b> (2006.01) <b>C12N 15/09</b> (2006.01) <b>C12N 5/10</b> (2006.01) <b>C07K 16/46</b> (2006.01) <b>A61K 39/395</b> (2006.01) <b>A61P 31/04</b> (2006.01) <b>G01N 33/569</b> (2006.01)	2536759 *	ANTIBODY AGAINST SEROTYPE I LIPOPOLYSACCHARIDE OF PSEUDOMONAS AERUGINOSA
Symphogen A/S	<b>C12P 21/08</b> (2006.01) <b>C07K 16/12</b> (2006.01) <b>C12N 15/09</b> (2006.01) <b>C12N 5/10</b> (2006.01) <b>C07K 16/46</b> (2006.01) <b>A61K 39/395</b> (2006.01) <b>A61P 31/04</b> (2006.01) <b>G01N 33/569</b> (2006.01)	2536759 *	ANTIBODY AGAINST SEROTYPE I LIPOPOLYSACCHARIDE OF PSEUDOMONAS AERUGINOSA
TLS System	<b>F41A 17/44</b> (2006.01) <b>F41A 17/38</b> (2006.01) <b>F41A 17/42</b> (2006.01)	2524186 *	SAFETY MAGAZINE FOR A FIREARM HAVING A MECHANISM FOR LOCKING AGAINST THE BREECH FACE
Ethicon Endo-Surgery, Inc.	<b>A61B 17/32</b> (2006.01) <b>A61B 17/22</b> (2006.01) <b>A61B 17/3207</b> (2006.01)	2533703 *	ULTRASONIC SURGICAL INSTRUMENTS WITH MOVING CUTTING IMPLEMENT
The Regents of the University of California	<b>C07D 211/08</b> (2006.01) <b>A61P 25/28</b> (2006.01) <b>C07C 255/43</b> (2006.01) <b>A61K 31/277</b> (2006.01) <b>C07D 265/30</b> (2006.01)	2509940 *	AMYLOID BINDING AGENTS
Packers Plus Energy Services Inc.	<b>E21B 17/00</b> (2006.01) <b>E21B 43/12</b> (2006.01) <b>E21B 43/22</b> (2006.01)	2521839 *	WELLBORE TREATMENT APPARATUS AND METHOD
Sanofi-Aventis Deutschland GmbH	<b>A61M 5/315</b> (2006.01)	2512563 *	DOSE SETTING MECHANISM WITH MAXIMUM DOSE LIMITING ELEMENT
Living Proof, Inc.	<b>C09B 62/00</b> (2006.01) <b>C09B 62/453</b> (2006.01)	2516555 *	COLORING AGENTS AND METHODS OF USE THEREOF

Podnosilac evropske prijave patenta (71)	MKP (51)	Broj objave evropske prijave patenta (97)	Naziv pronalaska (54)
Corporation De L'école Polytechnique De Montréal	<b>A61K 31/722</b> (2006.01) <b>C08K 3/16</b> (2006.01) <b>C08K 3/00</b> (2006.01) <b>C08L 5/08</b> (2006.01) <b>A61K 35/14</b> (2006.01) <b>C08K 11/00</b> (2006.01) <b>C08K 5/521</b> (2006.01)	2501392 *	SOLUBLE PHYSIOLOGICAL CHITOSAN FORMULATIONS COMBINED WITH PLATELET-RICH PLASMA (PRP) FOR TISSUE REPAIR
Meggitt (San Juan Capistrano), Inc.	<b>G01L 7/08</b> (2006.01) <b>B64C 3/00</b> (2006.01) <b>G01L 7/02</b> (2006.01) <b>G01L 9/06</b> (2006.01) <b>B64C 99/00</b> (2010.01)	2513623 *	WEATHERIZED DIRECT-MOUNT ABSOLUTE PRESSURE SENSOR
Almirall S.A.	<b>C07D 487/04</b> (2006.01) <b>A61P 35/00</b> (2006.01) <b>A61K 31/437</b> (2006.01) <b>A61K 31/4985</b> (2006.01)	2536728 *	PYRAZOLE DERIVATIVES AS JAK INHIBITORS
Commonwealth Scientific and Industrial Research Organisation	<b>C08G 63/199</b> (2006.01) <b>C08G 63/183</b> (2006.01) <b>C08G 63/672</b> (2006.01) <b>C08G 18/32</b> (2006.01) <b>C08G 63/42</b> (2006.01) <b>C08G 18/73</b> (2006.01) <b>C08G 18/76</b> (2006.01)	2507280 *	POLYMERIC MATERIALS
SIRAP-GEMA S.p.A.	<b>C08J 7/06</b> (2006.01) <b>B01J 21/06</b> (2006.01) <b>B05D 5/00</b> (2006.01) <b>C09G 1/00</b> (2006.01)	2418238	Titanium dioxide-coated expanded polymer sheet having photocatalytic activity, container and packaging for foodstuffs obtained from such polymer sheet
Mudmax KFT:	<b>B01D 17/02</b> (2006.01)	2512615 *	METHOD AND APPARATUS FOR HANDLING DRILLING MUD CONTAINING AN OIL/WATER EMULSION
Nektar Therapeutics	<b>A61P 35/00</b> (2006.01) <b>A61K 47/48</b> (2006.01)	2501412 *	SALT FORM OF A MULTI-ARM POLYMER-DRUG CONJUGATE
Doors Sistem S.r.L.	<b>H01L 31/042</b> (2006.01) <b>F24J 2/52</b> (2006.01)	2535661	Modular type assembly system for the installation of photovoltaic system
SANOFI	<b>C07C 237/04</b> (2006.01) <b>C07D 263/06</b> (2006.01)	2507218 *	COMBRETASTATIN DERIVATIVE PREPARATION METHOD
SANOFI	<b>C07D 307/82</b> (2006.01)	2509971 *	NEW PROCESS FOR THE PREPARATION OF DRONEDARONE
Chiesi Farmaceutici S.p.A.	<b>A61K 31/40</b> (2006.01) <b>A61K 9/00</b> (2006.01)	2515856 *	AEROSOL FORMULATION FOR COPD
Napatech A/S	<b>H04L 12/56</b> (2006.01)	2507952 *	AN ASSEMBLY AND A METHOD OF RECEIVING AND STORING DATA WHILE SAVING BANDWIDTH BY CONTROLLING UPDATING OF FILL LEVELS OF QUEUES
Eli Lilly and Company	<b>C07D 405/06</b> (2006.01) <b>A61K 31/438</b> (2006.01) <b>C07D 417/06</b> (2006.01) <b>C07D 409/06</b> (2006.01) <b>C07D 471/10</b> (2006.01) <b>C07D 413/06</b> (2006.01) <b>A61P 3/10</b> (2006.01)	2507228 *	NOVEL SPIROPIPERIDINE COMPOUNDS
Lifescan Scotland Limited	<b>G01N 33/487</b> (2006.01)	2531852 *	SHAPE MEMORY ALLOY EJECTION MECHANISM FOR EJECTING A TEST STRIP FROM A TEST METER
Kissei Pharmaceutical Co., Ltd.	<b>A61P 15/08</b> (2006.01) <b>A61P 5/04</b> (2006.01) <b>A61P 35/00</b> (2006.01) <b>A61K 31/519</b> (2006.01) <b>A61P 15/18</b> (2006.01) <b>A61P 15/16</b> (2006.01) <b>C07D 495/04</b> (2006.01)	2535342 *	SALT OF FUSED HETEROCYCLIC DERIVATIVE AND CRYSTAL THEREOF

Podnosilac evropske prijave patenta (71)	MKP (51)	Broj objave evropske prijave patenta (97)	Naziv pronalaska (54)
Novartis AG	<b>A61K 31/436</b> (2006.01) <b>A61P 35/00</b> (2006.01) <b>A61K 31/501</b> (2006.01) <b>A61K 31/5377</b> (2006.01) <b>A61K 31/00</b> (2006.01)	2501370 *	METHODS AND COMPOSITIONS FOR TREATING SOLID TUMORS AND OTHER MALIGNANCIES
SANOFI	<b>C12Q 1/68</b> (2006.01) <b>G01N 33/50</b> (2006.01)	2526204 *	METHODS AND USES RELATING TO THE IDENTIFICATION OF COMPOUND INVOLVED IN PAIN AS WELL AS METHODS OF DIAGNOSING ALGESIA
Boehringer Ingelheim International GmbH	<b>C07K 16/44</b> (2006.01) <b>A61K 39/00</b> (2006.01)	2525812 *	ANTICOAGULANT ANTIDOTES
Sutran I Mas D, S.L.	<b>A41B 17/00</b> (2006.01) <b>A41D 31/00</b> (2006.01)	2520187 *	INSULATING GARMENT
Exergy Limited	<b>G06F 11/30</b> (2006.01) <b>G06F 17/13</b> (2006.01) <b>F01K 13/02</b> (2006.01) <b>G05B 1/11</b> (2006.01) <b>F02B 43/02</b> (2006.01) <b>F01D 17/00</b> (2006.01) <b>G05B 6/05</b> (2006.01) <b>F22B 35/18</b> (2006.01)	2510441 *	SYSTEM AND METHOD FOR MAXIMISING THERMAL EFFICIENCY OF A POWER PLANT
Biogen Idec MA Inc.	<b>C12N 15/86</b> (2006.01) <b>C12Q 1/70</b> (2006.01)	2524060 *	ASSAY FOR JC VIRUS ANTIBODIES
Universitetet I Oslo	<b>C07K 14/435</b> (2006.01)	2536746 *	DISULPHIDE BOND-STABILIZED FUNCTIONAL SOLUBLE MHC CLASS II HETERODIMERS
Abbott Laboratories	<b>A61P 35/00</b> (2006.01) <b>C07D 295/14</b> (2006.01) <b>A61K 31/404</b> (2006.01) <b>C07D 249/04</b> (2006.01) <b>C07D 217/16</b> (2006.01) <b>C07D 405/14</b> (2006.01) <b>C07D 405/12</b> (2006.01) <b>C07D 235/26</b> (2006.01) <b>C07D 209/32</b> (2006.01) <b>C07D 309/14</b> (2006.01) <b>C07D 215/20</b> (2006.01) <b>C07D 231/56</b> (2006.01) <b>C07D 211/96</b> (2006.01) <b>C07D 401/12</b> (2006.01) <b>C07D 213/64</b> (2006.01) <b>C07D 295/125</b> (2006.01)	2507229 *	SULFONAMIDE DERIVATIVES AS BCL-2-SELECTIVE APOPTOSIS-INDUCING AGENTS FOR THE TREATMENT OF CANCER AND IMMUNE DISEASES
Abbott Laboratories	<b>G01N 33/48</b> (2006.01) <b>A61K 31/635</b> (2006.01) <b>A61K 31/675</b> (2006.01) <b>A61K 31/5377</b> (2006.01) <b>A61K 31/454</b> (2006.01) <b>C12Q 1/68</b> (2006.01) <b>A61P 35/00</b> (2006.01) <b>A61K 31/506</b> (2006.01) <b>A61K 45/06</b> (2006.01)	2506853 *	COMBINATION THERAPY FOR TREATING CANCER AND DIAGNOSTIC ASSAYS FOR USE THEREIN
Cephalon, Inc.	<b>C07D 513/04</b> (2006.01) <b>A61P 25/24</b> (2006.01) <b>A61P 25/08</b> (2006.01) <b>A61P 25/36</b> (2006.01) <b>A61P 25/16</b> (2006.01) <b>C07D 491/153</b> (2006.01) <b>A61P 25/28</b> (2006.01) <b>A61K 31/4355</b> (2006.01) <b>A61P 25/30</b> (2006.01) <b>A61P 25/06</b> (2006.01) <b>A61P 25/32</b> (2006.01) <b>C07D 491/20</b> (2006.01) <b>A61P 25/22</b> (2006.01) <b>C07D 491/048</b> (2006.01) <b>A61P 25/18</b> (2006.01)	2516445 *	TRICYCLIC DERIVATIVES AND THEIR PHARMACEUTICAL USE AND COMPOSITIONS

Podnosilac evropske prijave patenta (71)	MKP (51)	Broj objave evropske prijave patenta (97)	Naziv pronalaska (54)
Filimonov, Alexandr Iosifovich	<b>B60V 3/08</b> (2006.01) <b>B64C 5/06</b> (2006.01)	2508401 *	COMBINED AIRCRAFT
Aesculap AG	<b>A61L 17/14</b> (2006.01)	2425865	Medicinal thread having a polyhydroxyalkanoate coating
Wobben Properties GmbH	<b>B29C 44/12</b> (2006.01) <b>B29C 70/44</b> (2006.01) <b>B29C 45/14</b> (2006.01) <b>B29C 70/54</b> (2006.01)	2536547 *	METHOD FOR PRODUCING WIND POWER PLANT ROTOR BLADES AND A WIND POWER PLANT ROTOR BLADE
Sanofi-Aventis Deutschland GmbH	<b>A61M 5/32</b> (2006.01) <b>A61M 5/00</b> (2006.01) <b>A61M 5/20</b> (2006.01)	2536452 *	AUTO-INJECTOR
Gaudieri, Gianni SICPA Holding SA	<b>A01K 95/00</b> (2006.01) <b>B41M 3/14</b> (2006.01) <b>B42D 15/10</b> (2006.01) <b>B42D 15/00</b> (2006.01) <b>C09D 11/00</b> (2006.01) <b>B41M 5/28</b> (2006.01) <b>C09D 11/02</b> (2006.01)	2476310 2509794 *	A ballast weight for a fishing line MARKING BASED ON CHIRAL LIQUID CRYSTAL POLYMERS
Novelis, Inc.	<b>F27D 1/14</b> (2006.01)	2510298 *	COMPRESSIVE ROD ASSEMBLY FOR MOLTEN METAL CONTAINMENT STRUCTURE
Sanofi-Aventis Deutschland GmbH	<b>A61M 5/315</b> (2006.01)	2506901 *	DRIVE MECHANISM FOR DRUG DELIVERY DEVICES
Sinox Pharma, Inc.	<b>A61K 9/12</b> (2006.01) <b>A61P 11/02</b> (2006.01) <b>A61K 33/00</b> (2006.01) <b>A61K 33/14</b> (2006.01) <b>A61P 11/04</b> (2006.01)	2525802 *	A METHOD OF TREATING SINUSITIS, INCLUDING CHRONIC SINUSITIS
BPB Limited	<b>C04B 28/14</b> (2006.01) <b>C04B 28/16</b> (2006.01)	2507190 *	LIGHTWEIGHT GYPSUM PRODUCTS HAVING ENHANCED WATER RESISTANCE
Ethicon, Inc.	<b>A61H 39/02</b> (2006.01) <b>A61N 1/04</b> (2006.01) <b>A61N 1/08</b> (2006.01)	2512587 *	PLACEMENT DEVICES THAT ENABLE PATIENTS TO ACCURATELY POSITION MEDICAL PATCHES AT TARGET LOCATIONS AND METHODS THEREFOR
Sanofi-Aventis Deutschland GmbH	<b>A61M 5/00</b> (2006.01) <b>A61M 5/32</b> (2006.01) <b>A61M 5/20</b> (2006.01)	2536458 *	CLUTCH MECHANISM
Kimetec GmbH	<b>G04B 37/14</b> (2006.01) <b>A44C 3/00</b> (2006.01)	2442192	Holder unit
Sanofi-Aventis Deutschland GmbH	<b>A61J 1/06</b> (2006.01) <b>A61M 5/24</b> (2006.01) <b>G06K 7/10</b> (2006.01)	2525763 *	A MULTI-DIMENSIONAL IDENTIFIER
Ethicon Endo-Surgery, Inc.	<b>A61B 17/068</b> (2006.01) <b>A61B 17/072</b> (2006.01) <b>H01H 13/00</b> (2006.01) <b>A61B 17/00</b> (2006.01)	2515768 *	MOTOR-DRIVEN SURGICAL CUTTING INSTRUMENT WITH ELECTRIC ACTUATOR DIRECTIONAL CONTROL ASSEMBLY
SICPA HOLDING SA	<b>B42D 15/10</b> (2006.01) <b>B41M 3/00</b> (2006.01) <b>B44F 7/00</b> (2006.01) <b>G02B 5/30</b> (2006.01) <b>B41M 3/06</b> (2006.01) <b>G02B 27/22</b> (2006.01)	2529940	Printed device with three dimensional appearance
Ferraccioli, Luca	<b>B65F 1/14</b> (2006.01)	2501631 *	DUMPSTER FOR HOLDING WASTE MATERIAL
Janssen Pharmaceuticals Inc.	<b>C07D 413/04</b> (2006.01) <b>C07D 403/12</b> (2006.01) <b>C07D 471/04</b> (2006.01) <b>C07D 487/04</b> (2006.01) <b>A61K 31/4196</b> (2006.01) <b>C07D 401/14</b> (2006.01) <b>A61P 25/28</b> (2006.01) <b>C07D 401/12</b> (2006.01) <b>C07D 403/14</b> (2006.01) <b>C07D 403/10</b> (2006.01)	2523949 *	NOVEL SUBSTITUTED TRIAZOLE DERIVATIVES AS GAMMA SECRETASE MODULATORS

Podnosilac evropske prijave patenta (71)	MKP (51)	Broj objave evropske prijave patenta (97)	Naziv pronalaska (54)
Dow AgroSciences, LLC	<b>A01H 1/00</b> (2006.01) <b>A01H 5/00</b> (2006.01) <b>A01P 7/00</b> (2006.01)	2512221 *	COMBINED USE OF CRY1DA AND CRY1FA PROTEINS FOR INSECT RESISTANCE MANAGEMENT
Amgen Inc.	<b>A61K 38/18</b> (2006.01) <b>C07K 14/475</b> (2006.01) <b>A61K 38/00</b> (2006.01)	2506861 *	BINDING PROTEINS THAT BIND TO HUMAN FGFR1C, HUMAN B-KLOTHO AND BOTH HUMAN FGFR1C AND HUMAN B-KLOTHO
Les Laboratoires Servier	<b>A61K 31/445</b> (2006.01) <b>A61K 31/403</b> (2006.01) <b>A61K 45/06</b> (2006.01) <b>A61K 31/55</b> (2006.01) <b>A61P 25/16</b> (2006.01) <b>A61K 31/27</b> (2006.01) <b>A61P 25/28</b> (2006.01) <b>A61K 9/20</b> (2006.01)	2520296	New association between 4-{3-[cis-hexahydrocyclopenta[c]pyrrol-2(1h)-yl]propoxy} benzamide and an acetylcholinesterase inhibitor, and pharmaceutical compositions containing it.
Linde Aktiengesellschaft	<b>C10L 5/44</b> (2006.01) <b>C10J 3/46</b> (2006.01) <b>C10J 3/66</b> (2006.01) <b>C10B 53/02</b> (2006.01)	2504411 *	DEVICE AND METHOD FOR GENERATING A SYNTHESIS GAS FROM PROCESSED BIOMASS BY ENTRAINED-FLOW GASIFICATION
Tata Steel UK Limited	<b>B21B 1/085</b> (2006.01)	2504112 *	A METHOD OF ROLLING RAILS, APPARATUS FOR ROLLING RAILS AND RAIL PRODUCED ACCORDING TO SAID METHOD
Boehringer Ingelheim International GmbH	<b>C07D 405/14</b> (2006.01) <b>A61P 29/00</b> (2006.01) <b>C07D 491/10</b> (2006.01) <b>A61K 31/506</b> (2006.01)	2513093 *	NEW CCR2 RECEPTOR ANTAGONISTS AND USES THEREOF
Sanofi-Aventis Deutschland GmbH	<b>A61M 5/24</b> (2006.01)	2531233 *	CARTRIDGE HOLDER, DRUG DELIVERY DEVICE AND METHOD FOR SECURING A CARTRIDGE IN A CARTRIDGE HOLDER
Intas Biopharmaceuticals Limited	<b>A61K 38/24</b> (2006.01)	2533800 *	LIQUID FORMULATION OF FOLLICLE STIMULATING HORMONE
Amgen Inc.	<b>C07D 413/10</b> (2006.01) <b>C07D 405/04</b> (2006.01) <b>A61K 31/4709</b> (2006.01) <b>C07D 215/38</b> (2006.01) <b>C07D 471/08</b> (2006.01) <b>C07D 405/10</b> (2006.01) <b>A61P 25/28</b> (2006.01) <b>C07D 405/12</b> (2006.01) <b>C07D 403/10</b> (2006.01) <b>A61K 31/47</b> (2006.01) <b>C07D 471/04</b> (2006.01) <b>C07D 401/10</b> (2006.01) <b>C07D 498/08</b> (2006.01)	2526092 *	AMINO HETEROARYL COMPOUNDS AS BETA-SECRETASE MODULATORS AND METHODS OF USE
Omya Development AG	<b>F26B 23/00</b> (2006.01) <b>F26B 11/16</b> (2006.01)	2511637	Method for drying wet particulate matter, wherein the dried particulate matter is a white mineral having a brightness Ry of at least 65%, through drying in a direct superheated steam dryer
Dow AgroSciences, LLC	<b>A01P 7/00</b> (2006.01) <b>A01H 5/00</b> (2006.01) <b>A01H 1/00</b> (2006.01)	2512218 *	INSECT RESISTANCE MANAGEMENT WITH COMBINATIONS OF CRY1BE AND CRY1F PROTEINS
Chiesi Farmaceutici S.p.A.	<b>A61K 9/00</b> (2006.01) <b>A61K 31/167</b> (2006.01) <b>A61K 45/06</b> (2006.01) <b>A61K 31/40</b> (2006.01)	2515855 *	Combination therapy for COPD
Nestec S.A.	<b>A61P 35/00</b> (2006.01) <b>G01N 33/574</b> (2006.01) <b>C12Q 1/68</b> (2006.01) <b>G01N 33/15</b> (2006.01)	2524232 *	METHODS FOR PREDICTING RESPONSE OF TRIPLE-NEGATIVE BREAST CANCER TO THERAPY

Podnosilac evropske prijave patenta (71)	MKP (51)	Broj objave evropske prijave patenta (97)	Naziv pronalaska (54)
Janssen Pharmaceutica, N.V.	<b>C07D 491/04</b> (2006.01) <b>C07D 487/08</b> (2006.01) <b>A61K 31/496</b> (2006.01) <b>C07D 417/10</b> (2006.01) <b>C07D 417/14</b> (2006.01) <b>C07D 417/06</b> (2006.01) <b>A61P 35/00</b> (2006.01)	2513096 *	SUBSTITUTED AMINOTHIAZOLONE INDAZOLES AS ESTROGEN RELATED RECEPTOR-A MODULATORS
Curt G. Joa, Inc.	<b>B32B 7/00</b> (2006.01) <b>B32B 7/04</b> (2006.01) <b>B32B 27/00</b> (2006.01) <b>B32B 27/08</b> (2006.01) <b>B32B 25/08</b> (2006.01) <b>B32B 5/04</b> (2006.01) <b>B32B 3/26</b> (2006.01) <b>B32B 5/02</b> (2006.01) <b>B32B 25/00</b> (2006.01)	2535178	Registered stretch laminate and methods for forming a registered stretch laminate
RV Lizenz AG	<b>F23J 15/06</b> (2006.01) <b>C07C 29/151</b> (2006.01) <b>C10G 2/00</b> (2006.01) <b>F01K 23/06</b> (2006.01) <b>C10J 3/66</b> (2006.01) <b>F02C 3/28</b> (2006.01)	2501786 *	THERMAL-CHEMICAL UTILIZATION OF CARBON-CONTAINING MATERIALS, IN PARTICULAR FOR THE EMISSION-FREE GENERATION OF ENERGY
CLAAS Selbstfahrende Erntemaschinen GmbH	<b>A01D 43/08</b> (2006.01)	2452550	Agricultural harvester
IRM LLC	<b>C07K 16/40</b> (2006.01) <b>A61P 3/06</b> (2006.01) <b>A61K 39/395</b> (2006.01)	2510013 *	PCSK9 ANTAGONISTS
Novartis AG	<b>C07K 16/40</b> (2006.01) <b>A61P 3/06</b> (2006.01) <b>A61K 39/395</b> (2006.01)	2510013 *	PCSK9 ANTAGONISTS
Loïra	<b>C02F 1/74</b> (2006.01) <b>C02F 1/32</b> (2006.01) <b>C02F 1/44</b> (2006.01) <b>C02F 1/72</b> (2006.01)	2451747 *	PURIFYING DEVICE AND METHOD FOR ELIMINATION OF XENOBIOTICS IN WATER
Bavarian Nordic A/S	<b>A61K 35/12</b> (2006.01) <b>C12N 15/117</b> (2010.01) <b>A61P 37/04</b> (2006.01)	2513311 *	PRODUCTION OF IFN-LAMBDA BY CONVENTIONAL DENDRITIC CELLS AND USES THEREOF
Cassandra Oil AB.	<b>B01J 19/18</b> (2006.01) <b>B01J 8/10</b> (2006.01) <b>B02C 13/04</b> (2006.01)	2516051 *	REACTOR COMPRISING A ROTOR
Gilead Sciences, Inc.	<b>A61K 31/4436</b> (2006.01) <b>A61P 31/00</b> (2006.01) <b>A61K 31/381</b> (2006.01) <b>C07D 409/12</b> (2006.01)	2523950 *	INHIBITORS OF FLAVIVIRIDAE VIRUSES
Sanofi-Aventis Deutschland GmbH	<b>A61M 5/00</b> (2006.01)	2512553 *	MEDICAL DEVICE AND METHOD OF ASSEMBLY
Delphi Technologies Holding S.à.r.l.	<b>H01L 41/053</b> (2006.01)	2426749	Actuator arrangement for use in a fuel injector
TOTO LTD.	<b>E03D 9/08</b> (2006.01) <b>A61H 33/14</b> (2006.01)	2295653	Toilet with bidet function
Guardian Venture Oil&Gas Sdn. Bhd.	<b>C08L 67/06</b> (2006.01) <b>H01B 1/24</b> (2006.01) <b>C08K 3/04</b> (2006.01)	2513224 *	CONDUCTIVE TANK SUMP AND DISPENSER SUMP, AND METHOD OF EARTHING PROCESS OF THE SAME, AND ELECTRICALLY-CONDUCTIVE COMPOSITION FOR FABRICATION OF TANK SUMP
Neurotec Pharma, S.L.	<b>A61K 31/549</b> (2006.01) <b>A61P 25/00</b> (2006.01)	2521552 *	DIAZOXIDE FOR USE IN THE TREATMENT OF A CENTRAL NERVOUS SYSTEM (CNS) AUTOIMMUNE DEMYELINATING DISEASE
Cancer Genetics, Inc.	<b>C12Q 1/68</b> (2006.01)	2519649 *	TOOL FOR DIAGNOSIS AND PROGNOSIS OF MATURE B-CELL NEOPLASMS



Podnosilac evropske prijave patenta (71)	MKP (51)	Broj objave evropske prijave patenta (97)	Naziv pronalaska (54)
Boehringer Ingelheim International GmbH	<b>C07D 401/06</b> (2006.01) <b>A61K 31/506</b> (2006.01) <b>C07D 491/113</b> (2006.01) <b>C07D 487/04</b> (2006.01) <b>C07D 401/14</b> (2006.01) <b>A61P 35/00</b> (2006.01) <b>C07D 405/14</b> (2006.01) <b>C07D 413/14</b> (2006.01) <b>C07D 471/10</b> (2006.01) <b>C07D 498/04</b> (2006.01)	2528910 *	5-ALKYNYL PYRIMIDINES AND THEIR USE AS KINASE INHIBITORS
Injection Bottle Development AS	<b>B65D 81/32</b> (2006.01) <b>A61J 9/00</b> (2006.01) <b>B65D 47/24</b> (2006.01) <b>A45F 3/16</b> (2006.01)	2519457 *	DRINKING BOTTLE WITH MULTIPLE COMPARTMENTS AND REPLACEABLE AMPOULES



**OBJAVA POVUČENIH ZAHTJEVA ZA PROŠIRENJE EVROPSKIH PRIJAVA  
PATENTA**  
**PUBLICATION OF WITHDRAWN REQUESTS FOR EXTENSION OF EUROPEAN  
PATENT APPLICATION**

Broj objave evropske prijave patenta (97)	MKP (51)	Datum kada je zahtev za proširenje evropske prijave patenta povučen	Zahtev objavljen u CGIS-u broj	Naziv pronalaska (54)	Podnosilac evropske prijave patenta (71)
2374873	C12N 9/12	15.11.2011	4/2012	Rotary harrow	Maschio Gasparido S.p.A.
2437082	C12P 13/08	13.04.2012	1/2013	Modified aspartate kinase from corynebacterium and its application for amino acid production	Technische Universität Hamburg-Harburg



- (51) **A61K9/08** (11) **01118**  
**A61K31/136** (21) **P-2008-850**
- (30) MI20032463 16.12.2003 IT
- (96) 04078366.4 10.12.2004
- (97) EP 1543826 03.09.2008. 2008/36 En
- (54) (ME) **KONCENTROVANI VODENI RASTVOR AMBROKSOLA**  
(EN) **CONCENTRATED AQUEOUS SOLUTION OF AMBROXOL**
- (73) Advance Holdings Limited ; 2nd Floor, Level 5, The Mall Complex, Floriana (MT)
- (72) Pifferi, Giorgio; Via Carlo Antonio Carlone, 8, 20147 Milano (IT)
- (74) Anđelić Branko, Svetozara Markovića 12, Podgorica (ME)
- (57) Vodeni rastvor, naznačen time, što se sastoji od kisele adicione soli ambroksola i površinskog sredstva, pri čemu je površinsko sredstvo alkohol ili etoksilat alifaticna kiselina, pH vrednost je od 6 do 7 i sadržaja ambroksola je od 4 do 7% (w/v).  
Patent sadrži još 13 patentnih zahtjeva.

- (51) **C07D223/16**  
**A61K31/55**  
**A61P3/04**  
**A61P25/30**  
**A61P25/24**
- (11) **01090**  
(21) **P-2009-338**
- (30) 638221P 21.12.2004 EP  
(86) PCT/US2005/046983 20.12.2005.  
(87) WO 2006/069363 29.06.2006  
(96) 05855526.9 20.12.2005.  
(97) EP 1838677 09.09.2009. 2009/37 En
- (54) (ME) **KRISTALNU OBLICI (R)-8-HLORO-METIL-2,3,4,5-TETRAHIDRO-1H-3-BENZAZEPIN HLORHIDRAT**  
(EN) CRYSTALLINE FORMS OF (R)-8-CHLORO-1-METHYL- 2,3,4,5-TETRAHYDRO- 1H-3-BENZAZEPINE HYDROCHLORIDE
- (73) Arena Pharmaceuticals, Inc.; 6166 Nancy Ridge Drive, San Diego, CA 92121-3223 (US)  
(72) AGARWAL, Rajesh Kumar; 13237 Jacarte Court, San Diego, California 92130 (US)  
BETTS, III, William L.; 4518 Patria Drive, San Diego, California 92115 (US)  
HENSHILWOOD, James A.; 2501 Sombrosa Place, Carlsbad, California 92009 (US)  
KIANG, Yuan-Hon; 3871 Rodene Street, Newbury Park, California 91320 (US)  
POST, Noah; 3520 Lebon Drive, Apt. 5315, San Diego, California 92122 (US)
- (74) Anđelić Branko, Svetozara Markovića 12, Podgorica (ME)  
(57) Jedinjenje, naznačeno time, što e radi o (R)-8-hloro-1-metil-2,3,4,5-tetrahidro-1H-3-benzazepin hlorhidrat poluhidratu.  
Patent sadrži još 29 patentnih zahtjeva.

- (51) **A61K 31/135** (11) **01091**  
**A61K 31/55** (21) **P-2009-339**  
**A61P 3/04**

- (30) 638667 P 23.12.2004 US  
 688901 P 08.06.2005 US  
 (86) PCT/US2005/046654 21.12.2005.  
 (87) WO 2006/071740 06.07.2006  
 (96) 05855247.2 21.12.2005  
 (97) EP 1833473 09.09.2009. 2009/37 En

(54) (ME) **KOMPOZICIJE 5HT2C RECEPTOR MODULATORA I POSTUPCI NJIHOVE UPOTREBE**

(EN) 5HT2C RECEPTOR MODULATOR COMPOSITIONS AND METHODS OF USE

- (73) Arena Pharmaceuticals, Inc.; 6166 Nancy Ridge Drive, San Diego, CA 92121-3223 (US)  
 (72) BEHAN, Dominic P.; 11479 Weatherhill Way, San Diego, CA 92131 (US)  
 SMITH, Brian M.; 13182 Mesa Crest Place, San Diego, CA 92129 (US)  
 BJENNING, Christina; 768 Sonrisa Street, Solana Beach, CA 92075 (US)  
 (74) Anđelić Branko, Svetozara Markovića 12, Podgorica (ME)  
 (57) Kompozicija koja se sastoji od fentermina i selektivnog 5HT-2C receptor agonista, naznacena time, sto je navedeni selektivni 5HT-2C receptor agonist odabran od (R)-1-(5-Hloro-2-fluoro-fenil)-2-metil piperazina, jedinjenja formule (I) i njihovih farmaceutski prihvatljivih soli, solvata i hidrata:

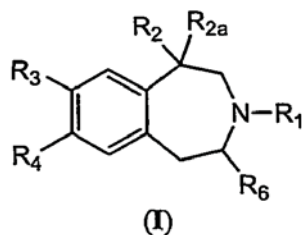

pri čemu:

R<sub>1</sub> je H ili C<sub>1-8</sub> alkil;

R<sub>2</sub> je C<sub>1-8</sub> alkil, -CH<sub>2</sub>-O-C<sub>1-8</sub> alkil, -C(=O)-O-C<sub>1-8</sub> alkil, -C(=O)-NH-C<sub>1-8</sub> alkil, OH, ili CH<sub>2</sub>OH;

R<sub>2a</sub> je H;

ili R<sub>2</sub> i R<sub>2a</sub> zajedno formiraju -CH<sub>2</sub>-CH<sub>2</sub>-;

R<sub>3</sub> i R<sub>4</sub> su svaki nezavisno H, halogen, perhaloalkil, CN, OR<sub>5</sub>, SR<sub>5</sub>, NHR<sub>5</sub>, N(R<sub>5</sub>)<sub>2</sub>, OH, aril, ili heteroaril, pri čemu navedeni aril može biti opciono supstituisan sa do dva supstituenata odabranih od C<sub>1-8</sub> alkil, halogen, perhalo alkil, i alkoksi, i navedeni heteroaril može biti opciono supstituisan sa do dva supstituenata odabranih od halogen i C<sub>1-8</sub> alkil; ili R<sub>3</sub> i R<sub>4</sub> zajedno sa atomima za koje su zakačeni mogu da formiraju 5- ili 6-člani heterociklični prsten koji ima jedan O atom; svaki R<sub>5</sub> je nezavisno C<sub>1-8</sub> alkil, C<sub>1-8</sub> alkenil, aril, heteroaril, arilalkil, heteroarilalkil ili perhaloalkil, ili alil; i R<sub>6</sub> je H ili C<sub>1-8</sub> alkil.

Patent sadrži još 36 patentnih zahtjeva.

(51) **C07D401/14**  
**A61K31/14**  
**C07D413/14**  
**A61P25/18**

(11) **01142**  
(21) **P-2010-127**

(30) 642058P 07.01.2005. US  
(86) PCT/IB2005/003937 22.12.2005.  
(87) WO 2006/072828 13.07.2006  
(96) 05824101.9 22.12.2005.  
(97) EP1841757 30.06.2010 2010/26 En

(54) (ME) **HETEROAROMATIČNA JEDINJENJA HINOLINA I NJIHOVA UPOTREBA  
**KAO PDE10 INHIBITORA****

(EN) HETEROAROMATIC QUINOLINE COMPOUNDS AND THEIR USE AS PDE10 INHIBITORS

(73) Pfizer Products Inc.; Eastern Point Road, Groton, CT 06340 (US)  
(72) VERHOEST, Patrick, Robert; 10 Cord Grass Lane, Old Lyme, CT 06371(US)  
HELAL, Christopher, John; 4 Mackinnon Place, East Lyme, CT 06333(US)  
HOOVER, Dennis, Jay; 472 Pequot Avenue, Mystic, CT 06355 (US)  
HUMPHREY, John, Michael; 110 Haley Road, Mystic, CT 06355 (US)  
(74) Lutovac Branimir, Bulevar Ivana Crnojevića 93, Podgorica (ME)  
(57) Jedinjenje formule I

ili njegova farmaceutski prihvatljiva so, gdje  
Z predstavlja

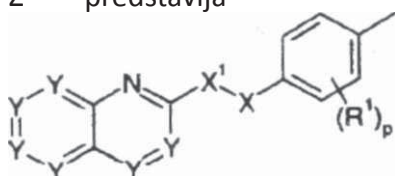

R<sup>1</sup> svaki nezavisno, se bira iz grupe koju čine vodonik i halogen; HET<sup>1</sup> se bira iz grupe koju čine monociklični heteroaril i biciklični heteroaril, pri čemu ovaj monociklični i biciklični heteroaril može opciono biti supstituisan sa najmanje jednim R<sup>4</sup>; R<sup>4</sup> se bira iz grupe koju čine C<sub>1</sub>-C<sub>8</sub> alkil i C<sub>1</sub>-C<sub>8</sub> alkil supstituisan sa nekim supstituentom koji se bira iz grupe koju čine -OR<sup>8</sup> i -NR<sup>8</sup>R<sup>8</sup>, gdje se R<sup>8</sup>, svaki nezavisno, bira iz grupe koju čine vodonik i C<sub>1</sub>-C<sub>8</sub>alkil; HET<sup>2</sup> je monociklični heteroaril, koji se bira iz grupe koju čine 4-piridil, 4-piridazin i izoksazol, a pri tome ovaj monociklični heteroaril može biti supstituisan sa najmanje jednim R<sup>5</sup>; R<sup>5</sup> svaki nezavisno, se bira iz grupe koju čine halogen i C<sub>1</sub>-C<sub>8</sub>alkil; B<sup>1</sup> i B<sup>2</sup> su susjedni atomi u HET<sup>1</sup>, koji se nezavisno biraju iz grupe koju čine ugljenik i azot; veza j predstavlja kovalentnu vezu između Z i B<sup>2</sup>; veza k predstavlja neku vezu u HET<sup>1</sup> između B<sup>1</sup> i B<sup>2</sup>; X i X<sup>1</sup> svaki nezavisno, se biraju iz grupe koju čine kiseonik i C(R<sup>2</sup>)<sub>2</sub>, pod uslovom da bar jedan od X i X<sup>1</sup> predstavlja ugljenik; R<sup>2</sup> svaki nezavisno, se bira iz grupe koju čine vodonik i C<sub>1</sub>-C<sub>8</sub>alkil; Y predstavlja ugljenik supstituisan sa R<sup>6</sup>; pri čemu se R<sup>6</sup>, svaki nezavisno, se bira iz grupe koju čine vodonik, halogen, C<sub>1</sub>-C<sub>8</sub>alkoksi i -NR<sup>7</sup>R<sup>7</sup>; pri čemu R<sup>7</sup>, svaki nezavisno, predstavlja C<sub>1</sub>-C<sub>8</sub>alkil; "heteroaril" se odnosi na aromatične grupe koje sadrže jedan ili više heteroatoma, uključujući multiciklične grupe



koje sadže jedan ili više heteroatoma, pri čemu je najmanje jedan prsten u toj grupi aromatičan; i P je jednako 1 ili 2  
Patent sadrži još 19 patentnih zahtjeva.

(51) **C07D215/227**  
**C07D215/36**  
**C07D401/06**  
**C07D409/06**  
**C07D215/12**  
**C07D407/04**  
**A61K31/47**  
**A61P31/04**

(11) **01127**  
(21) **P-2010-128**

(30) 06125546 06.12.2006. EP  
(86) PCT/EP2007/063312 04.12.2007  
(87) WO 2008/068266 12.06.2008.  
(96) 07857252.6 04.12.2007  
(97) EP2099762 12.05.2010. 2010/19 En

(54) (ME) **ANTIBAKTERIJSKI DERIVATI KVINOLINA**  
(EN) ANTIBACTERIAL QUINOLINE DERIVATIVES

(73) Janssen Pharmaceutica NV ; Turnhoutseweg 30, 2340 Beerse (BE)

(72) GUILLEMONT, Jérôme Emile Georges; Johnson & Johnson, Pharmaceutical Research and Development, A division of Janssen-Cilag, Campus de Maigremont BP615, 27106 Val de Reuil Cedex (FR)

DORANGE, Ismet; Sickla alle 21, 13165 Nacka (SE)

ANDRIES, Koenraad Jozef Lodewijk Marcel; Janssen Pharmaceutica N.V., Turnhoutseweg 30, 2340 Beerse (BE)

KOUL, Anil; Janssen Pharmaceutica N.V., Turnhoutseweg 30, 2340 Beerse (BE)

(74) Radulović Božidar, Jovana Tomaševića 9/III, Podgorica (ME)

(57) Jedinjenje formule (Ia) ili (Ib)

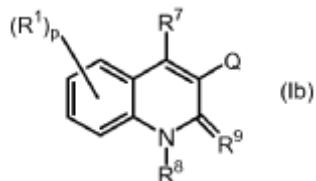
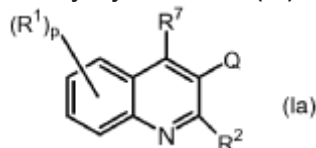

uključuju i bilo koju stereohemijski izomjernu formu od toga, naznačeno time da Q predstavlja radikal formule

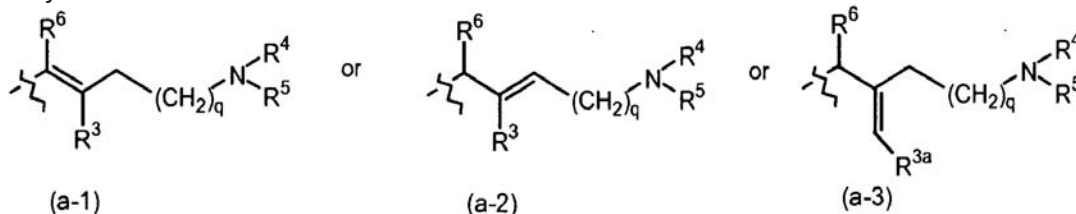

P je cio broj jednak 1, 2, 3 ili 4;

q je cio broj jednak nuli, 1, 2, 3 ili 4;

R' je vodonik, cijano, formil, karboksil, halo, alkil, C<sub>2-6</sub> alkenil, C<sub>2-6</sub> alkinil, haloalkil, hidroksi, alkiloksi, alkiltio, alkiltioalkil, -C=N-OR<sup>11</sup>, amino, mono ili di(alkil)amino, aminoalkil, mono ili di(alkil)aminoalkil, alkilkarbonilaminoalkil, aminokarbonil, mono ili di(alkil)aminokarbonil, arilalkil, arilkarbonil, R<sup>5a</sup>R<sup>4a</sup>Nalkil, di(aril)alkil, aril, R<sup>5a</sup>R<sup>4a</sup>N-, R<sup>5a</sup>R<sup>4a</sup>N-

C(=O)- ili Het;

R<sup>2</sup> je vodonik, alkiloksi, aril, ariloksi, hidroksi, merkpto, alkiloksialkiloksi, alkiltio, mono ili di(alkil)amino, pirolidino ili radikal formule

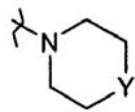

u čemu Y je CH<sub>2</sub>, O, S, NH ili N-alkil; R<sup>3</sup> je alkil, arilalkil, aril-O-alkil, aril-alkil-O-alkil, aril, aril-aril, Het, Het-alkil,

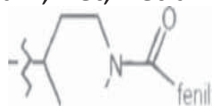

Het-O-alkil, Het-alkil-O-alkil ili R<sup>3a</sup> je vodonik, cijano, alkil, arilalkil, aril-O-alkil, aril-alkil-O-alkil, aril, aril-aril, Het, Het-alkil, Het-O-alkil ili Het-alkil-O-alkil; R<sup>4</sup> i R<sup>5</sup> svaki zasebno su vodonik; alkil; alkiloksialkil; arilalkil; Het-alkil; mono-ili dialkilaminoalkil; biciklo[2.2.1] heptil; Het; aril; ili -C(=NH)- NH<sub>2</sub>; ili zajedno sa atomom azota na kojeg su vezani formiraju radikal odabran iz grupe koja se sastoji od pirolidino, piperidino, piperazino, morfolino, 4-tiomorfolino, 1,1-dioksid-tiomorfolinil, azetidil, 2,3-dihidroizoindol-1-il, tiazolidin-3-il, 1,2,3,6-tetrahidropiridil, heksahidro-1H-azepinil, heksahidro-1H-1,4-diazepinil, heksahidro-1.4-oksazepinil, 1,2,3,4-tetrahidroizokvinolin-2-il, 2,5-diazabiciklo[2.2.1]heptil, pirolinil, pirolil, imidazolidinil, pirazolidinil, 2-imidazolinil, 2-pirazolinil, imidazolil, pirazolil, triazolil, piridinil, piridazinil, pirimidinil, pirazinil i triazinil, svaki radikal opcijski supstituisan sa 1, 2, 3 ili 4 supstituenta, svaki supstituent nezavisno odabran između alkil, haloalkil, alkilkarbonil, halo, arilalkil, hidroksi, alkiloksi, amino, mono- ili dialkilamino, aminoalkil, mono-ili dialkilaminoalkil, alkiltio, alkiltioalkil, aril, piridil, pirimidinil, piperidinil opcijski supstituisan sa alkilom ili pirolidinil opcijski supstituisan sa arilalkil; R<sup>4a</sup> i R<sup>5a</sup> zajedno sa atomom azota na kojeg su vezani formiraju radikal odabran iz grupe koja se sastoji od pirolidino, piperidino, piperazino, morfolino, 4-tiomorfolino, 2,3-dihidroizoindol-1-il, tiazolidin-3-il, 1,2,3,6-tetrahidropiridil, heksahidro-1H-azepinil, heksahidro-1H-1,4-diazepinil, heksahidro-1.4-oksazepinil, 1.2.3.4-tetrahidroizokvinolin-2-il, pirolinil, pirolil, imidazolidinil, pirazolidinil, 2-imidazolinil, 2-pirazolinil, imidazolil, pirazolil, triazolil, piridinil, piridazinil, pirimidinil, pirazinil i triazinil, svaki radikal opcijski supstituisan sa 1, 2, 3 ili 4 supstituenta, svaki supstituent nezavisno odabran između alkil, haloalkil, halo, arilalkil, hidroksi, alkiloksi, amino, mono- ili dialkilamino, alkiltio, alkiltioalkil, aril, piridil ili pirimidinil; R<sup>6</sup> je aril<sup>1</sup> ili Het; R<sup>7</sup> je vodonik, halo, alkil, aril ili Het; R<sup>8</sup> je vodonik ili alkil; R<sup>9</sup> je okso; ili R<sup>8</sup> i R<sup>9</sup> zajedno formiraju radikal -CH=CH-N=; R<sup>11</sup> je vodonik ili alkil; aril aril je homocikal odabran između fenil, naftil, acenaftil ili tetrahidronaftil, svaki opcijski supstituisan sa 1, 2 ili 3 supstituenta, svaki supstituent nezavisno odabran između hidroksi, halo, cijano, nitro, amino, mono- ili dialkilamino, alkil, C<sub>2-6</sub>-alkenil opcijski supstituisan sa fenil, haloalkil, alkiloksi, haloalkiloksi, karboksil, alkiloksikarbonil, aminokarbonil, morfolinil ili mono-ili dialkilaminokarbonil; aril<sup>1</sup> je homocikal odabran između fenil, naftil, acenaftil ili tetrahidronaftil, svaki opcijski supstituisan sa 1, 2 ili 3 supstituenta, svaki supstituent nezavisno odabran između hidroksi, halo, cijano, nitro, amino, mono- ili dialkilamino, alkil, haloalkil, alkiloksi, alkiltio, haloalkiloksi, karboksil, alkiloksikarbonil, aminokarbonil, morfolinil, Het ili mono- ili dialkilaminokarbonil; Het je monocikli ki heterocikal odabran između N-fenoksipiperidinil, piperidinil, pirolil, pirazolil, imidazolil, furanil, tienil, oksazolil, izoksazolil, tiazolil, izotiazolil, piridinil, pirimidinil, pirazinil ili piridazinil; ili bicikli ki heterocikal odabran između kvinolinil, kvinoksalinil, indolil, benzimidazolil, benzoksazolil, benzizoksazolil, benzotiazolil, benzizotiazolil, benzofuranil, benzotienil, 2,3-dihidrobenzo[1,4] dioksinil ili benzo[1,3]dioksolil; svaki monocikliki i bicikliki heterocikal opcijski supstituisan sa 1, 2 ili 3 supstituenta, svaki supstituent nezavisno odabran između halo, hidroksi, alkil ili

alkiloksi; N-oksid od toga, farmaceutske prihvatljiva so od toga ili solvat od toga.  
Patent sadrži još 29 patentnih zahtjeva.

- (51) **C07D401/14**  
**C07D403/12**  
**A61K31/4184**  
**C07D239/47**

- (11) **01143**  
(21) **P -2010-163**

- (30) 788190P 31.03.2006. US  
(86) PCT/US2007/008216 30.03.2007.  
(87) WO 2007/117399 18.10.2007  
(96) 07754700.8 30.03.2007.  
(97) EP2007752 18.08.2010. 2010/33 En

(54) (ME) **BENZOIMIDAZOL-2-IL PIRIMIDINI I PIRAZINI KAO MODULATORI HISTAMINSKOG H4 RECEPTORA**

(EN) BENZOIMIDAZOL-2-YL PYRIMIDINES AND PYRAZINES AS MODULATORS OF THE HISTAMINE H4 RECEPTOR

- (73) Janssen Pharmaceutica NV ; Turnhoutseweg 30, 2340 Beerse (BE)  
(72) EDWARDS, James, P.; 8723 Hesby Court, San Diego, CA 92129 (US)  
KINDRACHUK, David, E.; 1317 Evergreen Drive, Cardiff By The Sea, CA 92007 (US)  
VENABLE, Jennifer, D.; 609 Glencrest Pl, Solana Beach, CA 92075-1440 (US)  
MAPES, Christopher, M.; 8255 Pasadena Avenue, La Mesa, CA 91941(US)  
PIPPEL, Daniel, J.; 13106 Caminito Mar Villa, Del Mar, CA 92014 (US)  
(74) Lutovac Branimir, Bulevar Ivana Crnojevića 93, Podgorica (ME)  
(57) Hemijsko jedinjenje formule (I)

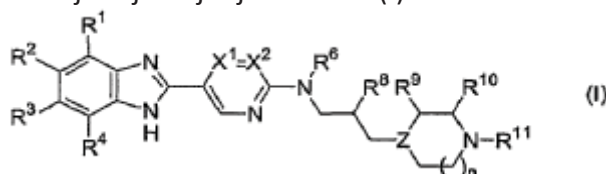

Gde svaki  $R^{1-4}$  je nezavisno H,  $C_{1-4}$  alkil,  $C_{2-4}$  alkenil,  $C_{2-4}$  alkinil, fenil,  $-CF_3$ ,  $-OCF_3$ ,  $-CN$ , halo,  $-NO_2$ ,  $-OC_{1-4}$  alkil,  $-SC_{1-4}$  alkil,  $-S(O)C_{1-4}$  alkil,  $-SO_2C_{1-4}$  alkil,  $-C(O)C_{1-4}$  alkil,  $-C(O)$ fenil,  $-C(O)NR^aR^b$ ,  $-CO_2C_{1-4}$  alkil,  $-CO_2H$ ,  $-C(O)NR^aR^b$  ili  $-NR^aR^b$  : gde  $R^a$  i  $R^b$  su svaki nezavisno H,  $C_{1-4}$  alkil ili  $C_{3-7}$  cikloalkil; jedan od  $X^1$  i  $X^2$  je N, a drugi je C- $R^c$ : gde je  $R^c$  H, metal, hidroksimetil, dimetilaminometil, etil, propel, izopropil,  $-CF_3$ , ciklopropil ili ciklobutil: n je 1 ili 2; Z je N, CH ili  $C(C_{1-4}$ alkil);  $R^6$  je H,  $C_{1-6}$  alkil ili monociklični cikloalkil;  $R^8$  je H ili  $C_{1-4}$  alkil;  $R^9$  i  $R^{10}$  su svaki nezavisno H ili  $C_{1-4}$  alkil; i  $R^{11}$  je H ili  $C_{M-4}$  alkil; farmaceutski prihvatljiva so jedinjenja formule (I) ili hidrat jedinjenja formule (I)

Patent sadrži još 32 patentna zahtjeva.

- (51) **A61K45/06**  
**A61K31/4178**  
**A61K31/439**  
**A61K31/265**  
**A61P1/12**
- (30) 040290384 12.02.2004. EP  
(86) PCT/IB2005/000351 14.02.2005.  
(87) WO 2005/079850 01.09.2005.  
(96) 05702484.6 14.02.2005.  
(97) EP 1718337 19.05.2010. 2010/20 En
- (54) (ME) **NOVE KOMBINACIJE ANTAGONISTA RECEPTORA 5-HT3 SA RACECADOTRILOM ILI DEKSECADOTRILOM**  
(EN) NEW COMBINATIONS OF A 5-HT3 RECEPTOR ANTAGONIST WITH RACECADOTRIL OR DEXECADOTRIL
- (73) BIOPROJET ; 30, rue des Francs-Bourgeois, 75003 Paris (FR) JET  
(72) 01 / SCHWARTZ, Jean-Charles; 9, villa Seurat, F-75014 Paris (FR)  
02 / LECOMTE, Jeanne-Marie; 30, rue des Francs-Bourgeois, F-75003 Paris (FR)  
(74) Ćupić Branislav, Dalmatinska 10, Podgorica (ME)  
(57) Kombinacija antagonista 5-HT3 receptora sa racecadotrilom ili deksecadotrilom.  
Patent sadrži još 18 patentnih zahtjeva.

- (51) **A61K9/16**  
**A61K9/32**  
**A61P3/10**
- (11) **01170**  
(21) **P-2010-172**
- (30) 20060009201 04.05.2006 EP  
(86) PCT/EP2007/054204 30.04.2007  
(87) WO 2007/128724 15.11.2007  
(96) 07728658.1 30.04.2007  
(97) EP 2023902 08.09.2010 2010/36 EN
- (54) (ME) **FORMULACIJE DPP IV INHIBITORA**  
(EN) DPP IV INHIBITOR FORMULATIONS
- (73) BOEHRINGER INGELHEIM INTERNATIONAL GMBH ; Binger Str. 173, 55216 Ingelheim am Rhein (DE)
- (72) KOHLRAUSCH, Anja ; Fuenf Linden 31, 88400 BIBERACH (DE)  
ROMER, Patrick; Huerblerstrasse 41, 88416 Ochsenhausen (DE)  
SEIFFERT, Gerd; Neidhardtstrasse 50, 88471 Laupheim (DE)
- (74) Radulović Božidar, Jovana Tomaševića 9/III, Podgorica (ME)
- (57) Farmaceutska kompozicija koja sadrži kao aktivni sastojak jedinjenje DPP IV inhibitora sa amino grupom odabranom od 1-[(4-metil-hinazolin-2-il)metil]-3-metil-7-(2-butin-1-il)-8-(3-(R)-amino-piperidin-1-il)-ksantin, 1-[[1,5]naftiridin-2-il)metil]-3-metil-7-(2-butin-1-il)-8-((R)-3-amino-piperidin-1-il)-ksantin, 1 -[(hinazolin-2-il)metil]-3-metil-7-(2-butin-1-il)-8-((R)-3-amino-piperidin-1 -il)-ksantin, 2-((R)-3-amino-piperidin-1-il)-3-(but-2-inil)-5-(4-metil-hinazolin-2-il)metil]-3,5-dihidroimidazo[4,5-d]piridazin-4-on, 1-[(4-metil-hinazolin-2-il)metil]-3-metil-7-(2-butin-1-il)-8-[(2-amino-2-metil-propil)-metilamino]-ksantin, 1-[ (3-cijano-hinolin-2-il)metil]-3-metil-7-(2-butin-1-il)-8-((R)-3-amino-piperidin-1 -il)-ksantin, 1 -(2-cijano-benzil)-3-metil-7-(2-butin-1 -il)-8-((R)-3-amino-piperidin-1 -il)-ksantin, 1-[(4-metil-hinazolin-2-il)metil]-3-metil-7-(2-butin-1-il)-8-[(S)-(2-amino-propil)-metilamino]-ksantin, 1-[(3-cijano-piridin-2-il)metil]-3-metil-7-(2-butin-1-il)-8-((R)-3-amino-piperidin-1 -il)-ksantin, 1-[(4-metil-pirimidin-2-il)metil]-3-metil-7-(2-butin-1-il)-8-((R)-3-amino-piperidin-1 -il)-ksantin, i 1-[(4,6-dimetil-pirimidin-2-il)metil]-3-metil-7-(2-butin-1-il)-8-((R)-3-amino-piridin-1 -il)-ksantin, 1 -[(hinoksalin-6-il)metil]-3-metil-7-(2-butin-1 -il)-8-((R)-3-amino-piperidin-1 -il)- ksantin, ili njihove soli, prvi razblaživač koji je manitol, drugi razblaživač koji je preželatinizovani skrob, vezivnu supstancu koja je kopovidon, dezintegrant koji je kukuruzni skrob, i lubrikant koji je magnezijum stearat.  
Patent sadrži još 13 patentnih zahtjeva.

- (51) **A61K31/485** (11) **01187**  
**A61K9/22** (21) **P-2011-79**  
**A61K9/32**
- (30) 840244P 25.08.2006. US  
(96) 09156838.6 24.08.2007.  
(97) EP 2080514 23.02.2011 2011/08 EN
- (54) (ME) **FARMACEUTSKI DOZNI OBLICI REZISTENTNI NA ZLOUPOTREBU KOJI SADRŽE OPIOIDNI ANALGETIK**  
(EN) TAMPER RESISTANT ORAL PHARMACEUTICAL DOSAGE FORMS COMPRISING AN OPIOID ANALGESIC
- (73) Purdue Pharma LP ; One Stamford Forum 201 Tresser Boulevard, Stamford, CT 06901 (US)  
(72) 01 / McKenna, William Henry; 10 Longmeadow Road, Yonkers, NY 10704 (US)  
02 / Mannion, Richard Owen; 3860 Green Ridge Road, Furlong, PA 18925 (US)  
03 / O'Donnell, Edward Patrick; 38 Chestnut Court, Basking Ridge, NJ 07920 (US)  
04 / Huang, Haiyong Hugh; 33 Ketley Place, Princeton, NJ 08540 (US)
- (74) Lutovac Branimir, Bulevar Ivana Crnojevića 93, Podgorica (ME)
- (57) Čvrsti oralni farmaceutski oblik za doziranje sa produženim oslobađanjem, koji sadrži formulaciju matrice sa produženim oslobađanjem, a formulacija matrice sa produženim oslobađanjem sadrži kompoziciju koja sadrži bar najmanje jedan polietilen-oksidi, koji na osnovu reoloških mjerenja ima molarnu masu od najmanje 1,000,000, i najmanje jedan aktivni agens izabran od opioidnih analgetika, gdje je opioidni analgetik oksikodon hidrohlorid i dozni oblik sadrži od 5 mg do 500 mg oksikodon hidrohlorida; i gdje kompozicija sadrži bar oko 80% (tež.) polietilen oksida koji na osnovu reoloških mjerenja ima približnu molarnu masu najmanje 1,000,000.  
Patent sadrži još 24 patentna zahtjeva.



- (51) **A61K31/353**  
**C07D311/80**  
**A61P1/08**  
**A61P3/00**  
**A61P29/00**
- (11) **01188**  
(21) **P-2011-98**
- (30) 630556P 22.11.2004 US  
(86) PCT/EP2005/012378 18.11.2005.  
(87) WO 2006/053766 26.05.2006.  
(96) 05807597.9 18.11.2005.  
(97) EP 1824475 09.03.2011. 2011/10 EN
- (54) (ME) **POSTUPCI ZA PREČIŠĆAVANJE TRANS-(-)- $\Delta^9$ -TETRAHIDROKANABINOLA I TRANS-(+)- $\Delta^9$ -TETRAHIDROKARABINOLA**  
(EN) METHODS FOR PURIFYING TRANS-(-)-DELTA9-TETRAHYDROCANNABINOL AND TRANS-(+)-DELTA9-TETRAHYDROCANNABINOL
- (73) EURO-CELIQUE S.A.; 2, avenue Charles de Gaulle, 1653 Luxembourg (LU)  
(72) GUTMAN, Arie, L.; Shindler Street 9/22, 34996 Haifa (IL)  
NISNEVICH, Gennady, A.; Margalit St. 23, 34464 Haifa (IL)  
RUKHMAN, Igor; Gilad Street 12, P.O. Box 9586, Yokneam (IL)  
TISHIN, Boris; Leon Blum Street 46/63, 33855 Haifa (IL)  
ETINGER, Marina; Savion Street 14/1, 36822 Nesher (IL)  
FEDOTEV, Irina; Strouma Street 3/7, 35708 Haifa (IL)  
PERTSIKOV, Boris; Native Harimon Street 4, 36781 Nesher (IL)  
KHANOLKAR, Ram; 2B Henry Court, Coventry, RI 02816 (US)
- (74) Lutovac Branimir, Bulevar Ivana Crnojevića 93, Podgorica (ME)
- (57) Postupak za dobijanje kompozicije trans-(-)- $\Delta^9$ -tetrahidrokanabinola, koji obuhvata: omogućavanje da se kompozicija koja sadrži ( $\pm$ )- $\Delta^9$ -tetrahidro-kanabinol i elucioni rastvarač odvojinahiralnojstacionarnofazidabisedobilakompozicijatrans-(-)- $\Delta^9$ -tetrahidrokanabinola, ili kompozicije trans-(+)-  $\Delta^9$ -tetrahidrokanabinola, koji obuhvata: omogućavanje da se kompozicija koja sadrži ( $\pm$ )- $\Delta^9$ -tetrahidrokanabinol i elucioni rastvarač odvoji na hiralnoj stacionarnoj fazi da bi se dobila kompozicija trans-(+)-  $\Delta^9$ -tetrahidrokanabinola, gde je ( $\pm$ )- $\Delta^9$ -tetrahidrokanabinol dobijen iz kristalnog ( $\pm$ )- $\Delta^9$ -tetrahidrokanabinola, a pri čemu je kristalni ( $\pm$ )- $\Delta^9$ -tetrahidrokanabinol dobijen omogućavanjem da trans-(-)-  $\Delta^9$ -tetrahidrokanabinol i trans-(+)-  $\Delta^9$ -tetrahidrokanabinol kristališu iz prve kompozicije koja sadrži trans-(-)-  $\Delta^9$ - tetrahidrokanabinol, trans-(+)-  $\Delta^9$ -tetrahydrocanabinol, i nepolarni organski rastvač da bi se dobio kristalni ( $\pm$ )- $\Delta^9$ -tetrahidrokanabinol, a gde je prva kompozicija dobijena: (a)obrazovanjem dvofazne kompozicije koja sadrži (i) prvu organsku fazu, i (ii) alkoholno-kaustičnu fazu koja sadrži trans-(-)- $\Delta^9$ -tetrahidrokanabinol i/ili trans-(+)-  $\Delta^9$ -tetrahidrokanabinol; (b) odvajanjem trans-(-)-  $\Delta^9$ -tetrahidrokanabinola i/ili trans-(+)-  $\Delta^9$ -tetrahidrokanabinola iz alkoholno-kaustične faze; i (c) obrazovanjem prve kompozicije koje sadrži trans-(+)-  $\Delta^9$ -tetrahidrokanabinol, trans-(-)-  $\Delta^9$ -tetrahidrokanabinol, i nepolarni organski rastvarač.  
Patent sadrži još 24 patentna zahtjeva.

- (51) **A61K31/4412** (11) **01189**  
**A61P11/00** (21) **P-2011-113**
- (30) 113107P 10.11.2008. US  
 228943P 27.07.2009. US  
 553292 03.09.2009. US  
 428393 22.04.2009. US
- (96) 09252572.4 06.11.2009.
- (97) EP 2191831 30.03.2011. 2011/13 EN
- (54) (ME) **MODIFIKOVANJE LIJEČENJA PIRFENIDONOM ZA PACIJENTE SA ATIPIČNOM FUNKCIJOM JETRE**  
 (EN) MODIFYING PIRFENIDONE TREATMENT FOR PATIENTS WITH ATYPICAL LIVER FUNCTION
- (73) Intermune, Inc. ; 3280 Bayshore Boulevard, Brisbane, CA 94005-1021 (US)
- (72) Bradford, Williamson Ziegler; PO Box 566, Ross, California 94957(US)  
 Szwarcberg, Javier; 2173 Bunker Hill Drive, San Mateo, California 94402 (US)
- (74) Lutovac Branimir, Bulevar Ivana Crnojevića 93, Podgorica (ME)
- (57) Pirfenidon za upotrebu u liječenju pacijenta sa idiopatskom pulmonarnom fibrozom (IPF), pri čemu pacijent ima nivo 2 abnormalnosti u jednom ili više biomarkera funkcije jetre posle davanja pirfenidona, i ima abnormalni nivo alanin transaminaze (ALT) i/ili aspartat transaminaze (AST) koji je više od 2.5- do 5.0 -puta povećan u poređenju sa gornjom normalnom vrednošću, posle davanja pirfenidona, gde (a) pomenutom pacijentu se daje pirfenidon u dozama od bar 1600 mg/danu ili 1602 mg/danu.  
 Patent sadrži još 15 patentnih zahtjeva.

(51) **F01K25/06**

(11) **01101**

(21) **P-2008-818**

(30) 200410018627 16.04.2004 DE

(86) PCT/EP2005/051617 13.04.2005.

(87) WO2005100755 27.10.2005

(96) 05733568.9 13.04.2005

(97) EP1613841 20.12.2006 2006/51 EN

(54) **(MN) POSTUPAK I INSTALACIJA ZA IZVOĐENJE TERMODINAMIČKOG KRUŽNOG PROCESA**

(EN) METHOD AND DEVICE FOR CARRYING OUT A THERMODYNAMIC CYCLIC PROCESS

(73) SIEMENS AKTIENGESELLSCHAFT; Wittelsbacherplatz 2, 80333 München / DE

(72) LENGERT, Jörg Schwalbenstr. 6 91475 Lonnerstadt / DE

(74) Čupić Branislav, Dalmatinska 10, Podgorica (ME)

(57) Postpak za izvođenje termodinamičkog kružnog procesa sa sledećim faznim koracima: potiskivanje putem pumpanja tečnog radnog fluida (13) radi povećanja pritiska i formiranje tečnog radnog fluida sa povišenim pritiskom (14) zagrevanje i delimično isparavanje tečnog radnog fluida sa povišenim pritiskom (14) pomoću toplote dobijene delimičnom kondenzacijom ekspaniranog radnog fluida (12) i formiranje prvi put delimično uparenog radnog fluida (15) i delimično kondenzovanog ekspaniranog radnog fluida 12a;dalje isparavanje delimično uparenog radnog fluida (15) sa toplotom koja se dobija od eksternog toplotnog izvora (20) i stvaranje po drugi put delimično uparenog radnog fluida (18);izdvajanje tečne faze (19) i parne faze (10) iz drugi put delimično uparenog radnog fluida (18);ekspaniranje parne faze (10) u turbini, čime se njena energija pretvara u koristan rad i na izlazu turbine se formira ekspanirana (rasterećena) parna faza (11); mešanje tečne faze (19) sa ekspaniranom parnom fazom (11) i formiranje ekspaniranog radnog fluida (12); potpuno kondenzovanje delimično kondenzovanog ekspaniranog, radnog fluida (12a) i obrazovanje tečnog radnog fluida (13).

Patent sadrži još 13 patentnih zahtjeva.

(51) **C07D213/82**  
**C07D401/04**  
**C07D401/12**  
**C07D401/14**  
**C07D413/04**  
**A61K31/44**  
**A61K31/444**  
**A61K31/4439**

(11) **01125**  
(21) **P-2010-148**

(30) 20060864303P 03.11.2006. US  
20060864247P 03.11.2006. US

(86) PCT/gb2007/004131 31.10.2007

(87) WO2008053194 08.05.2008

(96) 07824375.5 31.10.2007

(97) EP2086939 28.07.2010. 2010/30 en

(54) (ME) **PIRIDIN KARBOKSAMIDI KAO INHIBITORI 11-BETA-HSD1**  
(EN) **PYRIDINE CARBOXAMIDES AS 11-BETA-HSD1 INHIBITORS**

(73) AstraZeneca AB 151 85 Södertälje / SE

(72) MCCOULL, William AstraZeneca R & D Alderley Alderley Park Macclesfield Cheshire SK10 4TG / GB

PACKER, Martin AstraZeneca R & D Alderley Alderley Park Macclesfield Cheshire SK10 4TG / GB

SCOTT, James Stewart AstraZeneca R & D Alderley Alderley Park Macclesfield Cheshire SK10 4TG / GB

WHITTAMORE, Paul Robert Owen AstraZeneca R & D Alderley Alderley Park Macclesfield Cheshire SK10 4TG / GB

(74) Radulović Božidar, Jovana Tomaševića 9/III, Podgorica (ME)

(57) Jedinjenje sa formulom (I):

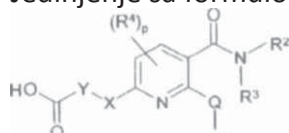

naznačeno time, da:

Q je pojedinačna veza. -O-, -S- ili -N(R<sup>15</sup>)- gde R<sup>15</sup> je vodonik. C<sub>1-3</sub>alkil ili C<sub>2-3</sub>alkanoil ili R<sup>15</sup> i R<sup>1</sup> zajedno sa azotnim atomom na koga su vezani formiraju 4-7-člani zasićeni prsten; R<sup>1</sup> je C<sub>1-6</sub>alkil, C<sub>2-6</sub>alkenil, C<sub>3-7</sub>alkinil, C<sub>3-7</sub>cikloalkil, C<sub>1-3</sub>alkil, C<sub>3-7</sub>cikloalkil, C<sub>2-3</sub>alkenil. fenil, fenilC<sub>1-3</sub>alkil, heleroaril, heteroarilC<sub>1-3</sub>alkil, heterociklil ili heterociklilC<sub>1-3</sub>alkil [svaki od njih je ponekad supstituisan sa 1, 2 ili 3 supstituenta koja su nezavisno izabrana iz C<sub>1-3</sub>alkila, hidroksi, halo, okso, cijano, trilluorometila. C<sub>1-3</sub>alkoksi, karboksiC<sub>1-3</sub>alkila, C<sub>1-3</sub>alkilS(O)<sub>n</sub>- (gde n je 0, 1, 2 ili 3), R<sup>s</sup>CON(R<sup>s</sup>)-, (R<sup>5'</sup>)(R<sup>5''</sup>)NC(O)-, R<sup>5'</sup>C(O)-, R<sup>5'</sup>OC(O)- i (R<sup>5'</sup>)(R<sup>5''</sup>)NSO<sub>2</sub>- (gde R<sup>5'</sup> je C<sub>1-3</sub>alkil ponekad supstituisan sa 1, 2 ili 3 supstituenta nezavisno izabranih iz hidroksila. halo i cijano; i R<sup>5'</sup> i R<sup>5''</sup> su nezavisno izabrani iz vodonika i C<sub>1-3</sub>alkila ponekad supstituisan sa 1, 2 ili 3 supstituenta nezavisno izabranih iz hidroksila. halo. C<sub>1-3</sub>alkoksi, karboksi i cijano ili R<sup>5'</sup> i R<sup>5''</sup> zajedno sa azotnim atomom na kojeg su vezani formiraju 4-7-člani zasićeni prsten)], a ponekad su supstituenti za heterociklil ili heterociklilnu grupu u heterociklilC<sub>1-3</sub>alkilu su dodatno izabrani iz R<sup>21</sup>, R<sup>21</sup>CO-, R<sup>21</sup>S(O)<sub>k</sub> (gde k je 0, 1 ili 2), a R<sup>21</sup>CH<sub>2</sub>OC(O)- gde R<sup>21</sup> je fenil ponekad supstituisan sa 1 ili 2 supstituenta nezavisno izabranih iz halo, hidroksi, cijano i trilluorometila; ili kada Q je veza, R<sup>1</sup> može takode da bude vodonik, gde heterociklil je 4-7-zasićeni monociklički prsten koji ima 1-3 heteroatoma u prstenu koja su izabrana iz azota. kiseonika

i sumpora;  $R^2$  je izabran iz C3-7cikloalkil(CH<sub>2</sub>)<sub>m</sub> - i C6-12policikloalkil(CH<sub>2</sub>)<sub>m</sub> - (gde cikloalkilni i policikloalkilni prsten ponekad sadrži 1 ili 2 atoma u prstenu koja su nezavisno izabrana iz azota, kiseonika i sumpora; m je 0, 1 ili 2, a pomenuti prsteni su ponekad supstituisani sa 1, 2 ili 3 supstituenta koja su izabrana iz R<sup>6</sup>);  $R^3$  je izabran iz vodonika, C1-4alkil C3-5cikloalkila i C3-5cikloalkilmetila;  $R^2$  i  $R^3$  zajedno sa azotnim atomom za kojeg su vezani formiraju zasićeni mono, biciklički ili premošćeni prstenski sistem koji ponekad sadrži 1 ili 2 dodatnih heteroatoma u prstenu koji su izabrani iz azota, kiseonika i sumpora i koji je ponekad fuzionisan na zasiceeni. delomično zasićeni ili nezasićeni monociklički prsten gde tako nastao prstenski sistem je ponekad supstituisan sa 1, 2 ili 3 supstituenta koji su nezavisno izabrani iz R<sup>7</sup>;  $R^4$  je nezavisno izabran iz halo. C1-2alkil cijano, C1-2alkoksi i tritluorometila;  $R^6$  i  $R^7$  su nezavisno izabrani iz hidroksila, halo, okso, karboksi, cijano, tritluorometila, R<sup>9</sup>, R<sup>9</sup>O-, R<sup>9</sup>CO-, R<sup>9</sup>C(O)O, R<sup>9</sup>CON(R<sup>9</sup>)-, (R<sup>9</sup>)(R<sup>9''</sup>)NC(O)-, (R<sup>9</sup>)(R<sup>9''</sup>)N-, R<sup>9</sup>S(O)<sub>a</sub>- gde a je od 0 do 2, R<sup>9</sup>OC(O)-, (R<sup>9'</sup>)(R<sup>9''</sup>)NSO<sub>2</sub>-, R<sup>9</sup>SO<sub>2</sub>N(R<sup>9</sup>)-, (R<sup>9</sup>)(R<sup>9''</sup>)NC(O)N(R<sup>9''''</sup>)-, fenila i heteroarila [gde su fenilne i heteroarilne grupe ponekad tuzionisane za fenil, heteroaril ili za zasićeni ili delomično zasićeni 5- ili 6-člani prsten koji ponekad sadrži 1, 2 ili 3 heteroatoma koja su nezavisno izabrana iz azota, kiseonika i sumpora, a takav prstenski sistem je ponekad supstituisan sa 1, 2 ili 3 supstituenta koja su nezavisno izabrana iz C1-4alkila. hidroksila, cijano. tritluorometila, tritluoromoksi, halo, C1-4ialkoksi, C1-4alkoksiC1-4alkila, C1-4alkoksiC1-4alkila, amino, N-C1-4alkilamino, di-N,N-(C1-4alkil)amino, N-C1-4alkilkarbamoila, di-N,N-(C1-4alkil)karbamoila, C1-4alkilS(O)<sub>r</sub>-, C<sub>1-4</sub>alkilS(O)<sub>r</sub>C<sub>1-4</sub>alkila (gde r je 0, 1 i 2)]; gde heteroaril, osim ako nije drugačije navedeno, je totalno nezasićen, monociklički prsten koji sadrži 5 ili 6 atoma od koji najmanje 1, 2 ili 3 atoma iz prstena su nezavisno izabrana iz azota, sumpora i kiseonika, koji mogu, osim ako nije drugačije navedeno. biti vezani preko ugljena;  $R^9$  je nezavisno C1-3alkil ponekad supstituisan sa 1. 2 ili 3 supstituenta koja su izabrana iz hidroksila. halo. C1-3alkoksi. karboksi i cijano;  $R^9$ ,  $R^{9'}$  i  $R^{9''}$  su nezavisno izabrani iz vodonika i C1-3alkila koji je ponekad supstituisan sa hidroksilom, halo, C1-4alkoksi, karboksi ili cijano); p je O, 1 ili 2: X je ili -O(CH<sub>2</sub>)<sub>q</sub>-S(CH<sub>2</sub>)<sub>q</sub> - ili -N(R<sup>12</sup>)(CH<sub>2</sub>)<sub>q</sub> - gde R<sup>12</sup> je vodonik, C1-3alkil ili C1-3alkanoil i q je 0 ili 1; i Y je:

1) C3-7cikloalkilni prsten, fenilenski prsten, adamantilna grupa, 5-7-člani zasieeni heterociklički prsten (povezan preko atoma ugljena iz prstena) koji sadrži 1 ili 2 prstenska heteroatoma koja su izabrana iz azota, kiseonika i sumpora ili -[C(R<sub>x</sub>)(R<sub>y</sub>)]<sub>v</sub>- (gde R<sub>x</sub> i R<sub>y</sub> su nezavisno izabrani iz vodonika. C1-3alkila, C1-3alkoksi i hidroksila ili R<sub>x</sub> i R<sub>y</sub> zajedno sa atomom ugljena na kojeg su vezani formiraju C3-7cikloalkilni prsten, a v je 1, 2, 3, 4 ili 5), a kada je v veći od 1, tada -[C(R<sub>x</sub>)(R<sub>y</sub>)]<sub>v</sub>- grupa može ponekad da bude prekinuta sa -O-, -S- ili -N(R<sup>20</sup>)- grupom gde R<sup>20</sup> je vodonik ili C1-3alkil ili

2) -X-Y- zajedno predstavljaju grupu sa formulom:

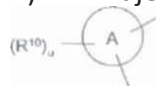

(Z)t[C(R<sup>13</sup>)(R<sup>14</sup>)]<sub>s</sub> -

gde:

prsten A je vezan za piridinsku grupu, a -(Z)t[C(R<sup>13</sup>)(R<sup>14</sup>)]<sub>s</sub> - je vezan za karboksilnu grupu; a A je 4-7-člani mono-, bi- ili spiro heterociklički prstenski sistem koji uključuje piperazinil, piperidinil i morfolinil koji sadrži atom azota u prstenu preko kojeg je vezan za piridinski prsten i ponekad dodatno neki drugi heteroatom u prstenu koji je izabran iz azota, kiseonika i sumpora; Z je -O-, -S- ili -N(R<sup>16</sup>)- gde R<sup>16</sup> je vodonik. C1-3alkil i C1-3alkanoil: t je 0 ili 1 pod uslovom da kada s je 0, tada t je 0; R<sup>10</sup> je nezavisno izabran iz C1-3alkenila, C2-3alkinila, C2-3alkinila, hidroksi, halo, okso, cijano, trifluorometila, C1-3alkoksi, C1-3alkilS(O)<sub>n</sub>- (gde n je 0, 1, 2 ili 3), R<sup>11</sup>CON(R<sup>11</sup>), (R<sup>11</sup>)(R<sup>11''</sup>)NC(O)-, R<sup>11</sup>OC(O)- i (R<sup>11'</sup>)(R<sup>11''</sup>)NSO<sub>2</sub>- (gde R<sup>11</sup> je C1-3alkil ponekad supstituisan sa hidroksil. halo ili cijano; i R<sup>11'</sup> i R<sup>11''</sup> su nezavisno izabrani iz vodonika i C1-4alkila. ponekad supstituisan sa hidroksilom, halo, C1-4alkoksi, karboksi ili cijano) ili R<sup>11</sup>

i R<sup>11</sup> zajedno sa azotnim atomom na kojeg su isti vezani formiraju 4-7-člani prsten; u je 0, 1 ili 2; R<sup>13</sup> i R<sup>14</sup> su nezavisno izabrani iz vodonika i C1-3alkila ili R<sup>13</sup> i R<sup>14</sup> mogu zajedno sa atomom ugljena na kojeg su vezani da formiraju C3-7cikloalkilni prsten; i S je O, 1 ili 2; ili njegova farmaceutski prihvatljiva so ili njegov ester koji može da se hidrolizira in vivo pod uslovom da pomenuto jedinjenje nije: {(SS)-1-[5-adamantan-1-ilkarbamoil]piridin-2-il]piperidin-3-il} sirćetna kiselina; ili {(3S)-1-[5-(cikloheksilkarbamoil)-6-(piperazin-1-il)piridin-2-il]piperidin-3-il} sirćetna kiselina; ili njegova farmaceutski prihvatljiva so ili njegov ester koji može da se hidrolizira in vivo.

Patent sadrži još 15 patentnih zahtjeva.

(51) **C07D401/04**  
**C07D451/14**  
**C07D471/04**  
**C07D471/08**  
**A61K31/498**  
**A61P25/04**

(11) **01191**  
(21) **P-2010-198**

(30) 20070880955P 16.01.2007 US  
20070930035P 11.05.2007 US

(86) PCT/us2008/051096 15.01.2008.

(87) WO2008089201 24.07.2008

(96) 08727696.0 15.01.2008

(97) EP2076506 22.09.2010. 2010/38 EN

(54) (ME) **HETEROCIKLIČNO SUPSTITUISANI PIPERIDINI KAO ORL-1 LIGANDI**  
(EN) HETEROCYCLIC-SUBSTITUTED PIPERIDINES AS ORL-1 LIGANDS

(73) Purdue Pharma L.P. 1 Stamford Forum, 8th Floor Stamford, CT 06901-3431 / US

Shionogi & Co., Ltd. 1-8, Doshomachi 3-chome Chuo-ku Osaka-shi, Osaka 5410045 / JP

(72) BABA, Yoshiyasu 12-4 Sagisu 5-chome Fukushima-ku Osaka-shi Osaka 553002 / JP

BROWN, Kevin C. 1715 Teesdale Street Philadelphia, PA 19111 / US

GOEHRING, R. Richard 6195 Potters Lane Pipersville, PA 18947 / US

TSUNO, Naoki 12-4 Sagisu 5-chome Fukushima-ku Osaka-shi Osaka 553002 / JP

(74) Lutovac Branimir, Bulevar Ivana Crnojevića 93, Podgorica (ME)

(57) Jedinjenje formule (I)

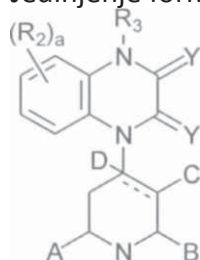

(I) ili njegov farmaceutski derivat gde: svaki  $R_2$  nezavisno je izabran od: -halo, -CN, -NO<sub>2</sub>, -OT<sub>3</sub>, -C(O)T<sub>3</sub>, -C(O)OT<sub>3</sub>, -C(O)N(T<sub>1</sub>)(T<sub>2</sub>), -S(O)<sub>3</sub>H, -S(O)T<sub>3</sub>, -S(O)<sub>2</sub>T<sub>3</sub>, -S(O)<sub>2</sub>N(T<sub>1</sub>)(T<sub>2</sub>), -N(T<sub>1</sub>)(T<sub>2</sub>), -N(T<sub>3</sub>)C(O)T<sub>3</sub>, -N(T<sub>3</sub>)C(O)N(T<sub>1</sub>)(T<sub>2</sub>), -N(T<sub>3</sub>)S(O)<sub>2</sub>T<sub>3</sub> ili -N(T<sub>3</sub>)S(O)<sub>2</sub>N(T<sub>1</sub>)(T<sub>2</sub>); ili -(C<sub>1</sub>-C<sub>6</sub>)alkil, -(C<sub>2</sub>-C<sub>6</sub>)alkenil, -(C<sub>2</sub>-C<sub>6</sub>)alkinil, -(C<sub>1</sub>-C<sub>6</sub>)cikloalkil, -(C<sub>3</sub>-C<sub>7</sub>)cikloalkil, -(C<sub>6</sub>-C<sub>14</sub>)bicikloalkil, -(C<sub>8</sub>-C<sub>20</sub>)tricikloalkil, -(C<sub>5</sub>-C<sub>10</sub>)cikloalkenil, -(C<sub>7</sub>-C<sub>14</sub>)bicikloalkenil, -(C<sub>5</sub>-C<sub>20</sub>)tricikloalkenil, -(5- ili 6-člani)heterocikl, ili -(7 do 10-člani)bicikloheterocikl, od kojih je svaki nesusptituisan ili supstituisan sa 1, 2 ili 3 nezavisno izabrane  $R_8$  grupe; ili -fenil, -naftalenil, -(C<sub>14</sub>)aril ili -(5 ili 6-člani)heteroaril, od kojih je svaki nesusptituisan ili supstituisan sa 1, 2 ili 3 nezavisno izabrane  $R_7$  grupe; a je ceo broj izabran od 0, 1 ili 2;  $R_3$  je izabran od: (a)-H; ili -(C<sub>1</sub>-C<sub>6</sub>)alkil, -(C<sub>2</sub>-C<sub>6</sub>)alkenil, -(C<sub>2</sub>-C<sub>6</sub>)alkinil, -O(C<sub>1</sub>-C<sub>6</sub>)alkil, -O(C<sub>2</sub>-C<sub>6</sub>)alkenil, -O(C<sub>2</sub>-C<sub>6</sub>)alkinil, -(C<sub>3</sub>-C<sub>7</sub>)cikloalkil, -(C<sub>3</sub>-C<sub>7</sub>)cikloalkenil, -(C<sub>3</sub>-C<sub>7</sub>)cikloalkoksi, -(C<sub>6</sub>-C<sub>14</sub>)bicikloalkil, -(C<sub>8</sub>-C<sub>20</sub>)tricikloalkil, -(C<sub>5</sub>-C<sub>10</sub>)cikloalkenil, -(C<sub>7</sub>-C<sub>14</sub>)bicikloalkenil, -(C<sub>8</sub>-C<sub>20</sub>)tricikloalkenil, -(3- ili 7-člani)heterocikl, ili -(7 do 10-člani)bicikloheterocikl, od kojih je svaki nesusptituisan ili supstituisan sa 1, 2 ili 3 nezavisno izabrane  $R_8$  grupe; ili -fenil, -naftalenil, -(C<sub>14</sub>)aril, ili -(5 do 10-clani)heteroaril, od koji je svaki supstituisan ili nesusptituiran sa 1, 2 ili 3 nezavisno izabrane  $R_7$  grupe; ili -(C<sub>1</sub>-C<sub>6</sub>)alkil(=O)W<sub>1</sub>, -(C<sub>1</sub>-C<sub>5</sub>)alkil(=NH)W<sub>1</sub>, -C(O)OV<sub>1</sub>, -C(O)N(V<sub>1</sub>)<sub>2</sub>, -S(O)<sub>2</sub>N(V<sub>1</sub>)<sub>2</sub> ili -S(O)<sub>2</sub>(C<sub>1</sub>-C<sub>6</sub>)alkil; ili -(C<sub>1</sub>-C<sub>4</sub>)alkil supstituisani sa 1, 2 ili 3 supstituenta nezavisno izabrana od -(C<sub>3</sub>-C<sub>7</sub>)cikloalkil, -(C<sub>3</sub>-C<sub>7</sub>)cikloalkenil, -(C<sub>3</sub>-C<sub>7</sub>)cikloalkoksi, -(C<sub>6</sub>-C<sub>14</sub>)bicikloalkil, -(C<sub>8</sub>-C<sub>20</sub>)tricikloalkil, -(C<sub>5</sub>-C<sub>10</sub>)cikloalkenil, -(C<sub>7</sub>-C<sub>14</sub>)bicikloalkenil, -(C<sub>8</sub>-C<sub>20</sub>)tricikloalkenil, -(3- do 7-člani)heterocikl, ili -(7 do 10-člani)bicikloheterocikl, -fenil, -nafta-

lenil,  $-(C_{1_4})$  aril ili  $-(5 \text{ do } 10\text{-člani})$  heteroaril; ili  $(f)$ - $(C_i-C_3)$  alkil supstituiran sa supstuentom izabranim od  $-N(R_6)_2$ ,  $-S(O)_2N(V1)_2$ ,  $-N(R_9)C(O)W1$ ,  $-N(R_9)S(O)_2W1$  i  $-C(O)N(V1)_2$ ; svaki W1 je nezavisno izabran od : (a)  $-H$ ,  $-(C_1-C_6)$  alkil,  $-(C_3-C_7)$  cikloalkil,  $-O(C_1-C_6)$  alkil,  $-(C_3-C_7)$  cikloalkoksi,  $-CH_2CH_2OH$ ,  $-N(R_6)_2$ ; ili (b)  $-(5 \text{ ili } 6\text{-člani})$  heteroaril opciono supstituisan sa 1, 2 ili 3 nezavisno izabrane  $-(C_1-C_6)$  alkil; svaki V1 je nezavisno izabran od  $-H$ ,  $-(C_1-C_6)$  alkil,  $-(C_3-C_7)$  cikloalkil,  $-$ fenil ili benzil; svaki Y je nezavisno izabran od O ili S; A i B su nezavisno izabrani od :  $-H$ ,  $-CN$ ,  $-C(O)OT_3$ ,  $-C(O)N(T_1)(T_2)$ ,  $-(C_3-C_{12})$  cikloalkil,  $-(C_3-C_{12})$  cikloalkoksi,  $-(C_1-C_6)$  alkil,  $-(C_2-C_6)$  alkenil,  $-(C_2-C_6)$  alkinil ili  $-(C_2-C_6)$  alkoksi, od kojih je svaki  $-(C_3-C_{12})$  cikloalkil,  $-(C_3-C_{12})$  cikloalkoksi,  $-(C_1-C_6)$  alkil,  $-(C_2-C_6)$  alkenil ili  $-(C_2-C_6)$  alkinil nesupstituisan ili supstituisan sa 1 ili 2 supstituenta nezavisno izabrana od  $-OH$ ,  $-S(O)_2NH_2$ ,  $-N(R_6)_2$ ,  $=NR_6$ ,  $-C(O)OT_3$ ,  $-C(O)N(R_6)_2$ ,  $-N(R_6)C(O)R_9$  (5- ili 6-člani) heterocikl ili 1,2 ili 3 nezavisno izabranih -halo; ili A-B zajedno obrazuju  $(C_2-C_6)$  most, koji je nesupstituisan ili supstituisan sa 1, 2 ili 3 nezavisno izabrane R8, a most opciono sadrži  $-HC=CH-$  u  $(C_2-C_6)$  mostu; gde piperazinski prsten koji je spojen sa fenil grupom može biti u endo- ili egzo-konformaciji u odnosu na A-B-most; ili (c) A-B zajedno obrazuju  $-CH_2-N(R_c)-CH_2-$  most,

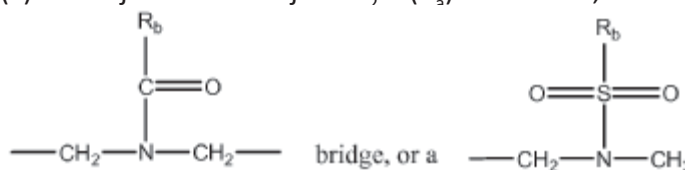

; gde piperazinski prsten koji je spojen sa fenil grupom može biti u endo- ili egzo-konformaciji u odnosu na A-B prsten;  $R_a$  je izabran od  $-H$ ,  $-(C_1-C_6)$  alkil,  $-(C_3-C_7)$  cikloalkil,  $-CH_2-C(O)-R_c$ ,  $-(CH_2)-C(O)-OR_c$ ,  $-(CH_2)-C(O)-N(R_c)_2$ ,  $-(CH_2)_2-O-R_c$ ,  $-(CH_2)_2-S(O)_2-N(R_c)_2$ ,  $F_c$  ili  $-(CH_2)_2-N(R_c)S(O)_2-R_c$ ;  $R_b$  je izabran od:  $-H$ ,  $-(C_1-C_6)$  alkil,  $-(C_3-C_7)$  cikloalkil,  $-(3 \text{ do } 7\text{-člani})$  heterocikl,  $-N(R_c)_2$ ,  $-N(R_c)-(C_3-C_7)$  cikloalkil ili  $-N(R_c)-(3 \text{ do } 7\text{-člani})$  heterocikl; ili  $-$ fenil,  $-$ naftalenil ili  $(5 \text{ ili } 6\text{-člani})$  heteroaril, od kojih je svaki nesupstituisan ili supstituisan sa 1, 2 ili 3 nezavisno izabrane  $R_7$  grupe; ili  $-N(R_c)$ -fenil,  $-N(R_c)$ -naftalenil,  $-N(R_c)-(C_{14})$  aril ili  $-N(R_c)-(5 \text{ do } 10 \text{ člani})$  heteroaril, od kojih je svaki nesupstituisan ili supstituisan sa 1, 2 ili 3 nezavisno izabrane  $R_7$  grupe; svaki  $R_c$  je nezavisno izabran od  $-H$  ili  $-(C_1-C_4)$  alkil; C je izabran od  $-H$ , halo,  $-CN$ ,  $-OT_3$ ,  $-C(O)OT_3$ ,  $-C(O)N(T_1)(T_2)$ ,  $-(C_3-C_{12})$  cikloalkil,  $-(C_3-C_{12})$  cikloalkoksi,  $-N(R_6)_2$ ,  $-N(R_6)C(O)R_9$ ,  $-NR_6SO_2N(R_6)_2$ ,  $-NR_6-C(=NR_6)N(R_6)_2$ ,  $-(C_1-C_6)$  alkil,  $-(C_2-C_6)$  alkenil ili  $-(C_2-C_6)$  alkinil od kojih je svaki  $-(C_1-C_6)$  alkil,  $-(C_2-C_6)$  alkenil ili  $-(C_2-C_6)$  alkinil nesupstituisan ili supstituisan sa 1 ili 2 supstituenta nezavisno izabrana od  $-OH$ ,  $-S(O)_2NH_2$ ,  $-N(R_6)_2$ ,  $=NR_6$ ,  $-C(O)OT_3$ ,  $-C(O)N(R_6)_2$ ,  $-N(R_6)C(O)R_9$  i  $(5 \text{ ili } 6\text{-člani})$  heterocikl ili 1 do 3 nezavisno izabranih -halo; ili isprekidana linija u piperidinskom ili premošćenom piperidinskom centralnom prstenu označava prisustvo ili odsustvo veze i kada isprekidana linija prikazuje prisustvo veze tadaje D odustan, u drugačijem slučaju D je: (a)  $-H$ ,  $-CN$ ,  $-C(O)OT_3$  ili  $-C(O)N(T_1)(T_2)$ ; ili  $-(C_1-C_{10})$  alkil koji je nesupstituisan ili supstituisan sa 1, 2 ili 3 nezavisno izabrane R8 grupe i opciono u kojima bilo koji C atom D grupe osim ugljenikovog atoma koji je vezan direktno za piperidin ili premošćeni piperidinski centralni atom je nezavisno zamenjen sa O ili S; ili  $-$ fenil,  $-$ naftalenil ili  $-(5 \text{ ili } 6\text{-člani})$  heteroaril, od kojih je svaki nesupstituisan ili supstituisan sa 1, 2 ili 3 nezavisno izabrane R7 grupe; Z je veza;  $R_i$  je izabran od:

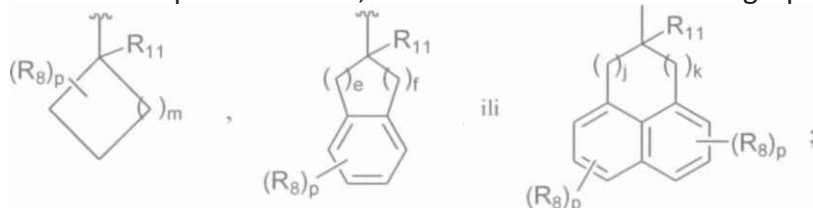

(i) (ii) (iii) m je celi broj izabran od 0, 1, 2, 3, 4, 5, 6 ili 7; svaki od e i f je celi broj, gde je e izabran od 1, 2, 3, 4 ili 5 i f je nezavisno izabran od 0, 1, 2, 3, 4 ili 5 uz uslov da  $2 \leq (e+f) \leq 5$ ; j i k su svaki ceo broj nezavisno izabran od 0, 1, 2, 3 ili 4 uz uslov da  $1 \leq (j+k) \leq 4$ ; svaki  $T_1$ ,  $T_2$  i



T<sub>3</sub> je nezavisno -H ili -(C|C|<sub>0</sub>)alkil koji je nesupstituisan ili supstituisan sa 1, 2 ili 3 nezavisno izabrane R<sub>8</sub> grupe i opciono u kojima bilo koji ugljenikov atom je nezavisno zamenjen sa O ili S, ili Ti i T<sub>2</sub> zajedno mogu obrazovati 5- do 8-člani prsten gde broj atoma u prstenu obuhvata azotov atom za koji su Ti i T<sub>2</sub> vezani, pomenuti 5- do 8-člani prsten je nesupstituisan ili supstituisan sa 1, 2 ili 3 nezavisno izabrane R<sub>8</sub> grupe i opciono bilo koji ugljenikov atom u pomenutom 5- do 8-članom prstenu je nezavisno zamenjen sa O ili S; svaki R<sub>6</sub> je nezavisno izabran od -H, -(C1-C<sub>6</sub>)alkil ili -(C3-C7) cikloalkil ili dve R<sub>6</sub> grupe vezane za isti ugljenikov atom mogu obrazovati 5- do 8-člani prsten, broj ugljenikovaih atoma u prstenu uključujući azotov atom, u kome je jedan od ugljenikovih atoma zamenjen opciono zamenjen sa O ili S; svaki R<sub>7</sub> je nezavisno izabran od -(C1-C<sub>6</sub>)alkil, ili -(C<sub>2</sub>-C<sub>6</sub>)alkenil, -(C<sub>2</sub>-C<sub>6</sub>)alkinil, -OR<sub>9</sub>, -SR<sub>9</sub>, -C(halo)<sub>3</sub>, -CH(halo)<sub>2</sub>, -CH<sub>2</sub>(halo), -CN, halo, -N<sub>3</sub>, -NO<sub>2</sub>, -CH=NR<sub>9</sub>, -NR<sub>9</sub>OH, -C(O)OR<sub>9</sub>, -OC(O)R<sub>9</sub>, -OC(O)OR<sub>9</sub>, -S(O)R<sub>9</sub> ili -S(O)<sub>2</sub>R<sub>9</sub>; svaki R<sub>8</sub> je nezavisno izabran od -(C1-C4)alkil, -(C<sub>2</sub>-C<sub>6</sub>)alkenil, -(C<sub>2</sub>-C<sub>6</sub>)alkinil, -OR<sub>9</sub>, -SR<sub>9</sub>, -C(halo)<sub>3</sub>, -CH(halo)<sub>2</sub>, -CH<sub>2</sub>(halo), -CN, okso, =S, -fenil, -halo, -N<sub>3</sub>, -NO<sub>2</sub>, -CH=NR<sub>9</sub>, -NR<sub>9</sub>OH, -C(O)OR<sub>9</sub>, -OC(O)R<sub>9</sub>, -OC(O)OR<sub>9</sub>, -S(O)R<sub>9</sub> ili -S(O)<sub>2</sub>R<sub>9</sub>; svaki R<sub>9</sub> je nezavisno izabran od -H, -(C1-C6)alkil, -(C<sub>2</sub>-C<sub>6</sub>)alkenil, -(C<sub>2</sub>-C<sub>6</sub>)alkinil, -(C<sub>3</sub>-C<sub>8</sub>)cikloalkil, -(C<sub>5</sub>-C<sub>8</sub>)cikloalkenil, -fenil, -benzil, -(3-do 7-člani)heterocikl, -C(halo)<sub>3</sub>, -CH(halo)<sub>2</sub> ili -CH<sub>2</sub>(halo); svaki p je celi broj nezavisno izabran od 0 ili 1; R<sub>11</sub> je izabran od -H, -C(O)OR<sub>9</sub>, -C(O)N(R<sub>6</sub>)<sub>2</sub> ili (C1-C4)alkil koji je nesupstituisan ili supstituisan sa -OH, -(C1-C<sub>4</sub>)alkoksi, -N(R<sub>6</sub>)<sub>2</sub>, -C(O)OR<sub>6</sub> ili C(O)N(R<sub>6</sub>)<sub>2</sub>; i svaki halo je izabran od -F, -Cl, -Br ili -I i gde je farmaceutsko prihvatljiv derivat izabran iz grupe: farmaceutski prihvatljive soli, solvata, radio aktivno-obeležjenog jedinjenja, sereoizomera, enantiomera, diasteroizomera i drugog stereoizomernog oblika, racemske smeše, geometrijskog izomera i/ili tautomera.

Patent sadrži još 27 patentnih zahtjeva.

- (51) **A61M5/24** (11) **01093**
- A61M5/145** (21) **P-2010-28**
- (30) 20050003110 14.02.2005 EP
- (86) PCT/IB2006/000262 23.01.2006
- (87) WO2006085204 17.08.2006
- (96) 06710353.1 23.01.2006
- (97) EP184879 31.10.2007 2007/44 EN
- (54) **(ME) UREĐAJ ZA ISPORUKU LIJEKA**  
**(EN) MEDICATION DELIVERY DEVICE**
- (73) ARES TRADING S.A.; Zone Industrielle de l’Ouriettas 1170 Aubonne / CH
- (72) CHAVEZ, Enrico69, rue Louis de Savoie CH-1110 Morges / CH  
PIOTELAT, Sandrine Chez FavreF-74130 Faucigny / FR  
PONGPAIROCHANA, Vincent Route de Belmont 47 CH-1093 LA CONVERSION / CH
- (74) Anđelić Branko, Svetozara Markovića 12, Podgorica (ME)
- (57) Uređaj za isporuku leka sredstvima (2) za primanje zamenjivog kontejnera za lek (5), kontrolne jedinice (4) i sredstvima isporuke (3; 6, 7), kontrolisanih navedenom kontrolnom jedinicom (4), za isporuku pacijentu bar jedne doze leka koji se sadrži u navedenom kontejneru za lek (5), naznačen time, što navedena kontrolna jedinica (4) sadrži sredstva za određivanje podešene doze leka AD za svaki medicinski kontejner (5) koji je primljen u uređaj za isporuku leka ukoliko primljena količina leka koji se sadrži u navedenom kontejneru za lek (5) nije višestruka od prepisane doze D, pri čemu je pomenuta podešena doza leka doza koja se ima isporučiti navedenim sredstvima isporuke (3; 6, 7) umesto primljene prepisane doze tokom svake upotrebe uredaja za isporuku leka sa navedenim kontejnerom za lek (5), pri čemu je navedena podešena doza utvrđena odabirom jedne od prvih doza, koja je visa od prepisane doze, i druge doze, koja je niža od prepisane doze, kao funkcija promenljive B koja kumulirše vrednosti nAD . (AD - D), pri čemu je nAD jednaka sa INT (Cont/AD) i Cont je količina primljenog leka u navedenom kontejneru za lek.

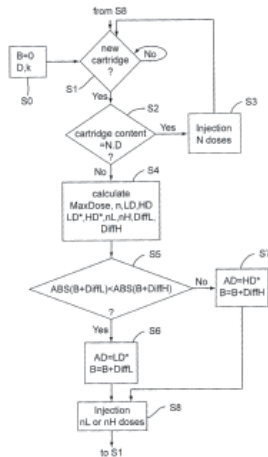

Patent sadrži još 14 patentnih zahtjeva.

(51) **A61K31/00**  
**A61K31/56**  
**A61K31/57**  
**A61P15/18**

(11) **01183**  
(21) **P-2010-149**

(30) DE200410019743 20.04.2004 DE

(86) PCT/ep2005/004022 15.04.2005.

(87) WO2005102247 03.11.2005

(96) 05730867.8 15.04.2005

(97) EP1740163 14.07.2010. 2010/28 EN

(54) (ME) **VIŠEFAZNI PREPARAT ZA KONTRACENCIJU NA BAZI PRIRODNOG ESTROGENA**

(EN) MULTI-PHASE CONTRACEPTIVE PREPARATION BASED ON A NATURAL ESTROGEN

(73) Bayer Schering Pharma Aktiengesellschaft; Müllerstrasse 178, 13353 Berlin, DE

(72) ENDRIKAT, Jan 2 Chianti, Kirkland Quebec H9H 5B5 / CA

DÜSTERBERG, Bernd Zu den Eichen 18 16727 Oberkrämer / DE

(74) Radulović Božidar, Jovana Tomaševića 9/III, Podgorica (ME)

(57) Višefazni preparat za kontracepciju na bazi prirodnog estrogena sa sintetičkim gestagenom naznačen time, da se prva faza sastoji od dve jedinice u okviru dnevne doze prirodnog estrogena estradiol valerata od 3 mg. druga faza se sastoji od dve grupe jedinica u okviru dnevne doze, pri čemu se prva grupa sastoji od 5 jedinica u okviru dnevne doze u kombinaciji 2 mg estradiol valerata i najmanje dvostruke ili trostruke doze sintetičkog gestagena za sprečavanje ovulacije. a druga grupa od 17 jedinica u okviru dnevne doze u kombinaciji 2 mg estradiol valerata i najmanje trostruke ili četverostruke doze sintetičkog gestagena za sprečavanje ovulacije, treća faza sastoji se od 2 jedinice u okviru dnevne doze od 1 mg estradiol valerata, i još jedna faza sastoji se od 2 jedinice u okviru dnevne doze farmaceutski bezopasnog placeba.

Patent sadrži još 3 patentnih zahtjeva.

- (51) **C07D401/04**  
**A61K31/473**  
**A61P11/08**
- (30) 0101619 02.03.2005 EP  
0108442 14.09.2005 EP
- (86) PCT/ep06/060377 01.03.2006.  
(87) WO2006092422 08.09.2006  
(96) 06708593.6 01.03.2006  
(97) EP1856093 02.12.2009. 2009/49 EN
- (54) (ME) **(2R,4AR,10BR)-6-(2,6-DIMETOKSIPIRIDIN-3-IL)-9-ETOKSI-8-METOKSI-2,3,4,4A, 10B-HEKSAHIDROFENANTRIDIN-2-OL HIDROHLORID**  
(EN) **(2R,4AR,10BR)-6-(2,6-DIMETHOXYPIRIDIN-3-YL)-9-ETHOXY-8-METHOXY-1,2,3,4,4A, 10B-HEXAHYDROPHENANTHRIDIN-2-OL, HCL SALT**
- (73) Nycomed GmbH Byk-Gulden-Strasse 2, 78467 Konstanz / DE  
(72) KAUTZ, Ulrich Prof.-Schmider-Str. 12 78476 Allensbach / DE  
WEBEL, Matthias Zum Lerchental 43/1 78315 Radolfzell / DE  
SCHEUFLER, Christian Lindenstr. 28 78234 Engen-Neuhausen / DE  
HUMMEL, Rolf-Peter Altbohlstr. 32 78315 Radolfzell / DE
- (74) Radulović Božidar, Jovana Tomaševića 9/III, Podgorica (ME)
- (57) (2R,4aR,10bR)-6-(2,6-dimetoksi-piridin-3-il)-9-etoksi-8-metoksi-2,3,4,4a, 10b-heksahidrofenantridin-2-ol hidrohlorid  
Patent sadrži još 8 patentnih zahtjeva.

- (51) **C07D211/38**  
**C07D265/30**  
**C07D295/192**  
**A61K31/496**  
**A61P25/00**
- (11) **01181**  
(21) **P-2010-94**
- (30) US20050717659P 16.09.2005 US  
(86) PCT/US2006/035877 14.09.2006.  
(87) WO2007035425 29.03.2007  
(96) 06824964.8 14.09.2006  
(97) EP1948607 07.04.2010. 2010/14 EN
- (54) (ME) **CIKLOPROPIL AMINI KAO MODULATORI HISTAMINSKOG H3 RECEPTORA**  
(EN) **CYCLOPROPYL AMINES AS MODULATORS OF THE HISTAMINE H3 RECEPTOR**
- (73) Janssen Pharmaceutica N.V. ; Turnhoutseweg 30 2340 Beerse / BE  
(72) ALLISON, Brett, D. 2741 Caminito Cedros Del Mar, California 92014 / US  
CARRUTHERS, Nicholas I. 14370 Silver Heights Road Poway, California 92064 / US  
GRICE, Cheryl A. 3449 Camino Corte Carlsbad, California 92009 / US  
LETAVIC, Michael A. 4379 Mistral Place San Diego, California 92130 / US
- (74) Lutovac Branimir, Bulevar Ivana Crnojevića 93, Podgorica (ME)
- (57) Jedinjenje koje je izabrano iz grupe koju čine: (4-ciklopropil-piperazin-1-il)-(4-morfolin-4-ilmetil-fenil)-metanon, (4-ciklopropil-piperazin-1 -il)-[4-(4-fluoro-piperidin-l-ilmetil)-fenil]-metanon, (4-ciklopropil-piperazin-1-il)-(4-tiomorfolin-4-ilmetil-fenil)metanon i (4-ciklopropil-piperazin-l-il)-[4-(2-hidroksimetil-morfolin-4-ilmetil)-fenil]-metanon i njihovi enantiomeri, hidrati. solvati i farmaceutski prihvatljive soli.  
Patent sadrži još 27 patentnih zahtjeva.

(51) **C07D489/02**(11) **01171****C07F7/08**(21) **P-2010-31**

(30) 0542711P 06.02.2004 US

(96) 07014411.8 04.02.2005

(97) EP1864987 09.12.2009. 2009/50 EN

(54) (ME) **POPSTUPCI PRAVLJENJA 3-O ZAŠTITNIH MORFINONA I 3-O ZAŠTIĆENIH MORFINON DENOL KARBOKSILATA**(EN) **METHODS FOR MAKING 3-O PROTECTED MORPHINONES AND 3-O-PROTECTED MORPHINONE DIENOL CARBOXYLATES**

(73) EURO-CELTIQUE S.A.; 2, avenue Charles de Gaulle 1653 Luxembourg / LU

(72) Stumpf, Andreas 5504 Aspen Street Dublin CA 94568-7678 / US

(74) Lutovac Branimir, Bulevar Ivana Crnojevića 93, Podgorica (ME)

(57) Postupak za dobijanje jedinjenja formule (III):

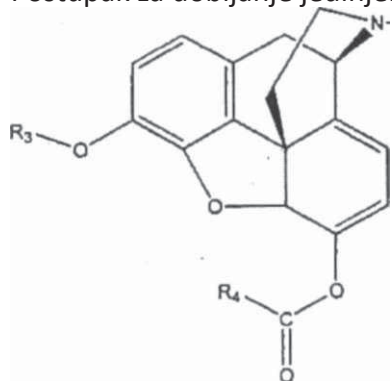

(III)

koji se sastoji od:

(a) reagovanja jedinjenja formule (I):

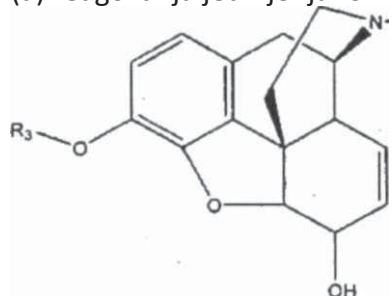
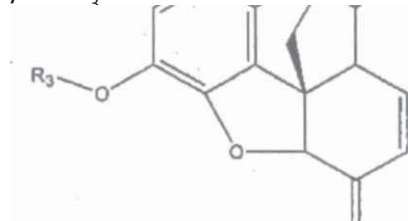
pod pogodnim uslovima, u prisustvu smeše jedinjenja formule R<sub>1</sub>SR<sub>2</sub> i trihloroizocijanurinske kiseline, tako da se dobije jedinjenje formule (II):/ -CH<sub>2</sub>

O (II) I

b) reagovanja jedinjenja formule (II) pod povoljnim uslovima sa prvom bazom i agensom za acilovanje, formule R<sub>4</sub>(C(O)OC(O)R<sub>4</sub> ili R<sub>4</sub>C(O)X, tako da se dobije jedinjenje formule (III), u kome su: R<sub>1</sub> i R<sub>2</sub> svaki nezavisno, -(C<sub>1</sub>C<sub>2</sub>)alkil, -(C<sub>3</sub>-C<sub>8</sub>)cikloalkil ili -fenil; R<sub>3</sub> je neka zaštitna grupa; R<sub>4</sub> je-(C<sub>1</sub>-C<sub>10</sub>)alkil; i X je-Cl, Br ili-I.

Patent sadrži još 22 patentnih zahtjeva.



- (51) **C07D309/10** (11) **01173**  
**A61K31/351** (21) **P-2010-27**
- (30) 20050009669 03.05.2005 EP  
 20050018012 19.08.2005 EP
- (86) PCT/EP06/061956 02.05.2006.  
 (87) WO2006117359 09.11.2006  
 (96) 06763074.9 02.05.2006  
 (97) EP1888552 23.12.2009. 2009/52 EN
- (54) (ME) **KRISTALNI OBLIK 1-HLORO-4-(B-D-GLUKOPIRANOZ-1-IL)-2-[4-((S)-TETRAHIDROFURAN-3-ILOKSI)-BENZIL]-BENZOLA, POSTUPAK ZA NJEGOVO DOBIJANJE I NJEGOVA PRIMJENA ZA DOBIJANJE LJEKOVA**  
 (EN) CRYSTALLINE FORM OF 1-CHLORO-4-(B-D-GLUCOPYRANOS-1-YL)-2-[4-((S)-TETRAHYDROFURAN-3-YLOXY)-BENZYL]-BENZENE, A METHOD FOR ITS PREPARATION AND THE USE THEREOF FOR PREPARING MEDICAMENTS
- (73) Boehringer Ingelheim International GmbH; Binger Strasse 173, 55216 Ingelheim am Rhein / DE
- (72) 01 / ECKHARDT, Matthias Kirschenweg 7 88400 Biberach / DE  
 02 / HIMMELSBACH, Frank Ahornweg 16 88441 Mittelbiberach / DE  
 03 / SICK, Sandra Erlenweg 3 88454 Hochdorf / DE  
 04 / SCHUEHLE, Martin Sebastian Sailer Strasse 38 88447 Oberhöfen / DE  
 05 / MARTIN, Hans-Jürgen Boehringer Ingelheim GmbH CD Patents Binger Strasse 173 55216 Ingelheim am Rhein / DE
- (74) Radulović Božidar, Jovana Tomaševića 9/III, Podgorica (ME)
- (57) Kristalni oblik 1-hloro-4-((3-D-glukopiranoz-1-il)-2-[4-((S)-tetrahidrofuran-3-iloksi)-benzil]-benzola koji ima difraktogram dobijen dejstvom rendgenskih zraka na praškasti uzorak koji ima vrhove na 18.84, 20.36 i 25.21 stepeni 20 ( $\pm 0.05$  stepeni 20), pri čemu je pomenuti difraktogram dobijen primenom CuK $\alpha$ 1 zračenja.  
 Patent sadrži još 10 patentnih zahtjeva.



(51) **A61K31/352****A61K31/353****A61K31/357****A61P29/00**

(30) 751686 P 19.12.2005 US

773812 P 15.02.2006 US

612071 18.12.2006 US

(86) PCT/US2006/048539 19.12.2006.

(87) WO2007075752 05.07.2007

(96) 06847800.7 19.12.2006

(97) EP1973540 11.11.2009. 2009/46 EN

(54) (ME) **UPOTREBA DERIVATA SULFONAMIDA SA BENZO-FUZIONISANIM HETEROCIKLOM ZA TRETMAN BOLA**(EN) **USE OF BENZO-FUSED HETEROCYCLE SULFAMIDE DERIVATIVES FOR THE TREATMENT OF PAIN**

(73) Janssen Pharmaceutica N.V. ; Turnhoutseweg 30, 2340 Beerse / BE

(72) 01 / SMITH-SWINTOSKY, Virginia L. 3163 Line Lexington Road Hatfield, PA 19440 / US

02 / REITZ, Allen B. 109 Greenbriar Road Lansdale, PA 19446 / US

(74) Lutovac Branimir, Bulevar Ivana Crnojevića 93, Podgorica (ME)

(57) Jedinjenje formule (I)

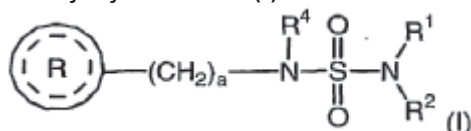

ili neka njegova farmaceutski prihvatljiva so za upotrebu u tretmanu bola, gde  $\text{R}^1$  i  $\text{R}^2$  svaki nezavisno, se bira iz grupe koju cine vodonik i niži alkil;  $\text{R}^4$  se bira iz grupe koju cine vodonik i niži alkil; a je ceo broj od 1 do 2;

se bira iz grupe koju cine:

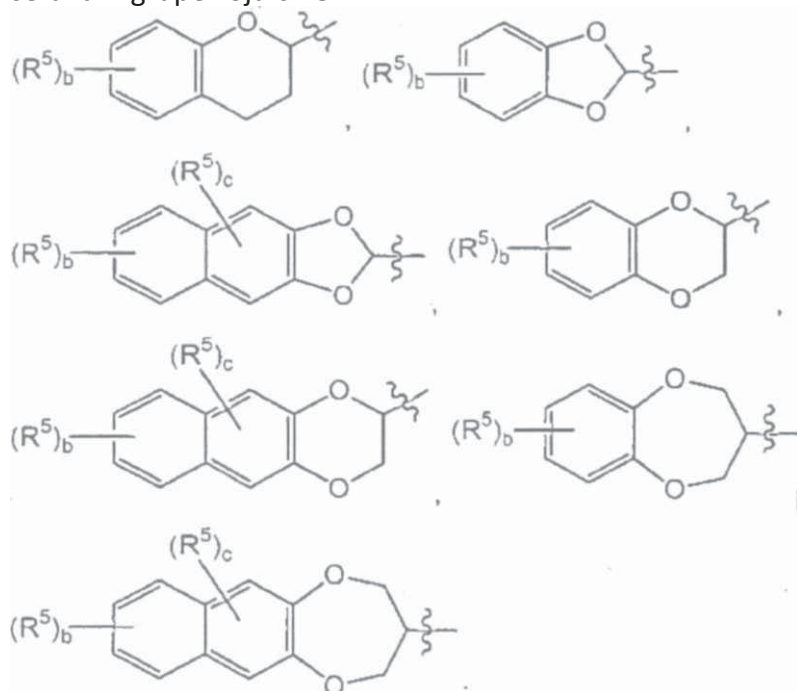

gde b predstavlja ceo broj od 0 do 4; i gde c predstavlja ceo broj od 0 do 2;  $R^5$ svaki nezavisno, se bira iz grupe koju cine halogen, niži alkil i nitro; sl.1 pod uslovom da kada predstavlja

ili

sl.2

, da je tada a jednakol, a pri tome, termin niži alkil, se odnosi na kompoziciju ugljeničnog lanca sa 1-4 atoma ugljenika.

Sl.1

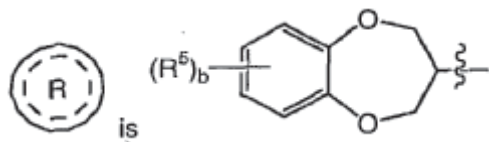

Sl.2

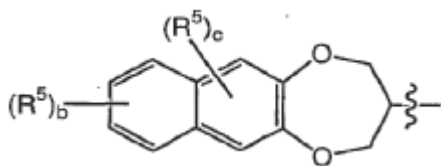

Patent sadži još 10 patentnih zahtjeva.

- (51) **A61K39/395** (11) **01178**  
(21) **P-2010-21**
- (30) US20030517337P 04.11.2003 US  
US20030525579P 26.11.2003 US  
US20040565710P 27.04.2004 US
- (86) PCT/us2004/037152 04.11.2004.  
(87) Wo2005/044854 19.05.2005.  
(96) 04810510.0 04.11.2004  
(97) EP1682180 04.11.2009. 2009/45 EP
- (54) (ME) **ANTAGONIST ANTI-CD40 MONOKLONALNA ANTITIJELA I METODE ZA NJIHOVU UPOTREBU**  
(EN) ANTAGONIST ANTI-CD40 MONOCLONAL ANTIBODIES AND METHODS FOR THEIR USE
- (73) Novartis Vaccines and Diagnostics, Inc. ; 4560 Horton Street, Emeryville, CA 94608 / US  
(72) 01 / LONG, Li Novartis Vaccines and Diagnostics, P.O. Box 8097 Emeryville, CA 94662-8097 / US  
02 / LUQMAN, Mohammad Novartis Vaccines and Diagnostics, P.O. Box 8097 Emeryville, CA 94662-8097 / US  
03 / YABANNAVAR, Asha Novartis Vaccines and Diagnostics, P.O. Box 8097 Emeryville, CA 94662-8097 / US  
04 / ZAROR, Isabel Novartis Vaccines and Diagnostics, P.O. Box 8097 Emeryville, CA 94662-8097 / US  
05 / CHEN, Bao-Lu Novartis Vaccines and Diagnostics, P.O. Box 8097 Emeryville, CA 94662-8097 / US  
06 / LU, Xiaofeng Novartis Vaccines and Diagnostics, P.O.Box 8097 Emeryville, CA 94662-8097 / US  
07 / LEE, Sang, Hoon Novartis Vaccines and Diagnostics, P.O.Box 8097 Emeryville, CA 94662-8097 / US  
08 / HURST, Deborah Novartis Vaccines and Diagnostics, P.O.Box 8097 Emeryville, CA 94662-8097 / US
- (74) Lutovac Branimir, Bulevar Ivana Crnojevića 93, Podgorica (ME)
- (57) Humano monoklonalno antitelo koje je sposobno da se specifično veže za humani CD40 antigen koji je eksprimiran na površini humanih CD-eksprimirajućih ćelija, pomenuto monoklonalno antitelo je bez značajne agonistočke aktivnosti, pri čemu, pomenuto monoklonalno antitelo se vezuje za CD40 antigen koji je ekprimiran na površini pomenute ćelije, rast ili diferencijacija pomenute ćelije je inhibirana, gde je pomenuto antitelo odabrano iz grupe koja se sastoji od: monoklonalnog antitela koje se vezuje za epitop koji je sposoban da veže monoklonalno antitelo CHIR-5.9 dobijeno iz hibridoma ćelijske linije deponovane u okviru ATCC kao Patent Deposit No. PTA-5542 ili monoklonalno antitelo CHIR-12.12 dobijeno iz hibridoma ćelijske linije deponovane u okviru ATCC kao Patent Deposit No. PTA-5543; monoklonalnog antitela koje se vezuje za epitop koji obuhvata ostatke 82-87 iz humane CD40 sekvence prikazane u SEQ ID NO:10 ili SEQ ID NO:12; monoklonalnog antitela koje se vezuje za epitop koji obuhvata ostatke 82-89 iz humane CD40 sekvence prikazane u SEQ ID NO: 10 ili SEQ ID NO: 12; i monoklonalnog antitela koje kompetira sa monoklonalnim antitelom CHIR-5.9 dobijenog iz hibridoma ćelijske linije deponovane u okviru ATCC kao Patent Deposit\* No. PTA-5543 ili monoklonalnog antitela CHIR-12.12 dobijenog iz hibridoma ćelijske linije deponovane u okviru ATCC kao Patent Deposit No. PTA-5543 u eseju kompetitivnog vezivanja.  
Patent sadrži još 33 patentnih zahtjeva.

(51) **A61K39/39**

(11) **01179**

(21) **P-2010-16**

(30) GB20060022282 08.11.2006 GB

(86) PCT/IB2007/004229 06.11.2007.

(87) WO2008056263 15.05.2008

(96) 07859275.5 06.11.2007

(97) EP2029170 28.10.2009. 2009/44 EN

(54) (ME) **POSTUPCI ZA KONTROLU KVALITETA EMULZIJA ULJA U VODI KOJE SADRŽE SKVALEN**

(EN) QUALITY CONTROL METHODS FOR OIL-IN-WATER EMULSIONS CONTAINING SQUALENE

(73) Novartis AG ; Lichtstrasse 35, 4056 Basel / CH

(72) 01 / KLEIN, Norbert Novartis Behring Emil-von-Behring-Strasse 76 035041 Marburg / DE

(74) Lutovac Branimir, Bulevar Ivana Crnojevića 93, Podgorica (ME)

(57) Postupak za proizvodnju emulzije ulja u vodi kao adjuvanta, koji se sastoji od koraka: (i) pripremanja submikronske emulzije ulja u vodi, korišćenjem poznatih količina nekog vodenog nosača, nekog surfaktanta i skvalena; (ii) podvrgavanja ove emulzije sterilizaciji filtriranjem da se dobije sterilizovana emulzija; (iii) merenja sadržaja skvalena u sterilizovanoj emulziji; i (iv) poređenja izmerenog sadržaja skvalena u koraku (iii) sa poznatim sadržajem skvalena iz koraka (i); gde korak (iv) poređenja otkriva da ako je sadržaj skvalena signifikantno promenjen između koraka (i) i (iii), da se taj adjuvant odbacuje.

Patent sadrži još 30 patentnih zahtjeva.

- (51) **A61K9/22**  
**A61K31/522**  
**A61K31/4468**  
**A61K31/4178**
- (30) EP20060290480 24.03.2006 EP  
(96) 07734862.1 23.03.2007  
(97) EP1998750 28.10.2009. 2009/44 EN
- (54) (ME) **MUKOZNI BIOADHEZIVNI NOSAČ ZA SPORO OSLOBAĐANJE AKTIVNIH SUPSTANCI**  
(EN) MUCOSAL BIOADHESIVE SLOW RELEASE CARRIER FOR DELIVERING ACTIVE PRINCIPLES
- (73) BioAlliance Pharma; 49, boulevard du Général Martial Valin, 75015 Paris / FR  
(72) COSTANTINI, Dominique 284, boulevard Raspail F-75014 Paris / FR  
LEMARCHAND, Caroline 11 Bis rue Maison Dieu F-75014 Paris / FR  
(74) Radulović Božidar, Jovana Tomaševića 9/III, Podgorica (ME)
- (57) Postupak dobijanja mukoznog bioadhezivnog nosača za sporo oslobađanje koji obuhvata: mešanje bar jedne aktivne supstance sa alkilsulfatom alkalnog metala i razblaživačem; vlaženje navedene smese vezivnim sredstvom; sušenje i kalibrisanje navedene smese; granulaciju navedene smese da bi se obrazovale primarne granule; mešanje navedenih primarnih granula sa bar jednim bioadhezivnim polimerom i bar jednim polimerom za odloženo oslobađanje i sa bar jednim kompresionim sredstvom; i kompresiju navedene mešavine dobijene u koraku e).  
Patent sadrži još 18 patentnih zahtjeva.

- (51) **A61M5/24** (11) **01094**  
**A61M5/145** (21) **P-2009-229**
- (30) 05003110 05003110 EP  
06000693 13.01.2006 EP
- (86) PCT/IB2006/000135 27.01.2006.
- (87) WO2006085175 17.08.2006
- (96) 06701065.2 27.01.2006
- (97) EP1885413 18.03.2009 2009/12 EN
- (54) (ME) **UREĐAJ ZA ISPORUKU LIJEKA**  
(EN) MEDICATION DELIVERY DEVICE
- (73) ARES TRADING S.A. ; Zone Industrielle de l'Ouriettaz 1170 Aubonne / CH
- (72) 01 / CHAVEZ, Enrico 69, rue Louis de Savoie CH-1110 Morges / CH  
02 / PIOTELAT, Sandrine Chez Favre F-74130 Faucigny / FR  
03 / PONGPAIROCHANA, Vincent Route de Belmont 47 CH-1093 LA CONVERSION / CH [2008/07]
- (74) Anđelić Branko, Svetozara Markovića 12, Podgorica (ME)
- (57) Uređaj za isporuku leka sredstvima (2) za primanje zamenjivog kontejnera za lek (5), kontrolne jedinice (4) i sredstvima isporuke (3; 6, 7), kontrolisanih navedenom kontrolnom jedinicom (4), za isporuku pacijentu bar jedne doze leka koji se sadrži u navedenom kontejneru za lek (5), naznačen time, što navedena kontrolna jedinica (4) sadrži sredstva za određivanje podešene doze leka AD pre svake isporuke leka koji se sadrži u navedenom kontejneru za lek ukoliko postojeći sadržaj kontejnera za lek nije višestruk od prepisane doze D a veći je od prepisane doze D, pri čemu je podešena doza leka AD doza koja se ima isporučiti navedenim sredstvima isporuke (3; 6, 7) umesto prepisane doze D tokom navedene isporuke leka, pri čemu je podešena doza leka AD utvrđena odabirom jedne od prvih doza, koja je viša od prepisane doze D, i druge doze, koja je niža od prepisane doze D, kao funkcija promenljive B koja kumulira vrednosti AD -D.  
Patent sadrži još 7 patentnih zahtjeva.

- (51) **C07D413/14** (11) **01089**  
**A61K31/4245** (21) **P-2009-323**  
**A61P9/12**
- (30) 20040048928 25.02.2004 JP  
 20050031057 07.01.2005 US
- (96) 07075609.3 23.02.2005
- (97) EP1857457 19.08.2009 2009/34 EN
- (54) (ME) **DERIVAT BENZIMIDAZOLA I NJEGOVA UPOTREBA KAO ANTAGONISTA RECEPTORA AII**  
 (EN) **BENZIMIDAZOLE DERIVATIVE AND ITS USE AS AII RECEPTOR ANTAGONIST**
- (73) Takeda Pharmaceutical Company Limited; 1-1, Doshomachi 4-chome Chuo-ku Osaka-shi, Osaka 541-0045 / JP
- (72) 01 / Kuroita, Takanobu, 10-13-302, Hoshida 4-chome, Katano-shi Osaka 5760016 / JP  
 02 / Sakamoto, Hiroki 11-1-215, Tsukaguchihonmachi 6-chome, Amagasaki-shi Hyogo 6610001 / JP  
 03 / Ojima, Mami 18-12-401, Tsukaguchicho 1-chome, Amagasaki-shi Hyogo 6610002 / JP
- (74) Ćupić Branislav, Dalmatinska 10, Podgorica (ME)
- (57) Lijek koji sadrži jedinjenje predstavljeno formulom (I)

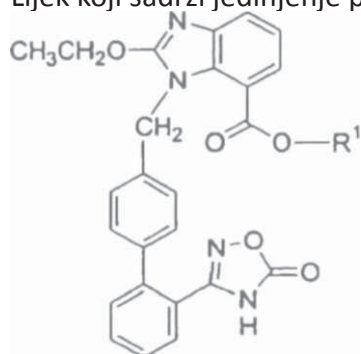

gde R<sup>1</sup> je grupa predstavljena formulom

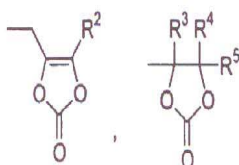

iii

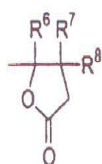

Pri čemu je svaki od R<sup>2</sup>, R<sup>3</sup>, R<sup>4</sup>, R<sup>5</sup>, R<sup>6</sup>, R<sup>7</sup> i R<sup>8</sup> nezavisno atom vodonika ili C<sub>1-6</sub> alkil, ili njegova so, za profilaksu ili liječenje oboljenja u koje je uključena insulinska rezistencija. Patent sadrži još 33 patentnih zahtjeva.

- (51) **C12P13/00** (11) **01107**  
**C12P7/40** (21) **P-2009-320**
- (30) 20040562133P 14.04.2004 US  
(86) PCT/IB2005/000873 01.04.2005  
(87) WO2005100580 27.10.2005  
(96) 05718347.7 01.04.2005  
(97) EP1745136 07.10.2009 2009/41 EN
- (54) (ME) **POSTUPAK ZA DOBIJANJE (S)-3-CIJANO-5-METILHEKSANOINSKE KISELINE POMOĆU ENIZIMA**  
(EN)METHOD FOR ENZYMATIC PREPARATION OF (S)-3-CYANO-5-METHYLHEXANOIC ACID
- (73) Pfizer Products Inc. ; Eastern Point Road, Groton, CT 06340-5146 / US
- (72) 01 / BURNS, Michael Paul Pfizer Global Res. & Dev. Eastern Point Road Groton, CT 06340 / US  
02 / WEAVER, Justin Kaine Pfizer Global Res. & Dev. 301 Henrietta Street Kalamazoo, MI 49001 / US  
03 / WONG, John Wing Pfizer Global Res. & Dev. Eastern Point Road Groton, CT 06340 / US
- (74) Ćupić Branislav, Dalmatinska 10, Podgorica (ME)
- (57) Postupak za dobijanje (S)-3-cijano-5-metilheksanoinske kiseline, naznačen time, što se sastoji od koraka:  
(a) dovođenja u kontakt racemskog 2-izobutil-sukcinonitrila sa nekim enzimskim katalizatorom koji ima aktivnost nitrilaze u medijumu reakcije; i  
(b) izolovanja (S)-3-cijano-5-metilheksanoinske kiseline iz medijuma reakcije; i opciono, izolovanja neizmenjenog (R)-2-izobutil-sukcinonitrila.  
Patent sadrži još 7 patentnih zahtjeva.



- (51) **A61K31/519** (11) **01087**  
**A61P35/00** (21) **P-2008-310**
- (30) 20040521593P 30.05.2004 US  
(86) PCT/US2005/019169 31.05.2005.  
(87) WO2005117891 15.12.2005  
(96) 05756183.9 31.05.2005  
(97) EP1750716 20.08.2008. 2007/07 EN
- (54) (ME) **TRETMAN LIMFOMA T-ĆELIJA PRIMJENOM 10-PROPARGIL-10-DEAZAAMINOPTERINA**  
(EN) TREATMENT OF T-CELL LYMPHOMA USING 10-PROPARGYL-10-DEAZAAMINOPTERIN
- (73) Sloan-Kettering Institute For Cancer Research ; 1275 York Avenue New York, New York 10021 / US
- (72) 01 / O'CONNOR, Owen, A. 2 Montgomery Road Scarsdale, NY 10583 / US  
02 / SIROTNAC, Francis 2 Bayview Drive West Hampton Bays, NY 11946 / US
- (74) Popović Miladin, Đoka Miraševića 21/III, Podgorica, (ME)
- (57) Primjena 10-propargil-10-deazaaminopterina u formulaciji farmaceutskog sredstva za liječenje T ćelijskog limfoma.  
Patent sadrži još 2 patentnih zahtjeva.

- (51) **A61K31/58**  
**A61K9/20**  
**A61K9/16**  
**A61K9/50**  
**A61P25/32**  
**A61P25/24**  
**A61P25/00**
- (30) US20050688905P 09.06.2005 US  
(86) PCT/EP2006/005574 09.06.2006.  
(87) WO2006131392 14.12.2006  
(96) 06754274.6 09.06.2006  
(97) EP1888080 14.04.2010. 2010/15 EN
- (54) (ME) **FARMACEUTSKE KOMPOZICIJE NEUROAKTIVNOG STEROIDA I NJIHOVA UPOTREBA**  
(EN) PHARMACEUTICAL COMPOSITIONS OF A NEUROACTIVE STEROID AND USES THEREOF
- (73) EURO-CELTIQUE S.A. ; 2, avenue Charles de Gaulle 1653 Luxembourg / LU  
(72) 01 / WOODWARD, Richard M. 2035 Welsh Valley Road Phoenixville, PA 19460-4638 / US  
(74) Lutovac Branimir, Bulevar Ivana Crnojevića 93, Podgorica (ME)
- (57) Farmaceutska kompozicija za upotrebu u tretmanu depresije, zavisnosti i/ili navike konzumiranja alkohola, predmenstrualne napetosti, predmenstrualnog sindroma ili predmenstrualnog disforičnog poremećaja, koja sadrži 3a-hidroksi-3p-metoksimetil-21-(1'-imidazolil)-5a-pregnan-20-on ili njegovu farmaceutski prihvatljivu so ili solvat, i jedan ili više farmaceutski prihvatljivih ekscipijenata, a pri tome ta kompozicija obezbeđuje ravnotežni sadržaj 3a-hidroksi-3p-metoksimetil-21-(1'-imidazolij)-5a-pregnan-20-ona u plazmi, u opsegu od 5 ng/mL do 500 ng/mL u trajanju od 12 h do 24 h posle ordiniranja. Patent sadrži još 5 patentnih zahtjeva.

- (51) **C07D473/04** (11) **01108**  
**A61K31/437** (21) **P-2009-235**  
**A61P3/10**
- (30) 102004008112 18.02.2004. DE  
 102004012921 17.03.2004. DE  
 102004032263 03.07.2004. DE
- (86) PCT/EP2005/001427 12.02.2005  
 (87) WO2005085246 15.09.2005  
 (96) 05707354.6 12.02.2005  
 (97) EP1758905 29.04.2009. 2009/18 EN
- (54) (ME) **8-[3-AMINO-PIPERIDIN-1-IL]-KSANTINI, NJHOVO DOBIJANJE I NJHOVA PRIMJENA KAO DDP-IV INHIBITORA**  
 (EN) **8-[3-AMINO-PIPERIDIN-1-YL]-XANTHINE, THE PRODUCTION THEREOF AND THE USE IN THE FORM OF A DPP-IV INHIBITOR**
- (73) Boehringer Ingelheim International GmbH ; Binger Strasse 173, 55216 Ingelheim am Rhein / DE
- (72) 01 / HIMMELSBACH, Frank Ahornweg 16 88441 Mittelbeberach / DE  
 02 / LANGKOPF, Elke Schloss 3 88447 Warthausen / DE  
 03 / ECKHARDT, Matthias Kirschenweg 7 88400 Biberach / DE  
 04 / TADAYYON, Mohammad 6, Bridges Court, St. Andrew Street SG14 1HQ Hertford / GB  
 05 / THOMAS, Leo Georg-Schinbain-Str. 221 88400 Biberach / DE
- (74) Radulović Božidar, Jovana Tomaševića 9/III, Podgorica (ME)
- (57) Jedinjenja op{te formule

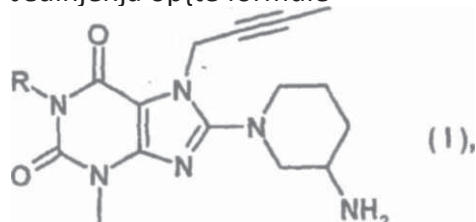

u kojoj R ozna~ava benzil -, 2 - fluorbenzil -, 3 - fluorbenzil -, 4 - fluorbenzil -, 2, 6 - difluorbenzil -, 3,4- difluorbenzil -, 2 - hlorbenzil -, 3 - hlorbenzil - ili 4 - hlorbenzil - grupu, 2 - trifluormetilbenzil -, 3 - trifluormetilbenzil - ili 4 - trifluormetilbenzil grupu, 3 - trifluormetoksi - benzil - ili 4 - trifluormetoksi - benzil - grupu, 2 - cijanobenzil -, 3 - cijanobenzil - ili 4 - cijanobenzil - grupu, 2, 6 - dicijanobenzil -, 3,4- dicijanobenzil -, 3,5- dicijanobenzil -, 2 - trifluormetil - 4 - cijano - benzil -, 3 - nitro - 4 - cijano - benzil -, 2 - cijano - 3 - metoksi - benzil -, 2 - cijano - 4 - metoksi - benzil -, 2 - cijano - 5 - metoksi - benzil -, 2 - cijano - 4 - fluor - benzil -, 2 - cijano - 5 - fluor - benzil -, 2 - cijano - 6 - fluor - benzil -, 3 - cijano - 4 - fluor - benzil -, 4 - cijano - 3 - fluor - benzil -, 2 - fluor - 4 - cijano - benzil -, 2 - cijano - 3 - hlorbenzil -, 2 - hlor - 4 - cijano - benzil - ili 2 - cijano - 4 - brombenzil - grupu, 2 - metoksi - benzil -, 3 - metoksi - benzil -, 4 - metoksi - benzil -, 2 - fluor - 3 - metoksi - benzil -, 2 - fluor - 4 - metoksi - benzil -, 2 - fluor - 5 - metoksi - benzil -, 3 - fluor - 4 - metoksibenzil -, 3, 4 - dimetoksi - benzil -, 3, 5 - dimetoksibenzil - ili 3, 4 - dimetoksi - 6 - fluorbenzil - grupu, (benzo[1, 3]dioksol - 5 - il)metil - grupu, [(4 - cijano - benzo[1, 3]dioksol - 5 - il)metil - grupu, 2 - (3 - ciklopropiloksi - fenil) - 2 - okso - etil -, 2 - (3 - ciklopropilmetoksi - fenil) - 2 - okso - etil - ili 2 - (3 - ciklobutiloksi - fenil) - 2 - okso - etil - grupu. 2 - okso - 2 - [2 - (piridin - 3 - il) - fenil] - etil - ili 2 - okso - 2 - [2 - (piridin - 4 - il) - fenil] - etil - grupu, (3 - cijano - naftalin - 1 - il)metil -, (1,4 - dicijano - naftalin - 2 - il)metil - ili (2, 4 - dimetoksi naftalin - 1 - il)metil - grupu, (furan - 2 - il)metil -, (furan - 3 - il)metil -, (5 - brom - furan - 2 - il)metil -, (5 - metil - furan - 2 - il)metil -, (5 - cijano - furan - 2 - il)metil - ili (5 - metoksikarbonil - furan - 2 - il)metil - grupu. (piridin - 2 - il)metil -. (6 - fluor - pi-

ridin - 2 - il)metil - ili (5 - metoksi - piridin - 2 - il)metil - grupu, (3 - cijanopiridin - 2 - il)metil -, (6 - cijanopiridin - 2 - il)metil -, (5 - cijano - piridin - 2 - il)metil -. (4 - cijano - piridin - 2 - il)metil -, (4 - cijano - piridin - 3 - il)metil -, (3 - cijano - piridin - 4 - il) - metil -, (2 - cijano - piridin - 3 - il)metil -, (2 - cijano - piridin - 4 - il)metil -, (5 - cijano - piridin - 3 - il)metil -, (6 - cijano - piridin - 3 - il)metil - ili (5 - cijano - 6 - metoksi - piridin - 2 - il)metil - grupu. (6 - fenil - piridin - 2 - il)metil - ili ([2. 2']bipiridinil - 6 - il)metil - grupu, (pirimidin - 2 - il)metil -, (4 - metil - pirimidin - 2 - il)metil - ili (4, 6 - dimetil - pirimidin - 2 - il)metil - grupu, (2 - fenil - pirimidin - 4 - il)metil - ili (4 - fenil - pirimidin - 2 - il)metil - grupu, [(1 - metil - 1 H - benzotriazol - 5 - il)metil] - grupu. (ft - fluor - hinolin - 2 - il)metil -, (7 - fluor - hinolin - 2 - il)metil -, (2 - metil - hinolin - il)metil -, (3 - cijano - hinolin - 2 - il)metil -, (3 - cijano - 4 - metil - hinolin - 2 - il)metil -, (4 - cijano - hinolin - 2 - il)metil -, (5 - cijano - hinolin - 2 - il)metil -, (8 - cijano - hinolin - 2 - il)metil -, (6 - amino - hinolin - 2 - il)metil -, (8 - amino - hinolin - 2 - il)metil -, (4 - metoksi - hinolin - 2 - il)metil -, (6 - metoksi - hinolin - 2 - il)metil -, (6, 7 - dimetoksi - hinolin - 2 - il)metil - ili (8 - cijano - hinolin - 7 - il)metil - grupu, (1 - cijano - izohinolin - 3 - il)metil -, (4 - cijano - izohinolin - 1 - il)metil -, (4 - cijanoizohinolin - 3 - il)metil - ili [(4 - (piridin - 2 - il) - izohinolin - 1 - il)metil - grupu, (hinazolin - 6 - il)metil -, (hinazolin - 7 - il)metil -, (2 - metil - hinazolin - 4 - il)metil -, (4, 5 - dimetil - hinazolin - 2 - il)metil -, (4 - etil - hinazolin - 2 - il)metil -, (4 - ciklopropil - hinazolin - 2 - il)metil -, (2 - fenil - hinazolin - 4 - il)metil -, (4 - cijano - hinazolin - 2 - il) - metil -, (4 - tenilamino - hinazolin - 2 - il)metil - ili (4 - benzilamino - hinazolin - 2 - il)metil - grupu, (hinoksalin - 5 - il)metil -, (hinoksalin - 6 - il)metil - ili (2, 3 - dimetil - hinoksalin - 6 - il)metil - grupu, ili ([1, 5]naftiridin - 3 - il)metil - grupu njihovi tautomeri, enantiomeri, diastereomeri, njihove smeše i njihove soli. 2.

Patent sadrži još 15 patentnih zahtjeva.

- (51) **A61K9/16**  
**A61K9/70**  
**A61K31/485**
- (30) 20040547196P 23.02.2004 EP  
(86) PCT/US05/004741 15.02.2005  
(87) WO2005US04741 09.09.2005.  
(96) 05713575.8 15.02.2005  
(97) EP1718258 25.03.2009 2009/13 EN
- (54) (ME) **OPIOIDNI TRANSDERMALNI PREPARAT OTPORAN NA ZLOUPOTREBU**  
(EN) ABUSE RESISTANCE OPIOID TRANSDERMAL DELIVERY DEVICE
- (73) EURO-CELTIQUE S.A. ; 2, avenue Charles de Gaulle, 1653 Luxembourg / LU  
(72) 01 / REIDENBERG, Bruce 1 Stonycrest Road Rye, New York NY 10580 / US  
02 / SHEVCHUK, Ihor 11 Shelburne Road Yonkers, NY 10710 / US  
03 / TAVARES, Lino 86 South Glen Road Kinnelon, NJ 07405 / US  
04 / LONG, Kevin 3 Hidden Hills Road Oak Ridge, NJ 07438 / US  
05 / MASKIEWICZ, Richard 120 East South Avenue Redlands, CA 92373 / US  
06 / SHAMEEM, Mohammed 4 Surim Court Nanuet, NY 10954 / US
- (74) Lutovac Branimir, Bulevar Ivana Crnojevića 93, Podgorica (ME)
- (57) Transdermalni preparat koji se sastoji od: sloja koji sadrži lek koji se sastoji od efikasne količine opioidnog agonista i velikog broja mikrosfera dispergovanih u sloju koji sadrži lek, a mikrosfere sadrže opioidni antagonist i što su mikrosfera srednje veličine od 1 do 300 u.m u prečniku.  
Patent sadrži još 22 patentnih zahtjeva.

- (51) **C07D231/20**  
**C07D453/02**  
**C07D401/06**  
**C07D487/08**  
**C07D453/06**  
**C07D403/06**  
**C07D231/14**  
**C07D231/12**  
**C07D401/04**  
**C07D409/04**  
**C07D403/04**  
**A61K31/41**  
**A61K31/435**
- (11) **01088**  
(21) **P-2009-246**
- (30) 20030013775 25.11.2003 FR  
(86) PCT/FR2004/002968 22.11.2004  
(87) WO2005051917 09.06.2005  
(96) 04805499.3 22.11.2004  
(97) EP1689720 15.04.2009. 2009/16 EN
- (54) (ME) **DERIVATI PIRAZOLILA U OBLIKU LJEKOVA ZA LIJEČENJE AKUTNIH ILI HRONIČNIH NEURONSKIH REGRESIJA**  
(EN) PYRAZOLYL DERIVATIVES IN THE FORM OF DRUGS FOR TREATING ACUTE OR CHRONIC NEURONAL REGRESSIONS
- (73) Aventis Pharma S.A. ; 20, avenue Raymond Aron 92160 Antony / FR  
(72) 01 / GENEVOIS-BORELLA, Arielle 28 Avenue Hoche F-94320 THIAIS / FR  
02 / MALLERON, Jean-Luc 2 Allée Renoir F-91460 MARCOUSSIS / FR  
03 / BOUQUEREL, Jean 40 rue de l'Emancipation F-93700 DRANCY / FR  
04 / DOERFLINGER, Gilles 2 Avenue du Berry F-91940 LES ULIS / FR  
05 / BOHME, Andrees 32 rue Vitruve F-75020 PARIS / FR  
06 / TOUYER, Gaetan 7 rue du Vieux Moulin F-77500 CHELLES / FR  
07 / SABUCO, Jean-François 198 bis Avenue du Maine F-75014 PARIS / FR  
08 / TERRIER, Corinne 98 bis Avenue du Colonel Fabien F-93190 LIVRY GARGAN / FR  
09 / MIGNANI, Serge 14 Avenue de Robinson F-92290 CHATENAY-MALABRY / FR  
10 / EVERS, Michel 8 rue Robert Schuman F-94510 LA QUEUE-EN-BRIE / FR  
11 / EL-AHMAD, Youssef 11 Avenue de Verdun F-94000 CRETEIL / FR
- (74) Ćupić Branislav, Dalmatinska 10, Podgorica (ME)
- (57) Jedinjenje formule (I)  
gde:  
A je, ukoliko je prisutno, (C1- C6) alkil radikal, (C3- C6) alkenil radikal, (C3- C6) alkinil radikal, (C3- C7) cikloalkil radikal ili a(C5-C7) cikloalkenil radikal; ovi radikali su po izboru supstituisan jednim ili vise supstituenata odabranih od (C1- C5) alkil, (C2- C5) alkenil, (C2- C5) alkinil, (C3- C7) cikloalkil, (C5-C7) cikloalkenil, arilalkil, heteroarilalkil, aril, heteroaril i halogen, R1 je NR6R7, (C4- C7) azacikloalkil, (C5-C7) azacikloalkenil, (C5-C9) azabicikloalkil ili (C5-C9) azabicikloalkenil grupa; ove grupe su po izboru supstituisan jednim ili vise supstituenata odabranih od (C1- C5) alkil, (C3- C5) cikloalkil i halogen, A-R1 je takav da azot iz R1 i azot u položaju -1 pirazola su odvojeni sa najmanje dva atoma ugljenika, R3 je H, halogen, OH, SH, NH2, ORc, SRc, SORa, SO2Ra, NHCHO, NRaRb, NHC(O)Ra, NHC(S)Ra ili NHSO2Ra radikal, R4 je aril ili heteroaril radikal po izboru supstituisan jednim ili vise supstituenata odabranih od

halogena, CN, NO<sub>2</sub>, NH<sub>2</sub>, OH, SH, COOH, CHO, C(O)NH<sub>2</sub>, C(S)NH<sub>2</sub>, SO<sub>2</sub>H, SO<sub>2</sub>NH<sub>2</sub>, NHCHO, C(O)Ra, C(O)ORa, C(O)NRaRb, C(S)NRaRb, S(O)Ra, SO<sub>2</sub>Ra, SO<sub>2</sub>NRaRb, ORc, SRc, O-C(O)Ra, -O-C(S)Ra, NRaRb, NHC(O)Ra, NHC(S)Ra, NHCONH<sub>2</sub>, NHCONRaRb, NHSO<sub>2</sub>Ra, aril, heteroaril, (C<sub>4</sub>-C<sub>7</sub>) heterocikloalkil, polifluoroalkil, trifluorometil-sulfanil, trifluorometoksi, linearan ili razgranat (C<sub>1</sub>-C<sub>6</sub>) alkil, (C<sub>2</sub>-C<sub>6</sub>) alkenil i (C<sub>2</sub>-C<sub>6</sub>) alkinil, ovi supstituenti su po izboru supstituisani jednim ili više alkil, halogen, OH, metoksi, R<sub>5</sub> je H, halogen, CF<sub>3</sub>, CHF<sub>2</sub>, CH<sub>2</sub>F, linearan ili razgranat (C<sub>1</sub>-C<sub>6</sub>) alkil ili (C<sub>3</sub>-C<sub>7</sub>) cikloalkil radikal, Ra je linearan ili razgranat (C<sub>1</sub>-C<sub>6</sub>) alkil, alkenil, alkinil, (C<sub>3</sub>-C<sub>7</sub>) cikloalkil, (C<sub>5</sub>-C<sub>7</sub>) cikloalkenil, (C<sub>4</sub>-C<sub>7</sub>) heterocikloalkil, arilalkil, heteroarilalkil, aril, heteroaril ili polifluoroalkil, Rb je, nezavisno od Ra, vodonik, linearan ili razgranat (C<sub>1</sub>-C<sub>6</sub>) alkil, alkenil, alkinil, (C<sub>3</sub>-C<sub>7</sub>) cikloalkil, (C<sub>5</sub>-C<sub>7</sub>) cikloalkenil, (C<sub>4</sub>-C<sub>7</sub>) heterocikloalkil, arilalkil, heteroarilalkil, aril, heteroaril ili polifluoroalkil, Ra i Rb mogu da formiraju zasićen ili nezasićen prsten koji sadrži 5, 6 ili 7 članova u prstenu, koji mogu da imaju ili ne moraju hetero atom kao što je O, S ili N, ovaj prsten je po izboru supstituisan jednim ili više alkil, halogen radikala, Rc je linearan ili razgranat (C<sub>1</sub>-C<sub>6</sub>) alkil, (C<sub>3</sub>-C<sub>6</sub>) alkenil, (C<sub>3</sub>-C<sub>6</sub>) alkinil, (C<sub>3</sub>-C<sub>7</sub>) cikloalkil, (C<sub>5</sub>-C<sub>7</sub>) cikloalkenil, (C<sub>4</sub>-C<sub>7</sub>) heterocikloalkil, (hetero) arilalkil, (hetero) aril, (poli)fluoroalkil, C(O)R<sub>8</sub>, C(S)R<sub>8</sub> ili SO<sub>2</sub>R<sub>8</sub> radikal, R<sub>6</sub> i R<sub>7</sub> su, nezavisno od drugog vodonik, (C<sub>1</sub>-C<sub>6</sub>) alkil, (C<sub>3</sub>-C<sub>6</sub>) alkenil, (C<sub>3</sub>-C<sub>6</sub>) alkinil, (C<sub>3</sub>-C<sub>7</sub>) cikloalkil, (C<sub>5</sub>-C<sub>7</sub>) cikloalkenil, (C<sub>4</sub>-C<sub>7</sub>) heterocikloalkil, arilalkil ili heteroarilalkil, R<sub>6</sub> i R<sub>7</sub> mogu da formiraju zasićeni ili nezasićeni prsten sa 5, 6 ili 7 članova u prstenu, koji mogu da imaju ili ne moraju hetero atom kao što je O, S ili N i koji je po izboru supstituisan jednim ili više alkila, halogena, R<sub>8</sub> je Ra ili NRaRb radikal, njihovi racemati, enantiomeri i diastereoizomeri i njihove smeše, tautomeri i farmaceutski prihvatljive soli, za izuzetkom 3-(3-piridinil)-1H-pirazol-1-butanamina, 4-(3-piridinil)-1H-pirazol-1-butanamina i N-(dietil)-4-fenil-1H-pirazol-1-etilamina.

Patent sadrži još 15 patentnih zahtjeva.

- (51) **C07D495/04**  
**A61P11/00**  
**A61K31/519**
- (30) 200510019201 21.04.2005 DE  
(86) PCT/ep06/061680 19.04.2006  
(87) WO2006111549 26.10.2006  
(96) 06743350.8 19.04.2006  
(97) EP1874781 24.06.2009. 2009/26 EN
- (54) (ME) **DIHIDROTIENOPIRIMIDINI ZA LIJEČENJE ZAPALJENSKIH BOLESTI**  
(EN) DIHYDROTHIENOPYRIMIDINES FOR THE TREATMENT OF INFLAMMATORY DISEASES
- (73) Boehringer Ingelheim International GmbH ; Binger Strasse 173, 55216 Ingelheim am Rhein / DE
- (72) 01 / POUZET, Pascale Zwingerstrasse 11 88400 Biberach / DE  
02 / HOENKE, Christoph Turnierstrasse 43 55218 Ingelheim / DE  
03 / MARTYRES, Domnic Klotzholzäcker 6 88400 Biberach / DE  
04 / NICKOLAUS, Peter Sattlergasse 3 88447 Warthausen / DE  
05 / JUNG, Birgit Schlossaecker 9 88471 Laupheim / DE
- (74) Radulović Božidar, Jovana Tomaševića 9/III, Podgorica (ME)
- (57)

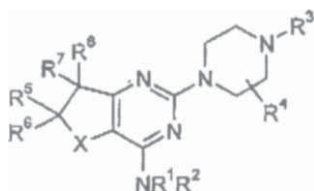

pri čemu

X označava O, S, SO ili SO<sub>2</sub>; R<sup>1</sup> označava H, C<sub>1-6</sub> - alkil, C<sub>2-6</sub> - alkenil, C<sub>2-6</sub>, - alkinil, C<sub>6-10</sub> - aril ili C<sub>6-10</sub> - aril - C<sub>6-10</sub> - alkilen, C<sub>5-10</sub> - heteroaril - C<sub>6-10</sub> - alkilen,; R<sup>2</sup> označava H ili eventualno jednostruko ili višestruko supstituisan radikal izabran iz grupe koja se sastoji od C<sub>1-6</sub>- alkila, C<sub>2-6</sub> - alkenila, C<sub>2-6</sub>- alkinila, eventualno jednostruko ili višestruko premo{ }en mono - ili biciklični C<sub>3-10</sub> - cikloalkil, C<sub>6-10</sub> - aril, aromati-ni ili nearomatični, heterociklični C<sub>3-10</sub> - prsten, biciklični prsten i C<sub>6-10</sub> - aril kondenzovan sa C<sub>3-10</sub> - heterociklom; ili NR<sup>1</sup>R<sup>2</sup> zajedno označavaju jedan heterociklični prsten, koji je eventualno supstituisan sa jednim ili više radikala izabranih između C<sub>1-4</sub> alkila, C<sub>2-6</sub> - alkenila, C<sub>2</sub> - alkinila, linearnog ili razgranatog C<sub>1-6</sub>- alkanola i okso; R<sup>3</sup> označava jedan jednostruko ili višestruko supstituisani radikal izabran iz grupe koja se sastoji od jednog heterocikličnog C<sub>6-10</sub>- prstena, C<sub>3-7</sub>- cikloalkila, C<sub>6-10</sub> - aril - C<sub>6-10</sub> - alkilena, C<sub>5-10</sub> - heteroaril - C<sub>1-6</sub> - alkilena, jednog kondenzovano bicikličnog prstena, koji može eventualno sadržati 1 - 4 heteroatoma izabranih nezavisno jedan od drugog između N, O, S, ili R<sup>3</sup> označava eventualno supstituisani fenil; ili R<sup>3</sup> označava jednu grupu COR<sup>37</sup>, COCH<sub>2</sub>R<sup>38</sup>, CONHR<sup>38</sup> ili SO<sub>2</sub>R<sup>38</sup>; pri -emu R<sup>37</sup> označava H, C<sub>1-6</sub> - alkil, C<sub>2-6</sub> - alkenil, C<sub>2-6</sub>- alkinil ili C<sub>6-10</sub>- aril; R<sup>378</sup> označava C<sub>1-6</sub> - alkil, C<sub>2-6</sub> - alkenil, C<sub>2-6</sub>, - alkinil, C<sub>3-7</sub> - cikloalkil ili radikal izabran iz grupe koja se sastoji od C<sub>6-10</sub> - arila, heterocikličnog C<sub>3-10</sub> - prstena i bicikličnog prstena, koji je eventualno supstituisan sa jednim ili više radikala izabranih iz grupe koja se sastoji od C<sub>1-6</sub> - arila, C<sub>2-6</sub> - alkenila, C<sub>2-6</sub> - alkinila, halogena, NR<sup>381</sup>, R<sup>382</sup>, C<sub>6-10</sub> - arila i heterocikličnog C<sub>3-10</sub> - prstena; pri -emu R<sup>381</sup> označava H, C<sub>1-8</sub>- alkil, C<sub>2-6</sub>- alkenil ili C<sub>2-6</sub> - alkinil; R<sup>4</sup> označava H, C<sub>1-4</sub>- alkil, C<sub>2-4</sub>- alkenil, C<sub>2-4</sub> - alkenil, ili okso; R<sup>5</sup> označava H, C<sub>1-4</sub>- alkil, C<sub>2-4</sub>- alkenil, C<sub>2-4</sub> - alkenil, R<sup>6</sup> označava H, C<sub>1-4</sub>- alkil, C<sub>2-4</sub>- alkenil, C<sub>2-4</sub> - alkenil,; R<sup>7</sup> označava H, C<sub>1-4</sub>- alkil, C<sub>2-4</sub>- alkenil, C<sub>2-4</sub> - alkenil, C<sub>6-10</sub>- aril, ili OH R<sup>8</sup> označava H, C<sub>1-4</sub>- alkil, C<sub>2-4</sub>- alkenil, C<sub>2-4</sub> - alkenil, C<sub>6-10</sub>- aril, ili OH ili R<sup>7</sup> i R<sup>8</sup> zajedno obrazuju okso; kao i njihove farmaceutski prihvatljive soli, diastereomeri, enantiomeri, racemati, hidrati ili solvati.



Patent sadrži još 28 patentnih zahtjeva.

(51) **E05B65/00**  
**E05C3/12**  
**F25D23/02**

(11) **01117**  
(21) **P-2009-103**

(30) PCT2006EP11428 28.11.2006 EP

(86) PCT/EP2007/010038 20.11.2007

(87) WO2008046666 24.04.2008

(96) 07819871.0 20.11.2007

(97) EP1937919 28.01.2009 2009/05 EN

(54) (ME) **ZATVARAČ ZA NAMJEŠTAJ**  
(EN) FURNITURE CLOSURE

(73) Hakemann, Fritz ; Barnstorfer Str. 29, 49424 Goldenstedt / DE

(72) Hakemann, Fritz Barnstorfer Str. 29 49424 Goldenstedt / DE

(74) Radulović Božidar, Jovana Tomaševića 9/III, Podgorica (ME)

(57) Nameštaj koji ima zatvarač za vrata, krila i fioke tog dela nameštaja, pri čemu svaki od ovih zatvarača zatvara jedan otvor (12) na nekom delu nameštaja (11) odnosno prihvaća se u taj otvor (12), pri čemu su površine naleganja (4) vrata ili krila odnosno prednje ploče (3) fioke izbačene iznad otvora (12) i u zatvorenom položaju naležu na površinu (13) nameštaja (11), čija površina se nalazi se na njihovoj suprotnoj strani, naznačen time što vrata, krilo ili prednja ploča (3) imaju na jednom rubnom predelu profilnu šinu (5) koja je snabdevena sa zaptivnim elementom (6) i sa elementom za blokiranje (7) i koji element za blokiranje se može pomeriti iz zatvorenog položaja u otvoreni položaj i obrnuto.

Patent sadrži još 32 patentnih zahtjeva.

(51) **C07D207/12**  
**C07D413/12**  
**C07D211/46**  
**C07D205/04**  
**A61K31/397**  
**A61K31/40**  
**A61K31/4409**  
**A61P37/00**

(11) **01106**

(21) **P-2009-96**

(30) US20050719467P 21.09.2005 US

(86) PCT/IB2006/002727 01.09.2006.

(87) WO2007034325 29.03.2007

(96) 06795581.5 01.09.2006

(97) EP1928821 07.01.2009. 2009/02 EN

(54) (ME) **DERIVATI KARBOKSAMIDA KAO ANTAGONISTI MUSKARINSKIH RECEPTORA**

(EN) CARBOXAMIDE DERIVATIVES AS MUSCARINIC RECEPTOR ANTAGONISTS

(73) Pfizer Limited ; Ramsgate Road, Sandwich, Kent CT13 9NJ / GB

(72) 01 / GLOSSOP, Paul, Alan Pfizer Global Research and Development Ramsgate Road Sandwich Kent, CT13 9NJ / GB

02 / MANTELL, Simon, John Pfizer Global Research and Development Ramsgate Road Sandwich Kent, CT13 9NJ / GB

03 / STRANG, Ross, Sinclair Pfizer Global Research and Development Ramsgate Road Sandwich Kent, CT13 9NJ / GB

04 / WATSON, Christine, Anne, Louise Pfizer Global Research and Development Ramsgate Road Sandwich, Kent CT13 9NJ / GB

05 / WOOD, Anthony Pfizer Global Research and Development Ramsgate Road Sandwich Kent, CT13 9NJ / GB

(74) Ćupić Branislav, Dalmatinska 10, Podgorica (ME)

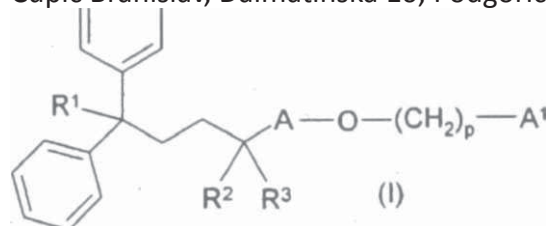

(57) GDJE R<sup>1</sup> je CN ili CONH<sub>2</sub>;  
 A je odabrano od

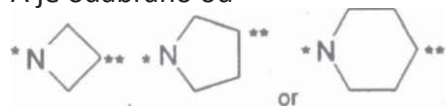

Pri čemu \* i \*\* predstavljaju mesta vezivanja. \*\* je vezan za kiseonik. - R<sup>2</sup> i R<sup>3</sup> su metil ili kada je A, grupa formule



R<sup>2</sup> i R<sup>3</sup> mogu takode sa atomom ugljenika za koji su vezani formiraju ciklopentanski prsten; p je 0 ili 1; A<sup>1</sup> je odabran od

a) fenila po izboru supstituisanog sa 1, 2 ili 3 grupe nezavisno odabrane od halo, CN, CF<sub>3</sub>, OR<sup>4</sup>, SR<sup>4</sup>, OCF<sub>3</sub>, (C|C<sub>4</sub>)alkil i fenil po izboru supstituisan sa OH; 4 4

b) naftila po izboru supstituisanog sa 1 ili 2 grupe odabrane od halo, CN, CF<sub>3</sub>, OR, SR,

OCF<sub>3</sub> i (Ci-C<sub>4</sub>)alkil;

c) 9 ili 10-člane biciklične aromatične heterociklične grupe, koja sadrži od 1, 2 ili 3 heteroatoma nezavisno odabrana od O, S ili N, podaci heterociklična grupa je po izboru supstituisana sa 1 ili 2 supstituenta nezavisno odabrana od OR<sup>4</sup>, (Ci-COalkil i halo; - R<sup>4</sup> je H ili (C,-C<sub>4</sub>) alkil; ili, ukoliko je to pogodno, njihove farmaceutski prihvatljive soli ili solvati.

Patent sadrži još 24 patentnih zahtjeva.

- (51) **F23G5/027**  
**F23G5/00**  
**F23G5/08**  
**F23G5/02**  
**F23G5/46**  
**F23G5/30**
- (30) 0513299 29.06.2005 GB  
0604691 08.03.2006 GB
- (86) PCT/GB2006/002409 29.06.2006
- (87) WO2007000607 04.01.2007
- (96) 06755679.5 29.06.2006
- (97) EP1896774 10.12.2008. 2008/50 EN
- (54) (ME) **POSTUPAK ZA OBRADU OTPADA I APARAT**  
(EN) WASTE TREATMENT PROCESS AND APPARATUS
- (73) Advanced Plasma Power Limited ; Aquis Court 31 Fishpool Street St. Albans, Hertfordshire AL3 4RF / GB
- (72) 01 / CHAPMAN, Chris, Nr. Fairford Gloucester GL7 4EU / GB  
02 / OVENS, David, Tetronics Limited, A2 Marston, Wiltshire SN3 4DE / GB  
03 / DEEGAN, David, Calais Dene Bampton Oxfordshire OX14 3YD / GB  
04 / ISMAIL, Saeed 149 Redcliffe Street Swindon SN2 2DF / GB
- (74) Popović Miladin, Đoka Miraševića 21/III, Podgorica, (ME)
- (57) Postupak za obradu otpada, naznačen time što obuhvata:  
(i) korak gasifikacije koji obuhvata korak obrade otpada u jedinici za gasifikaciju (1) u prisustvu kiseonika i pare radi dobijanja otpadnog gasa i čvrstog ugljenisanog materijala koji se ne prenosi vazduhom; I (ii) korak plazma obrade koji obuhvata podvrgavanje otpadnog gasa, i čvrstog ugljenisanog materijala koji se ne prenosi vazduhom, plazma postupku u jedinici za plazma obradu (4) u prisustvu kiseonika i, izborno, pare, pri čemu je jedinica plazma obrade (4) odvojena od jedinice za gasifikaciju (1).  
Patent sadrži još 42 patentnih zahtjeva.

(51) **C07C253/34**  
**C07C253/30**  
**C07C255/59**  
**C07D307/87**

(11) **01086**  
(21) **P-2008-777**

(30) 20040000217 12.02.2004 DK  
20040544970P 12.02.2004 US

(86) PCT/DK2005/000075 02.02.2005.

(87) WO2005077891 25.08.2005

(96) 05700625.6 02.02.2005

(97) EP1716108 15.10.2008. 2005/34 EN

(54) (ME) **POSTUPAK ZA ODVAJANJE INTERMEDIJERA KOJI SE MOGU KORISTITI ZA PRIPREMU ESCITALOPRAMA**

(EN) METHOD FOR THE SEPARATION OF INTERMEDIATES WHICH MAY BE USED FOR THE PREPARATION OF ESCITALOPRAM

(73) H. Lundbeck A/S ; Ottliavej 9, 2500 Valby-Copenhagen / DK

(72) LYGSO, Lars Ole, SKOVVANGSVEJ 6, SOSUM, DK-3670 VEKSO SJ. / DK

(74) Popović Miladin, Đoka Miraševića 21/III, Podgorica, (ME)

(57) Postupak za izolaciju i prečišćvanje jedinjenja koje ima formulu W

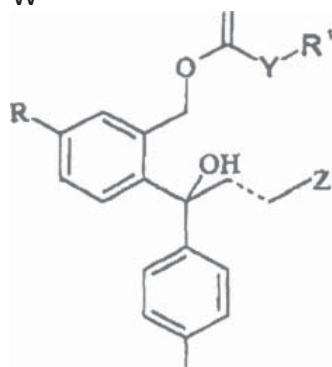

Hal (IV)

Gde R je cijano ili grupa koja može biti pretvorena u cijano grupu i izabrana je od halogena,  $\text{CF}_3$ - $(\text{CF}_2)_n$ ,  $-\text{SO}_2$ -O-, gde je n jednako 0-8, -OH, -CHO,  $-\text{CH}_2\text{OH}$ ,  $-\text{CH}_2\text{NH}_2$ ,  $-\text{CH}_2\text{NO}_2$ ,  $-\text{CH}_2\text{Cl}$ ,  $-\text{CH}_2\text{Br}$ ,  $-\text{CH}_3$ ,  $\text{NHR}^5$ ,  $-\text{CHNOH}$ ,  $-\text{COOR}^6$ ,  $-\text{CONR}^6\text{R}^7$ , gde je  $\text{R}^5$  jednako vodonik ili  $\text{C}_{1-6}$ -alkilkarbonil i  $\text{R}^6$  i  $\text{R}^7$  su izabrani od vodonika, izborno supstituisanog  $\text{C}_{1-6}$ -alkil, aril- $\text{C}_{1-6}$ -alkil ili aril, i grupe formule

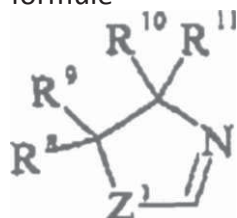

gde je  $\text{Z}^1$  jednako O ili S; svako  $\text{r}^8$  -  $\text{r}^9$  nezavisno su izabrani od vodonika i  $\text{C}_{1-6}$ -alkila ili  $\text{r}^8$  i  $\text{r}^9$  zajedno formiraju  $\text{C}_2$ -5-alkilen lanac čime formiraju spiro prsten;  $\text{r}^{10}$  je izabran od vodonika i  $\text{C}_{1-6}$ -alkil,  $\text{r}^{11}$  je izabran od vodonika,  $\text{C}_{1-6}$ -alkil, karboksi grupe ili njene prekursorske grupe, ili  $\text{r}^{10}$  i  $\text{r}^{11}$  zajedno formiraju  $\text{C}_2$ -5-alkilen lanac na taj način formirajući spiro prsten, isprekidana linija predstavlja dvogubu ili jednogubu vezu, Hal je halogen, Z je dimetilaminometil grupa ili Z je grupa koja može biti pretvorena u dimetilaminometil grupu i izabrana je iz grupe koju cine  $-\text{CH}_2\text{-L}$ ,  $-\text{CH}_2\text{-NO}_2$ ,  $-\text{MgHal}$ , cijano, aldehid,  $-\text{CH}_2\text{-O-Pg}$ ,  $-\text{CH}_2\text{-NP}_{g1}\text{Pg}_2$ ,  $-\text{CH}_2\text{-NMePg}$ ,  $-\text{CH}_2\text{NHCH}_3$ ,  $-\text{CH}_2\text{-NH}_2$ ,  $-\text{CO-N}(\text{CH}_3)_2$ ,  $-\text{CHCA}^{\text{r}'\text{A}'\text{R}^{13}}$ ,  $-(\text{A}'\text{R}^4)(\text{A}^2\text{R}^{15})(\text{A}^3\text{R}^{16})$ ,  $-\text{COOR}^{17}$ ,  $-\text{CH}_2\text{-CO-}$

$\text{NH}_2$ ,  $-\text{CH}=\text{CH}-\text{R}^{18}$  ili  $-\text{CONHR}^{19}$ , gde je Pg zaštitna grupa za alkoholnu grupu, Pgi i Pg<sub>2</sub> su zaštitne grupe za amino grupu, R<sup>2</sup> i R<sup>13</sup> su nezavisno izabrani iz grupe koju cine Ci-6-alkil, C<sub>2</sub>-6-alkenil, C<sub>2</sub>-alkinil i izborno alkil supstutuisane aril ili aralkil grupe ili R<sup>12</sup> i R<sup>13</sup> zajedno formiraju lanac 04 2 do 4 atoma ugljenika, svaki od R<sup>14</sup>-R<sup>18</sup> nezavisno su izabrani iz grupe koju cine Cm-alkil, fc<sub>2</sub>-6-alkenil, C|<sub>6</sub>-alkinil i izborno C|<sub>6</sub>-alkil supstutuisani aril ili aril-Ci<sub>6</sub>-alkil, R<sup>1</sup> je vodonik ili metil i A<sup>1</sup>, A<sup>2</sup> i A<sup>3</sup> su izabrani od O i S; L je odlazeća grupa, kao što je halogen ili -O-SO<sub>2</sub>-A, gde je A jednako Ci-<sub>6</sub> alkil, C<sub>2</sub><sub>6</sub> alkenil, C<sub>2</sub><sub>6</sub> alkinil ili izborno C<sub>t</sub>-6-alkil supstutuisani aril ili aril-C 1.6-alkil, WjeOili S, Yje veza, O, S ili NH,i R<sup>1</sup> je Ci-io-alkil, C<sub>2</sub>-io-alkenil ili C<sub>2</sub>-io-alkinil, gde svi oni mogu biti izborno supstutuisani sa jednim ili vise supstutuenata izabranih iz grupe koju cine Ci<sub>io</sub>-alkoksi, Ci-10-alkiltio, hidroksi, halogen, amino, nitro, cijano, Ci-io-alkilamino, di-(C<sub>M(r)</sub>alkil) amino, aril, ariloksi, ariltio i heteroaril, ili R<sup>1</sup> je aril, gde svaka od aril i heteroaril grupa može izborno biti supstutuisana jednom ili vise puta sa supstutuentima izabranim od Cmo-alkil, C<sub>2</sub>-io-alkenil, C<sub>2</sub>-io-alkinil, C\ 10-alkoksi, Ci-io-alkiltio, hidroksi, halogen, amino, nitro, cijano, C<sub>o</sub>-alkilamino i di-(Ci<sub>io</sub>-alkil) amino, ili njegova so, i/ili diol formule

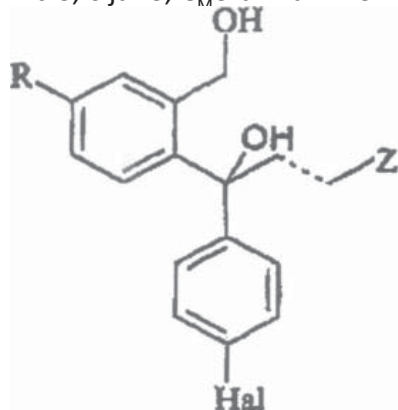

gde su R, Z, Hal i ispekidana linija kao što su defmisani u prethodnom tekstu, ili njegova so, iz smeše koja sadrži jedinjenje formule (IV) i diol formule (II), naznačen time što sadrži: reakciju navedene smeše koja sadrži jedinjenje formule (IV) i diol formule (II) sa cikličnim anhidridom ili imidom formule

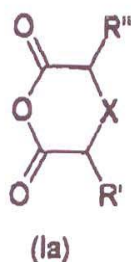

iii

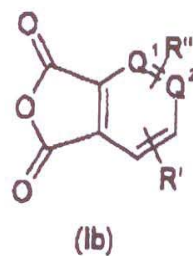

iii

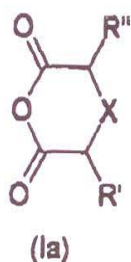
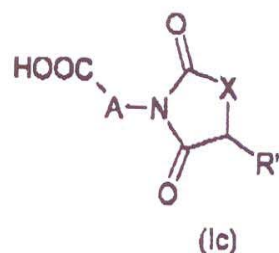

iii

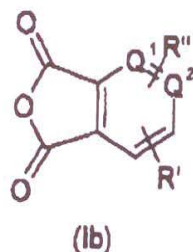

iii

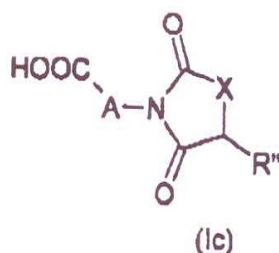

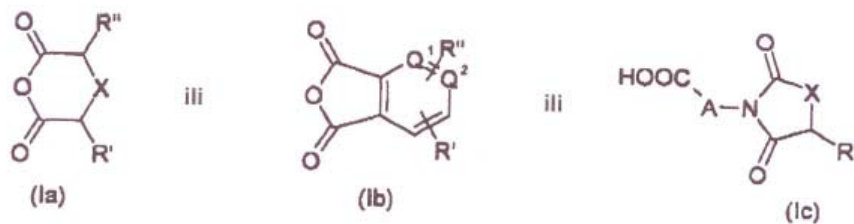

gde je X jednako  $-(CRR''')_n-$ , gde je n jednako 0-2; i R, R'' i R''' su nezavisno izabrani od vodonika, Ci<sub>6</sub>-alkil, Ci<sub>6</sub>-alkoksi, ariloksi, Ci<sub>6</sub>-aciloksi, aril-CO-O, gde svaki aril može biti supstituisan sa Ci<sub>6</sub>-alkil, ili R' i R'' u anhidridu formule (Ia) zajedno su  $-Q-CR^4R^5-O-$ , gde su R<sup>4</sup> i R<sup>5</sup> nezavisno vodonik ili Ci<sup>^</sup>-alkil, ili R' i R'' u anhidridu formule (Ib) su jedan pored drugog i zajedno sa dva toma ugljenika za koji su vezani formiraju benzolov prsten; 1 2 jedan od Q i Q je azot i drugi je ugljenik, ili su oba ugljenik; A je Ci<sub>6</sub>-alkilen, fenilen ili naftilen, gde Ci<sub>6</sub>-alkilen, fenilen ili naftilen grupe mogu izborno biti supstitusane jedan ili vise puta sa Ci<sub>6</sub>-alkil; da bi se formirala smeša jedinjenja formule (IV) i estra koji ima formulu

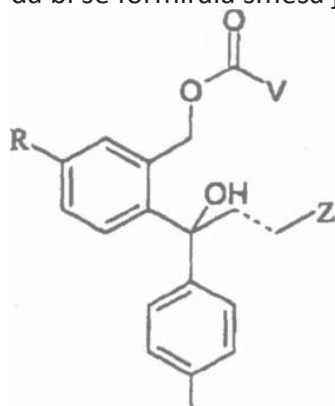

gde su R, Z i Hal kao što su defmisani u prethodnom tekstu i V je  $-CHR'-X-CR''-COOH$ ,  $-X-CHR''-CO-NH-A-COOH$ ,  $-CHR''-X-CO-NH-A-COOH$



b) odvajanje jedinjenja formule (IV) od estra formule (V) pomoću postupka koji je izabran iz grupe koju cine:

- i) omogućavanje taloženja kiseline formule (V) ili njene soli iz reakcione smeše, i odvajanje taloga jedinjenja formule (V) ili njegove soli iz reakcione smeše, nakon čega izborno sledi izolacija jedinjenja formule (IV) ili njegove soli iz reakcione smeše;
- ii) podela između organskog rastvarača i vodenog rastvarača usled čega će jedinjenje formule (IV) biti rastvoreno u organskoj fazi i jedinjenje formule (V) će biti rastvoreno u vodenoj fazi, razdvajanjem faza i izbornom izolovanjem jedinjenja formule (IV) ili njegove soli i/ili izolovanjem jedinjenja formule (V) ili njegove soli;
- iii) adsorpcija jedinjenja formule (V) na baznoj smoli, razdvajanje rastvarača koji sadrži jedinjenje formule (IV) iz smole, desorpcija jedinjenja formule (V) sa bazne smole i izbornom izolacija jedinjenja formule (IV) ili njegove soli i/ili izolacija jedinjenja formule (V) ili njegove soli, gde su R', R'', X i A kao što su definisani u prethodnom tekstu.

Patent sadrži još 31 patentnih zahtjeva.



- (51) **C12N7/04**  
**A61K39/00**  
**A61K39/187**
- (11) **01119**  
(21) **P-2009-56**
- (30) 200410025452 19.05.2004 DE  
(86) PCT/EP2005/005377 18.05.2005  
(87) WO2005111201 24.11.2005  
(96) 05741681.0 18.05.2005  
(97) EP1751276 14.01.2009 2009/03 EN
- (54) (ME) **VAKCINA KOJA SADRŽI OSLABLJENI PESTIVIRUS**  
(EN) VACCINE COMPRISING AN ATTENUATED PESTIVIRUS
- (73) Boehringer Ingelheim Vetmedica GmbH ; Binger Strasse 173, 55216 Ingelheim am Rhein / DE
- (72) 01 / MEYERS, Gregor Albstrasse 1 72141 Walddorfhaeslach / DE  
02 / EGE, Andreas Gottlieb Olpp Str. 37 72076 Tübingen / DE  
03 / MEYER, Christiane Treschowstrasse 31 48163 Münster / DE  
04 / VON FREYBURG, Martina Schickhardtstr. 15 74076 Heilbronn / DE
- (74) Radulović Božidar, Jovana Tomaševića 9/III, Podgorica (ME)
- (57) Oslabljeni pestivirus, koji ima bar jednu mutaciju u kodiranoj sekvenci za glikoprotein E<sup>n,s</sup> i bar još jednu mutaciju u kodiranoj sekvenci za N<sup>prH</sup>, gde navedena mutacija u kodiranoj sekvenci za glikoprotein E<sup>ms</sup> vodi do inaktivacije aktivnosti RNaze koja se nalazi u E<sup>ms</sup>, a navedena mutacija ii kodiranoj sekvenci za N<sup>pro</sup> vodi do inaktivacije navedenog N<sup>pr''</sup>.  
Patent sadrži još 37 patentnih zahtjeva.

(51) **C07D209/30**  
**C07D401/12**  
**A61K31/496**  
**A61P25/00**

(11) **01120**  
(21) **P-2009-53**

(30) 588555 P 16.07.2004. US  
20040112 16.07.2004. DK  
691736 P 17.06.2005. US  
200500893 17.06.2005 DK  
(86) PCT/DK2005/000491 13.07.2005  
(87) WO2006007843 26.01.2006  
(96) 05759183.6 13.07.2005  
(97) EP1771415 07.01.2009 2009/02 EN

(54) (ME) **DERIVATI 2-(1H-INDOLILSULFANIL)-ARILA ZA PRIMJENU U LIJEČENJU AFEKTIVNIH POREMEĆAJA, BOLA, POREMEĆAJA PAŽNJE I HIPERAKTIVNOSTI (ADHD) I STRES UNRINARNE INKONTINENCIJE**

(EN) 2-(1H-INDOLYLSULFANYL)-ARYL AMINE DERIVATIVES FOR USE IN THE TREATMENT OF AFFECTIVE DISORDERS, PAIN, ADHD AND STRESS URINARY INCONTINENCE

(73) H. Lundbeck A/S; Ottiliavej 9, 2500 Valby / DK

(72) 01 / KEHLER, Jan Nymöllevej 28 DK-2800 Lyngby / DK  
02 / KROLL, Friedrich Feeënstraat 3 2800 Mechelen / BE  
03 / JUHL, Karsten Brydeholm 56 DK-2670 Greve / DK

(74) Popović Miladin, Đoka Miraševića 21/III, Podgorica, (ME)

(57) Jedinjenje naznačeno time što ima opštu formulu 1 kao njegova slobodna baza ili

SOU

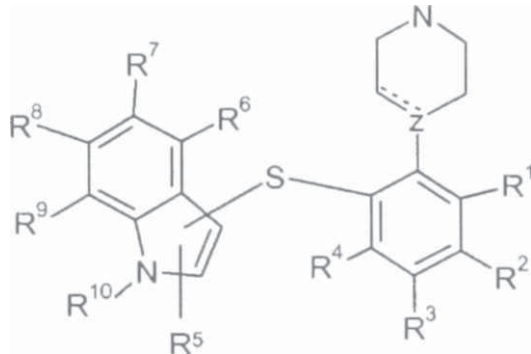

(I)

Gde isprekidana linija predstavlja izbornu vezu: svako od  $R^1$ – $R^4$  je nezavisno izabrano iz grupe koju cine vodonik, halogen, cijano, nitro. C1-6 alk(en/in)il, C3-8 -cikloalk(en)il. C3-8 -cikloalk(en)il-C1-6 -alk(en/in)il. amino. C1-6 alk(en/in)ilamino. di-(C1-6 -alk(en/in)il)amino, C1-6 -alk(en/in)ilkarbonil, aminokarbonil, C1-6 -alk(en/in)ilaminokarbonil, di-(C1-6 -alk(en)il)aminokarbonil. hidroksi, C1-6 alk(en/in)iloksi, C1-6 alk(en in)ilsulfanil. halo-C1-6 -alk(en/in)il. halo-C1-6 -alk(en in)ilsulfonil, halo-C1-6 -alk(en in)ilsulfonil i C1-6 -alk(en/in)ilsulfonil: i  $R^5$  je izabran iz grupe koju cine vodonik, halogen, cijano, C1-6 -alk(en/in)il. C3-8-cikloalk(en)il. Ci 3-8 cikloalk(en)il-C1-6 -alk(en'in)il. amino. C1-6,-alk(en/in)ilamino, di-(C1-6 -alk(en/in)il)amino, C1-6 -alk(en/in)ilkarbonil. aminokarbonil. C1-6 -alk(en/in)ilaminokarbonil. di-(C1-6 -alk(en)il(aminokarbonil, hidroksi. C1-6 -alk(en,'in)iloksi. C1-6 -alk(en/in)ilsulfanil. halo-C1-6- alk(en in)il. halo-C1-6 -alk(en/in)ilsulfonil, halo-C1-6 -alk(en/in)ilsulfanil i C1-6 -alk(en in)ilsulfonil: I svako od  $R^6$ - $R^9$  je nezavisno izabrano iz grupe koju cine vodonik, halogen, cijano, nitro. C1-6 -alk(en/in)il. C1-6 -cikloalk(en)il. C1-6 -cikloalk(en)il-C1-6

-alk(en in)il. amino. C1-6 -alk(en in)ilamino. di-(C1-6 -alk(en/in)il)amino, C1-6 -alk(en in) ilkarbonil, aminokarbonil. C1-6 alk(en in)ilaminokarbonil, di-(C1-6 -alk(en)ilkinokarbonil. hidroksi. C1-6 -alk(en/in)iloksi. C. 1-6 -alk(en/in)ilsullanil. halo-Ci.<sub>6</sub>-alk(en/in)il. halo-C1-6 -alk(en/in)ilsulfonil, halo-C1-6 -alk(en/in)ilsulfanil, C1-6 -alk(en/in)ilsulfonil i C1-6 -ak(en/in)il-0-CO-; R<sup>10</sup> je izabran iz grupe koju čine vodonik, C1-6 | -alk(en/in)il. C3-8-cikloalk(en)il i C3-8-cikloalk(en)il-C1-6 -alk(en/in)il; i Z je izabran iz grupe koju cine N. CH i C. uz uslov da isprekidana linija predstavlja vezu kada je Z jednako C i isprekidana linija ne predstavlja vezu kada je Z jednako CH ili N.

Patent sadrži još 24 patentnih zahtjeva.

- (51) **A61K31/47** (11) **01105**  
**A61P31/06** (21) **P-2008-89**
- (30) 20040102402 28.05.2004 EP  
 (86) PCT/EP2005/052371 24.05.2005.  
 (87) WO2005117875 15.12.2005  
 (96) 05743054.8 24.05.2005  
 (97) EP 1753427 02.04.2008. 2008/14 EN
- (54) (MN) **UPOTREBA SUPSTITUISANIH KINOLINSKIH DERIVATA ZA TRETMAN BOLESTI UZROKOVANIH MIKROBAKTERIJAMA OTPORNIM NA LJEKOVE**  
 (EN) **USE OF SUBSTITUTED QUINOLINE DERIVATIVES FOR THE TREATMENT OF DRUG RESISTANT MYCOBACTERIAL DISEASES**
- (73) Janssen Pharmaceutica NV; Turnhoutseweg 30, 2340 Beerse / BE  
 (72) 01 / ANDRIES, Koenraad, Jozef, Lodewijk, Marcel c/o JanssenPharmaceutica NV Turnhoutseweg 30 B-2340 Beerse / BE  
 02 / VAN GESTEL, Jozef, Frans, Elisabetha Renier Sniederspad 9 B-2350 Vosselaar / BE  
 (74) Lutovac Branimir, Bulevar Ivana Crnojevića 93, Podgorica (ME)  
 (57) Upotreba supstituisanog kinolinskog derivata, naznačna time, da se derivat koristi za proizvodnju leka za tretman infekcije sojem Mycobacterium koji je otporan na lek, a gde supstituisani kinolinski derivat je jedinjenje prema Formuli (Ia) ili Formuli (Ib) (R<sup>6</sup>),

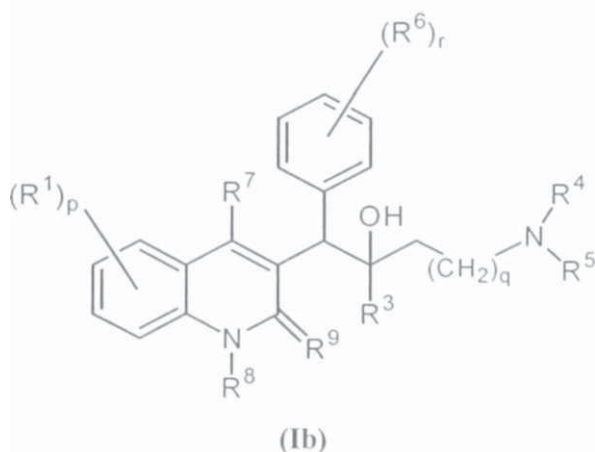
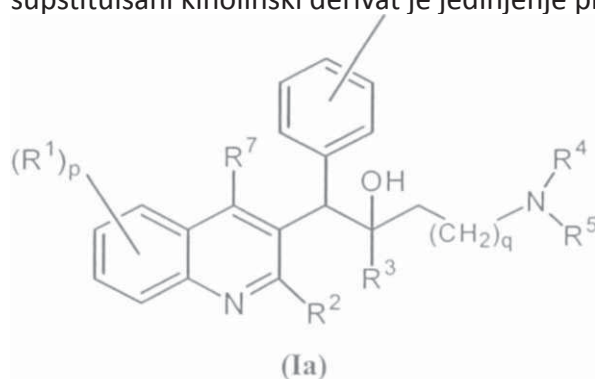

ili njegova farmaceutski korisna kiselinska ili bazna adicijona sol, stereohemijska izomema forma, tautomema forma ili N-oksid, gde:

R<sup>1</sup> je vodonik, halo, haloalkil, cijano, hidroksi, Ar, Het, alkil, alkoksi, alkiltio, alkiloksialkil, alkiltioalkil, Ar-alkil ili di(Ar)alkil;

p je ceo broj jednak 1, 2, 3 ili 4;

R<sup>2</sup> je vodonik, hidroksi, merkpto, alkiloksi, alkiloksialkiloksi, alkiltio, mono ili di(alkil) amino ili radikal sa formulom gde Y je CH<sub>2</sub>, O, S, NH ili N-alkil;

R<sup>3</sup> je alkil, Ar, Ar-alkil, Het ili Het-alkil;

q je ceo broj jednak nuli, 1, 2, 3 ili 4;

R<sup>4</sup> i R<sup>5</sup> svaki nezavisno je vodonik, alkil ili benzil; ili

R<sup>4</sup> i R<sup>5</sup> zajedno i uključujući i N kome su spojeni, mogu da formiraju radikal izabran iz grupe koja se sastoji od pirolidinila, 2//-pirolila, 2-pirolinila, 3-pirolinila, pirolila, imidazolidinila, pirazolidinila, 2-imidazolinila, 2-pirazolinila, imidazolila, pirazolila, tiazolila, piperidinila, piridinila, piperazinila, imidazolidinila, piridazinila, pirimidinila, pirazinila, triazinila, morfolinila i tiomorfolinila, ponekad supstituisan sa alkilom, halo, haloalkilom, hidroksi, alkiloksi, amino, mono ili dialkilamino, alkiltio, alkiloksialkilom, alkiltioalkilom i pirimidinilom;

R<sup>ft</sup> je vodonik, halo, haloalkil, hidroksi, Ar, alkil, alkiloksi, alkiltio, alkiloksialkil, alkiltioalkil, Ar-alkil ili di(Ar)alkil; ili dva susedna R' radikala mogu da budu uzeta zajedno da bi formirali dvovalentan radikal sa formulom -CH=CH-CH=CH-;

r je ceo broj jednak 1, 2, 3, 4 ili 5; i

R<sup>7</sup> je vodonik, alkil, Ar ili Het;

R<sup>8</sup> je vodonik ili alkil;

R je okso; ili

R<sup>8</sup> i R<sup>9</sup> zajedno formiraju radikal =N-CH=CH-;

alkil je pravolančani ili razgranati zasićeni ugljenovodonični radikal koji ima od 1 do 6 ugljenovih atoma; ili predstavlja ciklički zasićeni ugljenovodonični radikal koji ima od 3 do 6 ugljenova atoma; ili predstavlja ciklički zasićeni ugljenovodonični radikal koji ima od 3 do 6 ugljenovih atoma spojena na pravolančani ili razgranati zasićeni ugljenovodonični radikal koji ima od 1 do 6 ugljenovih atoma; gde svaki ugljenov atom može da bude ponekad supstituisan sa halo, hidroksi, alkiloksi ili okso;

Ar je homociklai izabran iz grupe koja obuhvata fenil, naftil, acenaftil, tetrahidronaftil, svaki ponekad supstituisan sa 1, 2 ili 3 supstituenta, a svaki supstituent je nezavisno izabran iz grupe koja obuhvata hidroksi, halo, cijano, nitro, amino, mono ili dialkilamino, alkil, haloalkil, alkiloksi, haloalkiloksi, karbonil, alkiloksikarbonil, aminokarbonil, morfolinil i mono ili dialkilaminokarbonil;

Het je monocikal izabran iz grupe koja obuhvata N-fenoksipiperidinil, pirolil, pirazolil, imidazolil, furanil, tienil, oksazolil, izooksazolil, tiazolil, izotiazolil, piridinil, pirimidinil, pirazinil i piridazinil; ili biciklički heterocikal izabran iz grupe koja obuhvata kinolinol, kinoksalinil, indolil, benzimidazolil, benzoksazolil, benzisoksazolil, benzotiazolil, benzisotiazolil, benzofuranil, benzotienil, 2,3-dihidrobenzo[1,4]dioksinil ili benzo[1,3]dioksolil; svaki monocikal i biciklički heterocikal mogu ponekad da budu supstituisani na ugljenovom atomu sa 1, 2 ili 3 supstituenta izabrana iz grupe koja obuhvata halo, hidroksi, alkil ili alkiloksi;

halo je supstituent izabran iz grupe koja obuhvata fluoro, hloro, bromo i jodo

i \*

haloalkil je pravolančani ili razgranati zasićeni ugljenovodonični radikal koji ima od 1 do 6 ugljenovih atoma ili ciklički zasićeni ugljenovodonični radikal koji ima od 3 do 6 ugljenovih atoma, gde jedan ili više ugljenovih atoma sli supstituisani sa jednim ili više halo-atoma.

Patent sadrži još 40 patentnih zahtjeva.

- (51) **C07D295/088** (11) **01103**  
**A6131/4453** (21) **P-2008-394**  
**A61P25/28**
- (30) 20050100942 10.02.2005 EP  
 (86) PCT/EP2006/050703 06.02.2006.  
 (87) WO2006084833 17.08.2006  
 (96) 06708050.7 06.02.2006  
 (97) EP 1846384 23.07.2008. 2008/30 EN
- (54) (MN) **MONOHIDROHLORIDNA SO 1-[3-[3-(4-HLOROPHENIL) PROPOKSI ] PROPIL]PIPERIDINA**  
 (EN) MONOHYDROCHLORIDE SALT OF 1-[3-[3-(4-HLOROPHENYL)PROPOXY]PROPYL]-PIPERIDINE
- (73) BIOPROJET ; 30, rue des Francs-Bourgeois, 75003 Paris / FR  
 (72) 01 / RAGA, Manuel M. Sors, 17-21 E-08024 Barcelona / ES  
 02 / SALLARES, Juan Pg. De La Creu, 25E-08226 Sant Cugat Del Vallès, Barcelona / ES  
 03 / GUERRERO, Marta Travessera De Dalt, 73 E-08024 Barcelona / ES  
 04 / GUGLIETTA, Antonio Magdalena Corcoll, 16 E-08750 Molins De Rei, Barcelona / ES  
 05 / ARRANG, Jean-Michel 3, avenue des Acacias 91410 Dourdan / FR  
 06 / SCHWARTZ, Jean-Charles 9, Villa Seurat 75014 Paris / FR  
 07 / LECOMTE, Jeanne-Marie 30, rue des Francs-Bourgeois 75003 Paris / FR  
 08 / LIGNEAU, Xavier Square Louis Vivier 35760 Saint-Gregoire / FR  
 09 / SCHUNACK, Walter Spanische Allee 95 14129 Berlin / DE  
 10 / GANELLIN, Charon, Robin 5 Fanshawe Road Thame OX9 3LF / GB  
 11 / STARK, Holger Am Elisabethenbrunnen 4 61348 Bad Homburg / DE
- (74) Lutovac Branimir, Bulevar Ivana Crnojevića 93, Podgorica (ME)
- (57) Kristalni I-[3-[3-(4-hlorofenil)propoksi]propil]-piperidin monohidrohlorid formule (I)

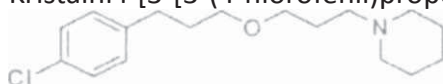

i njegovi farmaceutski prihvatljivi solvati, uključujući hidrate  
 Patent sadrži još 27 patentnih zahtjeva.

(51) **A61K9/48**(11) **01102**(21) **P-2008-589**

(30) 200510001332 11.01.2005 DE

(86) PCT/EP2006/050064 06.01.2006.

(87) WO2006074982 20.07.2006

(96) 06700744.3 06.01.2006

(97) EP 1838293 15.10.2008 2008/42 EN

(54) (MN) **DVODJELNA KAPSULA SA PRED-ZATVARANJEM ZA PRILAGOĐAVANJE FARMACEUTSKOG PREPARATA ZA INHALATORE PRAHA**

(EN) TWO-PIECE CAPSULE COMPRISING A PRELIMINARY CLOSURE FOR ACCOMMODATING PHARMACEUTICAL PREPARATIONS FOR POWDER INHALERS

(73) Boehringer Ingelheim Pharma GmbH &amp; Co.KG ; Binger Strasse 173, 55216 Ingelheim am Rhein / DE

(72) 01 / KUEHN, Torsten Welzbach Strasse 2155437 Appenheim / DE

02 / KUHN, Rolf Wackernheimerstrasse 48 55218 Ingelheim Am Rhein / DE

03 / METZGER, Burkhard Hausgartenstrasse 24 55218 Ingelheim Am Rhein / DE

04 / HOELZ, Hubert Am Sonnenhang 36 55413 Oberheimbach / DE

05 / LUSTENBERGER, Stefan Schlossstrasse 41 55457 Gensingen / DE 06 / WACHTEL, Herbert Im Muehlengarten 4 55218 Ingelheim Am Rhein / DE

(74) Radulović Božidar, Jovana Tomaševića 9/III, Podgorica (ME)

(57) Kapsula za upotrebu kao rezervoar za farmaceutske preparate u inhalatorima praha koja sadrži dva elementa kapsule otvorena na jednom kraju. telo kapsule i vrh kapsule koji može biti ubačen teleskopski jedan u drugi preko njihovih otvara tako da se formira stabilna. zatvorena šupljina defmisane zapremine. naznačna time, što su dva kružna kanala koji leže jedan iza drugoga, i koji idu periterno oko kućišta elementa kapsule. formirana na unutrašnjoj ili spoljašnjoj strani jednog elementa kapsule u blizini njegovog otvora i su dva kružna opeiono prekinuta kanala koji leže jedan iza drugog, i koji idu periferno oko kućišta tela kapsule, formirana na spoljašnjoj ili unutrašnjoj strani kućišta drugog elementa kapsule u blizini njegovog otvora, se uzdignuti delovi i kanali drže jedan za drugi na teleskopskom zatvaranju dva elementa kapsule, prvi uzdignuti deo na jednom elcmentu kapsule, koji se posmatra sa otvora, i prvt kanal drugog elementa kapsule formiraju pred-zatvaranje zajedničkim zatvaranjem što zahteva prvu silu kako bi se otvorila povlačenjein dva elementa kapsule. i drugi uzdignuti deo jednog elementa kapsule. koji se posmatra sa otvora, i prvi kanal na drugom elementu kapsule zajedno sa prvim uzdignutim delom jednog elementa kapsule i drugog kanala na drugom elementu kapsule formiraju glavno zatvaranje. što zahteva drugu silu kako bi se otvorila povlačenjem dva elementa kapsule. i prva sila koja se primenjuje za otvaranje je manja nego druga sila.

Patent sadrži još 12 patentnih zahtjeva.

(51) **C07D487/08**(11) **01184**(21) **P-2009-248**

(30) US20050658791P 04.03.2005 US

(86) PCT/EP2006/001798 27.02.2006.

(87) WO2006094672 14.09.2006

(96) 06707309.8 27.02.2006

(97) EP1861405 29.04.2009. 2009/18 EN

(54) **(ME) POSTUPAK SMANJENJA ALFA, BETA NEZASIĆENIH KETONA U OPIOIDNIM KOMPOZICIJAMA**

(EN)METHOD OF REDUCING ALPHA, BETA- UNSATURATED KETONES IN OPIOID COMPOSITIONS

(73) EURO-CELTIQUE S.A. ; 2, avenue Charles de Gaulle, 1653 Luxembourg / LU

(72) 01 / KUPPER, Robert, J. 755 Major Potter Road East Greenwich, RI 02818 / US

(74) Lutovac Branimir, Bulevar Ivana Crnojevića 93, Podgorica (ME)

(57) Postupak za smanjenje količine  $\alpha$ , ( $\beta$ -nezasićenih ketona u opioidnoj analgetičkoj kompoziciji koji se sastoji od hidrogenizacije polazne opioidne analgetičke kompozicija koja ima nečistoće  $\alpha$ ,  $\beta$ -nezasićenih ketona sa diimidom, 10 jedinjenjem koje daje diimid ili njihovom kombinacijom u pogodnom rastvaraču, da bi se dobila rezultujuća opioidna analgetička kompozicija koja ima nivo  $\alpha$ ,  $\beta$ -nezasićenih ketona manji od polazne kompozicije, a gde je opioidni analgetik jedinjenje formule (I):

1

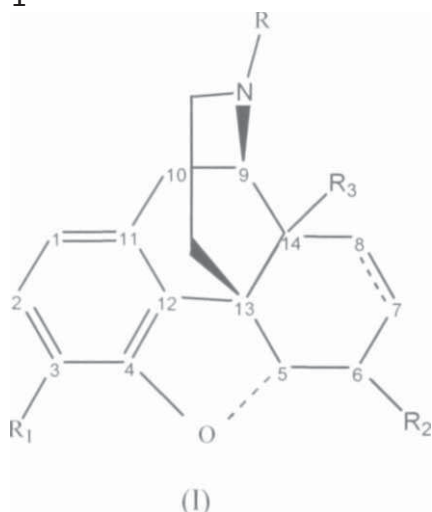

Gde R je izabran iz grupe koju cine vodonik; C1-8 alkil; C3-6cikloalkil; (C3-<sub>6</sub>)cikloalkil(C1-3) alkil; fenil(C1-3)alkil; i fenil(C1-3)alkil supstituisan sa 1-3 člana grupe koju čine C1-8 alkil, trifluorometil, nitro, dialkilamino i cijano;

R1 je izabran iz grupe koju cine vodonik; C1-8galkil; C3-6cikloalkil;

C1-8galkoksi; C3-6cikloalkoksi; 2-(4-morfolinil)etil; benziloksikarbonil; (R<sub>8</sub>)<sub>3</sub>C(O)-; fenil(C1-3) alkil; i fenil(C1-3)alkil supstituisan sa 1-3 člana grupe koju čine C1-8 alkil, trifluorometil, nitro, dialkilamino i cijano;

R2 je izabran iz grupe koju čine vodonik; okso; hidroksil; C1-8 alkil; 5 C1-8alkoksi; C3-6cikloalkil; i C3-6 cikloalkoksi; i

R3 je vodonik; hidroksil; ili alkoksi;

R<sub>8</sub> je nezavisno vodonik, C1-<sub>4</sub> alkil, C<sub>3-6</sub> cikloalkil, fenil ili benzil gde je R2 okso kadaje veza u položaju 7-8 zasićena; ili njegova farmaceutski prihvatljiva so.

Patent sadrži još 18 patentnih zahtjeva.



(51) **B32B27/32**  
**B32B37/00**  
**B29C69/02**  
**B29D24/00**

(11) **01104**  
(21) **P-2008-348**

(30) 2004MI00866 30.04.2004 IT

(86) PCT/EP2005/004503 25.04.2005.

(87) WO2005105436 10.11.2005

(96) 05726209.9 25.04.2005

(97) EP 1638770 04.04.2007. 2007/14 EN

(54) (MN) **POSTUPAK I UREĐAJ ZA PROIZVODNJU "SENDVIČ" TABLE**

(EN) PROCESS AND APPARATUS FOR THE PRODUCTION OF A SANDWICH SHEET

(73) COLINES S.p.A.; Via XX Settembre 15, 28100 Novara / IT

(72) 01 / LOMBARDINI, Francesco Via Buonarroti, 27/29 I-28060 Nibbia / IT

(74) Lutovac Branimir, Bulevar Ivana Crnojevića 93, Podgorica (ME)

(57) Kontinualni postupak za proizvodnju blister table koji se sastoji od sledećih koraka: ekstrudiranja donjeg filma, središnjeg filma i gornjeg filma, polazeći od odgovarajućih granula; termičkog formiranja središnjeg filma, pri čemu na kraju ovog termičkog formiranja središnji film potpuno kristališe, ali je još uvek relativno vruć; \* kalibrisanja i delimičnog hlađenja donjeg i gornjeg filma, pri čemu, na kraju ovog kalibrisanja i delimičnog hlađenja donji i gornji film potpuno kristališu, ali su još uvek relativno vrući; zagrijavanja najmanje jedne strane gornjeg i donjeg filma, pa spajanja i donjeg i gornjeg filma sa termički formiranim filmom.

Patent sadrži još 19 patentnih zahtjeva.

- (51) **C07D231/16** (11) **01092**  
 (21) **P-2008-384**
- (30) 20040629774P 19.11.2004 US  
 (86) PCT/US2005/041726 17.11.2005.  
 (87) WO2006055734 26.05.2006  
 (96) 05849546.6 17.11.2005  
 (97) EP1833799 10.09.2008 2008/37 EN
- (54) **(ME) 3-FENIL-PIRAZOL DERIVATI KAO MODULATORI 5-HT-2A SEROTONIN RECEPTORA KORISNI ZA LIJEČENJE SA TIM POVEZANIH POREMEĆAJA**  
**(EN) 3-P HENYL-PYRAZOLE DERIVATIVES AS MODULATORS OF THE 5-HT-2A SEROTONIN RECEPTOR USEFUL FOR THE TREATMENT OF DISORDERS RELATED THERETO**
- (73) Arena Pharmaceuticals, Inc. ; 6166 Nancy Ridge Drive San Diego, CA 92121-3223 / US  
 (72) 01 / TEEGARDEN, Bradley 11933 Windom Peak Way San Diego, California 92131 / US  
 02 / XIONG, Yifeng 5036 Pearlman Way San Diego, California 92130 / US  
 03 / STRAH-PLEYNET, Sonja 12542 Darkwood Road San Diego, California 92129 / US  
 04 / JAYAKUMAR, Honnappa 5555 Porter Creek Road San Diego, California 92130 / US  
 05 / DOSA, Peter I. 8458 Summerdale Road, Apt. B San Diego, California 92126 / US  
 06 / FEICHTINGER, Konrad 3533 6th Avenue, Apt. 3 San Diego, California 92103 / US  
 07 / CASPER, Martin 6341 Peach Way San Diego, California 92130 / US  
 08 / LEHMANN, Juerg 9840 La Tortola Court San Diego, California 92129 / US  
 09 / JONES, Robert M. 10937 Corte Luz Del Sol San Diego, California 92130 / US  
 10 / UNETT, David J. 11422 Cypress Terrace Place San Diego, California 92131 / US  
 11 / CHOI, Jin, Sun, Karoline 9926 Scripps Westview Way, N[deg] 251 San Diego, CA 92131 / US
- (74) Anđelić Branko, Svetozara Markovića 12, Podgorica (ME)  
 (57) Jedinjenje odabrano od jedinjenja formule (Ia) i njihove farmaceutski prihvatljive soli, hidrati i solvati:

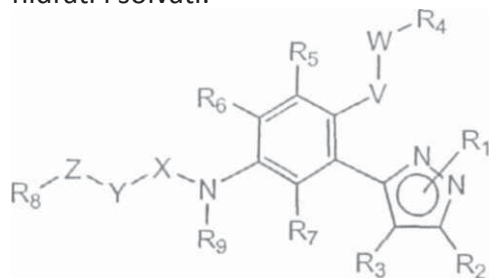

(Ia)

naznačeno time, što: V je O; W je C<sub>1-4</sub> alkilen opciono supstituisan sa 1 do 8 supstituenata nezavisno odabranih od grupe koja sadrži alkil, C-<sub>1-4</sub> alkoksi, karboksi, cijano, C<sup>3</sup> haloalkil, halogen i okso; ili W nije prisutan; X je C(=O), C(=S) ili nije prisutan; Z je d<sub>4</sub> alkilen ili C<sub>3-6</sub> cikloalkilen, svaki opciono supstituisan sa 1 do 8 supstituenata nezavisno odabranih od grupe koja sadrži C<sub>1-3</sub> alkil, C<sub>1-4</sub> alkoksi, karboksi, cijano, haloalkil, halogen, hidroksil i okso; ili Z nije prisutan; R-i je odabran od grupe koja sadrži H, alkil, C<sub>2-6</sub> alkenil, C<sub>2-6</sub> alkinil i C<sub>3-7</sub> cikloalkil; R<sub>2</sub> je odabran od grupe koja sadrži H, C-<sub>6</sub> acil, aciloksi, C<sub>2-6</sub> alkenil, C-<sub>6</sub> alkoksi, C-<sub>6</sub> alkil, alkilkarboksamid, C<sub>2-6</sub> alkinil, alkilsulfonamid, alkilsulfinil, alkilsulfonyl, alkiltio, C<sub>1-6</sub> alkilureil, amino, alkilamino, C<sub>2-8</sub> dialkilsulfonamid, halogen, C<sub>6</sub> haloalkoksi, C<sub>6</sub> haloalkil, d<sub>6</sub> haloalkilsulfinil, C<sub>6</sub> haloalkilsulfonyl, d<sub>6</sub> haloalkiltio, hidroksil, tiol nitro i sulfonamid; R<sub>3</sub> je odabran od grupe koja sadrži H, C<sub>2-6</sub> alkenil, d<sub>6</sub> aril, d<sub>6</sub> alkilkarboksamid, C<sub>2-6</sub> alkinil, d<sub>6</sub> alkilsulfonamid, karbo-d<sub>6</sub>-alkoksi, karboksamid, karboksi, cijano, C<sub>3-7</sub> cikloalkil, C<sub>2-8</sub> dialkylkarboksamid, halogen, heteroaril, i fenil; i pri čemu su svaka od navedenih

$C_{2-6}$  alkenil,  $d_{-6}$  alkil,  $C_{2-6}$  alkinil,  $d_{-6}$  alkilsulfonamid,  $C_{3-7}$  cikloalkil, heteroaril i fenil grupa opciono supstituisane sa 1-5 supstituenata nezavisno odabranih od grupe koja sadrži  $d_{-5}$  acil,  $d_{-5}$  aciloksi,  $C_{2-6}$  alkenil,  $d_{-4}$  alkoksi,  $d_{-8}$  alkil, d-6 alkilamino,  $C_{2-8}$  dialkilamino, d-4 alkilkarboksamid,  $C_{2-6}$  alkinil, d-4 alkilsulfonamid, Cm alkilsulfinil, d-4 alkilsulfonil,  $d_{-4}$  alkiltio, d-4 alkilureil, amino, karbo- $d_{-6}$ -alkoksi, karboksamid, karboksi, cijano,  $C_{3-6}$  cikloalkil,  $C_{2-6}$  dialkilkarboksamid, halogen, d-4 haloalkoksi, d-4 haloalkil, d-4 haloalkilsulfinil, d-4 haloalkilsulfonil, d-4 haloalkiltio, hidroksil, nitro i sulfonamid; Ra je heterobiciklik, heterociklik, ili heteroaril, svaki opciono supstituisan sa supstituentima nezavisno odabranim od grupe koja sadrži  $d_{-6}$  acil, d-12 aciloksi,  $C_{2-6}$  alkenil, Cm alkoksi,  $d_{-6}$  alkoksikarbonilamino, d-6 alkil, d-6 alkilamino,  $C_{2-8}$  dialkilamino, Cm alkilkarboksamid,  $C_{2-6}$  alkinil, d-4 alkilsulfonamid, d-4 alkilsulfinil, Cm alkilsulfonil,  $d_{-4}$  alkiltio, d-4 alkilureil, amino, karbo-CVe-alkoksi, karboksamid, karboksi, cijano,  $C_{3-6}$  cikloalkil,  $C_{3-7}$  cikloalkilkarbonil,  $C_{2-6}$  dialkilkarboksamid, formil, halogen,  $d_{-4}$  haloalkoksi,  $d_{-4}$  haloalkil,  $d_{-4}$  haloalkilsulfinil, Cm haloalkilsulfonil, d-4 haloalkiltio, heteroaril, hidroksil, nitro, fenil i sulfonamid, pri čemu su navedeni  $d_{-6}$  acil,  $d_{-12}$  aciloksi, d-4 alkoksi,  $d_{-6}$  alkil, C1.  $d_{-4}$  alkilkarboksamid, amino, karbo- $d_{-6}$ -alkoksi, i heteroaril svaki opciono supstituisani sa supstituentima nezavisno odabranim od grupe koja sadrži d-6 alkil, d-5 acil, d-4 alkoksi, d-6 alkilamino,  $C_{2-8}$  dialkilamino, d-4 alkilkarboksamid, d-4 alkilsulfonil, amino, karbo-d-e-alkoksi, karboksamid, karboksi, cijano,  $C_{3-6}$  cikloalkil, halogen, d-4 haloalkoksi, d-4 haloalkil, hidroksil i fenil;  $R_5$ ,  $R_6$  i  $R_7$  su svaki nezavisno odabrani od grupe koja sadrži H, d-6 acil, d-6 aciloksi,  $C_{2-6}$  alkenil, d-6 alkoksi, d-6 alkil, d-6 alkilkarboksamid,  $C_{2-6}$  alkinil, d-6 alkilsulfonamid, d-6 alkilsulfinil, d-6 alkilsulfonil, d-6 alkiltio, d-6 alkilureil, amino, d-6 alkilamino,  $C_{2-8}$  dialkilamino, d-6 alkilamino, karbo-d-6-alkoksi, karboksamid, karboksi, cijano,  $C_{3-7}$  cikloalkil, d-8 dialkilkarboksamid, d-8 dialkilsulfonamid, halogen, d-6 haloalkoksi, d-6 haloalkil, d-6 haloalkilsulfinil, d-6 haloalkilsulfonil, d-6 haloalkiltio, heterociklik, hidroksil, tiol, nitro, fenoksi i fenil;  $R_8$  je d-s alkil, d-6 alkenil, aril, d-7 cikloalkil, ili heteroaril, i svaki opciono supstituisan sa supstituentima nezavisno odabranim od grupe koja sadrži d-6 acil, d-6 aciloksi, d-6 alkenil, d-6 alkoksi,  $d_{-6}$  alkil, d-6 alkilkarboksamid, d-6 alkinil, d-6 alkilsulfonamid, d-6 alkilsulfinil, d-6 alkilsulfonil, d-6 alkiltio, d-6 alkilureil, amino, d-6 alkilamino,  $C_{2-8}$  dialkilamino, d-6 alkilamino, karbo- $d_{-6}$ -alkoksi, karboksamid, karboksi, cijano,  $d_{-7}$  cikloalkil, d-8 dialkilkarboksamid,  $C_{2-8}$  dialkilsulfonamid, halogen,  $d_{-6}$  haloalkoksi, d-6 haloalkil, d-6 haloalkilsulfinil, d-6 haloalkilsulfonil, d-6 haloalkiltio, heterociklik, hidroksil, tiol, nitro, fenoksi i fenil, ili dva susedna supstituenta zajedno sa navedenim arilom ili heteroarilom formiraju d-7 cikloalkil koji opciono sadrži 1 do 2 atoma kiseonika i opciono je supstituisan sa F, Cl ili Br, i pri čemu su navedeni d-6 alkenil, d-6 alkil- $C_{2-6}$  alkinil, d-6 alkilamino, d-6 alkilamino, d-8 dialkilamino, heterociklik i fenil svaki opciono supstituisani sa 1 do 5 supstituenata nezavisno odabranih od grupe koja sadrži d-6 acil, d-e aciloksi,  $C_{2-6}$  alkenil, d-6 alkoksi, d-e alkil, d-6 alkilkarboksamid,  $C_{2-6}$  alkinil, d-6 alkilsulfonamid, d-6 alkilsulfinil,  $C_{-6}^{\wedge}$  alkilsulfonil, d-e alkiltio, d-6 alkilureil, amino, d-6 alkilamino, d-e dialkilamino, karbo-d-6-alkoksi, karboksamid, karboksi, cijano,  $C_{3-7}$  cikloalkil,  $C_{2-8}$  dialkilkarboksamid, halogen, d-6 haloalkoksi, d-6 haloalkil, d-e haloalkilsulfinil, d-6 haloalkilsulfonil, d-6 haloalkiltio, hidroksil, tiol i nitro; i  $R_9$ ,  $R_{10}$  i  $R_{11}$  su svaki nezavisno H ili d-e alkil; pod uslovom da je  $R_4$  bilo koja grupa osim oksiranil grupe.

Patent sadrži još 63 patentnih zahtjeva.

(51) **A61K31/135**  
**A61P37/00**  
**A61P37/06**  
**A61P19/04**

(11) **01201**  
(21) **P-2010-166**

(30) 20050000529 13.04.2005. DK  
(96) 06007632.0 12.04.2006.  
(97) EP 1719507 14.07.2010 2010/28 En

(54) (ME) **BETA-2-ADRENOCEPTORSKI AGONISTI ZA TRETMAN BOLESTI EZNOG TKIVA KOŽE**

(EN) BETA-2 ADRENOCEPTOR AGONISTS FOR TREATING CONNECTIVE TISSUE DISEASES OF THE SKIN

(73) Astion Development A/S, Fruebjergvej 3 Postbox 115, 2100 Copenhagen (DK)

(72) Weidner, Morten Sloth; Kaningardsvej 27, 2830 Virum (DK)

(74) Radulović Božidar, Jovana Tomaševića 9/III, Podgorica (ME)

(57) Beta2-adrenoceptorski agonist, naznačen time, da služi kao terapijski aktivan sastojak za upotrebu kao dermatološki medikament za topikalnu administraciju u kožu neke individue tokom lokalnog tretmana kože od kutanih formi lupus erythematosus koje su izabrane iz grupe koja obuhvata Subakutni Kutani Lupus Erythematosus, Hronični Kutani Lupus Erythematosus, Diskoidni Lupus Erythematosus. Lupus Panniculitis i Lupus Erythematosus Profundus, kod pojedinca, gde beta2-adrenoceptorski agonist je definisan uz pomoć strukturne formule I, uključujući i njegov stereoizomer i njegovu farmaceutski prihvatljivu so.

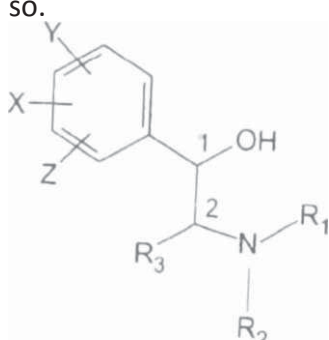

gdje termini Z, X i Y nezavisno označavaju radikale izabrane iz grupe koja obuhvata H; supstituisani C<sub>1-6</sub>-alkil, C<sub>4-6</sub>-cikloalkil, C<sub>2-6</sub>-alkenil, C<sub>2-6</sub>-alkinil, C<sub>1-6</sub>-alkoksil, fenil, C<sub>7-14</sub> alkaril i C<sub>7-14</sub> alkheterociklil; OOR', CN, NH-CO-NH<sub>2</sub>, NH-CO, trihalogenmetil, halogen, OH, OR', NH<sub>2</sub>, NHR', NR'R'', CO, CO- R', HSO<sub>2</sub>, R'-SO<sub>2</sub>, NH-SO<sub>2</sub>- R' i gde dvije od grupa izabranih iz Z, X i Y zajedno formiraju 5 ili 6-čani ugljenikov prsten ili ugljenikov prsten sa jednim atomom azota (N) u prstenu; termini R<sub>1</sub> i R<sub>2</sub> nezavisno opisuju radikal koji je izabran iz grupe koja obuhvata H, C<sub>1-6</sub>-alkil, C<sub>4-6</sub>-cikloalkil, C<sub>2-6</sub>-alkenil, C<sub>2-6</sub>-alkinil, C<sub>1-6</sub>-alkoksil, C<sub>7-14</sub> alkaril, C<sub>7-14</sub> alkheterociklil ili gdje R<sub>1</sub> i R<sub>2</sub> zajedno formiraju 5 ili 6-čani ugljenov prsten ili ugljenikov prsten sa jednim atomom azota (N) u prstenu; termin R<sub>3</sub> označava radikal koji je izabran iz grupe koja obuhvata H, halogen, C<sub>1-6</sub>-alkil, C<sub>4-6</sub>-cikloalkil, C<sub>2-6</sub>-alkenil i C<sub>2-6</sub>-alkinil; grupe C<sub>1-6</sub>-alkil, C<sub>4-6</sub>-cikloalkil, C<sub>2-6</sub>-alkenil, C<sub>2-6</sub>-alkinil, C<sub>1-6</sub>-alkoksil, C<sub>7-14</sub> alkaril i C<sub>7-14</sub> alkheterociklil su ponekad mono ili di-supstituisani sa NH<sub>2</sub>, NHR', NR'R'', OH, cijano, nitro i halogenom; i termini R' i R'' nezavisno opisuju radikal koji je izabran iz grupe koja obuhvata C<sub>1-6</sub>-alkil, C<sub>4-6</sub>-cikloalkil, C<sub>2-6</sub>-alkenil, C<sub>2-6</sub>-alkinil, C<sub>1-6</sub>-alkoksil, C<sub>7-14</sub> alkaril i C<sub>7-14</sub> alkheterociklil; i gde ugljenikov atom Ci sa strukturnom formulom I opisuje asimetrični ugljenov atom koji ima R-konfiguraciju.  
Patent sadrži još 31 patentni zahtjev.

- (51) **F16L21/04** (11) **01202**  
 (30) 20050000337 04.03.2005 DK  
 (86) PCT/DK2006/000124 02.03.2006.  
 (87) WO 2006/092144 08.09.2006  
 (96) 06706095.4 02.03.2006.  
 (97) EP 1864049 01.09.2010 2010/35 En

(54) **(ME) SPOJ ZA CIJEVI**  
**(EN) PIPE COUPLING**

- (73) Aage V. Kjaers Maskinfabrik A/S, Søndergade 33, 8464 Galten (DK)  
 (72) FREUDENDAHL, Erling, A., Havrevej 7, DK-8464 Galten / DK  
 (74) Radulović Božidar, Jovana Tomaševića 9/III, Podgorica (ME)

(57) . Spoj za cijevi (1), naznačen time, da obuhvata: kružni rukav (2) koji ima najmanje jedan kraj za uvođenje koji je oblikovan tako da u njega može da se uvede kraj neke cijevi, ali tako da se uvodi u smeru uvođenja (I), pri čemu pomenuti rukav sadrži produženi rub (4) koji ima kraj prednje strane (6) koji je zašiljen u smjeru uvođenja cijevi, kružno pomagalo za zatezanje (13) koje ima prednju stranu za zatezanje (24) koja je okrenuta prema spoljnoj prednjoj strani cijevi, kružno elastično pomagalo za zatvaranje (12) koje se nalazi među ruba (4) i pomagala za zatezanje (13) kada se posmatra u aksijalnom smjeru, kružno pomagalo za pritisak (8), i pomagalo za učvršćivanje tipa šraf/matica za pokretanje rukava (2) i pomagala za pritisak (8) jedan prema drugome sa ciljem da se pokrene prednja strana za zatezanje na pomagalu za zatezanje (13) i samo pomagalo za zatvaranje (12) prema unutra i u smislu zatezanja i zatvaranja, pri čemu spoljna prednja strana cijevi je karakterizovana sa time da je pomagalo za pritisak (8) podijeljeno u brojne odvojene prstenske segmente (10) i sadrži potpornu stranu (9) koja je prilagođena da dodiruje kraj prednje površine (6) samoga ruba (4) i koja je oblikovana tako da uz pomoć aksijalnog pomicanja pomagala za pritisak u odnosu na pomenuti rub segmenata sa pomagala za pritisak se pomiču prema unutra i prema spoljnoj prednjoj strani (16) cevi, i time da šrafovi koji se protežu kroz produžene, radijalno usmerene otvore (29, 30) u rubu (4), a ta pomagala su obezbijeđena sa ciljem da značajno zadrže šrafove radijalno u odnosu na pomagalo za pritisak (8) tako da istovremeno sa pomicanjem prstenskih segmenata (10) sa pomagala za pritisak (8) prema unutra sami sarafi se pomiču takode radijalno prema unutra.

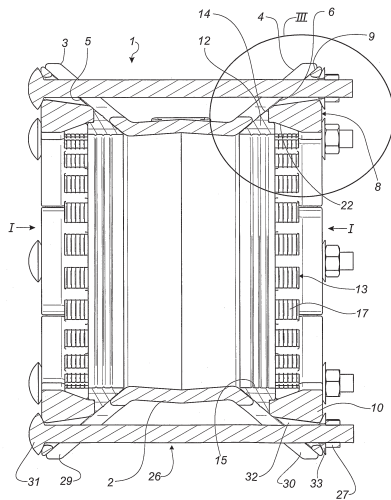

Patent sadrži još 9 patentnih zahtjeva.

(51) **C07D401/12**  
**C07D409/14**  
**A61K31/501**  
**A61P25/00**

(11) **01208**  
(21) **P-2011-61**

(30) 20050110028 26.10.2005. EP  
20060100209 10.01.2006. EP  
20060101545 10.02.2006 EP

(86) PCT/EP2006/067696 24.10.2006.

(87) WO 2007/048779 03.05.2007.

(96) 06807495.4 24.10.2006.

(97) EP1943242 12.01.2011. 2011/02 EN

(54) (ME) **DERIVATI PIPERIDIN-4-IL-PIRIDAZIN-3-ILAMINA KAO BRZO ISOCIRAJUĆI ANTAGONISTI DOPAMIN 2 RECEPTORA**

(EN) PIPERIDIN-4-YL-PYRIDAZIN-3-YLAMINE DERIVATIVES AS FAST DISSOCIATING DOPAMINE 2 RECEPTOR ANTAGONISTS

(73) Janssen Pharmaceutica NV, Turnhoutseweg 30, 2340 Beerse (BE)

(72) 01/ DE BRUYN, Marcel, Frans, Leopold; c/o Janssen Pharmaceutica N.V. Turnhoutseweg 30, B-2340 Beerse (BE)

02/ MACDONALD, Gregor, James; c/o Janssen Pharmaceutica N.V. Turnhoutseweg 30, B-2340 Beerse (BE)

03/ KENNIS, Ludo, Edmond, Josephine; Bosstraat 35, B-2500 Lier (BE)

04/ LANGLOIS, Xavier, Jean, Miche; c/o Janssen Pharmaceutica N.V. Turnhoutseweg 30, B-2340 Beerse (BE)

05/ VAN DEN KEYBUS, Frans, Alfons, Maria, c/o Janssen Pharmaceutica N.V. Turnhoutseweg 30, B-2340 Beerse (BE)

06/ VAN ROOSBROECK, Yves, Emiel, Maria, c/o Janssen Pharmaceutica N.V. Turnhoutseweg 30, B-2340 Beerse (BE)

(74) Radulović Božidar, Jovana Tomaševića 9/III, Podgorica (ME)

(57) Jedinjenje formule (I)

R

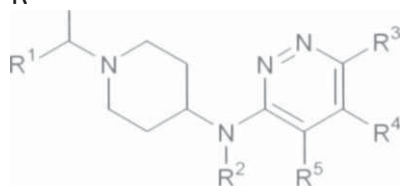

(I)

ili njegova farmaceutski prihvatljiva so, njegov hidrat ili solvat, ili njegova stereoizomerna forma, naznačeno time što u strukturi R je vodonik ili C<sub>1-6</sub> alkil; R<sup>1</sup> je fenil; fenil supstituisan s 1, 2 ili 3 supstituenta pri čemu je svaki nezavisno izabran iz grupe koju sačinjavaju vodonik, halogen, cijano, C<sub>1-4</sub> alkil, C<sub>1-4</sub> alkiloksi, perfluoroC<sub>1-4</sub> alkil, diC<sub>1-4</sub> alkilamino; tienil; tienil supstituisan s 1 ili 2 supstituenta koji su odabrani iz grupe koju sačinjavaju halogen i C<sub>1-4</sub> alkil; C<sub>3-8</sub> cikloalkil; ili C<sub>5-7</sub> cikloalkenil; R<sup>2</sup> je vodonik ili C<sub>1-6</sub> alkil; R<sup>3</sup> je halogen, C<sub>1-4</sub> alkil ili perfluoroC<sub>1-4</sub> alkil ; i R<sup>4</sup> i R<sup>5</sup> su svaki nezavisno vodonik ili halogen.

Patent sadrži još 10 patentnih zahtjeva.

- (51) **A61K31/381** (11) **01205**  
**A61P11/06** (21) **P-2011-62**
- (30) P20060100055 04.01.2006. EP  
 (86) PCT/EP2006/070135 22.12.2006.  
 (87) WO/2007/077162 12.07.2007.  
 (96) 06830792.5 22.12.2006.  
 (97) EP1971332 09.03.2011. 2011/10 EN

(54) (ME) **UPOTREBA SOLI TIOTROPIJUMA U LIJEČENJU UMJERENE TRAJNE ASTME**

(EN) USE OF TIOTROPIUM SALTS IN THE TREATMENT OF MODERATE PERSISTENT ASTHMA

- (73) Boehringer Ingelheim International GmbH, Binger Strasse 173, 55216 Ingelheim am Rhein (DE)  
 (72) 01/ ENGEL, Michael; Pfarrer-Weiss-Weg 3, 89077 Ulm (DE)  
 02/ HEINRICHS, Stefan; Wilhelmshoeher Str. 38, 60389 Frankfurt (DE)  
 (74) Radulović Božidar, Jovana Tomaševića 9/III, Podgorica (ME)  
 (57) Upotreba soli tiotropijuma 1

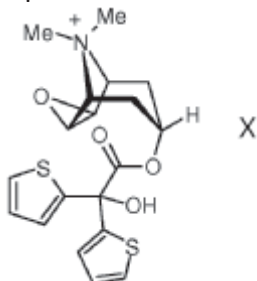

gdje

X- oznacava anjon sa jednim negativnim naelektrisanjem, prvenstveno anjon koji je odabran između hlorida, bromida, jodida, sulfata, fosfata, metansulfonata, nitrata, maleata, acetata, citrata, fumarata, tartrata, oksalata, sukcinata, benzoata i p-toluolsulfonata, opcionalno u obliku njihovih hidrata i/ili solvata, za proizvodnju lijeka za liječenje astme trećeg stepena težine prema GINA smjernicama

Patent sadrži još 7 patentnih zahtjeva.

- (51) **A01N43/56** (11) **01203**  
(21) **P-2011-66**

- (30) 20070008370 25.04.2007. EP  
(86) PCT/EP2008/003279 23.04.2008.  
(87) WO/2008/131901 06.11.2008.  
(96) 10157578.5 23.04.2008.  
(97) EP 2193716 16.02.2011. 2011/07 EN

(54) **(ME) FUNGICIDNE KOMPOZICIJE**  
**(EN) FUNGICIDAL COMPOSITIONS**

- (73) Syngenta Participations AG, Schwarzwaldallee 215, 4058 Basel (CH)  
(72) 01 / Tobler, Hans; Birsigstrasse 129, 4054, Basel (CH)  
02 / Walter, Harald; Syngenta Crop Protection Münchwilen AG, Schaffhau 4332, Stein (CH)  
03 / Haas, Ulrich Johannes; Syngenta Crop Protection Münchwilen AG, Schaffhau 4332, Stein (CH)  
(74) Radulović Božidar, Jovana Tomaševića 9/III, Podgorica (ME)  
(57) Sastav pogodan za kontrolisanje bolesti prouzrokovanih fitopatogenim organizmima uključujući (A) jedinjenje formule (I)

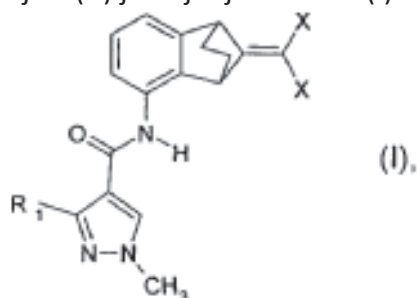

naznačen time da je R, difluorometil ili trifluorometil, a X hlоро, fluoro, ili bromo; i (B) jedinjenje fludioksonil.

Patent sadrži još 11 patentnih zahtjeva.



- (51) **A63B24/00** (11) **01204**  
**A63B22/08** (21) **P-2011-74**  
 (30) 20070001363 30.08.2007. AT  
 20070001364 30.08.2007. AT  
 (86) PCT/AT2008/000306 28.08.2008.  
 (87) WO 2009/026604 05.03.2009.  
 (96) 08782834.9 28.08.2008.  
 (97) EP2183034 26.01.2011. 2011/04 DE

(54) (ME) **ERGONOMETRIJSKI TRENAŽER**  
 (EN) **ERGOMETRIC TRAINING DEVICE**

(73) 1. Wilson, Ian John; Fairfield House, Widmerpool Lane Widmerpool, Nottingham NG12 5BA (GB)

2. Wilson, John Dudley; Harriets Old Hall Drive Widmerpool, Nottingham NG11 7HQ (GB)

3. Bacanovic, Milan; Rieglgasse 82-86/7, 1210 Wien (AT)

4. Adamovic, Dusan; A. Baumgartner Str. 125/10/10, 1230 Wien (AT)

(72) BACANOVIĆ Milan; Rieglgasse 82-86/7, A-1210 Wien (AT)

ADAMOVIĆ, Dusan; A. Baumgartner Str.125/10/10M, A-1230 Wien(AT)

(74) Lutovac Branimir, Bulevar Ivana Crnojevića 93, Podgorica (ME)

(57) . Stacionarni ergonometrijski trenažni uređaj sa ručnim ili nožnim pogonom sa dva naizmenično pogonjena pogonska elementa (16), prevashodno su to pedale za nožni pogon, pri čemu je pogon preko prenosioca povezan sa zamajcem (18), kao i sa mjernim uređajem (50) za mjerenje sile koja se proizvodi pogonom, odnosno odgovarajućeg obrtnog momenta, i mjernog sistema (30) za mjerenje pozicije okreta, naročito ugaone pozicije pogona, naznačen time, što mjerni sistem (30) za mjerenje pozicije okreta, sadrži par senzoraskih sistema (31,32), koji su montirani na točak (19) koji se sinhrono okreće sa pogonom, i koji se nalaze na pozicijama jedan nasuprot drugog, na pozicijama koje odgovaraju tačkama kod kojih dolazi do promjene opterećenja između dva pogonska elementa (16).

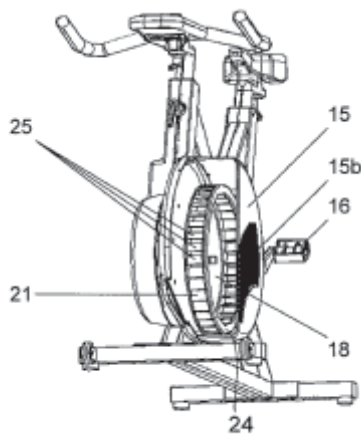

Fig. 6

Patent sadrži još 12 patentnih zahtjeva.

(51) **A01N43/56**(11) **01206**(21) **P-2011-82**

(30) 070008370 25.04.2007. EP

(86) PCT/EP2008/003279 23.04.2008.

(87) WO/2008/131901 06.11.2008.

(96) 10157580.1 23.04.2008.

(97) EP 2196089 16.03.2011. 2011/11 EN

(54) **(ME) FUNGICIDNI SASTAVI****(EN) FUNGICIDAL COMPOSITIONS**

(73) Syngenta Participations AG; Schwarzwaldallee 215, 4058 Basel (CH)

(72) 01 / Tobler, Hans; Birsigstrasse 129, 4054, Basel (CH)

02 / Walter, Harald; Syngenta Crop Protection Münchwilen AG, Schaffhauserstrasse 4332, Stein (CH)

03 / Haas, Ulrich Johannes; Syngenta Crop Protection Münchwilen AG, Schaffhauserstrasse 4332, Stein (CH)

(74) Radulović Božidar, Jovana Tomaševića 9/III, Podgorica (ME)

(57) Sastav pogodan za kontrolisanje bolesti prouzrokovanih fitopatogenim organizmima uključujući (A) jedinjenje formule I

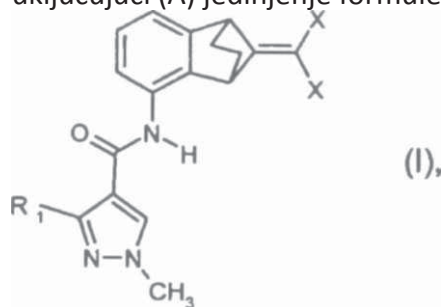

naznačen time da je R, difluorometil ili trifluorometil, a X hlоро, fluoro, ili bromo; i (B) jedinjenje hlorotalonil.

Patent sadrži još 11 patentnih zahtjeva.

- (51) **A61K31/47** (11) **01207**  
**A61K31/4704** (21) **P-2011-92**  
**A61P31/06**

- (30) 20040078529 24.12.2004 EP  
 20050105008 08.06.2005 EP  
 (86) PCT/EP2005/056594 08.12.2005.  
 (87) WO/2006/067048 29.06.2006.  
 (96) 05815816.3 08.12.2005.  
 (97) EP1830850 16.03.2011 2011/11 EN

(54) (ME) **DERIVATI HINOLINA ZA TRETIRANJE LATENTNE TUBERKULOZE**  
 (EN) **QUINOLINE DERIVATIVES FOR THE TREATMENT OF LATENT TUBERCULOSIS**

- (73) Janssen Pharmaceutica NV, Turnhoutseweg 30, 2340 Beerse (BE)  
 (72) 01 / ANDRIES, Koenraad Jozef Lodewijk Marcel; Janssen Pharmaceutica N.V.,  
 Turnhoutseweg 30, 2340 Beerse (BE)  
 02 / KOUL, Anil; Janssen Pharmaceutica N.V., Turnhoutseweg 30, 2340 Beerse (BE)  
 (74) Radulović Božidar, Jovana Tomaševića 9/III, Podgorica (ME)  
 (57) Upotreba jedinjenja formule (Ia) ili (Ib) za proizvodnju medikamenta za tretiranje latentne  
 tuberkuloze, naznačena time sto je jedinjenje (Ia) ili (Ib)  
 (R<sup>6</sup>).

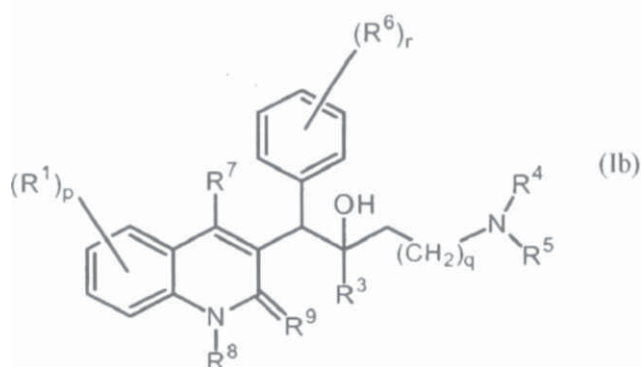
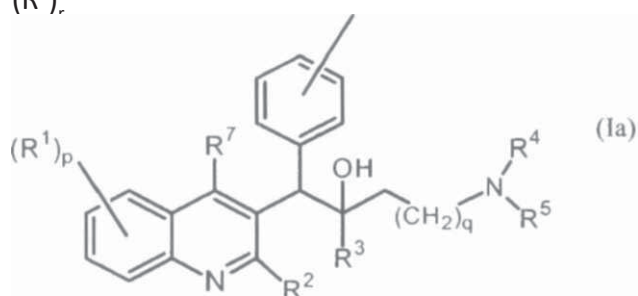

njegova farmaceutski prihvatljiva kiselina ili bazična adicijska so, njegov kvarterni amin, njegov N-oksid, njegova tautomerna forma ili njegova stereohemijska izomerna forma pri čemu R<sup>1</sup> je vodonik, halo, haloalkil, cijano, hidroksi, Ar, Het, alkil, alkiloksi, alkiltio, alkiloksialkil, alkiltioalkil, Ar-alkil ili di(Ar)alkil; p je cijeli broj jednak 1, 2, 3 ili 4; R<sup>2</sup> je vodonik, hidroksi, merkaptio, alkiloksi, alkiloksialkiloksi, alkiltio, mono ili di(alkil)amino ili radikal formule

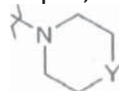

gde Y je CH<sub>2</sub>, O, S, NH ili N-alkil; R<sup>3</sup> je alkil, Ar, Ar-alkil, Het ili Het-alkil; q je cijeli broj jednak nula, 1, 2, 3 ili 4; R<sup>4</sup> i R<sup>5</sup> su svaki nezavisno vodonik, alkil ili benzil; ili R<sup>4</sup> i R<sup>5</sup> zajedno i uključuju

jući N za kojega su vezani mogu formirati radikal koji je odabran iz grupe koju sačinjavaju pirolidinil, 2-pirolinil, 3-pirolinil, pirolil, imidazolidinil, pirazolidinil, 2-imidazolinil, 2-pirazolinil, imidazolil, pirazolil, triazolil, piperidinil, piridinil, piperazinil, piridazinil, pirimidinil, pirazinil, triazinil, morfolinil i tiomorfolinil, a svaki od navedenih prstenastih sistema proizvoljno je supstituisan s alkil, halo, haloalkil, hidroksi, alkiloksi, amino, mono- ili dialkilamino, alkiltio, alkiloksialkil, alkiltioalkil i pirimidinil;  $R^6$  je vodonik, halo, haloalkil, hidroksi, Ar, alkil, alkiloksi, alkiltio, alkiloksialkil, alkiltioalkil, Ar-alkil ili di(Ar)alkil; ili dva susjedna  $R^6$  radikala mogu zajedno formirati bivalentni radikal formule  $-\text{CH}=\text{CH}-\text{CH}=\text{CH}-$ ; r je cijeli broj jednak 1, 2, 3, 4 ili 5;  $R^7$  je vodonik, alkil, Ar ili Het;  $R^8$  je vodonik ili alkil;  $R^9$  je okso; ili  $R^8$  i  $R^9$  zajedno formiraju radikal  $=\text{N}-\text{CH}=\text{CH}-$ ; alkil je lančasti ili razgranati zasićeni ugljovodonični radikal koji ima od 1 do 6 atoma ugljenika; ili je prstenasti zasićeni ugljovodonični radikal koji ima od 3 do 6 atoma ugljenika; ili je prstenasti zasićeni ugljovodonični radikal koji ima od 3 do 6 atoma ugljenika koji je vezan za lančasti ili razgranati zasićeni ugljovodonični radikal koji ima od 1 do 6 atoma ugljenika; pri čemu svaki atom ugljenika može da bude proizvoljno supstituisan s halo, hidroksi, alkiloksi ili okso; Ar je homocikl odabran iz grupe koju sačinjavaju fenil, naftil, acenaftil, tetrahidronaftil, a svaki homocikl proizvoljno je supstituisan s 1, 2 ili 3 supstituenta, pri čemu je svaki supstituent nezavisno odabran iz grupe koju sačinjavaju hidroksi, halo, cijano, nitro, amino, mono- ili dialkilamino, alkil, haloalkil, alkiloksi, haloalkiloksi, karboksil, alkiloksikarbonil, aminokarbonil, morfolinil te mono- ili dialkilaminokarbonil; Het je monociklički heterocikl odabran iz grupe koju sačinjavaju N-fenoksipiperidinil, piperidinil, pirolil, pirazolil, imidazolil, furanil, tienil, oksazolil, izoksazolil, tiazolil, izotiazolil, piridinil, pirimidinil, pirazinil i piridazinil; ili biciklički heterocikl odabran iz grupe koju sačinjavaju hinolinil, hinoksalinil, indolil, benzimidazolil, benzoksazolil, benzizoksazolil, benzotiazolil, benzizotiazolil, benzofuranil, benzotienil, 2,3-dihidrobenzo[1,4]dioksinil ili benzo[1,3]dioksolil; pri čemu svaki monociklički i biciklički heterocikl može proizvoljno biti supstituisan s 1, 2 ili 3 supstituenta odabrana iz grupe koju sačinjavaju halo, hidroksi, alkil, alkiloksi ili Ar-karbonil; halo je supstituent odabran iz grupe koju sačinjavaju fluoro, hloro, bromo i jodo; te haloalkil je lančasti ili razgranati zasićeni ugljikovodonični radikal koji ima od 1 do 6 atoma ugljenika ili je prstenasti zasićeni ugljikovodonični radikal koji ima od 3 do 6 atoma ugljenika, pri čemu su jedan ili više atoma ugljenika supstituisani s jednim ili više halo-atoma.

Patent sadrži još 28 patentnih zahtjeva.

(51) **A61K31/4985**  
**A61K31/519**  
**A61K31/4409**  
**A61K31/435**

(11) **P-2011-124**  
(21) **01209**

(30) 04019361 14.08.2004 EP  
04019448 17.08.2004 EP

(86) PCT/EP2005/008623 09.08.2005.

(87) WO 2006/018182 23.02.2006.

(96) 05770228.4 09.08.2005.

(97) EP1827441 15.06.2011 2011/24 EN

(54) (ME) **KOMBINACIJA ZA LIJEČENJE BOLESTI KOJE OBUHVATAJU ĆELIJSKU PROLIFERACIJU**

(EN) COMBINATIONS FOR THE TREATMENT OF DISEASES INVOLVING CELL PROLIFERATION

(73) Boehringer Ingelheim International GmbH, Binger Strasse 173, 55216 Ingelheim am Rhein (DE)

(72) 01/MUNZERT, Gerd; Merianweg 64, 89075 ULM (DE)

02/STEEGMAIER, Martin; Leni-Matthaei-Weg 29, 72762 Reutlingen (DE)

03/BAUM, Anke; Höglmüllergasse 4/8, A-1050 VIENNA (AT)

(74) Radulović Božidar, Jovana Tomaševića 9/III, Podgorica (ME)

1. Farmaceutska kompozicija koja sadrži efektivne količine:

(i) jedinjenja 1 Formule (I)

	$L_n, R^5_m$		
	$R^4$		
	$R^3$		
	Konfig. R <sup>1</sup> /R <sup>2</sup>	R	R
	$R^2$		
	$R^1$	H	H
Pr.	46	110	

(57)

gde skraćenice  $X_1, X_2, X_3, X_4$  i  $X_5$  korišćene u Tabeli u svakom slučaju označavaju poziciju u opštoj Formuli prikazanoj u Tabeli umesto odgovarajućih grupa  $R^1, R^2, R^3, R^4$  i  $L_n-R^5_m$ , opciono u obliku njegovih tautomera, racemata, enantiomera, diastereomera i njegovih smješa i

opciono u obliku njegovih farmaceutski prihvatljivih kiselih adicijonih soli, solvata ili hidrata. (ii) barem jednog dodatnog terapijskog agensa 2 odabranog iz grupe koja sadrži 4-[(3-hloro-4-fluorofenil)amino]-6-[[4-(N,N-dimetilamino)-1-okso-2-buten-1-il]amino]-7-((S)-tetrahidrofuran-3-iloksi)-hinazolin ili njegovu farmaceutski prihvatljivu so, 3-Z-[1-(4-(N-((4-metilpiperazin-1-il)-metilkarbonil)-N-metil-amino)-anilino)-1-fenil-metilen]-6-metoksikarbonil-2-indolinon, ili njegovu farmaceutski prihvatljivu so, jedinjenje platine izabrano iz grupe koja sadrzi cisplatin, karboplatin, oksaliplatin, satraplatin, tetraplatin, iproplatin, mitomicin, streptozocin, karmustin (BCNU), lomustin (CCNU), busulfan, ifosfamid, streptozocin, tiotepa i hlorambucil, analog pirimidina ili purina ili antagonist ili inhibitor nukleozid difosfat reduktaze izabran iz grupe koja sadrži citarabin, 5-fluorouracil (5-FU), perimetred, tegafur/uracil, uracil mustard, fludarabin, gemcitabin, kapecitabin, merkaptopurin, kladribin, tioguanin, metotreksat, pentostatin, hidroksiureju i folnu kiselinu, kamptotecin izabran iz grupe koja sadrži irinotekan i topotekan, inhibitor histonske deacetilaze izabran iz grupe koja sadrzi SAHA, MD-275, trihostatin A, CBHA, LAQ824 i valproičnu kiselinu, biljni anti-kancer izabran iz grupe koja sadrži paklitaksel, docetaksel i taksoter

Patent sadrži još 18 patentnih zahtjeva.

(51) **E05B21/06**  
**E05B19/00**

(11) **01215**  
(21) **P-2010-173**

(30) 20065422 19.06.2006. FI

(86) PCT/FI2007/050340 11.06.2007.

(87) WO 2007/147933 27.12.2007

(96) 07765910.0 11.06.2007.

(97) EP2029839 04.08.2010. 2010/31 En

(54) (ME) **KOMBINACIJA CILINDER BRAVE SA OBRTNIM DISK ULOŠCIMA ZADRŽAČIMA, KLJUČEM ZA TU BRAVU**

(EN) DISC TUMBLER CYLINDER LOCK AND KEY COMBINATION

(73) Abloy Oy, Wahlforssinkatu 20, 80100 Joensuu (FI)

(72) MARTIKAINEN, Kaarlo; Mastotie 4 A 1, 80160 Joensuu (FI)

(74) Anđelić Branko, Svetozara Markovića 12, Podgorica (ME)

(57) Kombinacija cilindrične brave sa obrtnim disk ulošcima zadržaćima i ključem (1), gdje brava obuhvata tijelo (9) cilindra i unutar njega unutrašnji cilindar (11, 28), gde unutrašnji cilindar sadrži naslagane obrtne disk uloške zadržaći koji obuhvataju obrtne disk uloške zadržaći (25) koji se okreću ključem (1), gdje je najmanje jedan od obrtnih disk uložaka zadržaći O-zadržać, gdje pomenuti obrtni disk ulošci zadržaći obuhvataju otvor (26) za prolaz ključa i obodni žlijeb (27) na spoljašnjoj ivici svakog uložka zadržaća, i gdje pomenuta cilindar brava takođe obuhvata zapornu čiviju (12) za zabavljanje brave, gde pomenuta zaporna čivija može biti smještena u obodne zlijebove (27) zadržaća okretanjem obrtnog disk uložka zadržaća (25) ključem (1) u položaj zapornih čivija za otvaranje brave, list (2) ključa koji sadrži spoljnu površinu (2A) oblikovanu kao nenarezani ključ i najmanje jednu kombinacionu oblast (4) u smjeru lista, u kom dijelu je moguće ustanoviti niz kombinacionih površina, pri čemu list (2) takođe sadrži najmanje jedan zlijeb (6) poprečno u odnosu na pravac lista, gdje pomenuti zlijeb sadrži donji dio (6A) i bočne djelove (6B) poprečno prema donjem dijelu (6A) između donjeg dijela (6A) i spoljašnje površine (2A) lista, i gdje je donji dio (6A) zlijeba (6) glavna pogonska površina preko koje se sila okretanja ključa (1) prenosi na unutrašnji cilindar (11, 28) cilindar brave sa disk ulošcima zadržaćima, naslagani disk ulosci zadržaći takođe sadrže prenosni disk (10, 30) koji sadrži otvore (14, 37) za prolaz ključa, čije ivice (15, 33) sadrže spojnu površinu (21, 34) za glavnu pogonsku površinu ključa, ivični zlijeb (13, 38) i prenosni element (19, 31), i unutrašnji cilindar (11, 28) sadrži oblast (23, 29) kretanja za prenosni element (19, 31) i spojne površine (22, 39A, 39B) na krajevima oblasti kretanja da prenesu silu okretanja prenosnog diska unutrašnjem cilindru (11, 28), ivični zlijeb (13, 38) pomenutog prenosnog diska (10, 30) mogu postavljati u položaje zaporne čivije (12) a prenosni element (19, 31) se može postavljati prema spojnim površinama (22, 39A) okretanjem ključa (1) za otvaranje brave tako da ivični zlijeb (27) obrtnih disk uložaka zadržaća (25) istovremeno postave položaje zaporne čivije (12).  
Patent sadrži još 14 patentnih zahtjeva.

- (51) **A61K9/06** (11) **01212**  
**A61K47/06** (21) **P-2009-198**
- (30) 200410030044 22.06.2004 DE  
(86) PCT/EP2005/006710 21.06.2005  
(87) WO 2005/123037 29.12.2005  
(96) 05756084.9 21.06.2005  
(97) EP 1758555 25.02.2009 2009/09 DE
- (54) (ME) **AGENS OLEOGELA SA SADRŽAJEM TRITERPENA, OLEOGEL SA SADRŽAJEM TRITERPENA I POSTUPAK ZA PROIZVODNJU OLEOGELA SA SADRŽAJEM TRITERPENA**  
(EN) TRITERPENE-CONTAINING OLEOGEL-FORMING AGENT, TRITERPENE-CONTAINING OLEOGEL AND METHOD FOR PRODUCING A TRITERPENE-CONTAINING OLEOGEL
- (73) BIRKEN AG ; Streiflingsweg 11, 75223 Niefern-Öschelbronn (DE)  
(72) SCHEFFLER, Armin; Bussardweg 15/1, 75229 Niefern-Öschelbronn (DE)  
(74) Kojić Ivana, Serdara Jola Piletica bb, Podgorica (ME)  
Rončević Milena, Serdara Jola Piletica bb, Podgorica (ME)
- (57) Primjena barem jednog visoko disperzivnog triterpena sa česticama srednje veličine manje od 50 µm kao agensa oleogela u oleogelu.  
Patent sadrži još 41 patentni zahtjev.



- (51) **C07D409/14**  
**C07D409/12**  
**C07D487/04**  
**C07D413/04**  
**C07D417/14**  
**C07D471/04**  
**A61K31/55**  
**A61P29/00**  
**A61P35/00**
- (30) 20050014270 30.06.2005 EP  
(86) PCT/EP2006/063611 28.06.2006.  
(87) WO2007003536 11.01.2007  
(96) 06763910.4 28.06.2006  
(97) EP1899330 24.11.2010. 2010/47 EN
- (54) (ME) **SUPSTITUISANI GLICINAMIDI KOJI IMAJU ANTITROMBOCITNO I FAKTOR XA-INHIBITORSKO DEJSTVO**  
(EN) SUBSTITUTED GLYCINAMIDES HAVING AN ANTITHROMBOTIC AND FACTOR XA-INHIBITING EFFECT
- (73) Boehringer Ingelheim International GmbH, Binger Strasse 173 55216 Ingelheim am Rhein / DE
- (72) 01 / WIENEN, Wolfgang ; Kirschenweg 27 88400 Biberach / DE  
02 / PFAU, Roland ; Pfluggasse 15 88400 Biberach / DE  
03 / GERLACH, Kai ; Mondstrasse 18/1 88400 Biberach / DE  
04 / DAHMANN, Georg ; Bahnhofstrasse 14 88448 Attenweiler / DE  
05 / PRIEPKE, Henning ; Birkenharderstr. 11 88447 Warthausen / DE  
06 / NAR, Herbert ; Hexenweg 19 88416 Ochsenhausen / DE  
07 / HANDSCHUH, Sandra ; Beim Fohrhaldedele 16 88400 Biberach / DE  
08 / SCHULER-METZ, Annette ; Holzgasse 7 89081 Ulm / DE
- (74) Radulović Božidar, Jovana Tomaševića 9 III-1, Podgorica (ME)
- (57) Jedinjenja opšte formule (I)

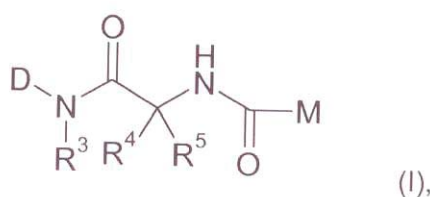

pri čemu

D označava supstituisani biciklični sistemski prsten formule (II),

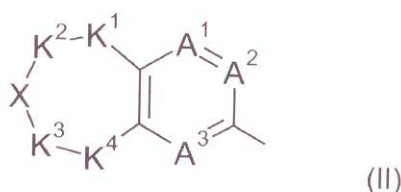

gdje

K<sup>1</sup> i K<sup>4</sup> svaki nezavisan jedan od drugog označava -CH<sub>2</sub>-, -CHR<sup>7a</sup>-, -CR<sup>7b</sup>R<sup>7c</sup>- ili -C(O)- grupu, i R<sup>7a</sup>/R<sup>7b</sup>/R<sup>7c</sup> svaki nezavisan jedan od drugog označava atom fluora, hidroksi, C1-5- alkiloksi,

tetrahidrofuranil, oksetanil, amino, C1-5-alkilamino, di-( C1-5-alkil)-amino, C<sub>3-5</sub>-cikloalkilenimino ili C<sub>1-5</sub>-alkilkarbonilamino grupu, C1-5-alkil grupu koja može biti supstituisana sa 1-3 atoma fluora, hidroksi-C1-<sub>5</sub>-alkil, C1-5- alkiloksi- C1-5- alkil, amino- C1-5- alkil, C1-5-alkilamino- C1-5-alkil, di-( C1-5-alkil)-amino- C1-5- alkil, C4-7-cikloalkilenimino-C1-5 -alkil, karboksi-Co-5-alkil, C<sub>1-5</sub>-alkiloksikarbonil-C<sub>0-5</sub>-alkil, aminokarbonil-C<sub>0-5</sub>-alkil, C<sub>5</sub>-alkilamino-karbonil-C<sub>0-5</sub>-alkil, di-(C1-5 alkil)-aminokarbonil-Co-5-alkil, C4-7-cikloalkilenimino-karbonil-Co-5-alkil- grupom, fenil grupom ili 5- ili 6-clanom heteroaril grupom koja može biti supstituisana sa 1-2 supstituenta odabrana od nitro, amino, hidroksi, metoksi, cijano, d-5-alkil grupe ili atoma fluora, hlora ili broma, pri čemu dve grupe R<sup>7b</sup>/R<sup>7c</sup> ne mogu istovremeno biti vezane za ciklični atom ugljenika preko heteroatoma, osim ako -(R<sup>7b</sup>R<sup>7c</sup>)- odgovara -CF<sub>2</sub>- grupi, ili dve grupe R<sup>7b</sup>/R<sup>7c</sup> zajedno sa cikličnim atomom ugljenika mogu obrazovati 3, 4, 5-, 6- ili 7-članu zasićenu karbocikličnu grupu ili ciklopenten, cikloheksen, oksetan, azetidin, tietan, tetrahidrofuran, pirolidin, tetrahidrotiofen, tetrahidropiran, piperidin, pentameten sulfid, heksametenimin, 1,3-dioksolan, 1,4-dioksan, heksahidropiridazin, piperazin, tiorfolin, morfolin, 2-imidazolidinon, 2-oksazolidinon, tetrahidro-2(1H)-pirimidinon, [1,3] oksazinan-2-on prsten, pri čemu njihove metilen grupe mogu biti supstituisane sa 1-2 d-3-alkil ili CF<sub>3</sub> grupom, i/ili njihove metilen grupe, ukoliko nisu vezane za heteroatom, mogu biti supstituisane sa 1-2 atoma fluora, i/ili gde -CH<sub>2</sub> grupa koja je u susedstvu atoma N može biti zamenjena sa -CO grupom, i/ili imino grupe koje mogu biti supstituisane u svakom slučaju sa C<sub>1-3</sub>-alkil ili C1-3alkilkarbonil grupom, i/ili gde atom sumpora može biti oksidisan kako bi obrazovao sulfoksidnu ili sulfon grupu, K<sup>2</sup> i K<sup>3</sup> svaki nezavisno jedan od drugoga označava -CH<sub>2</sub>-, -CHR<sup>8a</sup>-, -CR<sup>8b</sup>R<sup>8c</sup>- ili C(O)-grupu, i R<sup>8a</sup>/R<sup>8b</sup>/R<sup>8c</sup> svaki nezavisan jedan od drugoga označava C1-<sub>5</sub>-alkil grupu koja može biti supstituisana sa 1-3 atoma fluora, hidroksi-C<sub>1-5</sub>-alkil, C1-5-alkiloksi-C1-5-alkil, amino-C1-5-alkil, C1-5-alkilamino-d.s-alkil, di-(C1-5-alkil)-amino-C1-5-alkil, C<sub>4-7</sub>- cikloalkilenimino-d.s-alkil, karboksi-C<sub>0-5</sub>-alkil, C1-<sub>5</sub>-alkiloksikarbonil-Co-5-alkil, aminokarbonil-C1-5-alkil, d.s-alkilaminokarbonil-Co-s-alkil, di-(C1-<sub>5</sub>-alkil)-aminokarbonil- o-5-alkil, C<sub>4-7</sub>-cikloalkileniminokarbonil-Co-<sub>5</sub>-alkil grupom, ili dve grupe R<sup>3b</sup>/R<sup>3c</sup> zajedno sa cikličnim atomom ugljenika mogu obrazovati 3, 4, 5-, 6- ili 7-članu zasićenu karbocikličnu grupu ili ciklopenten, cikloheksen, oksetan, azetidin, tietan, tetrahidrofuran, pirolidin, tetrahidrotiofen, tetrahidropiran, piperidin, pentameten sulfid, heksametenimin, heksahidropiridazin, tetrahidro-2(1H)-pirimidinon, [1,3]oksazinan-2-on prsten, gde njihove metilen grupe mogu biti supstituisane sa 1-2 d-3-alkil ili CF<sub>3</sub> grupama, i/ili njihove metilen grupe, ukoliko nisu vezane za heteroatom, mogu biti supstituisane sa 1-2 atoma fluora, i/ili gde -CH<sub>2</sub> grupa pored atoma azota mogu biti zamenjeni sa -CO grupom, i/ili imino grupe koje mogu biti supstituisane u svakom slučaju sa C1-3-alkil ili C1-<sub>3</sub>-alkilkarbonil grupom, i/ili gde atom sumpora može biti oksidisan kako bi obrazovao sulfoksid ili sulfon grupu, uz uslov da heteroatom uvršten sa R<sup>8b</sup> ili R<sup>8c</sup> ne mora da bude odvojen od X u formuli (I) samo sa jednim atomom ugljenika, i prema tome ne bi trebalo da bude više od četiri grupe odabrane od R<sup>7a</sup>, R<sup>7b</sup>, R<sup>7c</sup>, R<sup>8a</sup>, R<sup>8b</sup> i R<sup>8c</sup> u formuli (II), i X označava atom kiseonika ili sumpora, sulfen, sulfon ili NR<sup>1</sup> grupu, gde R<sup>1</sup> označava atom vodonika ili hidroksi, C1-3- alkiloksi, amino, C1-3-alkilamino, di-( C1-3-alkil)-amino, C1-<sub>5</sub>-alkil, C<sub>2-5</sub>-alkenil-CH<sub>2</sub>, C<sub>2-5</sub>-alkinil-CH<sub>2</sub>, C<sub>3-6</sub>-cikloalkil, C<sub>4-6</sub>-cikloalkenil, oksetan-3-il, tetrahidrofuran-3-il, benzil, C1-5 -alkil-karbonil, trifluorometilkarbonil, C<sub>3-6</sub>-cikloalkil-karbonil, C1-<sub>5</sub>-alkil-sulfonil, C<sub>3-6</sub>-cikloalkil-sulfonil, aminokarbonil, C1-5-alkilaminokarbonil, di-(C<sub>1-5</sub> -alkil)-aminokarbonil, C1-5 -alkiloksikarbonil, C<sub>4-7</sub>-cikloalkileniminokarbonil grupu, gde metilen i metil grupe koje su prisutne u gore navedenim grupama, mogu dodatno da budu supstituisane sa d-<sub>3</sub>-alkil, karboksi, C1-<sub>5</sub>-alkoksikarbonil grupom ili sa hidroksi, C1-<sub>5</sub>-alkiloksi, amino, C<sub>1-5</sub>- alkilamino, C1-<sub>5</sub>- dialkilamino ili C<sub>4-7</sub>-cikloalkilenimino grupom, obezbeđujući da metilen ili metil grupe nisu direktno vezane za heteroatom odabran između O, N ili S, i/ili jedan do tri atoma vodonika mogu biti zamenjeni

sa atomima fluora, obezbeđujući da metilen ili metil grupe nisu direktno vezane za heteroatom odabran između O, N ili S, i gde A<sup>1</sup> označava ili N ili CR<sup>10</sup>, A<sup>2</sup> označava ili N ili CR<sup>11</sup>, (II-2) A<sup>3</sup> označava ili N ili CR<sup>12</sup>, gde R<sup>10</sup>, R<sup>11</sup> i R<sup>12</sup> svaki nezavisan jedan od drugoga predstavlja atom vodonika, fluora, hlora, broma ili joda, ili C<sub>1-5</sub>-alkil, CF<sub>3</sub>, C<sub>2-5</sub>-alkenil, C<sub>2-5</sub>-alkinil, cijano, karboksi-C<sub>1-5</sub>-alkiloksikarbonil, hidroksi, d.a-alkiloksi, CF<sub>3</sub>O, CHF<sub>2</sub>O, CH<sub>2</sub>FO, amino, C<sub>1-5</sub>-alkilamino, di-(C<sub>1-5</sub>-alkil)-amino ili C<sub>4-7</sub>-cikloalkilenimino grupu, ili D označava jednu od četiri grupe (II-1), (II-2), (II-3) ili (II-4)

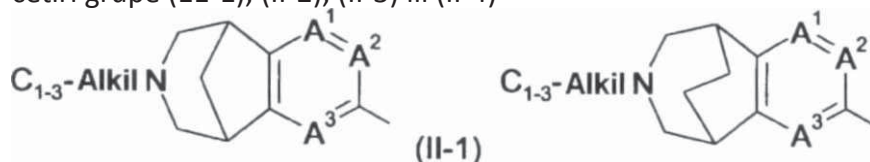

gde su grupe A<sup>1</sup>, A<sup>2</sup>, A<sup>3</sup>, K<sup>1</sup>, K<sup>2</sup>, K<sup>3</sup>, K<sup>4</sup> kao što je ovde definisano, a Anjon u (II-4) označava fluorid, hlorid, bromid, jodid, sulfat, vodonik sulfat, fosfat, vodonik fosfat, benzoat, salicilat, sukcinat, citrat ili tartrat, R<sup>3</sup> označava atom vodonika ili C<sub>1-3</sub>-alkil grupu, i R<sup>4</sup> i R<sup>5</sup> svaki nezavisan jedan od drugog predstavlja atom vodonika, prav lanac ili razgranatu C<sub>1-6</sub>-alkil, C<sub>2-6</sub>-alkenil ili C<sub>2-6</sub>-alkinil grupu, gde atomi vodonika metilen i/ili metil fragmenata pravog lanca ili razgranate C<sub>1-6</sub>-alkil, C<sub>2-6</sub>-alkenil ili C<sub>2-6</sub>-alkinil grupe mogu opciono u celosti ili delimično biti zamenjene sa atomima fluora, i/ili jedan ili dva atoma vodonika pravog lanca ili razgranate C<sub>1-6</sub>-alkil, C<sub>2-6</sub>-alkenil ili C<sub>2-6</sub>-alkinil grupe u njihovim metilen i/ili metil fragmentima mogu opciono svaki biti zamenjen nezavisno jedna od druge sa C<sub>3-7</sub>-cikloalkil grupom, nitril, hidroksi ili C<sub>1-5</sub>-alkiloksi grupom, gde atomi vodonika C<sub>1-5</sub>-alkiloksi grupe mogu opciono biti u celosti ili delimično biti zamenjeni sa atomima fluora, aliloksi, propargiloksi, fenilmetiloksi, fenetiloksi, C<sub>1-5</sub>-alkilkarboniloksi, C<sub>1-5</sub>-alkiloksikarboniloksi, karboksi-C<sub>1-5</sub>-alkiloksi, C<sup>^</sup>s-alkiloksikarbonil-d-s-alkiloksi, C<sub>1-5</sub>-alkiloksi-C<sub>2-5</sub>alkiloksi, merkpto, C<sub>1-5</sub>-alkilsulfanil, C<sub>1-5</sub>-alkilsulfinil, d-5-alkilsulfonil, karboksi, C<sub>1-5</sub>-alkiloksikarbonil, aminokarbonil, C<sub>1-5</sub>-alkilaminokarbonil, di-(C<sub>1-5</sub>-alkil)-aminokarbonil, C<sub>1-5</sub>-alkil-amino-karboniloksi, di-(C<sub>1-5</sub>-alkil)-aminokarboniloksi, C<sub>4-7</sub>-cikloalkilen-iminokarbonil, aminosulfonil, C<sub>1-5</sub>-alkilamino-sulfonil, di-(C<sub>1-5</sub>-alkil)-aminosulfonil, C<sub>4-7</sub>-cikloalkileniminosulfonil, di-(C<sub>1-5</sub>-alkil)-fosforil, amino, C<sub>1-5</sub>-alkilamino, di-(C<sub>1-5</sub>-alkil)-amino, C<sub>1-5</sub>-alkilkarbonilamino, trifluoracetilamino, C<sub>1-5</sub>-alkiloksi-C<sub>1-5</sub>-alkilkarbonilamino, fenilkarbonilamino, C<sub>1-5</sub>-alkilaminokarbonilamino, di-(C<sub>1-5</sub>-alkil)-aminokarbonilamino, C<sub>1-5</sub>-alkiloksi-karbonilamino, fenilmetiloksi-karbonilamino, C<sub>1-5</sub>-alkiloksi-C<sub>2-5</sub>-alkiloksi-C<sub>1-2</sub>-alkilkarbonilamino, C<sub>1-5</sub>-alkil-sulfonilamino, N-(C<sub>1-5</sub>-alkilsulfonil)-C<sub>1-5</sub>-alkilamino, C<sub>3-6</sub>-cikloalkilkarbonilamino grupom, 4-morfolino-karbonilamino, ili morfolinil, tiomorfolinil, pirolidinil, piperidinil, piperazinil, tetrahidrofuranil, tetrahidropiranil grupom, gde gore navedeni karbo- i heterocikli u prstenu mogu svaki biti supstituisani sa 1 do 4 -C<sub>1-3</sub>-alkil ili C<sub>13</sub>-alkilkarbonil grupe ili mogu svaki biti supstituisani sa 1 ili 2 okso grupe, i/ili gore navedene fenil i heteroanl grupe mogu biti zamenjene sa 1 ili 2 supstituenta odabrana između fluora, hlora, broma, metil, metoksi, amino ili trifluorometil ili dva susedna atoma ugljenika fenil prstena mogu biti supstituisani sa -CH<sub>2</sub>-O-CH<sub>2</sub> grupom, i/ili gore navedene alkil grupe mogu biti supstituisane sa cijano-C<sub>1-5</sub>-alkiloksikarbonil ili karboksi grupom, gde gore navedeni amid karboksilne kiseline ili sumporne kiseline može biti opciono dodatno supstituisan na azotu sa C<sub>1-5</sub>-alkil grupom, i/ili atomi vodonika sp<sup>2</sup>-hibridizovanih atoma ugljenika pravog lanca ili razgranate C<sub>2-6</sub>-alkenil grupe mogu opciono biti u potpunosti ili delimično zamenjeni sa atomima fluora, karboksi, aminokarbonil, d.s-alkilaminokarbonil, C<sub>3-6</sub>-cikloalkilaminokarbonil, di-(C<sub>1-5</sub>-alkil)-aminokarbonil, C<sub>1-5</sub>-alkiloksikarbonil, C<sub>4-7</sub>-cikloalkileniminokarbonil grupom, fenil, mono- ili bicikličnom heteroaril, fenil-C<sub>1-5</sub>-alkil ili mono- ili bicikličnom heteroaril-C<sub>1-5</sub>-alkil grupom, koja može opciono biti mono- do trisupstituisana u fenil ili heteroaril ostatku sa identičnim ili različitim supstituentima koji su odabrani između atoma fluora, hlora, broma i joda, i C<sub>1-5</sub>-alkil, trifluorometil,

benzil, amino, nitro, C1-5 -alkil-amino, di-(C<sub>1-5</sub>-alkil)-amino, hidroksi, C1-5-alkiloksi, mono-, di- ili trifluorometoksi, karboksi i C1-<sub>5</sub>-alkiloksikarbonil grupe, ili dva susedna atoma ugljenika fenil prstena mogu biti supstituisani sa -CH<sub>2</sub>-OCH<sub>2</sub>- grupom, ili C<sub>3-7</sub>-cikloalkil, morfolinil, tiomorfolinil, piroolidinil, piperidinil, piperazinil, tetrahidrofurani, tetrahidropirani grupom, koja može opciono biti supstituisana sa jednom ili dve grupe odabrane nezavisno jedna od druge iz C<sub>1-3</sub>-alkil, acetil, ds-alkiloksikarbonil, i hidroksikarbonil, ili R<sup>4</sup> i R<sup>5</sup> zajedno sa atomom ugljenika za koji su vezane, obrazuju C<sub>3-7</sub>-cikloalkil ili C<sub>5-7</sub>-cikloalkenil grupu, gde jedna od metilen grupa C<sub>4-7</sub>-cikloalkil grupe može biti zamenjena sa atomom kiseonika ili sumpora ili -NH-, -N(C1-5-alkil)-, -N(C1-<sub>4</sub>-alkilkarbonil)-, -N(C1-4-alkil-oksikarbonil)- ili karbonil, sulfinil ili sulfonyl grupom, i/ili dve direktno susedne metilen grupe C<sub>4-7</sub>-cikloalkil grupe mogu zajedno biti zamenjene sa -C(O)NH-, -C(O)N(C<sub>1-5</sub>-alkil)-, -S(O)<sub>2</sub>NH-, ili -S(O)<sub>2</sub>N(C1-<sub>5</sub>-alkil)- grupom, i/ili 1 do 3 atoma ugljenika C<sub>3-7</sub>-cikloalkil grupe može svaki opciono biti supstituisan nezavisan jedan od drugog sa jednim ili dva atoma fluora ili jednom ili dve C<sub>1-5</sub>-alkit grupe ili hidroksi, C1-<sub>5</sub>-alkiloksi, formiloksi, C1-5-alkilkarboniloksi, C<sub>1-5</sub>-alkilsulfanil, C<sub>1-5</sub>-alkilsulfonyl, aminosulfonyl, C1-5-alkilaminosulfonyl, di-(C<sub>1-5</sub>-alkil)-aminosulfonyl, C<sub>4-7</sub>-cikloalkilen-iminosulfonyl, amino, C1-5-alkilamino, di-(C1-5-alkil)-amino, C1-5-alkil-karbonilamino, 5-alkil-sulfonylamino, N-(C1-5-alkilsulfonyl)-C1-5-alkilamino, C<sub>6</sub>-cikloalkilkarbonilamino, Nitril, karboksi-C1-5-alkil, C1-5-alkiloksikarbonil-C1-5-alkil, karboksi, C1-5-alkiloksikarbonil, aminokarbonil, C1-5-alkilaminokarbonil, di-(C<sub>1-5</sub>-alkil)-aminokarbonil ili C4-7-cikloalkilen-iminokarbonil grupom, i/ili 1 do 2 atoma ugljenika C<sub>5-7</sub>-cikloalkenil grupe mogu opciono biti supstituisan nezavisno jedan od drugog u svakom slučaju sa C1-<sub>5</sub>-alkil, nitril, karboksi-C1-<sub>5</sub>-alkil, C1-<sub>5</sub>-alkiloksikarbonil-C1-<sub>5</sub>-alkil, karboksi, C1-5-alkiloksikarbonil, aminokarbonil, C1-5-alkilaminokarbonil, di-(C<sub>1-5</sub>-alkil)-aminokarbonil, C<sub>3-6</sub>-cikloalkileniminokarbonil, aminosulfonyl, C1-5-alkilamino-sulfonyl, di-(C1-5-alkil)-aminosulfonyl, C<sub>6</sub>-cikloalkileniminosulfonyl grupama ili 1-2 atomom fluora, i/ili 1 do 2 atoma ugljenika C4-7-cikloalkenil grupe koje nisu vezane za drugi atom ugljenika dvosturkom vezom, mogu opciono biti supstituisane nezavisno jedna od druge sa hidroksi, C1-5-alkiloksi, C1-5-alkilkarboniloksi, C1-5-alkilsulfanil, C1-5-alkilsulfonyl, amino, C1-5-alkilamino, di-(C1-5-alkil)-amino, C1-5-alkilkarbonilamino, C1-5-alkil-sulfonylamino, N-(C1-5-alkilsulfonyl)-C1-5-alkilamino ili C<sub>6</sub>-cikloalkilkarbonilamino grupama, uz uslov da C<sub>3-7</sub>-cikloalkil ili C<sub>5-7</sub>-cikloalkenil grupa ove vrste formirana iz R<sup>4</sup> i R<sup>5</sup> zajedno, gde su dva hetero atoma u cikličnoj grupi odabrana od kiseonika i azota odvojena jedan od drugog sa preciznom jednom opcionskom supstituisanom -CH<sub>2</sub>- grupom, i/ili gde jedna ili obe metilen grupe ciklične grupe koje su spojene direktno na atomu ugljenika za koji su grupe R<sup>4</sup> i R<sup>5</sup> vezane, su zamenjene heteroatomom odabranim od kiseonika, azota i sumpora, i/ili gde je supstituent vezan za cikličnu grupu, koja je naznačena time što je heteroatom koji je odabran od kiseonika, azota, sumpora i fluora direktno vezan za cikličnu grupu, odvojen od jednog drugog heteroatoma koji je odabran od kiseonika, azota i sumpora, uz izuzetak sulfonske grupe, sa tačno jednom, opcionskom supstituisanom, metilen grupom, i/ili gde dva atoma u prstenu obrazuju -O-O- ili -S-O-vezu, je isključen, M označava tiofen prsten prema formuli (III),

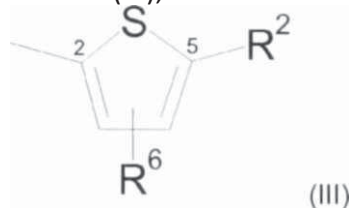

koji je vezan za karbonil grupu u formuli (I) preko 2-položaja i koji je supstituisan u 5-položaju sa R<sup>2</sup> i opciono dodatno sa R<sup>6</sup>, gde R<sup>2</sup> označava atom vodonika, fluora, hlora, broma ili joda ili metoksi, C1-2-alkil, formil, NH<sub>2</sub>CO ili etinil grupu, R<sup>6</sup> označava atom vodonika, fluora, hlora, broma ili joda ili C1-2-alkil ili amino grupu, gde, ukoliko nije drugačije naznačeno, po-

jam "heteroaril grupa" koji je ovde naveden u definiciji označava monocikličnu 5- ili 6-clanu heteroaril grupu, pri čemu 6-člana heteroaril grupa sadrži jedan, dva ili tri atoma azota, a 5-clana heteroaril grupa sadrži imino grupu opciono supstituisanu sa C1-3-alkil grupom, ili atom kiseonika ili sumpora, ili imino grupu opciono supstituisanu sa C1-3-alkil grupom ili atomom kiseonika ili sumpora i dodatno jednim ili dva atoma azota, ili imino grupu opciono supstituisanu sa C<sub>1-3</sub>-alkil grupom i tri atoma azota, a osim toga fenil prsten je opciono supstituisan sa atomom fluora, hlora ili broma, C1-3 -alkil, hidroksi, C1-3-alkiloksi grupom, amino, C1-3 -alkilamino, di-(C1-3-alkil)-amino ili C<sub>3-6</sub>-cikloalkilenimino grupom, fenilni prsten može biti spojen za gore navedene heteroaril grupe preko dva susedna atoma ugljenika, a veza je ostvarena preko atoma azota ili atoma ugljenika heterocikličnog ostatka ili spojena na fenilni prsten, i gde, ukoliko nije drugačije naznačeno, pojam "halogen atom" naveden ranije u definiciji označava atom odabran između fluora, hlora, broma i joda, i gde alkil, alkenil, alkinil i alkiloksi grupe koje su sadržane u ranije navedenim definicijama koje imaju više od dva atoma ugljenika mogu, ukoliko nije drugačije ukazano, biti ravnog lanca ili razgranate, a alkil grupe u prethodno navedenim dialkilisanim grupama, na primer dialkilamino grupe, mogu biti identične ili različite, a atomi vodonika metil ili etil grupe koje su sadržane u ranije navedenim definicijama, ukoliko nije drugačije naznačeno, mogu biti u celosti ili delimično zamenjeni sa atomima fluora, njihovi tautomeri, enantiomeri, diastereomeri, smeše i soli. Patent sadrži još 12 patentnih zahtjeva.

(51) **C07D311/08**  
**A61K31/352**  
**A61K31/47**  
**A61P31/18**  
**C07D215/22**  
**C07D215/14**  
**C07D215/18**  
**C07D311/12**  
**C07D311/14**  
**C07D401/04**  
**C07D401/12**  
**C07D405/04**  
**C07D409/04**  
**C07D413/12**  
**C07D215/227**

(11) **01217**  
(21) **2010-192**

(30) 20060747311P 16.05.2006 US  
(86) PCT/CA2007/000845 14.05.2007  
(87) WO2007131350 22.11.2007  
(96) 07784947.9 14.05.2007  
(97) EP2019825 01.09.2010. 2010/35 EN

(54) (ME) **INHIBITORI REPLIKACIJE VIRUSA LJUDSKE IMUNODEFICIJENCIJE**  
(EN) INHIBITORS OF HUMAN IMMUNODEFICIENCY VIRUS REPLICATION

(73) Gilead Sciences, Inc., 333 Lakeside Drive, Foster City California 94404, (US)  
(72) 01 / TSANTRIZOS, Youla, S. ; 2100 Cunard Street Laval, Quebec H7S 2G5 / CA  
02 / BOES, Michael, Tengstrasse 40 80796 Munich / DE  
03 / BROCHU, Christian ; 2100 Cunard Street Laval, Québec H7S 2G5 / CA  
04 / FENWICK, Craig ; 2100 Cunard Street Laval, Québec H7S 2G5 / CA  
05 / MALENFANT, Eric ; 2100 Cunard Street Laval, Québec H7S 2G5 / CA  
06 / MASON, Stephen ; 2100 Cunard Street Laval, Québec H7S 2G5 / CA  
07 / PESANT, Marc ; 2100 Cunard Street Laval, Québec H7S 2G5 / CA

(74) Radulović Božidar, Jovana Tomaševića 9 III-1, Podgorica (ME)

(57) Antropizomer, racemat, enantiomer, diastereomer ili tautomer jedinjenja predstavljeno formulom (I):

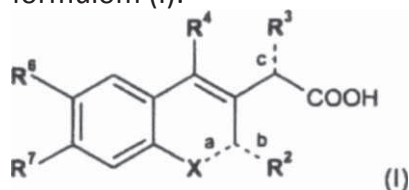

U kojoj

veza a je dvostruka veza, a veza b je jednostruka veza ili veza a je jednostruka veza, a veza b je dvostruka veza; X je O ili NR<sup>1</sup> kada je veza a jednostruka veza; ili X je N kada je veza a u kojoj

dvostruka veza;  $R^1$  je H, (C1-6)alkil, (C1-6)haloalkil, (C3-7)cikloalk-(C1-6)alkil-, aril-(C1-6)alkil- ili Het-(C1-4)alkil-; gde svaki od (C1-6)alkil, (C3-7)cikloalkil-(C1-6)alkil-, aril-(C1-6)alkil- i Het-(C<sub>1-6</sub>)alkil- je opciono supstituisan sa -OH, -O(C1-6)alkil, -SH, -S(C1-6)alkil, -NH<sub>2</sub>, -NH(C<sub>1-6</sub>)alkil, ili -N((C1-6)alkil)<sub>2</sub>;  $R^2$  je H, (C1-6)alkil ili -O(C1-6)alkil kada je veza b jednostruka veza; ili  $R^2$  je O kada je veza b dvostruka veza;  $R^3$  je (C1-6)alkil, (C1-6)haloalkil, (C<sub>2-6</sub>)alkenil, (C<sub>2-6</sub>)alkinil, (C3-7)cikloalkil-(C1-6)alkil-, aril-(C1-6)alkil-, Het-(C1-6)alkil- ili -Y-R<sup>31</sup>, a veza c je jednostruka veza; ili  $R^3$  je (C1-6)alkiliden, a veza c je dvostruka veza; gde Y je O ili S, a R<sup>31</sup> je (C1-6)alkil, (C1-6)haloalkil, (C<sub>2-6</sub>)alkenil, (C<sub>2-6</sub>)alkinil, (C<sub>3-7</sub>)cikloalkil, aril, (C3-7)cikloalkil-(C1-6)alkil-, aril-(C1-6)alkil- ili Het-(C1-6)alkil-; gde svaki od (C<sub>1-6</sub>)alkiliden, (C1-6)alkil, (C1-6)haloalkil, (C1-6)alkenil, (C<sub>2-6</sub>)alkinil, (C3-7)cikloalkil-(C1-6)alkil-, aril-(C1-6)alkil-, Het-(C1-6)alkil- i -Y-R<sup>31</sup> je opciono supstituisan sa 1 do 3 supstituenta, svaki nezavisno odabran od (d<sub>6</sub>)alkil, halo, cijano, okso i -O(C1-6)alkil;  $R^4$  je aril ili Het, gde svaka aril i Het je opciono supstituisan sa 1 do 5 supstituenata, svaki nezavisno odabran od halo, (C<sub>1-6</sub>)alkil, (C<sub>2-6</sub>)alkenil, (d<sub>6</sub>)haloalkil, (C<sub>3-7</sub>)cikloalkil, -OH, -O(C1-6)alkil-, -SH, -S(C1-6)alkil, -NH<sub>2</sub>, -NH(C1-6)alkil i -N((C1-6)alkil)<sub>2</sub>; gde je (C<sub>1-6</sub>)alkil opciono supstituisan sa hidroksi, cijano ili okso;  $R^6$  i  $R^7$  su svaki nezavisno odabrani od H, halo, (C1-6)alkil i (C<sub>1-6</sub>)haloalkil; pod uslovom da kada veza a je jednostruka veza i veza b je dvostruka veza; i X je NR<sup>1</sup>;  $R^1$  je H; i  $R^2$  je O; i  $R^4$  je ne supstituisani fenil;  $R^6$  je Cl;  $R^7$  je H; i veza c je dvostruka veza; onda  $R^3$  nije =CH-CH(CH<sub>3</sub>)<sub>2</sub>; i gde Het je 4- do 7-člani zasićeni, nezasićeni ili aromatični heterocikl koji ima 1 do 4 heteroatoma, svaki nezavisno odabran od O, N i S, ili 7- do 14-člani zasićeni, nezasićeni ili aromatični heteropolcikli koji gde god je moguće ima 1 do 5 heteroatoma, svaki nezavisno odabran od O, N i S; ili njegova so ili estar.

Patent sadrži još 14 patentnih zahtjeva.

- (51) **C07D487/04** (11) **01216**  
**A61K31/505** (21) **2010-203**  
**A61P9/08**
- (30) 20030027319 24.11.2003 GB  
(86) PCT/IB2004/003747 12.11.2004  
(87) WO2005049616 02.06.2005  
(96) 04798876.1 12.11.2004  
(97) EP1689751 20.10.2010. 2010/42 EN
- (54) (ME) **5,7-DIAMINOPIRAZOLO(4,3-D)PIRIMIDINI S AKTIVNOŠĆU INHIBITORA PDE-5**  
(EN) 5,7-DIAMINOPYRAZOLO[4,3-D]PYRIMIDINES WITH PDE-5 INHIBITING ACTIVITY
- (73) Pfizer, INC., 235 East 42nd Street, New York, NY 10017, USA  
(72) BELL, Andrew Simon, Pfizer Global R&D Ramsgate Road Sandwich, Kent CT13 9NJ / GB  
BROWN, David Graham, Pfizer Global R&D Ramsgate Road Sandwich, Kent CT13 9NJ / GB  
DACK, Kevin Neil, Pfizer Global R&D Ramsgate Road Sandwich, Kent CT13 9NJ / GB  
FOX, David Nathan A., Pfizer Global R&D Ramsgate Road Sandwich, Kent CT13 9NJ / GB  
MARSH, Ian Roger, Pfizer Global R&D Ramsgate Road Sandwich, Kent CT13 9NJ / GB  
MORRELL, Andrew Ian, Pfizer Global R&D Ramsgate Road Sandwich, Kent CT13 9NJ / GB  
PALMER, Michael John, Pfizer Global R&D Ramsgate Road Sandwich, Kent CT13 9NJ / GB  
WINSLOW, Carol Ann, Pfizer Global R&D Ramsgate Road Sandwich, Kent CT13 9NJ / GB
- (74) Čupić Branislav, Dalmatinska 10, Podgorica (ME)
- (57) Spoj fonule (1) nazoailen time lito RI je prstenasta skupina, koju se bira između  $R^A$ ,  $R^B$ ,  $R^C$  i  $R^D$ , od kojih je svaki izborno supstituiran s jednom iii ville skupina  $R_7$ ; svaki od  $R_3$  i  $R_4$  je neovisno CI-Cg alkil, CZ-Cg alkenil, Cz-Cg alkinil-iii — CIO cikloalkil, od kojih je svaki izborno supstituiran s jednom iii ville skupina.  $R_5$  je  $R^E$ . kojije izborno supstituiran s jednom iii ville skupina  $R_9$ , iii vodik; iii  $NR^3$   $R^4$  tvori  $R^F$ , kojije izborno supstituiran s jednom iii ville skupina RIO;  $R^6$  koji može biti vezan na  $N^1$  iii  $N^2$ . je CI— alkil, CI-C6 halogenalkil, Cz-C6 alkenil iii CZ-C6 alkinil. od kojih je svaki izborno supstituiran s C1-C6 alkoksi. C1-C6 halogenalkoksi iii prstenastom skupinom koju se bira između  $R^I$ ,  $R^K$ , RL i  $R^M$ . iii  $R_6$  je  $R^N$ . C3-~ cikloalkil iii C3-C7 halogencikloalkil, od kojih je svaki izborno supstituiran s CI-C6alkoksi iii CI-C6 halogenalkoksi. iii  $R_6$  je vodik;  $R_7$  je halogen, CI-C6 alkil, CI-C6 halogenalkil, CZ-C6 alkenil. Cz-C6 alkinil. C)-CIO cikloalkil. Q-CIO halogencikloalkil, fenil, ORIZ, OC(O)RIZ. NOZ • $NR^{12}R^{13}$ •NRIZC(O)RI3.  $NR^{12}CO_2RI4$ . C(O) $R^{12}$  •COZRIZ. COZIR.CONR<sup>12</sup>iii CN;  $R^5$  je halogen, fenil, CI-C6 alkoksifenil, ORIZ. OC(O) $R^{12}$ , NOz,  $NR^{12}R^{13}$ ,  $NR^{12}C(O)R^{13}$ , NRIZCOzRH. C(O)R . COZR<sup>12</sup>. CONR<sup>12</sup>R<sup>13</sup>, CN. ~-C6 cikloalkil. RG iii  $R^H$ , od kojih su potonja dva izborno supstituirana s jednom iii ville skupina  $R_9$ ;  $R_9$  je CI-C6alkil. CI-C6halogenalkil iii COZRI2; RIO je halogen. C3-CIO cikloalkil. C3-CIO halogencikloalkil. fenil, OR<sup>12</sup>. OC(O) $R^{12}$ , NOz,  $NR^{12}R^{13}$   $NR^{12}C(O)R^{13}$ , NRIZCOzRE C(O) $R^{12}$ , COzr<sup>13</sup>. CONR<sup>12</sup>R<sup>12</sup>, CN. okso. CI-C6 alkil iii C1-C6 halogenalkil. od kojih su potonja dva izborno supstituirana s RII; svaki od R i RI3 je neovisno vodik C1-C6 alkil iii C1-C6 halnaenalki:  $R^{15}$  je vodik ili C1-C6 alkil izborno supstituiran s jednom iii vi~ skupina, koje se bira između halogena, OH, C1-C6 alkiloksi, NH2, NH(CI-C6alkil) i N(CI-C6 alkil):R16 je izoster karboksilne kiseline, kojeg se bira između tetrazol-5-ila, 5-trifluormetil-1,2,4-triazol-3-ila, 5-(metilsulfonil)-1,2,4-triazol-3-ila, 2,5-dihidro-5-okso-1,2,4-oksadiazol-3-ila. -S02NHRI7 i -CONHR 18; RI7 se bira između CI-C6 alkila, fenila, -CO-(CJ-C6 alkil) i -CO-fenila; svaki od RA i R<sup>1</sup> je neovisno C3-C10 cikloalkilna iii — CIO cikloalkenilna skupina, od kojih svaka može biti bilo monociklička iii, kada je u prstenu dovoljan broj atoma, policiklička, te koja može biti kondenzirana bilo s monocikličkim aromatskim prstenom, kojeg se bira između benzenskog prstena i 5-iii 6-eroclanog heteroaromatskog prstena, koji sadrži do tri heteroatoma, koje se bira između duHka, kisika i sumpora, iii 5-, 6-ili 7-eroclanim heteroalickickim prstenom, koji sadrži do



tri heteroatoma, koje se bira između dužika, kisika i sumpora; svaki od RB i RK je neovisno fenilna ili naftilna skupina, od kojih svaka može biti kondenzirana s CS-C7 cikloalkilnim ili CS-C7 cikloalkenilnim prstenom, 5-, 6-ili 7-eročlanim heteroalicičkim prstenom, koji sadrži do tri heteroatoma, koje se bira između dužika, kisika i sumpora; svaki od R<sup>e</sup>, RL i RN je neovisno monociklički ili, kada je u prstenu dovoljan broj atoma, policiklički zasićeni ili djelomično nezasićeni prstenasti sustav, koji sadrži između 3 i 10 atoma u prstenu, od kojih je najmanje jedan heteroatom, kojeg se bira između dužika, kisika i sumpora, gdje navedeni prsten može biti kondenziran s CS-C7 cikloalkilnom ili CS-C7 cikloalkenilnom skupinom ili monocikličkim aromatskim prstenom, kojeg se bira između benzenskog prstena i 5-ili 6-eročlanog heteroaromatskog prstena, koji sadrži do tri heteroatoma. koje se bira između dužika, kisika i sumpora; svaki od RD i RM je neovisno 5-ili 6-eročlani heteroaromatski prsten. koji sadrži do tri heteroatoma, koje se neovisno bira između dužika, kisika i sumpora, gdje navedeni prsten može dodatno biti kondenziran s drugim 5-ili 6-eročlanim heteroaromatskim prstenom. koji sadrži do tri heteroatoma, koje se bira između dužika, kisika i sumpora; CS-C7 cikloalkilnim ili CS-C7 cikloalkenilnim prstenom; 5-, 6-ili 7-eročlanim heteroalicičkim prstenom, koji sadrži do tri heteroatoma, koje se bira između dužika, kisika i sumpora; ili benzenskim prstenom; svaki od R. RF i RG je neovisno monociklički ili, kada je u prstenu dovoljan broj atoma. Policiklički heteroatom, kojeg se bira između dužika, kisika i sumpora; RH je 5-ili 6-eročlani heteroaromatski prsten, koji sadrži do tri heteroatoma, koje se neovisno bira između dužika, kisika i sumpora; i Patent sadrži još 73 patentnih zahtjeva.





# ŽIGOVI

## TRADEMARKS

Službeni glasnik Zavoda za intelektualnu svojinu Crne Gore  
Official Gazette of the Montenegrin Intellectual Property Office

# 11 / 2013



Zavod za intelektualnu svojinu Crne Gore  
ul. Rimski trg br. 46,  
81000 Podgorica,  
Crna Gora



**MEĐUNARODNI KODOVI ZA IDENTIFIKACIJU BIBLIOGRAFSKIH  
PODATAKA O ŽIGOVIMA PREMA WIPO ST 60**  
RECOMMENDATION CONCERNING BIBLIOGRAFIC DATA RELATING TO  
TRADEMARKS- WIPO-ST. 60

<b>CRNOGORSKI</b>	<b>MDK</b>	<b>ENGLESKI</b>
REGISTRARSKI BROJ	<b>111</b>	NUMBER OF THE REGISTRATION
DATUM REGISTRACIJE	<b>151</b>	DATE OF THE REGISTRATION
OČEKIVANI DATUM PRESTANKA VAŽENJA ŽIGA	<b>181</b>	EXPECTED EXPIRATION DATE OF THE REGISTRATION
BROJ PRIJAVE	<b>210</b>	NUMBER OF THE APPLICATION
DATUM PODNOŠENJA PRIJAVE	<b>220</b>	DATE OF FILING OF THE APPLICATION
PODACI O IZLOŽBENOM PRAVU PRVENSTVA	<b>230</b>	DATA CONCERNING EXHIBITIONS
PODACI O PRAVU PRVENSTVA NA OSNOVU PARISKE KONVENCIJE	<b>300</b>	DATA RELATING TO PRIORITU UNDER THE PARIS CONVENTION
DATUM OBJAVLJIVANJA PRIJAVE	<b>442</b>	DATA OF PUBLICATION OF APPLICATION
SPISAK ROBA I USLUGA PREMA NIČANSKOJ KLASIFIKACIJI ROBA I USLUGA	<b>511</b>	LIST OF GOODS AND SERVICES ACCORDING THE NICE CLASSIFICATION OF GOODS AND SERVICE
IZJAVA PODNOSIOCA PRIJAVE DA NE TRAŽE EKSKLUZIVNO PRAVO ZA POJEDINE NEDINSTIKTIVNE ELEMENTE ZNAKA	<b>526</b>	DISCLAIMER
IZGLED ZNAKA	<b>540</b>	REPRODUCTION OF THE MARK
NAZNAKA O PRIRODI ILI VRSTI ZNAKA	<b>550</b>	INDICATION RELATING TO THE NATURE OR KIND OF MARK
INFORMACIJA O ZATRAŽENIM BOJAMA NA ZNAKU	<b>591</b>	INFORMATION CONCERNING THE COLORS CLAIMED
PODACI O PODNOSIOCU PRIJAVE	<b>731</b>	NAME AND ADRESS OF THE APPLICANT
IME I ADRESA NOSIOCA ŽIGA	<b>732</b>	NAME AND ADDRESS OF THE HOLDER OF THE REGISTRATION
INFORMACIJA O ZATRAŽENIM BOJAMA NA ZNAKU	<b>591</b>	INFORMATION CONCERNING THE COLORS CLAIMED
PODACI O PODNOSIOCU PRIJAVE	<b>731</b>	NAME AND ADRESS OF THE APPLICANT
IME I ADRESA NOSIOCA ŽIGA	<b>732</b>	NAME AND ADDRESS OF THE HOLDER OF THE REGISTRATION
IME I ADRESA PUNOMOĆNIKA	<b>740</b>	NAME AND ADDRESS OF THE REPRESENTATIVE



## OBAVJEŠTENJE NOTICE

Obavještavamo korisnike da se od 7-og broja Crnogorskog glasnika za intelektualnu svojinu koji se objavljuje na web stranici Zavoda za intelektualnu svojinu Crne Gore, u elektronskoj formi, odnosno od 20.12.2011 godine (Glasnik broj 7/2011) uvodi objava prijave za registraciju žiga. Stupanjem na snagu Pravilnika o postupku za priznanje, promjenama, obnovi i međunarodnoj registraciji žiga ("Sl. list CG" broj 55/11) stekli su se uslovi da Zavod postupa u skladu sa odredbom člana 29 stav 1 Zakona o žigu i uredne prijave, za koje nije utvrđen razlog za odbijanje registracije iz člana 28 ovog zakona, objavi u Službenom glasilu.

Od dana objavljivanja prijave u Službenom glasilu, shodno odredbi člana 30 stav 1 Zakona o žigu, pravna i fizička lica ili udruženja proizvođača roba ili usluga, pružaoci usluga, trgovci i potrošači mogu, u roku od 90 dana od datuma objavljivanja prijave, dostaviti Zavodu obrazloženo mišljenje u pisanoj formi o apsolutnim razlozima za odbijanje registracije iz člana 6 Zakona o žigu.

U roku od 90 dana od dana objavljivanja prijave u Službenom glasilu, nosilac ranijeg žiga ili sticalac licence, na osnovu ovlašćenja nosioca žiga, mogu zbog razloga iz čl. 7 i 8 Zakona o žigu, u roku od 90 dana od dana objavljivanja prijave, shodno odredbi člana 31 stav 1 i 2 Zakona o žigu podnijeti Zavodu Prigovor za odbijanje registracije žiga.





(210) **2010-289**

(442) **20.03.2013**

(220) 10.8.2010

(731) **NINE WEST DEVELOPMENT CORPORATION**, 1007 ORANGE STREET, SUITE 225, 19801 WILMINGTON, DE US

## EASY SPIRIT

(540)

(550) I

(740) Čejović Vladimir, 13. jula 21, Podgorica (ME)

(511) **Klasa 12:** Brodovi/čamci i njihovi djelovi i oprema; automobili, električna vozila uključujući električne automobile, vagone, kamione, kombi vozila, vozila koja se koriste u sportske svrhe, autobuse, rekreativna vozila (RV), sportske automobile, trkačke automobile, kamione, viljuškare, traktore za vuču (traktori), i njihove strukturne djelove i opremu; motorna vozila na dva točka, bicikla i njihovi djelovi i oprema; teretna kolica; auto-istovarivači, auto-gurači, auto-tegljači, traktore (mehanizmi za vuču); motori i mehanizmi za kopnena vozila; osovine za vozila; prenosnici snage i zupčanici za mašine; amortizeri; kočnice; motori sa naizmjeničnom strujom/motori sa jednosmjernom strujom za kopnena vozila; alarmni uređaji protiv krađe vozila; ljepljive gumene zakrpe za popravku unutrašnjih guma ili guma; sve uključeno u međunarodnu klasu 12.

(210) **2011-255**

(442) **20.03.2013**

(220) 24.5.2011

(731) **PHARMASWISS SA**, BUNDESPLATZ 1 6300 ZUG CH

## LEVOMAX

(540)

(550) I

(740) Radulović Božidar, Jovana Tomaševića 9/III, Podgorica (ME)

(511) **Klasa 05:** Farmaceutski preparati-lijekovi.

(210) **2011-256**

(442) **20.03.2013**

(220) 24.5.2011

(731) **PHARMASWISS SA**, BUNDESPLATZ 1, 6300 ZUG CH

## RAPIDOL

(540)

(550) I

(740) Radulović Božidar, Jovana Tomaševića 9/III, Podgorica (ME)

(511) **Klasa 05:** Farmaceutski preparati-dijetetske supstance prilagođene za upotrebu u medicini.

(210) **2011-257**

(442) **20.03.2013**

(220) 24.5.2011

(731) **AMO UPPSALA AB**, BOX 6406,751 36 UPPSALA SE

**HEALON ENDOCOAT**

(540)

(550) I

(740) Popović Miladin, Đoka Miraševića 21/III, Podgorica (ME)

(511) **Klasa 05:** Farmaceutski preparati, naime, hijaluronska kiselina natrijumove soli.

(210) **2011-259**

(442) **20.03.2013**

(220) 25.5.2011

(731) **COLGATE-PALMOLIVE COMPANY**, 300 PARK AVENUE, NEW YORK, NEW YORK 10022 US

**GOPURE**

(540)

(550) I

(740) Čupić Branislav, Dalmatinska 10, Podgorica (ME)

(511) **Klasa 03:** Pasta za zube.

(210) **2011-260**

(442) **20.03.2013**

(220) 25.5.2011

(731) **HEMOFARM A.D.**, BEOGRADSKI PUT BB, 26300 VRŠAC RS

**PEPTIX**

(540)

(550) I

(740) Popović Miladin, Đoka Miraševića 21/III, Podgorica (ME)

(511) **Klasa 05:** Farmaceutski i veterinarski preparati; sanitarni preparati za dijetetske supstan-

ce prilagođene za upotrebu u medicini, hi materijali za zavijanje; materijali za plomiranje zuba, zubarska sredstva; preparati za uništavanje štetočina; fungicidi, herbicidi.

(210) **2011-261**

(442) **20.03.2013**

(220) 25.5.2011

(300) TRINIDAD & TOBAGO BR.43097 OD 07 12 2010

(731) **INTEL CORPORATION**, 2200 MISSION COLLEGE BOULEVARD, SANTA CLARA, CALIFORNIA 95052-8119 US



(540)

(550) I

(740) Čejović Vladimir, 13. jula 21, Podgorica (ME)

(511) **Klasa 09:** Računari, računarski periferni uređaji, računarski terminali; računarski hardver; mašine za kompjuterske igre, mikroprocesori, memorijske ploče, monitori, displeji, tastature, kablovi, modemi, štampači, disk drajvovi, adapteri, kartice za adaptere, konektori i drajveri; nepopunjeni mediji za skladištenje kompjuterskog sadržaja; magnetni nosači podataka; kompjuterski softver; kompjuterski softver za kreiranje, preuzimanje, prenos, prijem, uređivanje, izvlačenje, kodiranje, dekodiranje, prikazivanje, čuvanje i organizovanje teksta, grafike, slike, i elektronskih publikacija; kompjuterski softver i firmver, naime, operativni sistemi, programi za sinhronizaciju podataka i programi aplikacija za razvijanje pomoćnih alatki za lične i ručne računare; kompjuterski hardver i softver za pružanje integrisane telefonske komunikacije sa kompjuterskim globalnim informacionim mrežama; prethodno snimljeni kompjuterski programi za lično upravljanje informacijama, softver za upravljanje bazama podataka, softver za prepoznavanje znakova, softver za upravljanje telefonijom, softver za elektronsku poštu i slanje poruka, pejdžing softver, softver za mobilni telefon; softver za sinhronizaciju baza podataka, kompjuterski programi za pristup, pregled i pretraživanje on-line baza podataka, kompjuterski softver za preusmeravanje poruka, elektronske pošte preko interneta, i / ili drugih podataka na jedan ili više elektronskih ručnih uređaja iz prodavnice podataka na ili u vezi sa ličnim računarima ili serverima; kompjuterski softver za sinhronizaciju podataka između daljinskih stanica ili uređaja i fiksnih stanica ili daljinskih stanica ili uređaja; elektronske publikacije koje se mogu preuzeti kao što su knjige, drame, pamfleti, brošure, bilteni, dnevne novine, magazini, i časopisi o širokom spektru tema od opšteg interesa; ručni digitalni elektronski uređaji i odgovarajući softver; MP3 i drugi audio plejeri u digitalnom formatu; ručni računari, tablet računari, lični digitalni asistenti, elektronski organizatori, elektronske sveske; mobilni digitalni elektronski uređaji, uređaji za globalni sistem pozicioniranja (GPS), telefoni; ručni i mobilni digitalni elektronski uređaji za slanje i primanje telefonskih poziva, faksova, elektronske pošte i drugih digitalnih podataka; bežični telefoni; mobilni telefoni; djelovi i pribor za mobilne telefone; faks mašine, telefonske sekretarice, kamere, uređaji za prenos videa preko telefona, softver i hardver za pronalaženje

informacija preko telefona; elektronske ručne jedinice za bežični prijem, skladištenje i / ili prenos podataka i poruka, i elektronski uređaji koji omogućavaju korisniku da prate i upravljaju ličnim podacima; elektronska komunikaciona oprema i instrumenti; telekomunikacioni aparati i instrumenti; fontovi, slogovi, štamparski dizajni i simboli u obliku snimljenih podataka; čipovi, diskovi i trake koje sadrže ili su za snimanje kompjuterskih programa i softvera; ram memorija, rom memorija; solid state memorijski aparat; kompjuterske i elektronske igre; uputstva za rukovanje u obliku kojih se može čitati elektronskim putem, putem mašina ili putem računara za upotrebu sa, i koji se prodaju zajedno sa svom gore navedenom robom; aparati za skladištenje podataka; hard drajvovi; minijaturni hard disk drajvovi za skladištenje podataka; audio-video diskovi, čitači kompakt diskova, i digitalni višenamjenski diskovi; podloge za miša; baterije; punjive baterije; punjači; punjači za električne baterije; slušalice; stereo slušalice; slušalice koje se stavljaju direktno u ušni kanal; stereo zvučnici; audio zvučnici; audio zvučnici za kućnu upotrebu; zvučnici za monitore; zvučnici za računare; zvučni sistemi za lični stereo; radio prijemnici, pojačala, aparati za snimanje i reprodukciju zvuka, električni fonografi, gramofoni, stereo uređaji za visoko kvalitetnu reprodukciju zvuka, magnetofoni i aparati za reprodukciju, zvučnici, jedinice sa više zvučnika, mikrofoni; digitalni audio i video uređaji; uređaji za snimanje i reprodukciju zvuka, uređaji za snimanje i reprodukciju pokretnih slika, uređaji za reprodukciju kompakt diskova, uređaji za snimanje i reprodukciju digitalnih višenamjenskih diskova, uređaji za snimanje i reprodukciju digitalnih audio kaseti; digitalni uređaji za reprodukciju muzike i/ili pokretnih slika; radio aparati; video kamere; audio, video, i digitalni mikseri; radio predajnici; zvučni uređaji za automobile; računarska oprema za upotrebu sa svom gore navedenom robom; elektronski aparati sa multimedijalnim funkcijama za upotrebu sa svom gore navedenom robom; elektronski aparati sa interaktivnim funkcijama za upotrebu sa svom gore navedenom robom; pribor, djelovi, oprema i aparati za testiranje za svu gore navedenu robu; djelovi i oprema za svu gore navedenu robu; pokrivači, torbe i futrole prilagođene ili oblikovane da sadrže svu gore navedenu robu, od kože, imitacije kože, tkanine, ili tekstilnih materijala.

(210) **2011-263**(442) **20.03.2013**

(220) 27.5.2011

(731) **PLAYBOY ENTERPRISES INTERNATIONAL INC**, 680 NORTH LAKE SHORE DRIVE, CHICAGO, ILLINOIS 60611 US

(540)

(550) I

(740) Ćupić Branislav, Dalmatinska 10, Podgorica (ME)

(511) **Klasa 18:** Koža i imitacije kože, artikli od ovih materijala, sirova koža i krzno, proizvodi od kože; sedlarska i tašnerska roba od kože i imitacije kože; škrinje i putne torbe, kišobrani, sunčobrani i štapovi za hodanje, asesoari od kože, koferi, ručne torbe, kaiševi, kutije za pisma od kože, akten-tašne, futrole za ključeve, futrole na preklapanje, kožni ženski novčanici, pri-

vesci za ključeve od kože, papirne futrole, sportske torbe, futrole za vozačke dozvole, futrole za saobraćajne dozvole, ženski novčanici, futrole za kartice, muški novčanici, novčanici na preklapanje, mapa za spise, mapa za spise na rajsferšlus, torbe, tašne, futrole, bičevi, saračka i sedlarska oprema, torbe od kože, torbe od imitacije kože, torbe od plastičnih materijala, koferi, neseseri, male putne torbe, vreće, torbe od kože za kupovinu, torbe koje se nose preko ramena, suvenir-torbe, torbe-navlake za odijela, torbe od tekstila za kupovinu, prazne torbe za alat, torbe od frotira, futrole za kišobrane, manje putne torbe za kraći boravak.

**Klasa 24:** Tekstil i roba od tekstila, koja nije uključena u druge klase; prekrivači za krevete i stolove.

**Klasa 25:** Odjeća, obuća i pokrivala za glavu.

(210) **2011-264**

(442) **20.03.2013**

(220) 27.5.2011

(731) **HYUNDAI MOTOR COMPANY**, 231,YANGJAE-DONG, SEOCHO-GU, SEOUL,137-938  
KR

HYUNDAI

(540)

(550) I

(740) Čejović Vladimir, 13. jula 21, Podgorica (ME)

(511) **Klasa 36:** Finansiranje zakupa; kreditno finansiranje; finansijske usluge u vezi sa mot vozilima; usluge davanja pozajmica; lizing finansiranje; konsulatntske usli vezi razvojnog finansiranja; finansijske usluge za razvoj; organizacija pozjamica; usluge bračnih pozajmica; finansiranje kupovine; konsluta usluge u vezi međunarodnih finansija; međunarodno bankarstvo; u međunarodnih investicionih fondova; vojno finansiranje; usluge def dragocjenosti; usluge sefova; konsultantske usluge u vezi finansija; brok usluge u vezi finansijskih instrumenata; upravljanje finansijskom imovi pružanje informacija u oblasti finansija; finansijsko posredovanje; akvizi transfer monetarnih potraživanja; organizovanje finansijskih investicija; u agencija za prikupljanje novčanih potraživanja; usluge korporativnih pozaj usluge domaćih berzanskih transakcija; pružanje informacija o dorr berzanskim transakcijama; finansiranje kredita za likvidnost; organizovanje pozajmica sa obezbjeđenjem; usluge hipotekarnih pozajmica; usluge tek računa; uslužna uplata i prijem novca; usluge zajmova; izdavanje sefova; ns dugova; konsultantske usluge u vezi zajmova; usluge debitnih kartica; u: hipotekarnih zajmova; usluge zajmova bez obezbjeđenja; usluge berza borkera putem bežičnih terminala; pružanje informacija u vezi finansiranja p bežičnih komunikacija; usluge berzanskih brokera putem bežičnih komunik usluge finansiranja međunarodne trgovine; pružanje cjenovnih informac investivcionim fondovima; finansiranje venčr kapitala; pozajmice obezbjeđenje; usluge jemstva; usluge jemstva; izdavanje lutrijskih Hi organizovanje finansiranja za kupovinu nekretnina; usluge finansiranja indus usluge komercijalnog bankarstva; usluge investicionih fondova; pru; informacija o cijeni terminskih ugovora; brokerske usluge u vezi termin tržišta; usluge potrošačkih kredita; usluge finansiranja izvoza; verifikacija čel izdavanje čekova; finansijske usluge za nove tehnologije; usluge kreditnog t usluge kreditnih i gotovinskih kartica; izdavanje kreditnih kartica; usluge krec kartica; usluge povjerenika; izdavanje mjenica; razmjena čekova na izdavanje i naplata obveznica; izdavanje čekova i kreditnih pisama; izda\

putnih čekova; usluge penzionih fondova; administriranje prijema depc usluge prijema depozita; usluge devizne razmjene; pružanje informaci vrijednosti stranih valuta; izdavanje hartija od vrijednosti; usluge sigurnosnog posredovanja; bankarske usluge u vezi prenosa sredstava sa rač konsultacije u vezi bankarstva; bankarske usluge; usluge internet bankar prikupljanje rente; finansiranje kupovine na lizing; novčane pozajmice; plas sredstava; novčani transferi; prikupljanje sredstava; novčano posredovi unovčavanje čekova; usluge direktne naplate; usluge bankomata; konsult u oblasti kapitalnih investicija; usluge kapitalnih investicija; finans bankarstvo; finansijsko sponzorisanje; hipotekarno bankarstvo; us štedionica; usluge zajmova sa obezbjeđenjem; elektronski transfer sredst usluge trgovine terminskim opcijama putem berzanskih indeksa; broke usluge u vezi akcija i obveznica; pružanje tržišnih informacija o hartijama« vrijednosti; usluge berzanskih kota; usluge procjene berzanskih kota; pozaji sa nekretninama kao sredstvima obezbjeđenja; organizovanje finansir zajmova za nekretnine; usluge poslovanja sa hartijama od vrijednosti; broke usluge u vezi sa hartijama od vrijednosti; konsultacije u oblasti berzanj investiranja; kupovina obveznica; izdavanje obveznica; brokerske usluge u sa obveznicama; usluge agencije za naplatu dugova; garantovanje obav izdavanje vrijednosnih bonova; elektronski transfer sredstava pitelemekunikacija; usluge isplate penzija; finansijske usluge u vezi invest kapitalne investicije; otkup dugova; uslužno investiranje sreds obezbjeđivanje zajmova za školarinu; davanje u zakup bankomata; us gotovinskih kartica; kućno bankarstvo; razmjena novca; usluge osigur usluge osiguranja automobila; usluge zdravstvenog osiguranja; usluge osigu obrazovnih zadužbina; usluge osiguranja potrošačkih kredita; usluge provalnog osiguranja; uslužno polaganje kaucije; usluge osiguranja od r usluge ocjene osiguranja; usluge agencije za osiguranje; procena osigui konsultacije u vezi osiguranja; procjena gubitka osiguranja; savjetodavne u u vezi osiguranja; pružanje informacija o osiguranju; brokerske usluge u osiguranja; aktuarske usluge; usluge osiguranja nekretnina; usluge obave socijalnog osiguranja; usluge osiguranja od industrijskog akcidenta; osiguranje robe u tranzitu; usluge osiguranja od nezgoda; usluge zajedničkog osigu usluge planiranje životnog osiguranja; usluge životnog osiguranja; osiguranje gubitaka; usluge osiguranja u vezi sa sportom; usluge osiguranja zadu; osiguranje anuiteta; usluge sportskog osiguranja; usluge tranzitnog osigu usluge medicinskog osiguranja; usluge reosiguranja; osiguranje od profesionalne odgovornosti; usluge osiguranja od odgovornosti; usluge aviaionog osiguranja procjena rizika osiguranja; usluge protiv požarnog osiguranja; usluge kreditnih upita u vezi sa finansijama; kreditni upiti preduzeća; usluge kreditnih upita sa osiguranjem; usluge agencija za kreditne izveštaje; usluge kreditnih upita.

(210) **2011-265**(442) **20.03.2013**

(220) 27.5.2011

(731) **HUNDAI MOTOR COMPANY**, 231, YANGJAE-DONG, SEOCHO-GU, SEOUL, 137-938, KOREA, KR;

(540)

(550) I

(740) Čejović Vladimir, 13. jula 21, Podgorica (ME)

(511) **Klasa 36:** Finansiranje zakupa; kreditno finansiranje; finansijske usluge u vezi sa mot vozilima; usluge davanja pozajmica; lizing finansiranje; konsulatntske usli vezi razvojnog finansiranja; finansijske usluge za razvoj; organizacija pozjamica; usluge bračnih pozajmica; finansiranje kupovine; konsluta usluge u vezi međunarodnih finansija; međunarodno bankarstvo; u međunarodnih investicionih fondova; vojno finansiranje; usluge def dragocjenosti; usluge sefova; konsultantske usluge u vezi finansija; brok usluge u vezi finansijskih instrumenata; upravljanje finansijskom imovi pružanje informacija u oblasti finansija; finansijsko posredovanje; akvizi transfer monetarnih potraživanja; organizovanje finansijskih investicija; u agencija za prikupljanje novčanih potraživanja; usluge korporativnih pozaj usluge domaćih berzanskih transakcija; pružanje informacija o dorr berzanskim transakcijama; finansiranje kredita za likvidnost; organizo pozajmica sa obezbjeđenjem; usluge hipotekarnih pozajmica; usluge tek računa; uslužna uplata i prijem novca; usluge zajmova; izdavanje sefova; ns dugova; konsultantske usluge u vezi zajmova; usluge debitnih kartica; u: hipotekarnih zajmova; usluge zajmova bez obezbjeđenja; usluge berza borkera putem bežičnih terminala; pružanje informacija u vezi finansiranja p bežičnih komunikacija; usluge berzanskih brokera putem bežičnih komunik usluge finansiranja međunarodne trgovine; pružanje cjenovnih informac investivcionim fondovima; finansiranje venčr kapitala; pozajmice obezbjeđenje; usluge jemstva; usluge jemstva; izdavanje lutrijskih Hi organizovanje finansiranja za kupovinu nekretnina; usluge finansiranja indus usluge komercijalnog bankarstva; usluge investicionih fondova; pru; informacija o cijeni terminskih ugovora; brokerske usluge u vezi termin tržišta; usluge potrošačkih kredita; usluge finansiranja izvoza; verifikacija čekova izdavanje čekova; finansijske usluge za nove tehnologije; usluge kreditnog t usluge kreditnih i gotovinskih kartica; izdavanje kreditnih kartica; usluge krec kartica; usluge povjerenika; izdavanje mjenica; razmjena čekova na p izdavanje i naplata obveznica; izdavanje čekova i kreditnih pisama; izdavanje putnih čekova; usluge penzionih fondova; administriranje prijema depc usluge prijema depozita; usluge devizne razmjene; pružanje informaci vrijednosti stranih valuta; izdavanje hartija od vrijednosti; usluge sigu posredovanja; bankarske usluge u vezi prenosa sredstava sa rač konsultacije u vezi bankarstva; bankarske usluge; usluge internet bankar prikupljanje rente; finansiranje kupovine na lizing; novčane pozajmice; plas sredstava; novčani transferi; prikupljanje sredstava; novčano posredovi unovčavavanje čekova; usluge direktne naplate; usluge bankomata; konsult u oblasti kapitalnih investicija; usluge kapitalnih investicija; finans bankarstvo; finansijsko sponzorisanje; hipotekarno bankarstvo; us štedionica; usluge zajmova sa obezbjeđenjem; elektronski transfer sredst usluge trgovine terminskim opcijama putem berzanskih indeksa; broke usluge u vezi akcija i obveznica; pružanje tržišnih informacija o hartijam« vrijednosti; usluge berzanskih kota; usluge procjene berzanskih kota; pozaji sa nekretninama kao sredstvima obezbjeđenja; organizovanje finansiranje zajmova za nekretnine; usluge poslovanja sa hartijama od vrijednosti; broke usluge u vezi sa hartijama od vrijednosti; konsultacije u oblasti berzanj investiranja; kupovina obveznica; izdavanje obveznica; brokerske usluge u sa obveznicama; usluge agencije za naplatu dugova; garantovanje obav izdavanje vrijednosnih bonova; elektronski transfer sredstava pitelemekomunikacija; usluge isplate penzija; finansijske usluge u vezi invesl kapitalne investicije; otkup dugova; uslužno investiranje sreds obezbjeđivanje zajmova za školarnu; davanje u zakup bankomata; us gotovinskih kartica; kućno bankarstvo; razmjena novca; usluge osigur usluge osiguranja automobila; usluge zdravstvenog osiguranja; usluge osiguranja obrazovnih zadužbina; usluge osiguranja potrošačkih kredita; usluge | provalnog osiguranja; uslužno polaganje kaucije; usluge osiguranja od r usluge ocjene osiguranja; usluge agencije za osiguranje; procena osiguranja konsultacije u vezi osiguranja; procjena gubitka osiguranja; savjetodavne u u vezi osiguranja; pružanje informacija o osiguranju; brokerske

usluge u osiguranja; aktuarske usluge; usluge osiguranja nekretnina; usluge obave socijalnog osiguranja; usluge osiguranja od industrijskog akcidenta; osigi robe u tranzitu; usluge osiguranja od nezgoda; usluge zajedničkog osigu usluge planiranje životnog osiguranja; usluge životnog osiguranja; osigurar gubitaka; usluge osiguranja u vezi sa sportom; usluge osiguranja zadu; osiguranje anuiteta; usluge sportskog osiguranja; usluge tranzitnog osiguranja usluge medicinskog osiguranja; usluge reosiguranja; osiguranje od profesionalne odgovornosti; usluge osiguranja od odgovornosti; usluge aviaionog osigu procjena rizika osiguranja; usluge protiv požarnog osiguranja; usluge kreditnih upita u vezi sa finansijama; kreditni upiti preduzeća; usluge kreditnih upita sa osiguranjem; usluge agencija za kreditne izveštaje; usluge kreditnih upita.

(210) **2011-266**

(442) **20.03.2013**

(220) 27.5.2011

(731) **PFIZER A.G.**, SCHARENMOOSSTRASSE 99,8052 ZURICH CH

**TOLANZA**

(540)

(550) I

(740) Čejović Vladimir, 13. jula 21, Podgorica (ME)

(511) **Klasa 05:** Farmaceutski i veterinarski preparati; sanitarni preparati za medicinske svrhe; dietetske supstance prilagođene za upotrebu u medicini, hrana za bebe; flasteri, materijali za zavijanje; materijali za plombiranje zuba, zubarska smola; dezinfekciona sredstva; preparati za uništavanje štetočina; fungicidi, herbicidi.

(210) **2011-271**

(442) **20.03.2013**

(220) 2.6.2011

(731) **BORA CREATIONS S.L.**, PASEO DE REVELLIN,NO 21,PLANTA 1,51001 CEUTA ES

**CATRICE**

(540)

(550) I

(740) Popović Miladin, Đoka Miraševića 21/III, Podgorica (ME)

(511) **Klasa 03:** Kozmetika; losioni za kosu; parfimerija; sapuni; eterična ulja.

(210) **2011-272**

(442) **20.03.2013**

(220) 2.6.2011

(731) **TEVA PHARMACEUTICALS INDUSTRIES LTD.**, SCIENCE BASED INDUSTRIES CAMPUS, HAR HOTZVIM.P.O BOX1142, JERUSALEM 91010 IL



# LAXADIN

(540)

(550) I

(740) Popović Miladin, Đoka Miraševića 21/III, Podgorica (ME)

(511) **Klasa 05:** Farmaceutski preparati za liječenje opstipacije.

(210) **2011-273**

(442) **20.03.2013**

(220) 2.6.2011

(731) **EASTERN COMPANY**, S.A.E, P.O. BOX 1543 CAIRO, 450 ALAHRAM STREET GIZA EG



(540)

(550) I

(740) Radulović Božidar, Jovana Tomaševića 9/III, Podgorica (ME)

(511) **Klasa 34:** Sirovi i prerađeni duvan, cigarete, duvan sa medom (moassel).

(210) **2011-274**

(442) **20.03.2013**

(220) 3.6.2011

(731) **SCANIA CV AKTIEBOLAG**, 151 8 SODERTALJE SE

# SCANIA

(540)

(550) I

(740) Stanković Mugoša Ana, Trg Republike 13, Podgorica, (ME)

(511) **Klasa 07:** Mašine i mašine alatke.

**Klasa 12:** Vozila, aparati za kretanje po zemlji, vazduh ili voda.

(210) **2011-276**(442) **20.03.2013**

(220) 3.6.2011

(731) **PODRAVKA DD**, A.STARČEVA 32,KOPRIVNICA HR

(540)

(550) I

(740) Božović Vesko, Rimski trg 50/11, Podgorica (ME)

(511) **Klasa 29:** Konzervisano, sušeno i kuvano povrće.**Klasa 30:** Sosovi (kao začini); začini.(210) **2011-279**(442) **20.03.2013**

(220) 8.6.2011

(731) **TEVA PHARMACEUTICAL INDUSTRIES LTD**, SCIENC BASED INDUSTRIES CAMPUS, HAR HOTZVIM, P.O. BOX 1142, JERUSALIM,921010 IL

(540)

(550) I

(740) Popović Miladin, Đoka Miraševića 21/III, Podgorica (ME)

(511) **Klasa 05:** Farmaceutski, veterinarski i sanitarni preparati; dijetetske supstance prilagođene za upotrebu u medicini, hrana za bebe; flasteri materijali za zavijanje; materijali za plom-biranje zuba, zubarska smola; dezinfekciona sredstva; preparati za uništavanje štetočina; fungicidi, herbicidi.**Klasa 10:** Hirurški, medicinski, zubarski i veterinarski aparati i instrumenti, vještački udovi, oči i zubi; ortopedski artikli; hirurški materijali za zašivanje.

(210) **2011-280**(442) **20.03.2013**

(220) 8.6.2011

(731) **TEVA PHARMACEUTICAL INDUSTRIES LTD**, SCIENC BASED INDUSTRIES CAMPUS, HAR HOTZVIM, P.O. BOX 1142, JERUSALIM, 921010 IL

(540)

(550) I

(740) Popović Miladin, Đoka Miraševića 21/III, Podgorica (ME)

(511) **Klasa 05:** Farmaceutski, veterinarski i sanitarni preparati; dijetetske supstance prilagođene za upotrebu u medicini, hrana za bebe; flasteri materijali za zavijanje; materijali za plom-biranje zuba, zubarska smola; dezinfekciona sredstva; preparati za uništavanje štetočina; fungicidi, herbicidi.**Klasa 10:** Hirurški, medicinski, zubarski i veterinarski aparati i instrumenti, vještački udovi, oči i zubi; ortopedski artikli; hirurški materijali za zašivanje.(210) **2011-284**(442) **20.03.2013**

(220) 10.6.2011

(731) **BELUPO LJEKOVI I KOZMETIKA D.D.**, DANICA 5, 48000 KOPRIVNICA HR

(540)

(550) I

(740) Popović Miladin, Đoka Miraševića 21/III, Podgorica (ME)

(511) **Klasa 05:** Farmaceutski proizvodi.(210) **2011-285**(442) **20.03.2013**

(220) 10.6.2011

(731) **BACARDI AND COMPANY LIMITED**, AEULESTRASSE 5, VADUZ LI



(540)

(550) I

(740) Popović Miladin, Đoka Miraševića 21/III, Podgorica (ME)

(511) **Klasa 33:** Tekila meksičkog porijekla.(210) **2011-286**(442) **20.03.2013**

(220) 16.6.2011

(731) **TREBJESA AD NIKŠIĆ, UL.NJEGOŠEVA BR.18 NIKŠIĆ ME**

(540)

(550) I

(740) Božović Vesko, Rimski trg 50/11, Podgorica (ME)

(511) **Klasa 32:** Pivo, mineralne i sodne vode i druga bezalkoholna pića; pića od voća i voćni sokovi; sirupi i drugi preparati za proizvodnju pića.

**Klasa 35:** Oglašavanje; vođenje poslova; poslovno upravljanje; kancelarijski poslovi. Obuhvata: usluge koje pružaju iica ili organizacije u pomoći u radu ili upravljanju preduzećima i u vodenju poslova preduzeća; usluge koje pružaju preuzeća koja se bave oglašavanjem (reklamiranjem), tako što, za račun drugih lica, komuniciraju sa javnošću (reklama) putem prenosa bilo kakvih informacija o proizvodima i uslugama omogućavajući potrošačima prigodan pogled na te proizvode i usluge; usluge koje se sastoje od upisivanja, uređivanja, obrade, prerade ili sistematizacije pisanih informacija i zapisa; usiuge reklamnih agencija; distribuciju prospekata i uzoraka direktno ili poštom; izradu i korišćenje matematičkih i statističkih podataka; organizovanje sajмова i izložbi u komercijalne ili reklamne svrhe.

(210) **2011-288**(442) **20.03.2013**

(220) 16.6.2011

(731) **BOSNALIJEK**, JUKIĆEVA 53 71 000 SARAJEVO BA

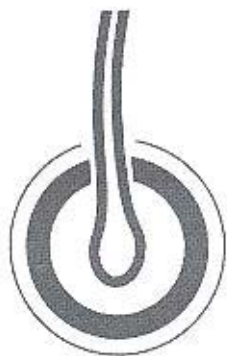

PILFUD

(540)

(550) I

(740) Radulović Božidar, Jovana Tomaševića 9/III, Podgorica (ME)

(511) **Klasa 03:** Preparati za bijeljenje i ostale tvari za pranje rublja; preparati za čišćenje, poliranje, odmaščivanje i struganje; sapuni; parfimerijski proizvodi, eterična ulja, kozmetički proizvodi, losioni za kosu; proizvodi za njegu zubi. (heading)

**Klasa 05:** Farmaceutski i veterinarski proizvodi; higijenski proizvodi za upotrebu u medicini; dijetne tvari za medicinske potrebe, hrana za dojenčad; flasteri, materijal za plombiranje zubi i za zubne otiske; dezinfekcijska sredstva; proizvodi za uništavanje životinjskih štetočina; fungicidi, herbicidi. (heading)

(210) **2011-290**

(442) **20.03.2013**

(220) 16.6.2011

(731) **NISSAN JIDOSHA KABUSHIKI KAISHA**, 2 TAKARACHO, KANAGAWA-KU, YOKOHAMA-SHI, KANAGAWA-KEN JP

DATSUN

(540)

(550) I

(740) Čejović Vladimir, 13. jula 21, Podgorica (ME)

(511) **Klasa 12:** Brodovi/čamci i njihovi djelovi i oprema; automobili, električna vozila uključujući električne automobile, vagone, kamione, kombi vozila, vozila koja se koriste u sportske svrhe, autobuse, rekreativna vozila (RV), sportske automobile, trkačke automobile, kamione, viljuškare, traktore za vuču (traktori), i njihove strukturne djelove i opremu; motorna vozila na dva točka, bicikla i njihovi djelovi i oprema; teretna kolica; auto-istovarivači, auto-gurači, auto-tegljači, traktore (mehanizmi za vuču); motori i mehanizmi za kopnena vozila; osovine za vozila; prenosioci snage i zupčanici za mašine; amortizeri; kočnice; motori sa naizmjeničnom strujom / motori sa jednosmjernom strujom za kopnena vozila; alarmni uređaji protiv krađe vozila; ljepljive gumene zakrpe za popravku unutrašnjih guma ili guma; sve uključeno u međunarodnu klasu 12.

(210) **2011-291**

(442) **20.03.2013**

(220) 17.6.2011

(731) **THE PROCTER & GAMBLE COMPANY**, ONE PROCTER & GAMBLE PLAZA, CINCINNATI, OHIO 45202 US

**LENOR TROPICAL FRESH**

(540)

(550) I

(740) Lutovac Branislav, Bulevar Crnojevića 93, Podgorica (ME)

(511) **Klasa 03:** Sredstva za beljenje i druge supstance za upotrebu kod pranja veša; preparati za čišćenje, poliranje, ribanje i nagrizanje; omekšivači za tekstil; sapuni za upotrebu u domaćinstvu.

(210) **2011-292**

(442) **20.03.2013**

(220) 17.6.2011

(731) **THE PROCTER & GAMBLE COMPANY**, ONE PROCTER & GAMBLE PLAZA, CINCINNATI, OHIO 45202 US

**ARIEL PROFESSIONAL**

(540)

(550) I

(740) Lutovac Branislav, Bulevar Crnojevića 93, Podgorica (ME)

(511) **Klasa 03:** Sredstva za beljenje i druge supstance za upotrebu kod pranja veša; preparati za čišćenje, poliranje, nagrizajuća sredstva, abrazivna sredstva; sapuni.

(210) **2011-300**

(442) **20.03.2013**

(220) 21.6.2011

(300) PRIJAVA IZ KINE BR.9164746 OD 02 03 2011 ZA KLASU

37

(731) **CHONGING YUAN INNOVATION TECHONOLGY CO.LTD**, FENGHUANG, SHAPINGBA DISTRICT, CHONGQING CN



(540)

(550) I

(740) Čejović Vladimir, 13. jula 21, Podgorica (ME)

(511) **Klasa 12:** Lokomotive; amortizeri za vozila; automobilske šasije; točkovi za vozila; cyclecar vozila; električna vozila; motori za kopnena vozila; automobili; motorna vozila; motocikli.

**Klasa 37:** Usluge građevinskog informisanja; izgradnja fabrika; građevinske usluge; usluge rudarskih iskopa; tapaciranje; održavanje i popravka motornih vozila; pranje vozila; usluge servisnih stanica za vozila (dosipanje goriva i održavanje); reparacija guma; usluge instaliranja, održavanja i popravke mašinerije.

(210) **2011-301**

(442) **20.03.2013**

(220) 22.6.2011

(731) **HELEN OF TROY LIMITED**, 13 8 AVENUE, BELLEVILLE, P.O. BOX 836E, ST.MICHAEL, BARBADOS BB

OXO

(540)

(550) I

(740) Lutovac Branislav, Bulevar Crnojevića 93, Podgorica (ME)

(511) **Klasa 08:** Ručni alati i sprave s ručnim pokretanjem; noževi, viljuške i kašike; hladno oružje; mehaničke i električne sprave za brijanje.

**Klasa 20:** Dječje visoke stolice, povišivači sjedišta za djecu, sjedišta za djecu za auto; vješalice; nemetalna zaštitna vrata (za djecu); nemetalne ljestvičaste stolice; dječje kutije/kovčezi; kukice na vakum; nemetalne kukice; spojnice za kućnu upotrebu; prostirači za sudopere; namještaj; polica za alat koja se namješta na zid; police za izlaganje; sastav za skladištenje i organizaciju koji se sastoji od polica, ladica, ormara, košara i šipki za odjeću; police za cipele;

**Klasa 21:** Pribor i posuđe za domaćinstvo ili za kuhinju; češljevi i sunđeri; četke (osim kistova); materijali za četke; pribor za čišćenje; žica za struganje parketa; sirovo ili polu obrađeno staklo (osim građevinskog stakla); stakleni proizvodi, porculansko i keramičko posuđe koje nije obuhvaćeno drugim razredima.

(210) **2011-302**

(442) **20.03.2013**

(220) 23.6.2011

(731) **THE PROCTER & GAMBLE COMPANY**, ONE PROCTER & GAMBLE PLAZA, CIN-

CINNATI, OHIO 45202 US



(540)

(550) I

(740) Lutovac Branislav, Bulevar Crnojevića 93, Podgorica (ME)

(511) **Klasa 05:** Ženski higijenski proizvodi kao što su higijenski ulošci, tamponi, dnevni ulošci, higijenske gaćice, interlabijalni ulošci za žensku higijenu; pelene za inkontinenciju, ulošci i gaćice za inkontinenciju

(210) **2011-483**

(442) **20.03.2013**

(220) 4.10.2011

(731) **ALKALOID AD-SKOPLJE**, BUL.ALEKSANDAR MAKEDONSKI 12,1000 SKOPLJE RM, MK



(540)

(550) I

(740) Popović Miladin, Đoka Miraševića 21/III, Podgorica (ME)

(511) **Klasa 03:** Pjenušava kupka.

(210) **2011-488**

(442) **20.03.2013**

(220) 10.10.2011

(731) **REGENT HOSPITALITY WORLDWIDE, INC**, THE CENTRE MARK, 287-299 QUEEN S ROAD, SUITE 1408, 14/F, CENTRAL, HONG KONG CN



## REGENT

(540)

(550) I

(740) Čejović Vladimir, 13. jula 21, Podgorica (ME)

(511) **Klasa 35:** Oglašavanje; kancelarijski poslovi; poslovno upravljanje, savjetovanje, i administrativne usluge; upravljanje i rad hotela, restorana, noćnih klubova, barova, banja, rekreativnih i fitnes objekata, maloprodajnih objekata, šoping centara, kondominijuma, stambenih zgrada, i odmarališta sa pravom vremenskog korišćenja; usluge maloprodajnih radnji; usluge šoping centara; maloprodajne online usluge; maloprodajne katalogne usluge; usluge za potrošače od povjerenja i nagradni programi; usluge oglašavanja; usluge poslovnog upravljanja u vezi sa rekreativnim klubovima u odmaralištima, klubovima za odmor, nepokretnostima koje se dijele na vremenskoj osnovi, klubovima koji omogućavaju pravo korišćenja na vremenskoj osnovi proporcionalno udjelima članova, klubovima za privatni boravak, klubovima sa pravom korišćenja, i projektima dugotrajnog zakupa, usluge poslovnih centara; poslovno upravljanje, savjetovanje i pomoć u upravljanju vlasnicima jahti i onima koji upravljaju jahtama.

**Klasa 36:** Osiguranje; finansijski poslovi; novčani poslovi; poslovi vezani za nekretnine; razvoj nekretnina; lizing, upravljanje, iznajmljivanje i posredovanje u vezi sa stanovima, kondominijumima, privatnim vlasništvom, vlasništvom koje se dijeli na vremenskoj osnovi i nekretninama svih vrsta i objektima i pogodnostima u vezi sa istima; finansiranje u vezi sa nekretninama; usluge u vezi sa kreditnim karticama; prikupljanje sredstava i donacija u dobrotvorne svrhe; obezbjeđivanje članstva za klubove koji omogućavaju pravo korišćenja na vremenskoj osnovi proporcionalno udjelima članova, klubove za privatni boravak, klubove sa pravom korišćenja; pružanje okalšica pri prodaji, razmjeni i trgovini vremena za odmor za članove rekreativnih klubova u okviru odmarališta, klubova za privatni boravak, klubova sa pravom korišćenja nepokretnosti koje se dijele na vremenskoj osnovi, klubova koji omogućavaju pravo korišćenja na vremenskoj osnovi proporcionalno udjelima članova, klubova za privatni boravak, klubova sa pravom korišćenja; organizovanje razmjene stanarskih prava između vlasnika nekretnina u okviru odmarališta.

**Klasa 39:** Transport; pakovanje i skladištenje robe; organizovanje putovanja; usluge turističkih agencija; rezervisanje prevoza; organizovanje i realizacija turističkih obilazaka i ponuda za odmor; organizovanje vazdušnog, kopnenog i pomorskog prevoza za pojedince i grupe; usluge krucera; organizovanje krstarenja; usklađivanje putnih aranžmana za pojedince i grupe; organizovanje ponuda za odmor i turističkih obilazaka, usluge rezervacija rentiranja automobila; pratnja i prevoz putnika; usluge u vezi sa poslovanjem garaža, parkinga, prtljaga, prenosa prtljaga, iznajmljivanja bicikala, i iznajmljivanja vozila za golf; usluge šoferi i limuzina; usluge marine; usluge iznajmljivanja jahti i brodova.

**Klasa 41:** Obrazovanje; pripremanje obuke; razonoda; sportske i kulturne aktivnosti, usluge kazina; usluge kabarea; usluge noćnih klubova; organizovanje rezervacija karata za priredbe i druge zabavne događaje; usluge zdravstvenih i fitnes klubova, obezbjeđivanje uputstava i opreme u vezi sa fizičkim vježbama; obezbjeđivanje objekata i opreme za fitnes, vježbe, tenis, plivanje, rekreativne aktivnosti, vožnju biciklom, golf, sportove na vodi, vožnju čam-

cem, jahanje, skijanje i društvene namjene; jahting klubovi; usluge golf kluba, golf terena i uputstava za golf; usluge planiranja vjenčanja i usluge upravljanja; usluge planiranja događaja i usluge upravljanja; realizacija i organizovanje obrazovnih, zabavnih i kulturnih časova, programa, radionica i događaja; umjetničke izložbe; umjetničke galerije.

**Klasa 43:** Usluge obezbjeđivanja hrane i pića; hotelske usluge; usluge restorana, keteringa, bara i salona; usluge odmarališta i smještaja; obezbjeđivanje privremenog smještaja; obezbjeđivanje objekata opšte namjene za sastanke, konferencije, i izložbe; obezbjeđivanje objekata za banket i društvene namjene za specijalne prilike; usluge rezervacije za hotel i drugi smještaj; usluge hotela koje karakteriše program podsticajnih nagrada i program nagrada za korisnike.

**Klasa 44:** Medicinske usluge; veterinarske usluge; higijenska i kozmetička njega zaljude i životinje; usluge poljoprivrede, vrtlarstva i šumarstva; spa usluge; obezbjeđivanje tretmana za lice, kosu, kožu i tijelo, usluge manikira i pedikira, usluge masaže, i usluge depilacije tijela; i usluge kozmetičkog salona.

(210) **2011-489** (442) **20.03.2013**

(220) 10.10.2011

(731) **REGENT HOSPITALITY WORLDWIDE, INC**, THE CENTRE MARK, 287-299 QUEEN S ROAD, SUITE 1408, 14/F, CENTRAL, HONG KONG CN

*Regent*

(540)

(550) I

(740) Čejović Vladimir, 13. jula 21, Podgorica (ME)

(511) **Klasa 35:** Oglašavanje; kancelarijski poslovi; poslovno upravljanje, savjetovanje, i administrativne usluge; upravljanje i rad hotela, restorana, nocnin klubova, barova, banja, rekreativnih i fitness objekata, maloprodajnih objekata, šoping centara, kondominijuma, stambenih zgrada, i odmarališta sa pravom vremenskog korišćenja; usluge maloprodajnih radnji; usluge šoping centara; maloprodajne online usluge; maloprodajne kataloške usluge; usluge za potrošače od povjerenja i nagradni programi; usluge oglašavanja; usluge poslovnog upravljanja u vezi sa rekreativnim klubovima u odmaralištima, klubovima za odmor, nepokretnostima koje se dijele na vremenskoj osnovi, klubovima koji omogućavaju pravo korišćenja na vremenskoj osnovi proporcionalno udjelima članova, klubovima za privatni boravak, klubovima sa pravom korišćenja, i projektima dugotrajnog zakupa, usluge poslovnih centara; poslovno upravljanje, savjetovanje i pomoć u upravljanju vlasnicima jahti i onima koji upravljaju jahtama.

**Klasa 36:** Osiguranje; finansijski poslovi; novčani poslovi; poslovi vezani za nekretnine; razvoj nekretnina; lizing, upravljanje, iznajmljivanje i posredovanje u vezi sa stanovima, kondominijumima, privatnim vlasništvom, vlasništvom koje se dijeli na vremenskoj osnovi i nekretninama svih vrsta i objektima i pogodnostima u vezi sa istima; finansiranje u vezi sa nekretninama; usluge u vezi sa kreditnim karticama; prikupljanje sredstava i donacija u dobrotvorne svrhe; obezbjeđivanje članstva za klubove koji omogućavaju pravo korišćenja na vremenskoj osnovi proporcionalno udjelima članova, klubove za privatni boravak, klubove sa pravom korišćenja; pružanje okalšica pri prodaji, razmjeni i trgovini vremena za odmor

za članove rekreativnih klubova u okviru odmarališta, klubova za privatni boravak, klubova sa pravom korišćenja nepokretnosti koje se dijele na vremenskoj osnovi, klubova koji omogućavaju pravo korišćenja na vremenskoj osnovi proporcionalno udjelima članova, klubova za privatni boravak, klubova sa pravom korišćenja; organizovanje razmjene stanarskih prava između vlasnika nekretnina u okviru odmarališta.

**Klasa 39:** Transport; pakovanje i skladištenje robe; organizovanje putovanja; usluge turističkih agencija; rezervisanje prevoza; organizovanje i realizacija turističkih obilazaka i ponuda za odmor; organizovanje vazdušnog, kopnenog i pomorskog prevoza za pojedince i grupe; usluge krucera; organizovanje krstarenja; usklađivanje putnih aranžmana za pojedince i grupe; organizovanje ponuda za odmor i turističkih obilazaka, usluge rezervacija rentiranja automobila; pratnja i prevoz putnika; usluge u vezi sa poslovanjem garaža, parkinga, prtljaga, prenosa prtljaga, iznajmljivanja bicikala, i iznajmljivanja vozila za golf; usluge šofera i limuzina; usluge marine; usluge iznajmljivanja jahti i brodova.

**Klasa 41:** Obrazovanje; pripremanje obuke; razonoda; sportske i kulturne aktivnosti, usluge kazina; usluge kabarea; usluge noćnih klubova; organizovanje rezervacija karata za priredbe i druge zabavne događaje; usluge zdravstvenih i fitnes klubova, obezbjeđivanje uputstava i opreme u vezi sa fizičkim vježbama; obezbjeđivanje objekata i opreme za fitnes, vježbe, tenis, plivanje, rekreativne aktivnosti, vožnju biciklom, golf, sportove na vodi, vožnju čamcem, jahanje, skijanje i društvene namjene; jahting klubovi; usluge golf kluba, golf terena i uputstava za golf; usluge planiranja vjenčanja i usluge upravljanja; usluge planiranja događaja i usluge upravljanja; realizacija i organizovanje obrazovnih, zabavnih i kulturnih časova, programa, radionica i događaja; umjetničke izložbe; umjetničke galerije.

**Klasa 43:** Usluge obezbjeđivanja hrane i pića; hotelske usluge; usluge restorana, keteringa, bara i salona; usluge odmarališta i smještaja; obezbjeđivanje privremenog smještaja; obezbjeđivanje objekata opšte namjene za sastanke, konferencije, i izložbe; obezbjeđivanje objekata za banket i društvene namjene za specijalne prilike; usluge rezervacije za hotel i drugi smještaj; usluge hotela koje karakteriše program podsticajnih nagrada i program nagrada za korisnike.

**Klasa 44:** Medicinske usluge; veterinarske usluge; higijenska i kozmetička njega zaljude i životinje; usluge poljoprivrede, vrtlarstva i šumarstva; spa usluge; obezbjeđivanje tretmana za lice, kosu, kožu i tijelo, usluge manikira i pedikira, usluge masaže, i uslugedepilacije tijela; i usluge kozmetičkog salona.

(210) **2011-490** (442) **20.03.2013**

(220) 10.10.2011

(731) **REGENT HOSPITALITY WORLDWIDE, INC, THE CENTRE MARK, 287-299 QUEEN S ROAD, SUITE 1408, 14/F, CENTRAL, HONG KONG CN**



(540)

(550) I

(740) Čejović Vladimir, 13. jula 21, Podgorica (ME)

(511) **Klasa 35:** Oglašavanje; kancelarijski poslovi; poslovno upravljanje, savjetovanje, i ad-

ministrativne usluge; upravljanje i rad hotela, restorana, nocnin klubova, barova, banja, rekreativnih i fitnes objekata, maloprodajnih objekata, šoping centara, kondominijuma, stambenih zgrada, i odmarališta sa pravom vremenskog korišćenja; usluge maloprodajnih radnji; usluge šoping centara; maloprodajne online usluge; maloprodajne kataloške usluge; usluge za potrošače od povjerenja i nagradni programi; usluge oglašavanja; usluge poslovnog upravljanja u vezi sa rekreativnim klubovima u odmaralištima, klubovima za odmor, nepokretnostima koje se dijele na vremenskoj osnovi, klubovima koji omogućavaju pravo korišćenja na vremenskoj osnovi proporcionalno udjelima članova, klubovima za privatni boravak, klubovima sa pravom korišćenja, i projektima dugotrajnog zakupa, usluge poslovnih centara; poslovno upravljanje, savjetovanje i pomoć u upravljanju vlasnicima jahti i onima koji upravljaju jahtama.

**Klasa 36:** Osiguranje; finansijski poslovi; novčani poslovi; poslovi vezani za nekretnine; razvoj nekretnina; lizing, upravljanje, iznajmljivanje i posredovanje u vezi sa stanovima, kondominijumima, privatnim vlasništvom, vlasništvom koje se dijeli na vremenskoj osnovi i nekretninama svih vrsta i objektima i pogodnostima u vezi sa istima; finansiranje u vezi sa nekretninama; usluge u vezi sa kreditnim karticama; prikupljanje sredstava i donacija u dobrotvorne svrhe; obezbjeđivanje članstva za klubove koji omogućavaju pravo korišćenja na vremenskoj osnovi proporcionalno udjelima članova, klubove za privatni boravak, klubove sa pravom korišćenja; pružanje okalšica pri prodaji, razmjeni i trgovini vremena za odmor za članove rekreativnih klubova u okviru odmarališta, klubova za privatni boravak, klubova sa pravom korišćenja nepokretnosti koje se dijele na vremenskoj osnovi, klubova koji omogućavaju pravo korišćenja na vremenskoj osnovi proporcionalno udjelima članova, klubova za privatni boravak, klubova sa pravom korišćenja; organizovanje razmjene stanarskih prava između vlasnika nekretnina u okviru odmarališta.

**Klasa 39:** Transport; pakovanje i skladištenje robe; organizovanje putovanja; usluge turističkih agencija; rezervisanje prevoza; organizovanje i realizacija turističkih obilazaka i ponuda za odmor; organizovanje vazdušnog, kopnenog i pomorskog prevoza za pojedince i grupe; usluge kruzera; organizovanje krstarenja; usklađivanje putnih aranžmana za pojedince i grupe; organizovanje ponuda za odmor i turističkih obilazaka, usluge rezervacija rentiranja automobila; pratnja i prevoz putnika; usluge u vezi sa poslovanjem garaža, parkinga, prtljaga, prenosa prtljaga, iznajmljivanja bicikala, i iznajmljivanja vozila za golf; usluge šoferi i limuzina; usluge marine; usluge iznajmljivanja jahti i brodova.

**Klasa 41:** Obrazovanje; pripremanje obuke; razonoda; sportske i kulturne aktivnosti, usluge kazina; usluge kabarea; usluge noćnih klubova; organizovanje rezervacija karata za priredbe i druge zabavne događaje; usluge zdravstvenih i fitnes klubova, obezbjeđivanje uputstava i opreme u vezi sa fizičkim vježbama; obezbjeđivanje objekata i opreme za fitnes, vježbe, tenis, plivanje, rekreativne aktivnosti, vožnju biciklom, golf, sportove na vodi, vožnju čamcem, jahanje, skijanje i društvene namjene; jahting klubovi; usluge golf kluba, golf terena i uputstava za golf; usluge planiranja vjenčanja i usluge upravljanja; usluge planiranja događaja i usluge upravljanja; realizacija i organizovanje obrazovnih, zabavnih i kulturnih časova, programa, radionica i događaja; umjetničke izložbe; umjetničke galerije.

**Klasa 43:** Usluge obezbjeđivanja hrane i pića; hotelske usluge; usluge restorana, kateringa, bara i salona; usluge odmarališta i smještaja; obezbjeđivanje privremenog smještaja; obezbjeđivanje objekata opšte namjene za sastanke, konferencije, i izložbe; obezbjeđivanje objekata za banket i društvene namjene za specijalne prilike; usluge rezervacije za hotel i drugi smještaj; usluge hotela koje karakteriše program podsticajnih nagrada i program nagrada za korisnike.

**Klasa 44:** Medicinske usluge; veterinarske usluge; higijenska i kozmetička njega zaljude i živo-

tinje; usluge poljoprivrede, vrtlarstva i šumarstva; spa usluge; obezbjeđivanje tretmana za lice, kosu, kožu i tijelo, usluge manikira i pedikira, usluge masaže, i usluge depilacije tijela; i usluge kozmetičkog salona.

(210) **2011-491**

(442) **20.03.2013**

(220) 10.10.2011

(731) **MEGGLE AG**, MEGGLESTRASSE 6-12,83512 WASSERRBURG DE



(540)

(550) I

(740) Čejović Vladimir, 13. jula 21, Podgorica (ME)

(511) **Klasa 29:** Mlijeko i mliječni proizvodi; maslac i proizvodi od maslaca; pavlaka i proizvodi od pavlake, sir i proizvodi od sira, namazi i prelivi za hljeb na bazi mliječnih proizvoda; proizvodi na bazi mlijeka i jogurta, mliječni napici sa povećanim sadržajem mlijeka, mliječni napici na bazi surutke, sve sa ili bez dodatog voća, sirupa; jestiva ulja i masti; proizvodi od soje, naime tofu, sojino mlijeko, sojin jogurt; napici na bazi sojinog mlijeka, deserti i slične namirnice na bazi soje (sadržane u klasi 29); jogurt; deserti i slične namirnice na bazi mliječnih proizvoda, takođe u obliku praha; supe; surutka, laktoza voćni i proteinski koncentrat i za prehrambenu industriju; voćni sosovi; marmelade; džemovi, kompoti; konzervisano, sušeno i kuvano voće, želatini (želei).

**Klasa 30:** Majonez; sosovi, uključujući i prelive za salatu i umake; začinki sosovi, začini, začinski preparati; proizvodi od soje, naime soja sos, začinski preparati na bazi soje, majonez na bazi soje, surogat kafe na bazi soje (sadržane u klasi 30); sva gore navedena roba, takođe u obliku praha; kakao; čokolada, čokoladni proizvodi, takođe u obliku praha; čokoladni napici; hljeba i peciva, takođe sa namazima ili prelivima, fina peciva i kolači; sladoled, sladoled u prahu; soli za kuvanje; prirodni zaslađivači; proizvodi od šećera.

**Klasa 32:** Bezalkoholni napici sa niskim sadržajem mlijeka i mliječnih komponenti; napici na bezi surutke sa ili bez dodatog voća i sirupa; voćni napici i voćni sokovi; sirupi i drugi preparati za pripremu pića.

(210) **2011-492**

(442) **20.03.2013**

(220) 10.10.2011

(731) **MEGGLE AG**, MEGGLESTRASSE 6-12,83512 WASSERRBURG DE

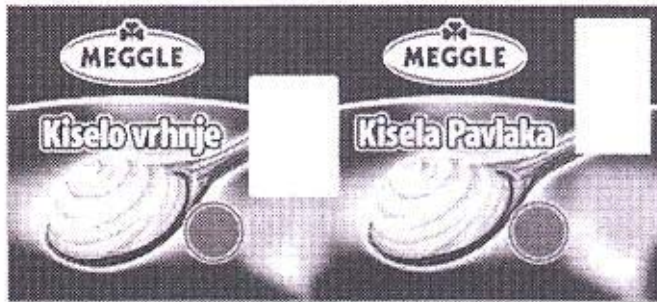

(540)

(550) I

(740) Čejović Vladimir, 13. jula 21, Podgorica (ME)

(511) **Klasa 29:** Mlijeko i mliječni proizvodi; maslac i proizvodi od maslaca; pavlaka i proizvodi od pavlake, sir i proizvodi od sira, namazi i prelivi za hljeb na bazi mliječnih proizvoda; proizvodi na bazi mlijeka i jogurta, mliječni napici sa povećanim sadržajem mlijeka, mliječni napici na bazi surutke, sve sa ili bez dodatog voća, sirupa; jestiva ulja i masti; proizvodi od soje, naime tofu, sojino mlijeko, sojin jogurt; napici na bazi sojinog mlijeka, deserti i slične namirnice na bazi soje (sadržane u klasi 29); jogurt; deserti i slične namirnice na bazi mliječnih proizvoda, takođe u obliku praha; supe; surutka, laktoza voćni i proteinski koncentрати za prehrambenu industriju; voćni sosovi; marmelade; džemovi, kompoti; konzervisano, sušeno i kuvano voće, želatini (želei).

**Klasa 30:** Majonez; sosovi, uključujući i prelive za salatu i umake; začinki sosovi, začini, začinski preparati; proizvodi od soje, naime soja sos, začinski preparati na bazi soje, majonez na bazi soje, surogat kafe na bazi soje (sadržane u klasi 30); sva gore navedena roba, takođe u obliku praha; kakao; čokolada, čokoladni proizvodi, takođe u obliku praha; čokoladni napici; hljeba i peciva, takođe sa namazima ili prelivima, fina peciva i kolači; sladoled, sladoled u prahu; soli za kuvanje; prirodni zaslađivači; proizvodi od šećera.

**Klasa 32:** Bezalkoholni napici sa niskim sadržajem mlijeka i mliječnih komponenti; napici na bezi surutke sa ili bez dodatog voća i sirupa; voćni napici i voćni sokovi; sirupi i drugi preparati za pripremu pića.

(210) **2011-493**(442) **20.03.2013**

(220) 11.10.2011

(731) **SUPREME PROTEIN**, INC, 2231 LANDMARK PLACE, MANASGUAN, 08736 NEW YERSEY US

**Supreme**  
Protein®

(540)

(550) I

(740) Čejović Vladimir, 13. jula 21, Podgorica (ME)

(511) **Klasa 05:** Hranljive namirnice, štangle za sportsku prehranu i proteinske štangle.

(210) **2011-498** (442) **20.03.2013**

(220) 12.10.2011

(731) **NOBEL ILAC SANAYII VE TICARET ANONIM SIRKETI**, INKILAP MAH., AKCAKOCA SK. NO.10. UMRANIYE, INSTANBUL TR

## ETOL

(540)

(550) I

(740) Božović Vesko, Rimski trg 50/11, Podgorica (ME)

(511) **Klasa 05:** Farmaceutski preparati i supstance.

(210) **2011-499** (442) **20.03.2013**

(220) 12.10.2011

(731) **NOBEL ILAC SANAYII TICARET ANONIM SIREKETI**, INKILAP MAH., AKCAKOCA SK.NO.10.UMRANIYE, INSTANBUL TR

## MYCOCUR

(540)

(550) I

(740) Božović Vesko, Rimski trg 50/11, Podgorica (ME)

(511) **Klasa 05:** Farmaceutskipreparatii supstance.

(210) **2011-500** (442) **20.03.2013**

(220) 12.10.2011

(731) **ATE MY HEART INC.**, 1880 CENTURY PARK EAST, SUITE 1600 LOS ANGELES, CA 90067 US

## LADY GAGA FAME

(540)

(550) I

(740) Popović Miladin, Đoka Miraševića 21/III, Podgorica (ME)

(511)

**Klasa 03:** Kozmetika, kozmetički preparati; šminka i preparati za skidanje šminke; ruž za usne; sjaj za usne; pomade za usne; držači za ruž za usne; ne-medicinski preparati za negu usana; krema za usne; mirisi; parfemi; eterična ulja; parfimerija, kolonjske vode; toaletne vode; parfimisana tečnost; parfemska voda; kolonjska voda; sjaj za usne i telo; losioni za lice, kreme, hidratanti, sredstva za čišćenje, kupke, piling kreme, sredstva za piling, i toneri; mleka za tijelo; ne-medicinski tretmani za lice u vidu emulzija za lice i maski za lice; losioni za kožu, kreme za kožu, balzami za kožu, hidratanti za kožu, hidratante maske za za kožu, i puderi; hidratanti za ruke, kreme i losioni; ne-medicinski losioni i kreme za stopala; preparati za uklanjanje bora; vještačke trepavice; ne-medicinska sredstva za higijenu; kupke; gelovi za tijelo; buteri za tijelo; sprejevi za tijelo; ulja i mirisi za tijelo; pilinzi za tijelo; puderi za tijelo; hidratanti za tijelo; losioni za tijelo; kreme za tijelo; pilinzi za tijelo; kreme za piling tijela; mirisi za tijelo; buteri za tijelo; učvršćujući gelovi i losioni za tijelo; maske za tijelo; gelovi za kupanje; ulja za kupanje; puderi za posle kupanje; kristali za kupanje; pena za kupanje; granule za kupanje; soli za kupanje; gelovi za tuširanje; kozmetički preparati za tuširanje; mirisni puderi; sapuni; mirisni sapuni; tečni sapuni; sapuni u prahu; toaletni sapuni; toaletna voda; preparati za brijanje, balzami za brijanje, kreme za brijanje, gelovi za brijanje, losioni za posle brijanja, abrazivni preparati za kožu, ne-medicinske kreme za kožu, i losioni za negu posekotina od brijača; preparati za zaštitu od sunca, preparati za sunčanje, ulja za sunčanje, losioni za posle sunčanja, preparati za samopotamnivanje, i kozmetički preparati za zaštitu od sunca; kreme za sunčanje; ne-medicinske masti za negu opekotina od sunca; kreme za aromaterapiju, losioni i ulja za aromaterapiju; dekorativne kutije za kozmetičke namene; preparati za negu i održavanje tijela, kože, kože glave, i kose; esencijalna ulja za ličnu upotrebu; kozmetička sredstva za skupljanje pora (astringenti); ulja za masažu; puderi od talka, penušave kupke; dezodoransi za ličnu upotrebu i negu tijela; sredstva za održavanje zuba; paste za zube; mirišljavi papir; sredstva za nanošenje šminke u vidu pamučnih tufera za kozmetičke svrhe; sve vrste pamučnih tufera za ličnu upotrebu i kozmetičke svrhe; kozmetički jastučići; vlažne kozmetičke maramice, vlažne kozmetičke maramice i ubrusi; maramice za bebe; preparati za negu noktiju; lakovi za nokte, lakovi za nokte - donji sloj, lakovi za nokte - gornji sloj, preparati za jačanje noktiju, preparati za čvrstinu noktiju, lakovi za ukrašavanje lakiranih noktiju, skidač laka za nokte, kreme za nokte, preparati za uklanjanje zanoktica, vještački nokti, i preparati za jačanje noktiju; preparati za negu kose; proizvodi za negu kose u vidu šampona, balzama, sredstva za ispiranje, pena, gelova, krema, losiona i sprejeva; farbe za kosu, losioni za kovrdžanje kose, preparati za trajne lokne, preparati za nijansiranje kose, boje za kosu, omekšivači za kosu, maskare za kosu, pomade za kosu, skidači farbe za kosu, preparati za opuštanje kose, i preparati za oblikovanje kose; potpuri; jastuci za aromaterapiju koji sadrže mješavinu suvih latica cveća i drugih aromatičnih biljaka (potpuri) u delovima tkanine; vrećice koje sadrže parfimisane preparate, i mješavine; kesice koje sadrže parfimisani prah za mirisanje odeće; jastučići za oči u obliku kesica koji sadrže mirise; mirisno keramičko kamenje; mirišljavi sprejevi za posteljinu i mirišljavi sprejevi za prostorije; mirisna ulja koja proizvode arome (mirise) nakon zagrevanja; mirisne borove šišarke; aromatične supstance koje proizvode miris nakon zagrevanja; mirisi za prostorije; mirisni fitilji za mirisne osveživače prostorija.

(210) **2011-501**

(442) **20.03.2013**

(220) 12.10.2011



## MAXXPRO

(540)

(550) I

(511) **Klasa 12:** Oklopna vozila, vozila, odnosno aparati za kretanje po zemlji, vazduhu ili vodi.

**Klasa 13:** Vatreno oružje, municija i projektili, motorizovana vojna vozila za lansiranje projektila.

**Klasa 37:** Popravljanje i održavanje oklopnih vozila, vozila, odnosno aparata za kretanje po zemlji, vazduhu i vodi.

---

(210) **2011-502**

(442) **20.03.2013**

(220) 13.10.2011

(731) **PFIZER INC.**, 235 EAST 42ND STREET, NEW YORK, NEW YORK 10017 US

## XALKORI

(540)

(550) I

(740) Čejović Vladimir, 13. jula 21, Podgorica (ME)

(511) **Klasa 05:** Farmaceutski i veterinarski preparati; sanitarni preparati koji se koriste u medicinske svrhe; dietetske supstance prilagodene za upotrebu u medicini, hrana za bebe; flasteri, materijali za zavijanje; materijali za plombiranje zuba, zubarska smola; dezinfekciona sredstva; preparati za unistavanje štetočina; fungicidi, herbicidi.

---

(210) **2011-504**

(442) **20.03.2013**

(220) 13.10.2011

(731) **ALKALOID AD SKOPLJE**, BUL.ALEKSANDAR MAKEDONSKI 12, 1000 SKOPLJE MK



(540)

(550) I

(740) Popović Miladin, Đoka Miraševića 21/III, Podgorica (ME)

(511) **Klasa 3:** Dječja krema.(210) **2011-505**(442) **20.03.2013**

(220) 13.10.2011

(731) **ALKALOID AD-SKOPLJE**, BUL.ALEKSANDAR MAKEDONSKI 12, 1000 SKOPLJE MK

(540)

(550) I

(740) Popović Miladin, Đoka Miraševića 21/III, Podgorica (ME)

(511) **Klasa 03:** Dječja vitaminska mast.(210) **2010-63**(442) **20.03.2013**

(220) 15.3.2010

(731) **BROADBAND MONTENEGRO BBM.DOO.**, BULERVAR REVOLUCIJE 66 PODGORICA ME

## GROUPON

(540)

(550) I

(511) **Klasa 35:** Oglašavanje; vođenje poslova; poslovno upravljanje; kancelarijski poslovi.

**Klasa 37:** Gradjevinsko konstruisanje; popravlanje; usluge instaliranja (instalacione usluge).

**Klasa 38:** Telekomunikacije.

**Klasa 39:** Transportne usluge; pakovanje i skladištenje robe; organizovanje putovanja .

**Klasa 43:** Usluge obezbjeđivanja hrane i pića; privremeni smještaj.

---

(210) **2011-258**

(442) **20.03.2013**

(220) 24.5.2011

(731) **INTEL CORPORATION**, 2200 MISSION COLLEGE BOULEVARD, SANTA CLARA, CALIFORNIA 95052-8119 US

(540)

(550) M

(740) Čejović Vladimir, 13. jula 21, Podgorica (ME)

(511) **Klasa 09:** Računarski softver; 3D animacioni softver; 3D animaciona obrada tehnološkog softvera za srvaranje, proizvodnju, snimanje, prenošenje ili reprodukciju zvuka, snimka, filma, animiranog sadržaja, softverskog programa, grafike i slike; računarski softver za upotrebu digitalnih animacija i specijalnih efekata za slike; softver za izradu slika, grafika i teksta; softver za kontrolu i poboljšanje računara i audio opreme zvučnog kvaliteta; softver za igre na računaru; grafički softver računara; softver za elektronske igre; softver za igre; softver za video igre; softver za virtuelne video igre; interaktivne video igre sadržane u hardveru i softveru računara; računari; serveri; radne stanice; računarski hardver, matične ploče, ujedinjena strujna kola, poluprovodnici i procesori; ketridži za video igre; računarski softver za igranje video igara i računarske igre za igranje putem globalnih računara i komunikacionih mreža; računarski softver za kompresovanje i dekompresovanje podataka i video slika; prenosni i laptop računari; portabl računari; ručni računari; tablet računari; ultra mobilni računari; računarski softver koji obezbjeđuje pristup većem broju korisnika na globalnu računarsku informacionu mrežu; računarski upravljački softver, naime, računarski operacioni sistem softvera, računarski korisnički softver i drugi računarski softver; portabl video plejeri; lični uređaji za igre; visoko određeni disk plejeri; DVD plejeri.

**Klasa 41:** Servisi za zabavu, naime, produkcija igranih filmova, snimaka i filmova; nabavka televizije, snimaka i specijalnih efekata filmske produkcije; razvoj softvera za upotrebu u filmskoj produkciji, snimcima i filmovima; servisi animirane produkcije; servisi za produkciju multimedialnih softvera.

---

(210) **2011-262**

(442) **20.03.2013**

(220) 26.5.2011

(731) **B.D. BAGGIES LTD.**, 112 CAPITOL TRAIL, DE-19711, NEWARK, DELAWARE US



B.D. BAGGIES

(540)

(550) I

(740) Čejović Vladimir, 13. jula 21, Podgorica (ME)

(511) **Klasa 25:** Odjeća, obuća, pokrivala za glavu; sportska odjeća i odjeća koja se nosi napo-  
lju; košulje, duksevi, majice; trikotaža; donje rublje; čarape; šalovi, kaiševi (odjeća), rukavice  
(odjeća).

(210) **2011-267**

(442) **20.03.2013**

(220) 31.5.2011

(731) **VLASINKA DOO**, BATAJNIČKI DRUM 14 -16 ZEMUN, BEOGRAD RS

KAPI ŽIVOTA

(540)

(550) I

(740) Popović Miladin, Đoka Miraševića 21/III, Podgorica (ME)

(511) **Klasa 32:** Piva; mineralne i sodne vode i druga bezalkoholna pića; voćna pića i voćni so-  
kovi; sirupi i drugi preparati za pravljenje pića.

(210) **2011-268**

(442) **20.03.2013**

(220) 31.5.2011

(731) **KRALJICA D.O.O.**, PARISKE KOMUNE 2/II, ZGRADA ČELEBIĆ, PODGORICA ME

BIJELA GORA

(540)

(550) I

(511) **Klasa 39:** Mlijeko i mliječni proizvodi.

(210) **2011-277**

(442) **20.03.2013**

(220) 7.6.2011

(731) **KOVING-M D.O.O** I PROLETERSKE B.B.85310 BUDVA, PJ.PIPERSKA BB, PODGORICA ME



(540)

(550) I

(511) **Klasa 37:** Usluge instaliranja (instalacione usluge).

**Klasa 38:** Telekomunikacije.

**Klasa 42:** Naučne i tehnološke usluge i istraživanje i projektovanje u vezi navedenih usluga, projektovanje i razvoj.

(210) **2011-278**

(442) **20.03.2013**

(220) 7.6.2011

(731) **TELEFONICA S.A.**, GRAN VIA, 28, 28013 MADRID ES



(540)

(550) I

(740) Lutovac Branislav, Bulevar Crnojevića 93, Podgorica (ME)

(511) **Klasa 09:** Aparati i instrumenti naučni pomorski, geodetski, električni, fotografski, kinematografski, optički, za vaganje, mjerenje, signalizaciju, kontrolu (inspekciju), spasavanje i nastavu; aparati i instrumenti za provođenje, isključivanje, transformisanje, akumuliranje, regulisanje ili kontrolisanje električne energije; aparati za snimanje, prenos i reprodukciju zvuka ili slike; magnetni nosioci podataka, diskovi za snimanje; automatske mašine i mehanizmi za aparate koji se pokreću novcem ili žetonom; registarske kase, računске mašine, oprema za obradu podataka i kompjuteri; aparati za gašenje požara.

**Klasa 35:** Oglašavanje; vođenje poslova; poslovno upravljanje; kancelarijski poslovi.

**Klasa 38:** telekomunikacije.

**Klasa 41:** Obrazovne usluge; obezbjeđivanje obuke; razonoda; sportske i kulturne aktivnosti.

(210) **2011-281**

(442) **20.03.2013**

(220) 10.6.2011

(731) **VLADIMIR RADONJIĆ**, FRUTAK BB DANILOVGRAD ME



(540)

(550) I

(511) **Klasa 33:** Alkoholna pića - vino(210) **2011-282**(442) **20.03.2013**

(220) 10.6.2011

(731) **KIPS D.O.O.**, NEZNANIH JUNAKA 143 PODGORICA ME

(540)

(550) I

(511) **Klasa 20:** Nameštaj, vrata i prozori od drveta, okviri za slike i ogledala.

**Klasa 35:** Vođenje trgovačkog poduzeća, posredovanje u prodaji, trgovina na malo i trgovina na veliko svim proizvodima, a naročito grubim građevinskim materijalom, željezom i crnom metalurgijom, elektroinstalacijama, vodovodnim i kanalizacionim instalacijama, aparatima za grejanje, podovima i stilarijom, keramikom i sanitarijama, sanitarnom galanterijom, bojama, lakovima i izolacijama, alatima, pločastim materijalima belom tehnikom, tehničkom robom, nameštajem, malim kućanskim aparatima, dekorativnom rasvetom, posuđem, proizvodima od tekstila, proizvodima od plastike, tepisima, zavesama i tapetama.

**Klasa 37:** Popravljanja aparata, mašina, nameštaja, alata odnosno usluge kojima se neka stvar dovodi u prvobitno stanje usled dotrajalosti oštećenja, delimičnog uništenja, usluga održavanja stvari i objekata.

**Klasa 39:** Pakovanje i skladištenje robe, organizovanje putovanja.

**Klasa 43:** Usluge obezbeđenja hrane i pića za potrošnju, ishrana i smeštaj u hotelima, pansionima, kampovima, planinarskim domovima.

(210) **2011-283**(442) **20.03.2013**

(220) 10.6.2011

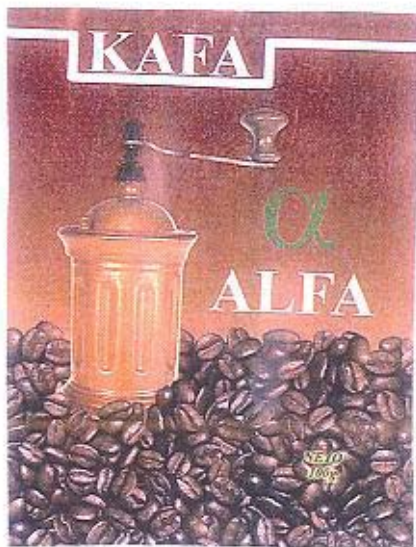
(731) **DOO RATKOVIĆ-ALFA-CETINJE**, X CRNOGORSKE S-65 CETINJE ME

(540)

(550) I

(511) **Klasa 30:** Kafa, čaj, kakao, pirinač, tapioka, sago, zamjena kafe.(210) **2011-294**(442) **20.03.2013**

(220) 17.6.2011

(731) **NOVARTIS AG**, 4002 BASEL CH

## AEROCOMP

(540)

(550) I

(740) Popović Miladin, Đoka Miraševića 21/III, Podgorica (ME)

(511) **Klasa 05:** Farmaceutski preparati, naime bronhodilatatori i preparati protiv astme.(210) **2011-295**(442) **20.03.2013**

(220) 17.6.2011

(731) **ASTELLAS PHARMA EUROPE B.V.**, SYLVIUSWEG 62,2333 Beelden NL

## LIPOBASE REPAIR

(540)

(550) I

(740) Popović Miladin, Đoka Miraševića 21/III, Podgorica (ME)

(511) **Klasa 03:** Kozmetika.

**Klasa 05:** Farmaceutski i medicinski preparati, proizvodi i supstance; farmaceutski i medicinski preparati, proizvodi i supstance za ljudsku upotrebu.

(210) **2011-297** (442) **20.03.2013**

(220) 20.6.2011

(731) **ICONIX EUROPE LLC**, 1450 BROADWAY NEW YORK, NEW YORK 10018 US

**ROCAWEAR**

(540)

(550) I

(511) **Klasa 25:** Muška, ženska i dečija odjeća, naročito, džins, jakne, pantalone, majice sa kragom, majice, džemperi, uske ženske majice, prsluci, široke pantalone, pantalone, uske majice, polo majice, mantili, dukserice, dukserice sa kapuljacom, trenerke, helanke, šorcevi, bluže, potkošulje, haljine, suknje, donji veš, čarape, kaiševi, šalovi, pokrivala za glavu; obuća.

(210) **2011-298** (442) **20.03.2013**

(220) 20.6.2011

(731) **ICONIX EUROPE LLC**, 1450 BROADWAY NEW YORK, NEW YORK 10018 US

**ROCAWEAR**

(540)

(550) I

(511) **Klasa 18:** Torbe naročito tašne, tašna na rame, rančevi, poštanske torbe, sportske torbe, cegeri, putne torbe i prtljag.

(210) **2011-446** (442) **20.03.2013**

(220) 7.9.2011

(300) RO M 2011 02034 11032011

(731) **JT INTERNATIONAL S.A.**, 1, RUE DE LA GABELE, 1211 GENEVA 26 CH

**SOBRANIE BEYOND COMPARE**

(540)

(550) I

(740) Čejović Vladimir, 13. jula 21, Podgorica (ME)

(511) **Klasa 34:** Duvan, koji je prerađen ili neprerađen; duvan za pušenje, duvan za lule, duvan za savijanje, duvan za žvakanje, duvan za sisanje; cigarete, cigare, cigarilosi; supstance za pušenje koje se prodaju odvojeno ili izmiješane sa duvanom, i koje nijesu za medicinsku ili svrhu liječenja; burmut; artikli za pušače uključeni u klasu 34; papir za cigarete; fišeci za cigarete i šibice.

(210) **2011-454** (442) **20.03.2013**



(220) 19.9.2011

(731) **PODRAVKA D.D.**, ANTE STARČEVICA 32 48000 KOPRIVNICA HR

(540)

(550) I

(740) Popović Miladin, Đoka Miraševića 21/III, Podgorica (ME)

(511) **Klasa 32:** Pivo, mineralne i sodne vode i druga bezalkoholna pića; pića od voća i voćni sokovi i drugi preparati za proizvodnju pića.(210) **2011-455**(442) **20.03.2013**

(220) 19.9.2011

(731) **PODRAVKA D.D.**, ANTE STARČEVICA 32 48000 KOPRIVNICA HR

(540)

(550) I

(740) Popović Miladin, Đoka Miraševića 21/III, Podgorica (ME)

(511) **Klasa 16:** Papir, karton i proizvodi od tih materijala koji nisu obuhvaćeni drugim klasama; štamparski proizvodi; proizvodi za uvezivanje knjiga; fotografije; pribor za pisanje; ljepila (ljepljive tvari za papirnate proizvode ili za domaćinstvo); slikarski pribor; kistovi; pisaće mašine i kancelarijski pribor (osim namještaja); oprema za nastavu i obuku (osim aparata); plastični materijali za ambalažu (koji nisu obuhvaćeni drugim klasama); štamparska slova; klišeji.**Klasa 35:** Oglašavanje i reklamiranje, vodjenje komercijalnih poslova; komercijalna administracija; kancelarijski poslovi.(210) **2011-457**(442) **20.03.2013**

(220) 20.9.2011

(731) **ALKALOID-AD-SKOPLJE**, BUL. ALEKSANDAR MAKEDONSKI 12,1000 SKOPLJE MK



(540) *koi klasifikaciji*

(550) I

(740) Popović Miladin, Đoka Miraševića 21/III, Podgorica (ME)

(511) **Klasa 03:** Ulje za njegu dečje kože.

(210) **2011-458**

(442) **20.03.2013**

(220) 20.9.2011

(731) **ALKALOID AD -SKOPLJE**, BUL.ALEKSANDAR MAKEDONSKI 12,1000 SKOPLJE MK



(540)

(550) I

(740) Popović Miladin, Đoka Miraševića 21/III, Podgorica (ME)

(511) **Klasa 03:** Šampon za djecu.

(210) **2011-461**

(442) **20.03.2013**

(220) 21.9.2011

(731) **VOČAR DOO**, 76207 GORNJI RAHIC 112, BRČKO BA



(540)

(550) I

(740) Radulović Božidar, Jovana Tomaševića 9/III, Podgorica (ME)

(511) **Klasa 30:** Punjeno čajno pecivo.(210) **2011-462**(442) **20.03.2013**

(220) 21.9.2011

(731) **VOĆAR DOO**, 76207 GORNJI RAHIC 112, BRČKO BA

(540)

(550) I

(740) Radulović Božidar, Jovana Tomaševića 9/III, Podgorica (ME)

(511) **Klasa 30:** Mješano čajno pecivo.(210) **2011-464**(442) **20.03.2013**

(220) 23.9.2011

(731) **DECKERS OUTDOOR CORPORATION**, 495-A SOUTH FAIRVIEW AVENUE GOLETA, CALIFORNIA 93117 US

yrr

(540)

(550) I

(740) Popović Miladin, Đoka Miraševića 21/III, Podgorica (ME)

(511) **Klasa 25:** Obuća, odjeća, pokrivala za glavu.(210) **2011-465**(442) **20.03.2013**

(220) 23.9.2011

(731) **OMAN PERFUMERY LLC**, P O BOX 307, CPO 111, SEEB OM(540) **na Nižanskoj klasifikaciji:**

(550) I

(740) Radulović Božidar, Jovana Tomaševića 9/III, Podgorica (ME)

(511) **Klasa 03:** Mirisi, kozmetika, preparati za njegu kose uključujući šampone, sprejeve za kosu, losione za kosu, preparati za uvijanje kose, boje za kosu, neutralizatori za trajno uvijanje, sapuni, talk, kozmetički preparati za kupanje i tuširanje, toaletna oprema, kozmetički preparati za njegu kože, dezodoransi.**Klasa 04:** Mirišljave svijeće.**Klasa 05:** Mirisi za domaćinstvo.(210) **2011-466**(442) **20.03.2013**

(220) 26.9.2011

(731) **JUB-H D.D.DOL** PRI LJUBLJANI 28, LJUBLJANA SI

# TAKRIL

(540)

(550) I

(740) Radulović Božidar, Jovana Tomaševića 9/III, Podgorica (ME)

(511) **Klasa 2:** Akrilni podni premaz u različitim tonovima.

---

(210) **2011-467**

(442) **20.03.2013**

(220) 26.9.2011

(731) **JUB-H D.D.DOL** PRI LJUBLJANI 28, LJUBLJANA SI

# JUBOCID

(540)

(550) I

(740) Radulović Božidar, Jovana Tomaševića 9/III, Podgorica (ME)

(511) **Klasa 05:** Sredstva za uništavanje zidne plijesi.

---

(210) **2011-468**

(442) **20.03.2013**

(220) 28.9.2011

(731) **SHISEIDO COMPANY LIMITED**, 7-5-5 GINZA, CHUO-KU,104-0061 TOKYO JP

## SHISEIDO BENEFIANCE WRINKLERESIST 24

(540)

(550) I

(740) Čejović Vladimir, 13. jula 21, Podgorica (ME)

(511) **Klasa 03:** Sapun; parfemi; kozmetika; kozmetički preparati za njegu kože; preparati za njegu kože; proizvodi za šmikanje; proizvodi za njegu kose.

(210) **2011-469**(442) **20.03.2013**

(220) 28.9.2011

(731) **TWENTIETX CENTURY FOX FILM CORPORATION**, 10201 WEST PICO BOULEVARD, LOS ANGELES, CALIFORNIA 90035 US

## FOX MOVIES

(540)

(550) I

(740) Čejović Vladimir, 13. jula 21, Podgorica (ME)

(511) **Klasa 09:** Aparati i instrumenti naučni, pomorski, geodetski, fotografski, kinematografski, optički, za vaganje, mjerenje, signalizaciju, kontrolu (nadzor), spašavanje života i nastavu; aparati i instrumenti za spovođenje, prekidanje, transformaciju, akumuliranje, regulaciju ili kontrolu struje; aparati za snimanje, prenošenje ili reprodukciju zvuka ili slike; magnetni nosioci podataka, diskovi za snimanje; automatske mašine i mehanizmi za aparate koji se pokreću novcem ili žetonom; registar kase, računске mašine, oprema za obradu podataka i računari; aparati za gašenje požara; melodije, grafike, pozadine, igre i muzika koje se mogu preuzeti sa globalne kompjuterske mreže ili bežičnih uređaja; filmovi, televizijski programi i audio vizuelni sadržaji zajedno sa igranim filmom i televizijskom zabavom koji se mogu preuzeti sa Interneta; audio i video zapisi zajedno sa igranim filmom i televizijskom zabavom koji se mogu preuzeti sa Interneta; računarski softver i dodatci; unaprijed snimljene video trake, DVDi i CDi zajedno sa igranim filmom i televizijskom zabavom, podloge za miš, dekorativni magneti, naočare.

**Klasa 38:** Telekomunikacije; usluge televizijskog prenosa i emitovanja, usluge radio emitovanja.

**Klasa 41:** Obrazovanje; obezbjeđivanje obuke, zabava, sportske i kulturne aktivnosti; produkcija i distribucija televizijskih programa, igranih filmova i audio vizuelne zabave; usluge zabave, u smislu televizijskog programiranja; obezbjeđivanje on-line informacija na polju televizije, igranog filma i video zabave putem Interneta; obezbjeđivanje televizije, igranog filma i video zabave putem bežičnih uređaja; usluge zabave, u smislu zapisa i slika zajedno sa televizijskim emisijama i zabavom koje se ne mogu preuzeti a prenose se putem Internet i bežičnih komunikacionih mreža; usluge zabave, naime obezbjeđivanje on-line igrice za računar; on-line novine, naime blog za iznošenje ličnih informacija i mišljenja; organizovanje zabave i kulturnih događaja; zabava u smislu takmičenja, nadmetanja i igara.

(210) **2011-470**(442) **20.03.2013**

(220) 28.9.2011

(731) **MEDIA-NEA D.O.O. PODGORICA**, KRALJA NIKOLE BB PODGORICA ME

Dnevne  
**novine**

(540)

(550) I

(740) Đurkovic Aleksandra, Podgorica (ME)

(511) **Klasa 35:** Oglašavanje; vođenje poslova; poslovno upravljanje; kancelarijski poslovi.

**Klasa 38:** Telekomunikacije.

(210) **2011-471**

(442) **20.03.2013**

(220) 29.9.2011

(731) **AB PH. NEDERMAN & CO**, BOX 602, 251 06 HELSINGBORG SE

**NEDERMAN**

(540)

(550) I

(740) Čupić Branislav, Dalmatinska 10, Podgorica (ME)

(511) **Klasa 07:** Mašine i mašinski alati; motori i pogonske mašine (osim za suvozemna vozila); djelovi mašina i pogonskih mašina; izduvni sistemi; uređaji za ekstrakciju; skupljači prašine; uređaji za razdvajanje dima i prašine; instalacije u zgradama za ekstrakciju izduvnih gasova iz vozila; pumpe, vakum pumpe i lubrikacione pumpe; pumpe za ekstrakciju gasova, tečnosti i pare; uređaji za razdvajanje uljane izmaglice; kompaktne jedinice; ventilatorski uređaji; filteri; obrtni ventili; oprema za čišćenje za industrijsku upotrebu; mašine za pranje veša; mašine za mljevenje; centrifugalne mašine; ciklonski odvajajući; sjekači; razdjelnici; mašine za peskiranje; usisivači; mašine za mljevenje; konvejeri; transportne jedinice; automatski kalemi i konvejeri za šmrkove, kablove, kanape i žice; djelovi i komponenti za svu gore navedenu robu.

**Klasa 11:** Aparati za osvjetljavanje, grijanje, proizvodnju pare, kuvanje, hlađenje, sušenje, ventilaciju, snabdjevanje vodom i za sanitarne svrhe; klima uređaji; aparati za ventilaciju i filtriranje i djelovi za iste; ventilatori i filteri za vazduh; ventilacione instalacije; filteri i ovlaživači za ventilacione sisteme; mobilni ventilatori i filterne jedinice; filteri za ventilacione jedinice; djelovi i komponenti za svu gore navedenu robu.

**Klasa 37:** Gradevinske konstrukcije; popravljavanje; usluge instaliranje (instalacione usluge).

(210) **2011-472**

(442) **20.03.2013**

(220) 29.9.2011

(731) **VISIOGEN INC**, 1700 EAST ST. ANDREW PLACE, P.O. BOX 25162, SANTA ANA, CALIFOR-

NIA 92705-4933 US

## SYNCHRONY VU

(540)

(550) I

(740) Popović Miladin, Đoka Miraševića 21/III, Podgorica (ME)

(511) **Klasa 10:** Očni implanti i hirurški ručni instrumenti za umetanje intraokularnih sočiva.

(210) **2011-473**

(442) **20.03.2013**

(220) 30.9.2011

(731) **PODRAVKA D.D.**, ANTE STARČEVIĆA, 32 48000 KOPRIVNICA HR



(540)

(550) I

(740) Popović Miladin, Đoka Miraševića 21/III, Podgorica (ME)

(511) **Klasa 29:** Meso, riba, živina i divljač; mesne preradjevine; konzervisano, zamrznuto, sušeno i kuvano voće i povrće; želei, džemovi, kompoti; jaja, mleko i mlečni proizvodi; jestiva ulja i masti.

**Klasa 30:** Kafa, čaj, kakao, šećer, pirinač, tapioka, sago, zamena kafe; brašno i proizvodi od žitarica, hleb, kolači i poslastice, sladoledi; med, melasa; kvasac, prašak za pecivo; so, senf; sirće, sosovi (kao dodaci); začini; led.

(210) **2011-478**

(442) **20.03.2013**

(220) 4.10.2011

(731) **SHANTHA BIOTECHNICS LIMITED**, FATEH MAIDAN ROAD BASHEERBAGH HYDERABAD 500 004 ANDHRA PRADESH IN

## SHANVAC

(540)

(550) I

(740) Popović Miladin, Đoka Miraševića 21/III, Podgorica (ME)

(511) **Klasa 05:** Farmaceutski proizvodi; vakcine.



(210) **2011-479** (442) **20.03.2013**

(220) 4.10.2011

(731) **ALKALOID AD-SKOPLJE**, BUL. ALEKSANDAR MAKEDONSKI 12, 1000 SKOPLJE MK



(540) \_\_\_\_\_

(550) I

(740) Popović Miladin, Đoka Miraševića 21/III, Podgorica (ME)

(511) **Klasa 03:** Dječja krema.

(210) **2011-480** (442) **20.03.2013**

(220) 4.10.2011

(731) **ALAKLOID AD-SKOPLJE**, BUL. ALEKSANDAR MAKEDONSKI 12, 1000 SKOPLJE MK



(540)

(550) I

(740) Popović Miladin, Đoka Miraševića 21/III, Podgorica (ME)

(511) **Klasa 03:** Hidratantno mlijeko.

(210) **2011-481** (442) **20.03.2013**

(220) 4.10.2011

(731) **ALKALOID AD-SKOPLJE**, BUL. ALEKSANDAR MAKEDONSKI 12, 1000 SKOPLJE MK



(540)

(550) I

(740) Popović Miladin, Đoka Miraševića 21/III, Podgorica (ME)

(511) **Klasa 03:** Šampon za djecu.(210) **2011-482**(442) **20.03.2013**

(220) 4.10.2011

(731) **ALKALOID AD-SKOPLJE**, BUL. ALEKSANDAR MAKEDONSKI 12, 1000 SKOPLJE MK

(540)

(550) I

(740) Popović Miladin, Đoka Miraševića 21/III, Podgorica (ME)

(511) **Klasa 03:** Pjenušava kupka sa kamilicom.(210) **2011-484**(442) **20.03.2013**

(220) 4.10.2011

(731) **ALKALOID AD-SKOPLJE**, BUL. ALEKSANDAR MAKEDONSKI 12, 1000 SKOPLJE MK



(540)

(550) I

(740) Popović Miladin, Đoka Miraševića 21/III, Podgorica (ME)

(511) **Klasa 03:** Puder za djecu.(210) **2011-485**(442) **20.03.2013**

(220) 5.10.2011

(731) **FORNAX D.O.O.**, UL. BULEVAR REVOLUCIJE 50/6 PODGORICA ME

(540)

(550) I

(511) **Klasa 09:** Aparati i instrumenti naučni, pomorski, geodetski, fotografski, kinematografski, optički, za vaganje, merenje, signalizaciju, kontrolu (inspekciju), spasavanje i nastavu; aparati i instrumenti za provođenje, prekid, transformaciju, akumulaciju, regulisanje ili kontrolu električne energije; aparati za snimanje, prenos i reprodukovanje zvuka ili slike; magnetni nosioci podataka, diskovi za snimanje; automatske mašine i mehanizmi za aparate koji se pokreću novcem ili žetonom; registar kase, računске mašine, oprema za obradu podataka i kompjuteri; aparati za gašenje požara.

**Klasa 35:** Ogllašavanje; vođenje poslova; poslovno upravljanje; kancelarijski poslovi.

**Klasa 42:** Naučne i tehnološke usluge i istraživanje i projektovanje u vezi navedenih usluga; usluge industrijske analize i istraživanja; projektovanje i razvoj kompjuterskog hardvera i softvera.

(210) **2011-487**(442) **20.03.2013**

(220) 7.10.2011

(731) **CORPORATION OF THE PRESIDENT OF THE CHURCH OF JESUS CHRIST**

OF LATTER-DAY SAINTS, 50 EAST NORTH TEMPLE STREET, SALT LAKE CITY, UTAH  
84150 US



(540)

(550) I

(740) Ćupić Branislav, Dalmatinska 10, Podgorica (ME)

(511) **Klasa 41:** Obrazovne i nastavne usluge u vezi sa međunarodnom humanitarnom pomoći i razvojem; usluge humanitarne pomoći za jadne i siromašne, naime podučavanje o dobrim higijenskim i zdravstveno-sanitarnim postupcima

**Klasa 43:** Usluge humanitarne pomoći i razvoja, naime: opskrbljivanje hranom, pićem, odjećom i zdravstveno-sanitarnim objektima, pružanje privremenog smještaja, omogućavanje sadržaja za rekreaciju.

**Klasa 45:** Socijalne usluge i personalne usluge u vezi sa humanitarnom pomoći i razvojem; usluge humanitarne pomoći i razvoja, naime: pružanje zdravstvenih usluga; usluge humanitarne pomoći i razvoja; naime: pružanje sanitarno-higijenskih usluga

(210) **2011-494**

(442) **20.03.2013**

(220) 12.10.2011

(731) **ADRIATIC MARINAS DOO**, OBALA BB, TIVAT ME

**Hilton Porto Montenegro**

(540)

(550) I

(511) **Klasa 43:** Usluge obezbjeđivanje hrane i pića; privremeni smještaj.

(210) **2011-495**

(442) **20.03.2013**

(220) 12.10.2011

(731) **ADRIATIC MARINAS DOO**, OBALA BB, TIVAT ME

**g.l.a. Porto Montenegro**

(540)

(550) I

(511) **Klasa 43:** Usluge obezbjeđivanje hrane i pića; privremeni smještaj.

- (210) **2011-496** (442) **20.03.2013**  
 (220) 12.10.2011  
 (731) **ADRIATIC MARINAS DOO**, OBALA BB, TIVAT ME

Regent Porto Montenegro

- (540)  
 (550) I  
 (511) **Klasa 43:** Usluge obezbjeđivanje hrane i pića; privremeni smještaj.

- (210) **2011-503** (442) **20.03.2013**  
 (220) 13.10.2011  
 (731) **ALKALOID AD- SKOPLJE**, BUL. ALEKSANDAR MAKEDONSKI 12, 1000 SKOPLJE MK



- (540)  
 (550) I  
 (740) Popović Miladin, Đoka Miraševića 21/III, Podgorica (ME)  
 (511) **Klasa 03:** Dječji sapun.

- (210) **2009-274** (442) **20.03.2013**  
 (220) 25.5.2009  
 (300) RS 21 05 2008  
 (731) **MAGINUS DOO**, KNEZA VIŠESLAVA 3/11 ČUKARICA BEOGRAD RS

SKUPLJAČ BOJA

- (540)  
 (550) I  
 (740) Ana Stanković-Mugoša, Podgorica, Trg Republike 13;

(511) **Klasa 03:** Sredstva za beljenje i druge supstance za upotrebu u perionicama; preparati za čišćenje, poliranje, ribanje i nagrizanje; sapuni; a naročito netkani tekstil, hartija i čvrste i tečne supstance za upotrebu u mašinama za pranje veša.

---

(210) **2009-400** (442) **20.03.2013**  
 (220) 28.5.2009  
 (300) Z-2008/1304 22 05 2008

(731) **GOOGLE INC**, 1600 AMPHITHEATRE PARKWAY, MOUNTAIN VIEW, CA 94043 US

## KNOL

(540)

(550) I

(740) Ćupić Branislav, Dalmatinska 10, Podgorica (ME)

(511) **Klasa 41:** Obrazovne usluge; pripremanje obuke; razonoda; sportske i kulturne aktivnosti; uključujući usluge izdavaštva i informacione usluge.

---

(210) **2010-178** (442) **20.03.2013**  
 (220) 28.5.2010

(731) **RVCA PLATFORM,LLC**, 960 WEST 16TH STREET, COSTA MESA, CALIFORNIA 92627 US

## RVCA

(540)

(550) I

(740) Lutovac Branislav, Bulevar Crnojevića 93, Podgorica (ME)

(511) **Klasa 18:** Koferi, putne torbe, i kaiševi izrađeni od kože, i kišobrani.

**Klasa 25:** Sandale, marame i ešarpe za glavu, rajfovi i trake za glavu, majice kratkih rukava, šortsevi i bermude, donji i gornji delovi trenerke, kupaći kostimi i gaće, jakne, ronilačka odela, odeća od teksasa, pantalone, košulje i bluze od tkanina, majice i bluze od pletenina, majice bez rukava, čarape, džemper, šeširi, kape i kačketi.

---

(210) **2011-177** (442) **20.03.2013**  
 (220) 11.4.2011

(731) **SANRIO COMPANY LTD**, TOKYO1-6-1 OSAKI, SHINAGAWA-KU JP

## HELLO KITTY

(540)

(550) I

(511) **Klasa 18:** Koferi, putne torbe, i kaiševi izrađeni od kože, i kišobrani.

**Klasa 25:** Sandale, marame i ešarpe za glavu, rajfovi i trake za glavu, majice kratkih rukava, šortsevi i bermude, donji i gornji delovi trenerke, kupaći kostimi i gaće, jakne, ronilačka odela, odeća od teksasa, pantalone, košulje i bluže od tkanina, majice i bluže od pletenina, majice bez rukava, čarape, džemper, šeširi, kape i kačketi.

(210) **2011-293**

(442) **20.03.2013**

(220) 17.6.2011

(731) **THE PROCTER & GAMBLE COMPANY**, ONE PROCTER & GAMBLE PLAZA, CINCINNATI, OHIO 45202 US



(540)

(550) I

(740) Lutovac Branislav, Bulevar Crnojevića 93, Podgorica (ME)

(511) **Klasa 08:** Sredstva za pranje, bijeljenje i druge supstance za upotrebu kod pranja veša; sapuni za upotrebu u domaćinstvu; nagrizajuća sredstva, preparati za poliranje, abrazivna sredstva; mirišljavi preparati za vazduh i tkanine.

(210) **2011-296**

(442) **20.03.2013**

(220) 20.6.2011

(731) **THE GILLETTE COMPANY**, ONE GILLETTE PARK, BOSTON, MA02127 US

# PROGLIDE

(540)

(550) I

(740) Lutovac Branislav, Bulevar Crnojevića 93, Podgorica (ME)

(511) **Klasa 8:** Brijači i noževi za brijanje; instrumenti za brijanje; dozne, kasete i patrone koje sadrže noževe za brijanje; delovi i dodaci za svu navedenu robu.;

(210) **2011-381**

(442) **20.03.2013**

(220) 25.7.2011

(300) 08.06.2011-ENGLESKA PRIJAVA GB 2583955

(731) **FIL LIMITED ABERMUDA COMPANY**, PEMBROKE HALL, 42 CROW LANE, PEMBROKE HM 19, P.O.BOX HM 670, HAMILTON HMCX BM



(540)

(550) I

(740) Ćupić Branislav, Dalmatinska 10, Podgorica (ME)

(511) **Klasa 05:** Farmaceutski i veterinarski preparati; sanitarni preparati za medicinsku upotrebu; dijetetske supstance prilagođene za upotrebu u medicini, hrana za bebe; flasteri, materijali za zavijanje; materijali za plombiranje zuba, zubarska smola; dezinfekciona sredstva; preparati za uništavanje štetočina; fungicidi, herbicidi.

**Klasa 10:** Hirurški, medicinski, zubarski i veterinarski aparati i instrumenti, veštački udovi, oči i zubi; ortopedski artikli; hirurški materijali za zašivanje.

(210) **2011-459**

(442) **20.03.2013**

(220) 20.9.2011

(731) **DIVERSEY, INC.**, 8310 16 STREET, STURTEVANT, WISCONSIN 53177 US

**DIVERSEY**

(540)

(550) I



(740) Lutovac Branislav, Bulevar Crnojevića 93, Podgorica (ME)

(511) **Klasa 21:** Kućne ili kuhinjske sprave i posude (koji nisu od dragocjenih metala ili sa presvlakama od njih); češljevi i sundjeri; četke (izuzev kičica); materijali za pravljenje četki; artikli koji se koriste pri čišćenju; čelična vuna; nepreradjeno ili polupreradjeno staklo (osim stakla koje se koristi u građevinarstvu); staklarija, porcelan, fajans, grnčarija i lončarija koja nije uključena u druge klase.

**Klasa 37:** Gradjevinsko konstruisanje; popravljanje; usluge instaliranja (instalacione usluge).

**Klasa 41:** Obrazovne usluge; obezbedjivanje obuke; razonoda; sportske i kulturne aktivnosti.

(210) **2011-460** (442) **20.03.2013**

(220) 20.9.2011

(731) **JOHNSON OUTDOORS MARINE ELECTRONICS, INC**, 678 HUMMINBIRD LANE, EUFAULA, ALABAMA 36027 US

## MINN KOTA

(540)

(550) I

(740) Lutovac Branislav, Bulevar Crnojevića 93, Podgorica (ME)

(511) **Klasa 06:** Nastavci za kormilarenje (račice); nosači za montažu.

**Klasa 07:** Vanbrodski motori, (mali) manevarski brodski motori i ribarski motori, i delovi za njih; nosači za motore.

**Klasa 09:** Sidra; brodski akumulatori, punjači za akumulatore, merači za akumulatore; bežični instrumenti i aparati za upravljanje i kontrolu.

**Klasa 12:** Elise za prevozna sredstva.

(210) **2011-463** (442) **20.03.2013**

(220) 22.9.2011

(731) **JOHNSON OUTDOORS MARINE ELECTRONICS, INC**, 678 HUMMINBIRD LANE, EUFAULA, ALABAMA 36027 US

## HUMMINBIRD

(540)

(550) I

(740) Lutovac Branislav, Bulevar Crnojevića 93, Podgorica (ME)

(511) **Klasa 09:** Aparati i instrument naučni, pomorski, geodetski, fotografski, kinematografski, optički, za vaganje, merenje, signalizaciju, kontrolu (inspekciju), spasavanje i nastavu; aparati i instrumenti za provodjenje, isklucivanje, transformisanje, akumuliranje, regulisanje ili kontrolisanje električne energije; magnetni nosioci podataka, diskovi za snimanje; auto-

matske mašine i mehanizmi za aparate koji se pokreću novcem ili žetonom; registar kase, računске mašine; aparati za gašenje požara; nautički elektronski uređaji, a naročito sonarni uređaji za merenje dubine i lociranje ribe; ploteri, elektronske mape i karte; ehografi i drugi tehnički uređaji i aparati za ribarenje i navigaciju; ultrazvučni nautički dubinomeri; dvo-smjerni radio uređaji; navigacioni uređaji, i prateća oprema; aparati za snimanje, prenos i reprodukovanje zvuka ili slike; oprema za obradu podataka i kompjuteri, i prateća oprema za naprijed navedenu robu.

(210) **2011-476** (442) **20.03.2013**

(220) 3.10.2011

(731) **VIACOM INTERNATIONAL INC**, 1515 BROADWAY, NEW YORK, NEW YORK, 10036 US

## VIACOM BLINK

(540)

(550) I

(740) Lutovac Branislav, Bulevar Crnojevića 93, Podgorica (ME)

(511) **Klasa 38:** Radio-difuzne i telekomunikacijske usluge; kablovske i satelitske usluge prenosa; wireless za mobilne telefone; omogućavanje download-ovanja melodija, muzike, mp3, grafika, igrice, slika i informacija za mobilne uređaje sa bežičnom komunikacijom; pružanje bežičnog prenosa pri upload-vanju i download-ovanju melodija, glasova, muzike, mp3, grafika, igrice, slika, informacija i novosti preko globalne kompjuterske mreže do mobilnog uređaja sa bežičnom komunikacijom, glasanje preko mobilnog uređaja sa bežičnom komunikacijom; slanje i primanje glasova preko mobilnog, slanje i primanje zvučnih i tekstualnih poruka između mobilnih uređaja sa bežičnom komunikacijom; omogućavanje glasanja online preko interneta ili bezicnog uređaja za komunikaciju ; internet usluge koje podrazumijevaju usluge komunikacije , uglavnom transmisije strimovanih zvukova i zvcno-vizuelnih snimaka preko interneta.

**Klasa 41:** Zabava; proizvodnja, priprema, izlaganje, distribucija i iznajmljivanje tv i radio programa i filmova, animiranih filmova, zvučnih i video snimaka kroz interaktivne i neinteraktivne medije, među kojima je internet; produkcija zabave uživo, produkcija tv zabave, muzički tv programi; organizacija, produkcija i prezentacija nadmetanja, takmičenja, igara, kvizova, izložbi, sportskih događaja, predstava, putujućih predstava, organizovanih događaja, pozorišnih izvođenja, koncerata, predstava uživo, događaja sa učešćem publike; organizacija interaktivnih igara; zabava i obrazovanje, sve navedene usluge takođe prenijete preko globalne kompjuterske mreže i drugih (interaktivnih) komunikacijskih mreža, uključujući internet; obezbjeđivanje internet informativnog portala koji sadrži linkove koji vode ka novim pričama i člancima o trenutnim dešavanjima; pružanje website portala u oblasti muzike.

(210) **2011-477** (442) **20.03.2013**

(220) 3.10.2011

(731) **STIEFEL LABORATORIES, INC**, CORPORATION SERVICE COMPANY, 2711 CENTER-

VILLE ROAD, SUITE 400, WILMINGTON, DELAWARE 19808 US

# BREVOXYL

(540)

(550) I

(740) Lutovac Branislav, Bulevar Crnojevića 93, Podgorica (ME)

(511) **Klasa 05:** Farmaceutski preparati i proizvodi; preparati na bazi benzoil peroksida za lečenje akni.

---

(210) **2011-486**

(442) **20.03.2013**

(220) 5.10.2011

(731) **KLIKOVAC DOO**, MAHALA BB, PODGORICA ME



Fidelinka

(540)

(550) I

(511) **Klasa 30:** Brašno i proizvodi od žitarica, hleb, kolači, poslastice i sladoled.

**Klasa 35:** Sakupljanje u korist drugih, čitavog niza roba ( uključujući i njihov transport ) omogućavajući klijentima da zgodno razgledaju i kupuju ovu robu, takve usluge mogu se pružati u prodavnicama na malo, rasprodajama, porudžbinama poštom preko kataloga ili putem elektronskih medija, na primjer preko web sajta ili televizijskih programa za kupovinu.

---

(210) **2011-516**

(442) **20.03.2013**

(220) 20.10.2011

(731) **KURARAY CO., LTD**, 1621, SAKAZU, KARUSHIKI CITY, OKOYAMA PREFECTURE JP



(540)

(550) I

(740) Popović Miladin, Đoka Miraševića 21/III, Podgorica (ME)

(511) **Klasa 01:** Hemijski proizvodi koji se upotrebljavaju u industriji, nauci i fotografiji, kao i u poljoprivredi, hortikulturi i šumarstvu; neprerađene vještačke smole, neprerađene plastične materije; đubriva; smješe za gašenje vatre; preparati za kaljenje i zavarivanje; hemijske supstance za očuvanje namirnica; materije za štavljenje; ljepljive supstance koje se upotrebljavaju u industriji; kopolimeri etilen-vinil alkohola.

**Klasa 16:** Hartija, karton i proizvodi od njih, koji nijesu uključeni u druge klase; ljepila za kancelarijske ili kućne potrebe; plastični materijali za uvijanje i pakovanje, koji nijesu uključeni u druge klase.

**Klasa 17:** Guma, gutaperka, kaučuk, azbest, liskun i proizvodi napravljeni od ovih materijala koji nijesu uključeni u druge klase; poluprerađeni plastični proizvodi; materijali za podbijačnje (podloške), zaptivanje i izolovanje; savitljive nemetalne cijevi; poluprerađena vještačka smola i poluprerađene plastične materije, posebno sastavljene od kopolimera etilen-vinil alkohola.

---

(210) **2011-521** (442) **20.03.2013**

(220) 26.10.2011

(731) **JONHSON CONTROS HYBRID AND RECYCLING GMBH**, AM LEINNEUFER 51  
30419, HANOVER DE

# VARTA

(540)

(550) I

(740) Popović Miladin, Đoka Miraševića 21/III, Podgorica (ME)

(511) **Klasa 09:** Akumulatori svih tipova koji se koriste kod vozila za transport ljudi i robe, uključujući automobile, kamione, čamce i motocikla, i djelovi i oprema za takve akumulatore, uključujući punjače za akumulatore, test aparate za akumulatore, kablove, žice, kućišta, kutije, aparate za praćenje akumulatora, prekidače, daljinske pokretače, zaštitnike za akumulatore, isključivače, konvertore, invertore, konektore, priključke, adaptore, ekstenzije, prstenje, aligator štipaljke, adaptore u vidu utičnica, utičnice za punjače, kablove za prespajanje, utičnice, kućišta za montiranje akumulatora, opremu za montiranje kućišta za akumulatore.

---

(210) **2011-522** (442) **20.03.2013**

(220) 26.10.2011

(731) **JONHSON CONTROLS HYBRID AND RECYCLING GMBH**, AM LEINNEUFER 51  
30419, HANOVER DE



(540)

(550) I

(740) Popović Miladin, Đoka Miraševića 21/III, Podgorica (ME)

(511) **Klasa 09:** Akumulatori svih tipova koji se koriste kod vozila za transport ljudi i robe, uključujući automobile, kamione, čamce i motocikla, i djelovi i oprema za takve akumulatore, uključujući punjače za akumulatore, test aparate za akumulatore, kablove, žice, kućišta, kutije, aparate za praćenje akumulatora, prekidače, daljinske pokretače, zaštitnike za akumulatore, isključivače, konvertore, invertore, konektore, priključke, adaptore, ekstenzije, prstenje, aligator štikaljke, adaptore u vidu utičnica, utičnice za punjače, kablove za prespajanje, utičnice, kućišta za montiranje akumulatora, opremu za montiranje kućišta za akumulatore.

---

(210) **2011-526**

(442) **20.03.2013**

(220) 31.10.2011

(731) **HEMOFARM A.D.**, BEOGRADSKI PUT BB 26300 VRŠAC RS

**VISUS**

(540)

(550) I

(740) Popović Miladin, Đoka Miraševića 21/III, Podgorica (ME)

(511) **Klasa 05:** Farmaceutski proizvodi.

---

(210) **2011-538**

(442) **20.03.2013**

(220) 4.11.2011

(731) **BRITISH AMERICAN TOBACCO(BRANDS)INC.**, 2711 CENTERVILLE ROAD, SUITE 300, WILMINGTON, DELAWARE 19808 US



(540)

(550) I

(740) Popović Miladin, Đoka Miraševića 21/III, Podgorica (ME)

(511) **Klasa 34:** Cigarete; Duvan; proizvodi od duvana; upaljači; šibice; artikli za pušače.

(210) **2011-539**

(442) **20.03.2013**

(220) 8.11.2011

(731) **ABBOTT MEDICAL OPTICS INC**, 1700 E.ST.ANDREW PLACE, SANTE ANA,CALIFORNIA  
92705-4933 US

# ELLIPS

(540)

(550) I

(740) Popović Miladin, Đoka Miraševića 21/III, Podgorica (ME)

(511) **Klasa 10:** Hirurški, medicinski, zubarski i veterinarski aparati i instrumenti; veštački udovi, oči i zubi; ortopedski artikli; hirurški materijali za zašivanje; naročito oftalmološki hirurški instrumenti; ručni uređaj koji se koristi u toku operacije katarakte i vitrektomije.

(210) **2011-546**

(442) **20.03.2013**

(220) 9.11.2011

(731) **CIRQUE DU SOLEIL I.I.I.** .S.A., 16, AVENUE PASTEUR, L-2310 LU

# CIRQUE DU SOLEIL



(540)

(550) I

(740) Popović Miladin, Đoka Miraševića 21/III, Podgorica (ME)

(511) **Klasa 41:** Usluge razonode, naime, osmišljavanje, stvaranje, produkcija, i prezentacija pozorišnih predstava; osmišljavanje, stvaranje, produkcija, distribucija i prezentacija audio-vizuelnih radova; produkcija multimedijalnih pozorišnih predstava; kazino usluge.

---

(210) **2011-547**

(442) **20.03.2013**

(220) 9.11.2011

(731) **CIRQUE DU SOLEIL I.I.I. .S.A., 16, AVENUE PASTEUR, L-2310 LU**

# CIRQUE DU SOLEIL

(540)

(550) I

(740) Popović Miladin, Đoka Miraševića 21/III, Podgorica (ME)

(511) **Klasa 41:** Usluge razonode, naime, osmišljavanje, stvaranje, produkcija, i prezentacija pozorišnih predstava; osmišljavanje, stvaranje, produkcija, distribucija i prezentacija audio-vizuelnih radova; produkcija multimedijalnih pozorišnih predstava; kazino usluge.;

---

(210) **2011-548**

(442) **20.03.2013**

(220) 9.11.2011

(731) **CIRQUE DU SOLEIL I.I.I. .S.A., 16, AVENUE PASTEUR, L-2310 LU**



(540)

(550) I

(740) Popović Miladin, Đoka Miraševića 21/III, Podgorica (ME)

(511) **Klasa 41:** Usluge razonode, naime, osmišljavanje, stvaranje, produkcija, i prezentacija pozorišnih predstava; osmišljavanje, stvaranje, produkcija, distribucija i prezentacija audiovizuelnih radova; produkcija multimedijalnih pozorišnih predstava; kazino usluge.;(210) **2011-549**(442) **20.03.2013**

(220) 10.11.2011

(731) **J.& P:COATS, LIMITED**, 1 GEORGE SQUARE, GLASGOW G2 1AL SCOTLAND UK

# SONAL

(540)

(550) I

(740) Popović Miladin, Đoka Miraševića 21/III, Podgorica (ME)

(511) **Klasa 23:** prediva i konci za tekstilnu upotrebu;(210) **2011-550**(442) **20.03.2013**

(220) 10.11.2011

(731) **J.& P. COATS, LIMITED**, 1 GEORGE SQUARE, GLASGOW G2 1AL SCOTLAND UK

# APTAN

(540)

(550) I

(740) Popović Miladin, Đoka Miraševića 21/III, Podgorica (ME)

(511) **Klasa 23:** prediva i konci za tekstilnu upotrebu;(210) **2011-551**(442) **20.03.2013**



(220) 10.11.2011

(731) **J. & P. COATS, LIMITED**, 1 GEORGE SQUARE, GLASGOW G2 1AL SCOTLAND UK, UK;

# DUAL DUTY

(540)

(550) I

(740) Popović Miladin, Đoka Miraševića 21/III, Podgorica (ME)

(511) **Klasa 23:** prediva i konci za tekstilnu upotrebu;

---

(210) **2011-553**

(442) **20.03.2013**

(220) 10.11.2011

(731) **J. & P. COATS, LIMITED**, 1 GEORGE SQUARE, GLASGOW G2 1AL SCOTLAND UK

# GRAL

(540)

(550) I

(740) Popović Miladin, Đoka Miraševića 21/III, Podgorica (ME)

(511) **Klasa 23:** prediva i konci za tekstilnu upotrebu;

---

(210) **2011-554**

(442) **20.03.2013**

(220) 10.11.2011

(731) **J. & P. COATS, LIMITED**, 1 GEORGE SQUARE, GLASGOW G2 1AL SCOTLAND UK

# GRAMAX

(540)

(550) I

(740) Popović Miladin, Đoka Miraševića 21/III, Podgorica (ME)

(511) **Klasa 23:** prediva i konci za tekstilnu upotrebu;

---

(210) **2011-563**

(442) **20.03.2013**

(220) 16.11.2011

(731) NIKON CORPORATION, 12-1,YURAKUCHO 1-CHOME,CHIYODA-KU, TOKYO JP

# Nikon

(540)

(550) I

(740) Popović Miladin, Đoka Miraševića 21/III, Podgorica (ME)

(511) **Klasa 07:** Mašine i mašinski alati; motori i pogonske mašine (osim za suvozemna vozila); mašinske spojnice i transmisioni elementi (osim za suvozemna vozila); poljoprivredne sprave; inkubatori za jaja; mašine i sistemi za proizvodnju poluprovodnika; aparati za izlaganje poluprovodnika; mašine i sistemi za proizvodnju tecnog kristala; aparati za izlaganje tecnog kristala; aparati za testiranje poluprovodnika; aparati za testiranje tecnog kristala; mašine za poliranje i aparati za vafel; delovi i dodaci za mašine i sisteme za proizvodnju poluprovodnika; delovi i dodaci za mašine i sisteme za proizvodnju tecnog kristala; delovi i dodaci za aparate za izlaganje poluprovodnika; delovi i dodaci za aparate za izlaganje tecnog kristala; delovi i dodaci za aparate za testiranje poluprovodnika; delovi i dodaci za aparate za testiranje tecnog kristala; delovi i dodaci za mašine za poliranje i aparate za vafel.;

**Klasa 14:** Dragoceni metali i njihove legure i proizvodi od dragocenih metala ili sa prevlakom od njih, koji nisu ukljuceni u druge klase; nakit, bižuterija, drago kamenje; casovnicarski i hronometrijski instrumenti; znanke; privesci za kljuceve od dragocenih metala.;

**Klasa 16:** Hartija, karton i proizvodi od njih, koji nisu ukljuceni u druge klase; štampane stvari; knjigovezacki materijal; fotografije; kancelarijski materijal; lepila za kancelarijske i kucne potrebe; umetnicki materijali; kicice; pisace mašine i kancelarijski rekviziti (izuzev nameštaja); materijali za obuku i nastavu (izuzev aparata); plasticni materijal za pakovanje (koji nije ukljucen u druge klase); štamparska slova; klišei; stalci za fotografije; kalendari; albumi; magazini (periodike); knjige; novine; stikeri (kancelarijski materijal); slicice.;

**Klasa 18:** Koža i imitacija kože, proizvodi izradeni od ovih materijala koji nisu ukljuceni u druge klase; životinjska koža; koferi i putne torbe; kišobrani, suncobrani i štapovi za hodanje; bicevi, saracka i sedlarska roba; torbe sa vrpcom; postavljene torbice; futrole za kartice (novcanici); poslovne futrole za kartice; torbice za kljuceve; torbe za kupovinu; ranci; ruksaci; rucne torbe.;

**Klasa 21:** Kućne ili kuhinjske sprave i posude (koje nisu od dragocenih metala ili sa prevlakama od njih); cešljevi i sunderi; cetke (izuzev kicica); materijali za pravljenje cetki; artikli koji se koriste pri cišćenju; celicna vuna; nepreradeno ili polupreradeno staklo (osim stakla koje se koristi u gradevinarstvu); staklarija, porcelan, fajans, grncarija i loncarija koja nije ukljucena u druge klase; čaše sa ravnim dnom, šolje, pljosnate boce za pića, boce za vodu, vacuum boce, čaše za pića, sudovi za pića, kutije za rucak.;

**Klasa 25:** Odeca, obuca, pokrivala za glavu; prsluci; muški prsluci; jakne; mantili; kape, šeširi, pokrivala za glavu; trake za rucne zglobove; sportske uniforme; kecelje, majice.;

**Klasa 37:** Gradevinsko konstruisanje; popravljanje; usluge instaliranja (instalacione usluge); instalacija mašina za proizvodnju poluprovodnika i sistema; instalacija mašina za proizvodnju tecnih kristala i sistema; usluge popravke ili održavanja mašina za proizvodnju tecnih kristala i sistema; usluge popravke ili održavanja mašina za proizvodnju poluprovodnika i sistema;

usluge popravke ili održavanja fotografske opreme; usluge popravke ili održavanja kamera; usluge popravke ili održavanja digitalnih fotoaparata; usluge popravke ili održavanja sociva fotoaparata; usluge popravke ili održavanja optičkih aparata i instrumenata; usluge popravke ili održavanja mikroskopa; usluge popravke ili održavanja dvogleda; usluge popravke ili održavanja teleskopa; usluge popravke ili održavanja daljinomera; instalacija aparata za testiranje poluprovodnika; instalacija aparata za testiranje tecnih kristala; usluge popravke ili održavanja aparata za testiranje poluprovodnika; usluge popravke ili održavanja aparata za testiranje tecnog kristala; usluge popravke naocara; usluge popravke ili održavanja mašina i instrumenata za merenje ili ispitivanje; usluge popravke ili održavanje telekomunikacionih uređaja i aparata; usluge popravke ili održavanje elektronskih mašina i aparata; usluge popravke ili održavanje slušnih aparata; usluge popravke ili održavanje medicinskih aparata i instrumenata.

**Klasa 41:** Obrazovne usluge; pripremanje obuke; razonoda; sportske i kulturne aktivnosti; fotografija i pružanje informacija o fotografiji; pripremanje, vodenje i organizovanje seminara za fotografe i pružanje informacija o fotografiji; pripremanje, vodenje i organizovanje fotografskih klasa i pružanje informacija o fotografskim klasama; pripremanje, vodenje i organizovanje događaja u vezi sa fotografijama i pružanje informacija o događajima u vezi sa fotografijama; pripremanje, vodenje i organizovanje takmicenja u fotografisanju i pružanje informacija o fotografskim takmicenjima; iznajmljivanje kamera i delova i pribora za njih; pripremanje, vodenje i organizovanje izložbi fotografija i pružanje informacija o izložbama fotografija; obezbeđivanje prostora za izložbe fotografija i pružanje informacija o prostoru za izložbe fotografija; usluge digitalnog fotografisanja; pružanje on-line usluga digitalnog fotografisanja; fotografisanje; obrazovne i nastavne usluge vezane za fotografisanje; obrazovne i nastavne usluge vezane za održavanje, popravku i rad fotografske opreme i delova i pribora za njih; obrazovne i nastavne usluge vezane za održavanje, popravku i rad mašina i instrumenata za merenje ili testiranje i delova i pribora za njih; obrazovne i nastavne usluge vezane za održavanje, popravku i rad optičkih instrumenata i mašina i delova i pribora za njih; obrazovne i nastavne usluge vezane za održavanje, popravku i rad mašina i sistema za proizvodnju poluprovodnika (uključujući aparate za testiranje poluprovodnika i drugih perifernih uređaja) i delova i pribora za njih; obrazovne i nastavne usluge vezane za održavanje, popravku i rad mašina i sistema za proizvodnju tecnih kristala (uključujući i aparate za testiranje tecnih kristala i drugih perifernih uređaja) i delova i pribora za njih; obrazovne i nastavne usluge vezane za održavanje, popravku i rad telekomunikacionih uređaja i aparata i delova i pribora za njih; obrazovne i nastavne usluge vezane za održavanje, popravku i rad elektronskih mašina i aparata i delova i pribora za njih; obrazovne i nastavne usluge vezane za održavanje, popravku i rad mašina i aparata za proizvodnju naocara i delova i pribora za njih; pružanje usluga on-line elektronskih publikacija [koje se ne mogu preuzeti]; pripremanje, vodenje i organizovanje seminara, i pružanje informacija o istim; usluge obezbeđivanje datoteka slika i video datoteka [koje se ne mogu preuzeti] preko Interneta; iznajmljivanje optičkih mašina i instrumenata; iznajmljivanje mašina i instrumenata za merenje ili testiranje; planiranje, uređivanje i proizvodnja publikacija.

**Klasa 42:** Naučne i tehnološke usluge i istraživanje i projektovanje u vezi navedenih usluga; usluge industrijske analize i istraživanja; projektovanje i razvoj kompjuterskog hardvera i softvera; iznajmljivanje web servera; iznajmljivanje prostora za skladištenje podataka sa servera preko Interneta; obezbeđivanje softvera za uređivanje i upravljanje fotografijama i filmovima preko Interneta [koji se ne mogu preuzeti]; iznajmljivanje web servera za razgovor putem Interneta.;

(220) 18.11.2011

(731) **GENERAL MOTORS LLC**, 300 RENAISSANCE CENTER, CITY OF DETROIT, STATE OF MICHIGAN 48265-3000 US**INTELLILINK**

(540)

(550) I

(740) Popović Miladin, Đoka Miraševića 21/III, Podgorica (ME)

(511) **Klasa 09:** Elektronski interfejs moduli koji se prodaju kao integralni delovi motornih drumskih vozila, za žicni i bežicni interfejs rucnih ili mobilnih elektronskih uređaja.(210) **2011-572**(442) **20.03.2013**

(220) 23.11.2011

(731) **THE HERSHEY COMPANY**, 100 CRYSTAL A DRIVE HERSHEY PENNSYLVANIA 17033 US**HERSHEY'S SPECIAL DARK**

(540)

(550) I

(740) Popović Miladin, Đoka Miraševića 21/III, Podgorica (ME)

(511) **Klasa 30:** Čokolade; proizvodi od čokolade; bombone, slatkiši; poslastice; kakao; proizvodi od kakaoa; keksi, biskviti; poslastice od čokolade za pečenje; komadici, ljuspice i kriške za pečenje; instant čokoladni miks (za hladne i tople napitke); čokoladni premazi; bezalkoholni čokoladni liker; čokoladom obloženi orasi; aromatizovani sirupi, naime, čokoladni sirupi, sirupi od jagode, karamel sirupi, butterscotch sirupi, aromatizovani sirupi od kikiriki putera; konditorski preliivi za sladoled i za deserte; kolaci, pecivo, sladoled; poslastice od sladoleda; smrznute poslastice; ne-mlečni, bezalkoholni napici na bazi čokolade; table od žitarica.(210) **2011-573**(442) **20.03.2013**

(220) 23.11.2011

(731) **THE HERSHEY COMPANY**, 100 CRYSTAL A DRIVE HERSHEY PENNSYLVANIA 17033 US**HERSHEY'S KISSES**

(540)

(550) I

(740) Popović Miladin, Đoka Miraševića 21/III, Podgorica (ME)

(511) **Klasa 30:** Čokolade; proizvodi od čokolade; bombone, slatkiši, poslastice; kakao; proizvodi od kakaoa; keksi, biskviti, poslastice od čokolade za pečenje, komadici, ljuspice i kriške za pečenje; instant čokoladni miks (za hladne i tople napitke); konditorski preliivi za sladoled i za deserte; kolaci, pecivo, sladoled, smrznute poslastice.;

---

(210) **2011-575** (442) **20.03.2013**

(220) 23.11.2011

(731) **THE HERSHEY COMPANY**, 100 CRYSTAL A DRIVE HERSHEY PENNSYLVANIA 17033 US

## REESE'S

(540)

(550) I

(740) Popović Miladin, Đoka Miraševića 21/III, Podgorica (ME)

(511) **Klasa 30:** Čokolade; proizvodi od čokolade; slatkiši; čokolada sa ili bez dodataka kao što su orasi ili kikiriki puter; poslastice; konditorske ljuspice za pečenje ili kao prelive za hranu; keksi, biskviti, kolaci, pecivo, pite, sladoled; poslastice od sladoleda; smrznute poslastice; gotovi deserti; aromatizovani sirupi, naime, čokoladni sirupi, sirupi sa ukusom kikiriki putera, čokolade i aromatizovani sirupi od kikiriki putera; konditorski prelive za sladolede i za deserte.

---

(210) **2011-578** (442) **20.03.2013**

(220) 23.11.2011

(731) **S2 YACHTS, INC.**, 725 EAST 40TH STREET, HOLLAND, MICHIGAN 49423 US

## TIARA

(540)

(550) I, V

(740) Radulović Božidar, Jovana Tomaševića 9/III, Podgorica (ME)

(511) **Klasa 12:** Brodovi i čamci i njihovi dodaci i oprema.

---

(210) **2011-579** (442) **20.03.2013**

(220) 28.11.2011

(731) **MARINE STOCK LIMITED**, 1ST FLOOR, COLUMBUS CENTRE BUILDING, P.O. BOX 901. ROAD TOWN, TORTUGA VG

# BK

(540)

(550) I,V

(740) Radulović Božidar, Jovana Tomaševića 9/III, Podgorica (ME)

(511) **Klasa 25:** Odjeća i obuća.(210) **2011-580**(442) **20.03.2013**

(220) 28.11.2011

(731) **MARINE STOCK LIMITED**, 1ST FLOOR,COLUMBUS CENTRE BUILDING, P.O.BOX 901.  
ROAD TOWN,TORTUGA VG

# BRITISH KNIGHTS

(540)

(550) I,V

(740) Radulović Božidar, Jovana Tomaševića 9/III, Podgorica (ME)

(511) **Klasa 25:** Odjeća i obuća.(210) **2011-582**(442) **20.03.2013**

(220) 30.11.2011

(731) **BASF AGRO B.V.ARNHEM** (NL), ZWEIGNIEDERLASSUNG WADENSSWIL MOOSACHER-  
STRASSE 2 AU

# ALIOS

(540)

(550) I

(740) Čupić Branislav, Dalmatinska 10, Podgorica (ME)

(511) **Klasa 01:** Hemijski proizvodi koji se upotrebljavaju u poljoprivredi, hortikulturi i šumarstvu, narocito preparati za ojačanje biljke, preparati za regulisanje rasta biljaka, hemijski preparati za tretiranje sjemena, surfaktanti, prirodne i vještacke hemikalije za upotrebu kao seksualni mamci ili agensi za zbunjivanje insekata.;**Klasa 05:** Preparati za uništavanje i borbu protiv štetocina, fungicidi, herbicidi, pesticidi.;**Klasa 31:** Poljoprivredni, hortikulturni i šumarski proizvodi kao i žitarice i cerealije koji nisu uključeni u drugim klasama; hrana za životinje.;

---

(210) **2011-583** (442) **20.03.2013**

(220) 30.11.2011

(731) **BASF SE**, CARL-BOSCH-STRASSE 38 LUDWIGSHAFEN AM RHEIN DE

## CYCOCEL

(540)

(550) I

(740) Ćupić Branislav, Dalmatinska 10, Podgorica (ME)

(511) **Klasa 01:** Hemijski proizvodi koji se upotrebljavaju u poljoprivredi, hortikulturi i šumarstvu, narocito preparati za ojacanje biljke, preparati za regulisanje rasta biljaka, hemijski preparati za tretiranje sjemena, surfaktanti, prirodne i vještacke hemikalije za upotrebu kao seksualni mamci ili agensi za zbunjivanje insekata.;

**Klasa 5:** Preparati za uništavanje i borbu protiv štetocina, fungicidi, herbicidi, pesticidi.;

---

(210) **2011-584** (442) **20.03.2013**

(220) 30.11.2011

(731) **BASF CORPORATION**, 100 CAMPUS DRIVE FLORHAM PARK, NJ 07932 US

## CELEBRITY

(540)

(550) I

(740) Ćupić Branislav, Dalmatinska 10, Podgorica (ME)

(511) **Klasa 01:** Preparati za uništavanje i borbu protiv štetočina, fungicidi, herbicidi, pesticidi.

---

(210) **2011-596** (442) **20.03.2013**

(220) 5.12.2011

(731) **DUN & BRADSTREET INTERNATIONAL.LTD**, 103 JFK PARKWAY, SHORT HILLS, NEW JERESEY 07078 US

# DUN & BRADSTREET

(540)

(550) I, V

(740) Radulović Božidar, Jovana Tomaševića 9/III, Podgorica (ME)

(511) **Klasa 35:** Usluge obezbeđivanja izveštaja o prodaji i tržištu za druge po narudžbini i/ili specifikaciji; usluge obezbeđivanja opštih poslovnih informacija koje se tiču prodaje, obima i pozicije; sprovođenje marketinških studija; usluge obezbeđivanja poslovnih informacija koje se odnose na oblast marketinga, demografije i statistike; pripisivanje i obezbeđivanje identifikacionih brojeva privrednim društvima za primenu u svrhe olakšavanja automatizacije plaćanja preko platnih računa i druge poslovne svrhe i nabavljanje poslovnih statistika i informacija; pružanje prodajnih i marketinških informacija koje se odnose na poslovnu zajednicu prema zahtevima klijenata, usluge pripreme lista sa poštanskim adresama; kompjuterizovane marketinške savetodavne usluge koje se pružaju privrednim društvima, naročito, pružanje informacija za identifikaciju pravaca poslovanja preduzeća i odnosa između nacionalnih i međunarodnih kompanija, pružanje demografskih informacija o različitim poslovanjima u određenim geografskim oblastima, prikupljanje i širenje reklamnih sadržaja za druge, pripremanje listi kompanija za druge; pružanje poslovnih informacija pomoću prethodno snimljenih telefonskih poruka; usluge ocene dobavljača roba i usluga u odnosu na ukupni finansijski nivo, operativni nivo i nivo rizika

**Klasa 36:** Obezbeđivanje informacija o kreditima i naplatama potraživanja koje se odnose na poslovanje; usluge agencija za naplatu potraživanja; obezbeđivanje usluga vraćanja kredita i naplate potraživanja; obezbeđivanje izveštaja o kreditnom rejtingu; usluge finansijskih izveštaja koji se odnose na naplatu kredita i kreditne izveštaje, prodaju, finansije i kreditnu i finansijsku analizu; usluge finansijskog marketinga i istraživanja; obezbeđivanje kreditnog rejtinga i finansijskih izveštaja i analiza; sprovođenje dobrotvornih programa u kojem se od strane pokrovitelja duplira (uvećava) vrednost svake pojedinačne donacije; usluge obezbeđivanja finansijski podataka o kreditnoj istoriji; usluge obezbeđivanja informacija i usluge investicionog rejtinga, uključujući usluge kreditnih informacija koje se obezbeđuju preko kompjuterskog softvera; usluge naplate dugovanja; obezbeđivanje kreditnih izveštaja i informacija o kreditnom rejtingu pomoću prethodno snimljenih telefonskih poruka; analiza kreditnog rizika.

(210) **2011-597**

(442) **20.03.2013**

(220) 5.12.2011

(731) **DUN & BRADSTREET INTERNATIONAL.LTD**, 103 JFK PARKWAY, SHORT HILLS, NEW JERSEY 07078 US



# DUNSRIGHT

(540)

(550) I,V

(740) Radulović Božidar, Jovana Tomaševića 9/III, Podgorica (ME)

(511) **Klasa 35:** Usluge obezbjeđivanja izveštaja o prodaji i tržištu za druge po narudžbini i/ili specifikaciji; usluge obezbjeđivanja opštih poslovnih informacija koje se tiču prodaje, obima i pozicije; sprovođenje marketinških studija; usluge obezbjeđivanja poslovnih informacija koje se odnose na oblast marketinga, demografije i statistike; pripisivanje i obezbjeđivanje identifikacionih brojeva privrednim društvima za primenu u svrhe olakšavanja automatizacije plaćanja preko platnih računa i druge poslovne svrhe i nabavljanje poslovnih statistika i informacija; pružanje prodajnih i marketinških informacija koje se odnose na poslovnu zajednicu prema zahtevima klijenata, usluge pripreme lista sa poštanskim adresama; kompjuterizovane marketinške savetodavne usluge koje se pružaju privrednim društvima, naročito, pružanje informacija za identifikaciju pravaca poslovanja preduzeća i odnosa između nacionalnih i međunarodnih kompanija, pružanje demografskih informacija o različitim poslovanjima u određenim geografskim oblastima, prikupljanje i širenje reklamnih sadržaja za druge, pripremanje listi kompanija za druge; pružanje poslovnih informacija pomoću prethodno snimljenih telefonskih poruka; usluge ocene dobavljača roba i usluga u odnosu na ukupni finansijski nivo, operativni nivo i nivo rizika

**Klasa 36:** Obezbjeđivanje informacija o kreditima i naplatama potraživanja koje se odnose na poslovanje; usluge agencija za naplatu potraživanja; obezbjeđivanje usluga vraćanja kredita i naplate potraživanja; obezbjeđivanje izveštaja o kreditnom rejtingu; usluge finansijskih izveštaja koji se odnose na naplatu kredita i kreditne izveštaje, prodaju, finansije i kreditnu i finansijsku analizu; usluge finansijskog marketinga i istraživanja; obezbjeđivanje kreditnog rejtinga i finansijskih izveštaja i analiza; sprovođenje dobrotvornih programa u kojem se od strane pokrovitelja duplira(uvećava) vrednost svake pojedinačne donacije; usluge obezbjeđivanja finansijski podataka o kreditnoj istoriji; usluge obezbjeđivanja informacija i usluge investicionog rejtinga, uključujući usluge kreditnih informacija koje se obezbeđuju preko kompjuterskog softvera; usluge naplate dugovanja; obezbjeđivanje kreditnih izveštaja i informacija o kreditnom rejtingu pomoću prethodno snimljenih telefonskih poruka; analiza kreditnog rizika.

(210) **2011-598**

(442) **20.03.2013**

(220) 5.12.2011

(731) **DUN & BRADSTREET INTERNATIONAL, LTD, 103 JFK PARKWAY, SHORT HILLS, NEW JERSEY 07078 US**

# D-U-N-S

(540)

(550) I, V

(740) Radulović Božidar, Jovana Tomaševića 9/III, Podgorica (ME)

(511) **Klasa 35:** Usluge obezbeđivanja izveštaja o prodaji i tržištu za druge po narudžbini i/ili specifikaciji; usluge obezbeđivanja opštih poslovnih informacija koje se tiču prodaje, obima i pozicije; sprovođenje marketinških studija; usluge obezbeđivanja poslovnih informacija koje se odnose na oblast marketinga, demografije i statistike; pripisivanje i obezbeđivanje indentifikacionih brojeva privrednim društvima za primenu u svrhe olakšavanja automatizacije plaćanja preko platnih računa i druge poslovne svrhe i nabavljanje poslovnih statistika i informacija; pružanje prodajnih i marketinških informacija koje se odnose na poslovnu zajednicu prema zahtevima klijenata, usluge pripreme lista sa poštanskim adresama; kompjuterizovane markentiške savetodavne usluge koje se pružaju privrednim društvima, naročito, pružanje informacija za identifikaciju pravaca poslovanja preduzeća i odnosa između nacionalnih i međunarodnih kompanija, pružanje demografskih informacija o različitim poslovanjima u određenim geografskim oblastima, prikupljanje i širenje reklamnih sadržaja za druge, pripremanje listi kompanija za druge; pružanje poslovnih informacija pomoću prethodno snimljenih telefonskih poruka; usluge ocene dobavljača roba i usluga u odnosu na ukupni finansijski nivo, operativni nivo i nivo rizika

**Klasa 36:** Obezbeđivanje informacija o kreditima i naplatama potraživanja koje se odnose na poslovanje; usluge agencija za naplatu potraživanja; obezbeđivanje usluga vraćanja kredita i naplate potraživanja; obezbeđivanje izveštaja o kreditnom rejtingu; usluge finansijskih izveštaja koji se odnose na naplatu kredita i kreditne izveštaje, prodaju, finansije i kreditnu i finansijsku analizu; usluge finansijskog marketinga i istraživanja; obezbeđivanje kreditnog rejtinga i finansijskih izveštaja i analiza; sprovođenje dobrotvornih programa u kojem se od strane pokrovitelja duplira (uvećava) vrednost svake pojedinačne donacije; usluge obezbeđivanja finansijski podataka o kreditnoj istoriji; usluge obezbeđivanja informacija i usluge investicionog rejtinga, uključujući usluge kreditnih informacija koje se obezbeđuju preko kompjuterskog softvera; usluge naplate dugovanja; obezbeđivanje kreditnih izveštaja i informacija o kreditnom rejtingu pomoću prethodno snimljenih telefonskih poruka; analiza kreditnog rizika.

(210) **2011-599**

(442) **20.03.2013**

(220) 5.12.2011

(731) **DUN & BRADSTREET INTERNATIONAL, LTD**, 103 JFK PARKWAY, SHORT HILLS, NEW JERSEY 07078 US

# D&B

(540)

(550) I,V

(740) Radulović Božidar, Jovana Tomaševića 9/III, Podgorica (ME)

(511) **Klasa 35:** Usluge obezbeđivanja izveštaja o prodaji i tržištu za druge po narudžbini i/ili specifikaciji; usluge obezbeđivanja opštih poslovnih informacija koje se tiču prodaje, obima i pozicije; sprovođenje marketinških studija; usluge obezbeđivanja poslovnih informacija koje se odnose na oblast marketinga, demografije i statistike; pripisivanje i obezbeđivanje indentifikacionih brojeva privrednim društvima za primenu u svrhe olakšavanja automatizacije plaćanja preko platnih računa i druge poslovne svrhe i nabavljanje poslovnih statistika i informacija; pružanje prodajnih i marketinških informacija koje se odnose na poslovnu zajednicu prema zahtevima klijenata, usluge pripreme lista sa poštanskim adresama; kompjuterizovane marketinške savetodavne usluge koje se pružaju privrednim društvima, naročito, pružanje informacija za identifikaciju pravaca poslovanja preduzeća i odnosa između nacionalnih i međunarodnih kompanija, pružanje demografskih informacija o različitim poslovanjima u određenim geografskim oblastima, prikupljanje i širenje reklamnih sadržaja za druge, pripremanje listi kompanija za druge; pružanje poslovnih informacija pomoću prethodno snimljenih telefonskih poruka; usluge ocene dobavljača roba i usluga u odnosu na ukupni finansijski nivo, operativni nivo i nivo rizika

**Klasa 36:** Obezbeđivanje informacija o kreditima i naplatama potraživanja koje se odnose na poslovanje; usluge agencija za naplatu potraživanja; obezbeđivanje usluga vraćanja kredita i naplate potraživanja; obezbeđivanje izveštaja o kreditnom rejtingu; usluge finansijskih izveštaja koji se odnose na naplatu kredita i kreditne izveštaje, prodaju, finansije i kreditnu i finansijsku analizu; usluge finansijskog marketinga i istraživanja; obezbeđivanje kreditnog rejtinga i finansijskih izveštaja i analiza; sprovođenje dobrotvornih programa u kojem se od strane pokrovitelja duplira (uvećava) vrednost svake pojedinačne donacije; usluge obezbeđivanja finansijski podataka o kreditnoj istoriji; usluge obezbeđivanja informacija i usluge investicionog rejtinga, uključujući usluge kreditnih informacija koje se obezbeđuju preko kompjuterskog softvera; usluge naplate dugovanja; obezbeđivanje kreditnih izveštaja i informacija o kreditnom rejtingu pomoću prethodno snimljenih telefonskih poruka; analiza kreditnog rizika.

(210) **2012-117**

(442) **20.03.2013**

(220) 24.2.2012

(731) **ADRIATIC MARINAS DOO**, OBALA BB 85320 TIVAT ME

(540)

(550) V

(740) Đurović Savo, Dom Vojske, Seljanovo b.b. Tivat (ME)

(511) **Klasa 36:** Osiguranja; finansijski poslovi; novčani (monetarni) poslovi; poslovi vezani za nepokretnosti.

**Klasa 39:** Transportne usluge; pakovanje i skladištenje robe; organizovanje putovanja.

**Klasa 41:** Obrazovne usluge; pripremanje obuke; razonoda; sportske i kulturne aktivnosti.

**Klasa 43:** Usluge obezbjeđivanje hrane i pića; privremeni smještaj.

**Klasa 44:** Medicinske usluge; veterinarske usluge; higijenska zaštita i njega ljepote za ljude ili životinje; agrikulturne, hortikulturne i šumarske usluge.

(210) **2009-579** (442) **20.03.2013**

(220) 28.9.2009

(731) **HONDA MOTOR CO LTD**, 1-1 MINAMI-AOYAMA 2-CHOME, MINATO-KU, TOKYO JP

# EU Handy

(540)

(550) I

(740) Radulović Božidar, Jovana Tomaševića 9/III, Podgorica (ME)

(511) **Klasa 07:** Generatori.

(210) **2010-1** (442) **20.03.2013**

(220) 1.4.2010

(731) **CRNOGORSKI TELEKOM**, MOSKOVSKA 29, PODGORICA ME

# MyTube

(540)

(550) I

(511) **Klasa 09:** Aparati i instrumenti naučni, pomorski, geodetski, fotografski ,kinematografski, optički, za vaganje, mjerenje, signalizaciju , kontrolu (inspekciju), spasavanje I nastavu ; Aparati I instrumenti za provodjenje, prekid , transformaciju , akumulaciju , regulisanje ili kontrolu elektricne energije; Aparati za snimanje, prenos i reprodukovanje zvuka ili slike; Magnetni nosioci podataka, diskovi za snimanje; Automatske mašine i mehanizmi koji se pokrecu novcem ili zetonom ; Registar kase, računске mašine, oprema za obradu podataka i kompjuteri; Aparati za gasenje pozara.

**Klasa 16:** Stampane stvari; fotografije ; kancelarijski rekviziti (izuzev namještaja); materijali za obuku i nastavu (izuzev aparata).

**Klasa 35:** Oglasavanje, poslovno upravljanje, vodjenje poslova, sistematizacija informacija u kompjuterske baze podataka, kompilacija informacija u kompjuterske baze podataka, malo-prodajne usluge (preko Interneta i ostalih sredstava komunikacije)

**Klasa 36:** Osiguranje, finansijski poslovi, novcani poslovi, poslovi vezani za nepokretnosti;

**Klasa 37:** Gradjevinsko konstruisanje, usluge instalacije , popravlanje i održavanje kompjutera i telekomunikacionih hardvera.

**Klasa 38:** Telekomunikacije .informacije o telekomunikacijama, usluge koje omogućavaju naj-

manje jednom lieu da komunicira sa drugim koristeći čula i to: 1) dozvoljavanje jednom lieu da komunicira sa drugim, 2) prenos poruka od jedne osobe do druge, 3) stavljanje lica u položaj vizuelne ili govorne komunikacije sa drugim (radio i televizija), komunikacija mobilnim telefonom; usluge koje sadrže difuziju radio ili televizijskih programa, emitovanje putem kablovske televizije; usluge prenosa podataka, slanje poruka. usluge telekonferencije, usluge govorne poste, slanje poruka i slika uz pomoć kompjutera. komunikacija preko optičke mreže; elektronska pošta. pristup globalnoj kompjuterskoj mreži, izdavanje i održavanje telekomunikacione opreme, izdavanje modema, izdavanje telefona.

**Klasa 41:** Obrazovne usluge; pripremanje obuke; razonoda; sportske i kulturne aktivnosti.

**Klasa 42:** Naučne i tehnološke usluge i istraživanje i projektovanje u vezi navedenih usluga; usluge industrijske analize i istraživanja; razvoj i projektovanje kompjuterskih hardvera i softvera; održavanje kompjuterskog softvera; tehničke konsultacije; dizajn kompjuterskog sistema; usluge zaštite od kompjuterskog virusa; kreiranje i održavanje web stranica za druge.

(210) **2010-31**

(442) **20.03.2013**

(220) 15.2.2010

(731) **ENVER KIKIĆ**, ORIJENSKI BATALJON 26 85340 HERCEG NOVI ME

**DAVOR TOMŠIĆ**, DUBROVAČKA 2,85347 IGALO, HERCEG NOVI ME

**SAŠA VELIČKOVIĆ**, LUKE VUKALOVIĆA 35,85347 IGALO, HERCEG NOVI ME

(540)

(550) I

(511) **Klasa 41:** Obrazovne; razonoda, kulturne aktivnosti.

(210) **2010-324**

(442) **20.03.2013**

(220) 8.9.2010

(731) **CASTELANA CO DOO**, TUZI BB PODGORICA ME

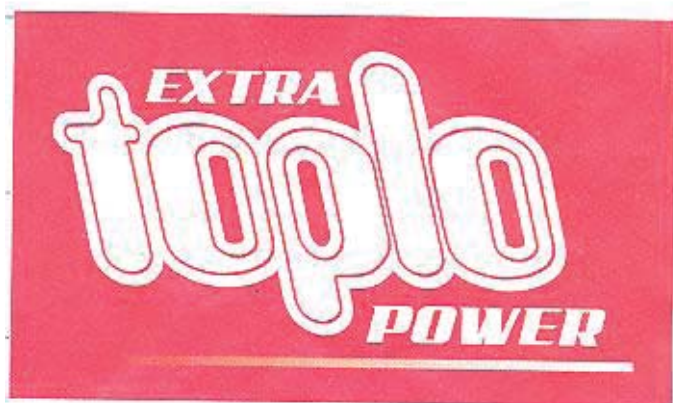

(540) I

(550) I

(740) Čejović Vladimir, 13. jula 21, Podgorica (ME)

(511) **Klasa 09:** Električni akumulatori.**Klasa 35:** Usluge prodaje i distribucije.(210) **2010-328**(442) **20.03.2013**

(220) 15.9.2010

(731) **KLIKOVAC DOO**, MAHALA BB PODGORICA ME

Goldy

(540)

(550) I

(511) **Klasa 35:** Usluge maloprodaje i veleprodaje od povrća.(210) **2010-329**(442) **20.03.2013**

(220) 15.9.2010

(731) **KLIKOVAC DOO**, MAHALA BB PODGORICA ME

Goldy pack

(540)

(550) I

(511) **Klasa 35:** Usluge maloprodaje i veleprodaje aluminskih folija.(210) **2010-340**(442) **20.03.2013**

(220) 23.9.2010

(731) **CRNOGORSKI TELECOM AD**, MOSKOVSKA 29, POGORICA ME

# Integris

(540)

(550) I

(740) Đurović Pavle, Moskovska br 29, Podgorica (ME)

(511) **Klasa 09:** Aparati i instrumenti naučni, pomorski, geodetski, fotografski, kinematografski, optički, za vaganje, mjerenje, signalizaciju, kontrolu (inspekciju), spasavanje i nastavu; Aparati i instrumenti za provodjenje, prekid, transformaciju, akumulaciju, regulisanje ili kontrolu elektricne energije; Aparati za snimanje, prenos i reprodukovanje zvuka ili slike; Magnetni nosioci podataka, diskovi za snimanje; Automatske mašine i mehanizmi koji se pokrecu novcem ili zetonom; Registar kase, računске mašine, oprema za obradu podataka i kompjuteri; Aparati za gasenje požara.

**Klasa 16:** Stampane stvari; fotografije; kancelarijski rekviziti (izuzev namještaja); materijali za obuku i nastavu (izuzev aparata).

**Klasa 35:** Oglasavanje, poslovno upravljanje, vodjenje poslova, sistematizacija informacija u kompjuterske baze podataka, kompilacija informacija u kompjuterske baze podataka, malo-prodajne usluge (preko Interneta i ostalih sredstava komunikacije)

**Klasa 36:** Osiguranje, finansijski poslovi, novčani poslovi, poslovi vezani za nepokretnosti;

**Klasa 37:** Gradjevinsko konstruisanje, usluge instalacije, popravlanje i održavanje kompjutera i telekomunikacionih hardvera.

**Klasa 38:** Telekomunikacije, izdavanje telekomunikacione opreme.

**Klasa 41:** Obrazovne usluge; pripremanje obuke; razonoda; sportske i kultume aktivnosti.

**Klasa 42:** Naučne i tehnoloske usluge i istraživanje i projektovanje u vezi navedenih usluga; usluge industrijske analize i istraživanja; razvoj i projektovanje kompjuterskih hardvera i softvera; održavanje kompjuterskog softvera; tehnicke konsultacije; dizajn kompjuterskog sistema; usluge zaštite od kompjuterskog virusa; kreiranje i održavanje web stranica za druge.

(210) **2010-341**

(442) **20.03.2013**

(220) 23.9.2010

(731) **CRNOGORSKI TELECOM AD** PODGORICA, MOSKOVSKA 29, PODGORICA, ME;

**INOVATORIUM**

(540)

(550) I

(740) Pavle Djurovic, Podgorica, (ME)

(511) **Klasa 09:** Aparati i instrumenti naučni, pomorski, geodetski, fotografski, kinematografski, optički, za vaganje, mjerenje, signalizaciju, kontrolu (inspekciju), spasavanje i nastavu; Aparati i instrumenti za provodjenje, prekid, transformaciju, akumulaciju, regulisanje ili kontrolu elektricne energije; Aparati za snimanje, prenos i reprodukovanje zvuka ili slike; Magnetni nosioci podataka, diskovi za snimanje; Automatske mašine i mehanizmi koji se pokrecu novcem ili zetonom; Registar kase, računске mašine, oprema za obradu podataka i kompjuteri; Aparati za gasenje požara.

**Klasa 16:** Stampane stvari; fotografije ; kancelarijski rekviziti (izuzev namještaja); materijali za obuku i nastavu (izuzev aparata).

**Klasa 35:** Oglasavanje, poslovno upravljanje, vođenje poslova, sistematizacija informacija u kompjuterske baze podataka, kompilacija informacija u kompjuterske baze podataka, malo-prodajne usluge (preko Interneta i ostalih sredstava komunikacije)

**Klasa 36:** Osiguranje, finansijski poslovi, novčani poslovi, poslovi vezani za nepokretnosti;

**Klasa 37:** Gradjevinsko konstruisanje, usluge instalacije, popravljanje i održavanje kompjutera i telekomunikacionih hardvera.

**Klasa 38:** Telekomunikacije, izdavanje telekomunikacione opreme .

**Klasa 41:** Obrazovne usluge; pripremanje obuke; razonoda; sportske i kulturne aktivnosti.

**Klasa 42:** Naučne i tehnološke usluge i istraživanje i projektovanje u vezi navedenih usluga; usluge industrijske analize i istraživanja; razvoj i projektovanje kompjuterskih hardvera i softvera; održavanje kompjuterskog softvera; tehnicke konsultacije; dizajn kompjuterskog sistema; usluge zaštite od kompjuterskog virusa; kreiranje i održavanje web stranica za druge.

(210) **2010-384** (442) **20.03.2013**  
(220) 25.10.2010

(731) **KARBON GRADJEVINSKI MATERIJALID.O.O.TOPOLA**, BULEVAR VOŽDA KARAOĐORĐA 126, 3431 TOPOLA RS

## FUGAFIL

(540)

(550) I

(511) **Klasa 01:** Lepljive supstance koje se upotrebljavaju u industriji. hemijski proizvodi koji se upotrebljavaju u industriji, nauci, fotografiji, poljoprivredi, hortikulturi i šumarstvu; nepre-rađene vještačke smole, nepre-rađene plastične materije; đubriva; smeše za gašenje vatre; preparati za kaljenje i zavarivanje; hemijske supstance za očuvanje namirnica; materije za štavljenje.

**Klasa 02:** Boje, firnajzi. lakovi: sredstva za zaštitu od rđe i truljenja drveta; materije za bojenje; sredstva za nagrivanje; sirove prirodne smole; metali u obliku listova i praha za slikare, dekoratere, štampare i umjetnike.

**Klasa 19:** Građevinski materijali (nemetalni); čvrste nemetalne cevi za građevine; asfalt, crna smola i bitumen; nemetalne prenosne građevine; spomenici, koji nisu od metala.

(210) **2010-385** (442) **20.03.2013**  
(220) 25.10.2010

(731) **KARBON GRADJEVINSKI MATERIJALID.O.O.TOPOLA**, BULEVAR VOŽDA KARAOĐORĐA 126, 3431 TOPOLA RS

## GLESTAR

(540)

(550) I

(511) **Klasa 01:** Lepljive supstance koje se upotrebljavaju u industriji. hemijski proizvodi koji se



upotrebljavaju u industriji, nauci, fotografiji, poljoprivredi, hortikulturi i šumarstvu; neprerađene vještačke smole, neprerađene plastične materije; đubriva; smeše za gašenje vatre; preparati za kaljenje i zavarivanje; hemijske supstance za očuvanje namirnica; materije za štavljenje.

**Klasa 02:** Boje, firnajzi. lakovi: sredstva za zaštitu od rđe i truljenja drveta; materije za bojenje; sredstva za nagrivanje; sirove prirodne smole; metali u obliku listova i praha za slikare, dekoratere, štampe i umjetnike.

**Klasa 19:** Građevinski materijali (nemetalni); čvrste nemetalne cevi za građevine; asfalt, crna smola i bitumen; nemetalne prenosne građevine; spomenici, koji nisu od metala.

---

(210) **2010-386** (442) **20.03.2013**

(220) 25.10.2010

(731) **KARBON GRADJEVINSKI MATERIJALID.O.O.TOPOLA**, BULEVAR VOŽDA KARADORĐA 126, 3431 TOPOLA RS

## KARBOGLET

(540)

(550) I

(511) **Klasa 01:** Lepljive supstance koje se upotrebljavaju u industriji. hemijski proizvodi koji se upotrebljavaju u industriji, nauci, fotografiji, poljoprivredi, hortikulturi i šumarstvu; neprerađene vještačke smole, neprerađene plastične materije; đubriva; smeše za gašenje vatre; preparati za kaljenje i zavarivanje; hemijske supstance za očuvanje namirnica; materije za štavljenje.

**Klasa 02:** Boje, firnajzi. lakovi: sredstva za zaštitu od rđe i truljenja drveta; materije za bojenje; sredstva za nagrivanje; sirove prirodne smole; metali u obliku listova i praha za slikare, dekoratere, štampe i umjetnike.

**Klasa 19:** Građevinski materijali (nemetalni); čvrste nemetalne cevi za građevine; asfalt, crna smola i bitumen; nemetalne prenosne građevine; spomenici, koji nisu od metala.

---

(210) **2010-387** (442) **20.03.2013**

(220) 25.10.2010

(731) **KARBON GRADJEVINSKI MATERIJALID.O.O.TOPOLA**, BULEVAR VOŽDA KARADORĐA 126, 3431 TOPOLA RS

## KARBOBET

(540)

(550) I

(511) **Klasa 01:** Lepljive supstance koje se upotrebljavaju u industriji. hemijski proizvodi koji se upotrebljavaju u industriji, nauci, fotografiji, poljoprivredi, hortikulturi i šumarstvu; neprerađene vještačke smole, neprerađene plastične materije; đubriva; smeše za gašenje vatre; preparati za kaljenje i zavarivanje; hemijske supstance za očuvanje namirnica; materije za štavljenje.

**Klasa 02:** Boje, firnajzi. lakovi: sredstva za zaštitu od rđe i truljenja drveta; materije za bojenje; sredstva za nagrivanje; sirove prirodne smole; metali u obliku listova i praha za slikare, dekoratere, štampe i umjetnike.

kare, dekoratere, štampare i umjetnike.

**Klasa 19:** Građevinski materijali (nemetalni); čvrste nemetalne cevi za građevine; asfalt, crna smola i bitumen; nemetalne prenosne građevine; spomenici, koji nisu od metala.

(210) **2010-388** (442) **20.03.2013**  
(220) 25.10.2010

(731) **KARBON GRADJEVINSKI MATERIJALID.O.O.TOPOLA**, BULEVAR VOŽDA KARADORĐA 126, 3431 TOPOLA RS

## KARBOKRIL

(540)  
(550) I

(511) **Klasa 01:** Leppljive supstance koje se upotrebljavaju u industriji. hemijski proizvodi koji se upotrebljavaju u industriji, nauci, fotografiji, poljoprivredi, hortikulturi i šumarstvu; nepre-rađene vještačke smole, nepre-rađene plastične materije; đubriva; smeše za gašenje vatre; preparati za kaljenje i zavarivanje; hemijske supstance za očuvanje namirnica; materije za štavljenje.

**Klasa 02:** Boje, firnajzi. lakovi: sredstva za zaštitu od rđe i truljenja drveta; materije za bojenje; sredstva za nagrivanje; sirove prirodne smole; metali u obliku listova i praha za slikare, dekoratere, štampare i umjetnike.

**Klasa 19:** Građevinski materijali (nemetalni); čvrste nemetalne cevi za građevine; asfalt, crna smola i bitumen; nemetalne prenosne građevine; spomenici, koji nisu od metala.

(210) **2010-389** (442) **20.03.2013**  
(220) 25.10.2010

(731) **KARBON GRADJEVINSKI MATERIJALID.O.O.TOPOLA**, BULEVAR VOŽDA KARADORĐA 126, 3431 TOPOLA RS

## KARBOKUL

(540)  
(550) I

(511) **Klasa 01:** Leppljive supstance koje se upotrebljavaju u industriji. hemijski proizvodi koji se upotrebljavaju u industriji, nauci, fotografiji, poljoprivredi, hortikulturi i šumarstvu; nepre-rađene vještačke smole, nepre-rađene plastične materije; đubriva; smeše za gašenje vatre; preparati za kaljenje i zavarivanje; hemijske supstance za očuvanje namirnica; materije za štavljenje.

**Klasa 02:** Boje, firnajzi. lakovi: sredstva za zaštitu od rđe i truljenja drveta; materije za bojenje; sredstva za nagrivanje; sirove prirodne smole; metali u obliku listova i praha za slikare, dekoratere, štampare i umjetnike.

**Klasa 19:** Građevinski materijali (nemetalni); čvrste nemetalne cevi za građevine; asfalt, crna smola i bitumen; nemetalne prenosne građevine; spomenici, koji nisu od metala.

(210) **2011-510** (442) **20.03.2013**

(220) 14.10.2011

(731) **RUBIN A.D.** NADE MARKOVIĆ 57, 37000 KRUŠEVAC RS

(540)

(550) I

(740) Radulović Božidar, Jovana Tomaševića 9/III, Podgorica (ME)

(511) **Klasa 16:** Hartija, karton i proizvodi od njih, koji nisu uključeni u druge klase; štampane stvari; fotografije; kancelarijski materijal; naročito etikete i naljepnice za proizvode i ambalaža za pakovanje proizvoda, štampani katalogi i marketinški materijal; sve navedeno za alkoholna pića, pivo, mineralne i sodne vode, pića od voća i voćne sokove, sirupe.

**Klasa 32:** Pivo, mineralne i sodne vode i druga bezalkoholna pića; pića od voća i voćni sokovi; sirupi i drugi preparati za proizvodnju pića.

**Klasa 33:** Alkoholna pića (izuzev piva).

(210) **2011-514**(442) **20.03.2013**

(220) 19.10.2011

(731) **THE GILLETTE COMPANY**, ONE GILLETTE PARK, BOSTON, MA 02127 US

## POWER RUSH

(540)

(550) I

(740) Lutovac Branislav, Bulevar Crnojevića 93, Podgorica (ME)

(511) **Klasa 03:** Sapuni; parfimerija, eterična ulja, kozmetika, losioni za kosu, naročito sredstva za upotrebu prije, u toku i posle brijanja, nemedicinski preparati za upotrebu u kadi ili tušu, talk puder, sredstva i materijali za depilaciju i epilaciju, antiperspiranti, dezodoransi, toaletni artikli.

(210) **2011-517**(442) **20.03.2013**

(220) 21.10.2011

(731) **SOCIETE DES PRODUITS NESTLE S.A.**, 1800 VEVEY CH

# JELLY FRUIT

(540)

(550) I

(740) Lutovac Branislav, Bulevar Crnojevića 93, Podgorica (ME)

(511) **Klasa 30:** Sladoled.

(210) **2011-519**

(442) **20.03.2013**

(220) 21.10.2011

(731) **MITSUBISHI SHOJI KAISHA LTD.**, 3-1,MARUNOUCHI 2-CHOME,CHIUDA-KU, TOKYO JP



(540)

(550) I

(740) Čejović Vladimir, 13. jula 21, Podgorica (ME)

(511) **Klasa 22:** Užad, kanapi, mreže, šatori, nadstrešnice od cirade, cirade, jedra, vreće; materijali za punjenje i tapaciranje (dlake, kapok, perja, morska trava, itd.); sirove vlaknaste tekstilne materije.

**Klasa 23:** Pređa, konac.

**Klasa 24:** Salvete (na komad), prekrivači za krevete i stolove; tekstilna roba.

**Klasa 29:** Meso, riba, živina i divljač; mesne prerađevine; konzervisano, sušeno I kuvano voće i povrće; želei i džemovi; jaja, mlijeko i drugi mliječni proizvodi; jestiva ulja i masti; ukuvano voće, kiseli krastavci.

(210) **2011-520**

(442) **20.03.2013**

(220) 25.10.2011

(731) **BLOOMERG FINANCE L.P.** (A DELAWARE LIMITED PARTNERSHIP) 731 LEXINGTON AVENUE, NEW YORK, NY 10022 US

# BLOOMBERG

(540)

(550) I

(740) Radulović Božidar, Jovana Tomaševića 9/III, Podgorica (ME)

(511) **Klasa 09:** Kompjuteri, kompjuterski hardver i kompjuterski programi koji se koriste za pristup bazama podataka, za obavljanje Menih kompjuterskih aplikacija, u oblasti vesti, poslovanja, finansija, aktuelnih dešavanja, industrije zabave i sporta, ličnih priča, hartija od vrijednosti, tržišta hartija od vrijednosti i energetske industrije, za analiziranje međunarodnog tržišta hartija od vrijednosti, i analiziranje i izveštavanje o međunarodnim poslovnim i finansijskim vestima; kompjuterski softver za interaktivnu elektronsku komunikaciju o hartijama od vrijednosti i za obavljanje ličnih kompjuterskih aplikacija, naročito, integrisanje podataka, kreiranje baza podataka i tabela, analitiku, pružanje na zahtev muldimedijalnog sadržaja, generisanje grafičkih prikaza, pružanje mogućnosti kalendara i elektronske pošte, i pružanje mogućnosti elektronske trgovine i upravljanje porudžbinama.

**Klasa 16:** Publikacije, naročito, izveštaji, direktorijumi, novine, pamfleti, magazinski dodaci novinama i časopisi u oblasti vesti, poslovanja, finansija, aktuelnih događaja, zabave, sporta, ličnih priča, hartija od vrijednosti, tržišta hartija od vrijednosti i energetske industrije.

**Klasa 35:** Usluge pružanja poslovnih informacija, naročito kompanijskih vesti, informacija u vezi sa analizama i profilima kompanija, finansijskih izveštaja, procena i uputstava, prezentacija i preporuka analitičara, saopštenja za javnost i SEC izveštaja (zvanični finansijski izveštaji koji se podnose Komisiji SAD-a za hartije od vrijednosti i berzu), istraga u vezi sa poslovanjem, upravljanja poslovanjem, ekonomskih predviđanja, poslovnih istraživanja i poslovnih statistika; obezbjeđivanje interaktivnih podataka telefonskog imenika i pomoći za javne kompanije; obezbjeđivanje interaktivnih, elektronskih, audio i vizuelnih komunikacionih i informacionih usluga koje se objavljuju preko, putem ili kroz mrežne.

(210) **2011-524** (442) **20.03.2013**

(220) 27.10.2011

(731) **ORION ELECTRIC CO. LTD** 41-1 LEHISA-CHO, ECHIZEN-CITY, FUKUI JP

# ORION

(540)

(550) I

(740) Radulović Božidar, Jovana Tomaševića 9/III, Podgorica (ME)

(511) **Klasa 09:** Radio prijemnici; Tejp rekorderi (Kasetofoni - na kojima se vrši snimanje); Tape Decks (dekovi za kasete); Tejp plejeri (kasetofoni sa kojih se pušta audio sadržaj); Stereo prijemnici; Gramofoni; Radio prijemnici za automobile; Stereo plejeri za automobile/Rekorde-ri; CD (kompakt disk) Plejeri; MD (mini disk) plejeri/Rekorde-ri; Memorijski plejeri/Rekorde-ri; Zvučnici; Tjuneri; Pojačala; Ekvalizatori; Slušalice; Sistemi kućnog bioskopa; Televizori sa katodnom cijevi; Digitalni Televizori; LCD televizori, Projekcijski televizori, Plazma televizori, LCD uređaj (Navigacioni sistemi za automobile, eto); STB (Set Top Box); Video plejeri/Rekorde-ri; Video tejp plejeri/Rekorde-ri: Video Disk Plejeri; Video kamere; Digitalni foto aparati / kamere ; DVD Plejeri/Rekorde-ri; HDD Plejeri/Rekorde-ri: HD DVD Plejeri/Rekorde-ri; Blu-ray Disk Plejeri/Rekorde-ri; Faks mašine; Mobilni telefoni; Kompjuteri; Monitori za kompjutere; Štampači; Periferalna oprema za kompjutere; Bilo koji kompozitni uređaj koji se sastoji od

dva ili vise stavki gore pomenute robe; Mini komponentni sistemski stereo risiver sa iPOD Dokom; iPOD Dok sa DVD plejerom sve u jednom uređaju; i Sound bar zvučnik; IP -STB (Video na zahtjev stream plejer).

(210) **2011-525** (442) **20.03.2013**

(220) 31.10.2011

(731) **JOCKEY INTERNATIONAL INC.** 2300 60TH STREET, KENOSHA, WISCONSIN US

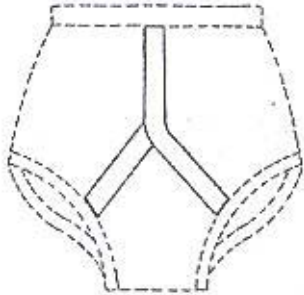

(540)

(550) I

(740) Lutovac Branislav, Bulevar Crnojevića 93, Podgorica (ME)

(511) **Klasa 25:** Muški veš.

(210) **2011-528** (442) **20.03.2013**

(220) 31.10.2011

(731) **ATLAS COPCO SECOROS AB,** BOX 521,737 25 FAGERSTA SE

**SECOROC**

(540)

(550) I

(740) Čejović Vladimir, 13. jula 21, Podgorica (ME)

(511) **Klasa 07:** Mašinski alati, mašine za miniranje, rotacione mašine za rudnike, mašine za utovar, mašine za transport; apatarti uključeni u klasu 7 a sve za upotrebu pri bušenju kamena i dijamanta, mašine za paljenje mina, bor-mašine, mašine za bušenje i mašine za jezgrovanje; mašine za lomljenje kamena, mašine za drobljenje minerala i rude zlata; ventilatori, pumpe, bušilice za kamen i aparati za utovar, sve uključeno u klasu 7; kompresori, i betonski finišeri, svi u vidu mašina; i svi djelovi i dodaci uključeni u klasu 7 za sve gore navedene robe.

**Klasa 08:** Ručni alati i ručni instrumenti uključeni u klasu 8, i djelovi i dodaci uključeni u klasu 8 za sve gore navedene robe.

(210) **2011-529** (442) **20.03.2013**

(220) 3.11.2011

(300) 85/313107 05052011 35 US

(731) **PROJECT MANAGEMENT INSTITUTE, INC** 14 CAMPUS BOULEVARD NEWTON SQUAPARE, PA 19073, USA A PENNSYLVANIA, USA CORPORATION US

## PMI-ACP

(540)

(550) I

(740) Čejović Vladimir, 13. jula 21, Podgorica (ME)

(511) **Klasa 35:** Oglašavanje; onlajn oglašavanje na računarskoj mreži; propaganda; odnosi sa javnošću; pomoć (podrška) u poslovnom upravljanju; konsultacije u vezi sa poslovnim upravljanjem i organizacijom; pomoć (podrška) u komercijalnom ili industrijskom upravljanju; profesionalne poslovne konsultacije; konsultacije u vezi sa organizovanjem posla; konsultacije u vezi sa upravljanjem kadrovima; psihološki testovi u vezi sa odabirom kadrova; poslovne informacije; agencije koje nude usluge komercijalnih informacija; komercijalne informacije i savjeti za potrošače (prodavnice za savjetovanje potrošača); prikupljanje informacija u kompjutersku bazu podataka; usluge poslovnog istraživanja; organizovanje izložbi u komercijalne ili reklamne svrhe; organizovanje sajмова u komercijalne ili reklamne svrhe; prezentacija robe u medijima za komunikaciju u maloprodajne svrhe; izlaganje (prikazivanje) robe; usluge udruženja, naime, promovisanje interesa profesije projektnog upravljanja; promovisanje javne svijesti o profesiji projektnog upravljanja; obezbjeđivanje informacija o projektnom upravljanju; testiranje u svrhu utvrđivanja profesionalne kompetentnosti u profesiji projektnog upravljanja; provjera i praćenje akreditiva profesionalaca za projektno upravljanje; onlajn maloprodajne usluge u vezi sa knjigama; istraživanje u oblasti projektnog upravljanja koje se odnosi na poslovanje; sve gore navedeno u oblasti projektnog upravljanja;

(210) **2011-530**(442) **20.03.2013**

(220) 3.11.2011

(300) 85/313092 05052011 35 US

(731) **PROJECT MANAGEMENT INSTITUTE, INC**, 14 CAMPUS BOULEVARD NEWTON SQUAPARE, PA 19073, USA A PENNSYLVANIA, USA CORPORATION US

## PMI AGILE CERTIFIED PRACTITIONER (PMI-ACP)

(540)

(550) I

(740) Čejović Vladimir, 13. jula 21, Podgorica (ME)

(511) **Klasa 35:** Oglašavanje; onlajn oglašavanje na računarskoj mreži; propaganda; odnosi sa javnošću; pomoć (podrška) u poslovnom upravljanju; konsultacije u vezi sa poslovnim upravljanjem i organizacijom; pomoć (podrška) u komercijalnom ili industrijskom upravljanju; profesionalne poslovne konsultacije; konsultacije u vezi sa organizovanjem posla; kon-

sultacije u vezi sa upravljanjem kadrovima; psihološki testovi u vezi sa odabirom kadrova; poslovne informacije; agencije koje nude usluge komercijalnih informacija; komercionalne informacije i savjeti za potrošače (prodavnice za savjetovanje potrošača); prikupljanje informacija u kompjutersku bazu podataka; usluge poslovnog istraživanja; organizovanje izložbi u komercijalne ili reklamne svrhe; organizovanje sajmova u komercijalne ili reklamne svrhe; prezentacija robe u medijima za komunikaciju u maloprodajne svrhe; izlaganje (prikazivanje) robe; usluge udruženja, naime, promovisanje interesa profesije projektnog upravljanja; promovisanje javne svijesti o profesiji projektnog upravljanja; obezbedjivanje informacija o projektnom upravljanju; testiranje u svrhu utvrdjivanja profesionalne kompetentnosti u profesiji projektnog upravljanja; provjera i praćenje akreditiva profesionalaca za projektno upravljanje; onlajn maloprodajne usluge u vezi sa knjigama; istraživanje u oblasti projektnog upravljanja koje se odnosi na poslovanje; sve gore navedeno u oblasti projektnog upravljanja;

(210) **2011-536** (442) **20.03.2013**

(220) 3.11.2011

(731) **WM. WRIGLEY JR. COMPANY**, 410 NORTH MICHIGAN AVENUE, CHICAGO, IL 60611 US

CRAZY CHERRY

(540)

(550) I

(740) Čejović Vladimir, 13. jula 21, Podgorica (ME)

(511) **Klasa 30:** Slatkiši, žvakaće gume, žvakaće gume od kojih mogu da se prave veliki baloni, bombone, dražeje peperminta, mali okrugli bomboni (drops) i pastile.

(210) **2011-537** (442) **20.03.2013**

(220) 3.11.2011

(731) **EDUCO CENTAR**, KRALJA NIKOLE 29 PODGORICA ME



EDUCO CENTAR

(540)

(550) I

(511) **Klasa 41:** Obrazovne usluge; pripremanja obuke; razonoda; sportske i kulturne aktivno-



sti.

- 
- (210) **2011-540** (442) **20.03.2013**  
 (220) 8.11.2011  
 (731) **DUKAT D.D.**, MARIJANA ČAVIĆA BR.9 1000 ZAGREB HR

## DUKAT

- (540)  
 (550) I  
 (740) Kojic Ivana, Serdar Jola Piletica bb; Podgorica (ME)  
 (511) **Klasa 29:** Meso, riba, živina i divljač; mesne prerađevine, konzervisano, sušeno i kuvano voće i povrće; želei, džemovi, kompoti; jaja, mlijeko i mliječni proizvodi; jestiva ulja i masti.  
**Klasa 30:** Kafa, čaj, kakao, šećer, pirinač, tapioka, sago, zamjena kafe; brašno i proizvodi od žitarica, hljeb, kolači, poslastice, sladoledi, med, melasa, kvasac, prašak za pecivo, so, senf; sirće, sosovi (kao začini); začini; led.  
**Klasa 32:** Pivo, mineralne i sodne vode i druga bezalkoholna pića; pića od voća i voćni sokovi; sirupi i drugi preparati za proizvodnju pića.

- 
- (210) **2011-555** (442) **20.03.2013**  
 (220) 14.11.2011  
 (731) **S.C. JONSON & SON, INC.**, 1525 HOWE STREET, RACINE, WISCONSIN 53403-2236 US

## RAID

- (540)  
 (550) I  
 (740) Čejović Vladimir, 13. jula 21, Podgorica (ME)  
 (511) **Klasa 05:** Osvježivači vazduha; dezodoransi za vazduh; preparati koji pročišćavaju vazduh; sintizeri vazduha; dezodoransi za tkanine; dezodoransi za tepihe i sobe.

- 
- (210) **2011-562** (442) **20.03.2013**  
 (220) 16.11.2011  
 (731) **GENERAL MOTORS LLC**, 300 RENAISSANCE CENTER, DETROIT, MICHIGAN 48265-3000 US

## CHEVROLET MYLINK

(540)

(550) I,V,

(740) Radulović Božidar, Jovana Tomaševića 9/III, Podgorica (ME)

(511) **Klasa 9:** elektronski moduli interfejsa koji se prodaju kao sastavni dio motornog vozila za kretanje po zemlji za žični i bežični interfejs ručnih i mobilnih elektronskih uređaja.

(210) **2011-569**

(442) **20.03.2013**

(220) 22.11.2011

(731) **CAESARS INTERACTIVE ENTERTAINMENT,INC**, ONE CAESARS PALACE DRIVE. LAS VEGAS, NEVADA 89109 US

# WSOP

(540)

(550) I

(740) Radulović Božidar, Jovana Tomaševića 9/III, Podgorica (ME)

(511) **Klasa 41:** Usluge obezbjeđivanja elektronskih igara; usluge igranja igara, kockanja i kazina; usluge interaktivnog igranja igara, kockanja i kazina; uključujući obezbjeđivanje onlajn napred navedenih usluga putem kompjuterskih baza podataka ili interneta; usluge televizijske razonode; usluge organizovanja i omogućavanja igranja igara i takmičenja u zabavne svrhe; informacione, konsultantske i savetodavne usluge u vezi sa napred navedenim

(210) **2011-570**

(442) **20.03.2013**

(220) 22.11.2011

(731) **CAESARS INTERACTIVE ENTERTAINMENT,INC**, ONE CAESARS PALACE DRIVE. LAS VEGAS, NEVADA 89109 US



(540)

(550) I

(740) Radulović Božidar, Jovana Tomaševića 9/III, Podgorica (ME)

(511) **Klasa 41:** Usluge obezbjeđivanja elektronskih igara; usluge igranja igara, kockanja i kazina; usluge interaktivnog igranja igara, kockanja i kazina; uključujući obezbjeđivanje onlajn napred navedenih usluga putem kompjuterskih baza podataka ili interneta; usluge televizijske razonode; usluge organizovanja i omogućavanja igranja igara i takmicenja u zabavne svrhe; informacione, konsultantske i savetodavne usluge u vezi sa napred navedenim.;

(210) **2011-581**

(442) **20.03.2013**

(220) 30.11.2011

(731) **DREŠEVIĆ RIFAT**, Šipčanik bb, Tuzi, Podgorica (ME)

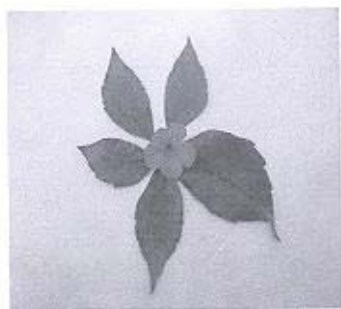

**LAZ +**

(540)

(550) I

(511) **Klasa 05:** Dijeteske supstance prilagođene za upotrebu u medicini; naime biljne kapi za bolesti jetre.

(210) **2011-586**

(442) **20.03.2013**

(220) 1.12.2011

(731) **MEGA DISPOSABLES S.A.**, 148 DEKELIASB ST.,13671 AHARNAI GR

**BABYLINO**

(540)

(550) I

(740) Čejović Vladimir, 13. jula 21, Podgorica (ME)

(511) **Klasa 05:** Pelene.

(210) **2011-588**

(442) **20.03.2013**

(220) 2.12.2011

(731) **BASF AGRO B.V.ARNHEM (NL)**, ZWEIGNIEDERLASSUNG WADENSWIL MOOSACHER-STRASSE 2, AU CH

**MYTHIC**

(540)

(550) I

(740) Stanković Mugoša Ana, Trg Republike 13, Podgorica,(ME)

(511) **Klasa 05:** Preparati za uništavanje i suzbijanje štetočina, fungicidi, herbicidi, pesticidi.

(210) **2011-589**(442) **20.03.2013**

(220) 2.12.2011

(731) **BASF SE**, CARL-BOSCH-STRABE 38 D-67056 LUDWIGSHAFEN AM RHEIN DE**LINOPRAX**

(540)

(550) I

(740) Stanković Mugoša Ana, Trg Republike 13, Podgorica,(ME)

(511) **Klasa 01:** Hemikalije koje se koriste u poljoprivredi, hortikulturi i šumarstvu, naročito preparati za jačanje biljaka, preparati za regulisanje rasta biljaka, hemijski preparati za tretiranje sjemena, površinski-aktivna sredstva, prirodne ili vještačke hemikalije koje se koriste kao seksualni mamci ili agensi za zbimjivanje insekata.**Klasa 05:** Preparati za uništavanje i suzbijanje štetočina, fungicidi, herbicidi, pesticide.(210) **2011-590**(442) **20.03.2013**

(220) 2.12.2011

(731) **BASF AGRO B.V.,ARNHEM (NL)**, ZWEIGNIEDERLASSUNG WADENSWIL MOOSACHERSTRASSE 2, AU CH**MASAI**

(540)

(550) I

(740) Stanković Mugoša Ana, Trg Republike 13, Podgorica,(ME)

(511) **Klasa 05:** Preparati za uništavanje i suzbijanje štetočina, fungicidi, herbicidi, pesticide.(210) **2011-595**(442) **20.03.2013**

(220) 5.12.2011

(731) **MB IMPEKS DOO**, JOVANA BIJELICA BB.7800 BANJA LUKA BA

(540)

(550) I,F

(740) Radulović Božidar, Jovana Tomaševića 9/III, Podgorica (ME)

(511) **Klasa 05:** Gorki liker.

(210) **2011-60**

(442) **20.03.2013**

(220) 4.2.2011

(731) **INDUSTRIJA PIVA I SOKOVA TREBJESA AD NIKŠIĆ**, NJEGOŠEVA BR 18 NIKŠIĆ  
ME

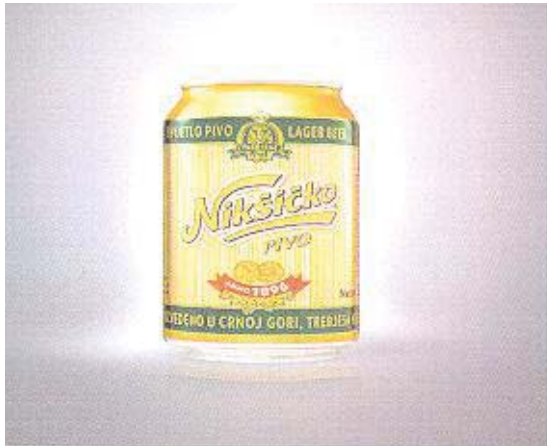

(540)

(550) I

(740) Božović Vesko, Rimski trg 50/11, Podgorica (ME)

(511) **Klasa 32:** pivo, mineralne i sodne vode i druga bezalkoholna pića; pića od voća i voćni sokovi; sirupi i drugi preparati za proizvodnju pića.

**Klasa 35:** oglašavanje; vodenje poslova; poslovno upravljanje; kancelarijski poslovi; usluge koje pružaju lica ili organizacije u pomoći u radu ili upravljanju preduzećima i u vodenju poslova preduzeća; usluge koje pružaju preduzeća koja se bave oglašavanjem (reklamiranjem), tako što, za račun drugih lica, komuniciraju sa javnošću (reklama) putem prenosa bilo kakvih informacija o proizvodima i uslugama omogućavajući potrošačima prigodan pogled na te proizvode i usluge; usluge koje se sastoje od upisivanja, uređivanja, obrade, prerade ili sistematizacije pisanih informacija i zapisa; usluge reklamnih agencija; distribuciju prospekata i uzoraka direktno ili poštom; izradu i korišćenje matematičkih i statističkih podataka; organizovanje sajмова i izložbi u komercijalne ili reklamne svrhe.

(210) **2011-600**

(442) **20.03.2013**

(220) 6.12.2011

(731) **THE GOODYEAR TIRE & RUBBER COMPANY**, 1144 EAST MARKET STREET,  
AKRON, OHIO 44316US

## MARATHON

(540)

(550) I

(740) Čejović Vladimir, 13. jula 21, Podgorica (ME)

(511) **Klasa 12:** gume za kamione za komercijalnu upotrebu.;

(210) 2011-61

(442) 20.03.2013

(220) 4.2.2011

(731) **INDUSTRIJA PIVA I SOKOVA TREBJESA AD NIKŠIĆ**, NJEGOŠEVA BR 18 NIKŠIĆ  
ME

**Uvijek među prijateljima**

(540)

(550) I

(740) Božović Vesko, Rimski trg 50/11, Podgorica (ME)

(511) **Klasa 32:** pivo, mineralne i sodne vode i druga bezalkoholna pića; pića od voća i voćni sokovi; sirupi i drugi preparati za proizvodnju pića.

**Klasa 35:** oglašavanje; vodenje poslova; poslovno upravljanje; kancelarijski poslovi; usluge koje pružaju lica ili organizacije u pomoći u radu ili upravljanju preduzećima i u vodenju poslova preduzeća; usluge koje pružaju preduzeća koja se bave oglašavanjem (reklamiranjem), tako što, za račun drugih lica, komuniciraju sa javnošću (reklama) putem prenosa bilo kakvih informacija o proizvodima i uslugama omogućavajući potrošačima prigodan pogled na te proizvode i usluge; usluge koje se sastoje od upisivanja, uređivanja, obrade, prerade ili sistematizacije pisanih informacija i zapisa; usluge reklamnih agencija; distribuciju prospekata i uzoraka direktno ili poštom; izradu i korišćenje matematičkih i statističkih podataka; organizovanje sajmova i izložbi u komercijalne ili reklamne svrhe.

(210) 2011-62

(442) 20.03.2013

(220) 4.2.2011

(731) **INDUSTRIJA PIVA I SOKOVA TREBJESA AD NIKŠIĆ**, NJEGOŠEVA BR 18 NIKŠIĆ  
ME

**Zajedno možemo mnogo.**

(540)

(550) I

(740) Božović Vesko, Rimski trg 50/11, Podgorica (ME)

(511) **Klasa 32:** pivo, mineralne i sodne vode i druga bezalkoholna pića; pića od voća i voćni sokovi; sirupi i drugi preparati za proizvodnju pića

**Klasa 35:** oglašavanje; vodenje poslova; poslovno upravljanje; kancelarijski poslovi; usluge koje pružaju lica ili organizacije u pomoći u radu ili upravljanju preduzećima i u vodenju poslova preduzeća; usluge koje pružaju preduzeća koja se bave oglašavanjem (reklamiranjem), tako što, za račun drugih lica, komuniciraju sa javnošću (reklama) putem prenosa bilo kakvih informacija o proizvodima i uslugama omogućavajući potrošačima prigodan pogled na te proizvode i usluge; usluge koje se sastoje od upisivanja, uređivanja, obrade, prerade ili sistematizacije pisanih informacija i zapisa; usluge reklamnih agencija; distribuciju prospekata i uzoraka direktno ili poštom; izradu i korišćenje matematičkih i statističkih podataka; organizovanje sajmova i izložbi u komercijalne ili reklamne svrhe.

(210) 2011-73

(442) 20.03.2013

si za jelke, karte za igru;

**Klasa 33:** Alkoholna pića (izuzev piva);  
Crnogorski glasnik intelektualne svojine

**Klasa 35:** Oglašavanje, vodenje poslova, poslovno upravljanje, kancelarijski poslovi.

**Klasa 38:** Telekomunikacije.

(220) 14.2.2011

(731) **INDUSTRIJA PIVA I SOKOVA TREBJESA AD NIKŠIĆ**, NJEGOŠEVA BR 18 NIKŠIĆ  
ME

(540)

(550) I

(740) Božović Vesko, Rimski trg 50/11, Podgorica (ME)

(511) **Klasa 32:** pivo, mineralne i sodne vode i druga bezalkoholna pića; pića od voća i voćni sokovi; sirupi i drugi preparati za proizvodnju pića

**Klasa 35:** oglašavanje; vodenje poslova; poslovno upravljanje; kancelarijski poslovi; usluge koje pružaju lica ili organizacije u pomoći u radu ili upravljanju preduzećima i u vodenju poslova preduzeća; usluge koje pružaju preduzeća koja se bave oglašavanjem (reklamiranjem), tako što, za račun drugih lica, komuniciraju sa javnošću (reklama) putem prenosa bilo kakvih informacija o proizvodima i uslugama omogućavajući potrošačima prigodan pogled na te proizvode i usluge; usluge koje se sastoje od upisivanja, uređivanja, obrade, prerade ili sistematizacije pisanih informacija i zapisa; usluge reklamnih agencija; distribuciju prospekata i uzoraka direktno ili poštom; izradu i korišćenje matematičkih i statističkih podataka; organizovanje sajmova i izložbi u komercijalne ili reklamne svrhe.

(210) **2012-127**(442) **20.03.2013**

(220) 24.2.2012

(731) **LABRIS COMPANY D.O.O.** NEMANJINA 4/9, BEOGRAD RS

(540)

(550) I

(740) Prelevic Dragan, ul.Slobode 74; Podgorica (ME)

(511) **Klasa 14:** dragocjeni metal i njihove legure i proizvodi od dragocenih metala ili sa prevlakom od njih, nakit, bižuterija, drago kamenje, časovničarski i hronometrijski instrumenti;

**Klasa 18:** koža i imitacija kože, proizvodi izrađeni od ovih materijala koji nisu uključeni u druge klase, životinjska koža, koferi i putne torbe, kišobrani, suncobrani i štapovi za hodanje, bičevi, saračka i sedlarska roba;

**Klasa 23:** Pređa i konac za tekstilnu upotrebu;**Klasa 25:** Odjeća, obuća, pokrivala za glavu;**Klasa 26:** čipka i vez, trake (pantljike) i gajtani, dugmad, kopče i petlje, špenadle i igle, vještačko cvijeće;**Klasa 28:** Igre i igračke, gimnastički i sportski artikli koji nisu obuhvaćeni drugim klasama, ukra-

(210) **2009-10** (442) **20.03.2013**  
(220) 14.1.2009

(731) **BARTON GUESTIER S.A.S.**, CHATEAU MAGNOL, 87 RUE DU DEHEZ, 33290 BLANGUE-FORT FR

## BARTON & GUESTIER

(540)  
(550) I  
(740) Čejović Vladimir, 13. jula 21, Podgorica (ME)  
(511) **Klasa 33:** Alkoholna pića.

(210) **2009-502** (442) **20.03.2013**  
(220) 11.8.2009

(731) **TUTUNSKI KOMBINAT AD PRILEP**, UL. MARKSOVA BR. 101 7500 PRILEP MK

## BRAND WHITE

(540)  
(550) I  
(740) Radulović Božidar, Jovana Tomaševića 9/III, Podgorica (ME)  
(511) **Klasa 34:** Duvan za pušače; artikli za pušače, šibice.

(210) **2010-110** (442) **20.03.2013**  
(220) 14.4.2010

(731) **DOO GORATON-PODGORICA ME**



(540)  
(550) I  
(511) **Klasa 09:** aparati i instrumenti naučni, pomorski, geodetski, fotografski, kinemato-grafski, optički, za vaganje, merenje, signalizaciju, kontrolu (inspekciju), spasavanje i nastavu; aparati i instrumenti za provođenje, prekid, transformaciju, akumulaciju, regulisanje i kontrolu elektriciteta; aparati za snimanje, prenos i reprodukovanje zvuka ili slike; magnetni nosioci podataka, diskovi za snimanje; automatske mašine i mehanizmi za aparate koji se pokreću novcem ili žetonom; registar kase, računске mašine, oprema za obradu podataka i kompjuteri; aparati za gašenje požara

**Klasa 15:** muzički instrumenti

**Klasa 35:** oglašavanje; vođenje poslova; poslovno upravljanje; kancelarijski poslovi

**Klasa 41:** obrazovne usluge; pripremanje obuke; razonoda; sportske i kulturne aktivnosti



(210) **2010-294** (442) **20.03.2013**

(220) 16.8.2010

(731) **ISLAND GLOBAL YACHTING LTD** (CAYMAN ISLANDS EXEMPT COMPANY), 717 FIFTH AVENUE, NEW YORK, NEW YORK 10022 US



(540)

(550) I

(740) Čejović Vladimir, 13. jula 21, Podgorica (ME)

(511) **Klasa 35:** Oglasavanje; poslovno upravljanje; poslovna administracija; kancelarijske djelatnosti; marketinske usluge u vezi sa nekretninama; poslovno i administrativno upravljanje marinama, i konsultacije u vezi sa istim; poslovno i administrativno upravljanje komercijalnim i stambenim vlasnistvom, i konsultacije u vezi sa istim; administrativno upravljanje klupskim objektima marine; objedinjavanje razlicitih usluga u vezi sa nekretninama i marinom, za korist drugih, omogucavanje klijentima da pogodno procijene i kupe te usluge.

**Klasa 37:** Gradevinske usluge, usluge opravke i instalacije; usluge razvoja nekretnina, i konsultacije u vezi sa istim; usluge razvoja nekretnina u marinama za stambenu i komercijalnu upotrebu, i konsultacije u vezi sa istim; izgradnja marina; obnova, i renoviranje zgrada; nadgledanje gradevinskih radova; upravljanje gradevinskim projektima; izgradnja hotela, veleprodaje za hranu i piće, maloprodajnih "outlet" radnji, kancelarija, luksuznih vila, apartmana, potkrovlja, gradskih kuca, jahting klubova i naselja u marini, opremanje kancelarija; opremanje objekata namijenjenih za stanovanje; inzinjerske usluge u marini.

**Klasa 39:** Transport; pakovanje i skladistenje robe, putni aranžmani i usluge rezervacije; poslovanje i upravljanje marinama, i konsultacije u vezi sa istim, obezbjeđivanje informacija u vezi sa marinama; usluge pristanista na suvom i u vodi; skladistenje jahti i brodova; transport jahti i brodova; obezbjeđivanje skladisnih objekata i usluga, i konsultacije u vezi sa istim.

(210) **2010-390** (442) **20.03.2013**

(220) 25.10.2010

(731) **KARBON GRADJEVINSKI MATERIJALI D.O.O.TOPOLA**, BULEVAR VOŽDA KARAOĐORĐA 126, 3431 TOPOLA RS

**RAZILIT**

(540)

(550) I

(511) **Klasa 01:** Ljepljive supstance koje se upotrebljavaju u industriji. hemijski proizvodi koji se upotrebljavaju u industriji, nauci, fotografiji, poljoprivredi, hortikulturi i šumarstvu; nepređane vještačke smole, nepređane plastične materije; đubriva; smeše za gašenje vatre; preparati za kaljenje i zavarivanje; hemijske supstance za očuvanje namirnica; materije za štavljenje;

**Klasa 02:** Boje, firnajzi, lakovi; sredstva za zaštitu od rđe i truljenja drveta; materije za bojenje; sredstva za nagrizanje; sirove prirodne smole; metali u obliku listova i praha za slikare, deko-

ratere, štampare i umjetnike.

**Klasa 19:** Građevinski materijali (nemetalni); čvrste nemetalne cevi za građevine; asfalt, crna smola i bitumen; nemetalne prenosne građevine; spomenici, koji nisu od metala.

(210) **2010-391** (442) **20.03.2013**

(220) 25.10.2010

(731) **KARBON GRADJEVINSKI MATERIJALID.O.O.TOPOLA**, BULEVAR VOŽDA KARADORĐA 126, 3431 TOPOLA RS

## POLIFLOR

(540)

(550) I

(511) **Klasa 01:** Lepljive supstance koje se upotrebljavaju u industriji. hemijski proizvodi koji se upotrebljavaju u industriji, nauci, fotografiji, poljoprivredi, hortikulturi i šumarstvu; neprerađene vještačke smole, neprerađene plastične materije; đubriva; smeše za gašenje vatre; preparati za kaljenje i zavarivanje; hemijske supstance za očuvanje namirnica; materije za štavljenje;

**Klasa 02:** Boje, firnajzi, lakovi; sredstva za zaštitu od rđe i truljenja drveta; materije za bojenje; sredstva za nagrizanje; sirove prirodne smole; metali u obliku listova i praha za slikare, dekoratere, štampare i umjetnike.

**Klasa 19:** Građevinski materijali (nemetalni); čvrste nemetalne cevi za građevine; asfalt, crna smola i bitumen; nemetalne prenosne građevine; spomenici, koji nisu od metala.

(210) **2010-392** (442) **20.03.2013**

(220) 25.10.2010

(731) **KARBON GRADJEVINSKI MATERIJALID.O.O.TOPOLA**, BULEVAR VOŽDA KARADORĐA 126, 3431 TOPOLA RS

## SIPROKOL

(540)

(550) I

(511) **Klasa 01:** Lepljive supstance koje se upotrebljavaju u industriji. hemijski proizvodi koji se upotrebljavaju u industriji, nauci, fotografiji, poljoprivredi, hortikulturi i šumarstvu; neprerađene vještačke smole, neprerađene plastične materije; đubriva; smeše za gašenje vatre; preparati za kaljenje i zavarivanje; hemijske supstance za očuvanje namirnica; materije za štavljenje;

**Klasa 02:** Boje, firnajzi, lakovi; sredstva za zaštitu od rđe i truljenja drveta; materije za bojenje; sredstva za nagrizanje; sirove prirodne smole; metali u obliku listova i praha za slikare, dekoratere, štampare i umjetnike.

**Klasa 19:** Građevinski materijali (nemetalni); čvrste nemetalne cijevi za građevine; asfalt, crna smola i bitumen; nemetalne prenosne građevine; spomenici, koji nisu od metala.

(210) **2010-393** (442) **20.03.2013**

(220) 25.10.2010

(731) **KARBON GRADJEVINSKI MATERIJALID.O.O.TOPOLA**, BULEVAR VOŽDA KARADORĐA 126, 3431 TOPOLA RS**KARBOSIL**

(540)

(550) I

(511) **Klasa 01:** Lepljive supstance koje se upotrebljavaju u industriji. hemijski proizvodi koji se upotrebljavaju u industriji, nauci, fotografiji, poljoprivredi, hortikulturi i šumarstvu; neprerađene vještačke smole, neprerađene plastične materije; đubriva; smeše za gašenje vatre; preparati za kaljenje i zavarivanje; hemijske supstance za očuvanje namirnica; materije za štavljenje;**Klasa 02:** Boje, firnajzi, lakovi; sredstva za zaštitu od rđe i truljenja drveta; materije za bojenje; sredstva za nagrizanje; sirove prirodne smole; metali u obliku listova i praha za slikare, dekoratere, štampare i umjetnike.**Klasa 19:** Građevinski materijali (nemetalni); čvrste nemetalne cevi za građevine; asfalt, crna smola i bitumen; nemetalne prenosne građevine; spomenici, koji nisu od metala.(210) **2010-404**(442) **20.03.2013**

(220) 2.11.2010

(731) **D-LINK CORPORATION**, NO.289,SINHU 3RD ROAD, NEIHU DISTRICT, TAIPEI CITY 114, TW**D-Link**

(540)

(550) I

(740) Radulović Božidar, Jovana Tomaševića 9/III, Podgorica (ME)

(511) **Klasa 09:** Mrežne kartice, interfejs kartice, čvorišta, prekidači, mostovi, ruter sa mostom, ruteri, napajanja, prenosiooci, integrisana kola, integrisana kola sa velikim brojem elemenata, adapteri, koncentratori, primopredajnici, ethernet primopredajnici, magnetne trake ili diskovi ili CD-ROM-ovi snimljeni sa programima za mreže, kompjuterski programi, kompjuterski softveri, antene, zaštitni zid za rad na mreži (firewall), mrežni adapteri, modemi, kablovski modemi, kablovski ruteri, bežični kablovski modemi, bežični kablovski ruteri, PC kamere (kamere za personalne računare), uređaji za snimanje videa, TV tjuneri, AV konvertori (audio/video konvertori), IP kamere (kamere za internet protokol), kompakt fleš kartice, blutut modemi, blutut adapter, blutut slušalice, blutut adapteri za štampače, blutut pristupne jedinice, bežične mrežne kartice, bežične pristupne jedinice, bežični portali, bežični serveri za štampače, bežične kompakt fleš kartice, bežični konvertori, bežični audio adapteri, bežični medija plejeri, ruteri za kućnu upotrebu, VPN portali (portali za virtuelnu privatnu mrežu), VPN ruteri (ruteri za virtuelnu privatnu mrežu), PC zaštitni zid (firewall),

serveri za štampače, IP telefoni (internet protokol telefoni), internet video telefoni, bežični ruteri za igranje igara, bežični adapteri za igranje igara, DMA (digitalni medija adapteri), internet kamere, jedinice za pohranjivanje podataka na mrežama, KVM prekidači (tastatura/video ekran/miš prekidači), USB fleš drajvovi (fleš drajvovi za univerzalnu serijsku magistralu), USB čvorišta (čvorišta za univerzalnu serijsku magistralu), USB adapteri (adapteri za univerzalnu serijsku magistralu), VoIP protokoli (protokoli za prenos glasa preko interneta), IP-PBX (internet protokol-privatne telefonske centrale), splitter, protokoli za bezbednost informacija, DSL modemi (modemi za digitalne pretplatničke linije), DSL ruteri (ruteri za digitalne pretplatničke linije), bežični DSL modemi, bežični DSL ruteri, ADSL modemi (modemi za asimetrične digitalne pretplatničke linije), ADSL ruteri (ruteri za asimetrične digitalne pretplatničke linije), VDSL prekidači (prekidači za DSL velike brzine), VDSL modemi (modemi za DSL velike brzine), SHDSL (pojedinačne digitalne pretplatničke linije sa visokim nivoom protoka), ISDN ruteri (ruteri za digitalnu telefoniju), ISDN terminal ruteri (terminal ruteri za digitalnu telefoniju), ISDN terminal adapteri (terminal adapteri za digitalnu telefoniju), CD plejeri, set-top box, analogni modemi, DSC (digitalni fotoaparati), internet radio, jedinice za skladištenje medija, MP3 plejer, CD-RW/DVD-RW (CD-ovi i DVD-ovi na kojima se može ponovo pisati), čitači kartica.

(210) **2010-431** (442) **20.03.2013**  
(220) 18.11.2010

(731) **ČISTI KRISTAL 000**, 6, UGOLNAYA, MYTISHCHI, MOSKOVSKA REGIJA, 141013 RU

## KALINKA

(540)

(550) I

(511) **Klasa 33:** Aperativi, Rakije, Vina, "Piquette"(komina,itd), Viski, Vodka, Džin, Digestivi (likeri i alkoholna pića), Kokteli na bazi alkohola, Alkoholni kokteli koji sadrže votku i/ili pelinkovac, Likeri, Alkoholna pića koja sadrže voće, Alkoholna pića, osim piva, Destilovana alkoholna pića, Žestoka alkoholna pića, Pića sa voćnim sokom koja sadrže alkohol, Medovina (hidromel), Likeri od nane, Likeri od ljekovitih biljaka, Rum, Sake, Jabukovače, Pirinčani alkohol, Alkoholni ekstrakti, Alkoholni voćni ekstrakti, Alkoholne esencije.

(210) **2011-1** (442) **20.03.2013**  
(220) 4.1.2011

(731) **ALFA WASSERMANN HANGARY KFT**, 1054 BUDAPEST, GARIBALDI U.4. HU

## XIFAXAN

(540)

(550) I

(511) **Klasa 05:** Farmaceutski i veterinarski preparati; Sanitarni preparati za medicinsku upotrebu; Dijetetske supstance prilagođene za upotrebu u medicini, hrana za bebe; Flasteri, materijali za zavijanje; Materijali za plombiranje zuba, zubarska smola; Dezinfekciona sredstva; Preparati za uništavanje štetočina; Fungicidi; Herbicidi;

(210) **2011-101** (442) **20.03.2013**

(220) 2.3.2011

(731) **CARPE DIEM GMBH & CO KG**, AM BRUNNEN 1,5330 FUSCHL AM SEE AT

(540)

(550) I

(740) Ćupić Branislav, Dalmatinska 10, Podgorica (ME)

(511) **Klasa 32:** Bezalkoholni napitci, voćni napitci, voćni sokovi, limunade, osvježavajuća pića, uključujući pića koja sadrže čaj, šećer, saharozu, glukozu, fruktozu, kvasac i mliječnu kiselinu; energetska pića, izotonična, hipertonična i hipotonična pića (koja koriste sportisti i/ili za potrebe sportista); napitci od surutke; mineralne i sodne vode; sirupi, esencije i drugi preparati za proizvodnju pića kao i pjenušajuće tablete i pjenušajući praškovi za pića i bezalkoholne koktele; pivo, hranljivo pivo, pivo od slada, pivo od žita, tamno (porter) pivo, svijetlo (ale) pivo, stout pivo i lager pivo; bezalkoholna pića od slada; kvas (napitak koji se dobija fermentacijom raži).

(210) **2011-102**(442) **20.03.2013**

(220) 2.3.2011

(300) 25 01 2011 DE 30 2011 000 703.9/09

(731) **ORACLE INTERNATIONAL CORPORATION**, 500 ORACLE PARKWAY REDWOOD SHORES, CALIFORNIA 94065 US

## SUPERCLUSTER

(540)

(550) I

(740) Radulović Božidar, Jovana Tomaševića 9/III, Podgorica (ME)

(511) **Klasa 9:** Kompjuterski hardver i kompjuterski softver.(210) **2011-103**(442) **20.03.2013**

(220) 3.3.2011

(731) **CORDIS CORPORATION**, 430 ROUTE 22 BRIDGEWATER, NEW JERSEY 08807 US

# POWERFLEX

(540)

(550) I

(740) Radulović Božidar, Jovana Tomaševića 9/III, Podgorica (ME)

(511) **Klasa 10:** Balon kateteri za angioplastiku.

---

(210) **2011-104**

(442) **20.03.2013**

(220) 3.3.2011

(731) **GENERAL MOTORS LLC**, 300 RENAISSANCE CENTER DETROIT, MICHIGAN 48265-3000 US

# MAKE IT HAPPEN

(540)

(550) I

(740) Radulović Božidar, Jovana Tomaševića 9/III, Podgorica (ME)

(511) **Klasa 12:** Motorna vozila i dijelovi za njih.

---

(210) **2011-105**

(442) **20.03.2013**

(220) 3.3.2011

(731) **SAUDI ARABIA OIL COMPANY**, 1 EASTERN AVENUE, DHAHRAN, 31311 SA

# SADARA

(540)

(550) I

(740) Popović Miladin, Đoka Miraševića 21/III, Podgorica (ME)

(511) **Klasa 01:** Hemijski proizvodi i neperđene plastične materije za dalju proizvodnju.

---

(210) **2011-106**

(442) **20.03.2013**

(220) 3.3.2011

(731) **NINE WEST DEVELOPMENT CORPORATION**, 1007 ORANGE STREET, SUITE 225, WILMINGTON, DELAWARE 19801 US

## LOVE FURY

(540)

(550) I

(740) Čejović Vladimir, 13. jula 21, Podgorica (ME)

(511) **Klasa 03:** Parfemi, toaletne vode, mirisni sprejevi, sapuni, sredstva za čišćenje kože, losioni i kreme za kožu, hidratne kreme, losioni i ulja za zatampljivanje kože; kozmetički proizvodi, naime, puderi za lice i tijelo, podloga, sjaj za tijelo, sjaj za lice, karmin, olovke za usne, rumenilo, sjenka za oči, krema za oči, ajlajner, maskara i olovke za obrve; gel za tuširanje; soli za kupanje; proizvodi za njegu kose, naime šampon i balsam; potpuri.

(210) **2011-107**

(442) **20.03.2013**

(220) 7.3.2011

(731) **JADRAN GALENSKI LABORATORIJ DD**, RIJEKA, PULAC BB HR

## KAO KAP VODE NA DLANU

(540)

(550) I

(740) Popović Miladin, Đoka Miraševića 21/III, Podgorica (ME)

(511) **Klasa 01:** Hemijski proizvodi koji se upotrebljavaju u industriji, nauci, fotografiji, poljoprivredi, hortikulturi, šumarstvu; neprerađene vještačke smole, neprerađene plastične materije; đubriva; hemijske supstance za očuvanje namirnica; lepljive supstance koje se upotrebljavaju u industriji.

**Klasa 03:** Sredstva za beljenje i druge supstance za upotrebu u perionicama; preparati za čišćenje, poliranje, ribanje i nagrizanje; sapuni; parfimerija, eterična ulja, ulje za kozmetičke potrebe, ulje za parfimeriju, ulje za čišćenje, kozmetički proizvodi, kozmetički preparati za sunčanje, kozmetički proizvodi za negu kože, kozmetički preparati za kupanje, kozmetički proizvodi za mršavljenje, kreme za kozmetičke potrebe, toaletni proizvodi, losioni, losioni za kosu; šamponi, proizvodi za negu zuba, negu usta.

**Klasa 05:** Lekovi za humanu medicinu, medicinski proizvodi, farmaceutski i veterinarski proizvodi; hemijsko-farmaceutski proizvodi, hemijski reagensi za medicinske potrebe, kreme za medicinske potrebe, higijenski proizvodi za upotrebu u medicini; dijetetski proizvodi, dijetetske supstance za medicinske potrebe, biološki preparati za medicinske potrebe, lekoviti čajevi, masti za farmaceutske potrebe, masti za medicinske potrebe, medicinski čaj, medicinski napici, sirup za farmaceutske potrebe, vitaminski preparati, hrana za bebe, flasteri, materijali za zavijanje; materijali za plombiranje zuba, zubarska smola; losioni za farmaceutsku upotrebu, dezinfekciona sredstva; proizvodi za uništavanje životinjskih štetočina; fungicidi, herbicidi.

**Klasa 10:** Hirurški, medicinski, zubarski i veterinarski aparati, instrumenti i pomagala; ortoped-

ski artikli; materijali za zašivanje.

**Klasa 30:** Kafa, čaj, kakao, šećer, pirinač, brašno i proizvodi od žitarica, pića, pastile (poslastice), hleb, kolači, poslastice, bombone; sladoled; med, melasa; alge, kvasac, prašak za pecivo; so, senf; sirće, sosovi (kao dodaci); mirođija; led za hlađenje.

**Klasa 35:** Oglašavanje i reklamiranje; vođenje komercijalnih poslova; komercijalna administracija; kancelarijski poslovi.

**Klasa 42:** Naučne usluge; usluge analiza (hemijske analize); bakteriološka istraživanja; biološka istraživanja; istraživanja u kozmetici; istraživanje i razvoj novih proizvoda; istraživanja u hemiji; kozmetička nauka (istraživanja u kozmetičkoj nauci).

**Klasa 44:** Medicinske usluge; higijenska nega i nega lepote za ljude; aromaterapija; estetska hirurgija; bolničke usluge; usluge farmaceuta; savetovanje o farmaciji; fizioterapija; klinike; kupke; usluge ulepšavanja; masaža; medicinska pomoć; oporavak; usluge sauna; usluge solarijuma; usluge banja; zdravstvene usluge.

(210) **2011-108**

(442) **20.03.2013**

(220) 7.3.2011

(731) **JADRAN GALENSKI LABORATORIJ DD**, RIJEKA, PULAC BB HR



(540)

(550) I

(740) Popović Miladin, Đoka Miraševića 21/III, Podgorica (ME)

(511) **Klasa 01:** Hemijski proizvodi koji se upotrebljavaju u industriji, nauci, fotografiji, poljoprivredi, hortikulturi, šumarstvu; neprerađene vještačke smole, neprerađene plastične materije; đubriva; hemijske supstance za očuvanje namirnica; lepljive supstance koje se upotrebljavaju u industriji.

**Klasa 03:** Sredstva za beljenje i druge supstance za upotrebu u perionicama; preparati za čišćenje, poliranje, ribanje i nagrizanje; sapuni; parfimerija, eterična ulja, ulje za kozmetičke potrebe, ulje za parfimeriju, ulje za čišćenje, kozmetički proizvodi, kozmetički preparati za sunčanje, kozmetički proizvodi za negu kože, kozmetički preparati za kupanje, kozmetički proizvodi za mršavljenje, kreme za kozmetičke potrebe, toaletni proizvodi, losioni, losioni za kosu; šamponi, proizvodi za negu zuba, negu usta.

**Klasa 05:** Lekovi za humanu medicinu, medicinski proizvodi, farmaceutski i veterinarski proizvodi; hemijsko-farmaceutski proizvodi, hemijski reagensi za medicinske potrebe, kreme za medicinske potrebe, higijenski proizvodi za upotrebu u medicini; dijetetski proizvodi, dijetetske supstance za medicinske potrebe, biološki preparati za medicinske potrebe, lekoviti čajevi, masti za farmaceutske potrebe, masti za medicinske potrebe, medicinski čaj, medicinski napici, sirup za farmaceutske potrebe, vitaminski preparati, hrana za bebe, flasteri, materijali za zavijanje; materijali za plombiranje zuba, zubarska smola; losioni za farmaceutsku upotrebu, dezinfekciona sredstva; proizvodi za uništavanje životinjskih štetočina; fungicidi, herbicidi.

**Klasa 10:** Hirurški, medicinski, zubarski i veterinarski aparati, instrumenti i pomagala; ortoped-



ski artikli; materijali za zašivanje.

**Klasa 30:** Kafa, čaj, kakao, šećer, pirinač, brašno i proizvodi od žitarica, pića, pastile (poslastice), hleb, kolači, poslastice, bombone; sladoled; med, melasa; alge, kvasac, prašak za pecivo; so, senf; sirće, sosovi (kao dodaci); mirođija; led za hlađenje.

**Klasa 35:** Oglašavanje i reklamiranje; vođenje komercijalnih poslova; komercijalna administracija; kancelarijski poslovi.

**Klasa 42:** Naučne usluge; usluge analiza (hemijske analize); bakteriološka istraživanja; biološka istraživanja; istraživanja u kozmetici; istraživanje i razvoj novih proizvoda; istraživanja u hemiji; kozmetička nauka (istraživanja u kozmetičkoj nauci).

**Klasa 44:** Medicinske usluge; higijenska nega i nega lepote za ljude; aromaterapija; estetska hirurgija; bolničke usluge; usluge farmaceuta; savetovanje o farmaciji; fizioterapija; klinike; kupke; usluge ulepšavanja; masaža; medicinska pomoć; oporavak; usluge sauna; usluge solarijuma; usluge banja; zdravstvene usluge.

(210) **2011-109**

(442) **20.03.2013**

(220) 7.3.2011

(731) **JADRAN GALENISKI LABORATORIJ DD**, RIJEKA, PULAC BB HR



(540)

(550) I

(740) Popović Miladin, Đoka Miraševića 21/III, Podgorica (ME)

(511) **Klasa 01:** Hemijski proizvodi koji se upotrebljavaju u industriji, nauci, fotografiji, poljoprivredi, hortikulturi, šumarstvu; neprerađene vještačke smole, neprerađene plastične materije; đubriva; hemijske supstance za očuvanje namirnica; lepljive supstance koje se upotrebljavaju u industriji.

**Klasa 03:** Sredstva za beljenje i druge supstance za upotrebu u perionicama; preparati za čišćenje, poliranje, ribanje i nagrizanje; sapuni; parfimerija, eterična ulja, ulje za kozmetičke potrebe, ulje za parfimeriju, ulje za čišćenje, kozmetički proizvodi, kozmetički preparati za sunčanje, kozmetički proizvodi za negu kože, kozmetički preparati za kupanje, kozmetički proizvodi za mršavljenje, kreme za kozmetičke potrebe, toaletni proizvodi, losioni, losioni za kosu; šamponi, proizvodi za negu zuba, negu usta.

**Klasa 05:** Lekovi za humanu medicinu, medicinski proizvodi, farmaceutski i veterinarski proizvodi; hemijsko-farmaceutski proizvodi, hemijski reagensi za medicinske potrebe, kreme za medicinske potrebe, higijenski proizvodi za upotrebu u medicini; dijetetski proizvodi, dijetetske supstance za medicinske potrebe, biološki preparati za medicinske potrebe, lekoviti čajevi, masti za farmaceutske potrebe, masti za medicinske potrebe, medicinski čaj, medicinski napici, sirup za farmaceutske potrebe, vitaminski preparati, hrana za bebe, flasteri, materijali za zavijanje; materijali za plombiranje zuba, zubarska smola; losioni za farmaceutsku upotrebu, dezinfekciona sredstva; proizvodi za uništavanje životinjskih štetočina; fungicidi, herbicidi.

**Klasa 10:** Hirurški, medicinski, zubarski i veterinarski aparati, instrumenti i pomagala; ortopedski artikli; materijali za zašivanje.

**Klasa 30:** Kafa, čaj, kakao, šećer, pirinač, brašno i proizvodi od žitarica, pića, pastile (poslastice), hleb, kolači, poslastice, bombone; sladoled; med, melasa; alge, kvasac, prašak za pecivo; so, senf; sirće, sosovi (kao dodaci); mirođija; led za hlađenje.

**Klasa 35:** Oglašavanje i reklamiranje; vođenje komercijalnih poslova; komercijalna administracija; kancelarijski poslovi.

**Klasa 42:** Naučne usluge; usluge analiza (hemijske analize); bakteriološka istraživanja; biološka istraživanja; istraživanja u kozmetici; istraživanje i razvoj novih proizvoda; istraživanja u hemiji; kozmetička nauka (istraživanja u kozmetičkoj nauci).

**Klasa 44:** Medicinske usluge; higijenska nega i nega lepote za ljude; aromaterapija; estetska hirurgija; bolničke usluge; usluge farmaceuta; savetovanje o farmaciji; fizioterapija; klinike; kupke; usluge ulepšavanja; masaža; medicinska pomoć; oporavak; usluge sauna; usluge solarijuma; usluge banja; zdravstvene usluge.

---

(210) **2011-11** (442) **20.03.2013**

(220) 11.1.2011

(731) **BRISTOL-MYERS SQUIBB SARL A FRENCH LIMITED LIABILITY COMPANY**, 3, RUE JOSEPH MONIER, 92500 RUEIL-MALMAISON FR

# UPSARIN

(540)

(550) I

(740) Ćupić Branislav, Dalmatinska 10, Podgorica (ME)

(511) **Klasa 05:** Farmaceutski preparati za ljudsku upotrebu.

---

(210) **2011-113** (442) **20.03.2013**

(220) 9.3.2011

(731) **BOSNALIJEK**, JUKIĆEVA 53, 71000 SARAJEVO BA

# MELPAMID

(540)

(550) I

(740) Radulović Božidar, Jovana Tomaševića 9/III, Podgorica (ME)

(511) **Klasa 05:** Farmaceutski proizvodi.

---

(210) **2011-114** (442) **20.03.2013**

(220) 9.3.2011

(731) **BOSNALIJEK**, FARMACEUTSKA I HEMIJSKA INDUSTRIJA, DD, JUKIĆEVA 53, 71000 SARAJEVO BA

# FLEXOFEN

(540)

(550) I

(740) Radulović Božidar, Jovana Tomaševića 9/III, Podgorica (ME)

(511) **Klasa 05:** Farmaceutski proizvodi.

---

(210) **2011-12**

(442) **20.03.2013**

(220) 11.1.2011

(731) **BRISTOL-MYERS SQUIBB COMPANY A DELAWARE CORPORATION**, 345  
PARK AVENUE, NEW YORK, NEW YORK 10154 US

# CCNU

(540)

(550) I

(740) Ćupić Branislav, Dalmatinska 10, Podgorica (ME)

(511) **Klasa 5:** Farmaceutski preparati za ljudsku upotrebu.

---

(210) **2011-13**

(442) **20.03.2013**

(220) 11.1.2011

(731) **SOLGAR HOLDINGS INC.**, 2100 SMITHTOWN AVENUE, RONKONKOMA, NEW YORK,  
11779 US



(540)

(550) I

(740) Lutovac Branislav, Bulevar Crnojevića 93, Podgorica (ME)

(511) **Klasa 05:** Vitamini; dijetetski, hranljivi i biljni dodaci za ishranu.

---

(210) **2011-14**

(442) **20.03.2013**

(220) 12.1.2011

(731) **TOYOTA JIDOSHA KABUSHIKI KAISHA/ALSO TRADING AS TOYOTA MOTOR CORPORATION** 1, TOYOTA-CHO, TOYOTA-SHI, AICHI-KEN JP

GS250

(540)

(550) I

(740) Čejović Vladimir, 13. jula 21, Podgorica (ME)

(511) **Klasa 12:** Automobili i njihovi strukturni dijelovi.

---

(210) **2011-16** (442) **20.03.2013**  
(220) 13.1.2011

(731) **GENERAL MOTORS LLC**, 300 RENAISSANCE CENTER, DETROIT, MICHIGAN 48265-3000 US

**GRAND BLAZER**

(540)

(550) I

(740) Radulović Božidar, Jovana Tomaševića 9/III, Podgorica (ME)

(511) **Klasa 12:** Motorna vozila i dijelovi za njih.

---

(210) **2011-18** (442) **20.03.2013**  
(220) 14.1.2011

(731) **GENZYME CORPORATION**, 500 KENDALL STREET CAMBRIDGE, MASSACHUSETTS 02142 US

**REMNIQ**

(540)

(550) I

(740) Radulović Božidar, Jovana Tomaševića 9/III, Podgorica (ME)

(511) **Klasa 05:** Farmaceutski i veterinarski preparati; sanitarni preparati za medicinske svrhe; dijetetske supstance za upotrebu u medicini, hrana za bebe; flasteri, materijal za zavijanje; materijali za plombiranje zuba, zubarska smola; dezinfekciona sredstva; preparati za uništa-

vanje štetočina; fungicidi, herbicidi; naročito terapijska antitijela za upotrebu kao anti-limfocitična sredstva.

(210) **2011-19** (442) **20.03.2013**

(220) 14.1.2011

(731) **GENZYME CORPORATION**, 500 KENDALL STREET CAMBRIDGE, MASSACHUSETTS 02142 US

## KYNAMRO

(540)

(550) I

(740) Radulović Božidar, Jovana Tomaševića 9/III, Podgorica (ME)

(511) **Klasa 05:** Farmaceutski i veterinarski preparati; sanitarni preparati za medicinske svrhe; dijetetske supstance za upotrebu u medicini, hrana za bebe; flasteri, materijal za zavijanje; materijali za plombiranje zuba, zubarska smola; dezinfekciona sredstva; preparati za uništavanje štetočina; fungicidi, herbicidi; naročito terapijska antitijela za upotrebu kao anti-limfocitična sredstva.

(210) **2011-2** (442) **20.03.2013**

(220) 10.1.2011

(731) **FRES & CO. DOO**, IVANA GORANA KOVAČIĆA 3, SUBOTICA 24000 RS

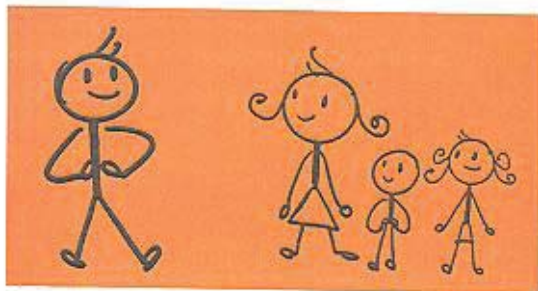

(540)

(550) I

(740) Popović Miladin, Đoka Miraševića 21/III, Podgorica (ME)

(511) **Klasa 32:** Piva; mineralne i sodne vode i druga bezalkoholna pića; pića od voća i voćni sokovi; sirupi i drugi preparati za proizvodnju pića.

(210) **2011-20** (442) **20.03.2013**

(220) 14.1.2011

(731) **GENZYME CORPORATION**, 500 KENDALL STREET CAMBRIDGE, MASSACHUSETTS 02142 US

# LEMTRADA

(540)

(550) I

(740) Radulović Božidar, Jovana Tomaševića 9/III, Podgorica (ME)

(511) **Klasa 05:** Farmaceutski i veterinarski preparati; sanitarni preparati za medicinske svrhe; dijetetske supstance za upotrebu u medicini, hrana za bebe; flasteri, materijal za zavijanje; materijali za plombiranje zuba, zubarska smola; dezinfekciona sredstva; preparati za uništavanje štetočina; fungicidi, herbicidi; naročito terapijska antitijela za upotrebu kao anti-limfocitična sredstva.

---

(210) **2011-21**

(442) **20.03.2013**

(220) 14.1.2011

(731) **GENZYME CORPORATION**, 500 KENDALL STREET CAMBRIDGE, MASSACHUSETTS 02142 US

# CAMPATH

(540)

(550) I

(740) Radulović Božidar, Jovana Tomaševića 9/III, Podgorica (ME)

(511) **Klasa 05:** Farmaceutski i veterinarski preparati; sanitarni preparati za medicinske svrhe; dijetetske supstance za upotrebu u medicini, hrana za bebe; flasteri, materijal za zavijanje; materijali za plombiranje zuba, zubarska smola; dezinfekciona sredstva; preparati za uništavanje štetočina; fungicidi, herbicidi; naročito terapijska antitijela za upotrebu kao anti-limfocitična sredstva.

---

(210) **2011-22**

(442) **20.03.2013**

(220) 17.1.2011

(731) **KRKA TOVARNA ZDRAVIL**, DD, NOVO MESTO, SMAJEVA CESTA 6 SI

# URTIRON

(540)

(550) I

(740) Popović Miladin, Đoka Miraševića 21/III, Podgorica (ME)

(511) **Klasa 05:** Farmaceutski proizvodi.

(210) **2011-23**

(442) **20.03.2013**

(220) 17.1.2011

(731) **KRKA, TOVARNA ZDRAVIL**, DD NOVO MESTO, NOVO MESTO, SMAJEVA CESTA 6 SI

## ETOGEL

(540)

(550) I

(740) Popović Miladin, Đoka Miraševića 21/III, Podgorica (ME)

(511) **Klasa 05:** Farmaceutski proizvodi-lijekovi.

---

(210) **2011-24**

(442) **20.03.2013**

(220) 20.1.2011

(731) **NATIONAL GEOGRAPHIC SOCIETY**, 1145 STREET, N.W., WASHINGTON, D.C.20036  
US

## NATIONAL GEOGRAPHIC TRAVELLER

(540)

(550) I

(740) Popović Miladin, Đoka Miraševića 21/III, Podgorica (ME)

(511) **Klasa 38:** Telekomunikacije; usluge televizijskog i radio emitovanja; usluge emitovanja kablovske televizije; usluge televizijskog emitovanja za ograničeni auditorijum; audio i video emitovanja putem interneta.

**Klasa 41:** Obrazovne usluge; obezbeđivanje obuke; razonoda; sportske i kulturne aktivnosti; produkcija televizijskih programa; pružanje onlajn igrice i aktivnosti za decu; pružanje onlajn mapa; pružanje onlajn rasporeda za događaje uživo i izložbe.

---

(210) **2011-27**

(442) **20.03.2013**

(220) 24.1.2011

(731) **GUESS? INC.**, 1444 SOUTH ALAMEDA STREET, LOS ANGELES, CA 90021US

## PAUL MARCIANO

(540)

(550) I

(740) Lutovac Branislav, Bulevar Crnojevića 93, Podgorica (ME)

(511) **Klasa 25:** Muška, ženska odeća, odeća za dečake i devojčice, decu i bebe, posebno donji veš, obuća, kupaći kostimi, kape, pokrivala za glavu, ogrtači, kućne haljine, spavaćice, odore, pidžame, čarape, rukavice, naramenice, kaiševi, kravate, potkošulje, čarape, majice, majice sa kratkim rukavima, donji delovi trenerke, gornji delovi trenerke, pleteni gornji delovi odeće, suknje, pantalone, šorcevi, duksevi, farmerke, prsluci, kaputi, jakne, radnička odela/kombinezoni, blejzeri, haljine, marame, bluze, džemper (kardigani), ogrtači, majice za golf, odela za trčanje, rolke, odela i polo majice; ženske gaće, brushalteri, uske majice, kratke majice, steznici, grudnjaci, ženske duže gaće i bodi kombinezoni; muške slip gaće i bokserice.

(210) **2011-28**(442) **20.03.2013**

(220) 24.1.2011

(731) **GUESS? INC.**, 1444 SOUTH ALAMEDA STREET, LOS ANGELES, CA 90021 US

## GUESS by PAUL MARCIANO

(540)

(550) I

(740) Lutovac Branislav, Bulevar Crnojevića 93, Podgorica (ME)

(511) **Klasa 25:** Muška, ženska odeća, odeća za dečake i devojčice, decu i bebe, posebno donji veš, obuća, kupaći kostimi, kape, pokrivala za glavu, ogrtači, kućne haljine, spavaćice, odore, pidžame, čarape, rukavice, naramenice, kaiševi, kravate, potkošulje, čarape, majice, majice sa kratkim rukavima, donji delovi trenerke, gornji delovi trenerke, pleteni gornji delovi odeće, suknje, pantalone, šorcevi, duksevi, farmerke, prsluci, kaputi, jakne, radnička odela/kombinezoni, blejzeri, haljine, marame, bluze, džemper (kardigani), ogrtači, majice za golf, odela za trčanje, rolke, odela i polo majice; ženske gaće, brushalteri, uske majice, kratke majice, steznici, grudnjaci, ženske duže gaće i bodi kombinezoni; muške slip gaće i bokserice.

(210) **2011-3**(442) **20.03.2013**

(220) 10.1.2011



(731) **FRESH & CO.DOO**, IVANA GORANA KOVAČIĆA 3, SUBOTICA 24000 RS

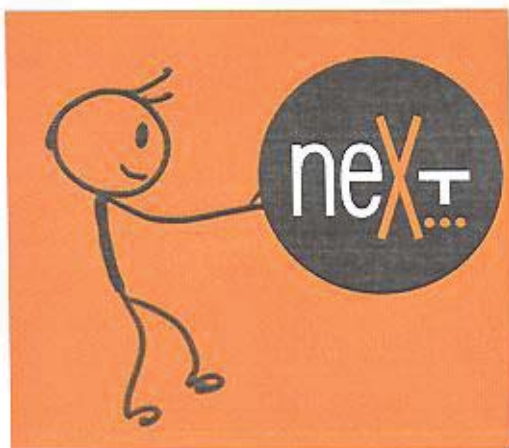

(540)

(550) I

(740) Popović Miladin, Đoka Miraševića 21/III, Podgorica (ME)

(511) **Klasa 32:** Piva; mineralne i sodne vode i druga bezalkoholna pića; pića od voća i voćni sokovi; sirupi i drugi preparati za proizvodnju pića.

(210) **2011-30**

(442) **20.03.2013**

(220) 24.1.2011

(731) **THE QUAKER OATS COMPANY**, 555 WEST MONROE STREET, CHICAGO, ILLIONS 60661 US;



(540)

(550) I

(740) Čejović Vladimir, 13. jula 21, Podgorica (ME)

(511) **Klasa 29:** Meso, riba, živina i divljač; mesne prerađevine; konzervisano, zamrznuto, sušeno i kuvano voće i povrće; želei; džemovi, kompoti; jaja, mlijeko i mliječni proizvodi; jestiva ulja i masti

**Klasa 30:** Kafa, čaj, kakao, šećer, pirinac, tapioka, sago, zamjena kafe; brašno i proizvodi od

žitarica, hljeb, kolači i poslastice, sladoledi; med, melasa; kvasac, prašak za pecivo; so, senf; sirće, sosevi (kao začini); začini; led

(210) **2011-32** (442) **20.03.2013**

(220) 26.1.2011

(731) **LOADING DOO**, SVETI STASIJE K4/A1 KOTOR ME



(540)

(550) I

(511) **Klasa 16:** štampane stvari (časopis).

**Klasa 35:** Reklamiranje putem oglasa u časopisu, reklamiranje putem web site-a

(210) **2011-33** (442) **20.03.2013**

(220) 26.1.2011

(731) **T.C. DEBICA S.A.**, 1,1, MAJA ST., 39-200 DEBICA PL

FRIGO

(540)

(550) I

(740) Čejović Vladimir, 13. jula 21, Podgorica (ME)

(511) **Klasa 12:** Gume.

(210) **2011-34** (442) **20.03.2013**

(220) 26.1.2011

(731) **TOYOTA JIDOSHA KABUSHIKI KAISHA**, 1, TOYOTA-CHO, TOYOTA-SHI, AICHI-KEN JP

TOYOTA  
TOUCH & GO

(540)

(550) I

(740) Čejović Vladimir, 13. jula 21, Podgorica (ME)

(511) **Klasa 09:** Uređaj za prenos zvuka sa ekranom i navigacionim sistemom za automobile.

---

(210) **2011-35** (442) **20.03.2013**

(220) 26.1.2011

(731) **TOYOTA JIDOSHA KABUSHIKI KAISHA**, 1, TOYOTA-CHO, TOYOTA-SHI, AICHI-KEN JP

## TOYOTA TOUCH

(540)

(550) I

(740) Čejović Vladimir, 13. jula 21, Podgorica (ME)

(511) **Klasa 09:** Uređaji za prenos zvuka sa ekranom za automobile.

---

(210) **2011-39** (442) **20.03.2013**

(220) 31.1.2011

(731) **THE GILLETTE COMPANY**, ONE GILLETTE PARK, BOSTON, MA 02127 US

## DRY TECH

(540)

(550) I

(740) Lutovac Branislav, Bulevar Crnojevića 93, Podgorica (ME)

(511) **Klasa 03:** Antiperspiranti i dezodoransi za ličnu upotrebu.

---

(210) **2011-41** (442) **20.03.2013**

(220) 31.1.2011

(731) **THE GILLETTE COMPANY**, ONE GILLETTE PARK, BOSTON, MA 02127 US

## MACH3

(540)

(550) I

(740) Lutovac Branislav, Bulevar Crnojevića 93, Podgorica (ME)

(511) **Klasa 03:** Sapuni, parfimerijski proizvodi, eterična ulja, kozmetika, losioni za kosu.

---

(210) **2011-42** (442) **20.03.2013**

(220) 31.1.2011

(731) **BONGARIN S.A.**, 42 RUE RIEUSSEC, 78220 VIROFLAY FR



(540)

(550) I

(740) Lutovac Branislav, Bulevar Crnojevića 93, Podgorica (ME)

(511) **Klasa 29:** Mlijeko, sir i mliječni proizvodi, jestiva ulja i masti.(210) **2011-44**(442) **20.03.2013**

(220) 31.1.2011

(731) **BONGARIN S.A.**, 42 RUE RIEUSSEC, 78220 VIROFLAY FR

GOZBAR

(540)

(550) I

(740) Lutovac Branislav, Bulevar Crnojevića 93, Podgorica (ME)

(511) **Klasa 29:** Mlijeko, sir i mliječni proizvodi, jestiva ulja i masti.(210) **2011-46**(442) **20.03.2013**

(220) 2.2.2011

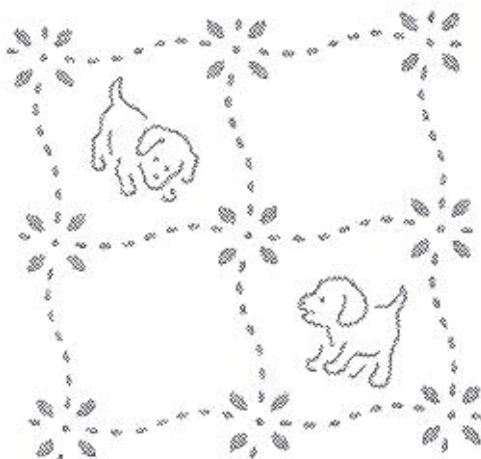
(731) **KIMBERLY-CLARK WORLDWIDE, INC**, NEENAH, WISCONSIN 54956 US

(540)

(550) I

(740) Lutovac Branislav, Bulevar Crnojevića 93, Podgorica (ME)

(511) **Klasa 03:** Vlažni papirni ubrusi i maramice za jednokratnu upotrebu, impregnirane jedi-njenjima za ličnu higijenu.

**Klasa 16:** Upijajući papirni proizvodi kao što su maramice za lice, toalet papir, papirni ubrusi i papirne salвете.

(210) **2011-47** (442) **20.03.2013**

(220) 2.2.2011

(731) **MILLER BREWING INTERNATIONAL, INC**, 3939 WEST HIGHLAND BOULEVARD, MILWAUKEE, WISCONSIN 53208 US



(540)

(550) I

(740) Čejović Vladimir, 13. jula 21, Podgorica (ME)

(511) **Klasa 32:** Pivo, mineralne i sodne vode i druga bezalkoholna pića: pića od voća I voćni sokovi: sirupi i drugi preparati za proizvodnju pića.

(210) **2011-49** (442) **20.03.2013**

(220) 4.2.2011

(731) **INDUSTRIJA PIVA I SOKOVA TREBJESA AD. NIKŠIĆ**, NJEGOŠEVA BR.18 NIKŠIĆ ME



(540)

(550) I

(740) Božović Vesko, Rimski trg 50/11, Podgorica (ME)

(511) **Klasa 32:** pivo, mineralne i sodne vode i druga bezalkoholna pića; pića od voća i voćni sokovi; sirupi i drugi preparati za proizvodnju pića.

**Klasa 35:** oglašavanje; vodenje poslova; poslovno upravljanje; kancelarijski poslovi; usluge

koje pružaju lica ili organizacije u pomoći u radu ili upravljanju preduzećima i u vodenju poslova preduzeća; usluge koje pružaju preuzeća koja se bave oglašavanjem (reklamiranjem), tako što, za račun drugih lica, komuniciraju sa javnošću (reklama) putem prenosa bilo kakvih informacija o proizvodima i uslugama omogućavajući potrošačima prigodan pogled na te proizvode i usluge; usluge koje se sastoje od upisivanja, uređivanja, obrade, prerade ili sistematizacije pisanih informacija i zapisa; usluge reklamnih agencija; distribuciju prospekata i uzoraka direktno ili poštom; izradu i korišćenje matematičkih i statističkih podataka; organizovanje sajmova i izložbi u komercijalne ili reklamne svrhe.

- (210) **2011-5** (442) **20.03.2013**  
 (220) 10.1.2011  
 (300) PRVENSTVO AMERICKE PRIJAVE SAD 85/096,153 OD  
 DANA 29 07 2010  
 (731) **MOTOROLA TRADEMARK HOLDINGS, LLC**, 600 NORTH US HIGHWAY 45, LIBERTYVILLE, IL 60048 US

MOTOROLA DEFY

- (540)  
 (550) I  
 (740) Čejović Vladimir, 13. jula 21, Podgorica (ME)  
 (511) **Klasa 09:** Mobilni telefoni.

- (210) **2011-50** (442) **20.03.2013**  
 (220) 4.2.2011  
 (731) **INDUSTRIJA PIVA I SOKOVA TREBJESA AD.NIKŠIĆ**, NJEGOŠEVA BR.18 NIKŠIĆ  
 ME



- (540)  
 (550) I  
 (740) Božović Vesko, Rimski trg 50/11, Podgorica (ME)  
 (511) **Klasa 32:** pivo, mineralne i sodne vode i druga bezalkoholna pića; pića od voća i voćni sokovi; sirupi i drugi preparati za proizvodnju pića.

**Klasa 35:** oglašavanje; vodenje poslova; poslovno upravljanje; kancelarijski poslovi; usluge koje pružaju lica ili organizacije u pomoći u radu ili upravljanju preduzećima i u vodenju poslova preduzeća; usluge koje pružaju preuzeća koja se bave oglašavanjem (reklamiranjem), tako što, za račun drugih lica, komuniciraju sa javnošću (reklama) putem prenosa bilo kakvih informacija o proizvodima i uslugama omogućavajući potrošačima prigodan pogled na te proizvode i usluge; usluge koje se sastoje od upisivanja, uređivanja, obrade, prerade ili sistematizacije pisanih informacija i zapisa; usluge reklamnih agencija; distribuciju prospekata i uzoraka direktno ili poštom; izradu i korišćenje matematičkih i statističkih podataka; organizovanje sajmova i izložbi u komercijalne ili reklamne svrhe.

(210) **2011-51**

(442) **20.03.2013**

(220) 4.2.2011

(731) **INDUSTRIJA PIVA I SOKOVA TREBJESA AD.NIKŠIĆ**, NJEGOŠEVA BR.18 NIKŠIĆ ME



(540)

(550) I

(740) Božović Vesko, Rimski trg 50/11, Podgorica (ME)

(511) **Klasa 32:** pivo, mineralne i sodne vode i druga bezalkoholna pića; pića od voća i voćni sokovi; sirupi i drugi preparati za proizvodnju pića.

**Klasa 35:** oglašavanje; vodenje poslova; poslovno upravljanje; kancelarijski poslovi; usluge koje pružaju lica ili organizacije u pomoći u radu ili upravljanju preduzećima i u vodenju poslova preduzeća; usluge koje pružaju preuzeća koja se bave oglašavanjem (reklamiranjem), tako što, za račun drugih lica, komuniciraju sa javnošću (reklama) putem prenosa bilo kakvih informacija o proizvodima i uslugama omogućavajući potrošačima prigodan pogled na te proizvode i usluge; usluge koje se sastoje od upisivanja, uređivanja, obrade, prerade ili sistematizacije pisanih informacija i zapisa; usluge reklamnih agencija; distribuciju prospekata i uzoraka direktno ili poštom; izradu i korišćenje matematičkih i statističkih podataka; organizovanje sajmova i izložbi u komercijalne ili reklamne svrhe.

(210) **2011-52**

(442) **20.03.2013**

(220) 4.2.2011

(731) **INDUSTRIJA PIVA I SOKOVA TREBJESA AD.NIKŠIĆ**, NJEGOŠEVA BR.18 NIKŠIĆ ME



(540)

(550) I

(740) Božović Vesko, Rimski trg 50/11, Podgorica (ME)

(511) **Klasa 32:** pivo, mineralne i sodne vode i druga bezalkoholna pića; pića od voća i voćni sokovi; sirupi i drugi preparati za proizvodnju pića.

**Klasa 35:** oglašavanje; vodenje poslova; poslovno upravljanje; kancelarijski poslovi; usluge koje pružaju lica ili organizacije u pomoći u radu ili upravljanju preduzećima i u vodenju poslova preduzeća; usluge koje pružaju preduzeća koja se bave oglašavanjem (reklamiranjem), tako što, za račun drugih lica, komuniciraju sa javnošću (reklama) putem prenosa bilo kakvih informacija o proizvodima i uslugama omogućavajući potrošačima prigodan pogled na te proizvode i usluge; usluge koje se sastoje od upisivanja, uređivanja, obrade, prerade ili sistematizacije pisanih informacija i zapisa; usluge reklamnih agencija; distribuciju prospekata i uzoraka direktno ili poštom; izradu i korišćenje matematičkih i statističkih podataka; organizovanje sajmova i izložbi u komercijalne ili reklamne svrhe.

(210) **2011-53**(442) **20.03.2013**

(220) 4.2.2011

(731) **INDUSTRIJA PIVA I SOKOVA TREBJESA AD.NIKŠIĆ**, NJEGOŠEVA BR.18 NIKŠIĆ ME

(540)

(550) I



(740) Božović Vesko, Rimski trg 50/11, Podgorica (ME)

(511) **Klasa 32:** pivo, mineralne i sodne vode i druga bezalkoholna pića; pića od voća i voćni sokovi; sirupi i drugi preparati za proizvodnju pića.

**Klasa 35:** oglašavanje; vodenje poslova; poslovno upravljanje; kancelarijski poslovi; usluge koje pružaju lica ili organizacije u pomoći u radu ili upravljanju preduzećima i u vodenju poslova preduzeća; usluge koje pružaju preduzeća koja se bave oglašavanjem (reklamiranjem), tako što, za račun drugih lica, komuniciraju sa javnošću (reklama) putem prenosa bilo kakvih informacija o proizvodima i uslugama omogućavajući potrošačima prigodan pogled na te proizvode i usluge; usluge koje se sastoje od upisivanja, uređivanja, obrade, prerade ili sistematizacije pisanih informacija i zapisa; usluge reklamnih agencija; distribuciju prospekata i uzoraka direktno ili poštom; izradu i korišćenje matematičkih i statističkih podataka; organizovanje sajmova i izložbi u komercijalne ili reklamne svrhe.

(210) **2011-54**

(442) **20.03.2013**

(220) 4.2.2011

(731) **INDUSTRIJA PIVA I SOKOVA TREBJESA AD.NIKŠIĆ**, NJEGOŠEVA BR.18 NIKŠIĆ ME



(540)

(550) I

(740) Božović Vesko, Rimski trg 50/11, Podgorica (ME)

(511)

**Klasa 32:** pivo, mineralne i sodne vode i druga bezalkoholna pića; pića od voća i voćni sokovi; sirupi i drugi preparati za proizvodnju pića.

**Klasa 35:** oglašavanje; vodenje poslova; poslovno upravljanje; kancelarijski poslovi; usluge koje pružaju lica ili organizacije u pomoći u radu ili upravljanju preduzećima i u vodenju poslova preduzeća; usluge koje pružaju preduzeća koja se bave oglašavanjem (reklamiranjem), tako što, za račun drugih lica, komuniciraju sa javnošću (reklama) putem prenosa bilo kakvih informacija o proizvodima i uslugama omogućavajući potrošačima prigodan pogled na te proizvode i usluge; usluge koje se sastoje od upisivanja, uređivanja, obrade, prerade ili sistematizacije pisanih informacija i zapisa; usluge reklamnih agencija; distribuciju prospekata i uzoraka direktno ili poštom; izradu i korišćenje matematičkih i statističkih podataka; organizovanje sajmova i izložbi u komercijalne ili reklamne svrhe.

(210) 2011-55

(442) 20.03.2013

(220) 4.2.2011

(731) **INDUSTRIJA PIVA I SOKOVA TREBJESA AD.NIKŠIĆ**, NJEGOŠEVA BR.18 NIKŠIĆ  
ME

(540)

(550) I

(740) Božović Vesko, Rimski trg 50/11, Podgorica (ME)

(511) **Klasa 32:** pivo, mineralne i sodne vode i druga bezalkoholna pića; pića od voća i voćni sokovi; sirupi i drugi preparati za proizvodnju pića.

**Klasa 35:** oglašavanje; vodenje poslova; poslovno upravljanje; kancelarijski poslovi; usluge koje pružaju lica ili organizacije u pomoći u radu ili upravljanju preduzećima i u vodenju poslova preduzeća; usluge koje pružaju preuzeća koja se bave oglašavanjem (reklamiranjem), tako što, za račun drugih lica, komuniciraju sa javnošću (reklama) putem prenosa bilo kakvih informacija o proizvodima i uslugama omogućavajući potrošačima prigodan pogled na te proizvode i usluge; usluge koje se sastoje od upisivanja, uređivanja, obrade, prerade ili sistematizacije pisanih informacija i zapisa; usluge reklamnih agencija; distribuciju prospekata i uzoraka direktno ili poštom; izradu i korišćenje matematičkih i statističkih podataka; organizovanje sajmova i izložbi u komercijalne ili reklamne svrhe.

(210) 2011-56

(442) 20.03.2013

(220) 4.2.2011

(731) **INDUSTRIJA PIVA I SOKOVA TREBJESA AD.NIKŠIĆ**, NJEGOŠEVA BR.18 NIKŠIĆ  
ME



(540)

(550) I

(740) Božović Vesko, Rimski trg 50/11, Podgorica (ME)

(511) **Klasa 32:** pivo, mineralne i sodne vode i druga bezalkoholna pića; pića od voća i voćni sokovi; sirupi i drugi preparati za proizvodnju pića.

**Klasa 35:** oglašavanje; vodenje poslova; poslovno upravljanje; kancelarijski poslovi; usluge koje pružaju lica ili organizacije u pomoći u radu ili upravljanju preduzećima i u vodenju poslova preduzeća; usluge koje pružaju preuzeća koja se bave oglašavanjem (reklamiranjem), tako što, za račun drugih lica, komuniciraju sa javnošću (reklama) putem prenosa bilo kakvih informacija o proizvodima i uslugama omogućavajući potrošačima prigodan pogled na te proizvode i usluge; usluge koje se sastoje od upisivanja, uređivanja, obrade, prerade ili sistematizacije pisanih informacija i zapisa; usluge reklamnih agencija; distribuciju prospekata i uzoraka direktno ili poštom; izradu i korišćenje matematičkih i statističkih podataka; organizovanje sajmova i izložbi u komercijalne ili reklamne svrhe.

(210) **2011-57**

(442) **20.03.2013**

(220) 4.2.2011

(731) **INDUSTRIJA PIVA I SOKOVA TREBJESA AD.NIKŠIĆ**, NJEGOŠEVA BR.18 NIKŠIĆ  
ME



(540)

(550) I

(740) Božović Vesko, Rimski trg 50/11, Podgorica (ME)

(511) **Klasa 32:** pivo, mineralne i sodne vode i druga bezalkoholna pića; pića od voća i voćni sokovi; sirupi i drugi preparati za proizvodnju pića.

**Klasa 35:** oglašavanje; vodenje poslova; poslovno upravljanje; kancelarijski poslovi; usluge koje pružaju lica ili organizacije u pomoći u radu ili upravljanju preduzećima i u vodenju poslova preduzeća; usluge koje pružaju preuzeća koja se bave oglašavanjem (reklamiranjem), tako što, za račun drugih lica, komuniciraju sa javnošću (reklama) putem prenosa bilo kakvih informacija o proizvodima i uslugama omogućavajući potrošačima prigodan pogled na te proizvode i usluge; usluge koje se sastoje od upisivanja, uredivanja, obrade, prerade ili sistematizacije pisanih informacija i zapisa; usluge reklamnih agencija; distribuciju prospekata i uzoraka direktno ili poštom; izradu i korišćenje matematičkih i statističkih podataka; organizovanje sajмова i izložbi u komercijalne ili reklamne svrhe.

(210) **2011-58**

(442) **20.03.2013**

(220) 4.2.2011

(731) **INDUSTRIJA PIVA I SOKOVA TREBJESA AD.NIKŠIĆ**, NJEGOŠEVA BR.18 NIKŠIĆ  
ME



(540)

(550) I

(740) Božović Vesko, Rimski trg 50/11, Podgorica (ME)

(511) **Klasa 32:** pivo, mineralne i sodne vode i druga bezalkoholna pića; pića od voća i voćni sokovi; sirupi i drugi preparati za proizvodnju pića.

**Klasa 35:** oglašavanje; vodenje poslova; poslovno upravljanje; kancelarijski poslovi; usluge koje pružaju lica ili organizacije u pomoći u radu ili upravljanju preduzećima i u vodenju poslova preduzeća; usluge koje pružaju preduzeća koja se bave oglašavanjem (reklamiranjem), tako što, za račun drugih lica, komuniciraju sa javnošću (reklama) putem prenosa bilo kakvih informacija o proizvodima i uslugama omogućavajući potrošačima prigodan pogled na te proizvode i usluge; usluge koje se sastoje od upisivanja, uređivanja, obrade, prerade ili sistematizacije pisanih informacija i zapisa; usluge reklamnih agencija; distribuciju prospekata i uzoraka direktno ili poštom; izradu i korišćenje matematičkih i statističkih podataka; organizovanje sajmova i izložbi u komercijalne ili reklamne svrhe.

(210) **2011-59**

(442) **20.03.2013**

(220) 4.2.2011

(731) **INDUSTRIJA PIVA I SOKOVA TREBJESA AD.NIKŠIĆ**, NJEGOŠEVA BR.18 NIKŠIĆ  
ME



(540)

(550) I

(740) Božović Vesko, Rimski trg 50/11, Podgorica (ME)

(511) **Klasa 32:** pivo, mineralne i sodne vode i druga bezalkoholna pića; pića od voća i voćni sokovi; sirupi i drugi preparati za proizvodnju pića.

**Klasa 35:** oglašavanje; vodenje poslova; poslovno upravljanje; kancelarijski poslovi; usluge koje pružaju lica ili organizacije u pomoći u radu ili upravljanju preduzećima i u vodenju poslova preduzeća; usluge koje pružaju preuzeća koja se bave oglašavanjem (reklamiranjem), tako što, za račun drugih lica, komuniciraju sa javnošću (reklama) putem prenosa bilo kakvih informacija o proizvodima i uslugama omogućavajući potrošačima prigodan pogled na te proizvode i usluge; usluge koje se sastoje od upisivanja, uređivanja, obrade, prerade ili sistematizacije pisanih informacija i zapisa; usluge reklamnih agencija; distribuciju prospekata i uzoraka direktno ili poštom; izradu i korišćenje matematičkih i statističkih podataka; organizovanje sajмова i izložbi u komercijalne ili reklamne svrhe.

(210) **2011-6**(442) **20.03.2013**

(220) 10.1.2011

(300) PRVENSTVO AMERICKE PRIJAVE SAD 85/116,689 OD

DANA 26 08 2010

(731) **MOTOROLA TRADEMARK HOLDINGS, LLC**, 600 NORTH US HIGHWAY 45, LIBERTYVILLE, IL 60048 US

## ATRIX

(540)

(550) I

(740) Čejović Vladimir, 13. jula 21, Podgorica (ME)

(511) **Klasa 9:** Mobilni telefoni i ručni mobilni uređaji za računanje.

(210) **2011-66**(442) **20.03.2013**

(220) 9.2.2011

(731) **CUMMINS INC.**, 500 JACKON SREET, COLUMBUS, INDIANA US

(540)

(550) I

(740) Popović Miladin, Đoka Miraševića 21/III, Podgorica (ME)

(511) **Klasa 07:** Mašine i mašinski alati; motori i pogonske mašine (osim za suvozemna vozila); delovi i oprema za motore i pogonske mašine; mašinske spojnice i transmisioni elementi (osim za suvozemna vozila); poljoprivredne sprave koje se ne pokreću ručno; inkubatori za jaja; motori sa sagorevanjem na dizel ili benzinski pogon i njihovi delovi; motori sa sagorevanjem; generatori električne energije i njihovi delovi; filteri za ulje; filteri za ulje, benzin, dizel gorivo i vazduh za motore i pogonske mašine; uređaji protiv zagađenja za motore, pogonske mašine i industrijske instalacije; turbo punjači i njihovi delovi; filteri za gorivo i sastavni delovi istih; filteri za ulje i vazduh i sastavni delovi istih; filteri za vazduh i ulje za mehaničke potrebe; hidraulični filteri za tečnosti za mehaničke potrebe; filteri za ulje, benzin, vazduh i gorivo za motore i pogonske mašine za suvozemna i brodska vozila; kanisteri i kućišta za sve prethodno navedene filtere; aparati, instalacije i filteri za redukciju emisije (ispuštanja) i redukciju buke za upotrebu kod pogonskih mašina.

**Klasa 12:** Vozila; aparati za kretanje po zemlji, vazduhu ili vodi; motori za vozila i delovi istih za upotrebu u vozilima; pumpe za vazduh (oprema za vozila); kvačila za suvozemna vozila; konverteri (obrotni momenat) za suvozemna vozila; pogonski lanci za suvozemna vozila; pogonski motori za suvozemna vozila; električna vozila; hidraulični sklop za vozila; motori, električni, za suvozemna vozila; prenosni lanci za suvozemna vozila; prenosne osovine za suvozemna vozila, osovine za suvozemna vozila; turbo punjači, vazdušni kompresori i raste-retni ventili turbokompresora, sve za suvozemna vozila; turbine za suvozemna vozila; vozila i sastavni delovi istih.

(210) **2011-67**(442) **20.03.2013**

(220) 9.2.2011

(731) **ENTERPRISE HOLDINGS INC.**, 600 CORPORATE PARK DRIVE, ST. LOUIS, MISSOURI US

# ENTERPRISE

(540)

(550) I

(740) Popović Miladin, Đoka Miraševića 21/III, Podgorica (ME)

(511) **Klasa 35:** Usluge prodaje vozila, usluge upravljanja voznim parkom.**Klasa 37:** Usluge popravke vozila.**Klasa 39:** Usluge iznajmljivanja i lizinga vozila; i usluge rezervacije za iznajmljivanje i lizing vozila.(210) **2011-68**(442) **20.03.2013**

(220) 9.2.2011

(731) **ENTERPRISE HOLDINGS, INC.**, 600 CORPORATE PARK DRIVE, ST. LOUIS, MISSOURI US

(540)

(550) I

(740) Popović Miladin, Đoka Miraševića 21/III, Podgorica (ME)

(511) **Klasa 35:** Usluge prodaje vozila, usluge upravljanja voznim parkom.**Klasa 37:** Usluge popravke vozila.**Klasa 39:** Usluge iznajmljivanja i lizinga vozila; i usluge rezervacije za iznajmljivanje i lizing vozila.(210) **2011-69**(442) **20.03.2013**

(220) 9.2.2011

(731) **ENTERPRISE HOLDINGS, INC.**, 600 CORPORATE PARK DRIVE, ST. LOUIS, MISSOURI US

(540)

(550) I



(740) Popović Miladin, Đoka Miraševića 21/III, Podgorica (ME)

(511) **Klasa 35:** Usluge prodaje vozila, usluge upravljanja voznim parkom.

**Klasa 37:** Usluge popravke vozila.

**Klasa 39:** Usluge iznajmljivanja i lizinga vozila; i usluge rezervacije za iznajmljivanje i lizing vozila.

(210) **2011-7** (442) **20.03.2013**

(220) 10.1.2011

(731) **REXALL SUNDOWN, INC**, 2100 SMITHTOWN AVENUE, RONKONKOMA, NEW YORK 11779 US

### OSTEO BI-FLEX

(540)

(550) I

(740) Lutovac Branislav, Bulevar Crnojevića 93, Podgorica (ME)

(511) **Klasa 05:** Vitamini; minerali; dijetetski i nutritivni dodaci ishrane.

(210) **2011-70** (442) **20.03.2013**

(220) 9.2.2011

(731) **EXPRESS, LLC**, 1 EXPRESS DRIVE COLUMBUS, OHIO 43230 US

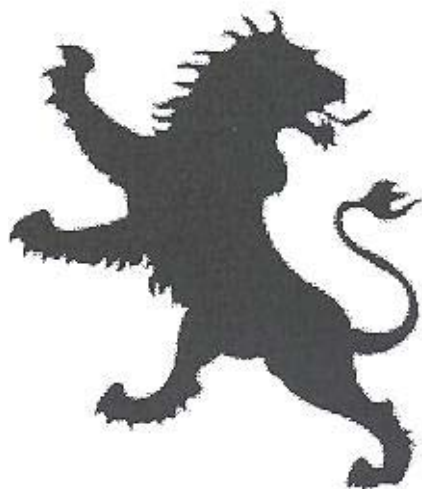

(540) \_\_\_\_\_

(550) I

(740) Radulović Božidar, Jovana Tomaševića 9/III, Podgorica (ME)

(511) **Klasa 9:** Naočare za sunce.

(210) **2011-71** (442) **20.03.2013**

(220) 11.2.2011

(731) **SKECHERS USA INC.II**, 228 MANHATTAN BEACH BLVD. MANHATTAN BEACH, CALIFORNIA 90266 US

# SHAPE-UPS

(540)

(550) I

(740) Čupić Branislav, Dalmatinska 10, Podgorica (ME)

(511) **Klasa 25:** Obuća.

**Klasa 35:** Usluge maloprodaje takozvane online maloprodaje i usluge kataloške maloprodaje porudžbinama putem pošte, za obuću i odjeću.

---

(210) **2011-72**

(442) **20.03.2013**

(220) 11.2.2011

(731) **SKECHERS USA INC.II**, 228 MANHATTAN BEACH BLVD. MANHATTAN BEACH, CALIFORNIA 90266 US



(540)

(550) I

(740) Čupić Branislav, Dalmatinska 10, Podgorica (ME)

(511) **Klasa 25:** Obuća.

---

(210) **2011-75**

(442) **20.03.2013**

(220) 14.2.2011

(731) **KAANE AMERICAN INTERNATIONAL TOBACCO CO.LTD**, PO BOX NO.61021, JEBEL ALI FREE ZONE, DUBAI AE



(540)

(550) I

(740) Čejović Vladimir, 13. jula 21, Podgorica (ME)

(511) **Klasa 34:** Cigarete, duvan i artikli za pušače.(210) **2011-76**(442) **20.03.2013**

(220) 14.2.2011

(731) **KAANE AMERICAN INTERNATIONAL TOBACCO CO.LTD.**, PO BOX NO.61021, JEBEL ALI FREE ZONE, DUBAI AE

(540)

(550) I

(740) Čejović Vladimir, 13. jula 21, Podgorica (ME)

(511) **Klasa 34:** Cigarete, duvan i artikli za pušače.(210) **2011-77**(442) **20.03.2013**

(220) 16.2.2011

(731) **EFAMOL LIMITED**, 14 THE MOLE BUSINESS PARK, LEATHERHEAD, SURREY,KT22 7BA GB

## EFAMOL

(540)

(550) I

(740) Čejović Vladimir, 13. jula 21, Podgorica (ME)

(511) **Klasa 05:** Dijetetske supstance prilagođene za upotrebu u medicini; hrana za bebe i ljude sa posebnim potrebama; vitaminski preparati; veterinarski preparati i supstance; ulje jagorčevine; riblje ulje.

(210) **2011-78**(442) **20.03.2013**

(220) 17.2.2011

(731) **BANANA REPUBLIC ITM, INC**, 2 FOLSOM STREET, SAN FRANCISCO, CA 94105 US

## BANANA REPUBLIC

(540)

(550) I

(740) Lutovac Branislav, Bulevar Crnojevića 93, Podgorica (ME)

(511) **Klasa 16:** Papir, karton i proizvodi od ovih materijala koji pripadaju ovoj klasi; štampane stvari; knjige; korice za knjige; čestitke; kalendari; nalepnice; preslikači; nalepnice za auto; poster; kancelarijski materijal; blokovi za beleške; registratori; blokovi - podsetnici; agende; rokovnici; pisači pribor; hemijske olovke; obične olovke; markeri; kutije za hemijske i obične olovke; etikete koje nisu od tekstila; fotografije; zastavice od kartona, papira i ojačanog papira; natpisi; podmetači/držači za papir sa oprugom; oglasne table; programi; albumi za slike; kutije za odlaganje slika; pelene za jednokratnu upotrebu; plastične kese za pelene za jednokratnu upotrebu; podmetači za stolove za presvlačenje beba, za jednokratnu upotrebu.

**Klasa 24:** Proizvodi od tekstila, tkanine ili plastičnog materijala (zamena za tkaninu) koji pripadaju ovoj klasi; rublje za upotrebu u domaćinstvu; posteljno rublje; stono rublje; rublje za kupatilo; peškiri; peškiri za ruke; prekrivači za krevete i stolove; salvete; etikete u ovoj klasi; zastavice i zastave koje nisu od papira; tekstili i tkanine (tkane i pletene); zavese; draperije; ćebad; zastavice od platna; čaršavi; jorgani; volani; ukrasni jastučići; portiklice za bebe; pokrivači od tkanine za podmetače za presvlačenje; podloge za presvlačenje beba.

**Klasa 26:** Čipka, vez; ukrasne mašne; ukrasne trake (pantljike); dugmad; kopče; petlje; špenadle; igle; veštačko cveće; dekorativne zakrpe; perike; perje; pričvršćivači za rajsferšluse; veštačko voće; čipke za obuću i odeću; detalji za kosu; štipaljke za kosu; šnale sa zatvaranjem

“na klik”; šnale; gumice za kosu od ukrasnog materijala; ukosnice; rajfovi; mašne za kosu; ukrasne kopče za kosu; klip šnale za kosu; ukrasi za kosu; šnalice; ukrasne trake za kosu; pričvršćivači za konjski rep.

---

(210) **2011-79** (442) **20.03.2013**

(220) 17.2.2011

(731) **GAP (ITM),INC**, A CALIFORNIA CORPORATION, 2 FOLSOM STREET, CA 94105 US

## GAP 1969

(540)

(550) I

(740) Lutovac Branislav, Bulevar Crnojevića 93, Podgorica (ME)

(511) **Klasa 18:** Koža i imitacija kože, proizvodi izradeni od ovih materijala koji nisu uključeni u druge klase; životinjska koža; koferi i putne torbe; kišobrani, suncobrani i štapovi za hodanje; bičevi, saračka i sedlarska roba.

**Klasa 25:** Odeća, obuća, pokrivala za glavu.

**Klasa 35:** Oglašavanje; vođenje poslova; poslovno upravljanje; kancelarijski poslovi

---

(210) **2011-8** (442) **20.03.2013**

(220) 10.1.2011

(731) **THE ESTER C COMPANY**, 2100 SMITHTOWN AVENUE, RONKONKOMA, NEW YORK 11779 US

## ESTER-C

(540)

(550) I

(740) Lutovac Branislav, Bulevar Crnojevića 93, Podgorica (ME)

(511) **Klasa 05:** Vitamini; minerali; dijetetski i nutritivni dodaci ishrane.

---

(210) **2011-80** (442) **20.03.2013**

(220) 17.2.2011

(731) **KIKA MOBEL-HANDELSGESELLSCHAFT M.B.H.**, ANTON-SCHEIBLIN-GASSE 1,3100 ST.POLTEN AT

# KiKa



(540)

(550) I

(740) Lutovac Branislav, Bulevar Crnojevića 93, Podgorica (ME)

(511) **Klasa 11:** Aparati za osvetljavanje, grejanje, proizvodnju pare, kuvanje, hlađenje, sušenje, ventilaciju, snabdevanje vodom i sanitame svrhe.**Klasa 20:** Nameštaj, ogledala, okviri za slike; proizvodi (koji nisu obuhvaćeni drugim klasama) od drveta, plute, trske, rogoza, vrbovog pruća, roga, kosti, slonovače, kitove kosti, školjki, ćilibara, sedefa, morske pene, zamene svih ovih materijala, ili od plastike.**Klasa 21:** Kućne ili kuhinjske sprave i posude (kpje nisu od dragocenih metala ili sa presvlakama od njih); češljevi i sunđeri; četke (izuzev kičica); materijali za pravljenje četki; artikli koji se koriste pri čišćenju; čelična vuna; neprerađeno ili poluprerađeno staklo (osim stakla koje se koristi u građevinarstvu); staklarija, porcelan, fajans, grnčarija i lončarija koja nije uključena u druge klase.**Klasa 24:** Tekstil i tekstilni proizvodi koji nisu obuhvaćeni drugim klasama; prekrivači za krevete i stolove.**Klasa 27:** Tepisi, ćilimi, prostirke i otirači, linoleum i drugi materijali za pokrivanje podova; prekrivači za zidove (netekstilni).**Klasa 37:** Instaliranje kuhinja; instaliranje nameštaja; tapacerski radovi; stolarski radovi; parketarski radovi; hoblavanje i lakiranje podova; postavljanje (izuzev postavljanja podupirača, nosača i šipki) prekrivača od plastičnih materijala, gume i/ili linoleuma ili tekstilnih materijala; kačenje zavesa i postavljanje garnišni; čišćenje jorgana.(210) **2011-82**(442) **20.03.2013**

(220) 18.2.2011

(731) **CHRYSLER GROUP LLC**, 100 CHRYSLER DRIVE, AUBURN HILLS, MICHIGAN 48326 US

# WAGONEER

(540)

(550) I

(740) Radulović Božidar, Jovana Tomaševića 9/III, Podgorica (ME)

(511) **Klasa 12:** Motorna vozila i djelovi za njih.

(210) **2011-83** (442) **20.03.2013**

(220) 21.2.2011

(731) **CELGENE CORPORATION**, 86 MORRIS AVENUE, SUMMIT, 07901 NEW JERSEY US

РЕВЛИМИД

(540)

(550) I

(740) Čejović Vladimir, 13. jula 21, Podgorica (ME)

(511) **Klasa 05:** Farmaceutski preparati, naime, citokinski inhibitori lijekova; farmaceutski preparati koji prilagođavaju imuni sistem, farmaceutski preparati za liječenje određenih vrsta raka.

(210) **2011-84** (442) **20.03.2013**

(220) 21.2.2011

(731) **KABUSHIKI KAISHA TOSHIBA (TOSHIBA CORPORATION)**, 1-1,SHIBAURA 1-CHOME, MINATO-KU TOKYO JP

TOSHIBA

(540)

(550) I

(740) Radulović Božidar, Jovana Tomaševića 9/III, Podgorica (ME)

(511) **Klasa 09:** Mašine za elektrolučno zavarivanje; mašine za sečenje metala (električnim lukom, gasom ili plazmom); mašine za lasersko zavarivanje; aparati za električno zavarivanje; ozonizatori; elektrolizeri (elektrolitičke ćelije); aparati za elektronsku kontrolu motora (za automobile); registar kase; mašine za brojanje ili sortiranje kovanog novca i žetona; ATM mašine; mašine za glasanje; mašine za naplaćivanje; mašine koje se pokreću novcem ili žetonom; oprema stanice za punjenje baterija; oprema za benzinske stanice; protivpožarni alarmi; protivgasni alarmi; DNK čipovi; aparati za testiranje DNK; drugi laboratorijski aparati i instrumenti; fokusirajuća ogledala; blicevi za fotografske svrhe; blic lampe za fotografske svrhe; kamere i fotografski aparati; druge fotografske mašine i aparati; kinematografske mašine i aparati; uveličavajuća stakla; drugi optički aparati i instrumenti; oprema za telemetriju; aparati za merenje kvaliteta vode; biohemijski analizatori; elektronske vage za merenje;

oprema za testiranje za poluprovodnike; merači debljine na bazi X ili Gama zračenja; merači nivoa na bazi Gama zračenja; elektromagnetski merači protoka; pametni merači; merači struje; druge mašine i aparati za merenje i testiranje; punjači za električne baterije; utičnice; šukoi; utikači; transformatori; invertori; regulatori indukovanog napona; kondenzatori; automatski prekidači; prekidači; komutacioni sto; prekidači za svetlo; električni releji; konvertori; konektori; ispravljači; osigurači; otpornici; statički kondenzatori; prekidači struje curenja; kutije sa prekidačima; limiteri; vakumski automatski prekidači; drugi uređaji i mašine za distribuciju ili kontrolu energije; rotacioni konvertori; modifikatori faza; fotonaponski paneli; kondicioneri snage; fotonaponski generatori energije i njihovi delovi; „suve“ baterije; akumulatori; fotonaponske ćelije; punjive baterije; solarne ćelije; gorivne ćelije; litijum-jonske baterije; druge baterije i ćelije; električna brojila; detektori struje curenja; osciloskopi; drugi električni ili magnetni merači i testeri; električne žice i kablovi; električne pegle; električni vikleri; električna zvona; telefonski setovi; mobilni telefoni; punjači za baterije za mobilne telefone; oprema za video-telefone; telefonske centrale; interfoni; primopredajnici; AC adapted; televizijski prijemnici (TV); televizijski odašiljači; televizijske kamere; CCTV (televizija zatvorenog kruga) kamere; CCTV (televizija zatvorenog kruga) monitori; druga televizijska oprema za CCTV; radio prijemnici sa satovima; radio uređaji za kola; drugi radio prijemnici; radio predajnici; mašine i aparati za emitovanje; radio komunikacione mašine i aparati; radio uređaji i mašine; faksimil mašine i njihovi delovi i oprema; kasetofoni; radio kasetofoni; tjuneri; gramofoni; mašine i aparati za snimanje zvuka; digitalni audio plejeri; CD plejeri; CD plejeri kombinovani sa kasetofonima; zvučnici; DVD plejeri; DVD rekorderi; DVD drajvovi; video kamere; video rekorderi; video disk plejeri; digitalni video disk rekorderi; digitalni foto ramovi; kamere za nadzor; digitalne kamere; digitalne video kamere; magnetne trake za rekordere; magnetne trake za video rekordere; video diskovi za video disk plejere; igle za gramofone; kertridži za gramofone; uređaji i jedinice za smanjenje brujanja za audio opremu; audio pojačivači; mikrofoni; slušalice; ekvilajzeri; antene; sistemi i instrumenti za javno obraćanje; drugi delovi i oprema za električne komunikacione mašine i aparate; druge električne komunikacione mašine i aparati; mašine sa elektrostatičkim postupkom kopiranja; skeneri slika; vise namenski periferni uređaji koji imaju funkcije mašine za kopiranje, štampača, skenera i faksimil mašina; personalni računari; kompjuteri; USB memorije; štampači za upotrebu sa kompjuterima; aparati sa magnetnim trakama i disk sistemima za upotrebu sa kompjuterima; čitači kartica za upotrebu sa kompjuterima; displeji za kompjutere; displej monitori za kompjutere; tastature za kompjutere; miševi za kompjutere; procesori reči; čitači i/ili snimači memorijskih kartica sa integrisanim kolom; pametni telefoni; lični digitalni pomoćnici koji imaju funkcije internet konekcije, slanja i primanja elektronske pošte, videa i podataka; lični digitalni pomoćnici; štampači za digitalne kamere; hard disk drajvovi; delovi i oprema za elektrostatičke mašine za kopiranje i štampače; kompjuterski server; mašine i uređaji za POS sisteme (sistemi na mestu prodaje), njihovi delovi i pomoćna oprema; barkod čitači; barkod štampači; uređaji za zapisivanje i/ili čitanje Radio-Frekventne identifikacije (RFID); kiosk terminali; digitalni informativno-oglasni displeji; nedestruktivni uređaji za testiranje na bazi X zračenja; nedestruktivni ultrazvučni uređaji za testiranje; električni i/ili elektronski uređaji za velike displeje; rendgenske cevi; pojačivači rendgenske slike; elektronske cevi; detektori zračenja; druge elektronske cevi; poluprovodnici; integrisana kola; ploče sa štampanim kolima; SSD drajv; memorijske kartice sa integrisanim kolima; druga elektronska kola; kompjuterski programi snimljeni na trake; kompjuterski programi snimljeni na diskove; kompjuterski programi za medicinske dijagnostičke aparati i aparate za terapiju; kompjuterski hardver i kompjuterski programi za upravljanje informacijama u bolnici; kompjuterski hardver i kompjuterski programi za upravljanje elektronskim medicinskim slikama (Sistem za arhiviranje slika i komunikaciju [PACS]); kompjuterski programi; dru-



gi kompjuterski programi i kompjuterski softver; LED displeji; displeji sa tečnim kristalom; LCD projektori; druge elektronske mašine, aparati i njihovi delovi; komunikacioni sateliti, drugi objekti koji se mogu lansirati; naočare (obične ili zaštitne); video igre; ručni uređaji za igranje igrica; elektronska kola i CD-ROM-ovi sa nasnimljenim programima za igrice koje se igraju iz ruke sa displejima sa tečnim kristalom; elektronska kola i CD-ROM-ovi sa nasnimljenim programima za automatsko izvođenje za elektronske muzičke instrumente; nasnimljeni video diskovi i video trake; elektronske publikacije; BD (blu-rej disk) plejeri, BD (blu-rej disk) rekorderi.

(210) **2011-85** (442) **20.03.2013**

(220) 22.2.2011

(731) **CELGENE CORPORATION**, 86 MORRIS AVENUE, SUMMIT, 07901 NEW JERSEY US

## ИСТОДАКС

(540)

(550) I

(740) Čejović Vladimir, 13. jula 21, Podgorica (ME)

(511) ; **Klasa 05:** Farmaceutski preparati kao lijek protiv raka za ljudsku upotrebu.

(210) **2011-86** (442) **20.03.2013**

(220) 23.2.2011

(731) **TENARIS CONNECTIONS BV**, LOCATELIKATE 1, 1076 AZ AMSTERDAM NL

## TENARIS

(540)

(550) I

(740) Popović Miladin, Đoka Miraševića 21/III, Podgorica (ME)

(511) **Klasa 06:** Obični metali i njihove legure; metalni građevinski materijali; metalne prenosne građevine; materijali od metala za željezničke sine; ne-električni kablovi i žice od običnog metala; bravarski proizvodi, mali metalni gvoždarski proizvodi; cevčice i cevi od metala; sefovi; proizvodi od običnih metala koji nisu uključeni u druge klase; rude.

(210) **2011-87** (442) **20.03.2013**

(220) 23.2.2011

(731) **TENARIS CONNECTIONS BV**, LOCATELIKATE 1, 1076 AZ AMSTERDAM NL

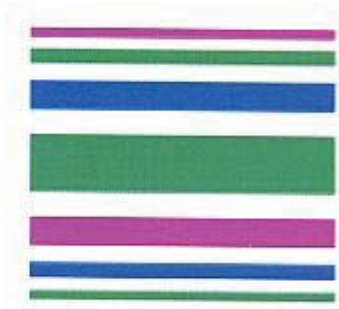

(540)

(550) I

(740) Popović Miladin, Đoka Miraševića 21/III, Podgorica (ME)

(511)

**Klasa 06:** Obični metali i njihove legure; metalni građevinski materijali; metalne prenosne građevine; materijali od metala za željezničke sine; ne-električni kablovi i žice od običnog metala; bravarski proizvodi, mali metalni gvoždarski proizvodi; cevčice i cevi od metala; sefovi; proizvodi od običnih metala koji nisu uključeni u druge klase; rude.

(210) **2011-88**

(442) **20.03.2013**

(220) 24.2.2011

(731) **NETFLIX**, INC A CORPORATION OF DELAWARE, 100 WINCHESTER CIRCLE, LOS GATOS, CALIFORNIA 95032 US

NETFLIX

(540)

(550) I

(740) Čejović Vladimir, 13. jula 21, Podgorica (ME)

(511) **Klasa 09:** aparati i instrumenti naučni, pomorski, geodetski, fotografski, kinemato-grafski, optički, za vaganje, mjerenje, signalizaciju, kontrolu (inspekciju), spašavanje i nastavu; aparati i instrumenti za provođenje, prekid, transformaciju, akumulaciju, regulisanje i kontrolu elektriciteta; aparati za snimanje, prenos i reprodukovanje zvuka ili slike; magnetni nosioci podataka, diskovi za snimanje; automatske mašine i mehanizmi za aparate koji se pokreću novcem ili žetonom; register kase, računске mašine, oprema za obradu podataka i kompjuteri; aparati za gašenje požara; kompjuterski hardver, firmver i softver; kompjuterski hardver, firmver, softver, aparati, instrumenti i materijali za snimanje, prenos i prijem audio, video i audio-vizuelnog sadržaja; kompjuterski hardver, firmver i softver za elektronske i uredjaje za emitovanje; elektronski uredjaji; uredjaji za emitovanje; daljinski upravljači; audio, video i audio-vizuelni snimci i sadržaj omogućen preuzimanjem ili emitovanjem sa kompjutera i komunikacionih mreža, uključujući i internet.

**Klasa 35:** Oglašavanje; vođenje poslova; poslovno upravljanje; kancelarijski poslovi; usluge maloprodajnih radnji i kompjuterizovane on-lajn maloprodajne usluge opremljene unaprijed snimljenim video i audio zapisima, video i audio-vizuelnim snimcima i sadržajem.

**Klasa 38:** Komunikacione usluge; telekomunikacione usluge; usluge pristupa telekomunikacijama; usluge emitovanja putem kompjutera, interneta i drugih komunikacionih mreža, uključujući audio, video i audio-vizuelni sadržaj; usluge prenosa videa na zahtjev; video emitovanje; prenos glasa, podataka, slika, signala, poruka i informacija; komunikacija putem kompjutera; telekomunikacione veze sa elektronskim komunikacionim mrežama, usluge emitovanja; pružanje on-lajn oglasnih tabli za prenos poruka.

**Klasa 41:** Obrazovne usluge; pripremanje obuke; razonoda; sportske i kulturne aktivnosti; pružanje on-lajn obrazovnih i usluga zabave; iznajmljivanje video snimaka, unaprijed snimljenih video kaseti, digitalnih video diskova, multimedijalnih snimaka; iznajmljivanje video snimaka, unaprijed snimljenih video kaseti, digitalnih video diskova putem komunikacionih mreža; pružanje informacija, pregleda i ličnih preporuka u oblasti zabave; pružanje informacija, pregleda i ličnih preporuka u oblasti zabave putem komunikacionih mreža.

(210) **2011-89** (442) **20.03.2013**

(220) 24.2.2011

(731) **NISSAN JIDOSHA KABUSHIKI KAISHA**, No.2 TAKARACHO, KANAGAWA-KU, YOKOHAMA-SHI, KANAGAWA-KEN JP

# NISSAN

(540)

(550) I

(740) Popović Miladin, Đoka Miraševića 21/III, Podgorica (ME)

(511) **Klasa 09:** Aparati i instrumenti za merenje; brojači; aparati za snimanje vremena; mašine i aparati za distribuciju ili kontrolu električne energije; električne razvodne kutije; rotacioni konvertori; fazni modifikatori; punjači; transformatori (strujni); baterije i ćelije; gorivne ćelije; električne žice i kablovi; električni komunikacioni aparati i instrumenti; telefonski aparati; mašine i aparati za radio komunikaciju u vozilima; automobilski telematički aparati; odašiljači i prijemnici podataka opremljeni u automobilima; aparati za automatska obaveštenja o prestanku punjenja; navigacioni aparati za vozila (on-board kompjuteri); aparati za davanje obaveštenja o punjenju a koja glase „nije još ubačen punjač“; elektronske mašine i aparati; integrisana kola; električna kola; kompjuteri; kompjuterski softver; kompjuterski programi; sistemi daljinske kontrole za dopunjavanje; elektrode; magneti; naočare; upaljači za automobile; zaštitni uređaji protiv nesreća za ličnu upotrebu; invertori (strujni); aparati protiv krađe.

(210) **2011-9** (442) **20.03.2013**

(220) 10.1.2011

(731) **SOLGAR HOLDINGS, INC.**, 2100 SMITHTOWN AVENUE, RONKONKOMA, NEW YORK 11779 US

## SOLGAR

(540)

(550) I

(740) Lutovac Branislav, Bulevar Crnojevića 93, Podgorica (ME)

(511) **Klasa 05:** Vitamini; dijetetski, hranljivi i biljni dodaci za ishranu.(210) **2011-90**(442) **20.03.2013**

(220) 24.2.2011

(731) **NISSAN JIDOSHA KABUSHIKI KAISHA**, No.2 TAKARACHO, KANAGAWA-KU, YOKOHAMA-SHI, KANAGAWA-KEN JP

(540)

(550) I

(740) Popović Miladin, Đoka Miraševića 21/III, Podgorica (ME)

(511) **Klasa 09:** Aparati i instrumenti za merenje; brojači; aparati za snimanje vremena; mašine i aparati za distribuciju ili kontrolu električne energije; električne razvodne kutije; rotacioni konvertori; fazni modifikatori; punjači; transformatori (strujni); baterije i ćelije; gorivne ćelije; električne žice i kablovi; električni komunikacioni aparati i instrumenti; telefonski aparati; mašine i aparati za radio komunikaciju u vozilima; automobilski telematički aparati; odašiljači i prijemnici podataka opremljeni u automobilima; aparati za automatska obaveštenja o prestanku punjenja; navigacioni aparati za vozila (on-board kompjuteri); aparati za davanje obaveštenja o punjenju a koja glase „nije još ubačen punjač“; elektronske mašine i aparati; integrisana kola; električna kola; kompjuteri; kompjuterski softver; kompjuterski programi; sistemi daljinske kontrole za dopunjavanje; elektrode; magneti; naočare; upaljači za automobile; zaštitni uređaji protiv nesreća za ličnu upotrebu; invertori (strujni); aparati protiv krađe.

(210) **2011-91**(442) **20.03.2013**

(220) 24.2.2011

(300) 16.11.2010. RS 1883/10-62237-25.01 2011

(731) **GALENKA AD.**, BATAJNICKI DRUM BB BEOGRAD RS

NIDOXA

НИДОКСА

(540)

(550) I

(511) **Klasa 5:** Farmaceutski proizvodi.

;

---

(210) **2011-95**

(442) **20.03.2013**

(220) 25.2.2011

(731) **CEMEX S.A.B.DE C.V.**, AVDA.CONSTITUCION 444 PTE.,COL. CENTRO, 64000 MONTERREY, NUEVO LEON MX



(540)

(550) I

(740) Čejović Vladimir, 13. jula 21, Podgorica (ME)

(511) **Klasa 19:** nemetalni građevinski materijali kao što su cement, beton, malter, kamen, kreč, gips, šljunak, podovi, pečene i nepečene cigle; pločice, mozaik, nemetalne čvrste cijevi za građu; asfalt, smola, katran, ne metalna prenosiva građa kao što su moduli, paneli, unaprijed izliveni stubovi i nemetalni spomenici/strukture.

---

(210) **2011-97**

(442) **20.03.2013**

(220) 28.2.2011

(300) US 01 09 2010 85120819

(731) **BEST WESTREN INTERNATIONAL, INC.**, 6201 NORTH 24 TH PARKWAY, PHOENIX, ARIZONA 85016 US



(540)

(550) I

(740) Lutovac Branislav, Bulevar Crnojevića 93, Podgorica (ME)

(511) **Klasa 43:** Hotelske usluge.

(210) **2011-98**

(442) **20.03.2013**

(220) 28.2.2011

(300) US 01 09 2010 85120792

(731) **BEST WESTERN INTERNATIONAL, INC,** 6201 NORTH 24 TH PARKWAY, PHOENIX, ARIZONA 85016 US



(540)

(550) I

(740) Lutovac Branislav, Bulevar Crnojevića 93, Podgorica (ME)

(511) **Klasa 43:** Hotelske usluge.

(210) **2011-17**

(442) **20.03.2013**

(220) 13.01.2011.

(731) **MASTERCARD INTERNATIONAL INCORPORATED (DELAWARE CORPORATION)** 2000 PURCHASE STREET PURCHASE NEW YORK 10577-2509 US

**MASTERCARD MONEYSSEND**

(540)

(550) I

(740) Radulović Božidar, Jovana Tomaševića 9/III, Podgorica (ME)

(511) **Klasa 36:** Usluge osiguranje; finansijski poslovi; novčani (monetarni) poslovi; finansijske usluge; bankarske i kreditne usluge; obezbjeđivanje kreditnih kartica, debitnih kartica, potrošačkih kartica i vrednosnih kartica; bankarske usluge, usluge plaćanja, kreditne usluge, usluge naplate, usluge izdavanja gotovog novca; usluge pristupa deponovanim sredstvima; usluge plaćanja računa; usluge kreditnih kartica, debitnih kartica, potrošačkih kartica; vrednosnih kartica i kartica sa deponovanim sredstvima; usluge verifikacije čekova i unovčavanja čekova; usluge ATM mašina; obrada finansijskih transakcija direktno (onlajn) preko kompjuterske baze podataka i preko telekomunikacija, kao i na mestima prodaje; usluge obrade finansijskih transakcija koje vrše vlasnici kartica preko ATM mašina; obezbjeđivanje uvida u stanje računa i u podatke o uplatama i isplatama, vlasnicima kartica, preko ATM mašina; usluge poravnanja i autorizacije; usluge putničkog osiguranja; izdavanje i otkup putničkih čekova i putničkih vaučera; usluge provere platioca; verifikacija finansijskih informacija; šifrovanje i dešifrovanje finansijskih informacija; održavanje finansijskih podataka; usluge transfera elektronskih fondova i usluge zamene valute; širenje finansijskih informacija preko interneta i drugih kompjuterskih mreža; usluge plaćanja na daljinu; usluge elektronskog plaćanja deponovanim sredstvima; obezbjeđivanje elektronskih fondova i transfera valuta, usluge elektronskog plaćanja, usluge korišćenja pretplatničkih telefonskih kartica, usluge izdavanja gotovine, i usluge overavanja transakcija i usluge poravnanja; obezbedenje debitnih i kreditnih usluga pomoću radio-frekventnih identifikacionih uređaja (transpondera); obezbjeđivanje debitnih i kreditnih usluga preko uređaja za komunikaciju i telekomunikaciju; usluge verifikacije čekova; usluge izdavanja i otkupa, sve u vezi sa putničkim čekovima i putničkim vaučerima; obezbjeđivanje finansijskih usluga za podršku uslugama vezanim za promet robe, preko sredstava mobilne telekomunikacije, uključujući usluge plaćanja preko bežičnih uređaja; obezbjeđivanje finansijskih usluga za podršku uslugama vezanim za promet robe direktno (onlajn), preko mreža ili drugih elektronskih sredstava korišćenjem elektronski digitalizovanih informacija; usluge berze vrijednosti, naročito usluge sigurne razmene vrijednosti, uključujući i elektronsku gotovinu, preko kompjuterske mreže kojoj se može pristupiti preko pametnih kartica; usluge plaćanja računa koje se obezbeđuju preko veb sajta; direktno (onlajn) elektronsko bankarstvo; finansijske usluge obezbedene preko telefona i putem globalne kompjuterske mreže ili interneta; obezbjeđivanje finansijskih usluga preko globalne kompjuterske mreže ili interneta; usluge vezane za nepokretnosti; usluge vezane za nepokretnu imovinu; usluge osiguranja nepokretnosti; osiguranje za vlasnike imovine; usluge osiguranja u vezi sa imovinom; finansiranje nepokretnosti; usluge posredovanja, vezane za nepokretnosti; ocena nepokretnosti; usluge agencija za nepokretnosti; procenjivanje nepokretnosti; administracija u vezi sa nepokretnostima; administracija finansijskih poslova u vezi sa nepokretnosti ma; obezbjeđivanje zajmova za nepokretnosti; usluge finansiranja u vezi sa razvojem nepokretnosti; usluge finansijskog posredovanja u vezi sa nepokretnostima; finansijske usluge u vezi sa nepokretnom imovinom i zgradama; finansijske usluge za kupovinu nepokretnosti; obezbjeđivanje ugovora o zajmu osiguranih

hipotekom; uređivanje suvlasništva nad nepokretnostima; obezbjeđivanje finansiranja kupovine nepokretnosti; pomoć pri sticanju nepokretnosti i korišćenju nepokretnosti; usluge kapitalnog investiranja u nepokretnosti; usluge investiranja u komecijalno vlasništvo; finansijske usluge u vezi sa sticanjem nepokretnosti; finansijske usluge u vezi za prodajom vlasništva; finansijska procena nepokretnosti u slobodnom vlasništvu; finansijska procena nepokretnosti pod zakupom; organizovanje davanja u zakup nepokretnosti; organizovanje davanja na korišćenje nepokretnosti; davanje u zakup; davanje u zakup nepokretnosti; davanje u zakup slobodne imovine; usluge upravljanja posedom u vezi sa transakcijama vezanim za nepokretnosti; procenjivanje imovine; upravljanjem portfoliom imovine; upravljanje imovinom; savetodavne usluge vezane za vlasništvo nad nepokretnostima; savetodavne usluge vezane za procenu nepokretnosti; savetodavne usluge u vezi sa nepokretnostima koje pripadaju korporacijama; usluge kompjuterizovanih podataka u vezi sa nepokretnostima; konsultanske usluge u vezi sa nepokretnom imovinom; obezbjeđivanje informacija u vezi sa nepokretnostima; obezbjeđivanje informacija u vezi sa tržištem imovine; usluge istraživanja u vezi sa sticanjem nepokretnosti; usluge istraživanja u vezi sa aukcijom nepokretnosti]

(210) **2010-361**

(442) **20.03.2013**

(220) 13.10.2010.

(731) **AGENCIJA ZA ZAŠTITU ŽIVOTNE SREDINE**, ul. IV Proleterske br. 19, Podgorica

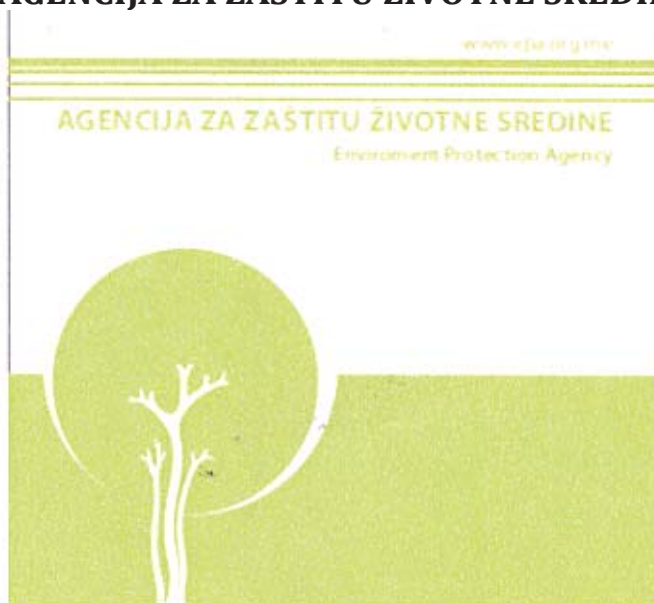

(540)

(550) I

(740)

(511) **Klasa 35:** oglašavanje; vodjenje poslova; poslovno upravljanje; kancelarijski poslovi.



- (111) 07335 (151) 29.01.2013  
 (210) **2010-72** (442) **20.06.2012**  
 (220) 17.03.2010  
 (732) **BOSNALIJEK**, FARMACEUTSKA I HEMIJSKA INDUSTRIJA DD, JUKIĆEVA 53, 71000 SARAJEVO BA

## STOMATIDIN

- (540)  
 (550) I  
 (740) Radulović Božidar, Jovana Tomaševića 9/III, Podgorica (ME)  
 (511) **Klasa 05:** Farmaceutski proizvodi.

- 
- (111) 07297 (151) 29.01.2013  
 (210) **2010-205** (442) **20.06.2012**  
 (220) 16.06.2010  
 (732) **SHARP KABUSHIKI KAISHA also trading as SHARP CORPORATION**, 22-22, NAGAIKE-CHO, ABENO-KU, OSAKA 545-8522 JP

## QUATTRON

- (540)  
 (550) I  
 (740) Popović Miladin, Đoka Miraševića 21/III, Podgorica (ME)  
 (511) **Klasa 09:** LCD televizijski prijemnici televizijski prijemnici LCD paneli LCD moduli LCD monitori kombinovani LCD televizori/monitori i DVD plejeri rikorderi sa optičkim diskom plejeri sa optičkim diskom DVD rikorderi DVD plejeri mobilni telefoni elektronski rečnici elektronski organizatori lični digitalni pomoćni uređaji elektronske računске mašine kompjuteri prenosivi kompjuteri aparati za snimanje, prenos ili reprodukovanje zvuka i slike u klasi 9.

- 
- (111) 07303 (151) 29.01.2013  
 (210) **2010-67** (442) **20.06.2012**  
 (220) 16.03.2010  
 (732) **AUXILIUM INTERNATIONAL HOLDING, INC**, 1105 N.MARKET STREET, SUITE 1300, WILMINGTON, DE 19801 US

## XIAPEX

(540)

(550) I

(740) Popović Miladin, Đoka Miraševića 21/III, Podgorica (ME)

(511) **Klasa 05:** Farmaceutski preparati.

(111) 07302

(151) 29.01.2013

(210) **2010-76**

(442) **20.06.2012**

(220) 24.03.2010

(732) **ZDRAVLJE AD**, VLAJKOVA 199, 16000 LESKOVAC RS

## ACTAPAX

(540)

(550) I

(740) Popović Miladin, Đoka Miraševića 21/III, Podgorica (ME)

(511) **Klasa 05:** Preparati za liječenje depresije, posebno psihoanaleptici.

(111) 07336

(151) 29.01.2013

(210) **2010-189**

(442) **20.06.2012**

(220) 04.06.2010

(732) **SUNDEK LLC**, 3950 EXECUTIVE PARK BLVD, SE, SOUTHPORT, NORT CAROLINA 28461 US

## SUNDEK

(540)

(550) I

(740) Popović Miladin, Đoka Miraševića 21/III, Podgorica (ME)

(511) **Klasa 25:** Odjevni predmeti, uključujući kupače kostime za muškarce i dječake, kupače kostime za žene i djevojčice, kosulje, majice, džempere, trenerke, dukserice, farmerke, obuću, šešire, kape i kape sa štitnikom.

(111) 07296

(151) 29.01.2013

(210) **2010-206**

(442) **20.06.2012**

(220) 16.06.2010

(732) SHARP KABUSHIKI KAISHA also trading as SHARP CORPORATION, 22-22, NAGAKIE-CHO, ABENO-KU, OSAKA 545-8522 JP



(540)

(550) I

(740) Popović Miladin, Đoka Miraševića 21/III, Podgorica (ME)

(511) **Klasa 09:** LCD televizijski prijemnici televizijski prijemnici LCD paneli LCD moduli LCD monitori kombinovani LCD televizori/monitori i DVD plejeri rikorderi sa optičkim diskom plejeri sa optičkim diskom DVD rikorderi DVD plejeri mobilni telefoni elektronski rečnici elektronski organizatori lični digitalni pomoćni uređaji elektronske računске marine kompjuteri prenosivi kompjuteri aparati za snimanje, prenos ili reprodukovanje zvuka i slike u klasi 9.

(111) 07331

(151) 29.01.2013

(210) **2010-55**

(442) **20.06.2012**

(220) 09.03.2010

(732) ALKALOID AD SKOPLJE, BULEVAR ALEKSANDAR MAKEDONSKI 12, 1000 SKOPLJE MK

## FAMOSAN

(540)

(550) I

(740) Božović Vesko, Rimski trg 50/11, Podgorica (ME)

(511) **Klasa 05:** Farmaceutski preparati.

(111) 07333

(151) 29.01.2013

(210) **2010-53**

(442) **20.06.2012**

(220) 08.03.2010

(732) IM CLONE LLC, 450 EAST 29TH STREET NEW YORK, NY 10016 US

## ERBITUX

(540)

(550) I

(740) Popović Miladin, Đoka Miraševića 21/III, Podgorica (ME)

(511) **Klasa 05:** Farmaceutski preparati, naime monoklonalna antitela za liječenje raka.

(111) 07346  
(210) **2010-217**

(151) 31.01.2013  
(442) **20.06.2012**  
(220) 28.06.2010

(732) GENERAL MOTORS LLC, 300 RENAISSANCE CENTER DETROIT, MICHINGAN 48265-3000 US

# TRACKER

(540)  
(550) I  
(740) Radulović Božidar, Jovana Tomaševića 9/III, Podgorica (ME)  
(511) **Klasa 12:** Motorna vozila i dijelovi za njih.

---

(111) 07294  
(210) **2010-230**

(151) 29.01.2013  
(442) **20.06.2012**  
(220) 15.07.2010

(732) GENERAL MOTORS LLC, 300 RENAISSANCE CENTER DETROIT, MICHIGAN 48265-3000 US

# EQUINOX

(540)  
(550) I  
(740) Radulović Božidar, Jovana Tomaševića 9/III, Podgorica (ME)  
(511) **Klasa 12:** Motorna vozila i dijelovi za njih.

---

(111) 07341  
(210) **2010-71**

(151) 29.01.2013  
(442) **20.06.2012**  
(220) 17.03.2010

(732) BOSNALIJEK, FARMACEUTSKA I HEMIJSKA INDUSTRIJA DD, JUKIĆEVA 53, 71000 SARAJEVO  
BA

# LODIX

(540)

(550) I

(740) Radulović Božidar, Jovana Tomaševića 9/III, Podgorica (ME)

(511) **Klasa 05:** Farmaceutski proizvodi.

---

(111) 07340

(151) 29.01.2013

(210) **2010-70**

(442) **20.06.2012**

(220) 17.03.2010

(732) BOSNALIJEK, FARMACEUTSKA I HEMIJSKA INDUSTRIJA DD, JUKIĆEVA 53, 71000 SARAJEVO  
BA

# LIDOPROCT

(540)

(550) I

(740) Radulović Božidar, Jovana Tomaševića 9/III, Podgorica (ME)

(511) **Klasa 05:** Farmaceutski proizvodi.

---

(111) 07339

(151) 29.01.2013

(210) **2010-69**

(442) **20.06.2012**

(220) 17.03.2010

(732) BOSNALIJEK, FARMACEUTSKA I HEMIJSKA INDUSTRIJA DD, JUKIĆEVA 53, 71000 SARAJEVO  
BA

# LANIBOS

(540)

(550) I

(740) Radulović Božidar, Jovana Tomaševića 9/III, Podgorica (ME)

(511) **Klasa 05:** Farmaceutski proizvodi.

- (111) 07337 (151) 29.01.2013  
 (210) **2010-176** (442) **20.06.2012**  
 (220) 26.05.2010  
 (732) HENKEL AG& CO KGaA, HENKELSTRASSE 67, DUSSELDORF DE

PERSIL- Vrhunska čistoća koju možete videti,  
 osetiti i pomirisati

- (540)  
 (550) I  
 (511) **Klasa 03:** Sredstva za beljenje i druge supstance za upotrebu u preionicama omekšivaci tkanina za upotrebu u perionicama, sredstva za ispiranje rublja i sredstva za pranje svih prekrivki i svih sredstava/pribora za konzumiranje obroka, sredstva za čišćenje tkanina, sredstva za uklanjanje mrlja štirak za rublje preparati za poliranje, ribanje i nagrizanje sapuni.

- (111) 07338 (151) 29.01.2013  
 (210) **2010-207** (442) **20.06.2012**  
 (220) 18.06.2010  
 (732) YINGLI GROUP CO, LTD, N 722 CUIZUAN ROAD, BAODING CN



- (540)  
 (550) I  
 (740) Radulović Božidar, Jovana Tomaševića 9/III, Podgorica (ME)  
 (511) **Klasa 4:** Industrisko ulje mast za podmazivanje gorivo mineralno gorivo industrijski vosak noćne svjetiljke (svijeće) preparati za odstranjivanje prašine električna energija motorno gorivo nehemijski aditivi, za motorna goriva ulje za konzervacije u zidarstvu ulje za osvjetljenje fluidi za rezanje.

**Klasa 9:** Optičke lampe optički proizvodi optičko staklo podmetači silikonski dijelovi, staklo prekriveno sa električnim provodnikom invertori (električni) kutije za povezivanje (električne) distributivne kutije (električne) kontrolni paneli (električne) kondenzatori strujni ispravljači polu-provodnici distributivne konzole (električne) integrirana kola fotonaponske ćelije električno regulirane aparate električni tranzistori, štampana kola, električni provodnici električni kolektori ploče za baterije, bateriske kutije, solarne baterije galvanske ćelije, punjači za baterije čip (integrisana kola) armature (električne) baterije za osvjetljenje baterije za džepne lampe električne baterije svjetlosni znaci aparati za saobraćajno osvjetljenje (signalni uređaji)

**Klasa 11:** Lampe lampe za projektiranje džepne lampe za osvjetljenje aparati za osvjetljenje u vozilima osvetljenje za vozila grijaci za vodu solarne peći grijaci za vozila grejni akumulatori

grejne pumpe solarni kolektori (grejni) instalacije za pročišćavanje vode radijatori (grejni) džepne lampe, električne ulične lampe toplotne ploče grejni aparati električni.

- 
- (111) 07304 (151) 29.01.2013  
 (210) **2010-66** (442) **20.06.2012**  
 (220) 16.03.2010  
 (732) APACER TECHNOLOGY INC, 3F,NO.83.KEWANG RD, LONGTAN TOWNSHIP, TAOYUAN COUNTY 325, TAIWAN, R.O.C.TW TW

# Apacer

- (540)  
 (550) I  
 (740) Radulović Božidar, Jovana Tomaševića 9/III, Podgorica (ME)  
 (511) **Klasa 09:** Kompjuterska memorija, memorija sa slučajnim pristupom (RAM), RAM moduli, dinamička memorija sa slučajnim pristupom (DRAM), DRAM moduli, kompjuterski disk drajvovi, hard disk drajvovi, fleš drajvovi, SSD (čvrsti disk zasnovan na fleš memoriji) drajv, SSD modul, SDD čip, fleš memorije, fleš memorijske kartice, memorijski stikovi, multimedijalni funkcionalni uređaji, plejeri/rekorderi za optičke diskove, digitalni audio plejeri/rekorderi, digitalni video plejeri/rekorderi, digitalne kamere, digitalni ramovi za fotografije, integrisana kola, mikrokontroleri, kompjuterska periferna oprema, naročito, čitači memorijskih kartica, adapter za memorijske kartice, USB čvorišta, USB bežični primopredajnici, USB veb kamere, miševi, prezenteri, uređaji za prenos podataka, uređaji za čuvanje podataka priključeni na mrežu (NAS), kompjuterski softveri, naročito, softveri koji se odnose na memoriju i pohranjivanje podataka, kompjuterski sistemi za elektronske uređaje, naročito, za prenosne kompjutere, stone (desktop) kompjutere, prenosne telefone, prenosne računarske uređaje, aparati za igre adaptirani za upotrebu sa kompjuterima, navigacioni aparati za vozila (kompjuteri ugrađeni u vozila), prenosni telefoni, Uređaji za snimanje video zapisa, naročito, mini DV, digitalni video rekorderi, IP kamere, Punjači, naročito, punjači baterija, USB strujni adapteri, bežični uređaji za punjenje, solarni punjači, Audio/Video dodatna oprema, naročito, HDMI kablovi, slušalice, dodatne kartice za fleš memoriju, žičani i bežični telekomunikacioni uređaji.

- 
- (111) 07216 (151) 17.01.2013  
 (210) **2010-156** (442) **20.06.2012**  
 (220) 11.05.2010  
 (732) SUMITOMO RUBBER INDUSTRIES. LTD, 6-9, 3-CHOME,WAKINOHAMA-CHO, CHUO-KU, KOBE-SHI, HUOGO JP

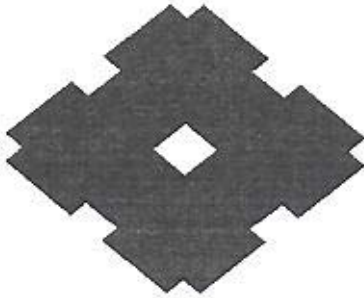

(540)

(550) I

(740) Popović Miladin, Đoka Miraševića 21/III, Podgorica (ME)

(511) **Klasa 12:** Gume za kopnena vozila gume za motorna vozila na dva točka.

(111) 06965

(151) 27.12.2012

(210) **2010-236**

(442) **20.06.2012**

(220) 15.07.2010

(732) TRANSATLANTIC HOLDINGS, INC, 80 PINE STREET, NEW YORK, NY 10005 US

## CALPE INSURANCE COMPANY

(540)

(550) I

(740) Čupić Branislav, Dalmatinska 10, Podgorica (ME)

(511) **Klasa 36:** Osiguranje, reosiguranje i usluge upravljanja sa osiguranjem.

(111) 06952

(151) 27.12.2012

(210) **2010-256**

(442) **20.06.2012**

(220) 22.07.2010

(732) ALKALOID AD SKOPLJE, BULEVAR ALEKSANDAR MAKEDONSKI 12, 1000 SKOPLJE MK

## WALZERA/BAJ3EPA

(540)

(550) I

(740) Božović Vesko, Rimski trg 50/11, Podgorica (ME)

(511) **Klasa 05:** Farmaceutski proizvodi.

(111) 07221

(151) 18.01.2013

(210) **2010-182**

(442) **20.06.2012**

(220) 31.05.2010

(732) MLJEKARA NIKA DOO-NIKSIĆ, PARTIZANSKI PUT BB NIKŠIĆ ME



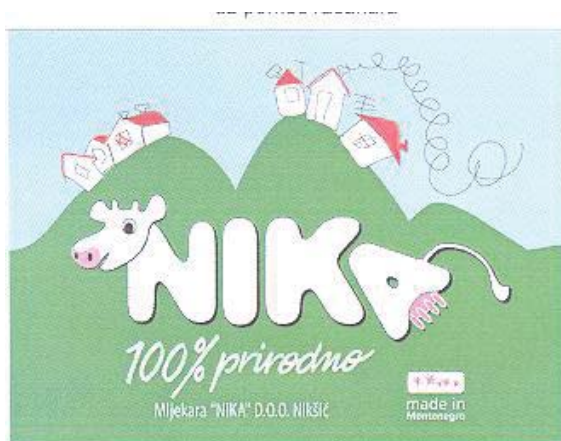

(540)

(550) I

(740) Božović Vesko, Rimski trg 50/11, Podgorica (ME)

(511) **Klasa 29:** Jaja mlijeko i mliječni proizvodi.**Klasa 35:** Oglašavanje i reklamiranje vođenje komercijalnih poslova komercijalna administracija uredski poslovi.

(111) 07208

(151) 17.01.2013

(210) **2010-242**(442) **20.06.2012**

(220) 19.07.2010

(732) UNILEVER N.V, WEENA 455, 3013 AL ROTTERDAM NL

## MOTIONSENSE

(540)

(550) I

(740) Popović Miladin, Đoka Miraševića 21/III, Podgorica (ME)

(511) **Klasa 03:** Sapuni, parfimerija, esencijalna ulja, kozmetika, kolonjske vode, toaletne vode, parfimisani sprejevi za telo, ulja, kreme i losioni za kožu, pena za brijanje, gel za brijanje, losioni za pre i posle brijanja, talk, preparati za kupanje i tuširanje, losioni za kosu, sredstva za negu zuba, ne-medicinski preparati za ispiranje usta, dezodoransi, antiperspiranti za ličnu upotrebu, ne-medicinski toaletni preparati.

(111) 07207

(151) 17.01.2013

(210) **2010-52**(442) **20.06.2012**

(220) 04.03.2010

(732) MONTE VJENNIKO DOO. NIKŠIĆ, NOVICE CEROVIĆA 11, 81400 NIKŠIĆ ME



(540)

(550) I

(740) Božović Vesko, Rimski trg 50/11, Podgorica (ME)

(511) **Klasa 35:** Oglašavanje i reklamiranje, vođenje komercijalnih poslova, komercijalna administracija, uredski poslovi.**Klasa 43:** Usluge hranjenja, privremeno primanje na stan.

(111) 07214

(151) 17.01.2013

(210) **2010-181**(442) **20.06.2012**

(220) 31.05.2010

(732) ALKALOID AD SKOPLJE, BUL.ALEKSANDAR MAKEDONSKI BR.12,1000 SKOPLJE MK



(540)

(550) I

(511) **Klasa 05:** Farmaceutski preparati, lijekovi.

(111) 07067

(151) 27.12.2012

(210) **2009-615**(442) **20.03.2012**

(220) 14.10.2009

(732) FLEKA DOO CETINJE; NASELJE 4 JUL S-28-4-12 ME



(540)

(550) I

(511) **Klasa 35:** Oglašavanje; vođenje poslova; poslovno upravljanje; kancelarijski poslovi.**Klasa 41:** Obrazovne usluge; pripremanje obuke; razonoda; sportske i kulturne aktivnosti.**Klasa 42:** naučne i tehnološke usluge i istraživanje i projektovanje u vezi navedenih usluga; usluge industrijske analize i istraživanja; projektovanje i razvoj kompjuterskog hardvera i softvera

(111) 07068

(151) 27.12.2012

(210) **2009-614**(442) **20.03.2012**

(220) 14.10.2009

(732) FLEKA DOO CETINJE; NASELJE 4 UL S-28-4-12 ME



(540)

(550) I

(511) **Klasa 35:** Oglašavanje; vođenje poslova; poslovno upravljanje; kancelarijski poslovi.**Klasa 39:** Transportne usluge; pakovanje i skladištenje robe; organizovanje putovanja**Klasa 41:** obrazovne usluge; pripremanje obuke; razonoda; sportske i kulturne aktivnosti.**Klasa 43:** usluge obezbjeđivanja hrane i pića; privremeni smještaj

(111) 06676

(151) 29.11.2012

(210) **2009-281**(442) **20.03.2012**

(220) 26.05.2009

(732) WIENER STADTISCHE VERSICHERUNG AG; SCHOTTENRING 30, 1010 VIENNA, AT



(540)

(550) I

(740) Otašević Đuro, Serdara Jola Piletića bb, Podgorica (ME)

(511) **Klasa 36:** Osiguranje, finansijski poslovi; novčani; (monetarni) poslovi; poslovi vezani za nepokretnosti.

(111) 06663

(151) 27.11.2012

(210) **2009-279**(442) **20.03.2012**

(220) 26.05.2009

(300) 20.02.2007 5.702.022 CTM

(732) LOREAL SA; 14 RUE ROYALE, 75008 PARIS FR

## DERMAGENESIS

(540)

(550) I

(740) Ćupić Branislav, Dalmatinska 10, Podgorica (ME)

(511) **Klasa 3:** Parfemi, toaletne vode, gelovi, soli za kupanje i tuširanje koje nisu za medicinsku upotrebu, toaletni sapuni, dezodoransi za tijelo, kozmetički proizvodi, naročito kreme, mlijeko, losioni, gelovi i puderi za lice, tijelo i ruke; preparati za zaštitu od sunca (kozmetički proizvodi); proizvodi za šminkanje; šamponi; gelovi, sprejovi, pjene i balzami za stiliziranje kose i negu kose; lakovi za kosu; preparati za farbanje i izbeljivanje kose; preparati za trajnu i mini-val; eterična ulja za ličnu upotrebu.

(111) 06674

(151) 29.11.2012

(210) **2009-677**(442) **20.03.2012**

(220) 17.12.2009

(732) JANSPOUT APPAREL CORP. -DELAWARE CORPORATION; 3411 SILVERSIDE ROAD, WILMINGTON, DELAWARE 19810 US

# QUALCOMM

(540)

(550) I

(740) Radulović Božidar, Jovana Tomaševića 9/III, Podgorica (ME)

(511) **Klasa 38:** Telekomunikacione usluge, a naročito obezbjeđivanje pristupa većem broju korisnika bazi podataka i globalnoj kompjuterskoj i informacionoj mreži putem kompjutera i komunikacionih uređaja; elektronski prenos glasa, video zapisa, slika, poruka i podataka; prenos igranih filmova, trejlara igranih filmova, reklama i audio-vizuelnih programa; digitalni prenos glasa, podataka, slika, signala i poruka; usluge komunikacije putem mobilnog telefona; usluge komunikacije putem teleksa; usluge komunikacije putem kompjuterskih terminala; usluge komunikacije putem telegrama; usluge komunikacije putem telefona; usluge komunikacije putem faksimila; usluge prenošenja poruka putem radija/telefona (pejdžing usluge); usluge televizijskog emitovanja; usluge emitovanja kablovske televizije; usluge radio emitovanja; usluge u vezi sa vijestima za komunikacione medije; iznajmljivanje/lizing opreme za komunikaciju, uključujući telefon/faksimil; usluge bežične komunikacije, uključujući usluge komunikacije glasom i podacima, koristeći zemaljske ili satelitske komunikacione sisteme; omogućavanje trećim licima pristup telekomunikacionim infrastrukturama.

**Klasa 41:** Usluge razonode, naročito, obezbjeđivanje kompjuterskih audio zapisa, video zapisa i podataka na komunikacionim uređajima i kompjuterima; omogućavanje onlajn kompjuterskih igrica preko mreže između komunikacionih mreža i kompjutera.

**Klasa 42:** Inženjerske usluge projektovanja, testiranja i proizvodnje za druge, kao i pomoći pri projektovanju, testiranju i proizvodnji za druge, satelitskih i zemaljskih komunikacionih sistema i mreža, bežičnih komunikacionih terminala; usluge planiranja razvoja i projektovanja telekomunikacionih mreža i mreža za obradu podataka, za druge; usluge savjetovanja, testiranja i tehničkog nadzora u oblasti integracija sistema i integracija proizvoda za telekomunikacione mreže, kao i obrade podataka u oblasti elektronskih usluga, naročito prikupljanje, čuvanje, prevod, prenos ili distribucija podataka, informacija, slika, video i audio sekvenci i u oblasti obezbjeđivanja i komunikacije informacija pohranjenih u bazi podataka putem interaktivnih komunikacionih kompjuterskih sistema; usluge razvoja i generisanja programa za obradu podataka, naročito, kompjuterskih programa za druge; kompjuterske usluge, naročito, obezbjeđivanje specifičnih informacija na zahtev korisnika putem interneta; usluge onlajn tehničke podrške u oblasti kompjutera, kompjuterskog softvera i kompjuterskih sistema; savjetodavne usluge u vezi sa kompjuterima i kompjuterskim softverom; usluge kompjuterske dijagnostike; ažuriranje kompjuterskog softvera za druge; usluge tehničke podrške, naročito, rješavanje hardverskih i softverskih problema kompjutera; omogućavanje onlajn ažuriranja kompjuterskog softvera za druge putem interneta; i obezbjeđivanje informacija u oblasti kompjutera, kompjuterskog softvera i kompjuterskih sistema.

(111) 07218

(151) 17.01.2013

(210) **2010-82**

(442) **20.06.2012**

(220) 26.03.2010

(732) HONDA MOTOR CO LTD, 1-1, MINAMI-AOYAMA 2-CHOME, MINATO-KU, TOKYO 107-8556 JP



(540)

(550) I

(740) Lutovac Branislav, Bulevar Crnojevića 93, Podgorica (ME)

(511) **Klasa 12:** Automobili, vozila, aparati za kretanje po zemlji, vazduhu ili vodi, i djelovi i oprema za naprijed navedenu robu obuhvaćeni međunarodnom klasom 12.

(111) 07219

(151) 17.01.2013

(210) **2010-81**(442) **20.06.2012**

(220) 26.03.2010

(732) HONDA MOTOR CO LTD, 1-1, MINAMI-AOYAMA 2-CHOME, MINATO-KU, TOKYO 107-8556 JP

# ECO ASSIST

(540)

(550) I

(740) Lutovac Branislav, Bulevar Crnojevića 93, Podgorica (ME)

(511) **Klasa 12:** Automobili, vozila, aparati za kretanje po zemlji, vazduhu ili vodi, i djelovi i oprema za naprijed navedenu robu obuhvaćeni međunarodnom klasom 12.

(111) 06953

(151) 27.12.2012

(210) **2010-255**(442) **20.06.2012**

(220) 22.07.2010

(732) ALKALOID AD SKOPLJE, BULEVAR ALEKSANDAR MAKEDONSKI 12, 1000 SKOPLJE MK

# RELIKA/ РЕЛИКА

(540)

(550) I

(740) Božović Vesko, Rimski trg 50/11, Podgorica (ME)

(511) **Klasa 05:** Farmaceutski proizvodi.

---

(111) 06942

(151) 27.12.2012

(210) **2010-258**

(442) **20.06.2012**

(220) 22.07.2010

(732) ALKALOID AD SKOPLJE, BULEVAR ALEKSANDAR MAKEDONSKI 12, 1000 SKOPLJE MK

caffetin COLDmax

(540)

(550) I

(740) Božović Vesko, Rimski trg 50/11, Podgorica (ME)

(511) **Klasa 05:** Farmaceutski proizvodi.

---

(111) 06951

(151) 27.12.2012

(210) **2010-257**

(442) **20.06.2012**

(220) 22.07.2010

(732) ALKALOID AD SKOPLJE, BULEVAR ALEKSANDAR MAKEDONSKI 12, 1000 SKOPLJE MK

LYVAM/ ЛИВАМ

(540)

(550) I

(740) Božović Vesko, Rimski trg 50/11, Podgorica (ME)

(511) **Klasa 05:** Farmaceutski proizvodi.

---

(111) 06963

(151) 27.12.2012

(210) **2010-243**

(442) **20.06.2012**

(220) 20.07.2010

(732) SANOFI PASTEUR, 2 AVENUE PONT PASTER, 69007 LYON FR

DULTAVAX

(540)

(550) I

(740) Popović Miladin, Đoka Miraševića 21/III, Podgorica (ME)

(511) **Klasa 05:** Farmaceutski preparati, vakcine.

---

(111) 06675

(151) 29.11.2012

(210) 2010-166

(442) **20.03.2012**

(220) 19.05.2010

(732) TEHNO PLUS DOO; UL. VASA RAIČKOVIĆA BB PODGORICA ME



(540)

(550) I

(511) **Klasa 9:** Aparati i instrumenti naučni, pomorski, geodetski, fotografski, kinemato-grafski, optički, za vaganje, mjerenje, signalizaciju, kontrolu (inspekciju), spasavanje i nastavu; aparati i instrumenti za provođenje, prekid, transformaciju, akumulaciju, regulisanje i kontrolu elektriciteta; aparati za snimanje, prenos i reprodukovanje zvuka ili slike; magnetni nosioci podataka, diskovi za snimanje; automatske mašine i mehanizmi za aparate koji se pokreću novcem ili žetonom; registar kase, računске mašine, oprema za obradu podataka i kompjuteri; aparati za gašenje požara.

**Klasa 11:** Aparati za osvjetljavanje, grejanje, proizvodnju pare, kuvanje, hlađenje, sušenje, ventilaciju, snabdevanje vodom i za sanitarne svrhe.

**Klasa 21:** Kućne ili kuhinjske sprave i posude (koje nisu od dragocenih metala ili sa prevlakama od njih); češljevi i sunđerri; četke (izuzev kičica); materijali za pravljenje četki; artikli koji se koriste pri čišćenju; čelična vuna; neprerađeno ili poluprerado staklo (osim stakla koje se koristi u građevinarstvu); staklarija, porcelan, fajans, grnčarija i lončarija koja nije uključena u druge klase.

**Klasa 35:** Oglašavanje; vođenje poslova; poslovno upravljanje; kancelarijski poslovi. Obuhvata: usluge koje pružaju lica ili organizacije u pomoći u radu ili upravljanju preduzećima i u vođenju poslova preduzeća; usluge koje pružaju preuzeća koja se bave oglašavanjem (reklamiranjem), tako što, za račun drugih lica, komuniciraju sa javnošću (reklama) putem prenosa bilo kakvih informacija o proizvodima i uslugama omogućavajući potrošačima prigodan pogled na te proizvode i usluge; usluge koje se sastoje od upisivanja, uređivanja, obrade, prerade ili sistematizacije pisanih informacija i zapisa; usluge reklamnih agencija; distribuciju prospekata i uzoraka direktno ili poštom; izradu i korišćenje matematičkih i statističkih podataka; organizovanje; organizovanje sajмова i izložbi u komercijalne ili reklamne svrhe.

(111) 07066

(151) 27.12.2012

(210) **2010-86**

(442) 27.12.2012

(220) 29.03.2010

(732) HOME BOX OFFICE INC, 1100 AVENUE OF THE AMERICAS, 9th FLOOR NEW YORK, NY 10036 US



(540)

(550) I



(740) Ćupić Branislav, Dalmatinska 10, Podgorica (ME)

(511) **Klasa 41:** Obuka, stručno osposobljavanje, razonoda, sportske i kulture djelatnosti, stručno osposobljavanje, sportske i kulturne djelatnosti, pružanje razonode i obuke, produkcija, prezentacija i distribucija audio, video, statičnih i pokretnih slika i podataka, usluge izdavaštva (uključujući usluge elektroničke publikacije), organiziranje foruma i blogova za rasprave, usluge razonode, osobito usluge programiranja, proizvodnje i distribucije video materijala.

(111) 07226

(151) 18.01.2013

(210) **2010-60**

(442) **20.06.2012**

(220) 10.03.2010

(732) CHERY AUTOMOBILE CO.LTD, 8 CHANGCHUN ROAD, ECONOMY I TECHNOLOGY DEVELOPMENT ZONE WUHU CITY, ANHUI PROVINCE CN



(540)

(550) I

(740) Đakonović Vido, Bajova 9, Cetinje (ME)

(511) **Klasa 12:** Vazdušni jastuci [sigurnosni uređaji za automobile], pumpe za vazduh [dodatna oprema za vozila], bolnička kola, uređaji protiv zasenjivanja za vozila, uređaji protiv krađe za vozila, karoserije i šasije za automobile, automobilske gume, automobili, osovine za vozila, trake za glavčine točkova, djelovi kočnica za vozila, kočione pedale za vozila, kočnice za vozila, autobusi, motorna vozila, kvačila za kopnena vozila, klipnjače za kopnena vozila, koje nisu djelovi motora i pogonskih mašina, konvertori za kopnena vozila, kućišta radilice i komponente terenskih vozila, koji nisu pogonski motor, pokazivači pravca za vozila, vrata za vozila, pogonski motori za kopnena vozila, električna vozila, lančanik slobodnog hoda za kopnena vozila, prenosnici brzine za kopnena vozila, sistem prenosnika za kopnena vozila, poklopci za motore na vozilima, poklopci za vozila, sirene za vozila, glavčine za točkove vozila, motori za upravljanje kopnenim vozilima, propulzioni mehanizmi za kopnena vozila, redukcionni prenosnici za kopnena vozila, alarm opomene za vožnju u rikverc, točkovi vozila, amortized za automobile, volani za vozila, konvertori obrtnog momenta za kopnena vozila, torzione poluge za vozila, prenosni lanci za kopnena vozila, prenosna vratila za kopnena vozila, prenosnici za kopnena vozila, turbine za kopnena vozila, stajni trap automobila, kamioni, kombiji i kamioneti, opruge za vješanje vozila, prozori za vozila, bicikli, motorcikli, vozila za prevoz kopnom, vazduhom, vodom ili železnicom.

**Klasa 37:** Održavanje i popravka motornih vozila, podmazivanje vozila, pranje vozila, poliranje vozila, zaštita vozila od rđe, stanice za servisiranje vozila (pumpe za gorivo i održavanje), popravka šara na gumama, vulkaniziranje i popravka guma, restauracija mašina koje su pohabane ili djelimično uništene, instaliranje i popravka alarma protiv provala

(111) 07227

(151) 18.01.2013

(210) **2010-59**

(442) **20.06.2012**

(220) 10.03.2010

(732) CHERY AUTOMOBILE CO.LTD, 8 CHANGCHUN ROAD, ECONOMY I TECHNOLOGY DEVELOPMENT ZONE WUHU CITY, ANHUI PROVINCE CN



(540)

(550) I

(740) Đakonović Vido, Bajova 9, Cetinje (ME)

(511) **Klasa 12:** Vazdušni jastuci [sigurnosni uređaji za automobile], pumpe za vazduh [dodatna oprema za vozila], bolnička kola, uređaji protiv zasjenjivanja za vozila, uređaji protiv krađe za vozila, karoserije i šasije za automobile, automobilske gume, automobili, osovine za vozila, trake za glavčine točkova, djelovi kočnica za vozila, kočione pedale za vozila, kočnice za vozila, autobusi, motorna vozila, kvačila za kopnena vozila, klipnjače za kopnena vozila, koje nisu djelovi motora i pogonskih mašina, konvertori za kopnena vozila, kućišta radilice i komponente terenskih vozila, koji nisu pogonski motor, pokazivači pravca za vozila, vrata za vozila, pogonski motori za kopnena vozila, električna vozila, lančanik slobodnog hoda za kopnena vozila, prenosnici brzine za kopnena vozila, sistem prenosnika za kopnena vozila, poklopci za motore na vozilima, poklopci za vozila, sirene za vozila, glavčine za točkove vozila, motori za upravljanje kopnenim vozilima, propulzioni mehanizmi za kopnena vozila, redukcionni prenosnici za kopnena vozila, alarm opomene za vožnju u rikverc, točkovi vozila, amortized za automobile, volani za vozila, konvertori obrtnog momenta za kopnena vozila, torzione poluge za vozila, prenosni lanci za kopnena vozila, prenosna vratila za kopnena vozila, prenosnici za kopnena vozila, turbine za kopnena vozila, stajni trap automobila, kamioni, kombiji i kamioneti, opruge za vješanje vozila, prozori za vozila, bicikli, motorcikli, vozila za prevoz kopnom, vazduhom, vodom ili železnicom.

**Klasa 37:** Održavanje i popravka motornih vozila, podmazivanje vozila, pranje vozila, poliranje vozila, zaštita vozila od rđe, stanice za servisiranje vozila (pumpe za gorivo i održavanje), popravka šara na gumama, vulkaniziranje i popravka guma, restauracija mašina koje su pohabane ili djelimično uništene, instaliranje i popravka alarma protiv provala.

(111) 07055

(151) 27.12.2012

(210) **2010-61**(442) **20.06.2012**

(220) 15.03.2010

(732) MENTOR WORLDWIDE LLC, 5425 HOLLISTER AVENUE, SANTA BARBARA CA 93111 US

# SILTEX

(540)

(550) I

(740) Radulović Božidar, Jovana Tomaševića 9/III, Podgorica (ME)

(511) **Klasa 10:** Hiruški implantanti koji sadrže vještačke materije.

(111) 07038

(151) 27.12.2012

(210) **2010-266**

(442) **20.06.2012**

(220) 27.07.2010

(732) PHARMASWISS SA, BUNDESPLATZ 1 6300 ZUG CH

## MEROCID

(540)

(550) I

(740) Radulović Božidar, Jovana Tomaševića 9/III, Podgorica (ME)

(511) **Klasa 05:** Farmaceutski preparati–lijekovi.

(111) 07202

(151) 17.01.2013

(210) **2010-186**

(442) **20.06.2012**

(220) 03.06.2010

(300) BA Z 1014512A 28.01.2010

(732) KWIZDA HOLDING GMBH, DR.KARL LUEGER-RING 6, A-1010 WIEN AT

## Trauma COLD

(540)

(550) I

(740) Čejović Vladimir, 13. jula 21, Podgorica (ME)

(511) **Klasa 05:** Farmaceutski i veterinarski proizvodi higijenski proizvodi za upotrebu u medicini dijetetske supstance prilagođene za upotrebu u medicini, hrana za bebe flasteri, materijali za previjanje materijali za plombiranje zuba, zubarska smola sredstva za dezinfekciju proizvodi za uništavanje životinjskih štetočina fungicidi, herbicidi.

(111) 06961

(151) 27.12.2012

(210) **2010-263**

(442) **20.06.2012**

(220) 23.07.2010

(732) NINE WEST DEVELOPMENT CORPORATION, 1007 ORANGE STREET, SUITE 225, WILMINGTON, DELAWARE 19801 US

## NINE WEST

(540)

(550) I

(740) Čejović Vladimir, 13. jula 21, Podgorica (ME)

(511) **Klasa 3:** Parfemi, toaletne vode, kolonske vode, mirisni sprejevi, sapuni, sredstva za či-

šćenje kože, losioni i kreme za kožu, hidrantne kreme, losioni i ulja za zatamljivanje kože, kozmetički proizvodi, naime, puderi za lice i tijelo, podloga, sjaj za tijelo, sjaj za lice, karmin, olovke za usne, rumenilo, sjenka za oči, krema za oči, ajlajner, maskara i olovke za obrve, razređivači za čišćenje, losioni i kreme za obuću, uključujući i sredstva za glancanje cipela i čizama.

- 
- (111) 06966 (151) 27.12.2012  
 (210) **2010-237** (442) **20.06.2012**  
 (220) 15.07.2010  
 (732) JAPAN TOBACCO INC, 2-2-1 TORANOMON, MINATO-KU, TOKYO JP

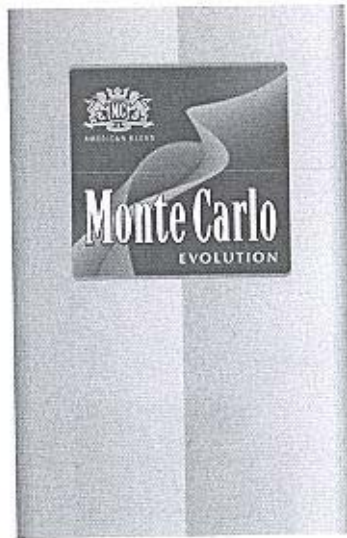

- (540)  
 (550) I  
 (740) Čejović Vladimir, 13. jula 21, Podgorica (ME)  
 (511) **Klasa 34:** Cigarete, prerađeni i neprerađeni duvan, artikli za pušače i šibice.

- 
- (111) 06967 (151) 27.12.2012  
 (210) **2010-233** (442) **20.06.2012**  
 (220) 15.07.2010  
 (732) PLAYBOY ENTERPRISES INTERNATIONAL INC, 680 NORTH LAKE SHORE DRIVE, CHICAGO, ILLIONS 60611 US

# PLAYBOY

- (540)  
 (550) I  
 (740) Ćupić Branislav, Dalmatinska 10, Podgorica (ME)  
 (511) **Klasa 04:** Industrijska ulja i masti, maziva, jedinjenja za skupljanje prašine vlaženjem i vezivanjem, goriva i materije za osvjetljavanje, svijeće i fitilji za osvjetljavanje, zapaljiva goriva, mirišljave svijeće, feromonske svijeće.

- 
- (111) 06968 (151) 27.12.2012

(210) **2010-234**(442) **20.06.2012**

(220) 15.07.2010

(732) PLAYBOY ENTERPRISES INTERNATIONAL INC, 680 NORTH LAKE SHORE DRIVE, CHICAGO, ILLIONS 60611, US

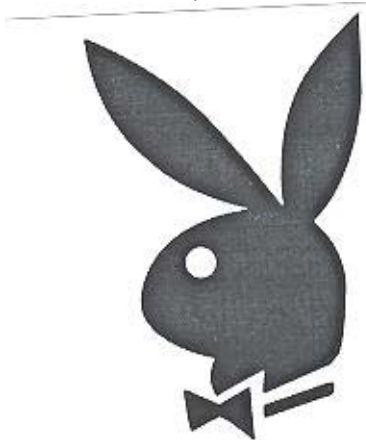

(540)

(550) I

(740) Ćupić Branislav, Dalmatinska 10, Podgorica (ME)

(511) **Klasa 05:** Farmaceutski i veterinarski preparati, sanitarni preparati za medicinsku upotrebu, dijetetske substance prilagođene za upotrebu u medicini, flasteri, materijali za zavijanje, materijali za plombiranje zuba, zubarska smola, dezinfekciona sredstva, preparati za uništavanje štetočina, fungicide, herbicidi, hrana i piće prilagođeni za upotrebu u medicinske svrhe, preparati za osvježavanje vazduha, proizvodi za uvećavanje muškosti u vidu pilula, tečnosti i losiona, lubrikanti za ličnu upotrebu, energetske dodaci. nutricionističko-farmaceutski preparati, vitamini.

(111) 06969

(151) 27.12.2012

(210) **2010-231**(442) **20.06.2012**

(220) 15.07.2010

(732) PLAYBOY ENTERPRISES INTERNATIONAL INC, 680 NORTH LAKE SHORE DRIVE, CHICAGO, ILLIONS 60611 US

# PLAYBOY

(540)

(550) I

(740) Ćupić Branislav, Dalmatinska 10, Podgorica (ME)

(511) **Klasa 05:** Farmaceutski i veterinarski preparati, sanitarni preparati za medicinsku upotrebu, dijetetske substance prilagođene za upotrebu u medicini, flasteri, materijali za zavijanje, materijali za plombiranje zuba, zubarska smola, dezinfekciona sredstva, preparati za uništavanje štetočina, fungicide, herbicidi, hrana i piće prilagođeni za upotrebu u medicinske svrhe, preparati za osvježavanje vazduha, proizvodi za uvećavanje muškosti u vidu pilula, tečnosti i losiona, lubrikanti za ličnu upotrebu, energetske dodaci, nutricionističko-farmaceutski preparati, vitamini.

utski preparati, vitamini.

(111) 06970

(151) 27.12.2012

(210) **2010-232**

(442) **20.06.2012**

(220) 15.07.2010

(732) PLAYBOY ENTERPRISES INTERNATIONAL INC, 680 NORTH LAKE SHORE DRIVE, CHICAGO, ILLIONS 60611 US



(540)

(550) I

(740) Ćupić Branislav, Dalmatinska 10, Podgorica (ME)

(511) **Klasa 04:** Industrijska ulja i masti, maziva, jedinjenja za skupljanje prašine vlaženjem i vezivanjem, goriva i materije za osvjetljavanje, svijeće i fitilji za osvjetljavanje, zapaljiva goriva, mirišljave svijeće, feromonske svijeće.

(111) 07057

(151) 27.12.2012

(210) **2010-204**

(442) **20.06.2012**

(220) 15.06.2010

(732) S.C. JOHNSON & SON, INC, 1525 HOWE STREET, RACINE, WISCONSIN 53403'2236 US

EARTH  
OPTIONS

(540)

(550) I

(740) Čejović Vladimir, 13. jula 21, Podgorica (ME)

(511) **Klasa 3:** Preparati za čišćenje, poliranje, ribanje i nagrizanje sredstva za bijeljenje i druge supstance za upotrebu na tkaninama preparati za pred-tretman i uklanjanje fleka i mrlja preparati u obliku voska za upotrebu na završenim i nezavršenim površinama preparati za uklanjanje voska preparati za otpušavanje odvođa sapuni deterdženti.

**Klasa 4:** svijeće vitke svijeće sa konusnim suženjem fitilji.

**Klasa 5:** Preparati za uništavanje korova i štetočina insekticidi sredstva protiv moljaca sredstva protiv insekata osjveživači vazduha sredstva za uklanjanje neprijatnih mirisa iz vazduha sredstva za pročišćavanje vazduha sredstva za sterilisanje vazduha sredstva za uklanjanje

neprijatnih mirisa iz tkanina sredstva za uklanjanje neprijatnih mirisa iz tepiha i soba.

- 
- |                       |                         |
|-----------------------|-------------------------|
| (111) 06940           | (151) 27.12.2012        |
| (210) <b>2010-214</b> | (442) <b>20.06.2012</b> |
|                       | (220) 25.06.2010        |
- (732) MARKWINS BEAUTY PRODUCTS, INC, 22067 FERRERO PARKWAZ CITY OF INDUSTY, CALIFORNIA 91789 US

## WET N WILD

- (540)
- (550) I
- (740) Radulović Božidar, Jovana Tomaševića 9/III, Podgorica (ME)
- (511) **Klasa 3:** Sredstva za bjeljenje i druge supstance za upotrebu pri pranju preparati za čišćenje, poliranje, ribanje i nagrizanje sapuni parfimerija, eterična ulja, kozmetika, losioni za kosu paste za zube naročito kozmetički proizvodi, uključujući senke za oči, senke za oči u obliku kreme, ajlajnere, maskare, olovke za oči, olovke za obrve, rumenilo, tečno rumenilo, ruz, puder za telo, puder za lice, karmine, boje za usne, sjaj za usne, lajnere za usne, ne medicinske balzame za usne, olovke za usne, kozmetičke komplete koji sadrže gore navedeno osnove i podloge za šminke proizvodi za skidanje šminke tečni sjaj za telo sjaj za telo u obliku pudera sjaj za telo krejoni za telo sredstva za davanje vlažnosti koži proizvodi za zatezanje za upotrebu u kozmetici preparati za čišćenje lica preparati za negu noktiju, naročito, lakovi i premazi za nokte, boje za nokte, sredstva za uklanjanje laka za nokte tuferi za uklanjanje laka za nokte, učvrscivaci za nokte, korektor laka za nokte, regeneratori za nokte, krema za masiranje zanoktica, krema za uklanjanje zanoktica.

- 
- |                       |                         |
|-----------------------|-------------------------|
| (111) 07000           | (151) 27.12.2012        |
| (210) <b>2010-267</b> | (442) <b>20.06.2012</b> |
|                       | (220) 27.07.2010        |
- (732) PHARMASWISS SA, BUNDESPLATZ 1 6300 ZUG CH

## MIPECID

- (540)
- (550) I
- (740) Radulović Božidar, Jovana Tomaševića 9/III, Podgorica (ME)
- (511) **Klasa 05:** Farmaceutski preparati-ljekovi.

- 
- |                       |                         |
|-----------------------|-------------------------|
| (111) 07381           | (151) 05.02.2013        |
| (210) <b>2010-211</b> | (442) <b>20.06.2012</b> |
|                       | (220) 23.06.2010        |
- (732) GOJO INDUSTRIES, INC, ONE GOJO PLAZA, SUITE 500, AKRON, OHIO 44311 US

# GOJO

(540)

(550) I

(740) Radulović Božidar, Jovana Tomaševića 9/III, Podgorica (ME)

(511) **Klasa 3:** Preparati za pranje ruku sa visokim ucinkom, sapuni za ruke, kreme za čišćenje ruku, losioni za čišćenje kože, zastitne kreme i losioni za tijelo, sapuni za tijelo u obliku losiona, kreme za ruke, samponi i preparati za tusiranje, maramice impregnirane sa supstanca-ma za čišćenje ruku i punjenja za iste.

**Klasa 5:** Antimikrobni i antibakterijski tecni sapuni, sredstva za trenutnu higijenu i dezinfekciju ruku.

**Klasa 21:** Uređaji za raspršivanje sapuna, uređaji za raspršivanje kreme i losiona.

(111) 07210

(151) 17.01.2013

(210) **2010-191**

(442) **20.06.2012**

(220) 07.06.2010

(732) CHOICE HOTELS INTERNATIONAL, INC, 10750 COLUMBIA PIKE, SILVER SPRING, MARYLAND 20901 US



(540)

(550) I

(740) Čejović Vladimir, 13. jula 21, Podgorica (ME)

(511) **Klasa 43:** Hotelske i motelske usluge, usluge hotelskih i motelskih rezervacija za druge, i usluge hotelskih i motelskih onlajn rezervacija za druge.

(111) 07205

(151) 17.01.2013

(210) **2010-90**

(442) **20.06.2012**

(220) 01.04.2010

(732) HENKEL SRBIJA D.O.O. BULEVAR OSLOBODJENJA 383, BEOGRAD SR



# GLAMUR

## ŠAMPON

(540)

(550) I

(740) Dedić Tomislav, Bulevar Ivana Crnojevića 139 Podgorica (ME)

(511) **Klasa 03:** Šamponi za kosu.

(111) 07215

(151) 17.01.2013

(210) **2010-157**

(442) **20.06.2012**

(220) 11.05.2010

(732) SUMITOMO RUBBER INDUSTRIES,LTD, 6-9, 3-CHOME,WAKINOHAMA-CHO, CHUO-KU, KOBE-SHI, HUOGO JP

# SUMITOMO

(540)

(550) I

(740) Popović Miladin, Đoka Miraševića 21/III, Podgorica (ME)

(511) **Klasa 12:** Gume za kopnena vozila gume za motorna vozila na dva točka

(111) 07332

(151) 29.01.2013

(210) **2010-54**

(442) **20.06.2012**

(220) 08.03.2010

(732) INTERVET INTERNATIONAL B.V.WIM DE KORVERSTRAAT 35, 5831 AN BOXMEER NL

# POSATEX

(540)

(550) I

(511) **Klasa 05:** Ljekovi i farmaceutski preparati za veterinarsku upotrebu.

(111) 07383

(151) 06.02.2013

(210) **2010-239**

(442) **20.06.2012**

(220) 16.07.2010

(732) CROWN BRANDS LIMITED, CROWN HOUSE, HOLLINS ROAD, DARWEN, LANCASHIRE BB3

OBG GB

## CROWN

(540)

(550) I

(740) Popović Miladin, Đoka Miraševića 21/III, Podgorica (ME)

(511) **Klasa 02:** Boje, firnajzi, lakovi, sredstva za zaštitu od rđe i truljenja drveta, materije za bojenje, boje, sredstva za nagrizanje.

(111) 07209

(151) 17.01.2013

(210) **2010-198**(442) **20.06.2012**

(220) 10.06.2010

(732) TUTINSKI KOMBINAT AD PRILEP, UL.MARKSOVA BR.101 7500 PRILEP MK

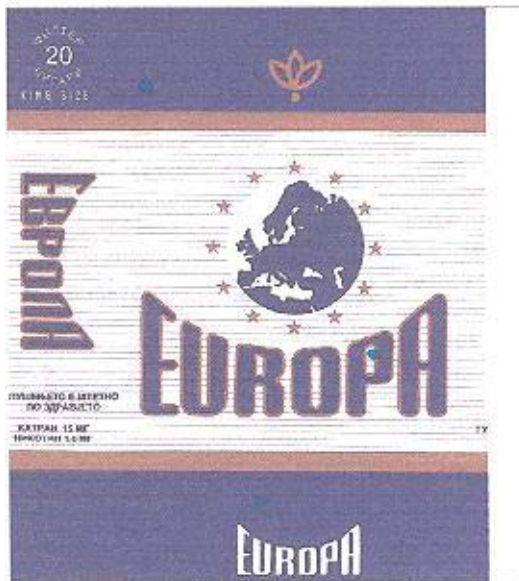
(540) **1**skoj klasifikaciji:

(550) I

(740) Radulović Božidar, Jovana Tomaševića 9/III, Podgorica (ME)

(511) **Klasa 34:** Duvan artikli za pušače, šibice.

(111) 07300

(151) 29.01.2013

(210) **2010-80**(442) **20.06.2012**

(220) 26.03.2010

(732) HONDA MOTOR CO LTD, 1-1, MINAMI-AOYAMA 2-CHOME, MINATO-KU, TOKYO 107-8556 JP

# IMA

(540)

(550) I

(740) Lutovac Branislav, Bulevar Crnojevića 93, Podgorica (ME)

(511) **Klasa 12:** Automobili, vozila, aparati za kretanje po zemlji, vazduhu ili vodi, i djelovi i oprema za napred navedenu robu obuhvaćeni međunarodnom klasom 12.

(111) 07345

(151) 29.01.2013

(210) **2010-184**

(442) **20.06.2012**

(220) 02.06.2010

(732) TDR DOO, OBALA V. NAZORA BR.1 52210 ROVINJ HR

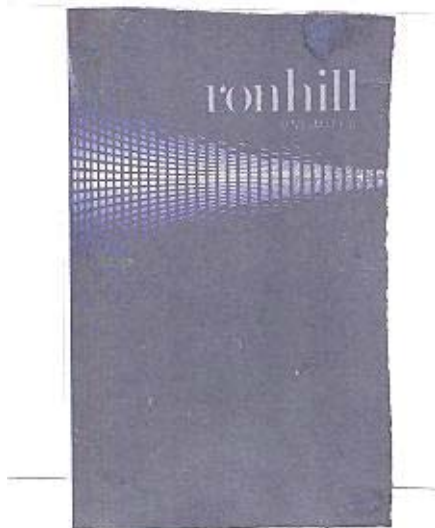

(540)

(550) I

(740) Vukotić Petar, Novaka Miloševa, Podgorica (ME)

(511) **Klasa 34:** Duvan sirov i prerađen, proizvodi od duvana, cigare, cigarete, filter, cigarete, cigarilos, artikli za pušace, upaljači, šibice.

**Klasa 35:** Usluge u vezi sa prometom robe, posebno usluge u prometu duvana i duvanskih proizvoda oglašavanje vođenje poslova poslovno upravljanje kancelarijski poslovi komercijalno zastupanje propagandne i reklamne usluge marketing usluge istraživanja tržišta usluge promocije, posebno promovisnje ili reklamiranje kulturnih i zabavnih događaja, sportskih takmičenja i modnih revija organizovanje i vođenje sajmova i izložbi u reklamne i komercijalne svrhe naprijed navedene usluge koje pripadaju ovoj klasi koje se obavljaju putem interneta davanje i širenje informacija u vezi sa gore navedenim uslugama.

(111) 07347

(151) 31.01.2013

(210) **2010-219**

(442) **20.06.2012**

(220) 28.06.2010

(732) TOYOTA JIDOSHA KABUSHIKI KAISHA, 1 TOYOTA'CHO,TOYOTA -SHI. AICHI-KEN JP



(540)  
 (550) I  
 (740) Čejović Vladimir, 13. jula 21, Podgorica (ME)  
 (511) **Klasa 12:** Automobili i njihovi strukturni dijelovi.

---

(111) 07348	(151) 31.01.2013
(210) <b>2010-210</b>	(442) <b>20.06.2012</b>
	(220) 21.06.2010

(732) TOYOTA JIDOSHA KABUSHIKI KAISHA, 1,TOYOTA-CHO, TOYOTA-SHI, AICHI-KEN JP

## TOYOTA 86

(540)  
 (550) I  
 (740) Čejović Vladimir, 13. jula 21, Podgorica (ME)  
 (511) **Klasa 12:** Automobili i njihovi strukturni dijelovi.

---

(111) 07352	(151) 31.01.2013
(210) <b>2010-271</b>	(442) <b>20.06.2012</b>
	(220) 02.08.2010

(732) PEPSI CO INC, 700 ANDERSON HILL ROAD, PURCHASE, NY 10577 US

## CHEETOS SWEETOS

(540)  
 (550) I  
 (740) Čejović Vladimir, 13. jula 21, Podgorica (ME)  
 (511) **Klasa 30:** Kafa, čaj, kakao, šećer, pirinač, tapioka, sago, zamjena kafe, brašno i proizvodi od žitarica, hljeb, kolači i poslastice, sladoledi, med, melasa, kvasac, prašak pecivo, so, sent, sirće, sosevi (kao začini), začini, led, grickalice na bazi brašna, kukuruza, žitarica, pirinča, obrađena sjemena žitarica.

---

(111) 07353	(151) 31.01.2013
(210) <b>2010-215</b>	(442) <b>20.06.2012</b>
	(220) 25.06.2010

(732) PEPSICO, INC, 700 ANDERSON HILL ROAD, PURCHASE, NY 10577 US

## ZA TRENUTKE PUNOG OKUSA

(540)

(550) I

(740) Čejović Vladimir, 13. jula 21, Podgorica (ME)

(511) **Klasa 29:** Meso, riba, zivina i divljac mesne preradevine konzervisano, smrznuto, suseno, i kuvano voće i povrće zelei, dzemovi kompoti jaja, mlijeko i mlijecni proizvodi jestiva ulja i masti cips grickalice na bazi voća, povrća, sira, mesa, kostunjavog voća obrađeno kostunjavo voće jestive sjemenke.

(111) 07344

(151) 29.01.2013

(210) **2010-151**

(442) **20.06.2012**

(220) 06.05.2010

(732) TDR DOO, OBALA V.NAZORA BR.1 52210 ROVINJ HR



(540)

(550) I

(740) Vukotić Petar, Novaka Miloševa, Podgorica (ME)

(511) **Klasa 34:** Duvan sirov i preraden, proizvodi od duvana, cigare, cigarete, filter, cigarete, cigarilosi, artikli za pušače, upaljači, šibice.

**Klasa 35:** Usluge u vezi sa prometom robe, posebno usluge u prometu duvana i duvanskih proizvoda oglašavanje vođenje poslova poslovno upravljanje kancelarijski poslovi komercijalno zastupanje propagandne i reklamne usluge marketing usluge istraživanja tržišta usluge promocije, posebno promovisanje ili reklamiranje kulturnih i zabavnih događaja, sportskih takmičenja i modnih revija organizovanje i vođenje sajмова i izložbi u reklamne i komercijalne svrhe naprijed navedene usluge koje pripadaju ovoj klasi koje se obavljaju putem interneta davanje i sirenje informacija u vezi sa gore navedenim uslugama.

(111) 06998

(151) 27.12.2012

(210) **2010-49**(442) **20.06.2012**

(220) 04.03.2010

(732) LUXOR DOO NIKŠIĆ, TRG SLOBODE 2,81400 NIKŠIĆ ME

LUXOR

(540)

(550) I

(740) Božović Vesko, Rimski trg 50/11, Podgorica (ME)

(511) **Klasa 35:** Oglašavanje i reklamiranje, vođenje komercijalnih poslova, komercijalna administracija, uredski poslovi.

(111) 06999

(151) 27.12.2012

(210) **2010-51**(442) **20.06.2012**

(220) 04.03.2010

(732) LUXOR DOO NIKŠIĆ, TRG SLOBODE 2,81400 NIKŠIĆ ME

CITY MODA  
CIVIL

(540)

(550) I

(740) Božović Vesko, Rimski trg 50/11, Podgorica (ME)

(511) **Klasa 35:** Oglašavanje i reklamiranje, vođenje komercijalnih poslova, komercijalna administracija, uredski poslovi.

(111) 06941

(151) 27.12.2012

(210) **2010-259**(442) **20.06.2012**

(220) 22.07.2010

(732) CAFE REKLAM REKLAMUGYNOKSEGI ES FILMSZOLGALTATO KFT, SEREGELY UTCA 3-5 BUDAPEST 1037 HU



(540)

(550) I

(740) Popović Miladin, Đoka Miraševića 21/III, Podgorica (ME)

(511) **Klasa 16:** Hartija, karton i proizvodi od njih, koji nisu uključeni u druge klase, štampane stvari, knjigovezački materijal, fotografije, kancelarijski materijal, pisaće mašine i kancelarijski rekviziti (izuzev Namještaja), materijali za obuku i nastavu (izuzev aparata), plastični materijali za pakovanje (koji nisu uključeni u druge klase), štamparska slova, klišeji.

**Klasa 35:** Oglašavanje, vođenje poslova, poslovno upravljanje, kancelarijski poslovi.

**Klasa 42:** Naučne i tehnološke usluge i istraživanje i projektovanje u vezi tih usluga, usluge industrijske analize i istraživanja, projektovanje i razvoj kompjuterskog hardvera i softvera, kreiranje i održavanje veb sajtova za druge, dizajn ambalaže.

(111) 07217

(151) 17.01.2013

(210) **2010-83**

(442) **20.06.2012**

(220) 26.03.2010

(732) HONDA MOTOR CO LTD, 1-1, MINAMI-AOYAMA 2-CHOME, MINATO-KU, TOKYO 107-8556 JP

# ECON

(540)

(550) I

(740) Lutovac Branislav, Bulevar Crnojevića 93, Podgorica (ME)

(511) **Klasa 12:** Automobili, vozila, aparati za kretanje po zemlji, vazduhu ili vodi, i djelovi i oprema za naprijed navedenu robu obuhvaćeni međunarodnom klasom 12.

(111) 07223

(151) 18.01.2013

(210) **2010-212**

(442) **20.06.2012**

(220) 24.06.2010

(732) NBA PROPERTIES, INC, OLIMPIC TOWER BLDG, 645 FIFTH AVENUE, NEW YORK, NY 10022 US



(540) \_\_\_\_\_

(550) I

(740) Popović Miladin, Đoka Miraševića 21/III, Podgorica (ME)

(511) **Klasa 25:** odjeća, naime čarape, obuća, cipele za košarku, patike za košarku, majice, košulje, polo majice, dukserice, donji djelovi trenerke, pantalone, majice na bretele, dzemperi, kratke pantalone, pidžame, sportske majice, ragbi majice, vunene majice, kaiSevi, kravate, spava&ce, šeširi, kape, štitnici na ka&ketima, trenerke, donji djelovi trenerki, dresovi, jakne, vetrovke, kišne krznene jakne, kaputi, portikle za bebe ne od papira, trake za glavu, narukvice, kecelje, donje rublje, bokserice, široke pantalone, štitnici za uši, rukavice, bokserske rukavice, salovi, pletene i štrikane majice, trikotazne haljine, haljine, dresovi i uniforme za navijalice, odjeća za plivanje, odjela za kupanje, kupaći kostimi, bikini, tamkini kupaći kostimi, gacice za plivanje, gacice za kupanje, šorcevi za surfovanje, šorcevi za kupanje, marama za plazu, pokrivala za kupaći kostim, ogrtači za kupadi kostim, sandale, sandale za plazu, šeširi za plazu, štitnici za sunce, kape za plivanje, kape za kupanje, nova pokrivala za glavu sa prikacnim umecima.

**Klasa 28:** Igračke, igre i sportske stvari, naime košarkaške lopte, loptice za golf, lopte za igraliste, sportske lopte, gumene lopte i penaste lopte, pliSane lopte za igru, plasticne lopte za igru, mrežice za košarku, table za košarku, minijaturne table za košarku, pumpe i igle za naduvavanje košarkaških lopti štapovi za golf, torbe za golf, podmetaci za golf, oprema za golf, naime, alat za popravku golf terena, kupice na koje se stavlja lopta, markeri lopti, torbe za golf opremu, pokrivala za glave golf štapova, rukavice za golf, kutije za golf lopte, elektronske table za košarkaške igrice na tabli, table za košarkaške igrice, košarkaške igrice, akcione igrice, društvene igrice za odrasle i djecu, trivia informacione igrice i elektronske video arka&da igrice, košarkaška torbica koja se sastoji od mrežice i zvizdaljke, lutke, dekorativne lutke, lutke za kolekciju, akcione figure za igru, akcione figure karikature, punjene igraške, nove pliSane igra&fike sa perikom, puzzle, montažni blokovi za igre, ukrasi za Božićnu jelku i Božićne čarape vozila za igru u obliku automobila, kamiona, vozova i kombija, svi sa temom košarke, nove penaste igracke u obliku prsta ili trofeja, igrački trofeji, karte za igru, igrice sa kartama, igradke koje prave zvuk, igradke za kucne ljubimce igra&fike za plazu, naime lopte za plazu, lopte na naduvavanje, kantice za igru, lopatice za igru, igračke za pesak, kutijice za pesak, gumene igra&fke za vodu oprema za bazen, naime plivačka oprema za plutanje, oprema za plutanje u bazenu, igradke za splavarenje na vodi, penasta oprema za plutanje, gume za plivanje, gume za plivanje u bazenu, penaste gume, daske za plivanje, daske za surfovanje, peraja za plivanje, peraja za surfovanje, mišici za plutanje i krila za pomoć pri plivanju u



rekreativne svrhe odbojkaške torbice za igru koje se sastoje od lopte, mrežice, sporednih stvari i zviždaljke, i vaterpolo torbice za igru koje se sastoje od lopte, mrežice i zviždaljke dekorativne igračke od tkanine koje se puštaju da lete na vetru.

**Klasa 41:** Razonoda i obrazovne usluge u smislu televizijskih događaja i radio programa u polju košarke i prikazivanja uzivo košarkaških igara i košarkaških priredbi usluge produkcije i distribucije radio i televizijskih šou programa o košarkaškim igrama, košarkaškim događajima i programima iz oblasti košarke usluge vođenja i organizovanja košarkaških klinika i kampova, klinika i kampova za trenere, klinika i kampova za plesne timove i košarkaške igre usluge razonode u vidu ličnog pojavljivanja u kostimiziranim maskotama ili u plesnim timovima na košarkaškim igrama i priredbama, klinikama, kampovima, promocijama i drugim događajima, specijalnim događajima i zurkama vezanim za košarku usluge kluba obožavalaca usluge razonode, naime one koje pružaju veb-sajt predstavljanje multimedijjskih sadržaja u vidu najvažnijih televizijskih događaja, interaktivnih najvažnijih televizijskih događaja, video snimaka, video strim snimaka, interaktivnih video izbora najvažnijih događaja, radio programa, najvažnijih radijskih događaja i audio snimaka u polju košarke usluge obezbjeđivanja vesti i informacija u vidu statistika i drugih stvari u polju košarke onlajn igrice koje se ne mogu preuzimati, naime kompjuterske igrice, video igrice, interaktivne video igrice, akcione igrice, arkadne igrice, društvene igrice za odrasle i djecu, igre na tabli, puzzle, trivia igrice usluge elektronskog izdavaštva, naime, izdavanje magazina, vodica, biltena, bojanki i igrica kod kojih se igradi određuju putem interneta, sve u vezi sa košarkom usluge obezbjeđivanja onlajn kompjuterske baze podataka u polju košarke.

---

(111) 07301	(151) 31.01.2013
(210) <b>2010-79</b>	(442) <b>20.06.2012</b>
	(220) 26.03.2010
(732) ZDRAVLJE AD, VLAJKOVA 199, 16000 LESKOVAC RS	

## ANTIAGREX

(540)  
 (550) I  
 (740) Popović Miladin, Đoka Miraševića 21/III, Podgorica (ME)  
 (511) **Klasa 05:** Preparati za prevenciju ishemijskih događaja, akutni koronarni sindrom.

---

(111) 30.11.2012	(151) 06938
(210) <b>2010-89</b>	(442) <b>20.06.2012</b>
	(220) 31.03.2010
	(300) CTM 008597361 06.10.2009.
(732) RECKITT & COLMAN (OVERSEAS) LIMITED DANSOM, LANE, HULL HU8 7DS UK	

## SMOOTH SATIN &amp; MOON LILY

(540)

(550) I

(740) Popović Miladin, Đoka Miraševića 21/III, Podgorica (ME)

(511) **Klasa 03:** Preparati za parfemisanje atmosfere, potpuri, esencijalna ulja, sobni parfemisani sprejevi, preparati za parfemisanje ili aromatizovanje vazduha.**Klasa 04:** Svijeće, aromatične ili mirisne svijeće.**Klasa 05:** Preparati za osvježavanje vazduha, preparati za prečišćavanje vazduha, sobni osvježivači vazduha, dezodoransi koji nisu za ličnu upotrebu, preparati za neutralisanje mirisa.**Klasa 11:** Aparati i instrumenti za ispuštanje mirisa, prečišćavanje ili osvježavanje atmosfere, djelovi i pribor za svu navedenu robu.

(111) 07059

(151) 27.12.2012

(210) **2010-194**(442) **20.06.2012**

(220) 08.06.2010

(732) S.C.JOHNSON&amp;SON, INC, 1525 HOWE STREET, RACINE, WISCONSIN 53403-2236 US

## MR. MUSCLE

(540)

(550) I

(740) Čejović Vladimir, 13. jula 21, Podgorica (ME)

(511) **Klasa 3:** Preparati za čišćenje, poliranje, ribanje i nagrizanje sredstva za bijeljenje i druge supstance za upotrebu na tkaninama maramice za jednokratnu upotrebu impregnirane hemikalijama ili jedinjenjima za upotrebu u domaćinstvu preparati za uklanjanje laka preparati u obliku voska za upotrebu na završenim i nezavršenim površinama preparati za uklanjanje voska preparati za otpušavanje odvoda preparati za poliranje cipela, kreme za cipele, preparati za čišćenje cipela sapuni deterdženti.**Klasa 5:** Sredstva za uklanjanje mikroba i sredstva za dezinfekciju.**Klasa 21:** Kuhinjski i pribor za domaćinstva za čišćenje, poliranje, ribanje, nagrizanje i voskiranje suđeri četke krpe odjeća za čišćenje odjeća impregnisana rastvorom za čišćenje.

(111) 07058

(151) 27.12.2012

(210) **2010-193**(442) **20.06.2012**

(220) 08.06.2010

(732) S.C. JOHNSON &amp; SON, INC, 1525 HOWE STREET, RACINE, WISCONSIN 53403-2236 US

## GLADE

(540)

(550) I

(740) Čejović Vladimir, 13. jula 21, Podgorica (ME)

(511) **Klasa 3:** Preparati za čišćenje, poliranje, ribanje i nagrizanje sredstva za bijeljenje i druge supstance za upotrebu na tkaninama sapuni deterdženti maramice za jednokratnu upotrebu impregnirane hemikalijama ili jedinjenjima za upotrebu u domaćinstvu preparati za parfemisanje atmosfere.

**Klasa 4:** svijeće vitke svijeće sa konusnim suženjem fitilji.

**Klasa 5:** Osvezivaci vazuha sredstva za uklanjanje neprijatnih mirisa iz vazduha sredstva za pročišćavanje vazduha sredstva za sterilisanje vazduha sredstva za uklanjanje neprijatnih mirisa iz tkanina sredstva za uklanjanje neprijatnih mirisa iz tepiha i soba sredstva za uklanjanje mikroba i sredstava za dezinfekciju.

**Klasa 9:** Električne jedinice za zagrijavanje različitih tipova materijala u cilju oslobađanja mirisa.

**Klasa 11:** Aparati za emitovanje mirisa, osveživača ili sredstava za uklanjanje neprijatnih mirisa u okolnu atmosferu djelovi i dodaci za takve aparate.

(111) 07065

(151) 27.12.2012

(210) **2010-85**(442) **20.06.2012**

(220) 29.03.2010

(732) HOME BOX OFFICE INC, 1100 AVENUE OF THE AMERICAS, 9th FLOOR NEW YORK, NY 10036 US

HBOOD

(540)

(550) I

(740) Ćupić Branislav, Dalmatinska 10, Podgorica (ME)

(511) **Klasa 41:** Obuka, stručno osposobljavanje, razonoda, sportske i kulturne djelatnosti, stručno osposobljavanje, sportske i kulturne djelatnosti, pružanje razonode i obuke, produkcija, prezentacija i distribucija audio, video, statičnih i pokretnih slika i podataka, usluge izdavaštva (uključujući usluge elektroničke publikacije), organiziranje foruma i blogova za rasprave, usluge razonode, osobito usluge programiranja, proizvodnje i distribucije video materijala.

(111) 06962 (151) 27.12.2012  
 (210) **2010-75** (442) **20.06.2012**  
 (220) 23.03.2010  
 (732) COLGATE-PALMOLIVE COMPANY, 300 PARK AVENUE, NEW YORK, N.Y.10022 US

### PLAX REVEAL

(540)  
 (550) I  
 (740) Lutovac Branislav, Bulevar Crnojevića 93, Podgorica (ME)  
 (511) **Klasa 03:** Vodica za ispiranje usta.

---

(111) 06939 (151) 27.12.2012  
 (210) **2010-260** (442) **20.06.2012**  
 (220) 23.07.2010  
 (732) PROJECT-CONSULTING, UL. VAKA ĐUROVIĆA 82, PODGORICA ME

D.O.O. „PROJECT – CONSULTING“ – PODGORICA

**PROCON**

Nacionalna jedinica za implementaciju projekata iz oblasti  
 komunalnih djelatnosti i zaštite životne sredine

(540)  
 (550) I  
 (511) **Klasa 35:** Vođenje poslova, poslovno upravljanje, kancelarijski poslovi.  
**Klasa 42:** Naučne i tehnološke usluge i istraživanje i projektovanje u vezi navedenih usluga, usluge industrijske analize i istraživanja, usluge inženjera o planiranju, ocjeni, istraživanja i izvještavanju u naučnim i tehnološkim oblastima.

---

(111) 07225 (151) 18.01.2013  
 (210) **2010-180** (442) **20.06.2012**  
 (220) 31.05.2010  
 (732) BAYER AKTINGESELLSCHAFT, D-51368, LEVERKUSEN DE

## PRESTIGE

(540)  
 (550) I  
 (740) Čupić Branislav, Dalmatinska 10, Podgorica (ME)  
 (511) **Klasa 1:** Hemijski preparati za upotrebu u poljoprivredi, hortikulturi i sumarstvu, hemijski

preparati za tretiranje semena vetačka dubriva.

**Klasa 05:** Preparati za uništavanje korova i štetočina insekticidi, herbicidi, fungicidi.

---

(111) 07220	(151) 17.01.2013
(210) <b>2010-152</b>	(442) <b>20.06.2012</b>
	(220) 06.05.2010

(732) MEDA AB, PIPERS VAG 2, A SE-170 09 SOLNA SE

## ASTEPRO

(540)  
 (550) I  
 (740) Čejović Vladimir, 13. jula 21, Podgorica (ME)  
 (511) **Klasa 05:** Farmaceutski proizvodi, sanitarni preparati za medicinsku upotrebu, dijetetske supstance prilagođene za upotrebu u medicini, flasteri i materijali za previjanje.

**Klasa 10:** Hirurški, medicinski, zubarski aparati i instrumenti, medicinska opreme i aparati.

---

(111) 07211	(151) 17.01.2013
(210) <b>2010-190</b>	(442) <b>20.06.2012</b>
	(220) 07.06.2010

(732) CHOICE HOTELS INTERNATIONAL INC, 10750 COLUMBIA PIKE, SILVER SPRING, MARYLAND 20901 US



(540)  
 (550) I  
 (740) Čejović Vladimir, 13. jula 21, Podgorica (ME)  
 (511) **Klasa 43:** Hotelske i motelske usluge, usluge hotelskih i motelskih rezervacija za druge, i usluge hotelskih i motelskih onlajn rezervacija za druge.

---

(111) 07204	(151) 17.01.2013
(210) <b>2010-188</b>	(442) <b>20.06.2012</b>
	(220) 03.06.2010
	(300) BA Z 1014514A 28.01.2010

(732) KWIZDA HOLDING GMBH, DR.KARL LUEGER-RING 6, A-1010 WIEN AT

## CLOPIX

(540)

(550) I

(740) Čejović Vladimir, 13. jula 21, Podgorica (ME)

(511) **Klasa 05:** Farmaceutski i veterinarski proizvodi higijenski proizvodi za upotrebu u medicini dijetetske supstance prilagođene za upotrebu u medicini, hrana za bebe flasteri, materijali za previjanje materijali za plombiranje zuba, zubarska smola sredstva za dezinfekciju proizvodi za uništavanje životinjskih štetočina fungicidi, herbicidi.

(111) 07203

(151) 17.01.2013

(210) **2010-185**(442) **20.06.2012**

(220) 03.06.2010

(300) BA Z 1014511A 28.01.2010

(732) KWIZDA HOLDING GMBH, DR.KARL LUEGER-RING 6, A-1010 WIEN AT

## Trauma HOT

(540)

(550) I

(740) Čejović Vladimir, 13. jula 21, Podgorica (ME)

(511) **Klasa 05:** Farmaceutski i veterinarski proizvodi higijenski proizvodi za upotrebu u medicini dijetetske supstance prilagođene za upotrebu u medicini, hrana za bebe flasteri, materijali za previjanje materijali za plombiranje zuba, zubarska smola sredstva za dezinfekciju proizvodi za uništavanje životinjskih štetočina fungicidi, herbicidi.

(111) 07212

(151) 17.01.2013

(210) **2010-221**(442) **20.06.2012**

(220) 05.07.2010

(732) Vujačić Saša, Moskovska 93, Podgorica (ME)



(540)

(550) I

(511) **Klasa 45:** Pravne usluge, sigurnosne usluge za zaštitu imovine i osoba, osobne i društvene usluge koje pružaju treći, namijenjene za zadovoljenje ljudskih potreba.

(111) 06937  
(210) **2010-268**

(151) 17.01.2013  
(442) **20.06.2012**  
(220) 29.07.2010

(732) WM WRIGLWY JR. COMPANY, 410 NORTH MICHIGAN AVENUE, CHICAGO, IL 60611 US

## TURBULENCE

(540)

(550) I

(740) Čejović Vladimir, 13. jula 21, Podgorica (ME)

(511) **Klasa 30:** Slatkiši, žvakaće gume, žvakaće gume od kojih mogu da se prave veliki baloni, bombone, dražeje peperminta, mali okrugli bomboni (drops) i pastille.

(111) 07299  
(210) **2010-199**

(151) 29.01.2013  
(442) **20.06.2012**  
(220) 10.06.2010

(732) TUTINSKI KOMBINAT AD PRILEP, UL.MARKSOVA BR.101 7500 PRILEP MK

## EUROPA

(540)

(550) I

(740) Radulović Božidar, Jovana Tomaševića 9/III, Podgorica (ME)

(511) **Klasa 34:** Duvan artikli za pušaće šibice.

(111) 07342  
(210) **2010-73**

(151) 29.01.2013  
(442) **20.06.2012**  
(220) 17.03.2010

(732) BOSNALIJEK, FARMACEUTSKA I HEMIJSKA INDUSTRIJA DD, JUKIĆEVA 53, 71000 SARAJEVO BA

## REUKAP

(540)

(550) I

(740) Radulović Božidar, Jovana Tomaševića 9/III, Podgorica (ME)

(511) **Klasa 05:** Farmaceutski proizvodi.

(111) 07224

(151) 18.01.2013

(210) **2010-213**(442) **20.06.2012**

(220) 24.06.2010

(732) NBA PROPERTIES INC, OLIMPIC TOWER BLDG, 645 FIFTH AVENUE, NEW YORK, NY 10022 US



(540) \_\_\_\_\_

(550) I

(740) Popović Miladin, Đoka Miraševića 21/III, Podgorica (ME)

(511) **Klasa 25:** odjeća, naime čarape, obuća, cipele za košarku, patike za košarku, majice, košulje, polo majice, dukserice, donji djelovi trenerke, pantalone, majice na bretele, dzemper, kratke pantalone, pidžame, sportske majice, ragbi majice, vunene majice, kaiSevi, kravate, spavačice, šeširi, kape, štitnici na kašketima, trenerke, donji djelovi trenerki, dresovi, jakne, vetrovke, kišne krznene jakne, kaputi, portikle za bebe ne od papira, trake za glavu, narukvice, kecelje, donje rublje, bokserice, široke pantalone, štitnici za uši, rukavice, bokserske rukavice, salovi, pletene i štrikane majice, trikotazne haljine, haljine, dresovi i uniforme za navijačice, odjeća za plivanje, odjela za kupanje, kupaći kostimi, bikini, tamkini kupaći kostimi, gacice za plivanje, gacice za kupanje, šorcevi za surfovanje, šorcevi za kupanje, marama za plazu, pokrivala za kupaći kostim, ogrtači za kupadi kostim, sandale, sandale za plazu, šeširi za plazu, štitnici za sunce, kape za plivanje, kape za kupanje, nova pokrivala za glavu sa prikacnim umecima.

**Klasa 28:** Igračke, igre i sportske stvari, naime košarkaške lopte, loptice za golf, lopte za igralište, sportske lopte, gumene lopte i penaste lopte, plišane lopte za igru, plasticne lopte za igru, mrežice za košarku, table za košarku, minijaturne table za košarku, pumpe i igle za naduvavanje košarkaških lopti štapovi za golf, torbe za golf, podmetaci za golf, oprema za golf, naime, alat za popravku golf terena, kupice na koje se stavlja lopta, markeri lopti, torbe za golf opremu, pokrivala za glave golf štapova, rukavice za golf, kutije za golf lopte, elektronske table za košarkaške igrice na tabli, table za košarkaške igrice, košarkaške igrice, akcione igrice, društvene igrice za odrasle i djecu, trivia informacione igrice i elektronske video arkaadne igrice, košarkaška torbica koja se sastoji od mrežice i zvizdaljke, lutke, dekorativne lutke, lutke za kolekciju, akcione figure za igru, akcione figure karikature, punjene igraške, nove plišane igraške sa perikom, puzzle, montažni blokovi za igre, ukrasi za Božićnu jelku i Božićne čarape vozila za igru u obliku automobila, kamiona, vozova i kombija, svi sa temom košarke, nove penaste igracke u obliku prsta ili trofeja, igrački trofeji, karte za igru, igrice sa kartama, igradke koje prave zvuk, igradke za kućne ljubimce igraške za plazu, naime lopte za plazu,



lopte na naduvavanje, kantice za igru, lopatice za igru, igračke za pesak, kutijice za pesak, gumene igračke za vodu oprema za bazen, naime plivačka oprema za plutanje, oprema za plutanje u bazenu, igradke za splavanje na vodi, penasta oprema za plutanje, gume za plivanje, gume za plivanje u bazenu, penaste gume, daske za plivanje, daske za surfovanje, peraja za plivanje, peraja za surfovanje, mišići za plutanje i krila za pomoć pri plivanju u rekreativne svrhe odbojkaške torbice za igru koje se sastoje od lopte, mrežice, sporednih stvari i zviždaljke, i vaterpolo torbice za igru koje se sastoje od lopte, mrežice i zviždaljke dekorativne igračke od tkanine koje se puštaju da lete na vetru.

**Klasa 41:** Razonoda i obrazovne usluge u smislu televizijskih događaja i radio programa u polju košarke i prikazivanja uzivo košarkaških igara i košarkaških priredbi usluge produkcije i distribucije radio i televizijskih šou programa o košarkaškim igrama, košarkaškim događajima i programima iz oblasti košarke usluge vođenja i organizovanja košarkaških klinika i kampova, klinika i kampova za trenere, klinika i kampova za plesne timove i košarkaške igre usluge rasonode u vidu ličnog pojavljivanja u kostimiziranim maskotama ili u plesnim timovima na košarkaškim igrama i priredbama, klinikama, kampovima, promocijama i drugim događajima, specijalnim događajima i zurkama vezanim za košarku usluge kluba obožavalaca usluge rasonode, naime one koje pružaju veb-sajt predstavljanje multimedijjskih sadržaja u vidu najvažnijih televizijskih događaja, interaktivnih najvažnijih televizijskih događaja, video snimaka, video strim snimaka, interaktivnih video izbora najvažnijih događaja, radio programa, najvažnijih radijskih događaja i audio snimaka u polju košarke usluge obezbjeđivanja vesti i informacija u vidu statistika i drugih stvari u polju košarke onlajn igrice koje se ne mogu preuzimati, naime kompjuterske igrice, video igrice, interaktivne video igrice, akcione igrice, arkadne igrice, društvene igrice za odrasle i djecu, igre na tabli, puzle, trivia igrice usluge elektronskog izdavaštva, naime, izdavanje magazina, vodica, biltena, bojanki i igrica kod kojih se igradi određuju putem interneta, sve u vezi sa košarkom usluge obezbjeđivanja onlajn kompjuterske baze podataka u polju košarke.

(111) 07330

(151) 29.01.2013

(210) **2010-64**

(442) **20.06.2012**

(220) 15.03.2010

(732) CITIGROUP INC DELAWARE CORPORATION, 399 PARK AVENUE NEW YORK, NY 10043 US



The image shows the Citi logo, which consists of the word "citi" in a bold, lowercase, sans-serif font. Above the letters "i" and "t" is a stylized arch that spans over the "i" and "t" and slightly over the "c".

(540)

(550) I

(740) Čejović Vladimir, 13. jula 21, Podgorica (ME)

(511) **Klasa 9:** Aparati i instrumenti naučni, pomorski, geodetski, električni, fotografski, kinematografski, optički, za vaganje, mjerenje, signalizaciju, kontrolu (nadzor), spašavanje živo-

ta i nastavu, aparati i instrumenti za sprovođenje, prekidanje, transformaciju, akumuliranje, regulaciju ili kontrolu struje, aparati za snimanje, prenošenje ili reprodukovanje zvuka ili slike, magnetni nosioci podataka, diskovi za snimanje, automatske mašine i mehanizmi za aparate koji se pokreću novcem ili žetonom, registar kase, računске mašine, oprema za obradu podataka i računari, aparati za gašenje požara, kompjuterski softver i elektronska oprema.

**Klasa 16:** Hartija, karton i proizvodi od njih, koji nisu uključeni u druge klase, štampane stvari, knjigovezački materijal, fotografije, kancelarijski materijal, ljepila za kancelarijske i kućne potrebe, umjetnički materijali, kičice, pisalice mašine i kancelarijski rekviziti (izuzev namještaja), materijali za obuku i nastavu (izuzev aparata), plastični materijali za pakovanje (koji nijesu uključeni u druge klase), štamparska slova, klišeji, proizvodi od papira, štampane stvari i publikacije.

**Klasa 36:** Osiguranje, finansijski poslovi, monetarni poslovi, poslovi u vezi sa nepokretnostima, finansijske procjene, novac (razmjena), upravljanje nepokretnostima, finansijske usluge i usluge osiguranja, usluge vezane za nepokretnosti, bankarske usluge, usluge investiranja i usluge kreditnih kartica.

**Klasa 42:** Naučne i tehnološke usluge i istraživanje i projektovanje u vezi navedenih usluga, usluge industrijske analize i istraživanja, projektovanje i razvoj kompjuterskog hardvera i softvera, usluge Interneta i obezbjeđivanja informacija na globalnoj kompjuterskoj mreži.

---

(111) 07329	(151) 29.01.2013
(210) <b>2010-65</b>	(442) <b>20.06.2012</b>
	(220) 15.03.2010
(732) CITIGROUP INC DELAWARE CORPORATION, 399 PARK AVENUE NEW YORK, NY 10043 US	

CITICORP

(540)  
 (550) I  
 (740) Čejović Vladimir, 13. jula 21, Podgorica (ME)  
 (511) **Klasa 36:** Osiguranje, finansijski poslovi, monetarni poslovi, poslovi u vezi sa nepokretnostima, finansijske i monetarne usluge, koje vrše banke, mjenjanice, kreditne ustanove, kao i izdavanje putnih čekova i kreditnih pisama, osiguranja svih vrsta, finansijsko upravljanje zgradama.

---

(111) 07328	(151) 29.01.2013
(210) <b>2010-192</b>	(442) <b>20.06.2012</b>
	(220) 07.06.2010
(732) CHOICE HOTELS INTERNATONAL, INC, 10750 COLUMBIA PIKE, SILVER SPRING, MARYLAND 20901 US	



(540)

(550) I

(740) Čejović Vladimir, 13. jula 21, Podgorica (ME)

(511) **Klasa 43:** Hotelske i motelske usluge, usluge hotelskih i motelskih rezervacija za druge, i usluge hotelskih i motelskih onlajn rezervacija za druge.

(111) 07222

(151) 18.01.2013

(210) **2010-87**(442) **20.06.2012**

(220) 29.03.2010

(732) AVON INTERNATIONAL OPERATIONS INC, 1345 AVENUE OF THE AMERICAS NEW YORK 10105-0196 US

## LIZ EARLE

(540)

(550) I

(740) Čejović Vladimir, 13. jula 21, Podgorica (ME)

(511) **Klasa 03:** Preparati za bijeljenje i ostale supstance za pranje rublja, preparati za čišćenje, poliranje, odmaščivanje i struganje, sapuni, parfimerijski proizvodi, eterična ulja, kozmetički proizvodi, losioni za kosu, proizvodi za njegu zuba.**Klasa 05:** Farmaceutski i veterinarski proizvodi, higijenski proizvodi za upotrebu u medicini, dijetetske supstance prilagođene za upotrebu u medicini, hrana za bebe, flasteri, materijali za previjanje, materijali za plombiranje zuba, zubarska smola, sredstva za dezinfekciju, proizvodi za uništavanje životinjskih štetočina, fungicidi, herbicidi.**Klasa 16:** Hartija, karton i proizvodi od njih, koji nisu uključeni u druge klase, štampane stvari (izuzev knjiga i periodičnih časopisa osim periodičnih brošura, flajera i kataloga koji se koriste u direktnoj prodaji), knjigovezački materijal, fotografije, kancelarijski materijal, ljepila za kancelarijske i kućne potrebe, umjetnički materijali, kičice, pisaće mašine i kancelarijski rekviziti (izuzev aparata), plastični materijali za pakovanje (koji nijesu uključeni u druge klase), štamparska slova, klišeji,

(111) 07213

(151) 18.01.2013

(210) **2010-218**(442) **20.06.2012**

(220) 28.06.2010

(732) ALKALOID AD SKOPLJE, BUL.ALEKSANDAR MAKEDONSKI 12,1000 SKOPLJE MK

ELORYQA

(540)

(550) I

(740) Božović Vesko, Rimski trg 50/11, Podgorica (ME)

(511) **Klasa 05:** Farmaceutski preparati-antidepresant.

(111) 07056

(151) 27.12.2012

(210) **2010-203**

(442) **20.06.2012**

(220) 15.06.2010

(732) S.C.JOHNSON & SON, INC, 1525 HOWE STREET, RACINE, WISCONSIN 53403'2236 US

CLIP ON

(540)

(550) I

(740) Čejović Vladimir, 13. jula 21, Podgorica (ME)

(511) **Klasa 05:** Preparati za uništavanje korova i štetočina insekticidi sredstva protiv moljaca sredstva protiv insekata.

(111) 03762

(151) 03.10.2012

(210) 2010-174

(442) **20.06.2012**

(220) 15.06.2010

(732) S.C.JOHNSON & SON, INC, 1525 HOWE STREET, RACINE, WISCONSIN 53403'2236 US

CLIP ON

(540)

(550) I

(740) Čejović Vladimir, 13. jula 21, Podgorica (ME)

(511) **Klasa 05:** Preparati za uništavanje korova i štetočina insekticidi sredstva protiv moljaca sredstva protiv insekata.

(111) 06662

(151) 29.11.2012

(210) **2009-679**

(442) **20.03.2012**

(220) 21.12.2009

(732) SANDFORD INVEST I TRADE; 1100 H STREET N. W. SUITE 840, WASHINGTON D. C.20005 US



(540)

(550) I

(740) Ćosović Dejan, 13. jul 1/5, Budva (ME)

(511) **Klasa 33:** Vina.

(111) 06661

(151) 29.11.2012

(210) **2010-161**(442) **20.03.2012**

(220) 17.05.2010

(732) TDR DOO; OBALA V NAYORA BR.1, 52210 ROVINJ HR

RONHILL  
UNLIMITED

(540)

(550) I

(740) Vukotić Petar, Novaka Miloševa, Podgorica (ME)

(511) **Klasa 34:** Duvan sirov i preraden, proizvodi od duvana, cigare, cigarete, filter, cigarete, cigarilosi, artikli za pušače, upaljači, šibice.

**Klasa 35:** Usluge u vezi sa prometom robe, posebno usluge u prometu duvana i duvanskih proizvoda; oglašavanje; vođenje poslova; poslovno upravljanje; kancelarijski poslovi; komercijalno zastupanje; propagandne i reklamne usluge; marketing; usluge istraživanja tržišta; usluge promocije, posebno promovisnje ili reklamiranje kulturnih i zabavnih događaja, sportskih takmičenja i modnih revija; organizovanje i vođenje sajmova i izložbi u reklamne i komercijalne svrhe; naprijed navedene usluge koje pripadaju ovoj klasi koje se obavljaju putem interneta; davanje i širenje informacija u vezi sa gore navedenim uslugama.

(111) 06960

(151) 27.12.2012

(210) **2010-248**(442) **20.06.2012**

(220) 22.07.2010

(732) McDonald s INTERNATIONAL PROPERTY COMPANY LTD, 2711 CENTERVILLE ROAD, SUITE

400, WILMINGTON, DELAWARE 19808 US



(540)

(550) I

(740) Ćupić Branislav, Dalmatinska 10, Podgorica (ME)

(511) **Klasa 16:** Štampane stvari.

**Klasa 25:** Odjeća, obuća i pokrivala za glavu.

**Klasa 28:** Igračke, igre i predmeti za igru.

(111) 06964

(151) 27.12.2012

(210) **2010-247**

(442) **20.06.2012**

(220) 22.07.2010

(732) McDonald s INTERNATIONAL PROPERTY COMPANY LTD, 2711 CENTERVILLE ROAD, SUITE 400, WILMINGTON, DELAWARE 19808 US



(540)

(550) I

(740) Ćupić Branislav, Dalmatinska 10, Podgorica (ME)

(511) **Klasa 16:** Štampane stvari.

**Klasa 25:** Odjeća, obuća i pokrivala za glavu.

**Klasa 28:** Igračke, igre i predmeti za igru.

**Klasa 41:** Usluge zabave, naime, lično pojavljivanje, obrazovne i promotivne aktivnosti i distribucija obrazovnih i rasonodnih stvari.

(111) 06955

(151) 27.12.2012

(210) **2010-253**

(442) **20.06.2012**

(220) 22.07.2010

(732) McDonald s INTERNATIONAL PROPERTY COMPANY LTD, 2711 CENTERVILLE ROAD, SUITE

400, WILMINGTON, DELAWARE 19808 US

## McTOAST

(540)

(550) I

(740) Ćupić Branislav, Dalmatinska 10, Podgorica (ME)

(511) **Klasa 30:** Jestivi sendviči, sendviči sa mesom, sendviči sa svinjskim mesom, riblji sendviči, sendviči sa piletinom, biskviti, hleb, kolači, keksi, čokolada, kafa, zamjena kafe, čaj, senf, ovsena kaša, poslastice, sosovi, začini, šećer.

(111) 06959

(151) 27.12.2012

(210) **2010-249**

(442) **20.06.2012**

(220) 22.07.2010

(732) McDonald s INTERNATONAL PROPERTY COMPANY, LTD, 2711 CENTERVILLE ROAD, SUITE 400, WILMINGTON, DELAWARE 19808 US

## RONALD McDONALD

(540)

(550) I

(740) Ćupić Branislav, Dalmatinska 10, Podgorica (ME)

(511) **Klasa 16:** Štampane stvari.

**Klasa 25:** Odjeća, obuća i pokrivala za glavu.

**Klasa 28:** Igračke, igre i predmeti za igru.

**Klasa 41:** Usluge zabave, naime, lično pojavljivanje, obrazovne i promotivne aktivnosti i distribucija obrazovnih i raznodnih stvari.

(111) 06954

(151) 27.12.2012

(210) **2010-254**

(442) **20.06.2012**

(220) 22.07.2010

(732) McDonald INTERNATONAL PROPERTY COMPANY LTD, 2711 CENTERVILLE ROAD, SUITE 400, WILMINGTON, DELAWARE 19808 US

## McMUFFIN

(540)

(550) I

(740) Ćupić Branislav, Dalmatinska 10, Podgorica (ME)

(511) **Klasa 30:** Jestivi sendviči, sendviči sa mesom, sendviči sa svinjskim mesom, riblji sendviči, sendviči sa piletinom, biskviti, hleb, kolači, keksi, čokolada, kafa, zamjena kafe, čaj, senf, ovsena kaša, poslastice, sosovi, začini, šećer.

(111) 06956  
(210) **2010-252**

(151) 27.12.2012  
(442) **20.06.2012**  
(220) 22.07.2010

(732) McDonald s INTERNATIONAL PROPERTY COMPANY LTD, 2711 CENTERVILLE ROAD, SUITE 400, WILMINGTON, DELAWARE 19808 US

## FILET-O-FISH

(540)

(550) I

(740) Ćupić Branislav, Dalmatinska 10, Podgorica (ME)

(511) **Klasa 30:** Jestivi sendviči, sendviči sa mesom, sendviči sa svinjskim mesom, riblji sendviči, sendviči sa piletinom, biskviti, hleb, kolači, keksi, čokolada, kafa, zamjena kafe, čaj, senf, ovsena kaša, poslastice, sosovi, začini, šećer.

(111) 06957  
(210) **2010-251**

(151) 27.12.2012  
(442) **20.06.2012**  
(220) 22.07.2010

(732) McDonald s INTERNATIONAL PROPERTY COMPANY LTD, 2711 CENTERVILLE ROAD, SUITE 400, WILMINGTON, DELAWARE 19808 US

## McWRAP

(540)

(550) I

(740) Ćupić Branislav, Dalmatinska 10, Podgorica (ME)

(511) **Klasa 30:** Jestivi sendviči, sendviči sa mesom, sendviči sa svinjskim mesom, riblji sendviči, sendviči sa piletinom, biskviti, hleb, kolači, keksi, čokolada, kafa, zamjena kafe, čaj, senf, ovsena kaša, poslastice, sosovi, začini, šećer.

(111) 06958  
(210) **2010-250**

(151) 27.12.2012  
(442) **20.06.2012**  
(220) 22.07.2010

(732) McDonald s INTERNATIONAL PROPERTY COMPANY LTD, 2711 CENTERVILLE ROAD, SUITE 400, WILMINGTON, DELAWARE 19808 US

## McDONALD'S

(540)

(550) I

(740) Ćupić Branislav, Dalmatinska 10, Podgorica (ME)



(511) **Klasa 16:** Štampane stvari.

**Klasa 25:** Odjeća, obuća i pokrivala za glavu.

**Klasa 28:** Igračke, igre i predmeti za igru.

(111) 07207

(151) 17.01.2013

(210) **2010-52**

(442) **20.06.2012**

(220) 04.03.2010

(732) MONTE VJENNIKO DOO. NIKŠIĆ, NOVICE CERoviČA 11, 81400 NIKŠIĆ ME



(540)

(550) I

(740) Božović Vesko, Rimski trg 50/11, Podgorica (ME)

(511) **Klasa 35:** Oглаšavanje i reklamiranje, vođenje komercijalnih poslova, komercijalna administracija, uredski poslovi.

**Klasa 43:** Usluge hranjenja, privremeno primanje na stan.

(111) 07354

(151) 05.02.2012

(210) **2010-246**

(442) **20.06.2012**

(220) 20.07.2010

(732) MARBO PRODUCT DOO, ĐORĐA STANOJEVIČA 14, 11000 BEOGRAD RS



(540)

(550) I

(740) Čejović Vladimir, 13. jula 21, Podgorica (ME)

(511) **Klasa 29:** Meso, riba, živina i divljač, mesne prerađevine, konzervisano, zamrznuto, sušeno i kuvano voće i povrće, želei, džemovi, kompoti, jaja, mlijeko i mliječni proizvodi, jestiva

ulja i masti, čips od krompira, grickalice na bazi voća, povrća, sira, mesa, orašastih plodova, orašasti plodovi, pripremljeni, jestive sjemenke.

- 
- (111) 07357 (151) 05.02.2013  
 (210) **2010-226** (442) **20.06.2012**  
 (220) 12.07.2010  
 (732) MARRIOTT WORDWIDE CORPORATION, A MERYLAND CORPORATION, 10400 FERNWOOD ROAD, BETHESDA, MARYLAND 20817 US

## JW MARRIOTT

- (540)  
 (550) I  
 (740) Čejović Vladimir, 13. jula 21, Podgorica (ME)  
 (511) **Klasa 36:** Usluge u vezi sa nepokretnostima, naime usluge razvoja, nabavke, prodaje, lizinga, finansija, upravljanja, posloводства, iznajmljivanja, promocije i posredovanja u vezi sa apartmanima, stanovima, dupleksima, nepokretnostima čije se korišćenje dijeli na vremenskoj osnovi, vilama, kućama za odmor i nepokretnostima svih vrsta, kao i objekti i prednosti u vezi sa istima, usluge posredovanja nepokretnostima, usluge kreditnih kartica, dobrotvorno prikupljanje sredstava i donacije.  
**Klasa 43:** Hotelske usluge, usluge restorana, kateringa, barova i salona, usluge odmarališta i smještaja, obezbjeđivanje objekata u opšte svrhe, za sastanke, konferencije i izložbe, obezbjeđivanje objekata za bankete i druga okupljanja u specijalnim prilikama, i usluge rezervacije hotelskog smještaja.  
**Klasa 44:** spa usluge, naime usluge tretmana lica, kose, kože i tijela, usluge manikira i pedikira, usluge masaže, usluge depilacije tijela i usluge kozmetičkog salona.

- 
- (111) 07054 (151) 05.02.2013  
 (210) **2010-261** (442) **20.06.2012**  
 (220) 23.07.2010  
 (732) KRAFT FOODS GLOBAL, BRANDS LLC THREE LAKES DRIVE NORTHFILED ILLINOIS, 60093 US



(540)

(550) I

(740) Ćupić Branislav, Dalmatinska 10, Podgorica (ME)

(511) **Klasa 30:** Nemedicinski slatkiši, slatkiši uključujući žvakaće gume.

(111) 07384

(151) 06.02.2013

(210) **2010-262**

(442) **20.06.2012**

(220) 23.07.2010

(732) KRAFT FOODS GLOBAL, BRANDS LLC THREE LAKES DRIVE NORTHFILED ILLINOIS, 60093 US

## TRIDENT SPLASH

(540)

(550) I

(740) Ćupić Branislav, Dalmatinska 10, Podgorica (ME)

(511) **Klasa 30:** Nemedicinski slatkiši, slatkiši uključujući žvakaće gume.

(111) 07334

(151) 05.02.2013

(210) **2009-605**

(442) **20.06.2012**

(220) 10.09.2009

(732) BONGRAIN SA-A FRENCH SOCIETE ANONYME-, 42 RUE RIEUSSEC, 78220 VIROFLAY FR

## TOST TOPI

(540)

(550) I

(740) Lutovac Branislav, Bulevar Crnojevića 93, Podgorica (ME)

(511) **Klasa 29:** Mlijeko, sir i mliječni proizvodi jestiva ulja i masti.

(111) 07203

(151) 17.01.2013

(210) **2010-185**

(442) **20.06.2012**

(220) 03.06.2010

(300) BA Z 1014511A 28.01.2010

(732) KWIZDA HOLDING GMBH, DR.KARL LUEGER-RING 6, A-1010 WIEN AT

## Trauma HOT

(540)

(550) I

(740) Čejović Vladimir, 13. jula 21, Podgorica (ME)

(511) **Klasa 05:** Farmaceutski i veterinarski proizvodi higijenski proizvodi za upotrebu u medicini dijetetske supstance prilagođene za upotrebu u medicini, hrana za bebe flasteri, mate-

rijali za previjanje materijali za plombiranje zuba, zubarska smola sredstva za dezinfekciju proizvodi za uništavanje životinjskih štetočina fungicidi, herbicidi.

---

(111) 07382 (151) 07.02.2013  
 (210) **2010-269** (442) **20.06.2012**  
 (220) 29.07.2010  
 (300) DE 30 2010 005 626.6/41 29.01.2010  
 (732) DEUTCHE TELEKOM AG, FRIEDRICH-EBERT-ALLEE 140 53113 BONN DE

## Telekom Academy

(540)  
 (550) I  
 (740) Popović Miladin, Đoka Miraševića 21/III, Podgorica (ME)  
 (511) **Klasa 09:** Aparati i instrumenti naučni, pomorski, geodetski, fotografski, kinematografski, optički, za vaganje, mjerenje, signalizaciju, kontrolu (inspekciju). spašavanje i nastavu, aparati i instrumenti za provođenje, prekid, transformaciju, akumulaciju, regulisanje ili kontrolu električne energije, aparati za snimanje, prenos. obradu i reprodukovanje zvuka, slike ili podataka, magnetni nosioci podataka, automatske mašine i mehanizmi za aparate koji se pokreću novcem ili žetonom, računске mašine, oprema za obradu podataka I kompjuteri, snimljeni i nesnimljeni nosači podataka svih vrsta (koji su uključeni u klasu 9), kompjuterski programi (sačuvani), podaci snimljeni u elektronskoj formi (koji se mogu preuzimati), elektronske publikacije (koje se mogu preuzimati).  
**Klasa 16:** Štampan materijal, fotografije, kancelarijski materijal (osim Namještaja), materijali za obuku i nastavu (osim aparata).  
**Klasa 35:** Usluge oglašavanja, usluge vođenja poslova, poslovno upravljanje, prikupljanje. sistematizacija, sastavljanje i stručna poslovna analiza podataka i intbrmacija u kompjuterskim bazama podataka, maloprodajne usluge (takode putem interneta i drugih komunikacijskih mreža) u vezi sa Klasama 9 i 16.  
**Klasa 41:** Obrazovne usluge, pripremanje obuke, razonoda, sportske i kultume aktivnosti.

---

(111) 07355 (151) 05.02.2013  
 (210) **2010-245** (442) **20.06.2012**  
 (220) 20.07.2010  
 (732) MARBO PRODUCT DOO, ĐORĐA STANOJEVIĆA 14, 11000 BEOGRAD RS



(540)

(550) I

(740) Čejović Vladimir, 13. jula 21, Podgorica (ME)

(511) **Klasa 29:** Meso, riba, živina i divljač, mesne prerađevine, konzervisano, zamrznuto, sušeno i kuvano voće i povrće, želei, džemovi, kompoti, jaja, mlijeko i mliječni proizvodi, jestiva ulja i masti, čips od krompira, grickalice na bazi voća, povrća, sira, mesa, orašastih plodova, orašasti plodovi, pripremljeni, jestive sjemenke.

(111) 07201

(151) 17.01.2013

(210) **2010-84**(442) **20.06.2012**

(220) 29.03.2010

(300) CH Z-61028-2009 06.10.2009

(732) PHILIP MORRIS PRODUCT S.A. SWISS CORPORATION, QUAI JEANRENAUD 3, 2000 NEUCHATEL CH

**BE >**

(540)

(550) I

(511) **Klasa 41:** Obrazovne usluge, pripremanje obuke, razonoda, sportske i kulturne aktivnosti.

(111) 06674

(151) 05.02.2013

(210) **2009-677**(442) **20.03.2012**

(220) 17.12.2009

(732) JANSPOUT APPAREL CORP. -DELAWARE CORPORATION; 3411 SILVERSIDE ROAD, WILMINGTON, DELAWARE 19810 US

# QUALCOMM

(540)

(550) I

(740) Radulović Božidar, Jovana Tomaševića 9/III, Podgorica (ME)

(511) **Klasa 38:** Telekomunikacione usluge, a naročito obezbjeđivanje pristupa većem broju korisnika bazi podataka i globalnoj kompjuterskoj i informacionoj mreži putem kompjutera i komunikacionih uređaja; elektronski prenos glasa, video zapisa, slika, poruka i podataka; prenos igranih filmova, trejlara igranih filmova, reklama i audio-vizuelnih programa; digitalni prenos glasa, podataka, slika, signala i poruka; usluge komunikacije putem mobilnog telefona; usluge komunikacije putem teleksa; usluge komunikacije putem kompjuterskih terminala; usluge komunikacije putem telegrama; usluge komunikacije putem telefona; usluge komunikacije putem faksimila; usluge prenošenja poruka putem radija/telefona (pejdžing usluge); usluge televizijskog emitovanja; usluge emitovanja kablovske televizije; usluge radio emitovanja; usluge u vezi sa vijestima za komunikacione medije; iznajmljivanje/lizing opreme za komunikaciju, uključujući telefon/faksimil; usluge bežične komunikacije, uključujući usluge komunikacije glasom i podacima, koristeći zemaljske ili satelitske komunikacione sisteme; omogućavanje trećim licima pristup telekomunikacionim infrastrukturama.

**Klasa 41:** Usluge razonode, naročito, obezbjeđivanje kompjuterskih audio zapisa, video zapisa i podataka na komunikacionim uređajima i kompjuterima; omogućavanje onlajn kompjuterskih igrica preko mreže između komunikacionih mreža i kompjutera.

**Klasa 42:** Inženjerske usluge projektovanja, testiranja i proizvodnje za druge, kao i pomoći pri projektovanju, testiranju i proizvodnji za druge, satelitskih i zemaljskih komunikacionih sistema i mreža, bežičnih komunikacionih terminala; usluge planiranja razvoja i projektovanja telekomunikacionih mreža i mreža za obradu podataka, za druge; usluge savjetovanja, testiranja i tehničkog nadzora u oblasti integracija sistema i integracija proizvoda za telekomunikacione mreže, kao i obrade podataka u oblasti elektronskih usluga, naročito prikupljanje, čuvanje, prevod, prenos ili distribucija podataka, informacija, slika, video i audio sekvenci i u oblasti obezbjeđivanja i komunikacije informacija pohranjenih u bazi podataka putem interaktivnih komunikacionih kompjuterskih sistema; usluge razvoja i generisanja programa za obradu podataka, naročito, kompjuterskih programa za druge; kompjuterske usluge, naročito, obezbjeđivanje specifičnih informacija na zahtev korisnika putem interneta; usluge onlajn tehničke podrške u oblasti kompjutera, kompjuterskog softvera i kompjuterskih sistema; savjetodavne usluge u vezi sa kompjuterima i kompjuterskim softverom; usluge kompjuterske dijagnostike; ažuriranje kompjuterskog softvera za druge; usluge tehničke podrške, naročito, rješavanje hardverskih i softverskih problema kompjutera; omogućavanje onlajn ažuriranja kompjuterskog softvera za druge putem interneta; i obezbjeđivanje informacija u oblasti kompjutera, kompjuterskog softvera i kompjuterskih sistema.

(111) 07356

(151) 05.02.2013

(210) **2010-228**

(442) **20.06.2012**

(220) 12.07.2010

(732) MARRIOTT WORLDWIDE CORPORATION, MARYLAND CORPORATION, 10400 FERNWOOD ROAD, BETHESDA, MARYLAND 20817 US

## COURTYARD

(540)

(550) I

(740) Čejović Vladimir, 13. jula 21, Podgorica (ME)

(511) **Klasa 35:** Usluge oglašavanja, usluge frašize, naime, nuđenje pomoći u poslovnom upravljanju u osnivanju i poslovanju hotela, restorana, barova, spa-a, rekreacionih i fitnes objekata, i maloprodajnih radnji, usluge poslovnog upravljanja, naime, upravljanje i posloводство hotelima, restoranima, barovima, rekreacionim i fitnes objektima, i maloprodajnim radnjama za druge, usluge maloprodajnih radnji, usluge poslovnih centara, konsultantske usluge u vezi sa poslovnim upravljanjem, obezbjeđivanje objekata za korišćenje kancelarijske opreme i mašina, usluge poslovne administracije, usluge planiranja poslovnih sastanaka, obezbjeđivanje objekata za konvencije i konferencije, upravljanje, iznajmljivanje i lizing kancelarija i maloprodajnih prostora.

**Klasa 41:** usluge zdravstvenih klubova, naime obezbjeđivanje uputstava i konsultacija na polju fizičkih vježbi, iznajmljivanje opreme za vježbanje, obezbjeđivanje fitness objekata i objekata za vježbanje, golf klubovi, golf kursevi i usluge obuke igranja golfa, obrazovanje, obezbjeđivanje treninga, zabava, sportske i kulturne aktivnosti, obrazovanje i zabava, naime, pripremanje konferencija, organizovanje izložbi u kulturne ili obrazovne svrhe, obezbjeđivanje objekata za rekreativne aktivnosti, obezbjeđivanje objekata i usluga za bazene i sportove na vodi, obezbjeđivanje objekata za tenis, iznajmljivanje teniskih terena i obuke za tenis, noćni klubovi.

**Klasa 43:** Hotelske usluge, usluge restorana, kateringa, barova i salona, usluge odmarališta i smještaja, obezbjeđivanje objekata u opšte svrhe, za sastanke, konferencije i izložbe, obezbjeđivanje objekata za bankete i druga okupljanja u specijalnim prilikama, i usluge rezervacije hotelskog smještaja.

---

(111) 07358

(151) 05.02.2013

(210) **2010-224**

(442) **20.06.2012**

(220) 12.07.2010

(732) MARRIOTT WORLDWIDE CORPORATION, A MARYLAND CORPORATION, 10400 FERNWOOD ROAD, BETHESDA, MARYLAND 20817 US

## MARRIOTT

(540)

(550) I

(740) Čejović Vladimir, 13. jula 21, Podgorica (ME)

(511) **Klasa 36:** Usluge u vezi sa nepokretnostima, naime usluge razvoja, nabavke, prodaje, lizinga, finansija, upravljanja, posloводства, iznajmljivanja, promocije i posredovanja u vezi sa apartmanima, stanovima, dupleksima, nepokretnostima čije se korišćenje dijeli na vremenskoj osnovi, vilama, kućama za odmor i nepokretnostima svih vrsta, kao i objekti i prednosti u vezi sa istima, usluge posredovanja nepokretnostima, usluge kreditnih kartica, dobrotvorno prikupljanje sredstava i donacije.

**Klasa 43:** Hotelske usluge, usluge restorana, kateringa, barova i salona, usluge odmarališta i smještaja, obezbjeđivanje objekata u opšte svrhe, za sastanke, konferencije i izložbe, obezbjeđivanje objekata za bankete i druga okupljanja u specijalnim prilikama i usluge rezervacije hotelskog smještaja.

**Klasa 44:** spa usluge, naime usluge tretmana lica, kose, kože i tijela, usluge manikira i pedikira, usluge masaže, usluge depilacije tijela i usluge kozmetičkog salona.

(111) 07359

(151) 05.02.2013

(210) **2010-227**(442) **20.06.2012**

(220) 12.07.2010

(732) MARRIOTT WORDWIDE CORPORATION, MARYLAND CORPORATION, 10400 FERNWOOD ROAD, BETHESDA, MARYLAND 20817 US

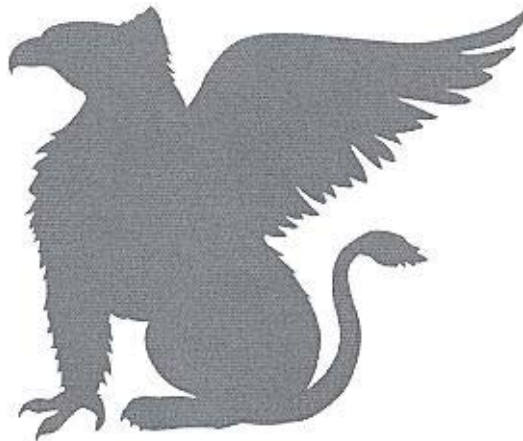

(540)

(550) I

(740) Čejović Vladimir, 13. jula 21, Podgorica (ME)

(511) **Klasa 36:** Usluge u vezi sa nepokretnostima, naime usluge razvoja, nabavke, prodaje, lizinga, finansija, upravljanja, posloводства, iznajmljivanja, promocije i posredovanja u vezi sa apartmanima, stanovima, dupleksima, nepokretnostima čije se korišćenje dijeli na vremenskoj osnovi, vilama, kućama za odmor i nepokretnostima svih vrsta, kao i objekti i prednosti u vezi sa istima, usluge posredovanja nepokretnostima, usluge kreditnih kartica, dobrotvorno prikupljanje sredstava i donacije.



**Klasa 43:** Hotelske usluge, usluge restorana, kateringa, barova i salona, usluge odmarališta i smještaja, obezbjeđivanje objekata u opšte svrhe, za sastanke, konferencije i izložbe, obezbjeđivanje objekata za bankete i druga okupljanja u specijalnim prilikama, i usluge rezervacije hotelskog smještaja.

**Klasa 44:** spa usluge, naime usluge tretmana lica, kose, kože i tijela, usluge manikira i pedikira, usluge masaže, usluge depilacije tijela i usluge kozmetičkog salona.

(111) 07360

(151) 05.02.2013

(210) **2010-229**

(442) **20.06.2012**

(220) 12.07.2010

(732) MARRIOTT WORDWIDE CORPORATION, A MARYLAND CORPORATION, 10400 FERNWOOD ROAD, BETHESDA, MARYLAND 20817 US



(540)

(550) I

(740) Čejović Vladimir, 13. jula 21, Podgorica (ME)

(511) **Klasa 35:** Usluge oglašavanja, usluge frašize, naime, nuđenje pomoći u poslovnom upravljanju u osnivanju i poslovanju hotela, restorana, barova, spa-a, rekreacionih i fitnes objekata, i maloprodajnih radnji, usluge poslovnog upravljanja, naime, upravljanje i posloводство hotelima, restoranima, barovima, rekreacionim i fitnes objektima, i maloprodajnim radnjama za druge, usluge maloprodajnih radnji, usluge poslovnih centara, konsultantske usluge u vezi sa poslovnim upravljanjem, obezbjeđivanje objekata za korišćenje kancelarijske opreme i mašina, usluge poslovne administracije, usluge planiranja poslovnih sastanaka, obezbjeđivanje objekata za konvencije i konferencije, upravljanje, iznajmljivanje i lizing kancelarija i maloprodajnih prostora.

**Klasa 41:** usluge zdravstvenih klubova, naime obezbjeđivanje uputstava i konsultacija na polju fizičkih vježbi, iznajmljivanje opreme za vježbanje, obezbjeđivanje fitness objekata i objekata za vježbanje, golf klubovi, golf kursevi i usluge obuke igranja golfa, obrazovanje, obezbjeđivanje treninga, zabava, sportske i kulturne aktivnosti, obrazovanje i zabava, naime, pripremanje konferencija, organizovanje izložbi u kulturne ili obrazovne svrhe, obezbjeđivanje objekata za rekreativne aktivnosti, obezbjeđivanje objekata i usluga za bazene i sportove na vodi, obezbjeđivanje objekata za tenis, iznajmljivanje teniskih terena i obuke za tenis, noćni klubovi.

**Klasa 43:** Hotelske usluge, usluge restorana, kateringa, barova i salona, usluge odmarališta i smještaja, obezbjeđivanje objekata u opšte svrhe, za sastanke, konferencije i izložbe, obezbjeđivanje objekata za bankete i druga okupljanja u specijalnim prilikama, i usluge rezervacije hotelskog smještaja.

---

(111) 07361

(151) 05.02.2013

(210) **2010-225**

(442) **20.06.2012**

(220) 12.07.2010

(732) MARRIOTT WORDWIDE CORPORATION, A MARYLAND CORPORATION, 10400 FERNWOOD ROAD, BETHESDA, MARYLAND 20817 US



(540)

(550) I

(740) Čejović Vladimir, 13. jula 21, Podgorica (ME)

(511) **Klasa 36:** Usluge u vezi sa nepokretnostima, naime usluge razvoja, nabavke, prodaje, lizinga, finansija, upravljanja, posloводства, iznajmljivanja, promocije i posredovanja u vezi sa apartmanima, stanovima, dupleksima, nepokretnostima čije se korišćenje dijeli na vremenskoj osnovi, vilama, kućama za odmor i nepokretnostima svih vrsta, kao i objekti i prednosti u vezi sa istima, usluge posredovanja nepokretnostima, usluge kreditnih kartica, dobrotvorno prikupljanje sredstava i donacije.

**Klasa 43:** Hotelske usluge, usluge restorana, kateringa, barova i salona, usluge odmarališta i smještaja, obezbjeđivanje objekata u opšte svrhe, za sastanke, konferencije i izložbe, obezbjeđivanje objekata za bankete i druga okupljanja u specijalnim prilikama, i usluge rezervacije hotelskog smještaja.

**Klasa 44:** spa usluge, naime usluge tretmana lica, kose, kože i tijela, usluge manikira i pedikira, usluge masaže, usluge depilacije tijela i usluge kozmetičkog salona.

---

(111) 06420

(151) 05.02.2013

(210) **2010-202**

(442) **20.06.2012**

(220) 14.06.2010

(732) JAPAN TOBACCO INC, 2-2-1-TORANOMON, MINATO-KU, TOKYO JP



(540)

(550) I

(740) Čejović Vladimir, 13. jula 21, Podgorica (ME)

(511) **Klasa 34:** Cigarete, prerađeni ili neprerađeni duvan, artikli za pušače i šibice.

(111) 07060

(151) 08.06.2010

(210) **2010-195**(442) **20.06.2012**

(220) 08.06.2010

(732) S.C. JOHNSON &amp; SON, INC, 1525 HOWE STREET, RACINE, WISCONSIN 53403-2236 US

OFF!

(540)

(550) I

(740) Čejović Vladimir, 13. jula 21, Podgorica (ME)

(511) **Klasa 4:** svijeće vitke svijeće sa konusnim suženjem fitilji.**Klasa 5:** Preparati za uništavanje korova i štetočina insekticidi sredstva protiv moljaca sredstva protiv insekata pesticidi fungicidi preparati za uništavanje mikroba i dezinfekciju.**Klasa 9:** Električne jedinice za zagrijavanje različitih tipova materijala u cilju oslobađanja insekticida i sredstava protiv insekata.**Klasa 11:** Aparati za emitovanje insekticida ili sredstava protiv insekata u okolnu atmosferu djelovi i dodatci za takve aparate.

(111) 07295

(151) 25.05.2010

(210) **2010-175**(442) **20.06.2012**

(220) 25.05.2010

(732) G-MARIN CONSULTING LIMITED, LEVEL 14, PORTOMASO BUSINESS TOWER, ST.JULIANS MT

## MOURJAN

(540)

(550) I

(740) Čejović Vladimir, 13. jula 21, Podgorica (ME)

(511) **Klasa 09:** Optički aparati i instrumenti naočare za vid, naočare, sunčane naočare okviri, futrole, vezice i lanci za gore pomenutu robu uveličavajuća stakla dvogledi kompasi torbe za nošenje računara prenosivi držači i futrole za telefone aparati za mjerenje pomorski i nautički aparati, instrumenti, oprema i instalacije elektronski pilot aparati za daljinsko upravljanje plovilima navigacioni aparati i instrumenti pomorski i nautički aparati za komunikaciju pomorski aparati za mjerenje dubine bove za pomorsku upotrebu.

**Klasa 12:** Brodovi, pomorski čamci, skuteri, barke, feriboti, brodovi, jahte, vozila za kretanje po suvom, vazduhu, vodi ili željeznici djelovi, pribor i dodaci za gore navedenu robu jarboli za brodove kuke za brodove klinovi dizalice za čamce oprema za rastavljanje brodova brodovi za produbljanje morskog dna branici za brodove bokobrani za brodove brodski dimnjaci brodska korita rampe za brodove motorni čamac sa otvorenom ili poluotvorenom palubom vesla kratka vesla sa širokom lopatom pontoni brodska okna kormila propeleri za brodove i čamce hidroavioni kormilarski mehanizam za brodove drvene konstrukcije za brodove spa-vaće kabine za brodove i čamce krmena vesla katarke za brodove i čamce.

**Klasa 14:** Roba napravljena od dragocjenih metala ili sa prevlakom od njih, koji nijesu uključeni u druge klase nakit dugmad za manžetne, igle za kravatu drago kamenje časovničarski i hronometrijski instrumenti, ručni satovi, satovi djelovi i oprema za sve gore navedenu robu.

**Klasa 16:** Papir i artikli od papira kartonski artikli štampani materijal instrumenti za pisanje futrole i vrećice za instrumente za pisanje mastilo i punila za instrumente za pisanje kancelarijski materijal brodski dnevnic pisači i pribor za stolove lični organizatori držači za pera i olovke pritiskivači za papire futrole za pasoše, futrole za čekovne knjižice futrole za pera i olovke držači i futrole za dokumenta albumi štupaljke za novac materijali za umotavanje čestitke.

**Klasa 18:** Proizvodi izrađeni od kože i imitacije kože koji nijesu uključeni u druge klase artikli za prtljag koferi, torbe i futrole putničke torbe, ranci i vreće za putovanja akten tašne i "diplomat" torbe za spise ženske torbe kišobrani, suncobrani štapovi za hodanje i stolice-štapovi (stolice koje se po potrebi mogu preinačiti u štapove za šetnju) toaletne torbe privjesci za ključeve i držači za ključeve futrole i držači za kreditne kartice novčanici, tašne bičevi, amovi i sedlarska roba.

**Klasa 25:** Odjeća, obuća i pokrivala za glavu.

**Klasa 34:** Artikli i šibice za pušače.

**Klasa 35:** Oglašavanje poslovno upravljanje poslovna administracija poslovno savjetovanje kancelarijsko poslovanje iznajmljivanje kancelarijskih mašina i opreme raznošenje oglasnog materijala iznajmljivanje i lizing oglasnih (reklamnih) mjesta komercijalne informacije i savjeti za potrošače poslovno i administrativno upravljanje marinama, lukama i pristaništima savjetodavne i konsultantske usluge koje se odnose na marine savjetodavne i konsultantske usluge koje se odnose na dizajn, razvoj, izgradnju i administrativno upravljanje marinama, lukama i pristaništima poslovno i administrativno upravljanje klupskim objektima marine

usluge hotelskog upravljanja oglašavanje direktnom poštom organizovanje izložbi u komercijalne i reklamne svrhe agencije za uvoz-izvoz organizovanje trgovačkih sajmova u komercijalne i reklamne svrhe oglašavanje na otvorenom odnosi sa javnošću prodajne pomoćije uređivanje izloga usluge poslovanja u oblasti razvoja tržišnog vlasništva iznajmljivanje kancelarija poslovanje maloprodajnih prostorija usluge maloprodaje vezane za prodaju proizvoda za uljepšavanje, kozmetike, toaletnih potrepština, mašina za kućnu upotrebu, optičkih proizvoda, kamera, električne i elektronske kućne opreme, nakita, satova, ručnih satova, kancelarijskog materijala, štampanih publikacija, proizvoda od kože, prtljaga, namještaja, kontejnera i potrepština za domaćinstvo, kućne opreme, tekstila, odjeće, obuće, pokrivala za glavu, galanterije, igračka i igrica, sportske opreme, prehrambenih proizvoda i pića bilo iz maloprodanih i "outlet" radnji ili iz robnih kuća ili putem Interneta.

**Klasa 36:** Iznajmljivanje apartmana, stanova, vila, potkrovlja, i gradskih kuća iznajmljivanje maloprodajnih prostorija iznajmljivanje trgovačke imovine kapitalne investicije agenti za nekretnine upravljanje nekretninama lizing nekretnina izdavanje polisa osiguranja za marinu brokeri nekretnina iznajmljivanje kancelarija usluge čuvanja u sefu.

**Klasa 37:** Inženjerske usluge u marini održavanje i opravka brodova, pomorskih i nautičkih čamaca renoviranje brodova, pomorskih i nautičkih čamaca opravlanje zgrada usluge razvoja nekretnina usluge razvoja zemljišta za stambenu i komercijalnu upotrebu izgradnja zgrada izgradnja luka izgradnja brodova izgradnja pod vodom izgradnja marina opravke pod vodom održavanje automobila održavanje zgrada izgradnja puteva i parking mjesta renoviranje zgrada krečenje i ukrašavanje zgrada nadgledanje građevinskih radova obnova, osvežavanje i renoviranje zgrada upravljanje građevinskim projektima izgradnja hotela, prodajnih mjesta za hranu i piće, maloprodajnih "outlet" radnji, kancelarija, luksuznih vila, apartmana, potkrovlja, gradskih kuća, jahting klubova i naselja u marini opremanje kancelarija opremanje objekata namijenjenih za stanovanje.

**Klasa 39:** Usluge upravljanja plovilom usluge suvih i vlažnih pristaništa utovar i istovar tereta posredovanje povodom jahti i brodova usluge poslovanja keja usluge poslovanja i upravljanja u luci, pristaništu i marini transport pakovanje i skladištenje roba putni aranžmani pružanje informacija u vezi sa marinom organizovanje krstarenja transport barki iznajmljivanje brodova skladištenje brodova transport brodova rezervacije sjedišta na putovanjima posredovanje oko prevoznine posredovanje oko transporta iznajmljivanje automobila transport automobila šoferske usluge iznajmljivanje vagona kurirske usluge iznajmljivanje odijela za ronjenje transport feribotom utovar roba dostava roba skladištenje roba transport u okviru marine iznajmljivanje parking mjesta transport putnika transport izletničkim bodovima dostavnina odsukavanje nasukanih brodova rezervacije transports i putovanja riječni transport spašavanje brodova podvodno spašavanje brodsko spašavanje obilasci i turizam te gljenje skladištenje brodova transport taksijem transport putnika informacije o transportu iznajmljivanje vozila.

**Klasa 41:** Pružanje usluga interaktivnih zabava zabavni parkovi zabave organizovanje i praćenje konferencija i seminara organizovanje i praćenje koncerata organizovanje i praćenje simpozijuma organizovanje i praćenje radionica rezervacija sjedišta za zabavne programe obezbjeđivanje objekata za kazino bioskopske projekcije usluge u diskotekama iznajmljivanje opreme za ronjenje sa aparatom za disanje nabavka za iznajmljivanje ili prodaju opreme za ronjenje sa bocom za kiseonik iznajmljivanje sportske opreme zabava i usluge zabave informacije o zabavama organizacija izložbi za kulturne i obrazovne svrhe obezbjeđivanje objekata za golf obezbjeđivanje objekata i usluga zdravstvenih i spa klubova predstavljanje performansa uživo obezbjeđenje prostora za muzeje noćne klubove muzičke sale organizacija zabavnih programa pružanje karaoka usluga, obezbjeđenje sportskih objekata obezbjeđenje objekata za rekreaciju i informacija o rekreaciji iznajmljivanje audio opreme, iznajmljiva-

nje kamkordera iznajmljivanje sportske opreme iznajmljivanje video kamera iznajmljivanje video traka pozorišne produkcije usluge biletarnice za svrhe zabave.

**Klasa 42:** Konsultantske usluge građevinskog dizajna podvodno istraživanje i procjena konsultantske usluge za istraživanja u marini.

**Klasa 43:** Iznajmljivanje privremenog smještaja smještajni biro i uključujući hotele, apartmane, stanove, potkrovlja, gradske kuće i gostionice rezervacije privremenog smještaja usluge barova rezervacije gostionice kafei kafeterije kantine catering hrane i pića dnevna obdaništa i jaslice starački domovi turistički domovi rezervacije hotela hoteli moteli iznajmljivanje stolica, stolova, stolnjaka i staklarije iznajmljivanje soba za sastanke restorani i restorani za samoposluživanje snec barovi.

---

(111) 07062	(151) 14.02.2013
(210) <b>2010-197</b>	(442) <b>20.06.2012</b>
	(220) 08.06.2010

(732) SC. Jonson&Son, Inc1525 Howe Street Rocine, Wisconsin 534003-2236, US

## RAID

(540)  
 (550) I  
 (511) **Klasa 4:** svijeće vitke svijeće sa konusnim suženjem fitilji.

**Klasa 5:** Preparati za unistavanje korova i štetočina insekticidi sredstva protiv moljaca sredstva protiv insekata pesticidi fungicidi herbicidi tablete i spirale protiv komaraca preparati za uništavanje mikroba i dezinfekciju.

**Klasa 9:** Električne jedinice za zagrijavanje različitih tipova materijala u cilju oslobađanja insekticida i sredstava protiv insekata.

**Klasa 11:** Aparati za emitovanje insekticida ili sredstava protiv insekata u okolnu atmosferu djelovi i dodatci za takve aparate.

**Klasa 21:** Zamke i mamci za insekte.

**Klasa 24:** Mreže za komarce.

---

(111) 07061	(151) 14.02.2013
(210) <b>2010-196</b>	(442) <b>20.06.2012</b>
	(220) 08.06.2010

(732) S.C. JONHSON & SON, INC, 1525 HOWE STREET, RACINE, WISCONSIN 53403-2236 US

## PLEDGE

(540)  
 (550) I  
 (740) Čejović Vladimir, 13. jula 21, Podgorica (ME)

(511) **Klasa 3:** Preparati za čišćenje, poliranje, ribanje i nagrizanje sredstva za bijeljenje i druge supstance za upotrebu na tkaninama maramice za jednokratnu upotrebu impregnirane hemikalijama ili jedinjenjima za upotrebu u domaćinstvu preparati za uklanjanje laka preparati u obliku voska za upotrebu na završenim i nezavršenim površinama preparati za uklanjanje voska preparati za poliranje cipela, kreme za cipele, preparati za čišćenje cipela sapuni deterdženti.

**Klasa 21:** Kuhinjski i pribor za domaćinstva za čišćenje, poliranje, nagrizanje i voskiranje sunđer i četke krpe odjeća za čišćenje odjeća impregnisana rastvorom za čišćenje.

(111) 07293

(151) 29.01.2013

(210) **2010-240**

(442) **20.06.2012**

(220) 19.07.2010

(732) THURAYA TELECOMMUNICATIONS COMPANY, SHEIKH RASHID BIN SAEED AL MAKTOUM STREET, ETISALAT TOWER, ABU-DHABI AE

THURAYA 

(540)

(550) I

(740) Ćosović Dejan, 13. jula 1/5, Budva (ME)

(511) **Klasa 9:** Aparati i instrumenti naučni, pomorski, geodetski i električni, uključujući bežične instrumente i aparate, telekomunikacijski instrumenti i aparati uključujući prijemnike i otpremnike, telefone i bežične telefone, mobilne i celularne telefone i njihove djelove, satelite, zemaljske stanice za prijem i odašiljanje, antene, tanjiraste antene i sve tipove dekodera.

**Klasa 16:** Štampane stvari, novine i časopisi, knjige i brošure, fotografije.

**Klasa 38:** Usluge u oblasti telekomunikacija uključujući bežičnu komunikaciju, preko zemaljskih stanica i telekomunikaciju preko satelita.

(111) 07206

(151) 17.01.2013

(210) **2010-241**

(442) **20.06.2012**

(220) 19.07.2010

(732) FIRMA PRODUKCYJNO-USLUGOWO-HANDLOWA MOKATE-TERESA MOKRYSZ, KATOWICKA 265, 43-450 USTRON PL



(540)

(550) I

(740) Ćosović Dejan, 13. jula 1/5, Budva (ME)

(511) **Klasa 30:** Kafa.

(111) 07064

(151) 06.02.2013

(210) **2010-88**(442) **20.06.2012**

(220) 30.03.2010

(732) HOME BOX OFFICE INC, 1100 AVENUE OF THE AMERICAS, 9th FLOOR NEW YORK, NY 10036 US

# HBO HD

(540)

(550) I

(740) Ćupić Branislav, Dalmatinska 10, Podgorica (ME)

(511) **Klasa 41:** Obuka, stručno osposobljavanje, razonoda, sportske i kulturne djelatnosti, stručno osposobljavanje, sportske i kulturne djelatnosti, pružanje razonode i obuke, produkcija, prezentacija i distribucija audio, video, statičnih i pokretnih slika i podataka, usluge izdavaštva (uključujući usluge elektroničke publikacije), organiziranje foruma i blogova za rasprave, usluge razonode, osobito usluge programiranja, proizvodnje i distribucije video materijala.

(111) 07063

(151) 06.02.2013

(210) **2010-235**(442) **20.06.2012**

(220) 15.07.2010

(732) HOME BOX OFFICE INC, 1100 AVENUE OF THE AMERICAS, 9th FLOOR NEW YORK, NY 10036 US





(540)

(550) I

(740) Ćupić Branislav, Dalmatinska 10, Podgorica (ME)

(511) **Klasa 09:** Naučni, nautički, geodetski, fotografski, kinematografski i optički aparati i instrumenti kao i aparati i instrumenti za vaganje, mjerenje, signalizaciju, kontrolu (inspekciju), za pomoć (spašavanje) i za obuku, aparati za snimanje, prijenos, reprodukciju zvuka ili slika, magnetne podloge za snimanje, akustičke ploče, automati i mehanizmi za automatske uređaje koji se pokreću uz prethodno ubacivanje kovanica, registarske blagajne, računari, oprema za obradu podataka i računala, uređaji za gašenje požara, računarski program, računarski program za upotrebu u procesiranju, prijenosu, primanju, organiziranju, manipulaciji, emitiranju, revidiranju, reproduciranju i tijeku audio, video i multimedijских sadržaja, uključujući tekstualne, podatkovne, fotografske, audio, video i audiovizualne materijale, računarski program za kontrolisanje rada audio i video uređaja za gledanje, pretraživanje i/ili emitiranje audio, video, televizijskih, filmskih, ostalih digitalnih materijala i ostalih multimedijских sadržaja, računarski program za interaktivnu razonodu koji dopušta korisnicima da si sami prilagođavaju načine gledanja, slušanja i igranja birajući i organizirajući izgled i karakteristike audio, video i audiovizualnih elemenata, audio, vizualni i audiovizualni materijali i snimke koji se mogu skidati s interneta i koji sadrže multimedijalne programe i sadržaje za zabavu, elektroničke publikacije koje se mogu skidati s interneta, unaprijed snimljeni video isječci i promotivni spotovi na CD-ovima i DVD-ovima, unaprijed snimljeni kratki filmovi i promotivni spotovi na CD-ovima i DVD-ovima, naglavne slušalice, slušalice, slušalice za uši, podlošci za miševе.

**Klasa 38:** Telekomunikacije, usluge mobilnih medija u smislu elektronskog prijenosa, emitiranja i isporuke audio, video i multimedijских sadržaja za zabavu uključujući tekstualne, podatkovne, fotografske, audio, video i audiovizualne materijale, putem interneta, bežične komunikacije, elektronskih komunikacijskih mreža i računalskih mreža.

**Klasa 41:** Obuka, stručno osposobljavanje, razonoda, sportske i kulturne djelatnosti, usluge razonode, usluge razonode u smislu pružanja programa i sadržaja za razonodu, televizijske emisije, isječci, grafika i informacije vezane uz televizijski program u području komedije, drame, akcije, pozorišta/varijete, pustolovine, sporta, mjuzikla, tekućih vijesti i vijesti iz svijeta zabave, dokumentaraca, animacije, putem interneta, elektronskih komunikacijskih mreža, računarskih mreža i bežičnih komunikacijskih mreža, organizacija događanja, predavanja i seminara uključujući i na internetu, usluge izdavaštva (uključujući usluge elektroničke publikacije), organizovanje foruma i blogova za rasprave.

(111) 07230

(151) 31.01.2013

(210) **2010-208**(442) **20.06.2012**

(220) 18.06.2010

(732) ANHUI JIANGHUAI AUTOMOBILE GROUP CO, N.176 DONGLIU ROAD, BAOHE DISTRICT, HEFEI CITY, ANHUI PROVINCE CN



(540)

(550) I

(740) Đakonović Vido, Bajova 9, Cetinje (ME)

(511) **Klasa 12:** Automobili autobusi sportski automobili kamioni električna vozila viljuskari dostavna vozila podvozja i šasije za vozila mali automobili sa tri sjedišta.

(111) 07229

(151) 29.01.2013

(210) **2010-56**

(442) **20.06.2012**

(220) 10.03.2010

(732) CHERY AUTOMOBILE CO, LTD, 8 CHANGCHUN ROAD, ECONOMY I TECHNOLOGY DEVELOPMENT ZONE WUHU CITY, ANHUI PROVINCE CN



(540)

(550) I

(740) Đakonović Vido, Bajova 9, Cetinje (ME)

(511) **Klasa 12:** Vazdušni jastuci [sigurnosni uređaji za automobile], pumpe za vazduh [dodatna oprema za vozila], bolnička kola, uređaji protiv zasjenjivanja za vozila, uređaji protiv krađe za vozila, karoserije i šasije za automobile, automobilske gume, automobili, osovine za vozila, trake za glavčine točkova, djelovi kočnica za vozila, kočione pedale za vozila, kočnice za vozila, autobusi, motorna vozila, kvačila za kopnena vozila, klipnjače za kopnena vozila, koje nisu djelovi motora i pogonskih mašina, konvertori za kopnena vozila, kućišta radilice i komponente terenskih vozila, koji nisu pogonski motor, pokazivači pravca za vozila, vrata za vozila, pogonski motori za kopnena vozila, električna vozila, lančanik slobodnog hoda za kopnena vozila, prenosnici brzine za kopnena vozila, sistem prenosnika za kopnena vozila, poklopci za motore na vozilima, poklopci za vozila, sirene za vozila, glavčine za točkove vozila, motori za upravljanje kopnenim vozilima, propulzioni mehanizmi za kopnena vozila, redukcionni prenosnici za kopnena vozila, alarm opomene za vožnju u rikverc, točkovi vozila, amortized za automobile, volani za vozila, konvertori obrtnog momenta za kopnena vozila, torzione poluge za vozila, prenosni lanci za kopnena vozila, prenosna vratila za kopnena vozila, prenosnici za kopnena vozila, turbine za kopnena vozila, stajni trap automobila, kamio-

ni, kombiji i kamioneti, opruge za vješanje vozila, prozori za vozila, bicikli, motorcikli, vozila za prevoz kopnom, vazduhom, vodom ili železnicom.

**Klasa 37:** Održavanje i popravka motornih vozila, podmazivanje vozila, pranje vozila, poliranje vozila, zaštita vozila od rde, stanice za servisiranje vozila (pumpe za gorivo i održavanje), popravka šara na gumama, vulkaniziranje i popravka guma, restauracija mašina koje su pohabane ili delimično uništene, instaliranje i popravka alarma protiv provala.

---

(111) 07228	(151) 29.01-2013
(210) <b>2010-57</b>	(442) <b>20.06.2012</b>
	(220) 10.03.2010
(732) CHERY AUTOMOBILE CO.LTD, 8 CHANGCHUN ROAD, ECONOMY I TECHNOLOGY DEVELOPMENT ZONE WUHU CITY, ANHUI PROVINCE CN	

**CHERY**

(540)  
 (550) I  
 (740) Đakonović Vido, Bajova 9, Cetinje (ME)  
 (511) **Klasa 12:** Vazdušni jastuci [sigurnosni uređaji za automobile], pumpe za vazduh [dodatna oprema za vozila], bolnička kola, uređaji protiv zasjenjivanja za vozila, uređaji protiv krađe za vozila, karoserije i šasije za automobile, automobilske gume, automobili, osovine za vozila, trake za glavčine točkova, djelovi kočnica za vozila, kočione pedale za vozila, kočnice za vozila, autobusi, motorna vozila, kvačila za kopnena vozila, klipnjače za kopnena vozila, koje nisu djelovi motora i pogonskih mašina, konvertori za kopnena vozila, kućišta radilice i komponente terenskih vozila, koji nisu pogonski motor, pokazivači pravca za vozila, vrata za vozila, pogonski motori za kopnena vozila, električna vozila, lančanik slobodnog hoda za kopnena vozila, prenosnici brzine za kopnena vozila, sistem prenosnika za kopnena vozila, poklopci za motore na vozilima, poklopci za vozila, sirene za vozila, glavčine za točkove vozila, motori za upravljanje kopnenim vozilima, propulzioni mehanizmi za kopnena vozila, redukcionni prenosnici za kopnena vozila, alarm opomene za vožnju u rikverc, točkovi vozila, amortized za automobile, volani za vozila, konvertori obrtnog momenta za kopnena vozila, torzione poluge za vozila, prenosni lanci za kopnena vozila, prenosna vratila za kopnena vozila, prenosnici za kopnena vozila, turbine za kopnena vozila, stajni trap automobila, kamioni, kombiji i kamioneti, opruge za vješanje vozila, prozori za vozila, bicikli, motorcikli, vozila za prevoz kopnom, vazduhom, vodom ili železnicom.

**Klasa 37:** Održavanje i popravka motornih vozila, podmazivanje vozila, pranje vozila, poliranje vozila, zaštita vozila od rđe, stanice za servisiranje vozila (pumpe za gorivo i održavanje), popravka šara na gumama, vulkaniziranje i popravka guma, restauracija mašina koje su pohabane ili delimično uništene, instaliranje i popravka alarma protiv provala.

---

(111) 06731	(151) 17.12.2012.
(210) <b>2009-134</b>	(442) <b>20.03.2012</b>
	(220) 23.02.2009
	(300) 09.08.2006 SR
(732) TELEKOM CRNE GORE AD; MOSKOVSKA 29 PODGORICA ME	

Sve što ste  
željeli da kažete!

(540)

(550) I

(740) Marković Tijana, Moskovska 29, Podgorica (ME)

(511) **Klasa 38:** Telekomunikacije; usluge koje omogućavaju najmanje jednom licu da komunicira sa drugim koristeći čula (da međusobno razgovaraju, da prenose poruke); usluge stavljanja lica u položaj vizuelne ili govorne komunikacije sa drugim; usluge prenosa podataka; usluge koje sadrže difuziju radio ili televizijskih programa.

**Klasa 41:** Obrazovne usluge; pripremanje obuke; razonoda; sportske i kulturne aktivnosti, usluge koje pružaju lica ili instalacije u razvijanju mentalnih sposobnosti drugih lica (obrazovanje) ili životinja (obuka, dresiranje); usluge kojima je cilj zabavljanje drugih lica, privlačenje pažnje, rekreacija; organizovanje (priređivanje) i vođenje seminara, konferencija, kongresa; organizovanje izložbi i kulturne i obrazovne svrhe, sportskih takmičenja, izdavanje tekstova i knjiga.

(111) 06732

(151) 17.12.2012.

(210) **2009-135**

(442) **20.03.2012**

(220) 23.02.2009

(300) 09.08.2006 RS

(732) CRNOGORSKI TELEKOM AD; MOSKOVSKA BR 29 PODGORICA ME



(540)

(550) I

(740) Marković Tijana, Moskovska 29, Podgorica (ME)

(511) **Klasa 38:** Telekomunikacije; usluge koje omogućavaju najmanje jednom licu da komunicira sa drugim koristeći čula (da međusobno razgovaraju, da prenose poruke); usluge stavljanja lica u položaj vizuelne ili govorne komunikacije sa drugim; usluge prenosa podataka; usluge koje sadrže difuziju radio ili televizijskih programa,

**Klasa 41:** Obrazovne usluge; pripremanje obuke; rasonoda; sportske i kulturne aktivnosti, usluge koje pružaju lica ili instalacije u razvijanju mentalnih sposobnosti drugih lica (obrazovanje) ili životinja (obuka, dresiranje); usluge kojima je cilj zabavljanje drugih lica, privlačenje pažnje, rekreacija; organizovanje (priređivanje) i vođenje seminara, konferencija, kongresa; organizovanje izložbi i kulturne i obrazovne svrhe, sportskih takmičenja, izdavanje tekstova i knjiga,

(111) 06733

(151) 17.12.2012

(210) **2009-136**(442) **20.03.2012**

(220) 23.02.2009

(300) 09.08.2006 RS

(732) CRNOGORSKI TELEKOM AD; MOSKOVSKA 29 PODGORICA ME

Sve što ste  
željeli da kažete!

(540)

(550) I

(740) Marković Tijana, Moskovska 29, Podgorica (ME)

(511) **Klasa 38:** Telekomunikacije; usluge koje omogućavaju najmanje jednom licu da komunicira sa drugim koristeći čula (da međusobno razgovaraju, da prenose poruke); usluge stavljanja lica u položaj vizuelne ili govorne komunikacije sa drugim; usluge prenosa podataka; usluge koje sadrže difuziju radio ili televizijskih programa,

**Klasa 41:** Obrazovne usluge; pripremanje obuke; rasonoda; sportske i kulturne aktivnosti, usluge koje pružaju lica ili instalacije u razvijanju mentalnih sposobnosti drugih lica (obrazova-

nje) ili životinja (obuka, dresiranje); usluge kojima je cilj zabavljanje drugih lica, privlačenje pažnje, rekreacija; organizovanje (priređivanje) i vođenje seminara, konferencija, kongresa; organizovanje izložbi i kulturne i obrazovne svrhe, sportskih takmičenja, izdavanje tekstova i knjiga,

---

(111) 06734 (151) 17.12.2012.  
 (210) **2009-137** (442) **20.03.2012**  
 (220) 23.02.2009  
 (300) 09.08.2006 RS  
 (732) CRNOGORSKI TELEKOM AD; MOSKOVSKA 29 PODGORICA ME

## Sve što ste željeli!

(540)  
 (550) I  
 (740) Marković Tijana, Moskovska 29, Podgorica (ME)  
 (511) **Klasa 38:** Telekomunikacije; usluge koje omogućavaju najmanje jednom licu da komunicira sa drugim koristeći čula (da međusobno razgovaraju, da prenose poruke); usluge stavljanja lica u položaj vizuelne ili govorne komunikacije sa drugim; usluge prenosa podataka; usluge koje sadrže difuziju radio iiii televizijskih programa,  
**Klasa 41:** Obrazovne usluge; pripremanje obuke; razonoda; sportske i kulturne aktivnosti, usluge koje pružaju lica ili instalacije u razvijanju mentalnih sposobnosti drugih lica (obrazovanje) ili životinja (obuka, dresiranje); usluge kojima je cilj zabavljanje drugih lica, privlačenje pažnje, rekreacija; organizovanje (priređivanje) i vođenje seminara, konferencija, kongresa; organizovanje izložbi i kulturne i obrazovne svrhe, sportskih takmičenja, izdavanje tekstova i knjiga,

---

(111) 06736 (151) 17.12.2012.  
 (210) **2009-308** (442) **20.06.2012**  
 (220) 27.05.2009  
 (300) RS Z-1070/07 15.05.2007  
 (732) SMITHERS-OASIS COMPANY, 2020 FRONT STRET, SUITE 301 CUYAHOGA FALLS, OHIO 44221 US

## OASIS

(540)  
 (550) I  
 (740) Radulović Božidar, Jovana Tomaševića 9/III, Podgorica (ME)  
 (511) **Klasa 01:** Podloge za sijanje (postavljanje) sjemena i razmnožavanje biljaka preparati za upotrebu sa cvijećem i biljkama, naročito sjaj za lišće preparati za održavanje života i ljepote sječenog cvijeća preparati za hidrataciju i pred-tretman svježeg sječenog cvijeća tečni sprej za završnu obradu, za osvježavanje, hidrataciju i zaštitu cvjetnih aranžmana i biljaka u saksijama.

(111) 06737

(151) 17.12.2012.

(210) **2009-403**(442) **20.03.2012**

(220) 28.05.2009

(300) 09.08.2006 RS

(732) CRNOGORSKI TELEKOM AD; MOSKOVSKA BR 29 PODGORICA ME



(540)

(550) I

(740) Đurović Pavle, Podgorica (ME)

(511) **Klasa 38:** Telekomunikacije; usluge koje omogućavaju najmanje jednom lieu da komunicira sa drugim koristeći čula (da međusobno razgovaraju, da prenose poruke); usluge stavljanja lica u položaj vizuelne ili govorne komunikacije sa drugim; usluge prenosa podataka; usluge koje sadrže difuziju radio ili televizijskih programa.

**Klasa 41:** Obrazovne usluge; pripremanje obuke; razonoda; sportske i kulturne aktivnosti, usluge koje pružaju lica ili instalacije u razvijanju mentalnih sposobnosti drugih lica (obrazovanje) ili životinja (obuka, dresiranje); usluge kojima je cilj zabavljanje drugih lica, privlačenje pažnje, rekreacija; organizovanje (priređivanje) i vođenje seminara, konferencija, kongresa; organizovanje izložbi i kulturne i obrazovne svrhe, sportskih takmičenja, izdavanje tekstova i knjiga.

(111) 06738

(151) 17.12.2012.

(210) **2009-404**(442) **20.03.2012**

(220) 28.05.2009

(300) 09.08.2006 RS

(732) CRNOGORSKI TELEKOM AD; MOSKOVSKA 29 PODGORICA ME

Sve što ste željeli da čujete

(540)

(550) I

(740) Đurović Pavle, Podgorica (ME)

(511) **Klasa 38:** Telekomunikacije; usluge koje omogućavaju najmanje jednom lieu da komuni-

cira sa drugim koristeći čula (da međusobno razgovaraju, da prenose poruke); usluge stavljanja lica u položaj vizuelne ili govorne komunikacije sa drugim; usluge prenosa podataka; usluge koje sadrže difuziju radio ili televizijskih programa.

**Klasa 41:** Obrazovne usluge; pripremanje obuke; razonoda; sportske i kulturne aktivnosti, usluge koje pružaju lica ili instalacije u razvijanju mentalnih sposobnosti drugih lica (obrazovanje) ili životinja (obuka, dresiranje); usluge kojima je cilj zabavljanje drugih lica, privlačenje pažnje, rekreacija; organizovanje (priređivanje) i vođenje seminara, konferencija, kongresa; organizovanje izložbi i kulturne i obrazovne svrhe, sportskih takmičenja, izdavanje tekstova i knjiga.

(111) 06739

(151) 17.12.2012.

(210) **2009-530**

(442) **20.06.2012**

(220) 25.08.2009

(732) GENZYME CORPORATION MASSACHUSETTS CORPORATION, 500 KENDALL STREET CAMBRIDGE, MASSACHUSETTS 02142 US



(540)

(550) I

(740) Radulović Božidar, Jovana Tomaševića 9/III, Podgorica (ME)

(511)

**Klasa 5:** Farmaceutski i veterinarski preparati sanitarni preparati za medicinske svrhe dijetetske supstance za upotrebu u medicini, hrana za bebe flasteri, materijal za zavijanje materijali za plombiranje zuba, zubarska smola dezinfekciona sredstva preparati za uništavanje štetočina fungicidi, herbicidi farmaceutski preparati, naročito unaprijed spakovani injektibilni biohemijski rastvori, posebno rastvori natrijum hilana.

(111) 06740

(151) 17.12.2012.

(210) **2009-531**

(442) **20.06.2012**

(220) 25.08.2009

(732) GENZYME CORPORATIN, 500 KENDALL STREET CAMBRIDGE, MASSACHUSETTS 02142 US

# SYNVISC-ONE

(540)

(550) I

(740) Radulović Božidar, Jovana Tomaševića 9/III, Podgorica (ME)

(511)

**Klasa 5:** Farmaceutski i veterinarski preparati sanitarni preparati za medicinske svrhe dijetetske supstance za upotrebu u medicini, hrana za bebe flasteri, materijal za zavijanje materijali za plombiranje zuba, zubarska smola dezinfekciona sredstva preparati za uništavanje štetočina fungicidi, herbicidi farmaceutski preparati, naročito unaprijed spakovani injektibilni biohemijski rastvori, posebno rastvori natrijum hilana.

(111) 06741

(151) 17.12.2012.



(210) **2009-545**(442) **20.06.2012**

(220) 01.09.2009

(732) SHERATON INTERNATIONAL INC, 1111 WESTCHESTER AVENUE, WHITE PLAINS, N Y 10604 US

**Link**  

---

**@Sheraton**

(540)

(550) I

(740) Lutovac Branislav, Bulevar Crnojevića 93, Podgorica (ME)

(511) **Klasa 43:** Hotelske usluge, naročito pružanje informacija putem interneta.

(111) 06742

(151) 17.12.2012.

(210) **2009-514**(442) **20.03.2012**

(220) 17.08.2009

(732) NAPREDAK AD KOTOR; TRG OD ORUŽJA BB, STARI GRAD KOTOR ME



KAMELIJA

(540)

(550) I

(511) **Klasa 36:** Osiguranje; finansijski poslovi; novčani (monetarni) poslovi; poslovi vezani za nepokretnosti.**Klasa 41:** Obrazovne usluge; pripremanje obuke; razonoda; sportske i kulturne aktivnosti.

(111) 06793

(151) 17.12.2012.

(210) **2009-598**(442) **20.06.2012**

(220) 10.06.2009

(732) UNIVERSAL CITY STUDIOS LLC, 100 UNIVERSAL CITY PLAZA, UNIVERSAL CITY, CALIFORNIA 91608 US

## SYFY

(540)

(550) I

(740) Radulović Božidar, Jovana Tomaševića 9/III, Podgorica (ME)

(511) **Klasa 38:** Telekomunikacije.**Klasa 41:** Obrazovne usluge pripremanje obuke, razonoda sportske i kulturne aktivnosti.

(111) 06794

(151) 17.12.2012.

(210) **2009-561**(442) **20.06.2012**

(220) 18.09.2009

(732) MTEL DOO, ULICA KRALJA NIKOLE 27A, PODGORICA ME

Imate prijatelje!

(540)

(550) I

(511) **Klasa 38:** Telekomunikacije usluge mobilne radiotelefonijske, GSM (Globalni sistem za mobilne komunikacije) i UMTS (Univerzalni mobilni telekomunikacioni sistem) mobilne radio usluge, prenos vijesti i slike posebno pomoću SMS i MMS servisa, omogućavanje pristupa internetu takođe putem mobilnih radio veza usluge elektronskog oglašavanja.

(111) 06795

(151) 17.12.2012.

(210) **2009-562**(442) **20.06.2012**

(220) 18.09.2009

(732) MTEL DOO, ULICA KRALJA NIKOLE 27A PODGORICA ME



(540)

(550) I

(511) **Klasa 38:** telekomunikacije uključuje usluge koje omogućavaju najmanje jednom licu da

komunicira sa drugim licem koristeći čula usluge telekomunikacija uključuju i usluge, koje dozvoljavaju jednom licu da komunicira sa drugim, prenosa poruka od jedne osobe do druge, koje stavljaju lica u položaj vizuelne ili govorne komunikacije sa drugim usluge koje sadrže difuziju radio ili televizijskih programa.

(111) 06796 (151) 17.12.2012  
 (210) **2009-563** (442) **20.06.2012**  
 (220) 18.09.2009  
 (732) MTEL DOO, ULICA KRALJA NIKOLE 27A PODGORICA ME



(540)  
 (550) I  
 (511) **Klasa 38:** Telekomunikacije uključuje usluge koje omogućavaju najmanje jednom licu da komunicira sa drugim licem koristeći čula usluge telekomunikacija uključuju i usluge, koje dozvoljavaju jednom licu da komunicira sa drugim, prenosa poruka od jedne osobe do druge, koje stavljaju lica u položaj vizuelne ili govorne komunikacije sa drugim usluge koje sadrže difuziju radio ili televizijskih programa.

(111) . 06797 (151) 17.12.2012  
 (210) **2009-564** (442) **20.06.2012**  
 (220) 18.09.2009  
 (732) MTEL DOO, ULICA KRALJA NIKOLE 27A, PODGORICA ME



(540)  
 (550) I  
 (511) **Klasa 38:** Telekomunikacije uključuje usluge koje omogućavaju najmanje jednom licu da komunicira sa drugim licem koristeći čula usluge telekomunikacija uključuju i usluge, koje dozvoljavaju jednom licu da komunicira sa drugim, prenosa poruka od jedne osobe do druge, koje stavljaju lica u položaj vizuelne ili govorne komunikacije sa drugim usluge koje sadrže difuziju radio ili televizijskih programa.

(111) 06798

(151) 18.12.2012.

(210) **2009-572**(442) **20.06.2012**

(220) 23.09.2009

(732) KABUSHIKI KAISHA ADVICS-ALSO TRADING AS ADVICS CO ., LTD, 2-1 SHOWACHO, KARIYA-SHI,AICHI-KEN JP



(540)

(550) I

(740) Lutovac Branislav, Bulevar Crnojevića 93, Podgorica (ME)

(511) **Klasa 12:** Vozila i aparati za kretanje po kopnu, vazduhu ili vodi i dijelovi i oprema za navedeno, kočnice i komponente za kočnice za vozila za kretanje po kopnu, uključujući kočiona kliješta, kočione pločice, kočione diskove, kočione cilindre, kočione paknove, kočione obloge, doboš kočnice, kočione poluge, pedale za kočnice, pojačivače kočenja, glavne kočione cilindre, kočione ventile, parking kočnice, ABS (sisteme protiv blokiranja kočenja), kočione podloške, kočione pločice sa indikatorima kočenja i habanja, šasije, vješanje i servo upravljački sistemi za vozila koja se kreću po kopnu, motori i pogonski uređaji za vozila koja se kreću po kopnu,starteri, sve vrste osovin, vratila i vretena, ležajevi, osovinske spojnice, zupčanici, kvačila, uređaji za prenos pogona, amortizeri, opruge i ventili sve za vozila koja se kreću pokopnu.

(111) 06799

(151) 18.12.2012.

(210) **2009-573**(442) **20.06.2012**

(220) 23.09.2009

(732) KABUSHIKI KAISHA ADVICS-ALSO TRADING AS ADVICS CO.,LTD, 2-1 SHOWACHO, KARIYA-SHI, AICHI-KEN JP



(540)

(550) I

(740) Lutovac Branislav, Bulevar Crnojevića 93, Podgorica (ME)

(511) **Klasa 12:** Vozila i mehanizmi za kretanje kopnom, vazduhom ili vodom i djelovi i oprema za navedeno , kočnice i komponenti za kočnice, drška za kočenje, diskovi za kočenje , kočni cilindar , kočnička papuča, kočnička obloga , kočioni valjak, kočnička poluga, pedala za kočenje, kočioni pojačivači, glavni kočioni cilindri, kočioni ventili, parking kočnica, ABS (sistem protiv blokiranja kočnica), podupirači za kočnice, kočione pločice sa indikatorima kočenja i

promjena, šasije, amortized i električni upravljači za vozila koja se kreću kopnom, motori i mašine za vozila koja se kreću kopnom, servomotori, osovine, stožeri, vretena, ležišta, osovinski spoj, mjenjači, kuplung, motorni prenosnici, upijači potresa, opruge i ventili za sva vozila koja se kreću kopnom.

---

(111) 06800 (151) 18.12.2012  
(210) **2009-575** (442) **20.06.2012**  
(220) 25.09.2009  
(732) SMITKLINE BEECHAM LIMITED US

## DUODART

(540)  
(550) I  
(740) Lutovac Branislav, Bulevar Crnojevića 93, Podgorica (ME)  
(511) **Klasa 05:** Farmaceutski preparati i supstance.

---

(111) 06801 (151) 18.12.2012.  
(210) **2009-576** (442) **20.06.2012**  
(220) 25.09.2009  
(732) SMITKLINE BEECHAM LIMITED US

## TISSIMA

(540)  
(550) I  
(740) Lutovac Branislav, Bulevar Crnojevića 93, Podgorica (ME)  
(511) **Klasa 05:** Farmaceutski preparati i supstance.

---

(111) 06802 (151) 18.12.2012.  
(210) **2009-577** (442) **20.06.2012**  
(220) 25.09.2009  
(732) SMITKLINE BEECHAM LIMITED US

## DUEDART

(540)  
(550) I  
(740) Lutovac Branislav, Bulevar Crnojevića 93, Podgorica (ME)  
(511) **Klasa 05:** Farmaceutski preparati i supstance.

---

(111) 06803 (151) 18.12.2012.  
 (210) **2009-578** (442) **20.06.2012**  
 (220) 25.09.2009  
 (732) SMITKLINE BEECHAM LIMITED US

## DUADART

(540)  
 (550) I  
 (740) Lutovac Branislav, Bulevar Crnojevića 93, Podgorica (ME)  
 (511) **Klasa 05:** Farmaceutski preparati i supstance.

---

(111) 06804 (151) 18.12.2012.  
 (210) **2009-581** (442) **20.06.2012**  
 (220) 29.09.2009  
 (732) UNIVERSAL CITY STUDIOS LLC, 100 UNIVERSAL CITY PLAZA, UNIVERSAL CITY, CALIFORNIA  
 91608 US

## 13TH STREET

(540)  
 (550) I  
 (740) Radulović Božidar, Jovana Tomaševića 9/III, Podgorica (ME)  
 (511) **Klasa 38:** Telekomunikacije.  
**Klasa 41:** Obrazovne usluge pripremanje obuke, razonoda sportske i kulturne aktivnosti.

---

(111) 06805 (151) 18.12.2012.  
 (210) **2009-584** (442) **20.06.2012**  
 (220) 30.09.2009  
 (732) TDK KABUSHIKI KAISHA-TDK CORPORATION, 13-1,1-CHOME, NIHONBASHI, CHUO-KU,  
 TOKYO JP



The logo consists of the letters 'TDK-EPC' in a bold, sans-serif font. The 'T' and 'D' are connected, as are the 'E' and 'P'. A vertical line is positioned to the right of the logo.

(540)  
 (550) I  
 (740) Lutovac Branislav, Bulevar Crnojevića 93, Podgorica (ME)  
 (511) **Klasa 09:** Aparati i instrumenti naučni, pomorski, geodetski, fotografski, kinematograf-

ski, optički, za vaganje, mjerenje, signalizaciju, kontrolu (inspekciju), spašavanje i nastavu, aparati i instrumenti za provođenje, isključivanje, transformisanje, akumuliranje, regulisanje ili kontrolisanje električne energije aparati za snimanje, prenos i reprodukovanje zvuka i slike magnetni nosioci podataka, diskovi za snimanje automatske mašine i mehanizmi za aparate koji se pokreću novcem ili žetonom registar kase, računске mašine, oprema za obradu podataka i kompjuteri aparati za gašenje požara oznaka kuće za punu liniju električnih, inženjerskih i elektronskih uređaja za industriju telekomunikacije, automotorne elektronike i elektronike za industriju i široku potrošnju električni, inženjerski i/ili elektronski uređaji za industriju telekomunikacije, automotorne elektronike i elektronike za industriju i široku potrošnju električni/elektronski djelovi električni/elektronski uređaji električne/elektronske komponente električni/elektronski materijali električne/elektronske pasivne komponente keramičke komponente mikrotalasna keramika kondenzatori keramički kondenzatori višeslojni keramički kondenzatori sklopovi elemenata sastavljenih od kondenzatora EMC komponente (komponente za elektromagnetnu kompatibilnost) feritni izolatori keramički izolatori izolacione kuglice za čipove električni/elektronski filteri filteri za električne signale filteri za kontrolu frekvencije signala filteri za suzbijanje interferencije radio talasa EMC filteri (filteri za elektromagnetnu kompatibilnost) filteri sa tri priključka filteri zajedničkog (opšteg) moda prigušni ventili kalemovi prigušnih ventila kalemovi prigušnog ventila zajedničkog (opšteg) moda namotaji prigušnog ventila diferencijalnog moda kalemovi vršne jačine struja kalupni kalemovi varistors stezni filteri (feritno jezgro sa kućistem) feriti feritni materijali feritna jezgra dielektrični filteri keramički filteri piezoelektrični filteri filteri na bazi feritnih kuglica filteri za šum induktori kalemovi transformatori električni/elektronski transformatori pulsni transformatori strujni transformatori limovi za prigušivanje šuma magnetni limovi materijali za apsorpciju i zaštitu od elektromagnetnog zračenja prigušivači mikrotalasa prigušivači elektromagnetnog zračenja prigušivači radio talasa visokofrekventne elektromagnetne supstance gluve sobe oprema/uređaji za sistem testiranja EMC (elektromagnetne kompatibilnosti), koji se prodaju pojedinačno ili u sklopovima senzori senzori za mjerenje temperature termistori NTC termistori PTC termistori termoosetljivi prekidači senzori vlage senzori površinskog potencijala senzori zupčanika senzori zupčanika za detektovanje uglova senzori zupčanika za detektovanje brzine mehanički senzori senzori koncentracije/preostale količine tonera senzori nivoa praha senzori otvorenih/zatvorenih vrata prekidači za reze (brave) za vrata elektromagnetni senzori pobudivači uranjaci uranjaci (djelovi mašina) komponente za mehanički pogon raspršivači jedinice raspršivača ultrazvučne jedinice raspršivača ovlaživači za sisteme raspršivača pumpe piezoelektronične komponente piezoelektrični proizvodi piezoelektronični keramički filteri rezonatori rezonantna kola keramički rezonatori tijela za sondiranje piezoelektrični prijemnici piezoelektrične zujalice elektromagnetne zujalice piezoelektronski pobudivači magnetostrikcioni rezonatori diskriminatori keramički diskriminatori termalne glave štampača tankoslojne termalne kuglice, glave za snimanje/reprodukciju magnetne glave tankoslojne magnetne glave kontoleri memorije kontoleri postojane memorije kontoleri fleš memorije kontoleri NAND fleš memorije fleš memorija memorijske kartice fleš memorijske kartice postojana memorija postojane memorijske kartice CF (kompakt fleš) kartice CF (kompakt fleš) kartice za industrijsku upotrebu SSD diskovi SSD diskovi za industrijsku upotrebu poluprovodnički uređaji poluprovodničke memorije adapteri za kartice za memoriju ekrani OLED ekrani LED diode OLED diode RF komponente (komponente za radio frekvenciju) antene keramičke antene viseslojne čip antene pojasni filteri dielektrični pojasni filteri cirkulatori cirkulatori za bazne stanice izolatori izolatori za bazne stanice multiplekseri duplekseri viseslojni duplekseri viseslojni pojasni filteri tankoslojni pojasni filteri fazni pomjerači višeslojni fazni pomjerači linije za kašnjenje linije opsega propusnici za niske frekvencije višeslojni propusnici za niske frekvencije propusnici

za visoke frekvencije višeslojni propusnici za visoke frekvencije baluni balun transformatori višeslojni balun transformatori tankoslojni balun transformatori spojnice direkcione spojnice višeslojne direkcione spojnice LAN komponente bežični LAN moduli uređaji za bežičnu radio transmisiju aparati za bežičnu telefoniju električni/elektronski otpornici duplo uravnoteženi mikseri terminatori transduktori akcelerometri elektrode magneti feritni magneti magnetni limovi magnetna jezgra magnetni materijali napajanje, dovodi naizmjenicne struje DC/DC konvertori (konvertori jednosmjerne u jednosmjernu struju ) DC/AC invertori (invertori jednosmjerne u naizmjenicnu struju ) dovodi struje sa prekidačem filteri za šum UPS (sistemi za neprekidno napajanje) solarne ćelije tankoslojne solarne ćelije invertori balasti za invertore balast za fluorescentne lampe za električno osvjetljavanje konvertori fabrički sistemi za automatizaciju oprema za obradu poluprovodničkih ploča oprema za izradu poluprovodnika FOUP Load Port (stanica za podršku kontejnera za transport poluprovodničkih ploča pri čemu je poklopac kontejnera za transport odvojen, ili odvojiv, od kontejnera za transport) mašina za montiranje flip čipova dispenser i flip čipova mašine za umetanje komponenti mašine za masovno napajanje (masovni fideri) mašine za sekvenciranje komponenti sistemi za lasersko obeležavanje mašine za montiranje komponenti čipova integrisana kola štampane ploče ploče sa integrisanim kolom baterije prazne magnetne trake prazni magnetni diskovi prazne magnetne optičke trake prazni optički diskovi SAW komponente (komponente za površinske akustične talase) SAW filteri (filteri za površinske akustične talase) SAW rezonatori (rezonatori za površinske akustične talase) duplekseri RF moduli (moduli za radio frekvencije) SAW moduli (moduli za površinske akustične talase) frontovani moduli (fronted modules) diode zaustavljači osigurači za zaštitu od naponskog udara osigurači od prenapona keramičke prekidačke komponente keramičke grejne komponente prekidači sa zazorom između elektroda filteri za konverziju kondenzatori napajanja tantal čip kondenzatori aluminijski elektrolitični kondenzatori ultra kondenzatori induktivne feritne komponente tankoslojni kondenzatori polimerski cis-kondenzatori dodaci za ferite induktivni otpornici za SMT (tehnologiju površinskog montiranja) otpornici za indukciju električne energije za SMT (tehnologiju površinskog montiranja) linijski transformatori filteri za oklopljene sobe EMC komponente za spoj između slojeva metal oksid varistori keramički poluprovodnici filteri za mikrotalasni pojas mikrotalasni rezonatori mikrotalasne keramičke komponente dielektrični keramički filteri moduli visoke frekvencije mikrotalasni moduli LTCC moduli komponente za površinske talase komponente za zapreminske talase dielektrični materijali materijali za elektrode BAW (bulk acoustic wave) komponente FBAR (film bulk acoustic wave) komponente MEMS komponente (komponente za mikro elektro mehanicki sistemi) MEMS senzori RF moduli moduli elektronskih kola H-ML (high level multilayer) uređaji ESD komponente (komponente za elektrostatičko praznjenje) EMI komponente (komponente za elektromagnetnu interferenciju) optičke komponente PLC kola TOSA (predajni optički podsklop) ROSA (prijemni optički podsklop) optički senzori optički senzori za opseg vidljivog reflektujućeg svjetla optički prigušivači optičke spojnice optički spliteri optički filteri optički prekidači optički izolatori optički cirkulatori optički modulatori optički konektori optički multiplekseri optički demultiplekseri (razdjelnici) optički prijemnici foto diode moduli optičkih senzora moduli optičkih senzora za opseg vidljivog reflektujućeg svjetla moduli optičkih prigušivača moduli optičkih spojnica moduli optičkih splitera moduli optičkih filtera moduli optičkih prekidača moduli optičkih izolatora moduli optičkih cirkulatora moduli faradej rotatora moduli optičkih modulatora moduli optičkih konektora moduli optičkih multipleksera moduli optičkih demultipleksera (razdjelnika) moduli optičkih prijemnika moduli foto dioda sklopovi optičkih senzora sklopovi optičkih senzora iz opsega vidljivog reflektujućeg svjetla sklopovi optičkih prigušivača sklopovi optičkih spojnica sklopovi optičkih splitera sklopovi optičkih filtera sklopovi optičkih prekidača sklopovi optičkih izolatora sklopovi op-



tičkih cirkulatora sklopovi faradej rotatora sklopovi optičkih modulatora sklopovi optičkih konektora sklopovi optičkih multipleksera sklopovi optičkih demultipleksera sklopovi optičkih prijemnika sklopovi foto dioda predajnički optički podsklopovi prijemnički optički podsklopovi faradej rotatori piezoelektrični uređaji višeslojni varistori višeslojni NTC termistori djelovi i oprema za naprijed navedenu robu i sva roba koja spada u klasu 09.

---

(111) 06806 (151) 18.12.2012.  
 (210) **2009-589** (442) **20.06.2012**  
 (220) 10.02.2009  
 (300) CTM 008198641 03.04.2009  
 (732) RECKITT I COLMAN-OVERSEAS- LIMITED, DANSOM LANE, HULL, HU8 7DS GB

## SUPREMESSENCE

(540)  
 (550) I  
 (740) Popović Miladin, Đoka Miraševića 21/III, Podgorica (ME)  
 (511) **Klasa 03:** Ne-medicinski toaletni preparati kozmetički preparati i preparati za ulepšavanje hidratantne kreme, losioni, pene i gelovi piling preparati za čišćenje kože preparati za izbeljivanje sve za ličnu upotrebu preparati za depilaciju voskovi za depilaciju inhibitori za ponovni rast kose preparati, uključujući kreme, gelove i pjene, za upotrebu prije, tokom i poslije brijanja ili otklanjanja dlaka maramice za brisanje poslije depilacije impregnirane maramice i tuferi za njegu kože.

---

(111) 06807 (151) 18.12.2012.  
 (210) **2009-591** (442) **20.03.2012**  
 (220) 10.05.2009  
 (732) GENERAL MEDIA COMMUNICATIONS, INC; 6800 BROKEN SOUND PKWY BOCA RATON FL 33487 US

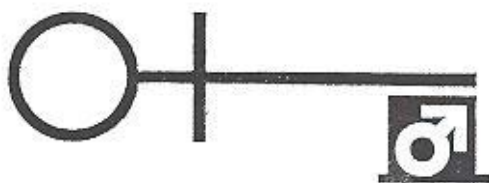

(540)  
 (550) I  
 (740) Prelević Dragan, Ul. Slobode 74/II, Podgorica (ME)  
 (511) **Klasa 09:** Televizijski set-top-boxevi, moduli sa kondicionalnim pristupom (CAM uređaji), smart kartice, pre-paid kartice za prijem kanala i radiodifuznih usluga, DVD-i biometrijske fleš memorije (ties memorije koje se aktiviraju otiskom prsta), drajvovi, fleš memorije, prijevoci sa ties memorijama i drugi kompjuterski memorijski uređaji za skladištenje podataka.

**Klasa 16:** Brošure, pamfleti, poster, knjige, novinska izdanja i drugi štampani materijali, kancelarijski pribor, ploče za pisanje, uključujući sveske, notese; sredstva za pisanje, uključujući olovke.

**Klasa 35:** Reklamiranje u novinama, magazinima, putem radija, televizije, Interneta i ostalih media; organizacija i učestvovanje na izložbama u komercijalne ili reklamne svrhe.

**Klasa 38:** Telekomunikacijske i radiodifuzne usluge, uključujući bez ograničenja rad jednog ili više kablovskih, satelitskih ili zemaljskih televizijskih kanala.

**Klasa 41:** Proizvodnja i distribucija igranih filmova i drugog zabavnog sadržaja koji se prikazuju putem jednog ili više kablovskih, satelitskih ili zemaljskih televizijskih kanala i radiodifuzne usluge; organizacija i učestvovanje na izložbama organizovanih u kulturne i obrazovne svrhe; organizacija i učestvovanje na novinskim konferencijama.

(111) 06808

(151) 18.12.2012.

(210) **2009-592**

(442) **20.03.2012**

(220) 10.05.2009

(732) GENERAL MEDIA COMMUNICATIONS, INC; 6800 BROKEN SOUND PKWY BOCA RATON FL 33487 US

## PENTHOUSE

(540)

(550) I

(740) Prelević Dragan, Ul. Slobode 74/II, Podgorica (ME)

(511) **Klasa 09:** Televizijski set-top-boxevi, moduli sa kondicionalnim pristupom (CAM uređaji), smart kartice, pre-paid kartice za prijem kanala i radiodifuznih usluga, DVD-i biometrijske fleš memorije (ties memorije koje se aktiviraju otiskom prsta), drajvovi, fleš memorije, pri-vesci sa ties memorijama i drugi kompjuterski memorijski uređaji za skladištenje podataka.

**Klasa 16:** Brošure, pamfleti, poster, knjige, novinska izdanja i drugi štampani materijali, kancelarijski pribor, ploče za pisanje, uključujući sveske, notese; sredstva za pisanje, uključujući olovke.

**Klasa 35:** Reklamiranje u novinama, magazinima, putem radija, televizije, Interneta i ostalih media; organizacija i učestvovanje na izložbama u komercijalne ili reklamne svrhe.

**Klasa 38:** Telekomunikacijske i radiodifuzne usluge, uključujući bez ograničenja rad jednog ili više kablovskih, satelitskih ili zemaljskih televizijskih kanala.

**Klasa 41:** Proizvodnja i distribucija igranih filmova i drugog zabavnog sadržaja koji se prikazuju putem jednog ili više kablovskih, satelitskih ili zemaljskih televizijskih kanala i radiodifuzne usluge; organizacija i učestvovanje na izložbama organizovanih u kulturne i obrazovne svrhe; organizacija i učestvovanje na novinskim konferencijama.

(111) 06809

(151) 18.12.2012.

(210) **2009-593**

(442) **20.03.2012**

(220) 10.05.2009

(732) GENERAL MEDIA COMMUNICATIONS INC; 6800 BROKEN SOUND PKWY BOCA RATON FL

33487 US

## PENTHOUSE HD

(540)

(550) I

(740) Prelević Dragan, Ul. Slobode 74/II, Podgorica (ME)

(511) **Klasa 09:** Televizijski set-top-boxevi, moduli sa kondicionalnim pristupom (CAM uređaji), smart kartice, pre-paid kartice za prijem kanala i radiodifuznih usluga, DVD-i biometrijske fleš memorije (ties memorije koje se aktiviraju otiskom prsta), drajvovi, fleš memorije, pri-vesci sa ties memorijama i drugi kompjuterski memorijski uređaji za skladištenje podataka.

**Klasa 16:** Brošure, pamfleti, poster, knjige, novinska izdanja i drugi štampani materijali, kancelarijski pribor, ploče za pisanje, uključujući sveske, notese; sredstva za pisanje, uključujući olovke.

**Klasa 35:** Reklamiranje u novinama, magazinima, putem radija, televizije, Interneta i ostalih media; organizacija i učestvovanje na izložbama u komercijalne ili reklamne svrhe.

**Klasa 38:** Telekomunikacijske i radiodifuzne usluge, uključujući bez ograničenja rad jednog ili više kablovskih, satelitskih ili zemaljskih televizijskih kanala.

**Klasa 41:** Proizvodnja i distribucija igranih filmova i drugog zabavnog sadržaja koji se prikazuju putem jednog ili više kablovskih, satelitskih ili zemaljskih televizijskih kanala i radiodifuzne usluge; organizacija i učestvovanje na izložbama organizovanih u kulturne i obrazovne svrhe; organizacija i učestvovanje na novinskim konferencijama.

(111) 06810

(151) 18.12.2012.

(210) **2009-597**(442) **20.06.2012**

(220) 10.06.2009

(300) NZ 813358 28.09.2009

(732) UNIVERSAL CITY STUDIOS LLC, 100 UNIVERSAL CITY PLAZA, UNIVERSAL CITY, CALIFORNIA 91608 US



(540)

(550) I

(740) Radulović Božidar, Jovana Tomaševića 9/III, Podgorica (ME)

(511) **Klasa 38:** Telekomunikacione usluge emitovanja usluge organizovanja i distribu-

cije televizijskih emisija/programa putem bežične i kablovske mreže prenos filmskih, televizijskih, teletext i videotext programa ili emisija usluge omogućavanja i odobravanja pristupa korisnicima za razne kompjuterske mreže, uključujući i pristup interaktivnim aplikacijama, naročito za distribuciju podataka usluge prikupljanja, isporuke i prenošenja poruka, novinskih izvještaja i informacija o istraživanju tržišta (uključujući korišćenje elektronskih sredstava i/ili putem kompjutera) prenos zvuka i slike putem satelita emitovanje obrađenih i neobrađenih podataka putem satelita postavljanje i osavremenjivanje (apdejtovanje) operativnog softvera putem kablovske mreže ili satelita emitovanje plaćene televizije, uključujući video zapise "na zahtjev" i "plaćanje po gledanju", kao i emitovanje za druge u svojstvu digitalne platforme usluge pružanja informacija drugima koje se odnose na programe i raspored emitovanja, emitovanje informacija putem bežične ili vođene mreže pružanje onlajn usluga i prenosa, naročito prenos informacija i poruka uključujući elektronsku poštu obezbjeđivanje telešop (kupovina putem televizije) kanala obezbjeđivanje komunikacijskih mreža uz pomoć digitalne multimedijalne tehnologije, naročito za pristup internetu, telešopu i telebankarstvu, i uz upotrebu televizijskih ekrana obezbjeđivanje mreža za prenos poruka, slika, teksta, govora i podataka usluge prenosa informacija, uključujući zvuk, sliku i podatke usluge prenosa podataka uz nadoknadu.

**Klasa 41:** Usluge razonode, obrazovne usluge i usluge davanja uputstava usluge televizijske razonode usluge filmske, muzičke, sportske, video i pozorišne razonode usluge proizvodnje, pripremanja, prikazivanja, distribuiranja, licenciranja, prodaje individualnim stanicama, umrežavanja, prodaje i iznajmljivanja televizijskih, teletext i videotext programa, i filmova, animiranih filmova, zvučnih i video zapisa produkcija zabavnih događaja uživo, produkcija zabavnih televizijskih događaja proizvodnja i iznajmljivanje obrazovnih i materijala sa uputstvima organizovanje, produkcija i prezentacija događaja u obrazovne, kulturne ili svrhe razonode organizovanje, produkcija i prezentacija takmičenja, konkursa, igara, kvizova, izložbi, sportskih događaja, šou-programa, putujućih šou-programa, izvođenja pred publikom, pozorišnih izvođenja, koncerata, izvođenja uživo i događaja u kojima učestvuje i publika obezbjeđivanje razonode i obrazovanja za pristup preko komunikacijskih i kompjuterskih mreža obezbjeđivanje informacija koje se odnose na bilo koju od gore pomenutih usluga.

(111) 06857

(151) 18.12.2012.

(210) **2010-4**

(442) **20.06.2012**

(220) 13.01.2010

(732) PFIZER INC, 235 EAST 42ND STREET, NEW YORK, NY 10017 US



(540)

(550) I

(740) Ćupić Branislav, Dalmatinska 10, Podgorica (ME)

(511) **Klasa 5:** Farmaceutski i veterinarski proizvodi higijenski proizvodi za upotrebu u medicini

dijetne stvari za medicinske potrebe, hrana za dojenčad flasteri, materijal za previjanje materijali za plombiranje zubi i za zubne otiske dezinfekcijska sredstva proizvodi za uništavanje životinjskih štetočina fungicidi, herbicidi.

- 
- (111) 06858 (151) 18.12.2012.  
 (210) **2010-11** (442) **20.06.2012**  
 (220) 22.01.2010  
 (732) ALKALOID AD SKOPLJE, BULEVAR ALEKSANDAR MAKEDONSKI 12, 1000 SKOPLJE MK

## NYPERO/НИПЕРО

- (540)  
 (550) I  
 (740) Božović Vesko, Rimski trg 50/11, Podgorica (ME)  
 (511) **Klasa 05:** Farmaceutski preparati–antiparkinsonian.

- 
- (111) 06735 (151) 17.12.2012  
 (210) **2009-156** (181) **06.03.2019.**  
 (220) 06.03.2009.  
 (300) 22.02.2007.  
 (732) FERRERO S.p.A., Piazzale Pietro Ferrero 1, 12051 Alba, Cuneo, IT



- (540)  
 (550) I  
 (740) Sekulić Vuk, Bulevar Despota Stefana 1a, 11000 Beograd, RS  
 (511) **Klasa 30:** Poslastice, naime lješnik i kakao krem.

- 
- (111) 06859 (151) 18.12.2012.  
 (210) **2010-14** (442) **20.06.2012**  
 (220) 28.01.2010  
 (732) McDONALD INTERNATIONAL PROPERTY COMPANY,LTD, A CORPORATION ORGANIZED AND EXISTING UNDER THE LAWS OF THE STATE OF DELAWARE 2711 CENTRVILLE ROAD, SUITE 400, WILMINGTON, DELAWARE 19808 US

# McFLURRY

(540)

(550) I

(740) Ćupić Branislav, Dalmatinska 10, Podgorica (ME)

(511) **Klasa 30:** Desert proizvodi na mliječnoj bazi, tj. sladoledi i zaleđene poslastice.

(111) 06860

(151) 18.12.2012.

(210) **2010-15**

(442) **20.06.2012**

(220) 02.02.2010

(732) AUSTRIA TABAK GMBH, KOPPSTRASSE 116, A-1160 WIEN AT



(540)

(550) I

(740) Ćejović Vladimir, 13. jula 21, Podgorica (ME)

(511) **Klasa 34:** Duvan, bilo prerađeni ili neprerađeni duvan za pušenje, duvan za lule, duvan na savijanje, duvan za žvakanje duvan za sisanje cigarete, cigare, cigarilosi supstance za pušenje koje se prodaju odvojeno ili izmiješano sa duvanom, koje nijesu za medicinske ili svrhe liječenja burmut.

(111) 06861

(151) 18.12.2012.

(210) **2010-18**

(442) **20.06.2012**

(220) 05.02.2010

(732) BRISTOL-MYERS SQUIBB COMPANY 345 PARK AVENUE, NEW YORK, NY10154 US

# NULOJIX

(540)

(550) I

(740) Ćupić Branislav, Dalmatinska 10, Podgorica (ME)

(511) **Klasa 05:** Farmaceutski preparati za ljudsku upotrebu.

(111) 06862

(151) 18.12.2012.

(210) **2010-20**

(442) **20.06.2012**

(220) 08.02.2010

(732) CHIGUITA BRANDS LLC, 250 EAST FIFTH STREET, CINCINNATI, OHIO 45202 US



(540) \_\_\_\_\_

(550) I

(740) Popović Miladin, Đoka Miraševića 21/III, Podgorica (ME)

(511) **Klasa 32:** Voćni sokovi voćni napitci.

(111) 06863

(151) 18.12.2012.

(210) **2010-28**

(442) **20.06.2012**

(220) 10.02.2010

(732) BROWN-FORMAN CORPORATION, 850 DIXIE HIGHWAY, LOUISVILLE KENTUCKY 40210 US

## HERRADURA

(540)

(550) I

(740) Ćupić Branislav, Dalmatinska 10, Podgorica (ME)

(511) **Klasa 25:** Alkoholna pića, uključujući žestoka pića.

(111) 06864

(151) 18.12.2012.

(210) **2010-29**

(442) **20.06.2012**

(220) 10.02.2010

(732) BROWN-FORMAN CORPORATION, 850 DIXIE HIGHWAY, LOUISVILLE KENTUCKY 40210 US

## EL JIMADOR

(540)

(550) I

(740) Ćupić Branislav, Dalmatinska 10, Podgorica (ME)

(511) **Klasa 33:** Alkoholna pića, uključujući žestoka pića.

---

(111) 06865

(151) 18.12.2012.

(210) **2010-30**

(442) **20.06.2012**

(220) 10.02.2010

(732) SAMSUNG ELECTRNICS CO.LTD, 416, MAETCHAN-DONG, YEONGTONG-GU, SUWON-SI, GU-ENGGI-DO KR

## HYPERREAL

(540)

(550) I

(740) Lutovac Branislav, Bulevar Crnojevića 93, Podgorica (ME)

(511) **Klasa 09:** Televizijski prijemnici DVD plejeri plejeri za optičke diskove pojačala i mikrofo-  
ni.

---

(111) 06866

(151) 18.12.2012.

(210) **2010-33**

(442) **20.06.2012**

(220) 18.02.2010

(732) GOOGLE INC, 16000 AMPHITRE PARKWAY, MOUNTIAN VIEW, CA 94043 US

## NEXUS ONE

(540)

(550) I

(740) Ćupić Branislav, Dalmatinska 10, Podgorica (ME)

(511) **Klasa 09:** Mobilni telefoni periferije i oprema za mobilne uređaje.

---

(111) 06885

(151) 18.12.2012.

(210) **2010-40**

(442) **20.06.2012**

(220) 23.02.2010

(732) ALKALOID AD SKOPLJE, BULEVAR ALEKSANDAR MAKEDONSKI 12,1000 SKOPLJE MK



## PIMEF

(540)

(550) I

(740) Božović Vesko, Rimski trg 50/11, Podgorica (ME)

(511) **Klasa 05:** Farmaceutski preparati.

(111) 06886

(151) 18.12.2012.

(210) **2010-41**(442) **20.06.2012**

(220) 23.02.2010

(732) AJINMOTO CO.INC, 15-1 KYOBASHI 1-CHOME, CHUO-KU TOKIO JP



(540)

(550) I

(740) Popović Miladin, Đoka Miraševića 21/III, Podgorica (ME)

(511) **Klasa 30:** Kafa, čaj kakao šećer pirinač tapioka sago zamjena kafe brašno proizvodi od žitarica hleb kolači i poslastice šerbeti sladoledi smrznuti jogurt (ledene poslastice) glazure čokoladne štangle med melasa kvasac prašak za pecivo so senf sirće sos od soje sos od ostrige kečap majonez sosovi (kao dodaci) mirođije začinjena so mešavina začina proizvodi od brašna začini arome (izuzev za esencijalna ulja) pojačivači aroma (izuzev za esencijalna ulja) biber nadevi sosovi od mesa šećer prirodni zaslađivači rezanci instant rezanci rezanci sa supom prženi pirinač prženi rezanci žitarice testenine prašak za omekšavanje mesa začinjena mešavina za pohovanje za primenu u prženju u dubokom ulju začini koji u sebi sadrže mononatrijum glutamat kao glavni sastojak.

(111) 06887

(151) 18.12.2012.

(210) **2010-42**(442) **20.06.2012**

(220) 24.02.2010

(732) OTIS ELEVATOR COMPANY, 10 FARM SPRINGS, FARMINGTON, CONNECTICUT 06032 US

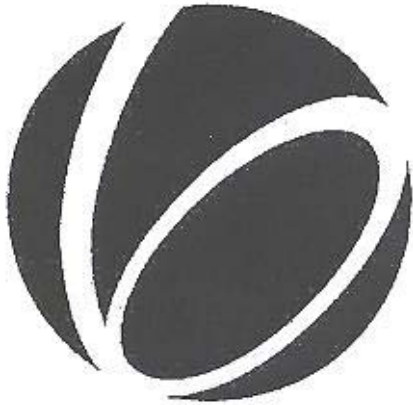

(540)

(550) I

(740) Lutovac Branislav, Bulevar Crnojevića 93, Podgorica (ME)

(511) **Klasa 7:** Liftovi i njihovi konstruktivni djelovi, a naročito grupni kontroleri za liftove pokretne stepenice i rezervni djelovi za iste, a naročito stepenice, rukohvati i pogonski mehanizmi i pokretne trake.

**Klasa 37:** Ugradnja i popravka liftova, pokretnih stepenica i pokretnih traka (koje nijesu za transport robe).

---

(111) 06888

(151) 18.12.2012.

(210) **2010-43**

(442) **20.06.2012**

(220) 24.02.2010

(732) OTIS ELEVATOR COMPANY, 10 FARM SPRINGS, FARMINGTON, CONNECTICUT 06032 US

# SIGMA

(540)

(550) I

(740) Lutovac Branislav, Bulevar Crnojevića 93, Podgorica (ME)

(511) **Klasa 7:** Liftovi i njihovi konstruktivni djelovi, a naročito grupni kontroleri za liftove pokretne stepenice i rezervni djelovi za iste, a naročito stepenice, rukohvati i pogonski mehanizmi i pokretne trake.

**Klasa 37:** Ugradnja i popravka liftova, pokretnih stepenica i pokretnih traka (koje nijesu za transport robe).

---

(111) 06889

(151) 18.12.2012.

(210) **2010-44**

(442) **20.06.2012**

(220) 25.02.2010

(732) DISCOVER FINANCIAL SERVICES STATE OF INCORPORATION, DELAWARE, USA, 2500 LAKE COOK ROAD, RIVERWOODS, IL60015 US

# DISCOVER

(540)

(550) I

(740) Ćupić Branislav, Dalmatinska 10, Podgorica (ME)

(511) **Klasa 36:** Finansijske usluge uključujući usluge kreditnih i debitnih kartica, izdavanje kreditnih i debitnih kartica usluge finansijskog poslovanja, usluge osiguranja, izdavanje prepaid kartica (kartica sa pokricem) emisija vrednosnih zetona mjenjacki poslovi kreditne i debitne transakcije elektronskim putem, gotovinske isplate i zamjena gotovine kreditnom karticom, elektronske gotovinske transakcije, ATM bankarske usluge, usluge verifikacije čekova, unovčavanja i namirenja, usluge obrade elektronskog plaćanja, usluge provjere autentičnosti i verifikacije pri transakcijama kreditnim karticama i gotovinom bankarske usluge, usluge plaćanja računa i izdavanja potvrda, usluge on-line plaćanja elektronskim putem, putem globalne kompjuterske mreže, pružanje finansijskih informacija, uključujući podatke i izvještaje o kreditnim i debitnim karticama, i nadgledanje i upravljanje finansijskim podacima, usluge elektronskog transfera fondova, usluge upravljanja kreditima, širenje finansijskih informacija putem globalne kompjuterske mreže.

(111) 06890

(151) 18.12.2012.

(210) **2010-45**

(442) **20.06.2012**

(220) 25.02.2010

(732) DISCOVER FINANCIAL SERVICER STATE OF INCORPORATION, DELAWARE, USA, 2500 LAKE COOK ROAD, RIVERWOODS, IL60013 US



(540)

(550) I

(740) Ćupić Branislav, Dalmatinska 10, Podgorica (ME)

(511) **Klasa 36:** Finansijske usluge uključujući usluge kreditnih i debitnih kartica, izdavanje kreditnih i debitnih kartica usluge finansijskog poslovanja, usluge osiguranja, izdavanje prepaid kartica (kartica sa pokrićem) emisija vrednosnih žetona mjenjački poslovi kreditne i debitne transakcije elektronskim putem, gotovinske isplate i zamjena gotovine kreditnom karticom, elektronske gotovinske transakcije, ATM bankarske usluge, usluge verifikacije čekova, unovčavanja i namirenja, usluge obrade elektronskog plaćanja, usluge provjere autentičnosti i verifikacije pri transakcijama kreditnim karticama i gotovinom bankarske usluge, usluge plaćanja računa i izdavanja potvrda, usluge on-line plaćanja elektronskim putem, putem globalne kompjuterske mreže, pružanje finansijskih informacija, uključujući podatke i izvještaje o kreditnim i debitnim karticama, i nadgledanje i upravljanje finansijskim podacima, usluge

elektronskog transfera fondova, usluge upravljanja kreditima, širenje finansijskih informacija putem globalne kompjuterske mreže.

- 
- (111) 06891 (151) 18.12.2012.  
 (210) **2010-47** (442) **20.06.2012**  
 (220) 02.03.2010  
 (732) WOLVERINE OUTDOORS, INC, 9341 COURTLAND DRIVE, N.W.ROCKFORD, MICHIGAN 49351 US



- (540)  
 (550) I  
 (740) Božović Radisav, 5 Crnogorske brigade 21, Igalo, Herceg Novi (ME)  
 (511) **Klasa 25:** Odjeća, pokrivala za glavu.

- 
- (111) 06892 (151) 18.12.2012.  
 (210) **2010-282** (442) **20.06.2012**  
 (220) 10.08.2010  
 (300) CTM 008878779 12.02.2010  
 (732) RECKITT BENCKISER-SWITZERLAND AG, RICHTISTRASSE 5 CH-8304 WALLISELLEN, ZURICH CH



- (540)  
 (550) I  
 (740) Popović Miladin, Đoka Miraševića 21/III, Podgorica (ME)  
 (511) **Klasa 03:** Parfimisani preparati za vazduh potpuri, eterična ulja, parfimisani sprejevi za prostorije preparati za parfimisanje ili aromatizaciju vazduha.

**Klasa 04:** Svijeće svijeće sa aromom ili mirišljave svijeće.

**Klasa 05:** Preparati za osvježavanje vazduha preparati za pročišćavanje vazduha osvježivači za prostorije dezodoransi koji nisu za ličnu upotrebu preparati za neutralisanje neprijatnih mirisa.

**Klasa 11:** Aparati i instrumenti, svi za parfimisanje, pročišćavanje ili osvježavanje vazduha delovi i oprema za sve pomenute robe.

(111) 06893

(151) 18.12.2012.

(210) **2010-285**

(442) **20.06.2012**

(220) 10.08.2010

(300) CTM 8871791 10.02.2010

(732) THE PROCTER & GAMBLE COMPANY, THE PROCTER & GAMBLE PLAZA CINCINNATI, OHIO 45202 US

# FUSION

(540)

(550) I

(740) Lutovac Branislav, Bulevar Crnojevića 93, Podgorica (ME)

(511) **Klasa 3:** Sredstva za pranje i beljenje i druge supstance za upotrebu kod pranja vesa preparati za čišćenje, poliranje, nagrizajuća sredstva, abrazivna sredstva sapuni partimerija, eterična ulja, kozmetika, losioni za kosu proizvodi za negu zuba.

(111) 06894

(151) 18.12.2012.

(210) **2010-293**

(442) **20.06.2012**

(220) 16.08.2010

(732) AMGEN INC, ONE AMGEN CENTER DRIVETHOURSAND OAKS, CALIFORNIA 91320-1799 US

# XGEVA

(540)

(550) I

(740) Radulović Božidar, Jovana Tomaševića 9/III, Podgorica (ME)

(511) **Klasa 05:** Farmaceutski preparati.

(111) 06895

(151) 18.12.2012.

(210) **2010-296**

(442) **20.06.2012**

(220) 20.08.2010

(300) TO M/10/02197 19.02.2010

(732) GOOGLE INC, 1600 AMPHITHEATRE PARKWAY, MOUNTAIN VIEW, CA 94043 US

## SPEEDBOOK

(540)  
(550) I  
(740) Ćupić Branislav, Dalmatinska 10, Podgorica (ME)  
(511) **Klasa 09:** Kompjuterski hardver.

---

(111) 06896 (151) 18.12.2012.  
(210) **2010-305** (442) **20.06.2012**  
(220) 24.08.2010  
(732) PATRON SPIRITIS INTERNATIONAL AG, QUAISTRASSE 11 CH-8200 SCHAFFHAUSEN CH

## LIVE ULTIMATELY

(540)  
(550) I  
(740) Lutovac Branislav, Bulevar Crnojevića 93, Podgorica (ME)  
(511) **Klasa 33:** Alkoholna pića destilovana žestoka pića i votka.

---

(111) 06897 (151) 18.12.2012.  
(210) **2010-313** (442) **20.06.2012**  
(220) 06.09.2010  
(732) OLD NAVY ITM INC, 900 CHERRY AVENUE SAN BRUNO, CA 94066 US

## Old Navy

(540)  
(550) I  
(740) Lutovac Branislav, Bulevar Crnojevića 93, Podgorica (ME)  
(511) **Klasa 25:** Odjeća obuća pokrivala za glavu.

---

(111) 06898 (151) 18.12.2012.  
(210) **2010-316** (442) **20.06.2012**  
(220) 08.09.2010  
(732) COMPEED APS, BLOKKEN 39 DK-3460, BIRKEROD DK

## COMPEED TOTAL CARE

(540)

(550) I

(740) Radulović Božidar, Jovana Tomaševića 9/III, Podgorica (ME)

(511) **Klasa 05:** Flasteri za herpes.

(111) 06899

(151) 18.12.2012.

(210) **2010-317**

(442) **20.06.2012**

(220) 08.09.2010

(732) BEST WESTERN INTERNATIONAL INC, 6201 N.24TH PARKWAY, PHOENIX, ARIZONA 85016-2023 US



(540)

(550) I

(740) Lutovac Branislav, Bulevar Crnojevića 93, Podgorica (ME)

(511) **Klasa 43:** Hotelske usluge.

(111) 06900

(151) 18.12.2012.

(210) **2010-318**

(442) **20.06.2012**

(220) 08.09.2010

(732) BEST WESTERN INTERNATIONAL, INC, 6201 N.24TH PARKWAY, PHOENIX, ARIZONA 85016-2023 US

## BEST WESTERN PREMIER

(540)

(550) I

(740) Lutovac Branislav, Bulevar Crnojevića 93, Podgorica (ME)

(511) **Klasa 43:** Hotelske usluge.

---

(111) 06901

(151) 18.12.2012.

(210) **2010-319**

(442) **20.06.2012**

(220) 08.09.2010

(732) BEST WESTERN INTERNATIONAL, INC, 6201 N.24TH PARKWAY, PHOENIX, ARIZONA 85016-2023 US

## WELCOME TO THE PREMIER LIFE

(540)

(550) I

(740) Lutovac Branislav, Bulevar Crnojevića 93, Podgorica (ME)

(511) **Klasa 43:** Hotelske usluge.

---

(111) 06902

(151) 18.12.2012.

(210) **2010-320**

(442) **20.06.2012**

(220) 08.09.2010

(732) BEST WESTERN INTERNATIONAL INC, 6201 N.24TH PARKWAY, PHOENIX, ARIZONA 85016-2023 US



## BEST WESTERN REWARDS

(540)

(550) I

(740) Lutovac Branislav, Bulevar Crnojevića 93, Podgorica (ME)

(511) **Klasa 35:** Usluge nagrađivanja lojalnosti potrošača (loyalty programi) i usluge klubova za potrošače sa komercijalnom, promotivnom i/ili reklamnom namenom.

---

(111) 06903

(151) 18.12.2012.

(210) **2010-321**

(442) **20.06.2012**

(220) 08.09.2010

(732) BEST WESTERN INTERNATIONAL INC, 6201 N.24TH PARKWAY, PHOENIX, ARIZONA 85016-2023 US

## BEST WESTERN PLUS

(540)

(550) I

(740) Lutovac Branislav, Bulevar Crnojevića 93, Podgorica (ME)

(511) **Klasa 43:** Hotelske usluge.

---

(111) 06904

(151) 18.12.2012.

(210) **2010-323**

(442) **20.06.2012**

(220) 08.09.2010

(732) BEST WESTERN INTERNATIONAL INC, 6201 N.24TH PARKWAY, PHOENIX, ARIZONA 85016-2023 US



(540) \_\_\_\_\_  
 (550) I  
 (740) Lutovac Branislav, Bulevar Crnojevića 93, Podgorica (ME)  
 (511) **Klasa 43:** Hotelske usluge.

(111) 06946 (151) 18.12.2012.  
 (210) **2009-52** (442) **20.03.2012**  
 (220) 28.01.2009  
 (300) 17.09.2006  
 (732) EXXON MOBIL CORPORATION; 5959 LAS COLINAS BOULEVARD, IRVING, TEHAS, 75039-2298 US

## SOMENTOR

(540)  
 (550) I  
 (740) Stanković Mugoša Ana, Trg Republike br.13 81000 Podgorica (ME)  
 (511) **Klasa 1:** Rastvori.

(111) 06947 (151) 18.12.2012.  
 (210) **2009-309** (442) **20.06.2012**  
 (220) 27.05.2009  
 (300) Z-2077/06 14.09.2006 RS  
 (732) BIOGEN IDEC MA INC, 14 CAMBRIDGE CENTER CAMBRIDGE, MASSACHUSETTS 02142 US

## AVOCLIP

(540)  
 (550) I  
 (740) Radulović Božidar, Jovana Tomaševića 9/III, Podgorica (ME)  
 (511) **Klasa 10:** Medicinski aparati i instrumenti, naročito uređaji za olakšano rukovanje injek-

cijama i davanje injekcija.

- 
- (111) 06948 (151) 18.12.2012  
 (210) **2009-310** (442) **20.06.2012**  
 (220) 27.05.2009  
 (300) Z-2076-06 14.09.2006 RS  
 (732) BIOGEN IDEC MA INC MASSACHUSETTS CORPORATION, 14 CAMBRIDGE CENTER CAMBRIDGE, MASSACHUSETTS 02142 US

**AVOCLIP**

- (540)  
 (550) I  
 (740) Radulović Božidar, Jovana Tomaševića 9/III, Podgorica (ME)  
 (511) **Klasa 10:** Medicinski aparati i instrumenti, naročito uređaji za olakšano rukovanje injekcijama i davanje injekcija.

- 
- (111) 06949 (151) 18.12.2012.  
 (210) **2009-550** (442) **20.06.2012**  
 (220) 04.09.2009  
 (300) 52534-2009 06.03.2009 CH  
 (732) PHILIP MORRIS BRANDS, SARL QUAI JEANRENLAND 32000 NEUCHATEL CH

**VIRGINIA S.**

- (540)  
 (550) I  
 (740) Čolović Branko, Mediteranska 2, Budva (ME)  
 (511) **Klasa 14:** Dragocjeni metali i njihove legure i proizvodi od dragocjenih metala ili sa presvlakom od njih koji nisu uključeni u druge klase nakit drago kamenje časovničarski i hronometrijski instrument.

**Klasa 34:** Duvan (sirov i prerađen), proizvodi od duvana, naročito, cigare, cigarete, cigarilosi/male cigarete, duvan za uvijanje cigareta, duvan za lule, duvan za žvakanje, duvan za šmrkanje, kretek, snus (vlažni duvanski prah za oralnu upotrebu), zamjena za duvan (za nemedicinsku upotrebu), artikli za pušače, naročito, papir za cigarete i lule, filteri za cigarete, kutije za duvan, kutije za cigarete i pepeljare, lule, ručni aparati/spravice za uvijanje cigareta, upaljači, šibice.

- 
- (111) 06950 (151) 18.12.2012.  
 (210) **2009-585** (442) **20.06.2012**  
 (220) 30.09.2009  
 (300) M 2009 04079 09.04.2009 UA  
 (732) JT INTERNATIONAL S.A, 1 RUE DE LA GABELE, 1211 GENEVA 26 CH



(540)

(550) I

(740) Čejović Vladimir, 13. jula 21, Podgorica (ME)

(511) **Klasa 34:** Duvan, bilo prerađeni ili neprerađeni duvan za pušenje, duvan za lule, duvan na savijanje, duvan za žvakanje cigarete, cigare, cigarilosi supstance za pušenje koje se prodaju odvojeno ili izmiješano sa duvanom, koje nijesu za medicinske ili svrhe liječenja burmut artikli za pušače uključeni u klasu 34 papir za cigarete, fišeci za cigarete i šibice.

(111) 06975

(151) 24.01.2013.

(210) **2009-167**(442) **20.06.2012**

(220) 18.03.2009

(732) T MOBILE CRNA GORA DOO PODGORICA, MOSKOVSKA 29, PODGORICA, ME

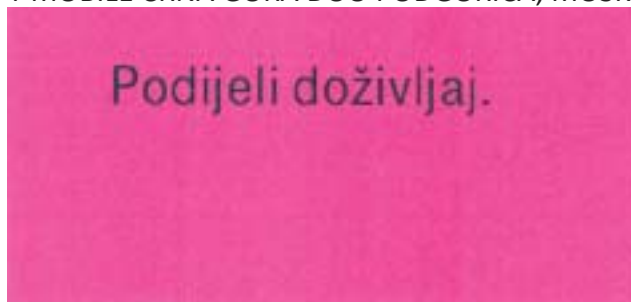

(540)

(550) I

(740) Popović Miladin, Đoka Miraševića 21/III, Podgorica (ME)

(511) **Klasa 09:** Uređaji, aparati za snimanje ,reprodukovanje prenos zvuka i slike , magnetni nosioci podataka, zvučne slike, diskovi za kompjutere, čipovi, kompjuteri, kompjuterski programi i ostale elektronske komponente.

**Klasa 35:** Usluge propagande, reklame, poslovi trgovine.

**Klasa 37:** Usluge instalacije, građevinski radovi, popravke, održavanja, izgradnja, rekonstrukcija.

**Klasa 38:** Telekomunikacije usluge koje omogućavaju najmanje jednom licu da komunicira sa drugim koristeći čula (da međusobno razgovaraju, da prenose poruke), usluge stavljanja lica u položaj vizuelne ili govorne komunikacije sa drugim, usluge prenosa podataka, usluge koje sadrže difuziju radio ili televizijskih programa.

**Klasa 41:** Obrazovne usluge, pripremanje obuke, razonoda, sportske i kulturne aktivnosti, usluge koje pružaju lica ili institucije u razvijanju mentalnih sposobnosti drugih lica (obrazovanje) ili životinja (obuka, dresiranje), usluge kojima je cilj zabavljanje drugih lica, privlačenje pažnje, rekreacija, organizovanje (priređivanje) i vođenje seminara, konferencija, kongresa,

organizovanje izložbi i kulturne i obrazovne svrhe, sportskih takmičenja, izdavanje tekstova i knjiga.

**Klasa 42:** Naučne i tehnološke usluge projektovanja, istraživanja, projektovanje i razvoj kompjuterskog hardvera i softvera.

**Klasa 45:** Konsultantske usluge, pravne usluge.

---

(111) 06976	(151) 24.01.2013.
(210) <b>2009-168</b>	(442) <b>20.06.2012</b>
	(220) 18.03.2009

(732) T MOBILE CRNA GORA DOO PODGORICA, MOSKOVSKA 29, PODGORICA ME

## Podijeli doživljaj.

(540)  
 (550) I  
 (740) Popović Miladin, Đoka Miraševića 21/III, Podgorica (ME)  
 (511) **Klasa 09:** Uređaji, aparati za snimanje, reprodukovanje prenos zvuka i slike, magnetni nosioci podataka, zvučne slike, diskovi za kompjutere, čipovi, kompjuteri, kompjuterski programi i ostale elektronske komponente.

**Klasa 35:** Usluge propagande, reklame, poslovi trgovine.

**Klasa 37:** Usluge instalacije, građevinski radovi, popravke, održavanja, izgradnja, rekonstrukcija.

**Klasa 38:** Telekomunikacije, usluge koje omogućavaju najmanje jednom licu da komunicira sa drugim koristeći čula (da međusobno razgovaraju, da prenose poruke), usluge stavljanja lica u položaj vizuelne ili govorne komunikacije sa drugim, usluge prenosa podataka, usluge koje sadrže difuziju radio ili televizijskih programa.

**Klasa 41:** Obrazovne usluge, pripremanje obuke, razonoda, sportske i kulturne aktivnosti, usluge koje pružaju lica ili institucije u razvijanju mentalnih sposobnosti drugih lica (obrazovanje) ili životinja (obuka, dresiranje), usluge kojima je cilj zabavljanje drugih lica, privlačenje pažnje, rekreacija, organizovanje (priređivanje) i vođenje seminara, konferencija, kongresa, organizovanje izložbi i kulturne i obrazovne svrhe, sportskih takmičenja, izdavanje tekstova i knjiga.

**Klasa 42:** Naučne i tehnološke usluge projektovanja, istraživanja, projektovanje i razvoj kompjuterskog hardvera i softvera.

**Klasa 45:** Konsultantske usluge, pravne usluge.

---

(111) 06977	(151) 24.01.2013.
(210) <b>2009-169</b>	(442) <b>20.06.2012</b>
	(220) 18.03.2009

(732) T MOBILE CRNA GORA DOO PODGORICA, MOSKOVSKA 29, PODGORICA ME



(540)  
 (550) I  
 (740) Popović Miladin, Đoka Miraševića 21/III, Podgorica (ME)

(511) **Klasa 09:** Uređaji, aparati za snimanje, reprodukovanje prenos zvuka i slike, magnetni nosioci podataka, zvučne slike, diskovi za kompjutere, čipovi, kompjuteri, kompjuterski programi i ostale elektronske komponente.

**Klasa 35:** Usluge propagande, reklame, poslovi trgovine.

**Klasa 37:** Usluge instalacije, građevinski radovi, popravke, održavanja, izgradnja, rekonstrukcija.

**Klasa 38:** Telekomunikacije, usluge koje omogućavaju najmanje jednom licu da komunicira sa drugim koristeći čula (da međusobno razgovaraju, da prenose poruke), usluge stavljanja lica u položaj vizuelne ili govorne komunikacije sa drugim, usluge prenosa podataka, usluge koje sadrže difuziju radio ili televizijskih programa.

**Klasa 41:** Obrazovne usluge, pripremanje obuke, razonoda, sportske i kulturne aktivnosti, usluge koje pružaju lica ili institucije u razvijanju mentalnih sposobnosti drugih lica (obrazovanje) ili životinja (obuka, dresiranje), usluge kojima je cilj zabavljanje drugih lica, privlačenje pažnje, rekreacija, organizovanje (priređivanje) i vođenje seminara, konferencija, kongresa, organizovanje izložbi i kulturne i obrazovne svrhe, sportskih takmičenja, izdavanje tekstova i knjiga.

**Klasa 42:** Naučne i tehnološke usluge projektovanja, istraživanja, projektovanje i razvoj kompjuterskog hardvera i softvera.

**Klasa 45:** Konsultantske usluge, pravne usluge.

(111) 06978

(151) 24.01.2013.

(210) **2009-311**

(442) **20.06.2012**

(220) 27.05.2009

(300) Z-1059/06 08.05.2006 RS

(732) GUTHY-RENKER CORPORATION, 41-550 ELECTRIC STREET SUITE 200 PALM DESERT, CA 92260 US

## PROACTIV

(540)

(550) I

(740) Popović Miladin, Đoka Miraševića 21/III, Podgorica (ME)

(511) **Klasa 03:** Preparati za njegu kože i tijela naime, sredstva za čišćenje kože, sredstva za vlaženje kože, losioni za kožu, sapuni za kožu, preparati za zaštitu od sunčevog zračenja, kozmetika, šminka, šminka kao podloga, podloga za nanošenje na kožu, puder za lice, ne-medicinski preparati za njegu kose, ne-medicinski preparati za njegu kože.

**Klasa 05:** Preparati za liječenje akni.

(111) 06979

(151) 24.01.2013.

(210) **2009-313**

(442) **20.03.2012**

(220) 27.05.2009

(300) 03.08.2007 Z-1767/07

30.08.2008 55 876 RS

(732) GALENIKA AD; BATAJNICKI DRUM BB 11 080 BEOGRAD RS

## ENAGAL

(540)

(550) I

(740) Kovačević Aleksandar, Kružni put bb, Cetinje (ME)

(511) **Klasa 5:** Farmaceutski preparati.

---

(111) 06980

(151) 24.01.2013.

(210) **2009-314**

(442) **20.03.2012**

(220) 27.05.2009

(300) 03.08.2007 Z-1766/07

30.08.2008 55 877 RS

(732) GALENIKA AD; BATAJNICKI DRUM BB 11 080 BEOGRAD RS

## DIKLOFEN DUO

(540)

(550) I

(740) Kovačević Aleksandar, Kružni put bb, Cetinje (ME)

(511) **Klasa 5:** Farmaceutski preparati.

---

(111) 06981

(151) 24.01.2013.

(210) **2009-315**

(442) **20.03.2012**

(220) 27.05.2009

(300) 28.11.2008 Z-2886-08

25.12.2008 56 865 RS

(732) GALENIKA AD; BATAJNICKI DRUM BB 11 080 BEOGRAD RS

## FESTY

(540)

(550) I

(740) Kovačević Aleksandar, Kružni put bb, Cetinje (ME)

(511) **Klasa 5:** Farmaceutski, veterinarski i sanitarni preparati, dijeteske supstance prilagođene za upotrebu u medicini, hrana za bebe, flasteri, materijali za zavijanje, materijali za plombranje zuba, zubarska smola, dezinfekciona sredstva.

---

(111) 06982

(151) 24.01.2013.

(210) **2009-319**

(442) **20.03.2012**

(220) 27.05.2009

(300) 29.07.2008 Z-1899/08

06.08.2008 55 888 RS

(732) GALENIKA AD; BATAJNICKI DRUM BB 11 080 BEOGRAD RS

VENLAX

ВЕНЛАКС

(540)

(550) I

(740) Kovačević Aleksandar, Kružni put bb, Cetinje (ME)

(511) **Klasa 5:** Farmaceutski preparati.

(111) 06983

(151) 24.01.2013.

(210) **2009-321**(442) **20.03.2012**

(220) 27.05.2009

(300) 21.07.2008 Z-1848/089 RS

04.08.2008 55 751 RB

(732) GALENIKA AD; BATAJNICKI DRUM BB 11 080 BEOGRAD RS

GALOPRAZOL

ГАЛОПРАЗОЛ

(540)

(550) I

(740) Kovačević Aleksandar, Kružni put bb, Cetinje (ME)

(511) **Klasa 5:** Farmaceutski preparati.

(111) 06984

(151) 24.01.2013.

(210) **2009-323**(442) **20.03.2012**

(220) 27.05.2009

(300) 09.06.2008 Z-1436/08

25.07.2008 55 658 RS

(732) GALENIKA AD; BATAJNICKI DRUM BB 11 080 BEOGRAD RS

SINACIKLAV

СИНАЦИКЛАВ

(540)

(550) I

(740) Kovačević Aleksandar, Kružni put bb, Cetinje (ME)

(511) **Klasa 5:** Farmaceutski preparati.



---

(111) 06985 (151) 24.01.2013.  
(210) **2009-324** (442) **20.03.2012**  
(220) 27.05.2009  
(300) 09.06.2008 Z-1435/08  
25.07.2008 55 659 RS  
(732) GALENIKA AD; BATAJNICKI DRUM BB 11 080 BEOGRAD RS

**RISPEX**  
**РИСПЕКС**

(540)  
(550) I  
(740) Kovačević Aleksandar, Kružni put bb, Cetinje (ME)  
(511) **Klasa 5:** Farmaceutski preparati.

---

(111) 06986 (151) 24.01.2013.  
(210) **2009-406** (442) **20.03.2012**  
(220) 01.06.2009  
(732) EKO-PER DOO; VUKA KARADZICA BR 3 84220 ZABLJAK ME

**diva**  
durmitorska izvorska voda

(540)  
(550) I  
(511) **Klasa 32:** Mineralne i sodne vode.

---

(111) 06987 (151) 24.01.2013.  
(210) **2010-2** (442) **20.06.2012**  
(220) 01.05.2010  
(300) EU 8413668 08.07.2009  
(732) DEUTCHE TELEKOM AG, FRIEDRICH-EBERT-ALLEE 140 53113 BON DE

## Start up!

(540)

(550) I

(740) Popović Miladin, Đoka Miraševića 21/III, Podgorica (ME)

(511) **Klasa 35:** Oglašavanje usluge agencija za zapošljavanje usluge regrutovanja kadrova usluge odabira kadrova putem psiholoških testiranja usluge savetovanja u upravljanju kadrovima prikupljanje, sistematizacija, sastavljanje i stručna poslovna analiza podataka i informacija u kompjuterskim bazama podataka usluge elektronskog čuvanja podataka maloprodajne usluge (takođe putem interneta i drugih komunikacijskih mreža) u vezi sa aparatima i instrumentima naučnim, pomorskim, geodetskim, fotografskim, kinematografskim, optičkim, za vaganje, mjerenje, signalizaciju, kontrolu (inspekciju), spašavanje i nastavu, aparati i instrumenti za provođenje, prekid, transformaciju, akumulaciju, regulisanje ili kontrolu električne energije, aparati za snimanje, prenos, obradu i reprodukovanje zvuka, slike ili podataka, magnetni nosači podataka, automatske mašine i mehanizmi za aparate koji se pokreću novcem ili žetonom računске mašine, oprema za obradu podataka i kompjuteri snimljeni i nesnimljeni nosači podataka svih vrsta, kompjuterski programi (sačuvani) elektronski sačuvani podaci (koji se mogu preuzimati) elektronske publikacije (koje se mogu preuzimati), štampani materijal, fotografije, kancelarijski materijal (osim Namještaja), materijali za nastavu i obuku (osim aparata).

**Klasa 38:** Telekomunikacije, usluge novinskih agencija usluge iznajmljivanja opreme za telekomunikacije usluge informisanja u vezi sa telekomunikacijama.

**Klasa 38:** Obrazovne usluge usluge obezbjeđivanja obuke gorepomenute usluge se ne odnose na poslovne početke (start-up) usluge zabave organizacija sportskih i kulturnih aktivnosti izdavanje knjiga, časopisa i drugog štampanog materijala, izdavanje štampanog materijala u formi elektronskih nosača podataka, naime CD-ROM-ova, CD-I, USB, flopi diskova, hard diskova i kasete.

**Klasa 42:** Naučne i tehnološke usluge i istraživanje i projektovanje u vezi sa njima usluge industrijske analize i istraživanja projektovanje i razvoj kompjuterskog hardvera, softvera i baza podataka: održavanje kompjuterskog softvera tehničke konsultacije kompjuterske usluge u vezi sa elektronskim čuvanjem podataka iznajmljivanje kompjutera dizajniranje veb stranica za druge.

---

(111) 07011

(151) 24.01.2013.

(210) **2009-122**

(442) **20.12.2011**

(220) 12.02.2009

(732) AKTIONERNO DROUJESTVO BULGARATABAC HOLDING; SOFIJA 1000 UL GRAF IGNJATEV NO 62 (BG)



(540)

(550) I

(740) Dedić Tomislav, Bulevar Ivana Crnojevića 139 Podgorica (ME)

(511) **Klasa 34:** Duvan, sirov, prerađen ili obrađen; proizvodi od duvana; cigarete, cigare i cigarilosi, filteri za cigarete; cigaret-papir; proizvodi za pušače; šibice; upaljači za pušače i pepeljare koji nisu od plemenitih metala

(111) 07012

(151) 24.01.2013.

(210) **2010-3**(442) **20.06.2012**

(220) 12.01.2010

(300) BX 1191823 11.11.2009

(732) UNILEVER N.V, WENNA 455,3013 AL, ROTTERDAM NL



(540)

(550) I

(740) Popović Miladin, Đoka Miraševića 21/III, Podgorica (ME)

(511) **Klasa 30:** Sladoledi, voćni sladoledi, smrznute poslastice.

(111) 07013

(151) 24.01.2013.

(210) **2010-5**(442) **20.06.2012**

(220) 13.01.2010

(732) MOTOROLA INC, A DELAWARE CORPORATION 1303 E ALGONGUIN ROAD, SCHUMBURG, IL 60196 US

## BACKTRACK

(540)

(550) I

(740) Ćupić Branislav, Dalmatinska 10, Podgorica (ME)

(511) **Klasa 09:** Mobilni telefoni mobilni telefoni sa mogućnošću slanja i primanja elektronskih poruka mobilni telefoni sa digitalnim fotoaparatom i video kamerom mobilni telefoni sa MP3, audio i video plejerom mobilni telefoni sa elektronskim igricama mobilni telefoni sa mogućnošću GPS-a i navigacije uređaji za bežičnu komunikaciju sa mogućnošću prenosa glasa, podataka i slike baterije za mobilne telefone punjači za baterije i adapteri za struju.

(111) 07014

(151) 24.01.2013.

(210) 2010-12

(442) **20.06.2012**

(220) 26.01.2010

(732) BRITISH AMERICAN TOBACCO BRANDS-INC, 2711 CENTREVILLE ROAD, SUITE 300, WILMINGTON, DELAWARE 19808 US

The logo consists of the words "HIGH DEFINITION" in a bold, serif font, centered within a rectangular border.

(540)

(550) I

(740) Popović Miladin, Đoka Miraševića 21/III, Podgorica (ME)

(511) **Klasa 34:** Cigarete duvan proizvodi od duvana upaljači šibice artikli za pušače.

(111) 07015

(151) 24.01.2013.

(210) **2010-16**

(442) **20.06.2012**

(220) 04.02.2010

(732) RAMADA INTERNATIONAL, INC, 22 SYLVAN WAY, PARSIPPANY NJ 07054 US

## RAMADA

(540)

(550) I

(740) Čejović Vladimir, 13. jula 21, Podgorica (ME)

(511) **Klasa 35:** Franšizing, naime, pružanje pomoći u radu, organizaciji i osnivanju hotel resorts-a, hotela, motela, smještaja, smještajnih objekata i restorana usluge poslovnog upravljanja i konsultacije omogućavanje poslovnog menadžmenta, pomoći, organizacije, konsultacija i analize usluge marketinga i istraživanja tržišta usluge oglašavanja i unapređenja prodaje reklamiranje nekretnina koje se izdaju za odmor a u ime drugih.

**Klasa 43:** Usluge smještaja u hotel resort-ima, hotelima, motelima i restoranske usluge, usluge iznajmljivanja apartmana pravljenje rezervacija smještaja u ime drugih usluge rezervacija smještaja i iznajmljivanja.

(111) 07016

(151) 24.01.2013.

(210) **2010-19**

(442) **20.06.2012**

(220) 08.02.2010

(732) SI-ING DOO, SERDARA JOLA PILETIĆA BB PODGORICA ME



(540) \_\_\_\_\_

(550) I

(740) Radulović Božidar, Jovana Tomaševića 9/III, Podgorica (ME)

(511) **Klasa 37:** Građevinsko konstruisanje popravljanje usluge instaliranja (instalacione usluge).

**Klasa 42:** Naučne i tehnološke usluge i istraživanje i projektovanje u vezi navedenih usluga usluge industrijske analize i istraživanja projektovanje i razvoj kompjuterskog hardvera i softvera.

(111) 07017

(151) 24.01.2013.

(210) **2010-21**

(442) **20.06.2012**

(220) 08.02.2010

(732) DAYS INNS WORLDWIDE, INC, 22 SYLVAN WAY, PARSIPANY, NY 07054 US

## DAYS INN

(540)

(550) I

(740) Čejović Vladimir, 13. jula 21, Podgorica (ME)

(511) **Klasa 43:** Usluge smještaja u hotel resort-ima, hotelima, motelima i restoranske usluge usluge iznajmljivanja apartmana pravljenje rezervacija smještaja u ime drugih usluge rezervacija smještaja i iznajmljivanja.

(111) 07018

(151) 24.01.2013.

(210) **2010-32**(442) **20.06.2012**

(220) 17.02.2010

(732) PODRAVKA DD, A.STARČEVIĆA 32, KOPRIVNICA HR



(540)

(550) I

(740) Božović Vesko, Rimski trg 50/11, Podgorica (ME)

(511) **Klasa 29:** Meso, riba, perad i divljač mesni ekstrakti konzervirano, sušeno i kuvano voće i povrće hladetina (želei), džemovi, kompoti jaja, mlijeko i mliječni proizvodi jestiva ulja i masti prerađena i konzervirana riba i riblji proizvodi.

(111) 07019

(151) 24.01.2013.

(210) **2010-34**(442) **20.06.2012**

(220) 19.02.2010

(300) IS 1642/2009 24.06.2009

(732) TOYOTA JIDOSHA KABUSHIKI KAISHA also trading as TOYOTA MOTOR CORPORATION, 1, toyota-cho, toyota-shi, aichi-ken JP



(540)

(550) I

(740) Čejović Vladimir, 13. jula 21, Podgorica (ME)

(511) **Klasa 36:** Finansiranje koje se odnosi na automobile, naime, finansiranje kupovine i lizinga motornih vozila izdavanje i upravljanje sporazumima o osiguranju, sporazumima o pružanju usluga, sporazumima o unaprijed placenom (prepaid) održavanju i sporazumima o otkazivanju duga, a sve u vezi motornih vozila.

**Klasa 37:** Oправка motornih vozila i usluge održavanja.

**Klasa 39:** Usluge iznajmljivanja motornih vozila i usluge lizinga

(111) 07020

(151) 24.01.2013.

(210) **2010-36**(442) **20.06.2012**

(220) 22.02.2010

(732) BRITISH AMERICAN TOBACCO BRANDS, 2711 CENTERVILLE ROAD, SUITE 300, WILMINGTON, DELAWARE 19808 US



(540)

(550) I

(740) Popović Miladin, Đoka Miraševića 21/III, Podgorica (ME)

(511) **Klasa 34:** Cigarete duvan proizvodi od duvana upaljači šibice artikli za pušače.

(111) 07021

(151) 24.01.2013.

(210) **2010-37**(442) **20.06.2012**

(220) 22.02.2010

(732) KIMBRELY-CLARK WORLDWIDE, INC, NEENAH, WISCONSIN 54956 US

## KLEENEX

(540)

(550) I

(740) Lutovac Branislav, Bulevar Crnojevića 93, Podgorica (ME)

(511) **Klasa 03:** Sapuni, antibakterijski gel, antibakterijske maramice, maramice impregnirane sredstvom za čišćenje.

**Klasa 21:** Ubrusi za jednokratnu upotrebu proizvedeni od materijala koji nije tkan.

(111) 07022

(151) 24.01.2013.

(210) **2010-38**

(442) **20.06.2012**

(220) 22.02.2010

(732) KIMBRELY-CLARK WORDWIDE, INC, NEENAH, WISCONSIN 54956 US



(540)

(550) I

(740) Lutovac Branislav, Bulevar Crnojevića 93, Podgorica (ME)

(511) **Klasa 3:** Sapuni, antibakterijski gel, antibakterijske maramice, maramice impregnirane sredstvom za čišćenje.

**Klasa 16:** Papirne maramice za lice, toalet papir, papirni ubrusi, brisači od papira, papirne salвете.

**Klasa 21:** Ubrusi za jednokratnu upotrebu proizvedeni od materijala koji nije tkan.

(111) 07023

(151) 24.01.2013.

(210) **2010-46**

(442) **20.06.2012**

(220) 26.02.2010

(732) GLOBAL CONQUISTADORS S.A, CUBA AVENUE N36-36 PO BOX 0816-06748, PANAMA 5 PA



## DENTO-MAX

(540)

(550) I

(740) Čejović Vladimir, 13. jula 21, Podgorica (ME)

(511) **Klasa 21:** Četkice za zube i četkice za zubne proteze i dijelovi i oprema za njih četkice i materijal za izradu četkica čačkalice materijali i instrumenti za čišćenje i poliranje prirodnih ili vještačkih zuba.

(111) 07024

(151) 24.01.2013.

(210) **2010-278**(442) **20.06.2012**

(220) 05.08.2010

(300) GB 2538639 09.02.2010

(732) G-MARIN CONSULTING LIMITED, LEVEL 14, PORTOMASO BUSINESS TOWER, ST.JULIANS MT

## MOURJAN MARINAS

(540)

(550) I

(740) Čejović Vladimir, 13. jula 21, Podgorica (ME)

(511) **Klasa 09:** Optički aparati i instrumenti naočare za vid, naočare, sunčane naočare okviri, futrole, vezice i lanci za gore pomenutu robu uveličavajuća stakla dvogledi kompasi torbe za nošenje računara prenosivi držači i futrole za telefone aparati za mjerenje pomorski i nautički aparati, instrumenti, oprema i instalacije elektronski pilot aparati za daljinsko upravljanje plovilima navigacioni aparati i instrumenti pomorski i nautički aparati za komunikaciju pomorski aparati za mjerenje dubine bove za pomorsku upotrebu.

**Klasa 12:** Brodovi, pomorski camci, skuteri, barke, feriboti, brodovi, jahte, vozila za kretanje po suvom, vazduhu, vodi ili željeznici djelovi, pribor i dodaci za gore navedenu robu jarboli za brodove kuke za brodove klinovi dizalice za čamce oprema za rastavljanje brodova brodovi za produbljanje morskog dna branici za brodove bokobrani za brodove brodski dimnjaci brodska korita rampe za brodove motorni čamac sa otvorenom ili poluotvorenom palubom vesla kratka vesla sa širokom lopatom pontoni brodska okna kormila propeleri za brodove i čamce hidroavioni kormilarski mehanizam za brodove drvene konstrukcije za brodove spavaće kabine za brodove i čamce krmena vesla katarke za brodove i čamce.

**Klasa 14:** Roba napravljena od dragocjenih metala ili sa prevlakom od njih, koji nijesu uključeni u druge klase nakit dugmad za manžetne, igle za kravatu drago kamenje časovnicarski i hronometrijski instrumenti, ručni satovi, satovi djelovi i oprema za sve gore navedenu robu.

**Klasa 16:** Papir i artikli od papira kartonski artikli štampani materijal instrumenti za pisanje futrole i vrećice za instrumente za pisanje mastilo i punila za instrumente za pisanje kancelarijski materijal brodski dnevnicu pisaci i pribor za stolove lični organizatori držači za pera

i olovke pritiskivači za papire futrole za pasoše, futrole za čekovne knjižice futrole za pera i olovke držači i futrole za dokumenta albumi stipaljke za novac materijali za umotavanje čestitke.

**Klasa 18:** Proizvodi izrađeni od kože i imitacije kože koji nijesu uključeni u druge klase, artikli za prtljag koferi, torbe i futrole putničke torbe, ranci i vreće za putovanja akten tašne i "diplomat" torbe za spise ženske torbe kišobrani, suncobrani stapovi za hodanje i stolice-stapovi (stolice koje se po potrebi mogu preinačiti u štapove za šetnju) toaletne torbe privjesci za ključeve i držači za ključeve futrole i držači za kreditne kartice novčanici, tašne bičevi, amovi i sedlarska roba.

**Klasa 25:** odjeća. obuća i pokrivala za glavu.

**Klasa 34:** Artikli i šibice za pušače.

**Klasa 35:** Oglašavanje poslovno upravljanje poslovna administracija poslovno savjetovanje kancelarijsko poslovanje iznajmljivanje kancelarijskih mašina i opreme raznošenje oglasnog materijala iznajmljivanje i lizing oglasnih (reklamnih) mjesta komercijalne informacije i savjeti za potrošače poslovno i administrativno upravljanje marinama, lukama i pristanistima savjetodavne i konsultantske usluge koje se odnose na marine savjetodavne i konsultantske usluge koje se odnose na dizajn, razvoj, izgradnju i administrativno upravljanje marinama, lukama i pristaništima poslovno i administrativno upravljanje klupskim objektima marine usluge hotelskog upravljanja oglašavanje direktnom postom organizovanje izložbi u komercijalne i reklamne svrhe agencije za uvoz-izvoz organizovanje trgovačkih sajmova u komercijalne i reklamne svrhe oglašavanje na otvorenom odnosi sa javnošću prodajne pomoćije uređivanje izloga usluge poslovanja u oblasti razvoja tržišnog vlasništva iznajmljivanje kancelarija poslovanje maloprodajnih prostorija usluge maloprodaje vezane za prodaju proizvoda za uljepšavanje, kozmetike, toaletnih potrepština, mašina za kućnu upotrebu, optičkih proizvoda, kamera, električne i elektronske kućne opreme, nakita, satova, ručnih satova, kancelarijskog materijala, štampanih publikacija, proizvoda od kože, prtljaga, namještaja, kontejnera i potrepština za domaćinstvo, kućne opreme, tekstila, odjeće, obuće, pokrivala za glavu, galanterije, igračaka i igrice, sportske opreme, prehrambenih proizvoda i pića bilo iz maloprodanih i "outlet" radnji ili iz robnih kuća ili putem Interneta.

**Klasa 36:** Iznajmljivanje apartmana, stanova, vila, potkrovlja, i gradskih kuća iznajmljivanje maloprodajnih prostorija iznajmljivanje trgovačke imovine kapitalne investicije agenti za nekretnine upravljanje nekretninama lizing nekretnina izdavanje polisa osiguranja za marinu brokeri nekretnina iznajmljivanje kancelarija usluge čuvanja u sefu.

**Klasa 37:** Inženjerske usluge u marini održavanje i opravka brodova, pomorskih i nautičkih čamaca renoviranje brodova, pomorskih i nautičkih čamaca upravljanje zgrada usluge razvoja nekretnina usluge razvoja zemljišta za stambenu i komercijalnu upotrebu izgradnja zgrada izgradnja luka izgradnja brodova izgradnja pod vodom izgradnja marina opravke pod vodom održavanje automobila održavanje zgrada izgradnja puteva i parking mjesta renoviranje zgrada krečenje i ukrašavanje zgrada nadgledanje građevinskih radova obnova, osvežavanje i renoviranje zgrada upravljanje građevinskim projektima izgradnja hotela, prodajnih mjesta za hranu i piće, maloprodajnih "outlet" radnji, kancelarija, luksuznih vila, apartmana, potkrovlja, gradskih kuća, jahting klubova i naselja u marini opremanje kancelarija opremanje objekata namijenjenih za stanovanje.

**Klasa 39:** Usluge upravljanja plovilom usluge suvih i vlažnih pristaništa utovar i istovar tereta posredovanje povodom jahti i brodova usluge poslovanja keja usluge poslovanja i upravljanja u luci, pristaništu i marini transport pakovanje i skladištenje roba putni aranžmani pružanje informacija u vezi sa marinom organizovanje krstarenja transport barki iznajmljivanje brodova skladištenje brodova transport brodova rezervacije sjedista na putovanjima posre-

dovanje oko prevoznine posredovanje oko transporta iznajmljivanje automobila transport automobila soferske usluge iznajmljivanje vagona kurirske usluge iznajmljivanje odijela za ronjenje transport feribotom utovar roba dostava roba skladištenje roba transport u okviru marine iznajmljivanje parking mjesta transport putnika transport izletničkim bodovima dostavnina odsukavanje nasukanih brodova rezervacije transports i putovanja riječni transport spašavanje brodova podvodno spašavanje brodsko spašavanje obilasci i turizam te gljenje skladištenje brodova transport taksijem transport putnika informacije o transportu iznajmljivanje vozila.

**Klasa 41:** Pružanje usluga interaktivnih zabava zabavni parkovi zabave organizovanje i praćenje konferencija i seminara organizovanje i praćenje koncerata organizovanje i praćenje simpozijuma organizovanje i praćenje radionica rezervacija sjedista za zabavne programe obezbjeđivanje objekata za kazino bioskopske projekcije usluge u diskotekama iznajmljivanje opreme za ronjenje sa aparatom za disanje nabavka za iznajmljivanje ili prodaju opreme za ronjenje sa bocom za kiseonik iznajmljivanje sportske opreme zabava i usluge zabave informacije o zabavama organizacija izložbi za kulturne i obrazovne svrhe obezbjeđivanje objekata za golf obezbjeđivanje objekata i usluga zdravstvenih i spa klubova predstavljanje performansa uživo obezbjeđenje prostora za muzeje noćne klubove muzičke sale organizacija zabavnih programa pružanje karaoka usluga, obezbjeđenje sportskih objekata obezbjeđenje objekata za rekreaciju i informacija o rekreaciji iznajmljivanje audio opreme, iznajmljivanje kamkordera iznajmljivanje sportske opreme iznajmljivanje video kamera iznajmljivanje video traka pozorišne produkcije usluge biletarnice za svrhe zabave.

**Klasa 42:** Konsultantske usluge građevinskog dizajna podvodno istraživanje i procjena konsultantske usluge za istraživanja u marini.

**Klasa 43:** Iznajmljivanje privremenog smještaja smještajni biro i uključujući hotele, apartmane, stanove, potkrovlja, gradske kuće i gostionice rezervacije privremenog smještaja usluge barova rezervacije gostionica gostionice kafei kafeterije kantine katering hrane i pića dnevna obdaništa i jaslice starački domovi turistički domovi rezervacije hotela hoteli moteli iznajmljivanje stolica, stolova, stolnjaka i staklarije iznajmljivanje soba za sastanke restorani i restorani za samoposluživanje snek barovi.

(111) 07025

(151) 24.01.2013.

(210) **2010-279**

(442) **20.06.2012**

(220) 05.08.2010

(300) GB 2538643 09.02.2010

(732) G-MARIN CONSULTING LIMITED, LEVEL 14, PORTOMASO BUSINESS TOWER, ST. JULIANS MT



(540)

(550) I

(740) Čejović Vladimir, 13. jula 21, Podgorica (ME)

(511) **Klasa 09:** Optički aparati i instrumenti naočare za vid, naočare, suncane naočare okviri, futrole, vezice i lanci za gore pomenutu robu uvelicavajuća stakla dvogledi kompasi torbe za nošenje računara prenosivi držači i futrole za telefone aparati za mjerenje pomorski i nautički aparati, instrumenti, oprema i instalacije elektronski pilot aparati za daljinsko upravljanje plovilima navigacioni aparati i instrumenti pomorski i nautički aparati za komunikaciju po-

morski aparati za mjerenje dubine bove za pomorsku upotrebu.

**Klasa 12:** Brodovi, pomorski čamci, skuteri, barke, feriboti, brodovi, jahte, vozila za kretanje po suvom, vazduhu, vodi ili željeznici djelovi, pribor i dodaci za gore navedenu robu jarboli za brodove kuke za brodove klinovi dizalice za čamce oprema za rastavljanje brodova brodovi za produbljanje morskog dna branici za brodove bokobrani za brodove brodski dimnjaci brodska korita rampe za brodove motorni čamac sa otvorenom ili poluotvorenom palubom vesla kratka vesla sa širokom lopatom pontoni brodska okna kormila propeleri za brodove i čamce hidroavioni kormilarski mehanizam za brodove drvene konstrukcije za brodove spa-vaće kabine za brodove i čamce krmena vesla katarke za brodove i čamce.

**Klasa 14:** Roba napravljena od dragocjenih metala ili sa prevlakom od njih, koji nijesu uključeni u druge klase nakit dugmad za manžetne, igle za kravatu drago kamenje časovničarski i hronometrijski instrumenti, ručni satovi, satovi djelovi i oprema za sve gore navedenu robu.

**Klasa 16:** Papir i artikli od papira kartonski artikli štampani materijal instrumenti za pisanje futrole i vrecice za instrumente za pisanje mastilo i punila za instrumente za pisanje kancelarijski materijal brodski dnevnic pisaci i pribor za stolove lični organizatori držači za pera i olovke pritiskivači za papire futrole za pasoše, futrole za čekovne knjižice futrole za pera i olovke držači i futrole za dokumenta albumi štipaljke za novac materijali za umotavanje čestitke.

**Klasa 18:** Proizvodi izrađeni od kože i imitacije kože koji nijesu uključeni u druge klase, artikli za prtljag koferi, torbe i futrole putničke torbe, ranci i vreće za putovanja akten tašne i "diplomat" torbe za spise ženske torbe kišobrani, suncobrani štapovi za hodanje i stolice-štapovi (stolice koje se po potrebi mogu preinačiti u štapove za šetnju) toaletne torbe privjesci za ključeve i držači za ključeve futrole i držači za kreditne kartice novčanici, tašne bičevi, amovi i sedlarska roba.

**Klasa 25:** odjeća. obuća i pokrivala za glavu.

**Klasa 34:** Artikli i šibice za pušače.

**Klasa 35:** Oglašavanje poslovno upravljanje poslovna administracija poslovno savjetovanje kancelarijsko poslovanje iznajmljivanje kancelarijskih mašina i opreme raznošenje oglasnog materijala iznajmljivanje i lizing oglasnih (reklamnih) mjesta komercijalne informacije i savjeti za potrošače poslovno i administrativno upravljanje marinama, lukama i pristaništima savjetodavne i konsultantske usluge koje se odnose na marine savjetodavne i konsultantske usluge koje se odnose na dizajn, razvoj, izgradnju i administrativno upravljanje marinama, lukama i pristaništima poslovno i administrativno upravljanje klupskim objekatima marine usluge hotelskog upravljanja oglašavanje direktnom poštom organizovanje izložbi u komercijalne i reklamne svrhe agencije za uvoz-izvoz organizovanje trgovačkih sajmova u komercijalne i reklamne svrhe oglašavanje na otvorenom odnosi sa javnošću prodajne pomocije uređivanje izloga usluge poslovanja u oblasti razvoja tržišnog vlasništva iznajmljivanje kancelarija poslovanje maloprodajnih prostorija usluge maloprodaje vezane za prodaju proizvoda za uljepšavanje, kozmetike, toaletnih potrepština, mašina za kućnu upotrebu, optičkih proizvoda, kamera, električne i elektronske kućne opreme, nakita, satova, ručnih satova, kancelarijskog materijala, štampanih publikacija, proizvoda od kože, prtljaga, namještaja, kontejnera i potrepština za domaćinstvo, kućne opreme, tekstila, odjeće, obuće, pokrivala za glavu, galanterije, igračka i igrica, sportske opreme, prehrambenih proizvoda i pića bilo iz maloprodanih i "outlet" radnji ili iz robnih kuća ili putem Interneta.

**Klasa 36:** Iznajmljivanje apartmana, stanova, vila, potkrovlja, i gradskih kuća iznajmljivanje maloprodajnih prostorija iznajmljivanje trgovačke imovine kapitalne investicije agenti za nekretnine upravljanje nekretninama lizing nekretnina izdavanje polisa osiguranja za marinu brokeri nekretnina iznajmljivanje kancelarija usluge čuvanja u sefu.

**Klasa 37:** Inženjerske usluge u marini održavanje i opravka brodova, pomorskih i nautičkih čamaca renoviranje brodova, pomorskih i nautičkih čamaca opravlanje zgrada usluge razvoja nekretnina usluge razvoja zemljišta za stambenu i komercijalnu upotrebu izgradnja zgrada izgradnja luka izgradnja brodova izgradnja pod vodom izgradnja marina opravke pod vodom održavanje automobila održavanje zgrada izgradnja puteva i parking mjesta renoviranje zgrada krečenje i ukrašavanje zgrada nadgledanje građevinskih radova obnova, osvježavanje i renoviranje zgrada upravljanje građevinskim projektima izgradnja hotela, prodajnih mjesta za hranu i piće, maloprodajnih "outlet" radnji, kancelarija, luksuznih vila, apartmana, potkrovlja, gradskih kuća, jahting klubova i naselja u marini opremanje kancelarija opremanje objekata namijenjenih za stanovanje.

**Klasa 39:** Usluge upravljanja plovilom usluge suvih i vlažnih pristaništa utovar i istovar tereta posredovanje povodom jahti i brodova usluge poslovanja keja usluge poslovanja i upravljanja u luci, pristaništu i marini transport pakovanje i skladištenje roba putni aranžmani pružanje informacija u vezi sa marinom organizovanje krstarenja transport barki iznajmljivanje brodova skladištenje brodova transport brodova rezervacije sjedišta na putovanjima posredovanje oko prevoznine posredovanje oko transporta iznajmljivanje automobila transport automobila soferske usluge iznajmljivanje vagona kurirske usluge iznajmljivanje odijela za ronjenje transport feribotom utovar roba dostava roba skladištenje roba transport u okviru marine iznajmljivanje parking mjesta transport putnika transport izletničkim bodovima dostavnina odsukavanje nasukanih brodova rezervacije transports i putovanja riječni transport spašavanje brodova podvodno spašavanje brodsko spašavanje obilasc i i turizam te gljenje skladištenje brodova transport taksijem transport putnika informacije o transportu iznajmljivanje vozila.

**Klasa 41:** Pružanje usluga interaktivnih zabava zabavni parkovi zabave organizovanje i praćenje konferencija i seminara organizovanje i praćenje koncerata organizovanje i praćenje simpozijuma organizovanje i praćenje radionica rezervacija sjedišta za zabavne programe obezbjeđivanje objekata za kazino bioskopske projekcije usluge u diskotekama iznajmljivanje opreme za ronjenje sa aparatom za disanje nabavka za iznajmljivanje ili prodaju opreme za ronjenje sa bocom za kiseonik iznajmljivanje sportske opreme zabava i usluge zabave informacije o zabavama organizacija izložbi za kulturne i obrazovne svrhe obezbjeđivanje objekata za golf obezbjeđivanje objekata i usluga zdravstvenih i spa klubova predstavljanje performansa uživo obezbjeđenje prostora za muzeje noćne klubove muzičke sale organizacija zabavnih programa pružanje karaoka usluga, obezbjeđenje sportskih objekata obezbjeđenje objekata za rekreaciju i informacija o rekreaciji iznajmljivanje audio opreme, iznajmljivanje kamkordera iznajmljivanje sportske opreme iznajmljivanje video kamera iznajmljivanje video traka pozorišne produkcije usluge biletarnice za svrhe zabave.

**Klasa 42:** Konsultantske usluge građevinskog dizajna podvodno istraživanje i procjena konsultantske usluge za istraživanja u marini.

**Klasa 43:** Iznajmljivanje privremenog smještaja smještajni biroi uključujući hotele, apartmane, stanove, potkrovlja, gradske kuće i gostionice rezervacije privremenog smještaja usluge barova rezervacije gostionica gostionice kafei kafeterije kantine katering hrane i pića dnevna obdaništa i jaslice starački domovi turistički domovi rezervacije hotela hoteli moteli iznajmljivanje stolica, stolova, stolnjaka i staklarije iznajmljivanje soba za sastanke restorani i restorani za samoposluživanje snek barovi.

(111) 07027

(151) 24.01.2013.

(210) **2010-299**

(442) **20.06.2012**

(220) 20.08.2010

(732) HYUNDAI MOTOR COMPANY, 231 YUNGJAE-DONG, SEICHO-GU, SEUL, 137-938 KR

## BLUELINK

(540)

(550) I

(740) Čejović Vladimir, 13. jula 21, Podgorica (ME)

(511) **Klasa 09:** Aparati za prenos videa interkomunikacioni aparati aparati za daljinsko upravljanje aparati za bežični prenos akustičnih informacija prenosnički setovi (telekomunikacioni) komunikacioni aparati za vozila telekomunikacioni predajnici aparati za prenos komunikacije mikrofoni (za telekomunikacione aparate) prenosni komunikacioni aparati elektronska zvana upozorenja predajnici elektronskih signala aparati za prenos podataka radio aparati za vozila satelitski prijemnici televizijski aparati za vozila navigacioni aparati za vozila (pri on-bord kompjuterima) aparati za satelitsku navigaciju kompjuteri snimljeni kompjuterski operativni programi snimljeni kompjuterski programi kompjuterski programi (za skidanje/daunload) aparati za obradu podataka kompjuterski softver za bežičnu isporuku sadržaja kompjuterski softver za enkripciju softver za obradu slika, grafike i teksta kompjuterski programi za obradu slika, zvuka i videa programi operativnog sistema komunikacioni kompjuteri unaprijed snimljeni elektronski nemuzički sadržaji (isključujući kompjuterski softver).

(111) 07028

(151) 24.01.2013.

(210) **2010-300**

(442) **20.06.2012**

(220) 20.08.2010

(732) HYUNDAI MOTOR COMPANY, 231, YANGJAE-DONG, SEICHO-GU, SEUL, 137-938 KR

## BLUELINK

(540)

(550) I

(740) Čejović Vladimir, 13. jula 21, Podgorica (ME)

(511) **Klasa 38:** Elektronski prenos informacija i podataka u vezi sa motornim vozilima prenos informacija putem nacionalnih i medunarodnih mreža prenos informacija optičkim telekomunikacionim mrežama prenos vijesti izdavanje instalacija za prenos podataka izdavanje telekomunikacione opreme predaja i prijem (transmisija) informacija iz baza podataka putem telekomunikacione mreže usluge servisa hitnih poruka putem telekomunikacionih mreža komunikacija razmjenom podataka bežične komunikacije VAN (Mreža sa Dodatnom Vrednošću) komunikacija satelitski prenos pružanje informacija o telekomunikacijama komunikacija putem kompjuterskih terminala prenos slika pružanje korisnickog pristupa globalnoj kompjuterskoj mrezi pružanje telekomunikacione veze ka globalnoj kompjuterskoj mrezi Internet emitovanje.

(111) 24.01.2013.

(151) 07029

(210) **2010-301**

(442) **20.06.2012**

(220) 20.08.2010

(732) HYUNDAI MOTOR COMPANY, 231, YANGJAE-DONG, SEICHO-GU, SEUL, 137-938 KR

## HYUNDAI iContact

(540)

(550) I

(740) Čejović Vladimir, 13. jula 21, Podgorica (ME)

(511) **Klasa 12:** Putnički automobili kamioni kombiji autobusi ambulantna kola djelovi i oprema za automobile prenosnički uređaji povezani unutar automobila za komunikaciju sa spoljnim izvorima tokom rada vozila priključni uređaji za prenos informacija za automobile priključni samo-nadzirani uređaji za automobilske preglede.

(111) 07030

(151) 24.01.2013.

(210) **2010-302**(442) **20.06.2012**

(220) 23.08.2010

(732) RED CHIP COMPANY LTD, TRIDENT CHAMBERS, WICKHAMS CAY, P.O. BOX 146, ROAD TOWN, TORTOLA, BRITISH VIRGIN ISLANDS VG



(540)

(550) I

(740) Radulović Božidar, Jovana Tomaševića 9/III, Podgorica (ME)

(511) **Klasa 09:** Aparati za stvaranje, snimanje, prijenos, obradu, pronalaženje, manipulaciju i reprodukciju zvuka mikrofoni, mikofonska predpojačala, direktni ulazni uređaji, miks pultovi, dinamički procesori, procesori efekata i signala, ekvilajzeri, krossoveri, zvučni kontroleri, zvučni interfejsi, uređaji za distribuciju signala, uređaji za pretvaranje signala, pojačala za slušalice, slušalice, snažna pojačala, zvučnici, uređaji za regulaciju rasvjete, računalni softver za stvaranje, snimanje, prijenos, obradu, pronalaženje, manipulacija i reprodukciju zvuka priručnici u elektronskom obliku, uključeni u klasu 9.

**Klasa 15:** Muzički instrumenti gitare klaviri sintesajzeri pribor za muzičke instrumente žice, vreće, kuferi i pedale za muzičke instrumente aparati za podešavanje muzičkih instrumenata dijelovi i pribor za navedene proizvode, uključene u klasu 15.

(111) 07031

(151) 24.01.2013.

(210) **2010-303**(442) **20.06.2012**

(220) 23.08.2010

(732) TOYOTA JIDOSHA KABUSHIKI KAISHA, 1,TOYOTA-CHO, TOYOTY-SHI, AICHI-KEN JP

## HYBRID SYNERGY DRIVE

(540)

(550) I

(740) Čejović Vladimir, 13. jula 21, Podgorica (ME)

(511) **Klasa 12:** Automobili i njihovi strukturni dijelovi, motori za vozila koja se kreću po zemlji, osim lančanih i remenih kontrolnih upravljačkih sistema.

(111) 07032

(151) 24.01.2013.

(210) **2010-306**

(442) **20.06.2012**

(220) 25.08.2010

(732) SHARP KABUSHIKI KAISHA also trading as SHARP CORPORATION, 22-22 NAGAIKE-CHO, ABE-NO-KU, OSAKA 545-8522 JP



(540)

(550) I

(740) Popović Miladin, Đoka Miraševića 21/III, Podgorica (ME)

(511) **Klasa 09:** Televizijski prijemnici, LCD televizijski prijemnici, DVD rekorderi, DVD plejeri, rekorderi sa optičkim diskom, plejeri sa optičkim diskom, LCD paneli, LCD moduli, LCD monitori, mobilni telefoni, elektronski rečnici, digitalni čitači knjiga, lični digitalni asistenti, digitalni foto ramovi, digitalne kamere, video kamere, LCD projektori, aparati za snimanje, prenos ili reprodukovanje zvuka ili slika u klasi 09.

**Klasa 28:** LCD igrice kojima se upravlja ručno u klasi 28

(111) 07033

(151) 24.01.2013.

(210) **2010-307**

(442) **20.06.2012**

(220) 27.08.2010

(732) SUPERMAX INTERNATIONAL PVT LTD, MALHOTRA HOUSE 4th FLOOP OPP GPO, FORT MUMBAI 400001 IN



## SYRINE

(540)

(550) I

(740) Čejović Vladimir, 13. jula 21, Podgorica (ME)

(511) **Klasa 08:** Brijači žileti za brijače kutije za brijače instrumenti za brijanje kutije i ulošci koji sadrže žilete za brijače djelovi i oprema za svu prethodno navedenu robu.

(111) 07034

(151) 24.01.2013.

(210) **2010-308**(442) **20.06.2012**

(220) 31.08.2010

(732) PODRAVKA DD KOPRIVNICA, A.STARČEVIĆA 32, KOPRIVNICA HR

## KVIKI GRIC

(540)

(550) I

(740) Božović Vesko, Rimski trg 50/11, Podgorica (ME)

(511) **Klasa 29:** Arašidi, bademi, čips/prženi krompirići.**Klasa 30:** Keks, krekeri, kukuruzne kokice, koktel peciva, slano trajno pecivo, štapići, flips, snack.

(111) 07035

(151) 24.01.2013.

(210) **2010-309**(442) **20.06.2012**

(220) 31.08.2010

(732) FOX INTERNATIONAL CHANNELS US, 1440 SEPULVEDA BOULEVARD, LOS ANGELES, CALIFORNIA 90025 US

## UTILISIMA

(540)

(550) I

(740) Čejović Vladimir, 13. jula 21, Podgorica (ME)

(511) **Klasa 09:** Melodije, slike, pozadine, igre, i muzika koje je moguće preuzeti preko globalne računarske mreže i bežičnih uređaja Filmovi, televizijski programi i audio-vizuelni sadržaj sa filmovima i televizijskim zabavnim programom koje je moguće preuzeti preko interneta audio i video snimci sa filmovima i televizijskim zabavnim programom koje je moguće preuzeti sa interneta kompjuterski softver i aplikacije unaprijed snimljene video kasete, DVD-i i CD-i sa filmovima i televizijskim zabavnim programom.**Klasa 16:** Časopisi, poster, razglednice, registratori, sveske, fascikle, blokčiči za beleške, prazne sveske za pisanje dnevnika, podsjetnici, adresari, rokovnici, korice za knjige, naljepnice za kola

naljepnice albumi za sličice stoni kalendari zidni kalendari graničnici za knjige sličice foto albumi uramljene i neuramljene fotografije čestitke knjige stripovi humoristična literatura penkala i olovke.

**Klasa 38:** Televizijsko emitovanje i usluge televizijskog prenosa.

**Klasa 41:** Produkcija i distribucija televizijskih programa, filmova i audio vizuelne zabave usluge zabave u vezi sa televizijskim programom prikazivanje i distribucija audio i vizuelnih radova u vezi sa televizijskim programom i filmovima pružanje onlajn informacija u oblasti televizije, filmova i video zabave preko interneta pružanje usluga televizijske, filmske i video zabave preko bežičnih uređaja za komunikaciju usluge zabave, naime, pružanje usluga u vezi sa onlajn igrama za kompjuter onlajn dnevnic, naime, blogovi koji sadrže lične informacije i mišljenja organizovanje zabave i kulturnih događaja zabava u smislu nadmetanja, takmičenja i igara.

(111) 07036

(151) 24.01.2013.

(210) **2010-314**

(442) **20.06.2012**

(220) 07.09.2010

(732) EMIRATES TELECOMMUNICATIONS CORPORATION, ETISALAT TOWER, P.O.BOX 3838, ABU DHABI AE

etisalat

(540)

(550) I

(740) Radulović Božidar, Jovana Tomaševića 9/III, Podgorica (ME)

(511) **Klasa 38:** Telekomunikacione usluge usluge koje se odnose na komunikaciju preko celularnih, mobilnih, satelitskih fiksni telefona komunikacija preko kompjuterskih terminala komunikacija preko mreže optičkih kablova usluge koje se odnose na prenos podataka usluge digitalnih komunikacija usluge razmjene elektronskih podataka usluge elektronske pošte elektronski prenos podataka, slika i dokumenata obezbjeđenje pristupa online kompjuterskom servisu Internet usluge Servis pristupa podacima na daljinu servisi koji uključuju mrežu sa dodatom vrijednošću (VAN) Obezbjedenje konekcija na bežičnu lokalnu mrežu (LAN)

(111) 07037

(151) 24.01.2013.

(210) **2010-315**

(442) **20.06.2012**

(220) 07.09.2010

(732) EMIRATES TELECOMMUNICATIONS CORPORATON, ETISALAT TOWER, P.O.BOX 3838, ABU DHABI AE



(540)

(550) I

(740) Radulović Božidar, Jovana Tomaševića 9/III, Podgorica (ME)

(511) **Klasa 38:** Telekomunikacione usluge usluge koje se odnose na komunikaciju preko celularnih, mobilnih, satelitskih fiksnih telefona komunikacija preko kompjuterskih terminala komunikacija preko mreže optičkih kablova usluge koje se odnose na prenos podataka usluge digitalnih komunikacija usluge razmjene elektronskih podataka usluge elektronske pošte elektronski prenos podataka, slika i dokumenata obezbjeđenje pristupa online kompjuterskom servisu Internet usluge Servis pristupa podacima na daljinu servisi koji uključuju mrežu sa dodatom vrijednošću (VAN) Obezbjedenje konekcija na bežičnu lokalnu mrežu (LAN).

(111) 07101

(151) 24.01.2013.

(210) **2010-13**

(442) **20.06.2012**

(220) 27.01.2010

(732) REYNOLDS CONSUMER PRODUCTS, INC. A DELAWARE CORPORATION, 6641 WEST BROAD STREET, RICHMOND, VIRGINIA 23230 US

## GEOWEB

(540)

(550) I

(740) Čejović Vladimir, 13. jula 21, Podgorica (ME)

(511) **Klasa 19:** Građevinski materijali, naime, plastični blokovi za kontrolu i zaštitu od erozije, table, prekrivači i mreže koje se koriste u izgradnji puteva, avionskih pista, prilaza, pruga, kolosjeka, parkinga, podova, terasa, trkačkih boksova, rampi za brodove, polica za staklenike, kosina/padina, rampi i kanala na branama, kao i za stabilizaciju zemljišta i tla, sprečavanje erozije i zaštitu travnjaka.

(111) 07102

(151) 24.01.2013.

(210) **2010-292**

(442) **20.06.2012**

(220) 16.08.2010

(732) SHANDONG LINGLONG TYRE CO, LTD, NO. 777 JINLONG ROAD, ZHAIYUAN CITY, SHANDONG CN

# GREEN MAX

(540)

(550) I

(740) Ćosović Dejan, 13. jula 1/5, Budva (ME)

(511) **Klasa 12:** Gume za točkove vozila gazed sloj za pneumatske gume punjene gume za točkove vozila (bez vazduha), pojasevi za protektiranje guma gume za avione gazed djelovi guma za vozila (kružni kaiševi) unutrašnje gume za pneumatike gume za automobile gazed dijelovi guma za vozila (za traktore).

(111) 07103

(151) 24.01.2013.

(210) **2010-325**

(442) **20.06.2012**

(220) 10.09.2010

(732) S.C.JOHNSON & SON, INC, 1525 HOWE STREET, RACINE, WISCONSIN 53403-2236 US

## GLADE DISCREET

(540)

(550) I

(740) Ćejović Vladimir, 13. jula 21, Podgorica (ME)

(511) **Klasa 5:** Osvježivači vazduha dezodoransi za vazduh preparati koji pročišćavaju vazduh sanitizeri vazduha dezodoransi za tkanine dezodoransi za tepihe i sobe.

(111) 07104

(151) 24.01.2013.

(210) **2010-326**

(442) **20.06.2012**

(220) 10.09.2010

(732) S.C.JONSON & SON, INC, 1525 HOWE STREET, RACINE, WISCONSIN 53403-2236 US

## GLADE REFRESH-AIR

(540)

(550) I

(740) Ćejović Vladimir, 13. jula 21, Podgorica (ME)

(511) **Klasa 5:** Osvježivači vazduha dezodoransi za vazduh preparati koji pročišćavaju vazduh sanitizeri vazduha dezodoransi za tkanine dezodoransi za tepihe i sobe.

(111) 07105

(151) 24.01.2013.

(210) **2010-327**

(442) **20.06.2012**

(220) 10.09.2010

(732) S.C.JOHNSON &amp; SON, INC, 1525 HOWE STREET, RACINE, WISCONSIN 53403-2236 US

## NIGHT &amp; DAY TRIO

(540)

(550) I

(740) Čejović Vladimir, 13. jula 21, Podgorica (ME)

(511) **Klasa 5:** Preparati za uništavanje korova i štetočina insekticidi preparati za zaštitu od moljaca sredstva koja odbijaju insekte, fungicidi deratizatori.

(111) 24.01.2013.

(151) 24.01.2013.

(210) **2010-330**(442) **20.06.2012**

(220) 17.09.2010

(732) HANSEN BEVERAGE COMPANY, 550 MONICA CIRCLE, SUITE 201 CORONA, CALIFORNIA 92880 US



(540)

(550) I

(740) Radulović Božidar, Jovana Tomaševića 9/III, Podgorica (ME)

(511) **Klasa 16:** Štampane stvari i publikacije, plakati, naljepnice, precrtane slike, kartice, kanceanjski material, natpisi.**Klasa 25:** Odjeća, obuća i pokrivala za glavu.

(111) 07107

(151) 24.01.2013.

(210) **2010-331**(442) **20.06.2012**

(220) 17.09.2010

(732) E.&amp; J.GALLO WINERY, 600 YOSEMITE BOULEVARD MODESTO, CALIFORNIA 95354 US

## WINEMAKER'S SEAL

(540)

(550) I

(740) Popović Miladin, Đoka Miraševića 21/III, Podgorica (ME)

(511) **Klasa 33:** Vina.

(111) 24.01.2013.

(151) 24.01.2013.

(210) **2010-332**

(442) **20.06.2012**

(220) 17.09.2010

(732) M & G BRANDS, LIMITED, UGLAND HOUSE, SOUTH CHURCH STREET P.O. BOX 309, GEORGE TOWN KY

## MCWILLIAM'S HANWOOD ESTATE

(540)

(550) I

(740) Popović Miladin, Đoka Miraševića 21/III, Podgorica (ME)

(511) **Klasa 33:** Alkoholna pića (izuzev piva)

(111) 07109

(151) 24.01.2013.

(210) **2010-335**

(442) **20.06.2012**

(220) 20.09.2010

(732) PwC BUSINESS TRUST A DELAWARE BUSINESS TRUST, 300 MADISON AVENUE, NEW YORK, NY 10017 US



(540)

(550) I

(740) Čupić Branislav, Dalmatinska 10, Podgorica (ME)

(511) **Klasa 45:** Pravne usluge usluge obezbjeđenja radi zaštite imovine i lica savjetodavne i konsultantske usluge u vezi sa regulatornim pitanjima u oblasti zaštite životne sredine analiza podataka, politike i procedure, i pružanje savjeta i pomoći u vezi sa poslovnim menadžmentom da bi se obezbjedila uskladenost sa zakonima i drugim propisima u oblasti javnih nabavki konsultantske usluge u oblasti krađe podataka i krađe identiteta konsultantske i pravne usluge u vezi sa zakonima, propisima i uslovima u oblasti privatnosti i bezbjednosti konsultantske usluge u oblasti prikupljanja i praćenja inostranih i domaćih vladinih regulatornih propisa za dobijanje dozvola i regulatornu uskladenost konsultantske usluge u oblasti

intelektualne svojine pružanje podrške (asistencije) u sudskim postupcima usluge u oblasti rješavanja sporova usluge pravnih asistenata (paralegal) pružanje onlajn interaktivne baze podataka sa pravnim informacijama pružanje informacija u vezi sa pravnim stvarima pružanje onlajn informacija i vijesti u oblasti prava pružanje informacija u vezi sa pravima intelektualne i industrijske svojine konsultantske usluge u vezi sa pitanjima regulatorne usklađenosti proučavanje standarda i prakse da bi se obezbjedila usklađenost sa važećim zakonima, propisima i pravilima usluge obezbjeđenja, naročito procjena bezbjednosti fizičkih lokacija, informacionih sistema i radnog okruženja usluge vještačenja usluge procjene rizika u vezi bezbjednosti robe, lica, ustanova i objekata sprečavanje kriminala i prevara usluge arbitraže pružanje informacija, savjeta i konsultantskih usluga u vezi sa svim navedenim uslugama u ovoj klasi, onlajn putem, kao i u štampanoj ili elektronskoj formi.

(111) 07110

(151) 24.01.2013.

(210) **2010-336**

(442) **20.06.2012**

(220) 20.09.2010

(732) PwC BUSINESS TRUST A DELAWARE BUSINESS TRUST, 300 MADISON AVENUE, NEW YORK, NY 10017 US



(540)

(550) I

(740) Ćupić Branislav, Dalmatinska 10, Podgorica (ME)

(511) **Klasa 45:** Pravne usluge usluge obezbjeđenja radi zaštite imovine i lica savjetodavne i konsultantske usluge u vezi sa regulatornim pitanjima u oblasti zaštite životne sredine analiza podataka, politike i procedure, i pružanje savjeta i pomoći u vezi sa poslovnim menadžmentom da bi se obezbjedila usklađenost sa zakonima i drugim propisima u oblasti javnih nabavki konsultantske usluge u oblasti krađe podataka i krađe identiteta konsultantske i pravne usluge u vezi sa zakonima, propisima i uslovima u oblasti privatnosti i bezbjednosti konsultantske usluge u oblasti prikupljanja i praćenja inostranih i domaćih vladinih regulatornih propisa za dobijanje dozvola i regulatornu usklađenost konsultantske usluge u oblasti intelektualne svojine pružanje podrške (asistencije) u sudskim postupcima usluge u oblasti rješavanja sporova usluge pravnih asistenata (paralegal) pružanje onlajn interaktivne baze podataka sa pravnim informacijama pružanje informacija u vezi sa pravnim stvarima pružanje onlajn informacija i vijesti u oblasti prava pružanje informacija u vezi sa pravima intelektualne i industrijske svojine konsultantske usluge u vezi sa pitanjima regulatorne usklađenosti proučavanje standarda i prakse da bi se obezbjedila usklađenost sa važećim zakonima, propisima i pravilima usluge obezbjeđenja, naročito procjena bezbjednosti fizičkih lokacija,

informativnih sistema i radnog okruženja usluge vještačenja usluge procjene rizika u vezi bezbjednosti robe, lica, ustanova i objekata sprečavanje kriminala i prevara usluge arbitraže pružanje informacija, savjeta i konsultantskih usluga u vezi sa svim navedenim uslugama u ovoj klasi, onlajn putem, kao i u štampanoj ili elektronskoj formi.

(111) 07111 (151) 24.01.2013.  
 (210) **2010-337** (442) **20.06.2012**  
 (220) 21.09.2010  
 (732) NECKOM DOO, PODGORIČKI PUT BB 81400 NIKŠIĆ ME



(540)  
 (550) I

(511) **Klasa 02:** Boje, firnaji, lakovi sredstva za zaštitu od rđe i truljenja drveta. materije za bojenje. sredstva za nagrizanje i td.

**Klasa 06:** Obični metali i njihove legure metalni građevinski materijali metalne prenosne građevine ne-električne kablove i žice od običnog metala bravarski proizvodi, mali metalni gvoždarski proizvodi cjevčice i cijevi od metala sefovi proizvodi od običnih metala koji nisu uključeni u druge klase

**Klasa 08:** Ručni alati i sprave (kojima se ručno upravlja) pribor za jelo

**Klasa 19:** Građevirski materijali (nemetalni) čvrste nemetalne cijevi za građevine asfalt, crna smola i bitumen nemetalne prenosne građevine

**Klasa 37:** Građevinsko konstruiranje popravljanje usluge instaliranja (instalacijske usluge).

**Klasa 39:** Transportne usluge.

(111) 07112 (151) 24.01.2013.  
 (210) **2010-338** (442) **20.06.2012**  
 (220) 21.09.2010  
 (732) LOHMANN HAAS PHARMACEUTICALS CHINA LIMITED, UNIT NOS.1310-11,LEVEL 13, TOWER II, GRAND CENTURY PLACE, 193 PRINCE EDWARD RD WEST, KLN HONGKONG HK





(540)

(550) I

(740) Čejović Vladimir, 13. jula 21, Podgorica (ME)

(511) **Klasa 3:** Preparati za pranje preparati za čišćenje, kozmetički preparati za kupanje dezinfekcioni sapuni kreme za kožu sredstva za zaštitu kože (sredstva za glancanje kože) kalup toaletnog sapuna sredstva za ispiranje usta, koja nisu za medicinsku upotrebu etarska ulja paste za zube sredstva za higijenu samponi losioni za kosu preparati za bjeljenje za upotrebu u perionicama preparati za poliranje namještaja i podova preparati za pranje veša.

**Klasa 5:** Losioni za farmaceutsku upotrebu preparati za kupanje, ljekovita tečnost za ispiranje usta za medicinske svrhe dezinfekciona sredstva za hemijske toalete preparati za sterilizaciju preparati za osvježavanje vazduha higijenski uložci tkanina impregnirana sa farmaceutskim losionima aseptična vata farmaceutski preparati dijetetske supstance koje su prilagođene za medicinsku upotrebu.

(111) 07113

(151) 24.01.2013.

(210) **2010-339**(442) **20.06.2012**

(220) 21.09.2010

(732) LOHMAN HAAS PHARMACEUTICALS CHINA LIMITED, UNIT NOS.1310-11,LEVEL 13,TOWER II,GRAND CENTURY PLACE,193 PRINCE EDWARD RD WEST, KLN, HONG KONG HK



(540)

(550) I

(740) Čejović Vladimir, 13. jula 21, Podgorica (ME)

(511) **Klasa 3:** Preparati za pranje preparati za čišćenje, kozmetički preparati za kupanje dezinfekcioni sapuni kreme za kožu sredstva za zaštitu kože (sredstva za glancanje kože) kalup toaletnog sapuna sredstva za ispiranje usta, koja nisu za medicinsku upotrebu etarska ulja paste za zube sredstva za higijenu šamponi losioni za kosu preparati za bjeljenje za upotrebu u perionicama preparati za poliranje Namještaja i podova preparati za pranje veša.

(111) 07114

(151) 24.01.2013.

(210) **2010-344**(442) **20.06.2012**

(220) 29.09.2010

(300) 761286 06.04.2001

(732) ZINO DAVIDOFF SA, RUE FAUCIGNY 5 CH-1700 FRIBOURG CH

**COOL WATER**

(540)

(550) I

(740) Popović Miladin, Đoka Miraševića 21/III, Podgorica (ME)

(511) **Klasa 25:** Odjeća, kravate, košulje, odijela, obuća, pokrivala za glavu.

(111) 07115

(151) 24.01.2013.

(210) **2010-345**(442) **20.06.2012**

(220) 04.10.2010

(732) CORPORACION HABANOS,S.A, AVENIDA 3RA.NO.2006 ENTRE 20 U 22, MIRAMAR, PLAYA, CIUDAD DE LA HABANA CU

**BEHIKE**

(540)

(550) I

(740) Stanković Mugoša Ana, Trg Republike 13, Podgorica (ME)

(511) **Klasa 34:** Duvan, uključujući cigare, cigarete, cigarilose, rezani duvan za lule artikli za pušače, uključujući pepeljare, nožice za cigare, kutije za šibice, kutije za cigare šibice.

(111) 07116

(151) 24.01.2013.

(210) **2010-346**(442) **20.06.2012**

(220) 05.10.2010

(732) ALKALOID AD SKOPLJE, BUL. ALEKSANDAR MAKEDONSKI 12 1000 SKOPLJE MK



(540)

(550) I

(740) Popović Miladin, Đoka Miraševića 21/III, Podgorica (ME)

(511) **Klasa 03:** Sredstva za beljenje i druge supstance za upotrebu u perionicama, preparati za čišćenje, poliranje, ribanje i nagrizanje, sapuni, parfimerija, eterična ulja, kozmetika, losioni za kosu, paste za zube.

(111) 07117

(151) 24.01.2013

(210) **2010-348**(442) **20.06.2012**

(220) 06.10.2010

(732) BERLIN-CHEMIE AG, GLIENICKER WEG 125,D-12489 BERLIN DE

# SENSETIN

(540)

(550) I

(740) Radulović Božidar, Jovana Tomaševića 9/III, Podgorica (ME)

(511) **Klasa 05:** Farmaceutski proizvodi, dijetetske supstance prilagođene za upotrebu u medicini.

---

(111) 07118

(151) 24.01.2013

(210) **2010-349**

(442) **20.06.2012**

(220) 06.10.2010

(732) BERLIN-CHEME AG, GLIENICKER WEG 125, D-12489 BERLIN DE

# OLBER

(540)

(550) I

(740) Radulović Božidar, Jovana Tomaševića 9/III, Podgorica (ME)

(511) **Klasa 05:** Farmaceutski proizvodi, dijetetske supstance prilagođene za upotrebu u medicini.

---

(111) 07119

(151) 24.01.2013

(210) **2010-350**

(442) **20.06.2012**

(220) 06.10.2010

(732) BERLIN-CHEME AG, GLIENICKER WEG 125, D-12489 BERLIN DE

# TAMID

(540)

(550) I

(740) Radulović Božidar, Jovana Tomaševića 9/III, Podgorica (ME)

(511) **Klasa 05:** Farmaceutski proizvodi, dijetetske supstance prilagođene za upotrebu u medicini.

---

(111) 07120

(151) 24.01.2013

(210) **2010-351**

(442) **20.06.2012**

(220) 06.10.2010

(732) OPO MEDICAL INC, 1030 INDUSTRY DRIVE, TUKWILA, WA 98188 US



(540) \_\_\_\_\_

(550) I

(740) Lutovac Branislav, Bulevar Crnojevića 93, Podgorica (ME)

(511) **Klasa 10:** Hirurški, medicinski, zubarski i veterinarski aparati i instrumenti, vještački udovi, oči i zubi, ortopedski pribor, hirurški materijali za zašivanje, vazdušni dušeci (madraci) i podloge za krevet od memorijske pjene za medicinske svrhe, vazdušni jastuci i jastuci od memorijske pjene za medicinsku upotrebu, štapovi za hodanje za medicinske svrhe, kompresione čarape, ortopedski umeci za petu, ortopedski ulošci za obuću, ortopedske podloge za stopala, bandaže za stopala, podmetači za sedenje za medicinske svrhe, dizalice za invalide, liftovi za invalide, ortopedska obuća, hemijski aktivirane tople i hladne terapijske obloge, pumpice sa aerosolima za medicinsku upotrebu, ulošci za obuću koji podupiru svod stopala, bandaži za anatomske zglobove, ćebad za medicinske svrhe, udlage i ortoze za zglobove i ekstremitete za medicinske svrhe, grudnjaci, štitnici, zaštitni delove i steznici za medicinsku upotrebu za gležanj, ruku, leđa, grudni koš, lakat, lice, stopalo, šaku, glavu, koleno, nogu, ćevanicu, rame, butinu, lumbalni pojas i članak ruke, kompresioni bandaži, elastični zavoji, tople obloge za medicinske svrhe, medicinska pakovanja leda, štitnici za usta za medicinsku upotrebu, neoprenski i elastični steznici za medicinsku upotrebu za gležanj, leđa, lakat, stopalo, zadnju ložu, koljeno, butinu, ćevanicu, lumbalni pojas i članak ruke, ne-medicinske komprese, ortopedski pojasevi, ortopedske proteze, ortopedski donovi, ortopedski potporni bandaži, ortopedski steznici, ortopedske komprese za medicinske svrhe, komprese za gležanj, ruku, leđa, grudni koš, lakat, šaku, glavu, ćevanicu, rame, butinu, lumbalni pojas i članak ruke.

**Klasa 28:** Sportska oprema, a naročito, elastični i neoprenski štitnici za gležanj, list, lakat, zadnju ložu, koleno, ćevanicu, butinu, lumbalni pojas i članak ruke, zaštitna oprema za sportiste, a naročito, štitnici za gležanj, ruku, stopalo, koleno i lakat, nogu, ćevanicu, butinu, lumbalni pojas i zglob ruke, atletske trake (elastični zavoji za sportsku upotrebu).

(111) 07162

(151) 24.01.2013

(210) **2010-22**

(442) **20.06.2012**

(220) 08.02.2010

(732) WUNDHAM HOTELS AND RESORTS LLC, 22 SYLVAN WAY, PARSIPANY, NY 07054 US

## WYNDHAM

(540)

(550) I

(740) Čejović Vladimir, 13. jula 21, Podgorica (ME)

(511) **Klasa 43:** Usluge smještaja u hotel resort-ima, hotelima, motelima i restoranske usluge usluge iznajmljivanja apartmana pravljenje rezervacija smještaja u ime drugih usluge rezervacija smještaja i iznajmljivanja.

(111) 07163

(151) 24.01.2013

(210) **2010-280**(442) **20.06.2012**

(220) 09.08.2010

(732) GERGIA-PACIFIC CONSUMER PRODUCTS LP, A DELAWARE LIMITED PARTNERSHIP, 133 PEACHTREE STREET NE, ATLANTA, GEORGIA 30303 US

## COMPACT

(540)

(550) I

(740) Čejović Vladimir, 13. jula 21, Podgorica (ME)

(511) **Klasa 16:** Toalet papir.**Klasa 21:** Držači za toalet papir.

(111) 07164

(151) 24.01.2013.

(210) **2010-281**(442) **20.06.2012**

(220) 09.08.2010

(732) GEOGIA-PACIFIC CONSUMER PRODUCTS LP, A DELAWARE LIMITED PARTNERSHIP, 133 PEACHTREE STREET NE, ATLANTA, GEORGIA 30303 US

## SERIE 3000

(540)

(550) I

(740) Čejović Vladimir, 13. jula 21, Podgorica (ME)

(511) **Klasa 3:** Sredstva za čišćenje daske na WC šolji.**Klasa 5:** Osvježivači vazduha.**Klasa 16:** Papirni ubrusi.**Klasa 21:** Korpe za otpadke, držači za papirne ubruse.

(111) 07165

(151) 24.01.2013.

(210) **2010-286**(442) **20.06.2012**

(220) 10.08.2010

(732) NINE WEST DEVELOPMENT CORPORATION, 1007 ORANGE STREET, SUITE 225, 19801

WILMINGTON, DE US

## BANDOLINO

(540)

(550) I

(740) Čejović Vladimir, 13. jula 21, Podgorica (ME)

(511) **Klasa 18:** Koža i imitacije kože, i proizvodi od tih materijala koji nijesu obuhvaćeni drugim Klasama životinjske kože, krzna kovčezi i putne torbe kišobrani, suncobrani i štapovi za hodanje bičevi, saračka i sedlarska roba ručne torbe.

**Klasa 25:** odjeća, obuća, pokrivala za glavu.

**Klasa 35:** Usluge maloprodajnih radnji.

---

(111) 07166

(151) 24.01.2013.

(210) **2010-287**

(442) **20.06.2012**

(220) 10.08.2010

(732) NINE WEST DEVELOPMENT CORPORATION, 1007 ORANGE STREET, SUITE 225, 19801 WILMINGTON, DE US

## BOUTIQUE 9

(540)

(550) I

(740) Čejović Vladimir, 13. jula 21, Podgorica (ME)

(511) **Klasa 18:** Koža i imitacije kože, i proizvodi od tih materijala koji nijesu obuhvaćeni drugim Klasama životinjske kože, krzna kovčezi i putne torbe kišobrani, suncobrani i štapovi za hodanje bičevi, saračka i sedlarska roba ručne torbe.

**Klasa 25:** Odjeća, obuća, pokrivala za glavu.

**Klasa 35:** Usluge maloprodajnih radnji.

---

(111) 07167

(151) 24.01.2013.

(210) **2010-288**

(442) **20.06.2012**

(220) 10.08.2010

(732) NINE WEST DEVELOPMENT CORPORATION, 1007 ORANGE STREET, SUITE 225, 19801 WILMINGTON, DE US

## CIRCA JOAN & DAVID

(540)

(550) I

(740) Čejović Vladimir, 13. jula 21, Podgorica (ME)

(511) **Klasa 18:** Koža i imitacije kože, i proizvodi od tih materijala koji nijesu obuhvaćeni drugim Klasama životinjske kože, krzna kovčezi i putne torbe kišobrani, suncobrani i štapovi za hodanje bičevi, saračka i sedlarska roba ručne torbe.

**Klasa 25:** Odjeća, obuća, pokrivala za glavu.

**Klasa 35:** Usluge maloprodajnih radnji.

---

(111) 07168

(151) 24.01.2013.

(210) **2010-289**

(442) **20.06.2012**

(220) 10.08.2010

(732) NINE WEST DEVELOPMENT CORPORATION, 1007 ORANGE STREET, SUITE 225, 19801 WILMINGTON, DE US

## EASY SPIRIT

(540)

(550) I

(740) Čejović Vladimir, 13. jula 21, Podgorica (ME)

(511) **Klasa 18:** Koža i imitacije kože, i proizvodi od tih materijala koji nijesu obuhvaćeni drugim Klasama životinjske kože, krzna kovčezi i putne torbe kišobrani, suncobrani i štapovi za hodanje bičevi, saračka i sedlarska roba ručne torbe.

**Klasa 25:** Odjeća, obuća, pokrivala za glavu.

**Klasa 35:** Usluge maloprodajnih radnji.

---

(111) 07169

(151) 24.01.2013.

(210) **2010-290**

(442) **20.06.2012**

(220) 10.08.2010

(732) NINE WEST DEVELOPMENT CORPORATION, 1007 ORANGE STREET, SUITE 225, 19801 WILMINGTON, DE US

## ENZO ANGIOLINI

(540)

(550) I

(740) Čejović Vladimir, 13. jula 21, Podgorica (ME)

(511) **Klasa 18:** Koža i imitacije kože, i proizvodi od tih materijala koji nijesu obuhvaćeni drugim Klasama životinjske kože, krzna kovčezi i putne torbe kišobrani, suncobrani i štapovi za hodanje bičevi, saračka i sedlarska roba ručne torbe.

**Klasa 25:** Odjeća, obuća, pokrivala za glavu.

**Klasa 35:** Usluge maloprodajnih radnji.

---

(111) 07170

(151) 24.01.2013.

(210) **2010-352**

(442) **20.06.2012**

(220) 06.10.2010

(732) LA POINTIQUE INTL LTD, 1030 INDUSTRY DRIVE, TUWILA, WA 98188 US



(540)

(550) I

(740) Lutovac Branislav, Bulevar Crnojevića 93, Podgorica (ME)

(511) **Klasa 10:** Hirurški, medicinski, zubarski i veterinarski aparati i instrumenti, vještački udovi, oči i zubi, ortopedski pribor, hirurški materijali za zašivanje, vazdušni dušeci (madraci) i podloge za krevet od memorijske pene za medicinske svrhe, vazdušni jastuci i jastuci od memorijske pjene za medicinsku upotrebu, štapovi za hodanje za medicinske svrhe, kompresione čarape, ortopedski umeci za petu, ortopedski ulošci za obuću, ortopedske podloge za stopala, bandaže za stopala, podmetači za sedenje za medicinske svrhe, dizalice za invalide, liftovi za invalide, ortopedska obuća, hemijski aktivirane tople i hladne terapijske obloge, pumpice sa aerosolima za medicinsku upotrebu, ulošci za obuću koji podupiru svod stopala, bandaži za anatomske zglobove, ćebad za medicinske svrhe, udlage i ortoze za zglobove i ekstremitete za medicinske svrhe, grudnjaci, štitnici, zaštitni delove i steznici za medicinsku upotrebu za gležanj, ruku, leđa, grudni koš, lakat, lice, stopalo, šaku, glavu, koleno, nogu, ćevanicu, rame, butinu, lumbalni pojas i članak ruke, kompresioni bandaži, elastični zavoji, tople obloge za medicinske svrhe, medicinska pakovanja leda, štitnici za usta za medicinsku upotrebu, neoprenski i elastični steznici za medicinsku upotrebu za gležanj, leđa, lakat, stopalo, zadnju ložu, koleno, butinu, ćevanicu, lumbalni pojas i članak ruke, ne-medicinske komprese, ortopedski pojasevi, ortopedske proteze, ortopedski donovi, ortopedski potporni bandaži, ortopedski steznici, ortopedske komprese za medicinske svrhe, komprese za gležanj, ruku, leđa, grudni koš, lakat, šaku, glavu, ćevanicu, rame, butinu, lumbalni pojas i članak ruke.

**Klasa 28:** Sportska oprema, a naročito, elastični i neoprenski štitnici za gležanj, list, lakat, zadnju ložu, koleno, ćevanicu, butinu, lumbalni pojas i članak ruke, zaštitna oprema za sportiste, a naročito, štitnici za gležanj, ruku, stopalo, koleno i lakat, nogu, ćevanicu, butinu, lumbalni pojas i zglob ruke, atletske trake (elastični zavoji za sportsku upotrebu).

(111) 07171

(151) 24.01.2013.

(210) **2010-353**

(442) **20.06.2012**

(220) 07.10.2010

(300) 1001839 26.01.2009

(732) DEUTCHE TELECOM AG, FRIEDRICH-EBERT-ALLEE 140, 53113 BON DE



## Speedphone

(540)

(550) I

(740) Popović Miladin, Đoka Miraševića 21/III, Podgorica (ME)

(511) **Klasa 09:** Aparati i instrumenti naučni, pomorski, geodetski, fotografski, kinematografski, optički, za vaganje, mjerenje, signalizaciju, kontrolu (inspekciju), spašavanje i nastavu, aparati i instrumenti za sprovođenje, prekid, transformaciju, akumulaciju, regulaciju ili kontrolu elektriciteta, aparati za snimanje, prenos, obradu i reprodukciju zvuka, slika ili podataka, magnetni nosioci podataka, automatske mašine i mehanizmi za aparate koji se pokreću novcem ili žetonom, računске mašine, oprema za obradu podataka i kompjuteri, snimljeni i nesnimljeni nosači podataka (koji su uključeni u ovu klasu), kompjuterski programi (sačuvani), elektronski snimljeni podaci (koji se mogu preuzimati), elektronske publikacije (koje se mogu preuzimati)

**Klasa 38:** Telekomunikacije, novinske agencije, iznajmljivanje telekomunikacijske opreme, informacije o telekomunikacijama

**Klasa 42:** Naučne i tehnološke usluge i istraživanje i projektovanje u vezi navedenih usluga, usluge industrijske analize i istraživanja, projektovanje i razvoj kompjuterskog hardvera, softvera i baza podataka, održavanje softvera, tehničko savetovanje u vezi sa uslugama uključenim u ovu klasu, usluge čuvanja elektronskih podataka, iznajmljivanje opreme za obradu podataka, projektovanje web stranica za druge

(111) 07172

(151) 24.01.2013.

(210) **2010-355**

(442) **20.06.2012**

(220) 07.10.2010

(732) B.D. BAGGIES LTD, 12 CAPITOL TRAIL, DE-19711, NEWARK, DELAWARE US



(540)

(550) I

(740) Čejović Vladimir, 13. jula 21, Podgorica (ME)

(511) **Klasa 25:** Odjeća, obuća, pokrivala za glavu, sportska odjeća i odjeća koja se nosi napolju, trikotaža, čarape, šalovi, kaiševi (odjeća), rukavice (odjeća).

(111) 07173

(151) 24.01.2013.

(210) **2010-356**(442) **20.06.2012**

(220) 08.10.2010

(300) CTM 009015041 09.04.2010

(732) THE PROCTER &amp; GAMBLE COMPANY, ONE PROCTER &amp; GAMBLE PLAZA, CINCINNATI, OHIO 45202 US

## Micro Boosters

(540)

(550) I

(740) Lutovac Branislav, Bulevar Crnojevića 93, Podgorica (ME)

(511) **Klasa 03:** Preparati za njegu i higijenu usta, zuba, grla, preparati za njegu i čišćenje zuba, paste za zube, sredstva za ispiranje usta, sprejevi za usta, preparati za pranje i beljenje za upotrebu u pranju veša, preparati za čišćenje kose, kože i tijela, tamjan, ulja za parfeme i mirise, mirišljava voda za upotrebu u domaćinstvu i za upotrebu na tkaninama, eterična ulja.

**Klasa 05:** Osvježivači vazduha, preparati za prečišćavanje vazduha, osvježivači vazduha za sobnu upotrebu, dezodoransi za tkanine i za vazduh, preparati za neutralisanje mirisa.

**Klasa 21:** Četkice za zube, električne četkice za zube, materijali pripremljeni za pravljenje četkica, ne-električni instrumenti i materijali za čišćenje, obuhvaćeni klasom 21, predmeti i posude za domaćinstvo ili kuhinju (ne od plemenitih metala ili prevučeni njima), gorionici za ulja i mirise, aparati za zagrijavanje ulja za parfeme i za ispuštanje mirisa u atmosferu ambijenta, automati i aparati za izdavanje parfimerijskih proizvoda, aparati i posude za ispuštanje mirisa u atmosferu ili za izdavanje parfema, osvježivača ili sredstava za prečišćavanje vazduha u atmosferu ambijenta, staklarska roba, porcelan i grnčarija

(111) 07174

(151) 24.01.2013.

(210) **2010-357**(442) **20.06.2012**

(220) 08.10.2010

(732) TALECRIS BIOTHERAPEUTICS, INC, 79 TW ALEXANDER DRIVE, 4101 RESEARCH COMMONS, RESEARCH TRIANGLE PARK, NORTH CAROLINA 27709 US

## PLASBUMIN

(540)

(550) I

(740) Lutovac Branislav, Bulevar Crnojevića 93, Podgorica (ME)

(511) **Klasa 05:** Farmaceutski preparati uključujući ljudski albumin.

(111) 07175

(151) 24.01.2013.

(210) **2010-358**(442) **20.06.2012**

(220) 11.10.2010

(732) POBJEDA, BULEVAR REVOLUCIJE BR15 PODGORICA ME



(540)

(550) I

(511) **Klasa 16:** Hartija, karton i proizvodi od njih, štampane stvari, knjigovezački materijal, fotografije

**Klasa 35:** Oglašavanje, vođenje poslova, poslovno upravljanje, kancelarijsko poslovanje

**Klasa 41:** Obrazovne usluge, razonoda i kulturne aktivnosti

(111) 07176

(151) 24.01.2013.

(210) **2010-359**(442) **20.06.2012**

(220) 11.10.2010

(732) PLIVA HRVATSKA DOO, PRILAZ BARUNA FILIPOVIĆA 25 10000 ZAGREB HR

## GRAFTOR

(540)

(550) I

(740) Radulović Božidar, Jovana Tomaševića 9/III, Podgorica (ME)

(511) **Klasa 05:** Farmaceutski i veterinarski proizvodi.

(111) 07177

(151) 24.01.2013.

(210) **2010-360**(442) **20.06.2012**

(220) 11.10.2010

(732) PLIVA HRVATSKA DOO, PRILAZ BARUNA FILIPOVICA 25 10 000 ZAGREB HR

## DINAMICO

(540)

(550) I

(740) Radulović Božidar, Jovana Tomaševića 9/III, Podgorica (ME)

(511) **Klasa 05:** Farmaceutski i veterinarski proizvodi.

(111) 07178

(151) 25.01.2013.

(210) **2010-362**(442) **20.06.2012**

(220) 14.10.2010

(732) 13 JUL PLANTAŽE, PUT R IVANOVIĆA, PODGORICA ME



(540) **opisni klasifikaciji:**

(550) I

(511) **Klasa 33:** Alkoholna pića (izuzev piva).

(111) 07179

(151) 24.01.2013.

(210) **2010-373**

(442) **20.06.2012**

(220) 18.10.2010

(300) 19 04 2010 ZIS RS Z-2010-658

(732) SUN STARS & SONS PTE LTD, 51 BUKIT BATOK CRECENT 07-18 UNITY CENTRE, SINGAPORE SG

# OneKey

(540)

(550) I

(740) Radulović Božidar, Jovana Tomaševića 9/III, Podgorica (ME)

(511) **Klasa 16:** Papir i papirni proizvodi, posebno naljepnice i kartonska ambalaža.

**Klasa 32:** Mineralne i gazirane vode, bezalkoholna pića, pivo.

**Klasa 33:** Alkoholna pića.

(111) 07180

(151) 24.01.2013.

(210) **2010-374**

(442) **20.06.2012**

(220) 20.10.2010

(732) FRES & CO DOO, IVANA GORANA KOVAČIĆA 3, 24000 SUBOTICA RS

## NEXT

(540)

(550) I

(740) Popović Miladin, Đoka Miraševića 21/III, Podgorica (ME)

(511) **Klasa 32:** Piva, mineralne i sodne vode i druga bezalkoholna pića, voćna pića i voćni sokovi, sirupi i drugi preparati za pravljenje pića.

---

(111) 07181

(151) 24.01.2013.

(210) **2010-375**

(442) **20.06.2012**

(220) 20.10.2010

(732) DECKERS OUTDOOR CORPORATION, 495-A SOUTH FAIRVIEW AVENUE GOLETA, CALIFORNIA 93117 US

## TEVA

(540)

(550) I

(740) Prelević Dragan, ul. Slobode 74/II, Podgorica (ME)

(511) **Klasa 25:** Jakne, pantalone, kratke pantalone (šortsevi), košulje, džemperi, prsluci, haljine, suknje, donji veš, kupaći kostimi, čarape, šeširi, kape, rukavice, rukavice sa palcem, kaiševi.

---

(111) 07182

(151) 25.01.2013.

(210) **2010-376**

(442) **20.06.2012**

(220) 20.10.2010

(732) DECKERS OUTDOOR CORPORATION, 495-A SOUTH FAIRVIEW AVENUE GOLETA, CALIFORNIA 93117 US

## MUSH

(540)

(550) I

(740) Prelević Dragan, ul. Slobode 74/II, Podgorica (ME)

(511) **Klasa 25:** Obuća, jakne, pantalone, kratke pantalone (šortsevi), košulje, džemperi, prsluci, haljine, suknje, donji veš, kupaći kostimi, čarape, šeširi, kape, rukavice, rukavice sa palcem, kaiševi.

(111) 07183

(151) 25.01.2013.

(210) **2010-377**(442) **20.06.2012**

(220) 21.10.2010

(300) 10/3 735 092 MAY 3,2010 FRANCUSKA

(732) GALLAHER LIMITED, MEMBERS HILL, BROOKLANDS ROAD, WEYBRIDGE SURREY KT13 0QU GB

## SPARKLING

(540)

(550) I

(740) Čejović Vladimir, 13. jula 21, Podgorica (ME)

(511) **Klasa 34:** Duvan, koji je prerađen ili neprerađen, duvan za pušenje, duvan za lule, duvan za savijanje, duvan za žvakanje, duvan za sisanje, cigarete, cigare, cigarilosi, supstance za pušenje koje se prodaju odvojeno ili izmiješane sa duvanom, i koje nijesu za medicinsku ili svrhu liječenja, burmut, artikli za pušače uključeni u klasu 34, papir za cigarete, fišeci za cigarete i šibice.

(111) 07184

(151) 25.01.2013.

(210) **2010-378**(442) **20.06.2012**

(220) 22.10.2010

(732) AVENTISUB II INC, 3711 KENNETT PIKE,SUITE19807 GREENVILLE, DELAWARE US

## FEXOTABS

(540)

(550) I

(740) Čupić Branislav, Dalmatinska 10, Podgorica (ME)

(511) **Klasa 05:** Farmaceutski preparati.

(111) 07185

(151) 25.01.2013.

(210) **2010-382**

(442) **20.06.2012**

(220) 22.10.2010

(732) ENERGY BRANDS INC, 17 20 WHITESTONE EXPRESSWAY, WHITESTONE, NEW YORK 11357 US

## VITAMINWATER

(540)

(550) I

(740) Popović Miladin, Đoka Miraševića 21/III, Podgorica (ME)

(511) **Klasa 03:** Kozmetika.

**Klasa 05:** Nutritivno pojačani losioni, melemi i balsami za usne za medicinske namjene.

**Klasa 16:** Hartija, karton i proizvodi od njih, koji nisu uključeni u druge klase, štampane stvari, knjigovezački materijal, fotografije, kancelarijski materijal, lepila za kancelarijske i kućne potrebe, umetnički materijali, kičice, pisaće mašine i kancelarijski rekviziti (izuzev Namještaja), materijali za obuku i nastavu (izuzev aparata), plastični materijal za pakovanje (koji nije uključen u druge klase), štamparska slova, klišeji.

**Klasa 18:** Koža i imitacija kože, proizvodi izrađeni od ovih materijala koji nisu uključeni u druge klase, životinjska koža, koferi i putne torbe, kišobrani, suncobrani i štapovi za hodanje, bičevi, saračka i sedlarska roba.

**Klasa 21:** Kućne ili kuhinjske sprave i posude (koje nisu od dragocjenih metala ili sa prevlakama od njih), češljevi i sunđeri, četke (izuzev kičica), materijali za pravljenje četki, artikli koji se koriste pri čišćenju, čelična vuna, neprerađeno ili poluprerađeno staklo (osim stakla koje se koristi u građevinarstvu), staklarija, porcelan, fajans, grnčarija i lončarija koja nije uključena u druge klase.

**Klasa 25:** odjeća, obuća, pokrivala za glavu.

**Klasa 32:** Nutritivno pojačana mineralna i gazirana voda, bezalkoholna pića, voćni sok i voćni sokovi, sirupi za proizvodnju pića.

**Klasa 41:** Obrazovne usluge, pripremanje obuke, razonoda, sportske i kulturne aktivnosti.

(111) 07186

(151) 25.01.2013.

(210) **2010-383**

(442) **20.06.2012**

(220) 25.10.2010

(732) TOYOTA JIDOSHA KABUSHIKI KAISHA, 1,TOYOTA-CHO, TOYOTA- SHIAI-CHI JP

## AURIS HSD

(540)

(550) I

(740) Čejović Vladimir, 13. jula 21, Podgorica (ME)

(511) **Klasa 12:** Automobili i njihovi strukturni dijelovi.

(111) 07187

(151) 25.01.2013.

(210) **2010-347**

(442) **20.06.2012**

(220) 06.10.2010

(732) MLADEGS PAK DOO, VIJAKA BB,78430 PRNJAVOR BA



(540)

(550) I

(740) Radulović Božidar, Jovana Tomaševića 9/III, Podgorica (ME)

(511) **Klasa 30:** Začini dodaci hrani.

(111) 07252

(151) 25.01.2013.

(210) **2010-363**

(442) **20.06.2012**

(220) 15.10.2010

(732) THE NORTH FACE APPAREL CORP, 3411 SILVERSIDE ROAD, WILMINGTON, DE 19810 US

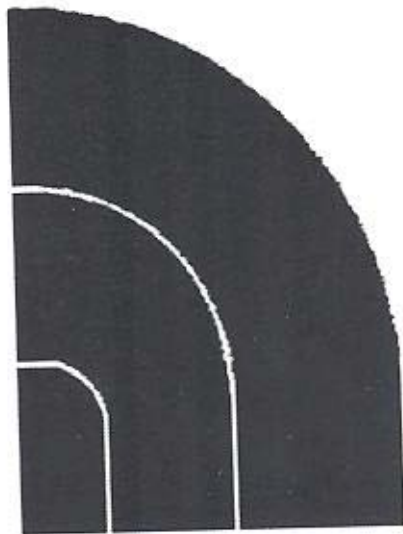

(540)

(550) I

(740) Čosović Dejan, 13. jula 1/5, Budva (ME)

(511) **Klasa 18:** Koža i imitacija kože, proizvodi izradjeni od ovih materijala koji nisu uključeni u druge klase, životinjske kože, krzna, koferi i putne torbe, kišobrani, suncobrani i štapovi za hodanje, bičevi, saračka i sedlarska oprema, naročito torbe za na leđa, torbe i prtljag.

**Klasa 20:** Namještaj, ogledala, okviri za slike, proizvodi (koji nisu obuhvaćeni drugim klasama) od drveta, plute, trske, rogoza, vrbovog pruća, roga, kosti, slonovače, kitove kosti, školjki, ćilibara, sedefa, morske pjene i zamjene svih ovih materijala, ili od plastike, naročito vreće za spavanje.



**Klasa 22:** Užad, kanapi, mreže, šatori, nadstrešnice od cirade, cirade, jedra, vreće i torbe (koji nisu uključeni u druge klase), materijal za punjenje madraca (osim od vune i plastike), sirove vlaknaste tekstilne materije, naročito šatori.

**Klasa 25:** Odjeća, obuća i pokrivala za glavu.

**Klasa 35:** Oglašavanje, poslovni menadžment, usluge poslovne administracije, usluge kancelarijskog poslovanja, naročito tzv. on-line prodaje i prodaje na malo.

(111) 07253

(151) 25.01.2013.

(210) **2010-364**

(442) **20.06.2012**

(220) 15.10.2010

(732) THE NORTHFACE APPAREL CORP, 3411 SILVERSIDE ROAD, WILMINGTON, DE 19810 US



(540) \_\_\_\_\_

(550) I

(740) Čosović Dejan, 13. jula 1/5, Budva (ME)

(511) **Klasa 18:** Koža i imitacija kože, proizvodi izradjeni od ovih materijala koji nisu uključeni u druge klase, životinjske kože, krzna, koferi i putne torbe, kišobrani, suncobrani i štapovi za hodanje, bičevi, saračka i sedlarska oprema, naročito torbe za na leđa, torbe i prtljag.

**Klasa 20:** Namještaj, ogledala, okviri za slike, proizvodi (koji nisu obuhvaćeni drugim klasama) od drveta, plute, trske, rogoza, vrbovog pruća, roga, kosti, slonovače, kitove kosti, školjki, ćilibara, sedefa, morske pjene i zamjene svih ovih materijala, ili od plastike, naročito vreće za spavanje.

**Klasa 22:** Užad, kanapi, mreže, šatori, nadstrešnice od cirade, cirade, jedra, vreće i torbe (koji nisu uključeni u druge klase), materijal za punjenje madraca (osim od vune i plastike), sirove vlaknaste tekstilne materije, naročito šatori.

**Klasa 25:** Odjeća, obuća i pokrivala za glavu.

(111) 07254

(151) 25.01.2013.

(210) **2010-365**

(442) **20.06.2012**

(220) 15.10.2010

(732) THE NORTH FACE APPAREL CORP, 3411 SILVERSIDE ROAD, WILMINGTON, DE 19810 US

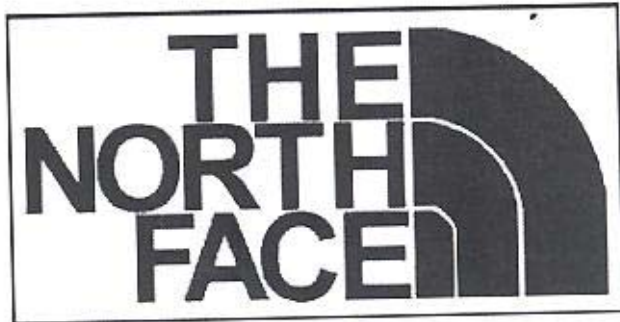

(540)

(550) I

(740) Ćosović Dejan, 13. jula 1/5, Budva (ME)

(511) **Klasa 18:** Koža i imitacija kože, proizvodi izradjeni od ovih materijala koji nisu uključeni u druge klase, životinjske kože, krzna, koferi i putne torbe, kišobrani, suncobrani i štapovi za hodanje, bičevi, saračka i sedlarska oprema, naročito torbe za na leđa, torbe i prtljag.

**Klasa 20:** Namještaj, ogledala, okviri za slike, proizvodi (koji nisu obuhvaćeni drugim klasama) od drveta, plute, trske, rogoza, vrbovog pruća, roga, kosti, slonovače, kitove kosti, školjki, ćilibara, sedefa, morske pjene i zamjene svih ovih materijala, ili od plastike, naročito vreće za spavanje.

**Klasa 22:** Užad, kanapi, mreže, šatori, nadstrešnice od cirade, cirade, jedra, vreće i torbe (koji nisu uključeni u druge klase), materijal za punjenje madraca (osim od vune i plastike), sirove vlaknaste tekstilne materije, naročito šatori.

**Klasa 25:** odjeća, obuća i pokrivala za glavu.

**Klasa 35:** Oglašavanje, poslovni menadžment, usluge poslovne administracije, usluge kancelarijskog poslovanja, naročito tzv. on-line prodaje i prodaje na malo.

(111) 07255

(151) 25.01.2013.

(210) **2010-366**

(442) **20.06.2012**

(220) 15.10.2010

(732) THE NORTH FACE APPAREL CORP, 3411 SILVERSIDE ROAD, WILMINGTON, DE 19810 US



**FLIGHT  
SERIES**

(540)

(550) I

(740) Čosović Dejan, 13. jula 1/5, Budva (ME)

(511) **Klasa 18:** Koža i imitacija kože, proizvodi izradjeni od ovih materijala koji nisu uključeni u druge klase, životinjske kože, krzna, koferi i putne torbe, kišobrani, suncobrani i štapovi za hodanje, bičevi, saračka i sedlarska oprema, naročito torbe za na leđa, torbe i prtljag.

**Klasa 20:** Namještaj, ogledala, okviri za slike, proizvodi (koji nisu obuhvaćeni drugim klasama) od drveta, plute, trske, rogoza, vrbovog pruća, roga, kosti, slonovače, kitove kosti, školjki, ćilibara, sedefa, morske pjene i zamjene svih ovih materijala, ili od plastike, naročito vreće za spavanje.

**Klasa 22:** Užad, kanapi, mreže, šatori, nadstrešnice od cirade, cirade, jedra, vreće i torbe (koji nisu uključeni u druge klase), materijal za punjenje madraca (osim od vune i plastike), sirove vlaknaste tekstilne materije, naročito šatori.

**Klasa 25:** odjeća, obuća i pokrivala za glavu.

(111) 07256

(151) 25.01.2013.

(210) **2010-367**

(442) **20.06.2012**

(220) 15.10.2010

(732) THE NORTH FACE APPAREL CORP, 3411 SILVERSIDE ROAD, WILMINGTON, DE 19810 US



(540)

(550) I

(740) Čosović Dejan, 13. jula 1/5, Budva (ME)

(511) **Klasa 18:** Koža i imitacija kože, proizvodi izradjeni od ovih materijala koji nisu uključeni u druge klase, životinjske kože, krzna, koferi i putne torbe, kišobrani, suncobrani i štapovi za hodanje, bičevi, saračka i sedlarska oprema, naročito torbe za na leđa, torbe i prtljag.

**Klasa 20:** Namještaj, ogledala, okviri za slike, proizvodi (koji nisu obuhvaćeni drugim klasama) od drveta, plute, trske, rogoza, vrbovog pruća, roga, kosti, slonovače, kitove kosti, školjki, ćilibara, sedefa, morske pjene i zamjene svih ovih materijala, ili od plastike, naročito vreće za spavanje.

**Klasa 22:** Užad, kanapi, mreže, šatori, nadstrešnice od cirade, cirade, jedra, vreće i torbe (koji nisu uključeni u druge klase), materijal za punjenje madraca (osim od vune i plastike), sirove vlaknaste tekstilne materije, naročito šatori.

**Klasa 25:** odjeća, obuća i pokrivala za glavu.

(111) 07257

(151) 25.01.2013.

(210) **2010-368**

(442) **20.06.2012**

(220) 15.10.2010

(732) THE NORTH FACE APPAREL CORP, 3411 SILVERSIDE ROAD, WILMINGTON, DE 19810 US

## FLIGHT SERIES

(540)

(550) I

(740) Ćosović Dejan, 13. jula 1/5, Budva (ME)

(511) **Klasa 18:** Koža i imitacija kože, proizvodi izradjeni od ovih materijala koji nisu uključeni u druge klase, životinjske kože, krzna, koferi i putne torbe, kišobrani, suncobrani i štapovi za hodanje, bičevi, saračka i sedlarska oprema, naročito torbe za na leđa, torbe i prtljag.

**Klasa 20:** Namještaj, ogledala, okviri za slike, proizvodi (koji nisu obuhvaćeni drugim klasama) od drveta, plute, trske, rogoza, vrbovog pruća, roga, kosti, slonovače, kitove kosti, školjki, ćilibara, sedefa, morske pjene i zamjene svih ovih materijala, ili od plastike, naročito vreće za spavanje.

**Klasa 22:** Užad, kanapi, mreže, šatori, nadstrešnice od cirade, cirade, jedra, vreće i torbe (koji nisu uključeni u druge klase), materijal za punjenje madraca (osim od vune i plastike), sirove vlaknaste tekstilne materije, naročito šatori.

**Klasa 25:** odjeća, obuća i pokrivala za glavu.

---

(111) 07258

(151) 25.01.2013.

(210) **2010-369**

(442) **20.06.2012**

(220) 15.10.2010

(732) THE NORTH FACE APPAREL CORP, 3411 SILVERSIDE ROAD, WILMINGTON, DE 19810 US

## SUMMIT SERIES

(540)

(550) I

(740) Ćosović Dejan, 13. jula 1/5, Budva (ME)

(511) **Klasa 18:** Koža i imitacija kože, proizvodi izradjeni od ovih materijala koji nisu uključeni u druge klase, životinjske kože, krzna, koferi i putne torbe, kišobrani, suncobrani i štapovi za hodanje, bičevi, saračka i sedlarska oprema, naročito torbe za na leđa, torbe i prtljag.

**Klasa 20:** Namještaj, ogledala, okviri za slike, proizvodi (koji nisu obuhvaćeni drugim klasama) od drveta, plute, trske, rogoza, vrbovog pruća, roga, kosti, slonovače, kitove kosti, školjki,

ćilibara, sedefa, morske pjene i zamjene svih ovih materijala, ili od plastike, naročito vreće za spavanje.

**Klasa 22:** Užad, kanapi, mreže, šatori, nadstrešnice od cirade, cirade, jedra, vreće i torbe (koji nisu uključeni u druge klase), materijal za punjenje madraca (osim od vune i plastike), sirove vlaknaste tekstilne materije, naročito šatori.

**Klasa 25:** odjeća, obuća i pokrivala za glavu.

(111) 07259

(151) 25.01.2013.

(210) **2010-370**

(442) **20.06.2012**

(220) 15.10.2010

(732) THE NORTH FACE APPAREL CORP, 3411 SILVERSIDE ROAD, WILMINGTON, DE 19810 US

## THE NORTH FACE

(540)

(550) I

(740) Ćosović Dejan, 13. jula 1/5, Budva (ME)

(511) **Klasa 18:** Koža i imitacija kože, proizvodi izradjeni od ovih materijala koji nisu uključeni u druge klase, životinjske kože, krzna, koferi i putne torbe, kišobrani, suncobrani i štapovi za hodanje, bičevi, saračka i sedlarska oprema, naročito torbe za na leđa, torbe i prtljag.

**Klasa 20:** Namještaj, ogledala, okviri za slike, proizvodi (koji nisu obuhvaćeni drugim klasama) od drveta, plute, trske, rogoza, vrbovog pruća, roga, kosti, slonovače, kitove kosti, školjki, ćilibara, sedefa, morske pjene i zamjene svih ovih materijala, ili od plastike, naročito vreće za spavanje.

**Klasa 22:** Užad, kanapi, mreže, šatori, nadstrešnice od cirade, cirade, jedra, vreće i torbe (koji nisu uključeni u druge klase), materijal za punjenje madraca (osim od vune i plastike), sirove vlaknaste tekstilne materije, naročito šatori.

**Klasa 25:** odjeća, obuća i pokrivala za glavu.

**Klasa 35:** Oglašavanje, poslovni menadžment, usluge poslovne administracije, usluge kancelarijskog poslovanja, naročito tzv. on-line prodaje i prodaje na malo.

(111) 07260

(151) 25.01.2013.

(210) **2010-371**

(442) **20.06.2012**

(220) 15.10.2010

(732) THE NORTH FACE APPAREL CORP, 3411 SILVERSIDE ROAD, WILMINGTON, DE 19810 US

## NEVER STOP EXPLORING

(540)

(550) I

(740) Ćosović Dejan, 13. jula 1/5, Budva (ME)

(511) **Klasa 18:** Koža i imitacija kože, proizvodi izradjeni od ovih materijala koji nisu uključeni u druge klase, životinjske kože, krzna, koferi i putne torbe, kišobrani, suncobrani i štapovi za hodanje, bičevi, saračka i sedlarska oprema, naročito torbe za na leđa, torbe i prtljag.

**Klasa 20:** Namještaj, ogledala, okviri za slike, proizvodi (koji nisu obuhvaćeni drugim klasama) od drveta, plute, trske, rogoza, vrbovog pruća, roga, kosti, slonovače, kitove kosti, školjki, ćilibara, sedefa, morske pjene i zamjene svih ovih materijala, ili od plastike, naročito vreće za spavanje.

**Klasa 22:** Užad, kanapi, mreže, šatori, nadstrešnice od cirade, cirade, jedra, vreće i torbe (koji nisu uključeni u druge klase), materijal za punjenje madraca (osim od vune i plastike), sirove vlaknaste tekstilne materije, naročito šatori.

**Klasa 25:** odjeća, obuća i pokrivala za glavu.

**Klasa 35:** Oglašavanje, poslovni menadžment, usluge poslovne administracije, usluge kancelarijskog poslovanja, naročito tzv. on-line prodaje i prodaje na malo.

(111) 07386

(151) 14.02.2013.

(210) **2010-311**

(442) **20.06.2012**

(220) 03.09.2010

(732) MERCK SHARP & DOHME CORP, ONE MERCK DRIVE, WHITEHOUSE STATION, NEW JERESY 08889-0100 US

## JENZYL

(540)

(550) I

(740) Ćupić Branislav, Dalmatinska 10, Podgorica (ME)

(511) **Klasa 05:** Farmaceutski preparati.

(111) 07039

(151) 25.01.2013.

(210) **Ž 2009-5**

(442) **20.03.2012**

(220) 14.01.2009

(300) 07.10.2007 Z-2442/2007 RS

(732) DIAGEO IRELAND; ST. JAMES S GATE DUBLIN 8 IE

## GUINNESS

(540)

(550) I

(740) Čejović Vladimir, 13. jul 21, Podgorica (ME)

(511) **Klasa 32:** Piva; ale, stout i porter; mineralne i gazirane vode i ostala negazirana pića; voćni napitci i voćni sokovi; sirup i ostali preparati za spravljanje pića.**Klasa 33:** Pića sa niskim procentom alkohola.

(111) 07040

(151) 04.02.2013.

(210) **2009-218**(442) **20.06.2012**

(220) 29.04.2009

(732) CRNOGORSKI TELEKOM AD, UL MOSKOVSKA BR 29 PODGORICA ME

T-Mobile  
tako blizu

(540)

(550) I

(740) Đurović Pavle, ul Moskovska br 29, Podgorica (ME)

(511) **Klasa 38:** Telekomunikacijske usluge koje omogućavaju najmanje jednom licu da komunicira sa drugim koristeći čula (da međusobno razgovaraju, da prenose poruke) usluge stavljanja lica u položaj vizuelne ili govorne komunikacije sa drugim usluge prenosa podataka usluge koje sadrže difuziju radio ili televizijskih programa,**Klasa 41:** Obrazovne usluge pripremanje obuke razonoda sportske i kulturne aktivnosti, usluge koje pružaju lica ili institucije u razvijanju mentalnih sposobnosti drugih lica (obrazovanje) ili životinja (obuka, dresiranje) usluge kojima je cilj zabavljanje drugih lica, privlačenje pažnje, rekreacija organizovanje (priređivanje) i vođenje seminara, konferencija, kongresa organizovanje izložbi i kulturne i obrazovne svrhe, sportskih takmičenja, izdavanje tekstova i knjiga,

(111) 07041

(151) 04.02.2013.

(210) **2009-219**(442) **20.06.2012**

(220) 29.04.2009

(732) CRNOGORSKI TELECOM AD, UL MOSKOVSKA BR 29 PODGORICA ME

T-Com  
Sve u mojoj kući!

(540)

(550) I

(740) Đurović Pavle, ul Moskovska br 29, Podgorica (ME)

(511) **Klasa 38:** Telekomunikacijske usluge koje omogućavaju najmanje jednom licu da komunicira sa drugim koristeći čula (da međusobno razgovaraju, da prenose poruke) usluge stavljanja lica u položaj vizuelne ili govorne komunikacije sa drugim uslugama prenosa podataka usluge koje sadrže difuziju radio ili televizijskih programa,

**Klasa 41:** Obrazovne usluge pripremanje obuke razonoda sportske i kulturne aktivnosti, usluge koje pružaju lica ili institucije u razvijanju mentalnih sposobnosti drugih lica (obrazovanje) ili životinja (obuka, dresiranje) usluge kojima je cilj zabavljanje drugih lica, privlačenje pažnje, rekreacija organizovanje (priređivanje) i vođenje seminara, konferencija, kongresa organizovanje izložbi i kulturne i obrazovne svrhe, sportskih takmičenja, izdavanje tekstova i knjiga,

(111) 07042

(151) 04.02.2013

(210) **2009-221**

(442) **20.06.2012**

(220) 29.04.2009

(732) CRNOGORSKI TELECOM AD, UL MOSKOVSKA BR 29 PODGORICA ME

**T · · Com ·**  
Sve u mojoj kući!

(540)

(550) I

(740) Đurović Pavle, ul Moskovska br 29, Podgorica (ME)

(511) **Klasa 38:** Telekomunikacijske obuhvata, usluge koje omogućavaju najmanje jednom licu da komunicira sa drugim koristeći čula (da međusobno razgovaraju, da prenose poruke) usluge stavljanja lica u položaj vizuelne ili govorne komunikacije sa drugim uslugama prenosa podataka usluge koje sadrže difuziju radio ili televizijskih programa

**Klasa 41:** Obrazovne usluge pripremanje obuke razonoda sportske i kulturne aktivnosti. obuhvata, usluge koje pružaju lica ili instalacije u razvijanju mentalnih sposobnosti drugih lica (obrazovanje) ili životinja (obuka, dresiranje) usluge kojima je cilj zabavljanje drugih lica, privlačenje pažnje, rekreacija organizovanje (priređivanje) i vođenje seminara, konferencija, kongresa organizovanje izložbi i kulturne i obrazovne svrhe, sportskih takmičenja, izdavanje tekstova i knjiga, telekom usluge - fiksne i mobilne, prenos i emitovanje radio i televizijskih programa, izdavanje i umnožavanje snimljenih zvučnih i video zapisa, obezbjeđivanje internet servisa, proizvodnja elektronskih komponenti, opšti i građevinski radovi i radovi specijalizovanih građevinskih struka, gradnja javne telekomunikacijske mreže, objekata i drugi građevinski radovi, električne i druge instalacije, posredovanje pri prodaji raznih proizvoda, drugatrgovina naveliko, trgovina na malo, obrada podataka, djelatnosti povezane s bazama podataka, savjetovanje iz oblasti telekomunikacija i informatike, održavanje i opravka uređaja i opreme, druge računarske djelatnosti, istraživanje i eksperimentalni razvoj na području telekomunikacione tehnologije, tehničke probe i analize, projektovanje, izgradnja, rekonstrukcija i održavanje telekomunikacionih objekata i opreme, obuka kadrova za potrebe telekomunikacija, davanje objekata i opreme u zakup, usluge reklame i ekonomske propagande, usluge ispitivanja tržišta, poslovi iz oblasti spoljne



trgovine, komercijalni poslovi na ostvarivanju prometa roba i usluga, inženjering.

---

(111) 07043 (151) 25.01.2013.  
 (210) **2009-427** (442) **20.06.2012**  
 (220) 24.06.2009  
 (732) AMERICAN INTERNATIONAL GROUP INC, 70 PINE STREET, NEW YORK, NY 10270 US  
 (540)  
 (550) I  
 (740) Ćupić Branislav, Dalmatinska 10, Podgorica (ME)  
 (511) **Klasa 39:** Iznajmljivanje novih i korišćenih letilica, brokerstvo i usluge posredovanja u oblasti korišćenih letilica, usluge distributerstva u oblasti novih i korišćenih letilica.

---

(111) 07048 (151) 25.01.2013.  
 (210) **2009-452** (442) **20.06.2012**  
 (220) 15.07.2009  
 (732) DUNHILL TOBACCO OF LONDON LIMITED, 1A ST.JAMES STREET, LONDON, SW1A JEF GB

## NANOCUT

(540)  
 (550) I  
 (740) Popović Miladin, Đoka Miraševića 21/III, Podgorica (ME)  
 (511) **Klasa 34:** Cigarete.

---

(111) 07049 (151) 25.01.2013.  
 (210) **2009-454** (442) **20.06.2012**  
 (220) 15.07.2009  
 (732) GECOMEWERT ANSTALIT,C/O SCHREIBER ZINDEL, KIRCHSTRASSE 39,9490 VADUZ CH

## CRESCINA RE-GROWTH

(540)  
 (550) I  
 (740) Čejović Vladimir, 13. jula 21, Podgorica (ME)  
 (511) **Klasa 3:** Preparati za čišćenje i poliranje, sapuni, parfimerija, eterična ulja, kozmetika, preparati za njegu kože, losioni za kosu, paste za zube.  
**Klasa 5:** Farmaceutski i veterinarski proizvodi sanitarni preparati za medicinsku upotrebu farmaceutski proizvodi za njegu kože dijetetske supstance prilagođene za upotrebu u medicini, hrana za bebe, materijali za plombiranje zuba, zubarska smola, fungicidi.

---

(111) 07050 (151) 25.01.2013.  
 (210) **2009-458** (442) **20.06.2012**  
 (220) 17.07.2009  
 (732) DANHILL TOBACCO OF LONDON LIMITED, 1A ST JAMES STREET, LONDON, SW1A IEF GB

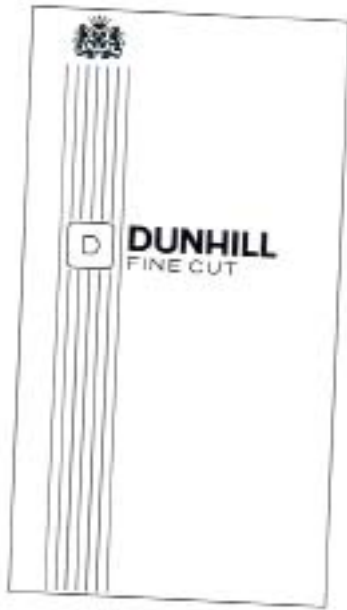

(540)

(550) I

(740) Popović Miladin, Đoka Miraševića 21/III, Podgorica (ME)

(511) **Klasa 34:** Cigarete, cigare, cigarilosi, duvan za uvijanje, duvan za lule, duvanski proizvodi.

(111) 07051

(151) 25.01.2013.

(210) **2009-493**

(442) **20.06.2012**

(220) 06.08.2009

(732) MOTOROLA INC A, DELAWARE CORPORATION, 1303 E. ALGONGUIN ROAD, SCHAUMBURG, IL 60196 US

(540)

(550) I

(740) Čejović Vladimir, 13. jula 21, Podgorica (ME)

Čupić Branislav, Dalmatinska 10, Podgorica (ME)

(511) **Klasa 9:** mobilni telefoni mobilni telefoni sa mogućnošću slanja i primanja elektronskih poruka mobilni telefoni sa digitalnim fotoaparatom i video kamerom mobilni telefoni sa MP3, audio i video plejerom mobilni telefoni sa elektronskim igricama mobilni telefoni sa mogućnošću GPS-a i navigacije uređaji za bežičnu komunikaciju sa mogućnošću prenosa glasa, podataka i slike baterije za mobilne telefone punjači za baterije i adapteri za struju.

(111) 07052

(151) 25.01.2013.

(210) **2009-511**

(442) **20.06.2012**

(220) 13.08.2009

(732) YILDIZ HOLDING A.S, KISIKLI MAH.FERAH CAD.CESME SK.NO.2/4 B.CAMLICA, USKUDAR ISTANBUL TR



(540)

(550) I

(740) Čejović Vladimir, 13. jula 21, Podgorica (ME)

(511) **Klasa 30:** Kafa, čaj, kakao, šećer, pirinač, tapioka, sago, zamjena kafe brašno i proizvodi od žitarica, hljeb, kolači i poslastice, čokolade, čokoladni proizvodi i čokoladice, biskviti, punjeni i preliveni biskviti keks, kolači, oblande, bomboni, med, melasa kvasac, prašak za pecivo so, senf sirće, sosovi (kao začini) začini sladoledi, led.

(111) 07069

(151) 28.01.2013.

(210) **2010-434**(442) **20.06.2012**

(220) 22.11.2010

(732) PURE FISHING, INC, 1900 18 TH STREET, 51360 SPIRT LAKE, LOWA US

# SPIDER

(540)

(550) I

(740) Radulović Božidar, Jovana Tomaševića 9/III, Podgorica (ME)

(511) **Klasa 28:** Ribarski pribor.

(111) 07070

(151) 25.01.2013.

(210) **2010-440**(442) **20.06.2012**

(220) 06.12.2010

(732) WIENER STADTISCHE ŽIVOTNO OSIGURANJE AD, BULEVAR REVOLUCIJE 50/1 PODGORICA ME



(540)

(550) I

(511) **Klasa 36:** Osiguranje usluge koje se bave osiguranjem kao što su usluge koje pružaju agenti ili broker uključeni u osiguranje, usluge koje se pružaju osiguranim licima i usluge koje podrazumijevaju osiguranje.

(111) 07071

(151) 25.01.2013.

(210) **2010-441**(442) **20.06.2012**

(220) 07.12.2010

(732) CHOICE HOTELS INTERNATIONAL, INC, 10750 COLUMBIA PIKE, SILVER SPRING, MARYLAND 20901 US

## CHOICE HOTELS

(540)

(550) I

(740) Čejović Vladimir, 13. jula 21, Podgorica (ME)

(511) **Klasa 43:** Hotelske i motelske usluge, usluge rezervacija hotela i motela za druge usluge rezervacija hotela i motela za druge putem interneta.

(111) 07156

(151) 25.01.2013.

(210) **2010-117**(442) **20.06.2012**

(220) 16.04.2010

(732) REXAIR LLC, 50 W BIG BEAVER ROAD, SUITE 350, TROY, MICHIGAN 48084 US



(540)

(550) I

(740) Čejović Vladimir, 13. jula 21, Podgorica (ME)

(511) **Klasa 07:** Mašine i mašinski alati motori i pogonske mašine (osim za suvozemna vozila) mašinske spojnice i transmisioni elementi (osim za suvozemna vozila) poljoprivredne sprave koje nijesu za menu upotrebu inkubatori za jaja usisivači, električni čistači za poliranje podova, električne mašine za čišćenje tepiha i presvlaka, električni ekstraktori na vodu, kao i djelovi i dodaci za iste cijevi za usisivač, papučice za usisivač i četke za usisivač.

**Klasa 37:** Građevinsko konstruisanje, popravljjanje usluge instaliranja popravka i održavanje usisivača, električnih čistača za poliranje podova, električnih mašina za čišćenje tepiha i presvlaka i električnih ekstraktora na vodu konsultanske usluge u vezi sa usisivačima, električnim čistačima za poliranje podova, električnim mašinama za čišćenje tepiha i presvlaka, električnim ekstraktorima na vodu.

(111) 07189

(151) 25.01.2013.

(210) **2010-400**

(442) **20.06.2012**

(220) 01.11.2010

(732) NUTCASE INC, 6224 SE MAIN STREET, PORTLAND, OREGON 97215 US

## NUTCASE

(540)

(550) I

(740) Čosović Dejan, 13. jula 1/5, Budva (ME)

(511) **Klasa 09:** Zaštitne kacige za sportove, kacige za biciklizam, kacige za skejting, kacige za snoubord, kacige za kajakarenje, kacige za penjanje po stijenama, kacige za motocikle, kacige za jahanje, zaštitne kacige za slučaj nesreće, pancir kacige, kacige za igre s loptom, kacige za pintbal sigurnosne kacige.

(111) 07131

(151) 25.01.2013.

(210) **2010-432**

(442) **20.06.2012**

(220) 22.11.2010

(732) PURE FISHING INC, 1900 18 TH STREET, 51360 SPIRT LAKE, LOWA US

# BERKLEY

(540)

(550) I

(740) Radulović Božidar, Jovana Tomaševića 9/III, Podgorica (ME)

(511) **Klasa 28:** Ribarski pribor.

(111) 07073

(151) 25.01.2013.

(210) **2010-445**

(442) **20.06.2012**

(220) 09.12.2010

(732) JONES INVESTMENT CO.INC, 1007 ORANGE STREET, SUITE 225 WILMINGTON, DELAWARE 19801 US

# AK ANNE KLEIN

(540)

(550) I

(740) Radulović Božidar, Jovana Tomaševića 9/III, Podgorica (ME)

(511) **Klasa 18:** Koža i imitacije kože, proizvodi izrađeni od ovih materijala koji nisu uključeni u druge klase životinjska koža, krzno koferi i putne torbe kišobrani, suncobrani i štapovi za hodanje bičevi, saračka i sedlarska roba naročito ručne torbe i mali kožni proizvodi.

**Klasa 25:** odjeća, obuća, pokrivala za glavu naročito kaiševi, bluže, majice na bretele, kaputi, cipele, čizme, sandale, papuče, rukavice, jakne, čarape (i tanke i obične), mufovi, pantalone, marame, majice, suknje, šalovi, odjevni predmeti za spavanje, kratke čarape, kupaći kostimi i prsluci.

**Klasa 35:** Oglašavanje vođenje poslova poslovno upravljanje kancelarijski poslovi naročito usluge u vezi sa prometom robe

(111) 07074

(151) 28.01.2013.

(210) **2010-464**

(442) **20.06.2012**

(220) 17.12.2010

(732) BELUPO LJEKOVI I KOZMETIKA DD, DANICA 5,48000 KOPRIVNICA HR

# MONLAST

(540)

(550) I

(740) Popović Miladin, Đoka Miraševića 21/III, Podgorica (ME)

(511) **Klasa 05:** Farmaceutski proizvodi.

(111) 07075

(151) 25.01.2013.

(210) **2010-468**(442) **20.06.2012**

(220) 21.12.2010

(732) RED BULL GMBH, AM BRUNNEN 1,5330 FUSCHL, AM SEE AT

## CRVENI BIK

(540)

(550) I

(740) Ćupić Branislav, Dalmatinska 10, Podgorica (ME)

(511) **Klasa 32:** Bezalkoholni napitci uključujući osvježavajuća pića energetska pića, napitci od surutke izotonična, hipertonična i hipotonična pića (koja koriste sportisti i/ili za potrebe sportista) pivo, pivo od slada, pivo od žita, tamno (porter) pivo, svijetlo (ale) pivo, stout pivo, lager pivo bezalkoholni napitci od slada, mineralna voda i sodne vode voćni napitci i voćni sokovi sirupi, esencije i drugi preparati za proizvodnju pića kao i pjenušajuće tablete i pjenušajući praškovi za pića i bezalkoholne koktele.

(111) 07194

(151) 28.01.2013.

(210) **2010-471**(442) **20.06.2012**

(220) 22.12.2010

(732) GLAXO GROUP LIMITED, GLAXO WELLCOME HOUSE, BERKELEY AVENUE, GREENFORD, MIDDLESEX, UB6 0NN GB

## COLDREX

(540)

(550) I

(740) Popović Miladin, Đoka Miraševića 21/III, Podgorica (ME)

(511) **Klasa 05:** Farmaceutski preparati za ljudsku upotrebu.

(111) 07198

(151) 28.01.2013.

(210) **2009-407**(442) **20.06.2012**

(220) 02.06.2009

(732) THE GILLETTE COMPANY, PRUDENTIAL TOWER BUILDING, BOSTON, MASSACHUSETTS 02199 US

## OCEANA

(540)

(550) I

(740) Lutovac Branislav, Bulevar Crnojevića 93, Podgorica (ME)

(511) **Klasa 08:** Brijači za jednokratnu upotrebu.

(111) 07044

(151) 25.01.2013.

(210) **2009-434**(442) **20.06.2012**

(220) 26.06.2009

(732) BVS COMMERCE SYSTEM DOO, SAVE KOVAČEVIĆA BR 22, HERCEG NOVI ME



(540)

(550) I

(740) Božović Vesko, Rimski trg 50/11, Podgorica (ME)

(511) **Klasa 25:** Odjeća, obuća, pokrivala za glavu.

(111) 07045

(151) 25.01.2013.

(210) **2009-435**(442) **20.06.2012**

(220) 26.06.2009

(732) DIAGEO NORTH AMERICA INC, 801 MAIN AVENUE, NORWALK, CONNECTICUT 06851 US



(540)

(550) I

(740) Čejović Vladimir, 13. jula 21, Podgorica (ME)

(511) **Klasa 33:** Alkoholna pića.

(111) 07046

(151) 25.01.2013.

(210) **2009-448**(442) **20.06.2012**

(220) 09.07.2009

(732) NITES DOO BANJA LUKA, UL PETRA KOČIĆA 41 78000 BANJA LUKA BA





(540)

(550) I

(740) Božović Vesko, Rimski trg 50/11, Podgorica (ME)

(511) **Klasa 9:** Aparati i instrumenti naučni, pomorski, geodetski, fotografski, kinemato-grafski, optički, za vaganje, mjerenje, signalizaciju, kontrolu (inspekciju), spa[avanje i nastavu aparati i instrumenti za provođenje, prekid, transformaciju, akumulaciju, regulisanje i kontrolu elektriciteta aparati za snimanje, prenos i reprodukovanje zvuka ili slike magnetni nosioci podataka, diskovi za snimanje automatske mašine i mehanizmi za aparate koji se pokreću novcem ili žetonom registar kase, računске mašine, oprema za obradu podataka i kompjuteri aparati za gašenje požara.

**Klasa 35:** Oglašavanje vođenje poslova poslovno upravljanje kancelarijski poslovi.

**Klasa 38:** Telekomunikacije.

**Klasa 42:** Naučne i tehnološke usluge i istraživanje i projektovanje u vezi navedenih usluga usluge industrijske analize i istraživanja projektovanje i razvoj kompjuterskog hardvera i softvera pravne usluge.

(111) 07047

(151) 25.01.2013.

(210) **2009-450**(442) **20.06.2012**

(220) 10.07.2009

(732) TDR DOO, OBALA V. NAZORA BR 1 52210 ROVINJ HR



(540)

(550) I

(740) Vukotić Petar, Novaka Miloševa, Podgorica (ME)

(511) **Klasa 34:** duvan sirov i prerađen, proizvodi od duvana, cigare cigarete, filter cigarete, cigarilosi i tompos cigare, zamjena za duvan koji nije u upotrebi u medicini, artikli za pušače koji nisu od plemenitih metala, šibice.

**Klasa 35:** usluge u vezi sa prometom robe, posebno usluge u prometu duvana i duvanskih proizvoda oglašavanje vođenje poslova poslovno upravljanje kancelarijski poslovi komercijalno zastupanje propagandne i reklamne usluge marketing usluge ispitivanja tržišta usluge promocije, posebno promovisanje ili reklamiranje kulturnih i zabavnih događaja, sportskih takmičenja i modnih revija organizovanje i vođenje sajмова i izložbi u komercijalne ili reklamne svrhe naprijed navedene usluge koje pripadaju ovoj klasi koje se obavljaju putem interneta davanje i širenje informacija u vezi sa navedenim uslugama izlaganje različite robe na jednom mjestu uključujući duvan sirov i prerađen, proizvode od duvana, cigare i cigarete, filter cigarete cigarilose i tompos cigare, zamjene za duvan koji nisu u upotrebi u medicini, artikle za pušače koji nisu od plemenitih metala, šibice omogućavanje potrošačima pogodno za razgledanje i kupovinu gore navedene robe u maloprodajnim radnjama.

(111) 07199

(151) 25.01.2013.

(210) **2009-488**

(442) **20.06.2012**

(220) 05.08.2009

(732) KARBON-NOVA DOO SARAJEVO, LUKAVIČKA CESTA BR 2 71000 SARAJEVO BA

## SIPROKOL

(540)

(550) I

(740) Radulović Božidar, Jovana Tomaševića 9/III, Podgorica (ME)

(511) **Klasa 01:** ljepila (ljepljive materije) namijenjene za industriju.

(111) 06821

(151) 25.01.2013.

(210) **2009-495**

(442) **20.06.2012**

(220) 07.08.2009

(732) FREMANTLEMEDIA LIMITED, 1 STEPHEN STREET, LONDON W1T 1AL V.B.SIMCO LIMITED BEDFORD HOUSE, 69-79 FULHAM HIGH STREET, LONDON, SW6 3JW V B, GB

## JA IMAM TALENAT!

(540)

(550) I

(740) Popović Miladin, Đoka Miraševića 21/III, Podgorica (ME)

(511) **Klasa 09:** kinematografski filmovi crtani filmovi dijafilmovi filmovi magnetni zapisi optički zapisi magnetno-optički zapisi zapisi na čvrstim podlogama audio-vizuelni aparati za nastavu aparati za zabavu adaptirani za upotrebu uz televizore elektronske knjige i publikacije elektronske igrice interaktivne igrice adaptirane za upotrebu uz televizore električni i video aparati i instrumenti za zabavu multimedijalni diskovi i publikacije multimedijalni zapisi i publikacije laserski čitljivi diskovi video diskovi i publikacije kompjuterski softver

kompjuterski programi kompjuterske igrice softveri za interaktivne igrice za kompjutere, mobilne telefone i uređaje kojima se manualno rukuje digitalni zapisi mediji za čuvanje ili snimanje zvuka i/ili video zapisa i/ili podataka i/ili informacija aparati i instrumenti za snimanje i/ili reprodukovanje zvuka i/ili video zapisa i/ili informacija hologrami flopi diskovi zvučni zapisi presnimljeni diskovi snimljeni diskovi kompakt diskovi gramofonske ploče audio kasete kasete video kasete laserski diskovi kompakt diskovi-interaktivni CD ROM-ovi digitalni video diskovi (DVD) aparati i instrumenti za komunikaciju telefoni mobilni telefoni punjači punjači za mobilne telefone hands-free aparati za mobilne telefone igrice za mobilne telefone karaoke mašine djelovi i oprema za svu gorenavedenu robu digitalne igrice, igrice za mobilne telefone DVD igrice.

**Klasa 38:** emitovanje televizijskog programa emitovanje radio programa emitovanje programa satelitske televizije emitovanje programa kablovske televizije telefonske komunikacije interaktivne telefonske usluge, usluge telefonskih poruka komunikacijske usluge putem radio talasa, telefona, Interneta, svetskog pretraživača, kablovskim putem, putem satelita, mikrotalasa i električnih mreža telefonija.

**Klasa 41:** usluge obrazovanja i razonode u formi televizijskih programa, radio programa, kablovskih, satelitskih i Internet programa produkcija i prezentacija radio i televizijskog programa, kinematografskih filmova, predstava, video programa, DVD programa, kablovskih programa, satelitskih programa i/ili Internet programa usluge organizovanja predstava iznajmljivanje zvučnih zapisa i prethodno snimljenih predstava, filmova, radio i televizijskih performansa produkcija video kasete i video diskova usluge zabave putem radija usluge zabave putem televizije usluge zabave putem bioskopa usluge zabave putem pozorišta zabavne emisije koje uključuju igru (takmičenje) usluge razonode putem televizije koje uključuju i učestvovanje gledalaca putem telefona interaktivna razonoda uz upotrebu mobilnog telefona igrice bazirane na Internetu usluge organizovanja lotoa i igara na sreću usluge pružanja zabave putem igrica usluge igre usluge klađenja usluge opklada usluge kazina usluge organizovanja igara sa kartama i kazino turnira, takmičenja, nadmetanja, igara i/ili događaja lutrija omogućavanje bilo koje gore navedene usluge na mobilnim telefonima putem mreže mobilne telefonije, satelitskom komunikacijom, mikrotalasima ili drugim elektronskim, digitalnim i analognim medijom, uživo, elektronski, putem kompjuterske mreže, putem interneta, online ili putem televizijskog medija organizovanje, produkcija i prezentacija događaja u obrazovne, kulturne ili zabavne svrhe organizovanje, produkcija, upravljanje i prezentacija takmičenja, nadmetanja, igara, predstava koje uključuju igru, kvizova, dana zabave, izložbi, predstava, parada na točkovima (roadshows) predstava na podijumima, rejvova, pozorišnih performansa, koncerata, performansa uživo i događaja u kojima se može učestvovati usluge obezbjeđivanja organizacije video klipova putem mobilne telefonije ili kompjuterske mreže za zabavu i/ili u obrazovne svrhe

---

(111) 07197	(151) 28.01.2013.
(210) <b>2009-49</b>	(442) <b>20.06.2012</b>
	(220) 28.01.2009
(732) Kolarević Ana, Bulevar Sv. Petra 149, Podgorica (ME)	



**ADVOKAT  
LAWYER**

*Ana Kolarević*

tel/fax: +381 81 205 420  
Bulevar Lenjina zgrada 1/3  
ulaz 2. sprat II  
81000 Podgorica  
Montenegro

(540)

(550) I

(511) **Klasa 35:** Oglašavanjevođenje poslova poslovno upravljanje kancelarijski poslovi.

**Klasa 38:** Telekomunikacije.

**Klasa 42:** naučne i tehnološke usluge i istraživanje i oglašavanje vođenje poslova, poslovno projektovanje u vezi navedenih usluga, usluge industrijske analize i istraživanja projektovanje i razvoj kompjuterskog hardvera i softvera.

**Klasa 45:** pravne usluge, usluge obezbjeđenja radi zaštite imovine i lica, individualne i društvene usluge koje pružaju drugi, radi zadovoljavanja potreba pojedinaca.

(111) 06850

(151) 25.01.2013.

(210) **2010-119**

(442) **20.06.2012**

(220) 21.04.2010

(732) GALLAHER LIMITED, MEMBERS HILL, BROKLANDS ROAD, WEYBRIDGE SURREY KT13 0QU GB



(540)

(550) I

(740) Čejović Vladimir, 13. jula 21, Podgorica (ME)

(511) **Klasa 34:** Duvan, koji je prerađen ili neprerađen, duvan za pušenje, duvan za lule, duvan za savijanje, duvan za žvakanje, duvan za sisanje, cigarete, cigare, cigarilosi, supstance za pušenje koje se prodaju odvojeno ili izmiješane sa duvanom, i koje nijesu za medicinsku ili svrhu liječenja, burmut, artikli za pušače uključeni u klasu 34, papir za cigarete, fišeci za cigarete i šibice.

(111) 07144

(151) 25.01.2013.

(210) **2010-396**

(442) **20.06.2012**

(220) 27.10.2010

(732) EDENRED, 166-180 BOULEVARD GABRIEL PERI, 92240 MALAKOFF FR

## EDENRED

(540)

(550) I

(740) Čejović Vladimir, 13. jula 21, Podgorica (ME)

(511) **Klasa 09:** Magnetne, kodirane, optičke kartice ili kartice sa integrisanim kolom (smart kartice), sa kontaktom ili bez kontakta (radio frekvencija, infracrvene ili druge), jednokratne ili punjive, mogu se koristiti kao pre-paid ili post-paid, koje mogu sadržati jedan ili više elektronskih novčanika, važe za sve vrste aplikacija, a pogotovu za kontrolu fizičkog pristupa, kontrolu pristupa kompjuterskim sistemima, kontrolu loyalty kartica, software-a za obradu komercijalne (kupovne) narudžbenice, software za obradu informacija, software za kreiranje, upravljanje, ažuriranje i korištenje baza podataka, software za obezbjeđenje pristupa elektronskim servisima za slanje poruka, software za obezbjeđenje pristupa kompjuterskoj mreži ili mreži za prenos podataka, pogotovu svjetskoj komunikacionoj mreži (kao što je Internet), kompjuterski serveri, kompjuterski, telematski i telefonski terminali, a naročito za svjetsku komunikacionu mrežu (kao što je Internet) ili privatne mreže i mreže za rezervisanim pristupom (kao što je Intranet), kompjuterski periferni uređaji kao što su kompjuterski ekrani, modemi, konektori na komunikacionu mrežu, naročito kompjutersku i telefonsku mrežu, komunikaciona oprema za prijem i prenos, interaktivni kompjuterski uređaji, kompjuterske mreže, a naročito lokalne kompjuterske mreže, naime oprema za obradu informacija, software (snimljeni programi), elektronske publikacije (koje se mogu preuzimati).

**Klasa 16:** Štampani materijali kao što su časopisi, novine, prospekti, vodiči, brošure, znamenja, kartice, karte, kuponi, kancelarijski materijal i rekviziti (osim namještaja).

**Klasa 35:** Menadžment (računovodstvo, administracija), analiza, obrada dematerijalizovanih i sigurnosnih komercijalnih informacija koje se odnose na oblasti hotelske industrije, restorana (hrana), trgovine, biznisa i finansija, obrada komercijalnih narudžbenica (kupovina), poslovni menadžment, komercijalna administracija, usluge komercijalne administracije za preuzimanje roba i usluga putem elektronskih kartica, kupona, vaučera ili countermarks, savjetovanje, konsultacije, informacije, stručna pomoć u poslovnoj organizaciji i menadžmentu, usluge pružanja poslovnih informacija koje se odnose na razglašavanje i korištenje prepaid kartica, poklon kartica i drugih vaučera za plaćanje, upravljanje računima klijenata, uključujući informacije koje se odnose na prepaid kartice, poklon kartice i druge vaučere za plaćanje, administrativno savjetovanje za organizovanje programa štednje unutar preduzeća, proučavanje tržišta i istraživanje, poslovna istraživanja, ekonomska predviđanja, knjigovodstvo i praćenje naplate faktura, pisanje i zavođenje administrativne i komercijalne korespondencije, sastavljanje i provjera završnih računa, priprema poreza, računovodstvenih izvještaja i izvjava i dokumenata privrednog društva, računovodstvena analiza, a naročito analiza proizvodnih i komercijalnih troškova, statističke informacije i studije, reklama, uključujući reklamiranje preko elektronskih i kompjuterskih medija, distribucija uzoraka i prospekata pa i putem elektronskih i kompjuterskih komunikacionih mreža, iznajmljivanje oglasnog prostora, uključujući i onog na elektronskim i kompjuterskim medijima, organizovanje operacija za jačanje lojalnosti klijenata, usluge organizovanja

prodajnih promocija, izdavanje i podjela reklamnog materijala (letaka, prospekata, uzoraka i štampanog materijala) [reklamiranje putem slanja direktnom poštom] , Reklama i dotjerivanje reklamnog materijala, pa i putem elektronskih i kompjuterskih komunikacionih mreža, odnosi s javnošću, organizovanje salona i sajmova zakomercijalne ili reklamne svrhe, uključujući i putem elektronskih i kompjuterskih medija, odabir i regrutovanje osoblja za druge, uključujući i putem elektronskih i kompjuterskih komunikacionih mreža, poslovne procjene, organizovanje komercijalnih kontakata (savjetovanje i traganje za partnerima u poslovnom svijetu, administrativno i komercijalno organizovanje poslovnih odnosa) između profesionalnih kupaca i prodavaca nove i polovne opreme ili između klijenata i davaoca usluga, savjetovanje, analize i davanje stručnog mišljenja prilikom ocjene administrativnih sredstava neophodnih za upravljanje komercijalnim narudžbama (kupovina), nabavka obroka, prehrambenih proizvoda i kućnih usluga, regrutovanja i upravljanje agencijskim i privremenim osobljem, studije, istraživanja i konsalting u vezi sa procjenom i unaprijeđenjem radnih uslova zapošljenih (revizija poslovne organizacije).

**Klasa 36:** Izdavanje, kompenzacija i nadoknada vaučera, karata, kupona, odrezaka, prepaid ili debitnih kreditnih kartica ili drugih sredstava plaćanja, a naročito putem kompjuterske mreže, omogućavajući organizovanje plaćanja nabavke obroka, prehrambenih proizvoda i svih drugih proizvoda i usluga, kreditna kartica i usluge loyalty kartica, upravljanje finansijskim prednostima korištenja loyalty kartice i usluga loyalty kartice (osim za reklamne svrhe) čime se omogućava kapitalizacije ovih prednosti, osiguravajući, finansijski i monetarni poslovi, savjetovanje, konsalting, informacije i davanje stručnog mišljenja u oblasti finansija, određivanje koeficijenta, upravljanje protokom gotovine (za druge), naplata dugovanja, elektronski transfer sredstava, finansiranje usluga za preuzimanje roba ili usluga pomoću elektronskih kartica, kupona, vaučera ili countermarks, stambena kuća ili upravljanje nekretninom, rentiranje stanova i nekretnine, zajednički fondovi i kapitalne investicije, upravljanje zajedničkim fondovima, formiranje i upravljanje portfoliima finansijskih interesa, finansijskih operacija uključujući i uspostavljanje i upravljanje programima štednje za kupovinu akcija firme u kojoj se radi, savjetovanje u vezi sa uspostavljanjem i upravljanjem programa štednje u okviru privrednog društva.

**Klasa 43:** Usluge hotela i restorana (hrana), catering (hrana i piće) i usluge pripreme hrane kod kuće, usluge rezervisanja hotela i pansiona, usluge pružanja informacija u oblasti hotela i restorana (hrana), vrtići, dnevni vrtići, jaslice.

(111) 07190	(151) 25.01.2013.
(210) <b>2010-420</b>	(442) <b>20.06.2012</b>
	(220) 11.11.2010
(732) JADRAN DD, RIJEKA PULAC BB HR	.



(540)  
(550) I

(740) Popović Miladin, Đoka Miraševića 21/III, Podgorica (ME)

(511) **Klasa 03:** Kozmetički i toaletni proizvodi, kozmetika i mirisni proizvodi

**Klasa 05:** Farmaceutski preparati, dietetske supstance prilagođene za upotrebu u medicini

**Klasa 35:** Oglašavanje vođenje poslova poslovno upravljanje kancelarijski poslovi

(111) 07191

(151) 25.01.2013.

(210) **2010-421**

(442) **20.06.2012**

(220) 11.11.2010

(732) JADRAN GALENSKI LABORATORIJ DD, RIJEKA, PULAC BB HR



**DRAMINA**

(540)

(550) I

(740) Popović Miladin, Đoka Miraševića 21/III, Podgorica (ME)

(511) **Klasa 03:** Kozmetički i toaletni proizvodi, kozmetika i mirisni proizvodi

**Klasa 05:** Farmaceutski preparati, dietetske supstance prilagođene za upotrebu u medicini

**Klasa 35:** Oglašavanje vođenje poslova poslovno upravljanje kancelarijski poslovi

(111) 07192

(151) 25.01.2013.

(210) **2010-422**

(442) **20.06.2012**

(220) 11.11.2010

(732) JADRAN GALENSKI LABORATORIJ DD, RIJEKA, PULAC BB HR



**LACTOGYN**

(540)

(550) I

(740) Popović Miladin, Đoka Miraševića 21/III, Podgorica (ME)

(511) **Klasa 03:** Kozmetički i toaletni proizvodi, kozmetika i mirisni proizvodi

**Klasa 05:** Farmaceutski preparati, dietetske supstance prilagođene za upotrebu u medicini

**Klasa 35:** Oglašavanje vođenje poslova poslovno upravljanje kancelarijski poslovi

(111) 07193

(151) 25.01.2013.

(210) **2010-423**(442) **20.06.2012**

(220) 11.11.2010

(732) JADRAN GALENSKI LABORATORIJ DD, RIJEKA, PULAC BB HR



(540)

(550) I

(740) Popović Miladin, Đoka Miraševića 21/III, Podgorica (ME)

(511) **Klasa 03:** Kozmetički i toaletni proizvodi, kozmetika i mirisni proizvodi**Klasa 05:** Farmaceutski preparati, dietetske supstance prilagođene za upotrebu u medicini**Klasa 35:** Oglašavanje vođenje poslova poslovno upravljanje kancelarijski poslovi

(111) 07129

(151) 25.01.2013.

(210) **2010-429**(442) **20.06.2012**

(220) 17.11.2010

(732) BEST WESTERN INTERNATIONAL, INC, 6201 NORTH 24 TH PARKWAY, PHOENIX, ARIZONA 85016-2023 US



(540)

(550) I

(740) Lutovac Branislav, Bulevar Crnojevića 93, Podgorica (ME)

(511) **Klasa 43:** Hotelske usluge.

(111) 07195

(151) 25.01.2013.

(210) **2010-481**(442) **20.06.2012**

(220) 27.12.2010

(732) ADVOKATSKA KANCELARIJA VMB ADVOKAT VESKO M. BOŽOVIĆ RIMSKI TRG 50/11, PODGORICA ME





(540)

(550) I

(740) Božović Vesko, Rimski trg 50/11, Podgorica (ME)

(511) **Klasa 35:** Oglašavanje i reklamiranje vođenje komercijalnih poslova, komercijalna administracija kancelarijski poslovi.**Klasa 36:** Osiguranje finansijski poslovi novčani (monetarni) poslovi poslovi vezani za nepokretnosti.**Klasa 45:** Pravne usluge, individualne i društvene usluge koje pružaju drugi, radi zadovoljavanja potreba pojedinaca usluge obezbjeđenja radi zaštite imovine i lica.

(111) 07196

(151) 29.01.2013.

(210) **2010-490**(442) **20.06.2012**

(220) 31.12.2010

(732) BOGOJEVIĆ MAJA, CRNOGORSKIH SERDARA BB, PODGORICA ME

(540)

(550) I

(511) **Klasa 41:** Obrazovne usluge, pripremanje obuke, razonoda, sportske i kulture aktivnosti.**Klasa 42:** Naučne i tehnološke usluge i istraživanje i projektovanje u vezi navedenih usluga, usluge industrijske analize i istraživanja, projektovanje i razvoj kompjuterskog hardvera i softvera.

(111) 07148

(151) 25.01.2013.

(210) **2010-95**(442) **20.06.2012**

(220) 06.04.2010

(732) NOVARTIS AG, 4002 BASEL CH

## САНДОЗ

(540)

(550) I

(740) Popović Miladin, Đoka Miraševića 21/III, Podgorica (ME)

(511) **Klasa 05:** Farmaceutski i veterinarski preparati, sanitarni preparati za medicinsku upotrebu, dijetetske supstance prilagođene za upotrebu u medicini, hrana za bebe, flasteri, materijali za zavijanje, materijali za plombiranje zuba, zubarska smola, dezinfekciona sredstva, preparati za uništavanje štetočina, fungicidi, herbicidi.

(111) 07149

(151) 25.01.2013.

(210) **2010-96**

(442) **20.06.2012**

(220) 08.04.2010

(732) NINE WEST DEVELOPMENT CORPORATION, 1007 ORANGE STREET, SUITE 225, WILMINGTON, DELAWARE 19801 US

## NINE WEST

(540)

(550) I

(740) Čejović Vladimir, 13. jula 21, Podgorica (ME)

(511) **Klasa 9:** Optički proizvodi, sunčane naočare, naočare, okviri za naočare, navlake za naočare, lančići za naočare, uzice za naočare.

**Klasa 14:** Plemeniti metali i njihove legure i proizvodi od tih metala ili obloženi tim metalima, koji nisu obuhvaćeni drugim klasama, pravi i lažni nakit, drago kamenje, časovničarski i hronometrijski instrumenti.

**Klasa 18:** Koža, imitacija kože, proizvodi od tih materijala koji nisu obuhvaćeni drugim klasama, životinjske kože, kovčezi i torbe, kišobrani, suncobrani i štapovi za hodanje, bičevi i sedlarsko remenarski proizvodi, ručne torbe.

**Klasa 25:** Odjeća, obuća, pokrivala za glavu.

**Klasa 35:** Usluge maloprodaje.

(111) 07150

(151) 25.01.2013.

(210) **2010-100**

(442) **20.06.2012**

(220) 12.04.2010

(732) ABBOT MEDICAL OPTICS INC, 1700 EAST ST.ANDREW PLACE.P.O.BOX 25162 SANTA ANA. CALIFORNIA 92705-4933 US

## COMPLETE REVITALENS

(540)

(550) I

(740) Popović Miladin, Đoka Miraševića 21/III, Podgorica (ME)

(511) **Klasa 05:** Preparati za njegu kontaktnih sočiva, nime, rastvori za dezinfekciju, čišćenje, vlaženje, zaštitu, potapanje, odlaganje, i/ili ispiranje kontaktnih sočiva.

(111) 07151

(151) 25.01.2013.

(210) **2010-111**

(442) **20.06.2012**

(220) 15.04.2010

(732) HOME BOX OFFICE, INC, 1100 AVENUE OF THE AMERICAS, 9 th FLOOR NEW YORK, NY 10036 US



(540)

(550) I

(740) Čupić Branislav, Dalmatinska 10, Podgorica (ME)

(511) **Klasa 09:** Računarski program računarski program za upotrebu u obradi, prenosu, primanju, organizovanju, manipulaciji, emitovanju, pregledu, reprodukciji i štimovanju audio, video i multimedijских sadržaja, uključujući tekst, podatke, slike, audio, video i audiovizuelne materijale računarski program za kontrolisanje rada audio i video uređaja za gledanje, pretraživanje i/ili emitovanje audio, video, televizijskih, filmskih, ostalih digitalnih materijala i ostalih multimedijских sadržaja računarski program za interaktivnu razonodu koji dopušta korisnicima da sami sebi prilagođavaju načine gledanja, slušanja i igranja birajući i organizujući izgled i karakteristike audio, video i audiovizuelnih elemenata audio, vizuelni i audiovizuelni materijali i snimci koji se mogu skidati s interneta i koji sadrže multimedijске programe i sadržaje za zabavu elektronske publikacije koje se mogu skidati s interneta.

**Klasa 38:** Telekomunikacije usluge mobilnih medija u smislu elektronskog prenosa, emitovanja i isporuke audio, video i multimedijских sadržaja za zabavu uključujući tekst, podatke, slike, audio, video i audiovizuelne materijale, putem interneta, bežične komunikacije, elektronskih komunikacijskih mreža i računarskih mreža.

**Klasa 41:** Usluge razonode usluge razonode u smislu pružanja programa i sadržaja za razonodu televizijske emisije, isječci, grafika i informacije vezane za televizijski program u području komedije, drame, akcije, raznovrsnosti, pustolovine, sporta, mjuzikla, tekućih vijesti i vijesti iz svijeta zabave, dokumentaraca, animacije, putem interneta, elektronskih komunikacijskih mreža, računarskih mreža i bežičnih komunikacijskih mreža organizacija događanja, predavanja i seminara uključujući i na internetu usluge izdavaštva (uključujući usluge elektronske publikacije) organizovanje foruma i blogova za rasprave.

(111) 07152

(151) 25.01.2013.

(210) **2010-112**(442) **20.06.2012**

(220) 15.04.2010

(732) HEME BOX OFFICE, INC, 1100 AVENUE OF THE AMERICAS, 9 th FLOOR NEW YORK, NY 10036 US

# HBO GO

(540)

(550) I

(740) Ćupić Branislav, Dalmatinska 10, Podgorica (ME)

(511) **Klasa 09:** Računarski program računarski program za upotrebu u obradi, prenosu, primanju, organizovanju, manipulaciji, emitovanju, pregledu, reprodukciji i štimovanju audio, video i multimedijских sadržaja, uključujući tekst, podatke, slike, audio, video i audiovizuelne materijale računarski program za kontrolisanje rada audio i video uređaja za gledanje, pretraživanje i/ili emitovanje audio, video, televizijskih, filmskih, ostalih digitalnih materijala i ostalih multimedijских sadržaja računarski program za interaktivnu razonodu koji dopušta korisnicima da sami sebi prilagođavaju načine gledanja. slušanja i igranja birajući i organizujući izgled i karakteristike audio, video i audiovizuelnih elemenata audio, vizuelni i audiovizuelni materijali i snimci koji se mogu skidati s interneta i koji sadrže multimedijске programe i sadržaje za zabavu elektronske publikacije koje se mogu skidati s interneta.

**Klasa 38:** Telekomunikacije usluge mobilnih medija u smislu elektronskog prenosa, emitovanja i isporuke audio, video i multimedijских sadržaja za zabavu uključujući tekst, podatke, slike, audio, video i audiovizuelne materijale, putem interneta, bežične komunikacije, elektronskih komunikacijskih mreža i računarskih mreža.

**Klasa 41:** Usluge razonode usluge razonode u smislu pružanja programa i sadržaja za razonodu televizijske emisije, isječci, grafika i informacije vezane za televizijski program u području komedije, drame, akcije, raznovrsnosti, pustolovine, sporta, mjuzikla, tekućih vijesti i vijesti iz svijeta zabave, dokumentaraca, animacije, putem interneta, elektronskih komunikacijskih mreža, računarskih mreža i bežičnih komunikacijskih mreža organizacija događanja, predavanja i seminara uključujući i na internetu usluge izdavaštva (uključujući usluge elektronske publikacije) organizovanje foruma i blogova za rasprave.

(111) 07153

(151) 25.01.2013.

(210) **2010-114**(442) **20.06.2012**

(220) 15.04.2010

(732) ABBOTT LABORATORIES, ABBOTT PARK, ILLINOIS 60064 US

# NORVIR

(540)

(550) I

(740) Popović Miladin, Đoka Miraševića 21/III, Podgorica (ME)

(511) **Klasa 05:** Farmaceutski preparati.

(111) 07154

(151) 25.01.2013.

(210) **2010-115**

(442) **20.06.2012**

(220) 15.04.2010

(732) PEPSI CO, INC, 700 ANDERSON HILL ROAD, PURCHASE, NY 10577 US

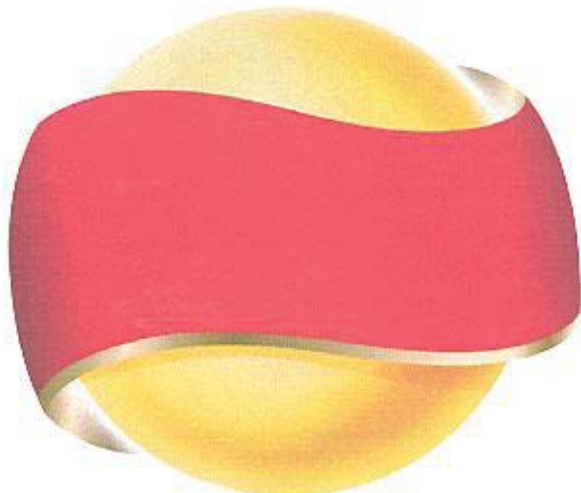

(540)

(550) I

(740) Čejović Vladimir, 13. jula 21, Podgorica (ME)

(511) **Klasa 29:** Meso, riba, živina i divljač mesne prerađevine konzervisano, zamrznuto, sušeno i kuvano voće i povrće želei džemovi, kompoti jaja, mlijeko i mliječni proizvodi jestiva ulja i masti grickalice na bazi voća, povrća, sira, mesa, koštunjavog voća pripremljeno (obrađeno) koštunjavo voće jestiva sjemena.

**Klasa 30:** Kafa, čaj, kakao, šećer, pirinač, tapioka, sago, zamjena kafe brašno i proizvodi od žitarica, hljeb, kolači i poslastice, sladoledi med, melasa kvasac, prašak za pecivo so, sent sirće, sosevi (kao začini) začini led grickalice na bazi brašna, kukuruza, žitarica, pirinča obrađena sjemena žitarica.

(111) 07155

(151) 25.01.2013.

(210) **2010-116**

(442) **20.06.2012**

(220) 15.04.2010

(732) PEPSICO, INC, 700 ANDERSON HILL ROAD, PURCHASE, NY 10577 US



(540)

(550) I

(740) Čejović Vladimir, 13. jula 21, Podgorica (ME)

(511) **Klasa 29:** Meso, riba, živina i divljač mesne prerađevine konzervisano, zamrznuto, sušeno i kuvano voće i povrće želei džemovi, kompoti jaja, mlijeko i mliječni proizvodi jestiva ulja i masti grickalice na bazi voća, povrća, sira, mesa, koštunjavog voća pripremljeno (obrađeno) koštunjavo voće jestiva sjemena.

**Klasa 30:** Kafa, čaj, kakao, šećer, pirinač, tapioka, sago, zamjena kafe brašno i proizvodi od žitarica, hljeb, kolači i poslastice, sladoledi med, melasa kvasac, prašak za pecivo so, sent sirće, sosevi (kao začini) začini led grickalice na bazi brašna, kukuruza, žitarica, pirinča obrađena sjemena žitarica.

(111) 07157

(151) 25.01.2013.

(210) **2010-121**(442) **20.06.2012**

(220) 21.04.2010

(732) VISIOGEN INC, 1700 EAST ST.ANDREW PLACE,P.O.BOX 25162 SANTA ANA, CALIFORNIA 92705-4933 US

## SYNCHRONY

(540)

(550) I

(740) Popović Miladin, Đoka Miraševića 21/III, Podgorica (ME)

(511) **Klasa 10:** Očni implanti i hirurški ručni instrumenti za umetanje intraokularnih sočiva.

(111) 07158

(151) 25.01.2013.

(210) **2010-125**(442) **20.06.2012**

(220) 23.04.2010

(732) VANGUARD TRADEMARK HOLDING USA LLC, A LIMITED LIABILITY COMPANY OF DELAWARE  
USA 600 CORPORATE PARK DRIVE, ST LOUIS, MISSOURI 63105 US

## EMERALD CLUB

(540)

(550) I

(740) Čejović Vladimir, 13. jula 21, Podgorica (ME)

(511) **Klasa 39:** Usluge iznajmljivanja i lizinga vozila i usluge rezervacija za iznajmljivanje i lizing vozila.

(111) 07159

(151) 25.01.2013.

(210) **2010-126**(442) **20.06.2012**

(220) 23.04.2010

(732) VANGUARD TRADEMARK HOLDING USA LLC, A LIMITED LIABILITY COMPANY OF DELAWARE  
USA 600 CORPORATE PARK DRIVE, ST LOUIS, MISSOURI 63105 US

## NATIONAL CAR RENTAL

(540)

(550) I

(740) Čejović Vladimir, 13. jula 21, Podgorica (ME)

(511) **Klasa 39:** Usluge iznajmljivanja i lizinga vozila i usluge rezervacija za iznajmljivanje i lizing vozila.

(111) 07160

(151) 25.01.2013.

(210) **2010-127**(442) **20.06.2012**

(220) 23.04.2010

(732) VANGUARD TRADEMARK HOLDING USA LLC, A LIMITED LIABILITY COMPANY OF DELAWARE  
USA 600 CORPORATE PARK DRIVE, ST LOUIS, MISSOURI 63105 US

(540)

(550) I

(740) Čejović Vladimir, 13. jula 21, Podgorica (ME)

(511) **Klasa 39:** Usluge iznajmljivanja i lizinga vozila i usluge rezervacija za iznajmljivanje i lizing vozila.

(111) 07161

(151) 25.01.2013.

(210) **2010-136**

(442) **20.06.2012**

(220) 28.04.2010

(732) BELUPO LJEKOVI I KOZMETIKA, D.D. KOPRIVNICA, DANICA 5 48000 KOPRIVNICA HR

## CITRAM

(540)

(550) I

(740) Božović Vesko, Rimski trg 50/11, Podgorica (ME)

(511) **Klasa 05:** Farmaceutski proizvodi.

---

(111) 07142

(151) 25.01.2013.

(210) **2010-137**

(442) **20.06.2012**

(220) 28.04.2010

(732) BELUPO LJEKOVI I KOZMETIKA, D.D.KOPRIVNICA, DANICA 5 48000 KOPRIVNICA HR

## BINELOL

(540)

(550) I

(740) Božović Vesko, Rimski trg 50/11, Podgorica (ME)

(511) **Klasa 05:** Farmaceutski proizvodi.

---

(111) 07143

(151) 25.01.2013.

(210) **2010-144**

(442) **20.06.2012**

(220) 05.05.2010

(732) VIIV HEALTHCARE UK LIMITED, 980 GREAT WEST ROAD, BRET福德, MIDDLESEX TW8 9 GS  
GB





(540) -----

(550) I

(740) Lutovac Branislav, Bulevar Crnojevića 93, Podgorica (ME)

(511) **Klasa 05:** Farmaceutski i medicinski preparati i substance vakcine.

**Klasa 10:** Medicinski i hirurški aparati i instrumenti, pumpice za inhaliranje, djelovi i oprema za naprijed navedenu robu.

**Klasa 41:** Obrazovne usluge naročito održavanje seminara u vezi sa zdravljem i zdravstvenom zaštitom i distribucija materijala u vezi sa istim.

**Klasa 42:** Usluge istraživanja i razvoja u vezi sa aktivnim (ljekovitim) materijama, proizvodima na bazi novootkrivenih aktivnih (ljekovitih) materija, farmaceutskim proizvodima, medicinskom dijagnostikom, biološkim proizvodima, medicinskim aparatima, uređajima i instrumentima vršenje kliničkih ispitivanja savetodavne usluge iz oblasti nauke pružanje informacija iz oblasti laboratoryske tehnologije medicinske laboratorijske usluge pružanje naučnih informacija putem internet portala.

**Klasa 44:** Pružanje zdravstvenih i medicinskih informacija u vezi sa medicinskim poremećajima savetovanje i dobrotvorne usluge, naročito pružanje informacija i pomoći u vezi sa zdravljem i zdravstvenom zaštitom pružanje medicinskih usluga putem internet portala sve napred navedeno savjetovanje i usluge dostupne i posredstvom data baze.

(111) 07145

(151) 25.01.2013.

(210) **2010-397**

(442) **20.06.2012**

(220) 28.10.2010

(300) FR 10/3 735 092 03.05.2010

(732) MOTOROLA TRADEMARK HOLDINGS LLC, 600 NORTH US HIGWAY 45, LIBERTYVILLE, IL 60048 US

## MOTOROLA XOOM

(540)

(550) I

(740) Čejović Vladimir, 13. jula 21, Podgorica (ME)

(511) **Klasa 09:** Mobilni računari i pripadajuća oprema, naime, dokovi, stalci s punjačem, pričvršćivači za stalke, držači, stalci, futrole za nošenje, navlake za mobilne telefone, zaštitne

ili dekorativne maske, baterije, punjači/adaptori, priključni kablovi, zvučnici i mikrofoni.

- (111) 07146 (151) 25.01.2013.  
 (210) **2010-398** (442) **20.06.2012**  
 (220) 29.10.2010  
 (300) FR 10 3 735 092 03.05.2010  
 (732) JAMIESON LABORATORIES LTD., 2 ST.CLAIR AVENUE WEST, TORONTO, ONTARIO M4V1 L5 CA



- (540)  
 (550) I  
 (740) Čejović Vladimir, 13. jula 21, Podgorica (ME)  
 (511) **Klasa 03:** Kozmetika i proizvodi za njegu kože, naročito, kreme, losioni, ulja, hidratantne kreme, sredstva za čišćenje lica, gelovi, preparati za zatezanje lica, tonici za čišćenje lica i zatvaranje pora.

**Klasa 05:** Vitamini, minerali i dodaci u ishrani, naročito izvori vitamina, minerala, lipida ili esencijalnih masnih kiselina, vlakana, proteina, ugljenih hidrata, enzima, fitohemijskih jedinjenja, aminokiselina, bakterijskih kultura, prirodna i modifikovana biljna jedinjenja i ekstrakti, biljni preparati ili druga hranljiva ili medicinska aktivna jedinjenja, naročito, nukleinske kiseline, elektroliti, koenzimi, estri i kulture kvasca i biljni dodaci, naročito, borovnica, ehinacea, zova, bijeli luk, ginko, žen-šen, mliječni kalj, sabal palma, kantarion, korijen valerijane, glukozamin i hondroitin sulfat, biljni diuretici, fitozom kompleks zelenog čaja, laksativni kompleks koji kombinuje koru kaskare i lišće sene, lutein i zeaksantin.

- (111) 07147 (151) 25.01.2013.  
 (210) **2010-399** (442) **20.06.2012**  
 (220) 29.10.2010  
 (732) FINLANDIA VODKA WORLDWIDE LTD, PORKKALANKATU 24,00180 HELSINKI FI



- (540)  
 (550) I  
 (740) Ćupić Branislav, Dalmatinska 10, Podgorica (ME)  
 (511) **Klasa 33:** Alkoholna pića, uključujući žestoka pića, iz Finske.

---

(111) 07121

(151) 28.01.2013.

(210) **2010-402**

(442) **20.06.2012**

(220) 01.11.2010

(732) BRITISH AMERICAN TOBACCO INC, 2711 CENTERVILLE ROAD, SUITE 300, WILMINGTON, DELAWARE 19808 US

## LUCKY STRIKE XT

(540)

(550) I

(740) Popović Miladin, Đoka Miraševića 21/III, Podgorica (ME)

(511) **Klasa 34:** Cigarete, duvan, proizvodi od duvana, upaljači, šibice, artikli za pušače.

---

(111) 07122

(151) 25.01.2013.

(210) **2010-403**

(442) **20.06.2012**

(220) 02.11.2010

(732) BRITANNIA PHARMACEUTICALS LIMITED, 65 LONDON ROAD NEWBURY, BERKSHIRE RG14 1 JN GB

## APO-GO

(540)

(550) I

(740) Radulović Božidar, Jovana Tomaševića 9/III, Podgorica (ME)

(511) **Klasa 05:** Farmaceutski preparati i supstance.

Klasa 10, medicinski i hiruški aparati i instrumenti, aparati i instrumenti za ubrizgavanje farmaceutskih preparata, instrumenti za ubrizgavanje koji se koriste u medicinske svrhe.

---

(111) 07123

(151) 25.01.2013.

(210) **2010-413**

(442) **20.06.2012**

(220) 09.11.2010

(732) NOVARTIS AG, 4002 BASEL CH

## BIVACYN

(540)

(550) I

(740) Popović Miladin, Đoka Miraševića 21/III, Podgorica (ME)

(511) **Klasa 05:** Farmaceutski preparati, isključujući oftalmološke preparate.

---

(111) 07124

(151) 25.01.2013.

(210) **2010-414**

(442) **20.06.2012**

(220) 09.11.2010

(732) KURARAY CO.,LTD, 1621, SAKAZU, KURASHIKI CITY, OKAYAMA PERFECTURE JP

## EVAL

(540)

(550) I

(740) Popović Miladin, Đoka Miraševića 21/III, Podgorica (ME)

(511) **Klasa 01:** Hemijski proizvodi koji se upotrebljavaju u industriji, nauci i fotografiji, kao i u poljoprivredi, hortikulturi i šumarstvu, neprerađene vještačke smole, neprerađene plastične materije, đubriva, smeše za gašenje vatre, preparati za kaljenje i zavarivanje, hemijske spustance za očuvanje namirnica, materije za štavljenje, lepljive supstance koje se upotrebljavaju u industriji, kopolimeri etilen-vinil alkohola.

**Klasa 16:** Hartija, karton i proizvodi od njih, koji nisu uključeni u druge klase, ljepila za kancelarijske ili kućne potrebe, plastični materijali za uvijanje i pakovanje, koji nisu uključeni u druge klase.

**Klasa 17:** Guma, gutaperka, kaučuk, azbest, liskun i proizvodi napravljeni od ovih materijala koji nisu uključeni u druge klase, poluprerađeni plastični proizvodi, materijali za podbijanje (podloške), zaptivanje i izolovanje, savitljive nemetalne cijevi, poluprerađena vještačka smola i puluprerađene plastične materije, posebno sastavljene od kopolimera etilen-vinil alkohola.

---

(111) 07125

(151) 25.01.2013.

(210) **2010-416**

(442) **20.06.2012**

(220) 10.11.2010

(732) HANSEN BEVERAGE COMPANY, 550 MONICA CIRCLE, SUITE 201 CORONA, CALIFORNIA 92880 US

X-PRESSO MONSTER

(540)

(550) I

(740) Radulović Božidar, Jovana Tomaševića 9/III, Podgorica (ME)

(511) **Klasa 5:** Nutritivni dodaci.

**Klasa 32:** Bezalkoholna pića odnosno energetska pića i energetska pića sa ukusom kafe i sva poboljšana sa vitaminima, mineralima, nutritivima, amino kiselinama i/ili biljkama.

(111) 07126

(151) 28.01.2013.

(210) **2010-417**

(442) **20.06.2012**

(220) 10.11.2010

(732) DOO DORI SISTEM BAR, BAR, ME,

DORI

(540)

(550) I

(511) **Klasa 09:** Aparati i instrumenti naučni, pomorski, geodetski, fotografski, kinematografski, optički, za vaganje, mjerenje, signalizaciju, košrolu (inspekciju), spašavanje i nastavu, aparati i instrumenti za provođenje, prekid, transformaciju, akumulaciju, regulisanje ili kontrolu električne energije, aparati za snimanje, prenos i reprodukovanje zvuka ili slike, magnetni nosioci podataka, diskovi za snimanje, automatske mašine i mehanizmi za aparate koji se pokreću novcem ili žetonom, registar kase, računске mašine, oprema za obradu podataka i kompjuteri, aparati za gašenje požara.

**Klasa 38:** Telekomunikacije.

**Klasa 42:** Naučne i tehnološke usluge i istraživanje i projektovanje u vezi navedenih usluga, usluge industrijske analize i istraživanja, projektovanje i razvoj kompjuterskog hardvera i softvera.

**Klasa 45:** Pravne usluge, usluge obezbjeđenja radi zaštite imovine i lica, individualne i društvene usluge koje pružaju drugi, radi zadovoljavanja potreba pojedinaca.

**Klasa 41:** Obrazovne usluge, pripremanje obuke, razonoda, sportske i kulturne aktivnosti.

**Klasa 35:** Oglašavanje, vođenje poslova, poslovno upravljanje, kancelarijski poslovi.

---

(111) 07127

(151) 25.01.2013

(210) **2010-424**

(442) **20.06.2012**

(220) 11.11.2010

(732) SUN,STARS & SONS PTE.LTD, BLK.22 HAVELOCK ROAD -01-711, SINGAPORE 160022 SG



(540)

(550) I

(740) Radulović Božidar, Jovana Tomaševića 9/III, Podgorica (ME)

(511) **Klasa 16:** Hartija, karton i proizvodi od njih, koji nisu uključeni u druge klase štampane stvari knjigovezački materijal fotografije kancelarijski materijal lepila za kancelarijske i kućne potrebe umjetnički materijali kičice pisaće mašine i kancelarijski rekviziti (izuzev namještaja) materijali za obuku i nastavu (izuzev aparata) plastični materijal za pakovanje (koji nije uključen u druge klase) štamparska slova kliše i naročito etikete i naljepnice za proizvode i ambalaža za pakovanje proizvoda, uputstva za upotrebu i garantni listovi, štampani katalozi i marketinški materijal.

**Klasa 35:** Oglašavanje vođenje poslova poslovno upravljanje kancelarijski poslovi, naročito usluge maloprodaje alkoholnih pića.

**Klasa 41:** Promocije pripremanje obuke, razonoda sportske i kulturne aktivnosti.

---

(111) 07128

(151) 25.01.2013

(210) **2010-426**

(442) **20.06.2012**

(220) 11.11.2010

(732) CEMEX HRVATSKA D.D. CESTA DR. FRANJE TUĐMANA BB. 21212 KAŠTEL SUĆURAC HR



(540) a Ničanskoj klasifikaciji:

(550) I

(740) Božović Vesko, Rimski trg 50/11, Podgorica (ME)

(511) **Klasa 06:** Metalni građevinski materijali kao što su skele/građa za skele, čelična vrata, rešetke prozori, vrata metalne prenosive konstrukcije kao što su nosači, stupovi, rešetkaste konstrukcije, metalni spremnici kao što su silosi, spremnici za cement i beton.

**Klasa 19:** Ploče od umjetnih materijala, ploče od drveta, cement, beton, žbuka za gradnju, kamen, vapno, gips, šljunak, crijepovi/pločice za oblaganje zidova, opeka, krovništa/krovni prekrivači, mozaici za gradnju krute nemetalne cijevi za ogradnju, asfalt, katran i bitumen, nemetalne prenosive konstrukcije, moduli, oplata, stupovi izljeveni prethodno iz kalupa, nemetalni spomenici.

**Klasa 35:** Komercijalizacija građevinskih materijala usluge vezane uz marketing (oglašavanje i reklamiranje, vođenje komercijalnih poslova) za proizvode, posebno za građevinski materijal bilo kojeg tipa ili vrste.

**Klasa 37:** Sve usluge vezane za gradnju, građenje, izgradnju, poslovanje i popravku.

**Klasa 39:** Usluge koje se odnose na transport, dobavu, distribuciju, isporuku i istovar bilo kojim sredstvima, za vrste građevinskog materijala, i posebno za cement, beton, klinker i materijali vezani za isto.

(111) 07130

(151) 25.01.2013

(210) **2010-430**

(442) **20.06.2012**

(220) 17.11.2010

(732) BERLIN-CHEME AG, GLIENICKER WEG 125 D-12489 BERLIN DE

# KALISTRA

(540)

(550) I

(740) Radulović Božidar, Jovana Tomaševića 9/III, Podgorica (ME)

(511) **Klasa 05:** Farmaceutski preparati za tretman osnovne hipertenzije.

---

(111) 07076 (151) 25.01.2013  
(210) **2010-469** (442) **20.06.2012**  
(220) 21.12.2010  
(732) KWIZDA HOLDING GMBH, DR.KARL LUEGER-RING 6, A-1010 WIEN AT

## BISOCOR

(540)  
(550) I  
(740) Čejović Vladimir, 13. jula 21, Podgorica (ME)  
(511) **Klasa 05:** Farmaceutski i veterinarski proizvodi, sanitarni preparati za medicinsku upotrebu, dijetetske supstance prilagođene za upotrebu u medicini, hrana za bebe, flasteri, materijali za previjanje, materijali za plombiranje zuba, zubarska smola, sredstva za dezinfekciju, proizvodi za uništavanje životinjskih štetočina, fungicidi, herbicidi.

---

(111) 07077 (151) 25.01.2013  
(210) **2010-470** (442) **20.06.2012**  
(220) 21.12.2010  
(732) KWIZDA HOLDING GMBH, DR.KARL LUEGER-RING 6,A-1010 WIEN AT

## MIRTARON

(540)  
(550) I  
(740) Čejović Vladimir, 13. jula 21, Podgorica (ME)  
(511) **Klasa 05:** Farmaceutski i veterinarski proizvodi, sanitarni preparati za medicinsku upotrebu, dijetetske supstance prilagođene za upotrebu u medicini, hrana za bebe, flasteri, materijali za previjanje, materijali za plombiranje zuba, zubarska smola, sredstva za dezinfekciju, proizvodi za uništavanje životinjskih štetočina, fungicidi, herbicidi.

---

(111) 07078 (151) 25.01.2013  
(210) **2010-473** (442) **20.06.2012**  
(220) 22.12.2010  
(732) SOLAE LLC, 4300 DUNCAN AVENUE,ST.LOUISE,MISSOURI 63110 US

## SOLAE

(540)  
(550) I  
(740) Čejović Vladimir, 13. jula 21, Podgorica (ME)  
(511)  
**Klasa 01:** Lecitin za upotrebu u proizvodnji prehrambenih proizvoda.  
**Klasa 05:** Soja protein za upotrebu kao nutritivni sastojak u napicima u prahu i unaprijed



pripremljenom piću.

**Klasa 29:** Mješavine koje sadrže proteine iz soje i povrća kao sastojke za hranu, mlijeko i mliječne proizvode.

**Klasa 30:** Lecitin i lecitinski preparati uključeni u ovu klasu.

**Klasa 32:** Napici na bazi soje.

(111) 06444

(151) 25.01.2013

(210) **2009-405**

(442) **20.03.2012**

(220) 28.05.2009

(732) MOTOROLA INC A DELAWARE CORPORATION; 1303 E ALGONQUIN ROAD, SCHAUMBURG. IL 60196 US

# MOTONAV

(540)

(550) I

(740) Ćupić Branislav, Dalmatinska 10, Podgorica (ME)

(511) **Klasa 9:** Mobilni telefoni, softver za mobilne telefone i digitalni prenosni GPS aparati koji koriste satelitske komunikacije da označe korisnikovu trenutnu lokaciju i smernice kako stići do unete destinacije ili željene tacke na osnovu informacija dostupnih preko mobilnog telefona ili internet veb strane; memorijske kartice koje sadrže kartografske podatke i mape.

(111) 07188

(151) 25.01.2013

(210) **2010-108**

(442) **20.06.2012**

(220) 13.04.2010

(732) SAMSUNG ELECTRONICS CO LTD, 416, MAETAN-DONG, YEONGTONG-GU, GUEONGGI-DO KR



(540)

(550) I

(740) Lutovac Branislav, Bulevar Crnojevića 93, Podgorica (ME)

(511) **Klasa 7:** Električne mašine za pranje veša električni usisivači za upotrebu u domaćinstvu električni mikseri za upotrebu u domaćinstvu automatske mašine za pranje posuđa kese za usisivače robotizovani usisivači kosilice za travu električne kosilice uređaji za uništavanje otpadaka od hrane mašine za šivenje za upotrebu u domaćinstvu vazdušni kompresori automatske mašine za pranje vozila generatori jednosmerne struje.

**Klasa 9:** Poluprovodnici USB kartice habovi, prekidači i ruteri za računarske mreže modemi smart mobilni telefoni mobilni telefoni bežični setovi sa mikrofonom i slušalicama za mobilne

telefone MP3 plejeri i/ili mobilni telefoni električni punjači za baterije za mobilne telefone računarski serveri, digitalni spoljni konvertori (dekoderi), a naročito prijelnici i dekoderi za digitalne medije konvertori za kablovsku televiziju konvertori za mrežni (Ethernet) striming saobraćaj hard diskovi optički uređaji za skladištenje podataka notebook računari računari štampači za računare monitori za računare lični digitalni asistenti TV prijelnici faks aparati registar kase baterije za mobilne telefone optički kablovi električne pegle aparati za zabavu koji koriste TV prijelnik kao izlazni uređaj video telefoni telefoni uređaji za snimanje na video traci DVD plejeri MP3 plejeri prenosni multimedijalni plejeri zvučnici za računare CD plejeri kamkorderi video kamere video projektori snimljene kompjuterske igrice miševi za računare podloge za miševe video rekorderi video disk plejeri sistemi "kućni bioskop" koji uključuju TV prijelnike, DVD plejere, audio pojačala i zvučnike.

**Klasa 11:** Prečišćivači za vodu za upotrebu u domaćinstvu sterilizacione vrećice za jednokratnu upotrebu u domaćinstvu frižideri za led, ne-električni ugradne ploče sa plinskim gorionicima bidei šporeti na gas klima uređaji ventilatori za upotrebu u domaćinstvu, a naročito za klima uređaje gasne lampe grejači vazduha za brodove klima uređaji za automobile instalacije za filtriranje vazduha mašine i uređaji za prečišćavanje vazduha aparati i mašine za proizvodnju leda (ledomati) električni ventilatori, električni frižideri ovlaživači vazduha aparati za sušenje kose električni šporeti električne mašine za sušenje veša električni tosteri grejni tepisi sa električnim napajanjem mikrotalasne pećnice indukcioni šporeti rerne.

(111) 07079

(151) 25.01.2013.

(210) **2010-487**

(442) **20.06.2012**

(220) 30.12.2010

(732) COLGATE-PALMOLIVE COMPANY, 300 PARK AVENUE, NEW YORK, NY 10022 US

AJAX

(540)

(550) I

(511) **Klasa 03:** Sredstva za bijeljenje i druge supstance za upotrebu u perionicama, preparati za čišćenje, poliranje, ribanje i nagrizanje, sapuni, parfimerija, eterična ulja, kozmetika, losioni za kosu, paste za zube.

(111) 06811

(151) 19.12.2012.

(210) **2008-1233**

(442) **20.12.2011**

(220) 29.12.2008

(732) ROYAL MONTENEGRO; LASTVA GRBALJSKA BB KOTOR (ME)

Royal Montenegro

(540)

(550) I

(511) **Klasa 35:** oglašavanje i reklamiranje; vođenje komercijalnih poslova; komercijalna administracija; kancelarijski poslovi.

**Klasa 37:** osiguranje; finansijski poslovi; monetarni poslovi; upravljanje nekretninama.

**Klasa 39:** popravke, usluge postavljanja, prevoz, ambalažiranje i uskladištenje proizvoda, organizovanje putovanja

**Klasa 41:** obuka, stručno osposobljavanje, razonoda, sportske i kulturne djelatnosti

**Klasa 45:** Pravne usluge; sigurnosne usluge za zaštitu imovine i osoba, lične i društvene usluge koje pružaju treći, namijenjene za zadovoljenje ljudskih potreba

(111) 06844

(151) 18.12.2012.

(210) **2009-45**

(442) **20.06.2012**

(220) 27.01.2009

(732) GALLAHER LIMITED, MEMBERS HILL, BROKLANDS ROAD, WEYBRIDGE SURREY KT130 QU GB

# STERLING

(540)

(550) I

(740) Čejović Vladimir, 13. jula 21, Podgorica (ME)

(511) **Klasa 34:** Duvan, prerađen ili neprerađen duvan za pušenje, duvan za lulu, duvan za ručno uvijanje, duvan za žvakanje cigarete, cigare i cigarilosi supstance za pušenje koje se prodaju zasebno ili koje su pomješane sa duvanom, a da nisu u medicinske svrhe ili svrhe liječenja duvan za ušmrkavanje pušački artikli papir za cigarete, cijevčice za cigarete i šibice.

(111) 06843

(151) 18.12.2012.

(210) **2009-428**

(442) **20.06.2012**

(220) 24.06.2009

(732) AMERICAN INTERNATIONAL GROUP INC, 70 PINE STREET, NEW YORK, NY 10270 US

# AIG

(540)

(550) I

(740) Ćupić Branislav, Dalmatinska 10, Podgorica (ME)

(511) **Klasa 36:** Usluge osiguranja u oblasti vazduhoplovstva, imovine, osiguranje od nezgoda i osiguranje života, usluge osiguranja i usluge povezane sa osiguranjem koje se pružaju korporativnim i drugim komercijalnim i individualnim klijentima, i to, usluge upravljanja osiguranjem, usluge samo-osiguranja, aktuarske usluge, administrativne usluge u domenu penzijskog fonda, usluge obrade štete, usluge osiguranja i usluge vezane za osiguranje koje se pružaju klijentima osiguravajuće kompanije, i to usluge reosiguranja i usluge obrade štete, finansijske usluge koje se pružaju institucijama i individualnim klijentima, i to, zamjene standardne i uobičajene stope, devizne zamjene, zamjene vlasničkih instrumenata i kreditne zamjene, i transakcije finansijskim derivatima koje su sa klijentima sastavni dio prodaje hartija od vrijednosti preko dilera ili grupe dilera koji kupuju i prodaju hartije od vrijednosti najmanje na početku za svoje sopstvene portfolije hartija od vrijednosti, pretpostavljajući tržišni rizik od držanja hartija od vrijednosti, i zatim prodaju hartija od vrijednosti prilikom povišenja cijene, brokersko-dilerske usluge vezane za hartije od vrijednosti, upravljanje penzionim i investicionim fondom, pružanje garancija i jemstva, zajmova i kredita, usluga kreditnih kartica i usluga upravljanja kreditnim karticama, investicione konsultacije, investicioni menadžment, usluge savjetovanja u oblasti investicija, usluge investicionog

menadžmenta i povezane savjetodavne usluge u vezi sa direktnim akcionim fondovima, investicije uzajamnog fonda, brokerstvo i distribucija, investiciono i trgovačko bankarstvo, bankarske usluge, upravljanje nekretninama, i njihovo iznajmljivanje, usluge davanja hipotekarnih zajmova vezanih za nekretnine, fmansijske usluge vezane za osiguranje koje se pružaju komercijalnim i individualnim klijentima, i to, usluge davanja zajma, finansijsko upravljanje i rukovođenje pianovima zdravstvenog osiguranja za druge, finansiranje premija.

(111) 06842

(151) 18.12.2012.

(210) **2009-430**

(442) **20.06.2012**

(220) 25.06.2009

(732) YONEX KABUSHIKI KAISHA, 23-13, YUSHIMA 3-CHOME, BUNKYO-KU, TOKYO JP



(540)

(550) I

(740) Ćupić Branislav, Dalmatinska 10, Podgorica (ME)

(511) **Klasa 18:** Putne torbe, rančevi, sportske torbe, tašne, ruksaci novčanici, torbice kišobrani, suncobrani.

**Klasa 25:** Odjeća, kaiševi, kaputi, rukavice, trake za glavu, jakne, bluze od pletene tkanine, trikotaža, odjeća osim veša, radna odijela, zimski kaputi, gaće, nepromočiva krznena bluza sa kapuljačom, košulje, suknje, čarape, dokoljenice, sportski dresovi, džemperi, majice, pantalone, donji veš, gaćice, rublje, prsluci, nepromočiva odjeća, manžete obuća, cipele, sportska obuća, obuća za badminton, obuća za tenis, obuća za golf, unutrašnji đon pokrivala za glavu, kape, šeširi, štitnik za sunce.

**Klasa 28:** Sportski artikli, reketi, reketi za badminton, reketi za tenis, loptice, lopte za igre, loptice za tenis, žica za rekete, strune za rekete, štapovi za golf, torbe za golf, rukavice za golf, rukavice za igre, suspenzori za muškarce, mreže za sportove, teniske mreže, aparat za izbacivanje teniskih loptica

(111) 06841

(151) 18.12.2012.

(210) **2009-431**

(442) **20.06.2012**

(220) 25.06.2009

(732) AMERICAN INTERNATIONAL GROUP INC, 70 PINE STREET, NEW YORK, NY 10270 US



(540)

(550) I

(740) Ćupić Branislav, Dalmatinska 10, Podgorica (ME)

(511) **Klasa 36:** Osiguranje u svim oblastima osiguranja, osim sigurnosnih programa upravljanja rizicima, usluge vezane za osiguranje i fmansijske usluge, to jest usluge upravljanja

osiguranjem, samo-osiguravajuće usluge osim životnog i osiguranja prava vlasništva, i to pružanje pomoći drugima za zaštitu od gubitka na taj način što se odvajaju rezerve protiv potencijalnih gubitaka, upravljanje rizikom tako da se svede na minimum uticaj svih gubitaka, aktuarske usluge, administrativne usluge penzionih fondova, usluge obrade štete, konsalting u oblasti osiguranja, i to evaluacija programa osiguranja drugih osoba u svrhu analiziranja trenutnih ili potencijalnih rizika, u svrhu preporuke korektivnih postupaka i izvođenja pratećih procjena rizika, u svrhu sprovođenja programa i anketa vezanih za osiguranje korporacije, i u svrhu povećanja sigurnosti i eliminacije stanja u kompaniji koja proizvode gubitke, usluge reosiguranja, i to podjela rizika osiguranja, ili prihvatanjem takvih rizika od klijenata ili smještanja sa drugim osiguravateljima, kamatne stope i devizne zamjene, naime kreiranje i marketing standardnih i prilagođenih finansijskih proizvoda, izvedenih iz kamatnih stopa i deviznih transakcija, kapitalno-izvedenih transakcija, brokersko-dilerske usluge vezane za hartije od vrijednosti, upravljanje penzionim i investicionim fondom, davanje kredita, jemstva i garancija, investicione konsultacije, investicioni menadžment i investicione savjetničke usluge, stvaranje uzajamnih fondova, marketing, trgovina i menadžment, investiciono i trgovačko bankarstvo, upravljanje nekretninama, i njihovo iznajmljivanje, usluge davanja hipotekarnih zajmova vezanih za nekretnine, usluge davanja zajma, i finansijski menadžment.

- 
- (111) 06840 (151) 18.12.2012.  
 (210) **2009-432** (442) **20.06.2012**  
 (220) 25.06.2009  
 (732) YONEX KABUSHIKI KAISHA, 23-13 YUSHIMA 3-CHOME, BUNKYO-KU, TOKYO JP  
 (540)  
 (550) I  
 (740) Ćupić Branislav, Dalmatinska 10, Podgorica (ME)  
 (511) **Klasa 18:** Putne torbe, rančevi, sportske torbe, tašne, ruksaci novčanici, torbice kišobrani, suncobrani.  
**Klasa 25:** odjeća, kaiševi, kaputi, rukavice, trake za glavu, jakne, bluze od pletene tkanine, trikotaža, odjeća osim veša, radna odijela, zimski kaputi, gaće, nepromoćiva krznena bluza sa kapuljačom, košulje, suknje, čarape, dokolenice, sportski dresovi, džemperi, majice, pantalone, donji veš, gaćice, rublje, prsluci, nepromoćiva odjeća, manžete obuća, cipele, sportska obuća, obuća za badminton, obuća za tenis, obuća za golf, unutrašnji đon pokrivala za glavu, kape, šeširi, štitnik za sunce.  
**Klasa 28:** Sportski artikli, reketi, reketi za badminton, reketi za tenis, loptice, lopte za igre, loptice za tenis, žica za rekete, strune za rekete, štapovi za golf, torbe za golf, rukavice za golf, rukavice za igre, suspenzori za muškarce, mreže za sportove, teniske mreže, aparat za izbacivanje teniskih loptica

- 
- (111) 06839 (151) 18.12.2012.  
 (210) **2009-480** (442) **20.06.2012**  
 (220) 28.07.2009  
 (732) SOCIETE DES PRODUCT NESTLE S.A, 1800 VEVEY CH  
 (540)  
 (550) I  
 (740) Lutovac Branislav, Bulevar Crnojevića 93, Podgorica (ME)  
 (511) **Klasa 29:** Povrće i krompir (konzervirano, zamrznuto, sušeno ili kuvano), voće (konzervirano, zamrznuto, sušeno ili kuvano), pečurke (konzervirane, sušene ili kuvane),

meso, živina, divljač, riba i plodovi mora, svi navedeni proizvodi i u obliku ekstrakta, supa, želea, paste, u konzerviranom obliku, u obliku gotovih jela, zamrznutom ili dehidriranom obliku džemovi jaja, mlijeko, pavlaka, puter, sir i drugi prehrambeni preparati na bazi mlijeka zamjene za mlijeko napici na bazi mlijeka dezerti na bazi mlijeka i dezerti na bazi pavlake jogurti sojino mlijeko (zamjena za mlijeko), preparati na bazi soje jestiva ulja i masti proteinski preparati za ljudsku prehranu zamjene za mlijeko za kafu kobasice suhomesnati proizvodi kikiriki puter supe, koncentradi supe, čorbe, kocke za supu, bujon, bistre supe (konzome).

**Klasa 30:** Kafa, ekstrakti kafe preparati i napici na bazi kafe ledena kafa („ajs kafe“) zamjene za kafu, ekstrakti zamjene za kafu, preparati i napici na bazi zamjena za kafu cikorija čaj, ekstrakti čaja, preparati i napici na bazi čaja ledeni čaj („ajs ti“) preparati na bazi slada kakao i preparati i napici na bazi kakaa čokolada, čokoladni proizvodi, preparati i napici na bazi čokolade poslastičarski proizvodi, bombone, slatkiši šećerleme šećer žvakaća guma prirodni zaslađivači pekarski proizvodi, hleb, kvasac, testo biskviti, kolači i torte, keksi, napolitanke i oblande, karamele, pudinzi sladoled, sladoledi na bazi vode, šerbeti, zaleđene poslastice, zaleđeni kolači, mekani sladoledi, zaleđeni dezerti, zaleđeni jogurti praškovi (vezivni agensi) za pravljenje sladoleda i/ili sladoleda na bazi leda i/ili šerbeta i/ili zaleđenih poslastica i/ili zaleđenih kolača i/ili mekih sladoleda i/ili zaleđenih dezerta i/ili zaleđenih jogurta med i zamjene za med prerađene žitarice za jutarnji obrok musli, kukuruznepahuljice (korn fleks), slatkiši (table) na bazi žitarica, gotove žitarice spremne za jelo preparati od žitarica pirinač, testenina, knedle (nudle) prehrambeni proizvodi na bazi pirinča, brašna ili žitarica, takođe u obliku gotovih jela pice, sendviči, mješavine prehrambene smješe i gotovog tijesta pripremljenog za pečenje sosovi soja sos kečap aromatični ili začinski proizvodi za prehranu, jestivi začini, sosovi (kao začin), salatni prelive, majonez senf sirće.

**Klasa 32:** Piva negazirana voda, gazirana ili sodna voda, prerađena voda, izvorska voda, mineralna voda, aromatizovana voda napici sa aromom voća i na bazi voća, sokovi od voća i povrća, nektari, limunade, soda voda i drugi bezalkoholni napici sirupi, ekstrakti i esencije i drugi preparati za pripremanje bezalkoholnih napitaka (izuzev esencijalnih ulja) napici na bazi fermentisanog mlijeka napici na bazi soje napici na bazi slada izotonični napici.

(111) 06838

(151) 18.12.2012.

(210) **2009-481**

(442) **20.06.2012**

(220) 29.07.2009

(732) CONVATEC INC, A DELAWARE CORPORATION, 200 HEADQUARTERS PARK DRIVE, SKILLMAN, NJ08558 US



(540)

(550) I

(740) Ćupić Branislav, Dalmatinska 10, Podgorica (ME)

(511) **Klasa 3:** Ne-medicinski proizvodi za njegu kože u obliku tečnosti. kreme ili praha, a naročito kreme za kožu, sredstva za čišćenje kože, sredstva za čišćenje perineuma. rastvori

i koncentрати za otklanjanje neprijatnih mirisa i za vlaženje zaštitne podloge za kožu, a naročito masti i sprejevi za lokalnu upotrebu, sredstva za čišćenje tijela i šamponi, masti za kožu za čišćenje, otklanjanje neprijatnih mirisa i za vlaženje losioni za kožu, i vlažni ubrusi za kupanje impregnisani sredstvima za čišćenje sredstva za ovlaživanje kože.

**Klasa 5:** Proizvodi za njegu i obradu rana, a naročito hirurški zavoji i oblozi za rane podloge za kožu ispune (ispunjači) za rane medicinske kreme, gelovi, sredstva za čišćenje i losioni za lokalnu upotrebu na koži koji se koriste u vezi sa obradom rana.

**Klasa 10:** Uređaji i naprave za ostomiju, uključujući kese, prirubnice, zaštitne podloge za kožu i djelove i opremu za njih kolektori za inkontinentne pacijente i djelovi i oprema za njih naprave za urinarnu i fekalnu inkontinenciju.

**Klasa 16:** Štampani materijal, a naročito bilteni, brošure, pamfleti, informativni listići, prikazi i posteri iz oblasti tretmana ostomije, njege kože i obrade rana.

**Klasa 44:** Usluge davanja medicinskih informacija, a naročito davanje informacija ljekarima, zdravstvenim radnicima i pacijentima na temu tretmana ostomije, njege kože i obrade rana.

(111) 06837

(151) 18.12.2012.

(210) **2009-483**

(442) **20.06.2012**

(220) 03.08.2009

(732) MARS INCORPORATED, 6885 ELM STREET, MCLEAN, VA 22101-3883 US



(540)

(550) I

(740) Čejović Vladimir, 13. jula 21, Podgorica (ME)

(511) **Klasa 29:** Meso, riba, živina i divljač mesne prerađevine konzervisano, sušeno i kuvano voće i povrće bilje jaja mlječni proizvodi želei, džemovi, kompoti mlijeko i mlječni napitci proizvodi pripremljeni za konzumiranje i koji se sastoje uglavnom od gore navedenih proizvoda.

**Klasa 30:** Kafa i zamjena kafe čaj, kakao, čokolada za piće šećer, pirinač, tapioka, sago brašno i proizvodi od žitarica hljeb, biskviti, kolači, pecivo, čokolada i slatkiši sladoled led, led sa dodatkom voćnog soka i šećera u vidu dezerta med, melasa so, senf sirće, sosevi pesto dodaci jelima bilje začini proizvodi pripremljeni za konzumiranje i koji se sastoje uglavnom od gore navedenih proizvoda.

(111) 06836

(151) 18.12.2012.

(210) **2009-485**

(442) **20.06.2012**

(220) 04.08.2009

(732) UNITED PARCEL SERVICE OF AMERICA, INC, 55 GLENLAKE PARKWAY, NE ATLANTA, GEORGIA

30328 US

**UPS IMPORT CONTROL**

(540)

(550) I

(740) Ćupić Branislav, Dalmatinska 10, Podgorica (ME)

(511) **Klasa 35:** Usluge poslovnog upravljanja, usluge poslovnog savjetovanja, usluge poslovne administracije, usluge kancelarijskih poslova, pomoć u vodenju, usluge savjetovanja o vođenju, usluge carinjenja, usluge obrade podataka, automatizovano pružanje informacija klijentima putem globalne računarske mreže o podacima o uvoznim pošiljkama, prikupljanje i sistematizacija podataka o traganju, izvršenju, zahtjevima, fakturisanju i posredovanju u vezi isporuka.

**Klasa 39:** Prevoz, otpremanje i dostava lične imovine avionom, željeznicom, brodom i motornim vozilom skladištenje, pakovanje, skladištenje i povraćaj vezano za prevoz i dostavu lične imovine usluge otpremanja pružanje informacija i podataka korisnicima o traganju, izvršenju, zahtjevima, fakturisanju i posredovanju u vezi isporuka.

(111) 06835

(151) 18.12.2012.

(210) **2009-489**(442) **20.06.2012**

(220) 06.08.2009

(732) WESTIN HOTEL MANAGEMENT L.P, 1111 WESTCHESTER AVENUE, HITE PLAINS, Y. 10604 US

**HEAVENLY**

(540)

(550) I

(740) Lutovac Branislav, Bulevar Crnojevića 93, Podgorica (ME)

(511) **Klasa 20:** Namještaj, ogledala, okviri za slike proizvodi (koji nisu obuhvaćeni drugim Klasama) od drveta, plute, trske, rogoza, vrbovog pruća, roga, kosti, slonovače, kitove kosti, školjki, ćilibara, sedefa, morske pjene i zamjene svih ovih materijala, ili od plastike.

**Klasa 24:** tekstil i tekstilni proizvodi koji nisu obuhvaćeni drugim Klasama prekrivači za krevete i stolove.

**Klasa 43:** usluge obezbjeđivanja hrane i pića privremeni smještaj

(111) 06834

(151) 18.12.2012.

(210) **2009-490**(442) **20.06.2012**

(220) 06.08.2009

(732) WESTION HOTEL MANAGMENT L.P, 1111 WESTCHESTER AVENUE, HITE PLAINS, N.Y.10604 US

**HEAVENLY BED**

(540)



(550) I

(740) Lutovac Branislav, Bulevar Crnojevića 93, Podgorica (ME)

(511) **Klasa 43:** usluge obezbjeđivanja hrane i pića privremeni smještaj.

(111) 06833

(151) 18.12.2012.

(210) **2009-491**

(442) **20.06.2012**

(220) 06.08.2009

(732) WESTIN HOTEL MANAGEMENT L.P, 1111 WESTCHESTER AVENUE, WHITE PLAINS, N.Y. 10604 US

## UNWIND

(540)

(550) I

(740) Lutovac Branislav, Bulevar Crnojevića 93, Podgorica (ME)

(511) **Klasa 43:** usluge obezbjeđivanja hrane i pića privremeni smještaj.

(111) 06822

(151) 18.12.2012.

(210) **2009-494**

(442) **20.06.2012**

(220) 07.08.2009

(732) PHILIP MORRIS BRANDS, SARL QUAI JEANRENLAND 32000 NEUCHATEL CH

## MOONSHINE AROMA

(540)

(550) I

(740) Čejović Vladimir, 13. jula 21, Podgorica (ME)

(511) **Klasa 34:** duvan, prerađen ili neprerađen duvan za pušenje, duvan za lulu, duvan za ručno uvijanje, duvan za žvakanje cigarete, cigare i cigarilosi supstance za pušenje koje se prodaju zasebno ili koje su pomješane sa duvanom, a da nisu u medicinske svrhe ili svrhe liječenja duvan za ušmrkavanje pušački artikli papir za cigarete, cjevčice za cigarete i šibice.

(111) 06820

(151) 18.12.2012.

(210) **2009-496**

(442) **20.06.2012**

(220) 11.08.2009

(732) TUTINSKI KOMBINAT AD PRILEP, UL.MARKSOVA BR.101 7500 PRILEP MK

## BRAND BLUE

(540)

(550) I

(740) Radulović Božidar, Jovana Tomaševića 9/III, Podgorica (ME)

(511) **Klasa 34:** duvan artikli za pušače šibice

---

(111) 06819

(151) 18.12.2012.

(210) **2009-497**

(442) **20.06.2012**

(220) 11.08.2009

(732) TUTINSKI KOMBINAT AD PRILEP, UL MARKSOVA BR.101 7500 PRILEP MK

## BRAND SKY BLUE

(540)

(550) I

(740) Radulović Božidar, Jovana Tomaševića 9/III, Podgorica (ME)

(511) **Klasa 34:** duvan artikli za pušače šibice

---

(111) 06818

(151) 18.12.2012.

(210) **2009-498**

(442) **20.06.2012**

(220) 11.08.2009

(732) TUTINSKI KOMBINAT AD PRILEP, UL MARKSOVA BR.101 7500 PRILEP MK



(540)

(550) I

(740) Radulović Božidar, Jovana Tomaševića 9/III, Podgorica (ME)

(511) **Klasa 34:** duvan artikli za pušače šibice

---

(111) 06817

(151) 18.12.2012.

(210) **2009-499**

(442) **20.06.2012**

(220) 11.08.2009

(732) TUTINSKI KOMBINAT AD PRILEP, UL MARKSOVA BR.101 7500 PRILEP MK

## SAN SLIMS

(540)

(550) I

(740) Radulović Božidar, Jovana Tomaševića 9/III, Podgorica (ME)

(511) **Klasa 34:** duvan artikli za pušače šibice.

(111) 06816

(151) 18.12.2012.

(210) **2009-500**

(442) **20.06.2012**

(220) 11.08.2009

(732) TUTINSKI KOMBINAT AD PRILEP, UL MARKSOVA BR.101 7500 PRILEP MK



(540)

(550) I

(740) Radulović Božidar, Jovana Tomaševića 9/III, Podgorica (ME)

(511) **Klasa 34:** Duvan artikli za pušače šibice.

(111) 06815

(151) 19.12.2012.

(210) **2009-501**

(442) **20.06.2012**

(220) 11.08.2009

(732) TUTINSKI KOMBINAT AD PRILEP, UL. MARKSOVA BR. 101 7500 PRILEP MK

## RONDO BLUE

(540)

(550) I

(740) Radulović Božidar, Jovana Tomaševića 9/III, Podgorica (ME)

(511) **Klasa 34:** Duvan artikli za pušače šibice.

(111) 06814

(151) 18.12.2012.

(210) **2009-506**

(442) **20.06.2012**

(220) 12.08.2009

(732) TUTUNSKI KOMBINAT AD PRILEP, UL. MARKSOVA BR. 101 7500 PRILEP MK

## RONDO BLUE LONG

(540)

(550) I

(740) Radulović Božidar, Jovana Tomaševića 9/III, Podgorica (ME)

(511) **Klasa 34:** Duvan artikli za pušače šibice.

(111) 06813

(151) 19.12.2012.

(210) **2009-507**(442) **20.06.2012**

(220) 12.08.2009

(732) TUTUNSKI KOMBINAT AD PRILEP, UL. MARKSOVA BR. 101 7500 PRILEP MK

**BRAND BLUE LONG**

(540)

(550) I

(740) Radulović Božidar, Jovana Tomaševića 9/III, Podgorica (ME)

(511) **Klasa 34:** Duvan artikli za pušače šibice.

(111) 06812

(151) 19.12.2012.

(210) **2009-509**(442) **20.06.2012**

(220) 12.08.2009

(732) TUTUNSKI KOMBINAT AD PRILEP, UL. MARKSOVA BR. 101 7500 PRILEP MK



(540)

(550) I

(740) Radulović Božidar, Jovana Tomaševića 9/III, Podgorica (ME)

(511) **Klasa 34:** Duvan artikli za pušače šibice.

(111) 06845

(151) 19.12.2012.

(210) **2010-98**(442) **20.06.2012**

(220) 12.04.2010

(732) ALKALOID AD SKOPLJE, BULEVAR ALEKSANDAR MAKEDONSKI 12, 1000 SKOPLJE MK

**LUNATA**

(540)

(550) I

(740) Božović Vesko, Rimski trg 50/11, Podgorica (ME)

(511) **Klasa 05:** Farmaceutski preparati.

(111) 06846

(151) 19.12.2012.

(210) **2010-99**(442) **20.06.2012**

(220) 12.04.2010

(732) TOTO LTD, NO.1-1 NAKASHIMA 2-CHOME, KOKURAKITA-KU, KITAKYUSU-SHI JP

NEOREST

(540)

(550) I

(740) Lutovac Branislav, Bulevar Crnojevića 93, Podgorica (ME)

(511) **Klasa 11:** Klozeti, garniture za wc šolje, šolje, bidei, garniture za wc šolje sa uređajem za ispiranje toplom vodom, Sedišta za wc šolje, sedišta za wc šolje sa uređajem za ispiranje toplom vodom, prenosni bidei, toaletni uređaji koji proizvode zvuk, djelovi za vodokotliće, pisoari (sanitarna oprema), slavine za puštanje vode, aparati za automatsko puštanje vode za toalete, koji se aktiviraju senzorima, lavaboi za pranje ruku (djelovi sanitarnih instalacija), lavaboi sa automatskim puštanjem vode (djelovi sanitarnih instalacija), lavaboi i umivaonici, vodovodne slavine, tj. baterije, usmjerivači mlaza na bateriji, cjevi za snabdjevanje vodom za sanitarne instalacije, slavine i ventili za sanitarne instalacije, aparati za prečišćavanje vode, rezervoari za vodu za kućnu upotrebu, montažna kupatila, kabine za tuširanje, kade, tuševi, postolja za tuširanje, tuš kade, montažni podovi za tuširanje, sudopere, aparati i oprema za kuvanje, kuhinjski aspiratori, pultovi i radne površine (stolovi), pultovi i podloge za umivaonike, toaletni pultovi i radne površine, kuhinjski pultovi i radne površine, plinski gorionici, aparati za solarno zagrijavanje vode, aparat za zagrijavanje vode uz korišćenje plina, bojleri, aparati za sušenje, aparati za grejanje, klima uređaji, peći, električne instalacije u kupatilima za grejanje, sušenje i ventilaciju, električni aparati za šusenje ruku toplim vazduhom u kupatilima, sudopere za ribanje, aparati za automatsko izdavanje papira za sedišta wc šolje, lampe i ksenon lampe.

(111) 06847

(151) 19.12.2012.

(210) **2010-102**(442) **20.06.2012**

(220) 13.04.2010

(732) THE PROCTER &amp; GAMBLE COMPANY, ONE PROCTER &amp; GAMBLE PLAZA, CINCINNATI, OHIO 45202 US

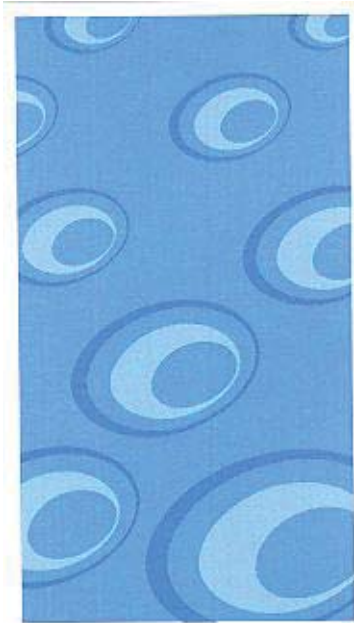

(540)

(550) I

(740) Lutovac Branislav, Bulevar Crnojevića 93, Podgorica (ME)

(511) **Klasa 3:** Sredstva za pranje i bijeljenje za upotrebu u domaćinstvu preparati za njegu, tretiranje i uljepšavanje tkanina preparati za čišćenje, poliranje, ribanje i nagrivanje tamjan ulja za parfeme i mirise mirišljava voda za upotrebu u domaćinstvu i na tkaninama eterična ulja mirišljava sredstva za osvježavanje vazduha i tkanina.

(111) 06867

(151) 19.12.2012.

(210) **2010-103**

(442) **20.06.2012**

(220) 13.04.2010

(732) THE PROCTER & GAMBLE COMPANY, ONE PROCTER & GAMBLE PLAZA, CINCINNATI, OHIO 45202 US



(540)

(550) I

(740) Lutovac Branislav, Bulevar Crnojevića 93, Podgorica (ME)

(511) **Klasa 3:** Omekšivači za tkanine, deterdženti za pranje veša.

---

(111) 06868

(151) 19.12.2012.

(210) **2010-104**

(442) **20.06.2012**

(220) 13.04.2010

(732) THE PROCTER & GAMBLE COMPANY, ONE PROCTER & GAMBLE PLAZA, CINCINNATI, OHIO 45202 US



(540)

(550) I

(740) Lutovac Branislav, Bulevar Crnojevića 93, Podgorica (ME)

(511) **Klasa 3:** Omekšivači za tkanine, deterdženti za pranje veša.

---

(111) 06848

(151) 19.12.2012.

(210) **2010-105**

(442) **20.06.2012**

(220) 13.04.2010

(732) THE PROCTER & GAMBLE COMPANY, ONE PROCTER & GAMBLE PLAZA, CINCINNATI, OHIO 45202 US



---

(540) .....

(550) I

(740) Lutovac Branislav, Bulevar Crnojevića 93, Podgorica (ME)

(511) **Klasa 3:** Sredstva za pranje i bijeljenje za upotrebu u domaćinstvu preparati za njegu, tretiranje uljepšavanje tkanina preparati za čišćenje, poliranje, ribanje i nagrivanje tamjan ulja za parfeme i mirise mirišljava voda za upotrebu u domaćinstvu i na tkaninama eterična ulja mirišljava sredstva za osvježavanje vazduha i tkanina.

(111) 06869

(151) 19.12.2012.

(210) **2010-106**

(442) **20.06.2012**

(220) 13.04.2010

(732) THE PROCTER & GAMBLE COMPANY, ONE PROCTER & GAMBLE PLAZA, CINCINNATI, OHIO 45202 US

# PRO-ZIM

(540)

(550) I

(740) Lutovac Branislav, Bulevar Crnojevića 93, Podgorica (ME)

(511) **Klasa 3:** Preparati za bijeljenje i druga sredstva za upotrebu pri pranju preprati za čišćenje, poliranje, ribanje i nagrivanje.

(111) 06870

(151) 19.12.2012.

(210) **2010-107**

(442) **20.06.2012**

(220) 13.04.2010

(732) THE PRCTER & GABLE COMPANY, ONE PROCTER & GAMBLE PLAZA, CINCINNATI, OHIO 45202 US



(540)

(550) I

(740) Lutovac Branislav, Bulevar Crnojevića 93, Podgorica (ME)



(511) **Klasa 3:** Omekšivači za tkanine, deterdženti za pranje veša.

(111) 06849

(151) 19.12.2012.

(210) **2010-113**

(442) **20.06.2012**

(220) 15.04.2010

(732) ASTELLAS PHARMA EUROPE B.V, ELISABETHOF 19,2353 EW LEIDERDROP NL

## LOCOBASE REPAIR

(540)

(550) I

(740) Popović Miladin, Đoka Miraševića 21/III, Podgorica (ME)

(511) **Klasa 03:** Kozmetika.

**Klasa 05:** Farmaceutski i medicinski preparati i supstance za ljudsku upotrebu.

(111) 06905

(151) 19.12.2012.

(210) **2010-120**

(442) **20.06.2012**

(220) 21.04.2010

(732) GALLAHER LIMITED, MEMBERS HILL, BROKLANDS ROAD, WEYBRIDGE SURREY KT13 0QU GB



(540)

(550) I

(740) Čejović Vladimir, 13. jula 21, Podgorica (ME)

(511) **Klasa 34:** Duvan, koji je prerađen ili neprerađen, duvan za pušenje, duvan za lule, duvan za savijanje, duvan za žvakanje, duvan za sisanje, cigarete, cigare, cigarilos, supstance za pušenje koje se prodaju odvojeno ili izmiješane sa duvanom, i koje nijesu za medicinsku ili svrhu liječenja, burmut, artikli za pušaće uključeni u klasu 34, papir za cigarete, fišeci za cigarete i šibice.

(111) 06851

(151) 19.12.2012.

(210) **2010-122**

(442) **20.06.2012**

(220) 22.04.2010

(732) FINLANDIA VODKA WORLDWIDE LTD A FINLAND CORPORATION, PORKKALANKATU 24, 00180 HESINKI FI

# VODKA FROM ABOVE

(540)

(550) I

(740) Ćupić Branislav, Dalmatinska 10, Podgorica (ME)

(511) **Klasa 33:** alkoholna pića, naime votka.

(111) 06871

(151) 19.12.2012.

(210) **2010-123**

(442) **20.06.2012**

(220) 22.04.2010

(732) JACK DANIELS PROPERTIS INC, A DELAWARE USA CORPORATION 4040 CIVIC CENTER DRIVE, SUITE 528 SAN RAFAEL, CALIFORNIA 94903 US



(540) ~~tekstualna klasifikacija:~~

(550) I

(740) Ćupić Branislav, Dalmatinska 10, Podgorica (ME)

(511) **Klasa 33:** Alkoholna pića, uključujući žestoka pića.

(111) 06852

(151) 19.12.2012.

(210) **2010-129**

(442) **20.06.2012**

(220) 26.04.2010

(732) CILAG GMBH INTERNATIONAL, LANDIS+GUR-STRASSE 1 CH-6300 ZUG CH

# LE PETIT MARSEILLAIS

(540)

(550) I

(740) Radulović Božidar, Jovana Tomaševića 9/III, Podgorica (ME)

(511) **Klasa 3:** Sredstva za bijeljenje i druge supstance za upotrebu pri pranju preparati za čišćenje, poliranje, ribanje i nagrizanje sapuni parfimerija, eterična ulja, kozmetika, losioni za kosu sredstva za njegu zuba.

(111) 06853

(151) 19.12.2012.

(210) **2010-130**

(442) **20.06.2012**

(220) 26.04.2010

(732) CILAG GMBH INTERNATIONAL, LANDIS+GUR-STRASSE 1 CH-6300 ZUG CH



(540)

(550) I

(740) Radulović Božidar, Jovana Tomaševića 9/III, Podgorica (ME)

(511) **Klasa 3:** Sredstva za bijeljenje i druge supstance za upotrebu pri pranju preparati za čišćenje, poliranje, ribanje i nagrizanje sapuni parfimerija, eterična ulja, kozmetika, losioni za kosu sredstva za negu zuba.

(111) 06854

(151) 19.12.2012.

(210) **2010-131**

(442) **20.06.2012**

(220) 26.04.2010

(732) GENZYME CORPORATION-MASSACHUSETTS CORPORATION, 500 KENDALL STREET CAMBRIDGE, MASSACHUSETTS 02142 US

# RenVela

(540)

(550) I

(740) Radulović Božidar, Jovana Tomaševića 9/III, Podgorica (ME)

(511) **Klasa 5:** Farmaceutski i veterinarski preparati sanitarni preparati za medicinske svrhe dijetetske supstance za upotrebu u medicini, hrana za bebe Hasten, materijal za zavijanje materijali za plombiranje zuba, zubarska smola dezinfekciona sredstva preparati za uništavanje štetočina fungicidi, herbicidi sredstva za vezivanje fosfata za tretiranje hiperfosfatemije.

(111) 06872

(151) 19.12.2012.

(210) **2010-132**(442) **20.06.2012**

(220) 26.04.2010

(732) JACK DANIELS PROPERTIES INC, A DELAWARE USA CORPORATION 4040 CIVIC CENTER DRIVE, SUITE 528 SAN RAFAEL, CALIFORNIA 94903 US



(540)

(550) I

(740) Čupić Branislav, Dalmatinska 10, Podgorica (ME)

(511) **Klasa 25:** Obuća, pokrivala glave naročito, kape, šeširi, trake, slamnati šeširi, širiti, marame odjeća naročito, kecelje, podvezice za rukave, majice sa i bez kragne, majice za golf, majice za bezbol, košulje, topovi (kratke majice), topovi (kratke majice) bez rukava, gornji djelovi trenerke (dukserice), donji djelovi trenerke, odjeća za džoging, pantalone, jakne, kaputi, kaiševi, mašne, kravate, ešarpe, tregeri, kožne jakne, odjeća za kišu, prsluci, kabanice, rukavice.

(111) 06943

(151) 19.12.2012.

(210) **2010-133**(442) **20.06.2012**

(220) 26.04.2010

(732) KT &amp; G CORPORATION, 100 PYONG CHON-DONG, DAEDEOG-GU, DAEJEON RK

# BOHEM

(540)

(550) I

(740) Popović Miladin, Đoka Miraševića 21/III, Podgorica (ME)

(511) **Klasa 34:** Duvan cigarete, cigare burmut papir za uvijanje lule filteri za cigarete kutije za cigarete (ne od neplemenitih metala) duvankese upaljači (ne od neplemenitih metala) šibice sprave za čišćenje lula pepeljare (ne od neplemenitih metala) za pušače rezači za cigare

(111) 06873

(151) 19.12.2012.

(210) **2010-139**(442) **20.06.2012**

(220) 28.04.2010

(732) JACK DANIELS PROPERTIES, INC, A DELAWARE USA CORPORATION 4040 CIVIC CENTER DRIVE, SUITE 528 SAN RAFAEL, CALIFORNIA 94903 US



(540)

(550) I

(740) Čupić Branislav, Dalmatinska 10, Podgorica (ME)

(511) **Klasa 09:** Pojačivači za muzičke instrumente, prigušivači za audio zvučnike.**Klasa 15:** Gitare, trzalice za gitare, kaiševi za gitare, sistem za karaoke za gitaru, bendžoi, ukulele, palice za bubnjeve, padovi za vježbanje oprema za žičane instrumente, naročito uključujući kaiševe, žice, trzalice, slajdere, kablove torbe i koferi za instrumente.

(111) 06855

(151) 19.12.2012.

(210) **2010-140**(442) **20.06.2012**

(220) 28.04.2010

(732) PHILIP MORRIS PRODUCTS S.A, A SWISS CORPORATION, QUAI JEANRENAUD 3,200 NEUCHATEL CH



(540) \_\_\_\_\_

(550) I

(511) **Klasa 34:** duvan, sirov i prerađen proizvodi od duvana, naročito cigarete, duvan za uvijanje cigareta, duvan za lule, duvan za žvakanje, duvan za šmrkanje, kretek snus (vlažni duvanski prah za oralnu upotrebu), osim cigara i cigarilosa zamjene za duvan (za nemedicinsku upotrebu) artikli za pušače, naročito papir i tube za cigarete, filteri za cigarete, kutije za duvan, kutije za cigarete i pepeljare, lule, ručni aparati/spravice za uvijanje cigareta, upaljači šibice.

(111) 06874

(151) 19.12.2012.

(210) **2010-142**

(442) **20.06.2012**

(220) 30.04.2010

(732) VITA-MIX CORPORATION,-OHIO CORPORATION-, 8615 USHER CLEVELAND, OHIO 44138,US

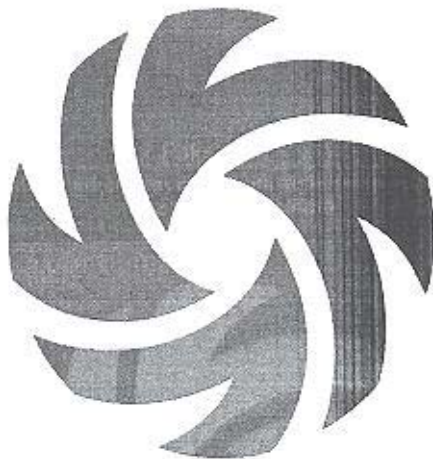

(540)

(550) I

(740) Radulović Božidar, Jovana Tomaševića 9/III, Podgorica (ME)

(511) **Klasa 7:** Električni blenderi i aparati za obradu hrane, njihovi dijelovi dodaci kombinovane posude za led i električni blenderi, njihovi dijelovi i dodaci.

(111) 06856

(151) 19.12.2012.

(210) **2010-143**(442) **20.06.2012**

(220) 30.04.2010

(732) AUXILIUM INTERNATIONAL HOLDINGS, INC, 1105 N. MARKET STREET, SUITE 1300, WILMINGTON, DE 19801 US

XIAPEX

(540)

(550) I

(740) Popović Miladin, Đoka Miraševića 21/III, Podgorica (ME)

(511) **Klasa 05:** Farmaceutski preparati.

(111) 06944

(151) 19.12.2012.

(210) **2010-401**(442) **20.06.2012**

(220) 01.11.2010

(732) BRISTOL-MYERS SQUIBB COMPANY, 345 PARK AVENUE, NEW YORK, NY 10154 US

YERVOY

(540)

(550) I

(740) Čupić Branislav, Dalmatinska 10, Podgorica (ME)

(511) **Klasa 05:** Farmaceutski preparati za ljudsku upotrebu.

(111) 06875

(151) 19.12.2012.

(210) **2010-418**(442) **20.06.2012**

(220) 11.11.2010

(732) JADRAN DD, PULAC BB, RIJEKA HR



(540)

(550) I

(740) Popović Miladin, Đoka Miraševića 21/III, Podgorica (ME)

(511) **Klasa 03:** Kozmetički i toaletni proizvodi, kozmetika i mirisni proizvodi.

**Klasa 05:** Farmaceutski preparati, dietetske supstance prilagođene za upotrebu u medicini.

**Klasa 36:** Oglašavanje, vođenje poslova, poslovno upravljanje, kancelarijski poslovi.

(111) 06876

(151) 19.12.2012.

(210) **2010-419**

(442) **20.06.2012**

(220) 11.11.2010

(732) JADRAN DD, PULAC BB, RIJEKA HR



(540)

(550) I

(740) Popović Miladin, Đoka Miraševića 21/III, Podgorica (ME)

(511) **Klasa 03:** Kozmetički i toaletni proizvodi, kozmetika i mirisni proizvodi.

**Klasa 05:** Farmaceutski preparati, dietetske supstance prilagođene za upotrebu u medicini.

**Klasa 36:** Oglašavanje, vođenje poslova, poslovno upravljanje, kancelarijski poslovi.

(111) 06906

(151) 19.12.2012.

(210) **2010-427**

(442) **20.06.2012**

(220) 15.11.2010

(732) BRIDGESTONE CORPORATION, 10-1, KYOBASHI 1 CHOME, CHOU-KU, TOKIO JP

## Adrenalin

(540)

(550) I

(740) Dedić Tomislav, Bulevar Ivana Crnojevića 139 Podgorica (ME)

(511) **Klasa 12:** Automobili i njihovi djelovi i fitinzi gume za putnička vozila gume za kamione gume za autobuse gume za trkačke automobile gume za automobile protektirane gume za putnička vozila protektirane gume za kamione protektirane gume za autobuse protektirane gume za trkačke automobile protektirane gume za automobile protektirane gume za avione unutrašnje gume za putnička vozila unutrašnje gume za kamione unutrašnje gume za autobuse unutrašnje gume za trkačke automobile unutrašnje gume za automobile točkovi za putnička vozila točkovi za kamione, točkovi za autobuse točkovi za trkačke automobile točkovi za automobile gumena traka sa profilima (protektor) za protektiranje guma za gore navedena vozila motorna vozila na dva točka i njihovi djelovi i fitinzi gume za motorna vozila na dva točka unutrašnje gume za motorna vozila na dva točka točkovi za motorna vozila na



dva točka bicikli i njihovi djelovi i fitinzi gume za bicikle unutrašnje gume za bicikle točkovi za bicikle gumena traka sa profilima (protektor) za obnavljanje guma motornih vozila na dva točka ili bicikle gume i unutrašnje gume za avione, gumena traka sa profilima (protektor) za protektiranje guma za avione lepljive gumene zakrpe za popravku pneumatika ili guma.

---

(111) 06877 (151) 19.12.2012.  
 (210) **2010-435** (442) **20.06.2012**  
 (220) 22.11.2010  
 (732) ALKALOID AD SKOPLJE, BUL.ALEKSANDAR MAKEDONSKI 12 1000 SKOPLJE MK

## ALDIZEM/АЛДИЗЕМ

(540)  
 (550) I  
 (740) Popović Miladin, Đoka Miraševića 21/III, Podgorica (ME)  
 (511) **Klasa 05:** Farmaceutski preparati.

---

(111) 06878 (151) 19.12.2012.  
 (210) **2010-438** (442) **20.06.2012**  
 (220) 25.11.2010  
 (732) ALKALOID AD SKOPLJE, BUL. ALEKSANDAR MAKEDONSKI 12 SKOPLJE MK

## ALKAGIN

(540)  
 (550) I  
 (740) Popović Miladin, Đoka Miraševića 21/III, Podgorica (ME)  
 (511) **Klasa 05:** Farmaceutski preparati.

---

(111) 06879 (151) 19.12.2012.  
 (210) **2010-446** (442) **20.06.2012**  
 (220) 09.12.2010  
 (732) JONES INVESTMENT CO.INC, 1007 ORANGE STREET, SUITE 225 WILMINGTON, DELAWARE 19801 US

## ANNE KLEIN

(540)  
 (550) I  
 (740) Radulović Božidar, Jovana Tomaševića 9/III, Podgorica (ME)  
 (511)

**Klasa 18:** Koža i imitacije kože, proizvodi izrađeni od ovih materijala koji nisu uključeni u druge

klase životinjska koža, krzno koferi i putne torbe kišobrani, suncobrani i štapovi za hodanje bičevi, saračka i sedlarska roba naročito ručne torbe i mali kožni proizvodi.

**Klasa 25:** odjeća, obuća pokrivala za glavu naročito kaiševi, bluze, majice na bretele, kaputi, cipele, čizme. sandale, papuče, rukavice, jakne, čarape (i tanke i obične), mufovi, pantalone, marame, majice, suknje, šalovi, odjevni predmeti za spavanje, kratke čarape, kupaći kostimi i prsluci.

**Klasa 35:** Oglašavanje, vođenje poslova poslovno upravljanje kancelarijski poslovi naročito usluge u vezi sa prometom robe.

(111) 06880

(151) 19.12.2012.

(210) **2010-447**

(442) **20.06.2012**

(220) 09.12.2010

(732) JONES INVESTMENT CO.INC, 1007 ORANGE STREET, SUITE 225 WILMINGTON, DELAWARE 19801 US



(540)

(550) I

(740) Radulović Božidar, Jovana Tomaševića 9/III, Podgorica (ME)

(511) **Klasa 18:** Koža i imitacije kože, proizvodi izrađeni od ovih materijala koji nisu uključeni u druge klase životinjska koža, krzno koferi i putne torbe kišobrani, suncobrani i štapovi za hodanje bičevi, saračka i sedlarska roba naročito ručne torbe i mali kožni proizvodi.

**Klasa 25:** odjeća, obuća pokrivala za glavu naročito kaiševi, bluze, majice na bretele, kaputi, cipele, čizme. sandale, papuče, rukavice, jakne, čarape (i tanke i obične), mufovi, pantalone, marame, majice, suknje, šalovi, odjevni predmeti za spavanje, kratke čarape, kupaći kostimi i prsluci.

**Klasa 35:** Oglašavanje, vođenje poslova poslovno upravljanje kancelarijski poslovi naročito usluge u vezi sa prometom robe.

(111) 06881

(151) 19.12.2012.

(210) **2010-448**

(442) **20.06.2012**

(220) 10.12.2010

(732) DAIICHI SANKYO COMPANY, LIMITED, 3-5-1, NIHONBASHI HONCHO, CHUO-KU, TOKYO 103 -8426 JP

# SELPATH

(540)

(550) I

(740) Ćupić Branislav, Dalmatinska 10, Podgorica (ME)

(511) **Klasa 05:** Farmaceutski preparati i supstance.

(111) 06907

(151) 19.12.2012.

(210) **2010-456**

(442) **20.06.2012**

(220) 14.12.2010

(732) BISON INTERNATIONAL B.V, DR.A.F. PHILIPSSTRAAT 9,4462 EW GOES NL

# MONTAGEKIT

(540)

(550) I

(740) Ćupić Branislav, Dalmatinska 10, Podgorica (ME)

(511) **Klasa 1:** Ljepila (ljepljive materije), athezivi i sredstva za zaptivanje namjenjeni za industriju, profesionalnu upotrebu i građenje.

**Klasa 16:** Ljepila (ljepljive materije) i athezivi namjenjeni za domaćinstva i kancelarije.

**Klasa 17:** Materijali za nepropusno zatvaranje, za zaptivanje i za završnu obradu.

(111) 06908

(151) 19.12.2012.

(210) **2010-458**

(442) **20.06.2012**

(220) 14.12.2010

(732) BRISTOL-MYERS SQUIBB COMPANY A DELAWARE CORPORATION, 345 PARK AVENUE, NEW YORK, NY 10154 US

# PENTREXYL

(540)

(550) I

(740) Ćupić Branislav, Dalmatinska 10, Podgorica (ME)

(511) **Klasa 05:** Farmaceutski preparati za ljudsku upotrebu.

(111) 06909

(151) 19.12.2012.

(210) **2010-459**

(442) **20.06.2012**

(220) 14.12.2010

(732) BRISTOL-MYERS SQUIBB SARL A FRENCH LIMITED LIABILITY COMPANY, 3 RUE JOSEPH MONIER, 92500 RUEIL-MALMASION FR

# FERVEX

(540)

(550) I

(740) Ćupić Branislav, Dalmatinska 10, Podgorica (ME)

(511) **Klasa 05:** Farmaceutski preparati za ljudsku upotrebu.

(111) 06882

(151) 19.12.2012.

(210) **2010-460**(442) **20.06.2012**

(220) 14.12.2010

(732) BRISTOL-MYERS SQUIBB SARL A FRENCH LIMITED LIABILITY COMPANY, 3 RUE JOSEPH MONIER, 92500 RUEIL-MALMASION FR

# UPSA

(540)

(550) I

(740) Ćupić Branislav, Dalmatinska 10, Podgorica (ME)

(511) **Klasa 05:** Farmaceutski preparati za ljudsku upotrebu.

(111) 06910

(151) 19.12.2012.

(210) **2010-462**(442) **20.06.2012**

(220) 15.12.2010

(732) C.I. UNION DE BANANEROSW DE URABA S,A, UNIBAN, CALLE 52 NO.47-42 PISO 15, MEDELLIN, ANTIGUIA CO



(540)

(550) I

(740) Ćupić Branislav, Dalmatinska 10, Podgorica (ME)

(511) **Klasa 31:** Poljoprivredni, vrtlarski i šumarski proizvodi i zrnevlje koji nisu uključeni u druge klase žive životinje svježe voće i povrće sjeme, prirodne biljke i cvijeće, hrana za životinje, slad banane i pisang (banana u kulinarstvu/za kvanje).

---

(111) 06945

(151) 19.12.2012.

(210) **2010-467**

(442) **20.06.2012**

(220) 20.12.2010

(732) CHUGAI SEIYAKU KABUSHIKI KAISHA, 5-1, UKIMA 5-CHOME, KITA-KU, TOKYO JP

## GRANOCYTE

(540)

(550) I

(740) Popović Miladin, Đoka Miraševića 21/III, Podgorica (ME)

(511) **Klasa 05:** Farmaceutski preparati.

---

(111) 06883

(151) 19.12.2012.

(210) **2010-485**

(442) **20.06.2012**

(220) 28.12.2010

(732) DURACELL BATTERIES BVBA, NIJVERHEIDSLAAN 7 3200 AARSCHOT BE

## DURACELL TURBO

(540)

(550) I

(740) Lutovac Branislav, Bulevar Crnojevića 93, Podgorica (ME)

(511) **Klasa 09:** Baterije i punjači za baterije.

---

(111) 06884

(151) 19.12.2012.

(210) **2010-488**

(442) **20.06.2012**

(220) 30.12.2010

(732) BENCOM DOO HERCEG NOVI, UL. PRIZRENSKA 19, IGALO HERCEG NOVI ME



(540)

(550) I

(511) **Klasa 09:** Roba, softver, poslovni softver, softver za elektronsku obradu podataka, u oblasti knjigovodstva, računovodstva, revizije i ostalih srodnim oblastima, ERP (Enterprise resource planning) softver, softver za elektronsku obradu podataka, u oblasti planiranja

resursa preduzeća, koji integriše i objedinjuje sve poslovne procese jednog preduzeća, POS (point of sale) softver, softver za elektronsku obradu podataka i podršku za rad sa fiskalnim štampačima u oblasti evidencije prometa (prodaje).

(111) 07072 (151) 04.02.2013.  
 (210) **2008-145** (442) **20.06.2012**  
 (220) 24.06.2008  
 (300) Ž-294/08 18.02.2008  
 (732) DEUTCHE TELEKOM AG, FRIEDRICH ALLEE 140, BONN DE

# PaySpot

(540)

(550) I

(740) Dobrijević Bralić Rada, Stari Grad, Kotor (ME)

(511) **Klasa 09:** Aparati i instrumenti naučni, pomorski, geodetski, fotografski, kinematografski, optički, za vaganje, mjerenje, signalizaciju, kontrolu (inspekciju), spašavanje i nastavu, aparati i instrumenti za provođenje, razvođenje, transformaciju, akumulaciju, regulaciju ili kontrolu elektriciteta, aparati za snimanje, prenos, obradu i reprodukciju zvuka, slika ili podataka, magnetni nosači podataka, automatske mašine i mehanizmi za aparate koji se pokreću novcem ili žetonom, računске mašine, oprema i kompjuteri za obradu podataka, snimljeni i nesnimljeni nosači podataka (koji su uključeni u klasu 9), kompjuterski programi (sačuvani), elektronski snimljeni podaci (koji se mogu preuzimati sa jednog računara na drugi), elektronske publikacije (koje se mogu preuzimati sa jednog računara na drugi).

**Klasa 16:** Štampane stvari, fotografije, kancelarijski rekviziti (izuzev Namještaja), materijali za obuku i nastavu (izuzev aparata).

**Klasa 35:** Oglašavanje, vođenje poslova, poslovno upravljanje, sakupljanje, sistematizacija, sastavljanje i ekonomska analiza podataka i informacija u kompjuterskim bazama podataka, usluge maloprodaje (takođe preko interneta i drugih komunikacionih mreža), koja se odnosi na robe iz klasa 9 i 16.

**Klasa 37:** Građevinsko konstruisanje, usluge instaliranja (instalacione usluge), popravlanje i održavanje kompjuterske i telekomunikacione opreme.

**Klasa 38:** Telekomunikacije, usluge novinskih agencija, iznajmljivanje telekomunikacione opreme, informacije o telekomunikacijama.

**Klasa 42:** Naučne i tehnološke usluge i istraživanje i projektovanje u vezi navedenih usluga, usluge industrijske analize i istraživanja, projektovanje i razvoj kompjuterskog hardvera, softvera i baza podataka, održavanje softvera, tehničko konsultovanje, usluge čuvanja elektronskih podataka, iznajmljivanje opreme za obradu podataka, projektovanje web

stranica za druge.

**Klasa 45:** Lincenciranje prava industrijske svojine

---

(111) 07275 (151) 28.01.2013.  
(210) **2009-370** (442) **20.06.2012**  
(220) 28.05.2009  
(300) SR 11.01.2008  
(732) BERLIN-CHEMIE AG, GLIENICKER WEG 125, D-12489 BERLIN DE



(540)  
(550) I  
(740) Ćosović Dejan, 13. jula 1/5, Budva (ME)  
(511) **Klasa 05:** Farmaceutski proizvodi dijetetske supstance prilagođene za medicinsku upotrebu.

---

(111) 07276 (151) 28.01.2013.  
(210) **2009-372** (442) **20.06.2012**  
(220) 28.05.2009  
(300) SR 26.06.2007  
(732) BERLIN-CHEMIE AG, GLIENICER WEG 125 D-12489, BERLIN DE

## BORENAR

(540)  
(550) I  
(740) Ćosović Dejan, 13. jula 1/5, Budva (ME)  
(511) **Klasa 05:** Farmaceutski proizvodi dijetetske supstance prilagođene za upotrebu u medicini.

---

(111) 07277 (151) 28.01.2013.  
(210) **2009-373** (442) **20.06.2012**  
(220) 28.05.2009  
(300) SR 05.06.2007

(732) BERLIN-CHEMIE AG, GLIENICER WEG 125 D-12489 BERLIN DE

## CLATRA

(540)

(550) I

(740) Ćosović Dejan, 13. jula 1/5, Budva (ME)

(511) **Klasa 05:** Farmaceutski proizvodi dijetetske supstance prilagođene za medicinsku upotrebu.

---

(111) 07278

(151) 28.01.2013.

(210) **2009-374**

(442) **20.06.2012**

(220) 28.05.2009

(300) SR 23.11.2007

(732) BERLIN-CHIEME AG, GLIENICER WEG 125 D-12489 BERLIN DE

## FLORALIV

(540)

(550) I

(740) Ćosović Dejan, 13. jula 1/5, Budva (ME)

(511) **Klasa 05:** Farmaceutski proizvodi dijetetske supstance prilagođene za medicinsku upotrebu.

---

(111) 07279

(151) 28.01.2013.

(210) **2009-375**

(442) **20.06.2012**

(220) 28.05.2009

(300) SR 09.08.2007

(732) BERLIN-CHEME AG, GLIENICER WEG 125 D-12489 BERLIN DE

## MIG-400

(540)

(550) I

(740) Ćosović Dejan, 13. jula 1/5, Budva (ME)

(511) **Klasa 05:** Farmaceutski proizvodi dijetetske supstance prilagođene za upotrebu u medicini.

---

(111) 07280

(151) 28.01.2013.

(210) **2009-376**

(442) **20.06.2012**

(220) 28.05.2009



(300) 17.01.2007

(732) SR BERLIN-CHEME AG, GLIENICER WEG 125 D-12489 BERLIN DE

# Flosin

(540)

(550) I

(740) Čosović Dejan, 13. jula 1/5, Budva (ME)

(511) **Klasa 05:** Farmaceutski proizvodi dijetetske supstance prilagođene za upotrebu u medicini.

(111) 07281

(151) 28.01.2013.

(210) **2009-379**(442) **20.06.2012**

(220) 28.05.2009

(300) SR 04.05.2007

(732) BERLIN-CHEMIE AG, GLIENICER WEG 125 D-12489 BERLIN DE

(540)

(550) I

(740) Čosović Dejan, 13. jula 1/5, Budva (ME)

(511) **Klasa 05:** Farmaceutski proizvodi dijetetske supstance prilagođene za upotrebu u medicini.

(111) 07241

(151) 28.01.2013.

(210) **2010-475**(442) **20.06.2012**

(220) 23.12.2010

(732) MILLIKEN &amp; COMPANY, 920 MILLIKEN ROAD, SPARTANBURG, SC 29303 US



(540)

(550) I

(740) Čejović Vladimir, 13. jula 21, Podgorica (ME)

(511) **Klasa 02:** Boje pigmenti isparive boje, aplikatori za tečna đubriva, fungicide, herbicide i insekticide sa jasno označenom naprskanom površinom vodene boje za tijela za korištenje isključivo u estetske svrhe.

(111) 07282

(151) 28.01.2013.

(210) **2009-451**(442) **20.06.2012**

(220) 10.07.2009

(732) TDR DOO, OBALA V.NAZORA BR.1,52210 ROVINJ HR



(540)

(550) I

(740) Vukotić Petar, Novaka Miloševa, Podgorica (ME)

(511) **Klasa 34:** duvan sirov i prerađen, proizvodi od duvana, cigare cigarete, filter cigarete, cigarilosi i tompos cigare, zamjena za duvan koji nije u upotrebi u medicini, artikli za pušače koji nisu od plemenitih metala, šibice.

**Klasa 35:** usluge u vezi sa prometom robe, posebno usluge u prometu duvana i duvanskih proizvoda oglašavanje vođenje poslova poslovno upravljanje kancelarijski poslovi komercijalno zastupanje propagandne i reklamne usluge marketing usluge ispitivanja tržišta usluge promocije, posebno promovisanje, ili reklamiranje kulturnih i zabavnih događaja, sportskih takmičenja i modnih revija organizovanje i vođenje sajмова i izložbi u komercijalne ili reklamne svrhe napred navedene usluge koje pripadaju ovoj klasi koje se obavljaju putem interneta davanje i širenje informacija u vezi sa navedenim uslugama izlaganje različite robe na jednom mjestu uključujući duvan sirov i prerađen, proizvode od duvana, cigare i cigarete, filter cigarete cigarilose i tompos cigare, zamjene za duvan koji nisu u upotrebi u medicini, artikle za pušače koji nisu od plemenitih metala, šibice omogućavanje potrošačima pogodno za razgledanje i kupovinu gore navedene robe u maloprodajnim radnjama.

(111) 07231

(151) 28.01.2013.

(210) **2010-118**(442) **20.06.2012**

(220) 20.04.2010

(732) MOTOROLA INC, A DELAWARE CORPORATION 1303 EAST ALGONGUIN ROAD, SCHAMBURG, ILLINOIS 60196 US

# FLIPOUT

(540)

(550) I

(740) Ćupić Branislav, Dalmatinska 10, Podgorica (ME)

(511) **Klasa 09:** Mobilni telefoni mobilni telefoni sa mogućnošću slanja i primanja elektronskih poruka mobilni telefoni sa digitalnim fotoaparatom i video kamerom mobilni telefoni sa MP3, audio i video plejerom mobilni telefoni sa elektronskim igricama mobilni telefoni sa

mogućnošću GPS-a i navigacije uređaji za bežičnu komunikaciju sa mogućnošću prenosa glasa, podataka i slike baterije za mobilne telefone punjači za baterije i adapted za struju.

(111) 07232 (151) 28.01.2013.  
 (210) **2010-146** (442) **20.06.2012**  
 (220) 06.05.2010  
 (732) TDR DOO, OBALA V.NAZORA BR.1 52210 ROVINJ HR



(540) \_\_\_\_\_  
 (550) I  
 (740) Vukotić Petar, Novaka Miloševa, Podgorica (ME)

(511) **Klasa 34:** Duvan sirov i prerađen, proizvodi od duvana, cigare, cigarete. filter, cigarete, cigarilosi, artikli za pušače, upaljači, šibice.

**Klasa 35:** Usluge u vezi sa prometom robe, posebno usluge u prometu duvana i duvanskih proizvoda oglašavanje vođenje poslova poslovno upravljanje kancelarijski poslovi komercijalno zastupanje propagandne i reklamne usluge marketing usluge istraživanja tržišta usluge promocije, posebno promovisanje ili reklamiranje kulturnih i zabavnih događaja, sportskih takmičenja i modnih revija organizovanje i vođenje sajmova i izložbi u reklamne i komercijalne svrhe naprijed navedene usluge koje pripadaju ovoj klasi koje se obavljaju putem interneta davanje i širenje informacija u vezi sa gore navedenim uslugama.

(111) 07233 (151) 28.01.2013.  
 (210) **2010-147** (442) **20.06.2012**  
 (220) 06.05.2010  
 (732) TDR DOO, OBALA V.NAZORA BR.1 52210 ROVINJ HR



(540)

(550) I

(740) Vukotić Petar, Novaka Miloševa, Podgorica (ME)

(511) **Klasa 34:** Duvan sirov i prerađen, proizvodi od duvana, cigare, cigarete. filter, cigarete, cigarilos, artikli za pušače, upaljači, šibice.

**Klasa 35:** Usluge u vezi sa prometom robe, posebno usluge u prometu duvana i duvanskih proizvoda oglašavanje vođenje poslova poslovno upravljanje kancelarijski poslovi komercijalno zastupanje propagandne i reklamne usluge marketing usluge istraživanja tržišta usluge promocije, posebno promovisanje ili reklamiranje kulturnih i zabavnih događaja, sportskih takmičenja i modnih revija organizovanje i vođenje sajмова i izložbi u reklamne i komercijalne svrhe naprijed navedene usluge koje pripadaju ovoj klasi koje se obavljaju putem interneta davanje i širenje informacija u vezi sa gore navedenim uslugama.

(111) 07234

(151) 28.01.2013.

(210) **2010-148**(442) **20.06.2012**

(220) 06.05.2010

(732) TDR DOO, OBALA V.NAZORA BR.1 52210 ROVINJ HR

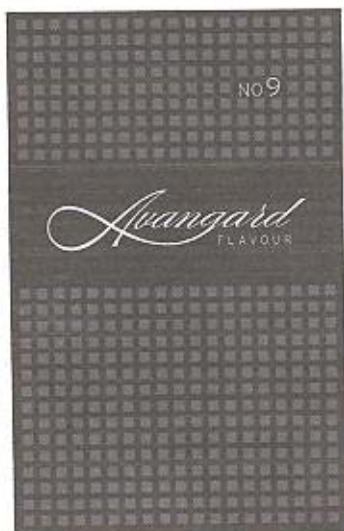

(540)

(550) I

(740) Vukotić Petar, Novaka Miloševa, Podgorica (ME)

(511) **Klasa 34:** Duvan sirov i prerađen, proizvodi od duvana, cigare, cigarete. filter, cigarete, cigarilosi, artikli za pušače, upaljači, šibice.

**Klasa 35:** Usluge u vezi sa prometom robe, posebno usluge u prometu duvana i duvanskih proizvoda oglašavanje vođenje poslova poslovno upravljanje kancelarijski poslovi komercijalno zastupanje propagandne i reklamne usluge marketing usluge istraživanja tržišta usluge promocije, posebno promovisanje ili reklamiranje kulturnih i zabavnih događaja, sportskih takmičenja i modnih revija organizovanje i vođenje sajмова i izložbi u reklamne i komercijalne svrhe naprijed navedene usluge koje pripadaju ovoj klasi koje se obavljaju putem interneta davanje i širenje informacija u vezi sa gore navedenim uslugama.

(111) 07235

(151) 28.01.2013.

(210) **2010-149**

(442) **20.06.2012**

(220) 06.05.2010

(732) TDR DOO, OBALA V.NAZORA BR.1 52210 ROVINJ HR



(540)

(550) I

(740) Vukotić Petar, Novaka Miloševa, Podgorica (ME)

(511) **Klasa 34:** Duvan sirov i prerađen, proizvodi od duvana, cigare, cigarete. filter, cigarete, cigarilosi, artikli za pušače, upaljači, šibice

**Klasa 35:** Usluge u vezi sa prometom robe, posebno usluge u prometu duvana i duvanskih proizvoda oglašavanje vođenje poslova poslovno upravljanje kancelarijski poslovi komercijalno zastupanje propagandne i reklamne usluge marketing usluge istraživanja tržišta usluge promocije, posebno promovisanje ili reklamiranje kulturnih i zabavnih događaja, sportskih takmičenja i modnih revija organizovanje i vođenje sajмова i izložbi u reklamne i komercijalne svrhe naprijed navedene usluge koje pripadaju ovoj klasi koje se obavljaju putem interneta davanje i širenje informacija u vezi sa gore navedenim uslugama.

(111) 07236

(151) 28.01.2013.

(210) **2010-150**

(442) **20.06.2012**

(220) 06.05.2010

(732) TDR DOO, OBALA V.NAZORA BR.1 52210 ROVINJ HR



(540)

(550) I

(740) Vukotić Petar, Novaka Miloševa, Podgorica (ME)

(511) **Klasa 34:** Duvan sirov i prerađen, proizvodi od duvana, cigare, cigarete. filter, cigarete, cigarilosi, artikli za pušaće, upaljači, šibice.

**Klasa 35:** Usluge u vezi sa prometom robe, posebno usluge u prometu duvana i duvanskih proizvoda oglašavanje vođenje poslova poslovno upravljanje kancelarijski poslovi komercijalno zastupanje propagandne i reklamne usluge marketing usluge istraživanja tržišta usluge promocije, posebno promovisanje ili reklamiranje kulturnih i zabavnih događaja, sportskih takmičenja i modnih revija organizovanje i vođenje sajмова i izložbi u reklamne i komercijalne svrhe naprijed navedene usluge koje pripadaju ovoj klasi koje se obavljaju putem interneta davanje i širenje informacija u vezi sa gore navedenim uslugama.

(111) 07239

(151) 28.01.2013.

(210) **2010-395**(442) **20.06.2012**

(220) 27.10.2010

(732) GOODYEAR DUNLOP TIRES GERMANY GMBH, DUNLOPSTRASSE 2,63450 HANAU DE

## FULDA

(540)

(550) I

(740) Čejović Vladimir, 13. jula 21, Podgorica (ME)

(511) **Klasa 12:** Gume.

(111) 07237

(151) 28.01.2013.

(210) **2010-433**(442) **20.06.2012**

(220) 22.11.2010

(732) PURE FISHING INC, 1900 18 TH STREET, 51360 SPIRT LAKE, LOWA US

# STREN

(540)

(550) I

(740) Radulović Božidar, Jovana Tomaševića 9/III, Podgorica (ME)

(511) **Klasa 26:** Ribarski pribor.

(111) 07238

(151) 28.01.2013.

(210) **2010-437**

(442) **20.06.2012**

(220) 24.11.2010

(732) ELI LILLY AND COMPANY, LILLY CORPORATE CENTER INDIANA POLIS, INDIANA 46285 US

# FORTEO

(540)

(550) I

(740) Radulović Božidar, Jovana Tomaševića 9/III, Podgorica (ME)

(511) **Klasa 05:** Farmaceutski preparati za prevenciju i liječenje bolesti kostiju/skeleta.

(111) 07240

(151) 28.01.2013.

(210) **2010-444**

(442) **20.06.2012**

(220) 08.12.2010

(732) LABORATORIE DE LA MER, AVNUE DU GENERAL PATTON ZAC DE LA MADELEINE 35400 SAINT MALO FR

# PHYSIOMER

(540)

(550) I

(740) Radulović Božidar, Jovana Tomaševića 9/III, Podgorica (ME)

(511) **Klasa 03:** Kreme za spoljnu upotrebu naročito za iritacije spoljašnjih strana nosa i za oko usta.

**Klasa 5:** Farmaceutski preparati lijekovi farmaceutski preparati na bazi morskih proizvoda, proizvodi sa prirodnim ili hemijskim porijeklom lijekovi na bazi morskih proizvoda farmaceutski preparati, naročito rastvori za ispiranje nosnih puteva i sinusa farmaceutski preparati, naročito rastvori za higijenu, očepljivanje, dezinfekciju i humidifikaciju (vlaženje) nosnih puteva i sinusa farmaceutski preparati i lijekovi za higijenu, očepljivanje, dezinfekciju

i humidifikaciju (vlaženje) nosnih puteva i sinusa očepljivači za nazalne puteve dezinfektanti nazalnih puteva očepljivači sinusa dezinfekciona sredstva za sinuse kapi za nos, kapi za nos za patološka stanja uključujući prehlade, rinitis, sinusitis, rinosinusitis, rinofaringitis, kapi protiv sušenja nosa i simptoma nazalnih alergija (alergija, alergijski rinitis), kapi za zaštitu, obnovu (naročito izliječenje), ispiranje, higijenu, očepljivanje, dezinfekciju, humidifikaciju (vlaženje), rehidraciju nosnih puteva i sinusa i naročito za prehlade, rinofaringitis, sinusitis, rinosinusitis, alergijski i nealergijski rinitis i za postoperativnu njegu nazalni sprej, hipertronični očepljujući nazalni sprej hipertronični morski serum hipertronični morski serum u spreju nazalni sprej za patološka stanja uključujući prehlade, rinitis, sinusitis, rinosinusitis, rinofaringitis sprej protiv isušivanja nosa i protiv simptoma nazalne alergije (alergija, alergijski rinitis), sprej za zaštitu, obnovu (naročito izliječenje), ispiranje, higijenu, očepljivanje, dezinfekciju, humidifikaciju (vlaženje), rehidraciju nosnih puteva i sinusa i naročito za prehlade, rinofaringitis, sinusitis, rinosinusitis, alergijski i nealergijski rinitis i za postoperativnu negu gel (krem) emulzija za nos, nazalni gel za patološka stanja uključujući prehlade, rinitis, sinusitis, rinosinusitis, rinofaringitis gel (krem) emulzija protiv isušivanja nosa i simptoma nazalne alergije (alergija, alergijski rinitis) rastvorljivi prah za higijenu, očepljivanje, dezinfekciju i humidifikaciju (vlaženje) nazalnih puteva i sinusa rastvorljivi prah za nos za patološka stanja uključujući prehlade, rinitis, sinusitis, rinosinusitis, rinofaringitis, rastvorljivi prah protiv isušivanja nosa i simptoma nazalne alegije (alergija, alergijski rinitis), rastvorljivi prah za zaštitu, regeneraciju (naročito izliječenje), ispiranje, higijenu, očepljivanje, dezinfekciju, humidifikaciju (vlaženje), rehidraciju nazalnih puteva i sinusa a naročito za prehlade, rinofaringitis, sinusitis, rinosinusitis, alergijski i nealergijski rinitis i za postoperativnu njegu.

**Klasa 10:** Medicinski aparati i instrumenti za higijenu, očepljivanje, dezinfekciju i humidifikaciju (vlaženje) nazalnih puteva i sinusa medicinske naprave za higijenu, dezinfekciju, očepljivanje i humidifikaciju (vlaženje) nazalnih puteva i sinusa.

(111) 07242

(151) 28.01.2013.

(210) **2010-449**

(442) **20.06.2012**

(220) 10.12.2010

(732) TDR DOO, OBALA VLADIMIRA NAZORA BR 1,52210 ROVINJ HR



(540)

(550) I

(740) Vukotić Petar, Novaka Miloševa, Podgorica (ME)



(511) **Klasa 34:** Duvan sirov i prerađen, proizvodi od duvana, cigare, cigarete, filter, cigarete, cigarilosi, artikli za pušače, upaljači, šibice.

**Klasa 35:** Usluge u vezi sa prometom robe, posebno usluge u prometu duvana i duvanskih proizvoda oglašavanje vođenje poslova poslovno upravljanje kancelarijski poslovi komercijalno zastupanje propagandne i reklamne usluge marketing usluge istraživanja tržišta usluge promocije, posebno promovisanje ili reklamiranje kulturnih i zabavnih događaja, sportskih takmičenja i modnih revija organizovanje i vođenje sajмова i izložbi u reklamne i komercijalne svrhe naprijed navedene usluge koje pripadaju ovoj klasi koje se obavljaju putem interneta davanje i širenje informacija u vezi sa gore navedenim uslugama.

(111) 07243

(151) 28.01.2013.

(210) **2010-450**

(442) **20.06.2012**

(220) 10.12.2010

(732) TDR DOO, OBALA VLADIMIRA NAZORA BR 1, 52210 ROVINJ HR

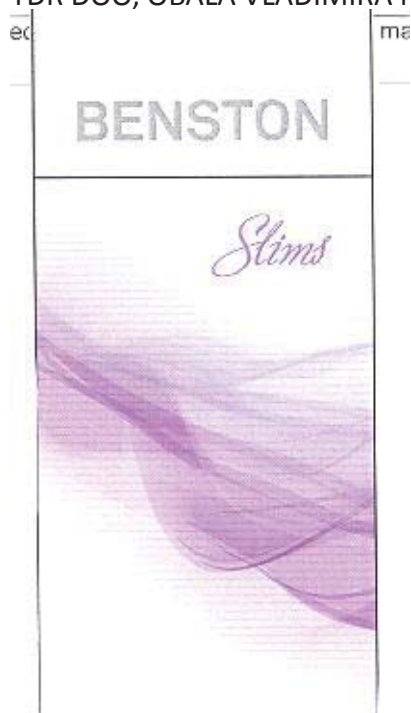

(540)

(550) I

(740) Vukotić Petar, Novaka Miloševa, Podgorica (ME)

(511) **Klasa 34:** Duvan sirov i prerađen, proizvodi od duvana, cigare, cigarete, filter, cigarete, cigarilosi, artikli za pušače, upaljači, šibice.

**Klasa 35:** Usluge u vezi sa prometom robe, posebno usluge u prometu duvana i duvanskih proizvoda oglašavanje vođenje poslova poslovno upravljanje kancelarijski poslovi komercijalno zastupanje propagandne i reklamne usluge marketing usluge istraživanja tržišta usluge promocije, posebno promovisanje ili reklamiranje kulturnih i zabavnih događaja, sportskih takmičenja i modnih revija organizovanje i vođenje sajмова i izložbi u reklamne i komercijalne svrhe naprijed navedene usluge koje pripadaju ovoj klasi koje se obavljaju putem interneta davanje i širenje informacija u vezi sa gore navedenim uslugama.

(111) 07244

(151) 28.01.2013.

(210) **2010-451**

(442) **20.06.2012**

(220) 10.12.2010

(732) TDR DOO, OBALA VLADIMIRA NAZORA BR 1, 52210 ROVINJ HR

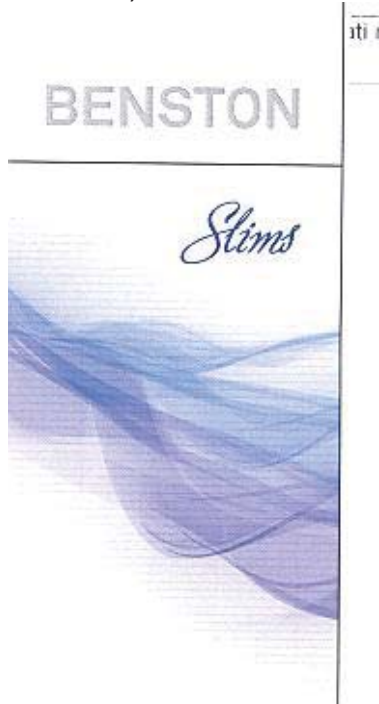

(540)

(550) I

(740) Vukotić Petar, Novaka Miloševa, Podgorica (ME)

(511) **Klasa 34:** Duvan sirov i prerađen, proizvodi od duvana, cigare, cigarete, filter, cigarete, cigarilosi, artikli za pušače, upaljači, šibice.

**Klasa 35:** Usluge u vezi sa prometom robe, posebno usluge u prometu duvana i duvanskih proizvoda oglašavanje vođenje poslova poslovno upravljanje kancelarijski poslovi komercijalno zastupanje propagandne i reklamne usluge marketing usluge istraživanja tržišta usluge promocije, posebno promovisnje ili reklamiranje kulturnih i zabavnih događaja, sportskih takmičenja i modnih revija organizovanje i vođenje sajмова i izložbi u reklamne i komercijalne svrhe naprijed navedene usluge koje pripadaju ovoj klasi koje se obavljaju putem interneta davanje i širenje informacija u vezi sa gore navedenim uslugama.

(111) 07245

(151) 28.01.2013.

(210) **2010-452**

(442) **20.06.2012**

(220) 10.12.2010

(732) TDR DOO, OBALA VLADIMIRA NAZORA BR 1, 52210 ROVINJ HR



(540) \_\_\_\_\_

(550) I

(740) Vukotić Petar, Novaka Miloševa, Podgorica (ME)

(511) **Klasa 34:** Duvan sirov i prerađen, proizvodi od duvana, cigare, cigarete, filter, cigarete, cigarilosi, artikli za pušače, upaljači, šibice.

**Klasa 35:** Usluge u vezi sa prometom robe, posebno usluge u prometu duvana i duvanskih proizvoda oglašavanje vođenje poslova poslovno upravljanje kancelarijski poslovi komercijalno zastupanje propagandne i reklamne usluge marketing usluge istraživanja tržišta usluge promocije, posebno promovisanje ili reklamiranje kulturnih i zabavnih događaja, sportskih takmičenja i modnih revija organizovanje i vođenje sajмова i izložbi u reklamne i komercijalne svrhe naprijed navedene usluge koje pripadaju ovoj klasi koje se obavljaju putem interneta davanje i širenje informacija u vezi sa gore navedenim uslugama.

(111) 07317

(151) 14.02.2013.

(210) **2010-439**

(442) **20.06.2012**

(220) 26.11.2010

(300) FR 10/3741952 28.05.2010

(732) EDENRED, 166-180 BOULEVARD GABRIEL PERI, 92240 MALAKOFF FR



(540)

(550) I

(740) Čejović Vladimir, 13. jula 21, Podgorica (ME)

(511) **Klasa 9:** Magnetne, kodirane, optičke kartice ili kartice sa integrisanim kolom (smart kartice), sa kontaktom ili bez kontakta (radio frekvencija, infracrvene ili druge), jednokratne ili punjive, mogu se koristiti kao pre-paid ili post-paid, koje mogu sadržati jedan ili više elektronskih novčanika, važe za sve vrste aplikacija, a pogotovu za kontrolu fizičkog pristupa, kontrolu pristupa kompjuterskim sistemima, kontrolu loyalty kartica software-a

za obradu komercijalne (kupovne) narudžbenice software za obradu informacija, software za kreiranje, upravljanje, ažuriranje i korištenje baza podataka, software za obezbjeđenje pristupa elektronskim servisima za slanje poruka, software za obezbjeđenje pristupa kompjuterskoj mreži ili mreži za prenos podataka, konkretno svjetskoj komunikacionoj mreži (kao što je Internet), ili privatnim mrežama i mrežama sa rezervisanim pristupom (kao što je Intranet) kompjuterski serveri, kompjuteri, telematski i telefonski terminali, a naročito za svjetsku komunikacionu mrežu (kao što je Internet), ili privatne mreže i mreže sa rezervisanim pristupom (kao što je Intranet) kompjuterski periferni uređaji kao što su kompjuterski ekrani, modemi konektori na komunikacionu mrežu, naročito kompjutersku i telefonsku mrežu, komunikaciona oprema za prijem i prenos interaktivni kompjuterski uređaji kompjuterske mreže, a naročito lokalne kompjuterske mreže, naime oprema za obradu informacija, software (snimljeni programi) elektronske publikacije (koje se mogu preuzimati).

**Klasa 16:** Štampani materijali kao što su časopisi, novine, prospekti, vodiči, brošure znamenja, kartice, karte, kuponi, kancelarijski materijal i rekviziti (osim namještaja).

**Klasa 35:** Menadžment (računovodstvo, administracija), analiza, obrada dematerijalizovanih i sigurnosnih komercijalnih informacija koje se odnose na oblasti hotelske industrije, restorana (hrana), trgovine, biznisa i finansija obrada komercijalnih narudžbenica (kupovina) poslovni menadžment, komercijalna administracija usluge komercijalne administracije za preuzimanje roba i usluga putem elektronskih kartica, kupona, vaučera ili countermarks savjetovanje, konsultacije, informacije, stručna pomoć u poslovnoj organizaciji i menadžmentu usluge pružanja poslovnih informacija koje se odnose na razglašavanje i korištenje prepaid kartica, poklon kartica i drugih vaučera za plaćanje upravljanje računima klijenata, uključujući informacije koje se odnose na prepaid kartice, poklon kartice i druge vaučere za plaćanje administrativno savjetovanje za organizovanje programa štednje unutar preduzeća proučavanje tržišta i istraživanje poslovna istraživanja ekonomska predviđanja prikupljanje (prije svega kompilacija) i sistemtizacija podataka u centralne datoteke, konkretno u kompjutersku bazu podataka knjigovodstvo i praćenje naplate faktura pisanje i zavođenje administrativne i komercijalne korespondencije sastavljanje i provjera završnih računa, priprema poreza. računovodstvenih izvještaja i izjava i dokumenata privrednog društva računovodstvena analiza, a naročito analiza proizvodnih i komercijalnih troškova statističke informacije i studije reklama, uključujući reklamiranje preko elektronskih i kompjuterskih medija, distribucija uzoraka i prospekata pa i putem elektronskih i kompjuterskih komunikacionih mreža iznajmljivanje oglasnog prostora, uključujući i onog na elektronskim i kompjuterskim medijima organizovanje operacija za jačanje lojalnosti klijenata usluge organizovanja prodajnih promocija izdavanje i podjela reklamnog materijala (letaka, prospekata, uzoraka i štampanog materijala) [reklamiranje putem slanja direktnom poštom] Reklama i ažuriranje reklamnog materijala, pa i putem elektronskih i kompjuterskih komunikacionih mreža odnosi s javnošću organizovanje salona sajмова za komercijalne ili reklamne svrhe, uključujući i putem elektronskih i kompjuterskih medija odabir i regrutovanje osoblja za druge, pa i putem elektronskih i kompjuterskih komunikacionih mreža poslovne procjene organizovanje komercijalnih kontakata (savjetovanje i traganje za partnerima u poslovnom svijetu administrativno i komercijalno organizovanje poslovnih odnosa) između profesionalnih kupaca i prodavaca nove i polovne opreme ili između klijenata i davaoca usluga savjetovanje, analize i davanje stručnog mišljenja prilikom ocjene administrativnih sredstava neophodnih za upravljanje komercijalnim narudžbama (kupovina), nabavka obroka, prehrambenih proizvoda i kućnih usluga regrutovanje i upravljanje agencijskim i privremenim osobljem studije, istraživanja i konsalting u vezi sa procjenom i unaprijeđenjem radnih uslova zapošljenih (revizija poslovne organizacije).

**Klasa 36:** Izdavanje, kompenzacija i nadoknada vaučera, karata, kupona, odrezaka, prepaid ili debitnih kreditnih kartica ili drugih sredstava plaćanja, a naročito putem kompjuterske mreže, omogućavajući organizovanje plaćanja nabavke obroka, prehrambenih proizvoda i svih drugih proizvoda ili usluga usluge kreditnih kartica i loyalty kartica upravljanje finansijskim prednostima korištenja loyalty kartice i usluga loyalty kartice (osim za reklamne svrhe) čime se omogućava kapitalizacije ovih prednosti osiguravajući, finansijski i monetarni poslovi savjetovanje, konsalting, informacije i davanje stručnog mišljenja u oblasti finansija određivanje koeficijenta, upravljanje protokom gotovine (za druge), naplata dugovanja, elektronski transfer sredstava finansiranje usluga za preuzimanje roba ili usluga pomoću elektronskih kartica, kupona, vaučera ili countermarks upravljanje stambenim kućama ili nekretninama rentiranje stanova i nekretnine zajednički fondovi i kapitalne investicije upravljanje zajedničkim fondovima, formiranje i upravljanje portfoliima finansijskih interesa, finansijskih operacija uključujući i uspostavljanje i upravljanje programima štednje za kupovinu akcija firme u kojoj se radi savjetovanje u vezi sa uspostavljanjem i upravljanjem programa štednje u okviru privrednog društva.

**Klasa 43:** Usluge hotela i restorana (hrana) catering (hrana i piće) i usluge pripreme hrane kod kuće usluge rezervisanja hotela i pansiona, usluge pružanja informacija u oblasti hotela i restorana (hrana) vrtići, dnevni vrtići, jaslice.

---

(111) 07310 (151) 14.02.2013.  
 (210) **2008-1160** (442) **20.12.2011**  
 (220) 01.12.2008  
 (732) ADRIATIC MARINAS DOO; OBALA BB TIVAT (ME)

**CASINO ROYALE**

(540)  
 (550) I  
 (511) **Klasa 41:** obrazovne usluge; pripremanje obuke; razonoda; sportske i kulturne aktivnosti  
**Klasa 43:** usluge obezbjeđivanja hrane i pica; privremeni smještaj.  
**Klasa 44:** medicinske usluge; veterinarske usluge; higijenska zaštita i njega ljepote za ljude i životinje; agrikulturne; hortikulturne i šumarske usluge

---

(111) 07311 (151) 14.02.2013.  
 (210) **2008-1161** (442) **20.12.2011**  
 (220) 01.12.2008  
 (732) ADRIATIC MARINAS DOO; OBALA BB TIVAT (ME)



(540)

(550) I

(511) **Klasa 41:** obrazovne usluge; pripremanje obuke; razonoda; sportske i kulturne aktivnosti**Klasa 43:** usluge obezbjeđivanja hrane i pica; privremeni smještaj.**Klasa 44:** medicinske usluge; veterinarske usluge; higijenska zaštita i njega ljepote za ljude i životinje; agrikulturne; hortikulturne i šumarske usluge

(111) 07312

(151) 14.02.2013.

(210) **2008-1162**(442) **20.12.2011**

(220) 01.12.2008

(732) ADRIATIC MARINAS DOO; OBALA BB TIVAT (ME)

**CASINO – ROYALE**

(540)

(550) I

(511) **Klasa 41:** obrazovne usluge; pripremanje obuke; razonoda; sportske i kulturne aktivnosti**Klasa 43:** usluge obezbjeđivanja hrane i pica; privremeni smještaj.**Klasa 44:** medicinske usluge; veterinarske usluge; higijenska zaštita i njega ljepote za ljude i životinje; agrikulturne; hortikulturne i šumarske usluge

(111) 07313

(151) 14.02.2013.

(210) **2008-1163**(442) **20.12.2011**

(220) 01.12.2008

(732) ADRIATIC MARINAS; OBALA BB TIVAT (ME)

CASINO ROYALE



PORTO MONTENEGRO

(540)

(550) I

(511) **Klasa 41:** obrazovne usluge; pripremanje obuke; razonoda; sportske i kulturne aktivnosti**Klasa 43:** usluge obezbjeđivanja hrane i pica; privremeni smještaj.**Klasa 44:** medicinske usluge; veterinarske usluge; higijenska zaštita i njega ljepote za ljude i životinje; agrikulturne; hortikulturne i šumarske usluge

(111) 07314

(151) 14.02.2013.

(210) **2008-1164**(442) **20.12.2011**

(220) 01.12.2008

(732) **ADRIATIC MARINAS DOO**; OBALA BB 85320 TIVAT (ME)

PORTO MONTENEGRO

(540)

(550) I

(511) **Klasa 41:** obrazovne usluge; pripremanje obuke; razonoda; sportske i kulturne aktivnosti**Klasa 43:** usluge obezbjeđivanja hrane i pica; privremeni smještaj.**Klasa 44:** medicinske usluge; veterinarske usluge; higijenska zaštita i njega ljepote za ljude i životinje; agrikulturne; hortikulturne i šumarske usluge

(111) 07315

(151) 14.02.2013.

(210) **2008-1201**(442) **20.12.2011**

(220) 12.12.2008

(732) **ADRIATIC MARINAS**; OBALA BB TIVAT (ME)**ROYAL MONTENEGRO GRAND RESORT**

(540)

(550) I

(511) **Klasa 41:** obrazovne usluge; pripremanje obuke; razonoda; sportske i kulturne aktivnosti**Klasa 43:** usluge obezbjeđivanja hrane i pica; privremeni smještaj.**Klasa 44:** medicinske usluge; veterinarske usluge; higijenska zaštita i njega ljepote za ljude i životinje; agrikulturne; hortikulturne i šumarske usluge

(111) 07351

(151) 14.02.2013.

(210) **2009-482**(442) **20.06.2012**

(220) 31.07.2009

(732) **NOVARTIS AG**, 4002 BASEL CH**LIVATE**

(540)

(550) I

(740) Radulović Božidar, Jovana Tomaševića 9/III, Podgorica (ME)

(511) **Klasa 05:** Vakcine za ljudsku upotrebu.

(111) 07318

(151) 14.02.2013.

(210) **2010-134**(442) **20.06.2012**

(220) 27.04.2010

(732) **THURAYA TELECOMMUNICATIONS COMPANY**, SHEIKH RASHID BIN SAEED AL MAKTOUM STREET, ETISALAT TOWER, ABU-DHABI AE(540) *skoi klasifikaciji*



(550) I

(740) Ćosović Dejan, 13. jula 1/5, Budva (ME)

(511) **Klasa 9:** Aparati i instrumenti naučni, pomorski, geodetski i električni, uključujući bežične instrumente i aparate, telekomunikacijski instrumenti i aparati uključujući prijemnike i otpremnike, telefone i bežične telefone, mobilne i celularne telefone i njihove djelove, satelite, zemaljske stanice za prijem i odašiljanje, antene, tanjiraste antene i sve tipove dekodera.

**Klasa 16:** Štampane stvari, novine i časopisi, knjige i brošure, fotografije.

**Klasa 38:** Usluge u oblasti telekomunikacija uključujući bežičnu komunikaciju, preko zemaljskih stanica i telekomunikaciju preko satelita.

(111) 07319

(151) 14.02.2013.

(210) **2010-135**

(442) **20.06.2012**

(220) 27.04.2010

(732) **AS DOO**, JELAH BB, TEŠANJ BA

## KENT ELIT

(540)

(550) I

(740) Ćosović Dejan, 13. jula 1/5, Budva (ME)

(511) **Klasa 29:** Meso, riba, živina i divljač mesne prerađevine konzervisano, zamrznuto, sušeno i kuvano voće i povrće želei, džemovi, kompoti jaja, mlijeko i mlječni proizvodi jestiva ulja i masti.

**Klasa 30:** Kafa, čaj, kakao, šećer, pirinač, tapioka, sago, zamjena kafe brašno i proizvodi od žitarica, hleb, kolači i poslastice, sladoledi med, melasa kvasac, prašak za pecivo so, senf sirće, sosovi (kao dodaci) začini led.

(111) 07349

(151) 14.02.2013.

(210) **2010-455**

(442) **20.06.2012**

(220) 13.12.2010

(732) **I.W.S. NOMINEE COMPANY LIMITED**, 100 NEW BRIDGE STREET, LONDON EC4V 6JA GB



(540)

(550) I

(740) Ćejović Vladimir, 13. jula 21, Podgorica (ME)

(511) **Klasa 09:** Električne pegle

---

(111) 07326

(151) 14.02.2013.

(210) **2010-465**

(442) **20.06.2012**

(220) 20.12.2010

(732) **GAP (ITM)**, INC,A CALIFORNIA CORPORATION, 2 FOLSOM STREET, SAN FRANCISCO, CA 94105 US

## GAP 1969

(540)

(550) I

(740) Lutovac Branislav, Bulevar Crnojevića 93, Podgorica (ME)

(511) **Klasa 06:** Metalni građevinski materijali kao što su skele/građa za skele, čelična vrata, rešetke prozori, vrata metalne prenosive konstrukcije kao što su nosači, stupovi, rešetkaste konstrukcije, metalni spremnici kao što su silosi, spremnici za cement i beton.

---

(111) 07327

(151) 14.02.2013.

(210) **2010-466**

(442) **20.06.2012**

(220) 20.12.2010

(732) **GAP (ITM)**, INC,A CALIFORNIA CORPORATION, 2 FOLSOM STREET, SAN FRANCISCO,CA 94105 US

## GAP 1969

(540)

(550) I

(740) Lutovac Branislav, Bulevar Crnojevića 93, Podgorica (ME)

(511) **Klasa 35:** Oglašavanje vođenje poslova poslovno upravljanje kancelarijski poslovi.

---

(111) 07350

(151) 14.02.2013.

(210) **2010-472**

(442) **20.06.2012**

(220) 22.12.2010

(732) **TOYOTA JIDOSHA KABUSHIKI KAISHA**, 1, TOYOTA-CHO, TOYOTA-SHI, AICHI-KEN JP



(540)

(550) I

(740) Čejović Vladimir, 13. jula 21, Podgorica (ME)

(511) **Klasa 12:** Automobili i njihovi strukturni djelovi.

(111) 07397

(151) 19.02.2013.

(210) **2009-508**(442) **20.06.2012**

(220) 12.08.2009

(732) **TUTUNSKI KOBINAT AD PRILEP**, UL. MARKSOVA BR. 101 7500 PRILEP MK

(540)

(550) I

(740) Radulović Božidar, Jovana Tomaševića 9/III, Podgorica (ME)

(511) **Klasa 34:** Duvan artikli za pušače šibice.

(111) 07395

(151) 19.02.2013.

(210) **2009-438**(442) **20.06.2012**

(220) 29.06.2009

(732) **OKOV DOO**, PODGORICA DOO JOSIPA BROZA TITA BR 26, PODGORICA ME

(540)

(550) I

(511) **Klasa 1:** hemijski proizvodi koji se upotrebljavaju u industriji, nauci, fotografiji, poljoprivredi, hortikulturi i šumarstvu neprerađene vještačke smole, neprerađene plastične materije đubriva smješe za gašenje vatre preparati za kaljenje i zavarivanje hemijske supstance za očuvanje namirnica materije za štavljenje ljepljive supstance koje se upotrebljavaju u industriji.

**Klasa 2:** boje, firnazji, lakovi, sredstva za zaštitu od rđe i truljenja drveta materije za bojenje sredstva za nagrizanje sirove prirodne smole metali u obliku listova i praha za slikare, dekoratere, štampare i umjetnike.

**Klasa 3:** sredstva za bijeljenje i druge supstance za upotrebu u perionicama preparati za čišćenje, poliranje, ribanje i nagrizanje sapuni parfimerija, eterična ulja, kozmetika, losioni za kosu paste za zube.

**Klasa 4:** industrijska ulja i masti maziva jedinjenja za skupljanje prašine vlaženjem i vezivanjem

goriva (uključujući motorna tečna goriva) i materije za osvjetljavanje svijeće i fitilji za osvjetljavanje.

**Klasa 5:** farmaceutski i veterinarski preparati sanitarni preparati za medicinsku upotrebu dijetetske supstance prilagođene za upotrebu u medicini, hrana za bebe flasteri, materijali za zavijanje materijali za plombiranje zuba, zubarska smola dezinfekciona sredstva preparati za uništavanje štetočina fungicidi, herbicidi.

**Klasa 6:** obični metali i njihove legure metalni građevinski materijali metalne prenosne građevine materijali od metala za železničke šine neelektrične žice i kablovi od običnog metala bravarski proizvodi mali metalni gvoždarski proizvodi cjevčice i cijevi od metala sefovi proizvodi od običnih metala koji nisu uključeni u druge klase rude.

**Klasa 7:** mašine i mašinski alati motori i pogonske mašine (osim za suvozemna vozila) mašinske spojnice i transmisioni elementi (osim za suvozemna vozila) poljoprivredne sprave inkubatori za jaja.

**Klasa 8:** ručni alati i sprave (kojima se ručno upravlja) pribor za jelo hladno oružje žileti.

**Klasa 9:** aparati i instrumenti naučni, pomorski, geodetski, fotografski, kinematografski, optički, za vaganje, mjerenje, signalizaciju, kontrolu (inspekciju), spašavanje i nastavu aparati i instrumenti za provođenje, prekid, transformaciju, akumulaciju, regulisanje i kontrolu elektriciteta aparati za snimanje, prenos i reprodukovanje zvuka ili slike magnetni nosioci podataka, diskovi za snimanje automatske mašine i mehanizmi za aparate koji se pokreću novcem ili žetonom registar kase, računске mašine, oprema za obradu podataka i kompjuteri aparati za gašenje požara.

**Klasa 10:** hirurški, medicinski, zubarski i veterinarski aparati i instrumenti vještački udovi, oči i zubi ortopedski artikli hirurški materijali za zašivanje.

**Klasa 11:** aparati za osvjetljavanje, grijanje, proizvodnju pare, kuvanje, hlađenje, sušenje, ventilaciju, snabdjevanje vodom i za sanitarne svrhe.

**Klasa 12:** vozila aparati za kretanje po zemlji, vazduhu ili vodi.

**Klasa 13:** vatreno oružje municija i projektili eksplozivni sredstva za vatromet.

**Klasa 14:** dragocjeni metali i njihove legure i proizvodi od dragocjenih metala ili sa prevlakom od njih, koji nisu uključeni u druge klase nakit, bižuterija, drago kamenje časovničarski i hronometrijski instrumenti.

**Klasa 15:** muzički instrumenti.

**Klasa 16:** hartija, karton i proizvodi od njih, koji nisu uključeni u druge klase štampane stvari knjigovezački materijal fotografije kancelarijski materijal ljepila za kancelarijske i kućne potrebe umjetnički materijali kičice pisaće mašine i kancelarijski rekviziti (izuzev namještaja) materijali za obuku i nastavu (izuzev aparata) plastični materijal za pakovanje (koji nije uključen u druge klase) štamparska slova klišeji.

**Klasa 17:** guma, gutaperka, kaučuk, azbest, liskun i proizvodi napravljeni od ovih materijala koji nisu uključeni u druge klase polupreradeni plastični proizvodi materijali za podbijanje (podloške), zaptivanje i izolovanje savitljive nemetalne cijevi.

**Klasa 18:** koža i imitacija kože, proizvodi izrađeni od ovih materijala koji nisu uključeni u druge klase životinjska koža koferi i putne torbe kišobrani, suncobrani i štapovi za hodanje bičevi, saračka i sedlarska roba.

**Klasa 19:** građevinski materijali (nemetalni) čvrste nemetalne cijevi za građevine asfalt, crna smola i bitumen, nemetalne prenosne građevine spomenici, koji nisu od metala.

**Klasa 20:** Namještaj, ogledala, okviri za slike proizvodi (koji nisu obuhvaćeni drugim Klasama) od drveta, plute, trske, rogoza, vrbovog pruća, roga, kosti, slonovače, kitove kosti, školjki, ćilibara, sedefa, morske pjene i zamjene svih ovih materijala, ili od plastike.

**Klasa 21:** kućne ili kuhinjske sprave i posude (koje nisu od dragocjenih metala ili sa prevlakama od njih) češljevi i sunđeri četke (izuzev kičica) materijali za pravljenje četki artikli koji se koriste pri čišćenju čelična vuna neprerađeno ili poluprerado staklo (osim stakla koje se koristi u građevinarstvu) staklarija, porcelan, fajans, grnčarija i lončarija koja nije uključena u druge klase.

**Klasa 22:** užad, kanapi, mreže, šatori, nadstrešnice od cirade, cirade, jedra, vreće (džakovi) i torbe (koje nisu uključene u druge klase) materijali za punjenje madraca (osim od gume ili plastike) sirove vlaknaste tekstilne materije.

**Klasa 23:** pređa i konac, za tekstilnu upotrebu.

**Klasa 24:** tekstil i tekstilni proizvodi koji nisu obuhvaćeni drugim Klasama prekrivači za krevete i stolove.

**Klasa 25:** odjeća, obuća, pokrivala za glavu.

**Klasa 26:** čipka i vez, trake (pantljike) i gajtani dugmad, kopče i petlje, špenadle i igle vještačko cvijeće.

**Klasa 27:** tepisi, asure, prostirke i otirači, linoleum i drugi materijali za pokrivanje podova prekrivači za zidove (netekstilni).

**Klasa 28:** igre i igračke gimnastički i sportski artikli koji nisu obuhvaćeni drugim Klasama ukrasi za jelke.

**Klasa 29:** meso, riba, živina i divljač mesne prerađevine konzervisano, sušeno i kuvano voće i povrće želei, džemovi, kompoti jaja, mlijeko i mliječni proizvodi jestiva ulja i masti.

**Klasa 30:** kafa, čaj, kakao, šećer, pirinač, tapioka, sago, zamjena kafe brašno i proizvodi od žitarica, hleb, kolači, poslastice, sladoledi med, melasa, kvasac, prašak za pecivo so, senf sirće, sosovi (kao začini) začini led.

**Klasa 31:** poljoprivredni, vrtlarski i šumarski proizvodi i zrnlje koji nisu uključeni u druge klase žive životinje svježe voće i povrće sjeme, prirodne biljke i cvijeće hrana za životinje, slad.

**Klasa 32:** pivo, mineralne i sodne vode i druga bezalkoholna pića od voća i voćni sokovi sirupi i drugi preparati za proizvodnju pića.

**Klasa 33:** alkoholna pića (izuzev piva).

**Klasa 34:** duvan artikli za pušače šibice.

**Klasa 35:** oglašavanje vođenje poslova poslovno upravljanje kancelarijski poslovi.

**Klasa 36:** osiguranje finansijski poslovi novčani (monetarni) poslovi vezani za nepokretnosti.

**Klasa 37:** građevinsko konstruisanje popravlanje usluge instaliranja (instalacione usluge).

**Klasa 38:** telekomunikacije.

**Klasa 39:** transportne usluge pakovanje i skladištenje robe organizovanje putovanja.

**Klasa 40:** obrađivanje materijala.

**Klasa 42:** naučne i tehnološke usluge i istraživanje i projektovanje u vezi navedenih usluga usluge industrijske analize i istraživanja projektovanje i razvoj kompjuterskog hardvera i softvera.

**Klasa 43:** usluge obezbjeđivanja hrane i pića privremeni smeštaj.

---

(111) 07388

(151) 19.02.2013.

(210) **2010-405**

(442) **20.06.2012**

(220) 02.11.2010

(732) **MERCATOR -CG DOO**, PUT RADOMIRA IVANOVIĆA 2,81000 PODGORICA ME



(540)

(550) I

(511) **Klasa 35:** Oglašavanje, vođenje poslova, poslovno upravljanje, kancelarijski poslovi, trgovina na malo robom, voćem i povrćem, mesom i proizvodima od mesa, ribom, ljuskarima i mekušcima, hljebom, kolačima i slatkišima, alkoholnim i bezalkoholnim pićima, proizvodima od duvana, kozmetičkim i toaletnim preparatima, tekstilom, odjećom, obućom i predmetima od kože, namještajem i opremom za osvjetljavanje, aparatima za domaćinstvo, radio i televizijskim uređajima, metalnom robom, bojama i staklom I knjigama, novinama i pisanim materijalom. trgovina na veliko robom, zrnastim proizvodima, sjemenjem i hranom za životinje, voćem i povrćem, mesom i proizvodima od mesa, mlječnim proizvodima, jajima i jestivim uljima i mastima, cvijećem i rastinjem, alkoholnim i drugim pićima, duvanskim proizvodima, šećerom, čokoladom i slatkišima od šećera, kafom, čajevima, kakaom i začинима, tekstilom, odjećom i obućom, električnim aparatima za domaćinstvo i radio i televizijskim uređajima, porculanom i staklarijom, parfimerijskim i kozmetičkim proizvodima, metalnom robom, cijevima, uređajima i opremom za centralno grijanje, hemijskim proizvodima i kancelarijskim mašinama i opremom. trgovina poštom preko kataloga, zrnastim proizvodima, sjemenjem i hranom za životinje, voćem i povrćem, mesom i proizvodima od mesa, mlječnim proizvodima, jajima i jestivim uljima i mastima, cvijećem i rastinjem, alkoholnim i drugim pićima, šećerom, čokoladom i slatkišima od šećera, kafom, čajevima, kakaom i začинима, tekstilom, odjećom i obućom, električnim aparatima za domaćinstvo i radio i televizijskim uređajima porculanom i staklarijom, parfimerijskim i kozmetičkim proizvodima, metalnom robom, cijevima, uređajima i opremom za centralno grijanje, hemijskim proizvodima i kancelarijskim mašinama i opremom. trgovina putem elektronskih medija (preko web-site-a ili televizijskih programa za kupovinu), zrnastim proizvodima, sjemenjem i hranom za životinje, voćem i povrćem, mesom i proizvodima od mesa, mlječnim proizvodima, jajima i jestivim uljima i mastima, cvijećem i rastinjem, alkoholnim i drugim pićima, šećerom, čokoladom i slatkišima od šećera kafom, čajevima, kakaom i začинима, tekstilom, odjećom i obućom, električnim aparatima za domaćinstvo i radio i televizijskim uređajima porculanom i staklarijom, parfimerijskim i kozmetičkim proizvodima, metalnom robom, cijevima, uređajima i opremom za centralno grijanje, hemijskim proizvodima i kancelarijskim mašinama i opremom.

**Klasa 39:** Transportne usluge, prevoz putnika u drumskom saobraćaju, prevoz robe u drumskom saobraćaju, iznajmljivanje automobila. pakovanje i skladištenje robe, organizovanje putovanja.

**Klasa 43:** Usluge obezbjeđivanja hrane i pića, restorani, barovi, kantine, ugostiteljske usluge, privremeni smještaj.

(111) 07389

(151) 19.02.2013.

(210) **2010-406**(442) **20.06.2012**

(220) 02.11.2010

(732) **MERCATOR-CG DOO PODGORICA**, PUT RADOMIRA IVANOVIĆA 2, PODGORICA ME

(540)

(550) I

(511) **Klasa 35:** Oglašavanje, vođenje poslova, poslovno upravljanje, kancelarijski poslovi, trgovina na malo robom, voćem i povrćem, mesom i proizvodima od mesa, ribom, ljuskarima i mekušcima, hljebom, kolačima i slatkišima, alkoholnim i bezalkoholnim pićima, proizvodima od duvana, kozmetičkim i toaletnim preparatima, tekstilom, odjećom, obućom i predmetima od kože, namještajem i opremom za osvjetljavanje, aparatima za domaćinstvo, radio i televizijskim uređajima, metalnom robom, bojama i staklom I knjigama, novinama i pisanim materijalom. trgovina na veliko robom, zrnastim proizvodima, sjemenjem i hranom za životinje, voćem i povrćem, mesom i proizvodima od mesa, mlječnim proizvodima, jajima i jestivim uljima i mastima, cvijećem i rastinjem, alkoholnim i drugim pićima, duvanskim proizvodima, šećerom, čokoladom i slatkišima od šećera, kafom, čajevima, kakaom i začинима, tekstilom, odjećom i obućom, električnim aparatima za domaćinstvo i radio i televizijskim uređajima, porculanom i staklarijom, parfimerijskim i kozmetičkim proizvodima, metalnom robom, cijevima, uređajima i opremom za centralno grijanje, hemijskim proizvodima i kancelarijskim mašinama i opremom. trgovina poštom preko kataloga, zrnastim proizvodima, sjemenjem i hranom za životinje, voćem i povrćem, mesom i proizvodima od mesa, mlječnim proizvodima, jajima i jestivim uljima i mastima, cvijećem i rastinjem, alkoholnim i drugim pićima, šećerom, čokoladom i slatkišima od šećera, kafom, čajevima, kakaom i začинима, tekstilom, odjećom i obućom, električnim aparatima za domaćinstvo i radio i televizijskim uređajima porculanom i staklarijom, parfimerijskim i kozmetičkim proizvodima, metalnom robom, cijevima, uređajima i opremom za centralno grijanje, hemijskim proizvodima i kancelarijskim mašinama i opremom. trgovina putem elektronskih medija (preko web-site-a ili televizijskih programa za kupovinu), zrnastim proizvodima, sjemenjem i hranom za životinje, voćem i povrćem, mesom i proizvodima od mesa, mlječnim proizvodima, jajima i jestivim uljima i mastima, cvijećem i rastinjem, alkoholnim i drugim pićima, šećerom, čokoladom i slatkišima od šećera kafom, čajevima, kakaom i začинима, tekstilom, odjećom i obućom, električnim aparatima za domaćinstvo i radio i televizijskim uređajima, porculanom i staklarijom, parfimerijskim i kozmetičkim proizvodima, metalnom robom, cijevima, uređajima i opremom za centralno grijanje, hemijskim proizvodima i kancelarijskim mašinama i opremom.

**Klasa 39:** Transportne usluge, prevoz putnika u drumskom saobraćaju, prevoz robe u drumskom saobraćaju, iznajmljivanje automobila. pakovanje i skladištenje robe, organizovanje putovanja.

**Klasa 43:** Usluge obezbjeđivanja hrane i pića, restorani, barovi, kantine, ugostiteljske usluge, privremeni smještaj.

(111) 07390

(151) 19.02.2013.

(210) **2010-407**(442) **20.06.2012**

(220) 02.11.2010

(732) **MERCATOR-CG DOO PODGORICA**, PUT RADOMIRA IVANOVIĆA 2, PODGORICA ME

(540)

(550) I

(511) **Klasa 35:** Oglašavanje, vođenje poslova, poslovno upravljanje, kancelarijski poslovi, trgovina na malo robom, voćem i povrćem, mesom i proizvodima od mesa, ribom, ljuskarima i mekušcima, hlebom, kolačima i slatkišima, alkoholnim i bezalkoholnim pićima, proizvodima od duvana, kozmetičkim i toaletnim preparatima, tekstilom, odjećom, obućom i predmetima od kože, namještajem i opremom za osvjtljavanje, aparatima za domaćinstvo, radio i televizijskim uređajima, metalnom robom, bojama i staklom I knjigama, novinama i pisanim materijalom. trgovina na veliko robom, zrnastim proizvodima, sjemenjem i hranom za životinje, voćem i povrćem, mesom i proizvodima od mesa, mlječnim proizvodima, jajima i jestivim uljima i mastima, cvijećem i rastinjem, alkoholnim i drugim pićima, duvanskim proizvodima, šećerom, čokoladom i slatkišima od šećera, kafom, čajevima, kakaom i začinima, tekstilom, odjećom i obućom, električnim aparatima za domaćinstvo i radio i televizijskim uređajima, porculanom i staklarijom, parfimerijskim i kozmetičkim proizvodima, metalnom robom, cijevima, uređajima i opremom za centralno grijanje, hemijskim proizvodima i kancelarijskim mašinama i opremom. trgovina poštom preko kataloga, zrnastim proizvodima, sjemenjem i hranom za životinje, voćem i povrćem, mesom i proizvodima od mesa, mlječnim proizvodima, jajima i jestivim uljima i mastima, cvijećem i rastinjem, alkoholnim i drugim pićima, šećerom, čokoladom i slatkišima od šećera, kafom, čajevima, kakaom i začinima, tekstilom, odjećom i obućom, električnim aparatima za domaćinstvo i radio i televizijskim uređajima porculanom i staklarijom, parfimerijskim i kozmetičkim proizvodima, metalnom robom, cijevima, uređajima i opremom za centralno grijanje, hemijskim proizvodima i kancelarijskim mašinama i opremom. trgovina putem elektronskih medija (preko web-site-a ili televizijskih programa za kupovinu), zrnastim proizvodima, sjemenjem i hranom za životinje, voćem i povrćem, mesom i proizvodima od mesa, mlječnim proizvodima, jajima i jestivim uljima i mastima, cvijećem i rastinjem, alkoholnim i drugim pićima, šećerom, čokoladom i slatkišima od šećera kafom, čajevima, kakaom i začinima, tekstilom, odjećom i obućom, električnim aparatima za domaćinstvo i radio i televizijskim uređajima porculanom i staklarijom, parfimerijskim i kozmetičkim proizvodima, metalnom robom, cijevima, uređajima i opremom za centralno grijanje, hemijskim proizvodima i kancelarijskim mašinama i opremom.

**Klasa 39:** Transportne usluge, prevoz putnika u drumskom saobraćaju, prevoz robe u drumskom saobraćaju, iznajmljivanje automobila. pakovanje i skladištenje robe, organizovanje putovanja.

**Klasa 43:** Usluge obezbjeđivanja hrane i pića, restorani, barovi, kantine, ugostiteljske usluge,



privremeni smještaj.

(111) 07391

(151) 19.02.2013.

(210) **2010-408**

(442) **20.06.2012**

(220) 02.11.2010

(732) **MERCATOR-CG DOO**, PUT RADOMIRA IVANOVIĆA 2, PODGORICA ME



(540) |

(550) |

(511) **Klasa 35:** Oglašavanje, vođenje poslova, poslovno upravljanje, kancelarijski poslovi, trgovina na malo robom, voćem i povrćem, mesom i proizvodima od mesa, ribom, ljuskarima i mekušcima, hljebom, kolačima i slatkišima, alkoholnim i bezalkoholnim pićima, proizvodima od duvana, kozmetičkim i toaletnim preparatima, tekstilom, odjećom, obućom i predmetima od kože, namještajem i opremom za osvjetljavanje, aparatima za domaćinstvo, radio i televizijskim uređajima, metalnom robom, bojama i staklom I knjigama, novinama i pisanim materijalom. trgovina na veliko robom, zrnastim proizvodima, sjemenjem i hranom za životinje, voćem i povrćem, mesom i proizvodima od mesa, mlječnim proizvodima, jajima i jestivim uljima i mastima, cvijećem i rastinjem, alkoholnim i drugim pićima, duvanskim proizvodima, šećerom, čokoladom i slatkišima od šećera, kafom, čajevima, kakaom i začинима, tekstilom, odjećom i obućom, električnim aparatima za domaćinstvo i radio i televizijskim uređajima, porculanom i staklarijom, parfimerijskim i kozmetičkim proizvodima, metalnom robom, cijevima, uređajima i opremom za centralno grijanje, hemijskim proizvodima i kancelarijskim mašinama i opremom. trgovina poštom preko kataloga, zrnastim proizvodima, sjemenjem i hranom za životinje, voćem i povrćem, mesom i proizvodima od mesa, mlječnim proizvodima, jajima i jestivim uljima i mastima, cvijećem i rastinjem, alkoholnim i drugim pićima, šećerom, čokoladom i slatkišima od šećera, kafom, čajevima, kakaom i začинима, tekstilom, odjećom i obućom, električnim aparatima za domaćinstvo i radio i televizijskim uređajima porculanom i staklarijom, parfimerijskim i kozmetičkim proizvodima, metalnom robom, cijevima, uređajima i opremom za centralno grijanje, hemijskim proizvodima i kancelarijskim mašinama i opremom. trgovina putem elektronskih medija (preko web-site-a ili televizijskih programa za kupovinu), zrnastim proizvodima, sjemenjem i hranom za životinje, voćem i povrćem, mesom i proizvodima od mesa, mlječnim proizvodima, jajima i jestivim uljima i mastima, cvijećem i rastinjem, alkoholnim i drugim pićima, šećerom, čokoladom i slatkišima od šećera kafom, čajevima, kakaom i začинима, tekstilom, odjećom i obućom, električnim aparatima za domaćinstvo i radio i televizijskim uređajima porculanom i staklarijom, parfimerijskim i kozmetičkim proizvodima, metalnom robom, cijevima, uređajima i opremom za centralno grijanje, hemijskim proizvodima i kancelarijskim mašinama i opremom.

**Klasa 39:** Transportne usluge, prevoz putnika u drumskom saobraćaju, prevoz robe u drumskom saobraćaju, iznajmljivanje automobila. pakovanje i skladištenje robe, organizovanje putovanja.

**Klasa 43:** Usluge obezbjeđivanja hrane i pića, restorani, barovi, kantine, ugostiteljske usluge, privremeni smještaj.

(111) 07392

(151) 19.02.2013.

(210) **2010-409**

(442) **20.06.2012**

(220) 02.11.2010

(732) **MERCATOR-CG DOO**, PUT RADOMIRA IVANOVIĆA 2, PODGORICA ME



(540)

(550) I

(511) **Klasa 35:** Oglašavanje, vođenje poslova, poslovno upravljanje, kancelarijski poslovi, trgovina na malo robom, voćem i povrćem, mesom i proizvodima od mesa, ribom, ljuskarima i mekušcima, hljebom, kolačima i slatkišima, alkoholnim i bezalkoholnim pićima, proizvodima od duvana, kozmetičkim i toaletnim preparatima, tekstilom, odjećom, obućom i predmetima od kože, namještajem i opremom za osvjetljavanje, aparatima za domaćinstvo, radio i televizijskim uređajima, metalnom robom, bojama i staklom I knjigama, novinama i pisanim materijalom. trgovina na veliko robom, zrnastim proizvodima, sjemenjem i hranom za životinje, voćem i povrćem, mesom i proizvodima od mesa, mlječnim proizvodima, jajima i jestivim uljima i mastima, cvijećem i rastinjem, alkoholnim i drugim pićima, duvanskim proizvodima, šećerom, čokoladom i slatkišima od šećera, kafom, čajevima, kakaom i začinima, tekstilom, odjećom i obućom, električnim aparatima za domaćinstvo i radio i televizijskim uređajima, porculanom i staklarijom, parfimerijskim i kozmetičkim proizvodima, metalnom robom, cijevima, uređajima i opremom za centralno grijanje, hemijskim proizvodima i kancelarijskim mašinama i opremom. trgovina poštom preko kataloga, zrnastim proizvodima, sjemenjem i hranom za životinje, voćem i povrćem, mesom i proizvodima od mesa, mlječnim proizvodima, jajima i jestivim uljima i mastima, cvijećem i rastinjem, alkoholnim i drugim pićima, šećerom, čokoladom i slatkišima od šećera, kafom, čajevima, kakaom i začinima, tekstilom, odjećom i obućom, električnim aparatima za domaćinstvo i radio i televizijskim uređajima porculanom i staklarijom, parfimerijskim i kozmetičkim proizvodima, metalnom robom, cijevima, uređajima i opremom za centralno grijanje, hemijskim proizvodima i kancelarijskim mašinama i opremom. trgovina putem elektronskih medija (preko web-site-a ili televizijskih programa za kupovinu), zrnastim proizvodima, sjemenjem i hranom za životinje, voćem i povrćem, mesom i proizvodima od mesa, mlječnim proizvodima, jajima i jestivim uljima i mastima, cvijećem i rastinjem, alkoholnim i drugim pićima, šećerom, čokoladom i slatkišima od šećera kafom, čajevima, kakaom i začinima, tekstilom, odjećom i obućom, električnim aparatima za domaćinstvo i radio i televizijskim uređajima porculanom i staklarijom, parfimerijskim i kozmetičkim proizvodima, metalnom robom, cijevima, uređajima i opremom za centralno grijanje, hemijskim proizvodima i kancelarijskim mašinama i opremom.

**Klasa 39:** Transportne usluge, prevoz putnika u drumskom saobraćaju, prevoz robe u drumskom saobraćaju, iznajmljivanje automobila. pakovanje i skladištenje robe, organizovanje

putovanja.

**Klasa 43:** Usluge obezbjeđivanja hrane i pića, restorani, barovi, kantine, ugostiteljske usluge, privremeni smještaj.

(111) 07393

(151) 19.02.2013.

(210) **2010-410**

(442) **20.06.2012**

(220) 02.11.2010

(732) **MERCATOR CG DOO**, PUT RADOMIRA IVANOVIĆA 2, PODGORICA ME

*Srećna kupovina!*

(540)

(550) I

(511) **Klasa 35:** Oglašavanje, vođenje poslova, poslovno upravljanje, kancelarijski poslovi, trgovina na malo robom, voćem i povrćem, mesom i proizvodima od mesa, ribom, ljuskarima i mekušcima, hljebom, kolačima i slatkišima, alkoholnim i bezalkoholnim pićima, proizvodima od duvana, kozmetičkim i toaletnim preparatima, tekstilom, odjećom, obućom i predmetima od kože, namještajem i opremom za osvjetljavanje, aparatima za domaćinstvo, radio i televizijskim uređajima, metalnom robom, bojama i staklom I knjigama, novinama i pisanim materijalom. trgovina na veliko robom, zrnastim proizvodima, sjemenjem i hranom za životinje, voćem i povrćem, mesom i proizvodima od mesa, mlječnim proizvodima, jajima i jestivim uljima i mastima, cvijećem i rastinjem, alkoholnim i drugim pićima, duvanskim proizvodima, šećerom, čokoladom i slatkišima od šećera, kafom, čajevima, kakaom i začинима, tekstilom, odjećom i obućom, električnim aparatima za domaćinstvo i radio i televizijskim uređajima, porculanom i staklarijom, parfimerijskim i kozmetičkim proizvodima, metalnom robom, cijevima, uređajima i opremom za centralno grijanje, hemijskim proizvodima i kancelarijskim mašinama i opremom. trgovina poštom preko kataloga, zrnastim proizvodima, sjemenjem i hranom za životinje, voćem i povrćem, mesom i proizvodima od mesa, mlječnim proizvodima, jajima i jestivim uljima i mastima, cvijećem i rastinjem, alkoholnim i drugim pićima, šećerom, čokoladom i slatkišima od šećera, kafom, čajevima, kakaom i začинима, tekstilom, odjećom i obućom, električnim aparatima za domaćinstvo i radio i televizijskim uređajima porculanom i staklarijom, parfimerijskim i kozmetičkim proizvodima, metalnom robom, cijevima, uređajima i opremom za centralno grijanje, hemijskim proizvodima i kancelarijskim mašinama i opremom. trgovina putem elektronskih medija (preko web-site-a ili televizijskih programa za kupovinu), zrnastim proizvodima, sjemenjem i hranom za životinje, voćem i povrćem, mesom i proizvodima od mesa, mlječnim proizvodima, jajima i jestivim uljima i mastima, cvijećem i rastinjem, alkoholnim i drugim pićima, šećerom, čokoladom i slatkišima od šećera kafom, čajevima, kakaom i začинима, tekstilom, odjećom i obućom, električnim aparatima za domaćinstvo i radio i televizijskim uređajima porculanom i staklarijom, parfimerijskim i kozmetičkim proizvodima, metalnom robom, cijevima, uređajima i opremom za centralno grijanje, hemijskim proizvodima i kancelarijskim mašinama i opremom.

**Klasa 39:** Transportne usluge, prevoz putnika u drumskom saobraćaju, prevoz robe u drumskom

saobraćaju, iznajmljivanje automobila. pakovanje i skladištenje robe, organizovanje putovanja.

**Klasa 43:** Usluge obezbjeđivanja hrane i pića, restorani, barovi, kantine, ugostiteljske usluge, privremeni smještaj.

(111) 07394

(151) 19.02.2013.

(210) **2010-411**

(442) **20.06.2012**

(220) 02.11.2010

(732) **MERCATOR CG DOO**, PUT RADOMIRA IVANOVIĆA 2, PODGORICA ME



(540)

(550) I

(511) **Klasa 35:** Oglašavanje, vođenje poslova, poslovno upravljanje, kancelarijski poslovi, trgovina na malo robom, voćem i povrćem, mesom i proizvodima od mesa, ribom, ljuskarima i mekušcima, hljebom, kolačima i slatkišima, alkoholnim i bezalkoholnim pićima, proizvodima od duvana, kozmetičkim i toaletnim preparatima, tekstilom, odjećom, obućom i predmetima od kože, namještajem i opremom za osvjetljavanje, aparatima za domaćinstvo, radio i televizijskim uređajima, metalnom robom, bojama i staklom I knjigama, novinama i pisanim materijalom. trgovina na veliko robom, zrnastim proizvodima, sjemenjem i hranom za životinje, voćem i povrćem, mesom i proizvodima od mesa, mlječnim proizvodima, jajima i jestivim uljima i mastima, cvijećem i rastinjem, alkoholnim i drugim pićima, duvanskim proizvodima, šećerom, čokoladom i slatkišima od šećera, kafom, čajevima, kakaom i začinicima, tekstilom, odjećom i obućom, električnim aparatima za domaćinstvo i radio i televizijskim uređajima, porculanom i staklarijom, parfimerijskim i kozmetičkim proizvodima, metalnom robom, cijevima, uređajima i opremom za centralno grijanje, hemijskim proizvodima i kancelarijskim mašinama i opremom. trgovina poštom preko kataloga, zrnastim proizvodima, sjemenjem i hranom za životinje, voćem i povrćem, mesom i proizvodima od mesa, mlječnim proizvodima, jajima i jestivim uljima i mastima, cvijećem i rastinjem, alkoholnim i drugim pićima, šećerom, čokoladom i slatkišima od šećera, kafom, čajevima, kakaom i začinicima, tekstilom, odjećom i obućom, električnim aparatima za domaćinstvo i radio i televizijskim uređajima porculanom i staklarijom, parfimerijskim i kozmetičkim proizvodima, metalnom robom, cijevima, uređajima i opremom za centralno grijanje, hemijskim proizvodima i kancelarijskim mašinama i opremom. trgovina putem elektronskih medija (preko web-site-a ili televizijskih programa za kupovinu), zrnastim proizvodima, sjemenjem i hranom za životinje, voćem i povrćem, mesom i proizvodima od mesa, mlječnim proizvodima, jajima i jestivim uljima i mastima, cvijećem i rastinjem, alkoholnim i drugim pićima, šećerom, čokoladom i slatkišima od šećera kafom, čajevima, kakaom i začinicima, tekstilom, odjećom i obućom, električnim aparatima za domaćinstvo i radio i televizijskim uređajima, porculanom i staklarijom, parfimerijskim i kozmetičkim proizvodima, metalnom robom, cijevima, uređajima i opremom za centralno grijanje, hemijskim proizvodima i kancelarijskim mašinama i opremom.

**Klasa 39:** Transportne usluge, prevoz putnika u drumskom saobraćaju, prevoz robe u drumskom

saobraćaju, iznajmljivanje automobila. pakovanje i skladištenje robe, organizovanje putovanja.

**Klasa 43:** Usluge obezbjeđivanja hrane i pića, restorani, barovi, kantine, ugostiteljske usluge, privremeni smještaj.

(111) 07396

(151) 19.02.2013.

(210) **2010-463**

(442) **20.06.2012**

(220) 15.12.2010

(732) **OKOV DOO**, UL JOSIPA BROZA TITA BR 26 PODGORICA ME



(540)

(550) I

(511) **Klasa 1:** hemijski proizvodi koji se upotrebljavaju u industriji, nauci, fotografiji, poljoprivredi, hortikulturi i šumarstvu, neprerađene vještačke smole, neprerađene plastične materije, đubriva, smeše za gašenje vatre, preparati za kaljenje i zavarivanje, hemijske spustance za očuvanje namirnica, materije za štavljenje, lepljive spustance koje se upotrebljavaju u industriji.

**Klasa 2:** boje, firnajzi, lakovi, sredstva za zaštitu od rđe i truljenja drveta, materije za bojenje, sredstva za nagrizanje, sirove prirodne smole, metali u obliku listova i praha za slikare, dekoratere, štampare i umjetnike.

**Klasa 3:** sredstva za beljenje i druge spustance za upotrebu u perionicama, preparati za čišćenje, poliranje, ribanje i nagrizanje, sapuni, parfimerija, eterična ulja, kozmetika, losioni za kosu, paste za zube.

**Klasa 4:** industrijska ulja i masti, maziva, jedinjenja za skupljanje prašine vlaženjem i vezivanjem, goriva (uključujući motorna tečna goriva) i materije za osvetljavanje, svijeće i fitilji za osvetljavanje.

**Klasa 5:** farmaceutski i veterinarski preparati, sanitarni preparati za medicinsku upotrebu, dijetetske supstance prilagođene za upotrebu u medicini, hrana za bebe, flasteri, materijali za zavijanje, materijali za plombiranje zuba, zubarska smola, dezinfekciona sredstva, preparati za uništavanje štetočina, fungicidi, herbicidi.

**Klasa 6:** obični metali i njihove legure, metalni građevinski materijali, metalne prenosne gradevine, materijali od metala za železničke sine, neelektrične žice i kablovi od običnog metala, bravarski proizvodi, mali metalni gvoždarski proizvodi, cijevčice i cijevi od metala, sefovi, proizvodi od običnih metala koji nisu uključeni u druge klase, rude.

**Klasa 7:** mašine i mašinski alati, motori i pogonske mašine (osim za suvozemna vozila), mašinske spojnice i transmisioni elementi (osim za suvozemna vozila), poljoprivredne sprave, inkubatori za jaja.

**Klasa 8:** ručni alati i sprave (kojima se ručno upravlja), pribor za jelo, hladno oružje, žileti.

**Klasa 9:** aparati i instrumenti naučni, pomorski, geodetski, fotografski, kinemato-grafski, optički, za vaganje, mjerenje, signalizaciju, kontrolu (inspekciju), spašavanje i nastavu, aparati i instrumenti za provođenje, prekid, transformaciju, akumulaciju, regulisanje i kontrolu elektriciteta, aparati za snimanje, prenos i reprodukovanje zvuka ili slike, magnetni nosioci podataka, diskovi za snimanje, automatske mašine i mehanizmi za aparate koji se pokreću novcem ili žetonom, registar kase, računске mašine, oprema za obradu podataka i kompjuteri, aparati za gašenje požara.

**Klasa 10:** hirurski, medicinski, zubarski i veterinarski aparati i instrumenti, vještački udovi, oči i zubi, ortopedski artikli, hirurški materijali za zašivanje.

**Klasa 11:** aparati za osvjetljavanje, grejanje, proizvodnju pare, kuvanje, hlađenje, sušenje, ventilaciju, snabjevanje vodom i za sanitarne svrhe.

**Klasa 12:** vozila, aparati za kretanje po zemlji, vazduhu ili vodi.

**Klasa 13:** vatreno oružje, municija i projektili, eksplozivi, sredstva za vatromet.

**Klasa 14:** dragocjeni metali i njihove legure i pro-izvodi od dragocjenih metala ili sa prevlakom od njih, koji nisu uključeni u druge klase, nakit, bižuterija, drago kamenje, časovničarski i hrono-metrijski instrumenti.

**Klasa 15:** muzički instrumenti.

**Klasa 16:** hartija, karton i proizvodi od njih, koji nisu uključeni u druge klase, štampane stvari, knjigovezački materijal, fotografije, kancelarijski materijal, lepila za kancelarijske i kućne potrebe, umetnički materijali, kičice, pisaće mašine i kancelarijski rekviziti (izuzev Namještaja), materijali za obuku i nastavu (izuzev aparata), plastični materijal za pakovanje (koji nije uključen u druge klase), štamparska slova, klišeji.

**Klasa 17:** guma, gutaperka, kaučuk, azbest, liskun i proizvodi napravljeni od ovih materijala koji nisu uključeni u druge klase, polupreradeni plastični proizvodi, materijali za podbijanje (podloške), zaptivanje i izolovanje, savitljive nemetalne cijevi.

**Klasa 18:** koža i imitacija kože, proizvodi izrađeni od ovih materijala koji nisu uključeni u druge klase, životinjska koža, koferi i putne torbe, kišobrani, suncobrani i štapovi za hodanje, bičevi, saračka i sedlarska roba.

**Klasa 19:** građevinski materijali (nemetalni), čvrste nemetalne cijevi za građevine, asfalt, crna smola i bitumen, nemetalne prenosne građevine, spomenici, koji nisu od metala.

**Klasa 20:** Namještaj, ogledala, okviri za slike, proizvodi (koji nisu obuhvaćeni drugim klasama) od drveta, plute, trske, rogoza, vrbovog pruća, roga, kosti, slonovače, kitove kosti, školjki, ćilibara, sedefa, morske pjene i zamjene svih ovih materijala, ili od plastike.

**Klasa 21:** kućne ili kuhinjske sprave i posude (koje nisu od dragocjenih metala ili sa prevlakama od njih), češljevi i sunđer, četke (izuzev kičica), materijali za pravljenje četki, artikli koji se koriste pri čišćenju, čelična vuna, nepreradeno ili polupreradeno staklo (osim stakla koje se koristi u građevinarstvu), staklarija, porcelan, fajans, grnčarija i lončarija koja nije uključena u druge klase.

**Klasa 22:** užad, kanapi, mreže, šatori, nadstrešnice od cirade, tirade, jedra, vreće (xakovi) i torbe (koje nisu uključene u druge klase), materijali za punjenje madraca (osim od gume ili plastike), sirove vlaknaste tekstilne materije.

**Klasa 23:** pređa i konac, za tekstilnu upotrebu.

**Klasa 24:** tekstil i tekstilni proizvodi koji nisu obuhvaćeni drugim klasama, prekrivači za krevete i stolove.

**Klasa 25:** odjeća, obuća, pokrivala za glavu.

**Klasa 26:** čipka i vez, trake (pantljike) i gajtani, dugmad, kopče i petlje, špenadle i igle, vještačko cvijeće.

**Klasa 27:** tepisi, asure, prostirke i otirači, linoleum i drugi materijali za pokrivanje podova, prekrivači za zidove (netekstilni).

**Klasa 28:** igre i igračke, gimnastički i sportski artikli koji nisu obuhvaćeni drugim klasama, ukrasi za jelke.

**Klasa 29:** meso, riba, živina i divljač, mesne prerađevine, konzervisano, sušeno i kuvano voće i povrće, želei, xemovi, kompoti, jaja, mlijeko i mliječni proizvodi, jestiva ulja i masti.

**Klasa 30:** kafa, čaj, kakao, šećer, pirinač, tapioka, sago, zamena kafe, brašno i proizvodi od žitarica, hleb, kolači, poslastice, sladoledi, med, melasa, kvasac, prašak za pecivo, so, senf, sirće, sosovi (kao začini), začini, led.

**Klasa 31:** poljoprivredni, vrtlarski i šumarski proizvodi i zrnavlje koji nisu uključeni u druge klase, žive životinje, sveže voće i povrće, sjeme, prirodne biljke i cvijeće, hrana za životinje, slad.

**Klasa 32:** pivo, mineralne i sodne vode i druga bezalkoholna pića, pića od voća i voćni sokovi, sirupi i drugi preparati za proizvodnju pića.

**Klasa 33:** alkoholna pića (izuzev piva).

**Klasa 34:** duvan, artikli za pušače, šibice.

**Klasa 35:** oglašavanje, vođenje poslova, poslovno upravljanje, kancelarijski poslovi.

**Klasa 36:** osiguranje, finansijski poslovi, novčani (monetarni) poslovi, poslovi vezani za nepokretnosti.

**Klasa 37:** građevinsko konstruisanje, popravljavanje, usluge instaliranja (instalacione usluge).

**Klasa 38:** telekomunikacije.

**Klasa 39:** transportne usluge, pakovanje i skladištenje robe, organizovanje putovanja.

**Klasa 40:** obrađivanje materijala.

**Klasa 42:** naučne i tehnološke usluge i istraživanje i projektovanje u vezi navedenih usluga, usluge industrijske analize i istraživanja, projektovanje i razvoj kompjuterskog hardvera i softvera, pravne usluge

**Klasa 43:** usluge obezbjeđivanja hrane i pića, privremeni smeštaj.





**INDEKS NOSILACA ŽIGOVA**  
**INDEX OF THE HOLDER OF THE REGISTRATION**

<b>(732)</b>	<b>(111)</b>	<b>(210)</b>
13 JUL PLANTAŽE	07178	2010-362
ABBOT MEDICAL OPTICS INC	07150	2010-100
ABBOTT LABORATORIES	07153	2010-114
ADRIATIC MARINAS	07310	2008-1160
ADRIATIC MARINAS	07311	2008-1161
ADRIATIC MARINAS	07312	2008-1162
ADRIATIC MARINAS	07313	2008-1163
ADRIATIC MARINAS	07315	2008-1201
ADRIATIC MARINAS DOO	07314	2008-1164
ADVOKATSKA KANCELARIJA VMB	07195	2010-481
AJINMOTO CO	06886	2010-41
AKTSIONERNO DROUJESTVO BULGARATABAC HOLDING	07011	2009-122
ALKALOID AD SKOPLJE	07331	2010-55
ALKALOID AD SKOPLJE	07116	2010-346
ALKALOID AD SKOPLJE	06878	2010-438
ALKALOID AD SKOPLJE	06877	2010-435
ALKALOID AD SKOPLJE	07213	2010-218
ALKALOID AD SKOPLJE	07214	2010-181
ALKALOID AD SKOPLJE	06952	2010-256
ALKALOID AD SKOPLJE	06953	2010-255
ALKALOID AD SKOPLJE	06942	2010-258
ALKALOID AD SKOPLJE	06951	2010-257
ALKALOID AD SKOPLJE	06858	2010-11
ALKALOID AD SKOPLJE	06845	2010-98
ALKALOID AD SKOPLJE	06885	2010-40
AMERICAN INTERNATIONAL GROUP INC	07043	2009-427
AMERICAN INTERNATIONAL GROUP INC	06843	2009-428
AMERICAN INTERNATIONAL GROUP INC	06841	2009-431
AMGEN INC	06894	2010-293
ANHUI JIANGHUAI AUTOMOBILE GROUP CO	07230	2010-208
APACER TECHNOLOGY INC	07304	2010-66
AS DOO	07319	2010-135
ASTELLAS PHARMA EUROPE B.V	06849	2010-113
AUSTRIA TABAK GMBH	06860	2010-15
AUXILIUM INTERNATIONAL HOLDING	07303	2010-67
AUXILIUM INTERNATIONAL HOLDINGS	06856	2010-143

AVENTISUB II INC	07184	2010-378
AVON INTERNATIONAL OPERATIONS INC	07222	2010-87
B.D. BAGGIES LTD	07172	2010-355
BAYER AKTINGESELLSCHAFT	07225	2010-180
BELUPO LJEKOVI I KOZMETIKA	07074	2010-464
BELUPO LJEKOVI I KOZMETIKA	07161	2010-136
BELUPO LJEKOVI I KOZMETIKA	07142	2010-137
BENCOM	06884	2010-488
BERLIN-CHEME AG	07279	2009-375
BERLIN-CHEME AG	07130	2010-430
BERLIN-CHEME AG	07118	2010-349
BERLIN-CHEME AG	07119	2010-350
BERLIN-CHEMIE AG	07277	2009-373
BERLIN-CHEMIE AG	07281	2009-379
BERLIN-CHEMIE AG	07276	2009-372
BERLIN-CHEMIE AG	07275	2009-370
BERLIN-CHEMIE AG	07117	2010-348
BERLIN-CHIEME AG	07278	2009-374
BEST WESTERN INTERNATIONAL	06899	2010-317
BEST WESTERN INTERNATIONAL	06902	2010-320
BEST WESTERN INTERNATIONAL	06903	2010-321
BEST WESTERN INTERNATIONAL	06904	2010-323
BEST WESTERN INTERNATIONAL	06900	2010-318
BEST WESTERN INTERNATIONAL	06901	2010-319
BEST WESTERN INTERNATIONAL	07129	2010-429
BIOGEN IDEC MA INC	06948	2009-310
BIOGEN IDEC MA INC	06947	2009-309
BISON INTERNATIONAL B.V	06907	2010-456
BOGOJEVIĆ MAJA	07196	2010-490
BONGRAIN SA	07334	2009-605
BOSNALIJEK	07335	2010-72
BOSNALIJEK	07341	2010-71
BOSNALIJEK	07340	2010-70
BOSNALIJEK	07339	2010-69
BOSNALIJEK	07342	2010-73
BRIDGESTONE CORPORATION	06906	2010-427
BRISTOL-MYERS SQUIBB	06861	2010-18
BRISTOL-MYERS SQUIBB	06882	2010-460
BRISTOL-MYERS SQUIBB	06908	2010-458
BRISTOL-MYERS SQUIBB	06944	2010-401
BRISTOL-MYERS SQUIBB	06909	2010-459

BRITANNIA PHARMACEUTICALS LIMITED	07122	2010-403
BRITISH AMERICAN TOBACCO	07121	2010-402
BRITISH AMERICAN TOBACCO BRANDS	07020	2010-36
BRITISH AMERICAN TOBACCO BRANDS	07014	2010-12
BROWN-FORMAN CORPORATION	06863	2010-28
BROWN-FORMAN CORPORATION	06864	2010-29
BVS COMMERCE SYSTEM	07044	2009-434
C.I. UNION DE BANANEROSW DE URABA	06910	2010-462
CAFE REKLAM REKLAMUGYNOKSEGI ES FILMSZOLGALTATO KFT	06941	2010-259
CEMEX HRVATSKA	07128	2010-426
CHERY AUTOMOBILE CO	07229	2010-56
CHERY AUTOMOBILE CO	07226	2010-60
CHERY AUTOMOBILE CO	07227	2010-59
CHERY AUTOMOBILE CO	07228	2010-57
CHIGUITA BRANDS LLC	06862	2010-20
CHOICE HOTELS INTERNATIONAL	07211	2010-190
CHOICE HOTELS INTERNATIONAL	07210	2010-191
CHOICE HOTELS INTERNATIONAL	07071	2010-441
CHOICE HOTELS INTERNATONAL	07328	2010-192
CHUGAI SEIYAKU KABUSHIKI KAISHA	06945	2010-467
CILAG GMBH INTERNATIONAL	06852	2010-129
CILAG GMBH INTERNATIONAL	06853	2010-130
CITIGROUP INC	07330	2010-64
CITIGROUP INC	07329	2010-65
COLGATE-PALMOLIVE COMPANY	06962	2010-75
COLGATE-PALMOLIVE COMPANY	07079	2010-487
COMPEED APS	06898	2010-316
CONVATEC INC	06838	2009-481
CORPORACION HABANOS	07115	2010-345
CRNOGORSKI TELECOM	07041	2009-219
CRNOGORSKI TELECOM	07042	2009-221
CRNOGORSKI TELEKOM	07040	2009-218
CRNOGORSKI TELEKOM	06733	2009-136
CRNOGORSKI TELEKOM	06734	2009-137
CRNOGORSKI TELEKOM	06738	2009-404
CRNOGORSKI TELEKOM	06732	2009-135
CRNOGORSKI TELEKOM	06737	2009-403
CROWN BRANDS LIMITED,	07383	2010-239
DAIICHI SANKYO COMPANY	06881	2010-448
DANHILL TOBACCO OF LONDON LIMITED	07050	2009-458

DAYS INNS WORLDWIDE	07017	2010-21
DECKERS OUTDOOR CORPORATION	07181	2010-375
DECKERS OUTODOOR CORPORATION	07182	2010-376
DEUTCHE TELECOM AG	07171	2010-353
DEUTCHE TELEKOM AG	07072	2008-145
DEUTCHE TELEKOM AG	06987	2010-2
DEUTCHE TELEKOM AG	07382	2010-269
DIAGEO IRELAND	07039	Ž 2009-5
DIAGEO NORTH AMERICA	07045	2009-435
DISCOVER FINANCIAL SERVICER STATE OF INCORPORATION	06890	2010-45
DISCOVER FINANCIAL SERVICES STATE OF INCORPORATION,	06889	2010-44
DOO DORI SISTEM	07126	2010-417
DUNHILL TOBACCO OF LONDON LIMITED	07048	2009-452
DURACELL BATTERIES BVBA	06883	2010-485
E.& J.GALLO WINERY	07107	2010-331
EDENRED	07317	2010-439
EDENRED	07144	2010-396
EKO-PER	06986	2009-406
ELI LILLY AND COMPANY	07238	2010-437
EMIRATES TELECOMMUNICATIONS CORPORATION	07036	2010-314
EMIRATES TELECOMMUNICATIONS CORPORATON	07037	2010-315
ENERGY BRANDS	07185	2010-382
EXXON MOBIL CORPORATION	06946	2009-52
FERRERO S.p.A.	06735	2009-156
FINLANDIA VODKA WORLDWIDE LTD	06851	2010-122
FINLANDIA VODKA WORLDWIDE LTD	07147	2010-399
FIRMA PRODUKCYJNO-USLUGOWO-HANDLOWA MOKATE-TERESA MOKRYSZ	07206	2010-241
FLEKA	07067	2009-615
FLEKA	07068	2009-614
FOX INTERNATIONAL CHANNELS US	07035	2010-309
FREMANTLEMEDIA LIMITED	06821	2009-495
FRES & CO	07180	2010-374
GALENKA	06979	2009-313
GALENKA	06980	2009-314
GALENKA	06981	2009-315
GALENKA	06982	2009-319
GALENKA	06984	2009-323
GALENKA	06985	2009-324
GALENKA AD	06983	2009-321

GALLAHER LIMITED	06844	2009-45
GALLAHER LIMITED	06850	2010-119
GALLAHER LIMITED	06905	2010-120
GALLAHER LIMITED	07183	2010-377
GAP (ITM)	07326	2010-465
GAP (ITM)	07327	2010-466
GECOMEWERT ANSTALIT	07049	2009-454
GENERAL MEDIA COMMUNICATIONS	06809	2009-593
GENERAL MEDIA COMUNICATIONS	06807	2009-591
GENERAL MEDIA COMUNICATIONS	06808	2009-592
GENERAL MOTORS LLC	07346	2010-217
GENERAL MOTORS LLC	07294	2010-230
GENZYME CORPORATIN	06740	2009-531
GENZYME CORPORATION	06739	2009-530
GENZYME CORPORATION	06854	2010-131
GEOGIA-PACIFIC CONSUMER PRODUCTS LP	07164	2010-281
GERGIA-PACIFIC CONSUMER PRODUCTS LP	07163	2010-280
GLAXO GROUP LIMITED	07194	2010-471
GLOBAL CONGUISTADORS S.A	07023	2010-46
G-MARIN CONSULTING LIMITED	07295	2010-175
G-MARIN CONSULTING LIMITED	07024	2010-278
G-MARIN CONSULTING LIMITED	07025	2010-279
GOJO INDUSTRIES	07381	2010-211
GOODYEAR DUNLOP TIRES GERMANY GMBH	07239	2010-395
GOOGLE	06895	2010-296
GOOGLE	06866	2010-33
GUTHY-RENKER CORPORATION	06978	2009-311
HANSEN BEVERAGE COMPANY	24.01.2013.	2010-330
HANSEN BEVERAGE COMPANY	07125	2010-416
HEME BOX OFFICE	07152	2010-112
HENKEL AG& CO KGaA	07337	2010-176
HENKEL SRBIJA	07205	2010-90
HOME BOX OFFICE	07066	2010-86
HOME BOX OFFICE	07065	2010-85
HOME BOX OFFICE	07064	2010-88
HOME BOX OFFICE	07063	2010-235
HOME BOX OFFICE	07151	2010-111
HONDA MOTOR CO LTD	07218	2010-82
HONDA MOTOR CO LTD	07219	2010-81
HONDA MOTOR CO LTD	07300	2010-80
HONDA MOTOR CO LTD	07217	2010-83

HYUNDAI MOTOR COMPANY	07027	2010-299
HYUNDAI MOTOR COMPANY	07028	2010-300
HYUNDAI MOTOR COMPANY	24.01.2013.	2010-301
I.W.S. NOMINEE COMPANY LIMITED	07349	2010-455
IM CLONE LLC	07333	2010-53
INTERVET INTERNATIONAL B.V.	07332	2010-54
JACK DANIELS PROPERTIES	06873	2010-139
JACK DANIELS PROPERTIES INC	06872	2010-132
JACK DANIELS PROPERTIS	06871	2010-123
JADRAN	06875	2010-418
JADRAN	06876	2010-419
JADRAN	07190	2010-420
JADRAN GALENSKI LABORATORIJ	07191	2010-421
JADRAN GALENSKI LABORATORIJ	07192	2010-422
JADRAN GALENSKI LABORATORIJ	07193	2010-423
JAMIESON LABORATORIES	07146	2010-398
JANSPORT APPAREL CORP.	06674	2009-677
JANSPORT APPAREL CORP.	06674	2009-677
JAPAN TOBACCO INC	06966	2010-237
JAPAN TOBACCO INC	06420	2010-202
JONES INVESTMENT CO.	07073	2010-445
JONES INVESTMENT CO.	06879	2010-446
JONES INVESTMENT CO.	06880	2010-447
JT INTERNATIONAL S.A	06950	2009-585
KABUSHIKI KAISHA ADVICS-ALSO TRADING AS ADVICS CO.	06798	2009-572
KABUSHIKI KAISHA ADVICS-ALSO TRADING AS ADVICS CO.	06799	2009-573
KARBON-NOVA	07199	2009-488
KIMBRELY-CLARK WORDWIDE	07022	2010-38
KIMBRELY-CLARK WORLDWIDE	07021	2010-37
Kolarević Ana	07197	2009-49
KRAFT FOODS GLOBAL	07054	2010-261
KRAFT FOODS GLOBAL	07384	2010-262
KT & G CORPORATION	06943	2010-133
KURARAY CO.	07124	2010-414
KWIZDA HOLDING GMBH	07202	2010-186
KWIZDA HOLDING GMBH	07204	2010-188
KWIZDA HOLDING GMBH	07203	2010-185
KWIZDA HOLDING GMBH	07203	2010-185
KWIZDA HOLDING GMBH	07076	2010-469
KWIZDA HOLDING GMBH	07077	2010-470

LA POINTIQUE INTL LTD	07170	2010-352
LABORATORIE DE LA MER	07240	2010-444
LOHMAN HAAS PHARMACEUTICALS CHINA LIMITED	07113	2010-339
LOHMANN HAAS PHARMACEUTICALS CHINA LIMITED	07112	2010-338
LOREAL	06663	2009-279
LUXOR	06998	2010-49
LUXOR	06999	2010-51
M & G BRANDS	24.01.2013.	2010-332
MARBO PRODUCT	07354	2010-246
MARBO PRODUCT	07355	2010-245
MARKWINS BEAUTY PRODUCTS	06940	2010-214
MARRIOT WORDWIDE CORPORATION	07361	2010-225
MARRIOTT WORDWIDE CORPORATION	07359	2010-227
MARRIOTT WORDWIDE CORPORATION	07357	2010-226
MARRIOTT WORDWIDE CORPORATION	07360	2010-229
MARRIOTT WORLDWIDE CORPORATION	07358	2010-224
MARRIOTT WORLDWIDE CORPORATION	07356	2010-228
MARS INCORPORATED	06837	2009-483
McDONALD INTERNATIONAL PROPERTY COMPANY	06859	2010-14
McDonald INTERNATIONAL PROPERTY COMPANY	06954	2010-254
McDonald s INTERNATIONAL PROPERTY COMPANY	06960	2010-248
McDonald s INTERNATIONAL PROPERTY COMPANY	06964	2010-247
McDonald s INTERNATIONAL PROPERTY COMPANY	06955	2010-253
McDonald s INTERNATIONAL PROPERTY COMPANY	06956	2010-252
McDonald s INTERNATIONAL PROPERTY COMPANY	06957	2010-251
McDonald s INTERNATIONAL PRPERTY COMPANY	06958	2010-250
McDonald s INTERNATONAL PROPERTY COMPANY	06959	2010-249
MEDA AB	07220	2010-152
MENTOR WORLDWIDE LLC	07055	2010-61
MERCATOR CG	07393	2010-410
MERCATOR CG	07394	2010-411
MERCATOR -CG	07388	2010-405
MERCATOR-CG	07391	2010-408
MERCATOR-CG	07392	2010-409
MERCATOR-CG	07389	2010-406
MERCATOR-CG	07390	2010-407
MERCK SHARP & DOHME CORP	07386	2010-311
MILLIKEN & COMPANY	07241	2010-475
MLADEGS PAK	07187	2010-347
MLJEKARA NIKA	07221	2010-182
MONTE VJENNIKO	07207	2010-52

MONTE VJENNIKO	07207	2010-52
MOTOROLA INC	06444	2009-405
MOTOROLA INC	07051	2009-493
MOTOROLA INC	07013	2010-5
MOTOROLA INC	07231	2010-118
MOTOROLA TRADEMARK HOLDINGS LLC	07145	2010-397
MTEL	06795	2009-562
MTEL	06796	2009-563
MTEL	06794	2009-561
MTEL	06797	2009-564
NAPREDAK	06742	2009-514
NBA PROPERTIES	07223	2010-212
NBA PROPERTIES INC	07224	2010-213
NECKOM	07111	2010-337
NINE WEST DEVELOPMENT CORPORATION	06961	2010-263
NINE WEST DEVELOPMENT CORPORATION	07165	2010-286
NINE WEST DEVELOPMENT CORPORATION	07166	2010-287
NINE WEST DEVELOPMENT CORPORATION	07167	2010-288
NINE WEST DEVELOPMENT CORPORATION	07168	2010-289
NINE WEST DEVELOPMENT CORPORATION	07169	2010-290
NINE WEST DEVELOPMENT CORPORATION	07149	2010-96
NITES	07046	2009-448
NOVARTIS AG	07351	2009-482
NOVARTIS AG	07148	2010-95
NOVARTIS AG	07123	2010-413
NUTCASE INC	07189	2010-400
OKOV	07395	2009-438
OKOV	07396	2010-463
OLD NAVY ITM	06897	2010-313
OPO MEDICAL	07120	2010-351
OTIS ELEVATOR COMPANY	06887	2010-42
OTIS ELEVATOR COMPANY	06888	2010-43
PATRON SPIRITIS INTERNATIONAL AG	06896	2010-305
PEPSI CO	07352	2010-271
PEPSI CO	07154	2010-115
PEPSICO	07155	2010-116
PEPSICO	07353	2010-215
PFIZER	06857	2010-4
PHARMASWISS SA	07038	2010-266
PHARMASWISS SA	07000	2010-267
PHILIP MORRIS BRANDS	06949	2009-550



PHILIP MORRIS BRANDS	06822	2009-494
PHILIP MORRIS PRODUCT S.A.	07201	2010-84
PHILIP MORRIS PRODUCTS S.A	06855	2010-140
PLAYBOY ENTERPRISES INTERNATIONAL INC	06967	2010-233
PLAYBOY ENTERPRISES INTERNATIONAL INC	06968	2010-234
PLAYBOY ENTERPRISES INTERNATIONAL INC	06969	2010-231
PLAYBOY ENTERPRISES INTERNATIONAL INC	06970	2010-232
PLIVA HRVATSKA	07177	2010-360
PLIVA HRVATSKA	07176	2010-359
POBJEDA	07175	2010-358
PODRAVKA	07034	2010-308
PODRAVKA	07018	2010-32
PROJECT-CONSULTING	06939	2010-260
PURE FISHING	07131	2010-432
PURE FISHING	07237	2010-433
PURE FISHING	07069	2010-434
PwC BUSINESS TRUST	07109	2010-335
PwC BUSINESS TRUST	07110	2010-336
RAMADA INTERNATIONAL	07015	2010-16
RECKITT & COLMAN (OVERSEAS) LIMITED DANSOM	30.11.2012	2010-89
RECKITT BENCKISER-SWITYELAND AG	06892	2010-282
RECKITT I COLMAN-OVERSEAS- LIMITED	06806	2009-589
RED BULL GMBH	07075	2010-468
RED CHIP COMPANY LTD	07030	2010-302
REXAIR LLC	07156	2010-117
REYNOLDS CONSUMER PRODUCTS	07101	2010-13
ROYAL MONTENEGRO	06811	2008-1233
S.C JOHNSON & SON	07058	2010-193
S.C. JOHNSON & SON	07057	2010-204
S.C. JOHNSON & SON	07060	2010-195
S.C. JONHSON & SON	07061	2010-196
S.C.JOHNSON & SON	07056	2010-203
S.C.JOHNSON & SON	03762	2010-174
S.C.JOHNSON & SON	07103	2010-325
S.C.JOHNSON & SON, INC	07105	2010-327
S.C.JOHNSON&SON	07059	2010-194
S.C.JONSON & SON	07104	2010-326
SAMSUNG ELECTRNICS CO	06865	2010-30
SAMSUNG ELECTRONICS CO	07188	2010-108
SANDFORD INVEST I TRADE	06662	2009-679
SANOFI PASTEUR	06963	2010-243

SC. Jonson&Son	07062	2010-197
SHANDONG LINGLONG TYRE CO	07102	2010-292
SHARP KABUSHIKI KAISHA	07297	2010-205
SHARP KABUSHIKI KAISHA	07296	2010-206
SHARP KABUSHIKI KAISHA	07032	2010-306
SHERATON INTERNATIONAL	06741	2009-545
SI-ING	07016	2010-19
SMITHERS-OASIS COMPANY	06736	2009-308
SMITKLINE BEECHAM LIMITED US	06800	2009-575
SMITKLINE BEECHAM LIMITED US	06801	2009-576
SMITKLINE BEECHAM LIMITED US	06802	2009-577
SMITKLINE BEECHAM LIMITED US	06803	2009-578
SOCIETE DES PRODUCT NESTLE S.A,	06839	2009-480
SOLAE LLC	07078	2010-473
SR BERLIN-CHEME AG	07280	2009-376
SUMITOMO RUBBER INDUSTRIES	07215	2010-157
SUMITOMO RUBBER INDUSTRIES	07216	2010-156
SUN STARS & SONS PTE LTD	07179	2010-373
SUN,STARS & SONS PTE	07127	2010-424
SUNDEK LLC	07336	2010-189
SUPERMAX INTERNATIONAL PVT LTD	07033	2010-307
T MOBILE CRNA GORA	06977	2009-169
T MOBILE CRNA GORA	06975	2009-167
T MOBILE CRNA GORA	06976	2009-168
TALECRIS BIOTHERAPEUTICS	07174	2010-357
TDK KABUSHIKI KAISHA-TDK CORPORATION	06805	2009-584
TDR	07047	2009-450
TDR	07345	2010-184
TDR	07344	2010-151
TDR	07232	2010-146
TDR	07233	2010-147
TDR	07234	2010-148
TDR	07235	2010-149
TDR	07236	2010-150
TDR	07282	2009-451
TDR	07243	2010-450
TDR	07244	2010-451
TDR	07242	2010-449
TDR	06661	2010-161
TDR DOO	07245	2010-452
TEHNO PLUS	06675	2010-166

TELEKOM CRNE GORE	06731	2009-134
THE GILLETTE COMPANY	07198	2009-407
THE NORTH FACE APPAREL CORP	07252	2010-363
THE NORTH FACE APPAREL CORP	07254	2010-365
THE NORTH FACE APPAREL CORP	07255	2010-366
THE NORTH FACE APPAREL CORP	07256	2010-367
THE NORTH FACE APPAREL CORP	07257	2010-368
THE NORTH FACE APPAREL CORP	07258	2010-369
THE NORTH FACE APPAREL CORP	07259	2010-370
THE NORTH FACE APPAREL CORP	07260	2010-371
THE NORTHFACE APPAREL CORP	07253	2010-364
THE PROCTER & GABLE COMPANY	06870	2010-107
THE PROCTER & GAMBLE COMPANY	07173	2010-356
THE PROCTER & GAMBLE COMPANY	06847	2010-102
THE PROCTER & GAMBLE COMPANY	06867	2010-103
THE PROCTER & GAMBLE COMPANY	06868	2010-104
THE PROCTER & GAMBLE COMPANY	06848	2010-105
THE PROCTER & GAMBLE COMPANY	06869	2010-106
THE PROCTER & GAMBLE COMPANY	06893	2010-285
THURAYA TELECOMMUNICATIONS COMPANY	07318	2010-134
THURAYA TELECOMMUNICATIONS COMPANY	07293	2010-240
TOTO LTD	06846	2010-99
TOYOTA JIDOSHA KABUSHIKI KAISHA	07350	2010-472
TOYOTA JIDOSHA KABUSHIKI KAISHA	07019	2010-34
TOYOTA JIDOSHA KABUSHIKI KAISHA	07347	2010-219
TOYOTA JIDOSHA KABUSHIKI KAISHA	07186	2010-383
TOYOTA JIDOSHA KABUSHIKI KAISHA	07348	2010-210
TOYOTA JIDOSHA KABUSHIKI KAISHA	07031	2010-303
TRANSATLANTIC HOLDINGS	06965	2010-236
TUTINSKI KOMBINAT AD PRILEP	06819	2009-497
TUTINSKI KOMBINAT AD PRILEP	06818	2009-498
TUTINSKI KOMBINAT AD PRILEP	06817	2009-499
TUTINSKI KOMBINAT AD PRILEP	06816	2009-500
TUTINSKI KOMBINAT AD PRILEP	06815	2009-501
TUTINSKI KOMBINAT AD PRILEP	07209	2010-198
TUTINSKI KOMBINAT AD PRILEP	07299	2010-199
TUTINSKI KOMBINAT AD PRILEP	06820	2009-496
TUTUNSKI KOBINAT AD PRILEP	07397	2009-508
TUTUNSKI KOMBINAT AD PRILEP	06814	2009-506
TUTUNSKI KOMBINAT AD PRILEP	06813	2009-507
TUTUNSKI KOMBINAT AD PRILEP	06812	2009-509

UNILEVER N.V	07208	2010-242
UNILEVER N.V	07012	2010-3
UNITED PARCEL SERVICE OF AMERICA	06836	2009-485
UNIVERSAL CITY STUDIOS LLC	06793	2009-598
UNIVERSAL CITY STUDIOS LLC	06804	2009-581
UNIVERSAL CITY STUDIOS LLC	06810	2009-597
VANGUARD TRADEMARK HOLDING USA LLC	07158	2010-125
VANGUARD TRADEMARK HOLDING USA LLC	07159	2010-126
VANGUARD TRADEMARK HOLDING USA LLC	07160	2010-127
VIIV HEALTHCARE UK LIMITED	07143	2010-144
VISIOGEN INC	07157	2010-121
VITA-MIX CORPORATION	06874	2010-142
Vujačić Saša	07212	2010-221
WESTIN HOTEL MANAGEMENT L.P	06833	2009-491
WESTIN HOTEL MANAGEMENT L.P	06835	2009-489
WESTION HOTEL MANAGMENT L.P	06834	2009-490
WIENER STADTISCHE VERSICHERUNG AG	06676	2009-281
WIENER STADTISCHE ŽIVOTNO OSIGURANJE AD	07070	2010-440
WM WRIGLWY JR. COMPANY	06937	2010-268
WOLVERINE OUTDOORS	06891	2010-47
WUNDHAM HOTELS AND RESORTS LLC	07162	2010-22
YILDIZ HOLDING A.S	07052	2009-511
YINGLI GROUP CO	07338	2010-207
YONEX KABUSHIKI KAISHA	06840	2009-432
YONEX KABUSHIKI KAISHA	06842	2009-430
ZDRAVLJE AD	07302	2010-76
ZDRAVLJE AD	07301	2010-79
ZINO DAVIDOFF SA	07114	2010-344
ZDRAVLJE AD	03844	2011-37
ZDRAVLJE AD	03843	2011-369

**INDEKS BROJEVA ŽIGOVA**  
INDEX OF THE TRADEMARK NUMBERS

(210)	(111)	(210)	(111)	(210)	(111)
2008-1160	07310	2009-427	07043	2009-561	06794
2008-1161	07311	2009-428	06843	2009-562	06795
2008-1162	07312	2009-430	06842	2009-563	06796
2008-1163	07313	2009-431	06841	2009-564	06797
2008-1164	07314	2009-432	06840	2009-572	06798
2008-1201	07315	2009-434	07044	2009-573	06799
2008-1233	06811	2009-435	07045	2009-575	06800
2008-145	07072	2009-438	07395	2009-576	06801
2009-122	07011	2009-448	07046	2009-577	06802
2009-134	06731	2009-45	06844	2009-578	06803
2009-135	06732	2009-450	07047	2009-581	06804
2009-136	06733	2009-451	07282	2009-584	06805
2009-137	06734	2009-452	07048	2009-585	06950
2009-156	06735	2009-454	07049	2009-589	06806
2009-167	06975	2009-458	07050	2009-591	06807
2009-168	06976	2009-480	06839	2009-592	06808
2009-169	06977	2009-481	06838	2009-593	06809
2009-218	07040	2009-482	07351	2009-597	06810
2009-219	07041	2009-483	06837	2009-598	06793
2009-221	07042	2009-485	06836	2009-605	07334
2009-279	06663	2009-488	07199	2009-614	07068
2009-281	06676	2009-489	06835	2009-615	07067
2009-308	06736	2009-49	07197	2009-677	06674
2009-309	06947	2009-490	06834	2009-677	06674
2009-310	06948	2009-491	06833	2009-679	06662
2009-311	06978	2009-493	07051	2010-100	07150
2009-313	06979	2009-494	06822	2010-102	06847
2009-314	06980	2009-495	06821	2010-103	06867
2009-315	06981	2009-496	06820	2010-104	06868
2009-319	06982	2009-497	06819	2010-105	06848
2009-321	06983	2009-498	06818	2010-106	06869
2009-323	06984	2009-499	06817	2010-107	06870
2009-324	06985	2009-500	06816	2010-108	07188
2009-370	07275	2009-501	06815	2010-11	06858
2009-372	07276	2009-506	06814	2010-111	07151
2009-373	07277	2009-507	06813	2010-112	07152
2009-374	07278	2009-508	07397	2010-113	06849
2009-375	07279	2009-509	06812	2010-114	07153
2009-376	07280	2009-511	07052	2010-115	07154
2009-379	07281	2009-514	06742	2010-116	07155
2009-403	06737	2009-52	06946	2010-117	07156
2009-404	06738	2009-530	06739	2010-118	07231
2009-405	06444	2009-531	06740	2010-119	06850
2009-406	06986	2009-545	06741	2010-12	07014
2009-407	07198	2009-550	06949	2010-120	06905

(210)	(111)	(210)	(111)	(210)	(111)
2010-121	07157	2010-19	07016	2010-241	07206
2010-122	06851	2010-190	07211	2010-242	07208
2010-123	06871	2010-191	07210	2010-243	06963
2010-125	07158	2010-192	07328	2010-245	07355
2010-126	07159	2010-193	07058	2010-246	07354
2010-127	07160	2010-194	07059	2010-247	06964
2010-129	06852	2010-195	07060	2010-248	06960
2010-13	07101	2010-196	07061	2010-249	06959
2010-130	06853	2010-197	07062	2010-250	06958
2010-131	06854	2010-198	07209	2010-251	06957
2010-132	06872	2010-199	07299	2010-252	06956
2010-133	06943	2010-2	06987	2010-253	06955
2010-134	07318	2010-20	06862	2010-254	06954
2010-135	07319	2010-202	06420	2010-255	06953
2010-136	07161	2010-203	07056	2010-256	06952
2010-137	07142	2010-204	07057	2010-257	06951
2010-139	06873	2010-205	07297	2010-258	06942
2010-14	06859	2010-206	07296	2010-259	06941
2010-140	06855	2010-207	07338	2010-260	06939
2010-142	06874	2010-208	07230	2010-261	07054
2010-143	06856	2010-21	07017	2010-262	07384
2010-144	07143	2010-210	07348	2010-263	06961
2010-146	07232	2010-211	07381	2010-266	07038
2010-147	07233	2010-212	07223	2010-267	07000
2010-148	07234	2010-213	07224	2010-268	06937
2010-149	07235	2010-214	06940	2010-269	07382
2010-15	06860	2010-215	07353	2010-271	07352
2010-150	07236	2010-217	07346	2010-278	07024
2010-151	07344	2010-218	07213	2010-279	07025
2010-152	07220	2010-219	07347	2010-28	06863
2010-156	07216	2010-22	07162	2010-280	07163
2010-157	07215	2010-221	07212	2010-281	07164
2010-16	07015	2010-224	07358	2010-282	06892
2010-161	06661	2010-225	07361	2010-285	06893
2010-166	06675	2010-226	07357	2010-286	07165
2010-174	03762	2010-227	07359	2010-287	07166
2010-175	07295	2010-228	07356	2010-288	07167
2010-176	07337	2010-229	07360	2010-289	07168
2010-18	06861	2010-230	07294	2010-29	06864
2010-180	07225	2010-231	06969	2010-290	07169
2010-181	07214	2010-232	06970	2010-292	07102
2010-182	07221	2010-233	06967	2010-293	06894
2010-184	07345	2010-234	06968	2010-296	06895
2010-185	07203	2010-235	07063	2010-299	07027
2010-185	07203	2010-236	06965	2010-3	07012
2010-186	07202	2010-237	06966	2010-30	06865
2010-188	07204	2010-239	07383	2010-300	07028
2010-189	07336	2010-240	07293	2010-301	24.01.2013.

(210)	(111)	(210)	(111)	(210)	(111)
2010-302	07030	2010-360	07177	2010-421	07191
2010-303	07031	2010-362	07178	2010-422	07192
2010-305	06896	2010-363	07252	2010-423	07193
2010-306	07032	2010-364	07253	2010-424	07127
2010-307	07033	2010-365	07254	2010-426	07128
2010-308	07034	2010-366	07255	2010-427	06906
2010-309	07035	2010-367	07256	2010-429	07129
2010-311	07386	2010-368	07257	2010-43	06888
2010-313	06897	2010-369	07258	2010-430	07130
2010-314	07036	2010-37	07021	2010-432	07131
2010-315	07037	2010-370	07259	2010-433	07237
2010-316	06898	2010-371	07260	2010-434	07069
2010-317	06899	2010-373	07179	2010-435	06877
2010-318	06900	2010-374	07180	2010-437	07238
2010-319	06901	2010-375	07181	2010-438	06878
2010-32	07018	2010-376	07182	2010-439	07317
2010-320	06902	2010-377	07183	2010-44	06889
2010-321	06903	2010-378	07184	2010-440	07070
2010-323	06904	2010-38	07022	2010-441	07071
2010-325	07103	2010-382	07185	2010-444	07240
2010-326	07104	2010-383	07186	2010-445	07073
2010-327	07105	2010-395	07239	2010-446	06879
2010-33	06866	2010-396	07144	2010-447	06880
2010-330	24.01.2013.	2010-397	07145	2010-448	06881
2010-331	07107	2010-398	07146	2010-449	07242
2010-332	24.01.2013.	2010-399	07147	2010-45	06890
2010-335	07109	2010-4	06857	2010-450	07243
2010-336	07110	2010-40	06885	2010-451	07244
2010-337	07111	2010-400	07189	2010-452	07245
2010-338	07112	2010-401	06944	2010-455	07349
2010-339	07113	2010-402	07121	2010-456	06907
2010-34	07019	2010-403	07122	2010-458	06908
2010-344	07114	2010-405	07388	2010-459	06909
2010-345	07115	2010-406	07389	2010-46	07023
2010-346	07116	2010-407	07390	2010-460	06882
2010-347	07187	2010-408	07391	2010-462	06910
2010-348	07117	2010-409	07392	2010-463	07396
2010-349	07118	2010-41	06886	2010-464	07074
2010-350	07119	2010-410	07393	2010-465	07326
2010-351	07120	2010-411	07394	2010-466	07327
2010-352	07170	2010-413	07123	2010-467	06945
2010-353	07171	2010-414	07124	2010-468	07075
2010-355	07172	2010-416	07125	2010-469	07076
2010-356	07173	2010-417	07126	2010-47	06891
2010-357	07174	2010-418	06875	2010-470	07077
2010-358	07175	2010-419	06876	2010-471	07194
2010-359	07176	2010-42	06887	2010-472	07350
2010-36	07020	2010-420	07190	2010-473	07078

(210)	(111)
2010-475	07241
2010-481	07195
2010-485	06883
2010-487	07079
2010-488	06884
2010-49	06998
2010-490	07196
2010-5	07013
2010-51	06999
2010-52	07207
2010-52	07207
2010-53	07333
2010-54	07332
2010-55	07331
2010-56	07229
2010-57	07228
2010-59	07227
2010-60	07226
2010-61	07055
2010-64	07330
2010-65	07329
2010-66	07304
2010-67	07303
2010-69	07339
2010-70	07340
2010-71	07341
2010-72	07335
2010-73	07342
2010-75	06962
2010-76	07302
2010-79	07301
2010-80	07300
2010-81	07219
2010-82	07218
2010-83	07217
2010-84	07201
2010-85	07065
2010-86	07066
2010-87	07222
2010-88	07064
2010-89	30.11.2012
2010-90	07205
2010-95	07148
2010-96	07149
2010-98	06845
2010-99	06846
Ž 2009-5	07039



INDEKS PO KLASAMA NIČANSKE KLASIFIKACIJE ROBA I USLUGA  
INDEX ACCORDING TO THE NICE CLASSIFICATION OF GOODS AND SERVICES

<b>Klasa 01</b>	07061	06849	07076	07276
06736	07079	06854	07077	07277
06907	07112	06856	07078	07278
06946	07113	06857	07103	07279
07078	07116	06858	07104	07280
07124	07146	06861	07105	07281
07199	07164	06875	07112	07301
07225	07173	06876	07117	07302
07395	07185	06877	07118	07303
07396	07190	06878	07119	07331
	07191	06881	07122	07332
<b>Klasa 02</b>	07192	06882	07123	07333
07111	07193	06885	07125	07335
07241	07205	06892	07130	07339
07383	07208	06894	07142	07340
07395	07222	06898	07143	07341
07396	07240	06908	07146	07342
	07337	06909	07148	07351
<b>Klasa 03</b>	07381	06942	07150	07381
06663	07395	06944	07153	07386
06806	07396	06945	07161	07395
06838	30.11.2012	06951	07164	07396
06847		06952	07173	30.11.2012
06848	<b>Klasa 04</b>	06953	07174	
06849	06892	06963	07176	<b>Klasa 06</b>
06852	06967	06968	07177	07111
06853	06970	06969	07184	07128
06867	07057	06978	07185	07326
06868	07058	06979	07190	07395
06869	07060	06980	07191	07396
06870	07062	06981	07192	
06875	07338	06982	07193	<b>Klasa 07</b>
06876	07395	06983	07194	06874
06892	07396	06984	07202	06887
06893	30.11.2012	06985	07203	06888
06940		07000	07203	07156
06961	<b>Klasa 05</b>	07038	07204	07188
06962	003762	07049	07213	07395
06978	06740	07056	07214	07396
07021	06800	07057	07220	
07022	06801	07058	07222	<b>Klasa 08</b>
07049	06802	07059	07225	07033
07057	06803	07060	07238	07111
07058	06838	07062	07240	07198
07059	06845	07074	07275	07395

07396	07318	07226	07025	07258
	07330	07227	07035	07259
<b>Klasa 09</b>	07338	07228	07072	07260
06444	07349	07229	07124	07295
06675	07382	07230	07127	07395
06805	07395	07239	07144	07396
06807	07396	07294	07163	
06808		07295	07164	<b>Klasa 19</b>
06809	<b>Klasa 10</b>	07300	07175	07101
06821	06838	07346	07179	07111
06865	06947	07347	07185	07128
06866	06948	07348	07222	07395
06873	07055	07350	07293	07396
06883	07120	07395	07295	
06884	07143	07396	07317	<b>Klasa 20</b>
06895	07157	24.01.2013.	07318	06835
06975	07170		07330	07252
06976	07220	<b>Klasa 13</b>	07382	07253
06977	07240	07395	07395	07254
07013	07395	07396	07396	07255
07024	07396		24.01.2013.	07256
07025		<b>Klasa 14</b>		07257
07027	<b>Klasa 11</b>	06949	<b>Klasa 17</b>	07258
07030	06675	07024	06907	07259
07032	06846	07025	07124	07260
07035	06892	07149	07395	07395
07046	07058	07295	07396	07396
07051	07060	07395		
07058	07062	07396	<b>Klasa 18</b>	<b>Klasa 21</b>
07060	07188		06840	06675
07062	07338	<b>Klasa 15</b>	06842	07021
07063	07395	06873	06879	07022
07072	07396	07030	06880	07023
07126	30.11.2012	07395	07024	07059
07144		07396	07025	07061
07145	<b>Klasa 12</b>		07073	07062
07149	06798	<b>Klasa 16</b>	07149	07163
07151	06799	06807	07165	07164
07152	06906	06808	07166	07173
07171	07024	06809	07167	07185
07188	07025	06838	07168	07381
07189	07031	06907	07169	07395
07231	07102	06941	07185	07396
07293	07186	06958	07252	
07295	07215	06959	07253	<b>Klasa 22</b>
07296	07216	06960	07254	07252
07297	07217	06964	07255	07253
07304	07218	07022	07256	07254
07317	07219	07024	07257	07255

07256	07253	07319	07185	07050
07257	07254	07334	07395	07115
07258	07255	07353	07396	07121
07259	07256	07354		07183
07260	07257	07355	<b>Klasa 33</b>	07209
07395	07258	07395	06662	07232
07396	07259	07396	06851	07233
	07260		06864	07234
<b>Klasa 23</b>	07295	<b>Klasa 30</b>	06871	07235
07395	07336	06735	06896	07236
07396	07395	06837	07039	07242
	07396	06839	07045	07243
<b>Klasa 24</b>	24.01.2013.	06859	07107	07244
06835		06886	07147	07245
07062	<b>Klasa 26</b>	06937	07178	07282
07395	07237	06954	07179	07295
07396	07395	06955	07395	07299
	07396	06956	07396	07344
<b>Klasa 25</b>		06957	24.01.2013.	07345
06840	<b>Klasa 27</b>	07012		07395
06842	07395	07034	<b>Klasa 34</b>	07396
06863	07396	07052	06420	07397
06872		07054	06661	
06879	<b>Klasa 28</b>	07078	06812	<b>Klasa 35</b>
06880	06840	07154	06813	06661
06891	06842	07155	06814	06675
06897	06958	07187	06815	06807
06958	06959	07206	06816	06808
06959	06960	07319	06817	06809
06960	06964	07352	06818	06811
06964	07032	07384	06819	06836
07024	07069	07395	06820	06879
07025	07120	07396	06822	06880
07044	07131		06844	06902
07073	07170	<b>Klasa 31</b>	06850	06939
07114	07223	06910	06855	06941
07149	07224	07395	06860	06975
07165	07395	07396	06905	06976
07166	07396		06943	06977
07167		<b>Klasa 32</b>	06949	06987
07168	<b>Klasa 29</b>	06839	06950	06998
07169	06837	06862	06966	06999
07172	06839	06986	07011	07015
07181	07018	07039	07014	07024
07182	07034	07075	07020	07025
07185	07078	07078	07024	07046
07223	07154	07125	07025	07047
07224	07155	07179	07047	07067
07252	07221	07180	07048	07068

07072	07393	07228	07396	06964
07073	07394	07229		06975
07126	07395	07295	<b>Klasa 39</b>	06976
07127	07396	07395	06811	06977
07128		07396	06836	07024
07144	<b>Klasa 36</b>		07019	07025
07149	06676	<b>Klasa 38</b>	07024	07035
07165	06742	06674	07025	07040
07166	06841	06674	07043	07041
07167	06843	06731	07068	07042
07168	06875	06732	07111	07063
07169	06876	06733	07128	07064
07175	06889	06734	07158	07065
07190	06890	06737	07159	07066
07191	06965	06738	07160	07067
07192	07019	06793	07295	07068
07193	07024	06794	07388	07126
07195	07025	06795	07389	07127
07197	07070	06796	07390	07143
07207	07144	06797	07391	07151
07207	07195	06804	07392	07152
07221	07295	06807	07393	07175
07232	07317	06808	07394	07185
07233	07329	06809	07395	07196
07234	07330	06810	07396	07201
07235	07357	06821		07223
07236	07358	06975	<b>Klasa 40</b>	07224
07242	07359	06976	07395	07295
07243	07361	06977	07396	07310
07244	07395	06987		07311
07245	07396	06987	<b>Klasa 41</b>	07312
07252		07028	06674	07313
07254	<b>Klasa 37</b>	07035	06674	07314
07259	06811	07036	06731	07315
07260	06887	07037	06732	07356
07282	06888	07040	06733	07360
07295	06975	07041	06734	07382
07317	06976	07042	06737	
07327	06977	07046	06738	<b>Klasa 42</b>
07344	07016	07063	06742	06674
07345	07019	07072	06793	06674
07356	07024	07126	06804	06939
07360	07025	07151	06807	06941
07382	07072	07152	06808	06975
07388	07111	07171	06809	06976
07389	07128	07197	06810	06977
07390	07156	07293	06811	06987
07391	07226	07318	06821	07016
07392	07227	07395	06959	07024

07025	07359
07046	07360
07067	07361
07072	07388
07126	07389
07143	07390
07171	07391
07196	07392
07197	07393
07295	07394
07330	07395
07395	07396
07396	

**Klasa 44**

<b>Klasa 43</b>	06838
06741	07143
06833	07310
06834	07311
06835	07312
06899	07313
06900	07314
06901	07315
06903	07357
06904	07358
07015	07359
07017	07361

**Klasa 45**

07024	
07025	06811
07068	06975
07071	06976
07129	06977
07144	07072
07162	07109
07207	07110
07207	07126
07210	07195
07211	07197
07295	07212
07310	
07311	
07312	
07313	
07314	
07315	
07317	
07328	
07356	
07357	
07358	



**OBJAVA ISPRAVKI  
CORRECTIONS**

U „Crnogorskom glasniku intelektualne svojine“ broj **10. od 20.03.2012.** godine objavljeni su pogrešni podaci za registrovani žig **2009-522**

***Pogrešni podaci***(111) **03656**(151) **26.07.2012**(210) **2009-552**(442) **20.03.2012**

(220) 09.09.2009

(300) 20.11.2007 947320 IR

(732) **ATLAS SPOLKA Z O O; UL SWIETEJ TERESY OD DZIECIATKA JEZUS  
105, PL-91-222 LODZ PL**

(540)

(550) I

(740) Čejović Vladimir, 13. jul 21, Podgorica (ME)

(511) **Klasa 01:** Hemijski proizvodi koji se upotrebljavaju u industriji, nauci i fotografiji, kao i u poljoprivredi, hortikulturi i šumarstvu; neprerađene vještačke smole; neprerađene plasične materije; đubriva; smješe za gašenje vatre; preparata za kaljenje i zavarivanje; hemijske supstance za očuvanje namirnica; materije za štavljenje; adhezivi koji se upotrebljavaju u industriji.

**Klasa 02:** Boje, firnajzi, lakovi; sredstva za zaštitu drveta od rđe i truljenja; materije za bojenje; sredstva za nagrizanje; sirove prirodne smole; metali u obliku listova i praha za slikare, dekoratere, štampare i umjetnike.

**Klasa 17:** Guma, gutaperka, kaučuk, azbest, liskun i proizvodi napravljeni od ovih materijala koji nijesu uključeni u druge klase; polupreradaeni plastični proizvodi; materijali za podbijanje, zaptivanje i izolovanje; savitljive nemetalne cevi.

**Klasa 19:** Građevinski materijali (nemetalni); čvrste nemetalne cijevi za građevine; asfalt; crna smola i bitumen, nemetalne prenosne građevine; spomenici koji nijesu od metala.

***Ispravni podaci***(111) **03656**(181) **25.08.2019**(210) **2009-522**(220) **25.08.2009**(151) **26.07.2012**

(732) GENZYME CORPORATION (MASSACHUSETTS CORPORATION), 500  
KENDALL STREET CAMBRIDGE, MASSACHUSETTS 02142 US

## CHOLESTAGEL

(540)

(550) I

(740) Radulović Božidar, Jovana Tomaševića 9/III, Podgorica ME

(511) **Klasa 05:** Farmaceutski i veterinarski preparati; sanitarni preparati za medicinske svrhe; dijetetske supstance za upotrebu u medicini, hrana za bebe; flasteri, materijal za zavijanje; materijali za plombiranje zuba, zubarska smola; dezinfekciona sredstva; preparati za uništavanje štetočina; fungicidi, herbicidi; farmaceutski preparati za upotrebu pri izdvajanju žučne kiseline iz gastrointestinalnog trakta.



## OBAVJEŠTENJE NOTICE

### Objava upisa u Registar žigova CG priznatih žigova, registrovanih u Zavodu SCG, odnosno Zavodu Srbije, prije otvaranja Zavoda CG

Članom 65 stav 1 Zakona o žigu ("Sl.list CG", br. 72/10) priznata su prava na žigovima koji su registrovani i upisani u Registar žigova u Zavodu za intelektualnu svojinu Srbije i Crne Gore, odnosno Zavodu za intelektualnu svojinu Srbije do 28. maja 2008. godine (do dana otvaranja Zavoda za intelektualnu svojinu Crne Gore) do isteka njihovog trajanja.

Zavod je implementirao odredbu člana 65 stav 2 Zakona o žigu i izvršio upis u Registar, po službenoj dužnosti žigove za koje je izdao uvjerenja o važenju žiga u formi zabilješke u 2008. godini.

Zavod je implementirao odredbu stava 4 istog člana i donio rješenja o upisu u Registar žigova za koje su podnijeti zahtjevi u 2008. godini za obnovu važnosti žiga, prenos prava i promjenu imena i adrese shodno koja propisuje da se ti zahtjevi smatraju kao zahtjevi za upis u registar.

### MEĐUNARODNI KODOVI ZA IDENTIFIKACIJU BIBLIOGRAFSKIH PODATAKA O ŽIGOVIMA PREMA WIPO ST 60 RECOMMENDATION CONCERNING BIBLIOGRAFIC DATA RELATING TO TRADEMARKS- WIPO-ST. 60

CRNOGORSKI	MDK	ENGLSKI
REGISTARSKI BROJ CG	<b>111</b>	NUMBER OF THE REGISTRATION CG
REGISTARSKI BROJ SCG	<b>111</b>	NUMBER OF THE REGISTRATION SCG
BROJ PRIJAVE	<b>210</b>	NUMBER OF THE APPLICATION
IME I ADRESA NOSIOCA ŽIGA	<b>732</b>	NAME AND ADDRESS OF THE HOLDER OF THE REGISTRATION



(111) CG	(210) Ž	(732)	(111) SCG
06272	1976-902	<b>THE PROCTER &amp; GAMBLE COMPANY (OHIO CORPORATION);</b> ONE PROCTER & GAMBLE PLAZA CINCINNATI, OHIO, US	24610
06265	1968-443	<b>FUJITSU LIMITED;</b> 1-1, KAMIKODANAKA 4-CHOME, NAKAHARA-KU, KAWASAKI-SHI, KANAGAWA-KEN, JP	18656
06270	1976-900	<b>THE PROCTER &amp; GAMBLE COMPANY (OHIO CORPORATION);</b> ONE PROCTER & GAMBLE PLAZA, CINCINNATI, OHIO, US	24608
06071	2000-555	<b>FARMACEUTSKO-HEMIJSKA INDUSTRIJA "ZDRAVLJE", AKCIONARSKO DRUŠTVO;</b> Vljakova 199, Leskovac, YU	43460
06267	1974-352	<b>THE PROCTER &amp; GAMBLE COMPANY;</b> ONE PROCTER & GAMBLE PLAZA, CINCINNATI, OHIO, US	24651
06262	1990-867	<b>THE CLOROX COMPANY;</b> 1221 BROADWAY, OAKLAND, CA 94612, US	35660
03214	1990-2172	<b>Mitsubishi Jidosha Kogyo Kabushiki Kaisha;</b> 33-8, Shiba 5-Chome, Minato-ku, Tokyo, JP	37286
03213	1990-2170	<b>Mitsubishi Jidosha Kogyo Kabushiki Kaisha;</b> 33-8, Shiba 5-Chome, Minato-ku, Tokyo, JP	37054
03212	1990-2169	<b>MITSUBISHI JIDOSHA KOGYO KABUSHIKI KAISHA;</b> 33-8, Shiba 5-Chome, Minato-ku, Tokyo, JP	37053
03227	2000-874	<b>MISS UNIVERSE L.P., LLLP (Delaware partnership);</b> 1370 Avenue of the Americas - 16th Floor, New York, New York 10019, US	46618
06264	2000-1006	<b>RECKITT &amp; COLMAN (OVERSEAS) LIMITED;</b> DANSOM LANE HULL, HU8 7DS, GB	47218
03228	1997-970	<b>THURAYA SATELLITE TELECOMMUNICATIONS COMPANY;</b> SHEIKH RASHID BIN SAEED AL-MAKTOOM STREET, ETISALAT TOWER, ABU-DHABI, AE	42966
06075	1990-868	<b>THE CLOROX COMPANY;</b> 1221 BROADWAY, OAKLAND, CA 94612, US	35625
06268	1969-136	<b>TAKEDA PHARMACEUTICAL COMPANY LIMITED;</b> 1-1, DOSHOMACHI 4-CHOME CHUO-KU, OSAKA, JP	18590
03226	1990-1546	<b>MAGNETEK, INC.;</b> N49 W13650 Campbell drive, Menomonee Falls, Wisconsin 53501, US	36744
03209	1990-1716	<b>GABRIELLE STUDIO, INC.;</b> 550 SEVENTH AVENUE, NEW YORK, NEW YORK 10018, US	36532
03215	1990-2168	<b>Mitsubishi Jidosha Kogyo Kabushiki Kaisha;</b> 33-8, Shiba 5-Chome, Minato-ku, Tokyo, JP	37052
06269	1976-901	<b>THE PROCTER &amp; GAMBLE COMPANY (OHIO CORPORATION);</b> ONE PROCTER & GAMBLE PLAZA, CINCINNATI, OHIO, US	24609
06072	2000-552	<b>FARMACEUTSKO-HEMIJSKA INDUSTRIJA "ZDRAVLJE" AKCIONARSKO DRUŠTVO;</b> Leskovac, Vljakova 199, YU	43402
06073	2000-479	<b>GENERAL RE CORPORATION, a Delaware corporation;</b> 120 Long Ridge Road, Stamford, Ct 06902 US	45798
03230	1989-665	<b>OMNI NAME COMPANY;</b> 420 Decker Drive, Suite 200 Irving, TX 75062, US	34752
03229	1990-1124	<b>WAHL CLIPPER CORPORATION;</b> P.O. BOX 578, STERLING, ILLINOIS 61081-0578, US	36252
06271	1976-899	<b>THE PROCTER &amp; GAMBLE COMPANY (OHIO CORPORATION);</b> ONE PROCTER & GAMBLE PLAZA, CINCINNATI, OHIO, US	24607
06070	2000-557	<b>Farmaceutsko-hemijska industrija "Zdravlje" akcionarsko društvo;</b> Vljakova 199, Leskovac, RS	43405
03208	1984-196	<b>Procter&amp;Gamble Service GmbH;</b> Berliner Alle 65 64274 Darmstadt, Germany	29981
06274	2000-697	<b>SAPONIA, KEMIJSKA, PREHRAMBENA I FARMACEUTSKA INDUSTRIJA D.D.;</b> Matije Gupca 2, Osijek, HR	45883
03211	1990-2173	<b>Mitsubishi Jidosha Kogyo Kabushiki Kaisha;</b> 33-8, Shiba 5-Chome, Minato-ku, Tokyo, JP	37629
03210	2000-1023	<b>HONDA GIKEN KOGYO KABUSHIKI KAISHA (HONDA MOTOR CO., LTD.);</b> No. 1-1, 2-chome, Minami-aoyama, Minato-ku, Tokyo, JP	46211

06273	1989-415	<b>SOCIEDAD ANONIMA VINA SANTA RITA; AV. APOQUINDO 3669, 6th FLOOR, LAS CONDES, SANTIAGO-CHILE, CL</b>	34350
03439	1991-154	<b>RUBINUM S.A.; Av.de La Llana 123,Pol.Ind."La Llana",08191 Rubi/ Barselona),ES</b>	38112
06263	1990-870	<b>THE CLOROX COMPANY; 1221 BROADWAY, OAKLAND, CA 94612, US</b>	35627
03445	1998-614	<b>FIL Limited A Bermuda Company; Pembroke Hall, 42 Crow Lane, Pembroke HM 19, P.O.Box HM 670, Hamilton HMCX, Bermude, BM</b>	44691
03589	2006-379	<b>Preduzece za proizvodnju, trgovinu i usluge DR.OETKER d.o.o.; Beograd, vladimira Popovica 40, RS</b>	53008
03586	2005-1011	<b>Preduzece za proizvodnju, trgovinu i usluge DR.OETKER d.o.o.; Beograd, Vladimira Popovica 40, RS</b>	50057
03442	2005-630	<b>Syngenta Participations AG and NOVARTIS AG; 4002 Basel, CH and CH-4002 Basel, CH</b>	51100
03436	1990-1501	<b>KRKA, TOVARNA ZDRAVIL D.D., NOVO MESTO; NOVO MESTO, ŠMARJEŠKA CESTA 6, SI</b>	36327
03444	1980-525	<b>KRKA, TOVARNA ZDRAVIL D.D., NOVO MESTO; NOVO MESTO, ŠMARJEŠKA CESTA 6, SI</b>	24957
06275	1976-789	<b>THE ROTEL CO. LTD.; Endo TN Building 2F, 6-12-21 Meguro-Honcho, Meguro-KU, Tokyo 152-0002, Japan</b>	24577
03440	1991-189	<b>SUNBEAM PRODUCTS, INC.; 2381 EXECUTIVE CENTER DRIVE, BOCA RATON, FLORIDA 33431, US</b>	37630
03449	1991-190	<b>SUNBEAM PRODUCTS, INC.; 2381 EXECUTIVE CENTER DRIVE, BOCA RATON, FLORIDA 33431, US</b>	37631
03441	1985-501	<b>LEK FARMACEVTSKA DRUŽBA D.D.; LJUBLJANA, VEROVŠKOVA 57, SI</b>	28504
03447	1991-176	<b>Techtronic Floor Care Technology Limited; P.O. Box 957, Offshore Incorporations Centre, Road Town, Tortola, Britanska Devičanska Ostrva</b>	37536
03590	2006-2660	<b>Preduzece za proizvodnju, trgovinu i usluge DR.OETKER d.o.o.; Beograd, Vladimira Popovica 40, RS</b>	54852
03452	1982-378	<b>LEK FARMACEVTSKA DRUŽBA DD; VEROVŠKOVA 57 1526 LJUBLJANA, SI</b>	26908
03443	2006-1233	<b>NOVARTIS AG; 4002 Basel, CH</b>	53616
03438	2006-1425	<b>NOVARTIS AG; CH-4002 Basel, CH</b>	53734
03588	2006-378	<b>Preduzece za proizvodnju, trgovinu i usluge DR.OETKER d.o.o.; Beograd, Vladimira popovica 40, RS</b>	53007
03435	1973-7	<b>TEXAS INSTRUMENTS INC.; Texas Instruments Incorporated and SENSATA TECHNOLOGIES, INC.; 34, FOREST STREET, ATTLEBORO, MASSACHUSETTS 02703, US; 12500 TI Boulevard, Dallas, Texas 75266, US and 529 Pleasant Street, Attleboro, Massachusetts 02703, US</b>	21318
06074	1990-889	<b>INVIMA AB; HOJDRODERGATAN 26, S-212 39 MALMO, SE</b>	35889
03448	1977-23	<b>ARMACELL ENTERPRISE GMBH; Robert-Bosch-Str. 10, D-48153 Munster Germany, DE</b>	25180
03446	2005-1125	<b>FIL Limited A Bermuda Company; Pembroke Hall, 42 Crow Lane, Pembroke HM 19, P.O.Box HM 670, Hamilton HMCX, Bermude, BM</b>	51539
03434	1990-732	<b>NBA PROPERTIES, INC.; 645 FIFTH AVENUE, NEW YORK, N.Y. 10022, US</b>	35504
03583	1999-806	<b>EXXON MOBIL CORPORATION, A NEW JERSEY CORPORATION; 5959 Las Colinas Boulevard, Irving, Texas, 75039-2298, US</b>	46114
03585	1988-963	<b>RICOH COMPANY, LTD.; 1-15-5, MINAMI-AOYAMA, MINATO-KU, TOKYO, 107, JP</b>	34408
03437	1961-94	<b>KRKA, TOVARNA ZDRAVIL D.D., NOVO MESTO; NOVO MESTO, ŠMARJEŠKA CESTA 6, SI</b>	15216
03591	2006-380	<b>Preduzece za proizvodnju, trgovinu i usluge DR.OETKER d.o.o.; Beograd, Vladimira Popovica 40, RS</b>	53009
03582	2000-520	<b>GENERAL MOTORS LLC; 300 Renaissance Center, Detroit, Michigan 48265-3000, US</b>	45646

06266	2000-1005	<b>RECKITT &amp; COLMAN (OVERSEAS) LIMITED;</b> DANSOM LANE HULL, HU8 7DS, VELIKA BRITANIJA, GB	46195
06318	1996-7	<b>HEMOFARM D.D., FARMACEUTSKO HEMIJSKA INDUSTRIJA and HEMOFARM KONCERN A.D. Farmaceutsko-hemijska industrija Vršac;</b> VRŠAC, BEOGRADSKI PUT B.B., YU and 26300 Vršac, Beogradski put b.b., YU	39290
06321	1998-235	<b>HEMOFARM KONCERN A.D.farmaceutsko-hemijska industrija Vršac;</b> Beogradski put bb, 26300 Vršac, RS	40917
06314	2005-1272	<b>HEMOFARM KONCERN A.D. farmaceutsko-hemijska industrija Vršac;</b> Beogradski put bb., 26300 Vršac, YU	49152
06426	1997-1153	<b>LINPAC PLASTICS LIMITED;</b> A1 BUSINESS PARK, KNOTTINGLEY, WEST YORKSHIRE, WF11 0BS, GB	42883
06478	2005-194	<b>NINTENDO Co., Ltd.;</b> 11-1, Hokotate-cho Kamitoba, Minami-ku Kzoto-shi, Kyoto, Japan, JP	51087
06312	1991-212	<b>THE UNITED STATES PLAYING CARD COMPANY;</b> 300 Gap Way Erlanger,Kentucky 41018,US	37297
06320	1994-562	<b>HEMOFARM KONCERN AD FARMACEUTSKO - HEMIJSKA INDUSTRIJA VRŠAC;</b> BEOGRADSKI PUT BB, 26300 VRŠAC, YU	38429
06311	1991-207	<b>THE UNITED STATES PLAYING CARD COMPANY;</b> 300 Gap Way Erlanger. Kentucky 41018, US	36838
06316	1995-326	<b>HEMOFARM KONCERN A.D., FARMACEUTSKO HEMIJSKA INDUSTRIJA;</b> VRŠAC, BEOGRADSKI PUT BB, YU	38907
06317	1986-272	<b>HEMOFARM KONCERN A.D. FARMACEUTSKO-HEMIJSKA INDUSTRIJA and HEMOFARM D.D., FARMACEUTSKO-HEMIJSKA INDUSTIJA;</b> Beogradski put bb, Vršac, 26300, Srbija i Crna Gora, ZR and VRŠAC, BEOGRADSKI PUT BB, YU	28822
06481	1997-643	<b>ELS EDUCATIONAL SERVICES, INC.;</b> 5761 BUCKINGHAM PARKWAY, CULVER CITY, CALIFORNIA 90230, US	43385
06315	1995-226	<b>HEMOFARM KONCERN A.D. FARMACEUTSKO-HEMIJSKA INDUSTRIJA VRŠAC;</b> BEOGRADSKI PUT B.B., VRŠAC, YU	38832
06433	1977-120	<b>VALENTINO GLOBE B.V.; VALENTINO GLOBE B.V.; VALENTINO GLOB B.V. and VALENTINO S. p. A.;</b> ROTTERDAM BUILDING, 4th FLOOR, 3012 CA ROTTERDAM, NL; Blaak 16, 3011, Rotterdam, NL; Prof.J.H. Bavincklaan 7, 1183 AT Amstelveen P.O. Box 7827, 1008, AA Amsterdam, NL and Via Turati, 16/18, Milano, IT	25269
06307	1991-206	<b>THE UNITED STATES PLAYING CARD COMPANY;</b> 300 Gap way Erlanger,Kentucky 41018,US	37299
06430	1998-304	<b>LINPAC PLASTICS LIMITED;</b> A1 Business Park, Knottingley, West Yorkshire, WF11 0BS, GB	44367
06427	1998-303	<b>LINPAC PLASTICS LIMITED;</b> A1 Business Park, Knottingley, West Yorkshire WF11 0BS, GB	43975
03580	1990-1385	<b>THE RYVITA COMPANY LIMITED;</b> Weston Centre 10 Grosevenor Street London W1K 4QY Ujedinjeno Kraljevstvo	36986
06310	2000-1275	<b>UNILEVER N.V.;</b> Weena 455, 3013 AL Rotterdam, NL	47409
06313	2000-830	<b>Citizen Holdings Kabushiki Kaisha (Citizen Holdings Co., Ltd.);</b> 1-12, 6-chome, Tanashi-cho, Nishi-tokyo-shi, Tokyo, JP	46343
06432	1991-740	<b>RECKITT &amp; COLMAN (OVERSEAS) LIMITED;</b> DANSOM LANE, HULL HU8 7DS, GB	38530
06322	1994-560	<b>HEMOFARM KONCERN D.D., FARMACEUTSKO-HEMIJSKA INDUSTRIJA VRŠAC;</b> Beogradski put bb, 26300 Vršac, YU	38427
06319	1994-539	<b>HEMOFARM KONCERN AD FARMACEUTSKO - HEMIJSKA INDUSTRIJA VRŠAC;</b> BEOGRADSKI PUT BB, 26300 VRŠAC, YU	38426
06431	1969-309	<b>CONOPCO, INC.;</b> 700 Sylvan Avenue Englewood Cliffs NJ 07632 USA	18953
06308	1991-211	<b>THE UNITED STATES PLAYING CARD COMPANY;</b> 300 Gap Way Erlanger,Kentucky 41018,US	37300

03579	2001-409	<b>DIAGEO NORTH AMERICA, INC.</b> ; 801 Main Avenue, Norwalk CT 06851-1127, US	46784
06428	1998-302	<b>LINPAC PLASTICS LIMITED (British limited company)</b> ; A1 Business Park, Knottingley, West Yorkshire, WF11 0BS, GB	43944
06479	2001-1094	<b>NINTENDO CO. Ltd.</b> ; 11-1, Hokotate-cho, Kamitoba, Minami-ku, Kyoto-shi, Kyoto, Japan, JP	47083
06480	2004-917	<b>BERLITZ INVESTMENT CORPORATION</b> ; 300 Delaware Avenue, Suite 501, Wilmington, DE 19801-1622, US	50317
06408	1969-639	<b>Land Rover</b> ; Banbury Road, Lightorne Warwick, Warwickshire CV35 ORG, GB	19093
06401	2003-270	<b>Reckitt Benckiser N.V.</b> ; Siriusdreef 14, 2132 WT, Hoofddorp, NL	48671
06404	2006-2279	<b>Reckitt Benckiser N.V.</b> ; Siriusdreef 14, 2132 WT Hoofddorp, NL	54117
06407	2002-621	<b>Reckitt Benckiser Healthcare (UK) Limited</b> ; Dansom Lane, Hull, HU8 7DS, England, GB	47862
06373	2009-333	<b>VITALIA NIKOLA I DR. DOO ehport-import</b> ; UL 516 BB 1000 SKOPLJE, MAKEDONIJA	
06409	1981-220	<b>sanofi-aventis</b> ; 174 avenue de France, Paris 75013, FR	25285
06424	2001-552	<b>Intervet, Inc.</b> ; 556 Morris Avenue Summit, New Jersey 07901, USA	46822
06410	1997-1034	<b>GENERALE BISCUIT</b> ; 3 rue Saarinen Batiment Saarinen 94150 Rungis, FR	42734
06403	2006-2288	<b>Reckitt Benckiser N.V.</b> ; Siriusdreef 14, 2132 WT Hoofddorp, NL	54336
06402	2006-2290	<b>Reckitt Benckiser N.V.</b> ; Siriusdreef 14, 2132 WT Hoofddorp, NL	54052
03242	1990-1591	<b>TRANSAMERICA CORPORATION</b> ; 600 MONTGOMERY STREET, SAN FRANCISCO, CALIFORNIA 94111, US	36434
06400	2003-1652	<b>Reckitt Benckiser N.V.</b> ; Siriusdreef 14, 2132 WT, Hoofddorp, NL	49525
03240	1990-1590	<b>TRANSAMERICA CORPORATION</b> ; 600 MONTGOMERY STREET, SAN FRANCISCO, CALIFORNIA 94111, US	36709
06425	1991-739	<b>LORILLARD LICENSING COMPANY LLC.</b> ; 1600 Wachovia Tower, 300 North Green Street, Suite 1601, City of Greensboro, State of North Carolina 27401, US	37836
06399	1995-802	<b>Reckitt Benckiser N.V.</b> ; Siriusdreef 14, 2132 WT, Hoofddorp, NL	41235
06326	2003-897	<b>HEMOFARM KONCERN A.D. farmaceutska-hemijska industrija Vršac</b> ; Beogradski put bb, Vršac, YU	46136
06486	1990-2126	<b>SEARS BRANDS, LLC (ILLINOIS LIMITED LIABILITY COMPANY)</b> ; 3333 BEVERLY ROAD HOFFMAN ESTATES, ILLINOIS 60179, US	37046
06518	1996-231	<b>HYUNDAI MOTOR COMPANY</b> ; 140-2, KYE-DONG, CHONGRO-KU, SEOUL, KR	41463
06492	1991-699	<b>Perry Ellis International Inc.</b> ; 3000 NW 107th Avenue, Miami, FL US	37832
06494	1991-690	<b>LORILLARD TOBACCO COMPANY</b> ; 1600 Wachovia Tower, 300 North Greene Street, Suite 1601, City of Greensboro, State of North Carolina 27401, US	37826
06525	2007-1740	<b>HEMOFARM A.D. farmaceutsko-hemijska industrija Vršac</b> ; Beogradski put bb, 26300 Vršac, RS	53156
06524	1983-352	<b>ZORKA-PHARMA AD</b> ; ŠABAC, NARODNIH HEROJA BB, YU	26959
06324	1995-323	<b>HEMOFARM KONCERN A.D. FARMACEUTSKO-HEMIJSKA INDUSTRIJA VRŠAC</b> ; BEOGRADSKI PUT BB, 26 300 VRŠAC, YU	38904
06157	1971-532	<b>Merck Sharp &amp; Dohme Corp., a New Jersey corporation</b> ; One Merck Drive, Whitehouse Station, New Jersey, 08889-0100, USA	20578
06514	2006-1809	<b>"M.J. PACK" Ltd</b> ; "Drujba". Bl. 101, entr. B, fl. 6 ap. 34 Sofia 1592, BG	54073
06328	2002-80	<b>HEMOFARM KONCERN A.D. farmaceutsko-hemijska industrija Vršac</b> ; Beogradski put bb, 26300 Vršac, YU	47645
06523	2002-404	<b>HEMOFARM A.D. farmaceutsko-hemijska industrija Vršac</b> ; Beogradski put bb, 26300 Vršac, YU	47800
06521	2003-1279	<b>Hyundai Motor Company</b> ; 231 Yangjae-Dong, Seocho-Gu, Seoul, Republic of Korea, KP	49342

06522	1996-1158	<b>ZORKA-PHARMA DEONIČKO DRUŠTVO U MEŠOVITOJ SVOJINI ZA PROIZVODNJU FARMACEUTSKIH PROIZVODA I FINIH HEMIKALIJA, SA P.O.; Hemofarm Koncern "Zorka-Pharma" akcionarsko društvo za proizvodnju farmaceutskih proizvoda; Akcionarsko društvo za proizvodnju farmaceutskih proizvoda i finih hemikalija "Zorka-Pharma" and Hemofarm Koncern "Zorka-Pharma" akcionarsko društvo za proizvodnju farmaceutskih proizvoda; ŠABAC, NARODNIH HEROJA B.B., YU; 15000 Šabac, Hajduk Veljkova b.b., YU; 15000 Šabac, Hajduk Veljkova b.b., YU and 15000 Šabac, Hajduk Veljkova b.b., YU</b>	39873
06327	1996-725	<b>HEMOFARM D.D., FARMACEUTSKO HEMIJSKA INDUSTRIJA and HEMOFARM KONCERN A.D. farmaceutsko-hemijska industrija Vršac; VRŠAC, BEOGRADSKI PUT B.B., YU and Beogradski put bb Vršac, 26300, YU</b>	39672
06483	2006-2278	<b>Reckitt Benckiser N.V.;</b> Siriusdreef 14, 2132 WT Hoofddorp, NL	54119
06516	2002-119	<b>HYUNDAI MOTOR COMPANY;</b> Yangjae-Dong, Seocho-Gu, Seoul, KR	47616
06493	1970-427	<b>SEALY TECHNOLOGY LLC;</b> ONE OFFICE PARKWAY TRINITY NORTH CAROLINA 27370, US	19794
06325	2004-344	<b>HEMOFARM KONCERN A.D. farmaceutsko-hemijska industrija Vršac;</b> Beogradski put bb, 26300 Vršac, YU	47286
06487	1991-713	<b>LORILLARD TOBACCO COMPANY LLC.;</b> 1600 Wachovia Tower, 300 North Green Street, Suite 1601, City og Greensboro, State of North Carolina 27401, US	37833
06484	2006-2277	<b>Reckitt Benckiser N.V.;</b> Siriusdreef 14, 2132 WT Hoofddorp, NL	54253
06323	1998-940	<b>HEMOFARM KONCERN akcionarsko društvo, farmaceutsko-hemijska industrija;</b> Vršac, Beogradski put b.b., YU	41852
06520	1995-335	<b>AUDIOVOX CORPORATION;</b> 150 MARCUS BOULEVARD, HAUPPAUGE, NEW YORK 11788, US	40707
06482	1998-517	<b>N.V. SUMATRA TOBACCO TRADING COMPANY;</b> Jln, Pattimura No. 3, Pematang Siantar, Sumatera Utara, Indonesia, ID	45995
03832	1994-879	<b>CANON KABUSHIKI KAISHA;</b> 30-2, 3-CHOME, SHIMOMARUKO, OHTA-KU, TOKYO, JP	40260
03770	2006-1687	<b>GEOVISION INC.;</b> 9Fl., No.246, Sec.1, Nei-Hu Road, Nei-Hu R.O.C. Taipei Taiwan, TW	53874
03835	1996-1296	<b>CANON KABUSHIKI KAISHA;</b> 30-2, 3-CHOME, SHIMOMARUKO, OHTA-KU, TOKYO, JP	42174
03829	1997-1488	<b>CANON KABUSHIKI KAISHA;</b> 30-2, SHIMOMARUKO 3-CHOME, OHTA-KU, TOKYO, JP	43063
06533	1993-675	<b>HEMOFARM KONCERN A.D., FARMACEUTSKO-HEMIJSKA INDUSTRIJA VRŠAC;</b> Beogradski put bb, 26300 Vršac, YU	37694
03771	1987-299	<b>UNIOR, KOVAŠKA INDUSTRIJA D.D.;</b> ZREČE, KOVAŠKA C.10, SI	30757
06545	2003-807	<b>HEMOFARM KONCERN A.D. farmaceutsko-hemijska industrija Vršac;</b> Beogradski put bb, Vršac, YU	46135
06538	1995-320	<b>HEMOFARM KONCERN A.D. FARMACEUTSKO-HEMIJSKA INDUSTRIJA VRŠAC;</b> BEOGRADSKI PUT B.B., 26300 VRŠAC, YU	38901
06528	1988-189	<b>HEMOFARM KONCERN A.D. farmaceutsko-hemijska industrija Vršac;</b> Beogradski put bb, 26300 Vršac, RS	31852
03788	1998-77	<b>CANON KABUSHIKI KAISHA;</b> 30-2, , Shimomaruko 3-chome, Ohta-ku, Tokyo, JP	43048
06534	1995-791	<b>HEMOFARM KONCERN A.D. FARMACEUTSKO HEMIJSKA INDUSTRIJA VRŠAC;</b> BEOGRADSKI PUT B.B., 26 300 VRŠAC, YU	39182
06544	1994-567	<b>HEMOFARM KONCERN AD FARMACEUTSKO - HEMIJSKOA INDUSTRIJA VRŠAC;</b> BEOGRADSKI PUT BB, 26300 VRŠAC, YU	38436
03857	2004-336	<b>CANON KABUSHIKI KAISHA;</b> 30-2, Shimomaruko 3-chome, Ohta-ku, Tokyo, Japan, JP	49782
06529	2003-1609	<b>HEMOFARM KONCERN A.D. farmaceutsko-hemijska industrija Vršac;</b> Beogradski put bb, 26300 Vršac, YU	49410
03782	2001-745	<b>COLOPLAST A/S;</b> Høltedam 1, DK-3050 Humlebaek,, DK	46791

03830	1997-1452	<b>CANON KABUSHIKI KAISHA;</b> 30-2, SHIMOMARUKO 3-CHOME, OHTA-KU, TOKYO, JP	42904
06531	2003-1576	<b>HEMOFARM KONCERN A.D. farmaceutsko-hemijska industrija Vršac;</b> Beogradski put bb, 26300 Vršac, YU	47452
06527	1988-190	<b>HEMOFARM KONCERN A.D. farmaceutsko-hemijska industrija Vršac;</b> Beogradski put bb, 26300 Vršac, RS	31853
03837	1983-377	<b>CANON KABUSHIKI KAISHA;</b> 30-2, 3-CHOME, SHIMOMARUKO, OHTA-KU, TOKYO, JP	29931
06536	1995-330	<b>HEMOFARM KONCERN A.D., FARMACEUTSKO HEMIJSKA INDUSTRIJA;</b> VRŠAC, BEOGRADSKI PUT BB, YU	38911
03833	1983-51	<b>CANON KABUSHIKI KAISHA;</b> 30-2, 3-CHOME, SHIMOMARUKO, OHTA-KU, TOKYO, JP	29336
03769	2003-729	<b>ReproKolinska d.d.;</b> Središka ulica 5, 1000 Ljubljana, SI	49300
03838	1985-652	<b>CANON KABUSHIKI KAISHA;</b> 30-2, 3-CHOME, SHIMOMARUKO, OHTA-KU, TOKYO, JP	30595
03834	1984-198	<b>CANON KABUSHIKI KAISHA;</b> 30-2, 3-CHOME, SHIMOMARUKO, OHTA-KU, TOKYO, JP	29247
03783	2001-744	<b>COLOPLAST A/S;</b> Holtedam 1, DK-3050 Humlebaek,, DK	46790
03787	2001-425	<b>Zohar Waterworks, LLC Limited Liability Company of the State of Delaware;</b> 222 E. Campus View Blvd., Columbus, Ohio 43235, US	47279
06537	1995-327	<b>HEMOFARM KONCERN A.D., FARMACEUTSKO HEMIJSKA INDUSTRIJA VRŠAC;</b> VRŠAC, BEOGRADSKI PUT B.B., YU	38908
03781	1936-321	<b>BAYER HEALTHCARE LLC;</b> 100 Bayer Road Pittsburgh, Pennsylvania 15205, SAD, US	9463
06543	1994-568	<b>HEMOFARM KONCERN A.D., FARMACEUTSKO-HEMIJSKA INDUSTRIJA VRŠAC;</b> BEOGRADSKI PUT B.B., 26 300 VRŠAC, YU	38434
03858	1977-568	<b>CANON KABUSHIKI KAISHA;</b> 30-1, 3-CHOME, SHIMOMARUKO, OHTA-KU, TOKYO, JP	27058
06532	2003-1519	<b>HEMOFARM KONCERN A.D. farmaceutsko-hemijska industrija Vršac;</b> Beogradski put bb, 26300 Vršac, YU	46593
03859	1990-2277	<b>SARA LEE CORPORATION;</b> 470 HANES MILL ROAD, WINSTON-SALEM, NORTH CAROLINA 27105, US	36595
03766	2001-907	<b>KABUSHIKI KAISHA MAKITA trading as MAKITA CORPORATION;</b> 11-8, 3-chome, Sumiyoshi-cho, Anjo-shi, Aichi-ken, JAPAN, JP	47287
03765	2001-859	<b>SHIMANO INC.;</b> 77, Oimatsu-Cho, 3-Cho, Sakai, Osaka, JAPAN, JP	47005
03786	2004-782	<b>Euromark Polska Sp. z o.o. and EUROMARK POLSKA S.A.;</b> Modlinska 244 A 03-152 Warszawa, PL and Modlinska 244 A, 03-152 Warszawa, PL	50563
06541	1996-6	<b>HEMOFARM D.D., FARMACEUTSKO HEMIJSKA INDUSTRIJA and HEMOFARM KONCERN A.D. Farmaceutsko-hemijska industrija Vršac;</b> VRŠAC, BEOGRADSKI PUT B.B., YU and 26300 Vršac, Beogradski put b.b., YU	39289
06542	1994-174	<b>HEMOFARM KONCERN AD FARMACEUTSKO HEMIJSKA INDUSTRIJA VRŠAC;</b> BEOGRADSKI PUT BB, 26300 VRŠAC, YU	37878
06539	1995-319	<b>HEMOFARM KONCERN A.D. FARMACEUTSKO-HEMIJSKA INDUSTRIJA VRŠAC;</b> BEOGRADSKI PUT B.B., 26 300 VRŠAC, YU	38900
06535	1995-790	<b>HEMOFARM KONCERN A.D. FARMACEUTSKO HEMIJSKA INDUSTRIJA VRŠAC;</b> BEOGRADSKI PUT B.B., 26 300 VRŠAC, YU	39181
03836	1984-692	<b>CANON KABUSHIKI KAISHA;</b> 30-2, 3-CHOME, SHIMOMARUKO, OHTA-KU, TOKYO, JP	29727
06540	1996-894	<b>HEMOFARM D.D., FARMACEUTSKO-HEMIJSKA INDUSTRIJA;</b> VRŠAC, BEOGRADSKI PUT B.B., YU	39687
03784	1991-1782	<b>Societe des Produits Nestle S.A.;</b> CH-1800 Vevey, Switzerland, CH	36956
06530	2003-1605	<b>HEMOFARM KONCERN A.D. farmaceutsko-hemijska industrija Vršac;</b> Beogradski put bb, 26300 Vršac, YU	49416
03568	2001-760	<b>Jt International S.A.;</b> 1 Rue de la Gabelle, 1211 Geneva 26, Switzerland	49153



03772	2004-783	<b>Euromark Polska Sp. z o.o. and Euromark Polska S.A.;</b> Modlinska 244 A 03-125 Warszawa, PL and Modlinska 244 A, 03-152 Warszawa, PL	50564
03785	2001-1861	<b>Mitsubishi Enpitsu Kabushiki Kaisha (Mitsubishi Pencil Co., Ltd.);</b> 5-23-37, Higashi Ohi, Shinagawa-ku, Tokyo, JAPAN, JP	47388
03768	1991-906	<b>GIORGIO BEVERLY HILLS, INC (a Delaware Corporation);</b> ONE PROCTER & GAMBLE PLAZA, CINCINNATI, OHIO, US	38052
06526	1991-2359	<b>AKCIONARSKO DRUŠTVO ZA PROIZVODNJU FARMACEUTSKIH PROIZVODA I FINIH HEMIKALIJA ZORKA-PHARMA, ŠABAC;</b> NARODNIH HEROJA B.B., ŠABAC, YU	36407
03767	1991-1205	<b>KYOCERA CORPORATION;</b> 6 Takeda Tobadono-cho, Fushimi-ku, Kyoto, 612-8501, JP	37222
03933	2006-685	<b>STADA Arzneimittel AG;</b> Stadastrasse 2-18, 61118 Bad Vilbel, Nemačka, DE	52544
03431	2002-20	<b>LEK farmacevtska družba d.d.;</b> Verovškova 57, 1526 Ljubljana, Slovenija, SI	48029
03430	1991-595	<b>LEK, TOVARNA FARMACEVTSKIH IN KEMIČNIH IZDELKOV, D.D.;</b> LJUBLJANA, VEROVŠKOVA 57, SI	36437
03425	2001-234	<b>THE PROCTER &amp; GAMBLE COMPANY (OHIO CORPORATION);</b> One Procter & Gamble Plaza, Cincinnati, OHIO, US	46711
03866	2006-2409	<b>STADA Arzneimittel AG;</b> Stadastrasse 2-18, 61118 Bad Vilbel, DE	54299
03419	1991-79	<b>HYUNDAI MOTOR COMPANY;</b> 140-2, KYE-DONG, JONGRO-KU, SEOUL, KR	36607
03417	1990-733	<b>NBA PROPERTIES, INC.;</b> 645 FIFTH AVENUE, NEW YORK, N.Y. 10022, US	35505
03860	1990-2276	<b>HBI Branded Apparel Limited, Inc. (Delaware corporation);</b> 1000 East Hanes Mill Road, Winston- Salem, North Carolina 27105, US	36594
03422	1991-1193	<b>HITACHI, LTD.;</b> 6, KANDA-SURUGADAI 4 CHOME, CHIYODA-KU, TOKYO, JP	37155
03861	1990-2275	<b>HBI Branded Apparel Limited, Inc. (Delaware corporation);</b> 1000 East Hanes Mill Road, Winston-Salem, North Carolina, 27105, US	38099
03931	2006-1739	<b>STADA Arzneimittel AG;</b> Stadastrasse 2-18. 61118 Bad Vilbel, DE	53905
03432	1991-209	<b>THE UNITED STATES PLAYING CARD COMPANY;</b> 300 Gap Way, Erlanger, Kentucky 41018,US	36839
03729	1998-630	<b>PHARMANOVA d.o.o. društvo za promet farmaceutskim proizvodima Beograd;</b> ul. Bore Stankovića br. 2 - Makiš, 11250 Beograd, RS	43839
03433	1991-205	<b>THE UNITED STATES PLAYING CARD COMPANY;</b> 300 Gap Way, Erlanger, Kentucky, 41018, US	36837
03423	1998-616	<b>FIL Limited, A Bermuda Company;</b> Pembroke Hall, 42 Crow Lane, Pembroke HM 19, P.O.Box HM 670, Hamilton HMCX, Bermude,, BM	44692
03418	1991-78	<b>HYUNDAI MOTOR COMPANY;</b> 140-2, KYE-DONG, JONGRO-KU, SEOUL, KR	36606
03429	2005-1126	<b>FIL Limited, A Bermuda Company;</b> Pembroke Hall, 42 Crow Lane, Pembroke HM 19, P.O.Box HM 670, Hamilton HMCX, Bermude, BM	51540
03424	1998-617	<b>FIL Limited, A Bermuda Company;</b> Pembroke Hall, 42 Crow Lane, Pembroke HM 19, P.O.Box HM 670, Hamilton HMCX, Bermude, BM	44693
03862	1990-2274	<b>HBI Branded Apparel Limited, Inc. ( Delaware corporation);</b> 1000 East Hanes Mill Road, Winston-Salem, North Carolina, 27105, US	36593
03865	2006-2107	<b>STADA Arzneimittel AG;</b> Stadastrasse 2-18. 61118 Bad Vilbel, DE	54298
03936	2006-168	<b>STADA Arzneimittel AG;</b> Stadastrasse 2-18. 61118 Bad Vilbel, DE	52010
03934	2004-1161	<b>STADA Arzneimittel AG;</b> Stadastrasse 2-18, 61118 Bad Vilbel, Nemačka, DE	50354
03932	2006-1738	<b>STADA Arzneimittel AG;</b> Stadastrasse 2-18. 61118 Bad Vilbel, DE	53904
03421	1991-1192	<b>HITACHI, LTD.;</b> 6, KANDA-SURUGADAI 4 CHOME, CHIYODA-KU, TOKYO, JP	36916
03935	2004-1420	<b>STADA Arzneimittel AG and STADA ARZNEIMITTEDL AG;</b> Stadastrasse 2-18, 61118 Bad Vilbel, DE and Stadastrasse 2-18. 61119 Bad Vilbel, Nemačka, DE	50854
03595	2004-588	<b>Georgia-Pacific S.a.r.l.;</b> 25, route d Esch, L-1470 Luxembourg	49974
03736	1960-23	<b>PLIVA HRVATSKA D.O.O.;</b> Prilaz baruna Filipovica 25 10000 Zagreb	14969
03410	1991-561	<b>AstraZeneca AB;</b> 151 85 Sodertalje, SE	37707

03402	1995-844	<b>GALENKA AD; BEOGRAD, BATAJNIČKI DRUM B.B., YU</b>	39295
03405	2002-53	<b>Concord Confections Inc.;</b> 345 Courtland Avenue, Concord, Ontario, L4K 5A6, CA	48588
03940	2001-603	<b>KOKA DD; Jalkovečka b.b., HR-42000 Varaždin, HRVATSKA, HR</b>	46935
03946	2001-616	<b>REED ELSEVIER PROPERTIES, INC.;</b> 9th Floor, 1105 North Market Street, Suite 912, Wilmington, Delaware 19801, US	46569
03941	2001-599	<b>KOKA DD; JALKOVEČKA BB HR-4200 VARAŽDIN, HR</b>	46932
03938	1969-79	<b>CEDARBLUE LIMITED;</b> Ashley House, 4 Bon Accord Crescent, Aberdeen, AB11 6DH, Scotland, GB	18821
03404	1991-2033	<b>GALENKA AD; BEOGRAD, BATAJNIČKI DRUM B.B., YU</b>	36332
06026	1997-352	<b>GENERAL MOTORS LLC;</b> 300 Renaissance Center, City of Detroit, State of Michigan 48265-3000, US	43706
03400	1990-2050	<b>Eveready Battery Company, Inc.;</b> 533 Maryville University Drive St. Louis Missouri 63141, US	37030
03735	1953-303	<b>PLIVA HRVATSKA D.O.O.;</b> Prilaz baruna Filipovica 25 10000 Zagreb	12874
03409	1976-593	<b>WM. WRIGLEY JR. COMPANY;</b> 410 NORTH MICHIGAN AVENUE, CHICAGO, ILLINOIS, US	25163
03408	1977-136	<b>YAMAHA CORPORATION;</b> 10-1, NAKAZAWA-CHO, HAMAMATSU-SHI, SHIZUOKA-KEN, JP	25291
03939	2001-612	<b>VIR 1898 D.D.;</b> Školjić 16 HR-51000 Rijeka, HRVATSKA, HR	47002
03943	1997-143	<b>RECKITT BENCKISER INC.;</b> 1655 VALLEY ROAD, WAYNE, NEW JERSEY, US	42433
03406	1977-75	<b>THE PROCTER &amp; GAMBLE COMPANY (OHIO CORPORATION);</b> ONE PROCTER & GAMBLE PLAZA CINCINNATI, OHIO, US	25233
03407	2001-151	<b>Wm. WRIGLEY JR. COMPANY;</b> 410 North Michigan Avenue, Chicago, Illinois 60611, US	46478
03945	2001-1093	<b>NINTENDO CO. Ltd.;</b> 11-1, Hokotate-cho, Kamitoba, Minami-ku, Kyoto-shi, Kyoto, Japan, JP	47084
03401	2000-995	<b>ACCENTURE GLOBAL SERVICES GMBH;</b> Herrenacker 15,CH-8200,Schaffhausen,Switzerland	46197
03942	2001-601	<b>KOKA DD; Jalkovečka b.b., HR-42000 Varaždin, HRVATSKA, HR</b>	46936
03727	2001-448	<b>ALTO PROFESSIONAL,LLC;</b> 200 Scenic View Drive,Cumberland,Rhode Island, USA	46692
03596	1967-308	<b>J. WRAY &amp; NEPHEW LIMITED;</b> 234, SPANISH TOWN ROAD, KINGSTON 11, JM	17658
03382	1991-1411	<b>HONDA GIKEN KOGYO KABUSHIKI KAISHA (HONDA MOTOR CO., LTD.);</b> 1-1, 2-CHOME, MINAMI-AOYAMA, MINATO-KU, TOKYO, JP	38213
03726	2004-348	<b>HYATT INTERNATIONAL CORPORATION ( a Delaware corporation);</b> 71 S. Wacker Drive,Chicago,Illinois 60606,USA	49785
03597	1981-33	<b>ALTIA PLC.;</b> Porkkaalankatu 22,FI-00180 Helsinki,Finland	28032
03724	1991-584	<b>SLAZENGERS LIMITED;</b> CHALLENGE COURT, BARNETT WOOD LANE, LEATHERHEAD, SURREY KT22 7LW, ENGLSKA, GB	37817
03725	2005-331	<b>HYATT INTERNATIONAL CORPORATION;</b> 71 S. Wacker Drive, Chicago, Illinois 60606, US	51224
03403	1991-2265	<b>GALENKA AD; BEOGRAD, BATAJNIČKI DRUM B.B., YU</b>	36383
03598	1991-423	<b>HYATT INTERNATIONAL CORPORATION;</b> 71 South Wacker Drive. Chicago,Illinois 60606,USA	36845
03723	1984-559	<b>HYATT INTERNATIONAL CORPORATION;</b> 71.S.Wacker Drive,Chicago.Illinois 60606,USA	30121
03899	2004-57	<b>ZIPPO MANUFACTURING COMPANY and ZIPPO MANUFACTURING COMPANY;</b> 33 Barbour Street 16701 Brandford, Pennsylvania, US and 33 Barbour Street 16701 Bradford, Pennsylvania,, US	53608
03702	1996-1483	<b>BAUSCH &amp; LOMB INCORPORATED;</b> One Bausch & Lomb Place Rochester, NY 14604, US	39990
03733	2000-1098	<b>PLIVA D.D.;</b> Prilaz baruna Filipovica 25 10000 Zagreb,HR	44398

03720	2002-249	<b>SUMITOMO CORPORATION</b> ; 8-11, Harumi 1-chome, Chuo-ku, Tokyo, Japan, JP	48199
03734	1963-173	<b>Pliva d.d.</b> ; Prilaz baruna Filipovica 25 10000 Zagreb,HR	16031
03722	1978-567	<b>CLUETT, PEABODY &amp; CO., INC.</b> ; 200 Madison Avenue, New York, NY 10016, USA	26161
03699	1996-1436	<b>Procter &amp; Gamble Manufacturing GmbH</b> ; Wilhelm-Mauser-Strasse 40,D-50827 Koln,Deutschland	42055
03709	1958-228	<b>KIDDE GRAVINER LIMITED</b> ; Mathisen Way, Colnbrook, Slough, Berkshire SL3 0HB, GB	14456
03710	1991-642	<b>HEMOFARM A.D. FARMACEUTSKO-HEMIJSKA INDUSTRIJA VRŠAC</b> ; BEOGRADSKI PUT BB, YU	35822
03708	1960-235	<b>KIDDE-GRAVINER LIMITED</b> ; PENTAGON HOUSE, SIR FRANK WHITTLE, ROAD DERBY, DE2 4EE, GB	14989
03706	2006-706	<b>BAUSCH &amp; LOMB INCORPORATED</b> ; One Bausch & Lomb Place Rochester, NY 14604, US	52539
03239	1991-1406	<b>HONDA GIKEN KOGYO KABUSHIKI KAISHA (HONDA MOTOR CO., LTD.)</b> ; NO.1-1, 2-CHOME, MINAMI-AOYAMA, MINATO-KU, TOKYO, JP	38210
03731	1968-824	<b>DIN "Fabrika duvana" Niš a.d., u sastavu Philip Morris International</b> ; 12. februar 74, Niš, RS	18375
03719	1993-290	<b>CANON KABUSHIKI KAISHA</b> ; 30-2, 3-CHOME, SHIMOMARUKO, OHTA-KU, TOKYO, JP	40029
03721	2003-707	<b>PAI PO-JEN</b> ; 3F, No.4, Alley 12, Lane 151, Bao Ping Rd., TW	49005
03737	2000-1097	<b>PLIVA HRVATSKA d.o.o.</b> ; Ulica grada Vukovara 49, 10000 Zagreb, HR	46396
03712	1976-758	<b>AKZO NOBEL SURFACE CHEMISTRY AKTIEBOLAG</b> ; 444 85 STENUNGSUND, SE	24910
03697	2004-1604	<b>KIMBERLY-CLARK S.P.z.o.o.</b> ; 32-310 Klucze, PL	50739
03705	2006-705	<b>BAUSCH &amp; LOMB INCORPORATED</b> ; One Bausch & Lomb Place Rochester, NY 14604, US	52538
03715	1990-503	<b>Gray Line Corporation</b> ; P.O.Box 18267 Denver,Colorado 80218-267,USA	35485
03714	1973-487	<b>ESCHMANN HOLDINGS LIMITED</b> ; PETER ROAD, WEST SUSSEX BN15 8T3, GB	21555
03703	1992-653	<b>Bausch &amp; Lomb Incorporated</b> ; One Bausch & Lomb Place, Rochester, New York 14604-2701, US	39453
03713	1981-245	<b>INTERGRAPH CORPORATION</b> ; 1, MADISON INDUSTRIAL PARK, HUNTSVILLE, ALABAMA 35805, US	30711
03704	2005-1815	<b>BAUSCH &amp; LOMB INCORPORATED</b> ; One Bausch & Lomb Place, Rochester, New York 14604 (US), US	51814
03700	1982-107	<b>DR. JOHANNES HEIDENHAIN GMBH</b> ; P.O.B. 1260, D-8225 TRAUNREUT, DE	29535
03600	1961-12	<b>KRATON POLYMERS RESEARCH B.V.</b> ; Asterweg 19A1, 1031 HL Amsterdam, Holandija	15073
03997	1984-417	<b>Burlington Fashion GmbH</b> ; Oststr.5, D-57392, Schmallenberg, DE	31364
03881	1991-973	<b>MAJOR LEAGUE BASEBALL PROPERTIES, INC.</b> ; 350 PARK AVENUE, NEW YORK, NEW YORK 10022, US	36689
03995	2007-2905	<b>Farmaceutsko hemijska industrija "ZDRAVLJE", akcionarsko društvo</b> ; Vlajkova 199, Leskovac, RS	53900
03998	2006-366	<b>Burlington Fashion GmbH</b> ; Oststr. 5, D-57392, Schmallenberg, DE	52378
03885 pp	1991-969	<b>MAJOR LEAGUE BASEBALL PROPERTIES, INC.</b> ; 350 PARK AVENUE, NEW YORK, NEW YORK 10022, US	36685
03882	1991-972	<b>MAJOR LEAGUE BASEBALL PROPERTIES, INC.</b> ; 350 PARK AVENUE, NEW YORK, NEW YORK 10022, US	36688
03880	1991-965	<b>MAJOR LEAGUE BASEBALL PROPERTIES, INC.</b> ; 350 PARK AVENUE, NEW YORK, NEW YORK 10022, US	36681
03606	2003-1474	<b>MAX ROHR, INC.</b> ; 300 Delaware Avenue, Wilmington, Delaware 19801, US	49358
03884	1991-970	<b>MAJOR LEAGUE BASEBALL PROPERTIES, INC.</b> ; 350 PARK AVENUE, NEW YORK, NEW YORK 10022, US	36686

03987	2002-1013	<b>Farmaceutsko-hemijska industrija "ZDRAVLJE" Akcionarsko društvo;</b> Vljakova 199, 16000 Leskovac, YU	45042
05771	1992-947	<b>PARKE, DAVIS &amp; COMPANY LLC;</b> 201 TABOR ROAD, MORRIS PLAINS, NEW JERSEY 07950, US	39602
03605	2001-533	<b>RECKITT &amp; COLMAN (OVERSEAS) LIMITED;</b> Dansom Lane, Hull, Yorkshire, VELIKA BRITANIJA, GB	46872
03879	1991-966	<b>MAJOR LEAGUE BASEBALL PROPERTIES, INC.;</b> 350 PARK AVENUE, NEW YORK, NEW YORK 10022, US	36682
03603	2006-370	<b>Preduzeće za proizvodnju, trgovinu i usluge DR. OETKER d.o.o.;</b> Beograd, Vladimira Popovića 40, RS	52337
03604	1983-623	<b>PVH Corp.;</b> 200 MADISON AVENUE, NEW YORK, NEW YORK 10016, US	29185
03717	1991-895	<b>BP PLC;</b> 1 ST JAMES*S SQUARE LONDON SW1 4PD, GB	37994
06286	2000-1090	<b>PLIVA D.D.;</b> Prilaz baruna Filipovica 25, 10000 Zagreb, HR	46389
03602	1991-424	<b>HYATT INTERNATIONAL CORPORATION;</b> 71 South wacker drive, Chicago, Illinois 60606, USA	36846
03947	1969-367	<b>SCHERING - PLOUGH HEALTHCARE PRODUCTS, INC.;</b> 3030 JACKSON AVENUE, MEMPHIS, TENNESSEE, US	18827
03991	1991-1887	<b>CONOPCO, INC.;</b> 700 Sylvan Avenue Englewood Cliffs NJ 07632 US	38614
06287	2000-1094	<b>PLIVA D.D.;</b> Prilaz baruna ilipovica 25, 1000 Zagreb, HR	46403
06288	2000-1096	<b>PLIVA D.D.;</b> Prilaz baruna Filipovica 25, 10000 Zagreb, HR	46391
03950	2003-586	<b>Farmaceutsko-hemijska industrija "ZDRAVLJE" Akcionarsko društvo;</b> Vljakova 199, Leskovac, YU	45934
03948	1976-439	<b>AVERY DENISON CORPORATION;</b> 150 NORTH ORANGE GROVE BOULEVARD, PASADENA, CALIFORNIA 91103, US	26361
03989	2001-1152	<b>CONOPCO, INC.;</b> 700 Sylvan Avenue Englewood Cliffs NJ 07632 US	47352
03610	2005-1106	<b>"CRNAGORACOOP NB" d.o.o. za proizvodnju, preradu i promet export-import;</b> Danilovgrad, ME	53510
03601	1957-30	<b>PLIVA HRVATSKA d.o.o.;</b> Prilaz baruna Filipovica 25, 10000 Zagreb, HR	13893
03994	2007-497	<b>Farmaceutsko hemijska industrija "ZDRAVLJE", akcionarsko društvo;</b> 16000 Leskovac, Vljakova 199, RS	52488
03986	2003-417	<b>Farmaceutsko-hemijska industrija "ZDRAVLJE" Akcionarsko društvo;</b> Vljakova 199, Leskovac, YU	45659
03993	2007-1342	<b>Farmaceutsko hemijska industrija "ZDRAVLJE", akcionarsko društvo;</b> 16000 Leskovac, Vljakova 199, RS	52897
03949	2007-495	<b>Farmaceutsko hemijska industrija "ZDRAVLJE", akcionarsko društvo;</b> 16000 Leskovac, Vljakova 199, RS	52492
03988	1995-612	<b>FARMACEUTSKO-HEMIJSKA INDUSTRIJA "ZDRAVLJE" AKCIONARSKO DRUŠTVO;</b> LESKOVAC, VLAJKOVA 199, YU	39074
03990	2001-1315	<b>UNILEVER N.V.;</b> Weena 455, 3013 AL Rotterdam, The Netherlands, NL	47358
06300	2001-143	<b>PLIVA, FARMACEUTSKA INDUSTRIJA, DIONIČKO DRUŠTVO;</b> Prilaz baruna Filipovića 25, 10000 Zagreb, HR	46409
06305	2001-142	<b>PLIVA, FARMACEUTSKA INDUSTRIJA, DIONIČKO DRUŠTVO;</b> Prilaz baruna Filipovića 25, 10000 Zagreb, HR	46410
06338	2001-730	<b>PANAVISION INTERNATIONAL L.P.;</b> 6219 De Soto Avenue, Woodland Hills, California 91367-2602,, US	46837
06336	1966-228	<b>WILLIAM GRANT &amp; SONS LIMITED;</b> THE GLENFIDDICH DISTILLERY, DUFFTOWN, BANFFSHIRE, SCOTLAND, GB	16996
06301	1980-806	<b>PLIVA, FARMACEUTSKA INDUSTRIJA, DIONIČKO DRUŠTVO;</b> Prilaz baruna Filipovića 25, 10000 Zagreb, HR	25116
06337	1967-313	<b>WILLIAM GRANT &amp; SONS LIMITED;</b> THE GLENFIDDICH DISTILLERY, DUFFTOWN, BANFFSHIRE, SCOTLAND, GB	17511
06330	1998-83	<b>EFG BANK EUROPEAN FINANCIAL GROUP S.A.;</b> Quai du Seujet 24, Case Postale 1211, Geneve 2, CH	44316
05676	2005-201	<b>Motors Liquidation Company;</b> 300 Renaissance Center, Detroit, Michigan 48265-3000, US	51406

06297	2000-1069	<b>PLIVA D.D.;</b> Ulica grada Vukovara 49, 10000 Zagreb, HR	46310
06333	1991-1413	<b>HONDA GIKEN KOGYO KABUSHIKI KAISHA (HONDA MOTOR CO., LTD.);</b> 1-1, 2-CHOME, MINAMI-AOYAMA, MINATO-KU, TOKYO, JP	38214
06501	1977-221	<b>SCHERING-PLOUGH ANIMAL HEALTH CORPORATION;</b> 1095 MORRIS AVENUE, UNION, NEW JERSEY, US	25324
06334	1991-1403	<b>HONDA GIKEN KOGYO KABUSHIKI KAISHA (HONDA MOTOR CO., LTD.);</b> NO.1-1, 2-CHOME, MINAMI-AOYAMA, MINATO-KU, TOKYO, JP	38205
06335	2001-692	<b>PFIZER PRODUCTS INC. , a corporation organized under the laws of Connecticut;</b> Eastern Point Road, Groton, Connecticut 06340,, US	46760
06495	1977-114	<b>G.D. SEARLE LLC;</b> 235 east 42nd Street,100017 New York,NY,US	25265
06332	2006-135	<b>EFG Bank European Financial Group SA;</b> 24 Quai du Seujet, Case Postale 1211. Geneva 2, CH	53352
06331	2006-2697	<b>EFG Bank European Financial Group SA;</b> 24 Quai du Seujet, Case Postale 1211. Geneva 2, CH	54654
06329	1998-82	<b>EFG BANK EUROPEAN FINANCIAL GROUP S.A.;</b> Quai du Seujet 24, Case Postale 1211, Geneve 2, CH	44317
03910	2004-1485	<b>BOMBARDIER RECREATIONAL PRODUCTS, Inc.;</b> 726 St. Joseph Street, Valcourt, Quebec JOE 2L0, CA	51292
03909	1995-206	<b>MUL-T-LOCK LTD.;</b> SOUTHERN INDUSTRIAL ZONE, P.O.B. 465, YAVNE, IL	41000
03907	2006-542	<b>HERBALIFE INTERNATIONAL, INC.,;</b> 1800 Century Park East, Los Angeles, California 90067, US	52605
06548	1994-718	<b>KOLINSKA, prehrambena industrija, d.d. and DROGA KOLINSKA Živilska industrija d.d.;</b> Kolinska ulica 1, 1544 Ljubljana, SI and Kolinska ulica 1, 1544 Ljubljana, SI	40595
06552	1991-1040	<b>MAJOR LEAGUE BASEBALL PROPERTIES, INC.;</b> 350 PARK AVENUE, NEW YORK, NEW YORK 10022, US	36883
03937	2003-1169	<b>Royal Elastics Holding Ltd;</b> Suite 3306, 33/F Tower 6, The Gateway, 9 Canton Road, Tsimshatsui, Hong Kong	49257
06339	2001-695	<b>Genzyme Corporation;</b> 500 Kendall Street, Cambridge, Massachusetts 02142, US	46745
06502	2002-731	<b>KOLINSKA prehrambena industrija d.d.;</b> Kolinska ulica 1, 1544 Ljubljana, Slovenija, SI	48026
06485	2006-2289	<b>Reckitt Benckiser N.V.;</b> Siriusdreef 14, 2132 WT Hoofddorp, NL	54120
06504	2005-464	<b>KOLINSKA PREHRAMBENA INDUSTRIJA D.D. and DROGA KOLINSKA Živilska industrija d.d.;</b> Kolinska ulica 1, 1544 Ljubljana, Slovenija, SI and Kolinska ulica 1, 1544 Ljubljana, Slovenija, SI	51368
03908	1993-700	<b>RECKITT &amp; COLMAN (OVERSEAS) Limited;</b> Dansom lane,Hull,HU8 7DS,UK	40347
06503	1994-719	<b>KOLINSKA, prehrambena industrija, d.d. and DROGA KOLINSKA;</b> Kolinska ulica 1, 1544 Ljubljana, SI and Kolinska ulica 1, 1544 Ljubljana, SI	40596
06561	1991-1400	<b>HONDA GIKEN KOGYO KABUSHIKI KAISHA (HONDA MOTOR CO., LTD.);</b> NO.1-1, 2-CHOME, MINAMI-AOYAMA, MINATO-KU, TOKYO, JP	36938
06550	1991-1038	<b>MAJOR LEAGUE BASEBALL PROPERTIES, INC.;</b> 350 PARK AVENUE, NEW YORK, NEW YORK 10022, US	36881
06563	1991-1410	<b>HONDA GIKEN KOGYO KABUSHIKI KAISHA (HONDA MOTOR CO., LTD.);</b> 1-1, 2-CHOME, MINAMI-AOYAMA, MINATO-KU, TOKYO, JP	38212
06551	1991-1039	<b>MAJOR LEAGUE BASEBALL PROPERTIES, INC.;</b> 350 PARK AVENUE, NEW YORK, NEW YORK 10022, US	36882
03489	1995-100	<b>GALENKA A.D.;</b> BEOGRAD, BATAJNIČKI DRUM B.B., YU	38774
06566	1991-1402	<b>HONDA GIKEN KOGYO KABUSHIKI KAISHA (HONDA MOTOR CO., LTD.);</b> NO.1-1, 2-CHOME, MINAMI-AOYAMA, MINATO-KU, TOKYO, JP	38204
06549	1991-1037	<b>MAJOR LEAGUE BASEBALL PROPERTIES, INC.;</b> 350 PARK AVENUE, NEW YORK, NEW YORK 10022, US	36880
06565	1991-1412	<b>HONDA GIKEN KOGYO KABUSHIKI KAISHA (HONDA MOTOR CO., LTD.);</b> 1-1, 2-CHOME, MINAMI-AOYAMA, MINATO-KU, TOKYO, JP	38371

06562	1991-1408	<b>HONDA GIKEN KOGYO KABUSHIKI KAISHA (HONDA MOTOR CO., LTD.);</b> NO.1-1, 2-CHOME, MINAMI-AOYAMA, MINATO-KU, TOKYO, JP	36939
06564	1991-1414	<b>HONDA GIKEN KOGYO KABUSHIKI KAISHA (HONDA MOTOR CO., LTD.);</b> 1-1, 2-CHOME, MINAMI-AOYAMA, MINATO-KU, TOKYO, JP	38215
03887	1991-967	<b>MAJOR LEAGUE BASEBALL PROPERTIES, INC.;</b> 350 PARK AVENUE, NEW YORK, NEW YORK 10022, US	36683
03999	1922-203	<b>OSRAM AG;</b> 1, Hellabrunner Strasse, D-81543 Munchem, DE	1796
06303	1991-203	<b>THE UNITED STATES PLAYING CARD COMPANY;</b> 300 Gap Way Erlanger, Kentucky 41018, US	36836
06306	1991-210	<b>THE UNITED STATES PLAYING CARD COMPANY;</b> 300 Gap Way Erlanger, Kentucky 41018, US	37320
03904	2001-980	<b>S.C.Johnson &amp; Son, INC. (Wisconsin corporation);</b> 1525 Howe Street Racine, Wisconsin 53403-2236, US	47237
06349	1991-1661	<b>NIHON NOHYAKU CO.,LTD;</b> 2-5 NIHONBASHI 1-CHOME,CHUO-KU,TOKYO,JAPAN, JP	38345
06345	2004-10	<b>ArmKel, LLC;</b> 469 North Harrison Street, Princeton, NJ 08543, US	49570
06343	2007-2115	<b>ADVANCED MICRO DEVICES INC., (A Delaware Corporation);</b> One AMD Place, PO Box 3453, Sunnyvale, California 94088, US	
03905	1969-397	<b>E.I. du Pont de Nemours and Company;</b> 1007 Market Street, Wilmington, Delaware 19898, US	18893
03903	1995-168	<b>KSIN Luxembourg II, S.ar.l.;</b> c/o Halsey Group S.a r.l. 174 Route de Longwy L-1940 , LU	40827
06344	1995-360	<b>Advanced Micro Devices, Inc.;</b> One AMD Place, P.O. Box 3453, Sunnyvale, California 94088, US	40416
03886	1991-968	<b>MAJOR LEAGUE BASEBALL PROPERTIES, INC.;</b> 350 PARK AVENUE, NEW YORK, NEW YORK 10022, US	36684
06342	2005-658	<b>ADVANCED MICRO DEVICES, INC.;</b> One AMD Place, P.O. Box 3453, Sunnyvale, California 94088, US	51116
03864	1990-2484	<b>CAMARA DE COMERCIO DE LA REPUBLICA DE CUBA;</b> 21 STREET, NO. 661, HAVANA CITY, CU	37426
03906	1995-207	<b>MUL-T-LOCK LTD.;</b> SOUTHERN INDUSTRIAL ZONE, P.O.B. 465, YAVNE, IL	41075
06350	2005-1151	<b>Reckitt Benckiser N.V.;</b> Siriusdreef 14, 2132 WT, Hoofddorp (NL), NL	51520
06346	2003-1580	<b>ARMKEL, LLC;</b> 469 North Harrison Street, Princeton, NJ 08543, US	49402
06347	1991-1280	<b>PARAMOUNT PICTURES CORPORATION;</b> 5555 MELROSE AVENUE, LOS ANGELES, CALIFORNIA 90038, US	36921
06348	1968-853	<b>DIAGEO NORTH AMERICA,INC.;</b> 801 Main Avenue, Norwalk CT 06851-1127, US	18877
06293	2000-1072	<b>PLIVA HRVATSKA d.o.o.;</b> Prilaz baruna Filipovića 25, 10000 Zagreb, HR	46308
06496	2001-904	<b>RECKITT &amp; COLMAN (OVERSEAS) LIMITED;</b> Dansom Lane, Hull, HU8 7DS, ENGLAND, GB	47060
03578	2000-715	<b>Tommy Hilfiger Licensing LLC;</b> 601 W. 26th St., 6th Floor, New York, NY 10001, US	45903
06497	2001-731	<b>RECKITT &amp; COLMAN (OVERSEAS) LIMITED;</b> Dansom Lane, HULL - Yorkshire HU8 7DS, UK, GB	46838
06498	1994-301	<b>ZDRAVLJE, FABRIKA FARMACEUTSKIH I HEMIJSKIH PROIZVODA;</b> LESKOVAC, VLAJKOVA 199, YU	37928
06302	1991-204	<b>THE UNITED STATES PLAYING CARD COMPANY;</b> 300 Gap Way Erlanger,Kentucky 41018 US	37298
06557	1991-1045	<b>MAJOR LEAGUE BASEBALL PROPERTIES, INC.;</b> 350 PARK AVENUE, NEW YORK, NEW YORK 10022, US	36888
06499	1992-611	<b>Farmaceutsko-hemijska industrija Zdravlje” akcionarsko društvo, Leskovac”;</b> LESKOVAC, VLAJKOVA 199, YU	36981
06500	1981-744	<b>FARMACEUTSKO-HEMIJSKA INDUSTRIJA ZDRAVLJE, AKCIONARSKO DRUŠTVO LESKOVAC;</b> Vljakova 199, 16000 LESKOVAC, YU	26249

06556	1991-1044	<b>MAJOR LEAGUE BASEBALL PROPERTIES, INC.;</b> 350 PARK AVENUE, NEW YORK, NEW YORK 10022, US	36887
06295	2000-1088	<b>PLIVA D.D.;</b> Prilaz baruna Filipovića 25,10000 Zagreb,HR	46326
06555	1991-1043	<b>MAJOR LEAGUE BASEBALL PROPERTIES, INC.;</b> 350 PARK AVENUE, NEW YORK, NEW YORK 10022, US	36886
06304	1991-208	<b>THE UNITED STATES PLAYING CARD COMPANY;</b> 300 Gap way Erlanger,kentucky 41018,US	37319
06567	1991-1405	<b>HONDA GIKEN KOGYO KABUSHIKI KAISHA (HONDA MOTOR CO., LTD.);</b> NO.1-1, 2-CHOME, MINAMI-AOYAMA, MINATO-KU, TOKYO, JP	38209
03917	1977-869	<b>ELI LILLY AND COMPANY;</b> LILLY CORPORATE CENTER, INDIANAPOLIS, INDIANA 46285, US	25607
06611	2005-135	<b>SUPERSTATION, INC., proizvodno i trgovinsko preduzeće organizovano po propisima države Georgia;</b> One CNN Center, Atlanta, Georgia 30303, US	53965
06341	1952-161	<b>OSRAM AG;</b> Hellabrunner Strasse 1, D-81543 Munchen, DE	12533
06572	1990-2414	<b>AKZO NOBEL DECORATIVE COATINGS AKTIEBOLAG;</b> 205 17 MALMO, SE	37145
06617	1921-501	<b>KOH-I-NOOR HARDTMUTH a.s.;</b> F.A. Gerstnera 21/3, 371 30 Český Budějovice , CZ	763
06613	1994-678	<b>HUSQVARNA AKTIEBOLAG;</b> DROTTNINGATTAN 1, S-561 82 HUSKVARNA, SE	40797
06577	1992-1239	<b>WILLIAM GRANT &amp; SONS LIMITED;</b> THE GLENFIDDICH DISTILLERY, DUFFTOWN, BANFFSHIRE, ŠKOTSKA, GB	39691
03918	1969-460	<b>ELI LILLY AND COMPANY, Proizvodno i trgovinsko preduzeće SAD,;</b> Lilly Corporate Center, Indianapolis, Indiana 46285, US	19010
06576	2001-729	<b>KNORR NAEHRMITTEL AKTIENGESELLSCHAFT;</b> Bahnhofstrasse 8240 Thayngen, SWITZERLAND, CH	47428
06615	1991-907	<b>GIORGIO BEVERLY HILLS, INC (a Delaware Corporation);</b> ONE PROCTER & GAMBLE PLAZA, CINCINNATI, OHIO, US	38053
06569	1991-1407	<b>HONDA GIKEN KOGYO KABUSHIKI KAISHA (HONDA MOTOR CO., LTD.);</b> NO.1-1, 2-CHOME, MINAMI-AOYAMA, MINATO-KU, TOKYO, JP	38211
06575	1968-768	<b>SUNBEAM PRODUCTS INC.;</b> 2381 EXECUTIVE CENTER DRIVE, BOCA RATON, FLORIDA 33431, US	18688
06568	1991-1404	<b>HONDA GIKEN KOGYO KABUSHIKI KAISHA (HONDA MOTOR CO., LTD.);</b> NO.1-1, 2-CHOME, MINAMI-AOYAMA, MINATO-KU, TOKYO, JP	38208
06573	2002-465	<b>HEMOFARM A.D. farmaceutsko-hemijska industrija Vršac,;</b> Beogradski put bb, 26300 Vršac, YU	48042
03914	2006-553	<b>HERBALIFE INTERNATIONAL, INC.,;</b> 1800 Century Park East, Los Angeles, California 90067, US	52380
06574	2002-464	<b>HEMOFARM A.D. farmaceutsko-hemijska industrija Vršac,;</b> Beogradski put bb, 26300 Vršac, YU	48018
06618	1991-923	<b>KRKA, TOVARNA ZDRAVIL, D.D. NOVO MESTO;</b> NOVO MESTO, ŠMARJEŠKA CESTA 6, SI	36158
03919	2005-88	<b>Turner Network Television, Inc.;</b> 1050 Techwood Drive, Atlanta, Georgia, US	52929
06571	1991-1401	<b>HONDA GIKEN KOGYO KABUSHIKI KAISHA (HONDA MOTOR CO., LTD.);</b> NO.1-1, 2-CHOME, MINAMI-AOYAMA, MINATO-KU, TOKYO, JP	38203
03920	2005-89	<b>SUPERSTATION, INC., proizvodno i trgovinsko preduzeće organizovano po propisima države Georgia;</b> One CNN Center, Atlanta, Georgia 30303, US	51066
06570	2001-696	<b>BIOMARIN/GENZYME LLC;</b> 500 Kendall Street, Cambridge, Massachusetts 02142, US	46746
03913	2002-267	<b>SIGNAL INVESTMENT &amp; MANAGEMENT CO.;</b> 1105 North Market Street, Suite 1300, Wilmington, Delaware, US	47882
06616	1971-659	<b>BAYER HEALTHCARE LLC;</b> 100 Bayer Road Pittsburgh, Pennsylvania 15205, SAD, US	20697
06291	2000-968	<b>PLIVA HRVATSKA d.o.o.;</b> Prilaz baruna Filipovića 25, 10000 Zagreb, HR	46152
03915	2006-551	<b>HERBALIFE INTERNATIONAL, INC.,;</b> 1800 Century Park East, Los Angeles, California 90067, US	52379

03912	2002-269	<b>SIGNAL INVESTMENT &amp; MANAGEMENT CO.;</b> 1105 North Market Street, Suite 1300, Wilmington, Delaware, US	47884
03916	2006-554	<b>HERBALIFE INTERNATIONAL, INC.;</b> 1800 Century Park East, Los Angeles, California 90067, US	52381
06289	2000-1099	<b>Pliva Hrvatska d.o.o.;</b> Prilaz baruna Filipovića 25, 10000 Zagreb, HR	46394
06612	2004-1457	<b>The Cartoon Network, Inc.;</b> 1050 Techwood Drive, N.W., Atlanta, Georgia, US	51053
06614	1991-905	<b>GIORGIO BEVERLY HILLS, INC (a Delaware Corporation);</b> ONE PROCTER & GAMBLE PLAZA, CINCINNATI, OHIO, US	38051
05920	1983-233	<b>Schering Corporation;</b> 2000 Galloping Hill Road, Kenilworth, New Jersey 07033, USA	29074
06559	1991-1047	<b>MAJOR LEAGUE BASEBALL PROPERTIES, INC.;</b> 350 PARK AVENUE, NEW YORK, NEW YORK 10022, US	36890
06558	1991-1046	<b>MAJOR LEAGUE BASEBALL PROPERTIES, INC.;</b> 350 PARK AVENUE, NEW YORK, NEW YORK 10022, US	36889
06560	1991-1048	<b>MAJOR LEAGUE BASEBALL PROPERTIES, INC.;</b> 350 PARK AVENUE, NEW YORK, NEW YORK 10022, US	36891
06664	1991-1049	<b>MAJOR LEAGUE BASEBALL PROPERTIES, INC.;</b> 350 PARK AVENUE, NEW YORK, NEW YORK 10022, US	36892
05925	1992-733	<b>MERCK Sharp &amp; Dohme Corp.;</b> One Merck Drive, Whitehouse station New Jersey, 08889 US	39475
05924	1985-927	<b>Schering Corporation;</b> 2000 Galloping Hill Road, Kenilworth, New Jersey 07033, USA	30540
05919	1997-1027	<b>Schering Corporation;</b> 2000 Galloping Hill Road, Kenilworth, New Jersey 07033, USA	43340
06161	2006-882	<b>Schering Corporation;</b> 2000 Galloping Hill Road, Kenilworth, New Jersey 07033, USA	52809
05923	1995-571	<b>Schering Corporation;</b> 2000 Galloping Hill Road, Kenilworth, New Jersey 07033, USA	42183
06171	1984-278	<b>Schering Corporation;</b> 2000 Galloping Hill Road, Kenilworth, New Jersey 07033, USA	29438
05921	1991-1190	<b>Schering Corporation;</b> 2000 Galloping Hill Road, Kenilworth, New Jersey 07033, USA	38157
06155	1971-693	<b>Schering Corporation;</b> 2000 Galloping Hill Road, Kenilworth, New Jersey 07033, USA	20774
05922	1991-665	<b>Schering Corporation;</b> 2000 Galloping Hill Road, Kenilworth, New Jersey 07033, USA	37820
05915	1992-131	<b>THE CLOROX COMPANY;</b> 1221 BROADWAY, OAKLAND, CA 94612, US	39196
06665	1991-1050	<b>MAJOR LEAGUE BASEBALL PROPERTIES, INC.;</b> 350 PARK AVENUE, NEW YORK, NEW YORK 10022, US	36893
06666	1991-1051	<b>MAJOR LEAGUE BASEBALL PROPERTIES, INC.;</b> 350 PARK AVENUE, NEW YORK, NEW YORK 10022, US	36894
06292	2000-1074	<b>PLIVA HRVATSKA d.o.o.;</b> Prilaz baruna Filipovića 25, 10000 Zagreb, HR	46306
06673	1991-1058	<b>MAJOR LEAGUE BASEBALL PROPERTIES, INC.;</b> 350 PARK AVENUE, NEW YORK, NEW YORK 10022, US	36901
06672	1991-1057	<b>MAJOR LEAGUE BASEBALL PROPERTIES, INC.;</b> 350 PARK AVENUE, NEW YORK, NEW YORK 10022, US	36900
06667	1991-1052	<b>MAJOR LEAGUE BASEBALL PROPERTIES, INC.;</b> 350 PARK AVENUE, NEW YORK, NEW YORK 10022, US	36895
06671	1991-1056	<b>MAJOR LEAGUE BASEBALL PROPERTIES, INC.;</b> 350 PARK AVENUE, NEW YORK, NEW YORK 10022, US	36899
06670	1991-1055	<b>MAJOR LEAGUE BASEBALL PROPERTIES, INC.;</b> 350 PARK AVENUE, NEW YORK, NEW YORK 10022, US	36898
06668	1991-1053	<b>MAJOR LEAGUE BASEBALL PROPERTIES, INC.;</b> 350 PARK AVENUE, NEW YORK, NEW YORK 10022, US	36896



06669	1991-1054	<b>MAJOR LEAGUE BASEBALL PROPERTIES, INC.</b> ; 350 PARK AVENUE, NEW YORK, NEW YORK 10022, US	36897
06631	1991-957	<b>MAJOR LEAGUE BASEBALL PROPERTIES, INC.</b> ; 350 PARK AVENUE, NEW YORK, NEW YORK 10022, US	36673
06632	1991-958	<b>MAJOR LEAGUE BASEBALL PROPERTIES, INC.</b> ; 350 PARK AVENUE, NEW YORK, NEW YORK 10022, US	36674
06633	1991-959	<b>MAJOR LEAGUE BASEBALL PROPERTIES, INC.</b> ; 350 PARK AVENUE, NEW YORK, NEW YORK 10022, US	36675
06630	1991-956	<b>MAJOR LEAGUE BASEBALL PROPERTIES, INC.</b> ; 350 PARK AVENUE, NEW YORK, NEW YORK 10022, US	36672
06634	1991-960	<b>MAJOR LEAGUE BASEBALL PROPERTIES, INC.</b> ; 350 PARK AVENUE, NEW YORK, NEW YORK 10022, US	36676
06578	2006-372	<b>Preduzeće za proizvodnju, trgovinu i usluge DR. OETKER d.o.o.</b> ; Beograd, Vladimira Popovica 40, RS	53001
06582	2006-371	<b>Preduzeće za proizvodnju, trgovinu i usluge DR.OETKER d.o.o.</b> ; Beograd, Vladimira Popovića 40, RS	53000
06579	2006-369	<b>Preduzeće za proizvodnju, trgovinu i usluge DR. OETKER d.o.o.</b> ; Beograd, Vladimira Popovića 40, RS	52336
06580	2006-2271	<b>Preduzeće za proizvodnju, trgovinu i usluge DR. OETKER d.o.o.</b> ; Beograd, Vladimira Popovića 40, RS	54340
06581	2006-368	<b>Preduzeće za proizvodnju, trgovinu i usluge DR. OETKER d.o.o.</b> ; Beograd, Vladimira Popovića 40, RS	52335
06685	1991-1067	<b>MAJOR LEAGUE BASEBALL PROPERTIES, INC.</b> ; 350 PARK AVENUE, NEW YORK, NEW YORK 10022, US	36910
06686	1991-1068	<b>MAJOR LEAGUE BASEBALL PROPERTIES, INC.</b> ; 350 PARK AVENUE, NEW YORK, NEW YORK 10022, US	36911
06677	1991-1059	<b>MAJOR LEAGUE BASEBALL PROPERTIES, INC.</b> ; 350 PARK AVENUE, NEW YORK, NEW YORK 10022, US	36902
06681	1991-1063	<b>MAJOR LEAGUE BASEBALL PROPERTIES, INC.</b> ; 350 PARK AVENUE, NEW YORK, NEW YORK 10022, US	36906
06680	1991-1062	<b>MAJOR LEAGUE BASEBALL PROPERTIES, INC.</b> ; 350 PARK AVENUE, NEW YORK, NEW YORK 10022, US	36905
06678	1991-1060	<b>MAJOR LEAGUE BASEBALL PROPERTIES, INC.</b> ; 350 PARK AVENUE, NEW YORK, NEW YORK 10022, US	36903
06683	1991-1065	<b>MAJOR LEAGUE BASEBALL PROPERTIES, INC.</b> ; 350 PARK AVENUE, NEW YORK, NEW YORK 10022, US	36908
06684	1991-1066	<b>MAJOR LEAGUE BASEBALL PROPERTIES, INC.</b> ; 350 PARK AVENUE, NEW YORK, NEW YORK 10022, US	36909
06691	1994-571	<b>HEMOFARM KONCERN AD FARMACEUTSKO - HEMIJSKA INDUSTRIJA VRŠAC</b> ; Beogradski put bb, 26300 Vršac, YU	38438
06690	1996-1009	<b>HEMOFARM D.D., FARMACEUTSKO HEMIJSKA INDUSTRIJA and HEMOFARM KONCERN A.D. farmaceutsko-hemijska industrija Vrsac</b> ; VRŠAC, BEOGRADSKI PUT B.B., YU and Beogradski put bb, 26300, Vrsac, YU	39697
06696	1997-635	<b>HEMOFARM KONCERN A.D., FARMACEUTSKO-HEMIJSKA INDUSTRIJA VRŠAC</b> ; Beogradski put bb, 26300 Vršac, YU	40168
06693	1993-227	<b>"ZORKA-PHARMA" A.D.</b> ; ŠABAC, NARODNIH HEROJA BB, YU	37456
06692	1994-570	<b>HEMOFARM KONCERN D.D., FARMACEUTSKO-HEMIJSKA INDUSTRIJA VRŠAC</b> ; Beogradski put bb, 26300 Vršac, YU	38437
06697	1994-566	<b>HEMOFARM KONCERN AD FARMACEUTSKO - HEMIJSKA INDUSTRIJA VRŠAC</b> ; BEOGRADSKI PUT BB, 26300 VRŠAC, YU	38435
06694	1991-1664	<b>HEMOFARM A.D. FARMACEUTSKO-HEMIJSKA INDUSTRIJA VRŠAC</b> ; BEOGRADSKI PUT BB, 26 300 VRŠAC, YU	36065
06695	2004-633	<b>HEMOFARM KONCERN A.D. farmaceutsko-hemijska industrija Vršac</b> ; Beogradski put bb, 26300 Vršac, YU	47285

06689	2006-1916	<b>Preduzece za proizvodnju, trgovinu i usluge DR.OETKER d.o.o.;</b> Beograd, Vladimira Popovica 40, RS	53713
03246	1974-621	<b>KOHLER CO.;</b> 444 Highland Drive, Kohler, Wisconsin, USA	24971
06583	2001-11	<b>KEYENCE CORPORATION;</b> 1-3-14, Higashinakajima, Higashiyodogawa-ku, Osaka, JP	46620
06698	1991-747	<b>BESTFORM APPAREL CORP.;</b> 3411 SILVERSIDE ROAD 200 WELDIN BUILDING WILMINGTON, DELAWARE,, US	37905
03515	1991-825	<b>FUNAI ELECTRIC COMPANY LIMITED;</b> 7-1, NAKAGAITO 7-CHOME, DAITO-SHI, OSAKA-FU, JP	38191
03529	1992-998	<b>DUNHILL TOBACCO OF LONDON LIMITED;</b> 1A ST. JAMES STREET, LONDON SW1 1ER, ENGLAND, GB	39553
03454	1977-9	<b>WARNER BROS. ENTERTAINMENT INC.;</b> 4000 WARNER BOULEVAD, BURBANK, CALIFORNIA 91522, US	25171
06585	2002-471	<b>GEORGIA-PACIFIC S.A.R.L.;</b> 25, route d'Esch, L1470 Luxembourg, Luxembourg	48086
03517	1977-135	<b>YAMAHA CORPORATION;</b> 10-1, NAKAZAWA-CHO, HAMAMATSU-SHI, SHIZUOKA-KEN, JP	25277
03514	2001-256	<b>UNILEVER N.V.;</b> Weena 455, 3013 AL ROTTERDAM,, NL	46688
03453	2001-120	<b>NOVEN PHARMACEUTICALS, INC. a Delaware corporation.;</b> 11960 S.W. 144th Street, Miami, Florida 33186, US	46446
03521	1975-619	<b>KIMBERLY-CLARK WORLDWIDE, INC.;</b> NEENAH, WISCONSIN 54956, US	24721
03533	1978-211	<b>KRKA tovarna zdravil d.d. Novo mesto;</b> 8501 Novo mesto, Šmarješka c. br. 6, SI	23046
03420	1991-286	<b>MSD Consumer Care, Inc.;</b> 3030 Jackson Avenue, Memphis, Tennessee, 38151, USA	38504
06700	2000-758	<b>LAZARD STRATEGIC COORDINATION COMPANY LLC a Delaware limited liability company;</b> 30 Rockefeller Plaza, New York, NY 10020, US	46030
06720	1992-370	<b>THE PROCTER &amp; GAMBLE COMPANY;</b> ONE PROCTER & GAMBLE PLAZA, CINCINNATI, OHIO, US	39078
06721	1992-629	<b>THE PROCTER &amp; GAMBLE COMPANY;</b> ONE PROCTER & GAMBLE PLAZA, CINCINNATI, OHIO, US	39325
06723	2001-1083	<b>mitsubishi shoji kaisha limited;</b> 3-1, Marunouchi 2-Chome, Chiyoda-ku, Tokyo 100-8086, Japan, JP	47193
06717	1994-15	<b>PROCTER &amp; GAMBLE HOLDING GmbH;</b> SULZBACHER STRASSE 40, D-65824 SCHWALBACH AM TAUNUS, DE	40540
06722	2001-1084	<b>mitsubishi shoji kaisha limited;</b> 6-Marunouchi 2 - Chome, Chiyoda - ku, TOKYO 100-8086, JAPAN, JP	47194
06718	1997-1165	<b>THE PROCTER &amp; GAMBLE COMPANY ( OHIO CORPORATION );</b> ONE PROCTER & GAMBLE PLAZA, CINCINNATI, OHIO, US	42990
06719	1997-1232	<b>THE PROCTER &amp; GAMBLE COMPANY;</b> ONE PROCTER & GAMBLE PLAZA, CINCINNATI, OHIO, US	42955
06716	1970-357	<b>THE PROCTER &amp; GAMBLE COMPANY;</b> ONE PROCTER & GAMBLE PLAZA, CINCINNATI, OHIO 45202, US	19507
03574	1990-2526	<b>GENERAL MOTORS LLC;</b> 300 Renaissance Center City of Detroit State of Michugan 48265-3000 US	38103
03577	1990-2528	<b>GENERAL MOTORS LLC;</b> 300 Renaissance Center City of Detroit State of Michigan 48265-3000 US	37376
06725	1995-401	<b>NU SKIN INTERNATIONAL, INC and NSE PRODUCTS, INC.;</b> ONE NU SKIN PLAZA, 75 WEST CENTER, PROVO, UTAH 84601, US and 75 West Center Street, Provo, Utah 84601, US	41445
06728	1977-903	<b>CUMMINS LTD.;</b> 49-51 Gresham Road, Staines, Middlesex TW18 2BD, UK	25616
06730	1963-197	<b>KAPMAN AB;</b> S-811 11 SANDVIKEN, SE	16070
06726	1995-396	<b>NU SKIN INTERNATIONAL, INC and NSE PRODUCTS, INC.;</b> ONE NU SKIN PLAZA, 75 WEST CENTER, PROVO, UTAH 84601, US and 75 West Center Street, Provo, Utah 84601, US	40453

06724	1995-397	<b>NU SKIN INTERNATIONAL, INC and NSE PRODUCTS, INC.;</b> ONE NU SKIN PLAZA, 75 WEST CENTER, PROVO, UTAH 84601, US and 75 West Center Street, Provo, Utah 84601, US	40451
06729	2001-1043	<b>SSANGYONG MOTOR COMPANY;</b> 150-3, CHILKOI-DONG, PYUNGTAEK-SI, KYUNGKI-DO, KOREA, KR	47135
06727	2001-1358	<b>BP p.l.c. Britannic House;</b> 1 St James's Square, LONDON SW1Y 4PD, GB	47230
06711	1991-1031	<b>MAJOR LEAGUE BASEBALL PROPERTIES, INC.;</b> 350 PARK AVENUE, NEW YORK, NEW YORK 10022, US	36874
06708	1991-1034	<b>MAJOR LEAGUE BASEBALL PROPERTIES, INC.;</b> 350 PARK AVENUE, NEW YORK, NEW YORK 10022, US	36877
06710	1991-1032	<b>MAJOR LEAGUE BASEBALL PROPERTIES, INC.;</b> 350 PARK AVENUE, NEW YORK, NEW YORK 10022, US	36875
06707	1991-1035	<b>MAJOR LEAGUE BASEBALL PROPERTIES, INC.;</b> 350 PARK AVENUE, NEW YORK, NEW YORK 10022, US	36878
06709	1991-1033	<b>MAJOR LEAGUE BASEBALL PROPERTIES, INC.;</b> 350 PARK AVENUE, NEW YORK, NEW YORK 10022, US	36876
06714	1991-1025	<b>MAJOR LEAGUE BASEBALL PROPERTIES, INC.;</b> 350 PARK AVENUE, NEW YORK, NEW YORK 10022, US	36871
06706	1991-1036	<b>MAJOR LEAGUE BASEBALL PROPERTIES, INC.;</b> 350 PARK AVENUE, NEW YORK, NEW YORK 10022, US	36879
06713	1991-1026	<b>MAJOR LEAGUE BASEBALL PROPERTIES, INC.;</b> 350 PARK AVENUE, NEW YORK, NEW YORK 10022, US	36872
06712	1991-1030	<b>MAJOR LEAGUE BASEBALL PROPERTIES, INC.;</b> 350 PARK AVENUE, NEW YORK, NEW YORK 10022, US	36873
06760	1991-1792	<b>GUARDSMARK, INC.;</b> 22 SOUTH SECOND STREET, MEMPHIS, TENNESSEE 38103-2695, US	38560
06756	2002-635	<b>THUYA, S.L.;</b> C. Sant Gervasi de Cassoles, 68, 08022 Barcelona, Španija, ES	47863
06758	1969-368	<b>SCHERING - PLOUGH HEALTHCARE PRODUCTS, INC.;</b> 3030 JACKSON AVENUE, MEMPHIS, TENNESSEE, US	18998
06754	1969-814	<b>KAPMAN AB;</b> S-811 11 SANDVIKEN, SE	19240
06755	2001-1101	<b>MONARCH BEVERAGES INTERNATIONAL,;</b> Villa Baudran, 26-28, Impasse Baudran, 94742 ARCUEIL Cedex, FRANCE, FR	47073
06762	1978-13	<b>SUN-MAID GROWERS OF CALIFORNIA;</b> 13525 SOUTH BETHEL AVENUE, KINGSBURG, CALIFORNIA, US	25923
06759	1991-1607	<b>Valio Ltd.;</b> Meijeritie 6, 00370 Helsinki, FI	38333
06761	1971-226	<b>KANEGAFUCHI KAGAKU KOGYO KABUSHIKI KAISHA (KANEGAFUCHI CHEMICAL INDUSTRY COMPANY LIMITED);</b> OSAKA, JP	20944
06757	1980-32	<b>ICL-IP AMERICA INC.;</b> A Delaware Corpration,430 Saw Mill River Road Ardsley,NY 10502,US	29927
06771	1961-79	<b>FILTRONA INTERNATIONAL LIMITED;</b> Milton Keynes, UK	15256
06769	2001-1286	<b>Genzyme Corporation;</b> 500 Kendall Street, Cambridge, Massachusetts 02142, US	47301
06764	2001-1036	<b>PLIVA , DD - farmaceutska industrija;</b> Prilaz baruna Filipovica 25,10 000 Zagreb,Hrvatska,HR	47142
06763	2001-1289	<b>Genzyme Corporation;</b> 500 Kendall Street, Cambridge, Massachusetts 02142, US	47372
06765	2001-1037	<b>PLIVA, DD - farmaceutska industrija,;</b> Prilaz baruna Filipovica 25,10 000 Zagreb,Hrvatska,HR	47143
06766	1993-265	<b>GOTTEX MODELS LTD. (an Israel company of 62);</b> 62 MORDEKHAI ANNILEVITCH STREET, TEL AVIV 67060, IL	38972
06768	1978-27	<b>SUN-MAID GROWERS OF CALIFORNIA;</b> 13525 SOUTH BETHEL AVENUE, KINGSBURG, CALIFORNIA, US	25929
06772	2003-412	<b>WOONGJIN COWAY CO., LTD.;</b> 658 Yougu-ri, Yougu-eup, Kongju-si, Choongchungnam-do, Koreja, KR	48709

06746	1991-1020	<b>MAJOR LEAGUE BASEBALL PROPERTIES, INC.;</b> 350 PARK AVENUE, NEW YORK, NEW YORK 10022, US	36866
06751	1991-1015	<b>MAJOR LEAGUE BASEBALL PROPERTIES, INC.;</b> 350 PARK AVENUE, NEW YORK, NEW YORK 10022, US	36700
06788	1969-396	<b>INVISTA Technologies S.a.r.l. and INVISTA Technologies S.a.r.l.;</b> Three Little Falls Centre, 2801 Centerville Road, Wilmington, DE 19808 U.S.A., US and Talstrasse 80, 8001 Zurich, CH	18894
06791	1996-1390	<b>DENSO CORPORATION;</b> 1-1 SHOWA-CHO, KARIYA-CITY, AICHI-PREF., JP	42553
06787	2005-913	<b>NIHON NOHYAKU Co., Ltd.;</b> 2-5 Nihonbashi 1-chome, Chuo-ku, Tokyo, Japan, JP	51578
06786	2005-912	<b>NIHON NOHYAKU Co., Ltd.;</b> 2-5 Nihonbashi 1-chome, Chuo-ku, Tokyo, Japan, JP	51577
06745	1991-1021	<b>MAJOR LEAGUE BASEBALL PROPERTIES, INC.;</b> 350 PARK AVENUE, NEW YORK, NEW YORK 10022, US	36867
03893	1971-295	<b>BRANDBREW S. A.;</b> 5 Parc d Activite Syrdall, L-5365 Munsbach, Luxembourg, LU	20428
06789	1969-300	<b>Davide Campari-Milano S.p.A.;</b> Via Franco sacchetti 20,20099 Sesto san Giovanni (MI),Italija ,IT	18954
06783	1969-249	<b>FRANKLIN ELECTRIC CO. INC.;</b> 400 EAST SPRING STREET, BLUFFTON, INDIANA, US	18933
06749	1991-1017	<b>MAJOR LEAGUE BASEBALL PROPERTIES, INC.;</b> 350 PARK AVENUE, NEW YORK, NEW YORK 10022, US	36860
06743	1991-1023	<b>MAJOR LEAGUE BASEBALL PROPERTIES, INC.;</b> 350 PARK AVENUE, NEW YORK, NEW YORK 10022, US	36869
06790	2004-581	<b>DENSO CORPORATION;</b> 1-1 Showa-cho, Kariya-city, Aichi-pref., Japan, JP	50044
06748	1991-1018	<b>MAJOR LEAGUE BASEBALL PROPERTIES, INC.;</b> 350 PARK AVENUE, NEW YORK, NEW YORK 10022, US	36864
06715	1991-1024	<b>MAJOR LEAGUE BASEBALL PROPERTIES, INC.;</b> 350 PARK AVENUE, NEW YORK, NEW YORK 10022, US	36870
03897	1974-295	<b>FUMAKILLA LIMITED;</b> 11, KANDA - MIKURACHO, CHIYODA-KU, TOKYO, JP	22470
06752	1991-983	<b>MAJOR LEAGUE BASEBALL PROPERTIES, INC.;</b> 350 PARK AVENUE, NEW YORK, NEW YORK 10022, US	36699
06750	1991-1016	<b>MAJOR LEAGUE BASEBALL PROPERTIES, INC.;</b> 350 PARK AVENUE, NEW YORK, NEW YORK 10022, US	36859
03896	1996-943	<b>ZIPPO MANUFACTURING COMPANY;</b> 33 BARBOUR STREET, BRADFORD, PENNSYLVANIA 16701, US	42004
06744	1991-1022	<b>MAJOR LEAGUE BASEBALL PROPERTIES, INC.;</b> 350 PARK AVENUE, NEW YORK, NEW YORK 10022, US	36868
06785	1992-783	<b>NIHON NOHYAKU CO., LTD.;</b> 2-5, NIHONBASHI 1-CHOME, CHUO-KU, TOKYO, JP	39367
06792	1996-1301	<b>DENSO CORPORATION;</b> 1-1 SHOWA-CHO, KARIYA-CITY, AICHI-PREF., JP	42552
06784	1979-477	<b>PLIVA HRVATSKA d.o.o.;</b> Prilaz Baruna Filipovica 25,10 000 Zagreb,Hrvatska,HR	25626
06747	1991-1019	<b>MAJOR LEAGUE BASEBALL PROPERTIES, INC.;</b> 350 PARK AVENUE, NEW YORK, NEW YORK 10022, US	36865
03898	1978-291	<b>FUMAKILLA LIMITED;</b> 11, KENDA-MIKURACHO, CHIYODA-KU, TOKYO, JP	27348
03891	1972-174	<b>IDEM PAPERS S.A.;</b> 2 rue d Asguempont,1460 Virginal,Belgium	21028
03539	1998-615	<b>FIL Limited,A Bermuda Company;</b> Pembroke Hall, 42 Crow Lane, Pembroke HM 19, P.O.Box HM 670, Hamilton HMCX, BM	45907
03892	1974-294	<b>FUMAKILLA LIMITED;</b> 11, KANDA - MIKURACHO, CHIYODA-KU, TOKYO, JP	22469
03894	1983-443	<b>SANYO ELECTRIC CO., LTD.;</b> 5-5, KEIHAN-HONDORI 2-CHOME, MORIGUCHI CITY, OSAKA 570, JP	29536

03888	1973-630	<b>BRANDBREW S. A.;</b> Parc D Activite Syrdall 5, L-5365 Munsbach, Luksemburg, LU	22133
06648	1996-1712	<b>ALTICOR INC.;</b> 7575 FULTON STREET, EAST ADA, MICHIGAN 49355, US	42454
06651	1971-294	<b>BRANDBREW S. A.;</b> Parc d Activite Syrdall, L-5365 Munsbach, Luxembourg, LU	20427
06827	2006-7	<b>3M Company a Delaware corporation;</b> 3M Center, 2501 Hudson Road, St. Paul, Minnesota, 55144, US	53371
06647	2004-1538	<b>ALTICOR INC. (a Michigan corporation);</b> 7575 Fulton Street, East Ada, Michigan 49355, US	50824
06641	1965-178	<b>DENON, LTD., and D &amp; M Holdings Inc.;</b> 16-11, YUSHIMA 3-CHOME, BUNKYO-KU TOKYO 113-0034 JAPAN, JP and 7-35-1 Sagamiono, Sagamihara-shi, Kanagawa, Japan, JP	16683
06824	1998-276	<b>3M COMPANY (a Delaware corporation);</b> 3M CENTER, 2501 HUDSON ROAD, SAINT PAUL, MINNESOTA 55144, US	43933
06832	1970-856	<b>3M COMPANY (a Delaware corporation);</b> 3M CENTER, 2501 HUDSON ROAD, SAINT PAUL, MINNESOTA 55144, US	22777
06831	2002-521	<b>3M COMPANY, korporacija države Delaware;</b> 3M Center, 2501 Hudson Road, St. Paul, Minnesota, 55144, US	47810
06830	2005-809	<b>3M Company a Delaware corporation;</b> 3M Center, 2501 Hudson Road, St. Paul, Minnesota, 55144 S.A.D., US	51333
06823	1991-1505	<b>MSG HOLDINGS,L.P.,a limited partnership organized under the laws of the state of Delaware;</b> Two Pensilylvania Plaza ,New York,new York 10121,US	38179
06642	1979-176	<b>LEGO Juris A/S;</b> 7190 Billund, DK	28332
06829	2006-559	<b>3M COMPANY (a Delaware corporation);</b> 3M CENTER, 2501 HUDSON ROAD, SAINT PAUL, MINNESOTA 55144, US	52339
06636	1982-6	<b>INTERNATIONAL PAINT LTD;</b> 26th FLOOR,PORTLAND HOUSE BRESSENDEN PLACE,ZW 1E 5BG LONDON,UK,GB	27884
06826	1974-896	<b>3M COMPANY (a Delaware corporation);</b> 3M CENTER, 2501 HUDSON ROAD, SAINT PAUL, MINNESOTA 55144, US	26353
06911	1997-1056	<b>E.I. DU PONT DE NEMOURS &amp; COMPANY;</b> 1007 Market Street, Wilmington, Delaware 19898, US	42738
06825	1998-145	<b>3M COMPANY (a Delaware corporation);</b> 3M CENTER, 2501 HUDSON ROAD, SAINT PAUL, MINNESOTA 55144, US	43875
06645	2004-1544	<b>ALTICOR INC. (a Michigan corporation);</b> 7575 Fulton Street, East Ada, Michigan 49355, US	50484
06639	1991-356	<b>AUSTRALASIAN CONFERENCE ASSOCIATION LIMITED (SANITARIUM HEALTH FOOD COMPANY);</b> 148, FOX VALLEY ROAD, WAHROONGA, NEW SOUTH WALES, 2076, AU	37529
06640	1982-8	<b>INTERNATIONAL PAINT LTD;</b> ORIEL HOUSE, 16 CONNAUGHT PLACE LONDON W2 2ZB, GB	27886
06637	1985-582	<b>INTERNATIONAL PAINT LTD.;</b> ORIEL HOUSE, 16 CONNAUGHT PLACE, LONDON W2 2ZB, ENGLAND, GB	31119
06914	1997-785	<b>OY HARTWALL AB;</b> P.O.BOX 31, HELSINKI, FI	43017
06916	1978-212	<b>KRKA, TOVARNA ZDRAVIL, D.D., NOVO MESTO;</b> Šmarješka cesta 6, Novo mesto, SI	25941
06767	1997-1116	<b>Kompanija "SIMPO" akcionarsko društvo za proizvodnju , promet i usluge,;</b> Vranje, ul. Radnička br.12, RS	43242
06644	1991-1376	<b>FYFFES GROUP LIMITED;</b> HOUNDMILLS INDUSTRIAL ESTATE HOUNDMILLS ROAD BASINGSTOKE HAMPSHIRE RG21 6XL, GB	38326
03460	1968-874	<b>3M COMPANY ( a Delaware corporation);</b> 3M CENTER, 2501 HUDSON ROAD, SAINT PAUL, MINNESOTA 55144, US	19175
03458	1969-18	<b>3M COMPANY (a Delaware corporation);</b> 3M CENTER, 2501 HUDSON ROAD, SAINT PAUL, MINNESOTA 55144, US	18820
06773	1991-982	<b>MAJOR LEAGUE BASEBALL PROPERTIES, INC.;</b> 350 PARK AVENUE, NEW YORK, NEW YORK 10022, US	36698

06774	1991-981	<b>MAJOR LEAGUE BASEBALL PROPERTIES, INC.;</b> 350 PARK AVENUE, NEW YORK, NEW YORK 10022, US	36697
03484	1946-79	<b>Motors Liquidation Company;</b> 300 Renaissance Center, Detroit, Michigan, 48265-3000, US	11122
06588	1969-403	<b>EMI (IP) LIMITED;</b> 27 Wrights Lane, London, W8 5SW, UK, GB	18863
06589	1998-618	<b>CORPORACION HABANOS, S.A.;</b> Avenida 3ra.No.2006 entre 20 y 22,Miramar,playa,Ciudad de la Habana,Cuba	44901
03581	1968-724	<b>E.I. DU PONT DE NEMOURS &amp; COMPANY;</b> 1007 Market Street, Wilmington, Delaware 19898, US	18681
06621	2005-1264	<b>ARYSTA LIFESCIENCE;</b> Route d Artix, 64150 Nogueres, FR	51747
06775	1991-980	<b>MAJOR LEAGUE BASEBALL PROPERTIES, INC.;</b> 350 PARK AVENUE, NEW YORK, NEW YORK 10022, US	36696
06776	1991-979	<b>MAJOR LEAGUE BASEBALL PROPERTIES, INC.;</b> 350 PARK AVENUE, NEW YORK, NEW YORK 10022, US	36695
06625	1991-962	<b>MAJOR LEAGUE BASEBALL PROPERTIES, INC.;</b> 350 PARK AVENUE, NEW YORK, NEW YORK 10022, US	36678
06995	2001-150	<b>QUALITEA CEYLON (PVT) LTD.;</b> No. 14, Station Road, Wattala, LK	46738
06997	1961-30	<b>SHELL BRANDS INTERNATIONAL AG;</b> Baarermatte, 6340 Baar Switzerland, CH	15097
06994	1997-1432	<b>3M COMPANY (a Delaware corporation);</b> 3M CENTER, 2501 HUDSON ROAD, SAINT PAUL, MINNESOTA 55144, US	42913
06624	1991-963	<b>MAJOR LEAGUE BASEBALL PROPERTIES, INC.;</b> 350 PARK AVENUE, NEW YORK, NEW YORK 10022, US	36679
06993	1997-1431	<b>3M COMPANY (a Delaware corporation);</b> 3M CENTER, 2501 HUDSON ROAD, SAINT PAUL, MINNESOTA 55144, US	42919
06629	1991-955	<b>MAJOR LEAGUE BASEBALL PROPERTIES, INC.;</b> 350 PARK AVENUE, NEW YORK, NEW YORK 10022, US	36671
06623	1991-964	<b>MAJOR LEAGUE BASEBALL PROPERTIES, INC.;</b> 350 PARK AVENUE, NEW YORK, NEW YORK 10022, US	36680
06779	1991-976	<b>MAJOR LEAGUE BASEBALL PROPERTIES, INC.;</b> 350 PARK AVENUE, NEW YORK, NEW YORK 10022, US	36692
06778	1991-977	<b>MAJOR LEAGUE BASEBALL PROPERTIES, INC.;</b> 350 PARK AVENUE, NEW YORK, NEW YORK 10022, US	36693
06991	1997-1429	<b>3M COMPANY (a Delaware corporation);</b> 3M CENTER, 2501 HUDSON ROAD, SAINT PAUL, MINNESOTA 55144, US	42917
06989	1998-12	<b>3M COMPANY (a Delaware corporation);</b> 3M CENTER, 2501 HUDSON ROAD, SAINT PAUL, MINNESOTA 55144, US	43449
06996	1996-985	<b>TORAY INDUSTRIES, INC. (TORAY KABUSHIKI KAISHA);</b> 1-1, 2-CHOME, NIHONBASHI, MURO-MACHI, CHUO-KU, TOKYO-TO, JP	42066
06988	1998-11	<b>3M COMPANY (a Delaware corporation);</b> 3M CENTER, 2501 HUDSON ROAD, SAINT PAUL, MINNESOTA 55144, US	43448
06992	1997-1430	<b>3M COMPANY (a Delaware corporation);</b> 3M CENTER, 2501 HUDSON ROAD, SAINT PAUL, MINNESOTA 55144, US	42918
06777	1991-978	<b>MAJOR LEAGUE BASEBALL PROPERTIES, INC.;</b> 350 PARK AVENUE, NEW YORK, NEW YORK 10022, US	36694
06780	1991-974	<b>MAJOR LEAGUE BASEBALL PROPERTIES, INC.;</b> 350 PARK AVENUE, NEW YORK, NEW YORK 10022, US	36690
06990	1997-1428	<b>3M COMPANY (a Delaware corporation);</b> 3M CENTER, 2501 HUDSON ROAD, SAINT PAUL, MINNESOTA 55144, US	42976
06932	1983-442	<b>SANYO ELECTRIC CO., LTD.;</b> 5-5, KEIHAN-HONDORI 2-CHOME, MORIGUCHI CITY, OSAKA 570, JP	29308
07004	2004-1128	<b>Ssangbangwool &amp; Try Group, Inc.;</b> 161-17, Samsung-dong, Kangnam-ku, Seoul, Koreja, KR	50371
07002	1969-394	<b>KRKA tovarna zdravil d.d., Novo mesto;</b> Novo mesto Šmarješka cesta 6, R. Slovenija, SI	18911

07001	1969-395	<b>KRKA tovarna zdravil d.d., Novo mesto;</b> Novo mesto, Šmarješka cesta 6, R. Slovenija, SI	18912
06638	1991-1339	<b>THE PROCTER &amp; GAMBLE COMPANY;</b> ONE PROCTER & GAMBLE PLAZA, CINCINNATI, OHIO, US	38070
07005	2001-1004	<b>PLIVA HRVATSKA d.o.o.;</b> Prilaz baruna Filipovića 25, 10 000 Zagreb, Hrvatska, HR	47397
06628	1921-1557	<b>KSIN Luxembourg II, S.ar.l.;</b> c/o Halsey Group S.a r.l. 174 Route de Longwy L-1940 , LU	1339
07053	1968-689	<b>Chemtura Corporation (Delaware Corporation);</b> Benson Road, Middlebury, Connecticut 06749, USA	18568
06915	2003-106	<b>Close Trustees (Cayman) Limited;</b> P.O.Box 1034, Grand Cayman, KY1-1102, Cayman Islands	48750
06933	2002-1387	<b>Close Trustees (Cayman) Limited;</b> P.O. Box 1034, rand Cayman, KY1-1102, Cayman Islands	48542
03522	1966-14	<b>TECHTRONIC OUTDOOR PRODUCTS TECHNOLOGY LIMITED;</b> CANONĚS COURT, 22 VICTORIA STREET, HAMILTON HM12 BERMUDA	16872
07007	1969-486	<b>HANNA-BARBERA PRODUCTIONS, INC.;</b> 15301 Ventura Boulevard, City of Sherman Oaks, State of California 91403, US	19290
07010	1998-583	<b>TURNER ENTERTAINMENT CO.;</b> 4000 Warner Blvd., Burbank, CA 91522, US	44303
07008	2004-712	<b>Hanna-Barbera Productions, Inc;</b> 15301 Ventura Boulevard, Sherman Oaks, California 91403, US	50375
07009	1996-21	<b>HANNA-BARBERA PRODUCTIONS, INC.;</b> 15301 VENTURA BOULEVARD, SHERMAN OAKS, CALIFORNIA 91403, US	42026
07006	1996-1624	<b>HANNA-BARBERA PRODUCTIONS, INC.;</b> 4000 Warner Boulevard, Burbank, California, 91522, US	42386
07083	1963-232	<b>SAPONIA - kemijska, prehrambena i farmaceutska industrija, d.d.;</b> OSIJEK, MATIJE GUPCA 2, HR	16112
07085	1998-326	<b>IBERICA HOTELERA and S.A. IBEROTEL;</b> Avenida 16 de Julio 73- Poligono La Victoria, 07009 PALMA DE MALLORCA (Balears), ES and Avenida 16 de Julio 73- Poligono La Victoria, 07009 PALMA DE MALLORCA (Balears), ES	44458
07087	1998-392	<b>DONALDSON COMPANY, INC. (a Delaware corporation);</b> 1400 West 94th Street, P.O.Box 1299, Minneapolis, Minnesota 55440-1299, US	45001
07088	2004-1543	<b>ALTICOR INC. (a Michigan corporation);</b> 7575 Fulton Street, East Ada, Michigan 49355, US	50830
07086	2001-924	<b>ELI LILLY AND COMPANY, proizvodno i trgovinsko preduzeće organizovano po propisima države Indiana;</b> Lilly Corporate Center Indianapolis, INDIANA, US	47097
07080	1998-585	<b>TURNER ENTERTAINMENT CO.;</b> 4000 Warner Blvd., Burbank, CA 91522, US	44305
07081	1993-191	<b>TURNER ENTERTAINMENT CO.(a Delaware corporation);</b> 4000 WARNER BOULEVARD, BURBANK, CA 91522, US	39967
07089	1991-2073	<b>ALTICOR INC.;</b> 7575 FULTON Street East, ADA, MICHIGAN 49355, US	38678
07082	1998-584	<b>TURNER ENTERTAINMENT CO.;</b> 4000 Warner Blvd., Burbank, CA 91522, US	44304
07084	2005-1257	<b>SAPONIA - kemijska, prehrambena i farmaceutska industrija d.d.;</b> Osijek, Matije Gupca 2, HR	53910
07139	1992-12	<b>ALTICOR INC.;</b> 7575 EAST FULTON ROAD, ADA, MICHIGAN 49355, US	38852
07135	1996-1715	<b>ALTICOR INC.;</b> 7575 FULTON STREET, EAST ADA, MICHIGAN 49355, US	42508
07138	1996-1719	<b>AMWAY CORPORATION and Alticor Inc.(Michigan corporation);</b> 7575 FULTON STREET, EAST ADA, MICHIGAN 49355, US and 7575 Fulton Street, East Ada, Michigan 49355, US	42457
07133	1996-1713	<b>AMWAY CORPORATION and Alticor Inc.(Michigan corporation);</b> 7575 FULTON STREET, EAST ADA, MICHIGAN 49355, US and 7575 Fulton Street, East Ada, Michigan 49355, US	42623
07137	2004-1540	<b>ALTICOR INC. (a Michigan corporation);</b> 7575 Fulton Street, East Ada, Michigan 49355, US	50510

06922	1991-1185	<b>SAUCONY, INC.</b> ; CENTENNIAL PARK, CENTENNIAL DRIVE, P.O. BOX 6046, PEABODY, MASSACHUSETTS 01961, US	38156
07132	1991-1555	<b>ALTICOR INC.</b> ; 7575 EAST FULTON ROAD, ADA, MICHIGAN 49355, US	38238
07134	2004-1541	<b>ALTICOR INC. (a Michigan corporation)</b> ; 7575 Fulton Street, East Ada, Michigan 49355, US	51017
07136	2004-1542	<b>ALTICOR INC. (a Michigan corporation)</b> ; 7575 Fulton Street, East Ada, Michigan 49355, US	50509
05178	2002-1502	<b>Kraft Foods Holdings, Inc. (A Delaware corporation)</b> ; Three Lakes Drive, Northfield, Illinois 60093, US	48364
05163	2006-1551	<b>Bristol-Myers Squibb Company, a Delaware corporation</b> ; 345 Park Avenue, New York, New York 10154, US	53814
05164	1999-582	<b>HEMOFARM KONCERN A.D., FARMACEUTSKO-HEMIJSKA INDUSTRIJA</b> ; Beogradski put bb, 26300 Vršac, YU	43259
05167	1989-926	<b>HEMOFARM D.D., FARMACEUTSKO-HEMIJSKA INDUSTRIJA</b> ; VRŠAC, BEOGRADSKI PUT BB, YU	33437
05166	1989-925	<b>HEMOFARM D.D., FARMACEUTSKO-HEMIJSKA INDUSTRIJA</b> ; VRŠAC, BEOGRADSKI PUT BB, YU	33436
06912	2003-836	<b>EFG Eurobank Ergasias S.A.</b> ; 8 Othonos Street, 10557 Athens, Grčka, GR	49012
05172	1989-931	<b>HEMOFARM D.D., FARMACEUTSKO-HEMIJSKA INDUSTRIJA</b> ; VRŠAC, BEOGRADSKI PUT BB, YU	33442
05171	1989-930	<b>HEMOFARM D.D., FARMACEUTSKO-HEMIJSKA INDUSTRIJA</b> ; VRŠAC, BEOGRADSKI PUT BB, YU	33441
05170	1989-929	<b>HEMOFARM KONCERN A.D., FARMACEUTSKO-HEMIJSKA INDUSTRIJA VRŠAC</b> ; Beogradski put bb, 26300 Vršac, YU	33440
05177	1974-788	<b>BRISTOL - MYERS SQUIBB COMPANY</b> ; 345 PARK AVENUE, NEW YORK, N.Y. 10154, US	22620
05175	1987-44	<b>E.R. SQUIBB &amp; SONS, L.L.C. a Delaware Limited Liability Company</b> ; Lawrenceville-Princeton Road, Princeton, New Jersey 08540, US	32854
05165	1989-882	<b>HEMOFARM D.D., FARMACEUTSKO-HEMIJSKA INDUSTRIJA</b> ; VRŠAC, BEOGRADSKI PUT BB, YU	33434
05162	1992-159	<b>BRISTOL-MYERS SQUIBB, A FRENCH COMPANY</b> ; 3, RUE JOSEPH MONIER, 92500 RUEIL MALMAISON, FR	39310
05169	1989-928	<b>HEMOFARM D.D., FARMACEUTSKO-HEMIJSKA INDUSTRIJA</b> ; VRŠAC, BEOGRADSKI PUT BB, YU	33439
05174	1988-459	<b>KENTUCKY FRIED CHICKEN INTERNATIONAL HOLDINGS, INC.</b> ; 1441 GARDINER LANE, LOUISVILLE, KENTUCKY 40213, US	33750
05176	1991-1787	<b>Danisco US Inc. a Delaware corporation</b> ; 925 Page Mill Road, Palo Alto, California 94304, US	38833
05168	1989-927	<b>HEMOFARM KONCERN A.D., FARMACEUTSKO-HEMIJSKA INDUSTRIJA VRŠAC</b> ; Beogradski put bb, 26300 Vršac, YU	33438
07141	1971-633	<b>Akzo Nobel Coatings International B.V.</b> ; Velperweg 76, 6824 BM Arnhem, NL	20991
07200	2002-1020	<b>Akzo Nobel Coatings International B.V.</b> ; Velperweg 76, 6824 BM Arnhem, NL	48184
07140	1972-470	<b>Akzo Nobel Coatings International B.V.</b> ; Velperweg 76, 6824 BM Arnhem, NL	21191
06657	2001-1141	<b>HYUNDAI MOTOR COMPANY</b> ; 231, Yangjae-Dong, Seocho-Gu, Seoul, Koreja, KR	47006
06659	2006-1212	<b>Genzyme Corporation (Massachusetts corporation)</b> ; 500 Kendall Street Cambridge, Massachusetts 02142, US	53518
06658	2004-1608	<b>ORION CORPORATION</b> ; 30-10, Munbae-Dong, Yongsan-Ku, Seoul, KP	53897
06655	1991-2392	<b>KRKA Tovarna zdravil d.d., Novo Mesto</b> ; Novo Mesto, Šmarješka cesta 6, R. Slovenija, SI	37123
06925	1991-2389	<b>KRKA Tovarna zdravil d.d., Novo Mesto</b> ; Novo Mesto, Šmarješka cesta 6, R. Slovenija, SI	37122



07246	1970-798	<b>Akzo Nobel Coatings International B.V.;</b> Velperweg 76, 6824 BW Arnhem, NL	20302
07248	1984-444	<b>ALPS ELECTRIC CO., LTD.;</b> 1-7, Yukigaya-otsukamachi, Ota-Ku, Tokyo, Japan, JP	31259
06627	1947-249	<b>KSIN Luxembourg II, S.arl.;</b> c/o Halsey Group S.a r.l. 174 Route de Longwy L-1940, LU	11520
07266	2006-667	<b>The Procter &amp; Gamble Company;</b> One Procter & Gamble Plaza, Cincinnati, Ohio 45202, USA, US	52513
07263	1996-637	<b>GIORGIO BEVERLY HILLS, INC.;</b> ONE PROCTER & GAMBLE PLAZA, CINCINNATI, OHIO, US	41780
07269	1997-739	<b>OLYMPUS CORPORATION;</b> 43-2, HATAGAYA 2-CHOME, SHIBUYA-KU, TOKYO, JP	43101
07251	1931-411	<b>MERIMA, HEMIJSKA INDUSTRIJA;</b> KRUŠEVAC, YU	7405
07264	1996-668	<b>GIORGIO BEVERLY HILLS, INC.;</b> ONE PROCTER & GAMBLE PLAZA, CINCINNATI, OHIO, US	42290
06936	2004-85	<b>CHRRH &amp; DWIGHT CO., INC. (Delaware corporation);</b> One Procter & Gamble Plaza Cincinnati, Ohio, US	49761
07265	1997-648	<b>THE PROCTER &amp; GAMBLE COMPANY ( OHIO CORPORATION);</b> ONE PROCTER & GAMBLE PLAZA, CINCINNATI, OHIO, US	43389
07250	2004-209	<b>Kao Kabushiki Kaisha ( Kao Corporation);</b> 14-10, Nihonbashi Kayabacho 1-chome, Chuo-ku, Tokyo, Japan, JP	49993
07261	1992-4	<b>NOXELL CORPORATION;</b> 11050 YORK ROAD, HUNT VALLEY, BALTIMORE CO., STATE OF MARYLAND, US	38817
07249	2004-208	<b>Kao Kabushiki Kaisha (Kao Corporation);</b> 14-10, Nihonbashi Kayabacho 1-chome, Chuo-ku, Tokyo, Japan,JP	49992
07262	1971-111	<b>NOXELL CORPORATION;</b> 11050 YORK ROAD, BALTIMORE, MARYLAND, US	20518
07305	2006-2115	<b>The Procter &amp; Gamble Company;</b> One Procter & Gamble Plaza, Cincinnati, Ohio 45202, US	53968
03457 pp	1959-338	<b>HENKEL SRBIJA D.O.O.;</b> BULEVAR OSLOBODJENJA 383,BEOGRAD,SRBIJA	14770
07283	1992-198	<b>THE PROCTER &amp; GAMBLE COMPANY;</b> ONE PROCTER & GAMBLE PLAZA, CINCINNATI, OHIO, US	38892
07272	1991-1504	<b>UNISTRUT INTERNATIONAL CORP.;</b> 777 EAST EISENHOWER PARKWAY, SUITE 600, ANN ARBOR, MI 48108, US	38231
03526	2001-293	<b>HEMOPARM A.D., FARMECEUTSKO-HEMIJSKA INDUSTRIJA VRŠAC;</b> Beogradski put bb 26300, Vršac, RS	43811
03455	2001-212	<b>UNILEVER NV;</b> Weena 455, 3013 AL ROTTERDAM, NL	46626
06592	2001-1137	<b>ROYAL BANK OF CANADA;</b> 1, Place Ville Marie, Montreal, Quebec, Canada, H3C 3A9,, CA	47003
07289	2005-268	<b>The Procter &amp; Gamble Company;</b> One Procter & Gamble Plaza, Cincinnati, Ohio, US	51164
07307	1969-280	<b>ZOTEFOAMS PLC;</b> 675 MITCHAM ROAD, CROYDON, SURREY CR9 3AL, ENGLAND, GB	18980
03461	1991-1939	<b>BRISTOL-MYERS SQUIBB COMPANY;</b> 345 PARK AVENUE, NEW YORK, NEW YORK, US	38541
03535	2001-184	<b>WM. WRIGLEY JR. COMPANY.;</b> 410 North Michigan Avenue, Chicago, Illinois 60611, United States of America, US	46603
03456	2001-211	<b>UNILEVER NV.;</b> Weena 455, 3013 AL Rotterdam, Holandija, NL	46646
03516	2001-390	<b>UNILEVER N.V.;</b> Weena 455 3013 AL Rotterdam, The Netherlands,, NL	47371
07286	1946-198	<b>THE PROCTER &amp; GAMBLE COMPANY;</b> ONE PROCTER & GAMBLE PLAZA, CINCINNATI, OHIO 45202, US	11229
07291	2003-723	<b>The Procter &amp; Gamble Company (Ohio Corporation);</b> One Procter & Gamble Plaza, Cincinnati, Ohio, US	49076

07288	1992-1187	<b>THE PROCTER &amp; GAMBLE COMPANY (OHIO CORPORATION);</b> ONE PROCTER & GAMBLE PLAZA CINCINNATI, OHIO, US	40629
07271	1982-105	<b>OLYMPUS CORPORATION;</b> 43-2, HATAGAYA 2-CHOME, SHIBUYA-KU, TOKYO, JP	31758
07270	1990-775	<b>OLYMPUS CORPORATION;</b> 43-2, HATAGAYA 2-CHOME, SHIBUYA-KU, TOKYO, JP	37762
03519	2001-232	<b>GRANT THORNTON INTERNATIONAL LIMITED;</b> Grant Thornton House, 22 Melton Street, Euston Square, London,NW1 2EP, United Kingdom	46709
07284	1992-37	<b>THE PROCTER &amp; GAMBLE COMPANY;</b> ONE PROCTER & GAMBLE PLAZA, CINCINNATI, OHIO, US	38819
07285	1992-784	<b>THE PROCTER AND GAMBLE COMPANY;</b> CINCINNATI, OHIO, US	39368
06593	1996-1541	<b>ISUZU JIDOSHA KABUSHIKI KAISHA (ISUZU MOTORS LIMITED);</b> 26-1, MINAMI-01 6-CHOME, SHINAGAWA-KU, TOKYO, JP	42201
07274	1983-223	<b>The Procter &amp; Gamble Company ( Ohio corporation);</b> One Procter & Gamble Plaza, Cincinnati, Ohio, US	29043
07306	2006-2116	<b>The Procter &amp; Gamble Company;</b> One Procter & Gamble Plaza, Cincinnati, Ohio 45202, US	53969
07290	1992-371	<b>THE PROCTER &amp; GAMBLE COMPANY;</b> ONE PROCTER & GAMBLE PLAZA, CINCINNATI, OHIO, US	39077
07287	1997-1129	<b>THE PROCTER &amp; GAMBLE COMPANY;</b> ONE PROCTER & GAMBLE PLAZA, CINCINNATI, OHIO, US	42758
07273	2002-101	<b>CHRRH &amp; DWIGHT CO. , INC. (Delaware corporation);</b> One Procter & Gamble Plaza, Cincinnati, Ohio, US	47623
03459	1968-868	<b>3M COMPANY (a Delaware corporation);</b> 3M CENTER, 2501 HUDSON ROAD, SAINT PAUL, MINNESOTA 55144, US	18878
03525	1991-308	<b>LEUNG KAI FOOK MEDICAL CO. PTE. LTD.;</b> 84, SOUTH BRIDGE ROAD - = 03-00 LEUNG KAI BUILDING, SINGAPORE 0105, SG	36841
03528	1960-317	<b>BRISTOL - MYERS SQUIBB COMPANY;</b> 234 PARK AVENUE, NEW YORK, N.Y. 10154, US	15142
03540	1991-180	<b>FEDERATION FRANCAISE DE TENNIS;</b> Stade Roland Garros 2, Avenue Gordon Bennett, 75016 Paris, Francuska, FR	36835
03523	2001-473	<b>SCHERING-PLOUGH LTD.;</b> Toepferstrasse 5, CH-6004 Lucerne, ŠVAJCARSKA, CH	46608
06600	2003-636	<b>CHRRH &amp; DWIGHT CO. , INC. (Delaware corporation);</b> One Procter & Gamble Plaza, Cincinnati, Ohio,, US	50759
06598	1971-577	<b>THE PROCTER &amp; GAMBLE COMPANY;</b> ONE PROCTER & GAMBLE PLAZA CINCINNATI,OHIO, US	20628
06599	2005-1396	<b>THE PROCTER &amp; GAMBLE COMPANY;</b> One Procter & Gamble Plaza, Cincinnati, Ohio 45202, US, US	51724
06610	1975-34	<b>Akzo Nobel Coatings International B.V.;</b> Velperweg 76, 6824 BM Arnhem, NL	23095
06596	1998-395	<b>THE PROCTER &amp; GAMBLE COMPANY;</b> ONE PROCTER & GAMBLE PLAZA CINCINNATI,OHIO, US	43942
06602	1981-158	<b>THE PROCTER &amp; GAMBLE COMPANY;</b> ONE PROCTER & GAMBLE PLAZA, CINCINNATI, OHIO 45202, US	29521
06603	1971-72	<b>THE PROCTER &amp; GAMBLE COMPANY;</b> ONE PROCTER & GAMBLE PLAZA, CINCINNATI, OHIO, US	20338
06601	1997-388	<b>THE PROCTER &amp; GAMBLE COMPANY;</b> ONE PROCTER & GAMBLE PLAZA, CINCINNATI, OHIO, US	42849
06604	1997-1199	<b>The Procter &amp; Gamble Company;</b> ONE PROCTER & GAMBLE PLAZA, CINCINNATI, OHIO, US	43043
06605	1997-88	<b>The Procter &amp; Gamble Company;</b> ONE PROCTER & GAMBLE PLAZA, CINCINNATI, OHIO, US	43646
06607	1993-697	<b>THE PROCTER &amp; GAMBLE COMPANY;</b> ONE PROCTER & GAMBLE PLAZA CINCINNATI, OHIO, US	40345

06606	2004-212	<b>CHRCH &amp; DWIGHT CO. , INC. (Delaware corporation);</b> One Procter & Gamble Plaza Cincinnati, Ohio, US	50066
06608	1997-862	<b>THE PROCTER &amp; GAMBLE COMPANY;</b> ONE PROCTER & GAMBLE PLAZA, CINCINNATI, OHIO, US	42756
06609	2006-503	<b>THE PROCTER &amp; GAMBLE COMPANY;</b> ONE PROCTER & GAMBLE PLAZA, CINCINNATI, OHIO 45202, US	52597
07362	1992-1042	<b>THE PROCTER &amp; GAMBLE COMPANY;</b> ONE PROCTER & GAMBLE PLAZA, CINCINNATI, OHIO, US	39644
06597	1980-29	<b>THE PROCTER &amp; GAMBLE COMPANY;</b> ONE PROCTER & GAMBLE PLAZA CINCINNATI, OHIO, US	27476
07363	1992-1043	<b>THE PROCTER &amp; GAMBLE COMPANY;</b> ONE PROCTER & GAMBLE PLAZA, CINCINNATI, OHIO, US	39645
07364	1992-630	<b>THE PROCTER &amp; GAMBLE COMPANY;</b> ONE PROCTER & GAMBLE PLAZA, CINCINNATI, OHIO, US	39326
07367	1991-1764	<b>INVISTA Technologies S.a.r.l. and INVISTA Technologies S.a.r.l.;</b> Three Little Falls Centre, 2801 Centerville Road, Wilmington, DE 19808 U.S.A., US and Talstrasse 80, 8001 Zurich, CH	38551
07369	1996-141	<b>Akzo Nobel Coatings International B.V.;</b> Velperweg 76, 6824 BM Arnhem, NL	42120
07370	2005-8	<b>Akzo Nobel Coatings International B.V.;</b> Velperweg 76, 6824 BM Arnhem, NL	50702
07378	1997-680	<b>Duracell Batteries BVBA;</b> Nijverheidslaan 7, B-3220 Aarschot, BE	42860
07371	1971-74	<b>THE PROCTER &amp; GAMBLE COMPANY;</b> ONE PROCTER & GAMBLE PLAZA, CINCINNATI, OHIO, US	20340





**DIZAJN**

**DESIGNS**

Službeni glasnik Zavoda za intelektualnu svojinu Crne Gore  
Official Gazette of the Montenegrin Intellectual Property Office

**11 / 2013**



Zavod za intelektualnu svojinu Crne Gore  
ul. Rimski trg br. 46,  
81000 Podgorica,  
Crna Gora



**MEĐUNARODNI KODOVI ZA IDENTIFIKACIJU BIBLIOGRAFSKIH  
PODATAKA O DIZAJNU PREMA WIPO CT.80**  
RECOMMENDATION CONCERNING BIBLIOGRAPHIC DATA RELATING TO  
INDUSTRIAL DESIGNS WIPO CT.80

<b>CRNOGORSKI</b>	<b>MDK</b>	<b>ENGLESKI</b>
Registarski broj	<b>11</b>	Number of registration
Datum registracije	<b>15</b>	Date of the registration
Očekivani datum isteka registracije	<b>18</b>	Expected expiration date of the registration
Broj prijave	<b>21</b>	Number of the application
Datum podnošenja prijave	<b>22</b>	Date of filing of the application
Podaci o izložbenom pravu prvenstva	<b>23</b>	Exhibition priority data
Broj prijavljenih dizajna	<b>28</b>	Number of industrial designs included in the application
Podaci o pravu prvenstva na osnovu Pariske konvencije	<b>30</b>	Data relating to priority under the Paris Convention
Klasa i podklasa Lokarnske klasifikacije	<b>51</b>	Class and subclass of the Locarno Classification
Naziv dizajna	<b>54</b>	Title of the industrial design
Prikaz	<b>55</b>	Reproduction of the industrial design (e.g., drawing, photograph) and explanations relating to the reproduction
Ime autora dizajna	<b>72</b>	Name of the creator
Ime i adresa nosioca prava	<b>73</b>	Name and address of the owner
Ime i adresa punomoćnika	<b>74</b>	Name and address of the representative





**OBJAVE OBNOVE VAŽENJA INDUSTRIJSKOG DIZAJNA**  
**PUBLICATION OF INDUSTRIAL DESIGN RENEWAL**

Registarski broj dizajna CG (11)	Ime i adresa nosioca industrijskog dizajna (73)	Datum do kojeg važi obnova industrijskog dizajna (18)	Registarski broj dizajna SCG (11)
00020 PP	SONY COMPUTER ENTERTAINMENT INC., 2-6-21, Minami-Aoyama, Minato-ku, Tokyo 107-0062, JP	<b>24.09.2013.</b>	10311
00021 PP	SONY COMPUTER ENTERTAINMENT INC., 2-6-21, Minami-Aoyama, Minato-ku, Tokyo 107-0062, JP	<b>24.09.2013.</b>	10312
00042 PP	ALUMIL YU INDUSTRY AD, Industrijska zona bb, 22330 Nova Pazova, RS	<b>07.05.2017.</b>	10204
00043 PP	ALUMIL YU INDUSTRY AD, Industrijska zona bb, 22330 Nova Pazova, RS	<b>23.04.2017.</b>	10056
00044 PP	ALUMIL YU INDUSTRY AD, Industrijska zona bb, 22330 Nova Pazova, RS	<b>18.04.2017.</b>	10053
00045 PP	ALUMIL YU INDUSTRY AD, Industrijska zona bb, 22330 Nova Pazova, RS	<b>23.04.2017.</b>	10046
00046 PP	ALUMIL YU INDUSTRY AD, Industrijska zona bb, 22330 Nova Pazova, RS	<b>23.04.2017.</b>	10044
00047 PP	ALUMIL YU INDUSTRY AD, Industrijska zona bb, 22330 Nova Pazova, RS	<b>13.06.2017.</b>	10131
00048 PP	ALUMIL YU INDUSTRY AD, Industrijska zona bb, 22330 Nova Pazova, RS	<b>06.06.2017.</b>	10127
00049 PP	ALUMIL YU INDUSTRY AD, Industrijska zona bb, 22330 Nova Pazova, RS	<b>01.04.2017.</b>	10115
00050 PP	ALUMIL YU INDUSTRY AD, Industrijska zona bb, 22330 Nova Pazova, RS	<b>15.04.2017.</b>	10103
00051 PP	ALUMIL YU INDUSTRY AD, Industrijska zona bb, 22330 Nova Pazova, RS	<b>27.06.2017.</b>	10143
00052 PP	ALUMIL YU INDUSTRY AD, Industrijska zona bb, 22330 Nova Pazova, RS	<b>13.06.2017.</b>	10134
00053 PP	ALUMIL YU INDUSTRY AD, Industrijska zona bb, 22330 Nova Pazova, RS	<b>13.06.2011.</b>	10133
00054 PP	ALUMIL YU INDUSTRY AD, Industrijska zona bb, 22330 Nova Pazova, RS	<b>13.06.2017.</b>	10132
00008 PP	SONY COMPUTER ENTERTAINMENT INC., 2-6-21, Minami-Aoyama, Minato-ku, Tokyo 107-0062, JP	<b>12.11.2013.</b>	10279
00027 PP	SONY COMPUTER ENTERTAINMENT INC., 2-6-21, Minami-Aoyama, Minato-ku, Tokyo 107-0062, JP	<b>11.11.2013.</b>	10344
00022 PP	SONY COMPUTER ENTERTAINMENT INC., 2-6-21, Minami-Aoyama, Minato-ku, Tokyo 107-0062, JP	<b>10.11.2013.</b>	10313
00023 PP	SONY COMPUTER ENTERTAINMENT INC., 2-6-21, Minami-Aoyama, Minato-ku, Tokyo 107-0062, JAPAN,JP	<b>10.11.2013.</b>	10314
00007 PP	SONY COMPUTER ENTERTAINMENT INC., 2-6-21, Minami-Aoyama, Minato-ku, Tokyo 107-0062, JP	<b>12.11.2013.</b>	10278
00018 PP	SONY COMPUTER ENTERTAINMENT INC., 1-1, Akasaka 7-chome, Minato-ku, Tokyo, JP	<b>08.12.2013.</b>	09835





# INFORMATOR

## INFORMATION

Službeni glasnik Zavoda za intelektualnu svojinu Crne Gore  
Official Gazette of the Montenegrin Intellectual Property Office

# 11 / 2013



Zavod za intelektualnu svojinu Crne Gore  
ul. Rimski trg br. 46,  
81000 Podgorica,  
Crna Gora



# INTELEKTUALNA SVOJINA

## AUTORSKO PRAVO I SRODNA PRAVA

## INDUSTRIJSKA SVOJINA

- \* Patenti
- \* Žigovi
- \* Industrijski dizajn
- \* Oznake geografskog porijekla roba i usluga
- \* Topografija integriranih kola

### AUTORSKO PRAVO

*(Koje se odnosi na duhovna tvorevine)*

Kao što su naročito:

- \* Književna djela  
(pisana, govorna, kompjuterski programi)
- \* Muzička djela
- \* Dramska i dramsko-muzička djela
- \* Koreografska i pantomimska djela
- \* Djela likovnih umjetnosti iz područja slikarstva, vajarstva i arhitekture
- \* Djela primjenjenih umjetnosti
- \* Fotografska djela
- \* Kinematografska djela
- \* Prevodi, obrade i druge prerade djela
- \* Zbirke autorskih djela, podataka ili druge građe

### SRODNA PRAVA

Koja se odnose:

- \* Izvođenja umjetnika izvodača
- \* Fonograme
- \* Emitovanja radnja i televizije

CIP - Каталогizacija u publikaciji  
Централна народна библиотека Црне Горе, Цетиње

347.77/78(497.16)

CRNOGORSKI glasnik intelektualne svojine : Službeni glasnik  
Zavoda za Intelektualnu svojinu Crne Gore = Journal of intel-  
lectual properti in Montenegro = Official Gazete of the Intellec-  
tual Property Office of Montenegro / glavni i odgovorni urednik  
Novak Adžić - 2011, br.7 - 322. - Podgorica (Bulevar Revolucije  
9) : Zavod za intelektualnu svojinu Crne Gore, 2010. - 30 cm

Tromjesečno.

ISSN 1800-8003 = Crnogorski glasnik intelektualne svojine  
(Podgorica)

COBISS.CG-ID 15168784

